



CRNOGORSKI GLASNIK INTELEKTUALNE SVOJINE

INTELLECTUAL PROPERTY GAZETTE OF MONTENEGRO

Službeni glasnik Zavoda za intelektualnu svojinu Crne Gore
Official Gazette of the Montenegrin Intellectual Property Office

15 / 2014



Zavod za intelektualnu svojinu Crne Gore
ul. Rimski trg br. 46,
81000 Podgorica,
Crna Gora

CRNOGORSKI GLASNIK INTELEKTUALNE SVOJINE

Godina V

Datum objavljivanja: 20. 09. 2014. god.

Izdavač:

ZAVOD ZA INTELEKTUALNU
SVOJINU CRNE GORE
Rimski trg br. 46,
81000 Podgorica, Crna Gora

Za izdavača:

Novak Adžić, direktor

Glavni i odgovorni urednik:

Novak Adžić

Urednički odbor:

Novak Adžić, Predrag Malbaša,
Dušanka Perović, Milica Savić,
Gordana Tripković

Tehnički urednik:

Predrag Malbaša

Prevod:

Gordana Tripković

Dizajn:

Aleksandar-Saša Samardžić

OVAJ BROJ SLUŽBENOG GLASNIKA OBJAVLJEN JE U ELEKTRONSKOJ FORMI

Crnogorski glasnik intelektualne svojine službeno je glasilo Zavoda za intelektualnu svojinu Crne Gore. U Glasniku se objavljuju sve relevantnim zakonima i pravilnicima propisane informacije iz postupka dodjele prava industrijskog vlasništva, informacije o dodijeljenim pravima te o kasnijim promjenama u vezi s tim pravima, kao i ostale službene informacije.

The Montenegrinan intellectual property gazette is the official gazette of the State Intellectual Property Office of the Montenegro. The Gazette publishes all the information, prescribed by the relevant laws and regulations, relating to the industrial property granting procedure concerning granted rights and subsequent changes made in connection with such right, as well as other official information.

SADRŽAJ

DVOSLOVNE OZNAKE ZEMALJA, TERITORIJA I MEĐUNARODNIH ORGANIZACIJA
TWO LETTER CODE COUNTRIES, TERRITORIES AND INTERNATIONAL ORGANIZATIONS 823

PATENTI

PATENTS 825

MEĐUNARODNI KODOVI ZA IDENTIFIKACIJU BIBLIOGRAFSKIH PODATAKA O PATENTIMA
PREMA WIPO STANDARDU ST. 9

RECOMMENDATION CONCERNING BIBLIOGRAFIC DATA ON AND RELATING TO
PATENTS- WIPO-ST. 9..... 827

OBAVJEŠTENJE

NOTICE 829

OBJAVE PRIJAVA PATENATA

PUBLICATION OF PATENT APPLICATIONS..... 831

INDEKS NOSILACA PATENTA

PATENT OWNER INDEX..... 845

INDEKS BROJEVA PRIJAVA PATENATA

APPLICANTS NUMBER INDEX 847

INDEKS OBJAVLJENIH PRIJAVA PATENATA PREMA MKP

INDEX OF PATENT APPLICANTS ACCORDINT TO IPC 849

OBJAVE ZAHTJEVA ZA PROŠIRENJE EVROPSKIH PRIJAVA PATENATA

PUBLICATION OF REQUEST FOR THE EXTENSION OF THE EFFECTS OF EUROPEAN PATENT
APPLICATIONS 851

INDEKS BROJEVA ZAHTJEVA ZA PROŠIRENJE EVROPSKIH PRIJAVA PATENTA

INDEX ON NUMBER OF REQUESTS FOR EXTENSION ON EUROPEAN PATENT APPLICATIONS . 1041

INDEKS KLASIFIKACIJSKIH OZNAKA BROJEVA ZAHTJEVA ZA PROŠIRENJE EVROPSKIH

PRIJAVA PATENTA PREMA MKP

INDEX ON CLASSIFICATION MARKS ON REQUESTS FOR EXTENSION OF EUROPEAN PATENT

APPLICATION IN ACCORDANCE WITH THE INTERNATIONAL PATENT CLASSIFICATION .. 1101

INDEKS PODNOSITELJA ZAHTJEVA ZA PROŠIRENJE EVROPSKIH PRIJAVA PATENTA

INDEX ON NUMBER OF APPLICATIONS FOR EXTENSION OF EUROPEAN PATENT
APPLICATION 1239

OBJAVA POVUČENIH ZAHTJEVA ZA PROŠIRENJE EVROPSKIH PRIJAVA PATENTA

PUBLICATION OF WITHDRAWN REQUESTS FOR EXTENSION OF EUROPEAN PATENT
APPLICATION 1339

OBJAVA PROŠIRENIH EVROPSKIH PATENATA

PUBLICATION OF EXTENDED EUROPEAN PATENTS..... 1341

OBJAVA UPISA PROMJENA

PUBLICATION OF RECORD OF CHANGES 1447

ŽIGOVI

TRADEMARKS..... 1451

MEĐUNARODNI KODOVI ZA IDENTIFIKACIJU BIBLIOGRAFSKIH PODATAKA O ŽIGOVIMA
PREMA WIPO ST 60

RECOMMENDATION CONCERNING BIBLIOGRAFIC DATA RELATING TO
TRADEMARKS- WIPO-ST. 60 1453

OBAVJEŠTENJE	
NOTICE	1455
OBJAVA PRIJAVA ŽIGOVA	
PUBLICATION OF TRADEMARK APPLICATIONS	1457
OBJAVA ŽIGOVA	
PUBLICATION OF TRADEMARKS	1733
INDEKS NOSILACA ŽIGOVA	
INDEX OF THE HOLDER OF THE REGISTRATION	1977
INDEKS BROJEVA ŽIGOVA	
INDEX OF THE TRADEMARK NUMBERS	1989
INDEKS PO KLASAMA NIČANSKE KLASIFIKACIJE ROBA I USLUGA	
INDEX ACCORDING TO THE NICE CLASSIFICATION OF GOODS AND SERVICES	1993
OBJAVA ISPRAVKI	
CORRECTIONS.....	1997
DIZAJN	
DESIGNS	2019
MEĐUNARODNI KODOVI ZA IDENTIFIKACIJU BIBLIOGRAFSKIH PODATAKA O DIZAJNU PREMA WIPO CT.80	
RECOMMENDATION CONCERNING BIBLIOGRAPHIC DATA RELATING TO INDUSTRIJAL DESIGNS WIPO CT.80	2021
OBJAVE DIZAJNA	
PUBLICATION OF DESIGNS.....	2023
INDEKS NOSILACA DIZAJNA	
INDEX OF INDUSTRIAL DESIGNS OWERS	2027
INDEKS BROJEVA DIZAJNA	
INDEX OF INDUSTRIAL DESIGNS NUMBERS.....	2029
INDEKS PO KLASAMA I PODKLASAMA LOKARNSKE KLASIFIKACIJE	
INDEX ACCORDING TO CLASSES SUBCLASSEN THE LOCARNO CLASSIFICATION	2031
OBJAVE OBNOVE VAŽENJA INDUSTRIJSKOG DIZAJNA	
PUBLICATION OF INDUSTRIAL DESIGN RENEWAL	2033
INFORMATOR	
INFORMATION.....	2035

**DVOSLOVNE OZNAKE ZEMALJA, TERITORIJA I MEĐUNARODNIH
ORGANIZACIJA
(prema WIPO standardu ST. 3)**

AD	Andora	CF	Centralna Afrička Republika	GB	Velika Britanija
AE	Ujedinjeni Arapski Emirati	CG	Kongo	GC	Patentna kancelarija Savjeta za saradnju država Arapskog Zaliva (GCC)
AF	Afganistan	CH	Švajcarska	GD	Grenada
AG	Antigva i Barbuda	CI	Obala Bjelokosti	GE	Gruzija
AI	Angvila	CK	Kukova ostrva	GG	Guernsey
AL	Albanija	CL	Čile	GH	Gana
AM	Armenija	CM	Kamerun	GI	Gibraltar
AN	Holandski Antili	CN	Kina	GL	Grenland
AO	Angola	CO	Kolumbija	GM	Gambija
AP	Afrička regionalna organizacija za industrijsko vlasništvo (ARIPO)	CR	Kostarika	GN	Gvineja
AR	Argentina	CU	Kuba	GQ	Ekvatorska Gvineja
AT	Austrija	CV	Kabo Verde	GR	Grčka
AU	Australija	CY	Kipar	GS	Južna Džordžija i Ostrva Južni Sendvič
AW	Aruba	CZ	Češka Republika	GT	Gvatemala
AZ	Azerbejdžan	DE	Njemačka	GW	Gvineja-Bisao
BA	Bosna i Hercegovina	DJ	Džibuti	GY	Gvajana
BB	Barbados	DK	Danska	HK	Hongkong – Posebna administrativna regija
BD	Bangladeš	DM	Dominika		NR Kine
BE	Belgija	DO	Dominikanska Republika	HN	Honduras
BF	Burkina Faso	DZ	Alžir	HR	Hrvatska
BG	Bugarska	EA	Evroazijska patentna organizacija (EAPO)	HT	Haiti
BH	Bahrein	EC	Ekvador	HU	Mađarska
BI	Burundi	EE	Estonija	IB	Međunarodna kancelarija Svjetske organizacije za intelektualno vlasništvo (WIPO)
BJ	Benin	EG	Egipat	ID	Indonezija
BM	Bermudi	EH	Zapadna Sahara	IE	Irska
BN	Brunej Darussalam	EM	Kancelarija za harmonizaciju Unutrašnjeg tržišta (žigovi i dizajn) (OHIM)	IL	Izrael
BO	Bolivija	EP	Evropska patentna kancelarija (EPO)	IM	Ostrvo Man
BR	Brazil	ER	Eritreja	IN	Indija
BS	Bahami	ES	Španija	IQ	Irak
BT	Butan	ET	Etiopija	IR	Iran (Islamska Republika)
BV	Ostrvo Buve	FI	Finska	IS	Island
BW	Bocvana	FJ	Fidži	IT	Italija
BX	Kancelarija za intelektualno vlasništvo Beneluksa (BOIP)	FK	Foklandska ostrva (Malvini)	JE	Džersi
BY	Bjelorusija	FO	Farska Ostrva	JM	Jamajka
BZ	Belize	FR	Francuska	JO	Jordan
CA	Kanada	GA	Gabon		
CD	Demokratska Republika Kongo				

JP	Japan	NA	Namibija	SY	Sirijska Arapska Republika
KE	Kenija	NE	Niger	SZ	Svazi
KG	Kirgistan	NG	Nigerija	TC	Turska i Kajkoska Ostrva
KH	Kambodža	NI	Nikaragva	TD	Čad
KI	Kiribati	NL	Holandija	TG	Togo
KM	Komori	NO	Norveška	TH	Tajland
KN	Sveti Kristofor i Nevis	NP	Nepal	TJ	Tadžikistan
KP	Demokratska Narodna Republika Koreja	NR	Nauru	TL	Istočni Timor
KR	Republika Koreja	NZ	Novi Zeland	TM	Turkmenistan
KW	Kuvajt	OA	Afrička organizacija za intelektualno vlasništvo (OAPI)	TN	Tunis
KY	Kajmanska Ostrva	OM	Oman	TO	Tonga
KZ	Kazahstan	PA	Panama	TR	Turska
LA	Narodna Demokratska Republika Laos	PE	Peru	TT	Trinidad i Tobago
LB	Libanon	PG	Papuanska Nova Gvineja	TV	Tuvalu
LC	Sveta Lucija	PH	Filipini	TW	Tajvan, Kineska Pokrajina
LI	Lihtenštajn	PK	Pakistan	TZ	Ujedinjena Republika Tanzanija
LK	Šri Lanka	PL	Poljska	UA	Ukrajina
LR	Liberija	PT	Portugal	UG	Uganda
LS	Lesoto	PW	Palau	US	Sjedinjene Američke Države
LT	Litva	PY	Paragvaj	UY	Urugvaj
LU	Luksemburg	QA	Katar	UZ	Uzbekistan
LV	Latvija	QZ	Kancelarija Zajednice za biljne sorte (Evropska Unija) (CPVO)	VA	Sveta Stolica (Vatikan)
LY	Libijska Arapska Džamahirija	RO	Rumunija	VC	Sveti Vincent i Grenadini
MA	Maroko	RS	Srbija	VE	Venecuela
MC	Monako	RU	Ruska Federacija	VG	Britanska Djevičanska Ostrva
MD	Republika Moldavija	RW	Ruanda	VN	Vijetnam
ME	Crna Gora	SA	Saudijska Arabija	VU	Vanuatu
MG	Madagaskar	SB	Solomonska Ostrva	WO	Svjetska organizacije za intelektualno vlasništvo (WIPO) (Međunarodna kancelarija)
MK	Bivša Jugoslovenska Republika Makedonija	SC	Sejšeli	WS	Samoa
ML	Mali	SD	Sudan	XN	Nordijski institut za patente (NPI)
MM	Mianmar	SE	Švedska	YE	Jemen
MN	Mongolija	SG	Singapur	ZA	Južnoafrička Republika
MO	Makao	SH	Sveta Jelena	ZM	Zambija
MP	Sjeverna Marijanska Ostrva	SI	Slovenija	ZW	Zimbabve
MR	Mauritanija	SK	Slovačka		
MS	Montserrat	SL	Sijera Leone		
MT	Malta	SM	San Marino		
MU	Mauricijus	SN	Senegal		
MV	Maldivi	SO	Somalija		
MW	Malavi	SR	Surinam		
MX	Meksiko	ST	Sveti Toma i Princip		
MY	Malezija	SV	Salvador		
MZ	Mozambik				



PATENTI

PATENTS

Službeni glasnik Zavoda za intelektualnu svojinu Crne Gore
Official Gazette of the Montenegrin Intellectual Property Office

15 / 2014



Zavod za intelektualnu svojinu Crne Gore
ul. Rimski trg br. 46,
81000 Podgorica,
Crna Gora

MEĐUNARODNI KODOVI ZA IDENTIFIKACIJU BIBLIOGRAFSKIH PODATAKA O PATENTIMA PREMA WIPO STANDARDU ST. 9
RECOMMENDATION CONCERNING BIBLIOGRAFIC DATA ON AND RELATING TO PATENTS- WIPO-ST. 9

CRNOGORSKI	MDK	ENGLJSKI
IDENTIFIKATOR DOKUMENTA	10	IDENTIFICATION OF THE PATENT
BROJ DOKUMENTA	11	NUMBER OF THE PATENT
VRST DOKUMENTA	13	KIND-OF-DOCUMENT CODE ACCORDING TO WIPO STANDARD
BROJ PRIJAVE	21	NUMBER(S) ASSIGNED TO THE APPLICATION(S)
DATUM PODNOŠENJA PRIJAVE	22	DATE(S) OF FILING THE APPLICATION(S)
DATUM IZLAGANJA NA MEĐUNARODNOJ IZLOŽBI	23	DATE OF EXHIBITING AT THE INTERNATIONAL EXHIBITION
PODACI O PRAVU PRVJENSTVA	30	PRIORITY DATA
DATUM OBJAVLJIVANJA PRIJAVE	43	PUBLICATION DATE OF THE UNEXAMINED APPLICATION
DATUM OBJAVLJIVANJA PATENTA	45	PUBLICATION DATE OF REGISTERED PATENT
MEĐUNARODNA KLASIFIKACIJA PATENATA	51	INTERNATIONAL PATENT CLASSIFICATION CODE
NAZIV PRONALASKA	54	TITLE OF THE INVENTION
APSTRAKT ILI PATENTNI ZAHTJEV	57	ABSTRACT OR CLAIM
BROJ OSNOVNE PRIJAVE (ILI PATENTA) ZA KOJI SE PODNOSI DOPUNSKA PRIJAVA	61	NUMBER OF THE EARLIER APPLICATION (OR PATENT) TO WHICH THE PRESENT DOCUMENT IS AN ADDITION
BROJ PRVOBITNE PRIJAVE IZ KOJE JE PRIJAVA IZDOJENA	62	NUMBER OF THE EARLIER APPLICATION FROM WHICH THE PRESENT DOCUMENT HAS BEEN DIVIDED UP
IME PODNOSIOCA PRIJAVE	71	NAME OF THE APPLICANT
IME PRONALAZAČA	72	NAME OF THE INVENTOR
IME NOSIOCA PATENTA	73	NAME OF THE OWNER OF PATENT
IME PUNOMOĆNIKA	74	NAME OF THE REPRESENTATIVE
BROJ I DATUM PODNOŠENJA MEĐUNARODNE PRIJAVE	86	NUMBER AND FILING DATE OF THE INTERNATIONAL APPLICATION
BROJ I DATUM MEĐUNARODNE OBJAVE	87	NUMBER AND DATE OF THE PUBLICATION OF THE INTERNATIONAL APPLICATION

VRSTA DOKUMENTA		TYPES OF DOCUMENTS
OBJAVA PRIJAVA PATENATA	A	PUBLICATION OF PATENT APPLICATIONS
REGISTROVANI PATENTI	B	REGISTERED PATENTS

OBAVJEŠTENJE
NOTICE

Obavještavamo korisnike da se od 6-og broja Crnogorskog glasnika za intelektualnu svojinu koji se objavljuje na web stranici Zavoda za intelektualnu svojinu Crne Gore, u elektronskoj formi, odnosno od 10.10.2011 godine (Glasnik broj 6/2011) uvode promjene u objavi patentnih dokumenata.

Tako, objavljena prijava patenta (dokument A) sadrži i broj pod kojim je patent upisan u Registar patenata, (međunarodni kod 11 – broj dokumenta), koji je do sada bio objavljivan u svakom narednom broju Crnogorskog glasnika za intelektualnu svojinu. Kako Zavoda za intelektualnu svojinu Crne Gore, ispituje samo formalne uslove za priznavanje patenta, izmjenu uvodimo da bi svi podaci o priznatom patentu bili u istom broju Crnogorskog glasnika za intelektualnu svojinu, a ujedno i pojednostavili put do dodjele isprave, sve u skladu sa članom 40 Zakona o patenima ("Sl. list CG" broj 66/2008 i 40/2010).

- (51) **A 61K 39/395**^{2006.01} (11) **01694** (13) **B**
(21) P-2012-121
(22) 12. 05. 2010
(30) 20090280567P 05. 11. 2009 US
(86) EP/10829204.6/05. 11. 2010
US/PCT2010US55745
(87) WO 2011057158/12. 05. 2011/2011/19
EP 2496259/12. 09. 2012/2012/37
(54) me **LIJEČENJE PAROKSIZMALNE NOĆNE HEMOGLOBINURIJE, HEMOLITIČKIH ANEMIJA
I BOLESNIH STANJA KOJA OBUHVATAJU INTRAVASKULARNU I
EKSTRAVASKULARNU HEMOLIZU**
en **TREATMENT OF PAROXYSMAL NOCTURNAL HEMOGLOBINURIA, HEMOLYTIC
ANEMIAS AND DISEASE STATES INVOLVING INTRAVASCULAR AND
EXTRAVASCULAR HEMOLYSIS**
(73) Alexion Cambridge Corporation, 352 Knotter Drive, Cheshire, CT 06410, US
Alexion Cambridge Corporation, 245 First Street, Suite 1100, Cambridge, MA 02142, US
(72) HOLERS, V., Michael, 242 S. Hudson Street, Denver, CO 80246, US
RISITANO, Antonio, M., Via Pansini 5, I-80131 Naples, IT
(74) LUTOVAC, Branislav, Bulevar Ivana Crnojevića 93, Podgorica, 81000, ME
(57) Postupak za lečenje subjekata koji imaju hemolitičke poremećaje posredovane komplementom, kao što je paroksizmalna noćna hemoglobinurija (PNH) i druge hemolitičke anemije, koji obuhvata davanje efikasne količine kompozicije koja inhibira aktivnost alternativnog puta komplementa.

(51) **A 61K 38/00**^{2006.01} **A 61K 38/17**^{2006.01} (11) **01699** (13) **B**
A 61K 38/39^{2006.01}

(21) P-2012-120

(22) 02. 07. 2010

(30) 20090222867P 02. 07. 2009 US

(86) EP/10794833.3/02. 07. 2010
US/PCT/US2010/040973/02. 07. 2010

(87) WO 2011/003098/06. 01. 2011/2011/01
EP 2453906/23. 05. 2012/2012/21

(54) me **METODE ZA STIMULACIJU REGENERACIJE JETRE**
en **METHODS OF STIMULATING LIVER REGENERATION**

(73) MUSC Foundation For Research Development,
19 Hagood Avenue, Suite 909,Charleston, SC 29425,US

(72) TOMLINSON, Stephen,1287 Abercorn Trace,Mount Pleasant SC 29466,US
HE, Songqing,40 Bee Street Apt. 409,Charleston SC 29403,US

ATKINSON, Carl,3249 Beaconsfield Road, Park West, Mount Pleasant,SC 29466,US

(74) LUTOVAC, Branislav,Bulevar Ivana Crnojevića 93,Podgorica,81000,ME

(57) Ovde su obezbeđene metode i kompozicije uključujući farmaceutske kompozicije, za stimulaciju regeneracije jetre nako delimične hepatotomije (uklanjanje dela jetre), masivne resekcije jetre i toksičnog oštećenja, ili nakon transplantacije jetre, uključujući "small-for-size" transplantaciju jetre putem inhibicije aktivacije komplementa.

(51) **B 29C 73/02**^{2006.01} **B 65D 77/04**^{2006.01} (11) **01722** (13) **B**
B 29C 73/24^{2006.01}

(21) P-2012-57

(22) 09. 11. 2010

(30) 0919975.3 16. 11. 2009 GB

(86) EP/PCT/EP2010/067087/09. 11. 2010

(87) WO 2011/057998/19. 05. 2011

(54) me **Kondicioniranje staklenih ploča**
en **Glazing panel conditioning**

(73) Belron Hungary Kft - Zug Branch, Gotthardstrasse 20, CH-6304 Zug, CH

(72) SYFKO, Paul, 6996 For Seasons Dr., Westerville, Ohio OH 43082, US

(74) POPOVIĆ, Miladin, Đoka Miraševića 21/III, Podgorica, 81000, ME

(57) Agens za kondicioniranje (koji je obično namenjen za primenu pri reparaciji defekta u staklenoj ploči) koji je smešten u hermetički zatvorenom unutrašnjem sudu za agens za kondicioniranje. Usled dejstva pritiska na spoljašnji sud sa elastičnim zidovima može se osloboditi agens za kondicioniranje iz unutrašnjeg suda za agens za kondicioniranje. Agens za kondicioniranje može sadržati higroskopni rastvarač (kao što je aceton) koji je pomešan sa jednim ili više aditiva za prajmiranje radi prajmiranja površine staklene ploče koja se reparira.

(51) C07D277/56^{2006.01} A61K38/55^{2006.01} (11) 01747 (13) A
C07K5/08^{2006.01}

(21) P-2013-39

(22) 22. 03. 2010

(30) 61/162,196 20. 03. 2009 US

61/180,561 22. 05. 2009 US

(86) US/PCT/US2010/028126/22. 03. 2010

(87) WO 2010/108172/23. 09. 2010/38/2010

(54) me **Kristalni tripeptidni epoksi ketonski inhibitori proteaze**

en **Crystalline Tripeptide Epoxy Ketone Protease Inhibitors**

(73) Onyx Therapeutics, Inc., 249 E. Grand Avenue, South San Francisco, CA 94080, US

(72) PHIASIVONGSA, Pasit, 2712 Saint Regis Avenue, Brentwood CA 94513, US

SEHL, Louis, C., 403 Alameda de la Pulgas, Redwood City CA 94062, US

(74) RADULOVIĆ, Božidar, Jovana Tomaševića 9/III-1, Podgorica, 81000, ME

(57) Predmetni pronalazak odnosi se na kristalna tripeptidna keta epoksidna jedinjenja, postupke za njihovo dobijanje i srodne farmaceutske preparate.

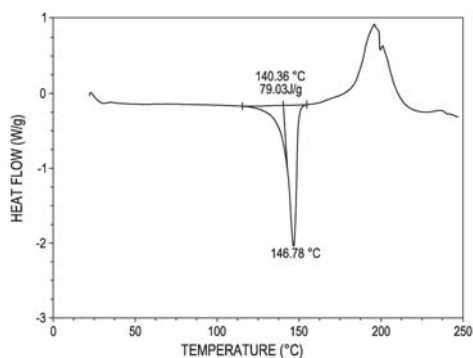

FIGURE 1

- (51) **A 61P 11/06**^{2006.01} **A 61P 11/00**^{2006.01} (11) **01761** (13) **B**
A 61K 9/12^{2006.01} **A 61K 45/06**^{2006.01}
A 61K 9/00^{2006.01} **A 61K 31/167**^{2006.01}
A 61K 31/40^{2006.01}
- (21) P-2012-82
(22) 22. 12. 2010
(30) 20090180671 23. 12. 2009 EP
(86) EP/10799030.1/22. 12. 2010
EP/PCT/EP2010/070479/22. 12. 2010
(87) WO 2011/076843/30. 06. 2011/26/2011
EP 2515855/31. 10. 2012/2012/44
EP 2515855/02. 04. 2014/2014/14
(54) me **KOMBINOVANA TERAPIJA ZA COPD**
en **Combination therapy for COPD**
(73) Chiesi Farmaceutici S.P.A., Via Palermo, 26/A, 43100 Parma, IT
(72) BONELLI, Sauro, c/o CHIESI FARMACEUTICI S.P.A., Via Palermo 26/A, I-43100 Parma, IT
USBERTI, Francesca, c/o CHIESI FARMACEUTICI S.P.A., Via Palermo 26/A, I-43100 Parma, IT
ZAMBELLI, Enrico, c/o CHIESI FARMACEUTICI S.P.A., Via Palermo 26/A, I-43100 Parma, IT
RADULOVIĆ, S. Božidar, Jovana Tomaševića 9/III-1, 81000 Podgorica,
(57) Predmetni pronalazak se odnosi na preparat aerosola pogodan za primenu kod pacijenata koji pate od COPD putem inhalatora pod pritiskom sa odmeravanjem doza (pMDI), koji sadrži glikopironijum bromid u kombinaciji sa formoterolom. Preparat dalje sadrži HFA propelent, surastvarač i određenu količinu neorganske kiseline koja je dovoljna da stabilizuje i glikopironijumsku i formoterolnu komponentu. Opciono, preparat dalje sadrži beklometazon dipropionat.

(51) **A 61K 45/06**^{2006.01} **A 61K 31/40**^{2006.01} (11) **01762** (13) **B**
A 61K 9/00^{2006.01} **A 61P 11/06**^{2006.01}
A 61P 11/00^{2006.01} **A 61K 9/12**^{2006.01}
A 61K 9/72^{2006.01}

(21) P-2012-83

(22) 22. 12. 2010

(30) 2009015980.7 23. 12. 2009 EP

(86) EP/10799029.3/22. 12. 2010

EP/PCT/EP2010/070478/22. 12. 2010

(87) WO 2011/076842/30. 06. 2011/48/2011

EP 2515854/31. 10. 2012/2012/44

EP 2515854/19. 03. 2014/2014/12

(54) me **AEROSOL FORMULISAN ZA COPD**
en **Aerosol formulation for COPD**

(73) Chiesi Farmaceutici S.p.A., Via Palermo, 26/A, 43100 Parma, IT

(72) BONELLI, Sauro, Chiesi Farmaceutici S.P.A., Via Palermo 26/A, I-43100 Parma, IT
USBERTI, Francesca, Chiesi Farmaceutici S.P.A., Via Palermo 26/A, I-43100 Parma, IT
ZAMBELLI, Enrico, Chiesi Farmaceutici S.P.A., Via Palermo 26/A, I-43100 Parma, IT

RADULOVIĆ, S. Božidar, Jovana Tomaševića 9/III-1, 81000 Podgorica,

(57) Predmetni pronalazak se odnosi na stabilne preparate rastvora- aerosola koji sadrže glikopironijum bromid za primenu kod pacijenata koji pate od COPD i drugih respiratornih oboljenja.

(51) **F 27B 17/00**^{2006.01} **F 22B 3/00**^{2006.01} (11) **01789** (13) **B**
F 23G 5/00^{2006.01} **C 22B 7/00**^{2006.01}
C 22B 59/00^{2006.01} **C 3B 8/00**^{2006.01}
F 04B 2/00^{2006.01} **C 04B 33/00**^{2006.01}

(21) P-2013-115
 (22) 07. 10. 2013
 (30) P-2013-115 07. 10. 2013 ME

(54) **me Postupak prerade industrijskog otpada**
en Procedure of processing industrial waste

(73) DENKOVYCH Roman, Trg Magnolije 3C, stan br.6,85320 Tivat, ME

(72) DENKOVYCH Roman, Trg Magnolije 3C, stan br.6,85320 Tivat, ME

(74) KAŠĆELAN, Novica, Stari grad 324,85330 Kotor, ME

(57) Postupak prerade industrijskog otpada, koji obuhvata kombinovanu peć, skladište sirovina: uglja, otpada sa sadržajem metala, tehnogenog otpada, topitelja; postrojenje za proizvodnju kiseonika, uređaj za pripremu metala izvan peći, odjeljenje za izlivanje livenog gvožđa, skladište livenog gvožđa, odjeljenje za izdvajanje šljake, skladište proizvoda od šljake ODLIKUJE SE TIME što smješa otpadnih gasova, koja se obrazuje u zoni topljenja i redukcije u kombinovanoj peći, odlazi u kotao-utilizator, a zatim u parno-turbinski uređaj binarnog ciklusa radi dobijanja električne energije. U procesu prečišćavanja otpadnih gasova koristi se apsorber na bazi CaO i nakon završnog prečišćavanja gas se šalje u odjeljenje karbonizacije, gdje se koristi za karbonizaciju u proizvodnji građevinskih materijala (opeke, građevinskih blokova, građevinskih panela, crijeva i t.d.). Prašina izdvojena iz otpadnih gasova se preko filtera-crijeva prebacuje u odjeljenje za dobijanje cinka, galijuma, germanijuma i drugih rijetkih metala. Sintezni gas, sa sadržajem SO₂, CO, H₂, CO₂, IiIO, odlazi u kotaoutilizator, a potom se, preko uređaja za prečišćavanje gasova sa sadržajem sumpora, dalje šalje u turbinu na paru i gas, koja proizvodi električnu energiju. Šljaka se šalje na penosilikatni generator i dalje na odjeljenje za proizvodnju keramike, penokeramike, penosilikata, kristalnog stakla, cementa. Para koja se obrazuje prilikom hlađenja penosilikatnog generatora šalje se u kotao-utilizator.

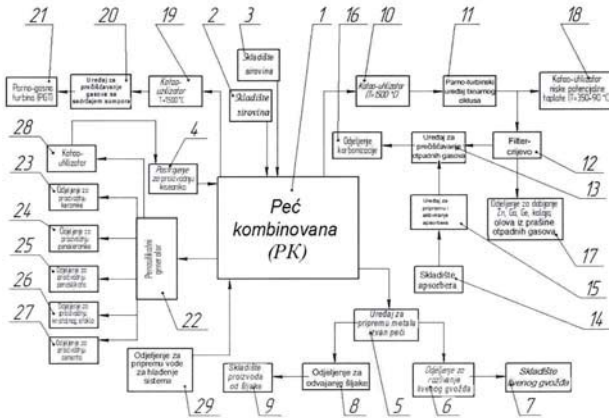

(51) F 27B 17/00

(11) 01770

(13) B

(21) 01790

(22) 18. 12. 2013

(30) 01790 18. 12. 2013 ME

(54) me **KOMBINOVANA PEĆ ZA GASIFIKACIJU KONTINUIRANO TOPLJENJE OTPADA SA SADRŽAJEM METALA I RAFINACIJU PRODUKATA PROCESA TOPLJENJA**
 en **Combined oven gasification , continuous melting waste from the refining of metal and products of the process of melting**

(73) DENKOVYCH ROMAN, Trg Magnolija 3C, stan br.6, TIVAT, ME

(72) DENKOVYCH ROMAN, Trg Magnolija 3C, stan br.6, TIVAT, ME

(74) KAŠĆELAN NOVICA, Stari grad 324, KOTOR, ME

(57) Peć kombinovana za gasifikaciju, kontinuirano topljenje otpada sa sadržajem metala i rafinaciju produkata procesa topljenja, opremljena je zvonastom šahtom I sa 2 zone koje su snabdjevene gornjim zasipnim uređajem, gornjim otvorom za odvenje gasova sa vertikalnom odvodnom cijevi, duvnicama gornjeg i donjeg reda, sifonom sa jednom ili više elektroda i ventilima za izlivanje zgure i metala, koji se u zoni topljenja i redukcije spojeni za cijev za evakuaciju dimnih gasova iz sifona. SAGLASNO PRONALASKU zona gasifikacije ima mogućnost zasebne evakuacije otpadnog sinteznog gasa iz gasifikacione zone peći, preko zasebnih otvora. Zona gasifikacije, zona topljenja i redukcije i izlivni sifon razdvojeni su poprečnim pregradama sa oknom koje je predviđeno za izlivanje zgure i metala. Pregrade tmaJu sistem vodenog hlađenja ili se iste mogu izvesti bez sistema vodenog hlađenja. Takođe je na granici zone topljenja i reukcije sa izlivnim sifonom ugrađen specijalni taložnik teško top lji ivih metala. Zona topljenja i redukcije može da se sastoj i od 2 ili više sekcija. U zoni gasifikacije pod je malo podignut u odnosu na zonu topljenja i redukcije za visinu koja iznosi 1 /3-2/3 visine koju zauzima rastopljeni metal u sloju taloženja u zoni topljenja i redukcije. Na taj način, sveobuhatnost odlika i karakteristika predlagane peći, omogućava da se obezbjedi dugoročna ekspoatacija peći po tehnološkom uputstvu uz održavanje minimalnih mehaničkih gubitaka metala. Istovremeno se povećava bezbjednost i pouzdanost rada peći na račun mogućnosti upravljanja procesima topljenja, povećava se efikasnost iskorišćenja toplote otpadnih gasova.

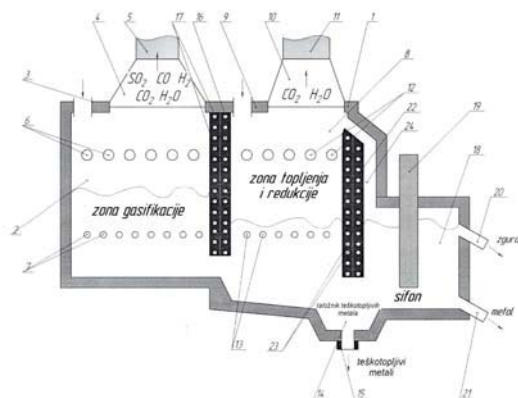

(51) E 04H12/10

(11) 01799

(13) B

(21) P-2012-142

(22) 13. 12. 2012

(54) me **SPOJNICA ZA PROSTORNE KONSTRUKCIJE "BUKO"**
en **NODE FOR THE SPACE STRUCTURES "BUKO"**

(73) BURIĆ A. Milorad, ulica Mila Radunovića bb, 81000 Podgorica,

(72) BURIĆ A. Milorad, ulica Mila Radunovića bb, 81000 Podgorica,

(57) Spojnica za prostorne rešetkaste konstrukcije "BUKO" od čelika ili Al-legure. Ovim pronalaskom je dato rješenje spojnice od čelika ili Al-legure kod kojeg su štapovi u obliku cijevi (11,12) deformisani na svojim krajevima i povezuju se zavrtnjima (5,6,7) sa L profilima (3,4) a ovi također sa zavrtnjima za ploču (1). Ploča (2) se vezuje sa pločom (1) zavrtnjem (8,9,10) tako da ploče (1,2) pritiskaju štapove (11,12).

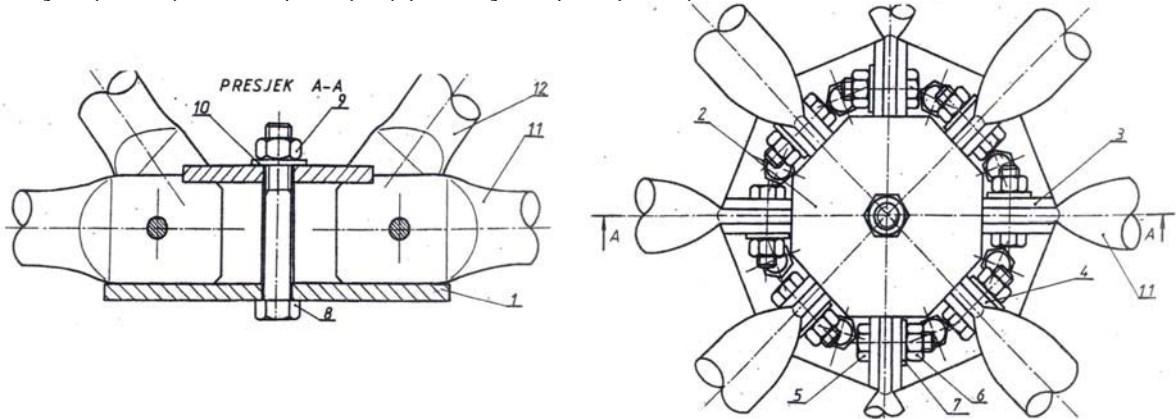

(51) F 16C 31/04

(11) 01808

(13) B

(21) P-2012-141

(22) 13. 12. 2012

(54) me LEŽAJ NA DILATACIONOM MJESTU DVIJE CIJEVI POD PRITISKOM
en EXPANSION BEARING ON THE PRESSURE PIPELINE

(73) BURIĆ A. Milorad, ulica Mila Radunovića bb, 81000 Podgorica,

(72) BURIĆ A. Milorad, ulica Mila Radunovića bb, 81000 Podgorica,

(57) Ležaj na dilatacionom mjestu dvije cijevi pod pritiskom (Sl. 1.) Kuglicama (6,7) se značajno eliminišu momenti koji se pojavljuju na spoju dvije cijevi (1,2, Sl. 1.). Naime, prilikom pojave sila i momenata od termičkih i drugih opterećenja, cijevi (1,2) klize jedna po drugoj oslanjajući se na kuglice (6,7) koje prenose samo sile i rasterećuju u mjesto gdje se vrši dihtovanje.

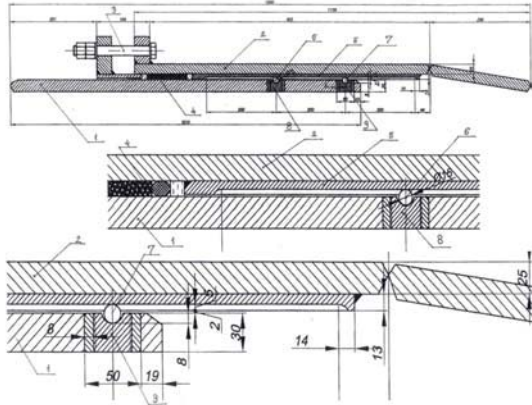

(51) C 02F 1 /00^{2006.01}
 C 02F 1 /50^{2006.01}
 C 02F 1 /78^{2006.01}

C 02F 1 /72^{2006.01}
 C 02F 1 /76^{2006.01}

(11) 01816

(13) B

(21) P-2013-1

(22) 09. 01. 2013

(54) me **SISTEM LOKALIZOVANE DEZINFEKCIJE SISTEMA VELIKIH VODENIH POVRŠINA**
 en **LOCALIZED DISINFECTION SYSTEM FOR LARGE WATER BODIES**

(73) CRYSTAL LAGOONS (CURACAO) B.V., Curacao, Kaya W.F.G . (Jombi) Mensing 14, Curaçao (CW)

(72) FERNANDO BENJAMIN FISCHMANN T.,
 CHILE, AVENIDA KENNEDY 8830, VITACU RA, SANTIAGO, CHILE (CL)

(74) ADVOKATSKA KANCELARIJA " VUJAČIĆ", „Radoičić Radmila, advokat, Moskovska 93, Podgorica, ME

(57) Predstavljeni pronalazak se odnosi na metode za kontrolu mikrobioloških karakteristika dijela vode u korpusu velike vodene površine uz tretman takve zone hemijskim agensima, prema temperaturi vode, njenom salinitetu, njenoj snazi razrjeđivanja i rasprostiranja hemikalija unutar korpusa velike vodene površine.

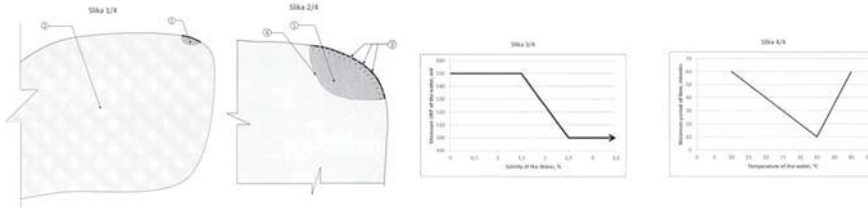

(51) **E 02B 3 /00**^{2006.01}

(11) **01817**

(13) **B**

(21) P-2012-48

(22) 11. 04. 2012

(54) me **Protočne akvatorije s pozivom na Mega luku Bar**
en **The flowing aquatories in relation to Mega port of Bar**

(73) MUGOŠA, Predrag, Velimira Terzića 15, Podgorica, 81000, ME

(72) MUGOŠA, Predrag, Velimira Terzića 15, Podgorica, 81000, ME

(57) Protočne akvatorije sa pozivom na Mega luku Bar ostvarile bi se formiranjem vodopropustnih lukobrana i gatova putem kamenog nabačaja i zacijevljenih betonskih blokova za njihovu izgradnju kojim putem bi se stvorili uslovi za proticanje i cirkulaciju morske vode unutar lučkih akvatorija, a na koji način bi se obezbijedilo osvježavanje ovih voda, koje bi posmatrano sa biološkog i ekološkog stanovišta imalo nemjerljive pozitivne odlike

(51) B 65F 3 /00

(11) 01818

(13) B

(21) P-2012-117

(22) 23. 10. 2012

(30) P-2012-117 23. 10. 2012 ME

(54) me **Zaštitni boksevi na vozilima gradske čistoće**
en **Protection box to vehicle city cleanlines**

(73) MUGOŠA, V. Predrag, Velimira Terzića 15, Podgorica, 81000, ME

(72) MUGOŠA, V. Predrag, Velimira Terzića 15, Podgorica, 81000, ME

(57) Zaštitni boksevi na vozilima gradske čistoće koncipirani su na taj način što primjenom lakih i čvrstih materijala formiraju zaštitne ćelije za radnike gradske čistoće (crtež 1), štiteći ih od saobraćajnih rizika, istovremeno udovoljavajući zahtjeve HTZ mjera i odstranjujući im neposredni kontakt sa respiratornim opterećivačima. Zamišljeni su tako što se na postojećim platformama za stajanje radnika nadograđuje boks (crtež 2) koj i preuzima sve zaštitne funkcije kojima je ovo mjesti izloženo. Kao dosad potpuno nepoznatom rješenju u primjeni obrađivač traži da mu se prizna pravo patentnog prioriteta.

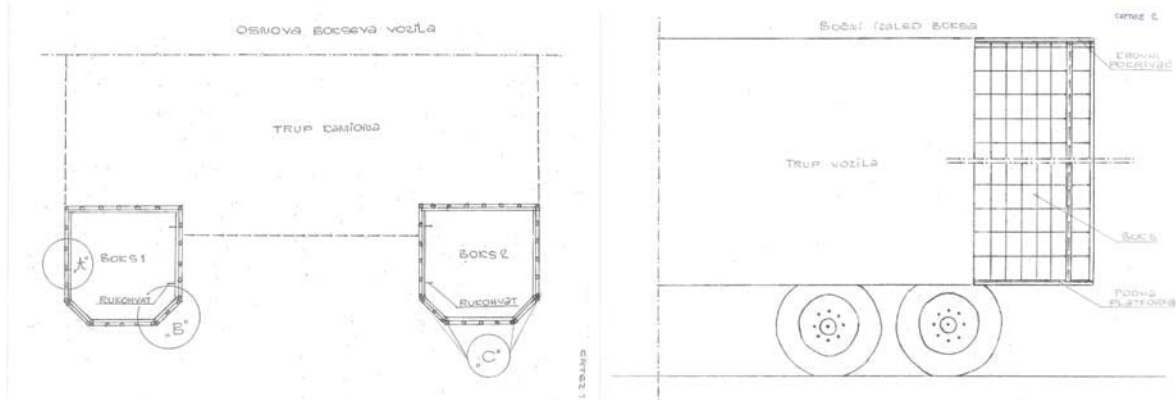

**INDEKS NOSILACA PATENTA
PATENT OWNER INDEX**

(73)	(51)	(21)
Alexion Cambridge Corporation	A 61 K 39 /395 ^{2006.01}	P-2012-121
Belron Hungary Kft - Zug Branch	B 29 C 73 /02 ^{2006.01}	P-2012-57
BURIĆ A. Milorad	B 65 D 77/04 ^{2006.01}	P-2012-57
BURIĆ A. Milorad	B 29 C 73 /24 ^{2006.01}	P-2012-142
	E 04 H 12 /10	P-2012-141
	F 16 C 31 /04	
	A 61 P 11 /06 ^{2006.01}	
	A 61 P 11 /00 ^{2006.01}	
	A 61 K 9 /12 ^{2006.01}	
Chiesi Farmaceutici S.P.A.	A 61 K 45 /06 ^{2006.01}	P-2012-82
	A 61 K 9 /00 ^{2006.01}	
	A 61 K 31 /167 ^{2006.01}	
	A 61 K 31 /40 ^{2006.01}	
	A 61 K 45 /06 ^{2006.01}	
	A 61 K 31 /40 ^{2006.01}	
	A 61 K 9 /00 ^{2006.01}	
Chiesi Farmaceutici S.p.A.	A 61 P 11 /06 ^{2006.01}	P-2012-83
	A 61 P 11 /00 ^{2006.01}	
	A 61 K 9 /12 ^{2006.01}	
	A 61 K 9 /72 ^{2006.01}	
	C 02 F 1 /00 ^{2006.01}	
	C 02 F 1 /72 ^{2006.01}	
CRYSTAL LAGOONS (CURACAO) B.V.	C 02 F 1 /50 ^{2006.01}	P-2013-1
	C 02 F 1 /76 ^{2006.01}	
	C 02 F 1 /78 ^{2006.01}	
	F 27 B 17 /00 ^{2006.01}	
	F 22 B 3 /00 ^{2006.01}	
	F 23 G 5 /00 ^{2006.01}	
DENKOVYCH Roman	C 22 B 7 /00 ^{2006.01}	P-2013-115
	C 22 B 59 /00 ^{2006.01}	
	C3 B 8 /00 ^{2006.01}	
	F 04 B 2 /00 ^{2006.01}	
	C 04 B 33 /00 ^{2006.01}	
DENKOVYCH ROMAN	F 27 B 17 /00	01790
MUGOŠA, Predrag	E 02 B 3 /00 ^{2006.01}	P-2012-48
MUGOŠA, V. Predrag	B 65 F 3 /00	P-2012-117
	A 61 K 38 /00 ^{2006.01}	
MUSC Foundation For Research Development	A 61 K 38 /17 ^{2006.01}	P-2012-120
	A 61 K 38 /39 ^{2006.01}	

Onyx Therapeutics

C 07 D 277 /56 ^{2006.01}

A 61 K 38 /55 ^{2006.01}

C 07 K 5 /08 ^{2006.01}

P-2013-39

**INDEKS BROJEVA PRIJAVA PATENATA
APPLICANTS NUMBER INDEX**

(21)	(51)	(21)	(51)
01790	F 27 B 17 /00	P-2013-115	F 27 B 17 /00 ^{2006.01}
P-2012-48	E 02 B 3 /00 ^{2006.01}		F 22 B 3 /00 ^{2006.01}
P-2012-57	B 29 C 73 /02 ^{2006.01}		F 23 G 5 /00 ^{2006.01}
	B 65 D 77/04 ^{2006.01}		C 22 B 7 /00 ^{2006.01}
	B 29 C 73 /24 ^{2006.01}		C 22 B 59 /00 ^{2006.01}
P-2012-82	A 61 P 11 /06 ^{2006.01}		C3 B 8 /00 ^{2006.01}
	A 61 P 11 /00 ^{2006.01}		F 04 B 2 /00 ^{2006.01}
	A 61 K 9 /12 ^{2006.01}		C 04 B 33 /00 ^{2006.01}
	A 61 K 45 /06 ^{2006.01}		
	A 61 K 9 /00 ^{2006.01}		
	A 61 K 31 /167 ^{2006.01}		
	A 61 K 31 /40 ^{2006.01}		
P-2012-83	A 61 K 45 /06 ^{2006.01}		
	A 61 K 31 /40 ^{2006.01}		
	A 61 K 9 /00 ^{2006.01}		
	A 61 P 11 /06 ^{2006.01}		
	A 61 P 11 /00 ^{2006.01}		
	A 61 K 9 /12 ^{2006.01}		
	A 61 K 9 /72 ^{2006.01}		
P-2012-117	B 65 F 3 /00		
P-2012-120	A 61 K 38 /00 ^{2006.01}		
	A 61 K 38 /17 ^{2006.01}		
	A 61 K 38 /39 ^{2006.01}		
P-2012-121	A 61 K 39 /395 ^{2006.01}		
P-2012-141	F 16 C 31 /04		
P-2012-142	E 04 H 12 /10		
P-2013-1	C 02 F 1 /00 ^{2006.01}		
	C 02 F 1 /72 ^{2006.01}		
	C 02 F 1 /50 ^{2006.01}		
	C 02 F 1 /76 ^{2006.01}		
	C 02 F 1 /78 ^{2006.01}		
P-2013-39	C 07 D 277 /56 ^{2006.01}		
	A 61 K 38 /55 ^{2006.01}		
	C 07 K 5 /08 ^{2006.01}		

INDEKS OBJAVLJENIH PRIJAVA PATENATA PREMA MKP
INDEX OF PATENT APPLICANTS ACCORDINT TO IPC

(51)	(21)	(51)	(21)
A 61 K 31 /167 ^{2006.01}	P-2012-82	C 04 B 33 /00 ^{2006.01}	P-2013-115
A 61 K 31 /40 ^{2006.01}	P-2012-82	C 07 D 277 /56 ^{2006.01}	P-2013-39
A 61 K 31 /40 ^{2006.01}	P-2012-83	C 07 K 5 /08 ^{2006.01}	P-2013-39
A 61 K 38 /00 ^{2006.01}	P-2012-120	C 22 B 59 /00 ^{2006.01}	P-2013-115
A 61 K 38 /17 ^{2006.01}	P-2012-120	C 22 B 7 /00 ^{2006.01}	P-2013-115
A 61 K 38 /39 ^{2006.01}	P-2012-120	C 3 B 8 /00 ^{2006.01}	P-2013-115
A 61 K 38 /55 ^{2006.01}	P-2013-39	E 02 B 3 /00 ^{2006.01}	P-2012-48
A 61 K 39 /395 ^{2006.01}	P-2012-121	E 04 H 12 /10	P-2012-142
A 61 K 45 /06 ^{2006.01}	P-2012-82	F 04 B 2 /00 ^{2006.01}	P-2013-115
A 61 K 45 /06 ^{2006.01}	P-2012-83	F 16 C 31 /04	P-2012-141
A 61 K 9 /00 ^{2006.01}	P-2012-82	F 22 B 3 /00 ^{2006.01}	P-2013-115
A 61 K 9 /00 ^{2006.01}	P-2012-83	F 23 G 5 /00 ^{2006.01}	P-2013-115
A 61 K 9 /12 ^{2006.01}	P-2012-82	F 27 B 17 /00	01790
A 61 K 9 /12 ^{2006.01}	P-2012-83	F 27 B 17 /00 ^{2006.01}	P-2013-115
A 61 K 9 /72 ^{2006.01}	P-2012-83		
A 61 P 11 /00 ^{2006.01}	P-2012-82		
A 61 P 11 /00 ^{2006.01}	P-2012-83		
A 61 P 11 /06 ^{2006.01}	P-2012-82		
A 61 P 11 /06 ^{2006.01}	P-2012-83		
B 29 C 73 /02 ^{2006.01}	P-2012-57		
B 29 C 73 /24 ^{2006.01}	P-2012-57		
B 65 D 77/04 ^{2006.01}	P-2012-57		
B 65 F 3 /00	P-2012-117		
C 02 F 1 /00 ^{2006.01}	P-2013-1		
C 02 F 1 /50 ^{2006.01}	P-2013-1		
C 02 F 1 /72 ^{2006.01}	P-2013-1		
C 02 F 1 /76 ^{2006.01}	P-2013-1		
C 02 F 1 /78 ^{2006.01}	P-2013-1		

OBJAVE ZAHTJEVA ZA PROŠIRENJE EVROPSKIH PRIJAVA PATENATA
PUBLICATION OF REQUEST FOR THE EXTENSION OF THE EFFECTS OF
EUROPEAN PATENT APPLICATIONS

(51) MKP
C08K 3/00 (2006.01) (97) **2729522 ***
C08K 3/34 (2006.01)
C08K 9/06 (2006.01)
C08L 67/04 (2006.01)
(86) IB2012053459 06.07.2012
(96) 12748550.6 14.05.2014
(87) WO2013008156, 06.07.2012
(97) 2729522, 14.05.2014 en
(54) BRANCHED LACTIC ACID POLYMERS WITH HIGH VISCOSITY IN THE MOLTEN STATE AND HIGH SHEAR SENSITIVITY, AND NANOCOMPOSITES THEREOF
(71) Università' degli Studi di Milano, Via Festa del Perdono, 7, 20122 Milano, IT
Fondazione Cariplo, Via Manin 23, 20121 Milano (MI), IT
(72) DI SILVESTRO, Giuseppe, Via Quasimodo 4, I-20823 Lentate Sul Seveso (MB), IT
CUIMING, Yuan, Via Sesto San Giovanni 31, I-20126 Milano, IT
ORTENZI, Marco, Via Stoppani 34, I-20129 Milano, IT
FARINA, Hermes, Via Carinei 10, I-24010 Sorisole (BG), IT
LUGATO, Tommaso, Via Grandi 1, I-20852 Villasanta (MB), IT
BASILISSI, Luca, Via Bergamo 24, I-20010 Cornaredo (MI), IT

(51) MKP
B01J 21/06 (2006.01) (97) **2720794 ***
B01J 21/12 (2006.01)
B01J 23/00 (2006.01)
B01J 23/10 (2006.01)
B01J 23/22 (2006.01)
B01J 23/31 (2006.01)
B01J 23/889 (2006.01)
B01J 37/00 (2006.01)
(86) EP2012002543 15.06.2012
(96) 12729870.1 23.04.2014
(87) WO2012171656, 15.06.2012
(97) 2720794, 23.04.2014 de
(54) MIXED METAL OXIDE-BASED POROUS MATERIALS AND THE PRODUCTION AND USE THEREOF
(71) Blücher GmbH, Mettmanner Strasse 25, 40699 Erkrath, DE
Universität Leipzig, Linnéstraße 3, 04103 Leipzig, DE
(72) GLÄSER, Roger, Otto-Engau-Straße 8, 07749 Jena, DE
LUTECKI, Michael, c/o Universität Leipzig Institut für technische Chemie Linnéstraße 3, 04103 Leipzig, DE
WITH, Patrick, Hirtenweg 34, 04425 Taucha, DE
HEINRICH, Astrid, c/o Universität Leipzig Institut für technische Chemie Linnéstraße 3, 04103 Leipzig, DE
FICHTNER, Sven, Bunsenstraße 5, 14727 Premnitz, DE
BÖHRINGER, Bertram, Bussardweg 33, 42115 Wuppertal, DE

(51) MKP
C07K 1/18 (2006.01) (97) **2748179 ***
C12N 9/64 (2006.01)
(86) EP2012070257 12.10.2012
(96) 12770496.3 02.07.2014
(87) WO2013053887, 12.10.2012
(97) 2748179, 02.07.2014 en
(54) PROTEIN PURIFICATION BY ANION EXCHANGE CHROMATOGRAPHY
(71) Baxter International Inc, One Baxter Parkway, Deerfield, IL 60015, US
Baxter Healthcare SA, Thurgauerstrasse 130, 8152 Glattpark (Opfikon), CH
(72) MITTERER, Artur, Schwarzeckerweg 10, 2304 Orth/Donau, AT
HASSLACHER, Meinhard, Vorgartenstrasse 221/1/7, 1020 Vienna, AT
FIEDLER, Christian, Raaberbahngasse 18/36, 1100 Vienna, AT

(51) MKP
A01N 37/18 (2006.01) (97) **2723716 ***
A61K 31/44 (2006.01)
A61K 31/4433 (2006.01)
A61P 33/00 (2006.01)
A61P 33/10 (2006.01)
A61P 33/14 (2006.01)
C07D 213/18 (2006.01)
(86) US2012044476 27.06.2012
(96) 12737648.1 30.04.2014
(87) WO2013003505, 27.06.2012
(97) 2723716, 30.04.2014 en
(54) AMIDO-PYRIDYL ETHER COMPOUNDS AND COMPOSITIONS AND THEIR USE AGAINST PARASITES
(71) Merial Limited, 3239 Satellite Blvd., Duluth, GA 30096, US
(72) MENG, Charles, Q., 7158 Belcrest Drive, Johns Creek, GA 30097, US
MURRAY, Clare, Louise, 200 Azalea Drive, Chapel Hill, NC 27517, US
BLUHN-CHERTUDI, Itta, 7 Huntscroft Court, Durham, NC 27713, US
SOUKRI, Mustapha, 7815 Clover Creek Court, Raleigh, NC 27613, US
JOHNSON, Mary, George, 3 Hazen Court, Durham, NC 27712, US

(51) MKP
A61B 17/072 (2006.01) (97) **2517640**
(96) 12166164.9 31.10.2012
(97) 2517640, 31.10.2012 en
(54) Tissue thickness compensator comprising detachable portions
(71) Ethicon Endo-Surgery, Inc., 4545 Creek Road, Cincinnati, OH 45242, US
(72) Shelton, IV, Frederick E., 245 East Main Street, Hillsboro, OH Ohio 45133, US
Baxter, III, Chester O., 6375 Pawnee Ridge, Loveland, OH Ohio 45140, US
Aronhalt, Taylor W., 306 Beech Road, Loveland, OH Ohio 45140, US
Scheib, Charles J., 11329 Donwiddle Drive, Loveland, OH Ohio 45140, US
Omaitis, Todd P., 7446 Airy View Drive, Liberty Township, OH Ohio 45044, US

(51) MKP
B21C 43/04 (2006.01) (97) **2766132 ***
B24D 13/10 (2006.01)
B24D 13/14 (2006.01)
(86) EP2012070051 10.10.2012
(96) 12780433.4 20.08.2014
(87) WO2013053750, 10.10.2012
(97) 2766132, 20.08.2014 en
(54) METAL WIRE CLEANING PADS AND METHOD AND DEVICE FOR CLEANING METAL WIRE
(71) Van Merksteijn Steel BV, Bedrijvenpark Twente 237, 7602 KJ Almelo, NL
(72) VAN MERKSTEIJN, Peter, c/o Bedrijvenpark Twente 237, NL-7602 KJ Almelo, NL

(51) MKP
B41M 3/14 (2006.01) (97) **2760674 ***
G07D 7/00 (2006.01)
(86) IT2012000295 26.09.2012
(96) 12794516.0 06.08.2014
(87) WO2013046240, 26.09.2012
(97) 2760674, 06.08.2014 en
(54) METHOD AND SYSTEM FOR ANTIFORGERY MARKING OF PRINTED PRODUCTS
(71) Viditrust S.r.l., Via Fontebranda, 69, 53100 Siena, IT
(72) CAPOBIANCO, Luca, Via Vallerozzi 33, I-53100 Siena, IT
CANCELLI, Giacomo, Via E. Fontebranda 13, I-53100 Siena, IT
BARNI, Mauro, Via Boni 108, I-59100 Prato, IT

- (51) MKP
C07D 215/46 (2006.01) (97) **2718268 ***
 (86) EP2012060553 05.06.2012
 (96) 12726414.1 16.04.2014
 (87) WO2012168213, 05.06.2012
 (97) 2718268, 16.04.2014 en
 (54) NOVEL PROCESS FOR THE SYNTHESIS OF 7-CHLORO-4-(PIPERAZIN-1-YL)-QUINOLINE
 (71) Sigma-Tau Industrie Farmaceutiche Riunite S.P.A., Viale Shakespeare 47, 00144 Rome, IT
 (72) CABRI, Walter, Via Pisacane 5, I-20089 Rozzano (MI), IT
 CASTAGNANI, Roberto, Via Bari s.n.c., I-04010 Sezze Scalo (LT), IT
 ARMAROLI, Silvia, Via della Chiesa 24, I-44020 Gallo Poggio Renatico (FE), IT
 QUATTROCIOCCI, Gianandrea, Via Santa Francesca 84, I-03029 Veroli (FR), IT
 COLANGELI, Vincenzo, Via Iacopo da Lentini 16, I-00040 Pomezia (RM), IT

- (51) MKP
C07D 487/04 (2006.01) (97) **2768834 ***
 (86) US2012061019 19.10.2012
 (96) 12842012.2 27.08.2014
 (87) WO2013059589, 19.10.2012
 (97) 2768834, 27.08.2014 en
 (54) SUBSTITUTED BICYCLIC AZA-HETEROCYCLES AND ANALOGUES AS SIRTUIN MODULATORS
 (71) GlaxoSmithKline LLC, Corporation Service Company 2711 Centerville Road, Suite 400, Wilmington DE 19808, US
 (72) BLUM, Charles A., 32 Middlesex Circle, Waltham, MA 02452, US
 SPRINGER, Stephanie, K., 3100 Connecticut Avenue, NW, Washington, DC 20008, US
 VU, Chi, B., 79 Bay State Road, Arlington, MA 02474, US

- (51) MKP
F03D 7/02 (2006.01) (97) **2751422 ***
 (86) EP2012065910 14.08.2012
 (96) 12746355.2 09.07.2014
 (87) WO2013029993, 14.08.2012
 (97) 2751422, 09.07.2014 de
 (54) METHOD FOR OPERATING A WIND TURBINE
 (71) Wobben Properties GmbH, Dreekamp 5, 26605 Aurich, DE
 (72) DE BOER, Wolfgang, Mißgunsterweg 7b, 26802 Moormerland, DE
 GIERTZ, Helge, Kolberger Straße 46, 26789 Leer, DE

- (51) MKP
A21C 11/16 (2006.01) (97) **2737800**
 (96) 13425152.9 04.06.2014
 (97) 2737800, 04.06.2014 en
 (54) Process for manufacturing dies for pasta, the dies themselves, and their use in the production of pasta
 (71) Rummo S.p.A., Z.I. Ponte Valentino Area ASI, 82100 Benevento, IT
 (72) Rummo, Cosimo, Via Filippo Raguzzini n.10, I - 82100 Benevento, IT

- (51) MKP
A61K 31/4985 (2006.01) (97) **2731611 ***
 (86) US2012046523 12.07.2012
 (96) 12811325.5 21.05.2014
 (87) WO2013010015, 12.07.2012
 (97) 2731611, 21.05.2014 en
 (54) COMBINATIONALS THERAPY
 (71) Cytokinetics, Inc., 280 East Grand Avenue, South San Francisco, CA 94080, US
 Cedarbaum, Jesse, 4946 17th Street, San Francisco, California 94117, US
 Mao, John, 1388 Broadway 107, Millbrae, California 94030, US
 Malik, Fady, 2884 Hillside Drive, Burlingame, California 94010, US
 Wolff, Andrew A., 2140 Taylor Street 803, San Francisco, California 94133, US
 (72) CEDARBAUM, Jesse, 4946 17th Street, San Francisco, California 94117, US
 MAO, John, 1388 Broadway 107, Millbrae, California 94030, US
 MALIK, Fady, 2884 Hillside Drive, Burlingame, California 94010, US
 WOLFF, Andrew A., 2140 Taylor Street 803, San Francisco, California 94133, US

- (51) MKP
C02F 1/68 (2006.01) (97) **2739575 ***
 (86) EP2012063973 17.07.2012
 (96) 12740542.1 11.06.2014
 (87) WO2013014026, 17.07.2012
 (97) 2739575, 11.06.2014 en
 (54) MICRONIZED CaCO₃ SLURRY INJECTION SYSTEM FOR THE REMINERALIZATION OF DESALINATED AND FRESH WATER
 (71) Onya International AG, Baslerstrasse 42, 4665 Oftringen, CH
 (72) SKOVBY, Michael, Wampflenstrasse 52, 8706 Meilen, CH
 POFFET, Martine, Belpstrasse 30, 3007 Berne, CH

- (51) MKP
A61K 9/00 (2006.01) (97) **2736525 ***
A61K 38/48 (2006.01)
A61P 1/00 (2006.01)
A61P 37/00 (2006.01)
A61P 39/00 (2006.01)
G01N 33/53 (2006.01)
 (86) US2012048149 25.07.2012
 (96) 12743036.1 04.06.2014
 (87) WO2013016427, 25.07.2012
 (97) 2736525, 04.06.2014 en
 (54) METHODS AND PHARMACEUTICAL COMPOSITIONS FOR TREATING CELIAC DISEASE AND GLUTEN INTOLERANCE
 (71) Alvine Pharmaceuticals, Inc., 75 Shoreway Road Suite B, San Carlos, CA 94070, US
 (72) ADELMAN, Daniel, C., Dr., 23 Woodleaf Avenue, Redwood City, CA 94061, US

- (51) MKP
B21D 5/08 (2006.01) (97) **2747913 ***
 (86) SE2012051268 16.11.2012
 (96) 12858455.4 02.07.2014
 (87) WO2013089611, 16.11.2012
 (97) 2747913, 02.07.2014 en
 (54) A ROLL-FORMING MACHINE AND METHOD FOR ROLL-FORMING
 (71) Ortic 3D AB, Rågåkersgatan 5, 78174 Borlänge, SE
 (72) Ingvarsson, Lars, Nol-Saras väg 8, S-784 54 Borlänge, SE

- (51) MKP
A47K 3/40 (2006.01) (97) **2687136**
 (96) 12177286.7 22.01.2014
 (97) 2687136, 22.01.2014 de
 (54) Shower element
 (71) Dallmer GmbH & Co. KG, Wiebelsheidestrasse 25, 59757 Arnsberg, DE
 (72) Dallmer, Johannes, Binnerfeld 27, 59757 Arnsberg, DE

(51) MKP
B41J 2/21 (2006.01) (97) **2756661 ***
H04N 1/407 (2006.01)
H04N 1/60 (2006.01)
(86) IB2012054792 14.09.2012
(96) 12787507.8 23.07.2014
(87) WO2013038370, 14.09.2012
(97) 2756661, 23.07.2014 en
(54) A METHOD FOR CONTROLLING A COLOUR CALIBRATION TARGET
(71) Maccari, Antonio, Via Bonanno Pisano, 109, 56125 Pisa, IT
(72) Maccari, Antonio, Via Bonanno Pisano, 109, 56125 Pisa, IT

(51) MKP
A61K 9/00 (2006.01) (97) **2706982 ***
A61K 9/08 (2006.01)
A61K 31/135 (2006.01)
A61P 25/36 (2006.01)
(86) EP2012058792 11.05.2012
(96) 12721507.7 19.03.2014
(87) WO2012156317, 11.05.2012
(97) 2706982, 19.03.2014 en
(54) INTRANASAL PHARMACEUTICAL DOSAGE FORMS COMPRISING NALOXONE
(71) Euro-Celtique S.A., 2, avenue Charles de Gaulle, 1653 Luxembourg, LU
(72) STRANG, John, c/o National Addiction Centre Addiction Sciences Building 4 Windsor Walk Denmark Hill, London SE5 8AF, GB
OKSCHE, Alexander, c/o Mundipharma GmbH Mundipharma Straße 2, 65549 Limburg, DE
HARRIS, Stephen, c/o Purdue Pharma L. P. One Stamford Forum 201 Tresser Boulevard, Stamford Connecticut 06901-3431, US
SMITH, Kevin, c/o Mundipharma Research Limited Cambridge Science Park Milton Road, Cambridge CB4 0GW, GB
MOTTIER, Lucie Helene Jeanne, c/o Mundipharma Research Limited Cambridge Science Park Milton Road, Cambridge CB4 0GW, GB

(51) MKP
F03B 3/12 (2006.01) (97) **2715120 ***
F03D 1/04 (2006.01)
F03D 1/06 (2006.01)
(86) US2012039660 25.05.2012
(96) 12726979.3 09.04.2014
(87) WO2012166632, 25.05.2012
(97) 2715120, 09.04.2014 en
(54) TURBINE BLADES WITH MIXED BLADE LOADING
(71) Flodesign Wind Turbine Corp., 221 Crescent St. Suite 103a, Waltham, MA 02453, US
(72) PRESZ, Walter, M., Jr., 40 Grove Street, Wilbraham, MA 01095, US
WERLE, Michael, J., 4 Porter Drive, West Hartford, CT 06117, US
DOLD, Robert, 54 Carpenter Road, Monson, MA 01057, US
HICKEY, Timothy, 45 Schuyler Drive, East Longmeadow, MA 01028, US

(51) MKP
(86) US2012046441 12.07.2012
(96) 12811563.1 21.05.2014
(87) WO2013009972, 12.07.2012
(97) 2731692, 21.05.2014 en
(54) PERSONALIZABLE HYBRID GAMES
(71) Gamblit Gaming, LLC, 620 North brand Boulevard, Suite 500, Glendale, CA 91203, US
(72) ARNONE, Miles, c/o Feinberg Law Group LLC. 57 River Street Suite 204, Wellesley, MA 02481, US
CIRE, Frank, c/o Feinberg Law Group LLC. 57 River Street Suite 204, Wellesley, MA 02481, US
MEYERHOFER, Eric, c/o Feinberg Law Group LLC. 57 River Street Suite 204, Wellesley, MA 02481, US

(51) MKP
A61K 31/535 (2006.01) (97) **2726079 ***
A61K 38/00 (2006.01)
C12N 15/113 (2010.01)
(86) US2012044618 28.06.2012
(96) 12804047.4 07.05.2014
(87) WO2013003575, 28.06.2012
(97) 2726079, 07.05.2014 en
(54) METHOD OF ADMINISTRATION AND TREATMENT
(71) Glaxosmithkline Intellectual Property (No. 2) Limited, 980 Great West Road, Brentford, Middlesex TW8 9SG, GB
(72) AUGER, Kurt, R., 1250 S. Collegeville Road, Collegeville, PA 19426-0989, US
DAR, Mohammed, M., 5 Moore Drive, Pesearch Triangle Park, NC 27709-3398, US
FLEMING, Ronald, A., 5 Moore Drive, Resrarch Triangle Park, NC 27709-3398, US

(51) MKP
B02C 17/14 (2006.01) (97) **2758176 ***
(86) US2012056490 21.09.2012
(96) 12833717.7 30.07.2014
(87) WO2013043971, 21.09.2012
(97) 2758176, 30.07.2014 en
(54) APPARATUS AND METHOD FOR LINER SYSTEM
(71) Telsmith, Inc., 10190 N. Industrial Dr. P.O. Box 539, Mequon, WI 53092, US
(72) VAN MULLEM, Albert, N59 W23790 Clover Drive, Sussex, WI 53089, US
HAVEN, Matthew, N62w 1025 Fairhaven Court, Cedarburg, WI 53012, US
DRICKEN, Chuck, 7920 Hunters Drive, Kewaskum, WI 53040, US
NEITZEL, Sean, 334 Brookside Drive 6, Mayville, WI 53050, US

(51) MKP
F16L 33/22 (2006.01) (97) **2667074**
F16L 37/091 (2006.01)
F16L 37/092 (2006.01)
(96) 12169551.4 27.11.2013
(97) 2667074, 27.11.2013 de
(54) System with clamp parts for connecting tubes
(71) Systemvertrieb Jäger GmbH Sanitär- und Heizungstechnik, Spitzeneckstrasse 34 A, 6845 Hohenems, AT
(72) Jäger, Daniel, St. Rochusweg 7, 6845 Hohenems, AT
Mainhart, Patrick, An den Bernhecken 17, 97499 Donnersdorf, DE

(51) MKP
G06F 3/0486 (2013.01) (97) **2642377**
G06F 3/0488 (2013.01)
H04M 1/725 (2006.01)
(96) 13001497.0 25.09.2013
(97) 2642377, 25.09.2013 en
(54) Handheld device and homescreen management method thereof
(71) HTC Corporation, No. 23, Xinghua Rd., Taoyuan City Taoyuan County, TW
(72) Yang, Chih-Wei, No. 23, Xinghua Rd., Taoyuan City Taoyuan County, TW
Su, Huan-Chun, No. 23, Xinghua Rd., Taoyuan City Taoyuan County, TW
Shih, Wei-Nien, No. 23, Xinghua Rd., Taoyuan City Taoyuan County, TW

- (51) MKP
A61K 31/4412 (2006.01) (97) **2714661 ***
A61P 31/10 (2006.01)
C07D 213/81 (2006.01)
(86) US2012039171 23.05.2012
(96) 12724507.4 09.04.2014
(87) WO2012162407, 23.05.2012
(97) 2714661, 09.04.2014 en
(54) PICOLINAMIDO - PROPANOIC ACID DERIVATIVES USEFUL AS GLUCAGON RECEPTOR ANTAGONISTS
(71) Janssen Pharmaceutica, N.V., Turnhoutseweg 30, 2340 Beerse, BE
(72) CHAKRAVARTY, Devraj, 3205 Astor Close, Hillsborough, NJ 08844, US
KREUTTER, Kevin, c/o Janssen Research&Development LLC Welsh&Mckean Roads, Spring House, PA 19477, US
POWELL, Mark, c/o Janssen Research&Development LLC Welsh&Mckean Roads, Springs House, PA 19477, US
SHOOK, Brian, c/o Janssen Research&Development LLC Welsh&Mckean Roads, Spring House, PA 19477, US
SONG, Fengbin, c/o Janssen Research&Development LLC Welsh&Mckean Roads, Spring House, PA 19477, US
XU, Guozhang, c/o Janssen Research&Development LLC Welsh&Mckean Roads, Spring House, PA 19477, US
YANG, Shyh-ming, c/o Janssen Research&Development LLC Welsh&Mckean Roads, Spring House, PA 19477, US
ZHANG, Rui, c/o Janssen Research&Development LLC Welsh&Mckean Roads, Spring House, PA 19477, US
ZHAO, Bao-ping, c/o Janssen Research&Development LLC Welsh&Mckean Roads, Spring House, PA 19477, US

- (51) MKP
B61G 9/14 (2006.01) (97) **2755879 ***
B61G 11/08 (2006.01)
F16F 3/08 (2006.01)
(86) US2012055010 13.09.2012
(96) 12831720.3 23.07.2014
(87) WO2013040128, 13.09.2012
(97) 2755879, 23.07.2014 en
(54) COMPRESSIBLE ELASTOMERIC SPRING
(71) Wabtec Holding Corp., 1001 Air Brake Avenue, Wilmerding, PA 15148, US
(72) SPRAINIS, Ronald, J., 39141 Easton Lane, Springfield, Oregon 97478, US
GREGAR, Peter, 1033 N 350 E., Chesterton, Indiana 46304, US

- (51) MKP
C12N 9/16 (2006.01) (97) **2729566 ***
(86) US2012045927 09.07.2012
(96) 12738681.1 14.05.2014
(87) WO2013009686, 09.07.2012
(97) 2729566, 14.05.2014 en
(54) METHODS FOR PURIFICATION OF ARYLSULFATASE A
(71) Shire Human Genetic Therapies, Inc., 300 Shire Way, Lexington MA 02421, US
(72) YANG, Ying, 22 Ridge Road, Belmont, MA 02478, US
WANG, Yong, 27 Pequot Road, Wayland, MA 01778, US

- (51) MKP
C12Q 1/02 (2006.01) (97) **2761065 ***
C12Q 1/68 (2006.01)
C40B 30/06 (2006.01)
(86) US2012057825 28.09.2012
(96) 12835606.0 06.08.2014
(87) WO2013049508, 28.09.2012
(97) 2761065, 06.08.2014 en
(54) COMPOSITIONS AND METHODS FOR TOXIGENICITY TESTING
(71) Cellsnap, LLC, 350 South Hamilton Street No. 801, Madison, WI 53703, US
(72) WHITEMARSH, Regina Clare Meyer, 2201 Van Hise Avenue, Madison Wisconsin 53726, US
JOHNSON, Eric Arthur, 350 South Hamilton Street Unit 801, Madison Wisconsin 53703, US
PELLETT, Sabine, 14 North Rock Road, Madison Wisconsin 53705, US
TEPP, William Howard, 909 Devonshire Court, Stoughton Wisconsin 53589, US

- (51) MKP
B31F 1/07 (2006.01) (97) **2664451**
(96) 12003812.0 20.11.2013
(97) 2664451, 20.11.2013 en
(54) Hybrid multi-ply tissue paper product and method for manufacturing the same
(71) SCA TISSUE FRANCE, 60, avenue de l'Europe, 92270 Bois-Colombes, FR
(72) Saas, Pascale, 17, rue Sainte Odile, 67600 Selestat, FR
Jeannot, Sébastien, 38, rue Principale, 68230 Holtzwihr, FR

- (51) MKP
A61K 9/66 (2006.01) (97) **2723325 ***
(86) US2012043493 21.06.2012
(96) 12802695.2 30.04.2014
(87) WO2012177840, 21.06.2012
(97) 2723325, 30.04.2014 en
(54) NOVEL FORMULATIONS AND METHODS FOR TREATING DERMATOLOGICAL DISORDERS OR DISEASES
(71) Vapogenix, Inc., 8285 El Rio Street, Suite 150, Houston, TX 77054, US
(72) SPAKEVICIUS, Danguole, 4030 Case Street, Houston, TX 77005, US

- (51) MKP
A61K 9/08 (2006.01) (97) **2741738 ***
A61K 31/557 (2006.01)
A61K 47/48 (2006.01)
(86) EP2012065742 10.08.2012
(96) 12748423.6 18.06.2014
(87) WO2013024051, 10.08.2012
(97) 2741738, 18.06.2014 en
(54) SUSTAINED RELEASE COMPOSITION OF PROSTACYCLIN
(71) Ascendis Pharma A/S, Tuborg Boulevard 12, 2900 Hellerup, DK
(72) SPROGØE, Kennett, 1982 West Bayshore Road 327, Palo Alto California 94303, US
RAU, Harald, Talstraße 41, 69221 Dossenheim, DE
HERSEL, Ulrich, Fritz-Frey-Strasse 8, 69121 Heidelberg, DE
WEGGE, Thomas, Kurfürstenanlage 45, 69115 Heidelberg, DE
ZETTLER, Joachim, Im Linsenbühl 10, 69221 Dossenheim, DE
KEIL, Oliver, Ladenburger Strasse 48, 69120 Heidelberg, DE

- (51) MKP
A61K 9/00 (2006.01) (97) **2741739 ***
A61K 9/16 (2006.01)
(86) GB2012051924 08.08.2012
(96) 12753216.6 18.06.2014
(87) WO2013021199, 08.08.2012
(97) 2741739, 18.06.2014 en
(54) PHARMACEUTICAL COMPOSITIONS
(71) Prosonix Limited, Magdalen Centre Robinson Avenue Oxford Science Park, Oxford, Oxfordshire OX4 4GA, GB
(72) RUECROFT, Graham, 24 Nelson Close, Wallingford Oxfordshire OX10 0LG, GB
PARIKH, Dipesh, The Magdalen Centre Robert Robinson Avenue Oxford Science Park, Oxford Oxfordshire OX4 4GA, GB

- (51) MKP
G08B 13/14 (2006.01) (97) **2721591 ***
G08B 25/00 (2006.01)
(86) RO2012000001 18.01.2012
(96) 12732888.8 23.04.2014
(87) WO2012177155, 18.01.2012
(97) 2721591, 23.04.2014 en
(54) ELECTRONIC THEFT/VANDALISM PROTECTION DEVICE WITH INSTANTANEOUS SIGNALING AND POSITIONING RESPONSE
(71) State, Adrian Florentin, No. 1 Oslo Street Mogosoia, 077135 Ilfov, RO
(72) State, Adrian Florentin, No. 1 Oslo Street Mogosoia, 077135 Ilfov, RO

(51) MKP
A61L 9/014 (2006.01) (97) **2723471 ***
B01D 53/02 (2006.01)
B01J 20/22 (2006.01)
(86) US2011045485 27.07.2011
(96) 11743405.0 30.04.2014
(87) WO2012177269, 27.07.2011
(97) 2723471, 30.04.2014 en
(54) MATERIAL SUCH AS FILM, FIBER, WOVEN AND NONWOVEN FABRIC WITH ADSORBANCY
(71) Cellresin Technologies, LLC, 1789 Buerkle Circle, St. Paul, MN 55110-5254, US
(72) WOOD, Willard E., 3470 Siems Court, Arden Hills, Minnesota 55112, US

(51) MKP
C23C 18/48 (2006.01) (97) **2757180**
C25D 3/56 (2006.01)
C25D 3/60 (2006.01)
(96) 13425013.3 23.07.2014
(97) 2757180, 23.07.2014 en
(54) A process for electrolytically depositing a tin- and ruthenium-based alloy, the electrolytic bath that permits said alloy to deposit and the alloy obtained by means of said process
(71) Valmet S.p.A., Via Erbosa n.5, 52041 Calenzano (FI), IT
(72) Bussetti, Samuele, Via Alvise Cadamosto n. 47, 59100 Prato (PO), IT

(51) MKP
A61K 31/535 (2006.01) (97) **2744501 ***
(86) US2012051247 17.08.2012
(96) 12824263.3 25.06.2014
(87) WO2013025958, 17.08.2012
(97) 2744501, 25.06.2014 en
(54) AMINO QUINAZOLINES AS KINASE INHIBITORS
(71) GlaxoSmithKline Intellectual Property Development Limited, 980 Great West Road, Brentford Middlesex TW8 9GS, GB
(72) BURY, Michael, Jonathan, 1250 South Collegeville Road, Collegeville, PA 19426, US
CASILLAS, Linda, N., 1250 South Collegeville Road, Collegeville, PA 19426, US
CHARNLEY, Adam, Kenneth, 1250 South Collegeville Road, Collegeville, PA 19426, US
DEMARTINO, Michael, P., 1250 South Collegeville Road, Collegeville, PA 19426, US
DONG, Xiaoyang, 1250 South Collegeville Road, Collegeville, PA 19426, US
EIDAM, Patrick, M., 1250 South Collegeville Road, Collegeville, PA 19426, US
HAILE, Pamela, A., 1250 South Collegeville Road, Collegeville, PA 19426, US
MARQUIS, Robert, W., Jr., 1250 South Collegeville Road, Collegeville, PA 19426, US
RAMANJULU, Joshi, M., 1250 South Collegeville Road, Collegeville, PA 19426, US
ROMANO, Joseph, J., 1250 South Collegeville Road, Collegeville, PA 19426, US
SINGHAUS, Robert, R., Jr., 1250 South Collegeville Road, Collegeville, PA 19426, US
SHAH, Ami, Lakdawala, 709 Swedeland Road, King Of Prussia, PA 19406, US
WANG, Gren, 1250 South Collegeville Road, Collegeville, PA 19426, US

(51) MKP
A61K 38/07 (2006.01) (97) **2701721 ***
(86) US2012035547 27.04.2012
(96) 12777016.2 05.03.2014
(87) WO2012149389, 27.04.2012
(97) 2701721, 05.03.2014 en
(54) METHODS OF TREATING ALZHEIMER'S DISEASE, HUNTINGTON'S DISEASE, AUTISM, OR OTHER DISORDERS
(71) North Western University, 633 Clark Street, Evanston, IL 60208, US
(72) MOSKAL, Joseph, 801 Central Street, Evanston, IL 60201, US

(51) MKP
H02K 3/487 (2006.01) (97) **2719061 ***
H02K 3/493 (2006.01)
(86) AT2012050080 08.06.2012
(96) 12743351.4 16.04.2014
(87) WO2012167299, 08.06.2012
(97) 2719061, 16.04.2014 de
(54) LOCKING KEY
(71) Seewald, Hansjörg, Oberwaltersdorferstraße 28, 2512 Tribuswinkel, AT
(72) Seewald, Hansjörg, Oberwaltersdorferstraße 28, 2512 Tribuswinkel, AT

(51) MKP
B60K 7/00 (2006.01) (97) **2708401 ***
B60L 11/00 (2006.01)
H02J 7/14 (2006.01)
(86) CN2012074795 27.04.2012
(96) 12782592.5 19.03.2014
(87) WO2012152192, 27.04.2012
(97) 2708401, 19.03.2014 en
(54) POWER GENERATION AND CHARGING DEVICE FOR CONTINUOUS RUNNING OF ELECTRIC AUTOMOBILE
(71) Han, Wenji, Saiwaijiangnan District 3-2-1102 No.1096 Karamay West Rd., Urumqi, Xinjiang 830009, CN
(72) Han, Wenji, Saiwaijiangnan District 3-2-1102 No.1096 Karamay West Rd., Urumqi, Xinjiang 830009, CN

(51) MKP
C07C 303/38 (2006.01) (97) **2714652 ***
C07C 303/40 (2006.01)
C07C 309/82 (2006.01)
C07C 311/28 (2006.01)
(86) EP2012059717 24.05.2012
(96) 12723865.7 09.04.2014
(87) WO2012163799, 24.05.2012
(97) 2714652, 09.04.2014 en
(54) CHIRAL SYNTHESIS OF N-{3,4-DIFLUORO-2-[(2-FLUORO-4-IODOPHENYL)AMINO]-6-METHOXYPHENYL}-1-[2,3-DIHYDROXY-PROPYL]CYCLOPROPANESULFONAMIDES
(71) Bayer Intellectual Property GmbH, Alfred-Nobel-Strasse 10, 40789 Monheim, DE
(72) FEY, Peter, Am Eickhof 23, 42111 Wuppertal, DE
MAYER, Agathe, Christine, Hansaring 131, 50670 Köln, DE

(51) MKP
B32B 27/34 (2006.01) (97) **2743936 ***
C08G 73/10 (2006.01)
H01B 3/30 (2006.01)
H01B 5/14 (2006.01)
H01L 31/04 (2014.01)
(86) JP2012069840 03.08.2012
(96) 12822029.0 18.06.2014
(87) WO2013021942, 03.08.2012
(97) 2743936, 18.06.2014 en
(54) TRANSPARENT FILM, TRANSPARENT CONDUCTIVE LAMINATE, AND TOUCH PANEL, SOLAR CELL AND DISPLAY DEVICE, USING SAME
(71) JX Nippon Oil & Energy Corporation, 6-3, Otemachi 2-chome, Chiyoda-ku Tokyo 100-8162, JP
(72) KOMATSU Shinichi, c/o JX Nippon Oil&Energy Corporation 6-3 Otemachi 2-chome Chiyoda-ku, Tokyo 100-8162, JP
SHIIBASHI Akira, c/o JX Nippon Oil&Energy Corporation 6-3 Otemachi 2-chome Chiyoda-ku, Tokyo 100-8162, JP
FUJISHIRO Rieko, c/o JX Nippon Oil&Energy Corporation 6-3 Otemachi 2-chome Chiyoda-ku, Tokyo 100-8162, JP
UENO Ryuichi, c/o JX Nippon Oil&Energy Corporation 6-3 Otemachi 2-chome Chiyoda-ku, Tokyo 100-8162, JP
MATSUMOTO Takaya, c/o JX Nippon Oil&Energy Corporation 6-3 Otemachi 2-chome Chiyoda-ku, Tokyo 100-8162, JP

(51) MKP
B21D 5/02 (2006.01) (97) **2674231**
B21D 37/02 (2006.01)
(96) 12172085.8 18.12.2013
(97) 2674231, 18.12.2013 de
(54) Device for bending metal pieces
(71) Bystronic Laser AG, Industriestrasse 21, 3362 Niederönz, CH
(72) Gerritsen, Gerrit, Rue du Temple 15, 1148 Cuarnens Vaud, CH

- (51) MKP
A61M 5/24 (2006.01) (97) **2720738 ***
 (86) EP2012061249 14.06.2012
 (96) 12728466.9 23.04.2014
 (87) WO2012171981, 14.06.2012
 (97) 2720738, 23.04.2014 en
 (54) CARTRIDGE HOLDER ASSEMBLY FOR DRUG DELIVERY DEVICES
 (71) Sanofi-Aventis Deutschland GmbH, Brüningstraße 50, 65929 Frankfurt am Main, DE
 (72) JUGL, Michael, Sanofi-Aventis Deutschland GmbH, 65926 Frankfurt am Main, DE
 KRAFT, Torsten, Sanofi-Aventis Deutschland GmbH, 65926 Frankfurt am Main, DE
 VOGT, Daniel, Sanofi-Aventis Deutschland GmbH, 65926 Frankfurt, DE
 FORSTREUTER, Axel, Sanofi-Aventis Deutschland GmbH, 65926 Frankfurt am Main, DE

- (51) MKP
C08G 59/42 (2006.01) (97) **2706091**
C08K 5/5313 (2006.01)
C08L 63/00 (2006.01)
 (96) 13160116.3 12.03.2014
 (97) 2706091, 12.03.2014 en
 (54) Epoxy resin composition, and prepreg and copper clad laminate made therefrom
 (71) Shengyi Technology Co., Ltd., 5 Industry West Road Northern Industrial Park Songshan Lake Sci. & Tech. Industry Park, 523000 Dongguan City Guangdong, CN
 (72) Zeng, Xianping, c/o Shengyi Technology Co., Ltd 5 Industry West Road, Northern Industrial Park Songshan Lake Sci. & Tech. Industry Park, 523000 Dongguan City, CN
 Ren, Nana, c/o Shengyi Technology Co., Ltd 5 Industry West Road, Northern Industrial Park Songshan Lake Sci. & Tech. Industry Park, 523000 Dongguan City, CN
 Zhou, Biao, c/o Shengyi Technology Co., Ltd 5 Industry West Road, Northern Industrial Park Songshan Lake Sci. & Tech. Industry Park, 523000 Dongguan City, CN

- (51) MKP
A23N 4/04 (2006.01) (97) **2731893 ***
B65G 47/248 (2006.01)
 (86) IT2012000209 10.07.2012
 (96) 12753833.8 21.05.2014
 (87) WO2013008262, 10.07.2012
 (97) 2731893, 21.05.2014 en
 (54) APPARATUS FOR POSITIONING MULTIPLE - LANE FRUIT, ESPECIALLY PEACHES
 (71) Crescenzo, Biagio, Via Vittorio Emanuele II 38, 84090 Montecorvino Pugliano, IT
 (72) Crescenzo, Biagio, Via Vittorio Emanuele II 38, 84090 Montecorvino Pugliano, IT

- (51) MKP
C07K 16/00 (2006.01) (97) **2714733 ***
 (86) US2012038219 16.05.2012
 (96) 12790075.1 09.04.2014
 (87) WO2012162067, 16.05.2012
 (97) 2714733, 09.04.2014 en
 (54) CD3-BINDING MOLECULES CAPABLE OF BINDING TO HUMAN AND NON-HUMAN CD3
 (71) MacroGenics, Inc., 9640 Medical Center Drive, Rockville, MD 20850, US
 (72) HUANG, Ling, 8210 Moorland Lane, Bethesda, MD 20817, US
 JOHNSON, Leslie, S., 14411 Poplar Hill Road, Darnestown, MD 20874, US

- (51) MKP
A61K 31/4704 (2006.01) (97) **2744498 ***
 (86) US2013026476 15.02.2013
 (96) 13749429.0 25.06.2014
 (87) WO2013123419, 15.02.2013
 (97) 2744498, 25.06.2014 en
 (54) N-ETHYL-N-PHENYL-1,2-DIHYDRO-4,5-DI-HYDROXY-1-METHYL-2-OXO-3-QUINOLINE CARBOXAMIDE, PREPARATION AND USES THEREOF
 (71) Teva Pharmaceutical Industries Ltd., 5 Basel Street P.O. Box 3190, 49131 Petah Tiqva, IL
 (72) The designation of the inventor has not yet been filed , null, null

- (51) MKP
A61B 3/10 (2006.01) (97) **2729049 ***
 (86) AU2012000816 06.07.2012
 (96) 12810708.3 14.05.2014
 (87) WO2013006897, 06.07.2012
 (97) 2729049, 14.05.2014 en
 (54) SYSTEM AND METHOD FOR CHARACTERISING EYE-RELATED SYSTEMS
 (71) Brien Holden Vision Institute, Level 4, Rupert Myers Building Barker Street University of New South Wales, Sydney, NSW 2052, AU
 (72) EHRMANN, Klaus, 11/74-78 Crown Road, Queenscliff, New South Wales 2096, AU
 FALK, Darrin Mark, 49 Clarendon Road, Stanmore, New South Wales 2048, AU
 FEDTKE, Cathleen, C/- Level 4 Rupert Myers Building Barker Street University of New South Wales, Sydney, New South Wales 2052, AU

- (51) MKP
E02D 29/14 (2006.01) (97) **2729628 ***
 (86) EP2012062898 03.07.2012
 (96) 12730990.4 14.05.2014
 (87) WO2013004688, 03.07.2012
 (97) 2729628, 14.05.2014 de
 (54) MANHOLE COVER
 (71) ACO Severin Ahlmann GmbH & Co. KG, Am Ahlmannkai, 24768 Rendsburg, DE
 (72) STOLTENBERG, Arne, Sandberg 1, 24782 Büdelsdorf, DE

- (51) MKP
A01N 37/18 (2006.01) (97) **2736330 ***
A61K 31/165 (2006.01)
C07C 233/00 (2006.01)
 (86) US2012048735 27.07.2012
 (96) 12820199.3 04.06.2014
 (87) WO2013019682, 27.07.2012
 (97) 2736330, 04.06.2014 en
 (54) COMPOUNDS AND METHODS
 (71) Tempero Pharmaceuticals, Inc., 200 Technology Square, Cambridge, MA 02139, US
 (72) BALOGLU, Erkan, 8 Benjamin Terrace, Stoneham, MA 02180, US
 BOHNERT, Gary, J., 200 Technology Square, Cambridge, MA 02139, US
 GHOSH, Shomir, 200 Technology Square, Cambridge, MA 02139, US
 LOBERA, Mercedes, 200 Technology Square, Cambridge, MA 02139, US
 SCHMIDT, Darby, R., 14 Mead Road, Arlington, MA 02474, US
 SUNG, Leonard, 200 Technology Square, Cambridge, MA 02139, US

- (51) MKP
A61B 17/072 (2006.01) (97) **2644113**
A61B 17/115 (2006.01)
 (96) 13161454.7 02.10.2013
 (97) 2644113, 02.10.2013 en
 (54) Tissue thickness compensator comprised of a plurality of materials
 (71) Ethicon Endo-Surgery, Inc., 4545 Creek Road, Cincinnati, OH 45242, US
 (72) Shelton, IV, Frederick E., 245 East Main Street, Hillsboro, OH Ohio 45133, US
 Swayze, Jeffrey S., 7047 Birchley Drive, Hamilton, OH Ohio 45011, US
 Contiliano, Joseph H., 303 Aldin Road, Stewartville, NJ New Jersey 08502, US
 Yang, Chunlin, 93 Matthews Farm Road, Belle Mead, NJ New Jersey 08502, US
 Henderson, Cortney E., 191 Hounds Run, Loveland, OH Ohio 45140, US
 Aronhalt, Taylor W., 306 Beech Road, Loveland, OH Ohio 45140, US
 Scheib, Charles J., 11329 Donwiddle Drive, Loveland, OH Ohio 45140, US
 Aldridge, Jeffrey L., 106 W. Concord Drive, Lebanon, OH Ohio 45036, US
 Schmid, Katherine J., 3936 Sharonview Drive, Cincinnati, OH Ohio 45241, US

(51) MKP
C07K 16/14 (2006.01) (97) **2743699 ***
G01N 33/15 (2006.01)
G01N 33/50 (2006.01)
G01N 33/53 (2006.01)
G01N 33/531 (2006.01)
G01N 33/68 (2006.01)
(86) JP2011068454 12.08.2011
(96) 11870979.9 18.06.2014
(87) WO2013024517, 12.08.2011
(97) 2743699, 18.06.2014 en
(54) METHOD FOR TESTING FOR, PREVENTING, AND TREATING INFECTIOUS DISEASE ASPERGILLUS FUMIGATUS, AND COMPOSITION
(71) National Institute of Infectious Diseases, 23-1 Toyama 1-chome, Shinjuku-ku Tokyo 162-8640, JP
Medical & Biological Laboratories Co., Ltd., 5-3, Sakae 4-chome, Naka-ku, Nagoya-shi, Aichi 460-0008, JP
(72) MIYAZAKI, Yoshitsugu, c/o National Institute of Infectious Diseases 1-23-1 Toyama Shinjuku-ku, Tokyo 162-8640, JP
YAMAGOE, Satoshi, c/o National Institute of Infectious Diseases 1-23-1 Toyama Shinjuku-ku, Tokyo 162-8640, JP
KAJIKAWA, Masunori, c/o ACTGen Inc. 15-502 Akaho, Komagane-shi Nagano 399-4117, JP
SUGIURA, Masahito, c/o ACTGen Inc. 15-502 Akaho, Komagane-shi Nagano 399-4117, JP
ITO, Reiko, c/o ACTGen Inc. 15-502 Akaho, Komagane-shi Nagano 399-4117, JP
KUMAGAI, Hirotaka, c/o ACTGen Inc. 15-502 Akaho, Komagane-shi Nagano 399-4117, JP

(51) MKP
G06F 11/14 (2006.01) (97) **2705429 ***
(86) US2012036028 01.05.2012
(96) 12779857.7 12.03.2014
(87) WO2012151224, 01.05.2012
(97) 2705429, 12.03.2014 en
(54) REMOTE CABLE ACCESS POINT RESET
(71) Ruckus Wireless, Inc., 350 West Java Drive, Sunnyvale, CA 94089, US
(72) SHEU, Ming-Jye, c/o Ruckus Wireless, Inc. 350 West Java Drive, Sunnyvale, CA 94089, US
MIU, Allen, c/o Ruckus Wireless, Inc. 350 West Java Drive, Sunnyvale, CA 94089, US

(51) MKP
G06F 19/00 (2011.01) (97) **2758905 ***
(86) US2012056632 21.09.2012
(96) 12833034.7 30.07.2014
(87) WO2013044069, 21.09.2012
(97) 2758905, 30.07.2014 en
(54) MONITORING, DIAGNOSTIC AND TRACKING TOOL FOR AUTONOMOUS MOBILE ROBOTS
(71) Aethon, Inc., 100 Business Center Drive, Pittsburgh, PA 15205, US
(72) WOLFE, David G., 235 Courtney Place., Wexford, Pennsylvania 15090, US
LUCAS, George F., 148 Hallock Street., Pittsburgh, Pennsylvania 15211, US
SWANEY, Mark, 3213 Apache Road., Pittsburgh, Pennsylvania 15241, US

(51) MKP
B01D 53/00 (2006.01) (97) **2671623**
E21B 47/10 (2012.01)
G01F 1/34 (2006.01)
(96) 12290194.5 11.12.2013
(97) 2671623, 11.12.2013 en
(54) Method and arrangement for preventing hydrocarbon based deposition
(71) Services Petroliers Schlumberger (SPS), 42 rue Saint Dominique, 75007 Paris, FR
Schlumberger Technology B.V. (STBV), Parkstraat 83-89, 2514 JG The Hague, NL
Schlumberger Holdings Limited (SHL), P.O. Box 71 Graigmuir Chambers Road Town, Tortola, VG
PRAD Research and Development Limited, P.O. Box 71 Craigmuir Chambers Road Town, Tortola 1110, VG
(72) Korkin, Roman, c/o Schlumberger-PTC 20 Wallace Road, Princeton Junction, NJ 08550, US
Zakharov, Lev, c/o 3-Phase Measurements AS P.O.Box 174, Sandsli, 5862 Bergen, NO
Zhdaneev, Oleg, c/o 3-Phase Measurements AS P.O. Box 174, Sandsli, 5862 Bergen, NO

(51) MKP
B01J 8/06 (2006.01) (97) **2723485 ***
B01J 19/00 (2006.01)
(86) US2012043670 22.06.2012
(96) 12733330.0 30.04.2014
(87) WO2013012518, 22.06.2012
(97) 2723485, 30.04.2014 en
(54) PRODUCTION OF OXIDIZED OLEFINS
(71) Dow Technology Investments LLC, 2020 Dow Center, Midland, MI 48674, US
(72) NEWMAN, Kent E., 120 Rolling Meadows, Scott Depot, West Virginia 25560, US
OSBORNE, Bernie B., 11 Greenbriar Avenue, Hurricane, West Virginia 25526, US
SZUL, John F., 130 Willowood Circle, Hurricane, West Virginia 25526, US

(51) MKP
C03C 4/02 (2006.01) (97) **2716614**
C03C 14/00 (2006.01)
(96) 12006868.9 09.04.2014
(97) 2716614, 09.04.2014 en
(54) Colored glass and method for its manufacturing
(71) RC eNeM d.o.o., Podvine 36, 1410 Zagorje ob Savi, SI
Music, Branka, Klemenciceva ulica 1, 1126 Ljubljana, SI
Nevenka, Rajnar, Kamniska cesta 4, 1235 Radomlje, SI
Koritnik, Mateja, Pod hribom 4., 1431 Dol pri Hrastniku, SI

(51) MKP
C12N 9/10 (2006.01) (97) **2723857 ***
(86) US2012043878 22.06.2012
(96) 12735373.8 30.04.2014
(87) WO2012178110, 22.06.2012
(97) 2723857, 30.04.2014 en
(54) RECOMBINANT PRODUCTION SYSTEMS FOR AROMATIC MOLECULES
(71) RHO Renewables, Inc., 6114 La Salle Ave. Ste. 141, Oakland, CA 94611, US
(72) BARR, Philip, J., 6114 La Salle Ave. Ste 141, Oakland, CA 94611, US

- (51) MKP
A61K 31/165 (2006.01) (97) **2731598 ***
A61P 9/12 (2006.01)
C07C 237/22 (2006.01)
(86) EP2012063492 10.07.2012
(96) 12733160.1 21.05.2014
(87) WO2013007725, 10.07.2012
(97) 2731598, 21.05.2014 en
(54) ALISKIREN HEMIFUMARATE, CRYSTAL FORM AND AMORPHOUS SOLID
(71) Djada Pharmaceutical SA, Via Clemente Maraini 39, 6900 Lugano, CH
(72) BADONE, Domenico, c/o DJADA PHARMACEUTICAL SA Via Clemente Maraini 39, 6900 Lugano, CH
C.K., Lau, c/o DJADA PHARMACEUTICAL SA Via Clemente Maraini 39, 6900 Lugano, CH
JIANDONG, Yuan, c/o DJADA PHARMACEUTICAL SA Via Clemente Maraini 39, 6900 Lugano, CH

- (51) MKP
C08F 212/04 (2006.01) (97) **2738189 ***
C08F 220/06 (2006.01)
C08F 220/28 (2006.01)
C08F 220/56 (2006.01)
C08F 220/58 (2006.01)
C08F 226/02 (2006.01)
C08F 232/04 (2006.01)
C09K 8/588 (2006.01)
(86) CN2011001576 16.09.2011
(96) 11869894.3 04.06.2014
(87) WO2013013354, 16.09.2011
(97) 2738189, 04.06.2014 en
(54) AMPHIPHILIC MACROMOLECULE AND USE THEREOF
(71) Beijing Junlun Runzhong Science&Technology Co., Limited, Rm. 2306, Block A, Focus Square No. 6 Futongdong Street Wangjing Community, Chaoyang District, Beijing 100102, CN
(72) WANG, Jinben, Zhongguancun North First Street 2 Haidian District, Beijing 100080, CN
XU, Xiaohui, Zhongguancun North First Street 2 Haidian District, Beijing 100080, CN
SHI, Xuefeng, Zhongguancun North First Street 2 Haidian District, Beijing 100080, CN
HAN, Yuchun, Zhongguancun North First Street 2 Haidian District, Beijing 100080, CN
WANG, Yilin, Zhongguancun North First Street 2 Haidian District, Beijing 100080, CN
YAN, Haike, Zhongguancun North First Street 2 Haidian District, Beijing 100080, CN

- (51) MKP
A23L 1/0532 (2006.01) (97) **2713773 ***
A23L 1/29 (2006.01)
A23L 1/308 (2006.01)
A61K 31/734 (2006.01)
(86) DK2012050192 01.06.2012
(96) 12726733.4 09.04.2014
(87) WO2012163366, 01.06.2012
(97) 2713773, 09.04.2014 en
(54) A COMPOSITION COMPRISING AT LEAST ONE ALGINATE FOR USE IN TREATMENT AND/OR PREVENTION OF OVERWEIGHT
(71) S-Biotek af 15. marts 2006 1 ApS, Københavnsvej 224, 4600 Køge, DK
(72) LARSEN, Finn, 18 Forest Road, Bronchester Bridge Hawick TD9 8JS, GB
MALM, Brian, Munkekærgård 21A, DK-4600 Køge, DK
OLSEN, Jens Steen, Ørsted Bygade 5, DK-4622 Havdrup, DK

- (51) MKP
A61K 9/70 (2006.01) (97) **2716287 ***
A61K 31/4045 (2006.01)
A61K 47/10 (2006.01)
A61K 47/14 (2006.01)
A61K 47/16 (2006.01)
A61K 47/34 (2006.01)
A61P 25/14 (2006.01)
A61P 25/16 (2006.01)
(86) JP2012063161 23.05.2012
(96) 12794152.4 09.04.2014
(87) WO2012165254, 23.05.2012
(97) 2716287, 09.04.2014 en
(54) ROPINIROLE-CONTAINING ADHESIVE SKIN PATCH AND PACKAGED PRODUCT THEREOF
(71) Hisamitsu Pharmaceutical Co., Inc., 408, Tashirodaikan-machi, Tosu-shi, Saga 841-0017, JP
(72) UCHIDA, Naoyuki, c/o Hisamitsu Pharmaceutical Co. Inc. 1-25-11 Kannondai, Tsukuba-shi Ibaraki 305-0856, JP
TAKAGI, Yuka, c/o Hisamitsu Pharmaceutical Co. Inc. 1-25-11 Kannondai, Tsukuba-shi Ibaraki 305-0856, JP
YAMAGUCHI, Toshiro, c/o Hisamitsu Pharmaceutical Co. Inc. 1-25-11 Kannondai, Tsukuba-shi Ibaraki 305-0856, JP

- (51) MKP
A61K 39/395 (2006.01) (97) **2755685 ***
(86) US2011051202 12.09.2011
(96) 11872271.9 23.07.2014
(87) WO2013039471, 12.09.2011
(97) 2755685, 23.07.2014 en
(54) TOLL-LIKE RECEPTOR 3 ANTAGONISTS FOR THE TREATMENT OF METABOLIC AND CARDIOVASCULAR DISEASES
(71) Janssen Biotech, Inc., 800/850 Ridgeview Drive, Horsham, PA 19044, US
(72) CUNNINGHAM, Mark, 1400 McKean Road, Spring House, PA 19477, US
FENG, Yiqing, 1400 McKean Road, Spring House, PA 19477, US
HEERINGA, Katharine, 1400 McKean Road, Spring House, PA 19477, US
LUO, Jinquan, 1400 McKean Road, Spring House, PA 19477, US
RAUCHENBERGER, Robert, Lena-christ-strasse 48, 82490 Martinsried, DE
RUTZ, Mark, Lena-christ-strasse 48, 82490 Martinsried, DE
SAN MATEO, Lani, 1400 McKean Road, Spring House, PA 19477, US
SARISKY, Robert, 2569 Cold Spring Road, Lansdale, PA 19446, US
STOJANOVIC-SUSULIC, Vedrana, 1400 McKean Road, Spring House, PA 19477, US
SWEET, Raymond, 1400 McKean Road, Spring House, PA 19477, US
TENG, Fang, 1400 McKean Road, Spring House, PA 19477, US
TEPLYAKOV, Alexey, 1400 McKean Road, Spring House, PA 19477, US
WU, Linda, 1400 McKean Road, Spring House, PA 19477, US
WU, Sheng-Jiun, 1400 McKean Road, Spring House, PA 19477, US

- (51) MKP
G06F 9/44 (2006.01) (97) **2711836**
(86) 12185819.5 26.03.2014
(97) 2711836, 26.03.2014 en
(54) Data distribution system
(71) RIMES Technologies Limited, No. 1 Cornhill, London EC3V 3ND, GB
(72) Fauvelais, Christian, Rimes Technologies Limited No. 1 Cornhill, London, EC3V 3ND, GB
Mancuso, Frederic, Rimes Technologies Limited No. 1 Cornhill, London, EC3V 3ND, GB

- (51) MKP
A61K 6/00 (2006.01) (97) **2649981**
 (96) 12163823.3 16.10.2013
 (97) 2649981, 16.10.2013 de
 (54) Polymerisable compounds with high polymerisation depth
 (71) Ivoclar Vivadent AG, Bendererstrasse 2, 9494 Schaan, LI
 (72) Burtscher, Dr. Peter, Birkenweg 10, 6830 Rankweil, AT
 Moszner, Prof. Dr. Norbert, Im Bannriet 58, 9493 Mauren, LI
 Rheinberger, Dr. Volker, Mareestrasse 34, 9490 Vaduz, LI

- (51) MKP
A01H 1/06 (2006.01) (97) **2757872 ***
A01H 5/00 (2006.01)
C12N 5/04 (2006.01)
C12N 15/01 (2006.01)
 (86) US2012056303 20.09.2012
 (96) 12834296.1 30.07.2014
 (87) WO2013043853, 20.09.2012
 (97) 2757872, 30.07.2014 en
 (54) TOBACCO HAVING REDUCED AMOUNTS OF AMINO ACIDS AND METHODS FOR PRODUCING SUCH LINES
 (71) Reynolds Technologies, Inc., 401 North Main Street, Winston-Salem, North Carolina 27101, US
 (72) ELLIOTT, Patsy E, 971 Silverleaf Drive., Winston-Salem, North Carolina 27103, US
 LAWSON, Darlene M., 7607 Calmeria Court., Kernersville, North Carolina 27284, US
 MOLDOVEANU, Serban C., 650 Woodbriar Court., Winston-Salem, North Carolina 27106, US

- (51) MKP
G06Q 20/00 (2012.01) (97) **2709048**
 (96) 12425169.5 19.03.2014
 (97) 2709048, 19.03.2014 en
 (54) System for furnishing in real time technical information, relative to the content of chemical substances regulated by rules of the European Union, of a product put on a commercial distribution network
 (71) Scibilia, Gabriele, Via Luigi Einaudi 12, 56021 Cascina (PI), IT
 (72) Scibilia, Gabriele, Via Luigi Einaudi 12, 56021 Cascina (PI), IT

- (51) MKP
B21F 9/02 (2006.01) (97) **2726229 ***
 (86) US2012044413 27.06.2012
 (96) 12803809.8 07.05.2014
 (87) WO2013003471, 27.06.2012
 (97) 2726229, 07.05.2014 en
 (54) CABLE TIE TENSIONING AND CUT-OFF TOOL
 (71) Hellermanntyton Corporation, 7930 N. Faulkner Road, Milwaukee, WI 53224, US
 (72) DYER, Edward, P., N1111 W16587 Esquire Court, Germantown, WI 53022, US

- (51) MKP
A23L 3/005 (2006.01) (97) **2645092**
A23L 3/26 (2006.01)
C12N 13/00 (2006.01)
G01N 27/24 (2006.01)
 (96) 12305391.0 02.10.2013
 (97) 2645092, 02.10.2013 en
 (54) Device comprising a window for transmitting radiation and an electrically conductive track arranged on the window for electrical detection of a break of the window
 (71) Claranor, 23 Chemin de la Rollande Agroparc, 84140 Montfavet, FR
 (72) Obin, Arnaud, 7 rue des Aubépines Villiers les Oudets, 78660 PARAY-DOUAVILLE, FR

- (51) MKP
A61K 39/00 (2006.01) (97) **2691110 ***
 (86) EP2012062950 04.07.2012
 (96) 12734884.5 05.02.2014
 (87) WO2013004708, 04.07.2012
 (97) 2691110, 05.02.2014 en
 (54) MEANS AND METHODS FOR ACTIVE CELLULAR IMMUNOTHERAPY OF CANCER BY USING TUMOR CELLS KILLED BY HIGH HYDROSTATIC PRESSURE AND DENDRITIC CELLS
 (71) Sotio a.s., Jankovcova 1518-2, 170 00 Prague 7, CZ
 (72) BARTUNKOVÁ, Jirina, Vladislavova 8, 110 00 Praha 1, CZ
 SPÍSEK, Radek, Velké Kunratické 1312/6, 148 00 Praha 4, CZ

- (51) MKP
A61K 9/20 (2006.01) (97) **2768487 ***
A61K 31/4439 (2006.01)
 (86) JP2012077662 19.10.2012
 (96) 12784752.3 27.08.2014
 (87) WO2013058409, 19.10.2012
 (97) 2768487, 27.08.2014 en
 (54) SUSTAINED-RELEASE PREPARATION
 (71) Takeda Pharmaceutical Company Limited, 1-1 Doshomachi 4-chome Chuo-ku, Osaka-shi, Osaka 541-0045, JP
 TANOUE, Yutaka, c/o TAKEDA PHARMACEUTICAL COMPANY LIMITED 17-85 Jusohonmachi 2-chome Yodogawa-ku, Osaka-shi Osaka 5320024, JP
 MURAKAWA, Yusuke, c/o TAKEDA PHARMACEUTICAL COMPANY LIMITED 17-85 Jusohonmachi 2-chome Yodogawa-ku, Osaka-shi Osaka 532-0024, JP
 ISHII, Yumiko, c/o TAKEDA PHARMACEUTICAL COMPANY LIMITED 17-85 Jusohonmachi 2-chome Yodogawa-ku, Osaka-shi Osaka 532-0024, JP
 TAKENAKA, Kaoru, c/o TAKEDA PHARMACEUTICAL COMPANY LIMITED 17-85 Jusohonmachi 2-chome Yodogawa-ku, Osaka-shi Osaka 532-0024, JP

- (51) MKP
F17C 11/00 (2006.01) (97) **2742275 ***
 (86) FR2012051841 02.08.2012
 (96) 12751096.4 18.06.2014
 (87) WO2013024224, 02.08.2012
 (97) 2742275, 18.06.2014 fr
 (54) METHOD FOR FILLING A GAS STORAGE TANK
 (71) Coldway, Lieu Dit Patau Route de Rivesaltes, 66380 Paris, FR
 (72) KINDBEITER, Francis, c/o COLDWAY Lieu dit "Patau" Route de Rivesaltes, F-66380 Pia, FR
 RIGAUD, Laurent, c/o COLDWAY Lieu dit "Patau" Route de Rivesaltes, F-66380 Pia, FR

- (51) MKP
A61K 31/423 (2006.01) (97) **2720697 ***
 (86) US2012042603 15.06.2012
 (96) 12801296.0 23.04.2014
 (87) WO2012174340, 15.06.2012
 (97) 2720697, 23.04.2014 en
 (54) TRPV4 ANTAGONISTS
 (71) Glaxosmithkline Intellectual Property (No. 2) Limited, 980 Great West Road, Brentford, Middlesex TW8 9GS, GB
 (72) BROOKS, Carl, 709 Swedeland Road, King of Prussia, PA 19406, US
 CHEUNG, Mui, 709 Swedeland Road, King of Prussia, PA 19406, US
 GOODMAN, Krista, B., 709 Swedeland Road, King of Prussia, PA 19406, US
 HAMMOND, Marlys, 4359 W. Ponds Circle, Littleton, CO 80123, US

- (51) MKP
A61K 31/40 (2006.01) (97) **2760826 ***
A61P 9/12 (2006.01)
A61P 29/00 (2006.01)
A61P 35/00 (2006.01)
C07D 207/08 (2006.01)
 (86) US2012057990 28.09.2012
 (96) 12772678.4 06.08.2014
 (87) WO2013049617, 28.09.2012
 (97) 2760826, 06.08.2014 en
 (54) CRYSTALLINE FORMS OF A 3-[2-METHANESULFONYL-1-(4-TRIFLUOROMETHYL-PHENOXY)ETHYL]PYRROLIDINE COMPOUND
 (71) Theravance, Inc., 901 Gateway Boulevard, South San Francisco, CA 94080, US
 (72) COLSON, Pierre-Jean, 301 Bryant Street, 403, San Francisco, CA 94107, US
 FASS, Timothy, 998 Burnett Avenue, San Francisco, CA 94131, US
 THALLADI, Venkat R., 888 Foster City Boulevard Apt. E3, Foster City, CA 94404, US

- (51) MKP
A61M 5/24 (2006.01) (97) **2731650 ***
A61M 5/315 (2006.01)
 (86) EP2012063636 12.07.2012
 (96) 12733747.5 21.05.2014
 (87) WO2013007769, 12.07.2012
 (97) 2731650, 21.05.2014 en
 (54) DRIVE MECHANISM OF A DRUG DELIVERY DEVICE
 (71) Sanofi-Aventis Deutschland GmbH, Brüningstraße 50, 65929 Frankfurt am Main, DE
 (72) JUGL, Michael, c/o Sanofi-Aventis Deutschland GmbH, 65926 Frankfurt am Main, DE
 SENDATZKI, Günther, c/o Sanofi-Aventis Deutschland GmbH, 65926 Frankfurt am Main, DE

- (51) MKP
A01N 43/713 (2006.01) (97) **2723730 ***
A01P 3/00 (2006.01)
C07D 401/06 (2006.01)
C07D 409/06 (2006.01)
C07D 417/06 (2006.01)
 (86) US2012043295 20.06.2012
 (96) 12801805.8 30.04.2014
 (87) WO2012177728, 20.06.2012
 (97) 2723730, 30.04.2014 en
 (54) METALLOENZYME INHIBITOR COMPOUNDS
 (71) Viamet Pharmaceuticals, Inc., 2250 Perimeter Park Drive Suite 320, Morrisville, NC 27560, US
 (72) HOEKSTRA, William, J., 7 Treviso Place, Durham, NC 27707, US
 SCHOTZINGER, Robert, J., 7000 Potomac Court, Raleigh, NC 27613, US

- (51) MKP
A61K 9/16 (2006.01) (97) **2736494 ***
A61K 9/20 (2006.01)
A61K 31/41 (2006.01)
A61K 31/549 (2006.01)
 (86) DE2012000740 24.07.2012
 (96) 12769586.4 04.06.2014
 (87) WO2013013657, 24.07.2012
 (97) 2736494, 04.06.2014 de
 (54) COMPRESSED SOLID PHARMACEUTICAL COMPOSITION COMPRISING AMORPHOUS PARTICULATE VALSARTAN AS THE ACTIVE INGREDIENT
 (71) STADA ARZNEIMITTEL AG, Stadastrasse 2-18, 61118 Bad Vilbel, DE
 (72) SCHÖNBORN, Jessica, Glossop-Ring 4a, 61118 Bad Vilbel, DE

- (51) MKP
E04B 5/10 (2006.01) (97) **2729637 ***
E04B 7/02 (2006.01)
E04C 3/08 (2006.01)
E04C 3/32 (2006.01)
 (86) IB2012053387 03.07.2012
 (96) 12745565.7 14.05.2014
 (87) WO2013005163, 03.07.2012
 (97) 2729637, 14.05.2014 en
 (54) LATTICE MEMBER AND SELF-SUPPORTING MODULAR STRUCTURE
 (71) Decia, Valter, Via Dell'Artigianato 44, 17024 Finale Ligure, IT
 (72) DECIA, Valter, Via San Rocco 27, I-17024 Orco Feglino (SV), IT

- (51) MKP
F21V 17/00 (2006.01) (97) **2759764 ***
 (86) KR2012007290 11.09.2012
 (96) 12832322.7 30.07.2014
 (87) WO2013039317, 11.09.2012
 (97) 2759764, 30.07.2014 en
 (54) LED LIGHTING ENGINE ADOPTING AN ICICLE TYPE DIFFUSION UNIT
 (71) Hyun, Dong Hoon, Jeongwang-dong Jugong Apt. 508 dong 106 ho 8 Jeongwang-daero 143beon-gil, Siheung-si, Gyeonggi-do 429-752, KR
 Noh, Myeung Jae, Sam-dongJang mi Apt. 103 dong 508 ho 20 Bugokbokjigwan-gil, Uiwang-si, Gyeonggi-do 437-815, KR
 (72) Hyun, Dong Hoon, Jeongwang-dong Jugong Apt. 508 dong 106 ho 8 Jeongwang-daero 143beon-gil, Siheung-si, Gyeonggi-do 429-752, KR
 Noh, Myeung Jae, Sam-dongJang mi Apt. 103 dong 508 ho 20 Bugokbokjigwan-gil, Uiwang-si, Gyeonggi-do 437-815, KR

- (51) MKP
C08F 220/06 (2006.01) (97) **2738190 ***
C08F 220/18 (2006.01)
C08F 220/28 (2006.01)
C08F 220/34 (2006.01)
C08F 220/56 (2006.01)
C08F 220/58 (2006.01)
C08F 226/02 (2006.01)
C08F 232/04 (2006.01)
C09K 8/588 (2006.01)
 (86) CN2011001578 16.09.2011
 (96) 11870061.6 04.06.2014
 (87) WO2013013356, 16.09.2011
 (97) 2738190, 04.06.2014 en
 (54) AMPHIPHILIC MACROMOLECULE AND USE
 (71) Beijing Junlun Runzhong Science&Technology Co., Limited, Rm. 2306, Block A, Focus Square No. 6 Futongdong Street Wangjing Community, Chaoyang District, Beijing 100102, CN
 (72) WANG, Jinben, Zhongguancun North First Street 2 Haidian District, Beijing 100080, CN
 SHI, Xuefeng, Zhongguancun North First Street 2 Haidian District, Beijing 100080, CN
 XU, Xiaohui, Zhongguancun North First Street 2 Haidian District, Beijing 100080, CN
 HAN, Yuchun, Zhongguancun North First Street 2 Haidian District, Beijing 100080, CN
 WANG, Yilin, Zhongguancun North First Street 2 Haidian District, Beijing 100080, CN
 YAN, Haike, Zhongguancun North First Street 2 Haidian District, Beijing 100080, CN

- (51) MKP
C12N 13/00 (2006.01) (97) **2718433 ***
 (86) US2012041689 08.06.2012
 (96) 12797633.0 16.04.2014
 (87) WO2012170909, 08.06.2012
 (97) 2718433, 16.04.2014 en
 (54) METHOD AND DEVICE FOR NON-INVASIVE ACOUSTIC STIMULATION OF STEM CELLS AND PROGENITOR CELLS IN A PATIENT
 (71) The Research Foundation Of State University Of New York, 35 State Street, Albany, NY 12207, US
 (72) SITHARAMAN, Balaji, 8 Windover Lane, Coram, NY 11727, US

- (51) MKP
A61K 31/4545 (2006.01) (97) **2736511 ***
A61P 33/14 (2006.01)
 (86) JP2012069263 19.07.2012
 (96) 12746402.2 04.06.2014
 (87) WO2013015429, 19.07.2012
 (97) 2736511, 04.06.2014 en
 (54) ANIMAL ECTOPARASITE-CONTROLLING AGENT AND METHOD FOR PREVENTING OR TREATING INFECTION IN ANIMALS CAUSED BY PARASITES BY USING THE CONTROLLING AGENT
 (71) Otsuka AgriTechno Co., Ltd, 2-2 Kanda Tsukasa-machi Chiyoda-ku, Tokyo 101-0048, JP
 (72) ENDO, Yasuhiro, c/o OTSUKA AGRITECHNO CO. LTD. 615 Aza Hanamen Satoura Satoura-cho, Naruto-shi Tokushima 772-0021, JP
 SHIRAI, Yuichi, c/o OTSUKA AGRITECHNO CO. LTD. 615 Aza Hanamen Satoura Satoura-cho, Naruto-shi Tokushima 772-0021, JP

(51) MKP
E04C 1/42 (2006.01) (97) **2702212 ***
F21S 9/03 (2006.01)
 (86) IB2012052085 26.04.2012
 (96) 12726493.5 05.03.2014
 (87) WO2012147041, 26.04.2012
 (97) 2702212, 05.03.2014 en
 (54) BRICK WITH PHOTOVOLTAIC CELL
 (71) SEVES S.p.A, Via Reginaldo Giuliani 360, 50141 Firenze, IT
 (72) PIROLI, Giovanni, Via del Tiglio 91, 56012 Calcinaia - Pisa, IT

(51) MKP
G06F 3/01 (2006.01) (97) **2664978**
G06F 3/0485 (2013.01)
 (96) 13168126.4 20.11.2013
 (97) 2664978, 20.11.2013 en
 (54) Systems and methods for haptically enabled metadata
 (71) Immersion Corporation, 30 Rio Robles, San Jose, CA 95134, US
 (72) Birnbaum, David, 311 Oak Street, No. 327, Oakland, CA 94607, US
 Short, Jason, 2186 15th Street, San Francisco, CA 94114, US
 Devenish, Ryan, 1600 Fell Street, No. 102, San Francisco, CA 94117, US
 Ullrich, Chris, 227 Palomares Avenue, Ventura, CA 93003, US
 Bothsa, Marcus, Aurelius, Immersion Corporation 30 Rio Robles, San Jose, CA 95134, US

(51) MKP
A61K 31/18 (2006.01) (97) **2760443 ***
A61K 31/33 (2006.01)
C07C 311/21 (2006.01)
C07C 311/29 (2006.01)
C07D 213/30 (2006.01)
C07D 213/38 (2006.01)
C07D 213/61 (2006.01)
C07D 213/65 (2006.01)
C07D 213/68 (2006.01)
C07D 213/75 (2006.01)
C07D 233/22 (2006.01)
C07D 239/28 (2006.01)
C07D 249/08 (2006.01)
C07D 257/04 (2006.01)
C07D 261/08 (2006.01)
 (86) EP2012068845 25.09.2012
 (96) 12766434.0 06.08.2014
 (87) WO2013045431, 25.09.2012
 (97) 2760443, 06.08.2014 en
 (54) SULFONAMIDE COMPOUNDS AND THEIR USE IN THE MODULATION RETINOID - RELATED ORPHAN RECEPTOR
 (71) Glaxo Group Limited, 980 Great West Road, Brentford, Middlesex TW8 9GS, GB
 (72) BIRAULT, Véronique, GlaxoSmithKline, Gunnells Wood Road,, Stevenage, Hertfordshire SG1 2NY, GB
 CAMPBELL, Amanda, Jennifer, GlaxoSmithKline, Gunnells Wood Road,, Stevenage, Hertfordshire SG1 2NY, GB
 HARRISON, Stephen, GlaxoSmithKline, Gunnells Wood Road,, Stevenage, Hertfordshire SG1 2NY, GB
 LE, Joelle, GlaxoSmithKline, Gunnells Wood Road,, Stevenage, Hertfordshire SG1 2NY, GB

(51) MKP
C07K 16/24 (2006.01) (97) **2734549 ***
G01N 33/53 (2006.01)
 (86) IB2012053450 05.07.2012
 (96) 12748547.2 28.05.2014
 (87) WO2013011407, 05.07.2012
 (97) 2734549, 28.05.2014 en
 (54) INTERLEUKIN-31 MONOCLONAL ANTIBODY
 (71) Zoetis LLC, 100 Campus Drive, Florham Park, New Jersey 07940, US
 (72) BAMMERT, Gary F., 5339 Woodmont Drive, Portage Michigan 49002, US
 DUNHAM, Steven A., 3939 Old Colony Road, Kalamazoo Michigan 49008, US

(51) MKP
B41F 33/00 (2006.01) (97) **2749417**
G06K 19/06 (2006.01)
 (96) 12386025.6 02.07.2014
 (97) 2749417, 02.07.2014 en
 (54) Quality control, method and device in production lines of solid and corrugated carton boxes, and advertising displays made of paper
 (71) P. Dimitropoulos - Electronic Systems and Software Applications S.A. Trading Name: SENSAP SA, Hydras 2, 18346 Moschato/Athens, GR
 (72) Panagiotis, Dimitropoulos D., Seferis 36, 14564 Kifissia/ Athens, GR

(51) MKP
A61K 36/28 (2006.01) (97) **2752194 ***
A61K 36/61 (2006.01)
A61P 31/16 (2006.01)
A61P 37/00 (2006.01)
A61P 39/06 (2006.01)
 (86) EC2012000027 31.08.2012
 (96) 12828167.2 09.07.2014
 (87) WO2013029634, 31.08.2012
 (97) 2752194, 09.07.2014 en
 (54) NATURAL ANTIOXIDANT ANTI-INFLUENZA COMPOSITION
 (71) Pharmabrand S.A., Avenida Ilaló 1048 Entre Conocoto y San Rafael, Quito, EC
 (72) CID VIVANCO, Roberto Francisco, Av. Ilaló No. 1048 e/ Conocoto y San Rafael, Quito, EC
 ANDRADE BEJARANO, Edwin Renato, Av. Ilaló No. 1048 e/ Conocoto y San Rafael, Quito, EC

(51) MKP
A61B 17/115 (2006.01) (97) **2524654**
 (96) 12168680.2 21.11.2012
 (97) 2524654, 21.11.2012 en
 (54) Circular stapler with frictional reducing member
 (71) Ethicon Endo-Surgery, Inc., 4545 Creek Road, Cincinnati, OH 45242, US
 (72) Nalagatla, Anil K., 6581 Gove Court, Mason, Ohio 45040, US
 Deupree, David A., 3395 Strata Court, Mason, Ohio 45040, US

(51) MKP
C09J 181/04 (2006.01) (97) **2707444 ***
 (86) SI2012000028 04.05.2012
 (96) 12756837.6 19.03.2014
 (87) WO2012154132, 04.05.2012
 (97) 2707444, 19.03.2014 en
 (54) ADHESIVE/SEALANT PREFERABLY USED FOR CONSTRUCTION PANELS
 (71) CBS Institut Celovite Gradbene Resitve, d.o.o., Prijateljjeva cesta 12, 8210 Trebnje, SI
 TTK Proizvodnja Kemicnih Izdelkov Srpencia Ob Soci D.D., Srpencia 1, 5224 Srpencia, SI
 (72) FIR, Mojca Japelj, Seidlova cesta 34, 8000 Novo Mesto, SI
 BRATU, Bojan, Avce 95a, 5213 Kanal ob Soci, SI
 KRALJ, Ale, Oki kega 25, 1000 Ljubljana, SI
 BEGU, Ada, Na Petelincu 11, 5220 Tolmin, SI

(51) MKP
C07C 253/30 (2006.01) (97) **2730562**
C07D 223/16 (2006.01)
 (96) 13191850.0 14.05.2014
 (97) 2730562, 14.05.2014 fr
 (54) Novel method for synthesising (2E)-3-(3,4-dimethoxyphenyl) prop-2-enitrile and use for synthesising ivabradine and the added salts thereof with a pharmaceutically acceptable acid
 (71) Les Laboratoires Servier, 35, rue de Verdun, 92284 Suresnes Cedex, FR
 (72) Carranza, Maria del Pilar, C. Ciudad Real 11, 13670 Villarrubia de los Ojos, ES
 Garcia Aranda, Maria Isabel, Rnda, Arroyo 1 PO2A, 45006 Toledo, ES
 Gonzalez, José Lorenzo, Avda Rio Boladiez 21 PO3C, 45007 Toledo, ES
 Sanchez, Frédéric, Calle Venus 39, 45111 Cobisa, ES

- (51) MKP
A61K 33/00 (2006.01) (97) **2734223 ***
A61K 38/42 (2006.01)
A61P 17/02 (2006.01)
(86) EP2012003086 23.07.2012
(96) 12743076.7 28.05.2014
(87) WO2013013799, 23.07.2012
(97) 2734223, 28.05.2014 en
(54) WOUND SPRAY
(71) SastoMed GmbH, Brüsseler Strasse 2, 49124 Georgsmarienhütte, DE
(72) SANDER, Michael, Barenhorst 65, 33824 Werther, DE
PÖTZSCHKE, Harald, Dresdener Ring 7, 65191 Wiesbaden, DE

- (51) MKP
E01F 15/04 (2006.01) (97) **2739789 ***
E01F 15/06 (2006.01)
E04H 12/22 (2006.01)
E04H 17/22 (2006.01)
(86) GB2012051904 06.08.2012
(96) 12753208.3 11.06.2014
(87) WO2013021189, 06.08.2012
(97) 2739789, 11.06.2014 en
(54) SECURITY BARRIER
(71) Hill & Smith Limited, Spring Vale Business & Industrial Park, Bilston, Wolverhampton WV14 0QL, GB
(72) SHARP, Graham, Hill&Smith Limited Springvale Business&Industrial Park, Bilston Wolverhampton WV14 0QL, GB
BOX, Simon, Hill&Smith Limited Springvale Business&Industrial Park, Bilston Wolverhampton WV14 0QL, GB

- (51) MKP
G01N 33/53 (2006.01) (97) **2710375 ***
G01N 33/566 (2006.01)
(86) US2012038704 18.05.2012
(96) 12725954.7 26.03.2014
(87) WO2012159084, 18.05.2012
(97) 2710375, 26.03.2014 en
(54) MODIFICATION-DEPENDENT ACTIVITY ASSAYS
(71) Baxter International Inc., One Baxter Parkway, Deerfield, IL 60015, US
Baxter Healthcare SA, Thurgauerstrasse 130, 8152 Glattpark (Opfikon), CH
(72) WEBER, Alfred, Skraupstrasse 24/42/8, 1210 Vienna, AT
ENGELMAIER, Andrea, Benedikt Schellingergasse 17/25, 1150 Vienna, AT
SCHWARZ, Hans, Peter, Weimarer Strasse 76, 1180 Vienna, AT

- (51) MKP
G06F 17/28 (2006.01) (97) **2727085 ***
G06T 11/60 (2006.01)
(86) US2012043876 22.06.2012
(96) 12733562.8 07.05.2014
(87) WO2013003242, 22.06.2012
(97) 2727085, 07.05.2014 en
(54) EFFICIENT BLENDING METHODS FOR AR APPLICATIONS
(71) Qualcomm Incorporated, International IP Administration 5775 Morehouse Drive, San Diego, CA 92121-1714, US
(72) KOO, Hyung-II, 5775 Morehouse Drive, San Diego, California 92121, US
BAIK, Young-Ki, 5775 Morehouse Drive, San Diego, California 92121, US
KIM, Beom-Su, 5775 Morehouse Drive, San Diego, California 92121, US

- (51) MKP
C07D 401/00 (2006.01) (97) **2755962 ***
(86) US2012054785 12.09.2012
(96) 12832131.2 23.07.2014
(87) WO2013039988, 12.09.2012
(97) 2755962, 23.07.2014 en
(54) AZAINDAZOLES
(71) GlaxoSmithKline LLC, One Franklin Plaza 200 North 16th Street, Philadelphia, PA 19102, US
(72) BURGESS, Joelle, Lorraine, 1250 South Collegeville Road, Collegeville, PA 19426, US
JOHNSON, Neil, W., 1250 South Collegeville Road, Collegeville, PA 19426, US
KNIGHT, Steven, David, 1250 South Collegeville Road, Collegeville, PA 19426, US
LAFRANCE, Louis, Vincent, III, 1250 South Collegeville Road, Collegeville, PA 19426, US
MILLER, William, H., 1250 South Collegeville Road, Collegeville, PA 19426, US
NEWLANDER, Kenneth, Allen, 1250 South Collegeville Road, Collegeville, PA 19426, US
ROMERIL, Stuart, Paul, 1250 South Collegeville Road, Collegeville, PA 19426, US
ROUSE, Meagan, B., 1250 South Collegeville Road, Collegeville, PA 19426, US
SUAREZ, Dominic, 1250 South Collegeville Road, Collegeville, PA 19426, US
TIAN, Xinrong, 1250 South Collegeville Road, Collegeville, PA 19426, US
VERMA, Sharad, Kumar, 1250 South Collegeville Road, Collegeville, PA 19426, US

- (51) MKP
A61K 9/70 (2006.01) (97) **2716286 ***
A61K 31/4045 (2006.01)
A61K 47/10 (2006.01)
A61K 47/14 (2006.01)
A61K 47/16 (2006.01)
A61K 47/32 (2006.01)
A61K 47/34 (2006.01)
A61P 25/14 (2006.01)
A61P 25/16 (2006.01)
(86) JP2012063160 23.05.2012
(96) 12793578.1 09.04.2014
(87) WO2012165253, 23.05.2012
(97) 2716286, 09.04.2014 en
(54) ROPINIROLE-CONTAINING ADHESIVE PATCH AND PACKAGING THEREFOR
(71) Hisamitsu Pharmaceutical Co., Inc., 408, Tashirodaikan-machi, Tosu-shi, Saga 841-0017, JP
(72) TAKAGI, Yuka, c/o Hisamitsu Pharmaceutical Co. Inc. 1-25-11 Kannondai, Tsukuba-shi Ibaraki 305-0856, JP
UCHIDA, Naoyuki, c/o Hisamitsu Pharmaceutical Co. Inc. 1-25-11 Kannondai, Tsukuba-shi Ibaraki 305-0856, JP
MICHINAKA, Yasunari, c/o Hisamitsu Pharmaceutical Co. Inc. 1-25-11 Kannondai, Tsukuba-shi Ibaraki 305-0856, JP

- (51) MKP
A47L 11/40 (2006.01) (97) **2757929 ***
C02F 1/78 (2006.01)
(86) IT2011000327 19.09.2011
(96) 11791056.2 30.07.2014
(87) WO2013042144, 19.09.2011
(97) 2757929, 30.07.2014 en
(54) APPARATUS FOR CLEANING FLOOR SURFACES
(71) VELOX SERVIZI S.r.l. Unipersonale, Viale del Lavoro 33, 37135 Verona, IT
(72) VILLA, Gianmaria, Via Generale Chinotto 4, I-37138 Verona, IT

- (51) MKP
F25B 7/00 (2006.01) (97) **2758726 ***
(86) NZ2012000145 17.08.2012
(96) 12849954.8 30.07.2014
(87) WO2013073957, 17.08.2012
(97) 2758726, 30.07.2014 en
(54) COOLANT RECOVERY AND WASTE SEPARATION SYSTEM
(71) Eigen Systems Limited, 30 Triton Drive, Albany Auckland 0632, NZ
Forlong, Murray Houlton, 1599 State Highway 17 Dairy Flat, Auckland 0794, NZ
(72) FORLONG, Murray Houlton, 1599 State Highway 17 Dairy Flat, Auckland 0794, NZ

(51) MKP
A61K 31/565 (2006.01) (97) **2741824 ***
A61P 15/18 (2006.01)
(86) EP2012065572 09.08.2012
(96) 12753086.3 18.06.2014
(87) WO2013021025, 09.08.2012
(97) 2741824, 18.06.2014 en
(54) USE OF ESTETROL AS EMERGENCY CONTRACEPTIVE
(71) Estetra S.P.R.L., Rue du Travail 16, 4460 Grâce-Hollogne, BE
(72) WOUTERS, Wout, Bodemanstraat 43, 1216 AJ Hilversum, NL
COELINGH BENNINK, Herman Jan Tijmen, Jachtrustlaan 1,
3985 MK Werkhoven, NL
PETIT, Ludivine, Rue de Paris 1, 4020 Liège, BE
FOIDART, Jean-Michel, Sur la Heid 3, 4870 Forêt Trooz, BE

(51) MKP
E04H 3/12 (2006.01) (97) **2626485**
E04H 3/14 (2006.01)
(96) 12153957.1 14.08.2013
(97) 2626485, 14.08.2013 de
(54) Tribune
(71) INTER+-POL Freie Forschungs- u. Entwicklungsges. f.
unfassb. Formate, exper. Proj.,ungesehene Filme dicke u.
dünne Bücher, grenzenl. Räume,mbH, Ballindamm 9, 20095
Hamburg, DE
(72) Rühmann, Lars, Monetastr. 4, 20146 Hamburg, DE
Pape, Timothy, Dipl. Ing. Architekt, Pappelallee 56, 10437
Berlin, DE
Schierwater, Tim, Dipl. Ing., Ansorgestr. 10 b, 22605 Hamburg,
DE
Höfler, Mark, Dipl. Ing., Karlsgartenstr. 3, 12049 Berlin, DE
Kloft, Harald, Prof. Dr. Ing., Walldorfer Str. 3, 60598 Frankfurt
am Main, DE
Brückner, Frank, Dipl. Ing., Karlstr. 28, 64367 Mühlthal, DE

(51) MKP
A61K 9/127 (2006.01) (97) **2706988 ***
(86) IL2012050168 10.05.2012
(96) 12781987.8 19.03.2014
(87) WO2012153338, 10.05.2012
(97) 2706988, 19.03.2014 en
(54) LIPOSOMES COMPRISING POLYMER-CONJUGATED
LIPIDS AND RELATED USES
(71) Yissum Research Development Company of the Hebrew
University of Jerusalem Ltd., Hi-Tech Park Edmond J. Safra
Campus Givat Ram, 91390 Jerusalem, IL
(72) YEDGAR, Saul, 1 Hai Tayeb Street, 95405 Jerusalem, IL

(51) MKP
A61K 9/00 (2006.01) (97) **2765990 ***
A61K 9/14 (2006.01)
A61K 9/20 (2006.01)
A61K 31/498 (2006.01)
A61K 47/32 (2006.01)
A61K 47/38 (2006.01)
A61P 35/00 (2006.01)
(86) US2012060044 12.10.2012
(96) 12809373.9 20.08.2014
(87) WO2013056108, 12.10.2012
(97) 2765990, 20.08.2014 en
(54) SOLID DISPERSION
(71) Array Biopharma, Inc., 3200 Walnut Street, Boulder, CO 80301,
US
(72) FRY, David Shank, c/o Array BioPharma Inc. 3200 Walnut
Street Boulder, Colorado, 80301, US
LINDEMANN, Christopher M., c/o Array BioPharma Inc. 3200
Walnut Street Boulder, Colorado, 80301, US
PREIGH, Michael, c/o Array BioPharma Inc. 3200 Walnut
Street Boulder, Colorado, 80301, US
BLOOM, Corey Jay, c/o Bend Research 64550 Research
Road, Bend, Oregon 97701, US
CRAIG, Christopher Donovan, c/o Bend Research 64550
Research Road, Bend, Oregon 97701, US
DUBOSE, Devon Brevard, c/o Bend Research 64550
Research Road, Bend, Oregon 97701, US
GAUTSCHI, Jeff, c/o Agere Pharmaceuticals 62925 NE, 18th
Street, Bend, Oregon 97701, US
SMITHEY, Dan, c/o Agere Pharmaceuticals 62925 NE, 18th
Street, Bend, Oregon 97701, US

(51) MKP
A61K 39/395 (2006.01) (97) **2758437 ***
A61P 35/00 (2006.01)
A61P 37/00 (2006.01)
C07K 16/28 (2006.01)
(86) US2012056429 20.09.2012
(96) 12766835.8 30.07.2014
(87) WO2013043933, 20.09.2012
(97) 2758437, 30.07.2014 en
(54) CD27L ANTIGEN BINDING PROTEINS
(71) Amgen Inc., One Amgen Center Drive, Thousand Oaks,
California 91320-1799, US
(72) DELANEY, John M., 4660 95th Avenue NE, Bellevue, WA
98004, US
FANSLow, William Christian, III, 18425 8th Avenue SW,
Normandy Park, WA 98166, US
KING, Chadwick Terence, 1325 Moody Avenue, North
Vancouver, British Columbia V7L 3T5, CA

(51) MKP
C07D 239/47 (2006.01) (97) **2748151 ***
(86) US2012051522 20.08.2012
(96) 12826375.3 02.07.2014
(87) WO2013028590, 20.08.2012
(97) 2748151, 02.07.2014 en
(54) PYRIMIDINE PDE10 INHIBITORS
(71) Merck Sharp & Dohme Corp., 126 East Lincoln Avenue,
Rahway NJ 07065-0907, US
(72) COX, Christopher, D., 770 Sumneytown Pike, West Point
Pennsylvania 19486, US
DUDKIN, Vadim, 770 Sumneytown Pike, West Point
Pennsylvania 19486, US
KERN, Jeffrey, 770 Sumneytown Pike, West Point
Pennsylvania 19486, US
LAYTON, Mark, E., 770 Sumneytown Pike, West Point
Pennsylvania 19486, US
RAHEEM, Izzat, T., 770 Sumneytown Pike, West Point
Pennsylvania 19486, US

- (51) MKP
C07D 237/32 (2006.01) (97) **2707361 ***
C07D 253/08 (2006.01)
C07D 265/22 (2006.01)
C07D 401/04 (2006.01)
C07D 401/06 (2006.01)
C07D 401/12 (2006.01)
C07D 403/04 (2006.01)
C07D 403/06 (2006.01)
C07D 403/08 (2006.01)
C07D 403/12 (2006.01)
C07D 403/14 (2006.01)
C07D 413/06 (2006.01)
C07D 413/12 (2006.01)
C07D 413/14 (2006.01)
C07D 417/06 (2006.01)
- (86) US2012036976 08.05.2012
(96) 12722595.1 19.03.2014
(87) WO2012154760, 08.05.2012
(97) 2707361, 19.03.2014 en
(54) FUSED HETEROCYCLIC COMPOUNDS AS SODIUM CHANNEL MODULATORS
- (71) Gilead Sciences, Inc., 333 Lakeside Drive, Foster City, CA 94404, US
(72) CORKEY, Britton Kenneth, 243 Harrison Avenue, Redwood City California 94062, US
ELZEIN, Elfatih, 4644 Creekwood Drive, Fremont California 94555, US
JIANG, Robert H., 8057 Park Villa Circle, Cupertino California 95014, US
KALLA, Rao V., 125 Connemara Way, 9, Sunnyvale California 94087, US
KOBAYASHI, Tetsuya, 1362 Arleen Avenue, Sunnyvale California 94087, US
KOLTUN, Dmitry, 1075 Grebe Street, Foster City California 94404, US
LI, Xiaofen, 161 Montelena Court, Mountain View California 94040, US
MARTINEZ, Ruben, 128 37th Avenue, San Mateo California 94403, US
NOTTE, Gregory, 21 Otay Avenue, San Mateo California 94403, US
PARKHILL, Eric Q., 1392 Funston Avenue, Apt. 2, San Francisco California 94122, US
PERRY, Thao, 5109 Adair Way, San Jose California 95124, US
ZABLOCKI, Jeff, 490 Raquel Court, Los Altos California 94022, US
VENKATARAMANI, Chandrasekar, 1 Chart Lane, Redwood City California 94065, US
GRAUPE, Michael, 1131 Banyan Way, Pacifica California 94044, US
GUERRERO, Juan, 2380 Saint George Drive, Concord California 94520, US
-
- (51) MKP
B23K 26/04 (2014.01) (97) **2687317**
B23K 26/14 (2014.01)
B23K 26/38 (2014.01)
- (96) 12177388.1 22.01.2014
(97) 2687317, 22.01.2014 de
(54) Laser processing machine, in particular laser cutting machine and method for adjusting a focused laser beam
- (71) Bystronic Laser AG, Industriestrasse 21, 3362 Niederönz, CH
(72) Lüdi, Andreas, Alpenstrasse 28, 3400 Burgdorf, CH
Cathry, Daniel, Wangenstrasse 33, 3373 Röthenbach bei Herzogenbuchsee, CH
-
- (51) MKP
A61M 15/00 (2006.01) (97) **2755707 ***
E05B 15/00 (2006.01)
- (86) GB2012052239 12.09.2012
(96) 12766134.6 23.07.2014
(87) WO2013038169, 12.09.2012
(97) 2755707, 23.07.2014 en
(54) INHALER
- (71) Astrazeneca AB, null, 151 85 Södertälje, SE
(72) ELGAARD, Svend, Erik, Bang&Olufsen Medicom Gimsinglundvej 20, DK-7600 Struer, DK
CHRISTIANSEN, Jonas, Dansk Ingenior Service A/S Jegstrupvej 36, DK-DV-8361 Hasselager, DK
RASMUSSEN, Jørgen, Solute ApS Ydunsvej 6, DK-7600 Struer, DK
TRENEMAN, William, UPC Cambridge Ltd Suite 16&17 Manchester House 113 Northgate Street, Bury St Edmunds Suffolk IP33 1HP, GB
-
- (51) MKP
C03C 25/14 (2006.01) (97) **2739680 ***
C03C 25/32 (2006.01)
C08F 251/00 (2006.01)
C08G 63/668 (2006.01)
C08J 3/24 (2006.01)
C08K 5/092 (2006.01)
C08K 5/1545 (2006.01)
C08K 5/51 (2006.01)
C08L 3/00 (2006.01)
C09J 11/08 (2006.01)
D04H 1/4209 (2012.01)
D04H 1/587 (2012.01)
D04H 1/645 (2012.01)
D04H 3/002 (2012.01)
D04H 3/12 (2006.01)
- (86) FR2012051774 26.07.2012
(96) 12744114.5 11.06.2014
(87) WO2013021112, 26.07.2012
(97) 2739680, 11.06.2014 fr
(54) SIZING COMPOSITION FOR MINERAL WOOL CONTAINING A REDUCING SACCHARIDE AND A HYDROGENATED SACCHARIDE, AND RESULTING INSULATING PRODUCTS
- (71) Saint-Gobain Isover, 18 Avenue d'Alsace, 92400 Courbevoie, FR
(72) JAFFRENNOU, Boris, 33 rue des Alouettes, F-75019 Paris, FR
OBERT, Edouard, 4 La Raizière, 60700 Fleurines, FR
KAPLAN, Benjamin, 16 rue de Montyon, F-75009 Paris, FR
-
- (51) MKP
A61K 38/00 (2006.01) (97) **2768526 ***
A61K 39/00 (2006.01)
A61P 13/06 (2006.01)
C12N 9/16 (2006.01)
- (86) US2012060869 18.10.2012
(96) 12842640.0 27.08.2014
(87) WO2013059491, 18.10.2012
(97) 2768526, 27.08.2014 en
(54) COMPOSITIONS COMPRISING ALKALINE PHOSPHATASE AND/OR NATRIURETIC PEPTIDE AND METHODS OF USE THEREOF
- (71) Alexion Pharma Holding, Canon's Court 22 Victoria Street, Hamilton HM EX, BM
Vanderbilt University, 305 Kirkland Hall, Nashville, Tennessee 37240, US
(72) CRINE, Philippe, 28, Avenue Claude-Champagne, Outremont, QC H2V 2X1, CA
ELEFTERIOU, Florent, 4110 Westlawn Drive, Nashville, TN 37209, CA
-
- (51) MKP
A61K 9/51 (2006.01) (97) **2706989 ***
- (86) IB2012052320 09.05.2012
(96) 12723747.7 19.03.2014
(87) WO2012153286, 09.05.2012
(97) 2706989, 19.03.2014 en
(54) POLYMERIC NANOPARTICLES FOR DRUG DELIVERY
- (71) Instituto Químico De Sarrià, Via Augusta 390, 08017 Barcelona, ES
(72) GOMEZ, Salvador Borros, c/o Via Augusta 390, 080107 Barcelona, ES
DI MAURO, Primiano Pio, c/o Via Augusta 390, 08017 Barcelona, ES

(51) MKP
F24D 17/00 (2006.01) (97) **2623871**
F24D 19/10 (2006.01)
F24H 9/20 (2006.01)
(96) 13153684.9 07.08.2013
(97) 2623871, 07.08.2013 en
(54) Household heating device for providing water comprising a control unit configured for providing control signals to a burner
(71) ROBERT BOSCH GMBH, Postfach 30 02 20, 70442 Stuttgart, DE
(72) Wierenga, Hendrik Jacob Lammert, 99, IJsseldijk, 8196 KC Welsum, NL
Verdaasdonk, Bart Willem, 34, Pastoor Eppinkstraat, 7554 MA Beckum (Hengelo OV), NL

(51) MKP
G01S 7/48 (2006.01) (97) **2715395 ***
G01S 7/481 (2006.01)
G01S 7/495 (2006.01)
G01S 17/93 (2006.01)
(86) NL2012050378 31.05.2012
(96) 12730663.7 09.04.2014
(87) WO2012165957, 31.05.2012
(97) 2715395, 09.04.2014 en
(54) VEHICLE, SYSTEM FOR RECEIVING AND TRANSMITTING OPTICAL SIGNALS, AND METHODS
(71) Phyco Trading B.V., Arkerweg 2, 3861 NH Nijkerk, NL
(72) VAN DER VELDE, Kornelis Jan, Stickerstraat 14, 7721 DP Daifsen, NL
RIJNSBURGER, Jasper Jeroen, Dreessingel 30, 8015 CB Zwolle, NL

(51) MKP
A01N 43/00 (2006.01) (97) **2713727 ***
(86) US2012040733 04.06.2012
(96) 12793812.4 09.04.2014
(87) WO2012167247, 04.06.2012
(97) 2713727, 09.04.2014 en
(54) COMBINATION OF MEK INHIBITORS AND SELECTIVE INHIBITORS OF AURORA A KINASE
(71) Millennium Pharmaceuticals, Inc., 40 Landsdowne Street, Cambridge, MA 02139, US
Takeda Pharmaceutical Company Ltd., Oncology DDU C-1 2F 1110 26-1 Muraokahigashi 2-chome Fujisawa, Kanagawa 251-0012, JP
(72) CHAKRAVARTY, Arijit, 2 Hawthorne Road, Lexington, MA 02420, US
VINCENT, Patrick, C/o Takeda California Inc. 10410 Science Center Drive, San Diego, CA 92121, US

(51) MKP
G01N 33/52 (2006.01) (97) **2761294 ***
G01N 33/53 (2006.01)
G01N 33/68 (2006.01)
G06F 17/10 (2006.01)
(86) US2012057736 28.09.2012
(96) 12836460.1 06.08.2014
(87) WO2013049455, 28.09.2012
(97) 2761294, 06.08.2014 en
(54) BIODOSIMETRY PANELS AND METHODS
(71) Blakely, William, 4503 Gridley Road, Silver Spring, Maryland 20906, US
Glezer, Eli N., 13746 Durango Drive, Del Mar, California 92014, US
Kenten, John, 21021 Sugar Ridge Terrace, Boyds, Maryland 20841, US
Kumar, Sudeep, 20427 Ivybridge Court, Gaithersburg, Maryland 20886, US
Mathew, Anu, 13925 Riding Loop Drive, North Potomac, Maryland 20878, US
Ossetrova, Natalia I., 4309 Emden Street, Silver Spring, Maryland 20906, US
Sigal, George, 5333 Trailway Drive, Rockville, Maryland 20853, US
(72) Blakely, William, 4503 Gridley Road, Silver Spring, Maryland 20906, US
Glezer, Eli N., 13746 Durango Drive, Del Mar, California 92014, US
Kenten, John, 21021 Sugar Ridge Terrace, Boyds, Maryland 20841, US
Kumar, Sudeep, 20427 Ivybridge Court, Gaithersburg, Maryland 20886, US
Mathew, Anu, 13925 Riding Loop Drive, North Potomac, Maryland 20878, US
Ossetrova, Natalia I., 4309 Emden Street, Silver Spring, Maryland 20906, US
Sigal, George, 5333 Trailway Drive, Rockville, Maryland 20853, US

(51) MKP
C12Q 1/68 (2006.01) (97) **2707503 ***
(86) EP2012058636 10.05.2012
(96) 12720488.1 19.03.2014
(87) WO2012152865, 10.05.2012
(97) 2707503, 19.03.2014 en
(54) GENOMIC MARKERS FOR PREDICTION OF LONG-TERM RESPONSE TO 2 YEARS OF GROWTH HORMONE (GH) THERAPY
(71) Ares Trading SA, Zone Industrielle de l'Ouriettaz, 1170 Aubonne, Vaud, CH
(72) CROTEAU, Pascal, 1029 rue Bessières, Laval Québec H7X 3B4, CA
DESTENAVES, Benoit, 555 rue de paruthiol, F-01630 Peron, FR
OLIVIER, Clément, CHemin de Chantegrive 30, CH-1260 Nyon, CH
RAELSON, John, 85 Elm street, Hudson Heights Quebec J0P 1J0, CA

(51) MKP
A01N 43/40 (2006.01) (97) **2713732 ***
(86) US2012039538 25.05.2012
(96) 12788732.1 09.04.2014
(87) WO2012162592, 25.05.2012
(97) 2713732, 09.04.2014 en
(54) PIRFENIDONE AND ANTI-FIBROTIC THERAPY IN SELECTED PATIENTS
(71) Intermune, Inc., 3280 Bayshore Boulevard, Brisbane, CA 94005-1021, US
(72) BRADFORD, Williamson, Ziegler, PO Box 566, Ross, CA 94957, US

- (51) MKP
E03B 1/04 (2006.01) (97) **2702330 ***
E03C 1/02 (2006.01)
F16K 15/14 (2006.01)
F24D 17/00 (2006.01)
- (86) SE2012050445 27.04.2012
(96) 12776283.9 05.03.2014
(87) WO2012148351, 27.04.2012
(97) 2702330, 05.03.2014 en
(54) A METHOD AND A LIQUID TAP DEVICE FOR RETAINING THE TEMPERATURE OF A LIQUID IN A LIQUID DISTRIBUTION SYSTEM
(71) 3Eflow AB, Aurorum Science Park 1C, 977 75 Luleå, SE
(72) ABBING, Erik, Residensgatan 6B, S-972 36 Luleå, SE
-
- (51) MKP
B01D 53/02 (2006.01) (97) **2726198 ***
B01J 20/20 (2006.01)
B01J 20/28 (2006.01)
B01J 20/32 (2006.01)
- (86) EP2012002243 25.05.2012
(96) 12726583.3 07.05.2014
(87) WO2013023714, 25.05.2012
(97) 2726198, 07.05.2014 de
(54) FILTER MATERIALS FOR TREATING AND PURIFYING GAS
(71) Blücher GmbH, Mettmanner Strasse 25, 40699 Erkrath, DE
Friedrich-Alexander-Universität Erlangen-Nürnberg,
Schlossplatz 4, 91023 Erlangen, DE
(72) BÖHRINGER, Bertram, Bussardweg 33, 42115 Wuppertal, DE
ECKLE, Ilsebill, Uckendorfer Strasse 12, 45886 Gelsenkirchen, DE
WASSERSCHIED, Peter, Humboldtstrasse 15, 91054 Erlangen, DE
ROTH, Daniel, c/o Friedrich-Alexander-Universität Lehrstuhl für chemische Reaktionstechnik Egerlandstrasse 3, 91058 Erlangen, DE
-
- (51) MKP
A23L 1/00 (2006.01) (97) **2731461 ***
A23L 1/275 (2006.01)
A23L 1/303 (2006.01)
- (86) US2012046658 13.07.2012
(96) 12762685.1 21.05.2014
(87) WO2013012716, 13.07.2012
(97) 2731461, 21.05.2014 en
(54) MULTICAROTENOID BEADLETS AND RELATED METHOD
(71) Access Business Group International LLC, 7575 Fulton Street East, Ada, Michigan 49355, US
(72) GELLENBECK, Kevin W., 14743 Laurelwood Street, Poway, California 92064, US
VENZON, Dawna Salter, 221 Laurel Avenue, Arcadia, California 91006, US
CHANDRA, Amitabh, 5382 Hartfield Court SE, Ada, Michigan 49301, US
INTRA, Janjira, 421 N. Wilson Street, La Habra, California 90631, US
GRANN, Kerry A., 12136 E. Greenfield Road, Lansing, Michigan 48917, US
-
- (51) MKP
C08F 10/06 (2006.01) (97) **2707399 ***
- (86) IN2012000334 07.05.2012
(96) 12756265.0 19.03.2014
(87) WO2012164574, 07.05.2012
(97) 2707399, 19.03.2014 en
(54) NITROGEN CONTAINING EXTERNAL DONOR SYSTEM FOR PROPYLENE POLYMERIZATION
(71) Reliance Industries Limited, 3rd Floor, Maker Chambers IV 222 Nariman Point, Mumbai 400 021 Maharashtra, IN
(72) PATIL, Harshad Ramdas, A-103 Laxmidarshan Apartment Nr. Merulaxmi Temple Rander Road Tadwadi, Surat 395 009 Gujarat, IN
VYAS, Priyanshu Bharkat Kumar, B-152, OM Prabhu Darshan Society Rander-Bheshan Road Ugat, Surat 395 005 Gujarat, IN
GUPTA, Virendrakumar, Apartment-703 Maitri Tower Sector - 29 Nerul (East), Navi Mumbai 400 706 Maharashtra, IN
-
- (51) MKP
A61K 31/444 (2006.01) (97) **2739623 ***
A61K 31/506 (2006.01)
A61P 31/16 (2006.01)
C07D 471/04 (2006.01)
- (86) US2012049097 01.08.2012
(96) 12746215.8 11.06.2014
(87) WO2013019828, 01.08.2012
(97) 2739623, 11.06.2014 en
(54) INHIBITORS OF INFLUENZA VIRUSES REPLICATION
(71) Vertex Pharmaceuticals Incorporated, 50 Northern Avenue, 15th Floor, Boston, MA 02210, US
(72) CHARIFSON, Paul, S., 7 Dartmouth Drive, Framingham, MA 01701, US
CLARK, Michael, P., 30 Kenney Lane, Concord, MA 01742, US
BANDARAGE, Upul, K., 11 Bates Road, Lexington, MA 02421, US
BETHIEL, Randy, S., 314 Massachusetts Avenue, Lexington, MA 02420, US
BOYD, Michael, J., 69 Florence Street 2, Winchester, MA 01890, US
DAVIES, Ioana, 10 Pawnee Drive, Arlington, MA 02474, US
DENG, Hongbo, 178 Woodland Road, Southborough, MA 01772, US
DUFFY, John, P., 175 Carriage Hill Road, Northborough, MA 01532, US
FARMER, Luc, J., 5186 Earnscliffe, Montreal, QC H3X 2P5, CA
GAO, Huai, 82 Summer Street Unit 7, Arlington, MA 02474, US
GU, Wenxin, 2 Dunbar Way, Concord, MA 01742, US
KENNEDY, Joseph, M., 28 Pleasant Street 1, Charlestown, MA 02129, US
LEDFORD, Brian, 53 Maple Street, Norton, MA 02766, US
LEDEBOER, Mark, W., 36 Faulkner Hill Road, Acton, MA 01720, US
MALTAIS, Francois, 24 Randolph Drive, Tewksbury, MA 01876, US
PEROLA, Emanuele, 6 Lanark Road Unit 3, Brookline, MA 02445, US
WANG, Tiansheng, 50 Sarah Way, Concord, MA 01742, US
-
- (51) MKP
A61B 5/01 (2006.01) (97) **2745817 ***
A61F 7/00 (2006.01)
- (86) CL2011000073 06.12.2011
(96) 11813524.3 25.06.2014
(87) WO2013023317, 06.12.2011
(97) 2745817, 25.06.2014 en
(54) DEVICE AND METHOD FOR CONTROLLING - EITHER INCREASING OR DECREASING - THE BODY TEMPERATURE OF A PATIENT
(71) Rivas Tapia, Rodrigo, Julia Berstein 720 Casa K, La Reina, Santiago, CL
(72) Rivas Tapia, Rodrigo, Julia Berstein 720 Casa K, La Reina, Santiago, CL
-
- (51) MKP
A61K 31/519 (2006.01) (97) **2736908 ***
A61P 25/28 (2006.01)
C07D 487/04 (2006.01)
- (86) EP2012064598 25.07.2012
(96) 12738465.9 04.06.2014
(87) WO2013014185, 25.07.2012
(97) 2736908, 04.06.2014 en
(54) BICYCLIC PYRIMIDONE COMPOUNDS
(71) Glaxo Group Limited, 980 Great West Road Brentford, Middlesex TW8 9GS, GB
(72) WAN, Zehong, GlaxoSmithKline (China) R&D Co. Ltd. Building 3 898 Halei Road Zhangjiang Hi-Tech Park, Shanghai 201203, CN
LONG, Kai, GlaxoSmithKline (China) R&D Co. Ltd. Building 3 898 Halei Road Zhangjiang Hi-Tech Park, Shanghai 201203, CN
ZHANG, Xiaomin, GlaxoSmithKline (China) R&D Co. Ltd. Building 3 898 Halei Road Zhangjiang Hi-Tech Park, Shanghai 201203, CN
YU, Haihua, GlaxoSmithKline (China) R&D Co. Ltd. Building 3 898 Halei Road Zhangjiang Hi-Tech Park, Shanghai 201203, CN

(51) MKP
C09K 3/18 (2006.01) (97) **2718386 ***
 (86) EP2012060542 05.06.2012
 (96) 12725454.8 16.04.2014
 (87) WO2012168205, 05.06.2012
 (97) 2718386, 16.04.2014 en
 (54) DEICING COMPOSITION
 (71) Akzo Nobel Chemicals International B.V., Stationsstraat 77, 3811 MH Amersfoort, NL
 (72) DEMMER, René Lodewijk Maria, Werfstraat 16, NL-7468 GG Enter, NL
 MASLOW, Wasil, Emmastraat 30, NL-7411 EK Deventer, NL
 DE JONG, Edwin Ronald, Amerstraat 20, NL-7417 CL Deventer, NL

(51) MKP
A61K 31/155 (2006.01) (97) **2750699 ***
A61K 31/4439 (2006.01)
A61K 38/26 (2006.01)
 (86) EP2012066617 27.08.2012
 (96) 12756417.7 09.07.2014
 (87) WO2013030160, 27.08.2012
 (97) 2750699, 09.07.2014 en
 (54) PHARMACEUTICAL COMBINATION FOR USE IN GLYCEMIC CONTROL IN DIABETES TYPE 2 PATIENTS
 (71) Sanofi-Aventis Deutschland GmbH, Brüningstraße 50, 65929 Frankfurt am Main, DE
 (72) NIEMÖLLER, Elisabeth, c/o Sanofi-Aventis Deutschland GmbH Industriepark Höchst, 65926 Frankfurt am Main, DE
 MÜHLEN-BARTMER, Isabel, c/o Sanofi-Aventis Deutschland GmbH Industriepark Höchst, 65926 Frankfurt am Main, DE
 SILVESTRE, Louise, c/o Sanofi-Aventis Département Brevets 54 rue La Boétie, F-75008 Paris, FR
 BOKA, Gabor, c/o Sanofi-Aventis Département Brevets 54 rue La Boétie, F-75008 Paris, FR
 MIOSECC, Patrick, c/o Sanofi-Aventis Département Brevets 54 rue La Boétie, F-75008 Paris, FR

(51) MKP
C12N 15/12 (2006.01) (97) **2744919 ***
C12Q 1/68 (2006.01)
 (86) US2012051447 17.08.2012
 (96) 12825690.6 25.06.2014
 (87) WO2013028554, 17.08.2012
 (97) 2744919, 25.06.2014 en
 (54) GENE SIGNATURES FOR LUNG CANCER PROGNOSIS AND THERAPY SELECTION
 (71) Myriad Genetics, Inc., 320 Wakara Way, Salt Lake City, UT 84108, US
 Wagner, Susanne, 320 Wakara Way, Salt Lake City, UT 84108, US
 Stone, Steve, 320 Wakara Way, Salt Lake City, UT 84108, US
 Gutin, Alexander, 320 Wakara Way, Salt Lake City, Utah 84108, US
 Reid, Julia E., 320 Wakara Way, Salt Lake City, UT 84108, US
 (72) WAGNER, Susanne, 320 Wakara Way, Salt Lake City Utah 84108, US
 STONE, Steven, 320 Wakara Way, Salt Lake City Utah 84108, US
 GUTIN, Alexander, 320 Wakara Way, Salt Lake City Utah 84108, US
 REID, Julia, 320 Wakara Way, Salt Lake City Utah 84108, US

(51) MKP
C08K 5/49 (2006.01) (97) **2770017**
 (96) 13156349.6 27.08.2014
 (97) 2770017, 27.08.2014 en
 (54) New surface treatment of white mineral materials for application in plastics
 (71) Omya International AG, Baslerstrasse 42, 4665 Oftringen, CH
 (72) Rentsch, Samuel, Burgpark 2, 4663 Aarburg, CH
 Buri, Matthias, Mätteliweg 20, 4852 Rothrist, CH
 Gane, Patrick Arthur Charles, Studenweg 8, 4852 Rothrist, CH

(51) MKP
A61K 39/395 (2006.01) (97) **2736530 ***
 (86) US2012048540 27.07.2012
 (96) 12817129.5 04.06.2014
 (87) WO2013016634, 27.07.2012
 (97) 2736530, 04.06.2014 en
 (54) USE OF IL-12 TO GENERATE ENDOGENOUS ERYTHROPOIETIN
 (71) Neumedicines, Inc, 133 North Altadena Drive Suite 310, Pasadena, California 91107, US
 (72) BASILE, Lena, A., 10426 Helendale Avenue, Tujunga, CA 91042, US

(51) MKP
A61K 38/16 (2006.01) (97) **2723367 ***
A61K 38/17 (2006.01)
A61K 38/26 (2006.01)
A61P 3/00 (2006.01)
A61P 3/04 (2006.01)
A61P 3/10 (2006.01)
 (86) US2012042084 12.06.2012
 (96) 12802005.4 30.04.2014
 (87) WO2012177443, 12.06.2012
 (97) 2723367, 30.04.2014 en
 (54) GLUCAGON/GLP-1 RECEPTOR CO-AGONISTS
 (71) Indiana University Research and Technology Corporation, 351 West 10th Street, Indianapolis, IN 46202, US
 (72) DIMARCHI, Richard, D., 10890 Wilmington Drive, Carmel, IN 46033, US
 SMILEY, David, L., 1013 Sherbrooke Drive, Bloomington, IN 47401, US

(51) MKP
A61K 31/554 (2006.01) (97) **2708535**
A61P 9/00 (2006.01)
A61P 19/08 (2006.01)
A61P 25/00 (2006.01)
C07D 281/10 (2006.01)
 (96) 12167732.2 19.03.2014
 (97) 2708535, 19.03.2014 en
 (54) Agents for treating disorders involving modulation of ryanodine receptors
 (71) Les Laboratoires Servier, 35, rue de Verdun, 92284 Suresnes Cedex, FR
 Armgo Pharma, Inc., 777 Old Saw Mill River Rd, Tarrytown, NY 10591, US
 (72) Yan, Jiaming, ARMGO Pharma Inc 100 La Salle Street, Apt 9C, New York, New York 10027, US
 Belvedere, Sandro, ARMGO Pharma Inc 393 W49th Street, NEW YORK, New York 10019, US
 Webb, Yael, ARMGO Pharma Inc 217 High Ridge Ct. Yorktown Heights, New York, New York 10598, US
 Bertrand, Marc, LES LABORATOIRES SERVIER 79 Route de Sandillon, 45650 Saint Jean Le Blanc, FR
 Villeneuve, Nicole, LES LABORATOIRES SERVIER 60, rue de la Chapelle, 92500 RUEIL MALMAISON, FR

(51) MKP
C07B 61/00 (2006.01) (97) **2736894 ***
C07D 333/54 (2006.01)
C07D 409/12 (2006.01)
 (86) JP2012069784 27.07.2012
 (96) 12748265.1 04.06.2014
 (87) WO2013015456, 27.07.2012
 (97) 2736894, 04.06.2014 en
 (54) METHOD FOR PRODUCING BENZO[B]THIOPHENE COMPOUND
 (71) Otsuka Pharmaceutical Co., Limited, 9, Kanda-Tsukasamachi 2-chome Chiyoda-ku, Tokyo 101-8535, JP
 (72) SHINHAMA, Koichi, c/o OTSUKA PHARMACEUTICAL CO. LTD. 1-7-1 Doshomachi Chuo-ku, Osaka-shi Osaka 541-0045, JP
 UTSUMI, Naoto, c/o OTSUKA PHARMACEUTICAL CO. LTD. 1-7-1 Doshomachi Chuo-ku, Osaka-shi Osaka 541-0045, JP
 SOTA, Masahiro, c/o OTSUKA PHARMACEUTICAL CO. LTD. 1-7-1 Doshomachi Chuo-ku, Osaka-shi Osaka 541-0045, JP
 FUJIEDA, Shigeo, c/o OTSUKA PHARMACEUTICAL CO. LTD. 1-7-1 Doshomachi Chuo-ku, Osaka-shi Osaka 541-0045, JP
 OGASAWARA, Shin, c/o OTSUKA PHARMACEUTICAL CO. LTD. 1-7-1 Doshomachi Chuo-ku, Osaka-shi Osaka 541-0045, JP

- (51) MKP
C08L 83/04 (2006.01) (97) **2734588 ***
- (86) US2012047144 18.07.2012
(96) 12740824.3 28.05.2014
(87) WO2013012897, 18.07.2012
(97) 2734588, 28.05.2014 en
- (54) COPPER CONTAINING COMPLEX, CONDENSATION REACTION COMPOSITIONS CONTAINING THE COMPLEX, AND METHODS FOR THE PREPARATION AND USE OF THE COMPOSITIONS
- (71) Dow Corning Corporation, 2200 West Salzburg Road, Midland, Michigan 48686-0994, US
(72) BRANDSTADT, Kurt, 5818 Wimbledon Court, Midland, MI 48642, US
COOK, Simon, 1601 Settlers Passage, Midland, MI 48642, US
DIAMOND, Gary, 1326 Hoover Street 1, Menlo Park, CA 94025, US
HALL, Keith, 390 South 15h Street, San Jose, CA 95112, US
LOWER, Loren, 4148 North Francis Shores Avenue, Sanford, MI 48657, US
SURGENOR, Avril, Avenue Du Champ De Mai 29, B-1410 Waterloo, GB
TAYLOR, Richard, 140 South Road, Sully Penarth CF64 5SP, GB
TONGE, James, 3105 North Lakeview Drive, Sanford, MI 48657, US
TZOU, Ming-Shin, 2611 Walden Woods Court, Midland, MI 48640, US

- (51) MKP
A61K 31/4523 (2006.01) (97) **2744497 ***
A61K 31/4748 (2006.01)
A61P 1/00 (2006.01)
A61P 25/00 (2006.01)
A61P 25/02 (2006.01)
- (86) IB2012002013 10.10.2012
(96) 12784677.2 25.06.2014
(87) WO2013057554, 10.10.2012
(97) 2744497, 25.06.2014 en
- (54) THERAPEUTIC COMBINATIONS OF NETUPITANT AND PALONOSETRON
- (71) Helsinn Healthcare SA, Via Pian Scairolo 9, 6912 Lugano-Pazzallo, CH
(72) PIETRA, Claudio, Via Scalabrini 56, I-Como, IT
CANTOREGGI, Sergio, Via Sarone 21A, CH-6955 Cagiallo, CH

- (51) MKP
A61K 31/496 (2006.01) (97) **2760452 ***
- (86) US2012058188 30.09.2012
(96) 12836842.0 06.08.2014
(87) WO2013049770, 30.09.2012
(97) 2760452, 06.08.2014 en
- (54) METHODS OF TREATING CANCER
- (71) Glaxosmithkline LLC, 2711 Centerville Road Suite 400 Wilmington, New Castle, DE 19808, US
(72) CREASY, Caretha, L., 1250 South Collegeville Road, Collegeville, PA 19426, US
GANJI, Gopinath, 1250 South Collegeville Road, Collegeville, PA 19426, US
McCABE, Michael, T., 1250 South Collegeville Road, Collegeville, PA 19426, US
SMITHEMAN, Kimberly, N., 1250 South Collegeville Road, Collegeville, PA 19426, US

- (51) MKP
A61K 31/4166 (2006.01) (97) **2744786 ***
A61P 35/00 (2006.01)
C07D 233/32 (2006.01)
- (86) CA2012000751 10.08.2012
(96) 12824264.1 25.06.2014
(87) WO2013023274, 10.08.2012
(97) 2744786, 25.06.2014 en
- (54) SUBSTITUTED 2-IMIDAZOLIDINONES AND 2-IMIDAZOLONONES AND THEIR USE IN THE TREATMENT OF CANCER
- (71) Université Laval, Cité Universitaire, Québec, Québec G1V 0A6, CA
(72) C.-GAUDREAU, René, 2102 chemin Aubin, Bémieres, Québec G7A 2N3, CA
FORTIN, Sébastien, 349 ave. Albert-Rousseau, St-Étienne-de-Lauzon, Québec G6J 0A7, CA

- (51) MKP
A61B 17/00 (2006.01) (97) **2644115**
A61B 17/064 (2006.01)
A61B 17/072 (2006.01)
A61B 17/115 (2006.01)
A61B 17/29 (2006.01)
A61B 19/08 (2006.01)
A61L 31/00 (2006.01)
- (96) 13161459.6 02.10.2013
(97) 2644115, 02.10.2013 en
- (54) Tissue thickness compensators for circular surgical staplers
(71) Ethicon Endo-Surgery, Inc., 4545 Creek Road, Cincinnati, OH 45242, US
(72) Alexander, III, Johnny H., 7966 Stillmeadow Drive, West Chester, OH Ohio 45069, US
Henderson, Courtney E., 191 Hounds Run, Loveland, OH Ohio 45140, US
Miller, Christopher C., 433 Pintail Drive, Loveland, OH Ohio 45140, US
Measamer, John P., 8780 Weller Station, Cincinnati, OH Ohio 45249, US
Schmid, Katherine J., 3969 Sharonview Drive, Cincinnati, OH Ohio 45241, US
Shelton, IV, Frederick E., 245 East Main Street, Hillsboro, OH Ohio 45133, US
Mutchler, Stephanie A., 328 Glen Lake Road, Loveland, OH Ohio 45140, US
Smith, Bret W., 4736 Eastport Drive, Kings Mills, OH Ohio 45034, US
Cropper, Michael S., 3232 Charter Oak, Edgewood, KY Kentucky 41017, US

- (51) MKP
H04L 12/18 (2006.01) (97) **2744184**
H04M 3/42 (2006.01)
- (96) 13005776.3 18.06.2014
(97) 2744184, 18.06.2014 en
- (54) File management system, method and computer program
(71) Hitachi Information & Telecommunication Engineering, Ltd., 2-3-3, Minatomirai, Nishi-ku Yokohama-shi, Kanagawa-ken 220-6122, JP
(72) Koyama, Toshiaki, c/o: Hitachi Information & Telecommunication Engineering, Ltd. 456, Sakai, Nakai-machi Ashigarakami-gun, Kanagawa, 259-0157, JP
Yamagishi, Toyoki, c/o: Hitachi Information & Telecommunication Engineering, Ltd. 2-3-3, Minatomirai, Nishi-ku, Yokohama-shi, Kanagawa, 220-6122, JP

- (51) MKP
C12N 5/04 (2006.01) (97) **2718443 ***
C12N 5/10 (2006.01)
C12N 9/16 (2006.01)
C12N 15/82 (2006.01)
- (86) EP2012060181 30.05.2012
(96) 12729391.8 16.04.2014
(87) WO2012168124, 30.05.2012
(97) 2718443, 16.04.2014 en
- (54) METHODS AND MEANS TO MODIFY A PLANT GENOME AT A PRESELECTED SITE
- (71) Bayer CropScience NV, J.E. Mommaertslaan 14, 1831 Diegem, BE
(72) D'HALLUIN, Katelijn, Hooiland 48, B-9030 Mariakerke, BE

- (51) MKP
H03M 3/02 (2006.01) (97) **2658131**
- (96) 12002892.3 30.10.2013
(97) 2658131, 30.10.2013 en
- (54) Electronic device and method for analogue to digital conversion according to Delta-Sigma modulation using double sampling
(71) Texas Instruments Deutschland, Haggertystrasse 1, 85356 Freising, DE
Texas Instruments Incorporated, 12500 TI Boulevard M/S 3999, Dallas TX 75243, US
(72) Schmid, Konstantin, Sophienstrasse 102, 91052 Erlangen, DE
Reinhold, Michael, Am Dinkelfeld 25, 91056 Erlangen, DE
Ohnhaeuser, Frank, Drosselweg 18, 90547 Stein, DE

(51) MKP
A61K 31/519 (2006.01) (97) **2705036 ***
A61P 3/04 (2006.01)
C07D 471/04 (2006.01)
C07D 487/04 (2006.01)
C07D 498/04 (2006.01)
(86) US2012036792 07.05.2012
(96) 12722592.8 12.03.2014
(87) WO2012154678, 07.05.2012
(97) 2705036, 12.03.2014 en
(54) TRICYCLIC SULFONAMIDE COMPOUNDS AND METHODS OF MAKING AND USING SAME
(71) ZAFGEN INC., One Broadway, 8th Floor, Cambridge, MA 02142, US
(72) CRAMP, Susan, Mary, 8/9 Spire Green Centre Flex Meadow, Harlow, Essex CM19 5TR, GB
DYKE, Hazel, Joan, 8/9 Spire Green Centre Flex Meadow, Harlow, Essex CM19 5TR, GB
PALLIN, Thomas, David, 8/9 Spire Green Centre Flex Meadow, Harlow, Essex CM19 5TR, GB
ZAHLER, Robert, 1 Cambridge Center, Suite 702, Cambridge, MA 02142, US

(51) MKP
A61K 38/20 (2006.01) (97) **2760465 ***
A61P 27/02 (2006.01)
(86) EP2012069333 01.10.2012
(96) 12772743.6 06.08.2014
(87) WO2013045694, 01.10.2012
(97) 2760465, 06.08.2014 en
(54) COMPOSITIONS AND METHODS FOR THE TREATMENT OF DEGENERATIVE RETINAL CONDITIONS
(71) The Provost, Fellows, Foundation Scholars, & the other members of Board, of the College of the Holy & Undiv. Trinity of Queen Elizabeth near Dublin, College Green, Dublin 2, IE
(72) CAMPBELL, Matthew, 37 Bramley View Castleknock, Dublin 15, IE
HUMPHRIES, Peter, 5 Holmwood Brennanstown Road Cabinteely, Dublin 18, IE
HUMPHRIES, Marian, 5 Holmwood Brennanstown Road Cabinteely, Dublin 18, IE
KIANG, Anna-Sophia, 48 Riddlesford Bray, Co Wicklow, IE
DOYLE, Sarah, 37 Bramley View Castleknock, Dublin 15, IE
O'NEILL, Luke, 4A Burdett Avenue Sandycove, Co. Dublin, IE

(51) MKP
C08F 212/14 (2006.01) (97) **2738237 ***
C08F 220/06 (2006.01)
C08F 220/10 (2006.01)
C08F 220/34 (2006.01)
C08F 220/56 (2006.01)
C08F 232/04 (2006.01)
C09K 8/588 (2006.01)
(86) CN2011001579 16.09.2011
(96) 11869802.6 04.06.2014
(87) WO2013013357, 16.09.2011
(97) 2738237, 04.06.2014 en
(54) AMPHIPHILIC MACROMOLECULE AND USE THEREOF
(71) Beijing Junlun Runzhong Science&Technology Co., Limited, Rm. 2306, Block A, Focus Square No. 6 Futongdong Street Wangjing Community, Chaoyang District, Beijing 100102, CN
(72) WANG, Jinben, Zhongguancun North First Street 2 Haidian District, Beijing 100080, CN
SHI, Xuefeng, Zhongguancun North First Street 2 Haidian District, Beijing 100080, CN
XU, Xiaohui, Zhongguancun North First Street 2 Haidian District, Beijing 100080, CN
YANG, Hui, Zhongguancun North First Street 2 Haidian District, Beijing 100080, CN
WANG, Yilin, Zhongguancun North First Street 2 Haidian District, Beijing 100080, CN
YAN, Haik, Zhongguancun North First Street 2 Haidian District, Beijing 100080, CN

(51) MKP
A23B 4/005 (2006.01) (97) **2671459**
A23L 1/325 (2006.01)
B65B 25/06 (2006.01)
B65B 55/02 (2006.01)
B65B 55/22 (2006.01)
(86) 13170303.5 11.12.2013
(97) 2671459, 11.12.2013 en
(54) Process for packing a product based on portions of fish in the solid form and relative packed product
(71) Bolton Alimentari S.P.A., via Einaudi 18/22, 22072 Cermenate (Como), IT
(72) CORTI, Adriana, Via Roma, 9, 22074 LOMAZZO (CO), IT
DE DIONIGI, Stefano, Via Sondrio, 5, 20010 INVERUNO (MI), IT
ROSA, Alberto, Via delle Grigne, 23, 20833 GIUSSANO (MB), IT

(51) MKP
A01N 43/40 (2006.01) (97) **2729006 ***
A01N 43/56 (2006.01)
A01N 43/90 (2006.01)
A01N 45/02 (2006.01)
A01N 47/16 (2006.01)
A01P 3/00 (2006.01)
(86) JP2012065925 15.06.2012
(96) 12731752.7 14.05.2014
(87) WO2013008604, 15.06.2012
(97) 2729006, 14.05.2014 en
(54) FUNGICIDAL COMPOSITION AND METHOD FOR CONTROLLING PLANT DISEASES
(71) Ishihara Sangyo Kaisha, Ltd., 3-15 Edobori 1-chome Nishi-ku, Osaka-shi, Osaka 550-0002, JP
(72) OGAWA, Munekazu, c/o Ishihara Sangyo Kaisha Ltd. Chuo Kenkyusho 3-1 Nishi-shibukawa 2-chome, Kusatsu-shi Shiga 525-0025, JP
KAWAI, Yuzuka, c/o Ishihara Sangyo Kaisha Ltd. Chuo Kenkyusho 3-1 Nishi-shibukawa 2-chome, Kusatsu-shi Shiga 525-0025, JP

(51) MKP
A61K 9/00 (2006.01) (97) **2750768 ***
A61K 9/19 (2006.01)
A61K 31/7068 (2006.01)
A61K 47/10 (2006.01)
A61K 47/20 (2006.01)
A61P 35/00 (2006.01)
(86) US2012052816 29.08.2012
(96) 12759857.1 09.07.2014
(87) WO2013033176, 29.08.2012
(97) 2750768, 09.07.2014 en
(54) DECITABINE DERIVATIVE FORMULATIONS
(71) Astex Pharmaceuticals, Inc., 4140 Dublin Blvd. Suite 200, Dublin CA 94568, US
(72) JOSHI-HANGAL, Rajashree, 1070 W. Lagoon Road, Pleasanton, CA 94566, US
TANG, Chunlin, 2563 Decca Lane, Walnut Creek, CA 94597, US
REDKAR, Sanjeev, 2740 Breaker Lane, Hayward, CA 94545, US
RAVIVARAPU, Harish, 1059 Serpentine Lane, Pleasanton, CA 94566, US

(51) MKP
H02G 15/10 (2006.01) (97) **2766967 ***
H02G 15/117 (2006.01)
(86) DE2012000988 10.10.2012
(96) 12783857.1 20.08.2014
(87) WO2013053349, 10.10.2012
(97) 2766967, 20.08.2014 de
(54) SPACERS IN CABLE SPLICING SLEEVES
(71) Mankiewicz Gebr. & Co. GmbH & Co. KG, Georg-Wilhelm-Strasse 189, 21107 Hamburg, DE
(72) JOHN, Günther, Lehmkoppel 6, 21493 Schwarzenbek, DE
SACHSE, Manuel, Behaimweg 8 B, 22119 Hamburg, DE
BOGUMIL, Mark, Dorfstrasse 85, 25364 Osterhorn, DE

- (51) MKP
B60P 1/00 (2006.01) (97) **2755856 ***
B60P 1/43 (2006.01)
- (86) US2012055320 14.09.2012
(86) 12832265.8 23.07.2014
(87) WO2013040301, 14.09.2012
(97) 2755856, 23.07.2014 en
(54) REGENERATIVE BRAKING SYSTEM FOR A VEHICLE RAMP
(71) Ricon Corp., 7900 Nelson Road, Panorama City, CA 91402, US
(72) FISHER, Steve, 2017 Markey Way, Rosamond, California 93560, US
CERVERA, Lluno, 8104 Sylmar Avenue, Panorama City, California 91402, US
WYSZKOWSKI, Christopher, 6774 Sandalwood Drive, Simi Valley, California 93063, US

- (51) MKP
A01N 1/02 (2006.01) (97) **2757879 ***
A61K 35/14 (2006.01)
A61L 2/00 (2006.01)
- (86) IB2012055062 24.09.2012
(96) 12780851.7 30.07.2014
(87) WO2013042095, 24.09.2012
(97) 2757879, 30.07.2014 en
(54) PLATELET LYSATE, USES AND METHOD FOR THE PREPARATION THEREOF
(71) Università degli Studi di Roma "La Sapienza", Piazzale Aldo Moro, 5, 00185 Roma, IT
Futura Stem Cells Sa, Via Pico 20, 6900 Lugano, CH
(72) FRATI, Giacomo, c/o Università degli Studi di Roma "La Sapienza" Piazzale Aldo Moro 5, 00185 Rome, IT
FRATI, Luigi, c/o Università degli Studi di Roma "La Sapienza" Piazzale Aldo Moro 5, 00185 Rome, IT
PIERELLI, Luca, c/o Università degli Studi di Roma "La Sapienza" Piazzale Aldo Moro 5, 00185 Rome, IT
NUTI, Marianna, c/o Università degli Studi di Roma "La Sapienza" Piazzale Aldo Moro 5, 00185 Rome, IT

- (51) MKP
C22C 38/44 (2006.01) (97) **2714955 ***
C22C 38/58 (2006.01)
- (86) SG2012000183 24.05.2012
(96) 12788999.6 09.04.2014
(87) WO2012161661, 24.05.2012
(97) 2714955, 09.04.2014 en
(54) AUSTENITIC STAINLESS STEEL
(71) United Pipelines Limited, Cue House Chapel Lane, Stockton Heath Warrington WA4 6LL, GB
(72) ROSCOE, Cecil Vernon, c/o United Pipelines Asia Pacific Pte Limited 50 Raffles Place 32-01 Singapore Land Tower, Singapore 048623, SG

- (51) MKP
B32B 5/24 (2006.01) (97) **2750879 ***
B32B 5/26 (2006.01)
B60R 13/00 (2006.01)
- (86) IB2011054829 31.10.2011
(96) 11804796.8 09.07.2014
(87) WO2013064859, 31.10.2011
(97) 2750879, 09.07.2014 en
(54) ARTICLE MADE OF A MULTILAYER COMPOSITE MATERIAL AND PREPARATION METHOD THEREOF
(71) Industrielud S.P.A., Via Tirone, 11, 00146 Roma, IT
(72) DI SANTE, Giuseppe, Via Antonelli 1, I-64026 Roseto Degli Abruzzi (te), IT
BIGGIO, Mario, Contrada Villa Pompetti s.n., I-64100 Teramo (te), IT
DI PAOLANTONIO, Mario, Via Amendola 22/A, I-64021 Giulianova (te), IT
GIOVINE, Gianluca, Via Galileo Galilei 23/C, I-64100 San Nicolò A Tordino (te), IT

- (51) MKP
F01N 3/20 (2006.01) (97) **2647803**
F04B 53/08 (2006.01)
- (96) 12163408.3 09.10.2013
(97) 2647803, 09.10.2013 en
(54) Reagent dosing pump assembly with connector element
(71) Delphi International Operations Luxembourg S.à.r.l., Avenue de Luxembourg, 4940 Bascharage, LU
(72) Wright, Keith, 6 Kinross Close Walderslade, Chatham, Kent ME5 7RS, GB
Needham, David, 77 High Street Lenham, Maidstone, Kent ME17 2LA, GB

- (51) MKP
A61K 31/496 (2006.01) (97) **2729448 ***
A61P 31/14 (2006.01)
C07D 213/40 (2006.01)
C07D 401/12 (2006.01)
C07D 401/14 (2006.01)
C07D 403/12 (2006.01)
C07D 403/14 (2006.01)
C07D 405/12 (2006.01)
C07D 471/04 (2006.01)
C07D 471/06 (2006.01)
C07D 487/04 (2006.01)
C07D 491/04 (2006.01)
C07D 495/04 (2006.01)
- (86) US2012045630 05.07.2012
(96) 12738307.3 14.05.2014
(87) WO2013006738, 05.07.2012
(97) 2729448, 14.05.2014 en
(54) COMPOUNDS FOR THE TREATMENT OF HIV
(71) Gilead Sciences, Inc., 333 Lakeside Drive, Foster City, CA 94404, US
(72) BONDY, Steven S., c/o Gilead Sciences, Inc. 333 Lakeside Drive, Foster City, California 94404, US
CANNIZZARO, Carina E., c/o Gilead Sciences, Inc. 333 Lakeside Drive, Foster City, California 94404, US
CHOU, Chien-hung, c/o Gilead Sciences, Inc. 333 Lakeside Drive, Livermore, California 94404, US
HALCOMB, Randall L., c/o Gilead Sciences, Inc. 333 Lakeside Drive, Foster City, California 94404, US
HU, Yunfeng Eric, c/o Gilead Sciences, Inc. 333 Lakeside Drive, Foster City, California 94404, US
LINK, John O., c/o Gilead Sciences, Inc. 333 Lakeside Drive, San Francisco, California 94404, US
LIU, Qi, c/o Gilead Sciences, Inc. 333 Lakeside Drive, Foster City, California 94404, US
SCHROEDER, Scott D., c/o Gilead Sciences, Inc. 333 Lakeside Drive, Foster City, California 94404, US
TSE, Winston C., c/o Gilead Sciences, Inc. 333 Lakeside Drive, Foster City, California 94404, US
ZHANG, Jennifer R., c/o Gilead Sciences, Inc. 333 Lakeside Drive, Foster City, California 94404, US

- (51) MKP
C04B 35/571 (2006.01) (97) **2647611**
C04B 35/626 (2006.01)
C04B 35/628 (2006.01)
C04B 37/00 (2006.01)
- (96) 13162400.9 09.10.2013
(97) 2647611, 09.10.2013 en
(54) High durability joints between ceramic articles, and methods of making and using same
(71) General Atomics, 3550 General Atomics Court, San Diego, California 92121, US
(72) Khalifa, Hesham Ezzat, 631 Kirkwood Place, La Jolla, CA 92037, US
Deck, Christian Peter, 2838 Juniper Street, San Diego, CA 92104, US
Back, Christina Allyssa, 4910 Marlborough Drive, San Diego, CA 92116, US

(51) MKP
F03D 1/02 (2006.01) (97) **2516844 ***
F03D 3/02 (2006.01)
F03D 5/02 (2006.01)
F03D 11/04 (2006.01)
(86) US2010061806 22.12.2010
(96) 10843574.4 31.10.2012
(87) WO2011087844, 22.12.2010
(97) 2516844, 31.10.2012 en
(54) ENERGY GENERATION SYSTEM AND RELATED METHODS
(71) Design Protom Inc., 37 Chemin Cleveland, Lac Brome, QC J2K 3G8, CA
(72) VAN DEN BULCKE, Marc, 37 Chemin Cleveland, Lac Brome Quebec J2K 3G8, CA

(51) MKP
E04B 1/348 (2006.01) (97) **2674538**
(96) 13170379.5 18.12.2013
(97) 2674538, 18.12.2013 fr
(54) Modular construction and corresponding assembly method
(71) Cougnaud, Yves, Parc d'Activites de Beaupuy, 85000 Mouilleron-Le-Captif, FR
(72) Defurme, Christophe, La Garlière, 85170 DOMPIERRE SUR YON, FR
Dubiez, Jean-Christophe, 21 rue de la Roseraie, 85000 LA ROCHE SUR YON, FR
Goumondie, Jérôme, La Beauculière, 44190 GETIGNE, FR

(51) MKP
A61M 1/00 (2006.01) (97) **2758089 ***
A61M 13/00 (2006.01)
A61M 16/04 (2006.01)
A61M 25/00 (2006.01)
A61M 39/08 (2006.01)
(86) DK2011050339 12.09.2011
(96) 11773665.2 30.07.2014
(87) WO2013037370, 12.09.2011
(97) 2758089, 30.07.2014 en
(54) METHODS OF MANUFACTURING FLEXIBLE POLYMERIC MEDICAL SPIRAL TUBINGS, TUBINGS MADE BY THE METHODS AND USES OF THE TUBINGS
(71) SafeAir AG, D4 Platz 3, 6039 Root Längenbold, CH
(72) BERNARD, Frédéric, Samsøvej 4, DK-3140 Ålsgårde, DK KORNØRUP, Niels, Gl. Vallerødvej 31B, DK-2960 Rungsted, DK
SIMONSEN, Jesper Schantz, Peter Holms Vej 8 st. tv., DK-2450 København, DK

(51) MKP
A61K 39/395 (2006.01) (97) **2763700 ***
(86) US2012058662 04.10.2012
(96) 12838379.1 13.08.2014
(87) WO2013052607, 04.10.2012
(97) 2763700, 13.08.2014 en
(54) HUMAN NOTCH1 DECOYS
(71) The Trustees of Columbia University in the City of New York, West 116th Street and Broadway, New York, NY 10027, US
(72) KITAJEWSKI, Jan, 323 Hillcrest Road, Ridgewood, NJ 07450, US
SHAWBER, Carrie, 418 Beech St., Township of Washington, NJ 07676, US
KANGSAMAKSIN, Thaned, 212 Bunyawat Rd. Suandok, Muang Lampang 52100, TH

(51) MKP
A61K 38/20 (2006.01) (97) **2736524 ***
B01D 15/36 (2006.01)
C07K 14/545 (2006.01)
(86) US2012048631 27.07.2012
(96) 12748087.9 04.06.2014
(87) WO2013019652, 27.07.2012
(97) 2736524, 04.06.2014 en
(54) PURIFIED PROTEINS
(71) Eleven Biotherapeutics, Inc., 215 First Street Suite 400, Cambridge, MA 02142, US
(72) BARNES, Thomas, M., 215 First Street Suite 400, Cambridge, MA 02142, US
HOU, Jinzhao, 215 First Street Suite 400, Cambridge, MA 02142, US
ZARBIS-PAPASTOITSIS, Gregory, 215 First Street Suite 400, Cambridge, MA 02142, US
SCHIRMER, Emily, Belcher, 215 First Street Suite 400, Cambridge, MA 02142, US
MCNEIL, Gary, L., 215 First Street Suite 400, Cambridge, MA 02142, US
GOLDEN, Kathryn, 215 First Street Suite 400, Cambridge, MA 02142, US

(51) MKP
A61B 5/05 (2006.01) (97) **2706911 ***
(86) US2012037855 14.05.2012
(96) 12782104.9 19.03.2014
(87) WO2012155150, 14.05.2012
(97) 2706911, 19.03.2014 en
(54) SYSTEM AND METHOD FOR SUB-COLUMN PARALLEL DIGITIZERS FOR HYBRID STACKED IMAGE SENSOR USING VERTICAL INTERCONNECTS
(71) Olive Medical Corporation, 2302 S. Presidents Drive, Suite D, Salt Lake City, UT 84120, US
(72) BLANQUART, Laurent, 2776 Great Smokey Court, Westlake Village CA 91362, US

(51) MKP
B65D 85/67 (2006.01) (97) **2758787 ***
B65H 75/18 (2006.01)
G01N 37/00 (2006.01)
(86) AU2012001116 17.09.2012
(96) 12833415.8 30.07.2014
(87) WO2013040630, 17.09.2012
(97) 2758787, 30.07.2014 en
(54) SEALING MEANS FOR TEST CASSETTE
(71) Bransgrove, Brandon, 7-9 Merriwa Street, Gordon New South Wales 2072, AU
(72) Bransgrove, Brandon, 7-9 Merriwa Street, Gordon New South Wales 2072, AU

(51) MKP
A01H 1/08 (2006.01) (97) **2741602 ***
A01H 5/00 (2006.01)
A01H 5/10 (2006.01)
(86) IL2012050309 13.08.2012
(96) 12761817.1 18.06.2014
(87) WO2013024481, 13.08.2012
(97) 2741602, 18.06.2014 en
(54) DURUM WHEAT PLANTS HAVING A PARTIALLY OR FULLY MULTIPLIED GENOME AND USES THEREOF
(71) Kaiima Bio Agritech Ltd., P.O. Box 508, 1524100 Kfar-Tavor, IL
(72) AVIDOV, Amit, 21 Hana Senesh Street, 3603621 Kiryat-Tivon, IL
LERNER, Alon, Moshav Sharona, 1523200 Doar-Na Gail Tachton, IL
LUPO, Itamar, Moshav Elad, 1292700 Doar-Na Ramat HaGolan, IL
BARUCH, Limor, Moshav Tel Adashim, 1931500 Doar-Na Hevel Megiddo, IL

- (51) MKP
E04F 11/18 (2006.01) (97) **2759655 ***
 (86) ES2012070629 17.08.2012
 (96) 12826244.1 30.07.2014
 (87) WO2013026945, 17.08.2012
 (97) 2759655, 30.07.2014 en
 (54) HANDRAIL CONSISTING OF PREFABRICATED TUBES AND PARTS MADE OF STAINLESS STEEL
 (71) Punter Gil, Jesús, Cl. Villareal Nº 1, 12400 Segorbe, ES
 (72) Punter Gil, Jesús, Cl. Villareal Nº 1, 12400 Segorbe, ES

- (51) MKP
A61K 31/405 (2006.01) (97) **2768499 ***
C07D 209/26 (2006.01)
 (86) US2012060508 17.10.2012
 (96) 12842553.5 27.08.2014
 (87) WO2013059245, 17.10.2012
 (97) 2768499, 27.08.2014 en
 (54) INDOMETHACIN ANALOGS FOR THE TREATMENT OF CASTRATE-RESISTANT PROSTATE CANCER
 (71) Vanderbilt University, Center for Technology Transfer and Commercialization 305 Kirkland Hall 2201 West End Avenue, Nashville, TN 37240, US
 The Trustees of the University of Pennsylvania, 3160 Chestnut Street, Suite 200, Philadelphia, PA 19104, US
 (72) MARNETT, Lawrence, J., 1884 Laurel Ridge Drive, Nashville, TN 37215, US
 LIEDTKE, Andy, J., c/o Vanderbilt University School of Medicine Department of Biochemistry 854 Robinson Research Building 2200 Pierce Avenue, Nashville, TN 37232-0146, US
 PENNING, Trevor, M., 525 West Woodland Avenue, Springfield, PA 19064, US
 ADENIJI, Adegoke, O., 61-8 Drexelbrook Drive, Drexel Hill, PA 19026, US
 BYRNS, Michael, C., 3365 Tyson Avenue, Philadelphia, PA 19149, US

- (51) MKP
A61K 38/16 (2006.01) (97) **2711016**
A61P 19/00 (2006.01)
C07K 14/00 (2006.01)
 (96) 12185425.1 26.03.2014
 (97) 2711016, 26.03.2014 en
 (54) Novel IL-17A binding molecules and medical uses thereof
 (71) Covagen AG, Wagistrasse 25, 8952 Zürich-Schlieren, CH
 (72) Silacci Melkko, Michela, Limmatstrasse 217, 8005 Zürich, CH
 Bänziger, Nadja, Feldstrasse 14, 8952 Schlieren, CH
 Woods, Richard, Limmattalstrasse 265, 8049 Zürich, CH
 Zha, Wenjuan, Regensbergstrasse 130, 8050 Zürich, CH
 Attinger, Isabella, Thurwiesenstrasse 15, 8037 Zürich, CH
 Santimaria, Roger, Brandschenkestrasse 157, 8002 Zürich, CH
 Lembke, Wibke, Segantinstrasse 50, 8049 Zürich, CH
 Batey, Sarah, Flat 6, Sycamore House, 173 New Cheveley Rd., Newmarket, Suffolk CB8 8BX, GB
 Von Der Bey, Ulrike, Neue Halde 3/1, 78359 Orsingen-Nenzingen, DE
 Bertschinger, Julian, Am Tobelbach 17, 8913 Ottenbach, CH
 Grabulovski, Dragan, Riedhofstrasse 57, 8049 Zürich, CH

- (51) MKP
H02J 3/26 (2006.01) (97) **2769448 ***
H02J 3/38 (2006.01)
 (86) EP2012070089 10.10.2012
 (96) 12784480.1 27.08.2014
 (87) WO2013057028, 10.10.2012
 (97) 2769448, 27.08.2014 de
 (54) METHOD AND APPARATUS FOR FEEDING ELECTRICAL CURRENT INTO AN ELECTRICAL POWER SUPPLY SYSTEM
 (71) Wobben Properties GmbH, Dreekamp 5, 26605 Aurich, DE
 (72) DIETRICH, Volker, Friedrich-Koopmann-Straße 30, 26203 Wardenburg, DE
 BEEKMANN, Alfred, Am Park 30, 26639 Wiesmoor, DE

- (51) MKP
C03C 13/06 (2006.01) (97) **2768781 ***
C03C 25/24 (2006.01)
C03C 25/26 (2006.01)
C03C 25/34 (2006.01)
C09J 177/06 (2006.01)
C09J 179/04 (2006.01)
C09J 179/08 (2006.01)
D04H 1/4209 (2012.01)
D04H 1/4218 (2012.01)
D04H 1/488 (2012.01)
 (86) FR2012052374 18.10.2012
 (96) 12790596.6 27.08.2014
 (87) WO2013057432, 18.10.2012
 (97) 2768781, 27.08.2014 fr
 (54) SIZING COMPOSITION HAVING A LOW FORMALDEHYDE CONTENT FOR FIRE-RESISTANT MINERAL WOOL AND INSULATION PRODUCT OBTAINED
 (71) Saint-Gobain Isover, 18 Avenue d'Alsace, 92400 Courbevoie, FR
 (72) KIEFER, Lionel, 8 rue Château Landon, 75010 Paris, FR
 ROUSSELET, Guillaume, 17 rue de la République, 60600 Clermont, FR

- (51) MKP
B28B 3/02 (2006.01) (97) **2583802**
B30B 15/06 (2006.01)
C25D 11/04 (2006.01)
 (96) 12188877.0 24.04.2013
 (97) 2583802, 24.04.2013 en
 (54) An improved buffer for mold for ceramic industry and mold comprising said buffer
 (71) Manenti S.p.A., Via Marco Biagi 2, 25045 Castegnato (BS), IT
 (72) Manenti, Mario, Via Caduti di Piazza della Loggia, 24, 25046 Cazzago San Martino (BS), IT

- (51) MKP
A61K 9/12 (2006.01) (97) **2743343 ***
A61K 35/36 (2006.01)
A61P 17/02 (2006.01)
C12N 5/0775 (2010.01)
 (86) CL2012000041 07.08.2012
 (96) 12822834.3 18.06.2014
 (87) WO2013020242, 07.08.2012
 (97) 2743343, 18.06.2014 en
 (54) SPRAY FORMULATION OF MESENCHYMAL STEM CELLS FOR THE TREATMENT OF CHRONIC WOUNDS
 (71) Pontificia Universidad Católica de Chile, Avda. Libertador Bernardo O'Higgins, 340, Santiago, CL
 (72) EBENSPERGER, Roberto, PONTIFICIA UNIVERSIDAD CATOLICA Avenida del Libertador Bernardo O'Higgins 340, Santiago, CL

- (51) MKP
H02J 3/38 (2006.01) (97) **2748908 ***
H02J 3/40 (2006.01)
 (86) EP2012065911 14.08.2012
 (96) 12746356.0 02.07.2014
 (87) WO2013026748, 14.08.2012
 (97) 2748908, 02.07.2014 de
 (54) METHOD FOR OPERATING A WIND ENERGY INSTALLATION
 (71) Wobben Properties GmbH, Dreekamp 5, 26605 Aurich, DE
 (72) GIERTZ, Helge, Kolberger Straße 46, 26789 Leer, DE

- (51) MKP
A61K 38/19 (2006.01) (97) **2750696 ***
A61P 11/00 (2006.01)
 (86) DK2012050320 29.08.2012
 (96) 12762204.1 09.07.2014
 (87) WO2013029627, 29.08.2012
 (97) 2750696, 09.07.2014 en
 (54) COMPOSITIONS AND METHODS FOR TREATING OR PREVENTING RADIATION- OR CHEMOTHERAPY-INDUCED PULMONARY DYSFUNCTION
 (71) Trifolium ApS, Siotsmarken 12, 1.th., 2970 Hørsholm, DK
 (72) HESLET, Lars, Parkovsvej 20, DK-2820 Gentofte, DK

(51) MKP
B23K 26/40 (2014.01) (97) **2714621 ***
C04B 35/622 (2006.01)
(86) EP2012060261 31.05.2012
(96) 12724644.5 09.04.2014
(87) WO2012164025, 31.05.2012
(97) 2714621, 09.04.2014 fr
(54) CERAMIC PARTICLE MIXTURE, AND METHOD FOR MANUFACTURING CERAMIC PARTS FROM SUCH A MIXTURE
(71) Centre de Recherche de l'Industrie Belge de la Ceramique (C.R.I.B.C.), Avenue Gouverneur Cornez 4, 7000 Mons, BE
(72) PETIT, Fabrice, 9 rue de Berlaimont, F-59440 Avesnes-Sur-Helpe, FR
LARDOT, Véronique, 30 rue de la Spaumerie, B-5081 St-Denis-Bovesse, BE
OTT, Cédric, 41 rue Chanzy, F-59199 Hergnies, FR
JUSTE, Enrique, 232-A boulevard Harpignies, F-59300 Valenciennes, FR
CAMBIER, Francis, 8 rue de Bouleng, B-7190 Ecaussines-d'Enghien, BE

(51) MKP
H01L 33/00 (2010.01) (97) **2761677 ***
(86) US2012057986 28.09.2012
(96) 12787547.4 06.08.2014
(87) WO2013049614, 28.09.2012
(97) 2761677, 06.08.2014 en
(54) LIGHT EMITTING DIODE FABRICATED BY EPITAXIAL LIFT-OFF
(71) Microlink Devices, Inc., 6457 W. Howard Street, Niles, IL 60714, US
Pan, Noren, 805 Westwood Lane, Wilmette, IL 60091, US
Elarde, Victor, C., 2600 W. Winnemac Ave Apt 1c, Chicago, IL 60625, US
Youtsey, Christopher, 223 Johnson Avenue, Libertyville, IL 60048, US
Osowski, Mark, 1015 Creek Bend Drive, Vernon Hills, IL 60061, US
(72) PAN, Noren, 805 Westwood Lane, Wilmette, IL 60091, US
ELARDE, Victor, C., 2600 W. Winnemac Avenue Apt 1c, Chicago, IL 60625, US
YOUTSEY, Christopher, 223 Johnson Avenue, Libertyville, IL 60048, US
OSOWSKI, Mark, 1015 Creek Bend Drive, Vernon Hills, IL 60061, US

(51) MKP
A61K 31/444 (2006.01) (97) **2739616 ***
A61K 31/497 (2006.01)
A61K 31/506 (2006.01)
A61P 11/06 (2006.01)
A61P 35/02 (2006.01)
A61P 37/06 (2006.01)
C07D 401/12 (2006.01)
C07D 401/14 (2006.01)
(86) EP2012064426 23.07.2012
(96) 12737308.2 11.06.2014
(87) WO2013017461, 23.07.2012
(97) 2739616, 11.06.2014 en
(54) PYRIDIN-2(1H)-ONE DERIVATIVES AS JAK INHIBITORS
(71) Almirall, S.A., Ronda del General Mitre 151, 08022 Barcelona, ES
(72) EASTWOOD, Paul Robert, C/ Laureà Miró 408-410, E-08980 Sant Feliu de Llobregat (Barcelona), ES
BACH TAÑA, Jordi, C/ Laureà Miró 408-410, E-08980 Sant Feliu de Llobregat (Barcelona), ES
PAGES SANTACANA, Lluís Miquel, C/ Laureà Miró 408-410, E-08980 Sant Feliu de Llobregat (Barcelona), ES

(51) MKP
A61K 39/395 (2006.01) (97) **2721065 ***
A61P 3/06 (2006.01)
C07K 16/22 (2006.01)
(86) US2012042338 14.06.2012
(96) 12727767.1 23.04.2014
(87) WO2012174178, 14.06.2012
(97) 2721065, 23.04.2014 en
(54) ANTI-ANGPTL3 ANTIBODIES AND USES THEREOF
(71) Regeneron Pharmaceuticals, Inc., 777 Old Saw Mill River Road, Tarrytown, NY 10591, US
(72) SLEEMAN, Mark, W., 2 Albert Place, Richmond, Victoria 3121, AU
GUSAROVA, Viktoria, 131 Sky Top Drive, Pleasantville, NY 10570, US
MURPHY, Andrew, J., 10 Newton Court, Croton-on-Hudson, NY 10520, US

(51) MKP
G06F 19/00 (2011.01) (97) **2721543 ***
(86) US2013057546 30.08.2013
(96) 13756800.2 23.04.2014
(87) WO2014042899, 30.08.2013
(97) 2721543, 23.04.2014 en
(54) SYSTEMS AND METHODS FOR ESTIMATING BLOOD FLOW CHARACTERISTICS FROM VESSEL GEOMETRY AND PHYSIOLOGY
(71) HeartFlow, Inc., 1400 Seaport Boulevard Building B, Redwood City, CA 94063, US
(72) GRADY, Leo, 1329 Lasuen Drive, Millbrae, CA 94030, US
CHOI, Gilwoo, 105 Pacchette Way, Mountain View, CA 94040, US
SINGER, Michael, 1100 Ralston Avenue, No. 404, Belmont, CA 94002, US

(51) MKP
A61P 35/00 (2006.01) (97) **2702155 ***
C12N 15/113 (2010.01)
(86) US2012034880 25.04.2012
(96) 12718549.4 05.03.2014
(87) WO2012148952, 25.04.2012
(97) 2702155, 05.03.2014 en
(54) MICRORNA COMPOUNDS AND METHODS FOR MODULATING MIR-21 ACTIVITY
(71) Regulus Therapeutics Inc, 3545 John Hopkins Court, Suite 210, San Diego CA 92121, US
(72) BHAT, Balkrishen, 3545 Johns Hopkins Court, San Diego California 92121, US

(51) MKP
B01J 20/04 (2006.01) (97) **2732872**
B01J 20/28 (2006.01)
C02F 1/28 (2006.01)
C02F 101/10 (2006.01)
C02F 103/00 (2006.01)
(96) 12461559.2 21.05.2014
(97) 2732872, 21.05.2014 en
(54) Method of producing agent for removing dissolved phosphorus compounds from water and agent for removing dissolved phosphorus compounds from water
(71) Zachodniopomorski Uniwersytet Technologiczny w Szczecinie, Aleja Piastów 17, 70-310 Szczecin, PL
(72) Siwek, Hanna, Zachodniopomorski Uniwersytet Technologiczny w Szczecinie Sieradzka 2b, 70-736 Szczecin, PL
W odarczyk, Ma gorzata, Zachodniopomorski Uniwersytet Technologiczny w Szczecinie wirki i Wigury 18/3, 71-176 Szczecin, PL
Bartkowiak, Artur, Zachodniopomorski Uniwersytet Technologiczny w Szczecinie Ksi cia Warcis awa I 26A/11, 71-667 Szczecin, PL
Sobecka, Katarzyna, Zachodniopomorski Uniwersytet Technologiczny w Szczecinie Poprzeczna 11, 71-742 Szczecin, PL

- (51) MKP
A61K 31/16 (2006.01) (97) **2752404**
A61P 11/00 (2006.01)
A61P 37/00 (2006.01)
C07C 237/14 (2006.01)
C07D 233/58 (2006.01)
(96) 14162956.8 09.07.2014
(97) 2752404, 09.07.2014 en
(54) Cysteine protease inhibitors
(71) Medivir UK Ltd, The Mansion Chesterford Research Park, Little Chesterford Essex CB10 1XL, GB
(72) AYESA, Susana, Medivir AB Lunastigen 7, S-141 22 Huddinge, SE
GRABOWSKA, Urszula, Medivir AB Lunastigen 7, S-141 22 Huddinge, SE
HEWITT, Ellen, Medivir AB Lunastigen 7, S-141 22 Huddinge, SE
JÖNSSON, Daniel, Medivir AB Lunastigen 7, S-141 22 Huddinge, SE
WIKTELIUS, Daniel, Medivir AB Lunastigen 7, S-141 22 Huddinge, SE
KLASSON, Bjorn, Medivir AB Lunastigen 7, S-141 22 Huddinge, SE
KAHNBERG, Pia, Medivir AB Lunastigen 7, S-141 22 Huddinge, SE
LUNDGREN, Stina, Medivir AB Lunastigen 7, S-141 22 Huddinge, SE
TEJBRANT, Jan, Medivir AB Lunastigen 7, S-141 22 Huddinge, SE

- (51) MKP
A61K 31/122 (2006.01) (97) **2701698 ***
A61K 31/185 (2006.01)
A61K 31/20 (2006.01)
A61K 31/201 (2006.01)
A61P 1/00 (2006.01)
A61P 1/16 (2006.01)
(86) US2012034835 24.04.2012
(96) 12777440.4 05.03.2014
(87) WO2012148929, 24.04.2012
(97) 2701698, 05.03.2014 en
(54) DISORDERS IMPLICATING PUFA OXIDATION
(71) Retrotope, Inc., 12133 Foothill Lane, Los Altos Hills, CA 94022-3319, US
(72) SHCHEPINOV, Mikhail, Sergeevich, 63 Barnfield Avenue, Kingston Upon Thames Surrey KT2 5RG, GB

- (51) MKP
A61K 31/421 (2006.01) (97) **2739615 ***
A61K 31/427 (2006.01)
A61K 31/437 (2006.01)
A61K 31/4439 (2006.01)
A61P 25/18 (2006.01)
A61P 25/28 (2006.01)
C07D 401/04 (2006.01)
C07D 403/04 (2006.01)
C07D 413/04 (2006.01)
C07D 413/14 (2006.01)
C07D 417/04 (2006.01)
C07D 471/04 (2006.01)
(86) EP2012065140 02.08.2012
(96) 12741022.3 11.06.2014
(87) WO2013017657, 02.08.2012
(97) 2739615, 11.06.2014 en
(54) PHENYL-3-AZA-BICYCLO[3.1.0]HEX-3-YL-METHANONES AND THE USE THEREOF AS MEDICAMENT
(71) Boehringer Ingelheim International GmbH, Binger Strasse 173, 55216 Ingelheim am Rhein, DE
(72) GIOVANNINI, Riccardo, Boehringer Ingelheim GmbH Corporate Patents Binger Str. 173, 55216 Ingelheim Am Rhein, DE
BERTANI, Barbara, Boehringer Ingelheim GmbH Corporate Patents Binger Str. 173, 55216 Ingelheim Am Rhein, DE
FERRARA, Marco, Boehringer Ingelheim GmbH Corporate Patents Binger Str. 173, 55216 Ingelheim Am Rhein, DE
LINGARD, Iain, Boehringer Ingelheim GmbH Corporate Patents Binger Str. 173, 55216 Ingelheim Am Rhein, DE
MAZZAFERRO, Rocco, Boehringer Ingelheim GmbH Corporate Patents Binger Str. 173, 55216 Ingelheim Am Rhein, DE
ROSENBROCK, Holger, Boehringer Ingelheim GmbH Corporate Patents Binger Str. 173, 55216 Ingelheim Am Rhein, DE

- (51) MKP
A23L 1/054 (2006.01) (97) **2653494**
A23L 2/52 (2006.01)
C08L 5/00 (2006.01)
(96) 12002784.2 23.10.2013
(97) 2653494, 23.10.2013 en
(54) Aqueous gellan dispersion
(71) Rudolf Wild GmbH & Co. KG, Rudolf-Wild-Strasse 107-115, 69214 Eppelheim, DE
(72) Heidebach Thomas, Lutherstr. 44b, 69120 Heidelberg, DE
Sattler Robert, Gartenstr. 35, 68723 Oftersheim, DE
Chatard Dominique, Rollossweg 37, 69121 Heidelberg, DE
Sass Matthias, Ernst-Barlach-Str. 103, 68723 Oftersheim, DE
De With Axel, Friedrichstrasse 14, 68723 Plankstadt, DE

- (51) MKP
B32B 9/00 (2006.01) (97) **2687364**
(96) 13177049.7 22.01.2014
(97) 2687364, 22.01.2014 en
(54) Composite conductive sheet, fabricating method and application thereof
(71) AVIC Composites Company Limited, AVIC international Industry & Trade Park Shuanghe Street Shunyi District, Beijing 101300, CN
AVIC Beijing Institute of Aeronautical Materials, Taizhouwu, Haidian District, 100095 Beijing, CN
(72) Yi, Xiaosu, AVIC Beijing Institute of Aeronautical Materials, Taizhouwu, Haidian District, 100095 BEIJING, CN
Guo, Miaocai, AVIC Beijing Institute of Aeronautical Materials, Taizhouwu, Haidian District, 100095 BEIJING, CN
Liu, Gang, AVIC Beijing Institute of Aeronautical Materials, Taizhouwu, Haidian District, 100095 BEIJING, CN
Zhao, Wenming, AVIC Beijing Institute of Aeronautical Materials, Taizhouwu, Haidian District, 100095 BEIJING, CN
Liu, Lipeng, AVIC Beijing Institute of Aeronautical Materials, Taizhouwu, Haidian District, 100095 BEIJING, CN
Cui, Haichao, AVIC Beijing Institute of Aeronautical Materials, Taizhouwu, Haidian District, 100095 BEIJING, CN

- (51) MKP
A61K 31/4725 (2006.01) (97) **2729461 ***
A61P 3/00 (2006.01)
A61P 9/00 (2006.01)
A61P 11/00 (2006.01)
C07D 401/12 (2006.01)
(86) EP2012062444 27.06.2012
(96) 12730525.8 14.05.2014
(87) WO2013007519, 27.06.2012
(97) 2729461, 14.05.2014 en
(54) POLYMORPHS OF 6-(PIPERIDIN-4-YLOXY)-2H-ISOQUINOLIN-1-ONE HYDROCHLORIDE
(71) SANOFI, 54 rue La Boétie, 75008 Paris, FR
(72) NAGEL, Norbert, Flughafenstrasse 50, 64546 M.-Walldorf, DE
BAUMGARTNER, Bruno, Roßdörfer Str. 22, 64287 Darmstadt, DE
BERCHTOLD, Harald, Oberhöchstädterstrasse 31a, 61476 Kronberg, DE
PLETTENBURG, Oliver, Hauptstrasse 36, 65779 Kelkheim, DE
KADEREIT, Dieter, Freiherr-vom-Stein-Strasse 3, 63071 Offenbach, DE
MOHNICKE, Mandy, Hauptstrasse 75a, 09661 Rossau, DE
GESSLER, Simon, August-Bebel-Str. 79, 68199 Mannheim, DE
TILLNER, Joachim, Von der Höhe 15, 61381 Friedrichsdorf, DE

- (51) MKP
F41G 3/04 (2006.01) (97) **2748555 ***
F41G 3/26 (2006.01)
F41G 3/32 (2006.01)
F41G 9/00 (2006.01)
G06Q 10/06 (2012.01)
(86) IB2013052367 25.03.2013
(96) 13721407.8 02.07.2014
(87) WO2013153471, 25.03.2013
(97) 2748555, 02.07.2014 en
(54) A TEST AND ANALYSIS SYSTEM AND A METHOD FOR THREAT EVALUATION AND SENSOR/WEAPON ASSIGNMENT ALGORITHMS
(71) Aselsan Elektronik Sanayi ve Ticaret Anonim Sirketi, Mehmet Akif Ersoy Mahallesi 296.cadde, No: 16, Yenimahalle, 06370 Ankara, TR
(72) YUKSEL ERGUN, Inci, Aselsan Elektronik Sanayi ve Ticaret Anonim Sirketi Mehmet Akif Ersoy Mahallesi 296. Cadde No:16 Yenimahalle, 06370 Ankara, TR

- (51) MKP
E21B 17/00 (2006.01) (97) **2721247 ***
E21B 29/00 (2006.01)
E21B 34/14 (2006.01)
E21B 43/12 (2006.01)
(86) CA2012050412 20.06.2012
(96) 12803334.7 23.04.2014
(87) WO2012174662, 20.06.2012
(97) 2721247, 23.04.2014 en
(54) KOBE SUB WITH INFLOW CONTROL, WELLBORE TUBING STRING AND METHOD
(71) Packers Plus Energy Services Inc., Bow Valley Square 2 Suite 2200, 205 - 5 Avenue SW, Calgary, Alberta T2P 2V7, CA
(72) THEMIG, Daniel Jon, 256 Woodhaven Place SW, Calgary, Alberta T2W 5P9, CA
COON, Robert, Joe, 8606 Hall Retreat CT, Missouri City, Texas 77459, US

- (51) MKP
C02F 3/00 (2006.01) (97) **2707334 ***
C02F 3/06 (2006.01)
C02F 3/12 (2006.01)
C02F 3/22 (2006.01)
(86) SK2012050009 10.05.2012
(96) 12730065.5 19.03.2014
(87) WO2012154135, 10.05.2012
(97) 2707334, 19.03.2014 en
(54) BIOLOGICAL TREATMENT PROCESS AND INSTALLATION INCLUDING AIR-LIFT AND POST -TREATMENT IN FILTER
(71) Penzes, Ladislav, Bac 57, Bac 930 30, SK
Csefalvay, Juraj, Zahradnicka 30, 900 44 Tomasov, SK
(72) Penzes, Ladislav, Bac 57, Bac 930 30, SK
Csefalvay, Juraj, Zahradnicka 30, 900 44 Tomasov, SK

- (51) MKP
A61K 31/138 (2006.01) (97) **2753322 ***
A61K 31/343 (2006.01)
A61K 31/704 (2006.01)
A61K 33/24 (2006.01)
A61P 35/00 (2006.01)
(86) FR2012052004 07.09.2012
(96) 12769146.7 16.07.2014
(87) WO2013034863, 07.09.2012
(97) 2753322, 16.07.2014 fr
(54) SCHEME FOR ADMINISTERING N-HYDROXY-4-[2-[3-(N,N-DIMETHYLAMINOMETHYL)BENZOFURAN-2-YLCARBONYLAMINO]ETHOXY]BENZAMIDE
(71) Les Laboratoires Servier, 35, rue de Verdun, 92284 Suresnes Cedex, FR
Pharmacyclics, Inc., 995 East Arques Avenue, Sunnyvale, CA 94085, US
(72) KLOOS, Ioana, 53 Bd Richelieu, F-92500 Rueil Malmaison, FR
ROBERT, Renata, 15 rue Gabriel Philippe, F-92150 Suresnes, FR
JACQUET-BESCOND, Anne, 9 rue du Carreau, F-92350 Le Plessis Robinson, FR
DEPIL, Stéphane, 14 rue Maurice Berteaux, F-92130 Issy les Moulineaux, FR
CHENEL, Marylore, 21, rue du Départ, F-75014 Paris, FR
FOULIARD, Sylvain, 27 rue Lemercier, F-75017 Paris, FR
BALASUBRAMANIAN, Sriram, 1623 Howard Ave., San Carlos, California 94070, US

- (51) MKP
C07K 16/24 (2006.01) (97) **2753937 ***
C12N 5/10 (2006.01)
G01N 33/68 (2006.01)
(86) EP2012069602 04.10.2012
(96) 12770473.2 16.07.2014
(87) WO2013050457, 04.10.2012
(97) 2753937, 16.07.2014 en
(54) CHARACTERIZATION OF CHO-MIF GENE AND PROTEIN, AND USE THEREOF
(71) Baxter Healthcare SA, Thurgauerstrasse 130, 8152 Glattpark (Opfikon), CH
Baxter International Inc, One Baxter Parkway, Deerfield, IL 60015, US
(72) KERSCHBAUMER, Randolf, J., Hoehenstrasse 19a, A-3400 Klosterneuburg, AT
VOELKEL, Dirk, Stadlbreitener Anger 17, A-1220 Wien, AT
ANTOINE, Gerhard, Holunderweg 11, A-2301 Groß-Enzersdorf, AT
SCHEIFLINGER, Friedrich, Michelbeuerngasse 4/17, A-1090 Wien, AT
MUDDER, C. Geert, Hochmayrstrasse 31, A-2384 Breitenfurt, AT

- (51) MKP
A01N 37/44 (2006.01) (97) **2714669 ***
C07D 249/12 (2006.01)
C07D 285/24 (2006.01)
(86) US2012039011 22.05.2012
(96) 12789268.5 09.04.2014
(87) WO2012162323, 22.05.2012
(97) 2714669, 09.04.2014 en
(54) HYPERTENSION AND HYPERURICEMIA
(71) Ardea Biosciences, Inc., 4939 Directors Place, San Diego, CA 92121, US
(72) MINER, Jeffrey, 4572 Pauling Avenue, San Diego, CA 92122, US

- (51) MKP
G06F 3/14 (2006.01) (97) **2660711**
(96) 13166506.9 06.11.2013
(97) 2660711, 06.11.2013 en
(54) Presentation system, receiver device, methods thereof, and computer-readable medium thereof
(71) Awind Inc., 17F., No.866-5, Zhongzheng Rd. Zhonghe Dist., 235 New Taipei City, TW
(72) Chang, Kuo-Lung, 17F., No.866-5, Zhongzheng Rd., Zhonghe Dist., 235 New Taipei City, TW
Fan, Jr-Rong, 17F., No.866-5, Zhongzheng Rd., Zhonghe Dist., 235 New Taipei City, TW
Tu, Ping-Yang, 17F., No.866-5, Zhongzheng Rd., Zhonghe Dist., 235 New Taipei City, TW
Wang, Hsing-Yung, 17F., No.866-5, Zhongzheng Rd., Zhonghe Dist., 235 New Taipei City, TW

- (51) MKP
A61K 31/519 (2006.01) (97) **2758402 ***
A61P 35/00 (2006.01)
C07D 487/04 (2006.01)
- (86) IB2012054702 10.09.2012
(96) 12780286.6 30.07.2014
(87) WO2013042006, 10.09.2012
(97) 2758402, 30.07.2014 en
(54) PYRROLOPYRIMIDINE AND PURINE DERIVATIVES
(71) Pfizer Inc, 235 East 42nd Street, New York, NY 10017, US
(72) CHENG, Hengmiao, 16213 Cayenne Ridge Road, San Diego California 92127, US
JOHNSON JR., Theodore Otto, 3612 Torrey View Court, San Diego California 92130, US
KATH, John Charles, 4168 Eastridge, La Mesa California 91941, US
LIU, Kevin Kun-Chin, Unit 101 Block No. 81 Lane 188 Mingyue Road PuDong, Shanghai 200135, CN
LUNNEY, Elizabeth Ann, 4205 Calle Mejillones, San Diego California 92130, US
NAGATA, Asako, 7335 Rock Canyon Drive, San Diego California 92126, US
NAIR, Sajiv Krishnan, 1923 White Birch Drive, Vista California 92081, US
PLANKEN, Simon Paul, c/o Pfizer Inc. 10555 Science Center Drive, San Diego, California 92121, US
SUTTON, Scott Channing, 11660 Weatherwood Place, San Diego, California 92131, US
-
- (51) MKP
A61K 31/506 (2006.01) (97) **2731945 ***
C07C 69/92 (2006.01)
C07D 205/04 (2006.01)
C07D 317/20 (2006.01)
C07D 317/24 (2006.01)
C07D 403/12 (2006.01)
- (86) GB2012051620 10.07.2012
(96) 12735323.3 21.05.2014
(87) WO2013008002, 10.07.2012
(97) 2731945, 21.05.2014 en
(54) N- (6- ((2R,3S) -3,4-DIHYDROXYBUTAN-2-YLOXY) -2- (4 - FLUOROBENZYLTHIO) PYRIMIDIN- 4 - YL) -3- METHYLAZETIDINE- 1 - SULFONAMIDE AS CHEMOKINE RECEPTOR MODULATOR
(71) AstraZeneca AB, null, 151 85 Södertälje, SE
(72) CONNOLLY, Stephen, c/o AstraZeneca Intellectual Property AstraZeneca R&D Alderley Alderley Park, Macclesfield, Cheshire SK10 4GT, GB
EBDEN, Mark, Richard, C/o AstraZeneca Intellectual Property AstraZeneca R&D Alderley Alderley Park, Macclesfield Cheshire SK10 4TG, GB
LANGER, Thomas, AstraZeneca Charter Way, Macclesfield Cheshire SK10 2NA, GB
STEVEN, Alan, Robert, AstraZeneca Charter Way, Macclesfield Cheshire SK10 2NA, GB
STEWART, Craig, Robert, AstraZeneca Charter Way, Macclesfield Cheshire SK10 2NA, GB
TOMLIN, Paula, Margaret, AstraZeneca Charter Way, Macclesfield Cheshire SK10 2NA, GB
WALTERS, Iain, Alastair, Stewart, C/o AstraZeneca Intellectual Property AstraZeneca R&D Alderley Alderley Park, Macclesfield Cheshire SK10 4TG, GB
WILLIAMS, Andrew, John, AstraZeneca Alderley Park, Macclesfield Cheshire SK10 4TG, GB
-
- (51) MKP
G01N 21/65 (2006.01) (97) **2748588 ***
G01N 33/483 (2006.01)
- (86) US2012051766 21.08.2012
(96) 12825347.3 02.07.2014
(87) WO2013028706, 21.08.2012
(97) 2748588, 02.07.2014 en
(54) RAPID DETECTION OF METABOLIC ACTIVITY
(71) Spectral Platforms, Inc., 5652 Stardust Road, La Canada, CA 91011, US
(72) VERMA, Ravi, Kant, 5652 Stardust Road, La Canada, CA 91011, US
IBRAHIM, Ashraf, Samir, 2 Conifer, Irvine, CA 92620, US
ZANGWILL, Kenneth, Matthew, 2006 Marengo Avenue, South Pasadena, CA 91030, US
-
- (51) MKP
A01N 43/16 (2006.01) (97) **2717692 ***
A61K 31/35 (2006.01)
- (86) US2012040380 01.06.2012
(96) 12796691.9 16.04.2014
(87) WO2012170290, 01.06.2012
(97) 2717692, 16.04.2014 en
(54) METHODS OF TREATING FIBROTIC DISEASES USING TETRAHYDROCANNABINOL-11-OIC ACIDS
(71) JB Therapeutics, Inc., 508 Dudley Road, Newton, MA 02459, US
(72) ZURIER, Robert, B., 303 Martom Road, Wyckoff, NJ 07481, US
SELVI, Enrico, Loc. Promona 39 Strada Chiantigiana 222, I-53011 Castellina in Chianti-Siena, IT
-
- (51) MKP
A61K 31/4965 (2006.01) (97) **2723722 ***
A61P 11/00 (2006.01)
C07D 239/48 (2006.01)
- (86) US2012044272 26.06.2012
(96) 12733368.0 30.04.2014
(87) WO2013003386, 26.06.2012
(97) 2723722, 30.04.2014 en
(54) 3,5-DIAMINO-6-CHLORO-N-(N-(4-(4-(2-(HEXYL (2,3,4,5,6-PENTAHYDROXYHEXYL) AMINO) ETHOXY) PHENYL) BUTYL) CARBAMIMIDOYL) PYRAZINE-2-CARBOXAMIDE
(71) Parion Sciences, Inc., 2525 Meridian Parkway Suite 260, Durham, NC 27713, US
(72) JOHNSON, Michael, R., c/o Gilead Sciences Inc. 333 Lakeside Drive, Foster City, CA 94404, US
-
- (51) MKP
B60K 6/10 (2006.01) (97) **2766587 ***
B60K 25/00 (2006.01)
F02B 67/06 (2006.01)
- (86) US2012052696 28.08.2012
(96) 12756611.5 20.08.2014
(87) WO2013048655, 28.08.2012
(97) 2766587, 20.08.2014 en
(54) FLYWHEEL HYBRID SYSTEM
(71) THE GATES CORPORATION, 1551 Wewetta Street, Denver, CO 80202, US
(72) SERKH, Alexander, 316 Falling Brook Drive, Troy, MI 48098, US
ALI, Imtiaz, 28441 Eldorado Place, Lathrup Village, MI 48076, US
-
- (51) MKP
H01C 7/12 (2006.01) (97) **2677524**
H01T 1/16 (2006.01)
- (96) 12177955.7 25.12.2013
(97) 2677524, 25.12.2013 en
(54) Overvoltage protection devices including a varistor member and an electrical conductive fusing member
(71) Raycap Intellectual Property, Ltd., 66 Akropoleos Avenue, 2012 Strovolos, Nicosia, CY
(72) Xepapas, Fotis, 17, Athinas Str. Drama, 66100 Drama, GR
Giannelaki, Evaggelia, 2, Vassileos Irakliou Str. Drama, 66100 Drama, GR
Kostakis, Gregoris, 31, Spartis Str. Kallithea, 17673 Athens, GR
Politiis, Zafiris, 5, 25th Martiou Str. St. Stefanos, 14565 Athens, GR
Samaras, Kostas, 3, Ritsou Str. Voula, 16673 Athens, GR
-
- (51) MKP
A01G 9/14 (2006.01) (97) **2327295**
- (96) 10013669.6 01.06.2011
(97) 2327295, 01.06.2011 de
(54) Greenhouse
(71) Sapa Building System GmbH, Anna-Schlinkheider-Strasse 7b, 40878 Ratingen, DE
(72) Erstling, Erich, Äckern Nr. 7, D-45549 Sprockhövel, DE
Gansen, Klaus Dieter, Honsbergerstrasse 120, D-42857 Remscheid, DE

- (51) MKP
A63H 33/08 (2006.01) (97) **2734682 ***
E01C 5/00 (2006.01)
E04C 1/00 (2006.01)
(86) HU2011000092 12.09.2011
(96) 11824642.0 28.05.2014
(87) WO2012035365, 12.09.2011
(97) 2734682, 28.05.2014 en
(54) INTERLOCKING BUILDING BLOCK, PAVING UNIT, TILE OR TOY ELEMENT AND THE CONSTRUCTION METHOD THEREOF
(71) Bálint, Adám, Keleti Károly utca 31/B., 1024 Budapest, HU
(72) Bálint, Adám, Keleti Károly utca 31/B., 1024 Budapest, HU

- (51) MKP
A61K 31/44 (2006.01) (97) **2760838 ***
A61P 11/00 (2006.01)
C07D 213/69 (2006.01)
C07D 213/89 (2006.01)
(86) EP2012067954 13.09.2012
(96) 12770435.1 06.08.2014
(87) WO2013045280, 13.09.2012
(97) 2760838, 06.08.2014 en
(54) DERIVATIVES OF 1-PHENYL-2-PYRIDINYL ALKYL ALCOHOLS AS PHOSPHODIESTERASE INHIBITORS
(71) Chiesi Farmaceutici S.p.A., Via Palermo, 26/A, 43100 Parma, IT
(72) ARMANI, Elisabetta, Chiesi Farmaceutici S.p.A. Via Palermo 26/A, 43100 Parma, IT
AMARI, Gabriele, Chiesi Farmaceutici S.p.A. Via Palermo 26/A, 43100 Parma, IT
CAPALDI, Carmelida, Chiesi Farmaceutici S.p.A. Via Palermo 26/A, 43100 Parma, IT
ESPOSITO, Oriana, Chiesi Farmaceutici S.p.A. Via Palermo 26/A, 43100 Parma, IT
PERETTO, Ilaria, Chiesi Farmaceutici S.p.A. Via Palermo 26/A, 43100 Parma, IT

- (51) MKP
G01N 21/64 (2006.01) (97) **2769204 ***
G01N 33/542 (2006.01)
G01N 33/569 (2006.01)
(86) US2013039350 02.05.2013
(96) 13730385.5 27.08.2014
(87) WO2013166338, 02.05.2013
(97) 2769204, 27.08.2014 en
(54) CELL CAPTURE SYSTEM AND USE THEREOF
(71) Charles River Laboratories, Inc., 251 Ballardvale Street, Wilmington, MA 01887-1000, US
REAMATRIX INC., 1585 Industrial Road, San Carlos, CA 94070, US
(72) WAINWRIGHT, Norman, R., 44 Cotton Hall, Johns Island, SC 29455, US
MANIAN, Bala, S., 14240 Berry Hill Court, Los Altos Hills, CA, US
STIMPSON, Eric, 902 Lansfaire Drive, Charleston, SC 29414, US
KOLONIA, Brian, J., 824 South Cottonwood Road, Walnutport, PA 18088, US
KOLONIA, Robert, K., 230 Andersen Road, Milford, NJ 08848, US

- (51) MKP
A61K 31/53 (2006.01) (97) **2726482 ***
A61P 27/00 (2006.01)
C07D 487/04 (2006.01)
(86) EP2012062366 26.06.2012
(96) 12730515.9 07.05.2014
(87) WO2013004551, 26.06.2012
(97) 2726482, 07.05.2014 en
(54) HYDROXYMETHYLARYL-SUBSTITUTED PYRROLOTRIAZINES AS ALK1 INHIBITORS
(71) Bayer Intellectual Property GmbH, Alfred-Nobel-Strasse 10, 40789 Monheim, DE
Bayer Pharma Aktiengesellschaft, Müllerstrasse 178, 13353 Berlin, DE
(72) KLAR, Jürgen, Mozartstrasse 48, 42115 Wuppertal, DE
VOEHRINGER, Verena, Fischergasse 17, 88364 Wolfegg, DE
TELSER, Joachim, Krummacherstrasse 127, 42115 Wuppertal, DE
LOBELL, Mario, Am Eigenbach 16, 42113 Wuppertal, DE
SÜßMEIER, Frank, Baubergerstrasse 5, 80992 München, DE
LI, Volkhart Min-Jian, Im Wiesengrund 40, 42553 Velbert, DE
BÖTTGER, Michael, Hainstr. 115, 42109 Wuppertal, DE
GOLZ, Stefan, Sperlingstrasse 17, 45472 Mülheim an der Ruhr, DE
LANG, Dieter, Wimmersberger Strasse 60, 42553 Velbert, DE
SCHLEMMER, Karl-Heinz, Wildsteig 22 a, 42113 Wuppertal, DE
SCHLANGE, Thomas, Dinkelweg 14, 42781 Haan, DE
SCHALL, Andreas, Wettinerstr. 4a, 42287 Wuppertal, DE
FU, Wenlang, 609 Sun Valley Way, Florham Park, New Jersey NJ 07932, US

- (51) MKP
H02H 3/08 (2006.01) (97) **2764593 ***
H02H 9/02 (2006.01)
(86) US2012054037 06.09.2012
(96) 12829628.2 13.08.2014
(87) WO2013036696, 06.09.2012
(97) 2764593, 13.08.2014 en
(54) MOTOR PROTECTION AND CONTROL APPARATUS, SYSTEM, AND/OR METHOD
(71) Franklin Control Systems, Inc., 22995 NW Evergreen Pkwy, Hillsboro, OR 97124, US
(72) PERRA, Andre, Pierre, 17050 NW Skyline Blvd., Portland, OR 97231, US
HOLCE, Kent, Jeffrey, 8445 NW Tuality Way, Portland, OR 97229, US
LEONARD, Scott, E., 949 NW Overton Unit 705, Portland, OR 97209, US

- (51) MKP
B01D 53/56 (2006.01) (97) **2704817 ***
(86) IB2011003106 02.12.2011
(96) 11815779.1 12.03.2014
(87) WO2012168758, 02.12.2011
(97) 2704817, 12.03.2014 en
(54) PROCESS AND APPARATUS FOR REDUCING THE CONTENT OF NITROGEN OXIDES
(71) Mehdau & Steinfath Umwelttechnik GmbH, Alfredstrasse 279, 45133 Essen, DE
Von Der Heide, Bernd, Graf-Spee-Strasse 5, 45133 Essen, DE
(72) VON DER HEIDE, Bernd, Graf-Spee-Strasse 5, D-45133 Essen, DE

- (51) MKP
F25B 3/00 (2006.01) (97) **2734793 ***
(86) US2012047005 17.07.2012
(96) 12815548.8 28.05.2014
(87) WO2013012836, 17.07.2012
(97) 2734793, 28.05.2014 en
(54) ASSEMBLY AND METHOD OF ATTACHING STUB SHAFT TO DRUM OF AXIAL COMPRESSOR ROTOR SHAFT
(71) Elliott Company, 901 North Fourth Street, Jeannette, PA 15644, US
(72) WATSON, Andrew, Paul, 1010 Pheasant Lane, Export Pennsylvania 15632, US

(51) MKP
A61K 31/4468 (2006.01) (97) **2648754 ***
A61K 31/451 (2006.01)
A61K 31/4985 (2006.01)
A61K 31/7088 (2006.01)
A61K 39/395 (2006.01)
A61P 35/04 (2006.01)
C07D 487/04 (2006.01)
C07K 16/24 (2006.01)
C07K 16/28 (2006.01)
(86) US2011063533 06.12.2011
(96) 11847605.0 16.10.2013
(87) WO2012078633, 06.12.2011
(97) 2648754, 16.10.2013 en
(54) METHODS OF INHIBITING METASTASIS FROM CANCER
(71) Philadelphia Health and Education Corporation D/B/A,
Drexel University College Of Medicine 245 N. 15th Street,
Philadelphia, PA 19102, US
Alliance Discovery, Inc., 3805 Old Easton Road, Doylestown,
PA 18902, US
(72) FATATIS, Alessandro, 1140 N. Woodbine Avenue, Penn Valley,
PA 19072, US
SALVINO, Joseph, M., 324 Welsh Circle, Chester Springs, PA
19425, US
MEUCCI, Olimpia, 1140 N. Woodbine Avenue, Penn Valley, PA
19072, US
JAMIESON, Whitney, L., 406 S. Elmwood Avenue, Glenolden,
PA 19036, US

(51) MKP
A61K 48/00 (2006.01) (97) **2763701 ***
C07H 21/02 (2006.01)
C07H 21/04 (2006.01)
(86) US2012058519 03.10.2012
(96) 12838676.0 13.08.2014
(87) WO2013052523, 03.10.2012
(97) 2763701, 13.08.2014 en
(54) MODIFIED NUCLEOSIDES, NUCLEOTIDES, AND NUCLEIC
ACIDS, AND USES THEREOF
(71) Moderna Therapeutics, Inc., 200 Technology Square,
Cambridge, MA 02139, US
(72) DE FOUGEROLLES, Antonin, 66 Summit Avenue, Brookline,
MA 02446, US
ROY, Atanu, 115 Hill Street, nr. 9., Stoneham, MA 02180, US
SCHRUM, Jason P., 20 Watertown St., Unit 129., Watertown
MA 02472-2580, US
SIDDIQI, Suhaib, 37 University Avenue, Burlington, MA 01803,
US
HATALA, Paul, 26 Monument Street, nr. 1, Charlestown, MA
02124, US
BANCEL, Stephane, 200 Technology Square, Boston, MA
02139, US

(51) MKP
C07K 1/18 (2006.01) (97) **2748180 ***
C12N 9/64 (2006.01)
(86) EP2012070259 12.10.2012
(96) 12770497.1 02.07.2014
(87) WO2013053888, 12.10.2012
(97) 2748180, 02.07.2014 en
(54) PROTEIN PURIFICATION BY ANION EXCHANGE
CHROMATOGRAPHY
(71) Baxter International Inc, One Baxter Parkway, Deerfield, IL
60015, US
Baxter Healthcare SA, Thurgauerstrasse 130, 8152 Glattpark
(Opfikon), CH
(72) MITTERER, Artur, Schwarzeckerweg 10, 2304 Orth/Donau, AT
HASSLACHER, Meinhard, Vorgartenstrasse 221/1/7, 1020
Wien, AT
FIEDLER, Christian, Raaberbahngasse 18/36, 1100 Wien, AT

(51) MKP
H03M 1/12 (2006.01) (97) **2751927 ***
H03M 1/66 (2006.01)
(86) US2012038829 21.05.2012
(96) 12788810.5 09.07.2014
(87) WO2012162236, 21.05.2012
(97) 2751927, 09.07.2014 en
(54) METHOD AND APPARATUS FOR PERFORMING DATA
CONVERSION WITH NON-UNIFORM QUANTIZATION
(71) Texas Instruments Incorporated, P.O. Box 655474 Mail Station
3999, Dallas, TX 75265-5474, US
(72) REDFERN, Arthur, J., 3448 Grand Mesa Drive, Plano, TX
75025, US
SATARZADEH, Patrick, 15695 Spectrum Drive 2402, Addison,
TX 75001, US

(51) MKP
A61Q 5/12 (2006.01) (97) **2720755 ***
(86) US2012042993 18.06.2012
(96) 12803202.6 23.04.2014
(87) WO2012177560, 18.06.2012
(97) 2720755, 23.04.2014 en
(54) COMPOSITIONS FOR DEPOSITING AGENTS USING
HIGHLY VOLATILE SILICONE SOLVENTS
(71) Thompson Cooper Laboratories, LLC, 612 Mann Road,
Horsham, Pennsylvania 19044, US
(72) COOPER, Eugene R, 2621 Crum Creek Drive, Berwyn,
Pennsylvania 19312, US
THOMPSON, Eric R, 612 Mann Road, Horsham, Pennsylvania
19044, US

(51) MKP
B23K 26/08 (2006.01) (97) **2674245**
B23K 37/02 (2006.01)
B23Q 1/48 (2006.01)
B26F 3/00 (2006.01)
(96) 12172142.7 18.12.2013
(97) 2674245, 18.12.2013 de
(54) Jet processing device
(71) Bystronic Laser AG, Industriestrasse 21, 3362 Niederönz, CH
Bossoni, Sergio, Hausacker 10, 8048 Zürich, CH
(72) Wüthrich, Matthias, Hinterbergweg 14, 4900 Langenthal, CH
Seiler, Thomas, Dohlenweg 30, 3661 Uetendorf, CH
Fink, Benjamin, Dorfstrasse 98, 4917 Melchnau, CH

(51) MKP
B24C 5/06 (2006.01) (97) **2650084**
(96) 13163341.4 16.10.2013
(97) 2650084, 16.10.2013 en
(54) Turbine
(71) Straaltechniek International N.V./S.A., Antwerpsesteenweg 100,
2630 Aartselaar, BE
(72) Naaijken, Geert-Jan Petrus, Dr. P.M. Hoekstraat 14, 5281 JZ
BOXTEL, NL

(51) MKP
B65B 43/30 (2006.01) (97) **2739535 ***
(86) EP2012065081 01.08.2012
(96) 12745667.1 11.06.2014
(87) WO2013017640, 01.08.2012
(97) 2739535, 11.06.2014 en
(54) METHOD AND APPARATUS FOR FEEDING TUBULAR
BLANKS TO A PACKAGING MACHINE
(71) I.M.A. Industria Macchine Automatiche S.p.A., Via Emilia no.
428-442, 40064 Ozzano dell'Emilia (BO), IT
(72) FERRETTI, Maurizio, 28 G/B Coastline Discovery Bay Lantao
Island, Hong Kong N. T., CN

- (51) MKP
C07C 405/00 (2006.01) (97) **2723714 ***
C07D 207/46 (2006.01)
C07D 209/48 (2006.01)
C07D 233/60 (2006.01)
C07D 307/935 (2006.01)
- (86) HU2012000045 25.05.2012
(96) 12730027.5 30.04.2014
(87) WO2012164324, 25.05.2012
(97) 2723714, 30.04.2014 en
(54) NOVEL PROCESSES FOR THE PREPARATION OF PROSTAGLANDIN AMIDES
(71) Chinoin Zrt., Tó u. 1-5., 1045 Budapest, HU
(72) HAVASI, Gábor, c/o Chinoin Gyógyszer és Vegyészeti Termékek Gyára Zrt. Iparjog Tó u. 1-5., 1045 Budapest, HU
KISS, Tibor, c/o Chinoin Gyógyszer és Vegyészeti Termékek Gyára Zrt. Iparjog Tó u. 1-5., 1045 Budapest, HU
HORTOBÁGYI, Irén, c/o Chinoin Gyógyszer és Vegyészeti Termékek Gyára Zrt. Iparjog Tó u. 1-5., 1045 Budapest, HU
KARDOS, Zsuzsanna, c/o Chinoin Gyógyszer és Vegyészeti Termékek Gyára Zrt. Iparjog Tó u. 1-5., 1045 Budapest, HU
LÁSZLÓFI, István, c/o Chinoin Gyógyszer és Vegyészeti Termékek Gyára Zrt. Iparjog Tó u. 1-5., 1045 Budapest, HU
BISCHOF, Zoltán, c/o Chinoin Gyógyszer és Vegyészeti Termékek Gyára Zrt. Iparjog Tó u. 1-5., 1045 Budapest, HU
BÓDIS, Ádám, c/o Chinoin Gyógyszer és Vegyészeti Termékek Gyára Zrt. Iparjog Tó u. 1-5., 1045 Budapest, HU

- (51) MKP
A61K 31/4412 (2006.01) (97) **2748146 ***
A61P 29/00 (2006.01)
C07D 213/89 (2006.01)
- (86) US2012047559 20.07.2012
(96) 12741219.5 02.07.2014
(87) WO2013016174, 20.07.2012
(97) 2748146, 02.07.2014 en
(54) A CRYSTALLINE FORM OF THE SODIUM SALT OF 4-TERT-BUTYL-N-[4-CHLORO-2-(1-OXY-PYRIDINE-4-CARBONYL)-PHENYL]-BENZENE SULFONAMIDE
(71) ChemoCentryx, Inc., 850 Maude Avenue, Mountain View California 94043, US
(72) PENNELL, Andrew, M.K., 442 Arlington Street, San Francisco, CA 94131, US
UNGASHE, Solomon, 36641 Reynolds Drive, Fremont, CA 94536, US

- (51) MKP
C03C 25/32 (2006.01) (97) **2736995 ***
C09J 105/00 (2006.01)
D06M 15/03 (2006.01)
- (86) FR2012051787 27.07.2012
(96) 12748747.8 04.06.2014
(87) WO2013014399, 27.07.2012
(97) 2736995, 04.06.2014 fr
(54) SIZING COMPOSITION FOR MINERAL WOOL BASED ON MALTITOL AND INSULATING PRODUCTS OBTAINED
(71) Saint-Gobain Isover, 18 Avenue d'Alsace, 92400 Courbevoie, FR
(72) JAFFRENNOU, Boris, 33 rue des Alouettes, F-75019 Paris, FR
OBERT, Edouard, 4 La Raizière, 60700 Fleurines, FR

- (51) MKP
B60J 7/06 (2006.01) (97) **2679423**
B60J 7/10 (2006.01)
F16B 21/18 (2006.01)
- (96) 13174134.0 01.01.2014
(97) 2679423, 01.01.2014 en
(54) Carriage for a roof of a trailer or truck
(71) Versus-Invest, Nijverheidslaan 1527A, 3660 Opglabbeek, BE
(72) Rogiers, Erik, Zwarteindestraat 78, 3850 Kozen, BE

- (51) MKP
A61K 31/47 (2006.01) (97) **2734503 ***
A61K 31/502 (2006.01)
A61P 3/10 (2006.01)
C07D 215/38 (2006.01)
C07D 239/94 (2006.01)
- (86) IB2012053575 12.07.2012
(96) 12750818.2 28.05.2014
(87) WO2013014569, 12.07.2012
(97) 2734503, 28.05.2014 en
(54) QUINOLINYL GLUCAGON RECEPTOR MODULATORS
(71) Pfizer Inc., 235 East 42nd Street, New York, NY 10017, US
(72) DIDIUK, Mary, 61 Hickory Lane, Madison, Connecticut 06443, US
FILIPSKI, Kevin J., 89 County Road, Reading, Massachusetts 01867, US
GUZMAN-PEREZ, Angel, 20 Gilmore Road, Belmont, Massachusetts 02478, US
LEE, Esther C., 58C Peabody Road, Shirley, Massachusetts 01464, US
PFEFFERKORN, Jeffrey A., 1 Nara Ridge Road, Acton, Massachusetts 01720, US
STEVENS, Benjamin, 100 Landsowne Street Apt. 4, Cambridge, Massachusetts 02139, US
TU, Meihua, 6 Henley Road, Acton, Massachusetts 01720, US

- (51) MKP
F16F 15/04 (2006.01) (97) **2722552 ***
- (86) JP2012003941 15.06.2012
(96) 12800446.2 23.04.2014
(87) WO2012172819, 15.06.2012
(97) 2722552, 23.04.2014 en
(54) METHOD FOR PREVENTING OVERTURN OF TRESTLE
(71) Sugita, Kikuo, 3 Mikage-cho Okazaki-shi, Aichi 444-0039, JP
(72) Sugita, Kikuo, 3 Mikage-cho Okazaki-shi, Aichi 444-0039, JP

- (51) MKP
A61K 9/00 (2006.01) (97) **2765994 ***
A61K 9/14 (2006.01)
A61K 9/16 (2006.01)
- (86) EP2012069943 09.10.2012
(96) 12780116.5 20.08.2014
(87) WO2013053696, 09.10.2012
(97) 2765994, 20.08.2014 en
(54) CRYSTALLINE MICROPARTICLES OF A BETA-AGONIST COATED WITH A FATTY ACID
(71) Chiesi Farmaceutici S.p.A., Via Palermo, 26/A, 43100 Parma, IT
(72) BRAMBILLA, Gaetano, c/o Chiesi Farmaceutici S.p.A. Via Palermo 26/A, I-43100 Parma, IT
COLOMBO, Paolo, c/o Chiesi Farmaceutici S.p.A. Via Palermo 26/A, I-43100 Parma, IT
BUTTINI, Francesca, c/o Chiesi Farmaceutici S.p.A. Via Palermo 26/A, I-43100 Parma, IT
MIOZZI, Michele, c/o Chiesi Farmaceutici S.p.A. Via Palermo 26/A, I-43100 Parma, IT

- (51) MKP
A61K 31/519 (2006.01) (97) **2744812 ***
A61P 29/00 (2006.01)
C07D 495/04 (2006.01)
C07D 513/04 (2006.01)
C07D 519/00 (2006.01)
- (86) GB2012051992 15.08.2012
(96) 12753225.7 25.06.2014
(87) WO2013024291, 15.08.2012
(97) 2744812, 25.06.2014 en
(54) THERAPEUTICALLY ACTIVE FUSED PYRIMIDINE DERIVATIVES
- (71) UCB Pharma, S.A., 60, allée de la Recherche, 1070 Brussels, BE
Katholieke Universiteit Leuven, K.U. Leuven R&D, Minderbroedersstraat 8a Bus 5105, 3000 Leuven, BE
- (72) BROOKINGS, Daniel Christopher, c/o UCB Celltech 208 Bath Road, Slough Berkshire SL1 3WE, GB
FORD, Daniel James, c/o UCB Celltech 208 Bath Road, Slough Berkshire SL1 3WE, GB
GHAWALKAR, Anant Ramrao, SAI Life Sciences 8-2-120/86/9/B Luxor Park Road No.2, Banjara Hills Hyderabad 500033 A.P., IN
HERMAN, Jean, Hoveniersdreef 100, B-3001 Heverlee, BE
HUANG, Qiuya, Remi Vandervaerenlaan 14/0403, B-3000 Leuven, BE
KULISA, Claire Louise, c/o UCB Celltech 208 Bath Road, Slough Berkshire SL1 3WE, GB
LOUAT, Thierry, Verbindingslaan 48 b303, B-3001 Heverlee, BE
NEUSS, Judi Charlotte, c/o UCB Celltech 208 Bath Road, Slough Berkshire SL1 3WE, GB
REUBERSON, James Thomas, c/o UCB Celltech 208 Bath Road, Slough Berkshire SL1 3WE, GB
VANDERHOYDONCK, Bart, Postbaan 49, B-3290 Diest, BE

- (51) MKP
A61K 31/4045 (2006.01) (97) **2720696 ***
A61K 31/519 (2006.01)
- (86) US2012042174 13.06.2012
(96) 12730099.4 23.04.2014
(87) WO2012174061, 13.06.2012
(97) 2720696, 23.04.2014 en
(54) COMBINATION OF PANOBINOSTAT AND RUXOLITINIB IN THE TREATMENT OF CANCER SUCH AS A MYELOPROLIFERATIVE NEOPLASM
- (71) Novartis AG, Lichtstrasse 35, 4056 Basel, CH
- (72) BAFFERT, Fabienne, Novartis Pharma AG Werk Klybeck Postfach, CH-4002 Basel, CH
RADIMERSKI, Thomas, Novartis Pharma AG Werk Klybeck Postfach, CH-4002 Basel, CH
GADBAW, Brian, Novartis Pharmaceuticals Corporation One Health Plaza, East Hanover, New Jersey 07936-1080, US

- (51) MKP
A01H 1/08 (2006.01) (97) **2734036 ***
A01H 5/00 (2006.01)
A01H 5/10 (2006.01)
- (86) IL2012050252 17.07.2012
(96) 12750621.0 28.05.2014
(87) WO2013011507, 17.07.2012
(97) 2734036, 28.05.2014 en
(54) MAIZE PLANTS HAVING A PARTIALLY OR FULLY MULTIPLIED GENOME AND USES THEREOF
- (71) Kaiima Bio Agritech Ltd., P.O. Box 508, 1524100 Kfar-Tavor, IL
- (72) AVIDOV, Amit, 21 Hana Senesh Street, 3603621 Kiryat-Tivon, IL
LERNER, Alon, Moshav Sharon, 1523200 Doar-Na Galil Tachton, IL
BARUCH, Limor, Moshav Tel Adashim, 1931500 Doar-Na Hevel Megiddo, IL

- (51) MKP
H02H 3/08 (2006.01) (97) **2754217 ***
H02H 9/02 (2006.01)
- (86) US2012054003 06.09.2012
(96) 12830542.2 16.07.2014
(87) WO2013036670, 06.09.2012
(97) 2754217, 16.07.2014 en
(54) STARTER APPARATUS, SYSTEM, AND/OR METHOD FOR A SEPARABLE-WINDING MOTOR
- (71) Franklin Control Systems, Inc., 22995 NW Evergreen Pkwy, Hillsboro, OR 97124, US
- (72) PERRA, Andre, Pierre, 17050 NW Skyline Blvd., Portland, OR 97231, US
HOLCE, Kent, Jeffrey, 8445 NW Tuality Way, Portland, OR 97229, US
LEONARD, Scott, E., 949 NW Overton Unit 705, Portland, OR 97209, US

- (51) MKP
B41M 5/42 (2006.01) (97) **2714415 ***
B41M 5/50 (2006.01)
B41M 5/52 (2006.01)
- (86) EP2012059374 21.05.2012
(96) 12721553.1 09.04.2014
(87) WO2012163711, 21.05.2012
(97) 2714415, 09.04.2014 en
(54) PROCESS FOR MANUFACTURING COATED SUBSTRATES
- (71) Omya International AG, Baslerstrasse 42, 4665 Oftringen, CH
- (72) GANE, Patrick A. C., Studenweg 8, CH-4852 Rothrist, CH
RIDGWAY, Catherine Jean, Wannenberg 12, CH-4812 Mühlethal, CH
SCHENKER, Michel, Starrkircherstrasse 11, 4600 Olten, CH

- (51) MKP
H05K 13/04 (2006.01) (97) **2389059**
- (96) 11166546.9 23.11.2011
(97) 2389059, 23.11.2011 de
(54) Mounting head for a mounting machine, mounting machine and mounting method
- (71) ASM Assembly Systems GmbH & Co. KG, Rupert-Mayer-Strasse 44, 81379 München, DE
- (72) Müller, Werner, ASM Assembly Systems GmbH & Co. KG Adolf-Kolping-Straße 33, 83607 Holzkirchen, DE

- (51) MKP
G06F 3/01 (2006.01) (97) **2740014 ***
- (86) US2012049361 02.08.2012
(96) 12746446.9 11.06.2014
(87) WO2013022712, 02.08.2012
(97) 2740014, 11.06.2014 en
(54) GESTURE RECOGNITION USING INERTIAL SENSORS IN COMBINATION WITH PROXIMITY LIGHT SENSORS
- (71) Qualcomm Incorporated, 5775 Morehouse Drive, San Diego, CA 92121-1714, US
- (72) BEVILACQUA, Mathew W., 5775 Morehouse Drive, San Diego, California 92121, US
HARRAT, Newfel, 5775 Morehouse Drive, San Diego, California 92121, US
SHEYNBLAT, Leonid, 5775 Morehouse Drive, San Diego, California 92121, US

- (51) MKP
A41D 19/015 (2006.01) (97) **2729029 ***
- (86) US2012042200 13.06.2012
(96) 12804855.0 14.05.2014
(87) WO2013003040, 13.06.2012
(97) 2729029, 14.05.2014 en
(54) PLAITED GLOVE
- (71) Banom, Inc., 3103 Phoenixville Pike, Malvern, PA 19355, US
- (72) HUGHES, Griffith, W., 1180 Lafayette Road, Wayne, PA 19087, US
HUGHES, Jon, C., 1180 Lafayette Road, Wayne, PA 19087, US

(51) MKP
A61B 17/072 (2006.01) (97) **2644123**
A61L 31/00 (2006.01)
(96) 13161492.7 02.10.2013
(97) 2644123, 02.10.2013 en
(54) Tissue thickness compensator comprising a plurality of medicaments
(71) Ethicon Endo-Surgery, Inc., 4545 Creek Road, Cincinnati, OH 45242, US
(72) Scheib, Charles J., 11329 Donwiddle Drive, Loveland, OH Ohio 45140, US
Shelton, IV, Frederick E., 245 East Main Street, Hillsboro, OH Ohio 45133, US

(51) MKP
B60F 5/02 (2006.01) (97) **2750905 ***
B64C 3/56 (2006.01)
B64C 37/00 (2006.01)
(86) SK2012000010 22.08.2012
(96) 12783374.7 09.07.2014
(87) WO2013032409, 22.08.2012
(97) 2750905, 09.07.2014 en
(54) TRANSFORMATION METHOD OF HYBRID TRANSPORTATION VEHICLE FOR GROUND AND AIR, AND HYBRID TRANSPORTATION VEHICLE ITSELF
(71) Aeromobil S.r.o., Búdková 28, 811 04 Bratislava, SK
(72) KLEIN, Stefan, Martinská 14, 949 01 Nitra, SK

(51) MKP
A61K 35/28 (2006.01) (97) **2739723 ***
C12N 5/0735 (2010.01)
C12N 5/0775 (2010.01)
C12N 5/0789 (2010.01)
C12N 5/0793 (2010.01)
(86) EP2012065327 06.08.2012
(96) 12756386.4 11.06.2014
(87) WO2013020945, 06.08.2012
(97) 2739723, 11.06.2014 en
(54) METHODS OF TREATMENT OF RETINAL DEGENERATION DISEASES
(71) Cosma, Maria Pia, Carrer Fernando Poo 16 2-3, 08005 Barcelona, ES
Sanges, M Daniela, C/Gombau, 12, 08003 Barcelona, ES
(72) Cosma, Maria Pia, Carrer Fernando Poo 16 2-3, 08005 Barcelona, ES
Sanges, M Daniela, C/Gombau, 12, 08003 Barcelona, ES

(51) MKP
A01N 37/20 (2006.01) (97) **2747564 ***
A01N 43/10 (2006.01)
A01N 43/56 (2006.01)
A01P 13/00 (2006.01)
(86) EP2012066158 20.08.2012
(96) 12748471.5 02.07.2014
(87) WO2013026811, 20.08.2012
(97) 2747564, 02.07.2014 en
(54) HERBICIDAL COMPOSITIONS COMPRISING CHLOROACETAMIDES
(71) BASF SE, null, 67056 Ludwigshafen, DE
(72) BREMER, Hagen, Ziegelofenweg 67, 67346 Speyer, DE
KEHLER, Ron, Am Taubenfeld 4, 69123 Heidelberg, DE

(51) MKP
C07D 233/64 (2006.01) (97) **2721010 ***
(86) JP2012065795 14.06.2012
(96) 12732719.5 23.04.2014
(87) WO2012173280, 14.06.2012
(97) 2721010, 23.04.2014 en
(54) PRODUCTION METHOD OF IMIDAZOLE DERIVATIVES
(71) Takeda Pharmaceutical Company Limited, 1-1 Doshomachi 4-chome Chuo-ku, Osaka-shi, Osaka 541-0045, JP
(72) KAWABATA, Yoichi, c/o TAKEDA PHARMACEUTICAL COMPANY LIMITED 17-85 Jusohonmachi 2-chome Yodogawaku, Osaka-shi Osaka 532-0024, JP
SAWAI, Yasuhiro, c/o TAKEDA PHARMACEUTICAL COMPANY LIMITED 17-85 Jusohonmachi 2-chome Yodogawaku, Osaka-shi Osaka 532-0024, JP
KANNO, Kazuaki, c/o TAKEDA PHARMACEUTICAL COMPANY LIMITED 17-85 Jusohonmachi 2-chome Yodogawaku, Osaka-shi Osaka 532-0024, JP
SAWADA, Naotaka, c/o TAKEDA PHARMACEUTICAL COMPANY LIMITED 17-85 Jusohonmachi 2-chome Yodogawaku, Osaka-shi Osaka 532-0024, JP

(51) MKP
C02F 3/28 (2006.01) (97) **2760978 ***
C10L 3/08 (2006.01)
C12P 5/02 (2006.01)
(86) EP2012068669 21.09.2012
(96) 12766425.8 06.08.2014
(87) WO2013045368, 21.09.2012
(97) 2760978, 06.08.2014 de
(54) PROCESS FOR PRODUCTION OF BIOGAS
(71) Rheinkalk GmbH, Am Kalkstein 1, 42489 Wülfrath, DE
(72) PICKBRENNER, Arnd, Schulstraße 9, 42489 Wülfrath, DE
SAURE, Heiko, Heidestraße 41, 58285 Gevelsberg, DE
PUST, Christopher, Akazienallee 9, 40625 Düsseldorf, DE
SPICKER, Volker, Ellenbeek 51, 42489 Wülfrath, DE

(51) MKP
C09K 3/18 (2006.01) (97) **2718387 ***
(86) EP2012060543 05.06.2012
(96) 12725765.7 16.04.2014
(87) WO2012168206, 05.06.2012
(97) 2718387, 16.04.2014 en
(54) DEICING COMPOSITION
(71) Akzo Nobel Chemicals International B.V., Stationsstraat 77, 3811 MH Amersfoort, NL
(72) DE JONG, Edwin Ronald, Amerstraat 20, NL-7417 CL Deventer, NL
MASLOW, Wasil, Emmastraat 30, NL-7411 EK Deventer, NL
DEMMEER, René, Lodewijk, Maria, Werfstraat 16, NL-7468 GG Enter, NL

(51) MKP
G01N 33/68 (2006.01) (97) **2748613 ***
(86) EP2012069598 04.10.2012
(96) 12769097.2 02.07.2014
(87) WO2013050453, 04.10.2012
(97) 2748613, 02.07.2014 en
(54) OXMIF AS A DIAGNOSTIC MARKER
(71) Baxter Healthcare SA, Thurgauerstrasse 130, 8152 Glattpark (Opfikon), CH
Baxter International Inc, One Baxter Parkway, Deerfield, IL 60015, US
(72) THIELE, Michael, Linke Bahngasse 9/24, A-1030 Wien, AT
KERSCHBAUMER, Randolph, J, Hoehenstrasse 19a, A-3400 Klosterneuburg, AT
VOELKEL, Dirk, Stadlbreitener Anger 17, A-1220 Wien, AT
DOUILLARD, Patrice, Stuerstrasse 9-11/9, A-1020 Wien, AT
SCHEIFLINGER, Friedrich, Michelbeuerngasse 4/17, A-1090 Wien, AT

- (51) MKP
B31C 1/00 (2006.01) (97) **2653299**
B31C 3/00 (2006.01)
B65H 75/10 (2006.01)
B65H 75/50 (2006.01)
(96) 12002798.2 23.10.2013
(97) 2653299, 23.10.2013 en
(54) A single ply core manufacturing method, a ply and a single ply core
(71) SCA TISSUE FRANCE, 60, avenue de l'Europe, 92270 Bois-Colombes, FR
(72) Sigwalt, René, 35, rue de Baltzenheim, 68320 Kunheim, FR

- (51) MKP
E21B 47/00 (2012.01) (97) **2637043**
G01V 1/44 (2006.01)
(96) 11290599.7 11.09.2013
(97) 2637043, 11.09.2013 en
(54) Systems and methods for downhole cement evaluation
(71) Services Pétroliers Schlumberger, 42, rue Saint Dominique, 75007 Paris, FR
Schlumberger Technology B.V., Parkstraat 83-89, 2514 JG The Hague, NL
Schlumberger Holdings Limited, P.O. Box 71 Craigmuir Chamber Road Town, Tortola BV1, VG
PRAD Research and Development Limited, P.O. Box 71 Craigmuir Chambers, Road Town, Tortola, VG
(72) Froelich, Benoit, 26 Bis, Chemin du Gaillon, 78160 Marly Le Roi, FR

- (51) MKP
E21B 34/14 (2006.01) (97) **2705287 ***
E21B 43/12 (2006.01)
E21B 43/26 (2006.01)
F16K 3/26 (2006.01)
F16K 3/30 (2006.01)
F16K 31/46 (2006.01)
(86) CA2012000412 02.05.2012
(96) 12780001.9 12.03.2014
(87) WO2012149638, 02.05.2012
(97) 2705287, 12.03.2014 en
(54) SLIDING SLEEVE VALVE AND METHOD FOR FLUID TREATING A SUBTERRANEAN FORMATION
(71) Packers Plus Energy Services Inc., Bow Valley Square 2 Suite 2200, 205 - 5 Avenue SW, Calgary, Alberta T2P 2V7, CA
(72) COON, Robert, Joe, 8606 Hall Retreat CT, Missouri City Texas 77459, US
THEMIG, Daniel, Jon, 256 Woodhaven Place SW, Calgary Alberta T2W 5P9, CA
EMERSON, John, Lee, 21607 Sandystone Ln., Katy texas 77449, US
MENDOZA, Gustavo, 1703 Thornhollow Dr., Houston Texas 77014, US

- (51) MKP
C22B 15/14 (2006.01) (97) **2716776 ***
(86) CN2012075939 23.05.2012
(96) 12789514.2 09.04.2014
(87) WO2012159567, 23.05.2012
(97) 2716776, 09.04.2014 en
(54) COMBINED FURNACE SYSTEM FOR FIRE REFINING RED IMPURE COPPER
(71) Jiangxi Rare Earth and Rare Metals Tungsten Group Corporation, No. 118, Beijing West Road Nanchang, Jiangxi 330046, CN
(72) ZHANG, Bingyan, No. 118 Beijing West Road, Nanchang Jiangxi 330046, CN
ZHANG, Xuanzhi, No. 118 Beijing West Road, Nanchang Jiangxi 330046, CN
YIN, Jiajun, No. 118 Beijing West Road, Nanchang Jiangxi 330046, CN
RAO, Yongping, No. 118 Beijing West Road, Nanchang Jiangxi 330046, CN

- (51) MKP
G01N 33/538 (2006.01) (97) **2729807 ***
(86) US2012045794 06.07.2012
(96) 12738310.7 14.05.2014
(87) WO2013006810, 06.07.2012
(97) 2729807, 14.05.2014 en
(54) ASSAYS FOR DETECTING NEUTRALIZING AUTOANTIBODIES TO BIOLOGIC THERAPY WITH TNF ALPHA
(71) Nestec S.A., Avenue Nestlé 55, 1800 Vevey, CH
(72) HAUENSTEIN, Scott, 3565 Caminito El Rincon 211, San Diego, California 92130, US
OHRMUND, Linda, 3519 Tennyson Street, San Diego, California 92106, US
SINGH, Sharat, 8171 Top of the Morning Way, Rancho Santa Fe, California 92127, US
WANG, Shui Long, 4555 Saddle Mountain Court, San Diego, California 92130, US

- (51) MKP
A61K 39/00 (2006.01) (97) **2714071 ***
C12Q 1/68 (2006.01)
(86) EP2012002209 23.05.2012
(96) 12723117.3 09.04.2014
(87) WO2012159754, 23.05.2012
(97) 2714071, 09.04.2014 en
(54) INDIVIDUALIZED VACCINES FOR CANCER
(71) Biontech AG, Hölderlinstrasse 8, 55131 Mainz, DE
TRON - Translationale Onkologie an der Universitätsmedizin der Johannes Gutenberg- Universität Mainz gemeinnützige GmbH, Langenbeckstrasse 1, 55131 Mainz, DE
(72) SAHIN, Ugur, Philipp-von-Zabern-Platz 1, 55116 Mainz, DE
KREITER, Sebastian, Niklas-Vogt-Str. 3, 55131 Mainz, DE
DIKEN, Mustafa, Hindenburgstr. 11, 55118 Mainz, DE
DIEKMANN, Jan, Pfannenstiel 27, 55270 Ober-Olm, DE
KOSLOWSKI, Michael, Am Ried 23, 85764 Oberschleissheim, DE
BRITTEN, Cedrik, Catharina-Lothary Str. 51, 55130 Mainz, DE
CASTLE, John, Rudolf-Diesel-Strasse 40, 55131 Mainz, DE
LÖWER, Martin, Franziska-Kessel-Strasse 61, 55131 Mainz, DE
RENARD, Bernhard, Josefsstrasse 55, 55118 Mainz, DE
OMOKOKO, Tana, Klarastrasse 1, 55116 Mainz, DE
DE GRAAF, Johannes Hendrikus, Nelkenstrasse 5, 55296 Lörzweiler, DE

- (51) MKP
A61K 9/51 (2006.01) (97) **2747761 ***
A61K 31/337 (2006.01)
A61K 47/34 (2006.01)
A61P 35/00 (2006.01)
(86) US2012056891 24.09.2012
(96) 12775568.4 02.07.2014
(87) WO2013044219, 24.09.2012
(97) 2747761, 02.07.2014 en
(54) METHODS OF TREATING CANCERS WITH THERAPEUTIC NANOPARTICLES
(71) Bind Therapeutics, Inc., 325 Vassar Street, Cambridge, Massachusetts 02139, US
(72) ZALE, Stephen, E., One Norcross Road, Hopkinton, MA 01748, US
TROIANO, Greg, 38 Lily's Way, Pembroke, MA 02359, US
HRKACH, Jeff, 21 Washington Street, Lexington, MA 02421, US
WRIGHT, James, 24 Bloomfield Street, Lexington, MA 02421, US
ALI, Mir, Mukkaram, 53 Cedar Street, Apt. 3205, Woburn, MA 01801, US

(51) MKP
A23L 2/06 (2006.01) (97) **2521461 ***
A23L 2/66 (2006.01)
(86) CA2011000006 04.01.2011
(96) 11728524.7 14.11.2012
(87) WO2011079398, 04.01.2011
(97) 2521461, 14.11.2012 en
(54) STABILIZATION OF CITRUS FRUIT BEVERAGES
COMPRISING SOY PROTEIN
(71) Burcon Nutrascience (MB) Corp., 1388 Waller Avenue,
Winnipeg, Manitoba R3T 1P9, CA
(72) MEDINA, Sarah, 315 Wildwood Park, Winnipeg Manitoba R3T
0E5, CA
SCHWEIZER, Martin, 117 Haig Avenue, Winnipeg Manitoba
R2M 0E3, CA

(51) MKP
A61F 2/00 (2006.01) (97) **2755598 ***
(86) US2012055765 17.09.2012
(96) 12832258.3 23.07.2014
(87) WO2013040559, 17.09.2012
(97) 2755598, 23.07.2014 en
(54) FABRICATION OF GELATIN HYDROGEL SHEET FOR THE
TRANSPLANTATION OF CORNEAL ENDOTHELIUM
(71) Wake Forest University Health Sciences, 391 Technology Way,
Suite 199, Winston-Salem, NC 27101, US
(72) NIU, Guoguang, 2359-D Ardmore Terrace, Winston-Salem, NC
27103, US
SOKER, Shay, 9 Roundtree Court, Greensboro, NC 27410, US

(51) MKP
C02F 11/12 (2006.01) (97) **2739711 ***
C10L 5/08 (2006.01)
C10L 5/28 (2006.01)
C10L 5/36 (2006.01)
C10L 5/46 (2006.01)
(86) HU2012000067 31.07.2012
(96) 12787067.3 11.06.2014
(87) WO2013024309, 31.07.2012
(97) 2739711, 11.06.2014 en
(54) PROCEDURE AND EQUIPMENT FOR THE PRODUCTION
OF SOLID FUEL FROM WASTEWATER SLUDGE
(71) Vereckey, István, Aradi v. u 15/b, 9021 Gyor, HU
Ifj. Vereckey, István, Aradi v. u 15/b, 9021 Gyor, HU
Bognár, Béla, Futódomb u.12, 9172 Gyozámoly, HU
Ercsey, László, Petofi u.6, 1198 Budapest, HU
(72) Vereckey, István, Aradi v. u 15/b, 9021 Gyor, HU
Ifj. Vereckey, István, Aradi v. u 15/b, 9021 Gyor, HU
Bognár, Béla, Futódomb u.12, 9172 Gyozámoly, HU
Ercsey, László, Petofi u.6, 1198 Budapest, HU

(51) MKP
A61K 31/122 (2006.01) (97) **2701695 ***
A61K 31/20 (2006.01)
A61K 31/202 (2006.01)
A61K 31/375 (2006.01)
A61P 25/00 (2006.01)
A61P 25/28 (2006.01)
(86) US2012034832 24.04.2012
(96) 12776294.6 05.03.2014
(87) WO2012148926, 24.04.2012
(97) 2701695, 05.03.2014 en
(54) NEURODEGENERATIVE DISORDERS AND MUSCLE
DISEASES IMPLICATING PUFAS
(71) Retrotope, Inc., 12133 Foothill Lane, Los Altos Hills, CA 94022-
3319, US
(72) SHCHEPINOV, Mikhail, Sergeevich, 63 Barnfield Avenue,
Kingston Upon Thames Surrey KT25RG, GB

(51) MKP
A23L 1/236 (2006.01) (97) **2741620 ***
(86) IB2012054114 13.08.2012
(96) 12769732.4 18.06.2014
(87) WO2013024422, 13.08.2012
(97) 2741620, 18.06.2014 en
(54) SWEETENER COMPOSITION
(71) Eridania Sadam S.p.A., Via degli Agresti, 4/6, 40123 Bologna,
IT
(72) VALLINI, Veronica, Via Matteotti 55/4, 60015 Falconara
Marittima, IT

(51) MKP
A61K 31/18 (2006.01) (97) **2706994 ***
A61K 33/06 (2006.01)
A61K 33/12 (2006.01)
A61K 33/38 (2006.01)
(86) IB2012052324 10.05.2012
(96) 12731678.4 19.03.2014
(87) WO2012153288, 10.05.2012
(97) 2706994, 19.03.2014 en
(54) PHARMACEUTICAL TOPICAL COMPOSITION FOR USE
IN THE TREATMENT AND/OR IN THE PREVENTION OF
INFECTIONS OF SKIN LESIONS
(71) Soveta Baltica Uab, Kalvariju str. 125, 08221 Vilnius, LT
(72) LABRUZZO, Carla, Via Melzi d'EriI 16, I-20154 Milano, IT

(51) MKP
A61K 39/145 (2006.01) (97) **2707393 ***
A61K 39/385 (2006.01)
A61P 31/16 (2006.01)
A61P 37/04 (2006.01)
C07K 14/285 (2006.01)
C07K 19/00 (2006.01)
C12N 15/00 (2006.01)
C12P 21/02 (2006.01)
(86) CA2012050236 12.04.2012
(96) 12771540.7 19.03.2014
(87) WO2012139225, 12.04.2012
(97) 2707393, 19.03.2014 en
(54) FUSION PROTEINS AND COMBINATION VACCINES
COMPRISING HAEMOPHILUS INFLUENZAE PROTEIN E
AND PILIN A
(71) GlaxoSmithKline Biologicals S.A., rue de l'Institut, 89, 1330
Rixensart, BE
(72) BLAIS, Normand, c/o GlaxoSmithKline Biologicals Canada 525
boulevard Cartier Ouest, Laval, Québec H7V 3S8, CA
LABBE, Steve, c/o GlaxoSmithKline Biologicals Canada 525
boulevard Cartier Ouest, Laval, Québec H7V 3S8, CA
POOLMAN, Jan, GlaxoSmithKline Biologicals S.A. Rue de
l'Institut 89, B-1330 Rixensart, BE

(51) MKP
A47B 47/04 (2006.01) (97) **2741632 ***
A47B 61/00 (2006.01)
(86) EP2012057354 23.04.2012
(96) 12716013.3 18.06.2014
(87) WO2013020721, 23.04.2012
(97) 2741632, 18.06.2014 en
(54) A MODULAR APPARATUS FOR REALIZATION OF
WARDROBES PROVIDED WITH PLASTIC STRUCTURE
(71) Tontarelli, Sergio, Via Verdi 123, 60022 Castelfidardo (AN), IT
(72) Tontarelli, Sergio, Via Verdi 123, 60022 Castelfidardo (AN), IT

(51) MKP
F16C 33/02 (2006.01) (97) **2764262 ***
(86) US2012058883 05.10.2012
(96) 12838239.7 13.08.2014
(87) WO2013052754, 05.10.2012
(97) 2764262, 13.08.2014 en
(54) APPARATUS AND METHOD FOR A BEARING ASSEMBLY
SYSTEM
(71) Telsmith, Inc., 10190 N. Industrial Dr. P.O. Box 539, Mequon,
WI 53092, US
(72) NEITZEL, Sean, 811 Wianecki Road, Kronenwetter, WI 54455,
US
HAVEN, Matthew, N62 W1025 Fairhaven Court, Cedarburg, WI
53012, US
DRICKEN, Chuck, 7920 Hunters Drive, Kewaskum, WI 53040,
US
VAN MULLEM, Albert, N59 W23790 Clover Drive, Sussex, WI
53089, US

- (51) MKP
B23B 31/20 (2006.01) (97) **2734327 ***
B23D 37/10 (2006.01)
B23D 37/20 (2006.01)
B23D 41/04 (2006.01)
(86) EP2012064058 18.07.2012
(96) 12745800.8 28.05.2014
(87) WO2013011051, 18.07.2012
(97) 2734327, 28.05.2014 de
(54) INTERNAL BROACHING MACHINE
(71) Gierth, Lothar, Im Schnitthölzchen 35, 58802 Balve, DE
(72) Gierth, Lothar, Im Schnitthölzchen 35, 58802 Balve, DE

- (51) MKP
A61K 9/16 (2006.01) (97) **2723341 ***
A61K 31/496 (2006.01)
A61P 43/00 (2006.01)
(86) US2012043499 21.06.2012
(96) 12730766.8 30.04.2014
(87) WO2012177842, 21.06.2012
(97) 2723341, 30.04.2014 en
(54) FAST DISSOLVING AZAPERONE GRANULATE FORMULATION
(71) Elanco Animal Health Ireland Limited, 70 Sir John Rogerson's Quay, Dublin, IE
(72) AMEYE, Dieter Bert Leen, c/o Eli Lilly and Company P.O. Box 6288, Indianapolis, Indiana 46206-6288, US
MEERTS, Peter, c/o Eli Lilly and Company P.O. Box 6288, Indianapolis, Indiana 46206-6288, US
VAN BEECK, Geert Louise F., c/o Eli Lilly and Company P.O. Box 6288, Indianapolis, Indiana 46206-6288, US
VAN VOOREN, Lieven, c/o Eli Lilly and Company P.O. Box 6288, Indianapolis, Indiana 46206-6288, US
YEKKALA, Raja Satyanarayana, c/o Eli Lilly and Company P.O. Box 6288, Indianapolis, Indiana 46206-6288, US

- (51) MKP
A01N 43/90 (2006.01) (97) **2757887 ***
(86) US2012055838 18.09.2012
(96) 12833476.0 30.07.2014
(87) WO2013043553, 18.09.2012
(97) 2757887, 30.07.2014 en
(54) PYRROLOPYRIDINONE COMPOUNDS AND METHODS FOR TREATING HIV
(71) VIIV Healthcare UK Limited, 980 Great West Road, Brentford, Middlesex TW8 9GS, GB
(72) HAYDAR, Simon, N., c/o GlaxoSmithKline, Global Patents Department Five Moore Drive P.O. Box 13398 Research Triangle Park, North Carolina 27709, US
JOHNS, Brian, Alvin, c/o GlaxoSmithKline, Global Patents Department Five Moore Drive P.O. Box 13398 Research Triangle Park, North Carolina 27709, US
VELTHUISEN, Emile Johann, c/o GlaxoSmithKline, Global Patents Department Five Moore Drive P.O. Box 13398 Research Triangle Park, North Carolina 27709, US

- (51) MKP
A61K 9/00 (2006.01) (97) **2714005 ***
A61K 31/56 (2006.01)
A61P 11/02 (2006.01)
(86) EP2012002222 24.05.2012
(96) 12745769.5 09.04.2014
(87) WO2012163501, 24.05.2012
(97) 2714005, 09.04.2014 de
(54) NASAL PHARMACEUTICAL FORMULATION
(71) MEDA Pharma GmbH & Co. KG, Benzstrasse 1, 61352 Bad Homburg, DE
(72) HILDEBRAND-CYRENER, Annegret, Altwahnsdorf 36, 01445 Radebeul, DE
MAUS, Joachim, Ludwigstrasse 30, 63165 Mühlheim am Main, DE
MUNZEL, Ullrich, Wetterstrasse 14 a, 61206 Wöllstadt, DE
TRITSCHLER, Hans, Laimerstrasse 44, 80639 München, DE
WEINGART, Mario, Am Pressgrund 16, 01328 Dresden, DE

- (51) MKP
G01F 1/74 (2006.01) (97) **2647970**
(96) 13162016.3 09.10.2013
(97) 2647970, 09.10.2013 de
(54) Needle probe for analysis of multiphase flows, production and use of needle probe
(71) Helmholtz-Zentrum Dresden - Rossendorf e.V., Bautzner Landstrasse 400, 01328 Dresden, DE
(72) Schleicher, Eckhard, Reicker Str. 40, 01219 Dresden, DE
Kayser, Stefan, Hohlsteinweg 20, 02796 Jonsdorf, DE

- (51) MKP
A61B 17/072 (2006.01) (97) **2644116**
A61L 31/04 (2006.01)
(96) 13161461.2 02.10.2013
(97) 2644116, 02.10.2013 en
(54) Tissue thickness compensator comprising a plurality of capsules
(71) Ethicon Endo-Surgery, Inc., 4545 Creek Road, Cincinnati, OH 45242, US
(72) Vasudevan, Venkataramanan Mandakolathur, Johnson House 64-66, Senapati Bapat Marg, Mahim (W), 400016 Mumbai, IN
Aronhalt, Taylor W., 306 Beech Road, Loveland, OH Ohio 45140, US
Aldridge, Jeffrey L., 106 W. Concord Drive, Lebanon, OH Ohio 45036, US
Scheib, Charles J., 11329 Donwiddle Drive, Loveland, OH Ohio 45140, US
Yang, Chunlin, 93 Matthews Farm Road, Belle Mead, NJ New Jersey 08502, US
Schall, Christopher J., 688 Whippoorwill Drive, Cincinnati, OH Ohio 45244, US
Baxter, III, Chester O., 6375 Pawnee Ridge, Loveland, OH Ohio 45140, US
Chun, Iksoo, 269 Shadybrook Lane, Princeton, NJ New Jersey 08540, US
Bezswana, Rao S., 1 Nevius Road, Whitehouse Station, NJ New Jersey 08889, US
Conlon, Sean P., 6234 C. North Shadow Hill Way, Loveland, OH Ohio 45140, US
Cropper, Michael S., 3232 Charter Oak, Edgewood, KY Kentucky 41017, US
Uth, Joshua R., 7752 Hunters Trail, Mason, OH Ohio 45040, US
Leimbach, Richard L., 2901 Markbreit Avenue, Cincinnati, OH Ohio 45209, US
Korvick, Donna L., 8158 Worcester Drive, Maineville, OH Ohio 45039, US

- (51) MKP
A01N 63/00 (2006.01) (97) **2753181 ***
(86) HU2012000084 30.08.2012
(96) 12783651.8 16.07.2014
(87) WO2013034938, 30.08.2012
(97) 2753181, 16.07.2014 en
(54) A COPPER RESISTANT, FENGYCIN-PRODUCING BACILLUS MOJAVENSIS STRAIN FOR CONTROLLING VEGETABLE PATHOGENS, ITS USE AND COMPOSITIONS CONTAINING IT
(71) Szegei Tudományegyetem, Dugonics tér 13, 6720 Szeged, HU
(72) MANCZINGER, László, Vadliba u. 48., H-6791 Szeged, HU
VÁGVÖLGYI, Csaba, Magyar u. 181., H-6771 Szöreg, HU
SAJBEN, Enikő, Pillich Kálmán u. 38., H-6726 Szeged, HU
NAGY, Árpád, Vas u. 2., H-6726 Szeged, HU
SZÖKE-KIS, Zoltán, Hajnal u. 17./A, H-5650 Mezöberény, HU
NAGY, Adrienn, Klapka u. 19., H-6000 Kecskemét, HU
TURÓCZI, György, Aulich Lajos u. 22., H-2100 Gödöllő, HU
KOVÁCS, András, Szivárvány u. 16., H-6000 Kecskemét, HU

(51) MKP
A61K 8/27 (2006.01) (97) **2713992 ***
A61K 33/42 (2006.01)
A61Q 11/00 (2006.01)
C01B 25/455 (2006.01)
(86) EP2011002606 26.05.2011
(96) 11725619.8 09.04.2014
(87) WO2012159645, 26.05.2011
(97) 2713992, 09.04.2014 en
(54) DENTAL CARE PRODUCTS COMPRISING CARBONATE-SUBSTITUTED FLUORO-HYDROXYAPATITE PARTICLES
(71) Coswell S.p.A., Via Gobetti 4, 40050 Funo di Argelato (BO), IT
(72) GUALANDI, Paolo, c/o Coswell S.p.A. Via Gobetti 4, I-40050 Funo di Argelato BO, IT
GUALANDI, Andrea, c/o Coswell S.p.A. Via Gobetti 4, I-40050 Funo di Argelato BO, IT
GUALANDI, Jacopo, c/o Coswell S.p.A. Via Gobetti 4, I-40050 Funo di Argelato BO, IT
FOLTRAN, Ismaela, Loc. Rive S. Pietro 23, I-31020 Tarzo TV, IT
FORESTI, Elisabetta, Via Capriglia 148, I-55045 Pietrasanta LU, IT
LELLI, Marco, Via San Michele 46, I-40063 Monghidoro BO, IT
MARCHETTI, Marco, Via San Giovanni 19, I - 63062 Montefiore dell'Aso (AP), IT
PIERINI, Filippo, Via Murri 132, I - 40137 Bologna, IT
ROVERI, Norberto, Via Q. di Marzio 20, I-40133 Bologna, IT
VECCHIOTTI, Stefania, Via Piane di Tesino 3/A, I - 63066 Grottammare (AP), IT
LESCI, Isidoro, Giorgio, Viale Firenze 235, I-48014 Castel Bolognese RA, IT

(51) MKP
B22F 9/08 (2006.01) (97) **2689873**
C22C 18/00 (2006.01)
(96) 13170994.1 29.01.2014
(97) 2689873, 29.01.2014 de
(54) Method for producing a powder of a metal alloy
(71) Rimmer, Karl, Oberdorferweg 3, 9231 Köstenberg, AT
(72) Rimmer, Karl, Oberdorferweg 3, 9231 Köstenberg, AT

(51) MKP
C12N 15/11 (2006.01) (97) **2739753 ***
C12Q 1/68 (2006.01)
(86) US2012049456 03.08.2012
(96) 12819493.3 11.06.2014
(87) WO2013020019, 03.08.2012
(97) 2739753, 11.06.2014 en
(54) HYPOXIA-RELATED GENE SIGNATURES FOR CANCER CLASSIFICATION
(71) Myriad Genetics, Inc., 320 Wakara Way, Salt Lake City, UT 84108, US
Gutin, Alexander, 320 Wakara Way, Salt Lake City, Utah 84108, US
Jammulapati, Srikanth, 320 Wakara Way, Salt Lake City, UT 84108, US
Wagner, Susanne, 320 Wakara Way, Salt Lake City, UT 84108, US
Reid, Julia E., 320 Wakara Way, Salt Lake City, UT 84108, US
Flake, Darl, 320 Wakara Way, Salt Lake City, Utah 84108, US
(72) GUTIN, Alexander, 320 Wakara Way, Salt Lake City, Utah 84108, US
JAMMULAPATI, Srikanth, 320 Wakara Way, Salt Lake City, Utah 84108, US
WAGNER, Susanne, 320 Wakara Way, Salt Lake City, Utah 84108, US
REID, Julia, 320 Wakara Way, Salt Lake City, Utah 84108, US
FLAKE, Darl, 320 Wakara Way, Salt Lake City, Utah 84108, US

(51) MKP
A61K 31/4439 (2006.01) (97) **2726074 ***
A61K 31/519 (2006.01)
A61K 31/535 (2006.01)
A61P 35/00 (2006.01)
(86) US2012045199 02.07.2012
(96) 12735408.2 07.05.2014
(87) WO2013006532, 02.07.2012
(97) 2726074, 07.05.2014 en
(54) COMBINATION THERAPY COMPRISING A CDK4/6 INHIBITOR AND A PI3K INHIBITOR FOR USE IN THE TREATMENT OF CANCER
(71) Novartis AG, Lichtstrasse 35, 4056 Basel, CH
(72) KIM, Sunkyoo, c/o Novartis Institutes for BioMedical Research Inc. 250 Massachusetts Avenue, Cambridge, Massachusetts 02139, US
DOSHI, Shivang, c/o Novartis Institutes for BioMedical Research Inc. 250 Massachusetts Avenue, Cambridge, Massachusetts 02139, US
HAAS, Kristy, c/o Novartis Institutes for BioMedical Research Inc. 250 Massachusetts Avenue, Cambridge, Massachusetts 02139, US
KOVATS, Steven, c/o Novartis Institutes for BioMedical Research Inc. 250 Massachusetts Avenue, Cambridge, Massachusetts 02139, US
HUANG, Alan Xizhong, c/o Novartis Institutes for BioMedical Research Inc. 250 Massachusetts Avenue, Cambridge, Massachusetts 02139, US
CHEN, Yan, c/o Novartis Institutes for BioMedical Research Inc. 250 Massachusetts Avenue, Cambridge, Massachusetts 02139, US

(51) MKP
H01M 2/12 (2006.01) (97) **2713419**
(96) 13186100.7 02.04.2014
(97) 2713419, 02.04.2014 en
(54) Lid for electric accumulators
(71) Biasin SRL, Via Natta, 17 - Z. A., 36045 Madonna di Lonigo (VI), IT
(72) BIASIN, Renato, Via 4 Novembre, 13, 36050 MONTORSO VICENTINO (VI), IT

(51) MKP
A61K 31/496 (2006.01) (97) **2760450 ***
A61P 3/06 (2006.01)
A61P 3/08 (2006.01)
A61P 3/10 (2006.01)
A61P 9/00 (2006.01)
A61P 9/10 (2006.01)
A61P 9/12 (2006.01)
A61P 11/00 (2006.01)
A61P 15/00 (2006.01)
A61P 15/12 (2006.01)
A61P 19/02 (2006.01)
A61P 21/00 (2006.01)
(86) US2012057465 27.09.2012
(96) 12775378.8 06.08.2014
(87) WO2013049289, 27.09.2012
(97) 2760450, 06.08.2014 en
(54) MONOACYLGLYCEROL LIPASE INHIBITORS FOR THE TREATMENT OF METABOLIC DISEASES AND RELATED DISORDERS
(71) Janssen Pharmaceutica, N.V., Turnhoutseweg 30, 2340 Beerse, BE
(72) CONNELLY, Margery, 700 US Highway 202 South, Raritan New Jersey 08869, US
FLORES, Christopher M., 1125 Trenton-Harbourton Road, Titusville New Jersey 08560, US
MACIELAG, Mark J., Welsh & McKean Roads, Spring House Pennsylvania 19477, US

(51) MKP
C12Q 1/68 (2006.01) (97) **2744912 ***
 (86) US2012051442 17.08.2012
 (96) 12753322.2 25.06.2014
 (87) WO2013026027, 17.08.2012
 (97) 2744912, 25.06.2014 en
 (54) COMPOSITIONS AND METHODS FOR DETECTING ALLELIC VARIANTS
 (71) Nestec S.A., Avenue Nestlé 55, 1800 Vevey, CH
 (72) PRINCEN, Fred, 610 Krikwood Place, La Jolla, California 92037, US
 SELVARAJ, Fabyola, 9704 Wren Bluff Drive, San Diego 92127, US
 SINGH, Sharat, 8171 Top of the Morning Way, Rancho Santa Fe, California 92127, US

(51) MKP
H01M 8/04 (2006.01) (97) **2710658 ***
 (86) IB2012052541 21.05.2012
 (96) 12729221.7 26.03.2014
 (87) WO2012156957, 21.05.2012
 (97) 2710658, 26.03.2014 en
 (54) METHOD OF CONTROLLING AND MAXIMIZING THE ELECTRIC EFFICIENCY AND THE POWER OUTPUT OF A FUEL CELL
 (71) Cavalli, Stefano, Via Mantova 2/e, 37019 Peschiera del Garda (Verona), IT
 (72) Cavalli, Stefano, Via Mantova 2/e, 37019 Peschiera del Garda (Verona), IT

(51) MKP
A61K 31/437 (2006.01) (97) **2769980 ***
A61K 31/444 (2006.01)
A61K 31/506 (2006.01)
A61P 25/28 (2006.01)
A61P 43/00 (2006.01)
C07D 471/04 (2006.01)
 (86) JP2012075748 04.10.2012
 (96) 12837953.4 27.08.2014
 (87) WO2013051639, 04.10.2012
 (97) 2769980, 27.08.2014 en
 (54) PYRAZOLOQUINOLINE DERIVATIVE
 (71) Eisai R&D Management Co., Ltd., 4-6-10 Koishikawa Bunkyo-ku, Tokyo 112-8088, JP
 (72) NORIMINE, Yoshihiko, c/o EISAI CO. LTD. Tsukuba Research Laboratories 5-1-3, Tokodai, Tsukuba-shi Ibaraki 3002635, JP
 TAKEDA, Kunitoshi, c/o EISAI CO. LTD. Tsukuba Research Laboratories 5-1-3, Tokodai, Tsukuba-shi Ibaraki 3002635, JP
 HAGIWARA, Koji, c/o EISAI CO. LTD. Tsukuba Research Laboratories 5-1-3 Tokodai, Tsukuba-shi Ibaraki 3002635, JP
 SUZUKI, Yuichi, c/o EISAI CO. LTD. Tsukuba Research Laboratories 5-1-3 Tokodai, Tsukuba-shi Ibaraki 3002635, JP
 ISHIHARA, Yuki, c/o EISAI CO. LTD. Tsukuba Research Laboratories 5-1-3 Tokodai, Tsukuba-shi Ibaraki 3002635, JP
 SATO, Nobuaki, c/o EISAI CO. LTD. Tsukuba Research Laboratories 5-1-3 Tokodai, Tsukuba-shi Ibaraki 3002635, JP

(51) MKP
A61K 31/44 (2006.01) (97) **2723718 ***
A61P 25/00 (2006.01)
C07D 213/40 (2006.01)
C07D 401/12 (2006.01)
C07D 401/14 (2006.01)
C07D 405/12 (2006.01)
C07D 409/12 (2006.01)
C07D 413/12 (2006.01)
 (86) US2012043569 21.06.2012
 (96) 12730135.6 30.04.2014
 (87) WO2012177896, 21.06.2012
 (97) 2723718, 30.04.2014 en
 (54) TRPM8 ANTAGONISTS AND THEIR USE IN TREATMENTS
 (71) Amgen Inc., One Amgen Center Drive, Thousand Oaks, California 91320-1799, US
 (72) BROWN, James, 4438 Appleglen Court, Moorpark, California 93021, US
 CHEN, Jian J., 5448 Castillo De Rosa, Camarillo, California 93012, US
 GORE, Vijay Keshav, 12 Dove Street, Aliso Viejo, California 92656, US
 HARRIED, Scott, 1407 Arch Street, Pittsburgh, Pennsylvania 15212, US
 HORNE, Daniel B., 125 Parkside Drive, Simi Valley, California 93065, US
 KALLER, Matthew R., 1644 Red Rock Avenue, Ventura, California 93004, US
 LIU, Qingyian, 4631 Paseo Girasol, Camarillo, California 93012, US
 MONENSCHHEIN, Holger, 8425 Kern Crescent, San Diego, California 92127, US
 NGUYEN, Thomas T., 468 Calle Veracruz, Newbury Park, California 91320, US
 NISHIMURA, Nobuko, 24050 Arminta Street, West Hills, California 91304, US
 ZHONG, Wenge, 2921 Venezia Lane, Thousand Oaks, California 91362, US

(51) MKP
C02F 3/30 (2006.01) (97) **2736852 ***
C02F 3/34 (2006.01)
 (86) EP2012003197 27.07.2012
 (96) 12745403.1 04.06.2014
 (87) WO2013017243, 27.07.2012
 (97) 2736852, 04.06.2014 en
 (54) A METHOD AND A SYSTEM FOR OUT-COMPETING GLYCOGEN-ACCUMULATING ORGANISMS IN A SUBSTANCE
 (71) Veolia Water Solutions & Technologies Support, Immeuble L'Aquarène 1 Place Montgolfier, 94417 Saint-Maurice Cedex, FR
 (72) NIELSEN, Per Halkjær, Lyngtoften 9, NL-9260 Gistrup, DK
 VOLLERTSEN, Jes, Løgtvedvej 21, NL-9352 Dybvad, DK
 SØRENSEN, Kim Helleshøj, 20 rue de la Porte d'en Haut, F-77320 Jouy sur Morin, FR

(51) MKP
G02B 6/44 (2006.01) (97) **2732323 ***
H02G 15/013 (2006.01)
 (86) US2012046958 16.07.2012
 (96) 12746420.4 21.05.2014
 (87) WO2013010180, 16.07.2012
 (97) 2732323, 21.05.2014 en
 (54) SEALING MECHANISM AND METHOD FOR DROP CABLE SPLICE ENCLOSURES
 (71) Channell Commercial Corporation, 26040 Ynez Road, Temecula, CA 92589, US
 (72) BURKE, Edward, J., 30944 Wellington Circle, Temecula, CA 92591, US
 GWILLIM, Robert, H., 41237 Pine Tree Circle, Temecula, CA 92591, US

- (51) MKP
A61K 31/4178 (2006.01) (97) **2692726**
A61K 31/4184 (2006.01)
A61K 31/4439 (2006.01)
A61K 31/454 (2006.01)
A61K 31/496 (2006.01)
A61K 31/506 (2006.01)
A61P 31/14 (2006.01)
C07D 401/14 (2006.01)
C07D 403/14 (2006.01)
C07D 417/14 (2006.01)
(96) 13191049.9 05.02.2014
(97) 2692726, 05.02.2014 en
(54) Anti-viral compounds
(71) Abbvie Inc., 1 North Waukegan Road, North Chicago, IL 60064, US
(72) Degoev, David A., 8649 226th Avenue, Salem, WI Wisconsin 53168, US
Kati, Warren M., 152 Knob Hill Lane, Gurnee, IL Illinois 60031, US
Hutchins, Charles W., 31005 Prairie Ridge Road, Green Oaks, IL Illinois 60048, US
Donner, Pamela L., 1901 McRae Lane, Mundelien, IL Illinois 60060, US
Krueger, Allan C., 7260 Presidential Drive, Gurnee, IL Illinois 60031, US
Randolph, John T., 304 Broadway Avenue, Libertyville, IL Illinois 60048, US
Motter, Christopher E., 10135 South Warwick Drive, Oak Creek, WI Wisconsin 53154, US
Nelson, Lissa T., 640 Broadview Avenue, Highland Park, IL Illinois 60035, US
Patel, Sachel V., 1259 S. Meadow Road, Round Lake, IL Illinois 60073, US
Matulenko, Mark A., 1875 Countryside Drive, Libertyville, IL Illinois 60048, US
Keddy, Ryan G., 10046 West Hendee Road, Beach Park, IL Illinois 60087, US
Jinkerson, Tammie K., 11129 10th Avenue, Pleasant Prairie, WI Wisconsin 53158, US
Gao, Yi, 210 East Baltusrol Drive, Vernon Hills, IL Illinois 60061, US
Liu, Dachun, 1276 Georgetown Way, Vernon Hills, IL Illinois 60061, US
Pratt, John K., 8210 61st Avenue, Kenosha, WI Wisconsin 53142, US
Rockway, Todd W., 34136 N. Lavender Circle, Grayslake, IL Illinois 60030, US
Maring, Clarence J., 1228 W. Borders Drive, Palatine, IL Illinois 60067, US
Hutchinson, Douglas K., 160 Depot Street, Antioch, IL Illinois 60002, US
Flentge, Charles A., 8628 225th Avenue, Salem, WI Wisconsin 53168, US
Wagner, Rolf, 42530 Sheridan Oaks Drive, Antioch, IL Illinois 60002, US
Tufano, Michael D., 6539 North Washtenaw, Chicago, IL Illinois 60645, US
Betebenner, David A., 32329 N. Forest Drive, Grayslake, IL Illinois 60030, US
Sarris, Kathy, 1309 Andover Drive, Mundelein, IL Illinois 60060, US
Woller, Kevin R., 1072 Joy Court, Antioch, IL Illinois 60002, US
Wagaw, Sebel H., 2311 Ridgeway, Evanston, IL Illinois 60201, US
Califano, Jean C., 6167 N. Bay Ridge, Whitefish Bay, WI Wisconsin 53217, US
Li, Wenke, 7203 Buchanan Drive, Gurnee, IL Illinois 60031, US
Caspi, Daniel D., 807 Davis Street 912, Evanston, IL Illinois 60201, US
Bellizzi, Mary E., 771 N. McKinley Road, Lake Forest, IL Illinois 60045, US
Carroll, William A., 2325 Ridgeway Avenue, Evanston, IL Illinois 60201, US

- (51) MKP
A61K 38/00 (2006.01) (97) **2750686 ***
(86) US2012042779 15.06.2012
(96) 12801238.2 09.07.2014
(87) WO2012174452, 15.06.2012
(97) 2750686, 09.07.2014 en
(54) MITOCHONDRIAL TARGETING AND THERAPEUTIC USE THEREOF
(71) Shire Human Genetic Therapies, Inc., 700 Main Street, Cambridge, MA 02139, US
(72) KEEFE, Dennis, 120 Church Street, Wilmington, MA 01887, US
HEARTLEIN, Michael, 167 Reed Farm Road, Boxborough, MA 01719, US
JOSIAH, Serene, 36-7 Irving Street, Cambridge, MA 02138, US
CONCINO, Michael, 297 Long Hill Road, Bolton, MA 01740, US
STRACK-LOGUE, Bettina, 26 Endicott Avenue, Somerville, MA 02144, US

- (51) MKP
A01N 37/18 (2006.01) (97) **2747560 ***
A61K 31/165 (2006.01)
C07C 233/00 (2006.01)
(86) US2012048588 27.07.2012
(96) 12820262.9 02.07.2014
(87) WO2013019635, 27.07.2012
(97) 2747560, 02.07.2014 en
(54) COMPOUNDS AND METHODS
(71) Tempero Pharmaceuticals, Inc., 200 Technology Square, Cambridge, MA 02139, US
(72) BALOGLU, Erkan, 8 Benjamin Terrace, Stoneham, MA 02180, US
GHOSH, Shomir, 200 Technology Square, Cambridge, MA 02139, US
LOBERA, Mercedes, 200 Technology Square, Cambridge, MA 02139, US
SCHMIDT, Darby, R., 14 Mead Road, Arlington, MA 02474, US

- (51) MKP
A61K 31/437 (2006.01) (97) **2736907 ***
A61K 31/55 (2006.01)
A61P 11/00 (2006.01)
C07D 471/04 (2006.01)
C07D 487/04 (2006.01)
(86) IB2012053546 11.07.2012
(96) 12756557.0 04.06.2014
(87) WO2013014567, 11.07.2012
(97) 2736907, 04.06.2014 en
(54) INDAZOLES
(71) Pfizer Limited, Ramsgate Road, Sandwich, Kent CT13 9NJ, GB
(72) COE, Jotham, Wadsworth, Pfizer Global Research and Development Eastern Point Road, Groton, CT 06340, US
DEHNHARDT, Christoph, Martin, Pfizer Global Research and Development 87 Cambridge Park Drive, Cambridge, MA 02140, US
JONES, Peter, Pfizer Global Research and Development 87 Cambridge Park Drive, Cambridge, MA 02140, US
KORTUM, Steven Wade, Pfizer Global Research and Development Eastern Point Road, Groton, CT 06340, US
SABNIS, Yogesh, Anil, c/o Pfizer Global Research and Development Ramsgate Road, Sandwich Kent CT13 9NJ, GB
WAKENHUT, Florian, Michel, c/o Pfizer Global Research and Development Ramsgate Road, Sandwich Kent CT13 9NJ, GB
WHITLOCK, Gavin, Alistair, c/o Pfizer Global Research and Development Ramsgate Road, Sandwich Kent CT13 9NJ, GB

- (51) MKP
A61K 31/122 (2006.01) (97) **2709608 ***
A61K 31/198 (2006.01)
A61K 31/275 (2006.01)
(86) US2012037770 14.05.2012
(96) 12722056.4 26.03.2014
(87) WO2012158612, 14.05.2012
(97) 2709608, 26.03.2014 en
(54) METHOD OF TREATING POSTURAL REFLEX ABNORMALITY CAUSED BY PARKINSON'S DISEASE
(71) Chelsea Therapeutics Inc., 3530 Toringdon Way, Charlotte, NC 28277, US
(72) FUKADA, Kei, 21-4 Higashi Korien-cho, Neyagawa-shi Osaka 572-0081, JP
SAKODA, Saburo, 11-2-104 Kawanishi-cho, Ashiya-shi Hyogo 659-0072, JP

(51) MKP
B28C 7/00 (2006.01) (97) **2266771**
B65G 53/32 (2006.01)
B65G 53/52 (2006.01)
C04B 40/06 (2006.01)
F25D 3/10 (2006.01)
(96) 10165079.4 29.12.2010
(97) 2266771, 29.12.2010 de
(54) Device and method for cooling and inserting a flow of pulverulent or granular materials in a storage container
(71) Messer Group GmbH, Messer-Platz 1, 65812 Bad Soden, DE
Messer Austria GmbH, Industriestrasse 5, 2352 Gumpoldskirchen, AT
(72) Hatz, Gottfried, Messer Austria GmbH Kap-Verde-Gasse 4/2, 8430, Leibnitz, AT
Tauchmann, Jens, SAT Messer Group GmbH Zum Peschekamp 31, 47259, Duisburg, DE

(51) MKP
A47L 5/36 (2006.01) (97) **2630902**
A47L 9/12 (2006.01)
A47L 9/20 (2006.01)
(96) 13156101.1 28.08.2013
(97) 2630902, 28.08.2013 en
(54) Vacuum cleaner with reverse air jet filter cleaning device
(71) Solarys S.r.l., Via Marie Curie, 1, 26030 Pessina Cremonese (CR), IT
(72) Bettella, Giancarlo, SOLARYS SRL Via S. Marco 1, 26100 Cremona, IT

(51) MKP
C07K 14/50 (2006.01) (97) **2764019 ***
C07K 14/605 (2006.01)
(86) US2012057371 26.09.2012
(96) 12773169.3 13.08.2014
(87) WO2013049234, 26.09.2012
(97) 2764019, 13.08.2014 en
(54) DUAL FUNCTION PROTEINS FOR TREATING METABOLIC DISORDERS
(71) Novartis AG, Lichtstrasse 35, 4056 Basel, CH
IRM LLC, 131 Front Street P.O. Box HM 2899, Hamilton HM LX, BM
(72) BOETTCHER, Brian R., Novartis Insitutes for BioMedical Research, Inc. 100 Technology Square, Cambridge, MA 02139, US
CAPLAN, Shari L., Novartis Insitutes for BioMedical Research, Inc. 100 Technology Square, Cambridge, MA 02139, US
LITTI, Susan E., Novartis Insitute for Functional Genomics, Inc. 10675 John Jay Hopkins Drive, San Diego, CA 92121, US
DANIELS, Douglas S., Novartis Insitutes for BioMedical Research, Inc. 100 Technology Square, Cambridge, MA 02139, US
HAMAMATSU, Norio, Novartis Insitutes for BioMedical Research, Inc. 100 Technology Square, Cambridge, MA 02139, US
GEIERSTANGER, Bernhard Hubert, Novartis Insitute for Functional Genomics, Inc. 10675 John Jay Hopkins Drive, San Diego, CA 92121, US
LICHT, Stuart, 100 Memorial Drive, Cambridge, MA 02142, US
LOEW, Andreas, Novartis Insitutes for BioMedical Research, Inc. 100 Technology Square, Cambridge, MA 02139, US
WELDON, Stephen Craig, Novartis Insitutes for BioMedical Research, Inc. 100 Technology Square, Cambridge, MA 02139, US

(51) MKP
G01N 33/50 (2006.01) (97) **2751562 ***
G01N 33/542 (2006.01)
(86) US2012053505 31.08.2012
(96) 12759331.7 09.07.2014
(87) WO2013033623, 31.08.2012
(97) 2751562, 09.07.2014 en
(54) PROFILING OF SIGNAL PATHWAY PROTEINS TO DETERMINE THERAPEUTIC EFFICACY
(71) Nestec S.A., Avenue Nestlé 55, 1800 Vevey, CH
(72) SINGH, Sharat, 8171 Top of the Morning Way, Rancho Santa Fe, California 92127, US
KIM, Phillip, 28 Exeter, Irvine, California 92612, US

(51) MKP
A61K 39/395 (2006.01) (97) **2739311 ***
A61P 19/00 (2006.01)
C07K 16/22 (2006.01)
(86) US2012049331 02.08.2012
(96) 12746235.6 11.06.2014
(87) WO2013019954, 02.08.2012
(97) 2739311, 11.06.2014 en
(54) METHOD FOR TREATING BONE GAP DEFECTS
(71) Amgen Inc., Patent Operations M/S 28-2-C One Amgen Center Drive, Thousand Oaks, California 91320-1799, US
(72) Li, Xiaodong, 1512 Sappanwood Avenue, Newbury Park, CA 91320, US
KE, Hua, Zhu, 5258 Via Dolores, Newbury Park, CA 91320, US

(51) MKP
F16K 27/02 (2006.01) (97) **2660496**
(96) 13165788.4 06.11.2013
(97) 2660496, 06.11.2013 en
(54) Valve
(71) Far Rubinetterie S.P.A., Via Morena 20, 28024 Gozzano (NO), IT
(72) ALLESINA, Guerrino, c/o FAR RUBINETTERIE S.p.A. Via Morena 20, 28020 Gozzano, IT

(51) MKP
B60R 19/26 (2006.01) (97) **2712344 ***
B60R 19/32 (2006.01)
B60R 19/36 (2006.01)
B60T 13/10 (2006.01)
F01C 1/00 (2006.01)
F03C 1/02 (2006.01)
(86) PL2011000068 01.07.2011
(96) 11748762.9 02.04.2014
(87) WO2012138237, 01.07.2011
(97) 2712344, 02.04.2014 en
(54) IMPACT ENERGY CONVERSION DEVICE
(71) Radowski, Piotr Mitre, Ul. Swierkowa 43/4, 81-526 Gdynia, PL
(72) Radowski, Piotr Mitre, Ul. Swierkowa 43/4, 81-526 Gdynia, PL

(51) MKP
A61K 9/00 (2006.01) (97) **2719376**
A61K 9/16 (2006.01)
A61K 9/20 (2006.01)
(96) 12188419.1 16.04.2014
(97) 2719376, 16.04.2014 en
(54) Gastroretentive drug formulation and delivery systems and their method of preparation using functionalized calcium carbonate
(71) Onya International AG, Baslerstrasse 42, 4665 Oftringen, CH
(72) Gerard, Daniel Edward, Rheinfelderstrasse 12, 4058 Basel, CH
Schoelkopf, Joachim, Buechbühlstrasse 3, 8956 Killwangen, CH
Gane, Patrick Arthur Charles, Studenweg 8, 4852 Rothrist, CH
Eberle, Veronika Anna, Gasstrasse 17, 4056 Basel, CH
Alles, Rainer, Riehenstrasse 232, 4058 Basel, CH
Puckhov, Maxim, Krebsenbachweg 13, 4148 Pfeffingen, CH
Huwlyer, Jörg, In der Schappe 91, 4144 Arlesheim, CH

- (51) MKP
A61K 8/02 (2006.01) (97) **2723304 ***
A61K 8/04 (2006.01)
A61K 8/44 (2006.01)
A61K 8/73 (2006.01)
A61K 8/81 (2006.01)
A61Q 19/00 (2006.01)
A61Q 19/10 (2006.01)
- (86) IB2012053170 22.06.2012
(96) 12740215.4 30.04.2014
(87) WO2012176166, 22.06.2012
(97) 2723304, 30.04.2014 en
(54) CLEANING COMPOSITION COMPRISING A GELLING AGENT AND A FOAMING SURFACTANT
(71) SCA TISSUE FRANCE, 60, avenue de l'Europe, 92270 Bois-Colombes, FR
(72) ANNAHEIM, Stéphanie, 1 rue des Prés, F-68520 Burnhaupt-le-Haut, FR
BRET, Bruno, 16 rue de Neufeld, F-68920 Wintzenheim, FR
WALGENWITZ, Hervé, 11 rue de Belgique, F-68170 Rixheim, FR
RUPPEL, Rémy, 6 rue des Vosges, F-68320 Durrenentzen, FR
CLERMONT, Anne-Gaëlle, 46b Sentier de la Luss Allée des Aquarelles, F-68000 Colmar, FR
PROBST, Pierre, 11 rue des Camélias, F-68770 Ammerschwihr, FR
JEANNOT, Sébastien, 38 rue Principale, F-68320 Holtzwihr, FR

- (51) MKP
A61M 5/24 (2006.01) (97) **2704776 ***
A61M 5/315 (2006.01)
- (86) EP2012058178 04.05.2012
(96) 12717785.5 12.03.2014
(87) WO2012152666, 04.05.2012
(97) 2704776, 12.03.2014 en
(54) ASSEMBLY FOR A DRUG DELIVERY DEVICE AND DRUG DELIVERY DEVICE
(71) Sanofi-Aventis Deutschland GmbH, Brüningsstraße 50, 65929 Frankfurt am Main, DE
(72) SCHNEIDER, Christiane, c/o Sanofi-Aventis Deutschland GmbH, 65926 Frankfurt am Main, DE
STEVEY, Tobias, c/o Sanofi-Aventis Deutschland GmbH, 65926 Frankfurt am Main, DE
HARMS, Michael, c/o Sanofi-Aventis Deutschland GmbH, 65926 Frankfurt am Main, DE
JAKOBI, Ulrik, c/o Sanofi-Aventis Deutschland GmbH, 65926 Frankfurt am Main, DE

- (51) MKP
E06B 7/215 (2006.01) (97) **2761120 ***
- (86) US2012056837 24.09.2012
(96) 12835603.7 06.08.2014
(87) WO2013048935, 24.09.2012
(97) 2761120, 06.08.2014 en
(54) SEALING ASSEMBLY FOR A SWING DOOR
(71) Wabtec Holding Corp., 1001 Air Brake Avenue, Wilmerding, PA 15148, US
(72) HEIDRICH, Peter, 1036 Alfini Drive, Des Plaines, Illinois 60016, US
GOLEMIS, Frank, 4946 W. Coyle Avenue, Skokie, Illinois 60077, US

- (51) MKP
C07D 209/14 (2006.01) (97) **2760831 ***
C07D 401/08 (2006.01)
C07D 401/12 (2006.01)
C07D 401/14 (2006.01)
C07D 403/08 (2006.01)
C07D 403/10 (2006.01)
C07D 403/12 (2006.01)
C07D 405/12 (2006.01)
C07D 409/08 (2006.01)
C07D 409/12 (2006.01)
C07D 413/08 (2006.01)
C07D 413/12 (2006.01)
C07D 417/14 (2006.01)
C07D 471/04 (2006.01)
C07D 487/04 (2006.01)
- (86) EP2012069007 26.09.2012
(96) 12775463.8 06.08.2014
(87) WO2013045516, 26.09.2012
(97) 2760831, 06.08.2014 en
(54) VIRAL REPLICATION INHIBITORS
(71) Katholieke Universiteit Leuven, K.U.Leuven R&D Waaistraat 6 Box 5105, 3000 Leuven, BE
(72) BARDIOT, Dorothee, c/o Waaistraat 6, B-3000 Leuven, BE
CARLENS, Gunter, c/o Waaistraat 6, B-3000 Leuven, BE
DALLMEIER, Kai, c/o Waaistraat 6, B-3000 Leuven, BE
KAPTEIN, Suzanne, c/o Waaistraat 6, B-3000 Leuven, BE
McNAUGHTON, Michael, c/o Waaistraat 6, B-3000 Leuven, BE
MARCHAND, Arnaud, c/o Waaistraat 6, B-3000 Leuven, BE
NEYTS, Johan, c/o Waaistraat 6, B-3000 Leuven, BE
SMETS, Wim, c/o Waaistraat 6, B-3000 Leuven, BE
KOUKNI, Mohamed, c/o Waaistraat 6, B-3000 Leuven, BE

- (51) MKP
E05B 17/00 (2006.01) (97) **2722470**
E05B 45/06 (2006.01)
- (96) 12189306.9 23.04.2014
(97) 2722470, 23.04.2014 en
(54) Alarm incorporated cylinder lock
(71) KALE Kilit ve Kalip Sanayi A.S., Atatürk cad. Basakli sok. No:39 Güngören, 34610 İstanbul, TR
(72) Karsil, Feramuz, KALE Kilit ve Kalip Sanayii A.S. Atatürk cad. Basakli sok. No:39 Güngören, 34610 İstanbul, TR
Bilgic, Ahmet, KALE Kilit ve Kalip Sanayii A.S. Atatürk cad. Basakli sok. No:39 Güngören, 34610 İstanbul, TR
Icibal, Kadir, KALE Kilit ve Kalip Sanayii A.S. Atatürk cad. Basakli sok. No:39 Güngören, 34610 İstanbul, TR

- (51) MKP
H02K 1/24 (2006.01) (97) **2719060 ***
H02K 15/02 (2006.01)
- (86) EP2012060595 05.06.2012
(96) 12725467.0 16.04.2014
(87) WO2012168238, 05.06.2012
(97) 2719060, 16.04.2014 de
(54) ELECTRIC MACHINE, SYNCHRONOUS GENERATOR-FIELD POLE, SYNCHRONOUS GENERATOR-ROTOR COMPRISING A PLURALITY OF FIELD POLES, AND METHOD FOR PRODUCING A SYNCHRONOUS GENERATOR-FIELD POLE OF AN ELECTRIC MACHINE
(71) Wobben Properties GmbH, Dreekamp 5, 26605 Aurich, DE
(72) JEPSEN, Torsten, Abraham-Wolffs-Straße 8, 26603 Aurich, DE
DUTSCH, Matthias, Extumer Gaste 55 a, 26605 Aurich, DE

- (51) MKP
A61B 17/064 (2006.01) (97) **2644212**
A61L 31/04 (2006.01)
A61L 31/14 (2006.01)
A61L 31/16 (2006.01)
- (96) 13161485.1 02.10.2013
(97) 2644212, 02.10.2013 en
(54) Tissue thickness compensator comprising controlled release and expansion
(71) Ethicon Endo-Surgery, Inc., 4545 Creek Road, Cincinnati, OH 45242, US
(72) BAXTER, III Chester O., 6375 Pawnee Ridge, Loveland, OH 45140, US
Shelton, IV Frederick E., 245 East Main Street, Hillsboro, OH 45133, US
Scheib, Charles J., 11329 Donwiddle Drive, Loveland, OH 45140, US
Widenhouse, Christopher W., 1005 Arabian Run Drive, Clarksville, OH 45113, US
Weisenburgh, II William B., 974 Airymeadows Drive, Maineville, OH 45039, US
Stammen, John L., 8238 Glenhaven Court, Cincinnati, OH 45241, US
Ransick, Mark H., 7501 Nordan Drive, West Chester, OH 45069, US
Mutchler, Stephanie A., 328 Glen Lake Road, Loveland, OH 45140, US
Knight, Gary W., 8264 Meadowlark Drive, West Chester, OH 45069, US
Cropper, Michael S., 3232 Charter Oak, Edgewood, KY 41017, US
Conlon, Sean P., 6234 C. North Shadow Hill Way, Loveland, OH 45140, US
Swayze, Jeffrey S., 7047 Birchley Drive, Hamilton, OH 45011, US

-
- (51) MKP
C07D 255/02 (2006.01) (97) **2709991 ***
- (86) US2012037970 15.05.2012
(96) 12786739.8 26.03.2014
(87) WO2012158707, 15.05.2012
(97) 2709991, 26.03.2014 en
(54) USE OF CXCR4 ANTAGONISTS
(71) Genzyme Corporation, 500 Kendall Street, Cambridge, MA 02142, US
University of Washington, Center for Commercialization 4311 11th Avenue NE, Suite 500, Seattle, WA 98105, US
(72) DALE, David, C., 5302 Ne 42nd Street, Seattle, WA 98105, US
BRIDGER, Gary, J., 445 South Garden Street, Bellingham, WA 98225, US
HSU, Frank, J., 55 Cambridge Parkway, Cambridge, MA 02142, US
-

- (51) MKP
A61K 31/519 (2006.01) (97) **2766368 ***
A61P 29/00 (2006.01)
A61P 37/00 (2006.01)
C07D 487/04 (2006.01)
- (86) US2012059282 09.10.2012
(96) 12775905.8 20.08.2014
(87) WO2013055645, 09.10.2012
(97) 2766368, 20.08.2014 en
(54) 5,7-SUBSTITUTED-IMIDAZO[1,2-C]PYRIMIDINES
(71) Array BioPharma Inc., 3200 Walnut Street, Boulder, CO 80301, US
(72) BOYS, Mark Laurence, c/o Array BioPharma Inc. 3200 Walnut Street, Boulder Colorado 80301, US
BURGESS, Laurence E., c/o Array BioPharma Inc. 3200 Walnut Street, Boulder Colorado 80301, US
EARLY, C. Todd, c/o Array BioPharma Inc. 3200 Walnut Street, Boulder Colorado 80301, US
GRONEBERG, Robert, 958 Yellow Pine Avenue, Boulder Colorado 80304, US
HACHE, Bruno P., c/o Array BioPharma Inc. 3200 Walnut Street, Boulder Colorado 80301, US
HARVEY, Darren, 3 Barker Road, Acton Massachusetts 01720, US
HICKEN, Erik James, c/o Array BioPharma Inc. 3200 Walnut Street, Boulder Colorado 80301, US
KRASER, Christopher F., c/o Array BioPharma Inc. 3200 Walnut Street, Boulder Colorado 80301, US
LAIRD, Ellen, c/o Array BioPharma Inc. 3200 Walnut Street, Boulder Colorado 80301, US
MORENO, David A., c/o Array BioPharma Inc. 3200 Walnut Street, Boulder Colorado 80301, US
MUNSON, Mark C., 45 Central Street, Acton Massachusetts 01720, US
REN, Li, c/o Array BioPharma Inc. 3200 Walnut Street, Boulder Colorado 80301, US
ROBINSON, John E., c/o Array BioPharma Inc. 3200 Walnut Street, Boulder Colorado 80301, US
SCHLACHTER, Stephen T., 2017 Lauraette Drive, Dallas Texas 75208-3110, US
-

(51) MKP
A61K 31/4245 (2006.01) (97) **2758394 ***
A61K 31/445 (2006.01)
A61P 25/00 (2006.01)
C07D 413/14 (2006.01)
(86) IN2012000011 05.01.2012
(96) 12716662.7 30.07.2014
(87) WO2013042135, 05.01.2012
(97) 2758394, 30.07.2014 en
(54) HETEROARYL COMPOUNDS AS 5-HT4 RECEPTOR LIGANDS
(71) Suven Life Sciences Limited, Serene Chambers Road No. 5, Avenue 7, Banjara Hills, Hyderabad 500 034, Andhra Pradesh, IN
(72) NIROGI, Ramakrishna, Suven Life Sciences Limited Serene Chambers Road - 5 Avenue - 7 Banjara Hills, Hyderabad Andhra Pradesh 500 034, IN
MOHAMMED, Abdul Rasheed, Suven Life Sciences Limited Serene Chambers Road - 5 Avenue - 7 Banjara Hills, Hyderabad Andhra Pradesh 500 034, IN
YARLAGADDA, Suresh, Suven Life Sciences Limited Serene Chambers Road - 5 Avenue - 7 Banjara Hills, Hyderabad Andhra Pradesh 500 034, IN
RAVELLA, Srinivasa Rao, Suven Life Sciences Limited Serene Chambers Road - 5 Avenue - 7 Banjara Hills, Hyderabad Andhra Pradesh 500 034, IN
SHINDE, Anil Karbhari, Suven Life Sciences Limited Serene Chambers Road - 5 Avenue - 7 Banjara Hills, Hyderabad Andhra Pradesh 500 034, IN
KAMBHAMPATI, Ramasastri, Suven Life Sciences Limited Serene Chambers Road - 5 Avenue - 7 Banjara Hills, Hyderabad Andhra Pradesh 500 034, IN
ROAYAPALLEY, Praveen Kumar, Suven Life Sciences Limited Serene Chambers Road - 5 Avenue - 7 Banjara Hills, Hyderabad Andhra Pradesh 500 034, IN
JAYARAJAN, Pradeep, Suven Life Sciences Limited Serene Chambers Road - 5 Avenue - 7 Banjara Hills, Hyderabad Andhra Pradesh 500 034, IN
BHYRAPUNENI, Gopinadh, Suven Life Sciences Limited Serene Chambers Road - 5 Avenue - 7 Banjara Hills, Hyderabad Andhra Pradesh 500 034, IN
PATNALA, Sriramachandra Murthy, Suven Life Sciences Limited Serene Chambers Road - 5 Avenue - 7 Banjara Hills, Hyderabad Andhra Pradesh 500 034, IN
RAVULA, Jyothsna, Suven Life Sciences Limited Serene Chambers Road - 5 Avenue - 7 Banjara Hills, Hyderabad Andhra Pradesh 500 034, IN
JASTI, Venkateswarlu, Suven Life Sciences Limited Serene Chambers Road - 5 Avenue - 7 Banjara Hills, Hyderabad Andhra Pradesh 500 034, IN

(51) MKP
A61K 9/20 (2006.01) (97) **2729132 ***
A61K 31/343 (2006.01)
A61K 47/02 (2006.01)
A61K 47/10 (2006.01)
A61K 47/12 (2006.01)
A61K 47/30 (2006.01)
A61K 47/32 (2006.01)
A61P 9/06 (2006.01)
(86) EP2012063312 06.07.2012
(96) 12733700.4 14.05.2014
(87) WO2013004830, 06.07.2012
(97) 2729132, 14.05.2014 fr
(54) PHARMACEUTICAL COMPOSITION AND SOLID GALENIC FORM HAVING A HIGH DRONEDARONE CONTENT, AND METHOD FOR PREPARING SAME
(71) SANOFI, 54 rue La Boétie, 75008 Paris, FR
(72) DUCASSOU, Jean, c/o Sanofi Patent Department 54 rue La Boétie, F-75008 Paris, FR
RENOUARD, Marie, c/o Sanofi Patent Department 54 rue La Boétie, F-75008 Paris, FR

(51) MKP
B29C 47/00 (2006.01) (97) **2711411 ***
B29C 47/08 (2006.01)
B29C 47/92 (2006.01)
C10L 5/46 (2006.01)
C10L 5/48 (2006.01)
(86) ES2012070353 18.05.2012
(96) 12730590.2 26.03.2014
(87) WO2012156567, 18.05.2012
(97) 2711411, 26.03.2014 en
(54) PROCESS AND APPARATUS FOR THE PRODUCTION OF A SOLID FUEL FROM COMBUSTIBLE WASTES
(71) Carrera Varela, José Antonio, Gascueña, 33, 28022 Madrid, ES
(72) SARALEGUI GUTIÉRREZ, Alberto, Isezaki Corporation S.I. Gascueña 33, E-28022 Madrid, ES
VEGA OTERINO, Juan Alberto, Isezaki Corporation S.I. Gascueña 33, E-28022 Madrid, ES

(51) MKP
A61K 31/4162 (2006.01) (97) **2702058 ***
A61P 19/02 (2006.01)
C07D 471/04 (2006.01)
(86) EP2012057652 26.04.2012
(96) 12717288.0 05.03.2014
(87) WO2012146657, 26.04.2012
(97) 2702058, 05.03.2014 en
(54) NOVEL COMPOUND USEFUL FOR THE TREATMENT OF DEGENERATIVE AND INFLAMMATORY DISEASES
(71) Galapagos N.V., Generaal de Wittelaan L11 A3, 2800 Mechelen, BE
(72) MENET, Christel, Jeanne, Marie, Galapagos NV Generaal De Wittelaan L11/A3, B-2800 Mechelen, BE
HODGES, Alastair, James, BioFocus DPI Ltd. Chesterford Research Park, Saffron Walden Essex CB10 1XL, GB
VATER, Huw, David, BioFocus DPI Ltd. Chesterford Research Park, Saffron Walden Essex CB10 1XL, GB

(51) MKP
A61M 5/32 (2006.01) (97) **2734257 ***
(86) EP2012063955 17.07.2012
(96) 12737274.6 28.05.2014
(87) WO2013011006, 17.07.2012
(97) 2734257, 28.05.2014 en
(54) NEEDLE SHIELD ASSEMBLY
(71) Sanofi-Aventis Deutschland GmbH, Brüningstraße 50, 65929 Frankfurt am Main, DE
(72) WENDLAND, Stefan, c/o Sanofi-Aventis Deutschland GmbH, 65926 Frankfurt am Main, DE

(51) MKP
B05C 1/02 (2006.01) (97) **2709848 ***
B41F 17/00 (2006.01)
B41F 35/00 (2006.01)
B41M 1/14 (2006.01)
B41M 1/40 (2006.01)
(86) BE2012000025 16.05.2012
(96) 12743643.4 26.03.2014
(87) WO2013000043, 16.05.2012
(97) 2709848, 26.03.2014 en
(54) PAD PRINTING SYSTEM AND METHOD THEREFOR
(71) De Volder, Laurent, Aalterstraat 11, 9880 Aalter, BE
Feyaerts, Filip, Duilhoekstraat 45, 9230 Wetteren, BE
(72) De Volder, Laurent, Aalterstraat 11, 9880 Aalter, BE
Feyaerts, Filip, Duilhoekstraat 45, 9230 Wetteren, BE

(51) MKP
A63H 19/32 (2006.01) (97) **2666529**
(96) 13168258.5 27.11.2013
(97) 2666529, 27.11.2013 en
(54) Device for actuating a switch for a model railroad
(71) Pigato, Massimo, Via Gropello Giambattista, 10, 10138 Torino, IT
Roncaglione, Piera, Via Gropello Giambattista, 10, 10138 Torino, IT
(72) Pigato, Massimo, Via Gropello Giambattista, 10, 10138 Torino, IT

- (51) MKP
C21C 5/00 (2006.01)
C21C 5/28 (2006.01)
C22B 3/00 (2006.01)
C22B 3/04 (2006.01)
C22B 3/20 (2006.01)
C22B 23/00 (2006.01)
C22C 1/00 (2006.01)
C22C 33/04 (2006.01)
C22C 38/40 (2006.01)
(96) 13171750.6 01.01.2014
(97) 2679691, 01.01.2014 en
(54) Method for manufacturing an austenitic stainless steel from a nickel laterite ore and a chromite ore
(71) Yieh United Steel Corp., 600, Shing Loong St., Jia Hsing Li, Kangshan Jenn, Kaohsiung Hsien, TW
(72) HSU, Wen-Chien, No. 41, Renchang St. Nanzih Dist., 81150 Kaohsiung City, TW
HUANG, Pei-Te, 6F.-4, No. 123-7 Ta-Pi Rd. Niao-Sung Dist., 833 Kaohsiung City, TW
WU, Yi-Cheng, 10F., No.50, Lane 177 Guangsing St. Zuoying Dist., 813 Kaohsiung City, TW
YANG, Cheng-Tung, No. 600, Shing Loong St. Kangshan Dist., 820 Kaohsiung City, TW
-
- (51) MKP
A61K 9/20 (2006.01)
A61K 9/28 (2006.01)
A61K 31/00 (2006.01)
A61K 31/519 (2006.01)
A61K 31/568 (2006.01)
(86) NL2012050336 14.05.2012
(96) 12724767.4 26.03.2014
(87) WO2012158030, 14.05.2012
(97) 2709597, 26.03.2014 en
(54) DRUG DELIVERY SYSTEM
(71) Emotional Brain B.V., Louis Armstrongweg 78, 1311 RL Almere, NL
(72) BLOEMERS, Johannes Martinus Maria, c/o Emotional Brain B.V. Louis Armstrongweg 78, NL-1311 RL Almere, NL
EISSENS, Anko Cornelus, Department of Pharmaceutical Technology and Biopharmacy Antonius Deusinglaan 1, NL-9713 AV Groningen, NL
FRIJLINK, Henderik Willem, Department of Pharmaceutical Technology and Biopharmacy Antonius Deusinglaan 1, NL-9713 AV Groningen, NL
DE LEEDE, Leonardus Gerardus Jozef, c/o Exelion Bio-Pharmaceutical Consultancy B.V. Woubrechterf 70, NL-2743 HM Waddinxveen, NL
-
- (51) MKP
A61K 31/4725 (2006.01)
A61P 29/00 (2006.01)
C07D 401/12 (2006.01)
C07D 401/14 (2006.01)
(86) US2012035251 26.04.2012
(96) 12776252.4 05.03.2014
(87) WO2012149186, 26.04.2012
(97) 2702054, 05.03.2014 en
(54) NOVEL BISAMINOQUINOLINE COMPOUNDS, PHARMACEUTICAL COMPOSITIONS PREPARED THEREFROM AND THEIR USE
(71) The Trustees Of The University Of Pennsylvania, 3160 Chestnut Street Suite 200, Philadelphia, PA 19104, US
(72) AMARAVADI, Ravi, K., 706 Iris Lane, Media, PA 19063, US
WINKLER, Jeffrey, 541 Ballytore Road, Wybbwood, PA 19096, US
-
- (51) MKP
A61K 39/395 (2006.01)
C07K 16/00 (2006.01)
C12P 21/08 (2006.01)
(86) US2012055057 13.09.2012
(96) 12833842.3 30.07.2014
(87) WO2013043452, 13.09.2012
(97) 2758430, 30.07.2014 en
(54) ANTI-C-MET ANTIBODIES
(71) Eli Lilly and Company, Lilly Corporate Center, Indianapolis, IN 46285, US
(72) DAVIES, Julian, c/o Eli Lilly and Company P.O. Box 6288, Indianapolis Indiana 46206-6288, US
LIU, Ling, c/o Eli Lilly and Company P.O. Box 6288, Indianapolis Indiana 46206-6288, US
LU, Jirong, c/o Eli Lilly and Company P.O. Box 6288, Indianapolis Indiana 46206-6288, US
-
- (51) MKP
B60J 5/04 (2006.01)
F16H 21/28 (2006.01)
(86) US2012036424 04.05.2012
(96) 12786325.6 26.03.2014
(87) WO2012158364, 04.05.2012
(97) 2709865, 26.03.2014 en
(54) ELECTRIC DOOR OPERATOR
(71) Wabtec Holding Corp., 1001 Air Brake Avenue, Wilmerding, PA 15148, US
(72) GIANNIS, Peter, M., 4110 N. Ridge, Arlington Heights, Illinois 60004, US
-
- (51) MKP
A01M 7/00 (2006.01)
(86) EP2012067699 11.09.2012
(96) 12756485.4 27.08.2014
(87) WO2013056897, 11.09.2012
(97) 2768302, 27.08.2014 de
(54) AGRICULTURAL FIELD-SPRAYING SYSTEM
(71) Amazonen-Werke H. Dreyer GmbH & Co. KG, Am Amazonenwerk 9-13, 49205 Hasbergen, DE
KIEFER, Stefan, Klusstr. 5, 49074 Osnabrück, DE
(72) HUBER, Robert, Donnersbergerstr. 5, 67117 Limburgerhof, DE
WEGKAMP, Heinz-Gerd, Augustinerstr. 42, 68642 Bürstadt, DE
-
- (51) MKP
B01J 8/00 (2006.01)
B01J 8/18 (2006.01)
B01J 8/22 (2006.01)
C07C 29/68 (2006.01)
C07C 209/52 (2006.01)
C07C 213/02 (2006.01)
(86) US2012041482 08.06.2012
(96) 12727998.2 05.03.2014
(87) WO2012177419, 08.06.2012
(97) 2701834, 05.03.2014 en
(54) PROCESS AND APPARATUS FOR PRODUCTION AND FILTRATION OF AMINOALCOHOLS USING A CONTINUOUS STIRRED TANK SLURRY REACTOR
(71) ANGUS Chemical Company, 1500 E. Lake Cook Road, Buffalo Grove, IL 60089, US
(72) MAJOR, Michael, E., 924 Maple Avenue, Evanston, IL 60202, US
GUMMERE, John, D., 27 Azalea Drive, Monroe, LA 71203, US

(51) MKP
A61K 31/4192 (2006.01) (97) **2721012 ***
A61K 31/4196 (2006.01)
A61P 25/18 (2006.01)
A61P 25/22 (2006.01)
A61P 25/24 (2006.01)
C07D 249/04 (2006.01)
C07D 249/12 (2006.01)
(86) US2012041229 07.06.2012
(96) 12729769.5 23.04.2014
(87) WO2012173850, 07.06.2012
(97) 2721012, 23.04.2014 en
(54) BICYCLO (3.1.0) HEXANE- 2, 6 -DICARBOXYLIC ACID DERIVATIVES AS MGLU2 RECEPTOR AGONIST
(71) Eli Lilly and Company, Lilly Corporate Center, Indianapolis, IN 46285, US
(72) MAN, Teresa, Tse Ki, c/o Eli Lilly and Company P.O. Box 6288, Indianapolis, IN 46206-6288, US
MONN, James, Allen, c/o Eli Lilly and Company P.O. Box 6288, Indianapolis, IN 46206-6288, US
MONTERO SALGADO, Carlos, c/o Eli Lilly and Company P.O. Box 6288, Indianapolis, IN 46206-6288, US
PRIETO, Lourdes, c/o Eli Lilly and Company P.O. Box 6288, Indianapolis, IN 46206-6288, US
WALTON, Lesley, c/o Eli Lilly and Company P.O. Box 6288, Indianapolis, IN 46206-6288, US
TUPPER, David, Edward, c/o Eli Lilly and Company P.O. Box 6288, Indianapolis, IN 46206-6288, US

(51) MKP
A61K 31/343 (2006.01) (97) **2729140 ***
A61P 9/04 (2006.01)
(86) EP2012063314 06.07.2012
(96) 12731504.2 14.05.2014
(87) WO2013004831, 06.07.2012
(97) 2729140, 14.05.2014 en
(54) DRONEDARONE FOR THE PREVENTION OF ATRIAL FIBRILLATION
(71) SANOFI, 54 rue La Boétie, 75008 Paris, FR
(72) BARET-CORMEL, Lydie, c/o Sanofi Patent Department 54 rue La Boétie, 75008 Paris, FR
RADZIK, Davide, c/o Sanofi Patent Department 54 rue La Boétie, 75008 Paris, FR
WEINLING, Estelle, c/o Sanofi Patent Department 54 rue La Boétie, 75008 Paris, FR

(51) MKP
A01K 67/027 (2006.01) (97) **2758534 ***
C07K 16/46 (2006.01)
C12N 15/85 (2006.01)
(86) GB2012052297 18.09.2012
(96) 12762377.5 30.07.2014
(87) WO2013041845, 18.09.2012
(97) 2758534, 30.07.2014 en
(54) ANIMALS, REPERTOIRES & METHODS FOR THE PRODUCTION OF HUMAN ANTIBODIES
(71) Kymab Limited, Meditrina (B260) Babraham Research Campus, Cambridge, Cambridgeshire CB22 3AT, GB
(72) BRADLEY, Alan, c/o Kymab Limited Meditrina (B260) Babraham Research Campus, Cambridge, Cambridgeshire CB223AT, GB
LEE, E-Chiang, c/o Kymab Limited Meditrina (B260) Babraham Research Campus, Cambridge, Cambridgeshire CB22 3AT, GB

(51) MKP
A23K 1/00 (2006.01) (97) **2764110 ***
A23L 1/305 (2006.01)
A23L 1/314 (2006.01)
C12P 7/06 (2006.01)
C12P 7/10 (2006.01)
(86) EP2012069601 04.10.2012
(96) 12767006.5 13.08.2014
(87) WO2013050456, 04.10.2012
(97) 2764110, 13.08.2014 en
(54) METHOD FOR THE SIMULTANEOUS PRODUCTION OF ETHANOL AND A FERMENTED, SOLID PRODUCT
(71) Hamlet Protein A/S, Saturnvej 51, 8700 Horsens, DK
(72) HANSEN, Ole, Kaae, Skæring Strandvej 36, DK-8250 Egå, DK
ELLEGÅRD, Katrine, Hvid, Ahornvej 54A, DK-8680 Ry, DK
THOMSEN, Karl, Kristian, Askevej 29, DK-8700 Horsens, DK

(51) MKP
A61K 31/11 (2006.01) (97) **2766002 ***
A61K 31/135 (2006.01)
A61K 31/21 (2006.01)
A61P 25/00 (2006.01)
(86) US2012059356 09.10.2012
(96) 12839776.7 20.08.2014
(87) WO2013055687, 09.10.2012
(97) 2766002, 20.08.2014 en
(54) R(+)-N-FORMYL-PROPARGYL-AMINOINDAN
(71) Teva Pharmaceutical Industries Ltd., 5 Basel Street P.O. Box 3190, 49131 Petach-Tikva, IL
(72) SAFADI, Muhammad, Panorama Salezian, 5A, Street 5005, PO Box 385., Nazareth, 16103, IL
FRENKEL, Anton, Amnon ve Tamar Str. 15/10., 42202 Netanya, IL
KEISAR, Michal, 8 Bareket Street., 40300 Kfar-Yona, IL
LICHT, Danit, 1 Keren Hayesod Street, Ramat Ilan, 54041 Givat Shmuel, IL
BAHAR, Eliezer, 95 Haim Levanon Street., 69345 Tel Aviv, IL
LIDOR-HADAS, Ramy, 19 Mor Str., 44242 Kfar-Saba, IL
ZHOLKOVSKY, Marina, Hahashmonaim Street, 53/2., Bat-Yam, IL
COHEN, Rachel, Ar Atzil Street., Hadera 3824417, IL

(51) MKP
A61K 31/724 (2006.01) (97) **2755664 ***
A61P 17/00 (2006.01)
A61P 17/04 (2006.01)
A61P 17/06 (2006.01)
A61P 17/10 (2006.01)
A61P 17/12 (2006.01)
A61P 29/00 (2006.01)
A61Q 19/00 (2006.01)
A61Q 19/02 (2006.01)
A61Q 19/08 (2006.01)
C07H 3/06 (2006.01)
(86) US2012027826 06.03.2012
(96) 12830502.6 23.07.2014
(87) WO2013036286, 06.03.2012
(97) 2755664, 23.07.2014 en
(54) RETINAL CYCLODEXTRIN ACETALS AND HEMIACETALS FOR CLARIFYING SKIN COMPLEXION
(71) Island Kinetics Inc., 460 South Benson Lane Suite 3, Chandler, AZ 85224, US
(72) PETER, David, Wayne, 31256 North Saddlebag Ln., San Tan Valley, AZ 85143, US
STANEK, John, Dillon, 11165 E. Serafina Ave., Mesa, AZ 85212, US
OROZCO, Cheria, L., 6920 E. Belleview St., Scottsdale, AZ 85257, US
GUPTA, Shyam, K., c/o Bioderm Research 5221 E. Windrose Dr., Scottsdale, AZ 85254, US

(51) MKP
G06F 1/16 (2006.01) (97) **2724210 ***
G06F 3/01 (2006.01)
G06F 3/03 (2006.01)
G06F 3/048 (2013.01)
(86) US2012035829 30.04.2012
(96) 12722574.6 30.04.2014
(87) WO2012177322, 30.04.2012
(97) 2724210, 30.04.2014 en
(54) GESTURE-CONTROLLED TECHNIQUE TO EXPAND INTERACTION RADIUS IN COMPUTER VISION APPLICATIONS
(71) Qualcomm Incorporated, 5775 Morehouse Drive, San Diego, CA 92121-1714, US
(72) RAUBER, Peter Hans, 5775 Morehouse Drive, San Diego, California 92121-1714, US

- (51) MKP
A61K 31/53 (2006.01) (97) **2714654 ***
A61P 9/00 (2006.01)
A61P 31/00 (2006.01)
C07C 311/13 (2006.01)
C07D 251/16 (2006.01)
C07D 251/22 (2006.01)
C07D 401/12 (2006.01)
C07D 405/04 (2006.01)
C07D 405/12 (2006.01)
C07D 413/12 (2006.01)
C07D 417/12 (2006.01)
(86) EP2012059399 21.05.2012
(96) 12721558.0 09.04.2014
(87) WO2012160034, 21.05.2012
(97) 2714654, 09.04.2014 en
(54) 4-ARYL-N-PHENYL-1,3,5-TRIAZIN-2-AMINES CONTAINING A SULFOXIMINE GROUP
(71) Bayer Intellectual Property GmbH, Alfred-Nobel-Strasse 10, 40789 Monheim, DE
(72) LÜCKING, Ulrich, Paula-Fürst-Str. 2, 10317 Berlin, DE
BOHLMANN, Rolf, Kuehler Weg 6a, 14055 Berlin, DE
SCHOLZ, Arne, Schönhauser Allee 170, 10435 Berlin, DE
SIEMEISTER, Gerhard, Reimerswalder Steig 26, 13503 Berlin, DE
GNOTH, Mark, Jean, Am Hang 53, 40822 Mettmann, DE
BÖMER, Ulf, Leipziger Str. 49, 16548 Glienicke, DE
KOSEMUND, Dirk, Klutstr. 14, 12587 Berlin, DE
LIENAU, Philip, Jahnstr. 13, 10967 Berlin, DE
RÜHTER, Gerd, Vierzigstücken 53 A, 21129 Hamburg, DE
SCHULZ-FADEMRECHT, Carsten, Scherrweg 37, 44309 Dortmund, DE

- (51) MKP
F16L 21/00 (2006.01) (97) **2677222**
F16L 21/08 (2006.01)
F16L 25/00 (2006.01)
(96) 13172912.1 25.12.2013
(97) 2677222, 25.12.2013 en
(54) A system for channeling and distributing fluids in pressure or depression
(71) C.T.A. S.R.L. Dei Fratelli Torresi, Via Sandro pertini, 51 Zona Industriale "A", 62012 Civitanova Marche (MC), IT
(72) Torresi, Simone, Via Montebello, 10, 62012 CIVITANOVA MARCHE (MC), IT

- (51) MKP
C10L 1/12 (2006.01) (97) **2726579 ***
C10L 1/198 (2006.01)
(86) EP2012062713 29.06.2012
(96) 12737237.3 07.05.2014
(87) WO2013001064, 29.06.2012
(97) 2726579, 07.05.2014 en
(54) COMPOSITION
(71) DuPont Nutrition Biosciences ApS, Langebrogade 1 P.O. Box 17, 1001 Copenhagen K, DK
(72) NIELSEN, Jens Mogens, Pebbelparken 16 St Jaer, DK-8464 Galten, DK
DUELUND, Maja, Kloveemarksvej 2, DK-8300 Odder, DK
BECH, Allan Torben, Emmasvej 15 3TH, DK-8220 Brabrand, DK

- (51) MKP
A61K 38/12 (2006.01) (97) **2768517 ***
(86) US2012060556 17.10.2012
(96) 12842339.9 27.08.2014
(87) WO2013059278, 17.10.2012
(97) 2768517, 27.08.2014 en
(54) HEPATITIS C VIRUS INHIBITORS
(71) Enanta Pharmaceuticals, Inc., 500 Arsenal Street, Watertown, MA 02472, US
(72) QIU, Yao-ling, 29 Linda Road, Andover, MA 01810, US
CAO, Hui, 53 Hill Road, Belmont, MA 02478, US
PENG, Xiaowen, 66 Homer Avenue 410, Cambridge, MA 02138, US
CHEN, Zhigang, 23 Birch Ridge Road, Acton, MA 01720, US
OR, Yat, Sun, 169 Fayette Street, Watertown, MA 02472, US

- (51) MKP
A61K 9/20 (2006.01) (97) **2753309 ***
A61K 47/10 (2006.01)
A61K 47/12 (2006.01)
(86) EP2012066288 21.08.2012
(96) 12758423.3 16.07.2014
(87) WO2013034436, 21.08.2012
(97) 2753309, 16.07.2014 de
(54) PHARMACEUTICAL COMPOSITION FOR ORAL ADMINISTRATION WITH A STATIN
(71) Hexal AG, Industriestrasse 25, 83607 Holzkirchen, DE
(72) TAEUBRICH, Theresa, Hexal AG Industriestrasse 25, 83607 Holzkirchen, DE
ROTHER, Patrick, Hexal AG Industriestrasse 25, 83607 Holzkirchen, DE

- (51) MKP
A61F 2/30 (2006.01) (97) **2713958 ***
A61F 2/42 (2006.01)
(86) EP2012059517 22.05.2012
(96) 12723646.1 09.04.2014
(87) WO2012160070, 22.05.2012
(97) 2713958, 09.04.2014 en
(54) FLEXIBLE SURGICALLY IMPLANTABLE DEVICE, MADE OF COATED SILICONE, FOR JOINING PHALANXES, METACARPUS-PHALANX OR METATARSUS-PHALANX BONES IN ARTHROPLASTY SURGERY
(71) Sambusseti, Antonio, Via San Predengo, 13, 26100 Cremona, IT
(72) Sambusseti, Antonio, Via San Predengo, 13, 26100 Cremona, IT

- (51) MKP
C07F 9/40 (2006.01) (97) **2710019 ***
C07F 9/44 (2006.01)
C07H 19/20 (2006.01)
(86) US2012038615 18.05.2012
(96) 12725570.1 26.03.2014
(87) WO2012159047, 18.05.2012
(97) 2710019, 26.03.2014 en
(54) PROCESSES AND INTERMEDIATES FOR PREPARING ANTI-HIV AGENTS
(71) Gilead Sciences, Inc., 333 Lakeside Drive, Foster City, CA 94404, US
(72) YU, Richard Hung Chiu, 2625 35th Avenue, San Francisco California 94116, US
BROWN, Brandon Heath, 6472 B. Buena Vista Drive, Newark California 94560, US
POLNIASZEK, Richard P., 2904 Alameda Avenue, Half Moon Bay California 94019, US
GRAETZ, Benjamin R., 2925 Isabelle Avenue, San Mateo California 94403, US
SUJINO, Keiko, 9647 80 Avenue, Edmonton Alberta T6C0V2, CA
TRAN, Duong Duc-Phi, 3207 23 Street, Edmonton Alberta T6T2A9, CA
TRIMAN, Alan Scott, 978 Bellomo Avenue, Apt. D, Sunnyvale California 94086, US
KENT, Kenneth M., 844 Gladiola Drive, Sunnyvale California 94086, US
PFEIFFER, Steven, 46421 Canyon Crest Ct., Temecula California 92592, US

- (51) MKP
A61C 5/06 (2006.01) (97) **2545878**
B65D 1/02 (2006.01)
B65D 39/16 (2006.01)
(96) 12176109.2 16.01.2013
(97) 2545878, 16.01.2013 en
(54) Liquid container
(71) SDI Limited, 5-9 Brunson Street (PO Box 314), Bayswater, VIC 3153, AU
(72) Cheetham, Joshua James, 23, Lewisham Road, Windsor, Victoria 3181, AU
Clayton, Anthony Brian, 2/25 Paddington Road, Hughesdale, Victoria, AU
Cosgriff, Amanda Jane, 81/115 Neerim Road, Glenhuntly, Victoria 3163, AU

(51) MKP
F21S 8/06 (2006.01) (97) **2511604**
F21V 5/06 (2006.01)
F21V 17/16 (2006.01)
(96) 11005852.6 17.10.2012
(97) 2511604, 17.10.2012 en
(54) Crystal mounting frame and light assembly
(71) Swarovski Lighting, Ltd., 61 Industrial Blvd., Plattsburg, NY 12901, US
(72) Sigel, Brian E., 340 Salmon River Road, Plattsburgh New York 12901, US

(51) MKP
A61K 9/00 (2006.01) (97) **2741735 ***
A61K 9/50 (2006.01)
A61K 31/55 (2006.01)
A61P 9/04 (2006.01)
(86) EP2012065704 10.08.2012
(96) 12744014.7 18.06.2014
(87) WO2013024036, 10.08.2012
(97) 2741735, 18.06.2014 en
(54) FUNNY CURRENT (IF) INHIBITORS FOR USE IN A METHOD OF TREATING AND PREVENTING HEART FAILURE IN FELINE
(71) Boehringer Ingelheim Vetmedica GmbH, Binger Strasse 173, 55216 Ingelheim am Rhein, DE
(72) ALBRECHT, Balazs, Boehringer Ingelheim GmbH Corporate Patents Binger Strasse 173, 55216 Ingelheim am Rhein, DE
FOLGER, Martin, Boehringer Ingelheim GmbH Corporate Patents Binger Strasse 173, 55216 Ingelheim am Rhein, DE
KLEY, Saskia, Boehringer Ingelheim GmbH Corporate Patents Binger Strasse 173, 55216 Ingelheim am Rhein, DE
LANG, Ingo, Boehringer Ingelheim GmbH Corporate Patents Binger Strasse 173, 55216 Ingelheim am Rhein, DE
SEIDLER, Randolph, Boehringer Ingelheim GmbH Corporate Patents Binger Strasse 173, 55216 Ingelheim am Rhein, DE

(51) MKP
A61K 31/519 (2006.01) (97) **2766366 ***
A61P 11/00 (2006.01)
C07D 487/04 (2006.01)
(86) EP2012067810 12.09.2012
(96) 12769346.3 20.08.2014
(87) WO2013037809, 12.09.2012
(97) 2766366, 20.08.2014 en
(54) TETRAHYDROTRIAZOLOPYRIMIDINE DERIVATIVES AS HUMAN NEUTROPHIL ELASTASE INHIBITORS
(71) Chiesi Farmaceutici S.p.A., Via Palermo, 26/A, 43100 Parma, IT
(72) BLENCH, Toby Jonathan, c/o CHIESI FARMACEUTICI S.p.A. Via Palermo 26/A, I-43100 Parma, IT
EDWARDS, Christine, c/o CHIESI FARMACEUTICI S.p.A. Via Palermo 26/A, I-43100 Parma, IT
HEALD, Robert Andrew, c/o CHIESI FARMACEUTICI S.p.A. Via Palermo 26/A, I-43100 Parma, IT
KULAGOWSKI, Janusz Jozef, c/o CHIESI FARMACEUTICI S.p.A. Via Palermo 26/A, I-43100 Parma, IT
SUTTON, Jonathan Mark, c/o CHIESI FARMACEUTICI S.p.A. Via Palermo 26/A, I-43100 Parma, IT
CAPALDI, Carmelida, c/o CHIESI FARMACEUTICI S.p.A. Via Palermo 26/A, I-43100 Parma, IT

(51) MKP
H04M 1/725 (2006.01) (97) **2732609 ***
H04W 4/02 (2009.01)
(86) US2012046762 13.07.2012
(96) 12743283.9 21.05.2014
(87) WO2013010122, 13.07.2012
(97) 2732609, 21.05.2014 en
(54) DYNAMIC SUBSUMPTION INFERENCE
(71) Qualcomm Incorporated, 5775 Morehouse Drive, San Diego, CA 92121, US
(72) KUHN, Lukas, D., 5775 Morehouse Drive, San Diego, California 92121, US
TADURI, Siddharth, S., 5775 Morehouse Drive, San Diego, California 92121, US
NARAYANAN, Vidya, 5775 Morehouse Drive, San Diego, California 92121, US
SHIH, Fuming, 5775 Morehouse Drive, San Diego, California 92121, US

(51) MKP
A61K 31/437 (2006.01) (97) **2721028 ***
A61K 31/519 (2006.01)
A61P 29/00 (2006.01)
A61P 35/00 (2006.01)
A61P 37/02 (2006.01)
C07D 471/04 (2006.01)
C07D 487/04 (2006.01)
(86) US2012043099 19.06.2012
(96) 12735369.6 23.04.2014
(87) WO2012177606, 19.06.2012
(97) 2721028, 23.04.2014 en
(54) AZETIDINYL PHENYL, PYRIDYL OR PYRAZINYL CARBOXAMIDE DERIVATIVES AS JAK INHIBITORS
(71) Incyte Corporation, Experimental Station Route 141 & Henry Clay Road Building E336/207, Wilmington, DE 19880, US
(72) YAO, Wenqing, 748 Meadowbank Road, Kennett Square, PA 19348, US
BURNS, David M., 7525 Claridge Street, Philadelphia, PA 19111, US
ZHUO, Jincong, 17 Forwood Drive, Garnet Valley, PA 19061, US

(51) MKP
F21S 8/00 (2006.01) (97) **2511593**
F21S 8/06 (2006.01)
F21V 5/00 (2006.01)
F21V 5/02 (2006.01)
F21V 5/06 (2006.01)
F21Y 101/02 (2006.01)
F21Y 105/00 (2006.01)
(96) 11005853.4 17.10.2012
(97) 2511593, 17.10.2012 en
(54) Lighting fixtures having illuminated crystal panels and methods for providing illumination
(71) Swarovski Lighting, Ltd., 61 Industrial Blvd., Plattsburg, NY 12901, US
(72) Kikoski, Andre B., 860 United Nations Plaza, 27B, New York New York 10017, US

(51) MKP
A61M 1/00 (2006.01) (97) **2723414 ***
(86) US2012043060 19.06.2012
(96) 12802456.9 30.04.2014
(87) WO2012177587, 19.06.2012
(97) 2723414, 30.04.2014 en
(54) IMPLANT INSERTION DEVICE AND METHOD OF USE THEREOF
(71) University Hospitals Cleveland Medical Center, 11100 Euclid Avenue, Cleveland, OH 44106, US
(72) ZOCHOWSKI, Christopher, G., 3598 Northcliffe Road, Cleveland, OH 44118, US

(51) MKP
C40B 40/10 (2006.01) (97) **2761066 ***
C40B 50/00 (2006.01)
(86) US2012057436 27.09.2012
(96) 12834641.8 06.08.2014
(87) WO2013049275, 27.09.2012
(97) 2761066, 06.08.2014 en
(54) FIBRONECTIN TYPE III REPEAT BASED PROTEIN SCAFFOLDS WITH ALTERNATIVE BINDING SURFACES
(71) Janssen Biotech, Inc., 800/850 Ridgeview Drive, Horsham, PA 19044, US
(72) DIEM, Michael, 1400 McKean Road, Spring House, PA 19477, US
JACOBS, Steven, 1400 McKean Road, Spring House, PA 19477, US

(51) MKP
G06F 17/30 (2006.01) (97) **2710587 ***
G10L 15/22 (2006.01)
H04M 3/493 (2006.01)
(86) US2012029114 14.03.2012
(96) 12712798.3 26.03.2014
(87) WO2012125755, 14.03.2012
(97) 2710587, 26.03.2014 en
(54) AUTOMATED CONVERSATION ASSISTANCE
(71) QUALCOMM INCORPORATED, International IP Administration
5775 Morehouse Drive, San Diego, California 92121-1714, US
(72) SOLIMAN, Samir S., c/o Qualcomm Incorporated 5775
Morehouse Drive, San Diego California 92121, US
SHETH, Soham V, c/o Qualcomm Incorporated 5775
Morehouse Drive, San Diego California 92121, US
RAVEENDRAN, Vijayalakshmi, R., c/o Qualcomm Incorporated
5775 Morehouse Drive, San Diego California 92121, US

(51) MKP
F01K 13/00 (2006.01) (97) **2703608**
(96) 13178388.8 05.03.2014
(97) 2703608, 05.03.2014 en
(54) Rankine cycle system
(71) KABUSHIKI KAISHA TOYOTA JIDOSHOKKI, 2-1, Toyoda-cho,
Kariya-shi, Aichi-ken 448-8671, JP
(72) Mori, Hidefumi, c/o KABUSHIKI KAISHA TOYOTA
JIDOSHOKKI 2-1, Toyoda-cho., Kariya-shi, Aichi-ken., 448-
8671, JP
Iguchi, Masao, c/o KABUSHIKI KAISHA TOYOTA JDIOSHOKKI
2-1, Toyoda-cho., Kariya-shi, Aichi-ken., 448-8671, JP
Enokijima, Fuminobu, c/o KABUSHIKI KAISHA TOYOTA
JIDOSHOKKI 2-1, Toyoda-cho., Kariya-shi, Aichi-ken., 448-
8671, JP
Takei, Hiroyuki, c/o KABUSHIKI KAISHA TOYOTA
JIDOSHOKKI 2-1, Toyoda-cho., Kariya-shi, Aichi-ken., 448-
8671, JP
Tamaru, Kojiro, c/o KABUSHIKI KAISHA TOYOTA
JIDOSHOKKI 2-1, Toyoda-cho., Kariya-shi, Aichi-ken., 448-
8671, JP
Ishiguro, Fumihiko, c/o KABUSHIKI KAISHA TOYOTA
JIDOSHOKKI 2-1, Toyoda-cho., Kariya-shi, Aichi-ken., 448-
8671, JP
Katayama, Kazuo, c/o KABUSHIKI KAISHA TOYOTA
JIDOSHOKKI 2-1, Toyoda-cho., Kariya-shi, Aichi-ken., 448-
8671, JP
Sasaki, Tomonori, c/o KABUSHIKI KAISHA TOYOTA
JIDOSHOKKI 2-1, Toyoda-cho., Kariya-shi, Aichi-ken., 448-
8671, JP

(51) MKP
A61B 17/00 (2006.01) (97) **2679175**
A61B 17/28 (2006.01)
A61B 17/29 (2006.01)
A61B 18/00 (2006.01)
A61B 18/08 (2006.01)
(96) 13186482.9 01.01.2014
(97) 2679175, 01.01.2014 en
(54) Surgical instrument
(71) Ethicon Endo-Surgery, Inc., 4545 Creek Road, Cincinnati, OH
45242, US
(72) Trees, Gregory, A., 9265 Hickory Hill Court, Loveland, OH Ohio
45140, US
Boudreaux, Chad, P., 10840 Lakehurst Court, Cincinnati, OH
Ohio 45242, US
Andreyko, Michael, J., 8575 Clough Pike, Cincinnati, OH Ohio
45244, US
Felder, Kevin, 2460 Downing Drive, Cincinnati, OH Ohio 45208,
US
Batross, Jonathan, T., 7883 Yellowwood Drive, Mason, OH
Ohio 45040, US
Giordano, James, R., 5647 Chestnutview Lane, Milford, OH
Ohio 45150, US
McFarland, Terry, A., 6396 Thistlewood Lane, Burlington, KY
Kentucky 41005, US

(51) MKP
A61K 31/4985 (2006.01) (97) **2702062 ***
A61P 25/18 (2006.01)
C07D 487/04 (2006.01)
(86) EP2012057618 26.04.2012
(96) 12717280.7 05.03.2014
(87) WO2012146644, 26.04.2012
(97) 2702062, 05.03.2014 en
(54) SALT OF AN INHIBITOR OF PHOSPHODIESTERASE 10
ENZYME
(71) Janssen Pharmaceutica, N.V., Turnhoutseweg 30, 2340
Beerse, BE
(72) SWINNEY, Kelly Ann, 509 East 2nd Street, Unit 8, Boston, MA
02127, US
WUYTS, Stijn, c/o Janssen Pharmaceutica NV Turnhoutseweg
30, B-2340 Beerse, BE

(51) MKP
B65B 7/16 (2006.01) (97) **2748088 ***
B65B 29/02 (2006.01)
B65B 61/20 (2006.01)
B65D 85/804 (2006.01)
(86) IB2012056042 31.10.2012
(96) 12799303.8 02.07.2014
(87) WO2013064988, 31.10.2012
(97) 2748088, 02.07.2014 en
(54) METHOD AND MACHINE FOR PRODUCING A SINGLE-USE
CAPSULE FOR BEVERAGES AND CAPSULE OBTAINED
USING METHOD
(71) IMA INDUSTRIES S.R.L., Via Emilia, 428-442, 40064 Ozzano
dell' Emilia (BO), IT
(72) BIANCHI, Mauro, Via Codivilla 24, I-40055 Castenaso, IT

(51) MKP
F02M 59/10 (2006.01) (97) **2657505**
F04B 1/04 (2006.01)
F16H 53/06 (2006.01)
(96) 12165506.2 30.10.2013
(97) 2657505, 30.10.2013 en
(54) High pressure fuel pump assembly
(71) Delphi International Operations Luxembourg S.à.r.l., Avenue
de Luxembourg, 4940 Bascharage, LU
(72) Jay, Mikko, 23 Chaucerwood Court, Canterbury, Kent CT1 1NZ,
GB
Whitehead, Leon, 38 Wyles Road, Chatham, Kent ME4 6LD,
GB

(51) MKP
E05D 7/00 (2006.01) (97) **2682551**
(96) 13172465.0 08.01.2014
(97) 2682551, 08.01.2014 en
(54) An adjustable hinge for windows and doors
(71) FAPIM S.p.A., Via delle Cerbaie 114, 55011 Altopascio (LU), IT
(72) Pacini, Sergio, Via San Giuseppe, 97, 55015 Montecarlo
(Lucca), IT

(51) MKP
A23G 3/36 (2006.01) (97) **2461797 ***
A23L 1/05 (2006.01)
A23P 1/10 (2006.01)
A61K 9/00 (2006.01)
A61K 31/137 (2006.01)
A61K 31/138 (2006.01)
A61K 31/167 (2006.01)
A61K 31/192 (2006.01)
A61K 31/4545 (2006.01)
A61K 31/495 (2006.01)
A61K 47/10 (2006.01)
A61K 47/26 (2006.01)
A61K 47/36 (2006.01)
A61K 47/42 (2006.01)
(86) CA2010001217 05.08.2010
(96) 10805919.7 13.06.2012
(87) WO2011014960, 05.08.2010
(97) 2461797, 13.06.2012 en
(54) PROCESS FOR PREPARATION OF OVER-THE-COUNTER GELATIN OR PECTIN-BASED DRUG DELIVERY
(71) 7267207 Canada Limited Corporation, 5040 Mainway Unit 6, Burlington, Ontario L7L 7G5, CA
(72) LOWTHER, Stuart A., 2109 Keith Close, Burlington Ontario L7M 3HA, CA
PLANTE, Real, 661 Rue Des Érables, Upton Quebec J04 2E0, CA
PILON, Bradley H., 13 Medwin Dr., Dundas Ontario L9H 7N4, CA
TARNOPOLSKY, Mark A., 19 Oakwood Place, Hamilton Ontario L8S 4C9, CA

(51) MKP
A61J 1/10 (2006.01) (97) **2767270 ***
B65D 30/16 (2006.01)
(86) JP2012076268 11.10.2012
(96) 12840043.9 20.08.2014
(87) WO2013054824, 11.10.2012
(97) 2767270, 20.08.2014 en
(54) STANDING BAG INFUSION CONTAINER
(71) Ajinomoto Co., Inc., 15-1, Kyobashi 1-chome Chuo-ku, Tokyo 104-8315, JP
(72) MOCHIZUKI, Shota, c/o Ajinomoto Pharmaceuticals Co., Ltd. 235 Miyakami Shimizu-ku, Shizuoka-shi Shizuoka 424-0911, JP
MORINAKA, Naoki, c/o Ajinomoto Pharmaceuticals Co., Ltd. 235 Miyakami Shimizu-ku, Shizuoka-shi Shizuoka 424-0911, JP

(51) MKP
A01N 25/28 (2006.01) (97) **2740532**
A23L 1/22 (2006.01)
A61K 9/50 (2006.01)
A61K 47/00 (2006.01)
B01J 13/02 (2006.01)
B01J 20/30 (2006.01)
C08B 30/12 (2006.01)
C08B 30/14 (2006.01)
C08L 3/00 (2006.01)
(96) 12461563.4 11.06.2014
(97) 2740532, 11.06.2014 en
(54) Method of producing a starch-containing material
(71) Zachodniopomorski Uniwersytet Technologiczny w Szczecinie, Aleja Piastów 17, 70-310 Szczecin, PL
(72) Bartkowiak, Artur, Zachodniopomorski Unowersytet Technologiczny w Szczecinie CBiIMO Ksiecica Warcislawa I 26A/11, 71-667 Szczecin, PL
Ternovoy, Garri, Zachodniopomorski Uniwersytet Technologiczny w Szczecinie CBiIMO ul. Rugianska 35/20, 71-635 Szczecin, PL

(51) MKP
B67D 1/00 (2006.01) (97) **2739559 ***
B67D 1/04 (2006.01)
B67D 3/00 (2006.01)
(86) US2012049356 02.08.2012
(96) 12748092.9 11.06.2014
(87) WO2013019963, 02.08.2012
(97) 2739559, 11.06.2014 en
(54) METHOD AND APPARATUS FOR CARTRIDGE-BASED CARBONATION OF BEVERAGES
(71) Keurig Green Mountain, Inc., 33 Coffee Lane, Waterbury, VT 05676, US
(72) NOVAK, Thomas, J., P.O. Box 3167, Stowe, VT 05672, US
PACKARD, Ross, 40 Proctor Avenue, South Burlington, VT 05403, US
PETERSON, Peter, 33 Coffee Lane, Waterbury, VT 05676, US
GULLA, Shawn, 37 Sligo Lane, Grand Isle, VT 05458, US
HUOT CARLSON, Jennifer, Caitlin, 34 Tyler Drive, Essex Junction, VT 05452, US
SCHMITT, Camilla, 33 Coffee Lane, Waterbury, VT 05676, US
HEWITT, Jim, 55 Walkers Brook Drive, Reading, MA 01867, US
ANGOTTI, Marc, 33 Coffee Lane, Waterbury, VT 05676, US
CARROLL, Ray, 55 Walkers Brook Drive, Reading, MA 01867, US
ESTABROOK, Richard, P.O.Box 231, Waterbury, VT 05676, US
HARTLEY, Kevin, 33 Coffee Lane, Waterbury, Vermont 05676, US
CONSOLI, Frank, 619 North Heilbron Drive, Media, PA 19063, US
COHEN, Mark, 27 Ash Grove, Melbourn Herts SG8 6BJ, GB
JONES, Ross, 84 Wulfstan Way, Cambridge CB1 8QH, GB
MARTINEZ, Nicolas, Alejandro, 1205 Hancock Street Apt. 601, Quincy, MA 02169, US
HEMBER, Miles William Noel, 10 Corona Road Flat 1, Cambridge CB4 3EB, GB
SCHMITT, Fabien, Yannick, 60 Canterbury Street, Cambridge CB4 3QF, GB
MOTTRAM, Nial, Allan, 100 Brampton Road, Cambridge CB1 3HL, GB
O'PREY, Cormac, 21 Long Meadow, Bishops Stortford CM23 4HH, GB
ROLLINGS, Nicholas, David, 2A Cavendish Road, St. Albans Hertfordshire AL1 5EE, GB
KILBY, Charles Frazer, 17 Murrell Close, St. Neots Cambridgeshire PE19 1LN, GB
RICHARDSON, Christopher Paul, Steet Farm Station Road, Elmswell IP30 9HD, GB
JACKSON, Thomas Bates, 8 Great Eastern Street, Cambridge CB1 3AD, GB
GRUBB, Scott, Harston Mill Royston Road, Harston Cambridge CB22 7GG, GB
CHAN, Wai, 1 Rexbury Court Sturton Street, Cambridge CB1 2RU, GB
CAMPBELL, Neil Lester, Dove Cottage 1 Church Path Ashwell Baldock, Hertfordshire SG7 5NU, GB
STACEY, Gary, 52 Woodlark Road, Cambridge CB3 0HS, GB
COVEY, Chris, Harston Mill Royston Road, Harston Cambridge CB22 7GG, GB
DOBSON, Barry, Harston Mill Royston Road, Harston Cambridge CB22 7GG, GB
WILKINS, Paul, Harston Mill Royston Road, Harston Cambridge CB22 7GG, GB
ROACH, Chris, Harston Mill Royston Road, Harston Cambridge CB22 7GG, GB
CAUWOOD, Peter, Special Agent Associates Ltd. 6 Newmarket Road, Cambridge CB5 8DT, GB
THOMPSON, Keith, Special Agent Associates Ltd. 6 Newmarket Road, Cambridge CB5 8DT, GB

(51) MKP
A61F 7/00 (2006.01) (97) **2701643 ***
(86) US2012035069 26.04.2012
(96) 12777729.0 05.03.2014
(87) WO2012149072, 26.04.2012
(97) 2701643, 05.03.2014 en
(54) APPARATUS AND METHOD FOR ENHANCED HGH GENERATION IN HUMANS
(71) Vasper Systems LLC, 62-2241 Kanehoa Place, Kamuela, HI 96743, US
(72) WASOWSKI, Peter Z., 62-2241 Kanehoa Place, Kamuela, Hawaii 96743, US

(51) MKP
B29D 22/04 (2006.01) (97) **2722160**
 (96) 13188149.2 23.04.2014
 (97) 2722160, 23.04.2014 de
 (54) Method for manufacturing plastic balls and plastic ball
 (71) John GmbH, Industriestr. 23, 83395 Freilassing, DE
 (72) John, Susanne, Obereichert 5, 83395 Freilassing, DE

(51) MKP
A61K 39/395 (2006.01) (97) **2744827 ***
A61P 35/00 (2006.01)
C07K 16/28 (2006.01)
 (86) US2012051038 16.08.2012
 (96) 12753873.4 25.06.2014
 (87) WO2013028442, 16.08.2012
 (97) 2744827, 25.06.2014 en
 (54) ANTI-TIE2 ANTIBODIES USES THEREOF
 (71) Regeneron Pharmaceuticals, Inc., 777 Old Saw Mill River Road, Tarrytown, NY 10591, US
 (72) THURSTON, Gavin, 15 Stewart Place Apt. 1M, White Plains, NY 10603, US

(51) MKP
C12N 15/86 (2006.01) (97) **2669381**
 (96) 12004148.8 04.12.2013
 (97) 2669381, 04.12.2013 en
 (54) Method for expression of heterologous proteins using a recombinant negative-strand RNA virus vector comprising a mutated P protein
 (71) AmVac AG, Metallstrasse 4, 6300 Zug, CH
 (72) Wiegand, Marian, Dr., Milchstrasse 1, 81667 München, DE

(51) MKP
G09F 7/18 (2006.01) (97) **2718923 ***
G09F 7/20 (2006.01)
G09F 15/00 (2006.01)
 (86) IB2012052039 23.04.2012
 (96) 12722540.7 16.04.2014
 (87) WO2012168805, 23.04.2012
 (97) 2718923, 16.04.2014 en
 (54) POSTER HOLDER
 (71) New Rainbow S.n.c., Via Monte Ortigara, 8, 10141 Torino, IT
 (72) Bronzoni, Pier Luigi, Via Orbetello 141, 10100 Torino, IT

(51) MKP
A61K 31/546 (2006.01) (97) **2703406 ***
A61P 31/04 (2006.01)
C07D 501/18 (2006.01)
C07D 501/46 (2006.01)
C07D 519/06 (2006.01)
 (86) JP2012061053 25.04.2012
 (96) 12777752.2 05.03.2014
 (87) WO2012147773, 25.04.2012
 (97) 2703406, 05.03.2014 en
 (54) NOVEL CEPHEM COMPOUND HAVING CATECHOL OR PSEUDO-CATECHOL STRUCTURE
 (71) Shionogi & Co., Ltd., 1-8, Doshomachi 3-chome Chuo-ku, Osaka-shi, Osaka 541-0045, JP
 (72) NISHITANI, Yasuhiro, c/o Shionogi&Co. Ltd. 1-1 Futaba-cho 3-chome, Toyonaka-shi Osaka 561-0825, JP
 AOKI, Toshiaki, c/o Shionogi&Co. Ltd. 1-1 Futaba-cho 3-chome, Toyonaka-shi Osaka 561-0825, JP
 SATO, Jun, c/o Shionogi&Co. Ltd. 1-1 Futaba-cho 3-chome, Toyonaka-shi Osaka 561-0825, JP
 YAMAWAKI, Kenji, c/o Shionogi&Co. Ltd. 1-1 Futaba-cho 3-chome, Toyonaka-shi Osaka 561-0825, JP
 YOKOO, Katsuki, c/o Shionogi&Co. Ltd. 1-1 Futaba-cho 3-chome, Toyonaka-shi Osaka 561-0825, JP
 SANO, Masayuki, c/o Shionogi&Co. Ltd. 1-1 Futaba-cho 3-chome, Toyonaka-shi Osaka 561-0825, JP

(51) MKP
A61K 39/08 (2006.01) (97) **2741785 ***
A61K 48/00 (2006.01)
 (86) US2012046422 12.07.2012
 (96) 12840108.0 18.06.2014
 (87) WO2013055420, 12.07.2012
 (97) 2741785, 18.06.2014 en
 (54) NOVEL CLOSTRIDIUM DIFFICILE DNA VACCINE
 (71) Philadelphia Health and Education Corporation, d/b/a Drexel University College of Medicine 245 N. 15th Street, Philadelphia, PA 19102, US
 Inovio Pharmaceuticals, Inc., 1787 Sentry Parkway West Building 18, Suite 400, Blue Bell, PA 19422, US
 The Trustees of the University of Pennsylvania, 3160 Chestnut Street, Suite 200, Philadelphia, PA 19104, US
 (72) KUTZLER, Michele, 18 Penn Avenue, Souderton, PA 18964, US
 BALIBAN, Scott, 6 Dorchester Drive, Southampton, NJ 08088, US
 WEINER, David, B., 717 Beacon Lane, Merion, PA 19066, US
 SARDESAL, Niranjana, Y., 1787 Sentry Parkway West Building 18, Suite 400, Blue Bell, PA 19422, US
 KIM, J. Joseph, 4 Camelot Way, Harleyville, PA 19483, US

(51) MKP
C07C 69/74 (2006.01) (97) **2718257 ***
 (86) US2012041715 08.06.2012
 (96) 12796164.7 16.04.2014
 (87) WO2012170923, 08.06.2012
 (97) 2718257, 16.04.2014 en
 (54) PROCESS FOR PREPARING HIGH PURITY AND CRYSTALLINE DIMETHYL FUMARATE
 (71) Biogen Idec MA Inc., 14 Cambridge Center, Cambridge, MA 02142, US
 (72) GUZOWSKI, John, 372 Upham Street, Melrose, MA 02176, US
 KIESMAN, William, 92 Old Sudbury Road, Wayland, MA 01778, US
 IRDAM, Erwin, 18 Island Hill Avenue No. 303, Melrose, MA 02176, US

(51) MKP
A61K 31/47 (2006.01) (97) **2751081 ***
A61P 3/00 (2006.01)
A61P 9/00 (2006.01)
B01D 9/02 (2006.01)
C07D 215/14 (2006.01)
 (86) EP2012067859 12.09.2012
 (96) 12756750.1 09.07.2014
 (87) WO2013037838, 12.09.2012
 (97) 2751081, 09.07.2014 en
 (54) POLYMORPHIC FORM OF PITAVASTATIN CALCIUM
 (71) Farma GRS, d.o.o., Seidlova cesta 70, 8000 Novo mesto, SI
 KLJAJIC, Alen, Smrekarjeva ulica 4, 3000 Celje, SI
 TROST, Sabina, Ljubljanska cesta 31, 1330 Kocevje, SI
 PECAVAR, Anica, Gotna vas 18, 8000 Novo mesto, SI
 ZUPET, Rok, Janeza Rozica 6, 1000 Ljubljana, SI

(51) MKP
A01G 9/14 (2006.01) (97) **2747549 ***
B32B 27/20 (2006.01)
B32B 27/30 (2006.01)
C08J 3/22 (2006.01)
C08K 3/22 (2006.01)
 (86) IB2012056005 30.10.2012
 (96) 12799302.0 02.07.2014
 (87) WO2013064970, 30.10.2012
 (97) 2747549, 02.07.2014 en
 (54) LAMINAR BODY FOR MAKING GREENHOUSE ROOFS AND METHOD OF GREENHOUSE CULTIVATION
 (71) Ultrabatch S.r.l., Via Botticelli, 20022 Castano Primo (MI), IT
 (72) BOLDRIN, Lanfranco, c/o ULTRABATCH S.r.l. Via Botticelli snc, I-20022 Castano Primo (MI), IT

(51) MKP
A01N 25/02 (2006.01) (97) **2734040 ***
A01N 25/30 (2006.01)
A01N 37/42 (2006.01)
A01N 43/40 (2006.01)
A01N 43/50 (2006.01)
A01N 43/653 (2006.01)
A01N 47/12 (2006.01)
A01N 47/20 (2006.01)
A01N 53/00 (2006.01)
(86) EP2012064237 19.07.2012
(96) 12737561.6 28.05.2014
(87) WO2013011108, 19.07.2012
(97) 2734040, 28.05.2014 en
(54) IMPROVED METHOD FOR PRODUCING EMULSIFIABLE PESTICIDE SOLUTIONS
(71) Agriphar S.A., Rue de Renory 26/1, 4102 Ougrée, BE
(72) PIROTTE, Alan, Cour de l'Abbaye 7, B-6660 Houffalize, BE

(51) MKP
A61K 38/04 (2006.01) (97) **2734218 ***
A61K 38/16 (2006.01)
C07K 14/025 (2006.01)
(86) EP2012064445 23.07.2012
(96) 12737822.2 28.05.2014
(87) WO2013014134, 23.07.2012
(97) 2734218, 28.05.2014 en
(54) POLYOMA VIRUS JC PEPTIDES AND PROTEINS IN VACCINATION AND DIAGNOSTIC APPLICATIONS
(71) Universität Zürich, Prorektorat MNW Rämistrasse 71, 8006 Zürich, CH
(72) JELCIC, Ilijas, Eidmattstr. 60, 8032 Zürich, CH
MARTIN, Roland, Voltastrasse 80, 8044 Zürich, CH
SCHIPPLING, Sven, Dölttschihalde 15, 8055 Zürich, CH
SOSPEDRA, Mireia, Voltastrasse 80, 8044 Zürich, CH
YOUSEF, Sara, Borstelers Chaussee 9, 22453 Hamburg, DE

(51) MKP
A61P 9/00 (2006.01) (97) **2714648 ***
C07C 233/00 (2006.01)
(86) US2012038517 18.05.2012
(96) 12724046.3 09.04.2014
(87) WO2012166389, 18.05.2012
(97) 2714648, 09.04.2014 en
(54) NEPRILYSIN INHIBITORS
(71) Theravance, Inc., 901 Gateway Boulevard, South San Francisco, CA 94080, US
(72) FLEURY, Melissa, 1023 Divisadero Street, San Francisco, California 94115, US
GENDRON, Roland, 345 Franconia Street, San Francisco, California 94110, US
HUGHES, Adam, D., 1221 Judson Street, Belmont, California 94002, US
SCHMIDT, Jane, 31 Paradise Avenue, San Francisco, California 94131, US

(51) MKP
A61K 39/395 (2006.01) (97) **2714079 ***
(86) US2012038227 16.05.2012
(96) 12789439.2 09.04.2014
(87) WO2012162068, 16.05.2012
(97) 2714079, 09.04.2014 en
(54) DEIMMUNIZED SERUM-BINDING DOMAINS AND THEIR USE FOR EXTENDING SERUM HALF-LIFE
(71) MacroGenics, Inc., 9640 Medical Center Drive, Rockville, MD 20850, US
(72) BONVINI, Ezio, 2 Shetland Ct., Rockville, MD 20851, US
BARAT, Bhaswati, 15504 Villisca Terrace, Derwood, MD 20855, US
HUANG, Ling, 8210 Moorland Lane, Bethesda, MD 20817, US
JOHNSON, Leslie S., 14411 Poplar Hill Road, Darnestown, MD 20874, US

(51) MKP
A61K 31/24 (2006.01) (97) **2579888 ***
A61K 31/341 (2006.01)
A61K 31/343 (2006.01)
A61K 31/351 (2006.01)
A61K 31/381 (2006.01)
A61K 31/40 (2006.01)
A61K 31/41 (2006.01)
A61K 31/415 (2006.01)
A61K 31/421 (2006.01)
A61K 31/423 (2006.01)
A61K 31/428 (2006.01)
A61K 31/433 (2006.01)
A61K 31/437 (2006.01)
A61K 31/4406 (2006.01)
A61K 31/445 (2006.01)
A61K 31/47 (2006.01)
A61K 31/495 (2006.01)
A61K 31/498 (2006.01)
A61K 31/5375 (2006.01)
A61K 38/16 (2006.01)
C07D 265/30 (2006.01)
(86) US2011039873 09.06.2011
(96) 11793202.0 17.04.2013
(87) WO2011156655, 09.06.2011
(97) 2579888, 17.04.2013 en
(54) NOVEL GLP-1 RECEPTOR STABILIZERS AND MODULATORS
(71) Receptos, Inc., 10835 Road to the Cure, 205, San Diego, CA 92121, US
(72) BOEHM, Marcus, F., 2811 Maple Street, San Diego CA 92104, US
MARTINBOROUGH, Esther, 11128 Portobelo Drive, San Diego CA 92124, US
MOORJANI, Manisha, 8389 Reagan Glen, San Diego CA 92127, US
HUANG, Liming, 12788 Adolphia Court, San Diego CA 92129, US
TAMIYA, Junko, 258 Argus Way, Oceanside CA 92057, US
GRIFFITH, Mark, T., 4824 67th St., San Diego CA 92115, US
FOWLER, Thomas, 15 Blacksmith End Stathern, Melton Mowbray LE14 4EZ, GB
NOVAK, Andrew, 35 Upper Wellington Street Long Eaton, Nottingham NG10 4NH, GB
KNAGGS, Michael, 2 St. Peters Street, Burton-on-trent DE15 9AW, GB
MEGHANI, Premji, 23 Nicolson Road Loughborough, Leicestershire LE11 3SD, GB

(51) MKP
A61K 31/5517 (2006.01) (97) **2705039 ***
A61P 35/00 (2006.01)
C07D 401/04 (2006.01)
C07D 487/04 (2006.01)
(86) US2012036569 04.05.2012
(96) 12779641.5 12.03.2014
(87) WO2012151512, 04.05.2012
(97) 2705039, 12.03.2014 en
(54) BROMODOMAIN INHIBITORS AND USES THEREOF
(71) Constellation Pharmaceuticals, Inc., 215 First Street, Suite 200, Cambridge, MA 02142, US
(72) ALBRECHT, Brian, K., 179 Chestnut Street, 2, Cambridge, MA 02139, US
GEHLING, Victor, S., 35 Jay Street, 3, Somerville, MA 02144, US
HEWITT, Michael, C., 186 Holland Street, Unit 2, Somerville, MA 02144, US
TAYLOR, Alexander, M., 33 Parker Street, 2, Cambridge, MA 02138, US
HARMANGE, Jean-Christophe, 57 William Street, Andover, MA 01810, US

(51) MKP
B01D 3/00 (2006.01) (97) **2755731 ***
 (86) US2012055187 13.09.2012
 (96) 12832522.2 23.07.2014
 (87) WO2013040228, 13.09.2012
 (97) 2755731, 23.07.2014 en
 (54) SYSTEM AND METHOD FOR WATER TREATMENT
 (71) Aquasource Technologies Corporation, 199 Katherine Drive, North Huntingdon, Pennsylvania 15642, US
 (72) DIGHE, Shyam, V., 199 Katherine Drive, North Huntingdon, Pennsylvania 15642, US

(51) MKP
C12Q 1/68 (2006.01) (97) **2723901 ***
 (86) US2012043747 22.06.2012
 (96) 12802835.4 30.04.2014
 (87) WO2012178007, 22.06.2012
 (97) 2723901, 30.04.2014 en
 (54) COMPOSITIONS AND METHODS OF DIAGNOSING DISEASES AND DISORDERS ASSOCIATED WITH CELL DEATH
 (71) Yale University, Two Whitney Avenue, New Haven, CT 06511, US
 (72) HEROLD, Kevan, C., 12 Pine Point Road, Rowayton, CT 06853, US
 AKIRAV, Eitan, Moshe, 578 Plainview Road, Plainview, NY 11803, US

(51) MKP
C07D 311/06 (2006.01) (97) **2758386 ***
C07D 417/04 (2006.01)
C07D 453/04 (2006.01)
 (86) EP2012068593 21.09.2012
 (96) 12762583.8 30.07.2014
 (87) WO2013041655, 21.09.2012
 (97) 2758386, 30.07.2014 en
 (54) PROCESSES AND INTERMEDIATES FOR PREPARING A MACROCYCLIC PROTEASE INHIBITOR OF HCV
 (71) Janssen Pharmaceuticals, Inc., 1125 Trenton-Harbourton Road, Titusville, NJ 08560, US
 (72) DEPRÉ, Dominique Paul Michel, Rue René Ménada 81, B-1320 Hamme-Mille, BE
 ORMEROD, Dominic John, Jan Van Cuyckstraat 24, B-2320 Hoogstraten, BE
 HORVATH, Andras, Dokter Paul Janssenlaan 16, B-2300 Turnhout, BE

(51) MKP
H01H 13/28 (2006.01) (97) **2672498**
H01H 13/56 (2006.01)
H01H 23/20 (2006.01)
H01H 23/24 (2006.01)
 (96) 13169939.9 11.12.2013
 (97) 2672498, 11.12.2013 en
 (54) Electrical device with axial control
 (71) Vimar SpA, Viale Vicenza 14, 36063 Marostica, (Vicenza), IT
 (72) Volpato, Alberto, Via Monte Grappa 16, 36064 Mason Vicentino (Vicenza), IT
 Cavalli, Antonio, Via Montello 16/B, 36063 Marostica (Vicenza), IT

(51) MKP
E21B 43/16 (2006.01) (97) **2718566 ***
F04B 9/02 (2006.01)
 (86) US2012038160 16.05.2012
 (96) 12860691.0 16.04.2014
 (87) WO2013095698, 16.05.2012
 (97) 2718566, 16.04.2014 en
 (54) CRANKED ROD PUMP APPARATUS AND METHOD
 (71) Unico, Inc., 3725 Nicholson Road, Franksville WI 53126-0505, US
 (72) GREGORY, Benjamin J., 810 Russet Street, Racine, Wisconsin 53405, US
 BECK, Thomas L., 16220 Durand Avenue, Union Grove, Wisconsin 53182, US
 PETERSON, Ronald G., 801 Blaine Avenue, Racine, Wisconsin 53405, US
 MacDONALD, Michael A., 5110 Old Farm Road, Racine, Wisconsin 53402, US
 DRY, Michael D., 1810 Autumn Drive, Racine, Wisconsin 53402, US

(51) MKP
A61B 1/04 (2006.01) (97) **2706904 ***
 (86) US2012037859 14.05.2012
 (96) 12782675.8 19.03.2014
 (87) WO2012155152, 14.05.2012
 (97) 2706904, 19.03.2014 en
 (54) IMPROVED IMAGE SENSOR FOR ENDOSCOPIC USE
 (71) Olive Medical Corporation, 2302 S. Presidents Drive, Suite D, Salt Lake City, UT 84120, US
 (72) BLANQUART, Laurent, 2776 Great Smokey Court, Westlake Village CA 91362, US
 TALBERT, Joshua, D., 1763 Fort Union Blvd., Cottonwood Heights UT 84121, US
 HENLEY, Jeremiah, D., 1763 Fort Union Blvd., Cottonwood Heights UT 84121, US
 WICHERN, Donald, M., 5591 South 1100 East, South Ogden UT 84405, US

(51) MKP
B60D 1/167 (2006.01) (97) **2741931 ***
B60D 1/32 (2006.01)
B60D 1/58 (2006.01)
 (86) AT2012000200 31.07.2012
 (96) 12753047.5 18.06.2014
 (87) WO2013020149, 31.07.2012
 (97) 2741931, 18.06.2014 de
 (54) TOW BAR
 (71) Scharmüller, Josef, Saxigen 14, 4892 Fornach, AT
 Scharmüller, Josef, jun., Saxigen 14, 4892 Fornach, AT
 (72) Scharmüller, Josef, Saxigen 14, 4892 Fornach, AT
 Scharmüller, Josef, jun., Saxigen 14, 4892 Fornach, AT

(51) MKP
C12P 7/56 (2006.01) (97) **2732043 ***
C12P 41/00 (2006.01)
 (86) GB2012051696 16.07.2012
 (96) 12740391.3 21.05.2014
 (87) WO2013011296, 16.07.2012
 (97) 2732043, 21.05.2014 en
 (54) SEPARATION PROCESS
 (71) Plaxica Limited, Imperial College Incubator Level 1 Bessemer Building Imperial College, London SW7 2AZ, GB
 (72) MARSHALL, Edward Leslie, c/o Plaxica Limited Imperial College Incubator Level 1 Bessemer Building Imperial College, London Greater London SW7 2AZ, GB
 OSEI-TUTU, Jade Jocelyn Afriye, c/o Plaxica Limited Imperial College Incubator Level 1 Bessemer Building Imperial College, London Greater London SW7 2AZ, GB
 SMITH, Stephen Alexander Calder, c/o PLaxica Limited Imperial College Incubator Level 1 Bessemer Building Imperial College, London Greater London SW7 2AZ, GB

(51) MKP
F02M 53/04 (2006.01) (97) **2385242**
F02M 61/14 (2006.01)
 (96) 11164536.2 09.11.2011
 (97) 2385242, 09.11.2011 en
 (54) Isolator for fuel injector
 (71) Delphi Technologies, Inc., P.O.Box 5052, Troy MI 48007, US
 (72) Xu, Wenbin, 53 Cambic Circle, Pittsford, NY 14534, US
 Braun, Charles, 6825 Coy Road, Livonia, NY 14487, US
 Perry, Robert, 4538 Caledonia Road, Leicester, NY 14481, US
 Flynn, Vicki, 1 Mallory Lane, Penfield, NY 14526, US

(51) MKP
C12N 5/10 (2006.01) (97) **2702146 ***
 (86) US2012000221 27.04.2012
 (96) 12775920.7 05.03.2014
 (87) WO2012148497, 27.04.2012
 (97) 2702146, 05.03.2014 en
 (54) IDENTIFICATION OF POLYNUCLEOTIDES ASSOCIATED WITH A SAMPLE
 (71) The Board of Trustees of the Leland Stanford Junior University, 1705 El Camino Real, Palo Alto CA 94306-1106, US
 Department of Veterans Affairs, Office of the General Counsel, Washington, DC 20420, US
 (72) ROBINSON, William H., 3801 Miranda, Palo Alto California 94304-1207, US
 TAN, Yann Chong, 4250 El Camino Real Apt. A201, Palo Alto California 94306, US
 SOKOLOVE, Jeremy, 243 Sierra Vista Avenue, Mountain View California 94043, US

(51) MKP
C07F 9/6561 (2006.01) (97) **2764002 ***
 (86) US2012000441 03.10.2012
 (96) 12798029.0 13.08.2014
 (87) WO2013052094, 03.10.2012
 (97) 2764002, 13.08.2014 en
 (54) METHODS FOR PREPARING ANTI-VIRAL NUCLEOTIDE ANALOGS
 (71) Gilead Sciences, Inc., 333 Lakeside Drive, Foster City, CA 94404, US
 (72) COLBY, Denise, A., 460 Monterey Boulevard Apt. 201, San Francisco, CA 94127, US
 MARTINS, Andrew, Anthony, 124 Carlson Close, Edmonton, Alberta T6R 2J7, CA
 ROBERTS, Benjamin, James, 49 36th Avenue Apt. 22, San Mateo, CA 94403, US
 SCOTT, Robert, William, 449 W. Ellsworth Court, San Mateo, CA 94401, US
 WHITE, Nicole, S., 1919 Alameda De Las Pulgas Apt.26, San Mateo, CA 94403, US

(51) MKP
C12N 5/00 (2006.01) (97) **2721144 ***
C12N 5/02 (2006.01)
 (86) US2012042446 14.06.2012
 (96) 12802495.7 23.04.2014
 (87) WO2012177480, 14.06.2012
 (97) 2721144, 23.04.2014 en
 (54) AMPLIFICATION ENHANCEMENT OF BLOOD DERIVED PROGENITOR CELLS USING A CLOSED CULTURE SYSTEM
 (71) University Hospitals Cleveland Medical Center, 11100 Euclid Avenue, Cleveland, OH 44106, US
 (72) COSTA, Marco, A., 2539 Cedarwood Drive, Pepper Pike, OH 44124, US
 ISHIKAWA, Masakazu, 2525 Kemper Road, Shaker Heights, OH 44120, US
 ASAHARA, Takayuki, 3-28 Oyamagaoka, Machida Tokyo 194-0215, JP
 MASUDA, Haruchika, 2-13-4 Morinosato Atsugi, Kanagawa 243-0122, JP

(51) MKP
A61K 36/14 (2006.01) (97) **2644202**
A61P 17/02 (2006.01)
A61P 17/06 (2006.01)
 (96) 13001347.7 02.10.2013
 (97) 2644202, 02.10.2013 en
 (54) Ointment for skin treatment, and method of its manufacture
 (71) Nurkovic, Suljo, Suho polje bb, 84310 Rozaje, ME
 (72) Nurkovic, Suljo, Suho polje bb, 84310 Rozaje, ME

(51) MKP
C07C 231/02 (2006.01) (97) **2768796 ***
C07C 233/59 (2006.01)
C07D 215/22 (2006.01)
C07D 413/12 (2006.01)
 (86) US2012061320 22.10.2012
 (96) 12783763.1 27.08.2014
 (87) WO2013059788, 22.10.2012
 (97) 2768796, 27.08.2014 en
 (54) PROCESS FOR PREPARING QUINOLINE DERIVATIVES
 (71) Exelixis, Inc., 210 East Grand Avenue, South San Francisco, CA 94080, US
 (72) WILSON, Jo, Ann, 74 Seward Street, San Francisco, CA 94114, US
 NAGANATHAN, Sriram, 599 Curie Drive, San Jose, CA 95123, US
 PFEIFFER, Matthew, 567 6th Avenue, Salt Lake City UT 84103, US
 ANDERSEN, Neil, G., Po Box 371608 Montara, San Francisco, CA 94037, US

(51) MKP
B32B 15/08 (2006.01) (97) **2740595 ***
B32B 23/08 (2006.01)
 (86) CN2011077694 27.07.2011
 (96) 11748538.3 11.06.2014
 (87) WO2013013400, 27.07.2011
 (97) 2740595, 11.06.2014 en
 (54) METHOD FOR MAKING AND PROCESSING FLEXIBLE PLATE MATERIAL
 (71) Shanghai Yi Hsin Industry Co., Ltd., No. 2666 Zhongchun Road Zhuanqiao Town Minhang District, Shanghai 201108, CN
 (72) HSU, Cheng chien, No. 2666 Zhongchun Road Zhuanqiao Town Minhang District, Shanghai 201108, CN
 HSU, Meng chien, No. 2666 Zhongchun Road Zhuanqiao Town Minhang District, Shanghai 201108, CN

(51) MKP
A61K 31/415 (2006.01) (97) **2621521 ***
A61K 31/496 (2006.01)
A61K 31/4965 (2006.01)
A61K 38/48 (2006.01)
A61P 1/00 (2006.01)
A61P 29/00 (2006.01)
A61P 31/04 (2006.01)
 (86) US2011054640 03.10.2011
 (96) 11830068.0 07.08.2013
 (87) WO2012045083, 03.10.2011
 (97) 2621521, 07.08.2013 en
 (54) MINIMIZING INTESTINAL DYSFUNCTION
 (71) The Regents of The University of California, 1111 Franklin Street 5th Floor, Oakland, CA 94607-5200, US
 (72) DELANO, Frank, A., 1886 Titus Street, San Diego CA 92110, US
 SCHMID-SCHONBEIN, Geert, W., 13425 Mango Drive, Del Mar CA 92014, US
 SALTZMAN, Darin, 1346 Moncado Drive, Glendale CA 91207, US

(51) MKP
H01H 71/12 (2006.01) (97) **2765590 ***
H01H 83/10 (2006.01)
 (86) CN2012084178 07.11.2012
 (96) 12847145.5 13.08.2014
 (87) WO2013067923, 07.11.2012
 (97) 2765590, 13.08.2014 en
 (54) TRIPPING MECHANISM FOR SURGE PROTECTOR AND SURGE PROTECTOR
 (71) Schneider Electric Industries SAS, 35, rue Joseph Monier, 92500 Rueil-Malmaison, FR
 (72) SUN, Wei, 9th Building, No. 3000 Longdong Rd., Pudong, Shanghai 201203, CN
 LIU, Quanhe, 9th Building, No. 3000 Longdong Rd., Pudong, Shanghai 201203, CN

- (51) MKP
F02M 59/20 (2006.01) (97) **2647824**
F02M 59/36 (2006.01)
F02M 59/46 (2006.01)
F02M 63/02 (2006.01)
(96) 12163322.6 09.10.2013
(97) 2647824, 09.10.2013 en
(54) Injection pump systems and methods of operation
(71) Delphi International Operations Luxembourg S.à.r.l., Avenue de Luxembourg, 4940 Bascharage, LU
(72) Harcombe, Anthony, 1 Warren Avenue, Richmond, Surrey TW10 5DZ, GB

- (51) MKP
E21B 33/072 (2006.01) (97) **2769052 ***
(86) NO2012050205 22.10.2012
(96) 12795628.2 27.08.2014
(87) WO2013058661, 22.10.2012
(97) 2769052, 27.08.2014 en
(54) DEVICE FOR RECIRCULATING GREASE/SEALING OIL IN RISERS
(71) Green Well Technology AS, Vestringsveien 139, 2651 Østre Gausdal, NO
(72) SEVALDSEN, Kjetil, Vestringsveien 139, N-2651 Østre Gausdal, NO

- (51) MKP
A61K 31/56 (2006.01) (97) **2739287 ***
(86) US2012024240 08.02.2012
(96) 12819597.1 11.06.2014
(87) WO2013019280, 08.02.2012
(97) 2739287, 11.06.2014 en
(54) CORTICOSTEROIDS FOR THE TREATMENT OF JOINT PAIN
(71) Flexion Therapeutics, Inc., 300 Trade Center, Suite 2460, Woburn, MA 01801, US
(72) BODICK, Neil, 224 Marlborough Street, Boston, MA 02116, US
BLANKS, Robert, C., 47 Hancock Street, Auburndale, MA 02466, US
KUMAR, Anjali, 57 Tobey Road, Belmont, MA 02478, US
CLAYMAN, Michael, D., 20 Bayberry Lane, Gloucester, MA 01930, US
MORAN, Mark, 55 Orinda View Road, Orinda, CA 94563, US

- (51) MKP
A61K 39/155 (2006.01) (97) **2702159 ***
C12N 7/01 (2006.01)
C12N 15/86 (2006.01)
(86) US2012033482 13.04.2012
(96) 12777657.3 05.03.2014
(87) WO2012148708, 13.04.2012
(97) 2702159, 05.03.2014 en
(54) MODIFIED SENDAI VIRUS VACCINE AND IMAGING VECTOR
(71) St. Jude Children's Research Hospital, 262 Danny Thomas Place Mail Stop 742, Memphis, TN 38105, US
(72) HURTWITZ, Julia, Marie, 1843 Hunters Hill Drive, Germantown, TN 38138, US
TAKIMOTO, Toru, 510 Gilmour Street, 6, West Henrietta, NY 14586, US
RUSSELL, Charles, John, 5207 Hare Creek Cove, Arlington, TN 38134, US
PORTNER, Allen, 2752 Glaxie, Bartlett, TN 38134, US
SLOBOD, Karen, S., 4 Foskett Street 1, Somerville, MA 02144, US

- (51) MKP
B23C 3/35 (2006.01) (97) **2714336 ***
B25B 1/24 (2006.01)
(86) EP2012059166 16.05.2012
(96) 12721535.8 09.04.2014
(87) WO2012159965, 16.05.2012
(97) 2714336, 09.04.2014 en
(54) CLAMPING DEVICE FOR A MACHINE FOR DUPLICATING KEYS
(71) Keyline S.P.A., Via Camillo Bianchi 2, 31015 Conegliano (TV), IT
(72) REBULI, David, Via S. Pio X 36, I-35010 Trebaseleghe (PD), IT
TOME', Enrico, Keyline S.p.A. Via Camillo Bianchi 2, I-31015 Conegliano (TV), IT

- (51) MKP
F04C 2/00 (2006.01) (97) **2739854 ***
(86) US2012049324 02.08.2012
(96) 12820569.7 11.06.2014
(87) WO2013019948, 02.08.2012
(97) 2739854, 11.06.2014 en
(54) PISTON WITH REPLACEABLE AND/OR ADJUSTABLE SURFACES
(71) Lobepro, Inc., 2610 Sidney Lanier Drive, Brunswick, Georgia 31525, US
(72) Ramos, Rolando, Nico, M, 2000 Presidential Way, Nr 504, West Palm Beach, FL 33401, US
Blodgett, William W., 323 West 31st Street, Sea Island, GA 31561, US

- (51) MKP
A01N 37/18 (2006.01) (97) **2736329 ***
A61K 31/165 (2006.01)
C07C 233/00 (2006.01)
(86) US2012048553 27.07.2012
(96) 12819992.4 04.06.2014
(87) WO2013019621, 27.07.2012
(97) 2736329, 04.06.2014 en
(54) COMPOUNDS AND METHODS
(71) Tempero Pharmaceuticals, Inc., 200 Technology Square, Cambridge, MA 02139, US
(72) BALOGLU, Erkan, 8 Benjamin Terrace, Stoneham, MA 02180, US
GHOSH, Shomir, 200 Technology Square, Cambridge, MA 02139, US
LOBERA, Mercedes, 200 Technology Square, Cambridge, MA 02139, US
SCHMIDT, Darby, R., 14 Mead Road, Arlington, MA 02474, US

- (51) MKP
F03D 7/02 (2006.01) (97) **2657516**
(96) 13161037.0 30.10.2013
(97) 2657516, 30.10.2013 fr
(54) Wind turbine including an electromagnetic retarder for slowing the blade rotation speed
(71) Eolys Ressources et Energies, Route de la Chataigneraie, 85120 St. Hilaire De Voust, FR
(72) Bousquet, Jérôme, 18 bis Chemin de Beaumanoir, 85550 La Barre-De-Monts, FR
Dybowski, Lionel, 4 ruelle des Pierres, 77220 Presles En Brie, FR

- (51) MKP
F01K 7/16 (2006.01) (97) **2718547 ***
F01K 23/10 (2006.01)
F01K 25/08 (2006.01)
(86) US2012038703 18.05.2012
(96) 12789604.1 16.04.2014
(87) WO2012162187, 18.05.2012
(97) 2718547, 16.04.2014 en
(54) DOUBLE PINCH CRITERION FOR OPTIMIZATION OF REGENERATIVE RANKINE CYCLES
(71) Massachusetts Institute of Technology, 77 Massachusetts Avenue, Cambridge, MA 02139, US
(72) ZEBIAN, Hussam, 70 Pacific Street, Cambridge, MA 02139, US
MITOS, Alexander, 31 Fletcher Avenue Unit 1, Lexington, MA 02420, US

- (51) MKP
E06B 9/26 (2006.01) (97) **2737151 ***
E06B 9/302 (2006.01)
(86) AU2012000888 26.07.2012
(96) 12819888.4 04.06.2014
(87) WO2013016761, 26.07.2012
(97) 2737151, 04.06.2014 en
(54) A RETRACTABLE LOUVRE SYSTEM
(71) Advanced Design Innovations Pty Limited, 24 Firestone Way, Wodonga, Victoria 3690, AU
(72) WHYTLAW, Michael, 24 Firestone Way, Wodonga, Victoria 3690, AU

(51) MKP
A61K 31/427 (2006.01) (97) **2714685 ***
A61P 35/00 (2006.01)
C07D 207/325 (2006.01)
C07D 401/12 (2006.01)
C07D 417/12 (2006.01)
(86) US2012039468 24.05.2012
(96) 12793459.4 09.04.2014
(87) WO2012166559, 24.05.2012
(97) 2714685, 09.04.2014 en
(54) COMPOSITIONS CONTAINING, METHODS INVOLVING, AND USES OF NON-NATURAL AMINO ACID LINKED DOLASTATIN DERIVATIVES
(71) Ambrx, Inc., 10975 North Torrey Pines Road, Suite 100, La Jolla, CA 92037, US
(72) MIAO, Zhenwei, 15887 Sunnyfield Place, San Diego, CA 92127, US
ATKINSON, Kyle, C., 2024 Golden Vue Drive, Golden, CO 80401, US
BIROC, Sandra, 1036 Camellia Drive, Alameda, CA 94502, US
BUSS, Timothy, 1745 Catalpa Road, Carlsbad, CA 92011, US
COOK, Melissa, 976 S. Mollison Avenue Apt. 5, El Cajon, CA 92020, US
KRAYNOV, Vadim, 5457 White Oak Lane, San Diego, CA 92130, US
MARSDEN, Robin, 6358 Budlong Lake Avenue, San Diego, CA 92119, US
PINKSTAFF, Jason, 2095 Wandering Road, Encinitas, CA 92024, US
SKIDMORE, Lillian, 6232 Canyon Bluff Court, San Diego, CA 92121, US
SUN, Ying, 14972 Avenida Venusto 65, San Diego, CA 92128, US
SZYDLIK, Agnieszka, 3050 Rue D'Orleans 283, San Diego, CA 92110, US
LOPEZ DE VALENTA, Delia Ianina, 13442 Sebago Avenue, Roway, CA 92064, US

(51) MKP
A61K 31/437 (2006.01) (97) **2766363 ***
A61P 35/00 (2006.01)
C07D 471/04 (2006.01)
(86) US2012060138 12.10.2012
(96) 12809374.7 20.08.2014
(87) WO2013056183, 12.10.2012
(97) 2766363, 20.08.2014 en
(54) POLYMORPHS OF ARRY-380, A SELECTIVE HERB2 INHIBITOR AND PHARMACEUTICAL COMPOSITIONS CONTAINING THEM
(71) Array Biopharma, Inc., 3200 Walnut Street, Boulder, CO 80301, US
(72) CORSON, Donald T., c/o Array BioPharma Inc., 3200 Walnut Street., Boulder, Colorado 80301, US
LINDEMANN, Christopher M., c/o Array BioPharma Inc., 3200 Walnut Street., Boulder, Colorado 80301, US
WATSON, Daniel J., c/o Array BioPharma Inc., 3200 Walnut Street., Boulder, Colorado 80301, US

(51) MKP
C21D 1/00 (2006.01) (97) **2734655 ***
C22C 19/05 (2006.01)
C22C 38/00 (2006.01)
C22C 38/44 (2006.01)
C22F 1/10 (2006.01)
(86) US2013036325 12.04.2013
(96) 13804541.4 28.05.2014
(87) WO2013188001, 12.04.2013
(97) 2734655, 28.05.2014 en
(54) HIGH-STRENGTH CORROSION-RESISTANT TUBING FOR OIL AND GAS COMPLETION AND DRILLING APPLICATIONS, AND PROCESS FOR MANUFACTURING THEREOF
(71) Huntington Alloys Corporation, 3200 Riverside Drive, Huntington, WV 25705, US
(72) MANNAN, Sarwan, Kumar, 1 Orchard Hill Road, Barboursville, West Virginia 25504, US

(51) MKP
A61K 39/395 (2006.01) (97) **2707029 ***
A61P 3/06 (2006.01)
C07K 16/40 (2006.01)
(86) US2012037394 10.05.2012
(96) 12722044.0 19.03.2014
(87) WO2012154999, 10.05.2012
(97) 2707029, 19.03.2014 en
(54) METHODS OF TREATING OR PREVENTING CHOLESTEROL RELATED DISORDERS
(71) Amgen Inc., One Amgen Center Drive, Thousand Oaks, California 91320-1799, US
(72) CHAN, Joyce Chi Yee, 314 College Avenue, San Francisco California 94112, US
GIBBS, John P., 4840 E. Mercer Way, Mercer Island Washington 98040, US
DIAS, Clapton S., 4278 Via Encanto, Newbury Park California 91320, US
WASSERMAN, Scott, 5238 Via Pisa, Newbury Park California 91320, US
SCOTT, Robert Andrew Donald, 701 N. Conejo School Road, Thousand Oaks California 91362, US
CLOGSTON, Christi L., 601 Country View Place, Camarillo California 93010, US
OSSLUND, Timothy David, 475 Vista Montana, Camarillo California 93010, US
STEIN, Evan, A., 25 E, Superior Street, Chicago, IL 60611, US

(51) MKP
A61K 9/70 (2006.01) (97) **2722040 ***
A61K 31/167 (2006.01)
A61K 47/12 (2006.01)
A61K 47/42 (2006.01)
A61P 23/02 (2006.01)
(86) JP2012065079 13.06.2012
(96) 12802705.9 23.04.2014
(87) WO2012176668, 13.06.2012
(97) 2722040, 23.04.2014 en
(54) LIDOCAINE-CONTAINING CATAPLASM
(71) Hisamitsu Pharmaceutical Co., Inc., 408, Tashirodaikan-machi, Tosu-shi, Saga 841-0017, JP
(72) KUBO Junichi, c/o Hisamitsu Pharmaceutical Co. Inc. 408 Tashirodaikan-machi, Tosu-shi Saga 841-0017, JP
TSURU Seiichiro, c/o Hisamitsu Pharmaceutical Co. Inc. 408 Tashirodaikan-machi, Tosu-shi Saga 841-0017, JP
TSURUSHIMA Keiichiro, c/o Hisamitsu Pharmaceutical Co. Inc. 408 Tashirodaikan-machi, Tosu-shi Saga 841-0017, JP
YAMASOTO Shinji, c/o Hisamitsu Pharmaceutical Co. Inc. 408 Tashirodaikan-machi, Tosu-shi Saga 841-0017, JP

(51) MKP
A61K 31/4196 (2006.01) (97) **2758053 ***
A61K 31/495 (2006.01)
A61K 45/06 (2006.01)
A61P 3/10 (2006.01)
(86) US2012056419 20.09.2012
(96) 12769826.4 30.07.2014
(87) WO2013043925, 20.09.2012
(97) 2758053, 30.07.2014 en
(54) SODIUM CHANNEL BLOCKERS REDUCE GLUCAGON SECRETION
(71) Gilead Sciences, Inc., 333 Lakeside Drive, Foster City, CA 94404, US
(72) DHALLA, Arvinder, c/o Gilead Sciences Inc. 333 Lakeside Drive, Foster City, California 94404, US
BELARDINELLI, Luiz, c/o Gilead Sciences Inc. 333 Lakeside Drive, Foster City, California 94404, US

- (51) MKP
A61K 9/00 (2006.01) (97) **2731588 ***
A61K 9/19 (2006.01)
A61K 9/70 (2006.01)
A61K 31/675 (2006.01)
A61K 47/38 (2006.01)
(86) EP2012063796 13.07.2012
(96) 12742822.5 21.05.2014
(87) WO2013010942, 13.07.2012
(97) 2731588, 21.05.2014 en
(54) COMPOSITION AND METHOD FOR TREATING HPV
(71) Femalon S.P.R.L., Rue de Travail 16, 4460 Grâce-Hollogne, BE
Université Libre de Bruxelles, Avenue F.D. Roosevelt 50, 1050
Brussels, BE
(72) PIETTE, Marie, Rue de Leumont 53, B-4520 Wanze, BE
EVRARD, Brigitte, Clos du Sartay 22, B-4300 Embourg, BE
COÏA, Isabelle, Clos des Neiges 7, B-4624 Romsée, BE

- (51) MKP
A23J 1/14 (2006.01) (97) **2709463 ***
A23J 3/16 (2006.01)
C07K 1/14 (2006.01)
C07K 14/415 (2006.01)
(86) CA2012000486 18.05.2012
(96) 12786275.3 26.03.2014
(87) WO2012155256, 18.05.2012
(97) 2709463, 26.03.2014 en
(54) PRODUCTION OF SOLUBLE SOY PROTEIN PRODUCT
("S704")
(71) Burcon Nutrascience (MB) Corp., 1388 Waller Avenue,
Winnipeg, Manitoba R3T 1P9, CA
(72) SCHWEIZER, Martin, 117 Haig Avenue, Winnipeg Manitoba
R2M 0E3, CA
SEGALL, Kevin I., 31 Dunbar Crescent, Winnipeg Manitoba
R3P 0W6, CA

- (51) MKP
A61K 31/202 (2006.01) (97) **2768495 ***
A61P 17/00 (2006.01)
A61P 17/10 (2006.01)
(86) EP2012070809 19.10.2012
(96) 12775679.9 27.08.2014
(87) WO2013057284, 19.10.2012
(97) 2768495, 27.08.2014 en
(54) PHARMACEUTICAL COMPOSITIONS COMPRISING DGLA,
15-OHEPA, AND/OR 15-HETRE AND METHODS OF USE
THEREOF
(71) Dignity Sciences Limited, The Oval Block 3, 1st Floor 160
Shelborne Road Ballsbridge, Dublin 4, IE
(72) CLIMAX, John, Dignity Sciences Limited First Floor Block 3
The Oval Shelbourne Road, Ballsbridge Dublin 44245, IE
COUGHLAN, David, Dignity Sciences Limited First Floor Block
3 The Oval Shelbourne Road, Ballsbridge Dublin 44245, IE
MANKU, Mehar, Dignity Sciences Limited First Floor Block 3
The Oval Shelbourne Road, Ballsbridge Dublin 44245, GB

- (51) MKP
G06Q 20/20 (2012.01) (97) **2702572 ***
G07F 7/08 (2006.01)
G07G 1/00 (2006.01)
(86) IB2012052017 22.04.2012
(96) 12724399.6 05.03.2014
(87) WO2012143911, 22.04.2012
(97) 2702572, 05.03.2014 en
(54) THE METHOD OF CASHLESS PERSON-TO-PERSON
MONEY TRANSFER OF USING A MOBILE PHONE
(71) Logomotion, s.r.o., Winterova 15, 921 01 Piestany, SK
(72) FLOREK, Miroslav, Sedmokraskova 4, 821 01 Bratislava, SK
MASARYK, Michal, Medzilaborecká 7, 821 01 Bratislava, SK

- (51) MKP
F16C 19/06 (2006.01) (97) **2711574**
F16C 33/60 (2006.01)
F16C 35/077 (2006.01)
F16C 43/04 (2006.01)
(86) 12184958.2 26.03.2014
(97) 2711574, 26.03.2014 de
(54) Ball bearing and method for manufacturing a ball bearing
(71) NP Poschmann GmbH, Zur Heide 33, 59929 Brilon, DE
(72) Baukloh, Horst, Südstr. 8, 58540 Meinerzhagen, DE

- (51) MKP
A47C 7/02 (2006.01) (97) **2735247**
(86) 12462014.7 28.05.2014
(97) 2735247, 28.05.2014 en
(54) Office-chair
(71) Antares Hungary Kft., Kossuth utca 14., 6763 Szatymaz, HU
(72) Sustik, Ferenc, Jokai utca 29., 6763 Szatymaz, HU

- (51) MKP
A45C 11/00 (2006.01) (97) **2764793 ***
(86) KR2012008126 08.10.2012
(96) 12837691.0 13.08.2014
(87) WO2013051911, 08.10.2012
(97) 2764793, 13.08.2014 en
(54) MOBILE COMMUNICATION TERMINAL CASE AND TABLET
PC CASE
(71) PenAndFree Co., Ltd., 801 Keumkang Hitech Valley 2nd
Sangdaewon1-Dong Jungwon-gu Seongnam-City, Gyeonggi-
do 462-720, KR
(72) LEE, Jae Jun, (Ssangyong Apt. Garak-dong) 203-1010 193
Dongnam-ro Songpa-gu, Seoul 138-747, KR

- (51) MKP
C07B 59/00 (2006.01) (97) **2722335 ***
C07H 1/02 (2006.01)
C07H 21/02 (2006.01)
(86) JP2012061652 07.05.2012
(96) 12782845.7 23.04.2014
(87) WO2012153704, 07.05.2012
(97) 2722335, 23.04.2014 en
(54) PROCESS FOR PREPARING PHOSPHATE COMPOUND
BEARING ISOTOPE
(71) Bonac Corporation, Fukuoka BIO Factory 4F 1488-4 Aikawa-
machi, Kurume-shi, Fukuoka 839-0861, JP
(72) HAMASAKI Tomohiro, c/o BONAC CORPORATION Fukuoka
BIO Factory 4F 1488-4 Aikawa-machi, Kurume-shi, Fukuoka
839-0861, JP
OHGI Tadaaki, c/o BONAC CORPORATION Fukuoka BIO
Factory 4F 1488-4 Aikawa-machi, Kurume-shi, Fukuoka 839-
0861, JP

- (51) MKP
A61K 39/12 (2006.01) (97) **2734230 ***
C07K 14/005 (2006.01)
C12N 15/86 (2006.01)
(86) US2012023658 02.02.2012
(96) 12705199.3 28.05.2014
(87) WO2013012446, 02.02.2012
(97) 2734230, 28.05.2014 en
(54) RECOMBINANT FELINE LEUKEMIA VIRUS VACCINE
CONTAINING OPTIMIZED FELINE LEUKEMIA VIRUS
ENVELOPE GENE
(71) Merial Limited, 3239 Satellite Blvd., Duluth, GA 30096, US
Centre National de la Recherche Scientifique, 3, rue Michel-
Ange, 75794 Paris Cedex 16, FR
Institut Gustave Roussy, 39, rue Camille Desmoulins, 94805
Villejuif Cédex, FR
Université Paris Sud, 15, rue Georges Clémenceau, 91405
Orsay, FR
(72) POULET, Hervé, 2 Place des Quatre Vierges, 69110 Sainte
Foy-Les Lyon, FR
HEIDMANN, Thierry, 11 rue Edouard Detaille, 7517 Paris, FR

(51) MKP
C12P 21/04 (2006.01) (97) **2705154 ***
G01N 33/00 (2006.01)
(86) US2012035495 27.04.2012
(96) 12777788.6 12.03.2014
(87) WO2012149351, 27.04.2012
(97) 2705154, 12.03.2014 en
(54) FECAL LACTOFERRIN AS A BIOMARKER FOR DETERMINING DISEASE SEVERITY AND FOR MONITORING INFECTION IN PATIENTS WITH CLOSTRIDIUM DIFFICILE DISEASE
(71) TechLab, Inc., 2001 Kraft Drive, Blacksburg, VA 24060-6358, US
(72) BOONE, James, Hunter, 545 Arrowhead Trail, Christiansburg, VA 24073, US
LYERLY, David, M., 204 Macarthur Avenue, Radford, VA 24142, US
WILKINS, Tracy, D., 6254 Chestnut Ridge Road, Riner, VA 24149, US
CARMAN, Robert, J., 1700 North Fork Road, Christiansburg, VA, US

(51) MKP
B23G 1/04 (2006.01) (97) **2650072**
B23G 1/18 (2006.01)
(96) 13160115.5 16.10.2013
(97) 2650072, 16.10.2013 en
(54) Automatic threading machine
(71) Bordignon Simone S.r.l., Via Ramon n. 84, 36028 Rossano Veneto (VI), IT
(72) Bordignon, Simone, Via Novelletta 67 Rossano Veneto, 36028 Vicenza, IT
Bordignon, Alberto, Via Garibaldi 27/A Rosa', 36027 Vicenza, IT

(51) MKP
A61K 31/05 (2006.01) (97) **2709606 ***
A61K 36/61 (2006.01)
A61K 45/06 (2006.01)
A61P 17/04 (2006.01)
(86) EP2012058647 10.05.2012
(96) 12725643.6 26.03.2014
(87) WO2012156275, 10.05.2012
(97) 2709606, 26.03.2014 en
(54) COMPOSITIONS CONTAINING RESVERATROL AND ESSENTIAL OIL OF CLOVES FOR THE TREATMENT OF ITCHING
(71) Difass International S.r.l., Via delle Fonti di Mezzana, 7, 59100 Prato, IT
(72) AGOSTINI, Alida, c/o DIFASS INTERNATIONAL S.R.L. Via Ausa 181 Loc. Cerasolo, I-47853 Coriano (m), IT
BALZI, Sonia, c/o DIFASS INTERNATIONAL S.R.L. Via Ausa 181 Loc. Cerasolo, I-47853 Coriano (m), IT

(51) MKP
G06F 3/01 (2006.01) (97) **2707787 ***
(86) FR2012051018 09.05.2012
(96) 12725119.7 19.03.2014
(87) WO2012153061, 09.05.2012
(97) 2707787, 19.03.2014 fr
(54) TRANSPARENT VIBRATING TOUCH INTERFACE
(71) Université Lille 1 - Sciences Et Technologies, Cité Scientifique, 59650 Villeneuve D'ascq Cedex, FR
(72) GIRAUD, Frédéric, 22 rue Charles Péguy, F-59700 Marcq En Baroeul, FR
AMBERG, Michel, 41 rue du Colibri, F-59650 Villeneuve D'ascq, FR
LEMAIRE-SEMAIL, Betty, 33 rue de la Barre, F-59000 Lille, FR

(51) MKP
A61K 31/4523 (2006.01) (97) **2760449 ***
A61K 31/5395 (2006.01)
A61K 35/28 (2006.01)
A61K 45/06 (2006.01)
A61P 43/00 (2006.01)
(86) HU2012000098 25.09.2012
(96) 12805749.4 06.08.2014
(87) WO2013045963, 25.09.2012
(97) 2760449, 06.08.2014 en
(54) A PHARMACEUTICAL COMPOSITION FOR THE TREATMENT OF STEM CELLS
(71) Literáti Nagy, Botond, Venyige u. 15, 8220 Balatonalmádi, HU

(51) MKP
A61K 39/00 (2006.01) (97) **2758433 ***
A61P 25/28 (2006.01)
C07K 14/47 (2006.01)
C07K 16/18 (2006.01)
G01N 33/53 (2006.01)
(86) IB2012002246 14.09.2012
(96) 12788639.8 30.07.2014
(87) WO2013041962, 14.09.2012
(97) 2758433, 30.07.2014 en
(54) PROTEIN-BASED THERAPY AND DIAGNOSIS OF TAU-MEDIATED PATHOLOGY IN ALZHEIMER'S DISEASE
(71) Axon Neuroscience SE, Grösslingova 45, 811 09 Bratislava, SK
(72) NOVÁK, Michal, Novosvetska 27, 811 04 Bratislava, SK
KONTSEKOVÁ, Eva, Lichnerova 41, 903 01 Senec, SK
KOVÁČEČ, Branislav, Snp 1461, 017 01 Povazská Bystrica, SK
ZILKA, Norbert, Prievozska 37, 821 05 Bratislava, SK

(51) MKP
F03D 1/04 (2006.01) (97) **2756187 ***
F03D 11/00 (2006.01)
(86) US2012055420 14.09.2012
(96) 12806193.4 23.07.2014
(87) WO2013040361, 14.09.2012
(97) 2756187, 23.07.2014 en
(54) FLUID TURBINE LIGHTNING PROTECTION SYSTEM
(71) Ogin, Inc., 221 Crescent Street Suite 103A, Waltham, MA 02453, US
(72) JENSEN, Rasmus, Peter, Sønderde 71B, DK-8883 Gjerm, DK
HJORT, Soren, Buskelundtoften 77, DK-8600 Silkeborg, DK

(51) MKP
C07D 239/47 (2006.01) (97) **2751086 ***
(86) US2012052617 28.08.2012
(96) 12827656.5 09.07.2014
(87) WO2013033068, 28.08.2012
(97) 2751086, 09.07.2014 en
(54) KYNURENINE-3-MONOOXYGENASE INHIBITORS, PHARMACEUTICAL COMPOSITIONS, AND METHODS OF USE THEREOF
(71) CHDI Foundation, Inc., 350 7th Avenue, Suite 601, New York, NY 10001, US
(72) COURTNEY, Stephen Martin, 43 Fawkner Way., Stanford in the Vale, Oxfordshire SN7 8FF, GB
PRIME, Michael, 7 Overmead., Abingdon, Oxfordshire OX14 5NB, GB
MITCHELL, William, Hunters Meet, Chapel Lane, Swallow., Market Rasen Lincolnshire LN7 6DE, GB
BROWN, Christopher John, 48 Howard Cornish Road., Marcham, Abingdon Oxon OX13 6PW, GB
DE AGUIAR PENA, Paula C., 22 Fallowfield Crescent., Madley Park, Witney Oxfordshire OX28 1AF, GB
JOHNSON, Peter, 59, Overmead., Abingdon Oxfordshire OX14 5ND, GB
DOMINGUEZ, Celia, 8606 Allenwood Road., Los Angeles, California 90046, US
TOLEDO-SHERMAN, Leticia M., 3015 Goldsmith Street, Santa Monica, California 90405, US
MUNOZ, Ignacio, 1029 N. Vista Street, Unit 101., West Hollywood, California 90046, US

(51) MKP
A23L 1/30 (2006.01) (97) **2753193 ***
A23L 1/38 (2006.01)
A61K 8/99 (2006.01)
A61K 36/06 (2006.01)
G01N 33/564 (2006.01)
(86) GB2012052192 06.09.2012
(96) 12766707.9 16.07.2014
(87) WO2013034911, 06.09.2012
(97) 2753193, 16.07.2014 en
(54) PRODUCTS AND METHODS
(71) IP Science Limited, 2nd Floor The Platinum Building St. John's Innovation Park Cowley Road, Cambridge CB5 0DS, GB
(72) PETYAEV, Ivan, IP Science Limited Browning House 3 Tunwells Lane, Great Shelford Cambridge CB22 5LJ, GB

- (51) MKP
A61K 31/519 (2006.01) (97) **2763985 ***
C07D 417/02 (2006.01)
- (86) EP2012069676 05.10.2012
(96) 12769098.0 13.08.2014
(87) WO2013050508, 05.10.2012
(97) 2763985, 13.08.2014 en
- (54) MORPHOLINO SUBSTITUTED BICYCLIC PYRIMIDINE UREA OR CARBAMATE DERIVATIVES AS MTOR INHIBITORS
- (71) Cellzome Limited, 980 Great West Road, Brentford, Middlesex TW8 9GS, GB
- (72) LYNCH, Rosemary, 44 Chalmers Road, Cambridge, CB1 3SX, GB
CANSFIELD, Andrew David, 4 The Limes Harston, Cambridge, CB22 7QT, GB
HARDY, Daniel Paul, 7 Convent Gardens, Baldock, Herts SG7 6FD, GB
FEUTRILL, John Thomas, 16 Lewellin Grove, Rosanna, Victoria 3084, AU
ADREGO, Rita, 39 Rowan Drive, Brandon, Suffolk IP27 0EX, GB
ELLARD, Katie, 19 Barnack Grove, Royston, Herts SG8 5HQ, GB
LADDUWAHETTY, Tammy, 50 Woodland Way Winchmore Hill, London N21 3QA, GB

- (51) MKP
A61K 35/12 (2006.01) (97) **2756521 ***
C12P 21/00 (2006.01)
H01L 21/00 (2006.01)
- (86) US2012055760 17.09.2012
(96) 12832609.7 23.07.2014
(87) WO2013040557, 17.09.2012
(97) 2756521, 23.07.2014 en
- (54) RNA ENGINEERED T CELLS FOR THE TREATMENT OF CANCER
- (71) The Trustees Of The University Of Pennsylvania, Center for Technology Transfer 3160 Chestnut Street Suite 200, Philadelphia, PA 19104, US
- (72) JUNE, Carl, H., 409 Baird Road, Merion Station, PA 19066, US
ZHAO, Yangbing, 23 Doncaster Rd., Cherry Hill, NJ08003, US

- (51) MKP
A61K 38/46 (2006.01) (97) **2704737 ***
- (86) US2012035614 27.04.2012
(96) 12777116.0 12.03.2014
(87) WO2012149440, 27.04.2012
(97) 2704737, 12.03.2014 en
- (54) THERAPEUTIC NUCLEASE COMPOSITIONS AND METHODS
- (71) THE UNIVERSITY OF WASHINGTON, UW Center for Commercialization 4311 11th Avenue NE, Suite 500, Seattle, WA 98105-4608, US
- (72) LEDBETTER, Jeffrey, A., c/o University Of Washington UW Center For Commercialization 4311 11th Avenue N.E. Suite 500, Seattle, WA 98105-4608, US
HAYDEN-LEDBETTER, Martha, c/o University Of Washington UW Center For Commercialization 4311 11th Avenue N.E. Suite 500, Seattle, WA 98105-4608, US
ELKON, Keith, c/o University Of Washington UW Center For Commercialization 4311 11th Avenue N.E. Suite 500, Seattle, WA 98105-4608, US
SUN, Xizhang, c/o University Of Washington UW Center For Commercialization 4311 11th Avenue N.E. Suite 500, Seattle, WA 98105-4608, US

- (51) MKP
A61K 31/337 (2006.01) (97) **2701700 ***
A61P 35/00 (2006.01)
- (86) US2012035381 27.04.2012
(96) 12776151.8 05.03.2014
(87) WO2012149267, 27.04.2012
(97) 2701700, 05.03.2014 en
- (54) DRUG THERAPY TO INHIBIT CHEMOTHERAPY-INDUCED ADVERSE EFFECTS AND RELATED PHARMACEUTICAL COMPOSITIONS, DIAGNOSTICS, SCREENING TECHNIQUES AND KITS
- (71) Yale University, Inc., 2 Whitney Avenue, New Haven, CT 06511, US
- (72) EHRlich, Barbara, 215 South Main St., Wallingford, CT 06492, US
ROCKWELL, Sara, 91 Green Hill Road, Madison, CT 06443, US
BENBOW, Jennifer, 9538 Bellhaven Ct., Frederick, MD 21701, US

- (51) MKP
C07J 75/00 (2006.01) (97) **2764008 ***
- (86) EP2012069761 05.10.2012
(96) 12778664.8 13.08.2014
(87) WO2013050553, 05.10.2012
(97) 2764008, 13.08.2014 en
- (54) PROCESS FOR THE PRODUCTION OF ESTETROL
- (71) Estetra S.P.R.L., Rue Saint Exupéry 17, 4460 Bierset, BE
- (72) PASCAL, Jean-Claude, 170 Avenue de Gairaut, 06100 Nice, FR

- (51) MKP
B01J 20/04 (2006.01) (97) **2733119**
B01J 20/28 (2006.01)
C02F 1/28 (2006.01)
C02F 101/10 (2006.01)
C02F 103/00 (2006.01)
- (96) 12461558.4 21.05.2014
(97) 2733119, 21.05.2014 en
- (54) Agent for removing dissolved phosphorus compounds from water
- (71) Zachodniopomorski Uniwersytet Technologiczny w Szczecinie, Aleja Piastów 17, 70-310 Szczecin, PL
- (72) Siwek, Hanna, Zachodniopomorski Uniwersytet Technologiczny w Szczecinie Sieradzka 2b, 70-736 Szczecin, PL
Włodarczyk, Małgorzata, Zachodniopomorski Uniwersytet Technologiczny w Szczecinie Zwirki i Wigury 18/3, 71-176 Szczecin, PL
Bartkowiak, Artur, Zachodniopomorski Uniwersytet Technologiczny w Szczecinie Ksiecica Wacislawa I 26A/11, 71-667 Szczecin, PL
Sobecka, Katarzyna, Zachodniopomorski Uniwersytet Technologiczny w Szczecinie Poprzeczna 11, 71-742 Szczecin, PL

- (51) MKP
A61K 38/47 (2006.01) (97) **2720713 ***
A61P 3/10 (2006.01)
- (86) US2012042818 15.06.2012
(96) 12745932.9 23.04.2014
(87) WO2012174480, 15.06.2012
(97) 2720713, 23.04.2014 en
- (54) CONTINUOUS SUBCUTANEOUS INSULIN INFUSION METHODS WITH A HYALURONAN DEGRADING ENZYME
- (71) Halozyne, Inc., 11388 Sorrento Valley Road, San Diego, CA 92121, US
- (72) VAUGHN, Daniel, Edward, 2230 14th St., Encinitas, CA 92024, US
MUCHMORE, Douglas, Boyer, 7037 Via Valverde, Lajolla, CA 92037, US
FROST, Gregory, Ian, 13662 Mercado Dr., Del Mar, CA 92014, US

(51) MKP
A01N 43/42 (2006.01) (97) **2744333 ***
 (86) US2012051064 16.08.2012
 (96) 12826459.5 25.06.2014
 (87) WO2013028447, 16.08.2012
 (97) 2744333, 25.06.2014 en
 (54) FATTY ACID SYNTHASE INHIBITORS
 (71) Glaxosmithkline Intellectual Property (No. 2) Limited, 980 Great West Road, Brentford, Middlesex TW8 9SG, GB
 (72) GHERGUROVICH, Jonathan, Michael, 1250 South Collegeville Road, Collegeville, PA 19426, US
 MOORE, Michael, Lee, 1250 South Collegeville Road, Collegeville, PA 19426, US
 PARRISH, Cynthia, Ann, 1250 South Collegeville Road, Collegeville, PA 19426, US
 RIDGERS, Lance, Howard, 1250 South Collegeville Road, Collegeville, PA 19426, US
 YU, Hongyi, 1250 South Collegeville Road, Collegeville, PA 19426, US

(51) MKP
A61K 31/505 (2006.01) (97) **2736901 ***
A61P 35/00 (2006.01)
C07D 403/12 (2006.01)
C07D 491/10 (2006.01)
 (86) EP2012064515 24.07.2012
 (96) 12738141.6 04.06.2014
 (87) WO2013014162, 24.07.2012
 (97) 2736901, 04.06.2014 en
 (54) HETEROCYCLYL PYRIMIDINE ANALOGUES AS JAK INHIBITORS
 (71) Cellzome Limited, 980 Great West Road, Brentford, Middlesex TW8 9GS, GB
 (72) FREEMAN, Jay, 30 The Lathes, Norwich Norfolk NR3 3DY, GB
 READER, Valerie, 6 Market Lane, Linton Cambridgeshire CB21 4HU, GB
 ADDISON, Glynn, 40 High Street, Babraham Cambridgeshire CB22 3AG, GB
 RAMSDEN, Nigel, Sparrows Lodge Green Lane Fowlmere Royston, Herts Hertfordshire SG8 7QP, GB
 SCANLON, Jane Elizabeth, 21 Hayfield Avenue, Sawston Cambridgeshire CB22 3LE, GB
 HARRISON, Richard John, 30 Chalmers Road, Cambridge Cambridgeshire CB1 3SX, GB

(51) MKP
A61K 31/47 (2006.01) (97) **2758057 ***
A61P 19/10 (2006.01)
 (86) US2012056281 20.09.2012
 (96) 12770368.4 30.07.2014
 (87) WO2013043840, 20.09.2012
 (97) 2758057, 30.07.2014 en
 (54) METHOD FOR TREATING OSTEOPOROSIS
 (71) Exelixis, Inc., 210 East Grand Avenue, South San Francisco, CA 94080, US
 (72) AFTAB, Dana, T., 736 Tamarack Drive, San Rafael, CA 94903, US
 CLARY, Douglas, 164 Midcrest Way, San Francisco, CA 94131, US

(51) MKP
C12P 7/64 (2006.01) (97) **2751275 ***
 (86) IL2011000699 31.08.2011
 (96) 11764620.8 09.07.2014
 (87) WO2013030816, 31.08.2011
 (97) 2751275, 09.07.2014 en
 (54) ENZYMATIC TRANSESTERIFICATION WITH LIPASES IMMOBILIZED ON HYDROPHOBIC RESINS IN WATER SOLUTIONS
 (71) Trans Bio-Diesel Ltd., Regional R&D Center P.O. Box 437, 20200 Shfaram, IL
 (72) BASHEER, Sobhi, P.O. Box 9327, 20173 Sakhnine, IL
 EGBARIEH, Ahmad, Musherfeh, 30920 Maeleh Eron, IL
 MASRI, Ramez, null, 20137 Nahef, IL

(51) MKP
C12Q 1/70 (2006.01) (97) **2714941 ***
 (86) US2012038938 22.05.2012
 (96) 12789638.9 09.04.2014
 (87) WO2012162291, 22.05.2012
 (97) 2714941, 09.04.2014 en
 (54) COMPOSITIONS AND METHODS FOR MODULATING THE ACTIVITY OF EPSTEIN-BARR NUCLEAR ANTIGEN 1
 (71) The Wistar Institute, 3601 Spruce Street, Philadelphia, PA 19104-4268, US
 (72) LIEBERMAN, Paul, M., 545 Manor Road, Wynnewood, PA 19096, US
 MESSICK, Troy, 145 S. Pennock Avenue, Upper Darby, PA 19082, US

(51) MKP
F02G 1/043 (2006.01) (97) **2707588 ***
 (86) IB2012000912 11.05.2012
 (96) 12729193.8 19.03.2014
 (87) WO2013050836, 11.05.2012
 (97) 2707588, 19.03.2014 en
 (54) EXTERNAL COMBUSTION ENGINE
 (71) Innovative Technological Systems S.r.l., Autoporto di Gorizia Polo Tecnologico Techno Area, 34170 Gorizia, IT
 (72) GENTILE, Davide, Strada del Friuli 457, I-34136 Trieste, IT

(51) MKP
H02J 3/26 (2006.01) (97) **2670041**
H02M 7/48 (2007.01)
 (96) 12170485.2 04.12.2013
 (97) 2670041, 04.12.2013 de
 (54) Power supply assembly with an inverter for creating N-phase alternating current
 (71) AEG Power Solutions GmbH, Emil-Siepmann-Straße 32, 59581 Warstein-Belecke, DE
 (72) Averbeg, Dr. Ing. Andreas, Kreuzbergweg 4, 53115 Bonn, DE

(51) MKP
C07C 403/20 (2006.01) (97) **2708530 ***
 (86) CN2012075130 07.05.2012
 (96) 12786430.4 19.03.2014
 (87) WO2012155796, 07.05.2012
 (97) 2708530, 19.03.2014 en
 (54) STEREOSPECIFIC SYNTHESIS PROCESS FOR TRETINOIN COMPOUNDS
 (71) Chongqing Huabangshengkai Pharm. Co., Ltd, No. 666 Rongjun Road Nanjin Street Sub-district Hechuan District, Chongqing 401520, CN
 (72) DENG, Qingjun, No.69 Xingguang Avenue Renhe Town Yubei District, Chongqing 401120, CN
 WANG, Shaohui, No.69 Xingguang Avenue Renhe Town Yubei District, Chongqing 401120, CN
 ZHU, Qiang, No.69 Xingguang Avenue Renhe Town Yubei District, Chongqing 401120, CN
 GAO, Taiping, No.69 Xingguang Avenue Renhe Town Yubei District, Chongqing 401120, CN
 LI, Yongsheng, No.69 Xingguang Avenue Renhe Town Yubei District, Chongqing 401120, CN

(51) MKP
A01N 43/50 (2006.01) (97) **2725904 ***
 (86) US2012044738 28.06.2012
 (96) 12804805.5 07.05.2014
 (87) WO2013003646, 28.06.2012
 (97) 2725904, 07.05.2014 en
 (54) HIGH DOSAGE MUCOADHESIVE METRONIDAZOLE AQUEOUS-BASED GEL FORMULATIONS THEIR USE TO TREAT BACTERIAL VAGINOSIS
 (71) Medicis Pharmaceutical Corporation, 7720 North Dobson Road, Scottsdale, AZ 85256, US
 (72) NORDSIEK, Michael, T., 208 Grouse Lane, Wayne, Pennsylvania 19087, US
 BALAJI, Kodumudi, S., 1521 Ide Drive, Lansdale, Pennsylvania 19446, US

(51) MKP
A61K 31/7105 (2006.01) (97) **2723350 ***
A61P 35/00 (2006.01)
(86) IB2012053196 25.06.2012
(96) 12738615.9 30.04.2014
(87) WO2012176175, 25.06.2012
(97) 2723350, 30.04.2014 en
(54) NEW USES OF NANOG INHIBITORS AND RELATED METHODS
(71) Université de Genève, 24 rue du Général-Dufour, 1211 Genève 4, CH
(72) RUIZ ALTABA, Ariel, 28 Boulevard des Philosophes, CH-1205 Geneve, CH

(51) MKP
B65D 1/02 (2006.01) (97) **2767583**
B67C 3/02 (2006.01)
C12G 1/00 (2006.01)
(96) 14167862.3 20.08.2014
(97) 2767583, 20.08.2014 en
(54) Wine packaged in aluminium containers
(71) Barokes PTY Ltd., 66 Lillie Crescent, 3043 Tullamarine Victoria, AU
(72) Stokes, Gregory John Charles, 7 Belford Court, Keilor, Victoria 3036, AU
Barics, Steven John Anthony, 51 Waratah Avenue, Tullamarine, Victoria 3043, AU

(51) MKP
C12Q 1/68 (2006.01) (97) **2761025 ***
(86) US2012057777 28.09.2012
(96) 12775890.2 06.08.2014
(87) WO2013055530, 28.09.2012
(97) 2761025, 06.08.2014 en
(54) DIAGNOSTIC METHYLATION MARKERS OF EPITHELIAL OR MESENCHYMAL PHENOTYPE AND RESPONSE TO EGFR KINASE INHIBITOR IN TUMOURS OR TUMOUR CELLS
(71) Genentech, Inc., 1 DNA Way, South San Francisco, CA 94080, US
(72) SHAMES, David, c/o Genentech Inc. 1 DNA Way, South San Francisco California 94080, US
HOLCOMB, Thomas M., c/o Genentech Inc. 1 DNA Way, South San Francisco California 94080, US
WALTER, Kimberly, c/o Genentech Inc. 1 DNA Way, South San Francisco California 94080, US

(51) MKP
C08F 10/06 (2006.01) (97) **2707400 ***
(86) IN2012000335 08.05.2012
(96) 12756266.8 19.03.2014
(87) WO2012156989, 08.05.2012
(97) 2707400, 19.03.2014 en
(54) CATALYST SYSTEM FOR POLYMERIZATION OF PROPYLENE
(71) Reliance Industries Limited, 3rd Floor, Maker Chambers IV Nariman Point, Mumbai 400 021 Maharashtra, IN
(72) PATIL, Harshad Ramdas, A-103 Laxmidarshan Apartment Nr. Merulaxmi Temple Rander Road Tadwadi, Surat-395 009 Gujarat, IN
VYAS, Priyanshu, Bharatkumar, B-152 OM Prabhu Darshan Society Rander-Bheshan Road Ugat, Surat-395 005 Gujarat, IN
GUPTA, Virendrakumar, Apartment 703 Maitri Tower Sector 29 Nerul (East), Navi Mumbai-400 706 Maharashtra, IN

(51) MKP
B61D 3/16 (2006.01) (97) **2684757**
B61D 45/00 (2006.01)
(96) 13450028.9 15.01.2014
(97) 2684757, 15.01.2014 de
(54) Freight cars
(71) Kutschera, Wilhelm, Untere Fellacherstrasse 8, 9500 Villach, AT
(72) Kutschera, Wilhelm, Untere Fellacherstrasse 8, 9500 Villach, AT

(51) MKP
A61K 31/519 (2006.01) (97) **2751106 ***
A61P 9/00 (2006.01)
C07D 471/04 (2006.01)
C07D 487/04 (2006.01)
C07D 519/00 (2006.01)
(86) EP2012066876 30.08.2012
(96) 12766292.2 09.07.2014
(87) WO2013030288, 30.08.2012
(97) 2751106, 09.07.2014 de
(54) SUBSTITUTED ANNELLATED PYRIMIDINE AND THE USE THEREOF
(71) Bayer Intellectual Property GmbH, Alfred-Nobel-Strasse 10, 40789 Monheim, DE
Bayer Pharma Aktiengesellschaft, Müllerstrasse 178, 13353 Berlin, DE
(72) FOLLMANN, Markus, Rosmarinweg 28, 50895 Köln, DE
STASCH, Johannes-Peter, Alfred-Nobel-Str. 109, 42651 Solingen, DE
REDLICH, Gorden, Schadowstr. 50, 44799 Bochum, DE
GRIEBENOW, Nils, Kurfürstenstr. 39, 41541 Dormagen, DE
LANG, Dieter, Wimmersberger Str. 60, 42553 Velbert, DE
WUNDER, Frank, Schwarzer Weg 251, 42117 Wuppertal, DE
HÜBSCH, Walter, Wildsteig 22, 42113 Wuppertal, DE
LINDNER, Niels, Bodelschwingweg 4, 42115 Wuppertal, DE
VAKALOPOULOS, Alexandros, Heinrich-Heine-Str. 79a, 40721 Hilden, DE
TERSTEEGEN, Adrian, Rübzahlweg 8, 42111 Wuppertal, DE

(51) MKP
A61B 17/34 (2006.01) (97) **2649972**
A61F 11/00 (2006.01)
(96) 13173409.7 16.10.2013
(97) 2649972, 16.10.2013 en
(54) Tympanostomy tube delivery system
(71) Acclarent, Inc., 1525-B O'Brien Drive, Menlo Park, CA 94025, US
(72) Liu, Greg, 1244 Parkington Avenue, Sunnyvale, CA California 94087, US
Girotra, Rohit, 886-A De Haro Street, San Francisco, CA California 94107, US
Morriss, John H., 725 A Wisconsin Street, San Francisco, CA California 94107, US
Vrany, Julie D., 317 Blue Oak Lane, Los Altos, CA California 94022, US
Ha, Hung, V., 2974 Delancey Court, San Jose, CA California 95135, US
Knodel, Bryan, 6050 W. Saskan Ranch Circle, Flagstaff, AZ Arizona 86001, US
Walker, Jeffrey, A., 2687 Elston Street, Livermore, CA California 94550, US
Gross, Thomas, Daniel, 200 Kimble Avenue, Los Gatos, CA California 95030, US
Clopp, Mathew, D., 570 Hickory Court, Santa Clara, California 95051, US
Andreas, Bernard, H., 633 California Way, Redwood City, CA California 94062, US

(51) MKP
A61K 39/245 (2006.01) (97) **2707026 ***
C07D 239/84 (2006.01)
C07D 401/04 (2006.01)
C07D 401/12 (2006.01)
C07D 413/04 (2006.01)
(86) EP2012058094 03.05.2012
(96) 12720137.4 19.03.2014
(87) WO2012152644, 03.05.2012
(97) 2707026, 19.03.2014 de
(54) PRODUCTION OF DENSE BODIES (DB) FROM HCMV-INFECTED CELLS
(71) AiCuris GmbH & Co. KG, Friedrich-Ebert-Strasse 475, 42117 Wuppertal, DE
(72) LISCHKA, Peter, Tussmannstr. 95, 40477 Düsseldorf, DE
SINZGER, Christian, Dietrich-Bonhoeffer-Straße 20/1, 72762 Reutlingen, DE

(51) MKP
A61K 39/395 (2006.01) (97) **2768855 ***
C07K 16/00 (2006.01)
C07K 16/22 (2006.01)
C07K 16/24 (2006.01)
C07K 16/46 (2006.01)
(86) EP2012004404 19.10.2012
(96) 12780659.4 27.08.2014
(87) WO2013056851, 19.10.2012
(97) 2768855, 27.08.2014 en
(54) STABLE MULTIPLE ANTIGEN-BINDING ANTIBODY
(71) ESBATech - a Novartis Company LLC, Wagistrasse 21, 8952 Schlieren, CH
(72) RIEGLER, Astrid C., Konradstrasse 55, 8005 Zürich, CH
BORRAS, Leonardo, Bوندentalstrasse 1, CH-8952 Schlieren, CH
SOMMAVILLA, Roberto, Famanstrasse 49, CH-8152 Opfikon, CH

(51) MKP
A01K 15/02 (2006.01) (97) **2661961**
(96) 12167536.7 13.11.2013
(97) 2661961, 13.11.2013 en
(54) A modular climbing tree and method of assembling the climbing tree
(71) Kattens No. 1, Fabriksvænget 1, 4130 Viby Sj., DK
(72) Hansen, Peter Werner, MOEF A/S Refshalevej 163A st. mf., 1432 Copenhagen K, DK
Jensen, Per Højland, Fugleparken 63, 2690 Karlslunde, DK
Bjerg, Bjarne, Bramsløkkevej 15, 2500 Valby, DK
Malsø, Ib, Carl Plougs Vej 63, 3460 Birkerød, DK

(51) MKP
G06G 7/58 (2006.01) (97) **2745235 ***
(86) US2012051257 17.08.2012
(96) 12825157.6 25.06.2014
(87) WO2013028480, 17.08.2012
(97) 2745235, 25.06.2014 en
(54) METHOD OF DRUG REPOSITIONING
(71) GlaxoSmithKline Intellectual Property Development Limited, 980 Great West Road, Brentford Middlesex TW8 9GS, GB
(72) AGARWAL, Pankaj, 709 Swedeland Road, King of Prussia, PA 19406, US
YANG, Lun, 709 Swedeland Road, King of Prussia, PA 19406, US

(51) MKP
B28B 7/00 (2006.01) (97) **2723544 ***
B28B 7/22 (2006.01)
B28B 17/00 (2006.01)
B28B 21/02 (2006.01)
B28B 21/82 (2006.01)
B28B 23/00 (2006.01)
E04H 12/12 (2006.01)
F03D 11/04 (2006.01)
G01B 11/24 (2006.01)
(86) EP2012061333 14.06.2012
(96) 12727379.5 30.04.2014
(87) WO2012175406, 14.06.2012
(97) 2723544, 30.04.2014 de
(54) PRODUCTION OF A TOWER
(71) Wobben Properties GmbH, Dreekamp 5, 26605 Aurich, DE
(72) KAPITZA, Jan, Neuer Weg 8, 26629 Großefehn, DE
ALBERS, Karsten, Tannenweg 10, 26759 Hinte, DE
HORN, Günther, Keersmakerskamp 35 a, 26605 Aurich, DE

(51) MKP
A61K 31/454 (2006.01) (97) **2730573 ***
A61K 31/4545 (2006.01)
A61K 31/506 (2006.01)
A61P 1/00 (2006.01)
A61P 5/00 (2006.01)
A61P 9/12 (2006.01)
A61P 25/04 (2006.01)
A61P 25/08 (2006.01)
A61P 25/16 (2006.01)
A61P 25/20 (2006.01)
A61P 25/22 (2006.01)
A61P 25/24 (2006.01)
A61P 25/28 (2006.01)
A61P 25/30 (2006.01)
A61P 29/00 (2006.01)
A61P 37/00 (2006.01)
A61P 43/00 (2006.01)
C07D 413/14 (2006.01)
C07D 498/04 (2006.01)

(86) JP2012067038 04.07.2012
(96) 12807591.8 14.05.2014
(87) WO2013005755, 04.07.2012
(97) 2730573, 14.05.2014 en
(54) METHYLPYPERIDINE DERIVATIVE
(71) Taisho Pharmaceutical Co., Ltd., 24-1, Takada 3-chome Toshima-ku, Tokyo 170-8633, JP
(72) ABE, Masahito, c/o TAISHO PHARMACEUTICAL CO. LTD. 24-1 Takada 3-chome Toshima-ku, Tokyo 170-8633, JP
FUTAMURA, Aya, c/o TAISHO PHARMACEUTICAL CO. LTD. 24-1 Takada 3-chome Toshima-ku, Tokyo 170-8633, JP
SUZUKI, Ryo, c/o TAISHO PHARMACEUTICAL CO. LTD. 24-1 Takada 3-chome Toshima-ku, Tokyo 170-8633, JP
NOZAWA, Dai, c/o TAISHO PHARMACEUTICAL CO. LTD. 24-1 Takada 3-chome Toshima-ku, Tokyo 170-8633, JP
OHTA, Hiroshi, c/o TAISHO PHARMACEUTICAL CO. LTD. 24-1 Takada 3-chome Toshima-ku, Tokyo 170-8633, JP
ARAKI, Yuko, c/o TAISHO PHARMACEUTICAL CO. LTD. 24-1 Takada 3-chome Toshima-ku, Tokyo 170-8633, JP

(51) MKP
A61J 3/07 (2006.01) (97) **2641582**
B26D 1/36 (2006.01)
B26D 1/38 (2006.01)
B26D 7/10 (2006.01)
(96) 13160521.4 25.09.2013
(97) 2641582, 25.09.2013 de
(54) Packaging device for a flat administration form
(71) Hexal AG, Industriestrasse 25, 83607 Holzkirchen, DE
(72) Kohr, Thomas, Hexal AG Industriestr. 25, 83607 Holzkirchen, DE

(51) MKP
A61K 36/185 (2006.01) (97) **2712319 ***
A61K 36/53 (2006.01)
(86) EP2012059156 16.05.2012
(96) 12722349.3 02.04.2014
(87) WO2012156461, 16.05.2012
(97) 2712319, 02.04.2014 en
(54) ALCOHOL-FREE PHARMACEUTICAL COMPOSITION COMPRISING THYME AND PRIMULA ROOT LIQUID EXTRACTS
(71) A. Nattermann & Cie. GmbH, Nattermannallee 1, 50829 Köln, DE
(72) HOFFMANN, Verena, c/o sanofi-aventis Deutschland GmbH Patent Department, 65926 Frankfurt Am Main, DE
HOLZSTEIN, Werner, c/o sanofi-aventis Deutschland GmbH Patent Department, 65926 Frankfurt Am Main, DE
WEISSENFELD, Jörn, c/o sanofi-aventis Deutschland GmbH Patent Department, 65926 Frankfurt Am Main, DE

- (51) MKP
A61K 8/02 (2006.01) (97) **2760424 ***
A61K 8/30 (2006.01)
A61K 8/37 (2006.01)
A61K 8/41 (2006.01)
A61K 8/72 (2006.01)
A61Q 19/00 (2006.01)
(86) US2012058297 01.10.2012
(96) 12850523.7 06.08.2014
(87) WO2013074210, 01.10.2012
(97) 2760424, 06.08.2014 en
(54) COSMETIC COMPOSITIONS COMPRISING LATEX FILM FORMERS
(71) L'Oréal, 14, rue Royale, 75008 Paris, FR
(72) LI, Chunhua, 8 Heitz LN, Hillsborough NJ 08844-4145, US
BUI, Hy SI, 47 Hedgerow Street, Piscataway, New Jersey 08854, US
SIMONNET, Jean-Thierry, 618 Woodstreet, Mamroneck., New York 10543, US
WAGNER, Anne, 2201 Pennsylvania Avenue, Apt. 509, Philadelphia, Pennsylvania 19130, US
DONAT, Ruth, Josie, 426 Burroughs Terrace, Union, New Jersey 07083, US

- (51) MKP
B60F 3/00 (2006.01) (97) **2726306 ***
B63B 1/12 (2006.01)
B63B 15/00 (2006.01)
B63B 25/00 (2006.01)
B63B 25/28 (2006.01)
B63B 27/14 (2006.01)
(86) IB2012053313 29.06.2012
(96) 12803988.0 07.05.2014
(87) WO2013001502, 29.06.2012
(97) 2726306, 07.05.2014 en
(54) IMPROVEMENTS IN OR RELATING TO A VESSEL
(71) Dick, Kyle, 461 Rosebank Road, Avondale, Auckland, NZ
(72) Dick, Kyle, 461 Rosebank Road, Avondale, Auckland, NZ

- (51) MKP
C12Q 1/68 (2006.01) (97) **2756298 ***
G01N 33/50 (2006.01)
G01N 33/68 (2006.01)
(86) US2011051269 12.09.2011
(96) 11872177.8 23.07.2014
(87) WO2013039477, 12.09.2011
(97) 2756298, 23.07.2014 en
(54) NON-INVASIVE METHODS OF DETECTING TARGET MOLECULES
(71) Creatics LLC, 60 Columbian Street West, Braintree, MA 02185, US
(72) PANNELL, Lewis, C/o University of South Alabama 775 University Boulevard Building II Suite 150, Mobile, AL 36608, US
ROCKER, Jana, C/o University of South Alabama 775 University Boulevard Building II Suite 150, Mobile, AL 36608, US
CONTRERAS, Carlos, C/o University of South Alabama 775 University Boulevard Building II Suite 150, Mobile, AL 36608, US
DI PALMA, Jack, C/o University of South Alabama 775 University Boulevard Building II Suite 150, Mobile, AL 36608, US

- (51) MKP
B02C 2/00 (2006.01) (97) **2763794 ***
(86) US2012058940 05.10.2012
(96) 12838455.9 13.08.2014
(87) WO2013052792, 05.10.2012
(97) 2763794, 13.08.2014 en
(54) APPARATUS AND METHOD FOR AN ANTI-SPIN SYSTEM
(71) TelSmith, Inc., 10190 N. Industrial Dr. P.O. Box 539, Mequon, WI 53092, US
(72) DRICKEN, Chuck, 7920 Hunters Drive, Kewaskum, WI 53040, US
NEITZEL, Sean, 811 Wianeck Road, Kronenwetter, WI 54455, US
WOLFE, Dean, 530 S. 5th Avenue, West Bend, WI 53095, US
HAVEN, Matthew, N62 W1025 Fairhaven Court, Cedarburg, WI 53012, US
VAN MULLEM, Albert, N59 W23790 Clover Dr., Sussex, WI 53089, US

- (51) MKP
H02J 3/00 (2006.01) (97) **2735081 ***
H02J 13/00 (2006.01)
(86) CA2011000850 22.07.2011
(96) 11869942.0 28.05.2014
(87) WO2013013282, 22.07.2011
(97) 2735081, 28.05.2014 en
(54) SWITCHING APPARATUS, CONTROL SYSTEM AND METHOD FOR VARYING AN IMPEDANCE OF A PHASE LINE
(71) Hydro-Québec, 75 Boulevard René-Lévesque Ouest, Montréal QC H2Z 1A4, CA
(72) COUTURE, Pierre, 1027 Rue Jean-Bochart, Boucherville, Québec J4B 4A4, CA

- (51) MKP
A61K 31/44 (2006.01) (97) **2721019 ***
A61K 31/4427 (2006.01)
A61P 35/00 (2006.01)
C07D 401/02 (2006.01)
C07D 401/04 (2006.01)
C07D 401/14 (2006.01)
C07D 405/00 (2006.01)
(86) CN2012000841 18.06.2012
(96) 12800001.5 23.04.2014
(87) WO2012171337, 18.06.2012
(97) 2721019, 23.04.2014 en
(54) THERAPEUTICALLY ACTIVE COMPOSITIONS AND THEIR METHODS OF USE
(71) Agios Pharmaceuticals, Inc., 38 Sidney Street, Cambridge, MA 02139, US
(72) CAO, Sheldon, 10521 Sand Crab Place, San Diego, CA 92130, US
POPOVICI-MULLER, Janeta, 2 Fern Street, Windham, NH 03087, US
SALITURO, Francesco G., 25 Baker Drive, Marlborough, MA 01752, US
SAUNDERS, Jeffrey, O., 188 Tower Road, Lincoln, MA 01773, US
TRAVINS, Jeremy, 14 Overlook Drive, Southborough, MA 01772, US
TAN, Xuefei, 300 Jingxiu Road Bldg 20, Rm 101 Pudong District, Shanghai 200135, CN
YAN, Shunqi, 55 Stepping Stone., Irvine, CA 92603, US
YE, Zhixiong, 3 Banff Dr., West Windsor, NJ 08550, US

- (51) MKP
F16L 11/12 (2006.01) (97) **2623843**
F16L 57/02 (2006.01)
(96) 13153681.5 07.08.2013
(97) 2623843, 07.08.2013 en
(54) Combination of a heating device, a connector, and a gas meter, as well as method for measuring a property of a gas
(71) ROBERT BOSCH GMBH, Postfach 30 02 20, 70442 Stuttgart, DE
(72) Langenkamp, Teunis Jan Hendrik, 4, Larikslaan, 7244 BA BARCHEM, NL
Moes, Sebastiaan, 39, Goorseweg, 7468 SH ENTER, NL

(51) MKP
A61K 31/166 (2006.01) (97) **2714647 ***
A61K 31/195 (2006.01)
A61P 3/08 (2006.01)
A61P 5/50 (2006.01)
C07C 231/12 (2006.01)
C07C 233/83 (2006.01)
(86) US2012039173 23.05.2012
(96) 12724508.2 09.04.2014
(87) WO2012162409, 23.05.2012
(97) 2714647, 09.04.2014 en
(54) BIPHENYL DERIVATIVES USEFUL AS GLUCAGON RECEPTOR ANTAGONISTS
(71) Janssen Pharmaceutica, N.V., Turnhoutseweg 30, 2340 Beerse, BE
(72) CHAKRAVARTY, Devraj, 3205 Astor Close, Hillsborough, NJ 08844, US
GRECO, Michael, N., c/o Janssen Research & Development LLC Welsh & Mckean Roads, Spring House, PA 19477, US
SHOOK, Brian, c/o Janssen Research & Development LLC Welsh & Mckean Roads, Spring House, PA 19477, US
XU, Guozhang, c/o Janssen Research & Development LLC Welsh & Mckean Roads, Spring House, PA 19477, US
ZHANG, Rui, c/o Janssen Research & Development LLC Welsh & Mckean Roads, Spring House, PA 19477, US

(51) MKP
E04B 1/76 (2006.01) (97) **2339078**
(96) 10195900.5 29.06.2011
(97) 2339078, 29.06.2011 de
(54) Insulating composite element and method for insulating a component wall and insulated wall structure
(71) ACO SEVERIN AHLMANN GMBH & CO. KG, Am Ahlmannkai, 24768 Rendsburg, DE
(72) Meincke, Arne, 250 5th Cross Road RMV Extension 2nd stage, 2nd Block, 560094 Bengaluru, IN
Reinisch, Sven, Ludwig-Koberstein-Str. 20, 97797 Völkersleier, DE
Harder, Bernd, Sandkoppel 6, 24808 Jevenstedt, DE
Richter, Udo, Berliner Straße 26, 97447 Gerolzhofen, DE

(51) MKP
A61K 31/495 (2006.01) (97) **2720989 ***
A61P 25/00 (2006.01)
C07B 59/00 (2006.01)
C07D 241/04 (2006.01)
(86) IB2012001386 19.06.2012
(96) 12748046.5 23.04.2014
(87) WO2012176066, 19.06.2012
(97) 2720989, 23.04.2014 en
(54) DEUTERATED 1-PIPERAZINO-3-PHENYL INDANES FOR TREATMENT OF SCHIZOPHRENIA
(71) H. Lundbeck A/S, 9, Ottiliavej, 2500 Valby, Copenhagen, DK
(72) JORGENSEN, Morten, Aldershvilevej 94, DK-2880 Bagsvaerd, DK
ANDERSEN, Peter, Hongaard, V.M. Amdrupsvej 13, DK-3520 Farum, DK
JENSEN, Klaus, Gjervig, Sofiegade 10 2.m.f., DK-1418 Kobenhavn K, DK
HVENEGAARD, Mette, Graulund, Jersie Solvaenge 13, DK-2680 Solrod Strand, DK
BADOLO, Lassina, Laekebakken 5, DK-2400 Kobenhavn Nv, DK
JACOBSEN, Mikkel, Fog, Nylandsvej 54 4th., DK-2000 Frederiksberg, DK

(51) MKP
F02M 47/02 (2006.01) (97) **2674608**
(96) 12171811.8 18.12.2013
(97) 2674608, 18.12.2013 en
(54) Fuel injector
(71) Delphi International Operations Luxembourg S.à.r.l., Avenue de Luxembourg, 4940 Bascharage, LU
(72) Graham, Mark, 123 Northover Road, Westbury-on-Trym, Bristol BS9 3LG, GB

(51) MKP
A01N 43/40 (2006.01) (97) **2734041 ***
(86) US2012047082 17.07.2012
(96) 12814994.5 28.05.2014
(87) WO2013012871, 17.07.2012
(97) 2734041, 28.05.2014 en
(54) PROCESSES FOR THE PREPARATION OF PERIPHERAL OPIOID ANTAGONIST COMPOUNDS AND INTERMEDIATES THERETO
(71) Adolor Corporation, 654 Hayden Avenue, Lexington, Massachusetts 02421, US
(72) DOLLE, Roland, E., 536 Elliott Drive, King of Prussia, Pennsylvania 19406, US
LE BOURDONNEC, Bertrand, 317 Ivy Lane, East Fallowfield, Pennsylvania 19320, US
MARTIN, Pierre, Meisenweg 38, CH-4310 Rheinfelden, CH
MOESSNER, Christian Steffen, Kreuzstrasse 30, 79540 Lörrach, DE
SPINDLER, Felix, Herbert, Dullikerstr. 15, CH-4656 Starrkirch-Wil, CH
SPIELVOGEL, Dirk, Jost, Stettengasse 34, 79540 Lörrach, DE

(51) MKP
A61K 31/4523 (2006.01) (97) **2760448 ***
A61K 31/5395 (2006.01)
A61P 21/00 (2006.01)
(86) HU2012000097 25.09.2012
(96) 12805748.6 06.08.2014
(87) WO2013045962, 25.09.2012
(97) 2760448, 06.08.2014 en
(54) PHARMACEUTICAL COMPOSITION FOR THE PREVENTION AND/OR TREATMENT OF MUSCLE ATROPHY
(71) Literáti Nagy, Botond, Venyige u. 15, 8220 Balatonalmádi, HU

(51) MKP
G06Q 10/04 (2012.01) (97) **2602752**
(96) 11192890.9 12.06.2013
(97) 2602752, 12.06.2013 en
(54) Method and system for sensor calibration support
(71) ATS Group (IP Holdings) Limited, PO Box 958 Pasea Estate, Road Town, Tortola, VG
(72) Huber, Marco, c/o AGT Group (R&D) GmbH Hilpertstr. 20A, 64295 Darmstadt, DE
Sasloglou, Konstantinos, c/o AGT Group (R&D) GmbH Hilpertstr. 20A, 64295 Darmstadt, DE
Zeiger, Florian, c/o AGT Group (R&D) GmbH Hilpertstr. 20A, 64295 Darmstadt, DE

(51) MKP
C07K 14/47 (2006.01) (97) **2751282 ***
C07K 16/30 (2006.01)
C12Q 1/68 (2006.01)
(86) EP2012066920 30.08.2012
(96) 12751532.8 09.07.2014
(87) WO2013030310, 30.08.2012
(97) 2751282, 09.07.2014 en
(54) DETECTION OF PRAME GENE EXPRESSION IN CANCER
(71) GlaxoSmithKline Biologicals S.A., rue de l'Institut, 89, 1330 Rixensart, BE
(72) MINGUET, Catherine, Glaxo Smith Kline Biologicals S.A. 89 rue de l'Institut, B-1330 Rixensart, BE

(51) MKP
E21B 23/10 (2006.01) (97) **2766561 ***
E21B 33/12 (2006.01)
E21B 34/08 (2006.01)
E21B 34/14 (2006.01)
E21B 43/12 (2006.01)
(86) CA2012050711 09.10.2012
(96) 12840384.7 20.08.2014
(87) WO2013053057, 09.10.2012
(97) 2766561, 20.08.2014 en
(54) WELLBORE ACTUATORS, TREATMENT STRINGS AND METHODS
(71) Packers Plus Energy Services Inc., Bow Valley Square 2 Suite 2200, 205 - 5 Avenue SW, Calgary, Alberta T2P 2V7, CA
(72) THEMIG, Daniel Jon, 256 Woodhaven Place SW, Calgary, Alberta T2W 5P9, CA
COON, Robert, Joe, 8606 Hall Retreat Court, Missouri City, Texas 77459, US

- (51) MKP
G09B 5/06 (2006.01) (97) **2727100 ***
G09B 19/00 (2006.01)
G09B 19/24 (2006.01)
G09B 23/28 (2006.01)
(86) EP2012062610 28.06.2012
(96) 12731423.5 07.05.2014
(87) WO2013001025, 28.06.2012
(97) 2727100, 07.05.2014 en
(54) A METHOD, A DEVICE AND A COMPUTER PROGRAM PRODUCT FOR TRAINING THE USE OF AN AUTO-INJECTOR
(71) Alk AG, Industriestrasse 30, 8604 Volketswil, CH
(72) GROVES, Bryce Vernon, 10A Blackett Street, Putney London SW15 1QG, GB
YEATES, Henry Samuel, 77 Woodcock Court Three Mile Cross, Reading Berkshire RG7 1BZ, GB
COADY, Gareth Michael, Ty'n Llwyn Chapel Road, Wick Vale of Glamorgan, GB
LOMBARDELLI, Stephen, 9 Park Lawn, Farnham Royal Slough SL2 3AP, GB
-
- (51) MKP
A47C 20/04 (2006.01) (97) **2705777**
A47C 23/00 (2006.01)
A47C 23/06 (2006.01)
(96) 12183401.4 12.03.2014
(97) 2705777, 12.03.2014 de
(54) Frame, in particular slatted frame
(71) OPTIMO Schlafsysteme Gesellschaft m.b.H., Industriezeile 10, 5280 Braunau am Inn, AT
(72) Wiedner, Horst, Brunning 16, A-5274 Burgkirchen, AT
-
- (51) MKP
A61K 31/337 (2006.01) (97) **2741745 ***
C07D 305/14 (2006.01)
(86) US2012049980 08.08.2012
(96) 12821894.8 18.06.2014
(87) WO2013022960, 08.08.2012
(97) 2741745, 18.06.2014 en
(54) CABAZITAXEL FORMULATIONS AND METHODS OF PREPARING THEREOF
(71) Scidose Llc, 196 North Pleasant Street, Amherst, MA 01002, US
(72) PALEPU, Nageswara, R., 30 Addis Drive, Southampton, PA 18966, US
-
- (51) MKP
B01D 1/00 (2006.01) (97) **2709957 ***
B01D 5/00 (2006.01)
C02F 1/04 (2006.01)
C02F 103/08 (2006.01)
(86) US2012031250 29.03.2012
(96) 12785549.2 26.03.2014
(87) WO2012158264, 29.03.2012
(97) 2709957, 26.03.2014 en
(54) HYDRAULIC DESALINATION DEVICE AND METHOD
(71) Pierre, Marvin, 4360 Beasley Court, Virginia Beach, VA 23462, US
(72) Pierre, Marvin, 4360 Beasley Court, Virginia Beach, VA 23462, US
-
- (51) MKP
A61K 9/20 (2006.01) (97) **2755640 ***
A61K 9/28 (2006.01)
A61K 31/485 (2006.01)
(86) IB2012001914 14.09.2012
(96) 12813950.8 23.07.2014
(87) WO2013038267, 14.09.2012
(97) 2755640, 23.07.2014 en
(54) TAMPER RESISTANT PHARMACEUTICAL FORMULATIONS
(71) Purdue Pharma LP, One Stamford Forum 201 Tresser Boulevard, Stamford, CT 06901-3431, US
(72) MCKENNA, William, 10 Longmeadow Road, Yonkers, NY 10704, US
MULEY, Sheetal, R., 145 Mountain Avenue, Piscataway, NJ 08854, US
ABU SHMEIS, Rama, 13 Buffalo Hollow Road, Branchburg, NJ 08876, US
-
- (51) MKP
F42B 5/02 (2006.01) (97) **2745069 ***
F42B 5/10 (2006.01)
F42B 33/02 (2006.01)
(86) US2012052023 23.08.2012
(96) 12838751.1 25.06.2014
(87) WO2013052209, 23.08.2012
(97) 2745069, 25.06.2014 en
(54) SHOTSHELL TYPE AMMUNITION, FIREARMS FOR FIRING SUCH SHOTSHELL TYPE AMMUNITION, AND METHODS OF MANUFACTURING SUCH SHOTSHELL TYPE AMMUNITION
(71) Intrepid Tactical Solutions LLC, 2355 South 1070 West, Salt Lake City, UT 84119, US
(72) DEJONG, William, E., 4052 East Pony Road, Hayden, ID 83835, US
-
- (51) MKP
G06Q 30/00 (2012.01) (97) **2734965 ***
(86) US2012047588 20.07.2012
(96) 12743308.4 28.05.2014
(87) WO2013013144, 20.07.2012
(97) 2734965, 28.05.2014 en
(54) METHOD AND SYSTEM OF DISPLAYING, MANAGING AND SELLING IMAGES IN AN EVENT PHOTOGRAPHY ENVIRONMENT
(71) Image Holdings, P.O. Box 10310 APO, Grand Cayman, KY1-1003, KY
(72) DAVIES, Brynley, P.O. Box 10310 Apo, Grand Cayman KY1-1003, KY
STARK, Jonathan, 195 President Avenue, Providence, RI 02906, US
-
- (51) MKP
B23Q 11/00 (2006.01) (97) **2744623 ***
B23Q 11/08 (2006.01)
B23Q 11/12 (2006.01)
(86) NZ2012000147 17.08.2012
(96) 12850332.3 25.06.2014
(87) WO2013073958, 17.08.2012
(97) 2744623, 25.06.2014 en
(54) ABOVE PLATE COOLANT CONTAINMENT AND RECOVERY SYSTEM
(71) Eigen Systems Limited, 30 Triton Drive, Albany Auckland 0632, NZ
(72) FORLONG MURRAY HOULTON, Murray Houlton, 1599 State Highway 17 Dairy Flat, Auckland 0794, NZ
-
- (51) MKP
A61G 3/06 (2006.01) (97) **2713978 ***
(86) IB2012052647 25.05.2012
(96) 12731708.9 09.04.2014
(87) WO2012160545, 25.05.2012
(97) 2713978, 09.04.2014 en
(54) METHOD FOR CONTROLLING THE AUTOMATIC SLIDING OF A TELESCOPIC RAMP, TELESCOPIC RAMP AND VEHICLE COMPRISING SUCH RAMP
(71) S. Marco-Rolfi S.r.l., Via Sibilla Aleramo 38, 25010 Ponte San Marco (BS), IT
(72) ROLFI, Dario, c/o S. MARCO-ROLFI S.R.L. Via Sibilla Aleramo 38, I-25010 Ponte San Marco (BS), IT
-
- (51) MKP
H04N 5/335 (2011.01) (97) **2708022 ***
(86) US2012037824 14.05.2012
(96) 12782963.8 19.03.2014
(87) WO2012155142, 14.05.2012
(97) 2708022, 19.03.2014 en
(54) PIXEL ARRAY AREA OPTIMIZATION USING STACKING SCHEME FOR HYBRID IMAGE SENSOR WITH MINIMAL VERTICAL INTERCONNECTS
(71) Olive Medical Corporation, 2302 S. Presidents Drive, Suite D, Salt Lake City, UT 84120, US
(72) BLANQUART, Laurent, 2776 Great Smokey Court, Westlake Village CA 91362, US

(51) MKP
A61K 31/7076 (2006.01) (97) **2768838 ***
A61P 31/12 (2006.01)
C07H 19/213 (2006.01)
(86) US2012059952 12.10.2012
(96) 12780359.1 27.08.2014
(87) WO2013056046, 12.10.2012
(97) 2768838, 27.08.2014 en
(54) SUBSTITUTED 3',5'-CYCLIC PHOSPHATES OF PURINE NUCLEOTIDE COMPOUNDS AND PHARMACEUTICAL COMPOSITIONS FOR THE TREATMENT OF VIRAL INFECTIONS
(71) IDENIX Pharmaceuticals, Inc., 320 Bent Street, Floor 4, Cambridge, MA 02141, US
(72) SURLERAUX, Dominique, Rue de la Scaillee 13, 1440 Wauthier-Braine, BE
DOUSSON, Cyril, B., 15 Lot la Source 1, 34800 Canet, FR
PARSY, Christophe, Claude, 6 Rue des Cedres, 34830 Jacou, FR

(51) MKP
A61K 31/155 (2006.01) (97) **2707016 ***
A61K 38/26 (2006.01)
A61P 3/04 (2006.01)
A61P 3/10 (2006.01)
(86) EP2012058745 11.05.2012
(96) 12722324.6 19.03.2014
(87) WO2012156296, 11.05.2012
(97) 2707016, 19.03.2014 en
(54) PHARMACEUTICAL COMBINATION FOR USE IN INDUCING WEIGHT LOSS IN DIABETES TYPE 2 PATIENTS OR/AND FOR PREVENTING WEIGHT GAIN IN DIABETES TYPE 2 PATIENTS
(71) Sanofi-Aventis Deutschland GmbH, Brüningstraße 50, 65929 Frankfurt am Main, DE
(72) SILVESTRE, Louise, c/o SANOFI Département Brevets 54 rue La Boétie, F-75008 Paris, FR
BOKA, Gabor, c/o SANOFI Département Brevets 54 rue La Boétie, F-75008 Paris, FR
MIOSSEC, Patrick, c/o SANOFI Département Brevets 54 rue La Boétie, F-75008 Paris, FR

(51) MKP
A01N 37/42 (2006.01) (97) **2404502**
A01N 37/46 (2006.01)
A01N 43/36 (2006.01)
A01N 59/20 (2006.01)
A01P 1/00 (2006.01)
A61K 8/49 (2006.01)
A61K 31/195 (2006.01)
A61Q 19/00 (2006.01)
(96) 11172876.2 11.01.2012
(97) 2404502, 11.01.2012 en
(54) Compositions containing pyrrolidone carboxylic acid (PCA) and metallic salts
(71) Laboratori Baldacci S.P.A., Via San Michele degli Scalzi, 73, 56124 Pisa, IT
(72) Baldacci, Massimo, Via San Michele degli Scalzi, 73, I-56124 Pisa, IT

(51) MKP
A61K 39/395 (2006.01) (97) **2714740 ***
A61P 5/00 (2006.01)
C07K 16/28 (2006.01)
(86) EP2012060078 31.05.2012
(96) 12729030.2 09.04.2014
(87) WO2012163932, 31.05.2012
(97) 2714740, 09.04.2014 en
(54) NEUTRALIZING PROLACTIN RECEPTOR ANTIBODY MAT3 AND ITS THERAPEUTIC USE
(71) Bayer Intellectual Property GmbH, Alfred-Nobel-Strasse 10, 40789 Monheim, DE
(72) FREIBERG, Christoph, Lipkenskothen 10, 42113 Wuppertal, DE
OTTO, Christiane, Jägerstrasse 2, 42117 Wuppertal, DE
LINDEN, Lars, Bruchstr. 72, 40235 Düsseldorf, DE
HARRENGA, Axel, Sadowastr. 17, 42115 Wuppertal, DE
TRAUTWEIN, Mark, Narzissenweg 4, 42489 Wülfrath, DE
GREVEN, Simone, Am Schneckenacker 45, 41541 Dormagen, DE
WILMEN, Andreas, Arndtstr. 5, 50676 Köln, DE

(51) MKP
A61K 31/40 (2006.01) (97) **2709614 ***
A61K 31/4164 (2006.01)
(86) US2012038292 17.05.2012
(96) 12785724.1 26.03.2014
(87) WO2012158884, 17.05.2012
(97) 2709614, 26.03.2014 en
(54) PHARMACEUTICAL COMPOSITIONS AND METHODS FOR TREATING CANCER
(71) Takeda Pharmaceutical Company Limited, 1-1 Doshomachi 4-chome Chuo-ku, Osaka-shi, Osaka 541-0045, JP
(72) ROSEN, Oliver, 48 Prince Street, 2, Jamaica Plain MA 02130, US
WEBB, Iain James, 20 Fayette Street, 2, Boston MA 02116, CA

(51) MKP
B65D 47/06 (2006.01) (97) **2712349 ***
B65D 47/22 (2006.01)
B65D 83/00 (2006.01)
B67D 7/36 (2010.01)
(86) CA2012000173 24.02.2012
(96) 12749140.5 02.04.2014
(87) WO2012113070, 24.02.2012
(97) 2712349, 02.04.2014 en
(54) DISPENSER FOR A CONTAINER
(71) Sariu, Costin, 7 Shawmeadows Place S.W., Calgary, AB T2Y 1G3, CA
(72) Sariu, Costin, 7 Shawmeadows Place S.W., Calgary, AB T2Y 1G3, CA

(51) MKP
B29C 45/00 (2006.01) (97) **2623291**
B29C 45/16 (2006.01)
F04D 29/22 (2006.01)
(96) 12193509.2 07.08.2013
(97) 2623291, 07.08.2013 de
(54) Pump impeller and method for producing a pump impeller
(71) NP Poschmann GmbH, Zur Heide 33, 59929 Brilon, DE
(72) Baukloh, Horst, Südstr. 8, 58540 Meinerzhagen, DE

(51) MKP
G01B 11/02 (2006.01) (97) **2748632 ***
G01S 17/32 (2006.01)
(86) US2012049722 06.08.2012
(96) 12753857.7 02.07.2014
(87) WO2013032635, 06.08.2012
(97) 2748632, 02.07.2014 en
(54) PROXIMITY SENSOR CALIBRATION
(71) Qualcomm Incorporated, 5775 Morehouse Drive, San Diego, CA 92121-1714, US
(72) SHEYNBLAT, Leonid, 5775 Morehouse Drive, San Diego, California 92121, US
BAYAPUREDDY, Chenna, 5775 Morehouse Drive, San Diego, California 92121, US
OH, Kyoung Cheol, 5775 Morehouse Drive, San Diego, California 92121, US

(51) MKP
G06F 3/041 (2006.01) (97) **2749053 ***
G06K 9/00 (2006.01)
H04W 12/06 (2009.01)
(86) CA2012000790 24.08.2012
(96) 12825512.2 02.07.2014
(87) WO2013026147, 24.08.2012
(97) 2749053, 02.07.2014 en
(54) METHOD AND SYSTEM TO CAPTURE AND VALIDATE A SIGNATURE USING A MOBILE DEVICE
(71) Hybrid Paytech World, Inc., 3-643 rue Notre-Dame Ouest, Montréal, QC H3C 1H8, CA
(72) CASTRONOVO, Abbondio, 8871, rue de Tilly, Laval, Quebec H7A 3X5, CA
BARONE, Massimo, 3079, ave. des Aristocrates, Laval, Quebec H7E 5H3, CA

- (51) MKP
B23Q 7/02 (2006.01) (97) **2747938 ***
B23Q 16/02 (2006.01)
B23Q 39/04 (2006.01)
- (86) IB2012055156 27.09.2012
(96) 12784707.7 02.07.2014
(87) WO2013046148, 27.09.2012
(97) 2747938, 02.07.2014 en
- (54) MACHINE TOOL WITH ROTATABLE TABLE
(71) Gnutti Transfer S.p.A., Via Domenico Ghidoni 187, 25035 Ospitaletto (Brescia), IT
(72) GABOARDI, Giordano, c/o Gnutti Transfer S.p.A. Via Domenico Ghidoni 187, I-25035 Ospitaletto BRESCIA, IT
CORAGLIA, Stefano, c/o Gnutti Transfer S.p.A. Via Domenico Ghidoni 187, I-25035 Ospitaletto BRESCIA, IT

- (51) MKP
A61K 31/135 (2006.01) (97) **2766004 ***
- (86) US2012059358 09.10.2012
(96) 12840761.6 20.08.2014
(87) WO2013055689, 09.10.2012
(97) 2766004, 20.08.2014 en
- (54) R(+)-N-METHYL-PROPARGYL-AMINOINDAN
(71) Teva Pharmaceuticals USA, Inc., 1090 Horsham Road P.O. Box 1090, North Wales, PA 19454, US
(72) SAFADI, Muhammad, Panorama Salezian 5A Street 5005 PO Box 385, 16103 Nazareth, IL
FRENKEL, Anton, Amnon ve Tamar Str. 15/10, 42202 Netanya, IL
KEISAR, Michal, 8 Bareket Street, 40300 Kfar-Yona, IL
LICHT, Danit, 1 Keren Hayesod Street Ramat Ilan, 54041 Givat Shmuel, IL
BAHAR, Eliezer, 95 Haim Levanon Street, 69345 Tel Aviv, IL
LIDOR-HADAS, Ramy, 19 Mor Str., 44242 Kfar-Saba, IL
ZHOLKOVSKY, Marina, Hahashmonaim Street 53/2, Bat-Yam, IL
COHEN, Rachel, Ar Atzil Street, Hadera 3824417, IL

- (51) MKP
G06F 17/00 (2006.01) (97) **2766865 ***
G06Q 30/02 (2012.01)
- (86) US2013038922 30.04.2013
(96) 13784938.6 20.08.2014
(87) WO2013166052, 30.04.2013
(97) 2766865, 20.08.2014 en
- (54) DETECTION OF EXIT BEHAVIOR OF AN INTERNET USER
(71) Bounce Exchange LLC, 137 Varick Street 2nd Floor, New York, New York 10013, US
(72) URBAN, Ryan Joshua, 320 W 38th Street Apartment 318, New York, New York 10018, US

- (51) MKP
E04B 1/34 (2006.01) (97) **2758609 ***
E04H 1/04 (2006.01)
E04H 1/06 (2006.01)
- (86) IB2012053304 28.06.2012
(96) 12748774.2 30.07.2014
(87) WO2013041981, 28.06.2012
(97) 2758609, 30.07.2014 en
- (54) ECOLOGICAL TERRACED SKYSCRAPER BUILDING
(71) Italian Designer S.r.l., Via del Caucaso 19, 00144 Roma, IT
(72) ALESSANDRINI, Piero, Via del Caucaso 19, I-00144 Roma, IT

- (51) MKP
G01N 33/53 (2006.01) (97) **2753928 ***
- (86) US2011050976 09.09.2011
(96) 11872018.4 16.07.2014
(87) WO2013036239, 09.09.2011
(97) 2753928, 16.07.2014 en
- (54) COMPOSITIONS AND METHODS FOR DETECTING AUTOANTIBODIES
(71) QUIDEL CORPORATION, 10165 McKellar Court, San Diego, California 92121, US
(72) LI, Yunsheng, 62 Mulligan Rd, Athens, OH 45701, US
OLIVO, Paul, D., 639 West Polo Dr, St. Louis, MO 63105, US
KIM, Jaekyung, 20 North Shannon Ave., Athens, OH 45701, US

- (51) MKP
D04B 21/14 (2006.01) (97) **2746437 ***
D04D 7/00 (2006.01)
- (86) BR2012000288 13.08.2012
(96) 12824099.1 25.06.2014
(87) WO2013023264, 13.08.2012
(97) 2746437, 25.06.2014 en
- (54) ARRANGEMENT INTRODUCED INTO THREADS FOR HANDWORK WITH KNITTING NEEDLES, CROCHET HOOKS OR THE LIKE
(71) Schmitz, Luiz Carlos, Rua Dr. Nereu Ramos 750 Centro, 89110-000 Gaspar - Santa Catarina, BR
(72) Schmitz, Luiz Carlos, Rua Dr. Nereu Ramos 750 Centro, 89110-000 Gaspar - Santa Catarina, BR

- (51) MKP
C07D 413/10 (2006.01) (97) **2753619 ***
C07D 413/14 (2006.01)
- (86) IN2012000599 10.09.2012
(96) 12839222.2 16.07.2014
(87) WO2013098833, 10.09.2012
(97) 2753619, 16.07.2014 en
- (54) PROCESSES AND INTERMEDIATES FOR PREPARING RIVAROXABAN
(71) Cadila Healthcare Limited, Zydus Tower Satellite Cross Roads, Ahmedabad 380 015, Gujarat, IN
(72) DWIVEDI, Shriprakash, Dhar, Cadila Healthcare Limited Zydus Tower Satellite Cross Roads, Ahmedabad 380 015 Gujarat, IN
PRASAD, Ashok, Cadila Healthcare Limited Zydus Tower Satellite Cross Roads, Ahmedabad 380 015 Gujarat, IN
PAL, Daya, Ram, Cadila Healthcare Limited Zydus Tower Satellite Cross Roads, Ahmedabad 380 015 Gujarat, IN
SHARMA, Mukul, Hari, Prasad, Cadila Healthcare Limited Zydus Tower Satellite Cross Roads, Ahmedabad 380 015 Gujarat, IN
JAIN, Kuldeep, Natwarlal, Cadila Healthcare Limited Zydus Tower Satellite Cross Roads, Ahmedabad 380 015 Gujarat, IN
PATEL, Naitik, Bharatbhai, Cadila Healthcare Limited Zydus Tower Satellite Cross Roads, Ahmedabad 380 015 Gujarat, IN

- (51) MKP
H04B 1/40 (2006.01) (97) **2742598 ***
H04W 88/06 (2009.01)
- (86) US2012049052 31.07.2012
(96) 12745962.6 18.06.2014
(87) WO2013025345, 31.07.2012
(97) 2742598, 18.06.2014 en
- (54) ANTENNA TO TRANSCIVER MAPPING OF A MULTIMODE WIRELESS DEVICE
(71) Qualcomm Incorporated, 5775 Morehouse Drive, San Diego, CA 92121-1714, US
(72) ZAWAIDEH, Fahed I., 5775 Morehouse Drive, San Diego, California 92121, US
SHAH, Chintan S., 5775 Morehouse Drive, San Diego, California 92121, US
MALLIKARJUNAN, Raghuvver, 5775 Morehouse Drive, San Diego, California 92121, US

- (51) MKP
F25D 7/00 (2006.01) (97) **2766677 ***
F25D 16/00 (2006.01)
F25D 31/00 (2006.01)
- (86) FR2012051453 25.06.2012
(96) 12772346.8 20.08.2014
(87) WO2012175898, 25.06.2012
(97) 2766677, 20.08.2014 fr
- (54) METHOD AND DEVICE FOR VACUUM COOLING
(71) Boucherie Vitel, Philippe, Christian, 23c rue de l'Église, 67280 Urmatt, FR
(72) Boucherie Vitel, Philippe, Christian, 23c rue de l'Église, 67280 Urmatt, FR

(51) MKP
A01N 43/08 (2006.01) (97) **2736332 ***
A61K 31/34 (2006.01)
(86) US2012048633 27.07.2012
(96) 12820077.1 04.06.2014
(87) WO2013019653, 27.07.2012
(97) 2736332, 04.06.2014 en
(54) COMPOUNDS AND METHODS
(71) Tempero Pharmaceuticals, Inc., 200 Technology Square, Cambridge, MA 02139, US
(72) BALOGLU, Erkan, 8 Benjamin Terrace, Stoneham, MA 02180, US
BOHNERT, Gary, J., 200 Technology Square, Cambridge, MA 02139, US
GHOSH, Shomir, 200 Technology Square, Cambridge, MA 02139, US
LOBERA, Mercedes, 200 Technology Square, Cambridge, MA 02139, US
SCHMIDT, Darby, R., 14 Mead Road, Arlington, MA 02474, US
SUNG, Leonard, 200 Technology Square, Cambridge, MA 02139, US

(51) MKP
A61K 31/439 (2006.01) (97) **2718280 ***
A61K 31/4709 (2006.01)
A61P 11/06 (2006.01)
A61P 11/08 (2006.01)
C07C 213/10 (2006.01)
C07D 401/12 (2006.01)
C07D 451/06 (2006.01)
C07D 453/02 (2006.01)
(86) EP2012060795 07.06.2012
(96) 12730176.0 16.04.2014
(87) WO2012168359, 07.06.2012
(97) 2718280, 16.04.2014 en
(54) COMPOUNDS HAVING MUSCARINIC RECEPTOR ANTAGONIST AND BETA2 ADRENERGIC RECEPTOR AGONIST ACTIVITY
(71) Chiesi Farmaceutici S.p.A., Via Palermo, 26/A, 43100 Parma, IT
(72) RANCATI, Fabio, c/o CHIESI FARMACEUTICI S.p.A. Via Palermo 26/A, I-43100 Parma, IT
RIZZI, Andrea, c/o CHIESI FARMACEUTICI S.p.A. Via Palermo 26/A, I-43100 Parma, IT
AMARI, Gabriele, c/o CHIESI FARMACEUTICI S.p.A. Via Palermo 26/A, I-43100 Parma, IT
BIAGETTI, Matteo, c/o CHIESI FARMACEUTICI S.p.A. Via Palermo 26/A, I-43100 Parma, IT
LINNEY, Ian, c/o CHIESI FARMACEUTICI S.p.A. Via Palermo 26/A, I-43100 Parma, IT

(51) MKP
C12Q 1/68 (2006.01) (97) **2764119 ***
G01N 33/50 (2006.01)
G01N 33/569 (2006.01)
G01N 33/574 (2006.01)
(86) US2012059126 05.10.2012
(96) 12778000.5 13.08.2014
(87) WO2013052915, 05.10.2012
(97) 2764119, 13.08.2014 en
(54) METHOD FOR DETECTING REPLICATION OR COLONIZATION OF A BIOLOGICAL THERAPEUTIC
(71) Genelux Corporation, 3030 Bunker Hill Road, San Diego, CA 92109, US
(72) SZALAY, Aladar, A., 7704 North Fork Road, Highland, CA 92364, US
STRITZKER, Jochen, Verdistr. 2, 84638 Kissing, DE
HESS, Michael, Ulrichstr.12, Wuersburg, DE

(51) MKP
C07K 16/00 (2006.01) (97) **2731965 ***
C07K 16/18 (2006.01)
C12N 15/11 (2006.01)
C12Q 1/68 (2006.01)
C40B 40/06 (2006.01)
(86) US2012046431 12.07.2012
(96) 12811637.3 21.05.2014
(87) WO2013009967, 12.07.2012
(97) 2731965, 21.05.2014 en
(54) IDENTIFYING AFFINITY-MATURED HUMAN ANTIBODIES
(71) XBiotech, Inc, 1055 West Hastings Street, Suite 300, Vancouver, British Columbia V6E 2E9, CA
(72) SIMARD, John, 8201 East Riverside Drive Bldg. 4 Suite 100, Austin, TX 78744, US

(51) MKP
A61K 31/407 (2006.01) (97) **2736883 ***
A61K 31/4196 (2006.01)
A61K 31/421 (2006.01)
A61K 31/4439 (2006.01)
A61K 31/454 (2006.01)
A61K 31/497 (2006.01)
A61K 31/506 (2006.01)
C07D 213/50 (2006.01)
C07D 401/08 (2006.01)
C07D 401/12 (2006.01)
C07D 401/14 (2006.01)
C07D 403/08 (2006.01)
C07D 403/12 (2006.01)
C07D 413/12 (2006.01)
C07D 487/10 (2006.01)
(86) US2012048368 26.07.2012
(96) 12748083.8 04.06.2014
(87) WO2013019561, 26.07.2012
(97) 2736883, 04.06.2014 en
(54) NUCLEAR TRANSPORT MODULATORS AND USES THEREOF
(71) Karyopharm Therapeutics, Inc., 2 Mercer Road, Natick, MA 01760, US
(72) SANDANAYAKA, Vincent, P., 10 Laurel Avenue, Northboro, MA 01532, US
SHACHAM, Sharon, 15 Bontempo Road, Newton, MA 02459, US
KAUFFMAN, Michael, 15 Bontempo Road, Newton, MA 02459, US
SHECHTER, Sharon, 18 Ivy Lane, Andover, MA 01810, US
MCCAULEY, Dilara, 85 Gore Street, Cambridge, MA 02141, US
LANDESMAN, Yosef, 260 Tappan Street, Brookline, MA 02445, US
SENAPEDIS, William, 364 Washington Street Unit 6A, Brighton, MA 02135, US
SAINT-MARTIN, Jean-Richard, 19 Decota Drive, Randolph, MA 02368, US

(51) MKP
A61K 31/202 (2006.01) (97) **2768496 ***
A61P 17/00 (2006.01)
(86) EP2012070813 19.10.2012
(96) 12775682.3 27.08.2014
(87) WO2013057287, 19.10.2012
(97) 2768496, 27.08.2014 en
(54) PHARMACEUTICAL COMPOSITIONS COMPRISING DGLA AND/OR 15-HETRE AND METHODS OF USE THEREOF
(71) Dignity Sciences Limited, The Oval Block 3, 1st Floor 160 Shelborne Road Ballsbridge, Dublin 4, IE
(72) CLIMAX, John, Dignity Sciences Limited First Floor Block 3 The Oval Shelbourne Road, Ballsbridge Dublin 44245, IE
COUGHLAN, David, Dignity Sciences Limited First Floor Block 3 The Oval Shelbourne Road, Ballsbridge Dublin 44245, IE
MANKU, Mehar, Dignity Sciences Limited First Floor Block 3 The Oval Shellbourne Road, Ballsbridge Dublin 44245, GB

- (51) MKP
A61K 9/14 (2006.01) (97) **2692340**
A61K 31/198 (2006.01)
A61K 47/32 (2006.01)
(96) 13386023.9 05.02.2014
(97) 2692340, 05.02.2014 en
(54) Stable pharmaceutical system (kit) for the preparation of oral solution of levothyroxine or pharmaceutically acceptable salt thereof
(71) Verisfield (UK) Ltd., 8 Vironos str., 152 31 Halandri, GR
(72) Koutsodimos, Christos, 8 Vironos & Githiou Str., 152 31 Halandri Attikis, GR

- (51) MKP
G21F 9/24 (2006.01) (97) **2727118 ***
G21F 9/34 (2006.01)
(86) US2012045084 29.06.2012
(96) 12738296.8 07.05.2014
(87) WO2013003796, 29.06.2012
(97) 2727118, 07.05.2014 en
(54) ABYSSAL SEQUESTRATION OF NUCLEAR WASTE AND OTHER TYPES OF HAZARDOUS WASTE
(71) Grand Directions, Llc, 2448 East 81st Suite 4040, Tulsa, OK 74137, US
(72) MURDOCH, Lawrence, C., Clemson University 340 Bracket Hall, Clemson, SC 29634, US
ROBINOWITZ, Marvin, 2448 East 81st Street Suite 4040, Tulsa, OK 74137, US

- (51) MKP
A23J 1/14 (2006.01) (97) **2725922 ***
(86) CA2012000618 26.06.2012
(96) 12804484.9 07.05.2014
(87) WO2013000066, 26.06.2012
(97) 2725922, 07.05.2014 en
(54) CANOLA PROTEIN PRODUCT WITH LOW PHYTIC ACID CONTENT ("C702")
(71) Burcon Nutrascience (MB) Corp., 1388 Waller Avenue, Winnipeg, Manitoba R3T 1P9, CA
(72) WILLARSEN, Randy, 1933 Park Oak Drive, Roseville, California 95661, US
SCHWEIZER, Martin, 117 Haig Avenue, Winnipeg, Manitoba R2M 0E3, CA
SEGALL, Kevin I., 31 Dunbar Crescent, Winnipeg, Manitoba R3P 0W6, CA

- (51) MKP
A61K 31/7004 (2006.01) (97) **2714050 ***
A61P 25/28 (2006.01)
(86) US2012040789 04.06.2012
(96) 12727719.2 09.04.2014
(87) WO2012173808, 04.06.2012
(97) 2714050, 09.04.2014 en
(54) SCYLLO-INOSITOL FOR THE TREATMENT OF BEHAVIORAL AND PSYCHIATRIC DISORDERS
(71) Elan Pharmaceuticals, Inc., 300 Technology Square, Cambridge, MA 02139, US
(72) ABUSHAKRA, Susan, 300 Technology Square, Third Floor, Cambridge, MA 02139, US
CRANS, Gerald, 300 Technology Square, Third Floor, Cambridge, MA 02139, US
CEDARBAUM, Jesse, 300 Technology Square, Third Floor, Cambridge, MA 02139, US
HERNANDEZ, Ramon, 300 Technology Square, Third Floor, Cambridge, MA 02139, US

- (51) MKP
A61K 9/00 (2006.01) (97) **2768508 ***
A61K 9/08 (2006.01)
A61K 31/185 (2006.01)
A61K 31/191 (2006.01)
A61K 31/194 (2006.01)
A61K 31/198 (2006.01)
A61K 31/496 (2006.01)
A61K 31/661 (2006.01)
A61K 47/02 (2006.01)
A61K 47/12 (2006.01)
(86) JP2012077668 19.10.2012
(96) 12784753.1 27.08.2014
(87) WO2013058411, 19.10.2012
(97) 2768508, 27.08.2014 en
(54) SOLUTION FOR ORAL ADMINISTRATION
(71) Otsuka Pharmaceutical Co., Ltd., 2-9, Kanda-Tsukasamachi Chiyoda-ku, Tokyo 101-8535, JP
(72) OKAMOTO, Ayako, c/o OTSUKA PHARMACEUTICAL CO., LTD., 3-2-27, Otedori, Chuo-ku., Osaka-shi, Osaka 5400021, JP

- (51) MKP
A61K 31/433 (2006.01) (97) **2706999 ***
(86) US2012037609 11.05.2012
(96) 12785231.7 19.03.2014
(87) WO2012158550, 11.05.2012
(97) 2706999, 19.03.2014 en
(54) SELECTIVE HETEROCYCLIC SPHINGOSINE 1 PHOSPHATE RECEPTOR MODULATORS
(71) Receptos, Inc., 10835 Road to the Cure, 205, San Diego, CA 92121, US
(72) BOEHM, Marcus, F., 2811 Maple St., San Diego, CA 92104, US
MARTINBOROUGH, Esther, 5054 Camino Playa Portofino, San Diego, CA 92124, US
BRAHMACHARY, Enugurthi, 11795 Spruce Run Dr. C, San Diego, CA 92131, US
MOORJANI, Manisha, 8389 Reagan Glen, San Diego, CA 92127, US
TAMIYA, Junko, 934 Daisy Ave., Carlsbad, CA 92011, US
HUANG, Liming, 12788 Adolphia Court, San Diego, CA 92129, US
YEAGER, Adam, Richard, 7958 Normal Ave., La Mesa, CA 91941, US

- (51) MKP
C07K 16/28 (2006.01) (97) **2718323 ***
(86) US2012040941 05.06.2012
(96) 12727726.7 16.04.2014
(87) WO2012170438, 05.06.2012
(97) 2718323, 16.04.2014 en
(54) HUMAN ANTIGEN BINDING PROTEINS THAT BIND TO A COMPLEX COMPRISING BETA-KLTHO AND AN FGF RECEPTOR
(71) Amgen Inc., One Amgen Center Drive, Thousand Oaks, California 91320-1799, US
(72) LI, Yang, 1142 Cuesta Drive, Mountain View, CA 94040, US
STEVENS, Jennitte, 9820 West Olympic Boulevard, Beverly Hills, CA 90212, US
KING, Chadwick, Terence, 1325 Moody Avenue, North Vancouver, British Columbia V7L 3T5, CA
FOLTZ, Ian, 2108 Knightswood Place, Burnaby, British Columbia V5A 4B9, CA
KANNAN, Gunasekaran, 1056 Amberton Lane, Newbury Park, CA 91320, US
YIE, Junming, 2623 Capella Way, Thousand Oaks, CA 91362, US
HU, Shaw-Fen, Sylvia, 986 Lynnmere Drive, Thousand Oaks, CA 91360, US

(51) MKP
A61K 31/7052 (2006.01) (97) **2736915 ***
C07H 17/00 (2006.01)
 (86) EP2012003215 27.07.2012
 (96) 12740899.5 04.06.2014
 (87) WO2013013834, 27.07.2012
 (97) 2736915, 04.06.2014 en
 (54) NEW CRYSTALLINE FORMS OF TULATHROMYCIN
 (71) Farma GRS, d.o.o., Seidlova cesta 70, 8000 Novo mesto, SI
 (72) KLJAJIC, Alen, Smrekarjeva ulica 4, 3000 Celje, SI
 TROST, Sabina, Ljubljijanska cesta 31, 1330 Ko evje, SI
 ZUPET, Rok, Janeza Rozica 6, 1000 Ljubljana, SI
 PECAVAR, Anica, Gotna vas 18, 8000 Novo mesto, SI

(51) MKP
B65D 19/38 (2006.01) (97) **2768742 ***
B65D 77/06 (2006.01)
 (86) IB2012002054 15.10.2012
 (96) 12790634.5 27.08.2014
 (87) WO2013057560, 15.10.2012
 (97) 2768742, 27.08.2014 en
 (54) A CONTAINMENT DEVICE FOR A BIG BAG AND A KIT THEREFOR
 (71) Palma, Guiseppa, Via del Corso 193, 51039 Quarrata (PT), IT
 (72) Palma, Guiseppa, Via del Corso 193, 51039 Quarrata (PT), IT

(51) MKP
A01M 7/00 (2006.01) (97) **2768303 ***
 (86) EP2012067936 13.09.2012
 (96) 12761589.6 27.08.2014
 (87) WO2013056908, 13.09.2012
 (97) 2768303, 27.08.2014 de
 (54) METHOD FOR FILLING AT LEAST ONE RESERVOIR CONTAINER
 (71) Amazonen-Werke H. Dreyer GmbH & Co. KG, Am Amazonenwerk 9-13, 49205 Hasbergen, DE
 (72) KIEFER, Stefan, Klusstr. 5, 49074 Osnabrück, DE
 WEGKAMP, Heinz - Gerd, Augustinerstr. 42, 68642 Bürstadt, DE

(51) MKP
A61K 31/47 (2006.01) (97) **2748147 ***
A61P 33/06 (2006.01)
C07D 217/26 (2006.01)
C07D 401/04 (2006.01)
C07D 405/04 (2006.01)
C07D 413/04 (2006.01)
C07D 417/04 (2006.01)
 (86) IB2012054305 24.08.2012
 (96) 12772470.6 02.07.2014
 (87) WO2013027196, 24.08.2012
 (97) 2748147, 02.07.2014 en
 (54) SUBSTITUTED 2-ALKYL-1-OXO-N-PHENYL-3-HETEROARYL-1,2,3,4-TETRAHYDROISOQUINOLINE-4-CARBOXAMIDES FOR ANTIMALARIAL THERAPIES
 (71) St. Jude Children's Research Hospital, 262 Danny Thomas Place, Memphis, TN 38105, US
 MMV Medicines for Malaria Venture, 20 route de Pré-Bois, ICC, 1215 Geneva, CH
 Rutgers, The State University Of New Jersey, null, New Brunswick, New Jersey 08901-1281, US
 (72) GUY, Rodney Kiplin, 73 Riverwalk Place, Memphis, Tennessee 38103, US
 ZHU, Fangyi, 50 Hannibal Cove Apt. 318, Memphis, Tennessee 38103, US
 GUIGUEMDE, Wendyam Armand, 271 North Lauderdale Street Apt. 106, Memphis, Tennessee 38105, US
 FLOYD, David, 4 Harbourton Ridge Drive, Pennington, New Jersey 08534, US
 KNAPP, Spencer, 43 Hollow Road, Skillman, New Jersey 08558, US
 STEIN, Philip, 3 Harbourton Ridge Drive, Pennington, New Jersey 08534, US
 CASTRO, Steve, 20 Donna Drive, East Hannover, New Jersey 07936, US

(51) MKP
A61K 31/52 (2006.01) (97) **2742048 ***
A61P 25/04 (2006.01)
C07D 473/08 (2006.01)
 (86) US2012050210 09.08.2012
 (96) 12748815.3 18.06.2014
 (87) WO2013023102, 09.08.2012
 (97) 2742048, 18.06.2014 en
 (54) INHIBITING TRANSIENT RECEPTOR POTENTIAL ION CHANNEL TRPA1
 (71) Hydra Biosciences, Inc., 790 Memorial Drive, Cambridge, MA 02139, US
 Cubist Pharmaceuticals, Inc., 65 Hayden Avenue, Lexington, MA 02421, US
 (72) METCALF, Chester A., III, 70 Blake Street, Needham, MA 02492, US
 GU, Yugui, 53 Canterbury Hill Road, Acton, MA 01720, US
 KIMBALL, Spencer David, 13 Charred Oak Lane, East Windsor, NJ 08520, US
 LI, Qingyi, 30 Middlesexcircle Apt. 22, Waltham, MA 02452, US
 LIPPA, Blaise S., null, null, US
 RYAN, M. Dominic, 544 Newtown Road, Littleton, MA 01460, US
 WU, Xinyuan, 935 Washington Street Apt 14, Newton, MA 02460, US
 ZOU, Dong, 26 Minuteman Drive, Concord, MA 01742, US

(51) MKP
F24D 3/10 (2006.01) (97) **2753880 ***
 (86) EP2012067052 03.09.2012
 (96) 12753489.9 16.07.2014
 (87) WO2013034508, 03.09.2012
 (97) 2753880, 16.07.2014 de
 (54) DIAPHRAGM PRESSURE EXPANSION VESSEL
 (71) Winkelmann Sp. z o.o., Ul. Jaworzynska 277, 59220 Legnica, PL
 (72) MÜLLER, Frank, Augustin-Wibbelstr. 29, 59227 Ahlen, DE
 SCHMITZ, Egon, Tschaikowskistr. 30, 04105 Leipzig, DE
 ÜNAL, Besim, Walther-Rathenau-Str. 83, 59229 Ahlen, DE

(51) MKP
C12C 5/02 (2006.01) (97) **2751249 ***
C12C 7/053 (2006.01)
 (86) IT2011000305 02.09.2011
 (96) 11770536.8 09.07.2014
 (87) WO2013030853, 02.09.2011
 (97) 2751249, 09.07.2014 en
 (54) BEER AND RELEVANT PRODUCTION METHOD.
 (71) Farchioni Olli S.p.A., Località Bastardo, 06030 Giano Dell'umbria, IT
 (72) CLERICI, Carlo, 30 Via Chiavellati, I-06034 Foligno, IT
 SETCHELL, Kenneth David Reginald, 3749 Harvard Acres, Cincinnati, OH 45227, US

(51) MKP
H04J 1/00 (2006.01) (97) **2759080 ***
 (86) US2012056018 19.09.2012
 (96) 12834462.9 30.07.2014
 (87) WO2013043665, 19.09.2012
 (97) 2759080, 30.07.2014 en
 (54) SYSTEMS AND METHODS FOR THE DEMAND-DRIVEN DEPLOYMENT OF LOCATION-NEUTRAL SOFTWARE
 (71) Aetherworks, LLC, 501 Fifth Avenue Suite 1803, New York, NY 10017, US
 (72) MACINNIS, Robert, Francis, 7 Sturges Hollow, Westport, CT 06880, US

(51) MKP
G09B 9/08 (2006.01) (97) **2642467**
 (86) 13160458.9 25.09.2013
 (97) 2642467, 25.09.2013 en
 (54) System and method for simulated aircraft control through desired direction of flight
 (71) Gaijin Entertainment Corporation, 901 North Pitt Str. Suite 325, Alexandria, Virginia 22314, US
 (72) Polyakov, Alexander, C/o Gaijin Entertainment Corporation 901 North Pitt Str. Suite 325, Alexandria, VA Virginia 22314, US
 Yudintsev, Kirill, C/o Gaijin Entertainment Corporation 901 North Pitt Str. Suite 325, Alexandria, VA Virginia 22314, US

(51) MKP
B28B 1/08 (2006.01) (97) **2714353 ***
B28B 3/00 (2006.01)
B28B 7/46 (2006.01)
B28B 13/02 (2006.01)
(86) IT2012000149 22.05.2012
(96) 12735949.5 09.04.2014
(87) WO2012160583, 22.05.2012
(97) 2714353, 09.04.2014 en
(54) APPARATUS FOR MANUFACTURING OF TILES
(71) Longinotti Group S.r.l., Viale Provinciale Lucchese 201, 50019 Sesto Fiorentino, IT
(72) CIPRIANI, Umberto, Viale Francesco Redi 61, I-50100 Firenze, IT

(51) MKP
C01B 3/04 (2006.01) (97) **2710235 ***
F01K 23/10 (2006.01)
(86) US2012038137 16.05.2012
(96) 12723062.1 26.03.2014
(87) WO2012158797, 16.05.2012
(97) 2710235, 26.03.2014 en
(54) STEAM GENERATION SYSTEM
(71) Powerdyne, Inc., 4740 Von Karman Avenue Suite 300, Newport Beach, California 92660, US
(72) SHOUSE, Gus, F., 4740 Von Karman Avenue, Suite 100, Newport Beach CA 92660, US
HIRSON, Geoffrey, 27715 Country Lane Road, Laguna Niguel CA 92677, US

(51) MKP
C07K 14/16 (2006.01) (97) **2761011 ***
C12N 15/867 (2006.01)
(86) IB2012002363 25.09.2012
(96) 12813090.3 06.08.2014
(87) WO2013046034, 25.09.2012
(97) 2761011, 06.08.2014 en
(54) USE OF NON-SUBTYPE B GAG PROTEINS FOR LENTIVIRAL PACKAGING
(71) Theravectys, 1 mail du Professeur Georges Mathé, 94800 Villejuif, FR
Institut Pasteur, 25-28 Rue du Docteur Roux, 75724 Paris Cedex 15, FR
(72) TRAN, Thi-Lan, 8 rue Anatole France, 78350 Jouy en Josas, FR
CHARNEAU, Pierre, 6 bis rue des Écoles, 75005 Paris, FR
BAUCHE, Cecile, 104 avenue de Choisy, 75013 Paris, FR

(51) MKP
C07D 487/04 (2006.01) (97) **2768833 ***
(86) US2012061026 19.10.2012
(96) 12840924.0 27.08.2014
(87) WO2013059594, 19.10.2012
(97) 2768833, 27.08.2014 en
(54) SUBSTITUTED BICYCLIC AZA-HETEROCYCLES AND ANALOGUES AS SIRTUIN MODULATORS
(71) Sirtris Pharmaceuticals, Inc., 200 Technology Square, Suite 300, Cambridge, MA 02139, US
Glaxosmithkline LLC, 2711 Centerville Road Suite 400 Wilmington, New Castle, DE 19808, US
(72) BLUM, Charles, A., 32 Middlesex Circle, Waltham, MA 02452, US
DISCH, Jeremy, S., 18 Waban Street, Natick, MA 01760, US
SPRINGER, Stephanie, K., 3100 Connecticut Avenue., NW, Washington, DC 20008, US

(51) MKP
C07C 253/00 (2006.01) (97) **2740725**
C07D 223/14 (2006.01)
(96) 13195800.1 11.06.2014
(97) 2740725, 11.06.2014 fr
(54) Novel method for synthesising 3-(2-bromo-4,5-dimethoxyphenyl)propanenitrile and use for synthesising ivabradine and the added salts thereof with a pharmaceutically acceptable acid
(71) Les Laboratoires Servier, 35, rue de Verdun, 92284 Suresnes Cedex, FR
(72) Carranza, Maria del Pilar, C. Ciudad Real 11, 13670 Villarrubia de los Ojos, ES
Garcia Aranda, Maria Isabel, Rnda, Arroyo 1 PO2A, 45006 Toledo, ES
Gonzalez, José Lorenzo, Avda Rio Boladiez 21 PO3C, 45007 Toledo, ES
Sanchez, Frédéric, Calle Venus 39, 45111 Cobisa, ES

(51) MKP
F03D 1/00 (2006.01) (97) **2702266 ***
F03D 1/06 (2006.01)
(86) EP2012057091 18.04.2012
(96) 12715985.3 05.03.2014
(87) WO2012146521, 18.04.2012
(97) 2702266, 05.03.2014 de
(54) WIND TURBINE
(71) Wobben Properties GmbH, Dreekamp 5, 26605 Aurich, DE
BRENNER, Albrecht, Bontjesweg 2, 26607 Aurich, DE
KNOOP, Frank, Nee Streek 13, 26607 Aurich, DE
UBBEN, Matthias, Blumenbrückstraße 2, 26721 Emden, DE

(51) MKP
A61K 38/16 (2006.01) (97) **2702069 ***
A61P 9/00 (2006.01)
A61P 11/00 (2006.01)
A61P 11/06 (2006.01)
A61P 17/00 (2006.01)
A61P 35/00 (2006.01)
C07K 14/00 (2006.01)
C12N 1/19 (2006.01)
C12N 1/21 (2006.01)
C12N 5/10 (2006.01)
C12N 7/01 (2006.01)
C12N 15/11 (2006.01)
C12N 15/63 (2006.01)
C12P 21/02 (2006.01)
(86) US2012035613 27.04.2012
(96) 12776643.4 05.03.2014
(87) WO2012149439, 27.04.2012
(97) 2702069, 05.03.2014 en
(54) IL4/IL13 BINDING REPEAT PROTEINS AND USES
(71) Janssen Biotech, Inc., 800/850 Ridgeview Drive, Horsham, PA 19044, US
Molecular Partners AG, Wagistrasse 14, 8952 Zurich-Schlieren, CH
(72) JACOBS, Steven A., 1400 McKean Road, Spring House, PA 19477, US
O'NEIL, Karyn T., 1400 McKean Road, Spring House, PA 19477, US
BAUMANN, Michael, Margrit-Rainer-Strasse 14, CH-8050 Zurich, CH
SENNHAUSER, Gaby, Burglenstrasse 7, CH-8330 Pfeffikon, CH

(51) MKP
A61K 47/48 (2006.01) (97) **2766048 ***
A61P 35/00 (2006.01)
C07D 487/04 (2006.01)
C07D 519/00 (2006.01)
(86) EP2013071236 11.10.2013
(96) 13780100.7 20.08.2014
(87) WO2014057074, 11.10.2013
(97) 2766048, 20.08.2014 en
(54) PYRROLOBENZODIAZEPINES AND CONJUGATES THEREOF
(71) Spirogen Sàrl, Rue Saint-Pierre2, 1003 Lausanne, CH
(72) HOWARD, Philip Wilson, Spirogen Limited The QMB Innovation Centre 42 New Road, London Greater London E1 2AX, GB

- (51) MKP
A61K 39/21 (2006.01) (97) **2755684 ***
 (86) GB2012052261 12.09.2012
 (96) 12775043.8 23.07.2014
 (87) WO2013038185, 12.09.2012
 (97) 2755684, 23.07.2014 en
 (54) METHODS AND COMPOSITIONS FOR RAISING AN IMMUNE RESPONSE TO HIV
 (71) Weber, Jonathan Norden, Imperial College Department of Medicine St Mary's Campus, London W2 1PG, GB
 Shattock, Robin John, Imperial College Department of Medicine St Mary's Campus, London W2 1PG, GB
 McKay, Paul Francis James, Imperial College Department of Medicine St Mary's Campus, London W2 1PG, GB
 McCormack, Sheena Mary Geraldine, Imperial College Department of Medicine South Kensington, London SW7 2AZ, GB
 (72) Weber, Jonathan Norden, Imperial College Department of Medicine St Mary's Campus, London W2 1PG, GB
 Shattock, Robin John, Imperial College Department of Medicine St Mary's Campus, London W2 1PG, GB
 McKay, Paul Francis James, Imperial College Department of Medicine St Mary's Campus, London W2 1PG, GB
 McCormack, Sheena Mary Geraldine, Imperial College Department of Medicine South Kensington, London SW7 2AZ, GB

- (51) MKP
F16L 21/03 (2006.01) (97) **2749803 ***
F16L 21/08 (2006.01)
 (86) CN2012086359 11.12.2012
 (96) 12882885.2 02.07.2014
 (87) WO2014044002, 11.12.2012
 (97) 2749803, 02.07.2014 en
 (54) BELL AND SPIGOT TYPE PIPING JOINT
 (71) Xinxing Ductile Iron Pipes Co., Ltd, Research Institute Xinxing Ductile Iron Pipes Industry Area, Wuan, Hebei 056300, CN
 (72) ZHANG, Tongbo, Research Institute Xinxing Ductile Iron Pipes Industry Area, Wuan Hebei 056300, CN
 Li, Jun, Research Institute Xinxing Ductile Iron Pipes Industry Area, Wuan Hebei 056300, CN
 XU, Jun, Research Institute Xinxing Ductile Iron Pipes Industry Area, Wuan Hebei 056300, CN
 LIU, Junfeng, Research Institute Xinxing Ductile Iron Pipes Industry Area, Wuan Hebei 056300, CN
 DONG, Jianzhong, Research Institute Xinxing Ductile Iron Pipes Industry Area, Wuan Hebei 056300, CN
 ZHAO, Fuen, Research Institute Xinxing Ductile Iron Pipes Industry Area, Wuan Hebei 056300, CN
 LIU, Zhili, Research Institute Xinxing Ductile Iron Pipes Industry Area, Wuan Hebei 056300, CN
 WANG, Yunfeng, Research Institute Xinxing Ductile Iron Pipes Industry Area, Wuan Hebei 056300, CN
 KONG, Guobin, Research Institute Xinxing Ductile Iron Pipes Industry Area, Wuan Hebei 056300, CN
 JIA, Qingbo, Research Institute Xinxing Ductile Iron Pipes Industry Area, Wuan Hebei 056300, CN

- (51) MKP
G01N 33/50 (2006.01) (97) **2707718 ***
G01N 33/566 (2006.01)
G01N 33/74 (2006.01)
 (86) US2012025815 20.02.2012
 (96) 12706412.9 19.03.2014
 (87) WO2012154263, 20.02.2012
 (97) 2707718, 19.03.2014 en
 (54) METHOD OF IDENTIFYING COMPOUNDS THAT SPECIFICALLY MODULATE THE INTERACTION OF FGFR1 AND BETA-KLTHO
 (71) Amgen Inc., One Amgen Center Drive, Thousand Oaks, California 91320-1799, US
 (72) LI, Yang, 1142 Cuesta Drive, Mountain View, CA 94040, US
 WU, Xinle, 12772 Via Nieve, San Diego, CA 92130, US
 GE, Hongfei, 784 Santa Maria Lane, Foster City, CA 94404, US
 BARIBAU, Helene, 816 Bain Place, Redwood City, CA 94062, US
 LEMON, Bryan, 2493 Dell Avenue, Mountain View, CA 94043, US
 SHENG, Jackie Zeqi, 559 Lone Oak Drive, Thousand Oaks, CA 91361, US
 VONDERFECHT, Steven, 282 Virgo Court, Thousand Oaks, CA 91360, US
 WEISZMANN, Jennifer Veronica, 30 Donna Maria Way, Orinda, CA 94563, US
 GARDNER, Jonitha, 181 Briarwood Drive, Hayward, CA 94544, US
 LEE, Ki Jeong, 1714 Creston Court, Simi Valley, CA 93065, US

- (51) MKP
G01N 33/48 (2006.01) (97) **2761289 ***
G01N 33/52 (2006.01)
 (86) US2012058060 28.09.2012
 (96) 12836076.5 06.08.2014
 (87) WO2013049674, 28.09.2012
 (97) 2761289, 06.08.2014 en
 (54) CARDIOVASCULAR RISK EVENT PREDICTION AND USES THEREOF
 (71) Somalogic, Inc., 2945 Wilderness Place, Boulder, CO 80301, US
 (72) GILL, Rosalynn Dianne, 357 Canyonside Drive, Boulder Colorado 80302, US
 WILLIAMS, Stephen Alaric, 1188 Forest Avenue, Boulder Colorado 80304, US
 STEWART, Alex A.E., 175 Stonecrest Drive, San Francisco California 94132, US
 MEHLER, Robert, 4702 Eldorado Springs Drive, Boulder Colorado 80303, US
 FOREMAN, Trudi, 2608 Carriage Hills Drive, Boulder Colorado 80302, US
 SINGER, Britta, 2090 Dartmouth Avenue, Boulder Colorado 80305, US

- (51) MKP
G06K 9/00 (2006.01) (97) **2710554 ***
G06T 7/00 (2006.01)
 (86) US2012036362 03.05.2012
 (96) 12720756.1 26.03.2014
 (87) WO2012158361, 03.05.2012
 (97) 2710554, 26.03.2014 en
 (54) HEAD POSE ESTIMATION USING RGBD CAMERA
 (71) Qualcomm Incorporated, International IP Administration 5775 Morehouse Drive, San Diego, CA 92121-1714, US
 (72) SHARMA, Piyush, 5775 Morehouse Drive, San Diego, California 92121, US
 SWAMINATHAN, Ashwin, 5775 Morehouse Drive, San Diego, California 92121, US
 REZAIIFAR, Ramin, 5775 Morehouse Drive, San Diego, California 92121, US
 XUE, Qi, 5775 Morehouse Drive, San Diego, California 92121, US

- (51) MKP
B41F 35/00 (2006.01) (97) **2684697**
 (96) 13450026.3 15.01.2014
 (97) 2684697, 15.01.2014 de
 (54) Treatment plant
 (71) Oesterreichische Banknoten- und Sicherheitsdruck GmbH, Garnisongasse 15, 1090 Wien, AT
 (72) Breinessl, Paul, Werfelgasse 22/10, 7400 Oberwart, AT

- (51) MKP
A61K 38/02 (2006.01) (97) **2630962**
A61K 38/16 (2006.01)
A61P 25/28 (2006.01)
(96) 13166080.5 28.08.2013
(97) 2630962, 28.08.2013 en
(54) Low Frequency Glatiramer Acetate Therapy
(71) YEDA RESEARCH & DEVELOPMENT COMPANY, LTD., P.O.
Box 95, 76100 Rehovot, IL
(72) Klinger, Ety, 16 Agadati Street, 39930 Tel Aviv, IL

- (51) MKP
G07F 17/32 (2006.01) (97) **2761606 ***
(86) EP2012067904 13.09.2012
(96) 12770002.9 06.08.2014
(87) WO2013045276, 13.09.2012
(97) 2761606, 06.08.2014 en
(54) GAMING DEVICES AND METHODS OF OPERATING THEM
(71) Novomatic AG, Wiener Strasse 158, 2352 Gumpoldskirchen,
AT
(72) WATTS, Ron, c/o IP&Legal Department Wiener Strasse 158,
A-2352 Gumpoldskirchen, AT
DINNING, Andy, c/o IP&Legal Department Wiener Strasse 158,
A-2352 Gumpoldskirchen, AT

- (51) MKP
C07K 16/00 (2006.01) (97) **2710032 ***
C12P 21/08 (2006.01)
(86) US2012038628 18.05.2012
(96) 12790362.3 26.03.2014
(87) WO2012162160, 18.05.2012
(97) 2710032, 26.03.2014 en
(54) MODIFIED GLYCOPROTEINS
(71) Momenta Pharmaceuticals, Inc., 675 West Kendall Street,
Cambridge, MA 02142, US
(72) BULIK, Dorota, A., 240 Hawthorne Street, Malden, MA 02148,
US
BOSQUES, Carlos, J., 40 Brattle Street 7, Arlington, MA 02476,
US
COLLINS, Brian, Edward, 30 Country Club Drive, Arlington, MA
02474, US
HAINS, Maurice, Gaston, 70 Bernice Avenue, Brockton, MA
02301, US
WASHBURN, Nathaniel, J., 543 King Street, Littleton, MA
01460, US
MEADOR, James, 38 Gryzboska Circle, Framingham, MA
01702, US
SMITH, Sean, 11 Crane Road, Littleton, MA 01460, US
BHATNAGAR, Naveen, 2 Bishop Drive, Framingham, MA
01702, US

- (51) MKP
A61K 9/16 (2006.01) (97) **2765997 ***
A61K 31/7088 (2006.01)
A61K 31/7105 (2006.01)
A61K 38/17 (2006.01)
A61K 47/48 (2006.01)
A61K 48/00 (2006.01)
A61K 49/08 (2006.01)
(86) US2012060072 12.10.2012
(96) 12840155.1 20.08.2014
(87) WO2013056132, 12.10.2012
(97) 2765997, 20.08.2014 en
(54) POROUS NANOPARTICLE-SUPPORTED LIPID BILAYERS
(PROTOCELLS) FOR TARGETED DELIVERY INCLUDING
TRANSDERMAL DELIVERY OF CARGO AND METHODS
THEREOF
(71) STC.UNM, 801 University Blvd. SE, Suite 101, Albuquerque,
NM 87106, US
Sandia Corporation, 1515 Eubank Boulevard SE, Albuquerque,
NM 87123, US
(72) ASHLEY, Carlee Erin, 3708 Tewa Drive NE, Albuquerque, NM
87111, US
BRINKER, C., Jeffrey, 14 Eagle Nest Drive NE, Albuquerque,
NM 87122, US
CARNES, Eric C., 13309 Chaco Cliff Trail SE, Albuquerque,
NM 87123, US
FEKRAZAD, Mohammad Houman, 4261 Altura Mesa Lane NE,
Albuquerque, NM 87110, US
FELTON, Linda A., 11500 Arroyo De Vista NE, Albuquerque,
NM 87111, US
NEGRETE, Oscar, 2341 Willet Way, Pleasanton, CA 64566, US
PADILLA, David Patrick, 11012 Escensia NW, Albuquerque,
NM 87114, US
WILKINSON, Brian S., 6308 Zimmerman Avenue NE,
Albuquerque, NM 87110, US
WILKINSON, Dan C., 6308 Zimmerman Avenue NE,
Albuquerque, NM 87110, US
WILLMAN, Cheryl L., 4633 Los Poblanos Circle NW,
Albuquerque, NM 87107, US

- (51) MKP
A61K 38/18 (2006.01) (97) **2750695 ***
A61P 3/00 (2006.01)
A61P 3/04 (2006.01)
A61P 3/06 (2006.01)
A61P 3/08 (2006.01)
A61P 3/10 (2006.01)
(86) US2012053216 30.08.2012
(96) 12766746.7 09.07.2014
(87) WO2013033452, 30.08.2012
(97) 2750695, 09.07.2014 en
(54) METHOD OF TREATING OR AMELIORATING TYPE 1
DIABETES USING FGF21
(71) Amgen Inc., One Amgen Center Drive, Thousand Oaks,
California 91320-1799, US
(72) ELLISON, Murielle Marie, 645 Camino Manzanitas, Thousand
Oaks, California 91360, US
STANISLAUS, Shanaka, 4196 Minnetocota Drive, Thousand
Oaks, California 91360, US
XU, Jing, 1677 Glider Court, Thousand Oaks, California 91320,
US

- (51) MKP
C12P 21/04 (2006.01) (97) **2718456 ***
(86) US2012042165 13.06.2012
(96) 12801163.2 16.04.2014
(87) WO2012174056, 13.06.2012
(97) 2718456, 16.04.2014 en
(54) MITIGATION OF CUTANEOUS INJURY WITH IL-12
(71) Neumedicines, Inc, 133 North Altadena Drive Suite 310,
Pasadena, California 91107, US
(72) BASILE, Lena, A., C/o Neumedicines Inc. 133 N. Altadena Dr.
310, Pasadena, CA 91107, US
ELLEFSON, Dolph, C/o Neumedicines Inc. 133 N. Altadena Dr.
310, Pasadena, CA 91107, US
GALLAHER, Timothy, K., C/o Neumedicines Inc. 133 N.
Altadena Dr 310, Pasadena, CA 91107, US

(51) MKP
A23B 4/005 (2006.01) (97) **2666362**
A23B 4/16 (2006.01)
A23L 1/325 (2006.01)
(96) 13168986.1 27.11.2013
(97) 2666362, 27.11.2013 en
(54) Process for packaging seafood raw material into a foodstuffs container and related package
(71) Bolton Alimentari S.P.A., via Einaudi 18/22, 22072 Cerenate (Como), IT
(72) Rosa, Alberto, Via delle Grigne, 23, 20833 Giuszano (MB), IT
Prina, Roberto, Via Monte Bisbino, 4, 22070 Bregnano (CO), IT

(51) MKP
A01N 25/22 (2006.01) (97) **2709449 ***
A01N 37/40 (2006.01)
A01N 43/12 (2006.01)
A01N 43/54 (2006.01)
A01N 43/653 (2006.01)
A01N 47/44 (2006.01)
A01N 59/02 (2006.01)
A01N 59/20 (2006.01)
A01P 3/00 (2006.01)
(86) EP2011057524 10.05.2011
(96) 11724569.6 26.03.2014
(87) WO2012152318, 10.05.2011
(97) 2709449, 26.03.2014 en
(54) AGROCHEMICAL FORMULATIONS COMPRISING DODECYLGUANIDINE AND A COMPATIBILITY AGENT
(71) Agriphar S.A., Rue de Renory 26/1, 4102 Ougrée, BE
(72) PIROTTE, Alan, Cour de l'Abbaye 7, B-6660 Houffalize, BE

(51) MKP
C02F 1/467 (2006.01) (97) **2706042**
C02F 1/72 (2006.01)
(96) 13181824.7 12.03.2014
(97) 2706042, 12.03.2014 de
(54) Point-of-use water dispenser and method for using said water dispenser
(71) Oxymount Technology GmbH, Ketschendorfer Str. 82-84, 96450 Coburg, DE
(72) Pflaum, Ulrich, Seidmannsdorfer Str. 179, 96450 Coburg, DE

(51) MKP
A01G 17/06 (2006.01) (97) **2734690 ***
E04H 12/20 (2006.01)
(86) EP2012063275 06.07.2012
(96) 12731500.0 28.05.2014
(87) WO2013010824, 06.07.2012
(97) 2734690, 28.05.2014 en
(54) GUY DEVICE FOR A POLE DRIVEN INTO THE GROUND
(71) Mollificio Bortolussi S.R.L., Via Trieste 93, 33080 Fiume Veneto, IT
(72) BORTOLUSSI, Claudio, Via Grigoletti 3, I-33080 Fiume Veneto (Pordenone), IT
BORTOLUSSI, Franco, Via Trieste 93, I-33080 Fiume Veneto (Pordenone), IT

(51) MKP
C07D 417/14 (2006.01) (97) **2768830 ***
(86) US2012059717 11.10.2012
(96) 12778012.0 27.08.2014
(87) WO2013055895, 11.10.2012
(97) 2768830, 27.08.2014 en
(54) APOPTOSIS-INDUCING AGENTS FOR THE TREATMENT OF CANCER AND IMMUNE AND AUTOIMMUNE DISEASES
(71) AbbVie Inc., 1 North Waukegan Road, North Chicago, IL 60064, US
(72) WANG, Le, 338 East Colonial Drive, Vernon Hills, Illinois 60061, US
DOHERTY, George, 1605 Bush Court, Libertyville, Illinois 60048, US
WANG, Xilu, 1617 Eric Lane, Libertyville, Illinois 60048, US
TAO, Zhi-Fu, 303 Hobbie Bush Lane, Vernon Hills, Illinois 60061, US
BRUNKO, Milan, 31231 Prairie Ridge, Green Oaks, Illinois 60048, US
KUNZER, Aaron R., 615 W. Burr Oak Drive, Arlington Heights, Illinois 60004, US
WENDT, Michael D., 1445 Maidstone Drive, Vernon Hills, Illinois 60061, US
SONG, Xiaohong, 34037 Sulkey Drive, Grayslake, Illinois 60030, US
FREY, Robin, 1037 Shari Lane, Libertyville, Illinois 60048, US
HANSEN, Todd M., 191 Seymour Avenue, Grayslake, Illinois 60030, US
SULLIVAN, Gerard M., 1212 Tulip Tree Court, Lake Villa, Illinois 60046, US
JUDD, Andrew, 138 Mainsail Drive, Grayslake, Illinois 60030, US
SOUERS, Andrew, 901 Hinman Apt. 3A, Evanston, Illinois 60202, US

(51) MKP
A61K 31/444 (2006.01) (97) **2763979 ***
A61K 31/506 (2006.01)
A61P 25/28 (2006.01)
C07D 401/10 (2006.01)
C07D 401/14 (2006.01)
C07D 405/14 (2006.01)
C07D 413/10 (2006.01)
C07D 413/14 (2006.01)
C07D 417/14 (2006.01)
C07D 498/08 (2006.01)
(86) JP2012076257 03.10.2012
(96) 12781479.6 13.08.2014
(87) WO2013054822, 03.10.2012
(97) 2763979, 13.08.2014 en
(54) 1 - ARYL CARBONYL - 4 - OXY - PIPERIDINE COMPOUNDS USEFUL FOR THE TREATMENT OF NEURODEGENERATIVE DISEASES
(71) Takeda Pharmaceutical Company Limited, 1-1 Doshomachi 4-chome Chuo-ku, Osaka-shi, Osaka 541-0045, JP
(72) KOIKE, Tatsuki, c/o TAKEDA PHARMACEUTICAL COMPANY LIMITED 26-1 Muraoka-Higashi 2-chome, Fujisawa-shi Kanagawa 251-0012, JP
YOSHIKAWA, Masato, c/o TAKEDA PHARMACEUTICAL COMPANY LIMITED 26-1 Muraoka-Higashi 2-chome, Fujisawa-shi Kanagawa 251-0012, JP
ANDO, Haruhi, c/o TAKEDA PHARMACEUTICAL COMPANY LIMITED 26-1 Muraoka-Higashi 2-chome, Fujisawa-shi Kanagawa 251-0012, JP
FARNABY, William John, c/o TAKEDA CAMBRIDGE LIMITED 418 Cambridge Science Park, Cambridge CB4 0PA, GB

(51) MKP
B65D 90/10 (2006.01) (97) **2761100 ***
E02D 29/14 (2006.01)
E03F 5/02 (2006.01)
(86) IB2011054256 28.09.2011
(96) 11828237.5 06.08.2014
(87) WO2012042478, 28.09.2011
(97) 2761100, 06.08.2014 en
(54) IMPROVEMENTS IN/OR AND RELATING TO UTILITY CHAMBERS AND SURROUNDS AND METHODS THEREFOR
(71) Sika Technology Limited, Level 2 116 Harris Road East Tamaki, Manukau 2010, NZ
(72) HILL, David, Edward, Unit D 24 James Cooks Crescent Remuera Auckland, 1050, NZ
CALDERON, Sergio, Felipe, 116 Ennis Avenue Pakuranga, Auckland 2010, NZ

(51) MKP
B01J 20/02 (2006.01) (97) **2744592 ***
B01J 20/04 (2006.01)
B01J 20/20 (2006.01)
B01J 20/28 (2006.01)
B01J 20/32 (2006.01)
C02F 1/28 (2006.01)
C02F 101/00 (2006.01)
G21F 9/12 (2006.01)
(86) EP2012065166 02.08.2012
(96) 12743969.3 25.06.2014
(87) WO2013023932, 02.08.2012
(97) 2744592, 25.06.2014 de
(54) ADSORBENT PRECIPITATED ON A CARRIER, METHOD FOR PRODUCING SAID ADSORBENT, AND USE OF SAID ADSORBENT
(71) Blücher GmbH, Mettmanner Strasse 25, 40699 Erkrath, DE
(72) SCHRAGE, Christian, Hechtstraße 11, 01097 Dresden, DE
GIEBELHAUSEN, Jann-Michael, An der Herrenlanke 35, 14712 Rathenow, DE
FICHTNER, Sven, Bunsenstraße 5, 14727 Premnitz, DE

(51) MKP
F41J 3/02 (2006.01) (97) **2729755 ***
(86) HU2012000044 25.05.2012
(96) 12807004.2 14.05.2014
(87) WO2013005064, 25.05.2012
(97) 2729755, 14.05.2014 en
(54) SCORING SYSTEM FOR ARCHERY
(71) Garas, Mihály, Déli u. 8, 2120 Dunakeszi, HU
(72) Garas, Mihály, Déli u. 8, 2120 Dunakeszi, HU

(51) MKP
A61K 31/4196 (2006.01) (97) **2744494 ***
A61K 31/513 (2006.01)
A61K 31/519 (2006.01)
A61K 31/7068 (2006.01)
A61K 45/06 (2006.01)
A61P 35/00 (2006.01)
A61P 35/02 (2006.01)
(86) US2012051316 17.08.2012
(96) 12753315.6 25.06.2014
(87) WO2013028505, 17.08.2012
(97) 2744494, 25.06.2014 en
(54) COMBINATION CANCER THERAPY OF HSP90 INHIBITOR WITH ANTIMETABOLITE
(71) Synta Pharmaceuticals Corporation, 45 Hartwell Avenue, Lexington, MA 02421, US
(72) PROIA, David, 30 Silver Lake Avenue, Newton, MA 02458, US
FRIEDLAND, Julie, 11 Seven Springs Lane Apt. 306, Burlington, MA 01803, US

(51) MKP
E21B 23/00 (2006.01) (97) **2737163 ***
E21B 33/122 (2006.01)
E21B 34/14 (2006.01)
E21B 34/16 (2006.01)
(86) CA2012050516 27.07.2012
(96) 12819715.9 04.06.2014
(87) WO2013016822, 27.07.2012
(97) 2737163, 04.06.2014 en
(54) WELLBORE TOOL WITH INDEXING MECHANISM AND METHOD
(71) Packers Plus Energy Services Inc., Bow Valley Square 2 Suite 2200, 205 - 5 Avenue SW, Calgary, Alberta T2P 2V7, CA
(72) ARABSKY, Serhiy, 3204 - 62 Street, Beaumont, Alberta T4X 1T6, CA
FEHR, James, 31 Woodfield Drive, Sherwood Park, Alberta T8A 4A1, CA
THEMIG, Daniel Jon, 256 Woodhaven Place SW, Calgary, Alberta T2W 5P9, CA

(51) MKP
A61K 31/519 (2006.01) (97) **2768832 ***
A61P 3/00 (2006.01)
A61P 9/00 (2006.01)
C07D 487/04 (2006.01)
(86) IB2012055598 15.10.2012
(96) 12791857.1 27.08.2014
(87) WO2013057650, 15.10.2012
(97) 2768832, 27.08.2014 en
(54) NOVEL SUBSTITUTED IMIDAZOPYRIMIDINES AS GPBAR1 RECEPTOR MODULATORS
(71) Torrent Pharmaceuticals Limited, Torrent House Off Ashram Road, State of Gujarat, 380 009 Ahmedabad, IN
(72) DUTT, Chaitanya, Torrent Research Centre Tal&Dist. Gandhinagar State of Gujarat, Bhat 382 428, IN
CHAUTHAIWALE, Vijay, Torrent Research Centre Tal&Dist. Gandhinagar State of Gujarat, Bhat 382 428, IN
GUPTA, Ramesh, Chandra, Torrent Research Centre Tal&Dist. Gandhinagar State of Gujarat, Bhat 382 428, IN
GHALSASI, Sameer, Torrent Research Centre Tal&Dist. Gandhinagar State of Gujarat, Bhat 382 428, IN
TULLI, Davinder, Torrent Research Centre Tal&Dist. Gandhinagar State of Gujarat, Bhat 382 428, IN
DESHPANDE, Shailesh, Torrent Research Centre Tal&Dist. Gandhinagar State of Gujarat, Bhat 382 428, IN
CHAUDHARI, Anita, Torrent Research Centre Tal&Dist. Gandhinagar State of Gujarat, Bhat 382 428, IN
ZAMBAD, Shitalkumar, Torrent Research Centre Tal&Dist. Gandhinagar State of Gujarat, Bhat 382 428, IN

(51) MKP
A61K 31/166 (2006.01) (97) **2734497 ***
A61K 31/167 (2006.01)
A61K 31/192 (2006.01)
A61K 31/205 (2006.01)
A61K 31/235 (2006.01)
A61P 29/00 (2006.01)
C07C 65/19 (2006.01)
C07C 69/76 (2006.01)
C07C 229/08 (2006.01)
C07C 235/42 (2006.01)
(86) IE2012000038 20.07.2012
(96) 12740703.9 28.05.2014
(87) WO2013014660, 20.07.2012
(97) 2734497, 28.05.2014 en
(54) INDANE DIMERS FOR USE IN THE TREATMENT OF AUTOIMMUNE INFLAMMATORY DISEASE
(71) Venantius Limited, The Tower Trinity Technology and Enterprise Campus Pearse Street, Dublin 2, IE
(72) SHERIDAN, Helen, 170 Rathfarnham Road, Dublin 14, IE
FRANKISH, Neil, 25 Farm Hill Road Goatstown, Dublin 14, IE

- (51) MKP
A01H 5/00 (2006.01) (97) **2726620 ***
C12N 15/82 (2006.01)
(86) US2012043121 19.06.2012
(96) 12807414.3 07.05.2014
(87) WO2013006263, 19.06.2012
(97) 2726620, 07.05.2014 en
(54) CONSTITUTIVELY ACTIVE ABA RECEPTOR MUTANTS
(71) The Regents of the University of California, 1111 Franklin Street, 12th Floor, Oakland, California 94607, US
(72) CUTLER, Sean, R., 1111 Franklin Street 12th Floor, Oakland, CA 94607, US
MOSQUANA, Assaf, 1111 Franklin Street 12th Floor, Oakland, CA 94607, US

- (51) MKP
A01N 63/00 (2006.01) (97) **2763540 ***
(86) US2012033753 16.04.2012
(96) 12829361.0 13.08.2014
(87) WO2013036290, 16.04.2012
(97) 2763540, 13.08.2014 en
(54) COMPOSITIONS AND METHODS FOR ASSESSING AND TREATING INFLAMMATORY DISEASES AND DISORDERS
(71) Yale University, Two Whitney Avenue, New Haven, CT 06511, US
(72) ELINAV, Eran, 16 Hageffen Street, Mazkeret Batya, IL
FLAVELL, Richard, A., 283 Moose Hill Road, Guilford, CT 06437, US
STROWIG, Till, 20 Tilton Street, New Haven, CT 06511, US
MEJIA, Jorge, H., 145 East Rock Road Apartment 3, New Haven, CT 06511, US
JIN, Chengcheng, 203 Lawrence Street 2nd floor, New Haven, CT 06511, US

- (51) MKP
B41F 33/00 (2006.01) (97) **2749418**
G06K 19/06 (2006.01)
(96) 12386026.4 02.07.2014
(97) 2749418, 02.07.2014 en
(54) Print fidelity control method and device in production lines of solid and corrugated carton boxes, and advertising displays made of paper
(71) P. Dimitropoulos - Electronic Systems and Software Applications S.A. Trading Name: SENSAP SA, Hydras 2, 18346 Moschato/Athens, GR
(72) Panagiotis, Dimitropoulos D., Seferis 36, 14564 Kifissia/Athens, GB

- (51) MKP
A61K 47/48 (2006.01) (97) **2662094**
A61P 35/00 (2006.01)
(96) 13167148.9 13.11.2013
(97) 2662094, 13.11.2013 en
(54) Cyclodextrin Complexation Methods for Formulating Peptide Proteasome Inhibitors
(71) Onyx Therapeutics, Inc., 249 E. Grand Avenue, South San Francisco, CA 94080, US
(72) Lewis, Evan, 631 Miller Ave, Pacifica, CA California 64044, US
Shwonek, Peter, 436 Capistrano Ave, San Francisco, CA California 94112, US
Dalziel, Sean, 400 Beale Street, Apt. 1901, San Francisco, CA California 94105, US
Jumaa, Mouhannad, 363 Catamaran St, Foster City, CA California 94404, US

- (51) MKP
C12Q 1/68 (2006.01) (97) **2684964**
(96) 12005067.9 15.01.2014
(97) 2684964, 15.01.2014 en
(54) Microarray-based methods for identifying single nucleotides at specific positions in nucleic acids
(71) OakLabs GmbH, Neuendorfstrasse 20 b, 16761 Hennigsdorf, DE
(72) Schad, Martina, Friedrichstrasse 129 c, 10117 Berlin, DE
Kallarackal, Jim, Friedrichstrasse 129 c, 10117 Berlin, DE

- (51) MKP
A61K 39/155 (2006.01) (97) **2729169 ***
B82Y 99/00 (2011.01)
(86) US2012045769 06.07.2012
(96) 12735418.1 14.05.2014
(87) WO2013006797, 06.07.2012
(97) 2729169, 14.05.2014 en
(54) HUMAN RESPIRATORY SYNCYTIAL VIRUS VACCINE
(71) Nanobio Corporation, 2311 Green Road, Suite A, Ann Arbor, MI 48105, US
Hamouda, Tarek, 2311 Green Road, Ann Arbor, MI 48105, US
Bitko, Vira, 2311 Green Road, Ann Arbor, MI 48105, US
(72) HAMOUDA, Tarek, c/o Nanobio Corporation 2311 Green Road, Ann Arbor, MI 48105, US
BITKO, Vira, c/o Nanobio Corporation 2311 Green Road, Ann Arbor, MI 48105, US
FATTOM, Ali, I., c/o Nanobio Corporation 2311 Green Road, Ann Arbor, MI 48105, US
LUKACS, Nicolas, c/o Nanobio Corporation 2311 Green Road, Ann Arbor, MI 48105, US
BAKER, James, R., c/o Nanobio Corporation 2311 Green Road, Ann Arbor, MI 48105, US

- (51) MKP
F16B 7/04 (2006.01) (97) **2685111**
(96) 12176195.1 15.01.2014
(97) 2685111, 15.01.2014 de
(54) Clamp piece for a detachable connection of two profile pieces
(71) Syma Intercontinental AG, Panoramastrasse 19, 9533 Kirchberg, CH
(72) Strässle, Marcel, Rosenbergstrasse 29, 9533 Kirchberg, CH
Züllig, Kurt, Rosenbergstrasse 23, 9533 Kirchberg, CH

- (51) MKP
C10L 1/10 (2006.01) (97) **2732025 ***
C11B 1/00 (2006.01)
C12N 1/12 (2006.01)
(86) US2012046696 13.07.2012
(96) 12810921.2 21.05.2014
(87) WO2013010090, 13.07.2012
(97) 2732025, 21.05.2014 en
(54) ALGAL LIPID COMPOSITIONS AND METHODS OF PREPARING AND UTILIZING THE SAME
(71) Alltech, Inc., 3031 Catnip Hill Pike, Nicholasville, KY 40356, US
(72) RANEY, Kyle, A., 115 Hibiscus Lane, Winchester, Kentucky 40391, US
TIMMONS, Rebecca, A., 1830 McDonald Avenue, Lexington, Kentucky 40503, US

- (51) MKP
B60N 2/42 (2006.01) (97) **2718145 ***
B60N 2/48 (2006.01)
(86) IB2012051944 18.04.2012
(96) 12724714.6 16.04.2014
(87) WO2012168804, 18.04.2012
(97) 2718145, 16.04.2014 en
(54) A RECLINING COLLAR HEADREST WITH ROTATABLE BLOCK ENDS
(71) MARTINO, Mirko, via Faentina n. 161, 50010 Fiesole (FI), IT
(72) MARTINO, Mirko, via Faentina n. 161, 50010 Fiesole (FI), IT

- (51) MKP
F17C 11/00 (2006.01) (97) **2742274 ***
(86) FR2012051840 02.08.2012
(96) 12751095.6 18.06.2014
(87) WO2013024223, 02.08.2012
(97) 2742274, 18.06.2014 fr
(54) METHOD FOR STORING A GAS BY CHEMISORPTION ON A POROUS MATERIAL COMPRISING EXPANDED GRAPHITE
(71) Coldway, Lieu Dit Patau Route de Rivesaltes, 66380 Paris, FR
(72) KINDBEITER, Francis, c/o COLDWAY Lieu dit "Patau" Route de Rivesaltes, F-66380 PIA, FR
RIGAUD, Laurent, c/o COLDWAY Lieu dit "Patau" Route de Rivesaltes, F-66380 PIA, FR

- (51) MKP
G10L 21/02 (2013.01) (97) **2715722 ***
 (86) US2012037783 14.05.2012
 (96) 12724453.1 09.04.2014
 (87) WO2012162009, 14.05.2012
 (97) 2715722, 09.04.2014 en
 (54) PRESERVING AUDIO DATA COLLECTION PRIVACY IN MOBILE DEVICES
 (71) Qualcomm Incorporated, International IP Administration 5775 Morehouse Drive, San Diego, CA 92121-1714, US
 (72) GROKOP, Leonard H., c/o Qualcomm Incorporated 5775 Morehouse Drive, San Diego, California 92121, US
 NARAYANAN, Vidya, c/o Qualcomm Incorporated 5775 Morehouse Drive, San Diego, California 92121, US
 DOLTER, James W., c/o Qualcomm Incorporated 5775 Morehouse Drive, San Diego, California 92121, US
 NANDA, Sanjiv, c/o Qualcomm Incorporated 5775 Morehouse Drive, San Diego, California 92121, US

- (51) MKP
A61K 9/48 (2006.01) (97) **2709600 ***
A61K 31/4545 (2006.01)
A61K 47/10 (2006.01)
 (86) EP2012059147 16.05.2012
 (96) 12723432.6 26.03.2014
 (87) WO2012159960, 16.05.2012
 (97) 2709600, 26.03.2014 en
 (54) PHARMACEUTICAL COMPOSITION COMPRISING FEXOFENADINE
 (71) Aventis Pharmaceuticals Inc., 55 Corporate Drive, Bridgewater, NJ 08807, US
 (72) BADABHAGNI, Sudhakara Rao, c/o Sanofi Patent Department 54 rue La Boétie, 75008 Paris, FR
 JAISWAL, Nilesh, c/o Sanofi Patent Department 54 rue La Boétie, 75008 Paris, FR
 KHULLAR, Praveen, c/o Sanofi Patent Department 54 rue La Boétie, 75008 Paris, FR
 PRASAD, Kum, c/o Sanofi Patent Department 54 rue La Boétie, 75008 Paris, FR

- (51) MKP
A63B 21/068 (2006.01) (97) **2664363**
A63B 22/00 (2006.01)
A63B 22/20 (2006.01)
A63B 23/04 (2006.01)
 (96) 12168043.3 20.11.2013
 (97) 2664363, 20.11.2013 en
 (54) Exercise machine
 (71) Kieser Training AG, Hardstrasse 223, 8005 Zürich, CH
 (72) Kieser, Werner, Bergstrasse 65, 8006 Zürich, CH

- (51) MKP
A61B 5/0472 (2006.01) (97) **2676604**
 (96) 12290201.8 25.12.2013
 (97) 2676604, 25.12.2013 en
 (54) Real time QRS duration measurement in electrocardiogram
 (71) Texas Instruments France, 821 Avenue Jack Kilby, 06271 Villeneuve Loubet Cedex, FR
 Texas Instruments Incorporated, 12500 TI Boulevard, Dallas, Texas 75243, US
 (72) Zoicas, Vasile, 10 Jardins de l'étoile, La Gaude 06610, FR

- (51) MKP
A61K 39/395 (2006.01) (97) **2731625 ***
G01N 33/574 (2006.01)
 (86) US2012046746 13.07.2012
 (96) 12814264.3 21.05.2014
 (87) WO2013012747, 13.07.2012
 (97) 2731625, 21.05.2014 en
 (54) RSPO BINDING AGENTS AND USES THEREOF
 (71) OncoMed Pharmaceuticals, Inc., 800 Chesapeake Drive, Redwood City, CA 94063, US
 (72) GURNEY, Austin, L., 946 Diamond Street, San Francisco, CA 94114, US
 AXELROD, Fumiko, Takada, 3780 Wright Place, Palo Alto, CA 94306, US
 HOEY, Timothy, Charles, 200 Darrell Road, Hillsborough, CA 94010, US
 CHARTIER-COURTAUD, Cecile, 1357 Cowper Street, Palo Alto, CA 94301, US

- (51) MKP
G03H 1/04 (2006.01) (97) **2751621 ***
 (86) GB2012052138 31.08.2012
 (96) 12780517.4 09.07.2014
 (87) WO2013030586, 31.08.2012
 (97) 2751621, 09.07.2014 en
 (54) HOLOGRAM
 (71) The Secretary of State for Business, Innovation And Skills of Her Majesty's Britannic Government, 1 Victoria Street, London, Greater London SW1 0ET, GB
 (72) HALL, Simon Richard Geoffrey, c/o The Secretary of State for Business Innovation&Skills of Her Majesty's Britannic Government 1 Victoria Street, London SW1 0ET, GB
 STEVENS, Richard Frederick, c/o The Secretary of State for Business Innovation&Skills of Her Majesty's Britannic Government 1 Victoria Street, London SW1 0ET, GB

- (51) MKP
H04L 12/46 (2006.01) (97) **2749048 ***
H04L 29/08 (2006.01)
H04W 4/02 (2009.01)
H04W 4/20 (2009.01)
H04W 8/06 (2009.01)
H04W 12/00 (2009.01)
H04W 48/16 (2009.01)
H04W 64/00 (2009.01)
H04W 80/08 (2009.01)
 (86) US2012052148 23.08.2012
 (96) 12756296.5 02.07.2014
 (87) WO2013032872, 23.08.2012
 (97) 2749048, 02.07.2014 en
 (54) SECURE USER PLANE LOCATION (SUPL) REDIRECTION AND MOBILE LOCATION PROTOCOL (MLP) TUNNELING TO A DISCOVERED SLP
 (71) Qualcomm Incorporated, 5775 Morehouse Drive, San Diego, CA 92121-1714, US
 (72) EDGE, Stephen, William, 5775 Morehouse Drive, San Diego, California 92121, US
 WACHTER, Andreas, Klaus, 5775 Morehouse Drive, San Diego, California 92121, US

- (51) MKP
H01M 4/52 (2010.01) (97) **2737565 ***
 (86) US2012048148 25.07.2012
 (96) 12817837.3 04.06.2014
 (87) WO2013016426, 25.07.2012
 (97) 2737565, 04.06.2014 en
 (54) BLENDED CATHODE MATERIALS
 (71) A123 Systems Inc., 200 West Street, Waltham, Massachusetts 02451, US
 (72) YOON, Sang-Young, 7 Meeting House Circle, Bedford, MA 01730, US
 IOCCO, Rocco, 43 Sunset Drive, Beverly, MA, US
 CHO, Jeong, Ju, 508 Katahdin Drive, Lexington, MA 02420, US
 XU, Chuanjing, 331 South Zeeb Road 283, Ann Arbor, MI 48103, US

- (51) MKP
A61K 47/48 (2006.01) (97) **2723389 ***
A61P 35/00 (2006.01)
 (86) US2012043488 21.06.2012
 (96) 12762422.9 30.04.2014
 (87) WO2012177837, 21.06.2012
 (97) 2723389, 30.04.2014 en
 (54) NOVEL MAYTANSINOID DERIVATIVES WITH PEPTIDE LINKER AND CONJUGATES THEREOF
 (71) Immunogen, Inc., 830 Winter Street, Waltham, MA 02451, US
 (72) WIDDISON, Wayne, C., 7 Holden Road, Belmont, MA 02478, US

(51) MKP
C07K 16/28 (2006.01) (97) **2714739 ***
 (86) EP2012060345 01.06.2012
 (96) 12727814.1 09.04.2014
 (87) WO2012164063, 01.06.2012
 (97) 2714739, 09.04.2014 en
 (54) HUMANISED ANTI-CD52 ANTIBODIES
 (71) Antitope Limited, Babraham Institute, Babraham, Cambridge CB2 4AT, GB
 (72) JONES, Timothy David, 27 Brick Row Babraham, Cambridge Cambridgeshire CB22 3AJ, GB
 HOLTGATE, Robert George Edward, 96 Princess Mews, Royston Hertfordshire SG8 9BL, GB
 CARR, Francis Joseph, Birchlea the holdings, Balmedie Aberdeenshire AB23 8WU, GB

(51) MKP
A61K 31/422 (2006.01) (97) **2704712 ***
 (86) US2012035832 30.04.2012
 (96) 12779959.1 12.03.2014
 (87) WO2012151158, 30.04.2012
 (97) 2704712, 12.03.2014 en
 (54) ISOXAZOLINES AS THERAPEUTIC AGENTS
 (71) AbbVie Inc., 1 North Waukegan Road, North Chicago, IL 60064, US
 (72) CALDERWOOD, David J., 4 McCarthy Circle, Framingham Massachusetts 01702, US
 BREINLINGER, Eric C., 54 Hanson Road, Charlton Massachusetts 01507, US
 SWANN, Steven L., 11703 Vail Court, San Diego California 01702, US
 MUKHERJEE, Subhendu, 132/A/3, Thakurbari Street (Kokil Bagan) P.O. Srirampur, Hooghly W. Bengal 712201, IN
 CHITTY, Venkata Srikanth, S/O C.V.S.S Sastry H.NO: 7-109 Madhurapuri Colony Dilsukhnagar, Hyderabad Andhra Pradesh 500060, IN
 THUNUGUNTLA, Siva Sanjeeva Rao, H.NO: 52 Phase II Jaya Prakash Narayan Nagar Colony Miyapur, Hyderabad 500049 Andhra Pradesh, IN
 HOSAHALLI, Subramanya Seetharama Shastry, A 103, Temple Meadows 3 27th Cross Banashankari 2nd Stage, Bangalore 560070 Karnataka, IN

(51) MKP
H04B 3/54 (2006.01) (97) **2742602 ***
H05B 37/02 (2006.01)
 (86) IT2012000254 10.08.2012
 (96) 12781174.3 18.06.2014
 (87) WO2013021408, 10.08.2012
 (97) 2742602, 18.06.2014 en
 (54) TELECONTROL ENERGY-SAVING APPARATUS FOR SIMULTANEOUS TRANSMISSION OF MULTIPLE SIGNALS WITH POWERLINE TECHNOLOGY
 (71) Menghi, Alberto, Via Caduti di Marzabotto 13, 47922 Rimini (RN), IT
 Fuochi, Demos, Via A. Ascari, 23, 40026 Imola (BO), IT
 (72) MENGHI, Alberto, Via Caduti di Marzabotto, 13, I-47922 Rimini (RN), IT

(51) MKP
A61K 31/519 (2006.01) (97) **2682394**
A61K 31/522 (2006.01)
A61P 9/00 (2006.01)
C07D 487/04 (2006.01)
 (96) 13180880.0 08.01.2014
 (97) 2682394, 08.01.2014 de
 (54) 1H-pyrazolo[3,4-b]pyridin-triazine derivatives and their use for the treatment or the prevention of cardiovascular diseases
 (71) Bayer Intellectual Property GmbH, Alfred-Nobel-Strasse 10, 40789 Monheim, DE
 (72) Follmann, Markus, Rosmarinweg 28, 50859 Köln, DE
 Stasch, Johannes-Peter, Alfred Nobel Strasse 109, 42651 Sollingen, DE
 Redlich, Gorden, Schadowstrasse 50, 44799 Bochum, DE
 Ackerstaff, Jens, Christophstrasse 27, 40225 Düsseldorf, DE
 Griebenow, Nils, Kurfürstenstrasse 39, 41541 Dormagen, DE
 Knorr, Andreas, Trillser Graben 10, 40699 Erkrath, DE
 Wunder, Frank, Schwarzer Weg 251, 42117 Wuppertal, DE
 Min-Jian Li, Volkhart, Im Wiesengrund 40, 42553 Velbert, DE
 Kroh, Walter, Breuerweg 18, 42115 Wuppertal, DE
 Bärfacker, Lars, Walter-Flex-Strasse 29, 46047 Oberhausen, DE

(51) MKP
A61K 31/4015 (2006.01) (97) **2762138 ***
A61P 3/04 (2006.01)
A61P 7/10 (2006.01)
A61P 9/00 (2006.01)
A61P 25/00 (2006.01)
A61P 37/02 (2006.01)
A61P 39/06 (2006.01)
A61P 43/00 (2006.01)
C07D 201/00 (2006.01)
C07D 201/16 (2006.01)
C07D 201/18 (2006.01)
 (86) RU2012000773 20.09.2012
 (96) 12834473.6 06.08.2014
 (87) WO2013043085, 20.09.2012
 (97) 2762138, 06.08.2014 en
 (54) PHARMACEUTICAL SUBSTANCE (VARIANTS) AND COMPOSITIONS BASED THEREON WHICH EXHIBIT MODULATORY ACTIVITY WITH A COMMENSURATE EFFECT
 (71) Akhapkina, Valentina Ivanovna, ul. 5-aya Parkovaya, 33-24, 105264 Moscow, RU
 Akhapkin, Roman Vitalyevich, Bolshoy Afanasyevsky pereulok 6 kv. 56, Moscow 119019, RU
 (72) Akhapkina, Valentina Ivanovna, ul. 5-aya Parkovaya, 33-24, 105264 Moscow, RU
 Akhapkin, Roman Vitalyevich, Bolshoy Afanasyevsky pereulok 6 kv. 56, Moscow 119019, RU

(51) MKP
C12N 9/02 (2006.01) (97) **2723868 ***
C12N 9/04 (2006.01)
C12N 15/52 (2006.01)
C12N 15/81 (2006.01)
C12P 33/00 (2006.01)
 (86) EP2012061601 18.06.2012
 (96) 12728522.9 30.04.2014
 (87) WO2012175453, 18.06.2012
 (97) 2723868, 30.04.2014 en
 (54) PROCESS FOR PREPARING GENETICALLY TRANSFORMED YEASTS CAPABLE OF PRODUCING A MOLECULE OF INTEREST AT A HIGH TITRE
 (71) SANOFI, 54 rue La Boétie, 75008 Paris, FR
 (72) BROCARD-MASSON, Corinne, c/o Sanofi Patent Department 54 rue La Boétie, F-75008 Paris, FR
 BONNIN, Isabelle, c/o Sanofi Patent Department 54 rue La Boétie, F-75008 Paris, FR
 DUMAS, Bruno, c/o Sanofi Patent Department 54 rue La Boétie, F-75008 Paris, FR

(51) MKP
B65G 5/00 (2006.01) (97) **2764164 ***
E02D 17/00 (2006.01)
E21B 21/01 (2006.01)
 (86) US2012000501 05.10.2012
 (96) 12838227.2 13.08.2014
 (87) WO2013052133, 05.10.2012
 (97) 2764164, 13.08.2014 en
 (54) FLUID CONTAINMENT AND MANAGEMENT SYSTEM
 (71) D.A. Nolt Inc., 53 Cross Keys Road, Berlin, NJ 08009, US
 (72) NOLT, David, A., 53 Cross Keys Road, Berlin, NJ 08009, US

(51) MKP
C09K 8/60 (2006.01) (97) **2766448 ***
C11D 3/382 (2006.01)
 (86) US2012059770 11.10.2012
 (96) 12842757.2 20.08.2014
 (87) WO2013062782, 11.10.2012
 (97) 2766448, 20.08.2014 en
 (54) COMPOSITIONS AND METHODS USEFUL FOR OIL EXTRACTION
 (71) Greenstract LLC, 1500 Main Street Suite 2700, Springfield, Massachusetts 01115-5507, US
 (72) REHAGE, Peter, 789 Hazel Drive, South Lake Tahoe, California 96150, US

- (51) MKP
H04N 21/431 (2011.01) (97) **2761885 ***
 (86) AU2012001195 28.09.2012
 (96) 12836060.9 06.08.2014
 (87) WO2013044327, 28.09.2012
 (97) 2761885, 06.08.2014 en
 (54) CONTENT MANAGEMENT SYSTEMS, METHODS, APPARATUS AND USER INTERFACES
 (71) Transcity Group Pty Ltd, 44-48 Rocco Drive, Scoresby, VIC 3179, AU
 (72) ALFORD, James, 4507 169th Ave. SE, Bellevue, Washington 98006, US
 MCNAIR, David, 60 Creamery Road, Toolern Vale, Victoria 3337, AU

- (51) MKP
C07K 16/28 (2006.01) (97) **2756001 ***
 (86) GB2012052268 13.09.2012
 (96) 12775045.3 23.07.2014
 (87) WO2013038191, 13.09.2012
 (97) 2756001, 23.07.2014 en
 (54) ANTI-CD134 (OX40) ANTIBODIES AND USES THEREOF
 (71) BiocerOX Products B.V., Yalelaan 46, 3584 CM Utrecht, NL
 SIMONS, Petrus Johannes, Leidsestraat 43, NL-2182DH Hillegom, NL
 (72) BOON, Louis, Orchideelaan 137, NL-1171MG Badhoevedorp, NL

- (51) MKP
A61K 31/565 (2006.01) (97) **2714712 ***
A61P 15/12 (2006.01)
C07J 75/00 (2006.01)
 (86) EP2012060446 01.06.2012
 (96) 12729053.4 09.04.2014
 (87) WO2012164095, 01.06.2012
 (97) 2714712, 09.04.2014 en
 (54) PROCESS FOR THE PRODUCTION OF ESTETROL INTERMEDIATES
 (71) Estetra S.A., Rue du Travail 16, 4460 Grâce-Hollogne, BE
 (72) PASCAL, Jean-Claude, 170 avenue de Gairaut, 06100 Nice, FR

- (51) MKP
A01N 43/54 (2006.01) (97) **2760285 ***
 (86) US2013031055 13.03.2013
 (96) 13772420.9 06.08.2014
 (87) WO2013151708, 13.03.2013
 (97) 2760285, 06.08.2014 en
 (54) INDAZOLE INHIBITORS OF THE WNT SIGNAL PATHWAY AND THERAPEUTIC USES THEREOF
 (71) Samumed, LLC, 9381 Judicial Drive Suite 160, San Diego, California 92121, US
 (72) HOOD, John, 10831 Vereda Sol Del Dios, San Diego, CA 92130, US
 WALLACE, David, Mark, 6448 Peinado Way, San Diego, CA 92121, US
 KC, Sunil, Kumar, 10504 Clasico Court, San Diego, CA 92127, US

- (51) MKP
F02M 59/02 (2006.01) (97) **2742231 ***
F02M 59/44 (2006.01)
F04B 1/04 (2006.01)
 (86) EP2012064209 19.07.2012
 (96) 12735582.4 18.06.2014
 (87) WO2013020789, 19.07.2012
 (97) 2742231, 18.06.2014 en
 (54) FUEL PUMP
 (71) Delphi International Operations Luxembourg S.à.r.l., Avenue de Luxembourg, 4940 Bascharage, LU
 (72) NAVAS SANCHEZ, Borja, Flat 4 95-97 High Street, Chatham Kent ME4 4DL, GB

- (51) MKP
D06F 95/00 (2006.01) (97) **2631358**
 (96) 13156214.2 28.08.2013
 (97) 2631358, 28.08.2013 en
 (54) Multi compartment bag
 (71) Jeppesen, Johnny Agaton, Skovvangsvej 31 Strobyegede, 4600 Koge, DK
 Jeppesen, Anne Marie Dorthea, Skovvangsvej 31 Strobyegede, 4600 Koge, DK
 (72) Jeppesen, Johnny Agaton, Skovvangsvej 31 Strøbyegede, 4600 Køge, DK

- (51) MKP
A61K 39/00 (2006.01) (97) **2662386**
C07K 16/18 (2006.01)
 (96) 12003552.2 13.11.2013
 (97) 2662386, 13.11.2013 en
 (54) Antibodies that bind to PLAC1 and block interaction between PLAC1 and FGF7
 (71) BioNTech AG, Hölderlinstrasse 8, 55131 Mainz, DE
 TRON - Translationale Onkologie an der Universitätsmedizin der Johannes Gutenberg- Universität Mainz gemeinnützige GmbH, Langenbeckstrasse 1, 55131 Mainz, DE
 Universitätsmedizin der Johannes Gutenberg-Universität Mainz, Langenbeckstraße 1, 55131 Mainz, DE
 (72) Sahin, Ugur, Philipp-von-Zabern-Platz 1, 55116 Mainz, DE
 Koslowski, Michael, Autogenstrasse 50, 65933 Frankfurt, DE
 Grimmler, Matthias, Anlagenweg 17, 65604 Elz, DE
 Barea Roldán, Diana, Sprendlinger Land Strasse 86, 63069 Offenbach, DE
 Hartmann, Christoph, Feststrasse 17, 60316 Frankfurt, DE
 Hubich, Stefanie, Peter-Cornelius-Platz 6, 55118 Mainz, DE

- (51) MKP
A61B 17/072 (2006.01) (97) **2517646**
 (96) 12166181.3 31.10.2012
 (97) 2517646, 31.10.2012 en
 (54) Compressible staple cartridge assembly
 (71) Ethicon Endo-Surgery, Inc., 4545 Creek Road, Cincinnati, OH 45242, US
 (72) Shelton, IV, Frederick E., 245 East Main Street, Hillsboro, OH Ohio 45133, US
 Baxter, III, Chester O., 6375 Pawnee Ridge, Loveland, OH Ohio 45140, US
 Aronhalt, Taylor W., 306 Beech Road, Loveland, OH Ohio 45140, US
 Young, Joseph E., 9523 Carroll Court, Loveland, OH Ohio 45140, US

- (51) MKP
A01K 31/04 (2006.01) (97) **2638799**
 (96) 13158651.3 18.09.2013
 (97) 2638799, 18.09.2013 en
 (54) Machine for cleaning barns for farming birds
 (71) Poddi, Roberto, Via Canapa, 21/A, 44100 Ferrara, IT
 Chiari, Andrea, Via Rodari, 8, 46035 Ostiglia (Mantova), IT
 (72) Poddi, Roberto, Via Canapa, 21/A, 44100 Ferrara, IT
 Chiari, Andrea, Via Rodari, 8, 46035 Ostiglia (Mantova), IT

(51) MKP
A61K 47/48 (2006.01) (97) **2760475 ***
C07K 14/50 (2006.01)
(86) US2012057384 26.09.2012
(96) 12768999.0 06.08.2014
(87) WO2013049247, 26.09.2012
(97) 2760475, 06.08.2014 en
(54) FUSION PROTEINS FOR TREATING METABOLIC DISORDERS
(71) Novartis AG, Lichtstrasse 35, 4056 Basel, CH
(72) BOETTCHER, Brian R., Novartis Institutes for BioMedical Research, Inc. 100 Technology Square, Cambridge, MA 02139, US
CAPLAN, Shari L., Novartis Institutes for BioMedical Research, Inc. 100 Technology Square, Cambridge, MA 02139, US
DANIELS, Douglas S., Novartis Institutes for BioMedical Research, Inc. 100 Technology Square, Cambridge, MA 02139, US
HAMAMATSU, Norio, Novartis Institutes for BioMedical Research, Inc. 100 Technology Square, Cambridge, MA 02139, US
LICHT, Stuart, Novartis Institutes for BioMedical Research, Inc. 100 Technology Square, Cambridge, MA 02139, US
WELDON, Stephen Craig, Novartis Institutes for BioMedical Research, Inc. 100 Technology Square, Cambridge, MA 02139, US

(51) MKP
A01H 1/08 (2006.01) (97) **2723164 ***
A01H 5/10 (2006.01)
(86) IL2012050211 19.06.2012
(96) 12738222.4 30.04.2014
(87) WO2012176203, 19.06.2012
(97) 2723164, 30.04.2014 en
(54) COMMON WHEAT, PLANTS OR PARTS THEREOF HAVING PARTIALLY OR FULLY MULTIPLIED GENOME, HYBRIDS AND PRODUCTS THEREOF AND METHODS OF GENERATING AND USING SAME
(71) Kaima Bio Agritech Ltd., P.O. Box 508, 1524100 Kfar-Tavor, IL
(72) AVIDOV, Amit, 21 Hana Senesh Street, 3603621 Kiryat-Tivon, IL
LERNER, Alon, Moshav Sharon, 1523200 Doar-Na Galil Tachton, IL
LUPO, Itamar, Moshav Elad, 1292700 Doar-Na Ramat HaGolan, IL

(51) MKP
A61J 1/14 (2006.01) (97) **2662065**
A61J 1/16 (2006.01)
B65B 21/00 (2006.01)
B65D 77/04 (2006.01)
(96) 13164845.3 13.11.2013
(97) 2662065, 13.11.2013 de
(54) Blinding device
(71) Fisher Clinical Services GmbH, Steinbühlweg 69, 4123 Allschwil, CH
(72) Hunkeler, Guido, Bruckmattweg 11, 4124 Schönenbuch, CH
Spettli, Jörg, Tumringerstrasse 287a, 79539 Lörrach, DE

(51) MKP
D01F 6/00 (2006.01) (97) **2723926 ***
(86) US2012044327 27.06.2012
(96) 12804785.9 30.04.2014
(87) WO2013003418, 27.06.2012
(97) 2723926, 30.04.2014 en
(54) FIBER MATS COATED WITH NANOGRID VISIBLE SPECTRUM PHOTOCATALYSTS
(71) The Research Foundation Of State University Of New York, 35 State Street, Albany, NY 12207, US
(72) GOUMA, Perena, 4 Vantage Court, Port Jefferson, NY 11777-2237, US
LEE, Jusang, 350 Circle Road Schomburg B311d, Stony Brook, NY 11790, US

(51) MKP
A61K 39/00 (2006.01) (97) **2726094 ***
(86) IB2012001680 28.06.2012
(96) 12770215.7 07.05.2014
(87) WO2013001369, 28.06.2012
(97) 2726094, 07.05.2014 en
(54) THERAPEUTIC AND DIAGNOSTIC TARGET
(71) Oxford Biotherapeutics Ltd., 94A Milton Park, Abingdon, Oxon OX14 4RY, GB
(72) ROHLFF, Christian, Oxford Biotherapeutics Ltd. 94a Milton Park, Abingdon Oxon OX14 4RY, GB
STAMPS, Alasdair, 94a Milton Park, Abingdon Oxon OX14 4RY, GB

(51) MKP
B29C 33/38 (2006.01) (97) **2753592 ***
C04B 28/00 (2006.01)
(86) CZ2012000088 29.08.2012
(96) 12766572.7 16.07.2014
(87) WO2013034117, 29.08.2012
(97) 2753592, 16.07.2014 en
(54) METHOD OF MAKING A PRODUCT WITH A FUNCTIONAL RELIEF SURFACE WITH HIGH RESOLUTION
(71) IQ Structures S.r.o., Na Hlinkach 199, 250 68 Husinec - Rez, CZ
(72) TETHAL, Tomas, Na Hlinkach 199, 250 68 Husinec - Rez, CZ
STEINEROVA, Michaela, Listopadova 282, 190 12 Praha 9, CZ

(51) MKP
C08L 23/04 (2006.01) (97) **2682424**
C08L 23/10 (2006.01)
(96) 13175262.8 08.01.2014
(97) 2682424, 08.01.2014 de
(54) Use of a polymer composition
(71) REHAU AG + Co, Otto-Hahn-Strasse 2, 95111 Rehau, DE
(72) Kania, Guido, Schlossweg 43, 91080 Marloffstein, DE

(51) MKP
A61K 9/24 (2006.01) (97) **2755641 ***
(86) US2012055574 14.09.2012
(96) 12831258.4 23.07.2014
(87) WO2013040457, 14.09.2012
(97) 2755641, 23.07.2014 en
(54) CONTROLLED DOSING OF CLOPIDOGREL WITH GASTRIC ACID INHIBITION THERAPIES
(71) Pozen, Inc., 1414 Rayleigh Road, Suite 400, Chapel Hill, NC 27517, US
(72) PLACHETKA, John, R., 321 Silver Creek Trail, Chapel Hill, NC 27514, US

(51) MKP
A61K 31/17 (2006.01) (97) **2726088 ***
A61K 31/435 (2006.01)
A61K 38/00 (2006.01)
A61K 39/00 (2006.01)
G01N 33/50 (2006.01)
G01N 33/574 (2006.01)
(86) US2012044673 28.06.2012
(96) 12737394.2 07.05.2014
(87) WO2013003606, 28.06.2012
(97) 2726088, 07.05.2014 en
(54) PREDICTIVE BIOMARKER OF SURVIVAL IN THE TREATMENT OF RENAL CELL CARCINOMA
(71) Amgen Inc., One Amgen Center Drive, Thousand Oaks, CA 91320-1799, US
(72) ANDERSON, Abraham, Antonio, 3494 Woodcliff Road, Sherman Oaks, California 91403, US
WEINREICH, David, M., 128 S. Stone-Hedge Dr., Basking Ridge, New Jersey 07920, US

- (51) MKP
H01M 8/02 (2006.01) (97) **2337132**
H01M 8/24 (2006.01)
(96) 10180696.6 22.06.2011
(97) 2337132, 22.06.2011 en
(54) Modularized fuel cell devices and fluid flow plate assemblies
(71) Industrial Technology Research Institute, No. 195, Sec. 4, Chung Hsing Road, Chutung., Hsinchu 31040, TW
(72) Chen, Chi-Chang, No. 180, Sec. 2, Yuanlu Rd. Puxin Township, 513, Taiwan, Changhua County, TW
Shiu, Huan-Ruei, No. 39, Donghu Village Cimei Township, 883, Taiwan, Penghu County, TW
Chang, Wen-Chen, 4F., No. 892, Sec. 4, Zhongxing Rd., Zhudong Town, 310, Taiwan, Hsinchu County, TW
Tsau, Fanghei, 4F., No. 6, Lane 54, Siwei 2nd Rd., Lingya Dist., 802, Taiwan, Kaohsiung City, TW
Wu, Chun-Hsing, 1F., No. 10, Alley 3, Lane 183, Sec. 1, Heping E. Rd. Da-an District, 106, Taiwan, Taipei City, TW

- (51) MKP
A61K 31/4985 (2006.01) (97) **2710006 ***
A61P 29/00 (2006.01)
C07D 487/04 (2006.01)
(86) US2012038120 16.05.2012
(96) 12723576.0 26.03.2014
(87) WO2012158785, 16.05.2012
(97) 2710006, 26.03.2014 en
(54) AZAINDOLE DERIVATIVES AS TYROSINE KINASE INHIBITORS
(71) Principia Biopharma Inc., 400 East Jamie Court, Suite 302, So. San Francisco, California 94080, US
(72) GOLDSTEIN, David Michael, 122 Danbury Lane, Redwood City California 94061, US
BRAMELD, Kenneth Albert, 345 Camino Al Lago, Menlo Park California 94027, US
VERNER, Erik, 1521 Notre Dame Ave., Belmont California 94002, US

- (51) MKP
A01K 67/027 (2006.01) (97) **2739740 ***
C07K 16/46 (2006.01)
C12N 9/64 (2006.01)
C12N 15/85 (2006.01)
(86) US2012049600 03.08.2012
(96) 12746246.3 11.06.2014
(87) WO2013022782, 03.08.2012
(97) 2739740, 11.06.2014 en
(54) HUMANIZED UNIVERSAL LIGHT CHAIN MICE
(71) Regeneron Pharmaceuticals, Inc., 777 Old Saw Mill River Road, Tarrytown, NY 10591, US
(72) MCWHIRTER, John, 2035 Crescent Drive, Tarrytown, NY 10591, US
MACDONALD, Lynn, 16 Gedney Way, White Plains, NY 10591, US
STEVENS, Sean, 355 Berry Street 413, San Francisco, CA 94158, US
DAVIS, Samuel, 332 West 88th Street Apt. B2, New York, NY 10024, US
BUCKLER, David, R., 6 Erick Court, Chester, NJ 07930, US
HOSIAWA, Karolina, A., 14 Church Street 2nd Floor, Tarrytown, NY 10591, US
MURPHY, Andrew, J., 10 Newton Court, Croton-on-hudson, NY 10520, US

- (51) MKP
A61B 17/115 (2006.01) (97) **2524659**
(96) 12168734.7 21.11.2012
(97) 2524659, 21.11.2012 en
(54) Reusable circular stapler handle with open assembly architecture
(71) Ethicon Endo-Surgery, Inc., 4545 Creek Road, Cincinnati, OH 45242, US
(72) Nalagatta, Anil K., 6581 Gove Court, Mason, Ohio 45040, US
Jamison, Barry Thomas, 2353 Brickhouse Lane, Fairfield, Ohio 45014, US
Pradhan, Debasish, S/o Surendra Mohan Pradhan At/Po Kamalibazar Samabalpur, 7680003 Orissa, IN
Deupree, David A., 3395 Strata Court, Mason, Ohio 45040, US
Sofi, Abdul Gani, P/O Soibugh Tehsil/District Budgam, 191111 Jammu and Kashmir, IN

- (51) MKP
C07K 16/30 (2006.01) (97) **2718327 ***
(86) US2012000274 06.06.2012
(96) 12729758.8 16.04.2014
(87) WO2012170071, 06.06.2012
(97) 2718327, 16.04.2014 en
(54) MCAM ANTAGONISTS AND METHODS OF TREATMENT
(71) Neotope Biosciences Limited, 25-28 Nrth Wall Quay, Dublin 1, IE
(72) FLANAGAN, Kenneth, 180 Oyster Point Boulevard, South San Francisco, CA 94080, US
JOHNSTON, Jennifer, 180 Oyster Point Boulevard, South San Francisco, CA 94080, US
YEDNOCK, Theodore, 180 Oyster Point Boulevard, South San Francisco, CA 94080, US
BAKER, Jeanne, 180 Oyster Point Boulevard, South San Francisco, CA 94080, US

- (51) MKP
C30B 11/00 (2006.01) (97) **2714968 ***
C30B 13/00 (2006.01)
C30B 13/10 (2006.01)
C30B 29/28 (2006.01)
(86) FR2012051136 22.05.2012
(96) 12731036.5 09.04.2014
(87) WO2012160306, 22.05.2012
(97) 2714968, 09.04.2014 fr
(54) PROCESS FOR THE GROWTH OF A CRYSTALLINE SOLID, ASSOCIATED CRYSTALLINE SOLID AND DEVICE
(71) Ecole Polytechnique, Route de Saclay, 91120 Palaiseau, FR
(72) CHANTELOUP, Jean-Christophe, 17 rue Emile Zola, F-91400 Saclay, FR
ANANYAN, Narine, 29a rue Gyulbenkyan apt 33, Erevan 375033, AM
GEVORGYAN, Vladimir, 7/2 rue Komitas apt 34, Erevan 375000, AM
ARZAKANTSYAN, Mikayel, 57 boulevard Jourdan, F-75014 Paris, FR

- (51) MKP
H02G 9/02 (2006.01) (97) **2530799**
H02G 15/04 (2006.01)
(96) 12003803.9 05.12.2012
(97) 2530799, 05.12.2012 de
(54) Device for sealing the end of a cable protection tube
(71) gabo Systemtechnik GmbH, Am Schaidweg 7, 94559 Niederwinkling, DE
(72) Geiger, Alexander, Birkenweg 3, 94559 Niederwinkling, DE
Lederer, Roland, Tassilostrasse 5, 94374 Schwarzach, DE
Karl, Markus, Degernbach 62, 94327 Bogen, DE

- (51) MKP
A23K 1/16 (2006.01) (97) **2717713 ***
A23K 1/175 (2006.01)
A23L 1/304 (2006.01)
A23L 1/305 (2006.01)
(86) US2011049262 26.08.2011
(96) 11757709.8 16.04.2014
(87) WO2012170055, 26.08.2011
(97) 2717713, 16.04.2014 en
(54) MIXED AMINO ACID METAL SALT COMPLEXES
(71) Zinpro Corporation, 10400 Viking Drive, Suite 240, Eden Prairie, MN 55344-7232, US
(72) STARK, Peter, A., 10400 Viking Drive Suite 240, Eden Prairie, Minnesota 55344-7232, US

(51) MKP
A61K 31/427 (2006.01) (97) **2755970 ***
A61P 9/06 (2006.01)
A61P 9/10 (2006.01)
C07D 417/12 (2006.01)
C07D 417/14 (2006.01)
C07D 471/04 (2006.01)
C07D 487/04 (2006.01)
(86) EP2012067622 10.09.2012
(96) 12756214.8 23.07.2014
(87) WO2013037724, 10.09.2012
(97) 2755970, 23.07.2014 en
(54) SUBSTITUTED 2-(CHROMAN-6-YLOXY)-THIAZOLES AND THEIR USE AS PHARMACEUTICALS
(71) SANOFI, 54 rue La Boétie, 75008 Paris, FR
(72) CZECHTIZKY, Werngard, c/o Sanofi-Aventis Deutschland GmbH, 65926 Frankfurt am Main, DE
WESTON, John, c/o Sanofi-Aventis Deutschland GmbH, 65926 Frankfurt am Main, DE
RACKELMANN, Nils, c/o Sanofi-Aventis Deutschland GmbH, 65926 Frankfurt am Main, DE
PODESCHWA, Michael, c/o Sanofi-Aventis Deutschland GmbH, 65926 Frankfurt am Main, DE
ARNDT, Petra, c/o Sanofi-Aventis Deutschland GmbH, 65926 Frankfurt am Main, DE
WIRTH, Klaus, c/o Sanofi-Aventis Deutschland GmbH, 65926 Frankfurt am Main, DE
GOEGELEIN, Heinz, c/o Sanofi-Aventis Deutschland GmbH, 65926 Frankfurt am Main, DE
RITZELER, Olaf, c/o Sanofi-Aventis Deutschland GmbH, 65926 Frankfurt am Main, DE
KRAFT, Volker, c/o Sanofi-Aventis Deutschland GmbH, 65926 Frankfurt am Main, DE
BELLEVERGUE, Patrice, c/o SANOFI Département Brevets 54 rue La Boétie, F-75008 Paris, FR
McCort, Gary, c/o SANOFI Département Brevets 54 rue La Boétie, F-75008 Paris, FR

(51) MKP
C40B 50/14 (2006.01) (97) **2748357 ***
C40B 50/16 (2006.01)
(86) US2012054228 07.09.2012
(96) 12830083.7 02.07.2014
(87) WO2013036810, 07.09.2012
(97) 2748357, 02.07.2014 en
(54) METHODS FOR TAGGING DNA-ENCODED LIBRARIES
(71) X-Chem, Inc., 100 Beaver Street, Suite 101, Waltham, Massachusetts 02453, US
(72) KEEFE, Anthony, D., 9 Bellis Circle, 6, Cambridge, MA 02140, US
WAGNER, Richard, W., 24 Coolidge Avenue, Cambridge, MA 02138, US
LITOVCHICK, Alexander, 468 Dutton Road, Sudbury, MA 01776, US
CLARK, Matthew, 36 Clelland Road, Lexington, MA 02421, US
CUOZZO, John, W., 106 Bacon Street, Natick, MA 01760, US
CENTRELLA, Paolo A., 17 Alcott Street, Acton, MA 01720, US
ZHANG, Ying, 84 Winter Street, Lexington, MA 02420, US
HUPP, Christopher D., 30 Millwood Drive, Shrewsbury, MA 01545, US

(51) MKP
A61K 9/00 (2006.01) (97) **2644189**
A61K 47/10 (2006.01)
(96) 12183276.0 02.10.2013
(97) 2644189, 02.10.2013 en
(54) Stable bortezomib formulations
(71) Innopharma, Inc., 10 Knightsbridge Road, Piscataway, New Jersey 08854, US
(72) Soppimath, Kumaresh, 8101 Timberline CT, Monmouth, NJ New Jersey 08852, US
Pejaver, Satish, 49 Huntley Way, Bridgewater, NJ New Jersey 08807, US
Patel, Kanaiyalal R., 252 Burroughs Terrace, Union, NJ New Jersey 07083, US
Dasaradhi, Lakkaraju, 14, Normandy Drive, Princeton Junction, NJ New Jersey 08550, US
Sodum, Rama, 4424 Sayre Drive, Princeton, NJ New Jersey 08540, US
Desu, Hari, 5105, Fox Run Drive, Plainsboro, NJ New Jersey 08536, US
Puri, Navneet, 33 Francis Drive, Bridgewater, NJ New Jersey 08807, US

(51) MKP
A01N 57/00 (2006.01) (97) **2763539 ***
(86) US2012058595 04.10.2012
(96) 12838132.4 13.08.2014
(87) WO2013052568, 04.10.2012
(97) 2763539, 13.08.2014 en
(54) ANTIBACTERIAL COMPOUNDS
(71) Glaxo Group Limited, 980 Great West Road, Brentford, Middlesex TW8 9GS, GB
Shionogi & Co., Ltd., 1-8, Doshomachi 3-chome Chuo-ku, Osaka-shi, Osaka 541-0045, JP
(72) LIAO, Xiangmin, 1250 South Collegeville Road., Collegeville, PA 19426, US
PEARSON, Neil David, 1250 South Collegeville Road., Collegeville, PA 19426, US
PENDRAK, Israil, 1250 South Collegeville Road., Collegeville, PA 19426, US
SANO, Masayuki, 3-1-1, Futaba-cho., Toyonaka-shi, Osaka, 561-0825, JP

(51) MKP
A62B 35/00 (2006.01) (97) **2670492 ***
A62B 35/04 (2006.01)
(86) EP2012051740 02.02.2012
(96) 12702251.5 11.12.2013
(87) WO2012104368, 02.02.2012
(97) 2670492, 11.12.2013 de
(54) SAFETY HARNESS
(71) Wobben Properties GmbH, Dreekamp 5, 26605 Aurich, DE
(72) GÖPFERT, Heinrich, Kapitän-Altmeppen-Straße 8, 26871 Papenburg, DE
GIMMERTHAL, Mike, Esenser Landstraße 5, 26607 Aurich, DE

(51) MKP
H01F 27/245 (2006.01) (97) **2693604**
H01F 27/26 (2006.01)
H02K 1/12 (2006.01)
H02K 1/14 (2006.01)
H02K 1/22 (2006.01)
H02K 15/02 (2006.01)
(96) 13178289.8 05.02.2014
(97) 2693604, 05.02.2014 en
(54) Element for lamination of an electrical machine, lamination made of said elements and method and apparatus for its manufacture
(71) Veco S.P.A., Via Enrico Mattei, 453, 37040 Bevilacqua (VR), IT
(72) Concato, Piergiuseppe, Via Conche, 35/A, 36071 ARZIGNANO (VI), IT

(51) MKP
A01N 47/00 (2006.01) (97) **2725908 ***
 (86) US2012044928 29.06.2012
 (96) 12805087.9 07.05.2014
 (87) WO2013003720, 29.06.2012
 (97) 2725908, 07.05.2014 en
 (54) PERIPHERALLY ACTING OPIOID COMPOUNDS
 (71) Alkermes, Inc., 852 Winter Street, Waltham, MA 02451, US
 (72) BLUMBERG, Laura, Cook, 37 Mill Street, Lincoln, MA 01773, US
 ARNELLE, Derrick, 54 Milton Street, Arlington, MA 02474, US

(51) MKP
A61K 31/137 (2006.01) (97) **2723330 ***
A61K 31/164 (2006.01)
A61K 31/4174 (2006.01)
A61K 31/4178 (2006.01)
A61K 31/505 (2006.01)
A61K 31/573 (2006.01)
A61K 31/592 (2006.01)
A61K 31/593 (2006.01)
A61K 31/728 (2006.01)
A61K 45/06 (2006.01)
A61P 11/02 (2006.01)
A61P 27/02 (2006.01)
 (86) EP2012003524 19.08.2012
 (96) 12750533.7 30.04.2014
 (87) WO2013026557, 19.08.2012
 (97) 2723330, 30.04.2014 de
 (54) VASOCONSTRICTOR-CONTAINING AGENT FOR COMBINATION THERAPY
 (71) Maria Clementine Martin Klosterfrau Vertriebsgesellschaft mbH, Gereonsmühlengasse 1-11, 50670 Köln, DE
 (72) GREVE, Harald, Schorlemerstraße 3a, 40545 Düsseldorf, DE

(51) MKP
C07C 231/00 (2006.01) (97) **2705023 ***
 (86) IN2011000003 04.01.2011
 (96) 11854945.0 12.03.2014
 (87) WO2012093402, 04.01.2011
 (97) 2705023, 12.03.2014 en
 (54) PROCESSES FOR THE PREPARATION OF N-[2-(7-METHOXY-1-NAPHTHYL)ETHYL]ACETAMIDE
 (71) Symed Labs Limited, 8-3-166/6 & 7 II Floor Sree Arcade Erragadda, Hyderabad 500 018 Andhra Pradesh, IN
 (72) MOHAN RAO, Dodda, 8-2-293/82/A/202 D.No.: 202 opp. Jubilee International Club Road No.: 14 Jubilee Hills, Hyderabad 500033 Andhra Pradesh, IN
 KRISHNA REDDY, Pingili, H.No.: 13-1-183/1 Plot No. 69 Snehapuri Colony Borabanda, Hyderabad 500018 Andhra Pradesh, IN
 ANNA REDDY, Ambati, H.No.: 1-118 Kachapur Shankarapatnam, Karimnagar 505470 Andhra Pradesh, IN

(51) MKP
A61K 39/395 (2006.01) (97) **2766395 ***
C07K 16/28 (2006.01)
 (86) US2012059977 12.10.2012
 12775423.2 20.08.2014
 (96) WO2013056068, 12.10.2012
 (87) 2766395, 20.08.2014 en
 (97) ANTIBODY POLYPEPTIDES THAT ANTAGONIZE CD40L
 (54) Bristol-Myers Squibb Company, Route 206 & Province Line Road, Princeton, NJ 08543, US
 Domantis Limited, 980 Great West Road, Brentford, Middlesex TW8 9GS, GB
 (72) NADLER, Steven G., c/o Bristol-Myers Squibb Company Route 206&Province Line Road, Princeton, New Jersey 08543, US
 TAMURA, James K., c/o Bristol-Myers Squibb Company Route 206&Province Line Road, Princeton, New Jersey 08543, US
 PRICE, Laura, c/o Bristol-Myers Squibb Company Route 206&Province Line Road, Princeton, New Jersey 08543, US
 REHFUSS, Robert P., c/o Bristol-Myers Squibb Company Route 206&Province Line Road, Princeton, New Jersey 08543, US
 SUCHARD, Suzanne J., c/o Bristol-Myers Squibb Company Route 206&Province Line Road, Princeton, New Jersey 08543, US
 SURI, Anish, c/o Bristol-Myers Squibb Company Route 206&Province Line Road, Princeton, New Jersey 08543, US
 BRYSON, James William, c/o Bristol-Myers Squibb Company Route 206&Province Line Road, Princeton, New Jersey 08543, US
 YAMNIUK, Aaron, c/o Bristol-Myers Squibb Company Route 206&Province Line Road, Princeton, New Jersey 08543, US
 GRANT, Steven, c/o Domantis Limited 315 Cambridge Science Park, Cambridge Cambridgeshire CB4 0WG, GB
 IGNATOVICH, Olga, c/o Domantis Limited 315 Cambridge Science Park, Cambridge Cambridgeshire CB4 0WG, GB
 DREW, Philip, c/o Domantis Limited 315 Cambridge Science Park, Cambridge Cambridgeshire CB4 0WG, GB

(51) MKP
E21B 7/30 (2006.01) (97) **2757296**
F16L 1/036 (2006.01)
F16L 55/165 (2006.01)
 (96) 13000303.1 23.07.2014
 (97) 2757296, 23.07.2014 en
 (54) Method and system for replacement of existing pipes.
 (71) Scandinavian No-Dig Centre ApS, Duedal 70, 9230 Svenstrup, DK
 (72) Nielsen, Jesper, Duedal 70, 9230 Svenstrup, DK
 Nielsen, Søren, Duedal 70, 9230 Svenstrup, DK

(51) MKP
C02F 3/00 (2006.01) (97) **2726417 ***
C02F 3/22 (2006.01)
C02F 3/26 (2006.01)
C02F 3/30 (2006.01)
 (86) IT2012000199 27.06.2012
 (96) 12753827.0 07.05.2014
 (87) WO2013001554, 27.06.2012
 (97) 2726417, 07.05.2014 en
 (54) SEWAGE WATER DEPURATION PLANT, COMPRISING A VERTICAL REACTOR, WITH IMPROVED NITROGEN TREATMENT
 (71) H.C. Development S.r.l., Corso di Francia 243, 00191 Roma, IT
 (72) PICCOLI Massimo, H.C. Development S.r.l. Via E. Duse 53, I-00197 Roma, IT
 DE FERRANTE Ranieri, H.C. Development S.r.l. Via E. Duse 53, I-00197 Roma, IT

(51) MKP
A61K 31/437 (2006.01) (97) **2716642 ***
A61K 31/439 (2006.01)
A61K 31/444 (2006.01)
A61K 31/4545 (2006.01)
A61K 31/496 (2006.01)
A61K 31/497 (2006.01)
A61K 31/501 (2006.01)
A61K 31/506 (2006.01)
A61K 31/53 (2006.01)
A61K 31/5377 (2006.01)
A61K 31/541 (2006.01)
A61P 7/02 (2006.01)
A61P 9/00 (2006.01)
A61P 9/04 (2006.01)
A61P 9/10 (2006.01)
A61P 9/12 (2006.01)
A61P 15/10 (2006.01)
A61P 43/00 (2006.01)
C07D 471/04 (2006.01)
C07D 519/00 (2006.01)
(86) JP2012063695 29.05.2012
(96) 12791965.2 09.04.2014
(87) WO2012165399, 29.05.2012
(97) 2716642, 09.04.2014 en
(54) IMIDAZOPYRIDINE COMPOUND
(71) Astellas Pharma Inc., 3-11 Nihonbashi-Honcho 2-chome Chuo-ku, Tokyo 103-8411, JP
(72) KOGA, Yuji, c/o Astellas Pharma Inc. 3-11 Nihonbashi-Honcho 2-chome Chuo-ku, Tokyo 103-8411, JP
MAENO, Kyoichi, c/o Astellas Pharma Inc. 3-11 Nihonbashi-Honcho 2-chome Chuo-ku, Tokyo 103-8411, JP
SATO, Ippei, c/o Astellas Pharma Inc. 3-11 Nihonbashi-Honcho 2-chome Chuo-ku, Tokyo 103-8411, JP
IMAMURA, Yoshimasa, c/o Astellas Pharma Inc. 3-11 Nihonbashi-Honcho 2-chome Chuo-ku, Tokyo 103-8411, JP
HANAZAWA, Takeshi, c/o Astellas Pharma Inc. 3-11 Nihonbashi-Honcho 2-chome Chuo-ku, Tokyo 103-8411, JP
IIDA, Maiko, c/o Astellas Pharma Inc. 3-11 Nihonbashi-Honcho 2-chome Chuo-ku, Tokyo 103-8411, JP
OHNE, Kazuhiko, c/o Astellas Pharma Inc. 3-11 Nihonbashi-Honcho 2-chome Chuo-ku, Tokyo 103-8411, JP
IMAMURA, Kenichiro, c/o Astellas Pharma Inc. 3-11 Nihonbashi-Honcho 2-chome Chuo-ku, Tokyo 103-8411, JP
WATANABE, Tsubasa, c/o Astellas Pharma Inc. 3-11 Nihonbashi-Honcho 2-chome Chuo-ku, Tokyo 103-8411, JP
NOZAWA, Eisuke, c/o Astellas Pharma Inc. 3-11 Nihonbashi-Honcho 2-chome Chuo-ku, Tokyo 103-8411, JP
SHIBATA, Hiroshi, c/o Astellas Pharma Inc. 3-11 Nihonbashi-Honcho 2-chome Chuo-ku, Tokyo 103-8411, JP

(51) MKP
C07D 303/36 (2006.01) (97) **2705028 ***
C07D 413/10 (2006.01)
C07D 413/14 (2006.01)
(86) HU2012000033 04.05.2012
(96) 12731645.3 12.03.2014
(87) WO2012153155, 04.05.2012
(97) 2705028, 12.03.2014 en
(54) PROCESS FOR THE PREPARATION OF A RIVAROXABAN AND INTERMEDIATES FORMED IN SAID PROCESS
(71) Egis Gyógyszergyár Nyilvánosan Működő Részvénytársaság, Keresztúri út 30-38, 1106 Budapest, HU
(72) SIPOS, Éva, Magyarhida u. 47, H-1172 Budapest, HU
KOVÁNYINÉ LAX, Györgyi, Mogyoródi út. 110, H-1141 Budapest, HU
HAVASI, Balázs, Felvidék u. 59, H-1202 Budapest, HU
VOLK, Balázs, Pilisí u. 54, H-1106 Budapest, HU
KRASZNAI, György, XIII u. 38, H-1172 Budapest, HU
RUZSICS, György, Bókay János u. 56, H-1083 Budapest, HU
BARKÓCZY, József, Szirom u. 4-6, H-1016 Budapest, HU
TÓTHNÉ LAURITZ, Mária, Venetiánér u. 4/a, H-1042 Budapest, HU
LUKÁCS, Gyula, Bronz u. 5, H-1163 Budapest, HU
BOZA, András, Bán u. 6-8 II/7, H-1123 Budapest, HU
HEGEDŰS, László József, Széchenyi u. 50, H-2234 Maglód, HU
TÁBORINE TÓTH, Mária Júlia, Balassi B. út 30, H-2251 Tápiószecső, HU
PÉCSI, Éva, Haller u. 80, H-1096 Budapest, HU

(51) MKP
F02M 63/00 (2006.01) (97) **2647826**
(96) 12163288.9 09.10.2013
(97) 2647826, 09.10.2013 en
(54) Valve arrangement
(71) Delphi International Operations Luxembourg S.à.r.l., Avenue de Luxembourg, 4940 Bascharage, LU
(72) Lecluse, Eric, 40 rue de Vendome, 41100 PEZOU, FR
Enters, Richard, 12 rue Villon, 41350 VINEUIL, FR

(51) MKP
A61M 15/00 (2006.01) (97) **2714164 ***
(86) US2012038969 22.05.2012
(96) 12727460.3 09.04.2014
(87) WO2012162305, 22.05.2012
(97) 2714164, 09.04.2014 en
(54) NEBULIZER
(71) Boehringer Ingelheim International GmbH, Binger Strasse 173, 55216 Ingelheim am Rhein, DE
(72) HOLAKOVSKY, Holger, Boehringer Ingelheim GmbH CD Patents Binger Strasse 173, 55216 Ingelheim Am Rhein, DE
WITTE, Florian, Boehringer Ingelheim GmbH CD Patents Binger Strasse 173, 55216 Ingelheim Am Rhein, DE
HERRMANN, Frank, Boehringer Ingelheim GmbH CD Patents Binger Strasse 173, 55216 Ingelheim Am Rhein, DE
SEARS, Charles, William, 39 Joseph Smith Lane, Boxford, MA 01921, US
CATINELLA, Christopher, Michael, 21 Redbud Way Apt. 23, Marlboro, MA 01752, US
GONZALEZ, Mario, Alberto, 115 Highland Avenue Apt. 13, Somerville, MA 02143, US
PHILIPS, Sean, Landis, P.o. Box 326, S. Lancaster, MA 01561, US
BERTRAM, Paul, 22 Catherine Avenue, Franklin, MA 02038, US
ROHRSCHEIDER, Marc, Boehringer Ingelheim GmbH CD Patents Binger Strasse 173, 55216 Ingelheim Am Rhein, DE

(51) MKP
G01N 33/542 (2006.01) (97) **2769218 ***
G01N 33/569 (2006.01)
G01N 33/58 (2006.01)
(86) US2013039347 02.05.2013
(96) 13731180.9 27.08.2014
(87) WO2013166336, 02.05.2013
(97) 2769218, 27.08.2014 en
(54) VIABILITY STAINING METHOD
(71) Charles River Laboratories, Inc., 251 Ballardvale Street, Wilmington, MA 01887-1000, US
(72) STIMPSON, Eric, 902 Lansfaire Dr., Charleston, SC 29414, US

(51) MKP
A61K 31/4412 (2006.01) (97) **2702994**
A61K 31/496 (2006.01)
(96) 13275196.7 05.03.2014
(97) 2702994, 05.03.2014 en
(54) Methods of administering pifrenidone therapy
(71) Intermune, Inc., 3280 Bayshore Boulevard, Brisbane, CA 94005-1021, US
(72) Bradford, Williamson Z., P.O. Box 566, Ross, CA California 94957, US

(51) MKP
A61B 17/072 (2006.01) (97) **2517644**
(96) 12166177.1 31.10.2012
(97) 2517644, 31.10.2012 en
(54) Surgical stapler anvil comprising a plurality of forming pockets
(71) Ethicon Endo-Surgery, Inc., 4545 Creek Road, Cincinnati, OH 45242, US
(72) Shelton, IV, Frederick E., 245 East Main Street, Hillsboro, OH Ohio 45133, US
Baxter, III, Chester O., 6375 Pawnee Ridge, Loveland, OH Ohio 45140, US

- (51) MKP
A61K 31/7034 (2006.01) (97) **2482823 ***
A61K 31/7048 (2006.01)
A61K 31/7056 (2006.01)
A61K 31/706 (2006.01)
A61P 19/10 (2006.01)
- (86) EP2010064620 01.10.2010
(96) 10765409.7 08.08.2012
(87) WO2011039338, 01.10.2010
(97) 2482823, 08.08.2012 en
(54) USE OF COMPOUNDS WITH SGLT-1/SGLT-2 INHIBITOR ACTIVITY FOR PRODUCING MEDICAMENTS FOR TREATMENT OF BONE DISEASES
- (71) SANOFI, 54, rue de la Boétie, 75008 Paris, FR
(72) KISSNER, Thomas, c/o Sanofi-Aventis Deutschland GmbH, 65926 Frankfurt am Main, DE
HEINRICH, Martin, Weinbergstr. 7a, 61440 Oberursel, DE
KRUPP, Eckart, c/o Sanofi-Aventis Deutschland GmbH, 65926 Frankfurt am Main, DE

- (51) MKP
A61P 11/00 (2006.01) (97) **2768859 ***
A61P 19/02 (2006.01)
A61P 29/00 (2006.01)
C07K 16/24 (2006.01)
- (86) EP2012070736 19.10.2012
(96) 12775247.5 27.08.2014
(87) WO2013057241, 19.10.2012
(97) 2768859, 27.08.2014 en
(54) ANTAGONISTS OF IL17C FOR THE TREATMENT OF INFLAMMATORY DISORDERS
- (71) MorphoSys AG, Lena-Christ-Strasse 48, 82152 Martinsried/Planegg, DE
Galapagos N.V., Generaal de Wittelaan L11 A3, 2800 Mechelen, BE
(72) BÜLTMANN, Andreas, Josef von Hirsch Str. 46, 82152 Planegg, DE
MÜHLBACHER, Robert, Buchbergerstr. 1a, 82538 Geretsried/Gelting, DE
GARCIA, Teresa, Galapagos SASU 102 Avenue Gaston Roussel, F-93230 Romainville, FR
BRY, Reginald Christophe Xavier, Galapagos SASU 102 Avenue Gaston Roussel, F-93230 Romainville, FR
NELLES, Luc, Galapagos NV Industriepark Mechelen Noord Generaal De Wittelaan L11 A3, B-2800 Mechelen, BE
CONRATH, Katja, Galapagos NV Industriepark Mechelen Noord Generaal De Wittelaan L11 A3, B-2800 Mechelen, BE

- (51) MKP
C12P 7/56 (2006.01) (97) **2732042 ***
C12P 41/00 (2006.01)
- (86) GB2012051698 16.07.2012
(96) 12740196.6 21.05.2014
(87) WO2013011298, 16.07.2012
(97) 2732042, 21.05.2014 en
(54) SEPARATION PROCESS
- (71) Plaxica Limited, Imperial College Incubator Level 1 Bessemer Building Imperial College, London SW7 2AZ, GB
(72) MARSHALL, Edward Leslie, c/o PLAXICA LIMITED Imperial College Incubator Level 1 Bessemer Building Imperial College, London Greater London SW7 2AZ, GB
OSEI-TUTU, Jade Jocelyn Afriye, c/o PLAXICA LIMITED Imperial College Incubator Level 1 Bessemer Building Imperial College, London Greater London SW7 2AZ, GB
SMITH, Stephen Alexander Calder, c/o PLAXICA LIMITED Imperial College Incubator Level 1 Bessemer Building Imperial College, London Greater London SW7 2AZ, GB

- (51) MKP
A01N 1/02 (2006.01) (97) **2704560 ***
A61B 19/00 (2006.01)
A61M 16/00 (2006.01)
- (86) US2012033626 13.04.2012
(96) 12770852.7 12.03.2014
(87) WO2012142487, 13.04.2012
(97) 2704560, 12.03.2014 en
(54) ORGAN CARE SOLUTION FOR EX-VIVO MACHINE PERFUSION OF DONOR LUNGS
- (71) Transmedics, Inc., 200 Minuteman Road, Suite 302, Andover MA 01810, US
(72) HASSANEIN, Waleed, H., 30 Windkist Farm Road, North Andover MA 01845, US
FATTAH, Ihab, Abdel, 530 Main Street, North Andover MA 01845, US
LEZBERG, Paul, 18 Sherwood Drive, Westford MA 01886, US
KHAYAL, Tamer, I., 17 Royal Crest Drive, Apt. 5, North Andover MA 01845, US
HAVENER, Robert, 559 Chestnut Street, Lynnfield MA 01940, US
ABDELAZIM, Anas, 26945 Amhearth Circle, 108, Beachwood OH 44122, US

- (51) MKP
B01D 3/00 (2006.01) (97) **2755729 ***
- (86) US2012055194 13.09.2012
(96) 12831350.9 23.07.2014
(87) WO2013040234, 13.09.2012
(97) 2755729, 23.07.2014 en
(54) SYSTEM AND METHOD FOR WATER TREATMENT
- (71) Aquasource Technologies Corporation, 199 Katherine Drive, North Huntingdon, Pennsylvania 15642, US
(72) DIGHE, Shyam V., 199 Katherine Drive, North Huntingdon, Pennsylvania 15642, US

- (51) MKP
A61K 31/337 (2006.01) (97) **2768820 ***
A61P 35/00 (2006.01)
C07D 305/14 (2006.01)
- (86) IB2012002767 10.10.2012
(96) 12839769.2 27.08.2014
(87) WO2013054204, 10.10.2012
(97) 2768820, 27.08.2014 en
(54) A PROCESS FOR MAKING AN INTERMEDIATE OF CABAZITAXEL
- (71) Scinopharm Taiwan Ltd., No. 1 Nan-ke 8th Road Tainan Southern Taiwan Science Park Shan-hua Town, Tainan Hsien 74144, TW
Scinopharm Singapore Pte, Ltd., 50, Raffles Place Nr. 06-00 Singapore Land Tower, Singapore 048623, SG
(72) HSIAO, Tsung Yu, No. 36, Lane 160 Jhongjhen Rd., Neimen Dist., Kaohsiung 845, TW
TSENG, HsinChang, No. 18, Aly. 6 LN. 560, Sec. 3. Yongda Rd. Yongkang Dist., Tainan 710, TW

- (51) MKP
A61K 31/4745 (2006.01) (97) **2701724 ***
A61K 31/505 (2006.01)
A61K 31/519 (2006.01)
A61K 38/17 (2006.01)
A61P 35/00 (2006.01)
- (86) EP2012057542 25.04.2012
(96) 12717129.6 05.03.2014
(87) WO2012146610, 25.04.2012
(97) 2701724, 05.03.2014 en
(54) COMPOSITION COMPRISING AFLIBERCEPT, FOLINIC ACID, 5-FLUOROURACIL (5-FU) AND IRINOCETAN (FOLFIRI)
- (71) SANOFI, 54 rue La Boétie, 75008 Paris, FR
(72) CASTAN, Rémi, c/o Sanofi Patent Department 54 rue La Boétie, F-75008 Paris, FR

(51) MKP
H05B 3/06 (2006.01) (97) **2767140 ***
H05B 3/34 (2006.01)
(86) EP2012004276 12.10.2012
(96) 12783508.0 20.08.2014
(87) WO2013053488, 12.10.2012
(97) 2767140, 20.08.2014 de
(54) TEMPERATURE CONTROL MAT
(71) REHAU AG + Co, Otto-Hahn-Strasse 2, 95111 Rehau, DE
(72) FRIEDRICH, Jochen, Badstrasse 33, 95119 Naila, DE
BÖCKMANN, Klaus, Goethestrasse 13, 91054 Erlangen, DE

(51) MKP
C07F 9/6593 (2006.01) (97) **2764003 ***
(86) US2012056838 24.09.2012
(96) 12838450.0 13.08.2014
(87) WO2013052294, 24.09.2012
(97) 2764003, 13.08.2014 en
(54) IONIC LIQUIDS, ELECTROLYTE SOLUTIONS INCLUDING THE IONIC LIQUIDS, AND ENERGY STORAGE DEVICES INCLUDING THE IONIC LIQUIDS
(71) Battelle Energy Alliance, LLC, P.O. Box 1625, Idaho Falls, ID 83415-3899, US
(72) GERING, Kevin, L., 2480 Princess Drive, Idaho Falls, ID 83406, US
HARRUP, Mason, K., 2967 Chaparral Drive, Idaho Falls, ID 83404, US
ROLLINS, Harry, W., 3010 Sandstone Drive, Idaho Falls, ID 83404, US

(51) MKP
A61K 38/36 (2006.01) (97) **2737311 ***
C07K 14/745 (2006.01)
G01N 33/48 (2006.01)
(86) US2012048191 25.07.2012
(96) 12817042.0 04.06.2014
(87) WO2013016454, 25.07.2012
(97) 2737311, 04.06.2014 en
(54) ASSAYS TO MONITOR BLEEDING DISORDERS
(71) BIOGEN IDEC HEMOPHILIA INC., 9 Fourth Avenue, Waltham, MA 02451, US
(72) SOMMER, Jurg, 30 Hampshire Road, Wayland Massachusetts 01778, US
JIANG, Haiyan, 3 Bayberry Lane, Belmont Massachusetts 02478, US
ZHANG, Xin, 133 Boston Post Road, Weston Massachusetts 02493, US
YANG, Buyue, 12 Old Colony Lane Apt 5, Arlington Massachusetts 02476, US
PIERCE, Glenn, P.O.Box 675486, Rancho Santa Fe California 92067, US

(51) MKP
C07D 209/88 (2006.01) (97) **2768807 ***
(86) EP2012070769 19.10.2012
(96) 12783161.8 27.08.2014
(87) WO2013057258, 19.10.2012
(97) 2768807, 27.08.2014 en
(54) PROCESSES FOR THE PREPARATION OF 6-CHLORO-2,3,4,9-TETRAHYDRO-1H-CARBAZOLE-1-CARBOXAMIDE AND OF ITS PRECURSORS
(71) Siena Biotech S.p.A., Via Banchi di Sotto, 34, 53100 Siena, IT
(72) DIODATO, Enrica, Siena Biotech S.P.A. Strada del Petriccio e Belriguardo 25, I-53100 Siena, IT
MARCUCCI, Katia, Siena Biotech S.P.A. Strada del Petriccio e Belriguardo 25, I-53100 Siena, IT
THOMAS, Russell, Siena Biotech S.P.A. Strada del Petriccio e Belriguardo 25, I-53100 Siena, IT
WIEDENAU, Paul, Siena Biotech S.P.A. Strada del Petriccio e Belriguardo 25, I-53100 Siena, IT
RETTIG, Martin, Untere Oberaustasse 8, 77963 Schwanau-Nonnenweiler, DE
ROBERTS, Huw, null, Flint, GB

(51) MKP
E06B 3/54 (2006.01) (97) **2634347**
(96) 13157428.7 04.09.2013
(97) 2634347, 04.09.2013 de
(54) Glass holder, profile assembly and frame construction
(71) EDUARD HUECK GmbH & CO. KG, Loher Strasse 9, 58511 Lüdenschheid, DE
(72) Jansen, Hans-Georg, Regattaweg 19, 33659 Bielefeld, DE

(51) MKP
B01D 29/11 (2006.01) (97) **2707331 ***
B01D 29/15 (2006.01)
B01D 29/21 (2006.01)
B01D 29/52 (2006.01)
B01D 29/58 (2006.01)
B01D 29/90 (2006.01)
B01D 35/04 (2006.01)
B01D 35/30 (2006.01)
C02F 1/00 (2006.01)
C02F 1/28 (2006.01)
C02F 1/42 (2006.01)
C02F 9/00 (2006.01)
(86) IL2012050160 08.05.2012
(96) 12724742.7 19.03.2014
(87) WO2012153330, 08.05.2012
(97) 2707331, 19.03.2014 en
(54) WATER FILTERING DEVICE
(71) Strauss Water Ltd, 49 Hasivim Street, 49517 Petach Tikva, IL
(72) WILDER, Haim, 7 Yehuda Halevi Street, 43555 Raanana, IL
KRYSTAL, Eyal, 19/17 Hatchia Street, 44250 Kfar Saba, IL
HILLEL, Shlomo, Daphna 4, 71700 Modiin, IL
FRENKEL, Hella, 9 Har Meron St., 44480 Kfar Saba, IL
RATNER; Stanislav, 19/1 Shelmon Street, Zur Hadassa 99875, IL

(51) MKP
A61K 31/4965 (2006.01) (97) **2704721 ***
A61K 31/497 (2006.01)
A61P 7/06 (2006.01)
(86) US2012036412 03.05.2012
(96) 12722013.5 12.03.2014
(87) WO2012151451, 03.05.2012
(97) 2704721, 12.03.2014 en
(54) PYRUVATE KINASE ACTIVATORS FOR USE IN THERAPY
(71) Agios Pharmaceuticals, Inc., 38 Sidney Street, Cambridge, MA 02139, US
(72) SU, Shin-San, Michael, 346 Hartman Road, Newton, MA 02459, US

(51) MKP
A61K 38/18 (2006.01) (97) **2763689 ***
C07K 14/50 (2006.01)
(86) US2012057053 25.09.2012
(96) 12766847.3 13.08.2014
(87) WO2013052311, 25.09.2012
(97) 2763689, 13.08.2014 en
(54) FIBROBLAST GROWTH FACTOR 21 VARIANTS
(71) Eli Lilly and Company, Lilly Corporate Center, Indianapolis, IN 46285, US
(72) DICKINSON, Craig, Duane, c/o Eli Lilly and Company P.O. Box 6288, Indianapolis, IN 46206-6288, US
DRIVER, David, Albert, c/o Eli Lilly and Company P.O. Box 6288, Indianapolis, IN 46206-6288, US
DARLING, Ryan, James, c/o Eli Lilly and Company P.O. Box 6288, Indianapolis, IN 46206-6288, US
GONCIARZ, Malgorzata, Donata, c/o Eli Lilly and Company P.O. Box 6288, Indianapolis, IN 46206-6288, US
MICANOVIC, Radmila, c/o Eli Lilly and Company P.O. Box 6288, Indianapolis, IN 46206-6288, US

- (51) MKP
G01N 1/28 (2006.01) (97) **2737294 ***
G01N 1/38 (2006.01)
G01N 1/44 (2006.01)
(86) EP2011003770 27.07.2011
(96) 11743026.4 04.06.2014
(87) WO2013013687, 27.07.2011
(97) 2737294, 04.06.2014 en
(54) APPARATUS AND METHOD FOR A LYSIS OF A SAMPLE, IN PARTICULAR FOR AN AUTOMATED AND/OR CONTROLLED LYSIS OF A SAMPLE
(71) Curetis AG, Max-Eyth-Strasse 42, 71088 Holzgerlingen, DE
(72) BOOS, Andreas, Schlehenstrasse 23/1, 71149 Bondorf, DE
LÜDKE, Gerd, Hülbenstrasse 28, 71088 Holzgerlingen, DE
BACHER, Johannes, Höhenweg 3, 71229 Leonberg-Warmbronn, NL

- (51) MKP
A61M 5/315 (2006.01) (97) **2704778 ***
(86) EP2012058181 04.05.2012
(96) 12718669.0 12.03.2014
(87) WO2012152667, 04.05.2012
(97) 2704778, 12.03.2014 en
(54) DRIVE ASSEMBLY FOR A DRUG DELIVERY DEVICE AND CORRESPONDING DRUG DELIVERY DEVICE
(71) Sanofi-Aventis Deutschland GmbH, Brüningstraße 50, 65929 Frankfurt am Main, DE
(72) SCHNEIDER, Christiane, Sanofi-Aventis Deutschland GmbH, 65926 Frankfurt am Main, DE
STEVER, Tobias, Sanofi-Aventis Deutschland GmbH, 65926 Frankfurt am Main, DE
HARMS, Michael, Sanofi-Aventis Deutschland GmbH, 65926 Frankfurt am Main, DE
JAKOBI, Ulrik, Sanofi-Aventis Deutschland GmbH, 65926 Frankfurt am Main, DE
LAM, Ngoc-Jane, Sanofi-Aventis Deutschland GmbH, 65926 Frankfurt am Main, DE
KRAFT, Torsten, c/o Sanofi-Aventis Deutschland GmbH, 65926 Frankfurt am Main, DE

- (51) MKP
F25C 3/04 (2006.01) (97) **2761238 ***
(86) EP2012004110 01.10.2012
(96) 12810065.8 06.08.2014
(87) WO2013045116, 01.10.2012
(97) 2761238, 06.08.2014 de
(54) METHOD, IN PARTICULAR FOR GENERATING SNOW, AND DEVICE FOR CARRYING OUT THE METHOD
(71) OKEANOS CORPORATION, Suite 9, Ansuya Estate, Revolution Avenue, Victoria, Mahe, SC
(72) GREGA, Samuel, Mukacevska 10, 080 01 Presov, SK

- (51) MKP
F25B 9/00 (2006.01) (97) **2667116**
(96) 12168675.2 27.11.2013
(97) 2667116, 27.11.2013 de
(54) Method and device for cooling
(71) Messer Group GmbH, Messer-Platz 1, 65812 Bad Soden, DE
Messer France S.A.S., 25, rue Auguste Blanche, 92816 Puteaux Cedex, FR
(72) Matheoud, Patrick, 15, Villa Edmond Rorchaert, 92390 Villeneuve La Garenne, FR
Herzog, Dr. Friedhelm, Josef-Brocker-Dyk 129, 47803 Krefeld, DE
Hennequin, James, 65 Bis, rue du Général de Gaulle, 77410 Annet sur Marne, FR

- (51) MKP
C12Q 1/42 (2006.01) (97) **2729809 ***
G01N 33/558 (2006.01)
G01N 33/573 (2006.01)
(86) GB2012051458 22.06.2012
(96) 12731634.7 14.05.2014
(87) WO2013005003, 22.06.2012
(97) 2729809, 14.05.2014 en
(54) ASSAY
(71) DuPont Nutrition Biosciences ApS, Langebrogade 1 P.O. Box 17, 1001 Copenhagen K, DK
(72) ISAKSEN, Mai Faurshou, Grumstolsvej 17A, 8270 Højbjerg, DK
KELLETT-SMITH, Anja Hemmingsen, Langelinieparken 3C st. lejl 2, 8000 Århus C, DK
MCLENNAN, Neil, BBInternational-Dundee Facility Alchemy House, Dundee DD2 1NH, GB
GILBERT, Ceinwen, 4 Bankwaters Road Rudloe, Corsham Wiltshire SN13 0LY, GB
KYNEB, Majbritt Hauge, Skjoldsgade 17, DK-8260 Viby J, DK

- (51) MKP
A61K 39/00 (2006.01) (97) **2758073 ***
C07K 16/00 (2006.01)
C12P 21/08 (2006.01)
(86) US2012056886 24.09.2012
(96) 12833767.2 30.07.2014
(87) WO2013044215, 24.09.2012
(97) 2758073, 30.07.2014 en
(54) VEGF/DLL4 BINDING AGENTS AND USES THEREOF
(71) OncoMed Pharmaceuticals, Inc., 800 Chesapeake Drive, Redwood City, CA 94063, US
(72) GURNEY, Austin L., 946 Diamond Street, San Francisco, CA 94114, US
SATO, Aaron Ken, 1640 Coronado Way, Burlingame, CA 94010, US
BOND, Christopher John, 511 30th Avenue, San Mateo, CA 94403, US

- (51) MKP
F16H 1/22 (2006.01) (97) **2685253**
F16L 55/40 (2006.01)
G01N 27/82 (2006.01)
(96) 13156721.6 15.01.2014
(97) 2685253, 15.01.2014 en
(54) Conduit sensor device and method for operating a conduit sensor device
(71) Inovdane Engineering Ltd., 30 Lesmill Road, Toronto ON M3B 2T6, CA
(72) Laursen, Paul, 34 Crosburn Drive, Toronto, Ontario M3B 2Z2, CA
Comello, Corry, 65 Crosland Drive, Scarborough, Ontario M1R 4M9, CA

- (51) MKP
C07K 16/00 (2006.01) (97) **2726600 ***
C12N 5/00 (2006.01)
C12N 5/10 (2006.01)
C12P 21/00 (2006.01)
(86) US2012045070 29.06.2012
(96) 12738674.6 07.05.2014
(87) WO2013006479, 29.06.2012
(97) 2726600, 07.05.2014 en
(54) MAMMALIAN CELL CULTURE
(71) Amgen Inc., One Amgen Center Drive, Thousand Oaks, California 91320, US
(72) FOLLSTAD, Brian, D., 3414 42nd Avenue West, Seattle, Washington 98199, US
MCCOY, Rebecca, E., 9884 SE Southworth Drive, Port Orchard, Washington 98366, US
MORRIS, Arvia, E., 4535 Thackeray Place NE, Seattle, Washington 98105, US

(51) MKP
C08K 3/00 (2006.01) (97) **2716715 ***
C08K 7/04 (2006.01)
C08L 77/00 (2006.01)
(86) JP2012063183 23.05.2012
(96) 12792506.3 09.04.2014
(87) WO2012165258, 23.05.2012
(97) 2716715, 09.04.2014 en
(54) REINFORCED POLYAMIDE RESIN PELLETS
(71) Asahi Kasei Chemicals Corporation, 1-105 Kanda Jinbocho Chiyoda-ku, Tokyo 101-8101, JP
(72) SASAKI, Yukiyooshi, 1-105 Kanda Jinbocho Chiyoda-ku, Tokyo 101-8101, JP
KURIHARA, Tetsuo, 1-105 Kanda Jinbocho Chiyoda-ku, Tokyo 101-8101, JP

(51) MKP
A61K 31/519 (2006.01) (97) **2739627 ***
A61P 9/10 (2006.01)
A61P 25/28 (2006.01)
C07D 487/04 (2006.01)
(86) CN2012000999 25.07.2012
(96) 12818124.5 11.06.2014
(87) WO2013013503, 25.07.2012
(97) 2739627, 11.06.2014 en
(54) 2,3-DIHYDROIMIDAZO[1,2-C]PYRIMIDIN-5(1H)-ONE COMPOUNDS USE AS LP-PLA² INHIBITORS
(71) Glaxo Group Limited, 980 Great West Road, Brentford, Middlesex TW8 9GS, GB
(72) WAN, Zehong, GlaxoSmithKline (China) R&D Co. Ltd. Building 3 898 Halei Road Zhangjiang Hi-Tech Park Pudong New Area, Shanghai 201203, CN
LONG, Kai, GlaxoSmithKline (China) R&D Co. Ltd. Building 3 898 Halei Road Zhangjiang Hi-Tech Park Pudong New Area, Shanghai 201203, CN
SANG, Yingxia, GlaxoSmithKline (China) R&D Co. Ltd. Building 3 898 Halei Road Zhangjiang Hi-Tech Park Pudong New Area, Shanghai 201203, CN
SU, Xiaobo, GlaxoSmithKline (China) R&D Co. Ltd. Building 3 898 Halei Road Zhangjiang Hi-Tech Park Pudong New Area, Shanghai 201203, CN

(51) MKP
A61K 38/04 (2006.01) (97) **2727931 ***
C07K 5/08 (2006.01)
C07K 5/10 (2006.01)
C07K 7/06 (2006.01)
(86) CU2012000003 29.06.2012
(96) 12743356.3 07.05.2014
(87) WO2013004203, 29.06.2012
(97) 2727931, 07.05.2014 en
(54) COMPOUNDS AND PHARMACEUTICAL COMBINATIONS FOR THE TREATMENT OF NEURODEGENERATIVE AND ISCHEMIC BRAIN DISEASES
(71) Centro De Ingenieria Genetica Y Biotecnologia, Avenida 31 entre 158 y 190 Cubanacán, Playa, La Habana 11600, CU
(72) PENTON ROL, Giselle, Calle 110 No. 539 entre 5ta F y 7ma Playa, La Habana 11600, CU
LLOPIZ ARZUAGA, Alexey, Calle Bayamesa No. 78 entre Vicente Quesada y 26 de julio, Ciro Redondo Bayamo Granma 85100, CU
MARÍN PRIDA, Javier, Calle B No. 18320^a entre 1ra y 2da Reparto Monterrey, San Miguel del Padrón La Habana 10300, CU
PENTÓN ARIAS, Eduardo, Calle 31 No. 18207 entre 182 y 184 Apto 49, Playa La Habana 11600, CU
RODRÍGUEZ JIMÉNEZ, Efrain, Ave 31 No 18207 apto 40 entre 182 y 184, Playa La Habana 11600, CU
MUSACCHIO LASA, Alexis, Calle 128 No 7117 entre 71 y 73, Mariel Artemisa 32100, CU
BESADA PÉREZ, Vladimir, Armando, Ave 33 Edif. C15 apto 3 entre 186 y 188, Playa La Habana 11600, CU
PARDO ANDREU, Gilberto, Lázaro, 5ta B No. 8201 entre 82 y 84. Miramar, Playa La Habana 10300, CU
GONZÁLEZ LÓPEZ, Luis, Javier, Calle 186 No. 3115 piso 8 Apto C entre 31 y 33, Playa La Habana 11600, CU
PAVÓN FUENTES, Nancy, Ave 1ra A No. 4610 entre 46 y 60 Miramar, Playa La Habana 11600, CU
GUILLÉN NIETO, Gerardo, Enrique, Calle Línea No. 6 entre N y O Apartamento 4, Vedado La Habana 10400, CU
LÓPEZ SAURA, Pedro, Antonio, Ave 13 No. 6810 entre 68 y 70, Playa La Habana 11300, CU

(51) MKP
G01R 33/12 (2006.01) (97) **2761318 ***
G01R 33/14 (2006.01)
H01F 29/08 (2006.01)
(86) SI2011000079 27.12.2011
(96) 11815738.7 06.08.2014
(87) WO2013048348, 27.12.2011
(97) 2761318, 06.08.2014 en
(54) DEVICE AND TESTING PROCEDURE FOR DETERMINATION OF MAGNETIC CIRCUIT QUALITY
(71) Univerza V Mariboru, Smetanova ulica 17, 2000 Maribor, SI
(72) DOLINAR, Drago, Borstnikova ulica 2, 2000 Maribor, SI
PETRUN, Martin, Hudi Kot 2, 2364 Ribnica na Pohorju, SI
KLOPCIC, Beno, Zorгова ulica 78, 1231 Crnuce, SI

(51) MKP
A61J 3/02 (2006.01) (97) **2756840 ***
A61K 9/14 (2006.01)
A61K 9/72 (2006.01)
A61K 31/4418 (2006.01)
A61K 47/10 (2006.01)
A61K 47/26 (2006.01)
A61K 47/30 (2006.01)
A61P 11/00 (2006.01)
(86) JP2012073514 13.09.2012
(96) 12832375.5 23.07.2014
(87) WO2013039167, 13.09.2012
(97) 2756840, 23.07.2014 en
(54) PHARMACEUTICAL COMPOSITION FOR INHALATION
(71) Shionogi & Co., Ltd., 1-8, Doshomachi 3-chome Chuo-ku, Osaka-shi, Osaka 541-0045, JP
Shizuoka Prefectural Universities Corporation, 2-2-1 Oshika, Suruga-ku Shizuoka-shi Shizuoka 422-8021, JP
(72) ONOUE, Satomi, c/o UNIVERSITY OF SHIZUOKA 52-1 Yada Suruga-ku, Shizuoka-shi Shizuoka 422-8526, JP
YAMADA, Shizuo, c/o UNIVERSITY OF SHIZUOKA 52-1 Yada Suruga-ku, Shizuoka-shi Shizuoka 422-8526, JP

(51) MKP
C03C 25/32 (2006.01) (97) **2720987 ***
C08K 3/30 (2006.01)
C08K 5/092 (2006.01)
C08K 5/42 (2006.01)
C08K 5/43 (2006.01)
C08K 7/14 (2006.01)
C08L 3/00 (2006.01)
C08L 5/00 (2006.01)
C08L 5/02 (2006.01)
C09J 11/06 (2006.01)
C09J 103/00 (2006.01)
C09J 103/02 (2006.01)
C09J 105/00 (2006.01)
D04H 1/4218 (2012.01)
D04H 1/64 (2012.01)
(86) FR2012051346 15.06.2012
(96) 12738498.0 23.04.2014
(87) WO2012172265, 15.06.2012
(97) 2720987, 23.04.2014 fr
(54) SIZING COMPOSITION FOR MINERAL WOOL HAVING A LOW EMISSION OF VOLATILE ORGANIC COMPOUNDS, AND INSULATING PRODUCTS OBTAINED
(71) Saint-Gobain Isover, 18 Avenue d'Alsace, 92400 Courbevoie, FR
(72) JAFFRENNOU, Boris, 33 rue des Alouettes, F-75019 Paris, FR
KAPLAN, Benjamin, 16 rue de Montyon, F-75009 Paris, FR
GIGNOUX, Vincent, 2 rue du Poirier Janot, F-60300 Chamant, FR

- (51) MKP
A61K 31/277 (2006.01) (97) **2720692 ***
A61K 31/4406 (2006.01)
A61P 25/00 (2006.01)
A61P 25/16 (2006.01)
A61P 25/28 (2006.01)
(86) US2012042992 18.06.2012
(96) 12800202.9 23.04.2014
(87) WO2012174552, 18.06.2012
(97) 2720692, 23.04.2014 en
(54) CATHEPSIN INHIBITORS FOR TREATING MICROGLIA-MEDIATED NEURON LOSS IN THE CENTRAL NERVOUS SYSTEM
(71) Virobay, Inc., 1490 O'Brien Drive, Suite G, Menlo Park, CA 94025, US
(72) BOOTH, Robert, 26700 Shady Oaks Court, Los Altos Hills, CA 94022, US

- (51) MKP
A61F 13/02 (2006.01) (97) **2747791 ***
A61L 15/24 (2006.01)
A61L 15/32 (2006.01)
A61L 15/58 (2006.01)
A61L 15/62 (2006.01)
A61L 15/64 (2006.01)
A61L 24/06 (2006.01)
A61L 26/00 (2006.01)
(86) US2012051691 21.08.2012
(96) 12754164.7 02.07.2014
(87) WO2013028672, 21.08.2012
(97) 2747791, 02.07.2014 en
(54) PROTECTIVE WOUND DRESSING DEVICE FOR ORAL AND PHARYNGEAL SPACE
(71) Ethicon, Inc., U.S. Route 22, Somerville, NJ 08876, US
(72) KEPLINGER, Scott, Alan, 17 Current Lane, Durham, NC 27712, US

- (51) MKP
C12Q 1/34 (2006.01) (97) **2751279 ***
G01N 33/574 (2006.01)
(86) US2012052629 28.08.2012
(96) 12761845.2 09.07.2014
(87) WO2013033074, 28.08.2012
(97) 2751279, 09.07.2014 en
(54) METHODS AND COMPOSITIONS TO DETECT THE LEVEL OF LYSOSOMAL EXOCYTOSIS ACTIVITY AND METHODS OF USE
(71) St. Jude Children's Research Hospital, 262 Danny Thomas Place, Memphis, TN 38105-2794, US
(72) ANNUNZIATA, Ida, 237 Brick Cottage Apt. 102, Memphis, TN 38105, US
D'AZZO, Alessandra, 159 East Cherry Drive, Memphis, TN 38117, US
WHITE-GILBERTSON, Shai, 1139 Braddock Avenue, North Charleston, SC 29405, US

- (51) MKP
C07K 16/28 (2006.01) (97) **2748197 ***
C07K 16/46 (2006.01)
(86) US2012052490 27.08.2012
(96) 12753368.5 02.07.2014
(87) WO2013033008, 27.08.2012
(97) 2748197, 02.07.2014 en
(54) TANDEM FC BISPECIFIC ANTIBODIES
(71) Merrimack Pharmaceuticals, Inc., One Kendall Square Suite B7201, Cambridge, MA 02139, US
(72) HARMS, Brian, 152 Walter Street 1, Roslindale, MA 02131, US
KOHLLI, Neeraj, 39 Shepard Street Apt. 17, Brighton, MA 02135, US
LUGOVSKOY, Alexey, 24 Center Street, Woburn, MA 01801, US
SU, Stephen, 1 Emerson Place Apt. 10c, Boston, MA 02114, US
GEDDIE, Melissa, 69 Highland Road 1, Somerville, MA 02144, US

- (51) MKP
B29C 33/00 (2006.01) (97) **2764973**
B29C 44/44 (2006.01)
B29C 44/58 (2006.01)
(96) 14154755.4 13.08.2014
(97) 2764973, 13.08.2014 en
(54) Expanded polypropylene foam-forming mold
(71) Dongshin Industry Inc., 344-1, Maegok-dong,, Buk-gu Ulsan 683-420, KR
(72) Kim, Gyong Ho, 304-204, Gangbyeon Greenville, Gulhwa-ri, Beomseo-eup, Ulju-gun, 689-705 Ulsan, KR

- (51) MKP
C07D 493/02 (2006.01) (97) **2742055 ***
C07H 13/00 (2006.01)
C07H 13/02 (2006.01)
C08F 24/00 (2006.01)
C08F 36/14 (2006.01)
C08F 224/00 (2006.01)
C08F 236/14 (2006.01)
(86) US2012050235 10.08.2012
(96) 12845143.2 18.06.2014
(87) WO2013066461, 10.08.2012
(97) 2742055, 18.06.2014 en
(54) RENEWABLE BIO-BASED (METH) ACRYLATED MONOMERS AS VINYL ESTER CROSS-LINKERS
(71) Drexel University, 3141 Chestnut Street, Philadelphia, Pennsylvania 19104, US
United States of America as Represented by the Secretary of the Army, 101 Army Pentagon, Washington, DC 20310, US
(72) PALMESE, Giuseppe R., 2 Cove Court, Hainesport New Jersey 08036, US
LA SCALA, John Joseph, 17 Bradley Drive, Wilmington Delaware 19803, US
SADLER, Joshua Matthew, 103 12-A Bird River Road, Middle River Maryland 2122, US
LAM, Anh-Phuong Thy, 99 Highland Circle, Newark Delaware 19713, US

- (51) MKP
F02M 47/02 (2006.01) (97) **2620632**
F02M 61/12 (2006.01)
F02M 61/16 (2006.01)
(96) 12152743.6 31.07.2013
(97) 2620632, 31.07.2013 en
(54) A control valve of a fuel injector
(71) Delphi International Operations Luxembourg S.à.r.l., Avenue de Luxembourg, 4940 Bascharage, LU
(72) Enters, Richard, 12 Rue Francois Villon, 41350 Vineuil, FR
Bonneau, David, 58 Rue Yves Genet, 41000 Blois, FR
Thibault, Thierry, 61 Rue de Bois de la Chainee, 37530 Saint Ouen Les Vignes, FR
Oge, Jean-Christophe, 15 Lotissement de la Boissiere, Route de Suissiere, 41250 Neuvy, FR
Legrand, Philippe, 39 Rue de Sully, 41350 St. Gervais La Foret, FR

- (51) MKP
A61K 9/127 (2006.01) (97) **2704703 ***
A61K 31/192 (2006.01)
(86) US2012036366 03.05.2012
(96) 12779275.2 12.03.2014
(87) WO2012151427, 03.05.2012
(97) 2704703, 12.03.2014 en
(54) TRANSDERMAL COMPOSITIONS OF IBUPROFEN AND METHODS OF USE THEREOF
(71) Aponia Laboratories, Inc., 67 Orchard Place, Greenwich, CT 06830, US
(72) CHEN, Haigang, 5250 Annapolis Lane North Apt. 2310, Plymouth, MN 55446, US
WINCKLE, Gareth, 1300 Sunset Drive, Petaluma, CA 94952, US
RILEY, Christopher, 1055 Forest Avenue, Maryville, MO 64468, US

(51) MKP
C08F 220/06 (2006.01) (97) **2738191 ***
C08F 220/18 (2006.01)
C08F 220/34 (2006.01)
C08F 220/56 (2006.01)
C08F 220/58 (2006.01)
C08F 226/02 (2006.01)
C08F 232/04 (2006.01)
C09K 8/588 (2006.01)
(86) CN2011001577 16.09.2011
(96) 11870106.9 04.06.2014
(87) WO2013013355, 16.09.2011
(97) 2738191, 04.06.2014 en
(54) AMPHIPHILIC MACROMOLECULE AND USE
(71) Beijing Junlun Runzhong Science&Technology Co., Limited, Rm. 2306, Block A, Focus Square No. 6 Futongdong Street Wangjing Community, Chaoyang District, Beijing 100102, CN
(72) WANG, Jinben, Zhongguancun North First Street 2 Haidian District, Beijing 100080, CN
SHI, Xuefeng, Zhongguancun North First Street 2 Haidian District, Beijing 100080, CN
XU, Xiaohui, Zhongguancun North First Street 2 Haidian District, Beijing 100080, CN
YANG, Hui, Zhongguancun North First Street 2 Haidian District, Beijing 100080, CN
WANG, Yilin, Zhongguancun North First Street 2 Haidian District, Beijing 100080, CN
YAN, Haikue, Zhongguancun North First Street 2 Haidian District, Beijing 100080, CN

(51) MKP
A61K 31/4985 (2006.01) (97) **2758399 ***
A61P 19/02 (2006.01)
C07D 487/04 (2006.01)
(86) EP2012068291 18.09.2012
(96) 12759725.0 30.07.2014
(87) WO2013041502, 18.09.2012
(97) 2758399, 30.07.2014 en
(54) N-[4-(1H-PYRAZOLO[3,4-B]PYRAZIN-6-YL)-PHENYL]-SULFONAMIDES AND THEIR USE AS PHARMACEUTICALS
(71) SANOFI, 54 rue La Boétie, 75008 Paris, FR
(72) NAZARE, Marc, Sanofi-Aventis Deutschland GmbH, 65926 Frankfurt am Main, DE
HALLAND, Nis, Sanofi-Aventis Deutschland GmbH, 65926 Frankfurt am Main, DE
SCHMIDT, Friedemann, Sanofi-Aventis Deutschland GmbH, 65926 Frankfurt am Main, DE
WEISS, Tilo, Sanofi-Aventis Deutschland GmbH, 65926 Frankfurt am Main, DE
DIETZ, Uwe, Sanofi-Aventis Deutschland GmbH, 65926 Frankfurt am Main, DE
HOFMEISTER, Armin, Sanofi-Aventis Deutschland GmbH, 65926 Frankfurt am Main, DE
CARRY, Jean-Christophe, c/o Sanofi, Patent Department 54 rue de la Boétie, 75008 Paris, FR

(51) MKP
B42F 7/04 (2006.01) (97) **2409853**
B43L 5/00 (2006.01)
(96) 11166338.1 25.01.2012
(97) 2409853, 25.01.2012 fr
(54) Bag of sheets, in particular for free-hand drawing
(71) Papeteries Sill, Rue du Moulin, 62570 Wizernes, FR
(72) Porrot, Jean-Yves, 27 avenue Gabriel Péri, 94300 Vincennes, FR

(51) MKP
C07C 67/29 (2006.01) (97) **2674413**
C07C 69/18 (2006.01)
C07F 7/18 (2006.01)
C12P 41/00 (2006.01)
(96) 12172191.4 18.12.2013
(97) 2674413, 18.12.2013 en
(54) Process for the preparation of treprostinil and derivatives thereof
(71) SciPharm SàRL, 33, rue Hiehl, 6131 Junglinster, LU
(72) Jain, Nareshkumar, F., The Chemistry Research Solution LLC 360 George Patterson Blvd. Suite 108, Bristol, PA 19007, US
Kirkup, Michael, P., The Chemistry Research Solution LLC 360 George Patterson Blvd. Suite 108, Bristol, PA 19007, US
Marella, Michael, A., The Chemistry Research Solution LLC 360 George Patterson Blvd. Suite 108, Bristol, PA 19007, US
Ghone, Sanjeevani, A., The Chemistry Research Solution LLC 360 George Patterson Blvd. Suite 108, Bristol, PA 19007, US

(51) MKP
B01J 29/00 (2006.01) (97) **2721280 ***
C07C 1/24 (2006.01)
F02M 27/02 (2006.01)
(86) US2012036994 09.05.2012
(96) 12723313.8 23.04.2014
(87) WO2012170140, 09.05.2012
(97) 2721280, 23.04.2014 en
(54) FUEL CONDITIONING MODULES AND METHODS
(71) Royce Walker & Co., Ltd, 11586 Pierson Road, West Palm Beach FL 33414, US
(72) RATNER, Joel, S., 2386 Players Court, West Palm Beach, FL 33414, US

(51) MKP
A61K 31/421 (2006.01) (97) **2703392 ***
A61K 31/4245 (2006.01)
A61K 31/426 (2006.01)
A61K 31/433 (2006.01)
A61K 31/4439 (2006.01)
A61P 3/04 (2006.01)
A61P 3/06 (2006.01)
A61P 3/10 (2006.01)
A61P 9/04 (2006.01)
A61P 9/10 (2006.01)
A61P 9/12 (2006.01)
A61P 15/00 (2006.01)
A61P 25/08 (2006.01)
A61P 25/20 (2006.01)
A61P 25/24 (2006.01)
A61P 43/00 (2006.01)
C07D 263/48 (2006.01)
C07D 271/06 (2006.01)
(86) JP2012061032 25.04.2012
(96) 12777012.1 05.03.2014
(87) WO2012147764, 25.04.2012
(97) 2703392, 05.03.2014 en
(54) 5-MEMBERED RING AROMATIC HETEROCYCLIC DERIVATIVE HAVING NPY Y5 RECEPTOR ANTAGONISTIC ACTIVITY
(71) Shionogi & Co., Ltd., 1-8, Doshomachi 3-chome Chuo-ku, Osaka-shi, Osaka 541-0045, JP
(72) HAYASHI, Kyohei, c/o Shionogi&Co. Ltd. 1-1 Futabacho 3-chome, Toyonaka-shi Osaka 561-0825, JP
TAMURA, Yuusuke, c/o Shionogi&Co. Ltd. 1-1 Futabacho 3-chome, Toyonaka-shi Osaka 561-0825, JP
OMORI, Naoki, c/o Shionogi&Co. Ltd. 1-1 Futabacho 3-chome, Toyonaka-shi Osaka 561-0825, JP

- (51) MKP
A61K 31/138 (2006.01) (97) **2717868 ***
A61K 31/439 (2006.01)
A61K 31/58 (2006.01)
A61K 45/06 (2006.01)
A61P 11/06 (2006.01)
A61P 11/08 (2006.01)
- (86) EP2012060444 01.06.2012
(96) 12725047.0 16.04.2014
(87) WO2012168161, 01.06.2012
(97) 2717868, 16.04.2014 en
(54) COMBINATION COMPRISING UMECLIDINIUM AND A CORTICOSTEROID
- (71) Glaxo Group Limited, 980 Great West Road, Brentford, Middlesex TW8 9GS, GB
(72) CRATER, Glenn, GlaxoSmithKline 7333 Mississauga Road North, Mississauga, Ontario L5N 6L4, CA

- (51) MKP
A61K 9/48 (2006.01) (97) **2709599 ***
A61K 31/47 (2006.01)
A61K 31/485 (2006.01)
- (86) EP2012059163 16.05.2012
(96) 12721534.1 26.03.2014
(87) WO2012159964, 16.05.2012
(97) 2709599, 26.03.2014 en
(54) PHARMACEUTICAL COMPOSITION COMPRISING DROTAVERINE
- (71) Chinoin Private Co Ltd, Tó u. 1-5, 1045 Budapest, HU
(72) BADABHAGNI, Sudhakara Rao, c/o Sanofi Patent Department 54 rue La Boétie, 75008 Paris, FR
JAISWAL, Nilesh, c/o Sanofi Patent Department 54 rue La Boétie, 75008 Paris, FR
KHULLAR, Praveen, c/o Sanofi Patent Department 54 rue La Boétie, 75013 Paris, FR
PRASAD, Kum, c/o Sanofi Patent Department 54 rue La Boétie, 75008 Paris, FR

- (51) MKP
A61K 47/48 (2006.01) (97) **2741783 ***
A61K 48/00 (2006.01)
- (86) EP2012065470 07.08.2012
(96) 12756126.4 18.06.2014
(87) WO2013020986, 07.08.2012
(97) 2741783, 18.06.2014 de
(54) POLYANION NANOCOMPLEXES FOR THERAPEUTIC APPLICATIONS
- (71) Universität Regensburg, Universitätsstrasse 31, 93053 Regensburg, DE
(72) GÖPPERICH, Achim, Enzianstr. 5a, 93161 Sinzing, DE
FERSTL, Matthias, Bundesstr. 4, 92331 Parsberg, DE

- (51) MKP
A61K 31/728 (2006.01) (97) **2766025 ***
A61K 31/737 (2006.01)
A61K 36/02 (2006.01)
- (86) US2012059104 05.10.2012
(96) 12775412.5 20.08.2014
(87) WO2013052899, 05.10.2012
(97) 2766025, 20.08.2014 en
(54) THERAPEUTIC SULFATED POLYSACCHARIDES, COMPOSITIONS THEREOF, AND METHODS FOR TREATING PATIENTS
- (71) Daniels, Bruce A., 4221 S. Western Ave. Suite 4045, Oklahoma City, OK 73109, US
(72) Daniels, Bruce A., 4221 S. Western Ave. Suite 4045, Oklahoma City, OK 73109, US

- (51) MKP
A61K 31/7072 (2006.01) (97) **2760858 ***
A61P 25/04 (2006.01)
A61P 25/28 (2006.01)
C07D 405/04 (2006.01)
C07D 405/14 (2006.01)
C07D 413/14 (2006.01)
C07F 9/09 (2006.01)
- (86) US2012058080 28.09.2012
(96) 12837369.3 06.08.2014
(87) WO2013049686, 28.09.2012
(97) 2760858, 06.08.2014 en
(54) URIDINE DIPHOSPHATE DERIVATIVES, COMPOSITIONS AND METHODS FOR TREATING NEURODEGENERATIVE DISORDERS
- (71) Tufts University, 136 Harrison Avenue, Boston, MA 02111, US
(72) HAYDON, Philip, 234 Causeway Street, 809, Andover, MA 02114, US
LEE, Jinbo, 10 Orchard Crossing, Andover, MA 01810, US
DONG, Jinghui, 180 Mountain Avenue, Unit 24, Malden, MA 02148, US
MOSS, Stephen, 10 Raleigh Road, Dover, MA 02030, US
REVILLA-SANCHEZ, Raquel, La Granja 9, 6A, Leon, ES

- (51) MKP
A61K 31/565 (2006.01) (97) **2714710 ***
A61P 5/30 (2006.01)
C07J 1/00 (2006.01)
C07J 13/00 (2006.01)
C07J 51/00 (2006.01)
- (86) EP2012060447 01.06.2012
(96) 12729054.2 09.04.2014
(87) WO2012164096, 01.06.2012
(97) 2714710, 09.04.2014 en
(54) PROCESS FOR THE PRODUCTION OF ESTETROL INTERMEDIATES
- (71) Estetra S.A., Rue du Travail 16, 4460 Grâce-Hollogne, BE
(72) PASCAL, Jean-Claude, 170, Avenue de Gairaut, 06100 Nice, FR

- (51) MKP
E04B 2/18 (2006.01) (97) **2739799 ***
E04B 2/24 (2006.01)
E04B 2/86 (2006.01)
E04B 5/19 (2006.01)
E04B 5/21 (2006.01)
E04B 5/38 (2006.01)
E04C 2/288 (2006.01)
- (86) RS2011000013 01.09.2011
(96) 11813460.0 11.06.2014
(87) WO2013019134, 01.09.2011
(97) 2739799, 11.06.2014 en
(54) BUILDING STRUCTURE OF PRE-CAST MONOLITHIC WALLS AND INTERFLOOR SLABS
- (71) Kekanovic, Milan, Palicka 7, 24000 Subotica, YU
(72) Kekanovic, Milan, Palicka 7, 24000 Subotica, YU

- (51) MKP
A01K 67/027 (2006.01) (97) **2702413 ***
G01N 33/92 (2006.01)
- (86) EP2012057890 30.04.2012
(96) 12720471.7 05.03.2014
(87) WO2012146776, 30.04.2012
(97) 2702413, 05.03.2014 en
(54) TEST SYSTEMS AND METHODS FOR IDENTIFYING AND CHARACTERISING LIPID LOWERING DRUGS
- (71) SANOFI, 54 rue La Boétie, 75008 Paris, FR
(72) SCHAEFER, Hans-Ludwig, c/o Sanofi-Aventis Deutschland GmbH Industriepark Hoechst, 65926 Frankfurt am Main, DE
FALK, Eugen, c/o Sanofi-Aventis Deutschland GmbH Industriepark Hoechst, 65926 Frankfurt am Main, DE
SCHWAHN, Uwe, c/o Sanofi-Aventis Deutschland GmbH Industriepark Hoechst, 65926 Frankfurt am Main, DE

(51) MKP
A61K 8/36 (2006.01) (97) **2703478 ***
A61K 8/42 (2006.01)
A61Q 5/02 (2006.01)
A61Q 19/10 (2006.01)
C11D 1/04 (2006.01)
C11D 1/10 (2006.01)
C11D 3/33 (2006.01)
(86) JP2012061430 27.04.2012
(96) 12777189.7 05.03.2014
(87) WO2012147940, 27.04.2012
(97) 2703478, 05.03.2014 en
(54) CLEANING AGENT COMPOSITION
(71) Ajinomoto Co., Inc., 15-1, Kyobashi 1-chome Chuo-ku, Tokyo 104-8315, JP
(72) INO, Masahiro, c/o AJINOMOTO CO. INC. 1-1 Suzuki-cho Kawasaki-ku, Kawasaki-shi Kanagawa 210-8681, JP
IKEDA, Naoaki, c/o AJINOMOTO CO. INC. 1-1 Suzuki-cho Kawasaki-ku, Kawasaki-shi Kanagawa 210-8681, JP
SUGIMOTO, Takanori, c/o AJINOMOTO CO. INC. 1-1 Suzuki-cho Kawasaki-ku, Kawasaki-shi Kanagawa 210-8681, JP

(51) MKP
G11C 27/02 (2006.01) (97) **2650881**
(96) 13157438.6 16.10.2013
(97) 2650881, 16.10.2013 en
(54) Electronic device and method for low leakage switching
(71) TEXAS INSTRUMENTS DEUTSCHLAND GMBH, Haggertystrasse 1, 85356 Freising, DE
Texas Instruments Incorporated, 12500 TI Boulevard M/S 3999, Dallas TX 75243, US
(72) Landoulsi, Aymen, Pestalozzistrasse 97, 72762 Reutlingen, DE
Arnold, Matthias, Am Woerth 29, 85354 Freising, DE

(51) MKP
B01D 53/62 (2006.01) (97) **2723475 ***
(86) CA2012050418 22.06.2012
(96) 12803141.6 30.04.2014
(87) WO2012174665, 22.06.2012
(97) 2723475, 30.04.2014 en
(54) SEQUESTRATION OF GREENHOUSE GASSES BY GENERATING AN UNSTABLE GAS/SALINE FRONT WITHIN A FORMATION
(71) Dusseault, Maurice B., 15532 Lorne Court, White Rock, BC V4B 5J6, CA
Bilak, Roman, 49 MacEwan Park Close NW, Calgary, AB T3K 3Z6, CA
(72) MALEKZADEH, Farshad A., 1011 9th Avenue SE Suite 208, Calgary, Alberta V4B 5J6, CA
DUSSEAULT Maurice B., 246 Shakespeare Drive, Waterloo, Ontario N2T6/CA, CA
BILAK Roman, 25 Rocky Vista terrace NW, Calgary, Alberta T3G/Ca, CA

(51) MKP
A61K 35/74 (2006.01) (97) **2763685 ***
A61P 1/00 (2006.01)
A61P 37/00 (2006.01)
(86) GB2012052495 08.10.2012
(96) 12775538.7 13.08.2014
(87) WO2013050792, 08.10.2012
(97) 2763685, 13.08.2014 en
(54) BACTERIUM FOR USE AS A PROBIOTIC FOR NUTRITIONAL AND MEDICAL APPLICATIONS
(71) Gt Biologics Ltd, Institute of Medical Sciences Foresterhill, Aberdeen, Aberdeenshire AB25 2ZD, GB
(72) KELLY, Denise, GT Biologics Ltd c/o Rowett Research Institute Greenburn Road, Aberdeen Aberdeenshire AB21 9SB, GB

(51) MKP
A61B 17/072 (2006.01) (97) **2517645**
(96) 12166178.9 31.10.2012
(97) 2517645, 31.10.2012 en
(54) Tissue thickness compensator for a surgical stapler comprising an adjustable anvil
(71) Ethicon Endo-Surgery, Inc., 4545 Creek Road, Cincinnati, OH 45242, US
(72) Shelton, IV, Frederick E., 245 East Main Street, Hillsboro, OH Ohio 45133, US
Baxter, III, Chester O., 6375 Pawnee Ridge, Loveland, OH Ohio 45140, US

(51) MKP
A61K 9/16 (2006.01) (97) **2734573 ***
C08G 81/00 (2006.01)
C08L 87/00 (2006.01)
(86) NL2012050529 23.07.2012
(96) 12748568.8 28.05.2014
(87) WO2013015685, 23.07.2012
(97) 2734573, 28.05.2014 en
(54) BIODEGRADABLE, SEMI-CRYSTALLINE, PHASE SEPARATED, THERMOPLASTIC MULTI BLOCK COPOLYMERS FOR CONTROLLED RELEASE OF BIOLOGICALLY ACTIVE COMPOUNDS
(71) InnoCore Technologies B.V., L.J. Zielstraweg 1, 9713 GX Groningen, NL
(72) STEENDAM, Rob, L.J. Zielstraweg 1, NL-9713 GX Groningen, NL
FLIPSEN, Theodorus Adrianus Cornelius, L.J. Zielstraweg 1, NL-9713 GX Groningen, NL
HIEMSTRA, Christine, L.J. Zielstraweg 1, NL-9713 GX Groningen, NL
ZUIDEMA, Johan, L.J. Zielstraweg 1, NL-9713 GX Groningen, NL

(51) MKP
A61K 31/335 (2006.01) (97) **2705030 ***
A61K 31/352 (2006.01)
A61K 31/397 (2006.01)
A61K 31/4025 (2006.01)
A61K 31/4355 (2006.01)
A61P 3/04 (2006.01)
C07D 311/94 (2006.01)
C07D 405/02 (2006.01)
C07D 491/048 (2006.01)
C07D 493/04 (2006.01)
(86) US2012036789 07.05.2012
(96) 12722591.0 12.03.2014
(87) WO2012154676, 07.05.2012
(97) 2705030, 12.03.2014 en
(54) PARTIALLY SATURATED TRICYCLIC COMPOUNDS AND METHODS OF MAKING AND USING SAME
(71) ZAFGEN INC., One Broadway, 8th Floor, Cambridge, MA 02142, US
(72) CRAMP, Susan, Mary, 8/9 Spire Green Centre Flex Meadow, Harlow, Essex CM19 5TR, GB
DYKE, Hazel, Joan, 8/9 Spire Green Centre Flex Meadow, Harlow, Essex CM19 5TR, GB
PALLIN, Thomas, David, 8/9 Spire Green Centre Flex Meadow, Harlow, Essex CM19 5TR, GB
ZAHLER, Robert, 1 Cambridge Center, Suite 702, Cambridge, MA 02142, US

(51) MKP
A61K 31/575 (2006.01) (97) **2662382**
A61P 35/00 (2006.01)
C07J 9/00 (2006.01)
C07J 41/00 (2006.01)
C07J 75/00 (2006.01)
(96) 12305518.8 13.11.2013
(97) 2662382, 13.11.2013 fr
(54) Sterol derivatives, method for preparing same, pharmaceutical compositions containing same and use thereof for the treatment of multiple glioblastomas
(71) Beta Innov, 49 rue Rouelle, 75015 Paris, FR
(72) Clarion, Ludovic, 71 rue Maurice Ravel, 34980 SAINT GELY DU FESC, FR
Mersel, Marcel, Chez Famille VIGNON Jacques, 23 rue du Vaccarès, Les hauts de Massane, 34080 MONTPELLIER, FR
Petite, Didier, 3 rue de Porto, 34000 MONTPELLIER, FR

(51) MKP
C09K 5/04 (2006.01)
C10M 105/18 (2006.01)
C10M 107/24 (2006.01)
C10M 107/34 (2006.01)
C10M 129/18 (2006.01)
C10M 133/04 (2006.01)
C10M 137/08 (2006.01)
C10M 169/04 (2006.01)
C10M 171/00 (2006.01)
C10N 30/06 (2006.01)
C10N 30/08 (2006.01)
C10N 30/10 (2006.01)
C10N 40/30 (2006.01)

(97) **2740784**

(96) 14000478.9 11.06.2014
(97) 2740784, 11.06.2014 en
(54) Refrigerant oil for freezers and operating fluid composition for freezers
(71) JX Nippon Oil & Energy Corporation, 6-3, Otemachi 2-chome., Chiyoda-ku, Tokyo 100-8162, JP
(72) Takigawa, Katsuya, c/o JX Nippon Oil & Energy Corporation 6-3, Otemachi 2-chome Chiyoda-ku, Tokyo 100-8162, JP
Shimomura, Yuji, c/o JX Nippon Oil & Energy Corporation 6-3, Otemachi 2-chome Chiyoda-ku, Tokyo 100-8162, JP
Saito, Masanori, c/o JX Nippon Oil & Energy Corporation 6-3, Otemachi 2-chome Chiyoda-ku, Tokyo 100-8162, JP
Sawada, Ken, c/o JX Nippon Oil & Energy Corporation 6-3, Otemachi 2-chome Chiyoda-ku, Tokyo 100-8162, JP
Okido, Takeshi, c/o JX Nippon Oil & Energy Corporation 6-3, Otemachi 2-chome Chiyoda-ku, Tokyo 100-8162, JP

(51) MKP
A61K 31/4545 (2006.01)
A61P 25/28 (2006.01)
C07D 401/12 (2006.01)

(97) **2751094 ***

(86) EP2012067027 31.08.2012
(96) 12756693.3 09.07.2014
(87) WO2013030374, 31.08.2012
(97) 2751094, 09.07.2014 en
(54) NOVEL CRYSTAL FORM
(71) Glaxo Group Limited, 980 Great West Road, Brentford, Middlesex TW8 9GS, GB
(72) LEE, Mei-yin, GlaxoSmithKline Gunnels Wood Road, Stevenage Hertfordshire SG1 2NY, GB

(51) MKP
F02M 59/06 (2006.01)
F02M 59/10 (2006.01)
F04B 1/04 (2006.01)

(97) **2639444**

(96) 12158980.8 18.09.2013
(97) 2639444, 18.09.2013 en
(54) Fuel pump assembly
(71) Delphi International Operations Luxembourg S.à.r.l., Avenue de Luxembourg, 4940 Bascharage, LU
(72) Navas Sanchez, Borja, Flat 4, 95-97 High Street, Chatham, Kent ME4 4DL, GB
Collingborn, Peter, 82 Burnham Walk, Gillingham, Kent ME8 8RX, GB
Laity, Kevin, Cobham Orchard Drive Weaving, Maidstone, Kent ME14 5JG, GB

(51) MKP
A61K 9/00 (2006.01)
A61K 9/127 (2006.01)
A61K 47/24 (2006.01)

(97) **2720680 ***

(86) US2012043001 18.06.2012
(96) 12728936.1 23.04.2014
(87) WO2012174559, 18.06.2012
(97) 2720680, 23.04.2014 en
(54) INHALABLE PHARMACEUTICAL COMPOSITIONS
(71) Berg LLC, 1845 Elm Hill Pike, Nashville, TN 37210, US
(72) NARAIN, Niven, Rajin, 73 Fresh Pond Parkway, Cambridge, MA 02138, US
MCCOOK, John, Patrick, 4913 Southern Hills Drive, Frisco, TX 75034, US

(51) MKP
C07K 16/22 (2006.01)

(97) **2736925 ***

(86) EP2012064632 25.07.2012
(96) 12738476.6 04.06.2014
(87) WO2013014208, 25.07.2012
(97) 2736925, 04.06.2014 en
(54) ANTI-VEGF SINGLE VARIABLE DOMAINS FUSED TO FC DOMAINS
(71) Glaxo Group Limited, 980 Great West Road, Brentford, Middlesex TW8 9GS, GB
(72) ASHMAN, Claire, GlaxoSmithKline Gunnels Wood Road, Stevenage Hertfordshire SG1 2NY, GB
CATCHPOLE, Ian Richard, GlaxoSmithKline Gunnels Wood Road, Stevenage Hertfordshire SG1 2NY, GB
HUGHES-THOMAS, Zoe, GlaxoSmithKline Gunnels Wood Road, Stevenage Hertfordshire SG1 2NY, GB
LEWIS, Alan Peter, GlaxoSmithKline Gunnels Wood Road, Stevenage Hertfordshire SG1 2NY, GB
STEWART, Michael, GlaxoSmithKline Gunnels Wood Road, Stevenage Hertfordshire SG1 2NY, GB

(51) MKP
A61J 1/14 (2006.01)
A61J 3/00 (2006.01)
B65D 81/32 (2006.01)

(97) **2729110 ***

(86) CA2012000650 05.07.2012
(96) 12807780.7 14.05.2014
(87) WO2013003951, 05.07.2012
(97) 2729110, 14.05.2014 en
(54) RECONSTITUTION DEVICE
(71) Duoject Medical Systems, Inc., 50 Rue de Gaspé Complex B-5, Bromont, Québec J2L 2N8, CA
(72) REYNOLDS, David L., 50 rue De Gaspe Complex B-5, Bromont, Quebec J2L 2N8, CA
MACDONALD, Daniel, 202-5 des Deux-Montagnes, Bromont, Quebec J2L 1P3, CA
TREMBLAY, Yan, 165 rue De L'Erabliere, Orford, Quebec J1X 6J8, CA
GEOFFROY, Eric, 1421 chemin Vallieres, Ayer's Cliff, Quebec J1X 6J8, CA
VIENS, Mathieu, 403 rue Georges-Cros, Granby, Quebec J2C 0C7, CA

(51) MKP
H04L 12/18 (2006.01)
H04M 3/42 (2006.01)

(97) **2744185**

(96) 13005777.1 18.06.2014
(97) 2744185, 18.06.2014 en
(54) File management system, method and computer program
(71) Hitachi Information & Telecommunication Engineering, Ltd., 2-3-3, Minatomirai, Nishi-ku Yokohama-shi, Kanagawa-ken 220-6122, JP
(72) Koyama, Toshiaki, c/o: Hitachi Information & Telecommunication Engineering, Ltd. 456, Sakai, Nakai-machi Ashigarakami-gun, Kanagawa, 259-0157, JP
Yamagishi, Toyoki, c/o: Hitachi Information & Telecommunication Engineering, Ltd. 2-3-3, Minatomirai, Nishi-ku, Yokohama-shi, Kanagawa, 220-6122, JP

(51) MKP
B62J 99/00 (2009.01)
B62K 21/02 (2006.01)
B62K 21/06 (2006.01)
B62K 21/18 (2006.01)

(97) **2718173 ***

(86) IB2012001110 08.06.2012
(96) 12731661.0 16.04.2014
(87) WO2012168781, 08.06.2012
(97) 2718173, 16.04.2014 en
(54) BICYCLE FORK
(71) Wilier Triestina S.p.A., Via Fratel M. Venzo 11, 36028 Rossano Veneto (VI), IT
(72) GENOVESE, Marco, Via Fratel M. Venzo 11, I-36028 Rossano Veneto (VI), IT
SALOMONI, Claudio, Via L. M. Fabris 11, I-36100 Vicenza, IT

(51) MKP
C10B 47/24 (2006.01) (97) **2707663 ***
C10J 3/50 (2006.01)
C10J 3/54 (2006.01)
F02C 3/28 (2006.01)
F26B 3/10 (2006.01)
(86) AU2012000497 09.05.2012
(96) 12782353.2 19.03.2014
(87) WO2012151625, 09.05.2012
(97) 2707663, 19.03.2014 en
(54) IMPROVEMENTS IN INTEGRATED DRYING GASIFICATION
(71) Hrl Treasury (idgcc) Pty Ltd, Level 1, Unit 9 677 Springvale Road, Mulgrave, Victoria 3170, AU
(72) ANDERSON, Bernard, C/- 677 Springvale Road, Mulgrave Victoria 3170, AU
BLATCHFORD, Alex, C/- 677 Springvale Road, Mulgrave Victoria 3170, AU
STEPHANOU, Tom, C/- 677 Springvale Road, Mulgrave Victoria 3170, AU

(51) MKP
A61K 31/4196 (2006.01) (97) **2714038 ***
A61K 31/675 (2006.01)
A61K 45/06 (2006.01)
A61P 35/00 (2006.01)
(86) US2012039106 23.05.2012
(96) 12723814.5 09.04.2014
(87) WO2012162372, 23.05.2012
(97) 2714038, 09.04.2014 en
(54) COMBINATION THERAPY OF HSP90 INHIBITORY COMPOUNDS WITH MTOR/PI3K INHIBITORS
(71) Synta Pharmaceuticals Corp., 45 Hartwell Avenue, Lexington, MA 02421, US
(72) PROIA, David, 30 Silver Lake Avenue, Newton, MA 02458, US
HE, Suqin, 12 Loyola Circle, West Roxbury, MA 02132, US

(51) MKP
A45C 11/00 (2006.01) (97) **2647306**
(96) 13161921.5 09.10.2013
(97) 2647306, 09.10.2013 en
(54) Protective apparatus for tablet electronic device
(71) Aevoe International Ltd., Sea Meadow House Blackburne Highway Road Town (P.O. Box 116), Tortola, VG
(72) Shao, Tzu-Ching, No. 40, Dadao Rd. Xinyi Dist., 110 Taipei City, TW
Lin, Li-Wen, Rm. 4, 2F., No. 190, Zhuangjing Rd. Xinyi Dist., 110 Taipei City, TW

(51) MKP
A61K 31/4188 (2006.01) (97) **2729143 ***
A61P 25/00 (2006.01)
(86) EP2013058936 29.04.2013
(96) 13719836.2 14.05.2014
(87) WO2014016003, 29.04.2013
(97) 2729143, 14.05.2014 en
(54) USE OF BIOTIN FOR THE TREATMENT OF MULTIPLE SCLEROSIS
(71) Assistance Publique Hôpitaux De Paris, 3 Avenue Victoria, 75004 Paris 4, FR
(72) SEDEL, Frédéric, 17 rue des rigoles, F-75020 Paris, FR

(51) MKP
A61K 39/395 (2006.01) (97) **2726100 ***
(86) US2012042164 13.06.2012
(96) 12803745.4 07.05.2014
(87) WO2013003037, 13.06.2012
(97) 2726100, 07.05.2014 en
(54) ANTI-ERBB3 ANTIBODIES IN COMBINATION WITH PACLITAXEL FOR TREATMENT OF GYNECOLOGICAL CANCERS
(71) Merrimack Pharmaceuticals, Inc., One Kendall Square Suite B7201, Cambridge, MA 02139, US
SANOFI, 54 rue La Boétie, 75008 Paris, FR
(72) KUBASEK, William, 165 Fairview Ave., Belmont, MA 02478, US
MOYO, Victor, 450 College Road, Concord, MA 01742, US
PEARLBERG, Joseph, 24 Grovenor Rd, Jamaica Plain, MA 02130, US
TABAH-FISCH, Isabelle, 62 Bis, Rue Bellevue, F-92100 Boulogne, FR
MACBEATH, Gavin, 4222 Kirkbride Drive, Danvers, MA 01923, AE

(51) MKP
C10B 53/07 (2006.01) (97) **2705117 ***
C10G 1/10 (2006.01)
(86) AT2012000127 04.05.2012
(96) 12723076.1 12.03.2014
(87) WO2012149590, 04.05.2012
(97) 2705117, 12.03.2014 de
(54) METHOD AND APPARATUS FOR ENERGY-EFFICIENT PROCESSING OF SECONDARY DEPOSITS
(71) OMV REFINING & MARKETING GMBH, Trabrennstrasse 6-8, 1020 Wien, AT
(72) HOFER, Wolfgang, Arbeiterstrandbadstrasse 43d, 1210 Wien, AT

(51) MKP
E04B 2/74 (2006.01) (97) **2718512 ***
F21V 33/00 (2006.01)
G02B 6/00 (2006.01)
(86) FR2012051279 07.06.2012
(96) 12731541.4 16.04.2014
(87) WO2012168660, 07.06.2012
(97) 2718512, 16.04.2014 fr
(54) ILLUMINATING GLASS PARTITION
(71) Saint-Gobain Glass France, 18 avenue d'Alsace, 92400 Courbevoie, FR
(72) GIERENS, Anne, 12 rue d'Amiens, F-60200 Compiègne, FR
MONTGERMONT, Aude, 12 rue de Châteaudun, F-75009 Paris, FR
ZHANG, Jingwei, 38 rue des Ruelles, F-91300 Massy, FR

(51) MKP
G08B 13/14 (2006.01) (97) **2740110 ***
G08B 29/04 (2006.01)
(86) EP2012064221 19.07.2012
(96) 12738442.8 11.06.2014
(87) WO2013017427, 19.07.2012
(97) 2740110, 11.06.2014 en
(54) ANTI-THEFT DEVICE FOR OBJECTS ON DISPLAY
(71) Total Protection Service S.r.l., Via Monza s.n.c., 20060 Gessate, IT
(72) TINTI, Fabrizio, Via Mazzini 20, I-20060 Gessate, IT

(51) MKP
A61B 17/04 (2006.01) (97) **2734124 ***
A61B 17/06 (2006.01)
(86) IB2012053319 29.06.2012
(96) 12748255.2 28.05.2014
(87) WO2013014553, 29.06.2012
(97) 2734124, 28.05.2014 en
(54) DEVICE FOR THE TRANSOSSEOUS INSERTION OF SUTURE THREADS
(71) NCS Lab S.r.l., Via Pola Esterna 4/12 Carpi, 41012 Modena, IT
(72) MANTOVANI, Matteo, Via D. Dal Verme, I-42124 Reggio Emilia, IT

(51) MKP
E04C 2/34 (2006.01) (97) **2660408**
(96) 12003427.7 06.11.2013
(97) 2660408, 06.11.2013 de
(54) Zigzag wooden elements comprising a core layer and multiple layer composite comprising the core layer
(71) Wood Innovations Ltd., Boja 42, 9492 Eschen, LI
(72) Möller, Achim, Dr., Max-Sachs-Str. 32, 01157 Dresden, DE
Eckstein, Thomas, Klingestr. 5, 01159 Dresden, DE
Gräßer, Johannes, Saalhausenerstr. 10, 01159 Dresden, DE

- (51) MKP
A61K 31/155 (2006.01) (97) **2707015 ***
A61K 38/26 (2006.01)
A61K 38/28 (2006.01)
A61P 3/04 (2006.01)
A61P 3/10 (2006.01)
- (86) EP2012058749 11.05.2012
(96) 12721268.6 19.03.2014
(87) WO2012156299, 11.05.2012
(97) 2707015, 19.03.2014 en
(54) LIXISENATIDE AS ADD-ON THERAPY TO BASAL INSULIN IN TYPE 2 DIABETES
(71) Sanofi-Aventis Deutschland GmbH, Brüningstraße 50, 65929 Frankfurt am Main, DE
(72) NIEMÖLLER, Elisabeth, c/o Sanofi-Aventis Deutschland GmbH, 65926 Frankfurt am Main, DE
SILVESTRE, Louise, c/o Sanofi Département Brevets 54 rue la Boétie, F-75008 Paris, FR
BOKA, Gabor, c/o Sanofi Département Brevets 54 rue la Boétie, F-75008 Paris, FR
MIOSSEC, Patrick, c/o Sanofi Département Brevets 54 rue la Boétie, F-75008 Paris, FR

- (51) MKP
B01D 33/15 (2006.01) (97) **2752229 ***
B01D 33/39 (2006.01)
B01D 33/74 (2006.01)
- (86) KR2012001877 15.03.2012
(96) 12827229.1 09.07.2014
(87) WO2013032085, 15.03.2012
(97) 2752229, 09.07.2014 en
(54) SUCTIONING APPARATUS FOR A FIBROUS FILTER, AND FILTERING DEVICE USING SAME
(71) ANT Corporation, 14 Block 2nd Nong-gong Complex 1771 Yeonjang-ri JInan-eup, Jinan-gun, Jeollabuk-do 567-807, KR
(72) Kuk, Younglong, 1208 Sindonga apartment 12B/D gil-dong gangnam-gu, Seoul 134-766, KR
Kim, Jaeku, 1008 Hwannhwa B/D 832-7 Yeoksam-dong Gangnam-gu, Seoul 138-080, KR

- (51) MKP
G06Q 10/00 (2012.01) (97) **2748776 ***
- (86) US2012052330 24.08.2012
(96) 12828641.6 02.07.2014
(87) WO2013032925, 24.08.2012
(97) 2748776, 02.07.2014 en
(54) NETWORK PREDICTIVE CUSTOMER SERVICE QUEUE MANAGEMENT
(71) Five9, Inc., 4000 Executive Parkway, Suite 400, San Ramon, CA 94583, US
(72) FRIED, Lance, 3530 Mystic Pointe Drive 1009, Aventura, Florida 33180, US
KATZ, Joseph, 1280 Old Woodbine Road, Atlanta, Georgia 30319, US
KORFIN, Rick, 4821 Almondwood Way, San Diego, California 92130, US

- (51) MKP
A47J 31/00 (2006.01) (97) **2739190 ***
A47J 43/27 (2006.01)
B65B 3/04 (2006.01)
F24H 1/18 (2006.01)
- (86) US2011046436 03.08.2011
(96) 11870208.3 11.06.2014
(87) WO2013019227, 03.08.2011
(97) 2739190, 11.06.2014 en
(54) POWDER DISPENSING APPARATUS
(71) Product Spring, LLC, 30 Butler Lane, New Canaan, CT 06840, US
Taylored Concepts, Llc, 40 Dellwood Avenue, Chatham, NJ 07928, US
Hartdesigni Ltd., P.O. Box 2444, Orland Park, IL 60462, US
(72) DOOLEY, Christopher, 30 Bulter Lane, New Canaan, CT 06840, US
TAYLOR, Loren, 40 Dellwood Avenue, Chatham, NJ 07928, US
HARTELIUS, Mark, E., 8112 S. Komensky Avenue, Chicago, IL 60652, US

- (51) MKP
A01N 43/34 (2006.01) (97) **2721022 ***
A01N 43/713 (2006.01)
A01P 3/00 (2006.01)
C07D 401/06 (2006.01)
C07D 401/14 (2006.01)
- (86) US2012043147 19.06.2012
(96) 12802997.2 23.04.2014
(87) WO2012177638, 19.06.2012
(97) 2721022, 23.04.2014 en
(54) METALLOENZYME INHIBITOR COMPOUNDS
(71) Viamet Pharmaceuticals, Inc., 2250 Perimeter Park Drive Suite 320, Morrisville, NC 27560, US
(72) HOEKSTRA, William, J., 7 Treviso Place, Durham, NC 27707, US
YATES, Christopher, M., 6201 Therfield Drive, Raleigh, NC 27614, US
SCHOTZINGER, Robert, J., 7000 Potomac Court, Raleigh, NC 27613, US
LOSO, Michael, 11439 Sutton Place, Carmel, IN 46032, US
BUCHAN, Zachary, A., 4704 W. 81st Pl., Indianapolis, IN 46268, US
SULLENBERGER, Michael, 910 Hadleigh Pass, Westfield, IN 46074, US

- (51) MKP
A61K 39/155 (2006.01) (97) **2707025 ***
- (86) US2012037839 14.05.2012
(96) 12785009.7 19.03.2014
(87) WO2012158643, 14.05.2012
(97) 2707025, 19.03.2014 en
(54) HENDRA AND NIPAH VIRUS G GLYCOPROTEIN IMMUNOGENIC COMPOSITIONS
(71) Zoetis LLC, 235 East 42nd Street, New York, NY 10017, US
HENRY M. JACKSON FOUNDATION FOR THE ADVANCEMENT OF MILITARY MEDICINE, INC., 6720-A Rockledge Drive, Suite 100, Bethesda, MD 20817, US
(72) ELHAY, Martin, 38-42 Warf Road, West Ryde, Nsw 2114, AU
BRODER, Christopher, C., 6720-a Rockledge Drive, Suite 100, Bethesda, MD 20817, US
HUANG, Jin-Ao, 12 Vista Court, Box Hill North, VIC 3129, AU

- (51) MKP
A61K 31/4985 (2006.01) (97) **2763989 ***
A61P 25/00 (2006.01)
C07D 471/14 (2006.01)
- (86) EP2012067639 10.09.2012
(96) 12756732.9 13.08.2014
(87) WO2013034761, 10.09.2012
(97) 2763989, 13.08.2014 en
(54) PYRIDINE COMPOUNDS AND USES THEREOF
(71) H. Lundbeck A/S, Ottiliavej 9, 2500 Valby, DK
(72) JØRGENSEN, Morten, Aldershvilevej 94, DK-2880 Bagsværd, DK
BRUUN, Anne Techau, Stavnsbjergvej 6, DK-2650 Hvidovre, DK
RASMUSSEN, Lars Kyhn, Højstrupvej 60, DK-2700 Brønshøj, DK

- (51) MKP
A01N 43/54 (2006.01) (97) **2713734 ***
A01N 43/56 (2006.01)
A01N 43/653 (2006.01)
A01N 43/80 (2006.01)
A01P 3/00 (2006.01)
- (86) EP2012060103 30.05.2012
(96) 12729043.5 09.04.2014
(87) WO2012163945, 30.05.2012
(97) 2713734, 09.04.2014 en
(54) PESTICIDAL MIXTURES COMPRISING ISOXAZOLINE DERIVATIVES
(71) Syngenta Participations AG, Schwarzwaldallee 215, 4058 Basel, CH
(72) CASSAYRE, Jérôme, Yves, Syngenta Crop Protection Münchwilen AG Schaffhauserstrasse, CH-4332 Stein, CH
EL QACEMI, Myriem, Syngenta Crop Protection Münchwilen AG Schaffhauserstrasse, CH-4332 Stein, CH

- (51) MKP
A61K 31/437 (2006.01) (97) **2768822 ***
A61K 31/4439 (2006.01)
A61K 31/498 (2006.01)
A61K 31/502 (2006.01)
A61K 31/517 (2006.01)
A61K 31/522 (2006.01)
C07D 401/12 (2006.01)
C07D 401/14 (2006.01)
C07D 409/14 (2006.01)
C07D 413/12 (2006.01)
C07D 413/14 (2006.01)
C07D 417/12 (2006.01)
C07D 417/14 (2006.01)
C07D 471/04 (2006.01)
C07D 473/04 (2006.01)
- (86) EP2012069999 10.10.2012
(96) 12778683.8 27.08.2014
(87) WO2013057013, 10.10.2012
(97) 2768822, 27.08.2014 en
(54) DERIVATIVES OF 1-PHENYL-2-PYRIDINYL ALKYL ALCOHOLS AS PHOSPHODIESTERASE INHIBITORS
(71) Chiesi Farmaceutici S.p.A., Via Palermo, 26/A, 43100 Parma, IT
(72) ARMANI, Elisabetta, Chiesi Farmaceutici S.P.A. Via Palermo 26/A, I-43100 Parma, IT
AMARI, Gabriele, Chiesi Farmaceutici S.P.A. Via Palermo 26/A, I-43100 Parma, IT
CAPALDI, Carmelida, Chiesi Farmaceutici S.P.A. Via Palermo 26/A, I-43100 Parma, IT
CARZANIGA, Laura, Chiesi Farmaceutici S.P.A. Via Palermo 26/A, I-43100 Parma, IT
LA PORTA, Elena, Chiesi Farmaceutici S.P.A. Via Palermo 26/A, I-43100 Parma, IT
GUALA, Matilde, Chiesi Farmaceutici S.P.A. Via Palermo 26/A, I-43100 Parma, IT
-
- (51) MKP
A61M 5/24 (2006.01) (97) **2731646 ***
A61M 5/315 (2006.01)
- (86) EP2012063638 12.07.2012
(96) 12734946.2 21.05.2014
(87) WO2013010895, 12.07.2012
(97) 2731646, 21.05.2014 en
(54) LOCKING INTERFACE, CARTRIDGE HOLDER AND DRUG DELIVERY DEVICE COMPRISING A LOCKING INTERFACE
(71) Sanofi-Aventis Deutschland GmbH, Brüningstraße 50, 65929 Frankfurt am Main, DE
(72) HARMS, Michael, c/o Sanofi-Aventis Deutschland GmbH, 65926 Frankfurt am Main, DE
STEVER, Tobias, c/o Sanofi-Aventis Deutschland GmbH, 65926 Frankfurt am Main, DE
SCHNEIDER, Christiane, c/o Sanofi-Aventis Deutschland GmbH, 65926 Frankfurt am Main, DE
WERNER, Meinolf, Nolaystraße 9, 67551 Worms, DE
ZECKAI, Olaf, Ortsstraße 14, 69469 Weinheim, DE
-
- (51) MKP
A61K 47/48 (2006.01) (97) **2710034 ***
C07K 16/28 (2006.01)
- (86) EP2012059141 16.05.2012
(96) 12721529.1 26.03.2014
(87) WO2012156455, 16.05.2012
(97) 2710034, 26.03.2014 en
(54) USE OF ANTI-CD19 MAYTANSINOID IMMUNOCONJUGATE ANTIBODY FOR THE TREATMENT OF B-CELL MALIGNANCIES SYMPTOMS
(71) SANOFI, 54 rue La Boétie, 75008 Paris, FR
(72) MORARIU, Rodica, Sanofi Patent Department 54 rue La Boétie, F-75008 Paris, FR

- (51) MKP
A61K 31/535 (2006.01) (97) **2768509 ***
- (86) US2012061015 19.10.2012
(96) 12842273.0 27.08.2014
(87) WO2013059587, 19.10.2012
(97) 2768509, 27.08.2014 en
(54) SUBSTITUTED BICYCLIC AZA-HETEROCYCLES AND ANALOGUES AS SIRTUIN MODULATORS
(71) Glaxosmithkline LLC, 2711 Centerville Road Suite 400 Wilmington, New Castle, DE 19808, US
(72) CASAUBON, Rebecca, L., 8 Oakland Street., Cambridge, MA 02139, US
NARAYAN, Radha, 22 Thomas Street., Belmont, MA 02478, US
OALMANN, Christopher, 146 Spring Street., Watertown, MA 02472, US
VU, Chi, B., 79 Bay State Road., Arlington, MA 02474, US
-
- (51) MKP
A61K 39/395 (2006.01) (97) **2734546 ***
C07K 16/22 (2006.01)
- (86) US2012047048 17.07.2012
(96) 12745942.8 28.05.2014
(87) WO2013012855, 17.07.2012
(97) 2734546, 28.05.2014 en
(54) APELIN ANTIGEN-BINDING PROTEINS AND USES THEREOF
(71) Amgen Inc., One Amgen Center Drive, Thousand Oaks, California 91320-1799, US
(72) LU, Shu-Chen, 2356 Rutland Place, Thousand Oaks, California 91362, US
WANG, Minghan, 4952 Via Bella, Newbury Park, California 91320, US
-
- (51) MKP
A61K 36/185 (2006.01) (97) **2744504 ***
A61K 36/515 (2006.01)
A61K 36/70 (2006.01)
A61K 36/85 (2006.01)
A61P 11/12 (2006.01)
A61P 31/00 (2006.01)
- (86) EP2012066212 20.08.2012
(96) 12762228.0 25.06.2014
(87) WO2013026830, 20.08.2012
(97) 2744504, 25.06.2014 de
(54) METHOD FOR PRODUCING DRY EXTRACTS
(71) Bionorica SE, Kerschensteiner Strasse 11-15, 92318 Neumarkt, DE
(72) POPP, Michael, Weinbergstr. 3, 91207 Lauf-Heuchling, DE
-
- (51) MKP
A61K 9/16 (2006.01) (97) **2701686 ***
A61K 38/17 (2006.01)
A61K 47/30 (2006.01)
A61K 47/48 (2006.01)
A61K 48/00 (2006.01)
- (86) US2012035529 27.04.2012
(96) 12776480.1 05.03.2014
(87) WO2012149376, 27.04.2012
(97) 2701686, 05.03.2014 en
(54) POROUS NANOPARTICLE-SUPPORTED LIPID BILAYERS (PROTOCELLS) FOR TARGETED DELIVERY AND METHODS OF USING SAME
(71) STC.UNM, 801 University Blvd. SE, Suite 101, Albuquerque, NM 87106, US
Sandia Corporation, 1515 Eubank Boulevard SE, Albuquerque, NM 87123, US
(72) BRINKER, Jeffrey, C., 14 Eagle Nest Drive NE, Albuquerque, NM 87122, US
CARNES, Eric, C., 13309 Chaco Cliff Trail SE, Albuquerque, NM 87123, US
ASHLEY, Carlee, Erin, 14316 Bauer Road NE, Albuquerque, NM 87123, US

- (51) MKP
A61K 31/506 (2006.01) (97) **2704722 ***
A61P 35/00 (2006.01)
- (86) AU2012000462 01.05.2012
(96) 12779619.1 12.03.2014
(87) WO2012149602, 01.05.2012
(97) 2704722, 12.03.2014 en
(54) MULTIPLE MYELOMA TREATMENT
- (71) YM BioSciences Australia Pty Ltd, 333 Lakeside Drive, Foster City, CA 94404, US
(72) BURNS, Christopher, John, 17 Arthur Street, Caulfield North Victoria 3161, AU
SPENCER, Andrew, 11 Albion Street, South Yarra Victoria 3141, AU
MONAGHAN, Katherine, Anne, 26C/20 Commercial Road, Melbourne Victoria 3004, AU

- (51) MKP
C12Q 1/68 (2006.01) (97) **2702173 ***
- (86) US2012034989 25.04.2012
(96) 12725171.8 05.03.2014
(87) WO2012149014, 25.04.2012
(97) 2702173, 05.03.2014 en
(54) USE OF EMT GENE SIGNATURES IN CANCER DRUG DISCOVERY, DIAGNOSTICS, AND TREATMENT
- (71) OSI Pharmaceuticals, LLC, 1 Bioscience Park Drive, Farmingdale, NY 11735, US
Aveo Pharmaceuticals, Inc., 75 Sidney Street, 4th Floor, Cambridge, MA 02139, US
(72) KAN, Julie, 10724 Science Center Drive, San Diego, CA 92121, US
THOMSON, Stuart, 1 Bioscience Park Drive, Farmingdale, NY 11735, US
ARGAST, Gretchen M., 1 Bioscience Park Drive, Farmingdale, NY 11735, US
O'CONNOR, Matthew E., 1 Bioscience Park Drive, Farmingdale, NY 11735, US
ROBINSON, Murray, 75 Sidney Street, Cambridge, MA 02139, US
FENG, Bin, 75 Sidney Street, Cambridge, MA 02139, US
HEYER, Joerg, 75 Sidney Street, Cambridge, MA 02139, US
CHIU, Maria Isabel, 75 Sidney Street, Cambridge, MA 02139, US
NICOLETTI, Richard, 75 Sidney Street, Cambridge, MA 02139, US

- (51) MKP
A47J 31/40 (2006.01) (97) **2763574 ***
A47J 31/42 (2006.01)
- (86) EP2012069669 04.10.2012
(96) 12783135.2 13.08.2014
(87) WO2013050504, 04.10.2012
(97) 2763574, 13.08.2014 de
(54) COFFEE MACHINE AND A METHOD FOR INTRODUCING A QUANTITY OF BEANS
- (71) Miele & Cie. KG, Carl-Miele-Straße 29, 33332 Gütersloh, DE
(72) RIESSBECK, Wolfgang, Im Seegarte 12, CH-8597 Landschlacht, CH
WÄGER, Simon, Gartenstrasse 3, CH-8580 Amriswil, CH

- (51) MKP
G06K 9/46 (2006.01) (97) **2631845**
- (96) 12157182.2 28.08.2013
(97) 2631845, 28.08.2013 en
(54) Local feature amount calculating device, method of calculating local feature amount, corresponding point searching apparatus, and method of searching corresponding point
- (71) Denso IT Laboratory, Inc., Shibuya Cross Tower 28th Floor 2-15-1, Shibuya Shibuya-ku, Tokyo 150-0002, JP
(72) Anbai, Mitsuru, c/o Denso IT Laboratory, Inc. Shibuya cross tower 28th floor, 2-15-1, Shibuya, Shibuya-ku, Tokyo, Tokyo 150-0002, JP
Yoshida, Yuichi, c/o Denso IT Laboratory, Inc. Shibuya cross tower 28th floor, 2-15-1, Shibuya, Shibuya-ku, Tokyo, Tokyo 150-0002, JP

- (51) MKP
A61K 31/77 (2006.01) (97) **2701715 ***
- (86) US2012035493 27.04.2012
(96) 12777458.6 05.03.2014
(87) WO2012149349, 27.04.2012
(97) 2701715, 05.03.2014 en
(54) PROPHYLAXIS AND TREATMENT OF ENTEROPATHOGENIC BACTERIAL INFECTION
- (71) NorthShore University HealthSystem, 1301 Central Avenue, Evanston IL 60201, US
(72) SAVKOVIC, Suzana, 409 S. East Ave, Oak Park, IL 60302, US
ROY, Hemant, K., 3340 Old Mill Road, Highland Park, IL 60035, US

- (51) MKP
B26F 1/00 (2006.01) (97) **2739549 ***
B31F 1/20 (2006.01)
B32B 3/00 (2006.01)
B32B 33/00 (2006.01)
B32B 38/04 (2006.01)
B65D 81/24 (2006.01)
- (86) NZ2012000133 01.08.2012
(96) 12820231.4 11.06.2014
(87) WO2013019126, 01.08.2012
(97) 2739549, 11.06.2014 en
(54) IMPROVEMENTS IN AND RELATING TO CORRUGATED BOARD AND THE MANUFACTURE THEREOF
- (71) Corcel IP Limited, Level 12, KPMG Centre 85 Alexandra Street, Hamilton 3204, NZ
(72) VAN BERLO, Patrick Petrus Antonius Maria, c/o James&Wells Intellectual Property Level 12 KPMG Centre 85 Alexandra Street, Hamilton 3204, NZ
ROGERS, Jason Paul, c/o James&Wells Intellectual Property Level 12 KPMG Centre 85 Alexandra Street, Hamilton 3204, NZ

- (51) MKP
B60C 3/00 (2006.01) (97) **2736737 ***
B60C 13/00 (2006.01)
- (86) IL2012050277 26.07.2012
(96) 12818321.7 04.06.2014
(87) WO2013014676, 26.07.2012
(97) 2736737, 04.06.2014 en
(54) TIRE FOR SURFACE VEHICLE
- (71) Galileo Wheel Ltd., 1 Hamelacha Street North Industrial Zone, 71520 Lod, IL
(72) NOVOPLANSKI, Avishay, Netiv Haoranim St. 46, 90815 Moshav Beit-Zait, IL

- (51) MKP
G06Q 10/08 (2012.01) (97) **2662813**
- (96) 13167156.2 13.11.2013
(97) 2662813, 13.11.2013 de
(54) Method for registering, inventory, managing, checking and monitoring of tangible and intangible rights and/or goods
- (71) Hörmann, Markus, Kirchplatz 3, 89281 Altstadt / Illereichen, DE
(72) Hörmann, Markus, Kirchplatz 3, 89281 Altstadt / Illereichen, DE

- (51) MKP
G01B 21/22 (2006.01) (97) **2761250 ***
- (86) US2012057013 25.09.2012
(96) 12835246.5 06.08.2014
(87) WO2013048998, 25.09.2012
(97) 2761250, 06.08.2014 en
(54) POSITION SENSING DEVICE FOR TRANSIT SHAFT AND ARM ASSEMBLY
- (71) Wabtec Holding Corp., 1001 Air Brake Avenue, Wilmerding, PA 15148, US
(72) CHAPMAN, Matthew, 276 9th Street, Wheeling, Illinois 60090, US

(51) MKP
A41B 13/06 (2006.01) (97) **2736361 ***
A41D 13/12 (2006.01)
A47D 15/00 (2006.01)
A47G 9/08 (2006.01)
(86) DK2012050260 06.07.2012
(96) 12746009.5 04.06.2014
(87) WO2013013675, 06.07.2012
(97) 2736361, 04.06.2014 en
(54) SWADDLING UNIT
(71) Alluna, Carinn, Langekærgardsvej 39, 3370 Melby, DK
(72) Alluna, Carinn, Langekærgardsvej 39, 3370 Melby, DK

(51) MKP
A61K 31/437 (2006.01) (97) **2710003 ***
A61K 31/4985 (2006.01)
A61P 35/00 (2006.01)
C07D 471/04 (2006.01)
C07D 487/04 (2006.01)
(86) US2012037866 15.05.2012
(96) 12723044.9 26.03.2014
(87) WO2012158658, 15.05.2012
(97) 2710003, 26.03.2014 en
(54) FUSED BICYCLIC KINASE INHIBITORS
(71) OSI Pharmaceuticals, LLC, 1 Bioscience Park Drive, Farmingdale, NY 11735, US
(72) JIN, Meizhong, Osi Pharmaceuticals LLC 1 Bioscience Park Drive, Farmingdale, NY 11735, US
MULVIHILL, Mark, J., Osi Pharmaceuticals LLC 1 Bioscience Park Drive, Farmingdale, NY 11735, US
STEINIG, Arno, G., Osi Pharmaceuticals LLC 1 Bioscience Park Drive, Farmingdale, NY 11735, US
WANG, Jing, Osi Pharmaceuticals LLC 1 Bioscience Park Drive, Farmingdale, NY 11735, US

(51) MKP
A61K 31/70 (2006.01) (97) **2707366 ***
C07D 409/10 (2006.01)
C07H 7/04 (2006.01)
(86) US2012037062 09.05.2012
(96) 12723013.4 19.03.2014
(87) WO2012154812, 09.05.2012
(97) 2707366, 19.03.2014 en
(54) L-PROLINE AND CITRIC ACID CO-CRYSTALS OF (2S, 3R, 4R, 5S, 6R)-2-(3-(5-(4-FLUOROPHENYL)THIOPHEN-2-YL) METHYL)-4-METHYLPHENYL)-6-(HYDROXYMETHYL) TETRAHYDRO-2H-PYRAN-3,4,5-TRIOLE
(71) Janssen Pharmaceutica, N.V., Turnhoutseweg 30, 2340 Beerse, BE
(72) NGUYEN, Minh, 18 Bearse Avenue, Apt. 3, Dorchester MA 02124, US
COLLIER, Edwin, A., C/o Janssen Research&Development Llc 1000 Route 202, Raritan NJ 08869, US

(51) MKP
A61K 8/04 (2006.01) (97) **2723305 ***
(86) GB2012051440 21.06.2012
(96) 12730023.4 30.04.2014
(87) WO2012175970, 21.06.2012
(97) 2723305, 30.04.2014 en
(54) SOLID COSMETIC COMPOSITION HAVING DISPERSED THEREIN GAS BUBBLES
(71) Cosmetic Warriors Ltd, 18-20 Market Street Poole, Dorset BH15 1NF, GB
(72) AMBROSEN, Helen Elizabeth, 21 Newmans Close, Wimborne Dorset BH21 1XA, GB
CONSTANTINE, Margaret Joan, 24 Constitution Hill Road, Poole Dorset, GB
CONSTANTINE, Mark, 24 Constitution Hill Road, Poole Dorset, GB

(51) MKP
E04H 3/12 (2006.01) (97) **2623690**
(96) 12153956.3 07.08.2013
(97) 2623690, 07.08.2013 de
(54) Tribune
(71) INTER+-POL Freie Forschungs- u. Entwicklungsges. f. unfassb. Formate, exper. Proj.,ungesehene Filme dicke u. dünne Bücher, grenzenl. Räume,mbH, Ballindamm 9, 20095 Hamburg, DE
(72) Rühmann, Lars, Monetastrasse 4, 20146 Hamburg, DE
Pape, Timothy, Pappelallee 56, 10437 Berlin, DE
Schierwater, Tim, Ansorgestrasse 10b, 22605 Hamburg, DE
Höfler, Mark, Karlsruhgartenstrasse 3, 12049 Berlin, DE

(51) MKP
A61K 39/395 (2006.01) (97) **2701741 ***
A61P 35/02 (2006.01)
C07K 16/28 (2006.01)
(86) EP2012001857 30.04.2012
(96) 12724289.9 05.03.2014
(87) WO2012146394, 30.04.2012
(97) 2701741, 05.03.2014 en
(54) DOSAGE REGIMEN FOR ADMINISTERING A CD19XCD3 BISPECIFIC ANTIBODY TO PATIENTS AT RISK FOR POTENTIAL ADVERSE EFFECTS
(71) Amgen Research (Munich) GmbH, Staffelseestrasse 2, 81477 München, DE
(72) NAGORSEN, Dirk, Amgen Research (Munich) GmbH Staffelseestrasse 2, 81477 München, DE

(51) MKP
A61K 9/08 (2006.01) (97) **2702997 ***
A61K 9/127 (2006.01)
A61K 9/70 (2006.01)
A61K 31/7048 (2006.01)
A61K 31/724 (2006.01)
A61K 38/17 (2006.01)
A61K 39/395 (2006.01)
A61P 35/00 (2006.01)
A61P 43/00 (2006.01)
(86) CN2012073202 28.03.2012
(96) 12765089.3 05.03.2014
(87) WO2012130141, 28.03.2012
(97) 2702997, 05.03.2014 en
(54) METHOD AND COMPOSITION FOR ENHANCING TARGET CELLS UPTAKE OF THERAPEUTIC AGENTS
(71) Tsinghua University, No. 1 QinghuaYuan, Haidian District Beijing 100084, CN
Beijing Protgen Ltd., Room B 412 Zhongguancun Biomedical Park No.5 Kaituo Road Haidian District, Beijing 100085, CN
LUO, Yongzhang, Qinghua Yuan 1 Haidian District, Beijing 100084, CN
CHEN, Yang, Qinghua Yuan 1 Haidian District, Beijing 100084, CN
FU, Yan, Qinghua Yuan 1 Haidian district, Beijing 100084, CN
JIA, Lin, Qinghua Yuan 1 Haidian District, Beijing 100084, CN
CHANG, Guodong, Room B412 Zhongguancun Biomedical Park NO.5 Kaituo Road Haidian District, Beijing 100085, CN

(51) MKP
A61G 5/02 (2006.01) (97) **2727568**
A61G 5/10 (2006.01)
(96) 13005159.2 07.05.2014
(97) 2727568, 07.05.2014 de
(54) Wheelchair, retrofit kit for a wheelchair and method for operating a wheelchair
(71) Junker, Thyl, Edenkobenerstr. 1, 50739 Köln, DE
Pagano, Roman, Vaalser Straße 15, 52064 Aachen, DE
Levedag, Daniel, Aachener Straße 3, 50674 Köln, DE
(72) Junker, Thyl, Edenkobenerstr. 1, 50739 Köln, DE
Pagano, Roman, Vaalser Straße 15, 52064 Aachen, DE
Levedag, Daniel, Aachener Straße 3, 50674 Köln, DE

- (51) MKP
A61B 6/00 (2006.01) (97) **2701605 ***
A61N 5/00 (2006.01)
- (86) US2012035682 27.04.2012
(96) 12777629.2 05.03.2014
(87) WO2012149488, 27.04.2012
(97) 2701605, 05.03.2014 en
(54) 3D TRACKING OF AN HDR SOURCE USING A FLAT PANEL DETECTOR
- (71) Virginia Commonwealth University, 11401 Fairfield Green Court, Richmond, VA 23238, US
(72) TODOR, Dorin, A., 11401 Fairfield Green Court, Richmond, VA 23238, US
BONDAL, Aditya, A., 132 East Wilson Street Apt. No. 701, Madison, WI 53703, US

- (51) MKP
A61K 31/4375 (2006.01) (97) **2742045 ***
A61P 31/04 (2006.01)
C07D 471/04 (2006.01)
C07D 487/04 (2006.01)
- (86) EP2012065733 10.08.2012
(96) 12746093.9 18.06.2014
(87) WO2013021054, 10.08.2012
(97) 2742045, 18.06.2014 en
(54) ANTIBACTERIAL CYCLOPENTA[C]PYRROLE SUBSTITUTED 3,4-DIHYDRO-1H-[1,8]NAPHTHYRIDINONES
- (71) Janssen R&D Ireland, Eastgate Village, Eastgate, Little Island, County Cork, IE
(72) GUILLEMONT, Jérôme, Emile, Georges, 51bis route de Muids, F-27430 Andé, FR
LANÇOIS, David, Francis, Alain, 13 chemin des Vignes Les Monts, F-27400 Louviers, FR
MOTTE, Magali, Madeleine, Simone, 27 route des 4 chemins, F-27400 Louviers, FR
KOUL, Anil, Parklaan 70, B-2650 Edegem, BE
BALEMANS, Wendy, Mia, Albert, Frans Raatsstraat 15, B-2920 Kalmthout, BE
ARNOULT, Eric, Pierre, Alexandre, 34 domaine de l'île au Moulin, F-27100 Le Vaudreuil, FR

- (51) MKP
A61B 5/00 (2006.01) (97) **2712425 ***
G01N 33/68 (2006.01)
- (86) US2012035193 26.04.2012
(96) 12725902.6 02.04.2014
(87) WO2012149145, 26.04.2012
(97) 2712425, 02.04.2014 en
(54) OCULAR DETECTION OF AMYLOID PROTEINS
- (71) Adlyfe, Inc., 9430 Key West Avenue, Suite 210, Rockville, MD 20850, US
(72) FEUERSTEIN, Giora, 540 Hoffman Drive, Bryn Mawr PA 19010, US
CLIFF, Richard, 620 Beulah Road, Vienna VA 22180, US

- (51) MKP
A61K 31/00 (2006.01) (97) **2701690 ***
A61K 31/519 (2006.01)
A61P 35/02 (2006.01)
- (86) US2012035442 27.04.2012
(96) 12720743.9 05.03.2014
(87) WO2012149308, 27.04.2012
(97) 2701690, 05.03.2014 en
(54) METHOD OF TREATING LYMPHOMA USING PYRIDOPYRIMIDINONE INHIBITORS OF PI3K/MTOR
- (71) Exelixis, Inc., 210 East Grand Avenue, South San Francisco, CA 94080, US
SANOFI, 54, rue de la Boétie, 75008 Paris, FR
(72) DECILLIS, Arthur, 80 Devonshire Lane, Madison, CT 06443, US
LAGER, Joanne, 33 Shedd Ln, Hollis, NH 03049, US
ZAKS, Tal, 122 Bellevue St., Newton, MA 02458, US

- (51) MKP
C07D 487/04 (2006.01) (97) **2753621 ***
C07D 491/10 (2006.01)
- (86) US2012053921 06.09.2012
(96) 12770334.6 16.07.2014
(87) WO2013036611, 06.09.2012
(97) 2753621, 16.07.2014 en
(54) PROCESSES AND INTERMEDIATES FOR MAKING A JAK INHIBITOR
- (71) Incyte Corporation, Experimental Station Route 141&Henry Clay Road Building E336/207, Wilmington, Delaware 19880, US
(72) ZHOU, Jiacheng, 46 Bay Boulevard, Newark, Delaware 19702, US
LIU, Pingli, 205 Pilot Court, Newark, Delaware 19702, US
CAO, Ganfeng, 119 Clear Creek Drive, Newark, Delaware 19701, US
WU, Yongzhong, 2 Robert Court, Chadds Ford, Pennsylvania 19317, US

- (51) MKP
B05D 1/42 (2006.01) (97) **2707151 ***
B41J 2/01 (2006.01)
G09F 19/22 (2006.01)
- (86) IB2012000929 11.05.2012
(96) 12729194.6 19.03.2014
(87) WO2012156797, 11.05.2012
(97) 2707151, 19.03.2014 en
(54) DEVICE TO REPRODUCE IMAGES OR GRAPHICAL PATTERNS IN GENERAL ON SURFACES, CORRESPONDING METHOD
- (71) Dal Col, Alessandro, Via Giulia 23, 34126 Trieste, IT
Tavian, Carlo, Via Mondini 12, 31029 Vittorio Veneto, IT
Battiston, Giacomo, Via Massimo D'Azeglio 26, 31029 Vittorio Veneto, IT
(72) Dal Col, Alessandro, Via Giulia 23, 34126 Trieste, IT
Tavian, Carlo, Via Mondini 12, 31029 Vittorio Veneto, IT
Battiston, Giacomo, Via Massimo D'Azeglio 26, 31029 Vittorio Veneto, IT

- (51) MKP
A61F 2/95 (2013.01) (97) **2736459 ***
- (86) AT2012000199 27.07.2012
(96) 12755947.4 04.06.2014
(87) WO2013016749, 27.07.2012
(97) 2736459, 04.06.2014 de
(54) DEVICE FOR THE PREDETERMINABLE ARRANGEMENT OF A STENT
- (71) Gaul, Georg, Hansi-Niese-Gasse 22a, 1190 Wien, AT
(72) Gaul, Georg, Hansi-Niese-Gasse 22a, 1190 Wien, AT

- (51) MKP
D04H 1/435 (2012.01) (97) **2749679**
- (96) 12199746.4 02.07.2014
(97) 2749679, 02.07.2014 en
(54) CaCO₃ in polyester for nonwoven and fibers
- (71) Onya International AG, Baslerstrasse 42, 4665 Oftringen, CH
(72) Brunner, Martin, Rosenstrasse 5, 4323 Wallbach, CH
Laursen, Erik, Bregnevang 5, 4690 Haslev, DK
Pullega, Francesco, Via dello Spiraglio, 5, 40138 Bologna, IT
Fornera, Tazio, Bifangstrasse 12, 4800 Zofingen, CH
Tinkl, Michael, Kornbergweg 5, 5073 Gipf-Oberfrick, CH
Rentsch, Samuel, Burgpark 2, 4663 Aarburg, CH

- (51) MKP
A61K 31/496 (2006.01) (97) **2720698 ***
A61P 25/18 (2006.01)
- (86) EP2012061779 20.06.2012
(96) 12729555.8 23.04.2014
(87) WO2012175531, 20.06.2012
(97) 2720698, 23.04.2014 en
(54) METHOD OF ADMINISTRATION OF 4-((1R,3S)-6-CHLORO-3-PHENYL-INDAN-1-YL)-1,2,2-TRIMETHYL-PIPERAZINE AND THE SALTS THEREOF IN THE TREATMENT OF SCHIZOPHRENIA
- (71) H. Lundbeck A/S, Ottiliavej 9, 2500 Valby, DK
(72) HOLM, René, Turkisvej 2, DK-4040 Jyllinge, DK
BRUUN, Lone, Østre Frihedsvej 24, DK-2680 Solrød Strand, DK

- (51) MKP
C04B 35/472 (2006.01) (97) **2706049**
H01L 21/02 (2006.01)
- (96) 13182908.7 12.03.2014
(97) 2706049, 12.03.2014 en
(54) Composition for forming ferroelectric thin film, method for forming thin film and thin film formed using the same method
(71) Mitsubishi Materials Corporation, 3-2, Otemachi 1-chome, Chiyoda-ku Tokyo 100-8117, JP
(72) Fujii, Jun, c/o Central Research Institute, Mitsubishi, Materials Corporation 1002-14 Mukohyama, Naka-shi, Ibaraki, JP
Sakurai, Hideaki, c/o Central Research Institute, Mitsubishi, Materials Corporation 1002-14 Mukohyama, Naka-shi., Ibaraki., JP
Soyama, Nobuyuki, c/o Central Research Institute, Mitsubishi, Materials Corporation 1002-14 Mukohyama, Naka-shi., Ibaraki., JP

- (51) MKP
C07K 16/40 (2006.01) (97) **2714744 ***
- (96) US2012040585 01.06.2012
(96) 12725601.4 09.04.2014
(87) WO2012167181, 01.06.2012
(97) 2714744, 09.04.2014 en
(54) LYSYL OXIDASE-LIKE 2 ASSAY AND METHODS OF USE THEREOF
(71) Gilead Biologics, Inc., Gilead Sciences Inc. 333 Lakeside Drive, Foster City, CA 94404, US
(72) SMITH, Victoria, c/o Gilead Sciences, Inc. 333 Lakeside Drive, Foster City, CA 94404, US
ADAMKEWICZ, Joanne, I., c/o Gilead Sciences, Inc. 333 Lakeside Drive, Foster City, CA 94404, US
LYMAN, Susan, K., c/o Gilead Sciences, Inc. 333 Lakeside Drive, Foster City, CA 94404, US
CHIEN, Jason, c/o Gilead Sciences, Inc. 333 Lakeside Drive, Foster City, CA 94404, US
LI, Xiaoming, c/o Gilead Sciences, Inc. 333 Lakeside Drive, Foster City, CA 94404, US
SHAO, Lixin, c/o Gilead Sciences, Inc. 333 Lakeside Drive, Foster City, CA 94404, US
BORNSTEIN, Jeffrey, D., c/o Gilead Sciences, Inc. 333 Lakeside Drive, Foster City, CA 94404, US

- (51) MKP
C07C 217/84 (2006.01) (97) **2755944 ***
- (96) EP2012067473 07.09.2012
(96) 12762245.4 23.07.2014
(87) WO2013037705, 07.09.2012
(97) 2755944, 23.07.2014 en
(54) ANILINE DERIVATIVES, THEIR PREPARATION AND THEIR THERAPEUTIC APPLICATION
(71) Fovea Pharmaceuticals, Institut de la Vision 17 Rue Moreau, 75012 Paris, FR
(72) FEUTRILL, John, 16 Lewellin Grove, Rosanna, Victoria 3084, AU
LERICHE, Caroline, FOVEA PHARMACEUTICALS Institut de la Vision 17 rue Moreau, F-75012 Paris, FR
MIDDLEMISS, David, 61 Thorley Hill, Bishop's Stortford Hertfordshire CM23 3NF, GB

- (51) MKP
A61K 31/4409 (2006.01) (97) **2734204 ***
- (96) US2012047513 20.07.2012
(96) 12817325.9 28.05.2014
(87) WO2013016156, 20.07.2012
(97) 2734204, 28.05.2014 en
(54) POLYMORPHIC FORMS OF THE SODIUM SALT OF 4-TERT-BUTYL -N-[4-CHLORO-2-(1-OXY-PYRIDINE-4-CARBONYL)-PHENYL]-BENZENE SULFONAMIDE
(71) ChemoCentryx, Inc., 850 Maude Avenue, Mountain View, California 94043, US
(72) BIS, Joanna, 130 Trafalgar Lane, Cary, NC 27513, US
IGO, David, H., Five Moore Drive, Research Triangle Park, NC 27709, US

- (51) MKP
H04N 21/472 (2011.01) (97) **2710807 ***
- (86) US2012038516 18.05.2012
(96) 12785552.6 26.03.2014
(87) WO2012159004, 18.05.2012
(97) 2710807, 26.03.2014 en
(54) METHOD AND SYSTEM FOR SEGMENTING AND TRANSMITTING ON-DEMAND LIVE-ACTION VIDEO IN REAL-TIME
(71) On Demand Real Time Llc, 25 Melrose Drive, New Rochelle, New York 10804, US
(72) VUNIC, Douglas W., 25 Melrose Dr, New Rochelle New York 10804, US
HOFFERT, Eric, 349 Montrose Ave, South Orange New Jersey 07079, US
GESSEL, David, 5233 Foothill Blvd., Oakland California 94601, US

- (51) MKP
B01J 19/00 (2006.01) (97) **2707130 ***
B01J 20/00 (2006.01)
B01J 21/00 (2006.01)
B01J 23/00 (2006.01)
C01B 3/16 (2006.01)
C01B 3/18 (2006.01)
C01B 3/24 (2006.01)
C01B 31/20 (2006.01)
- (86) GB2012000392 27.04.2012
(96) 12720930.2 19.03.2014
(87) WO2012153080, 27.04.2012
(97) 2707130, 19.03.2014 en
(54) SYNTHESIS GAS PROCESSING AND SYSTEM USING COPPER CATALYST IN TWO STEP REACTIONS AT 475-525°C AND 250-290°C
(71) Chinook End-Stage Recycling Limited, No. 1 Nottingham Science Park Jesse Boot Avenue University Boulevard, Nottingham, Nottinghamshire NG7 2RU, GB
(72) CHALABI, Rifat Al, Chinook Sciences Limited No. 1 Nottingham Science Park Jesse Boot Avenue University Boulevard, Nottingham Nottinghamshire NG7 2RU, GB
PERRY, Ophneil Henry, Chinook Sciences Limited No. 1 Nottingham Science Park Jesse Boot Avenue University Boulevard, Nottingham Nottinghamshire NG7 2RU, GB
LI, Ke, Chinook Sciences Limited No. 1 Nottingham Science Park Jesse Boot Avenue University Boulevard, Nottingham Nottinghamshire NG7 2RU, GB

- (51) MKP
F24F 3/14 (2006.01) (97) **2764296 ***
F24F 11/00 (2006.01)
- (86) IN2012000609 12.09.2012
(96) 12775846.4 13.08.2014
(87) WO2013038428, 12.09.2012
(97) 2764296, 13.08.2014 en
(54) APPARATUS AND METHOD FOR CONTROL OF SOLID DESICCANT DEHUMIDIFIERS
(71) Bry-Air (Asia) Pvt. Ltd., 20, Rajpur Road, Delhi 110 054, IN
(72) PAHWA, Deepak, 20 Rajpur Road, Delhi 110054, IN
GRIFFITHS, William, Charles, 6101 Myrtlewood Circle West, Palm Beach Gardens, FL 33418, US
SACHDEV, Rajan, C-1 1/222 Sector-3 Rohini, Delhi 110085, IN
MALIK, Kuldeep Singh, A-16 A-Block Phase-1 Dindarpur Ext. Shyam Vihar, Najafgarh New Delhi 110043, IN

- (51) MKP
A61K 9/16 (2006.01) (97) **2755638 ***
A61K 9/20 (2006.01)
A61K 9/28 (2006.01)
A61K 9/48 (2006.01)
A61K 9/50 (2006.01)
A61K 31/485 (2006.01)
- (86) IB2012001916 14.09.2012
(96) 12772421.9 23.07.2014
(87) WO2013038268, 14.09.2012
(97) 2755638, 23.07.2014 en
(54) TAMPER RESISTANT IMMEDIATE RELEASE FORMULATIONS
(71) Purdue Pharma LP, One Stamford Forum 201 Tresser Boulevard, Stamford, CT 06901-3431, US
(72) REILLY, Kevin, 23 Setter Place, Kendall Park, NJ 08824, US

- (51) MKP
A01N 25/00 (2006.01) (97) **2709447 ***
A61K 9/72 (2006.01)
A61L 9/02 (2006.01)
- (86) US2011036868 17.05.2011
(96) 11865780.8 26.03.2014
(87) WO2012158166, 17.05.2011
(97) 2709447, 26.03.2014 en
- (54) COMPOSITIONS, METHODS & SYSTEMS FOR RESPIRATORY DELIVERY OF TWO OR MORE ACTIVE AGENTS
- (71) Pearl Therapeutics, Inc., 200 Saginaw Drive, Redwood City, CA 94063, US
- (72) VEHRING, Reinhard, 10935 40A Avenue, Edmonton, Alberta T63 0T1, CA
HARTMAN, Michael, Steven, 412 Richmond Drive No.4, Millbrae, California 94030, US
LECHUGA-BALLESTEROS, David, 1897 Blossom Hill Road, San Jose, California 95124, US
SMITH, Adrian, Edward, 2 Wilmington Acres Court, Emerald Hills, California 94062, US
JOSHI, Vidya, B., 812 Seal Pointe Drive, Redwood City, California 94065, US
DWIVEDI, Sarvajna, Kumar, 409 Whisper Lane, Redwood City, California 94065, US
-
- (51) MKP
G01D 5/34 (2006.01) (97) **2702415 ***
G01P 1/02 (2006.01)
G01P 15/08 (2006.01)
G01P 15/093 (2006.01)
- (86) EP2012057098 18.04.2012
(96) 12722686.8 05.03.2014
(87) WO2012143408, 18.04.2012
(97) 2702415, 05.03.2014 de
- (54) METHOD FOR SENSING AND SENSOR
- (71) Donau-Universität Krems, Department für Gesundheitswissenschaften und Biomedizin Zentrum für integrierte Sensorsysteme Dr. Karl-Dorrek-Strasse 30, 3500 Krems/Donau, AT
Tecnet Equity Nö Technologiebeteiligungs Invest GmbH, Niederösterreichring 2, 3100 Sankt Pölten, AT
- (72) HORTSCHITZ, Wilfried, Guntrams 19, A-2625 Schwarza u. Stf., AT
KOHLE, Franz, Gattermaiergasse 7, A-2345 Brunn am Gebirge, AT
STEINER, Harald, Obere Gasse 4, A-2802 Hochwolkersdorf, AT
SACHSE, Matthias, Deutschgasse 4, A-2700 Wiener Neustadt, AT
-
- (51) MKP
A47F 5/08 (2006.01) (97) **2708163 ***
- (86) ES2011000154 09.05.2011
(96) 11865217.1 19.03.2014
(87) WO2012152954, 09.05.2011
(97) 2708163, 19.03.2014 en
- (54) DEVICE FOR HANGING UP A DISPLAY PANEL
- (71) Moreno Sarmiento, Roman, Espronceda 23, 08184 Palau-Solita I Plegamans (Barcelona), ES
Moreno Sarmiento, Roman, Espronceda 23, 08184 Palau-Solita I Plegamans (Barcelona), ES
-
- (51) MKP
B01J 19/12 (2006.01) (97) **2704822 ***
C02F 1/48 (2006.01)
- (86) EP2012001891 03.05.2012
(96) 12726015.6 12.03.2014
(87) WO2012150031, 03.05.2012
(97) 2704822, 12.03.2014 de
- (54) METHOD FOR PHYSICALLY WORKING AND/OR HEATING MEDIA, IN PARTICULAR LIQUIDS, AND DEVICE FOR CARRYING OUT THE METHOD
- (71) OKEANOS CORPORATION, Suite 9, Ansuya Estate, Revolution Avenue, Victoria, Mahe, SC
- (72) GREGA, Samuel, Mukacevska 10, 08001 Presov, SK
-
- (51) MKP
C07D 265/06 (2006.01) (97) **2760845 ***
C07D 413/04 (2006.01)
C07D 413/10 (2006.01)
C07D 413/12 (2006.01)
C07D 417/04 (2006.01)
- (86) US2012057389 26.09.2012
(96) 12775888.6 06.08.2014
(87) WO2013049250, 26.09.2012
(97) 2760845, 06.08.2014 en
- (54) HETEROCYCLIC COMPOUNDS AS MDM2 INHIBITORS FOR THE TREATMENT OF CANCER
- (71) Amgen Inc., One Amgen Center Drive, Thousand Oaks, California 91320-1799, US
- (72) Bartberger, Michael D., 4471 Ventura Canyon Avenue No.D-105, Sherman Oaks, California 91423, US
Beck, Hilary Plake, 416 Portofino Drive, No.306, San Carlos, California 94070, US
Chen, Xiaohong, 970 Blair Court, Palo Alto, California 94303, US
Connors, Richard V., 935 Crespi Drive, Pacifica, California 94044, US
Deignan, Jeffrey, 500 29th Street, San Francisco, California 94131, US
Duquette, Jason A., 1120 Veterans Boulevard M/S ASF2-3, South San Francisco, CA 94080, US
Eksterowicz, John, 1845 Church Street, San Francisco, California 94131, US
Fox, Brian M., 124 Swallowtail Court, Brisbane, California 94005, US
Fu, Jiasheng, 221 Pelican Court, Foster City, California 94404, US
Gonzalez Buenostro, Ana, 1409 Pershing Avenue, San Mateo, CA 94403, US
Gonzalez Lopez de Turiso, Felix, 10 De Sabla Road, Apt. 509, San Mateo, California 94402, US
Gustin, Darin J., 433 Kehoe Avenue, Half Moon Bay, California 94019, US
Heath, Julie A., 6 Ivy Drive, Orinda, California 94563, US
Johnson, Michael G., 409 Clipper Street, San Francisco, California 94114, US
Kayser, Frank, 4150 17th Street, Apt. 25, San Francisco, California 94114, US
Kopecky, David J., 55 Page Street No.720, San Francisco, CA 94102, US
Li, Yihong, 821 Taylor Boulevard, Millbrae, California 94030, US
Li, Zhihong, 467 Anita Drive, Millbrae, California 94030, US
Ma, Zhihua, 733 Celestial Lane, Foster City, California 94404, US
McIntosh, Joel, 540 Fremont Avenue, Pacifica, California 94044, US
Medina, Julio C., 1407 Cedar Street, San Carlos, California 94070, US
Mihalic, Jeffrey T., 300 3rd Street, No. 523, San Francisco, California 94107, US
Olson, Steven H., 406 Green Hills Drive, Millbrae, California 94030, US
Rew, Yosup, 828 Juno Lane, Foster City, California 94404, US
Roveto, Philip M., 500 29th Street, San Francisco, California 94131, US
Schmitt, Michael J., 1811 Melbourne Drive, McLean, Virginia 22101, US
Sun, Daqing, 804 Cortez Lane, Foster City, California 94404, US
Wang, Xiaodong, 821 Taylor Boulevard, Millbrae, California 94030, US
Wanska, Malgorzata, 5829 Hickory Drive, Apt. D, Oak Park, California 91377, US
Weathers, Christine, 6103 City Shores Lane, Katy, Texas 77494, US
Yan, Xuelei, 1120 Nimitz Lane, Foster City, California 94404, US

(51) MKP
A23L 1/29 (2006.01) (97) **2765869 ***
A23L 1/30 (2006.01)
A23L 1/32 (2006.01)
A61K 35/00 (2006.01)
(86) EP2012059251 18.05.2012
(96) 12721541.6 20.08.2014
(87) WO2013053503, 18.05.2012
(97) 2765869, 20.08.2014 en
(54) EGG PREPARATION WITH REGENERATING, ANALGESIC AND/OR ANTI-INFLAMMATORY PROPERTIES
(71) OVIVITY GROUP, S.L., C. Angli, 66, torre, 08017 Barcelona, ES
(72) CUNILL AIXELÀ, Juan, C. Anglí, 66, torre, 08017 Barcelona, ES

(51) MKP
A61K 9/00 (2006.01) (97) **2726059 ***
A61K 31/4412 (2006.01)
A61K 47/02 (2006.01)
A61K 47/06 (2006.01)
A61K 47/14 (2006.01)
A61K 47/26 (2006.01)
A61K 47/38 (2006.01)
(86) EP2012062365 26.06.2012
(96) 12731396.3 07.05.2014
(87) WO2013000917, 26.06.2012
(97) 2726059, 07.05.2014 en
(54) TOPICAL OPHTHALMOLOGICAL PHARMACEUTICAL COMPOSITION CONTAINING REGORAFENIB
(71) Bayer HealthCare LLC, 100 Bayer Boulevard, Whippany, NJ 07981-0915, US
(72) BÖTTGER, Michael, Hainstr. 115, 42109 Wuppertal, DE
VON DEGENFELD, Georges, Friedrich-Weskott-Str. 10, 51373 Leverkusen, DE
FREUNDLIEB, Julia, Heidkopf 24, 44229 Dortmund, DE
HIRTH-DIETRICH, Claudia, Stockmannsmühle 12, 42115 Wuppertal, DE
KELDENICH, Joerg, Damaschkeweg 49, 42113 Wuppertal, DE
KLAR, Jürgen, Mozartstr. 48, 42115 Wuppertal, DE
MUENSTER, Uwe, Langendorfer Str. 15, 42489 Wülfrath, DE
OHM, Andreas, St.-Georg-Str. 36, 41468 Neuss, DE
RICHTER, Annett, Danziger Str. 62, 10435 Berlin, DE
RIEDL, Bernd, Von-der-Goltz-Str. 7, 42329 Wuppertal, DE

(51) MKP
A61K 31/33 (2006.01) (97) **2704706 ***
(86) EP2012058294 04.05.2012
(96) 12719692.1 12.03.2014
(87) WO2012152718, 04.05.2012
(97) 2704706, 12.03.2014 en
(54) COMPOSITION COMPRISING ANGIOTENSIN II RECEPTOR ANTAGONIST AND ANTIOXIDANT FOR MAINTAINING AND/OR IMPROVING SKIN PROPERTIES
(71) Artskin D.O.O., Obrtna Cona Logatec 2+30, 1370 Logatec, SI
(72) SABOVIC, Miso., Ulica Bratov Ucakar 46, 1000 Ljubljana, SI

(51) MKP
F23C 9/08 (2006.01) (97) **2295859**
F23H 17/00 (2006.01)
F23H 17/08 (2006.01)
F23L 7/00 (2006.01)
F23L 9/06 (2006.01)
F23M 5/08 (2006.01)
(96) 10170412.0 16.03.2011
(97) 2295859, 16.03.2011 en
(54) Waste incineration plant with introduction of cooling gas
(71) Babcock & Wilcox Vølund A/S, Odinsvej 19, 2600 Glostrup, DK
(72) Andersen, Paw, Gårdager 12, 2640 Hedehusene, DK

(51) MKP
A61K 31/70 (2006.01) (97) **2763682 ***
(86) US2012000481 04.10.2012
(96) 12839027.5 13.08.2014
(87) WO2013052117, 04.10.2012
(97) 2763682, 13.08.2014 en
(54) CHOLINE COMPOSITION
(71) Golini, Jeffrey M., 2376 Main Street, Billings MT 59105, US
(72) Golini, Jeffrey M., 2376 Main Street, Billings MT 59105, US

(51) MKP
E01F 9/03 (2006.01) (97) **2518213**
(96) 12162440.7 31.10.2012
(97) 2518213, 31.10.2012 de
(54) Holding device
(71) Gürtelbauer, Thomas, Feldkellergasse 42, 1130 Wien, AT
(72) Gürtelbauer, Thomas, Feldkellergasse 42, 1130 Wien, AT

(51) MKP
A61K 9/14 (2006.01) (97) **2768537 ***
A61K 9/16 (2006.01)
A61K 9/20 (2006.01)
A61K 31/485 (2006.01)
A61K 47/32 (2006.01)
(86) IB2012002093 17.10.2012
(96) 12780812.9 27.08.2014
(87) WO2013057570, 17.10.2012
(97) 2768537, 27.08.2014 en
(54) ACRYLIC POLYMER FORMULATIONS
(71) Purdue Pharma LP, One Stamford Forum 201 Tresser Boulevard, Stamford, CT 06901-3431, US
(72) MICKENNA, Williams, 10 Longmeadow Road, Yonkers, NY 10704, US

(51) MKP
C02F 3/12 (2006.01) (97) **2766313 ***
C02F 3/30 (2006.01)
(86) HU2012000090 07.09.2012
(96) 12829690.2 20.08.2014
(87) WO2013034942, 07.09.2012
(97) 2766313, 20.08.2014 en
(54) SMALL INSTALLATION FOR BIOLOGICAL WASTEWATER TREATMENT WITH IMPROVED EFFICIENCY
(71) Schuster, Péter, Döböknút dulo 10282/5, 2500 Esztergom, HU
Krasznói, Anna, Döböknút dulo 10282/5, 2500 Esztergom, HU
(72) Schuster, Péter, Döböknút dulo 10282/5, 2500 Esztergom, HU
Krasznói, Anna, Döböknút dulo 10282/5, 2500 Esztergom, HU

(51) MKP
A23G 9/38 (2006.01) (97) **2763552 ***
A23J 3/14 (2006.01)
A23L 1/00 (2006.01)
A23L 1/035 (2006.01)
A23L 1/19 (2006.01)
(86) EP2012069530 03.10.2012
(96) 12766988.5 13.08.2014
(87) WO2013050412, 03.10.2012
(97) 2763552, 13.08.2014 en
(54) WHIPPING AGENT FOR FOOD PRODUCTS AND USE THEREOF
(71) DuPont Nutrition Biosciences ApS, Langebrogade 1 Postboks 17, 1001 Copenhagen K., DK
(72) CHRISTENSEN, Finn, Hjort, Edwin Rahrs Vej 38, DK-8220 Brabrand, DK
MADSEN, Finn, Ludvig Holbergs Vej 11, DK-8230 Åbyhøj, DK
ANDERSEN, Leo, Melosvej 6 Hårup, DK-8530 Hjortshøj, DK

- (51) MKP
A61K 31/4418 (2006.01) (97) **2726460 ***
A61P 25/30 (2006.01)
A61P 25/32 (2006.01)
A61P 25/34 (2006.01)
A61P 25/36 (2006.01)
C07D 213/64 (2006.01)
(86) US2012044809 29.06.2012
(96) 12735394.4 07.05.2014
(87) WO2013006400, 29.06.2012
(97) 2726460, 07.05.2014 en
(54) COMPOUNDS FOR THE TREATMENT OF ADDICTION
(71) Gilead Sciences, Inc., 333 Lakeside Drive, Foster City, CA 94404, US
(72) CANNIZZARO, Carina, E., c/o Gilead Sciences Inc. 333 Lakeside Drive, Foster City, CA 94404, US
GRAUPE, Michael, c/o Gilead Sciences Inc. 333 Lakeside Drive, Foster City, CA 94404, US
GUERRERO, Juan, A., c/o Gilead Sciences Inc. 333 Lakeside Drive, Foster City, CA 94404, US
LU, Yafan, c/o Gilead Sciences Inc. 333 Lakeside Drive, Foster City, CA 94404, US
STRICKLEY, Robert, G., c/o Gilead Sciences Inc. 333 Lakeside Drive, Foster City, CA 94404, US
VENKATARAMANI, Chandrasekar, c/o Gilead Sciences Inc. 333 Lakeside Drive, Foster City, CA 94404, US
ZABLOCKI, Jeff, c/o Gilead Sciences Inc. 333 Lakeside Drive, Foster City, CA 94404, US

- (51) MKP
G01S 19/09 (2010.01) (97) **2715401 ***
G01S 19/46 (2010.01)
(86) US2011059430 04.11.2011
(96) 11788654.9 09.04.2014
(87) WO2012166195, 04.11.2011
(97) 2715401, 09.04.2014 en
(54) HYBRID POSITIONING USING SYNCHRONOUS AND ASYNCHRONOUS TECHNIQUES
(71) Qualcomm Incorporated, 5775 Morehouse Drive, San Diego, CA 92121-1714, US
(72) WERNER, Benjamin A., 5775 Morehouse Drive, San Diego, California 92121, US

- (51) MKP
C07D 491/20 (2006.01) (97) **2733145**
(86) 14000519.0 21.05.2014
(97) 2733145, 21.05.2014 en
(54) Synthetic methods for spiro-oxindole compounds
(71) Xenon Pharmaceuticals Inc., 3650 Gilmore Way, Burnaby, BC V5G 4W8, CA
(72) Cadieux, Jean-Jacques, 7 5090 East Hastings Street, Burnaby, BC V5B 1P6, CA
Chafeev, Mikhail, 8 Kudryavceva St., Apt. 58 Himki, 141401 Moscow Region, RU
Chowdhury, Sultan, 7007 180th Street, Surrey, BC V3S 7S3, CA
Fu, Jianmin, 804 4288 Grange Street, Burnaby, BC V5H 1P2, CA
Jia, Qi, 7633 Buller Avenue, Burnaby, BC V5J 5M6, CA
Abel, Stefanie, Weidstraße 20, 8800 Thalwil, CH
El-Sayed, Emad, Kusnacherstraße 37, 8126 Zumikon, CH
Huthmann, Elke, Rigistraße 10, 5033 Buchs, CH
Isarno, Thomas, 1, rue de Hombourg, 68680 Niffer, FR

- (51) MKP
A61L 2/00 (2006.01) (97) **2732020 ***
C12M 1/00 (2006.01)
C12M 1/12 (2006.01)
C12N 5/00 (2006.01)
(86) US2013045663 13.06.2013
(96) 13731015.7 21.05.2014
(87) WO2013192009, 13.06.2013
(97) 2732020, 21.05.2014 en
(54) VIRUS FILTRATION OF CELL CULTURE MEDIA
(71) Baxter International Inc., One Baxter Parkway, Deerfield, IL 60015, US
Baxter Healthcare SA, Thurgauerstrasse 130, 8152 Glattpark (Opfikon), CH
Mundt, Wolfgang, Florianigasse 57/1/2/6, 1080 Vienna, AT
Mitterer, Artur, Schwarzeckerweg 10, 2304 Orth/Donau, AT
Reiter, Manfred, Gebrueder-Lang-Gasse 11/17, 1150 Vienna, AT
Hasslacher, Meinhard, Vorgartenstrasse 221/1/7, 1020 Vienna, AT
Grillberger, Leopold, Finsterergasse 1a, 1220 Vienna, AT
Kreil, Thomas, Ziegelofengasse 93-95, 3400 Klosterneuburg, AT
(72) MUNDT, Wolfgang, Florianigasse 57/1/2/6, A-1080 Vienna, AT
MITTERER, Artur, Schwarzeckerweg 10, A-2304 Orth/Donau, AT
REITER, Manfred, Gebrueder-Lang-Gasse 11/17, A-1150 Vienna, AT
HASSLACHER, Meinhard, Vorgartenstrasse 221/1/7, A-1020 Vienna, AT
GRILLBERGER, Leopold, Finsterergasse 1a, A-1220 Vienna, AT
KREIL, Thomas, Ziegelofengasse 93-95, A-3400 Klosterneuburg, AT

- (51) MKP
G01N 33/68 (2006.01) (97) **2748612 ***
(86) IB2012054092 10.08.2012
(96) 12768901.6 02.07.2014
(87) WO2013027149, 10.08.2012
(97) 2748612, 02.07.2014 en
(54) IMPROVED VACCINE DIAGNOSTICS
(71) Zoetis LLC, 100 Campus Drive, Florham Park NJ 07932, US
(72) ANKENBAUER, Robert, G., 6574 Sunburst Drive, Portage, MI 49024, US
NELSON, Lynn, D., 28180 28th Avenue, Paw Paw, MI 49079, US
OIEN, Nancee L., 5282 Saddle Club Drive, Kalamazoo, MI 49009, US
WELCH, Siao-Kun, W., 9087 South 6th Street, Kalamazoo, MI 49009, US

- (51) MKP
C12N 15/09 (2006.01) (97) **2742132 ***
(86) EP2012065574 09.08.2012
(96) 12745855.2 18.06.2014
(87) WO2013021027, 09.08.2012
(97) 2742132, 18.06.2014 en
(54) MATRIX AND METHOD FOR PURIFYING AND/OR ISOLATING NUCLEIC ACIDS
(71) Wirtz, Ralph Markus, Rolandstraße 82, 50677 Köln, DE
(72) Wirtz, Ralph Markus, Rolandstraße 82, 50677 Köln, DE

- (51) MKP
G01N 33/569 (2006.01) (97) **2718722 ***
G01N 33/68 (2006.01)
(86) US2012040910 05.06.2012
(96) 12726000.8 16.04.2014
(87) WO2012170422, 05.06.2012
(97) 2718722, 16.04.2014 en
(54) PROTEOMICS BASED DIAGNOSTIC DETECTION METHOD FOR CHRONIC SINUSITIS
(71) Nationwide Children's Hospital, Inc., 700 Children's Drive Room W172, Columbus, OH 43205, US
The Ohio State University, 1216 Kinnear Road, Columbus, OH 43212, US
(72) DAS, Subinoy, c/o Ohio State University 1216 Kinnear Road, Columbus, OH 43212, US
BAKALETZ, Lauren, O., 4825 Canterwood Court, Hilliard, OH 43026, US

(51) MKP
A61F 13/02 (2006.01) (97) **2713972 ***
 (86) DK2012050178 24.05.2012
 (96) 12724564.5 09.04.2014
 (87) WO2012159635, 24.05.2012
 (97) 2713972, 09.04.2014 en
 (54) ROLLED COLLAGEN CARRIER
 (71) Takeda Nycomed AS, Drammensveien 852, 1372 Asker, NO
 (72) SCHÖNHOFER, Wolfgang, Breitwiesenweg 8C, A-3100 St. Pölten, AT
 PEDERSEN, Pernille, Dybendal, Sprogøvej 6 4. tv., DK-2000 Frederiksberg, DK
 BERTELSEN, Poul, Joensuuvej 120B, DK-4000 Roskilde, DK
 BRÆNDER, Henrik, Tranemosevej 133, DK-4400 Kalundborg, DK
 BLANKA, Ingrid, Hochheide 8, A-4202 Hellmonsödt, AT
 LARSEN, Henrik, Neuschäfer, Ærtemarken 34, DK-2860 Søborg, DK

(51) MKP
B41J 2/315 (2006.01) (97) **2714411 ***
B41J 2/475 (2006.01)
B41M 3/00 (2006.01)
B41M 3/06 (2006.01)
B41M 3/14 (2006.01)
C08J 3/24 (2006.01)
G02B 1/02 (2006.01)
 (86) CA2012000517 28.05.2012
 (96) 12794050.0 09.04.2014
 (87) WO2012162805, 28.05.2012
 (97) 2714411, 09.04.2014 en
 (54) METHODS AND SYSTEMS FOR THERMAL PRINTING OF PHOTONIC CRYSTAL MATERIALS, AND THERMALLY PRINTABLE PHOTONIC CRYSTAL MATERIALS AND ASSEMBLIES
 (71) Opalux Incorporated, Lash Miller Laboratories Room 308 80 St. George Street, Toronto, Ontario M5S 3H6, CA
 (72) PERRIER-CORNET, Romain, Lash Miller Laboratories c/o Room 308 80 St. George Street, Toronto, Ontario M5S 3H6, CA
 ARSENAULT, Andre, 25 Holland Avenue, Toronto, Ontario M4B 2C4, CA

(51) MKP
A01N 37/18 (2006.01) (97) **2747569 ***
A01N 43/38 (2006.01)
A61K 31/40 (2006.01)
A61P 1/16 (2006.01)
 (86) US2012052216 24.08.2012
 (96) 12826268.0 02.07.2014
 (87) WO2013028953, 24.08.2012
 (97) 2747569, 02.07.2014 en
 (54) COMBINATION TREATMENTS FOR HEPATITIS C
 (71) GlaxoSmithKline LLC, Corporation Service Company 2711 Centreville Road Suite 400, Wilmington, Delaware 19808, US
 (72) WALKER, Jill, c/o GlaxoSmithKline Global Patents Five Moore Drive PO Box 13398, Research Triangle Park, North Carolina 27709, US
 VOITENLEITNER, Christian, c/o GlaxoSmithKline Global Patents Five Moore Drive PO Box 13398, Research Triangle Park, North Carolina 27709, US

(51) MKP
A47G 23/00 (2006.01) (97) **2739379 ***
B01F 3/04 (2006.01)
 (86) EP2012064978 31.07.2012
 (96) 12743137.7 11.06.2014
 (87) WO2013017604, 31.07.2012
 (97) 2739379, 11.06.2014 en
 (54) A WINE DECANTER DEVICE
 (71) Benati, Carlo, 28 Via Vittorio Veneto, 37060 Nogarole Rocca (VR), IT
 (72) Benati, Carlo, 28 Via Vittorio Veneto, 37060 Nogarole Rocca (VR), IT

(51) MKP
E21B 23/10 (2006.01) (97) **2766560 ***
E21B 34/14 (2006.01)
 (86) CA2012050704 04.10.2012
 (96) 12840174.2 20.08.2014
 (87) WO2013053055, 04.10.2012
 (97) 2766560, 20.08.2014 en
 (54) DOWNHOLE ACTUATION BALL, METHODS AND APPARATUS
 (71) Packers Plus Energy Services Inc., Bow Valley Square 2 Suite 2200, 205 - 5 Avenue SW, Calgary, Alberta T2P 2V7, CA
 (72) THEMIG, Daniel Jon, 256 Woodhaven Place SW, Calgary, Alberta T2W 5P9, CA
 COON, Robert Joe, 8606 Hall Retreat Court, Missouri City, Texas 77459, US

(51) MKP
G06F 17/30 (2006.01) (97) **2706467**
 (96) 12183153.1 12.03.2014
 (97) 2706467, 12.03.2014 en
 (54) Method for accessing a content item in a cloud storage system, and a corresponding cloud broker, cloud cache agent and client application
 (71) AWINGU NV, Antwerpsesteenweg 19, 9080 Lochristi, BE
 (72) Pizurica, Veselin, Krekelstraat 60, 9052 Gent, BE
 Bonne, Kurt, Wachtorenstraat 31, 1130 Haren, BE
 Abdelhameed, Mohab, 68 Mekka Street, Sheraton Heliopolis, 11799 Cairo, EG

(51) MKP
G01R 15/18 (2006.01) (97) **2761309 ***
 (86) FR2012051836 02.08.2012
 (96) 12756766.7 06.08.2014
 (87) WO2013045778, 02.08.2012
 (97) 2761309, 06.08.2014 fr
 (54) CONTACTLESS CURRENT SENSOR
 (71) Neelogy, 191 Avenue Aristide Briand, 94230 Cachan, FR
 (72) STOICHITA, Catalin, 9 Avenue Odette, F-94500 Champigny-sur-Marne, FR
 CIMA, Lionel, Fabien, 12 Avenue du Parc, F-92290 Chateaufort-Malabry, FR

(51) MKP
C07B 59/00 (2006.01) (97) **2721039 ***
C07F 9/24 (2006.01)
C07F 9/6515 (2006.01)
C07F 9/6524 (2006.01)
C07F 9/6527 (2006.01)
C07F 9/6528 (2006.01)
C07F 9/6558 (2006.01)
C07F 9/6561 (2006.01)
 (86) US2012042283 13.06.2012
 (96) 12731239.5 23.04.2014
 (87) WO2012174136, 13.06.2012
 (97) 2721039, 23.04.2014 en
 (54) CHELATED PSMA INHIBITORS
 (71) Cancer Targeted Technology LLC, 14241 Woodinville-Duvall Road, Suite 143, Woodinville, WA 98072, US
 (72) BERKMAN, Clifford, 970 SW Crestview Street, Pullman, WA 99163, US
 LANGTON-WEBSTER, Bea, 16201 NE 200th Court, Woodinville, WA 98072, US
 WANG, Xiaobing, 15618 NE 106th Court, Redmond, WA 98052, US

(51) MKP
A61K 31/4365 (2006.01) (97) **2755979 ***
C07D 495/04 (2006.01)
 (86) US2012055550 14.09.2012
 (96) 12830993.7 23.07.2014
 (87) WO2013040442, 14.09.2012
 (97) 2755979, 23.07.2014 en
 (54) PHASED DOSING OF CLOPIDOGREL
 (71) Pozen, Inc., 1414 Rayleigh Road, Suite 400, Chapel Hill, NC 27517, US
 (72) PLACHETKA, John, R., 321 Silver Creek Trail, Chapel Hill, NC 27514, US

- (51) MKP
H01F 7/16 (2006.01) (97) **2754159 ***
H02K 33/16 (2006.01)
- (86) EP2012063713 12.07.2012
(96) 12756120.7 16.07.2014
(87) WO2013034339, 12.07.2012
(97) 2754159, 16.07.2014 de
(54) MAGNET DEVICE
(71) SEH Limited, Suite 1 Level 2 TG Complex Brewery Street, 3000 Mriehel BKR, MT
(72) HEIN, Jérémy, 25 avenue Crovetto Frères, MC-98000 Monaco, MC
MARSCHNER VON HELMREICH, Martin, 16ter boulevard de Belgique, MC-98000 Monaco, MC
-
- (51) MKP
A61K 31/5513 (2006.01) (97) **2707370 ***
C07D 487/04 (2006.01)
- (86) EP2012058142 03.05.2012
(96) 12717780.6 19.03.2014
(87) WO2012150305, 03.05.2012
(97) 2707370, 19.03.2014 en
(54) NOVEL ANTIFUNGAL 5,6-DIHYDRO-4H-PYRROLO[1,2-a][1,4]BENZO-DIAZEPINES AND 6H-PYRROLO[1,2-a][1,4]BENZODIAZEPINES SUBSTITUTED WITH HETEROCYCLIC DERIVATIVES
(71) Janssen Pharmaceutica, N.V., Turnhoutseweg 30, 2340 Beerse, BE
(72) MEERPOEL, Lieven, Janssen Pharmaceutica NV Turnhoutseweg 30, B-2340 Beerse, BE
MAES, Louis, Jules, Roger, Marie, c/o University of Antwerp Prinsstraat 13, B-2000 Antwerp, BE
DE WIT, Kelly, Hendrik van Boutersemstraat 15, B-2170 Merksem, BE
AUGUSTYNS, Koen, Jan, Ludovicus, c/o University of Antwerp Prinsstraat 13, B-2000 Antwerp, BE
-
- (51) MKP
E04F 15/22 (2006.01) (97) **2642275**
G01N 3/30 (2006.01)
G01N 3/42 (2006.01)
G01N 3/48 (2006.01)
- (96) 13305316.5 25.09.2013
(97) 2642275, 25.09.2013 fr
(54) Device for measuring the comfort index of indoor sports surfaces after the impact of a force on the surface
(71) GERFLOR, 50, Cours de la République, 69100 Villeurbanne, FR
Sensix, Bâtiment B 4 B Rue Carol Helz, 86000 Poitiers, FR
Centre National de la Recherche Scientifique (CNRS), 3, rue Michel-Ange, 75794 Paris Cedex 16, FR
UNIVERSITE DE POITIERS, 15, rue de l'Hotel Dieu, 86034 Poitiers Cedex, FR
Ecole Nationale Supérieure de Mécanique et d'Aérotechnique, Site du Futuroscope, 86960 Futuroscope, FR
(72) Benkhemis, Inès, 95 rue de la Tranchée, 86000 POITIERS, FR
Lacouture, Patrick, 76 rue du Capitaine Bès, 86000 POITIERS, FR
Rivat, Alain, Les Terres, 69170 LES SAUVAGES, FR
-
- (51) MKP
B65H 75/36 (2006.01) (97) **2404857**
H02G 1/06 (2006.01)
- (96) 11004272.8 11.01.2012
(97) 2404857, 11.01.2012 de
(54) Storage container, subterranean cable storage and system for subterranean positioning of a cable storage
(71) gabo Systemtechnik GmbH, Am Schaidweg 7, 94559 Niederwinkling, DE
(72) Geiger, Alexander, Birkenweg 3, 94559 Niederwinkling, DE
Lederer, Roland, Tassilostrasse 5, 94374 Schwarzbach, DE
Karl, Markus, Degernbach 62, 94327 Bogen, DE
-
- (51) MKP
A61K 39/395 (2006.01) (97) **2707390 ***
C07K 16/30 (2006.01)
- (86) EP2012001721 20.04.2012
(96) 12715856.6 19.03.2014
(87) WO2012156018, 20.04.2012
(97) 2707390, 19.03.2014 en
(54) ANTIBODIES FOR TREATMENT OF CANCER EXPRESSING CLAUDIN 6
(71) Ganymed Pharmaceuticals AG, Freiligrathstrasse 12, 55131 Mainz, DE
Johannes- Gutenberg-Universität Mainz, Saarstrasse 21, 55122 Mainz, DE
(72) SAHIN, Ugur, Philipp-von-Zabern-Platz 1, 55116 Mainz, DE
TÜRECI, Özlem, Philipp-von-Zabern-Platz 1, 55116 Mainz, DE
KOSLOWSKI, Michael, Am Ried 23, 85764 Oberschleißheim, DE
WALTER, Korden, Hüglerstrasse 3, 65203 Wiesbaden, DE
WÖLL, Stefan, Pommardstrasse 22a, 55299 Nackenheim, DE
KREUZBERG, Maria, Freiherr-vom-Stein Strasse 1, 55131 Mainz, DE
HUBNER, Bernd, Thelottstrasse 14, 80933 München, DE
ERDELJAN, Michael, Freiherr-vom-Stein-Strasse 11, 55131 Mainz, DE
WEICHEL, Michael, Am Schaufelsbaum 4, 64732 Bad König, DE
-
- (51) MKP
A01K 67/027 (2006.01) (97) **2757875 ***
C07K 16/46 (2006.01)
C12N 15/85 (2006.01)
- (86) GB2012052298 18.09.2012
(96) 12762378.3 30.07.2014
(87) WO2013041846, 18.09.2012
(97) 2757875, 30.07.2014 en
(54) MANIPULATION OF IMMUNOGLOBULIN GENE DIVERSITY AND MULTI-ANTIBODY THERAPEUTICS
(71) Kymab Limited, Meditrina (B260) Babraham Research Campus, Cambridge, Cambridgeshire CB22 3AT, GB
(72) FRIEDRICH, Glenn, c/o Kymab Limited, Meditrina (B260), Babraham Research Campus, Cambridge, Cambridgeshire CB22 3AT, GB
LEE, E-Chiang, c/o Kymab Limited, Meditrina (B260), Babraham Research Campus, Cambridge Cambridgeshire CB22 3AT, GB
CLUBE, Jasper, c/o Kymab Limited, Meditrina (B260), Babraham Research Campus, Cambridge Cambridgeshire CB22 3AT, GB
ENGLAND, Nicholas, c/o Kymab Limited, Meditrina (B260), Babraham Research Campus, Cambridge Cambridgeshire CB22 3AT, GB
-
- (51) MKP
G06F 3/01 (2006.01) (97) **2715487 ***
G06F 3/033 (2013.01)
- (86) US2012038856 21.05.2012
(96) 12724815.1 09.04.2014
(87) WO2012166416, 21.05.2012
(97) 2715487, 09.04.2014 en
(54) METHOD AND APPARATUS FOR CLASSIFYING MULTIPLE DEVICE STATES
(71) Qualcomm Incorporated, International IP Administration 5775 Morehouse Drive, San Diego, CA 92121-1714, US
(72) GROKOP, Leonard H., 5775 Morehouse Drive, San Diego, California 92121-1714, US
SARAH, Anthony, 5775 Morehouse Drive, San Diego, California 92121-1714, US

(51) MKP
A61K 9/08 (2006.01) (97) **2421534 ***
A61K 31/495 (2006.01)
A61P 25/00 (2006.01)
A61P 25/22 (2006.01)
A61P 25/24 (2006.01)
A61P 25/28 (2006.01)
(86) DK2010050084 16.04.2010
(96) 10714164.0 29.02.2012
(87) WO2010121621, 16.04.2010
(97) 2421534, 29.02.2012 en
(54) LIQUID FORMULATIONS OF SALTS OF
1-[2-(2,4-DIMETHYLPHENYLSULFANYL)PHENYL]
PIPERAZINE
(71) H. Lundbeck A/S, Otiliavej 9, 2500 Valby, DK
(72) TREPPENDAHL, Svend, Frederiksdalsvej 221, DK-2830 Virum,
DK
LOPEZ DE DIEGO, Heidi, Hælderne 5, DK-2850 Nærum, DK

(51) MKP
A61K 39/395 (2006.01) (97) **2753357 ***
G01N 33/574 (2006.01)
G01N 33/68 (2006.01)
(86) US2012054312 07.09.2012
(96) 12766369.8 16.07.2014
(87) WO2013036872, 07.09.2012
(97) 2753357, 16.07.2014 en
(54) USE OF C-MET PROTEIN FOR PREDICTING THE EFFICACY
OF ANTI-HEPATOCYTE GROWTH FACTOR ("HGF")
ANTIBODIES IN ESOPHAGEAL AND GASTRIC CANCER
PATIENTS
(71) Amgen Inc., One Amgen Center Drive M/S 28-2-C, Thousand
Oaks, CA 91320-1799, US
(72) ANDERSON, Abraham, 3494 Woodcliff Road, Sherman Oaks,
California 91403, US
OLINER, Kelly, 115 Calle Del Prado, Newbury Park, California
91320, US
TANG, Rui, 1788 Fox Springs Circle, Thousand Oaks,
California 91320, US
LOH, Elwyn, 342 Beresford Avenue, Redwood City, California
94063, US
DUBEY, Sarita, 2725 Trousedale Drive, Burlingame, California
94070, US

(51) MKP
A61K 48/00 (2006.01) (97) **2753364 ***
C07H 21/04 (2006.01)
(86) US2012053599 04.09.2012
(96) 12830346.8 16.07.2014
(87) WO2013036465, 04.09.2012
(97) 2753364, 16.07.2014 en
(54) A CONDITIONAL REPLICATING CYTOMEGALOVIRUS AS A
VACCINE FOR CMV
(71) Merck Sharp & Dohme Corp., 126 East Lincoln Avenue,
Rahway NJ 07065-0907, US
(72) FU, Tong-Ming, 770 Sumneytown Pike, West Point, PA 19486,
US
WANG, Dai, 770 Sumneytown Pike, West Point, PA 19486, US
MEDI, Muneeswara Babu, 770 Sumneytown Pike, West Point,
PA 19486, US

(51) MKP
A61K 31/454 (2006.01) (97) **2692346**
A61P 31/14 (2006.01)
(96) 13191041.6 05.02.2014
(97) 2692346, 05.02.2014 en
(54) An antiviral 1-phenyl-2,5-dibenzimidazol-5-yl-pyrrolidine
derivative
(71) Abbvie Inc., 1 North Waukegan Road, North Chicago, IL 60064,
US
(72) Degoey, David A., 8649 226th Avenue, Salem, WI Wisconsin
53168, US
Kati, Warren M., 152 Knob Hill Lane, Gurnee, IL Illinois 60031,
US
Hutchins, Charles W., 31005 Prairie Ridge Road, Green Oaks,
IL Illinois 60048, US
Donner, Pamela L, 1901 McRae Lane, Mundelien, IL Illinois
60060, US
Krueger, Allan C., 7260 Presidential Drive, Gurnee, IL Illinois
60031, US
Randolph, John T., 304 Broadway Avenue, Libertyville, IL
Illinois 60048, US
Motte, Christopher E., 10135 South Warwick Drive, Oak Creek,
WI Wisconsin 53154, US
Nelson, Lissa T., 640 Broadview Avenue, Highland Park, IL
Illinois 60035, US
Patel, Sachel V., 1259 S. Meadow Road, Round Lake, IL Illinois
60073, US
Matulenko, Mark A., 1875 Countryside Drive, Libertyville, IL
Illinois 60048, US
Keddy, Ryan G., 10046 West Hendee Road, Beach Park, IL
Illinois 60087, US
Jinkerson, Tammie K., 11129 10th Avenue, Pleasant Prairie, WI
Wisconsin 53158, US
Gao, Yi, 210 East Baltusrol Drive, Vernon Hills, IL Illinois 60061,
US
Liu, Dachun, 1276 Georgetown Way, Vernon Hills, IL Illinois
60061, US
Pratt, John K., 8210 61st Avenue, Kenosha, WI Wisconsin
53142, US
Rockway, Todd W., 34136 N. Lavender Circle, Grayslake, IL
Illinois 60030, US
Maring, Clarence J., 1228 W. Borders Drive, Palatine, IL Illinois
60067, US
Hutchinson, Douglas K., 160 Depot Street, Antioch, IL Illinois
60002, US
Flentge, Charles A., 8628 225th Avenue, Salem, WI Wisconsin
53168, US
Wagner, Rolf, 42530 Sheridan Oaks Drive, Antioch, IL Illinois
60002, US
Tufano, Michael D., 6539 North Washtenaw, Chicago, IL Illinois
60645, US
Betebenner, David A., 32329 N. Forest Drive, Grayslake, IL
Illinois 60030, US
Sarris, Kathy, 1309 Andover Drive, Mundelein, IL Illinois 60060,
US
Woller, Kevin R., 1072 Joy Court, Antioch, IL Illinois 60002, US
Wagaw, Sebel H., 2311 Ridgeway, Evanston, IL Illinois 60201,
US
Califano, Jean C., 6167 N. Bay Ridge, Whitefish Bay, WI
Wisconsin 53217, US
Li, Wenke, 7203 Buchanan Drive, Gurnee, IL Illinois 60031, US
Caspí, Daniel D., 807 Davis Street 912, Evanston, IL Illinois
60201, US
Bellizzi, Mary E., 771 N. McKinley Road, Lake Forest, IL Illinois
60045, US
Carroll, William A., 2325 Ridgeway Avenue, Evanston, IL Illinois
60201, US

(51) MKP
A43B 21/08 (2006.01) (97) **2641497**
A43B 23/02 (2006.01)
A43D 8/00 (2006.01)
A43D 11/00 (2006.01)
(96) 13001476.4 25.09.2013
(97) 2641497, 25.09.2013 en
(54) Method for producing a leather shoe upper that is adaptable to
foot deformations
(71) Gold Star S.r.l., Via Raffaello Sanzio, 8, 47030 San Mauro
Pascoli, IT
(72) Montanari, Margherita, Via Cantagallo, 32, 48010 Fusignano,
IT

- (51) MKP
E01F 7/04 (2006.01) (97) **2650558**
F16F 7/12 (2006.01)
 (96) 13001844.3 16.10.2013
 (97) 2650558, 16.10.2013 en
 (54) Energy dissipation device for protecting structures or the like
 (71) Geoprotection S.r.l., Via Renato Del Din, 10/B, 33028 Tolmezzo (UD), IT
 (72) Orgnoni, Paolo, c/o Geoprotection S.r.l. Via Renato Del Din, 10/B, I - 33028 Tolmezzo (UD), IT

- (51) MKP
A61K 31/42 (2006.01) (97) **2731676 ***
A61P 1/16 (2006.01)
A61P 3/10 (2006.01)
A61P 35/00 (2006.01)
C07D 261/08 (2006.01)
C07D 413/12 (2006.01)
C07D 413/14 (2006.01)
 (86) EP2012002941 12.07.2012
 (96) 12735100.5 21.05.2014
 (87) WO2013007387, 12.07.2012
 (97) 2731676, 21.05.2014 en
 (54) NOVEL FXR (NR1H4) BINDING AND ACTIVITY MODULATING COMPOUNDS
 (71) Phenex Pharmaceuticals AG, Donnersbergweg 1, 67059 Ludwigshafen, DE
 (72) KINZEL, Olaf, Am Hackteufel 8, 69117 Heidelberg, DE
 STEENECK, Christoph, Schulstrasse 8, 69221 Dossenheim, DE
 KREMOSER, Claus, Gugenmusweg 20, 69121 Heidelberg, DE

- (51) MKP
A23L 1/30 (2006.01) (97) **2719288**
A61K 45/00 (2006.01)
 (96) 13003866.4 16.04.2014
 (97) 2719288, 16.04.2014 en
 (54) COMPOSITION FOR THE TREATMENT OR PREVENTION OF DYSLIPIDAEMIAS
 (71) Fulga, Ion Gigel, Calea Mosilor nr. 235, bl. 43 sc. 1, et. 4, ap. 16, sector 2, Bucuresti, RO
 Vasile, Danut, Str, Barbu Delavrancea nr. 35 sector 1, Bucuresti, RO
 (72) Fulga, Ion Gigel, Calea Mosilor nr. 235, bl. 43 sc. 1, et. 4, ap. 16, sector 2, Bucuresti, RO
 Vasile, Danut, Str, Barbu Delavrancea nr. 35 sector 1, Bucuresti, RO

- (51) MKP
A61K 38/26 (2006.01) (97) **2714070 ***
A61P 3/10 (2006.01)
A61P 7/12 (2006.01)
C07K 14/605 (2006.01)
 (86) US2012040744 04.06.2012
 (96) 12793107.9 09.04.2014
 (87) WO2012167251, 04.06.2012
 (97) 2714070, 09.04.2014 en
 (54) LONG-ACTING GLP-1/GLUCAGON RECEPTOR AGONISTS
 (71) Prolor Biotech Inc., 7 Golda Meyer Street Weizmann Science Park, 74140 Nes Ziona, IL
 (72) FIMA, Udi, Eyal, 30 Albek St., 84833 Beer-Sheva, IL
 HERSHKOVITZ, Oren, 10/17 Rupin Street, 75256 Rishon Lezion, IL

- (51) MKP
H02J 1/08 (2006.01) (97) **2751894 ***
 (86) US2012052906 29.08.2012
 (96) 12828821.4 09.07.2014
 (87) WO2013033247, 29.08.2012
 (97) 2751894, 09.07.2014 en
 (54) WALL BOX DEVICE FOR MANAGING ENERGY
 (71) Control4 Corporation, 11734 South Election Road, Suite 200, Salt Lake City, UT 84020, US
 (72) RUSSELL, James K., 11734 South Election Road Suite 200, Salt Lake City, Utah 84020, US
 BYTHEWAY, David Lynn, 11734 South Election Road Suite 200, Salt Lake City, Utah 84020, US
 SCHONLE, William Richard, 11734 South Election Road Suite 200, Salt Lake City, Utah 84020, US

- (51) MKP
A61K 31/21 (2006.01) (97) **2707354 ***
A61P 9/08 (2006.01)
C07C 203/04 (2006.01)
C07C 203/08 (2006.01)
 (86) EP2012070953 23.10.2012
 (96) 12788142.3 19.03.2014
 (87) WO2013060673, 23.10.2012
 (97) 2707354, 19.03.2014 en
 (54) QUINONE BASED NITRIC OXIDE DONATING COMPOUNDS
 (71) Nicox S.A., Taissounières HB4 1681 route des Dolines BP 313, 06560 Sophia Antipolis - Valbonne, FR
 (72) RONSIN, Gael, Via Francesco Albani 58, I-20148 Milano, IT
 STORONI, Laura, Via Dante 57, I-20031 Cesano Maderno (MI), IT
 BENEDINI, Francesca, Via Spilamberto 16, I-20097 San Donato Milanese (MI), IT

- (51) MKP
C07H 21/00 (2006.01) (97) **2632494 ***
C07K 14/00 (2006.01)
G01N 33/48 (2006.01)
 (86) US2011058278 28.10.2011
 (96) 11837153.3 04.09.2013
 (87) WO2012058532, 28.10.2011
 (97) 2632494, 04.09.2013 en
 (54) METHODS AND COMPOSITIONS FOR ASSESSING AND TREATING CANCER
 (71) Yale University, Inc., 2 Whitney Avenue, New Haven, CT 06511, US
 (72) HALABAN, Ruth, 205595 Yale Station, New Haven, CT 06520, US
 KRAUTHAMMER, Michael, 29 Linden Street, New Haven, CT 06511, US
 SCHLESSINGER, Joseph, 50 Rock Hill Road, Woodbridge, CT 06525, US
 BOGGON, Titus, J., 85 Viscount Drive Unit A41, Milford, CT 06460, US

- (51) MKP
E04H 12/08 (2006.01) (97) **2718519 ***
F03D 11/04 (2006.01)
 (86) EP2012060834 07.06.2012
 (96) 12725852.3 16.04.2014
 (87) WO2012168387, 07.06.2012
 (97) 2718519, 16.04.2014 de
 (54) WIND ENERGY PLANT TOWER
 (71) Wobben Properties GmbH, Dreekamp 5, 26605 Aurich, DE
 (72) BRENNER, Albrecht, Bontjesweg 2, 26607 Aurich, DE
 MERTENS, Rene, Hinter dem Schloßpark 13, 16515 Oranienburg, DE
 PAPAPOULOS, Panos, Esenserstraße 6, 26603 Aurich, DE
 KERSTEN, Roy, Hauptstraße 28, 39291 Hohen Warthe, DE

- (51) MKP
A01N 37/50 (2006.01) (97) **2713754 ***
A01N 43/16 (2006.01)
A01N 43/40 (2006.01)
A01N 43/50 (2006.01)
A01N 43/56 (2006.01)
A01N 43/76 (2006.01)
A01N 43/88 (2006.01)
A01N 47/24 (2006.01)
A01P 3/00 (2006.01)
 (86) JP2012064253 25.05.2012
 (96) 12726907.4 09.04.2014
 (87) WO2012161354, 25.05.2012
 (97) 2713754, 09.04.2014 en
 (54) AGRICULTURAL OR HORTICULTURAL FUNGICIDE COMPOSITION AND METHOD FOR CONTROLLING PLANT PATHOGEN
 (71) Ishihara Sangyo Kaisha, Ltd., 3-15 Edobori 1-chome Nishi-ku, Osaka-shi, Osaka 550-0002, JP
 (72) SUGIMOTO, Koji, c/o Ishihara Sangyo Kaisha, Ltd. Chuo Kenkyusho, 3-1., Nishi-shibukawa 2-chome Kusata-shi, Shiga 525-0025, JP
 SUZUKI, Takanori, c/o Ishihara Sangyo Kaisha, Ltd. Chuo Kenkyusho, 3-1., Nishi-shibukawa 2-chome Kusata-shi, Shiga 525-0025, JP
 YAMAMOTO, Koudai, c/o Ishihara Sangyo Kaisha, Ltd. Chuo Kenkyusho, 3-1., Nishi-shibukawa 2-chome Kusata-shi, Shiga 525-0025, JP

(51) MKP
A61K 38/18 (2006.01) (97) **2720710 ***
 (86) EP2012061495 15.06.2012
 (96) 12728509.6 23.04.2014
 (87) WO2012172072, 15.06.2012
 (97) 2720710, 23.04.2014 en
 (54) FREEZE-DRIED FORMULATIONS OF FGF-18
 (71) Ares Trading S.A., Zone Industrielle de l'Ouriettaz, 1170 Aubonne, CH
 (72) CERRETI, Alessandra, Via Gian Giacomo Caraglio 14, I-00188 Roma, IT
 DEL RIO, Alessandra, Via Ildebrando Vivanti 108, I-00144 Roma, IT

(51) MKP
A61K 9/00 (2006.01) (97) **2704687 ***
A61K 9/12 (2006.01)
A61K 31/573 (2006.01)
A61K 47/10 (2006.01)
A61K 47/18 (2006.01)
A61K 47/26 (2006.01)
A61K 47/36 (2006.01)
 (86) EP2012057065 18.04.2012
 (96) 12720127.5 12.03.2014
 (87) WO2012150130, 18.04.2012
 (97) 2704687, 12.03.2014 en
 (54) A TOPICAL FORMULATION COMPRISING A CORTICOSTEROID AS ACTIVE INGREDIENT
 (71) Chiesi Farmaceutici S.p.A., Via Palermo, 26/A, 43100 Parma, IT
 (72) CRISCIONE, Salvatore, Chiesi Farmaceutici S.p.A. Via Palermo 26/A, I-43100 Parma, IT

(51) MKP
G06Q 50/10 (2012.01) (97) **2761571 ***
H04W 4/02 (2009.01)
 (86) US2012058368 01.10.2012
 (96) 12835580.7 06.08.2014
 (87) WO2013049855, 01.10.2012
 (97) 2761571, 06.08.2014 en
 (54) LOCATION BASED AUGMENTED REALITY SYSTEM FOR EXCHANGE OF ITEMS BASED ON LOCATION SENSING AND METHODS AND DEVICES RELATED THERETO
 (71) iOculi Inc., 1201 1st Ave S. 335, Seattle, Washington 98134, US
 (72) BRYANT, Jesse, 1201 1st Ave S 335, Seattle, Washington 98134, US
 COWLES, Jonathan, 1201 1st Ave S 335, Seattle, Washington 98134, US
 CLEM, John, 1201 1st Ave S 335, Seattle, Washington 98134, US

(51) MKP
H04L 29/08 (2006.01) (97) **2704398**
 (96) 12181883.5 05.03.2014
 (97) 2704398, 05.03.2014 en
 (54) A method for content change notification in a cloud storage system, a corresponding cloud broker and cloud agent
 (71) AWINGU NV, Antwerpsesteenweg 19, 9080 Lochristi, BE
 (72) Pizurica, Veselin, Krekelsestraat 60, 9052 GENT, BE

(51) MKP
B65D 5/32 (2006.01) (97) **2731880 ***
 (86) US2012046180 11.07.2012
 (96) 12750892.7 21.05.2014
 (87) WO2013009816, 11.07.2012
 (97) 2731880, 21.05.2014 en
 (54) PRODUCT CARTON AND METHOD FOR FORMING SAME
 (71) SANOFI, 54 rue La Boétie, 75008 Paris, FR
 (72) MCLEESTER, Douglas E., c/o Sanofi US 1041 Route 202-206 BWD-303A, Bridgewater, New Jersey 08807, US
 BYRNE, Brian P., c/o Sanofi US 1041 Route 202-206 BWD-303A, Bridgewater, New Jersey 08807, US

(51) MKP
A61K 31/4523 (2006.01) (97) **2709620 ***
A61K 31/4725 (2006.01)
A61K 31/496 (2006.01)
A61K 31/5377 (2006.01)
A61P 25/02 (2006.01)
 (86) EP2012059232 18.05.2012
 (96) 12722716.3 26.03.2014
 (87) WO2012156497, 18.05.2012
 (97) 2709620, 26.03.2014 en
 (54) USE OF SIGMA LIGANDS IN DIABETES TYPE-2 ASSOCIATED PAIN
 (71) Laboratorios del. Dr. Esteve, S.A., Avda. Mare de Déu de Montserrat 221, 08041 Barcelona, ES
 (72) VELA HERNÁNDEZ, José Miguel, Rambla Badal nº 153, 8º, 3ª, E-08028 Barcelona, ES
 MARTIN FONTELLES, Maria Isabel, Valrerribas 48 1ª-2º D, E-28007 Madrid, ES

(51) MKP
A61K 31/5025 (2006.01) (97) **2758401 ***
A61P 35/00 (2006.01)
C07D 487/04 (2006.01)
 (86) EP2012067264 05.09.2012
 (96) 12761564.9 30.07.2014
 (87) WO2013034570, 05.09.2012
 (97) 2758401, 30.07.2014 en
 (54) AMINO-SUBSTITUTED IMIDAZOPYRIDAZINES
 (71) Bayer Intellectual Property GmbH, Alfred-Nobel-Strasse 10, 40789 Monheim am Rhein, DE
 (72) EIS, Knut, Fichtenweg 1, 13587 Berlin, DE
 PÜHLER, Florian, 303 Third Square, 6115, 02142 Cambridge, US
 ZORN, Ludwig, Osianderweg 45a, 13509 Berlin, DE
 SCHOLZ, Arne, Schönhauser Allee 170, 10435 Berlin, DE
 LIENAU, Philip, Jahnstr. 13, 10967 Berlin, DE
 GNÖTH, Mark, Jean, Am Hang 53, 40822 Mettmann, DE
 BÖMER, Ulf, Leipziger Str. 49, 16548 Glienicke/Nordbahn, DE
 GÜNTHER, Judith, Parkstr. 60, 13187 Berlin, DE
 HITCHCOCK, Marion, Pfeddersheimer Weg 51a, 14129 Berlin, DE

(51) MKP
A61M 39/10 (2006.01) (97) **2731663 ***
A61M 39/24 (2006.01)
A61M 39/26 (2006.01)
 (86) EP2011062179 15.07.2011
 (96) 11743474.6 21.05.2014
 (87) WO2013010572, 15.07.2011
 (97) 2731663, 21.05.2014 en
 (54) DUAL-VALVE CONTRAST FLUID DELIVERY SYSTEM
 (71) Peters, Jean-Pierre, Kiezelstraat 144, 3500 Hasselt, BE
 (72) Peters, Jean-Pierre, Kiezelstraat 144, 3500 Hasselt, BE

(51) MKP
C12N 15/11 (2006.01) (97) **2721181 ***
C12Q 1/68 (2006.01)
 (86) US2012042668 15.06.2012
 (96) 12801070.9 23.04.2014
 (87) WO2012174378, 15.06.2012
 (97) 2721181, 23.04.2014 en
 (54) METHODS AND MATERIALS FOR ASSESSING ALLELIC IMBALANCE
 (71) Myriad Genetics, Inc., 320 Wakara Way, Salt Lake City, UT 84108, US
 Gutin, Alexander, 320 Wakara Way, Salt Lake City, Utah 84108, US
 Timms, Kirsten, 320 Wakara Way, Salt Lake City, Utah 84108, US
 Lanchbury, Jerry, 320 Wakara Way, Salt Lake City, UT 84108, US
 (72) GUTIN, Alexander, 320 Wakara Way, Salt Lake City, Utah 84108, US
 TIMMS, Kirsten, 320 Wakara Way, Salt Lake City, Utah 84108, US
 LANCHBURY, Jerry, 320 Wakara Way, Salt Lake City, Utah 84108, US

(51) MKP
A61K 31/47 (2006.01) (97) **2704717 ***
A61P 35/00 (2006.01)
(86) US2012036191 02.05.2012
(96) 12720754.6 12.03.2014
(87) WO2012151326, 02.05.2012
(97) 2704717, 12.03.2014 en
(54) METHOD OF TREATING CANCER AND BONE CANCER PAIN
(71) Exelixis, Inc., 210 East Grand Avenue, South San Francisco, CA 94080, US
(72) SCHWAB, Gisela, 25530 Dario Terrace, Hayward, CA 94541, US
AFTAB, Dana, T., 736 Tamarack Drive, San Rafael, CA 94903, US

(51) MKP
A61P 3/06 (2006.01) (97) **2756004 ***
C07K 16/40 (2006.01)
(86) US2012054756 12.09.2012
(96) 12761864.3 23.07.2014
(87) WO2013039969, 12.09.2012
(97) 2756004, 23.07.2014 en
(54) METHODS FOR REDUCING LIPOPROTEIN(a) LEVELS BY ADMINISTERING AN INHIBITOR OF PROPROTEIN CONVERTASE SUBTILISIN KEXIN-9 (PCSK9)
(71) Regeneron Pharmaceuticals, Inc., 777 Old Saw Mill River Road, Tarrytown, NY 10591, US
(72) SWERGOLD, Gary, 75 Sheldrake Place, New Rochelle, NY 10804, US

(51) MKP
B29C 45/16 (2006.01) (97) **2718088 ***
B29C 45/18 (2006.01)
B29C 49/00 (2006.01)
B29C 49/22 (2006.01)
B65D 81/24 (2006.01)
B65D 81/26 (2006.01)
B65D 81/30 (2006.01)
(86) BE2012000027 21.05.2012
(96) 12743644.2 16.04.2014
(87) WO2013000044, 21.05.2012
(97) 2718088, 16.04.2014 en
(54) HOLLOW OBJECTS, IN PARTICULAR PLASTIC PREFORMS HAVING A BARRIER LAYER AND METHOD OF INJECTION MOULDING THE OBJECTS AND APPARATUS FOR MANUFACTURING THE OBJECTS
(71) Resilux, Damstraat 4, 9230 Wetteren, BE
(72) DIERICKX, William, Leenstraat 41, B-9070 Destelbergen, BE
DE CUYPER, Dirk, Molenweidestraat 5, B-9070 Destelbergen, BE

(51) MKP
B01L 3/00 (2006.01) (97) **2748583 ***
B01L 9/00 (2006.01)
G01N 21/03 (2006.01)
(86) GB2012052024 17.08.2012
(96) 12754081.3 02.07.2014
(87) WO2013027037, 17.08.2012
(97) 2748583, 02.07.2014 en
(54) CUVETTE
(71) Biochrom Limited, 22 Cambridge Science Park Milton Road, Cambridge CB4 0JF, GB
(72) GIFFORD, Graham Eric, c/o Biochrom Limited 22 Cambridge Science Park Milton Road, Cambridge, Cambridgeshire CB4 0FJ, GB
VENN, Bernard Robert, c/o Cambridge Microfab Limited Broadway Bourn, Cambridge, Cambridgeshire CB23 2TA, GB
PALMER, Danny Charles, c/o Cambridge Microfab Limited Broadway Bourn, Cambridge, Cambridgeshire CB23 2TA, GB
CHAMBERLAIN, Colin Edward, 64 Waysbrook Letchworth Garden City, Hertfordshire SG6 2DW, GB

(51) MKP
G06F 9/50 (2006.01) (97) **2685697**
H04L 29/08 (2006.01)
H04W 4/00 (2009.01)
(96) 12176461.7 15.01.2014
(97) 2685697, 15.01.2014 en
(54) A METHOD TO OBTAIN A VIRTUAL DESKTOP STORED IN A CLOUD STORAGE SYSTEM, A CORRESPONDING CLOUD BROKER AND CLOUD DESKTOP AGENT
(71) AWINGU NV, Antwerpsesteenweg 19, 9080 Lochristi, BE
(72) Pizurica, Veselin, Krekelstraat 60, 9052 GENT, BE
Bonne, Kurt, Wachtstorenstraat 31, 1130 HAREN, BE

(51) MKP
A61K 38/05 (2006.01) (97) **2736920 ***
A61P 35/00 (2006.01)
A61P 35/02 (2006.01)
C07D 401/04 (2006.01)
C07K 5/06 (2006.01)
(86) US2012047100 18.07.2012
(96) 12741192.4 04.06.2014
(87) WO2013016081, 18.07.2012
(97) 2736920, 04.06.2014 en
(54) NOTCH PATHWAY SIGNALING INHIBITOR COMPOUND
(71) ELI LILLY AND CO., Lilly Corporate Center, Indianapolis, IN 46285, US
(72) HIPSKIND, Philip, Arthur, c/o Eli Lilly and Company P.O. Box 6288, Indianapolis Indiana 46206-6288, US
STEPHENSON, Gregory, Alan, c/o Eli Lilly and Company P.O. Box 6288, Indianapolis Indiana 46206-6288, US

(51) MKP
A61K 31/422 (2006.01) (97) **2760841 ***
A61P 35/00 (2006.01)
C07C 229/40 (2006.01)
C07D 231/14 (2006.01)
C07D 471/04 (2006.01)
(86) EP2012068786 24.09.2012
(96) 12761636.5 06.08.2014
(87) WO2013045400, 24.09.2012
(97) 2760841, 06.08.2014 en
(54) PYRAZOLOQUINOLINONE DERIVATIVES, PREPARATION THEREOF AND THERAPEUTIC USE THEREOF
(71) SANOFI, 54 rue La Boétie, 75008 Paris, FR
(72) BENAÏT, Alexandre, c/o Sanofi Patent Department 54 rue La Boétie, F-75008 Paris, FR
DUCLOS, Olivier, c/o Sanofi Patent Department 54 rue La Boétie, F-75008 PARIS, FR
GUILLO, Nathalie, c/o Sanofi Patent Department 54 rue La Boétie, F-75008 PARIS, FR
LASSALLE, Gilbert, c/o Sanofi Patent Department 54 rue La Boétie, F-75008 PARIS, FR
MACARY, Karim, c/o Sanofi Patent Department 54 rue La Boétie, F-75008 PARIS, FR
VIN, Valérie, c/o Sanofi Patent Department 54 rue La Boétie, F-75008 PARIS, FR

(51) MKP
A47K 10/36 (2006.01) (97) **2266448**
(96) 10006217.3 29.12.2010
(97) 2266448, 29.12.2010 de
(54) Device for output of sections of paper strip
(71) Hagleitner, Hans Georg, Lindenallee 11, 5700 Zell am See, AT
(72) Hagleitner, Hans Georg, Lindenallee 11, 5700 Zell am See, AT

(51) MKP
E04B 2/74 (2006.01) (97) **2639376**
E04H 17/00 (2006.01)
(96) 13159451.7 18.09.2013
(97) 2639376, 18.09.2013 en
(54) Roll-up and unrollable closure, with a reinforced stretched bottom
(71) Van Hulle, David, Koning Albertlaan 26A, 9990 Maldegem, BE
Van Hulle, Joeri, Butswervestraat 29, 9990 Maldegem, BE
(72) Van Hulle, David, Koning Albertlaan 26A, 9990 Maldegem, BE
Van Hulle, Joeri, Butswervestraat 29, 9990 Maldegem, BE

(51) MKP
E05D 7/04 (2006.01) (97) **2761116 ***
 (86) US2012057044 25.09.2012
 (96) 12836115.1 06.08.2014
 (87) WO2013049017, 25.09.2012
 (97) 2761116, 06.08.2014 en
 (54) HEIGHT ADJUSTMENT DEVICE FOR TRANSIT SHAFT AND ARM ASSEMBLY
 (71) Wabtec Holding Corp., 1001 Air Brake Avenue, Wilmerding, PA 15148, US
 (72) CHAPMAN, Matthew, 276 9th Street, Wheeling, Illinois 60090, US

(51) MKP
G03F 7/20 (2006.01) (97) **2721447 ***
 (86) RO2012000012 12.06.2012
 (96) 12758669.1 23.04.2014
 (87) WO2012173506, 12.06.2012
 (97) 2721447, 23.04.2014 en
 (54) PROCEDURE OF 2D AND 3D OPTICALLY ASSISTED FOUNTAIN PEN NANOLITHOGRAPHY AND APERTURE PEN NANOLITHOGRAPHY
 (71) Institutul National de Cercetare-Dezvoltare Pentru Microtehnologie, Str. Erou lancu Nicolae 126A, 077190 Bucuresti-Voluntari, RO
 (72) MOAGĂR-POLADIAN, Gabriel, Aleea Fuiorului Nr. 6 Bloc Y3A Sc. 1 et 6 Ap. 27 Sector 3, Bucuresti, RO

(51) MKP
B01D 17/02 (2006.01) (97) **2623174**
C02F 1/40 (2006.01)
 (96) 13153599.9 07.08.2013
 (97) 2623174, 07.08.2013 de
 (54) Precipitator
 (71) ACO Severin Ahlmann GmbH & Co. KG, Am Ahlmannkai, 24782 Büdelsdorf, DE
 (72) Schmitz, Marc, Maxauer Straße 6, 68239 Mannheim, DE
 Grube, Stefan, Spessartstraße 7, 68642 Bürstadt, DE

(51) MKP
A61K 31/5383 (2006.01) (97) **2705035 ***
A61P 3/04 (2006.01)
C07D 471/04 (2006.01)
C07D 498/04 (2006.01)
 (86) US2012036793 07.05.2012
 (96) 12721140.7 12.03.2014
 (87) WO2012154679, 07.05.2012
 (97) 2705035, 12.03.2014 en
 (54) TRICYCLIC PYRAZOLE SULFONAMIDE COMPOUNDS AND METHODS OF MAKING AND USING SAME
 (71) Zafgen, Inc., One Broadway, 8th Floor, Cambridge, MA 02142, US
 (72) CRAMP, Susan, Mary, 8/9 Spire Green Centre Flex Meadow, Harlow, Essex CM19 5TR, GB
 DYKE, Hazel, Joan, 8/9 Spire Green Centre Flex Meadow, Harlow, Essex CM19 5TR, GB
 PALLIN, Thomas, David, 8/9 Spire Green Centre Flex Meadow, Harlow, Essex CM19 5TR, GB
 ZAHLER, Robert, 1 Cambridge Center, Suite 702, Cambridge, MA 02142, US

(51) MKP
B60R 21/34 (2011.01) (97) **2723615 ***
B60T 7/12 (2006.01)
 (86) AU2012000250 13.03.2012
 (96) 12802836.2 30.04.2014
 (87) WO2012174584, 13.03.2012
 (97) 2723615, 30.04.2014 en
 (54) AN ACCIDENT PREVENTION SYSTEM AND A VEHICLE INCLUDING THE ACCIDENT PREVENTION SYSTEM
 (71) Surveillance Guard Co Limited, 2/4 Commercial Drive, Shailer Park, QLD 4128, AU
 (72) KIEHNE, Bruce Leigh, 90 Shailer Road, Shailer Park, Queensland 4128, AU

(51) MKP
A61F 13/15 (2006.01) (97) **2730261**
A61F 13/532 (2006.01)
B32B 3/26 (2006.01)
B32B 5/02 (2006.01)
B32B 5/04 (2006.01)
B32B 5/26 (2006.01)
B32B 7/12 (2006.01)
 (96) 13192375.7 14.05.2014
 (97) 2730261, 14.05.2014 en
 (54) Apparatus and methods for forming laminates containing additive matter
 (71) Curt G. Joa, Inc., 100 Crocker Avenue, Sheboygan Falls, Wisconsin 53085, US
 (72) Handziak,, Perry, 5187 Lakeview Ridge Road, Belgium, WI Wisconsin 53004, US

(51) MKP
E04B 2/74 (2006.01) (97) **2718625 ***
F21V 3/00 (2006.01)
F21V 17/00 (2006.01)
F21V 33/00 (2006.01)
G02B 6/00 (2006.01)
 (86) FR2012051278 07.06.2012
 (96) 12731540.6 16.04.2014
 (87) WO2012168659, 07.06.2012
 (97) 2718625, 16.04.2014 fr
 (54) ILLUMINATING GLASS PARTITION
 (71) Saint-Gobain Glass France, 18 avenue d'Alsace, 92400 Courbevoie, FR
 (72) GIERENS, Anne, 12 rue d'Amiens, F-60200 Compiègne, FR
 MONTGERMONT, Aude, 12 rue de Châteaudun, F-75009 Paris, FR
 ZHANG, Jingwei, 38 rue des Ruelles, F-91300 Massy, FR

(51) MKP
A61K 31/53 (2006.01) (97) **2758379 ***
A61P 35/00 (2006.01)
A61P 37/02 (2006.01)
A61P 37/04 (2006.01)
A61P 37/06 (2006.01)
A61P 37/08 (2006.01)
C07D 251/22 (2006.01)
C07D 401/12 (2006.01)
C07D 407/12 (2006.01)
C07D 413/04 (2006.01)
 (86) EP2012068590 21.09.2012
 (96) 12761738.9 30.07.2014
 (87) WO2013041652, 21.09.2012
 (97) 2758379, 30.07.2014 en
 (54) MORPHOLINO SUBSTITUTED UREA OR CARBAMATE DERIVATIVES AS MTOR INHIBITORS
 (71) Cellzome Limited, 980 Great West Road, Brentford, Middlesex TW8 9GS, GB
 (72) LYNCH, Rosemary, 44 Chalmers Road, Cambridge, CB1 3SX, GB
 CANSFIELD, Andrew David, 4 The Limes Harston, Cambridge, CB22 7QT, GB
 HARDY, Daniel Paul, 7 Convent Gardens, Baldock, Herts SG7 6FD, GB
 SUNOSE, Mihiro, 18 Old Forge Way, Sawston, Cambridgeshire CB22 3BD, GB
 MOREL, Adeline, 11 The Maltings, Saffron Walden, Essex CB10 1DY, GB
 CONVERY, Laura, 17 Sanderling Close, Letchworth, Herts SG6 4HY, GB
 ADREGO, Rita, 39 Rowan Drive, Brandon, Suffolk IP27 0EX, GB

(51) MKP
A61K 9/00 (2006.01) (97) **2706986 ***
A61K 31/485 (2006.01)
 (86) GB2012052303 18.09.2012
 (96) 12775283.0 19.03.2014
 (87) WO2013041851, 18.09.2012
 (97) 2706986, 19.03.2014 en
 (54) NEW ABUSE-RESISTANT PHARMACEUTICAL COMPOSITION FOR THE TREATMENT OF OPIOID DEPENDENCE
 (71) Orexo AB, Box 303, 751 05 Uppsala, SE
 (72) FISCHER, Andreas, Orexo AB PO Box 303, SE-751 05 Uppsala, SE

- (51) MKP
F03D 3/02 (2006.01) (97) **2769089 ***
F03D 11/00 (2006.01)
- (86) AU2012000792 29.06.2012
(96) 12803545.8 27.08.2014
(87) WO2013000041, 29.06.2012
(97) 2769089, 27.08.2014 en
(54) VERTICAL AXIS WIND TURBINE WITH VARIABLE PITCH MECHANISM
(71) Radotec Pty Ltd, 5-7 Memorial Avenue, Ingleburn, NSW 2565, AU
(72) RADOVICH, Walter, c/o Radotec Pty Ltd 5-7 Memorial Avenue, Ingleburn, NSW 2666, AU
HUANG, Ricky, Zhong, c/o Radotec Pty Ltd 5-7 Memorial Avenue, Ingleburn, NSW 2666, AU
RUDLEY, Bjorn, c/o Radotec Pty Ltd 5-7 Memorial Avenue, Ingleburn, NSW 2666, AU
TAN, Jing, K., c/o Radotec Pty Ltd 5-7 Memorial Avenue, Ingleburn, NSW 2666, AU

- (51) MKP
A61K 39/395 (2006.01) (97) **2699602 ***
A61P 35/00 (2006.01)
C07H 21/04 (2006.01)
C07K 16/28 (2006.01)
- (86) US2012034244 19.04.2012
(96) 12773950.6 26.02.2014
(87) WO2012145507, 19.04.2012
(97) 2699602, 26.02.2014 en
(54) MONOSPECIFIC AND BISPECIFIC ANTI-IGF-1R AND ANTI-ERBB3 ANTIBODIES
(71) Merrimack Pharmaceuticals, Inc., One Kendall Square Suite B7201, Cambridge, MA 02139, US
(72) BAUM, Jason, 1 Stockdale Road, Needham MA 02492, US
JOHNSON, Bryan, 5 Purington Avenue, Natick MA 01760, US
LUGOVSKOY, Alexey, Alexandrovich, 24 Center Street, Woburn MA 01801, US
XU, Lihui, 106 Gerry Road, Chestnut Hill MA 02467, US
KOHLI, Neeraj, 39 Shepard Street, Apt. 17, Brighton MA 02135, US
FITZGERALD, Jonathan, Basil, 32 Magnolia Street, Arlington MA 02474, US
ADAMS, Sharlene, 45 Rosemont Avenue, Waltham MA 02451, US

- (51) MKP
A41D 13/00 (2006.01) (97) **2768585 ***
A42B 1/04 (2006.01)
A62B 17/04 (2006.01)
- (86) EP2012003956 21.09.2012
(96) 12772073.8 27.08.2014
(87) WO2013056774, 21.09.2012
(97) 2768585, 27.08.2014 de
(54) HOOD FOR AN ITEM OF CLOTHING OR AS A CONSTITUENT PART OF AN ITEM OF CLOTHING
(71) Blücher GmbH, Mettmanner Strasse 25, 40699 Erkrath, DE
(72) BÖHRINGER, Bertram, Bussardweg 33, 42115 Wuppertal, DE

- (51) MKP
B01J 19/00 (2006.01) (97) **2723488 ***
C01B 33/107 (2006.01)
- (86) US2011053477 27.09.2011
(96) 11769995.9 30.04.2014
(87) WO2012177274, 27.09.2011
(97) 2723488, 30.04.2014 en
(54) APPARATUS AND METHODS FOR CONVERSION OF SILICON TETRACHLORIDE TO TRICHLOROSILANE
(71) GTAT Corporation, 243 Daniel Webster Highway, Merrimack, NH 03054, US
(72) FAHRENBRUCK, Scott, 4905 Mallard Way, Missoula, MT 59808, US
HAZELTINE, Bruce, 4975 Evergreen, Missoula, MT 59804, US
SCHWEYEN, Andrew, 1820 Arthur Avenue, Missoula, MT 59801, US
SKINNER, Shawn, 11435 Melody Lane, Missoula, MT 59804, US

- (51) MKP
F02M 59/10 (2006.01) (97) **2660459**
F04B 1/04 (2006.01)
- (96) 12166665.5 06.11.2013
(97) 2660459, 06.11.2013 en
(54) Load reduction
(71) Delphi International Operations Luxembourg S.à.r.l., Avenue de Luxembourg, 4940 Bascharage, LU
(72) McCrindle, Christopher, 15 Russett Way Kings Hill, West Malling, Kent ME19 4FJ, GB

- (51) MKP
B32B 17/10 (2006.01) (97) **2736767 ***
B60J 1/00 (2006.01)
B60Q 3/00 (2006.01)
B60Q 3/02 (2006.01)
F21V 19/00 (2006.01)
F21Y 103/00 (2006.01)
G02B 6/00 (2006.01)
- (86) FR2012051792 30.07.2012
(96) 12753764.5 04.06.2014
(87) WO2013017790, 30.07.2012
(97) 2736767, 04.06.2014 fr
(54) ILLUMINATED GLASS PANEL FOR A VEHICLE, AND MANUFACTURE THEREOF
(71) Saint-Gobain Glass France, 18 avenue d'Alsace, 92400 Courbevoie, FR
(72) BÄUERLE, Pascal, 2A rue Pasteur, F-80700 Roye, FR
VERRAT-DEBAILLEUL, Adèle, 14 allée de la Montagne, F-60150 Villers-sur-coudun, FR
KLEO, Christophe, 17 rue Coqueret, F-60350 Attichy, FR
LAMOUREUX, Laurent, 148 rue de la Gaillarderie, F-60170 Ribecourt-dreslincourt, FR
LEFEVRE, Pascal, 29 rue Victor Hugo, F-02300 Viry Noureuil, FR

- (51) MKP
A61K 31/138 (2006.01) (97) **2744777 ***
A61P 3/06 (2006.01)
C07C 217/18 (2006.01)
- (86) US2012049451 03.08.2012
(96) 12750508.9 25.06.2014
(87) WO2013020017, 03.08.2012
(97) 2744777, 25.06.2014 en
(54) TRANS-CLOMIPHENE METABOLITES AND USES THEREOF
(71) Repros Therapeutics Inc., 2408 Timberloch Place, B-7, The Woodlands, TX 77380, US
(72) PODOLSKI, Joseph, S., 3 Pebble Hollow Court, The Woodlands, TX 77381, US
WIEHLE, Ronald, D., 13903 Viewfield Court, Houston, TX 77059, US

- (51) MKP
A61K 31/381 (2006.01) (97) **2734515 ***
A61P 31/14 (2006.01)
C07D 333/40 (2006.01)
- (86) US2012046741 13.07.2012
(96) 12738352.9 28.05.2014
(87) WO2013010112, 13.07.2012
(97) 2734515, 28.05.2014 en
(54) THIOPHEN-2-CARBOXYLIC ACID DERIVATIVES USEFUL AS INHIBITORS OF FLAVIVIRIDAE VIRUSES
(71) Gilead Sciences, Inc., 333 Lakeside Drive, Foster City, CA 94404, US
(72) WATKINS, William, J., 14275 Hilltop Way, Saratoga, California 95070, US
DOERFFLER, Edward Milton III, 2607 Royal Ann Drive, Union City, CA 94587, US
CANALES, Eda, 1409 Pershing Avenue, San Mateo, CA 94403, US
LAZERWITH, Scott Edward, 357 3rd Avenue, San Francisco, CA 94118, US
CLARK, Michael O'Neil Hanrahan, 545 Seastorm Drive, Redwood City, CA 94065, US

(51) MKP
G01N 33/00 (2006.01) (97) **2647991**
G01P 5/00 (2006.01)
(96) 13162587.3 09.10.2013
(97) 2647991, 09.10.2013 en
(54) Methods and apparatus for measuring gas flux
(71) LI-COR, INC., 4647 Superior Street, Lincoln NE 68504, US
(72) Burba, George G., 7121 Helen Witt Drive, 1304, Lincoln, NE 68512, US
McDermitt, Dayle, 4430 North 21st Street, Lincoln, NE 68521, US
Lin, Xiaomao, 8532 Barkley Drive, Lincoln, NE 68516, US
Xu, Liukang, 9511 Oakville Road, Lincoln, NE 68526, US
Johnson, Dave, 8325 Water Tower Court, Lincoln, NE 68516, US

(51) MKP
C07D 407/04 (2006.01) (97) **2712359 ***
(86) US2012038481 18.05.2012
(96) 12723800.4 02.04.2014
(87) WO2012162115, 18.05.2012
(97) 2712359, 02.04.2014 en
(54) PROCESS FOR THE PREPARATION OF COMPOUNDS USEFUL AS INHIBITORS OF SGLT-2
(71) Janssen Pharmaceutica, N.V., Turnhoutseweg 30, 2340 Beerse, BE
(72) WELLS, Kenneth, M., c/o Janssen Resarch&Development LLC Welsh&McKean Roads, Spring House, PA 19477, US
RUSSELL, Ronald, K., c/o Janssen Resarch&Development LLC Welsh&McKean Roads, Spring House, PA 19477, US
LI, Xun, c/o Janssen Resarch&Development LLC Welsh&McKean Roads, Spring House, PA 19477, US
BRANUM, Shawn, c/o Janssen Resarch&Development LLC Welsh&McKean Roads, Spring House, PA 19477, US
BEAUCHAMP, Derek, A., c/o Janssen Resarch&Development LLC Welsh&McKean Roads, Spring House, PA 19477, US
NOMURA, Sumihiro, c/o Mitsubishi Tanabe Pharma Corporation 2-6-18 Kitahama Chuo-ku, Osaka-shi Osaka 541-8505, JP
MATSUMURA, Yosuke, c/o Mitsubishi Tanabe Pharma Corporation 2-6-18 Kitahama Chuo-ku, Osaka-shi Osaka 541-8505, JP

(51) MKP
E21B 43/32 (2006.01) (97) **2677116**
E21B 47/10 (2012.01)
G01V 3/20 (2006.01)
(96) 12290182.0 25.12.2013
(97) 2677116, 25.12.2013 en
(54) Method and apparatus to detect an oil/water contact
(71) Services Pétroliers Schlumberger, 42, rue Saint Dominique, 75007 Paris, FR
Schlumberger Technology B.V., Parkstraat 83-89, 2514 JG The Hague, NL
Schlumberger Holdings Limited (SHL), P.O. Box 71 Graigmuir Chambers Road Town, Tortola, VG
PRAD Research and Development Limited, P.O. Box 71 Craigmuir Chambers, Road Town, Tortola 1110, VG
(72) Jannin, Gaele, 4 Rue René Jacques, 92130 Issy-les-Moulineaux, FR
Legendre, Emmanuel, 15 Rue Bernard Palissy, 92310 Sevres, FR
Nichols, Edward, 43 Rue Linois Boite 7, 75015 Paris, FR

(51) MKP
A61K 39/395 (2006.01) (97) **2760893 ***
C07K 16/32 (2006.01)
(86) US2012056446 21.09.2012
(96) 12768988.3 06.08.2014
(87) WO2013048883, 21.09.2012
(97) 2760893, 06.08.2014 en
(54) ANTI-ERBB3 ANTIBODIES AND USES THEREOF
(71) Regeneron Pharmaceuticals, Inc., 777 Old Saw Mill River Road, Tarrytown, NY 10591, US
(72) DALY, Christopher, 315 East 72nd Street Apt. 7H, New York, NY 10021, US
MACDONALD, Douglas, 260 West End Avenue Apt. 10C, New York, NY 10023, US
DUAN, Xunbao, 15 Beaver Hill Road, Horsham, PA 19044, US

(51) MKP
A61K 31/5365 (2006.01) (97) **2653473**
A61P 25/28 (2006.01)
C07D 498/04 (2006.01)
(96) 13176232.0 23.10.2013
(97) 2653473, 23.10.2013 en
(54) Fused Aminodihydro-Oxazine Derivatives
(71) Eisai R&D Management Co., Ltd., 6-10, Koishikawa 4-chome, Bunkyo-ku, Tokyo 112-8088, JP
(72) Ellard, John, Mark, Eisai Limited European Knowledge Centre Mosquito Way, Hatfield, Hertfordshire AL10 9SN, GB
Farthing, Christopher, Neil, Eisai Limited European Knowledge Centre Mosquito Way, Hatfield, Hertfordshire AL10 9SN, GB
Hall, Adrian, Eisai Limited European Knowledge Centre Mosquito Way, Hatfield, Hertfordshire AL10 9SN, GB

(51) MKP
C12Q 1/68 (2006.01) (97) **2715348 ***
G01N 33/50 (2006.01)
(86) US2012040805 04.06.2012
(96) 12793609.4 09.04.2014
(87) WO2012167278, 04.06.2012
(97) 2715348, 09.04.2014 en
(54) MOLECULAR DIAGNOSTIC TEST FOR CANCER
(71) Almac Diagnostics Limited, Almac House 20 Seagoe Industrial Estate, Craigavon, BT63 5QD, Northern Ireland, GB
HARKIN, Dennis, Paul, 195 Ballygowan Road, Dromore Co. Down BT25 IRQ Northern Ireland, GB
PATTERSON, Fionnuala, 144 Station Rd. Greenisland, Carrickfergus, BT38 8UN Northern Ireland, GB
TRINDER, Claire, The Coach House Wimpstone, Stratford-upon-Avon Warwickshire CV37 8NS, GB
O'BRIEN, Eamonn, J., 1 Abercorn Drive, Hillsborough Co. Down BT26 6LB Northern Ireland, GB
MICHIE, Caroline, 1 Kingsburgh Rd, Edinburgh EH12 6EG, GB
GOURLEY, Charlie, 46 Tarmachan Road, Dumfermline KY11 8LA, GB
HILL, Laura A., 10 Ballantine Gardens Lisburn, Co. Antrim, BT27 5FB Northern Ireland, GB
KEATING, Katherine, E., 44 Waterfoot Road, Magherafelt BT45 6LQ Northern Ireland, GB
O'DONNELL, Jude, 8 Camaghy Road South, Galbally Dungannon BT70 2NL Northern Ireland, GB
BYLESJO, Max, Flat 3/1, 6 Gullane Street, Glasgow G11 6AH, GB
DEHARO, Steve, 1Mill Pond Manor Hillsborough, County Down, BT26 6TD Northern Ireland, GB
PROUTSKI, Vitali, 4 Priors Forge, Oxford, OX2 8NN, GB
KENNEDY, Richard, 15 Edgcombe Gardens, Belfast BT4 2EG Northern Ireland, GB
DAVISON, Timothy, 21 Lakeland Road, Hillsborough, BT26 6PW, GB
WINTER, Andreas, Wallensteinstrasse 19, 86368 Gersthofen, DE
MCCAVIGAN, Andrena, 25 Pier Rampart Derryadd, Lurgan County Armagh BT66 6QH, IE

(51) MKP
H02K 33/16 (2006.01) (97) **2754231 ***
(86) EP2012067185 04.09.2012
(96) 12769336.4 16.07.2014
(87) WO2013034535, 04.09.2012
(97) 2754231, 16.07.2014 de
(54) MAGNET DEVICE IN WHICH THE TRANSLATOR MOVES IN A POLYGONAL MANNER
(71) Hein, Jérémy, 25 avenue Crovetto Frères, 98000 Monaco, MC
Marschner Von Helmreich, Martin, 16ter boulevard de Belgique, 98000 Monaco, MC
(72) Hein, Jérémy, 25 avenue Crovetto Frères, 98000 Monaco, MC
Marschner Von Helmreich, Martin, 16ter boulevard de Belgique, 98000 Monaco, MC

- (51) MKP
G10K 11/20 (2006.01) (97) **2710585 ***
 (86) US2012038645 18.05.2012
 (96) 12789762.7 26.03.2014
 (87) WO2012162170, 18.05.2012
 (97) 2710585, 26.03.2014 en
 (54) TRANSDUCER FOR PHASED ARRAY ACOUSTIC SYSTEMS
 (71) Second Wind Systems, Inc., 15 Riverdale Avenue, Newton MA 02458-1057, US
 (72) LAWWHITE, Niels, 25 High Street, Somerville, MA 02144, US
 HASTINGS-BLACK, Andrew, 5 Sherborn Court 12, Medford, MA 02155, US
 MANFREDI, Louis, 5 H Street, Hull, MA 02045, US
 JOBIN, Michael, 1682 Washington Street 3, Boston, MA 02118, US
 SASS, Walter, L., 20 Benton Road, Somerville, MA 02143, US

- (51) MKP
A01N 33/02 (2006.01) (97) **2713722 ***
A61K 31/13 (2006.01)
 (86) US2012040250 31.05.2012
 (96) 12793320.8 09.04.2014
 (87) WO2012166951, 31.05.2012
 (97) 2713722, 09.04.2014 en
 (54) NOVEL GLP-1 RECEPTOR STABILIZERS AND MODULATORS
 (71) Receptos, Inc., 10835 Road to the Cure, 205, San Diego, CA 92121, US
 (72) BOEHM, Marcus, F., 2811 Maple Street, San Diego, CA 92104, US
 MARTINBOROUGH, Esther, 11128 Portobelo Drive, San Diego, CA 92124, US
 MOORJANI, Manisha, 8389 Reagan Glen, San Diego, CA 92127, US
 TAMIYA, Junko, 258 Argus Way, Oceanside, CA 92057, US
 HUANG, Liming, 12788 Adolphia Court, San Diego, CA 92129, US
 FOWLER, Thomas, 15 Blacksmith End Stathem, Melton Mowbray LE14 4EZ, GB
 NOVAK, Andrew, 35 Upper Wellington St Long Eaton, Nottingham NG10 4NH, GB
 MEGHANI, Premji, 23 Nicolson Road, Loughborough Leicestershire LE11 3SD, GB
 BRAHMACHARY, Enugurthi, 11795 Spruce Run Drive No.C, San Diego, CA 92131, US
 YEAGER, Adam, Richard, 7958 Normal Avenue, La Mesa, CA 91941, US

- (51) MKP
C07C 43/00 (2006.01) (97) **2702030 ***
 (86) US2012035434 27.04.2012
 (96) 12777417.2 05.03.2014
 (87) WO2012149302, 27.04.2012
 (97) 2702030, 05.03.2014 en
 (54) COMPOSITIONS AND METHODS
 (71) Northshore University Healthsystem, 1301 Central Street, Evanston, IL 60201, US
 (72) ROY, Hemant, K., 3340 Old Mill Road, Highland Park, IL 60035, US
 WALI, Ramesh, K., 6640 Ridge Road, Darien, IL 60561, US
 KUNTE, Dhananjay, 1186 Georgetown Way, Vernon Hills, IL 60061, US

- (51) MKP
G01J 11/00 (2006.01) (97) **2766963 ***
H01S 3/00 (2006.01)
 (86) IB2012055522 11.10.2012
 (96) 12798377.3 20.08.2014
 (87) WO2013054292, 11.10.2012
 (97) 2766963, 20.08.2014 en
 (54) METHOD AND DEVICE FOR THE SIMULTANEOUS COMPRESSION AND CHARACTERIZATION OF ULTRASHORT LASER PULSES
 (71) Universidade Do Porto, Gabinete UPIN Praça Gomes Teixeira 4º andar Sala 419, 4099-002 Porto, PT
 (72) DA COSTA RIBEIRO DE MIRANDA, Miguel Nicolau, Rua do Campo Alegre 687, 4169-007 Porto, PT
 PAIVA REBELO CEREJO CRESPO, Helder Manuel, Rua do Campo Alegre 687, 4169-007 Porto, PT
 ANDREAS FORDELL, Thomas Peter, Sölvegatan 14, 22362 Lund, SE
 LOUIS ARNOLD, Cord, Sölvegatan 14, 22362 Lund, SE
 L'HUILLIER, Anne, Sölvegatan 14, 22362 Lund, SE

- (51) MKP
G05F 1/56 (2006.01) (97) **2650747**
G06F 1/32 (2006.01)
 (96) 12002605.9 16.10.2013
 (97) 2650747, 16.10.2013 en
 (54) Power-gated electronic device and method of operating the same
 (71) TEXAS INSTRUMENTS DEUTSCHLAND GMBH, Haggertystrasse 1, 85356 Freising, DE
 Texas Instruments Incorporated, 12500 TI Boulevard M/S 3999, Dallas TX 75243, US
 (72) Gerber, Johannes, Kiebitzstrasse 3, 85716 Unterschleißheim, DE
 Dornseifer, Frank, Katharina Geisler Strasse 16, 85356 Freising, DE

- (51) MKP
A61K 9/20 (2006.01) (97) **2763663 ***
A61K 9/50 (2006.01)
A61K 31/436 (2006.01)
 (86) EP2012069541 03.10.2012
 (96) 12766990.1 13.08.2014
 (87) WO2013050419, 03.10.2012
 (97) 2763663, 13.08.2014 en
 (54) PHARMACEUTICAL COMPOSITIONS COMPRISING 40 - O - (2 - HYDROXY) ETHYL - RAPAMYCIN
 (71) Novartis AG, Lichtstrasse 35, 4056 Basel, CH
 (72) DIEDERICH, Anke, c/o Novartis Pharma AG Postfach, 4002 Basel, CH
 LIECHTI, Kurt, c/o Novartis Pharma AG Postfach, 4002 Basel, CH
 KUEHL, Peter, c/o Novartis Pharma AG Postfach, 4002 Basel, CH
 CHEUNG, Wing, c/o Novartis Pharmaceuticals Corporation One Health Plaza, East Hanover New Jersey 07936-1080, US

- (51) MKP
A61K 39/21 (2006.01) (97) **2747779 ***
 (86) US2012051822 22.08.2012
 (96) 12825300.2 02.07.2014
 (87) WO2013028738, 22.08.2012
 (97) 2747779, 02.07.2014 en
 (54) HERPES SIMPLEX VIRUS NANOEMULSION VACCINE
 (71) Nanobio Corporation, 2311 Green Road, Suite A, Ann Arbor, MI 48105, US
 (72) FATTOM, Ali, I., c/o Nanobio Corporation 2311 Green Road, Ann Arbor, MI 48105, US
 SIMON, Jakub, c/o Nanobio Corporation 2311 Green Road, Ann Arbor, MI 48105, US
 BAKER, James, R., c/o Nanobio Corporation 2311 Green Road, Ann Arbor, MI 48105, US

(51) MKP
C07K 14/005 (2006.01) (97) **2729489 ***
C12N 15/86 (2006.01)
G01N 33/569 (2006.01)
(86) US2012045593 05.07.2012
(96) 12735415.7 14.05.2014
(87) WO2013006722, 05.07.2012
(97) 2729489, 14.05.2014 en
(54) HCV GENOTYPE 3 REPLICONS
(71) Gilead Sciences, Inc., 333 Lakeside Drive, Foster City, CA 94404, US
(72) DELANEY, William, E., IV, c/o Gilead Sciences, Inc. 333 Lakeside Drive, Foster City, CA 94404, US
CHENG, Guofeng, c/o Gilead Sciences, Inc. 333 Lakeside Drive, Foster City, CA 94404, US
YU, Mei, c/o Gilead Sciences, Inc. 333 Lakeside Drive, Foster City, CA 94404, US
MO Hongmei, c/o Gilead Sciences, Inc. 333 Lakeside Drive, Foster City, CA 94404, US
XU, Siminq, c/o Gilead Sciences, Inc. 333 Lakeside Drive, Foster City, CA 94404, US
CORSA, Amoreena, c/o Gilead Sciences, Inc. 333 Lakeside Drive, Foster City, CA 94404, US

(51) MKP
A61K 31/4745 (2006.01) (97) **2709622 ***
(86) US2012038417 17.05.2012
(96) 12786188.8 26.03.2014
(87) WO2012158957, 17.05.2012
(97) 2709622, 26.03.2014 en
(54) KINASE MODULATION AND INDICATIONS THEREFOR
(71) PLEXXIKON INC., 91 Bolivar Drive, Suite A, Berkeley, CA 94710, US
(72) ZHANG, Chao, 397 Springfield Plaza, Moraga, CA 94556, US
BOLLAG, Gideon, 168 Alice Lane, Orinda, CA 94563, US
HABETS, Gaston, 410 Beatrice Road, Pleasant Hill, CA 94523, US
ZHANG, Jiazhong, 888 Foster City Blvd., Apt. Q4, Foster City, CA 94404, US
IBRAHIM, Prabha N., 3380 Lubich Drive, Mountain View, CA 94040, US
WU, Guoxian, 489 Chesapeake Avenue, Foster City, CA 94404, US

(51) MKP
B65D 51/28 (2006.01) (97) **2704962 ***
B65D 51/30 (2006.01)
(86) IB2012051492 28.03.2012
(96) 12718366.3 12.03.2014
(87) WO2012153206, 28.03.2012
(97) 2704962, 12.03.2014 en
(54) CLOSURE
(71) Bormioli Rocco S.p.A., Via Martiri della Libertà, 1, 43036 Fidenza (Parma), IT
(72) BRAMBILLA, Francesco, Strada per Albareto 2/C, I-43017 San Secondo Parmense (Parma), IT
MALORI, Anna, Via Liguria 4, I-43121 Parma, IT
VALENTI, Roberto, Via Ulivi 22, I-43044 Ozzano Taro (Parma), IT

(51) MKP
A61K 31/135 (2006.01) (97) **2766020 ***
A61K 31/47 (2006.01)
(86) US2012059733 11.10.2012
(96) 12840715.2 20.08.2014
(87) WO2013055907, 11.10.2012
(97) 2766020, 20.08.2014 en
(54) TREATMENT OF MULTIPLE SCLEROSIS WITH COMBINATION OF LAQUINIMOD AND FINGOLIMOD
(71) Teva Pharmaceutical Industries Ltd., 5 Basel Street P.O. Box 3190, 49131 Petach-Tikva, IL
(72) HALLAK, Hussein, P.O. Box 19541, 91194 East Jerusalem, IL
TARCIC, Nora, Migdal David St. 29/1, Modin, IL
FLAXMAN KAYE, Joel, 14/5 Hazamir St., 42752 Netanya, IL

(51) MKP
A61K 31/47 (2006.01) (97) **2709986 ***
A61P 11/12 (2006.01)
C07B 59/00 (2006.01)
C07D 215/56 (2006.01)
(86) US2012038297 17.05.2012
(96) 12725197.3 26.03.2014
(87) WO2012158885, 17.05.2012
(97) 2709986, 26.03.2014 en
(54) DEUTERATED DERIVATIVES OF IVACAFTOR
(71) Concert Pharmaceuticals Inc., 99 Hayden Avenue, Lexington, MA 02421, US
(72) MORGAN, Adam, J., 14 Oak Ridge Lane, Ashland MA 01721, US

(51) MKP
A61K 9/14 (2006.01) (97) **2714012 ***
A61K 9/20 (2006.01)
(86) US2012039476 24.05.2012
(96) 12725988.5 09.04.2014
(87) WO2012162567, 24.05.2012
(97) 2714012, 09.04.2014 en
(54) CB-183,315 COMPOSITIONS AND RELATED METHODS
(71) Cubist Pharmaceuticals, Inc., 65 Hayden Avenue, Lexington, MA 02421, US
(72) O'CONNOR, Sandra, 7 High Pine Drive, Hudson, NH 03051, US
SUN, Sophie, 13 Mary Shepard Road, Littleton, MA 01460, US
NAIK, Gaauri, 4 Trowbridge Place Unit 2d, Cambridge, MA 02138, US

(51) MKP
A61K 31/4184 (2006.01) (97) **2755653 ***
A61K 31/437 (2006.01)
A61K 31/5377 (2006.01)
A61K 45/06 (2006.01)
A61P 35/00 (2006.01)
(86) EP2012068072 14.09.2012
(96) 12759137.8 23.07.2014
(87) WO2013037943, 14.09.2012
(97) 2755653, 23.07.2014 en
(54) COMPOSITIONS AND METHODS FOR TREATING CANCER USING PI3K BETA INHIBITOR AND MAPK PATHWAY INHIBITOR, INCLUDING MEK AND RAF INHIBITORS
(71) SANOFI, 54 rue La Boétie, 75008 Paris, FR
(72) GARCIA-ECHEVERRIA, Carlos, Sanofi Patent Department 54 rue La Boétie, F-75008 Paris, FR
VINCENT, Loic, Sanofi Patent Department 54 rue La Boétie, F-75008 Paris, FR
VIRONE-ODDOS, Angela, Sanofi Patent Department 54 rue La Boétie, F-75008 Paris, FR

(51) MKP
E01C 5/00 (2006.01) (97) **2662490**
E01C 9/00 (2006.01)
E01F 8/00 (2006.01)
E04F 13/08 (2006.01)
(96) 13166658.8 13.11.2013
(97) 2662490, 13.11.2013 fr
(54) Traffic surface for vehicles and pedestrians
(71) Terreal, 13-17 Rue Pagès, 92150 Suresnes, FR
(72) Male, Philippe, 23bis Chemin Maréchal Clabel, 31500 Toulouse, FR
Vincent, Paul, Renzo Piano Building Workshop 34 rue des archives, 75004 Paris, FR

(51) MKP
G01F 23/292 (2006.01) (97) **2718680 ***
(86) US2012041431 07.06.2012
(96) 12796298.3 16.04.2014
(87) WO2012170743, 07.06.2012
(97) 2718680, 16.04.2014 en
(54) OPTICAL SENSING DEVICE FOR FLUID SENSING AND METHODS THEREFOR
(71) Measurement Specialties, Inc., 1000 Lucas Way, Hampton, VA 23666, US
(72) COATES, John, 12 North Branch Road, Newtown, CT 06470, US
QUALLS, Robert, 12233 Leighton Court, Carmel, IN 46032, US

(51) MKP
A01N 37/38 (2006.01) (97) **2713735 ***
A01N 43/40 (2006.01)
A01N 43/80 (2006.01)
A01N 43/86 (2006.01)
A01N 47/30 (2006.01)
A01N 47/40 (2006.01)
A01N 51/00 (2006.01)
A01N 53/00 (2006.01)
A01P 5/00 (2006.01)
A01P 7/02 (2006.01)
A01P 7/04 (2006.01)
A01P 9/00 (2006.01)
(86) EP2012060126 30.05.2012
(96) 12724619.7 09.04.2014
(87) WO2012163960, 30.05.2012
(97) 2713735, 09.04.2014 en
(54) PESTICIDAL MIXTURES INCLUDING ISOXAZOLINE DERIVATIVES
(71) Syngenta Participations AG, Schwarzwaldallee 215, 4058 Basel, CH
(72) EL QACEMI, Myriem, Syngenta Crop Protection Münchwilen AG Schaffhauserstrasse, CH-4332 Stein, CH
CASSAYRE, Jérôme Yves, Syngenta Crop Protection Münchwilen AG Schaffhauserstrasse, CH-4332 Stein, CH

(51) MKP
A01N 43/80 (2006.01) (97) **2710000 ***
C07D 413/04 (2006.01)
C07D 413/14 (2006.01)
C07D 495/04 (2006.01)
(86) US2012036883 08.05.2012
(96) 12721146.4 26.03.2014
(87) WO2012158396, 08.05.2012
(97) 2710000, 26.03.2014 en
(54) PARASITICIDAL DIHYDROISOXAZOLE COMPOUNDS
(71) Eli Lilly and Company, Lilly Corporate Center, Indianapolis, IN 46285, US
(72) AN, Zengyun, c/o Eli Lilly and Company P.O. Box 6288, Indianapolis, Indiana 46206-6288, US
CHEN, Liang, c/o Eli Lilly and Company P.O. Box 6288, Indianapolis, Indiana 46206-6288, US
CHEN, Shuhui, c/o Eli Lilly and Company P.O. Box 6288, Indianapolis, Indiana 46206-6288, US
DEFAUW, Jean, Marie, c/o Eli Lilly and Company P.O. Box 6288, Indianapolis, Indiana 46206-6288, US
HOLMSTROM, Scott, Dale, c/o Eli Lilly and Company P.O. Box 6288, Indianapolis, Indiana 46206-6288, US
HU, Ping, c/o Eli Lilly and Company P.O. Box 6288, Indianapolis, Indiana 46206-6288, US
TANG, Chongzhi, c/o Eli Lilly and Company P.O. Box 6288, Indianapolis, Indiana 46206-6288, US
WHITE, William, Hunter, c/o Eli Lilly and Company P.O. Box 6288, Indianapolis, Indiana 46206-6288, US
WU, Wentao, c/o Eli Lilly and Company P.O. Box 6288, Indianapolis, Indiana 46206-6288, US
ZHANG, Yang, c/o Eli Lilly and Company P.O. Box 6288, Indianapolis, Indiana 46206-6288, US

(51) MKP
F01N 3/08 (2006.01) (97) **2647815**
F02D 41/00 (2006.01)
F02D 41/02 (2006.01)
F02D 41/18 (2006.01)
F02D 41/40 (2006.01)
(96) 12163298.8 09.10.2013
(97) 2647815, 09.10.2013 en
(54) Lean nox trap desulfation process
(71) Delphi International Operations Luxembourg S.à.r.l., Avenue de Luxembourg, 4940 Bascharage, LU
(72) Schmitt, Julien, 7 Rue du Vieux Chateau, F-57970 Kuntzig, FR
Michel, Eric, 42 Rue de Guerlange, B-6780 Messancy, BE

(51) MKP
C07D 491/14 (2006.01) (97) **2721034 ***
C07D 491/147 (2006.01)
(86) EP2012060953 11.06.2012
(96) 12728438.8 23.04.2014
(87) WO2012171860, 11.06.2012
(97) 2721034, 23.04.2014 en
(54) TRICYCLIC ANTIBIOTICS
(71) Basilea Pharmaceutica AG, Grenzacherstrasse 487, 4005 Basel, CH
(72) GAUCHER, Bérange, 11 rue due Hohneck, F-68100 Mulhouse, FR
DANEL, Franck Hubert, 9 rue de Brunstatt, F-68440 Bruebach, FR
XIE, Tong, Building No. 306 Room No. 502 East City Guardian, Haimen Jiangsu 226100, CN
XU, Lin, No. 451 Yichuan Road Building 21 Room 207, Shanghai China 200065, CN

(51) MKP
A47F 9/04 (2006.01) (97) **2614755**
(96) 13388001.3 17.07.2013
(97) 2614755, 17.07.2013 en
(54) A system comprising a tower module, a top module as well as a plurality of additional modules
(71) Ergonomic Solutions Manufacturing A/S, Stenholm 19, 9400 Nørresundby, DK
(72) Crysell, Mark Simon, c/o Ergonomic Solutions Manufacturing A/S Stenholm 19, 9400 Norresundby, DK

(51) MKP
A61K 9/00 (2006.01) (97) **2731589 ***
A61K 9/08 (2006.01)
A61K 9/10 (2006.01)
A61K 9/107 (2006.01)
A61K 31/473 (2006.01)
A61P 25/16 (2006.01)
(86) EP2012002916 11.07.2012
(96) 12735463.7 21.05.2014
(87) WO2013007381, 11.07.2012
(97) 2731589, 21.05.2014 en
(54) A NEW THERAPEUTICAL COMPOSITION CONTAINING APOMORPHINE AS ACTIVE INGREDIENT
(71) Britannia Pharmaceuticals Limited, Park View House 65 London Road, Newbury, Berkshire RG14 1JN, GB
(72) DEY, Michael, 40 Park Lane, Sandbach Cheshire CW11 1EW, GB
RICHARD, Joel, 1 rue Saint-Blaise, F-78490 Méré, FR
BARONNET, Marie-Madeleine, 18 rue Clovis Vigny, F-27530 Ezy sur Eure, FR
MONDOLY, Nathalie, 5 square Raphael, F-78150 Le Chesnay, FR
BERTOCCHI, Laurent, 1 chemin du Bois de Louvines - La Millerette, F-27240 Sylvains les Moulins, FR
HARNETT, Jeremiah, 32 allée de la Bergerie, F-91190 Gif-sur-Yvette, FR

(51) MKP
A61K 31/381 (2006.01) (97) **2709613 ***
A61K 31/4184 (2006.01)
A61K 31/4196 (2006.01)
A61K 31/513 (2006.01)
A61P 31/14 (2006.01)
(86) US2012055621 14.09.2012
(96) 12768967.7 26.03.2014
(87) WO2013040492, 14.09.2012
(97) 2709613, 26.03.2014 en
(54) METHODS FOR TREATING HCV
(71) Gilead Sciences, Inc., 333 Lakeside Drive, Foster City, CA 94404, US
(72) RAY, Adrian S., 19 Pilot Circle, Redwood City, California 94065, US
WATKINS, William J., 14275 Hilltop Way, Saratoga, California 95070, US
LINK, John O., 74 Prospect Avenue, San Francisco, California 94110, US
OLDACH, David W., 9111 Laurel Springs Drive, Chapel Hill, North Carolina 27516, US
DELANEY, IV, William E., 764 Crane Avenue, Foster City, California 94404, US

(51) MKP
A61K 31/519 (2006.01) (97) **2763994 ***
A61P 29/00 (2006.01)
A61P 35/00 (2006.01)
C07D 403/12 (2006.01)
C07D 487/04 (2006.01)
(86) US2012058800 04.10.2012
(96) 12838127.4 13.08.2014
(87) WO2013052699, 04.10.2012
(97) 2763994, 13.08.2014 en
(54) NOVEL QUINOXALINE INHIBITORS OF PI3K
(71) Gilead Calistoga LLC, Gilead Sciences, Inc. 333 Lakeside Drive, Foster City, CA 94404, US
(72) EVARTS, Jerry, B., c/o Gilead Sciences, Inc. 333 Lakeside Drive, Foster City, CA 94404, US
PURI, Kamal, D., c/o Gilead Sciences, Inc. 333 Lakeside Drive, Foster City, CA 94404, US
ULRICH, Roger, G., 22525-46th Place, Sammamish, WA 98075, US
KESICKI, Edward, A., 2504 208th Place SE, Bothell, WA 98012, US
JUDGE, Thomas, 1976 112th Avenue, Otsego, MI 49078, US

(51) MKP
C12N 15/09 (2006.01) (97) **2751267 ***
(86) US2012053551 31.08.2012
(96) 12827061.8 09.07.2014
(87) WO2013033656, 31.08.2012
(97) 2751267, 09.07.2014 en
(54) METHODS FOR THE TREATMENT OF BREAST CANCER
(71) Syndax Pharmaceuticals Inc., 460 Totten Pond Road Suite 650, Waltham, MA 02451, US
(72) GOODENOW, Robert, 38 Calle Ameno, San Clemente, CA 92672, US
ORDENTLICH, Peter, 4043 Grayson Drive, San Diego, CA 92130, US

(51) MKP
A61K 38/17 (2006.01) (97) **2736540 ***
A61K 48/00 (2006.01)
(86) US2012048543 27.07.2012
(96) 12820516.8 04.06.2014
(87) WO2013019615, 27.07.2012
(97) 2736540, 04.06.2014 en
(54) SWITCH COSTIMULATORY RECEPTORS
(71) The Trustees Of The University Of Pennsylvania, Center for Technology Transfer 3160 Chestnut Street Suite 200, Philadelphia, PA 19104-6283, US
(72) JUNE, Carl, H., 409 Baird Road, Merion Station, PA 19066, US
ZHAO, Yangbing, 23 Doncaster Road, Cherry Hill, NJ 08003, US

(51) MKP
C07D 498/04 (2006.01) (97) **2710013 ***
(86) US2012038523 18.05.2012
(96) 12789931.8 26.03.2014
(87) WO2012162129, 18.05.2012
(97) 2710013, 26.03.2014 en
(54) NOVEL COMPOUNDS AS DIACYLGLYCEROL ACYLTRANSFERASE INHIBITORS
(71) Glaxosmithkline Intellectual Property (No. 2) Limited, 980 Great West Road, Brentford, Middlesex TW8 9GS, GB
(72) QIN, Donghui, 1250 South Collegeville Road, Collegeville, PA 19426, US
CHEUNG, Mui, 709 Swedeland Road, King of Prussia, PA 19406, US
JOSHI, Hemant, One Franklin Plaza 200 North 16th Street, Navi-mumbai, IN
TANGIRALA, Raghuram, 709 Swedeland Road, Navi-Mumbai, IN
BETHI, Sridhar, Reddy, 1250 South Collegeville Road, Navi-Mumbai, IN

(51) MKP
A61K 31/381 (2006.01) (97) **2744806 ***
A61K 31/4709 (2006.01)
C07D 409/06 (2006.01)
(86) US2012050051 09.08.2012
(96) 12748334.5 25.06.2014
(87) WO2013025424, 09.08.2012
(97) 2744806, 25.06.2014 en
(54) NOVEL 1,2,3,4-TETRAHYDROQUINOLINE DERIVATIVE USEFUL FOR THE TREATMENT OF DIABETES
(71) Eli Lilly and Company, Lilly Corporate Center, Indianapolis, IN 46285, US
(72) HAMDOUCHI, Chafiq, c/o Eli Lilly and Company P.O. Box 6288, Indianapolis, Indiana 46206-6288, US

(51) MKP
B63H 1/36 (2006.01) (97) **2746147 ***
(86) ES2012070626 14.08.2012
(96) 12824208.8 25.06.2014
(87) WO2013024195, 14.08.2012
(97) 2746147, 25.06.2014 en
(54) AQUATIC PROPULSION BY MEANS OF OSCILLATING FINS
(71) San Gabino Ramirez, José, c/. Amadeo Desfilis 9 18ª, 46025 Valencia, ES
(72) San Gabino Ramirez, José, c/. Amadeo Desfilis 9 18ª, 46025 Valencia, ES

(51) MKP
A61K 31/519 (2006.01) (97) **2760863 ***
A61P 37/06 (2006.01)
C07D 471/04 (2006.01)
C07D 487/04 (2006.01)
(86) EP2012068504 20.09.2012
(96) 12762577.0 06.08.2014
(87) WO2013041605, 20.09.2012
(97) 2760863, 06.08.2014 en
(54) PYRAZOLO[4,3-C]PYRIDINE DERIVATIVES AS KINASE INHIBITORS
(71) Cellzome Limited, 980 Great West Road, Brentford, Middlesex TW8 9GS, GB
(72) RAMSDEN, Nigel, Sparrows Lodge Green Lane Fowlmere, Royston, Herts SG8 7QP, GB
DAGOSTIN, Claudio, 4 Roe Deer Close, Cambridge, Cambridgeshire CB1 9YY, GB

(51) MKP
A61L 15/18 (2006.01) (97) **2734244 ***
A61L 15/42 (2006.01)
(86) EP2012003661 31.08.2012
(96) 12756105.8 28.05.2014
(87) WO2013029798, 31.08.2012
(97) 2734244, 28.05.2014 de
(54) WOUND DRESSING WITH AN AIR PERMEABLE LAYER
(71) Blücher GmbH, Mettmanner Strasse 25, 40699 Erkrath, DE
(72) VON BLÜCHER, Hasso, Parkstrasse 10, 40699 Erkrath, DE
SCHÖNFELD, Raik, Am Forstkamp 24b, 30629 Hannover, DE
PALLASKE, Frank, Hauptstrasse 254, 09355 Gersdorf, DE

(51) MKP
A23L 1/30 (2006.01) (97) **2732023 ***
A61K 35/74 (2006.01)
C12N 1/00 (2006.01)
C12R 1/225 (2006.01)
C12R 1/23 (2006.01)
C12R 1/25 (2006.01)
(86) GB2012051686 13.07.2012
(96) 12737592.1 21.05.2014
(87) WO2013008039, 13.07.2012
(97) 2732023, 21.05.2014 en
(54) BACTERIAL STRAINS ISOLATED FROM PIGS
(71) GT Biologics Ltd., 6 Greenbank Row, Edinburgh, Lothian EH10 5SY, GB
(72) KELLY, Denise, c/o GT Biologics Ltd Institute of Medical Sciences University of Aberdeen Foresterhill, Aberdeen Aberdeenshire AB25 2ZD, GB

- (51) MKP
B63B 35/44 (2006.01) (97) **2709900 ***
 (86) EP2012059155 16.05.2012
 (96) 12722348.5 26.03.2014
 (87) WO2012156460, 16.05.2012
 (97) 2709900, 26.03.2014 de
 (54) FLOATING CARRIER FOR GENERATING ELECTRICAL ENERGY FROM EXCLUSIVELY REGENERATIVE ENERGY SOURCES
 (71) TETRASAN GmbH Spezialproblemlösungen für Asbestsanierung, Betonasanierung, Denkmalsanierung, Quellenstr. 42, 81669 München, DE
 (72) PAPADOPOULOS, Tilemachos-Dimitrios, Palmstraße 4, 80469 München, DE

- (51) MKP
F41H 5/04 (2006.01) (97) **2726809 ***
 (86) IL2012000264 27.06.2012
 (96) 12743231.8 07.05.2014
 (87) WO2013001529, 27.06.2012
 (97) 2726809, 07.05.2014 en
 (54) ANTIBALLISTIC ARTICLE AND METHOD OF PRODUCING SAME
 (71) ISRAEL MILITARY INDUSTRIES LTD., 64 Sderot Bialik P.O.Box 1044, Ramat Hasharon 47100, IL
 (72) BERGMAN, Ron, Begin Street 9, 55523 Kiriat-Ono, IL
 YAVIN, Benjamin, Ein-Hakore Street 1, 75289 Rishon Lezion, IL

- (51) MKP
A61K 31/365 (2006.01) (97) **2704709 ***
A61K 31/7048 (2006.01)
A61P 25/28 (2006.01)
A61P 35/00 (2006.01)
 (86) IB2012052165 01.05.2012
 (96) 12723917.6 12.03.2014
 (87) WO2012150543, 01.05.2012
 (97) 2704709, 12.03.2014 en
 (54) MACROCYCLIC LACTONES AND USE THEREOF
 (71) Université de Genève, 24 rue du Général-Dufour, 1211 Genève 14, CH
 (72) RUIZ ALTABA, Ariel, 28 Boulevard des Philosophes, 1205 Geneve, CH
 MAS, Christophe, 5B rue Crest de Vaulx, 74240 Gaillard, FR

- (51) MKP
G01N 33/564 (2006.01) (97) **2753931 ***
 (86) EP2012067574 07.09.2012
 (96) 12756727.9 16.07.2014
 (87) WO2013034738, 07.09.2012
 (97) 2753931, 16.07.2014 en
 (54) AUTOIMMUNE AND INFLAMMATORY DISORDER THERAPY
 (71) Katholieke Universiteit Leuven, K.U. Leuven R&D, Minderbroedersstraat 8a Bus 5105, 3000 Leuven, BE
 (72) HERMAN, Jean, Hoveniersdreef 100, 3001 Heverlee, BE
 LOUAT, Thierry, Verbindingslaan 48 b303, 3001 Heverlee, BE
 HUANG, Qiuya, Remi Vandervaerenlaan 14 / 0403, 3000 Leuven, BE
 VANDERHOYDONCK, Bart, Postbaan 49, 3290 Diest, BE
 WAER, Mark, Waversebaan 263, 3001 Heverlee, BE
 HERDEWIJN, Piet, Olivierstraat 21, 3111 Rotselaar, BE

- (51) MKP
B62D 55/07 (2006.01) (97) **2742184 ***
E02F 9/02 (2006.01)
 (86) GB2012051811 26.07.2012
 (96) 12753193.7 18.06.2014
 (87) WO2013021169, 26.07.2012
 (97) 2742184, 18.06.2014 en
 (54) EXCAVATOR VEHICLE
 (71) Thomas Gareth John, 21 Heol Cae Glas, Sarn, Bridgend, Mid Glamorgan CF32 9UG, GB
 (72) Thomas Gareth John, 21 Heol Cae Glas, Sarn, Bridgend, Mid Glamorgan CF32 9UG, GB

- (51) MKP
C07C 237/22 (2006.01) (97) **2729443 ***
C07C 311/06 (2006.01)
C07C 311/19 (2006.01)
C07D 207/16 (2006.01)
C07K 5/06 (2006.01)
 (86) GB2012051588 06.07.2012
 (96) 12735610.3 14.05.2014
 (87) WO2013005045, 06.07.2012
 (97) 2729443, 14.05.2014 en
 (54) BENZYLAMINE DERIVATIVES AS INHIBITORS OF PLASMA KALLIKREIN
 (71) Kalvista Pharmaceuticals Limited, Building 227 Tetricus Science park, Salisbury, Wiltshire SP4 0JQ, GB
 (72) EVANS, David Michael, c/o KalVista Pharmaceuticals Building 227 Tetricus Science Park, Salisbury SP4 0JQ, GB
 DAVIE, Rebecca Louise, c/o KalVista Pharmaceuticals Building 227 Tetricus Science Park, Salisbury SP4 0JQ, GB
 EDWARDS, Hannah Joy, c/o KalVista Pharmaceuticals Building 227 Tetricus Science Park, Salisbury SP4 0JQ, GB
 ROOKER, David Philip, c/o KalVista Pharmaceuticals Building 227 Tetricus Science Park, Salisbury SP4 0JQ, GB

- (51) MKP
C12Q 1/68 (2006.01) (97) **2707504 ***
G01N 33/564 (2006.01)
G01N 33/68 (2006.01)
 (86) US2012037375 10.05.2012
 (96) 12722621.5 19.03.2014
 (87) WO2012154987, 10.05.2012
 (97) 2707504, 19.03.2014 en
 (54) METHODS OF DISEASE ACTIVITY PROFILING FOR PERSONALIZED THERAPY MANAGEMENT
 (71) Nestec S.A., Avenue Nestlé 55, 1800 Vevey, CH
 (72) SINGH, Sharat, 8171 Top of the Morning Way, Rancho Santa Fe California 92127, US
 HOE, Nicholas, 9072 Renato Street, San Diego California 92129, US
 LOCKTON, Steve, 3319 Mount Tami Lane, San Diego CA 92111, US
 HAUENSTEIN, Scott, 3565 Caminito el Rincon 211, San Diego California 92130, US
 OHRMUND, Linda, 3519 Tennyson Street, San Diego California 92106, US

- (51) MKP
A01N 25/04 (2006.01) (97) **2753173 ***
A01N 25/10 (2006.01)
A01N 25/28 (2006.01)
A01N 37/40 (2006.01)
A01N 39/04 (2006.01)
A01N 43/90 (2006.01)
A01N 47/36 (2006.01)
 (86) EP2012067072 03.09.2012
 (96) 12756169.4 16.07.2014
 (87) WO2013034513, 03.09.2012
 (97) 2753173, 16.07.2014 en
 (54) HERBICIDAL COMPOSITION COMPRISING POLYMERIC MICROPARTICLES CONTAINING A HERBICIDE
 (71) Syngenta Limited, European Regional Centre Priestley Road Surrey Research Park, Guildford, Surrey GU2 7YH, GB
 (72) FORMSTONE, Carl Andrew, Syngenta Limited Jealott's Hill International Research Centre, Bracknell Berkshire RG42 6EY, GB
 DE HEER, Martine Ingrid, Syngenta Limited Jealott's Hill International Research Centre, Bracknell Berkshire RG42 6EY, GB
 TAYLOR, Philip, Syngenta Limited Jealott's Hill International Research Centre, Bracknell Berkshire RG42 6EY, GB
 HASELDINE, Sian Janet, Syngenta Limited Jealott's Hill International Research Centre, Bracknell Berkshire RG42 6EY, GB

(51) MKP
A61B 17/072 (2006.01) (97) **2644110**
 (96) 13161397.8 02.10.2013
 (97) 2644110, 02.10.2013 en
 (54) Tissue thickness compensator comprising resilient members
 (71) Ethicon Endo-Surgery, Inc., 4545 Creek Road, Cincinnati, OH 45242, US
 (72) Aldridge, Jeffrey L., 106 W. Concord Drive, Lebanon, OH Ohio 45036, US
 Yang, Chunlin, 93 Matthews Farm Road, Belle Mead, NJ New Jersey 08502, US
 Scheib, Charles J., 11329 Donwiddle Drive, Loveland, OH Ohio 45140, US
 Vasudevan, Venkataramanan Mandakolathur, Johnson House, 64-66, Senapati Bapat Marg, Mahim (W), 400016 Mumbai, IN Aronhalt, Taylor W., 306 Beech Road, Loveland, OH Ohio 45140, US
 Contiliano, Joseph H., 303 Aldin Road, Stewartsville, NJ New Jersey 08886, US
 Cropper, Michael S., 3232 Charter Oak, Edgewood, KY Kentucky 41017, US
 Timperman, Eugene L., 10639 Silverbrook Drive, Cincinnati, OH Ohio 45240, US
 Henderson, Courtney E., 191 Hounds Run, Loveland, OH Ohio 45140, US
 Schmid, Katherine J., 3969 Sharonview Drive, Cincinnati, OH Ohio 45241, US
 Shelton, IV, Frederick E., 245 East Main Street, Hillsboro, OH Ohio 45133, US

(51) MKP
H04L 9/08 (2006.01) (97) **2639997**
 (96) 12159764.5 18.09.2013
 (97) 2639997, 18.09.2013 en
 (54) Method and system for secure access of a first computer to a second computer
 (71) ATS Group (IP Holdings) Limited, 30 de Castro Street Wickhams Cay 1 P.O. Box 4519, Road Town, Tortola, VG
 (72) Wiesmaier, Alexander, c/o AGT Group (R&D) GbmH Hilperstr. 20A, 64295 Darmstadt, DE
 Braun, Johannes, Im Boden 30, 64846 Gross-Zimmern, DE Horsch, Moritz, Saalbaustr. 5, 64283 Darmstadt, DE

(51) MKP
A61K 39/395 (2006.01) (97) **2729498 ***
C07K 16/24 (2006.01)
C07K 16/28 (2006.01)
 (86) EP2012063207 06.07.2012
 (96) 12735498.3 14.05.2014
 (87) WO2013004806, 06.07.2012
 (97) 2729498, 14.05.2014 en
 (54) THERAPEUTIC COMBINATIONS OF ANTI -CD20 AND ANTI -GM - CSF ANTIBODIES AND USES THEREOF
 (71) MorphoSys AG, Lena-Christ-Strasse 48, 82152 Planegg-Martinsried, DE
 (72) STEIDL, Stefan, Ebenböckstr. 25, 81241 München, DE

(51) MKP
G01V 3/24 (2006.01) (97) **2639602**
 (96) 11290615.1 18.09.2013
 (97) 2639602, 18.09.2013 en
 (54) Methods and systems for obtainin an electrical impedivity and/ or resistivity image of a subterranean formation
 (71) Services Pétroliers Schlumberger, 42, rue Saint Dominique, 75007 Paris, FR
 Schlumberger Technology B.V., Parkstraat 83-89, 2514 JG The Hague, NL
 Schlumberger Holdings Limited, P.O. Box 71 Craigmuir Chamber Road Town, Tortola BV1, VG
 PRAD Research and Development Limited, P.O. Box 71 Craigmuir Chambers, Road Town, Tortola, VG
 (72) Cheung, Philip, 4, Place de Palfour, 78360 Montesson, FR Zhang, Tianhua, 8/F Chuangxin Building Tsinghua Science Park, Beijing 100084, CN

(51) MKP
C07D 263/52 (2006.01) (97) **2721016 ***
C07D 498/00 (2006.01)
 (86) US2012042622 15.06.2012
 (96) 12814591.9 23.04.2014
 (87) WO2013012500, 15.06.2012
 (97) 2721016, 23.04.2014 en
 (54) TRPV4 ANTAGONISTS
 (71) Glaxosmithkline Intellectual Property (No. 2) Limited, 980 Great West Road, Brentford, Middlesex TW8 9SG, GB
 (72) BROOKS, Carl, 709 Swedeland Road, King of Prussia, PA 19406, US
 CHEUNG, Mui, 709 Swedeland Road, King of Prussia, PA 19406, US
 EIDAM, Hilary, Schenck, 709 Swedeland Road, King of Prussia, PA 19406, US
 GOODMAN, Krista, B., 709 Swedeland Road, King of Prussia, PA 19406, US
 HAMMOND, Marlys, 4359 W. Ponds Circle, Littleton, CO 80123, US
 HILFIKER, Mark, A., 709 Swedeland Road, King of Prussia, PA 19406, US
 HOANG, Tram, H., 709 Swedeland Road, King of Prussia, PA 19406, US
 PATTERSON, Jaclyn, R., 709 Swedeland Road, King of Prussia, PA 19406, US
 STOY, Patrick, 709 Swedeland Road, King of Prussia, PA 19406, US
 YE, Guosen, 709 Swedeland Road, King of Prussia, PA 19406, US

(51) MKP
C07K 16/22 (2006.01) (97) **2743348 ***
C12N 1/15 (2006.01)
C12N 1/19 (2006.01)
C12N 1/21 (2006.01)
C12N 5/10 (2006.01)
C12N 15/09 (2006.01)
C12P 21/08 (2006.01)
 (86) JP2012070433 10.08.2012
 (96) 12821758.5 18.06.2014
 (87) WO2013022083, 10.08.2012
 (97) 2743348, 18.06.2014 en
 (54) NOVEL ANTI-HUMAN NGF ANTIBODY
 (71) Astellas Pharma Inc., 3-11, Nihonbashi-Honcho 2-chome Chuo-ku, Tokyo 103-8411, JP
 (72) KAMOHARA, Masazumi, c/o Astellas Pharma Inc. 3-11 Nihonbashi-Honcho 2-chome Chuo-ku, Tokyo 103-8411, JP
 TANAKA, Hirotsugu, c/o Astellas Pharma Inc. 3-11 Nihonbashi-Honcho 2-chome Chuo-ku, Tokyo 103-8411, JP
 KOYA, Yukari, c/o Astellas Pharma Inc. 3-11 Nihonbashi-Honcho 2-chome Chuo-ku, Tokyo 103-8411, JP
 TAKASAKI, Jun, c/o Astellas Pharma Inc. 3-11 Nihonbashi-Honcho 2-chome Chuo-ku, Tokyo 103-8411, JP
 YONEZAWA, Atsuo, c/o Astellas Pharma Inc. 3-11 Nihonbashi-Honcho 2-chome Chuo-ku, Tokyo 103-8411, JP
 YOSHIMI, Eiji, c/o Astellas Pharma Inc. 3-11 Nihonbashi-Honcho 2-chome Chuo-ku, Tokyo 103-8411, JP

(51) MKP
G01N 33/50 (2006.01) (97) **2718725 ***
G01N 33/68 (2006.01)
 (86) EP2012002409 06.06.2012
 (96) 12728976.7 16.04.2014
 (87) WO2012167925, 06.06.2012
 (97) 2718725, 16.04.2014 en
 (54) METHOD FOR THE DIAGNOSIS OF GAUCHER'S DISEASE
 (71) Centogene AG, Schillingallee 68, 18057 Rostock, DE
 (72) ROLFS, Arndt, Kleiststraße 21, 14163 Berlin, DE
 MASCHER, Hermann, Gregor-Mendelstraße 11/2/28, 2514 Traiskirchen, AT

- (51) MKP
A61K 9/00 (2006.01) (97) **2714004 ***
A61K 9/127 (2006.01)
A61K 38/00 (2006.01)
A61K 47/10 (2006.01)
A61K 47/14 (2006.01)
A61K 47/24 (2006.01)
(86) EP2012059917 25.05.2012
(96) 12731315.3 09.04.2014
(87) WO2012160213, 25.05.2012
(97) 2714004, 09.04.2014 en
(54) CONTROLLED RELEASE PEPTIDE FORMULATIONS
(71) Camurus AB, Ideon, Gamma 1 Solvegatan 41, 223 70 Lund, SE
(72) TIBERG, Fredrik, c/o Camurus AB Ideon Gamma 1 Solvegatan 41, SE-223 70 Lund, SE
NISTOR, Catalin, c/o Camurus AB Ideon Gamma 1 Solvegatan 41, SE-223 70 Lund, SE
JOHNSSON, Markus, c/o Camurus Ideon Gamma 1 Solvegatan 41, SE-223 70 Lund, SE

- (51) MKP
A61K 9/20 (2006.01) (97) **2714013 ***
(86) DE2012000542 24.05.2012
(96) 12737470.0 09.04.2014
(87) WO2012159609, 24.05.2012
(97) 2714013, 09.04.2014 de
(54) POWDERY MIXTURE FOR PRODUCING TABLETS CONTAINING LEVETIRACETAM
(71) STADA ARZNEIMITTEL AG, Stadastrasse 2-18, 61118 Bad Vilbel, DE
(72) SCHÖNBORN, Jessica, Glossop-Ring 4a, 61118 Bad Vilbel, DE

- (51) MKP
F16K 15/03 (2006.01) (97) **2734760 ***
(86) IB2011002893 04.10.2011
(96) 11819104.8 28.05.2014
(87) WO2013011348, 04.10.2011
(97) 2734760, 28.05.2014 en
(54) DUAL PLATE CHECK VALVE
(71) Hawa Valves (India) Private Limited, R-16 TTC Industrial Area Thane Belapur Road Rabale, Navi Mumbai 400701, IN
(72) HAWA, Javed, Anwar, 4th Floor Nav Sonarbala Annexe 28th Road Bandra (West), Mumbai 400050, IN

- (51) MKP
A61K 31/496 (2006.01) (97) **2760451 ***
A61P 3/06 (2006.01)
A61P 3/08 (2006.01)
A61P 3/10 (2006.01)
A61P 9/00 (2006.01)
A61P 9/10 (2006.01)
A61P 9/12 (2006.01)
A61P 11/00 (2006.01)
A61P 15/00 (2006.01)
A61P 15/12 (2006.01)
A61P 19/02 (2006.01)
A61P 21/00 (2006.01)
(86) US2012057470 27.09.2012
(96) 12780572.9 06.08.2014
(87) WO2013049293, 27.09.2012
(97) 2760451, 06.08.2014 en
(54) MONOACYLGLYCEROL LIPASE INHIBITORS FOR THE TREATMENT OF METABOLIC DISEASES AND RELATED DISORDERS
(71) Janssen Pharmaceutica N.V., Turnhoutseweg 30, 2340 Beerse, BE
(72) CONNELLY, Margery, 700 US Highway 202 South Raritan, New Jersey 08869, US
FLORES, Christopher M., 1125 Trenton-Harbourton Road Titusville, New Jersey 08560, US
MACIELAG, Mark J., Welsh & McKean Roads Spring House, Pennsylvania 19477, US

- (51) MKP
A01N 43/40 (2006.01) (97) **2721021 ***
C07D 401/06 (2006.01)
C07D 401/14 (2006.01)
C07D 409/14 (2006.01)
(86) US2012043101 19.06.2012
(96) 12802388.4 23.04.2014
(87) WO2012177608, 19.06.2012
(97) 2721021, 23.04.2014 en
(54) METALLOENZYME INHIBITOR COMPOUNDS
(71) Viamet Pharmaceuticals, Inc., 2250 Perimeter Park Drive Suite 320, Morrisville, NC 27560, US
(72) HOEKSTRA, William, J., 7 Treviso Place, Durham, NC 27707, US
RAFFERTY, Stephen, W., 7321 Abron Drive, Durham, NC 27713, US
YATES, Christopher, M., 6201 Therfield Drive, Raleigh, NC 27614, US
SCHOTZINGER, Robert, J., 7000 Potomac Court, Raleigh, NC 27613, US
LOSO, Michael, 11439 Sutton Place, Carmel, IN 46032, US
SULLENBERGER, Michael, 910 Hadleigh Pass, Westfield, IN 46074, US

- (51) MKP
A61K 31/137 (2006.01) (97) **2739277 ***
A61P 3/10 (2006.01)
(86) US2012049565 03.08.2012
(96) 12748097.8 11.06.2014
(87) WO2013020069, 03.08.2012
(97) 2739277, 11.06.2014 en
(54) TREATMENT OF TYPE 2 DIABETES WITH FTY720
(71) Ma, Zhongmin, 1600 Huron Parkway, Ann Arbor, Michigan 48109-2590, US
(72) Ma, Zhongmin, 1600 Huron Parkway, Ann Arbor, Michigan 48109-2590, US

- (51) MKP
G06Q 10/08 (2012.01) (97) **2662814**
(96) 13167157.0 13.11.2013
(97) 2662814, 13.11.2013 de
(54) Method for registering, inventory, managing, checking and monitoring of tangible and intangible objects
(71) Hörmann, Markus, Kirchplatz 3, 89281 Altenstadt / Illereichen, DE
(72) Hörmann, Markus, Kirchplatz 3, 89281 Altenstadt / Illereichen, DE

- (51) MKP
A61K 31/427 (2006.01) (97) **2719696 ***
A61K 31/4427 (2006.01)
A61K 31/497 (2006.01)
A61K 31/506 (2006.01)
A61P 35/00 (2006.01)
C07D 417/12 (2006.01)
C07D 417/14 (2006.01)
(86) RU2012000428 31.05.2012
(96) 12797262.8 16.04.2014
(87) WO2012169934, 31.05.2012
(97) 2719696, 16.04.2014 en
(54) NOVEL KINASE INHIBITORS
(71) Asinex Limited, Orlikov per. 5-2, Moscow 107078, RU
(72) KAZULKIN, Denis Nikolaevich, ul. Krasnoarmeyskaya 44-1-95 Nakhbino Krasnogorskiy r-n, Moskovskaya obl. 143430, RU
KOCHUBEY, Valeriy Sergeevich, ul. Solovinyaya roscha 8-76, Moscow 125466, RU

(51) MKP
A61K 9/00 (2006.01) (97) **2709595 ***
A61K 9/19 (2006.01)
A61K 38/21 (2006.01)
A61K 47/42 (2006.01)
(86) EP2012059086 16.05.2012
(96) 12721844.4 26.03.2014
(87) WO2012159945, 16.05.2012
(97) 2709595, 26.03.2014 en
(54) IFN-BETA COMPOSITIONS, PREPARATION METHODS AND USES THEREOF
(71) Ares Trading S.A., Zone Industrielle de l'Ouriettaz, 1170 Aubonne, CH
(72) LEBLANC, Daniel, Rue des Bains 50, CH-1205 Geneva, CH
LAMME, Evert Nicolaas, Chemin de Bonmont 6d, CH-1260 Nyon, CH
BALDASCINI, Helen Gabriela, Via Popolonia 26, I-00183 Roma, IT
RICHARD, Joel, 1 Rue Saint Blaise, F-78490 Méré, FR
CHÉCOT, Frédéric, 149 rue Vauban, F-69006 Lyon, FR
CHAN, You-Ping, 12 Avenue Haute Combe, F-69360 Ternay, FR
KRAVTZOFF, Roger, Les Estèves, F-81470 Algans, FR
POULIQUEN, Gauthier, 91 rue Jaboulay, F-69007 Lyon, FR

(51) MKP
A61K 39/00 (2006.01) (97) **2734539 ***
C07K 14/47 (2006.01)
(86) EP2012064340 20.07.2012
(96) 12738119.2 28.05.2014
(87) WO2013014105, 20.07.2012
(97) 2734539, 28.05.2014 en
(54) PRAME PURIFICATION
(71) GlaxoSmithKline Biologicals S.A., rue de l'Institut, 89, 1330 Rixensart, BE
(72) GERMAY, Olivier, C, GlaxoSmithKline Biologicals s.a. rue de l'Institut 89, B-1330 Rixensart, BE
GODART, Stephane, Andre, GlaxoSmithKline Biologicals s.a. rue de l'Institut 89, B-1330 Rixensart, BE
HARVENG, Pol, Guy, GlaxoSmithKline Biologicals s.a. rue de l'Institut 89, B-1330 Rixensart, BE
LAANAN, Amina, GlaxoSmithKline Biologicals s.a. rue de l'Institut 89, B-1330 Rixensart, BE
LE BUSSY, Olivier, Patrick, GlaxoSmithKline Biologicals s.a. rue de l'Institut 89, B-1330 Rixensart, BE
LEMOINE, Dominique, Ingrid, GlaxoSmithKline Biologicals s.a. rue de l'Institut 89, B-1330 Rixensart, BE
DODE, Leonard, GlaxoSmithKline Biologicals s.a. rue de l'Institut 89, B-1330 Rixensart, BE

(51) MKP
A61B 17/00 (2006.01) (97) **2644117**
A61B 17/072 (2006.01)
(96) 13161467.9 02.10.2013
(97) 2644117, 02.10.2013 en
(54) Tissue thickness compensator comprising a plurality of layers
(71) Ethicon Endo-Surgery, Inc., 4545 Creek Road, Cincinnati, OH 45242, US
(72) Gonzalez, Hamilton E., 7206 Winding Way, Cincinnati, OH Ohio 45236, US
Swayze, Jeffrey S., 7047 Birchley Drive, Hamilton, OH Ohio 45011, US
Cropper, Michael S., 3232 Charter Oak, Edgewood, KY Kentucky 41017, US
Scheib, Charles J., 11329 Donwiddle Drive, Loveland, OH Ohio 45140, US
Shelton, IV, Frederick E., 245 East Main Street, Hillsboro, OH Ohio 45133, US
Johnson, Gregory W., 907 Center Street, Milford, OH Ohio 45150, US

(51) MKP
F03B 3/12 (2006.01) (97) **2715119 ***
F03D 1/04 (2006.01)
F03D 1/06 (2006.01)
(86) US2012039644 25.05.2012
(96) 12726977.7 09.04.2014
(87) WO2012166625, 25.05.2012
(97) 2715119, 09.04.2014 en
(54) TURBINE WITH UNEVENLY LOADED ROTOR BLADES
(71) Flodesign Wind Turbine Corp., 221 Crescent St. Suite 103a, Waltham, MA 02453, US
(72) PRESZ, Walter M., 40 Grove Street, Wilbraham, MA 01095, US
WERLE, Michael J., 4 Porter Drive, West Hartford, CA 06117, US
DOLD, Robert, 54 Carpenter Road, Monson, MA 01057, US
HICKEY, Timothy, 45 Schuyler Drive, East Longmeadow, MA 01028, US

(51) MKP
A63B 21/055 (2006.01) (97) **2720763 ***
A63B 23/12 (2006.01)
(86) IB2012001205 18.06.2012
(96) 12743527.9 23.04.2014
(87) WO2012176040, 18.06.2012
(97) 2720763, 23.04.2014 fr
(54) COMPLETELY FLEXIBLE EXPANDER DEVICE CONSISTING OF AT LEAST TWO GRIPPING ELEMENTS, PREFERABLY 4, 6 OR 8 ELEMENTS
(71) Sveltus SAS, 1 rue Rameau, 42230 Roche La Molliere, FR
(72) BOYRE, Jean-Louis, 27 Allee de l'Aigue Marine, F-69890 La Tour de Salvagny, FR

(51) MKP
A61C 17/06 (2006.01) (97) **2720639 ***
(86) IL2012000090 23.02.2012
(96) 12749634.7 23.04.2014
(87) WO2012114335, 23.02.2012
(97) 2720639, 23.04.2014 en
(54) SEPARATION, SEDIMENTATION AND SEGREGATION CHAMBER WITH DUAL PORE-SIZE FILTER
(71) Bogen, Etai, Tomasjordnes 51/402, 9024 Tomasjord, TROMSA, NO
(72) Bogen, Etai, Tomasjordnes 51/402, 9024 Tomasjord, TROMSA, NO

(51) MKP
A01N 25/02 (2006.01) (97) **2704562 ***
A01N 43/40 (2006.01)
A01N 43/90 (2006.01)
A01N 57/12 (2006.01)
A01P 13/00 (2006.01)
(86) EP2012056766 13.04.2012
(96) 12713745.3 12.03.2014
(87) WO2012152527, 13.04.2012
(97) 2704562, 12.03.2014 en
(54) HERBICIDAL COMPOSITION COMPRISING PINOXADEN AND FLUROXYPYRESTER, AND METHODS OF USE THEREOF
(71) Syngenta Participations AG, Schwarzwaldallee 215, 4058 Basel, CH
(72) PORTER, Donald, John, Syngenta Crop Protection LLC 410 Swing Road, Greensboro, North Carolina 27409, US
POTTER, Shawn, Chignell, Syngenta Crop Protection LLC 410 Swing Road, Greensboro, North Carolina 27409, US
WEN, Xinyun, Syngenta Crop Protection LLC 410 Swing Road, Greensboro, North Carolina 27409, US
MILN, Colin, Douglas, Syngenta Crop Protection LLC 410 Swing Road, Greensboro, North Carolina 27409, US

- (51) MKP
A61K 8/891 (2006.01) (97) **2758032 ***
A61K 9/00 (2006.01)
A61K 47/24 (2006.01)
A61P 17/02 (2006.01)
- (86) US2012056667 21.09.2012
(96) 12775090.9 30.07.2014
(87) WO2013044098, 21.09.2012
(97) 2758032, 30.07.2014 en
(54) COMPOSITIONS AND METHODS FOR TREATING CONDITIONS OF COMPROMISED SKIN BARRIER FUNCTION
(71) Living Proof, Inc., 301 Binney Street, First Floor, Cambridge, MA 02142, US
(72) YU, Betty, 57 Reservoir Street Unit 2, Cambridge, MA 02138, US
LOMAKIN, Joseph, 140 Huron Avenue Unit 8, Cambridge, MA 02138, US
KANG, Soo-young, 65 Spiers Road, Newton, MA 02459, US
ADAMS, Benjamin, W., 22 Lowden Avenue 1, Somerville, MA 02144, US

- (51) MKP
A61K 38/17 (2006.01) (97) **2753347 ***
C12N 5/00 (2006.01)
- (86) DK2012050330 05.09.2012
(96) 12766380.5 16.07.2014
(87) WO2013034157, 05.09.2012
(97) 2753347, 16.07.2014 en
(54) TREATMENT OF ALLODYNIA, HYPERALGIA, SPONTANEOUS PAIN, AND PHANTOM PAIN
(71) NsGene A/S, Baltorpsvej 154, 2750 Ballerup, DK
(72) JØRGENSEN, Jesper Roland, Mariendalsvej 73 2.tv., DK-2000 Frederiksberg, DK
WAHLBERG, Lars Ulrik, 259 Riverside Dr., Tiverton, Rhode Island 02878, US
JOHANSEN, Teit E., Stampeengen 26, DK-2970 Hørsholm, DK

- (51) MKP
B27B 5/29 (2006.01) (97) **2750841 ***
- (86) NZ2012000154 31.08.2012
(96) 12850097.2 09.07.2014
(87) WO2013073963, 31.08.2012
(97) 2750841, 09.07.2014 en
(54) CUTTING MACHINE WASTE EXTRACTION APPARATUS
(71) Eigen Systems Limited, 30 Triton Drive, Albany Auckland 0632, NZ
Forlong, Murray Houlton, 1599 State Highway 17 Dairy Flat, Auckland 0794, NZ
(72) FORLONG, Murray Houlton, 1599 State Highway 17 Dairy Flat, Auckland 0794, NZ

- (51) MKP
B61D 19/02 (2006.01) (97) **2731846 ***
- (86) US2012056853 24.09.2012
(96) 12836711.7 21.05.2014
(87) WO2013048944, 24.09.2012
(97) 2731846, 21.05.2014 en
(54) BASE PLATE STRUCTURE FOR TRANSIT DOORS
(71) Wabtec Holding Corp., 1001 Air Brake Avenue, Wilmerding, PA 15148, US
(72) CHAPMAN, Matthew, 276 9th Street, Wheeling, Illinois 60090, US

- (51) MKP
C07C 253/30 (2006.01) (97) **2719689**
C07C 255/37 (2006.01)
C07D 223/14 (2006.01)
- (96) 13188228.4 16.04.2014
(97) 2719689, 16.04.2014 fr
(54) Novel method for synthesising 3-(2-bromo-4,5-dimethoxyphenyl) propanenitrile and use for synthesising ivabradine and the added salts thereof with a pharmaceutically acceptable acid
(71) Les Laboratoires Servier, 35, rue de Verdun, 92284 Suresnes Cedex, FR
(72) Carranza, Maria del Pilar, C. Ciudad Real 11, 13670 Villarrubia de los Ojos, ES
Garcia Aranda, Maria Isabel, Rnda Arroyo 1 PO2 A, 45006 Toledo, ES
Gonzalez, José Lorenzo, Avda Rio Boladiez 21 PO3 C, 45007 Toledo, ES
Sanchez, Frédéric, Calle Venus, 39, 45111 Cobisa, ES

- (51) MKP
A61K 9/00 (2006.01) (97) **2704688 ***
A61K 31/07 (2006.01)
A61K 31/20 (2006.01)
A61K 31/472 (2006.01)
A61K 31/496 (2006.01)
A61K 31/70 (2006.01)
A61K 31/704 (2006.01)
A61K 31/7048 (2006.01)
A61K 33/00 (2006.01)
A61K 33/26 (2006.01)
A61K 33/30 (2006.01)
A61K 36/54 (2006.01)
A61K 38/02 (2006.01)
A61K 39/00 (2006.01)
A61K 39/13 (2006.01)
A61K 39/145 (2006.01)
A61K 47/12 (2006.01)
- (86) US2012036576 04.05.2012
(96) 12779548.2 12.03.2014
(87) WO2012151517, 04.05.2012
(97) 2704688, 12.03.2014 en
(54) COCHLEATE COMPOSITIONS AND METHODS OF MAKING AND USING SAME
(71) Coordinated Program Development, LLC, 21 Sleepy Hollow Drive, Flemington, NJ 08822-4504, US
University Of Medicine And Dentistry Of New Jersey, 1 World's Fair Drive, Suite 2100, Somerset, NJ 08873, US
(72) LU, Ruying, 47 Newcomb Drive, New Providence, NJ 07974, US
MANNINO, Raphael, 518 Lannon Lane, Glen Gardner, NJ 08826, US

- (51) MKP
A01N 43/78 (2006.01) (97) **2490541 ***
A61K 31/425 (2006.01)
A61P 25/18 (2006.01)
C07D 277/56 (2006.01)
C07D 417/06 (2006.01)
C07D 491/04 (2006.01)
C07D 495/04 (2006.01)
- (86) US2010053379 20.10.2010
(96) 10825591.0 29.08.2012
(87) WO2011050063, 20.10.2010
(97) 2490541, 29.08.2012 en
(54) 2-SUBSTITUTED-ETHYNYLTHIAZOLE DERIVATIVES AND USES OF SAME
(71) H. Lundbeck A/S, Ottilievej 9, 2500 Valby-Copenhagen, DK
(72) PACKIARAJAN, Mathivanan, 275 Madison Ave, 2, Saddle Brook NJ 07663, US
HOPPER, Allen, 14 Moseman Avenue, Katonan NY 10536, US
SAMS, Anette, Graven, Thormosen 4, DK-3500 Vaerloese, DK
MIKKELSEN, Gitte, Kobberoe, 143 Skobovaenget, DK-2750 Ballerup, DK
GRENON, Michel, 117 Rochelle Parkway, Saddle Brook NJ 07663-4659, US

- (51) MKP
A61K 31/4985 (2006.01) (97) **2734522 ***
A61P 19/08 (2006.01)
A61P 29/00 (2006.01)
A61P 31/00 (2006.01)
A61P 35/00 (2006.01)
A61P 37/00 (2006.01)
C07D 487/04 (2006.01)
C07D 519/00 (2006.01)
- (86) EP2012063552 11.07.2012
(96) 12733505.7 28.05.2014
(87) WO2013010868, 11.07.2012
(97) 2734522, 28.05.2014 en
(54) 4 - IMIDAZOPYRIDAZIN- 1 -YL-BENZAMIDES AND 4 - IMIDAZOTRIAZIN- 1 - YL - BENZAMIDES AS BTK-INHIBITORS
- (71) Merck Sharp & Dohme B.V., Waarderweg 39, 2031 BN Haarlem, NL
- (72) BARF, Tjeerd A., St. Luciastraat 7, NL-5371AS Ravenstein, NL
JANS, Christiaan, Gerardus, Johannes, Maria, Heggerank 134, NL-5342CC Cuijk, NL
MAN, de Adrianus, Petrus, Antonius, N. V. Organon H.W. Van Heelstraat 4, NL-5327AH Hurwenen, NL
OUBRIE, Arthur A., Saltshof 1106, NL-6604EB Wijchen, NL
RAAIJMAKERS, Hans C.A., Eikakkerhoven 26, NL-5242KK Eindhoven, NL
REWINKEL, Johannes, Bernardus, Maria, Molenweg 16, NL-5351EV Berghem, NL
STERRENBURG, Jan-Gerard, Grote Omloop 18, NL-6871TE Renkum, NL
WIJKMANS, Jacobus C.H.M., N. V. Organon Oss, NL-5345LR Hurwenen, NL

- (51) MKP
A01C 7/20 (2006.01) (97) **2636294**
- (96) 13153212.9 11.09.2013
(97) 2636294, 11.09.2013 de
(54) Energy absorption device for a feed channel of a blade
- (71) Kverneland AS, null, 4355 Kverneland, NO
- (72) Budde, Michael, Antoniusstr. 6, 59609 Anröchte, NO

- (51) MKP
E21B 34/08 (2006.01) (97) **2756163 ***
E21B 34/16 (2006.01)
E21B 43/12 (2006.01)
E21B 43/22 (2006.01)
E21B 43/26 (2006.01)
- (86) CA2012050612 05.09.2012
(96) 12831984.5 23.07.2014
(87) WO2013037055, 05.09.2012
(97) 2756163, 23.07.2014 en
(54) WELLBORE FRAC TOOL WITH INFLOW CONTROL
- (71) Packers Plus Energy Services Inc., Bow Valley Square 2 Suite 2200, 205 - 5 Avenue SW, Calgary, Alberta T2P 2V7, CA
- (72) COON, Robert, Joe, 8606 Hall Retreat CT, Missouri City, Texas 77459, US

- (51) MKP
A61K 31/662 (2006.01) (97) **2707004 ***
A61P 31/14 (2006.01)
- (86) EP2011057519 10.05.2011
(96) 11722756.1 19.03.2014
(87) WO2012152317, 10.05.2011
(97) 2707004, 19.03.2014 en
(54) COMPOUNDS FOR USE IN THE TREATMENT OF FELINE RETROVIRAL INFECTIONS
- (71) Okapi Sciences NV, Ambachtenlaan 1, 3001 Heverlee, BE
- (72) JUSTA, Nina, Isartalstrasse 20, 80469 Munich, DE
HARTMANN, Katrin, Berenterstrasse 25, 81927 Munich, DE
DAMINET, Sylvie, Neuringen 21, B-9400 Denderwindeke, BE
DEBILLE, Mariella, Zoete Moederstraat 15A, B-9150 Rupelmonde, BE
AUWERX, Joeri, Bierbeekstraat 51, B-3360 Bierbeek, BE
GORIS, Nesy, Naamsevest 60, B-3000 Leuven, BE
WERA, Stefaan, Hoegaardsesteenweg 78, B-3360 Bierbeek, BE
BLOMSMA, Erwin, Houwaartstraat 94B, B-3210 Linden, BE
BILLIET, Aino, Dekenstraat 19, B-3000 Leuven, BE
SWINNEN, Jan, Geldenakenstraat 17, B-3350 Linter, BE
VRANCX, Bert, Ierse Heide 11, B-2221 Booischoot, BE
DEBEURME, Veerle, Emiel Vlieberghlaan 9, B-3010 Kessel-lo, BE
NEYTS, Johan, Heidebergstraat 278, B-3010 Kessel-lo, BE

- (51) MKP
A61K 9/127 (2006.01) (97) **2718269 ***
A61K 31/4164 (2006.01)
C07C 323/00 (2006.01)
C07D 233/64 (2006.01)
- (86) US2012041663 08.06.2012
(96) 12728004.8 16.04.2014
(87) WO2012170889, 08.06.2012
(97) 2718269, 16.04.2014 en
(54) CLEAVABLE LIPIDS
- (71) Shire Human Genetic Therapies, Inc., 300 Shire Way, Lexington, MA 02421, US
- (72) HEARTLEIN, Michael, 167 Reed Farm Road, Boxborough, MA 01719, US
GUILD, Braydon, Charles, 109 Riverdale Road, Concord, MA 01742, US
DEROSA, Frank, 26 Mount Auburn Street, Chelmsford, MA 01824, US
ZHANG, Jerry, Chi, 23 Heritage Drive, Lexington, MA 02420, US

- (51) MKP
A01G 31/00 (2006.01) (97) **2714977 ***
D04H 1/407 (2012.01)
D04H 1/4209 (2012.01)
D04H 1/46 (2012.01)
- (86) EP2012060311 31.05.2012
(96) 12724650.2 09.04.2014
(87) WO2012164044, 31.05.2012
(97) 2714977, 09.04.2014 en
(54) MINERAL WOOL PRODUCT
- (71) Knauf Insulation, Rue de Maestricht 95, 4600 Visé, BE
- (72) SUMI, Jure, Trata 32, 4220 Skofja Loka, SI
SEBENIK, Gorazd, Trata 32, 4220 Skofja Loka, SI
BAVEC, Sasa, Trata 32, 4220 Skofja Loka, SI
KEJZAR, Gregor, Trata 32, 4220 Skofja Loka, SI

- (51) MKP
A01N 25/12 (2006.01) (97) **2741608 ***
A01N 59/00 (2006.01)
A01P 1/00 (2006.01)
A01P 7/00 (2006.01)
(86) MY2012000228 08.08.2012
(96) 12822678.4 18.06.2014
(87) WO2013022337, 08.08.2012
(97) 2741608, 18.06.2014 en
(54) AN IMPROVED PLANT TREATMENT AGENT
(71) Universiti Putra Malaysia, UPM Serdang, 43400 Selangor, MY
(72) HARUNA, Ahmed Osmamu, Jabatan Sains Tanaman Fakulti Sains Pertanian dan Makanan Universiti Putra Malaysia Kampus Bintulu Jalan Nyabau Peti Surat 396, 97008 Bintulu Sarawak, MY
OMAR, Latifa, Jabatan Sains Tanaman Fakulti Sains Pertanian dan Makanan Universiti Putra Malaysia Kampus Bintulu Jalan Nyabau Peti Surat 396, 97008 Bintulu Sarawak, MY
AB MAJID, Nik Muhammad, Jabatan Sains Tanaman Fakulti Sains Pertanian dan Makanan Universiti Putra Malaysia Kampus Bintulu Jalan Nyabau Peti Surat 396, 97008 Bintulu Sarawak, MY

- (51) MKP
C07K 16/00 (2006.01) (97) **2744822 ***
(86) EP2012065782 13.08.2012
(96) 12746095.4 25.06.2014
(87) WO2013024059, 13.08.2012
(97) 2744822, 25.06.2014 en
(54) MODIFIED PROTEINS AND PEPTIDES
(71) Glaxo Group Limited, 980 Great West Road Brentford, Middlesex TW8 9GS, GB
(72) ASHMAN, Claire, GlaxoSmithKline Gunnels Wood Road, Stevenage Hertfordshire SG1 2NY, GB
BIRCHLER, Mary, GlaxoSmithKline 709 Swedeland Road, King of Prussia, Pennsylvania 19406, US
DE WILDT, Rudolf M T, GlaxoSmithKline Gunnels Wood Road, Stevenage Hertfordshire SG1 2NY, GB
HOLLAND, Claire, GlaxoSmithKline 709 Swedeland Road, King of Prussia, Pennsylvania 19406, US
LEWIS, Alan Peter, GlaxoSmithKline Gunnels Wood Road, Stevenage Hertfordshire SG1 2NY, GB
MORLEY, Peter, GlaxoSmithKline Gunnels Wood Road, Stevenage Hertfordshire SG1 2NY, GB
SANDAL, Thomas, c/o GlaxoSmithKline Gunnels Wood Road, Stevenage Hertfordshire SG1 2NY, GB
STEWART, Michael, GlaxoSmithKline Gunnels Wood Road, Stevenage Hertfordshire SG1 2NY, GB

- (51) MKP
A61K 38/55 (2006.01) (97) **2726092 ***
A61K 39/395 (2006.01)
A61K 39/40 (2006.01)
A61K 39/42 (2006.01)
A61P 1/00 (2006.01)
A61P 3/10 (2006.01)
A61P 9/00 (2006.01)
A61P 9/10 (2006.01)
A61P 11/00 (2006.01)
A61P 11/06 (2006.01)
A61P 19/02 (2006.01)
A61P 21/00 (2006.01)
A61P 29/00 (2006.01)
A61P 31/04 (2006.01)
A61P 31/10 (2006.01)
A61P 31/12 (2006.01)
A61P 35/00 (2006.01)
A61P 37/06 (2006.01)
C07K 19/00 (2006.01)
(86) US2012044730 28.06.2012
(96) 12804863.4 07.05.2014
(87) WO2013003641, 28.06.2012
(97) 2726092, 07.05.2014 en
(54) SERPIN FUSION POLYPEPTIDES AND METHODS OF USE THEREOF
(71) Inhibrx LLC, 11099 N. Torrey Pines Road Suite 130, La Jolla, CA 92037, US
(72) ECKELMAN, Brendan, P., 11099 N. Torrey Pines Road Suite 130, La Jolla, CA 92037, US
TIMMER, John, C., 11099 N. Torrey Pines Road Suite 130, La Jolla, CA 92037, US
NGUY, Peter, L., 11099 N. Torrey Pines Road Suite 130, La Jolla, CA 92037, US
GUENTHER, Grant, B., 11099 N. Torrey Pines Road Suite 130, La Jolla, CA 92037, US
DEVERAUX, Quinn, 11099 N. Torrey Pines Road Suite 130, La Jolla, CA 92037, US

- (51) MKP
A61K 9/00 (2006.01) (97) **2704724 ***
A61K 31/573 (2006.01)
(86) EP2012057068 18.04.2012
(96) 12719304.3 12.03.2014
(87) WO2012150131, 18.04.2012
(97) 2704724, 12.03.2014 en
(54) IMPROVED SUSPENSION FORMULATION OF A CORTICOSTEROID FOR ADMINISTRATION BY INHALATION
(71) Chiesi Farmaceutici S.p.A., Via Palermo, 26/A, 43100 Parma, IT
(72) CANTARELLI, Anna Maria, Chiesi Farmaceutici S.p.A. Via Palermo 26/A, I-43100 Parma, IT
MINARI, Stefano, Chiesi Farmaceutici S.p.A. Via Palermo 26/A, I-43100 Parma, IT
BASSI, Barbara, Chiesi Farmaceutici S.p.A. Via Palermo 26/A, I-43100 Parma, IT

- (51) MKP
G01N 33/68 (2006.01) (97) **2710383 ***
(86) US2012038197 16.05.2012
(96) 12735358.9 26.03.2014
(87) WO2012158831, 16.05.2012
(97) 2710383, 26.03.2014 en
(54) PERFORMANCE OF A BIOMARKER PANEL FOR IRRITABLE BOWEL SYNDROME
(71) Nestec S.A., Avenue Nestlé 55, 1800 Vevey, CH
(72) JONES, Michael, P., null, New South Wales, AU
TALLEY, Nicholas, J., null, New South Wales, AU

(51) MKP
A61K 9/16 (2006.01) (97) **2747752 ***
A61K 9/20 (2006.01)
A61K 9/50 (2006.01)
(86) EP2012072161 08.11.2012
(96) 12781346.7 02.07.2014
(87) WO2013068478, 08.11.2012
(97) 2747752, 02.07.2014 en
(54) NEW COATED CONTROLLED RELEASE ACTIVE AGENT CARRIERS
(71) Omya International AG, Baslerstrasse 42, 4665 Oftringen, CH
(72) SCHWARZENTRUBER, Patrick, Untere Lättenstrasse 193, CH-5245 Habsburg, CH
DI MAIUTA, Nicola, Amselweg 8, CH-4528 Zuchwil, CH
SCHOELKOPF, Joachim, Buechbühlstrasse 3, CH-8956 Killwangen, CH
RIDGWAY, Catherine Jean, Wannenberg 12, CH-4812 Mühlethal, CH
GANE, Patrick A.C., Studenweg 8, CH-4852 Rothrist, CH

(51) MKP
H01R 43/16 (2006.01) (97) **2654141**
H01R 43/20 (2006.01)
(96) 12164968.5 23.10.2013
(97) 2654141, 23.10.2013 de
(54) Method and device for producing a connector
(71) Schleuniger Holding AG, Biergutstrasse 9, 3608 Thun, CH
(72) Petermann, Manfred, Hofmattweg 4, 6033 Buchrain, CH
Messina, Camelo, Sonnenweg 6, 6340 Baar, CH
Knuchel, Walter, Fochenmattweg 2, 8624 Grüt, CH

(51) MKP
A01N 43/04 (2006.01) (97) **2741610 ***
(86) US2012050283 10.08.2012
(96) 12824414.2 18.06.2014
(87) WO2013025476, 10.08.2012
(97) 2741610, 18.06.2014 en
(54) MAINTENANCE OF PLATELET INHIBITION DURING ANTIPLATELET THERAPY
(71) The Medicines Company, 8 Sylvan Way, Parsippany, NJ 07054, US
(72) CHEN, Lisa, Ruderman, 296 Milton Road, Rye, NY 10580, US
SKERJANEC, Simona, 21 Mount Salem Road, Pittstown, NJ 08867, US
PRATS, Jayne, 394 River Road, Carlisle, MA 10741, US
TODD, Meredith, 921 Garden Street Apt. 3, Hoboken, NJ 07030, US
BELL, Dawn, 33 Vom Eigen Drive, Morristown, NJ 07960, US

(51) MKP
A61K 31/426 (2006.01) (97) **2738163 ***
A61K 31/427 (2006.01)
A61K 31/433 (2006.01)
A61K 31/4439 (2006.01)
A61K 31/454 (2006.01)
A61K 31/496 (2006.01)
A61K 31/497 (2006.01)
A61K 31/501 (2006.01)
A61K 31/506 (2006.01)
A61K 31/5377 (2006.01)
A61P 17/00 (2006.01)
A61P 31/10 (2006.01)
C07D 277/20 (2006.01)
C07D 277/28 (2006.01)
C07D 277/30 (2006.01)
C07D 277/34 (2006.01)
C07D 277/48 (2006.01)
C07D 277/56 (2006.01)
C07D 285/08 (2006.01)
C07D 417/04 (2006.01)
(86) JP2012069249 27.07.2012
(96) 12819674.8 04.06.2014
(87) WO2013018735, 27.07.2012
(97) 2738163, 04.06.2014 en
(54) AMIDINE COMPOUND OR SALT THEREOF
(71) Taisho Pharmaceutical Co., Ltd., 24-1, Takada 3-chome Toshima-ku, Tokyo 170-8633, JP
Toyama Chemical Co., Ltd., 2-5 Nishishinjuku 3-Chome, Shinjuku-ku Tokyo 160-0023, JP
(72) TANIKAWA, Tetsuya, c/o TAISHO PHARMACEUTICAL CO. LTD. 24-1 Takada 3-chome Toshima-ku, Tokyo 170-8633, JP
USHIKI, Yasunobu, c/o TAISHO PHARMACEUTICAL CO. LTD. 24-1 Takada 3-chome Toshima-ku, Tokyo 170-8633, JP
USHIYAMA, Fumihito, c/o TAISHO PHARMACEUTICAL CO. LTD. 24-1 Takada 3-chome Toshima-ku, Tokyo 170-8633, JP
YAMAGUCHI, Toru, c/o TAISHO PHARMACEUTICAL CO. LTD. 24-1 Takada 3-chome Toshima-ku, Tokyo 170-8633, JP
ONO, Naoya, c/o TAISHO PHARMACEUTICAL CO. LTD. 24-1 Takada 3-chome Toshima-ku, Tokyo 170-8633, JP
YAMAMOTO, Keiko, c/o TAISHO PHARMACEUTICAL CO. LTD. 24-1 Takada 3-chome Toshima-ku, Tokyo 170-8633, JP
TSURUTA, Risa, c/o TAISHO PHARMACEUTICAL CO. LTD. 24-1 Takada 3-chome Toshima-ku, Tokyo 170-8633, JP
TSUTSUI, Yasuhiro, c/o TOYAMA CHEMICAL CO. LTD. Toyama Works 4-1 Shimookui 2-chome, Toyama-shi Toyama 930-8508, JP
FUJINO, Noritomo, c/o TOYAMA CHEMICAL CO. LTD. Toyama Works 4-1 Shimookui 2-chome, Toyama-shi Toyama 930-8508, JP
MORI, Ayumu, c/o TOYAMA CHEMICAL CO. LTD. Toyama Works 4-1 Shimookui 2-chome, Toyama-shi Toyama 930-8508, JP

(51) MKP
F04D 7/04 (2006.01) (97) **2734736 ***
F04D 29/22 (2006.01)
F04D 29/42 (2006.01)
(86) AU2012000868 20.07.2012
(96) 12815181.8 28.05.2014
(87) WO2013010224, 20.07.2012
(97) 2734736, 28.05.2014 en
(54) IMPROVEMENTS TO PUMPS AND COMPONENTS THEREFOR
(71) Weir Minerals Australia Ltd, 1 Marden Street, Artarmon, NSW 2064, AU
(72) LAVAGNA, Luis Moscoso, Unit 1 32 Twin Road, North Ryde, New South Wales 2113, AU
GLAVES, Garry Bruce, Unit 66 7 Taranto Road, Marsfield, New South Wales 2122, AU

- (51) MKP
A61K 31/155 (2006.01) (97) **2707017 ***
A61K 38/26 (2006.01)
A61P 3/10 (2006.01)
(86) EP2012058747 11.05.2012
(96) 12723132.2 19.03.2014
(87) WO2012156298, 11.05.2012
(97) 2707017, 19.03.2014 en
(54) LIXISENATIDE AND METFORMIN FOR TREATMENT OF DIABETES TYPE 2
(71) Sanofi-Aventis Deutschland GmbH, Brüningstraße 50, 65929 Frankfurt am Main, DE
(72) RUUS, Peter, c/o Sanofi-Aventis Deutschland GmbH, 65926 Frankfurt am Main, DE
SILVESTRE, Louise, c/o Sanofi Département Brevets 54 rue La Boétie, F-75008 Paris, FR
MIOSSEC, Patrick, c/o Sanofi Département Brevets 54 rue La Boétie, F-75008 Paris, FR
PINQUIER, Jean-Louis, c/o Sanofi Département Brevets 54 rue La Boétie, F-75008 Paris, FR
HINCELIN-MERY, Agnes, c/p Sanofi Département Brevets 54 rue La Boétie, F-75008 Paris, FR

- (51) MKP
A61K 31/437 (2006.01) (97) **2702061**
A61K 31/4985 (2006.01)
A61P 35/00 (2006.01)
C07D 473/34 (2006.01)
C07D 487/04 (2006.01)
(96) 12717685.7 05.03.2014
(97) 2702061, 05.03.2014 en
(54) PYRROLOTRIAZINONE DERIVATIVES AS PI3K INHIBITORS
(71) Almirall S.A., Ronda del General Mitre, 151, 08022 Barcelona, ES
(72) BERNAL ANCHUELA, Francisco Javier, C/ Laureà Miró 408-410, Sant Feliu de Llobregat, Barcelona, ES
CARRASCAL RIERA, Marta, C/ Laureà Miró 408-410, Sant Feliu de Llobregat, Barcelona, ES
CATURLA JAVALOYES, Juan Francisco, C/ Laureà Miró 408-410, Sant Feliu de Llobregat, Barcelona, ES
GRACIA FERRER, Jordi, C/ Laureà Miró 408-410, Sant Feliu de Llobregat, Barcelona, ES
MATASSA, Victor Giulio, C/ Laureà Miró 408-410, Sant Feliu de Llobregat, Barcelona, ES
TERRICABRAS BELART, Emma, C/ Laureà Miró 408-410, Sant Feliu de Llobregat, Barcelona, ES
TALTAVULL MOLL, Joan, C/ Laureà Miró 408-410, Sant Feliu de Llobregat, Barcelona, ES
ERRA SOLA, Montserrat, C/ Laureà Miró 408-410, Sant Feliu de Llobregat, Barcelona, ES

- (51) MKP
G01B 11/16 (2006.01) (97) **2702352 ***
G01B 11/24 (2006.01)
(86) EP2012057705 27.04.2012
(96) 12720458.4 05.03.2014
(87) WO2012146687, 27.04.2012
(97) 2702352, 05.03.2014 de
(54) ANALYSIS APPARATUS FOR CONTACTLESS ANALYSIS OF THE SHAPE OF A TRANSPARENT BODY, AND METHOD FOR CARRYING OUT THE CONTACTLESS ANALYSIS
(71) Hamilton Bonaduz AG, Via Crusch 8, 7402 Bonaduz, CH
(72) ETZOLD, Carsten, Vignel 7, CH-7402 Bonaduz, CH
NEUHAEUSER-WESPY, Friedrich, Rieterstrasse 69, CH-8002 Zürich, CH

- (51) MKP
A61K 31/549 (2006.01) (97) **2760462 ***
A61K 38/16 (2006.01)
(86) US2012057258 26.09.2012
(96) 12780570.3 06.08.2014
(87) WO2013049149, 26.09.2012
(97) 2760462, 06.08.2014 en
(54) BROAD-SPECTRUM ANTIMICROBIAL COMPOSITIONS BASED ON COMBINATIONS OF TAUROLIDINE AND PROTAMINE AND MEDICAL DEVICES CONTAINING SUCH COMPOSITIONS
(71) Ethicon, Inc, P.O. Box 151 U.S. Route 22, Somerville, NJ 08876, US
(72) PRIEWE, Joerg., Krummbogen 43, 24113 Kiel, DE
MING, Xintian., 75 Shaffer Road Bridgewater, New Jersey 08807, US

- (51) MKP
A61K 31/505 (2006.01) (97) **2628732**
A61P 31/18 (2006.01)
C07D 239/48 (2006.01)
(96) 12156160.9 21.08.2013
(97) 2628732, 21.08.2013 en
(54) Novel crystalline form of rilpivirine hydrochloride
(71) Sandoz AG, Lichtstrasse 35, 4056 Basel, CH
(72) The designation of the inventor has not yet been filed, null, null

- (51) MKP
A61K 31/437 (2006.01) (97) **2723739 ***
A61P 11/00 (2006.01)
A61P 17/00 (2006.01)
A61P 19/00 (2006.01)
A61P 29/00 (2006.01)
A61P 35/00 (2006.01)
A61P 37/00 (2006.01)
C07D 471/04 (2006.01)
C07D 519/00 (2006.01)
(86) US2012043276 20.06.2012
(96) 12738263.8 30.04.2014
(87) WO2012177714, 20.06.2012
(97) 2723739, 30.04.2014 en
(54) SUBSTITUTED 6-AZA-ISOINDOLIN-1-ONE DERIVATIVES
(71) Takeda Pharmaceutical Company Limited, 1-1 Doshomachi 4-chome Chuo-ku, Osaka-shi, Osaka 541-0045, JP
(72) NIE, Zhe, c/o Takeda California, Inc. 10410 Science Center Drive, San Diego, CA 92121, US
CHEN, Rongliang, c/o Takeda California Inc. 10410 Science Center Drive, San Diego, CA 92121, US
KONO, Mitsunori, c/o Takeda Pharmaceutical Company Limited 17-85 Jusohonmachi 2-chome Yodogawa-ku, Osaka-shi Osaka 541-0045, JP
LAM, Betty, c/o Takeda California Inc. 10410 Science Center Drive, San Diego, CA 92121, US
LARDY, Matthew, c/o Takeda California Inc. 10410 Science Center Drive, San Diego, CA 92121, US
NATALA, Srinivasa, Reddy, c/o Takeda California, Inc. 10410 Science Center Drive, San Diego, CA 92121, US
WILKENS, Steven James, c/o Takeda California Inc. 10410 Science Center Drive, San Diego, CA 92121, US
ADAMS, Mark, E., c/o Takeda California Inc. 10410 Science Center Drive, San Diego, CA 92121, US

- (51) MKP
A61K 38/16 (2006.01) (97) **2709647 ***
C07K 14/00 (2006.01)
(86) US2012026353 23.02.2012
(96) 12750085.8 26.03.2014
(87) WO2012116203, 23.02.2012
(97) 2709647, 26.03.2014 en
(54) WATER SOLUBLE MEMBRANE PROTEINS AND METHODS FOR THE PREPARATION AND USE THEREOF
(71) Massachusetts Institute Of Technology, One Cambridge Center Kendall Square Building Ne-18-501, Cambridge, MA 02142-1493, US
(72) ZHANG, Shuguang, 25 Bowker Street, Lexington, MA 02421, US
RICH, Alexander, 2 Walnut Avenue, Cambridge, MA 02140, US
CORIN, Karolina, 101 Western Avenue, Cambridge, MA 02139, US
TEGLER, Lotta, T., 534 Beacon St. Apt. 503, Boston, MA 02215, US

- (51) MKP
A23K 1/16 (2006.01) (97) **2763550 ***
A23K 1/175 (2006.01)
(86) US2012057708 28.09.2012
(96) 12838742.0 13.08.2014
(87) WO2013052357, 28.09.2012
(97) 2763550, 13.08.2014 en
(54) USE OF SPENT BLEACHING EARTH FROM EDIBLE OIL PROCESSING IN THE FORMULATION OF SALT AND MINERAL FEED BLOCKS OR PELLETS FOR LIVESTOCK
(71) Smallwood, Norman J., 2601 Marsh Lane Unit 303, Plano, Texas 75093-8487, US
(72) Smallwood, Norman J., 2601 Marsh Lane Unit 303, Plano, Texas 75093-8487, US

(51) MKP
A61K 31/5415 (2006.01) (97) **2744808 ***
A61P 35/00 (2006.01)
C07D 279/28 (2006.01)
C07D 417/06 (2006.01)
(86) US2012051097 16.08.2012
(96) 12823881.3 25.06.2014
(87) WO2013025882, 16.08.2012
(97) 2744808, 25.06.2014 en
(54) TRICYCLIC COMPOUNDS AS ANTICANCER AGENTS
(71) Mount Sinai School of Medicine, One Gustave L. Levy Place
Box 1675, New York, NY 10029-6574, US
(72) OHLMEYER, Michael, 6 Beechtree Lane, Plainsboro, NJ
08536, US
NARLA, Goutham, 26800 Amhearst Circle Apt. 111,
Beachwood, OH 44122, US
DHAWAN, Neil, 50 E. 98th Street Apt. 11L, New York, NY
10029, US
KASTRINSKY, David, 15-11 Landzettel Way, Fair Lawn, NJ
07410, US

(51) MKP
A61K 39/42 (2006.01) (97) **2731967 ***
A61P 31/16 (2006.01)
C07K 16/10 (2006.01)
(86) EP2012063637 12.07.2012
(96) 12735516.2 21.05.2014
(87) WO2013007770, 12.07.2012
(97) 2731967, 21.05.2014 en
(54) HUMAN BINDING MOLECULES CAPABLE OF
NEUTRALIZING INFLUENZA A VIRUSES OF
PHYLOGENETIC GROUP 1 AND PHYLOGENETIC GROUP 2
AND INFLUENZA B VIRUSES
(71) Crucell Holland B.V., Archimedesweg 4, 2333 CN Leiden, NL
(72) KWAKS, Theodorus Hendrikus Jacobus, Archimedesweg 4-6,
NL-2333 CN Leiden, NL
ZUIJDEEST, David A.T.M., Archimedesweg 4-6, NL-2333 CN
Leiden, NL
VOGELS, Ronald, Archimedesweg 4-6, NL-2333 CN Leiden,
NL
FRIESEN, Robert Heinz Edward, Archimedesweg 4-6, NL-2333
CN Leiden, NL

(51) MKP
C07K 16/28 (2006.01) (97) **2731973 ***
C12N 15/70 (2006.01)
(86) EP2012002945 13.07.2012
(96) 12737492.4 21.05.2014
(87) WO2013007388, 13.07.2012
(97) 2731973, 21.05.2014 en
(54) BACTERIAL HOST STRAIN EXPRESSING RECOMBINANT
DSBC
(71) UCB Pharma, S.A., 60, allée de la Recherche, 1070 Brussels,
BE
(72) ELLIS, Mark, c/o IPD UCB Celltech 208 Bath Road, Slough
Berkshire SL1 3WE, GB
HUMPHREYS, David Paul, c/o IPD UCB Celltech 208 Bath
Road, Slough Berkshire SL1 3WE, GB

(51) MKP
A61K 31/341 (2006.01) (97) **2725016 ***
A61K 31/381 (2006.01)
A61K 31/4025 (2006.01)
A61K 31/427 (2006.01)
A61K 31/435 (2006.01)
A61K 31/4365 (2006.01)
A61K 38/00 (2006.01)
A61P 3/00 (2006.01)
A61P 3/04 (2006.01)
A61P 3/06 (2006.01)
A61P 3/08 (2006.01)
A61P 3/10 (2006.01)
A61P 5/50 (2006.01)
A61P 43/00 (2006.01)
C07D 307/68 (2006.01)
C07D 333/38 (2006.01)
C07D 405/06 (2006.01)
C07D 409/06 (2006.01)
C07D 417/06 (2006.01)
C07D 495/04 (2006.01)

(86) JP2012064664 07.06.2012
(96) 12797649.6 30.04.2014
(87) WO2012169579, 07.06.2012
(97) 2725016, 30.04.2014 en
(54) HETEROCYCLIC CARBOXYLIC ACID ESTER DERIVATIVE
(71) Ajinomoto Co., Inc., 15-1, Kyobashi 1-chome Chuo-ku, Tokyo
104-8315, JP
(72) SUZUKI, Tamotsu, c/o AJINOMOTO PHARMACEUTICALS
CO. LTD. 1-1 Suzuki-cho Kawasaki-ku, Kawasaki-shi
Kanagawa 210-8681, JP
KOSHIBA, Takahiro, c/o AJINOMOTO PHARMACEUTICALS
CO. LTD. 1-1 Suzuki-cho Kawasaki-ku, Kawasaki-shi
Kanagawa 210-8681, JP
TOKUMASU, Munetaka, c/o AJINOMOTO
PHARMACEUTICALS CO. LTD. 1-1 Suzuki-cho Kawasaki-ku,
Kawasaki-shi Kanagawa 210-8681, JP
OHSUMI, Koji, c/o AJINOMOTO PHARMACEUTICALS CO.
LTD. 1-1 Suzuki-cho Kawasaki-ku, Kawasaki-shi Kanagawa
210-8681, JP

(51) MKP
A61K 31/4725 (2006.01) (97) **2766361 ***
A61P 35/00 (2006.01)
C07D 417/14 (2006.01)
C07D 471/04 (2006.01)
C07D 487/04 (2006.01)
C07D 513/04 (2006.01)
(86) US2012059720 11.10.2012
(96) 12780605.7 20.08.2014
(87) WO2013055897, 11.10.2012
(97) 2766361, 20.08.2014 en
(54) 8 - CARBAMOYL - 2 - (2,3- DI SUBSTITUTED PYRID - 6 - YL)
-1,2,3,4 -TETRAHYDROISOQUINOLINE DERIVATIVES AS
APOPTOSIS - INDUCING AGENTS FOR THE TREATMENT
OF CANCER AND IMMUNE AND AUTOIMMUNE DISEASES
(71) AbbVie Inc., 1 North Waukegan Road, North Chicago, IL
60064, US
(72) WANG, Le, 338 East Colonial Drive, Vernon Hills, Illinois
60061, US
DOHERTY, George, 1605 Bush Court, Libertyville, Illinois
60048, US
WANG, Xilu, 1617 Eric Lane, Libertyville, Illinois 60048, US
TAO, Zhi-Fu, 303 Hobble Bush Lane, Vernon Hills, Illinois
60061, US
BRUNKO, Milan, 31231 Prairie Ridge, Green Oaks, Illinois
60048, US
KUNZER, Aaron R., 615 W. Burr Oak Drive, Arlington Heights,
Illinois 60004, US
WENDT, Michael D., 1445 Maidstone Drive, Vernon Hills,
Illinois 60061, US
SONG, Xiaohong, 34037 Sulkey Drive, Grayslake, Illinois
60030, US
FREY, Robin, 1037 Shari Lane, Libertyville, Illinois 60048, US
HANSEN, Todd M., 191 Seymour Avenue, Grayslake, Illinois
60030, US
SULLIVAN, Gerard M., 1212 Tulip Tree Court, Lake Villa, Illinois
60046, US
JUDD, Andrew, 138 Mainsail Drive, Grayslake, Illinois 60030,
US
SOUERS, Andrew, 901 Hinman Apt. 3A, Evanston, Illinois
60202, US

(51) MKP
A61K 31/44 (2006.01) (97) **2750677 ***
C07D 401/00 (2006.01)
(86) US2012052648 28.08.2012
(96) 12828501.2 09.07.2014
(87) WO2013033085, 28.08.2012
(97) 2750677, 09.07.2014 en
(54) KYNURENINE-3-MONOOXYGENASE INHIBITORS,
PHARMACEUTICAL COMPOSITIONS, AND METHODS OF
USE THEREOF
(71) CHDI Foundation, Inc., 350 7th Avenue, Suite 601, New York,
NY 10001, US
(72) COURTNEY, Stephen Martin, 43 Fawcner Way, Stanford in the
Vale Oxfordshire SN7 8FF, GB
PRIME, Michael, 7 Overmead,, Abingdon Oxfordshire OX14
5NB, GB
MITCHELL, William, Hunters Meet, Chapel Lane, Swallow,,
Market Rasen Lincolnshire LN7 6DE, GB
BROWN, Christopher John, 48 Howarc Cornish Road,
Marcham,, Abingdon Oxon OX13 6PW, GB
DE AGUIAR PENA, Paula C., 22 Fallowfield Crescent, Madley
Park,, Witney Oxfordshire OX28 1AF, GB
JOHNSON, Peter, 59, Overmead,, Abingdon Oxfordshire OX14
5ND, GB
DOMINGUEZ, Celia, 8606 Allenwood Road,, Los Angeles, CA
90046, US
TOLEDO-SHERMAN, Leticia M., 3015 Goldsmith Street, Santa
Monica, CA 90405, US
MUNOZ, Ignacio, 1029 N. Vista Street, Unit 101, West
Hollywood, CA 90046, US

(51) MKP
A01N 43/42 (2006.01) (97) **2720545 ***
C07D 215/00 (2006.01)
(86) US2012042336 14.06.2012
(96) 12799914.2 23.04.2014
(87) WO2012174176, 14.06.2012
(97) 2720545, 23.04.2014 en
(54) CYCLOALKYL-FUSED TETRAHYDROQUINOLINES AS
CRTH2 RECEPTOR MODULATORS
(71) Merck Sharp & Dohme Corp., 126 East Lincoln Avenue,
Rahway NJ 07065-0907, US
(72) PALANI, Anandan, 126 East Lincoln Avenue, Rahway, New
Jersey 07065-0907, US
HUANG, Xianhai, 126 East Lincoln Avenue,, Rahway, New
Jersey 07065-0907, US
BRUBAKER, Jason, 33 Avenue Louis Pasteur, Boston,
Massachusetts 02115-5727, US
PETERSON, Scott, L., 33 Avenue Louis Pasteur, Boston,
Massachusetts 02115-5727, US
BUTCHER, John, W., 33 Avenue Louis Pasteur, Boston,
Massachusetts 02115-5727, US
CLOSE, Joshua, T., 33 Avenue Louis Pasteur, Boston,
Massachusetts 02115-5727, US
MARTINEZ, Michelle, 33 Avenue Louis Pasteur, Boston,
Massachusetts 02115-5727, US
MACCOSS, Rachel, Nicola, 25 Staverton Road, Flat 2, Oxford,
Oxfordshire OX2 6XL, GB
JUNG, Joon, O., 111 Wendell, Newton, Massachusetts 02459,
US
SILIPHAIVANH, Phieng, 33 Avenue Louis Pasteur, Boston,
Massachusetts 02115-5727, US
ZHANG, Hongjun, 33 Avenue Louis Pasteur, Boston,
Massachusetts 02115-5727, US
ASLANIAN, Robert, G., 144 Philip Drive, Rockaway, New
Jersey 07866, US
BIJU, Purakkattle, Johny, 126 East Lincoln Avenue, Rahway,
New Jersey 07065-0907, US
DONG, Li, A39 Woodside Gardens, Roselle Park, New Jersey
07204, US
HUANG, Ying, 178 River Bend Road, Berkeley Heights, New
Jersey 07922, US
MCCORMICK, Kevin, D., 15 Brookfield Drive, Basking Ridge,
New Jersey 07920, US
SHAO, Ning, 126 East Lincoln Avenue, Rahway, New Jersey
07065-0907, US
ZHOU, Wei, 126 East Lincoln Avenue, Rahway, New Jersey
07065-0907, US

(51) MKP
E04D 3/30 (2006.01) (97) **2724088 ***
E04D 3/365 (2006.01)
F24J 2/52 (2006.01)
(86) FR2011000365 23.06.2011
(96) 11743560.2 30.04.2014
(87) WO2012175818, 23.06.2011
(97) 2724088, 30.04.2014 fr
(54) PANEL, ASSEMBLY OF PANELS AND ASSOCIATED
ROOFING
(71) Arcelormittal Investigación y Desarrollo SL, CL/Chavarrí, 6,
48910 Sestao, Bizkaia, ES
(72) CHABAS, Eric, 25 rue Massenet, F-77270 Villeparisis, FR
MASURE, David, 34 rue Yves Kermen, F-92100 Boulogne
Billancourt, FR

(51) MKP
F02M 55/02 (2006.01) (97) **2765301 ***
F02M 61/16 (2006.01)
F02M 63/00 (2006.01)
(86) JP2012075515 02.10.2012
(96) 12838429.4 13.08.2014
(87) WO2013051560, 02.10.2012
(97) 2765301, 13.08.2014 en
(54) COMMON RAIL FUEL INJECTION SYSTEM
(71) Usui Kokusai Sangyo Kaisha Ltd., 131-2, Nagasawa Shimizu-
cho Sunto-gun, Shizuoka 411-8610, JP
Hino Motors Ltd., 1-1, Hinodai 3-chome Hino-shi, Tokyo 191-
8660, JP
(72) SUZUKI Shuji, c/o USUI KOKUSAI SANGYO KAISHA LTD.
131-2 Nagasawa Shimizu-cho, Sunto-gun Shizuoka 411-8610,
JP
HAYASHI Koichi, c/o USUI KOKUSAI SANGYO KAISHA LTD.
131-2 Nagasawa Shimizu-cho, Sunto-gun Shizuoka 411-8610,
JP
ISHII Mori, c/o Hino Motors Ltd. 1-1 Hinodai 3-chome, Hino-shi
Tokyo 1918660, JP
SHIMOKAWA Kiyohiro, c/o Hino Motors Ltd. 1-1 Hinodai
3-chome, Hino-shi Tokyo 191-8660, JP
NAKAJIMA Hiroshi, c/o Hino Motors Ltd. 1-1 Hinodai 3-chome,
Hino-shi Tokyo 191-8660, JP

(51) MKP
A61K 9/00 (2006.01) (97) **2734186 ***
A61K 31/522 (2006.01)
A61P 11/06 (2006.01)
A61P 37/08 (2006.01)
(86) EP2012064139 19.07.2012
(96) 12740119.8 28.05.2014
(87) WO2013014052, 19.07.2012
(97) 2734186, 28.05.2014 en
(54) COMPOSITION
(71) GlaxoSmithKline LLC, Corporation Service Company 2711
Centreville Road Suite 400, Wilmington, Delaware 19808, US
(72) AMBERY, Claire Louise, GlaxoSmithKline Stockley Park West,
Uxbridge Middlesex UB11 1BT, GB
EDWARDS, Christopher David, GlaxoSmithKline Gunnels
Wood Road, Stevenage Hertfordshire SG1 2NY, GB

(51) MKP
A47C 7/62 (2006.01) (97) **2701556 ***
(86) EP2012074817 07.12.2012
(96) 12810144.1 05.03.2014
(87) WO2013110392, 07.12.2012
(97) 2701556, 05.03.2014 de
(54) HOLDING DEVICE
(71) DW-Spritzgiesstechnik Dieter Wandelt Inhaber Ulrich Koch
E.K., Kruppstraße 11, 58553 Halver, DE
(72) KOCH, Ulrich, Kruppstrasse 11, 58553 Halver, DE

(51) MKP
B67D 7/60 (2010.01) (97) **2751020 ***
 (86) US2012048777 30.07.2012
 (96) 12826749.9 09.07.2014
 (87) WO2013032612, 30.07.2012
 (97) 2751020, 09.07.2014 en
 (54) AEROSOL REFILL CARTRIDGE
 (71) C.H. & I. Technologies, Inc., 725 East Main Street, Suite 200, Santa Paula, CA 93060, US
 (72) LEVENSTEIN, Lawrence M., 2487 Canyon Oak Drive, Los Angeles, California 90068, US
 THIBODEAU, Robert D., 2320 Diamond Head Way, Oxnard, California 93036, US
 WILLIAMS, Eric A., 2471 Bonmark Drive, Ojai, California 93023, US

(51) MKP
A61B 17/00 (2006.01) (97) **2644122**
A61B 17/072 (2006.01)
 (96) 13161481.0 02.10.2013
 (97) 2644122, 02.10.2013 en
 (54) Tissue thickness compensators
 (71) Ethicon Endo-Surgery, Inc., 4545 Creek Road, Cincinnati, OH 45242, US
 (72) Baxter, Ill, Chester O., 6375 Pawnee Ridge, Loveland, OH Ohio 45140, US
 Shelton, IV, Frederick E., 245 East Main Street, Hillsboro, OH Ohio 45133, US
 Schmid, Katherine J., 3969 Sharonview Drive, Cincinnati, OH Ohio 45241, US
 Aronhalt, Taylor W., 306 Beech Road, Loveland, OH Ohio 45140, US
 Johnson, Gregory W., 907 Center Street, Milford, OH Ohio 45150, US
 Stammen, John L., 8238 Glenhaven Court, Cincinnati, OH Ohio 45241, US
 Knight, Gary W., 8264 Meadowlark Drive, West Chester, OH Ohio 45069, US
 Widenhouse, Christopher W., 1005 Arabian Run Drive, Clarksville, OH Ohio 45113, US
 Weisenburgh, II, William B., 974 Airy Meadows Drive, Maineville, OH Ohio 45039, US
 Mutchler, Stephanie A., 328 Glen Lake Road, Loveland, OH Ohio 45140, US
 Bedard, Timothy S., 413 Orchard Street, Sewickley, PA Pennsylvania 15143, US

(51) MKP
A47F 3/04 (2006.01) (97) **2750557 ***
 (86) IB2012054223 21.08.2012
 (96) 12772453.2 09.07.2014
 (87) WO2013030717, 21.08.2012
 (97) 2750557, 09.07.2014 en
 (54) REFRIGERATOR COMPRISING A PLURALITY OF OPENING/CLOSING MODULES WITH AT LEAST ONE SLIDING DOOR
 (71) Vetreria Valentini S.r.l., Via Sibilla Aleramo, 40 A/B/C, 25011 Calcinato Fraz. Ponte San Marco, Brescia, IT
 (72) NALDINI, Andrea, Via A. De Gasperi 13, I-25011 Calcinato (Brescia), IT

(51) MKP
B65D 39/00 (2006.01) (97) **2746183 ***
 (86) ES2011000221 06.07.2011
 (96) 11869021.3 25.06.2014
 (87) WO2013004855, 06.07.2011
 (97) 2746183, 25.06.2014 en
 (54) SILICONE STOPPER FOR CAVA BOTTLES AND THE LIKE
 (71) Termometros y Exclusivas, S.L., Murcia 33 P.I. Can Calderon, 08830 Sant Boi de Llobregat (Barcelona), ES
 (72) DORDELLA CAYUELAS, Andrés, Nou 30, E-08830 Sant Boi de Llobregat (Barcelona), ES

(51) MKP
E21B 33/13 (2006.01) (97) **2737167 ***
E21B 33/138 (2006.01)
E21B 34/06 (2006.01)
 (86) CA2012000487 22.05.2012
 (96) 12792178.1 04.06.2014
 (87) WO2012162792, 22.05.2012
 (97) 2737167, 04.06.2014 en
 (54) WELLBORE CEMENTING TOOL HAVING ONE WAY FLOW
 (71) Packers Plus Energy Services Inc., Bow Valley Square 2 Suite 2200, 205 - 5 Avenue SW, Calgary, Alberta T2P 2V7, CA
 (72) KENYON, Michael, 628 Lake Placid Drive SE, Calgary, Alberta T2J 4B3, CA
 THEMIG, Daniel Jon, 256 Woodhaven Place SW, Calgary, Alberta T2W 5P9, CA

(51) MKP
C07F 9/06 (2006.01) (97) **2755983 ***
 (86) US2012054679 11.09.2012
 (96) 12766523.0 23.07.2014
 (87) WO2013039920, 11.09.2012
 (97) 2755983, 23.07.2014 en
 (54) SUBSTITUTED CARBONYLOXYMETHYLPHOSPHORAMIDATE COMPOUNDS AND PHARMACEUTICAL COMPOSITIONS FOR THE TREATMENT OF VIRAL INFECTIONS
 (71) IDENIX Pharmaceuticals, Inc., 320 Bent Street, Floor 4, Cambridge, MA 02141, US
 Centre National de la Recherche Scientifique, 3, rue Michel-Ange, 75794 Paris Cedex 16, FR
 Université Montpellier 2 Sciences et Techniques, 2, place Eugène Bataillon, 34095 Montpellier Cedex 5, FR
 (72) SURLERAUX, Dominique, Rue de la Scaillee 13, B-1440 Wauthier-Braine, BE
 DOUSSON, Cyril B., 15 Lot la Source 1, F-34800 Canet, FR
 GOSSELIN, Gilles, 487 Rue Celleneuve St. Hilaire, F-34070 Montpellier, FR
 DUKHAN, David, 20 Rue Alphonse Daudet Parc les Vautes, F-34980 Saint Gely du Fesc, FR
 PIERRA, Claire, Lotissement Pioch Ourbatieu 6 Rue Ernestine Montreuil, F-34570 Montarnaud, FR
 PEYRONNET, Jerome, 45 Rue des Cedres, F-34830 Jacou, FR

(51) MKP
C07C 29/124 (2006.01) (97) **2736865 ***
C07C 33/22 (2006.01)
C07C 45/43 (2006.01)
C07C 47/54 (2006.01)
C07C 51/093 (2006.01)
C07C 63/06 (2006.01)
 (86) EP2011062850 26.07.2011
 (96) 11746509.6 04.06.2014
 (87) WO2013013709, 26.07.2011
 (97) 2736865, 04.06.2014 en
 (54) METHOD FOR HYDROLYZING ALPHA - CHLORINATED TOLUENE COMPOUNDS
 (71) INEOS ChloroToluenes Limited., Runcorn Site HQ South Parade PO Box 9, Runcorn, Cheshire WA7 4JE, GB
 (72) VAN DEYNSE, Dirk, Linkestraat 64, 3582 Koersel, BE
 VAN AKEN, Koen, Vijverhoek 68, 8520 Kuurne, BE
 VAN HECKE, Wouter, Kattedbroeckstraat 14C, 9290 Overmere, BE

(51) MKP
A01K 61/00 (2006.01) (97) **2760282 ***
A01K 63/00 (2006.01)
 (86) NO2012050185 27.09.2012
 (96) 12836917.0 06.08.2014
 (87) WO2013048259, 27.09.2012
 (97) 2760282, 06.08.2014 en
 (54) FISH FARMING PLANT, MODULE, METHOD AND USE
 (71) Preline Fishfarming System AS, Krabberudkollen 20, 3960 Stathelle, NO
 (72) MAABO, Rune, Ovregate 9., N-3960 STATHELLE, NO

- (51) MKP
F16L 9/17 (2006.01) (97) **2713116**
F16L 41/08 (2006.01)
F24F 13/02 (2006.01)
(96) 13185147.9 02.04.2014
(97) 2713116, 02.04.2014 en
(54) Ventilation duct
(71) Klimagieli S.r.l., Via Mezzacampagna 52, 37135 Verona, IT
(72) Granzotto, Lanfranco, Via Abba 1, 37126 Verona, IT

- (51) MKP
A01N 33/04 (2006.01) (97) **2638804**
A01N 33/08 (2006.01)
A01N 37/40 (2006.01)
A01N 39/04 (2006.01)
A01N 57/20 (2006.01)
(96) 13167450.9 18.09.2013
(97) 2638804, 18.09.2013 en
(54) Low volatile amine salts of anionic pesticides
(71) BASF SE, null, 67056 Ludwigshafen, DE
(72) Xu, Wen, 1016 Whisper rock trail, Cary, NC 27519, US
Kierkus, Paul Ch., 1169 Hidden Hills Dr., Wake Forest, NC 27587, US
Brunt, Steven, 12025 Panleys Mill Circle, Raleigh, NC 27614, US
Bowe, Steven, 425 Olde Thompson Creek Rd, Apex, NC 27523, US
Hixson, Adam, 8632 Paddle Wheel Dr., Raleigh, NC 27615, US
Cannan, Terrance M., 9009 Hometown Drive, Raleigh, North Carolina 27615, US

- (51) MKP
B63B 35/68 (2006.01) (97) **2704946 ***
(86) NL2011050306 04.05.2011
(96) 11720605.2 12.03.2014
(87) WO2011139154, 04.05.2011
(97) 2704946, 12.03.2014 en
(54) TOWING VESSEL
(71) Baldo Dielen Assessoria LTDA., 57 Braz Sebastiao Miano Antiga Travessa Itacolomi Rocio Grande, Sao Fransisco do Sul, Santa Catarina, BR
(72) BALDO ALOYSIUS MARIA, Dielen, 57 Braz Sebastiao Miano Antiga Travessa Itacolomi Rocio Grande, Sao Fransisco do Sul Santa Catarina, BR

- (51) MKP
A61K 31/4409 (2006.01) (97) **2739283 ***
(86) US2012047512 20.07.2012
(96) 12818186.4 11.06.2014
(87) WO2013016155, 20.07.2012
(97) 2739283, 11.06.2014 en
(54) POLYMORPHIC FORMS OF THE SODIUM SALT OF 4-TERT-BUTYL-N-[4-CHLORO-2-(1-OXY-PYRIDINE-4-CARBONYL)-PHENYL]-BENZENESULFONAMIDE
(71) ChemoCentryx, Inc., 850 Maude Avenue, Mountain View, California 94043, US
(72) BIS, Joanna, 130 Trafalgar Lane, Cary, NC 27513, US
IGO, David, H., Five Moore Drive, Research Triangle Park, NC 27709, US
HO, Bert, 101 Bacon Court, Layfayette, CA 94549, US
SHAH, Deven, 2301 Renaissance Boulevard, King of Prussia, PA 19406, US

- (51) MKP
A01N 43/42 (2006.01) (97) **2736335 ***
A61K 31/47 (2006.01)
(86) US2012048684 27.07.2012
(96) 12817089.1 04.06.2014
(87) WO2013016684, 27.07.2012
(97) 2736335, 04.06.2014 en
(54) TREATMENT OF MULTIPLE SCLEROSIS WITH COMBINATION OF LAQUINIMOD AND GLATIRAMER ACETATE
(71) Teva Pharmaceutical Industries Ltd., 5 Basel Street P.O. Box 3190, 49131 Petach-Tikva, IL
(72) GILGUN, Yossi, Hinanit 17 P.O. Box 1255, 42842 Bat Hefer, IL
TARCIC, Nora, Migdal David 29/1, Modiin, IL

- (51) MKP
B62J 1/16 (2006.01) (97) **2623403**
B62J 11/00 (2006.01)
(96) 13152248.4 07.08.2013
(97) 2623403, 07.08.2013 en
(54) Fastening device for a child seat on a frame of a bicycle
(71) OKBABY S.R.L., Via del Lavoro, 26, 24060 Telgate (Bergamo), IT
(72) Baldelli, Gian Battista, OKBABY S.R.L. c/o OKBABY S.R.L. Via del lavoro, 26, 24060 TELGATE (BG), IT

- (51) MKP
A23L 1/30 (2006.01) (97) **2701537 ***
A23L 2/385 (2006.01)
A23L 2/52 (2006.01)
A61P 25/28 (2006.01)
(86) IB2012052112 27.04.2012
(96) 12731670.1 05.03.2014
(87) WO2012147051, 27.04.2012
(97) 2701537, 05.03.2014 en
(54) FOOD, PARTICULARLY A BEVERAGE FOR HUMAN CONSUMPTION
(71) Zipoli, Marco, Via Molfino 6/40, 16154 Genova, IT
(72) Zipoli, Marco, Via Molfino 6/40, 16154 Genova, IT

- (51) MKP
A23L 1/30 (2006.01) (97) **2734845 ***
A61K 35/74 (2006.01)
G01N 33/569 (2006.01)
(86) EP2012064351 20.07.2012
(96) 12738122.6 28.05.2014
(87) WO2013011137, 20.07.2012
(97) 2734845, 28.05.2014 en
(54) PRODUCTION AND USE OF BACTERIAL HISTAMINE
(71) Biogaia AB, Kungsbrogatan 3A P.O. Box 3242, 103 64 Stockholm, SE
(72) VERSALOVIC, James, 534 South 3rd Street, Bellaire, TX 77401, US
THOMAS, Carissa Michelle, 8501 E Alameda Avenue Apt. 1233, Denver, CO 80230, US
CONNOLLY, Eamonn, Motionsvägen 3, 18130 Lindingo, SE

- (51) MKP
A01N 43/54 (2006.01) (97) **2744334 ***
A01P 3/00 (2006.01)
C07D 239/47 (2006.01)
(86) US2012050931 15.08.2012
(96) 12824095.9 25.06.2014
(87) WO2013025796, 15.08.2012
(97) 2744334, 25.06.2014 en
(54) N-(5-FLUORO-2-((4-METHYLBENZYL)OXY)PYRIMIDIN-4-YL) BENZAMIDE DERIVATIVES
(71) Dow AgroSciences LLC, 9330 Zionsville Road, Indianapolis, IN 46268, US
(72) BRYAN, Kristy, 1502 Cool Creek Drive, Carmel, IN 46033, US
LORSBACH, Beth, 6034 Haverford Avenue, Indianapolis, IN 46220, US
MEYER, Kevin, G., 100 Lexington Court, Zionsville, IN 46077, US
OWEN, W., John, 12421 Pebblepointe Pass, Carmel, IN 46033, US
SULLENBERGER, Michael, T., 910 Hadleigh Pass, Westfield, IN 46074, US
WEBSTER, Jeffery, D., 7581 West Oakwood Court, New Palestine, IN 46163, US
YAO, Chenglin, 14178 Esprit Drive, Westfield, IN 46074, US

- (51) MKP
A61K 31/192 (2006.01) (97) **2734496 ***
A61P 1/00 (2006.01)
C07C 65/19 (2006.01)
(86) IE2012000037 20.07.2012
(96) 12740702.1 28.05.2014
(87) WO2013014659, 20.07.2012
(97) 2734496, 28.05.2014 en
(54) INDENE DERIVATIVES FOR USE IN THE TREATMENT OF INFLAMMATORY BOWEL DISEASE
(71) Venantius Limited, The Tower Trinity Technology and Enterprise Campus Pearse Street, Dublin 2, IE
(72) SHERIDAN, Helen, 170 Rathfarnham Road, Dublin 14, IE
FRANKISH, Neil, 25 Farm Hill Road Goatstown, Dublin 14, IE

(51) MKP
E06B 3/66 (2006.01) (97) **2718530 ***
E06B 3/663 (2006.01)
(86) FR2012051280 07.06.2012
(96) 12731542.2 16.04.2014
(87) WO2012168661, 07.06.2012
(97) 2718530, 16.04.2014 fr
(54) LIGHTING UNIT MADE UP OF AN INSULATING GLASS PANEL AND LIGHT-EMITTING DIODES
(71) Saint-Gobain Glass France, 18 avenue d'Alsace, 92400 Courbevoie, FR
(72) GIERENS, Anne, 12 rue d'Amiens, F-60200 Compiègne, FR
MONTGERMONT, Aude, 12 rue de Châteaudun, F-75009 Paris, FR
ZHANG, Jingwei, 38 rue des Ruelles, F-91300 Massy, FR

(51) MKP
A61K 31/439 (2006.01) (97) **2702041 ***
A61P 11/00 (2006.01)
C07D 207/14 (2006.01)
C07D 211/62 (2006.01)
C07D 453/02 (2006.01)
(86) EP2012057062 18.04.2012
(96) 12719303.5 05.03.2014
(87) WO2012146515, 18.04.2012
(97) 2702041, 05.03.2014 en
(54) ALKALOID ESTER AND CARBAMATE DERIVATIVES AND MEDICINAL COMPOSITIONS THEREOF
(71) Chiesi Farmaceutici S.p.A., Via Palermo, 26/A, 43100 Parma, IT
(72) AMARI, Gabriele, c/o CHIESI FARMACEUTICI S.p.A. Via Palermo 26/A, I-43100 Parma, IT
RICCABONI, Mauro, c/o CHIESI FARMACEUTICI S.p.A. Via Palermo 26/A, I-43100 Parma, IT
DE ZANI, Daniele, c/o CHIESI FARMACEUTICI S.p.A. Via Palermo 26/A, I-43100 Parma, IT

(51) MKP
A61K 9/20 (2006.01) (97) **2767285 ***
A61K 9/28 (2006.01)
A61K 31/496 (2006.01)
A61K 47/02 (2006.01)
A61K 47/10 (2006.01)
A61K 47/12 (2006.01)
A61K 47/26 (2006.01)
A61K 47/38 (2006.01)
(86) JP2012076415 12.10.2012
(96) 12840025.6 20.08.2014
(87) WO2013054872, 12.10.2012
(97) 2767285, 20.08.2014 en
(54) TABLET INCLUDING 7-[4-(4-BENZO[BETA]THIOPHEN-4-YL-PIPERAZIN-1-YL) BUTOXY]-1H-QUINOLIN-2-ONE OR SALT THEREOF
(71) Otsuka Pharmaceutical Co., Ltd., 9, Kanda-Tsukusamachi 2-chome Chiyoda-ku, Tokyo 101-8535, JP
(72) INOUE, Yoshiharu, c/o OTSUKA PHARMACEUTICAL CO. LTD. 3-2-27, Otedori Chuo-ku, Osaka-shi Osaka 5400021, JP

(51) MKP
C08L 63/00 (2006.01) (97) **2725061**
C08L 79/04 (2006.01)
(96) 13160152.8 30.04.2014
(97) 2725061, 30.04.2014 en
(54) Cyanate ester resin composition, and a prepreg, a laminated material and a metal clad laminated material made therefrom
(71) Shengyi Technology Co., Ltd., 5 Industry West Road Northern Industrial Park Songshan Lake Sci. & Tech. Industry Park, 523000 Dongguan City Guangdong, CN
(72) Tang, Junqi, c/o Shengyi Technology Co., Ltd 5 Industry West Road, Northern Industrial Park Songshan Lake Sci. & Tech. Industry Park, 523000 Dongguan City, CN

(51) MKP
A23L 1/0524 (2006.01) (97) **2769627 ***
A23L 2/02 (2006.01)
A23L 2/52 (2006.01)
(86) HU2011000101 21.10.2011
(96) 11852205.1 27.08.2014
(87) WO2013057524, 21.10.2011
(97) 2769627, 27.08.2014 en
(54) METHOD FOR PRODUCING A CONCENTRATED JUICE-CONTAINING BEVERAGE ON THE BASIS OF LIQUID PECTIN
(71) Vasilyev, Pavel, Iozhef A. u. 12. 4/3, 1051 Budapest, HU
(72) VASILIEV, Andrei, Petofi SH. u. 12. VI. em. 1/A, H-1052 Budapest, HU
DONCHENKO, Ljudmila, Molnar u. 20. 3/12A, H-1056 Budapest, HU
TALOV, Mikhail, ul. Gagarina 18/137, Otrpadnoe 187330, RU

(51) MKP
A61K 31/445 (2006.01) (97) **2753603 ***
A61P 25/28 (2006.01)
C07D 211/24 (2006.01)
(86) EP2012067371 06.09.2012
(96) 12755869.0 16.07.2014
(87) WO2013034622, 06.09.2012
(97) 2753603, 16.07.2014 en
(54) POLYMORPHIC FORM OF PRIDOPIDINE HYDROCHLORIDE
(71) IVAX INTERNATIONAL GMBH, Alpenstrasse 2, 8640 Rapperswil, CH
(72) SONESSON, Clas, Billdals Hagenväg 18, S-427 37 Billdal, SE
PITTELKOW, Thomas, Elverhøjvej 5A, DK-4684 Holmegaard, DK
FRØSTRUP, Brian, Møllevænget 18, DK-2800 Lyngby, DK
ZIMMERMANN, Anne, Hulgårdsvej 124 2.tv., DK-2400 Copenhagen NV, DK

(51) MKP
A61M 5/00 (2006.01) (97) **2662102**
A61M 5/28 (2006.01)
A61M 5/31 (2006.01)
A61M 5/315 (2006.01)
B65D 81/113 (2006.01)
(96) 13164849.5 13.11.2013
(97) 2662102, 13.11.2013 de
(54) Transport carrier for syringes
(71) Fisher Clinical Services GmbH, Steinbühlweg 69, 4123 Allschwil, CH
(72) Hunkeler, Guido, Bruckmattweg 11, 4124 Schönenbuch, CH
Gerstmann, Ulrich, Maiengasse 13, 4123 Allschwil, CH

(51) MKP
G06Q 10/10 (2012.01) (97) **2657894**
G06Q 50/00 (2012.01)
(96) 13165660.5 30.10.2013
(97) 2657894, 30.10.2013 en
(54) Social connections migration
(71) Google Inc., 1600 Amphitheatre Parkway, Mountain View, CA 94043, US
(72) Ho, Ronald, 1600 Amphitheatre Parkway,, Mountain View, CA 94043, US
Sadowski, Justin, 1600 Amphitheatre Parkway,, Mountain View, CA 94043, US
Behal, Amit, 1600 Amphitheatre Parkway,, Mountain View, CA 94043, US

(51) MKP
A61K 38/17 (2006.01) (97) **2717901 ***
A61K 38/22 (2006.01)
A61K 39/395 (2006.01)
A61P 35/00 (2006.01)
(86) US2012041080 06.06.2012
(96) 12796174.6 16.04.2014
(87) WO2012170513, 06.06.2012
(97) 2717901, 16.04.2014 en
(54) HE4 BASED THERAPY FOR MALIGNANT DISEASE
(71) Women and Infants Hospital of Rhode Island, 101 Dudley Street, Providence, RI 02905, US
(72) MOORE, Richard, G., 160 Alpine Estates Drive, Cranston, RI 02921, US
SINGH, Rakesh, K., 7 Church Street, Barrington, RI 02806, US

- (51) MKP
A61K 31/454 (2006.01) (97) **2757103 ***
A61P 1/04 (2006.01)
A61P 43/00 (2006.01)
C07D 401/12 (2006.01)
(86) JP2012073171 11.09.2012
(96) 12831085.1 23.07.2014
(87) WO2013039057, 11.09.2012
(97) 2757103, 23.07.2014 en
(54) PYRROLIDINE-3-YLACETIC ACID DERIVATIVE
(71) Eisai R&D Management Co., Ltd., 6-10, Koishikawa 4-chome, Bunkyo-ku, Tokyo 112-8088, JP
(72) YOSHIDA Ichiro, c/o EISAI CO. LTD. Tsukuba Research Laboratories 1-3 Tokodai 5-chome, Tsukuba-shi Ibaraki 300-2635, JP
OKABE Tadashi, c/o EISAI CO. LTD. Tsukuba Research Laboratories 1-3 Tokodai 5-chome, Tsukuba-shi Ibaraki 300-2635, JP
MATSUMOTO Yasunobu, c/o EISAI CO. LTD. Tsukuba Research Laboratories 1-3 Tokodai 5-chome, Tsukuba-shi Ibaraki 300-2635, JP
WATANABE Nobuhisa, c/o EISAI CO. LTD. Tsukuba Research Laboratories 1-3 Tokodai 5-chome, Tsukuba-shi Ibaraki 300-2635, JP
OHASHI Yoshiaki, c/o EISAI CO. LTD. Tsukuba Research Laboratories 1-3 Tokodai 5-chome, Tsukuba-shi Ibaraki 300-2635, JP
ONIZAWA Yuji, c/o EISAI CO. LTD. Tsukuba Research Laboratories 1-3 Tokodai 5-chome, Tsukuba-shi Ibaraki 300-2635, JP
HARADA Hitoshi, c/o EISAI CO. LTD. Tsukuba Research Laboratories 1-3 Tokodai 5-chome, Tsukuba-shi Ibaraki 300-2635, JP

- (51) MKP
A44C 13/00 (2006.01) (97) **2636330**
A44C 17/02 (2006.01)
A44C 17/04 (2006.01)
A44C 25/00 (2006.01)
A44C 27/00 (2006.01)
(96) 13157831.2 11.09.2013
(97) 2636330, 11.09.2013 en
(54) A manufactured article and a method of obtaining thereof.
(71) Dibi S.p.A., Via Grande, 89, 36022 Cassola - Vicenza, IT
(72) Bizzotto, Giovanni, Via S. Chiara, 34, 36022 Cassola - Vicenza, IT

- (51) MKP
A61K 9/70 (2006.01) (97) **2682113**
(96) 12174672.1 08.01.2014
(97) 2682113, 08.01.2014 de
(54) Sealing laminates containing agents
(71) Acino AG, Am Windfeld 35, 83714 Miesbach, DE
(72) Dabdoub, Nicola, Kienestraße 15, 80933 München, DE
Antropius, Peter, Säggasse 5, 83666 Schäftlach, DE
Beckert, Thomas, Anton-Braith-Weg 30, 88447 Birkenhard, DE
Salman, Nouha, Hansastraße 118, 81272 München, DE
Schneider, Lorena, Westendstraße 14E, 83043 Bad Aibling, DE
Schurad, Björn, Michael-Huber-Weg 26, 81667 München, DE

- (51) MKP
A61K 31/519 (2006.01) (97) **2721030 ***
A61P 11/00 (2006.01)
C07D 487/04 (2006.01)
(86) EP2012061084 12.06.2012
(96) 12728453.7 23.04.2014
(87) WO2012171900, 12.06.2012
(97) 2721030, 23.04.2014 en
(54) NOVEL PHTHALAZINONE-PYRROLOPYRIMIDINECARBOXAMIDE DERIVATIVES
(71) Takeda GmbH, Byk-Gulden-Strasse 2, 78467 Konstanz, DE
(72) STENGEL, Thomas, Erfurter Ring 13, 76344 Eggenstein-Leopoldshafen, DE
MAIER, Thomas, Panoramaweg 31, 78333 Stockach, DE
MANN, Alexander, Emilie-Schneider-Str. 2, 78315 Radolfzell, DE
STADLWIESER, Josef, Im Apfelgarten 3, 78465 Konstanz, DE
FLOCKERZI, Dieter, Ackerweg 26, 78476 Allensbach, DE
PAHL, Andreas, Langer Anger 33, 69115 Heidelberg, DE
BENEDIKTUS, Ewald, Mondstr. 18, 88400 Biberach, DE
HESSMANN, Manuela, An der Schlossgärtnerei 7, 22926 Ahrensburg, DE
KANACHER, Tobias, Neugartenstr. 36, 88709 Hagnau, DE
HUSSONG, Ragna, Schultheiss-Heschel-Ring 14, 78652 Deißlingen, DE
ZITT, Christof, Mainaustr. 209 D, 78464 Konstanz, DE
HOLST, Hans Christof, Max-Stromeyer-Str. 3a, 78467 Konstanz, DE
HUMMEL, Rolf-Peter, Altbohlstr. 32, 78315 Radolfzell, DE
VIERTELHAUS, Martin, Dilsberger Str. 6, 68259 Mannheim, DE
TENOR, Hermann, St.-Gebhard-Str.38, 78467 Konstanz, DE
DUNKERN, Torsten, Humboldstr. 18, 41363 Jüchen Gierath, DE
HATZELMANN, Armin, Alter Wall 3, 78467 Konstanz, DE
HESSLINGER, Christian, Untere Haldenäcker 6, 78357 Zoznegg, DE

- (51) MKP
A61B 18/00 (2006.01) (97) **2726004 ***
A61B 18/14 (2006.01)
(86) DK2011050297 01.08.2011
(96) 11751803.5 07.05.2014
(87) WO2013000462, 01.08.2011
(97) 2726004, 07.05.2014 en
(54) AN ELONGATED ELECTROSURGICAL INSTRUMENT, A SWITCH MEANS FOR SAID INSTRUMENT, AND AN ASSEMBLY KIT
(71) SafeAir AG, D4 Platz 3, 6039 Root Längenbold, CH
(72) BERNARD, Frédéric, Samsøvej 4, DK-3140 Ålsgårde, DK
KORNERUP, Niels, Gl. Vallerødvej 31B, DK-2960 Rungsted, DK
SIMONSEN, Jesper Schantz, Peter Holms Vej 8 st. tv., DK-2450 København, DK

- (51) MKP
H04W 84/18 (2009.01) (97) **2595448**
(96) 11189417.6 22.05.2013
(97) 2595448, 22.05.2013 en
(54) Method and System for Spatio-Temporal Sensor Selection
(71) ATS Group (IP Holdings) Limited, PO Box 958 Pasea Estate, Road Town, Tortola, VG
(72) Strohbach, Martin, C70 AGT Group (R&D) GmbH Hilpertstr. 20A, 64295 Darmstadt, DE
Chandra-Sekaran, Ashok-Kumar, c/o AGT Group (R&D) GbmH Hilpertstr. 20A, 64295 Darmstadt, DE
Huber, Marco, c/o AGT Group (R&D) GbmH Hilpertstr. 20A, 64295 Darmstadt, DE

(51) MKP
G01N 33/50 (2006.01) (97) **2705363 ***
G01N 33/574 (2006.01)
(86) GB2012050964 03.05.2012
(96) 12730009.3 12.03.2014
(87) WO2012150453, 03.05.2012
(97) 2705363, 12.03.2014 en
(54) DEVICE AND METHOD FOR NON-INVASIVE COLLECTION OF COLORECTAL MUCOCELLULAR LAYER AND DISEASE DETECTION
(71) Diagnostus Limited, Building 502 Babraham Research Campus, Babraham, Cambridgeshire CB22 3AT, GB
(72) LOKTIONOV, Alexandre, 12 Joscelynes, Stapleford Cambridgeshire CB22 5EA, GB
BANDALETOVA, Tatiana, 12 Joscelynes, Stapleford Cambridgeshire CB22 5EA, GB
ANDERSON, Neil, 32 Wilson Close, Bishops Stortford Hertfordshire CM23 3US, GB

(51) MKP
A61K 9/10 (2006.01) (97) **2760433 ***
A61K 9/14 (2006.01)
A61K 9/16 (2006.01)
A61P 1/00 (2006.01)
A61P 1/04 (2006.01)
(86) US2012058163 29.09.2012
(96) 12837423.8 06.08.2014
(87) WO2013049749, 29.09.2012
(97) 2760433, 06.08.2014 en
(54) pH DEPENDENT CARRIERS FOR TARGETED RELEASE OF PHARMACEUTICALS ALONG THE GASTROINTESTINAL TRACT, COMPOSITIONS THEREFROM, AND MAKING AND USING SAME
(71) PLx Pharma LLC, 8285 El Rio Street, Suite 130, Houston, TX 77054, US
(72) MARATHI, Upendra, Plx Pharma Inc., 8285 El Rio, Suite 130,, Houston, TX 77054, US
CHILDRESS, Susann, Plx Pharma Inc., 8285 El Rio, Suite 130,, Houston, TX 77054, US
GAMMILL, Shaun, Plx Pharma Inc., 8285 El Rio, Suite 130, Houston, TX 77054, US
STROZIER, Robert, P.O. Box 429, Bellaire TX 77402-0429, US

(51) MKP
B65D 88/56 (2006.01) (97) **2753567 ***
B66C 1/10 (2006.01)
(86) EP2012064206 19.07.2012
(96) 12750538.6 16.07.2014
(87) WO2013011097, 19.07.2012
(97) 2753567, 16.07.2014 en
(54) APPARATUS FOR TIPPING CONTAINERS OR MOVABLE CASES
(71) Longagna, Bruno, Via Villa 60, 17043 Cengio (SV), IT
(72) Longagna, Bruno, Via Villa 60, 17043 Cengio (SV), IT

(51) MKP
C07C 201/04 (2006.01) (97) **2490997 ***
C07C 205/02 (2006.01)
(86) US2010048487 10.09.2010
(96) 10755056.8 29.08.2012
(87) WO2011049683, 10.09.2010
(97) 2490997, 29.08.2012 en
(54) PROCESS FOR NITROALKANE RECOVERY BY AQUEOUS PHASE RECYCLE TO NITRATION REACTOR
(71) Dow Global Technologies LLC, 2040 Dow Center, Midland, MI 48674, US
ANGUS Chemical Company, 1500 E. Lake Cook Road, Buffalo Grove, IL 60089, US
(72) SAWANT, Mahesh, C/9 Surabhi Enclave Nagras Road, Aundh Pune 411007, IN
TRAUTH, Daniel, M., 5817 Meadowbrook Lane, Crystal Lake, IL 60014, US
PENDERGAST, John, G., 60 Parsley Court, Lake Jackson, TX 77566, US

(51) MKP
A61K 31/421 (2006.01) (97) **2704723 ***
A61K 31/423 (2006.01)
A61K 31/505 (2006.01)
A61K 31/519 (2006.01)
(86) US2012036841 07.05.2012
(96) 12782025.6 12.03.2014
(87) WO2012154695, 07.05.2012
(97) 2704723, 12.03.2014 en
(54) TREATMENT OF POLYCYSTIC DISEASE
(71) The Regents of the University of California, 1111 Franklin Street, 12th Floor, Oakland, California 94607, US
Intellikine, LLC, 10931 North Torrey Pines Road, Suite 103, La Jolla, CA 92037, US
(72) PEARCE, David, 11 Hotaling Ct., Kentfield California 94904, US
LIU, Yi, 4841 Barlows Landing Cove, San Diego California 92130, US
MARTIN, Michael, 2327 Caringa Way, Carlsbad California 92009, US
ROMMEL, Christian, 528 Westbourne Street, La Jolla California 92037, US
REN, Pingda, 4148 Twilight Ridge, San Diego California 92130, US
WILSON, Troy Edward, 575 Old Mill Rd., San Marino California 91108, US

(51) MKP
A61K 31/16 (2006.01) (97) **2758052 ***
A61K 31/4164 (2006.01)
A61K 31/4184 (2006.01)
A61P 35/00 (2006.01)
(86) US2012055277 14.09.2012
(96) 12831417.6 30.07.2014
(87) WO2013040286, 14.09.2012
(97) 2758052, 30.07.2014 en
(54) PHARMACEUTICAL COMPOSITIONS
(71) EURO-CELTIQUE S.A., 2, avenue Charles de Gaulle, 1653 Luxembourg, LU
(72) CHEN, Yu, 5078 Kingston Way, San Jose, CA 95130, US
YANG, Lan, 108 Yuhangtang Road, Hangzhou Zhejiang Province 310011, CN
FENG, Feiyu, 108 Yuhangtang Road, Hangzhou Zhejiang Province 310011, US
GE, Qiufu, 108 Yuhangtang Road, Hangzhou Zhejiang Province 310011, CN
GUO, Dianwu, 108 Yuhangtang Road, Hangzhou Zhejiang Province 310011, CN
CHEN, Yi, 44 Emerson Gardens Road, Lexington, MA 02420, US

(51) MKP
E03C 1/00 (2006.01) (97) **2751352 ***
E03D 1/00 (2006.01)
(86) AU2012000995 24.08.2012
(96) 12826325.8 09.07.2014
(87) WO2013026101, 24.08.2012
(97) 2751352, 09.07.2014 en
(54) A SANITARY APPARATUS
(71) UUBEE Pty Ltd, Suite 1 Level 3, 200 Creek Street, Brisbane, Queensland 4000, AU
(72) CARVER, Malcolm James, 77 Pymble avenue, Pymble, New South Wales 2073, AU
PAUL, Stephan Ronald, 31 Bruckner Street, The Gap,, Brisbane, QLD 4061, AU
DEGIOIA, Luke Ralph, 13 Warrangarree Drive,, Woronora Heights, New South Wales 2233, AU

- (51) MKP
A61K 39/395 (2006.01) (97) **2729170 ***
A61P 35/00 (2006.01)
C07K 16/00 (2006.01)
C07K 16/28 (2006.01)
C07K 16/36 (2006.01)
(86) EP2012063339 06.07.2012
(96) 12740092.7 14.05.2014
(87) WO2013004842, 06.07.2012
(97) 2729170, 14.05.2014 en
(54) ANTIBODY VARIANTS AND USES THEREOF
(71) GENMAB B.V., Yalelaan 60, 3584 CM Utrecht, NL
(72) PARREN, Paul, c/o Genmab B.V. Yalelaan 60, NL-3584 CM Utrecht, NL
BEURSKENS, Frank, c/o Genmab B.V. Yalelaan 60, NL-3584 CM Utrecht, NL
DE JONG, Rob N., c/o Genmab B.V. Yalelaan 60, NL-3584 CM Utrecht, NL
LABRIJN, Aran Frank, c/o Genmab B.V. Yalelaan 60, NL-3584 CM Utrecht, NL
SCHUURMAN, Janine, c/o Genmab B.V. Yalelaan 60, NL-3584 CM Utrecht, NL

- (51) MKP
C07K 16/40 (2006.01) (97) **2756003 ***
(86) US2012054737 12.09.2012
(96) 12761863.5 23.07.2014
(87) WO2013039958, 12.09.2012
(97) 2756003, 23.07.2014 en
(54) ANTIBODIES TO PCSK9 AND USES THEREOF
(71) Eli Lilly and Company, Lilly Corporate Center, Indianapolis, IN 46285, US
(72) DAVIES, Julian, c/o Eli Lilly and Company P.O. Box 6288, Indianapolis, Indiana 46206-6288, US
ALLAN, Barrett, c/o Eli Lilly and Company P.O. Box 6288, Indianapolis, Indiana 46206-6288, US
DARLING, Ryan James, c/o Eli Lilly and Company P.O. Box 6288, Indianapolis, Indiana 46206-6288, US

- (51) MKP
A61K 39/125 (2006.01) (97) **2731621 ***
(86) US2012046222 11.07.2012
(96) 12811916.1 21.05.2014
(87) WO2013009849, 11.07.2012
(97) 2731621, 21.05.2014 en
(54) PARENTERAL NOROVIRUS VACCINE FORMULATIONS
(71) Takeda Vaccines, Inc., 2155 Analysis Drive, Bozeman, MT 59718, US
(72) RICHARDSON, Charles, c/o LIGOCYTE PHARMACEUTICALS INC. 2155 Analysis Drive, Bozeman Montana 59718, US
BARGATZE, Robert, F., c/o LIGOCYTE PHARMACEUTICALS INC. 2155 Analysis Drive, Bozeman Montana 59718, US
MENDELMAN, Paul, M., c/o LIGOCYTE PHARMACEUTICALS INC. 2155 Analysis Drive, Bozeman Montana 59718, US

- (51) MKP
G07F 17/32 (2006.01) (97) **2769366 ***
(86) EP2012070619 18.10.2012
(96) 12784505.5 27.08.2014
(87) WO2013057170, 18.10.2012
(97) 2769366, 27.08.2014 de
(54) GAMING MACHINE
(71) Novomatic AG, Wiener Strasse 158, 2352 Gumpoldskirchen, AT
(72) FAUL, Thomas, Vogelhammer Straße 20, 67659 Kaiserslautern, DE

- (51) MKP
A01N 25/00 (2006.01) (97) **2755473 ***
A61K 31/42 (2006.01)
A61P 33/00 (2006.01)
(86) US2012054719 12.09.2012
(96) 12772575.2 23.07.2014
(87) WO2013039948, 12.09.2012
(97) 2755473, 23.07.2014 en
(54) PARASITICIDAL COMPOSITIONS COMPRISING AN ISOXAZOLINE ACTIVE AGENT, METHODS AND USES THEREOF
(71) Merial Limited, 3239 Satellite Blvd., Duluth, GA 30096, US
(72) SOLL, Mark, D., 605 Newport Shore, Alpharetta, GA 30005, US
ROSENTEL, Joseph, K., 10675 Branham Fields Road, Johns Creek, GA 30097, US
PATE, James, 582 County Road 579, Hampton, NJ 08827, US
SHUB, Natalya, 2308 S. Front Street, Allentown, PA 18103, US
TEJWANI-MOTWANI, Monica, 575 Easton Avenue Suite 19e, Somerset, NJ 08873, US
BELANSKY, Carol, 292 West Colfax Ave, Roselle Park, NJ 07204, US

- (51) MKP
A61M 25/00 (2006.01) (97) **2734258 ***
A61M 25/10 (2013.01)
(86) EP2012001875 02.05.2012
(96) 12720798.3 28.05.2014
(87) WO2013010600, 02.05.2012
(97) 2734258, 28.05.2014 de
(54) CATHETER, PARTICULARLY AN INDWELLING CATHETER, FOR TREATING FUNCTIONAL PROBLEMS AND/OR DISEASES OF THE BLADDER AND/OR PROSTATE
(71) Otto, Ullrich, Fichtenstrasse 34, 34537 Bad Wildungen, DE
(72) Otto, Ullrich, Fichtenstrasse 34, 34537 Bad Wildungen, DE

- (51) MKP
A23C 9/00 (2006.01) (97) **2653040**
A23L 1/29 (2006.01)
(86) 13164605.1 23.10.2013
(97) 2653040, 23.10.2013 en
(54) Food based on donkey fortified milk for preterm infants and/or term infants with allergy or intolerance to cow's milk proteins and method of preparation thereof
(71) Dicofarm Spa, Via Casale della Marcigliana, 29, 00138 Roma, IT
(72) Aciri, Maurizio, Dicofarm Spa Via Casale della Marcigliana, 29, 00138 Roma, IT

- (51) MKP
A61K 31/437 (2006.01) (97) **2723738 ***
A61P 25/18 (2006.01)
C07D 471/04 (2006.01)
(86) JP2012066461 21.06.2012
(96) 12738230.7 30.04.2014
(87) WO2012176934, 21.06.2012
(97) 2723738, 30.04.2014 en
(54) CRYSTAL OF FUSED HETEROCYCLIC COMPOUND
(71) Takeda Pharmaceutical Company Limited, 1-1 Doshomachi 4-chome Chuo-ku, Osaka-shi, Osaka 541-0045, JP
(72) YAMAMOTO, Katsuhiko, c/o TAKEDA PHARMACEUTICAL COMPANY LIMITED 26-1 Muraoka-Higashi 2-chome, Fujisawa-shi Kanagawa 251-0012, JP

(51) MKP
A61K 31/5025 (2006.01) (97) **2721031 ***
A61P 35/00 (2006.01)
C07D 403/04 (2006.01)
C07D 487/04 (2006.01)
(86) US2012042825 15.06.2012
(96) 12799791.4 23.04.2014
(87) WO2012174487, 15.06.2012
(97) 2721031, 23.04.2014 en
(54) BROMODOMAIN INHIBITORS AND USES THEREOF
(71) Constellation Pharmaceuticals, Inc., 215 First Street, Suite 200, Cambridge, MA 02142, US
(72) ALBRECHT, Brian, K., 179 Chestnut Street 2, Cambridge, MA 02139, US
HARMANGE, Jean-Christophe, 57 William Street, Andover, MA 01810, US
CÔTÉ, Alexandre, 12 Florence Street, Cambridge, MA 02139, US
TAYLOR, Alexander, M., 33 Parker Street 2, Cambridge, MA 02138, US

(51) MKP
A61K 38/00 (2006.01) (97) **2701718 ***
(86) US2012031487 30.03.2012
(96) 12763052.3 05.03.2014
(87) WO2012135636, 30.03.2012
(97) 2701718, 05.03.2014 en
(54) LANTIBIOTIC NAI-802, PHARMACEUTICALLY ACCEPTABLE SALTS, COMPOSITIONS, AND USES THEREOF
(71) Sentinella Pharmaceuticals, Inc., 47 Hulfish Street, Princeton, NJ 08542, US
(72) MAFFIOLI, Sonia, Ilaria, Viale Brianza 35, I-20127 Milano (MI), IT
SIMONE, Matteo, Via Delle Regioni 34-10, I-20090 Segrate (Milano), IT
MONCIARDINI, Paolo, Via L. Sturzo 212, I-21040 Cislago (Varese), IT
GASPARI, Eleonora, Via Xv Giugno 1, I-21052 Busto Arsizio (Varese), IT

(51) MKP
A01N 37/18 (2006.01) (97) **2725902 ***
A61K 38/21 (2006.01)
A61K 39/395 (2006.01)
A61K 39/42 (2006.01)
(86) US2012032567 06.04.2012
(96) 12767211.1 07.05.2014
(87) WO2012139028, 06.04.2012
(97) 2725902, 07.05.2014 en
(54) ANTI-VIRAL COMBINATION THERAPY
(71) THE TRUSTEES OF PRINCETON UNIVERSITY, P.O. Box 36 4 New South Building, Princeton, New Jersey 08544, US
(72) KOYUNCU, Emre, 65 Meadow Road, Apt. 8302, Princeton, NJ 08540, US
SHENK, Thomas, E., 12 Boudinot Street, Princeton, NJ 08540, US
RABINOWITZ, Joshua, 2 Greenholm Street, Princeton, NJ 08540, US

(51) MKP
C07K 16/46 (2006.01) (97) **2761008 ***
C12N 5/10 (2006.01)
C12N 15/85 (2006.01)
(86) GB2012052380 26.09.2012
(96) 12766714.5 06.08.2014
(87) WO2013045916, 26.09.2012
(97) 2761008, 06.08.2014 en
(54) CHIMAERIC SURROGATE LIGHT CHAINS (SLC) COMPRISING HUMAN VPRED
(71) Kymab Limited, Meditrina (B260) Babraham Research Campus, Cambridge, Cambridgeshire CB22 3AT, GB
(72) BRADLEY, Allan, c/o Kymab Limited Meditrina (B260) Babraham Research Campus, Cambridge Cambridgeshire CB22 3AT, GB
LEE, E-Chiang, c/o Kymab Limited Meditrina (B260) Babraham Research Campus, Cambridge Cambridgeshire CB22 3AT, GB
LIANG, Qi, c/o Kymab Limited Meditrina (B260) Babraham Research Campus, Cambridge Cambridgeshire CB22 3AT, GB
SPENSBERGER, Dominik, c/o Kymab Limited Meditrina (B260) Babraham Research Campus, Cambridge Cambridgeshire CB22 3AT, GB
ENGLAND, Nicholas, c/o Kymab Limited Meditrina (B260) Babraham Research Campus, Cambridge Cambridgeshire CB22 3AT, GB

(51) MKP
C07D 487/04 (2006.01) (97) **2736909 ***
(86) EP2012003214 27.07.2012
(96) 12740505.8 04.06.2014
(87) WO2013013833, 27.07.2012
(97) 2736909, 04.06.2014 en
(54) PROCESS FOR THE PREPARATION OF SITAGLIPTIN AND ITS PHARMACEUTICALLY ACCEPTABLE SALTS
(71) Farma GRS, d.o.o., Seidlova cesta 70, 8000 Novo mesto, SI
(72) ZUPANCIC, Silvo, Zupnca 4b, 8000 Novo mesto, SI
ZUPET, Rok, Janeza Rozica 6, 1211 Ljubljana, SI

(51) MKP
A01N 37/12 (2006.01) (97) **2765857 ***
C12Q 1/68 (2006.01)
(86) US2012059352 09.10.2012
(96) 12840243.5 20.08.2014
(87) WO2013055683, 09.10.2012
(97) 2765857, 20.08.2014 en
(54) SINGLE NUCLEOTIDE POLYMORPHISMS USEFUL TO PREDICT CLINICAL RESPONSE FOR GLATIRAMER ACETATE
(71) Teva Pharmaceutical Industries Ltd., 5 Basel Street P.O. Box 3190, 49131 Petach-Tikva, IL
(72) TCHELET, Amir, 42 Bney-Brit St., Hod-Hasharaon 45265, IL
MACCIARDI, Fabio, 7 Pauling Court, Irvine, CA 92617, US
LEVY, Joseph, 8 Sheshet Hayamim St., Kfar-Saba 44249, IL

(51) MKP
C12P 7/56 (2006.01) (97) **2732041 ***
C12P 41/00 (2006.01)
(86) GB2012051695 16.07.2012
(96) 12740195.8 21.05.2014
(87) WO2013011295, 16.07.2012
(97) 2732041, 21.05.2014 en
(54) SEPARATION PROCESS
(71) Plaxica Limited, Imperial College Incubator Level 1 Bessemer Building Imperial College, London SW7 2AZ, GB
(72) MARSHALL, Edward Leslie, c/o Plaxica Limited Imperial College Incubator Level 1 Bessemer College Imperial College, London Greater London SW7 2AZ, GB
OSEI-TUTU, Jade Jocelyn Afriye, c/o Plaxica Limited Imperial College Incubator Level 1 Bessemer College Imperial College, London Greater London SW7 2AZ, GB
SMITH, Stephen Alexander Calder, cc/o Plaxica Limited Imperial College Incubator Level 1 Bessemer College Imperial College, London Greater London SW7 2AZ, GB

- (51) MKP
A61K 31/553 (2006.01) (97) **2726469 ***
C07D 267/14 (2006.01)
C07D 413/04 (2006.01)
C07D 413/12 (2006.01)
C07D 413/14 (2006.01)
C07D 498/04 (2006.01)
- (86) US2012045021 29.06.2012
(96) 12735400.9 07.05.2014
(87) WO2013006463, 29.06.2012
(97) 2726469, 07.05.2014 en
(54) OXAZEPINES AS ION CHANNEL MODULATORS
(71) Gilead Sciences, Inc., 333 Lakeside Drive, Foster City, CA 94404, US
(72) CORKEY, Britton, Kenneth, c/o Gilead Sciences, Inc. 333 Lakeside Drive, Foster City, CA 94404, US
ELZEIN, Elfatih, c/o Gilead Sciences, Inc. 333 Lakeside Drive, Foster City, CA 94404, US
JIANG, Robert, H., c/o Gilead Sciences, Inc. 333 Lakeside Drive, Foster City, CA 94404, US
KALLA, Rao, V., c/o Gilead Sciences, Inc. 333 Lakeside Drive, Foster City, CA 94404, US
KOLTUN, Dmitry, c/o Gilead Sciences, Inc. 333 Lakeside Drive, Foster City, CA 94404, US
LI, Xiaofen, c/o Gilead Sciences, Inc. 333 Lakeside Drive, Foster City, CA 94404, US
MARTINEZ, Ruben, c/o Gilead Sciences, Inc. 333 Lakeside Drive, Foster City, CA 94404, US
PARKHILL, Eric, Q., c/o Gilead Sciences, Inc. 333 Lakeside Drive, Foster City, CA 94404, US
PERRY, Thao, c/o Gilead Sciences, Inc. 333 Lakeside Drive, Foster City, CA 94404, US
ZABLOCKI, Jeff, c/o Gilead Sciences, Inc. 333 Lakeside Drive, Foster City, CA 94404, US
VENKATARAMANI, Chandrasekar, c/o Gilead Sciences, Inc. 333 Lakeside Drive, Foster City, CA 94404, US
GRAUPE, Michael, c/o Gilead Sciences, Inc. 333 Lakeside Drive, Foster City, CA 94404, US
GUERRERO, Juan, c/o Gilead Sciences, Inc. 333 Lakeside Drive, Foster City, CA 94404, US

- (51) MKP
A61K 31/45 (2006.01) (97) **2723717 ***
A61P 29/00 (2006.01)
C07D 213/40 (2006.01)
C07D 213/61 (2006.01)
C07D 213/81 (2006.01)
C07D 401/12 (2006.01)
C07D 401/14 (2006.01)
C07D 403/12 (2006.01)
C07D 405/12 (2006.01)
C07D 405/14 (2006.01)
C07D 409/12 (2006.01)
C07D 413/12 (2006.01)
C07D 417/12 (2006.01)
C07D 471/04 (2006.01)
C07D 487/04 (2006.01)
- (86) US2012043566 21.06.2012
(96) 12730134.9 30.04.2014
(87) WO2012177893, 21.06.2012
(97) 2723717, 30.04.2014 en
(54) TRPM8 ANTAGONISTS AND THEIR USE IN TREATMENTS
(71) Amgen Inc., One Amgen Center Drive, Thousand Oaks, California 91320-1799, US
(72) BISWAS, Kaustav, 5666 Silver Valley Avenue, Agoura Hills California 91301, US
BROWN, James, 4438 Appleglen Court, Moorpark California 93021, US
CHEN, Jian, J., 5448 Castillo de Rosa, Camarillo, US 93012, US
GORE, Vijay, Keshav, 12 Dove Street, Aliso Viejo California 92656, US
HARRIED, Scott, 1407 Arch Street, Pittsburgh Pennsylvania 15212, US
HORNE, Daniel, B., 125 Parkside Drive, Simi Valley California 93065, US
KALLER, Matthew, R., 1644 Red Rock Avenue, Ventura California 93004, US
LIU, Qingyian, 4631 Paseo Girasol, Camarillo California 93012, US
MA, Vu, Van, 356 Countryside Road, Oak Park California 91377, US
MONENSCHHEIN, Holger, 8425 Kern Crescent, San Diego California 92127, US
NGUYEN, Thomas, T., 468 Calle Veracruz, Newbury Park California 91320, US
YUAN, Chester, Chenguang, 1416 Geyser Court, Newbury Park California 91320, US
ZHONG, Wenge, 2921 Venezia Lane, Thousand Oaks California 91362, US
ST. JEAN, David, J., Jr., 4690 Marrisa Way, Camarillo California 93012, US

- (51) MKP
A61K 48/00 (2006.01) (97) **2636746**
C12N 15/86 (2006.01)
- (96) 12001507.8 11.09.2013
(97) 2636746, 11.09.2013 en
(54) A novel drug delivery system based on JCV-VLP
(71) Life Science Inkubator Betriebs GmbH & Co. KG, Ludwig-Erhard-Allee 2, 53175 Bonn, DE
(72) Demina, Victoria, Hugo-Haelschner-Strasse 5, 53129 Bonn, DE
Manninga, Helko, Judenstrasse 30, 37073 Göttingen, DE
Götzke, Armin, Neutorstrasse 5, 97070 Würzburg, DE
Glassmann, Alexander, Holzweg 25, 50999 Köln, DE

- (51) MKP
A61K 9/00 (2006.01) (97) **2719373**
A61K 9/20 (2006.01)
- (96) 12188344.1 16.04.2014
(97) 2719373, 16.04.2014 en
(54) Fast disintegrating solid dosage form formulation comprising functionalized calcium carbonate and method of their manufacture
(71) Omya International AG, Baslerstrasse 42, 4665 Oftringen, CH
(72) Gerard, Daniel, Rheinfelderstrasse 12, 4058 Basel, CH
Schölkopf, Joachim, Buechbühlstrasse 3, 8956 Kilwangen, CH
Gane, Patrick A.C., Studenweg 8, 4852 Rothrist, CH
Strinimann, Tanja, Unterer Burghaldenweg 5b, 4410 Liestal, CH
Alles, Rainer, Riehenstrasse 232, 4058 Basel, CH
Puchkov, Maxim, Krebsenbachwe13, 4148 Pfeffingen, CH
Huwlyer, Jörg, In der Schappe 91, 4144 Arlesheim, CH

(51) MKP
H04N 5/335 (2011.01) (97) **2708021 ***
 (86) US2012037825 14.05.2012
 (96) 12781991.0 19.03.2014
 (87) WO2012155143, 14.05.2012
 (97) 2708021, 19.03.2014 en
 (54) IMAGE SENSOR WITH TOLERANCE OPTIMIZING INTERCONNECTS
 (71) Olive Medical Corporation, 2302 S. Presidents Drive, Suite D, Salt Lake City, UT 84120, US
 (72) BLANQUART, Laurent, 2776 Great Smokey Court, Westlake Village CA 91362, US

(51) MKP
A61K 31/12 (2006.01) (97) **2734199 ***
A61K 31/28 (2006.01)
A61K 31/713 (2006.01)
A61K 33/24 (2006.01)
A61K 39/395 (2006.01)
A61P 35/00 (2006.01)
G01N 33/50 (2006.01)
G01N 33/68 (2006.01)
 (86) CA2012000696 23.07.2012
 (96) 12817041.2 28.05.2014
 (87) WO2013013302, 23.07.2012
 (97) 2734199, 28.05.2014 en
 (54) SYNTHETIC LETHALITY AND THE TREATMENT OF CANCER
 (71) Pacylex Pharmaceuticals Inc., 2600 Manulife Place 10180 - 101 Street, Edmonton, Alberta T5J 3Y2, CA
 (72) BERTHIAUME, Luc, G., 10061 90 Avenue, Edmonton T6E 4X2, CA
 BEAUCHAMP, Erwan, 13, Rue Renée Prévert, 35000 Rennes, FR
 PERINPANAYAGAM, Conganige Maneka Anne, Unit 8 2004 Grantham Court NW, Edmonton, Alberta T5T 6R9, CA
 YAP, Chuiyee, 4836, 155 Avenue, Edmonton T5Y 0C1, CA

(51) MKP
A61K 38/37 (2006.01) (97) **2729161 ***
C07K 14/755 (2006.01)
 (86) US2012045784 06.07.2012
 (96) 12811808.0 14.05.2014
 (87) WO2013009627, 06.07.2012
 (97) 2729161, 14.05.2014 en
 (54) FACTOR VIII CHIMERIC AND HYBRID POLYPEPTIDES, AND METHODS OF USE THEREOF
 (71) BIOGEN IDEC HEMOPHILIA INC., 9 Fourth Avenue, Waltham, MA 02451, US
 (72) DUMONT, Jennifer A., 37 Fawn Terrace Lane, Groton, Massachusetts 01450, US
 LOW, Susan, 86 Brookline Street, Pepperill, Massachusetts 01463, US
 BITONTI, Alan, J., 32 Carlton Drive, Acton, Massachusetts 01720, US
 PIERCE, Glenn, PO Box 675486, Rancho Santa Fe, California 92067, US
 LUK, Alvin, 101 Canal Street N907, Boston, Massachusetts 02114-1897, US
 JIANG, Haiyan, 3 Bayberry Lane, Belmont, Massachusetts 02478, US
 MCKINNEY, Byron, 7234 Shoreline Drive 156, San Diego, California 92122, US
 OTTMER, Matt, 112 Gibbs Street, Newton, Massachusetts 02459, US
 SOMMER, Jurg, 30 Hampshire Road, Wayland, Massachusetts 01778, US
 NUGENT, Karen, Owlswick Farmhouse, Owlswick Princes Risborough Buckinghamshire HP27 9RH, GB
 LI, Lian, 10 Carol Lane, Lexington, Massachusetts 02420, US
 PETERS, Robert, 51 New Filed Street, West Roxbury, Massachusetts 02132, US

(51) MKP
B01D 29/15 (2006.01) (97) **2623175**
B01D 29/58 (2006.01)
B01D 29/96 (2006.01)
B01D 35/18 (2006.01)
B01D 36/00 (2006.01)
 (96) 12153437.4 07.08.2013
 (97) 2623175, 07.08.2013 en
 (54) A serviceable filtration arrangement
 (71) Delphi International Operations Luxembourg S.à.r.l., Avenue de Luxembourg, 4940 Bascharage, LU
 Frouin, Thierry, 35 Haute Rue, 41350 Vineuil, FR
 Meunier, Cedric, 15 avenue Gambetta, bat C, appt. No. 40, 41000 Blois, FR
 Vincent, Laurent, 12 Impasse de la Saulaie, 41000 Saint Sulpice de Pommeray, FR
 Daniel, Patrick, 40 bis, rue Albert 1er, 41000 Blois, FR

(51) MKP
A01N 43/40 (2006.01) (97) **2709609 ***
A61K 31/165 (2006.01)
A61K 31/44 (2006.01)
A61K 31/497 (2006.01)
 (86) US2012038215 16.05.2012
 (96) 12785516.1 26.03.2014
 (87) WO2012158844, 16.05.2012
 (97) 2709609, 26.03.2014 en
 (54) HETEROCYCLIC COMPOUNDS
 (71) Shionogi & Co., Ltd., 1-8, Doshomachi 3-chome Chuo-ku, Osaka-shi, Osaka 541-0045, JP
 Purdue Pharma LP, One Stamford Forum 201 Tresser Boulevard, Stamford, CT 06901-3431, US
 (72) KUROSE, Noriyuki, Shionogi & Co. LTD. 1-1 Futabacho 3-chome, Toyonaka-Shi, Osaka 561-0825, JP
 FUCHINO, Kouki, Shionogi & Co. LTD. 1-1 Futabacho 3-chome, Toyonaka-shi, Osaka 561-0825, JP
 HATA, Kayoko, Shionogi & Co. LTD. 1-1 Futabacho 3-chome, Toyonaka-shi, Osaka 561-0825, JP
 ISO, Yasuyoshi, Shionogi & Co. LTD. 1-1 Futabacho 3-chome, Toyonaka-shi, Osaka 561-0825, JP
 YAMAGUCHI, Naoko, Shionogi & Co. LTD. 1-1 Futabacho 3-chome, Toyonaka-shi, Osaka 561-0825, JP
 SHAO, Bin, 23 Shelbourne Road, Richboro Pennsylvania 18954, US
 TAFESSE, Laykea, 11 Abington Lane, Robbinsville New Jersey 08691, US
 ZHOU, Xiaoming, 22 Dogwood Drive, Plainsboro New Jersey 08536, US
 YU, Jianming, 100 Marion Drive, Plainsboro New Jersey 08536, US

(51) MKP
A61K 31/496 (2006.01) (97) **2721033 ***
A61P 35/00 (2006.01)
C07D 217/26 (2006.01)
C07D 413/04 (2006.01)
C07D 491/052 (2006.01)
C07D 519/00 (2006.01)
 (86) CN2012077096 18.06.2012
 (96) 12799802.9 23.04.2014
 (87) WO2012171506, 18.06.2012
 (97) 2721033, 23.04.2014 en
 (54) COMPOUNDS, THEIR PHARMACEUTICAL COMPOSITIONS AND THEIR USES AS IDH1 MUTANTS INHIBITORS FOR TREATING CANCERS
 (71) Agios Pharmaceuticals, Inc., 38 Sidney Street, Cambridge, MA 02139, US
 (72) CAO, Sheldon, 10521 Sand Crab Place, San Diego, California 92130, US
 POPOVICI-MULLER, Janeta, 2 Fern Street, Windham, NH 03087, US
 SALITURO, Francesco G., 25 Baker Drive, Marlborough, Massachusetts 01752, US
 SAUNDERS, Jeffrey O., 188 Tower Road Lincoln, Massachusetts 01773, US
 TAN, Xuefei, 300 Jingxiu Road Bldg 20, Rm 101, Pudong District, Shanghai 200135, CN
 TRAVINS, Jeremy, 14 Overlook Drive Southbrough, Massachusetts 01772, US
 YAN, Shunqi, 55 Stepping Stone, Irvine, California 92603, US
 YE, Zhixiong, 3 Banff Dr., West Windsor, NJ 08550, US

- (51) MKP
A61K 31/4192 (2006.01) (97) **2719690 ***
A61K 31/42 (2006.01)
A61P 1/00 (2006.01)
A61P 17/04 (2006.01)
A61P 19/02 (2006.01)
A61P 25/00 (2006.01)
A61P 37/02 (2006.01)
A61P 43/00 (2006.01)
C07D 249/04 (2006.01)
C07D 261/08 (2006.01)
C07D 413/06 (2006.01)
(86) JP2012061352 27.04.2012
(96) 12776819.0 16.04.2014
(87) WO2012147916, 27.04.2012
(97) 2719690, 16.04.2014 en
(54) AMIDE COMPOUND AND PHARMACEUTICAL APPLICATION THEREFOR
(71) Japan Tobacco Inc., 2-1, Toranomon 2-chome Minato-ku, Tokyo 105-8422, JP
(72) MAEBA, Takaki, c/o Central Pharmaceutical Research Institute of Japan Tobacco Inc. 1-1 Murasaki-cho, Takatsuki-shi Osaka 569-1125, JP
MAEDA, Katsuya, c/o Central Pharmaceutical Research Institute of Japan Tobacco Inc. 1-1 Murasaki-cho, Takatsuki-shi Osaka 569-1125, JP
KOTOKU, Masayuki, c/o Central Pharmaceutical Research Institute of Japan Tobacco Inc. 1-1 Murasaki-cho, Takatsuki-shi Osaka 569-1125, JP
HIRATA, Kazuyuki, c/o Central Pharmaceutical Research Institute of Japan Tobacco Inc. 1-1 Murasaki-cho, Takatsuki-shi Osaka 569-1125, JP
SEKI, Noriyoshi, c/o Central Pharmaceutical Research Institute of Japan Tobacco Inc. 1-1 Murasaki-cho, Takatsuki-shi Osaka 569-1125, JP
YAMANAKA, Hiroshi, c/o Central Pharmaceutical Research Institute of Japan Tobacco Inc. 1-1 Murasaki-cho, Takatsuki-shi Osaka 569-1125, JP
SAKAI, Takayuki, c/o Central Pharmaceutical Research Institute of Japan Tobacco Inc. 1-1 Murasaki-cho, Takatsuki-shi Osaka 5691125, JP
HIRASHIMA, Shintaro, c/o Central Pharmaceutical Research Institute of Japan Tobacco Inc. 1-1 Murasaki-cho, Takatsuki-shi Osaka 569-1125, JP
OBIIKA, Shingo, c/o Central Pharmaceutical Research Institute of Japan Tobacco Inc. 1-1 Murasaki-cho, Takatsuki-shi Osaka 569-1125, JP
SHIOZAKI, Makoto, c/o Central Pharmaceutical Research Institute of Japan Tobacco Inc. 1-1 Murasaki-cho, Takatsuki-shi Osaka 569-1125, JP
YOKOTA, Masahiro, c/o Central Pharmaceutical Research Institute of Japan Tobacco Inc. 1-1 Murasaki-cho, Takatsuki-shi Osaka 569-1125, JP

- (51) MKP
G06F 3/14 (2006.01) (97) **2665244**
H04M 1/725 (2006.01)
(96) 13167235.4 20.11.2013
(97) 2665244, 20.11.2013 en
(54) Sender device and method of sharing screenshots and computer-readable medium thereof
(71) Awind Inc., 17F., No.866-5, Zhongzheng Rd. Zhonghe Dist., 235 New Taipei City, TW
(72) Chang, Kuo-Lung, 17F., No.866-5, Zhongzheng Rd., Zhonghe Dist., 235 New Taipei City, TW
Chang, Cheng-Hsiung, 17F., No.866-5, Zhongzheng Rd., Zhonghe Dist., 235 New Taipei City, TW
Hung, Meng-Chung, 17F., No.866-5, Zhongzheng Rd., Zhonghe Dist., 235 New Taipei City, TW
Liu, Shih-Ping, 17F., No.866-5, Zhongzheng Rd., Zhonghe Dist., 235 New Taipei City, TW
Chou, Kuan-Yu, 17F., No.866-5, Zhongzheng Rd., Zhonghe Dist., 235 New Taipei City, TW
Wang, Hsing-Yung, 17F., No.866-5, Zhongzheng Rd., Zhonghe Dist., 235 New Taipei City, TW

- (51) MKP
A01N 43/52 (2006.01) (97) **2720546 ***
A61K 31/415 (2006.01)
(86) US2012042607 15.06.2012
(96) 12800913.1 23.04.2014
(87) WO2012174342, 15.06.2012
(97) 2720546, 23.04.2014 en
(54) TRPV4 ANTAGONISTS
(71) Glaxosmithkline Intellectual Property (No. 2) Limited, 980 Great West Road, Brentford, Middlesex TW8 9SG, GB
(72) BROOKS, Carl, 709 Swedeland Road, King of Prussia, PA 19406, US
CHEUNG, Mui, 709 Swedeland Road, King of Prussia, PA 19406, US
EIDAM, Hilary, Schenck, 709 Swedeland Road, King of Prussia, PA 19406, US
GOODMAN, Krista, B., 709 Swedeland Road, King of Prussia, PA 19406, US
HAMMOND, Marlys, 4359 W. Ponds Circle, Littleton, CO 80123, US
HILFIKER, Mark, A., 709 Swedeland Road, King of Prussia, PA 19406, US
PATTERSON, Jaclyn, R., 709 Swedeland Road, King of Prussia, PA 19406, US
STOY, Patrick, 709 Swedeland Road, King of Prussia, PA 19406, US
YE, Guosen, 709 Swedeland Road, King of Prussia, PA 19406, US

- (51) MKP
A61K 35/74 (2006.01) (97) **2628793**
C07K 14/47 (2006.01)
C12N 1/21 (2006.01)
C12R 1/19 (2006.01)
(96) 12001091.3 21.08.2013
(97) 2628793, 21.08.2013 en
(54) Recombinant escherichia coli strains
(71) PHARMA-ZENTRALE GMBH, Loerfeldstrasse 20, 58313 Herdecke, DE
(72) Ölschläger, Tobias, Mainstrasse 68, 97318 Kitzingen, DE
Seo, Ean Jeong, Rheinallee 85, App. 110, 55118 Mainz, DE
Wehkamp, Jan, Königkarlstrasse 40, 70372 Stuttgart, DE
Stange, Eduard F., Happoldstrasse 71a, 70469 Stuttgart, DE
Sonnenborn, Ulrich, Eichenweg 6, 44799 Bochum, DE
Malinka, Jürgen, Paulswiese 11, 59379 Selm-Bork, DE
Proppert, Hans, Rosenstrasse 102, 58095 Hagen, DE

- (51) MKP
F03D 11/00 (2006.01) (97) **2707702 ***
G01N 21/88 (2006.01)
G01N 21/95 (2006.01)
(86) EP2012057188 19.04.2012
(96) 12716395.4 19.03.2014
(87) WO2012152561, 19.04.2012
(97) 2707702, 19.03.2014 de
(54) ASSESSMENT OF ROTOR BLADES
(71) Wobben Properties GmbH, Dreekamp 5, 26605 Aurich, DE
(72) JANSEN, Gerhard, Neuer Grund 17, 49757 Vrees, DE

- (51) MKP
C07K 14/00 (2006.01) (97) **2766484 ***
C12N 15/62 (2006.01)
(86) EP2012069981 10.10.2012
(96) 12774996.8 20.08.2014
(87) WO2013053719, 10.10.2012
(97) 2766484, 20.08.2014 en
(54) REGULATION OF RECEPTOR EXPRESSION THROUGH DELIVERY OF ARTIFICIAL TRANSCRIPTION FACTORS
(71) Aliophtha AG, Elisabethenstrasse 43, 4051 Basel, CH
(72) FLAMMER, Josef, Ob dem Hügliacker 76, 4102 Binningen, CH
NEUTZNER, Albert, Schwarzwaldblick 7, 79418 Schliengen, DE
HUXLEY, Alice, Huebweg 25, 4102 Binningen, CH

(51) MKP
A61L 15/18 (2006.01) (97) **2734245 ***
A61L 15/46 (2006.01)
 (86) EP2012003660 31.08.2012
 (96) 12756368.2 28.05.2014
 (87) WO2013029797, 31.08.2012
 (97) 2734245, 28.05.2014 de
 (54) WOUND DRESSING WITH AN ANTIMICROBIAL EFFECT
 (71) Blücher GmbH, Mettmanner Strasse 25, 40699 Erkrath, DE
 (72) VON BLÜCHER, Hasso, Parkstrasse 10, 40699 Erkrath, DE
 SCHÖNFELD, Raik, Am Forstkamp 24b, 30629 Hannover, DE
 PALLASKE, Frank, Hauptstrasse 254, 09355 Gersdorf, DE

(51) MKP
C07D 403/12 (2006.01) (97) **2729463 ***
 (86) EP2012062202 25.06.2012
 (96) 12730498.8 14.05.2014
 (87) WO2013007502, 25.06.2012
 (97) 2729463, 14.05.2014 en
 (54) SUBSTITUTED PHENYL COMPOUNDS
 (71) SANOFI, 54 rue La Boétie, 75008 Paris, FR
 (72) GESSLER, Dr., Simon, August-Bebel-Straße 79, 68199 Mannheim, DE
 WOLLMANN, Dr., Theo, Im Heideck 11, 65795 Hattersheim, DE

(51) MKP
C07K 16/28 (2006.01) (97) **2726508 ***
 (86) US2012044703 28.06.2012
 (96) 12735991.7 07.05.2014
 (87) WO2013003625, 28.06.2012
 (97) 2726508, 07.05.2014 en
 (54) ANTIBODIES TO ADP-RIBOSYL CYCLASE 2
 (71) Oxford Biotherapeutics Ltd., 94A Milton Park, Abingdon, Oxon OX14 4RY, GB
 (72) ROHLFF, Christian, Oxford Bio Therapeutics Ltd. 94A Milton Park, Abingdon Oxon OX14 4RY, GB
 TERRETT, Jonathan, Alexander, 5941 Optical Court, San Jose, CA 95138, US

(51) MKP
B29C 49/36 (2006.01) (97) **2574445**
B29C 49/42 (2006.01)
B29C 49/64 (2006.01)
B29C 49/68 (2006.01)
B65G 29/00 (2006.01)
B65G 33/04 (2006.01)
B65G 47/84 (2006.01)
 (96) 12184074.8 03.04.2013
 (97) 2574445, 03.04.2013 en
 (54) Oven for preforms applicable to blowing machines or stretch blowing machines
 (71) SMI S.p.A., Via Monte Grappa, 7, 24121 Bergamo, IT
 (72) Zacche, Vanni, c/o SMI S.p.A. Via Monte Grappa, 7, I-24121 BERGAMO, IT

(51) MKP
B23Q 3/06 (2006.01) (97) **2747937 ***
B23Q 16/10 (2006.01)
 (86) IB2012055155 27.09.2012
 (96) 12784706.9 02.07.2014
 (87) WO2013046147, 27.09.2012
 (97) 2747937, 02.07.2014 en
 (54) SUPPORT AND GRIPPING DEVICE OF A MECHANICAL PART, SUITABLE FOR A MACHINE TOOL
 (71) Gnutti Transfer S.p.A., Via Domenico Ghidoni 187, 25035 Ospitaletto (Brescia), IT
 (72) GABOARDI, Giordano, c/o GNUTTI TRANSFER S.p.A. Via Domenico Ghidoni 187, I-25035 Ospitaletto (Brescia), IT
 CORAGLIA, Stefano, c/o GNUTTI TRANSFER S.p.A. Via Domenico Ghidoni 187, I-25035 Ospitaletto (Brescia), IT

(51) MKP
A61K 38/19 (2006.01) (97) **2742948 ***
A61P 39/02 (2006.01)
 (86) ES2012070624 10.08.2012
 (96) 12772116.5 18.06.2014
 (87) WO2013021093, 10.08.2012
 (97) 2742948, 18.06.2014 en
 (54) USE OF CARDIOTROPHIN-1 FOR THE TREATMENT OF KIDNEY DISEASES
 (71) Digna Biotech, S.L., Avenida Pío XII, 22. Oficina 2, 31008 Pamplona Navarra, ES
 Universidad de Salamanca, Patio de Escuelas 1, 37008 Salamanca, ES

(72) GARCÍA CENADOR, Begoña, Digna Biotech S.L Avenida Pío XII 22 Oficina 2, E-31008 Pamplona, ES
 GARCÍA CRIADO, Javier, Digna Biotech S.L Avenida Pío XII 22 Oficina 2, E-31008 Pamplona, ES
 LÓPEZ HERNÁNDEZ, Francisco Javier, Digna Biotech S.L Avenida Pío XII 22 Oficina 2, E-31008 Pamplona, ES
 LÓPEZ NOVOA, Jose Miguel, Digna Biotech S.L Avenida Pío XII 22 Oficina 2, E-31008 Pamplona, ES
 PEREZ DE OBANOS MARTELL, María Pilar, Digna Biotech S.L Avenida Pío XII 22 Oficina 2, E-31008 Pamplona, ES
 RUIZ ECHEVERRÍA, Juan, Digna Biotech S.L Avenida Pío XII 22 Oficina 2, E-31008 Pamplona, ES

(51) MKP
A61F 2/04 (2013.01) (97) **2760383 ***
A61F 2/82 (2013.01)
A61F 2/88 (2006.01)
 (86) US2012057252 26.09.2012
 (96) 12778520.2 06.08.2014
 (87) WO2013049145, 26.09.2012
 (97) 2760383, 06.08.2014 en
 (54) NEGATIVE PRESSURE INTESTINAL ANASTOMOSIS PROTECTION DEVICES
 (71) Ethicon, Inc, P.O. Box 151 U.S. Route 22, Somerville, NJ 08876, US
 (72) ROUSSEAU, Robert, Anthony, 736 Geigel Hill Road, Ottsville, PA 18942, US

(51) MKP
C07C 45/55 (2006.01) (97) **2720995 ***
C07C 47/04 (2006.01)
C07C 201/12 (2006.01)
C07C 205/15 (2006.01)
C07C 213/00 (2006.01)
C07C 215/08 (2006.01)
 (86) US2012046855 16.07.2012
 (96) 12738697.7 23.04.2014
 (87) WO2013012777, 16.07.2012
 (97) 2720995, 23.04.2014 en
 (54) PROCESS FOR MAKING TERTIARY AMINOALCOHOL COMPOUNDS
 (71) ANGUS Chemical Company, 1500 E. Lake Cook Road, Buffalo Grove, IL 60089, US
 Angus Chemie GmbH, Zeppelinstrasse 30, DE-49479 Ibbenbueren, DE
 (72) MOORE, David, W., 8914 Johnson Road, Hebron, IL 60034, US
 SPIEKER, Christian, Elmendorfer Strasse 6a, D-49477 Ibbenbueren, DE
 GUMMRE, John, D., 27 Azalea Drive, Monroe, LA 71203, US

(51) MKP
C07C 211/42 (2006.01) (97) **2705021 ***
C07C 309/29 (2006.01)
C07C 309/35 (2006.01)
 (86) IN2012000329 04.05.2012
 (96) 12766333.4 12.03.2014
 (87) WO2012153349, 04.05.2012
 (97) 2705021, 12.03.2014 en
 (54) RASAGILINE AND ITS PHARMACEUTICALLY ACCEPTABLE SALTS
 (71) Cadila Healthcare Limited, Zydus Tower Satellite Cross Roads, Ahmedabad 380 015, Gujarat, IN
 (72) DWIVEDI, Shriprakash, Dhar, Cadila Healthcare Limited Zydus Tower Satellite Cross Roads, Ahmedabad 380015, Gujarat, IN
 PRASAD, Ashok, Cadila Healthcare Limited Zydus Tower Satellite Cross Roads, Ahmedabad 380015, Gujarat, IN
 PATEL, Mayur, Ramnikbhai, Cadila Healthcare Limited Zydus Tower Satellite Cross Roads, Ahmedabad 380015, Gujarat, IN

- (51) MKP
B29C 70/22 (2006.01) (97) **2758228 ***
D04H 3/04 (2012.01)
D04H 3/05 (2006.01)
D04H 3/12 (2006.01)
- (86) AT2012050112 02.08.2012
(96) 12762191.0 30.07.2014
(87) WO2013040618, 02.08.2012
(97) 2758228, 30.07.2014 de
(54) SEMI-FINISHED FIBER PRODUCT, FIBER COMPOSITE MATERIAL AND METHOD FOR THE PRODUCTION THEREOF
(71) Kapsch-Group Beteiligungs GmbH, Am Europlatz 2, 1120 Wien, AT
(72) SEDLACEK, Norbert, Hauptstraße 63, A-3033 Altlangbach, AT

- (51) MKP
F22B 21/02 (2006.01) (97) **2715229 ***
F22B 21/34 (2006.01)
F22B 29/02 (2006.01)
F22B 29/06 (2006.01)
F22B 33/10 (2006.01)
F22D 1/04 (2006.01)
F22G 1/02 (2006.01)
F22G 3/00 (2006.01)
F22G 7/14 (2006.01)
- (86) EP2012060127 30.05.2012
(96) 12724986.0 09.04.2014
(87) WO2012163961, 30.05.2012
(97) 2715229, 09.04.2014 de
(54) STEAM GENERATOR
(71) Völkerer, Klaus, Hauptplatz 4, 2620 Diepolz, AT
Eidler, Willibald, Aussichtsgasse 37, 2630 Ternitz, AT
Past, Arno, Ober-Danegg 49, 2632 Grafenbach, AT
Koglbauer, Josef, Feldgasse 3, 2632 Grafenbach, AT
(72) Völkerer, Klaus, Hauptplatz 4, 2620 Diepolz, AT
Eidler, Willibald, Aussichtsgasse 37, 2630 Ternitz, AT
Past, Arno, Ober-Danegg 49, 2632 Grafenbach, AT
Koglbauer, Josef, Feldgasse 3, 2632 Grafenbach, AT

- (51) MKP
B62D 7/09 (2006.01) (97) **2755882 ***
B62D 7/18 (2006.01)
B62D 7/20 (2006.01)
- (86) AT2012000236 13.09.2012
(96) 12778195.3 23.07.2014
(87) WO2013036978, 13.09.2012
(97) 2755882, 23.07.2014 de
(54) STEERING AXLE
(71) Scharmüller, Josef, Saxigen 14, 4892 Fornach, AT
Scharmüller, Josef, jun., Saxigen 14, 4892 Fornach, AT
(72) Scharmüller, Josef, Saxigen 14, 4892 Fornach, AT
Scharmüller, Josef, jun., Saxigen 14, 4892 Fornach, AT

- (51) MKP
B01D 46/10 (2006.01) (97) **2679292**
- (96) 13174433.6 01.01.2014
(97) 2679292, 01.01.2014 fr
(54) Regenerable flat filter for air with semi-rigid frame
(71) Schunk Electrographite SAS, 78 à 82 Rue Alfred Dequeant, 92000 Nanterre, FR
(72) Garnier, Gilles, 2, Allée des Vignerons, 92400 Courbevoie, FR
Couvert, Thierry, 6, Allée Francis Poulenc, 35830 Betton, FR

- (51) MKP
A61K 31/415 (2006.01) (97) **2714662 ***
A61K 31/4155 (2006.01)
A61P 9/00 (2006.01)
A61P 9/12 (2006.01)
C07D 231/14 (2006.01)
C07D 401/04 (2006.01)
C07D 401/06 (2006.01)
C07D 403/04 (2006.01)
C07D 403/06 (2006.01)
C07D 403/12 (2006.01)
C07D 405/04 (2006.01)
C07D 405/12 (2006.01)
C07D 413/04 (2006.01)
C07D 413/06 (2006.01)
- (86) US2012038511 18.05.2012
(96) 12725202.1 09.04.2014
(87) WO2012166387, 18.05.2012
(97) 2714662, 09.04.2014 en
(54) NEPRILYSIN INHIBITORS
(71) Theravance, Inc., 901 Gateway Boulevard, South San Francisco, CA 94080, US
(72) GENDRON, Roland, 345 Franconia Street, San Francisco, California 94110, US
HUGHES, Adam D., 1221 Judson Street, Belmont, California 94002, US

- (51) MKP
E04G 3/22 (2006.01) (97) **2769032 ***
E04G 3/24 (2006.01)
E04G 23/08 (2006.01)
- (86) IB2011054687 20.10.2011
(96) 11811131.9 27.08.2014
(87) WO2013057543, 20.10.2011
(97) 2769032, 27.08.2014 en
(54) EQUIPMENT AND METHOD FOR DEMOLISHING A BUILDING
(71) Despe S.p.A., Via Leonardo Da Vinci 12/14, 24069 Torre De' Roveri (Bergamo), IT
(72) PANSERI, Giuseppe, Via Vegino 7, I-24020 Scanzorosciate (Bergamo), IT
PANSERI, Stefano, Via Vegino 13, I-24020 Scanzorosciate (Bergamo), IT
PANSERI, Roberto, Via Vegino 3, I-24020 Scanzorosciate (Bergamo), IT

- (51) MKP
A61K 31/27 (2006.01) (97) **2701699 ***
- (86) US2012035814 30.04.2012
(96) 12775936.3 05.03.2014
(87) WO2012149540, 30.04.2012
(97) 2701699, 05.03.2014 en
(54) INHIBITORS OF HISTONE DEACETYLASE
(71) The Broad Institute, Inc., 7 Cambridge Center, Cambridge, MA02142, US
The General Hospital Corporation d/b/a Massachusetts General Hospital, 55 Fruit Street, Boston, MA 02114, US
Massachusetts Institute of Technology (MIT), 77 Massachusetts Avenue Rm. 46-4235, Cambridge, MA 02139, US
(72) HOLSON, Edward, 66 Forrest Street, Newton, MA 02461, US
WAGNER, Florence, Fevrier, 4 Old Country Path, Ashland, MA 01721, US
WEIWER, Michel, 18 Hunting Street Apt. No.1, Cambridge, MA 02141, US
TSAL, Li-Huei, 26 fresh Pond Pkwy., Cambridge, MA 02138, US
HAGGARTY, Stephen, 37 Beebe Road, Bridgewater, MA 02324, US
ZHANG, Yan-Ling, 33 Webster Road, Lexington, MA 02421, US

- (51) MKP
G01N 33/569 (2006.01) (97) **2758785 ***
- (86) DE2012100287 19.09.2012
(96) 12772206.4 30.07.2014
(87) WO2013041087, 19.09.2012
(97) 2758785, 30.07.2014 de
(54) METHOD FOR CHECKING THE SELF-HEALING PROCESS CARRIED OUT BY THE IMMUNE SYSTEM OF A TEST SUBJECT INFECTED WITH HUMAN PAPILLOMAVIRUS
(71) Hilfrich, Ralf, Zum Römberg 24, 65597 Hünfelden, DE
(72) Hilfrich, Ralf, Zum Römberg 24, 65597 Hünfelden, DE

(51) MKP
A61M 5/00 (2006.01) (97) **2753382 ***
A61M 5/20 (2006.01)
A61M 5/31 (2006.01)
A61M 5/315 (2006.01)
A61M 5/32 (2006.01)
(86) EP2012067438 06.09.2012
(96) 12754014.4 16.07.2014
(87) WO2013034651, 06.09.2012
(97) 2753382, 16.07.2014 en
(54) DEVICE FOR AUTOMATIC INJECTION OF DRUG DOSES
(71) Menarini International Operations Luxembourg S.A., 1, Avenue de la Gare, 1611 Luxembourg, LU
(72) EDHOUSE, Mark Jeffrey, 14 Berrylands 199 Milton Rd, Cambridge Cambridgeshire CB4 1XW, GB
DRIVER, Philip Jerome, 241 Victoria Road, Cambridge Cambridgeshire CB4 3LF, GB
MOSELEY, Guy Conwyn Julian, 6 Lode Avenue, Waterbeach Cambridgeshire CB25 9PX, GB
LEWIS, Scott Alexander, 32 Keynes Road, Cambridge Cambridgeshire CB5 8PR, GB

(51) MKP
B24D 15/00 (2006.01) (97) **2709800 ***
G09F 3/02 (2006.01)
G09F 3/10 (2006.01)
(86) EP2012002142 16.05.2012
(96) 12724898.7 26.03.2014
(87) WO2012156097, 16.05.2012
(97) 2709800, 26.03.2014 de
(54) METHOD FOR PRODUCING A NON-DETACHABLE SECURITY SEAL
(71) Radzey, Niklas, Holzeckstrasse 8, 79199 Kirchzarten, DE
Schmidt, Barbara, Holzeckstrasse 8, 79199 Kirchzarten, DE
(72) Radzey, Niklas, Holzeckstrasse 8, 79199 Kirchzarten, DE
Schmidt, Barbara, Holzeckstrasse 8, 79199 Kirchzarten, DE

(51) MKP
B65H 75/14 (2006.01) (97) **2634127**
B65H 75/22 (2006.01)
(96) 13157101.0 04.09.2013
(97) 2634127, 04.09.2013 en
(54) Cable carrier
(71) Imballaggi San Felice SRL, Via A. Vespucci, 38, 24056 Fontanella (BG), IT
(72) Pedrotti, Gianluca, Via Nazionale, 1/1, 25070 Caino (BS), IT

(51) MKP
A61B 17/072 (2006.01) (97) **2644124**
(96) 13161494.3 02.10.2013
(97) 2644124, 02.10.2013 en
(54) Tissue thickness compensator comprising capsules defining a low pressure environment
(71) Ethicon Endo-Surgery, Inc., 4545 Creek Road, Cincinnati, OH 45242, US
(72) Baxter, III, Chester O., 6375 Pawnee Ridge, Loveland, OH Ohio 45140, US
Shelton, IV, Frederick E., 245 East Main Street, Hillsboro, OH Ohio 45133, US
Swayze, Jeffrey S., 7047 Birchley Drive, Hamilton, OH Ohio 45011, US
Aronhalt, Taylor W., 306 Beech Road, Loveland, OH Ohio 45140, US
Schmid, Katherine J., 3969 Sharonview Drive, Cincinnati, OH Ohio 45241, US

(51) MKP
A01N 33/04 (2006.01) (97) **2638803**
A01N 33/08 (2006.01)
A01N 37/40 (2006.01)
A01N 39/04 (2006.01)
A01N 57/20 (2006.01)
(96) 13167445.9 18.09.2013
(97) 2638803, 18.09.2013 en
(54) Low volatile amine salts of anionic pesticides
(71) BASF SE, null, 67056 Ludwigshafen, DE
(72) Xu, Wen, 1016 Whisper rock trail, Cary, NC 27519, US
Kierkus, Paul Ch., 1169 Hidden Hills Dr., Wake Forest, NC 27587, US
Brunt, Steven, 12025 Panleys Mill Circle, Raleigh, NC 27614, US
Bowe, Steven, 425 Olde Thompson Creek Rd, Apex, NC 27523, US
Hixson, Adam, 8632 Paddle Wheel Dr., Raleigh, NC 27615, US
Cannan, Terrance M., 9009 Hometown Drive, Raleigh, North Carolina 27615, US

(51) MKP
C07D 207/40 (2006.01) (97) **2761296 ***
G01N 33/533 (2006.01)
(86) US2012057996 28.09.2012
(96) 12836127.6 06.08.2014
(87) WO2013049622, 28.09.2012
(97) 2761296, 06.08.2014 en
(54) RAPID FLUORESCENCE TAGGING OF GLYCANS AND OTHER BIOMOLECULES WITH ENHANCED MS SIGNALS
(71) Waters Technologies Corporation, a US Corporation 34 Maple Street, Milford, MA 01757, US
(72) BROUSMICHE, Darryl, W., 1 Meadowbrook Road Unit 3, Grafton, MA 01519, US
YU, Ying-qing, 28 Highview Drive, Uxbridge, MA 01569, US

(51) MKP
A61K 31/519 (2006.01) (97) **2751109 ***
A61P 1/00 (2006.01)
A61P 17/00 (2006.01)
A61P 19/00 (2006.01)
A61P 27/00 (2006.01)
A61P 29/00 (2006.01)
A61P 35/00 (2006.01)
C07D 471/04 (2006.01)
C07D 487/04 (2006.01)
(86) US2012053398 31.08.2012
(96) 12775861.3 09.07.2014
(87) WO2013033569, 31.08.2012
(97) 2751109, 09.07.2014 en
(54) HETEROCYCLYLAMINES AS PI3K INHIBITORS
(71) Incyte Corporation, Experimental Station Route 141&Henry Clay Road Building E336/207, Wilmington, Delaware 19880, US
(72) LI, Yun-Long, 1 Pin Oak Drive, Chadds Ford, Pennsylvania 19317, US
YAO, Wenqing, 748 Meadowbank Road, Kennett Square, Pennsylvania 19348, US
COMBS, Andrew, P., 329 East Doe Run Road, Kennett Square, Pennsylvania 19348, US
YUE, Eddy, W., 9 Altemus Drive, Landenberg, Pennsylvania 19350, US
MEI, Song, 151 Monet Circle, Wilmington, Delaware 19808, US
ZHU, Wenyu, 21 Abel Place, Media, Pennsylvania 19063, US
GLENN, Joseph, 103 Deer Horn Drive, Mount Royal, New Jersey 08061, US
MADUSKUIE, Thomas, P., Jr., 613 Foulkstone Road, Wilmington, Delaware 19803, US
SPARKS, Richard, B., 3316 Englewood Road, Wilmington, Delaware 19810, US
DOUTY, Brent, 3420 Strasburg Road East, Fallowfield, Pennsylvania 19320, US
HE, Chunhong, 40 Magnolia Way, Chadds Ford, PA 19317, US

- (51) MKP
A61K 31/52 (2006.01) (97) **2744810 ***
A61P 31/18 (2006.01)
A61P 31/20 (2006.01)
C07D 473/34 (2006.01)
(86) US2012050920 15.08.2012
(96) 12753867.6 25.06.2014
(87) WO2013025788, 15.08.2012
(97) 2744810, 25.06.2014 en
(54) TENOFOVIR ALAFENAMIDE HEMIFUMARATE
(71) Gilead Sciences, Inc., 333 Lakeside Drive, Foster City, CA 94404, US
(72) LIU, Dazhan, c/o Gilead Sciences, Inc. 333 Lakeside Drive, Foster City, CA 94404, US
SHI, Bing, c/o Gilead Sciences, Inc. 333 Lakeside Drive, Foster City, CA 94404, US
WANG, Fang, c/o Gilead Sciences, Inc. 333 Lakeside Drive, Foster City, CA 94404, US
YU, Richard, Hung Chiu, c/o Gilead Sciences, Inc. 333 Lakeside Drive, Foster City, CA 94404, US

- (51) MKP
A61K 47/48 (2006.01) (97) **2662095**
(96) 13167338.6 13.11.2013
(97) 2662095, 13.11.2013 en
(54) Pyrrolbenzodiazepines and conjugates thereof
(71) Spirogen Sàrl, Chemin de la Pacottaz 1 c/o Michael Forer, 1806, St-Légier-La Chiésaz, CH
(72) Howard, Philip Wilson, Spirogen Limited School of Pharmacy 29/39 Brunswick Square, London, Greater London WC1N 1AX, GB
Masterson, Luke, Spirogen Limited School of Pharmacy 29/39 Brunswick Square, London, Greater London WC1N 1AX, GB
Tiberghien, Arnaud, Spirogen Limited School of Pharmacy 29/39 Brunswick Square, London, Greater London WC1N 1AX, GB
Flygare, John A, Genentech Inc 1 Dna Way, San Francisco, CA California 94080, US
Gunzner, Janet L, Genentech Inc 1 Dna Way, San Francisco, CA California 94080, US
Polakis, Paul, Genentech Inc 1 Dna Way, San Francisco, CA California 94080, US
Polson, Andrew, Genentech Inc 1 Dna Way, San Francisco, CA California 94080, US
Raab, Helga E, Genentech Inc 1 Dna Way, San Francisco, CA California 94080, US
Spencer, Susan D, Genentech Inc 1 Dna Way, San Francisco, CA California 94080, US

- (51) MKP
A61K 31/397 (2006.01) (97) **2753326 ***
(86) US2012054191 07.09.2012
(96) 12830073.8 16.07.2014
(87) WO2013036783, 07.09.2012
(97) 2753326, 16.07.2014 en
(54) METHODS FOR TREATING INTRAPULMONARY INFECTIONS
(71) Cubist Pharmaceuticals, Inc., 65 Hayden Avenue, Lexington, MA 02421, US
(72) CHANDORKAR, Gurudatt, A., 267 Bishops Forest Drive, Waltham, MA 02452, US
HUNTINGTON, Jennifer, A., 55 Grand Street, Reading, MA 01867, US
PARSONS, Tara, 32 Shingle Mill Lane, Hanover, MA 02339, US
UMEH, Obiamiwe, C., 57 Stoneymeade Way, Acton, MA 01720, US

- (51) MKP
F02M 63/00 (2006.01) (97) **2647827**
(96) 12163309.3 09.10.2013
(97) 2647827, 09.10.2013 en
(54) Check valve assembly
(71) Delphi International Operations Luxembourg S.à.r.l., Avenue de Luxembourg, 4940 Bascharage, LU
(72) Graham, Mark, 123 Northover Road, Westbury-on-Trym, Bristol BS9 3LG, GB
Tremethick, Tristan, 34 Chandos Road, Redland, Bristol BS6 6PF, GB
Mallela Viswa, Venkata Ravindra, 53 India Road, Gloucestershire GL1 4DL, GB
Williams, Ryan, 13 Lesanne Court Parliament Street, Gloucestershire GL1 1YF, GB

- (51) MKP
A61K 31/416 (2006.01) (97) **2721009 ***
A61P 5/00 (2006.01)
A61P 9/00 (2006.01)
A61P 13/00 (2006.01)
C07D 231/54 (2006.01)
C07D 231/56 (2006.01)
(86) US2012041212 07.06.2012
(96) 12727984.2 23.04.2014
(87) WO2012173849, 07.06.2012
(97) 2721009, 23.04.2014 en
(54) PYRAZOLE DERIVATIVES USEFUL AS ALDOSTERONE SYNTHASE INHIBITORS
(71) Eli Lilly and Company, Lilly Corporate Center, Indianapolis, IN 46285, US
(72) BELL, Michael, Gregory, c/o Eli Lilly and Company P.O. Box 6288, Indianapolis Indiana 46206-6288, US
HOOGESTRAAT, Paul, J., c/o Eli Lilly and Company P.O. Box 6288, Indianapolis Indiana 46206-6288, US
MABRY, Thomas, Edward, c/o Eli Lilly and Company P.O. Box 6288, Indianapolis Indiana 46206-6288, US
SHEN, Quanrong, c/o Eli Lilly and Company P.O. Box 6288, Indianapolis Indiana 46206-6288, US
ESCRIBANO, Ana, Maria, c/o Eli Lilly and Company P.O. Box 6288, Indianapolis Indiana 46206-6288, US

- (51) MKP
G01N 24/00 (2006.01) (97) **2764351 ***
(86) US2012057649 27.09.2012
(96) 12834802.6 13.08.2014
(87) WO2013049410, 27.09.2012
(97) 2764351, 13.08.2014 en
(54) INTACT MASS DETERMINATION OF PROTEIN CONJUGATED AGENT COMPOUNDS
(71) Seattle Genetics, Inc., 21823 30th Drive, S.E., Bothell, WA 98021, US
(72) VALLIERE-DOUGLASS, John Fay, Seattle Genetics, Inc. 21823 30th Drive, S.E., Bothell, Washington 98021, US
SALAS, Oscar, Seattle Genetics, Inc. 21823 30th Drive, S.E., Bothell, Washington 98021, US

- (51) MKP
F21V 35/00 (2006.01) (97) **2729734 ***
F21V 37/02 (2006.01)
F23D 3/16 (2006.01)
(86) PL2012000052 06.07.2012
(96) 12748275.0 14.05.2014
(87) WO2013006070, 06.07.2012
(97) 2729734, 14.05.2014 en
(54) CONTAINER FOR CANDLES, WITH INTERNAL CIRCULATION OF AIR
(71) Korona S.A., Fabryczna 10, 98-300 Wielun, PL
(72) WROBEL, Andrzej, ul. Jesionowa 15, 98-300 Wielu, PL

- (51) MKP
A61P 41/00 (2006.01) (97) **2716684 ***
C07D 401/04 (2006.01)
C08G 73/06 (2006.01)
C08L 79/06 (2006.01)
(86) IB2012052483 17.05.2012
(96) 12785811.6 09.04.2014
(87) WO2012156938, 17.05.2012
(97) 2716684, 09.04.2014 en
(54) COMPOUNDS, PHARMACEUTICAL COMPOSITIONS AND A METHOD FOR THE PROPHYLAXIS AND TREATMENT OF THE ADHESION PROCESS
(71) Joint Stock Company "Pharmasyntez", Patent Attorney RF Fedorov D.V. Office 3 Dom 23 ul. Krasnogvardeyskaya, Irkutsk 664007, RU
(72) SHURYGIN, Mikhail Gennadievich, Marshal Zhukov Avenue 1-26, Irkutsk 664057, RU
SHURYGINA, Irina Aleksandrovna, Marshal Zhukov Avenue 1-26, Irkutsk 664057, RU

(51) MKP
A61K 39/395 (2006.01) (97) **2705058 ***
A61P 37/06 (2006.01)
C07K 16/24 (2006.01)
C07K 16/46 (2006.01)
(86) EP2012058313 04.05.2012
(96) 12726593.2 12.03.2014
(87) WO2012156219, 04.05.2012
(97) 2705058, 12.03.2014 en
(54) AMINO ACID SEQUENCES DIRECTED AGAINST IL-17A, IL-17F AND/OR IL-17-A/F AND POLYPEPTIDES COMPRISING THE SAME
(71) Merck Patent GmbH, Frankfurter Strasse 250, 64293 Darmstadt, DE
(72) ROMMELAERE, Heidi, Koepoortkaai 29, B-9000 Gent, BE
KOLKMAN, Joost Alexander, Voetweg 13, B-9830 Sint-Martens-Latem, BE
SAUNDERS, Michael John Scott, Avenue de la Jonction 38, B-1190 Brussel, BE
UNION, Ann, Savooien 15, B-9880 Aalter, BE
CHVATCKHO, Yolande, 46 chemin du Vuillonex, CH-1232 Confignon, CH
PROUDFOOT, Amanda E.I., 319 rue de Colvert, F-74140 Chens sur Léman, FR
VICARI, Alain, 32 la Ruelle, F-74160 Neydens, FR
BRUNIQUEL, Denis, 324 rue des Soldanelles, F-01710 Thoiry, FR
CHEVALET, Laurent, 1241 route de Ferrières, F-74350 Cuvat, FR
LEGER, Olivier, 603 route des Luches, F-74800 Saint-Sixt, FR

(51) MKP
C07D 403/14 (2006.01) (97) **2768825 ***
(86) US2012060560 17.10.2012
(96) 12842330.8 27.08.2014
(87) WO2013059281, 17.10.2012
(97) 2768825, 27.08.2014 en
(54) PROCESSES FOR THE PREPARATION OF NOVEL BENZIMIDAZOLE DERIVATIVES
(71) Enanta Pharmaceuticals, Inc., 500 Arsenal Street, Watertown, MA 02472, US
(72) TANG, Datong, 35 Court Street, Newton, MA 02458, US
XU, Guoyou, 17 Jay Drive, Framingham, MA 01701, US
PENG, Xiaowen, 66 Homer Avenue 410, Cambridge, MA 02138, US
YING, Lu, 1299 Ziyus Road, Shanghai 200331, CN
WANG, Ce, Building 20 18 Xue Yuan Road Apt. 1706 Hai Dinn District, Beijing 100083, CN
CAO, Hui, 53 Hill Road, Belmont, MA 02478, US
LONG, Jiang, 15 Wallace Road, Wayland, MA 01778, US
KIM, In, Jong, 20 Phinney Road, Lexington, MA 02421, US
WANG, Guoqiang, 65 Becket Road, Belmont, MA 02478, US
QIU, Yao-ling, 29 Linda Road, Andover, MA 01810, US
OR, Yat, Sun, 169 Fayette Street, Watertown, MA 02472, US

(51) MKP
A01K 3/00 (2006.01) (97) **2720530 ***
(86) NZ2012000098 14.06.2012
(96) 12801144.2 23.04.2014
(87) WO2012173500, 14.06.2012
(97) 2720530, 23.04.2014 en
(54) OUTRIGGER
(71) Dalrymple, Roger Kenneth Roy, Waitatapia, RD1, Bulls, NZ
(72) Dalrymple, Roger Kenneth Roy, Waitatapia, RD1, Bulls, NZ

(51) MKP
G01N 24/10 (2006.01) (97) **2702400 ***
G01N 24/12 (2006.01)
G01R 33/24 (2006.01)
G01R 33/60 (2006.01)
G01R 33/62 (2006.01)
(86) US2012035663 27.04.2012
(96) 12777683.9 05.03.2014
(87) WO2012149473, 27.04.2012
(97) 2702400, 05.03.2014 en
(54) COMPOSITIONS AND METHODS TO ASSESS THE CAPACITY OF HDL TO SUPPORT REVERSE CHOLESTEROL TRANSPORT
(71) Children's Hospital & Research Center at Oakland, 5700 Martin Luther King Jr. Way, Oakland, CA 94606, US
(72) ODA, Michael, N., 1988 Gentle Creek Drive, Fairfield, CA 94534, US

(51) MKP
A61K 31/131 (2006.01) (97) **2717893 ***
A61K 31/132 (2006.01)
A61K 31/215 (2006.01)
A61K 31/56 (2006.01)
A61K 38/00 (2006.01)
A61K 38/16 (2006.01)
A61K 38/43 (2006.01)
(86) US2012041724 08.06.2012
(96) 12728007.1 16.04.2014
(87) WO2012170930, 08.06.2012
(97) 2717893, 16.04.2014 en
(54) LIPID NANOPARTICLE COMPOSITIONS AND METHODS FOR MRNA DELIVERY
(71) Shire Human Genetic Therapies, Inc., 300 Shire Way, Lexington MA 02421, US
(72) GUILD, Braydon, Charles, 109 Riverdale Road, Concord, MA 01742, US
DEROSA, Frank, 26 Mount Auburn Street, Chelmsford, MA 01824, US
HEARTLEIN, Michael, 167 Reed Farm Road, Boxborough, MA 01719, US

(51) MKP
B65D 30/24 (2006.01) (97) **2684812**
(96) 13175530.8 15.01.2014
(97) 2684812, 15.01.2014 en
(54) Fluid container
(71) Schur Technology A/S, Fuglevangsvej 41, 8700 Horsens, DK
(72) Pape, Henrik, Lindevej 23, 8700 Horsens, DK

(51) MKP
A61K 39/395 (2006.01) (97) **2764023 ***
A61P 35/00 (2006.01)
A61P 37/08 (2006.01)
C07K 16/18 (2006.01)
(86) US2012058910 05.10.2012
(96) 12838824.6 13.08.2014
(87) WO2013052772, 05.10.2012
(97) 2764023, 13.08.2014 en
(54) ANTI-HUMAN SEMA4A ANTIBODIES USEFUL TO TREAT DISEASE
(71) Board of Regents, The University of Texas System, 201 West 7th Street, Austin, TX 78701, US
(72) LIU, Yong-jun, 2623 West Bainbridge Circle, Pearland, TX 77584, US
LU, Ning, 7900 Cambridge Apt. 26-1G, Houston, TX 77054, US
BOVER, Laura, 4522 Brookren Court, Pearland, TX 77584, US
TSURUSHITA, Naoya, 3719 Redwood Circle, Palo Alto, CA 94306, US
TSO, J., Yun, 445 Oak Grove Avenue 16, Menlo Park, CA 94025, US
KUMAR, Shankar, 3930 Kral Place, Pleasanton, CA 94588, US

(51) MKP
B29C 45/18 (2006.01) (97) **2718087 ***
B29C 49/00 (2006.01)
B29C 49/22 (2006.01)
B65D 81/24 (2006.01)
(86) BE2012000022 02.05.2012
(96) 12740451.5 16.04.2014
(87) WO2012145803, 02.05.2012
(97) 2718087, 16.04.2014 en
(54) POLYMER PRODUCT AND METHOD OF MANUFACTURING THE PRODUCT
(71) Resilux N.V., Damstraat 4, 9230 Wetteren, BE
(72) DIERICKX, William, Leenstraat 41, B-9070 Destelbergen, BE
DE CUYPER, Dirk, Molenweidestraat 5, B-9070 Destelbergen, BE
GUNDE-CIMERMAN, Nina, Presernova 15, 1000 Ljubljana, SI
POKLAR ULRIH, Natasa, Bezigrad 18, 1000 Ljubljana, SI

- (51) MKP
A01G 25/06 (2006.01) (97) **2760274 ***
 (86) EP2012068929 26.09.2012
 (96) 12762298.3 06.08.2014
 (87) WO2013045476, 26.09.2012
 (97) 2760274, 06.08.2014 en
 (54) IRRIGATION MAT
 (71) IGG-Internationale Geotextil Gesellschaft mbH, Am Bahnhof 54, 27239 Twistringen, DE
 (72) ROESS, Thomas, Buschweg 3, 27239 Twistringen, DE
 POLDERMAN, Todd, 895 Windridge Circle, San Marcos, CA 92078, US

- (51) MKP
F25D 3/08 (2006.01) (97) **2722618**
 (96) 13004966.1 23.04.2014
 (97) 2722618, 23.04.2014 en
 (54) Container with regulation of content temperature
 (71) Farmadent d.o.o., Minalikova ulica 6, 2000 Maribor, SI
 (72) Marolt, Robert, Ulica Mo'za Pijade 21b., 2000 Maribor, SI
 Verdel, David, Zavrh pri Galiciji 9., 3310 Zalec, SI

- (51) MKP
G06Q 50/00 (2012.01) (97) **2715650 ***
 (86) EP2012060452 01.06.2012
 (96) 12729910.5 09.04.2014
 (87) WO2012164098, 01.06.2012
 (97) 2715650, 09.04.2014 en
 (54) A REFUSE COLLECTION SYSTEM AND METHOD
 (71) Zerobin Group Limited, 10 Myrtle Park, Dun Laoghaire, County Dublin, IE
 (72) MCSWEENEY, Paul Terence, 10 Myrtle Park, Dun Laoghaire County Dublin, IE

- (51) MKP
A61K 31/519 (2006.01) (97) **2709627 ***
A61K 35/00 (2006.01)
 (86) US2012036405 03.05.2012
 (96) 12785624.3 26.03.2014
 (87) WO2012158362, 03.05.2012
 (97) 2709627, 26.03.2014 en
 (54) INDUCTION OF IMMUNE TOLERANCE BY USING METHOTREXATE
 (71) Genzyme Corporation, 500 Kendall Street, Cambridge, MA 02142, US
 (72) JOSEPH, Alexandra, 2 Berwick Road, Lexington, MA 02420, US
 RICHARDS, Susan, 44 Codman Drive, Sudbury, MA 01776, US
 RUZEK, Melanie, 3 Maddy Lane, Acton, MA 01720, US
 GARMAN, Richard, 1 Joshua Path, Natick, MA 01760, US

- (51) MKP
B27B 5/29 (2006.01) (97) **2750842 ***
 (86) NZ2012000153 31.08.2012
 (96) 12850588.0 09.07.2014
 (87) WO2013073962, 31.08.2012
 (97) 2750842, 09.07.2014 en
 (54) CUTTING MACHINE TABLE MANUFACTURING METHOD
 (71) Eigen Systems Limited, 30 Triton Drive, Albany Auckland 0632, NZ
 (72) FORLONG, Murray Houlton, 1599 State Highway 17 Dairy Flat, Auckland 0794, NZ

- (51) MKP
A23L 1/30 (2006.01) (97) **2704733 ***
A61K 35/74 (2006.01)
 (86) BG2012000014 03.05.2012
 (96) 12727221.9 12.03.2014
 (87) WO2012149615, 03.05.2012
 (97) 2704733, 12.03.2014 en
 (54) POLYBACTERIAL PREPARATION WITH HEALTH BENEFITS: ANTIOXIDANT EFFECT, REDUCTION OF CHOLESTEROL CONCENTRATION, ANTI-INFLAMMATORY IMMUNOMODULATING EFFECT AND RELEASE OF BIOACTIVE PEPTIDES INHIBITING ANGIOTENSIN-CONVERTING ENZYME
 (71) LB Bulgaricum PLC, 9 Saborna Street, 1000 Sofia, BG
 (72) DIMITROV, Zhechko, 10 Mitropolit Panaret Street, 1505 Sofia, BG
 MICHAYLOVA, Michaela, 23 Geo Milev Street App.4, 1111 Sofia, BG

- (51) MKP
B01F 3/04 (2006.01) (97) **2701832 ***
B01F 3/22 (2006.01)
B01F 5/04 (2006.01)
F04F 5/04 (2006.01)
 (86) DE2012100120 27.04.2012
 (96) 12727269.8 05.03.2014
 (87) WO2012146241, 27.04.2012
 (97) 2701832, 05.03.2014 de
 (54) METHOD AND DEVICE FOR ENRICHING A LIQUID WITH OXYGEN
 (71) Würdig, Uwe, Hunsrückstraße 10, 13086 Berlin, DE
 (72) Würdig, Uwe, Hunsrückstraße 10, 13086 Berlin, DE

- (51) MKP
A61K 31/122 (2006.01) (97) **2701697 ***
A61K 31/20 (2006.01)
A61K 31/202 (2006.01)
A61K 31/375 (2006.01)
A61P 27/00 (2006.01)
A61P 27/02 (2006.01)
 (86) US2012034836 24.04.2012
 (96) 12776521.2 05.03.2014
 (87) WO2012148930, 24.04.2012
 (97) 2701697, 05.03.2014 en
 (54) OXIDATIVE RETINAL DISEASES
 (71) Retrotape, Inc., 12133 Foothill Lane, Los Altos Hills, CA 94022-3319, US
 (72) SHCHEPINOV, Mikhail, Sergeevich, 63 Barnfield Avenue, Kingston Upon Thames Surrey KT2 5RG, GB

- (51) MKP
A61K 31/519 (2006.01) (97) **2748156 ***
A61P 29/00 (2006.01)
C07C 211/35 (2006.01)
C07D 401/04 (2006.01)
C07D 495/04 (2006.01)
 (86) EP2012066104 17.08.2012
 (96) 12762543.2 02.07.2014
 (87) WO2013026797, 17.08.2012
 (97) 2748156, 02.07.2014 en
 (54) NOVEL PIPERIDINO-DIHYDROTHIENOPYRIMIDINE SULFOXIDES AND THEIR USE FOR TREATING COPD AND ASTHMA
 (71) Boehringer Ingelheim International GmbH, Binger Straße 173, 55216 Ingelheim, DE
 (72) POUZET, Pascale, A., J., Boehringer Ingelheim GmbH Corporate Patents Binger Str. 173, 55216 Ingelheim Am Rhein, DE
 NICKOLAUS, Peter, Boehringer Ingelheim GmbH Corporate Patents Binger Str. 173, 55216 Ingelheim Am Rhein, DE
 WERTHMANN, Ulrike, Boehringer Ingelheim GmbH Corporate Patents Binger Str. 173, 55216 Ingelheim Am Rhein, DE
 FRUTOS, Rogelio, P., VP IP Legal Boehringer Ingelheim USA Corp. 900 Ridgebury Road, Ridgefield, Connecticut 06877, US
 YANG, Bing-Shiou, VP IP Legal Boehringer Ingelheim USA Corp. 900 Ridgebury Road, Ridgefield, Connecticut 06877, US
 KIM, Soojin, VP IP Legal Boehringer Ingelheim USA Corp. 900 Ridgebury Road, Ridgefield, Connecticut 06877, US
 MULDER, Jason, Alan, VP IP Legal Boehringer Ingelheim USA Corp. 900 Ridgebury Road, Ridgefield, Connecticut 06877, US
 PATEL, Nitinchandra, VP IP Legal Boehringer Ingelheim USA Corp. 900 Ridgebury Road, Ridgefield, Connecticut 06877, US
 SENANAYAKE, Chris, H., VP IP Legal Boehringer Ingelheim USA Corp. 900 Ridgebury Road, Ridgefield, Connecticut 06877, US
 TAMPONE, Thomas, G., VP IP Legal Boehringer Ingelheim USA Corp. 900 Ridgebury Road, Ridgefield, Connecticut 06877, US
 WEI, Xudong, VP IP Legal Boehringer Ingelheim USA Corp. 900 Ridgebury Road, Ridgefield, Connecticut 06877, US

(51) MKP
G06F 17/18 (2006.01) (97) **2764444 ***
 (86) IB2012055395 05.10.2012
 (96) 12838447.6 13.08.2014
 (87) WO2013050984, 05.10.2012
 (97) 2764444, 13.08.2014 en
 (54) DATA FUSION IN HIGH COMPUTATIONAL LOAD ENVIRONMENTS
 (71) ATS Group (IP Holdings) Limited, 30 de Castro Street Wickhams Cay 1 P.O. Box 4519, Road Town, Tortola, VG Painsky, Amichai, Hattalim 18, 43568 Ra'anana, IL
 (72) PAINSKY, Amichai, Hattalim 18, 43568 Ra'anana, IL

(51) MKP
A61K 39/395 (2006.01) (97) **2736529 ***
C07K 16/40 (2006.01)
 (86) US2012048574 27.07.2012
 (96) 12762426.0 04.06.2014
 (87) WO2013016648, 27.07.2012
 (97) 2736529, 04.06.2014 en
 (54) STABILIZED FORMULATIONS CONTAINING ANTI-PCSK9 ANTIBODIES
 (71) Regeneron Pharmaceuticals, Inc., 777 Old Saw Mill River Road, Tarrytown, NY 10591, US
 (72) WALSH, Scott, c/o Regeneron Pharmaceuticals, Inc. 777 Old Saw Mill River Road, Tarrytown, NY 10591, US
 DIX, Daniel, c/o Regeneron Pharmaceuticals, Inc. 777 Old Saw Mill River Road, Tarrytown, NY 10591, US

(51) MKP
F16K 3/02 (2006.01) (97) **2724085 ***
F16K 27/04 (2006.01)
F24F 13/12 (2006.01)
 (86) FR2012051468 26.06.2012
 (96) 12738529.2 30.04.2014
 (87) WO2013001229, 26.06.2012
 (97) 2724085, 30.04.2014 fr
 (54) SLIDE DAMPER FOR A FLUID-EXTRACTING SYSTEM, AND EQUIPMENT COMPRISING SUCH A SLIDE DAMPER
 (71) Cattin Filtration, 6, rue des Bouleaux, 25150 Pont de Roide, FR
 (72) CHOLET, Romuald, 10 rue de Chatey, F-25150 Pont de Roide, FR

(51) MKP
A61K 31/42 (2006.01) (97) **2766039 ***
A61K 31/519 (2006.01)
A61K 31/655 (2006.01)
A61K 39/395 (2006.01)
A61K 45/06 (2006.01)
C07K 16/28 (2006.01)
 (86) EP2012070052 10.10.2012
 (96) 12769684.7 20.08.2014
 (87) WO2013053751, 10.10.2012
 (97) 2766039, 20.08.2014 en
 (54) COMPOSITIONS FOR THE TREATMENT OF RHEUMATOID ARTHRITIS AND METHODS OF USING SAME
 (71) SANOFI, 54 rue La Boétie, 75008 Paris, FR
 Regeneron Pharmaceuticals, Inc., 777 Old Saw Mill River Road, Tarrytown, NY 10591-6707, US
 (72) HUANG, Xiaohong, c/o REGENERON PHARMACEUTICALS Inc. 777 Old Saw Mill River Road, Tarrytown New York 10591-6707, US
 JASSON, Martine, c/o Sanofi Patent Department 54 rue La Boétie, F-75008 Paris, FR
 MARKS, Vanessa, c/o Sanofi Patent Department 54 rue La Boétie, F-75008 Paris, FR
 RADIN, Allen, c/o REGENERON PHARMACEUTICALS Inc. 777 Old Saw Mill River Road, Tarrytown New York 10591-6707, US

(51) MKP
A61K 9/00 (2006.01) (97) **2765986 ***
A61K 31/573 (2006.01)
A61K 47/48 (2006.01)
A61P 27/02 (2006.01)
 (86) EP2012070212 11.10.2012
 (96) 12772778.2 20.08.2014
 (87) WO2013053856, 11.10.2012
 (97) 2765986, 20.08.2014 en
 (54) PREVENTION AND TREATMENT OF OCULAR CONDITIONS
 (71) Ascendis Pharma Ophthalmology Division A/S, Tuborg Boulevard 12, 2900 Hellerup, DK
 (72) KNAPPE, Thomas, Königsberger Str. 19a, 69124 Heidelberg, DE
 LAUFER, Burkhardt, Goethestrasse 8, 69221 Dossenheim, DE
 RAU, Harald, Talstrasse 41li, 69221 Dossenheim, DE
 SPROGØE, Kenneth, 4248H Rickey's Way, Palo Alto, California 94306, US
 VOIGT, Tobias, Karlsruher Strasse 188/1, 69126 Heidelberg, DE
 WEISBROD, Samuel, Husarenstr. 8, 69121 Heidelberg, DE

(51) MKP
A61K 9/00 (2006.01) (97) **2753302 ***
A61K 31/137 (2006.01)
A61K 47/10 (2006.01)
A61K 47/36 (2006.01)
A61K 47/38 (2006.01)
 (86) IB2012053683 19.07.2012
 (96) 12751609.4 16.07.2014
 (87) WO2013011477, 19.07.2012
 (97) 2753302, 16.07.2014 en
 (54) PHARMACEUTICAL INVENTION OF TAPENTADOL
 (71) Torrent Pharmaceuticals Ltd., "Torrent House" Near Dinesh Hall Off Ashram Road Ahmedabad 380 009, Gujarat, IN
 (72) NADKARNI, Sunil, Sadanand, Torrent Research Centre Village Bhat, Gandhinagar Gujarat 382 428, IN
 ABRAHAM, Jaya, Torrent Research Centre Village Bhat, Gandhinagar Gujarat 382 428, IN
 KHATRI, Kapil, Torrent Research Centre Village Bhat, Gandhinagar Gujarat 382 428, IN
 MITTAL, Vipul, Torrent Research Centre Village Bhat, Gandhinagar Gujarat 382 428, IN

(51) MKP
A23L 1/054 (2006.01) (97) **2745839**
A23L 1/30 (2006.01)
A61K 9/00 (2006.01)
A61K 9/10 (2006.01)
A61K 31/7048 (2006.01)
A61K 47/36 (2006.01)
 (96) 13198744.8 25.06.2014
 (97) 2745839, 25.06.2014 fr
 (54) Pharmaceutical composition in the form of an oral suspension including a flavonoid fraction and xanthan gum
 (71) Les Laboratoires Servier, 35, rue de Verdun, 92284 Suresnes Cedex, FR
 (72) Marsas, Stéphanie, 6, allée des Chartreux, 45430 Checy, FR
 Pean, Jean-Manuel, 12, rue Adolphe Crespin, 45000 Orleans, FR

(51) MKP
A61K 31/4995 (2006.01) (97) **2703402 ***
A61P 25/28 (2006.01)
C07D 471/08 (2006.01)
 (86) RU2012000267 10.04.2012
 (96) 12777274.7 05.03.2014
 (87) WO2012148308, 10.04.2012
 (97) 2703402, 05.03.2014 en
 (54) PHARMACOLOGICALLY ACTIVE ALICYCLIC N,N'-SUBSTITUTED 3,7-DIAZABICYCLO[3.3.1]NONANE DERIVATIVES AND DRUGS BASED THEREON
 (71) Zapolsky, Maxim Eduardovich, ul. Serafimovicha 6 Tomilino, Moskovskaya obl. 140073, RU
 (72) ZEFIROV, Nikolay Serafimovich, Leninskiy prospekt 99-553, Moscow 119421, RU
 PALYULIN, Vladimir Alexandrovich, pr. Vernadskogo 9/10-17, Moscow 119311, RU
 LAVROV, Mstislav Igorevich, ul. . Serpukhovskaya 36-8, Moscow 115093, RU

(51) MKP
F24J 3/00 (2006.01) (97) **2732220 ***
 (86) HU2012000059 12.07.2012
 (96) 12810923.8 21.05.2014
 (87) WO2013008045, 12.07.2012
 (97) 2732220, 21.05.2014 en
 (54) ENERGY CELL AND PROCEDURE FOR THE EXPLOITATION OF HEAT ENERGY ARISING DURING AEROBIC PROCESSES
 (71) Tyukodi, Peter, Sáfrány str 11/a, 8200 Veszprém, HU
 Tyukodiné Mikó, Györgyi, Sáfrány str 11/a, 8200 Veszprém, HU
 Tyukodi, Imre, Sáfrány str 11/a, 8200 Veszprém, HU
 Tyukodi, Lilla Györgyi, Sáfrány str 11/a, 8200 Veszprém, HU
 (72) ILLÉS, Zsolt, Szegfu str. 8., H-8308 Zalahaláp, HU
 ILLÉSNÉ ARANYODI, Ildikó, Szegfu str. 8., H-8308 Zalahaláp, HU

(51) MKP
F16H 1/22 (2006.01) (97) **2685252**
F16L 55/40 (2006.01)
G01N 27/82 (2006.01)
 (96) 13156720.8 15.01.2014
 (97) 2685252, 15.01.2014 en
 (54) Conduit sensor device and process for modifying a magnetic field of a conduit sensor device
 (71) Invodane Engineering Ltd., 30 Lesmill Road, Toronto ON M3B 2T6, CA
 (72) Larsen, Paul, 34 Crosburn Drive, Toronto, Ontario M3B 2Z2, CA
 Comello, Corry, 65 Crosland Drive, Scarborough, Ontario M1R 4M9, CA

(51) MKP
A61K 47/48 (2006.01) (97) **2714737 ***
C07K 16/28 (2006.01)
 (86) EP2012059762 24.05.2012
 (96) 12723206.4 09.04.2014
 (87) WO2012163805, 24.05.2012
 (97) 2714737, 09.04.2014 en
 (54) BCMA (CD269/TNFRSF17) -BINDING PROTEINS
 (71) Glaxo Group Limited, 980 Great West Road, Brentford, Middlesex TW8 9GS, GB
 (72) ALGATE, Paul, 580 Kalmia Place NW, Issaquah, Washington, US
 CLEGG, Stephanie Jane, GlaxoSmithKline Gunnels Wood Road, Stevenage Hertfordshire SG1 2NY, GB
 CRAIGEN, Jennifer, L., GlaxoSmithKline Gunnels Wood Road, Stevenage Hertfordshire SG1 2NY, GB
 HAMBLIN, Paul Andrew, GlaxoSmithKline Gunnels Wood Road, Stevenage Hertfordshire SG1 2NY, GB
 LEWIS, Alan Peter, GlaxoSmithKline Gunnels Wood Road, Stevenage Hertfordshire SG1 2NY, GB
 PARMAR, Radha Shah, GlaxoSmithKline Gunnels Wood Road, Stevenage Hertfordshire SG1 2NY, GB
 MAYES, Patrick, GlaxoSmithKline 1250 S. Collegeville Road, Collegeville, Pennsylvania 19426-0989, US
 WATTAM, Trevor Anthony Kenneth, GlaxoSmithKline Gunnels Wood Road, Stevenage Hertfordshire SG1 2NY, GB

(51) MKP
C12N 5/07 (2010.01) (97) **2768947 ***
 (86) EP2012000657 15.02.2012
 (96) 12705789.1 27.08.2014
 (87) WO2012110232, 15.02.2012
 (97) 2768947, 27.08.2014 de
 (54) METHOD FOR PRODUCING A PRODUCT USING CELLS OF THE HAIR ROOT SHEATH, PRODUCT AND KIT
 (71) Sinclair Pharmaceuticals Limited, Office Village Chester Business Park, Chester CH4 9QZ, GB
 (72) RICHTER, Wolfgang, Gartenstrasse 67, 85354 Freising, DE
 TOLOCZYKI, Christian, Schlossblick 12, 04827 Machern, DE

(51) MKP
A01N 43/54 (2006.01) (97) **2704572 ***
A01N 43/66 (2006.01)
A61K 31/505 (2006.01)
A61K 31/53 (2006.01)
C07D 401/00 (2006.01)
 (86) US2012036683 04.05.2012
 (96) 12779411.3 12.03.2014
 (87) WO2012151561, 04.05.2012
 (97) 2704572, 12.03.2014 en
 (54) COMPOUNDS FOR INHIBITING CELL PROLIFERATION IN EGFR-DRIVEN CANCERS
 (71) ARIAD Pharmaceuticals, Inc., 26 Landsdowne Street, Cambridge, MA 02139, US
 (72) DALGARNO, David, C., 50 Crowninshield Road, Brookline, MA 02446, US
 HUANG, Wei-sheng, 8 Mohegan Road, Acton, MA 01720, US
 SHAKESPEARE, William, C., 2 Hubley Lane, Southborough, MA 01772, US
 WANG, Yihan, 45 Madison Avenue, Newton, MA 02460, US
 ZHU, Xiaotian, 137 Temple Street, Newton, MA 02465, US

(51) MKP
A61K 31/437 (2006.01) (97) **2751104 ***
A61P 3/00 (2006.01)
A61P 11/00 (2006.01)
A61P 17/00 (2006.01)
A61P 29/00 (2006.01)
C07D 471/04 (2006.01)
 (86) US2012052802 29.08.2012
 (96) 12756885.5 09.07.2014
 (87) WO2013033167, 29.08.2012
 (97) 2751104, 09.07.2014 en
 (54) COMPOUNDS AND COMPOSITIONS AS C-KIT KINASE INHIBITORS
 (71) IRM LLC, 131 Front Street P.O. Box HM 2899, Hamilton HM LX, BM
 (72) MOLTENI, Valentina, Genomics Institute of the Novartis Research Foundation 10675 John Jay Hopkins Drive, San Diego, California 92121, US
 PETRASSI, Hank Michael James, Genomics Institute of the Novartis Research Foundation 10675 John Jay Hopkins Drive, San Diego, California 92121, US
 LI, Xiaolin, Genomics Institute of the Novartis Research Foundation 10675 John Jay Hopkins Drive, San Diego, California 92121, US
 LIU, Xiaodong, Genomics Institute of the Novartis Research Foundation 10675 John Jay Hopkins Drive, San Diego, California 92121, US
 LOREN, Jon, Genomics Institute of the Novartis Research Foundation 10675 John Jay Hopkins Drive, San Diego, California 92121, US
 NABAKKA, Juliet, Genomics Institute of the Novartis Research Foundation 10675 John Jay Hopkins Drive, San Diego, California 92121, US
 NGUYEN, Bao, Genomics Institute of the Novartis Research Foundation 10675 John Jay Hopkins Drive, San Diego, California 92121, US
 YEH, Vince, Genomics Institute of the Novartis Research Foundation 10675 John Jay Hopkins Drive, San Diego, California 92121, US

(51) MKP
G01N 21/90 (2006.01) (97) **2726856 ***
 (86) US2012041074 06.06.2012
 (96) 12731224.7 07.05.2014
 (87) WO2013002982, 06.06.2012
 (97) 2726856, 07.05.2014 en
 (54) OPTICAL INSPECTION OF CONTAINERS
 (71) Owens-Brockway Glass Container INC., One Michael Owens Way, Perrysburg, OH 43551, US
 (72) HALL, George, H., 140 University Blvd., Toledo, OH 43614, US
 DANIEL, Benjamin, L., 2595 Cr 74, Gibsonburg, OH 43431, US
 GRAFF, Stephen, M., 1911 Key Street Apt. D, Maumee, OH 43537, US
 JUVINALL, John, W., 9200 Head- O-lake Road, Ottawa Lake, MI 49267, US
 KOHLER, Timothy, A., 6952 Silverbrook Court, Waterville, OH 43566, US
 MICHALSKI, Thomas, F., 1055 Wall Street, Maumee, OH 43537, US
 RINGLIEN, James, A., 2210 Glenview Drive, Maumee, OH 43537, US

(51) MKP
H01M 2/02 (2006.01) (97) **2693513**
H01M 10/04 (2006.01)
 (96) 13177971.2 05.02.2014
 (97) 2693513, 05.02.2014 en
 (54) A container for plates of a battery
 (71) Biasin SRL, Via Natta, 17 - Z. A., 36045 Madonna di Lonigo (VI), IT
 (72) Biasin, Renato, Via 4 Novembre, 13, 36050 Montorso Vicentino (VI), IT

(51) MKP
A61K 38/16 (2006.01) (97) **2754718 ***
A61K 38/17 (2006.01)
A61K 47/48 (2006.01)
A61P 35/04 (2006.01)
C07K 14/435 (2006.01)
C12Q 1/42 (2006.01)
 (86) CN2012081210 10.09.2012
 (96) 12830317.9 16.07.2014
 (87) WO2013034116, 10.09.2012
 (97) 2754718, 16.07.2014 en
 (54) VASCULAR ENDOTHELIAL MYOSTATIN MUTANT THAT MUTATES AT ATP BINDING SITES
 (71) Tsinghua University, No. 1 QinghuaYuan, Haidian District Beijing 100084, CN
 Beijing Protgen Ltd., Room B 412 Zhongguancun Biomedical Park No.5 Kaituo Road Haidian District, Beijing 100085, CN
 (72) LUO, Yongzhang, Qinghua Yuan 1 Haidian District, Beijing 100084, CN
 LIU, Peng, Room B412 Zhongguancun Biomedical Park No.5 Kaituo Road Haidian District, Beijing 100085, CN
 LU, Xinan, Qinghua Yuan 1 Haidian District, Beijing 100084, CN
 CHEN, Yang, Qinghua Yuan 1 Haidian District, Beijing 100084, CN
 FU, Yan, Qinghua Yuan 1 Haidian district, Beijing 100084, CN
 CHANG, Guodong, Room B412 Zhongguancun Biomedical Park No.5 Kaituo Road Haidian District, Beijing 100085, CN
 ZHOU, Daifu, Room B412 Zhongguancun Biomedical Park No.5 Kaituo Road Haidian District, Beijing 100085, CN

(51) MKP
F16H 3/00 (2006.01) (97) **2749790**
F16H 3/093 (2006.01)
F16H 61/04 (2006.01)
 (96) 13198791.9 02.07.2014
 (97) 2749790, 02.07.2014 en
 (54) Torque assist system and automated manual transmission
 (71) Hyundai Wia Corporation, 153, Jeongdong-ro Seongsan-gu, Changwon-si, Gyeongsangnam-do 642-110, KR
 (72) Choi, Min Sik, 447-26, Onseok-dong, Hwaseong-si, 445-110 Gyeonggi-do, KR
 Park, Jae Sik, 447-26, Onseok-dong, Hwaseong-si, 445-110 Gyeonggi-do, KR
 Shin, Jae Woon, 447-26, Onseok-dong, Hwaseong-si, 445-110 Gyeonggi-do, KR

(51) MKP
C08L 97/02 (2006.01) (97) **2721110 ***
D04H 1/4218 (2012.01)
D04H 1/64 (2012.01)
 (86) FR2012051331 14.06.2012
 (96) 12731570.3 23.04.2014
 (87) WO2012172255, 14.06.2012
 (97) 2721110, 23.04.2014 fr
 (54) BINDER FOR A MAT MADE OF INORGANIC AND/OR ORGANIC FIBERS, AND RESULTING PRODUCTS
 (71) Saint-Gobain Adfors, 517, Avenue de la Boisse, 73000 Chambéry, FR
 (72) CHUDA, Katarzyna, 3 rue Marguerite Chapon, F-94800 Villejuif, FR
 COURAUD, Aurélien, 4 impasse de la Vigne du Bois, F-86540 Thure, FR

(51) MKP
F16C 19/18 (2006.01) (97) **2715162 ***
F16C 33/58 (2006.01)
 (86) EP2012059342 21.05.2012
 (96) 12722732.0 09.04.2014
 (87) WO2012163707, 21.05.2012
 (97) 2715162, 09.04.2014 de
 (54) LARGE ROLLING BEARING
 (71) Wobben Properties GmbH, Dreekamp 5, 26605 Aurich, DE
 (72) JEPSEN, Torsten, Abraham-Wolffs-Straße 8, 26603 Aurich, DE

(51) MKP
A61K 31/4155 (2006.01) (97) **2763984 ***
A61K 31/506 (2006.01)
C07D 403/12 (2006.01)
C07D 491/10 (2006.01)
 (86) GB2012052445 03.10.2012
 (96) 12772383.1 13.08.2014
 (87) WO2013050757, 03.10.2012
 (97) 2763984, 13.08.2014 en
 (54) 1-PYRAZOLYL-3- (4- ((2 -ANILINOPYRIMIDIN- 4 - YL) OXY) NAPHTHALEN- 1 - YL) UREAS AS P38 MAP KINASE INHIBITORS
 (71) Respivert Limited, 50-100 Holmers Farm Way, High Wycombe, Buckinghamshire HP12 4EG, GB
 (72) ITO, Kazuhiro, c/o Respivert Limited Imperial College Biolncubator Level 1 Bessemer Building, Imperial College London SW7 2AZ, GB
 CHARRON, Catherine Elisabeth, c/o Respivert Limited Imperial College Biolncubator Level 1 Bessemer Building, Imperial College London SW7 2AZ, GB
 KING-UNDERWOOD, John, Moorend Cottage School Lane, Pendock Worcestershire GL19 3PW, GB
 ONIONS, Stuart Thomas, c/o Sygnature Chemical Services Ltd Bicity Nottingham Pennyfoot Street, Nottingham NG1 1GF, GB
 LONGSHAW, Alistair Ian, c/o Sygnature Chemical Services Ltd Bicity Nottingham Pennyfoot Street, Nottingham Nottinghamshire NG1 1GF, GB
 BROECKX, Rudy, c/o Janssen Pharmaceutica NV Turnhoutseweg 30, B-2340 Beerse, BE
 FILLIERS, Walter, c/o Janssen Pharmaceutica NV Turnhoutseweg 30, B-2340 Beerse, BE
 COPMANS, Alex, c/o Janssen Pharmaceutica NV Turnhoutseweg 30, B-2340 Beerse, BE

(51) MKP
A61K 39/155 (2006.01) (97) **2753354 ***
 (86) US2012054395 10.09.2012
 (96) 12829559.9 16.07.2014
 (87) WO2013036907, 10.09.2012
 (97) 2753354, 16.07.2014 en
 (54) NANOEMULSION RESPIRATORY SYNCYTIAL VIRUS (RSV) SUBUNIT VACCINE
 (71) Nanobio Corporation, 2311 Green Road, Suite A, Ann Arbor, MI 48105, US
 (72) HAMOUDA, Tarek, c/o Nanobio Corporation 2311 Green Road, Ann Arbor, MI 48105, US
 FATTOM, Ali, I., c/o Nanobio Corporation 2311 Green Road, Ann Arbor, MI 48105, US
 BAKER, James, R., 3997 Holden Drive, Ann Arbor, MI 48103, US

- (51) MKP
A61K 31/4188 (2006.01) (97) **2741747 ***
A61K 31/7064 (2006.01)
A61P 35/00 (2006.01)
(86) US2012050252 10.08.2012
(96) 12748346.9 18.06.2014
(87) WO2013023119, 10.08.2012
(97) 2741747, 18.06.2014 en
(54) JAK P13K/mTOR COMBINATION THERAPY
(71) Novartis Pharma AG, Postfach, 4002 Basel, CH
Incyte Corporation, Experimental Station Route 141 & Henry Clay Road Building E336, Wilmington, DE 19880, US
(72) VANNUCCHI, Alessandro M., Viale Morgagni 85, 50134 Florence, IT
BOGANI, Costanza, Viale Morgagni 85, 50134 Florence, IT
BARTALUCCI, Niccolo, Viale Morgagni 85, 50134 Florence, IT

- (51) MKP
C07K 16/00 (2006.01) (97) **2729496 ***
(86) EP2012063338 06.07.2012
(96) 12731507.5 14.05.2014
(87) WO2013004841, 06.07.2012
(97) 2729496, 14.05.2014 en
(54) MODULATION OF COMPLEMENT-DEPENDENT CYTOTOXICITY THROUGH MODIFICATIONS OF THE C-TERMINUS OF ANTIBODY HEAVY CHAINS
(71) Genmab A/S, Bredgade 34 E, 1260 Copenhagen K, DK
(72) PARREN, Paul, c/o Genmab B.V. Yalelaan 60, NL-3584 CM Utrecht, NL
VAN BERKEL, Patrick, Derde Westerparklaan 321, NL-3544 NH Utrecht, NL
VAN DEN BREMER, Ewald, c/o Genmab B.V. Yalelaan 60, NL-3584 CM Utrecht, NL

- (51) MKP
B60K 28/06 (2006.01) (97) **2739498 ***
G08B 21/06 (2006.01)
(86) FR2012051784 27.07.2012
(96) 12751091.5 11.06.2014
(87) WO2013017787, 27.07.2012
(97) 2739498, 11.06.2014 fr
(54) SYSTEM AND METHOD FOR PREDICTING A STATE OF DROWSINESS OF A VEHICLE DRIVER
(71) Coyote System, 5 rue Salomon de Rothschild, 92150 Suresnes, FR
(72) PIERLOT, Fabien, c/o Coyote System 5 rue Salomon de Rothschild, F-92150 Suresnes, FR
VAN LAETHEM, Jean-Marc, c/o Coyote System 5 rue Salomon de Rothschild, F-92150 Suresnes, FR

- (51) MKP
E04F 13/14 (2006.01) (97) **2732211 ***
E04F 15/02 (2006.01)
F21S 2/00 (2006.01)
F21V 33/00 (2006.01)
(86) IB2012053414 04.07.2012
(96) 12750812.5 21.05.2014
(87) WO2013008145, 04.07.2012
(97) 2732211, 21.05.2014 en
(54) MODULAR ILLUMINATING TILE
(71) Kiss, Zoltán, Baky u. 1., 5630 Békés, HU
(72) Kiss, Zoltán, Baky u. 1., 5630 Békés, HU

- (51) MKP
C07C 69/753 (2006.01) (97) **2726452 ***
C07D 209/58 (2006.01)
C11D 1/74 (2006.01)
(86) IB2012002120 16.08.2012
(96) 12799591.8 07.05.2014
(87) WO2013024363, 16.08.2012
(97) 2726452, 07.05.2014 en
(54) BIORENEWABLE BIODEGRADABLE SURFACTANTS
(71) Dow Global Technologies LLC, 2040 Dow Center, Midland, MI 48674, US
(72) BAILEY, Brad, C., 6205 Nathan Court, Midland, MI 48642, US
NG, Sze-Sze, 2402 Plymouth, Midland, MI 48642, US
PIERRE, Cynthia, 5012 Meyers Street 4, Midland, MI 48640, US
RAND, Cynthia, L., 230 Barden Road, Sanford, MI 48657, US

- (51) MKP
B65D 79/00 (2006.01) (97) **2731890 ***
(86) BE2012000038 09.07.2012
(96) 12761877.5 21.05.2014
(87) WO2013006927, 09.07.2012
(97) 2731890, 21.05.2014 en
(54) CONTAINER WITH CLOSURE HAVING AN INTERNAL MEMBRANE AND METHOD FOR MANUFACTURING THEREOF
(71) Resilux, Damstraat 4, 9230 Wetteren, BE
(72) DE CUYPER, Dirk, Molenweidestraat 5, B-9070 Destelbergen, BE
DIERICKX, William, Leenstraat 41, B-9070 Destelbergen, BE

- (51) MKP
A61K 38/22 (2006.01) (97) **2701728 ***
A61K 47/48 (2006.01)
A61P 31/14 (2006.01)
(86) GB2013050539 05.03.2013
(96) 13709511.3 05.03.2014
(87) WO2014001749, 05.03.2013
(97) 2701728, 05.03.2014 en
(54) FORMULATION COMPRISING CRH AND ALPHA - 2 - IMMUNOGLOBULIN
(71) Aimsco Limited, 4a Gildredge Road, Eastbourne, East Sussex BN21 4RL, GB
(72) MCINTOSH, Deirdre.P., c/o Aimsco Limited 4a Gildredge Road,, Eastbourne East Sussex BN21 4RL, GB
SHOTTON, David.J., c/o Aimsco Limited 4a Gildredge Road,, Eastbourne East Sussex BN21 4RL, GB
HAQ, Syed. Ebadat., c/o Aimsco Limited 4a Gildredge Road,, Eastbourne East Sussex BN21 4RL, GB

- (51) MKP
A61K 31/519 (2006.01) (97) **2742049 ***
A61P 37/00 (2006.01)
C07D 487/14 (2006.01)
(86) JP2012070876 10.08.2012
(96) 12756572.9 18.06.2014
(87) WO2013024895, 10.08.2012
(97) 2742049, 18.06.2014 en
(54) TRICYCLIC HETEROCYCLIC COMPOUNDS AND JAK INHIBITORS
(71) Nissan Chemical Industries, Ltd., 7-1 Kanda-Nishiki-cho 3-chome, Chiyoda-ku Tokyo 101-0054, JP
(72) HAYASHI, Keishi, c/o Nissan Chemical Industries Ltd. Chemical Research Laboratories 10-1 Tsuboi-Nishi 2-chome, Funabashi-shi Chiba 274-8507, JP
WATANABE, Tsuneo, c/o Nissan Chemical Industries Ltd. Chemical Research Laboratories 10-1 Tsuboi-Nishi 2-chome, Funabashi-shi Chiba 274-8507, JP
TOYAMA, Koji, c/o Nissan Chemical Industries Ltd. Chemical Research Laboratories 10-1 Tsuboi-Nishi 2-chome, Funabashi-shi Chiba 274-8507, JP
KAMON, Junji, c/o Nissan Chemical Industries Ltd. Biological Research Laboratories 1470 Oaza-shiraoka Shiraoka-machi, Minamisaitama-gun Saitama 349-0294, JP
MINAMI, Masataka, c/o Nissan Chemical Industries Ltd. Chemical Research Laboratories 10-1 Tsuboi-Nishi 2-chome, Funabashi-shi Chiba 274-8507, JP
UNI, Miyuki, c/o Nissan Chemical Industries Ltd. Chemical Research Laboratories 10-1 Tsuboi-Nishi 2-chome, Funabashi-shi Chiba 274-8507, JP
NASU, Mariko, c/o Nissan Chemical Industries Ltd. Chemical Research Laboratories 10-1 Tsuboi-Nishi 2-chome, Funabashi-shi Chiba 274-8507, JP

(51) MKP
G01N 33/48 (2006.01) (97) **2769321 ***
G01N 33/53 (2006.01)
G06F 19/00 (2011.01)
(86) US2012061202 19.10.2012
(96) 12841790.4 27.08.2014
(87) WO2013059732, 19.10.2012
(97) 2769321, 27.08.2014 en
(54) METHODS FOR IMPROVING INFLAMMATORY BOWEL DISEASE DIAGNOSIS
(71) Nestec S.A., Avenue Nestlé 55, 1800 Vevey, CH
(72) PRINCEN, Fred, 610 Kirkwood Place, La Jolla California 92037, US
LOCKTON, Steven, 3319 Mt Tami Lane, San Diego California 92111, US
CRONER, Lisa, J., 11704 Ramsdell Court, San Diego California 92131, US
FLETCHER, Frederick, A., 1429 Dale Street, San Diego California 92102, US
STOCKFISCH, Thomas, 2336 Canyon Road, Escondido California 92025, US
SINGH, Sharat, 8171 Top of the Morning Way, Rancho Santa Fe California 92127, US

(51) MKP
B29B 7/88 (2006.01) (97) **2760924 ***
B29B 7/90 (2006.01)
B29B 17/00 (2006.01)
B29B 17/02 (2006.01)
B29B 17/04 (2006.01)
B29C 47/10 (2006.01)
C08J 11/04 (2006.01)
C08J 11/06 (2006.01)
(86) TR2011000265 10.11.2011
(96) 11802177.3 06.08.2014
(87) WO2013070176, 10.11.2011
(97) 2760924, 06.08.2014 en
(54) A METHOD FOR RECYCLING WASTE THERMOPLASTIC MATERIALS AND USING THIS RECYCLED THERMOPLASTIC IN COMPOSITE MATERIAL PRODUCTION
(71) Guven, Ali Hakan, Paris Caddesi 16/7, 06540 Ankara, TR
(72) Guven, Ali Hakan, Paris Caddesi 16/7, 06540 Ankara, TR

(51) MKP
G06K 9/00 (2006.01) (97) **2727104 ***
G06Q 10/10 (2012.01)
G10L 17/00 (2013.01)
H04L 29/06 (2006.01)
(86) US2012044723 28.06.2012
(96) 12743266.4 07.05.2014
(87) WO2013006385, 28.06.2012
(97) 2727104, 07.05.2014 en
(54) IDENTIFYING PEOPLE THAT ARE PROXIMATE TO A MOBILE DEVICE USER VIA SOCIAL GRAPHS, SPEECH MODELS, AND USER CONTEXT
(71) Qualcomm Incorporated, 5775 Morehouse Drive, San Diego, CA 92121-1714, US
(72) GROKOP, Leonard Henry, 5775 Morehouse Drive, San Diego, California 92121-1714, US
NARAYANAN, Vidya, 5775 Morehouse Drive, San Diego, California 92121-1714, US

(51) MKP
C12N 5/00 (2006.01) (97) **2718422 ***
(86) IB2012052950 11.06.2012
(96) 12729741.4 16.04.2014
(87) WO2012168930, 11.06.2012
(97) 2718422, 16.04.2014 en
(54) CULTURE MEDIA FOR STEM CELLS
(71) Koninklijke Nederlandse Akademie van Wetenschappen (KNAW), Hubrecht Institute Uppsalalaan 8, 3584 CT Utrecht, NL
(72) CLEVERS, Johannes Carolus, c/o Hubrecht Institute Uppsalalaan 8, NL-3584 CT Utrecht, NL
SATO, Toshiro, c/o Hubrecht Institute Uppsalalaan 8, NL-3584 CT Utrecht, NL
HUCH ORTEGA, Meritxell, c/o Hubrecht Institute Uppsalalaan 8, NL-3584 CT Utrecht, NL
KARTHAUS, Wouter Richard, c/o Hubrecht Institute Uppsalalaan 8, NL-3584 CT Utrecht, NL

(51) MKP
C12Q 1/68 (2006.01) (97) **2764120 ***
(86) US2012059137 05.10.2012
(96) 12780586.9 13.08.2014
(87) WO2013052922, 05.10.2012
(97) 2764120, 13.08.2014 en
(54) STIMULUS-ELICITED GENOMIC PROFILE MARKERS OF A NEURODEGENERATIVE CONDITION
(71) Blanchette Rockefeller Neurosciences Institute, 8 Medical Center Drive, Morgantown, WV 26505-3409, US
Alkon, Daniel L., 2 Seven Locks Court, Bethesda, MD 20817, US
Khan, Tapan Kumar, 710 Timberline, Morgantown, WV 26505, US
(72) ALKON, Daniel, L., 2 Seven Locks Court, Bethesda, MD 20817, US
KHAN, Tapan, K., 710 Timberline Street, Morgantown, WV 26505, US

(51) MKP
A61K 9/00 (2006.01) (97) **2741736 ***
A61K 9/50 (2006.01)
A61K 31/55 (2006.01)
(86) EP2012065680 10.08.2012
(96) 12751035.2 18.06.2014
(87) WO2013024023, 10.08.2012
(97) 2741736, 18.06.2014 en
(54) TASTE MASKED PHARMACEUTICAL COMPOSITION
(71) Boehringer Ingelheim Vetmedica GmbH, Binger Strasse 173, 55216 Ingelheim am Rhein, DE
(72) FOLGER, Martin, Boehringer Ingelheim GmbH Corporate Patents Binger Strasse 173, 55216 Ingelheim Am Rhein, DE
LEHNER, Stefan, Boehringer Ingelheim GmbH Corporate Patents Binger Strasse 173, 55216 Ingelheim Am Rhein, DE
GRAVE, Annette, Glatt GmbH Werner-Glatt-Str. 1, 79589 Binzen, DE
POELLINGER, Norbert, Glatt GmbH Werner-Glatt-Str. 1, 79589 Binzen, DE
SEIDLER, Randolph, Boehringer Ingelheim GmbH Corporate Patents Binger Strasse 173, 55216 Ingelheim am Rhein, DE

(51) MKP
B23K 26/10 (2006.01) (97) **2626165**
B23K 37/04 (2006.01)
(96) 12154242.7 14.08.2013
(97) 2626165, 14.08.2013 de
(54) Work piece support
(71) Bystronic Laser AG, Industriestrasse 21, 3362 Niederönz, CH
(72) Wüthrich, Matthias, Hinterbergweg 14, 4900 Langenthal, CH
Silberbauer, Günther, Fluhweg 383, 4813 Uerkheim, CH

(51) MKP
C07K 14/415 (2006.01) (97) **2742059 ***
C12N 15/82 (2006.01)
(86) EP2012065608 09.08.2012
(96) 12743996.6 18.06.2014
(87) WO2013023992, 09.08.2012
(97) 2742059, 18.06.2014 en
(54) GUARD CELL-SPECIFIC EXPRESSION OF TRANSGENES IN COTTON
(71) Bayer CropScience NV, J.E. Mommaertslaan 14, 1831 Diegem, BE
(72) PIEN, Stéphane, Ferdinand-Schmitz-Strasse 36, 51429 Bergisch Gladbach, DE
DEN BOER, Bart, Wilgenstraat 21, 9820 Merelbeke, BE

(51) MKP
A61K 39/395 (2006.01) (97) **2726103 ***
C07K 16/00 (2006.01)
(86) US2012044974 29.06.2012
(96) 12806897.0 07.05.2014
(87) WO2013006449, 29.06.2012
(97) 2726103, 07.05.2014 en
(54) ANTI-PROPERDIN ANTIBODIES AND USES THEREOF
(71) The Trustees of The University of Pennsylvania, Center for Technology Transfer 3160 Chestnut Street, Suite 200, Philadelphia, PA 19104-6283, US
(72) SONG, Wenchao, 213 Cornell Drive, Bryn Mawr, PA 19010, US

- (51) MKP
A61G 5/04 (2013.01) (97) **2606869**
A61G 5/10 (2006.01)
(86) 12008407.4 26.06.2013
(97) 2606869, 26.06.2013 en
(54) Handlebar for a powered wheelchair
(71) Brandale SAGL, Via Carlo Frasca, 3, 6901 Lugano, CH
(72) Badano, Paolo, Via Marmorassi, 62B, I - 17100 Savona, IT
-
- (51) MKP
A61K 39/395 (2006.01) (97) **2714082 ***
(86) US2012040397 01.06.2012
(96) 12793039.4 09.04.2014
(87) WO2012167032, 01.06.2012
(97) 2714082, 09.04.2014 en
(54) COMPOSITIONS AND METHODS FOR TREATING PAIN
(71) Children's Medical Center Corporation, 55 Shattuck Street, Boston, MA 02115, US
(72) GHASEMLOU, Nader, 51 Gorham Ave 3, Brookline Massachusetts 02445, US
VON HEHN, Christian A., 49 Marion St Apt 1C, Brookline Massachusetts 02446, US
WOOLF, Clifford J., 107 Franklin Street, Newton Massachusetts 02458, US
-
- (51) MKP
A61K 31/433 (2006.01) (97) **2710018 ***
A61K 31/4738 (2006.01)
A61K 31/5025 (2006.01)
A61K 31/519 (2006.01)
A61P 35/00 (2006.01)
C07D 401/00 (2006.01)
C07D 513/16 (2006.01)
C07D 513/22 (2006.01)
(86) GB2012051134 18.05.2012
(96) 12754044.1 26.03.2014
(87) WO2012156756, 18.05.2012
(97) 2710018, 26.03.2014 en
(54) NEW COMPOUNDS
(71) Centro Nacional de Investigaciones Oncológicas (CNIO), Melchor Fernández Almagro 3, 28029 Madrid, ES
(72) PASTOR FERNÁNDEZ, Joaquín, Centro Nacional de Investigaciones Oncológicas (CNIO) Melchor Fernández Almagro 3, E-28029 Madrid, ES
ÁLVAREZ ESCOBAR, Rosa María, Centro Nacional de Investigaciones Oncológicas (CNIO) Melchor Fernández Almagro 3, E-28029 Madrid, ES
RIESCO FAGUNDO, Rosario Concepción, Centro Nacional de Investigaciones Oncológicas (CNIO) Melchor Fernández Almagro 3, E-28029 Madrid, ES
GARCÍA GARCÍA, Ana Belén, Centro Nacional de Investigaciones Oncológicas (CNIO) Melchor Fernández Almagro 3, E-28029 Madrid, ES
RODRÍGUEZ HERGUETA, Antonio, Centro Nacional de Investigaciones Oncológicas (CNIO) Melchor Fernández Almagro 3, E-28029 Madrid, ES
MARTÍN HERNANDO, Jose Ignacio, Centro Nacional de Investigaciones Oncológicas (CNIO) Melchor Fernández Almagro 3, E-28029 Madrid, ES
BLANCO APARICIO, Carmen, Centro Nacional de Investigaciones Oncológicas (CNIO) Melchor Fernández Almagro 3, E-28029 Madrid, ES
CEBRIÁN MUÑOZ, David Álvaro, Centro Nacional de Investigaciones Oncológicas (CNIO) Melchor Fernández Almagro 3, E-28029 Madrid, ES
-
- (51) MKP
C07K 14/705 (2006.01) (97) **2751137 ***
(86) US2012054090 07.09.2012
(96) 12830779.0 09.07.2014
(87) WO2013036721, 07.09.2012
(97) 2751137, 09.07.2014 en
(54) MOLECULAR GENETIC APPROACH TO TREATMENT AND DIAGNOSIS OF ALCOHOL AND DRUG DEPENDENCE
(71) University of Virginia Patent Foundation, 250 West Main Street, Suite 300, Charlottesville, VA 22902, US
(72) JOHNSON, Bankole A., 2857 Carters Mountain Road, Charlottesville Virginia 22902, US

- (51) MKP
C12Q 1/68 (2006.01) (97) **2748356 ***
C40B 30/04 (2006.01)
C40B 40/06 (2006.01)
C40B 40/10 (2006.01)
G01N 33/574 (2006.01)
G06F 19/00 (2011.01)
(86) US2012051944 22.08.2012
(96) 12824991.9 02.07.2014
(87) WO2013028807, 22.08.2012
(97) 2748356, 02.07.2014 en
(54) RENAL CELL CARCINOMA BIOMARKERS AND USES THEREOF
(71) Somalogic, Inc., 2945 Wilderness Place, Boulder, CO 80301, US
(72) OSTROFF, Rachel M., 10203 King Court, Westminster Colorado 80031, US
WILLIAMS, Stephen Alaric, 1188 Forest Avenue, Boulder Colorado 80304, US
RIEL-MEHAN, Michael, 845 W. Linden St., Louisville Colorado 80027, US
BRODY, Edward N., 4121 S. Hampton Circle, Boulder Colorado 80301, US
STEWART, Alex A.E., 20 Wyola Prospect, Waltham Massachusetts 02451, US
KATO, Shintaro, 4840 Meredith Way Unit 10-203, Boulder Colorado 80303, US
-
- (51) MKP
H05K 7/20 (2006.01) (97) **2740337 ***
(86) CN2011001282 04.08.2011
(96) 11870254.7 11.06.2014
(87) WO2013016845, 04.08.2011
(97) 2740337, 11.06.2014 en
(54) METHOD AND DEVICE FOR DETECTING CLOGGING OF A FILTER
(71) Telefonaktiebolaget LM Ericsson (PUBL), null, 164 83 Stockholm, SE
(72) HE, Qingqing, Room 231 Building No.16 Mingjia Garden, Beijing 102209, CN
JIN, Jin, Unit 2 Building No.1 Nanhugu Xili, Beijing 100102, CN
-
- (51) MKP
G06F 11/32 (2006.01) (97) **2737405 ***
G06F 17/30 (2006.01)
(86) EP2012055614 29.03.2012
(96) 12714985.4 04.06.2014
(87) WO2013017296, 29.03.2012
(97) 2737405, 04.06.2014 en
(54) SYSTEMS AND METHODS FOR DATABASE USAGE VISUALIZATION
(71) Starcounter AB, Nybrogatan 15, 114 39 Stockholm, SE
(72) WESTER, Joachim, Bellmansgatan 8, S-118 20 Stockholm, SE

(51) MKP
C21B 5/00 (2006.01) (97) **2743357 ***
 (86) RU2011000960 06.12.2011
 (96) 11870736.3 18.06.2014
 (87) WO2013022372, 06.12.2011
 (97) 2743357, 18.06.2014 en
 (54) BLAST-FURNACE SMELTING METHOD
 (71) Obschestvo s Ogranichennoi Otvetstvennostyu
 "Promyshlennyye Innovatsionnyye Tekhnologii Natsionalnoi
 Koksokhimicheskoi Assotsiatsii", Ul. 8 Marta 14-A of. 402,
 Ekaterinburg 620014, RU
 (72) KOBEL'EV, Vladimir Andreevich, Sirenevyy bulvar 9-96,
 Ekaterinburg 620072, RU
 CHERNAVIN, Alexander Yurevich, ul. Tchaikovskogo 56-142,
 Ekaterinburg 620142, RU
 CHERNAVIN, Daniil Alexandrovich, ul. Tchaikovskogo 56-142,
 Ekaterinburg 620142, RU
 NECHKIN, Georgii Alexandrovich, ul. Jubileinaya 20-27,
 Lesnoy Sverdlovskaya obl. 624205, RU
 STUKOV, Mikhail Ivanovich, ul. Komsomolskaya 47-25,
 Ekaterinburg 620049, RU
 ZAGAINOV, Vladimir Semenovich, ul. Bardina 2/2-83,
 Ekaterinburg 620149, RU
 KOSOGOROV, Sergey Alexandrovich, ul. Lenina 63-28,
 Lesnoy Sverdlovskaya obl. 624205, RU
 ZORIN, Maxim Viktorovich, ul. Nachdiva Onufrieva 8-70,
 Ekaterinburg 620149, RU
 POSOKHOV, Yury Mikhailovich, ul. Bolshakova 101-76,
 Ekaterinburg 620144, RU
 ANDREYKOV, Eugenii Josifovich, ul. Malysheva 76-17,
 Ekaterinburg 620075, RU
 VALYAVIN, Gennady Georgievich, ul. Oktyabrya 180-68, Ufa
 450005, RU
 ZAPORIN, Viktor Pavlovich, ul. Koltsevaya 201/2-62, Ufa
 450068, RU
 SUKHOV, Sergey Vitalevich, ul. 8 Marta 20-1, Ufa 450005, RU
 BIDILO, Igor Viktorovich, ul. Partizanskaya 158-B-12,
 Petropavlovsk 150000, KZ
 MAMAEV, Mikhail Vladimirovich, ul. Marshala Tolbukhina 3-17,
 Perm 614030, RU

(51) MKP
B21K 7/08 (2006.01) (97) **2714991 ***
E01B 9/40 (2006.01)
E01B 9/68 (2006.01)
 (86) AU2012000587 25.05.2012
 (96) 12789049.9 09.04.2014
 (87) WO2012159167, 25.05.2012
 (97) 2714991, 09.04.2014 en
 (54) A RAILWAY RAIL SUPPORT PLATE
 (71) Intercast & Forge Pty Limited, 1 Schumacher Road, Wingfield,
 S.A. 5013, AU
 (72) HARKNESS, Steven, 1 Schumacker Road, Wingfield, S.A.
 5013, AU

(51) MKP
B65D 1/02 (2006.01) (97) **2704954 ***
 (86) US2012036430 04.05.2012
 (96) 12779363.6 12.03.2014
 (87) WO2012151458, 04.05.2012
 (97) 2704954, 12.03.2014 en
 (54) PRESSURE EQUALIZATION APPARATUS FOR A BOTTLE
 (71) Paha Designs, LLC, 818 Logan Street 1202, Denver, CO
 80203, US
 (72) MEAGER, Benjamin, 235 Turtle Way, Bozeman, MT 59715, US

(51) MKP
A47K 10/38 (2006.01) (97) **2641522**
E05D 11/08 (2006.01)
 (96) 12002059.9 25.09.2013
 (97) 2641522, 25.09.2013 en
 (54) A dispenser assembly
 (71) SCA TISSUE FRANCE, 60, avenue de l'Europe, 92270 Bois-
 Colombes, FR
 (72) Stoeffler, Yves, 279, rue de la Montagne, 57200
 Sarreguemines, FR
 Marietta-Tondin, Julien, 15 b, rue du Maréchal Joffre, 67390
 Marckolsheim, FR
 Cattacin, Gilles, 30, rue de Thann, 68000 Colmar, FR
 Janier-Dubry, Jean-Yves, 9 rue de la Combe au Prieur, 39130
 Clairvaux Les Lacs, FR
 Millet, Christine, 1 Sur la Roche, 39170 Saint-Lupicin, FR

(51) MKP
C03C 17/36 (2006.01) (97) **2721660 ***
H01L 51/52 (2006.01)
 (86) FR2012051336 14.06.2012
 (96) 12738490.7 23.04.2014
 (87) WO2012172258, 14.06.2012
 (97) 2721660, 23.04.2014 fr
 (54) SUBSTRATE WITH AN ELECTRODE FOR AN OLED DEVICE
 AND SUCH AN OLED DEVICE
 (71) Saint-Gobain Glass France, 18 avenue d'Alsace, 92400
 Courbevoie, FR
 (72) LIENHART, Fabien, 2276 Fenton Parkway - Apt 218, San
 Diego, CA 92108, US

(51) MKP
B31F 1/07 (2006.01) (97) **2685000**
D04H 1/00 (2006.01)
D21H 25/00 (2006.01)
D21H 27/00 (2006.01)
D21H 27/02 (2006.01)
 (96) 12290231.5 15.01.2014
 (97) 2685000, 15.01.2014 en
 (54) A cloth-like textured nonwoven fabric comprising papermaking
 fibers, calendering roller and method of manufacturing the
 same
 (71) SCA TISSUE FRANCE, 60, avenue de l'Europe, 92270 Bois-
 Colombes, FR
 (72) Pleyber, Emilie, 13, rue Jean Egen, 67600 Selestat, FR
 Jehl, Jean-Louis, 7, rue de Calviac, 67390 Artolsheim, FR
 Laurent, Pierre, 10, route des 3 Epis, 68230 Turkheim, FR
 Bourret, Christian, 8, avenue de la République, 45250
 Ouzouer-sur-Treze, FR
 Caresmel, Xavier, 10, allée des Mérisiers Les Buissons de
 Diane, 45500 Arrabloy, FR
 Hoefft, Benoit, 1, rue des Tilleuls, 68320 Bischwihr, FR

(51) MKP
A61L 2/232 (2006.01) (97) **2766112 ***
B01D 53/02 (2006.01)
B01J 20/02 (2006.01)
B01J 20/20 (2006.01)
B01J 20/28 (2006.01)
B01J 20/32 (2006.01)
 (86) EP2012004057 27.09.2012
 (96) 12769325.7 20.08.2014
 (87) WO2013097912, 27.09.2012
 (97) 2766112, 20.08.2014 de
 (54) METHOD FOR SELF-DETOXIFICATION OF ADSORBENTS
 (71) Blücher GmbH, Mettmanner Strasse 25, 40699 Erkrath, DE
 (72) Die Erfindernennung liegt noch nicht vor, null, null, null

(51) MKP
C23C 14/34 (2006.01) (97) **2742539 ***
H01L 31/042 (2014.01)
H01L 31/18 (2006.01)
 (86) US2012050418 10.08.2012
 (96) 12822137.1 18.06.2014
 (87) WO2013023173, 10.08.2012
 (97) 2742539, 18.06.2014 en
 (54) SPUTTERING SYSTEMS FOR LIQUID TARGET MATERIALS
 (71) Nuvosun, Inc., 1565 Barber Lane, Milpitas, CA 95035, US
 (72) HOLLARS, Dennis, R., 1908 Cresmont Drive, San Jose, CA
 95124-1103, US

(51) MKP
E04B 1/80 (2006.01) (97) **2729635 ***
E06B 3/663 (2006.01)
E06B 7/02 (2006.01)
 (86) SI2012000005 03.02.2012
 (96) 12714093.7 14.05.2014
 (87) WO2013006144, 03.02.2012
 (97) 2729635, 14.05.2014 en
 (54) MULTI CHAMBER GAS FILLED CONSTRUCTION PANEL
 (71) CBS Institut Celovite Gradbene Resitve, d.o.o., Prijateljstva
 cesta 12, 8210 Trebnje, SI
 Reflex, Gornja, Radgona, d.o.o., Podgrad 4, 9250 Gornja
 Radgona, SI
 (72) KRALJ, Ales, Okiskega 25, 1000 Ljubljana, SI
 HAJDINJAK, Rudy, Cresnjevc 69, 9250 Gornja Radgona, SI

- (51) MKP
A61K 31/4436 (2006.01) (97) **2718267 ***
A61K 31/4439 (2006.01)
A61P 11/00 (2006.01)
A61P 17/00 (2006.01)
A61P 37/08 (2006.01)
C07D 213/89 (2006.01)
C07D 401/12 (2006.01)
C07D 401/14 (2006.01)
C07D 405/14 (2006.01)
C07D 413/12 (2006.01)
C07D 417/12 (2006.01)
C07D 417/14 (2006.01)
(86) EP2012060579 05.06.2012
(96) 12732555.3 16.04.2014
(87) WO2012168226, 05.06.2012
(97) 2718267, 16.04.2014 en
(54) DERIVATIVES OF 1-PHENYL-2-PYRIDINYL ALKYL ALCOHOLS AS PHOSPHODIESTERASE INHIBITORS
(71) Chiesi Farmaceutici S.p.A., Via Palermo, 26/A, 43100 Parma, IT
(72) ARMANI, Elisabetta, c/o Chiesi Farmaceutici S.P.A. Via Palermo 26/A, I-43100 Parma, IT
AMARI, Gabriele, c/o Chiesi Farmaceutici S.P.A. Via Palermo 26/A, I-43100 Parma, IT
CARZANIGA, Laura, c/o Chiesi Farmaceutici S.P.A. Via Palermo 26/A, I-43100 Parma, IT
CAPALDI, Carmelida, c/o Chiesi Farmaceutici S.P.A. Via Palermo 26/A, I-43100 Parma, IT
ESPOSITO, Oriana, c/o Chiesi Farmaceutici S.P.A. Via Palermo 26/A, I-43100 Parma, IT
VILLETTI, Gino, c/o Chiesi Farmaceutici S.P.A. Via Palermo 26/A, I-43100 Parma, IT
DE FANTI, Renato, c/o Chiesi Farmaceutici S.P.A. Via Palermo 26/A, I-43100 Parma, IT
-
- (51) MKP
A61K 31/343 (2006.01) (97) **2753325 ***
A61P 31/14 (2006.01)
C07D 307/82 (2006.01)
C07D 405/10 (2006.01)
(86) CN2012001117 20.08.2012
(96) 12830590.1 16.07.2014
(87) WO2013033971, 20.08.2012
(97) 2753325, 16.07.2014 en
(54) TETRACYCLIC HETEROCYCLE COMPOUNDS AND METHODS OF USE THEREOF FOR THE TREATMENT OF VIRAL DISEASES
(71) Merck Sharp & Dohme Corp., 126 East Lincoln Avenue, Rahway NJ 07065-0907, US
MSD Italia S.r.l., Via Vitorchiano, 151, 00189 Rome, IT
(72) MCCOMAS, Casey Cameron, Merck Research Laboratories Sumneytown Pike P.O. Box 4, West Point, Pennsylvania 19486, US
LIVERTON, Nigel J., Merck Research Laboratories Sumneytown Pike P.O. Box 4, West Point, Pennsylvania 19486, US
HABERMANN, Joerg, Istituto di Ricerche di Biologia Molecolare P. Angeletti SpA Via Pontina KM 30 600 Pomezia, I-00040 Rome, IT
KOCH, Uwe, Istituto di Ricerche di Biologia Molecolare P. Angeletti SpA Via Pontina KM 30 600 Pomezia, I-00040 Rome, IT
NARJES, Frank, Istituto di Ricerche di Biologia Molecolare P. Angeletti SpA Via Pontina KM 30 600 Pomezia, I-00040 Rome, IT
LI, Peng, Wu Xi AppTec Co. Ltd. 288 Fute Zhong Road Waigaoqiao Free Trade Zone, Shanghai 200131, CN
PENG, Xuanjia, Wu Xi AppTec Co. Ltd. 288 Fute Zhong Road Waigaoqiao Free Trade Zone, Shanghai 200131, CN
SOLL, Richard, Wu Xi AppTec Co. Ltd. 288 Fute Zhong Road Waigaoqiao Free Trade Zone, Shanghai 200131, CN
WU, Hao, Wu Xi AppTec Co. Ltd. 288 Fute Zhong Road Waigaoqiao Free Trade Zone, Shanghai 200131, CN
PALANI, Anandan, 126 E. Lincoln Avenue, Rahway, New Jersey 07670, US
HE, Shuwen, 126 E. Lincoln Avenue, Rahway, New Jersey 07670, US
DAI, Xing, 126 E. Lincoln Avenue, Rahway, New Jersey 07670, US
LIU, Hong, 126 E. Lincoln Avenue, Rahway, New Jersey 07670, US
LAI, Zhong, 126 E. Lincoln Avenue, Rahway, New Jersey 07670, US
LONDON, Clare, 126 E. Lincoln Avenue, Rahway, New Jersey 07670, US
XIAO, Dong, 126 E. Lincoln Avenue, Rahway, New Jersey 07670, US
ZORN, Nicolas, 126 E. Lincoln Avenue, Rahway, New Jersey 07670, US
NARGUND, Ravi, 126 E. Lincoln Avenue, Rahway, New Jersey 07670, US
-
- (51) MKP
C12M 1/00 (2006.01) (97) **2739720 ***
C12M 1/12 (2006.01)
C12M 1/24 (2006.01)
C12M 3/00 (2006.01)
(86) IB2013058184 31.08.2013
(96) 13777343.8 11.06.2014
(87) WO2014037862, 31.08.2013
(97) 2739720, 11.06.2014 en
(54) DEVICES AND METHODS FOR CULTURE OF CELLS
(71) Pluristem Ltd., Matam Building 20, 31905 Haifa, IL
(72) KASUTO, Harel, Kibbutz Yifat, 3658300 Kibbutz Yifat, IL
ABRAHAM, Eytan, 11 Soroka Street, 3475923 Haifa, IL
-

(51) MKP
B32B 9/00 (2006.01) (97) **2704902 ***
 (86) US2012036790 07.05.2012
 (96) 12781824.3 12.03.2014
 (87) WO2012154677, 07.05.2012
 (97) 2704902, 12.03.2014 en
 (54) MAGNETIC GRAPHENE-LIKE NANOPARTICLES OR GRAPHITIC NANO-OR MICROPARTICLES AND METHOD OF PRODUCTION AND USES THEREOF
 (71) The Research Foundation for The State University of New York, 35 State Street, Albany NY 12207-2826, US
 (72) SITHARAMAN, Balaji, 8 Windover Lane, Coram NY 11727, US
 PARATALA, Bhavna, S., Flat No. Dt1 G R Grand Residency 70 Kanakapura Road J P Nagar 6th Phase, Bangalore Karnataka, IN

(51) MKP
A61K 8/37 (2006.01) (97) **2723452 ***
A61K 47/48 (2006.01)
A61P 17/10 (2006.01)
A61P 31/04 (2006.01)
A61Q 5/02 (2006.01)
A61Q 17/00 (2006.01)
 (86) US2012043717 22.06.2012
 (96) 12731271.8 30.04.2014
 (87) WO2012177986, 22.06.2012
 (97) 2723452, 30.04.2014 en
 (54) CONJUGATE-BASED ANTIFUNGAL AND ANTIBACTERIAL PRODRUGS
 (71) Vyome Biosciences Pvt Ltd, Plot No.459 First Floor F.I.E. Patparganj Industrial Area, Delhi 110092, IN
 (72) BAPAT, Abhijit S., C-5/128 Milan Vihar 72 I.P. Extension Patparganj, Delhi 110092, IN
 MAHESH, Gauthami, 5-C Sanchar Lok Near Max Hospital Patparganj, East Delhi 110092, IN
 GOKHALE, Rajesh S., Director's Bunglow Type VI-I CRR1 Colony C.V. Raman Marg Maharani Bagh, New Delhi 110065, IN
 SHAH, Sayali S., 5-C Sanchar Lok Near Max Hospital Patparganj, East Delhi 110092, IN
 SENGUPTA, Shiladitya, 606 South Street Apt. C, Waltham Massachusetts 02453, US
 PRASAD, Sudhanand, A/204 Eldeco Appartments Sector 4 Vaishali Ghaziabad, Uttar Pradesh 201010, IN
 GHOSH, Sumana, Ashoka Enclave Dwarka Sector-11 Plot No-8A Flat No. 2703, New Delhi 110065, IN
 CHAWRAI, Suresh R., 66 Vidhi Appartments Plot No. 116 I.P. Extension Patparganj, Delhi 110092, IN
 ARORA, Nidhi, G-1 Mansarover Garden (Ground Floor), New Delhi 110015, IN
 REDDY, D. Sreedhar, Ramachandrapuram Nelakondapally (MD), Khammam (DT) Andhra Pradesh 507160, IN
 MISHRA, Mallika, SF 66 Vardan Apartment Abhaykhand 3 Module 19&20 Indirapuram, Ghaziabad 201014, IN
 BAJAJ, Kirti, H. No. 1135 Ward No. 9 Mandi Dabwali Sirsa, Haryana 125104, IN

(51) MKP
C12N 9/24 (2006.01) (97) **2764104 ***
C12N 15/80 (2006.01)
 (86) EP2012069603 04.10.2012
 (96) 12810109.4 13.08.2014
 (87) WO2013050458, 04.10.2012
 (97) 2764104, 13.08.2014 en
 (54) UNCONVENTIONAL PROTEIN SECRETION
 (71) Heinrich-Heine-Universität Düsseldorf, Universitätsstrasse 1, 40225 Düsseldorf, DE
 (72) FELDBRUEGGE, Michael, Heinrich-Heine-Universität Düsseldorf Institut für Mikrobiologie, Gebäude 26.12 Universitätsstr. 1, 40225 Düsseldorf, DE

(51) MKP
B23P 11/00 (2006.01) (97) **2718116 ***
B60B 15/00 (2006.01)
 (86) US2012041619 08.06.2012
 (96) 12797514.2 16.04.2014
 (87) WO2012170858, 08.06.2012
 (97) 2718116, 16.04.2014 en
 (54) APPARATUS AND METHOD FOR INCREASING THE TRACTION OF VEHICLE WHEELS
 (71) Curry, Michael D., 1842 Buffalo Drive, Harrisonburg, Virginia 22802, US
 (72) Curry, Michael D., 1842 Buffalo Drive, Harrisonburg, Virginia 22802, US

(51) MKP
A61B 17/064 (2006.01) (97) **2517649**
A61B 17/072 (2006.01)
A61B 17/115 (2006.01)
 (96) 12166192.0 31.10.2012
 (97) 2517649, 31.10.2012 en
 (54) Staple cartridge comprising compressible distortion resistant components
 (71) Ethicon Endo-Surgery, Inc., 4545 Creek Road, Cincinnati, OH 45242, US
 (72) Shelton, IV, Frederick E., 245 East Main Street, Hillsboro, OH Ohio 45133, US
 Baxter, III, Chester O., 6375 Pawnee Ridge, Loveland, OH Ohio 45140, US
 Aronhalt, Taylor W., 306 Beech Road, Loveland, OH Ohio 45140, US
 Young, Joseph E., 9523 Carroll Court, Loveland, OH Ohio 45140, US

(51) MKP
A61K 31/122 (2006.01) (97) **2701696 ***
A61K 31/192 (2006.01)
A61K 31/20 (2006.01)
A61K 31/202 (2006.01)
 (86) US2012034833 24.04.2012
 (96) 12776313.4 05.03.2014
 (87) WO2012148927, 24.04.2012
 (97) 2701696, 05.03.2014 en
 (54) IMPAIRED ENERGY PROCESSING DISORDERS AND MITOCHONDRIAL DEFICIENCY
 (71) Retrotope, Inc., 12133 Foothill Lane, Los Altos Hills, CA 94022-3319, US
 (72) SHCHEPINOV, Mikhail, Sergeevich, 63 Barnfield Avenue, Kingston Upon Thames Surrey KT25RG, GB

(51) MKP
F41A 21/26 (2006.01) (97) **2739931 ***
F41A 21/36 (2006.01)
 (86) EP2012062794 02.07.2012
 (96) 12730572.0 11.06.2014
 (87) WO2013017351, 02.07.2012
 (97) 2739931, 11.06.2014 de
 (54) MANOEUVRES CARTRIDGE DEVICE AND SELF-LOADING FIREARM SUITABLE THEREFOR
 (71) Heckler & Koch GmbH, Heckler & Koch Strasse 1, 78727 Oberndorf/Neckar, DE
 (72) BECKMANN, Rudi, Schwanenmoos 10, 78733 Aichhalden-Roetenberg, DE
 HEZEL, Rolf, Fichtenweg 17, 78662 Boesingen, DE

(51) MKP
A61K 31/69 (2006.01) (97) **2723751 ***
C07F 5/02 (2006.01)
 (86) US2012043485 21.06.2012
 (96) 12730349.3 30.04.2014
 (87) WO2012177835, 21.06.2012
 (97) 2723751, 30.04.2014 en
 (54) PROTEASOME INHIBITORS AND PROCESSES FOR THEIR PREPARATION, PURIFICATION AND USE
 (71) Cephalon, Inc., 41 Moores Road P.O. Box 4011, Frazer, PA 19355, US
 (72) BAKALE, Roger P., 8 Devonshire Lane, Malvern, Pennsylvania 19355, US
 MALLAMO, John P., 98 McLeod Pond Road, Glenmoore, Pennsylvania 19343, US
 ROEMMELE, Renee Caroline, 1030 Fulton Road, Maple Glen, Pennsylvania 19002, US

- (51) MKP
H02J 3/38 (2006.01) (97) **2662945**
 (96) 13154280.5 13.11.2013
 (97) 2662945, 13.11.2013 en
 (54) Distributed power generation system, controlling means and method for controlling the power generation of the system
 (71) VPP Energy Zrt., Bocskai ut 134-146., 1113 Budapest, HU
 (72) Cservölgyi, Krisztián, Szent László u. 3., 2120 Dunakeszi, HU
 Dicso, Gábor, Ibrahim u. 26-28., 1113 Budapest, HU
 Németh, Lajos, Gyarmat u. 89/A., II/1., 1147 Budapest, HU
 Gál, István, Szent István út 56., 1212 Budapest, HU

- (51) MKP
A61K 31/5383 (2006.01) (97) **2731948 ***
A61P 25/28 (2006.01)
C07D 487/04 (2006.01)
C07D 498/04 (2006.01)
 (86) EP2012063667 12.07.2012
 (96) 12733754.1 21.05.2014
 (87) WO2013010904, 12.07.2012
 (97) 2731948, 21.05.2014 en
 (54) NOVEL SUBSTITUTED INDOLE DERIVATIVES AS GAMMA SECRETASE MODULATORS
 (71) Janssen Pharmaceuticals, Inc., 1125 Trenton-Harbourton Road, Titusville, NJ 08560, US
 Cellzome Limited, 980 Great West Road, Brentford, Middlesex TW8 9GS, GB
 (72) MINNE, Garrett, Berloni, Heulsestraat 39A, B-8501 Bissegem, BE
 BISCHOFF, François Paul, Janssen Pharmaceutica NV Turnhoutseweg 30, B-2340 Beerse, BE
 GIJSEN, Henricus, Jacobus, Maria, Janssen Pharmaceutica NV Turnhoutseweg 30, B-2340 Beerse, BE
 VELTER, Adriana, Ingrid, Janssen Pharmaceutica NV Turnhoutseweg 30, B-2340 Beerse, BE
 PIETERS, Serge, Maria, Aloysius, Janssen Pharmaceutica NV Turnhoutseweg 30, B-2340 Beerse, BE
 BERTHELOT, Didier, Jean-Claude, Janssen Pharmaceutica NV Turnhoutseweg 30, B-2340 Beerse, BE

- (51) MKP
C12M 1/00 (2006.01) (97) **2751255 ***
C12N 1/12 (2006.01)
 (86) EP2012066965 31.08.2012
 (96) 12756428.4 09.07.2014
 (87) WO2013030340, 31.08.2012
 (97) 2751255, 09.07.2014 de
 (54) METHOD AND DEVICE FOR FEEDING GASES OR GAS MIXTURES INTO A LIQUID, SUSPENSION, OR EMULSION IN A REACTOR IN A SPECIFIC MANNER
 (71) Gicon Grossmann Ingenieur Consult GmbH, Tiergartenstrasse 48, 01219 Dresden, DE
 (72) COTTA, Fritz, Am Kugelberg 13, 06667 Wolfen, DE
 GROSSMANN, Jochen, Bernhardstr. 117, 01187 Dresden, DE
 MATSCHKE, Martin, Pohlitzer Str. 53, 07973 Greiz, DE
 KOETZ, Andreas, Holunderweg 30, 06849 Dessau-Roßlau, DE

- (51) MKP
A61K 31/4439 (2006.01) (97) **2736887 ***
A61K 31/497 (2006.01)
A61K 31/498 (2006.01)
A61K 31/506 (2006.01)
A61K 31/5377 (2006.01)
A61K 31/55 (2006.01)
A61P 27/02 (2006.01)
A61P 29/00 (2006.01)
A61P 31/12 (2006.01)
A61P 35/00 (2006.01)
C07D 249/08 (2006.01)
C07D 401/12 (2006.01)
C07D 403/12 (2006.01)
C07D 409/12 (2006.01)
 (86) US2012048319 26.07.2012
 (96) 12743846.3 04.06.2014
 (87) WO2013019548, 26.07.2012
 (97) 2736887, 04.06.2014 en
 (54) HYDRAZIDE CONTAINING NUCLEAR TRANSPORT MODULATORS AND USES THEREOF
 (71) Karyopharm Therapeutics, Inc., 2 Mercer Road, Natick, MA 01760, US
 (72) SANDANAYAKA, Vincent, P., 10 Laurel Avenue, Northboro, MA 01532, US
 SHACHAM, Sharon, 15 Bontempo Road, Newton, MA 02459, US
 MCCAULEY, Dilara, 85 Gore Street, Cambridge, MA 02141, US
 SHECHTER, Sharon, 18 Ivy Lane, Andover, MA 01810, US

- (51) MKP
A61K 31/506 (2006.01) (97) **2702043 ***
A61P 35/00 (2006.01)
C07D 239/42 (2006.01)
C07D 401/04 (2006.01)
C07D 403/04 (2006.01)
C07D 403/12 (2006.01)
C07D 405/04 (2006.01)
C07D 405/12 (2006.01)
C07D 405/14 (2006.01)
C07D 409/04 (2006.01)
C07D 413/04 (2006.01)
C07D 417/04 (2006.01)
C07D 417/14 (2006.01)
 (86) US2012035794 30.04.2012
 (96) 12725560.2 05.03.2014
 (87) WO2012149528, 30.04.2012
 (97) 2702043, 05.03.2014 en
 (54) INHIBITORS OF INDUCIBLE FORM OF 6-PHOSPHOFRUCTOSE-2-KINASE
 (71) Exelixis, Inc., 210 East Grand Avenue, South San Francisco, CA 94080, US
 (72) TSUHAKO, Amy, Lew, 1232 Madruga Way, Milpitas, CA 95035, US
 MARLOWE, Charles, K., 636 California Way, Emerald Hills, CA 94062, US
 ZAHARIA, Christiana, A., 644 Topaz Street, Redwood City, CA 94061, US
 KABIGTING, Lori, 349 Commercial Avenue, South San Francisco, CA 94116, US
 BAJJALIEH, William, 2086 45th Avenue, San Francisco, CA 94116, US
 TESFAI, Zerom, 23219 Canyon Terrace, Castro Valley, CA 94522, US
 HUANG, Ping, 117 Whits Road, Mountain View, CA 94040, US
 MOON, Kim, 1128 Oregon Avenue, Palo Alto, CA 94303, US
 AAY, Naing, 112 N. Rochester Street, San Mateo, CA 94401, US
 TAMBO-ONG, Arlyn, 9 N. Spruce Avenue, South San Francisco, CA 94080, US
 NUSS, John, M., 16 Wood Ranch Circle, Danville, CA 94506, US
 XU, Wei, 327 Glasgow Circle, Danville, CA 94526, US
 KEARNEY, Patrick, 195 Bocana Street, San Francisco, CA 94110, US

(51) MKP
F21V 21/30 (2006.01) (97) **2690357**
F21V 23/04 (2006.01)
F21W 131/105 (2006.01)
F21W 131/107 (2006.01)
F21W 131/406 (2006.01)
(96) 13168429.2 29.01.2014
(97) 2690357, 29.01.2014 en
(54) A lighting device
(71) SGM A/S, Søren Frichs Vej 51, 8230 Åbyhøj, DK
(72) Johansen, Peter, Søvej 38, 8680 RY, DK

(51) MKP
G05F 1/14 (2006.01) (97) **2740132 ***
H01F 29/02 (2006.01)
(86) IT2011000275 01.08.2011
(96) 11770531.9 11.06.2014
(87) WO2013018108, 01.08.2011
(97) 2740132, 11.06.2014 en
(54) AN IMPROVED, HIGH-EFFICIENCY, ENERGY-SAVING DEVICE FOR INSERTING BETWEEN A POWER SOURCE AND A MOTIVE AND/OR LIGHTING POWER LOAD
(71) Energia Europa S.P.A., Via Trieste, 222/B, 36010 Zane' (VI), IT
(72) D'ANTUONO, Ernesto, Via Spinà 42, I-36033 Isola Vicentina (VI), IT

(51) MKP
A61K 9/70 (2006.01) (97) **2730290 ***
A61K 31/4178 (2006.01)
A61K 31/4184 (2006.01)
A61K 31/439 (2006.01)
A61K 45/00 (2006.01)
A61K 47/14 (2006.01)
A61K 47/18 (2006.01)
A61K 47/32 (2006.01)
A61P 1/08 (2006.01)
A61P 43/00 (2006.01)
(86) JP2012067052 04.07.2012
(96) 12808108.0 14.05.2014
(87) WO2013005760, 04.07.2012
(97) 2730290, 14.05.2014 en
(54) ADHESIVE SKIN PATCH CONTAINING SEROTONIN RECEPTOR ANTAGONIST DRUG
(71) Teikoku Seiyaku Co., Ltd., 567 Sanbonmatsu, Higashikagawa-shi, Kagawa 769-2695, JP
(72) KAMAKURA, Takashi, c/o TEIKOKU SEIYAKU CO. LTD. 567 Sanbonmatsu, Higashikagawa-shi Kagawa 769-2695, JP
TAKANO, Daiki, c/o TEIKOKU SEIYAKU CO. LTD. 567 Sanbonmatsu, Higashikagawa-shi Kagawa 769-2695, JP

(51) MKP
G06F 19/22 (2011.01) (97) **2628117 ***
(86) US2011055823 11.10.2011
(96) 11833271.7 21.08.2013
(87) WO2012051208, 11.10.2011
(97) 2628117, 21.08.2013 en
(54) IDENTIFYING REARRANGEMENTS IN A SEQUENCED GENOME
(71) Complete Genomics, Inc., 2071 Stierlin Court, Mountain View, CA 94043, US
(72) NAZARENKO, Igor, 660 Gail Avenue A4, Sunnyvale, California 94086, US
HALPERN, Aaron L., 940 Walnut Street, San Carlos, California 94070, US
CARNEVALI, Paolo, 1830 Frobisher Way, San Jose, California 95124, US

(51) MKP
B22F 9/08 (2006.01) (97) **2748476 ***
C22C 1/04 (2006.01)
C22C 1/10 (2006.01)
C23C 24/08 (2006.01)
F16C 33/12 (2006.01)
F16C 33/14 (2006.01)
(86) EP2012073947 29.11.2012
(96) 12799537.1 02.07.2014
(87) WO2013083471, 29.11.2012
(97) 2748476, 02.07.2014 de
(54) METHOD FOR PRODUCING A SLIDING BEARING COMPRISING A CuNi2Si, CuFe2P OR CuSnX COMPOUND
(71) Federal-Mogul Wiesbaden GmbH & Co.KG, Stielstrasse 11, 65201 Wiesbaden, DE
(72) SCHMITT, Holger, Mainstraße 32, 64319 Pfungstadt, DE
MEISTER, Daniel, Innsbrucker Str. 36, 55246 Mainz-Kostheim, DE
SAXTON, David M., 6106 Vineyard Avenue, Ann Arbor, Michigan 48108, US

(51) MKP
G06Q 20/18 (2012.01) (97) **2724304 ***
G06Q 20/20 (2012.01)
(86) AT2012000173 19.06.2012
(96) 12732946.4 30.04.2014
(87) WO2012174579, 19.06.2012
(97) 2724304, 30.04.2014 de
(54) METHOD AND DEVICE FOR CARRYING OUT CASHLESS PAYMENTS
(71) Secure Payment Technologies GmbH, Klosteranger 7/4, 6020 Innsbruck, AT
(72) SUITNER, Michael, Klosteranger 7/4, A-6020 Innsbruck, AT

(51) MKP
C09K 8/582 (2006.01) (97) **2714837 ***
C12P 7/10 (2006.01)
(86) GB2012051219 31.05.2012
(96) 12727398.5 09.04.2014
(87) WO2012164285, 31.05.2012
(97) 2714837, 09.04.2014 en
(54) METHOD FOR MICROBIAL CONTROL OF INJECTION LIQUID FLOW IN A HYDROCARBON RESERVOIR
(71) Goe-IP AS, Olsokveien 32, 4046 Hafrsfjord, NO
(72) RAVNAS, Asle, Olsokveien 32, 4046 Hafrsfjord, NO

(51) MKP
B60P 7/08 (2006.01) (97) **2671754**
(96) 12171354.9 11.12.2013
(97) 2671754, 11.12.2013 de
(54) Load securing system
(71) Bühler, Leo, Meierhofrain 14, 8820 Wädenswil, CH
(72) Bühler, Leo, Meierhofrain 14, 8820 Wädenswil, CH

(51) MKP
G01N 33/574 (2006.01) (97) **2753933 ***
G01N 33/74 (2006.01)
(86) US2012054137 07.09.2012
(96) 12766763.2 16.07.2014
(87) WO2013066491, 07.09.2012
(97) 2753933, 16.07.2014 en
(54) USE OF HUMAN PAPILLOMAVIRUS STATUS IN ESTABLISHING USE OF AN AGENT THAT BINDS EGFR IN THE TREATMENT OF CANCER
(71) Amgen Inc., One Amgen Center Drive, Thousand Oaks, California 91320-1799, US
(72) WIEZOREK, Jeffrey, Scott, 20749 Cool Oak Way, Malibu, CA 90265, US
BACH, Bruce, Allen, 342 Avenida De Royale, Thousand Oaks, CA 91320, US

- (51) MKP
A61K 31/55 (2006.01) (97) **2740478 ***
 (86) CN2012077079 18.06.2012
 (96) 12822557.0 11.06.2014
 (87) WO2013020416, 18.06.2012
 (97) 2740478, 11.06.2014 en
 (54) SUSTAINED-RELEASE PREPARATION OF IVABRADINE OR PHARMACEUTICALLY ACCEPTABLE SALTS THEREOF
 (71) Jiangsu Hengrui Medicine Co., Ltd., No. 7 Kunlunshan Road Economic and Technological Development Zone Lianyungang, Jiangsu 222047, CN
 (72) LIU, Kai, No.7 Kunlunshan Road Economic and Technological Development Zone, Lianyungang Jiangsu 222047, CN
 WU, Yuxia, No.7 Kunlunshan Road Economic and Technological Development Zone, Lianyungang Jiangsu 222047, CN

- (51) MKP
A61K 9/70 (2006.01) (97) **2734196 ***
A61K 31/185 (2006.01)
 (86) EP2012061468 15.06.2012
 (96) 12733619.6 28.05.2014
 (87) WO2013010737, 15.06.2012
 (97) 2734196, 28.05.2014 en
 (54) PATCH CONTAINING DICLOFENAC AND THIOCOLCHICOSIDE
 (71) Epifarma Srl, Via San Rocco 6, 85033 Episcopia (PZ), IT
 (72) IRIANNI, Giuseppe, c/o EPIFARMA SRL Via San Rocco 6, I-85033 Episcopia (PZ), IT

- (51) MKP
A61K 9/14 (2006.01) (97) **2734191 ***
A61K 9/16 (2006.01)
A61K 9/22 (2006.01)
A61K 47/30 (2006.01)
A61K 47/48 (2006.01)
A61P 35/00 (2006.01)
 (86) US2012047133 18.07.2012
 (96) 12815024.0 28.05.2014
 (87) WO2013012891, 18.07.2012
 (97) 2734191, 28.05.2014 en
 (54) INTRAPERITONEALLY-ADMINISTERED NANOCARRIERS THAT RELEASE THEIR THERAPEUTIC LOAD BASED ON THE INFLAMMATORY ENVIRONMENT OF CANCERS
 (71) STC.UNM, MSC 04 2750 801 University Blvd. SE Suite 101, Albuquerque, NM 87106, US
 (72) ZEINELDEN, Reema, 431 Lake Street, Shrewsbury, MA 01545, US

- (51) MKP
F02M 51/06 (2006.01) (97) **2660457**
F02M 61/04 (2006.01)
F02M 63/00 (2006.01)
 (96) 12166388.4 06.11.2013
 (97) 2660457, 06.11.2013 en
 (54) Fuel injector
 (71) Delphi International Operations Luxembourg S.à.r.l., Avenue de Luxembourg, 4940 Bascharage, LU
 (72) Guerrato, Diego, 85 Burnt Ash Road, Lee, London SE12 8RF, GB

- (51) MKP
A61K 8/64 (2006.01) (97) **2717851 ***
A61K 8/73 (2006.01)
A61K 8/97 (2006.01)
A61Q 19/08 (2006.01)
 (86) CA2012000584 13.06.2012
 (96) 12799831.8 16.04.2014
 (87) WO2012171106, 13.06.2012
 (97) 2717851, 16.04.2014 en
 (54) SKIN COSMETIC COMPOSITIONS COMPRISING MALUS DOMESTICA EXTRACT AND ARGANIA SPINOSA SPROUT EXTRACT FOR IMPROVING SKIN APPEARANCE
 (71) Levy, Phillip, 12 ch. Beau-Soleil, 1206 Geneva, CH
 (72) Levy, Phillip, 12 ch. Beau-Soleil, 1206 Geneva, CH

- (51) MKP
G01N 33/576 (2006.01) (97) **2737318 ***
 (86) IB2011002066 27.07.2011
 (96) 11776842.4 04.06.2014
 (87) WO2013014485, 27.07.2011
 (97) 2737318, 04.06.2014 en
 (54) A2M FRAGMENTS AND APPLICATIONS THEREOF
 (71) Bio-Rad Innovations, 3, Boulevard Raymond Poincaré, 92430 Marnes-La-Coquette, FR
 Centre National de la Recherche Scientifique, 3, rue Michel-Ange, 75794 Paris Cedex 16, FR
 (72) BATXELLI, Isabelle, Catherine, N° 7 Lotissement Volte-Basse Chemin de l'eau noire, F-30670 Aigues-Vives, FR
 WATELET, Bénédicte, Les Côteaux du Lac 4 rue de la Mairie Villa n° 2, F-34980 Saint Clement De Riviere, FR

- (51) MKP
A61K 47/48 (2006.01) (97) **2741781 ***
A61P 11/00 (2006.01)
 (86) EP2012065745 10.08.2012
 (96) 12748194.3 18.06.2014
 (87) WO2013024052, 10.08.2012
 (97) 2741781, 18.06.2014 en
 (54) CARRIER-LINKED TREPSTINIL PRODRUGS
 (71) Ascendis Pharma A/S, Tuborg Boulevard 12, 2900 Hellerup, DK
 (72) HERSEL, Ulrich, Fritz-Frey-Strasse 8, 69121 Heidelberg, DE
 RAU, Harald, Talstraße 41i, 69221 Dossenheim, DE
 LESSMANN, Torben, Hauberallee 11, 67434 Neustadt an der Weinstraße, DE
 BISEK, Nicola, Dantestrasse 50, 69115 Heidelberg, DE
 MAITRO, Guillaume, Rheingoldstr. 157, 68199 Mannheim, DE
 SPROGØE, Kennett, 1982 West Bayshore Road 327, Palo Alto, California 94303, US
 WEGGE, Thomas, Kurfürstenanlage 45, 69115 Heidelberg, DE
 ZETTLER, Joachim, Im Linsenbühl 10, 69221 Dossenheim, DE
 KEIL, Oliver, Ladenburger Strasse 48, 69120 Heidelberg, DE

- (51) MKP
C12N 15/11 (2006.01) (97) **2723897 ***
C12Q 1/68 (2006.01)
 (86) US2012043799 22.06.2012
 (96) 12802554.1 30.04.2014
 (87) WO2012178046, 22.06.2012
 (97) 2723897, 30.04.2014 en
 (54) MULTIVARIATE DIAGNOSTIC ASSAYS AND METHODS FOR USING SAME
 (71) Nanostring Technologies, Inc, 530 Fairview Ave N, Ste 2000, Seattle, WA 98109, US
 (72) GEISS, Gary, K., 647 NW 78th Street, Seattle, WA 98117, US
 FERREE, Sean, M., 7018 3rd Avenue NW, Seattle, WA 98117, US
 WEBSTER, Philippa, Jane, 4317 Densmore Avenue North, Seattle, WA 98103, US
 STORHOFF, James, Justin, 6520 36th Avenue NW, Seattle, WA 98117, US
 WALLDEN, Brett, 2613 143rd Place SE, Mill Creek, WA 98012, US
 PAYANDEH, Emily, 1175 Park Place, Apt. 227, San Mateo, CA 94403, US

(51) MKP
A61K 39/00 (2006.01) (97) **2739650 ***
A61K 39/395 (2006.01)
C07K 16/00 (2006.01)
(86) US2012049207 01.08.2012
(96) 12819810.8 11.06.2014
(87) WO2013019889, 01.08.2012
(97) 2739650, 11.06.2014 en
(54) BOVINE POLYCLONAL ANTIBODY SPECIFIC FOR HUMAN TNF
(71) Avaxia Biologics, Inc., 128 Spring Street, Suite 620, Lexington, MA 02421, US
(72) FOX, Barbara, S., c/o Avaxia Biologics, Inc. 128 Spring Street Suite 620, Lexington, MA 02421, US
BOSTWICK, Eileen, F., c/o Avaxia Biologics, Inc. 128 Spring Street Suite 620, Lexington, MA 02421, US
TRACEY, Daniel, E., c/o Avaxia Biologics, Inc. 128 Spring Street Suite 620, Lexington, MA 02421, US
SCHLEHUBER, Lisa, D., c/o Avaxia Biologics, Inc. 128 Spring Street Suite 620, Lexington, MA 02421, US
QUESENBERRY, Michael, S., c/o Avaxia Biologics, Inc. 128 Spring Street Suite 620, Lexington, MA 02421, US

(51) MKP
G21G 1/00 (2006.01) (97) **2618335**
(96) 12152024.1 24.07.2013
(97) 2618335, 24.07.2013 en
(54) Sorbent for receiving radionuclide arsenic-72, production of this sorbent and its use
(71) Instytut Chemii i Techniki Jadrowej, ul. Dorodna 16, 03-195 Warszawa, PL
(72) Polkowska-Motrenko, Halina, Laki 16C, 05-250 Laki, PL
Bilewicz, Aleksander, ul. Podgórna 18 m.13, 03-157 Warszawa, PL
Doner, Katarzyna, ul. Suwalska 30/55, 03-252 Warszawa, PL
Chajduk, Ewelina, Mostowa 9/11 m. 15., 96-300 Zyrardów, PL

(51) MKP
A61F 2/10 (2006.01) (97) **2572701**
A61K 8/34 (2006.01)
A61K 8/46 (2006.01)
A61K 8/67 (2006.01)
A61K 8/97 (2006.01)
A61Q 19/00 (2006.01)
A61Q 19/08 (2006.01)
(96) 11186402.1 27.03.2013
(97) 2572701, 27.03.2013 en
(54) Compositions comprising a retinoid and an NFkB-Inhibitor and their methods of use
(71) Johnson & Johnson Consumer Companies Inc., Grandview Road, Skillman, NJ 08558, US
(72) Oddos, Thierry, 9 rue du Professeur Calmette, F-92190 Meudon, FR

(51) MKP
G01N 33/574 (2006.01) (97) **2702411 ***
(86) US2012035842 30.04.2012
(96) 12777309.1 05.03.2014
(87) WO2012149550, 30.04.2012
(97) 2702411, 05.03.2014 en
(54) METHODS OF IDENTIFICATION AND DIAGNOSIS OF LUNG DISEASES USING CLASSIFICATION SYSTEMS AND KITS THEREOF
(71) Cancer Prevention And Cure, Ltd., 105 Washington Street, Michigan City, IN 46360, US
(72) STREEPER, Robert, T., 7738 Apple Green Road, San Antonio Texas 78240, US
IZBICKA, Elzbieta, 7738 Apple Green Road, San Antonio Texas 78240, US
MICHALEK, Joel, 2634 Pebble Valley, San Antonio Texas 78232, US
LOUDEN, Chris, 109 Settlers Circle, Banera Texas 78003, US

(51) MKP
A61K 31/4178 (2006.01) (97) **2751096 ***
A61P 31/12 (2006.01)
C07D 403/14 (2006.01)
C08L 77/00 (2006.01)
(86) US2012059604 10.10.2012
(96) 12840685.7 09.07.2014
(87) WO2013055825, 10.10.2012
(97) 2751096, 09.07.2014 en
(54) GUANIDINYL-SUBSTITUTED POLYAMIDES USEFUL FOR TREATING HUMAN PAPILLOMA VIRUS
(71) Nanovir, LLC, 4717 Campus Drive, Suite 1300, Kalamazoo, MI 49008, US
THE CURATORS OF THE UNIVERSITY OF MISSOURI, 341 Woods Hall, One University Blvd., St. Louis, MO 63121-4400, US
(72) BASHKIN, James, K., 4717 Campus Drive Suite 1300, Kalamazoo, MI 49008, US
EDWARDS, Terri, G., 4717 Campus Drive Suite 1300, Kalamazoo, MI 49008, US
FISHER, Christopher, 4717 Campus Drive Suite 1300, Kalamazoo, MI 49008, US
HARRIS JR., George, D., 4717 Campus Drive Suite 1300, Kalamazoo, MI 49008, US
KOELLER, Kevin, J., 4717 Campus Drive Suite 1300, Kalamazoo, MI 49008, US

(51) MKP
A01N 43/42 (2006.01) (97) **2711361 ***
A01N 43/60 (2006.01)
A01N 43/90 (2006.01)
A01P 3/00 (2006.01)
C07D 241/52 (2006.01)
C07D 401/12 (2006.01)
C07D 471/04 (2006.01)
(86) JP2012062618 17.05.2012
(96) 12790304.5 26.03.2014
(87) WO2012161071, 17.05.2012
(97) 2711361, 26.03.2014 en
(54) NITROGENATED HETEROCYCLIC COMPOUND AND AGRICULTURAL OR HORTICULTURAL FUNGICIDE
(71) Nippon Soda Co., Ltd., 2-1, Ohtemachi 2-chome Chiyoda-ku, Tokyo 100-8165, JP
(72) SHIBAYAMA Kotaro, c/o Odawara Research Center Nippon Soda Co. Ltd. 345 Takada, Odawara-shi Kanagawa 250-0280, JP
KUWAHARA Raito, c/o Odawara Research Center Nippon Soda Co. Ltd. 345 Takada, Odawara-shi Kanagawa 250-0280, JP
SATO Motoaki, c/o Odawara Research Center Nippon Soda Co. Ltd. 345 Takada, Odawara-shi Kanagawa 250-0280, JP
NISHIMURA Satoshi, c/o Odawara Research Center Nippon Soda Co. Ltd. 345 Takada, Odawara-shi Kanagawa 250-0280, JP
SHIINOKI Yasuyuki, c/o Odawara Research Center Nippon Soda Co. Ltd. 345 Takada, Odawara-shi Kanagawa 250-0280, JP
YOKOYAMA Masahiro, c/o Odawara Research Center Nippon Soda Co. Ltd. 345 Takada, Odawara-shi Kanagawa 250-0280, JP
KITAMURA Juri, c/o Odawara Research Center Nippon Soda Co. Ltd. 345 Takada, Odawara-shi Kanagawa 250-0280, JP

(51) MKP
C03C 3/087 (2006.01) (97) **2729424 ***
C03C 4/02 (2006.01)
C03C 4/08 (2006.01)
C03C 6/00 (2006.01)
(86) US2012041596 08.06.2012
(96) 12728901.5 14.05.2014
(87) WO2013009417, 08.06.2012
(97) 2729424, 14.05.2014 en
(54) GLASS CONTAINER COMPOSITION
(71) Owens-Brockway Glass Container INC., One Michael Owens Way, Perrysburg, OH 43551, US
(72) BARTON, Stephen, D., 11512 Mendoleine Road, Dansville, NY 14437, US
CLICK, Carol, A., P.O. Box 1055, Corning, NY 14830, US
HOWSE, Terence, K.G., 4243 W. Bancroft, Toledo, OH 43515, US

- (51) MKP
A61K 31/4155 (2006.01) (97) **2712358 ***
A61K 31/4162 (2006.01)
A61K 31/4178 (2006.01)
A61K 31/4192 (2006.01)
A61K 31/4196 (2006.01)
A61K 31/422 (2006.01)
A61K 31/4245 (2006.01)
A61K 31/427 (2006.01)
A61K 31/4439 (2006.01)
C07D 401/14 (2006.01)
C07D 403/12 (2006.01)
C07D 403/14 (2006.01)
C07D 405/14 (2006.01)
C07D 409/14 (2006.01)
C07D 413/14 (2006.01)
C07D 417/14 (2006.01)
C07D 471/04 (2006.01)
C07D 487/04 (2006.01)
C07D 491/04 (2006.01)
C07D 495/04 (2006.01)
- (86) US2012037003 09.05.2012
(96) 12743553.5 02.04.2014
(87) WO2012158413, 09.05.2012
(97) 2712358, 02.04.2014 en
(54) PYRROLIDINYL UREA, PYRROLIDINYL THIOUREA AND PYRROLIDINYL GUANIDINE COMPOUNDS AS TRKA KINASE INHIBITORS
- (71) Array Biopharma, Inc., 3200 Walnut Street, Boulder, CO 80301, US
(72) ALLEN, Shelley, c/o Array BioPharma Inc. 3200 Walnut Street, Boulder, Colorado 80301, US
ANDREWS, Steven, W., c/o Array BioPharma Inc. 3200 Walnut Street, Boulder, Colorado 80301, US
BLAKE, James, F., c/o Array BioPharma Inc. 3200 Walnut Street, Boulder, Colorado 80301, US
CONDROSKI, Kevin, R., 344 Main Street Unit B1, Wallingford, Connecticut 06492, US
HAAS, Julia, c/o Array BioPharma Inc. 3200 Walnut Street, Boulder, Colorado 80301, US
HUANG, Lily, 6104 John Chisum Lane, Austin, Texas 78749, US
JIANG, Yutong, c/o Array BioPharma Inc. 3200 Walnut Street Boulder, Colorado 80301, US
KERCHER, Timothy, c/o Array BioPharma Inc. 3200 Walnut Street, Boulder, Colorado 80301, US
KOLAKOWSKI, Gabrielle R., c/o Array BioPharma Inc. 3200 Walnut Street, Boulder, Colorado 80301, US
SEO, Jeongbeob, 11 Ironwood Circle, Baltimore, Maryland 21209, US

- (51) MKP
A61K 31/58 (2006.01) (97) **2739640 ***
A61P 5/44 (2006.01)
C07J 71/00 (2006.01)
- (86) EP2012063239 06.07.2012
(96) 12740918.3 11.06.2014
(87) WO2013017374, 06.07.2012
(97) 2739640, 11.06.2014 en
(54) ANTI-INFLAMMATORY STEROIDS CONDENSED IN POSITION 16,17 WITH PYRROLIDINE RING
- (71) Chiesi Farmaceutici S.p.A., Via Palermo, 26/A, 43100 Parma, IT
(72) GHIDINI, Eleonora, c/o Chiesi Farmaceutici S.P.A. Via Palermo 26/A, 43100 Parma, IT
CAPELLI, Anna Maria, c/o Chiesi Farmaceutici S.P.A. Via Palermo 26/A, 43100 Parma, IT

- (51) MKP
A61K 31/4192 (2006.01) (97) **2708537 ***
A61K 31/422 (2006.01)
A61K 31/4245 (2006.01)
A61K 31/4439 (2006.01)
A61K 31/506 (2006.01)
A61P 1/00 (2006.01)
A61P 5/00 (2006.01)
A61P 9/12 (2006.01)
A61P 25/08 (2006.01)
A61P 25/16 (2006.01)
A61P 25/20 (2006.01)
A61P 25/22 (2006.01)
A61P 25/24 (2006.01)
C07D 401/14 (2006.01)
- (86) JP2012061745 08.05.2012
(96) 12781685.8 19.03.2014
(87) WO2012153729, 08.05.2012
(97) 2708537, 19.03.2014 en
(54) HETEROAROMATIC RING DERIVATIVE
- (71) Taisho Pharmaceutical Co., Ltd., 24-1, Takada 3-chome Toshima-ku, Tokyo 170-8633, JP
(72) SUZUKI Ryo, c/o TAISHO PHARMACEUTICAL CO. LTD. 24-1 Takada 3-chome Toshima-ku, Tokyo 170-8633, JP
FUTAMURA Aya, c/o TAISHO PHARMACEUTICAL CO. LTD. 24-1 Takada 3-chome Toshima-ku, Tokyo 170-8633, JP
ABE Masahito, c/o TAISHO PHARMACEUTICAL CO. LTD. 24-1 Takada 3-chome Toshima-ku, Tokyo 170-8633, JP
KASHIWA Shuhei, c/o TAISHO PHARMACEUTICAL CO. LTD. 24-1 Takada 3-chome Toshima-ku, Tokyo 170-8633, JP
HATTORI Nobutaka, c/o TAISHO PHARMACEUTICAL CO. LTD. 24-1 Takada 3-chome Toshima-ku, Tokyo 170-8633, JP
NOZAWA Dai, c/o TAISHO PHARMACEUTICAL CO. LTD. 24-1 Takada 3-chome Toshima-ku, Tokyo 170-8633, JP
OHTA Hiroshi, c/o TAISHO PHARMACEUTICAL CO. LTD. 24-1 Takada 3-chome Toshima-ku, Tokyo 170-8633, JP
ARAKI Yuko, c/o TAISHO PHARMACEUTICAL CO. LTD. 24-1 Takada 3-chome Toshima-ku, Tokyo 170-8633, JP

- (51) MKP
A01N 43/56 (2006.01) (97) **2755483 ***
A61K 31/415 (2006.01)
- (86) US2012055172 13.09.2012
(96) 12830938.2 23.07.2014
(87) WO2013040215, 13.09.2012
(97) 2755483, 23.07.2014 en
(54) INDAZOLE-3-CARBOXAMIDES AND THEIR USE AS WNT/B-CATENIN SIGNALING PATHWAY INHIBITORS
- (71) Samumed, LLC, 10225 Barnes Canyon Road, Suite A104, San Diego, CA 92121, US
(72) HOOD, John, 10831 Vereda Sol del Dios, San Diego, California 92130, US
KC, Sunil Kumar, 10504 Clasico Court, San Diego, California 92127, US

- (51) MKP
F01N 5/02 (2006.01) (97) **2752573 ***
F02B 37/00 (2006.01)
F02G 5/00 (2006.01)
F02G 5/02 (2006.01)
F02G 5/04 (2006.01)
F22B 1/18 (2006.01)
- (86) JP2012060907 24.04.2012
(96) 12828237.3 09.07.2014
(87) WO2013031287, 24.04.2012
(97) 2752573, 09.07.2014 en
(54) WASTE HEAT UTILIZATION DEVICE
- (71) Kabushiki Kaisha Toyota Jidoshokki, 2-1, Toyoda-cho, Kariya-shi, Aichi 448-8671, JP
(72) MORI, Hidefumi, c/o KABUSHIKI KAISHA TOYOTA JIDOSHOKKI 2-1 Toyoda-cho, Kariya-shi Aichi 448-8671, JP
IGUCHI, Masao, c/o KABUSHIKI KAISHA TOYOTA JIDOSHOKKI 2-1 Toyoda-cho, Kariya-shi Aichi 448-8671, JP
ENOKIJIMA, Fuminobu, c/o KABUSHIKI KAISHA TOYOTA JIDOSHOKKI 2-1 Toyoda-cho, Kariya-shi Aichi 448-8671, JP
ISHIGURO, Fumihiko, c/o KABUSHIKI KAISHA TOYOTA JIDOSHOKKI 2-1 Toyoda-cho, Kariya-shi Aichi 448-8671, JP
TAKEI, Hiroyuki, c/o KABUSHIKI KAISHA TOYOTA JIDOSHOKKI 2-1 Toyoda-cho, Kariya-shi Aichi 448-8671, JP

(51) MKP
A61K 38/00 (2006.01) (97) **2739298 ***
A61K 38/27 (2006.01)
(86) IL2012050288 02.08.2012
(96) 12819794.4 11.06.2014
(87) WO2013018098, 02.08.2012
(97) 2739298, 11.06.2014 en
(54) LONG-ACTING GROWTH HORMONE AND METHODS OF PRODUCING SAME
(71) OPKO Biologics Ltd, 7 Golda Meir Street 2nd floor, 74140 Nes Ziona, IL
(72) FARES, Fuad, PO Box 423, 25155 Hourfish Village, IL
FIMA, Udi Eyal, 30 Albek Street, 84833 Beer-Sheva, IL

(51) MKP
C01B 31/20 (2006.01) (97) **2734470 ***
(86) GB2012051622 10.07.2012
(96) 12737585.5 28.05.2014
(87) WO2013011276, 10.07.2012
(97) 2734470, 28.05.2014 en
(54) CARBON DIOXIDE PRODUCTION
(71) Rockfuel Innovations Limited, 39 Shakespeare Road, Lexden Colchester, Essex CO3 4HL, GB
(72) STAMP, Clive R., 2 School Close Capel St. Mary, Ipswich, Suffolk IP9 2UP, GB

(51) MKP
A61F 2/24 (2006.01) (97) **2765954 ***
(86) US2012059845 12.10.2012
(96) 12840473.8 20.08.2014
(87) WO2013055977, 12.10.2012
(97) 2765954, 20.08.2014 en
(54) POLYMERIC HEART VALVE
(71) The Research Foundation Of State University Of New York, Post Office Box 9, Albany, NJ 12201-0009, US
Slepian, Marvin, University of Arizona 1501 N. Campbell Ave., Tucson, Arizona 85724, US
(72) SLEPIAN, Marvin, University of Arizona 1501 N. Campbell Ave., Tucson, Arizona 85724, US
BLUESTEIN, Danny, 17 Woodmont Rd, Melville., New York 11747, US
CLAIBORNE, Thomas E., 495 Gillette Ave., Bayport., New York 11794, US

(51) MKP
A61K 31/4196 (2006.01) (97) **2755654 ***
A61K 31/498 (2006.01)
A61K 31/519 (2006.01)
A61P 35/00 (2006.01)
(86) US2012055387 14.09.2012
(96) 12766542.0 23.07.2014
(87) WO2013040337, 14.09.2012
(97) 2755654, 23.07.2014 en
(54) PHOSPHATIDYLINOSITOL 3-KINASE INHIBITORS FOR THE TREATMENT OF CANCER
(71) Exelixis, Inc., 210 East Grand Avenue, South San Francisco, CA 94080, US
SANOFI, 54 rue La Boétie, 75008 Paris, FR
(72) DECILLIS, Arthur, 80 Devonshire Lane, Madison, CT 06443, US
RUIZ SOTO, Rodrigo, 1 Saint George Street Apartment 4A, Boston, MA 02118, US
EMMONS, Gary, Thomas, 5 Oakwood Lane, Washington, NJ 07882, US
LAGER, Joanne, 33 Shedd Lane, Hollis, NH 03049, US

(51) MKP
G03G 5/00 (2006.01) (97) **2746854 ***
G03G 5/10 (2006.01)
(86) JP2012070589 13.08.2012
(96) 12825604.7 25.06.2014
(87) WO2013027616, 13.08.2012
(97) 2746854, 25.06.2014 en
(54) SUBSTRATE FOR PHOTOSENSITIVE DRUM
(71) Showa Denko K.K., 13-9 Shibadaimon 1-chome Minato-ku, Tokyo 105-8518, JP
(72) AOYA Shigeru, c/o Oyama Regional Office Showa Denko K.K. 480 Inuzuka 1-chome, Oyama-shi Tochigi 323-8678, JP
OIDE Masaaki, 1-8-14 Fujimigaoka, Utsunomiya-shi Tochigi 320-0011, JP

(51) MKP
A61K 31/4196 (2006.01) (97) **2729144 ***
A61K 31/4439 (2006.01)
A61P 35/00 (2006.01)
(86) US2012045978 09.07.2012
(96) 12735423.1 14.05.2014
(87) WO2013006864, 09.07.2012
(97) 2729144, 14.05.2014 en
(54) TREATING CANCER WITH HSP90 INHIBITORY COMPOUNDS
(71) Synta Pharmaceuticals Corp., 45 Hartwell Avenue, Lexington, MA 02421, US
(72) EL-HARIRY, Iman, One Back Bay 135 Clarendon Street Apt 14U, Boston, MA 02116, US
PROIA, David, 30 Silver Lake Avenue, Newton, MA 02458, US
VUKOVIC, Vojo, 51 Wildwood Street, Winchester, MA 01890, US

(51) MKP
A01N 43/42 (2006.01) (97) **2731436 ***
A61K 31/44 (2006.01)
(86) US2012046354 12.07.2012
(96) 12814906.9 21.05.2014
(87) WO2013012649, 12.07.2012
(97) 2731436, 21.05.2014 en
(54) AZAINDOLE COMPOUNDS AND METHODS FOR TREATING HIV
(71) VIIV Healthcare UK Limited, 980 Great West Road, Brentford, Middlesex TW8 9GS, GB
(72) DE LA ROSA, Martha, Alicia, c/o GlaxoSmithKline Global Patents Five Moore Drive PO Box 13398, Research Triangle Park NC 27709, US
JOHNS, Brian, Alvin, c/o GlaxoSmithKline Global Patents Five Moore Drive PO Box 13398, Research Triangle Park NC 27709, US
SAMANO, Vicente, c/o GlaxoSmithKline Global Patents Five Moore Drive PO Box 13398, Research Triangle Park NC 27709, US
VELTHUISEN, Emile, Johann, c/o GlaxoSmithKline Global Patents Five Moore Drive PO Box 13398, Research Triangle Park NC 27709, US
WEATHERHEAD, Jason, c/o GlaxoSmithKline Global Patents Five Moore Drive PO Box 13398, Research Triangle Park NC 27709, US

(51) MKP
A61B 18/14 (2006.01) (97) **2758090 ***
A61B 18/18 (2006.01)
A61M 1/00 (2006.01)
A61M 13/00 (2006.01)
A61M 16/04 (2006.01)
A61M 25/00 (2006.01)
A61M 39/08 (2006.01)
(86) EP2012067849 12.09.2012
(96) 12756526.5 30.07.2014
(87) WO2013037830, 12.09.2012
(97) 2758090, 30.07.2014 en
(54) AN ELECTROSURGICAL PENCIL WITH A SMOKE EVACUATION TUBE
(71) SafeAir AG, D4 Platz 3, 6039 Root Längenbold, CH
(72) SIMONSEN, Jesper Schantz, Peter Holms Vej 8 st. tv., DK-2450 Copenhagen, DK
KORNERUP, Niels, Gl. Vallerødvej 31, DK-2960 Rungsted, DK

- (51) MKP
A61K 31/4985 (2006.01) (97) **2723744 ***
A61P 25/00 (2006.01)
C07D 487/04 (2006.01)
- (86) EP2012062381 26.06.2012
(96) 12729637.4 30.04.2014
(87) WO2013000924, 26.06.2012
(97) 2723744, 30.04.2014 en
- (54) 1-ARYL-4-METHYL-[1,2,4]TRIAZOLO[4,3-a]QUINOXALINE DERIVATIVES
- (71) Janssen Pharmaceutica, N.V., Turnhoutseweg 30, 2340 Beerse, BE
- (72) ANDRÉS-GIL, José, Ignacio, c/o Janssen-Cilag S.A. Calle Jarama 75 Poligono Industrial, E-45007 Toledo, ES
ROMBOUITS, Frederik, Jan, Rita, c/o Janssen Pharmaceutica NV Turnhoutseweg 30, B-2340 Beerse, BE
TRABANCO-SUÁREZ, Andrés, Avelino, c/o Janssen-Cilag S.A. Calle Jarama 75 Poligono Industrial, E-45007 Toledo, ES
VANHOOF, Greta, Constantia, Peter, c/o Janssen Pharmaceutica NV Turnhoutseweg 30, B-2340 Beerse, BE
DE ANGELIS, Merl, Werinherstrasse 97, 81541 Munich, DE
BUIJNSTERS, Peter, Jacobus, Johannes, Antonius, c/o Janssen Pharmaceutica NV Turnhoutseweg 30, B-2340 Beerse, BE
GUILLEMONT, Jérôme, Emile, Georges, c/o Janssen-Cilag Campus de Maigremont BP 615, F-27106 Val de Reuil Cedex, FR
BORMANS, Guy, Maurits R., c/o Katholieke Universiteit Leuven K.U.Leuven R&D Waaistraat 6 Bus 5105, B-3000 Leuven, BE
CELEN, Sofie, Jeanne, Leopoldine, c/o Katholieke Universiteit Leuven K.U.Leuven R&D Waaistraat 6 Bus 5105, B-3000 Leuven, BE
VLIEGEN, Maarten, c/o Janssen Pharmaceutica NV Turnhoutseweg 30, B-2340 Beerse, BE

- (51) MKP
H04L 29/08 (2006.01) (97) **2767074 ***
- (86) US2012059727 11.10.2012
(96) 12839640.5 20.08.2014
(87) WO2013055902, 11.10.2012
(97) 2767074, 20.08.2014 en
- (54) TIME SENSITIVE AUDIO AND TEXT FEEDBACK PROCESS FOR A PRIORITIZED MEDIA RICH DIGITAL MESSAGING SYSTEM
- (71) Gueramy, Timothy, 5404 Great Divide Drive, Austin, TX 78738, US
Haas, Tracey, 5404 Great Divide Drive, Austin, TX 78738, US
- (72) Gueramy, Timothy, 5404 Great Divide Drive, Austin, TX 78738, US
Haas, Tracey, 5404 Great Divide Drive, Austin, TX 78738, US

- (51) MKP
C12N 15/113 (2010.01) (97) **2674494**
- (96) 13184178.5 18.12.2013
(97) 2674494, 18.12.2013 en
- (54) Single-stranded RNA molecule having nitrogen-containing alicyclic skeleton
- (71) Bonac Corporation, Fukuoka BIO Factory 4F 1488-4 Aikawa-machi, Kurume-shi, Fukuoka 839-0861, JP
- (72) Ohgi, Tadaaki, c/o Bonac Corporation Fukuoka BIO Factory, 4F 1488-4 Aikawa-machi Kurume-shi, Fukuoka 839-0861, JP
Hayashi, Hirotake, c/o Bonac Corporation Fukuoka BIO Factory, 4F 1488-4 Aikawa-machi Kurume-shi, Fukuoka 839-0861, JP
Shirohzu, Hisao, c/o Bonac Corporation Fukuoka BIO Factory, 4F 1488-4 Aikawa-machi Kurume-shi, Fukuoka 839-0861, JP
Hamasaki, Tomohiro, c/o Bonac Corporation Fukuoka BIO Factory, 4F 1488-4 Aikawa-machi Kurume-shi, Fukuoka 839-0861, JP
Itoh, Akihiro, c/o Bonac Corporation Fukuoka BIO Factory, 4F 1488-4 Aikawa-machi Kurume-shi, Fukuoka 839-0861, JP
Suzuki, Hiroshi, c/o Bonac Corporation Fukuoka BIO Factory, 4F 1488-4 Aikawa-machi Kurume-shi, Fukuoka 839-0861, JP

- (51) MKP
A01N 25/24 (2006.01) (97) **2763529 ***
A01N 25/28 (2006.01)
A01N 43/40 (2006.01)
A01N 53/00 (2006.01)
A01N 57/20 (2006.01)
B01J 13/18 (2006.01)
- (86) EP2012069849 08.10.2012
(96) 12769658.1 13.08.2014
(87) WO2013050594, 08.10.2012
(97) 2763529, 13.08.2014 en
- (54) MANUFACTURING OF SPECIFICALLY TARGETING MICROCAPSULES
- (71) AGROSAVFE N.V., Technologiepark 4, 9052 Gent, BE
- (72) VERHEESEN, Peter, Julienne de Vetterstraat 19, B-9030 Gent, BE
DE JONGHE, Chris, Jan Davidlaan 50, B-2630 Aartselaar, BE

- (51) MKP
A61K 38/12 (2006.01) (97) **2717898 ***
- (86) US2012041777 09.06.2012
(96) 12797036.6 16.04.2014
(87) WO2012170969, 09.06.2012
(97) 2717898, 16.04.2014 en
- (54) PRO-COAGULANT COMPOUNDS AND METHODS OF USE THEREOF
- (71) Biogen Idec MA Inc., 14 Cambridge Center, Cambridge, MA 02142, US
- (72) THORN, Karina, 49 North Main St., Newmarket, NH 03857, US
TOBY, Garabet G., 9 School Hill Lane, North Reading, MA 01864, US
MEZO, Adam R., 86 Arch Street, Needham, MA 02492, US

- (51) MKP
A61K 39/395 (2006.01) (97) **2726101 ***
- (86) US2012045017 29.06.2012
(96) 12804528.3 07.05.2014
(87) WO2013003761, 29.06.2012
(97) 2726101, 07.05.2014 en
- (54) INHIBITORS OF T-CELL ACTIVATION
- (71) Genzyme Corporation, 500 Kendall Street, Cambridge, MA 02142, US
- (72) ZHU, Yunxiang, 10 Caulfield Road, Wayland, MA 01778, US
KARMAN, Jozsef, 419 Main Street, Brockton, MA 02301, US
WEI, Ronnie, 120 Central Avenue, Needham, MA 02494, US
JIANG, Canwen, 14 Heather Lane, Southborough, MA 01772, US
CHENG, Seng, 10 Jennison Circle, Natick, MA 01760, US

(51) MKP
B82Y 40/00 (2011.01) (97) **2729508 ***
C07H 3/06 (2006.01)
C08F 293/00 (2006.01)
C08G 73/06 (2006.01)
C08G 81/02 (2006.01)
G03F 7/00 (2006.01)
(86) US2012043491 21.06.2012
(96) 12733317.7 14.05.2014
(87) WO2012177839, 21.06.2012
(97) 2729508, 14.05.2014 en
(54) OLIGOSACCHARIDE/SILICON-CONTAINING BLOCK COPOLYMERS FOR LITHOGRAPHY APPLICATIONS
(71) Board of Regents, The University of Texas System, 201 West 7th Street, Austin, TX 78701, US
(72) ELLISON, Christopher, John, 8417 Alphonie Drive, Austin, TX 78739, US
CUSHEN, Julia, 7122 Wood Hollow Drive Apt 88, Austin, TX 78731, US
OTSUKA, Issei, 8 Avenue General Champon, F-38000 Grenoble, FR
WILLSON, C., Grant, 2103A Exposition Boulevard, Austin, TX 78751, US
BATES, Christopher, M., 1203 Ruth Avenue Unit B, Austin, TX 78757, US
EASLEY, Jeffery, Alan, 7304 Guadalupe Street, Austin, TX 78752, US
BORSALI, Redouane, CERMAV-CNSR 601 Avenue De La Chimie Domaine Universitaire De Grenoble-Saint Martin D'heres, F-BP53-38041 Grenoble Cedex 9, FR
FORT, Sebastien, CERMAV-CNSR 601 Avenue De La Chimie Domaine Universitaire De Grenoble-Saint Martin D'heres, F-BP53-38041 Grenoble Cedex 9, FR
HALILA, Sami, 130 Le Bourg, F-38140 Beaucroissant, FR

(51) MKP
A61K 31/165 (2006.01) (97) **2744778 ***
A61P 29/00 (2006.01)
C07C 233/06 (2006.01)
C07C 233/23 (2006.01)
C07D 309/14 (2006.01)
(86) US2012051478 17.08.2012
(96) 12826376.1 25.06.2014
(87) WO2013028570, 17.08.2012
(97) 2744778, 25.06.2014 en
(54) META-SUBSTITUTED BIPHENYL PERIPHERALLY RESTRICTED FAAH INHIBITORS
(71) The Regents of the University of California, 1111 Franklin Street, 12th Floor, Oakland, California 94607, US
Fondazione Istituto Italiano Di Tecnologia, Via Morego 30, 16163 Genova, IT
Università Degli Studi Di Urbino "Carlo Bo", Via Saffi, 2, 61029 Urbino, IT
Università degli Studi di Parma, Via Università 12, 43121 Parma, IT
(72) PIOMELLI, Daniele, 3 Valley View, Irvine, California 92612, US
MORENO-SANZ, Guillermo, 203 Berkeley Avenue, Irvine, California 92612, US
BANDIERA, Tiziano, Corso Vittorio Emanuele 44/A, 1-27025 Gambolo (PV), IT
MOR, Marco, Via Fabio Filzi 70, 25016 Ghedi, IT
TARZIA, Giorgio, Via Giovanni XXIII 17, 61020 Petriano, IT

(51) MKP
C12N 5/07 (2010.01) (97) **2729561 ***
C12P 21/00 (2006.01)
(86) US2012045848 06.07.2012
(96) 12810966.7 14.05.2014
(87) WO2013009648, 06.07.2012
(97) 2729561, 14.05.2014 en
(54) CELL CULTURE PROCESS
(71) Momenta Pharmaceuticals, Inc., 675 West Kendall Street, Cambridge, MA 02142, US
(72) PRENTICE, Holly, 35 Nathan Lane, Carlisle, MA 01741, US

(51) MKP
B01D 53/56 (2006.01) (97) **2726180 ***
(86) US2012044944 29.06.2012
(96) 12804926.9 07.05.2014
(87) WO2013003728, 29.06.2012
(97) 2726180, 07.05.2014 en
(54) ZEOLITE IMPREGNATED WITH TITANIUM DIOXIDE
(71) PQ Corporation, 300 Lindenwood Drive Valleybrooke Corporate Center, Malvern, PA 19355-1740, US
(72) RIBEIRO, Flavio Ernesto, 11661 Rushmore Drive, Plainfield, Illinois 60585, US
BAIRD, Gary A., 9150 Zollman Road, Marysville, Indiana 47141, US
DOS SANTOS FLOR, Ronaldo, Rua Cidade de São Sebastião Bairro nova Pet, CEP-09770-550 São Bernardo do Campo - SP, BR

(51) MKP
E04B 1/24 (2006.01) (97) **2574702**
E04B 1/342 (2006.01)
E04B 7/02 (2006.01)
E04H 15/00 (2006.01)
E04H 15/18 (2006.01)
(96) 12185516.7 03.04.2013
(97) 2574702, 03.04.2013 de
(54) Roof or wall structure
(71) Haltec Hallensysteme GmbH, Hauptstrasse 285, 58675 Hemer, DE
(72) Speck, Markus Wilhelm, Helmsheimer Strasse 12, 76646 Bruchsal, DE

(51) MKP
F03D 7/02 (2006.01) (97) **2721730 ***
H02K 7/09 (2006.01)
H02K 19/26 (2006.01)
H02P 9/14 (2006.01)
H02P 29/00 (2006.01)
(86) EP2012059782 24.05.2012
(96) 12724947.2 23.04.2014
(87) WO2012171769, 24.05.2012
(97) 2721730, 23.04.2014 de
(54) METHOD FOR CONTROLLING A WIND TURBINE
(71) Wobben Properties GmbH, Dreekamp 5, 26605 Aurich, DE
(72) DIETRICH, Volker, Friedrich-Koopmann-Straße 30, 26203 Wardenburg, DE

(51) MKP
G01S 19/17 (2010.01) (97) **2702430 ***
G01S 19/19 (2010.01)
G01S 19/51 (2010.01)
G01V 9/00 (2006.01)
(86) IB2012000811 26.04.2012
(96) 12726487.7 05.03.2014
(87) WO2013150328, 26.04.2012
(97) 2702430, 05.03.2014 en
(54) METHOD FOR ASSESSING THE RELIABILITY OF A DOG-MAN PAIR AND KIT FOR IMPLEMENTING SAID METHOD
(71) Giacomelli, Fabio, Via della Stamperia 66, 36014 Santorso (VI), IT
(72) Giacomelli, Fabio, Via della Stamperia 66, 36014 Santorso (VI), IT

- (51) MKP
A61M 15/00 (2006.01) (97) **2755708 ***
 (86) GB2012052240 12.09.2012
 (96) 12766135.3 23.07.2014
 (87) WO2013038170, 12.09.2012
 (97) 2755708, 23.07.2014 en
 (54) INHALER
 (71) Astrazeneca AB, null, 151 85 Södertälje, SE
 (72) BERRY, Simon, Christopher, AstraZeneca R&D Mölndal, SE-431 83 Mölndal, SE
 CHRISTIANSEN, Jonas, Dansk Ingenior Service A/S
 Jegstrupvej 36, DK-DV-8361 Hasselager, DK
 ELGAARD, Svend, Erik, Bang&Olufsen Medicom
 Gimsinglundvej 20, DK-7600 Struer, DK
 JOHANSEN, Esben, Bang&Olufsen Medicom Gimsinglundvej 20, DK-7600 Struer, DK
 MØLLER, Claus, Schmidt, Center for Produktudvikling Paludan
 Mullers Vej 7, DK-3480 Fredensborg, DK
 JØRGEN, Rasmussen, Solute ApS Ydunsvej 6, DK-7600
 Struer, DK
 TRENEMAN, William, UPC Cambridge Ltd Suite 16&17
 Manchester House 113 Northgate Street, Bury St Edmunds
 Suffolk IP33 1HP, GB

- (51) MKP
A01N 63/00 (2006.01) (97) **2739299 ***
A01N 65/00 (2009.01)
A61K 38/00 (2006.01)
 (86) US2012049295 02.08.2012
 (96) 12821880.7 11.06.2014
 (87) WO2013022692, 02.08.2012
 (97) 2739299, 11.06.2014 en
 (54) METHODS AND COMPOSITIONS FOR INHIBITING
 DELAYED GRAFT FUNCTION
 (71) Trustees Of The University Of Pennsylvania, 3160 Chestnut
 Street, Suite 200, Philadelphia, PA 19104, US
 (72) SHANNON, Richard, P., 3611 Chestnut Street 646,
 Philadelphia, PA 19104, US

- (51) MKP
C01G 23/00 (2006.01) (97) **2669253**
C01G 23/08 (2006.01)
C01G 33/00 (2006.01)
H02M 1/08 (2006.01)
 (96) 13169676.7 04.12.2013
 (97) 2669253, 04.12.2013 en
 (54) Titanium oxide for electrode and method for manufacturing the
 same
 (71) TITAN KOGYO KABUSHIKI KAISHA, 1978-25, Oaza Kogushi,
 Ube-shi Yamaguchi Yamaguchi 755-8567, JP
 Kabushiki Kaisha Toshiba, 1-1, Shibaura 1-Chome Minato-Ku,
 Tokyo 105-8001, JP
 (72) NAKAHARA, Kiyoshi, c/o Titan Kogyo Kabushiki Kaisha 1978-
 25, Oaza Kogushi, UBE-SHI, YAMAGUCHI, 755-8567, JP
 SEKI, Toshimasa, c/o Titan Kogyo Kabushiki Kaisha 1978-25,
 Oaza Kogushi, UBE-SHI, YAMAGUCHI, 755-8567, JP
 INAGAKI, Hiroki, c/o Intellectual Property Division Toshiba
 Corporation 1-1, Shibaura 1-chome Minato-ku, TOKYO, 105-
 8001, JP
 IWASAKI, Takuya, c/o Intellectual Property Division Toshiba
 Corporation 1-1, Shibaura 1-chome Minato-ku, TOKYO, 105-
 8001, JP
 TAKAMI, Norio, c/o Intellectual Property Division Toshiba
 Corporation 1-1, Shibaura 1-chome Minato-ku, TOKYO, 105-
 8001, JP

- (51) MKP
A61M 15/00 (2006.01) (97) **2714280 ***
B05B 11/00 (2006.01)
 (86) EP2012059454 22.05.2012
 (96) 12722389.9 09.04.2014
 (87) WO2012160047, 22.05.2012
 (97) 2714280, 09.04.2014 en
 (54) NEBULIZER
 (71) Boehringer Ingelheim International GmbH, Binger Strasse 173,
 55216 Ingelheim am Rhein, DE
 (72) HOLAKOVSKY, Holger, Boehringer Ingelheim GmbH Corporate
 Patents Binger Strasse 173, 55216 Ingelheim Am Rhein, DE
 ROHRSCHEIDER, Marc, Boehringer Ingelheim GmbH
 Corporate Patents Binger Strasse 173, 55216 Ingelheim Am
 Rhein, DE
 WITTE, Florian, Boehringer Ingelheim GmbH Corporate
 Patents Binger Strasse 173, 55216 Ingelheim Am Rhein, DE
 DEANE, Kevin, Peter, 24 Green End Fen Ditton, Cambridge
 Cambridgeshire CB5 8SX, GB
 JENNINGS, Douglas, Ivan, 73 Redwing Rise, Royston
 Hertfordshire SG8 7XU, GB
 HENDERSON, Charles, 63 Ainsworth Street, Cambridge
 Cambridgeshire CB1 2PF, GB

- (51) MKP
C07K 14/435 (2006.01) (97) **2721058 ***
 (86) US2012042960 18.06.2012
 (96) 12730340.2 23.04.2014
 (87) WO2012174534, 18.06.2012
 (97) 2721058, 23.04.2014 en
 (54) METHOD OF TREATING OR AMELIORATING METABOLIC
 DISORDERS USING CLEC-2
 (71) Amgen Inc., One Amgen Center Drive, Thousand Oaks,
 California 91320-1799, US
 (72) WU, Xinle, 12772 Via Nieve, San Diego, California 92130, US
 LI, Yang, 1142 Cuesta Drive, Mountain View, California 94040,
 US

- (51) MKP
B02C 13/16 (2006.01) (97) **2628541**
B02C 13/28 (2006.01)
 (96) 13153811.8 21.08.2013
 (97) 2628541, 21.08.2013 de
 (54) Drive for a grinding machine
 (71) Recuperma GmbH, Am Rapensweg 203, 44581 Castrop-
 Rauxel, DE
 (72) Lerchner, Peter, Iserlohner Straße 29e, 44894 Bochum, DE

- (51) MKP
C07K 16/18 (2006.01) (97) **2731968 ***
 (86) EP2012063213 06.07.2012
 (96) 12738057.4 21.05.2014
 (87) WO2013010812, 06.07.2012
 (97) 2731968, 21.05.2014 en
 (54) MONOCLONAL ANTIBODIES SPECIFIC FOR BETA-
 AMYLOID X-37 AND USES THEREOF
 (71) Janssen Pharmaceutica NV, Turnhoutseweg 30, 2340 Beerse,
 BE
 (72) MERCKEN, Marc Hubert, c/o Janssen Pharmaceutica NV
 Turnhoutseweg 30, 2340 Beerse, BE
 BORGERS, Marianne, Waterstraat 19, 2490 Balen, BE
 VANDERMEEREN, Marc Maria Pierre Pelagie, c/o Janssen
 Pharmaceutica NV Turnhoutseweg 30, 2340 Beerse, BE
 VAN BROECK, Bianca Julia J, c/o Janssen Pharmaceutica NV
 Turnhoutseweg 30, 2340 Beerse, BE

- (51) MKP
A61K 31/407 (2006.01) (97) **2707372 ***
A61P 35/00 (2006.01)
C07D 413/12 (2006.01)
C07D 487/10 (2006.01)
(86) US2012037570 11.05.2012
(96) 12782304.5 19.03.2014
(87) WO2012155066, 11.05.2012
(97) 2707372, 19.03.2014 en
(54) SPIRO-OXINDOLE MDM2 ANTAGONISTS
(71) The Regents Of The University Of Michigan, 1600 Huron Parkway, 2nd Floor, Ann Arbor, MI 48109-2590, US
Sanofi, 54 rue La Boétie, 75008 Paris, FR
(72) WANG, Shaomeng, 9343 Yorkshire Drive,, Saline, Michigan 48176, US
SUN, Wei, 1020 Island Drive Court, Apt. 106., Ann Arbor, Michigan 48105, US
AGUILAR, Angelo, 2364 Stone Road, Ann Arbor, Michigan 48105, US
GARCIA-ECHEVERRIA, Carlos, c/o Sanofi 54, rue La Boétie, 75008 Paris, FR

- (51) MKP
A61K 31/495 (2006.01) (97) **2702063 ***
A61P 35/00 (2006.01)
C07D 487/04 (2006.01)
(86) US2012034272 19.04.2012
(96) 12717554.5 05.03.2014
(87) WO2012148775, 19.04.2012
(97) 2702063, 05.03.2014 en
(54) BICYCLIC PYRIDAZINE COMPOUNDS AS PIM INHIBITORS
(71) Amgen Inc., One Amgen Center Drive Thousand Oaks, California 91320, US
(72) D'AMICO, Derin C., 4571 Calle Norte, Newbury Park, California 91320, US
HERBERICH, Bradley J., 1197 Ramona Dr., Newbury Park, California 91320, US
JACKSON, Claire L.M., 1922 Deerfield Street, Thousand Oaks, California 91362, US
PETTUS, Liping H., 3309 Big Cloud Circle, Thousand Oaks, California 91360, US
TASKER, Andrew, 390 Arbor Court, Simi Valley, California 93065, US
WANG, Hui-Ling, 822 Lynnmere Drive, Thousand Oaks, California 91360, US
WU, Bin, 3090 Hollycrest Avenue, Thousand Oaks, California 91362, US
WURZ, Ryan, 53 Ocatillo Avenue, Newbury Park, California 91320, US

- (51) MKP
E21B 47/08 (2012.01) (97) **2647790**
G01B 7/13 (2006.01)
G01B 21/04 (2006.01)
(96) 11290611.0 09.10.2013
(97) 2647790, 09.10.2013 en
(54) Calibrator for a downhole caliper and method of using same
Services Pétroliers Schlumberger, 42, rue Saint Dominique, 75007 Paris, FR
Schlumberger Technology B.V., Parkstraat 83-89, 2514 JG The Hague, NL
Schlumberger Holdings Limited, P.O. Box 71 Craigmuir Chamber Road Town, Tortola BV1, VG
PRAD Research and Development Limited, P.O. Box 71 Craigmuir Chambers, Road Town, Tortola, VG
(72) Mouget, Pierre, 5, Rue Anatole France, 92310 Sèvres, FR

- (51) MKP
B01J 21/06 (2006.01) (97) **2720789 ***
B01J 23/22 (2006.01)
B01J 37/00 (2006.01)
C01G 23/04 (2006.01)
C01G 31/02 (2006.01)
(86) EP2012002542 15.06.2012
(96) 12729869.3 23.04.2014
(87) WO2012171655, 15.06.2012
(97) 2720789, 23.04.2014 de
(54) TITANIUM OXIDE- AND/OR VANADIUM OXIDE-BASED POROUS MATERIALS AND THE PRODUCTION AND USE THEREOF
(71) Blücher GmbH, Mettmanner Strasse 25, 40699 Erkrath, DE
Universität Leipzig, Linnéstraße 3, 04103 Leipzig, DE
(72) GLÄSER, Roger, Otto-Engau-Straße 8, 07749 Jena, DE
LUTECKI, Michael, c/o Universität Leipzig Institut für technische Chemie Linnéstraße 3, 04103 Leipzig, DE
WITH, Patrick, Hirtenweg 34, 04425 Taucha, DE
HEINRICH, Astrid, c/o Universität Leipzig Institut für technische Chemie Linnéstraße 3, 04103 Leipzig, DE
FICHTNER, Sven, Bunsenstrasse 5, 14727 Premnitz, DE
BÖHRINGER, Bertram, Bussardweg 33, 42115 Wuppertal, DE

- (51) MKP
B05B 1/30 (2006.01) (97) **2664719**
E03C 1/084 (2006.01)
(96) 13000549.9 20.11.2013
(97) 2664719, 20.11.2013 de
(54) Sanitary fitting element
(71) Neoperl GmbH, Klostersstr. 11, 79379 Müllheim, DE
(72) Hart, Keith, Rose Cottage Marbank Road, Welland, Worcestershire WR136NE, GB
Blum, Gerhard, Obere Grub 3, 77793 Gutach, DE
Tempel, Marc, Dortustrasse 7, 79111 Freiburg, DE
Weis, Christoph, Am Lerchenbuck 6, 79379 Müllheim, DE

- (51) MKP
A61K 31/506 (2006.01) (97) **2727918**
A61P 35/00 (2006.01)
C07D 401/14 (2006.01)
C07D 403/04 (2006.01)
(96) 14152945.3 07.05.2014
(97) 2727918, 07.05.2014 en
(54) Compounds and Compositions as Protein Kinase Inhibitors
IRM LLC, 131 Front Street PO Box HM 2899, Hamilton HM LX, BM
Novartis AG, Lichtstrasse 35, 4056 Basel, CH
(72) Huang, Shenlin, 5768 Cape Jewels Trial, San Diego, CA 92130, US
Jin, Xianming, 3516 Sleeping Meadow Way, San Ramon, CA 94582, US
Liu, Zuosheng, 3911 Tynebourne Circle, San Diego, CA 92130, US
Poon, Daniel, 54 Lake Avenue, Piedmont, CA 94611, US
Tellew, John, 617 Caminito de la Costa, La Jolla, CA 92037, US
Wan, Yongqin, 19 Santa Eugenia, Irvine, CA 92606, US
Wang, Xing, 10445 Monterey Ridge Drive, San Diego, CA 92127, US
Xie, Yongping, 12596 Brickella Street, San Diego, CA 92129, US

- (51) MKP
A61K 9/48 (2006.01) (97) **2679243**
A61K 9/51 (2006.01)
A61K 31/05 (2006.01)
A61K 47/02 (2006.01)
(96) 13425091.9 01.01.2014
(97) 2679243, 01.01.2014 en
(54) Co-precipitate of one or more stilbene polyphenols and their derivatives in lamellar anionic solids, it's applications and related preparation method
(71) Fioretti, Bernard, Via S. Giuseppe, 11, 06038 Spello (PG), IT
(72) Fioretti, Bernard, VIA S. Giuseppe 11, 06038 Spello (PG), IT
Spogli, Roberto, VIA DEI Marcisi 19/A, 06100 Perugia (PG), IT
Sisani, Michele, VIA Piero Della Francesca 95, 06100 Perugia (PG), IT
Perioli, Luana, VIA Giorgio Vasari 18, 06012 Città DI Castello (PG), IT
Latterini, Loredana, VIA Madonna DEI Ramucci 22, 06053 Deruta (PG), IT

- (51) MKP
A01N 43/30 (2006.01) (97) **2744332 ***
A61K 31/36 (2006.01)
- (86) US2012050268 10.08.2012
(96) 12826498.3 25.06.2014
(97) WO2013028371, 10.08.2012
(97) 2744332, 25.06.2014 en
- (54) BENZOFURAN COMPOUNDS FOR THE TREATMENT OF HEPATITIS C VIRUS INFECTIONS
- (71) Glaxo Group Limited, 980 Great West Road Brentford, Middlesex TW8 9GS, GB
- (72) CHONG, Pek Yoke, c/o GlaxoSmithKline Global Patents Department Five Moore Drive P. O. Box 13398, Research Triangle Park, North Carolina 27709, US
MILLER, John F., c/o GlaxoSmithKline Global Patents Department Five Moore Drive P. O. Box 13398, Research Triangle Park, North Carolina 27709, US
PEAT, Andrew James, c/o GlaxoSmithKline Global Patents Department Five Moore Drive P. O. Box 13398, Research Triangle Park, North Carolina 27709, US
SHOTWELL, John Brad, c/o GlaxoSmithKline Global Patents Department Five Moore Drive P. O. Box 13398, Research Triangle Park, NC 27709, US

- (51) MKP
A47K 10/06 (2006.01) (97) **2677248**
F24D 19/00 (2006.01)
F24H 9/00 (2006.01)
- (96) 13425073.7 25.12.2013
(97) 2677248, 25.12.2013 en
- (54) Fan-assisted Radiator, Preferably a Fan-assisted Heated Towel Rail, and Related Ventilation System
- (71) Cordivari S.r.l., Zona Industriale Pagliare, 64020 Morro d'Oro (TE), IT
- (72) Cordivari, Ercole, Cordivari S.R.L. Zona Industriale Pagliare, 64020 Morro D'ORO (TE), IT

- (51) MKP
C08L 63/00 (2006.01) (97) **2722363**
C08L 79/04 (2006.01)
- (96) 13160136.1 23.04.2014
(97) 2722363, 23.04.2014 en
- (54) Cyanate Ester Resin Composition, and a Prepreg, a Laminated Material and a Metal Clad Laminated Material Made Therefrom
- (71) Shengyi Technology Co., Ltd., 5 Industry West Road Northern Industrial Park Songshan Lake Sci. & Tech. Industry Park, 523000 Dongguan City Guangdong, CN
- (72) TANG, Junqi, c/o Shengyi Technology Co., Ltd 5 Industry West Road, Northern Industrial Park Songshan Lake Sci. & Tech. Industry Park, 523000 Dongguan City, CN

- (51) MKP
A62D 5/00 (2006.01) (97) **2717973 ***
- (86) EP2012002432 08.06.2012
(96) 12727794.5 16.04.2014
(87) WO2012167939, 08.06.2012
(97) 2717973, 16.04.2014 de
- (54) FUNCTIONAL PROTECTIVE MATERIAL, IN PARTICULAR FOR USE IN PROTECTIVE CLOTHING
- (71) Blücher GmbH, Mettmanner Strasse 25, 40699 Erkrath, DE
- (72) AMEIL, Frederic, Am Birkenhain 36, 64390 Erzhausen, DE
GERL, Jürgen, Blumenweg 35a, 63128 Dietzenbach, DE
SUROWIEC, Alicja, Verbindungsstrasse 13, 63303 Dreieich, DE
VON BLÜCHER, Hasso, Parkstrasse 10, 40699 Erkrath, DE

- (51) MKP
B29C 47/06 (2006.01) (97) **2639038**
B29C 47/08 (2006.01)
B29C 47/26 (2006.01)
B29C 47/56 (2006.01)
B29C 47/70 (2006.01)
- (96) 13159821.1 18.09.2013
(97) 2639038, 18.09.2013 en
- (54) Layer sequence repeater module for a modular disk co-extrusion die and its usage
- (71) BBS Corporation, 2066 Pecan Drive, Spartanburg, South Carolina 29307, US
- (72) Schirmer, Henry G., 156 Edgecombe Road, Spartanburg, SC South Carolina 29307, US

- (51) MKP
A61K 9/00 (2006.01) (97) **2762133**
A61K 9/50 (2006.01)
- (96) 14161931.2 06.08.2014
(97) 2762133, 06.08.2014 en
- (54) Process for preparing carrier particles for dry powders for inhalation
- (71) CHIESI FARMACEUTICI S.p.A., Via Palermo, 26/A, 43100 Parma, IT
- (72) Musa, Rossella, c/o CHIESI FARMACEUTICI S.p.A. Via Palermo, 26/A, 43100 PARMA, IT
Cocconi, Daniela, c/o CHIESI FARMACEUTICI S.p.A. Via Palermo, 26/A, 43100 PARMA, IT
Chamayou, Alain, c/o CHIESI FARMACEUTICI S.p.A. Via Palermo, 26/A, 43100 PARMA, IT
Galet, Laurence, c/o CHIESI FARMACEUTICI S.p.A. Via Palermo, 26/A, 43100 PARMA, IT

- (51) MKP
A61K 31/50 (2006.01) (97) **2748149 ***
A61K 31/501 (2006.01)
A61P 25/18 (2006.01)
A61P 25/28 (2006.01)
A61P 29/00 (2006.01)
C07D 237/16 (2006.01)
C07D 401/10 (2006.01)
C07D 407/10 (2006.01)
- (86) GB2012000672 21.08.2012
(96) 12753164.8 02.07.2014
(87) WO2013027000, 21.08.2012
(97) 2748149, 02.07.2014 en
- (54) PYRIDAZINONE COMPOUNDS AND THEIR USE AS DAAO INHIBITORS
- (71) Takeda Pharmaceutical Company Limited, 1-1 Doshomachi 4-chome Chuo-ku, Osaka-shi, Osaka 541-0045, JP
- (72) FARNABY, William, Takeda Cambridge Ltd 418 Cambridge Science Park, Cambridge CB4 0PA, GB
FIELDHOUSE, Charlotte, Takeda Cambridge Ltd 418 Cambridge Science Park, Cambridge CB4 0PA, GB
HAZEL, Katherine, Takeda Cambridge Ltd 418 Cambridge Science Park, Cambridge CB4 0PA, GB
KERR, Catrina, 47 Gullane Place, Dundee DD2 3 BF, GB
KINSELLA, Natasha, African Bible University P.O. Box 71242, Clocktower Kampala, UG
LIVERMORE, David, Takeda Cambridge Ltd 418 Cambridge Science Park, Cambridge CB4 0PA, GB
MERCHANT, Kevin, Takeda Cambridge Ltd 418 Cambridge Science Park, Cambridge CB4 0PA, GB
MILLER, David, Takeda Cambridge Ltd 418 Cambridge Science Park, Cambridge CB4 0PA, GB

- (51) MKP
B32B 17/10 (2006.01) (97) **2718099 ***
F21K 99/00 (2010.01)
F21V 33/00 (2006.01)
F21Y 105/00 (2006.01)
G02B 6/00 (2006.01)
- (86) FR2012051257 06.06.2012
(96) 12731118.1 16.04.2014
(87) WO2012168646, 06.06.2012
(97) 2718099, 16.04.2014 fr
- (54) LIGHTING DEVICE COMPRISING LIGHT-EMITTING DIODES
- (71) Saint-Gobain Glass France, 18 avenue d'Alsace, 92400 Courbevoie, FR
- (72) GIERENS, Anne, 12 rue d'Amiens, F-60200 Compiègne, FR
MONTGERMONT, Aude, 12 rue de Châteaudun, F-75009 Paris, FR
ZHANG, Jingwei, 38 rue des Ruelles, F-91300 Massy, FR

(51) MKP
G05B 19/00 (2006.01) (97) **2722719 ***
H02J 13/00 (2006.01)
(86) RU2012000463 14.06.2012
(96) 12800502.2 23.04.2014
(87) WO2012173525, 14.06.2012
(97) 2722719, 23.04.2014 en
(54) AUTOMATED SYSTEM FOR MONITORING, PROTECTING AND CONTROLLING ELECTRICAL SUBSTATION EQUIPMENT
(71) Lysis Limited Liability Company, ul. Kolomenskaya 1, Moscow 115142, RU
(72) DOROFEEV, Ivan Nikolaevich, Mikrorayon Gagarina 13-26 Balashiha, Moskovskaya obl. 143905, RU
IVANOV, Dmitry Valeryevich, ul. Konenkova 13-96, Moscow 127560, RU

(51) MKP
A61K 39/395 (2006.01) (97) **2704743 ***
C07K 16/40 (2006.01)
C12N 1/19 (2006.01)
C12N 5/10 (2006.01)
C12N 15/13 (2006.01)
C12N 15/63 (2006.01)
C12P 21/08 (2006.01)
(86) US2012036509 04.05.2012
(96) 12779347.9 12.03.2014
(87) WO2012151481, 04.05.2012
(97) 2704743, 12.03.2014 en
(54) COMPOSITIONS FOR INHIBITING MASP-2 DEPENDENT COMPLEMENT ACITIVATION
(71) Omeros Corporation, 201 Elliott Avenue West, Seattle, WA 98119, US
(72) DUDLER, Thomas, 13410 NE 36th Street, Bellevue, WA 98005, US
GOMBOTZ, Wayne, R., 15545 61st Avenue NE, Kenmore, WA 98028, US
PARENT, James, Brian, P.O. Box 10278, Bainbridge Island, WA 98110, US
TEDFORD, Clark, E., 4058 NE Lookout Lane, Poulsbo, WA 98370, US
KAVLIE, Anita, Stromsborveien 39H, N-0287 Oslo, NO
HAGEMANN, Urs, Beat, Nydalen Alle 29, N-0484 Oslo, NO
REIERSEN, Herald, Njards Veo 5C, N-1412 Sofiemyr, NO
KIPRIJANOV, Sergej, Hovseterveien 98, N-0768 Oslo, NO

(51) MKP
H04L 29/06 (2006.01) (97) **2592805**
(96) 11188153.8 15.05.2013
(97) 2592805, 15.05.2013 en
(54) Method and system for preserving privacy and accountability
(71) ATS Group (IP Holdings) Limited, PO Box 958 Pasea Estate, Road Town, Tortola, VG
(72) Gorecki, Christian c/o AGT Group (R&D) GMBH, Hilpertstrasse 20A, 64295 Darmstadt, DE
Zeiger, Florian c/o AGT Group (R&D) GMBH, Hilpertstrasse 20A, 64295 Darmstadt, DE

(51) MKP
A61K 39/09 (2006.01) (97) **2709658 ***
A61P 31/00 (2006.01)
(86) EP2012058987 15.05.2012
(96) 12720518.5 26.03.2014
(87) WO2012156391, 15.05.2012
(97) 2709658, 26.03.2014 en
(54) VACCINE AGAINST STREPTOCOCCUS PNEUMONIAE
(71) GlaxoSmithKline Biologicals SA, Rue de l'Institut 89, 1330 Rixensart, BE
(72) DENOEL, Philippe, GlaxoSmithKline Biologicals s.a. Rue de l'Institut 89, B-1330 Rixensart, BE
POOLMAN, Jan, c/o GlaxoSmithKline Biologicals s.a. Rue de l'Institut 89, B-1330 Rixensart, BE
VERLANT, Vincent, GlaxoSmithKline Biologicals s.a. Rue de l'Institut 89, B-1330 Rixensart, BE
WALLEMACQ, Huguues, GlaxoSmithKline Biologicals s.a. Rue de l'Institut 89, B-1330 Rixensart, BE

(51) MKP
A61K 9/50 (2006.01) (97) **2726067 ***
A61K 31/07 (2006.01)
A61K 31/327 (2006.01)
A61K 31/695 (2006.01)
(86) IL2012050223 28.06.2012
(96) 12804460.9 07.05.2014
(87) WO2013001536, 28.06.2012
(97) 2726067, 07.05.2014 en
(54) STABILIZED TOPICAL FORMULATIONS CONTAINING CORE-SHELL MICROCAPSULES
(71) Sol-Gel Technologies Ltd., Gloda Meir Street 7 Weizmann Science Park, Ness Ziona 74036, IL
(72) TOLEDANO, Ofer, 15A Emek Zvulon Street, 44623 Kfar Saba, IL
BAR-SIMANTOV, Haim, 22 Sarah Imenu Street, 71727 Modi'in, IL

(51) MKP
D01F 9/12 (2006.01) (97) **2718487 ***
D01F 9/14 (2006.01)
D01F 9/16 (2006.01)
D06M 10/00 (2006.01)
(86) AT2012000165 11.06.2012
(96) 12733584.2 16.04.2014
(87) WO2012167298, 11.06.2012
(97) 2718487, 16.04.2014 de
(54) TEXTILE SHEET MATERIAL
(71) Helfenberger Immobilien LLC & Co Textilforschungs- und Entwicklungs KEG, Rohrbacher Strasse 6, 4184 Helfenberg, AT
(72) GLASER, Josef, Spanfeld 8, A-4184 Helfenberg, AT

(51) MKP
A61K 31/155 (2006.01) (97) **2757093 ***
A61K 31/404 (2006.01)
A61P 13/12 (2006.01)
A61P 43/00 (2006.01)
C07C 279/18 (2006.01)
C07C 307/10 (2006.01)
C07D 207/16 (2006.01)
C07D 209/20 (2006.01)
C07D 209/42 (2006.01)
C07D 211/62 (2006.01)
C07D 213/79 (2006.01)
C07D 215/20 (2006.01)
C07D 215/48 (2006.01)
C07D 215/50 (2006.01)
C07D 233/64 (2006.01)
C07D 257/04 (2006.01)
C07D 271/06 (2006.01)
C07D 277/20 (2006.01)
C07D 277/56 (2006.01)
C07D 295/12 (2006.01)
C07D 333/38 (2006.01)
(86) JP2012073576 14.09.2012
(96) 12831685.8 23.07.2014
(87) WO2013039187, 14.09.2012
(97) 2757093, 23.07.2014 en
(54) GUANIDINOBENZOIC ACID COMPOUND
(71) Astellas Pharma Inc., null, 5-1, Nihonbashi-honcho 2-chome, Chuo-ku Tokyo 103-8411, JP
(72) FUJIYASU, Jiro, c/o Astellas Pharma Inc. 3-11 Nihonbashi-Honcho 2-chome Chuo-ku, Tokyo 103-8411, JP
OHNE, Kazuhiko, c/o Astellas Pharma Inc. 3-11 Nihonbashi-Honcho 2-chome Chuo-ku, Tokyo 103-8411, JP
YAMAKI, Susumu, c/o Astellas Pharma Inc. 3-11 Nihonbashi-Honcho 2-chome Chuo-ku, Tokyo 103-8411, JP
IMAZUMI, Tomoyoshi, c/o Astellas Pharma Inc. 3-11 Nihonbashi-Honcho 2-chome Chuo-ku, Tokyo 103-8411, JP
HONDO, Takeshi, c/o Astellas Pharma Inc. 3-11 Nihonbashi-Honcho 2-chome Chuo-ku, Tokyo 103-8411, JP
MATSUURA, Keisuke, c/o Astellas Pharma Inc. 3-11 Nihonbashi-Honcho 2-chome Chuo-ku, Tokyo 103-8411, JP
SATOU, Tomohki, c/o Astellas Pharma Inc. 3-11 Nihonbashi-Honcho 2-chome Chuo-ku, Tokyo 103-8411, JP
SASAMURA, Satoshi, c/o Astellas Pharma Inc. 3-11 Nihonbashi-Honcho 2-chome Chuo-ku, Tokyo 103-8411, JP

- (51) MKP
A61K 31/167 (2006.01) (97) **2743256 ***
A61K 31/36 (2006.01)
A61K 31/366 (2006.01)
A61K 31/381 (2006.01)
A61K 31/40 (2006.01)
A61K 31/402 (2006.01)
A61K 31/4035 (2006.01)
A61K 31/404 (2006.01)
A61K 31/4184 (2006.01)
A61K 31/42 (2006.01)
A61K 31/421 (2006.01)
A61K 31/426 (2006.01)
A61K 31/428 (2006.01)
A61K 31/429 (2006.01)
A61K 31/433 (2006.01)
A61K 31/4406 (2006.01)
A61K 31/4409 (2006.01)
A61K 31/4453 (2006.01)
A61K 31/4468 (2006.01)
A61K 31/451 (2006.01)
C07C 233/80 (2006.01)
- (86) JP2012070267 08.08.2012
(96) 12821416.0 18.06.2014
(87) WO2013022047, 08.08.2012
(97) 2743256, 18.06.2014 en
(54) CYCLOPROPANEAMINE COMPOUND
(71) Takeda Pharmaceutical Company Limited, 1-1 Doshomachi 4-chome Chuo-ku, Osaka-shi, Osaka 541-0045, JP
(72) TOMITA, Naoki, c/o TAKEDA PHARMACEUTICAL COMPANY LIMITED 12-10, Nihonbashi 2-chome Chuo-ku, Tokyo 103-0027, JP
KAJII, Shigeo, c/o TAKEDA PHARMACEUTICAL COMPANY LIMITED 26-1 Muraoka-Higashi 2-chome, Fujisawa-shi Kanagawa 251-0012, JP
CARY, Douglas Robert, c/o TAKEDA PHARMACEUTICAL COMPANY LIMITED 26-1 Muraoka-Higashi 2-chome, Fujisawa-shi Kanagawa 251-0012, JP
TOMITA, Daisuke, c/o TAKEDA PHARMACEUTICAL COMPANY LIMITED 26-1 Muraoka-Higashi 2-chome, Fujisawa-shi Kanagawa 251-0012, JP
IMAMURA, Shinichi, c/o TAKEDA PHARMACEUTICAL COMPANY LIMITED 26-1 Muraoka-Higashi 2-chome, Fujisawa-shi Kanagawa 251-0012, JP
TSUCHIDA, Ken, c/o TAKEDA PHARMACEUTICAL COMPANY LIMITED 26-1 Muraoka-Higashi 2-chome, Fujisawa-shi Kanagawa 251-0012, JP
MATSUDA, Satoru, c/o TAKEDA PHARMACEUTICAL COMPANY LIMITED 26-1 Muraoka-Higashi 2-chome, Fujisawa-shi Kanagawa 251-0012, JP
HARA, Ryujiro, Sugimototerasu 101 1-17-16, Nagatsuta Midori-ku, Yokohama-shi Kanagawa 226-0027, JP
-
- (51) MKP
G06Q 50/00 (2012.01) (97) **2766866 ***
(86) US2012060260 15.10.2012
(96) 12840608.9 20.08.2014
(87) WO2013056230, 15.10.2012
(97) 2766866, 20.08.2014 en
(54) DISCHARGE DECISION SUPPORT SYSTEM FOR POST ACUTE CARE REFERRAL
(71) The Trustees Of The University Of Pennsylvania, Center for Technology Transfer 3160 Chestnut Street Suite 200, Philadelphia, PA 19104-6283, US
(72) BOWLES, Kathryn, H., 1435 Wynnemoor Way, Fort Washington, PA 19034, US
NAYLOR, Mary, D., 342 Echo Valley Lane, Newton Square, PA 19073, US

- (51) MKP
A01K 67/027 (2006.01) (97) **2758535 ***
C07K 16/46 (2006.01)
C12N 15/85 (2006.01)
(86) GB2012052296 18.09.2012
(96) 12772122.3 30.07.2014
(87) WO2013041844, 18.09.2012
(97) 2758535, 30.07.2014 en
(54) ANTIBODIES, VARIABLE DOMAINS&CHAINS TAILORED FOR HUMAN USE
(71) Kymab Limited, Meditrina (B260) Babraham Research Campus, Cambridge, Cambridgeshire CB22 3AT, GB
(72) BRADLEY, Allan, c/o Kymab Limited, Meditrina Babraham Research Campus, Cambridge, Cambridgeshire CB22 3AT, GB
FRIEDRICH, Glenn, c/o Kymab Limited, Meditrina Babraham Research Campus, Cambridge, Cambridgeshire CB22 3AT, GB
LEE, E-Chiang, c/o Kymab Limited, Meditrina Babraham Research Campus, Cambridge Cambridgeshire CB22 3AT, GB
STRIVENS, Mark, c/o Kymab Limited, Meditrina Babraham Research Campus, Cambridge, Cambridgeshire CB22 3AT, GB
ENGLAND, Nicholas, c/o Kymab Limited, Meditrina Babraham Research Campus, Cambridge, Cambridgeshire CB22 3AT, GB

- (51) MKP
G01N 33/53 (2006.01) (97) **2729806 ***
(86) US2012045864 06.07.2012
(96) 12811358.6 14.05.2014
(87) WO2013009657, 06.07.2012
(97) 2729806, 14.05.2014 en
(54) USES OF LABELED HSP90 INHIBITORS
(71) Sloan-kettering Institute For Cancer Research, 1275 York Avenue, New York, NY 10065, US
Cornell University, Cornell Center for Technology Enterprise & Commercialization 395 Pine Tree Road Suite 310, Ithaca, NY 14850, US
(72) CHIOSIS, Gabriela, 303 E 60 Street Apt 34G, New York, NY 10022, US
TALDONE, Tony, 425 Main Street Apt 12F, New York, NY 10044, US
ALPAUGH, Mary, L., 301 Farrant Terrace, Teaneck, NJ 07666, US
GOMES-DAGAMA, Erica, M., 59 Amherst Drive, New Rochelle, NY 10804, US
GUZMAN, Monica, L., 450 E 63rd Street Apt 11A, New York, NY 10065, US
ZONG, Hongliang, 465 Main Street Apt 10J, New York, NY 10044, US

- (51) MKP
H01S 3/06 (2006.01) (97) **2713457**
H01S 3/0941 (2006.01)
H01S 3/16 (2006.01)
H01S 3/23 (2006.01)
(86) 13178069.4 02.04.2014
(97) 2713457, 02.04.2014 en
(54) Optical amplifier and process
(71) Lee Laser, Inc., 7605 Presidents Drive, Orlando, FL 32809, US
(72) Peng, Xiaoyuan, 8105 NW Hazeltine Street, Portland, OR 97229, US

- (51) MKP
F16H 15/38 (2006.01) (97) **2705276 ***
F16H 15/44 (2006.01)
F16H 15/48 (2006.01)
F16H 15/52 (2006.01)
(86) AU2012000476 04.05.2012
(96) 12782593.3 12.03.2014
(87) WO2012151615, 04.05.2012
(97) 2705276, 12.03.2014 en
(54) TOROIDAL VARIABLE SPEED TRACTION DRIVE
(71) Ultimate Transmissions Pty Ltd, 31 Phillip Street, Strathfield, NSW 2135, AU
(72) DURACK, Michael, 223 Geddes Street, Toowoomba South, Queensland 4350, AU

- (51) MKP
A61K 39/08 (2006.01) (97) **2714911 ***
C07K 14/33 (2006.01)
C12N 15/62 (2006.01)
(86) EP2012059805 25.05.2012
(96) 12726374.7 09.04.2014
(87) WO2012163817, 25.05.2012
(97) 2714911, 09.04.2014 en
(54) IMMUNOGENIC COMPOSITION
(71) GlaxoSmithKline Biologicals S.A., rue de l'Institut, 89, 1330 Rixensart, BE
(72) CASTADO, Cindy, GlaxoSmithKline Biologicals S.A. Rue de l'Institut 89, B-1330 Rixensart, BE

- (51) MKP
E21B 23/02 (2006.01) (97) **2723972 ***
E21B 23/03 (2006.01)
E21B 33/124 (2006.01)
E21B 43/26 (2006.01)
(86) CA2012050413 20.06.2012
(96) 12803308.1 30.04.2014
(87) WO2012174663, 20.06.2012
(97) 2723972, 30.04.2014 en
(54) FRACTURING PORT LOCATOR AND ISOLATION TOOL
(71) Packers Plus Energy Services Inc., Bow Valley Square 2 Suite 2200, 205 - 5 Avenue SW, Calgary, Alberta T2P 2V7, CA
(72) THEMIG, Daniel Jon, 256 Woodhaven Place SW, Calgary, Alberta T2W 5P9, CA

- (51) MKP
H01C 7/12 (2006.01) (97) **2707892 ***
H01H 37/76 (2006.01)
H01T 1/14 (2006.01)
H02H 9/04 (2006.01)
(86) SI2012000030 11.05.2012
(96) 12741399.5 19.03.2014
(87) WO2012154134, 11.05.2012
(97) 2707892, 19.03.2014 en
(54) REDUNDANT EXCESS VOLTAGE CIRCUIT BREAKER WITH A ROTATIONAL DISK AND WITH AN ADDED ELECTRONIC ASSEMBLY INTENDED TO EXTEND A LIFE SPAN OF AN EXCESS -VOLTAGE COMPONENT
(71) Iskra Zascite D.o.o., Stegne 35, 1000 Ljubljana, SI
(72) JURI EV, Igor, Smrekarjeva 19, 6310 Izola, SI

- (51) MKP
A61K 31/438 (2006.01) (97) **2676958**
A61P 1/16 (2006.01)
A61P 3/10 (2006.01)
C07D 471/10 (2006.01)
(96) 13183518.3 25.12.2013
(97) 2676958, 25.12.2013 en
(54) N1-Pyrazolospiroketone acetyl-CoA carboxylase inhibitors
(71) Pfizer Inc., 235 East 42nd Street, New York, NY 10017, US
(72) Bagley, Scott William, Pfizer Global Research&Development Eastern Point Road, Groton, CT Connecticut 06340, US
Griffith, David Andrew, Pfizer Global Research&Development Eastern Point Road, Groton, CT Connecticut 06340, US
Kung, Daniel Wei-Shung, Pfizer Global Research&Development Eastern Point Road, Groton, CT Connecticut 06340, US

- (51) MKP
A61K 39/395 (2006.01) (97) **2723379 ***
(86) US2012043701 22.06.2012
(96) 12802721.6 30.04.2014
(87) WO2012177972, 22.06.2012
(97) 2723379, 30.04.2014 en
(54) ANTI-ALPHA SYNUCLEIN BINDING MOLECULES
(71) Biogen IDEC International Neuroscience GmbH, Wagistrasse 13, 8952 Schlieren, CH
University of Zürich, Rämistrasse 71, 8006 Zurich, CH
(72) WEIHOFEN, Andreas, Thurwiesenstrasse 15A, CH-8037 Zürich, CH
GRIMM, Jan, Bürglistrasse 16, CH-8600 Dübendorf, CH
HOCK, Christoph, Rietstrasse 43, CH-8703 Erlenbach, CH
NITSCH, Roger, Langwiesstrasse 27, CH-8126 Zumikon, CH
SU, Lihe, 976 Main Street, Reading Massachusetts 01867, US
WEINREB, Paul, 18 Brundette Avenue, Andover Massachusetts 01810, US

- (51) MKP
A61K 9/70 (2006.01) (97) **2714018 ***
A61K 31/485 (2006.01)
A61K 47/12 (2006.01)
A61P 25/04 (2006.01)
A61P 25/36 (2006.01)
(86) EP2012058950 14.05.2012
(96) 12723144.7 09.04.2014
(87) WO2012163665, 14.05.2012
(97) 2714018, 09.04.2014 de
(54) TRANSDERMAL THERAPEUTIC SYSTEM COMPRISING BUPRENORPHINE AND AN ALPHA-HYDROXY ACID
(71) Acino AG, Am Windfeld 35, 83714 Miesbach, DE
(72) FAHRMEIR, Julia, Blütenstraße 5, 80779 München, DE
SCHURAD, Björn, Michael-Huber-Weg 26, 81667 München, DE

- (51) MKP
A61K 38/17 (2006.01) (97) **2704735 ***
A61K 39/395 (2006.01)
A61P 35/00 (2006.01)
(86) US2012036181 02.05.2012
(96) 12724001.8 12.03.2014
(87) WO2012151317, 02.05.2012
(97) 2704735, 12.03.2014 en
(54) VASCULAR DISRUPTION AGENTS AND USES THEREOF
(71) Genentech, Inc., 1 DNA Way, South San Francisco, CA 94080, US
(72) ASHKENAZI, Avi J., Genentech Inc. 1 DNA Way, South San Francisco, California 94080, US

- (51) MKP
C07D 417/04 (2006.01) (97) **2674431**
C07D 417/14 (2006.01)
(96) 13184180.1 18.12.2013
(97) 2674431, 18.12.2013 en
(54) Stable SNS-595 compositions and methods of preparation
(71) Sunesis Pharmaceuticals, Inc., 395 Oyster Point Blvd., Suite 400, South San Francisco, CA 94080, US
(72) Sudhakar, Anantha, 42356 Troyer Avenue, Fremont, CA 94539, US
Jacobs, Jeff, 505 Cornell Avenue, San Mateo, CA 94402, US
Hashash, Ahmad, 5 Oland Lane, Southborough, MA 01772, US
Ritchie, Sean, 475 Kansas Way, Fremont, CA 94539, US
Cheng, Henqin, 607 Portofino, Foster City, CA 94404, US

- (51) MKP
C09C 1/02 (2006.01) (97) **2722368**
(96) 12188739.2 23.04.2014
(97) 2722368, 23.04.2014 en
(54) Process of controlled chemical reaction of a solid filler material surface and additives to produce a surface treated filler material product
(71) Omya International AG, Baslerstrasse 42, 4665 Oftringen, CH
(72) RENTSCH, Samuel, Burgpark 2, 4663 Aarburg, CH
BURI, Matthias, Mätteliweg 20, 4852 Rothrist, CH
BLUM, René Vinzenz, Sagiacher 3, 4915 St. Urban, CH
BRUNNER, Martin, Rosenstrasse 5, 4323 Wallbach, CH
GANE, Patrick A. C., Studenweg 8, 4852 Rothrist, CH

- (51) MKP
B27K 3/36 (2006.01) (97) **2760652 ***
B27N 1/00 (2006.01)
B27N 3/04 (2006.01)
(86) EP2012069086 27.09.2012
(96) 12766088.4 06.08.2014
(87) WO2013045551, 27.09.2012
(97) 2760652, 06.08.2014 en
(54) PANELS OF MEDIUM DENSITY FIBREBOARD
(71) Titan Wood Limited, Royal Albert House Sheet Street, Windsor SL4 1BE, GB
(72) POL, Bernardus, Jozef, Maria, c/o Titan Wood Limited Royal Albert House Sheet Street, Windsor SL4 1BE, GB
VAN DOMMELE, Stefan, c/o Titan Wood Limited Royal Albert House Sheet Street, Windsor SL4 1BE, GB
KAPPEN, Theorodus, Gerardus, Marinus, Maria, c/o Titan Wood Limited Royal Albert House Sheet Street, Windsor SL4 1BE, GB

- (51) MKP
E21D 11/00 (2006.01) (97) **2723987 ***
E21D 11/08 (2006.01)
E21D 11/10 (2006.01)
E21D 11/30 (2006.01)
E21D 11/38 (2006.01)
E21D 11/40 (2006.01)
E21F 16/02 (2006.01)
(86) NO2012050112 21.06.2012
(96) 12737622.6 30.04.2014
(87) WO2012177143, 21.06.2012
(97) 2723987, 30.04.2014 en
(54) A METHOD FOR CONSTRUCTING A TUNNEL COURSE, AND STRUCTURAL ELEMENT FOR USE BY THE METHOD
(71) Stabior AS, Kjellstadveien 16, 3400 Lier, NO
(72) DALEGÅRDEN, Torbjørn, Kjellstadveien 16, N-3400 Lier, NO

- (51) MKP
C07D 407/04 (2006.01) (97) **2712360 ***
(86) US2012038479 18.05.2012
(96) 12724044.8 02.04.2014
(87) WO2012162113, 18.05.2012
(97) 2712360, 02.04.2014 en
(54) PROCESS FOR THE PREPARATION OF COMPOUNDS USEFUL AS INHIBITORS OF SGLT-2
(71) Janssen Pharmaceutica, N.V., Turnhoutseweg 30, 2340 Beerse, BE
(72) WELLS, Kenneth, M., c/o Janssen Research&Development LLC Welsh&Mckean Roads, Spring House, PA 19477, US
LI, Xun, c/o Janssen Research&Development LLC Welsh&Mckean Roads, Spring House, PA 19477, US
BRANUM, Shawn, c/o Janssen Research&Development LLC Welsh&Mckean Roads, Spring House, PA 19477, US
NOMURA, Sumihiro, c/o Mitsubishi Tanabe Pharma Corporation 2-6-18 Kitahama Chuo-ku, Osaka-shi Osaka 541-8505, JP
MATSUMURA, Yosuke, c/o Mitsubishi Tanabe Pharma Corporation 2-6-18 Kitahama Chuo-ku, Osaka-shi Osaka 541-8505, JP

- (51) MKP
A61K 31/4245 (2006.01) (97) **2718283 ***
A61K 31/454 (2006.01)
A61K 31/4545 (2006.01)
A61K 31/5377 (2006.01)
A61P 1/00 (2006.01)
A61P 1/08 (2006.01)
A61P 1/10 (2006.01)
A61P 1/14 (2006.01)
A61P 13/02 (2006.01)
A61P 13/08 (2006.01)
A61P 17/00 (2006.01)
A61P 25/18 (2006.01)
A61P 25/22 (2006.01)
A61P 25/24 (2006.01)
A61P 25/28 (2006.01)
A61P 43/00 (2006.01)
C07D 401/14 (2006.01)
(86) JP2012065052 06.06.2012
(96) 12796621.6 16.04.2014
(87) WO2012169649, 06.06.2012
(97) 2718283, 16.04.2014 en
(54) INDAZOLE- AND PYRROLOPYRIDINE-DERIVATIVE AND PHARMACEUTICAL USE THEREOF
(71) Dainippon Sumitomo Pharma Co., Ltd., 6-8, Dosho-machi 2-chome Chuo-ku Osaka-shi, Osaka 541-8524, JP
(72) MIZUNO, Kazuhiro, c/o Dainippon Sumitomo Pharma Co. Ltd. 6-8 Dosho-machi 2-chome Chuo-ku, Osaka-shi Osaka 541-8524, JP
IKEDA, Junya, c/o Dainippon Sumitomo Pharma Co. Ltd. 1-98, Kasugadenaka 3-chome, Konohana-ku, Osaka-shi, Osaka 554-0022, JP
NAKAMURA, Takanori, c/o Dainippon Sumitomo Pharma Co. Ltd. 1-98, Kasugadenaka 3-chome, Konohana-ku, Osaka-shi, Osaka 554-0022, JP
IWATA, Masato, c/o Dainippon Sumitomo Pharma Co. Ltd. 1-98 Kasugadenaka 3-chome Konohana-ku, Osaka-shi Osaka 554-0022, JP
OTAKA, Hiromichi, c/o Dainippon Sumitomo Pharma Co. Ltd. 33-94 Enoki-cho, Suita-shi Osaka 564-0053, JP
GOTO, Nana, c/o Dainippon Sumitomo Pharma Co. Ltd. 33-94 Enoki-cho, Suita-shi Osaka 564-0053, JP

- (51) MKP
A01N 43/42 (2006.01) (97) **2736336 ***
A61K 31/47 (2006.01)
(86) US2012048689 27.07.2012
(96) 12817547.8 04.06.2014
(87) WO2013016686, 27.07.2012
(97) 2736336, 04.06.2014 en
(54) TREATMENT OF MULTIPLE SCLEROSIS WITH COMBINATION OF LAQUINIMOD AND INTERFERON-BETA
(71) Teva Pharmaceutical Industries Ltd., 5 Basel Street P.O. Box 3190, 49131 Petach-Tikva, IL
(72) GILGUN, Yossi, Hinanit 17 P.O. Box 1255, 42842 Bat Hefer, IL
TARCIC, Nora, Migdal David 29/1, Modiin, IL

- (51) MKP
C02F 1/14 (2006.01) (97) **2742004 ***
C02F 1/18 (2006.01)
(86) GR2012000037 30.07.2012
(96) 12756815.2 18.06.2014
(87) WO2013021220, 30.07.2012
(97) 2742004, 18.06.2014 en
(54) PORTABLE AND STATIONARY DISTILLATION UNIT FOR THE SIMULTANEOUS PRODUCTION OF DISTILLED WATER AND SALT, ENHANCED BY SOLAR COLLECTORS
(71) Hatzigiannis, Georgios, 26 Iraklidon, GR-166 73 Voula, Athens, GR
Hatzigiannis, Vassilios, 17 Athinas, GR-166 73 Voula, Athens, GR
Hatzigianni, Zoi, 26 Iraklidon, GR-166 73 Voula, Athens, GR
(72) Hatzigiannis, Georgios, 26 Iraklidon, GR-166 73 Voula, Athens, GR
Hatzigiannis, Vassilios, 17 Athinas, GR-166 73 Voula, Athens, GR
Hatzigianni, Zoi, 26 Iraklidon, GR-166 73 Voula, Athens, GR

- (51) MKP
C12N 9/00 (2006.01) (97) **2732031 ***
C12N 9/04 (2006.01)
C12N 9/12 (2006.01)
C12N 9/88 (2006.01)
C12P 7/28 (2006.01)
(86) EP2012063685 12.07.2012
(96) 12743917.2 21.05.2014
(87) WO2013007786, 12.07.2012
(97) 2732031, 21.05.2014 en
(54) RECOMBINANT MICROORGANISM FOR THE PRODUCTION OF USEFUL METABOLITES
(71) Scientist of Fortune S.A., 7a rue des Glacis, 1628 Luxembourg, LU
(72) MARLIERE, Philippe, 173 Rue de Rollegem, B-7700 Mouscron, BE

- (51) MKP
G01R 31/36 (2006.01) (97) **2621051**
H02J 7/00 (2006.01)
(86) 13152501.6 31.07.2013
(97) 2621051, 31.07.2013 fr
(54) Device for high-precision management of the charge of a battery, and method implemented by said device
(71) Accuwatt, Immeuble Le Diamant 4 rue Rene Razel, 91400 Saclay, FR
(72) Combiér, Michel, 73 allée de la Clairière, 91190 Gif-sur-Yvette, FR

- (51) MKP
F25B 15/06 (2006.01) (97) **2734794 ***
F25B 27/00 (2006.01)
(86) DK2012050270 18.07.2012
(96) 12748645.4 28.05.2014
(87) WO2013010549, 18.07.2012
(97) 2734794, 28.05.2014 en
(54) A METHOD FOR CHILLING A BUILDING
(71) Purix ApS, Langøgade 17, 2100 Copenhagen, DK
Purix S.r.l., Via A. Caracciolo 32, 70123 Bari, IT
(72) MUNKØE, Lars, Langøgade 17, DK-2100 København Ø, DK
FRIDBERG, Christian Holm, Tofledet 19, DK-2730 Herlev, DK

- (51) MKP
C12N 5/078 (2010.01) (97) **2729562 ***
 (86) GB2012051600 06.07.2012
 (96) 12735321.7 14.05.2014
 (87) WO2013005053, 06.07.2012
 (97) 2729562, 14.05.2014 en
 (54) PROGENITOR CELLS OF MESODERMAL LINEAGE
 (71) Cell Therapy Limited, Institute of Life Sciences First Floor,
 Room 137 School of Medicine Swansea University Singleton
 Park, Swansea SA2 8PP, GB
 (72) HOUZE, Thomas Averell, Skånegatan 16, S-504 38 Boras, SE
 EVANS, Martin John, Moyclare Windsor Road, Radyr Cardiff
 CF15 8BQ, GB
 REGINALD, Ajan, 5 Feldon Way, Stratford-Upon-Avon
 Warwickshire CV37 7EE, GB
 PIEPER, Ina Laura, 3 Bayswater Court, Swansea SA3 5AU,
 GB
 PERKINS, Brian Lee, 3 Bayswater Court, Swansea SA3 5AU,
 GB

- (51) MKP
F01C 1/40 (2006.01) (97) **2729706 ***
F03C 2/30 (2006.01)
F04C 2/40 (2006.01)
F04C 18/40 (2006.01)
 (86) AU2012000822 06.07.2012
 (96) 12811969.0 14.05.2014
 (87) WO2013006902, 06.07.2012
 (97) 2729706, 14.05.2014 en
 (54) ROTARY FLUID MACHINE
 (71) Greystone Technologies Pty Ltd, Unit 2 39 Colin Jamieson
 Drive, Welshpool, Western Australia 6106, AU
 (72) WHEELER, Daryl, Unit 2 7 Rocklea Place, Silver Sands,
 Western Australia 6210, AU
 ERWIN, Justin Wade, 17310 Meria Coves Drive, Houston,
 Texas 77095, US
 BURNS, Timothy Donald Sr., 437 Shannon Road, McAlester,
 Oklahoma 74501, US

- (51) MKP
A47J 31/44 (2006.01) (97) **2662002**
G07F 13/06 (2006.01)
 (96) 12167124.2 13.11.2013
 (97) 2662002, 13.11.2013 en
 (54) Goods supply apparatus
 (71) Sandenvendo Europe S.p.a., Regione Cavallino 2, 15030
 Casale Monferrato (AL), IT
 (72) Garbarino, Andrea, c/o SandenVendo Europe S.p.A. Regione
 Cavallino, 2, 15030 Coniolo (AI), IT

- (51) MKP
A61K 31/18 (2006.01) (97) **2758056 ***
A61K 31/335 (2006.01)
A61K 31/44 (2006.01)
A61K 31/4422 (2006.01)
A61K 31/445 (2006.01)
 (86) US2012056944 24.09.2012
 (96) 12833265.7 30.07.2014
 (87) WO2013044246, 24.09.2012
 (97) 2758056, 30.07.2014 en
 (54) BUFFERED UPPER GI ABSORPTION PROMOTER
 (71) AMIP, LLC, 101 North Main Street, Clearfield, UT 84015, US
 Bortz, Jonathan, 8117 Stanford Avenue, St. Louis, MO 63130,
 US
 Hartle, Jennifer, 101 North Main Street, Clearfield, UT 84015,
 US
 (72) BORTZ, Jonathan, 8117 Stanford Avenue, St. Louis, MO
 63130, US
 HARTLE, Jennifer, 101 North Main Street, Clearfield, UT
 84015, US

- (51) MKP
A61K 31/437 (2006.01) (97) **2736895 ***
A61K 31/506 (2006.01)
A61P 35/00 (2006.01)
C07D 401/02 (2006.01)
C07D 471/04 (2006.01)
 (86) GB2012051783 25.07.2012
 (96) 12759801.9 04.06.2014
 (87) WO2013014448, 25.07.2012
 (97) 2736895, 04.06.2014 en
 (54) 2 - (2, 4, 5 - SUBSTITUTED -ANILINO) PYRIMIDINE
 DERIVATIVES AS EGFR MODULATORS USEFUL FOR
 TREATING CANCER
 (71) AstraZeneca AB, null, SE-151 85 Södertälje, SE
 (72) BUTTERWORTH, Sam, c/o AstraZeneca R&D Alderley Alderley
 Park, Macclesfield Cheshire SK10 4TG, GB
 FINLAY, Maurice, Raymond, Verschoyle, AstraZeneca R&D
 Alderley Alderley Park, Macclesfield Cheshire SK10 4TG, GB
 WARD, Richard, Andrew, AstraZeneca R&D Alderley Alderley
 Park, Macclesfield Cheshire SK10 4TG, GB
 KADAMBAR, Vasantha, Krishna, AstraZeneca India Private
 Limited Hebbal Off Bellary Road, Bangalore 560024, IN
 CHINTAKUNTLA, Chandrasekhara, Reddy, AstraZeneca India
 Private Limited Hebbal Off Bellary Road, Bangalore 560024, IN
 MURUGAN, Andiappan, AstraZeneca India Private Limited
 Hebbal Off Bellary Road, Bangalore 560024, IN
 REDFEARN, Heather, Marie, AstraZeneca Charter Way,
 Macclesfield Cheshire SK10 2NA, GB
 CHUAQUI, Claudio Edmundo, AstraZeneca R&D Boston 35
 Gatehouse Drive, Waltham, Massachusetts 02451, US

- (51) MKP
B01J 14/00 (2006.01) (97) **2705020 ***
C07C 201/16 (2006.01)
C07C 205/06 (2006.01)
 (86) EP2012002139 18.05.2012
 (96) 12723831.9 12.03.2014
 (87) WO2012156095, 18.05.2012
 (97) 2705020, 12.03.2014 de
 (54) METHOD AND APPARATUS FOR PURIFYING NITRATION
 PRODUCTS
 (71) Josef Meissner GmbH & Co. KG, Bayenthalgürtel 16-20, 50968
 Köln, DE
 (72) PÖHLMANN, Jürgen, Türnischer Str. 3, 50969 Köln, DE
 HERMANN, Heinrich, Donauweg 27, 50858 Köln, DE
 HÄNDEL, Mirko, Weesbacher Str. 7, 53819 Neunkirchen-
 Seelscheid, DE
 GEBAUER, Jürgen, Richard-Wagner-Str. 12, 53840 Troisdorf,
 DE

- (51) MKP
A61M 5/00 (2006.01) (97) **2704777 ***
A61M 5/24 (2006.01)
A61M 5/31 (2006.01)
 (86) EP2012058182 04.05.2012
 (96) 12718670.8 12.03.2014
 (87) WO2012152668, 04.05.2012
 (97) 2704777, 12.03.2014 en
 (54) DRUG DELIVERY DEVICE AND CARTRIDGE HOLDER FOR
 A DRUG DELIVERY DEVICE
 (71) Sanofi-Aventis Deutschland GmbH, Brüningstraße 50, 65929
 Frankfurt am Main, DE
 (72) SCHNEIDER, Christiane, c/o Sanofi-Aventis Deutschland
 GmbH, 65926 Frankfurt am Main, DE
 STEVER, Tobias, c/o Sanofi-Aventis Deutschland GmbH,
 65926 Frankfurt am Main, DE
 HARMS, Michael, c/o Sanofi-Aventis Deutschland GmbH,
 65926 Frankfurt am Main, DE
 JAKOBI, Ulrik, c/o Sanofi-Aventis Deutschland GmbH, 65926
 Frankfurt am Main, DE

- (51) MKP
A61K 31/352 (2006.01) (97) **2751090 ***
A61K 31/397 (2006.01)
A61K 31/4178 (2006.01)
C07D 311/36 (2006.01)
C07D 405/06 (2006.01)
(86) US2012053110 30.08.2012
(96) 12769522.9 09.07.2014
(87) WO2013033377, 30.08.2012
(97) 2751090, 09.07.2014 en
(54) ALDH-2 INHIBITORS IN THE TREATMENT OF ADDICTION
(71) Gilead Sciences, Inc., 333 Lakeside Drive, Foster City, CA 94404, US
(72) GRAUPE, Michael, 1131 Banyan Way, Pacifica, CA 94044, US
VENKATARAMANI, Chandrasekar, 1 Chart Lane, Redwood City, CA 94065, US
ZABLOCKI, Jeff, 490 Raquel Court, Los Altos, CA 94022, US

- (51) MKP
C07F 7/00 (2006.01) (97) **2757113**
C08F 4/659 (2006.01)
C08F 10/00 (2006.01)
(96) 14164636.4 23.07.2014
(97) 2757113, 23.07.2014 en
(54) Catalysts, processes for making catalysts, processes for making polyolefin compositions and polyolefin compositions
(71) Dow Global Technologies LLC, 2040 Dow Center, Midland, MI 48674, US
(72) Kuhlman, Roger, 117 Dewberry, Lake Jackson, TX Texas 77566, US
Whiteker, Gregory, 1467 Trail Creek Court, Carmel, IN Indiana 46032, US

- (51) MKP
A61K 31/65 (2006.01) (97) **2707003 ***
C07C 237/26 (2006.01)
(86) US2012037838 14.05.2012
(96) 12782600.6 19.03.2014
(87) WO2012155146, 14.05.2012
(97) 2707003, 19.03.2014 en
(54) CRYSTALLINE SALTS OF (4S,4AS,5AR,12AS)-4-DIMETHYLAMINO-3,10,12,12A-TETRAHYDROXY-7-[(METHOXY(METHYL)AMINO)-METHYL]-1,11-DIOXO-1,4,4A,5,5A,6,11,12A-OCTAHYDRO-NAPHTHACENE-2-CARBOXYLIC ACID AMIDE AND METHODS OF USING THE SAME
(71) Paratek Pharmaceuticals, Inc., 75 Kneeland Street, Boston, MA 02111, US
Warner Chilcott Company, LLC, Union Street KM 1.1, Fajardo, Puerto Rico 00738-1005, PR
(72) COULTER, Catherine, 38 Church Road Gracehill, Ballymena Co Antrim, IE
JOHNSTON, Sean, M., 4360 Wismer Road, Doylestown PA 18902, US
SEYEDI, Farzaneh, 43 Ridgeview Lane, Mansfield MA 02048, US

- (51) MKP
B29C 70/02 (2006.01) (97) **2769019 ***
B29C 70/64 (2006.01)
E01C 11/06 (2006.01)
E01C 11/10 (2006.01)
(86) EP2012070829 19.10.2012
(96) 12786863.6 27.08.2014
(87) WO2013057299, 19.10.2012
(97) 2769019, 27.08.2014 en
(54) ARTICLE OF MANUFACTURE MADE OF COMPOSITE MATERIAL, FOR INCORPORATION INTO A CIVIL ENGINEERING STRUCTURE
(71) Voet, Hans, Heibaan 176, 2235 Hulshout, BE
Leitner, Leopold, Hofham 1, 4101 Feldkirchen an der Donau, AT
(72) VOET, Hans, Heibaan 176, B-2235 Hulshout, BE
LEITNER, Leopold, Hofham 1, A-4101 Feldkirchen an der Donau, AT

- (51) MKP
B28D 1/32 (2006.01) (97) **2660026**
(96) 13001804.7 06.11.2013
(97) 2660026, 06.11.2013 en
(54) Cutting method for crackly plate-shaped work piece and cutting device thereof
(71) Chiang, Chun-Sheng, No. 18-5, Da-Kerng Road Kwong-Jwa Tsun San-Hsing Hsiang, Yi-Lan Hsien, TW
(72) Chiang, Chun-Sheng, No. 18-5, Da-Kerng Road Kwong-Jwa Tsun San-Hsing Hsiang, Yi-Lan Hsien, TW

- (51) MKP
C07K 16/24 (2006.01) (97) **2734548 ***
(86) EP2012064129 19.07.2012
(96) 12738101.0 28.05.2014
(87) WO2013011076, 19.07.2012
(97) 2734548, 28.05.2014 en
(54) ANTIGEN-BINDING PROTEINS WITH INCREASED FCRN BINDING
(71) Glaxo Group Limited, 980 Great West Road, Brentford, Middlesex TW8 9GS, GB
(72) ELLIS, Jonathan, Henry, GlaxoSmithKline Gunnels Wood Road, Stevenage Hertfordshire SG1 2NY, GB
MOLLOY, Michael, J, GlaxoSmithKline Gunnels Wood Road, Stevenage Hertfordshire SG1 2NY, GB
SHAH, Tejash, GlaxoSmithKline Gunnels Wood Road, Stevenage Hertfordshire SG1 2NY, GB
TOMLINSON, Ian, M, GlaxoSmithKline Gunnels Wood Road, Stevenage Hertfordshire SG1 2NY, GB
YASIN, Ahmed, GlaxoSmithKline Gunnels Wood Road, Stevenage Hertfordshire SG1 2NY, GB

- (51) MKP
A61K 38/04 (2006.01) (97) **2729495 ***
C07K 14/78 (2006.01)
(86) FR2012051593 06.07.2012
(96) 12738574.8 14.05.2014
(87) WO2013007933, 06.07.2012
(97) 2729495, 14.05.2014 fr
(54) ANTAGONIST PEPTIDE OF THE BOND BETWEEN CD47 AND A PROTEIN BELONGING TO THE THROMBOSPONDIN FAMILY
(71) Université De Reims Champagne-Ardenne, Villa Douce 9 Boulevard de la Paix, 51100 Reims, FR
(72) DEDIEU, Stéphane, 140 Boulevard Dauphinot, F-51100 Reims, FR
FLOQUET, Nicolas, 57 Rue des Marguerites, F-34725 Saint Andre de Sangonis, FR
MARTINY, Laurent, 57 Rue Roger Salengro, F-51100 Reims, FR
SCHNEIDER, Christophe, 4 Rue de la Belle Image, F-51170 Aubilly, FR
JEANNE, Albin, 18/20 Rue du Progrès Appartement 7E, F-51100 Reims, FR
SICK, Emilie, 89 Rue d'Alsace Lorraine, F-51100 Reims, FR
DAUCHEZ, Manuel, 1 Rue des Tendonnières, F-51390 Rosnay, FR

- (51) MKP
D04C 3/00 (2006.01) (97) **2725128 ***
D04C 5/00 (2006.01)
(86) CN2011079947 21.09.2011
(96) 11868047.9 30.04.2014
(87) WO2012174801, 21.09.2011
(97) 2725128, 30.04.2014 en
(54) NET KNITTING METHOD
(71) Chen, Chung-Ping, No. 8 Lane 70, Wande Rd. Wanluan Township Pingtung County, Taiwan, TW
(72) Chen, Chung-Ping, No. 8 Lane 70, Wande Rd. Wanluan Township Pingtung County, Taiwan, TW

(51) MKP
B32B 23/00 (2006.01) (97) **2723564 ***
 (86) EP2012060292 31.05.2012
 (96) 12727336.5 30.04.2014
 (87) WO2012175309, 31.05.2012
 (97) 2723564, 30.04.2014 de
 (54) FIBROUS PRODUCT FOR PACKAGING
 (71) Smurfit Kappa Hoya Papier und Karton GmbH, Von-dem-Bussche-Straße 1, 27318 Hoya, DE
 (72) BUSCHMANN, Armin, Veilchenweg 1, 27324 Hassel, DE
 CADONAU, Fulvio, Grönlandstraße 1, 27333 Bücken, DE
 HONSBROK, Ralf, Im Koksbruch 19, 27333 Bücken, DE
 RICHTER, Detlev, Dunkerskamp 16, 27321 Morsum, DE
 TRUPPNER, Olaf, Grönlandstraße 3, 27333 Bücken, DE

(51) MKP
A61B 10/00 (2006.01) (97) **2720617 ***
B65D 51/28 (2006.01)
 (86) DK2011050434 11.11.2011
 (96) 11784584.2 23.04.2014
 (87) WO2012171529, 11.11.2011
 (97) 2720617, 23.04.2014 en
 (54) CONTAINER ASSEMBLY AND ASSOCIATED METHOD
 (71) AX-Lab Innovation ApS, Bygstubben 12, 2950 Vedbæk, DK
 (72) JAKOBSEN, Ole, Granhøj 1, 2900 Hellerup, DK
 BAY, Christoffer, Mønvej 41A, 4720 Præstø, DK
 ILSKOV, Jacob, Borghaven 30, 2500 Valby, DK

(51) MKP
G06Q 30/02 (2012.01) (97) **2677484**
 (96) 12172465.2 25.12.2013
 (97) 2677484, 25.12.2013 en
 (54) System and method for making personalised recommendations to a user of a mobile computing device, and computer program product
 (71) Argus Labs, Sint-Michielsstraat 9, 2000 Antwerpen, BE
 (72) Maertens, Filip, Pittemsesteenweg 32, 8700 Tielt, BE

(51) MKP
A23L 1/22 (2006.01) (97) **2641479**
A23L 1/226 (2006.01)
A23L 1/236 (2006.01)
A23L 1/30 (2006.01)
A23L 2/60 (2006.01)
 (96) 12001955.9 25.09.2013
 (97) 2641479, 25.09.2013 en
 (54) Composition comprising an extract from sweet blackberry leaves
 (71) Rudolf Wild GmbH & Co. KG, Rudolf-Wild-Strasse 107-115, 69214 Eppelheim, DE
 (72) Müller, Manfred, Frobenstraße 21, 13585 Berlin, DE
 Herrmann, Markus, Blakenheideweg 14, 13595 Berlin, DE
 Polunin, Ines, Topeliusweg 3-O, 14089 Berlin, DE
 Toews, Kerstin, Heideweg 19, 16556 Borgsdorf, DE

(51) MKP
A61K 9/00 (2006.01) (97) **2706983 ***
A61K 9/06 (2006.01)
A61K 9/08 (2006.01)
A61K 9/14 (2006.01)
A61K 31/155 (2006.01)
A61K 31/593 (2006.01)
A61P 17/02 (2006.01)
 (86) EP2012058738 11.05.2012
 (96) 12726753.2 19.03.2014
 (87) WO2012152910, 11.05.2012
 (97) 2706983, 19.03.2014 en
 (54) NOVEL PHARMACEUTICAL FORMULATION
 (71) Vockner, Helmut, Jodlfeld 4/4, 6370 Kitzbühel, AT
 (72) Vockner, Helmut, Jodlfeld 4/4, 6370 Kitzbühel, AT

(51) MKP
C07C 61/40 (2006.01) (97) **2647618**
 (96) 13172571.5 09.10.2013
 (97) 2647618, 09.10.2013 en
 (54) Novel polymorphs and salts
 (71) CHIESI FARMACEUTICI S.p.A., Via Palermo, 26/A, 43100 Parma, IT
 (72) Pivetti, Fausto, c/o CHIESI FARMACEUTICI S.p.A. Via Palermo, 26/A, 43100 PARMA, IT
 Delcanale, Maurizio, c/o CHIESI FARMACEUTICI S.p.A. Via Palermo, 26/A, PARMA 43100, IT
 Giaffreda, Stefano Luca, c/o CHIESI FARMACEUTICI S.p.A. Via Palermo, 26/A, 43100 PARMA, IT
 Curzi, Marco, c/o CHIESI FARMACEUTICI S.p.A. Via Palermo, 26/A, 43100 PARMA, IT

(51) MKP
A61K 38/46 (2006.01) (97) **2717906 ***
 (86) NL2012050400 08.06.2012
 (96) 12729755.4 16.04.2014
 (87) WO2012169892, 08.06.2012
 (97) 2717906, 16.04.2014 en
 (54) THE USE OF ALKALINE PHOSPHATASE FOR PRESERVING RENAL FUNCTION
 (71) AM-Pharma B.V., Rumpsterweg 6, 3981 AK Bunnik, NL
 (72) AREND, Jacques Salomon Robert, Kort Galgewater 12-a, NL-2312 BR Leiden, NL
 VAN DEN BERG, Erik Jan, Molhuysensingel 35, NL-5262 CD Vught, NL
 RAABEN, Willem, Kaasjeskruid 2, NL-3824 NW Amersfoort, NL

(51) MKP
A61K 31/166 (2006.01) (97) **2714039 ***
A61K 31/277 (2006.01)
A61K 31/352 (2006.01)
A61K 31/416 (2006.01)
A61K 31/4196 (2006.01)
A61K 31/675 (2006.01)
A61K 35/00 (2006.01)
A61K 45/06 (2006.01)
 (86) US2012038950 22.05.2012
 (96) 12724504.1 09.04.2014
 (87) WO2012162293, 22.05.2012
 (97) 2714039, 09.04.2014 en
 (54) COMBINATION THERAPY OF HSP90 INHIBITORY COMPOUNDS WITH MEK INHIBITORS
 (71) Synta Pharmaceuticals Corp., 45 Hartwell Avenue, Lexington, MA 02421, US
 (72) PROIA, David, 30 Silver Lake Avenue, Newton, MA 02458, US
 ACQUAVIVA, Jaime, 248 Algonquin Trail, Ashland, MA 01721, US

(51) MKP
A01K 5/02 (2006.01) (97) **2649876**
A01K 13/00 (2006.01)
 (96) 13163037.8 16.10.2013
 (97) 2649876, 16.10.2013 de
 (54) Device and method for dispensing solids and liquids to animals
 (71) Gnadt, Birgit, Achenweg 30, 83236 Übersee, DE
 (72) Gnadt, Birgit, Achenweg 30, 83236 Übersee, DE

- (51) MKP
A61K 38/55 (2006.01) (97) **2726093 ***
A61K 39/395 (2006.01)
A61P 29/00 (2006.01)
C07K 19/00 (2006.01)
(86) US2012044742 28.06.2012
(96) 12804947.5 07.05.2014
(87) WO2013003649, 28.06.2012
(97) 2726093, 07.05.2014 en
(54) WAP DOMAIN FUSION POLYPEPTIDES AND METHODS OF USE THEREOF
(71) Inhibrx LLC, 11099 N. Torrey Pines Road Suite 130, La Jolla, CA 92037, US
(72) TIMMER, John, C., 11099 N. Torrey Pines Road Suite 130, La Jolla, CA 92037, US
ECKELMAN, Brendan, P., 11099 N. Torrey Pines Road Suite 130, La Jolla, CA 92037, US
GUENTHER, Grant, B., 11099 N. Torrey Pines Road Suite 130, La Jolla, CA 92037, US
NGUY, Peter, L., 11099 N. Torrey Pines Road Suite 130, La Jolla, CA 92037, US
CHAN, Henry, 11099 N. Torrey Pines Road Suite 130, La Jolla, CA 92037, US
DEVERAUX, Quinn, 11099 N. Torrey Pines Road Suite 130, La Jolla, CA 92037, US

- (51) MKP
G03G 15/08 (2006.01) (97) **2634646**
G03G 21/16 (2006.01)
(96) 13154836.4 04.09.2013
(97) 2634646, 04.09.2013 en
(54) Developing device and image forming apparatus including the same
(71) Kyocera Document Solutions Inc., 2-28, Tamatsukuri, 1-chome, Chuo-ku Osaka-shi Osaka 540-8585, JP
(72) Kusakawa, Takashi, c/o Kyocera Document Solutions Inc. 2-28, 1-Chome, Tamatsukuri Chuo-Ku, Osaka 540-8585, JP
Mukai, Kenichi, c/o Kyocera Document Solutions Inc. 2-28, 1-Chome, Tamatsukuri Chuo-Ku, Osaka 540-8585, JP
Sue, Tomohiro, c/o Kyocera Document Solutions Inc. 2-28, 1-Chome, Tamatsukuri Chuo-Ku, Osaka 540-8585, JP

- (51) MKP
A61G 5/12 (2006.01) (97) **2662061**
(96) 13166967.3 13.11.2013
(97) 2662061, 13.11.2013 en
(54) Ergonomic back and side support for aids to disabled and application for wheelchairs
(71) Woltturnus A/S, Halkærvej 24B, 9240 Nibe, DK
(72) Libak, Peter, Halkærvej 24B, 9240 Nibe, DK

- (51) MKP
A61K 38/17 (2006.01) (97) **2734220 ***
(86) US2012047468 19.07.2012
(96) 12814119.9 28.05.2014
(87) WO2013013085, 19.07.2012
(97) 2734220, 28.05.2014 en
(54) ANTI-FIBROTIC PEPTIDES AND THEIR USE IN METHODS FOR TREATING DISEASES AND DISORDERS CHARACTERIZED BY FIBROSIS
(71) Thrasos Innovation, Inc., 2000 Peel Street Suite 900, Montreal, QC H3A 2W5, CA
(72) BOSUKONDA, Dattatreyamurty, 45 Trowbridge Lane, Shrewsbury, MA 01545, US
KECK, Peter, C., 50 Dolan Road, Millbury, MA 01527, US

- (51) MKP
B65D 23/06 (2006.01) (97) **2750982 ***
(86) EP2012067014 31.08.2012
(96) 12759402.6 09.07.2014
(87) WO2013030363, 31.08.2012
(97) 2750982, 09.07.2014 en
(54) IMPROVED DRIP STOP DEVICE
(71) PIERIBONI, Antonio, Via A. Volta 32/5, 36054 Montebello Vicentino (VI), IT
(72) PIERIBONI, Antonio, Via A. Volta 32/5, 36054 Montebello Vicentino (VI), IT

- (51) MKP
B01D 39/02 (2006.01) (97) **2741854 ***
B01D 53/02 (2006.01)
B01J 20/20 (2006.01)
B01J 20/28 (2006.01)
B01J 20/32 (2006.01)
(86) EP2012002246 25.05.2012
(96) 12724910.0 18.06.2014
(87) WO2013023715, 25.05.2012
(97) 2741854, 18.06.2014 de
(54) ACTIVATED CARBON WITH A METAL BASED COMPONENT
(71) Blücher GmbH, Mettmanner Strasse 25, 40699 Erkrath, DE
Friedrich-Alexander-Universität Erlangen-Nürnberg, Schlossplatz 4, 91023 Erlangen, DE
(72) BÖHRINGER, Bertram, Bussardweg 33, 42115 Wuppertal, DE
ECKLE, Ilsebill, Ückendorfer Strasse 12, 45886 Gelsenkirchen, DE
WASSERSCHIED, Peter, Humboldtstrasse 15, 91054 Erlangen, DE
ROTH, Daniel, Friedrich-Alexander-Universität Lehrstuhl für chemische Reaktionstechnik Egerlandstrasse 3, 91058 Erlangen, DE

- (51) MKP
A61K 31/4545 (2006.01) (97) **2718281 ***
A61K 31/4709 (2006.01)
A61P 11/06 (2006.01)
A61P 11/08 (2006.01)
C07D 401/12 (2006.01)
C07D 409/14 (2006.01)
C07D 417/12 (2006.01)
(86) EP2012060782 07.06.2012
(96) 12732561.1 16.04.2014
(87) WO2012168349, 07.06.2012
(97) 2718281, 16.04.2014 en
(54) COMPOUNDS HAVING MUSCARINIC RECEPTOR ANTAGONIST AND BETA2 ADRENERGIC RECEPTOR AGONIST ACTIVITY
(71) Chiesi Farmaceutici S.p.A., Via Palermo, 26/A, 43100 Parma, IT
(72) RANCATI, Fabio, Chiesi Farmaceutici S.p.A. Via Palermo 26/A, I-43100 Parma, IT
LINNEY, Ian, Chiesi Farmaceutici S.p.A. Via Palermo 26/A, I-43100 Parma, IT
RIZZI, Andrea, Chiesi Farmaceutici S.p.A. Via Palermo 26/A, I-43100 Parma, IT
BLACKABY, Wesley, Chiesi Farmaceutici S.p.A. Via Palermo 26/A, I-43100 Parma, IT
KNIGHT, Chris, Chiesi Farmaceutici S.p.A. Via Palermo 26/A, I-43100 Parma, IT

- (51) MKP
A61C 19/04 (2006.01) (97) **2707704 ***
G01N 27/62 (2006.01)
G01N 37/00 (2006.01)
H05H 1/46 (2006.01)
(86) AU2012000228 06.03.2012
(96) 12786033.6 19.03.2014
(87) WO2012155174, 06.03.2012
(97) 2707704, 19.03.2014 en
(54) METHOD OF ANALYZING A MATERIAL
(71) DBD Innovations Pty Ltd, Level 1, 570 President Avenue, Sutherland, NSW 2232, AU
(72) GLOWACKI, Piotr, 32 Onthonna Terrace, Ulmina Beach, New South Wales 2257, AU
REYNOLDS, Guy James, 61 The Ridge, Helensburgh, New South Wales 2508, AU

- (51) MKP
F24D 19/02 (2006.01) (97) **2642211**
(96) 12160440.9 25.09.2013
(97) 2642211, 25.09.2013 en
(54) Tilting radiator assembly
(71) Ribe Jernindustri A/S, Saltgade 11, 6760 Ribe, DK
(72) Olesen, Michael Boel, Hyldelund Bakkevej 8 Hyldelund, 6650 Brørup, DK

(51) MKP
C12N 7/02 (2006.01) (97) **2764094 ***
 (86) EP2012069713 05.10.2012
 (96) 12775654.2 13.08.2014
 (87) WO2013050523, 05.10.2012
 (97) 2764094, 13.08.2014 en
 (54) VIRAL VECTORS PURIFICATION SYSTEM
 (71) MolMed SpA, Via Olgettina 58, 20132 Milan, IT
 (72) BOVOLENTA, Chiara, MolMes SpA, Via Olgettina 58, 20132 Milan, IT
 STORNAIUOLO, Anna, MolMes SpA, Via Olgettina 58, 20132 Milan, IT

(51) MKP
A61K 31/337 (2006.01) (97) **2740477 ***
A61K 31/506 (2006.01)
A61P 35/00 (2006.01)
A61P 43/00 (2006.01)
C07D 401/14 (2006.01)
 (86) JP2012069586 01.08.2012
 (96) 12819172.3 11.06.2014
 (87) WO2013018829, 01.08.2012
 (97) 2740477, 11.06.2014 en
 (54) METHOD FOR TREATING CANCER BY COMBINED USE OF MEDICINAL AGENTS
 (71) Astellas Pharma Inc., 3-11, Nihonbashi-Honcho 2-chome Chuo-ku, Tokyo 103-8411, JP
 (72) ARAI, Yukinori, c/o Astellas Pharma Inc. 3-11 Nihonbashi-Honcho 2-chome Chuo-ku, Tokyo 103-8411, JP

(51) MKP
A61K 9/00 (2006.01) (97) **2497461**
A61K 9/08 (2006.01)
A61K 31/13 (2006.01)
 (96) 12155472.9 12.09.2012
 (97) 2497461, 12.09.2012 en
 (54) Paediatric solutions comprising a beta-blocker
 (71) Pierre Fabre Dermatologie, 45 Place Abel Gance,, 92100 Boulogne Billancourt, FR
 (72) Chaumont, Christine, c/o PIERRE FABRE DERMO-COSMETIQUE 45, place Abel Gance, 92100 BOULOGNE-BILLANCOURT, FR
 Cordoliani, Jean-François, c/o PIERRE FABRE DERMO-COSMETIQUE 45, place Abel Gance, 92100 BOULOGNE-BILLANCOURT, FR
 Leverd, Elie, c/o PIERRE FABRE DERMO-COSMETIQUE 45, place Abel Gance, 92100 BOULOGNE-BILLANCOURT, FR
 Muguet, Valérie, c/o PIERRE FABRE DERMO-COSMETIQUE 45, place Abel Gance, 92100 BOULOGNE-BILLANCOURT, FR

(51) MKP
A47C 7/02 (2006.01) (97) **2735248**
 (96) 12462015.4 28.05.2014
 (97) 2735248, 28.05.2014 en
 (54) Chair with two stable seating positions
 (71) Antares Hungary Kft., Kossuth utca 14., 6763 Szatymaz, HU
 (72) Sustik, Ferenc, Jokai utca 29., 6763 Szatymaz, HU

(51) MKP
A61K 31/551 (2006.01) (97) **2748170 ***
A61P 25/00 (2006.01)
C07D 498/04 (2006.01)
 (86) US2012051518 20.08.2012
 (96) 12753884.1 02.07.2014
 (87) WO2013028587, 20.08.2012
 (97) 2748170, 02.07.2014 en
 (54) 1,4-DIAZABICYCLO[3.2.2]NONANES AS NEURONAL NICOTINIC ACETYLCHOLINE RECEPTOR LIGANDS
 (71) Targacept, Inc., 200 East First Street Suite 300, Winston-Salem, NC 27101, US
 (72) MAZUROV, Anatoly A., 3704 Timberoak Drive, Greensboro, North Carolina 27410, US
 MIAO, Lan, 226 March Ferry Road, Advance, North Carolina 27006, US
 SHOWALTER, Todd, 100 Claron Court, Clemmons, North Carolina 27012, US

(51) MKP
A61K 31/16 (2006.01) (97) **2766007 ***
 (86) US2012059353 09.10.2012
 (96) 12840538.8 20.08.2014
 (87) WO2013055684, 09.10.2012
 (97) 2766007, 20.08.2014 en
 (54) RASAGILINE CITRAMIDE
 (71) Teva Pharmaceutical Industries Ltd., 5 Basel Street P.O. Box 3190, 49131 Petach-Tikva, IL
 (72) ULANENKO, Konstantin, 11 / 16 Leon Reich St., Netanya 42446, IL
 VERBA, Gregory, 201/17 Yad Lebanim St., Haifa 32802, IL
 SAFADI, Muhammad, Panorama Salezian, 5A, Street 5005 PO Box 385, Nazareth 16103, IL
 FRENKEL, Anton, Amnon ve Tamar Str. 15/10, Netanya 42202, IL
 KEISAR, Michal, 8 Bareket Street, Kfar-Yona 40300, IL
 LICHT, Danit, 1 Keren Hayesod Street, Ramat Ilan, Givat Shmuel 54041, IL
 BAHAR, Eliezer, 95 Haim Levanon Street, Tel Aviv 69345, IL
 LIDOR-HADAS, Ramy, 19 Mor Str., Kfar-Saba 44242, IL
 ZHOLKOVSKY, Marina, Hahasmonaim street, 53/2, Bat Yam, IL
 COHEN, Rachel, Ar Atzil Street, Hadera 3824417, IL

(51) MKP
B30B 9/06 (2006.01) (97) **2714381 ***
 (86) ZA2012000041 28.05.2012
 (96) 12790331.8 09.04.2014
 (87) WO2012162707, 28.05.2012
 (97) 2714381, 09.04.2014 en
 (54) A METHOD OF PRESSURIZING A SUBSTANCE
 (71) Green Cell Technologies (Pty) Ltd, 2 Paton Road, Claremont 7708 Cape Town, ZA
 (72) HENDERSON, Roy Walter, 2 Sally Close Milkwood Park Noordhoek, 7975 Cape Town, ZA
 VLOK, Jan Abraham, 2 Sally Close Milkwood Park Noordhoek, 7975 Cape Town, ZA

(51) MKP
A61K 31/427 (2006.01) (97) **2714684 ***
A61P 35/00 (2006.01)
C07D 207/08 (2006.01)
C07D 401/12 (2006.01)
C07D 417/12 (2006.01)
 (86) US2012039472 24.05.2012
 (96) 12793246.5 09.04.2014
 (87) WO2012166560, 24.05.2012
 (97) 2714684, 09.04.2014 en
 (54) COMPOSITIONS CONTAINING, METHODS INVOLVING, AND USES OF NON-NATURAL AMINO ACID LINKED DOLASTATIN DERIVATIVES
 (71) Ambrx, Inc., 10975 North Torrey Pines Road, Suite 100, La Jolla, CA 92037, US
 (72) MIAO, Zhenwei, 15887 Sunnyfield Place, San Diego, CA 92127, US
 ATKINSON, Kyle, C., 2024 Golden Vue Drive, Golden, CO 80401, US
 BIROC, Sandra, 1036 Camellia Drive, Alameda, CA 94502, US
 BUSS, Timothy, 1745 Catalpa Road, Carlsbad, CA 92011, US
 COOK, Melissa, 976 S. Mollison Avenue Apt. 5, El Cajon, CA 92020, US
 KRAYNOV, Vadim, 5457 White Oak Lane, San Diego, CA 92130, US
 MARSDEN, Robin, 6358 Budlong Lake Avenue, San Diego, CA 92119, US
 PINKSTAFF, Jason, 2095 Wandering Road, Encinitas, CA 92024, US
 SKIDMORE, Lillian, 6232 Canyon Bluff Court, San Diego, CA 92121, US
 SUN, Ying, 14972 Avenida Venusto 65, San Diego, CA 92128, US
 SZYDLIK, Angieszka, 3050 Rue D'Orleans 283, San Diego, CA 92110, US
 LOPEZ DE VALENTA, Ianina, 13442 Sebago Avenue, Poway, CA 92064, US

- (51) MKP
A61K 31/535 (2006.01) (97) **2710005 ***
A61P 35/00 (2006.01)
C07D 487/04 (2006.01)
(86) US2012038092 16.05.2012
(96) 12722662.9 26.03.2014
(87) WO2012158764, 16.05.2012
(97) 2710005, 26.03.2014 en
(54) TYROSINE KINASE INHIBITORS
(71) Principia Biopharma Inc., 400 East Jamie Court, Suite 302, So. San Francisco, California 94080, US
(72) GOLDSTEIN, David Michael, 122 Danbury Lane, Redwood City California 94061, US
BRAMELD, Kenneth Albert, 345 Camino Al Lago, Menlo Park California 94027, US

- (51) MKP
A61K 38/26 (2006.01) (97) **2750698 ***
A61P 25/28 (2006.01)
(86) EP2012067144 03.09.2012
(96) 12755853.4 09.07.2014
(87) WO2013030409, 03.09.2012
(97) 2750698, 09.07.2014 en
(54) PHARMACEUTICAL COMPOSITION FOR USE IN THE TREATMENT OF A NEURODEGENERATIVE DISEASE
(71) Sanofi-Aventis Deutschland GmbH, Brüningstraße 50, 65929 Frankfurt am Main, DE
University Of Ulster, Cromore Road Coleraine, County Londonderry BT52 1SA, GB
(72) HESS, Sibylle, Sanofi-Aventis Deutschland GmbH Industriepark Höchst, 65926 Frankfurt am Main, DE
HÖLSCHER, Christian, 44 Carthall Road, Coleraine County Londonderry BT51 3LP Northern Ireland, IE
BÖHME, Andrees, c/o Sanofi Département Brevets 54 rue La Boétie, F-75008 Paris, FR
MÉNUT, Agnes, c/o Sanofi Département Brevets 54 rue La Boétie, F-75008 Paris, FR
PRADIER, Laurent, c/o Sanofi Département Brevets 54 rue La Boétie, F-75008 Paris, FR
TAUPIN, Véronique, c/o Sanofi Département Brevets 54 rue La Boétie, F-75008 Paris, FR

- (51) MKP
A61K 31/404 (2006.01) (97) **2726457 ***
C07D 209/30 (2006.01)
C07D 403/04 (2006.01)
C07D 413/04 (2006.01)
(86) IB2012053309 28.06.2012
(96) 12762390.8 07.05.2014
(87) WO2013001499, 28.06.2012
(97) 2726457, 07.05.2014 en
(54) INDOLEAMINE DERIVATIVES FOR THE TREATMENT OF CENTRAL NERVOUS SYSTEM DISEASES
(71) Adamed sp. z o.o., Pienków 149, 05-152 Czostków k/ Warszawy, PL
(72) KOLACZKOWSKI, Marcin, ul. Lany 2, PL-32-020 Wieliczka, PL
MARCINKOWSKA, Monika, ul. Spasowskiego 1/9, PL-31-139 Kraków, PL
BUCKI, Adam, ul. 3 Maja 159, PL-32-100 Proszowice, PL
PAWLOWSKI, Maciej, ul. Reformacka 87, PL-32-020 Wieliczka, PL
KAZEK, Grzegorz, ul. Bohaterów Monte Cassino 48/26, PL-41-219 Sosnowiec, PL
BEDNARSKI, Marek, ul. Wodna 28C/13, 31-630 Kraków, PL
WESOLOWSKA, Anna, Os. Kombatantów 8/32, PL-31-630 Kraków, PL

- (51) MKP
C07K 14/005 (2006.01) (97) **2729490 ***
C12N 15/86 (2006.01)
G01N 33/569 (2006.01)
(86) US2012045592 05.07.2012
(96) 12737664.8 14.05.2014
(87) WO2013006721, 05.07.2012
(97) 2729490, 14.05.2014 en
(54) HCV GENOTYPE 4 REPLICONS
(71) Gilead Sciences, Inc., 333 Lakeside Drive, Foster City, CA 94404, US
(72) DELANEY, William, E., IV, c/o Gilead Sciences, Inc. 333 Lakeside Drive, Foster City, CA 94404, US
CHENG, Guofeng, c/o Gilead Sciences, Inc. 333 Lakeside Drive, Foster City, CA 94404, US
MO, Hongmei, c/o Gilead Sciences, Inc. 333 Lakeside Drive, Foster City, CA 94404, US
XU, Simin, c/o Gilead Sciences, Inc. 333 Lakeside Drive, Foster City, CA 94404, US
PENG, Betty, c/o Gilead Sciences, Inc. 333 Lakeside Drive, Foster City, CA 94404, US

- (51) MKP
A61K 31/00 (2006.01) (97) **2706990 ***
A61K 31/727 (2006.01)
A61P 7/02 (2006.01)
A61P 35/00 (2006.01)
(86) EP2012058766 11.05.2012
(96) 12719984.2 19.03.2014
(87) WO2012152918, 11.05.2012
(97) 2706990, 19.03.2014 en
(54) SEMULOPARIN FOR THE PREVENTION OF VENOUS THROMBOEMBOLISM IN CANCER PATIENTS RECEIVING CHEMOTHERAPY
(71) Aventis Pharma S.A., 20, avenue Raymond Aron, 92160 Antony, FR
(72) CHAUDHARI, Umesh, sanofi-aventis US.Inc. 1041 Route 202-206 Mail Code: D-303A, Bridgewater New Jersey 08807, US
DESTREE, Dominique, Sanofi Patent Department 54 rue La Boétie, 75008 Paris, FR
LAWSON, Francesca, Sanofi-Aventis US.Inc. 1041 Route 202-206 Mail Code: D-303A, Bridgewater New Jersey 08807, US
LECORPS, Guillaume, Sanofi Patent Department 54 rue La Boétie, 75008 Paris, FR

- (51) MKP
B25H 3/00 (2006.01) (97) **2747955 ***
(86) FR2012051920 22.08.2012
(96) 12758575.0 02.07.2014
(87) WO2013026988, 22.08.2012
(97) 2747955, 02.07.2014 fr
(54) MAGNETIC BIT-HOLDER BRACELET DEVICE
(71) Escherich, Fabien, Route de l'Alpe des Chaux 15, 1882 Gryon, CH
(72) Escherich, Fabien, Route de l'Alpe des Chaux 15, 1882 Gryon, CH

- (51) MKP
H04M 3/00 (2006.01) (97) **2754285 ***
(86) US2012054245 07.09.2012
(96) 12830570.3 16.07.2014
(87) WO2013036822, 07.09.2012
(97) 2754285, 16.07.2014 en
(54) SOCIAL PROXY AND PROTOCOL GATEWAY
(71) Five9, Inc., 4000 Executive Parkway, Suite 400, San Ramon, CA 94583, US
(72) FRIED, Lance, 3530 Mystic Pointe Drive 1009, Aventura, Florida 33180, US
KATZ, Joseph, 1280 Old Woodbine Road, Atlanta, Georgia 30319, US

- (51) MKP
A61K 31/52 (2006.01) (97) **2714686 ***
A61P 35/00 (2006.01)
A61P 37/06 (2006.01)
C07D 471/02 (2006.01)
C07D 473/00 (2006.01)
(86) EP2012059394 21.05.2012
(96) 12722152.1 09.04.2014
(87) WO2012160030, 21.05.2012
(97) 2714686, 09.04.2014 en
(54) PYRIDIN-2 (1H) -ONE DERIVATIVES USEFUL AS MEDICAMENTS FOR THE TREATMENT OF MYELOPROLIFERATIVE DISORDERS, TRANSPLANT REJECTION, IMMUNE-MEDIATED AND INFLAMMATORY DISEASES
(71) Almirall S.A., Ronda del General Mitre, 151, 08022 Barcelona, ES
(72) EASTWOOD, Paul Robert, C/ Laureà Miró 408-410 Sant Feliu de Llobregat, E-08980 Barcelona, ES
GONZALEZ RODRIGUEZ, Jacob, C/ Laureà Miró 408-410 Sant Feliu de Llobregat, E-08980 Barcelona, ES
GOMEZ CASTILLO, Elena, C/ Laureà Miró 408-410 Sant Feliu de Llobregat, E-08980 Barcelona, ES
BACH TAÑA, Jordi, C/ Laureà Miró 408-410 Sant Feliu de Llobregat, E-08980 Barcelona, ES

- (51) MKP
A01D 34/00 (2006.01) (97) **2656720**
A01D 34/81 (2006.01)
(96) 12165410.7 30.10.2013
(97) 2656720, 30.10.2013 en
(54) Cutter guard for a lawn mower
(71) Robert Bosch GmbH, C/ IPE Postfach 30 02 20, 70442 Stuttgart, DE
(72) Marshall, Lewis, c/o Bosch Lawn & Garden Limited Suffolk Works, Stowmarket, Suffolk IP14 1EY, GB
Baxter, Richard, c/o Bosch Lawn & Garden Limited Suffolk Works, Stowmarket, Suffolk IP14 1EY, GB
Johnson, William, c/o Bosch Lawn & Garden Limited Suffolk Works, Stowmarket, Suffolk IP14 1EY, GB

- (51) MKP
A61K 9/127 (2006.01) (97) **2723387 ***
A61K 47/48 (2006.01)
A61K 49/00 (2006.01)
A61K 49/18 (2006.01)
A61P 29/00 (2006.01)
A61P 35/00 (2006.01)
C07D 405/12 (2006.01)
C07K 7/02 (2006.01)
(86) EP2012002652 22.06.2012
(96) 12730388.1 30.04.2014
(87) WO2012175223, 22.06.2012
(97) 2723387, 30.04.2014 en
(54) CATHEPSIN-BINDING COMPOUNDS BOUND TO A CARRIER AND THEIR DIAGNOSTIC USE
(71) J. Stefan Institute, Jamova 39, 1000 Ljubljana, SI
Schaschke, Norbert, Hugelstrasse 1, 33613 Bielefeld, DE
(72) SCHASCHKE, Norbert, Hugelstrasse 1, 33613 Bielefeld, DE
VASILJEVA, Olga, Preloska cesta 16 Prelog, 1230 Domzale, SI
MIKHAYLOV, Georgy, ul Aleksandra Nevskogo 11a, 050040 Almaty, KZ
TURK, Boris, Gradisce IV 069, 1291 Skofljica, SI

- (51) MKP
B65D 65/42 (2006.01) (97) **2718359 ***
C08K 5/00 (2006.01)
C08K 5/07 (2006.01)
C08K 5/092 (2006.01)
C09D 129/04 (2006.01)
(86) EP2012060902 08.06.2012
(96) 12729419.7 16.04.2014
(87) WO2012168433, 08.06.2012
(97) 2718359, 16.04.2014 de
(54) METHOD FOR PRODUCING A COATED PACKAGING MATERIAL, AND PACKAGING MATERIAL HAVING AT LEAST ONE BARRIER LAYER FOR HYDROPHOBIC COMPOUNDS
(71) Mayr-Melnhof Karton AG, Brahmplatz 6, 1041 Wien, AT
ZISCHKA, Michael, Muhlenweg 28, A-8046 Stattegg-Muhl, AT
SPANRING, Julia, Lendkai 35, A-8020 Graz, AT
REISCHL, Martin, Kalchberg 107, A-8113 Stallhofen, AT

- (51) MKP
A61K 31/4418 (2006.01) (97) **2714660 ***
A61P 9/12 (2006.01)
C07D 213/81 (2006.01)
C07D 239/28 (2006.01)
C07D 249/10 (2006.01)
C07D 261/18 (2006.01)
C07D 401/06 (2006.01)
C07D 471/04 (2006.01)
C07D 487/04 (2006.01)
C07D 498/04 (2006.01)
(86) US2012038524 18.05.2012
(96) 12724047.1 09.04.2014
(87) WO2012166390, 18.05.2012
(97) 2714660, 09.04.2014 en
(54) NEPRILYSIN INHIBITORS
(71) Theravance, Inc., 901 Gateway Boulevard, South San Francisco, CA 94080, US
(72) FLEURY, Melissa, 1023 Divisadero Street, San Francisco, CA 94115, US
GENDRON, Roland, 345 Franconia Street, San Francisco, CA 94110, US
HUGHES, Adam, D., 1221 Judson Street, Belmont, CA 94002, US
SCHMIDT, Jane, 31 Paradise Avenue, San Francisco, CA 94131, US

- (51) MKP
A61K 8/00 (2006.01) (97) **2713988 ***
(86) US2012028446 09.03.2012
(96) 12792555.0 09.04.2014
(87) WO2012166227, 09.03.2012
(97) 2713988, 09.04.2014 en
(54) FORMULATION OF SMALL ADRENERGIC AGONIST SALT FORMS IN ORGANIC SOLVENTS
(71) Procetus Biopharm, Inc., 510 Charmany Drive Suite 175B, Madison, WI 53719, US
(72) FAHL, William, E., 5742 Schumann Drive, Fitchburg, WI 53711, US

- (51) MKP
A61K 39/395 (2006.01) (97) **2720719 ***
(86) US2012042601 15.06.2012
(96) 12800675.6 23.04.2014
(87) WO2012174338, 15.06.2012
(97) 2720719, 23.04.2014 en
(54) METHOD OF SELECTING THERAPEUTIC INDICATIONS
(71) Glaxosmithkline Intellectual Property (No. 2) Limited, 980 Great West Road, Brentford, Middlesex TW8 9SG, GB
(72) AGARWAL, Pankaj, 709 Swedeland Road, King of Prussia, PA 19406, US
CARDON, Lon, R., 709 Swedeland Road, King of Prussia, PA 19406, US
MOOSER, Vincent, Eugene, Rue Du Bugnon 21, CH-1011 Lausanne, CH
SANSEAU, Philippe, Gunnels Wood Road, Hertfordshire, Stevenage, GB

- (51) MKP
A23J 3/16 (2006.01) (97) **2709464 ***
(86) CA2012000443 09.05.2012
(96) 12786190.4 26.03.2014
(87) WO2012155242, 09.05.2012
(97) 2709464, 26.03.2014 en
(54) PREPARATION OF SOY PROTEIN ISOLATE USING CALCIUM CHLORIDE EXTRACTION ("S703 CIP")
(71) Burcon Nutrascience (MB) Corp., 1388 Waller Avenue, Winnipeg, Manitoba R3T 1P9, CA
(72) SEGALL, Kevin I., 31 Dunbar Crescent, Winnipeg, Manitoba R3P 0W6, CA
SCHWEIZER, Martin, 7 Birch Point Place, Winnipeg, Manitoba R3Y 0G1, CA
GREEN, Brent E., 24 Poplarwood Drive Box 603, Warren, Manitoba R0C 3E0, CA
MEDINA, Sarah, 315 Wildwood Park, Winnipeg, Manitoba R3T 0E5, CA
GOSNELL, Brandy, 118 Arden Avenue, Winnipeg, Manitoba R2M 2K2, CA

- (51) MKP
A61K 31/336 (2006.01) (97) **2763671 ***
A61K 31/7088 (2006.01)
A61K 31/713 (2006.01)
A61K 39/00 (2006.01)
A61P 3/04 (2006.01)
A61P 9/00 (2006.01)
A61P 19/00 (2006.01)
A61P 19/02 (2006.01)
A61P 21/00 (2006.01)
A61P 25/00 (2006.01)
A61P 25/24 (2006.01)
A61P 25/28 (2006.01)
A61P 39/00 (2006.01)
A61P 39/06 (2006.01)
(86) US2012000461 03.10.2012
(96) 12798444.1 13.08.2014
(87) WO2013055385, 03.10.2012
(97) 2763671, 13.08.2014 en
(54) METHODS OF TREATING AGE RELATED DISORDERS
(71) Zafgen, Inc., One Broadway, 8th Floor, Cambridge, MA 02142, US
Hughes, Thomas E., 89 Wilson Road, Concord, MA 01742, US
Vath, James E., 3 Green Meadow Drive, Lynnfield, MA 01940, US
(72) HUGHES, Thomas, E., 89 Wilson Road, Concord, MA 01742, US
VATH, James, E., 3 Green Meadow Drive, Lynnfield, MA 01940, US

- (51) MKP
A61K 31/4178 (2006.01) (97) **2741746 ***
C07D 403/14 (2006.01)
(86) US2012049681 06.08.2012
(96) 12822366.6 18.06.2014
(87) WO2013022810, 06.08.2012
(97) 2741746, 18.06.2014 en
(54) CHEMICAL COMPOUNDS
(71) GlaxoSmithKline LLC, Corporation Service Company 2711 Centreville Road Suite 400, Wilmington, Delaware 19808, US
(72) BASKARAN, Subramanian, c/o GlaxoSmithKline Global Patents Five Moore Drive P.O. Box 13398 Research Triangle Park, North Carolina 27709, US
GRIMES, Richard, Martin, c/o GlaxoSmithKline Global Patents Five Moore Drive P.O. Box 13398 Research Triangle Park, North Carolina 27709, US
KAZMIERSKI, Wieslaw, Miieczyslaw, c/o GlaxoSmithKline Global Patents Five Moore Drive P.O. Box 13398 Research Triangle Park, North Carolina 27709, US
LEIVERS, Martin, Robert, c/o GlaxoSmithKline Global Patents Five Moore Drive P.O. Box 13398 Research Triangle Park, North Carolina 27709, US

- (51) MKP
A23K 1/18 (2006.01) (97) **2701535 ***
A23L 1/30 (2006.01)
A61K 35/74 (2006.01)
(86) US2012035841 30.04.2012
(96) 12723773.3 05.03.2014
(87) WO2012149549, 30.04.2012
(97) 2701535, 05.03.2014 en
(54) BACILLUS BACTERIA FOR USE IN TREATING AND PREVENTING INFECTION IN AQUATIC ANIMALS
(71) Auburn University, 570 Devall Drive, Auburn, Alabama 36832, US
(72) TERHUNE, Jeffery, 2034 Highridge Ct., Auburn, AL 36830, US
LILES, Mark, 710 Sanders St., Auburn, AL 36830, US
KLOEPPER, Joseph, 735 S. Gay St., Auburn, AL 36830, US

- (51) MKP
A61K 39/395 (2006.01) (97) **2712320 ***
A61K 45/00 (2006.01)
(86) EP2012059098 16.05.2012
(96) 12720898.1 02.04.2014
(87) WO2012156437, 16.05.2012
(97) 2712320, 02.04.2014 en
(54) METHOD FOR EGFR DIRECTED COMBINATION TREATMENT OF CANCER
(71) Boehringer Ingelheim International GmbH, Binger Strasse 173, 55216 Ingelheim am Rhein, DE
(72) DENIS, Louis, Boehringer Ingelheim GmbH Corporate Patents Binger Strasse 173, 55216 Ingelheim Am Rhein, DE
LORENCE, Robert, VP IP Legal Boehringer Ingelheim USACorp. 900 Ridgebury Road, Ridgefield Connecticut 06877, US
SHAHIDI, Mehdi, Boehringer Ingelheim GmbH Corporate Patents Binger Strasse 173, 55216 Ingelheim Am Rhein, DE
SOLCA, Flavio, Boehringer Ingelheim GmbH Corporate Patents Binger Strasse 173, 55216 Ingelheim Am Rhein, DE

- (51) MKP
A61K 31/397 (2006.01) (97) **2758371 ***
A61K 31/4015 (2006.01)
A61K 31/45 (2006.01)
A61K 31/4709 (2006.01)
A61P 25/00 (2006.01)
A61P 29/00 (2006.01)
A61P 33/00 (2006.01)
A61P 35/00 (2006.01)
C07D 205/08 (2006.01)
C07D 207/277 (2006.01)
C07D 207/28 (2006.01)
C07D 211/78 (2006.01)
C07D 401/04 (2006.01)
(86) EP2012068230 17.09.2012
(96) 12761967.4 30.07.2014
(87) WO2013041480, 17.09.2012
(97) 2758371, 30.07.2014 en
(54) NEW THIO DERIVATIVES BEARING LACTAMS AS POTENT HDAC INHIBITORS AND THEIR USES AS MEDICAMENTS
(71) SIGMA-TAU Industrie Farmaceutiche Riunite S.p.A., Viale Shakespeare, 47, 00144 Rome, IT
(72) GIANNINI, Giuseppe, Via Boezio 46/B, 00040 Pomezia (RM), IT
CABRI, Walter, Via Pisacane 5, 20089 Rozzano (MI), IT
BATTISTUZZI, Gianfranco, Via Capo Spartivento 94, 00122 Rome, IT
VIGNOLA, Davide, Via Campotosto 4, 04011 Aprilia (LT), IT
FANTO', Nicola, Via Giulio Cesare 3, 00040 Pomezia (RM), IT
PISANO, Claudio, Via Cherubini 60/B, 04011 Aprilia (LT), IT
VESCI, Loredana, Via Elio Petri 3, 00128 Roma, IT

- (51) MKP
A61K 9/20 (2006.01) (97) **2731603 ***
A61K 31/357 (2006.01)
A61K 31/496 (2006.01)
A61P 33/06 (2006.01)
(86) IB2012053614 13.07.2012
(96) 12743776.2 21.05.2014
(87) WO2013008218, 13.07.2012
(97) 2731603, 21.05.2014 en
(54) STABLE DOSAGE FORMS OF ARTEROLANE AND PIPERAQUINE
(71) Ranbaxy Laboratories Limited, 12th Floor Devika Tower 06 Nehru Place New Delhi, Delhi 110019, IN
(72) ENOSE, Arno, Appavoo, Amal Cottage Fathima Nagar P.O., Kanya Kumari Tamil Nadu 629160, IN
MADAN, Harish, Kumar, House No. 705 Jamalpura, Sonapat Haryana 131001, IN
MADAN, Sumit, D-106 East of Kailash, New Delhi Delhi 110065, IN
TREHAN, Anupam, C-208 Mansarover Garden, New Delhi Delhi 110015, IN
TYAGI, Puneet, House No. 369 Sector 28, Faridabad Haryana 121005, IN
ARORA, Vinod, Kumar, S-340 IInd Floor Uppal's Southend Sector 48-49 Sohna Road, Gurgaon Haryana 122101, IN
BHATTACHARYYA, Sanjukta, V-39/2, DLF Phase III, Gurgaon 122 002 Haryana, IN
ROY, Arjun, 901/I, Sagabi Apt., Plot Nr 85, Sector 55, Gurgaon 122 003 Haryana, IN

(51) MKP
A01N 25/32 (2006.01) (97) **2701513 ***
A01N 43/80 (2006.01)
A01P 7/04 (2006.01)
(86) US2012033253 12.04.2012
(96) 12777530.2 05.03.2014
(87) WO2012148689, 12.04.2012
(97) 2701513, 05.03.2014 en
(54) USE OF 3-ISOXAZOLIDINONES AS SELECTIVE HERBICIDES IN GRASS AND BRASSICA CROPS
(71) FMC Corporation, 1735 Market Street, Philadelphia, PA 19103, US
(72) NICHOLSON, Paul, 615 Greenway Avenue, Ewing, NJ 08618, US
SHINN, Sandra L., 1351 Jacksonville Road, Columbus, NJ 08022, US
PEPPER, Robert F., 11 Gloucester Court, Bordentown, NJ 08505, US
BRAIN, David A., 35-33 Bloomingdale Drive, Hillsborough, NJ 08844, US

(51) MKP
A61K 9/08 (2006.01) (97) **2725033 ***
A61K 38/00 (2006.01)
A61K 39/395 (2006.01)
B01D 61/14 (2006.01)
B01D 61/22 (2006.01)
B01D 71/10 (2006.01)
B01D 71/26 (2006.01)
B01D 71/34 (2006.01)
B01D 71/68 (2006.01)
C07K 1/34 (2006.01)
C07K 16/00 (2006.01)
(86) JP2012065987 22.06.2012
(96) 12803267.9 30.04.2014
(87) WO2012176876, 22.06.2012
(97) 2725033, 30.04.2014 en
(54) METHOD FOR PRODUCING PROTEIN PREPARATION
(71) Asahi Kasei Kuraray Medical Co., Ltd., 1-105, Kanda Jinbocho, Chiyoda-ku Tokyo 101-8101, JP
(72) HONGO, Tomoko, 1-105 Kanda Jinbocho Chiyoda-ku, Tokyo 101-8101, JP
HAYASHIDA, Hirohisa, 1-105 Kanda Jinbocho Chiyoda-ku, Tokyo 101-8101, JP

(51) MKP
A61K 31/497 (2006.01) (97) **2763980 ***
A61P 25/00 (2006.01)
C07D 401/12 (2006.01)
(86) US2012055689 17.09.2012
(96) 12832299.7 13.08.2014
(87) WO2013040535, 17.09.2012
(97) 2763980, 13.08.2014 en
(54) BICARBOCYCLIC AND TRICARBOCYCLIC ETHYNYL DERIVATIVES AND USES OF SAME
(71) H. Lundbeck A/S, Ottiliavej 9, 2500 Valby, DK
(72) LI, Guiying, 76 Rutgers Place Apt. 1, River Edge, NJ 07661, US
DOLLER, Dario, 15 Quarterhorse Crossing, Sparta, NJ 07871, US

(51) MKP
B01D 53/14 (2006.01) (97) **2750782 ***
(86) EP2012065340 06.08.2012
(96) 12743735.8 09.07.2014
(87) WO2013029927, 06.08.2012
(97) 2750782, 09.07.2014 de
(54) METHOD AND SYSTEM FOR REMOVING CARBON DIOXIDE FROM FLUE GASES
(71) ThyssenKrupp Industrial Solutions GmbH, Graf-Galen-Strasse 17, 59269 Beckum, DE
(72) MENZEL, Johannes, Krummer Weg 8, 45731 Waltrop, DE

(51) MKP
A01K 5/01 (2006.01) (97) **2720531 ***
(86) NZ2012000097 14.06.2012
(96) 12800701.0 23.04.2014
(87) WO2012173499, 14.06.2012
(97) 2720531, 23.04.2014 en
(54) TROUGH
(71) Dalrymple, Roger Kenneth Roy, Waitatapia, RD1, Bulls, NZ
(72) Dalrymple, Roger Kenneth Roy, Waitatapia, RD1, Bulls, NZ

(51) MKP
B65H 18/14 (2006.01) (97) **2748090 ***
B65H 27/00 (2006.01)
(86) US2012052159 23.08.2012
(96) 12826249.0 02.07.2014
(87) WO2013028925, 23.08.2012
(97) 2748090, 02.07.2014 en
(54) SUBSTRATE ROLLERS
(71) Nuvosun, Inc., 1565 Barber Lane, Milpitas, CA 95035, US
(72) HACHTMANN, Bruce, 15218 Sycamore Avenue, San Martin, CA 95046, US
CLOVER, Preston, 712 San Conrado 5, Sunnyvale, CA 94085, US
PORTER, Ross, 2109 Pine Street 3F, Philadelphia, PA 19103, US
QUITUGUA-FLORES, Aaron, 558 Vista Avenue, Palo Alto, CA 94306, US

(51) MKP
B01J 35/00 (2006.01) (97) **2726203 ***
C04B 26/02 (2006.01)
C04B 35/00 (2006.01)
(86) IB2012053271 28.06.2012
(96) 12745553.3 07.05.2014
(87) WO2013005141, 28.06.2012
(97) 2726203, 07.05.2014 en
(54) PHOTOCATALYTIC AND ANTI - BACTERIAL MATERIAL AND USE THEREOF IN THE BUILDING, LIGHTING AND FURNISHING FIELD
(71) Buzzi & Buzzi S.r.l., Via Milano 17, 20060 Pozzo d'Adda (Milano), IT
(72) BUZZI, Dario, Via Baumann, I-24040 Canonica d'Adda (Bergamo), IT
BUZZI, Andrea, Via Manzoni 10/E, I-20069 Vaprio d'Adda (Milano), IT
CHIARI, Maria Luisa, Via Milano 33, I-20060 Pozzo d'Adda (Milano), IT

(51) MKP
C12N 15/113 (2010.01) (97) **2639307**
(96) 13167541.5 18.09.2013
(97) 2639307, 18.09.2013 en
(54) Single-stranded nucleic acid molecule having nitrogen-containing alicyclic skeleton
(71) Bonac Corporation, Fukuoka BIO Factory 4F 1488-4 Aikawa-machi, Kurume-shi, Fukuoka 839-0861, JP
(72) Ohgi, Tadaaki, c/o Bonac Corporation Fukuoka BIO Factory, 4F 1488-4 Aikawa-machi, Kurume-shi Fukuoka 839-0861, JP
Hayashi, Hirotake, c/o Bonac Corporation Fukuoka BIO Factory, 4F 1488-4 Aikawa-machi, Kurume-shi Fukuoka 839-0861, JP
Shirohzu, Hisao, c/o Bonac Corporation Fukuoka BIO Factory, 4F 1488-4 Aikawa-machi, Kurume-shi Fukuoka 839-0861, JP
Hamasaki, Tomohiro, c/o Bonac Corporation Fukuoka BIO Factory, 4F 1488-4 Aikawa-machi, Kurume-shi Fukuoka 839-0861, JP
Itoh, Akihiro, c/o Bonac Corporation Fukuoka BIO Factory, 4F 1488-4 Aikawa-machi, Kurume-shi Fukuoka 839-0861, JP
Suzuki, Hiroshi, c/o Bonac Corporation Fukuoka BIO Factory, 4F 1488-4 Aikawa-machi, Kurume-shi Fukuoka 839-0861, JP

(51) MKP
C08B 15/02 (2006.01) (97) **2712364 ***
(86) EP2013064776 12.07.2013
(96) 13735325.6 02.04.2014
(87) WO2014009517, 12.07.2013
(97) 2712364, 02.04.2014 en
(54) LOW ENERGY METHOD FOR THE PREPARATION OF NON-DERIVATIZED NANOCELLULOSE
(71) SAPPI Netherlands Services B.V., Biesenweg 16, 6211 AA Maastricht, NL
(72) GRAVESON, Ian, 75 Bettina Close, Nuneaton, Warwickshire CV10 9EX, GB
ENGLISH, Robert, 10 Panton Road, Hoole, Chester, Cheshire CH2 3HY, GB

- (51) MKP
A61K 31/428 (2006.01) (97) **2723732 ***
A61P 1/04 (2006.01)
A61P 13/00 (2006.01)
A61P 19/02 (2006.01)
A61P 25/02 (2006.01)
A61P 25/04 (2006.01)
A61P 29/00 (2006.01)
C07D 417/12 (2006.01)
C07D 417/14 (2006.01)
(86) IB2012001252 21.06.2012
(96) 12735333.2 30.04.2014
(87) WO2012176061, 21.06.2012
(97) 2723732, 30.04.2014 en
(54) TRPV1 ANTAGONISTS INCLUDING DIHYDROXY SUBSTITUENT AND USES THEREOF
(71) Purdue Pharma LP, One Stamford Forum 201 Tresser Boulevard, Stamford, CT 06901-3431, US
Shionogi & Co., Ltd., 1-8, Doshomachi 3-chome Chuo-ku Osaka-shi, Osaka-shi, Osaka 5410045, JP
(72) Shionogi&Co. Ltd., 1-8 Doshomachi 3-chome Chuo-ku Osaka-shi, Osaka 541-0045, JP
TAFESSE, Laykea, 8 Windward Way, Robbinsville, NJ 08690, US
ANDO, Shigeru, c/o Shionogi&Co. Ltd. 1-1 Futaba-cho 3-chome Toyonaka, Osaka 561-0825, JP
KUROSE, Noriyuki, c/o Shionogi&Co. Ltd. 1-1 Futaba-cho 3-chome Toyonaka, Osaka 561-0825, JP
-
- (51) MKP
A61K 31/515 (2006.01) (97) **2744500 ***
A61P 35/00 (2006.01)
(86) IB2012054160 15.08.2012
(96) 12770238.9 25.06.2014
(87) WO2013024447, 15.08.2012
(97) 2744500, 25.06.2014 en
(54) COMPOUNDS FOR USE IN CANCER THERAPY
(71) Nuhope LLC, 2711 Centreville Road Suite 400, Wilmington, Delaware 19808, US
(72) CONNOR, James R., 955 Beech Avenue, Hershey, Pennsylvania 17033, US
LEE, Sang Yong, 572 Coachman Lane, Palmyra, Pennsylvania 17078, US
BROWN, Thomas James, c/o TPP Global Development Limited 10 York Place, Edinburgh EH1 3EP, GB
COWLEY, Phillip Martin, c/o TPP Global Development Limited 10 York Place, Edinburgh EH1 3EP, GB
-
- (51) MKP
C07C 2/50 (2006.01) (97) **2766327 ***
C07C 2/52 (2006.01)
C07C 4/06 (2006.01)
C07C 5/03 (2006.01)
C07C 9/16 (2006.01)
C07C 9/18 (2006.01)
C07C 13/18 (2006.01)
C07C 13/20 (2006.01)
C10G 1/00 (2006.01)
C10G 45/32 (2006.01)
C10M 107/02 (2006.01)
C10M 109/02 (2006.01)
(86) EP2012070035 10.10.2012
(96) 12773296.4 20.08.2014
(87) WO2013053740, 10.10.2012
(97) 2766327, 20.08.2014 en
(54) PROCESS FOR PREPARING JET FUEL FROM MOLECULES DERIVED FROM BIOMASS
(71) Total Raffinage & Marketing, 24 cours Michelet, 92800 Puteaux, FR
(72) MAZURELLE, Jean, Avenue Hess de Lilez 35, B-1630 Linkebeek, BE
-
- (51) MKP
A61K 31/5415 (2006.01) (97) **2758403 ***
A61P 25/00 (2006.01)
C07D 279/18 (2006.01)
C07D 417/06 (2006.01)
C07D 491/04 (2006.01)
(86) US2012056143 19.09.2012
(96) 12833258.2 30.07.2014
(87) WO2013043744, 19.09.2012
(97) 2758403, 30.07.2014 en
(54) TRICYCLIC COMPOUNDS USEFUL AS NEUROGENIC AND NEUROPROTECTIVE AGENTS
(71) Inception 1, Inc., 5871 Oberlin Drive Suite 100, San Diego, CA 92121, US
(72) CHEN, Austin, Chih-Yu, 1142 Festival Road, San Marcos, CA 92078, US
STEARN, Brian, Andrew, 157 Beechtree Drive, Encinitas, CA 92024, US
STOCK, Nicholas, Simon, 429 Brenna Court, Encinitas, CA 92024, US
TRUONG, Yen, Pham, 12939 Calle De Las Rosas, San Diego, CA 92129, US
BACCEI, Jill, Melissa, 13630 Sagewood Drive, Poway, CA 92064, US
-
- (51) MKP
A61C 9/00 (2006.01) (97) **2682071**
A61C 13/00 (2006.01)
(96) 13174586.1 08.01.2014
(97) 2682071, 08.01.2014 en
(54) Method for copying and reproducing anatomical segments of a patient
(71) Villa Elisa Soverato S.r.l., Via Galliano 14, 88068 Soverato (CZ), IT
(72) Froio, Bruno, Via I° Maggio, 13, 88068 Soverato (CZ), IT
Froio, Salvatore, III° Traversa Corso Umberto I°, 88068 Soverato (CZ), IT
Wagerle, Giovanni Christian, Via dei Tulipani, 1, 88068 Soverato (CZ), IT
Toselli, Roberto, Via Galliera, 93, 40121 Bologna, IT
-
- (51) MKP
A61K 39/395 (2006.01) (97) **2736534 ***
A61K 47/48 (2006.01)
A61P 35/00 (2006.01)
C07K 16/28 (2006.01)
(86) EP2012064785 27.07.2012
(96) 12740174.3 04.06.2014
(87) WO2013017540, 27.07.2012
(97) 2736534, 04.06.2014 en
(54) COMBINATION THERAPY FOR THE TREATMENT OF CD19+ B-CELL MALIGNANCIES SYMPTOMS COMPRISING AN ANTI-CD19 MAYTANSINOID IMMUNOCONJUGATE AND RITUXIMAB
(71) SANOFI, 54 rue La Boétie, 75008 Paris, FR
(72) BESRET, Laurent, c/o Sanofi Patent Department 54 rue La Boétie, F-75008 Paris, FR
CARREZ, Chantal, c/o Sanofi Patent Department 54 rue La Boétie, F-75008 Paris, FR
PAYRARD, Sandrine, c/o Sanofi Patent Department 54 rue La Boétie, F-75008 Paris, FR
-

(51) MKP
A61K 31/546 (2006.01) (97) **2706062 ***
A61P 31/00 (2006.01)
C07D 501/34 (2006.01)
(86) KR2012002302 29.03.2012
(96) 12765589.2 12.03.2014
(87) WO2012134184, 29.03.2012
(97) 2706062, 12.03.2014 en
(54) NOVEL CEPHALOSPORIN DERIVATIVE AND PHARMACEUTICAL COMPOSITION THEREOF
(71) LegoChem Biosciences, Inc., 8-26, Munpyeongseo-ro Daedeok-gu, Daejeon 306-220, KR
(72) CHO, Young Lag, Legochem Biosciences, Inc. 8-26, Munpyeongseo-ro Daedeok-gu, Daejeon 306-220, KR
YUN, Joung Yul, Legochem Biosciences, Inc. 8-26, Munpyeongseo-ro Daedeok-gu, Daejeon 306-220, KR
PARK, Chul Soon, Legochem Biosciences, Inc. 8-26, Munpyeongseo-ro Daedeok-gu, Daejeon 306-220, KR
CHAE, Sang Eun, Legochem Biosciences, Inc. 8-26, Munpyeongseo-ro Daedeok-gu, Daejeon 306-220, KR
LEE, Hyang Sook, Legochem Biosciences, Inc. 8-26, Munpyeongseo-ro Daedeok-gu, Daejeon 306-220, KR
OH, Kyuman, Legochem Biosciences, Inc. 8-26, Munpyeongseo-ro Daedeok-gu, Daejeon 306-220, KR
HEO, Hye Jin, Legochem Biosciences, Inc. 8-26, Munpyeongseo-ro Daedeok-gu, Daejeon 306-220, KR
KANG, Dae Hyuck, Legochem Biosciences, Inc. 8-26, Munpyeongseo-ro Daedeok-gu, Daejeon 306-220, KR
YANG, Young Jae, Legochem Biosciences, Inc. 8-26, Munpyeongseo-ro Daedeok-gu, Daejeon 306-220, KR
KWON, Hyun Jin, Legochem Biosciences, Inc. 8-26, Munpyeongseo-ro Daedeok-gu, Daejeon 306-220, KR
PARK, Tae Kyo, Legochem Biosciences, Inc. 8-26, Munpyeongseo-ro Daedeok-gu, Daejeon 306-220, KR
WOO, Sung Ho, Legochem Biosciences, Inc. 8-26, Munpyeongseo-ro Daedeok-gu, Daejeon 306-220, KR
KIM, Yong Zu, Legochem Biosciences, Inc. 8-26, Munpyeongseo-ro Daedeok-gu, Daejeon 306-220, KR

(51) MKP
A61K 9/00 (2006.01) (97) **2620146**
A61K 31/192 (2006.01)
A61P 17/00 (2006.01)
(96) 13152804.4 31.07.2013
(97) 2620146, 31.07.2013 de
(54) Ibuprofen for treating actinic keratosis
(71) Dolorgiet GmbH & Co. KG, Otto-von-Guericke-Straße 1, 53757 Sankt Augustin, DE
(72) Warnecke, Jürgen, Dorfstr. 6, 25560 Oldenborstel, DE

(51) MKP
B02C 17/00 (2006.01) (97) **2758175 ***
(86) US2012056459 21.09.2012
(96) 12833369.7 30.07.2014
(87) WO2013043951, 21.09.2012
(97) 2758175, 30.07.2014 en
(54) APPARATUS AND METHOD FOR A SEALING SYSTEM
(71) Telsmith, Inc., 10190 N. Industrial Dr. P.O. Box 539, Mequon, WI 53092, US
(72) VAN MULLEM, Albert, N59 W23790 Clover Drive, Sussex, WI 53089, US
HAVEN, Matthew, N62W 1025 Fairhaven Court, Cedarburg, WI 53012, US
DRICKEN, Chuck, 7920 Hunters Drive, Kewaskum, WI 53040, US
NEITZEL, Sean, 334 Brookside Drive 6, Mayville, WI 53050, US

(51) MKP
A61B 17/115 (2006.01) (97) **2517651**
(96) 12166185.4 31.10.2012
(97) 2517651, 31.10.2012 en
(54) Tissue thickness compensator for a surgical stapler
(71) Ethicon Endo-Surgery, Inc., 4545 Creek Road, Cincinnati, OH 45242, US
(72) Shelton, IV, Frederick E., 245 East Main Street, Hillsboro, OH Ohio 45133, US
Baxter, III, Chester O., 6375 Pawnee Ridge, Loveland, OH Ohio 45140, US

(51) MKP
C07K 16/28 (2006.01) (97) **2758438 ***
C07K 16/30 (2006.01)
C07K 16/46 (2006.01)
(86) EP2012068673 21.09.2012
(96) 12778970.9 30.07.2014
(87) WO2013041687, 21.09.2012
(97) 2758438, 30.07.2014 en
(54) BISPECIFIC BINDING MOLECULES FOR 5T4 AND CD3
(71) Amgen Research (Munich) GmbH, Staffelseestrasse 2, 81477 München, DE
(72) KUFER, Peter, Amgen Research (Munich) GmbH, Staffelseestr. 2, 81477 Munich, DE
KISCHEL, Roman, Amgen Research (Munich) GmbH Staffelseestr. 2, 81477 Munich, DE
RAU, Doris, Amgen Research (Munich) GmbH Staffelseestr. 2, 81477 Munich, DE
RAUM, Tobias, Amgen Research (Munich) GmbH Staffelseestr. 2, 81477 Munich, DE
LUTTERBUESE, Ralf, Amgen Research (Munich) GmbH Staffelseestr. 2, 81477 Munich, DE
HOFFMANN, Patrick, Amgen Research (Munich) GmbH Staffelseestr. 2, 81477 Munich, DE

(51) MKP
G06F 17/30 (2006.01) (97) **2710499 ***
(86) US2012038639 18.05.2012
(96) 12786124.3 26.03.2014
(87) WO2012159057, 18.05.2012
(97) 2710499, 26.03.2014 en
(54) SYSTEM AND METHOD FOR CONDUCTING PROCESSOR-ASSISTED INDEXING AND SEARCHING
(71) Charite - Universitätsmedizin Berlin, Charitéplatz 1, 10117 Berlin, DE
Max-Planck-Gesellschaft Zur Foerderung Der Wissenschaften E.V., Hofgartenstraße 8, 80539 München, DE
(72) ROBINSON, Peter, Rudeloffweg 19, 14195 Berlin, DE
BAUER, Sebastian, Muensterlandstrasse 8, 13353 Berlin, DE
KOEHLER, Sebastian, Heinz-Kapelle-strasse 7, 10407 Berlin, DE
SCHULZ, Marcel H., 114 Elysian Street, Pittsburgh PA 15206, US

(51) MKP
A61K 31/44 (2006.01) (97) **2712861**
A61K 31/444 (2006.01)
A61K 31/4965 (2006.01)
A61P 9/00 (2006.01)
A61P 9/12 (2006.01)
A61P 19/06 (2006.01)
C07D 213/70 (2006.01)
C07D 239/38 (2006.01)
C07D 241/18 (2006.01)
C07D 401/04 (2006.01)
C07D 403/04 (2006.01)
C07D 405/04 (2006.01)
C07D 417/04 (2006.01)
(96) 13198843.8 02.04.2014
(97) 2712861, 02.04.2014 en
(54) Thioacetate compounds, compositions and methods of use
(71) Ardea Biosciences, Inc., 4939 Directors Place, San Diego, CA 92121, US
(72) Ouk, Samedy, 13987 Amber Pl., San Diego, CA California 92130, US
Gunic, Esmir, 8952 Capcano Road, San Diego, CA California 92129, US
Vernier, Jean-Michel, 5150 Sea Mist, San Diego, CA California 92121, US

- (51) MKP
A24F 47/00 (2006.01) (97) **2741626 ***
 (86) US2012049942 08.08.2012
 (96) 12748326.1 18.06.2014
 (87) WO2013022936, 08.08.2012
 (97) 2741626, 18.06.2014 en
 (54) SMOKING ARTICLES AND USE THEREOF FOR YIELDING INHALATION MATERIALS
 (71) R. J. Reynolds Tobacco Company, 401 North Main Street, Winston-Salem, NC 27101, US
 (72) WORM, Steven L., 4706 St. Thomas Place, Raleigh, North Carolina 27612, US
 CHRISTOPHERSON, David G., 4308 Woodlawn Drive, Raleigh, North Carolina 27616, US
 SEARS, Stephen Benson, 4343 Old U.S. Highway 421 North, Siler City, North Carolina 27344, US
 POTTER, Dennis Lee, 5635 Regents Park Road, Kernersville, North Carolina 27284, US
 AMPOLINI, Frederic Philippe, 4235 Birch Creek Trail, Winston-Salem, North Carolina 27106, US
 ADEME, Balager, 6100 Herinhut Road, Winston-Salem, North Carolina 27127, US

- (51) MKP
A61K 39/395 (2006.01) (97) **2726099 ***
C07K 16/28 (2006.01)
 (86) US2012044929 29.06.2012
 (96) 12736001.4 07.05.2014
 (87) WO2013006437, 29.06.2012
 (97) 2726099, 07.05.2014 en
 (54) METHOD FOR TREATING METABOLIC DISORDERS
 (71) Novartis AG, Lichtstrasse 35, 4056 Basel, CH
 (72) FEIGE, Jerome, Novartis Pharma AG Postfach, CH-4002 Basel, CH
 GLASS, David, Novartis Institutes for BioMedical Research Inc. 100 Technology Square, Cambridge, MA 02139, US
 HATAKEYAMA, Shinji, Novartis Pharma AG Postfach, CH-4002 Basel, CH
 RICHARDSON, Brian Peter, Novartis Pharma AG Postfach, CH-4002 Basel, CH
 TRIFILIEFF, Estelle, Novartis Pharma AG Postfach, CH-4002 Basel, CH

- (51) MKP
A61K 31/5513 (2006.01) (97) **2726466 ***
A61K 31/553 (2006.01)
A61K 31/554 (2006.01)
C07D 243/24 (2006.01)
C07D 267/14 (2006.01)
C07D 291/08 (2006.01)
C07D 403/06 (2006.01)
C07D 413/06 (2006.01)
C07D 413/12 (2006.01)
C07D 413/14 (2006.01)
C07D 419/06 (2006.01)
C07D 471/04 (2006.01)
C07D 487/04 (2006.01)
C07D 498/04 (2006.01)
 (86) US2012045086 29.06.2012
 (96) 12735402.5 07.05.2014
 (87) WO2013006485, 29.06.2012
 (97) 2726466, 07.05.2014 en
 (54) FUSED BENZOXAZEPINONES AS ION CHANNEL MODULATORS
 (71) Gilead Sciences, Inc., 333 Lakeside Drive, Foster City, CA 94404, US
 (72) CORKEY, Britton Kenneth, c/o Gilead Sciences, Inc. 333 Lakeside Drive, Foster City, CA 94404, US
 ELZEIN, Elfatih, c/o Gilead Sciences, Inc. 333 Lakeside Drive, Foster City, CA 94404, US
 JIANG, Robert H., c/o Gilead Sciences, Inc. 333 Lakeside Drive, Foster City, CA 94404, US
 KALLA, Rao V., c/o Gilead Sciences, Inc. 333 Lakeside Drive, Foster City, CA 94404, US
 KOLTUN, Dmitry, c/o Gilead Sciences, Inc. 333 Lakeside Drive, Foster City, California 94404, US
 LI, Xiaofen, c/o Gilead Sciences, Inc. 333 Lakeside Drive, Foster City, CA 94404, US
 MARTINEZ, Ruben, c/o Gilead Sciences, Inc. 333 Lakeside Drive, Foster City, CA 94404, US
 PARKHILL, Eric Q., c/o Gilead Sciences, Inc. 333 Lakeside Drive, Foster City, CA 94404, US
 PERRY, Thao, c/o Gilead Sciences, Inc. 333 Lakeside Drive, Foster City, CA 94404, US
 ZABLOCKI, Jeff, c/o Gilead Sciences, Inc. 333 Lakeside Drive, Foster City, CA 94404, US
 VENKATARAMANI, Chandrasekar, c/o Gilead Sciences, Inc. 333 Lakeside Drive, Foster City, CA 94404, US
 GRAUPE, Michael, c/o Gilead Sciences, Inc. 333 Lakeside Drive, Foster City, CA 94404, US
 GUERRERO, Juan, c/o Gilead Sciences, Inc. 333 Lakeside Drive, Foster City, CA 94404, US

- (51) MKP
A61K 38/28 (2006.01) (97) **2720712 ***
 (86) US2012042816 15.06.2012
 (96) 12735366.2 23.04.2014
 (87) WO2012174478, 15.06.2012
 (97) 2720712, 23.04.2014 en
 (54) STABLE FORMULATIONS OF A HYALURONAN-DEGRADING ENZYME
 (71) Halozyme, Inc., 11388 Sorrento Valley Road, San Diego, CA 92121, US
 (72) YANG, Tzung-Horn, 3480 Caminito Daniella, Del Mar, CA 92014, US
 LABARRE, Michael, James, 1432 Carleton Square, San Diego, CA 92106, US
 VAUGHN, Daniel, Edward, 2230 14th Street, Encinitas, CA 92024, US
 CASTER, Christopher, L., 2683 Via de la Valle G109, Del Mar, CA 92014, US
 NICOL, Francois, 3461 Camino Court, Carlsbad, CA 92009, US
 KIM, Donghyun, 3770 Mykonos Lane 75, San Diego, CA 92130, US

- (51) MKP
F16H 57/08 (2006.01) (97) **2647882**
 (96) 13162392.8 09.10.2013
 (97) 2647882, 09.10.2013 en
 (54) Torque transmitting assembly and method of producing Metal Forming & Coining Corporation, 1007 Illinois Avenue, Maumee, OH 43537, US
 (72) Cripsey, Timothy J, 668 East Buell Road, Rochester, MI Michigan 48306, US

(51) MKP
A61M 31/00 (2006.01) (97) **2747833 ***
 (86) US2012051995 23.08.2012
 (96) 12845917.9 02.07.2014
 (87) WO2013066480, 23.08.2012
 (97) 2747833, 02.07.2014 en
 (54) IMPROVED SKIN PORT CONNECTOR AND METHOD OF INSTALLATION
 (71) Aspire Bariatrics, Inc., 2711 Centerville Road Suite 400, Wilmington, DE 19808, US
 (72) WOJCIK, Steven, E., 19535 22nd Place NW, Shoreline, WA 98177, US

(51) MKP
A61K 39/40 (2006.01) (97) **2758432 ***
A61P 31/04 (2006.01)
C07K 16/12 (2006.01)
 (86) GB2012052222 10.09.2012
 (96) 12761789.2 30.07.2014
 (87) WO2013038156, 10.09.2012
 (97) 2758432, 30.07.2014 en
 (54) NEUTRALISING ANTIBODIES TO THE MAJOR EXOTOXINS TCDA AND TCDB OF CLOSTRIDIUM DIFFICILE
 (71) UCB Pharma, S.A., 60, Allée de la Recherche, 1070 Brussels, BE
 (72) HUMPHREYS, David Paul, c/o IPD UCB Celltech 208 Bath Road, Slough Berkshire SL1 3WE, GB
 LIGHTWOOD, Daniel John, c/o IPD UCB Celltech 208 Bath Road, Slough Berkshire SL1 3WE, GB
 TYSON, Kerry Louise, c/o IPD UCB Celltech 208 Bath Road, Slough Berkshire SL1 3WE, GB
 KNIGHT, David Edward Ormonde, c/o IPD UCB Celltech 208 Bath Road, Slough Berkshire SL1 3WE, GB
 HERVÉ, Karine Jeannine Madeleine, c/o IPD UCB Celltech 208 Bath Road, Slough Berkshire SL1 3WE, GB
 COMPSON, Joanne Elizabeth, c/o IPD UCB Celltech 208 Bath Road, Slough Berkshire SL1 3WE, GB
 PAGE, Matthew Jon Timothy, c/o IPD UCB Celltech 208 Bath Road, Slough Berkshire SL1 3WE, GB
 PAYNE, Andrew Charles, c/o IPD UCB Celltech 208 Bath Road, Slough Berkshire SL1 3WE, GB
 FISHER, Nicola Louise, c/o IPD UCB Celltech 208 Bath Road, Slough Berkshire SL1 3WE, GB
 MACKENZIE, Brendon, c/o IPD UCB Celltech 208 Bath Road, Slough Berkshire SL1 3WE, GB
 COX, Matthew, c/o IPD UCB Celltech 208 Bath Road, Slough Berkshire SL1 3WE, GB

(51) MKP
G06F 19/00 (2011.01) (97) **2645280**
 (96) 12305392.8 02.10.2013
 (97) 2645280, 02.10.2013 en
 (54) A rapidly converging atomic physics method and medium to calculate complex non-equilibrium radiative properties of matter with spectroscopic precision.
 (71) Ecole Polytechnique, Route de Saclay, 91120 Palaiseau, FR
 Université Pierre et Marie Curie - Paris 6, 4 Place Jussieu, 75005 Paris, FR
 (72) Rosmej, Frank, 38 rue de Courbevoie, 92000 NANTERRE, FR
 Aouad, Youcef, Porte 410 4 rue Aimé Césaire, 93400 Saint-Ouen, FR

(51) MKP
C12N 13/00 (2006.01) (97) **2710127 ***
 (86) US2012038535 18.05.2012
 (96) 12790065.2 26.03.2014
 (87) WO2012162133, 18.05.2012
 (97) 2710127, 26.03.2014 en
 (54) SELECTIVE ULTRASONIC LYSIS OF BLOOD AND OTHER BIOLOGICAL FLUIDS AND TISSUES
 (71) AdvanDx, Inc., 400 TradeCenter, Suite 6990, Woburn, MA 01801, US
 (72) FUCHS, Martin, 11 Sophia Dr., Uxbridge, MA 01569, US
 MELTZER, Michelle, 4 Northgate Rd., Chelmsford, MA 01824, US

(51) MKP
A61K 31/55 (2006.01) (97) **2722334**
A61P 35/00 (2006.01)
A61P 43/00 (2006.01)
C07D 487/04 (2006.01)
 (96) 13192666.9 23.04.2014
 (97) 2722334, 23.04.2014 en
 (54) Benzodiazepine bromodomain inhibitor
 (71) GlaxoSmithKline LLC, Corporation Service Company 2711 Centreville Road Suite 400, Wilmington, Delaware 19808, US
 (72) Gosmini, Romain Luc Marie, c/o Laboratoire GlaxoSmithKline Centre de Recherches Z.A. de Courtaboeuf 25 Avenue du Quebec, F-91940 Les Ulis, FR
 Mirguet, Olivier, c/o Laboratoire GlaxoSmithKline Centre de Recherches Z.A. de Courtaboeuf 25 Avenue du Quebec, F-91940 Les Ulis, FR

(51) MKP
A61K 31/138 (2006.01) (97) **2717867 ***
A61K 31/439 (2006.01)
A61K 31/58 (2006.01)
A61K 45/06 (2006.01)
A61P 11/06 (2006.01)
A61P 11/08 (2006.01)
 (86) EP2012060442 01.06.2012
 (96) 12725046.2 16.04.2014
 (87) WO2012168160, 01.06.2012
 (97) 2717867, 16.04.2014 en
 (54) DRY POWDER INHALER COMPOSITIONS COMPRISING UMECLIDINIUM
 (71) Glaxo Group Limited, 980 Great West Road, Brentford, Middlesex TW8 9GS, GB
 (72) CRATER, Glenn, GlaxoSmithKline 7333 Mississauga Road North, Mississauga, Ontario L5N 6L4, CA

(51) MKP
C07D 401/12 (2006.01) (97) **2707364 ***
 (86) HU2012000036 10.05.2012
 (96) 12737338.9 19.03.2014
 (87) WO2012153158, 10.05.2012
 (97) 2707364, 19.03.2014 en
 (54) PROCESS FOR THE MANUFACTURE OF DABIGATRAN ETEXILATE AND INTERMEDIATES THEREOF
 EGIS GYÓGYSZERGYÁR Nyilvánosan Működő Részvénytársaság, Keresztúri út 30-38, 1106 Budapest, HU
 (71) KIRÁLY, Imre, Iskola út 7, H-3100 Salgótarján, HU
 SZABÓ, Tibor, Szentmihályi u. 24/C, H-1144 Budapest, HU
 SIMIG, Gyula, Hollósy S. u. 25, H-1126 Budapest, HU
 VOLK, Balázs, Pilisí u.54, H-1106 Budapest, HU
 SZLÁVIK, László, Jász u 57., II/9, H-1135 Budapest, HU
 BARKÓCZY, József, Szirom u. 4-6, H-1016 Budapest, HU
 RUZSICS, György, Bókay János u. 56. II.em/27, H-1083 Budapest, HU
 (72) LUKÁCS, Gyula, Bronz u.5, H-1163 Budapest, HU
 PONGÓ, László, Hold u. 31, H-2144 Kerepes, HU
 BOZA, András, Bán u. 6-8. II/7, H-1123 Budapest, HU
 TÓTHNÉ LAURITZ, Mária, Venetiánér u. 4/a, H-1042 Budapest, HU
 KOVÁCS, Mária, Gyűszűvirág u. 42, H-1165 Budapest, HU

- (51) MKP
C07D 403/06 (2006.01) (97) **2726476 ***
 (86) IB2012053318 29.06.2012
 (96) 12762391.6 07.05.2014
 (87) WO2013001505, 29.06.2012
 (97) 2726476, 07.05.2014 en
 (54) SULPHONAMIDE DERIVATIVES OF ALICYCLIC AMINES FOR THE TREATMENT OF CENTRAL NERVOUS SYSTEM DISEASES
 (71) Adamed sp. z o.o., Pienków 149, 05-152 Czosnów k/ Warszawy, PL
 (72) KOLACZKOWSKI, Marcin, ul. Lany 2, PL-32-020 Wieliczka, PL
 MARCINKOWSKA, Monika, ul. Spasowskiego 1/9, PL-31-139 Kraków, PL
 BUCKI, Adam, ul. 3 Maja 159, PL-32-100 Proszowice, PL
 PAWLOWSKI, Maciej, ul. Reformacka 87, PL-32-020 Wieliczka, PL
 KRUKOWSKI, Andrzej, ul. Wielunska 10/35, PL-01-240 Warszawa, PL
 RUSIECKI, Rafa, ul. L. Staffa 12/14 m. 24, PL-01-891 Warszawa, PL
 SIWEK, Agata Magdalena, ul. 1-go Maja 19/6, PL-32-620 Brzeszcze, PL
 WOLAK, Malgorzata Anna, ul. Na Szaniec 10/3, PL-31-560 Kraków, PL

- (51) MKP
A61K 31/165 (2006.01) (97) **2723710 ***
A61P 25/00 (2006.01)
C07C 237/06 (2006.01)
C07D 209/08 (2006.01)
C07D 217/06 (2006.01)
C07D 265/36 (2006.01)
C07D 295/182 (2006.01)
C07D 295/185 (2006.01)
 (86) EP2012060006 29.05.2012
 (96) 12726067.7 30.04.2014
 (87) WO2013000651, 29.05.2012
 (97) 2723710, 30.04.2014 en
 (54) FLUORINATED ARYLALKYLAMINOCARBOXAMIDE DERIVATIVES
 (71) Newron Pharmaceuticals S.p.A., Via L. Ariosto, 21, 20091 Bresso (MI), IT
 (72) PEVARELLO, Paolo, Piazza San Pietro in Ciel d'Oro 7/A, 27100 Pavia (PV), IT

- (51) MKP
B32B 17/10 (2006.01) (97) **2718100 ***
F21K 99/00 (2010.01)
F21V 33/00 (2006.01)
G02B 6/00 (2006.01)
 (86) FR2012051259 06.06.2012
 (96) 12731120.7 16.04.2014
 (87) WO2012168647, 06.06.2012
 (97) 2718100, 16.04.2014 fr
 (54) LIGHTING DEVICE COMPRISING LIGHT-EMITTING DIODES
 (71) Saint-Gobain Glass France, 18 avenue d'Alsace, 92400 Courbevoie, FR
 (72) GIERENS, Anne, 12 rue d'Amiens, F-60200 Compiègne, FR
 MONTGERMONT, Aude, 12 rue de Châteaudun, F-75009 Paris, FR
 ZHANG, Jingwei, 38 rue des Ruelles, F-91300 Massy, FR

- (51) MKP
A61K 31/47 (2006.01) (97) **2711433 ***
A61P 35/00 (2006.01)
A61P 43/00 (2006.01)
C12N 15/09 (2006.01)
C12Q 1/68 (2006.01)
G01N 33/15 (2006.01)
G01N 33/50 (2006.01)
 (86) JP2012062509 16.05.2012
 (96) 12786619.2 26.03.2014
 (87) WO2012157672, 16.05.2012
 (97) 2711433, 26.03.2014 en
 (54) METHOD FOR PREDICTING EFFECTIVENESS OF ANGIOGENESIS INHIBITOR
 (71) Eisai R&D Management Co., Ltd., 6-10, Koishikawa 4-chome, Bunkyo-ku, Tokyo 112-8088, JP
 (72) SEMBA, Taro, c/o EISAI CO., LTD. Tsukuba Research Laboratories 1-3 Tokodai 5-chome, Tsukuba-shi Ibaraki 300-2635, JP
 NARITA, Yusuke, c/o EISAI CO., LTD. Tsukuba Research Laboratories 1-3 Tokodai 5-chome, Tsukuba-shi Ibaraki 300-2635, JP
 MINOSHIMA, Yukinori, c/o EISAI CO., LTD. Tsukuba Research Laboratories 1-3 Tokodai 5-chome, Tsukuba-shi Ibaraki 300-2635, JP
 YAMAGUCHI, Atsumi, c/o EISAI CO., LTD. Tsukuba Research Laboratories 1-3 Tokodai 5-chome, Tsukuba-shi Ibaraki 300-2635, JP
 ADACHI, Yusuke, c/o EISAI CO., LTD. Tsukuba Research Laboratories 1-3 Tokodai 5-chome, Tsukuba-shi Ibaraki 300-2635, JP
 YAMADA, Kazuhiko, c/o EISAI CO., LTD. Tsukuba Research Laboratories 1-3 Tokodai 5-chome, Tsukuba-shi Ibaraki 300-2635, JP
 MATSUI, Junji, c/o EISAI CO., LTD. Tsukuba Research Laboratories 1-3 Tokodai 5-chome, Tsukuba-shi Ibaraki 300-2635, JP
 KADOWAKI, Tadashi, c/o EISAI CO., LTD. Tsukuba Research Laboratories 1-3 Tokodai 5-chome, Tsukuba-shi Ibaraki 300-2635, JP
 TAKAHASHI, Kentaro, c/o EISAI CO., LTD. Tsukuba Research Laboratories 1-3 Tokodai 5-chome, Tsukuba-shi Ibaraki 300-2635, JP
 FUNAHASHI, Yasuhiro, c/o EISAI CO., LTD. Tsukuba Research Laboratories 1-3 Tokodai 5-chome, Tsukuba-shi Ibaraki 300-2635, JP

- (51) MKP
F02M 59/10 (2006.01) (97) **2662564**
F02M 63/00 (2006.01)
F04B 1/04 (2006.01)
F04B 9/04 (2006.01)
F04B 53/00 (2006.01)
F04B 53/18 (2006.01)
 (96) 12167216.6 13.11.2013
 (97) 2662564, 13.11.2013 en
 (54) Driveshaft lubrication
 (71) Delphi International Operations Luxembourg S.à.r.l., Avenue de Luxembourg, 4940 Bascharage, LU
 (72) Navas Sanchez, Borja, Flat 4, 95-97 High Street, Chatham, Kent ME4 4DL, GB
 Jay, Mikko, Flat 23, 23 Chaucerwood Court, Canterbury, Kent CT1 1NZ, GB
 West, Benjamin, 35 Elmwood Close, Whitstable, Kent CT5 2QR, GB
 Jury, Thomas, 67 Beanshaw, London, SE9 3HL, GB

- (51) MKP
H03K 3/537 (2006.01) (97) **2737627 ***
 (86) FR2012051745 23.07.2012
 (96) 12753760.3 04.06.2014
 (87) WO2013017774, 23.07.2012
 (97) 2737627, 04.06.2014 fr
 (54) GAS SWITCH TRIGGERED BY A LASER FILAMENT
 (71) Ecole Polytechnique, Route de Saclay, 91120 Palaiseau, FR
 Centre National de la Recherche Scientifique, 3, rue Michel-Ange, 75016 Paris, FR
 Ecole Nationale Supérieure de Techniques Avancées, 828 boulevard des Maréchaux, 91762 Palaiseau Cedex, FR
 (72) LAROUR, Jean, 30 rue Jean Rey, F-78220 Viroflay, FR
 ARANTCHOUK, Léonid, 15 rue George Sand, F-91120 Palaiseau, FR
 HOUARD, Aurélien, 216 rue du Faubourg Saint-Antoine, F-75012 Paris, FR
 MYSYROWICZ, André, 6 rue Gabriel, F-78000 Versailles, FR

- (51) MKP
A61K 31/4162 (2006.01) (97) **2702059 ***
A61P 19/02 (2006.01)
C07D 471/04 (2006.01)
 (86) EP2012057654 26.04.2012
 (96) 12717289.8 05.03.2014
 (87) WO2012146659, 26.04.2012
 (97) 2702059, 05.03.2014 en
 (54) NOVEL COMPOUND USEFUL FOR THE TREATMENT OF DEGENERATIVE AND INFLAMMATORY DISEASES
 (71) Galapagos N.V., Generaal de Wittelaan L11 A3, 2800 Mechelen, BE
 (72) MENET, Christel, Jeanne, Marie, Galapagos NV Generaal De Wittelaan L11/A3, B-2800 Mechelen, BE
 HODGES, Alastair, James, BioFocus DPI Ltd. Chesterford Research Park, Saffron Walden Essex CB10 1XL, GB
 VATER, Huw, David, BioFocus DPI Ltd. Chesterford Research Park, Saffron Walden Essex CB10 1XL, GB

- (51) MKP
H01M 12/06 (2006.01) (97) **2725653 ***
 (86) KR2012005004 25.06.2012
 (96) 12802278.7 30.04.2014
 (87) WO2012177104, 25.06.2012
 (97) 2725653, 30.04.2014 en
 (54) LITHIUM-AIR BATTERY
 (71) IUCF-HYU (Industry-University Cooperation Foundation Hanyang University), Hanyang University Hangdang-dong 17 Seongdong-gu, Seoul 133-791, KR
 (72) SUN, Yang Kook, 23-1308 Eunma Apt. Daechi-2dong Gangnam-gu, Seoul 135-969, KR
 JUNG, Hun Gi, 116-2401 Yeonsan Xi Apt. Yeonsan 1-dong Yeonje-gu, Busan 611-749, KR

- (51) MKP
C07D 211/70 (2006.01) (97) **2760832 ***
C07D 401/04 (2006.01)
C07F 9/24 (2006.01)
 (86) EP2012069164 28.09.2012
 (96) 12766452.2 06.08.2014
 (87) WO2013045599, 28.09.2012
 (97) 2760832, 06.08.2014 en
 (54) IMPROVED PROCESS FOR PREPARING 2-[(2E)-2-FLUORO-2-(3-PIPERIDINYLIDENE)ETHYL]-1H-ISOINDOLE-1,3(2H)-DIONE
 (71) Janssen Pharmaceutica, N.V., Turnhoutseweg 30, 2340 Beerse, BE
 (72) LANG, Yolande Lydia, c/o Janssen Pharmaceutica NV Turnhoutseweg 30, B-2340 Beerse, BE
 DEPRÉ, Dominique Paul Michel, c/o Janssen Pharmaceutica NV Turnhoutseweg 30, B-2340 Beerse, BE

- (51) MKP
A61K 31/155 (2006.01) (97) **2709652 ***
A61K 38/22 (2006.01)
A61P 3/10 (2006.01)
 (86) EP2012058779 11.05.2012
 (96) 12720196.0 26.03.2014
 (87) WO2012156312, 11.05.2012
 (97) 2709652, 26.03.2014 en
 (54) PHARMACEUTICAL COMBINATION FOR USE IN THE TREATMENT OF DIABETES TYPE 2
 (71) Sanofi-Aventis Deutschland GmbH, Brüningstraße 50, 65929 Frankfurt am Main, DE
 (72) SILVESTRE, Louise, c/o Sanofi Département Brevets 54 rue La Boétie, F-75008 Paris, FR
 BOKA, Gabor, c/o Sanofi Département Brevets 54 rue La Boétie, F-75008 Paris, FR
 MIOSECC, Patrick, c/o Sanofi Département Brevets 54 rue La Boétie, F-75008 Paris, FR

- (51) MKP
G06F 7/58 (2006.01) (97) **2705421 ***
 (86) EP2011002203 03.05.2011
 (96) 11717200.7 12.03.2014
 (87) WO2012149944, 03.05.2011
 (97) 2705421, 12.03.2014 de
 (54) RANDOM NUMBER GENERATOR
 (71) Novomatic AG, Wiener Strasse 158, 2352 Gumpoldskirchen, AT
 (72) KAIBLINGER, Harald, Wiener Straße 158, A-2352 Gumpoldskirchen, AT
 SCHRÖTTER, Florian, Wiener Straße 158, A-2352 Gumpoldskirchen, AT

- (51) MKP
A61K 31/437 (2006.01) (97) **2751102 ***
A61P 3/00 (2006.01)
A61P 11/00 (2006.01)
A61P 17/00 (2006.01)
A61P 29/00 (2006.01)
C07D 471/04 (2006.01)
 (86) US2012052621 28.08.2012
 (96) 12756879.8 09.07.2014
 (87) WO2013033070, 28.08.2012
 (97) 2751102, 09.07.2014 en
 (54) COMPOUNDS AND COMPOSITIONS AS c-KIT KINASE INHIBITORS
 (71) IRM LLC, 131 Front Street P.O. Box HM 2899, Hamilton HM LX, BM
 (72) YEH, Vince, 10675 John Jay Hopkins Drive, San Diego, California 92121, US
 LI, Xiaolin, 10675 John Jay Hopkins Drive, San Diego, California 92121, US
 LIU, Xiaodong, 10675 John Jay Hopkins Drive, San Diego, California 92121, US
 LOREN, Jon, 10675 John Jay Hopkins Drive, San Diego, California 92121, US
 MOLTENI, Valentina, 10675 John Jay Hopkins Drive, San Diego, California 92121, US
 NABAKKA, Juliet, 10675 John Jay Hopkins Drive, San Diego, California 92121, US
 NGUYEN, Bao, 10675 John Jay Hopkins Drive, San Diego, California 92121, US
 PETRASSI, Hank Michael James, 10675 John Jay Hopkins Drive, San Diego, California 92121, US

- (51) MKP
A61B 1/313 (2006.01) (97) **2765932 ***
A61B 5/00 (2006.01)
A61B 17/16 (2006.01)
A61B 17/34 (2006.01)
A61M 5/46 (2006.01)
G01N 21/00 (2006.01)
(86) US2012060278 15.10.2012
(96) 12784151.8 20.08.2014
(87) WO2013056243, 15.10.2012
(97) 2765932, 20.08.2014 en
(54) NEEDLE GUIDANCE SYSTEM
(71) Lumoptik LLC, 2700 West Park Blvd., Shaker Heights, OH 44120, US
(72) JANICKI, Thomas, I., 2700 West Park Blvd., Shaker Heights, OH 44120, US
JANICKI, Arthur, Anthony, 10234 Hightower Court, Cincinnati, OH 45249, US
JANICKI, Oscar, Thomas, 28732 Lynhaven Drive, North Olmstead, OH 44070, US

- (51) MKP
B24B 39/00 (2006.01) (97) **2759373**
B24B 49/08 (2006.01)
(96) 13461560.8 30.07.2014
(97) 2759373, 30.07.2014 en
(54) A method of fluid pressure control in a hydrostatic burnishing tool and hydrostatic burnishing tool
(71) Zachodniopomorski Uniwersytet Technologiczny w Szczecinie, Aleja Piastów 17, 70-310 Szczecin, PL
(72) Gubala, Rafal, ul. Ratajczaka 8/3, 71-174 Szczecin, PL
Grochala, Daniel, Kosciuszki 3a/13, 66-500 Strzelce Krajeńskie, PL
Olszak, Wieslaw, ul. Rosponda 16/4, 71-793 Szczecin, PL

- (51) MKP
F24C 7/08 (2006.01) (97) **2761227 ***
H05B 3/74 (2006.01)
(86) FR2012052061 14.09.2012
(96) 12773039.8 06.08.2014
(87) WO2013079833, 14.09.2012
(97) 2761227, 06.08.2014 fr
(54) HOB WITH WINDOW, COOKING APPLIANCE AND METHOD OF MANUFACTURING THE HOB
(71) Eurokera S.N.C., 1 Avenue du Général de Gaulle B.P. 182, 02407 Château Thierry, FR
(72) MALLET, Claire, 200 rue du Faubourg Saint Martin, F-75010 Paris, FR
VERRAT DEBAILLEUL, Adèle, 17 Allée de la Montagne, F-60150 Villers-sur-Coudun, FR
MOTTELET, Béatrice, 14 Boulevard Gambetta, F-60200 Compiègne, FR
DEMOL, Franck, 22 rue des Billards, F-02400 Chateau-Thierry, FR
HUCHET, Gérard, 9 bis rue du Point du Jour, F-60350 Autrechès, FR

- (51) MKP
A61K 39/102 (2006.01) (97) **2707024 ***
A61P 31/04 (2006.01)
C07K 14/285 (2006.01)
(86) SE2012050503 11.05.2012
(96) 12782623.8 19.03.2014
(87) WO2012154121, 11.05.2012
(97) 2707024, 19.03.2014 en
(54) PROTEIN F - A NOVEL HAEMOPHILUS INFLUENZAE ADHESIN WITH LAMININ AND VITRONECTIN BINDING PROPERTIES
(71) RIESBECK Healthcare Sweden AB, Kolbäcksgatan 5, 216 20 Malmö, SE
(72) RIESBECK, Kristian, Kolbäcksgatan 5, S-216 20 Malmö, SE
SU, Yu-Ching, Kolbäcksgatan 5, S-216 20 Malmö, SE

- (51) MKP
F02D 1/18 (2006.01) (97) **2660456**
F02M 41/14 (2006.01)
(96) 12166297.7 06.11.2013
(97) 2660456, 06.11.2013 en
(54) Fuel pump
(71) Delphi International Operations Luxembourg S.à.r.l., Avenue de Luxembourg, 4940 Bascharage, LU
(72) Bootle, Geoffrey, 19 Allington Way, Maidstone, Kent ME16 0HJ, GB
Dyason, Rodney, 18 Flamingo Close, Chatham, Kent ME5 7RF, GB

- (51) MKP
A61B 17/00 (2006.01) (97) **2679177**
A61B 17/3207 (2006.01)
(96) 13173767.8 01.01.2014
(97) 2679177, 01.01.2014 en
(54) Systems and apparatus for providing motor protection in a power tool and method of manufacturing the same
(71) Synthes GmbH, Eimattstrasse 3, 4436 Oberdorf, CH
(72) Dürrenberger, Urs, Eimattstrasse 3, Oberdorf 4436, CH
Münch, Martin, Eimattstrasse 3, Oberdorf 4436, CH
Schmuckli, Nils, Eimattstrasse 3, Oberdorf 4436, CH

- (51) MKP
C12Q 1/68 (2006.01) (97) **2751283 ***
(86) EP2012066842 30.08.2012
(96) 12756154.6 09.07.2014
(87) WO2013030263, 30.08.2012
(97) 2751283, 09.07.2014 en
(54) PROCESS FOR SEPARATION OF OLIGONUCLEOTIDE OF INTEREST FROM A MIXTURE
(71) Glaxo Group Limited, 980 Great West Road, Brentford, Middlesex TW8 9GS, GB
(72) DOUILLET, Nathalie, GlaxoSmithKline Gunnels Wood Road, Stevenage Hertfordshire SG1 2NY, GB
FREEBAIRN, Keith, GlaxoSmithKline Gunnels Wood Road, Stevenage Hertfordshire SG1 2NY, GB
GUZLEK, Hacer, GlaxoSmithKline Gunnels Wood Road, Stevenage Hertfordshire SG1 2NY, GB
HUBERT, Jane, University of Reims Champagne-Ardenne 9 Boulevard de la Paix, F-51097 Reims Cedex, FR
RENAULT, Jean-Hughes, University of Reims Champagne-Ardenne 9 Boulevard de la Paix, F-51097 Reims Cedex, FR
THICKITT, Christopher, GlaxoSmithKline Gunnels Wood Road, Stevenage Hertfordshire SG1 2NY, GB

- (51) MKP
A61K 31/00 (2006.01) (97) **2768491 ***
A61K 49/00 (2006.01)
A61P 35/00 (2006.01)
C07F 5/02 (2006.01)
(86) US2012060789 18.10.2012
(96) 12781004.2 27.08.2014
(87) WO2013059437, 18.10.2012
(97) 2768491, 27.08.2014 en
(54) INHIBITORS OF ARGINASE AND THEIR THERAPEUTIC APPLICATIONS
(71) Mars, Incorporated, 6885 Elm Street, McLean, VA 22101, US
(72) VAN ZANDT, Michael, c/o MARS INCORPORATED 6885 Elm Street, McClean, Virginia 22101, US
GOLEBIOWSKI, Adam, c/o MARS INCORPORATED 6885 Elm Street, McLean, Virginia 22101, US
JI, Min Koo, c/o MARS INCORPORATED 6885 Elm Street, McClean, Virginia 22101, US
WHITEHOUSE, Darren, c/o MARS INCORPORATED 6885 Elm Street, McClean, Virginia 22101, US
RYDER, Todd, c/o MARS INCORPORATED 6885 Elm Street, McClean, Virginia 22101, US
BECKETT, Raymond Paul, c/o MARS INCORPORATED 6885 Elm Street, McClean, Virginia 22101, US

(51) MKP
G01N 21/35 (2014.01) (97) **2743678 ***
 (86) ES2012070613 07.08.2012
 (96) 12821746.0 18.06.2014
 (87) WO2013021087, 07.08.2012
 (97) 2743678, 18.06.2014 en
 (54) INFRARED ANALYSIS OF PERIPHERAL BLOOD FRACTIONS OBTAINED TO INDICATE COGNITIVE DEVELOPMENT ASSOCIATED WITH ALZHEIMER'S DISEASE
 (71) Consejo Superior De Investigaciones Científicas (CSIC), C/ Serrano 117, 28006 Madrid, ES
 Instituto de Salud Carlos III, Avenida de Monforte de Lemos, 5, 28019 Madrid, ES
 Fundación Cien, C/ Valderrebollo 5, 28031 Madrid, ES
 Fundación Para La Investigación Biomédica Del Hospital 12 de Octubre, Avda. de Cordoba S/n Edif. Materno Infantil 4a planta, 28041 Madrid, ES
 (72) CARMONA HERNÁNDEZ, Pedro, Instituto de Estructura de la Materia (CSIC) Calle Serrano 121, E-28006 Madrid, ES
 TOLEDANO GASCA, Adolfo, Instituto Cajal Avenida Doctor Arce 37, E-28002 Madrid, ES
 CALERO LARA, Miguel, Instituto De Salud Carlos Iii Avenida Monforte de Lemos nº5, E-28019 Madrid, ES
 MARTÍNEZ MARTÍN, Pablo, Instituto De Salud Carlos III Avenida Monforte de Lemos nº5, E-28019 Madrid, ES
 BERMEJO PAREJA, Félix, Fundación Para La Investigación Biomédica Del Hospital Universitario 12 De Octubre Avenida de Córdoba s/n Edificio Maternal - 4ª planta, E-Madrid E-28041, ES

(51) MKP
B01D 3/00 (2006.01) (97) **2755730 ***
 (86) US2012055175 13.09.2012
 (96) 12832155.1 23.07.2014
 (87) WO2013040217, 13.09.2012
 (97) 2755730, 23.07.2014 en
 (54) SYSTEM AND METHOD FOR WATER TREATMENT
 (71) Aquasource Technologies Corporation, 199 Katherine Drive, North Huntingdon, Pennsylvania 15642, US
 (72) DIGHE, Shyam V., 199 Katherine Drive, North Huntingdon, Pennsylvania 15642, US

(51) MKP
A61K 31/4184 (2006.01) (97) **2766354 ***
A61K 31/4188 (2006.01)
A61P 35/00 (2006.01)
C07D 401/14 (2006.01)
C07D 403/04 (2006.01)
C07D 413/04 (2006.01)
C07D 471/04 (2006.01)
 (86) FI2012000040 09.10.2012
 (96) 12783247.5 20.08.2014
 (87) WO2013053983, 09.10.2012
 (97) 2766354, 20.08.2014 en
 (54) PROTEIN KINASE INHIBITORS
 (71) Orion Corporation, Orionintie 1, 02200 Espoo, FI
 (72) LINNANEN, Tero, Kalamestarintie 9 B 6, FI-04300 Tuusula, FI
 WOHLFAHRT, Gerd, Vattuniemenkatu 14 C 35, FI-00210 Helsinki, FI
 NANDURI, Srinivas, Plot 28 Krishna Sai Enclave HMT Colony Road, Miyapur Hyderabad 500049, IN
 UJJINAMATADA, Ravi, 295 13th Main 7th Sector HSR Layout, Bangalore Karnataka 560102, IN
 RAJAGOPALAN, Srinivasan, 33 4th Main BTM 1st Stage Venkateshwara Layout, Bangalore 560068, IN
 MUKHERJEE, Subhendu, 132/A/3 Thakurbari Street (Kobil Bagan) P.O. Srirampur, Hooghly 712201, IN

(51) MKP
H02P 6/08 (2006.01) (97) **2731262 ***
H02P 27/06 (2006.01)
 (86) CN2012070281 12.01.2012
 12811643.1 14.05.2014
 (96) WO2013007107, 12.01.2012
 (87) 2731262, 14.05.2014 en
 (54) VARIABLE FREQUENCY SPEED CONTROL SYSTEM FOR MOTOR
 (71) Dayu Electric Co., Ltd., No.1 Huangpi West Road, Xiaogan, Hubei 432000, CN
 (72) WANG, Yihua, No.1 Huangpi West Road, Xiaogan city Hubei 432000, CN
 CHENG, Shiguo, No.1 Huangpi West Road, Xiaogan city Hubei 432000, CN
 NING, Guoyun, No.1 Huangpi West Road, Xiaogan city Hubei 432000, CN
 ZENG, Xianjie, No.1 Huangpi West Road, Xiaogan city Hubei 432000, CN

(51) MKP
A61F 13/15 (2006.01) (97) **2736542 ***
A61L 15/18 (2006.01)
A61L 15/32 (2006.01)
A61L 15/42 (2006.01)
A61L 15/60 (2006.01)
 (86) EP2012003659 31.08.2012
 (96) 12756104.1 04.06.2014
 (87) WO2013029796, 31.08.2012
 (97) 2736542, 04.06.2014 de
 (54) MULTI-LAYERED WOUND DRESSING CONTAINING AN HYDROCOLLOID AND ACTIVATED CARBON
 (71) Blücher GmbH, Mettmanner Strasse 25, 40699 Erkrath, DE
 (72) VON BLÜCHER, Hasso, Parkstrasse 10, 40699 Erkrath, DE
 SCHÖNFELD, Raik, Am Forstkamp 24b, 30629 Hannover, DE
 PALLASKE, Frank, Hauptstrasse 254, 09355 Gersdorf, DE

(51) MKP
A61K 9/22 (2006.01) (97) **2704697 ***
A61K 31/167 (2006.01)
 (86) US2012036528 04.05.2012
 (96) 12782731.9 12.03.2014
 (87) WO2012154563, 04.05.2012
 (97) 2704697, 12.03.2014 en
 (54) SUSTAINED RELEASE PARACETAMOL FORMULATIONS
 (71) GlaxoSmithKline LLC, One Franklin Plaza 200 North 16th Street, Philadelphia, PA 19102, US
 (72) BUAN, Carla, Valenti, 1500 Littleton Road, Parsippany NJ 07054, US
 LIU, Dongzhou, 1500 Littleton Road, Parsippany NJ 07054, US
 MEGHPARA, Kanji, 1500 Littleton Road, Parsippany NJ 07054, US

(51) MKP
A61K 31/444 (2006.01) (97) **2766353 ***
A61P 25/06 (2006.01)
C07D 401/10 (2006.01)
C07D 401/14 (2006.01)
C07D 405/14 (2006.01)
C07D 413/14 (2006.01)
C07D 417/14 (2006.01)
 (86) EP2012070000 10.10.2012
 (96) 12772914.3 20.08.2014
 (87) WO2013053725, 10.10.2012
 (97) 2766353, 20.08.2014 en
 (54) 2-OXO-PIPERIDINYL DERIVATIVES
 (71) UCB Pharma, S.A., 60, allée de la Recherche, 1170 Brussels, BE
 (72) ATES, Ali, c/o UCB Pharma S.A. IP Department 60 Allée de la Recherche, B-1070 Brussels, BE
 MONTEL, Florian, c/o UCB Pharma S.A. IP Department 60 Allée de la Recherche, B-1070 Brussels, BE
 VALADE, Anne, c/o UCB Pharma S.A. IP Department 60 Allée de la Recherche, B-1070 Brussels, BE
 LORTHIOIR, Olivier, c/o UCB Pharma S.A. IP Department 60 Allée de la Recherche, B-1070 Brussels, BE

(51) MKP
A61K 31/505 (2006.01) (97) **2748168 ***
A61K 31/519 (2006.01)
A61P 35/00 (2006.01)
C07D 487/02 (2006.01)
C07D 487/04 (2006.01)
(86) US2012052007 23.08.2012
(96) 12825411.7 02.07.2014
(87) WO2013028832, 23.08.2012
(97) 2748168, 02.07.2014 en
(54) INHIBITORS OF NEDD8-ACTIVATING ENZYME
(71) Millennium Pharmaceuticals, Inc., 40 Landsdowne Street, Cambridge, MA 02139, US
(72) MCCARRON, Ashley, Sue, 21 Greenfield Parkway, Bedford, NH 03110, US
SELLS, Todd, B., 1 Davis Road, Southborough, MA 01772, US
STIRLING, Matthew, 1 Huckleberry Lane, Randolph, MA 02368, US
STROUD, Stephen, G., 53 Tesla Avenue, Medford, MA 02155, US

(51) MKP
H04N 7/18 (2006.01) (97) **2702763 ***
(86) IB2013052381 26.03.2013
(96) 13722543.9 05.03.2014
(87) WO2013144826, 26.03.2013
(97) 2702763, 05.03.2014 en
(54) INTERFACE DEVICE FOR VIDEO CAMERAS
(71) Videotec S.p.a., Via Friuli 6, 36015 Schio (VI), IT
(72) CAMPANA, Ottavio, Via delle Camelie 27/33, I-36030 Caldogno (VI), IT

(51) MKP
A61K 31/497 (2006.01) (97) **2729149 ***
(86) US2012045350 03.07.2012
(96) 12806889.7 14.05.2014
(87) WO2013006596, 03.07.2012
(97) 2729149, 14.05.2014 en
(54) VOLTAGE-GATED SODIUM CHANNEL BLOCKERS
(71) Glaxo Group Limited, 980 Great West Road Brentford, Middlesex TW8 9GS, GB
(72) BOEHM, Jeffrey, Charles, 709 Swedeland Road, King of Prussia, PA 19406, US
DAVIS, Roderick, S., 709 Swedeland Road, King of Prussia, PA 19406, US
KERNS, Jeffrey, 709 Swedeland Road, King of Prussia, PA 19406, US
LIN, Guoliang, Beijing Tongzhou Jingji Kaifaqu Guangyuan Dongjie 8 Beijing Wansheng, Beijing 101113, CN
MURDOCH, Robert, D., Gunnels Wood Road, Stevenage Hertfordshire SG1 2NY, GB
NIE, Hong, 709 Swedeland Road, King of Prussia, PA 19406, US

(51) MKP
A61K 31/537 (2006.01) (97) **2758406 ***
A61P 25/28 (2006.01)
C07D 498/10 (2006.01)
(86) US2012056658 21.09.2012
(96) 12766840.8 30.07.2014
(87) WO2013044092, 21.09.2012
(97) 2758406, 30.07.2014 en
(54) AMINO-OXAZINES AND AMINO-DIHYDROTHIAZINE COMPOUNDS AS BETA-SECRETASE MODULATORS AND METHODS OF USE
(71) Amgen Inc., One Amgen Center Drive, Thousand Oaks, California 91320, US
(72) WHITE, Ryan, 34 Willow Avenue, Unit 1, Somerville, Massachusetts 02144, US
CHENG, Yuan, 5329 Via Jacinto, Newbury Park, California 91320, US
MINATTI, Ana Elena, 2219 3rd Street unit 6, Santa Monica, California 90405, US
YANG, Bryant, 5454 Luis Drive, Agoura Hills, California 91301, US
ZHENG, Xiao Mel, 19 Allison Way, Natick, Massachusetts 01760, US
LOPEZ, Patricia, 5614 Le Sage Ave, Woodland Hills, California 91367, US
HUMAN, Jason B., 944 Dorchester Avenue, Unit 19, Boston, Massachusetts 02125, US
EPSTEIN, Oleg, 44 Trowbridge Street, Belmont, Massachusetts 02478, US
JUDD, Ted, 17179 Braxton Street, Granada Hills, California 91344, US
SHAM, Kelvin, 3111 La Casa Court, Thousand Oaks, California 91362, US
XUE, Qiufen, 5018 Via Mesita, Newbury Park, California 91320, US

(51) MKP
A01N 37/00 (2006.01) (97) **2713724 ***
A61K 31/19 (2006.01)
(86) US2012039721 25.05.2012
(96) 12789291.7 09.04.2014
(87) WO2012162669, 25.05.2012
(97) 2713724, 09.04.2014 en
(54) METHODS OF TREATING MULTIPLE SCLEROSIS AND PRESERVING AND/OR INCREASING MYELIN CONTENT
(71) Biogen Idec MA Inc., 14 Cambridge Center, Cambridge, MA 02142, US
(72) DAWSON, Katherine, 561 Canton Street, Westwood, MA 02090, US
O'NEILL, Gilmore, 17 Grove Street, Medford, MA 02155, US
SANDROCK, Alfred, 316 Hartman Road, Newton, MA 02459, US

(51) MKP
A61M 5/00 (2006.01) (97) **2707064 ***
A61M 5/32 (2006.01)
A61M 5/50 (2006.01)
(86) EP2012058709 11.05.2012
(96) 12723851.7 19.03.2014
(87) WO2012156286, 11.05.2012
(97) 2707064, 19.03.2014 en
(54) DRUG DELIVERY DEVICE COMPRISING SAFETY LOCK MEMBER
(71) Sanofi-Aventis Deutschland GmbH, Brüningstraße 50, 65929 Frankfurt am Main, DE
(72) TEUCHER, Axel, c/o Sanofi-Aventis Deutschland GmbH, 65926 Frankfurt am Main, DE
JUGL, Michael, c/o Sanofi-Aventis Deutschland GmbH, 65926 Frankfurt am Main, DE

(51) MKP
A01C 1/06 (2006.01) (97) **2719270**
 (96) 12007613.8 16.04.2014
 (97) 2719270, 16.04.2014 de
 (54) Coating compound and use
 (71) BYK-Chemie GmbH, Abelstraße 45, 46483 Wesel, DE
 (72) Dreuer, Anne, Hoyastraße 15, D - 48147 Münster, DE
 Hanitzsch, Ninja, Werdener Strasse 36, D - 46047 Oberhausen, DE
 Berkei, Michael, Dr., Ginsterstrasse 12, D - 45721 Haltern am See, DE
 Nolte, Ulrich, Dr., Wasserburgallee 40, D - 47533 Kleve, DE
 Tinhoff, Tobias, Potsdamstrasse 12, D - 46397 Bochold, DE
 Koch, Ralf, Bagelstrasse 89, D - 46485 Wesel, DE

(51) MKP
A61K 39/395 (2006.01) (97) **2711375**
A61P 3/04 (2006.01)
C07K 14/71 (2006.01)
C07K 16/18 (2006.01)
C07K 16/28 (2006.01)
C07K 19/00 (2006.01)
 (96) 13183846.8 26.03.2014
 (97) 2711375, 26.03.2014 en
 (54) Human Antigen Binding Proteins that bind Beta-Klotho, FGF Receptors and complexes thereof
 (71) Amgen Inc., One Amgen Center Drive, Thousand Oaks, California 91320-1799, US
 (72) Hu, Shaw-Fen, Sylvia, 986 Lynnmere Drive, Thousand Oaks, CA 91360, US
 Foltz, Ian, 2108 Knightswood Place, Burnaby British Columbia BC V5A 4B9, CA
 KING, Chadwick T., 1325 Moody Avenue, North Vancouver British Columbia V7L 3T5, CA
 Li, Yang, 1142 Cuesta Drive, Mountain View, CA 94040, US
 Arora, Taruna, 5380 Via Pisa, Thousand Oaks, CA 91320, US

(51) MKP
A61K 9/00 (2006.01) (97) **2637645 ***
A61K 9/48 (2006.01)
A61K 31/00 (2006.01)
A61K 31/343 (2006.01)
 (86) FR2011052622 10.11.2011
 (96) 11796739.8 18.09.2013
 (97) WO2012063005, 10.11.2011
 (87) 2637645, 18.09.2013 fr
 (54) PHARMACEUTICAL COMPOSITION AND DOSAGE FORM COMPRISING DRONEDARONE, AND PREPARATION METHOD THEREOF
 (71) SANOFI, 174, Avenue de France, 75013 Paris, FR
 (72) ABRAMOVICI, Bernard, c/o Sanofi Département Brevets 174 Avenue de France, F-75013 Paris, FR
 BEILLES, Stéphane, c/o Sanofi Département Brevets 174 Avenue de France, F-75013 Paris, FR
 GAUTIER, Jean-Claude, c/o Sanofi Département Brevets 174 Avenue de France, F-75013 Paris, FR
 CHAMBONNET, Sandra, c/o Sanofi Département Brevets 174 avenue de France, F-75013 Paris, FR

(51) MKP
C07K 14/31 (2006.01) (97) **2758436 ***
C07K 14/315 (2006.01)
C07K 16/28 (2006.01)
C07K 16/30 (2006.01)
 (86) EP2012068802 24.09.2012
 (96) 12762595.2 30.07.2014
 (87) WO2013041730, 24.09.2012
 (97) 2758436, 30.07.2014 en
 (54) SERUM HALF-LIFE EXTENSION USING IMMUNOGLOBULIN BINDING DOMAINS
 (71) Universität Stuttgart, Keplerstrasse 7, 70174 Stuttgart, DE
 (72) KONTERMANN, Roland, Schlesierstrasse 106, 72662 Nürtingen, DE
 UNVERDORBEN, Felix, Schwarenbergstrasse 157, 70184 Stuttgart, DE
 HUTT, Meike, Urbacherstrasse 9, 73614 Schorndorf, DE

(51) MKP
F24H 9/02 (2006.01) (97) **2623883**
 (96) 13153602.1 07.08.2013
 (97) 2623883, 07.08.2013 en
 (54) Heating device with removable front cover, method for maintaining a heating device
 (71) ROBERT BOSCH GMBH, Postfach 30 02 20, 70442 Stuttgart, DE
 (72) Langenkamp, Teunis Jan Hendrik, 5, Broekdijk, 7245 RA Laren, NL
 Mulling, Wouter Frank, 14, Bevertstraat, 7481 CX Haaksbergen, NL
 ten Elsen, Jan Willem, 10, Severdinkstraat, 7416 SJ Deventer, NL

(51) MKP
B01D 3/02 (2006.01) (97) **2755921 ***
C02F 1/06 (2006.01)
 (86) US2012055191 13.09.2012
 (96) 12831074.5 23.07.2014
 (87) WO2013040232, 13.09.2012
 (97) 2755921, 23.07.2014 en
 (54) SYSTEM AND METHOD FOR WATER TREATMENT
 (71) Aquasource Technologies Corporation, 199 Katherine Drive, North Huntingdon, Pennsylvania 15642, US
 (72) DIGHE, Shyam V., 199 Katherine Drive, North Huntingdon, Pennsylvania 15642, US

(51) MKP
B66C 1/10 (2006.01) (97) **2625130 ***
 (86) EP2011067311 04.10.2011
 (96) 11764201.7 14.08.2013
 (87) WO2012045741, 04.10.2011
 (97) 2625130, 14.08.2013 de
 (54) METHOD FOR REPLACING A TRANSFORMER IN A WIND ENERGY INSTALLATION
 (71) Wobben Properties GmbH, Dreekamp 5, 26605 Aurich, DE
 (72) MEYER, Ewald, Alte Poststraße 61, 26835 Holtland, DE
 GERBERS, Arnim, Alte Kolonate 12, 26607 Aurich, DE

(51) MKP
H04Q 9/00 (2006.01) (97) **2605539**
 (96) 11193128.3 19.06.2013
 (97) 2605539, 19.06.2013 en
 (54) Method and system for sensor classification
 (71) ATS Group (IP Holdings) Limited, PO Box 958 Pasea Estate, Road Town, Tortola, VG
 (72) Hartmann, Melanie c/o AGT Group (R&D) GMBH, Hilpertstrasse 20A, 64295 Darmstadt, DE
 Bauer, Alexander c/o AGT Group (R&D) GMBH, Hilpertstrasse 20A, 64295 Darmstadt, DE
 Blanke, Ulf c/o AGT Group (R&D) GMBH, Hilpertstrasse 20A, 64295 Darmstadt, DE

(51) MKP
H02G 3/08 (2006.01) (97) **2634877**
 (96) 12305241.7 04.09.2013
 (97) 2634877, 04.09.2013 fr
 (54) Method for manufacturing a control housing for a circulation pump
 (71) Pompes Salmson, 53 Boulevard de la République,, 78400 Chatou, FR
 (72) Leze, Adrien, 10 rue Simone de Beauvoir, 53000 Laval, FR
 Bouilly, Hervé, 16, rue de l'étamoire, 53940 Le Genest St. Isle, FR
 Dejean, Philippe, 9 rue de la lande, 53960 Bonchamp, FR
 Guillet, Donald, 12 rue verdict Gédé, 53960 Bonchamp, FR
 Pottier, Xavier, La Jarrière, 53970 Montigne le Brillant, FR

- (51) MKP
A01N 55/08 (2006.01) (97) **2744342 ***
A61K 31/69 (2006.01)
(86) US2012051349 17.08.2012
(96) 12824599.0 25.06.2014
(87) WO2013025992, 17.08.2012
(97) 2744342, 25.06.2014 en
(54) THERAPEUTIC METHODS
(71) GlaxoSmithKline LLC, Corporation Service Company 2711 Centreville Road Suite 400, Wilmington, Delaware 19808, US
(72) WALKER, Jill, c/o GlaxoSmithKline Global Patents Five Moore Drive P.O. Box 13398 Research Triangle Park, North Carolina 27709, US
VOITENLEITNER, Christian, c/o GlaxoSmithKline Global Patents FiveMooreDrive P.O.Box13398 Research Triangle Park, North Carolina 27709, US

- (51) MKP
A61K 31/17 (2006.01) (97) **2723332 ***
(86) US2012038520 18.05.2012
(96) 12789372.5 30.04.2014
(87) WO2012162127, 18.05.2012
(97) 2723332, 30.04.2014 en
(54) NOVEL COMPOUNDS AS DIACYLGLYCEROL ACYLTRANSFERASE INHIBITORS
(71) Glaxosmithkline Intellectual Property (No. 2) Limited, 980 Great West Road, Brentford, Middlesex TW8 9SG, GB
(72) QIN, Donghui, 1250 SouthCollegeville Road, Collegeville, PA 19426, US
JOSHI, Hemant, 709 Swedeland Road, UW2220, US
TANGIRALA, Raghuram, 709 Swedeland Road, UW2220, US

- (51) MKP
A61K 31/4745 (2006.01) (97) **2744809 ***
A61P 29/00 (2006.01)
A61P 37/00 (2006.01)
C07D 471/04 (2006.01)
(86) EP2012065918 15.08.2012
(96) 12748028.3 25.06.2014
(87) WO2013024104, 15.08.2012
(97) 2744809, 25.06.2014 en
(54) 4-(8-METHOXY-1-((1-METHOXYPROPAN-2-YL)-2-(TETRAHYDRO-2H-PYRAN-4-YL)-1 H-IMIDAZO[4,5-C]QUINOLIN-7-YL)-3,5-DIMETHYLSOXAZOLE AND ITS USE AS BROMODOMAIN INHIBITOR
(71) GlaxoSmithKline LLC, Corporation Service Company 2711 Centreville Road Suite 400, Wilmington, Delaware 19808, US
(72) DEMONT, Emmanuel, Hubert, GlaxoSmithKline Gunnels Wood Road, Stevenage Hertfordshire SG1 2NY, GB
JONES, Katherine, Louise, GlaxoSmithKline Gunnels Wood Road, Stevenage Hertfordshire SG1 2NY, GB
WATSON, Robert J, GlaxoSmithKline Gunnels Wood Road, Stevenage Hertfordshire SG1 2NY, GB

- (51) MKP
A61K 31/045 (2006.01) (97) **2723344 ***
A61K 31/35 (2006.01)
A61K 31/592 (2006.01)
A61K 31/593 (2006.01)
A61P 1/00 (2006.01)
A61P 11/00 (2006.01)
A61P 11/06 (2006.01)
(86) EP2012003523 19.08.2012
(96) 12756362.5 30.04.2014
(87) WO2013026556, 19.08.2012
(97) 2723344, 30.04.2014 de
(54) MONOTERPENE-CONTAINING AGENT FOR COMBINATION THERAPY
(71) Maria Clementine Martin Klosterfrau Vertriebsgesellschaft mbH, Gereonsmühlengasse 1-11, 50670 Köln, DE
(72) GREVE, Harald, Schorlemerstrasse 3a, 40545 Düsseldorf, DE

- (51) MKP
A61K 31/404 (2006.01) (97) **2744805 ***
A61K 31/4184 (2006.01)
A61P 29/00 (2006.01)
C07D 403/14 (2006.01)
C07D 417/12 (2006.01)
C07D 417/14 (2006.01)
(86) US2012051100 16.08.2012
(96) 12756842.6 25.06.2014
(87) WO2013025883, 16.08.2012
(97) 2744805, 25.06.2014 en
(54) HETEROARYL SODIUM CHANNEL INHIBITORS
(71) Amgen Inc., One Amgen Center Drive, Thousand Oaks, California 91320-1799, US
(72) DINEEN, Thomas, 36 Waterhouse Street, Somerville, MA 02144, US
MARX, Isaac, E., 159 Pemberton Street 1, Cambridge, MA 02140, US
NGUYEN, Hanh, Nho, 185 Brattle Street, Arlington, MA 02474, US
WEISS, Matthew, 99 Revere Street, Boston, MA 02114, US

- (51) MKP
H04L 29/00 (2006.01) (97) **2732594 ***
(86) NO2012050136 12.07.2012
(96) 12759280.6 21.05.2014
(87) WO2013009191, 12.07.2012
(97) 2732594, 21.05.2014 en
(54) SYSTEM AND METHOD FOR ALTERNATIVE DISTRIBUTION OF A PIN CODE
(71) Lemberg, Trond, Skotbuveien 81, 1409 Skotbu, NO
(72) Lemberg, Trond, Skotbuveien 81, 1409 Skotbu, NO

- (51) MKP
A61K 31/4166 (2006.01) (97) **2718285 ***
A61K 31/4439 (2006.01)
A61K 31/506 (2006.01)
A61P 25/00 (2006.01)
C07D 307/87 (2006.01)
C07D 307/94 (2006.01)
C07D 311/76 (2006.01)
C07D 401/04 (2006.01)
C07D 403/04 (2006.01)
C07D 405/12 (2006.01)
C07D 405/14 (2006.01)
(86) GB2012051278 07.06.2012
(96) 12726849.8 16.04.2014
(87) WO2012168710, 07.06.2012
(97) 2718285, 16.04.2014 en
(54) HYDANTOIN DERIVATES AS KV3 INHIBITORS
(71) Autifony Therapeutics Limited, B205 Imperial College Incubator Level 1 Bessemer Building Imperial College, London SW7 2AZ, GB
(72) ALVARO, Giuseppe, c/o Autifony Srl Medicines Research Centre Via Fleming 4, I-37135 Verona, IT
DECOR, Anne, c/o Autifony Srl Medicines Research Centre Via Fleming 4, I-37135 Verona, IT
HAMPRECHT, Dieter, c/o Autifony Srl Medicines Research Centre Via Fleming 4, I-37135 Verona, IT
MARASCO, Agostino, c/o Autifony Srl Medicines Research Centre Via Fleming 4, I-37135 Verona, IT

- (51) MKP
C02F 1/66 (2006.01) (97) **2751036 ***
C02F 1/68 (2006.01)
C02F 103/06 (2006.01)
C02F 103/42 (2006.01)
(86) EP2012066673 28.08.2012
(96) 12753473.3 09.07.2014
(87) WO2013030185, 28.08.2012
(97) 2751036, 09.07.2014 en
(54) REMINERALIZATION OF DESALINATED AND OF FRESH WATER BY DOSING OF A CALCIUM CARBONATE SOLUTION IN SOFT WATER
(71) Omya International AG, Baslerstrasse 42, 4665 Oftringen, CH
(72) POFFET, Martine, Belpstrasse 30, 3007 Berne, CH
SKOVBY, Michael, Wampflenstrasse 52, CH-8706 Meilen, CH
POHL, Michael, H.-v.-Tuerlin Strasse 11, A-9500 Villach, AT

(51) MKP
A61K 31/4418 (2006.01) (97) **2753606 ***
A61P 25/08 (2006.01)
C07D 233/90 (2006.01)
C07D 401/12 (2006.01)
C07D 401/14 (2006.01)
C07D 403/04 (2006.01)
C07D 403/12 (2006.01)
C07D 405/12 (2006.01)
C07D 405/14 (2006.01)
(86) IB2012001871 31.08.2012
(96) 12770217.3 16.07.2014
(87) WO2013030665, 31.08.2012
(97) 2753606, 16.07.2014 en
(54) PYRIMIDINES AS SODIUM CHANNEL BLOCKERS
(71) Purdue Pharma LP, One Stamford Forum 201 Tresser Boulevard, Stamford, CT 06901-3431, US
(72) NI, Chiyou, 5 Ford Court, Belle Mead, NJ 08502, US
PARK, Minnie, 22 Warwick Road, Princeton Junction, NJ 08550, US
SHAO, Bin, 23 Shelbourne Road, Richboro, PA 18954, US
TAFESSE, Laykea, 8 Windward Way, Robbinsville, NJ 08690, US
YAO, Jiangchao, 10 Bellflower Court, Princeton, NJ 08540, US
YOUNGMAN, Mark, 110 Franklin Court, North Wales, PA 19454, US

(51) MKP
A61B 18/14 (2006.01) (97) **2726005 ***
(86) DK2011050298 01.08.2011
(96) 11751804.3 07.05.2014
(87) WO2013000463, 01.08.2011
(97) 2726005, 07.05.2014 en
(54) AN ELECTROSURGICAL INSTRUMENT AND ELECTROSURGICAL CONDUCTIVE ELECTRODE FOR USE WITH THE INSTRUMENT
(71) SafeAir AG, D4 Platz 3, 6039 Root Längenbold, CH
(72) BERNARD, Frédéric, Samsøvej 4, DK-3140 Ålgårde, DK
KORNERUP, Niels, Gl. Vallerødvej 31B, DK-2960 Rungsted, DK
SIMONSEN, Jesper Schantz, Peter Holms Vej 8 st. tv., DK-2450 Koebenhavn, DK

(51) MKP
A01N 1/02 (2006.01) (97) **2717681 ***
G01N 31/00 (2006.01)
G01N 33/00 (2006.01)
(86) US2012041792 10.06.2012
(96) 12796754.5 16.04.2014
(87) WO2012170974, 10.06.2012
(97) 2717681, 16.04.2014 en
(54) SYSTEM AND METHOD OF CYTOMIC VASCULAR HEALTH PROFILING
(71) The Trustees Of The University Of Pennsylvania, Center for Technology Transfer 3160 Chestnut Street, Suite 200, Philadelphia PA 19104-6283, US
(72) MOHLER, Emile, R., 134 Woods Lane, Wayne, PA 19087, US
MOORE, Jonni, S., 435 Camden Avenue, Moorestown, NJ 08057, US
ZHANG, Lifeng, 18 Buttonwood Rd., Voorhees, NJ 08043, US
ROGERS, Wade, 607 Spring Line Dr., West Chester, PA 19382, US
BANTLY, Andrew, 3820 Sharp Street, Philadelphia, PA 19127, US

(51) MKP
B01D 53/04 (2006.01) (97) **2760579 ***
B01J 20/20 (2006.01)
B01J 20/24 (2006.01)
B01J 20/26 (2006.01)
B01J 20/28 (2006.01)
B01J 20/30 (2006.01)
(86) EP2012003742 06.09.2012
(96) 12765990.2 06.08.2014
(87) WO2013045024, 06.09.2012
(97) 2760579, 06.08.2014 de
(54) SELF-SUPPORTING STRUCTURES HAVING ADSORPTIVE PROPERTIES
(71) Blücher GmbH, Mettmanner Strasse 25, 40699 Erkrath, DE
(72) SCHRAGE, Christian, Hechtstraße 11, 01097 Dresden, DE
FICHTNER, Sven, Bunsenstrasse 5, 14727 Premnitz, DE
GIEBELHAUSEN, Jann-Michael, An der Herrenlanke 35, 14712 Rathenow, DE
KOPPKA, Christian, Philipp-Rosenthal-Straße 7, 04103 Leipzig, DE
KRENKEL, Sharon, Herwigstraße 19, 04279 Leipzig, DE

(51) MKP
B01D 21/24 (2006.01) (97) **2755736 ***
B01D 21/28 (2006.01)
C02F 1/52 (2006.01)
(86) US2012055665 15.09.2012
(96) 12832323.5 23.07.2014
(87) WO2013040521, 15.09.2012
(97) 2755736, 23.07.2014 en
(54) FLUID TREATMENT APPARATUS, SYSTEM, AND METHODS
Storm Drain Technologies, LLC, 1602 Lawrence Avenue Suite 109, Ocean, New Jersey 07712, US
(72) HANNEMANN, William Robert, 707 Ocean Gate Drive, Ocean Gate, New Jersey 08740, US
COHEN, Albert Mayer, 4 Cubero Court, West Long Branch, New Jersey 07764, US
GREECH, James, 79 Lancaster Drive, Freehold, New Jersey 07728, US
HANNEMANN, Michael, 1930 Ravenwood Drive, Toms River, New Jersey 08753, US

(51) MKP
A61B 17/00 (2006.01) (97) **2641550**
A61B 17/32 (2006.01)
H01H 15/00 (2006.01)
(96) 13160723.6 25.09.2013
(97) 2641550, 25.09.2013 en
(54) Activation feature for surgical instrument with pencil grip
Ethicon Endo-Surgery, Inc., 4545 Creek Road, Cincinnati, OH 45242, US
(72) Kimball, Cory G., 6136 Lagrange Lane, Cincinnati, OH Ohio 45239, US
Price, Daniel W., 185 Overlook Drive, Loveland, OH Ohio 45140, US
Clem, William E., 560 Evening Star Lane, Bozeman, MT Montana 59715, US

(51) MKP
A61K 38/00 (2006.01) (97) **2741771 ***
A61K 39/00 (2006.01)
C12N 5/071 (2010.01)
(86) US2012050146 09.08.2012
(96) 12821568.8 18.06.2014
(87) WO2013023059, 09.08.2012
(97) 2741771, 18.06.2014 en
(54) METHODS AND COMPOSITIONS FOR THE TREATMENT OF AUTOIMMUNE AND INFLAMMATORY DISEASES
Lankenau Institute for Medical Research, 100 East Lancaster Avenue, Wynnewood, PA 19096, US
(72) LAURY-KLEINTOP, Lisa, 232 Hendricks Street, Ambler, PA 19002, US
MANDIK-NAYAK, Laura, 907 Holly Court, Plymouth Meeting, PA 19462, US
PRENDERGAST, George, C., 112 Righters Mill Road, Penn Valley, PA 19072, US
DUHADAWAY, James, 800 Bellefonte Avenue, Wilmington, DE 19809, US

- (51) MKP
A61K 31/4725 (2006.01) (97) **2729460 ***
A61P 9/00 (2006.01)
C07D 401/12 (2006.01)
- (86) EP2012062431 27.06.2012
(96) 12730523.3 14.05.2014
(87) WO2013007518, 27.06.2012
(97) 2729460, 14.05.2014 en
- (54) CRYSTALLINE SOLVATES OF 6-(PIPERIDIN-4-YLOXY)-2H-ISOQUINOLIN-1-ONE HYDROCHLORIDE
- (71) SANOFI, 54 rue La Boétie, 75008 Paris, FR
(72) NAGEL, Norbert, Flughafenstraße 50, 64546 M.-Walldorf, DE
BAUMGARTNER, Bruno, Roßdörfer Str. 22, 64287 Darmstadt, DE
BERCHTOLD, Harald, Oberhöchstädterstraße 31a, 61476 Kronberg, DE
PLETTENBURG, Oliver, Hauptstraße 36, 65779 Kelkheim, DE
KADEREIT, Dieter, Freiherr-vom-Stein-Straße 3, 63071 Offenbach, DE
MOHNICKE, Mandy, Hauptstrasse 75a, 09661 Rossau, DE
GESSLER, Simon, August-Bebel-Str. 79, 68199 Mannheim, DE
TILLNER, Joachim, Von der Höhe 15, 61381 Friedrichsdorf, DE

- (51) MKP
A47J 27/04 (2006.01) (97) **2671476**
A47J 27/08 (2006.01)
A47J 27/62 (2006.01)
- (96) 13170755.6 11.12.2013
(97) 2671476, 11.12.2013 en
- (54) Insert for covers and/or containers for cooking foodstuff under vacuum
- (71) Tecla S.r.l., Via del Perlar 78, 37135 Verona, IT
(72) Schirò, Paoluccio, Via Tezone, 11, 37122 Verona, IT

- (51) MKP
A61M 5/28 (2006.01) (97) **2747809 ***
- (86) US2012051702 21.08.2012
(96) 12753638.1 02.07.2014
(87) WO2013032779, 21.08.2012
(97) 2747809, 02.07.2014 en
- (54) REFILL MODULE FOR AN INJECTION DEVICE
- (71) Eli Lilly and Company, Lilly Corporate Center, Indianapolis, IN 46285, US
(72) FOURT, Jesse, Arnold, c/o Eli Lilly and Company P.O. Box 6288, Indianapolis, Indiana 46206-6288, US
DAVIS-WILSON, Jennifer, Ellen, c/o Eli Lilly and Company P.O. Box 6288, Indianapolis, Indiana 46206-6288, US
YURCHENCO, James, R., c/o Eli Lilly and Company P.O. Box 6288, Indianapolis, Indiana 46206-6288, US

- (51) MKP
A61K 9/16 (2006.01) (97) **2750694 ***
A61K 9/20 (2006.01)
A61K 38/16 (2006.01)
A61K 38/17 (2006.01)
A61K 39/395 (2006.01)
A61K 48/00 (2006.01)
A61P 35/00 (2006.01)
- (86) US2012050024 08.08.2012
(96) 12821946.6 09.07.2014
(87) WO2013022991, 08.08.2012
(97) 2750694, 09.07.2014 en
- (54) METHODS AND COMPOSITIONS RELATING TO P62 FOR THE TREATMENT AND PROPHYLAXIS OF CANCER
- (71) Curelab Oncology, Inc., 10417 Louisiana Avenue 201, Los Angeles, California 90025, US
(72) SHNEIDER, Alexander, 43 Rybury Hillway, Needham, Massachusetts 02492, US
VENANZI, Franco, 29 Loc. San Marcello, I-62032 Camerino MC, IT
SHERMAN, Michael, 51 Charlotte Road, Newton, Massachusetts 02459, US
SHIFRIN, Victor, 105 Auburn Street, Newton, Massachusetts 02466, US

- (51) MKP
D06F 58/10 (2006.01) (97) **2642016**
D06F 58/20 (2006.01)
- (96) 13160204.7 25.09.2013
(97) 2642016, 25.09.2013 fr
- (54) Heating cabinet
- (71) Mobika, Zac Nord, 78660 Ablis, FR
(72) Camaret, Christophe, 62 avenue de l'entente, 78500 Sartrouville, FR

- (51) MKP
B27K 5/04 (2006.01) (97) **2736689 ***
B27K 5/06 (2006.01)
B27M 1/08 (2006.01)
- (86) ID2011000007 21.11.2011
(96) 11870005.3 04.06.2014
(87) WO2013014657, 21.11.2011
(97) 2736689, 04.06.2014 en
- (54) METHOD OF WOOD PRESERVATION USING EXPIRATION CONTROL
- (71) Pt. Karuna Sumber Jaya, Jl. BPM cikUDA No. 50 RT/RW. 004/02 Lebak Kongsil Cilkuda Kec. Cileungsi Kab., Bogor 16820, ID
(72) BUDI, Santoso, Jl. BPM cikUDA No. 50 RT/RW. 004/02 Lebak Kongsil Cilkuda Kec. Cileungsi Kab., Bogor 16820, ID

- (51) MKP
C03C 3/093 (2006.01) (97) **2753589 ***
C03C 3/118 (2006.01)
H05K 1/03 (2006.01)
- (86) US2012053742 05.09.2012
(96) 12762478.1 16.07.2014
(87) WO2013036505, 05.09.2012
(97) 2753589, 16.07.2014 en
- (54) LOW DIELECTRIC GLASS AND FIBER GLASS
- (71) PPG Industries Ohio, Inc., 3800 West 143rd Street, Cleveland, OH 44111, US
(72) LI, Hong, 1621 Norman Drive, Sewickley, Pennsylvania 15143, US
RICHARDS, Cheryl A., 104 Trotwood Drive, Monroeville, Pennsylvania 15146, US

- (51) MKP
A61K 31/4704 (2006.01) (97) **2763967 ***
A61P 11/00 (2006.01)
C07D 215/26 (2006.01)
- (86) EP2012069475 02.10.2012
(96) 12766692.3 13.08.2014
(87) WO2013050375, 02.10.2012
(97) 2763967, 13.08.2014 en
- (54) PROCESS FOR PREPARING 5-(2-[[6-(2,2-DIFLUORO-2-PHENYLETHOXY)HEXYL]AMINO)-1(R)-HYDROXYETHYL]-8-HYDROXYQUINOLIN-2(1H)-ONE VIA A NOVEL INTERMEDIATE
- (71) Almirall, S.A., Ronda del General Mitre 151, 08022 Barcelona, ES
(72) MARCHUETA HEREU, Iolanda, C/ Laurea Miro 408-410, E-08980 Sant Feliu de Llobrega, ES
MOYES VALLS, Enrique, C/ Laurea Miro 408-410, E-08980 Sant Feliu de Llobrega, ES

- (51) MKP
A61K 8/64 (2006.01) (97) **2741761 ***
A61K 38/19 (2006.01)
A61P 17/14 (2006.01)
A61Q 7/00 (2006.01)
- (86) GB2012051955 10.08.2012
(96) 12768879.4 18.06.2014
(87) WO2013021212, 10.08.2012
(97) 2741761, 18.06.2014 en
- (54) MODIFIED OSTEOPONTIN PEPTIDES HAVING AN INACTIVATED RGD DOMAIN AND USES THEREOF
- (71) Follicum AB, Scheelevägen 15, S-223 70 Lund, SE
(72) ALENFALL, Jan, Nybovägen 79, S-234 37 Lomma, SE
DUNÉR, Pontus, Östen Undéns Gata 35, S-227 62 Lund, SE
HULTGÄRDH NILSSON, Anna, Toppeladugård 331, S-247 99 Genarp, SE

- (51) MKP
A61K 31/567 (2006.01) (97) **2731613 ***
A61K 31/57 (2006.01)
A61P 5/36 (2006.01)
- (86) IB2012053577 12.07.2012
(96) 12755904.5 21.05.2014
(87) WO2013008202, 12.07.2012
(97) 2731613, 21.05.2014 en
- (54) Treatment of excessive menstrual bleeding associated with uterine fibroids
- (71) PregLem S.A., Chemin du Pré-Fleuri 3, 1228 Plan-les-Ouates Geneva, CH
- (72) LOUMAYE, Ernest, 29 Chemin de Planta, CH-1223 Cologny, CH
BESTEL, Elke, 2 Chemin de Crêt Millet, F-74160 Saint-Julien-en-Genevois, FR
OSTERLOH, Ian, Beechen House, Bridge Kent CT4 5AU, GB

- (51) MKP
A61K 31/519 (2006.01) (97) **2721036 ***
A61P 11/00 (2006.01)
C07D 495/04 (2006.01)
C07D 519/00 (2006.01)
- (86) EP2012061091 12.06.2012
(96) 12729458.5 23.04.2014
(87) WO2012171903, 12.06.2012
(97) 2721036, 23.04.2014 en
- (54) NOVEL 3,4,4A,10B-TETRAHYDRO-1H-THIOPYRANO[4,3-C] ISOQUINOLINE COMPOUNDS
- (71) Takeda GmbH, Byk-Gulden-Strasse 2, 78467 Konstanz, DE
(72) FLOCKERZI, Dieter, Ackerweg 26, 78476 Allensbach, DE
MANN, Alexander, Emilie-Schneider-Str. 2, 78315 Radolfzell, DE
STENGEL, Thomas, Erfurter Ring 13, 76344 Eggenstein-Leopoldshafen, DE
OHMER, Harald, Alemannfeld 8, 78224 Singen, DE
KAUTZ, Ulrich, Prof.-Schmider-Str. 12, 78476 Allensbach, DE
WEINBRENNER, Steffen, Luzzilonweg 4, 78465 Konstanz, DE
FISCHER, Stefan, Dr. Kausch Str. 40A, 67251 Freinsheim, DE
TENOR, Hermann, St.-Gebhard-Str. 38, 78467 Konstanz, DE
ZITT, Christof, Mainaustr. 209 D, 78464 Konstanz, DE
HATZELMANN, Armin, Alter Wall 3, 78467 Konstanz, DE
DUNKERN, Torsten, Humboldtstr. 18, 41363 Jüchen Gierath, DE
HESSLINGER, Christian, Untere Haldenäcker 6, 78357 Zoznegg, DE
BRAUN, Clemens, Obere Au 7, 88400 Biberbach, DE
BENEDIKTUS, Ewald, Mondstr. 18, 88400 Biberach, DE
PAHL, Andreas, Langer Anger 33, 69115 Heidelberg, DE
KÜLZER, Raimund, Takeda GmbH Byk-Gulden-Str. 2, 78467 Konstanz, DE
MARX, Degenhard, Obere Reute 15, 78345 Moos, DE

- (51) MKP
A61K 31/437 (2006.01) (97) **2768506 ***
- (86) US2012060971 19.10.2012
(96) 12840986.9 27.08.2014
(87) WO2013059559, 19.10.2012
(97) 2768506, 27.08.2014 en
- (54) COMPOUNDS AND METHODS FOR ENHANCING INNATE IMMUNE RESPONSES
- (71) GlaxoSmithKline LLC, 5 Crescent Drive, Philadelphia, PA 19112, US
- (72) BANKA, Anna, Lindsey, c/o Glaxosmithkline Global Patents Five Moore Drive PO Box 13398, Research Triangle Park, NC 27709, US
BOTYANSZKI, Janos, c/o Glaxosmithkline Global Patents Five Moore Drive PO Box 13398, Research Triangle Park, NC 27709, US
BURROUGHS, Eric, Gregory, c/o Glaxosmithkline Global Patents Five Moore Drive PO Box 13398, Research Triangle Park, NC 27709, US
CATALANO, John, George, c/o Glaxosmithkline Global Patents Five Moore Drive PO Box 13398, Research Triangle Park, NC 27709, US
CHERN, Wendy, Huang, c/o Glaxosmithkline Global Patents Five Moore Drive PO Box 13398, Research Triangle Park, NC 27709, US
DICKSON, Hamilton, D., c/o Glaxosmithkline Global Patents Five Moore Drive PO Box 13398, Research Triangle Park, NC 27709, US
GARTLAND, Margaret, J., c/o Glaxosmithkline Global Patents Five Moore Drive PO Box 13398, Research Triangle Park, NC 27709, US
HAMATAKE, Robert, c/o Glaxosmithkline Global Patents Five Moore Drive PO Box 13398, Research Triangle Park, NC 27709, US
HOFLAND, Hans, c/o Glaxosmithkline Global Patents Five Moore Drive PO Box 13398, Research Triangle Park, NC 27709, US
KEICHER, Jesse, Daniel, c/o Glaxosmithkline Global Patents Five Moore Drive PO Box 13398, Research Triangle Park, NC 27709, US
MOORE, Christopher, Brooks, c/o Glaxosmithkline Global Patents Five Moore Drive PO Box 13398, Research Triangle Park, NC 27709, US
SHOTWELL, John, Bradford, c/o Glaxosmithkline Global Patents Five Moore Drive PO Box 13398, Research Triangle Park, NC 27709, US
TALLANT, Matthew, David, c/o Glaxosmithkline Global Patents Five Moore Drive PO Box 13398, Research Triangle Park, NC 27709, US
THERRIEN, Jean-Philippe, c/o Glaxosmithkline Global Patents Five Moore Drive PO Box 13398, Research Triangle Park, NC 27709, US
YOU, Shihyun, c/o Glaxosmithkline Global Patents Five Moore Drive PO Box 13398, Research Triangle Park, NC 27709, US

- (51) MKP
A61B 17/072 (2006.01) (97) **2517642**
- (86) 12166171.4 31.10.2012
(97) 2517642, 31.10.2012 en
- (54) Staple cartridge comprising staples positioned within a compressible portion thereof
- (71) Ethicon Endo-Surgery, Inc., 4545 Creek Road, Cincinnati, OH 45242, US
- (72) Shelton, IV, Frederick E., 245 East Main Street, Hillsboro, OH Ohio 45133, US
Baxter, III, Chester O., 6375 Pawnee Ridge, Loveland, OH Ohio 45140, US
Aronhalt, Taylor W., 306 Beech Road, Loveland, OH Ohio 45140, US
Young, Joseph E., 9523 Carroll Court, Loveland, OH Ohio 45140, US

- (51) MKP
A61K 31/405 (2006.01) (97) **2714033 ***
A61K 31/4196 (2006.01)
A61K 31/4535 (2006.01)
A61K 31/497 (2006.01)
A61K 31/506 (2006.01)
A61K 31/519 (2006.01)
A61K 31/551 (2006.01)
A61P 35/00 (2006.01)
(86) US2012039519 25.05.2012
(96) 12724523.1 09.04.2014
(87) WO2012162584, 25.05.2012
(97) 2714033, 09.04.2014 en
(54) COMBINATION THERAPY OF HSP90 INHIBITORY COMPOUNDS WITH CHK INHIBITORS
(71) Synta Pharmaceuticals Corp., 45 Hartwell Avenue, Lexington, MA 02421, US
(72) PROIA, David, 30 Silver Lake Avenue, Newton, MA 02458, US
HE, Suqin, 12 Loyola Circle, West Roxbury, MA 02132, US

- (51) MKP
A61K 39/395 (2006.01) (97) **2704798 ***
A61P 1/00 (2006.01)
C07K 16/28 (2006.01)
(86) US2012036072 02.05.2012
(96) 12721093.8 12.03.2014
(87) WO2012151248, 02.05.2012
(97) 2704798, 12.03.2014 en
(54) FORMULATION FOR ANTI-ALPHA4BETA7 ANTIBODY
(71) Millennium Pharmaceuticals, Inc., 40 Landsdowne Street, Cambridge, MA 02139, US
(72) DILUZIO, Willow, 7 Fernwood Drive, Westford Massachusetts 01886, US
TRUONG, Nobel T., 26 Stallbrook Road, Milford Massachusetts 01757, US
VARGA, Csanad M., 95 Jackson Street, Cambridge Massachusetts 02140, US
PALANIAPPAN, Vaithianathan, 7 Spruce Circle, Andover Massachusetts 01810, US
BROWN, Jason, 10 September Lane, Burlington Massachusetts 01803, US
FOX, Irving H., 111 Livingston Road, Wellesley Massachusetts 02482, US
SCHOLZ, Catherine, 1 Nashua Street, Woburn Massachusetts 01801, US

- (51) MKP
A61K 9/00 (2006.01) (97) **2739314 ***
A61K 47/42 (2006.01)
A61P 35/00 (2006.01)
(86) EP2012064576 25.07.2012
(96) 12740137.0 11.06.2014
(87) WO2013017494, 25.07.2012
(97) 2739314, 11.06.2014 en
(54) PHARMACEUTICAL COMPOSITION OF OXIDISED AVIDIN SUITABLE FOR INHALATION
(71) Sigma-Tau Industrie Farmaceutiche Riunite S.P.A., Viale Shakespeare 47, 00144 Rome, IT
(72) DE SANTIS, Rita, Via Casa Serena 56, I-00040 Pomezia (RM), IT

- (51) MKP
A61F 2/08 (2006.01) (97) **2741791 ***
A61L 27/22 (2006.01)
A61L 31/04 (2006.01)
(86) GB2012051962 10.08.2012
(96) 12751590.6 18.06.2014
(87) WO2013021215, 10.08.2012
(97) 2741791, 18.06.2014 en
(54) MEDICAL DEVICE
(71) Oxford Biomaterials Limited, Magdalen Centre Oxford Science Park Robert Robinson Avenue, Oxford, Oxfordshire OX4 4GA, GB
(72) KNIGHT, David Philip, c/o Oxford Biomaterials Ltd Magdalen Centre Robert Robinson Avenue Oxford Science Park, Oxford Oxfordshire OX4 4GA, GB
LESAGE, Stephanie, c/o Oxford Biomaterials Ltd Magdalen Centre Robert Robinson Avenue Oxford Science Park, Oxford Oxfordshire OX4 4GA, GB

- (51) MKP
A61K 39/395 (2006.01) (97) **2734236 ***
A61K 45/00 (2006.01)
(86) US2012045268 02.07.2012
(96) 12811052.5 28.05.2014
(87) WO2013009521, 02.07.2012
(97) 2734236, 28.05.2014 en
(54) METHODS AND COMPOSITIONS FOR TREATING ASTHMA USING ANTI-IL-13 ANTIBODIES
(71) Abbvie Inc., 1 North Waukegan Road, North Chicago, IL 60064, US
(72) TRIPP, Catherine, 381 Plantation Street, Worcester, MA 01605, US

- (51) MKP
B22C 3/00 (2006.01) (97) **2626407**
C10M 141/04 (2006.01)
C10N 10/02 (2006.01)
C10N 10/04 (2006.01)
C10N 10/06 (2006.01)
C10N 20/02 (2006.01)
C10N 20/06 (2006.01)
C10N 40/24 (2006.01)
C10N 40/36 (2006.01)
C10N 50/02 (2006.01)
C10N 70/00 (2006.01)
(86) 13154413.2 14.08.2013
(97) 2626407, 14.08.2013 en
(54) Lubricating composition for continuous casting processes
(71) Prosimet S.p.A., Via Rodi, 10, 24040 Filago (BG), IT
(72) CARLI, Riccardo, c/o PROSIMET S.p.A. Via Rodi, 10, I-24040 Filago, BERGAMO, IT

- (51) MKP
E04B 2/74 (2006.01) (97) **2754769**
E04H 1/12 (2006.01)
(86) 13178735.0 16.07.2014
(97) 2754769, 16.07.2014 en
(54) Means for demarcation of space
(71) Compwood Products Kft., Szobor u. 2/a., 2367 Ujhartyan, HU
(72) Eckardt, László, Hernád utca 40., 1078 Budapest, HU

- (51) MKP
B01D 15/08 (2006.01) (97) **2702147 ***
C12M 3/00 (2006.01)
C12N 7/02 (2006.01)
(86) CA2012000406 27.04.2012
(96) 12776970.1 05.03.2014
(87) WO2012145837, 27.04.2012
(97) 2702147, 05.03.2014 en
(54) METHODS OF PURIFYING VIRUSES USING GEL PERMEATION CHROMATOGRAPHY
(71) Oncolytics Biotech Inc., Suite 210 1167 Kensington Crescent N. W., Calgary, AB T2N 1X7, CA
(72) COFFEY, Matthew C., 2231 Bowness Road NW, Calgary Alberta T2N 3L4, CA
HAGERMAN, Allison, Site 11, Box 7, Rr 2 Cochrane, Alberta T4C 1A2, CA
KAPADIA, Roxna, 36 Triumph Road Glenfield, Leicester Leicestershire LE3 8FS, GB
SERL, Sarah, 5-310 Brookmere Rd. SW, Calgary Alberta T2W 2T7, CA

- (51) MKP
A61K 31/045 (2006.01) (97) **2704734 ***
A61K 31/05 (2006.01)
A61K 31/122 (2006.01)
A61K 31/202 (2006.01)
A61K 31/205 (2006.01)
A61K 31/4415 (2006.01)
A61K 31/714 (2006.01)
A61K 36/062 (2006.01)
A61K 36/899 (2006.01)
(86) EP2012057428 24.04.2012
(96) 12716038.0 12.03.2014
(87) WO2012150146, 24.04.2012
(97) 2704734, 12.03.2014 en
(54) COMPOSITION USEFUL FOR THE TREATMENT OF LIPID METABOLISM DISORDERS
(71) Sigma-Tau Industrie Farmaceutiche Riunite S.P.A., Viale Shakespeare 47, 00144 Rome, IT
(72) KOVERECH, Aleardo, Via Aurelia Antica 200, I-00165 Rome, IT
VIRMANI, Ashraf, Via del Pometo 32/34, I-00040 Ariccia, IT
-

- (51) MKP
A63F 13/00 (2014.01) (97) **2705508 ***
G07F 17/32 (2006.01)
(86) EP2011002202 03.05.2011
(96) 11720380.2 12.03.2014
(87) WO2012149943, 03.05.2011
(97) 2705508, 12.03.2014 de
(54) GAMBLING AND/OR GAMING APPARATUS
(71) Novomatic AG, Wiener Strasse 158, 2352 Gumpoldskirchen, AT
(72) KAIBLINGER, Harald, An der Schleuse 7/3, A-2511 Pfaffstätten, AT
SCHRÖTTER, Florian, Gregor Mendel Straße 13/2/3, A-2514 Traiskirchen, AT
-

**INDEKS BROJEVA ZAHTJEVA ZA PROŠIRENJE EVROPSKIH PRIJAVA
PATENTA**
INDEX ON NUMBER OF REQUESTS FOR EXTENSION ON EUROPEAN PATENT
APPLICATIONS

Broj objave evropske prijave patenta (97)	MKP (51)	Broj objave evropske prijave patenta (97)	MKP (51)	Broj objave evropske prijave patenta (97)	MKP (51)
2729522 *	C08K 3/00 (2006.01) C08K 3/34 (2006.01) C08K 9/06 (2006.01) C08L 67/04 (2006.01)	2760674 *	B41M 3/14 (2006.01) G07D 7/00 (2006.01)	2715120 *	F03B 3/12 (2006.01) F03D 1/04 (2006.01) F03D 1/06 (2006.01)
		2718268 *	C07D 215/46 (2006.01)	2731692 *	
2720794 *	B01J 21/06 (2006.01) B01J 21/12 (2006.01) B01J 23/00 (2006.01) B01J 23/10 (2006.01) B01J 23/22 (2006.01) B01J 23/31 (2006.01) B01J 23/889 (2006.01) B01J 37/00 (2006.01)	2768834 *	C07D 487/04 (2006.01)	2726079 *	A61K 31/535 (2006.01) A61K 38/00 (2006.01) C12N 15/113 (2010.01)
		2751422 *	F03D 7/02 (2006.01)	2758176 *	B02C 17/14 (2006.01)
		2737800	A21C 11/16 (2006.01)	2667074	F16L 33/22 (2006.01) F16L 37/091 (2006.01) F16L 37/092 (2006.01)
		2731611 *	A61K 31/4985 (2006.01)	2642377	G06F 3/0486 (2013.01) G06F 3/0488 (2013.01) H04M 1/725 (2006.01)
		2739575 *	C02F 1/68 (2006.01)	2714661 *	A61K 31/4412 (2006.01) A61P 31/10 (2006.01) C07D 213/81 (2006.01)
2748179 *	C07K 1/18 (2006.01) C12N 9/64 (2006.01)	2736525 *	A61K 9/00 (2006.01) A61K 38/48 (2006.01) A61P 1/00 (2006.01) A61P 37/00 (2006.01) A61P 39/00 (2006.01) G01N 33/53 (2006.01)		
2723716 *	A01N 37/18 (2006.01) A61K 31/44 (2006.01) A61K 31/4433 (2006.01) A61P 33/00 (2006.01) A61P 33/10 (2006.01) A61P 33/14 (2006.01) C07D 213/18 (2006.01)	2747913 *	B21D 5/08 (2006.01)		
		2687136	A47K 3/40 (2006.01)	2755879 *	B61G 9/14 (2006.01) B61G 11/08 (2006.01) F16F 3/08 (2006.01)
		2756661 *	B41J 2/21 (2006.01) H04N 1/407 (2006.01) H04N 1/60 (2006.01)	2729566 *	C12N 9/16 (2006.01)
2517640	A61B 17/072 (2006.01)			2761065 *	C12Q 1/02 (2006.01) C12Q 1/68 (2006.01) C40B 30/06 (2006.01)
2766132 *	B21C 43/04 (2006.01) B24D 13/10 (2006.01) B24D 13/14 (2006.01)	2706982 *	A61K 9/00 (2006.01) A61K 9/08 (2006.01) A61K 31/135 (2006.01) A61P 25/36 (2006.01)		

Broj objave evropske prijave patenta (97)	MKP (51)	Broj objave evropske prijave patenta (97)	MKP (51)	Broj objave evropske prijave patenta (97)	MKP (51)
2664451	B31F 1/07 (2006.01)	2743936 *	B32B 27/34 (2006.01) C08G 73/10 (2006.01) H01B 3/30 (2006.01) H01B 5/14 (2006.01) H01L 31/04 (2014.01)	2743699 *	C07K 16/14 (2006.01) G01N 33/15 (2006.01) G01N 33/50 (2006.01) G01N 33/53 (2006.01) G01N 33/531 (2006.01) G01N 33/68 (2006.01)
2723325 *	A61K 9/66 (2006.01)				
2741738 *	A61K 9/08 (2006.01) A61K 31/557 (2006.01) A61K 47/48 (2006.01)	2674231	B21D 5/02 (2006.01) B21D 37/02 (2006.01)	2705429 *	G06F 11/14 (2006.01)
2741739 *	A61K 9/00 (2006.01) A61K 9/16 (2006.01)	2720738 *	A61M 5/24 (2006.01)	2758905 *	G06F 19/00 (2011.01)
2721591 *	G08B 13/14 (2006.01) G08B 25/00 (2006.01)	2706091	C08G 59/42 (2006.01) C08K 5/5313 (2006.01) C08L 63/00 (2006.01)	2671623	B01D 53/00 (2006.01) E21B 47/10 (2012.01) G01F 1/34 (2006.01)
2723471 *	A61L 9/014 (2006.01) B01D 53/02 (2006.01) B01J 20/22 (2006.01)	2731893 *	A23N 4/04 (2006.01) B65G 47/248 (2006.01)	2723485 *	B01J 8/06 (2006.01) B01J 19/00 (2006.01)
2757180	C23C 18/48 (2006.01) C25D 3/56 (2006.01) C25D 3/60 (2006.01)	2714733 *	C07K 16/00 (2006.01)	2716614	C03C 4/02 (2006.01) C03C 14/00 (2006.01)
2744501 *	A61K 31/535 (2006.01)	2744498 *	A61K 31/4704 (2006.01)	2723857 *	C12N 9/10 (2006.01)
2701721 *	A61K 38/07 (2006.01)	2729049 *	A61B 3/10 (2006.01)	2731598 *	A61K 31/165 (2006.01) A61P 9/12 (2006.01) C07C 237/22 (2006.01)
2719061 *	H02K 3/487 (2006.01) H02K 3/493 (2006.01)	2729628 *	E02D 29/14 (2006.01)		
2719061 *	H02K 3/487 (2006.01) H02K 3/493 (2006.01)	2736330 *	A01N 37/18 (2006.01) A61K 31/165 (2006.01) C07C 233/00 (2006.01)	2738189 *	C08F 212/04 (2006.01) C08F 220/06 (2006.01) C08F 220/28 (2006.01) C08F 220/56 (2006.01) C08F 220/58 (2006.01) C08F 226/02 (2006.01) C08F 232/04 (2006.01) C09K 8/588 (2006.01)
2708401 *	B60K 7/00 (2006.01) B60L 11/00 (2006.01) H02J 7/14 (2006.01)	2644113	A61B 17/072 (2006.01) A61B 17/115 (2006.01)		
2714652 *	C07C 303/38 (2006.01) C07C 303/40 (2006.01) C07C 309/82 (2006.01) C07C 311/28 (2006.01)				

Broj objave evropske prijava patenta (97)	MKP (51)	Broj objave evropske prijava patenta (97)	MKP (51)	Broj objave evropske prijava patenta (97)	MKP (51)
2713773 *	A23L 1/0532 (2006.01) A23L 1/29 (2006.01) A23L 1/308 (2006.01) A61K 31/734 (2006.01)	2768487 *	A61K 9/20 (2006.01) A61K 31/4439 (2006.01)	2738190 *	C08F 220/06 (2006.01) C08F 220/18 (2006.01) C08F 220/28 (2006.01) C08F 220/34 (2006.01) C08F 220/56 (2006.01) C08F 220/58 (2006.01) C08F 226/02 (2006.01) C08F 232/04 (2006.01) C09K 8/588 (2006.01)
2716287 *	A61K 9/70 (2006.01) A61K 31/4045 (2006.01) A61K 47/10 (2006.01) A61K 47/14 (2006.01) A61K 47/16 (2006.01) A61K 47/34 (2006.01) A61P 25/14 (2006.01) A61P 25/16 (2006.01)	2720697 *	A61K 31/423 (2006.01)	2718433 *	C12N 13/00 (2006.01)
2755685 *	A61K 39/395 (2006.01)	2760826 *	A61K 31/40 (2006.01) A61P 9/12 (2006.01) A61P 29/00 (2006.01) A61P 35/00 (2006.01) C07D 207/08 (2006.01)	2736511 *	A61K 31/4545 (2006.01) A61P 33/14 (2006.01)
2711836	G06F 9/44 (2006.01)	2731650 *	A61M 5/24 (2006.01) A61M 5/315 (2006.01)	2702212 *	E04C 1/42 (2006.01) F21S 9/03 (2006.01)
2649981	A61K 6/00 (2006.01)	2723730 *	A01N 43/713 (2006.01) A01P 3/00 (2006.01) C07D 401/06 (2006.01) C07D 409/06 (2006.01) C07D 417/06 (2006.01)	2664978	G06F 3/01 (2006.01) G06F 3/0485 (2013.01)
2757872 *	A01H 1/06 (2006.01) A01H 5/00 (2006.01) C12N 5/04 (2006.01) C12N 15/01 (2006.01)	2736494 *	A61K 9/16 (2006.01) A61K 9/20 (2006.01) A61K 31/41 (2006.01) A61K 31/549 (2006.01)	2760443 *	A61K 31/18 (2006.01) A61K 31/33 (2006.01) C07C 311/21 (2006.01) C07C 311/29 (2006.01) C07D 213/30 (2006.01) C07D 213/38 (2006.01) C07D 213/61 (2006.01) C07D 213/65 (2006.01) C07D 213/68 (2006.01) C07D 213/75 (2006.01) C07D 233/22 (2006.01) C07D 239/28 (2006.01) C07D 249/08 (2006.01) C07D 257/04 (2006.01) C07D 261/08 (2006.01)
2709048	G06Q 20/00 (2012.01)	2729637 *	E04B 5/10 (2006.01) E04B 7/02 (2006.01) E04C 3/08 (2006.01) E04C 3/32 (2006.01)		
2726229 *	B21F 9/02 (2006.01)	2759764 *	F21V 17/00 (2006.01)		
2645092	A23L 3/005 (2006.01) A23L 3/26 (2006.01) C12N 13/00 (2006.01) G01N 27/24 (2006.01)				
2691110 *	A61K 39/00 (2006.01)				

Broj objave evropske prijave patenta (97)	MKP (51)	Broj objave evropske prijave patenta (97)	MKP (51)	Broj objave evropske prijave patenta (97)	MKP (51)
2734549 *	C07K 16/24 (2006.01) G01N 33/53 (2006.01)	2716286 *	A61K 9/70 (2006.01) A61K 31/4045 (2006.01) A61K 47/10 (2006.01) A61K 47/14 (2006.01) A61K 47/16 (2006.01) A61K 47/32 (2006.01) A61K 47/34 (2006.01) A61P 25/14 (2006.01) A61P 25/16 (2006.01)	2707361 *	C07D 237/32 (2006.01) C07D 253/08 (2006.01) C07D 265/22 (2006.01) C07D 401/04 (2006.01) C07D 401/06 (2006.01) C07D 401/12 (2006.01) C07D 403/04 (2006.01) C07D 403/06 (2006.01) C07D 403/08 (2006.01) C07D 403/12 (2006.01) C07D 403/14 (2006.01) C07D 413/06 (2006.01) C07D 413/12 (2006.01) C07D 413/14 (2006.01) C07D 417/06 (2006.01)
2749417	B41F 33/00 (2006.01) G06K 19/06 (2006.01)				
2752194 *	A61K 36/28 (2006.01) A61K 36/61 (2006.01) A61P 31/16 (2006.01) A61P 37/00 (2006.01) A61P 39/06 (2006.01)	2757929 *	A47L 11/40 (2006.01) C02F 1/78 (2006.01)		
2524654	A61B 17/115 (2006.01)				
2707444 *	C09J 181/04 (2006.01)	2758726 *	F25B 7/00 (2006.01)		
2730562	C07C 253/30 (2006.01) C07D 223/16 (2006.01)	2741824 *	A61K 31/565 (2006.01) A61P 15/18 (2006.01)		
2734223 *	A61K 33/00 (2006.01) A61K 38/42 (2006.01) A61P 17/02 (2006.01)	2626485	E04H 3/12 (2006.01) E04H 3/14 (2006.01)	2687317	B23K 26/04 (2014.01) B23K 26/14 (2014.01) B23K 26/38 (2014.01)
2739789 *	E01F 15/04 (2006.01) E01F 15/06 (2006.01) E04H 12/22 (2006.01) E04H 17/22 (2006.01)	2706988 *	A61K 9/127 (2006.01)	2755707 *	A61M 15/00 (2006.01) E05B 15/00 (2006.01)
2710375 *	G01N 33/53 (2006.01) G01N 33/566 (2006.01)	2765990 *	A61K 9/00 (2006.01) A61K 9/14 (2006.01) A61K 9/20 (2006.01) A61K 31/498 (2006.01) A61K 47/32 (2006.01) A61K 47/38 (2006.01) A61P 35/00 (2006.01)		
2727085 *	G06F 17/28 (2006.01) G06T 11/60 (2006.01)	2758437 *	A61K 39/395 (2006.01) A61P 35/00 (2006.01) A61P 37/00 (2006.01) C07K 16/28 (2006.01)		
2755962 *	C07D 401/00 (2006.01)				
		2748151 *	C07D 239/47 (2006.01)		

Broj objave evropske prijave patenta (97)	MKP (51)	Broj objave evropske prijave patenta (97)	MKP (51)	Broj objave evropske prijave patenta (97)	MKP (51)
2739680 *	C03C 25/14 (2006.01) C03C 25/32 (2006.01) C08F 251/00 (2006.01) C08G 63/668 (2006.01) C08J 3/24 (2006.01) C08K 5/092 (2006.01) C08K 5/1545 (2006.01) C08K 5/51 (2006.01) C08L 3/00 (2006.01) C09J 11/08 (2006.01) D04H 1/4209 (2012.01) D04H 1/587 (2012.01) D04H 1/645 (2012.01) D04H 3/002 (2012.01) D04H 3/12 (2006.01)	2761294 *	G01N 33/52 (2006.01) G01N 33/53 (2006.01) G01N 33/68 (2006.01) G06F 17/10 (2006.01)	2718386 *	C09K 3/18 (2006.01)
		2707503 *	C12Q 1/68 (2006.01)	2750699 *	A61K 31/155 (2006.01) A61K 31/4439 (2006.01) A61K 38/26 (2006.01)
		2713732 *	A01N 43/40 (2006.01)	2744919 *	C12N 15/12 (2006.01) C12Q 1/68 (2006.01)
		2702330 *	E03B 1/04 (2006.01) E03C 1/02 (2006.01) F16K 15/14 (2006.01) F24D 17/00 (2006.01)	2770017	C08K 5/49 (2006.01)
		2726198 *	B01D 53/02 (2006.01) B01J 20/20 (2006.01) B01J 20/28 (2006.01) B01J 20/32 (2006.01)	2736530 *	A61K 39/395 (2006.01)
2768526 *	A61K 38/00 (2006.01) A61K 39/00 (2006.01) A61P 13/06 (2006.01) C12N 9/16 (2006.01)	2731461 *	A23L 1/00 (2006.01) A23L 1/275 (2006.01) A23L 1/303 (2006.01)	2723367 *	A61K 38/16 (2006.01) A61K 38/17 (2006.01) A61K 38/26 (2006.01) A61P 3/00 (2006.01) A61P 3/04 (2006.01) A61P 3/10 (2006.01)
2706989 *	A61K 9/51 (2006.01)	2707399 *	C08F 10/06 (2006.01)	2708535	A61K 31/554 (2006.01) A61P 9/00 (2006.01) A61P 19/08 (2006.01) A61P 25/00 (2006.01) C07D 281/10 (2006.01)
2623871	F24D 17/00 (2006.01) F24D 19/10 (2006.01) F24H 9/20 (2006.01)	2739623 *	A61K 31/444 (2006.01) A61K 31/506 (2006.01) A61P 31/16 (2006.01) C07D 471/04 (2006.01)	2736894 *	C07B 61/00 (2006.01) C07D 333/54 (2006.01) C07D 409/12 (2006.01)
2715395 *	G01S 7/48 (2006.01) G01S 7/481 (2006.01) G01S 7/495 (2006.01) G01S 17/93 (2006.01)	2745817 *	A61B 5/01 (2006.01) A61F 7/00 (2006.01)	2734588 *	C08L 83/04 (2006.01)
2713727 *	A01N 43/00 (2006.01)	2736908 *	A61K 31/519 (2006.01) A61P 25/28 (2006.01) C07D 487/04 (2006.01)	2744497 *	A61K 31/4523 (2006.01) A61K 31/4748 (2006.01) A61P 1/00 (2006.01) A61P 25/00 (2006.01) A61P 25/02 (2006.01)

Broj objave evropske prijave patenta (97)	MKP (51)	Broj objave evropske prijave patenta (97)	MKP (51)	Broj objave evropske prijave patenta (97)	MKP (51)
2760452 *	A61K 31/496 (2006.01)	2738237 *	C08F 212/14 (2006.01) C08F 220/06 (2006.01) C08F 220/10 (2006.01) C08F 220/34 (2006.01) C08F 220/56 (2006.01) C08F 232/04 (2006.01) C09K 8/588 (2006.01)	2757879 *	A01N 1/02 (2006.01) A61K 35/14 (2006.01) A61L 2/00 (2006.01)
2744786 *	A61K 31/4166 (2006.01) A61P 35/00 (2006.01) C07D 233/32 (2006.01)			2714955 *	C22C 38/44 (2006.01) C22C 38/58 (2006.01)
2644115	A61B 17/00 (2006.01) A61B 17/064 (2006.01) A61B 17/072 (2006.01) A61B 17/115 (2006.01) A61B 17/29 (2006.01) A61B 19/08 (2006.01) A61L 31/00 (2006.01)	2671459	A23B 4/005 (2006.01) A23L 1/325 (2006.01) B65B 25/06 (2006.01) B65B 55/02 (2006.01) B65B 55/22 (2006.01)	2750879 *	B32B 5/24 (2006.01) B32B 5/26 (2006.01) B60R 13/00 (2006.01)
2744184	H04L 12/18 (2006.01) H04M 3/42 (2006.01)	2729006 *	A01N 43/40 (2006.01) A01N 43/56 (2006.01) A01N 43/90 (2006.01) A01N 45/02 (2006.01) A01N 47/16 (2006.01) A01P 3/00 (2006.01)	2729448 *	A61K 31/496 (2006.01) A61P 31/14 (2006.01) C07D 213/40 (2006.01) C07D 401/12 (2006.01) C07D 401/14 (2006.01) C07D 403/12 (2006.01) C07D 403/14 (2006.01) C07D 405/12 (2006.01) C07D 471/04 (2006.01) C07D 471/06 (2006.01) C07D 487/04 (2006.01) C07D 491/04 (2006.01) C07D 495/04 (2006.01)
2658131	H03M 3/02 (2006.01)	2750768 *	A61K 9/00 (2006.01) A61K 9/19 (2006.01) A61K 31/7068 (2006.01) A61K 47/10 (2006.01) A61K 47/20 (2006.01) A61P 35/00 (2006.01)		
2705036 *	A61K 31/519 (2006.01) A61P 3/04 (2006.01) C07D 471/04 (2006.01) C07D 487/04 (2006.01) C07D 498/04 (2006.01)	2766967 *	H02G 15/10 (2006.01) H02G 15/117 (2006.01)	2647611	C04B 35/571 (2006.01) C04B 35/626 (2006.01) C04B 35/628 (2006.01) C04B 37/00 (2006.01)
2760465 *	A61K 38/20 (2006.01) A61P 27/02 (2006.01)	2755856 *	B60P 1/00 (2006.01) B60P 1/43 (2006.01)		

Broj objave evropske prijave patenta (97)	MKP (51)	Broj objave evropske prijave patenta (97)	MKP (51)	Broj objave evropske prijave patenta (97)	MKP (51)
2516844 *	F03D 1/02 (2006.01) F03D 3/02 (2006.01) F03D 5/02 (2006.01) F03D 11/04 (2006.01)	2769448 *	H02J 3/26 (2006.01) H02J 3/38 (2006.01)	2739616 *	A61K 31/444 (2006.01) A61K 31/497 (2006.01) A61K 31/506 (2006.01) A61P 11/06 (2006.01) A61P 35/02 (2006.01) A61P 37/06 (2006.01) A61P 37/06 (2006.01) C07D 401/12 (2006.01) C07D 401/14 (2006.01)
2674538	E04B 1/348 (2006.01)	2768781 *	C03C 13/06 (2006.01) C03C 25/24 (2006.01) C03C 25/26 (2006.01) C03C 25/34 (2006.01) C09J 177/06 (2006.01) C09J 179/04 (2006.01) C09J 179/08 (2006.01) D04H 1/4209 (2012.01) D04H 1/4218 (2012.01) D04H 1/488 (2012.01)	2721065 *	A61K 39/395 (2006.01) A61P 3/06 (2006.01) C07K 16/22 (2006.01)
2758089 *	A61M 1/00 (2006.01) A61M 13/00 (2006.01) A61M 16/04 (2006.01) A61M 25/00 (2006.01) A61M 39/08 (2006.01)	2763700 *	A61K 39/395 (2006.01)	2721543 *	G06F 19/00 (2011.01)
2736524 *	A61K 38/20 (2006.01) B01D 15/36 (2006.01) C07K 14/545 (2006.01)	2583802	B28B 3/02 (2006.01) B30B 15/06 (2006.01) C25D 11/04 (2006.01)	2702155 *	A61P 35/00 (2006.01) C12N 15/113 (2010.01)
2706911 *	A61B 5/05 (2006.01)	2743343 *	A61K 9/12 (2006.01) A61K 35/36 (2006.01) A61P 17/02 (2006.01) C12N 5/0775 (2010.01)	2732872	B01J 20/04 (2006.01) B01J 20/28 (2006.01) C02F 1/28 (2006.01) C02F 101/10 (2006.01) C02F 103/00 (2006.01)
2758787 *	B65D 85/67 (2006.01) B65H 75/18 (2006.01) G01N 37/00 (2006.01)	2748908 *	H02J 3/38 (2006.01) H02J 3/40 (2006.01)	2752404	A61K 31/16 (2006.01) A61P 11/00 (2006.01) A61P 37/00 (2006.01) C07C 237/14 (2006.01) C07D 233/58 (2006.01)
2741602 *	A01H 1/08 (2006.01) A01H 5/00 (2006.01) A01H 5/10 (2006.01)	2750696 *	A61K 38/19 (2006.01) A61P 11/00 (2006.01)	2701698 *	A61K 31/122 (2006.01) A61K 31/185 (2006.01) A61K 31/20 (2006.01) A61K 31/201 (2006.01) A61P 1/00 (2006.01) A61P 1/16 (2006.01)
2759655 *	E04F 11/18 (2006.01)	2714621 *	B23K 26/40 (2014.01) C04B 35/622 (2006.01)		
2768499 *	A61K 31/405 (2006.01) C07D 209/26 (2006.01)	2761677 *	H01L 33/00 (2010.01)		
2711016	A61K 38/16 (2006.01) A61P 19/00 (2006.01) C07K 14/00 (2006.01)				

Broj objave evropske prijave patenta (97)	MKP (51)	Broj objave evropske prijave patenta (97)	MKP (51)	Broj objave evropske prijave patenta (97)	MKP (51)
2739615 *	A61K 31/421 (2006.01) A61K 31/427 (2006.01) A61K 31/437 (2006.01) A61K 31/4439 (2006.01) A61P 25/18 (2006.01) A61P 25/28 (2006.01) C07D 401/04 (2006.01) C07D 403/04 (2006.01) C07D 413/04 (2006.01) C07D 413/14 (2006.01) C07D 417/04 (2006.01) C07D 471/04 (2006.01)	2707334 *	C02F 3/00 (2006.01) C02F 3/06 (2006.01) C02F 3/12 (2006.01) C02F 3/22 (2006.01)	2723722 *	A61K 31/4965 (2006.01) A61P 11/00 (2006.01) C07D 239/48 (2006.01)
		2753322 *	A61K 31/138 (2006.01) A61K 31/343 (2006.01) A61K 31/704 (2006.01) A61K 33/24 (2006.01) A61P 35/00 (2006.01)	2766587 *	B60K 6/10 (2006.01) B60K 25/00 (2006.01) F02B 67/06 (2006.01)
		2753937 *	C07K 16/24 (2006.01) C12N 5/10 (2006.01) G01N 33/68 (2006.01)	2677524	H01C 7/12 (2006.01) H01T 1/16 (2006.01)
2653494	A23L 1/054 (2006.01) A23L 2/52 (2006.01) C08L 5/00 (2006.01)			2327295	A01G 9/14 (2006.01)
		2714669 *	A01N 37/44 (2006.01) C07D 249/12 (2006.01) C07D 285/24 (2006.01)	2734682 *	A63H 33/08 (2006.01) E01C 5/00 (2006.01) E04C 1/00 (2006.01)
2687364	B32B 9/00 (2006.01)			2760838 *	A61K 31/44 (2006.01) A61P 11/00 (2006.01) C07D 213/69 (2006.01) C07D 213/89 (2006.01)
2729461 *	A61K 31/4725 (2006.01) A61P 3/00 (2006.01) A61P 9/00 (2006.01) A61P 11/00 (2006.01) C07D 401/12 (2006.01)	2660711	G06F 3/14 (2006.01)		
		2758402 *	A61K 31/519 (2006.01) A61P 35/00 (2006.01) C07D 487/04 (2006.01)	2769204 *	G01N 21/64 (2006.01) G01N 33/542 (2006.01) G01N 33/569 (2006.01)
2748555 *	F41G 3/04 (2006.01) F41G 3/26 (2006.01) F41G 3/32 (2006.01) F41G 9/00 (2006.01) G06Q 10/06 (2012.01)	2731945 *	A61K 31/506 (2006.01) C07C 69/92 (2006.01) C07D 205/04 (2006.01) C07D 317/20 (2006.01) C07D 317/24 (2006.01) C07D 403/12 (2006.01)	2726482 *	A61K 31/53 (2006.01) A61P 27/00 (2006.01) C07D 487/04 (2006.01)
2721247 *	E21B 17/00 (2006.01) E21B 29/00 (2006.01) E21B 34/14 (2006.01) E21B 43/12 (2006.01)	2748588 *	G01N 21/65 (2006.01) G01N 33/483 (2006.01)	2764593 *	H02H 3/08 (2006.01) H02H 9/02 (2006.01)
		2717692 *	A01N 43/16 (2006.01) A61K 31/35 (2006.01)	2704817 *	B01D 53/56 (2006.01)
				2734793 *	F25B 3/00 (2006.01)

Broj objave evropske prijava patenta (97)	MKP (51)	Broj objave evropske prijava patenta (97)	MKP (51)	Broj objave evropske prijava patenta (97)	MKP (51)
2648754 *	A61K 31/4468 (2006.01) A61K 31/451 (2006.01) A61K 31/4985 (2006.01) A61K 31/7088 (2006.01) A61K 39/395 (2006.01) A61P 35/04 (2006.01) C07D 487/04 (2006.01) C07K 16/24 (2006.01) C07K 16/28 (2006.01)	2748146 *	A61K 31/4412 (2006.01) A61P 29/00 (2006.01) C07D 213/89 (2006.01)	2754217 *	H02H 3/08 (2006.01) H02H 9/02 (2006.01)
		2736995 *	C03C 25/32 (2006.01) C09J 105/00 (2006.01) D06M 15/03 (2006.01)	2714415 *	B41M 5/42 (2006.01) B41M 5/50 (2006.01) B41M 5/52 (2006.01)
		2679423	B60J 7/06 (2006.01) B60J 7/10 (2006.01) F16B 21/18 (2006.01)	2389059	H05K 13/04 (2006.01)
2763701 *	A61K 48/00 (2006.01) C07H 21/02 (2006.01) C07H 21/04 (2006.01)	2734503 *	A61K 31/47 (2006.01) A61K 31/502 (2006.01) A61P 3/10 (2006.01) C07D 215/38 (2006.01) C07D 239/94 (2006.01)	2740014 *	G06F 3/01 (2006.01)
2748180 *	C07K 1/18 (2006.01) C12N 9/64 (2006.01)			2729029 *	A41D 19/015 (2006.01)
2751927 *	H03M 1/12 (2006.01) H03M 1/66 (2006.01)	2722552 *	F16F 15/04 (2006.01)	2644123	A61B 17/072 (2006.01) A61L 31/00 (2006.01)
2720755 *	A61Q 5/12 (2006.01)	2765994 *	A61K 9/00 (2006.01) A61K 9/14 (2006.01) A61K 9/16 (2006.01)	2750905 *	B60F 5/02 (2006.01) B64C 3/56 (2006.01) B64C 37/00 (2006.01)
2674245	B23K 26/08 (2006.01) B23K 37/02 (2006.01) B23Q 1/48 (2006.01) B26F 3/00 (2006.01)	2744812 *	A61K 31/519 (2006.01) A61P 29/00 (2006.01) C07D 495/04 (2006.01) C07D 513/04 (2006.01) C07D 519/00 (2006.01)	2739723 *	A61K 35/28 (2006.01) C12N 5/0735 (2010.01) C12N 5/0775 (2010.01) C12N 5/0789 (2010.01) C12N 5/0793 (2010.01)
2650084	B24C 5/06 (2006.01)			2747564 *	A01N 37/20 (2006.01) A01N 43/10 (2006.01) A01N 43/56 (2006.01) A01P 13/00 (2006.01)
2739535 *	B65B 43/30 (2006.01)	2720696 *	A61K 31/4045 (2006.01) A61K 31/519 (2006.01)	2721010 *	C07D 233/64 (2006.01)
2723714 *	C07C 405/00 (2006.01) C07D 207/46 (2006.01) C07D 209/48 (2006.01) C07D 233/60 (2006.01) C07D 307/935 (2006.01)	2734036 *	A01H 1/08 (2006.01) A01H 5/00 (2006.01) A01H 5/10 (2006.01)	2760978 *	C02F 3/28 (2006.01) C10L 3/08 (2006.01) C12P 5/02 (2006.01)

Broj objave evropske prijave patenta (97)	MKP (51)	Broj objave evropske prijave patenta (97)	MKP (51)	Broj objave evropske prijave patenta (97)	MKP (51)
2718387 *	C09K 3/18 (2006.01)	2739711 *	C02F 11/12 (2006.01) C10L 5/08 (2006.01) C10L 5/28 (2006.01) C10L 5/36 (2006.01) C10L 5/46 (2006.01)	2734327 *	B23B 31/20 (2006.01) B23D 37/10 (2006.01) B23D 37/20 (2006.01) B23D 41/04 (2006.01)
2748613 *	G01N 33/68 (2006.01)			2723341 *	A61K 9/16 (2006.01) A61K 31/496 (2006.01) A61P 43/00 (2006.01)
2653299	B31C 1/00 (2006.01) B31C 3/00 (2006.01) B65H 75/10 (2006.01) B65H 75/50 (2006.01)	2701695 *	A61K 31/122 (2006.01) A61K 31/20 (2006.01) A61K 31/202 (2006.01) A61K 31/375 (2006.01) A61P 25/00 (2006.01) A61P 25/28 (2006.01)	2757887 *	A01N 43/90 (2006.01)
2637043	E21B 47/00 (2012.01) G01V 1/44 (2006.01)			2714005 *	A61K 9/00 (2006.01) A61K 31/56 (2006.01) A61P 11/02 (2006.01)
2705287 *	E21B 34/14 (2006.01) E21B 43/12 (2006.01) E21B 43/26 (2006.01) F16K 3/26 (2006.01) F16K 3/30 (2006.01) F16K 31/46 (2006.01)	2741620 *	A23L 1/236 (2006.01)	2647970	G01F 1/74 (2006.01)
2716776 *	C22B 15/14 (2006.01)	2706994 *	A61K 31/18 (2006.01) A61K 33/06 (2006.01) A61K 33/12 (2006.01) A61K 33/38 (2006.01)	2644116	A61B 17/072 (2006.01) A61L 31/04 (2006.01)
2729807 *	G01N 33/538 (2006.01)	2707393 *	A61K 39/145 (2006.01) A61K 39/385 (2006.01) A61P 31/16 (2006.01) A61P 37/04 (2006.01) C07K 14/285 (2006.01) C07K 19/00 (2006.01) C12N 15/00 (2006.01) C12P 21/02 (2006.01)	2753181 *	A01N 63/00 (2006.01)
2714071 *	A61K 39/00 (2006.01) C12Q 1/68 (2006.01)			2713992 *	A61K 8/27 (2006.01) A61K 33/42 (2006.01) A61Q 11/00 (2006.01) C01B 25/455 (2006.01)
2747761 *	A61K 9/51 (2006.01) A61K 31/337 (2006.01) A61K 47/34 (2006.01) A61P 35/00 (2006.01)	2741632 *	A47B 47/04 (2006.01) A47B 61/00 (2006.01)	2689873	B22F 9/08 (2006.01) C22C 18/00 (2006.01)
2521461 *	A23L 2/06 (2006.01) A23L 2/66 (2006.01)	2764262 *	F16C 33/02 (2006.01)	2739753 *	C12N 15/11 (2006.01) C12Q 1/68 (2006.01)
2755598 *	A61F 2/00 (2006.01)			2726074 *	A61K 31/4439 (2006.01) A61K 31/519 (2006.01) A61K 31/535 (2006.01) A61P 35/00 (2006.01)

Broj objave evropske prijava patenta (97)	MKP (51)	Broj objave evropske prijava patenta (97)	MKP (51)	Broj objave evropske prijava patenta (97)	MKP (51)
2713419	H01M 2/12 (2006.01)	2736852 *	C02F 3/30 (2006.01) C02F 3/34 (2006.01)	2266771	B28C 7/00 (2006.01) B65G 53/32 (2006.01) B65G 53/52 (2006.01) C04B 40/06 (2006.01) F25D 3/10 (2006.01)
2760450 *	A61K 31/496 (2006.01) A61P 3/06 (2006.01) A61P 3/08 (2006.01) A61P 3/10 (2006.01) A61P 9/00 (2006.01) A61P 9/10 (2006.01) A61P 9/12 (2006.01) A61P 11/00 (2006.01) A61P 15/00 (2006.01) A61P 15/12 (2006.01) A61P 19/02 (2006.01) A61P 21/00 (2006.01)	2732323 *	G02B 6/44 (2006.01) H02G 15/013 (2006.01)	2630902	A47L 5/36 (2006.01) A47L 9/12 (2006.01) A47L 9/20 (2006.01)
		2692726	A61K 31/4178 (2006.01) A61K 31/4184 (2006.01) A61K 31/4439 (2006.01) A61K 31/454 (2006.01) A61K 31/496 (2006.01) A61K 31/506 (2006.01) A61P 31/14 (2006.01) C07D 401/14 (2006.01) C07D 403/14 (2006.01) C07D 417/14 (2006.01)	2764019 *	C07K 14/50 (2006.01) C07K 14/605 (2006.01)
2744912 *	C12Q 1/68 (2006.01)			2751562 *	G01N 33/50 (2006.01) G01N 33/542 (2006.01)
2710658 *	H01M 8/04 (2006.01)	2750686 *	A61K 38/00 (2006.01)	2739311 *	A61K 39/395 (2006.01) A61P 19/00 (2006.01) C07K 16/22 (2006.01)
2769980 *	A61K 31/437 (2006.01) A61K 31/444 (2006.01) A61K 31/506 (2006.01) A61P 25/28 (2006.01) A61P 43/00 (2006.01) C07D 471/04 (2006.01)	2747560 *	A01N 37/18 (2006.01) A61K 31/165 (2006.01) C07C 233/00 (2006.01)	2660496	F16K 27/02 (2006.01)
		2736907 *	A61K 31/437 (2006.01) A61K 31/55 (2006.01) A61P 11/00 (2006.01) C07D 471/04 (2006.01) C07D 487/04 (2006.01)	2712344 *	B60R 19/26 (2006.01) B60R 19/32 (2006.01) B60R 19/36 (2006.01) B60T 13/10 (2006.01) F01C 1/00 (2006.01) F03C 1/02 (2006.01)
2723718 *	A61K 31/44 (2006.01) A61P 25/00 (2006.01) C07D 213/40 (2006.01) C07D 401/12 (2006.01) C07D 401/14 (2006.01) C07D 405/12 (2006.01) C07D 409/12 (2006.01) C07D 413/12 (2006.01)	2709608 *	A61K 31/122 (2006.01) A61K 31/198 (2006.01) A61K 31/275 (2006.01)	2719376	A61K 9/00 (2006.01) A61K 9/16 (2006.01) A61K 9/20 (2006.01)

Broj objave evropske prijava patenta (97)	MKP (51)	Broj objave evropske prijava patenta (97)	MKP (51)	Broj objave evropske prijava patenta (97)	MKP (51)
2723304 *	A61K 8/02 (2006.01) A61K 8/04 (2006.01) A61K 8/44 (2006.01) A61K 8/73 (2006.01) A61K 8/81 (2006.01) A61Q 19/00 (2006.01) A61Q 19/10 (2006.01)	2644212	A61B 17/064 (2006.01) A61L 31/04 (2006.01) A61L 31/14 (2006.01) A61L 31/16 (2006.01)	2734257 *	A61M 5/32 (2006.01)
		2709991 *	C07D 255/02 (2006.01)	2709848 *	B05C 1/02 (2006.01) B41F 17/00 (2006.01) B41F 35/00 (2006.01) B41M 1/14 (2006.01) B41M 1/40 (2006.01)
		2766368 *	A61K 31/519 (2006.01) A61P 29/00 (2006.01) A61P 37/00 (2006.01) C07D 487/04 (2006.01)	2666529	A63H 19/32 (2006.01)
2704776 *	A61M 5/24 (2006.01) A61M 5/315 (2006.01)			2679691	C21C 5/00 (2006.01) C21C 5/28 (2006.01) C22B 3/00 (2006.01) C22B 3/04 (2006.01) C22B 3/20 (2006.01) C22B 23/00 (2006.01) C22C 1/00 (2006.01) C22C 33/04 (2006.01) C22C 38/40 (2006.01)
2761120 *	E06B 7/215 (2006.01)	2758394 *	A61K 31/4245 (2006.01) A61K 31/445 (2006.01) A61P 25/00 (2006.01) C07D 413/14 (2006.01)		
2760831 *	C07D 209/14 (2006.01) C07D 401/08 (2006.01) C07D 401/12 (2006.01) C07D 401/14 (2006.01) C07D 403/08 (2006.01) C07D 403/10 (2006.01) C07D 403/12 (2006.01) C07D 405/12 (2006.01) C07D 409/08 (2006.01) C07D 409/12 (2006.01) C07D 413/08 (2006.01) C07D 413/12 (2006.01) C07D 417/14 (2006.01) C07D 471/04 (2006.01) C07D 487/04 (2006.01)	2729132 *	A61K 9/20 (2006.01) A61K 31/343 (2006.01) A61K 47/02 (2006.01) A61K 47/10 (2006.01) A61K 47/12 (2006.01) A61K 47/30 (2006.01) A61K 47/32 (2006.01) A61P 9/06 (2006.01)	2709597 *	A61K 9/20 (2006.01) A61K 9/28 (2006.01) A61K 31/00 (2006.01) A61K 31/519 (2006.01) A61K 31/568 (2006.01)
		2711411 *	B29C 47/00 (2006.01) B29C 47/08 (2006.01) B29C 47/92 (2006.01) C10L 5/46 (2006.01) C10L 5/48 (2006.01)	2702054 *	A61K 31/4725 (2006.01) A61P 29/00 (2006.01) C07D 401/12 (2006.01) C07D 401/14 (2006.01)
2722470	E05B 17/00 (2006.01) E05B 45/06 (2006.01)			2758430 *	A61K 39/395 (2006.01) C07K 16/00 (2006.01) C12P 21/08 (2006.01)
2719060 *	H02K 1/24 (2006.01) H02K 15/02 (2006.01)	2702058 *	A61K 31/4162 (2006.01) A61P 19/02 (2006.01) C07D 471/04 (2006.01)		

Broj objave evropske prijave patenta (97)	MKP (51)	Broj objave evropske prijave patenta (97)	MKP (51)	Broj objave evropske prijave patenta (97)	MKP (51)
2709865 *	B60J 5/04 (2006.01) F16H 21/28 (2006.01)	2766002 *	A61K 31/11 (2006.01) A61K 31/135 (2006.01) A61K 31/21 (2006.01) A61P 25/00 (2006.01)	2677222	F16L 21/00 (2006.01) F16L 21/08 (2006.01) F16L 25/00 (2006.01)
2768302 *	A01M 7/00 (2006.01)			2726579 *	C10L 1/12 (2006.01) C10L 1/198 (2006.01)
2701834 *	B01J 8/00 (2006.01) B01J 8/18 (2006.01) B01J 8/22 (2006.01) C07C 29/68 (2006.01) C07C 209/52 (2006.01) C07C 213/02 (2006.01)	2755664 *	A61K 31/724 (2006.01) A61P 17/00 (2006.01) A61P 17/04 (2006.01) A61P 17/06 (2006.01) A61P 17/10 (2006.01) A61P 17/12 (2006.01) A61P 29/00 (2006.01) A61Q 19/00 (2006.01) A61Q 19/02 (2006.01) A61Q 19/08 (2006.01) C07H 3/06 (2006.01)	2768517 *	A61K 38/12 (2006.01)
2721012 *	A61K 31/4192 (2006.01) A61K 31/4196 (2006.01) A61P 25/18 (2006.01) A61P 25/22 (2006.01) A61P 25/24 (2006.01) C07D 249/04 (2006.01) C07D 249/12 (2006.01)			2753309 *	A61K 9/20 (2006.01) A61K 47/10 (2006.01) A61K 47/12 (2006.01)
		2724210 *	G06F 1/16 (2006.01) G06F 3/01 (2006.01) G06F 3/03 (2006.01) G06F 3/048 (2013.01)	2713958 *	A61F 2/30 (2006.01) A61F 2/42 (2006.01)
2729140 *	A61K 31/343 (2006.01) A61P 9/04 (2006.01)			2710019 *	C07F 9/40 (2006.01) C07F 9/44 (2006.01) C07H 19/20 (2006.01)
		2714654 *	A61K 31/53 (2006.01) A61P 9/00 (2006.01) A61P 31/00 (2006.01) C07C 311/13 (2006.01) C07D 251/16 (2006.01) C07D 251/22 (2006.01) C07D 401/12 (2006.01) C07D 405/04 (2006.01) C07D 405/12 (2006.01) C07D 413/12 (2006.01) C07D 417/12 (2006.01)	2545878	A61C 5/06 (2006.01) B65D 1/02 (2006.01) B65D 39/16 (2006.01)
2758534 *	A01K 67/027 (2006.01) C07K 16/46 (2006.01) C12N 15/85 (2006.01)			2511604	F21S 8/06 (2006.01) F21V 5/06 (2006.01) F21V 17/16 (2006.01)
2764110 *	A23K 1/00 (2006.01) A23L 1/305 (2006.01) A23L 1/314 (2006.01) C12P 7/06 (2006.01) C12P 7/10 (2006.01)			2741735 *	A61K 9/00 (2006.01) A61K 9/50 (2006.01) A61K 31/55 (2006.01) A61P 9/04 (2006.01)
				2766366 *	A61K 31/519 (2006.01) A61P 11/00 (2006.01) C07D 487/04 (2006.01)

Broj objave evropske prijave patenta (97)	MKP (51)	Broj objave evropske prijave patenta (97)	MKP (51)	Broj objave evropske prijave patenta (97)	MKP (51)
2732609 *	H04M 1/725 (2006.01) H04W 4/02 (2009.01)	2702062 *	A61K 31/4985 (2006.01) A61P 25/18 (2006.01) C07D 487/04 (2006.01)	2740532	A01N 25/28 (2006.01) A23L 1/22 (2006.01) A61K 9/50 (2006.01) A61K 47/00 (2006.01)
2721028 *	A61K 31/437 (2006.01) A61K 31/519 (2006.01) A61P 29/00 (2006.01) A61P 35/00 (2006.01) A61P 37/02 (2006.01) C07D 471/04 (2006.01) C07D 487/04 (2006.01)	2748088 *	B65B 7/16 (2006.01) B65B 29/02 (2006.01) B65B 61/20 (2006.01) B65D 85/804 (2006.01)		B01J 13/02 (2006.01) B01J 20/30 (2006.01) C08B 30/12 (2006.01) C08B 30/14 (2006.01) C08L 3/00 (2006.01)
2511593	F21S 8/00 (2006.01) F21S 8/06 (2006.01) F21V 5/00 (2006.01) F21V 5/02 (2006.01) F21V 5/06 (2006.01) F21Y 101/02 (2006.01) F21Y 105/00 (2006.01)	2657505	F02M 59/10 (2006.01) F04B 1/04 (2006.01) F16H 53/06 (2006.01)	2739559 *	B67D 1/00 (2006.01) B67D 1/04 (2006.01) B67D 3/00 (2006.01)
2723414 *	A61M 1/00 (2006.01)	2682551	E05D 7/00 (2006.01)	2701643 *	A61F 7/00 (2006.01)
2761066 *	C40B 40/10 (2006.01) C40B 50/00 (2006.01)	2461797 *	A23G 3/36 (2006.01) A23L 1/05 (2006.01) A23P 1/10 (2006.01) A61K 9/00 (2006.01) A61K 31/137 (2006.01) A61K 31/138 (2006.01) A61K 31/167 (2006.01) A61K 31/192 (2006.01) A61K 31/4545 (2006.01) A61K 31/495 (2006.01) A61K 47/10 (2006.01) A61K 47/26 (2006.01) A61K 47/36 (2006.01) A61K 47/42 (2006.01)	2722160	B29D 22/04 (2006.01)
2710587 *	G06F 17/30 (2006.01) G10L 15/22 (2006.01) H04M 3/493 (2006.01)			2744827 *	A61K 39/395 (2006.01) A61P 35/00 (2006.01) C07K 16/28 (2006.01)
2703608	F01K 13/00 (2006.01)			2669381	C12N 15/86 (2006.01)
2679175	A61B 17/00 (2006.01) A61B 17/28 (2006.01) A61B 17/29 (2006.01) A61B 18/00 (2006.01) A61B 18/08 (2006.01)	2767270 *	A61J 1/10 (2006.01) B65D 30/16 (2006.01)	2718923 *	G09F 7/18 (2006.01) G09F 7/20 (2006.01) G09F 15/00 (2006.01)
				2703406 *	A61K 31/546 (2006.01) A61P 31/04 (2006.01) C07D 501/18 (2006.01) C07D 501/46 (2006.01) C07D 519/06 (2006.01)
				2741785 *	A61K 39/08 (2006.01) A61K 48/00 (2006.01)

Broj objave evropske prijava patenta (97)	MKP (51)	Broj objave evropske prijava patenta (97)	MKP (51)	Broj objave evropske prijava patenta (97)	MKP (51)
2718257 *	C07C 69/74 (2006.01)	2579888 *	A61K 31/24 (2006.01)	2672498	H01H 13/28 (2006.01)
2751081 *	A61K 31/47 (2006.01)	A61K 31/341 (2006.01)	A61K 31/343 (2006.01)		H01H 13/56 (2006.01)
	A61P 3/00 (2006.01)	A61K 31/351 (2006.01)	A61K 31/381 (2006.01)		H01H 23/20 (2006.01)
	A61P 9/00 (2006.01)	A61K 31/40 (2006.01)	A61K 31/41 (2006.01)	2718566 *	H01H 23/24 (2006.01)
	B01D 9/02 (2006.01)	A61K 31/415 (2006.01)	A61K 31/421 (2006.01)		E21B 43/16 (2006.01)
	C07D 215/14 (2006.01)	A61K 31/423 (2006.01)	A61K 31/428 (2006.01)	2706904 *	F04B 9/02 (2006.01)
2747549 *	A01G 9/14 (2006.01)	A61K 31/433 (2006.01)	A61K 31/437 (2006.01)		A61B 1/04 (2006.01)
	B32B 27/20 (2006.01)	A61K 31/4406 (2006.01)	A61K 31/445 (2006.01)	2741931 *	B60D 1/167 (2006.01)
	B32B 27/30 (2006.01)	A61K 31/447 (2006.01)	A61K 31/495 (2006.01)		B60D 1/32 (2006.01)
	C08J 3/22 (2006.01)	A61K 31/498 (2006.01)	A61K 31/5375 (2006.01)	2732043 *	B60D 1/58 (2006.01)
	C08K 3/22 (2006.01)	A61K 38/16 (2006.01)	A61K 31/5517 (2006.01)		C12P 7/56 (2006.01)
2734040 *	A01N 25/02 (2006.01)	C07D 265/30 (2006.01)	A61P 35/00 (2006.01)	2385242	C12P 41/00 (2006.01)
	A01N 25/30 (2006.01)	2705039 *	C07D 401/04 (2006.01)		F02M 53/04 (2006.01)
	A01N 37/42 (2006.01)		C07D 487/04 (2006.01)	2702146 *	F02M 61/14 (2006.01)
	A01N 43/40 (2006.01)				C12N 5/10 (2006.01)
	A01N 43/50 (2006.01)			2764002 *	C07F 9/6561 (2006.01)
	A01N 43/653 (2006.01)				C12N 5/00 (2006.01)
	A01N 47/12 (2006.01)			2721144 *	C12N 5/02 (2006.01)
	A01N 47/20 (2006.01)				C12N 5/02 (2006.01)
	A01N 53/00 (2006.01)			2644202	A61K 36/14 (2006.01)
2734218 *	A61K 38/04 (2006.01)				A61P 17/02 (2006.01)
	A61K 38/16 (2006.01)				A61P 17/06 (2006.01)
	C07K 14/025 (2006.01)				A61P 17/06 (2006.01)
2714648 *	A61P 9/00 (2006.01)	2755731 *	B01D 3/00 (2006.01)		C12N 5/00 (2006.01)
	C07C 233/00 (2006.01)				C12N 5/02 (2006.01)
2714079 *	A61K 39/395 (2006.01)	2723901 *	C12Q 1/68 (2006.01)	2768796 *	C07C 231/02 (2006.01)
					C07C 233/59 (2006.01)
		2758386 *	C07D 311/06 (2006.01)		C07D 215/22 (2006.01)
			C07D 417/04 (2006.01)		C07D 413/12 (2006.01)
			C07D 453/04 (2006.01)		

Broj objave evropske prijava patenta (97)	MKP (51)	Broj objave evropske prijava patenta (97)	MKP (51)	Broj objave evropske prijava patenta (97)	MKP (51)
2740595 *	B32B 15/08 (2006.01) B32B 23/08 (2006.01)	2718547 *	F01K 7/16 (2006.01) F01K 23/10 (2006.01) F01K 25/08 (2006.01)	2758053 *	A61K 31/4196 (2006.01) A61K 31/495 (2006.01) A61K 45/06 (2006.01) A61P 3/10 (2006.01)
2621521 *	A61K 31/415 (2006.01) A61K 31/496 (2006.01) A61K 31/4965 (2006.01) A61K 38/48 (2006.01) A61P 1/00 (2006.01) A61P 29/00 (2006.01) A61P 31/04 (2006.01)	2737151 *	E06B 9/26 (2006.01) E06B 9/302 (2006.01)	2731588 *	A61K 9/00 (2006.01) A61K 9/19 (2006.01) A61K 9/70 (2006.01) A61K 31/675 (2006.01) A61K 47/38 (2006.01)
2765590 *	H01H 71/12 (2006.01) H01H 83/10 (2006.01)	2714685 *	A61K 31/427 (2006.01) A61P 35/00 (2006.01) C07D 207/325 (2006.01) C07D 401/12 (2006.01) C07D 417/12 (2006.01)	2709463 *	A23J 1/14 (2006.01) A23J 3/16 (2006.01) C07K 1/14 (2006.01) C07K 14/415 (2006.01)
2647824	F02M 59/20 (2006.01) F02M 59/36 (2006.01) F02M 59/46 (2006.01) F02M 63/02 (2006.01)	2766363 *	A61K 31/437 (2006.01) A61P 35/00 (2006.01) C07D 471/04 (2006.01)	2768495 *	A61K 31/202 (2006.01) A61P 17/00 (2006.01) A61P 17/10 (2006.01)
2769052 *	E21B 33/072 (2006.01)	2734655 *	C21D 1/00 (2006.01) C22C 19/05 (2006.01) C22C 38/00 (2006.01) C22C 38/44 (2006.01) C22F 1/10 (2006.01)	2702572 *	G06Q 20/20 (2012.01) G07F 7/08 (2006.01) G07G 1/00 (2006.01)
2739287 *	A61K 31/56 (2006.01)	2707029 *	A61K 39/395 (2006.01) A61P 3/06 (2006.01) C07K 16/40 (2006.01)	2711574	F16C 19/06 (2006.01) F16C 33/60 (2006.01) F16C 35/077 (2006.01) F16C 43/04 (2006.01)
2702159 *	A61K 39/155 (2006.01) C12N 7/01 (2006.01) C12N 15/86 (2006.01)	2722040 *	A61K 9/70 (2006.01) A61K 31/167 (2006.01) A61K 47/12 (2006.01) A61K 47/42 (2006.01) A61P 23/02 (2006.01)	2735247	A47C 7/02 (2006.01)
2714336 *	B23C 3/35 (2006.01) B25B 1/24 (2006.01)			2764793 *	A45C 11/00 (2006.01)
2739854 *	F04C 2/00 (2006.01)			2722335 *	C07B 59/00 (2006.01) C07H 1/02 (2006.01) C07H 21/02 (2006.01)
2736329 *	A01N 37/18 (2006.01) A61K 31/165 (2006.01) C07C 233/00 (2006.01)				
2657516	F03D 7/02 (2006.01)				

Broj objave evropske prijave patenta (97)	MKP (51)	Broj objave evropske prijave patenta (97)	MKP (51)	Broj objave evropske prijave patenta (97)	MKP (51)
2734230 *	A61K 39/12 (2006.01) C07K 14/005 (2006.01) C12N 15/86 (2006.01)	2753193 *	A23L 1/30 (2006.01) A23L 1/38 (2006.01) A61K 8/99 (2006.01) A61K 36/06 (2006.01) G01N 33/564 (2006.01)	2758057 *	A61K 31/47 (2006.01) A61P 19/10 (2006.01) C12P 7/64 (2006.01)
2705154 *	C12P 21/04 (2006.01) G01N 33/00 (2006.01)	2763985 *	A61K 31/519 (2006.01) C07D 417/02 (2006.01)	2714941 *	C12Q 1/70 (2006.01)
2650072	B23G 1/04 (2006.01) B23G 1/18 (2006.01)	2756521 *	A61K 35/12 (2006.01) C12P 21/00 (2006.01) H01L 21/00 (2006.01)	2707588 *	F02G 1/043 (2006.01)
2709606 *	A61K 31/05 (2006.01) A61K 36/61 (2006.01) A61K 45/06 (2006.01) A61P 17/04 (2006.01)	2704737 *	A61K 38/46 (2006.01)	2670041	H02J 3/26 (2006.01) H02M 7/48 (2007.01)
2707787 *	G06F 3/01 (2006.01)	2701700 *	A61K 31/337 (2006.01) A61P 35/00 (2006.01)	2708530 *	C07C 403/20 (2006.01)
2760449 *	A61K 31/4523 (2006.01) A61K 31/5395 (2006.01) A61K 35/28 (2006.01) A61K 45/06 (2006.01) A61P 43/00 (2006.01)	2725904 *	A61K 38/46 (2006.01)	2723350 *	A01N 43/50 (2006.01)
2758433 *	A61K 39/00 (2006.01) A61P 25/28 (2006.01) C07K 14/47 (2006.01) C07K 16/18 (2006.01) G01N 33/53 (2006.01)	2764008 *	C07J 75/00 (2006.01)	2723350 *	A61K 31/7105 (2006.01) A61P 35/00 (2006.01)
2756187 *	F03D 1/04 (2006.01) F03D 11/00 (2006.01)	2733119	B01J 20/04 (2006.01) B01J 20/28 (2006.01) C02F 1/28 (2006.01) C02F 101/10 (2006.01) C02F 103/00 (2006.01)	2767583	B65D 1/02 (2006.01) B67C 3/02 (2006.01) C12G 1/00 (2006.01)
2751086 *	C07D 239/47 (2006.01)	2761025 *	C02F 1/28 (2006.01) C02F 101/10 (2006.01) C02F 103/00 (2006.01)	2761025 *	C12Q 1/68 (2006.01)
		2720713 *	A61K 38/47 (2006.01) A61P 3/10 (2006.01)	2707400 *	C08F 10/06 (2006.01)
		2744333 *	A01N 43/42 (2006.01)	2684757	B61D 3/16 (2006.01) B61D 45/00 (2006.01)
		2736901 *	A61K 31/505 (2006.01) A61P 35/00 (2006.01) C07D 403/12 (2006.01) C07D 491/10 (2006.01)	2751106 *	A61K 31/519 (2006.01) A61P 9/00 (2006.01) C07D 471/04 (2006.01) C07D 487/04 (2006.01) C07D 519/00 (2006.01)
				2649972	A61B 17/34 (2006.01) A61F 11/00 (2006.01)

Broj objave evropske prijava patenta (97)	MKP (51)	Broj objave evropske prijava patenta (97)	MKP (51)	Broj objave evropske prijava patenta (97)	MKP (51)
2707026 *	A61K 39/245 (2006.01) C07D 239/84 (2006.01) C07D 401/04 (2006.01) C07D 401/12 (2006.01) C07D 413/04 (2006.01)	2730573 *	A61K 31/454 (2006.01) A61K 31/4545 (2006.01) A61K 31/506 (2006.01) A61P 1/00 (2006.01) A61P 5/00 (2006.01) A61P 9/12 (2006.01) A61P 25/04 (2006.01) A61P 25/08 (2006.01) A61P 25/16 (2006.01) A61P 25/20 (2006.01) A61P 25/22 (2006.01) A61P 25/24 (2006.01) A61P 25/28 (2006.01) A61P 25/30 (2006.01) A61P 29/00 (2006.01) A61P 37/00 (2006.01) A61P 43/00 (2006.01) C07D 413/14 (2006.01) C07D 498/04 (2006.01)	2726306 *	B60F 3/00 (2006.01) B63B 1/12 (2006.01) B63B 15/00 (2006.01) B63B 25/00 (2006.01) B63B 25/28 (2006.01) B63B 27/14 (2006.01)
2768855 *	A61K 39/395 (2006.01) C07K 16/00 (2006.01) C07K 16/22 (2006.01) C07K 16/24 (2006.01) C07K 16/46 (2006.01)			2756298 *	C12Q 1/68 (2006.01) G01N 33/50 (2006.01) G01N 33/68 (2006.01)
2661961	A01K 15/02 (2006.01)			2763794 *	B02C 2/00 (2006.01)
2745235 *	G06G 7/58 (2006.01)			2735081 *	H02J 3/00 (2006.01) H02J 13/00 (2006.01)
2723544 *	B28B 7/00 (2006.01) B28B 7/22 (2006.01) B28B 17/00 (2006.01) B28B 21/02 (2006.01) B28B 21/82 (2006.01) B28B 23/00 (2006.01) E04H 12/12 (2006.01) F03D 11/04 (2006.01) G01B 11/24 (2006.01)	2641582	A61J 3/07 (2006.01) B26D 1/36 (2006.01) B26D 1/38 (2006.01) B26D 7/10 (2006.01)	2721019 *	A61K 31/44 (2006.01) A61K 31/4427 (2006.01) A61P 35/00 (2006.01) C07D 401/02 (2006.01) C07D 401/04 (2006.01) C07D 401/14 (2006.01) C07D 405/00 (2006.01)
		2712319 *	A61K 36/185 (2006.01) A61K 36/53 (2006.01)	2623843	F16L 11/12 (2006.01) F16L 57/02 (2006.01)
		2760424 *	A61K 8/02 (2006.01) A61K 8/30 (2006.01) A61K 8/37 (2006.01) A61K 8/41 (2006.01) A61K 8/72 (2006.01) A61Q 19/00 (2006.01)	2714647 *	A61K 31/166 (2006.01) A61K 31/195 (2006.01) A61P 3/08 (2006.01) A61P 5/50 (2006.01) C07C 231/12 (2006.01) C07C 233/83 (2006.01)
				2339078	E04B 1/76 (2006.01)

Broj objave evropske prijave patenta (97)	MKP (51)	Broj objave evropske prijave patenta (97)	MKP (51)	Broj objave evropske prijave patenta (97)	MKP (51)
2720989 *	A61K 31/495 (2006.01) A61P 25/00 (2006.01) C07B 59/00 (2006.01) C07D 241/04 (2006.01)	2709957 *	B01D 1/00 (2006.01) B01D 5/00 (2006.01) C02F 1/04 (2006.01) C02F 103/08 (2006.01)	2404502	A01N 37/42 (2006.01) A01N 37/46 (2006.01) A01N 43/36 (2006.01) A01N 59/20 (2006.01) A01P 1/00 (2006.01) A61K 8/49 (2006.01) A61K 31/195 (2006.01) A61Q 19/00 (2006.01)
2674608	F02M 47/02 (2006.01)	2755640 *	A61K 9/20 (2006.01) A61K 9/28 (2006.01) A61K 31/485 (2006.01)		
2734041 *	A01N 43/40 (2006.01)				
2760448 *	A61K 31/4523 (2006.01) A61K 31/5395 (2006.01) A61P 21/00 (2006.01)	2745069 *	F42B 5/02 (2006.01) F42B 5/10 (2006.01) F42B 33/02 (2006.01)	2714740 *	A61K 39/395 (2006.01) A61P 5/00 (2006.01) C07K 16/28 (2006.01)
2602752	G06Q 10/04 (2012.01)	2734965 *	G06Q 30/00 (2012.01)	2709614 *	A61K 31/40 (2006.01) A61K 31/4164 (2006.01)
2751282 *	C07K 14/47 (2006.01) C07K 16/30 (2006.01) C12Q 1/68 (2006.01)	2744623 *	B23Q 11/00 (2006.01) B23Q 11/08 (2006.01) B23Q 11/12 (2006.01)	2712349 *	B65D 47/06 (2006.01) B65D 47/22 (2006.01) B65D 83/00 (2006.01) B67D 7/36 (2010.01)
2766561 *	E21B 23/10 (2006.01) E21B 33/12 (2006.01) E21B 34/08 (2006.01) E21B 34/14 (2006.01) E21B 43/12 (2006.01)	2713978 *	A61G 3/06 (2006.01)		
		2708022 *	H04N 5/335 (2011.01)	2623291	B29C 45/00 (2006.01) B29C 45/16 (2006.01) F04D 29/22 (2006.01)
		2768838 *	A61K 31/7076 (2006.01) A61P 31/12 (2006.01) C07H 19/213 (2006.01)	2748632 *	G01B 11/02 (2006.01) G01S 17/32 (2006.01)
2727100 *	G09B 5/06 (2006.01) G09B 19/00 (2006.01) G09B 19/24 (2006.01) G09B 23/28 (2006.01)	2707016 *	A61K 31/155 (2006.01) A61K 38/26 (2006.01) A61P 3/04 (2006.01) A61P 3/10 (2006.01)	2749053 *	G06F 3/041 (2006.01) G06K 9/00 (2006.01) H04W 12/06 (2009.01)
2705777	A47C 20/04 (2006.01) A47C 23/00 (2006.01) A47C 23/06 (2006.01)			2747938 *	B23Q 7/02 (2006.01) B23Q 16/02 (2006.01) B23Q 39/04 (2006.01)
2741745 *	A61K 31/337 (2006.01) C07D 305/14 (2006.01)			2766004 *	A61K 31/135 (2006.01)

Broj objave evropske prijave patenta (97)	MKP (51)	Broj objave evropske prijave patenta (97)	MKP (51)	Broj objave evropske prijave patenta (97)	MKP (51)
2766865 *	G06F 17/00 (2006.01) G06Q 30/02 (2012.01)	2764119 *	C12Q 1/68 (2006.01) G01N 33/50 (2006.01) G01N 33/569 (2006.01) G01N 33/574 (2006.01)	2725922 *	A23J 1/14 (2006.01)
2758609 *	E04B 1/34 (2006.01) E04H 1/04 (2006.01) E04H 1/06 (2006.01)	2731965 *	C07K 16/00 (2006.01) C07K 16/18 (2006.01) C12N 15/11 (2006.01) C12Q 1/68 (2006.01) C40B 40/06 (2006.01)	2714050 *	A61K 31/7004 (2006.01) A61P 25/28 (2006.01)
2753928 *	G01N 33/53 (2006.01)	2736883 *	A61K 31/407 (2006.01) A61K 31/4196 (2006.01) A61K 31/421 (2006.01) A61K 31/4439 (2006.01) A61K 31/454 (2006.01) A61K 31/497 (2006.01) A61K 31/506 (2006.01) C07D 213/50 (2006.01) C07D 401/08 (2006.01) C07D 401/12 (2006.01) C07D 401/14 (2006.01) C07D 403/08 (2006.01) C07D 403/12 (2006.01) C07D 413/12 (2006.01) C07D 487/10 (2006.01)	2768508 *	A61K 9/00 (2006.01) A61K 9/08 (2006.01) A61K 31/185 (2006.01) A61K 31/191 (2006.01) A61K 31/194 (2006.01) A61K 31/198 (2006.01) A61K 31/496 (2006.01) A61K 31/661 (2006.01) A61K 47/02 (2006.01) A61K 47/12 (2006.01)
2746437 *	D04B 21/14 (2006.01) D04D 7/00 (2006.01)	2742598 *	H04B 1/40 (2006.01) H04W 88/06 (2009.01)	2706999 *	A61K 31/433 (2006.01)
2753619 *	C07D 413/10 (2006.01) C07D 413/14 (2006.01)	2766677 *	F25D 7/00 (2006.01) F25D 16/00 (2006.01) F25D 31/00 (2006.01)	2718323 *	C07K 16/28 (2006.01)
2742598 *	H04B 1/40 (2006.01) H04W 88/06 (2009.01)	2736332 *	A01N 43/08 (2006.01) A61K 31/34 (2006.01)	2736915 *	A61K 31/7052 (2006.01) C07H 17/00 (2006.01)
2766677 *	F25D 7/00 (2006.01) F25D 16/00 (2006.01) F25D 31/00 (2006.01)	2718280 *	A61K 31/439 (2006.01) A61K 31/4709 (2006.01) A61P 11/06 (2006.01) A61P 11/08 (2006.01) C07C 213/10 (2006.01) C07D 401/12 (2006.01) C07D 451/06 (2006.01) C07D 453/02 (2006.01)	2768742 *	B65D 19/38 (2006.01) B65D 77/06 (2006.01)
2736332 *	A01N 43/08 (2006.01) A61K 31/34 (2006.01)	2768496 *	A61K 31/202 (2006.01) A61P 17/00 (2006.01)	2768303 *	A01M 7/00 (2006.01)
2718280 *	A61K 31/439 (2006.01) A61K 31/4709 (2006.01) A61P 11/06 (2006.01) A61P 11/08 (2006.01) C07C 213/10 (2006.01) C07D 401/12 (2006.01) C07D 451/06 (2006.01) C07D 453/02 (2006.01)	2692340	A61K 9/14 (2006.01) A61K 31/198 (2006.01) A61K 47/32 (2006.01)	2748147 *	A61K 31/47 (2006.01) A61P 33/06 (2006.01) C07D 217/26 (2006.01) C07D 401/04 (2006.01) C07D 405/04 (2006.01) C07D 413/04 (2006.01) C07D 417/04 (2006.01)
		2727118 *	G21F 9/24 (2006.01) G21F 9/34 (2006.01)		

Broj objave evropske prijava patenta (97)	MKP (51)	Broj objave evropske prijava patenta (97)	MKP (51)	Broj objave evropske prijava patenta (97)	MKP (51)
2742048 *	A61K 31/52 (2006.01) A61P 25/04 (2006.01) C07D 473/08 (2006.01)	2702069 *	A61K 38/16 (2006.01) A61P 9/00 (2006.01) A61P 11/00 (2006.01) A61P 11/06 (2006.01) A61P 17/00 (2006.01) A61P 35/00 (2006.01) C07K 14/00 (2006.01) C12N 1/19 (2006.01) C12N 1/21 (2006.01) C12N 5/10 (2006.01) C12N 7/01 (2006.01) C12N 15/11 (2006.01) C12N 15/63 (2006.01) C12P 21/02 (2006.01)	2630962	A61K 38/02 (2006.01) A61K 38/16 (2006.01) A61P 25/28 (2006.01)
2753880 *	F24D 3/10 (2006.01)			2761606 *	G07F 17/32 (2006.01)
2751249 *	C12C 5/02 (2006.01) C12C 7/053 (2006.01)			2710032 *	C07K 16/00 (2006.01) C12P 21/08 (2006.01)
2759080 *	H04J 1/00 (2006.01)			2765997 *	A61K 9/16 (2006.01) A61K 31/7088 (2006.01) A61K 31/7105 (2006.01) A61K 38/17 (2006.01) A61K 47/48 (2006.01) A61K 48/00 (2006.01) A61K 49/08 (2006.01)
2642467	G09B 9/08 (2006.01)			2750695 *	A61K 38/18 (2006.01) A61P 3/00 (2006.01) A61P 3/04 (2006.01) A61P 3/06 (2006.01) A61P 3/08 (2006.01) A61P 3/10 (2006.01)
2714353 *	B28B 1/08 (2006.01) B28B 3/00 (2006.01) B28B 7/46 (2006.01) B28B 13/02 (2006.01)	2766048 *	A61K 47/48 (2006.01) A61P 35/00 (2006.01) C07D 487/04 (2006.01) C07D 519/00 (2006.01)		
2710235 *	C01B 3/04 (2006.01) F01K 23/10 (2006.01)			2755684 *	A61K 39/21 (2006.01)
2761011 *	C07K 14/16 (2006.01) C12N 15/867 (2006.01)	2749803 *	F16L 21/03 (2006.01) F16L 21/08 (2006.01)	2718456 *	C12P 21/04 (2006.01)
2768833 *	C07D 487/04 (2006.01)				
2740725	C07C 253/00 (2006.01) C07D 223/14 (2006.01)	2707718 *	G01N 33/50 (2006.01) G01N 33/566 (2006.01) G01N 33/74 (2006.01)	2666362	A23B 4/005 (2006.01) A23B 4/16 (2006.01) A23L 1/325 (2006.01)
2702266 *	F03D 1/00 (2006.01) F03D 1/06 (2006.01)	2761289 *	G01N 33/48 (2006.01) G01N 33/52 (2006.01)		
		2710554 *	G06K 9/00 (2006.01) G06T 7/00 (2006.01)		
		2684697	B41F 35/00 (2006.01)		

Broj objave evropske prijava patenta (97)	MKP (51)	Broj objave evropske prijava patenta (97)	MKP (51)	Broj objave evropske prijava patenta (97)	MKP (51)
2709449 *	A01N 25/22 (2006.01) A01N 37/40 (2006.01) A01N 43/12 (2006.01) A01N 43/54 (2006.01) A01N 43/653 (2006.01) A01N 47/44 (2006.01) A01N 59/02 (2006.01) A01N 59/20 (2006.01) A01P 3/00 (2006.01)	2744592 *	B01J 20/02 (2006.01) B01J 20/04 (2006.01) B01J 20/20 (2006.01) B01J 20/28 (2006.01) B01J 20/32 (2006.01) C02F 1/28 (2006.01) C02F 101/00 (2006.01) G21F 9/12 (2006.01)	2734497 *	A61K 31/166 (2006.01) A61K 31/167 (2006.01) A61K 31/192 (2006.01) A61K 31/205 (2006.01) A61K 31/235 (2006.01) A61P 29/00 (2006.01) C07C 65/19 (2006.01) C07C 69/76 (2006.01) C07C 229/08 (2006.01) C07C 235/42 (2006.01)
2706042	C02F 1/467 (2006.01) C02F 1/72 (2006.01)	2729755 *	F41J 3/02 (2006.01)	2726620 *	A01H 5/00 (2006.01) C12N 15/82 (2006.01)
2734690 *	A01G 17/06 (2006.01) E04H 12/20 (2006.01)	2744494 *	A61K 31/4196 (2006.01) A61K 31/513 (2006.01) A61K 31/519 (2006.01) A61K 31/7068 (2006.01) A61K 45/06 (2006.01) A61P 35/00 (2006.01) A61P 35/02 (2006.01)	2763540 *	A01N 63/00 (2006.01)
2768830 *	C07D 417/14 (2006.01)	2749418	A61P 35/00 (2006.01) A61P 35/02 (2006.01)	2749418	B41F 33/00 (2006.01) G06K 19/06 (2006.01)
2763979 *	A61K 31/444 (2006.01) A61K 31/506 (2006.01) A61P 25/28 (2006.01) C07D 401/10 (2006.01) C07D 401/14 (2006.01) C07D 405/14 (2006.01) C07D 413/10 (2006.01) C07D 413/14 (2006.01) C07D 417/14 (2006.01) C07D 498/08 (2006.01)	2737163 *	E21B 23/00 (2006.01) E21B 33/122 (2006.01) E21B 34/14 (2006.01) E21B 34/16 (2006.01)	2662094	A61K 47/48 (2006.01) A61P 35/00 (2006.01)
2761100 *	B65D 90/10 (2006.01) E02D 29/14 (2006.01) E03F 5/02 (2006.01)	2768832 *	A61K 31/519 (2006.01) A61P 3/00 (2006.01) A61P 9/00 (2006.01) C07D 487/04 (2006.01)	2684964	C12Q 1/68 (2006.01)
				2729169 *	A61K 39/155 (2006.01) B82Y 99/00 (2011.01)
				2685111	F16B 7/04 (2006.01)
				2732025 *	C10L 1/10 (2006.01) C11B 1/00 (2006.01) C12N 1/12 (2006.01)
				2718145 *	B60N 2/42 (2006.01) B60N 2/48 (2006.01)
				2742274 *	F17C 11/00 (2006.01)

Broj objave evropske prijave patenta (97)	MKP (51)	Broj objave evropske prijave patenta (97)	MKP (51)	Broj objave evropske prijave patenta (97)	MKP (51)
2715722 *	G10L 21/02 (2013.01)	2742602 *	H04B 3/54 (2006.01) H05B 37/02 (2006.01)	2714712 *	A61K 31/565 (2006.01) A61P 15/12 (2006.01) C07J 75/00 (2006.01)
2709600 *	A61K 9/48 (2006.01) A61K 31/4545 (2006.01) A61K 47/10 (2006.01)	2682394	A61K 31/519 (2006.01) A61K 31/522 (2006.01) A61P 9/00 (2006.01) C07D 487/04 (2006.01)	2760285 *	A01N 43/54 (2006.01)
2664363	A63B 21/068 (2006.01) A63B 22/00 (2006.01) A63B 22/20 (2006.01) A63B 23/04 (2006.01)	2762138 *	A61K 31/4015 (2006.01) A61P 3/04 (2006.01) A61P 7/10 (2006.01) A61P 9/00 (2006.01) A61P 25/00 (2006.01) A61P 37/02 (2006.01) A61P 39/06 (2006.01) A61P 43/00 (2006.01) C07D 201/00 (2006.01) C07D 201/16 (2006.01) C07D 201/18 (2006.01)	2742231 *	F02M 59/02 (2006.01) F02M 59/44 (2006.01) F04B 1/04 (2006.01)
2676604	A61B 5/0472 (2006.01)			2631358	D06F 95/00 (2006.01)
2731625 *	A61K 39/395 (2006.01) G01N 33/574 (2006.01)			2662386	A61K 39/00 (2006.01) C07K 16/18 (2006.01)
2751621 *	G03H 1/04 (2006.01)			2517646	A61B 17/072 (2006.01)
2749048 *	H04L 12/46 (2006.01) H04L 29/08 (2006.01) H04W 4/02 (2009.01) H04W 4/20 (2009.01) H04W 8/06 (2009.01) H04W 12/00 (2009.01) H04W 48/16 (2009.01) H04W 64/00 (2009.01) H04W 80/08 (2009.01)	2723868 *	C12N 9/02 (2006.01) C12N 9/04 (2006.01) C12N 15/52 (2006.01) C12N 15/81 (2006.01) C12P 33/00 (2006.01)	2638799	A01K 31/04 (2006.01)
		2764164 *	B65G 5/00 (2006.01) E02D 17/00 (2006.01) E21B 21/01 (2006.01)	2760475 *	A61K 47/48 (2006.01) C07K 14/50 (2006.01)
2737565 *	H01M 4/52 (2010.01)			2723164 *	A01H 1/08 (2006.01) A01H 5/10 (2006.01)
2723389 *	A61K 47/48 (2006.01) A61P 35/00 (2006.01)	2766448 *	C09K 8/60 (2006.01) C11D 3/382 (2006.01)	2662065	A61J 1/14 (2006.01) A61J 1/16 (2006.01) B65B 21/00 (2006.01) B65D 77/04 (2006.01)
2714739 *	C07K 16/28 (2006.01)			2723926 *	D01F 6/00 (2006.01)
2704712 *	A61K 31/422 (2006.01)	2761885 *	H04N 21/431 (2011.01)	2726094 *	A61K 39/00 (2006.01)
		2756001 *	C07K 16/28 (2006.01)	2753592 *	B29C 33/38 (2006.01) C04B 28/00 (2006.01)

Broj objave evropske prijave patenta (97)	MKP (51)	Broj objave evropske prijave patenta (97)	MKP (51)	Broj objave evropske prijave patenta (97)	MKP (51)
2682424	C08L 23/04 (2006.01) C08L 23/10 (2006.01)	2717713 *	A23K 1/16 (2006.01) A23K 1/175 (2006.01) A23L 1/304 (2006.01) A23L 1/305 (2006.01)	2723330 *	A61K 31/137 (2006.01) A61K 31/164 (2006.01) A61K 31/4174 (2006.01) A61K 31/4178 (2006.01) A61K 31/505 (2006.01)
2755641 *	A61K 9/24 (2006.01)	2755970 *	A61K 31/427 (2006.01) A61P 9/06 (2006.01) A61P 9/10 (2006.01) C07D 417/12 (2006.01) C07D 417/14 (2006.01) C07D 471/04 (2006.01) C07D 487/04 (2006.01)		A61K 31/573 (2006.01) A61K 31/592 (2006.01) A61K 31/593 (2006.01) A61K 31/728 (2006.01) A61K 45/06 (2006.01) A61P 11/02 (2006.01) A61P 27/02 (2006.01)
2726088 *	A61K 31/17 (2006.01) A61K 31/435 (2006.01) A61K 38/00 (2006.01) A61K 39/00 (2006.01) G01N 33/50 (2006.01) G01N 33/574 (2006.01)	2748357 *	C40B 50/14 (2006.01) C40B 50/16 (2006.01)	2705023 *	C07C 231/00 (2006.01)
2337132	H01M 8/02 (2006.01) H01M 8/24 (2006.01)	2644189	A61K 9/00 (2006.01) A61K 47/10 (2006.01)	2766395 *	A61K 39/395 (2006.01) C07K 16/28 (2006.01)
2710006 *	A61K 31/4985 (2006.01) A61P 29/00 (2006.01) C07D 487/04 (2006.01)	2763539 *	A01N 57/00 (2006.01)	2757296	E21B 7/30 (2006.01) F16L 1/036 (2006.01) F16L 55/165 (2006.01)
2739740 *	A01K 67/027 (2006.01) C07K 16/46 (2006.01) C12N 9/64 (2006.01) C12N 15/85 (2006.01)	2670492 *	A62B 35/00 (2006.01) A62B 35/04 (2006.01)	2726417 *	C02F 3/00 (2006.01) C02F 3/22 (2006.01) C02F 3/26 (2006.01) C02F 3/30 (2006.01)
2524659	A61B 17/115 (2006.01)	2693604	H01F 27/245 (2006.01) H01F 27/26 (2006.01) H02K 1/12 (2006.01) H02K 1/14 (2006.01) H02K 1/22 (2006.01) H02K 15/02 (2006.01)		
2718327 *	C07K 16/30 (2006.01)	2725908 *	A01N 47/00 (2006.01)		
2714968 *	C30B 11/00 (2006.01) C30B 13/00 (2006.01) C30B 13/10 (2006.01) C30B 29/28 (2006.01)				
2530799	H02G 9/02 (2006.01) H02G 15/04 (2006.01)				

Broj objave evropske prijave patenta (97)	MKP (51)	Broj objave evropske prijave patenta (97)	MKP (51)	Broj objave evropske prijave patenta (97)	MKP (51)
2716642 *	A61K 31/437 (2006.01) A61K 31/439 (2006.01) A61K 31/444 (2006.01) A61K 31/4545 (2006.01) A61K 31/496 (2006.01) A61K 31/497 (2006.01) A61K 31/501 (2006.01) A61K 31/506 (2006.01) A61K 31/53 (2006.01) A61K 31/5377 (2006.01) A61K 31/541 (2006.01) A61P 7/02 (2006.01) A61P 9/00 (2006.01) A61P 9/04 (2006.01) A61P 9/10 (2006.01) A61P 9/12 (2006.01) A61P 15/10 (2006.01) A61P 43/00 (2006.01) C07D 471/04 (2006.01) C07D 519/00 (2006.01)	2517644	A61B 17/072 (2006.01)	2737311 *	A61K 38/36 (2006.01) C07K 14/745 (2006.01) G01N 33/48 (2006.01)
		2482823 *	A61K 31/7034 (2006.01) A61K 31/7048 (2006.01) A61K 31/7056 (2006.01) A61K 31/706 (2006.01) A61P 19/10 (2006.01)	2768807 *	C07D 209/88 (2006.01)
		2768859 *	A61P 11/00 (2006.01) A61P 19/02 (2006.01) A61P 29/00 (2006.01) C07K 16/24 (2006.01)	2634347	E06B 3/54 (2006.01)
		2732042 *	C12P 7/56 (2006.01) C12P 41/00 (2006.01)	2707331 *	B01D 29/11 (2006.01) B01D 29/15 (2006.01) B01D 29/21 (2006.01) B01D 29/52 (2006.01) B01D 29/58 (2006.01) B01D 29/90 (2006.01) B01D 35/04 (2006.01) B01D 35/30 (2006.01) C02F 1/00 (2006.01) C02F 1/28 (2006.01) C02F 1/42 (2006.01) C02F 9/00 (2006.01)
		2704560 *	A01N 1/02 (2006.01) A61B 19/00 (2006.01) A61M 16/00 (2006.01)		
		2755729 *	B01D 3/00 (2006.01)	2704721 *	A61K 31/4965 (2006.01) A61K 31/497 (2006.01) A61P 7/06 (2006.01)
2705028 *	C07D 303/36 (2006.01) C07D 413/10 (2006.01) C07D 413/14 (2006.01)	2768820 *	A61K 31/337 (2006.01) A61P 35/00 (2006.01) C07D 305/14 (2006.01)	2763689 *	A61K 38/18 (2006.01) C07K 14/50 (2006.01)
2647826	F02M 63/00 (2006.01)	2701724 *	A61K 31/4745 (2006.01) A61K 31/505 (2006.01) A61K 31/519 (2006.01) A61K 38/17 (2006.01) A61P 35/00 (2006.01)	2737294 *	G01N 1/28 (2006.01) G01N 1/38 (2006.01) G01N 1/44 (2006.01)
2714164 *	A61M 15/00 (2006.01)	2767140 *	H05B 3/06 (2006.01) H05B 3/34 (2006.01)	2704778 *	A61M 5/315 (2006.01)
2769218 *	G01N 33/542 (2006.01) G01N 33/569 (2006.01) G01N 33/58 (2006.01)	2764003 *	C07F 9/6593 (2006.01)	2761238 *	F25C 3/04 (2006.01)
2702994	A61K 31/4412 (2006.01) A61K 31/496 (2006.01)			2667116	F25B 9/00 (2006.01)

Broj objave evropske prijave patenta (97)	MKP (51)	Broj objave evropske prijave patenta (97)	MKP (51)	Broj objave evropske prijave patenta (97)	MKP (51)
2729809 *	C12Q 1/42 (2006.01) G01N 33/558 (2006.01) G01N 33/573 (2006.01)	2756840 *	A61J 3/02 (2006.01) A61K 9/14 (2006.01) A61K 9/72 (2006.01) A61K 31/4418 (2006.01) A61K 47/10 (2006.01) A61K 47/26 (2006.01) A61K 47/30 (2006.01) A61P 11/00 (2006.01)	2747791 *	A61F 13/02 (2006.01) A61L 15/24 (2006.01) A61L 15/32 (2006.01) A61L 15/58 (2006.01) A61L 15/62 (2006.01) A61L 15/64 (2006.01) A61L 24/06 (2006.01) A61L 26/00 (2006.01)
2758073 *	A61K 39/00 (2006.01) C07K 16/00 (2006.01) C12P 21/08 (2006.01)	2720987 *	C03C 25/32 (2006.01) C08K 3/30 (2006.01) C08K 5/092 (2006.01) C08K 5/42 (2006.01) C08K 5/43 (2006.01) C08K 7/14 (2006.01) C08L 3/00 (2006.01) C08L 5/00 (2006.01) C08L 5/02 (2006.01) C09J 11/06 (2006.01) C09J 103/00 (2006.01) C09J 103/02 (2006.01) C09J 105/00 (2006.01) D04H 1/4218 (2012.01) D04H 1/64 (2012.01)	2751279 *	C12Q 1/34 (2006.01) G01N 33/574 (2006.01)
2685253	F16H 1/22 (2006.01) F16L 55/40 (2006.01) G01N 27/82 (2006.01)	2726600 *	C07K 16/00 (2006.01) C12N 5/00 (2006.01) C12N 5/10 (2006.01) C12P 21/00 (2006.01)	2748197 *	C07K 16/28 (2006.01) C07K 16/46 (2006.01)
2716715 *	C08K 3/00 (2006.01) C08K 7/04 (2006.01) C08L 77/00 (2006.01)	2764973	C08K 3/00 (2006.01) C08L 5/00 (2006.01) C08L 5/02 (2006.01) C09J 11/06 (2006.01) C09J 103/00 (2006.01) C09J 103/02 (2006.01) C09J 105/00 (2006.01) D04H 1/4218 (2012.01) D04H 1/64 (2012.01)	2742055 *	B29C 33/00 (2006.01) B29C 44/44 (2006.01) B29C 44/58 (2006.01)
2739627 *	A61K 31/519 (2006.01) A61P 9/10 (2006.01) A61P 25/28 (2006.01) C07D 487/04 (2006.01)	2720692 *	A61K 31/277 (2006.01) A61K 31/4406 (2006.01) A61P 25/00 (2006.01) A61P 25/16 (2006.01) A61P 25/28 (2006.01)	2742055 *	C07D 493/02 (2006.01) C07H 13/00 (2006.01) C07H 13/02 (2006.01) C08F 24/00 (2006.01) C08F 36/14 (2006.01) C08F 224/00 (2006.01) C08F 236/14 (2006.01)
2727931 *	A61K 38/04 (2006.01) C07K 5/08 (2006.01) C07K 5/10 (2006.01) C07K 7/06 (2006.01)	2620632	A61K 31/277 (2006.01) A61K 31/4406 (2006.01) A61P 25/00 (2006.01) A61P 25/16 (2006.01) A61P 25/28 (2006.01)	2704703 *	F02M 47/02 (2006.01) F02M 61/12 (2006.01) F02M 61/16 (2006.01)
2761318 *	G01R 33/12 (2006.01) G01R 33/14 (2006.01) H01F 29/08 (2006.01)				A61K 9/127 (2006.01) A61K 31/192 (2006.01)

Broj objave evropske prijave patenta (97)	MKP (51)	Broj objave evropske prijave patenta (97)	MKP (51)	Broj objave evropske prijave patenta (97)	MKP (51)
2738191 *	C08F 220/06 (2006.01) C08F 220/18 (2006.01) C08F 220/34 (2006.01) C08F 220/56 (2006.01) C08F 220/58 (2006.01) C08F 226/02 (2006.01) C08F 232/04 (2006.01) C09K 8/588 (2006.01)	2703392 *	A61K 31/421 (2006.01) A61K 31/4245 (2006.01) A61K 31/426 (2006.01) A61K 31/433 (2006.01) A61K 31/4439 (2006.01) A61P 3/04 (2006.01) A61P 3/06 (2006.01) A61P 3/10 (2006.01) A61P 9/04 (2006.01) A61P 9/10 (2006.01) A61P 9/12 (2006.01) A61P 15/00 (2006.01) A61P 25/08 (2006.01) A61P 25/20 (2006.01) A61P 25/24 (2006.01) A61P 43/00 (2006.01) C07D 263/48 (2006.01) C07D 271/06 (2006.01)	2760858 *	A61K 31/7072 (2006.01) A61P 25/04 (2006.01) A61P 25/28 (2006.01) C07D 405/04 (2006.01) C07D 405/14 (2006.01) C07D 413/14 (2006.01) C07F 9/09 (2006.01)
2758399 *	A61K 31/4985 (2006.01) A61P 19/02 (2006.01) C07D 487/04 (2006.01)			2714710 *	A61K 31/565 (2006.01) A61P 5/30 (2006.01) C07J 1/00 (2006.01) C07J 13/00 (2006.01) C07J 51/00 (2006.01)
2409853	B42F 7/04 (2006.01) B43L 5/00 (2006.01)			2739799 *	E04B 2/18 (2006.01) E04B 2/24 (2006.01) E04B 2/86 (2006.01) E04B 5/19 (2006.01) E04B 5/21 (2006.01) E04B 5/38 (2006.01) E04C 2/288 (2006.01)
2674413	C07C 67/29 (2006.01) C07C 69/18 (2006.01) C07F 7/18 (2006.01) C12P 41/00 (2006.01)				
2721280 *	B01J 29/00 (2006.01) C07C 1/24 (2006.01) F02M 27/02 (2006.01)	2717868 *	A61K 31/138 (2006.01) A61K 31/439 (2006.01) A61K 31/58 (2006.01) A61K 45/06 (2006.01) A61P 11/06 (2006.01) A61P 11/08 (2006.01)	2702413 *	A01K 67/027 (2006.01) G01N 33/92 (2006.01)
		2709599 *	A61K 9/48 (2006.01) A61K 31/47 (2006.01) A61K 31/485 (2006.01)	2703478 *	A61K 8/36 (2006.01) A61K 8/42 (2006.01) A61Q 5/02 (2006.01) A61Q 19/10 (2006.01) C11D 1/04 (2006.01) C11D 1/10 (2006.01) C11D 3/33 (2006.01)
		2741783 *	A61K 47/48 (2006.01) A61K 48/00 (2006.01)	2650881	G11C 27/02 (2006.01)
		2766025 *	A61K 31/728 (2006.01) A61K 31/737 (2006.01) A61K 36/02 (2006.01)	2723475 *	B01D 53/62 (2006.01)

Broj objave evropske prijave patenta (97)	MKP (51)	Broj objave evropske prijave patenta (97)	MKP (51)	Broj objave evropske prijave patenta (97)	MKP (51)
2763685 *	A61K 35/74 (2006.01) A61P 1/00 (2006.01) A61P 37/00 (2006.01)	2740784	C09K 5/04 (2006.01) C10M 105/18 (2006.01) C10M 107/24 (2006.01) C10M 107/34 (2006.01) C10M 129/18 (2006.01) C10M 133/04 (2006.01) C10M 137/08 (2006.01) C10M 169/04 (2006.01) C10M 171/00 (2006.01) C10N 30/06 (2006.01) C10N 30/08 (2006.01) C10N 30/10 (2006.01) C10N 40/30 (2006.01)	2718173 *	B62J 99/00 (2009.01) B62K 21/02 (2006.01) B62K 21/06 (2006.01) B62K 21/18 (2006.01)
2517645	A61B 17/072 (2006.01)			2707663 *	C10B 47/24 (2006.01) C10J 3/50 (2006.01) C10J 3/54 (2006.01) F02C 3/28 (2006.01) F26B 3/10 (2006.01)
2734573 *	A61K 9/16 (2006.01) C08G 81/00 (2006.01) C08L 87/00 (2006.01)			2714038 *	A61K 31/4196 (2006.01) A61K 31/675 (2006.01) A61K 45/06 (2006.01) A61P 35/00 (2006.01)
2705030 *	A61K 31/335 (2006.01) A61K 31/352 (2006.01) A61K 31/397 (2006.01) A61K 31/4025 (2006.01) A61K 31/4355 (2006.01) A61P 3/04 (2006.01) C07D 311/94 (2006.01) C07D 405/02 (2006.01) C07D 491/048 (2006.01) C07D 493/04 (2006.01)	2751094 *	A61K 31/4545 (2006.01) A61P 25/28 (2006.01) C07D 401/12 (2006.01)	2647306	A45C 11/00 (2006.01)
		2639444	F02M 59/06 (2006.01) F02M 59/10 (2006.01) F04B 1/04 (2006.01)	2729143 *	A61K 31/4188 (2006.01) A61P 25/00 (2006.01)
2662382	A61K 31/575 (2006.01) A61P 35/00 (2006.01) C07J 9/00 (2006.01) C07J 41/00 (2006.01) C07J 75/00 (2006.01)	2720680 *	A61K 9/00 (2006.01) A61K 9/127 (2006.01) A61K 47/24 (2006.01)	2726100 *	A61K 39/395 (2006.01)
		2736925 *	C07K 16/22 (2006.01)	2705117 *	C10B 53/07 (2006.01) C10G 1/10 (2006.01)
		2729110 *	A61J 1/14 (2006.01) A61J 3/00 (2006.01) B65D 81/32 (2006.01)	2718512 *	E04B 2/74 (2006.01) F21V 33/00 (2006.01) G02B 6/00 (2006.01)
		2744185	H04L 12/18 (2006.01) H04M 3/42 (2006.01)	2740110 *	G08B 13/14 (2006.01) G08B 29/04 (2006.01)
				2734124 *	A61B 17/04 (2006.01) A61B 17/06 (2006.01)
				2660408	E04C 2/34 (2006.01)

Broj objave evropske prijave patenta (97)	MKP (51)	Broj objave evropske prijave patenta (97)	MKP (51)	Broj objave evropske prijave patenta (97)	MKP (51)
2707015 *	A61K 31/155 (2006.01) A61K 38/26 (2006.01) A61K 38/28 (2006.01) A61P 3/04 (2006.01) A61P 3/10 (2006.01)	2768822 *	A61K 31/437 (2006.01) A61K 31/4439 (2006.01) A61K 31/498 (2006.01) A61K 31/502 (2006.01) A61K 31/517 (2006.01) A61K 31/522 (2006.01) C07D 401/12 (2006.01) C07D 401/14 (2006.01) C07D 409/14 (2006.01) C07D 413/12 (2006.01) C07D 413/14 (2006.01) C07D 417/12 (2006.01) C07D 417/14 (2006.01) C07D 471/04 (2006.01) C07D 473/04 (2006.01)	2701686 *	A61K 9/16 (2006.01) A61K 38/17 (2006.01) A61K 47/30 (2006.01) A61K 47/48 (2006.01) A61K 48/00 (2006.01)
2752229 *	B01D 33/15 (2006.01) B01D 33/39 (2006.01) B01D 33/74 (2006.01)			2704722 *	A61K 31/506 (2006.01) A61P 35/00 (2006.01)
2748776 *	G06Q 10/00 (2012.01)			2702173 *	C12Q 1/68 (2006.01)
2739190 *	A47J 31/00 (2006.01) A47J 43/27 (2006.01) B65B 3/04 (2006.01) F24H 1/18 (2006.01)			2763574 *	A47J 31/40 (2006.01) A47J 31/42 (2006.01)
2721022 *	A01N 43/34 (2006.01) A01N 43/713 (2006.01) A01P 3/00 (2006.01) C07D 401/06 (2006.01) C07D 401/14 (2006.01)	2731646 *	A61M 5/24 (2006.01) A61M 5/315 (2006.01)	2739549 *	B26F 1/00 (2006.01) B31F 1/20 (2006.01) B32B 3/00 (2006.01) B32B 33/00 (2006.01) B32B 38/04 (2006.01) B65D 81/24 (2006.01)
2707025 *	A61K 39/155 (2006.01)	2710034 *	A61K 47/48 (2006.01) C07K 16/28 (2006.01)		
2763989 *	A61K 31/4985 (2006.01) A61P 25/00 (2006.01) C07D 471/14 (2006.01)	2768509 *	A61K 31/535 (2006.01)	2736737 *	B60C 3/00 (2006.01) B60C 13/00 (2006.01)
2713734 *	A01N 43/54 (2006.01) A01N 43/56 (2006.01) A01N 43/653 (2006.01) A01N 43/80 (2006.01) A01P 3/00 (2006.01)	2744504 *	A61K 36/185 (2006.01) A61K 36/515 (2006.01) A61K 36/70 (2006.01) A61K 36/85 (2006.01) A61P 11/12 (2006.01) A61P 31/00 (2006.01)	2662813	G06Q 10/08 (2012.01)
				2761250 *	G01B 21/22 (2006.01)
				2736361 *	A41B 13/06 (2006.01) A41D 13/12 (2006.01) A47D 15/00 (2006.01) A47G 9/08 (2006.01)

Broj objave evropske prijave patenta (97)	MKP (51)	Broj objave evropske prijave patenta (97)	MKP (51)	Broj objave evropske prijave patenta (97)	MKP (51)
2710003 *	A61K 31/437 (2006.01) A61K 31/4985 (2006.01) A61P 35/00 (2006.01) C07D 471/04 (2006.01) C07D 487/04 (2006.01)	2742045 *	A61K 31/4375 (2006.01) A61P 31/04 (2006.01) C07D 471/04 (2006.01) C07D 487/04 (2006.01)	2707130 *	B01J 19/00 (2006.01) B01J 20/00 (2006.01) B01J 21/00 (2006.01) B01J 23/00 (2006.01) C01B 3/16 (2006.01) C01B 3/18 (2006.01) C01B 3/24 (2006.01) C01B 31/20 (2006.01)
2707366 *	A61K 31/70 (2006.01) C07D 409/10 (2006.01) C07H 7/04 (2006.01)	2712425 *	A61B 5/00 (2006.01) G01N 33/68 (2006.01)	2764296 *	F24F 3/14 (2006.01) F24F 11/00 (2006.01)
2723305 *	A61K 8/04 (2006.01)	2701690 *	A61K 31/00 (2006.01) A61K 31/519 (2006.01) A61P 35/02 (2006.01)	2755638 *	A61K 9/16 (2006.01) A61K 9/20 (2006.01) A61K 9/28 (2006.01) A61K 9/48 (2006.01) A61K 9/50 (2006.01) A61K 31/485 (2006.01)
2623690	E04H 3/12 (2006.01)	2753621 *	C07D 487/04 (2006.01) C07D 491/10 (2006.01)	2709447 *	A01N 25/00 (2006.01) A61K 9/72 (2006.01) A61L 9/02 (2006.01)
2701741 *	A61K 39/395 (2006.01) A61P 35/02 (2006.01) C07K 16/28 (2006.01)	2707151 *	B05D 1/42 (2006.01) B41J 2/01 (2006.01) G09F 19/22 (2006.01)	2702415 *	G01D 5/34 (2006.01) G01P 1/02 (2006.01) G01P 15/08 (2006.01) G01P 15/093 (2006.01)
2702997 *	A61K 9/08 (2006.01) A61K 9/127 (2006.01) A61K 9/70 (2006.01) A61K 31/7048 (2006.01) A61K 31/724 (2006.01) A61K 38/17 (2006.01) A61K 39/395 (2006.01) A61P 35/00 (2006.01) A61P 43/00 (2006.01)	2736459 *	A61F 2/95 (2013.01)	2708163 *	A47F 5/08 (2006.01)
2727568	A61G 5/02 (2006.01) A61G 5/10 (2006.01)	2749679	D04H 1/435 (2012.01)	2704822 *	B01J 19/12 (2006.01) C02F 1/48 (2006.01)
2701605 *	A61B 6/00 (2006.01) A61N 5/00 (2006.01)	2720698 *	A61K 31/496 (2006.01) A61P 25/18 (2006.01)		
		2706049	C04B 35/472 (2006.01) H01L 21/02 (2006.01)		
		2714744 *	C07K 16/40 (2006.01)		
		2755944 *	C07C 217/84 (2006.01)		
		2734204 *	A61K 31/4409 (2006.01)		
		2710807 *	H04N 21/472 (2011.01)		

Broj objave evropske prijave patenta (97)	MKP (51)	Broj objave evropske prijave patenta (97)	MKP (51)	Broj objave evropske prijave patenta (97)	MKP (51)
2760845 *	C07D 265/06 (2006.01) C07D 413/04 (2006.01) C07D 413/10 (2006.01) C07D 413/12 (2006.01) C07D 417/04 (2006.01)	2768537 *	A61K 9/14 (2006.01) A61K 9/16 (2006.01) A61K 9/20 (2006.01) A61K 31/485 (2006.01) A61K 47/32 (2006.01)	2718722 *	G01N 33/569 (2006.01) G01N 33/68 (2006.01)
2765869 *	A23L 1/29 (2006.01) A23L 1/30 (2006.01) A23L 1/32 (2006.01) A61K 35/00 (2006.01)	2766313 *	C02F 3/12 (2006.01) C02F 3/30 (2006.01)	2713972 *	A61F 13/02 (2006.01)
2726059 *	A61K 9/00 (2006.01) A61K 31/4412 (2006.01) A61K 47/02 (2006.01) A61K 47/06 (2006.01) A61K 47/14 (2006.01) A61K 47/26 (2006.01) A61K 47/38 (2006.01)	2763552 *	A23G 9/38 (2006.01) A23J 3/14 (2006.01) A23L 1/00 (2006.01) A23L 1/035 (2006.01) A23L 1/19 (2006.01)	2714411 *	B41J 2/315 (2006.01) B41J 2/475 (2006.01) B41M 3/00 (2006.01) B41M 3/06 (2006.01) B41M 3/14 (2006.01) C08J 3/24 (2006.01) G02B 1/02 (2006.01)
2704706 *	A61K 31/33 (2006.01)	2726460 *	A61K 31/4418 (2006.01) A61P 25/30 (2006.01) A61P 25/32 (2006.01) A61P 25/34 (2006.01) A61P 25/36 (2006.01) C07D 213/64 (2006.01)	2747569 *	A01N 37/18 (2006.01) A01N 43/38 (2006.01) A61K 31/40 (2006.01) A61P 1/16 (2006.01)
2295859	F23C 9/08 (2006.01) F23H 17/00 (2006.01) F23H 17/08 (2006.01) F23L 7/00 (2006.01) F23L 9/06 (2006.01) F23M 5/08 (2006.01)	2715401 *	G01S 19/09 (2010.01) G01S 19/46 (2010.01)	2739379 *	A47G 23/00 (2006.01) B01F 3/04 (2006.01)
2763682 *	A61K 31/70 (2006.01)	2733145	C07D 491/20 (2006.01)	2766560 *	E21B 23/10 (2006.01) E21B 34/14 (2006.01)
2518213	E01F 9/03 (2006.01)	2732020 *	A61L 2/00 (2006.01) C12M 1/00 (2006.01) C12M 1/12 (2006.01) C12N 5/00 (2006.01)	2706467	G06F 17/30 (2006.01)
		2748612 *	G01N 33/68 (2006.01)	2761309 *	G01R 15/18 (2006.01)
		2742132 *	C12N 15/09 (2006.01)	2721039 *	C07B 59/00 (2006.01) C07F 9/24 (2006.01) C07F 9/6515 (2006.01) C07F 9/6524 (2006.01) C07F 9/6527 (2006.01) C07F 9/6558 (2006.01) C07F 9/6561 (2006.01)

Broj objave evropske prijave patenta (97)	MKP (51)	Broj objave evropske prijave patenta (97)	MKP (51)	Broj objave evropske prijave patenta (97)	MKP (51)
2755979 *	A61K 31/4365 (2006.01) C07D 495/04 (2006.01)	2753364 *	A61K 48/00 (2006.01) C07H 21/04 (2006.01)	2632494 *	C07H 21/00 (2006.01) C07K 14/00 (2006.01) G01N 33/48 (2006.01)
2754159 *	H01F 7/16 (2006.01) H02K 33/16 (2006.01)	2692346	A61K 31/454 (2006.01) A61P 31/14 (2006.01)	2718519 *	E04H 12/08 (2006.01) F03D 11/04 (2006.01)
2707370 *	A61K 31/5513 (2006.01) C07D 487/04 (2006.01)	2641497	A43B 21/08 (2006.01) A43B 23/02 (2006.01) A43D 8/00 (2006.01) A43D 11/00 (2006.01)	2713754 *	A01N 37/50 (2006.01) A01N 43/16 (2006.01) A01N 43/40 (2006.01) A01N 43/50 (2006.01) A01N 43/56 (2006.01) A01N 43/76 (2006.01) A01N 43/88 (2006.01) A01N 47/24 (2006.01) A01P 3/00 (2006.01)
2642275	E04F 15/22 (2006.01) G01N 3/30 (2006.01) G01N 3/42 (2006.01) G01N 3/48 (2006.01)	2650558	E01F 7/04 (2006.01) F16F 7/12 (2006.01)		
2404857	B65H 75/36 (2006.01) H02G 1/06 (2006.01)	2731676 *	A61K 31/42 (2006.01) A61P 1/16 (2006.01) A61P 3/10 (2006.01) A61P 35/00 (2006.01) C07D 261/08 (2006.01) C07D 413/12 (2006.01) C07D 413/14 (2006.01)	2720710 *	A61K 38/18 (2006.01)
2707390 *	A61K 39/395 (2006.01) C07K 16/30 (2006.01)			2704687 *	A61K 9/00 (2006.01) A61K 9/12 (2006.01) A61K 31/573 (2006.01) A61K 47/10 (2006.01) A61K 47/18 (2006.01) A61K 47/26 (2006.01) A61K 47/36 (2006.01)
2757875 *	A01K 67/027 (2006.01) C07K 16/46 (2006.01) C12N 15/85 (2006.01)	2719288	A23L 1/30 (2006.01) A61K 45/00 (2006.01)		
2715487 *	G06F 3/01 (2006.01) G06F 3/033 (2013.01)	2714070 *	A61K 38/26 (2006.01) A61P 3/10 (2006.01) A61P 7/12 (2006.01) C07K 14/605 (2006.01)		
2421534 *	A61K 9/08 (2006.01) A61K 31/495 (2006.01) A61P 25/00 (2006.01) A61P 25/22 (2006.01) A61P 25/24 (2006.01) A61P 25/28 (2006.01)	2751894 *	H02J 1/08 (2006.01)	2761571 *	G06Q 50/10 (2012.01) H04W 4/02 (2009.01)
		2707354 *	A61K 31/21 (2006.01) A61P 9/08 (2006.01) C07C 203/04 (2006.01) C07C 203/08 (2006.01)	2704398	H04L 29/08 (2006.01)
2753357 *	A61K 39/395 (2006.01) G01N 33/574 (2006.01) G01N 33/68 (2006.01)			2731880 *	B65D 5/32 (2006.01)

Broj objave evropske prijava patenta (97)	MKP (51)	Broj objave evropske prijava patenta (97)	MKP (51)	Broj objave evropske prijava patenta (97)	MKP (51)
2709620 *	A61K 31/4523 (2006.01) A61K 31/4725 (2006.01) A61K 31/496 (2006.01) A61K 31/5377 (2006.01) A61P 25/02 (2006.01)	2685697	G06F 9/50 (2006.01) H04L 29/08 (2006.01) H04W 4/00 (2009.01)	2730261	A61F 13/15 (2006.01) A61F 13/532 (2006.01) B32B 3/26 (2006.01) B32B 5/02 (2006.01) B32B 5/04 (2006.01) B32B 5/26 (2006.01) B32B 7/12 (2006.01)
2758401 *	A61K 31/5025 (2006.01) A61P 35/00 (2006.01) C07D 487/04 (2006.01)	2736920 *	A61K 38/05 (2006.01) A61P 35/00 (2006.01) A61P 35/02 (2006.01) C07D 401/04 (2006.01) C07K 5/06 (2006.01)	2718625 *	E04B 2/74 (2006.01) F21V 3/00 (2006.01) F21V 17/00 (2006.01) F21V 33/00 (2006.01) G02B 6/00 (2006.01)
2731663 *	A61M 39/10 (2006.01) A61M 39/24 (2006.01) A61M 39/26 (2006.01)	2760841 *	A61K 31/422 (2006.01) A61P 35/00 (2006.01) C07C 229/40 (2006.01) C07D 231/14 (2006.01) C07D 471/04 (2006.01)	2758379 *	A61K 31/53 (2006.01) A61P 35/00 (2006.01) A61P 37/02 (2006.01) A61P 37/04 (2006.01) A61P 37/06 (2006.01) A61P 37/08 (2006.01) C07D 251/22 (2006.01) C07D 401/12 (2006.01) C07D 407/12 (2006.01) C07D 413/04 (2006.01)
2721181 *	C12N 15/11 (2006.01) C12Q 1/68 (2006.01)	2266448	A47K 10/36 (2006.01)		
2704717 *	A61K 31/47 (2006.01) A61P 35/00 (2006.01)	2639376	E04B 2/74 (2006.01) E04H 17/00 (2006.01)		
2756004 *	A61P 3/06 (2006.01) C07K 16/40 (2006.01)	2761116 *	E05D 7/04 (2006.01)		
2718088 *	B29C 45/16 (2006.01) B29C 45/18 (2006.01) B29C 49/00 (2006.01) B29C 49/22 (2006.01) B65D 81/24 (2006.01) B65D 81/26 (2006.01) B65D 81/30 (2006.01)	2721447 *	G03F 7/20 (2006.01)		
		2623174	B01D 17/02 (2006.01) C02F 1/40 (2006.01)	2706986 *	A61K 9/00 (2006.01) A61K 31/485 (2006.01)
		2705035 *	A61K 31/5383 (2006.01) A61P 3/04 (2006.01) C07D 471/04 (2006.01) C07D 498/04 (2006.01)	2769089 *	F03D 3/02 (2006.01) F03D 11/00 (2006.01)
2748583 *	B01L 3/00 (2006.01) B01L 9/00 (2006.01) G01N 21/03 (2006.01)	2723615 *	B60R 21/34 (2011.01) B60T 7/12 (2006.01)	2699602 *	A61K 39/395 (2006.01) A61P 35/00 (2006.01) C07H 21/04 (2006.01) C07K 16/28 (2006.01)

Broj objave evropske prijave patenta (97)	MKP (51)	Broj objave evropske prijave patenta (97)	MKP (51)	Broj objave evropske prijave patenta (97)	MKP (51)
2768585 *	A41D 13/00 (2006.01) A42B 1/04 (2006.01) A62B 17/04 (2006.01)	2653473	A61K 31/5365 (2006.01) A61P 25/28 (2006.01) C07D 498/04 (2006.01)	2766020 *	A61K 31/135 (2006.01) A61K 31/47 (2006.01)
2723488 *	B01J 19/00 (2006.01) C01B 33/107 (2006.01)	2715348 *	C12Q 1/68 (2006.01) G01N 33/50 (2006.01)	2709986 *	A61K 31/47 (2006.01) A61P 11/12 (2006.01) C07B 59/00 (2006.01) C07D 215/56 (2006.01)
2660459	F02M 59/10 (2006.01) F04B 1/04 (2006.01)	2754231 *	H02K 33/16 (2006.01)	2714012 *	A61K 9/14 (2006.01) A61K 9/20 (2006.01)
2736767 *	B32B 17/10 (2006.01) B60J 1/00 (2006.01) B60Q 3/00 (2006.01) B60Q 3/02 (2006.01) F21V 19/00 (2006.01) F21Y 103/00 (2006.01) G02B 6/00 (2006.01)	2710585 *	G10K 11/20 (2006.01)	2755653 *	A61K 31/4184 (2006.01) A61K 31/437 (2006.01) A61K 31/5377 (2006.01) A61K 45/06 (2006.01) A61P 35/00 (2006.01)
2744777 *	A61K 31/138 (2006.01) A61P 3/06 (2006.01) C07C 217/18 (2006.01)	2713722 *	A01N 33/02 (2006.01) A61K 31/13 (2006.01)	2702030 *	C07C 43/00 (2006.01)
2734515 *	A61K 31/381 (2006.01) A61P 31/14 (2006.01) C07D 333/40 (2006.01)	2766963 *	G01J 11/00 (2006.01) H01S 3/00 (2006.01)	2662490	E01C 5/00 (2006.01) E01C 9/00 (2006.01) E01F 8/00 (2006.01) E04F 13/08 (2006.01)
2647991	G01N 33/00 (2006.01) G01P 5/00 (2006.01)	2650747	G05F 1/56 (2006.01) G06F 1/32 (2006.01)	2718680 *	G01F 23/292 (2006.01)
2712359 *	C07D 407/04 (2006.01)	2763663 *	A61K 9/20 (2006.01) A61K 9/50 (2006.01) A61K 31/436 (2006.01)	2713735 *	A01N 37/38 (2006.01) A01N 43/40 (2006.01) A01N 43/80 (2006.01) A01N 43/86 (2006.01) A01N 47/30 (2006.01) A01N 47/40 (2006.01) A01N 51/00 (2006.01) A01N 53/00 (2006.01) A01P 5/00 (2006.01) A01P 7/02 (2006.01) A01P 7/04 (2006.01) A01P 9/00 (2006.01)
2677116	E21B 43/32 (2006.01) E21B 47/10 (2012.01) G01V 3/20 (2006.01)	2747779 *	A61K 39/21 (2006.01)	2729489 *	C07K 14/005 (2006.01) C12N 15/86 (2006.01) G01N 33/569 (2006.01)
2760893 *	A61K 39/395 (2006.01) C07K 16/32 (2006.01)	2709622 *	A61K 31/4745 (2006.01)	2704962 *	B65D 51/28 (2006.01) B65D 51/30 (2006.01)

Broj objave evropske prijave patenta (97)	MKP (51)	Broj objave evropske prijave patenta (97)	MKP (51)	Broj objave evropske prijave patenta (97)	MKP (51)
2710000 *	A01N 43/80 (2006.01) C07D 413/04 (2006.01) C07D 413/14 (2006.01) C07D 495/04 (2006.01)	2736540 *	A61K 38/17 (2006.01) A61K 48/00 (2006.01)	2742184 *	B62D 55/07 (2006.01) E02F 9/02 (2006.01)
2647815	F01N 3/08 (2006.01) F02D 41/00 (2006.01) F02D 41/02 (2006.01) F02D 41/18 (2006.01) F02D 41/40 (2006.01)	2710013 *	C07D 498/04 (2006.01)	2729443 *	C07C 237/22 (2006.01) C07C 311/06 (2006.01) C07C 311/19 (2006.01) C07D 207/16 (2006.01) C07K 5/06 (2006.01)
2721034 *	C07D 491/14 (2006.01) C07D 491/147 (2006.01)	2744806 *	A61K 31/381 (2006.01) A61K 31/4709 (2006.01) C07D 409/06 (2006.01)	2707504 *	C12Q 1/68 (2006.01) G01N 33/564 (2006.01) G01N 33/68 (2006.01)
2614755	A47F 9/04 (2006.01)	2746147 *	B63H 1/36 (2006.01)	2753173 *	A01N 25/04 (2006.01) A01N 25/10 (2006.01) A01N 25/28 (2006.01) A01N 37/40 (2006.01) A01N 39/04 (2006.01) A01N 43/90 (2006.01) A01N 47/36 (2006.01)
2731589 *	A61K 9/00 (2006.01) A61K 9/08 (2006.01) A61K 9/10 (2006.01) A61K 9/107 (2006.01) A61K 31/473 (2006.01) A61P 25/16 (2006.01)	2734244 *	A61L 15/18 (2006.01) A61L 15/42 (2006.01)	2644110	A61B 17/072 (2006.01)
2709613 *	A61K 31/381 (2006.01) A61K 31/4184 (2006.01) A61K 31/4196 (2006.01) A61K 31/513 (2006.01) A61P 31/14 (2006.01)	2732023 *	A23L 1/30 (2006.01) A61K 35/74 (2006.01) C12N 1/00 (2006.01) C12R 1/225 (2006.01) C12R 1/23 (2006.01) C12R 1/25 (2006.01)	2639997	H04L 9/08 (2006.01)
2763994 *	A61K 31/519 (2006.01) A61P 29/00 (2006.01) A61P 35/00 (2006.01) C07D 403/12 (2006.01) C07D 487/04 (2006.01)	2709900 *	B63B 35/44 (2006.01)	2729498 *	A61K 39/395 (2006.01) C07K 16/24 (2006.01) C07K 16/28 (2006.01)
2751267 *	C12N 15/09 (2006.01)	2726809 *	F41H 5/04 (2006.01)	2639602	G01V 3/24 (2006.01)
		2704709 *	A61K 31/365 (2006.01) A61K 31/7048 (2006.01) A61P 25/28 (2006.01) A61P 35/00 (2006.01)	2721016 *	C07D 263/52 (2006.01) C07D 498/00 (2006.01)
		2753931 *	G01N 33/564 (2006.01)		

Broj objave evropske prijave patenta (97)	MKP (51)	Broj objave evropske prijave patenta (97)	MKP (51)	Broj objave evropske prijave patenta (97)	MKP (51)
2743348 *	C07K 16/22 (2006.01) C12N 1/15 (2006.01) C12N 1/19 (2006.01) C12N 1/21 (2006.01) C12N 5/10 (2006.01) C12N 15/09 (2006.01) C12P 21/08 (2006.01)	2721021 *	A01N 43/40 (2006.01) C07D 401/06 (2006.01) C07D 401/14 (2006.01) C07D 409/14 (2006.01)	2704562 *	A01N 25/02 (2006.01) A01N 43/40 (2006.01) A01N 43/90 (2006.01) A01N 57/12 (2006.01) A01P 13/00 (2006.01)
2718725 *	G01N 33/50 (2006.01) G01N 33/68 (2006.01)	2739277 *	A61K 31/137 (2006.01) A61P 3/10 (2006.01)	2758032 *	A61K 8/891 (2006.01) A61K 9/00 (2006.01) A61K 47/24 (2006.01) A61P 17/02 (2006.01)
2714004 *	A61K 9/00 (2006.01) A61K 9/127 (2006.01) A61K 38/00 (2006.01) A61K 47/10 (2006.01) A61K 47/14 (2006.01) A61K 47/24 (2006.01)	2662814	G06Q 10/08 (2012.01)	2753347 *	A61K 38/17 (2006.01) C12N 5/00 (2006.01)
2714013 *	A61K 9/20 (2006.01)	2719696 *	A61K 31/427 (2006.01) A61K 31/4427 (2006.01) A61K 31/497 (2006.01) A61K 31/506 (2006.01) A61P 35/00 (2006.01) C07D 417/12 (2006.01) C07D 417/14 (2006.01)	2750841 *	B27B 5/29 (2006.01)
2734760 *	F16K 15/03 (2006.01)	2709595 *	A61K 9/00 (2006.01) A61K 9/19 (2006.01) A61K 38/21 (2006.01) A61K 47/42 (2006.01)	2731846 *	B61D 19/02 (2006.01)
2760451 *	A61K 31/496 (2006.01) A61P 3/06 (2006.01) A61P 3/08 (2006.01) A61P 3/10 (2006.01) A61P 9/00 (2006.01) A61P 9/10 (2006.01) A61P 9/12 (2006.01) A61P 11/00 (2006.01) A61P 15/00 (2006.01) A61P 15/12 (2006.01) A61P 19/02 (2006.01) A61P 21/00 (2006.01)	2734539 *	A61K 39/00 (2006.01) C07K 14/47 (2006.01)	2719689	C07C 253/30 (2006.01) C07C 255/37 (2006.01) C07D 223/14 (2006.01)
		2644117	A61B 17/00 (2006.01) A61B 17/072 (2006.01)		
		2715119 *	F03B 3/12 (2006.01) F03D 1/04 (2006.01) F03D 1/06 (2006.01)		
		2720763 *	A63B 21/055 (2006.01) A63B 23/12 (2006.01)		
		2720639 *	A61C 17/06 (2006.01)		

Broj objave evropske prijave patenta (97)	MKP (51)	Broj objave evropske prijave patenta (97)	MKP (51)	Broj objave evropske prijave patenta (97)	MKP (51)
2704688 *	A61K 9/00 (2006.01) A61K 31/07 (2006.01) A61K 31/20 (2006.01) A61K 31/472 (2006.01) A61K 31/496 (2006.01) A61K 31/70 (2006.01) A61K 31/704 (2006.01) A61K 31/7048 (2006.01) A61K 33/00 (2006.01) A61K 33/26 (2006.01) A61K 33/30 (2006.01) A61K 36/54 (2006.01) A61K 38/02 (2006.01) A61K 39/00 (2006.01) A61K 39/13 (2006.01) A61K 39/145 (2006.01) A61K 47/12 (2006.01)	2636294	A01C 7/20 (2006.01)	2726092 *	A61K 38/55 (2006.01) A61K 39/395 (2006.01) A61K 39/40 (2006.01) A61K 39/42 (2006.01) A61P 1/00 (2006.01) A61P 3/10 (2006.01) A61P 9/00 (2006.01) A61P 9/10 (2006.01) A61P 11/00 (2006.01) A61P 11/06 (2006.01) A61P 19/02 (2006.01) A61P 21/00 (2006.01) A61P 29/00 (2006.01) A61P 31/04 (2006.01) A61P 31/10 (2006.01) A61P 31/12 (2006.01) A61P 35/00 (2006.01) A61P 37/06 (2006.01) C07K 19/00 (2006.01)
		2756163 *	E21B 34/08 (2006.01) E21B 34/16 (2006.01) E21B 43/12 (2006.01) E21B 43/22 (2006.01) E21B 43/26 (2006.01)		
		2707004 *	A61K 31/662 (2006.01) A61P 31/14 (2006.01)		
		2718269 *	A61K 9/127 (2006.01) A61K 31/4164 (2006.01) C07C 323/00 (2006.01) C07D 233/64 (2006.01)		
		2714977 *	A01G 31/00 (2006.01) D04H 1/407 (2012.01) D04H 1/4209 (2012.01) D04H 1/46 (2012.01)		
2490541 *	A01N 43/78 (2006.01) A61K 31/425 (2006.01) A61P 25/18 (2006.01) C07D 277/56 (2006.01) C07D 417/06 (2006.01) C07D 491/04 (2006.01) C07D 495/04 (2006.01)	2741608 *	A01N 25/12 (2006.01) A01N 59/00 (2006.01) A01P 1/00 (2006.01) A01P 7/00 (2006.01)	2704724 *	A61K 9/00 (2006.01) A61K 31/573 (2006.01)
		2744822 *	C07K 16/00 (2006.01)	2710383 *	G01N 33/68 (2006.01)
2734522 *	A61K 31/4985 (2006.01) A61P 19/08 (2006.01) A61P 29/00 (2006.01) A61P 31/00 (2006.01) A61P 35/00 (2006.01) A61P 37/00 (2006.01) C07D 487/04 (2006.01) C07D 519/00 (2006.01)			2747752 *	A61K 9/16 (2006.01) A61K 9/20 (2006.01) A61K 9/50 (2006.01)
				2654141	H01R 43/16 (2006.01) H01R 43/20 (2006.01)
				2741610 *	A01N 43/04 (2006.01)

Broj objave evropske prijave patenta (97)	MKP (51)	Broj objave evropske prijave patenta (97)	MKP (51)	Broj objave evropske prijave patenta (97)	MKP (51)
2738163 *	A61K 31/426 (2006.01) A61K 31/427 (2006.01) A61K 31/433 (2006.01) A61K 31/4439 (2006.01) A61K 31/454 (2006.01) A61K 31/496 (2006.01) A61K 31/497 (2006.01) A61K 31/501 (2006.01) A61K 31/506 (2006.01) A61K 31/5377 (2006.01) A61P 17/00 (2006.01) A61P 31/10 (2006.01) C07D 277/20 (2006.01) C07D 277/28 (2006.01) C07D 277/30 (2006.01) C07D 277/34 (2006.01) C07D 277/48 (2006.01) C07D 277/56 (2006.01) C07D 285/08 (2006.01) C07D 417/04 (2006.01)	2702352 *	G01B 11/16 (2006.01) G01B 11/24 (2006.01)	2725016 *	A61K 31/341 (2006.01) A61K 31/381 (2006.01) A61K 31/4025 (2006.01) A61K 31/427 (2006.01) A61K 31/435 (2006.01) A61K 31/4365 (2006.01) A61K 38/00 (2006.01) A61P 3/00 (2006.01) A61P 3/04 (2006.01) A61P 3/06 (2006.01) A61P 3/08 (2006.01) A61P 3/10 (2006.01) A61P 5/50 (2006.01) A61P 43/00 (2006.01) C07D 307/68 (2006.01) C07D 333/38 (2006.01) C07D 405/06 (2006.01) C07D 409/06 (2006.01) C07D 417/06 (2006.01) C07D 495/04 (2006.01)
		2760462 *	A61K 31/549 (2006.01) A61K 38/16 (2006.01)		
		2628732	A61K 31/505 (2006.01) A61P 31/18 (2006.01) C07D 239/48 (2006.01)		
		2723739 *	A61K 31/437 (2006.01) A61P 11/00 (2006.01) A61P 17/00 (2006.01) A61P 19/00 (2006.01) A61P 29/00 (2006.01) A61P 35/00 (2006.01) A61P 37/00 (2006.01) C07D 471/04 (2006.01) C07D 519/00 (2006.01)		
		2709647 *	A61K 38/16 (2006.01) C07K 14/00 (2006.01)	2766361 *	A61K 31/4725 (2006.01) A61P 35/00 (2006.01) C07D 417/14 (2006.01) C07D 471/04 (2006.01) C07D 487/04 (2006.01) C07D 513/04 (2006.01)
2734736 *	F04D 7/04 (2006.01) F04D 29/22 (2006.01) F04D 29/42 (2006.01)	2763550 *	A23K 1/16 (2006.01) A23K 1/175 (2006.01)		
2707017 *	A61K 31/155 (2006.01) A61K 38/26 (2006.01) A61P 3/10 (2006.01)	2744808 *	A61K 31/5415 (2006.01) A61P 35/00 (2006.01) C07D 279/28 (2006.01) C07D 417/06 (2006.01)	2750677 *	A61K 31/44 (2006.01) C07D 401/00 (2006.01)
2702061	A61K 31/437 (2006.01) A61K 31/4985 (2006.01) A61P 35/00 (2006.01) C07D 473/34 (2006.01) C07D 487/04 (2006.01)	2731967 *	A61K 39/42 (2006.01) A61P 31/16 (2006.01) C07K 16/10 (2006.01)	2720545 *	A01N 43/42 (2006.01) C07D 215/00 (2006.01)
		2731973 *	C07K 16/28 (2006.01) C12N 15/70 (2006.01)		

Broj objave evropske prijave patenta (97)	MKP (51)	Broj objave evropske prijave patenta (97)	MKP (51)	Broj objave evropske prijave patenta (97)	MKP (51)
2724088 *	E04D 3/30 (2006.01) E04D 3/365 (2006.01) F24J 2/52 (2006.01)	2760282 *	A01K 61/00 (2006.01) A01K 63/00 (2006.01)	2734496 *	A61K 31/192 (2006.01) A61P 1/00 (2006.01) C07C 65/19 (2006.01)
		2713116	F16L 9/17 (2006.01) F16L 41/08 (2006.01) F24F 13/02 (2006.01)	2718530 *	E06B 3/66 (2006.01) E06B 3/663 (2006.01)
2765301 *	F02M 55/02 (2006.01) F02M 61/16 (2006.01) F02M 63/00 (2006.01)	2638804	A01N 33/04 (2006.01) A01N 33/08 (2006.01) A01N 37/40 (2006.01) A01N 39/04 (2006.01) A01N 57/20 (2006.01)	2702041 *	A61K 31/439 (2006.01) A61P 11/00 (2006.01) C07D 207/14 (2006.01) C07D 211/62 (2006.01) C07D 453/02 (2006.01)
2734186 *	A61K 9/00 (2006.01) A61K 31/522 (2006.01) A61P 11/06 (2006.01) A61P 37/08 (2006.01)	2701556 *	A47C 7/62 (2006.01)	2704946 *	B63B 35/68 (2006.01)
		2751020 *	B67D 7/60 (2010.01)	2739283 *	A61K 31/4409 (2006.01)
2644122	A61B 17/00 (2006.01) A61B 17/072 (2006.01)	2736335 *	A01N 43/42 (2006.01) A61K 31/47 (2006.01)	2767285 *	A61K 9/20 (2006.01) A61K 9/28 (2006.01) A61K 31/496 (2006.01) A61K 47/02 (2006.01) A61K 47/10 (2006.01) A61K 47/12 (2006.01) A61K 47/26 (2006.01) A61K 47/38 (2006.01)
2750557 *	A47F 3/04 (2006.01)	2623403	B62J 1/16 (2006.01) B62J 11/00 (2006.01)		
2746183 *	B65D 39/00 (2006.01)	2701537 *	A23L 1/30 (2006.01) A23L 2/385 (2006.01) A23L 2/52 (2006.01) A61P 25/28 (2006.01)	2725061	C08L 63/00 (2006.01) C08L 79/04 (2006.01)
2737167 *	E21B 33/13 (2006.01) E21B 33/138 (2006.01) E21B 34/06 (2006.01)	2755983 *	C07F 9/06 (2006.01)	2769627 *	A23L 1/0524 (2006.01) A23L 2/02 (2006.01) A23L 2/52 (2006.01)
2755983 *	C07F 9/06 (2006.01)	2734845 *	A23L 1/30 (2006.01) A61K 35/74 (2006.01) G01N 33/569 (2006.01)	2753603 *	A61K 31/445 (2006.01) A61P 25/28 (2006.01) C07D 211/24 (2006.01)
2736865 *	C07C 29/124 (2006.01) C07C 33/22 (2006.01) C07C 45/43 (2006.01) C07C 47/54 (2006.01) C07C 51/093 (2006.01) C07C 63/06 (2006.01)	2744334 *	A01N 43/54 (2006.01) A01P 3/00 (2006.01) C07D 239/47 (2006.01)		

Broj objave evropske prijave patenta (97)	MKP (51)	Broj objave evropske prijave patenta (97)	MKP (51)	Broj objave evropske prijave patenta (97)	MKP (51)
2662102	A61M 5/00 (2006.01) A61M 5/28 (2006.01) A61M 5/31 (2006.01) A61M 5/315 (2006.01) B65D 81/113 (2006.01)	2705363 *	G01N 33/50 (2006.01) G01N 33/574 (2006.01)	2769366 *	G07F 17/32 (2006.01)
		2760433 *	A61K 9/10 (2006.01) A61K 9/14 (2006.01) A61K 9/16 (2006.01) A61P 1/00 (2006.01) A61P 1/04 (2006.01)	2755473 *	A01N 25/00 (2006.01) A61K 31/42 (2006.01) A61P 33/00 (2006.01)
2657894	G06Q 10/10 (2012.01) G06Q 50/00 (2012.01)			2734258 *	A61M 25/00 (2006.01) A61M 25/10 (2013.01)
2717901 *	A61K 38/17 (2006.01) A61K 38/22 (2006.01) A61K 39/395 (2006.01) A61P 35/00 (2006.01)	2753567 *	B65D 88/56 (2006.01) B66C 1/10 (2006.01)	2653040	A23C 9/00 (2006.01) A23L 1/29 (2006.01)
		2490997 *	C07C 201/04 (2006.01) C07C 205/02 (2006.01)	2723738 *	A61K 31/437 (2006.01) A61P 25/18 (2006.01) C07D 471/04 (2006.01)
2757103 *	A61K 31/454 (2006.01) A61P 1/04 (2006.01) A61P 43/00 (2006.01) C07D 401/12 (2006.01)	2704723 *	A61K 31/421 (2006.01) A61K 31/423 (2006.01) A61K 31/505 (2006.01) A61K 31/519 (2006.01)	2721031 *	A61K 31/5025 (2006.01) A61P 35/00 (2006.01) C07D 403/04 (2006.01) C07D 487/04 (2006.01)
2636330	A44C 13/00 (2006.01) A44C 17/02 (2006.01) A44C 17/04 (2006.01) A44C 25/00 (2006.01) A44C 27/00 (2006.01)	2758052 *	A61K 31/16 (2006.01) A61K 31/4164 (2006.01) A61K 31/4184 (2006.01) A61P 35/00 (2006.01)	2701718 *	A61K 38/00 (2006.01)
		2751352 *	E03C 1/00 (2006.01) E03D 1/00 (2006.01)	2725902 *	A01N 37/18 (2006.01) A61K 38/21 (2006.01) A61K 39/395 (2006.01) A61K 39/42 (2006.01)
2682113	A61K 9/70 (2006.01)			2761008 *	C07K 16/46 (2006.01) C12N 5/10 (2006.01) C12N 15/85 (2006.01)
2721030 *	A61K 31/519 (2006.01) A61P 11/00 (2006.01) C07D 487/04 (2006.01)	2729170 *	A61K 39/395 (2006.01) A61P 35/00 (2006.01) C07K 16/00 (2006.01) C07K 16/28 (2006.01) C07K 16/36 (2006.01)		
2726004 *	A61B 18/00 (2006.01) A61B 18/14 (2006.01)			2736909 *	C07D 487/04 (2006.01)
2595448	H04W 84/18 (2009.01)	2756003 *	C07K 16/40 (2006.01)	2765857 *	A01N 37/12 (2006.01) C12Q 1/68 (2006.01)
		2731621 *	A61K 39/125 (2006.01)		

Broj objave evropske prijave patenta (97)	MKP (51)	Broj objave evropske prijave patenta (97)	MKP (51)	Broj objave evropske prijave patenta (97)	MKP (51)
2732041 *	C12P 7/56 (2006.01) C12P 41/00 (2006.01)	2734199 *	A61K 31/12 (2006.01) A61K 31/28 (2006.01) A61K 31/713 (2006.01) A61K 33/24 (2006.01) A61K 39/395 (2006.01) A61P 35/00 (2006.01) G01N 33/50 (2006.01) G01N 33/68 (2006.01)	2719690 *	A61K 31/4192 (2006.01) A61K 31/42 (2006.01) A61P 1/00 (2006.01) A61P 17/04 (2006.01) A61P 19/02 (2006.01) A61P 25/00 (2006.01) A61P 37/02 (2006.01) A61P 43/00 (2006.01) C07D 249/04 (2006.01) C07D 261/08 (2006.01) C07D 413/06 (2006.01)
2726469 *	A61K 31/553 (2006.01) C07D 267/14 (2006.01) C07D 413/04 (2006.01) C07D 413/12 (2006.01) C07D 413/14 (2006.01) C07D 498/04 (2006.01)	2729161 *	A61K 38/37 (2006.01) C07K 14/755 (2006.01)	2665244	G06F 3/14 (2006.01) H04M 1/725 (2006.01)
2723717 *	A61K 31/45 (2006.01) A61P 29/00 (2006.01) C07D 213/40 (2006.01) C07D 213/61 (2006.01) C07D 213/81 (2006.01) C07D 401/12 (2006.01) C07D 401/14 (2006.01) C07D 403/12 (2006.01) C07D 405/12 (2006.01) C07D 405/14 (2006.01) C07D 409/12 (2006.01) C07D 413/12 (2006.01) C07D 417/12 (2006.01) C07D 471/04 (2006.01) C07D 487/04 (2006.01)	2623175	B01D 29/15 (2006.01) B01D 29/58 (2006.01) B01D 29/96 (2006.01) B01D 35/18 (2006.01) B01D 36/00 (2006.01)	2720546 *	A01N 43/52 (2006.01) A61K 31/415 (2006.01)
2636746	A61K 48/00 (2006.01) C12N 15/86 (2006.01)	2709609 *	A01N 43/40 (2006.01) A61K 31/165 (2006.01) A61K 31/44 (2006.01) A61K 31/497 (2006.01)	2628793	A61K 35/74 (2006.01) C07K 14/47 (2006.01) C12N 1/21 (2006.01) C12R 1/19 (2006.01)
2719373	A61K 9/00 (2006.01) A61K 9/20 (2006.01)	2721033 *	A61K 31/496 (2006.01) A61P 35/00 (2006.01) C07D 217/26 (2006.01) C07D 413/04 (2006.01) C07D 491/052 (2006.01) C07D 519/00 (2006.01)	2707702 *	F03D 11/00 (2006.01) G01N 21/88 (2006.01) G01N 21/95 (2006.01)
2708021 *	H04N 5/335 (2011.01)			2766484 *	C07K 14/00 (2006.01) C12N 15/62 (2006.01)
				2734245 *	A61L 15/18 (2006.01) A61L 15/46 (2006.01)
				2729463 *	C07D 403/12 (2006.01)
				2726508 *	C07K 16/28 (2006.01)

Broj objave evropske prijave patenta (97)	MKP (51)	Broj objave evropske prijave patenta (97)	MKP (51)	Broj objave evropske prijave patenta (97)	MKP (51)
2574445	B29C 49/36 (2006.01) B29C 49/42 (2006.01) B29C 49/64 (2006.01) B29C 49/68 (2006.01) B65G 29/00 (2006.01) B65G 33/04 (2006.01) B65G 47/84 (2006.01)	2715229 *	F22B 21/02 (2006.01) F22B 21/34 (2006.01) F22B 29/02 (2006.01) F22B 29/06 (2006.01) F22B 33/10 (2006.01) F22D 1/04 (2006.01) F22G 1/02 (2006.01) F22G 3/00 (2006.01) F22G 7/14 (2006.01)	2758785 *	G01N 33/569 (2006.01)
2747937 *	B23Q 3/06 (2006.01) B23Q 16/10 (2006.01)			2753382 *	A61M 5/00 (2006.01) A61M 5/20 (2006.01) A61M 5/31 (2006.01) A61M 5/315 (2006.01) A61M 5/32 (2006.01)
2742948 *	A61K 38/19 (2006.01) A61P 39/02 (2006.01)	2755882 *	B62D 7/09 (2006.01) B62D 7/18 (2006.01) B62D 7/20 (2006.01)	2709800 *	B24D 15/00 (2006.01) G09F 3/02 (2006.01) G09F 3/10 (2006.01)
2760383 *	A61F 2/04 (2013.01) A61F 2/82 (2013.01) A61F 2/88 (2006.01)	2679292	B01D 46/10 (2006.01)	2634127	B65H 75/14 (2006.01) B65H 75/22 (2006.01)
2720995 *	C07C 45/55 (2006.01) C07C 47/04 (2006.01) C07C 201/12 (2006.01) C07C 205/15 (2006.01) C07C 213/00 (2006.01) C07C 215/08 (2006.01)	2714662 *	A61K 31/415 (2006.01) A61K 31/4155 (2006.01) A61P 9/00 (2006.01) A61P 9/12 (2006.01) C07D 231/14 (2006.01) C07D 401/04 (2006.01) C07D 401/06 (2006.01) C07D 403/04 (2006.01) C07D 403/06 (2006.01) C07D 403/12 (2006.01) C07D 405/04 (2006.01) C07D 405/12 (2006.01) C07D 413/04 (2006.01) C07D 413/06 (2006.01)	2638803	A01N 33/04 (2006.01) A01N 33/08 (2006.01) A01N 37/40 (2006.01) A01N 39/04 (2006.01) A01N 57/20 (2006.01)
2705021 *	C07C 211/42 (2006.01) C07C 309/29 (2006.01) C07C 309/35 (2006.01)			2761296 *	C07D 207/40 (2006.01) G01N 33/533 (2006.01)
2758228 *	B29C 70/22 (2006.01) D04H 3/04 (2012.01) D04H 3/05 (2006.01) D04H 3/12 (2006.01)			2751109 *	A61K 31/519 (2006.01) A61P 1/00 (2006.01) A61P 17/00 (2006.01) A61P 19/00 (2006.01) A61P 27/00 (2006.01) A61P 29/00 (2006.01) A61P 35/00 (2006.01) C07D 471/04 (2006.01) C07D 487/04 (2006.01)
		2769032 *	E04G 3/22 (2006.01) E04G 3/24 (2006.01) E04G 23/08 (2006.01)		
		2701699 *	A61K 31/27 (2006.01)		

Broj objave evropske prijave patenta (97)	MKP (51)	Broj objave evropske prijave patenta (97)	MKP (51)	Broj objave evropske prijave patenta (97)	MKP (51)
2744810 *	A61K 31/52 (2006.01) A61P 31/18 (2006.01) A61P 31/20 (2006.01) C07D 473/34 (2006.01)	2702400 *	G01N 24/10 (2006.01) G01N 24/12 (2006.01) G01R 33/24 (2006.01) G01R 33/60 (2006.01) G01R 33/62 (2006.01)	2704733 *	A23L 1/30 (2006.01) A61K 35/74 (2006.01)
2662095	A61K 47/48 (2006.01)	2717893 *	A61K 31/131 (2006.01) A61K 31/132 (2006.01) A61K 31/215 (2006.01) A61K 31/56 (2006.01) A61K 38/00 (2006.01) A61K 38/16 (2006.01) A61K 38/43 (2006.01)	2701832 *	B01F 3/04 (2006.01) B01F 3/22 (2006.01) B01F 5/04 (2006.01) F04F 5/04 (2006.01)
2753326 *	A61K 31/397 (2006.01)	2684812	B65D 30/24 (2006.01)	2701697 *	A61K 31/122 (2006.01) A61K 31/20 (2006.01) A61K 31/202 (2006.01) A61K 31/375 (2006.01) A61P 27/00 (2006.01) A61P 27/02 (2006.01)
2647827	F02M 63/00 (2006.01)	2764023 *	A61K 39/395 (2006.01) A61P 35/00 (2006.01) A61P 37/08 (2006.01) C07K 16/18 (2006.01)	2748156 *	A61K 31/519 (2006.01) A61P 29/00 (2006.01) C07C 211/35 (2006.01) C07D 401/04 (2006.01) C07D 495/04 (2006.01)
2721009 *	A61K 31/416 (2006.01) A61P 5/00 (2006.01) A61P 9/00 (2006.01) A61P 13/00 (2006.01) C07D 231/54 (2006.01) C07D 231/56 (2006.01)	2718087 *	B29C 45/18 (2006.01) B29C 49/00 (2006.01) B29C 49/22 (2006.01) B65D 81/24 (2006.01)	2764444 *	G06F 17/18 (2006.01)
2764351 *	G01N 24/00 (2006.01)	2736529 *	A01G 25/06 (2006.01)	2736529 *	A61K 39/395 (2006.01) C07K 16/40 (2006.01)
2729734 *	F21V 35/00 (2006.01) F21V 37/02 (2006.01) F23D 3/16 (2006.01)	2760274 *	F25D 3/08 (2006.01)	2724085 *	F16K 3/02 (2006.01) F16K 27/04 (2006.01) F24F 13/12 (2006.01)
2716684 *	A61P 41/00 (2006.01) C07D 401/04 (2006.01) C08G 73/06 (2006.01) C08L 79/06 (2006.01)	2722618	F25D 3/08 (2006.01)	2766039 *	A61K 31/42 (2006.01) A61K 31/519 (2006.01) A61K 31/655 (2006.01) A61K 39/395 (2006.01) A61K 45/06 (2006.01) C07K 16/28 (2006.01)
2705058 *	A61K 39/395 (2006.01) A61P 37/06 (2006.01) C07K 16/24 (2006.01) C07K 16/46 (2006.01)	2715650 *	G06Q 50/00 (2012.01)		
2768825 *	C07D 403/14 (2006.01)	2709627 *	A61K 31/519 (2006.01) A61K 35/00 (2006.01)		
2720530 *	A01K 3/00 (2006.01)	2750842 *	B27B 5/29 (2006.01)		

Broj objave evropske prijave patenta (97)	MKP (51)	Broj objave evropske prijave patenta (97)	MKP (51)	Broj objave evropske prijave patenta (97)	MKP (51)
2765986 *	A61K 9/00 (2006.01) A61K 31/573 (2006.01) A61K 47/48 (2006.01) A61P 27/02 (2006.01)	2704572 *	A01N 43/54 (2006.01) A01N 43/66 (2006.01) A61K 31/505 (2006.01) A61K 31/53 (2006.01) C07D 401/00 (2006.01)	2763984 *	A61K 31/4155 (2006.01) A61K 31/506 (2006.01) C07D 403/12 (2006.01) C07D 491/10 (2006.01)
2753302 *	A61K 9/00 (2006.01) A61K 31/137 (2006.01) A61K 47/10 (2006.01) A61K 47/36 (2006.01) A61K 47/38 (2006.01)	2751104 *	A61K 31/437 (2006.01) A61P 3/00 (2006.01) A61P 11/00 (2006.01) A61P 17/00 (2006.01) A61P 29/00 (2006.01) C07D 471/04 (2006.01)	2753354 *	A61K 39/155 (2006.01)
2745839	A23L 1/054 (2006.01) A23L 1/30 (2006.01) A61K 9/00 (2006.01) A61K 9/10 (2006.01) A61K 31/7048 (2006.01) A61K 47/36 (2006.01)	2726856 *	G01N 21/90 (2006.01)	2729496 *	C07K 16/00 (2006.01)
2703402 *	A61K 31/4995 (2006.01) A61P 25/28 (2006.01) C07D 471/08 (2006.01)	2693513	H01M 2/02 (2006.01) H01M 10/04 (2006.01)	2739498 *	B60K 28/06 (2006.01) G08B 21/06 (2006.01)
2732220 *	F24J 3/00 (2006.01)	2754718 *	A61K 38/16 (2006.01) A61K 38/17 (2006.01) A61K 47/48 (2006.01) A61P 35/04 (2006.01) C07K 14/435 (2006.01) C12Q 1/42 (2006.01)	2732211 *	E04F 13/14 (2006.01) E04F 15/02 (2006.01) F21S 2/00 (2006.01) F21V 33/00 (2006.01)
2685252	F16H 1/22 (2006.01) F16L 55/40 (2006.01) G01N 27/82 (2006.01)	2749790	F16H 3/00 (2006.01) F16H 3/093 (2006.01) F16H 61/04 (2006.01)	2726452 *	C07C 69/753 (2006.01) C07D 209/58 (2006.01) C11D 1/74 (2006.01)
2714737 *	A61K 47/48 (2006.01) C07K 16/28 (2006.01)	2721110 *	C08L 97/02 (2006.01) D04H 1/4218 (2012.01) D04H 1/64 (2012.01)	2731890 *	B65D 79/00 (2006.01)
2768947 *	C12N 5/07 (2010.01)	2742049 *	F16C 19/18 (2006.01) F16C 33/58 (2006.01)	2701728 *	A61K 38/22 (2006.01) A61K 47/48 (2006.01) A61P 31/14 (2006.01)
		2715162 *			A61K 31/519 (2006.01) A61P 37/00 (2006.01) C07D 487/14 (2006.01)

Broj objave evropske prijave patenta (97)	MKP (51)	Broj objave evropske prijave patenta (97)	MKP (51)	Broj objave evropske prijave patenta (97)	MKP (51)
2769321 *	G01N 33/48 (2006.01) G01N 33/53 (2006.01) G06F 19/00 (2011.01)	2714082 *	A61K 39/395 (2006.01)	2721660 *	C03C 17/36 (2006.01) H01L 51/52 (2006.01)
2760924 *	B29B 7/88 (2006.01) B29B 7/90 (2006.01) B29B 17/00 (2006.01) B29B 17/02 (2006.01) B29B 17/04 (2006.01) B29C 47/10 (2006.01) C08J 11/04 (2006.01) C08J 11/06 (2006.01)	2710018 *	A61K 31/433 (2006.01) A61K 31/4738 (2006.01) A61K 31/5025 (2006.01) A61K 31/519 (2006.01) A61P 35/00 (2006.01) C07D 401/00 (2006.01) C07D 513/16 (2006.01) C07D 513/22 (2006.01)	2685000	B31F 1/07 (2006.01) D04H 1/00 (2006.01) D21H 25/00 (2006.01) D21H 27/00 (2006.01) D21H 27/02 (2006.01)
2727104 *	G06K 9/00 (2006.01) G06Q 10/10 (2012.01) G10L 17/00 (2013.01) H04L 29/06 (2006.01)	2751137 *	C07K 14/705 (2006.01)	2766112 *	A61L 2/232 (2006.01) B01D 53/02 (2006.01) B01J 20/02 (2006.01) B01J 20/20 (2006.01) B01J 20/28 (2006.01) B01J 20/32 (2006.01)
2718422 *	C12N 5/00 (2006.01)	2748356 *	C12Q 1/68 (2006.01) C40B 30/04 (2006.01) C40B 40/06 (2006.01) C40B 40/10 (2006.01) G01N 33/574 (2006.01) G06F 19/00 (2011.01)	2742539 *	C23C 14/34 (2006.01) H01L 31/042 (2014.01) H01L 31/18 (2006.01)
2764120 *	C12Q 1/68 (2006.01)	2740337 *	H05K 7/20 (2006.01)	2729635 *	E04B 1/80 (2006.01) E06B 3/663 (2006.01) E06B 7/02 (2006.01)
2741736 *	A61K 9/00 (2006.01) A61K 9/50 (2006.01) A61K 31/55 (2006.01)	2737405 *	G06F 11/32 (2006.01) G06F 17/30 (2006.01)	2718267 *	A61K 31/4436 (2006.01) A61K 31/4439 (2006.01) A61P 11/00 (2006.01) A61P 17/00 (2006.01) A61P 37/08 (2006.01) C07D 213/89 (2006.01) C07D 401/12 (2006.01) C07D 401/14 (2006.01) C07D 405/14 (2006.01) C07D 413/12 (2006.01) C07D 417/12 (2006.01) C07D 417/14 (2006.01)
2626165	B23K 26/10 (2006.01) B23K 37/04 (2006.01)	2743357 *	C21B 5/00 (2006.01)		
2742059 *	C07K 14/415 (2006.01) C12N 15/82 (2006.01)	2714991 *	B21K 7/08 (2006.01) E01B 9/40 (2006.01) E01B 9/68 (2006.01)		
2726103 *	A61K 39/395 (2006.01) C07K 16/00 (2006.01)	2704954 *	B65D 1/02 (2006.01)		
2606869	A61G 5/04 (2013.01) A61G 5/10 (2006.01)	2641522	A47K 10/38 (2006.01) E05D 11/08 (2006.01)		

Broj objave evropske prijave patenta (97)	MKP (51)	Broj objave evropske prijave patenta (97)	MKP (51)	Broj objave evropske prijave patenta (97)	MKP (51)
2753325 *	A61K 31/343 (2006.01) A61P 31/14 (2006.01) C07D 307/82 (2006.01) C07D 405/10 (2006.01)	2723751 *	A61K 31/69 (2006.01) C07F 5/02 (2006.01)	2702043 *	A61K 31/506 (2006.01) A61P 35/00 (2006.01) C07D 239/42 (2006.01) C07D 401/04 (2006.01) C07D 403/04 (2006.01) C07D 403/12 (2006.01) C07D 405/04 (2006.01) C07D 405/12 (2006.01) C07D 405/14 (2006.01) C07D 409/04 (2006.01) C07D 413/04 (2006.01) C07D 417/04 (2006.01) C07D 417/14 (2006.01)
2739720 *	C12M 1/00 (2006.01) C12M 1/12 (2006.01) C12M 1/24 (2006.01) C12M 3/00 (2006.01)	2662945	H02J 3/38 (2006.01)	2690357	F21V 21/30 (2006.01) F21V 23/04 (2006.01) F21W 131/105 (2006.01) F21W 131/107 (2006.01) F21W 131/406 (2006.01)
2704902 *	B32B 9/00 (2006.01)	2751255 *	C12M 1/00 (2006.01) C12N 1/12 (2006.01)	2740132 *	G05F 1/14 (2006.01) H01F 29/02 (2006.01)
2723452 *	A61K 8/37 (2006.01) A61K 47/48 (2006.01) A61P 17/10 (2006.01) A61P 31/04 (2006.01) A61Q 5/02 (2006.01) A61Q 17/00 (2006.01)	2736887 *	A61K 31/4439 (2006.01) A61K 31/497 (2006.01) A61K 31/498 (2006.01) A61K 31/506 (2006.01) A61K 31/5377 (2006.01) A61K 31/55 (2006.01) A61P 27/02 (2006.01) A61P 29/00 (2006.01) A61P 31/12 (2006.01) A61P 35/00 (2006.01) C07D 249/08 (2006.01) C07D 401/12 (2006.01) C07D 403/12 (2006.01) C07D 409/12 (2006.01)	2730290 *	A61K 9/70 (2006.01) A61K 31/4178 (2006.01) A61K 31/4184 (2006.01) A61K 31/439 (2006.01) A61K 45/00 (2006.01) A61K 47/14 (2006.01) A61K 47/18 (2006.01) A61K 47/32 (2006.01) A61P 1/08 (2006.01) A61P 43/00 (2006.01)
2764104 *	C12N 9/24 (2006.01) C12N 15/80 (2006.01)			2628117 *	G06F 19/22 (2011.01)
2718116 *	B23P 11/00 (2006.01) B60B 15/00 (2006.01)				
2517649	A61B 17/064 (2006.01) A61B 17/072 (2006.01) A61B 17/115 (2006.01)				
2701696 *	A61K 31/122 (2006.01) A61K 31/192 (2006.01) A61K 31/20 (2006.01) A61K 31/202 (2006.01)				
2739931 *	F41A 21/26 (2006.01) F41A 21/36 (2006.01)				

Broj objave evropske prijave patenta (97)	MKP (51)	Broj objave evropske prijave patenta (97)	MKP (51)	Broj objave evropske prijave patenta (97)	MKP (51)
2748476 *	B22F 9/08 (2006.01) C22C 1/04 (2006.01) C22C 1/10 (2006.01) C23C 24/08 (2006.01) F16C 33/12 (2006.01) F16C 33/14 (2006.01)	2717851 *	A61K 8/64 (2006.01) A61K 8/73 (2006.01) A61K 8/97 (2006.01) A61Q 19/08 (2006.01)	2711361 *	A01N 43/42 (2006.01) A01N 43/60 (2006.01) A01N 43/90 (2006.01) A01P 3/00 (2006.01) C07D 241/52 (2006.01) C07D 401/12 (2006.01) C07D 471/04 (2006.01)
2724304 *	G06Q 20/18 (2012.01) G06Q 20/20 (2012.01)	2741781 *	A61K 47/48 (2006.01) A61P 11/00 (2006.01)	2729424 *	C03C 3/087 (2006.01) C03C 4/02 (2006.01) C03C 4/08 (2006.01) C03C 6/00 (2006.01)
2714837 *	C09K 8/582 (2006.01) C12P 7/10 (2006.01)	2723897 *	C12N 15/11 (2006.01) C12Q 1/68 (2006.01)		
2671754	B60P 7/08 (2006.01)	2739650 *	A61K 39/00 (2006.01) A61K 39/395 (2006.01) C07K 16/00 (2006.01)	2712358 *	A61K 31/4155 (2006.01) A61K 31/4162 (2006.01) A61K 31/4178 (2006.01) A61K 31/4192 (2006.01) A61K 31/4196 (2006.01) A61K 31/422 (2006.01) A61K 31/4245 (2006.01) A61K 31/427 (2006.01) A61K 31/4439 (2006.01)
2753933 *	G01N 33/574 (2006.01) G01N 33/74 (2006.01)	2618335	G21G 1/00 (2006.01)		
2740478 *	A61K 31/55 (2006.01)	2572701	A61F 2/10 (2006.01) A61K 8/34 (2006.01) A61K 8/46 (2006.01) A61K 8/67 (2006.01) A61K 8/97 (2006.01) A61Q 19/00 (2006.01) A61Q 19/08 (2006.01)		
2734196 *	A61K 9/70 (2006.01) A61K 31/185 (2006.01)				
2734191 *	A61K 9/14 (2006.01) A61K 9/16 (2006.01) A61K 9/22 (2006.01) A61K 47/30 (2006.01) A61K 47/48 (2006.01) A61P 35/00 (2006.01)	2702411 *	G01N 33/574 (2006.01)		C07D 401/14 (2006.01) C07D 403/12 (2006.01) C07D 403/14 (2006.01) C07D 405/14 (2006.01) C07D 409/14 (2006.01) C07D 413/14 (2006.01) C07D 417/14 (2006.01) C07D 471/04 (2006.01) C07D 487/04 (2006.01) C07D 491/04 (2006.01) C07D 495/04 (2006.01)
2660457	F02M 51/06 (2006.01) F02M 61/04 (2006.01) F02M 63/00 (2006.01)	2751096 *	A61K 31/4178 (2006.01) A61P 31/12 (2006.01) C07D 403/14 (2006.01) C08L 77/00 (2006.01)		

Broj objave evropske prijave patenta (97)	MKP (51)	Broj objave evropske prijave patenta (97)	MKP (51)	Broj objave evropske prijave patenta (97)	MKP (51)
2739640 *	A61K 31/58 (2006.01) A61P 5/44 (2006.01) C07J 71/00 (2006.01)	2755654 *	A61K 31/4196 (2006.01) A61K 31/498 (2006.01) A61K 31/519 (2006.01) A61P 35/00 (2006.01)	2717898 *	A61K 38/12 (2006.01)
2708537 *	A61K 31/4192 (2006.01) A61K 31/422 (2006.01) A61K 31/4245 (2006.01) A61K 31/4439 (2006.01) A61K 31/506 (2006.01) A61P 1/00 (2006.01) A61P 5/00 (2006.01) A61P 9/12 (2006.01) A61P 25/08 (2006.01) A61P 25/16 (2006.01) A61P 25/20 (2006.01) A61P 25/22 (2006.01) A61P 25/24 (2006.01) C07D 401/14 (2006.01)	2746854 *	G03G 5/00 (2006.01) G03G 5/10 (2006.01)	2726101 *	A61K 39/395 (2006.01)
2755483 *	A01N 43/56 (2006.01) A61K 31/415 (2006.01)	2729144 *	A61K 31/4196 (2006.01) A61K 31/4439 (2006.01) A61P 35/00 (2006.01)	2729508 *	B82Y 40/00 (2011.01) C07H 3/06 (2006.01) C08F 293/00 (2006.01) C08G 73/06 (2006.01) C08G 81/02 (2006.01) G03F 7/00 (2006.01)
2752573 *	F01N 5/02 (2006.01) F02B 37/00 (2006.01) F02G 5/00 (2006.01) F02G 5/02 (2006.01) F02G 5/04 (2006.01) F22B 1/18 (2006.01)	2731436 *	A01N 43/42 (2006.01) A61K 31/44 (2006.01)	2744778 *	A61K 31/165 (2006.01) A61P 29/00 (2006.01) C07C 233/06 (2006.01) C07C 233/23 (2006.01) C07D 309/14 (2006.01)
2739298 *	A61K 38/00 (2006.01) A61K 38/27 (2006.01)	2758090 *	A61B 18/14 (2006.01) A61B 18/18 (2006.01) A61M 1/00 (2006.01) A61M 13/00 (2006.01) A61M 16/04 (2006.01) A61M 25/00 (2006.01) A61M 39/08 (2006.01)	2729561 *	C12N 5/07 (2010.01) C12P 21/00 (2006.01)
2734470 *	C01B 31/20 (2006.01)	2723744 *	A61K 31/4985 (2006.01) A61P 25/00 (2006.01) C07D 487/04 (2006.01)	2726180 *	B01D 53/56 (2006.01)
2765954 *	A61F 2/24 (2006.01)	2767074 *	H04L 29/08 (2006.01)	2574702	E04B 1/24 (2006.01) E04B 1/342 (2006.01) E04B 7/02 (2006.01) E04H 15/00 (2006.01) E04H 15/18 (2006.01)
		2674494	C12N 15/113 (2010.01)	2721730 *	F03D 7/02 (2006.01) H02K 7/09 (2006.01) H02K 19/26 (2006.01) H02P 9/14 (2006.01) H02P 29/00 (2006.01)
		2763529 *	A01N 25/24 (2006.01) A01N 25/28 (2006.01) A01N 43/40 (2006.01) A01N 53/00 (2006.01) A01N 57/20 (2006.01) B01J 13/18 (2006.01)		

Broj objave evropske prijave patenta (97)	MKP (51)	Broj objave evropske prijave patenta (97)	MKP (51)	Broj objave evropske prijave patenta (97)	MKP (51)
2702430 *	G01S 19/17 (2010.01) G01S 19/19 (2010.01) G01S 19/51 (2010.01) G01V 9/00 (2006.01)	2647790	E21B 47/08 (2012.01) G01B 7/13 (2006.01) G01B 21/04 (2006.01)	2639038	B29C 47/06 (2006.01) B29C 47/08 (2006.01) B29C 47/26 (2006.01) B29C 47/56 (2006.01) B29C 47/70 (2006.01)
2755708 *	A61M 15/00 (2006.01)	2720789 *	B01J 21/06 (2006.01) B01J 23/22 (2006.01) B01J 37/00 (2006.01) C01G 23/04 (2006.01) C01G 31/02 (2006.01)	2762133	A61K 9/00 (2006.01) A61K 9/50 (2006.01)
2739299 *	A01N 63/00 (2006.01) A01N 65/00 (2009.01) A61K 38/00 (2006.01)	2664719	B05B 1/30 (2006.01) E03C 1/084 (2006.01)	2748149 *	A61K 31/50 (2006.01) A61K 31/501 (2006.01) A61P 25/18 (2006.01) A61P 25/28 (2006.01) A61P 29/00 (2006.01) C07D 237/16 (2006.01) C07D 401/10 (2006.01) C07D 407/10 (2006.01)
2669253	C01G 23/00 (2006.01) C01G 23/08 (2006.01) C01G 33/00 (2006.01) H02M 1/08 (2006.01)	2727918	A61K 31/506 (2006.01) A61P 35/00 (2006.01) C07D 401/14 (2006.01) C07D 403/04 (2006.01)	2718099 *	B32B 17/10 (2006.01) F21K 99/00 (2010.01) F21V 33/00 (2006.01) F21Y 105/00 (2006.01) G02B 6/00 (2006.01)
2714280 *	A61M 15/00 (2006.01) B05B 11/00 (2006.01)	2679243	A61K 9/48 (2006.01) A61K 9/51 (2006.01) A61K 31/05 (2006.01) A61K 47/02 (2006.01)	2722719 *	G05B 19/00 (2006.01) H02J 13/00 (2006.01)
2721058 *	C07K 14/435 (2006.01)	2744332 *	A01N 43/30 (2006.01) A61K 31/36 (2006.01)	2704743 *	A61K 39/395 (2006.01) C07K 16/40 (2006.01) C12N 1/19 (2006.01) C12N 5/10 (2006.01) C12N 15/13 (2006.01) C12N 15/63 (2006.01) C12P 21/08 (2006.01)
2628541	B02C 13/16 (2006.01) B02C 13/28 (2006.01)	2677248	A47K 10/06 (2006.01) F24D 19/00 (2006.01) F24H 9/00 (2006.01)	2592805	H04L 29/06 (2006.01)
2731968 *	C07K 16/18 (2006.01)	2722363	C08L 63/00 (2006.01) C08L 79/04 (2006.01)		
2707372 *	A61K 31/407 (2006.01) A61P 35/00 (2006.01) C07D 413/12 (2006.01) C07D 487/10 (2006.01)	2717973 *	A62D 5/00 (2006.01)		
2702063 *	A61K 31/495 (2006.01) A61P 35/00 (2006.01) C07D 487/04 (2006.01)				

Broj objave evropske prijava patenta (97)	MKP (51)	Broj objave evropske prijava patenta (97)	MKP (51)	Broj objave evropske prijava patenta (97)	MKP (51)
2709658 *	A61K 39/09 (2006.01) A61P 31/00 (2006.01)	2743256 *	A61K 31/167 (2006.01) A61K 31/36 (2006.01) A61K 31/366 (2006.01) A61K 31/381 (2006.01) A61K 31/40 (2006.01) A61K 31/402 (2006.01) A61K 31/4035 (2006.01) A61K 31/404 (2006.01) A61K 31/4184 (2006.01) A61K 31/42 (2006.01) A61K 31/421 (2006.01) A61K 31/426 (2006.01) A61K 31/428 (2006.01) A61K 31/429 (2006.01) A61K 31/433 (2006.01) A61K 31/4406 (2006.01) A61K 31/4409 (2006.01) A61K 31/4453 (2006.01) A61K 31/4468 (2006.01) A61K 31/451 (2006.01) C07C 233/80 (2006.01)	2705276 *	F16H 15/38 (2006.01) F16H 15/44 (2006.01) F16H 15/48 (2006.01) F16H 15/52 (2006.01)
2726067 *	A61K 9/50 (2006.01) A61K 31/07 (2006.01) A61K 31/327 (2006.01) A61K 31/695 (2006.01)	2714911 *	A61K 31/404 (2006.01) A61K 31/4184 (2006.01) A61K 31/42 (2006.01) A61K 31/421 (2006.01) A61K 31/426 (2006.01) A61K 31/428 (2006.01) A61K 31/429 (2006.01) A61K 31/433 (2006.01) A61K 31/4406 (2006.01) A61K 31/4409 (2006.01) A61K 31/4453 (2006.01) A61K 31/4468 (2006.01) A61K 31/451 (2006.01) C07C 233/80 (2006.01)	2714911 *	A61K 39/08 (2006.01) C07K 14/33 (2006.01) C12N 15/62 (2006.01)
2718487 *	D01F 9/12 (2006.01) D01F 9/14 (2006.01) D01F 9/16 (2006.01) D06M 10/00 (2006.01)	2723972 *	A61K 31/404 (2006.01) A61K 31/4184 (2006.01) A61K 31/42 (2006.01) A61K 31/421 (2006.01) A61K 31/426 (2006.01) A61K 31/428 (2006.01) A61K 31/429 (2006.01) A61K 31/433 (2006.01) A61K 31/4406 (2006.01) A61K 31/4409 (2006.01) A61K 31/4453 (2006.01) A61K 31/4468 (2006.01) A61K 31/451 (2006.01) C07C 233/80 (2006.01)	2723972 *	E21B 23/02 (2006.01) E21B 23/03 (2006.01) E21B 33/124 (2006.01) E21B 43/26 (2006.01)
2757093 *	A61K 31/155 (2006.01) A61K 31/404 (2006.01) A61P 13/12 (2006.01) A61P 43/00 (2006.01) C07C 279/18 (2006.01) C07C 307/10 (2006.01) C07D 207/16 (2006.01) C07D 209/20 (2006.01) C07D 209/42 (2006.01) C07D 211/62 (2006.01) C07D 213/79 (2006.01) C07D 215/20 (2006.01) C07D 215/48 (2006.01) C07D 215/50 (2006.01) C07D 233/64 (2006.01) C07D 257/04 (2006.01) C07D 271/06 (2006.01) C07D 277/20 (2006.01) C07D 277/56 (2006.01) C07D 295/12 (2006.01) C07D 333/38 (2006.01)	2766866 *	A61K 31/404 (2006.01) A61K 31/429 (2006.01) A61K 31/433 (2006.01) A61K 31/4406 (2006.01) A61K 31/4409 (2006.01) A61K 31/4453 (2006.01) A61K 31/4468 (2006.01) A61K 31/451 (2006.01) C07C 233/80 (2006.01)	2707892 *	H01C 7/12 (2006.01) H01H 37/76 (2006.01) H01T 1/14 (2006.01) H02H 9/04 (2006.01)
		2758535 *	G06Q 50/00 (2012.01)	2676958	A61K 31/438 (2006.01) A61P 1/16 (2006.01) A61P 3/10 (2006.01) C07D 471/10 (2006.01)
		2729806 *	A01K 67/027 (2006.01) C07K 16/46 (2006.01) C12N 15/85 (2006.01)	2723379 *	A61K 39/395 (2006.01)
		2713457	A01K 67/027 (2006.01) C07K 16/46 (2006.01) C12N 15/85 (2006.01)	2714018 *	A61K 9/70 (2006.01) A61K 31/485 (2006.01) A61K 47/12 (2006.01) A61P 25/04 (2006.01) A61P 25/36 (2006.01)
			G01N 33/53 (2006.01)	2704735 *	A61K 38/17 (2006.01) A61K 39/395 (2006.01) A61P 35/00 (2006.01)

Broj objave evropske prijave patenta (97)	MKP (51)	Broj objave evropske prijave patenta (97)	MKP (51)	Broj objave evropske prijave patenta (97)	MKP (51)
2674431	C07D 417/04 (2006.01) C07D 417/14 (2006.01)	2736336 *	A01N 43/42 (2006.01) A61K 31/47 (2006.01)	2736895 *	A61K 31/437 (2006.01) A61K 31/506 (2006.01) A61P 35/00 (2006.01)
2722368	C09C 1/02 (2006.01)	2742004 *	C02F 1/14 (2006.01) C02F 1/18 (2006.01)		C07D 401/02 (2006.01) C07D 471/04 (2006.01)
2760652 *	B27K 3/36 (2006.01) B27N 1/00 (2006.01) B27N 3/04 (2006.01)	2732031 *	C12N 9/00 (2006.01) C12N 9/04 (2006.01) C12N 9/12 (2006.01) C12N 9/88 (2006.01) C12P 7/28 (2006.01)	2705020 *	B01J 14/00 (2006.01) C07C 201/16 (2006.01) C07C 205/06 (2006.01)
2723987 *	E21D 11/00 (2006.01) E21D 11/08 (2006.01) E21D 11/10 (2006.01) E21D 11/30 (2006.01) E21D 11/38 (2006.01) E21D 11/40 (2006.01) E21F 16/02 (2006.01)	2621051	G01R 31/36 (2006.01) H02J 7/00 (2006.01)	2704777 *	A61M 5/00 (2006.01) A61M 5/24 (2006.01) A61M 5/31 (2006.01)
2712360 *	C07D 407/04 (2006.01)	2734794 *	F25B 15/06 (2006.01) F25B 27/00 (2006.01)	2751090 *	A61K 31/352 (2006.01) A61K 31/397 (2006.01) A61K 31/4178 (2006.01) C07D 311/36 (2006.01) C07D 405/06 (2006.01)
2718283 *	A61K 31/4245 (2006.01) A61K 31/454 (2006.01) A61K 31/4545 (2006.01) A61K 31/5377 (2006.01) A61P 1/00 (2006.01) A61P 1/08 (2006.01) A61P 1/10 (2006.01) A61P 1/14 (2006.01) A61P 13/02 (2006.01) A61P 13/08 (2006.01) A61P 17/00 (2006.01) A61P 25/18 (2006.01) A61P 25/22 (2006.01) A61P 25/24 (2006.01) A61P 25/28 (2006.01) A61P 43/00 (2006.01) C07D 401/14 (2006.01)	2729562 *	C12N 5/078 (2010.01)		
		2729706 *	F01C 1/40 (2006.01) F03C 2/30 (2006.01) F04C 2/40 (2006.01) F04C 18/40 (2006.01)	2757113	C07F 7/00 (2006.01) C08F 4/659 (2006.01) C08F 10/00 (2006.01)
		2662002	A47J 31/44 (2006.01) G07F 13/06 (2006.01)	2707003 *	A61K 31/65 (2006.01) C07C 237/26 (2006.01)
		2758056 *	A61K 31/18 (2006.01) A61K 31/335 (2006.01) A61K 31/44 (2006.01) A61K 31/4422 (2006.01) A61K 31/445 (2006.01)	2769019 *	B29C 70/02 (2006.01) B29C 70/64 (2006.01) E01C 11/06 (2006.01) E01C 11/10 (2006.01)
				2660026	B28D 1/32 (2006.01)
				2734548 *	C07K 16/24 (2006.01)

Broj objave evropske prijave patenta (97)	MKP (51)	Broj objave evropske prijave patenta (97)	MKP (51)	Broj objave evropske prijave patenta (97)	MKP (51)
2729495 *	A61K 38/04 (2006.01) C07K 14/78 (2006.01)	2714039 *	A61K 31/166 (2006.01) A61K 31/277 (2006.01) A61K 31/352 (2006.01) A61K 31/416 (2006.01) A61K 31/4196 (2006.01) A61K 31/675 (2006.01) A61K 35/00 (2006.01) A61K 45/06 (2006.01)	2718281 *	A61K 31/4545 (2006.01) A61K 31/4709 (2006.01) A61P 11/06 (2006.01) A61P 11/08 (2006.01) C07D 401/12 (2006.01) C07D 409/14 (2006.01) C07D 417/12 (2006.01)
2725128 *	D04C 3/00 (2006.01) D04C 5/00 (2006.01)			2707704 *	A61C 19/04 (2006.01) G01N 27/62 (2006.01) G01N 37/00 (2006.01) H05H 1/46 (2006.01)
2723564 *	B32B 23/00 (2006.01)				
2720617 *	A61B 10/00 (2006.01) B65D 51/28 (2006.01)	2649876	A01K 5/02 (2006.01) A01K 13/00 (2006.01)		
2677484	G06Q 30/02 (2012.01)				
2641479	A23L 1/22 (2006.01) A23L 1/226 (2006.01) A23L 1/236 (2006.01) A23L 1/30 (2006.01) A23L 2/60 (2006.01)	2726093 *	A61K 38/55 (2006.01) A61K 39/395 (2006.01) A61P 29/00 (2006.01) C07K 19/00 (2006.01)	2642211	F24D 19/02 (2006.01)
		2634646	G03G 15/08 (2006.01) G03G 21/16 (2006.01)	2764094 *	C12N 7/02 (2006.01)
2706983 *	A61K 9/00 (2006.01) A61K 9/06 (2006.01) A61K 9/08 (2006.01) A61K 9/14 (2006.01) A61K 31/155 (2006.01) A61K 31/593 (2006.01) A61P 17/02 (2006.01)	2662061	A61G 5/12 (2006.01)	2740477 *	A61K 31/337 (2006.01) A61K 31/506 (2006.01) A61P 35/00 (2006.01) A61P 43/00 (2006.01) C07D 401/14 (2006.01)
		2734220 *	A61K 38/17 (2006.01)		
		2750982 *	B65D 23/06 (2006.01)	2497461	A61K 9/00 (2006.01) A61K 9/08 (2006.01) A61K 31/13 (2006.01)
		2741854 *	B01D 39/02 (2006.01) B01D 53/02 (2006.01) B01J 20/20 (2006.01) B01J 20/28 (2006.01) B01J 20/32 (2006.01)	2735248	A47C 7/02 (2006.01)
2647618	C07C 61/40 (2006.01)				
2717906 *	A61K 38/46 (2006.01)			2748170 *	A61K 31/551 (2006.01) A61P 25/00 (2006.01) C07D 498/04 (2006.01)
				2766007 *	A61K 31/16 (2006.01)
				2714381 *	B30B 9/06 (2006.01)

Broj objave evropske prijave patenta (97)	MKP (51)	Broj objave evropske prijave patenta (97)	MKP (51)	Broj objave evropske prijave patenta (97)	MKP (51)
2714684 *	A61K 31/427 (2006.01) A61P 35/00 (2006.01) C07D 207/08 (2006.01) C07D 401/12 (2006.01) C07D 417/12 (2006.01)	2656720	A01D 34/00 (2006.01) A01D 34/81 (2006.01)	2763671 *	A61K 31/336 (2006.01) A61K 31/7088 (2006.01) A61K 31/713 (2006.01) A61K 39/00 (2006.01) A61P 3/04 (2006.01) A61P 9/00 (2006.01) A61P 19/00 (2006.01) A61P 19/02 (2006.01) A61P 21/00 (2006.01) A61P 25/00 (2006.01) A61P 25/24 (2006.01) A61P 25/28 (2006.01) A61P 39/00 (2006.01) A61P 39/06 (2006.01)
		2723387 *	A61K 9/127 (2006.01) A61K 47/48 (2006.01) A61K 49/00 (2006.01) A61K 49/18 (2006.01) A61P 29/00 (2006.01) A61P 35/00 (2006.01) C07D 405/12 (2006.01) C07K 7/02 (2006.01)		
2710005 *	A61K 31/535 (2006.01) A61P 35/00 (2006.01) C07D 487/04 (2006.01)				
2750698 *	A61K 38/26 (2006.01) A61P 25/28 (2006.01)				
2726457 *	A61K 31/404 (2006.01) C07D 209/30 (2006.01) C07D 403/04 (2006.01) C07D 413/04 (2006.01)	2718359 *	B65D 65/42 (2006.01) C08K 5/00 (2006.01) C08K 5/07 (2006.01) C08K 5/092 (2006.01) C09D 129/04 (2006.01)	2741746 *	A61K 31/4178 (2006.01) C07D 403/14 (2006.01)
2729490 *	C07K 14/005 (2006.01) C12N 15/86 (2006.01) G01N 33/569 (2006.01)	2714660 *	A61K 31/4418 (2006.01) A61P 9/12 (2006.01) C07D 213/81 (2006.01) C07D 239/28 (2006.01) C07D 249/10 (2006.01) C07D 261/18 (2006.01) C07D 401/06 (2006.01) C07D 471/04 (2006.01) C07D 487/04 (2006.01) C07D 498/04 (2006.01)	2701535 *	A23K 1/18 (2006.01) A23L 1/30 (2006.01) A61K 35/74 (2006.01)
2706990 *	A61K 31/00 (2006.01) A61K 31/727 (2006.01) A61P 7/02 (2006.01) A61P 35/00 (2006.01)			2712320 *	A61K 39/395 (2006.01) A61K 45/00 (2006.01)
2747955 *	B25H 3/00 (2006.01)				
2754285 *	H04M 3/00 (2006.01)				
2714686 *	A61K 31/52 (2006.01) A61P 35/00 (2006.01) A61P 37/06 (2006.01) C07D 471/02 (2006.01) C07D 473/00 (2006.01)	2713988 *	A61K 8/00 (2006.01)		
		2720719 *	A61K 39/395 (2006.01)		
		2709464 *	A23J 3/16 (2006.01)		

Broj objave evropske prijave patenta (97)	MKP (51)	Broj objave evropske prijave patenta (97)	MKP (51)	Broj objave evropske prijave patenta (97)	MKP (51)
2758371 *	A61K 31/397 (2006.01) A61K 31/4015 (2006.01) A61K 31/45 (2006.01) A61K 31/4709 (2006.01) A61P 25/00 (2006.01) A61P 29/00 (2006.01) A61P 33/00 (2006.01) A61P 35/00 (2006.01) C07D 205/08 (2006.01) C07D 207/277 (2006.01) C07D 207/28 (2006.01) C07D 211/78 (2006.01) C07D 401/04 (2006.01)	2763980 *	A61K 31/497 (2006.01) A61P 25/00 (2006.01) C07D 401/12 (2006.01)	2766327 *	C07C 2/50 (2006.01) C07C 2/52 (2006.01) C07C 4/06 (2006.01) C07C 5/03 (2006.01) C07C 9/16 (2006.01) C07C 9/18 (2006.01) C07C 13/18 (2006.01) C07C 13/20 (2006.01) C10G 1/00 (2006.01) C10G 45/32 (2006.01) C10M 107/02 (2006.01) C10M 109/02 (2006.01)
		2750782 *	B01D 53/14 (2006.01)	2758403 *	A61K 31/5415 (2006.01) A61P 25/00 (2006.01) C07D 279/18 (2006.01) C07D 417/06 (2006.01) C07D 491/04 (2006.01)
		2720531 *	A01K 5/01 (2006.01)		
		2748090 *	B65H 18/14 (2006.01) B65H 27/00 (2006.01)	2682071	A61C 9/00 (2006.01) A61C 13/00 (2006.01)
		2726203 *	B01J 35/00 (2006.01) C04B 26/02 (2006.01) C04B 35/00 (2006.01)	2736534 *	A61K 39/395 (2006.01) A61K 47/48 (2006.01) A61P 35/00 (2006.01) C07K 16/28 (2006.01)
2731603 *	A61K 9/20 (2006.01) A61K 31/357 (2006.01) A61K 31/496 (2006.01) A61P 33/06 (2006.01)	2639307	C12N 15/113 (2010.01)		
		2712364 *	C08B 15/02 (2006.01)	2706062 *	A61K 31/546 (2006.01) A61P 31/00 (2006.01) C07D 501/34 (2006.01)
		2723732 *	A61K 31/428 (2006.01) A61P 1/04 (2006.01) A61P 13/00 (2006.01) A61P 19/02 (2006.01) A61P 25/02 (2006.01) A61P 25/04 (2006.01) A61P 29/00 (2006.01) C07D 417/12 (2006.01) C07D 417/14 (2006.01)	2620146	A61K 9/00 (2006.01) A61K 31/192 (2006.01) A61P 17/00 (2006.01)
2701513 *	A01N 25/32 (2006.01) A01N 43/80 (2006.01) A01P 7/04 (2006.01)			2758175 *	B02C 17/00 (2006.01)
2725033 *	A61K 9/08 (2006.01) A61K 38/00 (2006.01) A61K 39/395 (2006.01) B01D 61/14 (2006.01) B01D 61/22 (2006.01) B01D 71/10 (2006.01) B01D 71/26 (2006.01) B01D 71/34 (2006.01) B01D 71/68 (2006.01) C07K 1/34 (2006.01) C07K 16/00 (2006.01)	2744500 *	A61K 31/515 (2006.01) A61P 35/00 (2006.01)		

Broj objave evropske prijave patenta (97)	MKP (51)	Broj objave evropske prijave patenta (97)	MKP (51)	Broj objave evropske prijave patenta (97)	MKP (51)
2517651	A61B 17/115 (2006.01)	2726466 *	A61K 31/5513 (2006.01)	2717867 *	A61K 31/138 (2006.01)
2758438 *	C07K 16/28 (2006.01)		A61K 31/553 (2006.01)		A61K 31/439 (2006.01)
	C07K 16/30 (2006.01)		A61K 31/554 (2006.01)		A61K 31/58 (2006.01)
	C07K 16/46 (2006.01)		C07D 243/24 (2006.01)		A61K 45/06 (2006.01)
2710499 *	G06F 17/30 (2006.01)		C07D 267/14 (2006.01)		A61P 11/06 (2006.01)
2712861	A61K 31/44 (2006.01)		C07D 291/08 (2006.01)		A61P 11/08 (2006.01)
	A61K 31/444 (2006.01)		C07D 403/06 (2006.01)	2707364 *	C07D 401/12 (2006.01)
	A61K 31/4965 (2006.01)		C07D 413/06 (2006.01)	2726476 *	C07D 403/06 (2006.01)
	A61P 9/00 (2006.01)		C07D 413/12 (2006.01)	2723710 *	A61K 31/165 (2006.01)
	A61P 9/12 (2006.01)		C07D 413/14 (2006.01)		A61P 25/00 (2006.01)
	A61P 19/06 (2006.01)		C07D 419/06 (2006.01)		C07C 237/06 (2006.01)
	C07D 213/70 (2006.01)		C07D 471/04 (2006.01)		C07D 209/08 (2006.01)
	C07D 239/38 (2006.01)	2720712 *	C07D 487/04 (2006.01)		C07D 217/06 (2006.01)
	C07D 241/18 (2006.01)		C07D 498/04 (2006.01)		C07D 265/36 (2006.01)
	C07D 401/04 (2006.01)	2647882			C07D 295/182 (2006.01)
	C07D 403/04 (2006.01)		A61K 38/28 (2006.01)		C07D 295/185 (2006.01)
	C07D 405/04 (2006.01)	2747833 *		2718100 *	B32B 17/10 (2006.01)
	C07D 417/04 (2006.01)		A61M 31/00 (2006.01)		F21K 99/00 (2010.01)
2741626 *	A24F 47/00 (2006.01)	2758432 *	A61K 39/40 (2006.01)		F21V 33/00 (2006.01)
2726099 *	A61K 39/395 (2006.01)		A61P 31/04 (2006.01)		G02B 6/00 (2006.01)
	C07K 16/28 (2006.01)	2645280	C07K 16/12 (2006.01)		
				2711433 *	A61K 31/47 (2006.01)
		2710127 *	G06F 19/00 (2011.01)		A61P 35/00 (2006.01)
			C12N 13/00 (2006.01)		A61P 43/00 (2006.01)
		2722334			C12N 15/09 (2006.01)
			A61K 31/55 (2006.01)		C12Q 1/68 (2006.01)
			A61P 35/00 (2006.01)		G01N 33/15 (2006.01)
			A61P 43/00 (2006.01)		G01N 33/50 (2006.01)
			C07D 487/04 (2006.01)		

Broj objave evropske prijava patenta (97)	MKP (51)	Broj objave evropske prijava patenta (97)	MKP (51)	Broj objave evropske prijava patenta (97)	MKP (51)
2662564	F02M 59/10 (2006.01) F02M 63/00 (2006.01) F04B 1/04 (2006.01) F04B 9/04 (2006.01) F04B 53/00 (2006.01) F04B 53/18 (2006.01)	2765932 *	A61B 1/313 (2006.01) A61B 5/00 (2006.01) A61B 17/16 (2006.01) A61B 17/34 (2006.01) A61M 5/46 (2006.01) G01N 21/00 (2006.01)	2766354 *	A61K 31/4184 (2006.01) A61K 31/4188 (2006.01) A61P 35/00 (2006.01) C07D 401/14 (2006.01) C07D 403/04 (2006.01) C07D 413/04 (2006.01) C07D 471/04 (2006.01)
2737627 *	H03K 3/537 (2006.01)	2759373	B24B 39/00 (2006.01) B24B 49/08 (2006.01)	2731262 *	H02P 6/08 (2006.01) H02P 27/06 (2006.01)
2702059 *	A61K 31/4162 (2006.01) A61P 19/02 (2006.01) C07D 471/04 (2006.01)	2761227 *	F24C 7/08 (2006.01) H05B 3/74 (2006.01)	2736542 *	A61F 13/15 (2006.01) A61L 15/18 (2006.01) A61L 15/32 (2006.01) A61L 15/42 (2006.01) A61L 15/60 (2006.01)
2725653 *	H01M 12/06 (2006.01)	2707024 *	A61K 39/102 (2006.01) A61P 31/04 (2006.01) C07K 14/285 (2006.01)	2704697 *	A61K 9/22 (2006.01) A61K 31/167 (2006.01)
2760832 *	C07D 211/70 (2006.01) C07D 401/04 (2006.01) C07F 9/24 (2006.01)	2660456	F02D 1/18 (2006.01) F02M 41/14 (2006.01)	2766353 *	A61K 31/444 (2006.01) A61P 25/06 (2006.01) C07D 401/10 (2006.01) C07D 401/14 (2006.01) C07D 405/14 (2006.01) C07D 413/14 (2006.01) C07D 417/14 (2006.01)
2709652 *	A61K 31/155 (2006.01) A61K 38/22 (2006.01) A61P 3/10 (2006.01)	2679177	A61B 17/00 (2006.01) A61B 17/3207 (2006.01)	2748168 *	A61K 31/505 (2006.01) A61K 31/519 (2006.01) A61P 35/00 (2006.01) C07D 487/02 (2006.01) C07D 487/04 (2006.01)
2705421 *	G06F 7/58 (2006.01)	2751283 *	C12Q 1/68 (2006.01)	2702763 *	H04N 7/18 (2006.01)
2751102 *	A61K 31/437 (2006.01) A61P 3/00 (2006.01) A61P 11/00 (2006.01) A61P 17/00 (2006.01) A61P 29/00 (2006.01) C07D 471/04 (2006.01)	2768491 *	A61K 31/00 (2006.01) A61K 49/00 (2006.01) A61P 35/00 (2006.01) C07F 5/02 (2006.01)		
		2743678 *	G01N 21/35 (2014.01)		
		2755730 *	B01D 3/00 (2006.01)		

Broj objave evropske prijave patenta (97)	MKP (51)	Broj objave evropske prijave patenta (97)	MKP (51)	Broj objave evropske prijave patenta (97)	MKP (51)
2729149 *	A61K 31/497 (2006.01)	2625130 *	B66C 1/10 (2006.01)	2718285 *	A61K 31/4166 (2006.01) A61K 31/4439 (2006.01) A61K 31/506 (2006.01) A61P 25/00 (2006.01) C07D 307/87 (2006.01) C07D 307/94 (2006.01) C07D 311/76 (2006.01) C07D 401/04 (2006.01) C07D 403/04 (2006.01) C07D 405/12 (2006.01) C07D 405/14 (2006.01)
2758406 *	A61K 31/537 (2006.01) A61P 25/28 (2006.01) C07D 498/10 (2006.01)	2605539	H04Q 9/00 (2006.01)		
		2634877	H02G 3/08 (2006.01)		
2713724 *	A01N 37/00 (2006.01) A61K 31/19 (2006.01)	2744342 *	A01N 55/08 (2006.01) A61K 31/69 (2006.01)		
2707064 *	A61M 5/00 (2006.01) A61M 5/32 (2006.01) A61M 5/50 (2006.01)	2723332 *	A61K 31/17 (2006.01)		
		2744809 *	A61K 31/4745 (2006.01) A61P 29/00 (2006.01) A61P 37/00 (2006.01) C07D 471/04 (2006.01)	2751036 *	C02F 1/66 (2006.01) C02F 1/68 (2006.01) C02F 103/06 (2006.01) C02F 103/42 (2006.01)
2719270	A01C 1/06 (2006.01)				
2711375	A61K 39/395 (2006.01) A61P 3/04 (2006.01) C07K 14/71 (2006.01) C07K 16/18 (2006.01) C07K 16/28 (2006.01) C07K 19/00 (2006.01)	2723344 *	A61K 31/045 (2006.01) A61K 31/35 (2006.01) A61K 31/592 (2006.01) A61K 31/593 (2006.01) A61P 1/00 (2006.01) A61P 11/00 (2006.01) A61P 11/06 (2006.01)	2753606 *	A61K 31/4418 (2006.01) A61P 25/08 (2006.01) C07D 233/90 (2006.01) C07D 401/12 (2006.01) C07D 401/14 (2006.01) C07D 403/04 (2006.01) C07D 403/12 (2006.01) C07D 405/12 (2006.01) C07D 405/14 (2006.01)
2637645 *	A61K 9/00 (2006.01) A61K 9/48 (2006.01) A61K 31/00 (2006.01) A61K 31/343 (2006.01)	2744805 *	A61K 31/404 (2006.01) A61K 31/4184 (2006.01) A61P 29/00 (2006.01) C07D 403/14 (2006.01) C07D 417/12 (2006.01) C07D 417/14 (2006.01)		
2758436 *	C07K 14/31 (2006.01) C07K 14/315 (2006.01) C07K 16/28 (2006.01) C07K 16/30 (2006.01)			2726005 *	A61B 18/14 (2006.01)
		2732594 *	H04L 29/00 (2006.01)	2717681 *	A01N 1/02 (2006.01) G01N 31/00 (2006.01) G01N 33/00 (2006.01)
2623883	F24H 9/02 (2006.01)				
2755921 *	B01D 3/02 (2006.01) C02F 1/06 (2006.01)				

Broj objave evropske prijave patenta (97)	MKP (51)	Broj objave evropske prijave patenta (97)	MKP (51)	Broj objave evropske prijave patenta (97)	MKP (51)
2760579 *	B01D 53/04 (2006.01) B01J 20/20 (2006.01) B01J 20/24 (2006.01) B01J 20/26 (2006.01) B01J 20/28 (2006.01) B01J 20/30 (2006.01)	2642016	D06F 58/10 (2006.01) D06F 58/20 (2006.01)	2714033 *	A61K 31/405 (2006.01) A61K 31/4196 (2006.01) A61K 31/4535 (2006.01) A61K 31/497 (2006.01) A61K 31/506 (2006.01) A61K 31/519 (2006.01) A61K 31/551 (2006.01) A61P 35/00 (2006.01)
2755736 *	B01D 21/24 (2006.01) B01D 21/28 (2006.01) C02F 1/52 (2006.01)	2736689 *	B27K 5/04 (2006.01) B27K 5/06 (2006.01) B27M 1/08 (2006.01)	2704798 *	A61K 39/395 (2006.01) A61P 1/00 (2006.01) C07K 16/28 (2006.01)
2641550	A61B 17/00 (2006.01) A61B 17/32 (2006.01) H01H 15/00 (2006.01)	2763967 *	A61K 31/4704 (2006.01) A61P 11/00 (2006.01) C07D 215/26 (2006.01)	2739314 *	A61K 9/00 (2006.01) A61K 47/42 (2006.01) A61P 35/00 (2006.01)
2741771 *	A61K 38/00 (2006.01) A61K 39/00 (2006.01) C12N 5/071 (2010.01)	2741761 *	A61K 8/64 (2006.01) A61K 38/19 (2006.01) A61P 17/14 (2006.01) A61Q 7/00 (2006.01)	2741791 *	A61F 2/08 (2006.01) A61L 27/22 (2006.01) A61L 31/04 (2006.01)
2729460 *	A61K 31/4725 (2006.01) A61P 9/00 (2006.01) C07D 401/12 (2006.01)	2731613 *	A61K 31/567 (2006.01) A61K 31/57 (2006.01) A61P 5/36 (2006.01)	2734236 *	A61K 39/395 (2006.01) A61K 45/00 (2006.01)
2671476	A47J 27/04 (2006.01) A47J 27/08 (2006.01) A47J 27/62 (2006.01)	2721036 *	A61K 31/519 (2006.01) A61P 11/00 (2006.01) C07D 495/04 (2006.01) C07D 519/00 (2006.01)	2626407	B22C 3/00 (2006.01) C10M 141/04 (2006.01) C10N 10/02 (2006.01) C10N 10/04 (2006.01) C10N 10/06 (2006.01) C10N 20/02 (2006.01) C10N 20/06 (2006.01) C10N 40/24 (2006.01) C10N 40/36 (2006.01) C10N 50/02 (2006.01) C10N 70/00 (2006.01)
2747809 *	A61M 5/28 (2006.01)	2768506 *	A61K 31/437 (2006.01)		
2750694 *	A61K 9/16 (2006.01) A61K 9/20 (2006.01) A61K 38/16 (2006.01) A61K 38/17 (2006.01) A61K 39/395 (2006.01) A61K 48/00 (2006.01) A61P 35/00 (2006.01)	2517642	A61B 17/072 (2006.01)		

Broj objave evropske prijave patenta (97)	MKP (51)
2754769	E04B 2/74 (2006.01) E04H 1/12 (2006.01)
2702147 *	B01D 15/08 (2006.01) C12M 3/00 (2006.01) C12N 7/02 (2006.01)
2704734 *	A61K 31/045 (2006.01) A61K 31/05 (2006.01) A61K 31/122 (2006.01) A61K 31/202 (2006.01) A61K 31/205 (2006.01) A61K 31/4415 (2006.01) A61K 31/714 (2006.01) A61K 36/062 (2006.01) A61K 36/899 (2006.01)
2705508 *	A63F 13/00 (2014.01) G07F 17/32 (2006.01)

**INDEKS KLASIFIKACIJSKIH OZNAKA BROJEVA ZAHTJEVA ZA PROŠIRENJE
EVROPSKIH PRIJAVA PATENTA PREMA MKP
INDEX ON CLASSIFICATION MARKS ON REQUESTS FOR EXTENSION
OF EUROPEAN PATENT APPLICATION IN ACCORDANCE WITH THE
INTERNATIONAL PATENT CLASSIFICATION**

MKP (51)	Broj objave evropske prijava patenta (97)	Naziv pronalaska (54)	MKP (51)	Broj objave evropske prijava patenta (97)	Naziv pronalaska (54)
C08K 3/00 (2006.01)	2729522 *	BRANCHED LACTIC ACID POLYMERS WITH HIGH VISCOSITY IN THE MOLTEN STATE AND HIGH SHEAR SENSITIVITY, AND NANOCOMPOSITES THEREOF	B01J 37/00 (2006.01)	2720794 *	MIXED METAL OXIDE-BASED POROUS MATERIALS AND THE PRODUCTION AND USE THEREOF
C08K 3/34 (2006.01)	2729522 *	BRANCHED LACTIC ACID POLYMERS WITH HIGH VISCOSITY IN THE MOLTEN STATE AND HIGH SHEAR SENSITIVITY, AND NANOCOMPOSITES THEREOF	C07K 1/18 (2006.01)	2748179 *	PROTEIN PURIFICATION BY ANION EXCHANGE CHROMATOGRAPHY
C08K 9/06 (2006.01)	2729522 *	BRANCHED LACTIC ACID POLYMERS WITH HIGH VISCOSITY IN THE MOLTEN STATE AND HIGH SHEAR SENSITIVITY, AND NANOCOMPOSITES THEREOF	C12N 9/64 (2006.01)	2748179 *	PROTEIN PURIFICATION BY ANION EXCHANGE CHROMATOGRAPHY
C08L 67/04 (2006.01)	2729522 *	BRANCHED LACTIC ACID POLYMERS WITH HIGH VISCOSITY IN THE MOLTEN STATE AND HIGH SHEAR SENSITIVITY, AND NANOCOMPOSITES THEREOF	A01N 37/18 (2006.01)	2723716 *	AMIDO-PYRIDYL ETHER COMPOUNDS AND COMPOSITIONS AND THEIR USE AGAINST PARASITES
B01J 21/06 (2006.01)	2720794 *	MIXED METAL OXIDE-BASED POROUS MATERIALS AND THE PRODUCTION AND USE THEREOF	A61K 31/44 (2006.01)	2723716 *	AMIDO-PYRIDYL ETHER COMPOUNDS AND COMPOSITIONS AND THEIR USE AGAINST PARASITES
B01J 21/12 (2006.01)	2720794 *	MIXED METAL OXIDE-BASED POROUS MATERIALS AND THE PRODUCTION AND USE THEREOF	A61K 31/4433 (2006.01)	2723716 *	AMIDO-PYRIDYL ETHER COMPOUNDS AND COMPOSITIONS AND THEIR USE AGAINST PARASITES
B01J 23/00 (2006.01)	2720794 *	MIXED METAL OXIDE-BASED POROUS MATERIALS AND THE PRODUCTION AND USE THEREOF	A61P 33/00 (2006.01)	2723716 *	AMIDO-PYRIDYL ETHER COMPOUNDS AND COMPOSITIONS AND THEIR USE AGAINST PARASITES
B01J 23/10 (2006.01)	2720794 *	MIXED METAL OXIDE-BASED POROUS MATERIALS AND THE PRODUCTION AND USE THEREOF	A61P 33/10 (2006.01)	2723716 *	AMIDO-PYRIDYL ETHER COMPOUNDS AND COMPOSITIONS AND THEIR USE AGAINST PARASITES
B01J 23/22 (2006.01)	2720794 *	MIXED METAL OXIDE-BASED POROUS MATERIALS AND THE PRODUCTION AND USE THEREOF	A61P 33/14 (2006.01)	2723716 *	AMIDO-PYRIDYL ETHER COMPOUNDS AND COMPOSITIONS AND THEIR USE AGAINST PARASITES
B01J 23/31 (2006.01)	2720794 *	MIXED METAL OXIDE-BASED POROUS MATERIALS AND THE PRODUCTION AND USE THEREOF	C07D 213/18 (2006.01)	2723716 *	AMIDO-PYRIDYL ETHER COMPOUNDS AND COMPOSITIONS AND THEIR USE AGAINST PARASITES
B01J 23/889 (2006.01)	2720794 *	MIXED METAL OXIDE-BASED POROUS MATERIALS AND THE PRODUCTION AND USE THEREOF	A61B 17/072 (2006.01)	2517640	Tissue thickness compensator comprising detachable portions
			B21C 43/04 (2006.01)	2766132 *	METAL WIRE CLEANING PADS AND METHOD AND DEVICE FOR CLEANING METAL WIRE
			B24D 13/10 (2006.01)	2766132 *	METAL WIRE CLEANING PADS AND METHOD AND DEVICE FOR CLEANING METAL WIRE
			B24D 13/14 (2006.01)	2766132 *	METAL WIRE CLEANING PADS AND METHOD AND DEVICE FOR CLEANING METAL WIRE
			B41M 3/14 (2006.01)	2760674 *	METHOD AND SYSTEM FOR ANTIFORGERY MARKING OF PRINTED PRODUCTS

MKP (51)	Broj objave evropske prijava patenta (97)	Naziv pronalaska (54)	MKP (51)	Broj objave evropske prijava patenta (97)	Naziv pronalaska (54)
G07D 7/00 (2006.01)	2760674 *	METHOD AND SYSTEM FOR ANTIFORGERY MARKING OF PRINTED PRODUCTS	H04N 1/407 (2006.01)	2756661 *	A METHOD FOR CONTROLLING A COLOUR CALIBRATION TARGET
C07D 215/46 (2006.01)	2718268 *	NOVEL PROCESS FOR THE SYNTHESIS OF 7-CHLORO-4-(PIPERAZIN-1-YL)-QUINOLINE	H04N 1/60 (2006.01)	2756661 *	A METHOD FOR CONTROLLING A COLOUR CALIBRATION TARGET
C07D 487/04 (2006.01)	2768834 *	SUBSTITUTED BICYCLIC AZA-HETEROCYCLES AND ANALOGUES AS SIRTUIN MODULATORS	A61K 9/00 (2006.01)	2706982 *	INTRANASAL PHARMACEUTICAL DOSAGE FORMS COMPRISING NALOXONE
F03D 7/02 (2006.01)	2751422 *	METHOD FOR OPERATING A WIND TURBINE	A61K 9/08 (2006.01)	2706982 *	INTRANASAL PHARMACEUTICAL DOSAGE FORMS COMPRISING NALOXONE
A21C 11/16 (2006.01)	2737800	Process for manufacturing dies for pasta, the dies themselves, and their use in the production of pasta	A61K 31/135 (2006.01)	2706982 *	INTRANASAL PHARMACEUTICAL DOSAGE FORMS COMPRISING NALOXONE
A61K 31/4985 (2006.01)	2731611 *	COMBINATION ALS THERAPY	A61P 25/36 (2006.01)	2706982 *	INTRANASAL PHARMACEUTICAL DOSAGE FORMS COMPRISING NALOXONE
C02F 1/68 (2006.01)	2739575 *	MICRONIZED CaCO ₃ SLURRY INJECTION SYSTEM FOR THE REMINERALIZATION OF DESALINATED AND FRESH WATER	F03B 3/12 (2006.01)	2715120 *	TURBINE BLADES WITH MIXED BLADE LOADING
A61K 9/00 (2006.01)	2736525 *	METHODS AND PHARMACEUTICAL COMPOSITIONS FOR TREATING CELIAC DISEASE AND GLUTEN INTOLERANCE	F03D 1/04 (2006.01)	2715120 *	TURBINE BLADES WITH MIXED BLADE LOADING
A61K 38/48 (2006.01)	2736525 *	METHODS AND PHARMACEUTICAL COMPOSITIONS FOR TREATING CELIAC DISEASE AND GLUTEN INTOLERANCE	F03D 1/06 (2006.01)	2715120 *	TURBINE BLADES WITH MIXED BLADE LOADING
A61P 1/00 (2006.01)	2736525 *	METHODS AND PHARMACEUTICAL COMPOSITIONS FOR TREATING CELIAC DISEASE AND GLUTEN INTOLERANCE	A61K 31/535 (2006.01)	2726079 *	METHOD OF ADMINISTRATION AND TREATMENT
A61P 37/00 (2006.01)	2736525 *	METHODS AND PHARMACEUTICAL COMPOSITIONS FOR TREATING CELIAC DISEASE AND GLUTEN INTOLERANCE	A61K 38/00 (2006.01)	2726079 *	METHOD OF ADMINISTRATION AND TREATMENT
A61P 39/00 (2006.01)	2736525 *	METHODS AND PHARMACEUTICAL COMPOSITIONS FOR TREATING CELIAC DISEASE AND GLUTEN INTOLERANCE	C12N 15/113 (2010.01)	2726079 *	METHOD OF ADMINISTRATION AND TREATMENT
G01N 33/53 (2006.01)	2736525 *	METHODS AND PHARMACEUTICAL COMPOSITIONS FOR TREATING CELIAC DISEASE AND GLUTEN INTOLERANCE	B02C 17/14 (2006.01)	2758176 *	APPARATUS AND METHOD FOR LINER SYSTEM
B21D 5/08 (2006.01)	2747913 *	A ROLL-FORMING MACHINE AND METHOD FOR ROLL-FORMING	F16L 33/22 (2006.01)	2667074	System with clamp parts for connecting tubes
A47K 3/40 (2006.01)	2687136	Shower element	F16L 37/091 (2006.01)	2667074	System with clamp parts for connecting tubes
B41J 2/21 (2006.01)	2756661 *	A METHOD FOR CONTROLLING A COLOUR CALIBRATION TARGET	F16L 37/092 (2006.01)	2667074	System with clamp parts for connecting tubes
			G06F 3/0486 (2013.01)	2642377	Handheld device and homescreen management method thereof
			G06F 3/0488 (2013.01)	2642377	Handheld device and homescreen management method thereof
			H04M 1/725 (2006.01)	2642377	Handheld device and homescreen management method thereof
			A61K 31/4412 (2006.01)	2714661 *	PICOLINAMIDO - PROPANOIC ACID DERIVATIVES USEFUL AS GLUCAGON RECEPTOR ANTAGONISTS

MKP (51)	Broj objave evropske prijava patenta (97)	Naziv pronalaska (54)	MKP (51)	Broj objave evropske prijava patenta (97)	Naziv pronalaska (54)
A61P 31/10 (2006.01)	2714661 *	PICOLINAMIDO - PROPANOIC ACID DERIVATIVES USEFUL AS GLUCAGON RECEPTOR ANTAGONISTS	B01D 53/02 (2006.01)	2723471 *	MATERIAL SUCH AS FILM, FIBER, WOVEN AND NONWOVEN FABRIC WITH ADSORBANCY
C07D 213/81 (2006.01)	2714661 *	PICOLINAMIDO - PROPANOIC ACID DERIVATIVES USEFUL AS GLUCAGON RECEPTOR ANTAGONISTS	B01J 20/22 (2006.01)	2723471 *	MATERIAL SUCH AS FILM, FIBER, WOVEN AND NONWOVEN FABRIC WITH ADSORBANCY
B61G 9/14 (2006.01)	2755879 *	COMPRESSIBLE ELASTOMERIC SPRING	C23C 18/48 (2006.01)	2757180	A process for electrolytically depositing a tin- and ruthenium-based alloy, the electrolytic bath that permits said alloy to deposit and the alloy obtained by means of said process
B61G 11/08 (2006.01)	2755879 *	COMPRESSIBLE ELASTOMERIC SPRING	C25D 3/56 (2006.01)	2757180	A process for electrolytically depositing a tin- and ruthenium-based alloy, the electrolytic bath that permits said alloy to deposit and the alloy obtained by means of said process
F16F 3/08 (2006.01)	2755879 *	COMPRESSIBLE ELASTOMERIC SPRING	C25D 3/60 (2006.01)	2757180	A process for electrolytically depositing a tin- and ruthenium-based alloy, the electrolytic bath that permits said alloy to deposit and the alloy obtained by means of said process
C12N 9/16 (2006.01)	2729566 *	METHODS FOR PURIFICATION OF ARYLSULFATASE A	A61K 31/535 (2006.01)	2744501 *	AMINO QUINAZOLINES AS KINASE INHIBITORS
C12Q 1/02 (2006.01)	2761065 *	COMPOSITIONS AND METHODS FOR TOXIGENICITY TESTING	A61K 38/07 (2006.01)	2701721 *	METHODS OF TREATING ALZHEIMER'S DISEASE, HUNTINGTON'S DISEASE, AUTISM, OR OTHER DISORDERS
C12Q 1/68 (2006.01)	2761065 *	COMPOSITIONS AND METHODS FOR TOXIGENICITY TESTING	H02K 3/487 (2006.01)	2719061 *	LOCKING KEY
C40B 30/06 (2006.01)	2761065 *	COMPOSITIONS AND METHODS FOR TOXIGENICITY TESTING	H02K 3/493 (2006.01)	2719061 *	LOCKING KEY
B31F 1/07 (2006.01)	2664451	Hybrid multi-ply tissue paper product and method for manufacturing the same	B60K 7/00 (2006.01)	2708401 *	POWER GENERATION AND CHARGING DEVICE FOR CONTINUOUS RUNNING OF ELECTRIC AUTOMOBILE
A61K 9/66 (2006.01)	2723325 *	NOVEL FORMULATIONS AND METHODS FOR TREATING DERMATOLOGICAL DISORDERS OR DISEASES	B60L 11/00 (2006.01)	2708401 *	POWER GENERATION AND CHARGING DEVICE FOR CONTINUOUS RUNNING OF ELECTRIC AUTOMOBILE
A61K 9/08 (2006.01)	2741738 *	SUSTAINED RELEASE COMPOSITION OF PROSTACYCLIN	H02J 7/14 (2006.01)	2708401 *	POWER GENERATION AND CHARGING DEVICE FOR CONTINUOUS RUNNING OF ELECTRIC AUTOMOBILE
A61K 31/557 (2006.01)	2741738 *	SUSTAINED RELEASE COMPOSITION OF PROSTACYCLIN	C07C 303/38 (2006.01)	2714652 *	CHIRAL SYNTHESIS OF N-{3,4-DIFLUORO-2-[(2-FLUORO-4-IODOPHENYL)AMINO]-6-METHOXYPHENYL}-1-[2,3-DIHYDROXY-PROPYL] CYCLOPROPANESULFONAMIDES
A61K 47/48 (2006.01)	2741738 *	SUSTAINED RELEASE COMPOSITION OF PROSTACYCLIN	C07C 303/40 (2006.01)	2714652 *	CHIRAL SYNTHESIS OF N-{3,4-DIFLUORO-2-[(2-FLUORO-4-IODOPHENYL)AMINO]-6-METHOXYPHENYL}-1-[2,3-DIHYDROXY-PROPYL] CYCLOPROPANESULFONAMIDES
A61K 9/00 (2006.01)	2741739 *	PHARMACEUTICAL COMPOSITIONS			
A61K 9/16 (2006.01)	2741739 *	PHARMACEUTICAL COMPOSITIONS			
G08B 13/14 (2006.01)	2721591 *	ELECTRONIC THEFT/VANDALISM PROTECTION DEVICE WITH INSTANTANEOUS SIGNALING AND POSITIONING RESPONSE			
G08B 25/00 (2006.01)	2721591 *	ELECTRONIC THEFT/VANDALISM PROTECTION DEVICE WITH INSTANTANEOUS SIGNALING AND POSITIONING RESPONSE			
A61L 9/014 (2006.01)	2723471 *	MATERIAL SUCH AS FILM, FIBER, WOVEN AND NONWOVEN FABRIC WITH ADSORBANCY			

MKP (51)	Broj objave evropske prijava patenta (97)	Naziv pronalaska (54)	MKP (51)	Broj objave evropske prijava patenta (97)	Naziv pronalaska (54)
C07C 309/82 (2006.01)	2714652 *	CHIRAL SYNTHESIS OF N-{3,4-DIFLUORO-2-[(2-FLUORO-4-IODOPHENYL)AMINO]-6-METHOXYPHENYL}-1-[2,3-DIHYDROXY-PROPYL] CYCLOPROPANESULFONAMIDES	A61K 31/4704 (2006.01)	2744498 *	N-ETHYL-N-PHENYL-1,2-DIHYDRO-4,5-DI-HYDROXY-1-METHYL-2-OXO-3-QUINOLINE CARBOXAMIDE, PREPARATION AND USES THEREOF
C07C 311/28 (2006.01)	2714652 *	CHIRAL SYNTHESIS OF N-{3,4-DIFLUORO-2-[(2-FLUORO-4-IODOPHENYL)AMINO]-6-METHOXYPHENYL}-1-[2,3-DIHYDROXY-PROPYL] CYCLOPROPANESULFONAMIDES	A61B 3/10 (2006.01)	2729049 *	SYSTEM AND METHOD FOR CHARACTERISING EYE-RELATED SYSTEMS
B32B 27/34 (2006.01)	2743936 *	TRANSPARENT FILM, TRANSPARENT CONDUCTIVE LAMINATE, AND TOUCH PANEL, SOLAR CELL AND DISPLAY DEVICE, USING SAME	E02D 29/14 (2006.01)	2729628 *	MANHOLE COVER
C08G 73/10 (2006.01)	2743936 *	TRANSPARENT FILM, TRANSPARENT CONDUCTIVE LAMINATE, AND TOUCH PANEL, SOLAR CELL AND DISPLAY DEVICE, USING SAME	A01N 37/18 (2006.01)	2736330 *	COMPOUNDS AND METHODS
H01B 3/30 (2006.01)	2743936 *	TRANSPARENT FILM, TRANSPARENT CONDUCTIVE LAMINATE, AND TOUCH PANEL, SOLAR CELL AND DISPLAY DEVICE, USING SAME	A61K 31/165 (2006.01)	2736330 *	COMPOUNDS AND METHODS
H01B 5/14 (2006.01)	2743936 *	TRANSPARENT FILM, TRANSPARENT CONDUCTIVE LAMINATE, AND TOUCH PANEL, SOLAR CELL AND DISPLAY DEVICE, USING SAME	C07C 233/00 (2006.01)	2736330 *	COMPOUNDS AND METHODS
H01L 31/04 (2014.01)	2743936 *	TRANSPARENT FILM, TRANSPARENT CONDUCTIVE LAMINATE, AND TOUCH PANEL, SOLAR CELL AND DISPLAY DEVICE, USING SAME	A61B 17/072 (2006.01)	2644113	Tissue thickness compensator comprised of a plurality of materials
B21D 5/02 (2006.01)	2674231	Device for bending metal pieces	A61B 17/115 (2006.01)	2644113	Tissue thickness compensator comprised of a plurality of materials
B21D 37/02 (2006.01)	2674231	Device for bending metal pieces	C07K 16/14 (2006.01)	2743699 *	METHOD FOR TESTING FOR, PREVENTING, AND TREATING INFECTIOUS DISEASE ASPERGILLUS FUMIGATUS, AND COMPOSITION
A61M 5/24 (2006.01)	2720738 *	CARTRIDGE HOLDER ASSEMBLY FOR DRUG DELIVERY DEVICES	G01N 33/15 (2006.01)	2743699 *	METHOD FOR TESTING FOR, PREVENTING, AND TREATING INFECTIOUS DISEASE ASPERGILLUS FUMIGATUS, AND COMPOSITION
C08G 59/42 (2006.01)	2706091	Epoxy resin composition, and prepreg and copper clad laminate made therefrom	G01N 33/50 (2006.01)	2743699 *	METHOD FOR TESTING FOR, PREVENTING, AND TREATING INFECTIOUS DISEASE ASPERGILLUS FUMIGATUS, AND COMPOSITION
C08K 5/5313 (2006.01)	2706091	Epoxy resin composition, and prepreg and copper clad laminate made therefrom	G01N 33/53 (2006.01)	2743699 *	METHOD FOR TESTING FOR, PREVENTING, AND TREATING INFECTIOUS DISEASE ASPERGILLUS FUMIGATUS, AND COMPOSITION
C08L 63/00 (2006.01)	2706091	Epoxy resin composition, and prepreg and copper clad laminate made therefrom	G01N 33/531 (2006.01)	2743699 *	METHOD FOR TESTING FOR, PREVENTING, AND TREATING INFECTIOUS DISEASE ASPERGILLUS FUMIGATUS, AND COMPOSITION
A23N 4/04 (2006.01)	2731893 *	APPARATUS FOR POSITIONING MULTIPLE - LANE FRUIT, ESPECIALLY PEACHES	G01N 33/68 (2006.01)	2743699 *	METHOD FOR TESTING FOR, PREVENTING, AND TREATING INFECTIOUS DISEASE ASPERGILLUS FUMIGATUS, AND COMPOSITION
B65G 47/248 (2006.01)	2731893 *	APPARATUS FOR POSITIONING MULTIPLE - LANE FRUIT, ESPECIALLY PEACHES	G06F 11/14 (2006.01)	2705429 *	REMOTE CABLE ACCESS POINT RESET
C07K 16/00 (2006.01)	2714733 *	CD3-BINDING MOLECULES CAPABLE OF BINDING TO HUMAN AND NON-HUMAN CD3	G06F 19/00 (2011.01)	2758905 *	MONITORING, DIAGNOSTIC AND TRACKING TOOL FOR AUTONOMOUS MOBILE ROBOTS

MKP (51)	Broj objave evropske prijava patenta (97)	Naziv pronalaska (54)	MKP (51)	Broj objave evropske prijava patenta (97)	Naziv pronalaska (54)
B01D 53/00 (2006.01)	2671623	Method and arrangement for preventing hydrocarbon based deposition	A23L 1/29 (2006.01)	2713773 *	A COMPOSITION COMPRISING AT LEAST ONE ALGINATE FOR USE IN TREATMENT AND/OR PREVENTION OF OVERWEIGHT
E21B 47/10 (2012.01)	2671623	Method and arrangement for preventing hydrocarbon based deposition	A23L 1/308 (2006.01)	2713773 *	A COMPOSITION COMPRISING AT LEAST ONE ALGINATE FOR USE IN TREATMENT AND/OR PREVENTION OF OVERWEIGHT
G01F 1/34 (2006.01)	2671623	Method and arrangement for preventing hydrocarbon based deposition	A61K 31/734 (2006.01)	2713773 *	A COMPOSITION COMPRISING AT LEAST ONE ALGINATE FOR USE IN TREATMENT AND/OR PREVENTION OF OVERWEIGHT
B01J 8/06 (2006.01)	2723485 *	PRODUCTION OF OXIDIZED OLEFINS	A61K 9/70 (2006.01)	2716287 *	ROPINIROLE-CONTAINING ADHESIVE SKIN PATCH AND PACKAGED PRODUCT THEREOF
B01J 19/00 (2006.01)	2723485 *	PRODUCTION OF OXIDIZED OLEFINS	A61K 31/4045 (2006.01)	2716287 *	ROPINIROLE-CONTAINING ADHESIVE SKIN PATCH AND PACKAGED PRODUCT THEREOF
C03C 4/02 (2006.01)	2716614	Colored glass and method for its manufacturing	A61K 47/10 (2006.01)	2716287 *	ROPINIROLE-CONTAINING ADHESIVE SKIN PATCH AND PACKAGED PRODUCT THEREOF
C03C 14/00 (2006.01)	2716614	Colored glass and method for its manufacturing	A61K 47/14 (2006.01)	2716287 *	ROPINIROLE-CONTAINING ADHESIVE SKIN PATCH AND PACKAGED PRODUCT THEREOF
C12N 9/10 (2006.01)	2723857 *	RECOMBINANT PRODUCTION SYSTEMS FOR AROMATIC MOLECULES	A61K 47/16 (2006.01)	2716287 *	ROPINIROLE-CONTAINING ADHESIVE SKIN PATCH AND PACKAGED PRODUCT THEREOF
A61K 31/165 (2006.01)	2731598 *	ALISKIREN HEMIFUMARATE, CRYSTAL FORM AND AMORPHOUS SOLID	A61K 47/34 (2006.01)	2716287 *	ROPINIROLE-CONTAINING ADHESIVE SKIN PATCH AND PACKAGED PRODUCT THEREOF
A61P 9/12 (2006.01)	2731598 *	ALISKIREN HEMIFUMARATE, CRYSTAL FORM AND AMORPHOUS SOLID	A61P 25/14 (2006.01)	2716287 *	ROPINIROLE-CONTAINING ADHESIVE SKIN PATCH AND PACKAGED PRODUCT THEREOF
C07C 237/22 (2006.01)	2731598 *	ALISKIREN HEMIFUMARATE, CRYSTAL FORM AND AMORPHOUS SOLID	A61P 25/16 (2006.01)	2716287 *	ROPINIROLE-CONTAINING ADHESIVE SKIN PATCH AND PACKAGED PRODUCT THEREOF
C08F 212/04 (2006.01)	2738189 *	AMPHIPHILIC MACROMOLECULE AND USE THEREOF	A61K 39/395 (2006.01)	2755685 *	TOLL-LIKE RECEPTOR 3 ANTAGONISTS FOR THE TREATMENT OF METABOLIC AND CARDIOVASCULAR DISEASES
C08F 220/06 (2006.01)	2738189 *	AMPHIPHILIC MACROMOLECULE AND USE THEREOF	G06F 9/44 (2006.01)	2711836	Data distribution system
C08F 220/28 (2006.01)	2738189 *	AMPHIPHILIC MACROMOLECULE AND USE THEREOF	A61K 6/00 (2006.01)	2649981	Polymerisable compounds with high polymerisation depth
C08F 220/56 (2006.01)	2738189 *	AMPHIPHILIC MACROMOLECULE AND USE THEREOF	A01H 1/06 (2006.01)	2757872 *	TOBACCO HAVING REDUCED AMOUNTS OF AMINO ACIDS AND METHODS FOR PRODUCING SUCH LINES
C08F 220/58 (2006.01)	2738189 *	AMPHIPHILIC MACROMOLECULE AND USE THEREOF	A01H 5/00 (2006.01)	2757872 *	TOBACCO HAVING REDUCED AMOUNTS OF AMINO ACIDS AND METHODS FOR PRODUCING SUCH LINES
C08F 226/02 (2006.01)	2738189 *	AMPHIPHILIC MACROMOLECULE AND USE THEREOF	C12N 5/04 (2006.01)	2757872 *	TOBACCO HAVING REDUCED AMOUNTS OF AMINO ACIDS AND METHODS FOR PRODUCING SUCH LINES
C08F 232/04 (2006.01)	2738189 *	AMPHIPHILIC MACROMOLECULE AND USE THEREOF	C12N 15/01 (2006.01)	2757872 *	TOBACCO HAVING REDUCED AMOUNTS OF AMINO ACIDS AND METHODS FOR PRODUCING SUCH LINES
C09K 8/588 (2006.01)	2738189 *	AMPHIPHILIC MACROMOLECULE AND USE THEREOF			
A23L 1/0532 (2006.01)	2713773 *	A COMPOSITION COMPRISING AT LEAST ONE ALGINATE FOR USE IN TREATMENT AND/OR PREVENTION OF OVERWEIGHT			

MKP (51)	Broj objave evropske prijava patenta (97)	Naziv pronalaska (54)	MKP (51)	Broj objave evropske prijava patenta (97)	Naziv pronalaska (54)
G06Q 20/00 (2012.01)	2709048	System for furnishing in real time technical information, relative to the content of chemical substances regulated by rules of the European Union, of a product put on a commercial distribution network	A61P 29/00 (2006.01)	2760826 *	CRYSTALLINE FORMS OF A 3-[2-METHANESULFONYL-1-(4-TRIFLUOROMETHYL-PHENOXY)ETHYL]PYRROLIDINE COMPOUND
B21F 9/02 (2006.01)	2726229 *	CABLE TIE TENSIONING AND CUT-OFF TOOL	A61P 35/00 (2006.01)	2760826 *	CRYSTALLINE FORMS OF A 3-[2-METHANESULFONYL-1-(4-TRIFLUOROMETHYL-PHENOXY)ETHYL]PYRROLIDINE COMPOUND
A23L 3/005 (2006.01)	2645092	Device comprising a window for transmitting radiation and an electrically conductive track arranged on the window for electrical detection of a break of the window	C07D 207/08 (2006.01)	2760826 *	CRYSTALLINE FORMS OF A 3-[2-METHANESULFONYL-1-(4-TRIFLUOROMETHYL-PHENOXY)ETHYL]PYRROLIDINE COMPOUND
A23L 3/26 (2006.01)	2645092	Device comprising a window for transmitting radiation and an electrically conductive track arranged on the window for electrical detection of a break of the window	A61M 5/24 (2006.01)	2731650 *	DRIVE MECHANISM OF A DRUG DELIVERY DEVICE
C12N 13/00 (2006.01)	2645092	Device comprising a window for transmitting radiation and an electrically conductive track arranged on the window for electrical detection of a break of the window	A61M 5/315 (2006.01)	2731650 *	DRIVE MECHANISM OF A DRUG DELIVERY DEVICE
G01N 27/24 (2006.01)	2645092	Device comprising a window for transmitting radiation and an electrically conductive track arranged on the window for electrical detection of a break of the window	A01N 43/713 (2006.01)	2723730 *	METALLOENZYME INHIBITOR COMPOUNDS
G01N 27/24 (2006.01)	2645092	Device comprising a window for transmitting radiation and an electrically conductive track arranged on the window for electrical detection of a break of the window	A01P 3/00 (2006.01)	2723730 *	METALLOENZYME INHIBITOR COMPOUNDS
G01N 27/24 (2006.01)	2645092	Device comprising a window for transmitting radiation and an electrically conductive track arranged on the window for electrical detection of a break of the window	C07D 401/06 (2006.01)	2723730 *	METALLOENZYME INHIBITOR COMPOUNDS
A61K 39/00 (2006.01)	2691110 *	MEANS AND METHODS FOR ACTIVE CELLULAR IMMUNOTHERAPY OF CANCER BY USING TUMOR CELLS KILLED BY HIGH HYDROSTATIC PRESSURE AND DENDRITIC CELLS	C07D 409/06 (2006.01)	2723730 *	METALLOENZYME INHIBITOR COMPOUNDS
A61K 39/00 (2006.01)	2691110 *	MEANS AND METHODS FOR ACTIVE CELLULAR IMMUNOTHERAPY OF CANCER BY USING TUMOR CELLS KILLED BY HIGH HYDROSTATIC PRESSURE AND DENDRITIC CELLS	C07D 417/06 (2006.01)	2723730 *	METALLOENZYME INHIBITOR COMPOUNDS
A61K 9/20 (2006.01)	2768487 *	SUSTAINED-RELEASE PREPARATION	A61K 9/16 (2006.01)	2736494 *	COMPRESSED SOLID PHARMACEUTICAL COMPOSITION COMPRISING AMORPHOUS PARTICULATE VALSARTAN AS THE ACTIVE INGREDIENT
A61K 31/4439 (2006.01)	2768487 *	SUSTAINED-RELEASE PREPARATION	A61K 9/20 (2006.01)	2736494 *	COMPRESSED SOLID PHARMACEUTICAL COMPOSITION COMPRISING AMORPHOUS PARTICULATE VALSARTAN AS THE ACTIVE INGREDIENT
F17C 11/00 (2006.01)	2742275 *	METHOD FOR FILLING A GAS STORAGE TANK	A61K 31/41 (2006.01)	2736494 *	COMPRESSED SOLID PHARMACEUTICAL COMPOSITION COMPRISING AMORPHOUS PARTICULATE VALSARTAN AS THE ACTIVE INGREDIENT
A61K 31/423 (2006.01)	2720697 *	TRPV4 ANTAGONISTS	A61K 31/549 (2006.01)	2736494 *	COMPRESSED SOLID PHARMACEUTICAL COMPOSITION COMPRISING AMORPHOUS PARTICULATE VALSARTAN AS THE ACTIVE INGREDIENT
A61K 31/40 (2006.01)	2760826 *	CRYSTALLINE FORMS OF A 3-[2-METHANESULFONYL-1-(4-TRIFLUOROMETHYL-PHENOXY)ETHYL]PYRROLIDINE COMPOUND	E04B 5/10 (2006.01)	2729637 *	LATTICE MEMBER AND SELF-SUPPORTING MODULAR STRUCTURE
A61P 9/12 (2006.01)	2760826 *	CRYSTALLINE FORMS OF A 3-[2-METHANESULFONYL-1-(4-TRIFLUOROMETHYL-PHENOXY)ETHYL]PYRROLIDINE COMPOUND			

MKP (51)	Broj objave evropske prijava patenta (97)	Naziv pronalaska (54)	MKP (51)	Broj objave evropske prijava patenta (97)	Naziv pronalaska (54)
E04B 7/02 (2006.01)	2729637 *	LATTICE MEMBER AND SELF-SUPPORTING MODULAR STRUCTURE	F21S 9/03 (2006.01)	2702212 *	BRICK WITH PHOTOVOLTAIC CELL
E04C 3/08 (2006.01)	2729637 *	LATTICE MEMBER AND SELF-SUPPORTING MODULAR STRUCTURE	G06F 3/01 (2006.01)	2664978	Systems and methods for haptically enabled metadata
E04C 3/32 (2006.01)	2729637 *	LATTICE MEMBER AND SELF-SUPPORTING MODULAR STRUCTURE	G06F 3/0485 (2013.01)	2664978	Systems and methods for haptically enabled metadata
F21V 17/00 (2006.01)	2759764 *	LED LIGHTING ENGINE ADOPTING AN ICICLE TYPE DIFFUSION UNIT	A61K 31/18 (2006.01)	2760443 *	SULFONAMIDE COMPOUNDS AND THEIR USE IN THE MODULATION RETINOID - RELATED ORPHAN RECEPTOR
C08F 220/06 (2006.01)	2738190 *	AMPHIPHILIC MACROMOLECULE AND USE	A61K 31/33 (2006.01)	2760443 *	SULFONAMIDE COMPOUNDS AND THEIR USE IN THE MODULATION RETINOID - RELATED ORPHAN RECEPTOR
C08F 220/18 (2006.01)	2738190 *	AMPHIPHILIC MACROMOLECULE AND USE	C07C 311/21 (2006.01)	2760443 *	SULFONAMIDE COMPOUNDS AND THEIR USE IN THE MODULATION RETINOID - RELATED ORPHAN RECEPTOR
C08F 220/28 (2006.01)	2738190 *	AMPHIPHILIC MACROMOLECULE AND USE	C07C 311/29 (2006.01)	2760443 *	SULFONAMIDE COMPOUNDS AND THEIR USE IN THE MODULATION RETINOID - RELATED ORPHAN RECEPTOR
C08F 220/34 (2006.01)	2738190 *	AMPHIPHILIC MACROMOLECULE AND USE	C07D 213/30 (2006.01)	2760443 *	SULFONAMIDE COMPOUNDS AND THEIR USE IN THE MODULATION RETINOID - RELATED ORPHAN RECEPTOR
C08F 220/56 (2006.01)	2738190 *	AMPHIPHILIC MACROMOLECULE AND USE	C07D 213/38 (2006.01)	2760443 *	SULFONAMIDE COMPOUNDS AND THEIR USE IN THE MODULATION RETINOID - RELATED ORPHAN RECEPTOR
C08F 220/58 (2006.01)	2738190 *	AMPHIPHILIC MACROMOLECULE AND USE	C07D 213/61 (2006.01)	2760443 *	SULFONAMIDE COMPOUNDS AND THEIR USE IN THE MODULATION RETINOID - RELATED ORPHAN RECEPTOR
C08F 226/02 (2006.01)	2738190 *	AMPHIPHILIC MACROMOLECULE AND USE	C07D 213/65 (2006.01)	2760443 *	SULFONAMIDE COMPOUNDS AND THEIR USE IN THE MODULATION RETINOID - RELATED ORPHAN RECEPTOR
C08F 232/04 (2006.01)	2738190 *	AMPHIPHILIC MACROMOLECULE AND USE	C07D 213/68 (2006.01)	2760443 *	SULFONAMIDE COMPOUNDS AND THEIR USE IN THE MODULATION RETINOID - RELATED ORPHAN RECEPTOR
C09K 8/588 (2006.01)	2738190 *	AMPHIPHILIC MACROMOLECULE AND USE	C07D 213/75 (2006.01)	2760443 *	SULFONAMIDE COMPOUNDS AND THEIR USE IN THE MODULATION RETINOID - RELATED ORPHAN RECEPTOR
C12N 13/00 (2006.01)	2718433 *	METHOD AND DEVICE FOR NON-INVASIVE ACOUSTIC STIMULATION OF STEM CELLS AND PROGENITOR CELLS IN A PATIENT	C07D 233/22 (2006.01)	2760443 *	SULFONAMIDE COMPOUNDS AND THEIR USE IN THE MODULATION RETINOID - RELATED ORPHAN RECEPTOR
A61K 31/4545 (2006.01)	2736511 *	ANIMAL ECTOPARASITE-CONTROLLING AGENT AND METHOD FOR PREVENTING OR TREATING INFECTION IN ANIMALS CAUSED BY PARASITES BY USING THE CONTROLLING AGENT	C07D 239/28 (2006.01)	2760443 *	SULFONAMIDE COMPOUNDS AND THEIR USE IN THE MODULATION RETINOID - RELATED ORPHAN RECEPTOR
A61P 33/14 (2006.01)	2736511 *	ANIMAL ECTOPARASITE-CONTROLLING AGENT AND METHOD FOR PREVENTING OR TREATING INFECTION IN ANIMALS CAUSED BY PARASITES BY USING THE CONTROLLING AGENT	C07D 249/08 (2006.01)	2760443 *	SULFONAMIDE COMPOUNDS AND THEIR USE IN THE MODULATION RETINOID - RELATED ORPHAN RECEPTOR
E04C 1/42 (2006.01)	2702212 *	BRICK WITH PHOTOVOLTAIC CELL			

MKP (51)	Broj objave evropske prijava patenta (97)	Naziv pronalaska (54)	MKP (51)	Broj objave evropske prijava patenta (97)	Naziv pronalaska (54)
C07D 257/04 (2006.01)	2760443 *	SULFONAMIDE COMPOUNDS AND THEIR USE IN THE MODULATION RETINOID - RELATED ORPHAN RECEPTOR	A61P 17/02 (2006.01)	2734223 *	WOUND SPRAY
C07D 261/08 (2006.01)	2760443 *	SULFONAMIDE COMPOUNDS AND THEIR USE IN THE MODULATION RETINOID - RELATED ORPHAN RECEPTOR	E01F 15/04 (2006.01)	2739789 *	SECURITY BARRIER
C07K 16/24 (2006.01)	2734549 *	INTERLEUKIN-31 MONOCLONAL ANTIBODY	E01F 15/06 (2006.01)	2739789 *	SECURITY BARRIER
G01N 33/53 (2006.01)	2734549 *	INTERLEUKIN-31 MONOCLONAL ANTIBODY	E04H 12/22 (2006.01)	2739789 *	SECURITY BARRIER
B41F 33/00 (2006.01)	2749417	Quality control, method and device in production lines of solid and corrugated carton boxes, and advertising displays made of paper	E04H 17/22 (2006.01)	2739789 *	SECURITY BARRIER
G06K 19/06 (2006.01)	2749417	Quality control, method and device in production lines of solid and corrugated carton boxes, and advertising displays made of paper	G01N 33/53 (2006.01)	2710375 *	MODIFICATION-DEPENDENT ACTIVITY ASSAYS
A61K 36/28 (2006.01)	2752194 *	NATURAL ANTIOXIDANT ANTI- INFLUENZA COMPOSITION	G01N 33/566 (2006.01)	2710375 *	MODIFICATION-DEPENDENT ACTIVITY ASSAYS
A61K 36/61 (2006.01)	2752194 *	NATURAL ANTIOXIDANT ANTI- INFLUENZA COMPOSITION	G06F 17/28 (2006.01)	2727085 *	EFFICIENT BLENDING METHODS FOR AR APPLICATIONS
A61P 31/16 (2006.01)	2752194 *	NATURAL ANTIOXIDANT ANTI- INFLUENZA COMPOSITION	G06T 11/60 (2006.01)	2727085 *	EFFICIENT BLENDING METHODS FOR AR APPLICATIONS
A61P 37/00 (2006.01)	2752194 *	NATURAL ANTIOXIDANT ANTI- INFLUENZA COMPOSITION	C07D 401/00 (2006.01)	2755962 *	AZAINDAZOLES
A61P 39/06 (2006.01)	2752194 *	NATURAL ANTIOXIDANT ANTI- INFLUENZA COMPOSITION	A61K 9/70 (2006.01)	2716286 *	ROPINIROLE-CONTAINING ADHESIVE PATCH AND PACKAGING THEREFOR
A61B 17/115 (2006.01)	2524654	Circular stapler with frictional reducing member	A61K 31/4045 (2006.01)	2716286 *	ROPINIROLE-CONTAINING ADHESIVE PATCH AND PACKAGING THEREFOR
C09J 181/04 (2006.01)	2707444 *	ADHESIVE/SEALANT PREFERABLY USED FOR CONSTRUCTION PANELS	A61K 47/10 (2006.01)	2716286 *	ROPINIROLE-CONTAINING ADHESIVE PATCH AND PACKAGING THEREFOR
C07C 253/30 (2006.01)	2730562	Novel method for synthesising (2E)-3-(3,4-dimethoxyphenyl)prop- 2-enitrile and use for synthesising ivabradine and the added salts thereof with a pharmaceutically acceptable acid	A61K 47/14 (2006.01)	2716286 *	ROPINIROLE-CONTAINING ADHESIVE PATCH AND PACKAGING THEREFOR
C07D 223/16 (2006.01)	2730562	Novel method for synthesising (2E)-3-(3,4-dimethoxyphenyl)prop- 2-enitrile and use for synthesising ivabradine and the added salts thereof with a pharmaceutically acceptable acid	A61K 47/16 (2006.01)	2716286 *	ROPINIROLE-CONTAINING ADHESIVE PATCH AND PACKAGING THEREFOR
A61K 33/00 (2006.01)	2734223 *	WOUND SPRAY	A61K 47/32 (2006.01)	2716286 *	ROPINIROLE-CONTAINING ADHESIVE PATCH AND PACKAGING THEREFOR
A61K 38/42 (2006.01)	2734223 *	WOUND SPRAY	A61K 47/34 (2006.01)	2716286 *	ROPINIROLE-CONTAINING ADHESIVE PATCH AND PACKAGING THEREFOR
			A61P 25/14 (2006.01)	2716286 *	ROPINIROLE-CONTAINING ADHESIVE PATCH AND PACKAGING THEREFOR
			A61P 25/16 (2006.01)	2716286 *	ROPINIROLE-CONTAINING ADHESIVE PATCH AND PACKAGING THEREFOR
			A47L 11/40 (2006.01)	2757929 *	APPARATUS FOR CLEANING FLOOR SURFACES

MKP (51)	Broj objave evropske prijava patenta (97)	Naziv pronalaska (54)	MKP (51)	Broj objave evropske prijava patenta (97)	Naziv pronalaska (54)
C02F 1/78 (2006.01)	2757929 *	APPARATUS FOR CLEANING FLOOR SURFACES	C07D 253/08 (2006.01)	2707361 *	FUSED HETEROCYCLIC COMPOUNDS AS SODIUM CHANNEL MODULATORS
F25B 7/00 (2006.01)	2758726 *	COOLANT RECOVERY AND WASTE SEPARATION SYSTEM	C07D 265/22 (2006.01)	2707361 *	FUSED HETEROCYCLIC COMPOUNDS AS SODIUM CHANNEL MODULATORS
A61K 31/565 (2006.01)	2741824 *	USE OF ESTETROL AS EMERGENCY CONTRACEPTIVE	C07D 401/04 (2006.01)	2707361 *	FUSED HETEROCYCLIC COMPOUNDS AS SODIUM CHANNEL MODULATORS
A61P 15/18 (2006.01)	2741824 *	USE OF ESTETROL AS EMERGENCY CONTRACEPTIVE	C07D 401/06 (2006.01)	2707361 *	FUSED HETEROCYCLIC COMPOUNDS AS SODIUM CHANNEL MODULATORS
E04H 3/12 (2006.01)	2626485	Tribune	C07D 401/12 (2006.01)	2707361 *	FUSED HETEROCYCLIC COMPOUNDS AS SODIUM CHANNEL MODULATORS
E04H 3/14 (2006.01)	2626485	Tribune	C07D 403/04 (2006.01)	2707361 *	FUSED HETEROCYCLIC COMPOUNDS AS SODIUM CHANNEL MODULATORS
A61K 9/127 (2006.01)	2706988 *	LIPOSOMES COMPRISING POLYMER-CONJUGATED LIPIDS AND RELATED USES	C07D 403/06 (2006.01)	2707361 *	FUSED HETEROCYCLIC COMPOUNDS AS SODIUM CHANNEL MODULATORS
A61K 9/00 (2006.01)	2765990 *	SOLID DISPERSION	C07D 403/08 (2006.01)	2707361 *	FUSED HETEROCYCLIC COMPOUNDS AS SODIUM CHANNEL MODULATORS
A61K 9/14 (2006.01)	2765990 *	SOLID DISPERSION	C07D 403/12 (2006.01)	2707361 *	FUSED HETEROCYCLIC COMPOUNDS AS SODIUM CHANNEL MODULATORS
A61K 9/20 (2006.01)	2765990 *	SOLID DISPERSION	C07D 403/14 (2006.01)	2707361 *	FUSED HETEROCYCLIC COMPOUNDS AS SODIUM CHANNEL MODULATORS
A61K 31/498 (2006.01)	2765990 *	SOLID DISPERSION	C07D 413/06 (2006.01)	2707361 *	FUSED HETEROCYCLIC COMPOUNDS AS SODIUM CHANNEL MODULATORS
A61K 47/32 (2006.01)	2765990 *	SOLID DISPERSION	C07D 413/12 (2006.01)	2707361 *	FUSED HETEROCYCLIC COMPOUNDS AS SODIUM CHANNEL MODULATORS
A61K 47/38 (2006.01)	2765990 *	SOLID DISPERSION	C07D 413/14 (2006.01)	2707361 *	FUSED HETEROCYCLIC COMPOUNDS AS SODIUM CHANNEL MODULATORS
A61P 35/00 (2006.01)	2765990 *	SOLID DISPERSION	C07D 417/06 (2006.01)	2707361 *	FUSED HETEROCYCLIC COMPOUNDS AS SODIUM CHANNEL MODULATORS
A61K 39/395 (2006.01)	2758437 *	CD27L ANTIGEN BINDING PROTEINS	B23K 26/04 (2014.01)	2687317	Laser processing machine, in particular laser cutting machine and method for adjusting a focused laser beam
A61P 35/00 (2006.01)	2758437 *	CD27L ANTIGEN BINDING PROTEINS	B23K 26/14 (2014.01)	2687317	Laser processing machine, in particular laser cutting machine and method for adjusting a focused laser beam
A61P 37/00 (2006.01)	2758437 *	CD27L ANTIGEN BINDING PROTEINS	B23K 26/38 (2014.01)	2687317	Laser processing machine, in particular laser cutting machine and method for adjusting a focused laser beam
C07K 16/28 (2006.01)	2758437 *	CD27L ANTIGEN BINDING PROTEINS	A61M 15/00 (2006.01)	2755707 *	INHALER
C07D 239/47 (2006.01)	2748151 *	PYRIMIDINE PDE10 INHIBITORS	E05B 15/00 (2006.01)	2755707 *	INHALER
C07D 237/32 (2006.01)	2707361 *	FUSED HETEROCYCLIC COMPOUNDS AS SODIUM CHANNEL MODULATORS			

MKP (51)	Broj objave evropske prijava patenta (97)	Naziv pronalaska (54)	MKP (51)	Broj objave evropske prijava patenta (97)	Naziv pronalaska (54)
C03C 25/14 (2006.01)	2739680 *	SIZING COMPOSITION FOR MINERAL WOOL CONTAINING A REDUCING SACCHARIDE AND A HYDROGENATED SACCHARIDE, AND RESULTING INSULATING PRODUCTS	D04H 1/4209 (2012.01)	2739680 *	SIZING COMPOSITION FOR MINERAL WOOL CONTAINING A REDUCING SACCHARIDE AND A HYDROGENATED SACCHARIDE, AND RESULTING INSULATING PRODUCTS
C03C 25/32 (2006.01)	2739680 *	SIZING COMPOSITION FOR MINERAL WOOL CONTAINING A REDUCING SACCHARIDE AND A HYDROGENATED SACCHARIDE, AND RESULTING INSULATING PRODUCTS	D04H 1/587 (2012.01)	2739680 *	SIZING COMPOSITION FOR MINERAL WOOL CONTAINING A REDUCING SACCHARIDE AND A HYDROGENATED SACCHARIDE, AND RESULTING INSULATING PRODUCTS
C08F 251/00 (2006.01)	2739680 *	SIZING COMPOSITION FOR MINERAL WOOL CONTAINING A REDUCING SACCHARIDE AND A HYDROGENATED SACCHARIDE, AND RESULTING INSULATING PRODUCTS	D04H 1/645 (2012.01)	2739680 *	SIZING COMPOSITION FOR MINERAL WOOL CONTAINING A REDUCING SACCHARIDE AND A HYDROGENATED SACCHARIDE, AND RESULTING INSULATING PRODUCTS
C08G 63/668 (2006.01)	2739680 *	SIZING COMPOSITION FOR MINERAL WOOL CONTAINING A REDUCING SACCHARIDE AND A HYDROGENATED SACCHARIDE, AND RESULTING INSULATING PRODUCTS	D04H 3/002 (2012.01)	2739680 *	SIZING COMPOSITION FOR MINERAL WOOL CONTAINING A REDUCING SACCHARIDE AND A HYDROGENATED SACCHARIDE, AND RESULTING INSULATING PRODUCTS
C08J 3/24 (2006.01)	2739680 *	SIZING COMPOSITION FOR MINERAL WOOL CONTAINING A REDUCING SACCHARIDE AND A HYDROGENATED SACCHARIDE, AND RESULTING INSULATING PRODUCTS	D04H 3/12 (2006.01)	2739680 *	SIZING COMPOSITION FOR MINERAL WOOL CONTAINING A REDUCING SACCHARIDE AND A HYDROGENATED SACCHARIDE, AND RESULTING INSULATING PRODUCTS
C08K 5/092 (2006.01)	2739680 *	SIZING COMPOSITION FOR MINERAL WOOL CONTAINING A REDUCING SACCHARIDE AND A HYDROGENATED SACCHARIDE, AND RESULTING INSULATING PRODUCTS	A61K 38/00 (2006.01)	2768526 *	COMPOSITIONS COMPRISING ALKALINE PHOSPHATASE AND/OR NATRIURETIC PEPTIDE AND METHODS OF USE THEREOF
C08K 5/1545 (2006.01)	2739680 *	SIZING COMPOSITION FOR MINERAL WOOL CONTAINING A REDUCING SACCHARIDE AND A HYDROGENATED SACCHARIDE, AND RESULTING INSULATING PRODUCTS	A61K 39/00 (2006.01)	2768526 *	COMPOSITIONS COMPRISING ALKALINE PHOSPHATASE AND/OR NATRIURETIC PEPTIDE AND METHODS OF USE THEREOF
C08K 5/51 (2006.01)	2739680 *	SIZING COMPOSITION FOR MINERAL WOOL CONTAINING A REDUCING SACCHARIDE AND A HYDROGENATED SACCHARIDE, AND RESULTING INSULATING PRODUCTS	A61P 13/06 (2006.01)	2768526 *	COMPOSITIONS COMPRISING ALKALINE PHOSPHATASE AND/OR NATRIURETIC PEPTIDE AND METHODS OF USE THEREOF
C08L 3/00 (2006.01)	2739680 *	SIZING COMPOSITION FOR MINERAL WOOL CONTAINING A REDUCING SACCHARIDE AND A HYDROGENATED SACCHARIDE, AND RESULTING INSULATING PRODUCTS	C12N 9/16 (2006.01)	2768526 *	COMPOSITIONS COMPRISING ALKALINE PHOSPHATASE AND/OR NATRIURETIC PEPTIDE AND METHODS OF USE THEREOF
C09J 11/08 (2006.01)	2739680 *	SIZING COMPOSITION FOR MINERAL WOOL CONTAINING A REDUCING SACCHARIDE AND A HYDROGENATED SACCHARIDE, AND RESULTING INSULATING PRODUCTS	A61K 9/51 (2006.01)	2706989 *	POLYMERIC NANOPARTICLES FOR DRUG DELIVERY
			F24D 17/00 (2006.01)	2623871	Household heating device for providing water comprising a control unit configured for providing control signals to a burner
			F24D 19/10 (2006.01)	2623871	Household heating device for providing water comprising a control unit configured for providing control signals to a burner
			F24H 9/20 (2006.01)	2623871	Household heating device for providing water comprising a control unit configured for providing control signals to a burner

MKP (51)	Broj objave evropske prijava patenta (97)	Naziv pronalaska (54)	MKP (51)	Broj objave evropske prijava patenta (97)	Naziv pronalaska (54)
G01S 7/48 (2006.01)	2715395 *	VEHICLE, SYSTEM FOR RECEIVING AND TRANSMITTING OPTICAL SIGNALS, AND METHODS	B01J 20/28 (2006.01)	2726198 *	FILTER MATERIALS FOR TREATING AND PURIFYING GAS
G01S 7/481 (2006.01)	2715395 *	VEHICLE, SYSTEM FOR RECEIVING AND TRANSMITTING OPTICAL SIGNALS, AND METHODS	B01J 20/32 (2006.01)	2726198 *	FILTER MATERIALS FOR TREATING AND PURIFYING GAS
G01S 7/495 (2006.01)	2715395 *	VEHICLE, SYSTEM FOR RECEIVING AND TRANSMITTING OPTICAL SIGNALS, AND METHODS	A23L 1/00 (2006.01)	2731461 *	MULTICAROTENOID BEADLETS AND RELATED METHOD
G01S 17/93 (2006.01)	2715395 *	VEHICLE, SYSTEM FOR RECEIVING AND TRANSMITTING OPTICAL SIGNALS, AND METHODS	A23L 1/275 (2006.01)	2731461 *	MULTICAROTENOID BEADLETS AND RELATED METHOD
A01N 43/00 (2006.01)	2713727 *	COMBINATION OF MEK INHIBITORS AND SELECTIVE INHIBITORS OF AURORA A KINASE	A23L 1/303 (2006.01)	2731461 *	MULTICAROTENOID BEADLETS AND RELATED METHOD
G01N 33/52 (2006.01)	2761294 *	BIODOSIMETRY PANELS AND METHODS	C08F 10/06 (2006.01)	2707399 *	NITROGEN CONTAINING EXTERNAL DONOR SYSTEM FOR PROPYLENE POLYMERIZATION
G01N 33/53 (2006.01)	2761294 *	BIODOSIMETRY PANELS AND METHODS	A61K 31/444 (2006.01)	2739623 *	INHIBITORS OF INFLUENZA VIRUSES REPLICATION
G01N 33/68 (2006.01)	2761294 *	BIODOSIMETRY PANELS AND METHODS	A61K 31/506 (2006.01)	2739623 *	INHIBITORS OF INFLUENZA VIRUSES REPLICATION
G06F 17/10 (2006.01)	2761294 *	BIODOSIMETRY PANELS AND METHODS	A61P 31/16 (2006.01)	2739623 *	INHIBITORS OF INFLUENZA VIRUSES REPLICATION
C12Q 1/68 (2006.01)	2707503 *	GENOMIC MARKERS FOR PREDICTION OF LONG-TERM RESPONSE TO 2 YEARS OF GROWTH HORMONE (GH) THERAPY	C07D 471/04 (2006.01)	2739623 *	INHIBITORS OF INFLUENZA VIRUSES REPLICATION
A01N 43/40 (2006.01)	2713732 *	PIRFENIDONE AND ANTI-FIBROTIC THERAPY IN SELECTED PATIENTS	A61B 5/01 (2006.01)	2745817 *	DEVICE AND METHOD FOR CONTROLLING - EITHER INCREASING OR DECREASING - THE BODY TEMPERATURE OF A PATIENT
E03B 1/04 (2006.01)	2702330 *	A METHOD AND A LIQUID TAP DEVICE FOR RETAINING THE TEMPERATURE OF A LIQUID IN A LIQUID DISTRIBUTION SYSTEM	A61F 7/00 (2006.01)	2745817 *	DEVICE AND METHOD FOR CONTROLLING - EITHER INCREASING OR DECREASING - THE BODY TEMPERATURE OF A PATIENT
E03C 1/02 (2006.01)	2702330 *	A METHOD AND A LIQUID TAP DEVICE FOR RETAINING THE TEMPERATURE OF A LIQUID IN A LIQUID DISTRIBUTION SYSTEM	A61K 31/519 (2006.01)	2736908 *	BICYCLIC PYRIMIDONE COMPOUNDS
F16K 15/14 (2006.01)	2702330 *	A METHOD AND A LIQUID TAP DEVICE FOR RETAINING THE TEMPERATURE OF A LIQUID IN A LIQUID DISTRIBUTION SYSTEM	A61P 25/28 (2006.01)	2736908 *	BICYCLIC PYRIMIDONE COMPOUNDS
F24D 17/00 (2006.01)	2702330 *	A METHOD AND A LIQUID TAP DEVICE FOR RETAINING THE TEMPERATURE OF A LIQUID IN A LIQUID DISTRIBUTION SYSTEM	C07D 487/04 (2006.01)	2736908 *	BICYCLIC PYRIMIDONE COMPOUNDS
B01D 53/02 (2006.01)	2726198 *	FILTER MATERIALS FOR TREATING AND PURIFYING GAS	C09K 3/18 (2006.01)	2718386 *	DEICING COMPOSITION
B01J 20/20 (2006.01)	2726198 *	FILTER MATERIALS FOR TREATING AND PURIFYING GAS	A61K 31/155 (2006.01)	2750699 *	PHARMACEUTICAL COMBINATION FOR USE IN GLYCEMIC CONTROL IN DIABETES TYPE 2 PATIENTS
			A61K 31/4439 (2006.01)	2750699 *	PHARMACEUTICAL COMBINATION FOR USE IN GLYCEMIC CONTROL IN DIABETES TYPE 2 PATIENTS

MKP (51)	Broj objave evropske prijava patenta (97)	Naziv pronalaska (54)	MKP (51)	Broj objave evropske prijava patenta (97)	Naziv pronalaska (54)
A61K 38/26 (2006.01)	2750699 *	PHARMACEUTICAL COMBINATION FOR USE IN GLYCEMIC CONTROL IN DIABETES TYPE 2 PATIENTS	C08L 83/04 (2006.01)	2734588 *	COPPER CONTAINING COMPLEX, CONDENSATION REACTION COMPOSITIONS CONTAINING THE COMPLEX, AND METHODS FOR THE PREPARATION AND USE OF THE COMPOSITIONS
C12N 15/12 (2006.01)	2744919 *	GENE SIGNATURES FOR LUNG CANCER PROGNOSIS AND THERAPY SELECTION	A61K 31/4523 (2006.01)	2744497 *	THERAPEUTIC COMBINATIONS OF NETUPITANT AND PALONOSETRON
C12Q 1/68 (2006.01)	2744919 *	GENE SIGNATURES FOR LUNG CANCER PROGNOSIS AND THERAPY SELECTION	A61K 31/4748 (2006.01)	2744497 *	THERAPEUTIC COMBINATIONS OF NETUPITANT AND PALONOSETRON
C08K 5/49 (2006.01)	2770017	New surface treatment of white mineral materials for application in plastics	A61P 1/00 (2006.01)	2744497 *	THERAPEUTIC COMBINATIONS OF NETUPITANT AND PALONOSETRON
A61K 39/395 (2006.01)	2736530 *	USE OF IL-12 TO GENERATE ENDOGENOUS ERYTHROPOIETIN	A61P 25/00 (2006.01)	2744497 *	THERAPEUTIC COMBINATIONS OF NETUPITANT AND PALONOSETRON
A61K 38/16 (2006.01)	2723367 *	GLUCAGON/GLP-1 RECEPTOR CO-AGONISTS	A61P 25/02 (2006.01)	2744497 *	THERAPEUTIC COMBINATIONS OF NETUPITANT AND PALONOSETRON
A61K 38/17 (2006.01)	2723367 *	GLUCAGON/GLP-1 RECEPTOR CO-AGONISTS	A61K 31/496 (2006.01)	2760452 *	METHODS OF TREATING CANCER
A61K 38/26 (2006.01)	2723367 *	GLUCAGON/GLP-1 RECEPTOR CO-AGONISTS	A61K 31/4166 (2006.01)	2744786 *	SUBSTITUTED 2-IMIDAZOLIDINONES AND 2-IMIDAZOLONES AND THEIR USE IN THE TREATMENT OF CANCER
A61P 3/00 (2006.01)	2723367 *	GLUCAGON/GLP-1 RECEPTOR CO-AGONISTS	A61P 35/00 (2006.01)	2744786 *	SUBSTITUTED 2-IMIDAZOLIDINONES AND 2-IMIDAZOLONES AND THEIR USE IN THE TREATMENT OF CANCER
A61P 3/04 (2006.01)	2723367 *	GLUCAGON/GLP-1 RECEPTOR CO-AGONISTS	C07D 233/32 (2006.01)	2744786 *	SUBSTITUTED 2-IMIDAZOLIDINONES AND 2-IMIDAZOLONES AND THEIR USE IN THE TREATMENT OF CANCER
A61P 3/10 (2006.01)	2723367 *	GLUCAGON/GLP-1 RECEPTOR CO-AGONISTS	A61B 17/00 (2006.01)	2644115	Tissue thickness compensators for circular surgical staplers
A61K 31/554 (2006.01)	2708535	Agents for treating disorders involving modulation of ryanodine receptors	A61B 17/064 (2006.01)	2644115	Tissue thickness compensators for circular surgical staplers
A61P 9/00 (2006.01)	2708535	Agents for treating disorders involving modulation of ryanodine receptors	A61B 17/072 (2006.01)	2644115	Tissue thickness compensators for circular surgical staplers
A61P 19/08 (2006.01)	2708535	Agents for treating disorders involving modulation of ryanodine receptors	A61B 17/115 (2006.01)	2644115	Tissue thickness compensators for circular surgical staplers
A61P 25/00 (2006.01)	2708535	Agents for treating disorders involving modulation of ryanodine receptors	A61B 17/29 (2006.01)	2644115	Tissue thickness compensators for circular surgical staplers
C07D 281/10 (2006.01)	2708535	Agents for treating disorders involving modulation of ryanodine receptors	A61B 19/08 (2006.01)	2644115	Tissue thickness compensators for circular surgical staplers
C07B 61/00 (2006.01)	2736894 *	METHOD FOR PRODUCING BENZO[B]THIOPHENE COMPOUND	A61L 31/00 (2006.01)	2644115	Tissue thickness compensators for circular surgical staplers
C07D 333/54 (2006.01)	2736894 *	METHOD FOR PRODUCING BENZO[B]THIOPHENE COMPOUND			
C07D 409/12 (2006.01)	2736894 *	METHOD FOR PRODUCING BENZO[B]THIOPHENE COMPOUND			

MKP (51)	Broj objave evropske prijava patenta (97)	Naziv pronalaska (54)	MKP (51)	Broj objave evropske prijava patenta (97)	Naziv pronalaska (54)
H04L 12/18 (2006.01)	2744184	File management system, method and computer program	C08F 232/04 (2006.01)	2738237 *	AMPHIPHILIC MACROMOLECULE AND USE THEREOF
H04M 3/42 (2006.01)	2744184	File management system, method and computer program	C09K 8/588 (2006.01)	2738237 *	AMPHIPHILIC MACROMOLECULE AND USE THEREOF
C12N 5/04 (2006.01)	2718443 *	METHODS AND MEANS TO MODIFY A PLANT GENOME AT A PRESELECTED SITE	A23B 4/005 (2006.01)	2671459	Process for packing a product based on portions of fish in the solid form and relative packed product
C12N 5/10 (2006.01)	2718443 *	METHODS AND MEANS TO MODIFY A PLANT GENOME AT A PRESELECTED SITE	A23L 1/325 (2006.01)	2671459	Process for packing a product based on portions of fish in the solid form and relative packed product
C12N 9/16 (2006.01)	2718443 *	METHODS AND MEANS TO MODIFY A PLANT GENOME AT A PRESELECTED SITE	B65B 25/06 (2006.01)	2671459	Process for packing a product based on portions of fish in the solid form and relative packed product
C12N 15/82 (2006.01)	2718443 *	METHODS AND MEANS TO MODIFY A PLANT GENOME AT A PRESELECTED SITE	B65B 55/02 (2006.01)	2671459	Process for packing a product based on portions of fish in the solid form and relative packed product
H03M 3/02 (2006.01)	2658131	Electronic device and method for analogue to digital conversion according to Delta-Sigma modulation using double sampling	B65B 55/22 (2006.01)	2671459	Process for packing a product based on portions of fish in the solid form and relative packed product
A61K 31/519 (2006.01)	2705036 *	TRICYCLIC SULFONAMIDE COMPOUNDS AND METHODS OF MAKING AND USING SAME	A01N 43/40 (2006.01)	2729006 *	FUNGICIDAL COMPOSITION AND METHOD FOR CONTROLLING PLANT DISEASES
A61P 3/04 (2006.01)	2705036 *	TRICYCLIC SULFONAMIDE COMPOUNDS AND METHODS OF MAKING AND USING SAME	A01N 43/56 (2006.01)	2729006 *	FUNGICIDAL COMPOSITION AND METHOD FOR CONTROLLING PLANT DISEASES
C07D 471/04 (2006.01)	2705036 *	TRICYCLIC SULFONAMIDE COMPOUNDS AND METHODS OF MAKING AND USING SAME	A01N 43/90 (2006.01)	2729006 *	FUNGICIDAL COMPOSITION AND METHOD FOR CONTROLLING PLANT DISEASES
C07D 487/04 (2006.01)	2705036 *	TRICYCLIC SULFONAMIDE COMPOUNDS AND METHODS OF MAKING AND USING SAME	A01N 45/02 (2006.01)	2729006 *	FUNGICIDAL COMPOSITION AND METHOD FOR CONTROLLING PLANT DISEASES
C07D 498/04 (2006.01)	2705036 *	TRICYCLIC SULFONAMIDE COMPOUNDS AND METHODS OF MAKING AND USING SAME	A01N 47/16 (2006.01)	2729006 *	FUNGICIDAL COMPOSITION AND METHOD FOR CONTROLLING PLANT DISEASES
A61K 38/20 (2006.01)	2760465 *	COMPOSITIONS AND METHODS FOR THE TREATMENT OF DEGENERATIVE RETINAL CONDITIONS	A01P 3/00 (2006.01)	2729006 *	FUNGICIDAL COMPOSITION AND METHOD FOR CONTROLLING PLANT DISEASES
A61P 27/02 (2006.01)	2760465 *	COMPOSITIONS AND METHODS FOR THE TREATMENT OF DEGENERATIVE RETINAL CONDITIONS	A61K 9/00 (2006.01)	2750768 *	DECITABINE DERIVATIVE FORMULATIONS
C08F 212/14 (2006.01)	2738237 *	AMPHIPHILIC MACROMOLECULE AND USE THEREOF	A61K 9/19 (2006.01)	2750768 *	DECITABINE DERIVATIVE FORMULATIONS
C08F 220/06 (2006.01)	2738237 *	AMPHIPHILIC MACROMOLECULE AND USE THEREOF	A61K 31/7068 (2006.01)	2750768 *	DECITABINE DERIVATIVE FORMULATIONS
C08F 220/10 (2006.01)	2738237 *	AMPHIPHILIC MACROMOLECULE AND USE THEREOF	A61K 47/10 (2006.01)	2750768 *	DECITABINE DERIVATIVE FORMULATIONS
C08F 220/34 (2006.01)	2738237 *	AMPHIPHILIC MACROMOLECULE AND USE THEREOF	A61K 47/20 (2006.01)	2750768 *	DECITABINE DERIVATIVE FORMULATIONS
C08F 220/56 (2006.01)	2738237 *	AMPHIPHILIC MACROMOLECULE AND USE THEREOF	A61P 35/00 (2006.01)	2750768 *	DECITABINE DERIVATIVE FORMULATIONS
			H02G 15/10 (2006.01)	2766967 *	SPACERS IN CABLE SPLICING SLEEVES

MKP (51)	Broj objave evropske prijava patenta (97)	Naziv pronalaska (54)	MKP (51)	Broj objave evropske prijava patenta (97)	Naziv pronalaska (54)
H02G 15/117 (2006.01)	2766967 *	SPACERS IN CABLE SPLICING SLEEVES	C07D 403/14 (2006.01)	2729448 *	COMPOUNDS FOR THE TREATMENT OF HIV
B60P 1/00 (2006.01)	2755856 *	REGENERATIVE BRAKING SYSTEM FOR A VEHICLE RAMP	C07D 405/12 (2006.01)	2729448 *	COMPOUNDS FOR THE TREATMENT OF HIV
B60P 1/43 (2006.01)	2755856 *	REGENERATIVE BRAKING SYSTEM FOR A VEHICLE RAMP	C07D 471/04 (2006.01)	2729448 *	COMPOUNDS FOR THE TREATMENT OF HIV
A01N 1/02 (2006.01)	2757879 *	PLATELET LYSATE, USES AND METHOD FOR THE PREPARATION THEREOF	C07D 471/06 (2006.01)	2729448 *	COMPOUNDS FOR THE TREATMENT OF HIV
A61K 35/14 (2006.01)	2757879 *	PLATELET LYSATE, USES AND METHOD FOR THE PREPARATION THEREOF	C07D 487/04 (2006.01)	2729448 *	COMPOUNDS FOR THE TREATMENT OF HIV
A61L 2/00 (2006.01)	2757879 *	PLATELET LYSATE, USES AND METHOD FOR THE PREPARATION THEREOF	C07D 491/04 (2006.01)	2729448 *	COMPOUNDS FOR THE TREATMENT OF HIV
C22C 38/44 (2006.01)	2714955 *	AUSTENITIC STAINLESS STEEL	C07D 495/04 (2006.01)	2729448 *	COMPOUNDS FOR THE TREATMENT OF HIV
C22C 38/58 (2006.01)	2714955 *	AUSTENITIC STAINLESS STEEL	C04B 35/571 (2006.01)	2647611	High durability joints between ceramic articles, and methods of making and using same
B32B 5/24 (2006.01)	2750879 *	ARTICLE MADE OF A MULTILAYER COMPOSITE MATERIAL AND PREPARATION METHOD THEREOF	C04B 35/626 (2006.01)	2647611	High durability joints between ceramic articles, and methods of making and using same
B32B 5/26 (2006.01)	2750879 *	ARTICLE MADE OF A MULTILAYER COMPOSITE MATERIAL AND PREPARATION METHOD THEREOF	C04B 35/628 (2006.01)	2647611	High durability joints between ceramic articles, and methods of making and using same
B60R 13/00 (2006.01)	2750879 *	ARTICLE MADE OF A MULTILAYER COMPOSITE MATERIAL AND PREPARATION METHOD THEREOF	C04B 37/00 (2006.01)	2647611	High durability joints between ceramic articles, and methods of making and using same
F01N 3/20 (2006.01)	2647803	Reagent dosing pump assembly with connector element	F03D 1/02 (2006.01)	2516844 *	ENERGY GENERATION SYSTEM AND RELATED METHODS
F04B 53/08 (2006.01)	2647803	Reagent dosing pump assembly with connector element	F03D 3/02 (2006.01)	2516844 *	ENERGY GENERATION SYSTEM AND RELATED METHODS
A61K 31/496 (2006.01)	2729448 *	COMPOUNDS FOR THE TREATMENT OF HIV	F03D 5/02 (2006.01)	2516844 *	ENERGY GENERATION SYSTEM AND RELATED METHODS
A61P 31/14 (2006.01)	2729448 *	COMPOUNDS FOR THE TREATMENT OF HIV	F03D 11/04 (2006.01)	2516844 *	ENERGY GENERATION SYSTEM AND RELATED METHODS
C07D 213/40 (2006.01)	2729448 *	COMPOUNDS FOR THE TREATMENT OF HIV	E04B 1/348 (2006.01)	2674538	Modular construction and corresponding assembly method
C07D 401/12 (2006.01)	2729448 *	COMPOUNDS FOR THE TREATMENT OF HIV	A61M 1/00 (2006.01)	2758089 *	METHODS OF MANUFACTURING FLEXIBLE POLYMERIC MEDICAL SPIRAL TUBINGS, TUBINGS MADE BY THE METHODS AND USES OF THE TUBINGS
C07D 401/14 (2006.01)	2729448 *	COMPOUNDS FOR THE TREATMENT OF HIV	A61M 13/00 (2006.01)	2758089 *	METHODS OF MANUFACTURING FLEXIBLE POLYMERIC MEDICAL SPIRAL TUBINGS, TUBINGS MADE BY THE METHODS AND USES OF THE TUBINGS
C07D 403/12 (2006.01)	2729448 *	COMPOUNDS FOR THE TREATMENT OF HIV			

MKP (51)	Broj objave evropske prijava patenta (97)	Naziv pronalaska (54)	MKP (51)	Broj objave evropske prijava patenta (97)	Naziv pronalaska (54)
A61M 16/04 (2006.01)	2758089 *	METHODS OF MANUFACTURING FLEXIBLE POLYMERIC MEDICAL SPIRAL TUBINGS, TUBINGS MADE BY THE METHODS AND USES OF THE TUBINGS	A61K 38/16 (2006.01)	2711016	Novel IL-17A binding molecules and medical uses thereof
A61M 25/00 (2006.01)	2758089 *	METHODS OF MANUFACTURING FLEXIBLE POLYMERIC MEDICAL SPIRAL TUBINGS, TUBINGS MADE BY THE METHODS AND USES OF THE TUBINGS	A61P 19/00 (2006.01)	2711016	Novel IL-17A binding molecules and medical uses thereof
A61M 39/08 (2006.01)	2758089 *	METHODS OF MANUFACTURING FLEXIBLE POLYMERIC MEDICAL SPIRAL TUBINGS, TUBINGS MADE BY THE METHODS AND USES OF THE TUBINGS	C07K 14/00 (2006.01)	2711016	Novel IL-17A binding molecules and medical uses thereof
A61K 39/395 (2006.01)	2763700 *	HUMAN NOTCH1 DECOYS	H02J 3/26 (2006.01)	2769448 *	METHOD AND APPARATUS FOR FEEDING ELECTRICAL CURRENT INTO AN ELECTRICAL POWER SUPPLY SYSTEM
A61K 38/20 (2006.01)	2736524 *	PURIFIED PROTEINS	H02J 3/38 (2006.01)	2769448 *	METHOD AND APPARATUS FOR FEEDING ELECTRICAL CURRENT INTO AN ELECTRICAL POWER SUPPLY SYSTEM
B01D 15/36 (2006.01)	2736524 *	PURIFIED PROTEINS	C03C 13/06 (2006.01)	2768781 *	SIZING COMPOSITION HAVING A LOW FORMALDEHYDE CONTENT FOR FIRE-RESISTANT MINERAL WOOL AND INSULATION PRODUCT OBTAINED
C07K 14/545 (2006.01)	2736524 *	PURIFIED PROTEINS	C03C 25/24 (2006.01)	2768781 *	SIZING COMPOSITION HAVING A LOW FORMALDEHYDE CONTENT FOR FIRE-RESISTANT MINERAL WOOL AND INSULATION PRODUCT OBTAINED
A61B 5/05 (2006.01)	2706911 *	SYSTEM AND METHOD FOR SUB-COLUMN PARALLEL DIGITIZERS FOR HYBRID STACKED IMAGE SENSOR USING VERTICAL INTERCONNECTS	C03C 25/26 (2006.01)	2768781 *	SIZING COMPOSITION HAVING A LOW FORMALDEHYDE CONTENT FOR FIRE-RESISTANT MINERAL WOOL AND INSULATION PRODUCT OBTAINED
B65D 85/67 (2006.01)	2758787 *	SEALING MEANS FOR TEST CASSETTE	C03C 25/34 (2006.01)	2768781 *	SIZING COMPOSITION HAVING A LOW FORMALDEHYDE CONTENT FOR FIRE-RESISTANT MINERAL WOOL AND INSULATION PRODUCT OBTAINED
B65H 75/18 (2006.01)	2758787 *	SEALING MEANS FOR TEST CASSETTE	C09J 177/06 (2006.01)	2768781 *	SIZING COMPOSITION HAVING A LOW FORMALDEHYDE CONTENT FOR FIRE-RESISTANT MINERAL WOOL AND INSULATION PRODUCT OBTAINED
G01N 37/00 (2006.01)	2758787 *	SEALING MEANS FOR TEST CASSETTE	C09J 179/04 (2006.01)	2768781 *	SIZING COMPOSITION HAVING A LOW FORMALDEHYDE CONTENT FOR FIRE-RESISTANT MINERAL WOOL AND INSULATION PRODUCT OBTAINED
A01H 1/08 (2006.01)	2741602 *	DURUM WHEAT PLANTS HAVING A PARTIALLY OR FULLY MULTIPLIED GENOME AND USES THEREOF	C09J 179/08 (2006.01)	2768781 *	SIZING COMPOSITION HAVING A LOW FORMALDEHYDE CONTENT FOR FIRE-RESISTANT MINERAL WOOL AND INSULATION PRODUCT OBTAINED
A01H 5/00 (2006.01)	2741602 *	DURUM WHEAT PLANTS HAVING A PARTIALLY OR FULLY MULTIPLIED GENOME AND USES THEREOF	D04H 1/4209 (2012.01)	2768781 *	SIZING COMPOSITION HAVING A LOW FORMALDEHYDE CONTENT FOR FIRE-RESISTANT MINERAL WOOL AND INSULATION PRODUCT OBTAINED
A01H 5/10 (2006.01)	2741602 *	DURUM WHEAT PLANTS HAVING A PARTIALLY OR FULLY MULTIPLIED GENOME AND USES THEREOF	D04H 1/4218 (2012.01)	2768781 *	SIZING COMPOSITION HAVING A LOW FORMALDEHYDE CONTENT FOR FIRE-RESISTANT MINERAL WOOL AND INSULATION PRODUCT OBTAINED
E04F 11/18 (2006.01)	2759655 *	HANDRAIL CONSISTING OF PREFABRICATED TUBES AND PARTS MADE OF STAINLESS STEEL			
A61K 31/405 (2006.01)	2768499 *	INDOMETHACIN ANALOGS FOR THE TREATMENT OF CASTRATE-RESISTANT PROSTATE CANCER			
C07D 209/26 (2006.01)	2768499 *	INDOMETHACIN ANALOGS FOR THE TREATMENT OF CASTRATE-RESISTANT PROSTATE CANCER			

MKP (51)	Broj objave evropske prijava patenta (97)	Naziv pronalaska (54)	MKP (51)	Broj objave evropske prijava patenta (97)	Naziv pronalaska (54)
D04H 1/488 (2012.01)	2768781 *	SIZING COMPOSITION HAVING A LOW FORMALDEHYDE CONTENT FOR FIRE-RESISTANT MINERAL WOOL AND INSULATION PRODUCT OBTAINED	A61K 31/506 (2006.01)	2739616 *	PYRIDIN-2(1H)-ONE DERIVATIVES AS JAK INHIBITORS
B28B 3/02 (2006.01)	2583802	An improved buffer for mold for ceramic industry and mold comprising said buffer	A61P 11/06 (2006.01)	2739616 *	PYRIDIN-2(1H)-ONE DERIVATIVES AS JAK INHIBITORS
B30B 15/06 (2006.01)	2583802	An improved buffer for mold for ceramic industry and mold comprising said buffer	A61P 35/02 (2006.01)	2739616 *	PYRIDIN-2(1H)-ONE DERIVATIVES AS JAK INHIBITORS
C25D 11/04 (2006.01)	2583802	An improved buffer for mold for ceramic industry and mold comprising said buffer	A61P 37/06 (2006.01)	2739616 *	PYRIDIN-2(1H)-ONE DERIVATIVES AS JAK INHIBITORS
A61K 9/12 (2006.01)	2743343 *	SPRAY FORMULATION OF MESENCHYMAL STEM CELLS FOR THE TREATMENT OF CHRONIC WOUNDS	C07D 401/12 (2006.01)	2739616 *	PYRIDIN-2(1H)-ONE DERIVATIVES AS JAK INHIBITORS
A61K 35/36 (2006.01)	2743343 *	SPRAY FORMULATION OF MESENCHYMAL STEM CELLS FOR THE TREATMENT OF CHRONIC WOUNDS	C07D 401/14 (2006.01)	2739616 *	PYRIDIN-2(1H)-ONE DERIVATIVES AS JAK INHIBITORS
A61P 17/02 (2006.01)	2743343 *	SPRAY FORMULATION OF MESENCHYMAL STEM CELLS FOR THE TREATMENT OF CHRONIC WOUNDS	A61K 39/395 (2006.01)	2721065 *	ANTI-ANGPTL3 ANTIBODIES AND USES THEREOF
C12N 5/0775 (2010.01)	2743343 *	SPRAY FORMULATION OF MESENCHYMAL STEM CELLS FOR THE TREATMENT OF CHRONIC WOUNDS	A61P 3/06 (2006.01)	2721065 *	ANTI-ANGPTL3 ANTIBODIES AND USES THEREOF
H02J 3/38 (2006.01)	2748908 *	METHOD FOR OPERATING A WIND ENERGY INSTALLATION	C07K 16/22 (2006.01)	2721065 *	ANTI-ANGPTL3 ANTIBODIES AND USES THEREOF
H02J 3/40 (2006.01)	2748908 *	METHOD FOR OPERATING A WIND ENERGY INSTALLATION	G06F 19/00 (2011.01)	2721543 *	SYSTEMS AND METHODS FOR ESTIMATING BLOOD FLOW CHARACTERISTICS FROM VESSEL GEOMETRY AND PHYSIOLOGY
A61K 38/19 (2006.01)	2750696 *	COMPOSITIONS AND METHODS FOR TREATING OR PREVENTING RADIATION- OR CHEMOTHERAPY-INDUCED PULMONARY DYSFUNCTION	A61P 35/00 (2006.01)	2702155 *	MICRORNA COMPOUNDS AND METHODS FOR MODULATING MIR-21 ACTIVITY
A61P 11/00 (2006.01)	2750696 *	COMPOSITIONS AND METHODS FOR TREATING OR PREVENTING RADIATION- OR CHEMOTHERAPY-INDUCED PULMONARY DYSFUNCTION	C12N 15/113 (2010.01)	2702155 *	MICRORNA COMPOUNDS AND METHODS FOR MODULATING MIR-21 ACTIVITY
B23K 26/40 (2014.01)	2714621 *	CERAMIC PARTICLE MIXTURE, AND METHOD FOR MANUFACTURING CERAMIC PARTS FROM SUCH A MIXTURE	B01J 20/04 (2006.01)	2732872	Method of producing agent for removing dissolved phosphorus compounds from water and agent for removing dissolved phosphorus compounds from water
C04B 35/622 (2006.01)	2714621 *	CERAMIC PARTICLE MIXTURE, AND METHOD FOR MANUFACTURING CERAMIC PARTS FROM SUCH A MIXTURE	B01J 20/28 (2006.01)	2732872	Method of producing agent for removing dissolved phosphorus compounds from water and agent for removing dissolved phosphorus compounds from water
H01L 33/00 (2010.01)	2761677 *	LIGHT EMITTING DIODE FABRICATED BY EPITAXIAL LIFT-OFF	C02F 1/28 (2006.01)	2732872	Method of producing agent for removing dissolved phosphorus compounds from water and agent for removing dissolved phosphorus compounds from water
A61K 31/444 (2006.01)	2739616 *	PYRIDIN-2(1H)-ONE DERIVATIVES AS JAK INHIBITORS	C02F 101/10 (2006.01)	2732872	Method of producing agent for removing dissolved phosphorus compounds from water and agent for removing dissolved phosphorus compounds from water
A61K 31/497 (2006.01)	2739616 *	PYRIDIN-2(1H)-ONE DERIVATIVES AS JAK INHIBITORS	C02F 103/00 (2006.01)	2732872	Method of producing agent for removing dissolved phosphorus compounds from water and agent for removing dissolved phosphorus compounds from water

MKP (51)	Broj objave evropske prijava patenta (97)	Naziv pronalaska (54)	MKP (51)	Broj objave evropske prijava patenta (97)	Naziv pronalaska (54)
A61K 31/16 (2006.01)	2752404	Cysteine protease inhibitors	C07D 403/04 (2006.01)	2739615 *	PHENYL-3-AZA-BICYCLO[3.1.0] HEX-3-YL-METHANONES AND THE USE THEREOF AS MEDICAMENT
A61P 11/00 (2006.01)	2752404	Cysteine protease inhibitors	C07D 413/04 (2006.01)	2739615 *	PHENYL-3-AZA-BICYCLO[3.1.0] HEX-3-YL-METHANONES AND THE USE THEREOF AS MEDICAMENT
A61P 37/00 (2006.01)	2752404	Cysteine protease inhibitors	C07D 413/14 (2006.01)	2739615 *	PHENYL-3-AZA-BICYCLO[3.1.0] HEX-3-YL-METHANONES AND THE USE THEREOF AS MEDICAMENT
C07C 237/14 (2006.01)	2752404	Cysteine protease inhibitors	C07D 417/04 (2006.01)	2739615 *	PHENYL-3-AZA-BICYCLO[3.1.0] HEX-3-YL-METHANONES AND THE USE THEREOF AS MEDICAMENT
C07D 233/58 (2006.01)	2752404	Cysteine protease inhibitors	C07D 471/04 (2006.01)	2739615 *	PHENYL-3-AZA-BICYCLO[3.1.0] HEX-3-YL-METHANONES AND THE USE THEREOF AS MEDICAMENT
A61K 31/122 (2006.01)	2701698 *	DISORDERS IMPLICATING PUFA OXIDATION	A23L 1/054 (2006.01)	2653494	Aqueous gellan dispersion
A61K 31/185 (2006.01)	2701698 *	DISORDERS IMPLICATING PUFA OXIDATION	A23L 2/52 (2006.01)	2653494	Aqueous gellan dispersion
A61K 31/20 (2006.01)	2701698 *	DISORDERS IMPLICATING PUFA OXIDATION	C08L 5/00 (2006.01)	2653494	Aqueous gellan dispersion
A61K 31/201 (2006.01)	2701698 *	DISORDERS IMPLICATING PUFA OXIDATION	B32B 9/00 (2006.01)	2687364	Composite conductive sheet, fabricating method and application thereof
A61P 1/00 (2006.01)	2701698 *	DISORDERS IMPLICATING PUFA OXIDATION	A61K 31/4725 (2006.01)	2729461 *	POLYMORPHS OF 6-(PIPERIDIN-4-YLOXY)-2H-ISOQUINOLIN-1-ONE HYDROCHLORIDE
A61P 1/16 (2006.01)	2701698 *	DISORDERS IMPLICATING PUFA OXIDATION	A61P 3/00 (2006.01)	2729461 *	POLYMORPHS OF 6-(PIPERIDIN-4-YLOXY)-2H-ISOQUINOLIN-1-ONE HYDROCHLORIDE
A61K 31/421 (2006.01)	2739615 *	PHENYL-3-AZA-BICYCLO[3.1.0] HEX-3-YL-METHANONES AND THE USE THEREOF AS MEDICAMENT	A61P 9/00 (2006.01)	2729461 *	POLYMORPHS OF 6-(PIPERIDIN-4-YLOXY)-2H-ISOQUINOLIN-1-ONE HYDROCHLORIDE
A61K 31/427 (2006.01)	2739615 *	PHENYL-3-AZA-BICYCLO[3.1.0] HEX-3-YL-METHANONES AND THE USE THEREOF AS MEDICAMENT	A61P 11/00 (2006.01)	2729461 *	POLYMORPHS OF 6-(PIPERIDIN-4-YLOXY)-2H-ISOQUINOLIN-1-ONE HYDROCHLORIDE
A61K 31/437 (2006.01)	2739615 *	PHENYL-3-AZA-BICYCLO[3.1.0] HEX-3-YL-METHANONES AND THE USE THEREOF AS MEDICAMENT	C07D 401/12 (2006.01)	2729461 *	POLYMORPHS OF 6-(PIPERIDIN-4-YLOXY)-2H-ISOQUINOLIN-1-ONE HYDROCHLORIDE
A61K 31/4439 (2006.01)	2739615 *	PHENYL-3-AZA-BICYCLO[3.1.0] HEX-3-YL-METHANONES AND THE USE THEREOF AS MEDICAMENT	F41G 3/04 (2006.01)	2748555 *	A TEST AND ANALYSIS SYSTEM AND A METHOD FOR THREAT EVALUATION AND SENSOR/ WEAPON ASSIGNMENT ALGORITHMS
A61P 25/18 (2006.01)	2739615 *	PHENYL-3-AZA-BICYCLO[3.1.0] HEX-3-YL-METHANONES AND THE USE THEREOF AS MEDICAMENT	F41G 3/26 (2006.01)	2748555 *	A TEST AND ANALYSIS SYSTEM AND A METHOD FOR THREAT EVALUATION AND SENSOR/ WEAPON ASSIGNMENT ALGORITHMS
A61P 25/28 (2006.01)	2739615 *	PHENYL-3-AZA-BICYCLO[3.1.0] HEX-3-YL-METHANONES AND THE USE THEREOF AS MEDICAMENT	F41G 3/32 (2006.01)	2748555 *	A TEST AND ANALYSIS SYSTEM AND A METHOD FOR THREAT EVALUATION AND SENSOR/ WEAPON ASSIGNMENT ALGORITHMS
C07D 401/04 (2006.01)	2739615 *	PHENYL-3-AZA-BICYCLO[3.1.0] HEX-3-YL-METHANONES AND THE USE THEREOF AS MEDICAMENT			

MKP (51)	Broj objave evropske prijava patenta (97)	Naziv pronalaska (54)	MKP (51)	Broj objave evropske prijava patenta (97)	Naziv pronalaska (54)
F41G 9/00 (2006.01)	2748555 *	A TEST AND ANALYSIS SYSTEM AND A METHOD FOR THREAT EVALUATION AND SENSOR/ WEAPON ASSIGNMENT ALGORITHMS	A61P 35/00 (2006.01)	2753322 *	SCHEME FOR ADMINISTERING N-HYDROXY-4-{2-[3-(N,N-DIMETHYLAMINOMETHYL)-BENZOFURAN-2-YLCARBONYLAMINO]ETHOXY} BENZAMIDE
G06Q 10/06 (2012.01)	2748555 *	A TEST AND ANALYSIS SYSTEM AND A METHOD FOR THREAT EVALUATION AND SENSOR/ WEAPON ASSIGNMENT ALGORITHMS	C07K 16/24 (2006.01)	2753937 *	CHARACTERIZATION OF CHO-MIF GENE AND PROTEIN, AND USE THEREOF
E21B 17/00 (2006.01)	2721247 *	KOBE SUB WITH INFLOW CONTROL, WELLBORE TUBING STRING AND METHOD	C12N 5/10 (2006.01)	2753937 *	CHARACTERIZATION OF CHO-MIF GENE AND PROTEIN, AND USE THEREOF
E21B 29/00 (2006.01)	2721247 *	KOBE SUB WITH INFLOW CONTROL, WELLBORE TUBING STRING AND METHOD	G01N 33/68 (2006.01)	2753937 *	CHARACTERIZATION OF CHO-MIF GENE AND PROTEIN, AND USE THEREOF
E21B 34/14 (2006.01)	2721247 *	KOBE SUB WITH INFLOW CONTROL, WELLBORE TUBING STRING AND METHOD	A01N 37/44 (2006.01)	2714669 *	HYPERTENSION AND HYPERURICEMIA
E21B 43/12 (2006.01)	2721247 *	KOBE SUB WITH INFLOW CONTROL, WELLBORE TUBING STRING AND METHOD	C07D 249/12 (2006.01)	2714669 *	HYPERTENSION AND HYPERURICEMIA
C02F 3/00 (2006.01)	2707334 *	BIOLOGICAL TREATMENT PROCESS AND INSTALLATION INCLUDING AIR-LIFT AND POST -TREATMENT IN FILTER	C07D 285/24 (2006.01)	2714669 *	HYPERTENSION AND HYPERURICEMIA
C02F 3/06 (2006.01)	2707334 *	BIOLOGICAL TREATMENT PROCESS AND INSTALLATION INCLUDING AIR-LIFT AND POST -TREATMENT IN FILTER	G06F 3/14 (2006.01)	2660711	Presentation system, receiver device, methods thereof, and computer-readable medium thereof
C02F 3/12 (2006.01)	2707334 *	BIOLOGICAL TREATMENT PROCESS AND INSTALLATION INCLUDING AIR-LIFT AND POST -TREATMENT IN FILTER	A61K 31/519 (2006.01)	2758402 *	PYRROLOPYRIMIDINE AND PURINE DERIVATIVES
C02F 3/22 (2006.01)	2707334 *	BIOLOGICAL TREATMENT PROCESS AND INSTALLATION INCLUDING AIR-LIFT AND POST -TREATMENT IN FILTER	A61P 35/00 (2006.01)	2758402 *	PYRROLOPYRIMIDINE AND PURINE DERIVATIVES
A61K 31/138 (2006.01)	2753322 *	SCHEME FOR ADMINISTERING N-HYDROXY-4-{2-[3-(N,N-DIMETHYLAMINOMETHYL)-BENZOFURAN-2-YLCARBONYLAMINO]ETHOXY} BENZAMIDE	C07D 487/04 (2006.01)	2758402 *	PYRROLOPYRIMIDINE AND PURINE DERIVATIVES
A61K 31/343 (2006.01)	2753322 *	SCHEME FOR ADMINISTERING N-HYDROXY-4-{2-[3-(N,N-DIMETHYLAMINOMETHYL)-BENZOFURAN-2-YLCARBONYLAMINO]ETHOXY} BENZAMIDE	A61K 31/506 (2006.01)	2731945 *	N- (6- ((2R,3S) -3,4-DIHYDROXYBUTAN-2-YLOXY) -2- (4 - FLUOROBENZYLTHIO) PYRIMIDIN- 4 - YL) -3- METHYLAZETIDINE- 1 - SULFONAMIDE AS CHEMOKINE RECEPTOR MODULATOR
A61K 31/704 (2006.01)	2753322 *	SCHEME FOR ADMINISTERING N-HYDROXY-4-{2-[3-(N,N-DIMETHYLAMINOMETHYL)-BENZOFURAN-2-YLCARBONYLAMINO]ETHOXY} BENZAMIDE	C07C 69/92 (2006.01)	2731945 *	N- (6- ((2R,3S) -3,4-DIHYDROXYBUTAN-2-YLOXY) -2- (4 - FLUOROBENZYLTHIO) PYRIMIDIN- 4 - YL) -3- METHYLAZETIDINE- 1 - SULFONAMIDE AS CHEMOKINE RECEPTOR MODULATOR
A61K 33/24 (2006.01)	2753322 *	SCHEME FOR ADMINISTERING N-HYDROXY-4-{2-[3-(N,N-DIMETHYLAMINOMETHYL)-BENZOFURAN-2-YLCARBONYLAMINO]ETHOXY} BENZAMIDE	C07D 205/04 (2006.01)	2731945 *	N- (6- ((2R,3S) -3,4-DIHYDROXYBUTAN-2-YLOXY) -2- (4 - FLUOROBENZYLTHIO) PYRIMIDIN- 4 - YL) -3- METHYLAZETIDINE- 1 - SULFONAMIDE AS CHEMOKINE RECEPTOR MODULATOR

MKP (51)	Broj objave evropske prijava patenta (97)	Naziv pronalaska (54)	MKP (51)	Broj objave evropske prijava patenta (97)	Naziv pronalaska (54)
C07D 317/20 (2006.01)	2731945 *	N- (6- ((2R,3S) -3,4-DIHYDROXYBUTAN- 2-YLOXY) -2- (4 - FLUOROBENZYLTHIO) PYRIMIDIN- 4 - YL) -3- METHYLAZETIDINE- 1 - SULFONAMIDE AS CHEMOKINE RECEPTOR MODULATOR	H01C 7/12 (2006.01)	2677524	Overvoltage protection devices including a varistor member and an electrical conductive fusing member
C07D 317/24 (2006.01)	2731945 *	N- (6- ((2R,3S) -3,4-DIHYDROXYBUTAN- 2-YLOXY) -2- (4 - FLUOROBENZYLTHIO) PYRIMIDIN- 4 - YL) -3- METHYLAZETIDINE- 1 - SULFONAMIDE AS CHEMOKINE RECEPTOR MODULATOR	H01T 1/16 (2006.01)	2677524	Overvoltage protection devices including a varistor member and an electrical conductive fusing member
C07D 403/12 (2006.01)	2731945 *	N- (6- ((2R,3S) -3,4-DIHYDROXYBUTAN- 2-YLOXY) -2- (4 - FLUOROBENZYLTHIO) PYRIMIDIN- 4 - YL) -3- METHYLAZETIDINE- 1 - SULFONAMIDE AS CHEMOKINE RECEPTOR MODULATOR	A01G 9/14 (2006.01)	2327295	Greenhouse
G01N 21/65 (2006.01)	2748588 *	RAPID DETECTION OF METABOLIC ACTIVITY	A63H 33/08 (2006.01)	2734682 *	INTERLOCKING BUILDING BLOCK, PAVING UNIT, TILE OR TOY ELEMENT AND THE CONSTRUCTION METHOD THEREOF
G01N 33/483 (2006.01)	2748588 *	RAPID DETECTION OF METABOLIC ACTIVITY	E01C 5/00 (2006.01)	2734682 *	INTERLOCKING BUILDING BLOCK, PAVING UNIT, TILE OR TOY ELEMENT AND THE CONSTRUCTION METHOD THEREOF
A01N 43/16 (2006.01)	2717692 *	METHODS OF TREATING FIBROTIC DISEASES USING TETRAHYDROCANNABINOL-11- OIC ACIDS	E04C 1/00 (2006.01)	2734682 *	INTERLOCKING BUILDING BLOCK, PAVING UNIT, TILE OR TOY ELEMENT AND THE CONSTRUCTION METHOD THEREOF
A61K 31/35 (2006.01)	2717692 *	METHODS OF TREATING FIBROTIC DISEASES USING TETRAHYDROCANNABINOL-11- OIC ACIDS	A61K 31/44 (2006.01)	2760838 *	DERIVATIVES OF 1-PHENYL-2- PYRIDINYL ALKYL ALCOHOLS AS PHOSPHODIESTERASE INHIBITORS
A61K 31/4965 (2006.01)	2723722 *	3,5-DIAMINO-6-CHLORO- N-(N-(4-(4-(2-(HEXYL (2,3,4,5,6-PENTAHYDROXYHEXYL) AMINO) ETHOXY) PHENYL) BUTYL) CARBAMIMIDOYL) PYRAZINE-2- CARBOXAMIDE	A61P 11/00 (2006.01)	2760838 *	DERIVATIVES OF 1-PHENYL-2- PYRIDINYL ALKYL ALCOHOLS AS PHOSPHODIESTERASE INHIBITORS
A61P 11/00 (2006.01)	2723722 *	3,5-DIAMINO-6-CHLORO- N-(N-(4-(4-(2-(HEXYL (2,3,4,5,6-PENTAHYDROXYHEXYL) AMINO) ETHOXY) PHENYL) BUTYL) CARBAMIMIDOYL) PYRAZINE-2- CARBOXAMIDE	C07D 213/69 (2006.01)	2760838 *	DERIVATIVES OF 1-PHENYL-2- PYRIDINYL ALKYL ALCOHOLS AS PHOSPHODIESTERASE INHIBITORS
C07D 239/48 (2006.01)	2723722 *	3,5-DIAMINO-6-CHLORO- N-(N-(4-(4-(2-(HEXYL (2,3,4,5,6-PENTAHYDROXYHEXYL) AMINO) ETHOXY) PHENYL) BUTYL) CARBAMIMIDOYL) PYRAZINE-2- CARBOXAMIDE	C07D 213/89 (2006.01)	2760838 *	DERIVATIVES OF 1-PHENYL-2- PYRIDINYL ALKYL ALCOHOLS AS PHOSPHODIESTERASE INHIBITORS
B60K 6/10 (2006.01)	2766587 *	FLYWHEEL HYBRID SYSTEM	G01N 21/64 (2006.01)	2769204 *	CELL CAPTURE SYSTEM AND USE THEREOF
B60K 25/00 (2006.01)	2766587 *	FLYWHEEL HYBRID SYSTEM	G01N 33/542 (2006.01)	2769204 *	CELL CAPTURE SYSTEM AND USE THEREOF
F02B 67/06 (2006.01)	2766587 *	FLYWHEEL HYBRID SYSTEM	G01N 33/569 (2006.01)	2769204 *	CELL CAPTURE SYSTEM AND USE THEREOF
			A61K 31/53 (2006.01)	2726482 *	HYDROXYMETHYLARYL- SUBSTITUTED PYRROLOTRIAZINES AS ALK1 INHIBITORS
			A61P 27/00 (2006.01)	2726482 *	HYDROXYMETHYLARYL- SUBSTITUTED PYRROLOTRIAZINES AS ALK1 INHIBITORS
			C07D 487/04 (2006.01)	2726482 *	HYDROXYMETHYLARYL- SUBSTITUTED PYRROLOTRIAZINES AS ALK1 INHIBITORS

MKP (51)	Broj objave evropske prijava patenta (97)	Naziv pronalaska (54)	MKP (51)	Broj objave evropske prijava patenta (97)	Naziv pronalaska (54)
H02H 3/08 (2006.01)	2764593 *	MOTOR PROTECTION AND CONTROL APPARATUS, SYSTEM, AND/OR METHOD	H03M 1/66 (2006.01)	2751927 *	METHOD AND APPARATUS FOR PERFORMING DATA CONVERSION WITH NON-UNIFORM QUANTIZATION
H02H 9/02 (2006.01)	2764593 *	MOTOR PROTECTION AND CONTROL APPARATUS, SYSTEM, AND/OR METHOD	A61Q 5/12 (2006.01)	2720755 *	COMPOSITIONS FOR DEPOSITING AGENTS USING HIGHLY VOLATILE SILICONE SOLVENTS
B01D 53/56 (2006.01)	2704817 *	PROCESS AND APPARATUS FOR REDUCING THE CONTENT OF NITROGEN OXIDES	B23K 26/08 (2006.01)	2674245	Jet processing device
F25B 3/00 (2006.01)	2734793 *	ASSEMBLY AND METHOD OF ATTACHING STUB SHAFT TO DRUM OF AXIAL COMPRESSOR ROTOR SHAFT	B23K 37/02 (2006.01)	2674245	Jet processing device
A61K 31/4468 (2006.01)	2648754 *	METHODS OF INHIBITING METASTASIS FROM CANCER	B23Q 1/48 (2006.01)	2674245	Jet processing device
A61K 31/451 (2006.01)	2648754 *	METHODS OF INHIBITING METASTASIS FROM CANCER	B26F 3/00 (2006.01)	2674245	Jet processing device
A61K 31/4985 (2006.01)	2648754 *	METHODS OF INHIBITING METASTASIS FROM CANCER	B24C 5/06 (2006.01)	2650084	Turbine
A61K 31/7088 (2006.01)	2648754 *	METHODS OF INHIBITING METASTASIS FROM CANCER	B65B 43/30 (2006.01)	2739535 *	METHOD AND APPARATUS FOR FEEDING TUBULAR BLANKS TO A PACKAGING MACHINE
A61K 39/395 (2006.01)	2648754 *	METHODS OF INHIBITING METASTASIS FROM CANCER	C07C 405/00 (2006.01)	2723714 *	NOVEL PROCESSES FOR THE PREPARATION OF PROSTAGLANDIN AMIDES
A61P 35/04 (2006.01)	2648754 *	METHODS OF INHIBITING METASTASIS FROM CANCER	C07D 207/46 (2006.01)	2723714 *	NOVEL PROCESSES FOR THE PREPARATION OF PROSTAGLANDIN AMIDES
C07D 487/04 (2006.01)	2648754 *	METHODS OF INHIBITING METASTASIS FROM CANCER	C07D 209/48 (2006.01)	2723714 *	NOVEL PROCESSES FOR THE PREPARATION OF PROSTAGLANDIN AMIDES
C07K 16/24 (2006.01)	2648754 *	METHODS OF INHIBITING METASTASIS FROM CANCER	C07D 233/60 (2006.01)	2723714 *	NOVEL PROCESSES FOR THE PREPARATION OF PROSTAGLANDIN AMIDES
C07K 16/28 (2006.01)	2648754 *	METHODS OF INHIBITING METASTASIS FROM CANCER	C07D 307/935 (2006.01)	2723714 *	NOVEL PROCESSES FOR THE PREPARATION OF PROSTAGLANDIN AMIDES
A61K 48/00 (2006.01)	2763701 *	MODIFIED NUCLEOSIDES, NUCLEOTIDES, AND NUCLEIC ACIDS, AND USES THEREOF	A61K 31/4412 (2006.01)	2748146 *	A CRYSTALLINE FORM OF THE SODIUM SALT OF 4-TERT-BUTYL-N-[4-CHLORO-2-(1-OXY-PYRIDINE-4-CARBONYL)-PHENYL]-BENZENE SULFONAMIDE
C07H 21/02 (2006.01)	2763701 *	MODIFIED NUCLEOSIDES, NUCLEOTIDES, AND NUCLEIC ACIDS, AND USES THEREOF	A61P 29/00 (2006.01)	2748146 *	A CRYSTALLINE FORM OF THE SODIUM SALT OF 4-TERT-BUTYL-N-[4-CHLORO-2-(1-OXY-PYRIDINE-4-CARBONYL)-PHENYL]-BENZENE SULFONAMIDE
C07H 21/04 (2006.01)	2763701 *	MODIFIED NUCLEOSIDES, NUCLEOTIDES, AND NUCLEIC ACIDS, AND USES THEREOF	C07D 213/89 (2006.01)	2748146 *	A CRYSTALLINE FORM OF THE SODIUM SALT OF 4-TERT-BUTYL-N-[4-CHLORO-2-(1-OXY-PYRIDINE-4-CARBONYL)-PHENYL]-BENZENE SULFONAMIDE
C07K 1/18 (2006.01)	2748180 *	PROTEIN PURIFICATION BY ANION EXCHANGE CHROMATOGRAPHY	C03C 25/32 (2006.01)	2736995 *	SIZING COMPOSITION FOR MINERAL WOOL BASED ON MALTITOL AND INSULATING PRODUCTS OBTAINED
C12N 9/64 (2006.01)	2748180 *	PROTEIN PURIFICATION BY ANION EXCHANGE CHROMATOGRAPHY			
H03M 1/12 (2006.01)	2751927 *	METHOD AND APPARATUS FOR PERFORMING DATA CONVERSION WITH NON-UNIFORM QUANTIZATION			

MKP (51)	Broj objave evropske prijava patenta (97)	Naziv pronalaska (54)	MKP (51)	Broj objave evropske prijava patenta (97)	Naziv pronalaska (54)
C09J 105/00 (2006.01)	2736995 *	SIZING COMPOSITION FOR MINERAL WOOL BASED ON MALTITOL AND INSULATING PRODUCTS OBTAINED	A61K 31/4045 (2006.01)	2720696 *	COMBINATION OF PANOBINOSTAT AND RUXOLITINIB IN THE TREATMENT OF CANCER SUCH AS A MYELOPROLIFERATIVE NEOPLASM
D06M 15/03 (2006.01)	2736995 *	SIZING COMPOSITION FOR MINERAL WOOL BASED ON MALTITOL AND INSULATING PRODUCTS OBTAINED	A61K 31/519 (2006.01)	2720696 *	COMBINATION OF PANOBINOSTAT AND RUXOLITINIB IN THE TREATMENT OF CANCER SUCH AS A MYELOPROLIFERATIVE NEOPLASM
B60J 7/06 (2006.01)	2679423	Carriage for a roof of a trailer or truck	A01H 1/08 (2006.01)	2734036 *	MAIZE PLANTS HAVING A PARTIALLY OR FULLY MULTIPLIED GENOME AND USES THEREOF
B60J 7/10 (2006.01)	2679423	Carriage for a roof of a trailer or truck	A01H 5/00 (2006.01)	2734036 *	MAIZE PLANTS HAVING A PARTIALLY OR FULLY MULTIPLIED GENOME AND USES THEREOF
F16B 21/18 (2006.01)	2679423	Carriage for a roof of a trailer or truck	A01H 5/10 (2006.01)	2734036 *	MAIZE PLANTS HAVING A PARTIALLY OR FULLY MULTIPLIED GENOME AND USES THEREOF
A61K 31/47 (2006.01)	2734503 *	QUINOLINYL GLUCAGON RECEPTOR MODULATORS	H02H 3/08 (2006.01)	2754217 *	STARTER APPARATUS, SYSTEM, AND/OR METHOD FOR A SEPARABLE-WINDING MOTOR
A61K 31/502 (2006.01)	2734503 *	QUINOLINYL GLUCAGON RECEPTOR MODULATORS	H02H 9/02 (2006.01)	2754217 *	STARTER APPARATUS, SYSTEM, AND/OR METHOD FOR A SEPARABLE-WINDING MOTOR
A61P 3/10 (2006.01)	2734503 *	QUINOLINYL GLUCAGON RECEPTOR MODULATORS	B41M 5/42 (2006.01)	2714415 *	PROCESS FOR MANUFACTURING COATED SUBSTRATES
C07D 215/38 (2006.01)	2734503 *	QUINOLINYL GLUCAGON RECEPTOR MODULATORS	B41M 5/50 (2006.01)	2714415 *	PROCESS FOR MANUFACTURING COATED SUBSTRATES
C07D 239/94 (2006.01)	2734503 *	QUINOLINYL GLUCAGON RECEPTOR MODULATORS	B41M 5/52 (2006.01)	2714415 *	PROCESS FOR MANUFACTURING COATED SUBSTRATES
F16F 15/04 (2006.01)	2722552 *	METHOD FOR PREVENTING OVERTURN OF TRESTLE	H05K 13/04 (2006.01)	2389059	Mounting head for a mounting machine, mounting machine and mounting method
A61K 9/00 (2006.01)	2765994 *	CRYSTALLINE MICROPARTICLES OF A BETA-AGONIST COATED WITH A FATTY ACID	G06F 3/01 (2006.01)	2740014 *	GESTURE RECOGNITION USING INERTIAL SENSORS IN COMBINATION WITH PROXIMITY LIGHT SENSORS
A61K 9/14 (2006.01)	2765994 *	CRYSTALLINE MICROPARTICLES OF A BETA-AGONIST COATED WITH A FATTY ACID	A41D 19/015 (2006.01)	2729029 *	PLAITED GLOVE
A61K 9/16 (2006.01)	2765994 *	CRYSTALLINE MICROPARTICLES OF A BETA-AGONIST COATED WITH A FATTY ACID	A61B 17/072 (2006.01)	2644123	Tissue thickness compensator comprising a plurality of medicaments
A61K 31/519 (2006.01)	2744812 *	THERAPEUTICALLY ACTIVE FUSED PYRIMIDINE DERIVATIVES	A61L 31/00 (2006.01)	2644123	Tissue thickness compensator comprising a plurality of medicaments
A61P 29/00 (2006.01)	2744812 *	THERAPEUTICALLY ACTIVE FUSED PYRIMIDINE DERIVATIVES	B60F 5/02 (2006.01)	2750905 *	TRANSFORMATION METHOD OF HYBRID TRANSPORTATION VEHICLE FOR GROUND AND AIR, AND HYBRID TRANSPORTATION VEHICLE ITSELF
C07D 495/04 (2006.01)	2744812 *	THERAPEUTICALLY ACTIVE FUSED PYRIMIDINE DERIVATIVES			
C07D 513/04 (2006.01)	2744812 *	THERAPEUTICALLY ACTIVE FUSED PYRIMIDINE DERIVATIVES			
C07D 519/00 (2006.01)	2744812 *	THERAPEUTICALLY ACTIVE FUSED PYRIMIDINE DERIVATIVES			

MKP (51)	Broj objave evropske prijava patenta (97)	Naziv pronalaska (54)	MKP (51)	Broj objave evropske prijava patenta (97)	Naziv pronalaska (54)
B64C 3/56 (2006.01)	2750905 *	TRANSFORMATION METHOD OF HYBRID TRANSPORTATION VEHICLE FOR GROUND AND AIR, AND HYBRID TRANSPORTATION VEHICLE ITSELF	B65H 75/10 (2006.01)	2653299	A single ply core manufacturing method, a ply and a single ply core
B64C 37/00 (2006.01)	2750905 *	TRANSFORMATION METHOD OF HYBRID TRANSPORTATION VEHICLE FOR GROUND AND AIR, AND HYBRID TRANSPORTATION VEHICLE ITSELF	B65H 75/50 (2006.01)	2653299	A single ply core manufacturing method, a ply and a single ply core
A61K 35/28 (2006.01)	2739723 *	METHODS OF TREATMENT OF RETINAL DEGENERATION DISEASES	E21B 47/00 (2012.01)	2637043	Systems and methods for downhole cement evaluation
C12N 5/0735 (2010.01)	2739723 *	METHODS OF TREATMENT OF RETINAL DEGENERATION DISEASES	G01V 1/44 (2006.01)	2637043	Systems and methods for downhole cement evaluation
C12N 5/0775 (2010.01)	2739723 *	METHODS OF TREATMENT OF RETINAL DEGENERATION DISEASES	E21B 34/14 (2006.01)	2705287 *	SLIDING SLEEVE VALVE AND METHOD FOR FLUID TREATING A SUBTERRANEAN FORMATION
C12N 5/0789 (2010.01)	2739723 *	METHODS OF TREATMENT OF RETINAL DEGENERATION DISEASES	E21B 43/12 (2006.01)	2705287 *	SLIDING SLEEVE VALVE AND METHOD FOR FLUID TREATING A SUBTERRANEAN FORMATION
C12N 5/0793 (2010.01)	2739723 *	METHODS OF TREATMENT OF RETINAL DEGENERATION DISEASES	E21B 43/26 (2006.01)	2705287 *	SLIDING SLEEVE VALVE AND METHOD FOR FLUID TREATING A SUBTERRANEAN FORMATION
A01N 37/20 (2006.01)	2747564 *	HERBICIDAL COMPOSITIONS COMPRISING CHLOROACETAMIDES	F16K 3/26 (2006.01)	2705287 *	SLIDING SLEEVE VALVE AND METHOD FOR FLUID TREATING A SUBTERRANEAN FORMATION
A01N 43/10 (2006.01)	2747564 *	HERBICIDAL COMPOSITIONS COMPRISING CHLOROACETAMIDES	F16K 3/30 (2006.01)	2705287 *	SLIDING SLEEVE VALVE AND METHOD FOR FLUID TREATING A SUBTERRANEAN FORMATION
A01N 43/56 (2006.01)	2747564 *	HERBICIDAL COMPOSITIONS COMPRISING CHLOROACETAMIDES	F16K 31/46 (2006.01)	2705287 *	SLIDING SLEEVE VALVE AND METHOD FOR FLUID TREATING A SUBTERRANEAN FORMATION
A01P 13/00 (2006.01)	2747564 *	HERBICIDAL COMPOSITIONS COMPRISING CHLOROACETAMIDES	C22B 15/14 (2006.01)	2716776 *	COMBINED FURNACE SYSTEM FOR FIRE REFINING RED IMPURE COPPER
C07D 233/64 (2006.01)	2721010 *	PRODUCTION METHOD OF IMIDAZOLE DERIVATIVES	G01N 33/538 (2006.01)	2729807 *	ASSAYS FOR DETECTING NEUTRALIZING AUTOANTIBODIES TO BIOLOGIC THERAPY WITH TNF ALPHA
C02F 3/28 (2006.01)	2760978 *	PROCESS FOR PRODUCTION OF BIOGAS	A61K 39/00 (2006.01)	2714071 *	INDIVIDUALIZED VACCINES FOR CANCER
C10L 3/08 (2006.01)	2760978 *	PROCESS FOR PRODUCTION OF BIOGAS	C12Q 1/68 (2006.01)	2714071 *	INDIVIDUALIZED VACCINES FOR CANCER
C12P 5/02 (2006.01)	2760978 *	PROCESS FOR PRODUCTION OF BIOGAS	A61K 9/51 (2006.01)	2747761 *	METHODS OF TREATING CANCERS WITH THERAPEUTIC NANOPARTICLES
C09K 3/18 (2006.01)	2718387 *	DEICING COMPOSITION	A61K 31/337 (2006.01)	2747761 *	METHODS OF TREATING CANCERS WITH THERAPEUTIC NANOPARTICLES
G01N 33/68 (2006.01)	2748613 *	OXMIF AS A DIAGNOSTIC MARKER	A61K 47/34 (2006.01)	2747761 *	METHODS OF TREATING CANCERS WITH THERAPEUTIC NANOPARTICLES
B31C 1/00 (2006.01)	2653299	A single ply core manufacturing method, a ply and a single ply core	A61P 35/00 (2006.01)	2747761 *	METHODS OF TREATING CANCERS WITH THERAPEUTIC NANOPARTICLES
B31C 3/00 (2006.01)	2653299	A single ply core manufacturing method, a ply and a single ply core	A23L 2/06 (2006.01)	2521461 *	STABILIZATION OF CITRUS FRUIT BEVERAGES COMPRISING SOY PROTEIN
			A23L 2/66 (2006.01)	2521461 *	STABILIZATION OF CITRUS FRUIT BEVERAGES COMPRISING SOY PROTEIN

MKP (51)	Broj objave evropske prijava patenta (97)	Naziv pronalaska (54)	MKP (51)	Broj objave evropske prijava patenta (97)	Naziv pronalaska (54)
A61F 2/00 (2006.01)	2755598 *	FABRICATION OF GELATIN HYDROGEL SHEET FOR THE TRANSPLANTATION OF CORNEAL ENDOTHELIUM	A61K 33/38 (2006.01)	2706994 *	PHARMACEUTICAL TOPICAL COMPOSITION FOR USE IN THE TREATMENT AND/OR IN THE PREVENTION OF INFECTIONS OF SKIN LESIONS
C02F 11/12 (2006.01)	2739711 *	PROCEDURE AND EQUIPMENT FOR THE PRODUCTION OF SOLID FUEL FROM WASTEWATER SLUDGE	A61K 39/145 (2006.01)	2707393 *	FUSION PROTEINS AND COMBINATION VACCINES COMPRISING HAEMOPHILUS INFLUENZAE PROTEIN E AND PILIN A
C10L 5/08 (2006.01)	2739711 *	PROCEDURE AND EQUIPMENT FOR THE PRODUCTION OF SOLID FUEL FROM WASTEWATER SLUDGE	A61K 39/385 (2006.01)	2707393 *	FUSION PROTEINS AND COMBINATION VACCINES COMPRISING HAEMOPHILUS INFLUENZAE PROTEIN E AND PILIN A
C10L 5/28 (2006.01)	2739711 *	PROCEDURE AND EQUIPMENT FOR THE PRODUCTION OF SOLID FUEL FROM WASTEWATER SLUDGE	A61P 31/16 (2006.01)	2707393 *	FUSION PROTEINS AND COMBINATION VACCINES COMPRISING HAEMOPHILUS INFLUENZAE PROTEIN E AND PILIN A
C10L 5/36 (2006.01)	2739711 *	PROCEDURE AND EQUIPMENT FOR THE PRODUCTION OF SOLID FUEL FROM WASTEWATER SLUDGE	A61P 37/04 (2006.01)	2707393 *	FUSION PROTEINS AND COMBINATION VACCINES COMPRISING HAEMOPHILUS INFLUENZAE PROTEIN E AND PILIN A
C10L 5/46 (2006.01)	2739711 *	PROCEDURE AND EQUIPMENT FOR THE PRODUCTION OF SOLID FUEL FROM WASTEWATER SLUDGE	C07K 14/285 (2006.01)	2707393 *	FUSION PROTEINS AND COMBINATION VACCINES COMPRISING HAEMOPHILUS INFLUENZAE PROTEIN E AND PILIN A
A61K 31/122 (2006.01)	2701695 *	NEURODEGENERATIVE DISORDERS AND MUSCLE DISEASES IMPLICATING PUFAS	C07K 19/00 (2006.01)	2707393 *	FUSION PROTEINS AND COMBINATION VACCINES COMPRISING HAEMOPHILUS INFLUENZAE PROTEIN E AND PILIN A
A61K 31/20 (2006.01)	2701695 *	NEURODEGENERATIVE DISORDERS AND MUSCLE DISEASES IMPLICATING PUFAS	C12N 15/00 (2006.01)	2707393 *	FUSION PROTEINS AND COMBINATION VACCINES COMPRISING HAEMOPHILUS INFLUENZAE PROTEIN E AND PILIN A
A61K 31/202 (2006.01)	2701695 *	NEURODEGENERATIVE DISORDERS AND MUSCLE DISEASES IMPLICATING PUFAS	C12P 21/02 (2006.01)	2707393 *	FUSION PROTEINS AND COMBINATION VACCINES COMPRISING HAEMOPHILUS INFLUENZAE PROTEIN E AND PILIN A
A61K 31/375 (2006.01)	2701695 *	NEURODEGENERATIVE DISORDERS AND MUSCLE DISEASES IMPLICATING PUFAS	A47B 47/04 (2006.01)	2741632 *	A MODULAR APPARATUS FOR REALIZATION OF WARDROBES PROVIDED WITH PLASTIC STRUCTURE
A61P 25/00 (2006.01)	2701695 *	NEURODEGENERATIVE DISORDERS AND MUSCLE DISEASES IMPLICATING PUFAS	A47B 61/00 (2006.01)	2741632 *	A MODULAR APPARATUS FOR REALIZATION OF WARDROBES PROVIDED WITH PLASTIC STRUCTURE
A61P 25/28 (2006.01)	2701695 *	NEURODEGENERATIVE DISORDERS AND MUSCLE DISEASES IMPLICATING PUFAS	F16C 33/02 (2006.01)	2764262 *	APPARATUS AND METHOD FOR A BEARING ASSEMBLY SYSTEM
A23L 1/236 (2006.01)	2741620 *	SWEETENER COMPOSITION	B23B 31/20 (2006.01)	2734327 *	INTERNAL BROACHING MACHINE
A61K 31/18 (2006.01)	2706994 *	PHARMACEUTICAL TOPICAL COMPOSITION FOR USE IN THE TREATMENT AND/OR IN THE PREVENTION OF INFECTIONS OF SKIN LESIONS	B23D 37/10 (2006.01)	2734327 *	INTERNAL BROACHING MACHINE
A61K 33/06 (2006.01)	2706994 *	PHARMACEUTICAL TOPICAL COMPOSITION FOR USE IN THE TREATMENT AND/OR IN THE PREVENTION OF INFECTIONS OF SKIN LESIONS			
A61K 33/12 (2006.01)	2706994 *	PHARMACEUTICAL TOPICAL COMPOSITION FOR USE IN THE TREATMENT AND/OR IN THE PREVENTION OF INFECTIONS OF SKIN LESIONS			

MKP (51)	Broj objave evropske prijava patenta (97)	Naziv pronalaska (54)	MKP (51)	Broj objave evropske prijava patenta (97)	Naziv pronalaska (54)
B23D 37/20 (2006.01)	2734327 *	INTERNAL BROACHING MACHINE	C22C 18/00 (2006.01)	2689873	Method for producing a powder of a metal alloy
B23D 41/04 (2006.01)	2734327 *	INTERNAL BROACHING MACHINE	C12N 15/11 (2006.01)	2739753 *	HYPOXIA-RELATED GENE SIGNATURES FOR CANCER CLASSIFICATION
A61K 9/16 (2006.01)	2723341 *	FAST DISSOLVING AZAPERONE GRANULATE FORMULATION	C12Q 1/68 (2006.01)	2739753 *	HYPOXIA-RELATED GENE SIGNATURES FOR CANCER CLASSIFICATION
A61K 31/496 (2006.01)	2723341 *	FAST DISSOLVING AZAPERONE GRANULATE FORMULATION	A61K 31/4439 (2006.01)	2726074 *	COMBINATION THERAPY COMPRISING A CDK4/6 INHIBITOR AND A PI3K INHIBITOR FOR USE IN THE TREATMENT OF CANCER
A61P 43/00 (2006.01)	2723341 *	FAST DISSOLVING AZAPERONE GRANULATE FORMULATION	A61K 31/519 (2006.01)	2726074 *	COMBINATION THERAPY COMPRISING A CDK4/6 INHIBITOR AND A PI3K INHIBITOR FOR USE IN THE TREATMENT OF CANCER
A01N 43/90 (2006.01)	2757887 *	PYRROLOPYRIDINONE COMPOUNDS AND METHODS FOR TREATING HIV	A61K 31/535 (2006.01)	2726074 *	COMBINATION THERAPY COMPRISING A CDK4/6 INHIBITOR AND A PI3K INHIBITOR FOR USE IN THE TREATMENT OF CANCER
A61K 9/00 (2006.01)	2714005 *	NASAL PHARMACEUTICAL FORMULATION	A61P 35/00 (2006.01)	2726074 *	COMBINATION THERAPY COMPRISING A CDK4/6 INHIBITOR AND A PI3K INHIBITOR FOR USE IN THE TREATMENT OF CANCER
A61K 31/56 (2006.01)	2714005 *	NASAL PHARMACEUTICAL FORMULATION	H01M 2/12 (2006.01)	2713419	Lid for electric accumulators
A61P 11/02 (2006.01)	2714005 *	NASAL PHARMACEUTICAL FORMULATION	A61K 31/496 (2006.01)	2760450 *	MONOACYLGLYCEROL LIPASE INHIBITORS FOR THE TREATMENT OF METABOLIC DISEASES AND RELATED DISORDERS
G01F 1/74 (2006.01)	2647970	Needle probe for analysis of multiphase flows, production and us of needle probe	A61P 3/06 (2006.01)	2760450 *	MONOACYLGLYCEROL LIPASE INHIBITORS FOR THE TREATMENT OF METABOLIC DISEASES AND RELATED DISORDERS
A61B 17/072 (2006.01)	2644116	Tissue thickness compensator comprising a plurality of capsules	A61P 3/08 (2006.01)	2760450 *	MONOACYLGLYCEROL LIPASE INHIBITORS FOR THE TREATMENT OF METABOLIC DISEASES AND RELATED DISORDERS
A61L 31/04 (2006.01)	2644116	Tissue thickness compensator comprising a plurality of capsules	A61P 3/10 (2006.01)	2760450 *	MONOACYLGLYCEROL LIPASE INHIBITORS FOR THE TREATMENT OF METABOLIC DISEASES AND RELATED DISORDERS
A01N 63/00 (2006.01)	2753181 *	A COPPER RESISTANT, FENGYCIN-PRODUCING BACILLUS MOJAVENSIS STRAIN FOR CONTROLLING VEGETABLE PATHOGENS, ITS USE AND COMPOSITIONS CONTAINING IT	A61P 9/00 (2006.01)	2760450 *	MONOACYLGLYCEROL LIPASE INHIBITORS FOR THE TREATMENT OF METABOLIC DISEASES AND RELATED DISORDERS
A61K 8/27 (2006.01)	2713992 *	DENTAL CARE PRODUCTS COMPRISING CARBONATE- SUBSTITUTED FLUORO- HYDROXYAPATITE PARTICLES	A61P 9/10 (2006.01)	2760450 *	MONOACYLGLYCEROL LIPASE INHIBITORS FOR THE TREATMENT OF METABOLIC DISEASES AND RELATED DISORDERS
A61K 33/42 (2006.01)	2713992 *	DENTAL CARE PRODUCTS COMPRISING CARBONATE- SUBSTITUTED FLUORO- HYDROXYAPATITE PARTICLES			
A61Q 11/00 (2006.01)	2713992 *	DENTAL CARE PRODUCTS COMPRISING CARBONATE- SUBSTITUTED FLUORO- HYDROXYAPATITE PARTICLES			
C01B 25/455 (2006.01)	2713992 *	DENTAL CARE PRODUCTS COMPRISING CARBONATE- SUBSTITUTED FLUORO- HYDROXYAPATITE PARTICLES			
B22F 9/08 (2006.01)	2689873	Method for producing a powder of a metal alloy			

MKP (51)	Broj objave evropske prijava patenta (97)	Naziv pronalaska (54)	MKP (51)	Broj objave evropske prijava patenta (97)	Naziv pronalaska (54)
A61P 9/12 (2006.01)	2760450 *	MONOACYLGLYCEROL LIPASE INHIBITORS FOR THE TREATMENT OF METABOLIC DISEASES AND RELATED DISORDERS	C07D 213/40 (2006.01)	2723718 *	TRPM8 ANTAGONISTS AND THEIR USE IN TREATMENTS
A61P 11/00 (2006.01)	2760450 *	MONOACYLGLYCEROL LIPASE INHIBITORS FOR THE TREATMENT OF METABOLIC DISEASES AND RELATED DISORDERS	C07D 401/12 (2006.01)	2723718 *	TRPM8 ANTAGONISTS AND THEIR USE IN TREATMENTS
A61P 15/00 (2006.01)	2760450 *	MONOACYLGLYCEROL LIPASE INHIBITORS FOR THE TREATMENT OF METABOLIC DISEASES AND RELATED DISORDERS	C07D 401/14 (2006.01)	2723718 *	TRPM8 ANTAGONISTS AND THEIR USE IN TREATMENTS
A61P 15/12 (2006.01)	2760450 *	MONOACYLGLYCEROL LIPASE INHIBITORS FOR THE TREATMENT OF METABOLIC DISEASES AND RELATED DISORDERS	C07D 405/12 (2006.01)	2723718 *	TRPM8 ANTAGONISTS AND THEIR USE IN TREATMENTS
A61P 19/02 (2006.01)	2760450 *	MONOACYLGLYCEROL LIPASE INHIBITORS FOR THE TREATMENT OF METABOLIC DISEASES AND RELATED DISORDERS	C07D 409/12 (2006.01)	2723718 *	TRPM8 ANTAGONISTS AND THEIR USE IN TREATMENTS
A61P 21/00 (2006.01)	2760450 *	MONOACYLGLYCEROL LIPASE INHIBITORS FOR THE TREATMENT OF METABOLIC DISEASES AND RELATED DISORDERS	C07D 413/12 (2006.01)	2723718 *	TRPM8 ANTAGONISTS AND THEIR USE IN TREATMENTS
C12Q 1/68 (2006.01)	2744912 *	COMPOSITIONS AND METHODS FOR DETECTING ALLELIC VARIANTS	C02F 3/30 (2006.01)	2736852 *	A METHOD AND A SYSTEM FOR OUT-COMPETING GLYCOGEN- ACCUMULATING ORGANISMS IN A SUBSTANCE
H01M 8/04 (2006.01)	2710658 *	METHOD OF CONTROLLING AND MAXIMIZING THE ELECTRIC EFFICIENCY AND THE POWER OUTPUT OF A FUEL CELL	C02F 3/34 (2006.01)	2736852 *	A METHOD AND A SYSTEM FOR OUT-COMPETING GLYCOGEN- ACCUMULATING ORGANISMS IN A SUBSTANCE
A61K 31/437 (2006.01)	2769980 *	PYRAZOLOQUINOLINE DERIVATIVE	G02B 6/44 (2006.01)	2732323 *	SEALING MECHANISM AND METHOD FOR DROP CABLE SPlice ENCLOSURES
A61K 31/444 (2006.01)	2769980 *	PYRAZOLOQUINOLINE DERIVATIVE	H02G 15/013 (2006.01)	2732323 *	SEALING MECHANISM AND METHOD FOR DROP CABLE SPlice ENCLOSURES
A61K 31/506 (2006.01)	2769980 *	PYRAZOLOQUINOLINE DERIVATIVE	A61K 31/4178 (2006.01)	2692726	Anti-viral compounds
A61P 25/28 (2006.01)	2769980 *	PYRAZOLOQUINOLINE DERIVATIVE	A61K 31/4184 (2006.01)	2692726	Anti-viral compounds
A61P 43/00 (2006.01)	2769980 *	PYRAZOLOQUINOLINE DERIVATIVE	A61K 31/4439 (2006.01)	2692726	Anti-viral compounds
C07D 471/04 (2006.01)	2769980 *	PYRAZOLOQUINOLINE DERIVATIVE	A61K 31/454 (2006.01)	2692726	Anti-viral compounds
A61K 31/44 (2006.01)	2723718 *	TRPM8 ANTAGONISTS AND THEIR USE IN TREATMENTS	A61K 31/496 (2006.01)	2692726	Anti-viral compounds
A61P 25/00 (2006.01)	2723718 *	TRPM8 ANTAGONISTS AND THEIR USE IN TREATMENTS	A61K 31/506 (2006.01)	2692726	Anti-viral compounds
			A61P 31/14 (2006.01)	2692726	Anti-viral compounds
			C07D 401/14 (2006.01)	2692726	Anti-viral compounds
			C07D 403/14 (2006.01)	2692726	Anti-viral compounds

MKP (51)	Broj objave evropske prijava patenta (97)	Naziv pronalaska (54)	MKP (51)	Broj objave evropske prijava patenta (97)	Naziv pronalaska (54)
C07D 417/14 (2006.01)	2692726	Anti-viral compounds	A47L 5/36 (2006.01)	2630902	Vacuum cleaner with reverse air jet filter cleaning device
A61K 38/00 (2006.01)	2750686 *	MITOCHONDRIAL TARGETING AND THERAPEUTIC USE THEREOF	A47L 9/12 (2006.01)	2630902	Vacuum cleaner with reverse air jet filter cleaning device
A01N 37/18 (2006.01)	2747560 *	COMPOUNDS AND METHODS	A47L 9/20 (2006.01)	2630902	Vacuum cleaner with reverse air jet filter cleaning device
A61K 31/165 (2006.01)	2747560 *	COMPOUNDS AND METHODS	C07K 14/50 (2006.01)	2764019 *	DUAL FUNCTION PROTEINS FOR TREATING METABOLIC DISORDERS
C07C 233/00 (2006.01)	2747560 *	COMPOUNDS AND METHODS	C07K 14/605 (2006.01)	2764019 *	DUAL FUNCTION PROTEINS FOR TREATING METABOLIC DISORDERS
A61K 31/437 (2006.01)	2736907 *	INDAZOLES	G01N 33/50 (2006.01)	2751562 *	PROFILING OF SIGNAL PATHWAY PROTEINS TO DETERMINE THERAPEUTIC EFFICACY
A61K 31/55 (2006.01)	2736907 *	INDAZOLES	G01N 33/542 (2006.01)	2751562 *	PROFILING OF SIGNAL PATHWAY PROTEINS TO DETERMINE THERAPEUTIC EFFICACY
A61P 11/00 (2006.01)	2736907 *	INDAZOLES	A61K 39/395 (2006.01)	2739311 *	METHOD FOR TREATING BONE GAP DEFECTS
C07D 471/04 (2006.01)	2736907 *	INDAZOLES	A61P 19/00 (2006.01)	2739311 *	METHOD FOR TREATING BONE GAP DEFECTS
C07D 487/04 (2006.01)	2736907 *	INDAZOLES	C07K 16/22 (2006.01)	2739311 *	METHOD FOR TREATING BONE GAP DEFECTS
A61K 31/122 (2006.01)	2709608 *	METHOD OF TREATING POSTURAL REFLEX ABNORMALITY CAUSED BY PARKINSON'S DISEASE	F16K 27/02 (2006.01)	2660496	Valve
A61K 31/198 (2006.01)	2709608 *	METHOD OF TREATING POSTURAL REFLEX ABNORMALITY CAUSED BY PARKINSON'S DISEASE	B60R 19/26 (2006.01)	2712344 *	IMPACT ENERGY CONVERSION DEVICE
A61K 31/275 (2006.01)	2709608 *	METHOD OF TREATING POSTURAL REFLEX ABNORMALITY CAUSED BY PARKINSON'S DISEASE	B60R 19/32 (2006.01)	2712344 *	IMPACT ENERGY CONVERSION DEVICE
B28C 7/00 (2006.01)	2266771	Device and method for cooling and inserting a flow of pulverulent or granular materials in a storage container	B60R 19/36 (2006.01)	2712344 *	IMPACT ENERGY CONVERSION DEVICE
B65G 53/32 (2006.01)	2266771	Device and method for cooling and inserting a flow of pulverulent or granular materials in a storage container	B60T 13/10 (2006.01)	2712344 *	IMPACT ENERGY CONVERSION DEVICE
B65G 53/52 (2006.01)	2266771	Device and method for cooling and inserting a flow of pulverulent or granular materials in a storage container	F01C 1/00 (2006.01)	2712344 *	IMPACT ENERGY CONVERSION DEVICE
C04B 40/06 (2006.01)	2266771	Device and method for cooling and inserting a flow of pulverulent or granular materials in a storage container	F03C 1/02 (2006.01)	2712344 *	IMPACT ENERGY CONVERSION DEVICE
F25D 3/10 (2006.01)	2266771	Device and method for cooling and inserting a flow of pulverulent or granular materials in a storage container	A61K 9/00 (2006.01)	2719376	Gastroretentive drug formulation and delivery systems and their method of preparation using functionalized calcium carbonate
			A61K 9/16 (2006.01)	2719376	Gastroretentive drug formulation and delivery systems and their method of preparation using functionalized calcium carbonate

MKP (51)	Broj objave evropske prijava patenta (97)	Naziv pronalaska (54)	MKP (51)	Broj objave evropske prijava patenta (97)	Naziv pronalaska (54)
A61K 9/20 (2006.01)	2719376	Gastroretentive drug formulation and delivery systems and their method of preparation using functionalized calcium carbonate	C07D 409/12 (2006.01)	2760831 *	VIRAL REPLICATION INHIBITORS
A61K 8/02 (2006.01)	2723304 *	CLEANING COMPOSITION COMPRISING A GELLING AGENT AND A FOAMING SURFACTANT	C07D 413/08 (2006.01)	2760831 *	VIRAL REPLICATION INHIBITORS
A61K 8/04 (2006.01)	2723304 *	CLEANING COMPOSITION COMPRISING A GELLING AGENT AND A FOAMING SURFACTANT	C07D 413/12 (2006.01)	2760831 *	VIRAL REPLICATION INHIBITORS
A61K 8/44 (2006.01)	2723304 *	CLEANING COMPOSITION COMPRISING A GELLING AGENT AND A FOAMING SURFACTANT	C07D 417/14 (2006.01)	2760831 *	VIRAL REPLICATION INHIBITORS
A61K 8/73 (2006.01)	2723304 *	CLEANING COMPOSITION COMPRISING A GELLING AGENT AND A FOAMING SURFACTANT	C07D 471/04 (2006.01)	2760831 *	VIRAL REPLICATION INHIBITORS
A61K 8/81 (2006.01)	2723304 *	CLEANING COMPOSITION COMPRISING A GELLING AGENT AND A FOAMING SURFACTANT	C07D 487/04 (2006.01)	2760831 *	VIRAL REPLICATION INHIBITORS
A61Q 19/00 (2006.01)	2723304 *	CLEANING COMPOSITION COMPRISING A GELLING AGENT AND A FOAMING SURFACTANT	E05B 17/00 (2006.01)	2722470	Alarm incorporated cylinder lock
A61Q 19/10 (2006.01)	2723304 *	CLEANING COMPOSITION COMPRISING A GELLING AGENT AND A FOAMING SURFACTANT	E05B 45/06 (2006.01)	2722470	Alarm incorporated cylinder lock
A61M 5/24 (2006.01)	2704776 *	ASSEMBLY FOR A DRUG DELIVERY DEVICE AND DRUG DELIVERY DEVICE	H02K 1/24 (2006.01)	2719060 *	ELECTRIC MACHINE, SYNCHRONOUS GENERATOR-FIELD POLE, SYNCHRONOUS GENERATOR-ROTOR COMPRISING A PLURALITY OF FIELD POLES, AND METHOD FOR PRODUCING A SYNCHRONOUS GENERATOR-FIELD POLE OF AN ELECTRIC MACHINE
A61M 5/315 (2006.01)	2704776 *	ASSEMBLY FOR A DRUG DELIVERY DEVICE AND DRUG DELIVERY DEVICE	H02K 15/02 (2006.01)	2719060 *	ELECTRIC MACHINE, SYNCHRONOUS GENERATOR-FIELD POLE, SYNCHRONOUS GENERATOR-ROTOR COMPRISING A PLURALITY OF FIELD POLES, AND METHOD FOR PRODUCING A SYNCHRONOUS GENERATOR-FIELD POLE OF AN ELECTRIC MACHINE
E06B 7/215 (2006.01)	2761120 *	SEALING ASSEMBLY FOR A SWING DOOR	A61B 17/064 (2006.01)	2644212	Tissue thickness compensator comprising controlled release and expansion
C07D 209/14 (2006.01)	2760831 *	VIRAL REPLICATION INHIBITORS	A61L 31/04 (2006.01)	2644212	Tissue thickness compensator comprising controlled release and expansion
C07D 401/08 (2006.01)	2760831 *	VIRAL REPLICATION INHIBITORS	A61L 31/14 (2006.01)	2644212	Tissue thickness compensator comprising controlled release and expansion
C07D 401/12 (2006.01)	2760831 *	VIRAL REPLICATION INHIBITORS	A61L 31/16 (2006.01)	2644212	Tissue thickness compensator comprising controlled release and expansion
C07D 401/14 (2006.01)	2760831 *	VIRAL REPLICATION INHIBITORS	C07D 255/02 (2006.01)	2709991 *	USE OF CXCR4 ANTAGONISTS
C07D 403/08 (2006.01)	2760831 *	VIRAL REPLICATION INHIBITORS	A61K 31/519 (2006.01)	2766368 *	5,7-SUBSTITUTED-IMIDAZO[1,2-C]PYRIMIDINES
C07D 403/10 (2006.01)	2760831 *	VIRAL REPLICATION INHIBITORS	A61P 29/00 (2006.01)	2766368 *	5,7-SUBSTITUTED-IMIDAZO[1,2-C]PYRIMIDINES
C07D 403/12 (2006.01)	2760831 *	VIRAL REPLICATION INHIBITORS			
C07D 405/12 (2006.01)	2760831 *	VIRAL REPLICATION INHIBITORS			
C07D 409/08 (2006.01)	2760831 *	VIRAL REPLICATION INHIBITORS			

MKP (51)	Broj objave evropske prijava patenta (97)	Naziv pronalaska (54)	MKP (51)	Broj objave evropske prijava patenta (97)	Naziv pronalaska (54)
A61P 37/00 (2006.01)	2766368 *	5,7-SUBSTITUTED- IMIDAZO[1,2-C]PYRIMIDINES	B29C 47/08 (2006.01)	2711411 *	PROCESS AND APPARATUS FOR THE PRODUCTION OF A SOLID FUEL FROM COMBUSTIBLE WASTES
C07D 487/04 (2006.01)	2766368 *	5,7-SUBSTITUTED- IMIDAZO[1,2-C]PYRIMIDINES	B29C 47/92 (2006.01)	2711411 *	PROCESS AND APPARATUS FOR THE PRODUCTION OF A SOLID FUEL FROM COMBUSTIBLE WASTES
A61K 31/4245 (2006.01)	2758394 *	HETEROARYL COMPOUNDS AS 5-HT4 RECEPTOR LIGANDS	C10L 5/46 (2006.01)	2711411 *	PROCESS AND APPARATUS FOR THE PRODUCTION OF A SOLID FUEL FROM COMBUSTIBLE WASTES
A61K 31/445 (2006.01)	2758394 *	HETEROARYL COMPOUNDS AS 5-HT4 RECEPTOR LIGANDS	C10L 5/48 (2006.01)	2711411 *	PROCESS AND APPARATUS FOR THE PRODUCTION OF A SOLID FUEL FROM COMBUSTIBLE WASTES
A61P 25/00 (2006.01)	2758394 *	HETEROARYL COMPOUNDS AS 5-HT4 RECEPTOR LIGANDS	A61K 31/4162 (2006.01)	2702058 *	NOVEL COMPOUND USEFUL FOR THE TREATMENT OF DEGENERATIVE AND INFLAMMATORY DISEASES
C07D 413/14 (2006.01)	2758394 *	HETEROARYL COMPOUNDS AS 5-HT4 RECEPTOR LIGANDS	A61P 19/02 (2006.01)	2702058 *	NOVEL COMPOUND USEFUL FOR THE TREATMENT OF DEGENERATIVE AND INFLAMMATORY DISEASES
A61K 9/20 (2006.01)	2729132 *	PHARMACEUTICAL COMPOSITION AND SOLID GALENIC FORM HAVING A HIGH DRONEDARONE CONTENT, AND METHOD FOR PREPARING SAME	C07D 471/04 (2006.01)	2702058 *	NOVEL COMPOUND USEFUL FOR THE TREATMENT OF DEGENERATIVE AND INFLAMMATORY DISEASES
A61K 31/343 (2006.01)	2729132 *	PHARMACEUTICAL COMPOSITION AND SOLID GALENIC FORM HAVING A HIGH DRONEDARONE CONTENT, AND METHOD FOR PREPARING SAME	A61M 5/32 (2006.01)	2734257 *	NEEDLE SHIELD ASSEMBLY
A61K 47/02 (2006.01)	2729132 *	PHARMACEUTICAL COMPOSITION AND SOLID GALENIC FORM HAVING A HIGH DRONEDARONE CONTENT, AND METHOD FOR PREPARING SAME	B05C 1/02 (2006.01)	2709848 *	PAD PRINTING SYSTEM AND METHOD THEREFOR
A61K 47/10 (2006.01)	2729132 *	PHARMACEUTICAL COMPOSITION AND SOLID GALENIC FORM HAVING A HIGH DRONEDARONE CONTENT, AND METHOD FOR PREPARING SAME	B41F 17/00 (2006.01)	2709848 *	PAD PRINTING SYSTEM AND METHOD THEREFOR
A61K 47/12 (2006.01)	2729132 *	PHARMACEUTICAL COMPOSITION AND SOLID GALENIC FORM HAVING A HIGH DRONEDARONE CONTENT, AND METHOD FOR PREPARING SAME	B41F 35/00 (2006.01)	2709848 *	PAD PRINTING SYSTEM AND METHOD THEREFOR
A61K 47/30 (2006.01)	2729132 *	PHARMACEUTICAL COMPOSITION AND SOLID GALENIC FORM HAVING A HIGH DRONEDARONE CONTENT, AND METHOD FOR PREPARING SAME	B41M 1/14 (2006.01)	2709848 *	PAD PRINTING SYSTEM AND METHOD THEREFOR
A61K 47/32 (2006.01)	2729132 *	PHARMACEUTICAL COMPOSITION AND SOLID GALENIC FORM HAVING A HIGH DRONEDARONE CONTENT, AND METHOD FOR PREPARING SAME	B41M 1/40 (2006.01)	2709848 *	PAD PRINTING SYSTEM AND METHOD THEREFOR
A61P 9/06 (2006.01)	2729132 *	PHARMACEUTICAL COMPOSITION AND SOLID GALENIC FORM HAVING A HIGH DRONEDARONE CONTENT, AND METHOD FOR PREPARING SAME	A63H 19/32 (2006.01)	2666529	Device for actuating a switch for a model railroad
B29C 47/00 (2006.01)	2711411 *	PROCESS AND APPARATUS FOR THE PRODUCTION OF A SOLID FUEL FROM COMBUSTIBLE WASTES	C21C 5/00 (2006.01)	2679691	Method for manufacturing an austenitic stainless steel from a nickel laterite ore and a chromite ore
			C21C 5/28 (2006.01)	2679691	Method for manufacturing an austenitic stainless steel from a nickel laterite ore and a chromite ore
			C22B 3/00 (2006.01)	2679691	Method for manufacturing an austenitic stainless steel from a nickel laterite ore and a chromite ore

MKP (51)	Broj objave evropske prijava patenta (97)	Naziv pronalaska (54)	MKP (51)	Broj objave evropske prijava patenta (97)	Naziv pronalaska (54)
C22B 3/04 (2006.01)	2679691	Method for manufacturing an austenitic stainless steel from a nickel laterite ore and a chromite ore	C07K 16/00 (2006.01)	2758430 *	ANTI-C-MET ANTIBODIES
C22B 3/20 (2006.01)	2679691	Method for manufacturing an austenitic stainless steel from a nickel laterite ore and a chromite ore	C12P 21/08 (2006.01)	2758430 *	ANTI-C-MET ANTIBODIES
C22B 23/00 (2006.01)	2679691	Method for manufacturing an austenitic stainless steel from a nickel laterite ore and a chromite ore	B60J 5/04 (2006.01)	2709865 *	ELECTRIC DOOR OPERATOR
C22C 1/00 (2006.01)	2679691	Method for manufacturing an austenitic stainless steel from a nickel laterite ore and a chromite ore	F16H 21/28 (2006.01)	2709865 *	ELECTRIC DOOR OPERATOR
C22C 33/04 (2006.01)	2679691	Method for manufacturing an austenitic stainless steel from a nickel laterite ore and a chromite ore	A01M 7/00 (2006.01)	2768302 *	AGRICULTURAL FIELD- SPRAYING SYSTEM
C22C 38/40 (2006.01)	2679691	Method for manufacturing an austenitic stainless steel from a nickel laterite ore and a chromite ore	B01J 8/00 (2006.01)	2701834 *	PROCESS AND APPARATUS FOR PRODUCTION AND FILTRATION OF AMINOALCOHOLS USING A CONTINUOUS STIRRED TANK SLURRY REACTOR
A61K 9/20 (2006.01)	2709597 *	DRUG DELIVERY SYSTEM	B01J 8/18 (2006.01)	2701834 *	PROCESS AND APPARATUS FOR PRODUCTION AND FILTRATION OF AMINOALCOHOLS USING A CONTINUOUS STIRRED TANK SLURRY REACTOR
A61K 9/28 (2006.01)	2709597 *	DRUG DELIVERY SYSTEM	B01J 8/22 (2006.01)	2701834 *	PROCESS AND APPARATUS FOR PRODUCTION AND FILTRATION OF AMINOALCOHOLS USING A CONTINUOUS STIRRED TANK SLURRY REACTOR
A61K 31/00 (2006.01)	2709597 *	DRUG DELIVERY SYSTEM	C07C 29/68 (2006.01)	2701834 *	PROCESS AND APPARATUS FOR PRODUCTION AND FILTRATION OF AMINOALCOHOLS USING A CONTINUOUS STIRRED TANK SLURRY REACTOR
A61K 31/519 (2006.01)	2709597 *	DRUG DELIVERY SYSTEM	C07C 209/52 (2006.01)	2701834 *	PROCESS AND APPARATUS FOR PRODUCTION AND FILTRATION OF AMINOALCOHOLS USING A CONTINUOUS STIRRED TANK SLURRY REACTOR
A61K 31/568 (2006.01)	2709597 *	DRUG DELIVERY SYSTEM	C07C 213/02 (2006.01)	2701834 *	PROCESS AND APPARATUS FOR PRODUCTION AND FILTRATION OF AMINOALCOHOLS USING A CONTINUOUS STIRRED TANK SLURRY REACTOR
A61K 31/4725 (2006.01)	2702054 *	NOVEL BISAMINOQUINOLINE COMPOUNDS, PHARMACEUTICAL COMPOSITIONS PREPARED THEREFROM AND THEIR USE	A61K 31/4192 (2006.01)	2721012 *	BICYCLO (3.1.0) HEXANE- 2, 6 -DICARBOXYLIC ACID DERIVATIVES AS MGLU2 RECEPTOR AGONIST
A61P 29/00 (2006.01)	2702054 *	NOVEL BISAMINOQUINOLINE COMPOUNDS, PHARMACEUTICAL COMPOSITIONS PREPARED THEREFROM AND THEIR USE	A61K 31/4196 (2006.01)	2721012 *	BICYCLO (3.1.0) HEXANE- 2, 6 -DICARBOXYLIC ACID DERIVATIVES AS MGLU2 RECEPTOR AGONIST
C07D 401/12 (2006.01)	2702054 *	NOVEL BISAMINOQUINOLINE COMPOUNDS, PHARMACEUTICAL COMPOSITIONS PREPARED THEREFROM AND THEIR USE	A61P 25/18 (2006.01)	2721012 *	BICYCLO (3.1.0) HEXANE- 2, 6 -DICARBOXYLIC ACID DERIVATIVES AS MGLU2 RECEPTOR AGONIST
C07D 401/14 (2006.01)	2702054 *	NOVEL BISAMINOQUINOLINE COMPOUNDS, PHARMACEUTICAL COMPOSITIONS PREPARED THEREFROM AND THEIR USE	A61P 25/22 (2006.01)	2721012 *	BICYCLO (3.1.0) HEXANE- 2, 6 -DICARBOXYLIC ACID DERIVATIVES AS MGLU2 RECEPTOR AGONIST
A61K 39/395 (2006.01)	2758430 *	ANTI-C-MET ANTIBODIES			

MKP (51)	Broj objave evropske prijava patenta (97)	Naziv pronalaska (54)	MKP (51)	Broj objave evropske prijava patenta (97)	Naziv pronalaska (54)
A61P 25/24 (2006.01)	2721012 *	BICYCLO (3.1.0) HEXANE-2, 6 -DICARBOXYLIC ACID DERIVATIVES AS MGLU2 RECEPTOR AGONIST	A61K 31/724 (2006.01)	2755664 *	RETINAL CYCLODEXTRIN ACETALS AND HEMIACETALS FOR CLARIFYING SKIN COMPLEXION
C07D 249/04 (2006.01)	2721012 *	BICYCLO (3.1.0) HEXANE-2, 6 -DICARBOXYLIC ACID DERIVATIVES AS MGLU2 RECEPTOR AGONIST	A61P 17/00 (2006.01)	2755664 *	RETINAL CYCLODEXTRIN ACETALS AND HEMIACETALS FOR CLARIFYING SKIN COMPLEXION
C07D 249/12 (2006.01)	2721012 *	BICYCLO (3.1.0) HEXANE-2, 6 -DICARBOXYLIC ACID DERIVATIVES AS MGLU2 RECEPTOR AGONIST	A61P 17/04 (2006.01)	2755664 *	RETINAL CYCLODEXTRIN ACETALS AND HEMIACETALS FOR CLARIFYING SKIN COMPLEXION
A61K 31/343 (2006.01)	2729140 *	DRONEDARONE FOR THE PREVENTION OF ATRIAL FIBRILLATION	A61P 17/06 (2006.01)	2755664 *	RETINAL CYCLODEXTRIN ACETALS AND HEMIACETALS FOR CLARIFYING SKIN COMPLEXION
A61P 9/04 (2006.01)	2729140 *	DRONEDARONE FOR THE PREVENTION OF ATRIAL FIBRILLATION	A61P 17/10 (2006.01)	2755664 *	RETINAL CYCLODEXTRIN ACETALS AND HEMIACETALS FOR CLARIFYING SKIN COMPLEXION
A01K 67/027 (2006.01)	2758534 *	ANIMALS, REPERTOIRES & METHODS FOR THE PRODUCTION OF HUMAN ANTIBODIES	A61P 17/12 (2006.01)	2755664 *	RETINAL CYCLODEXTRIN ACETALS AND HEMIACETALS FOR CLARIFYING SKIN COMPLEXION
C07K 16/46 (2006.01)	2758534 *	ANIMALS, REPERTOIRES & METHODS FOR THE PRODUCTION OF HUMAN ANTIBODIES	A61P 29/00 (2006.01)	2755664 *	RETINAL CYCLODEXTRIN ACETALS AND HEMIACETALS FOR CLARIFYING SKIN COMPLEXION
C12N 15/85 (2006.01)	2758534 *	ANIMALS, REPERTOIRES & METHODS FOR THE PRODUCTION OF HUMAN ANTIBODIES	A61Q 19/00 (2006.01)	2755664 *	RETINAL CYCLODEXTRIN ACETALS AND HEMIACETALS FOR CLARIFYING SKIN COMPLEXION
A23K 1/00 (2006.01)	2764110 *	METHOD FOR THE SIMULTANEOUS PRODUCTION OF ETHANOL AND A FERMENTED, SOLID PRODUCT	A61Q 19/02 (2006.01)	2755664 *	RETINAL CYCLODEXTRIN ACETALS AND HEMIACETALS FOR CLARIFYING SKIN COMPLEXION
A23L 1/305 (2006.01)	2764110 *	METHOD FOR THE SIMULTANEOUS PRODUCTION OF ETHANOL AND A FERMENTED, SOLID PRODUCT	A61Q 19/08 (2006.01)	2755664 *	RETINAL CYCLODEXTRIN ACETALS AND HEMIACETALS FOR CLARIFYING SKIN COMPLEXION
A23L 1/314 (2006.01)	2764110 *	METHOD FOR THE SIMULTANEOUS PRODUCTION OF ETHANOL AND A FERMENTED, SOLID PRODUCT	C07H 3/06 (2006.01)	2755664 *	RETINAL CYCLODEXTRIN ACETALS AND HEMIACETALS FOR CLARIFYING SKIN COMPLEXION
C12P 7/06 (2006.01)	2764110 *	METHOD FOR THE SIMULTANEOUS PRODUCTION OF ETHANOL AND A FERMENTED, SOLID PRODUCT	G06F 1/16 (2006.01)	2724210 *	GESTURE-CONTROLLED TECHNIQUE TO EXPAND INTERACTION RADIUS IN COMPUTER VISION APPLICATIONS
C12P 7/10 (2006.01)	2764110 *	METHOD FOR THE SIMULTANEOUS PRODUCTION OF ETHANOL AND A FERMENTED, SOLID PRODUCT	G06F 3/01 (2006.01)	2724210 *	GESTURE-CONTROLLED TECHNIQUE TO EXPAND INTERACTION RADIUS IN COMPUTER VISION APPLICATIONS
A61K 31/11 (2006.01)	2766002 *	R(+)-N-FORMYL-PROPARGYL-AMINOINDAN	G06F 3/03 (2006.01)	2724210 *	GESTURE-CONTROLLED TECHNIQUE TO EXPAND INTERACTION RADIUS IN COMPUTER VISION APPLICATIONS
A61K 31/135 (2006.01)	2766002 *	R(+)-N-FORMYL-PROPARGYL-AMINOINDAN			
A61K 31/21 (2006.01)	2766002 *	R(+)-N-FORMYL-PROPARGYL-AMINOINDAN			
A61P 25/00 (2006.01)	2766002 *	R(+)-N-FORMYL-PROPARGYL-AMINOINDAN			

MKP (51)	Broj objave evropske prijava patenta (97)	Naziv pronalaska (54)	MKP (51)	Broj objave evropske prijava patenta (97)	Naziv pronalaska (54)
G06F 3/048 (2013.01)	2724210 *	GESTURE-CONTROLLED TECHNIQUE TO EXPAND INTERACTION RADIUS IN COMPUTER VISION APPLICATIONS	A61K 47/10 (2006.01)	2753309 *	PHARMACEUTICAL COMPOSITION FOR ORAL ADMINISTRATION WITH A STATIN
A61K 31/53 (2006.01)	2714654 *	4-ARYL-N-PHENYL-1,3,5-TRIAZIN- 2-AMINES CONTAINING A SULFOXIMINE GROUP	A61K 47/12 (2006.01)	2753309 *	PHARMACEUTICAL COMPOSITION FOR ORAL ADMINISTRATION WITH A STATIN
A61P 9/00 (2006.01)	2714654 *	4-ARYL-N-PHENYL-1,3,5-TRIAZIN- 2-AMINES CONTAINING A SULFOXIMINE GROUP	A61F 2/30 (2006.01)	2713958 *	FLEXIBLE SURGICALLY IMPLANTABLE DEVICE, MADE OF COATED SILICONE, FOR JOINING PHALANXES, METACARPUS-PHALANX OR METATARSUS-PHALANX BONES IN ARTHROPLASTY SURGERY
A61P 31/00 (2006.01)	2714654 *	4-ARYL-N-PHENYL-1,3,5-TRIAZIN- 2-AMINES CONTAINING A SULFOXIMINE GROUP	A61F 2/42 (2006.01)	2713958 *	FLEXIBLE SURGICALLY IMPLANTABLE DEVICE, MADE OF COATED SILICONE, FOR JOINING PHALANXES, METACARPUS-PHALANX OR METATARSUS-PHALANX BONES IN ARTHROPLASTY SURGERY
C07C 311/13 (2006.01)	2714654 *	4-ARYL-N-PHENYL-1,3,5-TRIAZIN- 2-AMINES CONTAINING A SULFOXIMINE GROUP	C07F 9/40 (2006.01)	2710019 *	PROCESSES AND INTERMEDIATES FOR PREPARING ANTI-HIV AGENTS
C07D 251/16 (2006.01)	2714654 *	4-ARYL-N-PHENYL-1,3,5-TRIAZIN- 2-AMINES CONTAINING A SULFOXIMINE GROUP	C07F 9/44 (2006.01)	2710019 *	PROCESSES AND INTERMEDIATES FOR PREPARING ANTI-HIV AGENTS
C07D 251/22 (2006.01)	2714654 *	4-ARYL-N-PHENYL-1,3,5-TRIAZIN- 2-AMINES CONTAINING A SULFOXIMINE GROUP	C07H 19/20 (2006.01)	2710019 *	PROCESSES AND INTERMEDIATES FOR PREPARING ANTI-HIV AGENTS
C07D 401/12 (2006.01)	2714654 *	4-ARYL-N-PHENYL-1,3,5-TRIAZIN- 2-AMINES CONTAINING A SULFOXIMINE GROUP	A61C 5/06 (2006.01)	2545878	Liquid container
C07D 405/04 (2006.01)	2714654 *	4-ARYL-N-PHENYL-1,3,5-TRIAZIN- 2-AMINES CONTAINING A SULFOXIMINE GROUP	B65D 1/02 (2006.01)	2545878	Liquid container
C07D 405/12 (2006.01)	2714654 *	4-ARYL-N-PHENYL-1,3,5-TRIAZIN- 2-AMINES CONTAINING A SULFOXIMINE GROUP	B65D 39/16 (2006.01)	2545878	Liquid container
C07D 413/12 (2006.01)	2714654 *	4-ARYL-N-PHENYL-1,3,5-TRIAZIN- 2-AMINES CONTAINING A SULFOXIMINE GROUP	F21S 8/06 (2006.01)	2511604	Crystal mounting frame and light assembly
C07D 417/12 (2006.01)	2714654 *	4-ARYL-N-PHENYL-1,3,5-TRIAZIN- 2-AMINES CONTAINING A SULFOXIMINE GROUP	F21V 5/06 (2006.01)	2511604	Crystal mounting frame and light assembly
F16L 21/00 (2006.01)	2677222	A system for channeling and distributing fluids in pressure or depression	F21V 17/16 (2006.01)	2511604	Crystal mounting frame and light assembly
F16L 21/08 (2006.01)	2677222	A system for channeling and distributing fluids in pressure or depression	A61K 9/00 (2006.01)	2741735 *	FUNNY CURRENT (IF) INHIBITORS FOR USE IN A METHOD OF TREATING AND PREVENTING HEART FAILURE IN FELINE
F16L 25/00 (2006.01)	2677222	A system for channeling and distributing fluids in pressure or depression	A61K 9/50 (2006.01)	2741735 *	FUNNY CURRENT (IF) INHIBITORS FOR USE IN A METHOD OF TREATING AND PREVENTING HEART FAILURE IN FELINE
C10L 1/12 (2006.01)	2726579 *	COMPOSITION	A61K 31/55 (2006.01)	2741735 *	FUNNY CURRENT (IF) INHIBITORS FOR USE IN A METHOD OF TREATING AND PREVENTING HEART FAILURE IN FELINE
C10L 1/198 (2006.01)	2726579 *	COMPOSITION			
A61K 38/12 (2006.01)	2768517 *	HEPATITIS C VIRUS INHIBITORS			
A61K 9/20 (2006.01)	2753309 *	PHARMACEUTICAL COMPOSITION FOR ORAL ADMINISTRATION WITH A STATIN			

MKP (51)	Broj objave evropske prijava patenta (97)	Naziv pronalaska (54)	MKP (51)	Broj objave evropske prijava patenta (97)	Naziv pronalaska (54)
A61P 9/04 (2006.01)	2741735 *	FUNNY CURRENT (IF) INHIBITORS FOR USE IN A METHOD OF TREATING AND PREVENTING HEART FAILURE IN FELINE	F21Y 105/00 (2006.01)	2511593	Lighting fixtures having illuminated crystal panels and methods for providing illumination
A61K 31/519 (2006.01)	2766366 *	TETRAHYDROTRIAZOLOPYRIMIDINE DERIVATIVES AS HUMAN NEUTROPHIL ELASTASE INHIBITORS	A61M 1/00 (2006.01)	2723414 *	IMPLANT INSERTION DEVICE AND METHOD OF USE THEREOF
A61P 11/00 (2006.01)	2766366 *	TETRAHYDROTRIAZOLOPYRIMIDINE DERIVATIVES AS HUMAN NEUTROPHIL ELASTASE INHIBITORS	C40B 40/10 (2006.01)	2761066 *	FIBRONECTIN TYPE III REPEAT BASED PROTEIN SCAFFOLDS WITH ALTERNATIVE BINDING SURFACES
C07D 487/04 (2006.01)	2766366 *	TETRAHYDROTRIAZOLOPYRIMIDINE DERIVATIVES AS HUMAN NEUTROPHIL ELASTASE INHIBITORS	C40B 50/00 (2006.01)	2761066 *	FIBRONECTIN TYPE III REPEAT BASED PROTEIN SCAFFOLDS WITH ALTERNATIVE BINDING SURFACES
H04M 1/725 (2006.01)	2732609 *	DYNAMIC SUBSUMPTION INFERENCE	G06F 17/30 (2006.01)	2710587 *	AUTOMATED CONVERSATION ASSISTANCE
H04W 4/02 (2009.01)	2732609 *	DYNAMIC SUBSUMPTION INFERENCE	G10L 15/22 (2006.01)	2710587 *	AUTOMATED CONVERSATION ASSISTANCE
A61K 31/437 (2006.01)	2721028 *	AZETIDINYL PHENYL, PYRIDYL OR PYRAZINYL CARBOXAMIDE DERIVATIVES AS JAK INHIBITORS	H04M 3/493 (2006.01)	2710587 *	AUTOMATED CONVERSATION ASSISTANCE
A61K 31/519 (2006.01)	2721028 *	AZETIDINYL PHENYL, PYRIDYL OR PYRAZINYL CARBOXAMIDE DERIVATIVES AS JAK INHIBITORS	F01K 13/00 (2006.01)	2703608	Rankine cycle system
A61P 29/00 (2006.01)	2721028 *	AZETIDINYL PHENYL, PYRIDYL OR PYRAZINYL CARBOXAMIDE DERIVATIVES AS JAK INHIBITORS	A61B 17/00 (2006.01)	2679175	Surgical instrument
A61P 35/00 (2006.01)	2721028 *	AZETIDINYL PHENYL, PYRIDYL OR PYRAZINYL CARBOXAMIDE DERIVATIVES AS JAK INHIBITORS	A61B 17/28 (2006.01)	2679175	Surgical instrument
A61P 37/02 (2006.01)	2721028 *	AZETIDINYL PHENYL, PYRIDYL OR PYRAZINYL CARBOXAMIDE DERIVATIVES AS JAK INHIBITORS	A61B 17/29 (2006.01)	2679175	Surgical instrument
C07D 471/04 (2006.01)	2721028 *	AZETIDINYL PHENYL, PYRIDYL OR PYRAZINYL CARBOXAMIDE DERIVATIVES AS JAK INHIBITORS	A61B 18/00 (2006.01)	2679175	Surgical instrument
C07D 487/04 (2006.01)	2721028 *	AZETIDINYL PHENYL, PYRIDYL OR PYRAZINYL CARBOXAMIDE DERIVATIVES AS JAK INHIBITORS	A61B 18/08 (2006.01)	2679175	Surgical instrument
F21S 8/00 (2006.01)	2511593	Lighting fixtures having illuminated crystal panels and methods for providing illumination	A61K 31/4985 (2006.01)	2702062 *	SALT OF AN INHIBITOR OF PHOSPHODIESTERASE 10 ENZYME
F21S 8/06 (2006.01)	2511593	Lighting fixtures having illuminated crystal panels and methods for providing illumination	A61P 25/18 (2006.01)	2702062 *	SALT OF AN INHIBITOR OF PHOSPHODIESTERASE 10 ENZYME
F21V 5/00 (2006.01)	2511593	Lighting fixtures having illuminated crystal panels and methods for providing illumination	C07D 487/04 (2006.01)	2702062 *	SALT OF AN INHIBITOR OF PHOSPHODIESTERASE 10 ENZYME
F21V 5/02 (2006.01)	2511593	Lighting fixtures having illuminated crystal panels and methods for providing illumination	B65B 7/16 (2006.01)	2748088 *	METHOD AND MACHINE FOR PRODUCING A SINGLE-USE CAPSULE FOR BEVERAGES AND CAPSULE OBTAINED USING METHOD
F21V 5/06 (2006.01)	2511593	Lighting fixtures having illuminated crystal panels and methods for providing illumination	B65B 29/02 (2006.01)	2748088 *	METHOD AND MACHINE FOR PRODUCING A SINGLE-USE CAPSULE FOR BEVERAGES AND CAPSULE OBTAINED USING METHOD
F21Y 101/02 (2006.01)	2511593	Lighting fixtures having illuminated crystal panels and methods for providing illumination			

MKP (51)	Broj objave evropske prijava patenta (97)	Naziv pronalaska (54)	MKP (51)	Broj objave evropske prijava patenta (97)	Naziv pronalaska (54)
B65B 61/20 (2006.01)	2748088 *	METHOD AND MACHINE FOR PRODUCING A SINGLE-USE CAPSULE FOR BEVERAGES AND CAPSULE OBTAINED USING METHOD	A61K 47/10 (2006.01)	2461797 *	PROCESS FOR PREPARATION OF OVER-THE-COUNTER GELATIN OR PECTIN-BASED DRUG DELIVERY
B65D 85/804 (2006.01)	2748088 *	METHOD AND MACHINE FOR PRODUCING A SINGLE-USE CAPSULE FOR BEVERAGES AND CAPSULE OBTAINED USING METHOD	A61K 47/26 (2006.01)	2461797 *	PROCESS FOR PREPARATION OF OVER-THE-COUNTER GELATIN OR PECTIN-BASED DRUG DELIVERY
F02M 59/10 (2006.01)	2657505	High pressure fuel pump assembly	A61K 47/36 (2006.01)	2461797 *	PROCESS FOR PREPARATION OF OVER-THE-COUNTER GELATIN OR PECTIN-BASED DRUG DELIVERY
F04B 1/04 (2006.01)	2657505	High pressure fuel pump assembly	A61K 47/42 (2006.01)	2461797 *	PROCESS FOR PREPARATION OF OVER-THE-COUNTER GELATIN OR PECTIN-BASED DRUG DELIVERY
F16H 53/06 (2006.01)	2657505	High pressure fuel pump assembly	A61J 1/10 (2006.01)	2767270 *	STANDING BAG INFUSION CONTAINER
E05D 7/00 (2006.01)	2682551	An adjustable hinge for windows and doors	B65D 30/16 (2006.01)	2767270 *	STANDING BAG INFUSION CONTAINER
A23G 3/36 (2006.01)	2461797 *	PROCESS FOR PREPARATION OF OVER-THE-COUNTER GELATIN OR PECTIN-BASED DRUG DELIVERY	A01N 25/28 (2006.01)	2740532	Method of producing a starch-containing material
A23L 1/05 (2006.01)	2461797 *	PROCESS FOR PREPARATION OF OVER-THE-COUNTER GELATIN OR PECTIN-BASED DRUG DELIVERY	A23L 1/22 (2006.01)	2740532	Method of producing a starch-containing material
A23P 1/10 (2006.01)	2461797 *	PROCESS FOR PREPARATION OF OVER-THE-COUNTER GELATIN OR PECTIN-BASED DRUG DELIVERY	A61K 9/50 (2006.01)	2740532	Method of producing a starch-containing material
A61K 9/00 (2006.01)	2461797 *	PROCESS FOR PREPARATION OF OVER-THE-COUNTER GELATIN OR PECTIN-BASED DRUG DELIVERY	A61K 47/00 (2006.01)	2740532	Method of producing a starch-containing material
A61K 31/137 (2006.01)	2461797 *	PROCESS FOR PREPARATION OF OVER-THE-COUNTER GELATIN OR PECTIN-BASED DRUG DELIVERY	B01J 13/02 (2006.01)	2740532	Method of producing a starch-containing material
A61K 31/138 (2006.01)	2461797 *	PROCESS FOR PREPARATION OF OVER-THE-COUNTER GELATIN OR PECTIN-BASED DRUG DELIVERY	B01J 20/30 (2006.01)	2740532	Method of producing a starch-containing material
A61K 31/167 (2006.01)	2461797 *	PROCESS FOR PREPARATION OF OVER-THE-COUNTER GELATIN OR PECTIN-BASED DRUG DELIVERY	C08B 30/12 (2006.01)	2740532	Method of producing a starch-containing material
A61K 31/192 (2006.01)	2461797 *	PROCESS FOR PREPARATION OF OVER-THE-COUNTER GELATIN OR PECTIN-BASED DRUG DELIVERY	C08B 30/14 (2006.01)	2740532	Method of producing a starch-containing material
A61K 31/4545 (2006.01)	2461797 *	PROCESS FOR PREPARATION OF OVER-THE-COUNTER GELATIN OR PECTIN-BASED DRUG DELIVERY	C08L 3/00 (2006.01)	2740532	Method of producing a starch-containing material
A61K 31/495 (2006.01)	2461797 *	PROCESS FOR PREPARATION OF OVER-THE-COUNTER GELATIN OR PECTIN-BASED DRUG DELIVERY	B67D 1/00 (2006.01)	2739559 *	METHOD AND APPARATUS FOR CARTRIDGE-BASED CARBONATION OF BEVERAGES
			B67D 1/04 (2006.01)	2739559 *	METHOD AND APPARATUS FOR CARTRIDGE-BASED CARBONATION OF BEVERAGES
			B67D 3/00 (2006.01)	2739559 *	METHOD AND APPARATUS FOR CARTRIDGE-BASED CARBONATION OF BEVERAGES
			A61F 7/00 (2006.01)	2701643 *	APPARATUS AND METHOD FOR ENHANCED HGH GENERATION IN HUMANS

MKP (51)	Broj objave evropske prijava patenta (97)	Naziv pronalaska (54)	MKP (51)	Broj objave evropske prijava patenta (97)	Naziv pronalaska (54)
B29D 22/04 (2006.01)	2722160	Method for manufacturing plastic balls and plastic ball	B01D 9/02 (2006.01)	2751081 *	POLYMORPHIC FORM OF PITAVASTATIN CALCIUM
A61K 39/395 (2006.01)	2744827 *	ANTI-TIE2 ANTIBODIES USES THEREOF	C07D 215/14 (2006.01)	2751081 *	POLYMORPHIC FORM OF PITAVASTATIN CALCIUM
A61P 35/00 (2006.01)	2744827 *	ANTI-TIE2 ANTIBODIES USES THEREOF	A01G 9/14 (2006.01)	2747549 *	LAMINAR BODY FOR MAKING GREENHOUSE ROOFS AND METHOD OF GREENHOUSE CULTIVATION
C07K 16/28 (2006.01)	2744827 *	ANTI-TIE2 ANTIBODIES USES THEREOF	B32B 27/20 (2006.01)	2747549 *	LAMINAR BODY FOR MAKING GREENHOUSE ROOFS AND METHOD OF GREENHOUSE CULTIVATION
C12N 15/86 (2006.01)	2669381	Method for expression of heterologous proteins using a recombinant negative-strand RNA virus vector comprising a mutated P protein	B32B 27/30 (2006.01)	2747549 *	LAMINAR BODY FOR MAKING GREENHOUSE ROOFS AND METHOD OF GREENHOUSE CULTIVATION
G09F 7/18 (2006.01)	2718923 *	POSTER HOLDER	C08J 3/22 (2006.01)	2747549 *	LAMINAR BODY FOR MAKING GREENHOUSE ROOFS AND METHOD OF GREENHOUSE CULTIVATION
G09F 7/20 (2006.01)	2718923 *	POSTER HOLDER	C08K 3/22 (2006.01)	2747549 *	LAMINAR BODY FOR MAKING GREENHOUSE ROOFS AND METHOD OF GREENHOUSE CULTIVATION
G09F 15/00 (2006.01)	2718923 *	POSTER HOLDER	A01N 25/02 (2006.01)	2734040 *	IMPROVED METHOD FOR PRODUCING EMULSIFIABLE PESTICIDE SOLUTIONS
A61K 31/546 (2006.01)	2703406 *	NOVEL CEPHEM COMPOUND HAVING CATECHOL OR PSEUDO-CATECHOL STRUCTURE	A01N 25/30 (2006.01)	2734040 *	IMPROVED METHOD FOR PRODUCING EMULSIFIABLE PESTICIDE SOLUTIONS
A61P 31/04 (2006.01)	2703406 *	NOVEL CEPHEM COMPOUND HAVING CATECHOL OR PSEUDO-CATECHOL STRUCTURE	A01N 37/42 (2006.01)	2734040 *	IMPROVED METHOD FOR PRODUCING EMULSIFIABLE PESTICIDE SOLUTIONS
C07D 501/18 (2006.01)	2703406 *	NOVEL CEPHEM COMPOUND HAVING CATECHOL OR PSEUDO-CATECHOL STRUCTURE	A01N 43/40 (2006.01)	2734040 *	IMPROVED METHOD FOR PRODUCING EMULSIFIABLE PESTICIDE SOLUTIONS
C07D 501/46 (2006.01)	2703406 *	NOVEL CEPHEM COMPOUND HAVING CATECHOL OR PSEUDO-CATECHOL STRUCTURE	A01N 43/50 (2006.01)	2734040 *	IMPROVED METHOD FOR PRODUCING EMULSIFIABLE PESTICIDE SOLUTIONS
C07D 519/06 (2006.01)	2703406 *	NOVEL CEPHEM COMPOUND HAVING CATECHOL OR PSEUDO-CATECHOL STRUCTURE	A01N 43/653 (2006.01)	2734040 *	IMPROVED METHOD FOR PRODUCING EMULSIFIABLE PESTICIDE SOLUTIONS
A61K 39/08 (2006.01)	2741785 *	NOVEL CLOSTRIDIUM DIFFICILE DNA VACCINE	A01N 47/12 (2006.01)	2734040 *	IMPROVED METHOD FOR PRODUCING EMULSIFIABLE PESTICIDE SOLUTIONS
A61K 48/00 (2006.01)	2741785 *	NOVEL CLOSTRIDIUM DIFFICILE DNA VACCINE	A01N 47/20 (2006.01)	2734040 *	IMPROVED METHOD FOR PRODUCING EMULSIFIABLE PESTICIDE SOLUTIONS
C07C 69/74 (2006.01)	2718257 *	PROCESS FOR PREPARING HIGH PURITY AND CRYSTALLINE DIMETHYL FUMARATE	A01N 53/00 (2006.01)	2734040 *	IMPROVED METHOD FOR PRODUCING EMULSIFIABLE PESTICIDE SOLUTIONS
A61K 31/47 (2006.01)	2751081 *	POLYMORPHIC FORM OF PITAVASTATIN CALCIUM	A61K 38/04 (2006.01)	2734218 *	POLYOMA VIRUS JC PEPTIDES AND PROTEINS IN VACCINATION AND DIAGNOSTIC APPLICATIONS
A61P 3/00 (2006.01)	2751081 *	POLYMORPHIC FORM OF PITAVASTATIN CALCIUM	A61K 38/16 (2006.01)	2734218 *	POLYOMA VIRUS JC PEPTIDES AND PROTEINS IN VACCINATION AND DIAGNOSTIC APPLICATIONS
A61P 9/00 (2006.01)	2751081 *	POLYMORPHIC FORM OF PITAVASTATIN CALCIUM	C07K 14/025 (2006.01)	2734218 *	POLYOMA VIRUS JC PEPTIDES AND PROTEINS IN VACCINATION AND DIAGNOSTIC APPLICATIONS

MKP (51)	Broj objave evropske prijava patenta (97)	Naziv pronalaska (54)	MKP (51)	Broj objave evropske prijava patenta (97)	Naziv pronalaska (54)
A61P 9/00 (2006.01)	2714648 *	NEPRILYSIN INHIBITORS	A61K 31/498 (2006.01)	2579888 *	NOVEL GLP-1 RECEPTOR STABILIZERS AND MODULATORS
C07C 233/00 (2006.01)	2714648 *	NEPRILYSIN INHIBITORS	A61K 31/5375 (2006.01)	2579888 *	NOVEL GLP-1 RECEPTOR STABILIZERS AND MODULATORS
A61K 39/395 (2006.01)	2714079 *	DEIMMUNIZED SERUM-BINDING DOMAINS AND THEIR USE FOR EXTENDING SERUM HALF-LIFE	A61K 38/16 (2006.01)	2579888 *	NOVEL GLP-1 RECEPTOR STABILIZERS AND MODULATORS
A61K 31/24 (2006.01)	2579888 *	NOVEL GLP-1 RECEPTOR STABILIZERS AND MODULATORS	C07D 265/30 (2006.01)	2579888 *	NOVEL GLP-1 RECEPTOR STABILIZERS AND MODULATORS
A61K 31/341 (2006.01)	2579888 *	NOVEL GLP-1 RECEPTOR STABILIZERS AND MODULATORS	A61K 31/5517 (2006.01)	2705039 *	BROMODOMAIN INHIBITORS AND USES THEREOF
A61K 31/343 (2006.01)	2579888 *	NOVEL GLP-1 RECEPTOR STABILIZERS AND MODULATORS	A61P 35/00 (2006.01)	2705039 *	BROMODOMAIN INHIBITORS AND USES THEREOF
A61K 31/351 (2006.01)	2579888 *	NOVEL GLP-1 RECEPTOR STABILIZERS AND MODULATORS	C07D 401/04 (2006.01)	2705039 *	BROMODOMAIN INHIBITORS AND USES THEREOF
A61K 31/381 (2006.01)	2579888 *	NOVEL GLP-1 RECEPTOR STABILIZERS AND MODULATORS	C07D 487/04 (2006.01)	2705039 *	BROMODOMAIN INHIBITORS AND USES THEREOF
A61K 31/40 (2006.01)	2579888 *	NOVEL GLP-1 RECEPTOR STABILIZERS AND MODULATORS	B01D 3/00 (2006.01)	2755731 *	SYSTEM AND METHOD FOR WATER TREATMENT
A61K 31/41 (2006.01)	2579888 *	NOVEL GLP-1 RECEPTOR STABILIZERS AND MODULATORS	C12Q 1/68 (2006.01)	2723901 *	COMPOSITIONS AND METHODS OF DIAGNOSING DISEASES AND DISORDERS ASSOCIATED WITH CELL DEATH
A61K 31/415 (2006.01)	2579888 *	NOVEL GLP-1 RECEPTOR STABILIZERS AND MODULATORS	C07D 311/06 (2006.01)	2758386 *	PROCESSES AND INTERMEDIATES FOR PREPARING A MACROCYCLIC PROTEASE INHIBITOR OF HCV
A61K 31/421 (2006.01)	2579888 *	NOVEL GLP-1 RECEPTOR STABILIZERS AND MODULATORS	C07D 417/04 (2006.01)	2758386 *	PROCESSES AND INTERMEDIATES FOR PREPARING A MACROCYCLIC PROTEASE INHIBITOR OF HCV
A61K 31/423 (2006.01)	2579888 *	NOVEL GLP-1 RECEPTOR STABILIZERS AND MODULATORS	C07D 453/04 (2006.01)	2758386 *	PROCESSES AND INTERMEDIATES FOR PREPARING A MACROCYCLIC PROTEASE INHIBITOR OF HCV
A61K 31/428 (2006.01)	2579888 *	NOVEL GLP-1 RECEPTOR STABILIZERS AND MODULATORS	H01H 13/28 (2006.01)	2672498	Electrical device with axial control
A61K 31/433 (2006.01)	2579888 *	NOVEL GLP-1 RECEPTOR STABILIZERS AND MODULATORS	H01H 13/56 (2006.01)	2672498	Electrical device with axial control
A61K 31/437 (2006.01)	2579888 *	NOVEL GLP-1 RECEPTOR STABILIZERS AND MODULATORS	H01H 23/20 (2006.01)	2672498	Electrical device with axial control
A61K 31/4406 (2006.01)	2579888 *	NOVEL GLP-1 RECEPTOR STABILIZERS AND MODULATORS	H01H 23/24 (2006.01)	2672498	Electrical device with axial control
A61K 31/445 (2006.01)	2579888 *	NOVEL GLP-1 RECEPTOR STABILIZERS AND MODULATORS	E21B 43/16 (2006.01)	2718566 *	CRANKED ROD PUMP APPARATUS AND METHOD
A61K 31/47 (2006.01)	2579888 *	NOVEL GLP-1 RECEPTOR STABILIZERS AND MODULATORS	F04B 9/02 (2006.01)	2718566 *	CRANKED ROD PUMP APPARATUS AND METHOD
A61K 31/495 (2006.01)	2579888 *	NOVEL GLP-1 RECEPTOR STABILIZERS AND MODULATORS			

MKP (51)	Broj objave evropske prijava patenta (97)	Naziv pronalaska (54)	MKP (51)	Broj objave evropske prijava patenta (97)	Naziv pronalaska (54)
A61B 1/04 (2006.01)	2706904 *	IMPROVED IMAGE SENSOR FOR ENDOSCOPIC USE	B32B 15/08 (2006.01)	2740595 *	METHOD FOR MAKING AND PROCESSING FLEXIBLE PLATE MATERIAL
B60D 1/167 (2006.01)	2741931 *	TOW BAR	B32B 23/08 (2006.01)	2740595 *	METHOD FOR MAKING AND PROCESSING FLEXIBLE PLATE MATERIAL
B60D 1/32 (2006.01)	2741931 *	TOW BAR	A61K 31/415 (2006.01)	2621521 *	MINIMIZING INTESTINAL DYSFUNCTION
B60D 1/58 (2006.01)	2741931 *	TOW BAR	A61K 31/496 (2006.01)	2621521 *	MINIMIZING INTESTINAL DYSFUNCTION
C12P 7/56 (2006.01)	2732043 *	SEPARATION PROCESS	A61K 31/4965 (2006.01)	2621521 *	MINIMIZING INTESTINAL DYSFUNCTION
C12P 41/00 (2006.01)	2732043 *	SEPARATION PROCESS	A61K 38/48 (2006.01)	2621521 *	MINIMIZING INTESTINAL DYSFUNCTION
F02M 53/04 (2006.01)	2385242	Isolator for fuel injector	A61P 1/00 (2006.01)	2621521 *	MINIMIZING INTESTINAL DYSFUNCTION
F02M 61/14 (2006.01)	2385242	Isolator for fuel injector	A61P 29/00 (2006.01)	2621521 *	MINIMIZING INTESTINAL DYSFUNCTION
C12N 5/10 (2006.01)	2702146 *	IDENTIFICATION OF POLYNUCLEOTIDES ASSOCIATED WITH A SAMPLE	A61P 31/04 (2006.01)	2621521 *	MINIMIZING INTESTINAL DYSFUNCTION
C07F 9/6561 (2006.01)	2764002 *	METHODS FOR PREPARING ANTI-VIRAL NUCLEOTIDE ANALOGS	H01H 71/12 (2006.01)	2765590 *	TRIPPING MECHANISM FOR SURGE PROTECTOR AND SURGE PROTECTOR
C12N 5/00 (2006.01)	2721144 *	AMPLIFICATION ENHANCEMENT OF BLOOD DERIVED PROGENITOR CELLS USING A CLOSED CULTURE SYSTEM	H01H 83/10 (2006.01)	2765590 *	TRIPPING MECHANISM FOR SURGE PROTECTOR AND SURGE PROTECTOR
C12N 5/02 (2006.01)	2721144 *	AMPLIFICATION ENHANCEMENT OF BLOOD DERIVED PROGENITOR CELLS USING A CLOSED CULTURE SYSTEM	F02M 59/20 (2006.01)	2647824	Injection pump systems and methods of operation
A61K 36/14 (2006.01)	2644202	Ointment for skin treatment, and method of its manufacture	F02M 59/36 (2006.01)	2647824	Injection pump systems and methods of operation
A61P 17/02 (2006.01)	2644202	Ointment for skin treatment, and method of its manufacture	F02M 59/46 (2006.01)	2647824	Injection pump systems and methods of operation
A61P 17/06 (2006.01)	2644202	Ointment for skin treatment, and method of its manufacture	F02M 63/02 (2006.01)	2647824	Injection pump systems and methods of operation
C07C 231/02 (2006.01)	2768796 *	PROCESS FOR PREPARING QUINOLINE DERIVATIVES	E21B 33/072 (2006.01)	2769052 *	DEVICE FOR RECIRCULATING GREASE/SEALING OIL IN RISERS
C07C 233/59 (2006.01)	2768796 *	PROCESS FOR PREPARING QUINOLINE DERIVATIVES	A61K 31/56 (2006.01)	2739287 *	CORTICOSTEROIDS FOR THE TREATMENT OF JOINT PAIN
C07D 215/22 (2006.01)	2768796 *	PROCESS FOR PREPARING QUINOLINE DERIVATIVES	A61K 39/155 (2006.01)	2702159 *	MODIFIED SENDAI VIRUS VACCINE AND IMAGING VECTOR
C07D 413/12 (2006.01)	2768796 *	PROCESS FOR PREPARING QUINOLINE DERIVATIVES	C12N 7/01 (2006.01)	2702159 *	MODIFIED SENDAI VIRUS VACCINE AND IMAGING VECTOR
			C12N 15/86 (2006.01)	2702159 *	MODIFIED SENDAI VIRUS VACCINE AND IMAGING VECTOR

MKP (51)	Broj objave evropske prijava patenta (97)	Naziv pronalaska (54)	MKP (51)	Broj objave evropske prijava patenta (97)	Naziv pronalaska (54)
B23C 3/35 (2006.01)	2714336 *	CLAMPING DEVICE FOR A MACHINE FOR DUPLICATING KEYS	C07D 417/12 (2006.01)	2714685 *	COMPOSITIONS CONTAINING, METHODS INVOLVING, AND USES OF NON-NATURAL AMINO ACID LINKED DOLASTATIN DERIVATIVES
B25B 1/24 (2006.01)	2714336 *	CLAMPING DEVICE FOR A MACHINE FOR DUPLICATING KEYS	A61K 31/437 (2006.01)	2766363 *	POLYMORPHS OF ARRY-380, A SELECTIVE HERB2 INHIBITOR AND PHARMACEUTICAL COMPOSITIONS CONTAINING THEM
F04C 2/00 (2006.01)	2739854 *	PISTON WITH REPLACEABLE AND/OR ADJUSTABLE SURFACES	A61P 35/00 (2006.01)	2766363 *	POLYMORPHS OF ARRY-380, A SELECTIVE HERB2 INHIBITOR AND PHARMACEUTICAL COMPOSITIONS CONTAINING THEM
A01N 37/18 (2006.01)	2736329 *	COMPOUNDS AND METHODS	C07D 471/04 (2006.01)	2766363 *	POLYMORPHS OF ARRY-380, A SELECTIVE HERB2 INHIBITOR AND PHARMACEUTICAL COMPOSITIONS CONTAINING THEM
A61K 31/165 (2006.01)	2736329 *	COMPOUNDS AND METHODS	C21D 1/00 (2006.01)	2734655 *	HIGH-STRENGTH CORROSION-RESISTANT TUBING FOR OIL AND GAS COMPLETION AND DRILLING APPLICATIONS, AND PROCESS FOR MANUFACTURING THEREOF
C07C 233/00 (2006.01)	2736329 *	COMPOUNDS AND METHODS	C22C 19/05 (2006.01)	2734655 *	HIGH-STRENGTH CORROSION-RESISTANT TUBING FOR OIL AND GAS COMPLETION AND DRILLING APPLICATIONS, AND PROCESS FOR MANUFACTURING THEREOF
F03D 7/02 (2006.01)	2657516	Wind turbine including an electromagnetic retarder for slowing the blade rotation speed	C22C 38/00 (2006.01)	2734655 *	HIGH-STRENGTH CORROSION-RESISTANT TUBING FOR OIL AND GAS COMPLETION AND DRILLING APPLICATIONS, AND PROCESS FOR MANUFACTURING THEREOF
F01K 7/16 (2006.01)	2718547 *	DOUBLE PINCH CRITERION FOR OPTIMIZATION OF REGENERATIVE RANKINE CYCLES	C22C 38/44 (2006.01)	2734655 *	HIGH-STRENGTH CORROSION-RESISTANT TUBING FOR OIL AND GAS COMPLETION AND DRILLING APPLICATIONS, AND PROCESS FOR MANUFACTURING THEREOF
F01K 23/10 (2006.01)	2718547 *	DOUBLE PINCH CRITERION FOR OPTIMIZATION OF REGENERATIVE RANKINE CYCLES	C22F 1/10 (2006.01)	2734655 *	HIGH-STRENGTH CORROSION-RESISTANT TUBING FOR OIL AND GAS COMPLETION AND DRILLING APPLICATIONS, AND PROCESS FOR MANUFACTURING THEREOF
F01K 25/08 (2006.01)	2718547 *	DOUBLE PINCH CRITERION FOR OPTIMIZATION OF REGENERATIVE RANKINE CYCLES	A61K 39/395 (2006.01)	2707029 *	METHODS OF TREATING OR PREVENTING CHOLESTEROL RELATED DISORDERS
E06B 9/26 (2006.01)	2737151 *	A RETRACTABLE LOUVRE SYSTEM	A61P 3/06 (2006.01)	2707029 *	METHODS OF TREATING OR PREVENTING CHOLESTEROL RELATED DISORDERS
E06B 9/302 (2006.01)	2737151 *	A RETRACTABLE LOUVRE SYSTEM	C07K 16/40 (2006.01)	2707029 *	METHODS OF TREATING OR PREVENTING CHOLESTEROL RELATED DISORDERS
A61K 31/427 (2006.01)	2714685 *	COMPOSITIONS CONTAINING, METHODS INVOLVING, AND USES OF NON-NATURAL AMINO ACID LINKED DOLASTATIN DERIVATIVES	A61K 9/70 (2006.01)	2722040 *	LIDOCAINE-CONTAINING CATAPLASM
A61P 35/00 (2006.01)	2714685 *	COMPOSITIONS CONTAINING, METHODS INVOLVING, AND USES OF NON-NATURAL AMINO ACID LINKED DOLASTATIN DERIVATIVES			
C07D 207/325 (2006.01)	2714685 *	COMPOSITIONS CONTAINING, METHODS INVOLVING, AND USES OF NON-NATURAL AMINO ACID LINKED DOLASTATIN DERIVATIVES			
C07D 401/12 (2006.01)	2714685 *	COMPOSITIONS CONTAINING, METHODS INVOLVING, AND USES OF NON-NATURAL AMINO ACID LINKED DOLASTATIN DERIVATIVES			

MKP (51)	Broj objave evropske prijava patenta (97)	Naziv pronalaska (54)	MKP (51)	Broj objave evropske prijava patenta (97)	Naziv pronalaska (54)
A61K 31/167 (2006.01)	2722040 *	LIDOCAINE-CONTAINING CATAPLASM	A61P 17/10 (2006.01)	2768495 *	PHARMACEUTICAL COMPOSITIONS COMPRISING DGLA, 15-OHEPA, AND/OR 15-HETRE AND METHODS OF USE THEREOF
A61K 47/12 (2006.01)	2722040 *	LIDOCAINE-CONTAINING CATAPLASM	G06Q 20/20 (2012.01)	2702572 *	THE METHOD OF CASHLESS PERSON-TO-PERSON MONEY TRANSFER OF USING A MOBILE PHONE
A61K 47/42 (2006.01)	2722040 *	LIDOCAINE-CONTAINING CATAPLASM	G07F 7/08 (2006.01)	2702572 *	THE METHOD OF CASHLESS PERSON-TO-PERSON MONEY TRANSFER OF USING A MOBILE PHONE
A61P 23/02 (2006.01)	2722040 *	LIDOCAINE-CONTAINING CATAPLASM	G07G 1/00 (2006.01)	2702572 *	THE METHOD OF CASHLESS PERSON-TO-PERSON MONEY TRANSFER OF USING A MOBILE PHONE
A61K 31/4196 (2006.01)	2758053 *	SODIUM CHANNEL BLOCKERS REDUCE GLUCAGON SECRETION	F16C 19/06 (2006.01)	2711574	Ball bearing and method for manufacturing a ball bearing
A61K 31/495 (2006.01)	2758053 *	SODIUM CHANNEL BLOCKERS REDUCE GLUCAGON SECRETION	F16C 33/60 (2006.01)	2711574	Ball bearing and method for manufacturing a ball bearing
A61K 45/06 (2006.01)	2758053 *	SODIUM CHANNEL BLOCKERS REDUCE GLUCAGON SECRETION	F16C 35/077 (2006.01)	2711574	Ball bearing and method for manufacturing a ball bearing
A61P 3/10 (2006.01)	2758053 *	SODIUM CHANNEL BLOCKERS REDUCE GLUCAGON SECRETION	F16C 43/04 (2006.01)	2711574	Ball bearing and method for manufacturing a ball bearing
A61K 9/00 (2006.01)	2731588 *	COMPOSITION AND METHOD FOR TREATING HPV	A47C 7/02 (2006.01)	2735247	Office-chair
A61K 9/19 (2006.01)	2731588 *	COMPOSITION AND METHOD FOR TREATING HPV	A45C 11/00 (2006.01)	2764793 *	MOBILE COMMUNICATION TERMINAL CASE AND TABLET PC CASE
A61K 9/70 (2006.01)	2731588 *	COMPOSITION AND METHOD FOR TREATING HPV	C07B 59/00 (2006.01)	2722335 *	PROCESS FOR PREPARING PHOSPHATE COMPOUND BEARING ISOTOPE
A61K 31/675 (2006.01)	2731588 *	COMPOSITION AND METHOD FOR TREATING HPV	C07H 1/02 (2006.01)	2722335 *	PROCESS FOR PREPARING PHOSPHATE COMPOUND BEARING ISOTOPE
A61K 47/38 (2006.01)	2731588 *	COMPOSITION AND METHOD FOR TREATING HPV	C07H 21/02 (2006.01)	2722335 *	PROCESS FOR PREPARING PHOSPHATE COMPOUND BEARING ISOTOPE
A23J 1/14 (2006.01)	2709463 *	PRODUCTION OF SOLUBLE SOY PROTEIN PRODUCT ("S704")	A61K 39/12 (2006.01)	2734230 *	RECOMBINANT FELINE LEUKEMIA VIRUS VACCINE CONTAINING OPTIMIZED FELINE LEUKEMIA VIRUS ENVELOPE GENE
A23J 3/16 (2006.01)	2709463 *	PRODUCTION OF SOLUBLE SOY PROTEIN PRODUCT ("S704")	C07K 14/005 (2006.01)	2734230 *	RECOMBINANT FELINE LEUKEMIA VIRUS VACCINE CONTAINING OPTIMIZED FELINE LEUKEMIA VIRUS ENVELOPE GENE
C07K 1/14 (2006.01)	2709463 *	PRODUCTION OF SOLUBLE SOY PROTEIN PRODUCT ("S704")	C12N 15/86 (2006.01)	2734230 *	RECOMBINANT FELINE LEUKEMIA VIRUS VACCINE CONTAINING OPTIMIZED FELINE LEUKEMIA VIRUS ENVELOPE GENE
C07K 14/415 (2006.01)	2709463 *	PRODUCTION OF SOLUBLE SOY PROTEIN PRODUCT ("S704")			
A61K 31/202 (2006.01)	2768495 *	PHARMACEUTICAL COMPOSITIONS COMPRISING DGLA, 15-OHEPA, AND/OR 15-HETRE AND METHODS OF USE THEREOF			
A61P 17/00 (2006.01)	2768495 *	PHARMACEUTICAL COMPOSITIONS COMPRISING DGLA, 15-OHEPA, AND/OR 15-HETRE AND METHODS OF USE THEREOF			

MKP (51)	Broj objave evropske prijava patenta (97)	Naziv pronalaska (54)	MKP (51)	Broj objave evropske prijava patenta (97)	Naziv pronalaska (54)
C12P 21/04 (2006.01)	2705154 *	FECAL LACTOFERRIN AS A BIOMARKER FOR DETERMINING DISEASE SEVERITY AND FOR MONITORING INFECTION IN PATIENTS WITH CLOSTRIDIUM DIFFICILE DISEASE	C07K 14/47 (2006.01)	2758433 *	PROTEIN-BASED THERAPY AND DIAGNOSIS OF TAU-MEDIATED PATHOLOGY IN ALZHEIMER'S DISEASE
G01N 33/00 (2006.01)	2705154 *	FECAL LACTOFERRIN AS A BIOMARKER FOR DETERMINING DISEASE SEVERITY AND FOR MONITORING INFECTION IN PATIENTS WITH CLOSTRIDIUM DIFFICILE DISEASE	C07K 16/18 (2006.01)	2758433 *	PROTEIN-BASED THERAPY AND DIAGNOSIS OF TAU-MEDIATED PATHOLOGY IN ALZHEIMER'S DISEASE
B23G 1/04 (2006.01)	2650072	Automatic threading machine	G01N 33/53 (2006.01)	2758433 *	PROTEIN-BASED THERAPY AND DIAGNOSIS OF TAU-MEDIATED PATHOLOGY IN ALZHEIMER'S DISEASE
B23G 1/18 (2006.01)	2650072	Automatic threading machine	F03D 1/04 (2006.01)	2756187 *	FLUID TURBINE LIGHTNING PROTECTION SYSTEM
A61K 31/05 (2006.01)	2709606 *	COMPOSITIONS CONTAINING RESVERATROL AND ESSENTIAL OIL OF CLOVES FOR THE TREATMENT OF ITCHING	F03D 11/00 (2006.01)	2756187 *	FLUID TURBINE LIGHTNING PROTECTION SYSTEM
A61K 36/61 (2006.01)	2709606 *	COMPOSITIONS CONTAINING RESVERATROL AND ESSENTIAL OIL OF CLOVES FOR THE TREATMENT OF ITCHING	C07D 239/47 (2006.01)	2751086 *	KYNURENINE-3-MONOOXYGENASE INHIBITORS, PHARMACEUTICAL COMPOSITIONS, AND METHODS OF USE THEREOF
A61K 45/06 (2006.01)	2709606 *	COMPOSITIONS CONTAINING RESVERATROL AND ESSENTIAL OIL OF CLOVES FOR THE TREATMENT OF ITCHING	A23L 1/30 (2006.01)	2753193 *	PRODUCTS AND METHODS
A61P 17/04 (2006.01)	2709606 *	COMPOSITIONS CONTAINING RESVERATROL AND ESSENTIAL OIL OF CLOVES FOR THE TREATMENT OF ITCHING	A23L 1/38 (2006.01)	2753193 *	PRODUCTS AND METHODS
G06F 3/01 (2006.01)	2707787 *	TRANSPARENT VIBRATING TOUCH INTERFACE	A61K 8/99 (2006.01)	2753193 *	PRODUCTS AND METHODS
A61K 31/4523 (2006.01)	2760449 *	A PHARMACEUTICAL COMPOSITION FOR THE TREATMENT OF STEM CELLS	A61K 36/06 (2006.01)	2753193 *	PRODUCTS AND METHODS
A61K 31/5395 (2006.01)	2760449 *	A PHARMACEUTICAL COMPOSITION FOR THE TREATMENT OF STEM CELLS	G01N 33/564 (2006.01)	2753193 *	PRODUCTS AND METHODS
A61K 35/28 (2006.01)	2760449 *	A PHARMACEUTICAL COMPOSITION FOR THE TREATMENT OF STEM CELLS	A61K 31/519 (2006.01)	2763985 *	MORPHOLINO SUBSTITUTED BICYCLIC PYRIMIDINE UREA OR CARBAMATE DERIVATIVES AS MTOR INHIBITORS
A61K 45/06 (2006.01)	2760449 *	A PHARMACEUTICAL COMPOSITION FOR THE TREATMENT OF STEM CELLS	C07D 417/02 (2006.01)	2763985 *	MORPHOLINO SUBSTITUTED BICYCLIC PYRIMIDINE UREA OR CARBAMATE DERIVATIVES AS MTOR INHIBITORS
A61P 43/00 (2006.01)	2760449 *	A PHARMACEUTICAL COMPOSITION FOR THE TREATMENT OF STEM CELLS	A61K 35/12 (2006.01)	2756521 *	RNA ENGINEERED T CELLS FOR THE TREATMENT OF CANCER
A61K 39/00 (2006.01)	2758433 *	PROTEIN-BASED THERAPY AND DIAGNOSIS OF TAU-MEDIATED PATHOLOGY IN ALZHEIMER'S DISEASE	C12P 21/00 (2006.01)	2756521 *	RNA ENGINEERED T CELLS FOR THE TREATMENT OF CANCER
A61P 25/28 (2006.01)	2758433 *	PROTEIN-BASED THERAPY AND DIAGNOSIS OF TAU-MEDIATED PATHOLOGY IN ALZHEIMER'S DISEASE	H01L 21/00 (2006.01)	2756521 *	RNA ENGINEERED T CELLS FOR THE TREATMENT OF CANCER
			A61K 38/46 (2006.01)	2704737 *	THERAPEUTIC NUCLEASE COMPOSITIONS AND METHODS

MKP (51)	Broj objave evropske prijava patenta (97)	Naziv pronalaska (54)	MKP (51)	Broj objave evropske prijava patenta (97)	Naziv pronalaska (54)
A61K 31/337 (2006.01)	2701700 *	DRUG THERAPY TO INHIBIT CHEMOTHERAPY-INDUCED ADVERSE EFFECTS AND RELATED PHARMACEUTICAL COMPOSITIONS, DIAGNOSTICS, SCREENING TECHNIQUES AND KITS	C12P 7/64 (2006.01)	2751275 *	ENZYMATIC TRANSESTERIFICATION WITH LIPASES IMMOBILIZED ON HYDROPHOBIC RESINS IN WATER SOLUTIONS
A61P 35/00 (2006.01)	2701700 *	DRUG THERAPY TO INHIBIT CHEMOTHERAPY-INDUCED ADVERSE EFFECTS AND RELATED PHARMACEUTICAL COMPOSITIONS, DIAGNOSTICS, SCREENING TECHNIQUES AND KITS	C12Q 1/70 (2006.01)	2714941 *	COMPOSITIONS AND METHODS FOR MODULATING THE ACTIVITY OF EPSTEIN-BARR NUCLEAR ANTIGEN 1
C07J 75/00 (2006.01)	2764008 *	PROCESS FOR THE PRODUCTION OF ESTETROL	F02G 1/043 (2006.01)	2707588 *	EXTERNAL COMBUSTION ENGINE
B01J 20/04 (2006.01)	2733119	Agent for removing dissolved phosphorus compounds from water	H02J 3/26 (2006.01)	2670041	Power supply assembly with an inverter for creating N-phase alternating current
B01J 20/28 (2006.01)	2733119	Agent for removing dissolved phosphorus compounds from water	H02M 7/48 (2007.01)	2670041	Power supply assembly with an inverter for creating N-phase alternating current
C02F 1/28 (2006.01)	2733119	Agent for removing dissolved phosphorus compounds from water	C07C 403/20 (2006.01)	2708530 *	STEREOSPECIFIC SYNTHESIS PROCESS FOR TRETINOIN COMPOUNDS
C02F 101/10 (2006.01)	2733119	Agent for removing dissolved phosphorus compounds from water	A01N 43/50 (2006.01)	2725904 *	HIGH DOSAGE MUCOADHESIVE METRONIDAZOLE AQUEOUS-BASED GEL FORMULATIONS THEIR USE TO TREAT BACTERIAL VAGINOSIS
C02F 103/00 (2006.01)	2733119	Agent for removing dissolved phosphorus compounds from water	A61K 31/7105 (2006.01)	2723350 *	NEW USES OF NANOG INHIBITORS AND RELATED METHODS
A61K 38/47 (2006.01)	2720713 *	CONTINUOUS SUBCUTANEOUS INSULIN INFUSION METHODS WITH A HYALURONAN DEGRADING ENZYME	A61P 35/00 (2006.01)	2723350 *	NEW USES OF NANOG INHIBITORS AND RELATED METHODS
A61P 3/10 (2006.01)	2720713 *	CONTINUOUS SUBCUTANEOUS INSULIN INFUSION METHODS WITH A HYALURONAN DEGRADING ENZYME	B65D 1/02 (2006.01)	2767583	Wine packaged in aluminium containers
A01N 43/42 (2006.01)	2744333 *	FATTY ACID SYNTHASE INHIBITORS	B67C 3/02 (2006.01)	2767583	Wine packaged in aluminium containers
A61K 31/505 (2006.01)	2736901 *	HETEROCYCLYL PYRIMIDINE ANALOGUES AS JAK INHIBITORS	C12G 1/00 (2006.01)	2767583	Wine packaged in aluminium containers
A61P 35/00 (2006.01)	2736901 *	HETEROCYCLYL PYRIMIDINE ANALOGUES AS JAK INHIBITORS	C12Q 1/68 (2006.01)	2761025 *	DIAGNOSTIC METHYLATION MARKERS OF EPITHELIAL OR MESENCHYMAL PHENOTYPE AND RESPONSE TO EGFR KINASE INHIBITOR IN TUMOURS OR TUMOUR CELLS
C07D 403/12 (2006.01)	2736901 *	HETEROCYCLYL PYRIMIDINE ANALOGUES AS JAK INHIBITORS	C08F 10/06 (2006.01)	2707400 *	CATALYST SYSTEM FOR POLYMERIZATION OF PROPYLENE
C07D 491/10 (2006.01)	2736901 *	HETEROCYCLYL PYRIMIDINE ANALOGUES AS JAK INHIBITORS	B61D 3/16 (2006.01)	2684757	Freight cars
A61K 31/47 (2006.01)	2758057 *	METHOD FOR TREATING OSTEOPOROSIS	B61D 45/00 (2006.01)	2684757	Freight cars
A61P 19/10 (2006.01)	2758057 *	METHOD FOR TREATING OSTEOPOROSIS	A61K 31/519 (2006.01)	2751106 *	SUBSTITUTED ANNELLATED PYRIMIDINE AND THE USE THEREOF
			A61P 9/00 (2006.01)	2751106 *	SUBSTITUTED ANNELLATED PYRIMIDINE AND THE USE THEREOF

MKP (51)	Broj objave evropske prijava patenta (97)	Naziv pronalaska (54)	MKP (51)	Broj objave evropske prijava patenta (97)	Naziv pronalaska (54)
C07D 471/04 (2006.01)	2751106 *	SUBSTITUTED ANNELLATED PYRIMIDINE AND THE USE THEREOF	B28B 21/02 (2006.01)	2723544 *	PRODUCTION OF A TOWER
C07D 487/04 (2006.01)	2751106 *	SUBSTITUTED ANNELLATED PYRIMIDINE AND THE USE THEREOF	B28B 21/82 (2006.01)	2723544 *	PRODUCTION OF A TOWER
C07D 519/00 (2006.01)	2751106 *	SUBSTITUTED ANNELLATED PYRIMIDINE AND THE USE THEREOF	B28B 23/00 (2006.01)	2723544 *	PRODUCTION OF A TOWER
A61B 17/34 (2006.01)	2649972	Tympanostomy tube delivery system	E04H 12/12 (2006.01)	2723544 *	PRODUCTION OF A TOWER
A61F 11/00 (2006.01)	2649972	Tympanostomy tube delivery system	F03D 11/04 (2006.01)	2723544 *	PRODUCTION OF A TOWER
A61K 39/245 (2006.01)	2707026 *	PRODUCTION OF DENSE BODIES (DB) FROM HCMV- INFECTED CELLS	G01B 11/24 (2006.01)	2723544 *	PRODUCTION OF A TOWER
C07D 239/84 (2006.01)	2707026 *	PRODUCTION OF DENSE BODIES (DB) FROM HCMV- INFECTED CELLS	A61K 31/454 (2006.01)	2730573 *	METHYLPYPERIDINE DERIVATIVE
C07D 401/04 (2006.01)	2707026 *	PRODUCTION OF DENSE BODIES (DB) FROM HCMV- INFECTED CELLS	A61K 31/4545 (2006.01)	2730573 *	METHYLPYPERIDINE DERIVATIVE
C07D 401/12 (2006.01)	2707026 *	PRODUCTION OF DENSE BODIES (DB) FROM HCMV- INFECTED CELLS	A61K 31/506 (2006.01)	2730573 *	METHYLPYPERIDINE DERIVATIVE
C07D 413/04 (2006.01)	2707026 *	PRODUCTION OF DENSE BODIES (DB) FROM HCMV- INFECTED CELLS	A61P 1/00 (2006.01)	2730573 *	METHYLPYPERIDINE DERIVATIVE
A61K 39/395 (2006.01)	2768855 *	STABLE MULTIPLE ANTIGEN- BINDING ANTIBODY	A61P 5/00 (2006.01)	2730573 *	METHYLPYPERIDINE DERIVATIVE
C07K 16/00 (2006.01)	2768855 *	STABLE MULTIPLE ANTIGEN- BINDING ANTIBODY	A61P 9/12 (2006.01)	2730573 *	METHYLPYPERIDINE DERIVATIVE
C07K 16/22 (2006.01)	2768855 *	STABLE MULTIPLE ANTIGEN- BINDING ANTIBODY	A61P 25/04 (2006.01)	2730573 *	METHYLPYPERIDINE DERIVATIVE
C07K 16/24 (2006.01)	2768855 *	STABLE MULTIPLE ANTIGEN- BINDING ANTIBODY	A61P 25/08 (2006.01)	2730573 *	METHYLPYPERIDINE DERIVATIVE
C07K 16/46 (2006.01)	2768855 *	STABLE MULTIPLE ANTIGEN- BINDING ANTIBODY	A61P 25/16 (2006.01)	2730573 *	METHYLPYPERIDINE DERIVATIVE
A01K 15/02 (2006.01)	2661961	A modular climbing tree and method of assembling the climbing tree	A61P 25/20 (2006.01)	2730573 *	METHYLPYPERIDINE DERIVATIVE
G06G 7/58 (2006.01)	2745235 *	METHOD OF DRUG REPOSITIONING	A61P 25/22 (2006.01)	2730573 *	METHYLPYPERIDINE DERIVATIVE
B28B 7/00 (2006.01)	2723544 *	PRODUCTION OF A TOWER	A61P 25/24 (2006.01)	2730573 *	METHYLPYPERIDINE DERIVATIVE
B28B 7/22 (2006.01)	2723544 *	PRODUCTION OF A TOWER	A61P 25/28 (2006.01)	2730573 *	METHYLPYPERIDINE DERIVATIVE
B28B 17/00 (2006.01)	2723544 *	PRODUCTION OF A TOWER	A61P 25/30 (2006.01)	2730573 *	METHYLPYPERIDINE DERIVATIVE

MKP (51)	Broj objave evropske prijava patenta (97)	Naziv pronalaska (54)	MKP (51)	Broj objave evropske prijava patenta (97)	Naziv pronalaska (54)
A61P 29/00 (2006.01)	2730573 *	METHYLPYPERIDINE DERIVATIVE	B63B 15/00 (2006.01)	2726306 *	IMPROVEMENTS IN OR RELATING TO A VESSEL
A61P 37/00 (2006.01)	2730573 *	METHYLPYPERIDINE DERIVATIVE	B63B 25/00 (2006.01)	2726306 *	IMPROVEMENTS IN OR RELATING TO A VESSEL
A61P 43/00 (2006.01)	2730573 *	METHYLPYPERIDINE DERIVATIVE	B63B 25/28 (2006.01)	2726306 *	IMPROVEMENTS IN OR RELATING TO A VESSEL
C07D 413/14 (2006.01)	2730573 *	METHYLPYPERIDINE DERIVATIVE	B63B 27/14 (2006.01)	2726306 *	IMPROVEMENTS IN OR RELATING TO A VESSEL
C07D 498/04 (2006.01)	2730573 *	METHYLPYPERIDINE DERIVATIVE	C12Q 1/68 (2006.01)	2756298 *	NON-INVASIVE METHODS OF DETECTING TARGET MOLECULES
A61J 3/07 (2006.01)	2641582	Packaging device for a flat administration form	G01N 33/50 (2006.01)	2756298 *	NON-INVASIVE METHODS OF DETECTING TARGET MOLECULES
B26D 1/36 (2006.01)	2641582	Packaging device for a flat administration form	G01N 33/68 (2006.01)	2756298 *	NON-INVASIVE METHODS OF DETECTING TARGET MOLECULES
B26D 1/38 (2006.01)	2641582	Packaging device for a flat administration form	B02C 2/00 (2006.01)	2763794 *	APPARATUS AND METHOD FOR AN ANTI-SPIN SYSTEM
B26D 7/10 (2006.01)	2641582	Packaging device for a flat administration form	H02J 3/00 (2006.01)	2735081 *	SWITCHING APPARATUS, CONTROL SYSTEM AND METHOD FOR VARYING AN IMPEDANCE OF A PHASE LINE
A61K 36/185 (2006.01)	2712319 *	ALCOHOL-FREE PHARMACEUTICAL COMPOSITION COMPRISING THYME AND PRIMULA ROOT LIQUID EXTRACTS	H02J 13/00 (2006.01)	2735081 *	SWITCHING APPARATUS, CONTROL SYSTEM AND METHOD FOR VARYING AN IMPEDANCE OF A PHASE LINE
A61K 36/53 (2006.01)	2712319 *	ALCOHOL-FREE PHARMACEUTICAL COMPOSITION COMPRISING THYME AND PRIMULA ROOT LIQUID EXTRACTS	A61K 31/44 (2006.01)	2721019 *	THERAPEUTICALLY ACTIVE COMPOSITIONS AND THEIR METHODS OF USE
A61K 8/02 (2006.01)	2760424 *	COSMETIC COMPOSITIONS COMPRISING LATEX FILM FORMERS	A61K 31/4427 (2006.01)	2721019 *	THERAPEUTICALLY ACTIVE COMPOSITIONS AND THEIR METHODS OF USE
A61K 8/30 (2006.01)	2760424 *	COSMETIC COMPOSITIONS COMPRISING LATEX FILM FORMERS	A61P 35/00 (2006.01)	2721019 *	THERAPEUTICALLY ACTIVE COMPOSITIONS AND THEIR METHODS OF USE
A61K 8/37 (2006.01)	2760424 *	COSMETIC COMPOSITIONS COMPRISING LATEX FILM FORMERS	C07D 401/02 (2006.01)	2721019 *	THERAPEUTICALLY ACTIVE COMPOSITIONS AND THEIR METHODS OF USE
A61K 8/41 (2006.01)	2760424 *	COSMETIC COMPOSITIONS COMPRISING LATEX FILM FORMERS	C07D 401/04 (2006.01)	2721019 *	THERAPEUTICALLY ACTIVE COMPOSITIONS AND THEIR METHODS OF USE
A61K 8/72 (2006.01)	2760424 *	COSMETIC COMPOSITIONS COMPRISING LATEX FILM FORMERS	C07D 401/14 (2006.01)	2721019 *	THERAPEUTICALLY ACTIVE COMPOSITIONS AND THEIR METHODS OF USE
A61Q 19/00 (2006.01)	2760424 *	COSMETIC COMPOSITIONS COMPRISING LATEX FILM FORMERS	C07D 405/00 (2006.01)	2721019 *	THERAPEUTICALLY ACTIVE COMPOSITIONS AND THEIR METHODS OF USE
B60F 3/00 (2006.01)	2726306 *	IMPROVEMENTS IN OR RELATING TO A VESSEL	F16L 11/12 (2006.01)	2623843	Combination of a heating device, a connector, and a gas meter, as well as method for measuring a property of a gas
B63B 1/12 (2006.01)	2726306 *	IMPROVEMENTS IN OR RELATING TO A VESSEL	F16L 57/02 (2006.01)	2623843	Combination of a heating device, a connector, and a gas meter, as well as method for measuring a property of a gas

MKP (51)	Broj objave evropske prijava patenta (97)	Naziv pronalaska (54)	MKP (51)	Broj objave evropske prijava patenta (97)	Naziv pronalaska (54)
A61K 31/166 (2006.01)	2714647 *	BIPHENYL DERIVATIVES USEFUL AS GLUCAGON RECEPTOR ANTAGONISTS	C07K 16/30 (2006.01)	2751282 *	DETECTION OF PRAME GENE EXPRESSION IN CANCER
A61K 31/195 (2006.01)	2714647 *	BIPHENYL DERIVATIVES USEFUL AS GLUCAGON RECEPTOR ANTAGONISTS	C12Q 1/68 (2006.01)	2751282 *	DETECTION OF PRAME GENE EXPRESSION IN CANCER
A61P 3/08 (2006.01)	2714647 *	BIPHENYL DERIVATIVES USEFUL AS GLUCAGON RECEPTOR ANTAGONISTS	E21B 23/10 (2006.01)	2766561 *	WELLBORE ACTUATORS, TREATMENT STRINGS AND METHODS
A61P 5/50 (2006.01)	2714647 *	BIPHENYL DERIVATIVES USEFUL AS GLUCAGON RECEPTOR ANTAGONISTS	E21B 33/12 (2006.01)	2766561 *	WELLBORE ACTUATORS, TREATMENT STRINGS AND METHODS
C07C 231/12 (2006.01)	2714647 *	BIPHENYL DERIVATIVES USEFUL AS GLUCAGON RECEPTOR ANTAGONISTS	E21B 34/08 (2006.01)	2766561 *	WELLBORE ACTUATORS, TREATMENT STRINGS AND METHODS
C07C 233/83 (2006.01)	2714647 *	BIPHENYL DERIVATIVES USEFUL AS GLUCAGON RECEPTOR ANTAGONISTS	E21B 34/14 (2006.01)	2766561 *	WELLBORE ACTUATORS, TREATMENT STRINGS AND METHODS
E04B 1/76 (2006.01)	2339078	Insulating composite element and method for insulating a component wall and insulated wall structure	E21B 43/12 (2006.01)	2766561 *	WELLBORE ACTUATORS, TREATMENT STRINGS AND METHODS
A61K 31/495 (2006.01)	2720989 *	DEUTERATED 1-PIPERAZINO-3-PHENYL INDANES FOR TREATMENT OF SCHIZOPHRENIA	G09B 5/06 (2006.01)	2727100 *	A METHOD, A DEVICE AND A COMPUTER PROGRAM PRODUCT FOR TRAINING THE USE OF AN AUTO-INJECTOR
A61P 25/00 (2006.01)	2720989 *	DEUTERATED 1-PIPERAZINO-3-PHENYL INDANES FOR TREATMENT OF SCHIZOPHRENIA	G09B 19/00 (2006.01)	2727100 *	A METHOD, A DEVICE AND A COMPUTER PROGRAM PRODUCT FOR TRAINING THE USE OF AN AUTO-INJECTOR
C07B 59/00 (2006.01)	2720989 *	DEUTERATED 1-PIPERAZINO-3-PHENYL INDANES FOR TREATMENT OF SCHIZOPHRENIA	G09B 19/24 (2006.01)	2727100 *	A METHOD, A DEVICE AND A COMPUTER PROGRAM PRODUCT FOR TRAINING THE USE OF AN AUTO-INJECTOR
C07D 241/04 (2006.01)	2720989 *	DEUTERATED 1-PIPERAZINO-3-PHENYL INDANES FOR TREATMENT OF SCHIZOPHRENIA	G09B 23/28 (2006.01)	2727100 *	A METHOD, A DEVICE AND A COMPUTER PROGRAM PRODUCT FOR TRAINING THE USE OF AN AUTO-INJECTOR
F02M 47/02 (2006.01)	2674608	Fuel injector	A47C 20/04 (2006.01)	2705777	Frame, in particular slatted frame
A01N 43/40 (2006.01)	2734041 *	PROCESSES FOR THE PREPARATION OF PERIPHERAL OPIOID ANTAGONIST COMPOUNDS AND INTERMEDIATES THERETO	A47C 23/00 (2006.01)	2705777	Frame, in particular slatted frame
A61K 31/4523 (2006.01)	2760448 *	PHARMACEUTICAL COMPOSITION FOR THE PREVENTION AND/OR TREATMENT OF MUSCLE ATROPHY	A47C 23/06 (2006.01)	2705777	Frame, in particular slatted frame
A61K 31/5395 (2006.01)	2760448 *	PHARMACEUTICAL COMPOSITION FOR THE PREVENTION AND/OR TREATMENT OF MUSCLE ATROPHY	A61K 31/337 (2006.01)	2741745 *	CABAZITAXEL FORMULATIONS AND METHODS OF PREPARING THEREOF
A61P 21/00 (2006.01)	2760448 *	PHARMACEUTICAL COMPOSITION FOR THE PREVENTION AND/OR TREATMENT OF MUSCLE ATROPHY	C07D 305/14 (2006.01)	2741745 *	CABAZITAXEL FORMULATIONS AND METHODS OF PREPARING THEREOF
G06Q 10/04 (2012.01)	2602752	Method and system for sensor calibration support	B01D 1/00 (2006.01)	2709957 *	HYDRAULIC DESALINATION DEVICE AND METHOD
C07K 14/47 (2006.01)	2751282 *	DETECTION OF PRAME GENE EXPRESSION IN CANCER	B01D 5/00 (2006.01)	2709957 *	HYDRAULIC DESALINATION DEVICE AND METHOD
			C02F 1/04 (2006.01)	2709957 *	HYDRAULIC DESALINATION DEVICE AND METHOD

MKP (51)	Broj objave evropske prijava patenta (97)	Naziv pronalaska (54)	MKP (51)	Broj objave evropske prijava patenta (97)	Naziv pronalaska (54)
C02F 103/08 (2006.01)	2709957 *	HYDRAULIC DESALINATION DEVICE AND METHOD	A61P 31/12 (2006.01)	2768838 *	SUBSTITUTED 3',5'-CYCLIC PHOSPHATES OF PURINE NUCLEOTIDE COMPOUNDS AND PHARMACEUTICAL COMPOSITIONS FOR THE TREATMENT OF VIRAL INFECTIONS
A61K 9/20 (2006.01)	2755640 *	TAMPER RESISTANT PHARMACEUTICAL FORMULATIONS	C07H 19/213 (2006.01)	2768838 *	SUBSTITUTED 3',5'-CYCLIC PHOSPHATES OF PURINE NUCLEOTIDE COMPOUNDS AND PHARMACEUTICAL COMPOSITIONS FOR THE TREATMENT OF VIRAL INFECTIONS
A61K 9/28 (2006.01)	2755640 *	TAMPER RESISTANT PHARMACEUTICAL FORMULATIONS	A61K 31/155 (2006.01)	2707016 *	PHARMACEUTICAL COMBINATION FOR USE IN INDUCING WEIGHT LOSS IN DIABETES TYPE 2 PATIENTS OR/ AND FOR PREVENTING WEIGHT GAIN IN DIABETES TYPE 2 PATIENTS
A61K 31/485 (2006.01)	2755640 *	TAMPER RESISTANT PHARMACEUTICAL FORMULATIONS	A61K 38/26 (2006.01)	2707016 *	PHARMACEUTICAL COMBINATION FOR USE IN INDUCING WEIGHT LOSS IN DIABETES TYPE 2 PATIENTS OR/ AND FOR PREVENTING WEIGHT GAIN IN DIABETES TYPE 2 PATIENTS
F42B 5/02 (2006.01)	2745069 *	SHOTSHELL TYPE AMMUNITION, FIREARMS FOR FIRING SUCH SHOTSHELL TYPE AMMUNITION, AND METHODS OF MANUFACTURING SUCH SHOTSHELL TYPE AMMUNITION	A61P 3/04 (2006.01)	2707016 *	PHARMACEUTICAL COMBINATION FOR USE IN INDUCING WEIGHT LOSS IN DIABETES TYPE 2 PATIENTS OR/ AND FOR PREVENTING WEIGHT GAIN IN DIABETES TYPE 2 PATIENTS
F42B 5/10 (2006.01)	2745069 *	SHOTSHELL TYPE AMMUNITION, FIREARMS FOR FIRING SUCH SHOTSHELL TYPE AMMUNITION, AND METHODS OF MANUFACTURING SUCH SHOTSHELL TYPE AMMUNITION	A61P 3/04 (2006.01)	2707016 *	PHARMACEUTICAL COMBINATION FOR USE IN INDUCING WEIGHT LOSS IN DIABETES TYPE 2 PATIENTS OR/ AND FOR PREVENTING WEIGHT GAIN IN DIABETES TYPE 2 PATIENTS
F42B 33/02 (2006.01)	2745069 *	SHOTSHELL TYPE AMMUNITION, FIREARMS FOR FIRING SUCH SHOTSHELL TYPE AMMUNITION, AND METHODS OF MANUFACTURING SUCH SHOTSHELL TYPE AMMUNITION	A61P 3/10 (2006.01)	2707016 *	PHARMACEUTICAL COMBINATION FOR USE IN INDUCING WEIGHT LOSS IN DIABETES TYPE 2 PATIENTS OR/ AND FOR PREVENTING WEIGHT GAIN IN DIABETES TYPE 2 PATIENTS
G06Q 30/00 (2012.01)	2734965 *	METHOD AND SYSTEM OF DISPLAYING, MANAGING AND SELLING IMAGES IN AN EVENT PHOTOGRAPHY ENVIRONMENT	A01N 37/42 (2006.01)	2404502	Compositions containing pyrrolidone carboxylic acid (PCA) and metallic salts
B23Q 11/00 (2006.01)	2744623 *	ABOVE PLATE COOLANT CONTAINMENT AND RECOVERY SYSTEM	A01N 37/46 (2006.01)	2404502	Compositions containing pyrrolidone carboxylic acid (PCA) and metallic salts
B23Q 11/08 (2006.01)	2744623 *	ABOVE PLATE COOLANT CONTAINMENT AND RECOVERY SYSTEM	A01N 43/36 (2006.01)	2404502	Compositions containing pyrrolidone carboxylic acid (PCA) and metallic salts
B23Q 11/12 (2006.01)	2744623 *	ABOVE PLATE COOLANT CONTAINMENT AND RECOVERY SYSTEM	A01N 59/20 (2006.01)	2404502	Compositions containing pyrrolidone carboxylic acid (PCA) and metallic salts
A61G 3/06 (2006.01)	2713978 *	METHOD FOR CONTROLLING THE AUTOMATIC SLIDING OF A TELESCOPIC RAMP, TELESCOPIC RAMP AND VEHICLE COMPRISING SUCH RAMP	A01P 1/00 (2006.01)	2404502	Compositions containing pyrrolidone carboxylic acid (PCA) and metallic salts
H04N 5/335 (2011.01)	2708022 *	PIXEL ARRAY AREA OPTIMIZATION USING STACKING SCHEME FOR HYBRID IMAGE SENSOR WITH MINIMAL VERTICAL INTERCONNECTS	A61K 8/49 (2006.01)	2404502	Compositions containing pyrrolidone carboxylic acid (PCA) and metallic salts
A61K 31/7076 (2006.01)	2768838 *	SUBSTITUTED 3',5'-CYCLIC PHOSPHATES OF PURINE NUCLEOTIDE COMPOUNDS AND PHARMACEUTICAL COMPOSITIONS FOR THE TREATMENT OF VIRAL INFECTIONS	A61K 31/195 (2006.01)	2404502	Compositions containing pyrrolidone carboxylic acid (PCA) and metallic salts

MKP (51)	Broj objave evropske prijava patenta (97)	Naziv pronalaska (54)	MKP (51)	Broj objave evropske prijava patenta (97)	Naziv pronalaska (54)
A61Q 19/00 (2006.01)	2404502	Compositions containing pyrrolidone carboxylic acid (PCA) and metallic salts	B23Q 16/02 (2006.01)	2747938 *	MACHINE TOOL WITH ROTATABLE TABLE
A61K 39/395 (2006.01)	2714740 *	NEUTRALIZING PROLACTIN RECEPTOR ANTIBODY MAT3 AND ITS THERAPEUTIC USE	B23Q 39/04 (2006.01)	2747938 *	MACHINE TOOL WITH ROTATABLE TABLE
A61P 5/00 (2006.01)	2714740 *	NEUTRALIZING PROLACTIN RECEPTOR ANTIBODY MAT3 AND ITS THERAPEUTIC USE	A61K 31/135 (2006.01)	2766004 *	R(+)-N-METHYL-PROPARGYL-AMINOINDAN
C07K 16/28 (2006.01)	2714740 *	NEUTRALIZING PROLACTIN RECEPTOR ANTIBODY MAT3 AND ITS THERAPEUTIC USE	G06F 17/00 (2006.01)	2766865 *	DETECTION OF EXIT BEHAVIOR OF AN INTERNET USER
A61K 31/40 (2006.01)	2709614 *	PHARMACEUTICAL COMPOSITIONS AND METHODS FOR TREATING CANCER	G06Q 30/02 (2012.01)	2766865 *	DETECTION OF EXIT BEHAVIOR OF AN INTERNET USER
A61K 31/4164 (2006.01)	2709614 *	PHARMACEUTICAL COMPOSITIONS AND METHODS FOR TREATING CANCER	E04B 1/34 (2006.01)	2758609 *	ECOLOGICAL TERRACED SKYSCRAPER BUILDING
B65D 47/06 (2006.01)	2712349 *	DISPENSER FOR A CONTAINER	E04H 1/04 (2006.01)	2758609 *	ECOLOGICAL TERRACED SKYSCRAPER BUILDING
B65D 47/22 (2006.01)	2712349 *	DISPENSER FOR A CONTAINER	E04H 1/06 (2006.01)	2758609 *	ECOLOGICAL TERRACED SKYSCRAPER BUILDING
B65D 83/00 (2006.01)	2712349 *	DISPENSER FOR A CONTAINER	G01N 33/53 (2006.01)	2753928 *	COMPOSITIONS AND METHODS FOR DETECTING AUTOANTIBODIES
B67D 7/36 (2010.01)	2712349 *	DISPENSER FOR A CONTAINER	D04B 21/14 (2006.01)	2746437 *	ARRANGEMENT INTRODUCED INTO THREADS FOR HANDWORK WITH KNITTING NEEDLES, CROCHET HOOKS OR THE LIKE
B29C 45/00 (2006.01)	2623291	Pump impeller and method for producing a pump impeller	D04D 7/00 (2006.01)	2746437 *	ARRANGEMENT INTRODUCED INTO THREADS FOR HANDWORK WITH KNITTING NEEDLES, CROCHET HOOKS OR THE LIKE
B29C 45/16 (2006.01)	2623291	Pump impeller and method for producing a pump impeller	C07D 413/10 (2006.01)	2753619 *	PROCESSES AND INTERMEDIATES FOR PREPARING RIVAROXABAN
F04D 29/22 (2006.01)	2623291	Pump impeller and method for producing a pump impeller	C07D 413/14 (2006.01)	2753619 *	PROCESSES AND INTERMEDIATES FOR PREPARING RIVAROXABAN
G01B 11/02 (2006.01)	2748632 *	PROXIMITY SENSOR CALIBRATION	H04B 1/40 (2006.01)	2742598 *	ANTENNA TO TRANSCEIVER MAPPING OF A MULTIMODE WIRELESS DEVICE
G01S 17/32 (2006.01)	2748632 *	PROXIMITY SENSOR CALIBRATION	H04W 88/06 (2009.01)	2742598 *	ANTENNA TO TRANSCEIVER MAPPING OF A MULTIMODE WIRELESS DEVICE
G06F 3/041 (2006.01)	2749053 *	METHOD AND SYSTEM TO CAPTURE AND VALIDATE A SIGNATURE USING A MOBILE DEVICE	F25D 7/00 (2006.01)	2766677 *	METHOD AND DEVICE FOR VACUUM COOLING
G06K 9/00 (2006.01)	2749053 *	METHOD AND SYSTEM TO CAPTURE AND VALIDATE A SIGNATURE USING A MOBILE DEVICE	F25D 16/00 (2006.01)	2766677 *	METHOD AND DEVICE FOR VACUUM COOLING
H04W 12/06 (2009.01)	2749053 *	METHOD AND SYSTEM TO CAPTURE AND VALIDATE A SIGNATURE USING A MOBILE DEVICE	F25D 31/00 (2006.01)	2766677 *	METHOD AND DEVICE FOR VACUUM COOLING
B23Q 7/02 (2006.01)	2747938 *	MACHINE TOOL WITH ROTATABLE TABLE	A01N 43/08 (2006.01)	2736332 *	COMPOUNDS AND METHODS

MKP (51)	Broj objave evropske prijava patenta (97)	Naziv pronalaska (54)	MKP (51)	Broj objave evropske prijava patenta (97)	Naziv pronalaska (54)
A61K 31/34 (2006.01)	2736332 *	COMPOUNDS AND METHODS	C12N 15/11 (2006.01)	2731965 *	IDENTIFYING AFFINITY-MATURED HUMAN ANTIBODIES
A61K 31/439 (2006.01)	2718280 *	COMPOUNDS HAVING MUSCARINIC RECEPTOR ANTAGONIST AND BETA2 ADRENERGIC RECEPTOR AGONIST ACTIVITY	C12Q 1/68 (2006.01)	2731965 *	IDENTIFYING AFFINITY-MATURED HUMAN ANTIBODIES
A61K 31/4709 (2006.01)	2718280 *	COMPOUNDS HAVING MUSCARINIC RECEPTOR ANTAGONIST AND BETA2 ADRENERGIC RECEPTOR AGONIST ACTIVITY	C40B 40/06 (2006.01)	2731965 *	IDENTIFYING AFFINITY-MATURED HUMAN ANTIBODIES
A61P 11/06 (2006.01)	2718280 *	COMPOUNDS HAVING MUSCARINIC RECEPTOR ANTAGONIST AND BETA2 ADRENERGIC RECEPTOR AGONIST ACTIVITY	A61K 31/407 (2006.01)	2736883 *	NUCLEAR TRANSPORT MODULATORS AND USES THEREOF
A61P 11/08 (2006.01)	2718280 *	COMPOUNDS HAVING MUSCARINIC RECEPTOR ANTAGONIST AND BETA2 ADRENERGIC RECEPTOR AGONIST ACTIVITY	A61K 31/4196 (2006.01)	2736883 *	NUCLEAR TRANSPORT MODULATORS AND USES THEREOF
C07C 213/10 (2006.01)	2718280 *	COMPOUNDS HAVING MUSCARINIC RECEPTOR ANTAGONIST AND BETA2 ADRENERGIC RECEPTOR AGONIST ACTIVITY	A61K 31/421 (2006.01)	2736883 *	NUCLEAR TRANSPORT MODULATORS AND USES THEREOF
C07D 401/12 (2006.01)	2718280 *	COMPOUNDS HAVING MUSCARINIC RECEPTOR ANTAGONIST AND BETA2 ADRENERGIC RECEPTOR AGONIST ACTIVITY	A61K 31/4439 (2006.01)	2736883 *	NUCLEAR TRANSPORT MODULATORS AND USES THEREOF
C07D 451/06 (2006.01)	2718280 *	COMPOUNDS HAVING MUSCARINIC RECEPTOR ANTAGONIST AND BETA2 ADRENERGIC RECEPTOR AGONIST ACTIVITY	A61K 31/454 (2006.01)	2736883 *	NUCLEAR TRANSPORT MODULATORS AND USES THEREOF
C07D 453/02 (2006.01)	2718280 *	COMPOUNDS HAVING MUSCARINIC RECEPTOR ANTAGONIST AND BETA2 ADRENERGIC RECEPTOR AGONIST ACTIVITY	A61K 31/497 (2006.01)	2736883 *	NUCLEAR TRANSPORT MODULATORS AND USES THEREOF
C12Q 1/68 (2006.01)	2764119 *	METHOD FOR DETECTING REPLICATION OR COLONIZATION OF A BIOLOGICAL THERAPEUTIC	A61K 31/506 (2006.01)	2736883 *	NUCLEAR TRANSPORT MODULATORS AND USES THEREOF
G01N 33/50 (2006.01)	2764119 *	METHOD FOR DETECTING REPLICATION OR COLONIZATION OF A BIOLOGICAL THERAPEUTIC	C07D 213/50 (2006.01)	2736883 *	NUCLEAR TRANSPORT MODULATORS AND USES THEREOF
G01N 33/569 (2006.01)	2764119 *	METHOD FOR DETECTING REPLICATION OR COLONIZATION OF A BIOLOGICAL THERAPEUTIC	C07D 401/08 (2006.01)	2736883 *	NUCLEAR TRANSPORT MODULATORS AND USES THEREOF
G01N 33/574 (2006.01)	2764119 *	METHOD FOR DETECTING REPLICATION OR COLONIZATION OF A BIOLOGICAL THERAPEUTIC	C07D 401/12 (2006.01)	2736883 *	NUCLEAR TRANSPORT MODULATORS AND USES THEREOF
C07K 16/00 (2006.01)	2731965 *	IDENTIFYING AFFINITY-MATURED HUMAN ANTIBODIES	C07D 401/14 (2006.01)	2736883 *	NUCLEAR TRANSPORT MODULATORS AND USES THEREOF
C07K 16/18 (2006.01)	2731965 *	IDENTIFYING AFFINITY-MATURED HUMAN ANTIBODIES	C07D 403/08 (2006.01)	2736883 *	NUCLEAR TRANSPORT MODULATORS AND USES THEREOF
			C07D 403/12 (2006.01)	2736883 *	NUCLEAR TRANSPORT MODULATORS AND USES THEREOF
			C07D 413/12 (2006.01)	2736883 *	NUCLEAR TRANSPORT MODULATORS AND USES THEREOF
			C07D 487/10 (2006.01)	2736883 *	NUCLEAR TRANSPORT MODULATORS AND USES THEREOF
			A61K 31/202 (2006.01)	2768496 *	PHARMACEUTICAL COMPOSITIONS COMPRISING DGLA AND/OR 15-HETRE AND METHODS OF USE THEREOF

MKP (51)	Broj objave evropske prijava patenta (97)	Naziv pronalaska (54)	MKP (51)	Broj objave evropske prijava patenta (97)	Naziv pronalaska (54)
A61P 17/00 (2006.01)	2768496 *	PHARMACEUTICAL COMPOSITIONS COMPRISING DGLA AND/OR 15-HETRE AND METHODS OF USE THEREOF	A61K 31/433 (2006.01)	2706999 *	SELECTIVE HETEROCYCLIC SPHINGOSINE 1 PHOSPHATE RECEPTOR MODULATORS
A61K 9/14 (2006.01)	2692340	Stable pharmaceutical system (kit) for the preparation of oral solution of levothyroxine or pharmaceutically acceptable salt thereof	C07K 16/28 (2006.01)	2718323 *	HUMAN ANTIGEN BINDING PROTEINS THAT BIND TO A COMPLEX COMPRISING BETA-KLOTRO AND AN FGF RECEPTOR
A61K 31/198 (2006.01)	2692340	Stable pharmaceutical system (kit) for the preparation of oral solution of levothyroxine or pharmaceutically acceptable salt thereof	A61K 31/7052 (2006.01)	2736915 *	NEW CRYSTALLINE FORMS OF TULATHROMYCIN
A61K 47/32 (2006.01)	2692340	Stable pharmaceutical system (kit) for the preparation of oral solution of levothyroxine or pharmaceutically acceptable salt thereof	C07H 17/00 (2006.01)	2736915 *	NEW CRYSTALLINE FORMS OF TULATHROMYCIN
G21F 9/24 (2006.01)	2727118 *	ABYSSAL SEQUESTRATION OF NUCLEAR WASTE AND OTHER TYPES OF HAZARDOUS WASTE	B65D 19/38 (2006.01)	2768742 *	A CONTAINMENT DEVICE FOR A BIG BAG AND A KIT THEREFOR
G21F 9/34 (2006.01)	2727118 *	ABYSSAL SEQUESTRATION OF NUCLEAR WASTE AND OTHER TYPES OF HAZARDOUS WASTE	B65D 77/06 (2006.01)	2768742 *	A CONTAINMENT DEVICE FOR A BIG BAG AND A KIT THEREFOR
A23J 1/14 (2006.01)	2725922 *	CANOLA PROTEIN PRODUCT WITH LOW PHYTIC ACID CONTENT ("C702")	A01M 7/00 (2006.01)	2768303 *	METHOD FOR FILLING AT LEAST ONE RESERVOIR CONTAINER
A61K 31/7004 (2006.01)	2714050 *	SCYLLO-INOSITOL FOR THE TREATMENT OF BEHAVIORAL AND PSYCHIATRIC DISORDERS	A61K 31/47 (2006.01)	2748147 *	SUBSTITUTED 2-ALKYL-1-OXO-N- PHENYL-3-HETEROARYL-1,2,3,4- TETRAHYDROISOQUINOLINE- 4-CARBOXAMIDES FOR ANTIMALARIAL THERAPIES
A61P 25/28 (2006.01)	2714050 *	SCYLLO-INOSITOL FOR THE TREATMENT OF BEHAVIORAL AND PSYCHIATRIC DISORDERS	A61P 33/06 (2006.01)	2748147 *	SUBSTITUTED 2-ALKYL-1-OXO-N- PHENYL-3-HETEROARYL-1,2,3,4- TETRAHYDROISOQUINOLINE- 4-CARBOXAMIDES FOR ANTIMALARIAL THERAPIES
A61K 9/00 (2006.01)	2768508 *	SOLUTION FOR ORAL ADMINISTRATION	C07D 217/26 (2006.01)	2748147 *	SUBSTITUTED 2-ALKYL-1-OXO-N- PHENYL-3-HETEROARYL-1,2,3,4- TETRAHYDROISOQUINOLINE- 4-CARBOXAMIDES FOR ANTIMALARIAL THERAPIES
A61K 9/08 (2006.01)	2768508 *	SOLUTION FOR ORAL ADMINISTRATION	C07D 401/04 (2006.01)	2748147 *	SUBSTITUTED 2-ALKYL-1-OXO-N- PHENYL-3-HETEROARYL-1,2,3,4- TETRAHYDROISOQUINOLINE- 4-CARBOXAMIDES FOR ANTIMALARIAL THERAPIES
A61K 31/185 (2006.01)	2768508 *	SOLUTION FOR ORAL ADMINISTRATION	C07D 405/04 (2006.01)	2748147 *	SUBSTITUTED 2-ALKYL-1-OXO-N- PHENYL-3-HETEROARYL-1,2,3,4- TETRAHYDROISOQUINOLINE- 4-CARBOXAMIDES FOR ANTIMALARIAL THERAPIES
A61K 31/191 (2006.01)	2768508 *	SOLUTION FOR ORAL ADMINISTRATION	C07D 413/04 (2006.01)	2748147 *	SUBSTITUTED 2-ALKYL-1-OXO-N- PHENYL-3-HETEROARYL-1,2,3,4- TETRAHYDROISOQUINOLINE- 4-CARBOXAMIDES FOR ANTIMALARIAL THERAPIES
A61K 31/194 (2006.01)	2768508 *	SOLUTION FOR ORAL ADMINISTRATION	C07D 417/04 (2006.01)	2748147 *	SUBSTITUTED 2-ALKYL-1-OXO-N- PHENYL-3-HETEROARYL-1,2,3,4- TETRAHYDROISOQUINOLINE- 4-CARBOXAMIDES FOR ANTIMALARIAL THERAPIES
A61K 31/198 (2006.01)	2768508 *	SOLUTION FOR ORAL ADMINISTRATION	A61K 31/52 (2006.01)	2742048 *	INHIBITING TRANSIENT RECEPTOR POTENTIAL ION CHANNEL TRPA1
A61K 31/496 (2006.01)	2768508 *	SOLUTION FOR ORAL ADMINISTRATION			
A61K 31/661 (2006.01)	2768508 *	SOLUTION FOR ORAL ADMINISTRATION			
A61K 47/02 (2006.01)	2768508 *	SOLUTION FOR ORAL ADMINISTRATION			
A61K 47/12 (2006.01)	2768508 *	SOLUTION FOR ORAL ADMINISTRATION			

MKP (51)	Broj objave evropske prijava patenta (97)	Naziv pronalaska (54)	MKP (51)	Broj objave evropske prijava patenta (97)	Naziv pronalaska (54)
A61P 25/04 (2006.01)	2742048 *	INHIBITING TRANSIENT RECEPTOR POTENTIAL ION CHANNEL TRPA1	F03D 1/00 (2006.01)	2702266 *	WIND TURBINE
C07D 473/08 (2006.01)	2742048 *	INHIBITING TRANSIENT RECEPTOR POTENTIAL ION CHANNEL TRPA1	F03D 1/06 (2006.01)	2702266 *	WIND TURBINE
F24D 3/10 (2006.01)	2753880 *	DIAPHRAGM PRESSURE EXPANSION VESSEL	A61K 38/16 (2006.01)	2702069 *	IL4/IL13 BINDING REPEAT PROTEINS AND USES
C12C 5/02 (2006.01)	2751249 *	BEER AND RELEVANT PRODUCTION METHOD.	A61P 9/00 (2006.01)	2702069 *	IL4/IL13 BINDING REPEAT PROTEINS AND USES
C12C 7/053 (2006.01)	2751249 *	BEER AND RELEVANT PRODUCTION METHOD.	A61P 11/00 (2006.01)	2702069 *	IL4/IL13 BINDING REPEAT PROTEINS AND USES
H04J 1/00 (2006.01)	2759080 *	SYSTEMS AND METHODS FOR THE DEMAND-DRIVEN DEPLOYMENT OF LOCATION-NEUTRAL SOFTWARE	A61P 11/06 (2006.01)	2702069 *	IL4/IL13 BINDING REPEAT PROTEINS AND USES
G09B 9/08 (2006.01)	2642467	System and method for simulated aircraft control through desired direction of flight	A61P 17/00 (2006.01)	2702069 *	IL4/IL13 BINDING REPEAT PROTEINS AND USES
B28B 1/08 (2006.01)	2714353 *	APPARATUS FOR MANUFACTURING OF TILES	A61P 35/00 (2006.01)	2702069 *	IL4/IL13 BINDING REPEAT PROTEINS AND USES
B28B 3/00 (2006.01)	2714353 *	APPARATUS FOR MANUFACTURING OF TILES	C07K 14/00 (2006.01)	2702069 *	IL4/IL13 BINDING REPEAT PROTEINS AND USES
B28B 7/46 (2006.01)	2714353 *	APPARATUS FOR MANUFACTURING OF TILES	C12N 1/19 (2006.01)	2702069 *	IL4/IL13 BINDING REPEAT PROTEINS AND USES
B28B 13/02 (2006.01)	2714353 *	APPARATUS FOR MANUFACTURING OF TILES	C12N 1/21 (2006.01)	2702069 *	IL4/IL13 BINDING REPEAT PROTEINS AND USES
C01B 3/04 (2006.01)	2710235 *	STEAM GENERATION SYSTEM	C12N 5/10 (2006.01)	2702069 *	IL4/IL13 BINDING REPEAT PROTEINS AND USES
F01K 23/10 (2006.01)	2710235 *	STEAM GENERATION SYSTEM	C12N 7/01 (2006.01)	2702069 *	IL4/IL13 BINDING REPEAT PROTEINS AND USES
C07K 14/16 (2006.01)	2761011 *	USE OF NON-SUBTYPE B GAG PROTEINS FOR LENTIVIRAL PACKAGING	C12N 15/11 (2006.01)	2702069 *	IL4/IL13 BINDING REPEAT PROTEINS AND USES
C12N 15/867 (2006.01)	2761011 *	USE OF NON-SUBTYPE B GAG PROTEINS FOR LENTIVIRAL PACKAGING	C12N 15/63 (2006.01)	2702069 *	IL4/IL13 BINDING REPEAT PROTEINS AND USES
C07D 487/04 (2006.01)	2768833 *	SUBSTITUTED BICYCLIC AZA-HETEROCYCLES AND ANALOGUES AS SIRTUIN MODULATORS	C12P 21/02 (2006.01)	2702069 *	IL4/IL13 BINDING REPEAT PROTEINS AND USES
C07C 253/00 (2006.01)	2740725	Novel method for synthesising 3-(2-bromo-4,5-dimethoxyphenyl) propanenitrile and use for synthesising ivabradine and the added salts thereof with a pharmaceutically acceptable acid	A61K 47/48 (2006.01)	2766048 *	PYRROLOBENZODIAZEPINES AND CONJUGATES THEREOF
C07D 223/14 (2006.01)	2740725	Novel method for synthesising 3-(2-bromo-4,5-dimethoxyphenyl) propanenitrile and use for synthesising ivabradine and the added salts thereof with a pharmaceutically acceptable acid	A61P 35/00 (2006.01)	2766048 *	PYRROLOBENZODIAZEPINES AND CONJUGATES THEREOF
			C07D 487/04 (2006.01)	2766048 *	PYRROLOBENZODIAZEPINES AND CONJUGATES THEREOF
			C07D 519/00 (2006.01)	2766048 *	PYRROLOBENZODIAZEPINES AND CONJUGATES THEREOF

MKP (51)	Broj objave evropske prijava patenta (97)	Naziv pronalaska (54)	MKP (51)	Broj objave evropske prijava patenta (97)	Naziv pronalaska (54)
A61K 39/21 (2006.01)	2755684 *	METHODS AND COMPOSITIONS FOR RAISING AN IMMUNE RESPONSE TO HIV	A61K 9/16 (2006.01)	2765997 *	POROUS NANOPARTICLE-SUPPORTED LIPID BILAYERS (PROTOCELLS) FOR TARGETED DELIVERY INCLUDING TRANSDERMAL DELIVERY OF CARGO AND METHODS THEREOF
F16L 21/03 (2006.01)	2749803 *	BELL AND SPIGOT TYPE PIPING JOINT			
F16L 21/08 (2006.01)	2749803 *	BELL AND SPIGOT TYPE PIPING JOINT	A61K 31/7088 (2006.01)	2765997 *	POROUS NANOPARTICLE-SUPPORTED LIPID BILAYERS (PROTOCELLS) FOR TARGETED DELIVERY INCLUDING TRANSDERMAL DELIVERY OF CARGO AND METHODS THEREOF
G01N 33/50 (2006.01)	2707718 *	METHOD OF IDENTIFYING COMPOUNDS THAT SPECIFICALLY MODULATE THE INTERACTION OF FGFR1 AND BETA-KLOTTHO			
G01N 33/566 (2006.01)	2707718 *	METHOD OF IDENTIFYING COMPOUNDS THAT SPECIFICALLY MODULATE THE INTERACTION OF FGFR1 AND BETA-KLOTTHO	A61K 31/7105 (2006.01)	2765997 *	POROUS NANOPARTICLE-SUPPORTED LIPID BILAYERS (PROTOCELLS) FOR TARGETED DELIVERY INCLUDING TRANSDERMAL DELIVERY OF CARGO AND METHODS THEREOF
G01N 33/74 (2006.01)	2707718 *	METHOD OF IDENTIFYING COMPOUNDS THAT SPECIFICALLY MODULATE THE INTERACTION OF FGFR1 AND BETA-KLOTTHO	A61K 38/17 (2006.01)	2765997 *	POROUS NANOPARTICLE-SUPPORTED LIPID BILAYERS (PROTOCELLS) FOR TARGETED DELIVERY INCLUDING TRANSDERMAL DELIVERY OF CARGO AND METHODS THEREOF
G01N 33/48 (2006.01)	2761289 *	CARDIOVASCULAR RISK EVENT PREDICTION AND USES THEREOF			
G01N 33/52 (2006.01)	2761289 *	CARDIOVASCULAR RISK EVENT PREDICTION AND USES THEREOF	A61K 47/48 (2006.01)	2765997 *	POROUS NANOPARTICLE-SUPPORTED LIPID BILAYERS (PROTOCELLS) FOR TARGETED DELIVERY INCLUDING TRANSDERMAL DELIVERY OF CARGO AND METHODS THEREOF
G06K 9/00 (2006.01)	2710554 *	HEAD POSE ESTIMATION USING RGBD CAMERA			
G06T 7/00 (2006.01)	2710554 *	HEAD POSE ESTIMATION USING RGBD CAMERA	A61K 48/00 (2006.01)	2765997 *	POROUS NANOPARTICLE-SUPPORTED LIPID BILAYERS (PROTOCELLS) FOR TARGETED DELIVERY INCLUDING TRANSDERMAL DELIVERY OF CARGO AND METHODS THEREOF
B41F 35/00 (2006.01)	2684697	Treatment plant			
A61K 38/02 (2006.01)	2630962	Low Frequency Glatiramer Acetate Therapy	A61K 49/08 (2006.01)	2765997 *	POROUS NANOPARTICLE-SUPPORTED LIPID BILAYERS (PROTOCELLS) FOR TARGETED DELIVERY INCLUDING TRANSDERMAL DELIVERY OF CARGO AND METHODS THEREOF
A61K 38/16 (2006.01)	2630962	Low Frequency Glatiramer Acetate Therapy			
A61P 25/28 (2006.01)	2630962	Low Frequency Glatiramer Acetate Therapy	A61K 38/18 (2006.01)	2750695 *	METHOD OF TREATING OR AMELIORATING TYPE 1 DIABETES USING FGF21
G07F 17/32 (2006.01)	2761606 *	GAMING DEVICES AND METHODS OF OPERATING THEM	A61P 3/00 (2006.01)	2750695 *	METHOD OF TREATING OR AMELIORATING TYPE 1 DIABETES USING FGF21
C07K 16/00 (2006.01)	2710032 *	MODIFIED GLYCOPROTEINS	A61P 3/04 (2006.01)	2750695 *	METHOD OF TREATING OR AMELIORATING TYPE 1 DIABETES USING FGF21
C12P 21/08 (2006.01)	2710032 *	MODIFIED GLYCOPROTEINS	A61P 3/06 (2006.01)	2750695 *	METHOD OF TREATING OR AMELIORATING TYPE 1 DIABETES USING FGF21
			A61P 3/08 (2006.01)	2750695 *	METHOD OF TREATING OR AMELIORATING TYPE 1 DIABETES USING FGF21

MKP (51)	Broj objave evropske prijava patenta (97)	Naziv pronalaska (54)	MKP (51)	Broj objave evropske prijava patenta (97)	Naziv pronalaska (54)
A61P 3/10 (2006.01)	2750695 *	METHOD OF TREATING OR AMELIORATING TYPE 1 DIABETES USING FGF21	E04H 12/20 (2006.01)	2734690 *	GUY DEVICE FOR A POLE DRIVEN INTO THE GROUND
C12P 21/04 (2006.01)	2718456 *	MITIGATION OF CUTANEOUS INJURY WITH IL-12	C07D 417/14 (2006.01)	2768830 *	APOPTOSIS-INDUCING AGENTS FOR THE TREATMENT OF CANCER AND IMMUNE AND AUTOIMMUNE DISEASES
A23B 4/005 (2006.01)	2666362	Process for packaging seafood raw material into a foodstuffs container and related package	A61K 31/444 (2006.01)	2763979 *	1 - ARYLCARBONYL - 4 - OXY - PIPERIDINE COMPOUNDS USEFUL FOR THE TREATMENT OF NEURODEGENERATIVE DISEASES
A23B 4/16 (2006.01)	2666362	Process for packaging seafood raw material into a foodstuffs container and related package	A61K 31/506 (2006.01)	2763979 *	1 - ARYLCARBONYL - 4 - OXY - PIPERIDINE COMPOUNDS USEFUL FOR THE TREATMENT OF NEURODEGENERATIVE DISEASES
A23L 1/325 (2006.01)	2666362	Process for packaging seafood raw material into a foodstuffs container and related package	A61P 25/28 (2006.01)	2763979 *	1 - ARYLCARBONYL - 4 - OXY - PIPERIDINE COMPOUNDS USEFUL FOR THE TREATMENT OF NEURODEGENERATIVE DISEASES
A01N 25/22 (2006.01)	2709449 *	AGROCHEMICAL FORMULATIONS COMPRISING DODECYLGUANIDINE AND A COMPATIBILITY AGENT	C07D 401/10 (2006.01)	2763979 *	1 - ARYLCARBONYL - 4 - OXY - PIPERIDINE COMPOUNDS USEFUL FOR THE TREATMENT OF NEURODEGENERATIVE DISEASES
A01N 37/40 (2006.01)	2709449 *	AGROCHEMICAL FORMULATIONS COMPRISING DODECYLGUANIDINE AND A COMPATIBILITY AGENT	C07D 401/14 (2006.01)	2763979 *	1 - ARYLCARBONYL - 4 - OXY - PIPERIDINE COMPOUNDS USEFUL FOR THE TREATMENT OF NEURODEGENERATIVE DISEASES
A01N 43/12 (2006.01)	2709449 *	AGROCHEMICAL FORMULATIONS COMPRISING DODECYLGUANIDINE AND A COMPATIBILITY AGENT	C07D 405/14 (2006.01)	2763979 *	1 - ARYLCARBONYL - 4 - OXY - PIPERIDINE COMPOUNDS USEFUL FOR THE TREATMENT OF NEURODEGENERATIVE DISEASES
A01N 43/54 (2006.01)	2709449 *	AGROCHEMICAL FORMULATIONS COMPRISING DODECYLGUANIDINE AND A COMPATIBILITY AGENT	C07D 413/10 (2006.01)	2763979 *	1 - ARYLCARBONYL - 4 - OXY - PIPERIDINE COMPOUNDS USEFUL FOR THE TREATMENT OF NEURODEGENERATIVE DISEASES
A01N 43/653 (2006.01)	2709449 *	AGROCHEMICAL FORMULATIONS COMPRISING DODECYLGUANIDINE AND A COMPATIBILITY AGENT	C07D 413/14 (2006.01)	2763979 *	1 - ARYLCARBONYL - 4 - OXY - PIPERIDINE COMPOUNDS USEFUL FOR THE TREATMENT OF NEURODEGENERATIVE DISEASES
A01N 47/44 (2006.01)	2709449 *	AGROCHEMICAL FORMULATIONS COMPRISING DODECYLGUANIDINE AND A COMPATIBILITY AGENT	C07D 417/14 (2006.01)	2763979 *	1 - ARYLCARBONYL - 4 - OXY - PIPERIDINE COMPOUNDS USEFUL FOR THE TREATMENT OF NEURODEGENERATIVE DISEASES
A01N 59/02 (2006.01)	2709449 *	AGROCHEMICAL FORMULATIONS COMPRISING DODECYLGUANIDINE AND A COMPATIBILITY AGENT	C07D 498/08 (2006.01)	2763979 *	1 - ARYLCARBONYL - 4 - OXY - PIPERIDINE COMPOUNDS USEFUL FOR THE TREATMENT OF NEURODEGENERATIVE DISEASES
A01N 59/20 (2006.01)	2709449 *	AGROCHEMICAL FORMULATIONS COMPRISING DODECYLGUANIDINE AND A COMPATIBILITY AGENT	B65D 90/10 (2006.01)	2761100 *	IMPROVEMENTS IN/OR AND RELATING TO UTILITY CHAMBERS AND SURROUNDS AND METHODS THEREFOR
A01P 3/00 (2006.01)	2709449 *	AGROCHEMICAL FORMULATIONS COMPRISING DODECYLGUANIDINE AND A COMPATIBILITY AGENT			
C02F 1/467 (2006.01)	2706042	Point-of-use water dispenser and method for using said water dispenser			
C02F 1/72 (2006.01)	2706042	Point-of-use water dispenser and method for using said water dispenser			
A01G 17/06 (2006.01)	2734690 *	GUY DEVICE FOR A POLE DRIVEN INTO THE GROUND			

MKP (51)	Broj objave evropske prijava patenta (97)	Naziv pronalaska (54)	MKP (51)	Broj objave evropske prijava patenta (97)	Naziv pronalaska (54)
E02D 29/14 (2006.01)	2761100 *	IMPROVEMENTS IN/OR AND RELATING TO UTILITY CHAMBERS AND SURROUNDS AND METHODS THERFOR	A61P 35/02 (2006.01)	2744494 *	COMBINATION CANCER THERAPY OF HSP90 INHIBITOR WITH ANTIMETABOLITE
E03F 5/02 (2006.01)	2761100 *	IMPROVEMENTS IN/OR AND RELATING TO UTILITY CHAMBERS AND SURROUNDS AND METHODS THERFOR	E21B 23/00 (2006.01)	2737163 *	WELLBORE TOOL WITH INDEXING MECHANISM AND METHOD
B01J 20/02 (2006.01)	2744592 *	ADSORBENT PRECIPITATED ON A CARRIER, METHOD FOR PRODUCING SAID ADSORBENT, AND USE OF SAID ADSORBENT	E21B 33/122 (2006.01)	2737163 *	WELLBORE TOOL WITH INDEXING MECHANISM AND METHOD
B01J 20/04 (2006.01)	2744592 *	ADSORBENT PRECIPITATED ON A CARRIER, METHOD FOR PRODUCING SAID ADSORBENT, AND USE OF SAID ADSORBENT	E21B 34/14 (2006.01)	2737163 *	WELLBORE TOOL WITH INDEXING MECHANISM AND METHOD
B01J 20/04 (2006.01)	2744592 *	ADSORBENT PRECIPITATED ON A CARRIER, METHOD FOR PRODUCING SAID ADSORBENT, AND USE OF SAID ADSORBENT	E21B 34/16 (2006.01)	2737163 *	WELLBORE TOOL WITH INDEXING MECHANISM AND METHOD
B01J 20/20 (2006.01)	2744592 *	ADSORBENT PRECIPITATED ON A CARRIER, METHOD FOR PRODUCING SAID ADSORBENT, AND USE OF SAID ADSORBENT	A61K 31/519 (2006.01)	2768832 *	NOVEL SUBSTITUTED IMIDAZOPYRIMIDINES AS GPBAR1 RECEPTOR MODULATORS
B01J 20/28 (2006.01)	2744592 *	ADSORBENT PRECIPITATED ON A CARRIER, METHOD FOR PRODUCING SAID ADSORBENT, AND USE OF SAID ADSORBENT	A61P 3/00 (2006.01)	2768832 *	NOVEL SUBSTITUTED IMIDAZOPYRIMIDINES AS GPBAR1 RECEPTOR MODULATORS
B01J 20/32 (2006.01)	2744592 *	ADSORBENT PRECIPITATED ON A CARRIER, METHOD FOR PRODUCING SAID ADSORBENT, AND USE OF SAID ADSORBENT	A61P 9/00 (2006.01)	2768832 *	NOVEL SUBSTITUTED IMIDAZOPYRIMIDINES AS GPBAR1 RECEPTOR MODULATORS
C02F 1/28 (2006.01)	2744592 *	ADSORBENT PRECIPITATED ON A CARRIER, METHOD FOR PRODUCING SAID ADSORBENT, AND USE OF SAID ADSORBENT	C07D 487/04 (2006.01)	2768832 *	NOVEL SUBSTITUTED IMIDAZOPYRIMIDINES AS GPBAR1 RECEPTOR MODULATORS
C02F 101/00 (2006.01)	2744592 *	ADSORBENT PRECIPITATED ON A CARRIER, METHOD FOR PRODUCING SAID ADSORBENT, AND USE OF SAID ADSORBENT	A61K 31/166 (2006.01)	2734497 *	INDANE DIMERS FOR USE IN THE TREATMENT OF AUTOIMMUNE INFLAMMATORY DISEASE
G21F 9/12 (2006.01)	2744592 *	ADSORBENT PRECIPITATED ON A CARRIER, METHOD FOR PRODUCING SAID ADSORBENT, AND USE OF SAID ADSORBENT	A61K 31/167 (2006.01)	2734497 *	INDANE DIMERS FOR USE IN THE TREATMENT OF AUTOIMMUNE INFLAMMATORY DISEASE
F41J 3/02 (2006.01)	2729755 *	SCORING SYSTEM FOR ARCHERY	A61K 31/192 (2006.01)	2734497 *	INDANE DIMERS FOR USE IN THE TREATMENT OF AUTOIMMUNE INFLAMMATORY DISEASE
A61K 31/4196 (2006.01)	2744494 *	COMBINATION CANCER THERAPY OF HSP90 INHIBITOR WITH ANTIMETABOLITE	A61K 31/205 (2006.01)	2734497 *	INDANE DIMERS FOR USE IN THE TREATMENT OF AUTOIMMUNE INFLAMMATORY DISEASE
A61K 31/513 (2006.01)	2744494 *	COMBINATION CANCER THERAPY OF HSP90 INHIBITOR WITH ANTIMETABOLITE	A61K 31/235 (2006.01)	2734497 *	INDANE DIMERS FOR USE IN THE TREATMENT OF AUTOIMMUNE INFLAMMATORY DISEASE
A61K 31/519 (2006.01)	2744494 *	COMBINATION CANCER THERAPY OF HSP90 INHIBITOR WITH ANTIMETABOLITE	A61P 29/00 (2006.01)	2734497 *	INDANE DIMERS FOR USE IN THE TREATMENT OF AUTOIMMUNE INFLAMMATORY DISEASE
A61K 31/7068 (2006.01)	2744494 *	COMBINATION CANCER THERAPY OF HSP90 INHIBITOR WITH ANTIMETABOLITE	C07C 65/19 (2006.01)	2734497 *	INDANE DIMERS FOR USE IN THE TREATMENT OF AUTOIMMUNE INFLAMMATORY DISEASE
A61K 45/06 (2006.01)	2744494 *	COMBINATION CANCER THERAPY OF HSP90 INHIBITOR WITH ANTIMETABOLITE	C07C 69/76 (2006.01)	2734497 *	INDANE DIMERS FOR USE IN THE TREATMENT OF AUTOIMMUNE INFLAMMATORY DISEASE
A61P 35/00 (2006.01)	2744494 *	COMBINATION CANCER THERAPY OF HSP90 INHIBITOR WITH ANTIMETABOLITE			

MKP (51)	Broj objave evropske prijava patenta (97)	Naziv pronalaska (54)	MKP (51)	Broj objave evropske prijava patenta (97)	Naziv pronalaska (54)
C07C 229/08 (2006.01)	2734497 *	INDANE DIMERS FOR USE IN THE TREATMENT OF AUTOIMMUNE INFLAMMATORY DISEASE	F17C 11/00 (2006.01)	2742274 *	METHOD FOR STORING A GAS BY CHEMISORPTION ON A POROUS MATERIAL COMPRISING EXPANDED GRAPHITE
C07C 235/42 (2006.01)	2734497 *	INDANE DIMERS FOR USE IN THE TREATMENT OF AUTOIMMUNE INFLAMMATORY DISEASE	G10L 21/02 (2013.01)	2715722 *	PRESERVING AUDIO DATA COLLECTION PRIVACY IN MOBILE DEVICES
A01H 5/00 (2006.01)	2726620 *	CONSTITUTIVELY ACTIVE ABA RECEPTOR MUTANTS	A61K 9/48 (2006.01)	2709600 *	PHARMACEUTICAL COMPOSITION COMPRISING FEXOFENADINE
C12N 15/82 (2006.01)	2726620 *	CONSTITUTIVELY ACTIVE ABA RECEPTOR MUTANTS	A61K 31/4545 (2006.01)	2709600 *	PHARMACEUTICAL COMPOSITION COMPRISING FEXOFENADINE
A01N 63/00 (2006.01)	2763540 *	COMPOSITIONS AND METHODS FOR ASSESSING AND TREATING INFLAMMATORY DISEASES AND DISORDERS	A61K 47/10 (2006.01)	2709600 *	PHARMACEUTICAL COMPOSITION COMPRISING FEXOFENADINE
B41F 33/00 (2006.01)	2749418	Print fidelity control method and device in production lines of solid and corrugated carton boxes, and advertising displays made of paper	A63B 21/068 (2006.01)	2664363	Exercise machine
G06K 19/06 (2006.01)	2749418	Print fidelity control method and device in production lines of solid and corrugated carton boxes, and advertising displays made of paper	A63B 22/00 (2006.01)	2664363	Exercise machine
A61K 47/48 (2006.01)	2662094	Cyclodextrin Complexation Methods for Formulating Peptide Proteasome Inhibitors	A63B 23/04 (2006.01)	2664363	Exercise machine
A61P 35/00 (2006.01)	2662094	Cyclodextrin Complexation Methods for Formulating Peptide Proteasome Inhibitors	A61B 5/0472 (2006.01)	2676604	Real time QRS duration measurement in electrocardiogram
C12Q 1/68 (2006.01)	2684964	Microarray-based methods for identifying single nucleotides at specific positions in nucleic acids	A61K 39/395 (2006.01)	2731625 *	RSPO BINDING AGENTS AND USES THEREOF
A61K 39/155 (2006.01)	2729169 *	HUMAN RESPIRATORY SYNCYTIAL VIRUS VACCINE	G01N 33/574 (2006.01)	2731625 *	RSPO BINDING AGENTS AND USES THEREOF
B82Y 99/00 (2011.01)	2729169 *	HUMAN RESPIRATORY SYNCYTIAL VIRUS VACCINE	G03H 1/04 (2006.01)	2751621 *	HOLOGRAM
F16B 7/04 (2006.01)	2685111	Clamp piece for a detachable connection of two profile pieces	H04L 12/46 (2006.01)	2749048 *	SECURE USER PLANE LOCATION (SUPL) REDIRECTION AND MOBILE LOCATION PROTOCOL (MLP) TUNNELING TO A DISCOVERED SLP
C10L 1/10 (2006.01)	2732025 *	ALGAL LIPID COMPOSITIONS AND METHODS OF PREPARING AND UTILIZING THE SAME	H04L 29/08 (2006.01)	2749048 *	SECURE USER PLANE LOCATION (SUPL) REDIRECTION AND MOBILE LOCATION PROTOCOL (MLP) TUNNELING TO A DISCOVERED SLP
C11B 1/00 (2006.01)	2732025 *	ALGAL LIPID COMPOSITIONS AND METHODS OF PREPARING AND UTILIZING THE SAME	H04W 4/02 (2009.01)	2749048 *	SECURE USER PLANE LOCATION (SUPL) REDIRECTION AND MOBILE LOCATION PROTOCOL (MLP) TUNNELING TO A DISCOVERED SLP
C12N 1/12 (2006.01)	2732025 *	ALGAL LIPID COMPOSITIONS AND METHODS OF PREPARING AND UTILIZING THE SAME	H04W 4/20 (2009.01)	2749048 *	SECURE USER PLANE LOCATION (SUPL) REDIRECTION AND MOBILE LOCATION PROTOCOL (MLP) TUNNELING TO A DISCOVERED SLP
B60N 2/42 (2006.01)	2718145 *	A RECLINING COLLAR HEADREST WITH ROTATABLE BLOCK ENDS			
B60N 2/48 (2006.01)	2718145 *	A RECLINING COLLAR HEADREST WITH ROTATABLE BLOCK ENDS			

MKP (51)	Broj objave evropske prijava patenta (97)	Naziv pronalaska (54)	MKP (51)	Broj objave evropske prijava patenta (97)	Naziv pronalaska (54)
H04W 8/06 (2009.01)	2749048 *	SECURE USER PLANE LOCATION (SUPL) REDIRECTION AND MOBILE LOCATION PROTOCOL (MLP) TUNNELING TO A DISCOVERED SLP	A61P 9/00 (2006.01)	2682394	1H-pyrazolo[3,4-b]pyridin-triazine derivatives and their use for the treatment or the prevention of cardiovascular diseases
H04W 12/00 (2009.01)	2749048 *	SECURE USER PLANE LOCATION (SUPL) REDIRECTION AND MOBILE LOCATION PROTOCOL (MLP) TUNNELING TO A DISCOVERED SLP	C07D 487/04 (2006.01)	2682394	1H-pyrazolo[3,4-b]pyridin-triazine derivatives and their use for the treatment or the prevention of cardiovascular diseases
H04W 48/16 (2009.01)	2749048 *	SECURE USER PLANE LOCATION (SUPL) REDIRECTION AND MOBILE LOCATION PROTOCOL (MLP) TUNNELING TO A DISCOVERED SLP	A61K 31/4015 (2006.01)	2762138 *	PHARMACEUTICAL SUBSTANCE (VARIANTS) AND COMPOSITIONS BASED THEREON WHICH EXHIBIT MODULATORY ACTIVITY WITH A COMMENSURATE EFFECT
H04W 64/00 (2009.01)	2749048 *	SECURE USER PLANE LOCATION (SUPL) REDIRECTION AND MOBILE LOCATION PROTOCOL (MLP) TUNNELING TO A DISCOVERED SLP	A61P 3/04 (2006.01)	2762138 *	PHARMACEUTICAL SUBSTANCE (VARIANTS) AND COMPOSITIONS BASED THEREON WHICH EXHIBIT MODULATORY ACTIVITY WITH A COMMENSURATE EFFECT
H04W 80/08 (2009.01)	2749048 *	SECURE USER PLANE LOCATION (SUPL) REDIRECTION AND MOBILE LOCATION PROTOCOL (MLP) TUNNELING TO A DISCOVERED SLP	A61P 7/10 (2006.01)	2762138 *	PHARMACEUTICAL SUBSTANCE (VARIANTS) AND COMPOSITIONS BASED THEREON WHICH EXHIBIT MODULATORY ACTIVITY WITH A COMMENSURATE EFFECT
H01M 4/52 (2010.01)	2737565 *	BLENDED CATHODE MATERIALS	A61P 9/00 (2006.01)	2762138 *	PHARMACEUTICAL SUBSTANCE (VARIANTS) AND COMPOSITIONS BASED THEREON WHICH EXHIBIT MODULATORY ACTIVITY WITH A COMMENSURATE EFFECT
A61K 47/48 (2006.01)	2723389 *	NOVEL MAYTANSINOID DERIVATIVES WITH PEPTIDE LINKER AND CONJUGATES THEREOF	A61P 25/00 (2006.01)	2762138 *	PHARMACEUTICAL SUBSTANCE (VARIANTS) AND COMPOSITIONS BASED THEREON WHICH EXHIBIT MODULATORY ACTIVITY WITH A COMMENSURATE EFFECT
A61P 35/00 (2006.01)	2723389 *	NOVEL MAYTANSINOID DERIVATIVES WITH PEPTIDE LINKER AND CONJUGATES THEREOF	A61P 37/02 (2006.01)	2762138 *	PHARMACEUTICAL SUBSTANCE (VARIANTS) AND COMPOSITIONS BASED THEREON WHICH EXHIBIT MODULATORY ACTIVITY WITH A COMMENSURATE EFFECT
C07K 16/28 (2006.01)	2714739 *	HUMANISED ANTI-CD52 ANTIBODIES	A61P 39/06 (2006.01)	2762138 *	PHARMACEUTICAL SUBSTANCE (VARIANTS) AND COMPOSITIONS BASED THEREON WHICH EXHIBIT MODULATORY ACTIVITY WITH A COMMENSURATE EFFECT
A61K 31/422 (2006.01)	2704712 *	ISOXAZOLINES AS THERAPEUTIC AGENTS	A61P 43/00 (2006.01)	2762138 *	PHARMACEUTICAL SUBSTANCE (VARIANTS) AND COMPOSITIONS BASED THEREON WHICH EXHIBIT MODULATORY ACTIVITY WITH A COMMENSURATE EFFECT
H04B 3/54 (2006.01)	2742602 *	TELECONTROL ENERGY-SAVING APPARATUS FOR SIMULTANEOUS TRANSMISSION OF MULTIPLE SIGNALS WITH POWERLINE TECHNOLOGY	C07D 201/00 (2006.01)	2762138 *	PHARMACEUTICAL SUBSTANCE (VARIANTS) AND COMPOSITIONS BASED THEREON WHICH EXHIBIT MODULATORY ACTIVITY WITH A COMMENSURATE EFFECT
H05B 37/02 (2006.01)	2742602 *	TELECONTROL ENERGY-SAVING APPARATUS FOR SIMULTANEOUS TRANSMISSION OF MULTIPLE SIGNALS WITH POWERLINE TECHNOLOGY			
A61K 31/519 (2006.01)	2682394	1H-pyrazolo[3,4-b]pyridin-triazine derivatives and their use for the treatment or the prevention of cardiovascular diseases			
A61K 31/522 (2006.01)	2682394	1H-pyrazolo[3,4-b]pyridin-triazine derivatives and their use for the treatment or the prevention of cardiovascular diseases			

MKP (51)	Broj objave evropske prijava patenta (97)	Naziv pronalaska (54)	MKP (51)	Broj objave evropske prijava patenta (97)	Naziv pronalaska (54)
C07D 201/16 (2006.01)	2762138 *	PHARMACEUTICAL SUBSTANCE (VARIANTS) AND COMPOSITIONS BASED THEREON WHICH EXHIBIT MODULATORY ACTIVITY WITH A COMMENSURATE EFFECT	A61P 15/12 (2006.01)	2714712 *	PROCESS FOR THE PRODUCTION OF ESTETROL INTERMEDIATES
C07D 201/18 (2006.01)	2762138 *	PHARMACEUTICAL SUBSTANCE (VARIANTS) AND COMPOSITIONS BASED THEREON WHICH EXHIBIT MODULATORY ACTIVITY WITH A COMMENSURATE EFFECT	C07J 75/00 (2006.01)	2714712 *	PROCESS FOR THE PRODUCTION OF ESTETROL INTERMEDIATES
C12N 9/02 (2006.01)	2723868 *	PROCESS FOR PREPARING GENETICALLY TRANSFORMED YEASTS CAPABLE OF PRODUCING A MOLECULE OF INTEREST AT A HIGH TITRE	A01N 43/54 (2006.01)	2760285 *	INDAZOLE INHIBITORS OF THE WNT SIGNAL PATHWAY AND THERAPEUTIC USES THEREOF
C12N 9/04 (2006.01)	2723868 *	PROCESS FOR PREPARING GENETICALLY TRANSFORMED YEASTS CAPABLE OF PRODUCING A MOLECULE OF INTEREST AT A HIGH TITRE	F02M 59/02 (2006.01)	2742231 *	FUEL PUMP
C12N 15/52 (2006.01)	2723868 *	PROCESS FOR PREPARING GENETICALLY TRANSFORMED YEASTS CAPABLE OF PRODUCING A MOLECULE OF INTEREST AT A HIGH TITRE	F02M 59/44 (2006.01)	2742231 *	FUEL PUMP
C12N 15/81 (2006.01)	2723868 *	PROCESS FOR PREPARING GENETICALLY TRANSFORMED YEASTS CAPABLE OF PRODUCING A MOLECULE OF INTEREST AT A HIGH TITRE	F04B 1/04 (2006.01)	2742231 *	FUEL PUMP
C12P 33/00 (2006.01)	2723868 *	PROCESS FOR PREPARING GENETICALLY TRANSFORMED YEASTS CAPABLE OF PRODUCING A MOLECULE OF INTEREST AT A HIGH TITRE	D06F 95/00 (2006.01)	2631358	Multi compartment bag
B65G 5/00 (2006.01)	2764164 *	FLUID CONTAINMENT AND MANAGEMENT SYSTEM	A61K 39/00 (2006.01)	2662386	Antibodies that bind to PLAC1 and block interaction between PLAC1 and FGF7
E02D 17/00 (2006.01)	2764164 *	FLUID CONTAINMENT AND MANAGEMENT SYSTEM	C07K 16/18 (2006.01)	2662386	Antibodies that bind to PLAC1 and block interaction between PLAC1 and FGF7
E21B 21/01 (2006.01)	2764164 *	FLUID CONTAINMENT AND MANAGEMENT SYSTEM	A61B 17/072 (2006.01)	2517646	Compressible staple cartridge assembly
C09K 8/60 (2006.01)	2766448 *	COMPOSITIONS AND METHODS USEFUL FOR OIL EXTRACTION	A01K 31/04 (2006.01)	2638799	Machine for cleaning barns for farming birds
C11D 3/382 (2006.01)	2766448 *	COMPOSITIONS AND METHODS USEFUL FOR OIL EXTRACTION	A61K 47/48 (2006.01)	2760475 *	FUSION PROTEINS FOR TREATING METABOLIC DISORDERS
H04N 21/431 (2011.01)	2761885 *	CONTENT MANAGEMENT SYSTEMS, METHODS, APPARATUS AND USER INTERFACES	C07K 14/50 (2006.01)	2760475 *	FUSION PROTEINS FOR TREATING METABOLIC DISORDERS
C07K 16/28 (2006.01)	2756001 *	ANTI-CD134 (OX40) ANTIBODIES AND USES THEREOF	A01H 1/08 (2006.01)	2723164 *	COMMON WHEAT, PLANTS OR PARTS THEREOF HAVING PARTIALLY OR FULLY MULTIPLIED GENOME, HYBRIDS AND PRODUCTS THEREOF AND METHODS OF GENERATING AND USING SAME
A61K 31/565 (2006.01)	2714712 *	PROCESS FOR THE PRODUCTION OF ESTETROL INTERMEDIATES	A01H 5/10 (2006.01)	2723164 *	COMMON WHEAT, PLANTS OR PARTS THEREOF HAVING PARTIALLY OR FULLY MULTIPLIED GENOME, HYBRIDS AND PRODUCTS THEREOF AND METHODS OF GENERATING AND USING SAME
			A61J 1/14 (2006.01)	2662065	Blinding device
			A61J 1/16 (2006.01)	2662065	Blinding device
			B65B 21/00 (2006.01)	2662065	Blinding device

MKP (51)	Broj objave evropske prijava patenta (97)	Naziv pronalaska (54)	MKP (51)	Broj objave evropske prijava patenta (97)	Naziv pronalaska (54)
B65D 77/04 (2006.01)	2662065	Blinding device	A01K 67/027 (2006.01)	2739740 *	HUMANIZED UNIVERSAL LIGHT CHAIN MICE
D01F 6/00 (2006.01)	2723926 *	FIBER MATS COATED WITH NANOGRID VISIBLE SPECTRUM PHOTOCATALYSTS	C07K 16/46 (2006.01)	2739740 *	HUMANIZED UNIVERSAL LIGHT CHAIN MICE
A61K 39/00 (2006.01)	2726094 *	THERAPEUTIC AND DIAGNOSTIC TARGET	C12N 9/64 (2006.01)	2739740 *	HUMANIZED UNIVERSAL LIGHT CHAIN MICE
B29C 33/38 (2006.01)	2753592 *	METHOD OF MAKING A PRODUCT WITH A FUNCTIONAL RELIEF SURFACE WITH HIGH RESOLUTION	C12N 15/85 (2006.01)	2739740 *	HUMANIZED UNIVERSAL LIGHT CHAIN MICE
C04B 28/00 (2006.01)	2753592 *	METHOD OF MAKING A PRODUCT WITH A FUNCTIONAL RELIEF SURFACE WITH HIGH RESOLUTION	A61B 17/115 (2006.01)	2524659	Reusable circular stapler handle with open assembly architecture
C08L 23/04 (2006.01)	2682424	Use of a polymer composition	C07K 16/30 (2006.01)	2718327 *	MCAM ANTAGONISTS AND METHODS OF TREATMENT
C08L 23/10 (2006.01)	2682424	Use of a polymer composition	C30B 11/00 (2006.01)	2714968 *	PROCESS FOR THE GROWTH OF A CRYSTALLINE SOLID, ASSOCIATED CRYSTALLINE SOLID AND DEVICE
A61K 9/24 (2006.01)	2755641 *	CONTROLLED DOSING OF CLOPIDOGREL WITH GASTRIC ACID INHIBITION THERAPIES	C30B 13/00 (2006.01)	2714968 *	PROCESS FOR THE GROWTH OF A CRYSTALLINE SOLID, ASSOCIATED CRYSTALLINE SOLID AND DEVICE
A61K 31/17 (2006.01)	2726088 *	PREDICTIVE BIOMARKER OF SURVIVAL IN THE TREATMENT OF RENAL CELL CARCINOMA	C30B 13/10 (2006.01)	2714968 *	PROCESS FOR THE GROWTH OF A CRYSTALLINE SOLID, ASSOCIATED CRYSTALLINE SOLID AND DEVICE
A61K 31/435 (2006.01)	2726088 *	PREDICTIVE BIOMARKER OF SURVIVAL IN THE TREATMENT OF RENAL CELL CARCINOMA	C30B 29/28 (2006.01)	2714968 *	PROCESS FOR THE GROWTH OF A CRYSTALLINE SOLID, ASSOCIATED CRYSTALLINE SOLID AND DEVICE
A61K 38/00 (2006.01)	2726088 *	PREDICTIVE BIOMARKER OF SURVIVAL IN THE TREATMENT OF RENAL CELL CARCINOMA	H02G 9/02 (2006.01)	2530799	Device for sealing the end of a cable protection tube
A61K 39/00 (2006.01)	2726088 *	PREDICTIVE BIOMARKER OF SURVIVAL IN THE TREATMENT OF RENAL CELL CARCINOMA	H02G 15/04 (2006.01)	2530799	Device for sealing the end of a cable protection tube
G01N 33/50 (2006.01)	2726088 *	PREDICTIVE BIOMARKER OF SURVIVAL IN THE TREATMENT OF RENAL CELL CARCINOMA	A23K 1/16 (2006.01)	2717713 *	MIXED AMINO ACID METAL SALT COMPLEXES
G01N 33/574 (2006.01)	2726088 *	PREDICTIVE BIOMARKER OF SURVIVAL IN THE TREATMENT OF RENAL CELL CARCINOMA	A23K 1/175 (2006.01)	2717713 *	MIXED AMINO ACID METAL SALT COMPLEXES
H01M 8/02 (2006.01)	2337132	Modularized fuel cell devices and fluid flow plate assemblies	A23L 1/304 (2006.01)	2717713 *	MIXED AMINO ACID METAL SALT COMPLEXES
H01M 8/24 (2006.01)	2337132	Modularized fuel cell devices and fluid flow plate assemblies	A23L 1/305 (2006.01)	2717713 *	MIXED AMINO ACID METAL SALT COMPLEXES
A61K 31/4985 (2006.01)	2710006 *	AZAINDOLE DERIVATIVES AS TYROSINE KINASE INHIBITORS	A61K 31/427 (2006.01)	2755970 *	SUBSTITUTED 2-(CHROMAN-6-YLOXY)-THIAZOLES AND THEIR USE AS PHARMACEUTICALS
A61P 29/00 (2006.01)	2710006 *	AZAINDOLE DERIVATIVES AS TYROSINE KINASE INHIBITORS	A61P 9/06 (2006.01)	2755970 *	SUBSTITUTED 2-(CHROMAN-6-YLOXY)-THIAZOLES AND THEIR USE AS PHARMACEUTICALS
C07D 487/04 (2006.01)	2710006 *	AZAINDOLE DERIVATIVES AS TYROSINE KINASE INHIBITORS	A61P 9/10 (2006.01)	2755970 *	SUBSTITUTED 2-(CHROMAN-6-YLOXY)-THIAZOLES AND THEIR USE AS PHARMACEUTICALS

MKP (51)	Broj objave evropske prijava patenta (97)	Naziv pronalaska (54)	MKP (51)	Broj objave evropske prijava patenta (97)	Naziv pronalaska (54)
C07D 417/12 (2006.01)	2755970 *	SUBSTITUTED 2-(CHROMAN-6-YLOXY)-THIAZOLES AND THEIR USE AS PHARMACEUTICALS	A61K 31/137 (2006.01)	2723330 *	VASOCONSTRICTOR-CONTAINING AGENT FOR COMBINATION THERAPY
C07D 417/14 (2006.01)	2755970 *	SUBSTITUTED 2-(CHROMAN-6-YLOXY)-THIAZOLES AND THEIR USE AS PHARMACEUTICALS	A61K 31/164 (2006.01)	2723330 *	VASOCONSTRICTOR-CONTAINING AGENT FOR COMBINATION THERAPY
C07D 471/04 (2006.01)	2755970 *	SUBSTITUTED 2-(CHROMAN-6-YLOXY)-THIAZOLES AND THEIR USE AS PHARMACEUTICALS	A61K 31/4174 (2006.01)	2723330 *	VASOCONSTRICTOR-CONTAINING AGENT FOR COMBINATION THERAPY
C07D 487/04 (2006.01)	2755970 *	SUBSTITUTED 2-(CHROMAN-6-YLOXY)-THIAZOLES AND THEIR USE AS PHARMACEUTICALS	A61K 31/4178 (2006.01)	2723330 *	VASOCONSTRICTOR-CONTAINING AGENT FOR COMBINATION THERAPY
C40B 50/14 (2006.01)	2748357 *	METHODS FOR TAGGING DNA-ENCODED LIBRARIES	A61K 31/505 (2006.01)	2723330 *	VASOCONSTRICTOR-CONTAINING AGENT FOR COMBINATION THERAPY
C40B 50/16 (2006.01)	2748357 *	METHODS FOR TAGGING DNA-ENCODED LIBRARIES	A61K 31/573 (2006.01)	2723330 *	VASOCONSTRICTOR-CONTAINING AGENT FOR COMBINATION THERAPY
A61K 9/00 (2006.01)	2644189	Stable bortezomib formulations	A61K 31/592 (2006.01)	2723330 *	VASOCONSTRICTOR-CONTAINING AGENT FOR COMBINATION THERAPY
A61K 47/10 (2006.01)	2644189	Stable bortezomib formulations	A61K 31/593 (2006.01)	2723330 *	VASOCONSTRICTOR-CONTAINING AGENT FOR COMBINATION THERAPY
A01N 57/00 (2006.01)	2763539 *	ANTIBACTERIAL COMPOUNDS	A61K 31/728 (2006.01)	2723330 *	VASOCONSTRICTOR-CONTAINING AGENT FOR COMBINATION THERAPY
A62B 35/00 (2006.01)	2670492 *	SAFETY HARNESS	A61K 45/06 (2006.01)	2723330 *	VASOCONSTRICTOR-CONTAINING AGENT FOR COMBINATION THERAPY
A62B 35/04 (2006.01)	2670492 *	SAFETY HARNESS	A61P 11/02 (2006.01)	2723330 *	VASOCONSTRICTOR-CONTAINING AGENT FOR COMBINATION THERAPY
H01F 27/245 (2006.01)	2693604	Element for lamination of an electrical machine, lamination made of said elements and method and apparatus for its manufacture	A61P 27/02 (2006.01)	2723330 *	VASOCONSTRICTOR-CONTAINING AGENT FOR COMBINATION THERAPY
H01F 27/26 (2006.01)	2693604	Element for lamination of an electrical machine, lamination made of said elements and method and apparatus for its manufacture	C07C 231/00 (2006.01)	2705023 *	PROCESSES FOR THE PREPARATION OF N-[2-(7-METHOXY-1-NAPHTHYL)ETHYL] ACETAMIDE
H02K 1/12 (2006.01)	2693604	Element for lamination of an electrical machine, lamination made of said elements and method and apparatus for its manufacture	A61K 39/395 (2006.01)	2766395 *	ANTIBODY POLYPEPTIDES THAT ANTAGONIZE CD40L
H02K 1/14 (2006.01)	2693604	Element for lamination of an electrical machine, lamination made of said elements and method and apparatus for its manufacture	C07K 16/28 (2006.01)	2766395 *	ANTIBODY POLYPEPTIDES THAT ANTAGONIZE CD40L
H02K 1/22 (2006.01)	2693604	Element for lamination of an electrical machine, lamination made of said elements and method and apparatus for its manufacture	E21B 7/30 (2006.01)	2757296	Method and system for replacement of existing pipes.
H02K 15/02 (2006.01)	2693604	Element for lamination of an electrical machine, lamination made of said elements and method and apparatus for its manufacture	F16L 1/036 (2006.01)	2757296	Method and system for replacement of existing pipes.
A01N 47/00 (2006.01)	2725908 *	PERIPHERALLY ACTING OPIOID COMPOUNDS	F16L 55/165 (2006.01)	2757296	Method and system for replacement of existing pipes.
			C02F 3/00 (2006.01)	2726417 *	SEWAGE WATER DEPURATION PLANT, COMPRISING A VERTICAL REACTOR, WITH IMPROVED NITROGEN TREATMENT

MKP (51)	Broj objave evropske prijava patenta (97)	Naziv pronalaska (54)	MKP (51)	Broj objave evropske prijava patenta (97)	Naziv pronalaska (54)
C02F 3/22 (2006.01)	2726417 *	SEWAGE WATER DEPURATION PLANT, COMPRISING A VERTICAL REACTOR, WITH IMPROVED NITROGEN TREATMENT	A61P 15/10 (2006.01)	2716642 *	IMIDAZOPYRIDINE COMPOUND
C02F 3/26 (2006.01)	2726417 *	SEWAGE WATER DEPURATION PLANT, COMPRISING A VERTICAL REACTOR, WITH IMPROVED NITROGEN TREATMENT	A61P 43/00 (2006.01)	2716642 *	IMIDAZOPYRIDINE COMPOUND
C02F 3/30 (2006.01)	2726417 *	SEWAGE WATER DEPURATION PLANT, COMPRISING A VERTICAL REACTOR, WITH IMPROVED NITROGEN TREATMENT	C07D 471/04 (2006.01)	2716642 *	IMIDAZOPYRIDINE COMPOUND
A61K 31/437 (2006.01)	2716642 *	IMIDAZOPYRIDINE COMPOUND	C07D 519/00 (2006.01)	2716642 *	IMIDAZOPYRIDINE COMPOUND
A61K 31/439 (2006.01)	2716642 *	IMIDAZOPYRIDINE COMPOUND	C07D 303/36 (2006.01)	2705028 *	PROCESS FOR THE PREPARATION OF A RIVAROXABAN AND INTERMEDIATES FORMED IN SAID PROCESS
A61K 31/444 (2006.01)	2716642 *	IMIDAZOPYRIDINE COMPOUND	C07D 413/10 (2006.01)	2705028 *	PROCESS FOR THE PREPARATION OF A RIVAROXABAN AND INTERMEDIATES FORMED IN SAID PROCESS
A61K 31/4545 (2006.01)	2716642 *	IMIDAZOPYRIDINE COMPOUND	C07D 413/14 (2006.01)	2705028 *	PROCESS FOR THE PREPARATION OF A RIVAROXABAN AND INTERMEDIATES FORMED IN SAID PROCESS
A61K 31/496 (2006.01)	2716642 *	IMIDAZOPYRIDINE COMPOUND	F02M 63/00 (2006.01)	2647826	Valve arrangement
A61K 31/497 (2006.01)	2716642 *	IMIDAZOPYRIDINE COMPOUND	A61M 15/00 (2006.01)	2714164 *	NEBULIZER
A61K 31/501 (2006.01)	2716642 *	IMIDAZOPYRIDINE COMPOUND	G01N 33/542 (2006.01)	2769218 *	VIABILITY STAINING METHOD
A61K 31/506 (2006.01)	2716642 *	IMIDAZOPYRIDINE COMPOUND	G01N 33/569 (2006.01)	2769218 *	VIABILITY STAINING METHOD
A61K 31/53 (2006.01)	2716642 *	IMIDAZOPYRIDINE COMPOUND	G01N 33/58 (2006.01)	2769218 *	VIABILITY STAINING METHOD
A61K 31/5377 (2006.01)	2716642 *	IMIDAZOPYRIDINE COMPOUND	A61K 31/4412 (2006.01)	2702994	Methods of administering pifrenidone therapy
A61K 31/541 (2006.01)	2716642 *	IMIDAZOPYRIDINE COMPOUND	A61K 31/496 (2006.01)	2702994	Methods of administering pifrenidone therapy
A61P 7/02 (2006.01)	2716642 *	IMIDAZOPYRIDINE COMPOUND	A61B 17/072 (2006.01)	2517644	Surgical stapler anvil comprising a plurality of forming pockets
A61P 9/00 (2006.01)	2716642 *	IMIDAZOPYRIDINE COMPOUND	A61K 31/7034 (2006.01)	2482823 *	USE OF COMPOUNDS WITH SGLT-1/SGLT-2 INHIBITOR ACTIVITY FOR PRODUCING MEDICAMENTS FOR TREATMENT OF BONE DISEASES
A61P 9/04 (2006.01)	2716642 *	IMIDAZOPYRIDINE COMPOUND	A61K 31/7048 (2006.01)	2482823 *	USE OF COMPOUNDS WITH SGLT-1/SGLT-2 INHIBITOR ACTIVITY FOR PRODUCING MEDICAMENTS FOR TREATMENT OF BONE DISEASES
A61P 9/10 (2006.01)	2716642 *	IMIDAZOPYRIDINE COMPOUND			
A61P 9/12 (2006.01)	2716642 *	IMIDAZOPYRIDINE COMPOUND			

MKP (51)	Broj objave evropske prijava patenta (97)	Naziv pronalaska (54)	MKP (51)	Broj objave evropske prijava patenta (97)	Naziv pronalaska (54)
A61K 31/7056 (2006.01)	2482823 *	USE OF COMPOUNDS WITH SGLT-1/SGLT-2 INHIBITOR ACTIVITY FOR PRODUCING MEDICAMENTS FOR TREATMENT OF BONE DISEASES	A61K 31/519 (2006.01)	2701724 *	COMPOSITION COMPRISING AFLIBERCEPT, FOLINIC ACID, 5-FLUOROURACIL (5-FU) AND IRINOCETAN (FOLFIRI)
A61K 31/706 (2006.01)	2482823 *	USE OF COMPOUNDS WITH SGLT-1/SGLT-2 INHIBITOR ACTIVITY FOR PRODUCING MEDICAMENTS FOR TREATMENT OF BONE DISEASES	A61K 38/17 (2006.01)	2701724 *	COMPOSITION COMPRISING AFLIBERCEPT, FOLINIC ACID, 5-FLUOROURACIL (5-FU) AND IRINOCETAN (FOLFIRI)
A61P 19/10 (2006.01)	2482823 *	USE OF COMPOUNDS WITH SGLT-1/SGLT-2 INHIBITOR ACTIVITY FOR PRODUCING MEDICAMENTS FOR TREATMENT OF BONE DISEASES	A61P 35/00 (2006.01)	2701724 *	COMPOSITION COMPRISING AFLIBERCEPT, FOLINIC ACID, 5-FLUOROURACIL (5-FU) AND IRINOCETAN (FOLFIRI)
A61P 11/00 (2006.01)	2768859 *	ANTAGONISTS OF IL17C FOR THE TREATMENT OF INFLAMMATORY DISORDERS	H05B 3/06 (2006.01)	2767140 *	TEMPERATURE CONTROL MAT
A61P 19/02 (2006.01)	2768859 *	ANTAGONISTS OF IL17C FOR THE TREATMENT OF INFLAMMATORY DISORDERS	H05B 3/34 (2006.01)	2767140 *	TEMPERATURE CONTROL MAT
A61P 29/00 (2006.01)	2768859 *	ANTAGONISTS OF IL17C FOR THE TREATMENT OF INFLAMMATORY DISORDERS	C07F 9/6593 (2006.01)	2764003 *	IONIC LIQUIDS, ELECTROLYTE SOLUTIONS INCLUDING THE IONIC LIQUIDS, AND ENERGY STORAGE DEVICES INCLUDING THE IONIC LIQUIDS
C07K 16/24 (2006.01)	2768859 *	ANTAGONISTS OF IL17C FOR THE TREATMENT OF INFLAMMATORY DISORDERS	A61K 38/36 (2006.01)	2737311 *	ASSAYS TO MONITOR BLEEDING DISORDERS
C12P 7/56 (2006.01)	2732042 *	SEPARATION PROCESS	C07K 14/745 (2006.01)	2737311 *	ASSAYS TO MONITOR BLEEDING DISORDERS
C12P 41/00 (2006.01)	2732042 *	SEPARATION PROCESS	G01N 33/48 (2006.01)	2737311 *	ASSAYS TO MONITOR BLEEDING DISORDERS
A01N 1/02 (2006.01)	2704560 *	ORGAN CARE SOLUTION FOR EX-VIVO MACHINE PERFUSION OF DONOR LUNGS	C07D 209/88 (2006.01)	2768807 *	PROCESSES FOR THE PREPARATION OF 6-CHLORO-2,3,4,9-TETRAHYDRO-1H-CARBAZOLE-1-CARBOXAMIDE AND OF ITS PRECURSORS
A61B 19/00 (2006.01)	2704560 *	ORGAN CARE SOLUTION FOR EX-VIVO MACHINE PERFUSION OF DONOR LUNGS	E06B 3/54 (2006.01)	2634347	Glass holder, profile assembly and frame construction
A61M 16/00 (2006.01)	2704560 *	ORGAN CARE SOLUTION FOR EX-VIVO MACHINE PERFUSION OF DONOR LUNGS	B01D 29/11 (2006.01)	2707331 *	WATER FILTERING DEVICE
B01D 3/00 (2006.01)	2755729 *	SYSTEM AND METHOD FOR WATER TREATMENT	B01D 29/15 (2006.01)	2707331 *	WATER FILTERING DEVICE
A61K 31/337 (2006.01)	2768820 *	A PROCESS FOR MAKING AN INTERMEDIATE OF CABAZITAXEL	B01D 29/21 (2006.01)	2707331 *	WATER FILTERING DEVICE
A61P 35/00 (2006.01)	2768820 *	A PROCESS FOR MAKING AN INTERMEDIATE OF CABAZITAXEL	B01D 29/52 (2006.01)	2707331 *	WATER FILTERING DEVICE
C07D 305/14 (2006.01)	2768820 *	A PROCESS FOR MAKING AN INTERMEDIATE OF CABAZITAXEL	B01D 29/58 (2006.01)	2707331 *	WATER FILTERING DEVICE
A61K 31/4745 (2006.01)	2701724 *	COMPOSITION COMPRISING AFLIBERCEPT, FOLINIC ACID, 5-FLUOROURACIL (5-FU) AND IRINOCETAN (FOLFIRI)	B01D 29/90 (2006.01)	2707331 *	WATER FILTERING DEVICE
A61K 31/505 (2006.01)	2701724 *	COMPOSITION COMPRISING AFLIBERCEPT, FOLINIC ACID, 5-FLUOROURACIL (5-FU) AND IRINOCETAN (FOLFIRI)	B01D 35/04 (2006.01)	2707331 *	WATER FILTERING DEVICE

MKP (51)	Broj objave evropske prijava patenta (97)	Naziv pronalaska (54)	MKP (51)	Broj objave evropske prijava patenta (97)	Naziv pronalaska (54)
B01D 35/30 (2006.01)	2707331 *	WATER FILTERING DEVICE	G01N 33/558 (2006.01)	2729809 *	ASSAY
C02F 1/00 (2006.01)	2707331 *	WATER FILTERING DEVICE	G01N 33/573 (2006.01)	2729809 *	ASSAY
C02F 1/28 (2006.01)	2707331 *	WATER FILTERING DEVICE	A61K 39/00 (2006.01)	2758073 *	VEGF/DLL4 BINDING AGENTS AND USES THEREOF
C02F 1/42 (2006.01)	2707331 *	WATER FILTERING DEVICE	C07K 16/00 (2006.01)	2758073 *	VEGF/DLL4 BINDING AGENTS AND USES THEREOF
C02F 9/00 (2006.01)	2707331 *	WATER FILTERING DEVICE	C12P 21/08 (2006.01)	2758073 *	VEGF/DLL4 BINDING AGENTS AND USES THEREOF
A61K 31/4965 (2006.01)	2704721 *	PYRUVATE KINASE ACTIVATORS FOR USE IN THERAPY	F16H 1/22 (2006.01)	2685253	Conduit sensor device and method for operating a conduit sensor device
A61K 31/497 (2006.01)	2704721 *	PYRUVATE KINASE ACTIVATORS FOR USE IN THERAPY	F16L 55/40 (2006.01)	2685253	Conduit sensor device and method for operating a conduit sensor device
A61P 7/06 (2006.01)	2704721 *	PYRUVATE KINASE ACTIVATORS FOR USE IN THERAPY	G01N 27/82 (2006.01)	2685253	Conduit sensor device and method for operating a conduit sensor device
A61K 38/18 (2006.01)	2763689 *	FIBROBLAST GROWTH FACTOR 21 VARIANTS	C07K 16/00 (2006.01)	2726600 *	MAMMALIAN CELL CULTURE
C07K 14/50 (2006.01)	2763689 *	FIBROBLAST GROWTH FACTOR 21 VARIANTS	C12N 5/00 (2006.01)	2726600 *	MAMMALIAN CELL CULTURE
G01N 1/28 (2006.01)	2737294 *	APPARATUS AND METHOD FOR A LYSIS OF A SAMPLE, IN PARTICULAR FOR AN AUTOMATED AND/OR CONTROLLED LYSIS OF A SAMPLE	C12N 5/10 (2006.01)	2726600 *	MAMMALIAN CELL CULTURE
G01N 1/38 (2006.01)	2737294 *	APPARATUS AND METHOD FOR A LYSIS OF A SAMPLE, IN PARTICULAR FOR AN AUTOMATED AND/OR CONTROLLED LYSIS OF A SAMPLE	C12P 21/00 (2006.01)	2726600 *	MAMMALIAN CELL CULTURE
G01N 1/44 (2006.01)	2737294 *	APPARATUS AND METHOD FOR A LYSIS OF A SAMPLE, IN PARTICULAR FOR AN AUTOMATED AND/OR CONTROLLED LYSIS OF A SAMPLE	C08K 3/00 (2006.01)	2716715 *	REINFORCED POLYAMIDE RESIN PELLETS
A61M 5/315 (2006.01)	2704778 *	DRIVE ASSEMBLY FOR A DRUG DELIVERY DEVICE AND CORRESPONDING DRUG DELIVERY DEVICE	C08K 7/04 (2006.01)	2716715 *	REINFORCED POLYAMIDE RESIN PELLETS
F25C 3/04 (2006.01)	2761238 *	METHOD, IN PARTICULAR FOR GENERATING SNOW, AND DEVICE FOR CARRYING OUT THE METHOD	C08L 77/00 (2006.01)	2716715 *	REINFORCED POLYAMIDE RESIN PELLETS
F25B 9/00 (2006.01)	2667116	Method and device for cooling	A61K 31/519 (2006.01)	2739627 *	2,3-DIHYDROIMIDAZO[1,2-C] PYRIMIDIN-5(1H)-ONE COMPOUNDS USE AS LP-PLA ² INHIBITORS
C12Q 1/42 (2006.01)	2729809 *	ASSAY	A61P 9/10 (2006.01)	2739627 *	2,3-DIHYDROIMIDAZO[1,2-C] PYRIMIDIN-5(1H)-ONE COMPOUNDS USE AS LP-PLA ² INHIBITORS
			A61P 25/28 (2006.01)	2739627 *	2,3-DIHYDROIMIDAZO[1,2-C] PYRIMIDIN-5(1H)-ONE COMPOUNDS USE AS LP-PLA ² INHIBITORS
			C07D 487/04 (2006.01)	2739627 *	2,3-DIHYDROIMIDAZO[1,2-C] PYRIMIDIN-5(1H)-ONE COMPOUNDS USE AS LP-PLA ² INHIBITORS

MKP (51)	Broj objave evropske prijava patenta (97)	Naziv pronalaska (54)	MKP (51)	Broj objave evropske prijava patenta (97)	Naziv pronalaska (54)
A61K 38/04 (2006.01)	2727931 *	COMPOUNDS AND PHARMACEUTICAL COMBINATIONS FOR THE TREATMENT OF NEURODEGENERATIVE AND ISCHEMIC BRAIN DISEASES	C03C 25/32 (2006.01)	2720987 *	SIZING COMPOSITION FOR MINERAL WOOL HAVING A LOW EMISSION OF VOLATILE ORGANIC COMPOUNDS, AND INSULATING PRODUCTS OBTAINED
C07K 5/08 (2006.01)	2727931 *	COMPOUNDS AND PHARMACEUTICAL COMBINATIONS FOR THE TREATMENT OF NEURODEGENERATIVE AND ISCHEMIC BRAIN DISEASES	C08K 3/30 (2006.01)	2720987 *	SIZING COMPOSITION FOR MINERAL WOOL HAVING A LOW EMISSION OF VOLATILE ORGANIC COMPOUNDS, AND INSULATING PRODUCTS OBTAINED
C07K 5/10 (2006.01)	2727931 *	COMPOUNDS AND PHARMACEUTICAL COMBINATIONS FOR THE TREATMENT OF NEURODEGENERATIVE AND ISCHEMIC BRAIN DISEASES	C08K 5/092 (2006.01)	2720987 *	SIZING COMPOSITION FOR MINERAL WOOL HAVING A LOW EMISSION OF VOLATILE ORGANIC COMPOUNDS, AND INSULATING PRODUCTS OBTAINED
C07K 7/06 (2006.01)	2727931 *	COMPOUNDS AND PHARMACEUTICAL COMBINATIONS FOR THE TREATMENT OF NEURODEGENERATIVE AND ISCHEMIC BRAIN DISEASES	C08K 5/42 (2006.01)	2720987 *	SIZING COMPOSITION FOR MINERAL WOOL HAVING A LOW EMISSION OF VOLATILE ORGANIC COMPOUNDS, AND INSULATING PRODUCTS OBTAINED
G01R 33/12 (2006.01)	2761318 *	DEVICE AND TESTING PROCEDURE FOR DETERMINATION OF MAGNETIC CIRCUIT QUALITY	C08K 5/43 (2006.01)	2720987 *	SIZING COMPOSITION FOR MINERAL WOOL HAVING A LOW EMISSION OF VOLATILE ORGANIC COMPOUNDS, AND INSULATING PRODUCTS OBTAINED
G01R 33/14 (2006.01)	2761318 *	DEVICE AND TESTING PROCEDURE FOR DETERMINATION OF MAGNETIC CIRCUIT QUALITY	C08K 7/14 (2006.01)	2720987 *	SIZING COMPOSITION FOR MINERAL WOOL HAVING A LOW EMISSION OF VOLATILE ORGANIC COMPOUNDS, AND INSULATING PRODUCTS OBTAINED
H01F 29/08 (2006.01)	2761318 *	DEVICE AND TESTING PROCEDURE FOR DETERMINATION OF MAGNETIC CIRCUIT QUALITY	C08L 3/00 (2006.01)	2720987 *	SIZING COMPOSITION FOR MINERAL WOOL HAVING A LOW EMISSION OF VOLATILE ORGANIC COMPOUNDS, AND INSULATING PRODUCTS OBTAINED
A61J 3/02 (2006.01)	2756840 *	PHARMACEUTICAL COMPOSITION FOR INHALATION	C08L 5/00 (2006.01)	2720987 *	SIZING COMPOSITION FOR MINERAL WOOL HAVING A LOW EMISSION OF VOLATILE ORGANIC COMPOUNDS, AND INSULATING PRODUCTS OBTAINED
A61K 9/14 (2006.01)	2756840 *	PHARMACEUTICAL COMPOSITION FOR INHALATION	C08L 5/02 (2006.01)	2720987 *	SIZING COMPOSITION FOR MINERAL WOOL HAVING A LOW EMISSION OF VOLATILE ORGANIC COMPOUNDS, AND INSULATING PRODUCTS OBTAINED
A61K 9/72 (2006.01)	2756840 *	PHARMACEUTICAL COMPOSITION FOR INHALATION	C08L 5/02 (2006.01)	2720987 *	SIZING COMPOSITION FOR MINERAL WOOL HAVING A LOW EMISSION OF VOLATILE ORGANIC COMPOUNDS, AND INSULATING PRODUCTS OBTAINED
A61K 31/4418 (2006.01)	2756840 *	PHARMACEUTICAL COMPOSITION FOR INHALATION	C09J 11/06 (2006.01)	2720987 *	SIZING COMPOSITION FOR MINERAL WOOL HAVING A LOW EMISSION OF VOLATILE ORGANIC COMPOUNDS, AND INSULATING PRODUCTS OBTAINED
A61K 47/10 (2006.01)	2756840 *	PHARMACEUTICAL COMPOSITION FOR INHALATION			
A61K 47/26 (2006.01)	2756840 *	PHARMACEUTICAL COMPOSITION FOR INHALATION			
A61K 47/30 (2006.01)	2756840 *	PHARMACEUTICAL COMPOSITION FOR INHALATION			
A61P 11/00 (2006.01)	2756840 *	PHARMACEUTICAL COMPOSITION FOR INHALATION			

MKP (51)	Broj objave evropske prijava patenta (97)	Naziv pronalaska (54)	MKP (51)	Broj objave evropske prijava patenta (97)	Naziv pronalaska (54)
C09J 103/00 (2006.01)	2720987 *	SIZING COMPOSITION FOR MINERAL WOOL HAVING A LOW EMISSION OF VOLATILE ORGANIC COMPOUNDS, AND INSULATING PRODUCTS OBTAINED	A61L 15/58 (2006.01)	2747791 *	PROTECTIVE WOUND DRESSING DEVICE FOR ORAL AND PHARYNGEAL SPACE
C09J 103/02 (2006.01)	2720987 *	SIZING COMPOSITION FOR MINERAL WOOL HAVING A LOW EMISSION OF VOLATILE ORGANIC COMPOUNDS, AND INSULATING PRODUCTS OBTAINED	A61L 15/62 (2006.01)	2747791 *	PROTECTIVE WOUND DRESSING DEVICE FOR ORAL AND PHARYNGEAL SPACE
C09J 105/00 (2006.01)	2720987 *	SIZING COMPOSITION FOR MINERAL WOOL HAVING A LOW EMISSION OF VOLATILE ORGANIC COMPOUNDS, AND INSULATING PRODUCTS OBTAINED	A61L 15/64 (2006.01)	2747791 *	PROTECTIVE WOUND DRESSING DEVICE FOR ORAL AND PHARYNGEAL SPACE
D04H 1/4218 (2012.01)	2720987 *	SIZING COMPOSITION FOR MINERAL WOOL HAVING A LOW EMISSION OF VOLATILE ORGANIC COMPOUNDS, AND INSULATING PRODUCTS OBTAINED	A61L 24/06 (2006.01)	2747791 *	PROTECTIVE WOUND DRESSING DEVICE FOR ORAL AND PHARYNGEAL SPACE
D04H 1/64 (2012.01)	2720987 *	SIZING COMPOSITION FOR MINERAL WOOL HAVING A LOW EMISSION OF VOLATILE ORGANIC COMPOUNDS, AND INSULATING PRODUCTS OBTAINED	A61L 26/00 (2006.01)	2747791 *	PROTECTIVE WOUND DRESSING DEVICE FOR ORAL AND PHARYNGEAL SPACE
A61K 31/277 (2006.01)	2720692 *	CATHEPSIN INHIBITORS FOR TREATING MICROGLIA-MEDIATED NEURON LOSS IN THE CENTRAL NERVOUS SYSTEM	C12Q 1/34 (2006.01)	2751279 *	METHODS AND COMPOSITIONS TO DETECT THE LEVEL OF LYSOSOMAL EXOCYTOSIS ACTIVITY AND METHODS OF USE
A61K 31/4406 (2006.01)	2720692 *	CATHEPSIN INHIBITORS FOR TREATING MICROGLIA-MEDIATED NEURON LOSS IN THE CENTRAL NERVOUS SYSTEM	G01N 33/574 (2006.01)	2751279 *	METHODS AND COMPOSITIONS TO DETECT THE LEVEL OF LYSOSOMAL EXOCYTOSIS ACTIVITY AND METHODS OF USE
A61P 25/00 (2006.01)	2720692 *	CATHEPSIN INHIBITORS FOR TREATING MICROGLIA-MEDIATED NEURON LOSS IN THE CENTRAL NERVOUS SYSTEM	C07K 16/28 (2006.01)	2748197 *	TANDEM FC BISPECIFIC ANTIBODIES
A61P 25/16 (2006.01)	2720692 *	CATHEPSIN INHIBITORS FOR TREATING MICROGLIA-MEDIATED NEURON LOSS IN THE CENTRAL NERVOUS SYSTEM	C07K 16/46 (2006.01)	2748197 *	TANDEM FC BISPECIFIC ANTIBODIES
A61P 25/28 (2006.01)	2720692 *	CATHEPSIN INHIBITORS FOR TREATING MICROGLIA-MEDIATED NEURON LOSS IN THE CENTRAL NERVOUS SYSTEM	B29C 33/00 (2006.01)	2764973	Expanded polypropylene foam-forming mold
A61F 13/02 (2006.01)	2747791 *	PROTECTIVE WOUND DRESSING DEVICE FOR ORAL AND PHARYNGEAL SPACE	B29C 44/44 (2006.01)	2764973	Expanded polypropylene foam-forming mold
A61L 15/24 (2006.01)	2747791 *	PROTECTIVE WOUND DRESSING DEVICE FOR ORAL AND PHARYNGEAL SPACE	B29C 44/58 (2006.01)	2764973	Expanded polypropylene foam-forming mold
A61L 15/32 (2006.01)	2747791 *	PROTECTIVE WOUND DRESSING DEVICE FOR ORAL AND PHARYNGEAL SPACE	C07D 493/02 (2006.01)	2742055 *	RENEWABLE BIO-BASED (METH) ACRYLATED MONOMERS AS VINYL ESTER CROSS-LINKERS
			C07H 13/00 (2006.01)	2742055 *	RENEWABLE BIO-BASED (METH) ACRYLATED MONOMERS AS VINYL ESTER CROSS-LINKERS
			C07H 13/02 (2006.01)	2742055 *	RENEWABLE BIO-BASED (METH) ACRYLATED MONOMERS AS VINYL ESTER CROSS-LINKERS
			C08F 24/00 (2006.01)	2742055 *	RENEWABLE BIO-BASED (METH) ACRYLATED MONOMERS AS VINYL ESTER CROSS-LINKERS
			C08F 36/14 (2006.01)	2742055 *	RENEWABLE BIO-BASED (METH) ACRYLATED MONOMERS AS VINYL ESTER CROSS-LINKERS
			C08F 224/00 (2006.01)	2742055 *	RENEWABLE BIO-BASED (METH) ACRYLATED MONOMERS AS VINYL ESTER CROSS-LINKERS
			C08F 236/14 (2006.01)	2742055 *	RENEWABLE BIO-BASED (METH) ACRYLATED MONOMERS AS VINYL ESTER CROSS-LINKERS

MKP (51)	Broj objave evropske prijava patenta (97)	Naziv pronalaska (54)	MKP (51)	Broj objave evropske prijava patenta (97)	Naziv pronalaska (54)
F02M 47/02 (2006.01)	2620632	A control valve of a fuel injector	C07C 69/18 (2006.01)	2674413	Process for the preparation of treprostinil and derivatives thereof
F02M 61/12 (2006.01)	2620632	A control valve of a fuel injector	C07F 7/18 (2006.01)	2674413	Process for the preparation of treprostinil and derivatives thereof
F02M 61/16 (2006.01)	2620632	A control valve of a fuel injector	C12P 41/00 (2006.01)	2674413	Process for the preparation of treprostinil and derivatives thereof
A61K 9/127 (2006.01)	2704703 *	TRANSDERMAL COMPOSITIONS OF IBUPROFEN AND METHODS OF USE THEREOF	B01J 29/00 (2006.01)	2721280 *	FUEL CONDITIONING MODULES AND METHODS
A61K 31/192 (2006.01)	2704703 *	TRANSDERMAL COMPOSITIONS OF IBUPROFEN AND METHODS OF USE THEREOF	C07C 1/24 (2006.01)	2721280 *	FUEL CONDITIONING MODULES AND METHODS
C08F 220/06 (2006.01)	2738191 *	AMPHIPHILIC MACROMOLECULE AND USE	F02M 27/02 (2006.01)	2721280 *	FUEL CONDITIONING MODULES AND METHODS
C08F 220/18 (2006.01)	2738191 *	AMPHIPHILIC MACROMOLECULE AND USE	A61K 31/421 (2006.01)	2703392 *	5-MEMBERED RING AROMATIC HETEROCYCLIC DERIVATIVE HAVING NPY Y5 RECEPTOR ANTAGONISTIC ACTIVITY
C08F 220/34 (2006.01)	2738191 *	AMPHIPHILIC MACROMOLECULE AND USE	A61K 31/4245 (2006.01)	2703392 *	5-MEMBERED RING AROMATIC HETEROCYCLIC DERIVATIVE HAVING NPY Y5 RECEPTOR ANTAGONISTIC ACTIVITY
C08F 220/56 (2006.01)	2738191 *	AMPHIPHILIC MACROMOLECULE AND USE	A61K 31/426 (2006.01)	2703392 *	5-MEMBERED RING AROMATIC HETEROCYCLIC DERIVATIVE HAVING NPY Y5 RECEPTOR ANTAGONISTIC ACTIVITY
C08F 220/58 (2006.01)	2738191 *	AMPHIPHILIC MACROMOLECULE AND USE	A61K 31/433 (2006.01)	2703392 *	5-MEMBERED RING AROMATIC HETEROCYCLIC DERIVATIVE HAVING NPY Y5 RECEPTOR ANTAGONISTIC ACTIVITY
C08F 226/02 (2006.01)	2738191 *	AMPHIPHILIC MACROMOLECULE AND USE	A61K 31/4439 (2006.01)	2703392 *	5-MEMBERED RING AROMATIC HETEROCYCLIC DERIVATIVE HAVING NPY Y5 RECEPTOR ANTAGONISTIC ACTIVITY
C08F 232/04 (2006.01)	2738191 *	AMPHIPHILIC MACROMOLECULE AND USE	A61P 3/04 (2006.01)	2703392 *	5-MEMBERED RING AROMATIC HETEROCYCLIC DERIVATIVE HAVING NPY Y5 RECEPTOR ANTAGONISTIC ACTIVITY
C09K 8/588 (2006.01)	2738191 *	AMPHIPHILIC MACROMOLECULE AND USE	A61P 3/06 (2006.01)	2703392 *	5-MEMBERED RING AROMATIC HETEROCYCLIC DERIVATIVE HAVING NPY Y5 RECEPTOR ANTAGONISTIC ACTIVITY
A61K 31/4985 (2006.01)	2758399 *	N-[4-(1H-PYRAZOLO[3,4-B] PYRAZIN-6-YL)-PHENYL]- SULFONAMIDES AND THEIR USE AS PHARMACEUTICALS	A61P 3/10 (2006.01)	2703392 *	5-MEMBERED RING AROMATIC HETEROCYCLIC DERIVATIVE HAVING NPY Y5 RECEPTOR ANTAGONISTIC ACTIVITY
A61P 19/02 (2006.01)	2758399 *	N-[4-(1H-PYRAZOLO[3,4-B] PYRAZIN-6-YL)-PHENYL]- SULFONAMIDES AND THEIR USE AS PHARMACEUTICALS	A61P 9/04 (2006.01)	2703392 *	5-MEMBERED RING AROMATIC HETEROCYCLIC DERIVATIVE HAVING NPY Y5 RECEPTOR ANTAGONISTIC ACTIVITY
C07D 487/04 (2006.01)	2758399 *	N-[4-(1H-PYRAZOLO[3,4-B] PYRAZIN-6-YL)-PHENYL]- SULFONAMIDES AND THEIR USE AS PHARMACEUTICALS	A61P 9/10 (2006.01)	2703392 *	5-MEMBERED RING AROMATIC HETEROCYCLIC DERIVATIVE HAVING NPY Y5 RECEPTOR ANTAGONISTIC ACTIVITY
B42F 7/04 (2006.01)	2409853	Bag of sheets, in particular for free- hand drawing	A61P 9/12 (2006.01)	2703392 *	5-MEMBERED RING AROMATIC HETEROCYCLIC DERIVATIVE HAVING NPY Y5 RECEPTOR ANTAGONISTIC ACTIVITY
B43L 5/00 (2006.01)	2409853	Bag of sheets, in particular for free- hand drawing			
C07C 67/29 (2006.01)	2674413	Process for the preparation of treprostinil and derivatives thereof			

MKP (51)	Broj objave evropske prijava patenta (97)	Naziv pronalaska (54)	MKP (51)	Broj objave evropske prijava patenta (97)	Naziv pronalaska (54)
A61P 15/00 (2006.01)	2703392 *	5-MEMBERED RING AROMATIC HETEROCYCLIC DERIVATIVE HAVING NPY Y5 RECEPTOR ANTAGONISTIC ACTIVITY	A61K 31/728 (2006.01)	2766025 *	THERAPEUTIC SULFATED POLYSACCHARIDES, COMPOSITIONS THEREOF, AND METHODS FOR TREATING PATIENTS
A61P 25/08 (2006.01)	2703392 *	5-MEMBERED RING AROMATIC HETEROCYCLIC DERIVATIVE HAVING NPY Y5 RECEPTOR ANTAGONISTIC ACTIVITY	A61K 31/737 (2006.01)	2766025 *	THERAPEUTIC SULFATED POLYSACCHARIDES, COMPOSITIONS THEREOF, AND METHODS FOR TREATING PATIENTS
A61P 25/20 (2006.01)	2703392 *	5-MEMBERED RING AROMATIC HETEROCYCLIC DERIVATIVE HAVING NPY Y5 RECEPTOR ANTAGONISTIC ACTIVITY	A61K 36/02 (2006.01)	2766025 *	THERAPEUTIC SULFATED POLYSACCHARIDES, COMPOSITIONS THEREOF, AND METHODS FOR TREATING PATIENTS
A61P 25/24 (2006.01)	2703392 *	5-MEMBERED RING AROMATIC HETEROCYCLIC DERIVATIVE HAVING NPY Y5 RECEPTOR ANTAGONISTIC ACTIVITY	A61K 31/7072 (2006.01)	2760858 *	URIDINE DIPHOSPHATE DERIVATIVES, COMPOSITIONS AND METHODS FOR TREATING NEURODEGENERATIVE DISORDERS
A61P 43/00 (2006.01)	2703392 *	5-MEMBERED RING AROMATIC HETEROCYCLIC DERIVATIVE HAVING NPY Y5 RECEPTOR ANTAGONISTIC ACTIVITY	A61P 25/04 (2006.01)	2760858 *	URIDINE DIPHOSPHATE DERIVATIVES, COMPOSITIONS AND METHODS FOR TREATING NEURODEGENERATIVE DISORDERS
C07D 263/48 (2006.01)	2703392 *	5-MEMBERED RING AROMATIC HETEROCYCLIC DERIVATIVE HAVING NPY Y5 RECEPTOR ANTAGONISTIC ACTIVITY	A61P 25/28 (2006.01)	2760858 *	URIDINE DIPHOSPHATE DERIVATIVES, COMPOSITIONS AND METHODS FOR TREATING NEURODEGENERATIVE DISORDERS
C07D 271/06 (2006.01)	2703392 *	5-MEMBERED RING AROMATIC HETEROCYCLIC DERIVATIVE HAVING NPY Y5 RECEPTOR ANTAGONISTIC ACTIVITY	C07D 405/04 (2006.01)	2760858 *	URIDINE DIPHOSPHATE DERIVATIVES, COMPOSITIONS AND METHODS FOR TREATING NEURODEGENERATIVE DISORDERS
A61K 31/138 (2006.01)	2717868 *	COMBINATION COMPRISING UMECLIDINIUM AND A CORTICOSTEROID	C07D 405/14 (2006.01)	2760858 *	URIDINE DIPHOSPHATE DERIVATIVES, COMPOSITIONS AND METHODS FOR TREATING NEURODEGENERATIVE DISORDERS
A61K 31/439 (2006.01)	2717868 *	COMBINATION COMPRISING UMECLIDINIUM AND A CORTICOSTEROID	C07D 413/14 (2006.01)	2760858 *	URIDINE DIPHOSPHATE DERIVATIVES, COMPOSITIONS AND METHODS FOR TREATING NEURODEGENERATIVE DISORDERS
A61K 31/58 (2006.01)	2717868 *	COMBINATION COMPRISING UMECLIDINIUM AND A CORTICOSTEROID	C07F 9/09 (2006.01)	2760858 *	URIDINE DIPHOSPHATE DERIVATIVES, COMPOSITIONS AND METHODS FOR TREATING NEURODEGENERATIVE DISORDERS
A61K 45/06 (2006.01)	2717868 *	COMBINATION COMPRISING UMECLIDINIUM AND A CORTICOSTEROID	A61K 31/565 (2006.01)	2714710 *	PROCESS FOR THE PRODUCTION OF ESTETROL INTERMEDIATES
A61P 11/06 (2006.01)	2717868 *	COMBINATION COMPRISING UMECLIDINIUM AND A CORTICOSTEROID	A61P 5/30 (2006.01)	2714710 *	PROCESS FOR THE PRODUCTION OF ESTETROL INTERMEDIATES
A61P 11/08 (2006.01)	2717868 *	COMBINATION COMPRISING UMECLIDINIUM AND A CORTICOSTEROID	C07J 1/00 (2006.01)	2714710 *	PROCESS FOR THE PRODUCTION OF ESTETROL INTERMEDIATES
A61K 9/48 (2006.01)	2709599 *	PHARMACEUTICAL COMPOSITION COMPRISING DROTAVERINE	C07J 13/00 (2006.01)	2714710 *	PROCESS FOR THE PRODUCTION OF ESTETROL INTERMEDIATES
A61K 31/47 (2006.01)	2709599 *	PHARMACEUTICAL COMPOSITION COMPRISING DROTAVERINE			
A61K 31/485 (2006.01)	2709599 *	PHARMACEUTICAL COMPOSITION COMPRISING DROTAVERINE			
A61K 47/48 (2006.01)	2741783 *	POLYANION NANOCOMPLEXES FOR THERAPEUTIC APPLICATIONS			
A61K 48/00 (2006.01)	2741783 *	POLYANION NANOCOMPLEXES FOR THERAPEUTIC APPLICATIONS			

MKP (51)	Broj objave evropske prijava patenta (97)	Naziv pronalaska (54)	MKP (51)	Broj objave evropske prijava patenta (97)	Naziv pronalaska (54)
C07J 51/00 (2006.01)	2714710 *	PROCESS FOR THE PRODUCTION OF ESTETROL INTERMEDIATES	A61K 35/74 (2006.01)	2763685 *	BACTERIUM FOR USE AS A PROBIOTIC FOR NUTRITIONAL AND MEDICAL APPLICATIONS
E04B 2/18 (2006.01)	2739799 *	BUILDING STRUCTURE OF PRE-CAST MONOLITHIC WALLS AND INTERFLOOR SLABS	A61P 1/00 (2006.01)	2763685 *	BACTERIUM FOR USE AS A PROBIOTIC FOR NUTRITIONAL AND MEDICAL APPLICATIONS
E04B 2/24 (2006.01)	2739799 *	BUILDING STRUCTURE OF PRE-CAST MONOLITHIC WALLS AND INTERFLOOR SLABS	A61P 37/00 (2006.01)	2763685 *	BACTERIUM FOR USE AS A PROBIOTIC FOR NUTRITIONAL AND MEDICAL APPLICATIONS
E04B 2/86 (2006.01)	2739799 *	BUILDING STRUCTURE OF PRE-CAST MONOLITHIC WALLS AND INTERFLOOR SLABS	A61B 17/072 (2006.01)	2517645	Tissue thickness compensator for a surgical stapler comprising an adjustable anvil
E04B 5/19 (2006.01)	2739799 *	BUILDING STRUCTURE OF PRE-CAST MONOLITHIC WALLS AND INTERFLOOR SLABS	A61K 9/16 (2006.01)	2734573 *	BIODEGRADABLE, SEMI-CRYSTALLINE, PHASE SEPARATED, THERMOPLASTIC MULTI BLOCK COPOLYMERS FOR CONTROLLED RELEASE OF BIOLOGICALLY ACTIVE COMPOUNDS
E04B 5/21 (2006.01)	2739799 *	BUILDING STRUCTURE OF PRE-CAST MONOLITHIC WALLS AND INTERFLOOR SLABS	C08G 81/00 (2006.01)	2734573 *	BIODEGRADABLE, SEMI-CRYSTALLINE, PHASE SEPARATED, THERMOPLASTIC MULTI BLOCK COPOLYMERS FOR CONTROLLED RELEASE OF BIOLOGICALLY ACTIVE COMPOUNDS
E04B 5/38 (2006.01)	2739799 *	BUILDING STRUCTURE OF PRE-CAST MONOLITHIC WALLS AND INTERFLOOR SLABS	C08L 87/00 (2006.01)	2734573 *	BIODEGRADABLE, SEMI-CRYSTALLINE, PHASE SEPARATED, THERMOPLASTIC MULTI BLOCK COPOLYMERS FOR CONTROLLED RELEASE OF BIOLOGICALLY ACTIVE COMPOUNDS
E04C 2/288 (2006.01)	2739799 *	BUILDING STRUCTURE OF PRE-CAST MONOLITHIC WALLS AND INTERFLOOR SLABS	A61K 31/335 (2006.01)	2705030 *	PARTIALLY SATURATED TRICYCLIC COMPOUNDS AND METHODS OF MAKING AND USING SAME
A01K 67/027 (2006.01)	2702413 *	TEST SYSTEMS AND METHODS FOR IDENTIFYING AND CHARACTERISING LIPID LOWERING DRUGS	A61K 31/352 (2006.01)	2705030 *	PARTIALLY SATURATED TRICYCLIC COMPOUNDS AND METHODS OF MAKING AND USING SAME
G01N 33/92 (2006.01)	2702413 *	TEST SYSTEMS AND METHODS FOR IDENTIFYING AND CHARACTERISING LIPID LOWERING DRUGS	A61K 31/397 (2006.01)	2705030 *	PARTIALLY SATURATED TRICYCLIC COMPOUNDS AND METHODS OF MAKING AND USING SAME
A61K 8/36 (2006.01)	2703478 *	CLEANING AGENT COMPOSITION	A61K 31/4025 (2006.01)	2705030 *	PARTIALLY SATURATED TRICYCLIC COMPOUNDS AND METHODS OF MAKING AND USING SAME
A61K 8/42 (2006.01)	2703478 *	CLEANING AGENT COMPOSITION	A61K 31/4355 (2006.01)	2705030 *	PARTIALLY SATURATED TRICYCLIC COMPOUNDS AND METHODS OF MAKING AND USING SAME
A61Q 5/02 (2006.01)	2703478 *	CLEANING AGENT COMPOSITION	A61P 3/04 (2006.01)	2705030 *	PARTIALLY SATURATED TRICYCLIC COMPOUNDS AND METHODS OF MAKING AND USING SAME
A61Q 19/10 (2006.01)	2703478 *	CLEANING AGENT COMPOSITION	C07D 311/94 (2006.01)	2705030 *	PARTIALLY SATURATED TRICYCLIC COMPOUNDS AND METHODS OF MAKING AND USING SAME
C11D 1/04 (2006.01)	2703478 *	CLEANING AGENT COMPOSITION			
C11D 1/10 (2006.01)	2703478 *	CLEANING AGENT COMPOSITION			
C11D 3/33 (2006.01)	2703478 *	CLEANING AGENT COMPOSITION			
G11C 27/02 (2006.01)	2650881	Electronic device and method for low leakage switching			
B01D 53/62 (2006.01)	2723475 *	SEQUESTRATION OF GREENHOUSE GASSES BY GENERATING AN UNSTABLE GAS/SALINE FRONT WITHIN A FORMATION			

MKP (51)	Broj objave evropske prijava patenta (97)	Naziv pronalaska (54)	MKP (51)	Broj objave evropske prijava patenta (97)	Naziv pronalaska (54)
C07D 405/02 (2006.01)	2705030 *	PARTIALLY SATURATED TRICYCLIC COMPOUNDS AND METHODS OF MAKING AND USING SAME	C10M 171/00 (2006.01)	2740784	Refrigerant oil for freezers and operating fluid composition for freezers
C07D 491/048 (2006.01)	2705030 *	PARTIALLY SATURATED TRICYCLIC COMPOUNDS AND METHODS OF MAKING AND USING SAME	C10N 30/06 (2006.01)	2740784	Refrigerant oil for freezers and operating fluid composition for freezers
C07D 493/04 (2006.01)	2705030 *	PARTIALLY SATURATED TRICYCLIC COMPOUNDS AND METHODS OF MAKING AND USING SAME	C10N 30/08 (2006.01)	2740784	Refrigerant oil for freezers and operating fluid composition for freezers
A61K 31/575 (2006.01)	2662382	Sterol derivatives, method for preparing same, pharmaceutical compositions containing same and use thereof for the treatment of multiple glioblastomas	C10N 30/10 (2006.01)	2740784	Refrigerant oil for freezers and operating fluid composition for freezers
A61P 35/00 (2006.01)	2662382	Sterol derivatives, method for preparing same, pharmaceutical compositions containing same and use thereof for the treatment of multiple glioblastomas	C10N 40/30 (2006.01)	2740784	Refrigerant oil for freezers and operating fluid composition for freezers
C07J 9/00 (2006.01)	2662382	Sterol derivatives, method for preparing same, pharmaceutical compositions containing same and use thereof for the treatment of multiple glioblastomas	A61K 31/4545 (2006.01)	2751094 *	NOVEL CRYSTAL FORM
C07J 41/00 (2006.01)	2662382	Sterol derivatives, method for preparing same, pharmaceutical compositions containing same and use thereof for the treatment of multiple glioblastomas	A61P 25/28 (2006.01)	2751094 *	NOVEL CRYSTAL FORM
C07J 75/00 (2006.01)	2662382	Sterol derivatives, method for preparing same, pharmaceutical compositions containing same and use thereof for the treatment of multiple glioblastomas	C07D 401/12 (2006.01)	2751094 *	NOVEL CRYSTAL FORM
C09K 5/04 (2006.01)	2740784	Refrigerant oil for freezers and operating fluid composition for freezers	F02M 59/06 (2006.01)	2639444	Fuel pump assembly
C10M 105/18 (2006.01)	2740784	Refrigerant oil for freezers and operating fluid composition for freezers	F02M 59/10 (2006.01)	2639444	Fuel pump assembly
C10M 107/24 (2006.01)	2740784	Refrigerant oil for freezers and operating fluid composition for freezers	F04B 1/04 (2006.01)	2639444	Fuel pump assembly
C10M 107/34 (2006.01)	2740784	Refrigerant oil for freezers and operating fluid composition for freezers	A61K 9/00 (2006.01)	2720680 *	INHALABLE PHARMACEUTICAL COMPOSITIONS
C10M 129/18 (2006.01)	2740784	Refrigerant oil for freezers and operating fluid composition for freezers	A61K 9/127 (2006.01)	2720680 *	INHALABLE PHARMACEUTICAL COMPOSITIONS
C10M 133/04 (2006.01)	2740784	Refrigerant oil for freezers and operating fluid composition for freezers	A61K 47/24 (2006.01)	2720680 *	INHALABLE PHARMACEUTICAL COMPOSITIONS
C10M 137/08 (2006.01)	2740784	Refrigerant oil for freezers and operating fluid composition for freezers	C07K 16/22 (2006.01)	2736925 *	ANTI-VEGF SINGLE VARIABLE DOMAINS FUSED TO FC DOMAINS
C10M 169/04 (2006.01)	2740784	Refrigerant oil for freezers and operating fluid composition for freezers	A61J 1/14 (2006.01)	2729110 *	RECONSTITUTION DEVICE
			A61J 3/00 (2006.01)	2729110 *	RECONSTITUTION DEVICE
			B65D 81/32 (2006.01)	2729110 *	RECONSTITUTION DEVICE
			H04L 12/18 (2006.01)	2744185	File management system, method and computer program
			H04M 3/42 (2006.01)	2744185	File management system, method and computer program

MKP (51)	Broj objave evropske prijava patenta (97)	Naziv pronalaska (54)	MKP (51)	Broj objave evropske prijava patenta (97)	Naziv pronalaska (54)
B62J 99/00 (2009.01)	2718173 *	BICYCLE FORK	E04B 2/74 (2006.01)	2718512 *	ILLUMINATING GLASS PARTITION
B62K 21/02 (2006.01)	2718173 *	BICYCLE FORK	F21V 33/00 (2006.01)	2718512 *	ILLUMINATING GLASS PARTITION
B62K 21/06 (2006.01)	2718173 *	BICYCLE FORK	G02B 6/00 (2006.01)	2718512 *	ILLUMINATING GLASS PARTITION
B62K 21/18 (2006.01)	2718173 *	BICYCLE FORK	G08B 13/14 (2006.01)	2740110 *	ANTI-THEFT DEVICE FOR OBJECTS ON DISPLAY
C10B 47/24 (2006.01)	2707663 *	IMPROVEMENTS IN INTEGRATED DRYING GASIFICATION	G08B 29/04 (2006.01)	2740110 *	ANTI-THEFT DEVICE FOR OBJECTS ON DISPLAY
C10J 3/50 (2006.01)	2707663 *	IMPROVEMENTS IN INTEGRATED DRYING GASIFICATION	A61B 17/04 (2006.01)	2734124 *	DEVICE FOR THE TRANSOSSEOUS INSERTION OF SUTURE THREADS
C10J 3/54 (2006.01)	2707663 *	IMPROVEMENTS IN INTEGRATED DRYING GASIFICATION	A61B 17/06 (2006.01)	2734124 *	DEVICE FOR THE TRANSOSSEOUS INSERTION OF SUTURE THREADS
F02C 3/28 (2006.01)	2707663 *	IMPROVEMENTS IN INTEGRATED DRYING GASIFICATION	E04C 2/34 (2006.01)	2660408	Zigzag wooden elements comprising a core layer and multiple layer composite comprising the core layer
F26B 3/10 (2006.01)	2707663 *	IMPROVEMENTS IN INTEGRATED DRYING GASIFICATION	A61K 31/155 (2006.01)	2707015 *	LIXISENATIDE AS ADD-ON THERAPY TO BASAL INSULIN IN TYPE 2 DIABETES
A61K 31/4196 (2006.01)	2714038 *	COMBINATION THERAPY OF HSP90 INHIBITORY COMPOUNDS WITH MTOR/PI3K INHIBITORS	A61K 38/26 (2006.01)	2707015 *	LIXISENATIDE AS ADD-ON THERAPY TO BASAL INSULIN IN TYPE 2 DIABETES
A61K 31/675 (2006.01)	2714038 *	COMBINATION THERAPY OF HSP90 INHIBITORY COMPOUNDS WITH MTOR/PI3K INHIBITORS	A61K 38/28 (2006.01)	2707015 *	LIXISENATIDE AS ADD-ON THERAPY TO BASAL INSULIN IN TYPE 2 DIABETES
A61K 45/06 (2006.01)	2714038 *	COMBINATION THERAPY OF HSP90 INHIBITORY COMPOUNDS WITH MTOR/PI3K INHIBITORS	A61P 3/04 (2006.01)	2707015 *	LIXISENATIDE AS ADD-ON THERAPY TO BASAL INSULIN IN TYPE 2 DIABETES
A61P 35/00 (2006.01)	2714038 *	COMBINATION THERAPY OF HSP90 INHIBITORY COMPOUNDS WITH MTOR/PI3K INHIBITORS	A61P 3/10 (2006.01)	2707015 *	LIXISENATIDE AS ADD-ON THERAPY TO BASAL INSULIN IN TYPE 2 DIABETES
A45C 11/00 (2006.01)	2647306	Protective apparatus for tablet electronic device	B01D 33/15 (2006.01)	2752229 *	SUCTIONING APPARATUS FOR A FIBROUS FILTER, AND FILTERING DEVICE USING SAME
A61K 31/4188 (2006.01)	2729143 *	USE OF BIOTIN FOR THE TREATMENT OF MULTIPLE SCLEROSIS	B01D 33/39 (2006.01)	2752229 *	SUCTIONING APPARATUS FOR A FIBROUS FILTER, AND FILTERING DEVICE USING SAME
A61P 25/00 (2006.01)	2729143 *	USE OF BIOTIN FOR THE TREATMENT OF MULTIPLE SCLEROSIS	B01D 33/74 (2006.01)	2752229 *	SUCTIONING APPARATUS FOR A FIBROUS FILTER, AND FILTERING DEVICE USING SAME
A61K 39/395 (2006.01)	2726100 *	ANTI-ERBB3 ANTIBODIES IN COMBINATION WITH PACLITAXEL FOR TREATMENT OF GYNECOLOGICAL CANCERS	G06Q 10/00 (2012.01)	2748776 *	NETWORK PREDICTIVE CUSTOMER SERVICE QUEUE MANAGEMENT
C10B 53/07 (2006.01)	2705117 *	METHOD AND APPARATUS FOR ENERGY-EFFICIENT PROCESSING OF SECONDARY DEPOSITS	A47J 31/00 (2006.01)	2739190 *	POWDER DISPENSING APPARATUS
C10G 1/10 (2006.01)	2705117 *	METHOD AND APPARATUS FOR ENERGY-EFFICIENT PROCESSING OF SECONDARY DEPOSITS	A47J 43/27 (2006.01)	2739190 *	POWDER DISPENSING APPARATUS
			B65B 3/04 (2006.01)	2739190 *	POWDER DISPENSING APPARATUS

MKP (51)	Broj objave evropske prijava patenta (97)	Naziv pronalaska (54)	MKP (51)	Broj objave evropske prijava patenta (97)	Naziv pronalaska (54)
F24H 1/18 (2006.01)	2739190 *	POWDER DISPENSING APPARATUS	A61K 31/517 (2006.01)	2768822 *	DERIVATIVES OF 1-PHENYL-2- PYRIDINYL ALKYL ALCOHOLS AS PHOSPHODIESTERASE INHIBITORS
A01N 43/34 (2006.01)	2721022 *	METALLOENZYME INHIBITOR COMPOUNDS	A61K 31/522 (2006.01)	2768822 *	DERIVATIVES OF 1-PHENYL-2- PYRIDINYL ALKYL ALCOHOLS AS PHOSPHODIESTERASE INHIBITORS
A01N 43/713 (2006.01)	2721022 *	METALLOENZYME INHIBITOR COMPOUNDS	C07D 401/12 (2006.01)	2768822 *	DERIVATIVES OF 1-PHENYL-2- PYRIDINYL ALKYL ALCOHOLS AS PHOSPHODIESTERASE INHIBITORS
A01P 3/00 (2006.01)	2721022 *	METALLOENZYME INHIBITOR COMPOUNDS	C07D 401/14 (2006.01)	2768822 *	DERIVATIVES OF 1-PHENYL-2- PYRIDINYL ALKYL ALCOHOLS AS PHOSPHODIESTERASE INHIBITORS
C07D 401/06 (2006.01)	2721022 *	METALLOENZYME INHIBITOR COMPOUNDS	C07D 409/14 (2006.01)	2768822 *	DERIVATIVES OF 1-PHENYL-2- PYRIDINYL ALKYL ALCOHOLS AS PHOSPHODIESTERASE INHIBITORS
C07D 401/14 (2006.01)	2721022 *	METALLOENZYME INHIBITOR COMPOUNDS	C07D 413/12 (2006.01)	2768822 *	DERIVATIVES OF 1-PHENYL-2- PYRIDINYL ALKYL ALCOHOLS AS PHOSPHODIESTERASE INHIBITORS
A61K 39/155 (2006.01)	2707025 *	HENDRA AND NIPAH VIRUS G GLYCOPROTEIN IMMUNOGENIC COMPOSITIONS	C07D 413/14 (2006.01)	2768822 *	DERIVATIVES OF 1-PHENYL-2- PYRIDINYL ALKYL ALCOHOLS AS PHOSPHODIESTERASE INHIBITORS
A61K 31/4985 (2006.01)	2763989 *	PYRIDINE COMPOUNDS AND USES THEREOF	C07D 417/12 (2006.01)	2768822 *	DERIVATIVES OF 1-PHENYL-2- PYRIDINYL ALKYL ALCOHOLS AS PHOSPHODIESTERASE INHIBITORS
A61P 25/00 (2006.01)	2763989 *	PYRIDINE COMPOUNDS AND USES THEREOF	C07D 417/14 (2006.01)	2768822 *	DERIVATIVES OF 1-PHENYL-2- PYRIDINYL ALKYL ALCOHOLS AS PHOSPHODIESTERASE INHIBITORS
C07D 471/14 (2006.01)	2763989 *	PYRIDINE COMPOUNDS AND USES THEREOF	C07D 417/14 (2006.01)	2768822 *	DERIVATIVES OF 1-PHENYL-2- PYRIDINYL ALKYL ALCOHOLS AS PHOSPHODIESTERASE INHIBITORS
A01N 43/54 (2006.01)	2713734 *	PESTICIDAL MIXTURES COMPRISING ISOXAZOLINE DERIVATIVES	C07D 471/04 (2006.01)	2768822 *	DERIVATIVES OF 1-PHENYL-2- PYRIDINYL ALKYL ALCOHOLS AS PHOSPHODIESTERASE INHIBITORS
A01N 43/56 (2006.01)	2713734 *	PESTICIDAL MIXTURES COMPRISING ISOXAZOLINE DERIVATIVES	C07D 473/04 (2006.01)	2768822 *	DERIVATIVES OF 1-PHENYL-2- PYRIDINYL ALKYL ALCOHOLS AS PHOSPHODIESTERASE INHIBITORS
A01N 43/653 (2006.01)	2713734 *	PESTICIDAL MIXTURES COMPRISING ISOXAZOLINE DERIVATIVES	A61M 5/24 (2006.01)	2731646 *	LOCKING INTERFACE, CARTRIDGE HOLDER AND DRUG DELIVERY DEVICE COMPRISING A LOCKING INTERFACE
A01N 43/80 (2006.01)	2713734 *	PESTICIDAL MIXTURES COMPRISING ISOXAZOLINE DERIVATIVES	A61M 5/315 (2006.01)	2731646 *	LOCKING INTERFACE, CARTRIDGE HOLDER AND DRUG DELIVERY DEVICE COMPRISING A LOCKING INTERFACE
A01P 3/00 (2006.01)	2713734 *	PESTICIDAL MIXTURES COMPRISING ISOXAZOLINE DERIVATIVES	A61K 47/48 (2006.01)	2710034 *	USE OF ANTI-CD19 MAYTANSINOID IMMUNOCONJUGATE ANTIBODY FOR THE TREATMENT OF B-CELL MALIGNANCIES SYMPTOMS
A61K 31/437 (2006.01)	2768822 *	DERIVATIVES OF 1-PHENYL-2- PYRIDINYL ALKYL ALCOHOLS AS PHOSPHODIESTERASE INHIBITORS	C07K 16/28 (2006.01)	2710034 *	USE OF ANTI-CD19 MAYTANSINOID IMMUNOCONJUGATE ANTIBODY FOR THE TREATMENT OF B-CELL MALIGNANCIES SYMPTOMS
A61K 31/4439 (2006.01)	2768822 *	DERIVATIVES OF 1-PHENYL-2- PYRIDINYL ALKYL ALCOHOLS AS PHOSPHODIESTERASE INHIBITORS			
A61K 31/498 (2006.01)	2768822 *	DERIVATIVES OF 1-PHENYL-2- PYRIDINYL ALKYL ALCOHOLS AS PHOSPHODIESTERASE INHIBITORS			
A61K 31/502 (2006.01)	2768822 *	DERIVATIVES OF 1-PHENYL-2- PYRIDINYL ALKYL ALCOHOLS AS PHOSPHODIESTERASE INHIBITORS			

MKP (51)	Broj objave evropske prijava patenta (97)	Naziv pronalaska (54)	MKP (51)	Broj objave evropske prijava patenta (97)	Naziv pronalaska (54)
A61K 31/535 (2006.01)	2768509 *	SUBSTITUTED BICYCLIC AZA-HETEROCYCLES AND ANALOGUES AS SIRTUIN MODULATORS	A47J 31/40 (2006.01)	2763574 *	COFFEE MACHINE AND A METHOD FOR INTRODUCING A QUANTITY OF BEANS
A61K 39/395 (2006.01)	2734546 *	APELIN ANTIGEN-BINDING PROTEINS AND USES THEREOF	A47J 31/42 (2006.01)	2763574 *	COFFEE MACHINE AND A METHOD FOR INTRODUCING A QUANTITY OF BEANS
C07K 16/22 (2006.01)	2734546 *	APELIN ANTIGEN-BINDING PROTEINS AND USES THEREOF	G06K 9/46 (2006.01)	2631845	Local feature amount calculating device, method of calculating local feature amount, corresponding point searching apparatus, and method of searching corresponding point
A61K 36/185 (2006.01)	2744504 *	METHOD FOR PRODUCING DRY EXTRACTS	A61K 31/77 (2006.01)	2701715 *	PROPHYLAXIS AND TREATMENT OF ENTEROPATHOGENIC BACTERIAL INFECTION
A61K 36/515 (2006.01)	2744504 *	METHOD FOR PRODUCING DRY EXTRACTS	B26F 1/00 (2006.01)	2739549 *	IMPROVEMENTS IN AND RELATING TO CORRUGATED BOARD AND THE MANUFACTURE THEREOF
A61K 36/70 (2006.01)	2744504 *	METHOD FOR PRODUCING DRY EXTRACTS	B31F 1/20 (2006.01)	2739549 *	IMPROVEMENTS IN AND RELATING TO CORRUGATED BOARD AND THE MANUFACTURE THEREOF
A61K 36/85 (2006.01)	2744504 *	METHOD FOR PRODUCING DRY EXTRACTS	B32B 3/00 (2006.01)	2739549 *	IMPROVEMENTS IN AND RELATING TO CORRUGATED BOARD AND THE MANUFACTURE THEREOF
A61P 11/12 (2006.01)	2744504 *	METHOD FOR PRODUCING DRY EXTRACTS	B32B 33/00 (2006.01)	2739549 *	IMPROVEMENTS IN AND RELATING TO CORRUGATED BOARD AND THE MANUFACTURE THEREOF
A61P 31/00 (2006.01)	2744504 *	METHOD FOR PRODUCING DRY EXTRACTS	B32B 38/04 (2006.01)	2739549 *	IMPROVEMENTS IN AND RELATING TO CORRUGATED BOARD AND THE MANUFACTURE THEREOF
A61K 9/16 (2006.01)	2701686 *	POROUS NANOPARTICLE- SUPPORTED LIPID BILAYERS (PROTOCELLS) FOR TARGETED DELIVERY AND METHODS OF USING SAME	B65D 81/24 (2006.01)	2739549 *	IMPROVEMENTS IN AND RELATING TO CORRUGATED BOARD AND THE MANUFACTURE THEREOF
A61K 38/17 (2006.01)	2701686 *	POROUS NANOPARTICLE- SUPPORTED LIPID BILAYERS (PROTOCELLS) FOR TARGETED DELIVERY AND METHODS OF USING SAME	B60C 3/00 (2006.01)	2736737 *	TIRE FOR SURFACE VEHICLE
A61K 47/30 (2006.01)	2701686 *	POROUS NANOPARTICLE- SUPPORTED LIPID BILAYERS (PROTOCELLS) FOR TARGETED DELIVERY AND METHODS OF USING SAME	B60C 13/00 (2006.01)	2736737 *	TIRE FOR SURFACE VEHICLE
A61K 47/48 (2006.01)	2701686 *	POROUS NANOPARTICLE- SUPPORTED LIPID BILAYERS (PROTOCELLS) FOR TARGETED DELIVERY AND METHODS OF USING SAME	G06Q 10/08 (2012.01)	2662813	Method for registering, inventory, managing, checking and monitoring of tangible and intangible rights and/ or goods
A61K 48/00 (2006.01)	2701686 *	POROUS NANOPARTICLE- SUPPORTED LIPID BILAYERS (PROTOCELLS) FOR TARGETED DELIVERY AND METHODS OF USING SAME	G01B 21/22 (2006.01)	2761250 *	POSITION SENSING DEVICE FOR TRANSIT SHAFT AND ARM ASSEMBLY
A61K 31/506 (2006.01)	2704722 *	MULTIPLE MYELOMA TREATMENT	A41B 13/06 (2006.01)	2736361 *	SWADDLING UNIT
A61P 35/00 (2006.01)	2704722 *	MULTIPLE MYELOMA TREATMENT	A41D 13/12 (2006.01)	2736361 *	SWADDLING UNIT
C12Q 1/68 (2006.01)	2702173 *	USE OF EMT GENE SIGNATURES IN CANCER DRUG DISCOVERY, DIAGNOSTICS, AND TREATMENT	A47D 15/00 (2006.01)	2736361 *	SWADDLING UNIT

MKP (51)	Broj objave evropske prijava patenta (97)	Naziv pronalaska (54)	MKP (51)	Broj objave evropske prijava patenta (97)	Naziv pronalaska (54)
A47G 9/08 (2006.01)	2736361 *	SWADDLING UNIT	A61K 9/08 (2006.01)	2702997 *	METHOD AND COMPOSITION FOR ENHANCING TARGET CELLS UPTAKE OF THERAPEUTIC AGENTS
A61K 31/437 (2006.01)	2710003 *	FUSED BICYCLIC KINASE INHIBITORS	A61K 9/127 (2006.01)	2702997 *	METHOD AND COMPOSITION FOR ENHANCING TARGET CELLS UPTAKE OF THERAPEUTIC AGENTS
A61K 31/4985 (2006.01)	2710003 *	FUSED BICYCLIC KINASE INHIBITORS	A61K 9/70 (2006.01)	2702997 *	METHOD AND COMPOSITION FOR ENHANCING TARGET CELLS UPTAKE OF THERAPEUTIC AGENTS
A61P 35/00 (2006.01)	2710003 *	FUSED BICYCLIC KINASE INHIBITORS	A61K 31/7048 (2006.01)	2702997 *	METHOD AND COMPOSITION FOR ENHANCING TARGET CELLS UPTAKE OF THERAPEUTIC AGENTS
C07D 471/04 (2006.01)	2710003 *	FUSED BICYCLIC KINASE INHIBITORS	A61K 31/724 (2006.01)	2702997 *	METHOD AND COMPOSITION FOR ENHANCING TARGET CELLS UPTAKE OF THERAPEUTIC AGENTS
C07D 487/04 (2006.01)	2710003 *	FUSED BICYCLIC KINASE INHIBITORS	A61K 38/17 (2006.01)	2702997 *	METHOD AND COMPOSITION FOR ENHANCING TARGET CELLS UPTAKE OF THERAPEUTIC AGENTS
A61K 31/70 (2006.01)	2707366 *	L-PROLINE AND CITRIC ACID CO-CRYSTALS OF (2S, 3R, 4R, 5S, 6R)-2-(3-((5-(4-FLUOROPHENYL)THIOPHEN-2-YL)METHYL)-4-METHYLPHENYL)-6-(HYDROXYMETHYL)TETRAHYDRO-2H-PYRAN-3,4,5-TRIOLE	A61K 39/395 (2006.01)	2702997 *	METHOD AND COMPOSITION FOR ENHANCING TARGET CELLS UPTAKE OF THERAPEUTIC AGENTS
C07D 409/10 (2006.01)	2707366 *	L-PROLINE AND CITRIC ACID CO-CRYSTALS OF (2S, 3R, 4R, 5S, 6R)-2-(3-((5-(4-FLUOROPHENYL)THIOPHEN-2-YL)METHYL)-4-METHYLPHENYL)-6-(HYDROXYMETHYL)TETRAHYDRO-2H-PYRAN-3,4,5-TRIOLE	A61P 35/00 (2006.01)	2702997 *	METHOD AND COMPOSITION FOR ENHANCING TARGET CELLS UPTAKE OF THERAPEUTIC AGENTS
C07H 7/04 (2006.01)	2707366 *	L-PROLINE AND CITRIC ACID CO-CRYSTALS OF (2S, 3R, 4R, 5S, 6R)-2-(3-((5-(4-FLUOROPHENYL)THIOPHEN-2-YL)METHYL)-4-METHYLPHENYL)-6-(HYDROXYMETHYL)TETRAHYDRO-2H-PYRAN-3,4,5-TRIOLE	A61P 43/00 (2006.01)	2702997 *	METHOD AND COMPOSITION FOR ENHANCING TARGET CELLS UPTAKE OF THERAPEUTIC AGENTS
A61K 8/04 (2006.01)	2723305 *	SOLID COSMETIC COMPOSITION HAVING DISPERSED THEREIN GAS BUBBLES	A61G 5/02 (2006.01)	2727568	Wheelchair, retrofit kit for a wheelchair and method for operating a wheelchair
E04H 3/12 (2006.01)	2623690	Tribune	A61G 5/10 (2006.01)	2727568	Wheelchair, retrofit kit for a wheelchair and method for operating a wheelchair
A61K 39/395 (2006.01)	2701741 *	DOSAGE REGIMEN FOR ADMINISTERING A CD19XCD3 BISPECIFIC ANTIBODY TO PATIENTS AT RISK FOR POTENTIAL ADVERSE EFFECTS	A61B 6/00 (2006.01)	2701605 *	3D TRACKING OF AN HDR SOURCE USING A FLAT PANEL DETECTOR
A61P 35/02 (2006.01)	2701741 *	DOSAGE REGIMEN FOR ADMINISTERING A CD19XCD3 BISPECIFIC ANTIBODY TO PATIENTS AT RISK FOR POTENTIAL ADVERSE EFFECTS	A61N 5/00 (2006.01)	2701605 *	3D TRACKING OF AN HDR SOURCE USING A FLAT PANEL DETECTOR
C07K 16/28 (2006.01)	2701741 *	DOSAGE REGIMEN FOR ADMINISTERING A CD19XCD3 BISPECIFIC ANTIBODY TO PATIENTS AT RISK FOR POTENTIAL ADVERSE EFFECTS	A61K 31/4375 (2006.01)	2742045 *	ANTIBACTERIAL CYCLOPENTA[C]PYRROLE SUBSTITUTED 3,4-DIHYDRO-1H-[1,8]NAPHTHYRIDINONES
			A61P 31/04 (2006.01)	2742045 *	ANTIBACTERIAL CYCLOPENTA[C]PYRROLE SUBSTITUTED 3,4-DIHYDRO-1H-[1,8]NAPHTHYRIDINONES
			C07D 471/04 (2006.01)	2742045 *	ANTIBACTERIAL CYCLOPENTA[C]PYRROLE SUBSTITUTED 3,4-DIHYDRO-1H-[1,8]NAPHTHYRIDINONES

MKP (51)	Broj objave evropske prijava patenta (97)	Naziv pronalaska (54)	MKP (51)	Broj objave evropske prijava patenta (97)	Naziv pronalaska (54)
C07D 487/04 (2006.01)	2742045 *	ANTIBACTERIAL CYCLOPENTA[C] PYRROLE SUBSTITUTED 3,4-DIHYDRO-1H-[1,8] NAPHTHYRIDINONES	C04B 35/472 (2006.01)	2706049	Composition for forming ferroelectric thin film, method for forming thin film and thin film formed using the same method
A61B 5/00 (2006.01)	2712425 *	OCULAR DETECTION OF AMYLOID PROTEINS	H01L 21/02 (2006.01)	2706049	Composition for forming ferroelectric thin film, method for forming thin film and thin film formed using the same method
G01N 33/68 (2006.01)	2712425 *	OCULAR DETECTION OF AMYLOID PROTEINS	C07K 16/40 (2006.01)	2714744 *	LYSYL OXIDASE-LIKE 2 ASSAY AND METHODS OF USE THEREOF
A61K 31/00 (2006.01)	2701690 *	METHOD OF TREATING LYMPHOMA USING PYRIDOPYRIMIDINONE INHIBITORS OF PI3K/MTOR	C07C 217/84 (2006.01)	2755944 *	ANILINE DERIVATIVES, THEIR PREPARATION AND THEIR THERAPEUTIC APPLICATION
A61K 31/519 (2006.01)	2701690 *	METHOD OF TREATING LYMPHOMA USING PYRIDOPYRIMIDINONE INHIBITORS OF PI3K/MTOR	A61K 31/4409 (2006.01)	2734204 *	POLYMORPHIC FORMS OF THE SODIUM SALT OF 4-TERT- BUTYL -N-[4-CHLORO- 2-(1-OXY-PYRIDINE-4- CARBONYL)-PHENYL]-BENZENE SULFONAMIDE
A61P 35/02 (2006.01)	2701690 *	METHOD OF TREATING LYMPHOMA USING PYRIDOPYRIMIDINONE INHIBITORS OF PI3K/MTOR	H04N 21/472 (2011.01)	2710807 *	METHOD AND SYSTEM FOR SEGMENTING AND TRANSMITTING ON-DEMAND LIVE-ACTION VIDEO IN REAL- TIME
C07D 487/04 (2006.01)	2753621 *	PROCESSES AND INTERMEDIATES FOR MAKING A JAK INHIBITOR	B01J 19/00 (2006.01)	2707130 *	SYNTHESIS GAS PROCESSING AND SYSTEM USING COPPER CATALYST IN TWO STEP REACTIONS AT475-525°C AND 250-290°C
C07D 491/10 (2006.01)	2753621 *	PROCESSES AND INTERMEDIATES FOR MAKING A JAK INHIBITOR	B01J 20/00 (2006.01)	2707130 *	SYNTHESIS GAS PROCESSING AND SYSTEM USING COPPER CATALYST IN TWO STEP REACTIONS AT475-525°C AND 250-290°C
B05D 1/42 (2006.01)	2707151 *	DEVICE TO REPRODUCE IMAGES OR GRAPHICAL PATTERNS IN GENERAL ON SURFACES, CORRESPONDING METHOD	B01J 21/00 (2006.01)	2707130 *	SYNTHESIS GAS PROCESSING AND SYSTEM USING COPPER CATALYST IN TWO STEP REACTIONS AT475-525°C AND 250-290°C
B41J 2/01 (2006.01)	2707151 *	DEVICE TO REPRODUCE IMAGES OR GRAPHICAL PATTERNS IN GENERAL ON SURFACES, CORRESPONDING METHOD	B01J 23/00 (2006.01)	2707130 *	SYNTHESIS GAS PROCESSING AND SYSTEM USING COPPER CATALYST IN TWO STEP REACTIONS AT475-525°C AND 250-290°C
G09F 19/22 (2006.01)	2707151 *	DEVICE TO REPRODUCE IMAGES OR GRAPHICAL PATTERNS IN GENERAL ON SURFACES, CORRESPONDING METHOD	C01B 3/16 (2006.01)	2707130 *	SYNTHESIS GAS PROCESSING AND SYSTEM USING COPPER CATALYST IN TWO STEP REACTIONS AT475-525°C AND 250-290°C
A61F 2/95 (2013.01)	2736459 *	DEVICE FOR THE PREDETERMINABLE ARRANGEMENT OF A STENT	C01B 3/18 (2006.01)	2707130 *	SYNTHESIS GAS PROCESSING AND SYSTEM USING COPPER CATALYST IN TWO STEP REACTIONS AT475-525°C AND 250-290°C
D04H 1/435 (2012.01)	2749679	CaCO ₃ in polyester for nonwoven and fibers	C01B 3/24 (2006.01)	2707130 *	SYNTHESIS GAS PROCESSING AND SYSTEM USING COPPER CATALYST IN TWO STEP REACTIONS AT475-525°C AND 250-290°C
A61K 31/496 (2006.01)	2720698 *	METHOD OF ADMINISTRATION OF 4-((1R,3S)-6-CHLORO-3- PHENYL-INDAN-1-YL)-1,2,2- TRIMETHYL-PIPERAZINE AND THE SALTS THEREOF IN THE TREATMENT OF SCHIZOPHRENIA			
A61P 25/18 (2006.01)	2720698 *	METHOD OF ADMINISTRATION OF 4-((1R,3S)-6-CHLORO-3- PHENYL-INDAN-1-YL)-1,2,2- TRIMETHYL-PIPERAZINE AND THE SALTS THEREOF IN THE TREATMENT OF SCHIZOPHRENIA			

MKP (51)	Broj objave evropske prijava patenta (97)	Naziv pronalaska (54)	MKP (51)	Broj objave evropske prijava patenta (97)	Naziv pronalaska (54)
C01B 31/20 (2006.01)	2707130 *	SYNTHESIS GAS PROCESSING AND SYSTEM USING COPPER CATALYST IN TWO STEP REACTIONS AT 475-525°C AND 250-290°C	C02F 1/48 (2006.01)	2704822 *	METHOD FOR PHYSICALLY WORKING AND/OR HEATING MEDIA, IN PARTICULAR LIQUIDS, AND DEVICE FOR CARRYING OUT THE METHOD
F24F 3/14 (2006.01)	2764296 *	APPARATUS AND METHOD FOR CONTROL OF SOLID DESICCANT DEHUMIDIFIERS	C07D 265/06 (2006.01)	2760845 *	HETEROCYCLIC COMPOUNDS AS MDM2 INHIBITORS FOR THE TREATMENT OF CANCER
F24F 11/00 (2006.01)	2764296 *	APPARATUS AND METHOD FOR CONTROL OF SOLID DESICCANT DEHUMIDIFIERS	C07D 413/04 (2006.01)	2760845 *	HETEROCYCLIC COMPOUNDS AS MDM2 INHIBITORS FOR THE TREATMENT OF CANCER
A61K 9/16 (2006.01)	2755638 *	TAMPER RESISTANT IMMEDIATE RELEASE FORMULATIONS	C07D 413/10 (2006.01)	2760845 *	HETEROCYCLIC COMPOUNDS AS MDM2 INHIBITORS FOR THE TREATMENT OF CANCER
A61K 9/20 (2006.01)	2755638 *	TAMPER RESISTANT IMMEDIATE RELEASE FORMULATIONS	C07D 413/12 (2006.01)	2760845 *	HETEROCYCLIC COMPOUNDS AS MDM2 INHIBITORS FOR THE TREATMENT OF CANCER
A61K 9/28 (2006.01)	2755638 *	TAMPER RESISTANT IMMEDIATE RELEASE FORMULATIONS	C07D 417/04 (2006.01)	2760845 *	HETEROCYCLIC COMPOUNDS AS MDM2 INHIBITORS FOR THE TREATMENT OF CANCER
A61K 9/48 (2006.01)	2755638 *	TAMPER RESISTANT IMMEDIATE RELEASE FORMULATIONS	A23L 1/29 (2006.01)	2765869 *	EGG PREPARATION WITH REGENERATING, ANALGESIC AND/OR ANTI-INFLAMMATORY PROPERTIES
A61K 9/50 (2006.01)	2755638 *	TAMPER RESISTANT IMMEDIATE RELEASE FORMULATIONS	A23L 1/30 (2006.01)	2765869 *	EGG PREPARATION WITH REGENERATING, ANALGESIC AND/OR ANTI-INFLAMMATORY PROPERTIES
A61K 31/485 (2006.01)	2755638 *	TAMPER RESISTANT IMMEDIATE RELEASE FORMULATIONS	A23L 1/32 (2006.01)	2765869 *	EGG PREPARATION WITH REGENERATING, ANALGESIC AND/OR ANTI-INFLAMMATORY PROPERTIES
A01N 25/00 (2006.01)	2709447 *	COMPOSITIONS, METHODS & SYSTEMS FOR RESPIRATORY DELIVERY OF TWO OR MORE ACTIVE AGENTS	A61K 35/00 (2006.01)	2765869 *	EGG PREPARATION WITH REGENERATING, ANALGESIC AND/OR ANTI-INFLAMMATORY PROPERTIES
A61K 9/72 (2006.01)	2709447 *	COMPOSITIONS, METHODS & SYSTEMS FOR RESPIRATORY DELIVERY OF TWO OR MORE ACTIVE AGENTS	A61K 9/00 (2006.01)	2726059 *	TOPICAL OPHTHALMOLOGICAL PHARMACEUTICAL COMPOSITION CONTAINING REGORAFENIB
A61L 9/02 (2006.01)	2709447 *	COMPOSITIONS, METHODS & SYSTEMS FOR RESPIRATORY DELIVERY OF TWO OR MORE ACTIVE AGENTS	A61K 31/4412 (2006.01)	2726059 *	TOPICAL OPHTHALMOLOGICAL PHARMACEUTICAL COMPOSITION CONTAINING REGORAFENIB
G01D 5/34 (2006.01)	2702415 *	METHOD FOR SENSING AND SENSOR	A61K 47/02 (2006.01)	2726059 *	TOPICAL OPHTHALMOLOGICAL PHARMACEUTICAL COMPOSITION CONTAINING REGORAFENIB
G01P 1/02 (2006.01)	2702415 *	METHOD FOR SENSING AND SENSOR	A61K 47/06 (2006.01)	2726059 *	TOPICAL OPHTHALMOLOGICAL PHARMACEUTICAL COMPOSITION CONTAINING REGORAFENIB
G01P 15/08 (2006.01)	2702415 *	METHOD FOR SENSING AND SENSOR	A61K 47/14 (2006.01)	2726059 *	TOPICAL OPHTHALMOLOGICAL PHARMACEUTICAL COMPOSITION CONTAINING REGORAFENIB
G01P 15/093 (2006.01)	2702415 *	METHOD FOR SENSING AND SENSOR	A61K 47/26 (2006.01)	2726059 *	TOPICAL OPHTHALMOLOGICAL PHARMACEUTICAL COMPOSITION CONTAINING REGORAFENIB
A47F 5/08 (2006.01)	2708163 *	DEVICE FOR HANGING UP A DISPLAY PANEL			
B01J 19/12 (2006.01)	2704822 *	METHOD FOR PHYSICALLY WORKING AND/OR HEATING MEDIA, IN PARTICULAR LIQUIDS, AND DEVICE FOR CARRYING OUT THE METHOD			

MKP (51)	Broj objave evropske prijava patenta (97)	Naziv pronalaska (54)	MKP (51)	Broj objave evropske prijava patenta (97)	Naziv pronalaska (54)
A61K 47/38 (2006.01)	2726059 *	TOPICAL OPHTHALMOLOGICAL PHARMACEUTICAL COMPOSITION CONTAINING REGORAFENIB	A23L 1/00 (2006.01)	2763552 *	WHIPPING AGENT FOR FOOD PRODUCTS AND USE THEREOF
A61K 31/33 (2006.01)	2704706 *	COMPOSITION COMPRISING ANGIOTENSIN II RECEPTOR ANTAGONIST AND ANTIOXIDANT FOR MAINTAINING AND/OR IMPROVING SKIN PROPERTIES	A23L 1/035 (2006.01)	2763552 *	WHIPPING AGENT FOR FOOD PRODUCTS AND USE THEREOF
F23C 9/08 (2006.01)	2295859	Waste incineration plant with introduction of cooling gas	A23L 1/19 (2006.01)	2763552 *	WHIPPING AGENT FOR FOOD PRODUCTS AND USE THEREOF
F23H 17/00 (2006.01)	2295859	Waste incineration plant with introduction of cooling gas	A61K 31/4418 (2006.01)	2726460 *	COMPOUNDS FOR THE TREATMENT OF ADDICTION
F23H 17/08 (2006.01)	2295859	Waste incineration plant with introduction of cooling gas	A61P 25/30 (2006.01)	2726460 *	COMPOUNDS FOR THE TREATMENT OF ADDICTION
F23L 7/00 (2006.01)	2295859	Waste incineration plant with introduction of cooling gas	A61P 25/32 (2006.01)	2726460 *	COMPOUNDS FOR THE TREATMENT OF ADDICTION
F23L 9/06 (2006.01)	2295859	Waste incineration plant with introduction of cooling gas	A61P 25/34 (2006.01)	2726460 *	COMPOUNDS FOR THE TREATMENT OF ADDICTION
F23M 5/08 (2006.01)	2295859	Waste incineration plant with introduction of cooling gas	A61P 25/36 (2006.01)	2726460 *	COMPOUNDS FOR THE TREATMENT OF ADDICTION
A61K 31/70 (2006.01)	2763682 *	CHOLINE COMPOSITION	C07D 213/64 (2006.01)	2726460 *	COMPOUNDS FOR THE TREATMENT OF ADDICTION
E01F 9/03 (2006.01)	2518213	Holding device	G01S 19/09 (2010.01)	2715401 *	HYBRID POSITIONING USING SYNCHRONOUS AND ASYNCHRONOUS TECHNIQUES
A61K 9/14 (2006.01)	2768537 *	ACRYLIC POLYMER FORMULATIONS	G01S 19/46 (2010.01)	2715401 *	HYBRID POSITIONING USING SYNCHRONOUS AND ASYNCHRONOUS TECHNIQUES
A61K 9/16 (2006.01)	2768537 *	ACRYLIC POLYMER FORMULATIONS	C07D 491/20 (2006.01)	2733145	Synthetic methods for spiro-oxindole compounds
A61K 9/20 (2006.01)	2768537 *	ACRYLIC POLYMER FORMULATIONS	A61L 2/00 (2006.01)	2732020 *	VIRUS FILTRATION OF CELL CULTURE MEDIA
A61K 31/485 (2006.01)	2768537 *	ACRYLIC POLYMER FORMULATIONS	C12M 1/00 (2006.01)	2732020 *	VIRUS FILTRATION OF CELL CULTURE MEDIA
A61K 47/32 (2006.01)	2768537 *	ACRYLIC POLYMER FORMULATIONS	C12M 1/12 (2006.01)	2732020 *	VIRUS FILTRATION OF CELL CULTURE MEDIA
C02F 3/12 (2006.01)	2766313 *	SMALL INSTALLATION FOR BIOLOGICAL WASTEWATER TREATMENT WITH IMPROVED EFFICIENCY	C12N 5/00 (2006.01)	2732020 *	VIRUS FILTRATION OF CELL CULTURE MEDIA
C02F 3/30 (2006.01)	2766313 *	SMALL INSTALLATION FOR BIOLOGICAL WASTEWATER TREATMENT WITH IMPROVED EFFICIENCY	G01N 33/68 (2006.01)	2748612 *	IMPROVED VACCINE DIAGNOSTICS
A23G 9/38 (2006.01)	2763552 *	WHIPPING AGENT FOR FOOD PRODUCTS AND USE THEREOF	C12N 15/09 (2006.01)	2742132 *	MATRIX AND METHOD FOR PURIFYING AND/OR ISOLATING NUCLEIC ACIDS
A23J 3/14 (2006.01)	2763552 *	WHIPPING AGENT FOR FOOD PRODUCTS AND USE THEREOF	G01N 33/569 (2006.01)	2718722 *	PROTEOMICS BASED DIAGNOSTIC DETECTION METHOD FOR CHRONIC SINUSITIS

MKP (51)	Broj objave evropske prijava patenta (97)	Naziv pronalaska (54)	MKP (51)	Broj objave evropske prijava patenta (97)	Naziv pronalaska (54)
G01N 33/68 (2006.01)	2718722 *	PROTEOMICS BASED DIAGNOSTIC DETECTION METHOD FOR CHRONIC SINUSITIS	B01F 3/04 (2006.01)	2739379 *	A WINE DECANTER DEVICE
A61F 13/02 (2006.01)	2713972 *	ROLLED COLLAGEN CARRIER	E21B 23/10 (2006.01)	2766560 *	DOWNHOLE ACTUATION BALL, METHODS AND APPARATUS
B41J 2/315 (2006.01)	2714411 *	METHODS AND SYSTEMS FOR THERMAL PRINTING OF PHOTONIC CRYSTAL MATERIALS, AND THERMALLY PRINTABLE PHOTONIC CRYSTAL MATERIALS AND ASSEMBLIES	E21B 34/14 (2006.01)	2766560 *	DOWNHOLE ACTUATION BALL, METHODS AND APPARATUS
B41J 2/475 (2006.01)	2714411 *	METHODS AND SYSTEMS FOR THERMAL PRINTING OF PHOTONIC CRYSTAL MATERIALS, AND THERMALLY PRINTABLE PHOTONIC CRYSTAL MATERIALS AND ASSEMBLIES	G06F 17/30 (2006.01)	2706467	Method for accessing a content item in a cloud storage system, and a corresponding cloud broker, cloud cache agent and client application
B41M 3/00 (2006.01)	2714411 *	METHODS AND SYSTEMS FOR THERMAL PRINTING OF PHOTONIC CRYSTAL MATERIALS, AND THERMALLY PRINTABLE PHOTONIC CRYSTAL MATERIALS AND ASSEMBLIES	G01R 15/18 (2006.01)	2761309 *	CONTACTLESS CURRENT SENSOR
B41M 3/06 (2006.01)	2714411 *	METHODS AND SYSTEMS FOR THERMAL PRINTING OF PHOTONIC CRYSTAL MATERIALS, AND THERMALLY PRINTABLE PHOTONIC CRYSTAL MATERIALS AND ASSEMBLIES	C07B 59/00 (2006.01)	2721039 *	CHELATED PSMA INHIBITORS
B41M 3/14 (2006.01)	2714411 *	METHODS AND SYSTEMS FOR THERMAL PRINTING OF PHOTONIC CRYSTAL MATERIALS, AND THERMALLY PRINTABLE PHOTONIC CRYSTAL MATERIALS AND ASSEMBLIES	C07F 9/24 (2006.01)	2721039 *	CHELATED PSMA INHIBITORS
B41M 3/14 (2006.01)	2714411 *	METHODS AND SYSTEMS FOR THERMAL PRINTING OF PHOTONIC CRYSTAL MATERIALS, AND THERMALLY PRINTABLE PHOTONIC CRYSTAL MATERIALS AND ASSEMBLIES	C07F 9/6515 (2006.01)	2721039 *	CHELATED PSMA INHIBITORS
C08J 3/24 (2006.01)	2714411 *	METHODS AND SYSTEMS FOR THERMAL PRINTING OF PHOTONIC CRYSTAL MATERIALS, AND THERMALLY PRINTABLE PHOTONIC CRYSTAL MATERIALS AND ASSEMBLIES	C07F 9/6524 (2006.01)	2721039 *	CHELATED PSMA INHIBITORS
G02B 1/02 (2006.01)	2714411 *	METHODS AND SYSTEMS FOR THERMAL PRINTING OF PHOTONIC CRYSTAL MATERIALS, AND THERMALLY PRINTABLE PHOTONIC CRYSTAL MATERIALS AND ASSEMBLIES	C07F 9/6527 (2006.01)	2721039 *	CHELATED PSMA INHIBITORS
A01N 37/18 (2006.01)	2747569 *	COMBINATION TREATMENTS FOR HEPATITIS C	C07F 9/6558 (2006.01)	2721039 *	CHELATED PSMA INHIBITORS
A01N 43/38 (2006.01)	2747569 *	COMBINATION TREATMENTS FOR HEPATITIS C	C07F 9/6561 (2006.01)	2721039 *	CHELATED PSMA INHIBITORS
A61K 31/40 (2006.01)	2747569 *	COMBINATION TREATMENTS FOR HEPATITIS C	A61K 31/4365 (2006.01)	2755979 *	PHASED DOSING OF CLOPIDOGREL
A61P 1/16 (2006.01)	2747569 *	COMBINATION TREATMENTS FOR HEPATITIS C	C07D 495/04 (2006.01)	2755979 *	PHASED DOSING OF CLOPIDOGREL
A47G 23/00 (2006.01)	2739379 *	A WINE DECANTER DEVICE	H01F 7/16 (2006.01)	2754159 *	MAGNET DEVICE
			H02K 33/16 (2006.01)	2754159 *	MAGNET DEVICE
			A61K 31/5513 (2006.01)	2707370 *	NOVEL ANTIFUNGAL 5,6-DIHYDRO-4H-PYRROLO[1,2-a] [1,4]BENZO-DIAZEPINES AND 6H-PYRROLO[1,2-a] [1,4]BENZODIAZEPINES SUBSTITUTED WITH HETEROCYCLIC DERIVATIVES

MKP (51)	Broj objave evropske prijava patenta (97)	Naziv pronalaska (54)	MKP (51)	Broj objave evropske prijava patenta (97)	Naziv pronalaska (54)
C07D 487/04 (2006.01)	2707370 *	NOVEL ANTIFUNGAL 5,6-DIHYDRO-4H-PYRROLO[1,2-a] [1,4]BENZO-DIAZEPINES AND 6H-PYRROLO[1,2-a] [1,4]BENZODIAZEPINES SUBSTITUTED WITH HETEROCYCLIC DERIVATIVES	A61P 25/22 (2006.01)	2421534 *	LIQUID FORMULATIONS OF SALTS OF 1-[2-(2,4-DIMETHYLPHENYLSULFANYL) PHENYL]PIPERAZINE
E04F 15/22 (2006.01)	2642275	Device for measuring the comfort index of indoor sports surfaces after the impact of a force on the surface	A61P 25/24 (2006.01)	2421534 *	LIQUID FORMULATIONS OF SALTS OF 1-[2-(2,4-DIMETHYLPHENYLSULFANYL) PHENYL]PIPERAZINE
G01N 3/30 (2006.01)	2642275	Device for measuring the comfort index of indoor sports surfaces after the impact of a force on the surface	A61P 25/28 (2006.01)	2421534 *	LIQUID FORMULATIONS OF SALTS OF 1-[2-(2,4-DIMETHYLPHENYLSULFANYL) PHENYL]PIPERAZINE
G01N 3/42 (2006.01)	2642275	Device for measuring the comfort index of indoor sports surfaces after the impact of a force on the surface	A61K 39/395 (2006.01)	2753357 *	USE OF C-MET PROTEIN FOR PREDICTING THE EFFICACY OF ANTI-HEPATOCTE GROWTH FACTOR ("HGF") ANTIBODIES IN ESOPHAGEAL AND GASTRIC CANCER PATIENTS
G01N 3/48 (2006.01)	2642275	Device for measuring the comfort index of indoor sports surfaces after the impact of a force on the surface	G01N 33/574 (2006.01)	2753357 *	USE OF C-MET PROTEIN FOR PREDICTING THE EFFICACY OF ANTI-HEPATOCTE GROWTH FACTOR ("HGF") ANTIBODIES IN ESOPHAGEAL AND GASTRIC CANCER PATIENTS
B65H 75/36 (2006.01)	2404857	Storage container, subterranean cable storage and system for subterranean positioning of a cable storage	G01N 33/68 (2006.01)	2753357 *	USE OF C-MET PROTEIN FOR PREDICTING THE EFFICACY OF ANTI-HEPATOCTE GROWTH FACTOR ("HGF") ANTIBODIES IN ESOPHAGEAL AND GASTRIC CANCER PATIENTS
H02G 1/06 (2006.01)	2404857	Storage container, subterranean cable storage and system for subterranean positioning of a cable storage	A61K 48/00 (2006.01)	2753364 *	A CONDITIONAL REPLICATING CYTOMEGALOVIRUS AS A VACCINE FOR CMV
A61K 39/395 (2006.01)	2707390 *	ANTIBODIES FOR TREATMENT OF CANCER EXPRESSING CLAUDIN 6	C07H 21/04 (2006.01)	2753364 *	A CONDITIONAL REPLICATING CYTOMEGALOVIRUS AS A VACCINE FOR CMV
C07K 16/30 (2006.01)	2707390 *	ANTIBODIES FOR TREATMENT OF CANCER EXPRESSING CLAUDIN 6	A61K 31/454 (2006.01)	2692346	An antiviral 1-phenyl-2,5- dibenzimidazol-5-yl-pyrrolidine derivative
A01K 67/027 (2006.01)	2757875 *	MANIPULATION OF IMMUNOGLOBULIN GENE DIVERSITY AND MULTI- ANTIBODY THERAPEUTICS	A61P 31/14 (2006.01)	2692346	An antiviral 1-phenyl-2,5- dibenzimidazol-5-yl-pyrrolidine derivative
C07K 16/46 (2006.01)	2757875 *	MANIPULATION OF IMMUNOGLOBULIN GENE DIVERSITY AND MULTI- ANTIBODY THERAPEUTICS	A43B 21/08 (2006.01)	2641497	Method for producing a leather shoe upper that is adaptable to foot deformations
C12N 15/85 (2006.01)	2757875 *	MANIPULATION OF IMMUNOGLOBULIN GENE DIVERSITY AND MULTI- ANTIBODY THERAPEUTICS	A43B 23/02 (2006.01)	2641497	Method for producing a leather shoe upper that is adaptable to foot deformations
G06F 3/01 (2006.01)	2715487 *	METHOD AND APPARATUS FOR CLASSIFYING MULTIPLE DEVICE STATES	A43D 8/00 (2006.01)	2641497	Method for producing a leather shoe upper that is adaptable to foot deformations
G06F 3/033 (2013.01)	2715487 *	METHOD AND APPARATUS FOR CLASSIFYING MULTIPLE DEVICE STATES	A43D 11/00 (2006.01)	2641497	Method for producing a leather shoe upper that is adaptable to foot deformations
A61K 9/08 (2006.01)	2421534 *	LIQUID FORMULATIONS OF SALTS OF 1-[2-(2,4-DIMETHYLPHENYLSULFANYL) PHENYL]PIPERAZINE	E01F 7/04 (2006.01)	2650558	Energy dissipation device for protecting structures or the like
A61K 31/495 (2006.01)	2421534 *	LIQUID FORMULATIONS OF SALTS OF 1-[2-(2,4-DIMETHYLPHENYLSULFANYL) PHENYL]PIPERAZINE	F16F 7/12 (2006.01)	2650558	Energy dissipation device for protecting structures or the like
A61P 25/00 (2006.01)	2421534 *	LIQUID FORMULATIONS OF SALTS OF 1-[2-(2,4-DIMETHYLPHENYLSULFANYL) PHENYL]PIPERAZINE	A61K 31/42 (2006.01)	2731676 *	NOVEL FXR (NR1H4) BINDING AND ACTIVITY MODULATING COMPOUNDS

MKP (51)	Broj objave evropske prijava patenta (97)	Naziv pronalaska (54)	MKP (51)	Broj objave evropske prijava patenta (97)	Naziv pronalaska (54)
A61P 1/16 (2006.01)	2731676 *	NOVEL FXR (NR1H4) BINDING AND ACTIVITY MODULATING COMPOUNDS	E04H 12/08 (2006.01)	2718519 *	WIND ENERGY PLANT TOWER
A61P 3/10 (2006.01)	2731676 *	NOVEL FXR (NR1H4) BINDING AND ACTIVITY MODULATING COMPOUNDS	F03D 11/04 (2006.01)	2718519 *	WIND ENERGY PLANT TOWER
A61P 35/00 (2006.01)	2731676 *	NOVEL FXR (NR1H4) BINDING AND ACTIVITY MODULATING COMPOUNDS	A01N 37/50 (2006.01)	2713754 *	AGRICULTURAL OR HORTICULTURAL FUNGICIDE COMPOSITION AND METHOD FOR CONTROLLING PLANT PATHOGEN
C07D 261/08 (2006.01)	2731676 *	NOVEL FXR (NR1H4) BINDING AND ACTIVITY MODULATING COMPOUNDS	A01N 43/16 (2006.01)	2713754 *	AGRICULTURAL OR HORTICULTURAL FUNGICIDE COMPOSITION AND METHOD FOR CONTROLLING PLANT PATHOGEN
C07D 413/12 (2006.01)	2731676 *	NOVEL FXR (NR1H4) BINDING AND ACTIVITY MODULATING COMPOUNDS	A01N 43/40 (2006.01)	2713754 *	AGRICULTURAL OR HORTICULTURAL FUNGICIDE COMPOSITION AND METHOD FOR CONTROLLING PLANT PATHOGEN
C07D 413/14 (2006.01)	2731676 *	NOVEL FXR (NR1H4) BINDING AND ACTIVITY MODULATING COMPOUNDS	A01N 43/50 (2006.01)	2713754 *	AGRICULTURAL OR HORTICULTURAL FUNGICIDE COMPOSITION AND METHOD FOR CONTROLLING PLANT PATHOGEN
A23L 1/30 (2006.01)	2719288	COMPOSITION FOR THE TREATMENT OR PREVENTION OF DYSLIPIDAEMIAS	A01N 43/50 (2006.01)	2713754 *	AGRICULTURAL OR HORTICULTURAL FUNGICIDE COMPOSITION AND METHOD FOR CONTROLLING PLANT PATHOGEN
A61K 45/00 (2006.01)	2719288	COMPOSITION FOR THE TREATMENT OR PREVENTION OF DYSLIPIDAEMIAS	A01N 43/56 (2006.01)	2713754 *	AGRICULTURAL OR HORTICULTURAL FUNGICIDE COMPOSITION AND METHOD FOR CONTROLLING PLANT PATHOGEN
A61K 38/26 (2006.01)	2714070 *	LONG-ACTING GLP-1/GLUCAGON RECEPTOR AGONISTS	A01N 43/76 (2006.01)	2713754 *	AGRICULTURAL OR HORTICULTURAL FUNGICIDE COMPOSITION AND METHOD FOR CONTROLLING PLANT PATHOGEN
A61P 3/10 (2006.01)	2714070 *	LONG-ACTING GLP-1/GLUCAGON RECEPTOR AGONISTS	A01N 43/88 (2006.01)	2713754 *	AGRICULTURAL OR HORTICULTURAL FUNGICIDE COMPOSITION AND METHOD FOR CONTROLLING PLANT PATHOGEN
A61P 7/12 (2006.01)	2714070 *	LONG-ACTING GLP-1/GLUCAGON RECEPTOR AGONISTS	A01N 47/24 (2006.01)	2713754 *	AGRICULTURAL OR HORTICULTURAL FUNGICIDE COMPOSITION AND METHOD FOR CONTROLLING PLANT PATHOGEN
C07K 14/605 (2006.01)	2714070 *	LONG-ACTING GLP-1/GLUCAGON RECEPTOR AGONISTS	A01P 3/00 (2006.01)	2713754 *	AGRICULTURAL OR HORTICULTURAL FUNGICIDE COMPOSITION AND METHOD FOR CONTROLLING PLANT PATHOGEN
H02J 1/08 (2006.01)	2751894 *	WALL BOX DEVICE FOR MANAGING ENERGY	A61K 38/18 (2006.01)	2720710 *	FREEZE-DRIED FORMULATIONS OF FGF-18
A61K 31/21 (2006.01)	2707354 *	QUINONE BASED NITRIC OXIDE DONATING COMPOUNDS	A61K 9/00 (2006.01)	2704687 *	A TOPICAL FORMULATION COMPRISING A CORTICOSTEROID AS ACTIVE INGREDIENT
A61P 9/08 (2006.01)	2707354 *	QUINONE BASED NITRIC OXIDE DONATING COMPOUNDS	A61K 9/12 (2006.01)	2704687 *	A TOPICAL FORMULATION COMPRISING A CORTICOSTEROID AS ACTIVE INGREDIENT
C07C 203/04 (2006.01)	2707354 *	QUINONE BASED NITRIC OXIDE DONATING COMPOUNDS			
C07C 203/08 (2006.01)	2707354 *	QUINONE BASED NITRIC OXIDE DONATING COMPOUNDS			
C07H 21/00 (2006.01)	2632494 *	METHODS AND COMPOSITIONS FOR ASSESSING AND TREATING CANCER			
C07K 14/00 (2006.01)	2632494 *	METHODS AND COMPOSITIONS FOR ASSESSING AND TREATING CANCER			
G01N 33/48 (2006.01)	2632494 *	METHODS AND COMPOSITIONS FOR ASSESSING AND TREATING CANCER			

MKP (51)	Broj objave evropske prijava patenta (97)	Naziv pronalaska (54)	MKP (51)	Broj objave evropske prijava patenta (97)	Naziv pronalaska (54)
A61K 31/573 (2006.01)	2704687 *	A TOPICAL FORMULATION COMPRISING A CORTICOSTEROID AS ACTIVE INGREDIENT	A61M 39/10 (2006.01)	2731663 *	DUAL-VALVE CONTRAST FLUID DELIVERY SYSTEM
A61K 47/10 (2006.01)	2704687 *	A TOPICAL FORMULATION COMPRISING A CORTICOSTEROID AS ACTIVE INGREDIENT	A61M 39/24 (2006.01)	2731663 *	DUAL-VALVE CONTRAST FLUID DELIVERY SYSTEM
A61K 47/18 (2006.01)	2704687 *	A TOPICAL FORMULATION COMPRISING A CORTICOSTEROID AS ACTIVE INGREDIENT	A61M 39/26 (2006.01)	2731663 *	DUAL-VALVE CONTRAST FLUID DELIVERY SYSTEM
A61K 47/26 (2006.01)	2704687 *	A TOPICAL FORMULATION COMPRISING A CORTICOSTEROID AS ACTIVE INGREDIENT	C12N 15/11 (2006.01)	2721181 *	METHODS AND MATERIALS FOR ASSESSING ALLELIC IMBALANCE
A61K 47/36 (2006.01)	2704687 *	A TOPICAL FORMULATION COMPRISING A CORTICOSTEROID AS ACTIVE INGREDIENT	C12Q 1/68 (2006.01)	2721181 *	METHODS AND MATERIALS FOR ASSESSING ALLELIC IMBALANCE
G06Q 50/10 (2012.01)	2761571 *	LOCATION BASED AUGMENTED REALITY SYSTEM FOR EXCHANGE OF ITEMS BASED ON LOCATION SENSING AND METHODS AND DEVICES RELATED THERETO	A61K 31/47 (2006.01)	2704717 *	METHOD OF TREATING CANCER AND BONE CANCER PAIN
H04W 4/02 (2009.01)	2761571 *	LOCATION BASED AUGMENTED REALITY SYSTEM FOR EXCHANGE OF ITEMS BASED ON LOCATION SENSING AND METHODS AND DEVICES RELATED THERETO	A61P 35/00 (2006.01)	2704717 *	METHOD OF TREATING CANCER AND BONE CANCER PAIN
H04L 29/08 (2006.01)	2704398	A method for content change notification in a cloud storage system, a corresponding cloud broker and cloud agent	A61P 3/06 (2006.01)	2756004 *	METHODS FOR REDUCING LIPOPROTEIN(a) LEVELS BY ADMINISTERING AN INHIBITOR OF PROPROTEIN CONVERTASE SUBTILISIN KEXIN-9 (PCSK9)
B65D 5/32 (2006.01)	2731880 *	PRODUCT CARTON AND METHOD FOR FORMING SAME	C07K 16/40 (2006.01)	2756004 *	METHODS FOR REDUCING LIPOPROTEIN(a) LEVELS BY ADMINISTERING AN INHIBITOR OF PROPROTEIN CONVERTASE SUBTILISIN KEXIN-9 (PCSK9)
A61K 31/4523 (2006.01)	2709620 *	USE OF SIGMA LIGANDS IN DIABETES TYPE-2 ASSOCIATED PAIN	B29C 45/16 (2006.01)	2718088 *	HOLLOW OBJECTS, IN PARTICULAR PLASTIC PREFORMS HAVING A BARRIER LAYER AND METHOD OF INJECTION MOULDING THE OBJECTS AND APPARATUS FOR MANUFACTURING THE OBJECTS
A61K 31/4725 (2006.01)	2709620 *	USE OF SIGMA LIGANDS IN DIABETES TYPE-2 ASSOCIATED PAIN	B29C 45/18 (2006.01)	2718088 *	HOLLOW OBJECTS, IN PARTICULAR PLASTIC PREFORMS HAVING A BARRIER LAYER AND METHOD OF INJECTION MOULDING THE OBJECTS AND APPARATUS FOR MANUFACTURING THE OBJECTS
A61K 31/496 (2006.01)	2709620 *	USE OF SIGMA LIGANDS IN DIABETES TYPE-2 ASSOCIATED PAIN	B29C 49/00 (2006.01)	2718088 *	HOLLOW OBJECTS, IN PARTICULAR PLASTIC PREFORMS HAVING A BARRIER LAYER AND METHOD OF INJECTION MOULDING THE OBJECTS AND APPARATUS FOR MANUFACTURING THE OBJECTS
A61K 31/5377 (2006.01)	2709620 *	USE OF SIGMA LIGANDS IN DIABETES TYPE-2 ASSOCIATED PAIN	B29C 49/22 (2006.01)	2718088 *	HOLLOW OBJECTS, IN PARTICULAR PLASTIC PREFORMS HAVING A BARRIER LAYER AND METHOD OF INJECTION MOULDING THE OBJECTS AND APPARATUS FOR MANUFACTURING THE OBJECTS
A61P 25/02 (2006.01)	2709620 *	USE OF SIGMA LIGANDS IN DIABETES TYPE-2 ASSOCIATED PAIN			
A61K 31/5025 (2006.01)	2758401 *	AMINO-SUBSTITUTED IMIDAZOPYRIDAZINES			
A61P 35/00 (2006.01)	2758401 *	AMINO-SUBSTITUTED IMIDAZOPYRIDAZINES			
C07D 487/04 (2006.01)	2758401 *	AMINO-SUBSTITUTED IMIDAZOPYRIDAZINES			

MKP (51)	Broj objave evropske prijava patenta (97)	Naziv pronalaska (54)	MKP (51)	Broj objave evropske prijava patenta (97)	Naziv pronalaska (54)
B65D 81/24 (2006.01)	2718088 *	HOLLOW OBJECTS, IN PARTICULAR PLASTIC PREFORMS HAVING A BARRIER LAYER AND METHOD OF INJECTION MOULDING THE OBJECTS AND APPARATUS FOR MANUFACTURING THE OBJECTS	A61K 31/422 (2006.01)	2760841 *	PYRAZOLOQUINOLINONE DERIVATIVES, PREPARATION THEREOF AND THERAPEUTIC USE THEREOF
B65D 81/26 (2006.01)	2718088 *	HOLLOW OBJECTS, IN PARTICULAR PLASTIC PREFORMS HAVING A BARRIER LAYER AND METHOD OF INJECTION MOULDING THE OBJECTS AND APPARATUS FOR MANUFACTURING THE OBJECTS	A61P 35/00 (2006.01)	2760841 *	PYRAZOLOQUINOLINONE DERIVATIVES, PREPARATION THEREOF AND THERAPEUTIC USE THEREOF
B65D 81/30 (2006.01)	2718088 *	HOLLOW OBJECTS, IN PARTICULAR PLASTIC PREFORMS HAVING A BARRIER LAYER AND METHOD OF INJECTION MOULDING THE OBJECTS AND APPARATUS FOR MANUFACTURING THE OBJECTS	C07C 229/40 (2006.01)	2760841 *	PYRAZOLOQUINOLINONE DERIVATIVES, PREPARATION THEREOF AND THERAPEUTIC USE THEREOF
B01L 3/00 (2006.01)	2748583 *	CUVETTE	C07D 231/14 (2006.01)	2760841 *	PYRAZOLOQUINOLINONE DERIVATIVES, PREPARATION THEREOF AND THERAPEUTIC USE THEREOF
B01L 9/00 (2006.01)	2748583 *	CUVETTE	C07D 471/04 (2006.01)	2760841 *	PYRAZOLOQUINOLINONE DERIVATIVES, PREPARATION THEREOF AND THERAPEUTIC USE THEREOF
G01N 21/03 (2006.01)	2748583 *	CUVETTE	A47K 10/36 (2006.01)	2266448	Device for output of sections of paper strip
G06F 9/50 (2006.01)	2685697	A METHOD TO OBTAIN A VIRTUAL DESKTOP STORED IN A CLOUD STORAGE SYSTEM, A CORRESPONDING CLOUD BROKER AND CLOUD DESKTOP AGENT	E04B 2/74 (2006.01)	2639376	Roll-up and unrollable closure, with a reinforced stretched bottom
H04L 29/08 (2006.01)	2685697	A METHOD TO OBTAIN A VIRTUAL DESKTOP STORED IN A CLOUD STORAGE SYSTEM, A CORRESPONDING CLOUD BROKER AND CLOUD DESKTOP AGENT	E04H 17/00 (2006.01)	2639376	Roll-up and unrollable closure, with a reinforced stretched bottom
H04W 4/00 (2009.01)	2685697	A METHOD TO OBTAIN A VIRTUAL DESKTOP STORED IN A CLOUD STORAGE SYSTEM, A CORRESPONDING CLOUD BROKER AND CLOUD DESKTOP AGENT	E05D 7/04 (2006.01)	2761116 *	HEIGHT ADJUSTMENT DEVICE FOR TRANSIT SHAFT AND ARM ASSEMBLY
A61K 38/05 (2006.01)	2736920 *	NOTCH PATHWAY SIGNALING INHIBITOR COMPOUND	G03F 7/20 (2006.01)	2721447 *	PROCEDURE OF 2D AND 3D OPTICALLY ASSISTED FOUNTAIN PEN NANOLITHOGRAPHY AND APERTURE PEN NANOLITHOGRAPHY
A61P 35/00 (2006.01)	2736920 *	NOTCH PATHWAY SIGNALING INHIBITOR COMPOUND	B01D 17/02 (2006.01)	2623174	Precipitator
A61P 35/02 (2006.01)	2736920 *	NOTCH PATHWAY SIGNALING INHIBITOR COMPOUND	C02F 1/40 (2006.01)	2623174	Precipitator
C07D 401/04 (2006.01)	2736920 *	NOTCH PATHWAY SIGNALING INHIBITOR COMPOUND	A61K 31/5383 (2006.01)	2705035 *	TRICYCLIC PYRAZOLE SULFONAMIDE COMPOUNDS AND METHODS OF MAKING AND USING SAME
C07K 5/06 (2006.01)	2736920 *	NOTCH PATHWAY SIGNALING INHIBITOR COMPOUND	A61P 3/04 (2006.01)	2705035 *	TRICYCLIC PYRAZOLE SULFONAMIDE COMPOUNDS AND METHODS OF MAKING AND USING SAME
			C07D 471/04 (2006.01)	2705035 *	TRICYCLIC PYRAZOLE SULFONAMIDE COMPOUNDS AND METHODS OF MAKING AND USING SAME
			C07D 498/04 (2006.01)	2705035 *	TRICYCLIC PYRAZOLE SULFONAMIDE COMPOUNDS AND METHODS OF MAKING AND USING SAME
			B60R 21/34 (2011.01)	2723615 *	AN ACCIDENT PREVENTION SYSTEM AND A VEHICLE INCLUDING THE ACCIDENT PREVENTION SYSTEM

MKP (51)	Broj objave evropske prijava patenta (97)	Naziv pronalaska (54)	MKP (51)	Broj objave evropske prijava patenta (97)	Naziv pronalaska (54)
B60T 7/12 (2006.01)	2723615 *	AN ACCIDENT PREVENTION SYSTEM AND A VEHICLE INCLUDING THE ACCIDENT PREVENTION SYSTEM	A61P 37/08 (2006.01)	2758379 *	MORPHOLINO SUBSTITUTED UREA OR CARBAMATE DERIVATIVES AS MTOR INHIBITORS
A61F 13/15 (2006.01)	2730261	Apparatus and methods for forming laminates containing additive matter	C07D 251/22 (2006.01)	2758379 *	MORPHOLINO SUBSTITUTED UREA OR CARBAMATE DERIVATIVES AS MTOR INHIBITORS
A61F 13/532 (2006.01)	2730261	Apparatus and methods for forming laminates containing additive matter	C07D 401/12 (2006.01)	2758379 *	MORPHOLINO SUBSTITUTED UREA OR CARBAMATE DERIVATIVES AS MTOR INHIBITORS
B32B 3/26 (2006.01)	2730261	Apparatus and methods for forming laminates containing additive matter	C07D 407/12 (2006.01)	2758379 *	MORPHOLINO SUBSTITUTED UREA OR CARBAMATE DERIVATIVES AS MTOR INHIBITORS
B32B 5/02 (2006.01)	2730261	Apparatus and methods for forming laminates containing additive matter	C07D 413/04 (2006.01)	2758379 *	MORPHOLINO SUBSTITUTED UREA OR CARBAMATE DERIVATIVES AS MTOR INHIBITORS
B32B 5/04 (2006.01)	2730261	Apparatus and methods for forming laminates containing additive matter	A61K 9/00 (2006.01)	2706986 *	NEW ABUSE-RESISTANT PHARMACEUTICAL COMPOSITION FOR THE TREATMENT OF OPIOID DEPENDENCE
B32B 5/26 (2006.01)	2730261	Apparatus and methods for forming laminates containing additive matter	A61K 31/485 (2006.01)	2706986 *	NEW ABUSE-RESISTANT PHARMACEUTICAL COMPOSITION FOR THE TREATMENT OF OPIOID DEPENDENCE
B32B 7/12 (2006.01)	2730261	Apparatus and methods for forming laminates containing additive matter	F03D 3/02 (2006.01)	2769089 *	VERTICAL AXIS WIND TURBINE WITH VARIABLE PITCH MECHANISM
E04B 2/74 (2006.01)	2718625 *	ILLUMINATING GLASS PARTITION	F03D 11/00 (2006.01)	2769089 *	VERTICAL AXIS WIND TURBINE WITH VARIABLE PITCH MECHANISM
F21V 3/00 (2006.01)	2718625 *	ILLUMINATING GLASS PARTITION	A61K 39/395 (2006.01)	2699602 *	MONOSPECIFIC AND BISPECIFIC ANTI-IGF-1R AND ANTI-ERBB3 ANTIBODIES
F21V 17/00 (2006.01)	2718625 *	ILLUMINATING GLASS PARTITION	A61P 35/00 (2006.01)	2699602 *	MONOSPECIFIC AND BISPECIFIC ANTI-IGF-1R AND ANTI-ERBB3 ANTIBODIES
F21V 33/00 (2006.01)	2718625 *	ILLUMINATING GLASS PARTITION	C07H 21/04 (2006.01)	2699602 *	MONOSPECIFIC AND BISPECIFIC ANTI-IGF-1R AND ANTI-ERBB3 ANTIBODIES
G02B 6/00 (2006.01)	2718625 *	ILLUMINATING GLASS PARTITION	C07K 16/28 (2006.01)	2699602 *	MONOSPECIFIC AND BISPECIFIC ANTI-IGF-1R AND ANTI-ERBB3 ANTIBODIES
A61K 31/53 (2006.01)	2758379 *	MORPHOLINO SUBSTITUTED UREA OR CARBAMATE DERIVATIVES AS MTOR INHIBITORS	A41D 13/00 (2006.01)	2768585 *	HOOD FOR AN ITEM OF CLOTHING OR AS A CONSTITUENT PART OF AN ITEM OF CLOTHING
A61P 35/00 (2006.01)	2758379 *	MORPHOLINO SUBSTITUTED UREA OR CARBAMATE DERIVATIVES AS MTOR INHIBITORS	A42B 1/04 (2006.01)	2768585 *	HOOD FOR AN ITEM OF CLOTHING OR AS A CONSTITUENT PART OF AN ITEM OF CLOTHING
A61P 37/02 (2006.01)	2758379 *	MORPHOLINO SUBSTITUTED UREA OR CARBAMATE DERIVATIVES AS MTOR INHIBITORS	A62B 17/04 (2006.01)	2768585 *	HOOD FOR AN ITEM OF CLOTHING OR AS A CONSTITUENT PART OF AN ITEM OF CLOTHING
A61P 37/04 (2006.01)	2758379 *	MORPHOLINO SUBSTITUTED UREA OR CARBAMATE DERIVATIVES AS MTOR INHIBITORS			
A61P 37/06 (2006.01)	2758379 *	MORPHOLINO SUBSTITUTED UREA OR CARBAMATE DERIVATIVES AS MTOR INHIBITORS			

MKP (51)	Broj objave evropske prijava patenta (97)	Naziv pronalaska (54)	MKP (51)	Broj objave evropske prijava patenta (97)	Naziv pronalaska (54)
B01J 19/00 (2006.01)	2723488 *	APPARATUS AND METHODS FOR CONVERSION OF SILICON TETRACHLORIDE TO TRICHLOROSILANE	C07D 407/04 (2006.01)	2712359 *	PROCESS FOR THE PREPARATION OF COMPOUNDS USEFUL AS INHIBITORS OF SGLT-2
C01B 33/107 (2006.01)	2723488 *	APPARATUS AND METHODS FOR CONVERSION OF SILICON TETRACHLORIDE TO TRICHLOROSILANE	E21B 43/32 (2006.01)	2677116	Method and apparatus to detect an oil/water contact
F02M 59/10 (2006.01)	2660459	Load reduction	E21B 47/10 (2012.01)	2677116	Method and apparatus to detect an oil/water contact
F04B 1/04 (2006.01)	2660459	Load reduction	G01V 3/20 (2006.01)	2677116	Method and apparatus to detect an oil/water contact
B32B 17/10 (2006.01)	2736767 *	ILLUMINATED GLASS PANEL FOR A VEHICLE, AND MANUFACTURE THEREOF	A61K 39/395 (2006.01)	2760893 *	ANTI-ERBB3 ANTIBODIES AND USES THEREOF
B60J 1/00 (2006.01)	2736767 *	ILLUMINATED GLASS PANEL FOR A VEHICLE, AND MANUFACTURE THEREOF	C07K 16/32 (2006.01)	2760893 *	ANTI-ERBB3 ANTIBODIES AND USES THEREOF
B60Q 3/00 (2006.01)	2736767 *	ILLUMINATED GLASS PANEL FOR A VEHICLE, AND MANUFACTURE THEREOF	A61K 31/5365 (2006.01)	2653473	Fused Aminodihydro-Oxazine Derivatives
B60Q 3/02 (2006.01)	2736767 *	ILLUMINATED GLASS PANEL FOR A VEHICLE, AND MANUFACTURE THEREOF	A61P 25/28 (2006.01)	2653473	Fused Aminodihydro-Oxazine Derivatives
F21V 19/00 (2006.01)	2736767 *	ILLUMINATED GLASS PANEL FOR A VEHICLE, AND MANUFACTURE THEREOF	C07D 498/04 (2006.01)	2653473	Fused Aminodihydro-Oxazine Derivatives
F21Y 103/00 (2006.01)	2736767 *	ILLUMINATED GLASS PANEL FOR A VEHICLE, AND MANUFACTURE THEREOF	C12Q 1/68 (2006.01)	2715348 *	MOLECULAR DIAGNOSTIC TEST FOR CANCER
G02B 6/00 (2006.01)	2736767 *	ILLUMINATED GLASS PANEL FOR A VEHICLE, AND MANUFACTURE THEREOF	G01N 33/50 (2006.01)	2715348 *	MOLECULAR DIAGNOSTIC TEST FOR CANCER
A61K 31/138 (2006.01)	2744777 *	TRANS-CLOMIPHENE METABOLITES AND USES THEREOF	H02K 33/16 (2006.01)	2754231 *	MAGNET DEVICE IN WHICH THE TRANSLATOR MOVES IN A POLYGONAL MANNER
A61P 3/06 (2006.01)	2744777 *	TRANS-CLOMIPHENE METABOLITES AND USES THEREOF	G10K 11/20 (2006.01)	2710585 *	TRANSDUCER FOR PHASED ARRAY ACOUSTIC SYSTEMS
C07C 217/18 (2006.01)	2744777 *	TRANS-CLOMIPHENE METABOLITES AND USES THEREOF	A01N 33/02 (2006.01)	2713722 *	NOVEL GLP-1 RECEPTOR STABILIZERS AND MODULATORS
A61K 31/381 (2006.01)	2734515 *	THIOPHEN-2-CARBOXYLIC ACID DERIVATIVES USEFUL AS INHIBITORS OF FLAVIVIRIDAE VIRUSES	A61K 31/13 (2006.01)	2713722 *	NOVEL GLP-1 RECEPTOR STABILIZERS AND MODULATORS
A61P 31/14 (2006.01)	2734515 *	THIOPHEN-2-CARBOXYLIC ACID DERIVATIVES USEFUL AS INHIBITORS OF FLAVIVIRIDAE VIRUSES	C07C 43/00 (2006.01)	2702030 *	COMPOSITIONS AND METHODS
C07D 333/40 (2006.01)	2734515 *	THIOPHEN-2-CARBOXYLIC ACID DERIVATIVES USEFUL AS INHIBITORS OF FLAVIVIRIDAE VIRUSES	G01J 11/00 (2006.01)	2766963 *	METHOD AND DEVICE FOR THE SIMULTANEOUS COMPRESSION AND CHARACTERIZATION OF ULTRASHORT LASER PULSES
G01N 33/00 (2006.01)	2647991	Methods and apparatus for measuring gas flux	H01S 3/00 (2006.01)	2766963 *	METHOD AND DEVICE FOR THE SIMULTANEOUS COMPRESSION AND CHARACTERIZATION OF ULTRASHORT LASER PULSES
G01P 5/00 (2006.01)	2647991	Methods and apparatus for measuring gas flux	G05F 1/56 (2006.01)	2650747	Power-gated electronic device and method of operating the same

MKP (51)	Broj objave evropske prijava patenta (97)	Naziv pronalaska (54)	MKP (51)	Broj objave evropske prijava patenta (97)	Naziv pronalaska (54)
G06F 1/32 (2006.01)	2650747	Power-gated electronic device and method of operating the same	A61K 31/4184 (2006.01)	2755653 *	COMPOSITIONS AND METHODS FOR TREATING CANCER USING PI3K BETA INHIBITOR AND MAPK PATHWAY INHIBITOR, INCLUDING MEK AND RAF INHIBITORS
A61K 9/20 (2006.01)	2763663 *	PHARMACEUTICAL COMPOSITIONS COMPRISING 40 - O - (2 - HYDROXY) ETHYL - RAPAMYCIN	A61K 31/437 (2006.01)	2755653 *	COMPOSITIONS AND METHODS FOR TREATING CANCER USING PI3K BETA INHIBITOR AND MAPK PATHWAY INHIBITOR, INCLUDING MEK AND RAF INHIBITORS
A61K 9/50 (2006.01)	2763663 *	PHARMACEUTICAL COMPOSITIONS COMPRISING 40 - O - (2 - HYDROXY) ETHYL - RAPAMYCIN	A61K 31/5377 (2006.01)	2755653 *	COMPOSITIONS AND METHODS FOR TREATING CANCER USING PI3K BETA INHIBITOR AND MAPK PATHWAY INHIBITOR, INCLUDING MEK AND RAF INHIBITORS
A61K 31/436 (2006.01)	2763663 *	PHARMACEUTICAL COMPOSITIONS COMPRISING 40 - O - (2 - HYDROXY) ETHYL - RAPAMYCIN	A61K 45/06 (2006.01)	2755653 *	COMPOSITIONS AND METHODS FOR TREATING CANCER USING PI3K BETA INHIBITOR AND MAPK PATHWAY INHIBITOR, INCLUDING MEK AND RAF INHIBITORS
A61K 39/21 (2006.01)	2747779 *	HERPES SIMPLEX VIRUS NANOEMULSION VACCINE	A61P 35/00 (2006.01)	2755653 *	COMPOSITIONS AND METHODS FOR TREATING CANCER USING PI3K BETA INHIBITOR AND MAPK PATHWAY INHIBITOR, INCLUDING MEK AND RAF INHIBITORS
C07K 14/005 (2006.01)	2729489 *	HCV GENOTYPE 3 REPLICONS	E01C 5/00 (2006.01)	2662490	Traffic surface for vehicles and pedestrians
C12N 15/86 (2006.01)	2729489 *	HCV GENOTYPE 3 REPLICONS	E01C 9/00 (2006.01)	2662490	Traffic surface for vehicles and pedestrians
G01N 33/569 (2006.01)	2729489 *	HCV GENOTYPE 3 REPLICONS	E01F 8/00 (2006.01)	2662490	Traffic surface for vehicles and pedestrians
A61K 31/4745 (2006.01)	2709622 *	KINASE MODULATION AND INDICATIONS THEREFOR	E04F 13/08 (2006.01)	2662490	Traffic surface for vehicles and pedestrians
B65D 51/28 (2006.01)	2704962 *	CLOSURE	G01F 23/292 (2006.01)	2718680 *	OPTICAL SENSING DEVICE FOR FLUID SENSING AND METHODS THEREFOR
B65D 51/30 (2006.01)	2704962 *	CLOSURE	A01N 37/38 (2006.01)	2713735 *	PESTICIDAL MIXTURES INCLUDING ISOXAZOLINE DERIVATIVES
A61K 31/135 (2006.01)	2766020 *	TREATMENT OF MULTIPLE SCLEROSIS WITH COMBINATION OF LAQUINIMOD AND FINGOLIMOD	A01N 43/40 (2006.01)	2713735 *	PESTICIDAL MIXTURES INCLUDING ISOXAZOLINE DERIVATIVES
A61K 31/47 (2006.01)	2766020 *	TREATMENT OF MULTIPLE SCLEROSIS WITH COMBINATION OF LAQUINIMOD AND FINGOLIMOD	A01N 43/80 (2006.01)	2713735 *	PESTICIDAL MIXTURES INCLUDING ISOXAZOLINE DERIVATIVES
A61K 31/47 (2006.01)	2709986 *	DEUTERATED DERIVATIVES OF IVACAFTOR	A01N 43/86 (2006.01)	2713735 *	PESTICIDAL MIXTURES INCLUDING ISOXAZOLINE DERIVATIVES
A61P 11/12 (2006.01)	2709986 *	DEUTERATED DERIVATIVES OF IVACAFTOR	A01N 47/30 (2006.01)	2713735 *	PESTICIDAL MIXTURES INCLUDING ISOXAZOLINE DERIVATIVES
C07B 59/00 (2006.01)	2709986 *	DEUTERATED DERIVATIVES OF IVACAFTOR	A01N 47/40 (2006.01)	2713735 *	PESTICIDAL MIXTURES INCLUDING ISOXAZOLINE DERIVATIVES
C07D 215/56 (2006.01)	2709986 *	DEUTERATED DERIVATIVES OF IVACAFTOR	A01N 51/00 (2006.01)	2713735 *	PESTICIDAL MIXTURES INCLUDING ISOXAZOLINE DERIVATIVES
A61K 9/14 (2006.01)	2714012 *	CB-183,315 COMPOSITIONS AND RELATED METHODS			
A61K 9/20 (2006.01)	2714012 *	CB-183,315 COMPOSITIONS AND RELATED METHODS			

MKP (51)	Broj objave evropske prijava patenta (97)	Naziv pronalaska (54)	MKP (51)	Broj objave evropske prijava patenta (97)	Naziv pronalaska (54)
A01N 53/00 (2006.01)	2713735 *	PESTICIDAL MIXTURES INCLUDING ISOXAZOLINE DERIVATIVES	A61K 9/10 (2006.01)	2731589 *	A NEW THERAPEUTICAL COMPOSITION CONTAINING APOMORPHINE AS ACTIVE INGREDIENT
A01P 5/00 (2006.01)	2713735 *	PESTICIDAL MIXTURES INCLUDING ISOXAZOLINE DERIVATIVES	A61K 9/107 (2006.01)	2731589 *	A NEW THERAPEUTICAL COMPOSITION CONTAINING APOMORPHINE AS ACTIVE INGREDIENT
A01P 7/02 (2006.01)	2713735 *	PESTICIDAL MIXTURES INCLUDING ISOXAZOLINE DERIVATIVES	A61K 31/473 (2006.01)	2731589 *	A NEW THERAPEUTICAL COMPOSITION CONTAINING APOMORPHINE AS ACTIVE INGREDIENT
A01P 7/04 (2006.01)	2713735 *	PESTICIDAL MIXTURES INCLUDING ISOXAZOLINE DERIVATIVES	A61P 25/16 (2006.01)	2731589 *	A NEW THERAPEUTICAL COMPOSITION CONTAINING APOMORPHINE AS ACTIVE INGREDIENT
A01P 9/00 (2006.01)	2713735 *	PESTICIDAL MIXTURES INCLUDING ISOXAZOLINE DERIVATIVES	A61K 31/381 (2006.01)	2709613 *	METHODS FOR TREATING HCV
A01N 43/80 (2006.01)	2710000 *	PARASITICIDAL DIHYDROISOXAZOLE COMPOUNDS	A61K 31/4184 (2006.01)	2709613 *	METHODS FOR TREATING HCV
C07D 413/04 (2006.01)	2710000 *	PARASITICIDAL DIHYDROISOXAZOLE COMPOUNDS	A61K 31/4196 (2006.01)	2709613 *	METHODS FOR TREATING HCV
C07D 413/14 (2006.01)	2710000 *	PARASITICIDAL DIHYDROISOXAZOLE COMPOUNDS	A61K 31/513 (2006.01)	2709613 *	METHODS FOR TREATING HCV
C07D 495/04 (2006.01)	2710000 *	PARASITICIDAL DIHYDROISOXAZOLE COMPOUNDS	A61P 31/14 (2006.01)	2709613 *	METHODS FOR TREATING HCV
F01N 3/08 (2006.01)	2647815	Lean nox trap desulfation process	A61K 31/519 (2006.01)	2763994 *	NOVEL QUINOXALINE INHIBITORS OF PI3K
F02D 41/00 (2006.01)	2647815	Lean nox trap desulfation process	A61P 29/00 (2006.01)	2763994 *	NOVEL QUINOXALINE INHIBITORS OF PI3K
F02D 41/02 (2006.01)	2647815	Lean nox trap desulfation process	A61P 35/00 (2006.01)	2763994 *	NOVEL QUINOXALINE INHIBITORS OF PI3K
F02D 41/18 (2006.01)	2647815	Lean nox trap desulfation process	C07D 403/12 (2006.01)	2763994 *	NOVEL QUINOXALINE INHIBITORS OF PI3K
F02D 41/40 (2006.01)	2647815	Lean nox trap desulfation process	C07D 487/04 (2006.01)	2763994 *	NOVEL QUINOXALINE INHIBITORS OF PI3K
C07D 491/14 (2006.01)	2721034 *	TRICYCLIC ANTIBIOTICS	C12N 15/09 (2006.01)	2751267 *	METHODS FOR THE TREATMENT OF BREAST CANCER
C07D 491/147 (2006.01)	2721034 *	TRICYCLIC ANTIBIOTICS	A61K 38/17 (2006.01)	2736540 *	SWITCH COSTIMULATORY RECEPTORS
A47F 9/04 (2006.01)	2614755	A system comprising a tower module, a top module as well as a plurality of additional modules	A61K 48/00 (2006.01)	2736540 *	SWITCH COSTIMULATORY RECEPTORS
A61K 9/00 (2006.01)	2731589 *	A NEW THERAPEUTICAL COMPOSITION CONTAINING APOMORPHINE AS ACTIVE INGREDIENT	C07D 498/04 (2006.01)	2710013 *	NOVEL COMPOUNDS AS DIACYLGLYCEROL ACYLTRANSFERASE INHIBITORS
A61K 9/08 (2006.01)	2731589 *	A NEW THERAPEUTICAL COMPOSITION CONTAINING APOMORPHINE AS ACTIVE INGREDIENT	A61K 31/381 (2006.01)	2744806 *	NOVEL 1,2,3,4-TETRAHYDROQUINOLINE DERIVATIVE USEFUL FOR THE TREATMENT OF DIABETES

MKP (51)	Broj objave evropske prijava patenta (97)	Naziv pronalaska (54)	MKP (51)	Broj objave evropske prijava patenta (97)	Naziv pronalaska (54)
A61K 31/4709 (2006.01)	2744806 *	NOVEL 1,2,3,4-TETRAHYDROQUINOLINE DERIVATIVE USEFUL FOR THE TREATMENT OF DIABETES	A61P 25/28 (2006.01)	2704709 *	MACROCYCLIC LACTONES AND USE THEREOF
C07D 409/06 (2006.01)	2744806 *	NOVEL 1,2,3,4-TETRAHYDROQUINOLINE DERIVATIVE USEFUL FOR THE TREATMENT OF DIABETES	A61P 35/00 (2006.01)	2704709 *	MACROCYCLIC LACTONES AND USE THEREOF
B63H 1/36 (2006.01)	2746147 *	AQUATIC PROPULSION BY MEANS OF OSCILLATING FINS	G01N 33/564 (2006.01)	2753931 *	AUTOIMMUNE AND INFLAMMATORY DISORDER THERAPY
A61K 31/519 (2006.01)	2760863 *	PYRAZOLO[4,3-C]PYRIDINE DERIVATIVES AS KINASE INHIBITORS	B62D 55/07 (2006.01)	2742184 *	EXCAVATOR VEHICLE
A61P 37/06 (2006.01)	2760863 *	PYRAZOLO[4,3-C]PYRIDINE DERIVATIVES AS KINASE INHIBITORS	E02F 9/02 (2006.01)	2742184 *	EXCAVATOR VEHICLE
C07D 471/04 (2006.01)	2760863 *	PYRAZOLO[4,3-C]PYRIDINE DERIVATIVES AS KINASE INHIBITORS	C07C 237/22 (2006.01)	2729443 *	BENZYLAMINE DERIVATIVES AS INHIBITORS OF PLASMA KALLIKREIN
C07D 487/04 (2006.01)	2760863 *	PYRAZOLO[4,3-C]PYRIDINE DERIVATIVES AS KINASE INHIBITORS	C07C 311/06 (2006.01)	2729443 *	BENZYLAMINE DERIVATIVES AS INHIBITORS OF PLASMA KALLIKREIN
A61L 15/18 (2006.01)	2734244 *	WOUND DRESSING WITH AN AIR PERMEABLE LAYER	C07C 311/19 (2006.01)	2729443 *	BENZYLAMINE DERIVATIVES AS INHIBITORS OF PLASMA KALLIKREIN
A61L 15/42 (2006.01)	2734244 *	WOUND DRESSING WITH AN AIR PERMEABLE LAYER	C07D 207/16 (2006.01)	2729443 *	BENZYLAMINE DERIVATIVES AS INHIBITORS OF PLASMA KALLIKREIN
A23L 1/30 (2006.01)	2732023 *	BACTERIAL STRAINS ISOLATED FROM PIGS	C07K 5/06 (2006.01)	2729443 *	BENZYLAMINE DERIVATIVES AS INHIBITORS OF PLASMA KALLIKREIN
A61K 35/74 (2006.01)	2732023 *	BACTERIAL STRAINS ISOLATED FROM PIGS	C12Q 1/68 (2006.01)	2707504 *	METHODS OF DISEASE ACTIVITY PROFILING FOR PERSONALIZED THERAPY MANAGEMENT
C12N 1/00 (2006.01)	2732023 *	BACTERIAL STRAINS ISOLATED FROM PIGS	G01N 33/564 (2006.01)	2707504 *	METHODS OF DISEASE ACTIVITY PROFILING FOR PERSONALIZED THERAPY MANAGEMENT
C12R 1/225 (2006.01)	2732023 *	BACTERIAL STRAINS ISOLATED FROM PIGS	G01N 33/68 (2006.01)	2707504 *	METHODS OF DISEASE ACTIVITY PROFILING FOR PERSONALIZED THERAPY MANAGEMENT
C12R 1/23 (2006.01)	2732023 *	BACTERIAL STRAINS ISOLATED FROM PIGS	A01N 25/04 (2006.01)	2753173 *	HERBICIDAL COMPOSITION COMPRISING POLYMERIC MICROPARTICLES CONTAINING A HERBICIDE
C12R 1/25 (2006.01)	2732023 *	BACTERIAL STRAINS ISOLATED FROM PIGS	A01N 25/10 (2006.01)	2753173 *	HERBICIDAL COMPOSITION COMPRISING POLYMERIC MICROPARTICLES CONTAINING A HERBICIDE
B63B 35/44 (2006.01)	2709900 *	FLOATING CARRIER FOR GENERATING ELECTRICAL ENERGY FROM EXCLUSIVELY REGENERATIVE ENERGY SOURCES	A01N 25/28 (2006.01)	2753173 *	HERBICIDAL COMPOSITION COMPRISING POLYMERIC MICROPARTICLES CONTAINING A HERBICIDE
F41H 5/04 (2006.01)	2726809 *	ANTIBALLISTIC ARTICLE AND METHOD OF PRODUCING SAME	A01N 37/40 (2006.01)	2753173 *	HERBICIDAL COMPOSITION COMPRISING POLYMERIC MICROPARTICLES CONTAINING A HERBICIDE
A61K 31/365 (2006.01)	2704709 *	MACROCYCLIC LACTONES AND USE THEREOF	A01N 39/04 (2006.01)	2753173 *	HERBICIDAL COMPOSITION COMPRISING POLYMERIC MICROPARTICLES CONTAINING A HERBICIDE
A61K 31/7048 (2006.01)	2704709 *	MACROCYCLIC LACTONES AND USE THEREOF			

MKP (51)	Broj objave evropske prijava patenta (97)	Naziv pronalaska (54)	MKP (51)	Broj objave evropske prijava patenta (97)	Naziv pronalaska (54)
A01N 43/90 (2006.01)	2753173 *	HERBICIDAL COMPOSITION COMPRISING POLYMERIC MICROPARTICLES CONTAINING A HERBICIDE	G01N 33/68 (2006.01)	2718725 *	METHOD FOR THE DIAGNOSIS OF GAUCHER'S DISEASE
A01N 47/36 (2006.01)	2753173 *	HERBICIDAL COMPOSITION COMPRISING POLYMERIC MICROPARTICLES CONTAINING A HERBICIDE	A61K 9/00 (2006.01)	2714004 *	CONTROLLED RELEASE PEPTIDE FORMULATIONS
A61B 17/072 (2006.01)	2644110	Tissue thickness compensator comprising resilient members	A61K 9/127 (2006.01)	2714004 *	CONTROLLED RELEASE PEPTIDE FORMULATIONS
H04L 9/08 (2006.01)	2639997	Method and system for secure access of a first computer to a second computer	A61K 38/00 (2006.01)	2714004 *	CONTROLLED RELEASE PEPTIDE FORMULATIONS
A61K 39/395 (2006.01)	2729498 *	THERAPEUTIC COMBINATIONS OF ANTI -CD20 AND ANTI - GM - CSF ANTIBODIES AND USES THEREOF	A61K 47/10 (2006.01)	2714004 *	CONTROLLED RELEASE PEPTIDE FORMULATIONS
C07K 16/24 (2006.01)	2729498 *	THERAPEUTIC COMBINATIONS OF ANTI -CD20 AND ANTI - GM - CSF ANTIBODIES AND USES THEREOF	A61K 47/14 (2006.01)	2714004 *	CONTROLLED RELEASE PEPTIDE FORMULATIONS
C07K 16/28 (2006.01)	2729498 *	THERAPEUTIC COMBINATIONS OF ANTI -CD20 AND ANTI - GM - CSF ANTIBODIES AND USES THEREOF	A61K 47/24 (2006.01)	2714004 *	CONTROLLED RELEASE PEPTIDE FORMULATIONS
G01V 3/24 (2006.01)	2639602	Methods and systems for obtainin an electrical impedivity and/or resistivity image of a subterranean formation	A61K 9/20 (2006.01)	2714013 *	POWDERY MIXTURE FOR PRODUCING TABLETS CONTAINING LEVETIRACETAM
C07D 263/52 (2006.01)	2721016 *	TRPV4 ANTAGONISTS	F16K 15/03 (2006.01)	2734760 *	DUAL PLATE CHECK VALVE
C07D 498/00 (2006.01)	2721016 *	TRPV4 ANTAGONISTS	A61K 31/496 (2006.01)	2760451 *	MONOACYLGLYCEROL LIPASE INHIBITORS FOR THE TREATMENT OF METABOLIC DISEASES AND RELATED DISORDERS
C07K 16/22 (2006.01)	2743348 *	NOVEL ANTI-HUMAN NGF ANTIBODY	A61P 3/06 (2006.01)	2760451 *	MONOACYLGLYCEROL LIPASE INHIBITORS FOR THE TREATMENT OF METABOLIC DISEASES AND RELATED DISORDERS
C12N 1/15 (2006.01)	2743348 *	NOVEL ANTI-HUMAN NGF ANTIBODY	A61P 3/08 (2006.01)	2760451 *	MONOACYLGLYCEROL LIPASE INHIBITORS FOR THE TREATMENT OF METABOLIC DISEASES AND RELATED DISORDERS
C12N 1/19 (2006.01)	2743348 *	NOVEL ANTI-HUMAN NGF ANTIBODY	A61P 3/10 (2006.01)	2760451 *	MONOACYLGLYCEROL LIPASE INHIBITORS FOR THE TREATMENT OF METABOLIC DISEASES AND RELATED DISORDERS
C12N 1/21 (2006.01)	2743348 *	NOVEL ANTI-HUMAN NGF ANTIBODY	A61P 9/00 (2006.01)	2760451 *	MONOACYLGLYCEROL LIPASE INHIBITORS FOR THE TREATMENT OF METABOLIC DISEASES AND RELATED DISORDERS
C12N 5/10 (2006.01)	2743348 *	NOVEL ANTI-HUMAN NGF ANTIBODY	A61P 9/10 (2006.01)	2760451 *	MONOACYLGLYCEROL LIPASE INHIBITORS FOR THE TREATMENT OF METABOLIC DISEASES AND RELATED DISORDERS
C12N 15/09 (2006.01)	2743348 *	NOVEL ANTI-HUMAN NGF ANTIBODY	A61P 9/12 (2006.01)	2760451 *	MONOACYLGLYCEROL LIPASE INHIBITORS FOR THE TREATMENT OF METABOLIC DISEASES AND RELATED DISORDERS
C12P 21/08 (2006.01)	2743348 *	NOVEL ANTI-HUMAN NGF ANTIBODY			
G01N 33/50 (2006.01)	2718725 *	METHOD FOR THE DIAGNOSIS OF GAUCHER'S DISEASE			

MKP (51)	Broj objave evropske prijava patenta (97)	Naziv pronalaska (54)	MKP (51)	Broj objave evropske prijava patenta (97)	Naziv pronalaska (54)
A61P 11/00 (2006.01)	2760451 *	MONOACYLGLYCEROL LIPASE INHIBITORS FOR THE TREATMENT OF METABOLIC DISEASES AND RELATED DISORDERS	C07D 417/12 (2006.01)	2719696 *	NOVEL KINASE INHIBITORS
A61P 15/00 (2006.01)	2760451 *	MONOACYLGLYCEROL LIPASE INHIBITORS FOR THE TREATMENT OF METABOLIC DISEASES AND RELATED DISORDERS	C07D 417/14 (2006.01)	2719696 *	NOVEL KINASE INHIBITORS
A61P 15/12 (2006.01)	2760451 *	MONOACYLGLYCEROL LIPASE INHIBITORS FOR THE TREATMENT OF METABOLIC DISEASES AND RELATED DISORDERS	A61K 9/00 (2006.01)	2709595 *	IFN-BETA COMPOSITIONS, PREPARATION METHODS AND USES THEREOF
A61P 19/02 (2006.01)	2760451 *	MONOACYLGLYCEROL LIPASE INHIBITORS FOR THE TREATMENT OF METABOLIC DISEASES AND RELATED DISORDERS	A61K 9/19 (2006.01)	2709595 *	IFN-BETA COMPOSITIONS, PREPARATION METHODS AND USES THEREOF
A61P 21/00 (2006.01)	2760451 *	MONOACYLGLYCEROL LIPASE INHIBITORS FOR THE TREATMENT OF METABOLIC DISEASES AND RELATED DISORDERS	A61K 38/21 (2006.01)	2709595 *	IFN-BETA COMPOSITIONS, PREPARATION METHODS AND USES THEREOF
A01N 43/40 (2006.01)	2721021 *	METALLOENZYME INHIBITOR COMPOUNDS	A61K 47/42 (2006.01)	2709595 *	IFN-BETA COMPOSITIONS, PREPARATION METHODS AND USES THEREOF
C07D 401/06 (2006.01)	2721021 *	METALLOENZYME INHIBITOR COMPOUNDS	A61K 39/00 (2006.01)	2734539 *	PRAME PURIFICATION
C07D 401/14 (2006.01)	2721021 *	METALLOENZYME INHIBITOR COMPOUNDS	C07K 14/47 (2006.01)	2734539 *	PRAME PURIFICATION
C07D 409/14 (2006.01)	2721021 *	METALLOENZYME INHIBITOR COMPOUNDS	A61B 17/00 (2006.01)	2644117	Tissue thickness compensator comprising a plurality of layers
A61K 31/137 (2006.01)	2739277 *	TREATMENT OF TYPE 2 DIABETES WITH FTY720	A61B 17/072 (2006.01)	2644117	Tissue thickness compensator comprising a plurality of layers
A61P 3/10 (2006.01)	2739277 *	TREATMENT OF TYPE 2 DIABETES WITH FTY720	F03B 3/12 (2006.01)	2715119 *	TURBINE WITH UNEVENLY LOADED ROTOR BLADES
G06Q 10/08 (2012.01)	2662814	Method for registering, inventory, managing, checking and monitoring of tangible and intangible objects	F03D 1/04 (2006.01)	2715119 *	TURBINE WITH UNEVENLY LOADED ROTOR BLADES
A61K 31/427 (2006.01)	2719696 *	NOVEL KINASE INHIBITORS	F03D 1/06 (2006.01)	2715119 *	TURBINE WITH UNEVENLY LOADED ROTOR BLADES
A61K 31/4427 (2006.01)	2719696 *	NOVEL KINASE INHIBITORS	A63B 21/055 (2006.01)	2720763 *	COMPLETELY FLEXIBLE EXPANDER DEVICE CONSISTING OF AT LEAST TWO GRIPPING ELEMENTS, PREFERABLY 4, 6 OR 8 ELEMENTS
A61K 31/497 (2006.01)	2719696 *	NOVEL KINASE INHIBITORS	A63B 23/12 (2006.01)	2720763 *	COMPLETELY FLEXIBLE EXPANDER DEVICE CONSISTING OF AT LEAST TWO GRIPPING ELEMENTS, PREFERABLY 4, 6 OR 8 ELEMENTS
A61K 31/506 (2006.01)	2719696 *	NOVEL KINASE INHIBITORS	A61C 17/06 (2006.01)	2720639 *	SEPARATION, SEDIMENTATION AND SEGREGATION CHAMBER WITH DUAL PORE-SIZE FILTER
A61P 35/00 (2006.01)	2719696 *	NOVEL KINASE INHIBITORS	A01N 25/02 (2006.01)	2704562 *	HERBICIDAL COMPOSITION COMPRISING PINOXADEN AND FLUROXYPYRESTER, AND METHODS OF USE THEREOF
			A01N 43/40 (2006.01)	2704562 *	HERBICIDAL COMPOSITION COMPRISING PINOXADEN AND FLUROXYPYRESTER, AND METHODS OF USE THEREOF

MKP (51)	Broj objave evropske prijava patenta (97)	Naziv pronalaska (54)	MKP (51)	Broj objave evropske prijava patenta (97)	Naziv pronalaska (54)
A01N 43/90 (2006.01)	2704562 *	HERBICIDAL COMPOSITION COMPRISING PINOXADEN AND FLUROXYPYRESTER, AND METHODS OF USE THEREOF	A61K 31/07 (2006.01)	2704688 *	COCHLEATE COMPOSITIONS AND METHODS OF MAKING AND USING SAME
A01N 57/12 (2006.01)	2704562 *	HERBICIDAL COMPOSITION COMPRISING PINOXADEN AND FLUROXYPYRESTER, AND METHODS OF USE THEREOF	A61K 31/20 (2006.01)	2704688 *	COCHLEATE COMPOSITIONS AND METHODS OF MAKING AND USING SAME
A01P 13/00 (2006.01)	2704562 *	HERBICIDAL COMPOSITION COMPRISING PINOXADEN AND FLUROXYPYRESTER, AND METHODS OF USE THEREOF	A61K 31/472 (2006.01)	2704688 *	COCHLEATE COMPOSITIONS AND METHODS OF MAKING AND USING SAME
A61K 8/891 (2006.01)	2758032 *	COMPOSITIONS AND METHODS FOR TREATING CONDITIONS OF COMPROMISED SKIN BARRIER FUNCTION	A61K 31/496 (2006.01)	2704688 *	COCHLEATE COMPOSITIONS AND METHODS OF MAKING AND USING SAME
A61K 9/00 (2006.01)	2758032 *	COMPOSITIONS AND METHODS FOR TREATING CONDITIONS OF COMPROMISED SKIN BARRIER FUNCTION	A61K 31/70 (2006.01)	2704688 *	COCHLEATE COMPOSITIONS AND METHODS OF MAKING AND USING SAME
A61K 47/24 (2006.01)	2758032 *	COMPOSITIONS AND METHODS FOR TREATING CONDITIONS OF COMPROMISED SKIN BARRIER FUNCTION	A61K 31/704 (2006.01)	2704688 *	COCHLEATE COMPOSITIONS AND METHODS OF MAKING AND USING SAME
A61P 17/02 (2006.01)	2758032 *	COMPOSITIONS AND METHODS FOR TREATING CONDITIONS OF COMPROMISED SKIN BARRIER FUNCTION	A61K 31/7048 (2006.01)	2704688 *	COCHLEATE COMPOSITIONS AND METHODS OF MAKING AND USING SAME
A61K 38/17 (2006.01)	2753347 *	TREATMENT OF ALLODYNIA, HYPERALGIA, SPONTANEOUS PAIN, AND PHANTOM PAIN	A61K 33/00 (2006.01)	2704688 *	COCHLEATE COMPOSITIONS AND METHODS OF MAKING AND USING SAME
C12N 5/00 (2006.01)	2753347 *	TREATMENT OF ALLODYNIA, HYPERALGIA, SPONTANEOUS PAIN, AND PHANTOM PAIN	A61K 33/26 (2006.01)	2704688 *	COCHLEATE COMPOSITIONS AND METHODS OF MAKING AND USING SAME
B27B 5/29 (2006.01)	2750841 *	CUTTING MACHINE WASTE EXTRACTION APPARATUS	A61K 33/30 (2006.01)	2704688 *	COCHLEATE COMPOSITIONS AND METHODS OF MAKING AND USING SAME
B61D 19/02 (2006.01)	2731846 *	BASE PLATE STRUCTURE FOR TRANSIT DOORS	A61K 33/30 (2006.01)	2704688 *	COCHLEATE COMPOSITIONS AND METHODS OF MAKING AND USING SAME
C07C 253/30 (2006.01)	2719689	Novel method for synthesising 3-(2-bromo-4,5-dimethoxyphenyl) propanenitrile and use for synthesising ivabradine and the added salts thereof with a pharmaceutically acceptable acid	A61K 33/54 (2006.01)	2704688 *	COCHLEATE COMPOSITIONS AND METHODS OF MAKING AND USING SAME
C07C 255/37 (2006.01)	2719689	Novel method for synthesising 3-(2-bromo-4,5-dimethoxyphenyl) propanenitrile and use for synthesising ivabradine and the added salts thereof with a pharmaceutically acceptable acid	A61K 38/02 (2006.01)	2704688 *	COCHLEATE COMPOSITIONS AND METHODS OF MAKING AND USING SAME
C07D 223/14 (2006.01)	2719689	Novel method for synthesising 3-(2-bromo-4,5-dimethoxyphenyl) propanenitrile and use for synthesising ivabradine and the added salts thereof with a pharmaceutically acceptable acid	A61K 39/00 (2006.01)	2704688 *	COCHLEATE COMPOSITIONS AND METHODS OF MAKING AND USING SAME
A61K 9/00 (2006.01)	2704688 *	COCHLEATE COMPOSITIONS AND METHODS OF MAKING AND USING SAME	A61K 39/13 (2006.01)	2704688 *	COCHLEATE COMPOSITIONS AND METHODS OF MAKING AND USING SAME
			A61K 39/145 (2006.01)	2704688 *	COCHLEATE COMPOSITIONS AND METHODS OF MAKING AND USING SAME
			A61K 47/12 (2006.01)	2704688 *	COCHLEATE COMPOSITIONS AND METHODS OF MAKING AND USING SAME
			A01N 43/78 (2006.01)	2490541 *	2-SUBSTITUTED- ETHYNYLTHIAZOLE DERIVATIVES AND USES OF SAME
			A61K 31/425 (2006.01)	2490541 *	2-SUBSTITUTED- ETHYNYLTHIAZOLE DERIVATIVES AND USES OF SAME
			A61P 25/18 (2006.01)	2490541 *	2-SUBSTITUTED- ETHYNYLTHIAZOLE DERIVATIVES AND USES OF SAME

MKP (51)	Broj objave evropske prijava patenta (97)	Naziv pronalaska (54)	MKP (51)	Broj objave evropske prijava patenta (97)	Naziv pronalaska (54)
C07D 277/56 (2006.01)	2490541 *	2-SUBSTITUTED-ETHYNYLTHIAZOLE DERIVATIVES AND USES OF SAME	E21B 34/16 (2006.01)	2756163 *	WELLBORE FRAC TOOL WITH INFLOW CONTROL
C07D 417/06 (2006.01)	2490541 *	2-SUBSTITUTED-ETHYNYLTHIAZOLE DERIVATIVES AND USES OF SAME	E21B 43/12 (2006.01)	2756163 *	WELLBORE FRAC TOOL WITH INFLOW CONTROL
C07D 491/04 (2006.01)	2490541 *	2-SUBSTITUTED-ETHYNYLTHIAZOLE DERIVATIVES AND USES OF SAME	E21B 43/22 (2006.01)	2756163 *	WELLBORE FRAC TOOL WITH INFLOW CONTROL
C07D 495/04 (2006.01)	2490541 *	2-SUBSTITUTED-ETHYNYLTHIAZOLE DERIVATIVES AND USES OF SAME	E21B 43/26 (2006.01)	2756163 *	WELLBORE FRAC TOOL WITH INFLOW CONTROL
A61K 31/4985 (2006.01)	2734522 *	4 - IMIDAZOPYRIDAZIN- 1 -YL-BENZAMIDES AND 4 - IMIDAZOTRIAZIN- 1 - YL - BENZAMIDES AS BTK-INHIBITORS	A61K 31/662 (2006.01)	2707004 *	COMPOUNDS FOR USE IN THE TREATMENT OF FELINE RETROVIRAL INFECTIONS
A61P 19/08 (2006.01)	2734522 *	4 - IMIDAZOPYRIDAZIN- 1 -YL-BENZAMIDES AND 4 - IMIDAZOTRIAZIN- 1 - YL - BENZAMIDES AS BTK-INHIBITORS	A61P 31/14 (2006.01)	2707004 *	COMPOUNDS FOR USE IN THE TREATMENT OF FELINE RETROVIRAL INFECTIONS
A61P 29/00 (2006.01)	2734522 *	4 - IMIDAZOPYRIDAZIN- 1 -YL-BENZAMIDES AND 4 - IMIDAZOTRIAZIN- 1 - YL - BENZAMIDES AS BTK-INHIBITORS	A61K 9/127 (2006.01)	2718269 *	CLEAVABLE LIPIDS
A61P 31/00 (2006.01)	2734522 *	4 - IMIDAZOPYRIDAZIN- 1 -YL-BENZAMIDES AND 4 - IMIDAZOTRIAZIN- 1 - YL - BENZAMIDES AS BTK-INHIBITORS	A61K 31/4164 (2006.01)	2718269 *	CLEAVABLE LIPIDS
A61P 35/00 (2006.01)	2734522 *	4 - IMIDAZOPYRIDAZIN- 1 -YL-BENZAMIDES AND 4 - IMIDAZOTRIAZIN- 1 - YL - BENZAMIDES AS BTK-INHIBITORS	C07C 323/00 (2006.01)	2718269 *	CLEAVABLE LIPIDS
A61P 37/00 (2006.01)	2734522 *	4 - IMIDAZOPYRIDAZIN- 1 -YL-BENZAMIDES AND 4 - IMIDAZOTRIAZIN- 1 - YL - BENZAMIDES AS BTK-INHIBITORS	C07D 233/64 (2006.01)	2718269 *	CLEAVABLE LIPIDS
C07D 487/04 (2006.01)	2734522 *	4 - IMIDAZOPYRIDAZIN- 1 -YL-BENZAMIDES AND 4 - IMIDAZOTRIAZIN- 1 - YL - BENZAMIDES AS BTK-INHIBITORS	A01G 31/00 (2006.01)	2714977 *	MINERAL WOOL PRODUCT
C07D 519/00 (2006.01)	2734522 *	4 - IMIDAZOPYRIDAZIN- 1 -YL-BENZAMIDES AND 4 - IMIDAZOTRIAZIN- 1 - YL - BENZAMIDES AS BTK-INHIBITORS	D04H 1/407 (2012.01)	2714977 *	MINERAL WOOL PRODUCT
A01C 7/20 (2006.01)	2636294	Energy absorption device for a feed channel of a blade	D04H 1/4209 (2012.01)	2714977 *	MINERAL WOOL PRODUCT
E21B 34/08 (2006.01)	2756163 *	WELLBORE FRAC TOOL WITH INFLOW CONTROL	D04H 1/46 (2012.01)	2714977 *	MINERAL WOOL PRODUCT
			A01N 25/12 (2006.01)	2741608 *	AN IMPROVED PLANT TREATMENT AGENT
			A01N 59/00 (2006.01)	2741608 *	AN IMPROVED PLANT TREATMENT AGENT
			A01P 1/00 (2006.01)	2741608 *	AN IMPROVED PLANT TREATMENT AGENT
			A01P 7/00 (2006.01)	2741608 *	AN IMPROVED PLANT TREATMENT AGENT
			C07K 16/00 (2006.01)	2744822 *	MODIFIED PROTEINS AND PEPTIDES
			A61K 38/55 (2006.01)	2726092 *	SERPIN FUSION POLYPEPTIDES AND METHODS OF USE THEREOF

MKP (51)	Broj objave evropske prijava patenta (97)	Naziv pronalaska (54)	MKP (51)	Broj objave evropske prijava patenta (97)	Naziv pronalaska (54)
A61K 39/395 (2006.01)	2726092 *	SERPIN FUSION POLYPEPTIDES AND METHODS OF USE THEREOF	A61K 31/573 (2006.01)	2704724 *	IMPROVED SUSPENSION FORMULATION OF A CORTICOSTEROID FOR ADMINISTRATION BY INHALATION
A61K 39/40 (2006.01)	2726092 *	SERPIN FUSION POLYPEPTIDES AND METHODS OF USE THEREOF	G01N 33/68 (2006.01)	2710383 *	PERFORMANCE OF A BIOMARKER PANEL FOR IRRITABLE BOWEL SYNDROME
A61K 39/42 (2006.01)	2726092 *	SERPIN FUSION POLYPEPTIDES AND METHODS OF USE THEREOF	A61K 9/16 (2006.01)	2747752 *	NEW COATED CONTROLLED RELEASE ACTIVE AGENT CARRIERS
A61P 1/00 (2006.01)	2726092 *	SERPIN FUSION POLYPEPTIDES AND METHODS OF USE THEREOF	A61K 9/20 (2006.01)	2747752 *	NEW COATED CONTROLLED RELEASE ACTIVE AGENT CARRIERS
A61P 3/10 (2006.01)	2726092 *	SERPIN FUSION POLYPEPTIDES AND METHODS OF USE THEREOF	A61K 9/50 (2006.01)	2747752 *	NEW COATED CONTROLLED RELEASE ACTIVE AGENT CARRIERS
A61P 9/00 (2006.01)	2726092 *	SERPIN FUSION POLYPEPTIDES AND METHODS OF USE THEREOF	H01R 43/16 (2006.01)	2654141	Method and device for producing a connector
A61P 9/10 (2006.01)	2726092 *	SERPIN FUSION POLYPEPTIDES AND METHODS OF USE THEREOF	H01R 43/20 (2006.01)	2654141	Method and device for producing a connector
A61P 11/00 (2006.01)	2726092 *	SERPIN FUSION POLYPEPTIDES AND METHODS OF USE THEREOF	A01N 43/04 (2006.01)	2741610 *	MAINTENANCE OF PLATELET INHIBITION DURING ANTIPLATELET THERAPY
A61P 11/06 (2006.01)	2726092 *	SERPIN FUSION POLYPEPTIDES AND METHODS OF USE THEREOF	A61K 31/426 (2006.01)	2738163 *	AMIDINE COMPOUND OR SALT THEREOF
A61P 19/02 (2006.01)	2726092 *	SERPIN FUSION POLYPEPTIDES AND METHODS OF USE THEREOF	A61K 31/427 (2006.01)	2738163 *	AMIDINE COMPOUND OR SALT THEREOF
A61P 21/00 (2006.01)	2726092 *	SERPIN FUSION POLYPEPTIDES AND METHODS OF USE THEREOF	A61K 31/433 (2006.01)	2738163 *	AMIDINE COMPOUND OR SALT THEREOF
A61P 29/00 (2006.01)	2726092 *	SERPIN FUSION POLYPEPTIDES AND METHODS OF USE THEREOF	A61K 31/4439 (2006.01)	2738163 *	AMIDINE COMPOUND OR SALT THEREOF
A61P 31/04 (2006.01)	2726092 *	SERPIN FUSION POLYPEPTIDES AND METHODS OF USE THEREOF	A61K 31/454 (2006.01)	2738163 *	AMIDINE COMPOUND OR SALT THEREOF
A61P 31/10 (2006.01)	2726092 *	SERPIN FUSION POLYPEPTIDES AND METHODS OF USE THEREOF	A61K 31/496 (2006.01)	2738163 *	AMIDINE COMPOUND OR SALT THEREOF
A61P 31/12 (2006.01)	2726092 *	SERPIN FUSION POLYPEPTIDES AND METHODS OF USE THEREOF	A61K 31/497 (2006.01)	2738163 *	AMIDINE COMPOUND OR SALT THEREOF
A61P 35/00 (2006.01)	2726092 *	SERPIN FUSION POLYPEPTIDES AND METHODS OF USE THEREOF	A61K 31/501 (2006.01)	2738163 *	AMIDINE COMPOUND OR SALT THEREOF
A61P 37/06 (2006.01)	2726092 *	SERPIN FUSION POLYPEPTIDES AND METHODS OF USE THEREOF	A61K 31/506 (2006.01)	2738163 *	AMIDINE COMPOUND OR SALT THEREOF
C07K 19/00 (2006.01)	2726092 *	SERPIN FUSION POLYPEPTIDES AND METHODS OF USE THEREOF	A61K 31/5377 (2006.01)	2738163 *	AMIDINE COMPOUND OR SALT THEREOF
A61K 9/00 (2006.01)	2704724 *	IMPROVED SUSPENSION FORMULATION OF A CORTICOSTEROID FOR ADMINISTRATION BY INHALATION	A61P 17/00 (2006.01)	2738163 *	AMIDINE COMPOUND OR SALT THEREOF

MKP (51)	Broj objave evropske prijava patenta (97)	Naziv pronalaska (54)	MKP (51)	Broj objave evropske prijava patenta (97)	Naziv pronalaska (54)
A61P 31/10 (2006.01)	2738163 *	AMIDINE COMPOUND OR SALT THEREOF	G01B 11/16 (2006.01)	2702352 *	ANALYSIS APPARATUS FOR CONTACTLESS ANALYSIS OF THE SHAPE OF A TRANSPARENT BODY, AND METHOD FOR CARRYING OUT THE CONTACTLESS ANALYSIS
C07D 277/20 (2006.01)	2738163 *	AMIDINE COMPOUND OR SALT THEREOF	G01B 11/24 (2006.01)	2702352 *	ANALYSIS APPARATUS FOR CONTACTLESS ANALYSIS OF THE SHAPE OF A TRANSPARENT BODY, AND METHOD FOR CARRYING OUT THE CONTACTLESS ANALYSIS
C07D 277/28 (2006.01)	2738163 *	AMIDINE COMPOUND OR SALT THEREOF	A61K 31/549 (2006.01)	2760462 *	BROAD-SPECTRUM ANTIMICROBIAL COMPOSITIONS BASED ON COMBINATIONS OF TAUROLIDINE AND PROTAMINE AND MEDICAL DEVICES CONTAINING SUCH COMPOSITIONS
C07D 277/30 (2006.01)	2738163 *	AMIDINE COMPOUND OR SALT THEREOF	A61K 38/16 (2006.01)	2760462 *	BROAD-SPECTRUM ANTIMICROBIAL COMPOSITIONS BASED ON COMBINATIONS OF TAUROLIDINE AND PROTAMINE AND MEDICAL DEVICES CONTAINING SUCH COMPOSITIONS
C07D 277/34 (2006.01)	2738163 *	AMIDINE COMPOUND OR SALT THEREOF	A61K 31/505 (2006.01)	2628732	Novel crystalline form of rilpivirine hydrochloride
C07D 277/48 (2006.01)	2738163 *	AMIDINE COMPOUND OR SALT THEREOF	A61P 31/18 (2006.01)	2628732	Novel crystalline form of rilpivirine hydrochloride
C07D 277/56 (2006.01)	2738163 *	AMIDINE COMPOUND OR SALT THEREOF	C07D 239/48 (2006.01)	2628732	Novel crystalline form of rilpivirine hydrochloride
C07D 285/08 (2006.01)	2738163 *	AMIDINE COMPOUND OR SALT THEREOF	A61K 31/437 (2006.01)	2723739 *	SUBSTITUTED 6-AZA-ISOINDOLIN-1-ONE DERIVATIVES
C07D 417/04 (2006.01)	2738163 *	AMIDINE COMPOUND OR SALT THEREOF	A61P 11/00 (2006.01)	2723739 *	SUBSTITUTED 6-AZA-ISOINDOLIN-1-ONE DERIVATIVES
F04D 7/04 (2006.01)	2734736 *	IMPROVEMENTS TO PUMPS AND COMPONENTS THEREFOR	A61P 17/00 (2006.01)	2723739 *	SUBSTITUTED 6-AZA-ISOINDOLIN-1-ONE DERIVATIVES
F04D 29/22 (2006.01)	2734736 *	IMPROVEMENTS TO PUMPS AND COMPONENTS THEREFOR	A61P 19/00 (2006.01)	2723739 *	SUBSTITUTED 6-AZA-ISOINDOLIN-1-ONE DERIVATIVES
F04D 29/42 (2006.01)	2734736 *	IMPROVEMENTS TO PUMPS AND COMPONENTS THEREFOR	A61P 29/00 (2006.01)	2723739 *	SUBSTITUTED 6-AZA-ISOINDOLIN-1-ONE DERIVATIVES
A61K 31/155 (2006.01)	2707017 *	LIXISENATIDE AND METFORMIN FOR TREATMENT OF DIABETES TYPE 2	A61P 35/00 (2006.01)	2723739 *	SUBSTITUTED 6-AZA-ISOINDOLIN-1-ONE DERIVATIVES
A61K 38/26 (2006.01)	2707017 *	LIXISENATIDE AND METFORMIN FOR TREATMENT OF DIABETES TYPE 2	A61P 37/00 (2006.01)	2723739 *	SUBSTITUTED 6-AZA-ISOINDOLIN-1-ONE DERIVATIVES
A61P 3/10 (2006.01)	2707017 *	LIXISENATIDE AND METFORMIN FOR TREATMENT OF DIABETES TYPE 2	C07D 471/04 (2006.01)	2723739 *	SUBSTITUTED 6-AZA-ISOINDOLIN-1-ONE DERIVATIVES
A61K 31/437 (2006.01)	2702061	PYRROLOTRIAZINONE DERIVATIVES AS PI3K INHIBITORS	C07D 519/00 (2006.01)	2723739 *	SUBSTITUTED 6-AZA-ISOINDOLIN-1-ONE DERIVATIVES
A61K 31/4985 (2006.01)	2702061	PYRROLOTRIAZINONE DERIVATIVES AS PI3K INHIBITORS			
A61P 35/00 (2006.01)	2702061	PYRROLOTRIAZINONE DERIVATIVES AS PI3K INHIBITORS			
C07D 473/34 (2006.01)	2702061	PYRROLOTRIAZINONE DERIVATIVES AS PI3K INHIBITORS			
C07D 487/04 (2006.01)	2702061	PYRROLOTRIAZINONE DERIVATIVES AS PI3K INHIBITORS			

MKP (51)	Broj objave evropske prijava patenta (97)	Naziv pronalaska (54)	MKP (51)	Broj objave evropske prijava patenta (97)	Naziv pronalaska (54)
A61K 38/16 (2006.01)	2709647 *	WATER SOLUBLE MEMBRANE PROTEINS AND METHODS FOR THE PREPARATION AND USE THEREOF	A61K 31/4025 (2006.01)	2725016 *	HETEROCYCLIC CARBOXYLIC ACID ESTER DERIVATIVE
C07K 14/00 (2006.01)	2709647 *	WATER SOLUBLE MEMBRANE PROTEINS AND METHODS FOR THE PREPARATION AND USE THEREOF	A61K 31/427 (2006.01)	2725016 *	HETEROCYCLIC CARBOXYLIC ACID ESTER DERIVATIVE
A23K 1/16 (2006.01)	2763550 *	USE OF SPENT BLEACHING EARTH FROM EDIBLE OIL PROCESSING IN THE FORMULATION OF SALT AND MINERAL FEED BLOCKS OR PELLETS FOR LIVESTOCK	A61K 31/435 (2006.01)	2725016 *	HETEROCYCLIC CARBOXYLIC ACID ESTER DERIVATIVE
A23K 1/175 (2006.01)	2763550 *	USE OF SPENT BLEACHING EARTH FROM EDIBLE OIL PROCESSING IN THE FORMULATION OF SALT AND MINERAL FEED BLOCKS OR PELLETS FOR LIVESTOCK	A61K 31/4365 (2006.01)	2725016 *	HETEROCYCLIC CARBOXYLIC ACID ESTER DERIVATIVE
A61K 31/5415 (2006.01)	2744808 *	TRICYCLIC COMPOUNDS AS ANTICANCER AGENTS	A61K 38/00 (2006.01)	2725016 *	HETEROCYCLIC CARBOXYLIC ACID ESTER DERIVATIVE
A61P 35/00 (2006.01)	2744808 *	TRICYCLIC COMPOUNDS AS ANTICANCER AGENTS	A61P 3/00 (2006.01)	2725016 *	HETEROCYCLIC CARBOXYLIC ACID ESTER DERIVATIVE
C07D 279/28 (2006.01)	2744808 *	TRICYCLIC COMPOUNDS AS ANTICANCER AGENTS	A61P 3/04 (2006.01)	2725016 *	HETEROCYCLIC CARBOXYLIC ACID ESTER DERIVATIVE
C07D 417/06 (2006.01)	2744808 *	TRICYCLIC COMPOUNDS AS ANTICANCER AGENTS	A61P 3/06 (2006.01)	2725016 *	HETEROCYCLIC CARBOXYLIC ACID ESTER DERIVATIVE
A61K 39/42 (2006.01)	2731967 *	HUMAN BINDING MOLECULES CAPABLE OF NEUTRALIZING INFLUENZA A VIRUSES OF PHYLOGENETIC GROUP 1 AND PHYLOGENETIC GROUP 2 AND INFLUENZA B VIRUSES	A61P 3/08 (2006.01)	2725016 *	HETEROCYCLIC CARBOXYLIC ACID ESTER DERIVATIVE
A61P 31/16 (2006.01)	2731967 *	HUMAN BINDING MOLECULES CAPABLE OF NEUTRALIZING INFLUENZA A VIRUSES OF PHYLOGENETIC GROUP 1 AND PHYLOGENETIC GROUP 2 AND INFLUENZA B VIRUSES	A61P 3/10 (2006.01)	2725016 *	HETEROCYCLIC CARBOXYLIC ACID ESTER DERIVATIVE
C07K 16/10 (2006.01)	2731967 *	HUMAN BINDING MOLECULES CAPABLE OF NEUTRALIZING INFLUENZA A VIRUSES OF PHYLOGENETIC GROUP 1 AND PHYLOGENETIC GROUP 2 AND INFLUENZA B VIRUSES	A61P 5/50 (2006.01)	2725016 *	HETEROCYCLIC CARBOXYLIC ACID ESTER DERIVATIVE
C07K 16/28 (2006.01)	2731973 *	BACTERIAL HOST STRAIN EXPRESSING RECOMBINANT DSBC	A61P 43/00 (2006.01)	2725016 *	HETEROCYCLIC CARBOXYLIC ACID ESTER DERIVATIVE
C12N 15/70 (2006.01)	2731973 *	BACTERIAL HOST STRAIN EXPRESSING RECOMBINANT DSBC	C07D 307/68 (2006.01)	2725016 *	HETEROCYCLIC CARBOXYLIC ACID ESTER DERIVATIVE
A61K 31/341 (2006.01)	2725016 *	HETEROCYCLIC CARBOXYLIC ACID ESTER DERIVATIVE	C07D 333/38 (2006.01)	2725016 *	HETEROCYCLIC CARBOXYLIC ACID ESTER DERIVATIVE
A61K 31/381 (2006.01)	2725016 *	HETEROCYCLIC CARBOXYLIC ACID ESTER DERIVATIVE	C07D 307/68 (2006.01)	2725016 *	HETEROCYCLIC CARBOXYLIC ACID ESTER DERIVATIVE
			C07D 405/06 (2006.01)	2725016 *	HETEROCYCLIC CARBOXYLIC ACID ESTER DERIVATIVE
			C07D 409/06 (2006.01)	2725016 *	HETEROCYCLIC CARBOXYLIC ACID ESTER DERIVATIVE
			C07D 417/06 (2006.01)	2725016 *	HETEROCYCLIC CARBOXYLIC ACID ESTER DERIVATIVE
			C07D 495/04 (2006.01)	2725016 *	HETEROCYCLIC CARBOXYLIC ACID ESTER DERIVATIVE

MKP (51)	Broj objave evropske prijava patenta (97)	Naziv pronalaska (54)	MKP (51)	Broj objave evropske prijava patenta (97)	Naziv pronalaska (54)
A61K 31/4725 (2006.01)	2766361 *	8 - CARBAMOYL - 2 - (2,3- DI SUBSTITUTED PYRID - 6 - YL) -1,2,3,4 -TETRAHYDROISOQUINOLINE DERIVATIVES AS APOPTOSIS - INDUCING AGENTS FOR THE TREATMENT OF CANCER AND IMMUNE AND AUTOIMMUNE DISEASES	A01N 43/42 (2006.01)	2720545 *	CYCLOALKYL-FUSED TETRAHYDROQUINOLINES AS CRTH2 RECEPTOR MODULATORS
A61P 35/00 (2006.01)	2766361 *	8 - CARBAMOYL - 2 - (2,3- DI SUBSTITUTED PYRID - 6 - YL) -1,2,3,4 -TETRAHYDROISOQUINOLINE DERIVATIVES AS APOPTOSIS - INDUCING AGENTS FOR THE TREATMENT OF CANCER AND IMMUNE AND AUTOIMMUNE DISEASES	C07D 215/00 (2006.01)	2720545 *	CYCLOALKYL-FUSED TETRAHYDROQUINOLINES AS CRTH2 RECEPTOR MODULATORS
C07D 417/14 (2006.01)	2766361 *	8 - CARBAMOYL - 2 - (2,3- DI SUBSTITUTED PYRID - 6 - YL) -1,2,3,4 -TETRAHYDROISOQUINOLINE DERIVATIVES AS APOPTOSIS - INDUCING AGENTS FOR THE TREATMENT OF CANCER AND IMMUNE AND AUTOIMMUNE DISEASES	E04D 3/30 (2006.01)	2724088 *	PANEL, ASSEMBLY OF PANELS AND ASSOCIATED ROOFING
C07D 471/04 (2006.01)	2766361 *	8 - CARBAMOYL - 2 - (2,3- DI SUBSTITUTED PYRID - 6 - YL) -1,2,3,4 -TETRAHYDROISOQUINOLINE DERIVATIVES AS APOPTOSIS - INDUCING AGENTS FOR THE TREATMENT OF CANCER AND IMMUNE AND AUTOIMMUNE DISEASES	E04D 3/365 (2006.01)	2724088 *	PANEL, ASSEMBLY OF PANELS AND ASSOCIATED ROOFING
C07D 487/04 (2006.01)	2766361 *	8 - CARBAMOYL - 2 - (2,3- DI SUBSTITUTED PYRID - 6 - YL) -1,2,3,4 -TETRAHYDROISOQUINOLINE DERIVATIVES AS APOPTOSIS - INDUCING AGENTS FOR THE TREATMENT OF CANCER AND IMMUNE AND AUTOIMMUNE DISEASES	F24J 2/52 (2006.01)	2724088 *	PANEL, ASSEMBLY OF PANELS AND ASSOCIATED ROOFING
C07D 513/04 (2006.01)	2766361 *	8 - CARBAMOYL - 2 - (2,3- DI SUBSTITUTED PYRID - 6 - YL) -1,2,3,4 -TETRAHYDROISOQUINOLINE DERIVATIVES AS APOPTOSIS - INDUCING AGENTS FOR THE TREATMENT OF CANCER AND IMMUNE AND AUTOIMMUNE DISEASES	F02M 55/02 (2006.01)	2765301 *	COMMON RAIL FUEL INJECTION SYSTEM
A61K 31/44 (2006.01)	2750677 *	KYNURENINE-3- MONOOXYGENASE INHIBITORS, PHARMACEUTICAL COMPOSITIONS, AND METHODS OF USE THEREOF	F02M 61/16 (2006.01)	2765301 *	COMMON RAIL FUEL INJECTION SYSTEM
C07D 401/00 (2006.01)	2750677 *	KYNURENINE-3- MONOOXYGENASE INHIBITORS, PHARMACEUTICAL COMPOSITIONS, AND METHODS OF USE THEREOF	F02M 63/00 (2006.01)	2765301 *	COMMON RAIL FUEL INJECTION SYSTEM
			A61K 9/00 (2006.01)	2734186 *	COMPOSITION
			A61K 31/522 (2006.01)	2734186 *	COMPOSITION
			A61P 11/06 (2006.01)	2734186 *	COMPOSITION
			A61P 37/08 (2006.01)	2734186 *	COMPOSITION
			A47C 7/62 (2006.01)	2701556 *	HOLDING DEVICE
			B67D 7/60 (2010.01)	2751020 *	AEROSOL REFILL CARTRIDGE
			A61B 17/00 (2006.01)	2644122	Tissue thickness compensators
			A61B 17/072 (2006.01)	2644122	Tissue thickness compensators
			A47F 3/04 (2006.01)	2750557 *	REFRIGERATOR COMPRISING A PLURALITY OF OPENING/ CLOSING MODULES WITH AT LEAST ONE SLIDING DOOR
			B65D 39/00 (2006.01)	2746183 *	SILICONE STOPPER FOR CAVA BOTTLES AND THE LIKE
			E21B 33/13 (2006.01)	2737167 *	WELLBORE CEMENTING TOOL HAVING ONE WAY FLOW

MKP (51)	Broj objave evropske prijava patenta (97)	Naziv pronalaska (54)	MKP (51)	Broj objave evropske prijava patenta (97)	Naziv pronalaska (54)
E21B 33/138 (2006.01)	2737167 *	WELLBORE CEMENTING TOOL HAVING ONE WAY FLOW	A61K 31/4409 (2006.01)	2739283 *	POLYMORPHIC FORMS OF THE SODIUM SALT OF 4-TERT-BUTYL-N-[4- CHLORO-2-(1-OXY-PYRIDINE- 4-CARBONYL)-PHENYL]- BENZENESULFONAMIDE
E21B 34/06 (2006.01)	2737167 *	WELLBORE CEMENTING TOOL HAVING ONE WAY FLOW	A01N 43/42 (2006.01)	2736335 *	TREATMENT OF MULTIPLE SCLEROSIS WITH COMBINATION OF LAQUINIMOD AND GLATIRAMER ACETATE
C07F 9/06 (2006.01)	2755983 *	SUBSTITUTED CARBOXYLOXYMETHYLPHOSPHORAMIDATE COMPOUNDS AND PHARMACEUTICAL COMPOSITIONS FOR THE TREATMENT OF VIRAL INFECTIONS	A61K 31/47 (2006.01)	2736335 *	TREATMENT OF MULTIPLE SCLEROSIS WITH COMBINATION OF LAQUINIMOD AND GLATIRAMER ACETATE
C07C 29/124 (2006.01)	2736865 *	METHOD FOR HYDROLYZING ALPHA - CHLORINATED TOLUENE COMPOUNDS	B62J 1/16 (2006.01)	2623403	Fastening device for a child seat on a frame of a bicycle
C07C 33/22 (2006.01)	2736865 *	METHOD FOR HYDROLYZING ALPHA - CHLORINATED TOLUENE COMPOUNDS	B62J 11/00 (2006.01)	2623403	Fastening device for a child seat on a frame of a bicycle
C07C 45/43 (2006.01)	2736865 *	METHOD FOR HYDROLYZING ALPHA - CHLORINATED TOLUENE COMPOUNDS	A23L 1/30 (2006.01)	2701537 *	FOOD, PARTICULARLY A BEVERAGE FOR HUMAN CONSUMPTION
C07C 47/54 (2006.01)	2736865 *	METHOD FOR HYDROLYZING ALPHA - CHLORINATED TOLUENE COMPOUNDS	A23L 2/385 (2006.01)	2701537 *	FOOD, PARTICULARLY A BEVERAGE FOR HUMAN CONSUMPTION
C07C 51/093 (2006.01)	2736865 *	METHOD FOR HYDROLYZING ALPHA - CHLORINATED TOLUENE COMPOUNDS	A23L 2/52 (2006.01)	2701537 *	FOOD, PARTICULARLY A BEVERAGE FOR HUMAN CONSUMPTION
C07C 63/06 (2006.01)	2736865 *	METHOD FOR HYDROLYZING ALPHA - CHLORINATED TOLUENE COMPOUNDS	A61P 25/28 (2006.01)	2701537 *	FOOD, PARTICULARLY A BEVERAGE FOR HUMAN CONSUMPTION
A01K 61/00 (2006.01)	2760282 *	FISH FARMING PLANT, MODULE, METHOD AND USE	A23L 1/30 (2006.01)	2734845 *	PRODUCTION AND USE OF BACTERIAL HISTAMINE
A01K 63/00 (2006.01)	2760282 *	FISH FARMING PLANT, MODULE, METHOD AND USE	A61K 35/74 (2006.01)	2734845 *	PRODUCTION AND USE OF BACTERIAL HISTAMINE
F16L 9/17 (2006.01)	2713116	Ventilation duct	G01N 33/569 (2006.01)	2734845 *	PRODUCTION AND USE OF BACTERIAL HISTAMINE
F16L 41/08 (2006.01)	2713116	Ventilation duct	A01N 43/54 (2006.01)	2744334 *	N-(5-FLUORO-2((4- METHYLBENZYL)OXY) PYRIMIDIN-4-YL) BENZAMIDE DERIVATIVES
F24F 13/02 (2006.01)	2713116	Ventilation duct	A01P 3/00 (2006.01)	2744334 *	N-(5-FLUORO-2((4- METHYLBENZYL)OXY) PYRIMIDIN-4-YL) BENZAMIDE DERIVATIVES
A01N 33/04 (2006.01)	2638804	Low volatile amine salts of anionic pesticides	C07D 239/47 (2006.01)	2744334 *	N-(5-FLUORO-2((4- METHYLBENZYL)OXY) PYRIMIDIN-4-YL) BENZAMIDE DERIVATIVES
A01N 33/08 (2006.01)	2638804	Low volatile amine salts of anionic pesticides	A61K 31/192 (2006.01)	2734496 *	INDENE DERIVATIVES FOR USE IN THE TREATMENT OF INFLAMMATORY BOWEL DISEASE
A01N 37/40 (2006.01)	2638804	Low volatile amine salts of anionic pesticides	A61P 1/00 (2006.01)	2734496 *	INDENE DERIVATIVES FOR USE IN THE TREATMENT OF INFLAMMATORY BOWEL DISEASE
A01N 39/04 (2006.01)	2638804	Low volatile amine salts of anionic pesticides			
A01N 57/20 (2006.01)	2638804	Low volatile amine salts of anionic pesticides			
B63B 35/68 (2006.01)	2704946 *	TOWING VESSEL			

MKP (51)	Broj objave evropske prijava patenta (97)	Naziv pronalaska (54)	MKP (51)	Broj objave evropske prijava patenta (97)	Naziv pronalaska (54)
C07C 65/19 (2006.01)	2734496 *	INDENE DERIVATIVES FOR USE IN THE TREATMENT OF INFLAMMATORY BOWEL DISEASE	A61K 47/26 (2006.01)	2767285 *	TABLET INCLUDING 7-[4-(4-BENZO[BETA]THIOPHEN-4-YL-PIPERAZIN-1-YL) BUTOXY]-1H-QUINOLIN-2-ONE OR SALT THEREOF
E06B 3/66 (2006.01)	2718530 *	LIGHTING UNIT MADE UP OF AN INSULATING GLASS PANEL AND LIGHT-EMITTING DIODES	A61K 47/38 (2006.01)	2767285 *	TABLET INCLUDING 7-[4-(4-BENZO[BETA]THIOPHEN-4-YL-PIPERAZIN-1-YL) BUTOXY]-1H-QUINOLIN-2-ONE OR SALT THEREOF
E06B 3/663 (2006.01)	2718530 *	LIGHTING UNIT MADE UP OF AN INSULATING GLASS PANEL AND LIGHT-EMITTING DIODES	C08L 63/00 (2006.01)	2725061	Cyanate ester resin composition, and a prepreg, a laminated material and a metal clad laminated material made therefrom
A61K 31/439 (2006.01)	2702041 *	ALKALOID ESTER AND CARBAMATE DERIVATIVES AND MEDICINAL COMPOSITIONS THEREOF	C08L 79/04 (2006.01)	2725061	Cyanate ester resin composition, and a prepreg, a laminated material and a metal clad laminated material made therefrom
A61P 11/00 (2006.01)	2702041 *	ALKALOID ESTER AND CARBAMATE DERIVATIVES AND MEDICINAL COMPOSITIONS THEREOF	A23L 1/0524 (2006.01)	2769627 *	METHOD FOR PRODUCING A CONCENTRATED JUICE-CONTAINING BEVERAGE ON THE BASIS OF LIQUID PECTIN
C07D 207/14 (2006.01)	2702041 *	ALKALOID ESTER AND CARBAMATE DERIVATIVES AND MEDICINAL COMPOSITIONS THEREOF	A23L 2/02 (2006.01)	2769627 *	METHOD FOR PRODUCING A CONCENTRATED JUICE-CONTAINING BEVERAGE ON THE BASIS OF LIQUID PECTIN
C07D 211/62 (2006.01)	2702041 *	ALKALOID ESTER AND CARBAMATE DERIVATIVES AND MEDICINAL COMPOSITIONS THEREOF	A23L 2/52 (2006.01)	2769627 *	METHOD FOR PRODUCING A CONCENTRATED JUICE-CONTAINING BEVERAGE ON THE BASIS OF LIQUID PECTIN
C07D 453/02 (2006.01)	2702041 *	ALKALOID ESTER AND CARBAMATE DERIVATIVES AND MEDICINAL COMPOSITIONS THEREOF	A61K 31/445 (2006.01)	2753603 *	POLYMORPHIC FORM OF PRIDOPIDINE HYDROCHLORIDE
A61K 9/20 (2006.01)	2767285 *	TABLET INCLUDING 7-[4-(4-BENZO[BETA]THIOPHEN-4-YL-PIPERAZIN-1-YL) BUTOXY]-1H-QUINOLIN-2-ONE OR SALT THEREOF	A61P 25/28 (2006.01)	2753603 *	POLYMORPHIC FORM OF PRIDOPIDINE HYDROCHLORIDE
A61K 9/28 (2006.01)	2767285 *	TABLET INCLUDING 7-[4-(4-BENZO[BETA]THIOPHEN-4-YL-PIPERAZIN-1-YL) BUTOXY]-1H-QUINOLIN-2-ONE OR SALT THEREOF	C07D 211/24 (2006.01)	2753603 *	POLYMORPHIC FORM OF PRIDOPIDINE HYDROCHLORIDE
A61K 31/496 (2006.01)	2767285 *	TABLET INCLUDING 7-[4-(4-BENZO[BETA]THIOPHEN-4-YL-PIPERAZIN-1-YL) BUTOXY]-1H-QUINOLIN-2-ONE OR SALT THEREOF	A61M 5/00 (2006.01)	2662102	Transport carrier for syringes
A61K 47/02 (2006.01)	2767285 *	TABLET INCLUDING 7-[4-(4-BENZO[BETA]THIOPHEN-4-YL-PIPERAZIN-1-YL) BUTOXY]-1H-QUINOLIN-2-ONE OR SALT THEREOF	A61M 5/28 (2006.01)	2662102	Transport carrier for syringes
A61K 47/10 (2006.01)	2767285 *	TABLET INCLUDING 7-[4-(4-BENZO[BETA]THIOPHEN-4-YL-PIPERAZIN-1-YL) BUTOXY]-1H-QUINOLIN-2-ONE OR SALT THEREOF	A61M 5/31 (2006.01)	2662102	Transport carrier for syringes
A61K 47/12 (2006.01)	2767285 *	TABLET INCLUDING 7-[4-(4-BENZO[BETA]THIOPHEN-4-YL-PIPERAZIN-1-YL) BUTOXY]-1H-QUINOLIN-2-ONE OR SALT THEREOF	A61M 5/315 (2006.01)	2662102	Transport carrier for syringes
			B65D 81/113 (2006.01)	2662102	Transport carrier for syringes
			G06Q 10/10 (2012.01)	2657894	Social connections migration
			G06Q 50/00 (2012.01)	2657894	Social connections migration

MKP (51)	Broj objave evropske prijava patenta (97)	Naziv pronalaska (54)	MKP (51)	Broj objave evropske prijava patenta (97)	Naziv pronalaska (54)
A61K 38/17 (2006.01)	2717901 *	HE4 BASED THERAPY FOR MALIGNANT DISEASE	H04W 84/18 (2009.01)	2595448	Method and System for Spatio-Temporal Sensor Selection
A61K 38/22 (2006.01)	2717901 *	HE4 BASED THERAPY FOR MALIGNANT DISEASE	G01N 33/50 (2006.01)	2705363 *	DEVICE AND METHOD FOR NON-INVASIVE COLLECTION OF COLORECTAL MUCOCELLULAR LAYER AND DISEASE DETECTION
A61K 39/395 (2006.01)	2717901 *	HE4 BASED THERAPY FOR MALIGNANT DISEASE	G01N 33/574 (2006.01)	2705363 *	DEVICE AND METHOD FOR NON-INVASIVE COLLECTION OF COLORECTAL MUCOCELLULAR LAYER AND DISEASE DETECTION
A61P 35/00 (2006.01)	2717901 *	HE4 BASED THERAPY FOR MALIGNANT DISEASE	A61K 9/10 (2006.01)	2760433 *	pH DEPENDENT CARRIERS FOR TARGETED RELEASE OF PHARMACEUTICALS ALONG THE GASTROINTESTINAL TRACT, COMPOSITIONS THEREFROM, AND MAKING AND USING SAME
A61K 31/454 (2006.01)	2757103 *	PYRROLIDINE-3-YLACETIC ACID DERIVATIVE	A61K 9/14 (2006.01)	2760433 *	pH DEPENDENT CARRIERS FOR TARGETED RELEASE OF PHARMACEUTICALS ALONG THE GASTROINTESTINAL TRACT, COMPOSITIONS THEREFROM, AND MAKING AND USING SAME
A61P 1/04 (2006.01)	2757103 *	PYRROLIDINE-3-YLACETIC ACID DERIVATIVE	A61K 9/16 (2006.01)	2760433 *	pH DEPENDENT CARRIERS FOR TARGETED RELEASE OF PHARMACEUTICALS ALONG THE GASTROINTESTINAL TRACT, COMPOSITIONS THEREFROM, AND MAKING AND USING SAME
A61P 43/00 (2006.01)	2757103 *	PYRROLIDINE-3-YLACETIC ACID DERIVATIVE	A61P 1/00 (2006.01)	2760433 *	pH DEPENDENT CARRIERS FOR TARGETED RELEASE OF PHARMACEUTICALS ALONG THE GASTROINTESTINAL TRACT, COMPOSITIONS THEREFROM, AND MAKING AND USING SAME
C07D 401/12 (2006.01)	2757103 *	PYRROLIDINE-3-YLACETIC ACID DERIVATIVE	A61P 1/04 (2006.01)	2760433 *	pH DEPENDENT CARRIERS FOR TARGETED RELEASE OF PHARMACEUTICALS ALONG THE GASTROINTESTINAL TRACT, COMPOSITIONS THEREFROM, AND MAKING AND USING SAME
A44C 13/00 (2006.01)	2636330	A manufactured article and a method of obtaining thereof.	B65D 88/56 (2006.01)	2753567 *	APPARATUS FOR TIPPING CONTAINERS OR MOVABLE CASES
A44C 17/02 (2006.01)	2636330	A manufactured article and a method of obtaining thereof.	B66C 1/10 (2006.01)	2753567 *	APPARATUS FOR TIPPING CONTAINERS OR MOVABLE CASES
A44C 17/04 (2006.01)	2636330	A manufactured article and a method of obtaining thereof.	C07C 201/04 (2006.01)	2490997 *	PROCESS FOR NITROALKANE RECOVERY BY AQUEOUS PHASE RECYCLE TO NITRATION REACTOR
A44C 25/00 (2006.01)	2636330	A manufactured article and a method of obtaining thereof.	C07C 205/02 (2006.01)	2490997 *	PROCESS FOR NITROALKANE RECOVERY BY AQUEOUS PHASE RECYCLE TO NITRATION REACTOR
A44C 27/00 (2006.01)	2636330	A manufactured article and a method of obtaining thereof.	A61K 31/421 (2006.01)	2704723 *	TREATMENT OF POLYCYSTIC DISEASE
A61K 9/70 (2006.01)	2682113	Sealing laminates containing agents	A61K 31/423 (2006.01)	2704723 *	TREATMENT OF POLYCYSTIC DISEASE
A61K 31/519 (2006.01)	2721030 *	NOVEL PHTHALAZINONE-PYRROLOPYRIMIDINECARBOXAMIDE DERIVATIVES			
A61P 11/00 (2006.01)	2721030 *	NOVEL PHTHALAZINONE-PYRROLOPYRIMIDINECARBOXAMIDE DERIVATIVES			
C07D 487/04 (2006.01)	2721030 *	NOVEL PHTHALAZINONE-PYRROLOPYRIMIDINECARBOXAMIDE DERIVATIVES			
A61B 18/00 (2006.01)	2726004 *	AN ELONGATED ELECTROSURGICAL INSTRUMENT, A SWITCH MEANS FOR SAID INSTRUMENT, AND AN ASSEMBLY KIT			
A61B 18/14 (2006.01)	2726004 *	AN ELONGATED ELECTROSURGICAL INSTRUMENT, A SWITCH MEANS FOR SAID INSTRUMENT, AND AN ASSEMBLY KIT			

MKP (51)	Broj objave evropske prijava patenta (97)	Naziv pronalaska (54)	MKP (51)	Broj objave evropske prijava patenta (97)	Naziv pronalaska (54)
A61K 31/505 (2006.01)	2704723 *	TREATMENT OF POLYCYSTIC DISEASE	A61M 25/00 (2006.01)	2734258 *	CATHETER, PARTICULARLY AN INDWELLING CATHETER, FOR TREATING FUNCTIONAL PROBLEMS AND/OR DISEASES OF THE BLADDER AND/OR PROSTATE
A61K 31/519 (2006.01)	2704723 *	TREATMENT OF POLYCYSTIC DISEASE	A61M 25/10 (2013.01)	2734258 *	CATHETER, PARTICULARLY AN INDWELLING CATHETER, FOR TREATING FUNCTIONAL PROBLEMS AND/OR DISEASES OF THE BLADDER AND/OR PROSTATE
A61K 31/16 (2006.01)	2758052 *	PHARMACEUTICAL COMPOSITIONS	A23C 9/00 (2006.01)	2653040	Food based on donkey fortified milk for preterm infants and/or term infants with allergy or intolerance to cow's milk proteins and method of preparation thereof
A61K 31/4164 (2006.01)	2758052 *	PHARMACEUTICAL COMPOSITIONS	A23L 1/29 (2006.01)	2653040	Food based on donkey fortified milk for preterm infants and/or term infants with allergy or intolerance to cow's milk proteins and method of preparation thereof
A61K 31/4184 (2006.01)	2758052 *	PHARMACEUTICAL COMPOSITIONS	A61K 31/437 (2006.01)	2723738 *	CRYSTAL OF FUSED HETEROCYCLIC COMPOUND
A61P 35/00 (2006.01)	2758052 *	PHARMACEUTICAL COMPOSITIONS	A61P 25/18 (2006.01)	2723738 *	CRYSTAL OF FUSED HETEROCYCLIC COMPOUND
E03C 1/00 (2006.01)	2751352 *	A SANITARY APPARATUS	C07D 471/04 (2006.01)	2723738 *	CRYSTAL OF FUSED HETEROCYCLIC COMPOUND
E03D 1/00 (2006.01)	2751352 *	A SANITARY APPARATUS	A61K 31/5025 (2006.01)	2721031 *	BROMODOMAIN INHIBITORS AND USES THEREOF
A61K 39/395 (2006.01)	2729170 *	ANTIBODY VARIANTS AND USES THEREOF	A61P 35/00 (2006.01)	2721031 *	BROMODOMAIN INHIBITORS AND USES THEREOF
A61P 35/00 (2006.01)	2729170 *	ANTIBODY VARIANTS AND USES THEREOF	C07D 403/04 (2006.01)	2721031 *	BROMODOMAIN INHIBITORS AND USES THEREOF
C07K 16/00 (2006.01)	2729170 *	ANTIBODY VARIANTS AND USES THEREOF	C07D 487/04 (2006.01)	2721031 *	BROMODOMAIN INHIBITORS AND USES THEREOF
C07K 16/28 (2006.01)	2729170 *	ANTIBODY VARIANTS AND USES THEREOF	A61K 38/00 (2006.01)	2701718 *	LANTIBIOTIC NAI-802, PHARMACEUTICALLY ACCEPTABLE SALTS, COMPOSITIONS, AND USES THEREOF
C07K 16/36 (2006.01)	2729170 *	ANTIBODY VARIANTS AND USES THEREOF	A01N 37/18 (2006.01)	2725902 *	ANTI-VIRAL COMBINATION THERAPY
C07K 16/40 (2006.01)	2756003 *	ANTIBODIES TO PCSK9 AND USES THEREOF	A61K 38/21 (2006.01)	2725902 *	ANTI-VIRAL COMBINATION THERAPY
A61K 39/125 (2006.01)	2731621 *	PARENTERAL NOROVIRUS VACCINE FORMULATIONS	A61K 39/395 (2006.01)	2725902 *	ANTI-VIRAL COMBINATION THERAPY
G07F 17/32 (2006.01)	2769366 *	GAMING MACHINE	A61K 39/42 (2006.01)	2725902 *	ANTI-VIRAL COMBINATION THERAPY
A01N 25/00 (2006.01)	2755473 *	PARASITICIDAL COMPOSITIONS COMPRISING AN ISOXAZOLINE ACTIVE AGENT, METHODS AND USES THEREOF	C07K 16/46 (2006.01)	2761008 *	CHIMAERIC SURROGATE LIGHT CHAINS (SLC) COMPRISING HUMAN VPRES
A61K 31/42 (2006.01)	2755473 *	PARASITICIDAL COMPOSITIONS COMPRISING AN ISOXAZOLINE ACTIVE AGENT, METHODS AND USES THEREOF			
A61P 33/00 (2006.01)	2755473 *	PARASITICIDAL COMPOSITIONS COMPRISING AN ISOXAZOLINE ACTIVE AGENT, METHODS AND USES THEREOF			

MKP (51)	Broj objave evropske prijava patenta (97)	Naziv pronalaska (54)	MKP (51)	Broj objave evropske prijava patenta (97)	Naziv pronalaska (54)
C12N 5/10 (2006.01)	2761008 *	CHIMAERIC SURROGATE LIGHT CHAINS (SLC) COMPRISING HUMAN VPRED	C07D 401/14 (2006.01)	2723717 *	TRPM8 ANTAGONISTS AND THEIR USE IN TREATMENTS
C12N 15/85 (2006.01)	2761008 *	CHIMAERIC SURROGATE LIGHT CHAINS (SLC) COMPRISING HUMAN VPRED	C07D 403/12 (2006.01)	2723717 *	TRPM8 ANTAGONISTS AND THEIR USE IN TREATMENTS
C07D 487/04 (2006.01)	2736909 *	PROCESS FOR THE PREPARATION OF SITAGLIPTIN AND ITS PHARMACEUTICALLY ACCEPTABLE SALTS	C07D 405/12 (2006.01)	2723717 *	TRPM8 ANTAGONISTS AND THEIR USE IN TREATMENTS
A01N 37/12 (2006.01)	2765857 *	SINGLE NUCLEOTIDE POLYMORPHISMS USEFUL TO PREDICT CLINICAL RESPONSE FOR GLATIRAMER ACETATE	C07D 405/14 (2006.01)	2723717 *	TRPM8 ANTAGONISTS AND THEIR USE IN TREATMENTS
C12Q 1/68 (2006.01)	2765857 *	SINGLE NUCLEOTIDE POLYMORPHISMS USEFUL TO PREDICT CLINICAL RESPONSE FOR GLATIRAMER ACETATE	C07D 409/12 (2006.01)	2723717 *	TRPM8 ANTAGONISTS AND THEIR USE IN TREATMENTS
C12P 7/56 (2006.01)	2732041 *	SEPARATION PROCESS	C07D 413/12 (2006.01)	2723717 *	TRPM8 ANTAGONISTS AND THEIR USE IN TREATMENTS
C12P 41/00 (2006.01)	2732041 *	SEPARATION PROCESS	C07D 417/12 (2006.01)	2723717 *	TRPM8 ANTAGONISTS AND THEIR USE IN TREATMENTS
A61K 31/553 (2006.01)	2726469 *	OXAZEPINES AS ION CHANNEL MODULATORS	C07D 471/04 (2006.01)	2723717 *	TRPM8 ANTAGONISTS AND THEIR USE IN TREATMENTS
C07D 267/14 (2006.01)	2726469 *	OXAZEPINES AS ION CHANNEL MODULATORS	C07D 487/04 (2006.01)	2723717 *	TRPM8 ANTAGONISTS AND THEIR USE IN TREATMENTS
C07D 413/04 (2006.01)	2726469 *	OXAZEPINES AS ION CHANNEL MODULATORS	A61K 48/00 (2006.01)	2636746	A novel drug delivery system based on JCV-VLP
C07D 413/12 (2006.01)	2726469 *	OXAZEPINES AS ION CHANNEL MODULATORS	C12N 15/86 (2006.01)	2636746	A novel drug delivery system based on JCV-VLP
C07D 413/14 (2006.01)	2726469 *	OXAZEPINES AS ION CHANNEL MODULATORS	A61K 9/00 (2006.01)	2719373	Fast disintegrating solid dosage form formulation comprising functionalized calcium carbonate and method of their manufacture
C07D 498/04 (2006.01)	2726469 *	OXAZEPINES AS ION CHANNEL MODULATORS	A61K 9/20 (2006.01)	2719373	Fast disintegrating solid dosage form formulation comprising functionalized calcium carbonate and method of their manufacture
A61K 31/45 (2006.01)	2723717 *	TRPM8 ANTAGONISTS AND THEIR USE IN TREATMENTS	H04N 5/335 (2011.01)	2708021 *	IMAGE SENSOR WITH TOLERANCE OPTIMIZING INTERCONNECTS
A61P 29/00 (2006.01)	2723717 *	TRPM8 ANTAGONISTS AND THEIR USE IN TREATMENTS	A61K 31/12 (2006.01)	2734199 *	SYNTHETIC LETHALITY AND THE TREATMENT OF CANCER
C07D 213/40 (2006.01)	2723717 *	TRPM8 ANTAGONISTS AND THEIR USE IN TREATMENTS	A61K 31/28 (2006.01)	2734199 *	SYNTHETIC LETHALITY AND THE TREATMENT OF CANCER
C07D 213/61 (2006.01)	2723717 *	TRPM8 ANTAGONISTS AND THEIR USE IN TREATMENTS	A61K 31/713 (2006.01)	2734199 *	SYNTHETIC LETHALITY AND THE TREATMENT OF CANCER
C07D 213/81 (2006.01)	2723717 *	TRPM8 ANTAGONISTS AND THEIR USE IN TREATMENTS	A61K 33/24 (2006.01)	2734199 *	SYNTHETIC LETHALITY AND THE TREATMENT OF CANCER
C07D 401/12 (2006.01)	2723717 *	TRPM8 ANTAGONISTS AND THEIR USE IN TREATMENTS	A61K 39/395 (2006.01)	2734199 *	SYNTHETIC LETHALITY AND THE TREATMENT OF CANCER

MKP (51)	Broj objave evropske prijava patenta (97)	Naziv pronalaska (54)	MKP (51)	Broj objave evropske prijava patenta (97)	Naziv pronalaska (54)
A61P 35/00 (2006.01)	2734199 *	SYNTHETIC LETHALITY AND THE TREATMENT OF CANCER	C07D 413/04 (2006.01)	2721033 *	COMPOUNDS, THEIR PHARMACEUTICAL COMPOSITIONS AND THEIR USES AS IDH1 MUTANTS INHIBITORS FOR TREATING CANCERS
G01N 33/50 (2006.01)	2734199 *	SYNTHETIC LETHALITY AND THE TREATMENT OF CANCER	C07D 491/052 (2006.01)	2721033 *	COMPOUNDS, THEIR PHARMACEUTICAL COMPOSITIONS AND THEIR USES AS IDH1 MUTANTS INHIBITORS FOR TREATING CANCERS
G01N 33/68 (2006.01)	2734199 *	SYNTHETIC LETHALITY AND THE TREATMENT OF CANCER	C07D 519/00 (2006.01)	2721033 *	COMPOUNDS, THEIR PHARMACEUTICAL COMPOSITIONS AND THEIR USES AS IDH1 MUTANTS INHIBITORS FOR TREATING CANCERS
A61K 38/37 (2006.01)	2729161 *	FACTOR VIII CHIMERIC AND HYBRID POLYPEPTIDES, AND METHODS OF USE THEREOF	A61K 31/4192 (2006.01)	2719690 *	AMIDE COMPOUND AND PHARMACEUTICAL APPLICATION THEREFOR
C07K 14/755 (2006.01)	2729161 *	FACTOR VIII CHIMERIC AND HYBRID POLYPEPTIDES, AND METHODS OF USE THEREOF	A61K 31/42 (2006.01)	2719690 *	AMIDE COMPOUND AND PHARMACEUTICAL APPLICATION THEREFOR
B01D 29/15 (2006.01)	2623175	A serviceable filtration arrangement	A61P 1/00 (2006.01)	2719690 *	AMIDE COMPOUND AND PHARMACEUTICAL APPLICATION THEREFOR
B01D 29/58 (2006.01)	2623175	A serviceable filtration arrangement	A61P 17/04 (2006.01)	2719690 *	AMIDE COMPOUND AND PHARMACEUTICAL APPLICATION THEREFOR
B01D 29/96 (2006.01)	2623175	A serviceable filtration arrangement	A61P 19/02 (2006.01)	2719690 *	AMIDE COMPOUND AND PHARMACEUTICAL APPLICATION THEREFOR
B01D 35/18 (2006.01)	2623175	A serviceable filtration arrangement	A61P 25/00 (2006.01)	2719690 *	AMIDE COMPOUND AND PHARMACEUTICAL APPLICATION THEREFOR
B01D 36/00 (2006.01)	2623175	A serviceable filtration arrangement	A61P 37/02 (2006.01)	2719690 *	AMIDE COMPOUND AND PHARMACEUTICAL APPLICATION THEREFOR
A01N 43/40 (2006.01)	2709609 *	HETEROCYCLIC COMPOUNDS	A61P 43/00 (2006.01)	2719690 *	AMIDE COMPOUND AND PHARMACEUTICAL APPLICATION THEREFOR
A61K 31/165 (2006.01)	2709609 *	HETEROCYCLIC COMPOUNDS	C07D 249/04 (2006.01)	2719690 *	AMIDE COMPOUND AND PHARMACEUTICAL APPLICATION THEREFOR
A61K 31/44 (2006.01)	2709609 *	HETEROCYCLIC COMPOUNDS	C07D 261/08 (2006.01)	2719690 *	AMIDE COMPOUND AND PHARMACEUTICAL APPLICATION THEREFOR
A61K 31/497 (2006.01)	2709609 *	HETEROCYCLIC COMPOUNDS	C07D 413/06 (2006.01)	2719690 *	AMIDE COMPOUND AND PHARMACEUTICAL APPLICATION THEREFOR
A61K 31/496 (2006.01)	2721033 *	COMPOUNDS, THEIR PHARMACEUTICAL COMPOSITIONS AND THEIR USES AS IDH1 MUTANTS INHIBITORS FOR TREATING CANCERS	G06F 3/14 (2006.01)	2665244	Sender device and method of sharing screenshots and computer-readable medium thereof
A61P 35/00 (2006.01)	2721033 *	COMPOUNDS, THEIR PHARMACEUTICAL COMPOSITIONS AND THEIR USES AS IDH1 MUTANTS INHIBITORS FOR TREATING CANCERS	H04M 1/725 (2006.01)	2665244	Sender device and method of sharing screenshots and computer-readable medium thereof
C07D 217/26 (2006.01)	2721033 *	COMPOUNDS, THEIR PHARMACEUTICAL COMPOSITIONS AND THEIR USES AS IDH1 MUTANTS INHIBITORS FOR TREATING CANCERS	A01N 43/52 (2006.01)	2720546 *	TRPV4 ANTAGONISTS

MKP (51)	Broj objave evropske prijava patenta (97)	Naziv pronalaska (54)	MKP (51)	Broj objave evropske prijava patenta (97)	Naziv pronalaska (54)
A61K 31/415 (2006.01)	2720546 *	TRPV4 ANTAGONISTS	B65G 33/04 (2006.01)	2574445	Oven for preforms applicable to blowing machines or stretch blowing machines
A61K 35/74 (2006.01)	2628793	Recombinant escherichia coli strains	B65G 47/84 (2006.01)	2574445	Oven for preforms applicable to blowing machines or stretch blowing machines
C07K 14/47 (2006.01)	2628793	Recombinant escherichia coli strains	B23Q 3/06 (2006.01)	2747937 *	SUPPORT AND GRIPPING DEVICE OF A MECHANICAL PART, SUITABLE FOR A MACHINE TOOL
C12N 1/21 (2006.01)	2628793	Recombinant escherichia coli strains	B23Q 16/10 (2006.01)	2747937 *	SUPPORT AND GRIPPING DEVICE OF A MECHANICAL PART, SUITABLE FOR A MACHINE TOOL
C12R 1/19 (2006.01)	2628793	Recombinant escherichia coli strains	A61K 38/19 (2006.01)	2742948 *	USE OF CARDIOTROPHIN-1 FOR THE TREATMENT OF KIDNEY DISEASES
F03D 11/00 (2006.01)	2707702 *	ASSESSMENT OF ROTOR BLADES	A61P 39/02 (2006.01)	2742948 *	USE OF CARDIOTROPHIN-1 FOR THE TREATMENT OF KIDNEY DISEASES
G01N 21/88 (2006.01)	2707702 *	ASSESSMENT OF ROTOR BLADES	A61F 2/04 (2013.01)	2760383 *	NEGATIVE PRESSURE INTESTINAL ANASTOMOSIS PROTECTION DEVICES
G01N 21/95 (2006.01)	2707702 *	ASSESSMENT OF ROTOR BLADES	A61F 2/82 (2013.01)	2760383 *	NEGATIVE PRESSURE INTESTINAL ANASTOMOSIS PROTECTION DEVICES
C07K 14/00 (2006.01)	2766484 *	REGULATION OF RECEPTOR EXPRESSION THROUGH DELIVERY OF ARTIFICIAL TRANSCRIPTION FACTORS	A61F 2/88 (2006.01)	2760383 *	NEGATIVE PRESSURE INTESTINAL ANASTOMOSIS PROTECTION DEVICES
C12N 15/62 (2006.01)	2766484 *	REGULATION OF RECEPTOR EXPRESSION THROUGH DELIVERY OF ARTIFICIAL TRANSCRIPTION FACTORS	C07C 45/55 (2006.01)	2720995 *	PROCESS FOR MAKING TERTIARY AMINOALCOHOL COMPOUNDS
A61L 15/18 (2006.01)	2734245 *	WOUND DRESSING WITH AN ANTIMICROBIAL EFFECT	C07C 47/04 (2006.01)	2720995 *	PROCESS FOR MAKING TERTIARY AMINOALCOHOL COMPOUNDS
A61L 15/46 (2006.01)	2734245 *	WOUND DRESSING WITH AN ANTIMICROBIAL EFFECT	C07C 201/12 (2006.01)	2720995 *	PROCESS FOR MAKING TERTIARY AMINOALCOHOL COMPOUNDS
C07D 403/12 (2006.01)	2729463 *	SUBSTITUTED PHENYL COMPOUNDS	C07C 205/15 (2006.01)	2720995 *	PROCESS FOR MAKING TERTIARY AMINOALCOHOL COMPOUNDS
C07K 16/28 (2006.01)	2726508 *	ANTIBODIES TO ADP-RIBOSYL CYCLASE 2	C07C 213/00 (2006.01)	2720995 *	PROCESS FOR MAKING TERTIARY AMINOALCOHOL COMPOUNDS
B29C 49/36 (2006.01)	2574445	Oven for preforms applicable to blowing machines or stretch blowing machines	C07C 215/08 (2006.01)	2720995 *	PROCESS FOR MAKING TERTIARY AMINOALCOHOL COMPOUNDS
B29C 49/42 (2006.01)	2574445	Oven for preforms applicable to blowing machines or stretch blowing machines	C07C 211/42 (2006.01)	2705021 *	RASAGILINE AND ITS PHARMACEUTICALLY ACCEPTABLE SALTS
B29C 49/64 (2006.01)	2574445	Oven for preforms applicable to blowing machines or stretch blowing machines	C07C 309/29 (2006.01)	2705021 *	RASAGILINE AND ITS PHARMACEUTICALLY ACCEPTABLE SALTS
B29C 49/68 (2006.01)	2574445	Oven for preforms applicable to blowing machines or stretch blowing machines	C07C 309/35 (2006.01)	2705021 *	RASAGILINE AND ITS PHARMACEUTICALLY ACCEPTABLE SALTS
B65G 29/00 (2006.01)	2574445	Oven for preforms applicable to blowing machines or stretch blowing machines	B29C 70/22 (2006.01)	2758228 *	SEMI-FINISHED FIBER PRODUCT, FIBER COMPOSITE MATERIAL AND METHOD FOR THE PRODUCTION THEREOF

MKP (51)	Broj objave evropske prijava patenta (97)	Naziv pronalaska (54)	MKP (51)	Broj objave evropske prijava patenta (97)	Naziv pronalaska (54)
D04H 3/04 (2012.01)	2758228 *	SEMI-FINISHED FIBER PRODUCT, FIBER COMPOSITE MATERIAL AND METHOD FOR THE PRODUCTION THEREOF	A61P 9/12 (2006.01)	2714662 *	NEPRILYSIN INHIBITORS
D04H 3/05 (2006.01)	2758228 *	SEMI-FINISHED FIBER PRODUCT, FIBER COMPOSITE MATERIAL AND METHOD FOR THE PRODUCTION THEREOF	C07D 231/14 (2006.01)	2714662 *	NEPRILYSIN INHIBITORS
D04H 3/12 (2006.01)	2758228 *	SEMI-FINISHED FIBER PRODUCT, FIBER COMPOSITE MATERIAL AND METHOD FOR THE PRODUCTION THEREOF	C07D 401/04 (2006.01)	2714662 *	NEPRILYSIN INHIBITORS
F22B 21/02 (2006.01)	2715229 *	STEAM GENERATOR	C07D 401/06 (2006.01)	2714662 *	NEPRILYSIN INHIBITORS
F22B 21/34 (2006.01)	2715229 *	STEAM GENERATOR	C07D 403/04 (2006.01)	2714662 *	NEPRILYSIN INHIBITORS
F22B 29/02 (2006.01)	2715229 *	STEAM GENERATOR	C07D 403/06 (2006.01)	2714662 *	NEPRILYSIN INHIBITORS
F22B 29/06 (2006.01)	2715229 *	STEAM GENERATOR	C07D 405/04 (2006.01)	2714662 *	NEPRILYSIN INHIBITORS
F22B 33/10 (2006.01)	2715229 *	STEAM GENERATOR	C07D 405/12 (2006.01)	2714662 *	NEPRILYSIN INHIBITORS
F22D 1/04 (2006.01)	2715229 *	STEAM GENERATOR	C07D 413/04 (2006.01)	2714662 *	NEPRILYSIN INHIBITORS
F22G 1/02 (2006.01)	2715229 *	STEAM GENERATOR	C07D 413/06 (2006.01)	2714662 *	NEPRILYSIN INHIBITORS
F22G 3/00 (2006.01)	2715229 *	STEAM GENERATOR	E04G 3/22 (2006.01)	2769032 *	EQUIPMENT AND METHOD FOR DEMOLISHING A BUILDING
F22G 7/14 (2006.01)	2715229 *	STEAM GENERATOR	E04G 3/24 (2006.01)	2769032 *	EQUIPMENT AND METHOD FOR DEMOLISHING A BUILDING
B62D 7/09 (2006.01)	2755882 *	STEERING AXLE	E04G 23/08 (2006.01)	2769032 *	EQUIPMENT AND METHOD FOR DEMOLISHING A BUILDING
B62D 7/18 (2006.01)	2755882 *	STEERING AXLE	A61K 31/27 (2006.01)	2701699 *	INHIBITORS OF HISTONE DEACETYLASE
B62D 7/20 (2006.01)	2755882 *	STEERING AXLE	G01N 33/569 (2006.01)	2758785 *	METHOD FOR CHECKING THE SELF-HEALING PROCESS CARRIED OUT BY THE IMMUNE SYSTEM OF A TEST SUBJECT INFECTED WITH HUMAN PAPILLOMAVIRUS
B01D 46/10 (2006.01)	2679292	Regenerable flat filter for air with semi-rigid frame	A61M 5/00 (2006.01)	2753382 *	DEVICE FOR AUTOMATIC INJECTION OF DRUG DOSES
A61K 31/415 (2006.01)	2714662 *	NEPRILYSIN INHIBITORS	A61M 5/20 (2006.01)	2753382 *	DEVICE FOR AUTOMATIC INJECTION OF DRUG DOSES
A61K 31/4155 (2006.01)	2714662 *	NEPRILYSIN INHIBITORS	A61M 5/31 (2006.01)	2753382 *	DEVICE FOR AUTOMATIC INJECTION OF DRUG DOSES
A61P 9/00 (2006.01)	2714662 *	NEPRILYSIN INHIBITORS			

MKP (51)	Broj objave evropske prijava patenta (97)	Naziv pronalaska (54)	MKP (51)	Broj objave evropske prijava patenta (97)	Naziv pronalaska (54)
A61M 5/315 (2006.01)	2753382 *	DEVICE FOR AUTOMATIC INJECTION OF DRUG DOSES	A61P 27/00 (2006.01)	2751109 *	HETEROCYCLYLAMINES AS PI3K INHIBITORS
A61M 5/32 (2006.01)	2753382 *	DEVICE FOR AUTOMATIC INJECTION OF DRUG DOSES	A61P 29/00 (2006.01)	2751109 *	HETEROCYCLYLAMINES AS PI3K INHIBITORS
B24D 15/00 (2006.01)	2709800 *	METHOD FOR PRODUCING A NON-DETACHABLE SECURITY SEAL	A61P 35/00 (2006.01)	2751109 *	HETEROCYCLYLAMINES AS PI3K INHIBITORS
G09F 3/02 (2006.01)	2709800 *	METHOD FOR PRODUCING A NON-DETACHABLE SECURITY SEAL	C07D 471/04 (2006.01)	2751109 *	HETEROCYCLYLAMINES AS PI3K INHIBITORS
G09F 3/10 (2006.01)	2709800 *	METHOD FOR PRODUCING A NON-DETACHABLE SECURITY SEAL	C07D 487/04 (2006.01)	2751109 *	HETEROCYCLYLAMINES AS PI3K INHIBITORS
B65H 75/14 (2006.01)	2634127	Cable carrier	A61K 31/52 (2006.01)	2744810 *	TENOFOVIR ALAFENAMIDE HEMIFUMARATE
B65H 75/22 (2006.01)	2634127	Cable carrier	A61P 31/18 (2006.01)	2744810 *	TENOFOVIR ALAFENAMIDE HEMIFUMARATE
A61B 17/072 (2006.01)	2644124	Tissue thickness compensator comprising capsules defining a low pressure environment	A61P 31/20 (2006.01)	2744810 *	TENOFOVIR ALAFENAMIDE HEMIFUMARATE
A01N 33/04 (2006.01)	2638803	Low volatile amine salts of anionic pesticides	C07D 473/34 (2006.01)	2744810 *	TENOFOVIR ALAFENAMIDE HEMIFUMARATE
A01N 33/08 (2006.01)	2638803	Low volatile amine salts of anionic pesticides	A61K 47/48 (2006.01)	2662095	Pyrrrolobenzodiazepines and conjugates thereof
A01N 37/40 (2006.01)	2638803	Low volatile amine salts of anionic pesticides	A61K 31/397 (2006.01)	2753326 *	METHODS FOR TREATING INTRAPULMONARY INFECTIONS
A01N 39/04 (2006.01)	2638803	Low volatile amine salts of anionic pesticides	F02M 63/00 (2006.01)	2647827	Check valve assembly
A01N 57/20 (2006.01)	2638803	Low volatile amine salts of anionic pesticides	A61K 31/416 (2006.01)	2721009 *	PYRAZOLE DERIVATIVES USEFUL AS ALDOSTERONE SYNTHASE INHIBITORS
C07D 207/40 (2006.01)	2761296 *	RAPID FLUORESCENCE TAGGING OF GLYCANS AND OTHER BIOMOLECULES WITH ENHANCED MS SIGNALS	A61P 5/00 (2006.01)	2721009 *	PYRAZOLE DERIVATIVES USEFUL AS ALDOSTERONE SYNTHASE INHIBITORS
G01N 33/533 (2006.01)	2761296 *	RAPID FLUORESCENCE TAGGING OF GLYCANS AND OTHER BIOMOLECULES WITH ENHANCED MS SIGNALS	A61P 9/00 (2006.01)	2721009 *	PYRAZOLE DERIVATIVES USEFUL AS ALDOSTERONE SYNTHASE INHIBITORS
A61K 31/519 (2006.01)	2751109 *	HETEROCYCLYLAMINES AS PI3K INHIBITORS	A61P 13/00 (2006.01)	2721009 *	PYRAZOLE DERIVATIVES USEFUL AS ALDOSTERONE SYNTHASE INHIBITORS
A61P 1/00 (2006.01)	2751109 *	HETEROCYCLYLAMINES AS PI3K INHIBITORS	C07D 231/54 (2006.01)	2721009 *	PYRAZOLE DERIVATIVES USEFUL AS ALDOSTERONE SYNTHASE INHIBITORS
A61P 17/00 (2006.01)	2751109 *	HETEROCYCLYLAMINES AS PI3K INHIBITORS	C07D 231/56 (2006.01)	2721009 *	PYRAZOLE DERIVATIVES USEFUL AS ALDOSTERONE SYNTHASE INHIBITORS
A61P 19/00 (2006.01)	2751109 *	HETEROCYCLYLAMINES AS PI3K INHIBITORS	G01N 24/00 (2006.01)	2764351 *	INTACT MASS DETERMINATION OF PROTEIN CONJUGATED AGENT COMPOUNDS
			F21V 35/00 (2006.01)	2729734 *	CONTAINER FOR CANDLES, WITH INTERNAL CIRCULATION OF AIR

MKP (51)	Broj objave evropske prijava patenta (97)	Naziv pronalaska (54)	MKP (51)	Broj objave evropske prijava patenta (97)	Naziv pronalaska (54)
F21V 37/02 (2006.01)	2729734 *	CONTAINER FOR CANDLES, WITH INTERNAL CIRCULATION OF AIR	G01R 33/24 (2006.01)	2702400 *	COMPOSITIONS AND METHODS TO ASSESS THE CAPACITY OF HDL TO SUPPORT REVERSE CHOLESTEROL TRANSPORT
F23D 3/16 (2006.01)	2729734 *	CONTAINER FOR CANDLES, WITH INTERNAL CIRCULATION OF AIR	G01R 33/60 (2006.01)	2702400 *	COMPOSITIONS AND METHODS TO ASSESS THE CAPACITY OF HDL TO SUPPORT REVERSE CHOLESTEROL TRANSPORT
A61P 41/00 (2006.01)	2716684 *	COMPOUNDS, PHARMACEUTICAL COMPOSITIONS AND A METHOD FOR THE PROPHYLAXIS AND TREATMENT OF THE ADHESION PROCESS	G01R 33/62 (2006.01)	2702400 *	COMPOSITIONS AND METHODS TO ASSESS THE CAPACITY OF HDL TO SUPPORT REVERSE CHOLESTEROL TRANSPORT
C07D 401/04 (2006.01)	2716684 *	COMPOUNDS, PHARMACEUTICAL COMPOSITIONS AND A METHOD FOR THE PROPHYLAXIS AND TREATMENT OF THE ADHESION PROCESS	A61K 31/131 (2006.01)	2717893 *	LIPID NANOPARTICLE COMPOSITIONS AND METHODS FOR MRNA DELIVERY
C08G 73/06 (2006.01)	2716684 *	COMPOUNDS, PHARMACEUTICAL COMPOSITIONS AND A METHOD FOR THE PROPHYLAXIS AND TREATMENT OF THE ADHESION PROCESS	A61K 31/132 (2006.01)	2717893 *	LIPID NANOPARTICLE COMPOSITIONS AND METHODS FOR MRNA DELIVERY
C08L 79/06 (2006.01)	2716684 *	COMPOUNDS, PHARMACEUTICAL COMPOSITIONS AND A METHOD FOR THE PROPHYLAXIS AND TREATMENT OF THE ADHESION PROCESS	A61K 31/215 (2006.01)	2717893 *	LIPID NANOPARTICLE COMPOSITIONS AND METHODS FOR MRNA DELIVERY
A61K 39/395 (2006.01)	2705058 *	AMINO ACID SEQUENCES DIRECTED AGAINST IL-17A, IL-17F AND/OR IL17-A/F AND POLYPEPTIDES COMPRISING THE SAME	A61K 31/56 (2006.01)	2717893 *	LIPID NANOPARTICLE COMPOSITIONS AND METHODS FOR MRNA DELIVERY
A61P 37/06 (2006.01)	2705058 *	AMINO ACID SEQUENCES DIRECTED AGAINST IL-17A, IL-17F AND/OR IL17-A/F AND POLYPEPTIDES COMPRISING THE SAME	A61K 38/00 (2006.01)	2717893 *	LIPID NANOPARTICLE COMPOSITIONS AND METHODS FOR MRNA DELIVERY
C07K 16/24 (2006.01)	2705058 *	AMINO ACID SEQUENCES DIRECTED AGAINST IL-17A, IL-17F AND/OR IL17-A/F AND POLYPEPTIDES COMPRISING THE SAME	A61K 38/16 (2006.01)	2717893 *	LIPID NANOPARTICLE COMPOSITIONS AND METHODS FOR MRNA DELIVERY
C07K 16/46 (2006.01)	2705058 *	AMINO ACID SEQUENCES DIRECTED AGAINST IL-17A, IL-17F AND/OR IL17-A/F AND POLYPEPTIDES COMPRISING THE SAME	A61K 38/43 (2006.01)	2717893 *	LIPID NANOPARTICLE COMPOSITIONS AND METHODS FOR MRNA DELIVERY
C07D 403/14 (2006.01)	2768825 *	PROCESSES FOR THE PREPARATION OF NOVEL BENZIMIDAZOLE DERIVATIVES	B65D 30/24 (2006.01)	2684812	Fluid container
A01K 3/00 (2006.01)	2720530 *	OUTRIGGER	A61K 39/395 (2006.01)	2764023 *	ANTI-HUMAN SEMA4A ANTIBODIES USEFUL TO TREAT DISEASE
G01N 24/10 (2006.01)	2702400 *	COMPOSITIONS AND METHODS TO ASSESS THE CAPACITY OF HDL TO SUPPORT REVERSE CHOLESTEROL TRANSPORT	A61P 35/00 (2006.01)	2764023 *	ANTI-HUMAN SEMA4A ANTIBODIES USEFUL TO TREAT DISEASE
G01N 24/12 (2006.01)	2702400 *	COMPOSITIONS AND METHODS TO ASSESS THE CAPACITY OF HDL TO SUPPORT REVERSE CHOLESTEROL TRANSPORT	A61P 37/08 (2006.01)	2764023 *	ANTI-HUMAN SEMA4A ANTIBODIES USEFUL TO TREAT DISEASE
			C07K 16/18 (2006.01)	2764023 *	ANTI-HUMAN SEMA4A ANTIBODIES USEFUL TO TREAT DISEASE
			B29C 45/18 (2006.01)	2718087 *	POLYMER PRODUCT AND METHOD OF MANUFACTURING THE PRODUCT
			B29C 49/00 (2006.01)	2718087 *	POLYMER PRODUCT AND METHOD OF MANUFACTURING THE PRODUCT
			B29C 49/22 (2006.01)	2718087 *	POLYMER PRODUCT AND METHOD OF MANUFACTURING THE PRODUCT
			B65D 81/24 (2006.01)	2718087 *	POLYMER PRODUCT AND METHOD OF MANUFACTURING THE PRODUCT

MKP (51)	Broj objave evropske prijava patenta (97)	Naziv pronalaska (54)	MKP (51)	Broj objave evropske prijava patenta (97)	Naziv pronalaska (54)
A01G 25/06 (2006.01)	2760274 *	IRRIGATION MAT	A61K 31/375 (2006.01)	2701697 *	OXIDATIVE RETINAL DISEASES
F25D 3/08 (2006.01)	2722618	Container with regulation of content temperature	A61P 27/00 (2006.01)	2701697 *	OXIDATIVE RETINAL DISEASES
G06Q 50/00 (2012.01)	2715650 *	A REFUSE COLLECTION SYSTEM AND METHOD	A61P 27/02 (2006.01)	2701697 *	OXIDATIVE RETINAL DISEASES
A61K 31/519 (2006.01)	2709627 *	INDUCTION OF IMMUNE TOLERANCE BY USING METHOTREXATE	A61K 31/519 (2006.01)	2748156 *	NOVEL PIPERIDINO-DIHYDROTHIENOPYRIMIDINE SULFOXIDES AND THEIR USE FOR TREATING COPD AND ASTHMA
A61K 35/00 (2006.01)	2709627 *	INDUCTION OF IMMUNE TOLERANCE BY USING METHOTREXATE	A61P 29/00 (2006.01)	2748156 *	NOVEL PIPERIDINO-DIHYDROTHIENOPYRIMIDINE SULFOXIDES AND THEIR USE FOR TREATING COPD AND ASTHMA
B27B 5/29 (2006.01)	2750842 *	CUTTING MACHINE TABLE MANUFACTURING METHOD	C07C 211/35 (2006.01)	2748156 *	NOVEL PIPERIDINO-DIHYDROTHIENOPYRIMIDINE SULFOXIDES AND THEIR USE FOR TREATING COPD AND ASTHMA
A23L 1/30 (2006.01)	2704733 *	POLYBACTERIAL PREPARATION WITH HEALTH BENEFITS: ANTIOXIDANT EFFECT, REDUCTION OF CHOLESTEROL CONCENTRATION, ANTI-INFLAMMATORY IMMUNOMODULATING EFFECT AND RELEASE OF BIOACTIVE PEPTIDES INHIBITING ANGIOTENSIN-CONVERTING ENZYME	C07D 401/04 (2006.01)	2748156 *	NOVEL PIPERIDINO-DIHYDROTHIENOPYRIMIDINE SULFOXIDES AND THEIR USE FOR TREATING COPD AND ASTHMA
A61K 35/74 (2006.01)	2704733 *	POLYBACTERIAL PREPARATION WITH HEALTH BENEFITS: ANTIOXIDANT EFFECT, REDUCTION OF CHOLESTEROL CONCENTRATION, ANTI-INFLAMMATORY IMMUNOMODULATING EFFECT AND RELEASE OF BIOACTIVE PEPTIDES INHIBITING ANGIOTENSIN-CONVERTING ENZYME	C07D 495/04 (2006.01)	2748156 *	NOVEL PIPERIDINO-DIHYDROTHIENOPYRIMIDINE SULFOXIDES AND THEIR USE FOR TREATING COPD AND ASTHMA
B01F 3/04 (2006.01)	2701832 *	METHOD AND DEVICE FOR ENRICHING A LIQUID WITH OXYGEN	G06F 17/18 (2006.01)	2764444 *	DATA FUSION IN HIGH COMPUTATIONAL LOAD ENVIRONMENTS
B01F 3/22 (2006.01)	2701832 *	METHOD AND DEVICE FOR ENRICHING A LIQUID WITH OXYGEN	A61K 39/395 (2006.01)	2736529 *	STABILIZED FORMULATIONS CONTAINING ANTI-PCSK9 ANTIBODIES
B01F 5/04 (2006.01)	2701832 *	METHOD AND DEVICE FOR ENRICHING A LIQUID WITH OXYGEN	C07K 16/40 (2006.01)	2736529 *	STABILIZED FORMULATIONS CONTAINING ANTI-PCSK9 ANTIBODIES
F04F 5/04 (2006.01)	2701832 *	METHOD AND DEVICE FOR ENRICHING A LIQUID WITH OXYGEN	F16K 3/02 (2006.01)	2724085 *	SLIDE DAMPER FOR A FLUID-EXTRACTING SYSTEM, AND EQUIPMENT COMPRISING SUCH A SLIDE DAMPER
A61K 31/122 (2006.01)	2701697 *	OXIDATIVE RETINAL DISEASES	F16K 27/04 (2006.01)	2724085 *	SLIDE DAMPER FOR A FLUID-EXTRACTING SYSTEM, AND EQUIPMENT COMPRISING SUCH A SLIDE DAMPER
A61K 31/20 (2006.01)	2701697 *	OXIDATIVE RETINAL DISEASES	F24F 13/12 (2006.01)	2724085 *	SLIDE DAMPER FOR A FLUID-EXTRACTING SYSTEM, AND EQUIPMENT COMPRISING SUCH A SLIDE DAMPER
A61K 31/202 (2006.01)	2701697 *	OXIDATIVE RETINAL DISEASES	A61K 31/42 (2006.01)	2766039 *	COMPOSITIONS FOR THE TREATMENT OF RHEUMATOID ARTHRITIS AND METHODS OF USING SAME
			A61K 31/519 (2006.01)	2766039 *	COMPOSITIONS FOR THE TREATMENT OF RHEUMATOID ARTHRITIS AND METHODS OF USING SAME

MKP (51)	Broj objave evropske prijava patenta (97)	Naziv pronalaska (54)	MKP (51)	Broj objave evropske prijava patenta (97)	Naziv pronalaska (54)
A61K 31/655 (2006.01)	2766039 *	COMPOSITIONS FOR THE TREATMENT OF RHEUMATOID ARTHRITIS AND METHODS OF USING SAME	A61K 31/7048 (2006.01)	2745839	Pharmaceutical composition in the form of an oral suspension including a flavonoid fraction and xanthan gum
A61K 39/395 (2006.01)	2766039 *	COMPOSITIONS FOR THE TREATMENT OF RHEUMATOID ARTHRITIS AND METHODS OF USING SAME	A61K 47/36 (2006.01)	2745839	Pharmaceutical composition in the form of an oral suspension including a flavonoid fraction and xanthan gum
A61K 45/06 (2006.01)	2766039 *	COMPOSITIONS FOR THE TREATMENT OF RHEUMATOID ARTHRITIS AND METHODS OF USING SAME	A61K 31/4995 (2006.01)	2703402 *	PHARMACOLOGICALLY ACTIVE ALICYCLIC N,N'-SUBSTITUTED 3,7-DIAZABICYCLO[3.3.1]NONANE DERIVATIVES AND DRUGS BASED THEREON
C07K 16/28 (2006.01)	2766039 *	COMPOSITIONS FOR THE TREATMENT OF RHEUMATOID ARTHRITIS AND METHODS OF USING SAME	A61P 25/28 (2006.01)	2703402 *	PHARMACOLOGICALLY ACTIVE ALICYCLIC N,N'-SUBSTITUTED 3,7-DIAZABICYCLO[3.3.1]NONANE DERIVATIVES AND DRUGS BASED THEREON
A61K 9/00 (2006.01)	2765986 *	PREVENTION AND TREATMENT OF OCULAR CONDITIONS	C07D 471/08 (2006.01)	2703402 *	PHARMACOLOGICALLY ACTIVE ALICYCLIC N,N'-SUBSTITUTED 3,7-DIAZABICYCLO[3.3.1]NONANE DERIVATIVES AND DRUGS BASED THEREON
A61K 31/573 (2006.01)	2765986 *	PREVENTION AND TREATMENT OF OCULAR CONDITIONS	F24J 3/00 (2006.01)	2732220 *	ENERGY CELL AND PROCEDURE FOR THE EXPLOITATION OF HEAT ENERGY ARISING DURING AEROBIC PROCESSES
A61K 47/48 (2006.01)	2765986 *	PREVENTION AND TREATMENT OF OCULAR CONDITIONS	F16H 1/22 (2006.01)	2685252	Conduit sensor device and process for modifying a magnetic field of a conduit sensor device
A61P 27/02 (2006.01)	2765986 *	PREVENTION AND TREATMENT OF OCULAR CONDITIONS	F16L 55/40 (2006.01)	2685252	Conduit sensor device and process for modifying a magnetic field of a conduit sensor device
A61K 9/00 (2006.01)	2753302 *	PHARMACEUTICAL INVENTION OF TAPENTADOL	G01N 27/82 (2006.01)	2685252	Conduit sensor device and process for modifying a magnetic field of a conduit sensor device
A61K 31/137 (2006.01)	2753302 *	PHARMACEUTICAL INVENTION OF TAPENTADOL	A61K 47/48 (2006.01)	2714737 *	BCMA (CD269/TNFRSF17) -BINDING PROTEINS
A61K 47/10 (2006.01)	2753302 *	PHARMACEUTICAL INVENTION OF TAPENTADOL	C07K 16/28 (2006.01)	2714737 *	BCMA (CD269/TNFRSF17) -BINDING PROTEINS
A61K 47/36 (2006.01)	2753302 *	PHARMACEUTICAL INVENTION OF TAPENTADOL	C12N 5/07 (2010.01)	2768947 *	METHOD FOR PRODUCING A PRODUCT USING CELLS OF THE HAIR ROOT SHEATH, PRODUCT AND KIT
A61K 47/38 (2006.01)	2753302 *	PHARMACEUTICAL INVENTION OF TAPENTADOL	A01N 43/54 (2006.01)	2704572 *	COMPOUNDS FOR INHIBITING CELL PROLIFERATION IN EGFR-DRIVEN CANCERS
A23L 1/054 (2006.01)	2745839	Pharmaceutical composition in the form of an oral suspension including a flavonoid fraction and xanthan gum	A01N 43/66 (2006.01)	2704572 *	COMPOUNDS FOR INHIBITING CELL PROLIFERATION IN EGFR-DRIVEN CANCERS
A23L 1/30 (2006.01)	2745839	Pharmaceutical composition in the form of an oral suspension including a flavonoid fraction and xanthan gum	A61K 31/505 (2006.01)	2704572 *	COMPOUNDS FOR INHIBITING CELL PROLIFERATION IN EGFR-DRIVEN CANCERS
A61K 9/00 (2006.01)	2745839	Pharmaceutical composition in the form of an oral suspension including a flavonoid fraction and xanthan gum	A61K 31/53 (2006.01)	2704572 *	COMPOUNDS FOR INHIBITING CELL PROLIFERATION IN EGFR-DRIVEN CANCERS
A61K 9/10 (2006.01)	2745839	Pharmaceutical composition in the form of an oral suspension including a flavonoid fraction and xanthan gum	C07D 401/00 (2006.01)	2704572 *	COMPOUNDS FOR INHIBITING CELL PROLIFERATION IN EGFR-DRIVEN CANCERS

MKP (51)	Broj objave evropske prijava patenta (97)	Naziv pronalaska (54)	MKP (51)	Broj objave evropske prijava patenta (97)	Naziv pronalaska (54)
A61K 31/437 (2006.01)	2751104 *	COMPOUNDS AND COMPOSITIONS AS C-KIT KINASE INHIBITORS	D04H 1/4218 (2012.01)	2721110 *	BINDER FOR A MAT MADE OF INORGANIC AND/OR ORGANIC FIBERS, AND RESULTING PRODUCTS
A61P 3/00 (2006.01)	2751104 *	COMPOUNDS AND COMPOSITIONS AS C-KIT KINASE INHIBITORS	D04H 1/64 (2012.01)	2721110 *	BINDER FOR A MAT MADE OF INORGANIC AND/OR ORGANIC FIBERS, AND RESULTING PRODUCTS
A61P 11/00 (2006.01)	2751104 *	COMPOUNDS AND COMPOSITIONS AS C-KIT KINASE INHIBITORS	F16C 19/18 (2006.01)	2715162 *	LARGE ROLLING BEARING
A61P 17/00 (2006.01)	2751104 *	COMPOUNDS AND COMPOSITIONS AS C-KIT KINASE INHIBITORS	F16C 33/58 (2006.01)	2715162 *	LARGE ROLLING BEARING
A61P 29/00 (2006.01)	2751104 *	COMPOUNDS AND COMPOSITIONS AS C-KIT KINASE INHIBITORS	A61K 31/4155 (2006.01)	2763984 *	1-PYRAZOLYL-3- (4- ((2 -ANILINOPYRIMIDIN- 4 - YL) OXY) NAPHTHALEN- 1 - YL) UREAS AS P38 MAP KINASE INHIBITORS
C07D 471/04 (2006.01)	2751104 *	COMPOUNDS AND COMPOSITIONS AS C-KIT KINASE INHIBITORS	A61K 31/506 (2006.01)	2763984 *	1-PYRAZOLYL-3- (4- ((2 -ANILINOPYRIMIDIN- 4 - YL) OXY) NAPHTHALEN- 1 - YL) UREAS AS P38 MAP KINASE INHIBITORS
G01N 21/90 (2006.01)	2726856 *	OPTICAL INSPECTION OF CONTAINERS	C07D 403/12 (2006.01)	2763984 *	1-PYRAZOLYL-3- (4- ((2 -ANILINOPYRIMIDIN- 4 - YL) OXY) NAPHTHALEN- 1 - YL) UREAS AS P38 MAP KINASE INHIBITORS
H01M 2/02 (2006.01)	2693513	A container for plates of a battery	C07D 491/10 (2006.01)	2763984 *	1-PYRAZOLYL-3- (4- ((2 -ANILINOPYRIMIDIN- 4 - YL) OXY) NAPHTHALEN- 1 - YL) UREAS AS P38 MAP KINASE INHIBITORS
H01M 10/04 (2006.01)	2693513	A container for plates of a battery	A61K 39/155 (2006.01)	2753354 *	NANOEMULSION RESPIRATORY SYNCYTIAL VIRUS (RSV) SUBUNIT VACCINE
A61K 38/16 (2006.01)	2754718 *	VASCULAR ENDOTHELIAL MYOSTATIN MUTANT THAT MUTATES AT ATP BINDING SITES	A61K 31/4188 (2006.01)	2741747 *	JAK P13K/mTOR COMBINATION THERAPY
A61K 38/17 (2006.01)	2754718 *	VASCULAR ENDOTHELIAL MYOSTATIN MUTANT THAT MUTATES AT ATP BINDING SITES	A61K 31/7064 (2006.01)	2741747 *	JAK P13K/mTOR COMBINATION THERAPY
A61K 47/48 (2006.01)	2754718 *	VASCULAR ENDOTHELIAL MYOSTATIN MUTANT THAT MUTATES AT ATP BINDING SITES	A61P 35/00 (2006.01)	2741747 *	JAK P13K/mTOR COMBINATION THERAPY
A61P 35/04 (2006.01)	2754718 *	VASCULAR ENDOTHELIAL MYOSTATIN MUTANT THAT MUTATES AT ATP BINDING SITES	C07K 16/00 (2006.01)	2729496 *	MODULATION OF COMPLEMENT- DEPENDENT CYTOTOXICITY THROUGH MODIFICATIONS OF THE C-TERMINUS OF ANTIBODY HEAVY CHAINS
C07K 14/435 (2006.01)	2754718 *	VASCULAR ENDOTHELIAL MYOSTATIN MUTANT THAT MUTATES AT ATP BINDING SITES	B60K 28/06 (2006.01)	2739498 *	SYSTEM AND METHOD FOR PREDICTING A STATE OF DROWSINESS OF A VEHICLE DRIVER
C12Q 1/42 (2006.01)	2754718 *	VASCULAR ENDOTHELIAL MYOSTATIN MUTANT THAT MUTATES AT ATP BINDING SITES	G08B 21/06 (2006.01)	2739498 *	SYSTEM AND METHOD FOR PREDICTING A STATE OF DROWSINESS OF A VEHICLE DRIVER
F16H 3/00 (2006.01)	2749790	Torque assist system and automated manual transmission	E04F 13/14 (2006.01)	2732211 *	MODULAR ILLUMINATING TILE
F16H 3/093 (2006.01)	2749790	Torque assist system and automated manual transmission	E04F 15/02 (2006.01)	2732211 *	MODULAR ILLUMINATING TILE
F16H 61/04 (2006.01)	2749790	Torque assist system and automated manual transmission			
C08L 97/02 (2006.01)	2721110 *	BINDER FOR A MAT MADE OF INORGANIC AND/OR ORGANIC FIBERS, AND RESULTING PRODUCTS			

MKP (51)	Broj objave evropske prijava patenta (97)	Naziv pronalaska (54)	MKP (51)	Broj objave evropske prijava patenta (97)	Naziv pronalaska (54)
F21S 2/00 (2006.01)	2732211 *	MODULAR ILLUMINATING TILE	B29B 17/00 (2006.01)	2760924 *	A METHOD FOR RECYCLING WASTE THERMOPLASTIC MATERIALS AND USING THIS RECYCLED THERMOPLASTIC IN COMPOSITE MATERIAL PRODUCTION
F21V 33/00 (2006.01)	2732211 *	MODULAR ILLUMINATING TILE	B29B 17/02 (2006.01)	2760924 *	A METHOD FOR RECYCLING WASTE THERMOPLASTIC MATERIALS AND USING THIS RECYCLED THERMOPLASTIC IN COMPOSITE MATERIAL PRODUCTION
C07C 69/753 (2006.01)	2726452 *	BIORENEWABLE BIODEGRADABLE SURFACTANTS	B29B 17/04 (2006.01)	2760924 *	A METHOD FOR RECYCLING WASTE THERMOPLASTIC MATERIALS AND USING THIS RECYCLED THERMOPLASTIC IN COMPOSITE MATERIAL PRODUCTION
C07D 209/58 (2006.01)	2726452 *	BIORENEWABLE BIODEGRADABLE SURFACTANTS	B29B 17/04 (2006.01)	2760924 *	A METHOD FOR RECYCLING WASTE THERMOPLASTIC MATERIALS AND USING THIS RECYCLED THERMOPLASTIC IN COMPOSITE MATERIAL PRODUCTION
C11D 1/74 (2006.01)	2726452 *	BIORENEWABLE BIODEGRADABLE SURFACTANTS	B29C 47/10 (2006.01)	2760924 *	A METHOD FOR RECYCLING WASTE THERMOPLASTIC MATERIALS AND USING THIS RECYCLED THERMOPLASTIC IN COMPOSITE MATERIAL PRODUCTION
B65D 79/00 (2006.01)	2731890 *	CONTAINER WITH CLOSURE HAVING AN INTERNAL MEMBRANE AND METHOD FOR MANUFACTURING THEREOF	B29C 47/10 (2006.01)	2760924 *	A METHOD FOR RECYCLING WASTE THERMOPLASTIC MATERIALS AND USING THIS RECYCLED THERMOPLASTIC IN COMPOSITE MATERIAL PRODUCTION
A61K 38/22 (2006.01)	2701728 *	FORMULATION COMPRISING CRH AND ALPHA - 2 - IMMUNOGLOBULIN	C08J 11/04 (2006.01)	2760924 *	A METHOD FOR RECYCLING WASTE THERMOPLASTIC MATERIALS AND USING THIS RECYCLED THERMOPLASTIC IN COMPOSITE MATERIAL PRODUCTION
A61K 47/48 (2006.01)	2701728 *	FORMULATION COMPRISING CRH AND ALPHA - 2 - IMMUNOGLOBULIN	C08J 11/06 (2006.01)	2760924 *	A METHOD FOR RECYCLING WASTE THERMOPLASTIC MATERIALS AND USING THIS RECYCLED THERMOPLASTIC IN COMPOSITE MATERIAL PRODUCTION
A61P 31/14 (2006.01)	2701728 *	FORMULATION COMPRISING CRH AND ALPHA - 2 - IMMUNOGLOBULIN	G06K 9/00 (2006.01)	2727104 *	IDENTIFYING PEOPLE THAT ARE PROXIMATE TO A MOBILE DEVICE USER VIA SOCIAL GRAPHS, SPEECH MODELS, AND USER CONTEXT
A61K 31/519 (2006.01)	2742049 *	TRICYCLIC HETEROCYCLIC COMPOUNDS AND JAK INHIBITORS	G06Q 10/10 (2012.01)	2727104 *	IDENTIFYING PEOPLE THAT ARE PROXIMATE TO A MOBILE DEVICE USER VIA SOCIAL GRAPHS, SPEECH MODELS, AND USER CONTEXT
A61P 37/00 (2006.01)	2742049 *	TRICYCLIC HETEROCYCLIC COMPOUNDS AND JAK INHIBITORS	G10L 17/00 (2013.01)	2727104 *	IDENTIFYING PEOPLE THAT ARE PROXIMATE TO A MOBILE DEVICE USER VIA SOCIAL GRAPHS, SPEECH MODELS, AND USER CONTEXT
C07D 487/14 (2006.01)	2742049 *	TRICYCLIC HETEROCYCLIC COMPOUNDS AND JAK INHIBITORS	H04L 29/06 (2006.01)	2727104 *	IDENTIFYING PEOPLE THAT ARE PROXIMATE TO A MOBILE DEVICE USER VIA SOCIAL GRAPHS, SPEECH MODELS, AND USER CONTEXT
G01N 33/48 (2006.01)	2769321 *	METHODS FOR IMPROVING INFLAMMATORY BOWEL DISEASE DIAGNOSIS	C12N 5/00 (2006.01)	2718422 *	CULTURE MEDIA FOR STEM CELLS
G01N 33/53 (2006.01)	2769321 *	METHODS FOR IMPROVING INFLAMMATORY BOWEL DISEASE DIAGNOSIS	C12Q 1/68 (2006.01)	2764120 *	STIMULUS-ELICITED GENOMIC PROFILE MARKERS OF A NEURODEGENERATIVE CONDITION
G06F 19/00 (2011.01)	2769321 *	METHODS FOR IMPROVING INFLAMMATORY BOWEL DISEASE DIAGNOSIS			
B29B 7/88 (2006.01)	2760924 *	A METHOD FOR RECYCLING WASTE THERMOPLASTIC MATERIALS AND USING THIS RECYCLED THERMOPLASTIC IN COMPOSITE MATERIAL PRODUCTION			
B29B 7/90 (2006.01)	2760924 *	A METHOD FOR RECYCLING WASTE THERMOPLASTIC MATERIALS AND USING THIS RECYCLED THERMOPLASTIC IN COMPOSITE MATERIAL PRODUCTION			

MKP (51)	Broj objave evropske prijava patenta (97)	Naziv pronalaska (54)	MKP (51)	Broj objave evropske prijava patenta (97)	Naziv pronalaska (54)
A61K 9/00 (2006.01)	2741736 *	TASTE MASKED PHARMACEUTICAL COMPOSITION	C07K 14/705 (2006.01)	2751137 *	MOLECULAR GENETIC APPROACH TO TREATMENT AND DIAGNOSIS OF ALCOHOL AND DRUG DEPENDENCE
A61K 9/50 (2006.01)	2741736 *	TASTE MASKED PHARMACEUTICAL COMPOSITION	C12Q 1/68 (2006.01)	2748356 *	RENAL CELL CARCINOMA BIOMARKERS AND USES THEREOF
A61K 31/55 (2006.01)	2741736 *	TASTE MASKED PHARMACEUTICAL COMPOSITION	C40B 30/04 (2006.01)	2748356 *	RENAL CELL CARCINOMA BIOMARKERS AND USES THEREOF
B23K 26/10 (2006.01)	2626165	Work piece support	C40B 40/06 (2006.01)	2748356 *	RENAL CELL CARCINOMA BIOMARKERS AND USES THEREOF
B23K 37/04 (2006.01)	2626165	Work piece support	C40B 40/10 (2006.01)	2748356 *	RENAL CELL CARCINOMA BIOMARKERS AND USES THEREOF
C07K 14/415 (2006.01)	2742059 *	GUARD CELL-SPECIFIC EXPRESSION OF TRANSGENES IN COTTON	G01N 33/574 (2006.01)	2748356 *	RENAL CELL CARCINOMA BIOMARKERS AND USES THEREOF
C12N 15/82 (2006.01)	2742059 *	GUARD CELL-SPECIFIC EXPRESSION OF TRANSGENES IN COTTON	G06F 19/00 (2011.01)	2748356 *	RENAL CELL CARCINOMA BIOMARKERS AND USES THEREOF
A61K 39/395 (2006.01)	2726103 *	ANTI-PROPERDIN ANTIBODIES AND USES THEREOF	H05K 7/20 (2006.01)	2740337 *	METHOD AND DEVICE FOR DETECTING CLOGGING OF A FILTER
C07K 16/00 (2006.01)	2726103 *	ANTI-PROPERDIN ANTIBODIES AND USES THEREOF	G06F 11/32 (2006.01)	2737405 *	SYSTEMS AND METHODS FOR DATABASE USAGE VISUALIZATION
A61G 5/04 (2013.01)	2606869	Handlebar for a powered wheelchair	G06F 17/30 (2006.01)	2737405 *	SYSTEMS AND METHODS FOR DATABASE USAGE VISUALIZATION
A61G 5/10 (2006.01)	2606869	Handlebar for a powered wheelchair	C21B 5/00 (2006.01)	2743357 *	BLAST-FURNACE SMELTING METHOD
A61K 39/395 (2006.01)	2714082 *	COMPOSITIONS AND METHODS FOR TREATING PAIN	B21K 7/08 (2006.01)	2714991 *	A RAILWAY RAIL SUPPORT PLATE
A61K 31/433 (2006.01)	2710018 *	NEW COMPOUNDS	E01B 9/40 (2006.01)	2714991 *	A RAILWAY RAIL SUPPORT PLATE
A61K 31/4738 (2006.01)	2710018 *	NEW COMPOUNDS	E01B 9/68 (2006.01)	2714991 *	A RAILWAY RAIL SUPPORT PLATE
A61K 31/5025 (2006.01)	2710018 *	NEW COMPOUNDS	B65D 1/02 (2006.01)	2704954 *	PRESSURE EQUALIZATION APPARATUS FOR A BOTTLE
A61K 31/519 (2006.01)	2710018 *	NEW COMPOUNDS	A47K 10/38 (2006.01)	2641522	A dispenser assembly
A61P 35/00 (2006.01)	2710018 *	NEW COMPOUNDS	E05D 11/08 (2006.01)	2641522	A dispenser assembly
C07D 401/00 (2006.01)	2710018 *	NEW COMPOUNDS	C03C 17/36 (2006.01)	2721660 *	SUBSTRATE WITH AN ELECTRODE FOR AN OLED DEVICE AND SUCH AN OLED DEVICE
C07D 513/16 (2006.01)	2710018 *	NEW COMPOUNDS	H01L 51/52 (2006.01)	2721660 *	SUBSTRATE WITH AN ELECTRODE FOR AN OLED DEVICE AND SUCH AN OLED DEVICE
C07D 513/22 (2006.01)	2710018 *	NEW COMPOUNDS			

MKP (51)	Broj objave evropske prijava patenta (97)	Naziv pronalaska (54)	MKP (51)	Broj objave evropske prijava patenta (97)	Naziv pronalaska (54)
B31F 1/07 (2006.01)	2685000	A cloth-like textured nonwoven fabric comprising papermaking fibers, calendering roller and method of manufacturing the same	A61K 31/4439 (2006.01)	2718267 *	DERIVATIVES OF 1-PHENYL-2-PYRIDINYL ALKYL ALCOHOLS AS PHOSPHODIESTERASE INHIBITORS
D04H 1/00 (2006.01)	2685000	A cloth-like textured nonwoven fabric comprising papermaking fibers, calendering roller and method of manufacturing the same	A61P 11/00 (2006.01)	2718267 *	DERIVATIVES OF 1-PHENYL-2-PYRIDINYL ALKYL ALCOHOLS AS PHOSPHODIESTERASE INHIBITORS
D21H 25/00 (2006.01)	2685000	A cloth-like textured nonwoven fabric comprising papermaking fibers, calendering roller and method of manufacturing the same	A61P 17/00 (2006.01)	2718267 *	DERIVATIVES OF 1-PHENYL-2-PYRIDINYL ALKYL ALCOHOLS AS PHOSPHODIESTERASE INHIBITORS
D21H 27/00 (2006.01)	2685000	A cloth-like textured nonwoven fabric comprising papermaking fibers, calendering roller and method of manufacturing the same	A61P 37/08 (2006.01)	2718267 *	DERIVATIVES OF 1-PHENYL-2-PYRIDINYL ALKYL ALCOHOLS AS PHOSPHODIESTERASE INHIBITORS
D21H 27/02 (2006.01)	2685000	A cloth-like textured nonwoven fabric comprising papermaking fibers, calendering roller and method of manufacturing the same	C07D 213/89 (2006.01)	2718267 *	DERIVATIVES OF 1-PHENYL-2-PYRIDINYL ALKYL ALCOHOLS AS PHOSPHODIESTERASE INHIBITORS
A61L 2/232 (2006.01)	2766112 *	METHOD FOR SELF-DETOXIFICATION OF ADSORBENTS	C07D 401/12 (2006.01)	2718267 *	DERIVATIVES OF 1-PHENYL-2-PYRIDINYL ALKYL ALCOHOLS AS PHOSPHODIESTERASE INHIBITORS
B01D 53/02 (2006.01)	2766112 *	METHOD FOR SELF-DETOXIFICATION OF ADSORBENTS	C07D 401/14 (2006.01)	2718267 *	DERIVATIVES OF 1-PHENYL-2-PYRIDINYL ALKYL ALCOHOLS AS PHOSPHODIESTERASE INHIBITORS
B01J 20/02 (2006.01)	2766112 *	METHOD FOR SELF-DETOXIFICATION OF ADSORBENTS	C07D 405/14 (2006.01)	2718267 *	DERIVATIVES OF 1-PHENYL-2-PYRIDINYL ALKYL ALCOHOLS AS PHOSPHODIESTERASE INHIBITORS
B01J 20/20 (2006.01)	2766112 *	METHOD FOR SELF-DETOXIFICATION OF ADSORBENTS	C07D 413/12 (2006.01)	2718267 *	DERIVATIVES OF 1-PHENYL-2-PYRIDINYL ALKYL ALCOHOLS AS PHOSPHODIESTERASE INHIBITORS
B01J 20/28 (2006.01)	2766112 *	METHOD FOR SELF-DETOXIFICATION OF ADSORBENTS	C07D 417/12 (2006.01)	2718267 *	DERIVATIVES OF 1-PHENYL-2-PYRIDINYL ALKYL ALCOHOLS AS PHOSPHODIESTERASE INHIBITORS
B01J 20/32 (2006.01)	2766112 *	METHOD FOR SELF-DETOXIFICATION OF ADSORBENTS	C07D 417/14 (2006.01)	2718267 *	DERIVATIVES OF 1-PHENYL-2-PYRIDINYL ALKYL ALCOHOLS AS PHOSPHODIESTERASE INHIBITORS
C23C 14/34 (2006.01)	2742539 *	SPUTTERING SYSTEMS FOR LIQUID TARGET MATERIALS	A61K 31/343 (2006.01)	2753325 *	TETRACYCLIC HETEROCYCLE COMPOUNDS AND METHODS OF USE THEREOF FOR THE TREATMENT OF VIRAL DISEASES
H01L 31/042 (2014.01)	2742539 *	SPUTTERING SYSTEMS FOR LIQUID TARGET MATERIALS	A61P 31/14 (2006.01)	2753325 *	TETRACYCLIC HETEROCYCLE COMPOUNDS AND METHODS OF USE THEREOF FOR THE TREATMENT OF VIRAL DISEASES
H01L 31/18 (2006.01)	2742539 *	SPUTTERING SYSTEMS FOR LIQUID TARGET MATERIALS	C07D 307/82 (2006.01)	2753325 *	TETRACYCLIC HETEROCYCLE COMPOUNDS AND METHODS OF USE THEREOF FOR THE TREATMENT OF VIRAL DISEASES
E04B 1/80 (2006.01)	2729635 *	MULTI CHAMBER GAS FILLED CONSTRUCTION PANEL	C07D 405/10 (2006.01)	2753325 *	TETRACYCLIC HETEROCYCLE COMPOUNDS AND METHODS OF USE THEREOF FOR THE TREATMENT OF VIRAL DISEASES
E06B 3/663 (2006.01)	2729635 *	MULTI CHAMBER GAS FILLED CONSTRUCTION PANEL	C12M 1/00 (2006.01)	2739720 *	DEVICES AND METHODS FOR CULTURE OF CELLS
E06B 7/02 (2006.01)	2729635 *	MULTI CHAMBER GAS FILLED CONSTRUCTION PANEL			
A61K 31/4436 (2006.01)	2718267 *	DERIVATIVES OF 1-PHENYL-2-PYRIDINYL ALKYL ALCOHOLS AS PHOSPHODIESTERASE INHIBITORS			

MKP (51)	Broj objave evropske prijava patenta (97)	Naziv pronalaska (54)	MKP (51)	Broj objave evropske prijava patenta (97)	Naziv pronalaska (54)
C12M 1/12 (2006.01)	2739720 *	DEVICES AND METHODS FOR CULTURE OF CELLS	A61K 31/20 (2006.01)	2701696 *	IMPAIRED ENERGY PROCESSING DISORDERS AND MITOCHONDRIAL DEFICIENCY
C12M 1/24 (2006.01)	2739720 *	DEVICES AND METHODS FOR CULTURE OF CELLS	A61K 31/202 (2006.01)	2701696 *	IMPAIRED ENERGY PROCESSING DISORDERS AND MITOCHONDRIAL DEFICIENCY
C12M 3/00 (2006.01)	2739720 *	DEVICES AND METHODS FOR CULTURE OF CELLS	F41A 21/26 (2006.01)	2739931 *	MANOEUVRES CARTRIDGE DEVICE AND SELF-LOADING FIREARM SUITABLE THEREFOR
B32B 9/00 (2006.01)	2704902 *	MAGNETIC GRAPHENE-LIKE NANOPARTICLES OR GRAPHITIC NANO-OR MICROPARTICLES AND METHOD OF PRODUCTION AND USES THEREOF	F41A 21/36 (2006.01)	2739931 *	MANOEUVRES CARTRIDGE DEVICE AND SELF-LOADING FIREARM SUITABLE THEREFOR
A61K 8/37 (2006.01)	2723452 *	CONJUGATE-BASED ANTIFUNGAL AND ANTIBACTERIAL PRODRUGS	A61K 31/69 (2006.01)	2723751 *	PROTEASOME INHIBITORS AND PROCESSES FOR THEIR PREPARATION, PURIFICATION AND USE
A61K 47/48 (2006.01)	2723452 *	CONJUGATE-BASED ANTIFUNGAL AND ANTIBACTERIAL PRODRUGS	C07F 5/02 (2006.01)	2723751 *	PROTEASOME INHIBITORS AND PROCESSES FOR THEIR PREPARATION, PURIFICATION AND USE
A61P 17/10 (2006.01)	2723452 *	CONJUGATE-BASED ANTIFUNGAL AND ANTIBACTERIAL PRODRUGS	H02J 3/38 (2006.01)	2662945	Distributed power generation system, controlling means and method for controlling the power generation of the system
A61P 31/04 (2006.01)	2723452 *	CONJUGATE-BASED ANTIFUNGAL AND ANTIBACTERIAL PRODRUGS	A61K 31/5383 (2006.01)	2731948 *	NOVEL SUBSTITUTED INDOLE DERIVATIVES AS GAMMA SECRETASE MODULATORS
A61Q 5/02 (2006.01)	2723452 *	CONJUGATE-BASED ANTIFUNGAL AND ANTIBACTERIAL PRODRUGS	A61P 25/28 (2006.01)	2731948 *	NOVEL SUBSTITUTED INDOLE DERIVATIVES AS GAMMA SECRETASE MODULATORS
A61Q 17/00 (2006.01)	2723452 *	CONJUGATE-BASED ANTIFUNGAL AND ANTIBACTERIAL PRODRUGS	C07D 487/04 (2006.01)	2731948 *	NOVEL SUBSTITUTED INDOLE DERIVATIVES AS GAMMA SECRETASE MODULATORS
C12N 9/24 (2006.01)	2764104 *	UNCONVENTIONAL PROTEIN SECRETION	C07D 498/04 (2006.01)	2731948 *	NOVEL SUBSTITUTED INDOLE DERIVATIVES AS GAMMA SECRETASE MODULATORS
C12N 15/80 (2006.01)	2764104 *	UNCONVENTIONAL PROTEIN SECRETION	C12M 1/00 (2006.01)	2751255 *	METHOD AND DEVICE FOR FEEDING GASES OR GAS MIXTURES INTO A LIQUID, SUSPENSION, OR EMULSION IN A REACTOR IN A SPECIFIC MANNER
B23P 11/00 (2006.01)	2718116 *	APPARATUS AND METHOD FOR INCREASING THE TRACTION OF VEHICLE WHEELS	C12N 1/12 (2006.01)	2751255 *	METHOD AND DEVICE FOR FEEDING GASES OR GAS MIXTURES INTO A LIQUID, SUSPENSION, OR EMULSION IN A REACTOR IN A SPECIFIC MANNER
B60B 15/00 (2006.01)	2718116 *	APPARATUS AND METHOD FOR INCREASING THE TRACTION OF VEHICLE WHEELS	A61K 31/4439 (2006.01)	2736887 *	HYDRAZIDE CONTAINING NUCLEAR TRANSPORT MODULATORS AND USES THEREOF
A61B 17/064 (2006.01)	2517649	Staple cartridge comprising compressible distortion resistant components	A61K 31/497 (2006.01)	2736887 *	HYDRAZIDE CONTAINING NUCLEAR TRANSPORT MODULATORS AND USES THEREOF
A61B 17/072 (2006.01)	2517649	Staple cartridge comprising compressible distortion resistant components	A61K 31/498 (2006.01)	2736887 *	HYDRAZIDE CONTAINING NUCLEAR TRANSPORT MODULATORS AND USES THEREOF
A61B 17/115 (2006.01)	2517649	Staple cartridge comprising compressible distortion resistant components			
A61K 31/122 (2006.01)	2701696 *	IMPAIRED ENERGY PROCESSING DISORDERS AND MITOCHONDRIAL DEFICIENCY			
A61K 31/192 (2006.01)	2701696 *	IMPAIRED ENERGY PROCESSING DISORDERS AND MITOCHONDRIAL DEFICIENCY			

MKP (51)	Broj objave evropske prijava patenta (97)	Naziv pronalaska (54)	MKP (51)	Broj objave evropske prijava patenta (97)	Naziv pronalaska (54)
A61K 31/506 (2006.01)	2736887 *	HYDRAZIDE CONTAINING NUCLEAR TRANSPORT MODULATORS AND USES THEREOF	C07D 403/04 (2006.01)	2702043 *	INHIBITORS OF INDUCIBLE FORM OF 6-PHOSPHOFRUCTOSE-2- KINASE
A61K 31/5377 (2006.01)	2736887 *	HYDRAZIDE CONTAINING NUCLEAR TRANSPORT MODULATORS AND USES THEREOF	C07D 403/12 (2006.01)	2702043 *	INHIBITORS OF INDUCIBLE FORM OF 6-PHOSPHOFRUCTOSE-2- KINASE
A61K 31/55 (2006.01)	2736887 *	HYDRAZIDE CONTAINING NUCLEAR TRANSPORT MODULATORS AND USES THEREOF	C07D 405/04 (2006.01)	2702043 *	INHIBITORS OF INDUCIBLE FORM OF 6-PHOSPHOFRUCTOSE-2- KINASE
A61P 27/02 (2006.01)	2736887 *	HYDRAZIDE CONTAINING NUCLEAR TRANSPORT MODULATORS AND USES THEREOF	C07D 405/12 (2006.01)	2702043 *	INHIBITORS OF INDUCIBLE FORM OF 6-PHOSPHOFRUCTOSE-2- KINASE
A61P 29/00 (2006.01)	2736887 *	HYDRAZIDE CONTAINING NUCLEAR TRANSPORT MODULATORS AND USES THEREOF	C07D 405/14 (2006.01)	2702043 *	INHIBITORS OF INDUCIBLE FORM OF 6-PHOSPHOFRUCTOSE-2- KINASE
A61P 31/12 (2006.01)	2736887 *	HYDRAZIDE CONTAINING NUCLEAR TRANSPORT MODULATORS AND USES THEREOF	C07D 409/04 (2006.01)	2702043 *	INHIBITORS OF INDUCIBLE FORM OF 6-PHOSPHOFRUCTOSE-2- KINASE
A61P 35/00 (2006.01)	2736887 *	HYDRAZIDE CONTAINING NUCLEAR TRANSPORT MODULATORS AND USES THEREOF	C07D 413/04 (2006.01)	2702043 *	INHIBITORS OF INDUCIBLE FORM OF 6-PHOSPHOFRUCTOSE-2- KINASE
C07D 249/08 (2006.01)	2736887 *	HYDRAZIDE CONTAINING NUCLEAR TRANSPORT MODULATORS AND USES THEREOF	C07D 417/04 (2006.01)	2702043 *	INHIBITORS OF INDUCIBLE FORM OF 6-PHOSPHOFRUCTOSE-2- KINASE
C07D 401/12 (2006.01)	2736887 *	HYDRAZIDE CONTAINING NUCLEAR TRANSPORT MODULATORS AND USES THEREOF	C07D 417/14 (2006.01)	2702043 *	INHIBITORS OF INDUCIBLE FORM OF 6-PHOSPHOFRUCTOSE-2- KINASE
C07D 403/12 (2006.01)	2736887 *	HYDRAZIDE CONTAINING NUCLEAR TRANSPORT MODULATORS AND USES THEREOF	F21V 21/30 (2006.01)	2690357	A lighting device
C07D 409/12 (2006.01)	2736887 *	HYDRAZIDE CONTAINING NUCLEAR TRANSPORT MODULATORS AND USES THEREOF	F21V 23/04 (2006.01)	2690357	A lighting device
A61K 31/506 (2006.01)	2702043 *	INHIBITORS OF INDUCIBLE FORM OF 6-PHOSPHOFRUCTOSE-2- KINASE	F21W 131/105 (2006.01)	2690357	A lighting device
A61P 35/00 (2006.01)	2702043 *	INHIBITORS OF INDUCIBLE FORM OF 6-PHOSPHOFRUCTOSE-2- KINASE	F21W 131/107 (2006.01)	2690357	A lighting device
C07D 239/42 (2006.01)	2702043 *	INHIBITORS OF INDUCIBLE FORM OF 6-PHOSPHOFRUCTOSE-2- KINASE	F21W 131/406 (2006.01)	2690357	A lighting device
C07D 401/04 (2006.01)	2702043 *	INHIBITORS OF INDUCIBLE FORM OF 6-PHOSPHOFRUCTOSE-2- KINASE	G05F 1/14 (2006.01)	2740132 *	AN IMPROVED, HIGH- EFFICIENCY, ENERGY-SAVING DEVICE FOR INSERTING BETWEEN A POWER SOURCE AND A MOTIVE AND/OR LIGHTING POWER LOAD
			H01F 29/02 (2006.01)	2740132 *	AN IMPROVED, HIGH- EFFICIENCY, ENERGY-SAVING DEVICE FOR INSERTING BETWEEN A POWER SOURCE AND A MOTIVE AND/OR LIGHTING POWER LOAD

MKP (51)	Broj objave evropske prijava patenta (97)	Naziv pronalaska (54)	MKP (51)	Broj objave evropske prijava patenta (97)	Naziv pronalaska (54)
A61K 9/70 (2006.01)	2730290 *	ADHESIVE SKIN PATCH CONTAINING SEROTONIN RECEPTOR ANTAGONIST DRUG	G06Q 20/20 (2012.01)	2724304 *	METHOD AND DEVICE FOR CARRYING OUT CASHLESS PAYMENTS
A61K 31/4178 (2006.01)	2730290 *	ADHESIVE SKIN PATCH CONTAINING SEROTONIN RECEPTOR ANTAGONIST DRUG	C09K 8/582 (2006.01)	2714837 *	METHOD FOR MICROBIAL CONTROL OF INJECTION LIQUID FLOW IN A HYDROCARBON RESERVOIR
A61K 31/4184 (2006.01)	2730290 *	ADHESIVE SKIN PATCH CONTAINING SEROTONIN RECEPTOR ANTAGONIST DRUG	C12P 7/10 (2006.01)	2714837 *	METHOD FOR MICROBIAL CONTROL OF INJECTION LIQUID FLOW IN A HYDROCARBON RESERVOIR
A61K 31/439 (2006.01)	2730290 *	ADHESIVE SKIN PATCH CONTAINING SEROTONIN RECEPTOR ANTAGONIST DRUG	B60P 7/08 (2006.01)	2671754	Load securing system
A61K 45/00 (2006.01)	2730290 *	ADHESIVE SKIN PATCH CONTAINING SEROTONIN RECEPTOR ANTAGONIST DRUG	G01N 33/574 (2006.01)	2753933 *	USE OF HUMAN PAPILLOMAVIRUS STATUS IN ESTABLISHING USE OF AN AGENT THAT BINDS EGFR IN THE TREATMENT OF CANCER
A61K 47/14 (2006.01)	2730290 *	ADHESIVE SKIN PATCH CONTAINING SEROTONIN RECEPTOR ANTAGONIST DRUG	G01N 33/74 (2006.01)	2753933 *	USE OF HUMAN PAPILLOMAVIRUS STATUS IN ESTABLISHING USE OF AN AGENT THAT BINDS EGFR IN THE TREATMENT OF CANCER
A61K 47/18 (2006.01)	2730290 *	ADHESIVE SKIN PATCH CONTAINING SEROTONIN RECEPTOR ANTAGONIST DRUG	A61K 31/55 (2006.01)	2740478 *	SUSTAINED-RELEASE PREPARATION OF IVABRADINE OR PHARMACEUTICALLY ACCEPTABLE SALTS THEREOF
A61K 47/32 (2006.01)	2730290 *	ADHESIVE SKIN PATCH CONTAINING SEROTONIN RECEPTOR ANTAGONIST DRUG	A61K 9/70 (2006.01)	2734196 *	PATCH CONTAINING DICLOFENAC AND THIACOLCHICOSIDE
A61P 1/08 (2006.01)	2730290 *	ADHESIVE SKIN PATCH CONTAINING SEROTONIN RECEPTOR ANTAGONIST DRUG	A61K 31/185 (2006.01)	2734196 *	PATCH CONTAINING DICLOFENAC AND THIACOLCHICOSIDE
A61P 43/00 (2006.01)	2730290 *	ADHESIVE SKIN PATCH CONTAINING SEROTONIN RECEPTOR ANTAGONIST DRUG	A61K 9/14 (2006.01)	2734191 *	INTRAPERITONEALLY- ADMINISTERED NANOCARRIERS THAT RELEASE THEIR THERAPEUTIC LOAD BASED ON THE INFLAMMATORY ENVIRONMENT OF CANCERS
G06F 19/22 (2011.01)	2628117 *	IDENTIFYING REARRANGEMENTS IN A SEQUENCED GENOME	A61K 9/16 (2006.01)	2734191 *	INTRAPERITONEALLY- ADMINISTERED NANOCARRIERS THAT RELEASE THEIR THERAPEUTIC LOAD BASED ON THE INFLAMMATORY ENVIRONMENT OF CANCERS
B22F 9/08 (2006.01)	2748476 *	METHOD FOR PRODUCING A SLIDING BEARING COMPRISING A CuNi2Si, CuFe2P OR CuSnX COMPOUND	A61K 9/22 (2006.01)	2734191 *	INTRAPERITONEALLY- ADMINISTERED NANOCARRIERS THAT RELEASE THEIR THERAPEUTIC LOAD BASED ON THE INFLAMMATORY ENVIRONMENT OF CANCERS
C22C 1/04 (2006.01)	2748476 *	METHOD FOR PRODUCING A SLIDING BEARING COMPRISING A CuNi2Si, CuFe2P OR CuSnX COMPOUND	A61K 47/30 (2006.01)	2734191 *	INTRAPERITONEALLY- ADMINISTERED NANOCARRIERS THAT RELEASE THEIR THERAPEUTIC LOAD BASED ON THE INFLAMMATORY ENVIRONMENT OF CANCERS
C22C 1/10 (2006.01)	2748476 *	METHOD FOR PRODUCING A SLIDING BEARING COMPRISING A CuNi2Si, CuFe2P OR CuSnX COMPOUND	A61K 47/48 (2006.01)	2734191 *	INTRAPERITONEALLY- ADMINISTERED NANOCARRIERS THAT RELEASE THEIR THERAPEUTIC LOAD BASED ON THE INFLAMMATORY ENVIRONMENT OF CANCERS
C23C 24/08 (2006.01)	2748476 *	METHOD FOR PRODUCING A SLIDING BEARING COMPRISING A CuNi2Si, CuFe2P OR CuSnX COMPOUND			
F16C 33/12 (2006.01)	2748476 *	METHOD FOR PRODUCING A SLIDING BEARING COMPRISING A CuNi2Si, CuFe2P OR CuSnX COMPOUND			
F16C 33/14 (2006.01)	2748476 *	METHOD FOR PRODUCING A SLIDING BEARING COMPRISING A CuNi2Si, CuFe2P OR CuSnX COMPOUND			
G06Q 20/18 (2012.01)	2724304 *	METHOD AND DEVICE FOR CARRYING OUT CASHLESS PAYMENTS			

MKP (51)	Broj objave evropske prijava patenta (97)	Naziv pronalaska (54)	MKP (51)	Broj objave evropske prijava patenta (97)	Naziv pronalaska (54)
A61P 35/00 (2006.01)	2734191 *	INTRAPERITONEALLY- ADMINISTERED NANOCARRIERS THAT RELEASE THEIR THERAPEUTIC LOAD BASED ON THE INFLAMMATORY ENVIRONMENT OF CANCERS	G21G 1/00 (2006.01)	2618335	Sorbent for receiving radionuclide arsenic-72, production of this sorbent and its use
F02M 51/06 (2006.01)	2660457	Fuel injector	A61F 2/10 (2006.01)	2572701	Compositions comprising a retinoid and an NFkB-Inhibitor and their methods of use
F02M 61/04 (2006.01)	2660457	Fuel injector	A61K 8/34 (2006.01)	2572701	Compositions comprising a retinoid and an NFkB-Inhibitor and their methods of use
F02M 63/00 (2006.01)	2660457	Fuel injector	A61K 8/46 (2006.01)	2572701	Compositions comprising a retinoid and an NFkB-Inhibitor and their methods of use
A61K 8/64 (2006.01)	2717851 *	SKIN COSMETIC COMPOSITIONS COMPRISING MALUS DOMESTICA EXTRACT AND ARGANIA SPINOSA SPROUT EXTRACT FOR IMPROVING SKIN APPEARANCE	A61K 8/67 (2006.01)	2572701	Compositions comprising a retinoid and an NFkB-Inhibitor and their methods of use
A61K 8/73 (2006.01)	2717851 *	SKIN COSMETIC COMPOSITIONS COMPRISING MALUS DOMESTICA EXTRACT AND ARGANIA SPINOSA SPROUT EXTRACT FOR IMPROVING SKIN APPEARANCE	A61K 8/97 (2006.01)	2572701	Compositions comprising a retinoid and an NFkB-Inhibitor and their methods of use
A61K 8/97 (2006.01)	2717851 *	SKIN COSMETIC COMPOSITIONS COMPRISING MALUS DOMESTICA EXTRACT AND ARGANIA SPINOSA SPROUT EXTRACT FOR IMPROVING SKIN APPEARANCE	A61Q 19/00 (2006.01)	2572701	Compositions comprising a retinoid and an NFkB-Inhibitor and their methods of use
A61Q 19/08 (2006.01)	2717851 *	SKIN COSMETIC COMPOSITIONS COMPRISING MALUS DOMESTICA EXTRACT AND ARGANIA SPINOSA SPROUT EXTRACT FOR IMPROVING SKIN APPEARANCE	A61Q 19/08 (2006.01)	2572701	Compositions comprising a retinoid and an NFkB-Inhibitor and their methods of use
G01N 33/576 (2006.01)	2737318 *	A2M FRAGMENTS AND APPLICATIONS THEREOF	G01N 33/574 (2006.01)	2702411 *	METHODS OF IDENTIFICATION AND DIAGNOSIS OF LUNG DISEASES USING CLASSIFICATION SYSTEMS AND KITS THEREOF
A61K 47/48 (2006.01)	2741781 *	CARRIER-LINKED TREPROSTINIL PRODRUGS	A61K 31/4178 (2006.01)	2751096 *	GUANIDINYL-SUBSTITUTED POLYAMIDES USEFUL FOR TREATING HUMAN PAPILLOMA VIRUS
A61P 11/00 (2006.01)	2741781 *	CARRIER-LINKED TREPROSTINIL PRODRUGS	A61P 31/12 (2006.01)	2751096 *	GUANIDINYL-SUBSTITUTED POLYAMIDES USEFUL FOR TREATING HUMAN PAPILLOMA VIRUS
C12N 15/11 (2006.01)	2723897 *	MULTIVARIATE DIAGNOSTIC ASSAYS AND METHODS FOR USING SAME	C07D 403/14 (2006.01)	2751096 *	GUANIDINYL-SUBSTITUTED POLYAMIDES USEFUL FOR TREATING HUMAN PAPILLOMA VIRUS
C12Q 1/68 (2006.01)	2723897 *	MULTIVARIATE DIAGNOSTIC ASSAYS AND METHODS FOR USING SAME	C08L 77/00 (2006.01)	2751096 *	GUANIDINYL-SUBSTITUTED POLYAMIDES USEFUL FOR TREATING HUMAN PAPILLOMA VIRUS
A61K 39/00 (2006.01)	2739650 *	BOVINE POLYCLONAL ANTIBODY SPECIFIC FOR HUMAN TNF	A01N 43/42 (2006.01)	2711361 *	NITROGENATED HETEROCYCLIC COMPOUND AND AGRICULTURAL OR HORTICULTURAL FUNGICIDE
A61K 39/395 (2006.01)	2739650 *	BOVINE POLYCLONAL ANTIBODY SPECIFIC FOR HUMAN TNF	A01N 43/60 (2006.01)	2711361 *	NITROGENATED HETEROCYCLIC COMPOUND AND AGRICULTURAL OR HORTICULTURAL FUNGICIDE
C07K 16/00 (2006.01)	2739650 *	BOVINE POLYCLONAL ANTIBODY SPECIFIC FOR HUMAN TNF	A01N 43/90 (2006.01)	2711361 *	NITROGENATED HETEROCYCLIC COMPOUND AND AGRICULTURAL OR HORTICULTURAL FUNGICIDE
			A01P 3/00 (2006.01)	2711361 *	NITROGENATED HETEROCYCLIC COMPOUND AND AGRICULTURAL OR HORTICULTURAL FUNGICIDE
			C07D 241/52 (2006.01)	2711361 *	NITROGENATED HETEROCYCLIC COMPOUND AND AGRICULTURAL OR HORTICULTURAL FUNGICIDE

MKP (51)	Broj objave evropske prijava patenta (97)	Naziv pronalaska (54)	MKP (51)	Broj objave evropske prijava patenta (97)	Naziv pronalaska (54)
C07D 401/12 (2006.01)	2711361 *	NITROGENATED HETEROCYCLIC COMPOUND AND AGRICULTURAL OR HORTICULTURAL FUNGICIDE	C07D 401/14 (2006.01)	2712358 *	PYRROLIDINYL UREA, PYRROLIDINYL THIOUREA AND PYRROLIDINYL GUANIDINE COMPOUNDS AS TRKA KINASE INHIBITORS
C07D 471/04 (2006.01)	2711361 *	NITROGENATED HETEROCYCLIC COMPOUND AND AGRICULTURAL OR HORTICULTURAL FUNGICIDE	C07D 403/12 (2006.01)	2712358 *	PYRROLIDINYL UREA, PYRROLIDINYL THIOUREA AND PYRROLIDINYL GUANIDINE COMPOUNDS AS TRKA KINASE INHIBITORS
C03C 3/087 (2006.01)	2729424 *	GLASS CONTAINER COMPOSITION	C07D 403/14 (2006.01)	2712358 *	PYRROLIDINYL UREA, PYRROLIDINYL THIOUREA AND PYRROLIDINYL GUANIDINE COMPOUNDS AS TRKA KINASE INHIBITORS
C03C 4/02 (2006.01)	2729424 *	GLASS CONTAINER COMPOSITION	C07D 405/14 (2006.01)	2712358 *	PYRROLIDINYL UREA, PYRROLIDINYL THIOUREA AND PYRROLIDINYL GUANIDINE COMPOUNDS AS TRKA KINASE INHIBITORS
C03C 4/08 (2006.01)	2729424 *	GLASS CONTAINER COMPOSITION	C07D 409/14 (2006.01)	2712358 *	PYRROLIDINYL UREA, PYRROLIDINYL THIOUREA AND PYRROLIDINYL GUANIDINE COMPOUNDS AS TRKA KINASE INHIBITORS
C03C 6/00 (2006.01)	2729424 *	GLASS CONTAINER COMPOSITION	C07D 413/14 (2006.01)	2712358 *	PYRROLIDINYL UREA, PYRROLIDINYL THIOUREA AND PYRROLIDINYL GUANIDINE COMPOUNDS AS TRKA KINASE INHIBITORS
A61K 31/4155 (2006.01)	2712358 *	PYRROLIDINYL UREA, PYRROLIDINYL THIOUREA AND PYRROLIDINYL GUANIDINE COMPOUNDS AS TRKA KINASE INHIBITORS	C07D 417/14 (2006.01)	2712358 *	PYRROLIDINYL UREA, PYRROLIDINYL THIOUREA AND PYRROLIDINYL GUANIDINE COMPOUNDS AS TRKA KINASE INHIBITORS
A61K 31/4162 (2006.01)	2712358 *	PYRROLIDINYL UREA, PYRROLIDINYL THIOUREA AND PYRROLIDINYL GUANIDINE COMPOUNDS AS TRKA KINASE INHIBITORS	C07D 471/04 (2006.01)	2712358 *	PYRROLIDINYL UREA, PYRROLIDINYL THIOUREA AND PYRROLIDINYL GUANIDINE COMPOUNDS AS TRKA KINASE INHIBITORS
A61K 31/4178 (2006.01)	2712358 *	PYRROLIDINYL UREA, PYRROLIDINYL THIOUREA AND PYRROLIDINYL GUANIDINE COMPOUNDS AS TRKA KINASE INHIBITORS	C07D 487/04 (2006.01)	2712358 *	PYRROLIDINYL UREA, PYRROLIDINYL THIOUREA AND PYRROLIDINYL GUANIDINE COMPOUNDS AS TRKA KINASE INHIBITORS
A61K 31/4192 (2006.01)	2712358 *	PYRROLIDINYL UREA, PYRROLIDINYL THIOUREA AND PYRROLIDINYL GUANIDINE COMPOUNDS AS TRKA KINASE INHIBITORS	C07D 491/04 (2006.01)	2712358 *	PYRROLIDINYL UREA, PYRROLIDINYL THIOUREA AND PYRROLIDINYL GUANIDINE COMPOUNDS AS TRKA KINASE INHIBITORS
A61K 31/4196 (2006.01)	2712358 *	PYRROLIDINYL UREA, PYRROLIDINYL THIOUREA AND PYRROLIDINYL GUANIDINE COMPOUNDS AS TRKA KINASE INHIBITORS	C07D 495/04 (2006.01)	2712358 *	PYRROLIDINYL UREA, PYRROLIDINYL THIOUREA AND PYRROLIDINYL GUANIDINE COMPOUNDS AS TRKA KINASE INHIBITORS
A61K 31/422 (2006.01)	2712358 *	PYRROLIDINYL UREA, PYRROLIDINYL THIOUREA AND PYRROLIDINYL GUANIDINE COMPOUNDS AS TRKA KINASE INHIBITORS	A61K 31/58 (2006.01)	2739640 *	ANTI -INFLAMMATORY STEROIDS CONDENSED IN POSITION 16,17 WITH PYRROLIDINE RING
A61K 31/4245 (2006.01)	2712358 *	PYRROLIDINYL UREA, PYRROLIDINYL THIOUREA AND PYRROLIDINYL GUANIDINE COMPOUNDS AS TRKA KINASE INHIBITORS	A61P 5/44 (2006.01)	2739640 *	ANTI -INFLAMMATORY STEROIDS CONDENSED IN POSITION 16,17 WITH PYRROLIDINE RING
A61K 31/427 (2006.01)	2712358 *	PYRROLIDINYL UREA, PYRROLIDINYL THIOUREA AND PYRROLIDINYL GUANIDINE COMPOUNDS AS TRKA KINASE INHIBITORS	C07J 71/00 (2006.01)	2739640 *	ANTI -INFLAMMATORY STEROIDS CONDENSED IN POSITION 16,17 WITH PYRROLIDINE RING
A61K 31/4439 (2006.01)	2712358 *	PYRROLIDINYL UREA, PYRROLIDINYL THIOUREA AND PYRROLIDINYL GUANIDINE COMPOUNDS AS TRKA KINASE INHIBITORS			

MKP (51)	Broj objave evropske prijava patenta (97)	Naziv pronalaska (54)	MKP (51)	Broj objave evropske prijava patenta (97)	Naziv pronalaska (54)
A61K 31/4192 (2006.01)	2708537 *	HETEROAROMATIC RING DERIVATIVE	F02G 5/02 (2006.01)	2752573 *	WASTE HEAT UTILIZATION DEVICE
A61K 31/422 (2006.01)	2708537 *	HETEROAROMATIC RING DERIVATIVE	F02G 5/04 (2006.01)	2752573 *	WASTE HEAT UTILIZATION DEVICE
A61K 31/4245 (2006.01)	2708537 *	HETEROAROMATIC RING DERIVATIVE	F22B 1/18 (2006.01)	2752573 *	WASTE HEAT UTILIZATION DEVICE
A61K 31/4439 (2006.01)	2708537 *	HETEROAROMATIC RING DERIVATIVE	A61K 38/00 (2006.01)	2739298 *	LONG-ACTING GROWTH HORMONE AND METHODS OF PRODUCING SAME
A61K 31/506 (2006.01)	2708537 *	HETEROAROMATIC RING DERIVATIVE	A61K 38/27 (2006.01)	2739298 *	LONG-ACTING GROWTH HORMONE AND METHODS OF PRODUCING SAME
A61P 1/00 (2006.01)	2708537 *	HETEROAROMATIC RING DERIVATIVE	C01B 31/20 (2006.01)	2734470 *	CARBON DIOXIDE PRODUCTION
A61P 5/00 (2006.01)	2708537 *	HETEROAROMATIC RING DERIVATIVE	A61F 2/24 (2006.01)	2765954 *	POLYMERIC HEART VALVE
A61P 9/12 (2006.01)	2708537 *	HETEROAROMATIC RING DERIVATIVE	A61K 31/4196 (2006.01)	2755654 *	PHOSPHATIDYLINOSITOL 3-KINASE INHIBITORS FOR THE TREATMENT OF CANCER
A61P 25/08 (2006.01)	2708537 *	HETEROAROMATIC RING DERIVATIVE	A61K 31/498 (2006.01)	2755654 *	PHOSPHATIDYLINOSITOL 3-KINASE INHIBITORS FOR THE TREATMENT OF CANCER
A61P 25/16 (2006.01)	2708537 *	HETEROAROMATIC RING DERIVATIVE	A61K 31/519 (2006.01)	2755654 *	PHOSPHATIDYLINOSITOL 3-KINASE INHIBITORS FOR THE TREATMENT OF CANCER
A61P 25/20 (2006.01)	2708537 *	HETEROAROMATIC RING DERIVATIVE	A61P 35/00 (2006.01)	2755654 *	PHOSPHATIDYLINOSITOL 3-KINASE INHIBITORS FOR THE TREATMENT OF CANCER
A61P 25/22 (2006.01)	2708537 *	HETEROAROMATIC RING DERIVATIVE	G03G 5/00 (2006.01)	2746854 *	SUBSTRATE FOR PHOTOSENSITIVE DRUM
A61P 25/24 (2006.01)	2708537 *	HETEROAROMATIC RING DERIVATIVE	G03G 5/10 (2006.01)	2746854 *	SUBSTRATE FOR PHOTOSENSITIVE DRUM
C07D 401/14 (2006.01)	2708537 *	HETEROAROMATIC RING DERIVATIVE	A61K 31/4196 (2006.01)	2729144 *	TREATING CANCER WITH HSP90 INHIBITORY COMPOUNDS
A01N 43/56 (2006.01)	2755483 *	INDAZOLE-3-CARBOXAMIDES AND THEIR USE AS WNT/B- CATENIN SIGNALING PATHWAY INHIBITORS	A61K 31/4439 (2006.01)	2729144 *	TREATING CANCER WITH HSP90 INHIBITORY COMPOUNDS
A61K 31/415 (2006.01)	2755483 *	INDAZOLE-3-CARBOXAMIDES AND THEIR USE AS WNT/B- CATENIN SIGNALING PATHWAY INHIBITORS	A61P 35/00 (2006.01)	2729144 *	TREATING CANCER WITH HSP90 INHIBITORY COMPOUNDS
F01N 5/02 (2006.01)	2752573 *	WASTE HEAT UTILIZATION DEVICE	A01N 43/42 (2006.01)	2731436 *	AZAINDOLE COMPOUNDS AND METHODS FOR TREATING HIV
F02B 37/00 (2006.01)	2752573 *	WASTE HEAT UTILIZATION DEVICE	A61K 31/44 (2006.01)	2731436 *	AZAINDOLE COMPOUNDS AND METHODS FOR TREATING HIV
F02G 5/00 (2006.01)	2752573 *	WASTE HEAT UTILIZATION DEVICE	A61B 18/14 (2006.01)	2758090 *	AN ELECTROSURGICAL PENCIL WITH A SMOKE EVACUATION TUBE
			A61B 18/18 (2006.01)	2758090 *	AN ELECTROSURGICAL PENCIL WITH A SMOKE EVACUATION TUBE

MKP (51)	Broj objave evropske prijava patenta (97)	Naziv pronalaska (54)	MKP (51)	Broj objave evropske prijava patenta (97)	Naziv pronalaska (54)
A61M 1/00 (2006.01)	2758090 *	AN ELECTROSURGICAL PENCIL WITH A SMOKE EVACUATION TUBE	C07H 3/06 (2006.01)	2729508 *	OLIGOSACCHARIDE/ SILICON-CONTAINING BLOCK COPOLYMERS FOR LITHOGRAPHY APPLICATIONS
A61M 13/00 (2006.01)	2758090 *	AN ELECTROSURGICAL PENCIL WITH A SMOKE EVACUATION TUBE	C08F 293/00 (2006.01)	2729508 *	OLIGOSACCHARIDE/ SILICON-CONTAINING BLOCK COPOLYMERS FOR LITHOGRAPHY APPLICATIONS
A61M 16/04 (2006.01)	2758090 *	AN ELECTROSURGICAL PENCIL WITH A SMOKE EVACUATION TUBE	C08G 73/06 (2006.01)	2729508 *	OLIGOSACCHARIDE/ SILICON-CONTAINING BLOCK COPOLYMERS FOR LITHOGRAPHY APPLICATIONS
A61M 25/00 (2006.01)	2758090 *	AN ELECTROSURGICAL PENCIL WITH A SMOKE EVACUATION TUBE	C08G 81/02 (2006.01)	2729508 *	OLIGOSACCHARIDE/ SILICON-CONTAINING BLOCK COPOLYMERS FOR LITHOGRAPHY APPLICATIONS
A61M 39/08 (2006.01)	2758090 *	AN ELECTROSURGICAL PENCIL WITH A SMOKE EVACUATION TUBE	G03F 7/00 (2006.01)	2729508 *	OLIGOSACCHARIDE/ SILICON-CONTAINING BLOCK COPOLYMERS FOR LITHOGRAPHY APPLICATIONS
A61K 31/4985 (2006.01)	2723744 *	1-ARYL-4-METHYL-[1,2,4] TRIAZOLO[4,3-a]QUINOXALINE DERIVATIVES	A61K 31/165 (2006.01)	2744778 *	META-SUBSTITUTED BIPHENYL PERIPHERALLY RESTRICTED FAAH INHIBITORS
A61P 25/00 (2006.01)	2723744 *	1-ARYL-4-METHYL-[1,2,4] TRIAZOLO[4,3-a]QUINOXALINE DERIVATIVES	A61P 29/00 (2006.01)	2744778 *	META-SUBSTITUTED BIPHENYL PERIPHERALLY RESTRICTED FAAH INHIBITORS
C07D 487/04 (2006.01)	2723744 *	1-ARYL-4-METHYL-[1,2,4] TRIAZOLO[4,3-a]QUINOXALINE DERIVATIVES	C07C 233/06 (2006.01)	2744778 *	META-SUBSTITUTED BIPHENYL PERIPHERALLY RESTRICTED FAAH INHIBITORS
H04L 29/08 (2006.01)	2767074 *	TIME SENSITIVE AUDIO AND TEXT FEEDBACK PROCESS FOR A PRIORITIZED MEDIA RICH DIGITAL MESSAGING SYSTEM	C07C 233/23 (2006.01)	2744778 *	META-SUBSTITUTED BIPHENYL PERIPHERALLY RESTRICTED FAAH INHIBITORS
C12N 15/113 (2010.01)	2674494	Single-stranded RNA molecule having nitrogen-containing alicyclic skeleton	C07D 309/14 (2006.01)	2744778 *	META-SUBSTITUTED BIPHENYL PERIPHERALLY RESTRICTED FAAH INHIBITORS
A01N 25/24 (2006.01)	2763529 *	MANUFACTURING OF SPECIFICALLY TARGETING MICROCAPSULES	C12N 5/07 (2010.01)	2729561 *	CELL CULTURE PROCESS
A01N 25/28 (2006.01)	2763529 *	MANUFACTURING OF SPECIFICALLY TARGETING MICROCAPSULES	C12P 21/00 (2006.01)	2729561 *	CELL CULTURE PROCESS
A01N 43/40 (2006.01)	2763529 *	MANUFACTURING OF SPECIFICALLY TARGETING MICROCAPSULES	B01D 53/56 (2006.01)	2726180 *	ZEOLITE IMPREGNATED WITH TITANIUM DIOXIDE
A01N 53/00 (2006.01)	2763529 *	MANUFACTURING OF SPECIFICALLY TARGETING MICROCAPSULES	E04B 1/24 (2006.01)	2574702	Roof or wall structure
A01N 57/20 (2006.01)	2763529 *	MANUFACTURING OF SPECIFICALLY TARGETING MICROCAPSULES	E04B 1/342 (2006.01)	2574702	Roof or wall structure
B01J 13/18 (2006.01)	2763529 *	MANUFACTURING OF SPECIFICALLY TARGETING MICROCAPSULES	E04B 7/02 (2006.01)	2574702	Roof or wall structure
A61K 38/12 (2006.01)	2717898 *	PRO-COAGULANT COMPOUNDS AND METHODS OF USE THEREOF	E04H 15/00 (2006.01)	2574702	Roof or wall structure
A61K 39/395 (2006.01)	2726101 *	INHIBITORS OF T-CELL ACTIVATION	E04H 15/18 (2006.01)	2574702	Roof or wall structure
B82Y 40/00 (2011.01)	2729508 *	OLIGOSACCHARIDE/ SILICON-CONTAINING BLOCK COPOLYMERS FOR LITHOGRAPHY APPLICATIONS	F03D 7/02 (2006.01)	2721730 *	METHOD FOR CONTROLLING A WIND TURBINE

MKP (51)	Broj objave evropske prijava patenta (97)	Naziv pronalaska (54)	MKP (51)	Broj objave evropske prijava patenta (97)	Naziv pronalaska (54)
H02K 7/09 (2006.01)	2721730 *	METHOD FOR CONTROLLING A WIND TURBINE	B02C 13/16 (2006.01)	2628541	Drive for a grinding machine
H02K 19/26 (2006.01)	2721730 *	METHOD FOR CONTROLLING A WIND TURBINE	B02C 13/28 (2006.01)	2628541	Drive for a grinding machine
H02P 9/14 (2006.01)	2721730 *	METHOD FOR CONTROLLING A WIND TURBINE	C07K 16/18 (2006.01)	2731968 *	MONOCLONAL ANTIBODIES SPECIFIC FOR BETA-AMYLOID X-37 AND USES THEREOF
H02P 29/00 (2006.01)	2721730 *	METHOD FOR CONTROLLING A WIND TURBINE	A61K 31/407 (2006.01)	2707372 *	SPIRO-OXINDOLE MDM2 ANTAGONISTS
G01S 19/17 (2010.01)	2702430 *	METHOD FOR ASSESSING THE RELIABILITY OF A DOG-MAN PAIR AND KIT FOR IMPLEMENTING SAID METHOD	A61P 35/00 (2006.01)	2707372 *	SPIRO-OXINDOLE MDM2 ANTAGONISTS
G01S 19/19 (2010.01)	2702430 *	METHOD FOR ASSESSING THE RELIABILITY OF A DOG-MAN PAIR AND KIT FOR IMPLEMENTING SAID METHOD	C07D 413/12 (2006.01)	2707372 *	SPIRO-OXINDOLE MDM2 ANTAGONISTS
G01S 19/51 (2010.01)	2702430 *	METHOD FOR ASSESSING THE RELIABILITY OF A DOG-MAN PAIR AND KIT FOR IMPLEMENTING SAID METHOD	C07D 487/10 (2006.01)	2707372 *	SPIRO-OXINDOLE MDM2 ANTAGONISTS
G01V 9/00 (2006.01)	2702430 *	METHOD FOR ASSESSING THE RELIABILITY OF A DOG-MAN PAIR AND KIT FOR IMPLEMENTING SAID METHOD	A61K 31/495 (2006.01)	2702063 *	BICYCLIC PYRIDAZINE COMPOUNDS AS PIM INHIBITORS
A61M 15/00 (2006.01)	2755708 *	INHALER	A61P 35/00 (2006.01)	2702063 *	BICYCLIC PYRIDAZINE COMPOUNDS AS PIM INHIBITORS
A01N 63/00 (2006.01)	2739299 *	METHODS AND COMPOSITIONS FOR INHIBITING DELAYED GRAFT FUNCTION	C07D 487/04 (2006.01)	2702063 *	BICYCLIC PYRIDAZINE COMPOUNDS AS PIM INHIBITORS
A01N 65/00 (2009.01)	2739299 *	METHODS AND COMPOSITIONS FOR INHIBITING DELAYED GRAFT FUNCTION	E21B 47/08 (2012.01)	2647790	Calibrator for a downhole caliper and method of using same
A61K 38/00 (2006.01)	2739299 *	METHODS AND COMPOSITIONS FOR INHIBITING DELAYED GRAFT FUNCTION	G01B 7/13 (2006.01)	2647790	Calibrator for a downhole caliper and method of using same
C01G 23/00 (2006.01)	2669253	Titanium oxide for electrode and method for manufacturing the same	G01B 21/04 (2006.01)	2647790	Calibrator for a downhole caliper and method of using same
C01G 23/08 (2006.01)	2669253	Titanium oxide for electrode and method for manufacturing the same	B01J 21/06 (2006.01)	2720789 *	TITANIUM OXIDE- AND/OR VANADIUM OXIDE-BASED POROUS MATERIALS AND THE PRODUCTION AND USE THEREOF
C01G 33/00 (2006.01)	2669253	Titanium oxide for electrode and method for manufacturing the same	B01J 23/22 (2006.01)	2720789 *	TITANIUM OXIDE- AND/OR VANADIUM OXIDE-BASED POROUS MATERIALS AND THE PRODUCTION AND USE THEREOF
H02M 1/08 (2006.01)	2669253	Titanium oxide for electrode and method for manufacturing the same	B01J 37/00 (2006.01)	2720789 *	TITANIUM OXIDE- AND/OR VANADIUM OXIDE-BASED POROUS MATERIALS AND THE PRODUCTION AND USE THEREOF
A61M 15/00 (2006.01)	2714280 *	NEBULIZER	C01G 23/04 (2006.01)	2720789 *	TITANIUM OXIDE- AND/OR VANADIUM OXIDE-BASED POROUS MATERIALS AND THE PRODUCTION AND USE THEREOF
B05B 11/00 (2006.01)	2714280 *	NEBULIZER			
C07K 14/435 (2006.01)	2721058 *	METHOD OF TREATING OR AMELIORATING METABOLIC DISORDERS USING CLEC-2			

MKP (51)	Broj objave evropske prijava patenta (97)	Naziv pronalaska (54)	MKP (51)	Broj objave evropske prijava patenta (97)	Naziv pronalaska (54)
C01G 31/02 (2006.01)	2720789 *	TITANIUM OXIDE- AND/OR VANADIUM OXIDE-BASED POROUS MATERIALS AND THE PRODUCTION AND USE THEREOF	C08L 79/04 (2006.01)	2722363	Cyanate Ester Resin Composition, and a Prepreg, a Laminated Material and a Metal Clad Laminated Material Made Therefrom
B05B 1/30 (2006.01)	2664719	Sanitary fitting element	A62D 5/00 (2006.01)	2717973 *	FUNCTIONAL PROTECTIVE MATERIAL, IN PARTICULAR FOR USE IN PROTECTIVE CLOTHING
E03C 1/084 (2006.01)	2664719	Sanitary fitting element	B29C 47/06 (2006.01)	2639038	Layer sequence repeater module for a modular disk co-extrusion die and its usage
A61K 31/506 (2006.01)	2727918	Compounds and Compositions as Protein Kinase Inhibitors	B29C 47/08 (2006.01)	2639038	Layer sequence repeater module for a modular disk co-extrusion die and its usage
A61P 35/00 (2006.01)	2727918	Compounds and Compositions as Protein Kinase Inhibitors	B29C 47/26 (2006.01)	2639038	Layer sequence repeater module for a modular disk co-extrusion die and its usage
C07D 401/14 (2006.01)	2727918	Compounds and Compositions as Protein Kinase Inhibitors	B29C 47/56 (2006.01)	2639038	Layer sequence repeater module for a modular disk co-extrusion die and its usage
C07D 403/04 (2006.01)	2727918	Compounds and Compositions as Protein Kinase Inhibitors	B29C 47/70 (2006.01)	2639038	Layer sequence repeater module for a modular disk co-extrusion die and its usage
A61K 9/48 (2006.01)	2679243	Co-precipitate of one or more stilbene polyphenols and their derivatives in lamellar anionic solids, it's applications and related preparation method	A61K 9/00 (2006.01)	2762133	Process for preparing carrier particles for dry powders for inhalation
A61K 9/51 (2006.01)	2679243	Co-precipitate of one or more stilbene polyphenols and their derivatives in lamellar anionic solids, it's applications and related preparation method	A61K 9/50 (2006.01)	2762133	Process for preparing carrier particles for dry powders for inhalation
A61K 31/05 (2006.01)	2679243	Co-precipitate of one or more stilbene polyphenols and their derivatives in lamellar anionic solids, it's applications and related preparation method	A61K 31/50 (2006.01)	2748149 *	PYRIDAZINONE COMPOUNDS AND THEIR USE AS DAAO INHIBITORS
A61K 47/02 (2006.01)	2679243	Co-precipitate of one or more stilbene polyphenols and their derivatives in lamellar anionic solids, it's applications and related preparation method	A61K 31/501 (2006.01)	2748149 *	PYRIDAZINONE COMPOUNDS AND THEIR USE AS DAAO INHIBITORS
A61K 47/02 (2006.01)	2679243	Co-precipitate of one or more stilbene polyphenols and their derivatives in lamellar anionic solids, it's applications and related preparation method	A61P 25/18 (2006.01)	2748149 *	PYRIDAZINONE COMPOUNDS AND THEIR USE AS DAAO INHIBITORS
A01N 43/30 (2006.01)	2744332 *	BENZOFURAN COMPOUNDS FOR THE TREATMENT OF HEPATITIS C VIRUS INFECTIONS	A61P 25/28 (2006.01)	2748149 *	PYRIDAZINONE COMPOUNDS AND THEIR USE AS DAAO INHIBITORS
A61K 31/36 (2006.01)	2744332 *	BENZOFURAN COMPOUNDS FOR THE TREATMENT OF HEPATITIS C VIRUS INFECTIONS	A61P 29/00 (2006.01)	2748149 *	PYRIDAZINONE COMPOUNDS AND THEIR USE AS DAAO INHIBITORS
A47K 10/06 (2006.01)	2677248	Fan-assisted Radiator, Preferably a Fan-assisted Heated Towel Rail, and Related Ventilation System	C07D 237/16 (2006.01)	2748149 *	PYRIDAZINONE COMPOUNDS AND THEIR USE AS DAAO INHIBITORS
F24D 19/00 (2006.01)	2677248	Fan-assisted Radiator, Preferably a Fan-assisted Heated Towel Rail, and Related Ventilation System	C07D 401/10 (2006.01)	2748149 *	PYRIDAZINONE COMPOUNDS AND THEIR USE AS DAAO INHIBITORS
F24H 9/00 (2006.01)	2677248	Fan-assisted Radiator, Preferably a Fan-assisted Heated Towel Rail, and Related Ventilation System	C07D 407/10 (2006.01)	2748149 *	PYRIDAZINONE COMPOUNDS AND THEIR USE AS DAAO INHIBITORS
C08L 63/00 (2006.01)	2722363	Cyanate Ester Resin Composition, and a Prepreg, a Laminated Material and a Metal Clad Laminated Material Made Therefrom	B32B 17/10 (2006.01)	2718099 *	LIGHTING DEVICE COMPRISING LIGHT-EMITTING DIODES
			F21K 99/00 (2010.01)	2718099 *	LIGHTING DEVICE COMPRISING LIGHT-EMITTING DIODES

MKP (51)	Broj objave evropske prijava patenta (97)	Naziv pronalaska (54)	MKP (51)	Broj objave evropske prijava patenta (97)	Naziv pronalaska (54)
F21V 33/00 (2006.01)	2718099 *	LIGHTING DEVICE COMPRISING LIGHT-EMITTING DIODES	D01F 9/12 (2006.01)	2718487 *	TEXTILE SHEET MATERIAL
F21Y 105/00 (2006.01)	2718099 *	LIGHTING DEVICE COMPRISING LIGHT-EMITTING DIODES	D01F 9/14 (2006.01)	2718487 *	TEXTILE SHEET MATERIAL
G02B 6/00 (2006.01)	2718099 *	LIGHTING DEVICE COMPRISING LIGHT-EMITTING DIODES	D01F 9/16 (2006.01)	2718487 *	TEXTILE SHEET MATERIAL
G05B 19/00 (2006.01)	2722719 *	AUTOMATED SYSTEM FOR MONITORING, PROTECTING AND CONTROLLING ELECTRICAL SUBSTATION EQUIPMENT	D06M 10/00 (2006.01)	2718487 *	TEXTILE SHEET MATERIAL
H02J 13/00 (2006.01)	2722719 *	AUTOMATED SYSTEM FOR MONITORING, PROTECTING AND CONTROLLING ELECTRICAL SUBSTATION EQUIPMENT	A61K 31/155 (2006.01)	2757093 *	GUANIDINOBENZOIC ACID COMPOUND
A61K 39/395 (2006.01)	2704743 *	COMPOSITIONS FOR INHIBITING MASP-2 DEPENDENT COMPLEMENT ACITIVATION	A61K 31/404 (2006.01)	2757093 *	GUANIDINOBENZOIC ACID COMPOUND
C07K 16/40 (2006.01)	2704743 *	COMPOSITIONS FOR INHIBITING MASP-2 DEPENDENT COMPLEMENT ACITIVATION	A61P 13/12 (2006.01)	2757093 *	GUANIDINOBENZOIC ACID COMPOUND
C12N 1/19 (2006.01)	2704743 *	COMPOSITIONS FOR INHIBITING MASP-2 DEPENDENT COMPLEMENT ACITIVATION	A61P 43/00 (2006.01)	2757093 *	GUANIDINOBENZOIC ACID COMPOUND
C12N 5/10 (2006.01)	2704743 *	COMPOSITIONS FOR INHIBITING MASP-2 DEPENDENT COMPLEMENT ACITIVATION	C07C 279/18 (2006.01)	2757093 *	GUANIDINOBENZOIC ACID COMPOUND
C12N 15/13 (2006.01)	2704743 *	COMPOSITIONS FOR INHIBITING MASP-2 DEPENDENT COMPLEMENT ACITIVATION	C07C 307/10 (2006.01)	2757093 *	GUANIDINOBENZOIC ACID COMPOUND
C12N 15/63 (2006.01)	2704743 *	COMPOSITIONS FOR INHIBITING MASP-2 DEPENDENT COMPLEMENT ACITIVATION	C07D 207/16 (2006.01)	2757093 *	GUANIDINOBENZOIC ACID COMPOUND
C12P 21/08 (2006.01)	2704743 *	COMPOSITIONS FOR INHIBITING MASP-2 DEPENDENT COMPLEMENT ACITIVATION	C07D 209/20 (2006.01)	2757093 *	GUANIDINOBENZOIC ACID COMPOUND
H04L 29/06 (2006.01)	2592805	Method and system for preserving privacy and accountability	C07D 209/42 (2006.01)	2757093 *	GUANIDINOBENZOIC ACID COMPOUND
A61K 39/09 (2006.01)	2709658 *	VACCINE AGAINST STREPTOCOCCUS PNEUMONIAE	C07D 211/62 (2006.01)	2757093 *	GUANIDINOBENZOIC ACID COMPOUND
A61P 31/00 (2006.01)	2709658 *	VACCINE AGAINST STREPTOCOCCUS PNEUMONIAE	C07D 213/79 (2006.01)	2757093 *	GUANIDINOBENZOIC ACID COMPOUND
A61K 9/50 (2006.01)	2726067 *	STABILIZED TOPICAL FORMULATIONS CONTAINING CORE-SHELL MICROCAPSULES	C07D 215/20 (2006.01)	2757093 *	GUANIDINOBENZOIC ACID COMPOUND
A61K 31/07 (2006.01)	2726067 *	STABILIZED TOPICAL FORMULATIONS CONTAINING CORE-SHELL MICROCAPSULES	C07D 215/48 (2006.01)	2757093 *	GUANIDINOBENZOIC ACID COMPOUND
A61K 31/327 (2006.01)	2726067 *	STABILIZED TOPICAL FORMULATIONS CONTAINING CORE-SHELL MICROCAPSULES	C07D 215/50 (2006.01)	2757093 *	GUANIDINOBENZOIC ACID COMPOUND
A61K 31/695 (2006.01)	2726067 *	STABILIZED TOPICAL FORMULATIONS CONTAINING CORE-SHELL MICROCAPSULES	C07D 233/64 (2006.01)	2757093 *	GUANIDINOBENZOIC ACID COMPOUND
			C07D 257/04 (2006.01)	2757093 *	GUANIDINOBENZOIC ACID COMPOUND

MKP (51)	Broj objave evropske prijava patenta (97)	Naziv pronalaska (54)	MKP (51)	Broj objave evropske prijava patenta (97)	Naziv pronalaska (54)
C07D 271/06 (2006.01)	2757093 *	GUANIDINO BENZOIC ACID COMPOUND	A61K 31/4406 (2006.01)	2743256 *	CYCLOPROPANEAMINE COMPOUND
C07D 277/20 (2006.01)	2757093 *	GUANIDINO BENZOIC ACID COMPOUND	A61K 31/4409 (2006.01)	2743256 *	CYCLOPROPANEAMINE COMPOUND
C07D 277/56 (2006.01)	2757093 *	GUANIDINO BENZOIC ACID COMPOUND	A61K 31/4453 (2006.01)	2743256 *	CYCLOPROPANEAMINE COMPOUND
C07D 295/12 (2006.01)	2757093 *	GUANIDINO BENZOIC ACID COMPOUND	A61K 31/4468 (2006.01)	2743256 *	CYCLOPROPANEAMINE COMPOUND
C07D 333/38 (2006.01)	2757093 *	GUANIDINO BENZOIC ACID COMPOUND	A61K 31/451 (2006.01)	2743256 *	CYCLOPROPANEAMINE COMPOUND
A61K 31/167 (2006.01)	2743256 *	CYCLOPROPANEAMINE COMPOUND	C07C 233/80 (2006.01)	2743256 *	CYCLOPROPANEAMINE COMPOUND
A61K 31/36 (2006.01)	2743256 *	CYCLOPROPANEAMINE COMPOUND	G06Q 50/00 (2012.01)	2766866 *	DISCHARGE DECISION SUPPORT SYSTEM FOR POST ACUTE CARE REFERRAL
A61K 31/366 (2006.01)	2743256 *	CYCLOPROPANEAMINE COMPOUND	A01K 67/027 (2006.01)	2758535 *	ANTIBODIES, VARIABLE DOMAINS&CHAINS TAILORED FOR HUMAN USE
A61K 31/381 (2006.01)	2743256 *	CYCLOPROPANEAMINE COMPOUND	C07K 16/46 (2006.01)	2758535 *	ANTIBODIES, VARIABLE DOMAINS&CHAINS TAILORED FOR HUMAN USE
A61K 31/40 (2006.01)	2743256 *	CYCLOPROPANEAMINE COMPOUND	C12N 15/85 (2006.01)	2758535 *	ANTIBODIES, VARIABLE DOMAINS&CHAINS TAILORED FOR HUMAN USE
A61K 31/402 (2006.01)	2743256 *	CYCLOPROPANEAMINE COMPOUND	G01N 33/53 (2006.01)	2729806 *	USES OF LABELED HSP90 INHIBITORS
A61K 31/4035 (2006.01)	2743256 *	CYCLOPROPANEAMINE COMPOUND	H01S 3/06 (2006.01)	2713457	Optical amplifier and process
A61K 31/404 (2006.01)	2743256 *	CYCLOPROPANEAMINE COMPOUND	H01S 3/0941 (2006.01)	2713457	Optical amplifier and process
A61K 31/4184 (2006.01)	2743256 *	CYCLOPROPANEAMINE COMPOUND	H01S 3/16 (2006.01)	2713457	Optical amplifier and process
A61K 31/42 (2006.01)	2743256 *	CYCLOPROPANEAMINE COMPOUND	H01S 3/23 (2006.01)	2713457	Optical amplifier and process
A61K 31/421 (2006.01)	2743256 *	CYCLOPROPANEAMINE COMPOUND	F16H 15/38 (2006.01)	2705276 *	TOROIDAL VARIABLE SPEED TRACTION DRIVE
A61K 31/426 (2006.01)	2743256 *	CYCLOPROPANEAMINE COMPOUND	F16H 15/44 (2006.01)	2705276 *	TOROIDAL VARIABLE SPEED TRACTION DRIVE
A61K 31/428 (2006.01)	2743256 *	CYCLOPROPANEAMINE COMPOUND	F16H 15/48 (2006.01)	2705276 *	TOROIDAL VARIABLE SPEED TRACTION DRIVE
A61K 31/429 (2006.01)	2743256 *	CYCLOPROPANEAMINE COMPOUND	F16H 15/52 (2006.01)	2705276 *	TOROIDAL VARIABLE SPEED TRACTION DRIVE
A61K 31/433 (2006.01)	2743256 *	CYCLOPROPANEAMINE COMPOUND	A61K 39/08 (2006.01)	2714911 *	IMMUNOGENIC COMPOSITION

MKP (51)	Broj objave evropske prijava patenta (97)	Naziv pronalaska (54)	MKP (51)	Broj objave evropske prijava patenta (97)	Naziv pronalaska (54)
C07K 14/33 (2006.01)	2714911 *	IMMUNOGENIC COMPOSITION	A61K 9/70 (2006.01)	2714018 *	TRANSDERMAL THERAPEUTIC SYSTEM COMPRISING BUPRENORPHINE AND AN ALPHA-HYDROXY ACID
C12N 15/62 (2006.01)	2714911 *	IMMUNOGENIC COMPOSITION	A61K 31/485 (2006.01)	2714018 *	TRANSDERMAL THERAPEUTIC SYSTEM COMPRISING BUPRENORPHINE AND AN ALPHA-HYDROXY ACID
E21B 23/02 (2006.01)	2723972 *	FRACTURING PORT LOCATOR AND ISOLATION TOOL	A61K 47/12 (2006.01)	2714018 *	TRANSDERMAL THERAPEUTIC SYSTEM COMPRISING BUPRENORPHINE AND AN ALPHA-HYDROXY ACID
E21B 23/03 (2006.01)	2723972 *	FRACTURING PORT LOCATOR AND ISOLATION TOOL	A61P 25/04 (2006.01)	2714018 *	TRANSDERMAL THERAPEUTIC SYSTEM COMPRISING BUPRENORPHINE AND AN ALPHA-HYDROXY ACID
E21B 33/124 (2006.01)	2723972 *	FRACTURING PORT LOCATOR AND ISOLATION TOOL	A61P 25/36 (2006.01)	2714018 *	TRANSDERMAL THERAPEUTIC SYSTEM COMPRISING BUPRENORPHINE AND AN ALPHA-HYDROXY ACID
E21B 43/26 (2006.01)	2723972 *	FRACTURING PORT LOCATOR AND ISOLATION TOOL	A61K 38/17 (2006.01)	2704735 *	VASCULAR DISRUPTION AGENTS AND USES THEREOF
H01C 7/12 (2006.01)	2707892 *	REDUNDANT EXCESS VOLTAGE CIRCUIT BREAKER WITH A ROTATIONAL DISK AND WITH AN ADDED ELECTRONIC ASSEMBLY INTENDED TO EXTEND A LIFE SPAN OF AN EXCESS -VOLTAGE COMPONENT	A61K 39/395 (2006.01)	2704735 *	VASCULAR DISRUPTION AGENTS AND USES THEREOF
H01H 37/76 (2006.01)	2707892 *	REDUNDANT EXCESS VOLTAGE CIRCUIT BREAKER WITH A ROTATIONAL DISK AND WITH AN ADDED ELECTRONIC ASSEMBLY INTENDED TO EXTEND A LIFE SPAN OF AN EXCESS -VOLTAGE COMPONENT	A61P 35/00 (2006.01)	2704735 *	VASCULAR DISRUPTION AGENTS AND USES THEREOF
H01T 1/14 (2006.01)	2707892 *	REDUNDANT EXCESS VOLTAGE CIRCUIT BREAKER WITH A ROTATIONAL DISK AND WITH AN ADDED ELECTRONIC ASSEMBLY INTENDED TO EXTEND A LIFE SPAN OF AN EXCESS -VOLTAGE COMPONENT	C07D 417/04 (2006.01)	2674431	Stable SNS-595 compositions and methods of preparation
H02H 9/04 (2006.01)	2707892 *	REDUNDANT EXCESS VOLTAGE CIRCUIT BREAKER WITH A ROTATIONAL DISK AND WITH AN ADDED ELECTRONIC ASSEMBLY INTENDED TO EXTEND A LIFE SPAN OF AN EXCESS -VOLTAGE COMPONENT	C07D 417/14 (2006.01)	2674431	Stable SNS-595 compositions and methods of preparation
A61K 31/438 (2006.01)	2676958	N1-Pyrazolospiroketone acetyl-CoA carboxylase inhibitors	C09C 1/02 (2006.01)	2722368	Process of controlled chemical reaction of a solid filler material surface and additives to produce a surface treated filler material product
A61P 1/16 (2006.01)	2676958	N1-Pyrazolospiroketone acetyl-CoA carboxylase inhibitors	B27K 3/36 (2006.01)	2760652 *	PANELS OF MEDIUM DENSITY FIBREBOARD
A61P 3/10 (2006.01)	2676958	N1-Pyrazolospiroketone acetyl-CoA carboxylase inhibitors	B27N 1/00 (2006.01)	2760652 *	PANELS OF MEDIUM DENSITY FIBREBOARD
C07D 471/10 (2006.01)	2676958	N1-Pyrazolospiroketone acetyl-CoA carboxylase inhibitors	B27N 3/04 (2006.01)	2760652 *	PANELS OF MEDIUM DENSITY FIBREBOARD
A61K 39/395 (2006.01)	2723379 *	ANTI-ALPHA SYNUCLEIN BINDING MOLECULES	E21D 11/00 (2006.01)	2723987 *	A METHOD FOR CONSTRUCTING A TUNNEL COURSE, AND STRUCTURAL ELEMENT FOR USE BY THE METHOD
			E21D 11/08 (2006.01)	2723987 *	A METHOD FOR CONSTRUCTING A TUNNEL COURSE, AND STRUCTURAL ELEMENT FOR USE BY THE METHOD
			E21D 11/10 (2006.01)	2723987 *	A METHOD FOR CONSTRUCTING A TUNNEL COURSE, AND STRUCTURAL ELEMENT FOR USE BY THE METHOD

MKP (51)	Broj objave evropske prijava patenta (97)	Naziv pronalaska (54)	MKP (51)	Broj objave evropske prijava patenta (97)	Naziv pronalaska (54)
E21D 11/30 (2006.01)	2723987 *	A METHOD FOR CONSTRUCTING A TUNNEL COURSE, AND STRUCTURAL ELEMENT FOR USE BY THE METHOD	A61P 17/00 (2006.01)	2718283 *	INDAZOLE- AND PYRROLOPYRIDINE-DERIVATIVE AND PHARMACEUTICAL USE THEREOF
E21D 11/38 (2006.01)	2723987 *	A METHOD FOR CONSTRUCTING A TUNNEL COURSE, AND STRUCTURAL ELEMENT FOR USE BY THE METHOD	A61P 25/18 (2006.01)	2718283 *	INDAZOLE- AND PYRROLOPYRIDINE-DERIVATIVE AND PHARMACEUTICAL USE THEREOF
E21D 11/40 (2006.01)	2723987 *	A METHOD FOR CONSTRUCTING A TUNNEL COURSE, AND STRUCTURAL ELEMENT FOR USE BY THE METHOD	A61P 25/22 (2006.01)	2718283 *	INDAZOLE- AND PYRROLOPYRIDINE-DERIVATIVE AND PHARMACEUTICAL USE THEREOF
E21F 16/02 (2006.01)	2723987 *	A METHOD FOR CONSTRUCTING A TUNNEL COURSE, AND STRUCTURAL ELEMENT FOR USE BY THE METHOD	A61P 25/24 (2006.01)	2718283 *	INDAZOLE- AND PYRROLOPYRIDINE-DERIVATIVE AND PHARMACEUTICAL USE THEREOF
C07D 407/04 (2006.01)	2712360 *	PROCESS FOR THE PREPARATION OF COMPOUNDS USEFUL AS INHIBITORS OF SGLT-2	A61P 25/28 (2006.01)	2718283 *	INDAZOLE- AND PYRROLOPYRIDINE-DERIVATIVE AND PHARMACEUTICAL USE THEREOF
A61K 31/4245 (2006.01)	2718283 *	INDAZOLE- AND PYRROLOPYRIDINE-DERIVATIVE AND PHARMACEUTICAL USE THEREOF	A61P 43/00 (2006.01)	2718283 *	INDAZOLE- AND PYRROLOPYRIDINE-DERIVATIVE AND PHARMACEUTICAL USE THEREOF
A61K 31/454 (2006.01)	2718283 *	INDAZOLE- AND PYRROLOPYRIDINE-DERIVATIVE AND PHARMACEUTICAL USE THEREOF	C07D 401/14 (2006.01)	2718283 *	INDAZOLE- AND PYRROLOPYRIDINE-DERIVATIVE AND PHARMACEUTICAL USE THEREOF
A61K 31/4545 (2006.01)	2718283 *	INDAZOLE- AND PYRROLOPYRIDINE-DERIVATIVE AND PHARMACEUTICAL USE THEREOF	A01N 43/42 (2006.01)	2736336 *	TREATMENT OF MULTIPLE SCLEROSIS WITH COMBINATION OF LAQUINIMOD AND INTERFERON-BETA
A61K 31/5377 (2006.01)	2718283 *	INDAZOLE- AND PYRROLOPYRIDINE-DERIVATIVE AND PHARMACEUTICAL USE THEREOF	A61K 31/47 (2006.01)	2736336 *	TREATMENT OF MULTIPLE SCLEROSIS WITH COMBINATION OF LAQUINIMOD AND INTERFERON-BETA
A61P 1/00 (2006.01)	2718283 *	INDAZOLE- AND PYRROLOPYRIDINE-DERIVATIVE AND PHARMACEUTICAL USE THEREOF	C02F 1/14 (2006.01)	2742004 *	PORTABLE AND STATIONARY DISTILLATION UNIT FOR THE SIMULTANEOUS PRODUCTION OF DISTILLED WATER AND SALT, ENHANCED BY SOLAR COLLECTORS
A61P 1/08 (2006.01)	2718283 *	INDAZOLE- AND PYRROLOPYRIDINE-DERIVATIVE AND PHARMACEUTICAL USE THEREOF	C02F 1/18 (2006.01)	2742004 *	PORTABLE AND STATIONARY DISTILLATION UNIT FOR THE SIMULTANEOUS PRODUCTION OF DISTILLED WATER AND SALT, ENHANCED BY SOLAR COLLECTORS
A61P 1/10 (2006.01)	2718283 *	INDAZOLE- AND PYRROLOPYRIDINE-DERIVATIVE AND PHARMACEUTICAL USE THEREOF	C12N 9/00 (2006.01)	2732031 *	RECOMBINANT MICROORGANISM FOR THE PRODUCTION OF USEFUL METABOLITES
A61P 1/14 (2006.01)	2718283 *	INDAZOLE- AND PYRROLOPYRIDINE-DERIVATIVE AND PHARMACEUTICAL USE THEREOF	C12N 9/04 (2006.01)	2732031 *	RECOMBINANT MICROORGANISM FOR THE PRODUCTION OF USEFUL METABOLITES
A61P 13/02 (2006.01)	2718283 *	INDAZOLE- AND PYRROLOPYRIDINE-DERIVATIVE AND PHARMACEUTICAL USE THEREOF	C12N 9/12 (2006.01)	2732031 *	RECOMBINANT MICROORGANISM FOR THE PRODUCTION OF USEFUL METABOLITES
A61P 13/08 (2006.01)	2718283 *	INDAZOLE- AND PYRROLOPYRIDINE-DERIVATIVE AND PHARMACEUTICAL USE THEREOF			

MKP (51)	Broj objave evropske prijava patenta (97)	Naziv pronalaska (54)	MKP (51)	Broj objave evropske prijava patenta (97)	Naziv pronalaska (54)
C12N 9/88 (2006.01)	2732031 *	RECOMBINANT MICROORGANISM FOR THE PRODUCTION OF USEFUL METABOLITES	A61K 31/437 (2006.01)	2736895 *	2 - (2, 4, 5 - SUBSTITUTED -ANILINO) PYRIMIDINE DERIVATIVES AS EGFR MODULATORS USEFUL FOR TREATING CANCER
C12P 7/28 (2006.01)	2732031 *	RECOMBINANT MICROORGANISM FOR THE PRODUCTION OF USEFUL METABOLITES	A61K 31/506 (2006.01)	2736895 *	2 - (2, 4, 5 - SUBSTITUTED -ANILINO) PYRIMIDINE DERIVATIVES AS EGFR MODULATORS USEFUL FOR TREATING CANCER
G01R 31/36 (2006.01)	2621051	Device for high-precision management of the charge of a battery, and method implemented by said device	A61P 35/00 (2006.01)	2736895 *	2 - (2, 4, 5 - SUBSTITUTED -ANILINO) PYRIMIDINE DERIVATIVES AS EGFR MODULATORS USEFUL FOR TREATING CANCER
H02J 7/00 (2006.01)	2621051	Device for high-precision management of the charge of a battery, and method implemented by said device	C07D 401/02 (2006.01)	2736895 *	2 - (2, 4, 5 - SUBSTITUTED -ANILINO) PYRIMIDINE DERIVATIVES AS EGFR MODULATORS USEFUL FOR TREATING CANCER
F25B 15/06 (2006.01)	2734794 *	A METHOD FOR CHILLING A BUILDING	C07D 471/04 (2006.01)	2736895 *	2 - (2, 4, 5 - SUBSTITUTED -ANILINO) PYRIMIDINE DERIVATIVES AS EGFR MODULATORS USEFUL FOR TREATING CANCER
F25B 27/00 (2006.01)	2734794 *	A METHOD FOR CHILLING A BUILDING	B01J 14/00 (2006.01)	2705020 *	METHOD AND APPARATUS FOR PURIFYING NITRATION PRODUCTS
C12N 5/078 (2010.01)	2729562 *	PROGENITOR CELLS OF MESODERMAL LINEAGE	C07C 201/16 (2006.01)	2705020 *	METHOD AND APPARATUS FOR PURIFYING NITRATION PRODUCTS
F01C 1/40 (2006.01)	2729706 *	ROTARY FLUID MACHINE	C07C 205/06 (2006.01)	2705020 *	METHOD AND APPARATUS FOR PURIFYING NITRATION PRODUCTS
F03C 2/30 (2006.01)	2729706 *	ROTARY FLUID MACHINE	A61M 5/00 (2006.01)	2704777 *	DRUG DELIVERY DEVICE AND CARTRIDGE HOLDER FOR A DRUG DELIVERY DEVICE
F04C 2/40 (2006.01)	2729706 *	ROTARY FLUID MACHINE	A61M 5/24 (2006.01)	2704777 *	DRUG DELIVERY DEVICE AND CARTRIDGE HOLDER FOR A DRUG DELIVERY DEVICE
F04C 18/40 (2006.01)	2729706 *	ROTARY FLUID MACHINE	A61M 5/31 (2006.01)	2704777 *	DRUG DELIVERY DEVICE AND CARTRIDGE HOLDER FOR A DRUG DELIVERY DEVICE
A47J 31/44 (2006.01)	2662002	Goods supply apparatus	A61K 31/352 (2006.01)	2751090 *	ALDH-2 INHIBITORS IN THE TREATMENT OF ADDICTION
G07F 13/06 (2006.01)	2662002	Goods supply apparatus	A61K 31/397 (2006.01)	2751090 *	ALDH-2 INHIBITORS IN THE TREATMENT OF ADDICTION
A61K 31/18 (2006.01)	2758056 *	BUFFERED UPPER GI ABSORPTION PROMOTER	A61K 31/4178 (2006.01)	2751090 *	ALDH-2 INHIBITORS IN THE TREATMENT OF ADDICTION
A61K 31/335 (2006.01)	2758056 *	BUFFERED UPPER GI ABSORPTION PROMOTER	C07D 311/36 (2006.01)	2751090 *	ALDH-2 INHIBITORS IN THE TREATMENT OF ADDICTION
A61K 31/44 (2006.01)	2758056 *	BUFFERED UPPER GI ABSORPTION PROMOTER	C07D 405/06 (2006.01)	2751090 *	ALDH-2 INHIBITORS IN THE TREATMENT OF ADDICTION
A61K 31/4422 (2006.01)	2758056 *	BUFFERED UPPER GI ABSORPTION PROMOTER	C07F 7/00 (2006.01)	2757113	Catalysts, processes for making catalysts, processes for making polyolefin compositions and polyolefin compositions
A61K 31/445 (2006.01)	2758056 *	BUFFERED UPPER GI ABSORPTION PROMOTER			

MKP (51)	Broj objave evropske prijava patenta (97)	Naziv pronalaska (54)	MKP (51)	Broj objave evropske prijava patenta (97)	Naziv pronalaska (54)
C08F 4/659 (2006.01)	2757113	Catalysts, processes for making catalysts, processes for making polyolefin compositions and polyolefin compositions	D04C 3/00 (2006.01)	2725128 *	NET KNITTING METHOD
C08F 10/00 (2006.01)	2757113	Catalysts, processes for making catalysts, processes for making polyolefin compositions and polyolefin compositions	D04C 5/00 (2006.01)	2725128 *	NET KNITTING METHOD
A61K 31/65 (2006.01)	2707003 *	CRYSTALLINE SALTS OF (4S,4AS,5AR,12AS)-4-DIMETHYLAMINO-3,10,12,12A-TETRAHYDROXY-7-[(METHOXY(METHYL)AMINO)-METHYL]-1,11-DIOXO-1,4,4A,5,5A,6,11,12A-OCTAHYDRO-NAPHTHACENE-2-CARBOXYLIC ACID AMIDE AND METHODS OF USING THE SAME	B32B 23/00 (2006.01)	2723564 *	FIBROUS PRODUCT FOR PACKAGING
C07C 237/26 (2006.01)	2707003 *	CRYSTALLINE SALTS OF (4S,4AS,5AR,12AS)-4-DIMETHYLAMINO-3,10,12,12A-TETRAHYDROXY-7-[(METHOXY(METHYL)AMINO)-METHYL]-1,11-DIOXO-1,4,4A,5,5A,6,11,12A-OCTAHYDRO-NAPHTHACENE-2-CARBOXYLIC ACID AMIDE AND METHODS OF USING THE SAME	A61B 10/00 (2006.01)	2720617 *	CONTAINER ASSEMBLY AND ASSOCIATED METHOD
B29C 70/02 (2006.01)	2769019 *	ARTICLE OF MANUFACTURE MADE OF COMPOSITE MATERIAL, FOR INCORPORATION INTO A CIVIL ENGINEERING STRUCTURE	B65D 51/28 (2006.01)	2720617 *	CONTAINER ASSEMBLY AND ASSOCIATED METHOD
B29C 70/64 (2006.01)	2769019 *	ARTICLE OF MANUFACTURE MADE OF COMPOSITE MATERIAL, FOR INCORPORATION INTO A CIVIL ENGINEERING STRUCTURE	G06Q 30/02 (2012.01)	2677484	System and method for making personalised recommendations to a user of a mobile computing device, and computer program product
E01C 11/06 (2006.01)	2769019 *	ARTICLE OF MANUFACTURE MADE OF COMPOSITE MATERIAL, FOR INCORPORATION INTO A CIVIL ENGINEERING STRUCTURE	A23L 1/22 (2006.01)	2641479	Composition comprising an extract from sweet blackberry leaves
E01C 11/10 (2006.01)	2769019 *	ARTICLE OF MANUFACTURE MADE OF COMPOSITE MATERIAL, FOR INCORPORATION INTO A CIVIL ENGINEERING STRUCTURE	A23L 1/226 (2006.01)	2641479	Composition comprising an extract from sweet blackberry leaves
B28D 1/32 (2006.01)	2660026	Cutting method for crackly plate-shaped work piece and cutting device thereof	A23L 1/236 (2006.01)	2641479	Composition comprising an extract from sweet blackberry leaves
C07K 16/24 (2006.01)	2734548 *	ANTIGEN-BINDING PROTEINS WITH INCREASED FCRN BINDING	A23L 1/30 (2006.01)	2641479	Composition comprising an extract from sweet blackberry leaves
A61K 38/04 (2006.01)	2729495 *	ANTAGONIST PEPTIDE OF THE BOND BETWEEN CD47 AND A PROTEIN BELONGING TO THE THROMBOSPONDIN FAMILY	A23L 2/60 (2006.01)	2641479	Composition comprising an extract from sweet blackberry leaves
C07K 14/78 (2006.01)	2729495 *	ANTAGONIST PEPTIDE OF THE BOND BETWEEN CD47 AND A PROTEIN BELONGING TO THE THROMBOSPONDIN FAMILY	A61K 9/00 (2006.01)	2706983 *	NOVEL PHARMACEUTICAL FORMULATION
			A61K 9/06 (2006.01)	2706983 *	NOVEL PHARMACEUTICAL FORMULATION
			A61K 9/08 (2006.01)	2706983 *	NOVEL PHARMACEUTICAL FORMULATION
			A61K 9/14 (2006.01)	2706983 *	NOVEL PHARMACEUTICAL FORMULATION
			A61K 31/155 (2006.01)	2706983 *	NOVEL PHARMACEUTICAL FORMULATION
			A61K 31/593 (2006.01)	2706983 *	NOVEL PHARMACEUTICAL FORMULATION
			A61P 17/02 (2006.01)	2706983 *	NOVEL PHARMACEUTICAL FORMULATION
			C07C 61/40 (2006.01)	2647618	Novel polymorphs and salts
			A61K 38/46 (2006.01)	2717906 *	THE USE OF ALKALINE PHOSPHATASE FOR PRESERVING RENAL FUNCTION

MKP (51)	Broj objave evropske prijava patenta (97)	Naziv pronalaska (54)	MKP (51)	Broj objave evropske prijava patenta (97)	Naziv pronalaska (54)
A61K 31/166 (2006.01)	2714039 *	COMBINATION THERAPY OF HSP90 INHIBITORY COMPOUNDS WITH MEK INHIBITORS	B01D 39/02 (2006.01)	2741854 *	ACTIVATED CARBON WITH A METAL BASED COMPONENT
A61K 31/277 (2006.01)	2714039 *	COMBINATION THERAPY OF HSP90 INHIBITORY COMPOUNDS WITH MEK INHIBITORS	B01D 53/02 (2006.01)	2741854 *	ACTIVATED CARBON WITH A METAL BASED COMPONENT
A61K 31/352 (2006.01)	2714039 *	COMBINATION THERAPY OF HSP90 INHIBITORY COMPOUNDS WITH MEK INHIBITORS	B01J 20/20 (2006.01)	2741854 *	ACTIVATED CARBON WITH A METAL BASED COMPONENT
A61K 31/416 (2006.01)	2714039 *	COMBINATION THERAPY OF HSP90 INHIBITORY COMPOUNDS WITH MEK INHIBITORS	B01J 20/28 (2006.01)	2741854 *	ACTIVATED CARBON WITH A METAL BASED COMPONENT
A61K 31/4196 (2006.01)	2714039 *	COMBINATION THERAPY OF HSP90 INHIBITORY COMPOUNDS WITH MEK INHIBITORS	B01J 20/32 (2006.01)	2741854 *	ACTIVATED CARBON WITH A METAL BASED COMPONENT
A61K 31/675 (2006.01)	2714039 *	COMBINATION THERAPY OF HSP90 INHIBITORY COMPOUNDS WITH MEK INHIBITORS	A61K 31/4545 (2006.01)	2718281 *	COMPOUNDS HAVING MUSCARINIC RECEPTOR ANTAGONIST AND BETA2 ADRENERGIC RECEPTOR AGONIST ACTIVITY
A61K 35/00 (2006.01)	2714039 *	COMBINATION THERAPY OF HSP90 INHIBITORY COMPOUNDS WITH MEK INHIBITORS	A61K 31/4709 (2006.01)	2718281 *	COMPOUNDS HAVING MUSCARINIC RECEPTOR ANTAGONIST AND BETA2 ADRENERGIC RECEPTOR AGONIST ACTIVITY
A61K 45/06 (2006.01)	2714039 *	COMBINATION THERAPY OF HSP90 INHIBITORY COMPOUNDS WITH MEK INHIBITORS	A61P 11/06 (2006.01)	2718281 *	COMPOUNDS HAVING MUSCARINIC RECEPTOR ANTAGONIST AND BETA2 ADRENERGIC RECEPTOR AGONIST ACTIVITY
A01K 5/02 (2006.01)	2649876	Device and method for dispensing solids and liquids to animals	A61P 11/08 (2006.01)	2718281 *	COMPOUNDS HAVING MUSCARINIC RECEPTOR ANTAGONIST AND BETA2 ADRENERGIC RECEPTOR AGONIST ACTIVITY
A01K 13/00 (2006.01)	2649876	Device and method for dispensing solids and liquids to animals	A61P 11/08 (2006.01)	2718281 *	COMPOUNDS HAVING MUSCARINIC RECEPTOR ANTAGONIST AND BETA2 ADRENERGIC RECEPTOR AGONIST ACTIVITY
A61K 38/55 (2006.01)	2726093 *	WAP DOMAIN FUSION POLYPEPTIDES AND METHODS OF USE THEREOF	C07D 401/12 (2006.01)	2718281 *	COMPOUNDS HAVING MUSCARINIC RECEPTOR ANTAGONIST AND BETA2 ADRENERGIC RECEPTOR AGONIST ACTIVITY
A61K 39/395 (2006.01)	2726093 *	WAP DOMAIN FUSION POLYPEPTIDES AND METHODS OF USE THEREOF	C07D 409/14 (2006.01)	2718281 *	COMPOUNDS HAVING MUSCARINIC RECEPTOR ANTAGONIST AND BETA2 ADRENERGIC RECEPTOR AGONIST ACTIVITY
A61P 29/00 (2006.01)	2726093 *	WAP DOMAIN FUSION POLYPEPTIDES AND METHODS OF USE THEREOF	C07D 417/12 (2006.01)	2718281 *	COMPOUNDS HAVING MUSCARINIC RECEPTOR ANTAGONIST AND BETA2 ADRENERGIC RECEPTOR AGONIST ACTIVITY
C07K 19/00 (2006.01)	2726093 *	WAP DOMAIN FUSION POLYPEPTIDES AND METHODS OF USE THEREOF	A61C 19/04 (2006.01)	2707704 *	METHOD OF ANALYZING A MATERIAL
G03G 15/08 (2006.01)	2634646	Developing device and image forming apparatus including the same	G01N 27/62 (2006.01)	2707704 *	METHOD OF ANALYZING A MATERIAL
G03G 21/16 (2006.01)	2634646	Developing device and image forming apparatus including the same	G01N 37/00 (2006.01)	2707704 *	METHOD OF ANALYZING A MATERIAL
A61G 5/12 (2006.01)	2662061	Ergonomic back and side support for aids to disabled and application for wheelchairs	H05H 1/46 (2006.01)	2707704 *	METHOD OF ANALYZING A MATERIAL
A61K 38/17 (2006.01)	2734220 *	ANTI-FIBROTIC PEPTIDES AND THEIR USE IN METHODS FOR TREATING DISEASES AND DISORDERS CHARACTERIZED BY FIBROSIS			
B65D 23/06 (2006.01)	2750982 *	IMPROVED DRIP STOP DEVICE			

MKP (51)	Broj objave evropske prijava patenta (97)	Naziv pronalaska (54)	MKP (51)	Broj objave evropske prijava patenta (97)	Naziv pronalaska (54)
F24D 19/02 (2006.01)	2642211	Tilting radiator assembly	C07D 207/08 (2006.01)	2714684 *	COMPOSITIONS CONTAINING, METHODS INVOLVING, AND USES OF NON-NATURAL AMINO ACID LINKED DOLASTATIN DERIVATIVES
C12N 7/02 (2006.01)	2764094 *	VIRAL VECTORS PURIFICATION SYSTEM	C07D 401/12 (2006.01)	2714684 *	COMPOSITIONS CONTAINING, METHODS INVOLVING, AND USES OF NON-NATURAL AMINO ACID LINKED DOLASTATIN DERIVATIVES
A61K 31/337 (2006.01)	2740477 *	METHOD FOR TREATING CANCER BY COMBINED USE OF MEDICINAL AGENTS	C07D 417/12 (2006.01)	2714684 *	COMPOSITIONS CONTAINING, METHODS INVOLVING, AND USES OF NON-NATURAL AMINO ACID LINKED DOLASTATIN DERIVATIVES
A61K 31/506 (2006.01)	2740477 *	METHOD FOR TREATING CANCER BY COMBINED USE OF MEDICINAL AGENTS	A61K 31/535 (2006.01)	2710005 *	TYROSINE KINASE INHIBITORS
A61P 35/00 (2006.01)	2740477 *	METHOD FOR TREATING CANCER BY COMBINED USE OF MEDICINAL AGENTS	A61P 35/00 (2006.01)	2710005 *	TYROSINE KINASE INHIBITORS
A61P 43/00 (2006.01)	2740477 *	METHOD FOR TREATING CANCER BY COMBINED USE OF MEDICINAL AGENTS	C07D 487/04 (2006.01)	2710005 *	TYROSINE KINASE INHIBITORS
C07D 401/14 (2006.01)	2740477 *	METHOD FOR TREATING CANCER BY COMBINED USE OF MEDICINAL AGENTS	A61K 38/26 (2006.01)	2750698 *	PHARMACEUTICAL COMPOSITION FOR USE IN THE TREATMENT OF A NEURODEGENERATIVE DISEASE
A61K 9/00 (2006.01)	2497461	Paediatric solutions comprising a beta-blocker	A61P 25/28 (2006.01)	2750698 *	PHARMACEUTICAL COMPOSITION FOR USE IN THE TREATMENT OF A NEURODEGENERATIVE DISEASE
A61K 9/08 (2006.01)	2497461	Paediatric solutions comprising a beta-blocker	A61K 31/404 (2006.01)	2726457 *	INDOLEAMINE DERIVATIVES FOR THE TREATMENT OF CENTRAL NERVOUS SYSTEM DISEASES
A61K 31/13 (2006.01)	2497461	Paediatric solutions comprising a beta-blocker	C07D 209/30 (2006.01)	2726457 *	INDOLEAMINE DERIVATIVES FOR THE TREATMENT OF CENTRAL NERVOUS SYSTEM DISEASES
A47C 7/02 (2006.01)	2735248	Chair with two stable seating positions	C07D 403/04 (2006.01)	2726457 *	INDOLEAMINE DERIVATIVES FOR THE TREATMENT OF CENTRAL NERVOUS SYSTEM DISEASES
A61K 31/551 (2006.01)	2748170 *	1,4-DIAZABICYCLO[3.2.2]NONANES AS NEURONAL NICOTINIC ACETYLCHOLINE RECEPTOR LIGANDS	C07D 413/04 (2006.01)	2726457 *	INDOLEAMINE DERIVATIVES FOR THE TREATMENT OF CENTRAL NERVOUS SYSTEM DISEASES
A61P 25/00 (2006.01)	2748170 *	1,4-DIAZABICYCLO[3.2.2]NONANES AS NEURONAL NICOTINIC ACETYLCHOLINE RECEPTOR LIGANDS	C07K 14/005 (2006.01)	2729490 *	HCV GENOTYPE 4 REPLICONS
C07D 498/04 (2006.01)	2748170 *	1,4-DIAZABICYCLO[3.2.2]NONANES AS NEURONAL NICOTINIC ACETYLCHOLINE RECEPTOR LIGANDS	C12N 15/86 (2006.01)	2729490 *	HCV GENOTYPE 4 REPLICONS
A61K 31/16 (2006.01)	2766007 *	RASAGILINE CITRAMIDE	G01N 33/569 (2006.01)	2729490 *	HCV GENOTYPE 4 REPLICONS
B30B 9/06 (2006.01)	2714381 *	A METHOD OF PRESSURIZING A SUBSTANCE	A61K 31/00 (2006.01)	2706990 *	SEMULOPARIN FOR THE PREVENTION OF VENOUS THROMBOEMBOLISM IN CANCER PATIENTS RECEIVING CHEMOTHERAPY
A61K 31/427 (2006.01)	2714684 *	COMPOSITIONS CONTAINING, METHODS INVOLVING, AND USES OF NON-NATURAL AMINO ACID LINKED DOLASTATIN DERIVATIVES	A61K 31/727 (2006.01)	2706990 *	SEMULOPARIN FOR THE PREVENTION OF VENOUS THROMBOEMBOLISM IN CANCER PATIENTS RECEIVING CHEMOTHERAPY
A61P 35/00 (2006.01)	2714684 *	COMPOSITIONS CONTAINING, METHODS INVOLVING, AND USES OF NON-NATURAL AMINO ACID LINKED DOLASTATIN DERIVATIVES			

MKP (51)	Broj objave evropske prijava patenta (97)	Naziv pronalaska (54)	MKP (51)	Broj objave evropske prijava patenta (97)	Naziv pronalaska (54)
A61P 7/02 (2006.01)	2706990 *	SEMULOPARIN FOR THE PREVENTION OF VENOUS THROMBOEMBOLISM IN CANCER PATIENTS RECEIVING CHEMOTHERAPY	A61K 9/127 (2006.01)	2723387 *	CATHEPSIN-BINDING COMPOUNDS BOUND TO A CARRIER AND THEIR DIAGNOSTIC USE
A61P 35/00 (2006.01)	2706990 *	SEMULOPARIN FOR THE PREVENTION OF VENOUS THROMBOEMBOLISM IN CANCER PATIENTS RECEIVING CHEMOTHERAPY	A61K 47/48 (2006.01)	2723387 *	CATHEPSIN-BINDING COMPOUNDS BOUND TO A CARRIER AND THEIR DIAGNOSTIC USE
B25H 3/00 (2006.01)	2747955 *	MAGNETIC BIT-HOLDER BRACELET DEVICE	A61K 49/00 (2006.01)	2723387 *	CATHEPSIN-BINDING COMPOUNDS BOUND TO A CARRIER AND THEIR DIAGNOSTIC USE
H04M 3/00 (2006.01)	2754285 *	SOCIAL PROXY AND PROTOCOL GATEWAY	A61K 49/18 (2006.01)	2723387 *	CATHEPSIN-BINDING COMPOUNDS BOUND TO A CARRIER AND THEIR DIAGNOSTIC USE
A61K 31/52 (2006.01)	2714686 *	PYRIDIN-2 (1H) -ONE DERIVATIVES USEFUL AS MEDICAMENTS FOR THE TREATMENT OF MYELOPROLIFERATIVE DISORDERS, TRANSPLANT REJECTION, IMMUNE-MEDIATED AND INFLAMMATORY DISEASES	A61P 29/00 (2006.01)	2723387 *	CATHEPSIN-BINDING COMPOUNDS BOUND TO A CARRIER AND THEIR DIAGNOSTIC USE
A61P 35/00 (2006.01)	2714686 *	PYRIDIN-2 (1H) -ONE DERIVATIVES USEFUL AS MEDICAMENTS FOR THE TREATMENT OF MYELOPROLIFERATIVE DISORDERS, TRANSPLANT REJECTION, IMMUNE-MEDIATED AND INFLAMMATORY DISEASES	A61P 35/00 (2006.01)	2723387 *	CATHEPSIN-BINDING COMPOUNDS BOUND TO A CARRIER AND THEIR DIAGNOSTIC USE
A61P 37/06 (2006.01)	2714686 *	PYRIDIN-2 (1H) -ONE DERIVATIVES USEFUL AS MEDICAMENTS FOR THE TREATMENT OF MYELOPROLIFERATIVE DISORDERS, TRANSPLANT REJECTION, IMMUNE-MEDIATED AND INFLAMMATORY DISEASES	C07D 405/12 (2006.01)	2723387 *	CATHEPSIN-BINDING COMPOUNDS BOUND TO A CARRIER AND THEIR DIAGNOSTIC USE
C07D 471/02 (2006.01)	2714686 *	PYRIDIN-2 (1H) -ONE DERIVATIVES USEFUL AS MEDICAMENTS FOR THE TREATMENT OF MYELOPROLIFERATIVE DISORDERS, TRANSPLANT REJECTION, IMMUNE-MEDIATED AND INFLAMMATORY DISEASES	C07K 7/02 (2006.01)	2723387 *	CATHEPSIN-BINDING COMPOUNDS BOUND TO A CARRIER AND THEIR DIAGNOSTIC USE
C07D 473/00 (2006.01)	2714686 *	PYRIDIN-2 (1H) -ONE DERIVATIVES USEFUL AS MEDICAMENTS FOR THE TREATMENT OF MYELOPROLIFERATIVE DISORDERS, TRANSPLANT REJECTION, IMMUNE-MEDIATED AND INFLAMMATORY DISEASES	B65D 65/42 (2006.01)	2718359 *	METHOD FOR PRODUCING A COATED PACKAGING MATERIAL, AND PACKAGING MATERIAL HAVING AT LEAST ONE BARRIER LAYER FOR HYDROPHOBIC COMPOUNDS
A01D 34/00 (2006.01)	2656720	Cutter guard for a lawn mower	C08K 5/00 (2006.01)	2718359 *	METHOD FOR PRODUCING A COATED PACKAGING MATERIAL, AND PACKAGING MATERIAL HAVING AT LEAST ONE BARRIER LAYER FOR HYDROPHOBIC COMPOUNDS
A01D 34/81 (2006.01)	2656720	Cutter guard for a lawn mower	C08K 5/07 (2006.01)	2718359 *	METHOD FOR PRODUCING A COATED PACKAGING MATERIAL, AND PACKAGING MATERIAL HAVING AT LEAST ONE BARRIER LAYER FOR HYDROPHOBIC COMPOUNDS
			C08K 5/092 (2006.01)	2718359 *	METHOD FOR PRODUCING A COATED PACKAGING MATERIAL, AND PACKAGING MATERIAL HAVING AT LEAST ONE BARRIER LAYER FOR HYDROPHOBIC COMPOUNDS
			C09D 129/04 (2006.01)	2718359 *	METHOD FOR PRODUCING A COATED PACKAGING MATERIAL, AND PACKAGING MATERIAL HAVING AT LEAST ONE BARRIER LAYER FOR HYDROPHOBIC COMPOUNDS

MKP (51)	Broj objave evropske prijava patenta (97)	Naziv pronalaska (54)	MKP (51)	Broj objave evropske prijava patenta (97)	Naziv pronalaska (54)
A61K 31/4418 (2006.01)	2714660 *	NEPRILYSIN INHIBITORS	A61P 19/02 (2006.01)	2763671 *	METHODS OF TREATING AGE RELATED DISORDERS
A61P 9/12 (2006.01)	2714660 *	NEPRILYSIN INHIBITORS	A61P 21/00 (2006.01)	2763671 *	METHODS OF TREATING AGE RELATED DISORDERS
C07D 213/81 (2006.01)	2714660 *	NEPRILYSIN INHIBITORS	A61P 25/00 (2006.01)	2763671 *	METHODS OF TREATING AGE RELATED DISORDERS
C07D 239/28 (2006.01)	2714660 *	NEPRILYSIN INHIBITORS	A61P 25/24 (2006.01)	2763671 *	METHODS OF TREATING AGE RELATED DISORDERS
C07D 249/10 (2006.01)	2714660 *	NEPRILYSIN INHIBITORS	A61P 25/28 (2006.01)	2763671 *	METHODS OF TREATING AGE RELATED DISORDERS
C07D 261/18 (2006.01)	2714660 *	NEPRILYSIN INHIBITORS	A61P 39/00 (2006.01)	2763671 *	METHODS OF TREATING AGE RELATED DISORDERS
C07D 401/06 (2006.01)	2714660 *	NEPRILYSIN INHIBITORS	A61P 39/06 (2006.01)	2763671 *	METHODS OF TREATING AGE RELATED DISORDERS
C07D 471/04 (2006.01)	2714660 *	NEPRILYSIN INHIBITORS	A61K 31/4178 (2006.01)	2741746 *	CHEMICAL COMPOUNDS
C07D 487/04 (2006.01)	2714660 *	NEPRILYSIN INHIBITORS	C07D 403/14 (2006.01)	2741746 *	CHEMICAL COMPOUNDS
C07D 498/04 (2006.01)	2714660 *	NEPRILYSIN INHIBITORS	A23K 1/18 (2006.01)	2701535 *	BACILLUS BACTERIA FOR USE IN TREATING AND PREVENTING INFECTION IN AQUATIC ANIMALS
A61K 8/00 (2006.01)	2713988 *	FORMULATION OF SMALL ADRENERGIC AGONIST SALT FORMS IN ORGANIC SOLVENTS	A23L 1/30 (2006.01)	2701535 *	BACILLUS BACTERIA FOR USE IN TREATING AND PREVENTING INFECTION IN AQUATIC ANIMALS
A61K 39/395 (2006.01)	2720719 *	METHOD OF SELECTING THERAPEUTIC INDICATIONS	A61K 35/74 (2006.01)	2701535 *	BACILLUS BACTERIA FOR USE IN TREATING AND PREVENTING INFECTION IN AQUATIC ANIMALS
A23J 3/16 (2006.01)	2709464 *	PREPARATION OF SOY PROTEIN ISOLATE USING CALCIUM CHLORIDE EXTRACTION ("S703 CIP")	A61K 39/395 (2006.01)	2712320 *	METHOD FOR EGFR DIRECTED COMBINATION TREATMENT OF CANCER
A61K 31/336 (2006.01)	2763671 *	METHODS OF TREATING AGE RELATED DISORDERS	A61K 45/00 (2006.01)	2712320 *	METHOD FOR EGFR DIRECTED COMBINATION TREATMENT OF CANCER
A61K 31/7088 (2006.01)	2763671 *	METHODS OF TREATING AGE RELATED DISORDERS	A61K 31/397 (2006.01)	2758371 *	NEW THIO DERIVATIVES BEARING LACTAMS AS POTENT HDAC INHIBITORS AND THEIR USES AS MEDICAMENTS
A61K 31/713 (2006.01)	2763671 *	METHODS OF TREATING AGE RELATED DISORDERS	A61K 31/4015 (2006.01)	2758371 *	NEW THIO DERIVATIVES BEARING LACTAMS AS POTENT HDAC INHIBITORS AND THEIR USES AS MEDICAMENTS
A61K 39/00 (2006.01)	2763671 *	METHODS OF TREATING AGE RELATED DISORDERS	A61K 31/45 (2006.01)	2758371 *	NEW THIO DERIVATIVES BEARING LACTAMS AS POTENT HDAC INHIBITORS AND THEIR USES AS MEDICAMENTS
A61P 3/04 (2006.01)	2763671 *	METHODS OF TREATING AGE RELATED DISORDERS	A61K 31/4709 (2006.01)	2758371 *	NEW THIO DERIVATIVES BEARING LACTAMS AS POTENT HDAC INHIBITORS AND THEIR USES AS MEDICAMENTS
A61P 9/00 (2006.01)	2763671 *	METHODS OF TREATING AGE RELATED DISORDERS	A61P 25/00 (2006.01)	2758371 *	NEW THIO DERIVATIVES BEARING LACTAMS AS POTENT HDAC INHIBITORS AND THEIR USES AS MEDICAMENTS
A61P 19/00 (2006.01)	2763671 *	METHODS OF TREATING AGE RELATED DISORDERS			

MKP (51)	Broj objave evropske prijava patenta (97)	Naziv pronalaska (54)	MKP (51)	Broj objave evropske prijava patenta (97)	Naziv pronalaska (54)
A61P 29/00 (2006.01)	2758371 *	NEW THIO DERIVATIVES BEARING LACTAMS AS POTENT HDAC INHIBITORS AND THEIR USES AS MEDICAMENTS	B01D 61/14 (2006.01)	2725033 *	METHOD FOR PRODUCING PROTEIN PREPARATION
A61P 33/00 (2006.01)	2758371 *	NEW THIO DERIVATIVES BEARING LACTAMS AS POTENT HDAC INHIBITORS AND THEIR USES AS MEDICAMENTS	B01D 61/22 (2006.01)	2725033 *	METHOD FOR PRODUCING PROTEIN PREPARATION
A61P 35/00 (2006.01)	2758371 *	NEW THIO DERIVATIVES BEARING LACTAMS AS POTENT HDAC INHIBITORS AND THEIR USES AS MEDICAMENTS	B01D 71/10 (2006.01)	2725033 *	METHOD FOR PRODUCING PROTEIN PREPARATION
C07D 205/08 (2006.01)	2758371 *	NEW THIO DERIVATIVES BEARING LACTAMS AS POTENT HDAC INHIBITORS AND THEIR USES AS MEDICAMENTS	B01D 71/26 (2006.01)	2725033 *	METHOD FOR PRODUCING PROTEIN PREPARATION
C07D 207/277 (2006.01)	2758371 *	NEW THIO DERIVATIVES BEARING LACTAMS AS POTENT HDAC INHIBITORS AND THEIR USES AS MEDICAMENTS	B01D 71/34 (2006.01)	2725033 *	METHOD FOR PRODUCING PROTEIN PREPARATION
C07D 207/28 (2006.01)	2758371 *	NEW THIO DERIVATIVES BEARING LACTAMS AS POTENT HDAC INHIBITORS AND THEIR USES AS MEDICAMENTS	B01D 71/68 (2006.01)	2725033 *	METHOD FOR PRODUCING PROTEIN PREPARATION
C07D 211/78 (2006.01)	2758371 *	NEW THIO DERIVATIVES BEARING LACTAMS AS POTENT HDAC INHIBITORS AND THEIR USES AS MEDICAMENTS	C07K 1/34 (2006.01)	2725033 *	METHOD FOR PRODUCING PROTEIN PREPARATION
C07D 401/04 (2006.01)	2758371 *	NEW THIO DERIVATIVES BEARING LACTAMS AS POTENT HDAC INHIBITORS AND THEIR USES AS MEDICAMENTS	C07K 16/00 (2006.01)	2725033 *	METHOD FOR PRODUCING PROTEIN PREPARATION
A61K 9/20 (2006.01)	2731603 *	STABLE DOSAGE FORMS OF ARTEROLANE AND PIPERAQUINE	A61K 31/497 (2006.01)	2763980 *	BICARBOCYCLIC AND TRICARBOCYCLIC ETHYNYL DERIVATIVES AND USES OF SAME
A61K 31/357 (2006.01)	2731603 *	STABLE DOSAGE FORMS OF ARTEROLANE AND PIPERAQUINE	A61P 25/00 (2006.01)	2763980 *	BICARBOCYCLIC AND TRICARBOCYCLIC ETHYNYL DERIVATIVES AND USES OF SAME
A61K 31/496 (2006.01)	2731603 *	STABLE DOSAGE FORMS OF ARTEROLANE AND PIPERAQUINE	C07D 401/12 (2006.01)	2763980 *	BICARBOCYCLIC AND TRICARBOCYCLIC ETHYNYL DERIVATIVES AND USES OF SAME
A61P 33/06 (2006.01)	2731603 *	STABLE DOSAGE FORMS OF ARTEROLANE AND PIPERAQUINE	B01D 53/14 (2006.01)	2750782 *	METHOD AND SYSTEM FOR REMOVING CARBON DIOXIDE FROM FLUE GASES
A01N 25/32 (2006.01)	2701513 *	USE OF 3-ISOXAZOLIDINONES AS SELECTIVE HERBICIDES IN GRASS AND BRASSICA CROPS	A01K 5/01 (2006.01)	2720531 *	TROUGH
A01N 43/80 (2006.01)	2701513 *	USE OF 3-ISOXAZOLIDINONES AS SELECTIVE HERBICIDES IN GRASS AND BRASSICA CROPS	B65H 18/14 (2006.01)	2748090 *	SUBSTRATE ROLLERS
A01P 7/04 (2006.01)	2701513 *	USE OF 3-ISOXAZOLIDINONES AS SELECTIVE HERBICIDES IN GRASS AND BRASSICA CROPS	B65H 27/00 (2006.01)	2748090 *	SUBSTRATE ROLLERS
A61K 9/08 (2006.01)	2725033 *	METHOD FOR PRODUCING PROTEIN PREPARATION	B01J 35/00 (2006.01)	2726203 *	PHOTOCATALYTIC AND ANTI - BACTERIAL MATERIAL AND USE THEREOF IN THE BUILDING, LIGHTING AND FURNISHING FIELD
A61K 38/00 (2006.01)	2725033 *	METHOD FOR PRODUCING PROTEIN PREPARATION	C04B 26/02 (2006.01)	2726203 *	PHOTOCATALYTIC AND ANTI - BACTERIAL MATERIAL AND USE THEREOF IN THE BUILDING, LIGHTING AND FURNISHING FIELD
A61K 39/395 (2006.01)	2725033 *	METHOD FOR PRODUCING PROTEIN PREPARATION			

MKP (51)	Broj objave evropske prijava patenta (97)	Naziv pronalaska (54)	MKP (51)	Broj objave evropske prijava patenta (97)	Naziv pronalaska (54)
C04B 35/00 (2006.01)	2726203 *	PHOTOCATALYTIC AND ANTI - BACTERIAL MATERIAL AND USE THEREOF IN THE BUILDING, LIGHTING AND FURNISHING FIELD	C07C 5/03 (2006.01)	2766327 *	PROCESS FOR PREPARING JET FUEL FROM MOLECULES DERIVED FROM BIOMASS
C12N 15/113 (2010.01)	2639307	Single-stranded nucleic acid molecule having nitrogen-containing alicyclic skeleton	C07C 9/16 (2006.01)	2766327 *	PROCESS FOR PREPARING JET FUEL FROM MOLECULES DERIVED FROM BIOMASS
C08B 15/02 (2006.01)	2712364 *	LOW ENERGY METHOD FOR THE PREPARATION OF NON- DERIVATIZED NANOCELLULOSE	C07C 9/18 (2006.01)	2766327 *	PROCESS FOR PREPARING JET FUEL FROM MOLECULES DERIVED FROM BIOMASS
A61K 31/428 (2006.01)	2723732 *	TRPV1 ANTAGONISTS INCLUDING DIHYDROXY SUBSTITUENT AND USES THEREOF	C07C 13/18 (2006.01)	2766327 *	PROCESS FOR PREPARING JET FUEL FROM MOLECULES DERIVED FROM BIOMASS
A61P 1/04 (2006.01)	2723732 *	TRPV1 ANTAGONISTS INCLUDING DIHYDROXY SUBSTITUENT AND USES THEREOF	C07C 13/20 (2006.01)	2766327 *	PROCESS FOR PREPARING JET FUEL FROM MOLECULES DERIVED FROM BIOMASS
A61P 13/00 (2006.01)	2723732 *	TRPV1 ANTAGONISTS INCLUDING DIHYDROXY SUBSTITUENT AND USES THEREOF	C10G 1/00 (2006.01)	2766327 *	PROCESS FOR PREPARING JET FUEL FROM MOLECULES DERIVED FROM BIOMASS
A61P 19/02 (2006.01)	2723732 *	TRPV1 ANTAGONISTS INCLUDING DIHYDROXY SUBSTITUENT AND USES THEREOF	C10G 45/32 (2006.01)	2766327 *	PROCESS FOR PREPARING JET FUEL FROM MOLECULES DERIVED FROM BIOMASS
A61P 25/02 (2006.01)	2723732 *	TRPV1 ANTAGONISTS INCLUDING DIHYDROXY SUBSTITUENT AND USES THEREOF	C10M 107/02 (2006.01)	2766327 *	PROCESS FOR PREPARING JET FUEL FROM MOLECULES DERIVED FROM BIOMASS
A61P 25/04 (2006.01)	2723732 *	TRPV1 ANTAGONISTS INCLUDING DIHYDROXY SUBSTITUENT AND USES THEREOF	C10M 109/02 (2006.01)	2766327 *	PROCESS FOR PREPARING JET FUEL FROM MOLECULES DERIVED FROM BIOMASS
A61P 29/00 (2006.01)	2723732 *	TRPV1 ANTAGONISTS INCLUDING DIHYDROXY SUBSTITUENT AND USES THEREOF	A61K 31/5415 (2006.01)	2758403 *	TRICYCLIC COMPOUNDS USEFUL AS NEUROGENIC AND NEUROPROTECTIVE AGENTS
C07D 417/12 (2006.01)	2723732 *	TRPV1 ANTAGONISTS INCLUDING DIHYDROXY SUBSTITUENT AND USES THEREOF	A61P 25/00 (2006.01)	2758403 *	TRICYCLIC COMPOUNDS USEFUL AS NEUROGENIC AND NEUROPROTECTIVE AGENTS
C07D 417/14 (2006.01)	2723732 *	TRPV1 ANTAGONISTS INCLUDING DIHYDROXY SUBSTITUENT AND USES THEREOF	C07D 279/18 (2006.01)	2758403 *	TRICYCLIC COMPOUNDS USEFUL AS NEUROGENIC AND NEUROPROTECTIVE AGENTS
A61K 31/515 (2006.01)	2744500 *	COMPOUNDS FOR USE IN CANCER THERAPY	C07D 417/06 (2006.01)	2758403 *	TRICYCLIC COMPOUNDS USEFUL AS NEUROGENIC AND NEUROPROTECTIVE AGENTS
A61P 35/00 (2006.01)	2744500 *	COMPOUNDS FOR USE IN CANCER THERAPY	C07D 491/04 (2006.01)	2758403 *	TRICYCLIC COMPOUNDS USEFUL AS NEUROGENIC AND NEUROPROTECTIVE AGENTS
C07C 2/50 (2006.01)	2766327 *	PROCESS FOR PREPARING JET FUEL FROM MOLECULES DERIVED FROM BIOMASS	A61C 9/00 (2006.01)	2682071	Method for copying and reproducing anatomical segments of a patient
C07C 2/52 (2006.01)	2766327 *	PROCESS FOR PREPARING JET FUEL FROM MOLECULES DERIVED FROM BIOMASS	A61C 13/00 (2006.01)	2682071	Method for copying and reproducing anatomical segments of a patient
C07C 4/06 (2006.01)	2766327 *	PROCESS FOR PREPARING JET FUEL FROM MOLECULES DERIVED FROM BIOMASS	A61K 39/395 (2006.01)	2736534 *	COMBINATION THERAPY FOR THE TREATMENT OF CD19+ B-CELL MALIGNANCIES SYMPTOMS COMPRISING AN ANTI-CD19 MAYTANSINOID IMMUNOCONJUGATE AND RITUXIMAB
			A61K 47/48 (2006.01)	2736534 *	COMBINATION THERAPY FOR THE TREATMENT OF CD19+ B-CELL MALIGNANCIES SYMPTOMS COMPRISING AN ANTI-CD19 MAYTANSINOID IMMUNOCONJUGATE AND RITUXIMAB

MKP (51)	Broj objave evropske prijava patenta (97)	Naziv pronalaska (54)	MKP (51)	Broj objave evropske prijava patenta (97)	Naziv pronalaska (54)
A61P 35/00 (2006.01)	2736534 *	COMBINATION THERAPY FOR THE TREATMENT OF CD19+ B-CELL MALIGNANCIES SYMPTOMS COMPRISING AN ANTI-CD19 MAYTANSINOID IMMUNOCONJUGATE AND RITUXIMAB	A61P 9/00 (2006.01)	2712861	Thioacetate compounds, compositions and methods of use
C07K 16/28 (2006.01)	2736534 *	COMBINATION THERAPY FOR THE TREATMENT OF CD19+ B-CELL MALIGNANCIES SYMPTOMS COMPRISING AN ANTI-CD19 MAYTANSINOID IMMUNOCONJUGATE AND RITUXIMAB	A61P 9/12 (2006.01)	2712861	Thioacetate compounds, compositions and methods of use
A61K 31/546 (2006.01)	2706062 *	NOVEL CEPHALOSPORIN DERIVATIVE AND PHARMACEUTICAL COMPOSITION THEREOF	A61P 19/06 (2006.01)	2712861	Thioacetate compounds, compositions and methods of use
A61P 31/00 (2006.01)	2706062 *	NOVEL CEPHALOSPORIN DERIVATIVE AND PHARMACEUTICAL COMPOSITION THEREOF	C07D 213/70 (2006.01)	2712861	Thioacetate compounds, compositions and methods of use
C07D 501/34 (2006.01)	2706062 *	NOVEL CEPHALOSPORIN DERIVATIVE AND PHARMACEUTICAL COMPOSITION THEREOF	C07D 239/38 (2006.01)	2712861	Thioacetate compounds, compositions and methods of use
A61K 9/00 (2006.01)	2620146	Ibuprofen for treating actinic keratosis	C07D 241/18 (2006.01)	2712861	Thioacetate compounds, compositions and methods of use
A61K 31/192 (2006.01)	2620146	Ibuprofen for treating actinic keratosis	C07D 401/04 (2006.01)	2712861	Thioacetate compounds, compositions and methods of use
A61P 17/00 (2006.01)	2620146	Ibuprofen for treating actinic keratosis	C07D 403/04 (2006.01)	2712861	Thioacetate compounds, compositions and methods of use
B02C 17/00 (2006.01)	2758175 *	APPARATUS AND METHOD FOR A SEALING SYSTEM	C07D 405/04 (2006.01)	2712861	Thioacetate compounds, compositions and methods of use
A61B 17/115 (2006.01)	2517651	Tissue thickness compensator for a surgical stapler	C07D 417/04 (2006.01)	2712861	Thioacetate compounds, compositions and methods of use
C07K 16/28 (2006.01)	2758438 *	BISPECIFIC BINDING MOLECULES FOR 5T4 AND CD3	A24F 47/00 (2006.01)	2741626 *	SMOKING ARTICLES AND USE THEREOF FOR YIELDING INHALATION MATERIALS
C07K 16/30 (2006.01)	2758438 *	BISPECIFIC BINDING MOLECULES FOR 5T4 AND CD3	A61K 39/395 (2006.01)	2726099 *	METHOD FOR TREATING METABOLIC DISORDERS
C07K 16/46 (2006.01)	2758438 *	BISPECIFIC BINDING MOLECULES FOR 5T4 AND CD3	C07K 16/28 (2006.01)	2726099 *	METHOD FOR TREATING METABOLIC DISORDERS
G06F 17/30 (2006.01)	2710499 *	SYSTEM AND METHOD FOR CONDUCTING PROCESSOR-ASSISTED INDEXING AND SEARCHING	A61K 31/5513 (2006.01)	2726466 *	FUSED BENZOXAZEPINONES AS ION CHANNEL MODULATORS
A61K 31/44 (2006.01)	2712861	Thioacetate compounds, compositions and methods of use	A61K 31/553 (2006.01)	2726466 *	FUSED BENZOXAZEPINONES AS ION CHANNEL MODULATORS
A61K 31/444 (2006.01)	2712861	Thioacetate compounds, compositions and methods of use	A61K 31/554 (2006.01)	2726466 *	FUSED BENZOXAZEPINONES AS ION CHANNEL MODULATORS
A61K 31/4965 (2006.01)	2712861	Thioacetate compounds, compositions and methods of use	C07D 243/24 (2006.01)	2726466 *	FUSED BENZOXAZEPINONES AS ION CHANNEL MODULATORS
			C07D 267/14 (2006.01)	2726466 *	FUSED BENZOXAZEPINONES AS ION CHANNEL MODULATORS
			C07D 291/08 (2006.01)	2726466 *	FUSED BENZOXAZEPINONES AS ION CHANNEL MODULATORS
			C07D 403/06 (2006.01)	2726466 *	FUSED BENZOXAZEPINONES AS ION CHANNEL MODULATORS

MKP (51)	Broj objave evropske prijava patenta (97)	Naziv pronalaska (54)	MKP (51)	Broj objave evropske prijava patenta (97)	Naziv pronalaska (54)
C07D 413/06 (2006.01)	2726466 *	FUSED BENZOXAZEPINONES AS ION CHANNEL MODULATORS	C07D 487/04 (2006.01)	2722334	Benzodiazepine bromodomain inhibitor
C07D 413/12 (2006.01)	2726466 *	FUSED BENZOXAZEPINONES AS ION CHANNEL MODULATORS	A61K 31/138 (2006.01)	2717867 *	DRY POWDER INHALER COMPOSITIONS COMPRISING UMECLIDINIUM
C07D 413/14 (2006.01)	2726466 *	FUSED BENZOXAZEPINONES AS ION CHANNEL MODULATORS	A61K 31/439 (2006.01)	2717867 *	DRY POWDER INHALER COMPOSITIONS COMPRISING UMECLIDINIUM
C07D 419/06 (2006.01)	2726466 *	FUSED BENZOXAZEPINONES AS ION CHANNEL MODULATORS	A61K 31/58 (2006.01)	2717867 *	DRY POWDER INHALER COMPOSITIONS COMPRISING UMECLIDINIUM
C07D 471/04 (2006.01)	2726466 *	FUSED BENZOXAZEPINONES AS ION CHANNEL MODULATORS	A61K 45/06 (2006.01)	2717867 *	DRY POWDER INHALER COMPOSITIONS COMPRISING UMECLIDINIUM
C07D 487/04 (2006.01)	2726466 *	FUSED BENZOXAZEPINONES AS ION CHANNEL MODULATORS	A61P 11/06 (2006.01)	2717867 *	DRY POWDER INHALER COMPOSITIONS COMPRISING UMECLIDINIUM
C07D 498/04 (2006.01)	2726466 *	FUSED BENZOXAZEPINONES AS ION CHANNEL MODULATORS	A61P 11/08 (2006.01)	2717867 *	DRY POWDER INHALER COMPOSITIONS COMPRISING UMECLIDINIUM
A61K 38/28 (2006.01)	2720712 *	STABLE FORMULATIONS OF A HYALURONAN-DEGRADING ENZYME	C07D 401/12 (2006.01)	2707364 *	PROCESS FOR THE MANUFACTURE OF DABIGATRAN ETEXILATE AND INTERMEDIATES THEREOF
F16H 57/08 (2006.01)	2647882	Torque transmitting assembly and method of producing	C07D 403/06 (2006.01)	2726476 *	SULPHONAMIDE DERIVATIVES OF ALICYCLIC AMINES FOR THE TREATMENT OF CENTRAL NERVOUS SYSTEM DISEASES
A61M 31/00 (2006.01)	2747833 *	IMPROVED SKIN PORT CONNECTOR AND METHOD OF INSTALLATION	A61K 31/165 (2006.01)	2723710 *	FLUORINATED ARYLALKYLAMINOCARBOXAMIDE DERIVATIVES
A61K 39/40 (2006.01)	2758432 *	NEUTRALISING ANTIBODIES TO THE MAJOR EXOTOXINS TCDA AND TCDB OF CLOSTRIDIUM DIFFICILE	A61P 25/00 (2006.01)	2723710 *	FLUORINATED ARYLALKYLAMINOCARBOXAMIDE DERIVATIVES
A61P 31/04 (2006.01)	2758432 *	NEUTRALISING ANTIBODIES TO THE MAJOR EXOTOXINS TCDA AND TCDB OF CLOSTRIDIUM DIFFICILE	C07C 237/06 (2006.01)	2723710 *	FLUORINATED ARYLALKYLAMINOCARBOXAMIDE DERIVATIVES
C07K 16/12 (2006.01)	2758432 *	NEUTRALISING ANTIBODIES TO THE MAJOR EXOTOXINS TCDA AND TCDB OF CLOSTRIDIUM DIFFICILE	C07D 209/08 (2006.01)	2723710 *	FLUORINATED ARYLALKYLAMINOCARBOXAMIDE DERIVATIVES
G06F 19/00 (2011.01)	2645280	A rapidly converging atomic physics method and medium to calculate complex non-equilibrium radiative properties of matter with spectroscopic precision.	C07D 217/06 (2006.01)	2723710 *	FLUORINATED ARYLALKYLAMINOCARBOXAMIDE DERIVATIVES
C12N 13/00 (2006.01)	2710127 *	SELECTIVE ULTRASONIC LYSIS OF BLOOD AND OTHER BIOLOGICAL FLUIDS AND TISSUES	C07D 265/36 (2006.01)	2723710 *	FLUORINATED ARYLALKYLAMINOCARBOXAMIDE DERIVATIVES
A61K 31/55 (2006.01)	2722334	Benzodiazepine bromodomain inhibitor	C07D 295/182 (2006.01)	2723710 *	FLUORINATED ARYLALKYLAMINOCARBOXAMIDE DERIVATIVES
A61P 35/00 (2006.01)	2722334	Benzodiazepine bromodomain inhibitor	C07D 295/185 (2006.01)	2723710 *	FLUORINATED ARYLALKYLAMINOCARBOXAMIDE DERIVATIVES
A61P 43/00 (2006.01)	2722334	Benzodiazepine bromodomain inhibitor	B32B 17/10 (2006.01)	2718100 *	LIGHTING DEVICE COMPRISING LIGHT-EMITTING DIODES
			F21K 99/00 (2010.01)	2718100 *	LIGHTING DEVICE COMPRISING LIGHT-EMITTING DIODES

MKP (51)	Broj objave evropske prijava patenta (97)	Naziv pronalaska (54)	MKP (51)	Broj objave evropske prijava patenta (97)	Naziv pronalaska (54)
F21V 33/00 (2006.01)	2718100 *	LIGHTING DEVICE COMPRISING LIGHT-EMITTING DIODES	H01M 12/06 (2006.01)	2725653 *	LITHIUM-AIR BATTERY
G02B 6/00 (2006.01)	2718100 *	LIGHTING DEVICE COMPRISING LIGHT-EMITTING DIODES	C07D 211/70 (2006.01)	2760832 *	IMPROVED PROCESS FOR PREPARING 2-[(2E)-2-FLUORO-2-(3-PIPERIDINYLDENE)ETHYL]-1H-ISOINDOLE-1,3(2H)-DIONE
A61K 31/47 (2006.01)	2711433 *	METHOD FOR PREDICTING EFFECTIVENESS OF ANGIOGENESIS INHIBITOR	C07D 401/04 (2006.01)	2760832 *	IMPROVED PROCESS FOR PREPARING 2-[(2E)-2-FLUORO-2-(3-PIPERIDINYLDENE)ETHYL]-1H-ISOINDOLE-1,3(2H)-DIONE
A61P 35/00 (2006.01)	2711433 *	METHOD FOR PREDICTING EFFECTIVENESS OF ANGIOGENESIS INHIBITOR	C07F 9/24 (2006.01)	2760832 *	IMPROVED PROCESS FOR PREPARING 2-[(2E)-2-FLUORO-2-(3-PIPERIDINYLDENE)ETHYL]-1H-ISOINDOLE-1,3(2H)-DIONE
A61P 43/00 (2006.01)	2711433 *	METHOD FOR PREDICTING EFFECTIVENESS OF ANGIOGENESIS INHIBITOR	A61K 31/155 (2006.01)	2709652 *	PHARMACEUTICAL COMBINATION FOR USE IN THE TREATMENT OF DIABETES TYPE 2
C12N 15/09 (2006.01)	2711433 *	METHOD FOR PREDICTING EFFECTIVENESS OF ANGIOGENESIS INHIBITOR	A61K 38/22 (2006.01)	2709652 *	PHARMACEUTICAL COMBINATION FOR USE IN THE TREATMENT OF DIABETES TYPE 2
C12Q 1/68 (2006.01)	2711433 *	METHOD FOR PREDICTING EFFECTIVENESS OF ANGIOGENESIS INHIBITOR	A61P 3/10 (2006.01)	2709652 *	PHARMACEUTICAL COMBINATION FOR USE IN THE TREATMENT OF DIABETES TYPE 2
G01N 33/15 (2006.01)	2711433 *	METHOD FOR PREDICTING EFFECTIVENESS OF ANGIOGENESIS INHIBITOR	G06F 7/58 (2006.01)	2705421 *	RANDOM NUMBER GENERATOR
G01N 33/50 (2006.01)	2711433 *	METHOD FOR PREDICTING EFFECTIVENESS OF ANGIOGENESIS INHIBITOR	A61K 31/437 (2006.01)	2751102 *	COMPOUNDS AND COMPOSITIONS AS c-KIT KINASE INHIBITORS
F02M 59/10 (2006.01)	2662564	Driveshaft lubrication	A61P 3/00 (2006.01)	2751102 *	COMPOUNDS AND COMPOSITIONS AS c-KIT KINASE INHIBITORS
F02M 63/00 (2006.01)	2662564	Driveshaft lubrication	A61P 11/00 (2006.01)	2751102 *	COMPOUNDS AND COMPOSITIONS AS c-KIT KINASE INHIBITORS
F04B 1/04 (2006.01)	2662564	Driveshaft lubrication	A61P 17/00 (2006.01)	2751102 *	COMPOUNDS AND COMPOSITIONS AS c-KIT KINASE INHIBITORS
F04B 9/04 (2006.01)	2662564	Driveshaft lubrication	A61P 29/00 (2006.01)	2751102 *	COMPOUNDS AND COMPOSITIONS AS c-KIT KINASE INHIBITORS
F04B 53/00 (2006.01)	2662564	Driveshaft lubrication	C07D 471/04 (2006.01)	2751102 *	COMPOUNDS AND COMPOSITIONS AS c-KIT KINASE INHIBITORS
F04B 53/18 (2006.01)	2662564	Driveshaft lubrication	A61B 1/313 (2006.01)	2765932 *	NEEDLE GUIDANCE SYSTEM
H03K 3/537 (2006.01)	2737627 *	GAS SWITCH TRIGGERED BY A LASER FILAMENT	A61B 5/00 (2006.01)	2765932 *	NEEDLE GUIDANCE SYSTEM
A61K 31/4162 (2006.01)	2702059 *	NOVEL COMPOUND USEFUL FOR THE TREATMENT OF DEGENERATIVE AND INFLAMMATORY DISEASES	A61B 17/16 (2006.01)	2765932 *	NEEDLE GUIDANCE SYSTEM
A61P 19/02 (2006.01)	2702059 *	NOVEL COMPOUND USEFUL FOR THE TREATMENT OF DEGENERATIVE AND INFLAMMATORY DISEASES	A61B 17/34 (2006.01)	2765932 *	NEEDLE GUIDANCE SYSTEM
C07D 471/04 (2006.01)	2702059 *	NOVEL COMPOUND USEFUL FOR THE TREATMENT OF DEGENERATIVE AND INFLAMMATORY DISEASES			

MKP (51)	Broj objave evropske prijava patenta (97)	Naziv pronalaska (54)	MKP (51)	Broj objave evropske prijava patenta (97)	Naziv pronalaska (54)
A61M 5/46 (2006.01)	2765932 *	NEEDLE GUIDANCE SYSTEM	G01N 21/35 (2014.01)	2743678 *	INFRARED ANALYSIS OF PERIPHERAL BLOOD FRACTIONS OBTAINED TO INDICATE COGNITIVE DEVELOPMENT ASSOCIATED WITH ALZHEIMER'S DISEASE
G01N 21/00 (2006.01)	2765932 *	NEEDLE GUIDANCE SYSTEM	B01D 3/00 (2006.01)	2755730 *	SYSTEM AND METHOD FOR WATER TREATMENT
B24B 39/00 (2006.01)	2759373	A method of fluid pressure control in a hydrostatic burnishing tool and hydrostatic burnishing tool	A61K 31/4184 (2006.01)	2766354 *	PROTEIN KINASE INHIBITORS
B24B 49/08 (2006.01)	2759373	A method of fluid pressure control in a hydrostatic burnishing tool and hydrostatic burnishing tool	A61K 31/4188 (2006.01)	2766354 *	PROTEIN KINASE INHIBITORS
F24C 7/08 (2006.01)	2761227 *	HOB WITH WINDOW, COOKING APPLIANCE AND METHOD OF MANUFACTURING THE HOB	A61P 35/00 (2006.01)	2766354 *	PROTEIN KINASE INHIBITORS
H05B 3/74 (2006.01)	2761227 *	HOB WITH WINDOW, COOKING APPLIANCE AND METHOD OF MANUFACTURING THE HOB	C07D 401/14 (2006.01)	2766354 *	PROTEIN KINASE INHIBITORS
A61K 39/102 (2006.01)	2707024 *	PROTEIN F - A NOVEL HAEMOPHILUS INFLUENZAE ADHESIN WITH LAMININ AND VITRONECTIN BINDING PROPERTIES	C07D 403/04 (2006.01)	2766354 *	PROTEIN KINASE INHIBITORS
A61P 31/04 (2006.01)	2707024 *	PROTEIN F - A NOVEL HAEMOPHILUS INFLUENZAE ADHESIN WITH LAMININ AND VITRONECTIN BINDING PROPERTIES	C07D 413/04 (2006.01)	2766354 *	PROTEIN KINASE INHIBITORS
C07K 14/285 (2006.01)	2707024 *	PROTEIN F - A NOVEL HAEMOPHILUS INFLUENZAE ADHESIN WITH LAMININ AND VITRONECTIN BINDING PROPERTIES	C07D 471/04 (2006.01)	2766354 *	PROTEIN KINASE INHIBITORS
F02D 1/18 (2006.01)	2660456	Fuel pump	H02P 6/08 (2006.01)	2731262 *	VARIABLE FREQUENCY SPEED CONTROL SYSTEM FOR MOTOR
F02M 41/14 (2006.01)	2660456	Fuel pump	H02P 27/06 (2006.01)	2731262 *	VARIABLE FREQUENCY SPEED CONTROL SYSTEM FOR MOTOR
A61B 17/00 (2006.01)	2679177	Systems and apparatus for providing motor protection in a power tool and method of manufacturing the same	A61F 13/15 (2006.01)	2736542 *	MULTI-LAYERED WOUND DRESSING CONTAINING AN HYDROCOLLOID AND ACTIVATED CARBON
A61B 17/3207 (2006.01)	2679177	Systems and apparatus for providing motor protection in a power tool and method of manufacturing the same	A61L 15/18 (2006.01)	2736542 *	MULTI-LAYERED WOUND DRESSING CONTAINING AN HYDROCOLLOID AND ACTIVATED CARBON
C12Q 1/68 (2006.01)	2751283 *	PROCESS FOR SEPARATION OF OLIGONUCLEOTIDE OF INTEREST FROM A MIXTURE	A61L 15/32 (2006.01)	2736542 *	MULTI-LAYERED WOUND DRESSING CONTAINING AN HYDROCOLLOID AND ACTIVATED CARBON
A61K 31/00 (2006.01)	2768491 *	INHIBITORS OF ARGINASE AND THEIR THERAPEUTIC APPLICATIONS	A61L 15/42 (2006.01)	2736542 *	MULTI-LAYERED WOUND DRESSING CONTAINING AN HYDROCOLLOID AND ACTIVATED CARBON
A61K 49/00 (2006.01)	2768491 *	INHIBITORS OF ARGINASE AND THEIR THERAPEUTIC APPLICATIONS	A61L 15/60 (2006.01)	2736542 *	MULTI-LAYERED WOUND DRESSING CONTAINING AN HYDROCOLLOID AND ACTIVATED CARBON
A61P 35/00 (2006.01)	2768491 *	INHIBITORS OF ARGINASE AND THEIR THERAPEUTIC APPLICATIONS	A61K 9/22 (2006.01)	2704697 *	SUSTAINED RELEASE PARACETAMOL FORMULATIONS
C07F 5/02 (2006.01)	2768491 *	INHIBITORS OF ARGINASE AND THEIR THERAPEUTIC APPLICATIONS	A61K 31/167 (2006.01)	2704697 *	SUSTAINED RELEASE PARACETAMOL FORMULATIONS

MKP (51)	Broj objave evropske prijava patenta (97)	Naziv pronalaska (54)	MKP (51)	Broj objave evropske prijava patenta (97)	Naziv pronalaska (54)
A61K 31/444 (2006.01)	2766353 *	2-OXO-PIPERIDINYL DERIVATIVES	A61K 31/19 (2006.01)	2713724 *	METHODS OF TREATING MULTIPLE SCLEROSIS AND PRESERVING AND/OR INCREASING MYELIN CONTENT
A61P 25/06 (2006.01)	2766353 *	2-OXO-PIPERIDINYL DERIVATIVES	A61M 5/00 (2006.01)	2707064 *	DRUG DELIVERY DEVICE COMPRISING SAFETY LOCK MEMBER
C07D 401/10 (2006.01)	2766353 *	2-OXO-PIPERIDINYL DERIVATIVES	A61M 5/32 (2006.01)	2707064 *	DRUG DELIVERY DEVICE COMPRISING SAFETY LOCK MEMBER
C07D 401/14 (2006.01)	2766353 *	2-OXO-PIPERIDINYL DERIVATIVES	A61M 5/50 (2006.01)	2707064 *	DRUG DELIVERY DEVICE COMPRISING SAFETY LOCK MEMBER
C07D 405/14 (2006.01)	2766353 *	2-OXO-PIPERIDINYL DERIVATIVES	A01C 1/06 (2006.01)	2719270	Coating compound and use
C07D 413/14 (2006.01)	2766353 *	2-OXO-PIPERIDINYL DERIVATIVES	A61K 39/395 (2006.01)	2711375	Human Antigen Binding Proteins that bind Beta-Klotho, FGF Receptors and complexes thereof
C07D 417/14 (2006.01)	2766353 *	2-OXO-PIPERIDINYL DERIVATIVES	A61P 3/04 (2006.01)	2711375	Human Antigen Binding Proteins that bind Beta-Klotho, FGF Receptors and complexes thereof
A61K 31/505 (2006.01)	2748168 *	INHIBITORS OF NEDD8- ACTIVATING ENZYME	C07K 14/71 (2006.01)	2711375	Human Antigen Binding Proteins that bind Beta-Klotho, FGF Receptors and complexes thereof
A61K 31/519 (2006.01)	2748168 *	INHIBITORS OF NEDD8- ACTIVATING ENZYME	C07K 16/18 (2006.01)	2711375	Human Antigen Binding Proteins that bind Beta-Klotho, FGF Receptors and complexes thereof
A61P 35/00 (2006.01)	2748168 *	INHIBITORS OF NEDD8- ACTIVATING ENZYME	C07K 16/28 (2006.01)	2711375	Human Antigen Binding Proteins that bind Beta-Klotho, FGF Receptors and complexes thereof
C07D 487/02 (2006.01)	2748168 *	INHIBITORS OF NEDD8- ACTIVATING ENZYME	C07K 19/00 (2006.01)	2711375	Human Antigen Binding Proteins that bind Beta-Klotho, FGF Receptors and complexes thereof
C07D 487/04 (2006.01)	2748168 *	INHIBITORS OF NEDD8- ACTIVATING ENZYME	A61K 9/00 (2006.01)	2637645 *	PHARMACEUTICAL COMPOSITION AND DOSAGE FORM COMPRISING DRONEDARONE, AND PREPARATION METHOD THEREOF
H04N 7/18 (2006.01)	2702763 *	INTERFACE DEVICE FOR VIDEO CAMERAS	A61K 9/48 (2006.01)	2637645 *	PHARMACEUTICAL COMPOSITION AND DOSAGE FORM COMPRISING DRONEDARONE, AND PREPARATION METHOD THEREOF
A61K 31/497 (2006.01)	2729149 *	VOLTAGE-GATED SODIUM CHANNEL BLOCKERS	A61K 31/00 (2006.01)	2637645 *	PHARMACEUTICAL COMPOSITION AND DOSAGE FORM COMPRISING DRONEDARONE, AND PREPARATION METHOD THEREOF
A61K 31/537 (2006.01)	2758406 *	AMINO-OXAZINES AND AMINO- DIHYDROTHIAZINE COMPOUNDS AS BETA-SECRETASE MODULATORS AND METHODS OF USE	A61K 31/343 (2006.01)	2637645 *	PHARMACEUTICAL COMPOSITION AND DOSAGE FORM COMPRISING DRONEDARONE, AND PREPARATION METHOD THEREOF
A61P 25/28 (2006.01)	2758406 *	AMINO-OXAZINES AND AMINO- DIHYDROTHIAZINE COMPOUNDS AS BETA-SECRETASE MODULATORS AND METHODS OF USE	C07K 14/31 (2006.01)	2758436 *	SERUM HALF-LIFE EXTENSION USING IMMUNOGLOBULIN BINDING DOMAINS
C07D 498/10 (2006.01)	2758406 *	AMINO-OXAZINES AND AMINO- DIHYDROTHIAZINE COMPOUNDS AS BETA-SECRETASE MODULATORS AND METHODS OF USE			
A01N 37/00 (2006.01)	2713724 *	METHODS OF TREATING MULTIPLE SCLEROSIS AND PRESERVING AND/OR INCREASING MYELIN CONTENT			

MKP (51)	Broj objave evropske prijava patenta (97)	Naziv pronalaska (54)	MKP (51)	Broj objave evropske prijava patenta (97)	Naziv pronalaska (54)
C07K 14/315 (2006.01)	2758436 *	SERUM HALF-LIFE EXTENSION USING IMMUNOGLOBULIN BINDING DOMAINS	C07D 471/04 (2006.01)	2744809 *	4-(8-METHOXY-1-((1-METHOXYPROPAN-2-YL)-2-(TETRAHYDRO-2H-PYRAN-4-YL)-1 H-IMIDAZO[4,5-C]QUINOLIN-7-YL)-3,5-DIMETHYLISOXAZOLE AND ITS USE AS BROMODOMAIN INHIBITOR
C07K 16/28 (2006.01)	2758436 *	SERUM HALF-LIFE EXTENSION USING IMMUNOGLOBULIN BINDING DOMAINS	A61K 31/045 (2006.01)	2723344 *	MONOTERPENE-CONTAINING AGENT FOR COMBINATION THERAPY
C07K 16/30 (2006.01)	2758436 *	SERUM HALF-LIFE EXTENSION USING IMMUNOGLOBULIN BINDING DOMAINS	A61K 31/35 (2006.01)	2723344 *	MONOTERPENE-CONTAINING AGENT FOR COMBINATION THERAPY
F24H 9/02 (2006.01)	2623883	Heating device with removable front cover, method for maintaining a heating device	A61K 31/592 (2006.01)	2723344 *	MONOTERPENE-CONTAINING AGENT FOR COMBINATION THERAPY
B01D 3/02 (2006.01)	2755921 *	SYSTEM AND METHOD FOR WATER TREATMENT	A61K 31/593 (2006.01)	2723344 *	MONOTERPENE-CONTAINING AGENT FOR COMBINATION THERAPY
C02F 1/06 (2006.01)	2755921 *	SYSTEM AND METHOD FOR WATER TREATMENT	A61P 1/00 (2006.01)	2723344 *	MONOTERPENE-CONTAINING AGENT FOR COMBINATION THERAPY
B66C 1/10 (2006.01)	2625130 *	METHOD FOR REPLACING A TRANSFORMER IN A WIND ENERGY INSTALLATION	A61P 11/00 (2006.01)	2723344 *	MONOTERPENE-CONTAINING AGENT FOR COMBINATION THERAPY
H04Q 9/00 (2006.01)	2605539	Method and system for sensor classification	A61P 11/06 (2006.01)	2723344 *	MONOTERPENE-CONTAINING AGENT FOR COMBINATION THERAPY
H02G 3/08 (2006.01)	2634877	Method for manufacturing a control housing for a circulation pump	A61K 31/404 (2006.01)	2744805 *	HETEROARYL SODIUM CHANNEL INHIBITORS
A01N 55/08 (2006.01)	2744342 *	THERAPEUTIC METHODS	A61K 31/4184 (2006.01)	2744805 *	HETEROARYL SODIUM CHANNEL INHIBITORS
A61K 31/69 (2006.01)	2744342 *	THERAPEUTIC METHODS	A61P 29/00 (2006.01)	2744805 *	HETEROARYL SODIUM CHANNEL INHIBITORS
A61K 31/17 (2006.01)	2723332 *	NOVEL COMPOUNDS AS DIACYLGLYCEROL ACYLTRANSFERASE INHIBITORS	C07D 403/14 (2006.01)	2744805 *	HETEROARYL SODIUM CHANNEL INHIBITORS
A61K 31/4745 (2006.01)	2744809 *	4-(8-METHOXY-1-((1-METHOXYPROPAN-2-YL)-2-(TETRAHYDRO-2H-PYRAN-4-YL)-1 H-IMIDAZO[4,5-C]QUINOLIN-7-YL)-3,5-DIMETHYLISOXAZOLE AND ITS USE AS BROMODOMAIN INHIBITOR	C07D 417/12 (2006.01)	2744805 *	HETEROARYL SODIUM CHANNEL INHIBITORS
A61P 29/00 (2006.01)	2744809 *	4-(8-METHOXY-1-((1-METHOXYPROPAN-2-YL)-2-(TETRAHYDRO-2H-PYRAN-4-YL)-1 H-IMIDAZO[4,5-C]QUINOLIN-7-YL)-3,5-DIMETHYLISOXAZOLE AND ITS USE AS BROMODOMAIN INHIBITOR	C07D 417/14 (2006.01)	2744805 *	HETEROARYL SODIUM CHANNEL INHIBITORS
A61P 37/00 (2006.01)	2744809 *	4-(8-METHOXY-1-((1-METHOXYPROPAN-2-YL)-2-(TETRAHYDRO-2H-PYRAN-4-YL)-1 H-IMIDAZO[4,5-C]QUINOLIN-7-YL)-3,5-DIMETHYLISOXAZOLE AND ITS USE AS BROMODOMAIN INHIBITOR	H04L 29/00 (2006.01)	2732594 *	SYSTEM AND METHOD FOR ALTERNATIVE DISTRIBUTION OF A PIN CODE
			A61K 31/4166 (2006.01)	2718285 *	HYDANTOIN DERIVATES AS KV3 INHIBITORS
			A61K 31/4439 (2006.01)	2718285 *	HYDANTOIN DERIVATES AS KV3 INHIBITORS
			A61K 31/506 (2006.01)	2718285 *	HYDANTOIN DERIVATES AS KV3 INHIBITORS
			A61P 25/00 (2006.01)	2718285 *	HYDANTOIN DERIVATES AS KV3 INHIBITORS

MKP (51)	Broj objave evropske prijava patenta (97)	Naziv pronalaska (54)	MKP (51)	Broj objave evropske prijava patenta (97)	Naziv pronalaska (54)
C07D 307/87 (2006.01)	2718285 *	HYDANTOIN DERIVATES AS KV3 INHIBITORS	C07D 405/12 (2006.01)	2753606 *	PYRIMIDINES AS SODIUM CHANNEL BLOCKERS
C07D 307/94 (2006.01)	2718285 *	HYDANTOIN DERIVATES AS KV3 INHIBITORS	C07D 405/14 (2006.01)	2753606 *	PYRIMIDINES AS SODIUM CHANNEL BLOCKERS
C07D 311/76 (2006.01)	2718285 *	HYDANTOIN DERIVATES AS KV3 INHIBITORS	A61B 18/14 (2006.01)	2726005 *	AN ELECTROSURGICAL INSTRUMENT AND ELECTROSURGICAL CONDUCTIVE ELECTRODE FOR USE WITH THE INSTRUMENT
C07D 401/04 (2006.01)	2718285 *	HYDANTOIN DERIVATES AS KV3 INHIBITORS	A01N 1/02 (2006.01)	2717681 *	SYSTEM AND METHOD OF CYTOMIC VASCULAR HEALTH PROFILING
C07D 403/04 (2006.01)	2718285 *	HYDANTOIN DERIVATES AS KV3 INHIBITORS	G01N 31/00 (2006.01)	2717681 *	SYSTEM AND METHOD OF CYTOMIC VASCULAR HEALTH PROFILING
C07D 405/12 (2006.01)	2718285 *	HYDANTOIN DERIVATES AS KV3 INHIBITORS	G01N 33/00 (2006.01)	2717681 *	SYSTEM AND METHOD OF CYTOMIC VASCULAR HEALTH PROFILING
C07D 405/14 (2006.01)	2718285 *	HYDANTOIN DERIVATES AS KV3 INHIBITORS	B01D 53/04 (2006.01)	2760579 *	SELF-SUPPORTING STRUCTURES HAVING ADSORPTIVE PROPERTIES
C02F 1/66 (2006.01)	2751036 *	REMINERALIZATION OF DESALINATED AND OF FRESH WATER BY DOSING OF A CALCIUM CARBONATE SOLUTION IN SOFT WATER	B01J 20/20 (2006.01)	2760579 *	SELF-SUPPORTING STRUCTURES HAVING ADSORPTIVE PROPERTIES
C02F 1/68 (2006.01)	2751036 *	REMINERALIZATION OF DESALINATED AND OF FRESH WATER BY DOSING OF A CALCIUM CARBONATE SOLUTION IN SOFT WATER	B01J 20/24 (2006.01)	2760579 *	SELF-SUPPORTING STRUCTURES HAVING ADSORPTIVE PROPERTIES
C02F 103/06 (2006.01)	2751036 *	REMINERALIZATION OF DESALINATED AND OF FRESH WATER BY DOSING OF A CALCIUM CARBONATE SOLUTION IN SOFT WATER	B01J 20/26 (2006.01)	2760579 *	SELF-SUPPORTING STRUCTURES HAVING ADSORPTIVE PROPERTIES
C02F 103/42 (2006.01)	2751036 *	REMINERALIZATION OF DESALINATED AND OF FRESH WATER BY DOSING OF A CALCIUM CARBONATE SOLUTION IN SOFT WATER	B01J 20/28 (2006.01)	2760579 *	SELF-SUPPORTING STRUCTURES HAVING ADSORPTIVE PROPERTIES
A61K 31/4418 (2006.01)	2753606 *	PYRIMIDINES AS SODIUM CHANNEL BLOCKERS	B01J 20/30 (2006.01)	2760579 *	SELF-SUPPORTING STRUCTURES HAVING ADSORPTIVE PROPERTIES
A61P 25/08 (2006.01)	2753606 *	PYRIMIDINES AS SODIUM CHANNEL BLOCKERS	B01D 21/24 (2006.01)	2755736 *	FLUID TREATMENT APPARATUS, SYSTEM, AND METHODS
C07D 233/90 (2006.01)	2753606 *	PYRIMIDINES AS SODIUM CHANNEL BLOCKERS	B01D 21/28 (2006.01)	2755736 *	FLUID TREATMENT APPARATUS, SYSTEM, AND METHODS
C07D 401/12 (2006.01)	2753606 *	PYRIMIDINES AS SODIUM CHANNEL BLOCKERS	C02F 1/52 (2006.01)	2755736 *	FLUID TREATMENT APPARATUS, SYSTEM, AND METHODS
C07D 401/14 (2006.01)	2753606 *	PYRIMIDINES AS SODIUM CHANNEL BLOCKERS	A61B 17/00 (2006.01)	2641550	Activation feature for surgical instrument with pencil grip
C07D 403/04 (2006.01)	2753606 *	PYRIMIDINES AS SODIUM CHANNEL BLOCKERS	A61B 17/32 (2006.01)	2641550	Activation feature for surgical instrument with pencil grip
C07D 403/12 (2006.01)	2753606 *	PYRIMIDINES AS SODIUM CHANNEL BLOCKERS	H01H 15/00 (2006.01)	2641550	Activation feature for surgical instrument with pencil grip
			A61K 38/00 (2006.01)	2741771 *	METHODS AND COMPOSITIONS FOR THE TREATMENT OF AUTOIMMUNE AND INFLAMMATORY DISEASES

MKP (51)	Broj objave evropske prijava patenta (97)	Naziv pronalaska (54)	MKP (51)	Broj objave evropske prijava patenta (97)	Naziv pronalaska (54)
A61K 39/00 (2006.01)	2741771 *	METHODS AND COMPOSITIONS FOR THE TREATMENT OF AUTOIMMUNE AND INFLAMMATORY DISEASES	D06F 58/20 (2006.01)	2642016	Heating cabinet
C12N 5/071 (2010.01)	2741771 *	METHODS AND COMPOSITIONS FOR THE TREATMENT OF AUTOIMMUNE AND INFLAMMATORY DISEASES	B27K 5/04 (2006.01)	2736689 *	METHOD OF WOOD PRESERVATION USING EXPIRATION CONTROL
A61K 31/4725 (2006.01)	2729460 *	CRYSTALLINE SOLVATES OF 6-(PIPERIDIN-4-YLOXY)-2H-ISOQUINOLIN-1-ONE HYDROCHLORIDE	B27K 5/06 (2006.01)	2736689 *	METHOD OF WOOD PRESERVATION USING EXPIRATION CONTROL
A61P 9/00 (2006.01)	2729460 *	CRYSTALLINE SOLVATES OF 6-(PIPERIDIN-4-YLOXY)-2H-ISOQUINOLIN-1-ONE HYDROCHLORIDE	B27M 1/08 (2006.01)	2736689 *	METHOD OF WOOD PRESERVATION USING EXPIRATION CONTROL
C07D 401/12 (2006.01)	2729460 *	CRYSTALLINE SOLVATES OF 6-(PIPERIDIN-4-YLOXY)-2H-ISOQUINOLIN-1-ONE HYDROCHLORIDE	C03C 3/093 (2006.01)	2753589 *	LOW DIELECTRIC GLASS AND FIBER GLASS
A47J 27/04 (2006.01)	2671476	Insert for covers and/or containers for cooking foodstuff under vacuum	C03C 3/118 (2006.01)	2753589 *	LOW DIELECTRIC GLASS AND FIBER GLASS
A47J 27/08 (2006.01)	2671476	Insert for covers and/or containers for cooking foodstuff under vacuum	H05K 1/03 (2006.01)	2753589 *	LOW DIELECTRIC GLASS AND FIBER GLASS
A47J 27/62 (2006.01)	2671476	Insert for covers and/or containers for cooking foodstuff under vacuum	A61K 31/4704 (2006.01)	2763967 *	PROCESS FOR PREPARING 5-(2-[[6-(2,2-DIFLUORO-2-PHENYLETHOXY)HEXYL] AMINO]-1(R)-HYDROXYETHYL)-8-HYDROXYQUINOLIN-2(1H)-ONE VIA A NOVEL INTERMEDIATE
A61M 5/28 (2006.01)	2747809 *	REFILL MODULE FOR AN INJECTION DEVICE	A61P 11/00 (2006.01)	2763967 *	PROCESS FOR PREPARING 5-(2-[[6-(2,2-DIFLUORO-2-PHENYLETHOXY)HEXYL] AMINO]-1(R)-HYDROXYETHYL)-8-HYDROXYQUINOLIN-2(1H)-ONE VIA A NOVEL INTERMEDIATE
A61K 9/16 (2006.01)	2750694 *	METHODS AND COMPOSITIONS RELATING TO P62 FOR THE TREATMENT AND PROPHYLAXIS OF CANCER	C07D 215/26 (2006.01)	2763967 *	PROCESS FOR PREPARING 5-(2-[[6-(2,2-DIFLUORO-2-PHENYLETHOXY)HEXYL] AMINO]-1(R)-HYDROXYETHYL)-8-HYDROXYQUINOLIN-2(1H)-ONE VIA A NOVEL INTERMEDIATE
A61K 9/20 (2006.01)	2750694 *	METHODS AND COMPOSITIONS RELATING TO P62 FOR THE TREATMENT AND PROPHYLAXIS OF CANCER	A61K 8/64 (2006.01)	2741761 *	MODIFIED OSTEOPONTIN PEPTIDES HAVING AN INACTIVATED RGD DOMAIN AND USES THEREOF
A61K 38/16 (2006.01)	2750694 *	METHODS AND COMPOSITIONS RELATING TO P62 FOR THE TREATMENT AND PROPHYLAXIS OF CANCER	A61K 38/19 (2006.01)	2741761 *	MODIFIED OSTEOPONTIN PEPTIDES HAVING AN INACTIVATED RGD DOMAIN AND USES THEREOF
A61K 38/17 (2006.01)	2750694 *	METHODS AND COMPOSITIONS RELATING TO P62 FOR THE TREATMENT AND PROPHYLAXIS OF CANCER	A61P 17/14 (2006.01)	2741761 *	MODIFIED OSTEOPONTIN PEPTIDES HAVING AN INACTIVATED RGD DOMAIN AND USES THEREOF
A61K 39/395 (2006.01)	2750694 *	METHODS AND COMPOSITIONS RELATING TO P62 FOR THE TREATMENT AND PROPHYLAXIS OF CANCER	A61Q 7/00 (2006.01)	2741761 *	MODIFIED OSTEOPONTIN PEPTIDES HAVING AN INACTIVATED RGD DOMAIN AND USES THEREOF
A61K 48/00 (2006.01)	2750694 *	METHODS AND COMPOSITIONS RELATING TO P62 FOR THE TREATMENT AND PROPHYLAXIS OF CANCER	A61K 31/567 (2006.01)	2731613 *	Treatment of excessive menstrual bleeding associated with uterine fibroids
A61P 35/00 (2006.01)	2750694 *	METHODS AND COMPOSITIONS RELATING TO P62 FOR THE TREATMENT AND PROPHYLAXIS OF CANCER	A61K 31/57 (2006.01)	2731613 *	Treatment of excessive menstrual bleeding associated with uterine fibroids
D06F 58/10 (2006.01)	2642016	Heating cabinet			

MKP (51)	Broj objave evropske prijava patenta (97)	Naziv pronalaska (54)	MKP (51)	Broj objave evropske prijava patenta (97)	Naziv pronalaska (54)
A61P 5/36 (2006.01)	2731613 *	Treatment of excessive menstrual bleeding associated with uterine fibroids	A61K 47/42 (2006.01)	2739314 *	PHARMACEUTICAL COMPOSITION OF OXIDISED AVIDIN SUITABLE FOR INHALATION
A61K 31/519 (2006.01)	2721036 *	NOVEL 3,4,4A,10B-TETRAHYDRO-1H-THIOPYRANO[4,3-C] ISOQUINOLINE COMPOUNDS	A61P 35/00 (2006.01)	2739314 *	PHARMACEUTICAL COMPOSITION OF OXIDISED AVIDIN SUITABLE FOR INHALATION
A61P 11/00 (2006.01)	2721036 *	NOVEL 3,4,4A,10B-TETRAHYDRO-1H-THIOPYRANO[4,3-C] ISOQUINOLINE COMPOUNDS	A61F 2/08 (2006.01)	2741791 *	MEDICAL DEVICE
C07D 495/04 (2006.01)	2721036 *	NOVEL 3,4,4A,10B-TETRAHYDRO-1H-THIOPYRANO[4,3-C] ISOQUINOLINE COMPOUNDS	A61L 27/22 (2006.01)	2741791 *	MEDICAL DEVICE
C07D 519/00 (2006.01)	2721036 *	NOVEL 3,4,4A,10B-TETRAHYDRO-1H-THIOPYRANO[4,3-C] ISOQUINOLINE COMPOUNDS	A61L 31/04 (2006.01)	2741791 *	MEDICAL DEVICE
A61K 31/437 (2006.01)	2768506 *	COMPOUNDS AND METHODS FOR ENHANCING INNATE IMMUNE RESPONSES	A61K 39/395 (2006.01)	2734236 *	METHODS AND COMPOSITIONS FOR TREATING ASTHMA USING ANTI-IL-13 ANTIBODIES
A61B 17/072 (2006.01)	2517642	Staple cartridge comprising staples positioned within a compressible portion thereof	A61K 45/00 (2006.01)	2734236 *	METHODS AND COMPOSITIONS FOR TREATING ASTHMA USING ANTI-IL-13 ANTIBODIES
A61K 31/405 (2006.01)	2714033 *	COMBINATION THERAPY OF HSP90 INHIBITORY COMPOUNDS WITH CHK INHIBITORS	B22C 3/00 (2006.01)	2626407	Lubricating composition for continuous casting processes
A61K 31/4196 (2006.01)	2714033 *	COMBINATION THERAPY OF HSP90 INHIBITORY COMPOUNDS WITH CHK INHIBITORS	C10M 141/04 (2006.01)	2626407	Lubricating composition for continuous casting processes
A61K 31/4535 (2006.01)	2714033 *	COMBINATION THERAPY OF HSP90 INHIBITORY COMPOUNDS WITH CHK INHIBITORS	C10N 10/02 (2006.01)	2626407	Lubricating composition for continuous casting processes
A61K 31/497 (2006.01)	2714033 *	COMBINATION THERAPY OF HSP90 INHIBITORY COMPOUNDS WITH CHK INHIBITORS	C10N 10/04 (2006.01)	2626407	Lubricating composition for continuous casting processes
A61K 31/506 (2006.01)	2714033 *	COMBINATION THERAPY OF HSP90 INHIBITORY COMPOUNDS WITH CHK INHIBITORS	C10N 10/06 (2006.01)	2626407	Lubricating composition for continuous casting processes
A61K 31/519 (2006.01)	2714033 *	COMBINATION THERAPY OF HSP90 INHIBITORY COMPOUNDS WITH CHK INHIBITORS	C10N 20/02 (2006.01)	2626407	Lubricating composition for continuous casting processes
A61K 31/551 (2006.01)	2714033 *	COMBINATION THERAPY OF HSP90 INHIBITORY COMPOUNDS WITH CHK INHIBITORS	C10N 20/06 (2006.01)	2626407	Lubricating composition for continuous casting processes
A61P 35/00 (2006.01)	2714033 *	COMBINATION THERAPY OF HSP90 INHIBITORY COMPOUNDS WITH CHK INHIBITORS	C10N 40/24 (2006.01)	2626407	Lubricating composition for continuous casting processes
A61K 39/395 (2006.01)	2704798 *	FORMULATION FOR ANTI-ALPHA4BETA7 ANTIBODY	C10N 40/36 (2006.01)	2626407	Lubricating composition for continuous casting processes
A61P 1/00 (2006.01)	2704798 *	FORMULATION FOR ANTI-ALPHA4BETA7 ANTIBODY	C10N 50/02 (2006.01)	2626407	Lubricating composition for continuous casting processes
C07K 16/28 (2006.01)	2704798 *	FORMULATION FOR ANTI-ALPHA4BETA7 ANTIBODY	C10N 70/00 (2006.01)	2626407	Lubricating composition for continuous casting processes
A61K 9/00 (2006.01)	2739314 *	PHARMACEUTICAL COMPOSITION OF OXIDISED AVIDIN SUITABLE FOR INHALATION	E04B 2/74 (2006.01)	2754769	Means for demarcation of space

MKP (51)	Broj objave evropske prijave patenta (97)	Naziv pronalaska (54)
E04H 1/12 (2006.01)	2754769	Means for demarcation of space
B01D 15/08 (2006.01)	2702147 *	METHODS OF PURIFYING VIRUSES USING GEL PERMEATION CHROMATOGRAPHY
C12M 3/00 (2006.01)	2702147 *	METHODS OF PURIFYING VIRUSES USING GEL PERMEATION CHROMATOGRAPHY
C12N 7/02 (2006.01)	2702147 *	METHODS OF PURIFYING VIRUSES USING GEL PERMEATION CHROMATOGRAPHY
A61K 31/045 (2006.01)	2704734 *	COMPOSITION USEFUL FOR THE TREATMENT OF LIPID METABOLISM DISORDERS
A61K 31/05 (2006.01)	2704734 *	COMPOSITION USEFUL FOR THE TREATMENT OF LIPID METABOLISM DISORDERS
A61K 31/122 (2006.01)	2704734 *	COMPOSITION USEFUL FOR THE TREATMENT OF LIPID METABOLISM DISORDERS
A61K 31/202 (2006.01)	2704734 *	COMPOSITION USEFUL FOR THE TREATMENT OF LIPID METABOLISM DISORDERS
A61K 31/205 (2006.01)	2704734 *	COMPOSITION USEFUL FOR THE TREATMENT OF LIPID METABOLISM DISORDERS
A61K 31/4415 (2006.01)	2704734 *	COMPOSITION USEFUL FOR THE TREATMENT OF LIPID METABOLISM DISORDERS
A61K 31/714 (2006.01)	2704734 *	COMPOSITION USEFUL FOR THE TREATMENT OF LIPID METABOLISM DISORDERS
A61K 36/062 (2006.01)	2704734 *	COMPOSITION USEFUL FOR THE TREATMENT OF LIPID METABOLISM DISORDERS
A61K 36/899 (2006.01)	2704734 *	COMPOSITION USEFUL FOR THE TREATMENT OF LIPID METABOLISM DISORDERS
A63F 13/00 (2014.01)	2705508 *	GAMBLING AND/OR GAMING APPARATUS
G07F 17/32 (2006.01)	2705508 *	GAMBLING AND/OR GAMING APPARATUS

INDEKS PODNOSITELJA ZAHTEVA ZA PROŠIRENJE EVROPSKIH PRIJAVA PATENTA

INDEX ON NUMBER OF APPLICATIONS FOR EXTENSION OF EUROPEAN PATENT APPLICATION

Podnosilac evropske prijave patenta (71)	MKP (51)	Broj objave evropske prijave patenta (97)	Naziv pronalaska (54)
Universita' degli Studi di Milano	C08K 3/00 (2006.01) C08K 3/34 (2006.01) C08K 9/06 (2006.01) C08L 67/04 (2006.01)	2729522 *	BRANCHED LACTIC ACID POLYMERS WITH HIGH VISCOSITY IN THE MOLTEN STATE AND HIGH SHEAR SENSITIVITY, AND NANOCOMPOSITES THEREOF
Fondazione Cariplo	C08K 3/00 (2006.01) C08K 3/34 (2006.01) C08K 9/06 (2006.01) C08L 67/04 (2006.01)	2729522 *	BRANCHED LACTIC ACID POLYMERS WITH HIGH VISCOSITY IN THE MOLTEN STATE AND HIGH SHEAR SENSITIVITY, AND NANOCOMPOSITES THEREOF
Blücher GmbH	B01J 21/06 (2006.01) B01J 21/12 (2006.01) B01J 23/00 (2006.01) B01J 23/10 (2006.01) B01J 23/22 (2006.01) B01J 23/31 (2006.01) B01J 23/889 (2006.01) B01J 37/00 (2006.01)	2720794 *	MIXED METAL OXIDE-BASED POROUS MATERIALS AND THE PRODUCTION AND USE THEREOF
Universität Leipzig	B01J 21/06 (2006.01) B01J 21/12 (2006.01) B01J 23/00 (2006.01) B01J 23/10 (2006.01) B01J 23/22 (2006.01) B01J 23/31 (2006.01) B01J 23/889 (2006.01) B01J 37/00 (2006.01)	2720794 *	MIXED METAL OXIDE-BASED POROUS MATERIALS AND THE PRODUCTION AND USE THEREOF
Baxter International Inc	C07K 1/18 (2006.01) C12N 9/64 (2006.01)	2748179 *	PROTEIN PURIFICATION BY ANION EXCHANGE CHROMATOGRAPHY
Baxter Healthcare SA	C07K 1/18 (2006.01) C12N 9/64 (2006.01)	2748179 *	PROTEIN PURIFICATION BY ANION EXCHANGE CHROMATOGRAPHY
Merial Limited	A01N 37/18 (2006.01) A61K 31/44 (2006.01) A61K 31/4433 (2006.01) A61P 33/00 (2006.01) A61P 33/10 (2006.01) A61P 33/14 (2006.01) C07D 213/18 (2006.01)	2723716 *	AMIDO-PYRIDYL ETHER COMPOUNDS AND COMPOSITIONS AND THEIR USE AGAINST PARASITES
Ethicon Endo-Surgery, Inc.	A61B 17/072 (2006.01)	2517640	Tissue thickness compensator comprising detachable portions
Van Merksteijn Steel BV	B21C 43/04 (2006.01) B24D 13/10 (2006.01) B24D 13/14 (2006.01)	2766132 *	METAL WIRE CLEANING PADS AND METHOD AND DEVICE FOR CLEANING METAL WIRE
Viditrust S.r.l.	B41M 3/14 (2006.01) G07D 7/00 (2006.01)	2760674 *	METHOD AND SYSTEM FOR ANTIFORGERY MARKING OF PRINTED PRODUCTS
Sigma-Tau Industrie Farmaceutiche Riunite S.P.A.	C07D 215/46 (2006.01)	2718268 *	NOVEL PROCESS FOR THE SYNTHESIS OF 7-CHLORO-4-(PIPERAZIN-1-YL)-QUINOLINE
GlaxoSmithKline LLC	C07D 487/04 (2006.01)	2768834 *	SUBSTITUTED BICYCLIC AZA-HETEROCYCLES AND ANALOGUES AS SIRTUIN MODULATORS
Wobben Properties GmbH	F03D 7/02 (2006.01)	2751422 *	METHOD FOR OPERATING A WIND TURBINE
Rummo S.p.A.	A21C 11/16 (2006.01)	2737800	Process for manufacturing dies for pasta, the dies themselves, and their use in the production of pasta
Cytokinetics, Inc.	A61K 31/4985 (2006.01)	2731611 *	COMBINATION ALS THERAPY
Cedarbaum, Jesse	A61K 31/4985 (2006.01)	2731611 *	COMBINATION ALS THERAPY
Mao, John	A61K 31/4985 (2006.01)	2731611 *	COMBINATION ALS THERAPY
Malik, Fady	A61K 31/4985 (2006.01)	2731611 *	COMBINATION ALS THERAPY

Podnosilac evropske prijave patenta (71)	MKP (51)	Broj objave evropske prijave patenta (97)	Naziv pronalaska (54)
Wolff, Andrew A.	A61K 31/4985 (2006.01)	2731611 *	COMBINATION ALS THERAPY
Omya International AG	C02F 1/68 (2006.01)	2739575 *	MICRONIZED CaCO ₃ SLURRY INJECTION SYSTEM FOR THE REMINERALIZATION OF DESALINATED AND FRESH WATER
Alvine Pharmaceuticals, Inc.	A61K 9/00 (2006.01) A61K 38/48 (2006.01) A61P 1/00 (2006.01) A61P 37/00 (2006.01) A61P 39/00 (2006.01) G01N 33/53 (2006.01)	2736525 *	METHODS AND PHARMACEUTICAL COMPOSITIONS FOR TREATING CELIAC DISEASE AND GLUTEN INTOLERANCE
Ortic 3D AB	B21D 5/08 (2006.01)	2747913 *	A ROLL-FORMING MACHINE AND METHOD FOR ROLL-FORMING
Dallmer GmbH & Co. KG	A47K 3/40 (2006.01)	2687136	Shower element
Maccari, Antonio	B41J 2/21 (2006.01) H04N 1/407 (2006.01) H04N 1/60 (2006.01)	2756661 *	A METHOD FOR CONTROLLING A COLOUR CALIBRATION TARGET
Euro-Celtique S.A.	A61K 9/00 (2006.01) A61K 9/08 (2006.01) A61K 31/135 (2006.01) A61P 25/36 (2006.01)	2706982 *	INTRANASAL PHARMACEUTICAL DOSAGE FORMS COMPRISING NALOXONE
Flodesign Wind Turbine Corp.	F03B 3/12 (2006.01) F03D 1/04 (2006.01) F03D 1/06 (2006.01)	2715120 *	TURBINE BLADES WITH MIXED BLADE LOADING
Gamblit Gaming, LLC		2731692 *	PERSONALIZABLE HYBRID GAMES
Glaxosmithkline Intellectual Property (No. 2) Limited	A61K 31/535 (2006.01) A61K 38/00 (2006.01) C12N 15/113 (2010.01)	2726079 *	METHOD OF ADMINISTRATION AND TREATMENT
Telsmith, Inc.	B02C 17/14 (2006.01)	2758176 *	APPARATUS AND METHOD FOR LINER SYSTEM
Systemvertrieb Jäger GmbH Sanitär- und Heizungstechnik	F16L 33/22 (2006.01) F16L 37/091 (2006.01) F16L 37/092 (2006.01)	2667074	System with clamp parts for connecting tubes
HTC Corporation	G06F 3/0486 (2013.01) G06F 3/0488 (2013.01) H04M 1/725 (2006.01)	2642377	Handheld device and homescreen management method thereof
Janssen Pharmaceutica, N.V.	A61K 31/4412 (2006.01) A61P 31/10 (2006.01) C07D 213/81 (2006.01)	2714661 *	PICOLINAMIDO - PROPANOIC ACID DERIVATIVES USEFUL AS GLUCAGON RECEPTOR ANTAGONISTS
Wabtec Holding Corp.	B61G 9/14 (2006.01) B61G 11/08 (2006.01) F16F 3/08 (2006.01)	2755879 *	COMPRESSIBLE ELASTOMERIC SPRING
Shire Human Genetic Therapies, Inc.	C12N 9/16 (2006.01)	2729566 *	METHODS FOR PURIFICATION OF ARYLSULFATASE A
Cellsnap, LLC	C12Q 1/02 (2006.01) C12Q 1/68 (2006.01) C40B 30/06 (2006.01)	2761065 *	COMPOSITIONS AND METHODS FOR TOXIGENICITY TESTING
SCA TISSUE FRANCE	B31F 1/07 (2006.01)	2664451	Hybrid multi-ply tissue paper product and method for manufacturing the same
Vapogenix, Inc.	A61K 9/66 (2006.01)	2723325 *	NOVEL FORMULATIONS AND METHODS FOR TREATING DERMATOLOGICAL DISORDERS OR DISEASES
Ascendis Pharma A/S	A61K 9/08 (2006.01) A61K 31/557 (2006.01) A61K 47/48 (2006.01)	2741738 *	SUSTAINED RELEASE COMPOSITION OF PROSTACYCLIN
Prosonix Limited	A61K 9/00 (2006.01) A61K 9/16 (2006.01)	2741739 *	PHARMACEUTICAL COMPOSITIONS
State, Adrian Florentin	G08B 13/14 (2006.01) G08B 25/00 (2006.01)	2721591 *	ELECTRONIC THEFT/VANDALISM PROTECTION DEVICE WITH INSTANTANEOUS SIGNALING AND POSITIONING RESPONSE

Podnosilac evropske prijave patenta (71)	MKP (51)	Broj objave evropske prijave patenta (97)	Naziv pronalaska (54)
Cellresin Technologies, LLC	A61L 9/014 (2006.01) B01D 53/02 (2006.01) B01J 20/22 (2006.01)	2723471 *	MATERIAL SUCH AS FILM, FIBER, WOVEN AND NONWOVEN FABRIC WITH ADSORBANCY
Valmet S.p.A.	C23C 18/48 (2006.01) C25D 3/56 (2006.01) C25D 3/60 (2006.01)	2757180	A process for electrolytically depositing a tin- and ruthenium-based alloy, the electrolytic bath that permits said alloy to deposit and the alloy obtained by means of said process
GlaxoSmithKline Intellectual Property Development Limited	A61K 31/535 (2006.01)	2744501 *	AMINO QUINAZOLINES AS KINASE INHIBITORS
North Western University	A61K 38/07 (2006.01)	2701721 *	METHODS OF TREATING ALZHEIMER'S DISEASE, HUNTINGTON'S DISEASE, AUTISM, OR OTHER DISORDERS
Seewald, Hansjörg	H02K 3/487 (2006.01) H02K 3/493 (2006.01)	2719061 *	LOCKING KEY
Han, Wenji	B60K 7/00 (2006.01) B60L 11/00 (2006.01) H02J 7/14 (2006.01)	2708401 *	POWER GENERATION AND CHARGING DEVICE FOR CONTINUOUS RUNNING OF ELECTRIC AUTOMOBILE
Bayer Intellectual Property GmbH	C07C 303/38 (2006.01) C07C 303/40 (2006.01) C07C 309/82 (2006.01) C07C 311/28 (2006.01)	2714652 *	CHIRAL SYNTHESIS OF N-{3,4-DIFLUORO-2-[(2-FLUORO-4-IODOPHENYL)AMINO]-6-METHOXYPHENYL}-1-[2,3-DIHYDROXY-PROPYL] CYCLOPROPANESULFONAMIDES
JX Nippon Oil & Energy Corporation	B32B 27/34 (2006.01) C08G 73/10 (2006.01) H01B 3/30 (2006.01) H01B 5/14 (2006.01) H01L 31/04 (2014.01)	2743936 *	TRANSPARENT FILM, TRANSPARENT CONDUCTIVE LAMINATE, AND TOUCH PANEL, SOLAR CELL AND DISPLAY DEVICE, USING SAME
Bystronic Laser AG	B21D 5/02 (2006.01) B21D 37/02 (2006.01)	2674231	Device for bending metal pieces
Sanofi-Aventis Deutschland GmbH	A61M 5/24 (2006.01)	2720738 *	CARTRIDGE HOLDER ASSEMBLY FOR DRUG DELIVERY DEVICES
Shengyi Technology Co., Ltd.	C08G 59/42 (2006.01) C08K 5/5313 (2006.01) C08L 63/00 (2006.01)	2706091	Epoxy resin composition, and prepreg and copper clad laminate made therefrom
Crescenzo, Biagio	A23N 4/04 (2006.01) B65G 47/248 (2006.01)	2731893 *	APPARATUS FOR POSITIONING MULTIPLE - LANE FRUIT, ESPECIALLY PEACHES
MacroGenics, Inc.	C07K 16/00 (2006.01)	2714733 *	CD3-BINDING MOLECULES CAPABLE OF BINDING TO HUMAN AND NON-HUMAN CD3
Teva Pharmaceutical Industries Ltd.	A61K 31/4704 (2006.01)	2744498 *	N-ETHYL-N-PHENYL-1,2-DIHYDRO-4,5-DI-HYDROXY-1-METHYL-2-OXO-3-QUINOLINE CARBOXAMIDE, PREPARATION AND USES THEREOF
Brien Holden Vision Institute	A61B 3/10 (2006.01)	2729049 *	SYSTEM AND METHOD FOR CHARACTERISING EYE-RELATED SYSTEMS
ACO Severin Ahlmann GmbH & Co. KG	E02D 29/14 (2006.01)	2729628 *	MANHOLE COVER
Tempero Pharmaceuticals, Inc.	A01N 37/18 (2006.01) A61K 31/165 (2006.01) C07C 233/00 (2006.01)	2736330 *	COMPOUNDS AND METHODS
Ethicon Endo-Surgery, Inc.	A61B 17/072 (2006.01) A61B 17/115 (2006.01)	2644113	Tissue thickness compensator comprised of a plurality of materials
National Institute of Infectious Diseases	C07K 16/14 (2006.01) G01N 33/15 (2006.01) G01N 33/50 (2006.01) G01N 33/53 (2006.01) G01N 33/531 (2006.01) G01N 33/68 (2006.01)	2743699 *	METHOD FOR TESTING FOR, PREVENTING, AND TREATING INFECTIOUS DISEASE ASPERGILLUS FUMIGATUS, AND COMPOSITION
Medical & Biological Laboratories Co., Ltd.	C07K 16/14 (2006.01) G01N 33/15 (2006.01) G01N 33/50 (2006.01) G01N 33/53 (2006.01) G01N 33/531 (2006.01) G01N 33/68 (2006.01)	2743699 *	METHOD FOR TESTING FOR, PREVENTING, AND TREATING INFECTIOUS DISEASE ASPERGILLUS FUMIGATUS, AND COMPOSITION

Podnosilac evropske prijave patenta (71)	MKP (51)	Broj objave evropske prijave patenta (97)	Naziv pronalaska (54)
Ruckus Wireless, Inc.	G06F 11/14 (2006.01)	2705429 *	REMOTE CABLE ACCESS POINT RESET
Aethon, Inc.	G06F 19/00 (2011.01)	2758905 *	MONITORING, DIAGNOSTIC AND TRACKING TOOL FOR AUTONOMOUS MOBILE ROBOTS
Services Petroliers Schlumberger (SPS)	B01D 53/00 (2006.01) E21B 47/10 (2012.01) G01F 1/34 (2006.01)	2671623	Method and arrangement for preventing hydrocarbon based deposition
Schlumberger Technology B.V. (STBV)	B01D 53/00 (2006.01) E21B 47/10 (2012.01) G01F 1/34 (2006.01)	2671623	Method and arrangement for preventing hydrocarbon based deposition
Schlumberger Holdings Limited (SHL)	B01D 53/00 (2006.01) E21B 47/10 (2012.01) G01F 1/34 (2006.01)	2671623	Method and arrangement for preventing hydrocarbon based deposition
PRAD Research and Development Limited	B01D 53/00 (2006.01) E21B 47/10 (2012.01) G01F 1/34 (2006.01)	2671623	Method and arrangement for preventing hydrocarbon based deposition
Dow Technology Investments LLC	B01J 8/06 (2006.01) B01J 19/00 (2006.01)	2723485 *	PRODUCTION OF OXIDIZED OLEFINS
RC eNeM d.o.o.	C03C 4/02 (2006.01) C03C 14/00 (2006.01)	2716614	Colored glass and method for its manufacturing
RHO Renewables, Inc.	C12N 9/10 (2006.01)	2723857 *	RECOMBINANT PRODUCTION SYSTEMS FOR AROMATIC MOLECULES
Djada Pharmaceutical SA	A61K 31/165 (2006.01) A61P 9/12 (2006.01) C07C 237/22 (2006.01)	2731598 *	ALISKIREN HEMIFUMARATE, CRYSTAL FORM AND AMORPHOUS SOLID
Beijing Junlun Runzhong Science&Technology Co., Limited	C08F 212/04 (2006.01) C08F 220/06 (2006.01) C08F 220/28 (2006.01) C08F 220/56 (2006.01) C08F 220/58 (2006.01) C08F 226/02 (2006.01) C08F 232/04 (2006.01) C09K 8/588 (2006.01)	2738189 *	AMPHIPHILIC MACROMOLECULE AND USE THEREOF
S-Biotek af 15. marts 2006 1 ApS	A23L 1/0532 (2006.01) A23L 1/29 (2006.01) A23L 1/308 (2006.01) A61K 31/734 (2006.01)	2713773 *	A COMPOSITION COMPRISING AT LEAST ONE ALGINATE FOR USE IN TREATMENT AND/OR PREVENTION OF OVERWEIGHT
Hisamitsu Pharmaceutical Co., Inc.	A61K 9/70 (2006.01) A61K 31/4045 (2006.01) A61K 47/10 (2006.01) A61K 47/14 (2006.01) A61K 47/16 (2006.01) A61K 47/34 (2006.01) A61P 25/14 (2006.01) A61P 25/16 (2006.01)	2716287 *	ROPINIROLE-CONTAINING ADHESIVE SKIN PATCH AND PACKAGED PRODUCT THEREOF
Janssen Biotech, Inc.	A61K 39/395 (2006.01)	2755685 *	TOLL-LIKE RECEPTOR 3 ANTAGONISTS FOR THE TREATMENT OF METABOLIC AND CARDIOVASCULAR DISEASES
RIMES Technologies Limited	G06F 9/44 (2006.01)	2711836	Data distribution system
Ivoclar Vivadent AG	A61K 6/00 (2006.01)	2649981	Polymerisable compounds with high polymerisation depth
Reynolds Technologies, Inc.	A01H 1/06 (2006.01) A01H 5/00 (2006.01) C12N 5/04 (2006.01) C12N 15/01 (2006.01)	2757872 *	TOBACCO HAVING REDUCED AMOUNTS OF AMINO ACIDS AND METHODS FOR PRODUCING SUCH LINES
Scibilia, Gabriele	G06Q 20/00 (2012.01)	2709048	System for furnishing in real time technical information, relative to the content of chemical substances regulated by rules of the European Union, of a product put on a commercial distribution network
Hellermannntyton Corporation	B21F 9/02 (2006.01)	2726229 *	CABLE TIE TENSIONING AND CUT-OFF TOOL

Podnosilac evropske prijave patenta (71)	MKP (51)	Broj objave evropske prijave patenta (97)	Naziv pronalaska (54)
Claranor	A23L 3/005 (2006.01) A23L 3/26 (2006.01) C12N 13/00 (2006.01) G01N 27/24 (2006.01)	2645092	Device comprising a window for transmitting radiation and an electrically conductive track arranged on the window for electrical detection of a break of the window
Sotio a.s.	A61K 39/00 (2006.01)	2691110 *	MEANS AND METHODS FOR ACTIVE CELLULAR IMMUNOTHERAPY OF CANCER BY USING TUMOR CELLS KILLED BY HIGH HYDROSTATIC PRESSURE AND DENDRITIC CELLS
Takeda Pharmaceutical Company Limited	A61K 9/20 (2006.01) A61K 31/4439 (2006.01)	2768487 *	SUSTAINED-RELEASE PREPARATION
Coldway	F17C 11/00 (2006.01)	2742275 *	METHOD FOR FILLING A GAS STORAGE TANK
Glaxosmithkline Intellectual Property (No. 2) Limited	A61K 31/423 (2006.01)	2720697 *	TRPV4 ANTAGONISTS
Theravance, Inc.	A61K 31/40 (2006.01) A61P 9/12 (2006.01) A61P 29/00 (2006.01) A61P 35/00 (2006.01) C07D 207/08 (2006.01)	2760826 *	CRYSTALLINE FORMS OF A 3-[2-METHANESULFONYL-1-(4-TRIFLUOROMETHYL-PHENOXY)ETHYL]PYRROLIDINE COMPOUND
Sanofi-Aventis Deutschland GmbH	A61M 5/24 (2006.01) A61M 5/315 (2006.01)	2731650 *	DRIVE MECHANISM OF A DRUG DELIVERY DEVICE
Viamet Pharmaceuticals, Inc.	A01N 43/713 (2006.01) A01P 3/00 (2006.01) C07D 401/06 (2006.01) C07D 409/06 (2006.01) C07D 417/06 (2006.01)	2723730 *	METALLOENZYME INHIBITOR COMPOUNDS
STADA ARZNEIMITTEL AG	A61K 9/16 (2006.01) A61K 9/20 (2006.01) A61K 31/41 (2006.01) A61K 31/549 (2006.01)	2736494 *	COMPRESSED SOLID PHARMACEUTICAL COMPOSITION COMPRISING AMORPHOUS PARTICULATE VALSARTAN AS THE ACTIVE INGREDIENT
Decia, Valter	E04B 5/10 (2006.01) E04B 7/02 (2006.01) E04C 3/08 (2006.01) E04C 3/32 (2006.01)	2729637 *	LATTICE MEMBER AND SELF-SUPPORTING MODULAR STRUCTURE
Hyun, Dong Hoon	F21V 17/00 (2006.01)	2759764 *	LED LIGHTING ENGINE ADOPTING AN ICICLE TYPE DIFFUSION UNIT
Noh, Myeung Jae	F21V 17/00 (2006.01)	2759764 *	LED LIGHTING ENGINE ADOPTING AN ICICLE TYPE DIFFUSION UNIT
Beijing Junlun Runzhong Science&Technology Co., Limited	C08F 220/06 (2006.01) C08F 220/18 (2006.01) C08F 220/28 (2006.01) C08F 220/34 (2006.01) C08F 220/56 (2006.01) C08F 220/58 (2006.01) C08F 226/02 (2006.01) C08F 232/04 (2006.01) C09K 8/588 (2006.01)	2738190 *	AMPHIPHILIC MACROMOLECULE AND USE
The Research Foundation Of State University Of New York	C12N 13/00 (2006.01)	2718433 *	METHOD AND DEVICE FOR NON-INVASIVE ACOUSTIC STIMULATION OF STEM CELLS AND PROGENITOR CELLS IN A PATIENT
Otsuka AgriTechno Co., Ltd	A61K 31/4545 (2006.01) A61P 33/14 (2006.01)	2736511 *	ANIMAL ECTOPARASITE-CONTROLLING AGENT AND METHOD FOR PREVENTING OR TREATING INFECTION IN ANIMALS CAUSED BY PARASITES BY USING THE CONTROLLING AGENT
SEVES S.p.A	E04C 1/42 (2006.01) F21S 9/03 (2006.01)	2702212 *	BRICK WITH PHOTOVOLTAIC CELL
Immersion Corporation	G06F 3/01 (2006.01) G06F 3/0485 (2013.01)	2664978	Systems and methods for haptically enabled metadata

Podnosilac evropske prijave patenta (71)	MKP (51)	Broj objave evropske prijave patenta (97)	Naziv pronalaska (54)
Glaxo Group Limited	A61K 31/18 (2006.01) A61K 31/33 (2006.01) C07C 311/21 (2006.01) C07C 311/29 (2006.01) C07D 213/30 (2006.01) C07D 213/38 (2006.01) C07D 213/61 (2006.01) C07D 213/65 (2006.01) C07D 213/68 (2006.01) C07D 213/75 (2006.01) C07D 233/22 (2006.01) C07D 239/28 (2006.01) C07D 249/08 (2006.01) C07D 257/04 (2006.01) C07D 261/08 (2006.01)	2760443 *	SULFONAMIDE COMPOUNDS AND THEIR USE IN THE MODULATION RETINOID - RELATED ORPHAN RECEPTOR
Zoetis LLC	C07K 16/24 (2006.01) G01N 33/53 (2006.01)	2734549 *	INTERLEUKIN-31 MONOCLONAL ANTIBODY
P. Dimitropoulos - Electronic Systems and Software Applications S.A. Trading Name: SENSAP SA	B41F 33/00 (2006.01) G06K 19/06 (2006.01)	2749417	Quality control, method and device in production lines of solid and corrugated carton boxes, and advertising displays made of paper
Pharmabrand S.A.	A61K 36/28 (2006.01) A61K 36/61 (2006.01) A61P 31/16 (2006.01) A61P 37/00 (2006.01) A61P 39/06 (2006.01)	2752194 *	NATURAL ANTIOXIDANT ANTI-INFLUENZA COMPOSITION
Ethicon Endo-Surgery, Inc.	A61B 17/115 (2006.01)	2524654	Circular stapler with frictional reducing member
CBS Institut Celovite Gradbene Resitve, d.o.o.	C09J 181/04 (2006.01)	2707444 *	ADHESIVE/SEALANT PREFERABLY USED FOR CONSTRUCTION PANELS
TKK Proizvodnja Kemicnih Izdelkov Srpenica Ob Soci D.D.	C09J 181/04 (2006.01)	2707444 *	ADHESIVE/SEALANT PREFERABLY USED FOR CONSTRUCTION PANELS
Les Laboratoires Servier	C07C 253/30 (2006.01) C07D 223/16 (2006.01)	2730562	Novel method for synthesising (2E)-3-(3,4-dimethoxyphenyl)prop-2-enitrile and use for synthesising ivabradine and the added salts thereof with a pharmaceutically acceptable acid
SastoMed GmbH	A61K 33/00 (2006.01) A61K 38/42 (2006.01) A61P 17/02 (2006.01)	2734223 *	WOUND SPRAY
Hill & Smith Limited	E01F 15/04 (2006.01) E01F 15/06 (2006.01) E04H 12/22 (2006.01) E04H 17/22 (2006.01)	2739789 *	SECURITY BARRIER
Baxter International Inc.	G01N 33/53 (2006.01) G01N 33/566 (2006.01)	2710375 *	MODIFICATION-DEPENDENT ACTIVITY ASSAYS
Baxter Healthcare SA	G01N 33/53 (2006.01) G01N 33/566 (2006.01)	2710375 *	MODIFICATION-DEPENDENT ACTIVITY ASSAYS
Qualcomm Incorporated	G06F 17/28 (2006.01) G06T 11/60 (2006.01)	2727085 *	EFFICIENT BLENDING METHODS FOR AR APPLICATIONS
GlaxoSmithKline LLC	C07D 401/00 (2006.01)	2755962 *	AZAINDAZOLES
Hisamitsu Pharmaceutical Co., Inc.	A61K 9/70 (2006.01) A61K 31/4045 (2006.01) A61K 47/10 (2006.01) A61K 47/14 (2006.01) A61K 47/16 (2006.01) A61K 47/32 (2006.01) A61K 47/34 (2006.01) A61P 25/14 (2006.01) A61P 25/16 (2006.01)	2716286 *	ROPINIROLE-CONTAINING ADHESIVE PATCH AND PACKAGING THEREFOR
VELOX SERVIZI S.r.l. Unipersonale	A47L 11/40 (2006.01) C02F 1/78 (2006.01)	2757929 *	APPARATUS FOR CLEANING FLOOR SURFACES

Podnosilac evropske prijave patenta (71)	MKP (51)	Broj objave evropske prijave patenta (97)	Naziv pronalaska (54)
Eigen Systems Limited	F25B 7/00 (2006.01)	2758726 *	COOLANT RECOVERY AND WASTE SEPARATION SYSTEM
Forlong, Murray Houlton	F25B 7/00 (2006.01)	2758726 *	COOLANT RECOVERY AND WASTE SEPARATION SYSTEM
Estetra S.P.R.L.	A61K 31/565 (2006.01) A61P 15/18 (2006.01)	2741824 *	USE OF ESTETROL AS EMERGENCY CONTRACEPTIVE
INTER+-POL Freie Forschungs- u. Entwicklungsges. f. unfassb. Formate, exper. Proj., ungesehene Filme dicke u. dünne Bücher, grenzenl. Räume, mbH	E04H 3/12 (2006.01) E04H 3/14 (2006.01)	2626485	Tribune
Yissum Research Development Company of the Hebrew University of Jerusalem Ltd.	A61K 9/127 (2006.01)	2706988 *	LIPOSOMES COMPRISING POLYMER-CONJUGATED LIPIDS AND RELATED USES
Array Biopharma, Inc.	A61K 9/00 (2006.01) A61K 9/14 (2006.01) A61K 9/20 (2006.01) A61K 31/498 (2006.01) A61K 47/32 (2006.01) A61K 47/38 (2006.01) A61P 35/00 (2006.01)	2765990 *	SOLID DISPERSION
Amgen Inc.	A61K 39/395 (2006.01) A61P 35/00 (2006.01) A61P 37/00 (2006.01) C07K 16/28 (2006.01)	2758437 *	CD27L ANTIGEN BINDING PROTEINS
Merck Sharp & Dohme Corp.	C07D 239/47 (2006.01)	2748151 *	PYRIMIDINE PDE10 INHIBITORS
Gilead Sciences, Inc.	C07D 237/32 (2006.01) C07D 253/08 (2006.01) C07D 265/22 (2006.01) C07D 401/04 (2006.01) C07D 401/06 (2006.01) C07D 401/12 (2006.01) C07D 403/04 (2006.01) C07D 403/06 (2006.01) C07D 403/08 (2006.01) C07D 403/12 (2006.01) C07D 403/14 (2006.01) C07D 413/06 (2006.01) C07D 413/12 (2006.01) C07D 413/14 (2006.01) C07D 417/06 (2006.01)	2707361 *	FUSED HETEROCYCLIC COMPOUNDS AS SODIUM CHANNEL MODULATORS
Bystronic Laser AG	B23K 26/04 (2014.01) B23K 26/14 (2014.01) B23K 26/38 (2014.01)	2687317	Laser processing machine, in particular laser cutting machine and method for adjusting a focused laser beam
Astrazeneca AB	A61M 15/00 (2006.01) E05B 15/00 (2006.01)	2755707 *	INHALER

Podnosilac evropske prijave patenta (71)	MKP (51)	Broj objave evropske prijave patenta (97)	Naziv pronalaska (54)
Saint-Gobain Isover	C03C 25/14 (2006.01) C03C 25/32 (2006.01) C08F 251/00 (2006.01) C08G 63/668 (2006.01) C08J 3/24 (2006.01) C08K 5/092 (2006.01) C08K 5/1545 (2006.01) C08K 5/51 (2006.01) C08L 3/00 (2006.01) C09J 11/08 (2006.01) D04H 1/4209 (2012.01) D04H 1/587 (2012.01) D04H 1/645 (2012.01) D04H 3/002 (2012.01) D04H 3/12 (2006.01)	2739680 *	SIZING COMPOSITION FOR MINERAL WOOL CONTAINING A REDUCING SACCHARIDE AND A HYDROGENATED SACCHARIDE, AND RESULTING INSULATING PRODUCTS
Alexion Pharma Holding	A61K 38/00 (2006.01) A61K 39/00 (2006.01) A61P 13/06 (2006.01) C12N 9/16 (2006.01)	2768526 *	COMPOSITIONS COMPRISING ALKALINE PHOSPHATASE AND/OR NATRIURETIC PEPTIDE AND METHODS OF USE THEREOF
Vanderbilt University	A61K 38/00 (2006.01) A61K 39/00 (2006.01) A61P 13/06 (2006.01) C12N 9/16 (2006.01)	2768526 *	COMPOSITIONS COMPRISING ALKALINE PHOSPHATASE AND/OR NATRIURETIC PEPTIDE AND METHODS OF USE THEREOF
Instituto Químico De Sarrià	A61K 9/51 (2006.01)	2706989 *	POLYMERIC NANOPARTICLES FOR DRUG DELIVERY
ROBERT BOSCH GMBH	F24D 17/00 (2006.01) F24D 19/10 (2006.01) F24H 9/20 (2006.01)	2623871	Household heating device for providing water comprising a control unit configured for providing control signals to a burner
Phyco Trading B.V.	G01S 7/48 (2006.01) G01S 7/481 (2006.01) G01S 7/495 (2006.01) G01S 17/93 (2006.01)	2715395 *	VEHICLE, SYSTEM FOR RECEIVING AND TRANSMITTING OPTICAL SIGNALS, AND METHODS
Millennium Pharmaceuticals, Inc.	A01N 43/00 (2006.01)	2713727 *	COMBINATION OF MEK INHIBITORS AND SELECTIVE INHIBITORS OF AURORA A KINASE
Takeda Pharmaceutical Company Ltd.	A01N 43/00 (2006.01)	2713727 *	COMBINATION OF MEK INHIBITORS AND SELECTIVE INHIBITORS OF AURORA A KINASE
Blakely, William	G01N 33/52 (2006.01) G01N 33/53 (2006.01) G01N 33/68 (2006.01) G06F 17/10 (2006.01)	2761294 *	BIODOSIMETRY PANELS AND METHODS
Glezer, Eli N.	G01N 33/52 (2006.01) G01N 33/53 (2006.01) G01N 33/68 (2006.01) G06F 17/10 (2006.01)	2761294 *	BIODOSIMETRY PANELS AND METHODS
Kenten, John	G01N 33/52 (2006.01) G01N 33/53 (2006.01) G01N 33/68 (2006.01) G06F 17/10 (2006.01)	2761294 *	BIODOSIMETRY PANELS AND METHODS
Kumar, Sudeep	G01N 33/52 (2006.01) G01N 33/53 (2006.01) G01N 33/68 (2006.01) G06F 17/10 (2006.01)	2761294 *	BIODOSIMETRY PANELS AND METHODS
Mathew, Anu	G01N 33/52 (2006.01) G01N 33/53 (2006.01) G01N 33/68 (2006.01) G06F 17/10 (2006.01)	2761294 *	BIODOSIMETRY PANELS AND METHODS
Ossetrova, Natalia I.	G01N 33/52 (2006.01) G01N 33/53 (2006.01) G01N 33/68 (2006.01) G06F 17/10 (2006.01)	2761294 *	BIODOSIMETRY PANELS AND METHODS
Sigal, George	G01N 33/52 (2006.01) G01N 33/53 (2006.01) G01N 33/68 (2006.01) G06F 17/10 (2006.01)	2761294 *	BIODOSIMETRY PANELS AND METHODS

Podnosilac evropske prijave patenta (71)	MKP (51)	Broj objave evropske prijave patenta (97)	Naziv pronalaska (54)
Ares Trading SA	C12Q 1/68 (2006.01)	2707503 *	GENOMIC MARKERS FOR PREDICTION OF LONG-TERM RESPONSE TO 2 YEARS OF GROWTH HORMONE (GH) THERAPY
Intermune, Inc.	A01N 43/40 (2006.01)	2713732 *	PIRFENIDONE AND ANTI-FIBROTIC THERAPY IN SELECTED PATIENTS
3Eflow AB	E03B 1/04 (2006.01) E03C 1/02 (2006.01) F16K 15/14 (2006.01) F24D 17/00 (2006.01)	2702330 *	A METHOD AND A LIQUID TAP DEVICE FOR RETAINING THE TEMPERATURE OF A LIQUID IN A LIQUID DISTRIBUTION SYSTEM
Blücher GmbH	B01D 53/02 (2006.01) B01J 20/20 (2006.01) B01J 20/28 (2006.01) B01J 20/32 (2006.01)	2726198 *	FILTER MATERIALS FOR TREATING AND PURIFYING GAS
Friedrich-Alexander-Universität Erlangen-Nürnberg	B01D 53/02 (2006.01) B01J 20/20 (2006.01) B01J 20/28 (2006.01) B01J 20/32 (2006.01)	2726198 *	FILTER MATERIALS FOR TREATING AND PURIFYING GAS
Access Business Group International LLC	A23L 1/00 (2006.01) A23L 1/275 (2006.01) A23L 1/303 (2006.01)	2731461 *	MULTICAROTENOID BEADLETS AND RELATED METHOD
Reliance Industries Limited	C08F 10/06 (2006.01)	2707399 *	NITROGEN CONTAINING EXTERNAL DONOR SYSTEM FOR PROPYLENE POLYMERIZATION
Vertex Pharmaceuticals Incorporated	A61K 31/444 (2006.01) A61K 31/506 (2006.01) A61P 31/16 (2006.01) C07D 471/04 (2006.01)	2739623 *	INHIBITORS OF INFLUENZA VIRUSES REPLICATION
Rivas Tapia, Rodrigo	A61B 5/01 (2006.01) A61F 7/00 (2006.01)	2745817 *	DEVICE AND METHOD FOR CONTROLLING - EITHER INCREASING OR DECREASING - THE BODY TEMPERATURE OF A PATIENT
Glaxo Group Limited	A61K 31/519 (2006.01) A61P 25/28 (2006.01) C07D 487/04 (2006.01)	2736908 *	BICYCLIC PYRIMIDONE COMPOUNDS
Akzo Nobel Chemicals International B.V.	C09K 3/18 (2006.01)	2718386 *	DEICING COMPOSITION
Sanofi-Aventis Deutschland GmbH	A61K 31/155 (2006.01) A61K 31/4439 (2006.01) A61K 38/26 (2006.01)	2750699 *	PHARMACEUTICAL COMBINATION FOR USE IN GLYCEMIC CONTROL IN DIABETES TYPE 2 PATIENTS
Myriad Genetics, Inc.	C12N 15/12 (2006.01) C12Q 1/68 (2006.01)	2744919 *	GENE SIGNATURES FOR LUNG CANCER PROGNOSIS AND THERAPY SELECTION
Wagner, Susanne	C12N 15/12 (2006.01) C12Q 1/68 (2006.01)	2744919 *	GENE SIGNATURES FOR LUNG CANCER PROGNOSIS AND THERAPY SELECTION
Stone, Steve	C12N 15/12 (2006.01) C12Q 1/68 (2006.01)	2744919 *	GENE SIGNATURES FOR LUNG CANCER PROGNOSIS AND THERAPY SELECTION
Gutin, Alexander	C12N 15/12 (2006.01) C12Q 1/68 (2006.01)	2744919 *	GENE SIGNATURES FOR LUNG CANCER PROGNOSIS AND THERAPY SELECTION
Reid, Julia E.	C12N 15/12 (2006.01) C12Q 1/68 (2006.01)	2744919 *	GENE SIGNATURES FOR LUNG CANCER PROGNOSIS AND THERAPY SELECTION
Omya International AG	C08K 5/49 (2006.01)	2770017	New surface treatment of white mineral materials for application in plastics
Neumedicines, Inc	A61K 39/395 (2006.01)	2736530 *	USE OF IL-12 TO GENERATE ENDOGENOUS ERYTHROPOIETIN
Indiana University Research and Technology Corporation	A61K 38/16 (2006.01) A61K 38/17 (2006.01) A61K 38/26 (2006.01) A61P 3/00 (2006.01) A61P 3/04 (2006.01) A61P 3/10 (2006.01)	2723367 *	GLUCAGON/GLP-1 RECEPTOR CO-AGONISTS

Podnosilac evropske prijave patenta (71)	MKP (51)	Broj objave evropske prijave patenta (97)	Naziv pronalaska (54)
Les Laboratoires Servier	A61K 31/554 (2006.01) A61P 9/00 (2006.01) A61P 19/08 (2006.01) A61P 25/00 (2006.01) C07D 281/10 (2006.01)	2708535	Agents for treating disorders involving modulation of ryanodine receptors
Armgo Pharma, Inc.	A61K 31/554 (2006.01) A61P 9/00 (2006.01) A61P 19/08 (2006.01) A61P 25/00 (2006.01) C07D 281/10 (2006.01)	2708535	Agents for treating disorders involving modulation of ryanodine receptors
Otsuka Pharmaceutical Co., Limited	C07B 61/00 (2006.01) C07D 333/54 (2006.01) C07D 409/12 (2006.01)	2736894 *	METHOD FOR PRODUCING BENZO[B]THIOPHENE COMPOUND
Dow Corning Corporation	C08L 83/04 (2006.01)	2734588 *	COPPER CONTAINING COMPLEX, CONDENSATION REACTION COMPOSITIONS CONTAINING THE COMPLEX, AND METHODS FOR THE PREPARATION AND USE OF THE COMPOSITIONS
Helsinn Healthcare SA	A61K 31/4523 (2006.01) A61K 31/4748 (2006.01) A61P 1/00 (2006.01) A61P 25/00 (2006.01) A61P 25/02 (2006.01)	2744497 *	THERAPEUTIC COMBINATIONS OF NETUPITANT AND PALONOSETRON
Glaxosmithkline LLC	A61K 31/496 (2006.01)	2760452 *	METHODS OF TREATING CANCER
Université Laval	A61K 31/4166 (2006.01) A61P 35/00 (2006.01) C07D 233/32 (2006.01)	2744786 *	SUBSTITUTED 2-IMIDAZOLIDINONES AND 2-IMIDAZOLONES AND THEIR USE IN THE TREATMENT OF CANCER
Ethicon Endo-Surgery, Inc.	A61B 17/00 (2006.01) A61B 17/064 (2006.01) A61B 17/072 (2006.01) A61B 17/115 (2006.01) A61B 17/29 (2006.01) A61B 19/08 (2006.01) A61L 31/00 (2006.01)	2644115	Tissue thickness compensators for circular surgical staplers
Hitachi Information & Telecommunication Engineering, Ltd.	H04L 12/18 (2006.01) H04M 3/42 (2006.01)	2744184	File management system, method and computer program
Bayer CropScience NV	C12N 5/04 (2006.01) C12N 5/10 (2006.01) C12N 9/16 (2006.01) C12N 15/82 (2006.01)	2718443 *	METHODS AND MEANS TO MODIFY A PLANT GENOME AT A PRESELECTED SITE
Texas Instruments Deutschland	H03M 3/02 (2006.01)	2658131	Electronic device and method for analogue to digital conversion according to Delta-Sigma modulation using double sampling
Texas Instruments Incorporated	H03M 3/02 (2006.01)	2658131	Electronic device and method for analogue to digital conversion according to Delta-Sigma modulation using double sampling
ZAFGEN INC.	A61K 31/519 (2006.01) A61P 3/04 (2006.01) C07D 471/04 (2006.01) C07D 487/04 (2006.01) C07D 498/04 (2006.01)	2705036 *	TRICYCLIC SULFONAMIDE COMPOUNDS AND METHODS OF MAKING AND USING SAME
The Provost, Fellows, Foundation Scholars, & the other members of Board, of the College of the Holy & Undiv. Trinity of Queen Elizabeth near Dublin	A61K 38/20 (2006.01) A61P 27/02 (2006.01)	2760465 *	COMPOSITIONS AND METHODS FOR THE TREATMENT OF DEGENERATIVE RETINAL CONDITIONS

Podnosilac evropske prijave patenta (71)	MKP (51)	Broj objave evropske prijave patenta (97)	Naziv pronalaska (54)
Beijing Junlun Runzhong Science&Technology Co., Limited	C08F 212/14 (2006.01) C08F 220/06 (2006.01) C08F 220/10 (2006.01) C08F 220/34 (2006.01) C08F 220/56 (2006.01) C08F 232/04 (2006.01) C09K 8/588 (2006.01)	2738237 *	AMPHIPHILIC MACROMOLECULE AND USE THEREOF
Bolton Alimentari S.P.A.	A23B 4/005 (2006.01) A23L 1/325 (2006.01) B65B 25/06 (2006.01) B65B 55/02 (2006.01) B65B 55/22 (2006.01)	2671459	Process for packing a product based on portions of fish in the solid form and relative packed product
Ishihara Sangyo Kaisha, Ltd.	A01N 43/40 (2006.01) A01N 43/56 (2006.01) A01N 43/90 (2006.01) A01N 45/02 (2006.01) A01N 47/16 (2006.01) A01P 3/00 (2006.01)	2729006 *	FUNGICIDAL COMPOSITION AND METHOD FOR CONTROLLING PLANT DISEASES
Astex Pharmaceuticals, Inc.	A61K 9/00 (2006.01) A61K 9/19 (2006.01) A61K 31/7068 (2006.01) A61K 47/10 (2006.01) A61K 47/20 (2006.01) A61P 35/00 (2006.01)	2750768 *	DECITABINE DERIVATIVE FORMULATIONS
Mankiewicz Gebr. & Co. GmbH & Co. KG	H02G 15/10 (2006.01) H02G 15/117 (2006.01)	2766967 *	SPACERS IN CABLE SPLICING SLEEVES
Ricon Corp.	B60P 1/00 (2006.01) B60P 1/43 (2006.01)	2755856 *	REGENERATIVE BRAKING SYSTEM FOR A VEHICLE RAMP
Università degli Studi di Roma "La Sapienza"	A01N 1/02 (2006.01) A61K 35/14 (2006.01) A61L 2/00 (2006.01)	2757879 *	PLATELET LYSATE, USES AND METHOD FOR THE PREPARATION THEREOF
Futura Stem Cells Sa	A01N 1/02 (2006.01) A61K 35/14 (2006.01) A61L 2/00 (2006.01)	2757879 *	PLATELET LYSATE, USES AND METHOD FOR THE PREPARATION THEREOF
United Pipelines Limited	C22C 38/44 (2006.01) C22C 38/58 (2006.01)	2714955 *	AUSTENITIC STAINLESS STEEL
Industrialesud S.P.A.	B32B 5/24 (2006.01) B32B 5/26 (2006.01) B60R 13/00 (2006.01)	2750879 *	ARTICLE MADE OF A MULTILAYER COMPOSITE MATERIAL AND PREPARATION METHOD THEREOF
Delphi International Operations Luxembourg S.à.r.l.	F01N 3/20 (2006.01) F04B 53/08 (2006.01)	2647803	Reagent dosing pump assembly with connector element
Gilead Sciences, Inc.	A61K 31/496 (2006.01) A61P 31/14 (2006.01) C07D 213/40 (2006.01) C07D 401/12 (2006.01) C07D 401/14 (2006.01) C07D 403/12 (2006.01) C07D 403/14 (2006.01) C07D 405/12 (2006.01) C07D 471/04 (2006.01) C07D 471/06 (2006.01) C07D 487/04 (2006.01) C07D 491/04 (2006.01) C07D 495/04 (2006.01)	2729448 *	COMPOUNDS FOR THE TREATMENT OF HIV
General Atomics	C04B 35/571 (2006.01) C04B 35/626 (2006.01) C04B 35/628 (2006.01) C04B 37/00 (2006.01)	2647611	High durability joints between ceramic articles, and methods of making and using same
Design Protom Inc.	F03D 1/02 (2006.01) F03D 3/02 (2006.01) F03D 5/02 (2006.01) F03D 11/04 (2006.01)	2516844 *	ENERGY GENERATION SYSTEM AND RELATED METHODS

Podnosilac evropske prijave patenta (71)	MKP (51)	Broj objave evropske prijave patenta (97)	Naziv pronalaska (54)
Cougnaud, Yves	E04B 1/348 (2006.01)	2674538	Modular construction and corresponding assembly method
SafeAir AG	A61M 1/00 (2006.01) A61M 13/00 (2006.01) A61M 16/04 (2006.01) A61M 25/00 (2006.01) A61M 39/08 (2006.01)	2758089 *	METHODS OF MANUFACTURING FLEXIBLE POLYMERIC MEDICAL SPIRAL TUBINGS, TUBINGS MADE BY THE METHODS AND USES OF THE TUBINGS
The Trustees of Columbia University in the City of New York	A61K 39/395 (2006.01)	2763700 *	HUMAN NOTCH1 DECOYS
Eleven Biotherapeutics, Inc.	A61K 38/20 (2006.01) B01D 15/36 (2006.01) C07K 14/545 (2006.01)	2736524 *	PURIFIED PROTEINS
Olive Medical Corporation	A61B 5/05 (2006.01)	2706911 *	SYSTEM AND METHOD FOR SUB-COLUMN PARALLEL DIGITIZERS FOR HYBRID STACKED IMAGE SENSOR USING VERTICAL INTERCONNECTS
Bransgrove, Brandon	B65D 85/67 (2006.01) B65H 75/18 (2006.01) G01N 37/00 (2006.01)	2758787 *	SEALING MEANS FOR TEST CASSETTE
Kaiima Bio Agritech Ltd.	A01H 1/08 (2006.01) A01H 5/00 (2006.01) A01H 5/10 (2006.01)	2741602 *	DURUM WHEAT PLANTS HAVING A PARTIALLY OR FULLY MULTIPLIED GENOME AND USES THEREOF
Punter Gil, Jesús	E04F 11/18 (2006.01)	2759655 *	HANDRAIL CONSISTING OF PREFABRICATED TUBES AND PARTS MADE OF STAINLESS STEEL
Vanderbilt University	A61K 31/405 (2006.01) C07D 209/26 (2006.01)	2768499 *	INDOMETHACIN ANALOGS FOR THE TREATMENT OF CASTRATE-RESISTANT PROSTATE CANCER
The Trustees of the University of Pennsylvania	A61K 31/405 (2006.01) C07D 209/26 (2006.01)	2768499 *	INDOMETHACIN ANALOGS FOR THE TREATMENT OF CASTRATE-RESISTANT PROSTATE CANCER
Covagen AG	A61K 38/16 (2006.01) A61P 19/00 (2006.01) C07K 14/00 (2006.01)	2711016	Novel IL-17A binding molecules and medical uses thereof
Wobben Properties GmbH	H02J 3/26 (2006.01) H02J 3/38 (2006.01)	2769448 *	METHOD AND APPARATUS FOR FEEDING ELECTRICAL CURRENT INTO AN ELECTRICAL POWER SUPPLY SYSTEM
Saint-Gobain Isover	C03C 13/06 (2006.01) C03C 25/24 (2006.01) C03C 25/26 (2006.01) C03C 25/34 (2006.01) C09J 177/06 (2006.01) C09J 179/04 (2006.01) C09J 179/08 (2006.01) D04H 1/4209 (2012.01) D04H 1/4218 (2012.01) D04H 1/488 (2012.01)	2768781 *	SIZING COMPOSITION HAVING A LOW FORMALDEHYDE CONTENT FOR FIRE-RESISTANT MINERAL WOOL AND INSULATION PRODUCT OBTAINED
Manenti S.p.A.	B28B 3/02 (2006.01) B30B 15/06 (2006.01) C25D 11/04 (2006.01)	2583802	An improved buffer for mold for ceramic industry and mold comprising said buffer
Pontificia Universidad Católica de Chile	A61K 9/12 (2006.01) A61K 35/36 (2006.01) A61P 17/02 (2006.01) C12N 5/0775 (2010.01)	2743343 *	SPRAY FORMULATION OF MESENCHYMAL STEM CELLS FOR THE TREATMENT OF CHRONIC WOUNDS
Wobben Properties GmbH	H02J 3/38 (2006.01) H02J 3/40 (2006.01)	2748908 *	METHOD FOR OPERATING A WIND ENERGY INSTALLATION
Trifolium ApS	A61K 38/19 (2006.01) A61P 11/00 (2006.01)	2750696 *	COMPOSITIONS AND METHODS FOR TREATING OR PREVENTING RADIATION- OR CHEMOTHERAPY-INDUCED PULMONARY DYSFUNCTION
Centre de Recherche de l'Industrie Belge de la Ceramique (C.R.I.B.C.)	B23K 26/40 (2014.01) C04B 35/622 (2006.01)	2714621 *	CERAMIC PARTICLE MIXTURE, AND METHOD FOR MANUFACTURING CERAMIC PARTS FROM SUCH A MIXTURE

Podnosilac evropske prijave patenta (71)	MKP (51)	Broj objave evropske prijave patenta (97)	Naziv pronalaska (54)
Microlink Devices, Inc.	H01L 33/00 (2010.01)	2761677 *	LIGHT EMITTING DIODE FABRICATED BY EPITAXIAL LIFT-OFF
Pan, Noren	H01L 33/00 (2010.01)	2761677 *	LIGHT EMITTING DIODE FABRICATED BY EPITAXIAL LIFT-OFF
Elarde, Victor, C.	H01L 33/00 (2010.01)	2761677 *	LIGHT EMITTING DIODE FABRICATED BY EPITAXIAL LIFT-OFF
Youtsey, Christopher	H01L 33/00 (2010.01)	2761677 *	LIGHT EMITTING DIODE FABRICATED BY EPITAXIAL LIFT-OFF
Osowski, Mark	H01L 33/00 (2010.01)	2761677 *	LIGHT EMITTING DIODE FABRICATED BY EPITAXIAL LIFT-OFF
Almirall, S.A.	A61K 31/444 (2006.01) A61K 31/497 (2006.01) A61K 31/506 (2006.01) A61P 11/06 (2006.01) A61P 35/02 (2006.01) A61P 37/06 (2006.01) C07D 401/12 (2006.01) C07D 401/14 (2006.01)	2739616 *	PYRIDIN-2(1H)-ONE DERIVATIVES AS JAK INHIBITORS
Regeneron Pharmaceuticals, Inc.	A61K 39/395 (2006.01) A61P 3/06 (2006.01) C07K 16/22 (2006.01)	2721065 *	ANTI-ANGPTL3 ANTIBODIES AND USES THEREOF
HeartFlow, Inc.	G06F 19/00 (2011.01)	2721543 *	SYSTEMS AND METHODS FOR ESTIMATING BLOOD FLOW CHARACTERISTICS FROM VESSEL GEOMETRY AND PHYSIOLOGY
Regulus Therapeutics Inc	A61P 35/00 (2006.01) C12N 15/113 (2010.01)	2702155 *	MICRORNA COMPOUNDS AND METHODS FOR MODULATING MIR-21 ACTIVITY
Zachodniopomorski Uniwersytet Technologiczny w Szczecinie	B01J 20/04 (2006.01) B01J 20/28 (2006.01) C02F 1/28 (2006.01) C02F 101/10 (2006.01) C02F 103/00 (2006.01)	2732872	Method of producing agent for removing dissolved phosphorus compounds from water and agent for removing dissolved phosphorus compounds from water
Medivir UK Ltd	A61K 31/16 (2006.01) A61P 11/00 (2006.01) A61P 37/00 (2006.01) C07C 237/14 (2006.01) C07D 233/58 (2006.01)	2752404	Cysteine protease inhibitors
Retrotope, Inc.	A61K 31/122 (2006.01) A61K 31/185 (2006.01) A61K 31/20 (2006.01) A61K 31/201 (2006.01) A61P 1/00 (2006.01) A61P 1/16 (2006.01)	2701698 *	DISORDERS IMPLICATING PUFA OXIDATION
Boehringer Ingelheim International GmbH	A61K 31/421 (2006.01) A61K 31/427 (2006.01) A61K 31/437 (2006.01) A61K 31/4439 (2006.01) A61P 25/18 (2006.01) A61P 25/28 (2006.01) C07D 401/04 (2006.01) C07D 403/04 (2006.01) C07D 413/04 (2006.01) C07D 413/14 (2006.01) C07D 417/04 (2006.01) C07D 471/04 (2006.01)	2739615 *	PHENYL-3-AZA-BICYCLO[3.1.0]HEX-3-YL-METHANONES AND THE USE THEREOF AS MEDICAMENT
Rudolf Wild GmbH & Co. KG	A23L 1/054 (2006.01) A23L 2/52 (2006.01) C08L 5/00 (2006.01)	2653494	Aqueous gellan dispersion
AVIC Composites Company Limited	B32B 9/00 (2006.01)	2687364	Composite conductive sheet, fabricating method and application thereof
AVIC Beijing Institute of Aeronautical Materials	B32B 9/00 (2006.01)	2687364	Composite conductive sheet, fabricating method and application thereof

Podnosilac evropske prijave patenta (71)	MKP (51)	Broj objave evropske prijave patenta (97)	Naziv pronalaska (54)
SANOFI	A61K 31/4725 (2006.01) A61P 3/00 (2006.01) A61P 9/00 (2006.01) A61P 11/00 (2006.01) C07D 401/12 (2006.01)	2729461 *	POLYMORPHS OF 6-(PIPERIDIN-4-YLOXY)-2H-ISOQUINOLIN-1-ONE HYDROCHLORIDE
Aselsan Elektronik Sanayi ve Ticaret Anonim Sirketi	F41G 3/04 (2006.01) F41G 3/26 (2006.01) F41G 3/32 (2006.01) F41G 9/00 (2006.01) G06Q 10/06 (2012.01)	2748555 *	A TEST AND ANALYSIS SYSTEM AND A METHOD FOR THREAT EVALUATION AND SENSOR/WEAPON ASSIGNMENT ALGORITHMS
Packers Plus Energy Services Inc.	E21B 17/00 (2006.01) E21B 29/00 (2006.01) E21B 34/14 (2006.01) E21B 43/12 (2006.01)	2721247 *	KOBE SUB WITH INFLOW CONTROL, WELLBORE TUBING STRING AND METHOD
Penzes, Ladislav	C02F 3/00 (2006.01) C02F 3/06 (2006.01) C02F 3/12 (2006.01) C02F 3/22 (2006.01)	2707334 *	BIOLOGICAL TREATMENT PROCESS AND INSTALLATION INCLUDING AIR-LIFT AND POST-TREATMENT IN FILTER
Csefalvay, Juraj	C02F 3/00 (2006.01) C02F 3/06 (2006.01) C02F 3/12 (2006.01) C02F 3/22 (2006.01)	2707334 *	BIOLOGICAL TREATMENT PROCESS AND INSTALLATION INCLUDING AIR-LIFT AND POST-TREATMENT IN FILTER
Les Laboratoires Servier	A61K 31/138 (2006.01) A61K 31/343 (2006.01) A61K 31/704 (2006.01) A61K 33/24 (2006.01) A61P 35/00 (2006.01)	2753322 *	SCHEME FOR ADMINISTERING N-HYDROXY-4-{2-[3-(N,N-DIMETHYLAMINOMETHYL)BENZOFURAN-2-YLCARBONYLAMINO]ETHOXY}BENZAMIDE
Pharmacyclics, Inc.	A61K 31/138 (2006.01) A61K 31/343 (2006.01) A61K 31/704 (2006.01) A61K 33/24 (2006.01) A61P 35/00 (2006.01)	2753322 *	SCHEME FOR ADMINISTERING N-HYDROXY-4-{2-[3-(N,N-DIMETHYLAMINOMETHYL)BENZOFURAN-2-YLCARBONYLAMINO]ETHOXY}BENZAMIDE
Baxter Healthcare SA	C07K 16/24 (2006.01) C12N 5/10 (2006.01) G01N 33/68 (2006.01)	2753937 *	CHARACTERIZATION OF CHO-MIF GENE AND PROTEIN, AND USE THEREOF
Baxter International Inc	C07K 16/24 (2006.01) C12N 5/10 (2006.01) G01N 33/68 (2006.01)	2753937 *	CHARACTERIZATION OF CHO-MIF GENE AND PROTEIN, AND USE THEREOF
Ardea Biosciences, Inc.	A01N 37/44 (2006.01) C07D 249/12 (2006.01) C07D 285/24 (2006.01)	2714669 *	HYPERTENSION AND HYPERURICEMIA
Awind Inc.	G06F 3/14 (2006.01)	2660711	Presentation system, receiver device, methods thereof, and computer-readable medium thereof
Pfizer Inc	A61K 31/519 (2006.01) A61P 35/00 (2006.01) C07D 487/04 (2006.01)	2758402 *	PYRROLOPYRIMIDINE AND PURINE DERIVATIVES
AstraZeneca AB	A61K 31/506 (2006.01) C07C 69/92 (2006.01) C07D 205/04 (2006.01) C07D 317/20 (2006.01) C07D 317/24 (2006.01) C07D 403/12 (2006.01)	2731945 *	N- (6- ((2R,3S) -3,4-DIHYDROXYBUTAN-2-YLOXY) -2- (4 - FLUOROBENZYLTHIO) PYRIMIDIN- 4 - YL) -3- METHYLAZETIDINE- 1 - SULFONAMIDE AS CHEMOKINE RECEPTOR MODULATOR
Spectral Platforms, Inc.	G01N 21/65 (2006.01) G01N 33/483 (2006.01)	2748588 *	RAPID DETECTION OF METABOLIC ACTIVITY
JB Therapeutics, Inc.	A01N 43/16 (2006.01) A61K 31/35 (2006.01)	2717692 *	METHODS OF TREATING FIBROTIC DISEASES USING TETRAHYDROCANNABINOL-11-OIC ACIDS
Parion Sciences, Inc.	A61K 31/4965 (2006.01) A61P 11/00 (2006.01) C07D 239/48 (2006.01)	2723722 *	3,5-DIAMINO-6-CHLORO-N-(N-(4-(4-(2-(HEXYL (2,3,4,5,6-PENTAHYDROXYHEXYL) AMINO) ETHOXY) PHENYL) BUTYL) CARBAMIMIDOYL) PYRAZINE-2-CARBOXAMIDE
THE GATES CORPORATION	B60K 6/10 (2006.01) B60K 25/00 (2006.01) F02B 67/06 (2006.01)	2766587 *	FLYWHEEL HYBRID SYSTEM

Podnosilac evropske prijave patenta (71)	MKP (51)	Broj objave evropske prijave patenta (97)	Naziv pronalaska (54)
Raycap Intellectual Property, Ltd.	H01C 7/12 (2006.01) H01T 1/16 (2006.01)	2677524	Overvoltage protection devices including a varistor member and an electrical conductive fusing member
Sapa Building System GmbH	A01G 9/14 (2006.01)	2327295	Greenhouse
Bálint, Adám	A63H 33/08 (2006.01) E01C 5/00 (2006.01) E04C 1/00 (2006.01)	2734682 *	INTERLOCKING BUILDING BLOCK, PAVING UNIT, TILE OR TOY ELEMENT AND THE CONSTRUCTION METHOD THEREOF
Chiesi Farmaceutici S.p.A.	A61K 31/44 (2006.01) A61P 11/00 (2006.01) C07D 213/69 (2006.01) C07D 213/89 (2006.01)	2760838 *	DERIVATIVES OF 1-PHENYL-2-PYRIDINYL ALKYL ALCOHOLS AS PHOSPHODIESTERASE INHIBITORS
Charles River Laboratories, Inc.	G01N 21/64 (2006.01) G01N 33/542 (2006.01) G01N 33/569 (2006.01)	2769204 *	CELL CAPTURE SYSTEM AND USE THEREOF
REAMETRIX INC.	G01N 21/64 (2006.01) G01N 33/542 (2006.01) G01N 33/569 (2006.01)	2769204 *	CELL CAPTURE SYSTEM AND USE THEREOF
Bayer Intellectual Property GmbH	A61K 31/53 (2006.01) A61P 27/00 (2006.01) C07D 487/04 (2006.01)	2726482 *	HYDROXYMETHYLARYL-SUBSTITUTED PYRROLOTRIAZINES AS ALK1 INHIBITORS
Bayer Pharma Aktiengesellschaft	A61K 31/53 (2006.01) A61P 27/00 (2006.01) C07D 487/04 (2006.01)	2726482 *	HYDROXYMETHYLARYL-SUBSTITUTED PYRROLOTRIAZINES AS ALK1 INHIBITORS
Franklin Control Systems, Inc.	H02H 3/08 (2006.01) H02H 9/02 (2006.01)	2764593 *	MOTOR PROTECTION AND CONTROL APPARATUS, SYSTEM, AND/OR METHOD
Mehldau & Steinfath Umwelttechnik GmbH	B01D 53/56 (2006.01)	2704817 *	PROCESS AND APPARATUS FOR REDUCING THE CONTENT OF NITROGEN OXIDES
Von Der Heide, Bernd	B01D 53/56 (2006.01)	2704817 *	PROCESS AND APPARATUS FOR REDUCING THE CONTENT OF NITROGEN OXIDES
Elliott Company	F25B 3/00 (2006.01)	2734793 *	ASSEMBLY AND METHOD OF ATTACHING STUB SHAFT TO DRUM OF AXIAL COMPRESSOR ROTOR SHAFT
Philadelphia Health and Education Corporation D/B/A	A61K 31/4468 (2006.01) A61K 31/451 (2006.01) A61K 31/4985 (2006.01) A61K 31/7088 (2006.01) A61K 39/395 (2006.01) A61P 35/04 (2006.01) C07D 487/04 (2006.01) C07K 16/24 (2006.01) C07K 16/28 (2006.01)	2648754 *	METHODS OF INHIBITING METASTASIS FROM CANCER
Alliance Discovery, Inc.	A61K 31/4468 (2006.01) A61K 31/451 (2006.01) A61K 31/4985 (2006.01) A61K 31/7088 (2006.01) A61K 39/395 (2006.01) A61P 35/04 (2006.01) C07D 487/04 (2006.01) C07K 16/24 (2006.01) C07K 16/28 (2006.01)	2648754 *	METHODS OF INHIBITING METASTASIS FROM CANCER
Moderna Therapeutics, Inc.	A61K 48/00 (2006.01) C07H 21/02 (2006.01) C07H 21/04 (2006.01)	2763701 *	MODIFIED NUCLEOSIDES, NUCLEOTIDES, AND NUCLEIC ACIDS, AND USES THEREOF
Baxter International Inc	C07K 1/18 (2006.01) C12N 9/64 (2006.01)	2748180 *	PROTEIN PURIFICATION BY ANION EXCHANGE CHROMATOGRAPHY
Baxter Healthcare SA	C07K 1/18 (2006.01) C12N 9/64 (2006.01)	2748180 *	PROTEIN PURIFICATION BY ANION EXCHANGE CHROMATOGRAPHY
Texas Instruments Incorporated	H03M 1/12 (2006.01) H03M 1/66 (2006.01)	2751927 *	METHOD AND APPARATUS FOR PERFORMING DATA CONVERSION WITH NON-UNIFORM QUANTIZATION
Thompson Cooper Laboratories, LLC	A61Q 5/12 (2006.01)	2720755 *	COMPOSITIONS FOR DEPOSITING AGENTS USING HIGHLY VOLATILE SILICONE SOLVENTS

Podnosilac evropske prijave patenta (71)	MKP (51)	Broj objave evropske prijave patenta (97)	Naziv pronalaska (54)
Bystronic Laser AG	B23K 26/08 (2006.01) B23K 37/02 (2006.01) B23Q 1/48 (2006.01) B26F 3/00 (2006.01)	2674245	Jet processing device
Straaltechniek International N.V./S.A.	B24C 5/06 (2006.01)	2650084	Turbine
I.M.A. Industria Macchine Automatiche S.p.A.	B65B 43/30 (2006.01)	2739535 *	METHOD AND APPARATUS FOR FEEDING TUBULAR BLANKS TO A PACKAGING MACHINE
Chinoïn Zrt.	C07C 405/00 (2006.01) C07D 207/46 (2006.01) C07D 209/48 (2006.01) C07D 233/60 (2006.01) C07D 307/935 (2006.01)	2723714 *	NOVEL PROCESSES FOR THE PREPARATION OF PROSTAGLANDIN AMIDES
ChemoCentryx, Inc.	A61K 31/4412 (2006.01) A61P 29/00 (2006.01) C07D 213/89 (2006.01)	2748146 *	A CRYSTALLINE FORM OF THE SODIUM SALT OF 4-TERT-BUTYL-N-[4-CHLORO-2-(1-OXY-PYRIDINE-4-CARBONYL)-PHENYL]-BENZENE SULFONAMIDE
Saint-Gobain Isover	C03C 25/32 (2006.01) C09J 105/00 (2006.01) D06M 15/03 (2006.01)	2736995 *	SIZING COMPOSITION FOR MINERAL WOOL BASED ON MALTITOL AND INSULATING PRODUCTS OBTAINED
Versus-Invest	B60J 7/06 (2006.01) B60J 7/10 (2006.01) F16B 21/18 (2006.01)	2679423	Carriage for a roof of a trailer or truck
Pfizer Inc.	A61K 31/47 (2006.01) A61K 31/502 (2006.01) A61P 3/10 (2006.01) C07D 215/38 (2006.01) C07D 239/94 (2006.01)	2734503 *	QUINOLINYL GLUCAGON RECEPTOR MODULATORS
Sugita, Kikuo	F16F 15/04 (2006.01)	2722552 *	METHOD FOR PREVENTING OVERTURN OF TRESTLE
Chiesi Farmaceutici S.p.A.	A61K 9/00 (2006.01) A61K 9/14 (2006.01) A61K 9/16 (2006.01)	2765994 *	CRYSTALLINE MICROPARTICLES OF A BETA-AGONIST COATED WITH A FATTY ACID
UCB Pharma, S.A.	A61K 31/519 (2006.01) A61P 29/00 (2006.01) C07D 495/04 (2006.01) C07D 513/04 (2006.01) C07D 519/00 (2006.01)	2744812 *	THERAPEUTICALLY ACTIVE FUSED PYRIMIDINE DERIVATIVES
Katholieke Universiteit Leuven, K.U. Leuven R&D	A61K 31/519 (2006.01) A61P 29/00 (2006.01) C07D 495/04 (2006.01) C07D 513/04 (2006.01) C07D 519/00 (2006.01)	2744812 *	THERAPEUTICALLY ACTIVE FUSED PYRIMIDINE DERIVATIVES
Novartis AG	A61K 31/4045 (2006.01) A61K 31/519 (2006.01)	2720696 *	COMBINATION OF PANOBINOSTAT AND RUXOLITINIB IN THE TREATMENT OF CANCER SUCH AS A MYELOPROLIFERATIVE NEOPLASM
Kaiima Bio Agritech Ltd.	A01H 1/08 (2006.01) A01H 5/00 (2006.01) A01H 5/10 (2006.01)	2734036 *	MAIZE PLANTS HAVING A PARTIALLY OR FULLY MULTIPLIED GENOME AND USES THEREOF
Franklin Control Systems, Inc.	H02H 3/08 (2006.01) H02H 9/02 (2006.01)	2754217 *	STARTER APPARATUS, SYSTEM, AND/OR METHOD FOR A SEPARABLE-WINDING MOTOR
Omya International AG	B41M 5/42 (2006.01) B41M 5/50 (2006.01) B41M 5/52 (2006.01)	2714415 *	PROCESS FOR MANUFACTURING COATED SUBSTRATES
ASM Assembly Systems GmbH & Co. KG	H05K 13/04 (2006.01)	2389059	Mounting head for a mounting machine, mounting machine and mounting method
Qualcomm Incorporated	G06F 3/01 (2006.01)	2740014 *	GESTURE RECOGNITION USING INERTIAL SENSORS IN COMBINATION WITH PROXIMITY LIGHT SENSORS
Banom, Inc.	A41D 19/015 (2006.01)	2729029 *	PLAITED GLOVE
Ethicon Endo-Surgery, Inc.	A61B 17/072 (2006.01) A61L 31/00 (2006.01)	2644123	Tissue thickness compensator comprising a plurality of medicaments

Podnosilac evropske prijave patenta (71)	MKP (51)	Broj objave evropske prijave patenta (97)	Naziv pronalaska (54)
Aeromobil S.r.o.	B60F 5/02 (2006.01) B64C 3/56 (2006.01) B64C 37/00 (2006.01)	2750905 *	TRANSFORMATION METHOD OF HYBRID TRANSPORTATION VEHICLE FOR GROUND AND AIR, AND HYBRID TRANSPORTATION VEHICLE ITSELF
Cosma, Maria Pia	A61K 35/28 (2006.01) C12N 5/0735 (2010.01) C12N 5/0775 (2010.01) C12N 5/0789 (2010.01) C12N 5/0793 (2010.01)	2739723 *	METHODS OF TREATMENT OF RETINAL DEGENERATION DISEASES
Sanges, M Daniela	A61K 35/28 (2006.01) C12N 5/0735 (2010.01) C12N 5/0775 (2010.01) C12N 5/0789 (2010.01) C12N 5/0793 (2010.01)	2739723 *	METHODS OF TREATMENT OF RETINAL DEGENERATION DISEASES
BASF SE	A01N 37/20 (2006.01) A01N 43/10 (2006.01) A01N 43/56 (2006.01) A01P 13/00 (2006.01)	2747564 *	HERBICIDAL COMPOSITIONS COMPRISING CHLOROACETAMIDES
Takeda Pharmaceutical Company Limited	C07D 233/64 (2006.01)	2721010 *	PRODUCTION METHOD OF IMIDAZOLE DERIVATIVES
Rheinkalk GmbH	C02F 3/28 (2006.01) C10L 3/08 (2006.01) C12P 5/02 (2006.01)	2760978 *	PROCESS FOR PRODUCTION OF BIOGAS
Akzo Nobel Chemicals International B.V.	C09K 3/18 (2006.01)	2718387 *	DEICING COMPOSITION
Baxter Healthcare SA	G01N 33/68 (2006.01)	2748613 *	OXMIF AS A DIAGNOSTIC MARKER
Baxter International Inc	G01N 33/68 (2006.01)	2748613 *	OXMIF AS A DIAGNOSTIC MARKER
SCA TISSUE FRANCE	B31C 1/00 (2006.01) B31C 3/00 (2006.01) B65H 75/10 (2006.01) B65H 75/50 (2006.01)	2653299	A single ply core manufacturing method, a ply and a single ply core
Services Pétroliers Schlumberger	E21B 47/00 (2012.01) G01V 1/44 (2006.01)	2637043	Systems and methods for downhole cement evaluation
Schlumberger Technology B.V.	E21B 47/00 (2012.01) G01V 1/44 (2006.01)	2637043	Systems and methods for downhole cement evaluation
Schlumberger Holdings Limited	E21B 47/00 (2012.01) G01V 1/44 (2006.01)	2637043	Systems and methods for downhole cement evaluation
PRAD Research and Development Limited	E21B 47/00 (2012.01) G01V 1/44 (2006.01)	2637043	Systems and methods for downhole cement evaluation
Packers Plus Energy Services Inc.	E21B 34/14 (2006.01) E21B 43/12 (2006.01) E21B 43/26 (2006.01) F16K 3/26 (2006.01) F16K 3/30 (2006.01) F16K 31/46 (2006.01)	2705287 *	SLIDING SLEEVE VALVE AND METHOD FOR FLUID TREATING A SUBTERRANEAN FORMATION
Jiangxi Rare Earth and Rare Metals Tungsten Group Corporation	C22B 15/14 (2006.01)	2716776 *	COMBINED FURNACE SYSTEM FOR FIRE REFINING RED IMPURE COPPER
Nestec S.A.	G01N 33/538 (2006.01)	2729807 *	ASSAYS FOR DETECTING NEUTRALIZING AUTOANTIBODIES TO BIOLOGIC THERAPY WITH TNF ALPHA
Biontech AG	A61K 39/00 (2006.01) C12Q 1/68 (2006.01)	2714071 *	INDIVIDUALIZED VACCINES FOR CANCER
TRON - Translationale Onkologie an der Universitätsmedizin der Johannes Gutenberg-Universität Mainz gemeinnützige GmbH	A61K 39/00 (2006.01) C12Q 1/68 (2006.01)	2714071 *	INDIVIDUALIZED VACCINES FOR CANCER

Podnosilac evropske prijave patenta (71)	MKP (51)	Broj objave evropske prijave patenta (97)	Naziv pronalaska (54)
Bind Therapeutics, Inc.	A61K 9/51 (2006.01) A61K 31/337 (2006.01) A61K 47/34 (2006.01) A61P 35/00 (2006.01)	2747761 *	METHODS OF TREATING CANCERS WITH THERAPEUTIC NANOPARTICLES
Burcon Nutrascience (MB) Corp.	A23L 2/06 (2006.01) A23L 2/66 (2006.01)	2521461 *	STABILIZATION OF CITRUS FRUIT BEVERAGES COMPRISING SOY PROTEIN
Wake Forest University Health Sciences	A61F 2/00 (2006.01)	2755598 *	FABRICATION OF GELATIN HYDROGEL SHEET FOR THE TRANSPLANTATION OF CORNEAL ENDOTHELIUM
Vereckey, István	C02F 11/12 (2006.01) C10L 5/08 (2006.01) C10L 5/28 (2006.01) C10L 5/36 (2006.01) C10L 5/46 (2006.01)	2739711 *	PROCEDURE AND EQUIPMENT FOR THE PRODUCTION OF SOLID FUEL FROM WASTEWATER SLUDGE
Ij. Vereckey, István	C02F 11/12 (2006.01) C10L 5/08 (2006.01) C10L 5/28 (2006.01) C10L 5/36 (2006.01) C10L 5/46 (2006.01)	2739711 *	PROCEDURE AND EQUIPMENT FOR THE PRODUCTION OF SOLID FUEL FROM WASTEWATER SLUDGE
Bognár, Béla	C02F 11/12 (2006.01) C10L 5/08 (2006.01) C10L 5/28 (2006.01) C10L 5/36 (2006.01) C10L 5/46 (2006.01)	2739711 *	PROCEDURE AND EQUIPMENT FOR THE PRODUCTION OF SOLID FUEL FROM WASTEWATER SLUDGE
Ercsey, László	C02F 11/12 (2006.01) C10L 5/08 (2006.01) C10L 5/28 (2006.01) C10L 5/36 (2006.01) C10L 5/46 (2006.01)	2739711 *	PROCEDURE AND EQUIPMENT FOR THE PRODUCTION OF SOLID FUEL FROM WASTEWATER SLUDGE
Retrotope, Inc.	A61K 31/122 (2006.01) A61K 31/20 (2006.01) A61K 31/202 (2006.01) A61K 31/375 (2006.01) A61P 25/00 (2006.01) A61P 25/28 (2006.01)	2701695 *	NEURODEGENERATIVE DISORDERS AND MUSCLE DISEASES IMPLICATING PUFAS
Eridania Sadam S.p.A.	A23L 1/236 (2006.01)	2741620 *	SWEETENER COMPOSITION
Soveta Baltica Uab	A61K 31/18 (2006.01) A61K 33/06 (2006.01) A61K 33/12 (2006.01) A61K 33/38 (2006.01)	2706994 *	PHARMACEUTICAL TOPICAL COMPOSITION FOR USE IN THE TREATMENT AND/OR IN THE PREVENTION OF INFECTIONS OF SKIN LESIONS
GlaxoSmithKline Biologicals S.A.	A61K 39/145 (2006.01) A61K 39/385 (2006.01) A61P 31/16 (2006.01) A61P 37/04 (2006.01) C07K 14/285 (2006.01) C07K 19/00 (2006.01) C12N 15/00 (2006.01) C12P 21/02 (2006.01)	2707393 *	FUSION PROTEINS AND COMBINATION VACCINES COMPRISING HAEMOPHILUS INFLUENZAE PROTEIN E AND PILIN A
Tontarelli, Sergio	A47B 47/04 (2006.01) A47B 61/00 (2006.01)	2741632 *	A MODULAR APPARATUS FOR REALIZATION OF WARDROBES PROVIDED WITH PLASTIC STRUCTURE
Telsmith, Inc.	F16C 33/02 (2006.01)	2764262 *	APPARATUS AND METHOD FOR A BEARING ASSEMBLY SYSTEM
Gierth, Lothar	B23B 31/20 (2006.01) B23D 37/10 (2006.01) B23D 37/20 (2006.01) B23D 41/04 (2006.01)	2734327 *	INTERNAL BROACHING MACHINE
Elanco Animal Health Ireland Limited	A61K 9/16 (2006.01) A61K 31/496 (2006.01) A61P 43/00 (2006.01)	2723341 *	FAST DISSOLVING AZAPERONE GRANULATE FORMULATION
VIIV Healthcare UK Limited	A01N 43/90 (2006.01)	2757887 *	PYRROLOPYRIDINONE COMPOUNDS AND METHODS FOR TREATING HIV

Podnosilac evropske prijave patenta (71)	MKP (51)	Broj objave evropske prijave patenta (97)	Naziv pronalaska (54)
MEDA Pharma GmbH & Co. KG	A61K 9/00 (2006.01) A61K 31/56 (2006.01) A61P 11/02 (2006.01)	2714005 *	NASAL PHARMACEUTICAL FORMULATION
Helmholtz-Zentrum Dresden - Rossendorf e.V.	G01F 1/74 (2006.01)	2647970	Needle probe for analysis of multiphase flows, production and use of needle probe
Ethicon Endo-Surgery, Inc.	A61B 17/072 (2006.01) A61L 31/04 (2006.01)	2644116	Tissue thickness compensator comprising a plurality of capsules
Szegedi Tudományegyetem	A01N 63/00 (2006.01)	2753181 *	A COPPER RESISTANT, FENGYCIN-PRODUCING BACILLUS MOJAVENSIS STRAIN FOR CONTROLLING VEGETABLE PATHOGENS, ITS USE AND COMPOSITIONS CONTAINING IT
Coswell S.p.A.	A61K 8/27 (2006.01) A61K 33/42 (2006.01) A61Q 11/00 (2006.01) C01B 25/455 (2006.01)	2713992 *	DENTAL CARE PRODUCTS COMPRISING CARBONATE-SUBSTITUTED FLUORO-HYDROXYAPATITE PARTICLES
Rimmer, Karl	B22F 9/08 (2006.01) C22C 18/00 (2006.01)	2689873	Method for producing a powder of a metal alloy
Myriad Genetics, Inc.	C12N 15/11 (2006.01) C12Q 1/68 (2006.01)	2739753 *	HYPOXIA-RELATED GENE SIGNATURES FOR CANCER CLASSIFICATION
Gutin, Alexander	C12N 15/11 (2006.01) C12Q 1/68 (2006.01)	2739753 *	HYPOXIA-RELATED GENE SIGNATURES FOR CANCER CLASSIFICATION
Jammulapati, Srikanth	C12N 15/11 (2006.01) C12Q 1/68 (2006.01)	2739753 *	HYPOXIA-RELATED GENE SIGNATURES FOR CANCER CLASSIFICATION
Wagner, Susanne	C12N 15/11 (2006.01) C12Q 1/68 (2006.01)	2739753 *	HYPOXIA-RELATED GENE SIGNATURES FOR CANCER CLASSIFICATION
Reid, Julia E.	C12N 15/11 (2006.01) C12Q 1/68 (2006.01)	2739753 *	HYPOXIA-RELATED GENE SIGNATURES FOR CANCER CLASSIFICATION
Flake, Darl	C12N 15/11 (2006.01) C12Q 1/68 (2006.01)	2739753 *	HYPOXIA-RELATED GENE SIGNATURES FOR CANCER CLASSIFICATION
Novartis AG	A61K 31/4439 (2006.01) A61K 31/519 (2006.01) A61K 31/535 (2006.01) A61P 35/00 (2006.01)	2726074 *	COMBINATION THERAPY COMPRISING A CDK4/6 INHIBITOR AND A PI3K INHIBITOR FOR USE IN THE TREATMENT OF CANCER
Biasin SRL	H01M 2/12 (2006.01)	2713419	Lid for electric accumulators
Janssen Pharmaceutica, N.V.	A61K 31/496 (2006.01) A61P 3/06 (2006.01) A61P 3/08 (2006.01) A61P 3/10 (2006.01) A61P 9/00 (2006.01) A61P 9/10 (2006.01) A61P 9/12 (2006.01) A61P 11/00 (2006.01) A61P 15/00 (2006.01) A61P 15/12 (2006.01) A61P 19/02 (2006.01) A61P 21/00 (2006.01)	2760450 *	MONOACYLGLYCEROL LIPASE INHIBITORS FOR THE TREATMENT OF METABOLIC DISEASES AND RELATED DISORDERS
Nestec S.A.	C12Q 1/68 (2006.01)	2744912 *	COMPOSITIONS AND METHODS FOR DETECTING ALLELIC VARIANTS
Cavalli, Stefano	H01M 8/04 (2006.01)	2710658 *	METHOD OF CONTROLLING AND MAXIMIZING THE ELECTRIC EFFICIENCY AND THE POWER OUTPUT OF A FUEL CELL
Eisai R&D Management Co., Ltd.	A61K 31/437 (2006.01) A61K 31/444 (2006.01) A61K 31/506 (2006.01) A61P 25/28 (2006.01) A61P 43/00 (2006.01) C07D 471/04 (2006.01)	2769980 *	PYRAZOLOQUINOLINE DERIVATIVE

Podnosilac evropske prijave patenta (71)	MKP (51)	Broj objave evropske prijave patenta (97)	Naziv pronalaska (54)
Amgen Inc.	A61K 31/44 (2006.01) A61P 25/00 (2006.01) C07D 213/40 (2006.01) C07D 401/12 (2006.01) C07D 401/14 (2006.01) C07D 405/12 (2006.01) C07D 409/12 (2006.01) C07D 413/12 (2006.01)	2723718 *	TRPM8 ANTAGONISTS AND THEIR USE IN TREATMENTS
Veolia Water Solutions & Technologies Support	C02F 3/30 (2006.01) C02F 3/34 (2006.01)	2736852 *	A METHOD AND A SYSTEM FOR OUT-COMPETING GLYCOGEN-ACCUMULATING ORGANISMS IN A SUBSTANCE
Channell Commercial Corporation	G02B 6/44 (2006.01) H02G 15/013 (2006.01)	2732323 *	SEALING MECHANISM AND METHOD FOR DROP CABLE SPLICE ENCLOSURES
Abbvie Inc.	A61K 31/4178 (2006.01) A61K 31/4184 (2006.01) A61K 31/4439 (2006.01) A61K 31/454 (2006.01) A61K 31/496 (2006.01) A61K 31/506 (2006.01) A61P 31/14 (2006.01) C07D 401/14 (2006.01) C07D 403/14 (2006.01) C07D 417/14 (2006.01)	2692726	Anti-viral compounds
Shire Human Genetic Therapies, Inc.	A61K 38/00 (2006.01)	2750686 *	MITOCHONDRIAL TARGETING AND THERAPEUTIC USE THEREOF
Tempero Pharmaceuticals, Inc.	A01N 37/18 (2006.01) A61K 31/165 (2006.01) C07C 233/00 (2006.01)	2747560 *	COMPOUNDS AND METHODS
Pfizer Limited	A61K 31/437 (2006.01) A61K 31/55 (2006.01) A61P 11/00 (2006.01) C07D 471/04 (2006.01) C07D 487/04 (2006.01)	2736907 *	INDAZOLES
Chelsea Therapeutics Inc.	A61K 31/122 (2006.01) A61K 31/198 (2006.01) A61K 31/275 (2006.01)	2709608 *	METHOD OF TREATING POSTURAL REFLEX ABNORMALITY CAUSED BY PARKINSON'S DISEASE
Messer Group GmbH	B28C 7/00 (2006.01) B65G 53/32 (2006.01) B65G 53/52 (2006.01) C04B 40/06 (2006.01) F25D 3/10 (2006.01)	2266771	Device and method for cooling and inserting a flow of pulverulent or granular materials in a storage container
Messer Austria GmbH	B28C 7/00 (2006.01) B65G 53/32 (2006.01) B65G 53/52 (2006.01) C04B 40/06 (2006.01) F25D 3/10 (2006.01)	2266771	Device and method for cooling and inserting a flow of pulverulent or granular materials in a storage container
Solarys S.r.L.	A47L 5/36 (2006.01) A47L 9/12 (2006.01) A47L 9/20 (2006.01)	2630902	Vacuum cleaner with reverse air jet filter cleaning device
Novartis AG	C07K 14/50 (2006.01) C07K 14/605 (2006.01)	2764019 *	DUAL FUNCTION PROTEINS FOR TREATING METABOLIC DISORDERS
IRM LLC	C07K 14/50 (2006.01) C07K 14/605 (2006.01)	2764019 *	DUAL FUNCTION PROTEINS FOR TREATING METABOLIC DISORDERS
Nestec S.A.	G01N 33/50 (2006.01) G01N 33/542 (2006.01)	2751562 *	PROFILING OF SIGNAL PATHWAY PROTEINS TO DETERMINE THERAPEUTIC EFFICACY
Amgen Inc.	A61K 39/395 (2006.01) A61P 19/00 (2006.01) C07K 16/22 (2006.01)	2739311 *	METHOD FOR TREATING BONE GAP DEFECTS
Far Rubinetterie S.P.A.	F16K 27/02 (2006.01)	2660496	Valve

Podnosilac evropske prijave patenta (71)	MKP (51)	Broj objave evropske prijave patenta (97)	Naziv pronalaska (54)
Radowski, Piotr Mitre	B60R 19/26 (2006.01) B60R 19/32 (2006.01) B60R 19/36 (2006.01) B60T 13/10 (2006.01) F01C 1/00 (2006.01) F03C 1/02 (2006.01)	2712344 *	IMPACT ENERGY CONVERSION DEVICE
Omya International AG	A61K 9/00 (2006.01) A61K 9/16 (2006.01) A61K 9/20 (2006.01)	2719376	Gastroretentive drug formulation and delivery systems and their method of preparation using functionalized calcium carbonate
SCA TISSUE FRANCE	A61K 8/02 (2006.01) A61K 8/04 (2006.01) A61K 8/44 (2006.01) A61K 8/73 (2006.01) A61K 8/81 (2006.01) A61Q 19/00 (2006.01) A61Q 19/10 (2006.01)	2723304 *	CLEANING COMPOSITION COMPRISING A GELLING AGENT AND A FOAMING SURFACTANT
Sanofi-Aventis Deutschland GmbH	A61M 5/24 (2006.01) A61M 5/315 (2006.01)	2704776 *	ASSEMBLY FOR A DRUG DELIVERY DEVICE AND DRUG DELIVERY DEVICE
Wabtec Holding Corp.	E06B 7/215 (2006.01)	2761120 *	SEALING ASSEMBLY FOR A SWING DOOR
Katholieke Universiteit Leuven	C07D 209/14 (2006.01) C07D 401/08 (2006.01) C07D 401/12 (2006.01) C07D 401/14 (2006.01) C07D 403/08 (2006.01) C07D 403/10 (2006.01) C07D 403/12 (2006.01) C07D 405/12 (2006.01) C07D 409/08 (2006.01) C07D 409/12 (2006.01) C07D 413/08 (2006.01) C07D 413/12 (2006.01) C07D 417/14 (2006.01) C07D 471/04 (2006.01) C07D 487/04 (2006.01)	2760831 *	VIRAL REPLICATION INHIBITORS
KALE Kilit ve Kalip Sanayi A.S.	E05B 17/00 (2006.01) E05B 45/06 (2006.01)	2722470	Alarm incorporated cylinder lock
Wobben Properties GmbH	H02K 1/24 (2006.01) H02K 15/02 (2006.01)	2719060 *	ELECTRIC MACHINE, SYNCHRONOUS GENERATOR-FIELD POLE, SYNCHRONOUS GENERATOR-ROTOR COMPRISING A PLURALITY OF FIELD POLES, AND METHOD FOR PRODUCING A SYNCHRONOUS GENERATOR-FIELD POLE OF AN ELECTRIC MACHINE
Ethicon Endo-Surgery, Inc.	A61B 17/064 (2006.01) A61L 31/04 (2006.01) A61L 31/14 (2006.01) A61L 31/16 (2006.01)	2644212	Tissue thickness compensator comprising controlled release and expansion
Genzyme Corporation	C07D 255/02 (2006.01)	2709991 *	USE OF CXCR4 ANTAGONISTS
University of Washington	C07D 255/02 (2006.01)	2709991 *	USE OF CXCR4 ANTAGONISTS
Array Biopharma Inc.	A61K 31/519 (2006.01) A61P 29/00 (2006.01) A61P 37/00 (2006.01) C07D 487/04 (2006.01)	2766368 *	5,7-SUBSTITUTED-IMIDAZO[1,2-C]PYRIMIDINES
Suven Life Sciences Limited	A61K 31/4245 (2006.01) A61K 31/445 (2006.01) A61P 25/00 (2006.01) C07D 413/14 (2006.01)	2758394 *	HETEROARYL COMPOUNDS AS 5-HT ₄ RECEPTOR LIGANDS
SANOFI	A61K 9/20 (2006.01) A61K 31/343 (2006.01) A61K 47/02 (2006.01) A61K 47/10 (2006.01) A61K 47/12 (2006.01) A61K 47/30 (2006.01) A61K 47/32 (2006.01) A61P 9/06 (2006.01)	2729132 *	PHARMACEUTICAL COMPOSITION AND SOLID GALENIC FORM HAVING A HIGH DRONEDARONE CONTENT, AND METHOD FOR PREPARING SAME

Podnosilac evropske prijave patenta (71)	MKP (51)	Broj objave evropske prijave patenta (97)	Naziv pronalaska (54)
Carrera Varela, José Antonio	B29C 47/00 (2006.01) B29C 47/08 (2006.01) B29C 47/92 (2006.01) C10L 5/46 (2006.01) C10L 5/48 (2006.01)	2711411 *	PROCESS AND APPARATUS FOR THE PRODUCTION OF A SOLID FUEL FROM COMBUSTIBLE WASTES
Galapagos N.V.	A61K 31/4162 (2006.01) A61P 19/02 (2006.01) C07D 471/04 (2006.01)	2702058 *	NOVEL COMPOUND USEFUL FOR THE TREATMENT OF DEGENERATIVE AND INFLAMMATORY DISEASES
Sanofi-Aventis Deutschland GmbH	A61M 5/32 (2006.01)	2734257 *	NEEDLE SHIELD ASSEMBLY
De Volder, Laurent	B05C 1/02 (2006.01) B41F 17/00 (2006.01) B41F 35/00 (2006.01) B41M 1/14 (2006.01) B41M 1/40 (2006.01)	2709848 *	PAD PRINTING SYSTEM AND METHOD THEREFOR
Feyaerts, Filip	B05C 1/02 (2006.01) B41F 17/00 (2006.01) B41F 35/00 (2006.01) B41M 1/14 (2006.01) B41M 1/40 (2006.01)	2709848 *	PAD PRINTING SYSTEM AND METHOD THEREFOR
Pigato, Massimo	A63H 19/32 (2006.01)	2666529	Device for actuating a switch for a model railroad
Roncaglione, Piera	A63H 19/32 (2006.01)	2666529	Device for actuating a switch for a model railroad
Yieh United Steel Corp.	C21C 5/00 (2006.01) C21C 5/28 (2006.01) C22B 3/00 (2006.01) C22B 3/04 (2006.01) C22B 3/20 (2006.01) C22B 23/00 (2006.01) C22C 1/00 (2006.01) C22C 33/04 (2006.01) C22C 38/40 (2006.01)	2679691	Method for manufacturing an austenitic stainless steel from a nickel laterite ore and a chromite ore
Emotional Brain B.V.	A61K 9/20 (2006.01) A61K 9/28 (2006.01) A61K 31/00 (2006.01) A61K 31/519 (2006.01) A61K 31/568 (2006.01)	2709597 *	DRUG DELIVERY SYSTEM
The Trustees Of The University Of Pennsylvania	A61K 31/4725 (2006.01) A61P 29/00 (2006.01) C07D 401/12 (2006.01) C07D 401/14 (2006.01)	2702054 *	NOVEL BISAMINOQUINOLINE COMPOUNDS, PHARMACEUTICAL COMPOSITIONS PREPARED THEREFROM AND THEIR USE
Eli Lilly and Company	A61K 39/395 (2006.01) C07K 16/00 (2006.01) C12P 21/08 (2006.01)	2758430 *	ANTI-C-MET ANTIBODIES
Wabtec Holding Corp.	B60J 5/04 (2006.01) F16H 21/28 (2006.01)	2709865 *	ELECTRIC DOOR OPERATOR
Amazonen-Werke H. Dreyer GmbH & Co. KG	A01M 7/00 (2006.01)	2768302 *	AGRICULTURAL FIELD-SPRAYING SYSTEM
ANGUS Chemical Company	B01J 8/00 (2006.01) B01J 8/18 (2006.01) B01J 8/22 (2006.01) C07C 29/68 (2006.01) C07C 209/52 (2006.01) C07C 213/02 (2006.01)	2701834 *	PROCESS AND APPARATUS FOR PRODUCTION AND FILTRATION OF AMINOALCOHOLS USING A CONTINUOUS STIRRED TANK SLURRY REACTOR
Eli Lilly and Company	A61K 31/4192 (2006.01) A61K 31/4196 (2006.01) A61P 25/18 (2006.01) A61P 25/22 (2006.01) A61P 25/24 (2006.01) C07D 249/04 (2006.01) C07D 249/12 (2006.01)	2721012 *	BICYCLO (3.1.0) HEXANE- 2, 6 -DICARBOXYLIC ACID DERIVATIVES AS MGLU2 RECEPTOR AGONIST
SANOFI	A61K 31/343 (2006.01) A61P 9/04 (2006.01)	2729140 *	DRONEDARONE FOR THE PREVENTION OF ATRIAL FIBRILLATION

Podnosilac evropske prijave patenta (71)	MKP (51)	Broj objave evropske prijave patenta (97)	Naziv pronalaska (54)
Kymab Limited	A01K 67/027 (2006.01) C07K 16/46 (2006.01) C12N 15/85 (2006.01)	2758534 *	ANIMALS, REPERTOIRES & METHODS FOR THE PRODUCTION OF HUMAN ANTIBODIES
Hamlet Protein A/S	A23K 1/00 (2006.01) A23L 1/305 (2006.01) A23L 1/314 (2006.01) C12P 7/06 (2006.01) C12P 7/10 (2006.01)	2764110 *	METHOD FOR THE SIMULTANEOUS PRODUCTION OF ETHANOL AND A FERMENTED, SOLID PRODUCT
Teva Pharmaceutical Industries Ltd.	A61K 31/11 (2006.01) A61K 31/135 (2006.01) A61K 31/21 (2006.01) A61P 25/00 (2006.01)	2766002 *	R(+)-N-FORMYL-PROPARGYL-AMINOINDAN
Island Kinetics Inc.	A61K 31/724 (2006.01) A61P 17/00 (2006.01) A61P 17/04 (2006.01) A61P 17/06 (2006.01) A61P 17/10 (2006.01) A61P 17/12 (2006.01) A61P 29/00 (2006.01) A61Q 19/00 (2006.01) A61Q 19/02 (2006.01) A61Q 19/08 (2006.01) C07H 3/06 (2006.01)	2755664 *	RETINAL CYCLODEXTRIN ACETALS AND HEMIACETALS FOR CLARIFYING SKIN COMPLEXION
Qualcomm Incorporated	G06F 1/16 (2006.01) G06F 3/01 (2006.01) G06F 3/03 (2006.01) G06F 3/048 (2013.01)	2724210 *	GESTURE-CONTROLLED TECHNIQUE TO EXPAND INTERACTION RADIUS IN COMPUTER VISION APPLICATIONS
Bayer Intellectual Property GmbH	A61K 31/53 (2006.01) A61P 9/00 (2006.01) A61P 31/00 (2006.01) C07C 311/13 (2006.01) C07D 251/16 (2006.01) C07D 251/22 (2006.01) C07D 401/12 (2006.01) C07D 405/04 (2006.01) C07D 405/12 (2006.01) C07D 413/12 (2006.01) C07D 417/12 (2006.01)	2714654 *	4-ARYL-N-PHENYL-1,3,5-TRIAZIN-2-AMINES CONTAINING A SULFOXIMINE GROUP
C.T.A. S.R.L. Dei Fratelli Torresi	F16L 21/00 (2006.01) F16L 21/08 (2006.01) F16L 25/00 (2006.01)	2677222	A system for channeling and distributing fluids in pressure or depression
DuPont Nutrition Biosciences ApS	C10L 1/12 (2006.01) C10L 1/198 (2006.01)	2726579 *	COMPOSITION
Enanta Pharmaceuticals, Inc.	A61K 38/12 (2006.01)	2768517 *	HEPATITIS C VIRUS INHIBITORS
Hexal AG	A61K 9/20 (2006.01) A61K 47/10 (2006.01) A61K 47/12 (2006.01)	2753309 *	PHARMACEUTICAL COMPOSITION FOR ORAL ADMINISTRATION WITH A STATIN
Sambusseti, Antonio	A61F 2/30 (2006.01) A61F 2/42 (2006.01)	2713958 *	FLEXIBLE SURGICALLY IMPLANTABLE DEVICE, MADE OF COATED SILICONE, FOR JOINING PHALANXES, METACARPUS-PHALANX OR METATARSUS-PHALANX BONES IN ARTHROPLASTY SURGERY
Gilead Sciences, Inc.	C07F 9/40 (2006.01) C07F 9/44 (2006.01) C07H 19/20 (2006.01)	2710019 *	PROCESSES AND INTERMEDIATES FOR PREPARING ANTI-HIV AGENTS
SDI Limited	A61C 5/06 (2006.01) B65D 1/02 (2006.01) B65D 39/16 (2006.01)	2545878	Liquid container
Swarovski Lighting, Ltd.	F21S 8/06 (2006.01) F21V 5/06 (2006.01) F21V 17/16 (2006.01)	2511604	Crystal mounting frame and light assembly

Podnosilac evropske prijave patenta (71)	MKP (51)	Broj objave evropske prijave patenta (97)	Naziv pronalaska (54)
Boehringer Ingelheim Vetmedica GmbH	A61K 9/00 (2006.01) A61K 9/50 (2006.01) A61K 31/55 (2006.01) A61P 9/04 (2006.01)	2741735 *	FUNNY CURRENT (IF) INHIBITORS FOR USE IN A METHOD OF TREATING AND PREVENTING HEART FAILURE IN FELINE
Chiesi Farmaceutici S.p.A.	A61K 31/519 (2006.01) A61P 11/00 (2006.01) C07D 487/04 (2006.01)	2766366 *	TETRAHYDROTRIAZOLOPYRIMIDINE DERIVATIVES AS HUMAN NEUTROPHIL ELASTASE INHIBITORS
Qualcomm Incorporated	H04M 1/725 (2006.01) H04W 4/02 (2009.01)	2732609 *	DYNAMIC SUBSUMPTION INFERENCE
Incyte Corporation	A61K 31/437 (2006.01) A61K 31/519 (2006.01) A61P 29/00 (2006.01) A61P 35/00 (2006.01) A61P 37/02 (2006.01) C07D 471/04 (2006.01) C07D 487/04 (2006.01)	2721028 *	AZETIDINYL PHENYL, PYRIDYL OR PYRAZINYL CARBOXYAMIDE DERIVATIVES AS JAK INHIBITORS
Swarovski Lighting, Ltd.	F21S 8/00 (2006.01) F21S 8/06 (2006.01) F21V 5/00 (2006.01) F21V 5/02 (2006.01) F21V 5/06 (2006.01) F21Y 101/02 (2006.01) F21Y 105/00 (2006.01)	2511593	Lighting fixtures having illuminated crystal panels and methods for providing illumination
University Hospitals Cleveland Medical Center	A61M 1/00 (2006.01)	2723414 *	IMPLANT INSERTION DEVICE AND METHOD OF USE THEREOF
Janssen Biotech, Inc.	C40B 40/10 (2006.01) C40B 50/00 (2006.01)	2761066 *	FIBRONECTIN TYPE III REPEAT BASED PROTEIN SCAFFOLDS WITH ALTERNATIVE BINDING SURFACES
QUALCOMM INCORPORATED	G06F 17/30 (2006.01) G10L 15/22 (2006.01) H04M 3/493 (2006.01)	2710587 *	AUTOMATED CONVERSATION ASSISTANCE
KABUSHIKI KAISHA TOYOTA JIDOSHOKKI	F01K 13/00 (2006.01)	2703608	Rankine cycle system
Ethicon Endo-Surgery, Inc.	A61B 17/00 (2006.01) A61B 17/28 (2006.01) A61B 17/29 (2006.01) A61B 18/00 (2006.01) A61B 18/08 (2006.01)	2679175	Surgical instrument
Janssen Pharmaceutica, N.V.	A61K 31/4985 (2006.01) A61P 25/18 (2006.01) C07D 487/04 (2006.01)	2702062 *	SALT OF AN INHIBITOR OF PHOSPHODIESTERASE 10 ENZYME
IMA INDUSTRIES S.R.L.	B65B 7/16 (2006.01) B65B 29/02 (2006.01) B65B 61/20 (2006.01) B65D 85/804 (2006.01)	2748088 *	METHOD AND MACHINE FOR PRODUCING A SINGLE-USE CAPSULE FOR BEVERAGES AND CAPSULE OBTAINED USING METHOD
Delphi International Operations Luxembourg S.à.r.l.	F02M 59/10 (2006.01) F04B 1/04 (2006.01) F16H 53/06 (2006.01)	2657505	High pressure fuel pump assembly
FAPIM S.p.A.	E05D 7/00 (2006.01)	2682551	An adjustable hinge for windows and doors
7267207 Canada Limited Corporation	A23G 3/36 (2006.01) A23L 1/05 (2006.01) A23P 1/10 (2006.01) A61K 9/00 (2006.01) A61K 31/137 (2006.01) A61K 31/138 (2006.01) A61K 31/167 (2006.01) A61K 31/192 (2006.01) A61K 31/4545 (2006.01) A61K 31/495 (2006.01) A61K 47/10 (2006.01) A61K 47/26 (2006.01) A61K 47/36 (2006.01) A61K 47/42 (2006.01)	2461797 *	PROCESS FOR PREPARATION OF OVER-THE-COUNTER GELATIN OR PECTIN-BASED DRUG DELIVERY

Podnosilac evropske prijave patenta (71)	MKP (51)	Broj objave evropske prijave patenta (97)	Naziv pronalaska (54)
Ajinomoto Co., Inc.	A61J 1/10 (2006.01) B65D 30/16 (2006.01)	2767270 *	STANDING BAG INFUSION CONTAINER
Zachodniopomorski Uniwerytet Technologiczny w Szczecinie	A01N 25/28 (2006.01) A23L 1/22 (2006.01) A61K 9/50 (2006.01) A61K 47/00 (2006.01) B01J 13/02 (2006.01) B01J 20/30 (2006.01) C08B 30/12 (2006.01) C08B 30/14 (2006.01) C08L 3/00 (2006.01)	2740532	Method of producing a starch-containing material
Keurig Green Mountain, Inc.	B67D 1/00 (2006.01) B67D 1/04 (2006.01) B67D 3/00 (2006.01)	2739559 *	METHOD AND APPARATUS FOR CARTRIDGE-BASED CARBONATION OF BEVERAGES
Vasper Systems LLC	A61F 7/00 (2006.01)	2701643 *	APPARATUS AND METHOD FOR ENHANCED GHG GENERATION IN HUMANS
John GmbH	B29D 22/04 (2006.01)	2722160	Method for manufacturing plastic balls and plastic ball
Regeneron Pharmaceuticals, Inc.	A61K 39/395 (2006.01) A61P 35/00 (2006.01) C07K 16/28 (2006.01)	2744827 *	ANTI-TIE2 ANTIBODIES USES THEREOF
AmVac AG	C12N 15/86 (2006.01)	2669381	Method for expression of heterologous proteins using a recombinant negative-strand RNA virus vector comprising a mutated P protein
New Rainbow S.n.c.	G09F 7/18 (2006.01) G09F 7/20 (2006.01) G09F 15/00 (2006.01)	2718923 *	POSTER HOLDER
Shionogi & Co., Ltd.	A61K 31/546 (2006.01) A61P 31/04 (2006.01) C07D 501/18 (2006.01) C07D 501/46 (2006.01) C07D 519/06 (2006.01)	2703406 *	NOVEL CEPHEM COMPOUND HAVING CATECHOL OR PSEUDO-CATECHOL STRUCTURE
Philadelphia Health and Education Corporation	A61K 39/08 (2006.01) A61K 48/00 (2006.01)	2741785 *	NOVEL CLOSTRIDIUM DIFFICILE DNA VACCINE
Inovio Pharmaceuticals, Inc.	A61K 39/08 (2006.01) A61K 48/00 (2006.01)	2741785 *	NOVEL CLOSTRIDIUM DIFFICILE DNA VACCINE
The Trustees of the University of Pennsylvania	A61K 39/08 (2006.01) A61K 48/00 (2006.01)	2741785 *	NOVEL CLOSTRIDIUM DIFFICILE DNA VACCINE
Biogen Idec MA Inc.	C07C 69/74 (2006.01)	2718257 *	PROCESS FOR PREPARING HIGH PURITY AND CRYSTALLINE DIMETHYL FUMARATE
Farma GRS, d.o.o.	A61K 31/47 (2006.01) A61P 3/00 (2006.01) A61P 9/00 (2006.01) B01D 9/02 (2006.01) C07D 215/14 (2006.01)	2751081 *	POLYMORPHIC FORM OF PITAVASTATIN CALCIUM
Ultrabatch S.r.l.	A01G 9/14 (2006.01) B32B 27/20 (2006.01) B32B 27/30 (2006.01) C08J 3/22 (2006.01) C08K 3/22 (2006.01)	2747549 *	LAMINAR BODY FOR MAKING GREENHOUSE ROOFS AND METHOD OF GREENHOUSE CULTIVATION
Agriphar S.A.	A01N 25/02 (2006.01) A01N 25/30 (2006.01) A01N 37/42 (2006.01) A01N 43/40 (2006.01) A01N 43/50 (2006.01) A01N 43/653 (2006.01) A01N 47/12 (2006.01) A01N 47/20 (2006.01) A01N 53/00 (2006.01)	2734040 *	IMPROVED METHOD FOR PRODUCING EMULSIFIABLE PESTICIDE SOLUTIONS
Universität Zürich	A61K 38/04 (2006.01) A61K 38/16 (2006.01) C07K 14/025 (2006.01)	2734218 *	POLYOMA VIRUS JC PEPTIDES AND PROTEINS IN VACCINATION AND DIAGNOSTIC APPLICATIONS

Podnosilac evropske prijave patenta (71)	MKP (51)	Broj objave evropske prijave patenta (97)	Naziv pronalaska (54)
Theravance, Inc.	A61P 9/00 (2006.01) C07C 233/00 (2006.01)	2714648 *	NEPRILYSIN INHIBITORS
MacroGenics, Inc.	A61K 39/395 (2006.01)	2714079 *	DEIMMUNIZED SERUM-BINDING DOMAINS AND THEIR USE FOR EXTENDING SERUM HALF-LIFE
Receptos, Inc.	A61K 31/24 (2006.01) A61K 31/341 (2006.01) A61K 31/343 (2006.01) A61K 31/351 (2006.01) A61K 31/381 (2006.01) A61K 31/40 (2006.01) A61K 31/41 (2006.01) A61K 31/415 (2006.01) A61K 31/421 (2006.01) A61K 31/423 (2006.01) A61K 31/428 (2006.01) A61K 31/433 (2006.01) A61K 31/437 (2006.01) A61K 31/4406 (2006.01) A61K 31/445 (2006.01) A61K 31/47 (2006.01) A61K 31/495 (2006.01) A61K 31/498 (2006.01) A61K 31/5375 (2006.01) A61K 38/16 (2006.01) C07D 265/30 (2006.01)	2579888 *	NOVEL GLP-1 RECEPTOR STABILIZERS AND MODULATORS
Constellation Pharmaceuticals, Inc.	A61K 31/5517 (2006.01) A61P 35/00 (2006.01) C07D 401/04 (2006.01) C07D 487/04 (2006.01)	2705039 *	BROMODOMAIN INHIBITORS AND USES THEREOF
Aquasource Technologies Corporation	B01D 3/00 (2006.01)	2755731 *	SYSTEM AND METHOD FOR WATER TREATMENT
Yale University	C12Q 1/68 (2006.01)	2723901 *	COMPOSITIONS AND METHODS OF DIAGNOSING DISEASES AND DISORDERS ASSOCIATED WITH CELL DEATH
Janssen Pharmaceuticals, Inc.	C07D 311/06 (2006.01) C07D 417/04 (2006.01) C07D 453/04 (2006.01)	2758386 *	PROCESSES AND INTERMEDIATES FOR PREPARING A MACROCYCLIC PROTEASE INHIBITOR OF HCV
Vimar SpA	H01H 13/28 (2006.01) H01H 13/56 (2006.01) H01H 23/20 (2006.01) H01H 23/24 (2006.01)	2672498	Electrical device with axial control
Unico, Inc.	E21B 43/16 (2006.01) F04B 9/02 (2006.01)	2718566 *	CRANKED ROD PUMP APPARATUS AND METHOD
Olive Medical Corporation	A61B 1/04 (2006.01)	2706904 *	IMPROVED IMAGE SENSOR FOR ENDOSCOPIC USE
Scharmüller, Josef	B60D 1/167 (2006.01) B60D 1/32 (2006.01) B60D 1/58 (2006.01)	2741931 *	TOW BAR
Scharmüller, Josef, jun.	B60D 1/167 (2006.01) B60D 1/32 (2006.01) B60D 1/58 (2006.01)	2741931 *	TOW BAR
Plaxica Limited	C12P 7/56 (2006.01) C12P 41/00 (2006.01)	2732043 *	SEPARATION PROCESS
Delphi Technologies, Inc.	F02M 53/04 (2006.01) F02M 61/14 (2006.01)	2385242	Isolator for fuel injector
The Board of Trustees of the Leland Stanford Junior University	C12N 5/10 (2006.01)	2702146 *	IDENTIFICATION OF POLYNUCLEOTIDES ASSOCIATED WITH A SAMPLE
Department of Veterans Affairs	C12N 5/10 (2006.01)	2702146 *	IDENTIFICATION OF POLYNUCLEOTIDES ASSOCIATED WITH A SAMPLE
Gilead Sciences, Inc.	C07F 9/6561 (2006.01)	2764002 *	METHODS FOR PREPARING ANTI-VIRAL NUCLEOTIDE ANALOGS

Podnosilac evropske prijave patenta (71)	MKP (51)	Broj objave evropske prijave patenta (97)	Naziv pronalaska (54)
University Hospitals Cleveland Medical Center	C12N 5/00 (2006.01) C12N 5/02 (2006.01)	2721144 *	AMPLIFICATION ENHANCEMENT OF BLOOD DERIVED PROGENITOR CELLS USING A CLOSED CULTURE SYSTEM
Nurkovic, Suljo	A61K 36/14 (2006.01) A61P 17/02 (2006.01) A61P 17/06 (2006.01)	2644202	Ointment for skin treatment, and method of its manufacture
Exelixis, Inc.	C07C 231/02 (2006.01) C07C 233/59 (2006.01) C07D 215/22 (2006.01) C07D 413/12 (2006.01)	2768796 *	PROCESS FOR PREPARING QUINOLINE DERIVATIVES
Shanghai Yi Hsin Industry Co., Ltd.	B32B 15/08 (2006.01) B32B 23/08 (2006.01)	2740595 *	METHOD FOR MAKING AND PROCESSING FLEXIBLE PLATE MATERIAL
The Regents of The University of California	A61K 31/415 (2006.01) A61K 31/496 (2006.01) A61K 31/4965 (2006.01) A61K 38/48 (2006.01) A61P 1/00 (2006.01) A61P 29/00 (2006.01) A61P 31/04 (2006.01)	2621521 *	MINIMIZING INTESTINAL DYSFUNCTION
Schneider Electric Industries SAS	H01H 71/12 (2006.01) H01H 83/10 (2006.01)	2765590 *	TRIPPING MECHANISM FOR SURGE PROTECTOR AND SURGE PROTECTOR
Delphi International Operations Luxembourg S.à.r.l.	F02M 59/20 (2006.01) F02M 59/36 (2006.01) F02M 59/46 (2006.01) F02M 63/02 (2006.01)	2647824	Injection pump systems and methods of operation
Green Well Technology AS	E21B 33/072 (2006.01)	2769052 *	DEVICE FOR RECIRCULATING GREASE/SEALING OIL IN RISERS
Flexion Therapeutics, Inc.	A61K 31/56 (2006.01)	2739287 *	CORTICOSTEROIDS FOR THE TREATMENT OF JOINT PAIN
St. Jude Children's Research Hospital	A61K 39/155 (2006.01) C12N 7/01 (2006.01) C12N 15/86 (2006.01)	2702159 *	MODIFIED SENDAI VIRUS VACCINE AND IMAGING VECTOR
Keyline S.P.A.	B23C 3/35 (2006.01) B25B 1/24 (2006.01)	2714336 *	CLAMPING DEVICE FOR A MACHINE FOR DUPLICATING KEYS
Lobepro, Inc.	F04C 2/00 (2006.01)	2739854 *	PISTON WITH REPLACEABLE AND/OR ADJUSTABLE SURFACES
Tempero Pharmaceuticals, Inc.	A01N 37/18 (2006.01) A61K 31/165 (2006.01) C07C 233/00 (2006.01)	2736329 *	COMPOUNDS AND METHODS
Eolys Ressources et Energies	F03D 7/02 (2006.01)	2657516	Wind turbine including an electromagnetic retarder for slowing the blade rotation speed
Massachusetts Institute of Technology	F01K 7/16 (2006.01) F01K 23/10 (2006.01) F01K 25/08 (2006.01)	2718547 *	DOUBLE PINCH CRITERION FOR OPTIMIZATION OF REGENERATIVE RANKINE CYCLES
Advanced Design Innovations Pty Limited	E06B 9/26 (2006.01) E06B 9/302 (2006.01)	2737151 *	A RETRACTABLE LOUVRE SYSTEM
Ambrx, Inc.	A61K 31/427 (2006.01) A61P 35/00 (2006.01) C07D 207/325 (2006.01) C07D 401/12 (2006.01) C07D 417/12 (2006.01)	2714685 *	COMPOSITIONS CONTAINING, METHODS INVOLVING, AND USES OF NON-NATURAL AMINO ACID LINKED DOLASTATIN DERIVATIVES
Array Biopharma, Inc.	A61K 31/437 (2006.01) A61P 35/00 (2006.01) C07D 471/04 (2006.01)	2766363 *	POLYMORPHS OF ARRY-380, A SELECTIVE HERB2 INHIBITOR AND PHARMACEUTICAL COMPOSITIONS CONTAINING THEM
Huntington Alloys Corporation	C21D 1/00 (2006.01) C22C 19/05 (2006.01) C22C 38/00 (2006.01) C22C 38/44 (2006.01) C22F 1/10 (2006.01)	2734655 *	HIGH-STRENGTH CORROSION-RESISTANT TUBING FOR OIL AND GAS COMPLETION AND DRILLING APPLICATIONS, AND PROCESS FOR MANUFACTURING THEREOF
Amgen Inc.	A61K 39/395 (2006.01) A61P 3/06 (2006.01) C07K 16/40 (2006.01)	2707029 *	METHODS OF TREATING OR PREVENTING CHOLESTEROL RELATED DISORDERS

Podnosilac evropske prijave patenta (71)	MKP (51)	Broj objave evropske prijave patenta (97)	Naziv pronalaska (54)
Hisamitsu Pharmaceutical Co., Inc.	A61K 9/70 (2006.01) A61K 31/167 (2006.01) A61K 47/12 (2006.01) A61K 47/42 (2006.01) A61P 23/02 (2006.01)	2722040 *	LIDOCAINE-CONTAINING CATAPLASM
Gilead Sciences, Inc.	A61K 31/4196 (2006.01) A61K 31/495 (2006.01) A61K 45/06 (2006.01) A61P 3/10 (2006.01)	2758053 *	SODIUM CHANNEL BLOCKERS REDUCE GLUCAGON SECRETION
Femalon S.P.R.L.	A61K 9/00 (2006.01) A61K 9/19 (2006.01) A61K 9/70 (2006.01) A61K 31/675 (2006.01) A61K 47/38 (2006.01)	2731588 *	COMPOSITION AND METHOD FOR TREATING HPV
Université Libre de Bruxelles	A61K 9/00 (2006.01) A61K 9/19 (2006.01) A61K 9/70 (2006.01) A61K 31/675 (2006.01) A61K 47/38 (2006.01)	2731588 *	COMPOSITION AND METHOD FOR TREATING HPV
Burcon Nutrascience (MB) Corp.	A23J 1/14 (2006.01) A23J 3/16 (2006.01) C07K 1/14 (2006.01) C07K 14/415 (2006.01)	2709463 *	PRODUCTION OF SOLUBLE SOY PROTEIN PRODUCT ("S704")
Dignity Sciences Limited	A61K 31/202 (2006.01) A61P 17/00 (2006.01) A61P 17/10 (2006.01)	2768495 *	PHARMACEUTICAL COMPOSITIONS COMPRISING DGLA, 15-OHEPA, AND/OR 15-HETRE AND METHODS OF USE THEREOF
Logomotion, s.r.o.	G06Q 20/20 (2012.01) G07F 7/08 (2006.01) G07G 1/00 (2006.01)	2702572 *	THE METHOD OF CASHLESS PERSON-TO-PERSON MONEY TRANSFER OF USING A MOBILE PHONE
NP Poschmann GmbH	F16C 19/06 (2006.01) F16C 33/60 (2006.01) F16C 35/077 (2006.01) F16C 43/04 (2006.01)	2711574	Ball bearing and method for manufacturing a ball bearing
Antares Hungary Kft.	A47C 7/02 (2006.01)	2735247	Office-chair
PenAndFree Co., Ltd.	A45C 11/00 (2006.01)	2764793 *	MOBILE COMMUNICATION TERMINAL CASE AND TABLET PC CASE
Bonac Corporation	C07B 59/00 (2006.01) C07H 1/02 (2006.01) C07H 21/02 (2006.01)	2722335 *	PROCESS FOR PREPARING PHOSPHATE COMPOUND BEARING ISOTOPE
Merial Limited	A61K 39/12 (2006.01) C07K 14/005 (2006.01) C12N 15/86 (2006.01)	2734230 *	RECOMBINANT FELINE LEUKEMIA VIRUS VACCINE CONTAINING OPTIMIZED FELINE LEUKEMIA VIRUS ENVELOPE GENE
Centre National de la Recherche Scientifique	A61K 39/12 (2006.01) C07K 14/005 (2006.01) C12N 15/86 (2006.01)	2734230 *	RECOMBINANT FELINE LEUKEMIA VIRUS VACCINE CONTAINING OPTIMIZED FELINE LEUKEMIA VIRUS ENVELOPE GENE
Institut Gustave Roussy	A61K 39/12 (2006.01) C07K 14/005 (2006.01) C12N 15/86 (2006.01)	2734230 *	RECOMBINANT FELINE LEUKEMIA VIRUS VACCINE CONTAINING OPTIMIZED FELINE LEUKEMIA VIRUS ENVELOPE GENE
Université Paris Sud	A61K 39/12 (2006.01) C07K 14/005 (2006.01) C12N 15/86 (2006.01)	2734230 *	RECOMBINANT FELINE LEUKEMIA VIRUS VACCINE CONTAINING OPTIMIZED FELINE LEUKEMIA VIRUS ENVELOPE GENE
TechLab, Inc.	C12P 21/04 (2006.01) G01N 33/00 (2006.01)	2705154 *	FECAL LACTOFERRIN AS A BIOMARKER FOR DETERMINING DISEASE SEVERITY AND FOR MONITORING INFECTION IN PATIENTS WITH CLOSTRIDIUM DIFFICILE DISEASE
Bordignon Simone S.r.l.	B23G 1/04 (2006.01) B23G 1/18 (2006.01)	2650072	Automatic threading machine
Difass International S.r.l.	A61K 31/05 (2006.01) A61K 36/61 (2006.01) A61K 45/06 (2006.01) A61P 17/04 (2006.01)	2709606 *	COMPOSITIONS CONTAINING RESVERATROL AND ESSENTIAL OIL OF CLOVES FOR THE TREATMENT OF ITCHING

Podnosilac evropske prijave patenta (71)	MKP (51)	Broj objave evropske prijave patenta (97)	Naziv pronalaska (54)
Université Lille 1 - Sciences Et Technologies	G06F 3/01 (2006.01)	2707787 *	TRANSPARENT VIBRATING TOUCH INTERFACE
Literáti Nagy, Botond	A61K 31/4523 (2006.01) A61K 31/5395 (2006.01) A61K 35/28 (2006.01) A61K 45/06 (2006.01) A61P 43/00 (2006.01)	2760449 *	A PHARMACEUTICAL COMPOSITION FOR THE TREATMENT OF STEM CELLS
Axon Neuroscience SE	A61K 39/00 (2006.01) A61P 25/28 (2006.01) C07K 14/47 (2006.01) C07K 16/18 (2006.01) G01N 33/53 (2006.01)	2758433 *	PROTEIN-BASED THERAPY AND DIAGNOSIS OF TAU-MEDIATED PATHOLOGY IN ALZHEIMER'S DISEASE
Ogin, Inc.	F03D 1/04 (2006.01) F03D 11/00 (2006.01)	2756187 *	FLUID TURBINE LIGHTNING PROTECTION SYSTEM
CHDI Foundation, Inc.	C07D 239/47 (2006.01)	2751086 *	KYNURENINE-3-MONOOXYGENASE INHIBITORS, PHARMACEUTICAL COMPOSITIONS, AND METHODS OF USE THEREOF
IP Science Limited	A23L 1/30 (2006.01) A23L 1/38 (2006.01) A61K 8/99 (2006.01) A61K 36/06 (2006.01) G01N 33/564 (2006.01)	2753193 *	PRODUCTS AND METHODS
Cellzome Limited	A61K 31/519 (2006.01) C07D 417/02 (2006.01)	2763985 *	MORPHOLINO SUBSTITUTED BICYCLIC PYRIMIDINE UREA OR CARBAMATE DERIVATIVES AS MTOR INHIBITORS
The Trustees Of The University Of Pennsylvania	A61K 35/12 (2006.01) C12P 21/00 (2006.01) H01L 21/00 (2006.01)	2756521 *	RNA ENGINEERED T CELLS FOR THE TREATMENT OF CANCER
THE UNIVERSITY OF WASHINGTON	A61K 38/46 (2006.01)	2704737 *	THERAPEUTIC NUCLEASE COMPOSITIONS AND METHODS
Yale University, Inc.	A61K 31/337 (2006.01) A61P 35/00 (2006.01)	2701700 *	DRUG THERAPY TO INHIBIT CHEMOTHERAPY-INDUCED ADVERSE EFFECTS AND RELATED PHARMACEUTICAL COMPOSITIONS, DIAGNOSTICS, SCREENING TECHNIQUES AND KITS
Estetra S.P.R.L.	C07J 75/00 (2006.01)	2764008 *	PROCESS FOR THE PRODUCTION OF ESTETROL
Zachodniopomorski Uniwersytet Technologiczny w Szczecinie	B01J 20/04 (2006.01) B01J 20/28 (2006.01) C02F 1/28 (2006.01) C02F 101/10 (2006.01) C02F 103/00 (2006.01)	2733119	Agent for removing dissolved phosphorus compounds from water
Halozyme, Inc.	A61K 38/47 (2006.01) A61P 3/10 (2006.01)	2720713 *	CONTINUOUS SUBCUTANEOUS INSULIN INFUSION METHODS WITH A HYALURONAN DEGRADING ENZYME
Glaxosmithkline Intellectual Property (No. 2) Limited	A01N 43/42 (2006.01)	2744333 *	FATTY ACID SYNTHASE INHIBITORS
Cellzome Limited	A61K 31/505 (2006.01) A61P 35/00 (2006.01) C07D 403/12 (2006.01) C07D 491/10 (2006.01)	2736901 *	HETEROCYCLYL PYRIMIDINE ANALOGUES AS JAK INHIBITORS
Exelixis, Inc.	A61K 31/47 (2006.01) A61P 19/10 (2006.01)	2758057 *	METHOD FOR TREATING OSTEOPOROSIS
Trans Bio-Diesel Ltd.	C12P 7/64 (2006.01)	2751275 *	ENZYMATIC TRANSESTERIFICATION WITH LIPASES IMMOBILIZED ON HYDROPHOBIC RESINS IN WATER SOLUTIONS
The Wistar Institute	C12Q 1/70 (2006.01)	2714941 *	COMPOSITIONS AND METHODS FOR MODULATING THE ACTIVITY OF EPSTEIN-BARR NUCLEAR ANTIGEN 1
Innovative Technological Systems S.r.l.	F02G 1/043 (2006.01)	2707588 *	EXTERNAL COMBUSTION ENGINE

Podnosilac evropske prijave patenta (71)	MKP (51)	Broj objave evropske prijave patenta (97)	Naziv pronalaska (54)
AEG Power Solutions GmbH	H02J 3/26 (2006.01) H02M 7/48 (2007.01)	2670041	Power supply assembly with an inverter for creating N-phase alternating current
Chongqing Huabangshengkai Pharm. Co., Ltd	C07C 403/20 (2006.01)	2708530 *	STEREOSPECIFIC SYNTHESIS PROCESS FOR TRETINOIN COMPOUNDS
Medicis Pharmaceutical Corporation	A01N 43/50 (2006.01)	2725904 *	HIGH DOSAGE MUCOADHESIVE METRONIDAZOLE AQUEOUS-BASED GEL FORMULATIONS THEIR USE TO TREAT BACTERIAL VAGINOSIS
Université de Genève	A61K 31/7105 (2006.01) A61P 35/00 (2006.01)	2723350 *	NEW USES OF NANOG INHIBITORS AND RELATED METHODS
Barokes PTY Ltd.	B65D 1/02 (2006.01) B67C 3/02 (2006.01) C12G 1/00 (2006.01)	2767583	Wine packaged in aluminium containers
Genentech, Inc.	C12Q 1/68 (2006.01)	2761025 *	DIAGNOSTIC METHYLATION MARKERS OF EPITHELIAL OR MESENCHYMAL PHENOTYPE AND RESPONSE TO EGFR KINASE INHIBITOR IN TUMOURS OR TUMOUR CELLS
Reliance Industries Limited	C08F 10/06 (2006.01)	2707400 *	CATALYST SYSTEM FOR POLYMERIZATION OF PROPYLENE
Kutschera, Wilhelm	B61D 3/16 (2006.01) B61D 45/00 (2006.01)	2684757	Freight cars
Bayer Intellectual Property GmbH	A61K 31/519 (2006.01) A61P 9/00 (2006.01) C07D 471/04 (2006.01) C07D 487/04 (2006.01) C07D 519/00 (2006.01)	2751106 *	SUBSTITUTED ANNELLATED PYRIMIDINE AND THE USE THEREOF
Bayer Pharma Aktiengesellschaft	A61K 31/519 (2006.01) A61P 9/00 (2006.01) C07D 471/04 (2006.01) C07D 487/04 (2006.01) C07D 519/00 (2006.01)	2751106 *	SUBSTITUTED ANNELLATED PYRIMIDINE AND THE USE THEREOF
Acclarent, Inc.	A61B 17/34 (2006.01) A61F 11/00 (2006.01)	2649972	Tympanostomy tube delivery system
AiCuris GmbH & Co. KG	A61K 39/245 (2006.01) C07D 239/84 (2006.01) C07D 401/04 (2006.01) C07D 401/12 (2006.01) C07D 413/04 (2006.01)	2707026 *	PRODUCTION OF DENSE BODIES (DB) FROM HCMV-INFECTED CELLS
ESBATEch - a Novartis Company LLC	A61K 39/395 (2006.01) C07K 16/00 (2006.01) C07K 16/22 (2006.01) C07K 16/24 (2006.01) C07K 16/46 (2006.01)	2768855 *	STABLE MULTIPLE ANTIGEN-BINDING ANTIBODY
Kattens No. 1	A01K 15/02 (2006.01)	2661961	A modular climbing tree and method of assembling the climbing tree
GlaxoSmithKline Intellectual Property Development Limited	G06G 7/58 (2006.01)	2745235 *	METHOD OF DRUG REPOSITIONING
Wobben Properties GmbH	B28B 7/00 (2006.01) B28B 7/22 (2006.01) B28B 17/00 (2006.01) B28B 21/02 (2006.01) B28B 21/82 (2006.01) B28B 23/00 (2006.01) E04H 12/12 (2006.01) F03D 11/04 (2006.01) G01B 11/24 (2006.01)	2723544 *	PRODUCTION OF A TOWER

Podnosilac evropske prijave patenta (71)	MKP (51)	Broj objave evropske prijave patenta (97)	Naziv pronalaska (54)
Taisho Pharmaceutical Co., Ltd.	A61K 31/454 (2006.01) A61K 31/4545 (2006.01) A61K 31/506 (2006.01) A61P 1/00 (2006.01) A61P 5/00 (2006.01) A61P 9/12 (2006.01) A61P 25/04 (2006.01) A61P 25/08 (2006.01) A61P 25/16 (2006.01) A61P 25/20 (2006.01) A61P 25/22 (2006.01) A61P 25/24 (2006.01) A61P 25/28 (2006.01) A61P 25/30 (2006.01) A61P 29/00 (2006.01) A61P 37/00 (2006.01) A61P 43/00 (2006.01) C07D 413/14 (2006.01) C07D 498/04 (2006.01)	2730573 *	METHYLPYPERIDINE DERIVATIVE
Hexal AG	A61J 3/07 (2006.01) B26D 1/36 (2006.01) B26D 1/38 (2006.01) B26D 7/10 (2006.01)	2641582	Packaging device for a flat administration form
A. Nattermann & Cie. GmbH	A61K 36/185 (2006.01) A61K 36/53 (2006.01)	2712319 *	ALCOHOL-FREE PHARMACEUTICAL COMPOSITION COMPRISING THYME AND PRIMULA ROOT LIQUID EXTRACTS
L'Oréal	A61K 8/02 (2006.01) A61K 8/30 (2006.01) A61K 8/37 (2006.01) A61K 8/41 (2006.01) A61K 8/72 (2006.01) A61Q 19/00 (2006.01)	2760424 *	COSMETIC COMPOSITIONS COMPRISING LATEX FILM FORMERS
Dick, Kyle	B60F 3/00 (2006.01) B63B 1/12 (2006.01) B63B 15/00 (2006.01) B63B 25/00 (2006.01) B63B 25/28 (2006.01) B63B 27/14 (2006.01)	2726306 *	IMPROVEMENTS IN OR RELATING TO A VESSEL
Creatics LLC	C12Q 1/68 (2006.01) G01N 33/50 (2006.01) G01N 33/68 (2006.01)	2756298 *	NON-INVASIVE METHODS OF DETECTING TARGET MOLECULES
Telsmith, Inc.	B02C 2/00 (2006.01)	2763794 *	APPARATUS AND METHOD FOR AN ANTI-SPIN SYSTEM
Hydro-Québec	H02J 3/00 (2006.01) H02J 13/00 (2006.01)	2735081 *	SWITCHING APPARATUS, CONTROL SYSTEM AND METHOD FOR VARYING AN IMPEDANCE OF A PHASE LINE
Agios Pharmaceuticals, Inc.	A61K 31/44 (2006.01) A61K 31/4427 (2006.01) A61P 35/00 (2006.01) C07D 401/02 (2006.01) C07D 401/04 (2006.01) C07D 401/14 (2006.01) C07D 405/00 (2006.01)	2721019 *	THERAPEUTICALLY ACTIVE COMPOSITIONS AND THEIR METHODS OF USE
ROBERT BOSCH GMBH	F16L 11/12 (2006.01) F16L 57/02 (2006.01)	2623843	Combination of a heating device, a connector, and a gas meter, as well as method for measuring a property of a gas
Janssen Pharmaceutica, N.V.	A61K 31/166 (2006.01) A61K 31/195 (2006.01) A61P 3/08 (2006.01) A61P 5/50 (2006.01) C07C 231/12 (2006.01) C07C 233/83 (2006.01)	2714647 *	BIPHENYL DERIVATIVES USEFUL AS GLUCAGON RECEPTOR ANTAGONISTS
ACO SEVERIN AHLMANN GMBH & CO. KG	E04B 1/76 (2006.01)	2339078	Insulating composite element and method for insulating a component wall and insulated wall structure

Podnosilac evropske prijave patenta (71)	MKP (51)	Broj objave evropske prijave patenta (97)	Naziv pronalaska (54)
H. Lundbeck A/S	A61K 31/495 (2006.01) A61P 25/00 (2006.01) C07B 59/00 (2006.01) C07D 241/04 (2006.01)	2720989 *	DEUTERATED 1-PIPERAZINO-3-PHENYL INDANES FOR TREATMENT OF SCHIZOPHRENIA
Delphi International Operations Luxembourg S.à.r.l.	F02M 47/02 (2006.01)	2674608	Fuel injector
Adolor Corporation	A01N 43/40 (2006.01)	2734041 *	PROCESSES FOR THE PREPARATION OF PERIPHERAL OPIOID ANTAGONIST COMPOUNDS AND INTERMEDIATES THERETO
Literáti Nagy, Botond	A61K 31/4523 (2006.01) A61K 31/5395 (2006.01) A61P 21/00 (2006.01)	2760448 *	PHARMACEUTICAL COMPOSITION FOR THE PREVENTION AND/OR TREATMENT OF MUSCLE ATROPHY
ATS Group (IP Holdings) Limited	G06Q 10/04 (2012.01)	2602752	Method and system for sensor calibration support
GlaxoSmithKline Biologicals S.A.	C07K 14/47 (2006.01) C07K 16/30 (2006.01) C12Q 1/68 (2006.01)	2751282 *	DETECTION OF PRAME GENE EXPRESSION IN CANCER
Packers Plus Energy Services Inc.	E21B 23/10 (2006.01) E21B 33/12 (2006.01) E21B 34/08 (2006.01) E21B 34/14 (2006.01) E21B 43/12 (2006.01)	2766561 *	WELLBORE ACTUATORS, TREATMENT STRINGS AND METHODS
Alk AG	G09B 5/06 (2006.01) G09B 19/00 (2006.01) G09B 19/24 (2006.01) G09B 23/28 (2006.01)	2727100 *	A METHOD, A DEVICE AND A COMPUTER PROGRAM PRODUCT FOR TRAINING THE USE OF AN AUTO-INJECTOR
OPTIMO Schlafsysteme Gesellschaft m.b.H.	A47C 20/04 (2006.01) A47C 23/00 (2006.01) A47C 23/06 (2006.01)	2705777	Frame, in particular slatted frame
Scidose Llc	A61K 31/337 (2006.01) C07D 305/14 (2006.01)	2741745 *	CABAZITAXEL FORMULATIONS AND METHODS OF PREPARING THEREOF
Pierre, Marvin	B01D 1/00 (2006.01) B01D 5/00 (2006.01) C02F 1/04 (2006.01) C02F 103/08 (2006.01)	2709957 *	HYDRAULIC DESALINATION DEVICE AND METHOD
Purdue Pharma LP	A61K 9/20 (2006.01) A61K 9/28 (2006.01) A61K 31/485 (2006.01)	2755640 *	TAMPER RESISTANT PHARMACEUTICAL FORMULATIONS
Intrepid Tactical Solutions LLC	F42B 5/02 (2006.01) F42B 5/10 (2006.01) F42B 33/02 (2006.01)	2745069 *	SHOTSHELL TYPE AMMUNITION, FIREARMS FOR FIRING SUCH SHOTSHELL TYPE AMMUNITION, AND METHODS OF MANUFACTURING SUCH SHOTSHELL TYPE AMMUNITION
Image Holdings	G06Q 30/00 (2012.01)	2734965 *	METHOD AND SYSTEM OF DISPLAYING, MANAGING AND SELLING IMAGES IN AN EVENT PHOTOGRAPHY ENVIRONMENT
Eigen Systems Limited	B23Q 11/00 (2006.01) B23Q 11/08 (2006.01) B23Q 11/12 (2006.01)	2744623 *	ABOVE PLATE COOLANT CONTAINMENT AND RECOVERY SYSTEM
S. Marco-Rolfi S.r.l.	A61G 3/06 (2006.01)	2713978 *	METHOD FOR CONTROLLING THE AUTOMATIC SLIDING OF A TELESCOPIC RAMP, TELESCOPIC RAMP AND VEHICLE COMPRISING SUCH RAMP
Olive Medical Corporation	H04N 5/335 (2011.01)	2708022 *	PIXEL ARRAY AREA OPTIMIZATION USING STACKING SCHEME FOR HYBRID IMAGE SENSOR WITH MINIMAL VERTICAL INTERCONNECTS
IDENIX Pharmaceuticals, Inc.	A61K 31/7076 (2006.01) A61P 31/12 (2006.01) C07H 19/213 (2006.01)	2768838 *	SUBSTITUTED 3',5'-CYCLIC PHOSPHATES OF PURINE NUCLEOTIDE COMPOUNDS AND PHARMACEUTICAL COMPOSITIONS FOR THE TREATMENT OF VIRAL INFECTIONS

Podnosilac evropske prijave patenta (71)	MKP (51)	Broj objave evropske prijave patenta (97)	Naziv pronalaska (54)
Sanofi-Aventis Deutschland GmbH	A61K 31/155 (2006.01) A61K 38/26 (2006.01) A61P 3/04 (2006.01) A61P 3/10 (2006.01)	2707016 *	PHARMACEUTICAL COMBINATION FOR USE IN INDUCING WEIGHT LOSS IN DIABETES TYPE 2 PATIENTS OR/AND FOR PREVENTING WEIGHT GAIN IN DIABETES TYPE 2 PATIENTS
Laboratori Baldacci S.P.A.	A01N 37/42 (2006.01) A01N 37/46 (2006.01) A01N 43/36 (2006.01) A01N 59/20 (2006.01) A01P 1/00 (2006.01) A61K 8/49 (2006.01) A61K 31/195 (2006.01) A61Q 19/00 (2006.01)	2404502	Compositions containing pyrrolidone carboxylic acid (PCA) and metallic salts
Bayer Intellectual Property GmbH	A61K 39/395 (2006.01) A61P 5/00 (2006.01) C07K 16/28 (2006.01)	2714740 *	NEUTRALIZING PROLACTIN RECEPTOR ANTIBODY MAT3 AND ITS THERAPEUTIC USE
Takeda Pharmaceutical Company Limited	A61K 31/40 (2006.01) A61K 31/4164 (2006.01)	2709614 *	PHARMACEUTICAL COMPOSITIONS AND METHODS FOR TREATING CANCER
Sariu, Costin	B65D 47/06 (2006.01) B65D 47/22 (2006.01) B65D 83/00 (2006.01) B67D 7/36 (2010.01)	2712349 *	DISPENSER FOR A CONTAINER
NP Poschmann GmbH	B29C 45/00 (2006.01) B29C 45/16 (2006.01) F04D 29/22 (2006.01)	2623291	Pump impeller and method for producing a pump impeller
Qualcomm Incorporated	G01B 11/02 (2006.01) G01S 17/32 (2006.01)	2748632 *	PROXIMITY SENSOR CALIBRATION
Hybrid Paytech World, Inc.	G06F 3/041 (2006.01) G06K 9/00 (2006.01) H04W 12/06 (2009.01)	2749053 *	METHOD AND SYSTEM TO CAPTURE AND VALIDATE A SIGNATURE USING A MOBILE DEVICE
Gnutti Transfer S.p.A.	B23Q 7/02 (2006.01) B23Q 16/02 (2006.01) B23Q 39/04 (2006.01)	2747938 *	MACHINE TOOL WITH ROTATABLE TABLE
Teva Pharmaceuticals USA, Inc.	A61K 31/135 (2006.01)	2766004 *	R(+)-N-METHYL-PROPARGYL-AMINOINDAN
Bounce Exchange LLC	G06F 17/00 (2006.01) G06Q 30/02 (2012.01)	2766865 *	DETECTION OF EXIT BEHAVIOR OF AN INTERNET USER
Italian Designer S.r.l.	E04B 1/34 (2006.01) E04H 1/04 (2006.01) E04H 1/06 (2006.01)	2758609 *	ECOLOGICAL TERRACED SKYSCRAPER BUILDING
QUIDEL CORPORATION	G01N 33/53 (2006.01)	2753928 *	COMPOSITIONS AND METHODS FOR DETECTING AUTOANTIBODIES
Schmitz, Luiz Carlos	D04B 21/14 (2006.01) D04D 7/00 (2006.01)	2746437 *	ARRANGEMENT INTRODUCED INTO THREADS FOR HANDWORK WITH KNITTING NEEDLES, CROCHET HOOKS OR THE LIKE
Cadila Healthcare Limited	C07D 413/10 (2006.01) C07D 413/14 (2006.01)	2753619 *	PROCESSES AND INTERMEDIATES FOR PREPARING RIVAROXABAN
Qualcomm Incorporated	H04B 1/40 (2006.01) H04W 88/06 (2009.01)	2742598 *	ANTENNA TO TRANSCEIVER MAPPING OF A MULTIMODE WIRELESS DEVICE
Boucherie Vitel, Philippe, Christian	F25D 7/00 (2006.01) F25D 16/00 (2006.01) F25D 31/00 (2006.01)	2766677 *	METHOD AND DEVICE FOR VACUUM COOLING
Tempero Pharmaceuticals, Inc.	A01N 43/08 (2006.01) A61K 31/34 (2006.01)	2736332 *	COMPOUNDS AND METHODS
Chiesi Farmaceutici S.p.A.	A61K 31/439 (2006.01) A61K 31/4709 (2006.01) A61P 11/06 (2006.01) A61P 11/08 (2006.01) C07C 213/10 (2006.01) C07D 401/12 (2006.01) C07D 451/06 (2006.01) C07D 453/02 (2006.01)	2718280 *	COMPOUNDS HAVING MUSCARINIC RECEPTOR ANTAGONIST AND BETA2 ADRENERGIC RECEPTOR AGONIST ACTIVITY

Podnosilac evropske prijave patenta (71)	MKP (51)	Broj objave evropske prijave patenta (97)	Naziv pronalaska (54)
Genelux Corporation	C12Q 1/68 (2006.01) G01N 33/50 (2006.01) G01N 33/569 (2006.01) G01N 33/574 (2006.01)	2764119 *	METHOD FOR DETECTING REPLICATION OR COLONIZATION OF A BIOLOGICAL THERAPEUTIC
XBiotech, Inc	C07K 16/00 (2006.01) C07K 16/18 (2006.01) C12N 15/11 (2006.01) C12Q 1/68 (2006.01) C40B 40/06 (2006.01)	2731965 *	IDENTIFYING AFFINITY-MATURED HUMAN ANTIBODIES
Karyopharm Therapeutics, Inc.	A61K 31/407 (2006.01) A61K 31/4196 (2006.01) A61K 31/421 (2006.01) A61K 31/4439 (2006.01) A61K 31/454 (2006.01) A61K 31/497 (2006.01) A61K 31/506 (2006.01) C07D 213/50 (2006.01) C07D 401/08 (2006.01) C07D 401/12 (2006.01) C07D 401/14 (2006.01) C07D 403/08 (2006.01) C07D 403/12 (2006.01) C07D 413/12 (2006.01) C07D 487/10 (2006.01)	2736883 *	NUCLEAR TRANSPORT MODULATORS AND USES THEREOF
Dignity Sciences Limited	A61K 31/202 (2006.01) A61P 17/00 (2006.01)	2768496 *	PHARMACEUTICAL COMPOSITIONS COMPRISING DGLA AND/OR 15-HETRE AND METHODS OF USE THEREOF
Verisfield (UK) Ltd.	A61K 9/14 (2006.01) A61K 31/198 (2006.01) A61K 47/32 (2006.01)	2692340	Stable pharmaceutical system (kit) for the preparation of oral solution of levothyroxine or pharmaceutically acceptable salt thereof
Grand Directions, Llc	G21F 9/24 (2006.01) G21F 9/34 (2006.01)	2727118 *	ABYSSAL SEQUESTRATION OF NUCLEAR WASTE AND OTHER TYPES OF HAZARDOUS WASTE
Burcon Nutrascience (MB) Corp.	A23J 1/14 (2006.01)	2725922 *	CANOLA PROTEIN PRODUCT WITH LOW PHYTIC ACID CONTENT ("C702")
Elan Pharmaceuticals, Inc.	A61K 31/7004 (2006.01) A61P 25/28 (2006.01)	2714050 *	SCYLLO-INOSITOL FOR THE TREATMENT OF BEHAVIORAL AND PSYCHIATRIC DISORDERS
Otsuka Pharmaceutical Co., Ltd.	A61K 9/00 (2006.01) A61K 9/08 (2006.01) A61K 31/185 (2006.01) A61K 31/191 (2006.01) A61K 31/194 (2006.01) A61K 31/198 (2006.01) A61K 31/496 (2006.01) A61K 31/661 (2006.01) A61K 47/02 (2006.01) A61K 47/12 (2006.01)	2768508 *	SOLUTION FOR ORAL ADMINISTRATION
Receptos, Inc.	A61K 31/433 (2006.01)	2706999 *	SELECTIVE HETEROCYCLIC SPHINGOSINE 1 PHOSPHATE RECEPTOR MODULATORS
Amgen Inc.	C07K 16/28 (2006.01)	2718323 *	HUMAN ANTIGEN BINDING PROTEINS THAT BIND TO A COMPLEX COMPRISING BETA-KLOTHO AND AN FGF RECEPTOR
Farma GRS, d.o.o.	A61K 31/7052 (2006.01) C07H 17/00 (2006.01)	2736915 *	NEW CRYSTALLINE FORMS OF TULATHROMYCIN
Palma, Guiseppe	B65D 19/38 (2006.01) B65D 77/06 (2006.01)	2768742 *	A CONTAINMENT DEVICE FOR A BIG BAG AND A KIT THEREFOR
Amazonen-Werke H. Dreyer GmbH & Co. KG	A01M 7/00 (2006.01)	2768303 *	METHOD FOR FILLING AT LEAST ONE RESERVOIR CONTAINER
St. Jude Children's Research Hospital	A61K 31/47 (2006.01) A61P 33/06 (2006.01) C07D 217/26 (2006.01) C07D 401/04 (2006.01) C07D 405/04 (2006.01) C07D 413/04 (2006.01) C07D 417/04 (2006.01)	2748147 *	SUBSTITUTED 2-ALKYL-1-OXO-N-PHENYL-3-HETEROARYL-1,2,3,4-TETRAHYDROISOQUINOLINE-4-CARBOXAMIDES FOR ANTIMALARIAL THERAPIES

Podnosilac evropske prijave patenta (71)	MKP (51)	Broj objave evropske prijave patenta (97)	Naziv pronalaska (54)
MMV Medicines for Malaria Venture	A61K 31/47 (2006.01) A61P 33/06 (2006.01) C07D 217/26 (2006.01) C07D 401/04 (2006.01) C07D 405/04 (2006.01) C07D 413/04 (2006.01) C07D 417/04 (2006.01)	2748147 *	SUBSTITUTED 2-ALKYL-1-OXO-N-PHENYL-3-HETEROARYL-1,2,3,4-TETRAHYDROISOQUINOLINE-4-CARBOXAMIDES FOR ANTIMALARIAL THERAPIES
Rutgers, The State University Of New Jersey	A61K 31/47 (2006.01) A61P 33/06 (2006.01) C07D 217/26 (2006.01) C07D 401/04 (2006.01) C07D 405/04 (2006.01) C07D 413/04 (2006.01) C07D 417/04 (2006.01)	2748147 *	SUBSTITUTED 2-ALKYL-1-OXO-N-PHENYL-3-HETEROARYL-1,2,3,4-TETRAHYDROISOQUINOLINE-4-CARBOXAMIDES FOR ANTIMALARIAL THERAPIES
Hydra Biosciences, Inc.	A61K 31/52 (2006.01) A61P 25/04 (2006.01) C07D 473/08 (2006.01)	2742048 *	INHIBITING TRANSIENT RECEPTOR POTENTIAL ION CHANNEL TRPA1
Cubist Pharmaceuticals, Inc.	A61K 31/52 (2006.01) A61P 25/04 (2006.01) C07D 473/08 (2006.01)	2742048 *	INHIBITING TRANSIENT RECEPTOR POTENTIAL ION CHANNEL TRPA1
Winkelmann Sp. z o.o.	F24D 3/10 (2006.01)	2753880 *	DIAPHRAGM PRESSURE EXPANSION VESSEL
Farchioni Ollii S.p.A.	C12C 5/02 (2006.01) C12C 7/053 (2006.01)	2751249 *	BEER AND RELEVANT PRODUCTION METHOD.
Aetherworks, LLC	H04J 1/00 (2006.01)	2759080 *	SYSTEMS AND METHODS FOR THE DEMAND-DRIVEN DEPLOYMENT OF LOCATION-NEUTRAL SOFTWARE
Gaijin Entertainment Corporation	G09B 9/08 (2006.01)	2642467	System and method for simulated aircraft control through desired direction of flight
Longinotti Group S.r.l.	B28B 1/08 (2006.01) B28B 3/00 (2006.01) B28B 7/46 (2006.01) B28B 13/02 (2006.01)	2714353 *	APPARATUS FOR MANUFACTURING OF TILES
Powerdyne, Inc.	C01B 3/04 (2006.01) F01K 23/10 (2006.01)	2710235 *	STEAM GENERATION SYSTEM
Theravectys	C07K 14/16 (2006.01) C12N 15/867 (2006.01)	2761011 *	USE OF NON-SUBTYPE B GAG PROTEINS FOR LENTIVIRAL PACKAGING
Institut Pasteur	C07K 14/16 (2006.01) C12N 15/867 (2006.01)	2761011 *	USE OF NON-SUBTYPE B GAG PROTEINS FOR LENTIVIRAL PACKAGING
Sirtris Pharmaceuticals, Inc.	C07D 487/04 (2006.01)	2768833 *	SUBSTITUTED BICYCLIC AZA-HETEROCYCLES AND ANALOGUES AS SIRTUIN MODULATORS
Glaxosmithkline LLC	C07D 487/04 (2006.01)	2768833 *	SUBSTITUTED BICYCLIC AZA-HETEROCYCLES AND ANALOGUES AS SIRTUIN MODULATORS
Les Laboratoires Servier	C07C 253/00 (2006.01) C07D 223/14 (2006.01)	2740725	Novel method for synthesising 3-(2-bromo-4,5-dimethoxyphenyl)propanenitrile and use for synthesising ivabradine and the added salts thereof with a pharmaceutically acceptable acid
Wobben Properties GmbH	F03D 1/00 (2006.01) F03D 1/06 (2006.01)	2702266 *	WIND TURBINE
Janssen Biotech, Inc.	A61K 38/16 (2006.01) A61P 9/00 (2006.01) A61P 11/00 (2006.01) A61P 11/06 (2006.01) A61P 17/00 (2006.01) A61P 35/00 (2006.01) C07K 14/00 (2006.01) C12N 1/19 (2006.01) C12N 1/21 (2006.01) C12N 5/10 (2006.01) C12N 7/01 (2006.01) C12N 15/11 (2006.01) C12N 15/63 (2006.01) C12P 21/02 (2006.01)	2702069 *	IL4/IL13 BINDING REPEAT PROTEINS AND USES

Podnosilac evropske prijave patenta (71)	MKP (51)	Broj objave evropske prijave patenta (97)	Naziv pronalaska (54)
Molecular Partners AG	A61K 38/16 (2006.01) A61P 9/00 (2006.01) A61P 11/00 (2006.01) A61P 11/06 (2006.01) A61P 17/00 (2006.01) A61P 35/00 (2006.01) C07K 14/00 (2006.01) C12N 1/19 (2006.01) C12N 1/21 (2006.01) C12N 5/10 (2006.01) C12N 7/01 (2006.01) C12N 15/11 (2006.01) C12N 15/63 (2006.01) C12P 21/02 (2006.01)	2702069 *	IL4/IL13 BINDING REPEAT PROTEINS AND USES
Spirogen Sàrl	A61K 47/48 (2006.01) A61P 35/00 (2006.01) C07D 487/04 (2006.01) C07D 519/00 (2006.01)	2766048 *	PYRROLOBENZODIAZEPINES AND CONJUGATES THEREOF
Weber, Jonathan Norden	A61K 39/21 (2006.01)	2755684 *	METHODS AND COMPOSITIONS FOR RAISING AN IMMUNE RESPONSE TO HIV
Shattock, Robin John	A61K 39/21 (2006.01)	2755684 *	METHODS AND COMPOSITIONS FOR RAISING AN IMMUNE RESPONSE TO HIV
McKay, Paul Francis James	A61K 39/21 (2006.01)	2755684 *	METHODS AND COMPOSITIONS FOR RAISING AN IMMUNE RESPONSE TO HIV
McCormack, Sheena Mary Geraldine	A61K 39/21 (2006.01)	2755684 *	METHODS AND COMPOSITIONS FOR RAISING AN IMMUNE RESPONSE TO HIV
Xinxing Ductile Iron Pipes Co., Ltd	F16L 21/03 (2006.01) F16L 21/08 (2006.01)	2749803 *	BELL AND SPIGOT TYPE PIPING JOINT
Amgen Inc.	G01N 33/50 (2006.01) G01N 33/566 (2006.01) G01N 33/74 (2006.01)	2707718 *	METHOD OF IDENTIFYING COMPOUNDS THAT SPECIFICALLY MODULATE THE INTERACTION OF FGFR1 AND BETA-KLTHO
Somalogic, Inc.	G01N 33/48 (2006.01) G01N 33/52 (2006.01)	2761289 *	CARDIOVASCULAR RISK EVENT PREDICTION AND USES THEREOF
Qualcomm Incorporated	G06K 9/00 (2006.01) G06T 7/00 (2006.01)	2710554 *	HEAD POSE ESTIMATION USING RGBD CAMERA
Oesterreichische Banknoten- und Sicherheitsdruck GmbH	B41F 35/00 (2006.01)	2684697	Treatment plant
YEDA RESEARCH & DEVELOPMENT COMPANY, LTD.	A61K 38/02 (2006.01) A61K 38/16 (2006.01) A61P 25/28 (2006.01)	2630962	Low Frequency Glatiramer Acetate Therapy
Novomatic AG	G07F 17/32 (2006.01)	2761606 *	GAMING DEVICES AND METHODS OF OPERATING THEM
Momenta Pharmaceuticals, Inc.	C07K 16/00 (2006.01) C12P 21/08 (2006.01)	2710032 *	MODIFIED GLYCOPROTEINS
STC.UNM	A61K 9/16 (2006.01) A61K 31/7088 (2006.01) A61K 31/7105 (2006.01) A61K 38/17 (2006.01) A61K 47/48 (2006.01) A61K 48/00 (2006.01) A61K 49/08 (2006.01)	2765997 *	POROUS NANOPARTICLE-SUPPORTED LIPID BILAYERS (PROTOCELLS) FOR TARGETED DELIVERY INCLUDING TRANSDERMAL DELIVERY OF CARGO AND METHODS THEREOF
Sandia Corporation	A61K 9/16 (2006.01) A61K 31/7088 (2006.01) A61K 31/7105 (2006.01) A61K 38/17 (2006.01) A61K 47/48 (2006.01) A61K 48/00 (2006.01) A61K 49/08 (2006.01)	2765997 *	POROUS NANOPARTICLE-SUPPORTED LIPID BILAYERS (PROTOCELLS) FOR TARGETED DELIVERY INCLUDING TRANSDERMAL DELIVERY OF CARGO AND METHODS THEREOF

Podnosilac evropske prijave patenta (71)	MKP (51)	Broj objave evropske prijave patenta (97)	Naziv pronalaska (54)
Amgen Inc.	A61K 38/18 (2006.01) A61P 3/00 (2006.01) A61P 3/04 (2006.01) A61P 3/06 (2006.01) A61P 3/08 (2006.01) A61P 3/10 (2006.01)	2750695 *	METHOD OF TREATING OR AMELIORATING TYPE 1 DIABETES USING FGF21
Neumedicines, Inc	C12P 21/04 (2006.01)	2718456 *	MITIGATION OF CUTANEOUS INJURY WITH IL-12
Bolton Alimentari S.P.A.	A23B 4/005 (2006.01) A23B 4/16 (2006.01) A23L 1/325 (2006.01)	2666362	Process for packaging seafood raw material into a foodstuffs container and related package
Agriphar S.A.	A01N 25/22 (2006.01) A01N 37/40 (2006.01) A01N 43/12 (2006.01) A01N 43/54 (2006.01) A01N 43/653 (2006.01) A01N 47/44 (2006.01) A01N 59/02 (2006.01) A01N 59/20 (2006.01) A01P 3/00 (2006.01)	2709449 *	AGROCHEMICAL FORMULATIONS COMPRISING DODECYLGUANIDINE AND A COMPATIBILITY AGENT
Oxymount Technology GmbH	C02F 1/467 (2006.01) C02F 1/72 (2006.01)	2706042	Point-of-use water dispenser and method for using said water dispenser
Mollificio Bortolussi S.R.L.	A01G 17/06 (2006.01) E04H 12/20 (2006.01)	2734690 *	GUY DEVICE FOR A POLE DRIVEN INTO THE GROUND
AbbVie Inc.	C07D 417/14 (2006.01)	2768830 *	APOPTOSIS-INDUCING AGENTS FOR THE TREATMENT OF CANCER AND IMMUNE AND AUTOIMMUNE DISEASES
Takeda Pharmaceutical Company Limited	A61K 31/444 (2006.01) A61K 31/506 (2006.01) A61P 25/28 (2006.01) C07D 401/10 (2006.01) C07D 401/14 (2006.01) C07D 405/14 (2006.01) C07D 413/10 (2006.01) C07D 413/14 (2006.01) C07D 417/14 (2006.01) C07D 498/08 (2006.01)	2763979 *	1 - ARYLCARBONYL - 4 - OXY - PIPERIDINE COMPOUNDS USEFUL FOR THE TREATMENT OF NEURODEGENERATIVE DISEASES
Sika Technology Limited	B65D 90/10 (2006.01) E02D 29/14 (2006.01) E03F 5/02 (2006.01)	2761100 *	IMPROVEMENTS IN/OR AND RELATING TO UTILITY CHAMBERS AND SURROUNDS AND METHODS THEREFOR
Blücher GmbH	B01J 20/02 (2006.01) B01J 20/04 (2006.01) B01J 20/20 (2006.01) B01J 20/28 (2006.01) B01J 20/32 (2006.01) C02F 1/28 (2006.01) C02F 101/00 (2006.01) G21F 9/12 (2006.01)	2744592 *	ADSORBENT PRECIPITATED ON A CARRIER, METHOD FOR PRODUCING SAID ADSORBENT, AND USE OF SAID ADSORBENT
Garas, Mihály	F41J 3/02 (2006.01)	2729755 *	SCORING SYSTEM FOR ARCHERY
Synta Pharmaceuticals Corporation	A61K 31/4196 (2006.01) A61K 31/513 (2006.01) A61K 31/519 (2006.01) A61K 31/7068 (2006.01) A61K 45/06 (2006.01) A61P 35/00 (2006.01) A61P 35/02 (2006.01)	2744494 *	COMBINATION CANCER THERAPY OF HSP90 INHIBITOR WITH ANTIMETABOLITE
Packers Plus Energy Services Inc.	E21B 23/00 (2006.01) E21B 33/122 (2006.01) E21B 34/14 (2006.01) E21B 34/16 (2006.01)	2737163 *	WELLBORE TOOL WITH INDEXING MECHANISM AND METHOD
Torrent Pharmaceuticals Limited	A61K 31/519 (2006.01) A61P 3/00 (2006.01) A61P 9/00 (2006.01) C07D 487/04 (2006.01)	2768832 *	NOVEL SUBSTITUTED IMIDAZOPYRIMIDINES AS GPBAR1 RECEPTOR MODULATORS

Podnosilac evropske prijave patenta (71)	MKP (51)	Broj objave evropske prijave patenta (97)	Naziv pronalaska (54)
Venantius Limited	A61K 31/166 (2006.01) A61K 31/167 (2006.01) A61K 31/192 (2006.01) A61K 31/205 (2006.01) A61K 31/235 (2006.01) A61P 29/00 (2006.01) C07C 65/19 (2006.01) C07C 69/76 (2006.01) C07C 229/08 (2006.01) C07C 235/42 (2006.01)	2734497 *	INDANE DIMERS FOR USE IN THE TREATMENT OF AUTOIMMUNE INFLAMMATORY DISEASE
The Regents of the University of California	A01H 5/00 (2006.01) C12N 15/82 (2006.01)	2726620 *	CONSTITUTIVELY ACTIVE ABA RECEPTOR MUTANTS
Yale University	A01N 63/00 (2006.01)	2763540 *	COMPOSITIONS AND METHODS FOR ASSESSING AND TREATING INFLAMMATORY DISEASES AND DISORDERS
P. Dimitropoulos - Electronic Systems and Software Applications S.A. Trading Name: SENSAP SA	B41F 33/00 (2006.01) G06K 19/06 (2006.01)	2749418	Print fidelity control method and device in production lines of solid and corrugated carton boxes, and advertising displays made of paper
Onyx Therapeutics, Inc.	A61K 47/48 (2006.01) A61P 35/00 (2006.01)	2662094	Cyclodextrin Complexation Methods for Formulating Peptide Proteasome Inhibitors
OakLabs GmbH	C12Q 1/68 (2006.01)	2684964	Microarray-based methods for identifying single nucleotides at specific positions in nucleic acids
Nanobio Corporation	A61K 39/155 (2006.01) B82Y 99/00 (2011.01)	2729169 *	HUMAN RESPIRATORY SYNCYTIAL VIRUS VACCINE
Hamouda, Tarek	A61K 39/155 (2006.01) B82Y 99/00 (2011.01)	2729169 *	HUMAN RESPIRATORY SYNCYTIAL VIRUS VACCINE
Bitko, Vira	A61K 39/155 (2006.01) B82Y 99/00 (2011.01)	2729169 *	HUMAN RESPIRATORY SYNCYTIAL VIRUS VACCINE
Syma Intercontinental AG	F16B 7/04 (2006.01)	2685111	Clamp piece for a detachable connection of two profile pieces
Alltech, Inc.	C10L 1/10 (2006.01) C11B 1/00 (2006.01) C12N 1/12 (2006.01)	2732025 *	ALGAL LIPID COMPOSITIONS AND METHODS OF PREPARING AND UTILIZING THE SAME
MARTINO, Mirko	B60N 2/42 (2006.01) B60N 2/48 (2006.01)	2718145 *	A RECLINING COLLAR HEADREST WITH ROTATABLE BLOCK ENDS
Coldway	F17C 11/00 (2006.01)	2742274 *	METHOD FOR STORING A GAS BY CHEMISORPTION ON A POROUS MATERIAL COMPRISING EXPANDED GRAPHITE
Qualcomm Incorporated	G10L 21/02 (2013.01)	2715722 *	PRESERVING AUDIO DATA COLLECTION PRIVACY IN MOBILE DEVICES
Aventis Pharmaceuticals Inc.	A61K 9/48 (2006.01) A61K 31/4545 (2006.01) A61K 47/10 (2006.01)	2709600 *	PHARMACEUTICAL COMPOSITION COMPRISING FEXOFENADINE
Kieser Training AG	A63B 21/068 (2006.01) A63B 22/00 (2006.01) A63B 22/20 (2006.01) A63B 23/04 (2006.01)	2664363	Exercise machine
Texas Instruments France	A61B 5/0472 (2006.01)	2676604	Real time QRS duration measurement in electrocardiogram
Texas Instruments Incorporated	A61B 5/0472 (2006.01)	2676604	Real time QRS duration measurement in electrocardiogram
OncoMed Pharmaceuticals, Inc.	A61K 39/395 (2006.01) G01N 33/574 (2006.01)	2731625 *	RSPO BINDING AGENTS AND USES THEREOF
The Secretary of State for Business, Innovation And Skills of Her Majesty's Britannic Government	G03H 1/04 (2006.01)	2751621 *	HOLOGRAM

Podnosilac evropske prijave patenta (71)	MKP (51)	Broj objave evropske prijave patenta (97)	Naziv pronalaska (54)
Qualcomm Incorporated	H04L 12/46 (2006.01) H04L 29/08 (2006.01) H04W 4/02 (2009.01) H04W 4/20 (2009.01) H04W 8/06 (2009.01) H04W 12/00 (2009.01) H04W 48/16 (2009.01) H04W 64/00 (2009.01) H04W 80/08 (2009.01)	2749048 *	SECURE USER PLANE LOCATION (SUPL) REDIRECTION AND MOBILE LOCATION PROTOCOL (MLP) TUNNELING TO A DISCOVERED SLP
A123 Systems Inc.	H01M 4/52 (2010.01)	2737565 *	BLENDED CATHODE MATERIALS
Immunogen, Inc.	A61K 47/48 (2006.01) A61P 35/00 (2006.01)	2723389 *	NOVEL MAYTANSINOID DERIVATIVES WITH PEPTIDE LINKER AND CONJUGATES THEREOF
Antitope Limited	C07K 16/28 (2006.01)	2714739 *	HUMANISED ANTI-CD52 ANTIBODIES
AbbVie Inc.	A61K 31/422 (2006.01)	2704712 *	ISOXAZOLINES AS THERAPEUTIC AGENTS
Menghi, Alberto	H04B 3/54 (2006.01) H05B 37/02 (2006.01)	2742602 *	TELECONTROL ENERGY-SAVING APPARATUS FOR SIMULTANEOUS TRANSMISSION OF MULTIPLE SIGNALS WITH POWERLINE TECHNOLOGY
Fuochi, Demos	H04B 3/54 (2006.01) H05B 37/02 (2006.01)	2742602 *	TELECONTROL ENERGY-SAVING APPARATUS FOR SIMULTANEOUS TRANSMISSION OF MULTIPLE SIGNALS WITH POWERLINE TECHNOLOGY
Bayer Intellectual Property GmbH	A61K 31/519 (2006.01) A61K 31/522 (2006.01) A61P 9/00 (2006.01) C07D 487/04 (2006.01)	2682394	1H-pyrazolo[3,4-b]pyridin-triazine derivatives and their use for the treatment or the prevention of cardiovascular diseases
Akhapkina, Valentina Ivanovna	A61K 31/4015 (2006.01) A61P 3/04 (2006.01) A61P 7/10 (2006.01) A61P 9/00 (2006.01) A61P 25/00 (2006.01) A61P 37/02 (2006.01) A61P 39/06 (2006.01) A61P 43/00 (2006.01) C07D 201/00 (2006.01) C07D 201/16 (2006.01) C07D 201/18 (2006.01)	2762138 *	PHARMACEUTICAL SUBSTANCE (VARIANTS) AND COMPOSITIONS BASED THEREON WHICH EXHIBIT MODULATORY ACTIVITY WITH A COMMENSURATE EFFECT
Akhapkin, Roman Vitalyevich	A61K 31/4015 (2006.01) A61P 3/04 (2006.01) A61P 7/10 (2006.01) A61P 9/00 (2006.01) A61P 25/00 (2006.01) A61P 37/02 (2006.01) A61P 39/06 (2006.01) A61P 43/00 (2006.01) C07D 201/00 (2006.01) C07D 201/16 (2006.01) C07D 201/18 (2006.01)	2762138 *	PHARMACEUTICAL SUBSTANCE (VARIANTS) AND COMPOSITIONS BASED THEREON WHICH EXHIBIT MODULATORY ACTIVITY WITH A COMMENSURATE EFFECT
SANOFI	C12N 9/02 (2006.01) C12N 9/04 (2006.01) C12N 15/52 (2006.01) C12N 15/81 (2006.01) C12P 33/00 (2006.01)	2723868 *	PROCESS FOR PREPARING GENETICALLY TRANSFORMED YEASTS CAPABLE OF PRODUCING A MOLECULE OF INTEREST AT A HIGH TITRE
D.A. Nolt Inc.	B65G 5/00 (2006.01) E02D 17/00 (2006.01) E21B 21/01 (2006.01)	2764164 *	FLUID CONTAINMENT AND MANAGEMENT SYSTEM
Greenstract LLC	C09K 8/60 (2006.01) C11D 3/382 (2006.01)	2766448 *	COMPOSITIONS AND METHODS USEFUL FOR OIL EXTRACTION
Transcity Group Pty Ltd	H04N 21/431 (2011.01)	2761885 *	CONTENT MANAGEMENT SYSTEMS, METHODS, APPARATUS AND USER INTERFACES
BiocerOX Products B.V.	C07K 16/28 (2006.01)	2756001 *	ANTI-CD134 (OX40) ANTIBODIES AND USES THEREOF
Estetra S.A.	A61K 31/565 (2006.01) A61P 15/12 (2006.01) C07J 75/00 (2006.01)	2714712 *	PROCESS FOR THE PRODUCTION OF ESTETROL INTERMEDIATES

Podnosilac evropske prijave patenta (71)	MKP (51)	Broj objave evropske prijave patenta (97)	Naziv pronalaska (54)
Samumed, LLC	A01N 43/54 (2006.01)	2760285 *	INDAZOLE INHIBITORS OF THE WNT SIGNAL PATHWAY AND THERAPEUTIC USES THEREOF
Delphi International Operations Luxembourg S.à.r.l.	F02M 59/02 (2006.01) F02M 59/44 (2006.01) F04B 1/04 (2006.01)	2742231 *	FUEL PUMP
Jeppesen, Johnny Agaton	D06F 95/00 (2006.01)	2631358	Multi compartment bag
Jeppesen, Anne Marie Dorthea	D06F 95/00 (2006.01)	2631358	Multi compartment bag
BioNTech AG	A61K 39/00 (2006.01) C07K 16/18 (2006.01)	2662386	Antibodies that bind to PLAC1 and block interaction between PLAC1 and FGF7
TRON - Translationale Onkologie an der Universitätsmedizin der Johannes Gutenberg-Universität Mainz gemeinnützige GmbH	A61K 39/00 (2006.01) C07K 16/18 (2006.01)	2662386	Antibodies that bind to PLAC1 and block interaction between PLAC1 and FGF7
Universitätsmedizin der Johannes Gutenberg-Universität Mainz	A61K 39/00 (2006.01) C07K 16/18 (2006.01)	2662386	Antibodies that bind to PLAC1 and block interaction between PLAC1 and FGF7
Ethicon Endo-Surgery, Inc.	A61B 17/072 (2006.01)	2517646	Compressible staple cartridge assembly
Poddi, Roberto	A01K 31/04 (2006.01)	2638799	Machine for cleaning barns for farming birds
Chiari, Andrea	A01K 31/04 (2006.01)	2638799	Machine for cleaning barns for farming birds
Novartis AG	A61K 47/48 (2006.01) C07K 14/50 (2006.01)	2760475 *	FUSION PROTEINS FOR TREATING METABOLIC DISORDERS
Kaiima Bio Agritech Ltd.	A01H 1/08 (2006.01) A01H 5/10 (2006.01)	2723164 *	COMMON WHEAT, PLANTS OR PARTS THEREOF HAVING PARTIALLY OR FULLY MULTIPLIED GENOME, HYBRIDS AND PRODUCTS THEREOF AND METHODS OF GENERATING AND USING SAME
Fisher Clinical Services GmbH	A61J 1/14 (2006.01) A61J 1/16 (2006.01) B65B 21/00 (2006.01) B65D 77/04 (2006.01)	2662065	Blinding device
The Research Foundation Of State University Of New York	D01F 6/00 (2006.01)	2723926 *	FIBER MATS COATED WITH NANOGRID VISIBLE SPECTRUM PHOTOCATALYSTS
Oxford Biotherapeutics Ltd.	A61K 39/00 (2006.01)	2726094 *	THERAPEUTIC AND DIAGNOSTIC TARGET
IQ Structures S.r.o.	B29C 33/38 (2006.01) C04B 28/00 (2006.01)	2753592 *	METHOD OF MAKING A PRODUCT WITH A FUNCTIONAL RELIEF SURFACE WITH HIGH RESOLUTION
REHAU AG + Co	C08L 23/04 (2006.01) C08L 23/10 (2006.01)	2682424	Use of a polymer composition
Pozen, Inc.	A61K 9/24 (2006.01)	2755641 *	CONTROLLED DOSING OF CLOPIDOGREL WITH GASTRIC ACID INHIBITION THERAPIES
Amgen Inc.	A61K 31/17 (2006.01) A61K 31/435 (2006.01) A61K 38/00 (2006.01) A61K 39/00 (2006.01) G01N 33/50 (2006.01) G01N 33/574 (2006.01)	2726088 *	PREDICTIVE BIOMARKER OF SURVIVAL IN THE TREATMENT OF RENAL CELL CARCINOMA
Industrial Technology Research Institute	H01M 8/02 (2006.01) H01M 8/24 (2006.01)	2337132	Modularized fuel cell devices and fluid flow plate assemblies
Principia Biopharma Inc.	A61K 31/4985 (2006.01) A61P 29/00 (2006.01) C07D 487/04 (2006.01)	2710006 *	AZAINDOLE DERIVATIVES AS TYROSINE KINASE INHIBITORS
Regeneron Pharmaceuticals, Inc.	A01K 67/027 (2006.01) C07K 16/46 (2006.01) C12N 9/64 (2006.01) C12N 15/85 (2006.01)	2739740 *	HUMANIZED UNIVERSAL LIGHT CHAIN MICE

Podnosilac evropske prijave patenta (71)	MKP (51)	Broj objave evropske prijave patenta (97)	Naziv pronalaska (54)
Ethicon Endo-Surgery, Inc.	A61B 17/115 (2006.01)	2524659	Reusable circular stapler handle with open assembly architecture
Neotope Biosciences Limited	C07K 16/30 (2006.01)	2718327 *	MCAM ANTAGONISTS AND METHODS OF TREATMENT
Ecole Polytechnique	C30B 11/00 (2006.01) C30B 13/00 (2006.01) C30B 13/10 (2006.01) C30B 29/28 (2006.01)	2714968 *	PROCESS FOR THE GROWTH OF A CRYSTALLINE SOLID, ASSOCIATED CRYSTALLINE SOLID AND DEVICE
gabo Systemtechnik GmbH	H02G 9/02 (2006.01) H02G 15/04 (2006.01)	2530799	Device for sealing the end of a cable protection tube
Zinpro Corporation	A23K 1/16 (2006.01) A23K 1/175 (2006.01) A23L 1/304 (2006.01) A23L 1/305 (2006.01)	2717713 *	MIXED AMINO ACID METAL SALT COMPLEXES
SANOFI	A61K 31/427 (2006.01) A61P 9/06 (2006.01) A61P 9/10 (2006.01) C07D 417/12 (2006.01) C07D 417/14 (2006.01) C07D 471/04 (2006.01) C07D 487/04 (2006.01)	2755970 *	SUBSTITUTED 2-(CHROMAN-6-YLOXY)-THIAZOLES AND THEIR USE AS PHARMACEUTICALS
X-Chem, Inc.	C40B 50/14 (2006.01) C40B 50/16 (2006.01)	2748357 *	METHODS FOR TAGGING DNA-ENCODED LIBRARIES
Innopharma, Inc.	A61K 9/00 (2006.01) A61K 47/10 (2006.01)	2644189	Stable bortezomib formulations
Glaxo Group Limited	A01N 57/00 (2006.01)	2763539 *	ANTIBACTERIAL COMPOUNDS
Shionogi & Co., Ltd.	A01N 57/00 (2006.01)	2763539 *	ANTIBACTERIAL COMPOUNDS
Wobben Properties GmbH	A62B 35/00 (2006.01) A62B 35/04 (2006.01)	2670492 *	SAFETY HARNESS
Veco S.P.A.	H01F 27/245 (2006.01) H01F 27/26 (2006.01) H02K 1/12 (2006.01) H02K 1/14 (2006.01) H02K 1/22 (2006.01) H02K 15/02 (2006.01)	2693604	Element for lamination of an electrical machine, lamination made of said elements and method and apparatus for its manufacture
Alkermes, Inc.	A01N 47/00 (2006.01)	2725908 *	PERIPHERALLY ACTING OPIOID COMPOUNDS
Maria Clementine Martin Klosterfrau Vertriebsgesellschaft mbH	A61K 31/137 (2006.01) A61K 31/164 (2006.01) A61K 31/4174 (2006.01) A61K 31/4178 (2006.01) A61K 31/505 (2006.01) A61K 31/573 (2006.01) A61K 31/592 (2006.01) A61K 31/593 (2006.01) A61K 31/728 (2006.01) A61K 45/06 (2006.01) A61P 11/02 (2006.01) A61P 27/02 (2006.01)	2723330 *	VASOCONSTRICTOR-CONTAINING AGENT FOR COMBINATION THERAPY
Symed Labs Limited	C07C 231/00 (2006.01)	2705023 *	PROCESSES FOR THE PREPARATION OF N-[2-(7-METHOXY-1-NAPHTHYL)ETHYL]ACETAMIDE
Bristol-Myers Squibb Company	A61K 39/395 (2006.01) C07K 16/28 (2006.01)	2766395 *	ANTIBODY POLYPEPTIDES THAT ANTAGONIZE CD40L
Domantis Limited	A61K 39/395 (2006.01) C07K 16/28 (2006.01)	2766395 *	ANTIBODY POLYPEPTIDES THAT ANTAGONIZE CD40L
Scandinavian No-Dig Centre ApS	E21B 7/30 (2006.01) F16L 1/036 (2006.01) F16L 55/165 (2006.01)	2757296	Method and system for replacement of existing pipes.
H.C. Development S.r.l.	C02F 3/00 (2006.01) C02F 3/22 (2006.01) C02F 3/26 (2006.01) C02F 3/30 (2006.01)	2726417 *	SEWAGE WATER DEPURATION PLANT, COMPRISING A VERTICAL REACTOR, WITH IMPROVED NITROGEN TREATMENT

Podnosilac evropske prijave patenta (71)	MKP (51)	Broj objave evropske prijave patenta (97)	Naziv pronalaska (54)
Astellas Pharma Inc.	A61K 31/437 (2006.01) A61K 31/439 (2006.01) A61K 31/444 (2006.01) A61K 31/4545 (2006.01) A61K 31/496 (2006.01) A61K 31/497 (2006.01) A61K 31/501 (2006.01) A61K 31/506 (2006.01) A61K 31/53 (2006.01) A61K 31/5377 (2006.01) A61K 31/541 (2006.01) A61P 7/02 (2006.01) A61P 9/00 (2006.01) A61P 9/04 (2006.01) A61P 9/10 (2006.01) A61P 9/12 (2006.01) A61P 15/10 (2006.01) A61P 43/00 (2006.01) C07D 471/04 (2006.01) C07D 519/00 (2006.01)	2716642 *	IMIDAZOPYRIDINE COMPOUND
Egis Gyógyszergyár Nyilvánosan Működő Részvény-Társaság	C07D 303/36 (2006.01) C07D 413/10 (2006.01) C07D 413/14 (2006.01)	2705028 *	PROCESS FOR THE PREPARATION OF A RIVAROXABAN AND INTERMEDIATES FORMED IN SAID PROCESS
Delphi International Operations Luxembourg S.à.r.l.	F02M 63/00 (2006.01)	2647826	Valve arrangement
Boehringer Ingelheim International GmbH	A61M 15/00 (2006.01)	2714164 *	NEBULIZER
Charles River Laboratories, Inc.	G01N 33/542 (2006.01) G01N 33/569 (2006.01) G01N 33/58 (2006.01)	2769218 *	VIABILITY STAINING METHOD
Intermune, Inc.	A61K 31/4412 (2006.01) A61K 31/496 (2006.01)	2702994	Methods of administering pirfenidone therapy
Ethicon Endo-Surgery, Inc.	A61B 17/072 (2006.01)	2517644	Surgical stapler anvil comprising a plurality of forming pockets
SANOFI	A61K 31/7034 (2006.01) A61K 31/7048 (2006.01) A61K 31/7056 (2006.01) A61K 31/706 (2006.01) A61P 19/10 (2006.01)	2482823 *	USE OF COMPOUNDS WITH SGLT-1/SGLT-2 INHIBITOR ACTIVITY FOR PRODUCING MEDICAMENTS FOR TREATMENT OF BONE DISEASES
MorphoSys AG	A61P 11/00 (2006.01) A61P 19/02 (2006.01) A61P 29/00 (2006.01) C07K 16/24 (2006.01)	2768859 *	ANTAGONISTS OF IL17C FOR THE TREATMENT OF INFLAMMATORY DISORDERS
Galapagos N.V.	A61P 11/00 (2006.01) A61P 19/02 (2006.01) A61P 29/00 (2006.01) C07K 16/24 (2006.01)	2768859 *	ANTAGONISTS OF IL17C FOR THE TREATMENT OF INFLAMMATORY DISORDERS
Plaxica Limited	C12P 7/56 (2006.01) C12P 41/00 (2006.01)	2732042 *	SEPARATION PROCESS
Transmedics, Inc.	A01N 1/02 (2006.01) A61B 19/00 (2006.01) A61M 16/00 (2006.01)	2704560 *	ORGAN CARE SOLUTION FOR EX-VIVO MACHINE PERFUSION OF DONOR LUNGS
Aquasource Technologies Corporation	B01D 3/00 (2006.01)	2755729 *	SYSTEM AND METHOD FOR WATER TREATMENT
Scinopharm Taiwan Ltd.	A61K 31/337 (2006.01) A61P 35/00 (2006.01) C07D 305/14 (2006.01)	2768820 *	A PROCESS FOR MAKING AN INTERMEDIATE OF CABAZITAXEL
Scinopharm Singapore Pte, Ltd.	A61K 31/337 (2006.01) A61P 35/00 (2006.01) C07D 305/14 (2006.01)	2768820 *	A PROCESS FOR MAKING AN INTERMEDIATE OF CABAZITAXEL

Podnosilac evropske prijave patenta (71)	MKP (51)	Broj objave evropske prijave patenta (97)	Naziv pronalaska (54)
SANOFI	A61K 31/4745 (2006.01) A61K 31/505 (2006.01) A61K 31/519 (2006.01) A61K 38/17 (2006.01) A61P 35/00 (2006.01)	2701724 *	COMPOSITION COMPRISING AFLIBERCEPT, FOLINIC ACID, 5-FLUOROURACIL (5-FU) AND IRINOCETAN (FOLFIRI)
REHAU AG + Co	H05B 3/06 (2006.01) H05B 3/34 (2006.01)	2767140 *	TEMPERATURE CONTROL MAT
Battelle Energy Alliance, LLC	C07F 9/6593 (2006.01)	2764003 *	IONIC LIQUIDS, ELECTROLYTE SOLUTIONS INCLUDING THE IONIC LIQUIDS, AND ENERGY STORAGE DEVICES INCLUDING THE IONIC LIQUIDS
BIOGEN IDEC HEMOPHILIA INC.	A61K 38/36 (2006.01) C07K 14/745 (2006.01) G01N 33/48 (2006.01)	2737311 *	ASSAYS TO MONITOR BLEEDING DISORDERS
Siena Biotech S.p.A.	C07D 209/88 (2006.01)	2768807 *	PROCESSES FOR THE PREPARATION OF 6-CHLORO-2,3,4,9-TETRAHYDRO-1H-CARBAZOLE-1-CARBOXAMIDE AND OF ITS PRECURSORS
EDUARD HUECK GmbH & CO. KG	E06B 3/54 (2006.01)	2634347	Glass holder, profile assembly and frame construction
Strauss Water Ltd	B01D 29/11 (2006.01) B01D 29/15 (2006.01) B01D 29/21 (2006.01) B01D 29/52 (2006.01) B01D 29/58 (2006.01) B01D 29/90 (2006.01) B01D 35/04 (2006.01) B01D 35/30 (2006.01) C02F 1/00 (2006.01) C02F 1/28 (2006.01) C02F 1/42 (2006.01) C02F 9/00 (2006.01)	2707331 *	WATER FILTERING DEVICE
Agios Pharmaceuticals, Inc.	A61K 31/4965 (2006.01) A61K 31/497 (2006.01) A61P 7/06 (2006.01)	2704721 *	PYRUVATE KINASE ACTIVATORS FOR USE IN THERAPY
Eli Lilly and Company	A61K 38/18 (2006.01) C07K 14/50 (2006.01)	2763689 *	FIBROBLAST GROWTH FACTOR 21 VARIANTS
Curetis AG	G01N 1/28 (2006.01) G01N 1/38 (2006.01) G01N 1/44 (2006.01)	2737294 *	APPARATUS AND METHOD FOR A LYSIS OF A SAMPLE, IN PARTICULAR FOR AN AUTOMATED AND/OR CONTROLLED LYSIS OF A SAMPLE
Sanofi-Aventis Deutschland GmbH	A61M 5/315 (2006.01)	2704778 *	DRIVE ASSEMBLY FOR A DRUG DELIVERY DEVICE AND CORRESPONDING DRUG DELIVERY DEVICE
OKEANOS CORPORATION	F25C 3/04 (2006.01)	2761238 *	METHOD, IN PARTICULAR FOR GENERATING SNOW, AND DEVICE FOR CARRYING OUT THE METHOD
Messer Group GmbH	F25B 9/00 (2006.01)	2667116	Method and device for cooling
Messer France S.A.S.	F25B 9/00 (2006.01)	2667116	Method and device for cooling
DuPont Nutrition Biosciences ApS	C12Q 1/42 (2006.01) G01N 33/558 (2006.01) G01N 33/573 (2006.01)	2729809 *	ASSAY
OncoMed Pharmaceuticals, Inc.	A61K 39/00 (2006.01) C07K 16/00 (2006.01) C12P 21/08 (2006.01)	2758073 *	VEGF/DLL4 BINDING AGENTS AND USES THEREOF
Invodane Engineering Ltd.	F16H 1/22 (2006.01) F16L 55/40 (2006.01) G01N 27/82 (2006.01)	2685253	Conduit sensor device and method for operating a conduit sensor device
Amgen Inc.	C07K 16/00 (2006.01) C12N 5/00 (2006.01) C12N 5/10 (2006.01) C12P 21/00 (2006.01)	2726600 *	MAMMALIAN CELL CULTURE
Asahi Kasei Chemicals Corporation	C08K 3/00 (2006.01) C08K 7/04 (2006.01) C08L 77/00 (2006.01)	2716715 *	REINFORCED POLYAMIDE RESIN PELLETS

Podnosilac evropske prijave patenta (71)	MKP (51)	Broj objave evropske prijave patenta (97)	Naziv pronalaska (54)
Glaxo Group Limited	A61K 31/519 (2006.01) A61P 9/10 (2006.01) A61P 25/28 (2006.01) C07D 487/04 (2006.01)	2739627 *	2,3-DIHYDROIMIDAZO[1,2-C]PYRIMIDIN-5(1H)-ONE COMPOUNDS USE AS LP-PLA ² INHIBITORS
Centro De Ingenieria Genetica Y Biotecnologia	A61K 38/04 (2006.01) C07K 5/08 (2006.01) C07K 5/10 (2006.01) C07K 7/06 (2006.01)	2727931 *	COMPOUNDS AND PHARMACEUTICAL COMBINATIONS FOR THE TREATMENT OF NEURODEGENERATIVE AND ISCHEMIC BRAIN DISEASES
Univerza V Mariboru	G01R 33/12 (2006.01) G01R 33/14 (2006.01) H01F 29/08 (2006.01)	2761318 *	DEVICE AND TESTING PROCEDURE FOR DETERMINATION OF MAGNETIC CIRCUIT QUALITY
Shionogi & Co., Ltd.	A61J 3/02 (2006.01) A61K 9/14 (2006.01) A61K 9/72 (2006.01) A61K 31/4418 (2006.01) A61K 47/10 (2006.01) A61K 47/26 (2006.01) A61K 47/30 (2006.01) A61P 11/00 (2006.01)	2756840 *	PHARMACEUTICAL COMPOSITION FOR INHALATION
Shizuoka Prefectural Universities Corporation	A61J 3/02 (2006.01) A61K 9/14 (2006.01) A61K 9/72 (2006.01) A61K 31/4418 (2006.01) A61K 47/10 (2006.01) A61K 47/26 (2006.01) A61K 47/30 (2006.01) A61P 11/00 (2006.01)	2756840 *	PHARMACEUTICAL COMPOSITION FOR INHALATION
Saint-Gobain Isover	C03C 25/32 (2006.01) C08K 3/30 (2006.01) C08K 5/092 (2006.01) C08K 5/42 (2006.01) C08K 5/43 (2006.01) C08K 7/14 (2006.01) C08L 3/00 (2006.01) C08L 5/00 (2006.01) C08L 5/02 (2006.01) C09J 11/06 (2006.01) C09J 103/00 (2006.01) C09J 103/02 (2006.01) C09J 105/00 (2006.01) D04H 1/4218 (2012.01) D04H 1/64 (2012.01)	2720987 *	SIZING COMPOSITION FOR MINERAL WOOL HAVING A LOW EMISSION OF VOLATILE ORGANIC COMPOUNDS, AND INSULATING PRODUCTS OBTAINED
Virobay, Inc.	A61K 31/277 (2006.01) A61K 31/4406 (2006.01) A61P 25/00 (2006.01) A61P 25/16 (2006.01) A61P 25/28 (2006.01)	2720692 *	CATHEPSIN INHIBITORS FOR TREATING MICROGLIA-MEDIATED NEURON LOSS IN THE CENTRAL NERVOUS SYSTEM
Ethicon, Inc.	A61F 13/02 (2006.01) A61L 15/24 (2006.01) A61L 15/32 (2006.01) A61L 15/58 (2006.01) A61L 15/62 (2006.01) A61L 15/64 (2006.01) A61L 24/06 (2006.01) A61L 26/00 (2006.01)	2747791 *	PROTECTIVE WOUND DRESSING DEVICE FOR ORAL AND PHARYNGEAL SPACE
St. Jude Children's Research Hospital	C12Q 1/34 (2006.01) G01N 33/574 (2006.01)	2751279 *	METHODS AND COMPOSITIONS TO DETECT THE LEVEL OF LYSOSOMAL EXOCYTOSIS ACTIVITY AND METHODS OF USE
Merrimack Pharmaceuticals, Inc.	C07K 16/28 (2006.01) C07K 16/46 (2006.01)	2748197 *	TANDEM FC BISPECIFIC ANTIBODIES
Dongshin Industry Inc.	B29C 33/00 (2006.01) B29C 44/44 (2006.01) B29C 44/58 (2006.01)	2764973	Expanded polypropylene foam-forming mold

Podnosilac evropske prijave patenta (71)	MKP (51)	Broj objave evropske prijave patenta (97)	Naziv pronalaska (54)
Drexel University	C07D 493/02 (2006.01) C07H 13/00 (2006.01) C07H 13/02 (2006.01) C08F 24/00 (2006.01) C08F 36/14 (2006.01) C08F 224/00 (2006.01) C08F 236/14 (2006.01)	2742055 *	RENEWABLE BIO-BASED (METH) ACRYLATED MONOMERS AS VINYL ESTER CROSS-LINKERS
United States of America as Represented by the Secretary of the Army	C07D 493/02 (2006.01) C07H 13/00 (2006.01) C07H 13/02 (2006.01) C08F 24/00 (2006.01) C08F 36/14 (2006.01) C08F 224/00 (2006.01) C08F 236/14 (2006.01)	2742055 *	RENEWABLE BIO-BASED (METH) ACRYLATED MONOMERS AS VINYL ESTER CROSS-LINKERS
Delphi International Operations Luxembourg S.à.r.l.	F02M 47/02 (2006.01) F02M 61/12 (2006.01) F02M 61/16 (2006.01)	2620632	A control valve of a fuel injector
Aponia Laboratories, Inc.	A61K 9/127 (2006.01) A61K 31/192 (2006.01)	2704703 *	TRANSDERMAL COMPOSITIONS OF IBUPROFEN AND METHODS OF USE THEREOF
Beijing Junlun Runzhong Science&Technology Co., Limited	C08F 220/06 (2006.01) C08F 220/18 (2006.01) C08F 220/34 (2006.01) C08F 220/56 (2006.01) C08F 220/58 (2006.01) C08F 226/02 (2006.01) C08F 232/04 (2006.01) C09K 8/588 (2006.01)	2738191 *	AMPHIPHILIC MACROMOLECULE AND USE
SANOFI	A61K 31/4985 (2006.01) A61P 19/02 (2006.01) C07D 487/04 (2006.01)	2758399 *	N-[4-(1H-PYRAZOLO[3,4-B]PYRAZIN-6-YL)-PHENYL]-SULFONAMIDES AND THEIR USE AS PHARMACEUTICALS
Papeteries Sill	B42F 7/04 (2006.01) B43L 5/00 (2006.01)	2409853	Bag of sheets, in particular for free-hand drawing
SciPharm SàRL	C07C 67/29 (2006.01) C07C 69/18 (2006.01) C07F 7/18 (2006.01) C12P 41/00 (2006.01)	2674413	Process for the preparation of treprostinil and derivatives thereof
Royce Walker & Co., Ltd	B01J 29/00 (2006.01) C07C 1/24 (2006.01) F02M 27/02 (2006.01)	2721280 *	FUEL CONDITIONING MODULES AND METHODS
Shionogi & Co., Ltd.	A61K 31/421 (2006.01) A61K 31/4245 (2006.01) A61K 31/426 (2006.01) A61K 31/433 (2006.01) A61K 31/4439 (2006.01) A61P 3/04 (2006.01) A61P 3/06 (2006.01) A61P 3/10 (2006.01) A61P 9/04 (2006.01) A61P 9/10 (2006.01) A61P 9/12 (2006.01) A61P 15/00 (2006.01) A61P 25/08 (2006.01) A61P 25/20 (2006.01) A61P 25/24 (2006.01) A61P 43/00 (2006.01) C07D 263/48 (2006.01) C07D 271/06 (2006.01)	2703392 *	5-MEMBERED RING AROMATIC HETEROCYCLIC DERIVATIVE HAVING NPY Y5 RECEPTOR ANTAGONISTIC ACTIVITY
Glaxo Group Limited	A61K 31/138 (2006.01) A61K 31/439 (2006.01) A61K 31/58 (2006.01) A61K 45/06 (2006.01) A61P 11/06 (2006.01) A61P 11/08 (2006.01)	2717868 *	COMBINATION COMPRISING UMECLIDINIUM AND A CORTICOSTEROID

Podnosilac evropske prijave patenta (71)	MKP (51)	Broj objave evropske prijave patenta (97)	Naziv pronalaska (54)
Chinoin Private Co Ltd	A61K 9/48 (2006.01) A61K 31/47 (2006.01) A61K 31/485 (2006.01)	2709599 *	PHARMACEUTICAL COMPOSITION COMPRISING DROTAVERINE
Universität Regensburg	A61K 47/48 (2006.01) A61K 48/00 (2006.01)	2741783 *	POLYANION NANOCOMPLEXES FOR THERAPEUTIC APPLICATIONS
Daniels, Bruce A.	A61K 31/728 (2006.01) A61K 31/737 (2006.01) A61K 36/02 (2006.01)	2766025 *	THERAPEUTIC SULFATED POLYSACCHARIDES, COMPOSITIONS THEREOF, AND METHODS FOR TREATING PATIENTS
Tufts University	A61K 31/7072 (2006.01) A61P 25/04 (2006.01) A61P 25/28 (2006.01) C07D 405/04 (2006.01) C07D 405/14 (2006.01) C07D 413/14 (2006.01) C07F 9/09 (2006.01)	2760858 *	URIDINE DIPHOSPHATE DERIVATIVES, COMPOSITIONS AND METHODS FOR TREATING NEURODEGENERATIVE DISORDERS
Estetra S.A.	A61K 31/565 (2006.01) A61P 5/30 (2006.01) C07J 1/00 (2006.01) C07J 13/00 (2006.01) C07J 51/00 (2006.01)	2714710 *	PROCESS FOR THE PRODUCTION OF ESTETROL INTERMEDIATES
Kekanovic, Milan	E04B 2/18 (2006.01) E04B 2/24 (2006.01) E04B 2/86 (2006.01) E04B 5/19 (2006.01) E04B 5/21 (2006.01) E04B 5/38 (2006.01) E04C 2/288 (2006.01)	2739799 *	BUILDING STRUCTURE OF PRE-CAST MONOLITHIC WALLS AND INTERFLOOR SLABS
SANOFI	A01K 67/027 (2006.01) G01N 33/92 (2006.01)	2702413 *	TEST SYSTEMS AND METHODS FOR IDENTIFYING AND CHARACTERISING LIPID LOWERING DRUGS
Ajinomoto Co., Inc.	A61K 8/36 (2006.01) A61K 8/42 (2006.01) A61Q 5/02 (2006.01) A61Q 19/10 (2006.01) C11D 1/04 (2006.01) C11D 1/10 (2006.01) C11D 3/33 (2006.01)	2703478 *	CLEANING AGENT COMPOSITION
TEXAS INSTRUMENTS DEUTSCHLAND GMBH	G11C 27/02 (2006.01)	2650881	Electronic device and method for low leakage switching
Texas Instruments Incorporated	G11C 27/02 (2006.01)	2650881	Electronic device and method for low leakage switching
Dusseault, Maurice B.	B01D 53/62 (2006.01)	2723475 *	SEQUESTRATION OF GREENHOUSE GASSES BY GENERATING AN UNSTABLE GAS/SALINE FRONT WITHIN A FORMATION
Bilak, Roman	B01D 53/62 (2006.01)	2723475 *	SEQUESTRATION OF GREENHOUSE GASSES BY GENERATING AN UNSTABLE GAS/SALINE FRONT WITHIN A FORMATION
Gt Biologics Ltd	A61K 35/74 (2006.01) A61P 1/00 (2006.01) A61P 37/00 (2006.01)	2763685 *	BACTERIUM FOR USE AS A PROBIOTIC FOR NUTRITIONAL AND MEDICAL APPLICATIONS
Ethicon Endo-Surgery, Inc.	A61B 17/072 (2006.01)	2517645	Tissue thickness compensator for a surgical stapler comprising an adjustable anvil
InnoCore Technologies B.V.	A61K 9/16 (2006.01) C08G 81/00 (2006.01) C08L 87/00 (2006.01)	2734573 *	BIODEGRADABLE, SEMI-CRYSTALLINE, PHASE SEPARATED, THERMOPLASTIC MULTI BLOCK COPOLYMERS FOR CONTROLLED RELEASE OF BIOLOGICALLY ACTIVE COMPOUNDS

Podnosilac evropske prijave patenta (71)	MKP (51)	Broj objave evropske prijave patenta (97)	Naziv pronalaska (54)
ZAFGEN INC.	A61K 31/335 (2006.01) A61K 31/352 (2006.01) A61K 31/397 (2006.01) A61K 31/4025 (2006.01) A61K 31/4355 (2006.01) A61P 3/04 (2006.01) C07D 311/94 (2006.01) C07D 405/02 (2006.01) C07D 491/048 (2006.01) C07D 493/04 (2006.01)	2705030 *	PARTIALLY SATURATED TRICYCLIC COMPOUNDS AND METHODS OF MAKING AND USING SAME
Beta Innov	A61K 31/575 (2006.01) A61P 35/00 (2006.01) C07J 9/00 (2006.01) C07J 41/00 (2006.01) C07J 75/00 (2006.01)	2662382	Sterol derivatives, method for preparing same, pharmaceutical compositions containing same and use thereof for the treatment of multiple glioblastomas
JX Nippon Oil & Energy Corporation	C09K 5/04 (2006.01) C10M 105/18 (2006.01) C10M 107/24 (2006.01) C10M 107/34 (2006.01) C10M 129/18 (2006.01) C10M 133/04 (2006.01) C10M 137/08 (2006.01) C10M 169/04 (2006.01) C10M 171/00 (2006.01) C10N 30/06 (2006.01) C10N 30/08 (2006.01) C10N 30/10 (2006.01) C10N 40/30 (2006.01)	2740784	Refrigerant oil for freezers and operating fluid composition for freezers
Glaxo Group Limited	A61K 31/4545 (2006.01) A61P 25/28 (2006.01) C07D 401/12 (2006.01)	2751094 *	NOVEL CRYSTAL FORM
Delphi International Operations Luxembourg S.à.r.l.	F02M 59/06 (2006.01) F02M 59/10 (2006.01) F04B 1/04 (2006.01)	2639444	Fuel pump assembly
Berg LLC	A61K 9/00 (2006.01) A61K 9/127 (2006.01) A61K 47/24 (2006.01)	2720680 *	INHALABLE PHARMACEUTICAL COMPOSITIONS
Glaxo Group Limited	C07K 16/22 (2006.01)	2736925 *	ANTI-VEGF SINGLE VARIABLE DOMAINS FUSED TO FC DOMAINS
Duoject Medical Systems, Inc.	A61J 1/14 (2006.01) A61J 3/00 (2006.01) B65D 81/32 (2006.01)	2729110 *	RECONSTITUTION DEVICE
Hitachi Information & Telecommunication Engineering, Ltd.	H04L 12/18 (2006.01) H04M 3/42 (2006.01)	2744185	File management system, method and computer program
Wilier Triestina S.p.A.	B62J 99/00 (2009.01) B62K 21/02 (2006.01) B62K 21/06 (2006.01) B62K 21/18 (2006.01)	2718173 *	BICYCLE FORK
Hrl Treasury (idgcc) Pty Ltd	C10B 47/24 (2006.01) C10J 3/50 (2006.01) C10J 3/54 (2006.01) F02C 3/28 (2006.01) F26B 3/10 (2006.01)	2707663 *	IMPROVEMENTS IN INTEGRATED DRYING GASIFICATION
Synta Pharmaceuticals Corp.	A61K 31/4196 (2006.01) A61K 31/675 (2006.01) A61K 45/06 (2006.01) A61P 35/00 (2006.01)	2714038 *	COMBINATION THERAPY OF HSP90 INHIBITORY COMPOUNDS WITH MTOR/PI3K INHIBITORS
Aevoe International Ltd.	A45C 11/00 (2006.01)	2647306	Protective apparatus for tablet electronic device
Assistance Publique Hôpitaux De Paris	A61K 31/4188 (2006.01) A61P 25/00 (2006.01)	2729143 *	USE OF BIOTIN FOR THE TREATMENT OF MULTIPLE SCLEROSIS
Merrimack Pharmaceuticals, Inc.	A61K 39/395 (2006.01)	2726100 *	ANTI-ERBB3 ANTIBODIES IN COMBINATION WITH PACLITAXEL FOR TREATMENT OF GYNECOLOGICAL CANCERS

Podnosilac evropske prijave patenta (71)	MKP (51)	Broj objave evropske prijave patenta (97)	Naziv pronalaska (54)
SANOFI	A61K 39/395 (2006.01)	2726100 *	ANTI-ERBB3 ANTIBODIES IN COMBINATION WITH PACLITAXEL FOR TREATMENT OF GYNECOLOGICAL CANCERS
OMV REFINING & MARKETING GMBH	C10B 53/07 (2006.01) C10G 1/10 (2006.01)	2705117 *	METHOD AND APPARATUS FOR ENERGY-EFFICIENT PROCESSING OF SECONDARY DEPOSITS
Saint-Gobain Glass France	E04B 2/74 (2006.01) F21V 33/00 (2006.01) G02B 6/00 (2006.01)	2718512 *	ILLUMINATING GLASS PARTITION
Total Protection Service S.r.l.	G08B 13/14 (2006.01) G08B 29/04 (2006.01)	2740110 *	ANTI-THEFT DEVICE FOR OBJECTS ON DISPLAY
NCS Lab S.r.l.	A61B 17/04 (2006.01) A61B 17/06 (2006.01)	2734124 *	DEVICE FOR THE TRANSOSSEOUS INSERTION OF SUTURE THREADS
Wood Innovations Ltd.	E04C 2/34 (2006.01)	2660408	Zigzag wooden elements comprising a core layer and multiple layer composite comprising the core layer
Sanofi-Aventis Deutschland GmbH	A61K 31/155 (2006.01) A61K 38/26 (2006.01) A61K 38/28 (2006.01) A61P 3/04 (2006.01) A61P 3/10 (2006.01)	2707015 *	LIXISENATIDE AS ADD-ON THERAPY TO BASAL INSULIN IN TYPE 2 DIABETES
ANT Corporation	B01D 33/15 (2006.01) B01D 33/39 (2006.01) B01D 33/74 (2006.01)	2752229 *	SUCTIONING APPARATUS FOR A FIBROUS FILTER, AND FILTERING DEVICE USING SAME
Five9, Inc.	G06Q 10/00 (2012.01)	2748776 *	NETWORK PREDICTIVE CUSTOMER SERVICE QUEUE MANAGEMENT
Product Spring, LLC	A47J 31/00 (2006.01) A47J 43/27 (2006.01) B65B 3/04 (2006.01) F24H 1/18 (2006.01)	2739190 *	POWDER DISPENSING APPARATUS
Taylor Concepts, LLC	A47J 31/00 (2006.01) A47J 43/27 (2006.01) B65B 3/04 (2006.01) F24H 1/18 (2006.01)	2739190 *	POWDER DISPENSING APPARATUS
Hartdesigni Ltd.	A47J 31/00 (2006.01) A47J 43/27 (2006.01) B65B 3/04 (2006.01) F24H 1/18 (2006.01)	2739190 *	POWDER DISPENSING APPARATUS
Viamet Pharmaceuticals, Inc.	A01N 43/34 (2006.01) A01N 43/713 (2006.01) A01P 3/00 (2006.01) C07D 401/06 (2006.01) C07D 401/14 (2006.01)	2721022 *	METALLOENZYME INHIBITOR COMPOUNDS
Zoetis LLC	A61K 39/155 (2006.01)	2707025 *	HENDRA AND NIPAH VIRUS G GLYCOPROTEIN IMMUNOGENIC COMPOSITIONS
HENRY M. JACKSON FOUNDATION FOR THE ADVANCEMENT OF MILITARY MEDICINE, INC.	A61K 39/155 (2006.01)	2707025 *	HENDRA AND NIPAH VIRUS G GLYCOPROTEIN IMMUNOGENIC COMPOSITIONS
H. Lundbeck A/S	A61K 31/4985 (2006.01) A61P 25/00 (2006.01) C07D 471/14 (2006.01)	2763989 *	PYRIDINE COMPOUNDS AND USES THEREOF
Syngenta Participations AG	A01N 43/54 (2006.01) A01N 43/56 (2006.01) A01N 43/653 (2006.01) A01N 43/80 (2006.01) A01P 3/00 (2006.01)	2713734 *	PESTICIDAL MIXTURES COMPRISING ISOXAZOLINE DERIVATIVES

Podnosilac evropske prijave patenta (71)	MKP (51)	Broj objave evropske prijave patenta (97)	Naziv pronalaska (54)
Chiesi Farmaceutici S.p.A.	A61K 31/437 (2006.01) A61K 31/4439 (2006.01) A61K 31/498 (2006.01) A61K 31/502 (2006.01) A61K 31/517 (2006.01) A61K 31/522 (2006.01) C07D 401/12 (2006.01) C07D 401/14 (2006.01) C07D 409/14 (2006.01) C07D 413/12 (2006.01) C07D 413/14 (2006.01) C07D 417/12 (2006.01) C07D 417/14 (2006.01) C07D 471/04 (2006.01) C07D 473/04 (2006.01)	2768822 *	DERIVATIVES OF 1-PHENYL-2-PYRIDINYL ALKYL ALCOHOLS AS PHOSPHODIESTERASE INHIBITORS
Sanofi-Aventis Deutschland GmbH	A61M 5/24 (2006.01) A61M 5/315 (2006.01)	2731646 *	LOCKING INTERFACE, CARTRIDGE HOLDER AND DRUG DELIVERY DEVICE COMPRISING A LOCKING INTERFACE
SANOFI	A61K 47/48 (2006.01) C07K 16/28 (2006.01)	2710034 *	USE OF ANTI-CD19 MAYTANSINOID IMMUNOCONJUGATE ANTIBODY FOR THE TREATMENT OF B-CELL MALIGNANCIES SYMPTOMS
Glaxosmithkline LLC	A61K 31/535 (2006.01)	2768509 *	SUBSTITUTED BICYCLIC AZA-HETEROCYCLES AND ANALOGUES AS SIRTUIN MODULATORS
Amgen Inc.	A61K 39/395 (2006.01) C07K 16/22 (2006.01)	2734546 *	APELIN ANTIGEN-BINDING PROTEINS AND USES THEREOF
Bionorica SE	A61K 36/185 (2006.01) A61K 36/515 (2006.01) A61K 36/70 (2006.01) A61K 36/85 (2006.01) A61P 11/12 (2006.01) A61P 31/00 (2006.01)	2744504 *	METHOD FOR PRODUCING DRY EXTRACTS
STC.UNM	A61K 9/16 (2006.01) A61K 38/17 (2006.01) A61K 47/30 (2006.01) A61K 47/48 (2006.01) A61K 48/00 (2006.01)	2701686 *	POROUS NANOPARTICLE-SUPPORTED LIPID BILAYERS (PROTOCELLS) FOR TARGETED DELIVERY AND METHODS OF USING SAME
Sandia Corporation	A61K 9/16 (2006.01) A61K 38/17 (2006.01) A61K 47/30 (2006.01) A61K 47/48 (2006.01) A61K 48/00 (2006.01)	2701686 *	POROUS NANOPARTICLE-SUPPORTED LIPID BILAYERS (PROTOCELLS) FOR TARGETED DELIVERY AND METHODS OF USING SAME
YM BioSciences Australia Pty Ltd	A61K 31/506 (2006.01) A61P 35/00 (2006.01)	2704722 *	MULTIPLE MYELOMA TREATMENT
OSI Pharmaceuticals, LLC	C12Q 1/68 (2006.01)	2702173 *	USE OF EMT GENE SIGNATURES IN CANCER DRUG DISCOVERY, DIAGNOSTICS, AND TREATMENT
Aveo Pharmaceuticals, Inc.	C12Q 1/68 (2006.01)	2702173 *	USE OF EMT GENE SIGNATURES IN CANCER DRUG DISCOVERY, DIAGNOSTICS, AND TREATMENT
Miele & Cie. KG	A47J 31/40 (2006.01) A47J 31/42 (2006.01)	2763574 *	COFFEE MACHINE AND A METHOD FOR INTRODUCING A QUANTITY OF BEANS
Denso IT Laboratory, Inc.	G06K 9/46 (2006.01)	2631845	Local feature amount calculating device, method of calculating local feature amount, corresponding point searching apparatus, and method of searching corresponding point
NorthShore University HealthSystem	A61K 31/77 (2006.01)	2701715 *	PROPHYLAXIS AND TREATMENT OF ENTEROPATHOGENIC BACTERIAL INFECTION
Corcel IP Limited	B26F 1/00 (2006.01) B31F 1/20 (2006.01) B32B 3/00 (2006.01) B32B 33/00 (2006.01) B32B 38/04 (2006.01) B65D 81/24 (2006.01)	2739549 *	IMPROVEMENTS IN AND RELATING TO CORRUGATED BOARD AND THE MANUFACTURE THEREOF
Galileo Wheel Ltd.	B60C 3/00 (2006.01) B60C 13/00 (2006.01)	2736737 *	TIRE FOR SURFACE VEHICLE

Podnosilac evropske prijave patenta (71)	MKP (51)	Broj objave evropske prijave patenta (97)	Naziv pronalaska (54)
Hörmann, Markus	G06Q 10/08 (2012.01)	2662813	Method for registering, inventory, managing, checking and monitoring of tangible and intangible rights and/or goods
Wabtec Holding Corp.	G01B 21/22 (2006.01)	2761250 *	POSITION SENSING DEVICE FOR TRANSIT SHAFT AND ARM ASSEMBLY
Alluna, Carinn	A41B 13/06 (2006.01) A41D 13/12 (2006.01) A47D 15/00 (2006.01) A47G 9/08 (2006.01)	2736361 *	SWADDLING UNIT
OSI Pharmaceuticals, LLC	A61K 31/437 (2006.01) A61K 31/4985 (2006.01) A61P 35/00 (2006.01) C07D 471/04 (2006.01) C07D 487/04 (2006.01)	2710003 *	FUSED BICYCLIC KINASE INHIBITORS
Janssen Pharmaceutica, N.V.	A61K 31/70 (2006.01) C07D 409/10 (2006.01) C07H 7/04 (2006.01)	2707366 *	L-PROLINE AND CITRIC ACID CO-CRYSTALS OF (2S, 3R, 4R, 5S, 6R)- 2- (3- ((5- (4-FLUOROPHENYL) THIOPHEN-2-YL) METHYL) -4-METHYLPHENYL)-6- (HYDROXYMETHYL)TETRAHYDRO-2H-PYRAN-3,4,5-TRIOL
Cosmetic Warriors Ltd	A61K 8/04 (2006.01)	2723305 *	SOLID COSMETIC COMPOSITION HAVING DISPERSED THEREIN GAS BUBBLES
INTER+-POL Freie Forschungs- u. Entwicklungsges. f. unfassb. Formate, exper. Proj., ungesehene Filme dicke u. dünne Bücher, grenzenl. Räume, mbH	E04H 3/12 (2006.01)	2623690	Tribune
Amgen Research (Munich) GmbH	A61K 39/395 (2006.01) A61P 35/02 (2006.01) C07K 16/28 (2006.01)	2701741 *	DOSAGE REGIMEN FOR ADMINISTERING A CD19XCD3 BISPECIFIC ANTIBODY TO PATIENTS AT RISK FOR POTENTIAL ADVERSE EFFECTS
Tsinghua University	A61K 9/08 (2006.01) A61K 9/127 (2006.01) A61K 9/70 (2006.01) A61K 31/7048 (2006.01) A61K 31/724 (2006.01) A61K 38/17 (2006.01) A61K 39/395 (2006.01) A61P 35/00 (2006.01) A61P 43/00 (2006.01)	2702997 *	METHOD AND COMPOSITION FOR ENHANCING TARGET CELLS UPTAKE OF THERAPEUTIC AGENTS
Beijing Protgen Ltd.	A61K 9/08 (2006.01) A61K 9/127 (2006.01) A61K 9/70 (2006.01) A61K 31/7048 (2006.01) A61K 31/724 (2006.01) A61K 38/17 (2006.01) A61K 39/395 (2006.01) A61P 35/00 (2006.01) A61P 43/00 (2006.01)	2702997 *	METHOD AND COMPOSITION FOR ENHANCING TARGET CELLS UPTAKE OF THERAPEUTIC AGENTS
Junker, Thyl	A61G 5/02 (2006.01) A61G 5/10 (2006.01)	2727568	Wheelchair, retrofit kit for a wheelchair and method for operating a wheelchair
Pagano, Roman	A61G 5/02 (2006.01) A61G 5/10 (2006.01)	2727568	Wheelchair, retrofit kit for a wheelchair and method for operating a wheelchair
Levedag, Daniel	A61G 5/02 (2006.01) A61G 5/10 (2006.01)	2727568	Wheelchair, retrofit kit for a wheelchair and method for operating a wheelchair
Virginia Commonwealth University	A61B 6/00 (2006.01) A61N 5/00 (2006.01)	2701605 *	3D TRACKING OF AN HDR SOURCE USING A FLAT PANEL DETECTOR
Janssen R&D Ireland	A61K 31/4375 (2006.01) A61P 31/04 (2006.01) C07D 471/04 (2006.01) C07D 487/04 (2006.01)	2742045 *	ANTIBACTERIAL CYCLOPENTA[C]PYRROLE SUBSTITUTED 3,4-DIHYDRO-1H-[1,8] NAPHTHYRIDINONES
Adlyfe, Inc.	A61B 5/00 (2006.01) G01N 33/68 (2006.01)	2712425 *	OCULAR DETECTION OF AMYLOID PROTEINS

Podnosilac evropske prijave patenta (71)	MKP (51)	Broj objave evropske prijave patenta (97)	Naziv pronalaska (54)
Exelixis, Inc.	A61K 31/00 (2006.01) A61K 31/519 (2006.01) A61P 35/02 (2006.01)	2701690 *	METHOD OF TREATING LYMPHOMA USING PYRIDOPYRIMIDINONE INHIBITORS OF PI3K/MTOR
SANOFI	A61K 31/00 (2006.01) A61K 31/519 (2006.01) A61P 35/02 (2006.01)	2701690 *	METHOD OF TREATING LYMPHOMA USING PYRIDOPYRIMIDINONE INHIBITORS OF PI3K/MTOR
Incyte Corporation	C07D 487/04 (2006.01) C07D 491/10 (2006.01)	2753621 *	PROCESSES AND INTERMEDIATES FOR MAKING A JAK INHIBITOR
Dal Col, Alessandro	B05D 1/42 (2006.01) B41J 2/01 (2006.01) G09F 19/22 (2006.01)	2707151 *	DEVICE TO REPRODUCE IMAGES OR GRAPHICAL PATTERNS IN GENERAL ON SURFACES, CORRESPONDING METHOD
Tavian, Carlo	B05D 1/42 (2006.01) B41J 2/01 (2006.01) G09F 19/22 (2006.01)	2707151 *	DEVICE TO REPRODUCE IMAGES OR GRAPHICAL PATTERNS IN GENERAL ON SURFACES, CORRESPONDING METHOD
Battiston, Giacomo	B05D 1/42 (2006.01) B41J 2/01 (2006.01) G09F 19/22 (2006.01)	2707151 *	DEVICE TO REPRODUCE IMAGES OR GRAPHICAL PATTERNS IN GENERAL ON SURFACES, CORRESPONDING METHOD
Gaul, Georg	A61F 2/95 (2013.01)	2736459 *	DEVICE FOR THE PREDETERMINABLE ARRANGEMENT OF A STENT
Omya International AG	D04H 1/435 (2012.01)	2749679	CaCO ₃ in polyester for nonwoven and fibers
H. Lundbeck A/S	A61K 31/496 (2006.01) A61P 25/18 (2006.01)	2720698 *	METHOD OF ADMINISTRATION OF 4-((1R,3S)-6-CHLORO-3-PHENYL-INDAN-1-YL)-1,2,2-TRIMETHYL-PIPERAZINE AND THE SALTS THEREOF IN THE TREATMENT OF SCHIZOPHRENIA
Mitsubishi Materials Corporation	C04B 35/472 (2006.01) H01L 21/02 (2006.01)	2706049	Composition for forming ferroelectric thin film, method for forming thin film and thin film formed using the same method
Gilead Biologics, Inc.	C07K 16/40 (2006.01)	2714744 *	LYSYL OXIDASE-LIKE 2 ASSAY AND METHODS OF USE THEREOF
Fovea Pharmaceuticals	C07C 217/84 (2006.01)	2755944 *	ANILINE DERIVATIVES, THEIR PREPARATION AND THEIR THERAPEUTIC APPLICATION
ChemoCentryx, Inc.	A61K 31/4409 (2006.01)	2734204 *	POLYMORPHIC FORMS OF THE SODIUM SALT OF 4-TERT-BUTYL-N-[4-CHLORO-2-(1-OXY-PYRIDINE-4-CARBONYL)-PHENYL]-BENZENE SULFONAMIDE
On Demand Real Time Llc	H04N 21/472 (2011.01)	2710807 *	METHOD AND SYSTEM FOR SEGMENTING AND TRANSMITTING ON-DEMAND LIVE-ACTION VIDEO IN REAL-TIME
Chinook End-Stage Recycling Limited	B01J 19/00 (2006.01) B01J 20/00 (2006.01) B01J 21/00 (2006.01) B01J 23/00 (2006.01) C01B 3/16 (2006.01) C01B 3/18 (2006.01) C01B 3/24 (2006.01) C01B 31/20 (2006.01)	2707130 *	SYNTHESIS GAS PROCESSING AND SYSTEM USING COPPER CATALYST IN TWO STEP REACTIONS AT 475-525°C AND 250-290°C
Bry-Air (Asia) Pvt. Ltd.	F24F 3/14 (2006.01) F24F 11/00 (2006.01)	2764296 *	APPARATUS AND METHOD FOR CONTROL OF SOLID DESICCANT DEHUMIDIFIERS
Purdue Pharma LP	A61K 9/16 (2006.01) A61K 9/20 (2006.01) A61K 9/28 (2006.01) A61K 9/48 (2006.01) A61K 9/50 (2006.01) A61K 31/485 (2006.01)	2755638 *	TAMPER RESISTANT IMMEDIATE RELEASE FORMULATIONS
Pearl Therapeutics, Inc.	A01N 25/00 (2006.01) A61K 9/72 (2006.01) A61L 9/02 (2006.01)	2709447 *	COMPOSITIONS, METHODS & SYSTEMS FOR RESPIRATORY DELIVERY OF TWO OR MORE ACTIVE AGENTS
Donau-Universität Krems	G01D 5/34 (2006.01) G01P 1/02 (2006.01) G01P 15/08 (2006.01) G01P 15/093 (2006.01)	2702415 *	METHOD FOR SENSING AND SENSOR

Podnosilac evropske prijave patenta (71)	MKP (51)	Broj objave evropske prijave patenta (97)	Naziv pronalaska (54)
Tecnet Equity Nö Technologiebeteiligungs Invest GmbH	G01D 5/34 (2006.01) G01P 1/02 (2006.01) G01P 15/08 (2006.01) G01P 15/093 (2006.01)	2702415 *	METHOD FOR SENSING AND SENSOR
Moreno Sarmiento, Roman	A47F 5/08 (2006.01)	2708163 *	DEVICE FOR HANGING UP A DISPLAY PANEL
OKEANOS CORPORATION	B01J 19/12 (2006.01) C02F 1/48 (2006.01)	2704822 *	METHOD FOR PHYSICALLY WORKING AND/OR HEATING MEDIA, IN PARTICULAR LIQUIDS, AND DEVICE FOR CARRYING OUT THE METHOD
Amgen Inc.	C07D 265/06 (2006.01) C07D 413/04 (2006.01) C07D 413/10 (2006.01) C07D 413/12 (2006.01) C07D 417/04 (2006.01)	2760845 *	HETEROCYCLIC COMPOUNDS AS MDM2 INHIBITORS FOR THE TREATMENT OF CANCER
OVIVITY GROUP, S.L.	A23L 1/29 (2006.01) A23L 1/30 (2006.01) A23L 1/32 (2006.01) A61K 35/00 (2006.01)	2765869 *	EGG PREPARATION WITH REGENERATING, ANALGESIC AND/OR ANTI-INFLAMMATORY PROPERTIES
Bayer HealthCare LLC	A61K 9/00 (2006.01) A61K 31/4412 (2006.01) A61K 47/02 (2006.01) A61K 47/06 (2006.01) A61K 47/14 (2006.01) A61K 47/26 (2006.01) A61K 47/38 (2006.01)	2726059 *	TOPICAL OPHTHALMOLOGICAL PHARMACEUTICAL COMPOSITION CONTAINING REGORAFENIB
Artskin D.O.O.	A61K 31/33 (2006.01)	2704706 *	COMPOSITION COMPRISING ANGIOTENSIN II RECEPTOR ANTAGONIST AND ANTIOXIDANT FOR MAINTAINING AND/OR IMPROVING SKIN PROPERTIES
Babcock & Wilcox Vølund A/S	F23C 9/08 (2006.01) F23H 17/00 (2006.01) F23H 17/08 (2006.01) F23L 7/00 (2006.01) F23L 9/06 (2006.01) F23M 5/08 (2006.01)	2295859	Waste incineration plant with introduction of cooling gas
Golini, Jeffrey M.	A61K 31/70 (2006.01)	2763682 *	CHOLINE COMPOSITION
Gürtelbauer, Thomas	E01F 9/03 (2006.01)	2518213	Holding device
Purdue Pharma LP	A61K 9/14 (2006.01) A61K 9/16 (2006.01) A61K 9/20 (2006.01) A61K 31/485 (2006.01) A61K 47/32 (2006.01)	2768537 *	ACRYLIC POLYMER FORMULATIONS
Schuster, Péter	C02F 3/12 (2006.01) C02F 3/30 (2006.01)	2766313 *	SMALL INSTALLATION FOR BIOLOGICAL WASTEWATER TREATMENT WITH IMPROVED EFFICIENCY
Krasznói, Anna	C02F 3/12 (2006.01) C02F 3/30 (2006.01)	2766313 *	SMALL INSTALLATION FOR BIOLOGICAL WASTEWATER TREATMENT WITH IMPROVED EFFICIENCY
DuPont Nutrition Biosciences ApS	A23G 9/38 (2006.01) A23J 3/14 (2006.01) A23L 1/00 (2006.01) A23L 1/035 (2006.01) A23L 1/19 (2006.01)	2763552 *	WHIPPING AGENT FOR FOOD PRODUCTS AND USE THEREOF
Gilead Sciences, Inc.	A61K 31/4418 (2006.01) A61P 25/30 (2006.01) A61P 25/32 (2006.01) A61P 25/34 (2006.01) A61P 25/36 (2006.01) C07D 213/64 (2006.01)	2726460 *	COMPOUNDS FOR THE TREATMENT OF ADDICTION
Qualcomm Incorporated	G01S 19/09 (2010.01) G01S 19/46 (2010.01)	2715401 *	HYBRID POSITIONING USING SYNCHRONOUS AND ASYNCHRONOUS TECHNIQUES
Xenon Pharmaceuticals Inc.	C07D 491/20 (2006.01)	2733145	Synthetic methods for spiro-oxindole compounds

Podnosilac evropske prijave patenta (71)	MKP (51)	Broj objave evropske prijave patenta (97)	Naziv pronalaska (54)
Baxter International Inc.	A61L 2/00 (2006.01) C12M 1/00 (2006.01) C12M 1/12 (2006.01) C12N 5/00 (2006.01)	2732020 *	VIRUS FILTRATION OF CELL CULTURE MEDIA
Baxter Healthcare SA	A61L 2/00 (2006.01) C12M 1/00 (2006.01) C12M 1/12 (2006.01) C12N 5/00 (2006.01)	2732020 *	VIRUS FILTRATION OF CELL CULTURE MEDIA
Mundt, Wolfgang	A61L 2/00 (2006.01) C12M 1/00 (2006.01) C12M 1/12 (2006.01) C12N 5/00 (2006.01)	2732020 *	VIRUS FILTRATION OF CELL CULTURE MEDIA
Mitterer, Artur	A61L 2/00 (2006.01) C12M 1/00 (2006.01) C12M 1/12 (2006.01) C12N 5/00 (2006.01)	2732020 *	VIRUS FILTRATION OF CELL CULTURE MEDIA
Reiter, Manfred	A61L 2/00 (2006.01) C12M 1/00 (2006.01) C12M 1/12 (2006.01) C12N 5/00 (2006.01)	2732020 *	VIRUS FILTRATION OF CELL CULTURE MEDIA
Hasslacher, Meinhard	A61L 2/00 (2006.01) C12M 1/00 (2006.01) C12M 1/12 (2006.01) C12N 5/00 (2006.01)	2732020 *	VIRUS FILTRATION OF CELL CULTURE MEDIA
Grillberger, Leopold	A61L 2/00 (2006.01) C12M 1/00 (2006.01) C12M 1/12 (2006.01) C12N 5/00 (2006.01)	2732020 *	VIRUS FILTRATION OF CELL CULTURE MEDIA
Kreil, Thomas	A61L 2/00 (2006.01) C12M 1/00 (2006.01) C12M 1/12 (2006.01) C12N 5/00 (2006.01)	2732020 *	VIRUS FILTRATION OF CELL CULTURE MEDIA
Zoetis LLC	G01N 33/68 (2006.01)	2748612 *	IMPROVED VACCINE DIAGNOSTICS
Wirtz, Ralph Markus	C12N 15/09 (2006.01)	2742132 *	MATRIX AND METHOD FOR PURIFYING AND/OR ISOLATING NUCLEIC ACIDS
Nationwide Children's Hospital, Inc.	G01N 33/569 (2006.01) G01N 33/68 (2006.01)	2718722 *	PROTEOMICS BASED DIAGNOSTIC DETECTION METHOD FOR CHRONIC SINUSITIS
The Ohio State University	G01N 33/569 (2006.01) G01N 33/68 (2006.01)	2718722 *	PROTEOMICS BASED DIAGNOSTIC DETECTION METHOD FOR CHRONIC SINUSITIS
Takeda Nycomed AS	A61F 13/02 (2006.01)	2713972 *	ROLLED COLLAGEN CARRIER
Opalux Incorporated	B41J 2/315 (2006.01) B41J 2/475 (2006.01) B41M 3/00 (2006.01) B41M 3/06 (2006.01) B41M 3/14 (2006.01) C08J 3/24 (2006.01) G02B 1/02 (2006.01)	2714411 *	METHODS AND SYSTEMS FOR THERMAL PRINTING OF PHOTONIC CRYSTAL MATERIALS, AND THERMALLY PRINTABLE PHOTONIC CRYSTAL MATERIALS AND ASSEMBLIES
GlaxoSmithKline LLC	A01N 37/18 (2006.01) A01N 43/38 (2006.01) A61K 31/40 (2006.01) A61P 1/16 (2006.01)	2747569 *	COMBINATION TREATMENTS FOR HEPATITIS C
Benati, Carlo	A47G 23/00 (2006.01) B01F 3/04 (2006.01)	2739379 *	A WINE DECANTER DEVICE
Packers Plus Energy Services Inc.	E21B 23/10 (2006.01) E21B 34/14 (2006.01)	2766560 *	DOWNHOLE ACTUATION BALL, METHODS AND APPARATUS
AWINGU NV	G06F 17/30 (2006.01)	2706467	Method for accessing a content item in a cloud storage system, and a corresponding cloud broker, cloud cache agent and client application
Neelogy	G01R 15/18 (2006.01)	2761309 *	CONTACTLESS CURRENT SENSOR

Podnosilac evropske prijave patenta (71)	MKP (51)	Broj objave evropske prijave patenta (97)	Naziv pronalaska (54)
Cancer Targeted Technology LLC	C07B 59/00 (2006.01) C07F 9/24 (2006.01) C07F 9/6515 (2006.01) C07F 9/6524 (2006.01) C07F 9/6527 (2006.01) C07F 9/6558 (2006.01) C07F 9/6561 (2006.01)	2721039 *	CHELATED PSMA INHIBITORS
Pozen, Inc.	A61K 31/4365 (2006.01) C07D 495/04 (2006.01)	2755979 *	PHASED DOSING OF CLOPIDOGREL
SEH Limited	H01F 7/16 (2006.01) H02K 33/16 (2006.01)	2754159 *	MAGNET DEVICE
Janssen Pharmaceutica, N.V.	A61K 31/5513 (2006.01) C07D 487/04 (2006.01)	2707370 *	NOVEL ANTIFUNGAL 5,6-DIHYDRO-4H-PYRROLO[1,2-a][1,4]BENZO-DIAZEPINES AND 6H-PYRROLO[1,2-a][1,4]BENZODIAZEPINES SUBSTITUTED WITH HETEROCYCLIC DERIVATIVES
GERFLOR	E04F 15/22 (2006.01) G01N 3/30 (2006.01) G01N 3/42 (2006.01) G01N 3/48 (2006.01)	2642275	Device for measuring the comfort index of indoor sports surfaces after the impact of a force on the surface
Sensix	E04F 15/22 (2006.01) G01N 3/30 (2006.01) G01N 3/42 (2006.01) G01N 3/48 (2006.01)	2642275	Device for measuring the comfort index of indoor sports surfaces after the impact of a force on the surface
Centre National de la Recherche Scientifique (CNRS)	E04F 15/22 (2006.01) G01N 3/30 (2006.01) G01N 3/42 (2006.01) G01N 3/48 (2006.01)	2642275	Device for measuring the comfort index of indoor sports surfaces after the impact of a force on the surface
UNIVERSITE DE POITIERS	E04F 15/22 (2006.01) G01N 3/30 (2006.01) G01N 3/42 (2006.01) G01N 3/48 (2006.01)	2642275	Device for measuring the comfort index of indoor sports surfaces after the impact of a force on the surface
Ecole Nationale Supérieure de Mécanique et d'Aérotechnique	E04F 15/22 (2006.01) G01N 3/30 (2006.01) G01N 3/42 (2006.01) G01N 3/48 (2006.01)	2642275	Device for measuring the comfort index of indoor sports surfaces after the impact of a force on the surface
gabo Systemtechnik GmbH	B65H 75/36 (2006.01) H02G 1/06 (2006.01)	2404857	Storage container, subterranean cable storage and system for subterranean positioning of a cable storage
Ganymed Pharmaceuticals AG	A61K 39/395 (2006.01) C07K 16/30 (2006.01)	2707390 *	ANTIBODIES FOR TREATMENT OF CANCER EXPRESSING CLAUDIN 6
Johannes- Gutenberg- Universität Mainz	A61K 39/395 (2006.01) C07K 16/30 (2006.01)	2707390 *	ANTIBODIES FOR TREATMENT OF CANCER EXPRESSING CLAUDIN 6
Kymab Limited	A01K 67/027 (2006.01) C07K 16/46 (2006.01) C12N 15/85 (2006.01)	2757875 *	MANIPULATION OF IMMUNOGLOBULIN GENE DIVERSITY AND MULTI-ANTIBODY THERAPEUTICS
Qualcomm Incorporated	G06F 3/01 (2006.01) G06F 3/033 (2013.01)	2715487 *	METHOD AND APPARATUS FOR CLASSIFYING MULTIPLE DEVICE STATES
H. Lundbeck A/S	A61K 9/08 (2006.01) A61K 31/495 (2006.01) A61P 25/00 (2006.01) A61P 25/22 (2006.01) A61P 25/24 (2006.01) A61P 25/28 (2006.01)	2421534 *	LIQUID FORMULATIONS OF SALTS OF 1-[2-(2,4-DIMETHYLPHENYLSULFANYL)PHENYL] PIPERAZINE
Amgen Inc.	A61K 39/395 (2006.01) G01N 33/574 (2006.01) G01N 33/68 (2006.01)	2753357 *	USE OF C-MET PROTEIN FOR PREDICTING THE EFFICACY OF ANTI-HEPATOCTE GROWTH FACTOR ("HGF") ANTIBODIES IN ESOPHAGEAL AND GASTRIC CANCER PATIENTS
Merck Sharp & Dohme Corp.	A61K 48/00 (2006.01) C07H 21/04 (2006.01)	2753364 *	A CONDITIONAL REPLICATING CYTOMEGALOVIRUS AS A VACCINE FOR CMV
Abbvie Inc.	A61K 31/454 (2006.01) A61P 31/14 (2006.01)	2692346	An antiviral 1-phenyl-2,5-dibenzimidazol-5-yl-pyrrolidine derivative

Podnosilac evropske prijave patenta (71)	MKP (51)	Broj objave evropske prijave patenta (97)	Naziv pronalaska (54)
Gold Star S.r.l.	A43B 21/08 (2006.01) A43B 23/02 (2006.01) A43D 8/00 (2006.01) A43D 11/00 (2006.01)	2641497	Method for producing a leather shoe upper that is adaptable to foot deformations
Geoprotection S.r.l.	E01F 7/04 (2006.01) F16F 7/12 (2006.01)	2650558	Energy dissipation device for protecting structures or the like
Phenex Pharmaceuticals AG	A61K 31/42 (2006.01) A61P 1/16 (2006.01) A61P 3/10 (2006.01) A61P 35/00 (2006.01) C07D 261/08 (2006.01) C07D 413/12 (2006.01) C07D 413/14 (2006.01)	2731676 *	NOVEL FXR (NR1H4) BINDING AND ACTIVITY MODULATING COMPOUNDS
Fulga, Ion Gigel	A23L 1/30 (2006.01) A61K 45/00 (2006.01)	2719288	COMPOSITION FOR THE TREATMENT OR PREVENTION OF DYSLIPIDAEMIAS
Vasile, Danut	A23L 1/30 (2006.01) A61K 45/00 (2006.01)	2719288	COMPOSITION FOR THE TREATMENT OR PREVENTION OF DYSLIPIDAEMIAS
Prozor Biotech Inc.	A61K 38/26 (2006.01) A61P 3/10 (2006.01) A61P 7/12 (2006.01) C07K 14/605 (2006.01)	2714070 *	LONG-ACTING GLP-1/GLUCAGON RECEPTOR AGONISTS
Control4 Corporation	H02J 1/08 (2006.01)	2751894 *	WALL BOX DEVICE FOR MANAGING ENERGY
Nicox S.A.	A61K 31/21 (2006.01) A61P 9/08 (2006.01) C07C 203/04 (2006.01) C07C 203/08 (2006.01)	2707354 *	QUINONE BASED NITRIC OXIDE DONATING COMPOUNDS
Yale University, Inc.	C07H 21/00 (2006.01) C07K 14/00 (2006.01) G01N 33/48 (2006.01)	2632494 *	METHODS AND COMPOSITIONS FOR ASSESSING AND TREATING CANCER
Wobben Properties GmbH	E04H 12/08 (2006.01) F03D 11/04 (2006.01)	2718519 *	WIND ENERGY PLANT TOWER
Ishihara Sangyo Kaisha, Ltd.	A01N 37/50 (2006.01) A01N 43/16 (2006.01) A01N 43/40 (2006.01) A01N 43/50 (2006.01) A01N 43/56 (2006.01) A01N 43/76 (2006.01) A01N 43/88 (2006.01) A01N 47/24 (2006.01) A01P 3/00 (2006.01)	2713754 *	AGRICULTURAL OR HORTICULTURAL FUNGICIDE COMPOSITION AND METHOD FOR CONTROLLING PLANT PATHOGEN
Ares Trading S.A.	A61K 38/18 (2006.01)	2720710 *	FREEZE-DRIED FORMULATIONS OF FGF-18
Chiesi Farmaceutici S.p.A.	A61K 9/00 (2006.01) A61K 9/12 (2006.01) A61K 31/573 (2006.01) A61K 47/10 (2006.01) A61K 47/18 (2006.01) A61K 47/26 (2006.01) A61K 47/36 (2006.01)	2704687 *	A TOPICAL FORMULATION COMPRISING A CORTICOSTEROID AS ACTIVE INGREDIENT
iOculi Inc.	G06Q 50/10 (2012.01) H04W 4/02 (2009.01)	2761571 *	LOCATION BASED AUGMENTED REALITY SYSTEM FOR EXCHANGE OF ITEMS BASED ON LOCATION SENSING AND METHODS AND DEVICES RELATED THERETO
AWINGU NV	H04L 29/08 (2006.01)	2704398	A method for content change notification in a cloud storage system, a corresponding cloud broker and cloud agent
SANOFI	B65D 5/32 (2006.01)	2731880 *	PRODUCT CARTON AND METHOD FOR FORMING SAME
Laboratorios del. Dr. Esteve, S.A.	A61K 31/4523 (2006.01) A61K 31/4725 (2006.01) A61K 31/496 (2006.01) A61K 31/5377 (2006.01) A61P 25/02 (2006.01)	2709620 *	USE OF SIGMA LIGANDS IN DIABETES TYPE-2 ASSOCIATED PAIN

Podnosilac evropske prijave patenta (71)	MKP (51)	Broj objave evropske prijave patenta (97)	Naziv pronalaska (54)
Bayer Intellectual Property GmbH	A61K 31/5025 (2006.01) A61P 35/00 (2006.01) C07D 487/04 (2006.01)	2758401 *	AMINO-SUBSTITUTED IMIDAZOPYRIDAZINES
Peters, Jean-Pierre	A61M 39/10 (2006.01) A61M 39/24 (2006.01) A61M 39/26 (2006.01)	2731663 *	DUAL-VALVE CONTRAST FLUID DELIVERY SYSTEM
Myriad Genetics, Inc.	C12N 15/11 (2006.01) C12Q 1/68 (2006.01)	2721181 *	METHODS AND MATERIALS FOR ASSESSING ALLELIC IMBALANCE
Gutin, Alexander	C12N 15/11 (2006.01) C12Q 1/68 (2006.01)	2721181 *	METHODS AND MATERIALS FOR ASSESSING ALLELIC IMBALANCE
Timms, Kirsten	C12N 15/11 (2006.01) C12Q 1/68 (2006.01)	2721181 *	METHODS AND MATERIALS FOR ASSESSING ALLELIC IMBALANCE
Lanchbury, Jerry	C12N 15/11 (2006.01) C12Q 1/68 (2006.01)	2721181 *	METHODS AND MATERIALS FOR ASSESSING ALLELIC IMBALANCE
Exelixis, Inc.	A61K 31/47 (2006.01) A61P 35/00 (2006.01)	2704717 *	METHOD OF TREATING CANCER AND BONE CANCER PAIN
Regeneron Pharmaceuticals, Inc.	A61P 3/06 (2006.01) C07K 16/40 (2006.01)	2756004 *	METHODS FOR REDUCING LIPOPROTEIN(a) LEVELS BY ADMINISTERING AN INHIBITOR OF PROTEIN CONVERTASE SUBTILISIN KEXIN-9 (PCSK9)
Resilux	B29C 45/16 (2006.01) B29C 45/18 (2006.01) B29C 49/00 (2006.01) B29C 49/22 (2006.01) B65D 81/24 (2006.01) B65D 81/26 (2006.01) B65D 81/30 (2006.01)	2718088 *	HOLLOW OBJECTS, IN PARTICULAR PLASTIC PREFORMS HAVING A BARRIER LAYER AND METHOD OF INJECTION MOULDING THE OBJECTS AND APPARATUS FOR MANUFACTURING THE OBJECTS
Biochrom Limited	B01L 3/00 (2006.01) B01L 9/00 (2006.01) G01N 21/03 (2006.01)	2748583 *	CUVETTE
AWINGU NV	G06F 9/50 (2006.01) H04L 29/08 (2006.01) H04W 4/00 (2009.01)	2685697	A METHOD TO OBTAIN A VIRTUAL DESKTOP STORED IN A CLOUD STORAGE SYSTEM, A CORRESPONDING CLOUD BROKER AND CLOUD DESKTOP AGENT
ELI LILLY AND CO.	A61K 38/05 (2006.01) A61P 35/00 (2006.01) A61P 35/02 (2006.01) C07D 401/04 (2006.01) C07K 5/06 (2006.01)	2736920 *	NOTCH PATHWAY SIGNALING INHIBITOR COMPOUND
SANOFI	A61K 31/422 (2006.01) A61P 35/00 (2006.01) C07C 229/40 (2006.01) C07D 231/14 (2006.01) C07D 471/04 (2006.01)	2760841 *	PYRAZOLOQUINOLINONE DERIVATIVES, PREPARATION THEREOF AND THERAPEUTIC USE THEREOF
Hagleitner, Hans Georg	A47K 10/36 (2006.01)	2266448	Device for output of sections of paper strip
Van Hulle, David	E04B 2/74 (2006.01) E04H 17/00 (2006.01)	2639376	Roll-up and unrollable closure, with a reinforced stretched bottom
Van Hulle, Joeri	E04B 2/74 (2006.01) E04H 17/00 (2006.01)	2639376	Roll-up and unrollable closure, with a reinforced stretched bottom
Wabtec Holding Corp.	E05D 7/04 (2006.01)	2761116 *	HEIGHT ADJUSTMENT DEVICE FOR TRANSIT SHAFT AND ARM ASSEMBLY
Institutul National de Cercetare-Dezvoltare Pentru Microtehnologie	G03F 7/20 (2006.01)	2721447 *	PROCEDURE OF 2D AND 3D OPTICALLY ASSISTED FOUNTAIN PEN NANOLITHOGRAPHY AND APERTURE PEN NANOLITHOGRAPHY
ACO Severin Ahlmann GmbH & Co. KG	B01D 17/02 (2006.01) C02F 1/40 (2006.01)	2623174	Precipitator
Zafgen, Inc.	A61K 31/5383 (2006.01) A61P 3/04 (2006.01) C07D 471/04 (2006.01) C07D 498/04 (2006.01)	2705035 *	TRICYCLIC PYRAZOLE SULFONAMIDE COMPOUNDS AND METHODS OF MAKING AND USING SAME

Podnosilac evropske prijave patenta (71)	MKP (51)	Broj objave evropske prijave patenta (97)	Naziv pronalaska (54)
Surveillance Guard Co Limited	B60R 21/34 (2011.01) B60T 7/12 (2006.01)	2723615 *	AN ACCIDENT PREVENTION SYSTEM AND A VEHICLE INCLUDING THE ACCIDENT PREVENTION SYSTEM
Curt G. Joa, Inc.	A61F 13/15 (2006.01) A61F 13/532 (2006.01) B32B 3/26 (2006.01) B32B 5/02 (2006.01) B32B 5/04 (2006.01) B32B 5/26 (2006.01) B32B 7/12 (2006.01)	2730261	Apparatus and methods for forming laminates containing additive matter
Saint-Gobain Glass France	E04B 2/74 (2006.01) F21V 3/00 (2006.01) F21V 17/00 (2006.01) F21V 33/00 (2006.01) G02B 6/00 (2006.01)	2718625 *	ILLUMINATING GLASS PARTITION
Cellzome Limited	A61K 31/53 (2006.01) A61P 35/00 (2006.01) A61P 37/02 (2006.01) A61P 37/04 (2006.01) A61P 37/06 (2006.01) A61P 37/08 (2006.01) C07D 251/22 (2006.01) C07D 401/12 (2006.01) C07D 407/12 (2006.01) C07D 413/04 (2006.01)	2758379 *	MORPHOLINO SUBSTITUTED UREA OR CARBAMATE DERIVATIVES AS MTOR INHIBITORS
Orexo AB	A61K 9/00 (2006.01) A61K 31/485 (2006.01)	2706986 *	NEW ABUSE-RESISTANT PHARMACEUTICAL COMPOSITION FOR THE TREATMENT OF OPIOID DEPENDENCE
Radotec Pty Ltd	F03D 3/02 (2006.01) F03D 11/00 (2006.01)	2769089 *	VERTICAL AXIS WIND TURBINE WITH VARIABLE PITCH MECHANISM
Merrimack Pharmaceuticals, Inc.	A61K 39/395 (2006.01) A61P 35/00 (2006.01) C07H 21/04 (2006.01) C07K 16/28 (2006.01)	2699602 *	MONOSPECIFIC AND BISPECIFIC ANTI-IGF-1R AND ANTI-ERBB3 ANTIBODIES
Blücher GmbH	A41D 13/00 (2006.01) A42B 1/04 (2006.01) A62B 17/04 (2006.01)	2768585 *	HOOD FOR AN ITEM OF CLOTHING OR AS A CONSTITUENT PART OF AN ITEM OF CLOTHING
GTAT Corporation	B01J 19/00 (2006.01) C01B 33/107 (2006.01)	2723488 *	APPARATUS AND METHODS FOR CONVERSION OF SILICON TETRACHLORIDE TO TRICHLOROSILANE
Delphi International Operations Luxembourg S.à.r.l.	F02M 59/10 (2006.01) F04B 1/04 (2006.01)	2660459	Load reduction
Saint-Gobain Glass France	B32B 17/10 (2006.01) B60J 1/00 (2006.01) B60Q 3/00 (2006.01) B60Q 3/02 (2006.01) F21V 19/00 (2006.01) F21Y 103/00 (2006.01) G02B 6/00 (2006.01)	2736767 *	ILLUMINATED GLASS PANEL FOR A VEHICLE, AND MANUFACTURE THEREOF
Repros Therapeutics Inc.	A61K 31/138 (2006.01) A61P 3/06 (2006.01) C07C 217/18 (2006.01)	2744777 *	TRANS-CLOMIPHENE METABOLITES AND USES THEREOF
Gilead Sciences, Inc.	A61K 31/381 (2006.01) A61P 31/14 (2006.01) C07D 333/40 (2006.01)	2734515 *	THIOPHEN-2-CARBOXYLIC ACID DERIVATIVES USEFUL AS INHIBITORS OF FLAVIVIRIDAE VIRUSES
LI-COR, INC.	G01N 33/00 (2006.01) G01P 5/00 (2006.01)	2647991	Methods and apparatus for measuring gas flux
Janssen Pharmaceutica, N.V.	C07D 407/04 (2006.01)	2712359 *	PROCESS FOR THE PREPARATION OF COMPOUNDS USEFUL AS INHIBITORS OF SGLT-2
Services Pétroliers Schlumberger	E21B 43/32 (2006.01) E21B 47/10 (2012.01) G01V 3/20 (2006.01)	2677116	Method and apparatus to detect an oil/water contact

Podnosilac evropske prijave patenta (71)	MKP (51)	Broj objave evropske prijave patenta (97)	Naziv pronalaska (54)
Schlumberger Technology B.V.	E21B 43/32 (2006.01) E21B 47/10 (2012.01) G01V 3/20 (2006.01)	2677116	Method and apparatus to detect an oil/water contact
Schlumberger Holdings Limited (SHL)	E21B 43/32 (2006.01) E21B 47/10 (2012.01) G01V 3/20 (2006.01)	2677116	Method and apparatus to detect an oil/water contact
PRAD Research and Development Limited	E21B 43/32 (2006.01) E21B 47/10 (2012.01) G01V 3/20 (2006.01)	2677116	Method and apparatus to detect an oil/water contact
Regeneron Pharmaceuticals, Inc.	A61K 39/395 (2006.01) C07K 16/32 (2006.01)	2760893 *	ANTI-ERBB3 ANTIBODIES AND USES THEREOF
Eisai R&D Management Co., Ltd.	A61K 31/5365 (2006.01) A61P 25/28 (2006.01) C07D 498/04 (2006.01)	2653473	Fused Aminodihydro-Oxazine Derivatives
Almac Diagnostics Limited	C12Q 1/68 (2006.01) G01N 33/50 (2006.01)	2715348 *	MOLECULAR DIAGNOSTIC TEST FOR CANCER
Hein, Jérémy	H02K 33/16 (2006.01)	2754231 *	MAGNET DEVICE IN WHICH THE TRANSLATOR MOVES IN A POLYGONAL MANNER
Marschner Von Helmreich, Martin	H02K 33/16 (2006.01)	2754231 *	MAGNET DEVICE IN WHICH THE TRANSLATOR MOVES IN A POLYGONAL MANNER
Second Wind Systems, Inc.	G10K 11/20 (2006.01)	2710585 *	TRANSDUCER FOR PHASED ARRAY ACOUSTIC SYSTEMS
Receptos, Inc.	A01N 33/02 (2006.01) A61K 31/13 (2006.01)	2713722 *	NOVEL GLP-1 RECEPTOR STABILIZERS AND MODULATORS
Northshore University Healthsystem	C07C 43/00 (2006.01)	2702030 *	COMPOSITIONS AND METHODS
Universidade Do Porto	G01J 11/00 (2006.01) H01S 3/00 (2006.01)	2766963 *	METHOD AND DEVICE FOR THE SIMULTANEOUS COMPRESSION AND CHARACTERIZATION OF ULTRASHORT LASER PULSES
TEXAS INSTRUMENTS DEUTSCHLAND GMBH	G05F 1/56 (2006.01) G06F 1/32 (2006.01)	2650747	Power-gated electronic device and method of operating the same
Texas Instruments Incorporated	G05F 1/56 (2006.01) G06F 1/32 (2006.01)	2650747	Power-gated electronic device and method of operating the same
Novartis AG	A61K 9/20 (2006.01) A61K 9/50 (2006.01) A61K 31/436 (2006.01)	2763663 *	PHARMACEUTICAL COMPOSITIONS COMPRISING 40 - O - (2 - HYDROXY) ETHYL - RAPAMYCIN
Nanobio Corporation	A61K 39/21 (2006.01)	2747779 *	HERPES SIMPLEX VIRUS NANOEMULSION VACCINE
Gilead Sciences, Inc.	C07K 14/005 (2006.01) C12N 15/86 (2006.01) G01N 33/569 (2006.01)	2729489 *	HCV GENOTYPE 3 REPLICONS
PLEXXIKON INC.	A61K 31/4745 (2006.01)	2709622 *	KINASE MODULATION AND INDICATIONS THEREFOR
Bormioli Rocco S.p.A.	B65D 51/28 (2006.01) B65D 51/30 (2006.01)	2704962 *	CLOSURE
Teva Pharmaceutical Industries Ltd.	A61K 31/135 (2006.01) A61K 31/47 (2006.01)	2766020 *	TREATMENT OF MULTIPLE SCLEROSIS WITH COMBINATION OF LAQUINIMOD AND FINGOLIMOD
Concert Pharmaceuticals Inc.	A61K 31/47 (2006.01) A61P 11/12 (2006.01) C07B 59/00 (2006.01) C07D 215/56 (2006.01)	2709986 *	DEUTERATED DERIVATIVES OF IVACAFTOR
Cubist Pharmaceuticals, Inc.	A61K 9/14 (2006.01) A61K 9/20 (2006.01)	2714012 *	CB-183,315 COMPOSITIONS AND RELATED METHODS
SANOFI	A61K 31/4184 (2006.01) A61K 31/437 (2006.01) A61K 31/5377 (2006.01) A61K 45/06 (2006.01) A61P 35/00 (2006.01)	2755653 *	COMPOSITIONS AND METHODS FOR TREATING CANCER USING PI3K BETA INHIBITOR AND MAPK PATHWAY INHIBITOR, INCLUDING MEK AND RAF INHIBITORS

Podnosilac evropske prijave patenta (71)	MKP (51)	Broj objave evropske prijave patenta (97)	Naziv pronalaska (54)
Terreal	E01C 5/00 (2006.01) E01C 9/00 (2006.01) E01F 8/00 (2006.01) E04F 13/08 (2006.01)	2662490	Traffic surface for vehicles and pedestrians
Measurement Specialties, Inc.	G01F 23/292 (2006.01)	2718680 *	OPTICAL SENSING DEVICE FOR FLUID SENSING AND METHODS THEREFOR
Syngenta Participations AG	A01N 37/38 (2006.01) A01N 43/40 (2006.01) A01N 43/80 (2006.01) A01N 43/86 (2006.01) A01N 47/30 (2006.01) A01N 47/40 (2006.01) A01N 51/00 (2006.01) A01N 53/00 (2006.01) A01P 5/00 (2006.01) A01P 7/02 (2006.01) A01P 7/04 (2006.01) A01P 9/00 (2006.01)	2713735 *	PESTICIDAL MIXTURES INCLUDING ISOXAZOLINE DERIVATIVES
Eli Lilly and Company	A01N 43/80 (2006.01) C07D 413/04 (2006.01) C07D 413/14 (2006.01) C07D 495/04 (2006.01)	2710000 *	PARASITICIDAL DIHYDROISOXAZOLE COMPOUNDS
Delphi International Operations Luxembourg S.à.r.l.	F01N 3/08 (2006.01) F02D 41/00 (2006.01) F02D 41/02 (2006.01) F02D 41/18 (2006.01) F02D 41/40 (2006.01)	2647815	Lean nox trap desulfation process
Basilea Pharmaceutica AG	C07D 491/14 (2006.01) C07D 491/147 (2006.01)	2721034 *	TRICYCLIC ANTIBIOTICS
Ergonomic Solutions Manufacturing A/S	A47F 9/04 (2006.01)	2614755	A system comprising a tower module, a top module as well as a plurality of additional modules
Britannia Pharmaceuticals Limited	A61K 9/00 (2006.01) A61K 9/08 (2006.01) A61K 9/10 (2006.01) A61K 9/107 (2006.01) A61K 31/473 (2006.01) A61P 25/16 (2006.01)	2731589 *	A NEW THERAPEUTICAL COMPOSITION CONTAINING APOMORPHINE AS ACTIVE INGREDIENT
Gilead Sciences, Inc.	A61K 31/381 (2006.01) A61K 31/4184 (2006.01) A61K 31/4196 (2006.01) A61K 31/513 (2006.01) A61P 31/14 (2006.01)	2709613 *	METHODS FOR TREATING HCV
Gilead Calistoga LLC	A61K 31/519 (2006.01) A61P 29/00 (2006.01) A61P 35/00 (2006.01) C07D 403/12 (2006.01) C07D 487/04 (2006.01)	2763994 *	NOVEL QUINOXALINE INHIBITORS OF PI3K
Syndax Pharmaceuticals Inc.	C12N 15/09 (2006.01)	2751267 *	METHODS FOR THE TREATMENT OF BREAST CANCER
The Trustees Of The University Of Pennsylvania	A61K 38/17 (2006.01) A61K 48/00 (2006.01)	2736540 *	SWITCH COSTIMULATORY RECEPTORS
Glaxosmithkline Intellectual Property (No. 2) Limited	C07D 498/04 (2006.01)	2710013 *	NOVEL COMPOUNDS AS DIACYLGLYCEROL ACYLTRANSFERASE INHIBITORS
Eli Lilly and Company	A61K 31/381 (2006.01) A61K 31/4709 (2006.01) C07D 409/06 (2006.01)	2744806 *	NOVEL 1,2,3,4-TETRAHYDROQUINOLINE DERIVATIVE USEFUL FOR THE TREATMENT OF DIABETES
San Gabino Ramirez, José	B63H 1/36 (2006.01)	2746147 *	AQUATIC PROPULSION BY MEANS OF OSCILLATING FINS
Cellzome Limited	A61K 31/519 (2006.01) A61P 37/06 (2006.01) C07D 471/04 (2006.01) C07D 487/04 (2006.01)	2760863 *	PYRAZOLO[4,3-C]PYRIDINE DERIVATIVES AS KINASE INHIBITORS

Podnosilac evropske prijave patenta (71)	MKP (51)	Broj objave evropske prijave patenta (97)	Naziv pronalaska (54)
Blücher GmbH	A61L 15/18 (2006.01) A61L 15/42 (2006.01)	2734244 *	WOUND DRESSING WITH AN AIR PERMEABLE LAYER
GT Biologics Ltd.	A23L 1/30 (2006.01) A61K 35/74 (2006.01) C12N 1/00 (2006.01) C12R 1/225 (2006.01) C12R 1/23 (2006.01) C12R 1/25 (2006.01)	2732023 *	BACTERIAL STRAINS ISOLATED FROM PIGS
TETRASAN GmbH Spezialproblemlösungen für Asbestsanierung, Betonasanierung, Denkmalsanierung	B63B 35/44 (2006.01)	2709900 *	FLOATING CARRIER FOR GENERATING ELECTRICAL ENERGY FROM EXCLUSIVELY REGENERATIVE ENERGY SOURCES
ISRAEL MILITARY INDUSTRIES LTD.	F41H 5/04 (2006.01)	2726809 *	ANTIBALLISTIC ARTICLE AND METHOD OF PRODUCING SAME
Université de Genève	A61K 31/365 (2006.01) A61K 31/7048 (2006.01) A61P 25/28 (2006.01) A61P 35/00 (2006.01)	2704709 *	MACROCYCLIC LACTONES AND USE THEREOF
Katholieke Universiteit Leuven, K.U. Leuven R&D	G01N 33/564 (2006.01)	2753931 *	AUTOIMMUNE AND INFLAMMATORY DISORDER THERAPY
Thomas Gareth John	B62D 55/07 (2006.01) E02F 9/02 (2006.01)	2742184 *	EXCAVATOR VEHICLE
Kalvista Pharmaceuticals Limited	C07C 237/22 (2006.01) C07C 311/06 (2006.01) C07C 311/19 (2006.01) C07D 207/16 (2006.01) C07K 5/06 (2006.01)	2729443 *	BENZYLAMINE DERIVATIVES AS INHIBITORS OF PLASMA KALLIKREIN
Nestec S.A.	C12Q 1/68 (2006.01) G01N 33/564 (2006.01) G01N 33/68 (2006.01)	2707504 *	METHODS OF DISEASE ACTIVITY PROFILING FOR PERSONALIZED THERAPY MANAGEMENT
Syngenta Limited	A01N 25/04 (2006.01) A01N 25/10 (2006.01) A01N 25/28 (2006.01) A01N 37/40 (2006.01) A01N 39/04 (2006.01) A01N 43/90 (2006.01) A01N 47/36 (2006.01)	2753173 *	HERBICIDAL COMPOSITION COMPRISING POLYMERIC MICROPARTICLES CONTAINING A HERBICIDE
Ethicon Endo-Surgery, Inc.	A61B 17/072 (2006.01)	2644110	Tissue thickness compensator comprising resilient members
ATS Group (IP Holdings) Limited	H04L 9/08 (2006.01)	2639997	Method and system for secure access of a first computer to a second computer
MorphoSys AG	A61K 39/395 (2006.01) C07K 16/24 (2006.01) C07K 16/28 (2006.01)	2729498 *	THERAPEUTIC COMBINATIONS OF ANTI -CD20 AND ANTI - GM - CSF ANTIBODIES AND USES THEREOF
Services Pétroliers Schlumberger	G01V 3/24 (2006.01)	2639602	Methods and systems for obtainin an electrical impedivity and/or resistivity image of a subterranean formation
Schlumberger Technology B.V.	G01V 3/24 (2006.01)	2639602	Methods and systems for obtainin an electrical impedivity and/or resistivity image of a subterranean formation
Schlumberger Holdings Limited	G01V 3/24 (2006.01)	2639602	Methods and systems for obtainin an electrical impedivity and/or resistivity image of a subterranean formation
PRAD Research and Development Limited	G01V 3/24 (2006.01)	2639602	Methods and systems for obtainin an electrical impedivity and/or resistivity image of a subterranean formation
Glaxosmithkline Intellectual Property (No. 2) Limited	C07D 263/52 (2006.01) C07D 498/00 (2006.01)	2721016 *	TRPV4 ANTAGONISTS

Podnosilac evropske prijave patenta (71)	MKP (51)	Broj objave evropske prijave patenta (97)	Naziv pronalaska (54)
Astellas Pharma Inc.	C07K 16/22 (2006.01) C12N 1/15 (2006.01) C12N 1/19 (2006.01) C12N 1/21 (2006.01) C12N 5/10 (2006.01) C12N 15/09 (2006.01) C12P 21/08 (2006.01)	2743348 *	NOVEL ANTI-HUMAN NGF ANTIBODY
Centogene AG	G01N 33/50 (2006.01) G01N 33/68 (2006.01)	2718725 *	METHOD FOR THE DIAGNOSIS OF GAUCHER'S DISEASE
Camurus AB	A61K 9/00 (2006.01) A61K 9/127 (2006.01) A61K 38/00 (2006.01) A61K 47/10 (2006.01) A61K 47/14 (2006.01) A61K 47/24 (2006.01)	2714004 *	CONTROLLED RELEASE PEPTIDE FORMULATIONS
STADA ARZNEIMITTEL AG	A61K 9/20 (2006.01)	2714013 *	POWDERY MIXTURE FOR PRODUCING TABLETS CONTAINING LEVETIRACETAM
Hawa Valves (India) Private Limited	F16K 15/03 (2006.01)	2734760 *	DUAL PLATE CHECK VALVE
Janssen Pharmaceutica N.V.	A61K 31/496 (2006.01) A61P 3/06 (2006.01) A61P 3/08 (2006.01) A61P 3/10 (2006.01) A61P 9/00 (2006.01) A61P 9/10 (2006.01) A61P 9/12 (2006.01) A61P 11/00 (2006.01) A61P 15/00 (2006.01) A61P 15/12 (2006.01) A61P 19/02 (2006.01) A61P 21/00 (2006.01)	2760451 *	MONOACYLGLYCEROL LIPASE INHIBITORS FOR THE TREATMENT OF METABOLIC DISEASES AND RELATED DISORDERS
Viamet Pharmaceuticals, Inc.	A01N 43/40 (2006.01) C07D 401/06 (2006.01) C07D 401/14 (2006.01) C07D 409/14 (2006.01)	2721021 *	METALLOENZYME INHIBITOR COMPOUNDS
Ma, Zhongmin	A61K 31/137 (2006.01) A61P 3/10 (2006.01)	2739277 *	TREATMENT OF TYPE 2 DIABETES WITH FTY720
Hörmann, Markus	G06Q 10/08 (2012.01)	2662814	Method for registering, inventory, managing, checking and monitoring of tangible and intangible objects
Asinex Limited	A61K 31/427 (2006.01) A61K 31/4427 (2006.01) A61K 31/497 (2006.01) A61K 31/506 (2006.01) A61P 35/00 (2006.01) C07D 417/12 (2006.01) C07D 417/14 (2006.01)	2719696 *	NOVEL KINASE INHIBITORS
Ares Trading S.A.	A61K 9/00 (2006.01) A61K 9/19 (2006.01) A61K 38/21 (2006.01) A61K 47/42 (2006.01)	2709595 *	IFN-BETA COMPOSITIONS, PREPARATION METHODS AND USES THEREOF
GlaxoSmithKline Biologicals S.A.	A61K 39/00 (2006.01) C07K 14/47 (2006.01)	2734539 *	PRAME PURIFICATION
Ethicon Endo-Surgery, Inc.	A61B 17/00 (2006.01) A61B 17/072 (2006.01)	2644117	Tissue thickness compensator comprising a plurality of layers
Flodesign Wind Turbine Corp.	F03B 3/12 (2006.01) F03D 1/04 (2006.01) F03D 1/06 (2006.01)	2715119 *	TURBINE WITH UNEVENLY LOADED ROTOR BLADES
Sveltus SAS	A63B 21/055 (2006.01) A63B 23/12 (2006.01)	2720763 *	COMPLETELY FLEXIBLE EXPANDER DEVICE CONSISTING OF AT LEAST TWO GRIPPING ELEMENTS, PREFERABLY 4, 6 OR 8 ELEMENTS
Bogen, Etai	A61C 17/06 (2006.01)	2720639 *	SEPARATION, SEDIMENTATION AND SEGREGATION CHAMBER WITH DUAL PORE-SIZE FILTER

Podnosilac evropske prijave patenta (71)	MKP (51)	Broj objave evropske prijave patenta (97)	Naziv pronalaska (54)
Syngenta Participations AG	A01N 25/02 (2006.01) A01N 43/40 (2006.01) A01N 43/90 (2006.01) A01N 57/12 (2006.01) A01P 13/00 (2006.01)	2704562 *	HERBICIDAL COMPOSITION COMPRISING PINOXADEN AND FLUROXYPYRESTER, AND METHODS OF USE THEREOF
Living Proof, Inc.	A61K 8/891 (2006.01) A61K 9/00 (2006.01) A61K 47/24 (2006.01) A61P 17/02 (2006.01)	2758032 *	COMPOSITIONS AND METHODS FOR TREATING CONDITIONS OF COMPROMISED SKIN BARRIER FUNCTION
NsGene A/S	A61K 38/17 (2006.01) C12N 5/00 (2006.01)	2753347 *	TREATMENT OF ALLODYNIA, HYPERALGIA, SPONTANEOUS PAIN, AND PHANTOM PAIN
Eigen Systems Limited	B27B 5/29 (2006.01)	2750841 *	CUTTING MACHINE WASTE EXTRACTION APPARATUS
Forlong, Murray Houlton	B27B 5/29 (2006.01)	2750841 *	CUTTING MACHINE WASTE EXTRACTION APPARATUS
Wabtec Holding Corp.	B61D 19/02 (2006.01)	2731846 *	BASE PLATE STRUCTURE FOR TRANSIT DOORS
Les Laboratoires Servier	C07C 253/30 (2006.01) C07C 255/37 (2006.01) C07D 223/14 (2006.01)	2719689	Novel method for synthesising 3-(2-bromo-4,5-dimethoxyphenyl) propanenitrile and use for synthesising ivabradine and the added salts thereof with a pharmaceutically acceptable acid
Coordinated Program Development, LLC	A61K 9/00 (2006.01) A61K 31/07 (2006.01) A61K 31/20 (2006.01) A61K 31/472 (2006.01) A61K 31/496 (2006.01) A61K 31/70 (2006.01) A61K 31/704 (2006.01) A61K 31/7048 (2006.01) A61K 33/00 (2006.01) A61K 33/26 (2006.01) A61K 33/30 (2006.01) A61K 36/54 (2006.01) A61K 38/02 (2006.01) A61K 39/00 (2006.01) A61K 39/13 (2006.01) A61K 39/145 (2006.01) A61K 47/12 (2006.01)	2704688 *	COCHLEATE COMPOSITIONS AND METHODS OF MAKING AND USING SAME
University Of Medicine And Dentistry Of New Jersey	A61K 9/00 (2006.01) A61K 31/07 (2006.01) A61K 31/20 (2006.01) A61K 31/472 (2006.01) A61K 31/496 (2006.01) A61K 31/70 (2006.01) A61K 31/704 (2006.01) A61K 31/7048 (2006.01) A61K 33/00 (2006.01) A61K 33/26 (2006.01) A61K 33/30 (2006.01) A61K 36/54 (2006.01) A61K 38/02 (2006.01) A61K 39/00 (2006.01) A61K 39/13 (2006.01) A61K 39/145 (2006.01) A61K 47/12 (2006.01)	2704688 *	COCHLEATE COMPOSITIONS AND METHODS OF MAKING AND USING SAME
H. Lundbeck A/S	A01N 43/78 (2006.01) A61K 31/425 (2006.01) A61P 25/18 (2006.01) C07D 277/56 (2006.01) C07D 417/06 (2006.01) C07D 491/04 (2006.01) C07D 495/04 (2006.01)	2490541 *	2-SUBSTITUTED-ETHYNYLTHIAZOLE DERIVATIVES AND USES OF SAME

Podnosilac evropske prijave patenta (71)	MKP (51)	Broj objave evropske prijave patenta (97)	Naziv pronalaska (54)
Merck Sharp & Dohme B.V.	A61K 31/4985 (2006.01) A61P 19/08 (2006.01) A61P 29/00 (2006.01) A61P 31/00 (2006.01) A61P 35/00 (2006.01) A61P 37/00 (2006.01) C07D 487/04 (2006.01) C07D 519/00 (2006.01)	2734522 *	4 - IMIDAZOPYRIDAZIN- 1 -YL-BENZAMIDES AND 4 - IMIDAZOTRIAZIN- 1 - YL - BENZAMIDES AS BTK-INHIBITORS
Kverneland AS	A01C 7/20 (2006.01)	2636294	Energy absorption device for a feed channel of a blade
Packers Plus Energy Services Inc.	E21B 34/08 (2006.01) E21B 34/16 (2006.01) E21B 43/12 (2006.01) E21B 43/22 (2006.01) E21B 43/26 (2006.01)	2756163 *	WELLBORE FRAC TOOL WITH INFLOW CONTROL
Okapi Sciences NV	A61K 31/662 (2006.01) A61P 31/14 (2006.01)	2707004 *	COMPOUNDS FOR USE IN THE TREATMENT OF FELINE RETROVIRAL INFECTIONS
Shire Human Genetic Therapies, Inc.	A61K 9/127 (2006.01) A61K 31/4164 (2006.01) C07C 323/00 (2006.01) C07D 233/64 (2006.01)	2718269 *	CLEAVABLE LIPIDS
Knauf Insulation	A01G 31/00 (2006.01) D04H 1/407 (2012.01) D04H 1/4209 (2012.01) D04H 1/46 (2012.01)	2714977 *	MINERAL WOOL PRODUCT
Universiti Putra Malaysia	A01N 25/12 (2006.01) A01N 59/00 (2006.01) A01P 1/00 (2006.01) A01P 7/00 (2006.01)	2741608 *	AN IMPROVED PLANT TREATMENT AGENT
Glaxo Group Limited	C07K 16/00 (2006.01)	2744822 *	MODIFIED PROTEINS AND PEPTIDES
Inhibrx LLC	A61K 38/55 (2006.01) A61K 39/395 (2006.01) A61K 39/40 (2006.01) A61K 39/42 (2006.01) A61P 1/00 (2006.01) A61P 3/10 (2006.01) A61P 9/00 (2006.01) A61P 9/10 (2006.01) A61P 11/00 (2006.01) A61P 11/06 (2006.01) A61P 19/02 (2006.01) A61P 21/00 (2006.01) A61P 29/00 (2006.01) A61P 31/04 (2006.01) A61P 31/10 (2006.01) A61P 31/12 (2006.01) A61P 35/00 (2006.01) A61P 37/06 (2006.01) C07K 19/00 (2006.01)	2726092 *	SERPIN FUSION POLYPEPTIDES AND METHODS OF USE THEREOF
Chiesi Farmaceutici S.p.A.	A61K 9/00 (2006.01) A61K 31/573 (2006.01)	2704724 *	IMPROVED SUSPENSION FORMULATION OF A CORTICOSTEROID FOR ADMINISTRATION BY INHALATION
Nestec S.A.	G01N 33/68 (2006.01)	2710383 *	PERFORMANCE OF A BIOMARKER PANEL FOR IRRITABLE BOWEL SYNDROME
Omya International AG	A61K 9/16 (2006.01) A61K 9/20 (2006.01) A61K 9/50 (2006.01)	2747752 *	NEW COATED CONTROLLED RELEASE ACTIVE AGENT CARRIERS
Schleuniger Holding AG	H01R 43/16 (2006.01) H01R 43/20 (2006.01)	2654141	Method and device for producing a connector
The Medicines Company	A01N 43/04 (2006.01)	2741610 *	MAINTENANCE OF PLATELET INHIBITION DURING ANTIPLATELET THERAPY

Podnosilac evropske prijave patenta (71)	MKP (51)	Broj objave evropske prijave patenta (97)	Naziv pronalaska (54)
Taisho Pharmaceutical Co., Ltd.	A61K 31/426 (2006.01) A61K 31/427 (2006.01) A61K 31/433 (2006.01) A61K 31/4439 (2006.01) A61K 31/454 (2006.01) A61K 31/496 (2006.01) A61K 31/497 (2006.01) A61K 31/501 (2006.01) A61K 31/506 (2006.01) A61K 31/5377 (2006.01) A61P 17/00 (2006.01) A61P 31/10 (2006.01) C07D 277/20 (2006.01) C07D 277/28 (2006.01) C07D 277/30 (2006.01) C07D 277/34 (2006.01) C07D 277/48 (2006.01) C07D 277/56 (2006.01) C07D 285/08 (2006.01) C07D 417/04 (2006.01)	2738163 *	AMIDINE COMPOUND OR SALT THEREOF
Toyama Chemical Co., Ltd.	A61K 31/426 (2006.01) A61K 31/427 (2006.01) A61K 31/433 (2006.01) A61K 31/4439 (2006.01) A61K 31/454 (2006.01) A61K 31/496 (2006.01) A61K 31/497 (2006.01) A61K 31/501 (2006.01) A61K 31/506 (2006.01) A61K 31/5377 (2006.01) A61P 17/00 (2006.01) A61P 31/10 (2006.01) C07D 277/20 (2006.01) C07D 277/28 (2006.01) C07D 277/30 (2006.01) C07D 277/34 (2006.01) C07D 277/48 (2006.01) C07D 277/56 (2006.01) C07D 285/08 (2006.01) C07D 417/04 (2006.01)	2738163 *	AMIDINE COMPOUND OR SALT THEREOF
Weir Minerals Australia Ltd	F04D 7/04 (2006.01) F04D 29/22 (2006.01) F04D 29/42 (2006.01)	2734736 *	IMPROVEMENTS TO PUMPS AND COMPONENTS THEREFOR
Sanofi-Aventis Deutschland GmbH	A61K 31/155 (2006.01) A61K 38/26 (2006.01) A61P 3/10 (2006.01)	2707017 *	LIXISENATIDE AND METFORMIN FOR TREATMENT OF DIABETES TYPE 2
Almirall S.A.	A61K 31/437 (2006.01) A61K 31/4985 (2006.01) A61P 35/00 (2006.01) C07D 473/34 (2006.01) C07D 487/04 (2006.01)	2702061	PYRROLOTRIAZINONE DERIVATIVES AS PI3K INHIBITORS
Hamilton Bonaduz AG	G01B 11/16 (2006.01) G01B 11/24 (2006.01)	2702352 *	ANALYSIS APPARATUS FOR CONTACTLESS ANALYSIS OF THE SHAPE OF A TRANSPARENT BODY, AND METHOD FOR CARRYING OUT THE CONTACTLESS ANALYSIS
Ethicon, Inc	A61K 31/549 (2006.01) A61K 38/16 (2006.01)	2760462 *	BROAD-SPECTRUM ANTIMICROBIAL COMPOSITIONS BASED ON COMBINATIONS OF TAUROLIDINE AND PROTAMINE AND MEDICAL DEVICES CONTAINING SUCH COMPOSITIONS
Sandoz AG	A61K 31/505 (2006.01) A61P 31/18 (2006.01) C07D 239/48 (2006.01)	2628732	Novel crystalline form of rilpivirine hydrochloride

Podnosilac evropske prijave patenta (71)	MKP (51)	Broj objave evropske prijave patenta (97)	Naziv pronalaska (54)
Takeda Pharmaceutical Company Limited	A61K 31/437 (2006.01) A61P 11/00 (2006.01) A61P 17/00 (2006.01) A61P 19/00 (2006.01) A61P 29/00 (2006.01) A61P 35/00 (2006.01) A61P 37/00 (2006.01) C07D 471/04 (2006.01) C07D 519/00 (2006.01)	2723739 *	SUBSTITUTED 6-AZA-ISOINDOLIN-1-ONE DERIVATIVES
Massachusetts Institute Of Technology	A61K 38/16 (2006.01) C07K 14/00 (2006.01)	2709647 *	WATER SOLUBLE MEMBRANE PROTEINS AND METHODS FOR THE PREPARATION AND USE THEREOF
Smallwood, Norman J.	A23K 1/16 (2006.01) A23K 1/175 (2006.01)	2763550 *	USE OF SPENT BLEACHING EARTH FROM EDIBLE OIL PROCESSING IN THE FORMULATION OF SALT AND MINERAL FEED BLOCKS OR PELLETS FOR LIVESTOCK
Mount Sinai School of Medicine	A61K 31/5415 (2006.01) A61P 35/00 (2006.01) C07D 279/28 (2006.01) C07D 417/06 (2006.01)	2744808 *	TRICYCLIC COMPOUNDS AS ANTICANCER AGENTS
Crucell Holland B.V.	A61K 39/42 (2006.01) A61P 31/16 (2006.01) C07K 16/10 (2006.01)	2731967 *	HUMAN BINDING MOLECULES CAPABLE OF NEUTRALIZING INFLUENZA A VIRUSES OF PHYLOGENETIC GROUP 1 AND PHYLOGENETIC GROUP 2 AND INFLUENZA B VIRUSES
UCB Pharma, S.A.	C07K 16/28 (2006.01) C12N 15/70 (2006.01)	2731973 *	BACTERIAL HOST STRAIN EXPRESSING RECOMBINANT DSBC
Ajinomoto Co., Inc.	A61K 31/341 (2006.01) A61K 31/381 (2006.01) A61K 31/4025 (2006.01) A61K 31/427 (2006.01) A61K 31/435 (2006.01) A61K 31/4365 (2006.01) A61K 38/00 (2006.01) A61P 3/00 (2006.01) A61P 3/04 (2006.01) A61P 3/06 (2006.01) A61P 3/08 (2006.01) A61P 3/10 (2006.01) A61P 5/50 (2006.01) A61P 43/00 (2006.01) C07D 307/68 (2006.01) C07D 333/38 (2006.01) C07D 405/06 (2006.01) C07D 409/06 (2006.01) C07D 417/06 (2006.01) C07D 495/04 (2006.01)	2725016 *	HETEROCYCLIC CARBOXYLIC ACID ESTER DERIVATIVE
AbbVie Inc.	A61K 31/4725 (2006.01) A61P 35/00 (2006.01) C07D 417/14 (2006.01) C07D 471/04 (2006.01) C07D 487/04 (2006.01) C07D 513/04 (2006.01)	2766361 *	8 - CARBAMOYL - 2 - (2,3- DI SUBSTITUTED PYRID - 6 - YL) -1,2,3,4 -TETRAHYDROISOQUINOLINE DERIVATIVES AS APOPTOSIS - INDUCING AGENTS FOR THE TREATMENT OF CANCER AND IMMUNE AND AUTOIMMUNE DISEASES
CHDI Foundation, Inc.	A61K 31/44 (2006.01) C07D 401/00 (2006.01)	2750677 *	KYNURENINE-3-MONOOXYGENASE INHIBITORS, PHARMACEUTICAL COMPOSITIONS, AND METHODS OF USE THEREOF
Merck Sharp & Dohme Corp.	A01N 43/42 (2006.01) C07D 215/00 (2006.01)	2720545 *	CYCLOALKYL-FUSED TETRAHYDROQUINOLINES AS CRTH2 RECEPTOR MODULATORS
Arcelormittal Investigación y Desarrollo SL	E04D 3/30 (2006.01) E04D 3/365 (2006.01) F24J 2/52 (2006.01)	2724088 *	PANEL, ASSEMBLY OF PANELS AND ASSOCIATED ROOFING
Usui Kokusai Sangyo Kaisha Ltd.	F02M 55/02 (2006.01) F02M 61/16 (2006.01) F02M 63/00 (2006.01)	2765301 *	COMMON RAIL FUEL INJECTION SYSTEM

Podnosilac evropske prijave patenta (71)	MKP (51)	Broj objave evropske prijave patenta (97)	Naziv pronalaska (54)
Hino Motors Ltd.	F02M 55/02 (2006.01) F02M 61/16 (2006.01) F02M 63/00 (2006.01)	2765301 *	COMMON RAIL FUEL INJECTION SYSTEM
GlaxoSmithKline LLC	A61K 9/00 (2006.01) A61K 31/522 (2006.01) A61P 11/06 (2006.01) A61P 37/08 (2006.01)	2734186 *	COMPOSITION
DW-Spritzgiesstechnik Dieter Wandelt Inhaber Ulrich Koch E.K.	A47C 7/62 (2006.01)	2701556 *	HOLDING DEVICE
C.H. & I. Technologies, Inc.	B67D 7/60 (2010.01)	2751020 *	AEROSOL REFILL CARTRIDGE
Ethicon Endo-Surgery, Inc.	A61B 17/00 (2006.01) A61B 17/072 (2006.01)	2644122	Tissue thickness compensators
Vetzeria Valentini S.r.l.	A47F 3/04 (2006.01)	2750557 *	REFRIGERATOR COMPRISING A PLURALITY OF OPENING/CLOSING MODULES WITH AT LEAST ONE SLIDING DOOR
Termometros y Exclusivas, S.L.	B65D 39/00 (2006.01)	2746183 *	SILICONE STOPPER FOR CAVA BOTTLES AND THE LIKE
Packers Plus Energy Services Inc.	E21B 33/13 (2006.01) E21B 33/138 (2006.01) E21B 34/06 (2006.01)	2737167 *	WELLBORE CEMENTING TOOL HAVING ONE WAY FLOW
IDENIX Pharmaceuticals, Inc.	C07F 9/06 (2006.01)	2755983 *	SUBSTITUTED CARBONYLOXYMETHYLPHOSPHORAMIDATE COMPOUNDS AND PHARMACEUTICAL COMPOSITIONS FOR THE TREATMENT OF VIRAL INFECTIONS
Centre National de la Recherche Scientifique	C07F 9/06 (2006.01)	2755983 *	SUBSTITUTED CARBONYLOXYMETHYLPHOSPHORAMIDATE COMPOUNDS AND PHARMACEUTICAL COMPOSITIONS FOR THE TREATMENT OF VIRAL INFECTIONS
Université Montpellier 2 Sciences et Techniques	C07F 9/06 (2006.01)	2755983 *	SUBSTITUTED CARBONYLOXYMETHYLPHOSPHORAMIDATE COMPOUNDS AND PHARMACEUTICAL COMPOSITIONS FOR THE TREATMENT OF VIRAL INFECTIONS
INEOS ChloroToluenes Limited.	C07C 29/124 (2006.01) C07C 33/22 (2006.01) C07C 45/43 (2006.01) C07C 47/54 (2006.01) C07C 51/093 (2006.01) C07C 63/06 (2006.01)	2736865 *	METHOD FOR HYDROLYZING ALPHA - CHLORINATED TOLUENE COMPOUNDS
Preline Fishfarming System AS	A01K 61/00 (2006.01) A01K 63/00 (2006.01)	2760282 *	FISH FARMING PLANT, MODULE, METHOD AND USE
Klimagiel S.r.l.	F16L 9/17 (2006.01) F16L 41/08 (2006.01) F24F 13/02 (2006.01)	2713116	Ventilation duct
BASF SE	A01N 33/04 (2006.01) A01N 33/08 (2006.01) A01N 37/40 (2006.01) A01N 39/04 (2006.01) A01N 57/20 (2006.01)	2638804	Low volatile amine salts of anionic pesticides
Baldo Dielen Assessoria LTDA.	B63B 35/68 (2006.01)	2704946 *	TOWING VESSEL
ChemoCentryx, Inc.	A61K 31/4409 (2006.01)	2739283 *	POLYMORPHIC FORMS OF THE SODIUM SALT OF 4-TERT-BUTYL-N-[4-CHLORO-2-(1-OXY-PYRIDINE-4- CARBONYL)-PHENYL]-BENZENESULFONAMIDE
Teva Pharmaceutical Industries Ltd.	A01N 43/42 (2006.01) A61K 31/47 (2006.01)	2736335 *	TREATMENT OF MULTIPLE SCLEROSIS WITH COMBINATION OF LAQUINIMOD AND GLATIRAMER ACETATE

Podnosilac evropske prijave patenta (71)	MKP (51)	Broj objave evropske prijave patenta (97)	Naziv pronalaska (54)
OKBABY S.R.L.	B62J 1/16 (2006.01) B62J 11/00 (2006.01)	2623403	Fastening device for a child seat on a frame of a bicycle
Zipoli, Marco	A23L 1/30 (2006.01) A23L 2/385 (2006.01) A23L 2/52 (2006.01) A61P 25/28 (2006.01)	2701537 *	FOOD, PARTICULARLY A BEVERAGE FOR HUMAN CONSUMPTION
Biogaia AB	A23L 1/30 (2006.01) A61K 35/74 (2006.01) G01N 33/569 (2006.01)	2734845 *	PRODUCTION AND USE OF BACTERIAL HISTAMINE
Dow AgroSciences LLC	A01N 43/54 (2006.01) A01P 3/00 (2006.01) C07D 239/47 (2006.01)	2744334 *	N-(5-FLUORO-2((4-METHYLBENZYL)OXY)PYRIMIDIN-4-YL) BENZAMIDE DERIVATIVES
Venantius Limited	A61K 31/192 (2006.01) A61P 1/00 (2006.01) C07C 65/19 (2006.01)	2734496 *	INDENE DERIVATIVES FOR USE IN THE TREATMENT OF INFLAMMATORY BOWEL DISEASE
Saint-Gobain Glass France	E06B 3/66 (2006.01) E06B 3/663 (2006.01)	2718530 *	LIGHTING UNIT MADE UP OF AN INSULATING GLASS PANEL AND LIGHT-EMITTING DIODES
Chiesi Farmaceutici S.p.A.	A61K 31/439 (2006.01) A61P 11/00 (2006.01) C07D 207/14 (2006.01) C07D 211/62 (2006.01) C07D 453/02 (2006.01)	2702041 *	ALKALOID ESTER AND CARBAMATE DERIVATIVES AND MEDICINAL COMPOSITIONS THEREOF
Otsuka Pharmaceutical Co., Ltd.	A61K 9/20 (2006.01) A61K 9/28 (2006.01) A61K 31/496 (2006.01) A61K 47/02 (2006.01) A61K 47/10 (2006.01) A61K 47/12 (2006.01) A61K 47/26 (2006.01) A61K 47/38 (2006.01)	2767285 *	TABLET INCLUDING 7-[4-(4-BENZO[BETA]THIOPHEN-4-YL-PIPERAZIN-1-YL) BUTOXY]-1H-QUINOLIN-2-ONE OR SALT THEREOF
Shengyi Technology Co., Ltd.	C08L 63/00 (2006.01) C08L 79/04 (2006.01)	2725061	Cyanate ester resin composition, and a prepreg, a laminated material and a metal clad laminated material made therefrom
Vasilyev, Pavel	A23L 1/0524 (2006.01) A23L 2/02 (2006.01) A23L 2/52 (2006.01)	2769627 *	METHOD FOR PRODUCING A CONCENTRATED JUICE-CONTAINING BEVERAGE ON THE BASIS OF LIQUID PECTIN
IVAX INTERNATIONAL GMBH	A61K 31/445 (2006.01) A61P 25/28 (2006.01) C07D 211/24 (2006.01)	2753603 *	POLYMORPHIC FORM OF PRIDOPIDINE HYDROCHLORIDE
Fisher Clinical Services GmbH	A61M 5/00 (2006.01) A61M 5/28 (2006.01) A61M 5/31 (2006.01) A61M 5/315 (2006.01) B65D 81/113 (2006.01)	2662102	Transport carrier for syringes
Google Inc.	G06Q 10/10 (2012.01) G06Q 50/00 (2012.01)	2657894	Social connections migration
Women and Infants Hospital of Rhode Island	A61K 38/17 (2006.01) A61K 38/22 (2006.01) A61K 39/395 (2006.01) A61P 35/00 (2006.01)	2717901 *	HE4 BASED THERAPY FOR MALIGNANT DISEASE
Eisai R&D Management Co., Ltd.	A61K 31/454 (2006.01) A61P 1/04 (2006.01) A61P 43/00 (2006.01) C07D 401/12 (2006.01)	2757103 *	PYRROLIDINE-3-YLACETIC ACID DERIVATIVE
Dibi S.p.A.	A44C 13/00 (2006.01) A44C 17/02 (2006.01) A44C 17/04 (2006.01) A44C 25/00 (2006.01) A44C 27/00 (2006.01)	2636330	A manufactured article and a method of obtaining thereof.
Acino AG	A61K 9/70 (2006.01)	2682113	Sealing laminates containing agents
Takeda GmbH	A61K 31/519 (2006.01) A61P 11/00 (2006.01) C07D 487/04 (2006.01)	2721030 *	NOVEL PHTHALAZINONE-PYRROLOPYRIMIDINECARBOXAMIDE DERIVATIVES

Podnosilac evropske prijave patenta (71)	MKP (51)	Broj objave evropske prijave patenta (97)	Naziv pronalaska (54)
SafeAir AG	A61B 18/00 (2006.01) A61B 18/14 (2006.01)	2726004 *	AN ELONGATED ELECTROSURGICAL INSTRUMENT, A SWITCH MEANS FOR SAID INSTRUMENT, AND AN ASSEMBLY KIT
ATS Group (IP Holdings) Limited	H04W 84/18 (2009.01)	2595448	Method and System for Spatio-Temporal Sensor Selection
Diagnodus Limited	G01N 33/50 (2006.01) G01N 33/574 (2006.01)	2705363 *	DEVICE AND METHOD FOR NON-INVASIVE COLLECTION OF COLORECTAL MUCOCELLULAR LAYER AND DISEASE DETECTION
PLx Pharma LLC	A61K 9/10 (2006.01) A61K 9/14 (2006.01) A61K 9/16 (2006.01) A61P 1/00 (2006.01) A61P 1/04 (2006.01)	2760433 *	pH DEPENDENT CARRIERS FOR TARGETED RELEASE OF PHARMACEUTICALS ALONG THE GASTROINTESTINAL TRACT, COMPOSITIONS THEREFROM, AND MAKING AND USING SAME
Longagna, Bruno	B65D 88/56 (2006.01) B66C 1/10 (2006.01)	2753567 *	APPARATUS FOR TIPPING CONTAINERS OR MOVABLE CASES
Dow Global Technologies LLC	C07C 201/04 (2006.01) C07C 205/02 (2006.01)	2490997 *	PROCESS FOR NITROALKANE RECOVERY BY AQUEOUS PHASE RECYCLE TO NITRATION REACTOR
ANGUS Chemical Company	C07C 201/04 (2006.01) C07C 205/02 (2006.01)	2490997 *	PROCESS FOR NITROALKANE RECOVERY BY AQUEOUS PHASE RECYCLE TO NITRATION REACTOR
The Regents of the University of California	A61K 31/421 (2006.01) A61K 31/423 (2006.01) A61K 31/505 (2006.01) A61K 31/519 (2006.01)	2704723 *	TREATMENT OF POLYCYSTIC DISEASE
Intellikine, LLC	A61K 31/421 (2006.01) A61K 31/423 (2006.01) A61K 31/505 (2006.01) A61K 31/519 (2006.01)	2704723 *	TREATMENT OF POLYCYSTIC DISEASE
EURO-CELTIQUE S.A.	A61K 31/16 (2006.01) A61K 31/4164 (2006.01) A61K 31/4184 (2006.01) A61P 35/00 (2006.01)	2758052 *	PHARMACEUTICAL COMPOSITIONS
UUBEE Pty Ltd	E03C 1/00 (2006.01) E03D 1/00 (2006.01)	2751352 *	A SANITARY APPARATUS
GENMAB B.V.	A61K 39/395 (2006.01) A61P 35/00 (2006.01) C07K 16/00 (2006.01) C07K 16/28 (2006.01) C07K 16/36 (2006.01)	2729170 *	ANTIBODY VARIANTS AND USES THEREOF
Eli Lilly and Company	C07K 16/40 (2006.01)	2756003 *	ANTIBODIES TO PCSK9 AND USES THEREOF
Takeda Vaccines, Inc.	A61K 39/125 (2006.01)	2731621 *	PARENTERAL NOROVIRUS VACCINE FORMULATIONS
Novomatic AG	G07F 17/32 (2006.01)	2769366 *	GAMING MACHINE
Merial Limited	A01N 25/00 (2006.01) A61K 31/42 (2006.01) A61P 33/00 (2006.01)	2755473 *	PARASITICIDAL COMPOSITIONS COMPRISING AN ISOXAZOLINE ACTIVE AGENT, METHODS AND USES THEREOF
Otto, Ullrich	A61M 25/00 (2006.01) A61M 25/10 (2013.01)	2734258 *	CATHETER, PARTICULARLY AN INDWELLING CATHETER, FOR TREATING FUNCTIONAL PROBLEMS AND/OR DISEASES OF THE BLADDER AND/OR PROSTATE
Dicofarm Spa	A23C 9/00 (2006.01) A23L 1/29 (2006.01)	2653040	Food based on donkey fortified milk for preterm infants and/or term infants with allergy or intolerance to cow's milk proteins and method of preparation thereof
Takeda Pharmaceutical Company Limited	A61K 31/437 (2006.01) A61P 25/18 (2006.01) C07D 471/04 (2006.01)	2723738 *	CRYSTAL OF FUSED HETEROCYCLIC COMPOUND
Constellation Pharmaceuticals, Inc.	A61K 31/5025 (2006.01) A61P 35/00 (2006.01) C07D 403/04 (2006.01) C07D 487/04 (2006.01)	2721031 *	BROMODOMAIN INHIBITORS AND USES THEREOF

Podnosilac evropske prijave patenta (71)	MKP (51)	Broj objave evropske prijave patenta (97)	Naziv pronalaska (54)
Sentinella Pharmaceuticals, Inc.	A61K 38/00 (2006.01)	2701718 *	LANTIBIOTIC NAI-802, PHARMACEUTICALLY ACCEPTABLE SALTS, COMPOSITIONS, AND USES THEREOF
THE TRUSTEES OF PRINCETON UNIVERSITY	A01N 37/18 (2006.01) A61K 38/21 (2006.01) A61K 39/395 (2006.01) A61K 39/42 (2006.01)	2725902 *	ANTI-VIRAL COMBINATION THERAPY
Kymab Limited	C07K 16/46 (2006.01) C12N 5/10 (2006.01) C12N 15/85 (2006.01)	2761008 *	CHIMAERIC SURROGATE LIGHT CHAINS (SLC) COMPRISING HUMAN VPRED
Farma GRS, d.o.o.	C07D 487/04 (2006.01)	2736909 *	PROCESS FOR THE PREPARATION OF SITAGLIPTIN AND ITS PHARMACEUTICALLY ACCEPTABLE SALTS
Teva Pharmaceutical Industries Ltd.	A01N 37/12 (2006.01) C12Q 1/68 (2006.01)	2765857 *	SINGLE NUCLEOTIDE POLYMORPHISMS USEFUL TO PREDICT CLINICAL RESPONSE FOR GLATIRAMER ACETATE
Plaxica Limited	C12P 7/56 (2006.01) C12P 41/00 (2006.01)	2732041 *	SEPARATION PROCESS
Gilead Sciences, Inc.	A61K 31/553 (2006.01) C07D 267/14 (2006.01) C07D 413/04 (2006.01) C07D 413/12 (2006.01) C07D 413/14 (2006.01) C07D 498/04 (2006.01)	2726469 *	OXAZEPINES AS ION CHANNEL MODULATORS
Amgen Inc.	A61K 31/45 (2006.01) A61P 29/00 (2006.01) C07D 213/40 (2006.01) C07D 213/61 (2006.01) C07D 213/81 (2006.01) C07D 401/12 (2006.01) C07D 401/14 (2006.01) C07D 403/12 (2006.01) C07D 405/12 (2006.01) C07D 405/14 (2006.01) C07D 409/12 (2006.01) C07D 413/12 (2006.01) C07D 417/12 (2006.01) C07D 471/04 (2006.01) C07D 487/04 (2006.01)	2723717 *	TRPM8 ANTAGONISTS AND THEIR USE IN TREATMENTS
Life Science Inkubator Betriebs GmbH & Co. KG	A61K 48/00 (2006.01) C12N 15/86 (2006.01)	2636746	A novel drug delivery system based on JCV-VLP
Omya International AG	A61K 9/00 (2006.01) A61K 9/20 (2006.01)	2719373	Fast disintegrating solid dosage form formulation comprising functionalized calcium carbonate and method of their manufacture
Olive Medical Corporation	H04N 5/335 (2011.01)	2708021 *	IMAGE SENSOR WITH TOLERANCE OPTIMIZING INTERCONNECTS
Pacylex Pharmaceuticals Inc.	A61K 31/12 (2006.01) A61K 31/28 (2006.01) A61K 31/713 (2006.01) A61K 33/24 (2006.01) A61K 39/395 (2006.01) A61P 35/00 (2006.01) G01N 33/50 (2006.01) G01N 33/68 (2006.01)	2734199 *	SYNTHETIC LETHALITY AND THE TREATMENT OF CANCER
BIOGEN IDEC HEMOPHILIA INC.	A61K 38/37 (2006.01) C07K 14/755 (2006.01)	2729161 *	FACTOR VIII CHIMERIC AND HYBRID POLYPEPTIDES, AND METHODS OF USE THEREOF
Delphi International Operations Luxembourg S.à.r.l.	B01D 29/15 (2006.01) B01D 29/58 (2006.01) B01D 29/96 (2006.01) B01D 35/18 (2006.01) B01D 36/00 (2006.01)	2623175	A serviceable filtration arrangement

Podnosilac evropske prijave patenta (71)	MKP (51)	Broj objave evropske prijave patenta (97)	Naziv pronalaska (54)
Shionogi & Co., Ltd.	A01N 43/40 (2006.01) A61K 31/165 (2006.01) A61K 31/44 (2006.01) A61K 31/497 (2006.01)	2709609 *	HETEROCYCLIC COMPOUNDS
Purdue Pharma LP	A01N 43/40 (2006.01) A61K 31/165 (2006.01) A61K 31/44 (2006.01) A61K 31/497 (2006.01)	2709609 *	HETEROCYCLIC COMPOUNDS
Agios Pharmaceuticals, Inc.	A61K 31/496 (2006.01) A61P 35/00 (2006.01) C07D 217/26 (2006.01) C07D 413/04 (2006.01) C07D 491/052 (2006.01) C07D 519/00 (2006.01)	2721033 *	COMPOUNDS, THEIR PHARMACEUTICAL COMPOSITIONS AND THEIR USES AS IDH1 MUTANTS INHIBITORS FOR TREATING CANCERS
Japan Tobacco Inc.	A61K 31/4192 (2006.01) A61K 31/42 (2006.01) A61P 1/00 (2006.01) A61P 17/04 (2006.01) A61P 19/02 (2006.01) A61P 25/00 (2006.01) A61P 37/02 (2006.01) A61P 43/00 (2006.01) C07D 249/04 (2006.01) C07D 261/08 (2006.01) C07D 413/06 (2006.01)	2719690 *	AMIDE COMPOUND AND PHARMACEUTICAL APPLICATION THEREFOR
Awind Inc.	G06F 3/14 (2006.01) H04M 1/725 (2006.01)	2665244	Sender device and method of sharing screenshots and computer-readable medium thereof
Glaxosmithkline Intellectual Property (No. 2) Limited	A01N 43/52 (2006.01) A61K 31/415 (2006.01)	2720546 *	TRPV4 ANTAGONISTS
PHARMA-ZENTRALE GMBH	A61K 35/74 (2006.01) C07K 14/47 (2006.01) C12N 1/21 (2006.01) C12R 1/19 (2006.01)	2628793	Recombinant escherichia coli strains
Wobben Properties GmbH	F03D 11/00 (2006.01) G01N 21/88 (2006.01) G01N 21/95 (2006.01)	2707702 *	ASSESSMENT OF ROTOR BLADES
Aliophtha AG	C07K 14/00 (2006.01) C12N 15/62 (2006.01)	2766484 *	REGULATION OF RECEPTOR EXPRESSION THROUGH DELIVERY OF ARTIFICIAL TRANSCRIPTION FACTORS
Blücher GmbH	A61L 15/18 (2006.01) A61L 15/46 (2006.01)	2734245 *	WOUND DRESSING WITH AN ANTIMICROBIAL EFFECT
SANOFI	C07D 403/12 (2006.01)	2729463 *	SUBSTITUTED PHENYL COMPOUNDS
Oxford Biotherapeutics Ltd.	C07K 16/28 (2006.01)	2726508 *	ANTIBODIES TO ADP-RIBOSYL CYCLASE 2
SMI S.p.A.	B29C 49/36 (2006.01) B29C 49/42 (2006.01) B29C 49/64 (2006.01) B29C 49/68 (2006.01) B65G 29/00 (2006.01) B65G 33/04 (2006.01) B65G 47/84 (2006.01)	2574445	Oven for preforms applicable to blowing machines or stretch blowing machines
Gnutti Transfer S.p.A.	B23Q 3/06 (2006.01) B23Q 16/10 (2006.01)	2747937 *	SUPPORT AND GRIPPING DEVICE OF A MECHANICAL PART, SUITABLE FOR A MACHINE TOOL
Digna Biotech, S.L.	A61K 38/19 (2006.01) A61P 39/02 (2006.01)	2742948 *	USE OF CARDIOTROPHIN-1 FOR THE TREATMENT OF KIDNEY DISEASES
Universidad de Salamanca	A61K 38/19 (2006.01) A61P 39/02 (2006.01)	2742948 *	USE OF CARDIOTROPHIN-1 FOR THE TREATMENT OF KIDNEY DISEASES
Ethicon, Inc	A61F 2/04 (2013.01) A61F 2/82 (2013.01) A61F 2/88 (2006.01)	2760383 *	NEGATIVE PRESSURE INTESTINAL ANASTOMOSIS PROTECTION DEVICES

Podnosilac evropske prijave patenta (71)	MKP (51)	Broj objave evropske prijave patenta (97)	Naziv pronalaska (54)
ANGUS Chemical Company	C07C 45/55 (2006.01) C07C 47/04 (2006.01) C07C 201/12 (2006.01) C07C 205/15 (2006.01) C07C 213/00 (2006.01) C07C 215/08 (2006.01)	2720995 *	PROCESS FOR MAKING TERTIARY AMINOALCOHOL COMPOUNDS
Angus Chemie GmbH	C07C 45/55 (2006.01) C07C 47/04 (2006.01) C07C 201/12 (2006.01) C07C 205/15 (2006.01) C07C 213/00 (2006.01) C07C 215/08 (2006.01)	2720995 *	PROCESS FOR MAKING TERTIARY AMINOALCOHOL COMPOUNDS
Cadila Healthcare Limited	C07C 211/42 (2006.01) C07C 309/29 (2006.01) C07C 309/35 (2006.01)	2705021 *	RASAGILINE AND ITS PHARMACEUTICALLY ACCEPTABLE SALTS
Kapsch-Group Beteiligungs GmbH	B29C 70/22 (2006.01) D04H 3/04 (2012.01) D04H 3/05 (2006.01) D04H 3/12 (2006.01)	2758228 *	SEMI-FINISHED FIBER PRODUCT, FIBER COMPOSITE MATERIAL AND METHOD FOR THE PRODUCTION THEREOF
Völkerer, Klaus	F22B 21/02 (2006.01) F22B 21/34 (2006.01) F22B 29/02 (2006.01) F22B 29/06 (2006.01) F22B 33/10 (2006.01) F22D 1/04 (2006.01) F22G 1/02 (2006.01) F22G 3/00 (2006.01) F22G 7/14 (2006.01)	2715229 *	STEAM GENERATOR
Eidler, Willibald	F22B 21/02 (2006.01) F22B 21/34 (2006.01) F22B 29/02 (2006.01) F22B 29/06 (2006.01) F22B 33/10 (2006.01) F22D 1/04 (2006.01) F22G 1/02 (2006.01) F22G 3/00 (2006.01) F22G 7/14 (2006.01)	2715229 *	STEAM GENERATOR
Past, Arno	F22B 21/02 (2006.01) F22B 21/34 (2006.01) F22B 29/02 (2006.01) F22B 29/06 (2006.01) F22B 33/10 (2006.01) F22D 1/04 (2006.01) F22G 1/02 (2006.01) F22G 3/00 (2006.01) F22G 7/14 (2006.01)	2715229 *	STEAM GENERATOR
Koglbauer, Josef	F22B 21/02 (2006.01) F22B 21/34 (2006.01) F22B 29/02 (2006.01) F22B 29/06 (2006.01) F22B 33/10 (2006.01) F22D 1/04 (2006.01) F22G 1/02 (2006.01) F22G 3/00 (2006.01) F22G 7/14 (2006.01)	2715229 *	STEAM GENERATOR
Scharmüller, Josef	B62D 7/09 (2006.01) B62D 7/18 (2006.01) B62D 7/20 (2006.01)	2755882 *	STEERING AXLE
Scharmüller, Josef, jun.	B62D 7/09 (2006.01) B62D 7/18 (2006.01) B62D 7/20 (2006.01)	2755882 *	STEERING AXLE
Schunk Electrographite SAS	B01D 46/10 (2006.01)	2679292	Regenerable flat filter for air with semi-rigid frame

Podnosilac evropske prijave patenta (71)	MKP (51)	Broj objave evropske prijave patenta (97)	Naziv pronalaska (54)
Theravance, Inc.	A61K 31/415 (2006.01) A61K 31/4155 (2006.01) A61P 9/00 (2006.01) A61P 9/12 (2006.01) C07D 231/14 (2006.01) C07D 401/04 (2006.01) C07D 401/06 (2006.01) C07D 403/04 (2006.01) C07D 403/06 (2006.01) C07D 403/12 (2006.01) C07D 405/04 (2006.01) C07D 405/12 (2006.01) C07D 413/04 (2006.01) C07D 413/06 (2006.01)	2714662 *	NEPRILYSIN INHIBITORS
Despe S.p.A.	E04G 3/22 (2006.01) E04G 3/24 (2006.01) E04G 23/08 (2006.01)	2769032 *	EQUIPMENT AND METHOD FOR DEMOLISHING A BUILDING
The Broad Institute, Inc.	A61K 31/27 (2006.01)	2701699 *	INHIBITORS OF HISTONE DEACETYLASE
The General Hospital Corporation d/b/a Massachusetts General Hospital	A61K 31/27 (2006.01)	2701699 *	INHIBITORS OF HISTONE DEACETYLASE
Massachusetts Institute of Technology (MIT)	A61K 31/27 (2006.01)	2701699 *	INHIBITORS OF HISTONE DEACETYLASE
Hilfrich, Ralf	G01N 33/569 (2006.01)	2758785 *	METHOD FOR CHECKING THE SELF-HEALING PROCESS CARRIED OUT BY THE IMMUNE SYSTEM OF A TEST SUBJECT INFECTED WITH HUMAN PAPILLOMAVIRUS
Menarini International Operations Luxembourg S.A.	A61M 5/00 (2006.01) A61M 5/20 (2006.01) A61M 5/31 (2006.01) A61M 5/315 (2006.01) A61M 5/32 (2006.01)	2753382 *	DEVICE FOR AUTOMATIC INJECTION OF DRUG DOSES
Radzey, Niklas	B24D 15/00 (2006.01) G09F 3/02 (2006.01) G09F 3/10 (2006.01)	2709800 *	METHOD FOR PRODUCING A NON-DETACHABLE SECURITY SEAL
Schmidt, Barbara	B24D 15/00 (2006.01) G09F 3/02 (2006.01) G09F 3/10 (2006.01)	2709800 *	METHOD FOR PRODUCING A NON-DETACHABLE SECURITY SEAL
Imballaggi San Felice SRL	B65H 75/14 (2006.01) B65H 75/22 (2006.01)	2634127	Cable carrier
Ethicon Endo-Surgery, Inc.	A61B 17/072 (2006.01)	2644124	Tissue thickness compensator comprising capsules defining a low pressure environment
BASF SE	A01N 33/04 (2006.01) A01N 33/08 (2006.01) A01N 37/40 (2006.01) A01N 39/04 (2006.01) A01N 57/20 (2006.01)	2638803	Low volatile amine salts of anionic pesticides
Waters Technologies Corporation	C07D 207/40 (2006.01) G01N 33/533 (2006.01)	2761296 *	RAPID FLUORESCENCE TAGGING OF GLYCANS AND OTHER BIOMOLECULES WITH ENHANCED MS SIGNALS
Incyte Corporation	A61K 31/519 (2006.01) A61P 1/00 (2006.01) A61P 17/00 (2006.01) A61P 19/00 (2006.01) A61P 27/00 (2006.01) A61P 29/00 (2006.01) A61P 35/00 (2006.01) C07D 471/04 (2006.01) C07D 487/04 (2006.01)	2751109 *	HETEROCYCLYLAMINES AS PI3K INHIBITORS
Gilead Sciences, Inc.	A61K 31/52 (2006.01) A61P 31/18 (2006.01) A61P 31/20 (2006.01) C07D 473/34 (2006.01)	2744810 *	TENOFOVIR ALAFENAMIDE HEMIFUMARATE

Podnosilac evropske prijave patenta (71)	MKP (51)	Broj objave evropske prijave patenta (97)	Naziv pronalaska (54)
Spirogen Sàrl	A61K 47/48 (2006.01)	2662095	Pyrrlobenzodiazepines and conjugates thereof
Cubist Pharmaceuticals, Inc.	A61K 31/397 (2006.01)	2753326 *	METHODS FOR TREATING INTRAPULMONARY INFECTIONS
Delphi International Operations Luxembourg S.à.r.l.	F02M 63/00 (2006.01)	2647827	Check valve assembly
Eli Lilly and Company	A61K 31/416 (2006.01) A61P 5/00 (2006.01) A61P 9/00 (2006.01) A61P 13/00 (2006.01) C07D 231/54 (2006.01) C07D 231/56 (2006.01)	2721009 *	PYRAZOLE DERIVATIVES USEFUL AS ALDOSTERONE SYNTHASE INHIBITORS
Seattle Genetics, Inc.	G01N 24/00 (2006.01)	2764351 *	INTACT MASS DETERMINATION OF PROTEIN CONJUGATED AGENT COMPOUNDS
Korona S.A.	F21V 35/00 (2006.01) F21V 37/02 (2006.01) F23D 3/16 (2006.01)	2729734 *	CONTAINER FOR CANDLES, WITH INTERNAL CIRCULATION OF AIR
Joint Stock Company "Pharmasyntez"	A61P 41/00 (2006.01) C07D 401/04 (2006.01) C08G 73/06 (2006.01) C08L 79/06 (2006.01)	2716684 *	COMPOUNDS, PHARMACEUTICAL COMPOSITIONS AND A METHOD FOR THE PROPHYLAXIS AND TREATMENT OF THE ADHESION PROCESS
Merck Patent GmbH	A61K 39/395 (2006.01) A61P 37/06 (2006.01) C07K 16/24 (2006.01) C07K 16/46 (2006.01)	2705058 *	AMINO ACID SEQUENCES DIRECTED AGAINST IL-17A, IL-17F AND/OR IL17-A/F AND POLYPEPTIDES COMPRISING THE SAME
Enanta Pharmaceuticals, Inc.	C07D 403/14 (2006.01)	2768825 *	PROCESSES FOR THE PREPARATION OF NOVEL BENZIMIDAZOLE DERIVATIVES
Dalrymple, Roger Kenneth Roy	A01K 3/00 (2006.01)	2720530 *	OUTRIGGER
Children's Hospital & Research Center at Oakland	G01N 24/10 (2006.01) G01N 24/12 (2006.01) G01R 33/24 (2006.01) G01R 33/60 (2006.01) G01R 33/62 (2006.01)	2702400 *	COMPOSITIONS AND METHODS TO ASSESS THE CAPACITY OF HDL TO SUPPORT REVERSE CHOLESTEROL TRANSPORT
Shire Human Genetic Therapies, Inc.	A61K 31/131 (2006.01) A61K 31/132 (2006.01) A61K 31/215 (2006.01) A61K 31/56 (2006.01) A61K 38/00 (2006.01) A61K 38/16 (2006.01) A61K 38/43 (2006.01)	2717893 *	LIPID NANOPARTICLE COMPOSITIONS AND METHODS FOR MRNA DELIVERY
Schur Technology A/S	B65D 30/24 (2006.01)	2684812	Fluid container
Board of Regents, The University of Texas System	A61K 39/395 (2006.01) A61P 35/00 (2006.01) A61P 37/08 (2006.01) C07K 16/18 (2006.01)	2764023 *	ANTI-HUMAN SEMA4A ANTIBODIES USEFUL TO TREAT DISEASE
Resilux N.V.	B29C 45/18 (2006.01) B29C 49/00 (2006.01) B29C 49/22 (2006.01) B65D 81/24 (2006.01)	2718087 *	POLYMER PRODUCT AND METHOD OF MANUFACTURING THE PRODUCT
IGG-Internationale Geotextil Gesellschaft mbH	A01G 25/06 (2006.01)	2760274 *	IRRIGATION MAT
Farmadent d.o.o.	F25D 3/08 (2006.01)	2722618	Container with regulation of content temperature
Zerobin Group Limited	G06Q 50/00 (2012.01)	2715650 *	A REFUSE COLLECTION SYSTEM AND METHOD
Genzyme Corporation	A61K 31/519 (2006.01) A61K 35/00 (2006.01)	2709627 *	INDUCTION OF IMMUNE TOLERANCE BY USING METHOTREXATE
Eigen Systems Limited	B27B 5/29 (2006.01)	2750842 *	CUTTING MACHINE TABLE MANUFACTURING METHOD

Podnosilac evropske prijave patenta (71)	MKP (51)	Broj objave evropske prijave patenta (97)	Naziv pronalaska (54)
LB Bulgaricum PLC	A23L 1/30 (2006.01) A61K 35/74 (2006.01)	2704733 *	POLYBACTERIAL PREPARATION WITH HEALTH BENEFITS: ANTIOXIDANT EFFECT, REDUCTION OF CHOLESTEROL CONCENTRATION, ANTI-INFLAMMATORY IMMUNOMODULATING EFFECT AND RELEASE OF BIOACTIVE PEPTIDES INHIBITING ANGIOTENSIN-CONVERTING ENZYME
Würdig, Uwe	B01F 3/04 (2006.01) B01F 3/22 (2006.01) B01F 5/04 (2006.01) F04F 5/04 (2006.01)	2701832 *	METHOD AND DEVICE FOR ENRICHING A LIQUID WITH OXYGEN
Retrotope, Inc.	A61K 31/122 (2006.01) A61K 31/20 (2006.01) A61K 31/202 (2006.01) A61K 31/375 (2006.01) A61P 27/00 (2006.01) A61P 27/02 (2006.01)	2701697 *	OXIDATIVE RETINAL DISEASES
Boehringer Ingelheim International GmbH	A61K 31/519 (2006.01) A61P 29/00 (2006.01) C07C 211/35 (2006.01) C07D 401/04 (2006.01) C07D 495/04 (2006.01)	2748156 *	NOVEL PIPERIDINO-DIHYDROTHIENOPYRIMIDINE SULFOXIDES AND THEIR USE FOR TREATING COPD AND ASTHMA
ATS Group (IP Holdings) Limited	G06F 17/18 (2006.01)	2764444 *	DATA FUSION IN HIGH COMPUTATIONAL LOAD ENVIRONMENTS
Painsky, Amichai	G06F 17/18 (2006.01)	2764444 *	DATA FUSION IN HIGH COMPUTATIONAL LOAD ENVIRONMENTS
Regeneron Pharmaceuticals, Inc.	A61K 39/395 (2006.01) C07K 16/40 (2006.01)	2736529 *	STABILIZED FORMULATIONS CONTAINING ANTI-PCSK9 ANTIBODIES
Cattin Filtration	F16K 3/02 (2006.01) F16K 27/04 (2006.01) F24F 13/12 (2006.01)	2724085 *	SLIDE DAMPER FOR A FLUID-EXTRACTING SYSTEM, AND EQUIPMENT COMPRISING SUCH A SLIDE DAMPER
SANOFI	A61K 31/42 (2006.01) A61K 31/519 (2006.01) A61K 31/655 (2006.01) A61K 39/395 (2006.01) A61K 45/06 (2006.01) C07K 16/28 (2006.01)	2766039 *	COMPOSITIONS FOR THE TREATMENT OF RHEUMATOID ARTHRITIS AND METHODS OF USING SAME
Regeneron Pharmaceuticals, Inc.	A61K 31/42 (2006.01) A61K 31/519 (2006.01) A61K 31/655 (2006.01) A61K 39/395 (2006.01) A61K 45/06 (2006.01) C07K 16/28 (2006.01)	2766039 *	COMPOSITIONS FOR THE TREATMENT OF RHEUMATOID ARTHRITIS AND METHODS OF USING SAME
Ascendis Pharma Ophthalmology Division A/S	A61K 9/00 (2006.01) A61K 31/573 (2006.01) A61K 47/48 (2006.01) A61P 27/02 (2006.01)	2765986 *	PREVENTION AND TREATMENT OF OCULAR CONDITIONS
Torrent Pharmaceuticals Ltd.	A61K 9/00 (2006.01) A61K 31/137 (2006.01) A61K 47/10 (2006.01) A61K 47/36 (2006.01) A61K 47/38 (2006.01)	2753302 *	PHARMACEUTICAL INVENTION OF TAPENTADOL
Les Laboratoires Servier	A23L 1/054 (2006.01) A23L 1/30 (2006.01) A61K 9/00 (2006.01) A61K 9/10 (2006.01) A61K 31/7048 (2006.01) A61K 47/36 (2006.01)	2745839	Pharmaceutical composition in the form of an oral suspension including a flavonoid fraction and xanthan gum
Zapolsky, Maxim Eduardovich	A61K 31/4995 (2006.01) A61P 25/28 (2006.01) C07D 471/08 (2006.01)	2703402 *	PHARMACOLOGICALLY ACTIVE ALICYCLIC N,N'-SUBSTITUTED 3,7-DIAZABICYCLO[3.3.1]NONANE DERIVATIVES AND DRUGS BASED THEREON
Tyukodi, Peter	F24J 3/00 (2006.01)	2732220 *	ENERGY CELL AND PROCEDURE FOR THE EXPLOITATION OF HEAT ENERGY ARISING DURING AEROBIC PROCESSES

Podnosilac evropske prijave patenta (71)	MKP (51)	Broj objave evropske prijave patenta (97)	Naziv pronalaska (54)
Tyukodiné Mikó, Györgyi	F24J 3/00 (2006.01)	2732220 *	ENERGY CELL AND PROCEDURE FOR THE EXPLOITATION OF HEAT ENERGY ARISING DURING AEROBIC PROCESSES
Tyukodi, Imre	F24J 3/00 (2006.01)	2732220 *	ENERGY CELL AND PROCEDURE FOR THE EXPLOITATION OF HEAT ENERGY ARISING DURING AEROBIC PROCESSES
Tyukodi, Lilla Györgyi	F24J 3/00 (2006.01)	2732220 *	ENERGY CELL AND PROCEDURE FOR THE EXPLOITATION OF HEAT ENERGY ARISING DURING AEROBIC PROCESSES
Invodane Engineering Ltd.	F16H 1/22 (2006.01) F16L 55/40 (2006.01) G01N 27/82 (2006.01)	2685252	Conduit sensor device and process for modifying a magnetic field of a conduit sensor device
Glaxo Group Limited	A61K 47/48 (2006.01) C07K 16/28 (2006.01)	2714737 *	BCMA (CD269/TNFRSF17) -BINDING PROTEINS
Sinclair Pharmaceuticals Limited	C12N 5/07 (2010.01)	2768947 *	METHOD FOR PRODUCING A PRODUCT USING CELLS OF THE HAIR ROOT SHEATH, PRODUCT AND KIT
ARIAD Pharmaceuticals, Inc.	A01N 43/54 (2006.01) A01N 43/66 (2006.01) A61K 31/505 (2006.01) A61K 31/53 (2006.01) C07D 401/00 (2006.01)	2704572 *	COMPOUNDS FOR INHIBITING CELL PROLIFERATION IN EGFR-DRIVEN CANCERS
IRM LLC	A61K 31/437 (2006.01) A61P 3/00 (2006.01) A61P 11/00 (2006.01) A61P 17/00 (2006.01) A61P 29/00 (2006.01) C07D 471/04 (2006.01)	2751104 *	COMPOUNDS AND COMPOSITIONS AS C-KIT KINASE INHIBITORS
Owens-Brockway Glass Container INC.	G01N 21/90 (2006.01)	2726856 *	OPTICAL INSPECTION OF CONTAINERS
Biasin SRL	H01M 2/02 (2006.01) H01M 10/04 (2006.01)	2693513	A container for plates of a battery
Tsinghua University	A61K 38/16 (2006.01) A61K 38/17 (2006.01) A61K 47/48 (2006.01) A61P 35/04 (2006.01) C07K 14/435 (2006.01) C12Q 1/42 (2006.01)	2754718 *	VASCULAR ENDOTHELIAL MYOSTATIN MUTANT THAT MUTATES AT ATP BINDING SITES
Beijing Protgen Ltd.	A61K 38/16 (2006.01) A61K 38/17 (2006.01) A61K 47/48 (2006.01) A61P 35/04 (2006.01) C07K 14/435 (2006.01) C12Q 1/42 (2006.01)	2754718 *	VASCULAR ENDOTHELIAL MYOSTATIN MUTANT THAT MUTATES AT ATP BINDING SITES
Hyundai Wia Corporation	F16H 3/00 (2006.01) F16H 3/093 (2006.01) F16H 61/04 (2006.01)	2749790	Torque assist system and automated manual transmission
Saint-Gobain Adfors	C08L 97/02 (2006.01) D04H 1/4218 (2012.01) D04H 1/64 (2012.01)	2721110 *	BINDER FOR A MAT MADE OF INORGANIC AND/OR ORGANIC FIBERS, AND RESULTING PRODUCTS
Wobben Properties GmbH	F16C 19/18 (2006.01) F16C 33/58 (2006.01)	2715162 *	LARGE ROLLING BEARING
Respivert Limited	A61K 31/4155 (2006.01) A61K 31/506 (2006.01) C07D 403/12 (2006.01) C07D 491/10 (2006.01)	2763984 *	1-PYRAZOLYL-3- (4- ((2 -ANILINOPYRIMIDIN- 4 - YL) OXY) NAPHTHALEN- 1 - YL) UREAS AS P38 MAP KINASE INHIBITORS
Nanobio Corporation	A61K 39/155 (2006.01)	2753354 *	NANOEMULSION RESPIRATORY SYNCYTIAL VIRUS (RSV) SUBUNIT VACCINE
Novartis Pharma AG	A61K 31/4188 (2006.01) A61K 31/7064 (2006.01) A61P 35/00 (2006.01)	2741747 *	JAK P13K/mTOR COMBINATION THERAPY

Podnosilac evropske prijave patenta (71)	MKP (51)	Broj objave evropske prijave patenta (97)	Naziv pronalaska (54)
Incyte Corporation	A61K 31/4188 (2006.01) A61K 31/7064 (2006.01) A61P 35/00 (2006.01)	2741747 *	JAK P13K/mTOR COMBINATION THERAPY
Genmab A/S	C07K 16/00 (2006.01)	2729496 *	MODULATION OF COMPLEMENT-DEPENDENT CYTOTOXICITY THROUGH MODIFICATIONS OF THE C-TERMINUS OF ANTIBODY HEAVY CHAINS
Coyote System	B60K 28/06 (2006.01) G08B 21/06 (2006.01)	2739498 *	SYSTEM AND METHOD FOR PREDICTING A STATE OF DROWSINESS OF A VEHICLE DRIVER
Kiss, Zoltán	E04F 13/14 (2006.01) E04F 15/02 (2006.01) F21S 2/00 (2006.01) F21V 33/00 (2006.01)	2732211 *	MODULAR ILLUMINATING TILE
Dow Global Technologies LLC	C07C 69/753 (2006.01) C07D 209/58 (2006.01) C11D 1/74 (2006.01)	2726452 *	BIORENEWABLE BIODEGRADABLE SURFACTANTS
Resilux	B65D 79/00 (2006.01)	2731890 *	CONTAINER WITH CLOSURE HAVING AN INTERNAL MEMBRANE AND METHOD FOR MANUFACTURING THEREOF
Aimsco Limited	A61K 38/22 (2006.01) A61K 47/48 (2006.01) A61P 31/14 (2006.01)	2701728 *	FORMULATION COMPRISING CRH AND ALPHA - 2 - IMMUNOGLOBULIN
Nissan Chemical Industries, Ltd.	A61K 31/519 (2006.01) A61P 37/00 (2006.01) C07D 487/14 (2006.01)	2742049 *	TRICYCLIC HETEROCYCLIC COMPOUNDS AND JAK INHIBITORS
Nestec S.A.	G01N 33/48 (2006.01) G01N 33/53 (2006.01) G06F 19/00 (2011.01)	2769321 *	METHODS FOR IMPROVING INFLAMMATORY BOWEL DISEASE DIAGNOSIS
Guven, Ali Hakan	B29B 7/88 (2006.01) B29B 7/90 (2006.01) B29B 17/00 (2006.01) B29B 17/02 (2006.01) B29B 17/04 (2006.01) B29C 47/10 (2006.01) C08J 11/04 (2006.01) C08J 11/06 (2006.01)	2760924 *	A METHOD FOR RECYCLING WASTE THERMOPLASTIC MATERIALS AND USING THIS RECYCLED THERMOPLASTIC IN COMPOSITE MATERIAL PRODUCTION
Qualcomm Incorporated	G06K 9/00 (2006.01) G06Q 10/10 (2012.01) G10L 17/00 (2013.01) H04L 29/06 (2006.01)	2727104 *	IDENTIFYING PEOPLE THAT ARE PROXIMATE TO A MOBILE DEVICE USER VIA SOCIAL GRAPHS, SPEECH MODELS, AND USER CONTEXT
Koninklijke Nederlandse Akademie van Wetenschappen (KNAW)	C12N 5/00 (2006.01)	2718422 *	CULTURE MEDIA FOR STEM CELLS
Blanchette Rockefeller Neurosciences Institute	C12Q 1/68 (2006.01)	2764120 *	STIMULUS-ELICITED GENOMIC PROFILE MARKERS OF A NEURODEGENERATIVE CONDITION
Alkon, Daniel L.	C12Q 1/68 (2006.01)	2764120 *	STIMULUS-ELICITED GENOMIC PROFILE MARKERS OF A NEURODEGENERATIVE CONDITION
Khan, Tapan Kumar	C12Q 1/68 (2006.01)	2764120 *	STIMULUS-ELICITED GENOMIC PROFILE MARKERS OF A NEURODEGENERATIVE CONDITION
Boehringer Ingelheim Vetmedica GmbH	A61K 9/00 (2006.01) A61K 9/50 (2006.01) A61K 31/55 (2006.01)	2741736 *	TASTE MASKED PHARMACEUTICAL COMPOSITION
Bystronic Laser AG	B23K 26/10 (2006.01) B23K 37/04 (2006.01)	2626165	Work piece support
Bayer CropScience NV	C07K 14/415 (2006.01) C12N 15/82 (2006.01)	2742059 *	GUARD CELL-SPECIFIC EXPRESSION OF TRANSGENES IN COTTON
The Trustees of The University of Pennsylvania	A61K 39/395 (2006.01) C07K 16/00 (2006.01)	2726103 *	ANTI-PROPERDIN ANTIBODIES AND USES THEREOF
Brandale SAGL	A61G 5/04 (2013.01) A61G 5/10 (2006.01)	2606869	Handlebar for a powered wheelchair

Podnosilac evropske prijave patenta (71)	MKP (51)	Broj objave evropske prijave patenta (97)	Naziv pronalaska (54)
Children's Medical Center Corporation	A61K 39/395 (2006.01)	2714082 *	COMPOSITIONS AND METHODS FOR TREATING PAIN
Centro Nacional de Investigaciones Oncológicas (CNIO)	A61K 31/433 (2006.01) A61K 31/4738 (2006.01) A61K 31/5025 (2006.01) A61K 31/519 (2006.01) A61P 35/00 (2006.01) C07D 401/00 (2006.01) C07D 513/16 (2006.01) C07D 513/22 (2006.01)	2710018 *	NEW COMPOUNDS
University of Virginia Patent Foundation	C07K 14/705 (2006.01)	2751137 *	MOLECULAR GENETIC APPROACH TO TREATMENT AND DIAGNOSIS OF ALCOHOL AND DRUG DEPENDENCE
Somalogic, Inc.	C12Q 1/68 (2006.01) C40B 30/04 (2006.01) C40B 40/06 (2006.01) C40B 40/10 (2006.01) G01N 33/574 (2006.01) G06F 19/00 (2011.01)	2748356 *	RENAL CELL CARCINOMA BIOMARKERS AND USES THEREOF
Telefonaktiebolaget LM Ericsson (PUBL)	H05K 7/20 (2006.01)	2740337 *	METHOD AND DEVICE FOR DETECTING CLOGGING OF A FILTER
Starcounter AB	G06F 11/32 (2006.01) G06F 17/30 (2006.01)	2737405 *	SYSTEMS AND METHODS FOR DATABASE USAGE VISUALIZATION
Obschestvo s Ogranichennoi Otvetstvennostyu "Promyshlennyye Innovatsionnyye Tekhnologii Natsionalnoi Koksokhimicheskoi Assotsiatsii"	C21B 5/00 (2006.01)	2743357 *	BLAST-FURNACE SMELTING METHOD
Intercast & Forge Pty Limited	B21K 7/08 (2006.01) E01B 9/40 (2006.01) E01B 9/68 (2006.01)	2714991 *	A RAILWAY RAIL SUPPORT PLATE
Paha Designs, LLC	B65D 1/02 (2006.01)	2704954 *	PRESSURE EQUALIZATION APPARATUS FOR A BOTTLE
SCA TISSUE FRANCE	A47K 10/38 (2006.01) E05D 11/08 (2006.01)	2641522	A dispenser assembly
Saint-Gobain Glass France	C03C 17/36 (2006.01) H01L 51/52 (2006.01)	2721660 *	SUBSTRATE WITH AN ELECTRODE FOR AN OLED DEVICE AND SUCH AN OLED DEVICE
SCA TISSUE FRANCE	B31F 1/07 (2006.01) D04H 1/00 (2006.01) D21H 25/00 (2006.01) D21H 27/00 (2006.01) D21H 27/02 (2006.01)	2685000	A cloth-like textured nonwoven fabric comprising papermaking fibers, calendering roller and method of manufacturing the same
Blücher GmbH	A61L 2/232 (2006.01) B01D 53/02 (2006.01) B01J 20/02 (2006.01) B01J 20/20 (2006.01) B01J 20/28 (2006.01) B01J 20/32 (2006.01)	2766112 *	METHOD FOR SELF-DETOXIFICATION OF ADSORBENTS
Nuvosun, Inc.	C23C 14/34 (2006.01) H01L 31/042 (2014.01) H01L 31/18 (2006.01)	2742539 *	SPUTTERING SYSTEMS FOR LIQUID TARGET MATERIALS
CBS Institut Celovite Gradbene Resitve, d.o.o.	E04B 1/80 (2006.01) E06B 3/663 (2006.01) E06B 7/02 (2006.01)	2729635 *	MULTI CHAMBER GAS FILLED CONSTRUCTION PANEL
Reflex, Gornja, Radgona, d.o.o.	E04B 1/80 (2006.01) E06B 3/663 (2006.01) E06B 7/02 (2006.01)	2729635 *	MULTI CHAMBER GAS FILLED CONSTRUCTION PANEL

Podnosilac evropske prijave patenta (71)	MKP (51)	Broj objave evropske prijave patenta (97)	Naziv pronalaska (54)
Chiesi Farmaceutici S.p.A.	A61K 31/4436 (2006.01) A61K 31/4439 (2006.01) A61P 11/00 (2006.01) A61P 17/00 (2006.01) A61P 37/08 (2006.01) C07D 213/89 (2006.01) C07D 401/12 (2006.01) C07D 401/14 (2006.01) C07D 405/14 (2006.01) C07D 413/12 (2006.01) C07D 417/12 (2006.01) C07D 417/14 (2006.01)	2718267 *	DERIVATIVES OF 1-PHENYL-2-PYRIDINYL ALKYL ALCOHOLS AS PHOSPHODIESTERASE INHIBITORS
Merck Sharp & Dohme Corp.	A61K 31/343 (2006.01) A61P 31/14 (2006.01) C07D 307/82 (2006.01) C07D 405/10 (2006.01)	2753325 *	TETRACYCLIC HETEROCYCLE COMPOUNDS AND METHODS OF USE THEREOF FOR THE TREATMENT OF VIRAL DISEASES
MSD Italia S.r.l.	A61K 31/343 (2006.01) A61P 31/14 (2006.01) C07D 307/82 (2006.01) C07D 405/10 (2006.01)	2753325 *	TETRACYCLIC HETEROCYCLE COMPOUNDS AND METHODS OF USE THEREOF FOR THE TREATMENT OF VIRAL DISEASES
Pluristem Ltd.	C12M 1/00 (2006.01) C12M 1/12 (2006.01) C12M 1/24 (2006.01) C12M 3/00 (2006.01)	2739720 *	DEVICES AND METHODS FOR CULTURE OF CELLS
The Research Foundation for The State University of New York	B32B 9/00 (2006.01)	2704902 *	MAGNETIC GRAPHENE-LIKE NANOPARTICLES OR GRAPHITIC NANO-OR MICROPARTICLES AND METHOD OF PRODUCTION AND USES THEREOF
Vyome Biosciences Pvt Ltd	A61K 8/37 (2006.01) A61K 47/48 (2006.01) A61P 17/10 (2006.01) A61P 31/04 (2006.01) A61Q 5/02 (2006.01) A61Q 17/00 (2006.01)	2723452 *	CONJUGATE-BASED ANTIFUNGAL AND ANTIBACTERIAL PRODRUGS
Heinrich-Heine-Universität Düsseldorf	C12N 9/24 (2006.01) C12N 15/80 (2006.01)	2764104 *	UNCONVENTIONAL PROTEIN SECRETION
Curry, Michael D.	B23P 11/00 (2006.01) B60B 15/00 (2006.01)	2718116 *	APPARATUS AND METHOD FOR INCREASING THE TRACTION OF VEHICLE WHEELS
Ethicon Endo-Surgery, Inc.	A61B 17/064 (2006.01) A61B 17/072 (2006.01) A61B 17/115 (2006.01)	2517649	Staple cartridge comprising compressible distortion resistant components
Retrotope, Inc.	A61K 31/122 (2006.01) A61K 31/192 (2006.01) A61K 31/20 (2006.01) A61K 31/202 (2006.01)	2701696 *	IMPAIRED ENERGY PROCESSING DISORDERS AND MITOCHONDRIAL DEFICIENCY
Heckler & Koch GmbH	F41A 21/26 (2006.01) F41A 21/36 (2006.01)	2739931 *	MANOEUVRES CARTRIDGE DEVICE AND SELF-LOADING FIREARM SUITABLE THEREFOR
Cephalon, Inc.	A61K 31/69 (2006.01) C07F 5/02 (2006.01)	2723751 *	PROTEASOME INHIBITORS AND PROCESSES FOR THEIR PREPARATION, PURIFICATION AND USE
VPP Energy Zrt.	H02J 3/38 (2006.01)	2662945	Distributed power generation system, controlling means and method for controlling the power generation of the system
Janssen Pharmaceuticals, Inc.	A61K 31/5383 (2006.01) A61P 25/28 (2006.01) C07D 487/04 (2006.01) C07D 498/04 (2006.01)	2731948 *	NOVEL SUBSTITUTED INDOLE DERIVATIVES AS GAMMA SECRETASE MODULATORS
Cellzome Limited	A61K 31/5383 (2006.01) A61P 25/28 (2006.01) C07D 487/04 (2006.01) C07D 498/04 (2006.01)	2731948 *	NOVEL SUBSTITUTED INDOLE DERIVATIVES AS GAMMA SECRETASE MODULATORS
Gicon Grossmann Ingenieur Consult GmbH	C12M 1/00 (2006.01) C12N 1/12 (2006.01)	2751255 *	METHOD AND DEVICE FOR FEEDING GASES OR GAS MIXTURES INTO A LIQUID, SUSPENSION, OR EMULSION IN A REACTOR IN A SPECIFIC MANNER

Podnosilac evropske prijave patenta (71)	MKP (51)	Broj objave evropske prijave patenta (97)	Naziv pronalaska (54)
Karyopharm Therapeutics, Inc.	A61K 31/4439 (2006.01) A61K 31/497 (2006.01) A61K 31/498 (2006.01) A61K 31/506 (2006.01) A61K 31/5377 (2006.01) A61K 31/55 (2006.01) A61P 27/02 (2006.01) A61P 29/00 (2006.01) A61P 31/12 (2006.01) A61P 35/00 (2006.01) C07D 249/08 (2006.01) C07D 401/12 (2006.01) C07D 403/12 (2006.01) C07D 409/12 (2006.01)	2736887 *	HYDRAZIDE CONTAINING NUCLEAR TRANSPORT MODULATORS AND USES THEREOF
Exelixis, Inc.	A61K 31/506 (2006.01) A61P 35/00 (2006.01) C07D 239/42 (2006.01) C07D 401/04 (2006.01) C07D 403/04 (2006.01) C07D 403/12 (2006.01) C07D 405/04 (2006.01) C07D 405/12 (2006.01) C07D 405/14 (2006.01) C07D 409/04 (2006.01) C07D 413/04 (2006.01) C07D 417/04 (2006.01) C07D 417/14 (2006.01)	2702043 *	INHIBITORS OF INDUCIBLE FORM OF 6-PHOSPHOFRUCTOSE-2-KINASE
SGM A/S	F21V 21/30 (2006.01) F21V 23/04 (2006.01) F21W 131/105 (2006.01) F21W 131/107 (2006.01) F21W 131/406 (2006.01)	2690357	A lighting device
Energia Europa S.P.A.	G05F 1/14 (2006.01) H01F 29/02 (2006.01)	2740132 *	AN IMPROVED, HIGH-EFFICIENCY, ENERGY-SAVING DEVICE FOR INSERTING BETWEEN A POWER SOURCE AND A MOTIVE AND/OR LIGHTING POWER LOAD
Teikoku Seiyaku Co., Ltd.	A61K 9/70 (2006.01) A61K 31/4178 (2006.01) A61K 31/4184 (2006.01) A61K 31/439 (2006.01) A61K 45/00 (2006.01) A61K 47/14 (2006.01) A61K 47/18 (2006.01) A61K 47/32 (2006.01) A61P 1/08 (2006.01) A61P 43/00 (2006.01)	2730290 *	ADHESIVE SKIN PATCH CONTAINING SEROTONIN RECEPTOR ANTAGONIST DRUG
Complete Genomics, Inc.	G06F 19/22 (2011.01)	2628117 *	IDENTIFYING REARRANGEMENTS IN A SEQUENCED GENOME
Federal-Mogul Wiesbaden GmbH & Co.KG	B22F 9/08 (2006.01) C22C 1/04 (2006.01) C22C 1/10 (2006.01) C23C 24/08 (2006.01) F16C 33/12 (2006.01) F16C 33/14 (2006.01)	2748476 *	METHOD FOR PRODUCING A SLIDING BEARING COMPRISING A CuNi2Si, CuFe2P OR CuSnX COMPOUND
Secure Payment Technologies GmbH	G06Q 20/18 (2012.01) G06Q 20/20 (2012.01)	2724304 *	METHOD AND DEVICE FOR CARRYING OUT CASHLESS PAYMENTS
Goe-IP AS	C09K 8/582 (2006.01) C12P 7/10 (2006.01)	2714837 *	METHOD FOR MICROBIAL CONTROL OF INJECTION LIQUID FLOW IN A HYDROCARBON RESERVOIR
Bühler, Leo	B60P 7/08 (2006.01)	2671754	Load securing system
Amgen Inc.	G01N 33/574 (2006.01) G01N 33/74 (2006.01)	2753933 *	USE OF HUMAN PAPILLOMAVIRUS STATUS IN ESTABLISHING USE OF AN AGENT THAT BINDS EGFR IN THE TREATMENT OF CANCER
Jiangsu Hengrui Medicine Co., Ltd.	A61K 31/55 (2006.01)	2740478 *	SUSTAINED-RELEASE PREPARATION OF IVABRADINE OR PHARMACEUTICALLY ACCEPTABLE SALTS THEREOF

Podnosilac evropske prijave patenta (71)	MKP (51)	Broj objave evropske prijave patenta (97)	Naziv pronalaska (54)
Epifarma Srl	A61K 9/70 (2006.01) A61K 31/185 (2006.01)	2734196 *	PATCH CONTAINING DICLOFENAC AND THIOCOLCHICOSIDE
STC.UNM	A61K 9/14 (2006.01) A61K 9/16 (2006.01) A61K 9/22 (2006.01) A61K 47/30 (2006.01) A61K 47/48 (2006.01) A61P 35/00 (2006.01)	2734191 *	INTRAPERITONEALLY-ADMINISTERED NANOCARRIERS THAT RELEASE THEIR THERAPEUTIC LOAD BASED ON THE INFLAMMATORY ENVIRONMENT OF CANCERS
Delphi International Operations Luxembourg S.à.r.l.	F02M 51/06 (2006.01) F02M 61/04 (2006.01) F02M 63/00 (2006.01)	2660457	Fuel injector
Levy, Phillip	A61K 8/64 (2006.01) A61K 8/73 (2006.01) A61K 8/97 (2006.01) A61Q 19/08 (2006.01)	2717851 *	SKIN COSMETIC COMPOSITIONS COMPRISING MALUS DOMESTICA EXTRACT AND ARGANIA SPINOSA SPROUT EXTRACT FOR IMPROVING SKIN APPEARANCE
Bio-Rad Innovations	G01N 33/576 (2006.01)	2737318 *	A2M FRAGMENTS AND APPLICATIONS THEREOF
Centre National de la Recherche Scientifique	G01N 33/576 (2006.01)	2737318 *	A2M FRAGMENTS AND APPLICATIONS THEREOF
Ascendis Pharma A/S	A61K 47/48 (2006.01) A61P 11/00 (2006.01)	2741781 *	CARRIER-LINKED TREPROSTINIL PRODRUGS
Nanostring Technologies, Inc	C12N 15/11 (2006.01) C12Q 1/68 (2006.01)	2723897 *	MULTIVARIATE DIAGNOSTIC ASSAYS AND METHODS FOR USING SAME
Avaxia Biologics, Inc.	A61K 39/00 (2006.01) A61K 39/395 (2006.01) C07K 16/00 (2006.01)	2739650 *	BOVINE POLYCLONAL ANTIBODY SPECIFIC FOR HUMAN TNF
Instytut Chemii i Techniki Jadrowej	G21G 1/00 (2006.01)	2618335	Sorbent for receiving radionuclide arsenic-72, production of this sorbent and its use
Johnson & Johnson Consumer Companies Inc.	A61F 2/10 (2006.01) A61K 8/34 (2006.01) A61K 8/46 (2006.01) A61K 8/67 (2006.01) A61K 8/97 (2006.01) A61Q 19/00 (2006.01) A61Q 19/08 (2006.01)	2572701	Compositions comprising a retinoid and an NFkB-Inhibitor and their methods of use
Cancer Prevention And Cure, Ltd.	G01N 33/574 (2006.01)	2702411 *	METHODS OF IDENTIFICATION AND DIAGNOSIS OF LUNG DISEASES USING CLASSIFICATION SYSTEMS AND KITS THEREOF
Nanovir, LLC	A61K 31/4178 (2006.01) A61P 31/12 (2006.01) C07D 403/14 (2006.01) C08L 77/00 (2006.01)	2751096 *	GUANIDINYL-SUBSTITUTED POLYAMIDES USEFUL FOR TREATING HUMAN PAPILLOMA VIRUS
THE CURATORS OF THE UNIVERSITY OF MISSOURI	A61K 31/4178 (2006.01) A61P 31/12 (2006.01) C07D 403/14 (2006.01) C08L 77/00 (2006.01)	2751096 *	GUANIDINYL-SUBSTITUTED POLYAMIDES USEFUL FOR TREATING HUMAN PAPILLOMA VIRUS
Nippon Soda Co., Ltd.	A01N 43/42 (2006.01) A01N 43/60 (2006.01) A01N 43/90 (2006.01) A01P 3/00 (2006.01) C07D 241/52 (2006.01) C07D 401/12 (2006.01) C07D 471/04 (2006.01)	2711361 *	NITROGENATED HETEROCYCLIC COMPOUND AND AGRICULTURAL OR HORTICULTURAL FUNGICIDE
Owens-Brockway Glass Container INC.	C03C 3/087 (2006.01) C03C 4/02 (2006.01) C03C 4/08 (2006.01) C03C 6/00 (2006.01)	2729424 *	GLASS CONTAINER COMPOSITION

Podnosilac evropske prijave patenta (71)	MKP (51)	Broj objave evropske prijave patenta (97)	Naziv pronalaska (54)
Array Biopharma, Inc.	A61K 31/4155 (2006.01) A61K 31/4162 (2006.01) A61K 31/4178 (2006.01) A61K 31/4192 (2006.01) A61K 31/4196 (2006.01) A61K 31/422 (2006.01) A61K 31/4245 (2006.01) A61K 31/427 (2006.01) A61K 31/4439 (2006.01) C07D 401/14 (2006.01) C07D 403/12 (2006.01) C07D 403/14 (2006.01) C07D 405/14 (2006.01) C07D 409/14 (2006.01) C07D 413/14 (2006.01) C07D 417/14 (2006.01) C07D 471/04 (2006.01) C07D 487/04 (2006.01) C07D 491/04 (2006.01) C07D 495/04 (2006.01)	2712358 *	PYRROLIDINYL UREA, PYRROLIDINYL THIOUREA AND PYRROLIDINYL GUANIDINE COMPOUNDS AS TRKA KINASE INHIBITORS
Chiesi Farmaceutici S.p.A.	A61K 31/58 (2006.01) A61P 5/44 (2006.01) C07J 71/00 (2006.01)	2739640 *	ANTI -INFLAMMATORY STEROIDS CONDENSED IN POSITION 16,17 WITH PYRROLIDINE RING
Taisho Pharmaceutical Co., Ltd.	A61K 31/4192 (2006.01) A61K 31/422 (2006.01) A61K 31/4245 (2006.01) A61K 31/4439 (2006.01) A61K 31/506 (2006.01) A61P 1/00 (2006.01) A61P 5/00 (2006.01) A61P 9/12 (2006.01) A61P 25/08 (2006.01) A61P 25/16 (2006.01) A61P 25/20 (2006.01) A61P 25/22 (2006.01) A61P 25/24 (2006.01) C07D 401/14 (2006.01)	2708537 *	HETEROAROMATIC RING DERIVATIVE
Samumed, LLC	A01N 43/56 (2006.01) A61K 31/415 (2006.01)	2755483 *	INDAZOLE-3-CARBOXAMIDES AND THEIR USE AS WNT/B-CATENIN SIGNALING PATHWAY INHIBITORS
Kabushiki Kaisha Toyota Jidoshokki	F01N 5/02 (2006.01) F02B 37/00 (2006.01) F02G 5/00 (2006.01) F02G 5/02 (2006.01) F02G 5/04 (2006.01) F22B 1/18 (2006.01)	2752573 *	WASTE HEAT UTILIZATION DEVICE
OPKO Biologics Ltd	A61K 38/00 (2006.01) A61K 38/27 (2006.01)	2739298 *	LONG-ACTING GROWTH HORMONE AND METHODS OF PRODUCING SAME
Rockfuel Innovations Limited	C01B 31/20 (2006.01)	2734470 *	CARBON DIOXIDE PRODUCTION
The Research Foundation Of State University Of New York	A61F 2/24 (2006.01)	2765954 *	POLYMERIC HEART VALVE
Slepian, Marvin	A61F 2/24 (2006.01)	2765954 *	POLYMERIC HEART VALVE
Exelixis, Inc.	A61K 31/4196 (2006.01) A61K 31/498 (2006.01) A61K 31/519 (2006.01) A61P 35/00 (2006.01)	2755654 *	PHOSPHATIDYLINOSITOL 3-KINASE INHIBITORS FOR THE TREATMENT OF CANCER
SANOFI	A61K 31/4196 (2006.01) A61K 31/498 (2006.01) A61K 31/519 (2006.01) A61P 35/00 (2006.01)	2755654 *	PHOSPHATIDYLINOSITOL 3-KINASE INHIBITORS FOR THE TREATMENT OF CANCER
Showa Denko K.K.	G03G 5/00 (2006.01) G03G 5/10 (2006.01)	2746854 *	SUBSTRATE FOR PHOTSENSITIVE DRUM

Podnosilac evropske prijave patenta (71)	MKP (51)	Broj objave evropske prijave patenta (97)	Naziv pronalaska (54)
Synta Pharmaceuticals Corp.	A61K 31/4196 (2006.01) A61K 31/4439 (2006.01) A61P 35/00 (2006.01)	2729144 *	TREATING CANCER WITH HSP90 INHIBITORY COMPOUNDS
VIIV Healthcare UK Limited	A01N 43/42 (2006.01) A61K 31/44 (2006.01)	2731436 *	AZAINDOLE COMPOUNDS AND METHODS FOR TREATING HIV
SafeAir AG	A61B 18/14 (2006.01) A61B 18/18 (2006.01) A61M 1/00 (2006.01) A61M 13/00 (2006.01) A61M 16/04 (2006.01) A61M 25/00 (2006.01) A61M 39/08 (2006.01)	2758090 *	AN ELECTROSURGICAL PENCIL WITH A SMOKE EVACUATION TUBE
Janssen Pharmaceutica, N.V.	A61K 31/4985 (2006.01) A61P 25/00 (2006.01) C07D 487/04 (2006.01)	2723744 *	1-ARYL-4-METHYL-[1,2,4]TRIAZOLO[4,3-a]QUINOXALINE DERIVATIVES
Gueramy, Timothy	H04L 29/08 (2006.01)	2767074 *	TIME SENSITIVE AUDIO AND TEXT FEEDBACK PROCESS FOR A PRIORITIZED MEDIA RICH DIGITAL MESSAGING SYSTEM
Haas, Tracey	H04L 29/08 (2006.01)	2767074 *	TIME SENSITIVE AUDIO AND TEXT FEEDBACK PROCESS FOR A PRIORITIZED MEDIA RICH DIGITAL MESSAGING SYSTEM
Bonac Corporation	C12N 15/113 (2010.01)	2674494	Single-stranded RNA molecule having nitrogen-containing alicyclic skeleton
AGROSAVFE N.V.	A01N 25/24 (2006.01) A01N 25/28 (2006.01) A01N 43/40 (2006.01) A01N 53/00 (2006.01) A01N 57/20 (2006.01) B01J 13/18 (2006.01)	2763529 *	MANUFACTURING OF SPECIFICALLY TARGETING MICROCAPSULES
Biogen Idec MA Inc.	A61K 38/12 (2006.01)	2717898 *	PRO-COAGULANT COMPOUNDS AND METHODS OF USE THEREOF
Genzyme Corporation	A61K 39/395 (2006.01)	2726101 *	INHIBITORS OF T-CELL ACTIVATION
Board of Regents, The University of Texas System	B82Y 40/00 (2011.01) C07H 3/06 (2006.01) C08F 293/00 (2006.01) C08G 73/06 (2006.01) C08G 81/02 (2006.01) G03F 7/00 (2006.01)	2729508 *	OLIGOSACCHARIDE/SILICON-CONTAINING BLOCK COPOLYMERS FOR LITHOGRAPHY APPLICATIONS
The Regents of the University of California	A61K 31/165 (2006.01) A61P 29/00 (2006.01) C07C 233/06 (2006.01) C07C 233/23 (2006.01) C07D 309/14 (2006.01)	2744778 *	META-SUBSTITUTED BIPHENYL PERIPHERALLY RESTRICTED FAAH INHIBITORS
Fondazione Istituto Italiano Di Tecnologia	A61K 31/165 (2006.01) A61P 29/00 (2006.01) C07C 233/06 (2006.01) C07C 233/23 (2006.01) C07D 309/14 (2006.01)	2744778 *	META-SUBSTITUTED BIPHENYL PERIPHERALLY RESTRICTED FAAH INHIBITORS
Università Degli Studi Di Urbino "Carlo Bo"	A61K 31/165 (2006.01) A61P 29/00 (2006.01) C07C 233/06 (2006.01) C07C 233/23 (2006.01) C07D 309/14 (2006.01)	2744778 *	META-SUBSTITUTED BIPHENYL PERIPHERALLY RESTRICTED FAAH INHIBITORS
Università degli Studi di Parma	A61K 31/165 (2006.01) A61P 29/00 (2006.01) C07C 233/06 (2006.01) C07C 233/23 (2006.01) C07D 309/14 (2006.01)	2744778 *	META-SUBSTITUTED BIPHENYL PERIPHERALLY RESTRICTED FAAH INHIBITORS
Momenta Pharmaceuticals, Inc.	C12N 5/07 (2010.01) C12P 21/00 (2006.01)	2729561 *	CELL CULTURE PROCESS
PQ Corporation	B01D 53/56 (2006.01)	2726180 *	ZEOLITE IMPREGNATED WITH TITANIUM DIOXIDE

Podnosilac evropske prijave patenta (71)	MKP (51)	Broj objave evropske prijave patenta (97)	Naziv pronalaska (54)
Haltec Hallensysteme GmbH	E04B 1/24 (2006.01) E04B 1/342 (2006.01) E04B 7/02 (2006.01) E04H 15/00 (2006.01) E04H 15/18 (2006.01)	2574702	Roof or wall structure
Wobben Properties GmbH	F03D 7/02 (2006.01) H02K 7/09 (2006.01) H02K 19/26 (2006.01) H02P 9/14 (2006.01) H02P 29/00 (2006.01)	2721730 *	METHOD FOR CONTROLLING A WIND TURBINE
Giacomelli, Fabio	G01S 19/17 (2010.01) G01S 19/19 (2010.01) G01S 19/51 (2010.01) G01V 9/00 (2006.01)	2702430 *	METHOD FOR ASSESSING THE RELIABILITY OF A DOG-MAN PAIR AND KIT FOR IMPLEMENTING SAID METHOD
Astrazeneca AB	A61M 15/00 (2006.01)	2755708 *	INHALER
Trustees Of The University Of Pennsylvania	A01N 63/00 (2006.01) A01N 65/00 (2009.01) A61K 38/00 (2006.01)	2739299 *	METHODS AND COMPOSITIONS FOR INHIBITING DELAYED GRAFT FUNCTION
TITAN KOGYO KABUSHIKI KAISHA	C01G 23/00 (2006.01) C01G 23/08 (2006.01) C01G 33/00 (2006.01) H02M 1/08 (2006.01)	2669253	Titanium oxide for electrode and method for manufacturing the same
Kabushiki Kaisha Toshiba	C01G 23/00 (2006.01) C01G 23/08 (2006.01) C01G 33/00 (2006.01) H02M 1/08 (2006.01)	2669253	Titanium oxide for electrode and method for manufacturing the same
Boehringer Ingelheim International GmbH	A61M 15/00 (2006.01) B05B 11/00 (2006.01)	2714280 *	NEBULIZER
Amgen Inc.	C07K 14/435 (2006.01)	2721058 *	METHOD OF TREATING OR AMELIORATING METABOLIC DISORDERS USING CLEC-2
Recuperma GmbH	B02C 13/16 (2006.01) B02C 13/28 (2006.01)	2628541	Drive for a grinding machine
Janssen Pharmaceutica NV	C07K 16/18 (2006.01)	2731968 *	MONOCLONAL ANTIBODIES SPECIFIC FOR BETA-AMYLOID X-37 AND USES THEREOF
The Regents Of The University Of Michigan	A61K 31/407 (2006.01) A61P 35/00 (2006.01) C07D 413/12 (2006.01) C07D 487/10 (2006.01)	2707372 *	SPIRO-OXINDOLE MDM2 ANTAGONISTS
Sanofi	A61K 31/407 (2006.01) A61P 35/00 (2006.01) C07D 413/12 (2006.01) C07D 487/10 (2006.01)	2707372 *	SPIRO-OXINDOLE MDM2 ANTAGONISTS
Amgen Inc.	A61K 31/495 (2006.01) A61P 35/00 (2006.01) C07D 487/04 (2006.01)	2702063 *	BICYCLIC PYRIDAZINE COMPOUNDS AS PIM INHIBITORS
Services Pétroliers Schlumberger	E21B 47/08 (2012.01) G01B 7/13 (2006.01) G01B 21/04 (2006.01)	2647790	Calibrator for a downhole caliper and method of using same
Schlumberger Technology B.V.	E21B 47/08 (2012.01) G01B 7/13 (2006.01) G01B 21/04 (2006.01)	2647790	Calibrator for a downhole caliper and method of using same
Schlumberger Holdings Limited	E21B 47/08 (2012.01) G01B 7/13 (2006.01) G01B 21/04 (2006.01)	2647790	Calibrator for a downhole caliper and method of using same
PRAD Research and Development Limited	E21B 47/08 (2012.01) G01B 7/13 (2006.01) G01B 21/04 (2006.01)	2647790	Calibrator for a downhole caliper and method of using same
Blücher GmbH	B01J 21/06 (2006.01) B01J 23/22 (2006.01) B01J 37/00 (2006.01) C01G 23/04 (2006.01) C01G 31/02 (2006.01)	2720789 *	TITANIUM OXIDE- AND/OR VANADIUM OXIDE-BASED POROUS MATERIALS AND THE PRODUCTION AND USE THEREOF

Podnosilac evropske prijave patenta (71)	MKP (51)	Broj objave evropske prijave patenta (97)	Naziv pronalaska (54)
Universität Leipzig	B01J 21/06 (2006.01) B01J 23/22 (2006.01) B01J 37/00 (2006.01) C01G 23/04 (2006.01) C01G 31/02 (2006.01)	2720789 *	TITANIUM OXIDE- AND/OR VANADIUM OXIDE-BASED POROUS MATERIALS AND THE PRODUCTION AND USE THEREOF
Neoperl GmbH	B05B 1/30 (2006.01) E03C 1/084 (2006.01)	2664719	Sanitary fitting element
IRM LLC	A61K 31/506 (2006.01) A61P 35/00 (2006.01) C07D 401/14 (2006.01) C07D 403/04 (2006.01)	2727918	Compounds and Compositions as Protein Kinase Inhibitors
Novartis AG	A61K 31/506 (2006.01) A61P 35/00 (2006.01) C07D 401/14 (2006.01) C07D 403/04 (2006.01)	2727918	Compounds and Compositions as Protein Kinase Inhibitors
Fioretti, Bernard	A61K 9/48 (2006.01) A61K 9/51 (2006.01) A61K 31/05 (2006.01) A61K 47/02 (2006.01)	2679243	Co-precipitate of one or more stilbene polyphenols and their derivatives in lamellar anionic solids, it's applications and related preparation method
Glaxo Group Limited	A01N 43/30 (2006.01) A61K 31/36 (2006.01)	2744332 *	BENZOFURAN COMPOUNDS FOR THE TREATMENT OF HEPATITIS C VIRUS INFECTIONS
Cordivari S.r.L.	A47K 10/06 (2006.01) F24D 19/00 (2006.01) F24H 9/00 (2006.01)	2677248	Fan-assisted Radiator, Preferably a Fan-assisted Heated Towel Rail, and Related Ventilation System
Shengyi Technology Co., Ltd.	C08L 63/00 (2006.01) C08L 79/04 (2006.01)	2722363	Cyanate Ester Resin Composition, and a Prepreg, a Laminated Material and a Metal Clad Laminated Material Made Therefrom
Blücher GmbH	A62D 5/00 (2006.01)	2717973 *	FUNCTIONAL PROTECTIVE MATERIAL, IN PARTICULAR FOR USE IN PROTECTIVE CLOTHING
BBS Corporation	B29C 47/06 (2006.01) B29C 47/08 (2006.01) B29C 47/26 (2006.01) B29C 47/56 (2006.01) B29C 47/70 (2006.01)	2639038	Layer sequence repeater module for a modular disk co-extrusion die and its usage
CHIESI FARMACEUTICI S.p.A.	A61K 9/00 (2006.01) A61K 9/50 (2006.01)	2762133	Process for preparing carrier particles for dry powders for inhalation
Takeda Pharmaceutical Company Limited	A61K 31/50 (2006.01) A61K 31/501 (2006.01) A61P 25/18 (2006.01) A61P 25/28 (2006.01) A61P 29/00 (2006.01) C07D 237/16 (2006.01) C07D 401/10 (2006.01) C07D 407/10 (2006.01)	2748149 *	PYRIDAZINONE COMPOUNDS AND THEIR USE AS DAAO INHIBITORS
Saint-Gobain Glass France	B32B 17/10 (2006.01) F21K 99/00 (2010.01) F21V 33/00 (2006.01) F21Y 105/00 (2006.01) G02B 6/00 (2006.01)	2718099 *	LIGHTING DEVICE COMPRISING LIGHT-EMITTING DIODES
Lysis Limited Liability Company	G05B 19/00 (2006.01) H02J 13/00 (2006.01)	2722719 *	AUTOMATED SYSTEM FOR MONITORING, PROTECTING AND CONTROLLING ELECTRICAL SUBSTATION EQUIPMENT
Omeros Corporation	A61K 39/395 (2006.01) C07K 16/40 (2006.01) C12N 1/19 (2006.01) C12N 5/10 (2006.01) C12N 15/13 (2006.01) C12N 15/63 (2006.01) C12P 21/08 (2006.01)	2704743 *	COMPOSITIONS FOR INHIBITING MASP-2 DEPENDENT COMPLEMENT ACITIVATION
ATS Group (IP Holdings) Limited	H04L 29/06 (2006.01)	2592805	Method and system for preserving privacy and accountability
GlaxoSmithKline Biologicals SA	A61K 39/09 (2006.01) A61P 31/00 (2006.01)	2709658 *	VACCINE AGAINST STREPTOCOCCUS PNEUMONIAE

Podnosilac evropske prijave patenta (71)	MKP (51)	Broj objave evropske prijave patenta (97)	Naziv pronalaska (54)
Sol-Gel Technologies Ltd.	A61K 9/50 (2006.01) A61K 31/07 (2006.01) A61K 31/327 (2006.01) A61K 31/695 (2006.01)	2726067 *	STABILIZED TOPICAL FORMULATIONS CONTAINING CORE-SHELL MICROCAPSULES
Helfenberger Immobilien LLC & Co Textilforschungs- und Entwicklungs KEG	D01F 9/12 (2006.01) D01F 9/14 (2006.01) D01F 9/16 (2006.01) D06M 10/00 (2006.01)	2718487 *	TEXTILE SHEET MATERIAL
Astellas Pharma Inc.	A61K 31/155 (2006.01) A61K 31/404 (2006.01) A61P 13/12 (2006.01) A61P 43/00 (2006.01) C07C 279/18 (2006.01) C07C 307/10 (2006.01) C07D 207/16 (2006.01) C07D 209/20 (2006.01) C07D 209/42 (2006.01) C07D 211/62 (2006.01) C07D 213/79 (2006.01) C07D 215/20 (2006.01) C07D 215/48 (2006.01) C07D 215/50 (2006.01) C07D 233/64 (2006.01) C07D 257/04 (2006.01) C07D 271/06 (2006.01) C07D 277/20 (2006.01) C07D 277/56 (2006.01) C07D 295/12 (2006.01) C07D 333/38 (2006.01)	2757093 *	GUANIDINO BENZOIC ACID COMPOUND
Takeda Pharmaceutical Company Limited	A61K 31/167 (2006.01) A61K 31/36 (2006.01) A61K 31/366 (2006.01) A61K 31/381 (2006.01) A61K 31/40 (2006.01) A61K 31/402 (2006.01) A61K 31/4035 (2006.01) A61K 31/404 (2006.01) A61K 31/4184 (2006.01) A61K 31/42 (2006.01) A61K 31/421 (2006.01) A61K 31/426 (2006.01) A61K 31/428 (2006.01) A61K 31/429 (2006.01) A61K 31/433 (2006.01) A61K 31/4406 (2006.01) A61K 31/4409 (2006.01) A61K 31/4453 (2006.01) A61K 31/4468 (2006.01) A61K 31/451 (2006.01) C07C 233/80 (2006.01)	2743256 *	CYCLOPROPANEAMINE COMPOUND
The Trustees Of The University Of Pennsylvania	G06Q 50/00 (2012.01)	2766866 *	DISCHARGE DECISION SUPPORT SYSTEM FOR POST ACUTE CARE REFERRAL
Kymab Limited	A01K 67/027 (2006.01) C07K 16/46 (2006.01) C12N 15/85 (2006.01)	2758535 *	ANTIBODIES, VARIABLE DOMAINS&CHAINS TAILORED FOR HUMAN USE
Sloan-kettering Institute For Cancer Research	G01N 33/53 (2006.01)	2729806 *	USES OF LABELED HSP90 INHIBITORS
Cornell University	G01N 33/53 (2006.01)	2729806 *	USES OF LABELED HSP90 INHIBITORS
Lee Laser, Inc.	H01S 3/06 (2006.01) H01S 3/0941 (2006.01) H01S 3/16 (2006.01) H01S 3/23 (2006.01)	2713457	Optical amplifier and process

Podnosilac evropske prijave patenta (71)	MKP (51)	Broj objave evropske prijave patenta (97)	Naziv pronalaska (54)
Ultimate Transmissions Pty Ltd	F16H 15/38 (2006.01) F16H 15/44 (2006.01) F16H 15/48 (2006.01) F16H 15/52 (2006.01)	2705276 *	TOROIDAL VARIABLE SPEED TRACTION DRIVE
GlaxoSmithKline Biologicals S.A.	A61K 39/08 (2006.01) C07K 14/33 (2006.01) C12N 15/62 (2006.01)	2714911 *	IMMUNOGENIC COMPOSITION
Packers Plus Energy Services Inc.	E21B 23/02 (2006.01) E21B 23/03 (2006.01) E21B 33/124 (2006.01) E21B 43/26 (2006.01)	2723972 *	FRACTURING PORT LOCATOR AND ISOLATION TOOL
Iskra Zascite D.o.o.	H01C 7/12 (2006.01) H01H 37/76 (2006.01) H01T 1/14 (2006.01) H02H 9/04 (2006.01)	2707892 *	REDUNDANT EXCESS VOLTAGE CIRCUIT BREAKER WITH A ROTATIONAL DISK AND WITH AN ADDED ELECTRONIC ASSEMBLY INTENDED TO EXTEND A LIFE SPAN OF AN EXCESS -VOLTAGE COMPONENT
Pfizer Inc.	A61K 31/438 (2006.01) A61P 1/16 (2006.01) A61P 3/10 (2006.01) C07D 471/10 (2006.01)	2676958	N1-Pyrazolospiroketone acetyl-CoA carboxylase inhibitors
Biogen IDEC International Neuroscience GmbH	A61K 39/395 (2006.01)	2723379 *	ANTI-ALPHA SYNUCLEIN BINDING MOLECULES
University of Zürich	A61K 39/395 (2006.01)	2723379 *	ANTI-ALPHA SYNUCLEIN BINDING MOLECULES
Acino AG	A61K 9/70 (2006.01) A61K 31/485 (2006.01) A61K 47/12 (2006.01) A61P 25/04 (2006.01) A61P 25/36 (2006.01)	2714018 *	TRANSDERMAL THERAPEUTIC SYSTEM COMPRISING BUPRENORPHINE AND AN ALPHA-HYDROXY ACID
Genentech, Inc.	A61K 38/17 (2006.01) A61K 39/395 (2006.01) A61P 35/00 (2006.01)	2704735 *	VASCULAR DISRUPTION AGENTS AND USES THEREOF
Sunesis Pharmaceuticals, Inc.	C07D 417/04 (2006.01) C07D 417/14 (2006.01)	2674431	Stable SNS-595 compositions and methods of preparation
Omya International AG	C09C 1/02 (2006.01)	2722368	Process of controlled chemical reaction of a solid filler material surface and additives to produce a surface treated filler material product
Titan Wood Limited	B27K 3/36 (2006.01) B27N 1/00 (2006.01) B27N 3/04 (2006.01)	2760652 *	PANELS OF MEDIUM DENSITY FIBREBOARD
Stabinor AS	E21D 11/00 (2006.01) E21D 11/08 (2006.01) E21D 11/10 (2006.01) E21D 11/30 (2006.01) E21D 11/38 (2006.01) E21D 11/40 (2006.01) E21F 16/02 (2006.01)	2723987 *	A METHOD FOR CONSTRUCTING A TUNNEL COURSE, AND STRUCTURAL ELEMENT FOR USE BY THE METHOD
Janssen Pharmaceutica, N.V.	C07D 407/04 (2006.01)	2712360 *	PROCESS FOR THE PREPARATION OF COMPOUNDS USEFUL AS INHIBITORS OF SGLT-2

Podnosilac evropske prijave patenta (71)	MKP (51)	Broj objave evropske prijave patenta (97)	Naziv pronalaska (54)
Dainippon Sumitomo Pharma Co., Ltd.	A61K 31/4245 (2006.01) A61K 31/454 (2006.01) A61K 31/4545 (2006.01) A61K 31/5377 (2006.01) A61P 1/00 (2006.01) A61P 1/08 (2006.01) A61P 1/10 (2006.01) A61P 1/14 (2006.01) A61P 13/02 (2006.01) A61P 13/08 (2006.01) A61P 17/00 (2006.01) A61P 25/18 (2006.01) A61P 25/22 (2006.01) A61P 25/24 (2006.01) A61P 25/28 (2006.01) A61P 43/00 (2006.01) C07D 401/14 (2006.01)	2718283 *	INDAZOLE- AND PYRROLOPYRIDINE-DERIVATIVE AND PHARMACEUTICAL USE THEREOF
Teva Pharmaceutical Industries Ltd.	A01N 43/42 (2006.01) A61K 31/47 (2006.01)	2736336 *	TREATMENT OF MULTIPLE SCLEROSIS WITH COMBINATION OF LAQUINIMOD AND INTERFERON-BETA
Hatzigiannis, Georgios	C02F 1/14 (2006.01) C02F 1/18 (2006.01)	2742004 *	PORTABLE AND STATIONARY DISTILLATION UNIT FOR THE SIMULTANEOUS PRODUCTION OF DISTILLED WATER AND SALT, ENHANCED BY SOLAR COLLECTORS
Hatzigiannis, Vassilios	C02F 1/14 (2006.01) C02F 1/18 (2006.01)	2742004 *	PORTABLE AND STATIONARY DISTILLATION UNIT FOR THE SIMULTANEOUS PRODUCTION OF DISTILLED WATER AND SALT, ENHANCED BY SOLAR COLLECTORS
Hatzigianni, Zoi	C02F 1/14 (2006.01) C02F 1/18 (2006.01)	2742004 *	PORTABLE AND STATIONARY DISTILLATION UNIT FOR THE SIMULTANEOUS PRODUCTION OF DISTILLED WATER AND SALT, ENHANCED BY SOLAR COLLECTORS
Scientist of Fortune S.A.	C12N 9/00 (2006.01) C12N 9/04 (2006.01) C12N 9/12 (2006.01) C12N 9/88 (2006.01) C12P 7/28 (2006.01)	2732031 *	RECOMBINANT MICROORGANISM FOR THE PRODUCTION OF USEFUL METABOLITES
Accuwatt	G01R 31/36 (2006.01) H02J 7/00 (2006.01)	2621051	Device for high-precision management of the charge of a battery, and method implemented by said device
Purix ApS	F25B 15/06 (2006.01) F25B 27/00 (2006.01)	2734794 *	A METHOD FOR CHILLING A BUILDING
Purix S.r.l.	F25B 15/06 (2006.01) F25B 27/00 (2006.01)	2734794 *	A METHOD FOR CHILLING A BUILDING
Cell Therapy Limited	C12N 5/078 (2010.01)	2729562 *	PROGENITOR CELLS OF MESODERMAL LINEAGE
Greystone Technologies Pty Ltd	F01C 1/40 (2006.01) F03C 2/30 (2006.01) F04C 2/40 (2006.01) F04C 18/40 (2006.01)	2729706 *	ROTARY FLUID MACHINE
Sandenvendo Europe S.p.a.	A47J 31/44 (2006.01) G07F 13/06 (2006.01)	2662002	Goods supply apparatus
AMIP, LLC	A61K 31/18 (2006.01) A61K 31/335 (2006.01) A61K 31/44 (2006.01) A61K 31/4422 (2006.01) A61K 31/445 (2006.01)	2758056 *	BUFFERED UPPER GI ABSORPTION PROMOTER
Bortz, Jonathan	A61K 31/18 (2006.01) A61K 31/335 (2006.01) A61K 31/44 (2006.01) A61K 31/4422 (2006.01) A61K 31/445 (2006.01)	2758056 *	BUFFERED UPPER GI ABSORPTION PROMOTER

Podnosilac evropske prijave patenta (71)	MKP (51)	Broj objave evropske prijave patenta (97)	Naziv pronalaska (54)
Hartle, Jennifer	A61K 31/18 (2006.01) A61K 31/335 (2006.01) A61K 31/44 (2006.01) A61K 31/4422 (2006.01) A61K 31/445 (2006.01)	2758056 *	BUFFERED UPPER GI ABSORPTION PROMOTER
Astrazeneca AB	A61K 31/437 (2006.01) A61K 31/506 (2006.01) A61P 35/00 (2006.01) C07D 401/02 (2006.01) C07D 471/04 (2006.01)	2736895 *	2 - (2, 4, 5 - SUBSTITUTED -ANILINO) PYRIMIDINE DERIVATIVES AS EGFR MODULATORS USEFUL FOR TREATING CANCER
Josef Meissner GmbH & Co. KG	B01J 14/00 (2006.01) C07C 201/16 (2006.01) C07C 205/06 (2006.01)	2705020 *	METHOD AND APPARATUS FOR PURIFYING NITRATION PRODUCTS
Sanofi-Aventis Deutschland GmbH	A61M 5/00 (2006.01) A61M 5/24 (2006.01) A61M 5/31 (2006.01)	2704777 *	DRUG DELIVERY DEVICE AND CARTRIDGE HOLDER FOR A DRUG DELIVERY DEVICE
Gilead Sciences, Inc.	A61K 31/352 (2006.01) A61K 31/397 (2006.01) A61K 31/4178 (2006.01) C07D 311/36 (2006.01) C07D 405/06 (2006.01)	2751090 *	ALDH-2 INHIBITORS IN THE TREATMENT OF ADDICTION
Dow Global Technologies LLC	C07F 7/00 (2006.01) C08F 4/659 (2006.01) C08F 10/00 (2006.01)	2757113	Catalysts, processes for making catalysts, processes for making polyolefin compositions and polyolefin compositions
Paratek Pharmaceuticals, Inc.	A61K 31/65 (2006.01) C07C 237/26 (2006.01)	2707003 *	CRYSTALLINE SALTS OF (4S,4AS,5AR,12AS)-4-DIMETHYLAMINO-3,10,12,12A-TETRAHYDROXY-7-[(METHOXY(METHYL)AMINO)-METHYL]-1,11-DIOXO-1,4,4A,5,5A,6,11,12A-OCTAHYDRO-NAPHTHACENE-2-CARBOXYLIC ACID AMIDE AND METHODS OF USING THE SAME
Warner Chilcott Company, LLC	A61K 31/65 (2006.01) C07C 237/26 (2006.01)	2707003 *	CRYSTALLINE SALTS OF (4S,4AS,5AR,12AS)-4-DIMETHYLAMINO-3,10,12,12A-TETRAHYDROXY-7-[(METHOXY(METHYL)AMINO)-METHYL]-1,11-DIOXO-1,4,4A,5,5A,6,11,12A-OCTAHYDRO-NAPHTHACENE-2-CARBOXYLIC ACID AMIDE AND METHODS OF USING THE SAME
Voet, Hans	B29C 70/02 (2006.01) B29C 70/64 (2006.01) E01C 11/06 (2006.01) E01C 11/10 (2006.01)	2769019 *	ARTICLE OF MANUFACTURE MADE OF COMPOSITE MATERIAL, FOR INCORPORATION INTO A CIVIL ENGINEERING STRUCTURE
Leitner, Leopold	B29C 70/02 (2006.01) B29C 70/64 (2006.01) E01C 11/06 (2006.01) E01C 11/10 (2006.01)	2769019 *	ARTICLE OF MANUFACTURE MADE OF COMPOSITE MATERIAL, FOR INCORPORATION INTO A CIVIL ENGINEERING STRUCTURE
Chiang, Chun-Sheng	B28D 1/32 (2006.01)	2660026	Cutting method for crackly plate-shaped work piece and cutting device thereof
Glaxo Group Limited	C07K 16/24 (2006.01)	2734548 *	ANTIGEN-BINDING PROTEINS WITH INCREASED FCRN BINDING
Université De Reims Champagne-Ardenne	A61K 38/04 (2006.01) C07K 14/78 (2006.01)	2729495 *	ANTAGONIST PEPTIDE OF THE BOND BETWEEN CD47 AND A PROTEIN BELONGING TO THE THROMBOSPONDIN FAMILY
Chen, Chung-Ping	D04C 3/00 (2006.01) D04C 5/00 (2006.01)	2725128 *	NET KNITTING METHOD
Smurfit Kappa Hoya Papier und Karton GmbH	B32B 23/00 (2006.01)	2723564 *	FIBROUS PRODUCT FOR PACKAGING
AX-Lab Innovation ApS	A61B 10/00 (2006.01) B65D 51/28 (2006.01)	2720617 *	CONTAINER ASSEMBLY AND ASSOCIATED METHOD
Argus Labs	G06Q 30/02 (2012.01)	2677484	System and method for making personalised recommendations to a user of a mobile computing device, and computer program product

Podnosilac evropske prijave patenta (71)	MKP (51)	Broj objave evropske prijave patenta (97)	Naziv pronalaska (54)
Rudolf Wild GmbH & Co. KG	A23L 1/22 (2006.01) A23L 1/226 (2006.01) A23L 1/236 (2006.01) A23L 1/30 (2006.01) A23L 2/60 (2006.01)	2641479	Composition comprising an extract from sweet blackberry leaves
Vockner, Helmut	A61K 9/00 (2006.01) A61K 9/06 (2006.01) A61K 9/08 (2006.01) A61K 9/14 (2006.01) A61K 31/155 (2006.01) A61K 31/593 (2006.01) A61P 17/02 (2006.01)	2706983 *	NOVEL PHARMACEUTICAL FORMULATION
CHIESI FARMACEUTICI S.p.A.	C07C 61/40 (2006.01)	2647618	Novel polymorphs and salts
AM-Pharma B.V.	A61K 38/46 (2006.01)	2717906 *	THE USE OF ALKALINE PHOSPHATASE FOR PRESERVING RENAL FUNCTION
Synta Pharmaceuticals Corp.	A61K 31/166 (2006.01) A61K 31/277 (2006.01) A61K 31/352 (2006.01) A61K 31/416 (2006.01) A61K 31/4196 (2006.01) A61K 31/675 (2006.01) A61K 35/00 (2006.01) A61K 45/06 (2006.01)	2714039 *	COMBINATION THERAPY OF HSP90 INHIBITORY COMPOUNDS WITH MEK INHIBITORS
Gnadt, Birgit	A01K 5/02 (2006.01) A01K 13/00 (2006.01)	2649876	Device and method for dispensing solids and liquids to animals
Inhibrx LLC	A61K 38/55 (2006.01) A61K 39/395 (2006.01) A61P 29/00 (2006.01) C07K 19/00 (2006.01)	2726093 *	WAP DOMAIN FUSION POLYPEPTIDES AND METHODS OF USE THEREOF
Kyocera Document Solutions Inc.	G03G 15/08 (2006.01) G03G 21/16 (2006.01)	2634646	Developing device and image forming apparatus including the same
Wolturnus A/S	A61G 5/12 (2006.01)	2662061	Ergonomic back and side support for aids to disabled and application for wheelchairs
Thrasos Innovation, Inc.	A61K 38/17 (2006.01)	2734220 *	ANTI-FIBROTIC PEPTIDES AND THEIR USE IN METHODS FOR TREATING DISEASES AND DISORDERS CHARACTERIZED BY FIBROSIS
PIERIBONI, Antonio	B65D 23/06 (2006.01)	2750982 *	IMPROVED DRIP STOP DEVICE
Blücher GmbH	B01D 39/02 (2006.01) B01D 53/02 (2006.01) B01J 20/20 (2006.01) B01J 20/28 (2006.01) B01J 20/32 (2006.01)	2741854 *	ACTIVATED CARBON WITH A METAL BASED COMPONENT
Friedrich-Alexander-Universität Erlangen-Nürnberg	B01D 39/02 (2006.01) B01D 53/02 (2006.01) B01J 20/20 (2006.01) B01J 20/28 (2006.01) B01J 20/32 (2006.01)	2741854 *	ACTIVATED CARBON WITH A METAL BASED COMPONENT
Chiesi Farmaceutici S.p.A.	A61K 31/4545 (2006.01) A61K 31/4709 (2006.01) A61P 11/06 (2006.01) A61P 11/08 (2006.01) C07D 401/12 (2006.01) C07D 409/14 (2006.01) C07D 417/12 (2006.01)	2718281 *	COMPOUNDS HAVING MUSCARINIC RECEPTOR ANTAGONIST AND BETA2 ADRENERGIC RECEPTOR AGONIST ACTIVITY
DBD Innovations Pty Ltd	A61C 19/04 (2006.01) G01N 27/62 (2006.01) G01N 37/00 (2006.01) H05H 1/46 (2006.01)	2707704 *	METHOD OF ANALYZING A MATERIAL
Ribe Jernindustri A/S	F24D 19/02 (2006.01)	2642211	Tilting radiator assembly
MolMed SpA	C12N 7/02 (2006.01)	2764094 *	VIRAL VECTORS PURIFICATION SYSTEM

Podnosilac evropske prijave patenta (71)	MKP (51)	Broj objave evropske prijave patenta (97)	Naziv pronalaska (54)
Astellas Pharma Inc.	A61K 31/337 (2006.01) A61K 31/506 (2006.01) A61P 35/00 (2006.01) A61P 43/00 (2006.01) C07D 401/14 (2006.01)	2740477 *	METHOD FOR TREATING CANCER BY COMBINED USE OF MEDICINAL AGENTS
Pierre Fabre Dermatologie	A61K 9/00 (2006.01) A61K 9/08 (2006.01) A61K 31/13 (2006.01)	2497461	Paediatric solutions comprising a beta-blocker
Antares Hungary Kft.	A47C 7/02 (2006.01)	2735248	Chair with two stable seating positions
Targacept, Inc.	A61K 31/551 (2006.01) A61P 25/00 (2006.01) C07D 498/04 (2006.01)	2748170 *	1,4-DIAZABICYCLO[3.2.2]NONANES AS NEURONAL NICOTINIC ACETYLCHOLINE RECEPTOR LIGANDS
Teva Pharmaceutical Industries Ltd.	A61K 31/16 (2006.01)	2766007 *	RASAGILINE CITRAMIDE
Green Cell Technologies (Pty) Ltd	B30B 9/06 (2006.01)	2714381 *	A METHOD OF PRESSURIZING A SUBSTANCE
Ambrx, Inc.	A61K 31/427 (2006.01) A61P 35/00 (2006.01) C07D 207/08 (2006.01) C07D 401/12 (2006.01) C07D 417/12 (2006.01)	2714684 *	COMPOSITIONS CONTAINING, METHODS INVOLVING, AND USES OF NON-NATURAL AMINO ACID LINKED DOLASTATIN DERIVATIVES
Principia Biopharma Inc.	A61K 31/535 (2006.01) A61P 35/00 (2006.01) C07D 487/04 (2006.01)	2710005 *	TYROSINE KINASE INHIBITORS
Sanofi-Aventis Deutschland GmbH	A61K 38/26 (2006.01) A61P 25/28 (2006.01)	2750698 *	PHARMACEUTICAL COMPOSITION FOR USE IN THE TREATMENT OF A NEURODEGENERATIVE DISEASE
University Of Ulster	A61K 38/26 (2006.01) A61P 25/28 (2006.01)	2750698 *	PHARMACEUTICAL COMPOSITION FOR USE IN THE TREATMENT OF A NEURODEGENERATIVE DISEASE
Adamed sp. z o.o.	A61K 31/404 (2006.01) C07D 209/30 (2006.01) C07D 403/04 (2006.01) C07D 413/04 (2006.01)	2726457 *	INDOLEAMINE DERIVATIVES FOR THE TREATMENT OF CENTRAL NERVOUS SYSTEM DISEASES
Gilead Sciences, Inc.	C07K 14/005 (2006.01) C12N 15/86 (2006.01) G01N 33/569 (2006.01)	2729490 *	HCV GENOTYPE 4 REPLICONS
Aventis Pharma S.A.	A61K 31/00 (2006.01) A61K 31/727 (2006.01) A61P 7/02 (2006.01) A61P 35/00 (2006.01)	2706990 *	SEMULOPARIN FOR THE PREVENTION OF VENOUS THROMBOEMBOLISM IN CANCER PATIENTS RECEIVING CHEMOTHERAPY
Escherich, Fabien	B25H 3/00 (2006.01)	2747955 *	MAGNETIC BIT-HOLDER BRACELET DEVICE
Five9, Inc.	H04M 3/00 (2006.01)	2754285 *	SOCIAL PROXY AND PROTOCOL GATEWAY
Almirall S.A.	A61K 31/52 (2006.01) A61P 35/00 (2006.01) A61P 37/06 (2006.01) C07D 471/02 (2006.01) C07D 473/00 (2006.01)	2714686 *	PYRIDIN-2 (1H) -ONE DERIVATIVES USEFUL AS MEDICAMENTS FOR THE TREATMENT OF MYELOPROLIFERATIVE DISORDERS, TRANSPLANT REJECTION, IMMUNE-MEDIATED AND INFLAMMATORY DISEASES
Robert Bosch GmbH	A01D 34/00 (2006.01) A01D 34/81 (2006.01)	2656720	Cutter guard for a lawn mower
J. Stefan Institute	A61K 9/127 (2006.01) A61K 47/48 (2006.01) A61K 49/00 (2006.01) A61K 49/18 (2006.01) A61P 29/00 (2006.01) A61P 35/00 (2006.01) C07D 405/12 (2006.01) C07K 7/02 (2006.01)	2723387 *	CATHEPSIN-BINDING COMPOUNDS BOUND TO A CARRIER AND THEIR DIAGNOSTIC USE

Podnosilac evropske prijave patenta (71)	MKP (51)	Broj objave evropske prijave patenta (97)	Naziv pronalaska (54)
Schaschke, Norbert	A61K 9/127 (2006.01) A61K 47/48 (2006.01) A61K 49/00 (2006.01) A61K 49/18 (2006.01) A61P 29/00 (2006.01) A61P 35/00 (2006.01) C07D 405/12 (2006.01) C07K 7/02 (2006.01)	2723387 *	CATHEPSIN-BINDING COMPOUNDS BOUND TO A CARRIER AND THEIR DIAGNOSTIC USE
Mayr-Melnhof Karton AG	B65D 65/42 (2006.01) C08K 5/00 (2006.01) C08K 5/07 (2006.01) C08K 5/092 (2006.01) C09D 129/04 (2006.01)	2718359 *	METHOD FOR PRODUCING A COATED PACKAGING MATERIAL, AND PACKAGING MATERIAL HAVING AT LEAST ONE BARRIER LAYER FOR HYDROPHOBIC COMPOUNDS
Theravance, Inc.	A61K 31/4418 (2006.01) A61P 9/12 (2006.01) C07D 213/81 (2006.01) C07D 239/28 (2006.01) C07D 249/10 (2006.01) C07D 261/18 (2006.01) C07D 401/06 (2006.01) C07D 471/04 (2006.01) C07D 487/04 (2006.01) C07D 498/04 (2006.01)	2714660 *	NEPRILYSIN INHIBITORS
Procertus Biopharm, Inc.	A61K 8/00 (2006.01)	2713988 *	FORMULATION OF SMALL ADRENERGIC AGONIST SALT FORMS IN ORGANIC SOLVENTS
Glaxosmithkline Intellectual Property (No. 2) Limited	A61K 39/395 (2006.01)	2720719 *	METHOD OF SELECTING THERAPEUTIC INDICATIONS
Burcon Nutrascience (MB) Corp.	A23J 3/16 (2006.01)	2709464 *	PREPARATION OF SOY PROTEIN ISOLATE USING CALCIUM CHLORIDE EXTRACTION ("S703 CIP")
Zafgen, Inc.	A61K 31/336 (2006.01) A61K 31/7088 (2006.01) A61K 31/713 (2006.01) A61K 39/00 (2006.01) A61P 3/04 (2006.01) A61P 9/00 (2006.01) A61P 19/00 (2006.01) A61P 19/02 (2006.01) A61P 21/00 (2006.01) A61P 25/00 (2006.01) A61P 25/24 (2006.01) A61P 25/28 (2006.01) A61P 39/00 (2006.01) A61P 39/06 (2006.01)	2763671 *	METHODS OF TREATING AGE RELATED DISORDERS
Hughes, Thomas E.	A61K 31/336 (2006.01) A61K 31/7088 (2006.01) A61K 31/713 (2006.01) A61K 39/00 (2006.01) A61P 3/04 (2006.01) A61P 9/00 (2006.01) A61P 19/00 (2006.01) A61P 19/02 (2006.01) A61P 21/00 (2006.01) A61P 25/00 (2006.01) A61P 25/24 (2006.01) A61P 25/28 (2006.01) A61P 39/00 (2006.01) A61P 39/06 (2006.01)	2763671 *	METHODS OF TREATING AGE RELATED DISORDERS

Podnosilac evropske prijave patenta (71)	MKP (51)	Broj objave evropske prijave patenta (97)	Naziv pronalaska (54)
Vath, James E.	A61K 31/336 (2006.01) A61K 31/7088 (2006.01) A61K 31/713 (2006.01) A61K 39/00 (2006.01) A61P 3/04 (2006.01) A61P 9/00 (2006.01) A61P 19/00 (2006.01) A61P 19/02 (2006.01) A61P 21/00 (2006.01) A61P 25/00 (2006.01) A61P 25/24 (2006.01) A61P 25/28 (2006.01) A61P 39/00 (2006.01) A61P 39/06 (2006.01)	2763671 *	METHODS OF TREATING AGE RELATED DISORDERS
GlaxoSmithKline LLC	A61K 31/4178 (2006.01) C07D 403/14 (2006.01)	2741746 *	CHEMICAL COMPOUNDS
Auburn University	A23K 1/18 (2006.01) A23L 1/30 (2006.01) A61K 35/74 (2006.01)	2701535 *	BACILLUS BACTERIA FOR USE IN TREATING AND PREVENTING INFECTION IN AQUATIC ANIMALS
Boehringer Ingelheim International GmbH	A61K 39/395 (2006.01) A61K 45/00 (2006.01)	2712320 *	METHOD FOR EGFR DIRECTED COMBINATION TREATMENT OF CANCER
SIGMA-TAU Industrie Farmaceutiche Riunite S.p.A.	A61K 31/397 (2006.01) A61K 31/4015 (2006.01) A61K 31/45 (2006.01) A61K 31/4709 (2006.01) A61P 25/00 (2006.01) A61P 29/00 (2006.01) A61P 33/00 (2006.01) A61P 35/00 (2006.01) C07D 205/08 (2006.01) C07D 207/277 (2006.01) C07D 207/28 (2006.01) C07D 211/78 (2006.01) C07D 401/04 (2006.01)	2758371 *	NEW THIO DERIVATIVES BEARING LACTAMS AS POTENT HDAC INHIBITORS AND THEIR USES AS MEDICAMENTS
Ranbaxy Laboratories Limited	A61K 9/20 (2006.01) A61K 31/357 (2006.01) A61K 31/496 (2006.01) A61P 33/06 (2006.01)	2731603 *	STABLE DOSAGE FORMS OF ARTEROLANE AND PIPERAQUINE
FMC Corporation	A01N 25/32 (2006.01) A01N 43/80 (2006.01) A01P 7/04 (2006.01)	2701513 *	USE OF 3-ISOXAZOLIDINONES AS SELECTIVE HERBICIDES IN GRASS AND BRASSICA CROPS
Asahi Kasei Kuraray Medical Co., Ltd.	A61K 9/08 (2006.01) A61K 38/00 (2006.01) A61K 39/395 (2006.01) B01D 61/14 (2006.01) B01D 61/22 (2006.01) B01D 71/10 (2006.01) B01D 71/26 (2006.01) B01D 71/34 (2006.01) B01D 71/68 (2006.01) C07K 1/34 (2006.01) C07K 16/00 (2006.01)	2725033 *	METHOD FOR PRODUCING PROTEIN PREPARATION
H. Lundbeck A/S	A61K 31/497 (2006.01) A61P 25/00 (2006.01) C07D 401/12 (2006.01)	2763980 *	BICARBOCYCLIC AND TRICARBOCYCLIC ETHYNYL DERIVATIVES AND USES OF SAME
ThyssenKrupp Industrial Solutions GmbH	B01D 53/14 (2006.01)	2750782 *	METHOD AND SYSTEM FOR REMOVING CARBON DIOXIDE FROM FLUE GASES
Dalrymple, Roger Kenneth Roy	A01K 5/01 (2006.01)	2720531 *	TROUGH
Nuvosun, Inc.	B65H 18/14 (2006.01) B65H 27/00 (2006.01)	2748090 *	SUBSTRATE ROLLERS
Buzzi & Buzzi S.r.l.	B01J 35/00 (2006.01) C04B 26/02 (2006.01) C04B 35/00 (2006.01)	2726203 *	PHOTOCATALYTIC AND ANTI - BACTERIAL MATERIAL AND USE THEREOF IN THE BUILDING, LIGHTING AND FURNISHING FIELD

Podnosilac evropske prijave patenta (71)	MKP (51)	Broj objave evropske prijave patenta (97)	Naziv pronalaska (54)
Bonac Corporation	C12N 15/113 (2010.01)	2639307	Single-stranded nucleic acid molecule having nitrogen-containing alicyclic skeleton
SAPPI Netherlands Services B.V.	C08B 15/02 (2006.01)	2712364 *	LOW ENERGY METHOD FOR THE PREPARATION OF NON-DERIVATIZED NANOCELLULOSE
Purdue Pharma LP	A61K 31/428 (2006.01) A61P 1/04 (2006.01) A61P 13/00 (2006.01) A61P 19/02 (2006.01) A61P 25/02 (2006.01) A61P 25/04 (2006.01) A61P 29/00 (2006.01) C07D 417/12 (2006.01) C07D 417/14 (2006.01)	2723732 *	TRPV1 ANTAGONISTS INCLUDING DIHYDROXY SUBSTITUENT AND USES THEREOF
Shionogi & Co., Ltd.	A61K 31/428 (2006.01) A61P 1/04 (2006.01) A61P 13/00 (2006.01) A61P 19/02 (2006.01) A61P 25/02 (2006.01) A61P 25/04 (2006.01) A61P 29/00 (2006.01) C07D 417/12 (2006.01) C07D 417/14 (2006.01)	2723732 *	TRPV1 ANTAGONISTS INCLUDING DIHYDROXY SUBSTITUENT AND USES THEREOF
Nuhope LLC	A61K 31/515 (2006.01) A61P 35/00 (2006.01)	2744500 *	COMPOUNDS FOR USE IN CANCER THERAPY
Total Raffinage & Marketing	C07C 2/50 (2006.01) C07C 2/52 (2006.01) C07C 4/06 (2006.01) C07C 5/03 (2006.01) C07C 9/16 (2006.01) C07C 9/18 (2006.01) C07C 13/18 (2006.01) C07C 13/20 (2006.01) C10G 1/00 (2006.01) C10G 45/32 (2006.01) C10M 107/02 (2006.01) C10M 109/02 (2006.01)	2766327 *	PROCESS FOR PREPARING JET FUEL FROM MOLECULES DERIVED FROM BIOMASS
Inception 1, Inc.	A61K 31/5415 (2006.01) A61P 25/00 (2006.01) C07D 279/18 (2006.01) C07D 417/06 (2006.01) C07D 491/04 (2006.01)	2758403 *	TRICYCLIC COMPOUNDS USEFUL AS NEUROGENIC AND NEUROPROTECTIVE AGENTS
Villa Elisa Soverato S.r.l.	A61C 9/00 (2006.01) A61C 13/00 (2006.01)	2682071	Method for copying and reproducing anatomical segments of a patient
SANOFI	A61K 39/395 (2006.01) A61K 47/48 (2006.01) A61P 35/00 (2006.01) C07K 16/28 (2006.01)	2736534 *	COMBINATION THERAPY FOR THE TREATMENT OF CD19+ B-CELL MALIGNANCIES SYMPTOMS COMPRISING AN ANTI-CD19 MAYTANSINOID IMMUNOCONJUGATE AND RITUXIMAB
LegoChem Biosciences, Inc.	A61K 31/546 (2006.01) A61P 31/00 (2006.01) C07D 501/34 (2006.01)	2706062 *	NOVEL CEPHALOSPORIN DERIVATIVE AND PHARMACEUTICAL COMPOSITION THEREOF
Dolorgiet GmbH & Co. KG	A61K 9/00 (2006.01) A61K 31/192 (2006.01) A61P 17/00 (2006.01)	2620146	Ibuprofen for treating actinic keratosis
Telsmith, Inc.	B02C 17/00 (2006.01)	2758175 *	APPARATUS AND METHOD FOR A SEALING SYSTEM
Ethicon Endo-Surgery, Inc.	A61B 17/115 (2006.01)	2517651	Tissue thickness compensator for a surgical stapler
Amgen Research (Munich) GmbH	C07K 16/28 (2006.01) C07K 16/30 (2006.01) C07K 16/46 (2006.01)	2758438 *	BISPECIFIC BINDING MOLECULES FOR 5T4 AND CD3
Charite - Universitätsmedizin Berlin	G06F 17/30 (2006.01)	2710499 *	SYSTEM AND METHOD FOR CONDUCTING PROCESSOR-ASSISTED INDEXING AND SEARCHING

Podnosilac evropske prijave patenta (71)	MKP (51)	Broj objave evropske prijave patenta (97)	Naziv pronalaska (54)
Max-Planck-Gesellschaft Zur Foerderung Der Wissenschaften E.V.	G06F 17/30 (2006.01)	2710499 *	SYSTEM AND METHOD FOR CONDUCTING PROCESSOR-ASSISTED INDEXING AND SEARCHING
Ardea Biosciences, Inc.	A61K 31/44 (2006.01) A61K 31/444 (2006.01) A61K 31/4965 (2006.01) A61P 9/00 (2006.01) A61P 9/12 (2006.01) A61P 19/06 (2006.01) C07D 213/70 (2006.01) C07D 239/38 (2006.01) C07D 241/18 (2006.01) C07D 401/04 (2006.01) C07D 403/04 (2006.01) C07D 405/04 (2006.01) C07D 417/04 (2006.01)	2712861	Thioacetate compounds, compositions and methods of use
R. J. Reynolds Tobacco Company	A24F 47/00 (2006.01)	2741626 *	SMOKING ARTICLES AND USE THEREOF FOR YIELDING INHALATION MATERIALS
Novartis AG	A61K 39/395 (2006.01) C07K 16/28 (2006.01)	2726099 *	METHOD FOR TREATING METABOLIC DISORDERS
Gilead Sciences, Inc.	A61K 31/5513 (2006.01) A61K 31/553 (2006.01) A61K 31/554 (2006.01) C07D 243/24 (2006.01) C07D 267/14 (2006.01) C07D 291/08 (2006.01) C07D 403/06 (2006.01) C07D 413/06 (2006.01) C07D 413/12 (2006.01) C07D 413/14 (2006.01) C07D 419/06 (2006.01) C07D 471/04 (2006.01) C07D 487/04 (2006.01) C07D 498/04 (2006.01)	2726466 *	FUSED BENZOXAZEPINONES AS ION CHANNEL MODULATORS
Halozyyme, Inc.	A61K 38/28 (2006.01)	2720712 *	STABLE FORMULATIONS OF A HYALURONAN-DEGRADING ENZYME
Metal Forming & Coining Corporation	F16H 57/08 (2006.01)	2647882	Torque transmitting assembly and method of producing
Aspire Bariatrics, Inc.	A61M 31/00 (2006.01)	2747833 *	IMPROVED SKIN PORT CONNECTOR AND METHOD OF INSTALLATION
UCB Pharma, S.A.	A61K 39/40 (2006.01) A61P 31/04 (2006.01) C07K 16/12 (2006.01)	2758432 *	NEUTRALISING ANTIBODIES TO THE MAJOR EXOTOXINS TCDA AND TCDB OF CLOSTRIDIUM DIFFICILE
Ecole Polytechnique	G06F 19/00 (2011.01)	2645280	A rapidly converging atomic physics method and medium to calculate complex non-equilibrium radiative properties of matter with spectroscopic precision.
Université Pierre et Marie Curie - Paris 6	G06F 19/00 (2011.01)	2645280	A rapidly converging atomic physics method and medium to calculate complex non-equilibrium radiative properties of matter with spectroscopic precision.
AdvanDx, Inc.	C12N 13/00 (2006.01)	2710127 *	SELECTIVE ULTRASONIC LYSIS OF BLOOD AND OTHER BIOLOGICAL FLUIDS AND TISSUES
GlaxoSmithKline LLC	A61K 31/55 (2006.01) A61P 35/00 (2006.01) A61P 43/00 (2006.01) C07D 487/04 (2006.01)	2722334	Benzodiazepine bromodomain inhibitor
Glaxo Group Limited	A61K 31/138 (2006.01) A61K 31/439 (2006.01) A61K 31/58 (2006.01) A61K 45/06 (2006.01) A61P 11/06 (2006.01) A61P 11/08 (2006.01)	2717867 *	DRY POWDER INHALER COMPOSITIONS COMPRISING UMECLIDINIUM

Podnosilac evropske prijave patenta (71)	MKP (51)	Broj objave evropske prijave patenta (97)	Naziv pronalaska (54)
EGIS GYÓGYSZERGYÁR Nyilvánosan Működő Részvénytársaság	C07D 401/12 (2006.01)	2707364 *	PROCESS FOR THE MANUFACTURE OF DABIGATRAN ETEXILATE AND INTERMEDIATES THEREOF
Adamed sp. z o.o.	C07D 403/06 (2006.01)	2726476 *	SULPHONAMIDE DERIVATIVES OF ALICYCLIC AMINES FOR THE TREATMENT OF CENTRAL NERVOUS SYSTEM DISEASES
Newron Pharmaceuticals S.p.A.	A61K 31/165 (2006.01) A61P 25/00 (2006.01) C07C 237/06 (2006.01) C07D 209/08 (2006.01) C07D 217/06 (2006.01) C07D 265/36 (2006.01) C07D 295/182 (2006.01) C07D 295/185 (2006.01)	2723710 *	FLUORINATED ARYLALKYLAMINOCARBOXAMIDE DERIVATIVES
Saint-Gobain Glass France	B32B 17/10 (2006.01) F21K 99/00 (2010.01) F21V 33/00 (2006.01) G02B 6/00 (2006.01)	2718100 *	LIGHTING DEVICE COMPRISING LIGHT-EMITTING DIODES
Eisai R&D Management Co., Ltd.	A61K 31/47 (2006.01) A61P 35/00 (2006.01) A61P 43/00 (2006.01) C12N 15/09 (2006.01) C12Q 1/68 (2006.01) G01N 33/15 (2006.01) G01N 33/50 (2006.01)	2711433 *	METHOD FOR PREDICTING EFFECTIVENESS OF ANGIOGENESIS INHIBITOR
Delphi International Operations Luxembourg S.à.r.l.	F02M 59/10 (2006.01) F02M 63/00 (2006.01) F04B 1/04 (2006.01) F04B 9/04 (2006.01) F04B 53/00 (2006.01) F04B 53/18 (2006.01)	2662564	Driveshaft lubrication
Ecole Polytechnique Centre National de la Recherche Scientifique	H03K 3/537 (2006.01) H03K 3/537 (2006.01)	2737627 * 2737627 *	GAS SWITCH TRIGGERED BY A LASER FILAMENT GAS SWITCH TRIGGERED BY A LASER FILAMENT
Ecole Nationale Supérieure de Techniques Avancées	H03K 3/537 (2006.01)	2737627 *	GAS SWITCH TRIGGERED BY A LASER FILAMENT
Galapagos N.V.	A61K 31/4162 (2006.01) A61P 19/02 (2006.01) C07D 471/04 (2006.01)	2702059 *	NOVEL COMPOUND USEFUL FOR THE TREATMENT OF DEGENERATIVE AND INFLAMMATORY DISEASES
IUCF-HYU (Industry- University Cooperation Foundation Hanyang University)	H01M 12/06 (2006.01)	2725653 *	LITHIUM-AIR BATTERY
Janssen Pharmaceutica, N.V.	C07D 211/70 (2006.01) C07D 401/04 (2006.01) C07F 9/24 (2006.01)	2760832 *	IMPROVED PROCESS FOR PREPARING 2-[(2E)-2-FLUORO-2-(3-PIPERIDINYLDENE)ETHYL]-1H-ISOINDOLE-1,3(2H)-DIONE
Sanofi-Aventis Deutschland GmbH	A61K 31/155 (2006.01) A61K 38/22 (2006.01) A61P 3/10 (2006.01)	2709652 *	PHARMACEUTICAL COMBINATION FOR USE IN THE TREATMENT OF DIABETES TYPE 2
Novomatic AG	G06F 7/58 (2006.01)	2705421 *	RANDOM NUMBER GENERATOR
IRM LLC	A61K 31/437 (2006.01) A61P 3/00 (2006.01) A61P 11/00 (2006.01) A61P 17/00 (2006.01) A61P 29/00 (2006.01) C07D 471/04 (2006.01)	2751102 *	COMPOUNDS AND COMPOSITIONS AS c-KIT KINASE INHIBITORS
Lumoptik LLC	A61B 1/313 (2006.01) A61B 5/00 (2006.01) A61B 17/16 (2006.01) A61B 17/34 (2006.01) A61M 5/46 (2006.01) G01N 21/00 (2006.01)	2765932 *	NEEDLE GUIDANCE SYSTEM

Podnosilac evropske prijave patenta (71)	MKP (51)	Broj objave evropske prijave patenta (97)	Naziv pronalaska (54)
Zachodniopomorski Univerzitet Technologiczny w Szczecinie	B24B 39/00 (2006.01) B24B 49/08 (2006.01)	2759373	A method of fluid pressure control in a hydrostatic burnishing tool and hydrostatic burnishing tool
Eurokera S.N.C.	F24C 7/08 (2006.01) H05B 3/74 (2006.01)	2761227 *	HOB WITH WINDOW, COOKING APPLIANCE AND METHOD OF MANUFACTURING THE HOB
Riesbeck Healthcare Sweden AB	A61K 39/102 (2006.01) A61P 31/04 (2006.01) C07K 14/285 (2006.01)	2707024 *	PROTEIN F - A NOVEL HAEMOPHILUS INFLUENZAE ADHESIN WITH LAMININ AND VITRONECTIN BINDING PROPERTIES
Delphi International Operations Luxembourg S.à.r.l.	F02D 1/18 (2006.01) F02M 41/14 (2006.01)	2660456	Fuel pump
Synthes GmbH	A61B 17/00 (2006.01) A61B 17/3207 (2006.01)	2679177	Systems and apparatus for providing motor protection in a power tool and method of manufacturing the same
Glaxo Group Limited	C12Q 1/68 (2006.01)	2751283 *	PROCESS FOR SEPARATION OF OLIGONUCLEOTIDE OF INTEREST FROM A MIXTURE
Mars, Incorporated	A61K 31/00 (2006.01) A61K 49/00 (2006.01) A61P 35/00 (2006.01) C07F 5/02 (2006.01)	2768491 *	INHIBITORS OF ARGINASE AND THEIR THERAPEUTIC APPLICATIONS
Consejo Superior De Investigaciones Científicas (CSIC)	G01N 21/35 (2014.01)	2743678 *	INFRARED ANALYSIS OF PERIPHERAL BLOOD FRACTIONS OBTAINED TO INDICATE COGNITIVE DEVELOPMENT ASSOCIATED WITH ALZHEIMER'S DISEASE
Instituto de Salud Carlos III	G01N 21/35 (2014.01)	2743678 *	INFRARED ANALYSIS OF PERIPHERAL BLOOD FRACTIONS OBTAINED TO INDICATE COGNITIVE DEVELOPMENT ASSOCIATED WITH ALZHEIMER'S DISEASE
Fundación Cien	G01N 21/35 (2014.01)	2743678 *	INFRARED ANALYSIS OF PERIPHERAL BLOOD FRACTIONS OBTAINED TO INDICATE COGNITIVE DEVELOPMENT ASSOCIATED WITH ALZHEIMER'S DISEASE
Fundación Para La Investigación Biomédica Del Hospital 12 de Octubre	G01N 21/35 (2014.01)	2743678 *	INFRARED ANALYSIS OF PERIPHERAL BLOOD FRACTIONS OBTAINED TO INDICATE COGNITIVE DEVELOPMENT ASSOCIATED WITH ALZHEIMER'S DISEASE
Aquasource Technologies Corporation	B01D 3/00 (2006.01)	2755730 *	SYSTEM AND METHOD FOR WATER TREATMENT
Orion Corporation	A61K 31/4184 (2006.01) A61K 31/4188 (2006.01) A61P 35/00 (2006.01) C07D 401/14 (2006.01) C07D 403/04 (2006.01) C07D 413/04 (2006.01) C07D 471/04 (2006.01)	2766354 *	PROTEIN KINASE INHIBITORS
Dayu Electric Co., Ltd.	H02P 6/08 (2006.01) H02P 27/06 (2006.01)	2731262 *	VARIABLE FREQUENCY SPEED CONTROL SYSTEM FOR MOTOR
Blücher GmbH	A61F 13/15 (2006.01) A61L 15/18 (2006.01) A61L 15/32 (2006.01) A61L 15/42 (2006.01) A61L 15/60 (2006.01)	2736542 *	MULTI-LAYERED WOUND DRESSING CONTAINING AN HYDROCOLLOID AND ACTIVATED CARBON
GlaxoSmithKline LLC	A61K 9/22 (2006.01) A61K 31/167 (2006.01)	2704697 *	SUSTAINED RELEASE PARACETAMOL FORMULATIONS
UCB Pharma, S.A.	A61K 31/444 (2006.01) A61P 25/06 (2006.01) C07D 401/10 (2006.01) C07D 401/14 (2006.01) C07D 405/14 (2006.01) C07D 413/14 (2006.01) C07D 417/14 (2006.01)	2766353 *	2-OXO-PIPERIDINYL DERIVATIVES

Podnosilac evropske prijave patenta (71)	MKP (51)	Broj objave evropske prijave patenta (97)	Naziv pronalaska (54)
Millennium Pharmaceuticals, Inc.	A61K 31/505 (2006.01) A61K 31/519 (2006.01) A61P 35/00 (2006.01) C07D 487/02 (2006.01) C07D 487/04 (2006.01)	2748168 *	INHIBITORS OF NEDD8-ACTIVATING ENZYME
Videotec S.p.a.	H04N 7/18 (2006.01)	2702763 *	INTERFACE DEVICE FOR VIDEO CAMERAS
Glaxo Group Limited	A61K 31/497 (2006.01)	2729149 *	VOLTAGE-GATED SODIUM CHANNEL BLOCKERS
Amgen Inc.	A61K 31/537 (2006.01) A61P 25/28 (2006.01) C07D 498/10 (2006.01)	2758406 *	AMINO-OXAZINES AND AMINO-DIHYDROTHIAZINE COMPOUNDS AS BETA-SECRETASE MODULATORS AND METHODS OF USE
Biogen Idec MA Inc.	A01N 37/00 (2006.01) A61K 31/19 (2006.01)	2713724 *	METHODS OF TREATING MULTIPLE SCLEROSIS AND PRESERVING AND/OR INCREASING MYELIN CONTENT
Sanofi-Aventis Deutschland GmbH	A61M 5/00 (2006.01) A61M 5/32 (2006.01) A61M 5/50 (2006.01)	2707064 *	DRUG DELIVERY DEVICE COMPRISING SAFETY LOCK MEMBER
BYK-Chemie GmbH	A01C 1/06 (2006.01)	2719270	Coating compound and use
Amgen Inc.	A61K 39/395 (2006.01) A61P 3/04 (2006.01) C07K 14/71 (2006.01) C07K 16/18 (2006.01) C07K 16/28 (2006.01) C07K 19/00 (2006.01)	2711375	Human Antigen Binding Proteins that bind Beta-Klotho, FGF Receptors and complexes thereof
SANOFI	A61K 9/00 (2006.01) A61K 9/48 (2006.01) A61K 31/00 (2006.01) A61K 31/343 (2006.01)	2637645 *	PHARMACEUTICAL COMPOSITION AND DOSAGE FORM COMPRISING DRONEDARONE, AND PREPARATION METHOD THEREOF
Universität Stuttgart	C07K 14/31 (2006.01) C07K 14/315 (2006.01) C07K 16/28 (2006.01) C07K 16/30 (2006.01)	2758436 *	SERUM HALF-LIFE EXTENSION USING IMMUNOGLOBULIN BINDING DOMAINS
ROBERT BOSCH GMBH	F24H 9/02 (2006.01)	2623883	Heating device with removable front cover, method for maintaining a heating device
Aquasource Technologies Corporation	B01D 3/02 (2006.01) C02F 1/06 (2006.01)	2755921 *	SYSTEM AND METHOD FOR WATER TREATMENT
Wobben Properties GmbH	B66C 1/10 (2006.01)	2625130 *	METHOD FOR REPLACING A TRANSFORMER IN A WIND ENERGY INSTALLATION
ATS Group (IP Holdings) Limited	H04Q 9/00 (2006.01)	2605539	Method and system for sensor classification
Pompes Salmson	H02G 3/08 (2006.01)	2634877	Method for manufacturing a control housing for a circulation pump
GlaxoSmithKline LLC	A01N 55/08 (2006.01) A61K 31/69 (2006.01)	2744342 *	THERAPEUTIC METHODS
Glaxosmithkline Intellectual Property (No. 2) Limited	A61K 31/17 (2006.01)	2723332 *	NOVEL COMPOUNDS AS DIACYLGLYCEROL ACYLTRANSFERASE INHIBITORS
GlaxoSmithKline LLC	A61K 31/4745 (2006.01) A61P 29/00 (2006.01) A61P 37/00 (2006.01) C07D 471/04 (2006.01)	2744809 *	4-(8-METHOXY-1-((1-METHOXYPROPAN-2-YL)-2-(TETRAHYDRO-2H-PYRAN-4-YL)-1 H-IMIDAZO[4,5-C]QUINOLIN-7-YL)-3,5-DIMETHYLISOXAZOLE AND ITS USE AS BROMODOMAIN INHIBITOR
Maria Clementine Martin Klosterfrau Vertriebsgesellschaft mbH	A61K 31/045 (2006.01) A61K 31/35 (2006.01) A61K 31/592 (2006.01) A61K 31/593 (2006.01) A61P 1/00 (2006.01) A61P 11/00 (2006.01) A61P 11/06 (2006.01)	2723344 *	MONOTERPENE-CONTAINING AGENT FOR COMBINATION THERAPY

Podnosilac evropske prijave patenta (71)	MKP (51)	Broj objave evropske prijave patenta (97)	Naziv pronalaska (54)
Amgen Inc.	A61K 31/404 (2006.01) A61K 31/4184 (2006.01) A61P 29/00 (2006.01) C07D 403/14 (2006.01) C07D 417/12 (2006.01) C07D 417/14 (2006.01)	2744805 *	HETEROARYL SODIUM CHANNEL INHIBITORS
Lemberg, Trond	H04L 29/00 (2006.01)	2732594 *	SYSTEM AND METHOD FOR ALTERNATIVE DISTRIBUTION OF A PIN CODE
Autifony Therapeutics Limited	A61K 31/4166 (2006.01) A61K 31/4439 (2006.01) A61K 31/506 (2006.01) A61P 25/00 (2006.01) C07D 307/87 (2006.01) C07D 307/94 (2006.01) C07D 311/76 (2006.01) C07D 401/04 (2006.01) C07D 403/04 (2006.01) C07D 405/12 (2006.01) C07D 405/14 (2006.01)	2718285 *	HYDANTOIN DERIVATES AS KV3 INHIBITORS
Omya International AG	C02F 1/66 (2006.01) C02F 1/68 (2006.01) C02F 103/06 (2006.01) C02F 103/42 (2006.01)	2751036 *	REMINERALIZATION OF DESALINATED AND OF FRESH WATER BY DOSING OF A CALCIUM CARBONATE SOLUTION IN SOFT WATER
Purdue Pharma LP	A61K 31/4418 (2006.01) A61P 25/08 (2006.01) C07D 233/90 (2006.01) C07D 401/12 (2006.01) C07D 401/14 (2006.01) C07D 403/04 (2006.01) C07D 403/12 (2006.01) C07D 405/12 (2006.01) C07D 405/14 (2006.01)	2753606 *	PYRIMIDINES AS SODIUM CHANNEL BLOCKERS
SafeAir AG	A61B 18/14 (2006.01)	2726005 *	AN ELECTROSURGICAL INSTRUMENT AND ELECTROSURGICAL CONDUCTIVE ELECTRODE FOR USE WITH THE INSTRUMENT
The Trustees Of The University Of Pennsylvania	A01N 1/02 (2006.01) G01N 31/00 (2006.01) G01N 33/00 (2006.01)	2717681 *	SYSTEM AND METHOD OF CYTOMIC VASCULAR HEALTH PROFILING
Blücher GmbH	B01D 53/04 (2006.01) B01J 20/20 (2006.01) B01J 20/24 (2006.01) B01J 20/26 (2006.01) B01J 20/28 (2006.01) B01J 20/30 (2006.01)	2760579 *	SELF-SUPPORTING STRUCTURES HAVING ADSORPTIVE PROPERTIES
Storm Drain Technologies, LLC	B01D 21/24 (2006.01) B01D 21/28 (2006.01) C02F 1/52 (2006.01)	2755736 *	FLUID TREATMENT APPARATUS, SYSTEM, AND METHODS
Ethicon Endo-Surgery, Inc.	A61B 17/00 (2006.01) A61B 17/32 (2006.01) H01H 15/00 (2006.01)	2641550	Activation feature for surgical instrument with pencil grip
Lankenau Institute for Medical Research	A61K 38/00 (2006.01) A61K 39/00 (2006.01) C12N 5/071 (2010.01)	2741771 *	METHODS AND COMPOSITIONS FOR THE TREATMENT OF AUTOIMMUNE AND INFLAMMATORY DISEASES
SANOFI	A61K 31/4725 (2006.01) A61P 9/00 (2006.01) C07D 401/12 (2006.01)	2729460 *	CRYSTALLINE SOLVATES OF 6-(PIPERIDIN-4-YLOXY)-2H-ISOQUINOLIN-1-ONE HYDROCHLORIDE
Tecla S.r.l.	A47J 27/04 (2006.01) A47J 27/08 (2006.01) A47J 27/62 (2006.01)	2671476	Insert for covers and/or containers for cooking foodstuff under vacuum
Eli Lilly and Company	A61M 5/28 (2006.01)	2747809 *	REFILL MODULE FOR AN INJECTION DEVICE

Podnosilac evropske prijave patenta (71)	MKP (51)	Broj objave evropske prijave patenta (97)	Naziv pronalaska (54)
Curelab Oncology, Inc.	A61K 9/16 (2006.01) A61K 9/20 (2006.01) A61K 38/16 (2006.01) A61K 38/17 (2006.01) A61K 39/395 (2006.01) A61K 48/00 (2006.01) A61P 35/00 (2006.01)	2750694 *	METHODS AND COMPOSITIONS RELATING TO P62 FOR THE TREATMENT AND PROPHYLAXIS OF CANCER
Mobika	D06F 58/10 (2006.01) D06F 58/20 (2006.01)	2642016	Heating cabinet
Pt. Karuna Sumber Jaya	B27K 5/04 (2006.01) B27K 5/06 (2006.01) B27M 1/08 (2006.01)	2736689 *	METHOD OF WOOD PRESERVATION USING EXPIRATION CONTROL
PPG Industries Ohio, Inc.	C03C 3/093 (2006.01) C03C 3/118 (2006.01) H05K 1/03 (2006.01)	2753589 *	LOW DIELECTRIC GLASS AND FIBER GLASS
Almirall, S.A.	A61K 31/4704 (2006.01) A61P 11/00 (2006.01) C07D 215/26 (2006.01)	2763967 *	PROCESS FOR PREPARING 5-(2-[[6-(2,2-DIFLUORO-2-PHENYLETHOXY)HEXYL]AMINO]-1(R)-HYDROXYETHYL)-8-HYDROXYQUINOLIN-2(1H)-ONE VIA A NOVEL INTERMEDIATE
Follicum AB	A61K 8/64 (2006.01) A61K 38/19 (2006.01) A61P 17/14 (2006.01) A61Q 7/00 (2006.01)	2741761 *	MODIFIED OSTEOPONTIN PEPTIDES HAVING AN INACTIVATED RGD DOMAIN AND USES THEREOF
PregLem S.A.	A61K 31/567 (2006.01) A61K 31/57 (2006.01) A61P 5/36 (2006.01)	2731613 *	Treatment of excessive menstrual bleeding associated with uterine fibroids
Takeda GmbH	A61K 31/519 (2006.01) A61P 11/00 (2006.01) C07D 495/04 (2006.01) C07D 519/00 (2006.01)	2721036 *	NOVEL 3,4,4A,10B-TETRAHYDRO-1H-THIOPYRANO[4,3-C]ISOQUINOLINE COMPOUNDS
GlaxoSmithKline LLC	A61K 31/437 (2006.01)	2768506 *	COMPOUNDS AND METHODS FOR ENHANCING INNATE IMMUNE RESPONSES
Ethicon Endo-Surgery, Inc.	A61B 17/072 (2006.01)	2517642	Staple cartridge comprising staples positioned within a compressible portion thereof
Synta Pharmaceuticals Corp.	A61K 31/405 (2006.01) A61K 31/4196 (2006.01) A61K 31/4535 (2006.01) A61K 31/497 (2006.01) A61K 31/506 (2006.01) A61K 31/519 (2006.01) A61K 31/551 (2006.01) A61P 35/00 (2006.01)	2714033 *	COMBINATION THERAPY OF HSP90 INHIBITORY COMPOUNDS WITH CHK INHIBITORS
Millennium Pharmaceuticals, Inc.	A61K 39/395 (2006.01) A61P 1/00 (2006.01) C07K 16/28 (2006.01)	2704798 *	FORMULATION FOR ANTI- ALPHA4BETA7 ANTIBODY
Sigma-Tau Industrie Farmaceutiche Riunite S.P.A.	A61K 9/00 (2006.01) A61K 47/42 (2006.01) A61P 35/00 (2006.01)	2739314 *	PHARMACEUTICAL COMPOSITION OF OXIDISED AVIDIN SUITABLE FOR INHALATION
Oxford Biomaterials Limited	A61F 2/08 (2006.01) A61L 27/22 (2006.01) A61L 31/04 (2006.01)	2741791 *	MEDICAL DEVICE
Abbvie Inc.	A61K 39/395 (2006.01) A61K 45/00 (2006.01)	2734236 *	METHODS AND COMPOSITIONS FOR TREATING ASTHMA USING ANTI-IL-13 ANTIBODIES
Prosimet S.p.A.	B22C 3/00 (2006.01) C10M 141/04 (2006.01) C10N 10/02 (2006.01) C10N 10/04 (2006.01) C10N 10/06 (2006.01) C10N 20/02 (2006.01) C10N 20/06 (2006.01) C10N 40/24 (2006.01) C10N 40/36 (2006.01) C10N 50/02 (2006.01) C10N 70/00 (2006.01)	2626407	Lubricating composition for continuous casting processes

Podnosilac evropske prijave patenta (71)	MKP (51)	Broj objave evropske prijave patenta (97)	Naziv pronalaska (54)
Compwood Products Kft.	E04B 2/74 (2006.01) E04H 1/12 (2006.01)	2754769	Means for demarcation of space
Oncolytics Biotech Inc.	B01D 15/08 (2006.01) C12M 3/00 (2006.01) C12N 7/02 (2006.01)	2702147 *	METHODS OF PURIFYING VIRUSES USING GEL PERMEATION CHROMATOGRAPHY
Sigma-Tau Industrie Farmaceutiche Riunite S.P.A.	A61K 31/045 (2006.01) A61K 31/05 (2006.01) A61K 31/122 (2006.01) A61K 31/202 (2006.01) A61K 31/205 (2006.01) A61K 31/4415 (2006.01) A61K 31/714 (2006.01) A61K 36/062 (2006.01) A61K 36/899 (2006.01)	2704734 *	COMPOSITION USEFUL FOR THE TREATMENT OF LIPID METABOLISM DISORDERS
Novomatic AG	A63F 13/00 (2014.01) G07F 17/32 (2006.01)	2705508 *	GAMBLING AND/OR GAMING APPARATUS

**OBJAVA POVUČENIH ZAHTJEVA ZA PROŠIRENJE EVROPSKIH PRIJAVA
PATENTA**
**PUBLICATION OF WITHDRAWN REQUESTS FOR EXTENSION OF EUROPEAN
PATENT APPLICATION**

Broj objave evropske prijave patenta (97)	MKP (51)	Datum kada je zahtev za proširenje evropske prijave patenta povučen	Zahtev objavljen u CGIS-u broj	Naziv pronalaska (54)	Podnosilac evropske prijave patenta (71)
2579888 *	A61K 31/24 A61K 31/341 A61K 31/343 A61K 31/351 A61K 31/381 A61K 31/40 A61K 31/41 A61K 31/415 A61K 31/421 A61K 31/423 A61K 31/428 A61K 31/433 A61K 31/437 A61K 31/4406 A61K 31/445 A61K 31/47 A61K 31/495 A61K 31/498 A61K 31/5375 A61K 38/16 C07D 265/30	28.01.2014	3/2014	NOVEL GLP-1 RECEPTOR STABILIZERS AND MODULATORS	Receptos, Inc.
2482823 *	A61K 31/7034 A61K 31/7048 A61K 31/7056 A61K 31/706 A61P 19/10	30.01.2014	3/2014	USE OF COMPOUNDS WITH SGLT-1/SGLT-2 INHIBITOR ACTIVITY FOR PRODUCING MEDICAMENTS FOR TREATMENT OF BONE DISEASES	SANOFI
2719696 *	A61K 31/427 A61K 31/4427 A61K 31/497 A61K 31/506 A61P 35/00 C07D 417/12 C07D 417/14	23.04.2014	3/2014	NOVEL KINASE INHIBITORS	Asinex Limited
2628732	A61K 31/505 A61P 31/18 C07D 239/48	02.02.2014	3/2014	Novel crystalline form of rilpivirine hydrochloride	Sandoz AG
2740477 *	A61K 31/337 A61K 31/506 A61P 35/00 A61P 43/00 C07D 401/14	02.07.2014	3/2014	METHOD FOR TREATING CANCER BY COMBINED USE OF MEDICINAL AGENTS	Astellas Pharma Inc.

**OBJAVA PROŠIRENIH EUROPSKIH PATENATA
PUBLICATION OF EXTENDED EUROPEAN PATENTS**

- (51) **A 61P 1/12**^{2006.01} **A 61K 35/44**^{2006.01} (11) **01562** (13) **B**
A 61K 35/50^{2006.01} **A 61K 35/64**^{2006.01}
A 61K 38/21^{2006.01} **A 61P 37/06**^{2006.01}
- (21) P-2013-96
(22) 12.02.2008
(30) 20070901067P 12. 02. 2007 US
(86) EP/08725458.7/12. 02. 2008
US/PCT/US2008/001831/12. 02. 2008
(87) WO 2008/100498/21. 08. 2008/2008/34
EP 2120977/25. 11. 2009/2009/48
EP 2120977/15. 05. 2013/2013/20
- (54) me **LIJEČENJE PROTUUPALNIH BOLESTI PUTEV MATIČNIH STANICA POSTELJICE**
en **TREATMENT OF INFLAMMATORY DISEASES USING PLACENTAL STEM CELLS**
- (73) Anthrogenesis Corporation, 7 Powder Horn Drive, Warren, NJ 07059, US
(72) EDINGER, James, W., 273 Leonardville Road, Belford, NJ 07718, US
HARIRI, Robert, J., 5 Heritage Road, Florham Park, NJ 07932, US
WANG, Jia-lun, 212 Rabbit Run Road, Cherry Hill, NJ 08003, US
YE, Qian, 10 Mount Haven Drive, Livingston, NJ 07039, US
FALECK, Herbert, 19 Lakeview Drive, West Orange, NJ 07052, US
(74) ČUPIĆ, Branislav, Dalmatinska 10, Podgorica, 81000, ME

- (57) Matične stanice posteljice za uporabu u metodi kod lij eče nja upalne bolesti crijeva, naznačenoj time što se metoda sastoji u primjeni navedenih matičnih stan ica posteljice u terapijski učinkovitoj količini koja je dovoljna da dovede do zamjetnog poboljšanja kod jednog ili više simptoma navedene upalne bolesti crijeva; gdje su matične stanice placente CD 10+, CD34-, CD 105+ i CD200+.

Preostalo patentnih zahtjeva 11.

- (51) **E 04 C 3 /08**^{2006.01} **E 04 C 3 /09**^{2006.01} (11) **01563** (13) **B**
(21) P-2013-100
(22) 10. 09. 2013
(30) 102009047958.9 01. 10. 2009 DE
(86) EP/10763123.6/23. 09. 2010
EP/PCT/EP2010/005834/23. 09. 2010
(87) WO 2011038860/07. 04. 2011/2011/14
EP 2467545 /27. 06. 2012/2012/26
EP 2467545 /12. 06. 2013/2013/24
(54) me **PROFILNI ELEMENT I POSTUPAK ZA IZRADU PROFILNOG ELEMENTA**
en **PROFILE ELEMENT AND METHOD FOR MANUFACTURING A PROFILE ELEMENT**
(73) Protektorwerk Florenz Maisch GmbH & Co. KG, Viktoriastrasse 58, 76571 Gaggenau, DE
(72) MAISCH, Christof, Baden-Badener-Str. 15, 76571 Gaggenau, DE
(74) RADULOVIĆ, S. Božidar, Jovana Tomašević, 9/III-1, Podgorica, 81000, ME

- (57) Profilni element, posebno građevinski profil, na primjer, profil suhe gradnje, fasadni kao i profil žbuke, eštriha, pločica ili kabelnoseći profil ili šina regala ili odvoda, sa uzdužnim profilnim tijelom (2), koji se sastoji naročito od metala ili plastike, u kojem je formirano mnoštvo otvora (5), pri čemu profilno tijelo (2) obuhvata najmanje dva zasebno formirana uzdužna segmenta (10, 11); svaki uzdužni segmenat (10, 11) obuhvata jednu vijugavo formiranu uzdužnu ivicu (12, 13); uzdužni segmenti (10, 11) imaju uzajamno preklapajuća područja (28, 29), koja su regionalno ograničena vijugavim uzdužnim ivicama (12, 13); u područjima preklapanja (28, 29) formirana su sredstva za spajanje (16, 17; 30, 31; 37, 40) preko kojih su uzdužni segmenti (10, 11) utaknuto sastavljeni u jednom pravcu poprečno njihovom uzdužnom pravcu; a otvori (5) su formirani između segmenata (24, 25) vijugavih uzdužnih ivica (12, 13) oba uzdužna segmenta (10, 11), naznačen time, što se prorezi (16, 17) pružaju, polazeći u svakom slučaju od vijugavih uzdužnih ivica (12, 13) prema preklapajućim oblastima (28, 29) uzdužnih segmenata (10, 11) i pružaju se poprečno na uzdužni pravac odnosnog uzdužnog segmenta (10, 11); i time što su uzdužni segmenti (10, 11) spojeni pomoću proreza (16, 17).

Preostalo patentnih zahtjeva 15.

(51) C 07D 213/80^{2006.01} A 61K 31/455^{2006.01} (11) 01564 (13) B
 A 61P 37/00^{2006.01}

(21) P-2013-106
 (22) 11. 03. 2010
 (30) 20090382031 13. 03. 2009 EP
 (86) EP/10708932.8/11. 03. 2010
 EP/PCT/EP2010/001550/11. 03. 2010
 (87) WO 2010/102826/16. 09. 2010/2010/37
 EP 2406225/18. 01. 2012/2012/03
 EP 2406225/26. 06. 2013/2013/26

(54) me **ADICIONE SOLI AMINA KOJI SADRŽE HIDROKSILNE I/ ILI KARBOKSILNE GRUPE S
 DERIVATIMA AMINONIKOTINSKE KISELINE KAO DHODH INHIBITORIMA**
 en **ADDITION SALTS OF AMINES CONTAINING HYDROXYL AND/OR CARBOXYLIC
 GROUPS WITH AMINO NICOTINIC ACID DERIVATIVES AS DHODH INHIBITORS**

(73) Almirall S.A., Ronda del General Mitre, 151, 08022 Barcelona, ES
 (72) PEREZ GARCIA, Juan, Bautista, C/ Laureá Mir 408-410, E-08980 Sant Feliu de Llobregat, ES
 CARRERA CARRERA, Francesc, C/ Laureá Mir 408-410, E-08980 Sant Feliu de Llobregat, ES
 GARCIA MARTIN, Digna, José, C/ Laureá Mir 408-410, E-08980 Sant Feliu de Llobregat, ES
 BOIX BERNARDINI, Maria, Carmen, C/ Laureá Mir 408-410, E-08980 Sant Feliu de Llobregat, ES
 (74) ĐAKONOVIĆ, Vido, Bajova 9, Cetinje, 81250, ME
 (57)

(57) Farmaceutski prihvatljiva kristalna adiciona so (i) amina koji sadrži jednu ili više hidroksilnih i/ ili karboksilnih grupa s (ii) derivatom aminonikotinske kiseline formule (1), naznačena time,

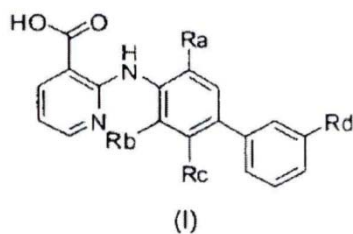

Što R^a, R^b, R^c i R^d zasebno predstavljaju grupe odabrane iz atoma vodonika, atoma halogena, C₁₋₄ alkilnih grupa koje se mogu opcionalno supstituirati s 1, 2, ili 3 supstituenta odabrana iz atoma halogena i hidroksi grupa, i C₁₋₄ alkoksi grupe koje se mogu opcionalno supstituirati s 1, 2 ili 3 supstituenta odabrana iz atoma halogena i hidroksi grupa, i njihove farmaceutski prihvatljive solvate.

Preostalo patentnih zahtjeva 14.

(51) **C 07K 14/71**^{2006.01}
C 12N 15/67^{2006.01}
C 12N 5/16^{2006.01}

C 12N 15/85^{2006.01}
C 12N 15/79^{2006.01}

(11) **01566**

(13) **B**

(21) P-2013-126

(22) 20. 07. 2010

(86) EP/10740573.0/20. 07. 2010

EP/PCT/EP2010/060469/20. 07. 2010

(87) WO 2011012496/03. 02. 2011/2011/05

EP 2459721 /06. 06. 2012/2012/23

EP 2459721 /18. 09. 2013/2013/38

(54) me **POBOLJŠANI HUMANI DUGI PENTRAKSIN 3 EKSPESIONI SISTEM I NJEGOVE
 POTREBE**

en **IMPROVED HUMAN LONG PENTRAXIN 3 EXPRESSION SYSTEM AND USES THEREOF**

(73) SIGMA-TAU Industrie Farmaceutiche Riunite S.p.A., Viale Shakespeare 47,00144 Roma, IT

(72) SASSANO, Marica, Via Bernardo Tanucci, 52, I-81100 Caserta, IT

ESPOSITO, Adelaide, Via Volturmo 4, I-80028 Grumo Nevano (NA), IT

RIVIECCIO, Vincenzo, Via degli Emigranti 7, I-80059 Torre del Greco (NA), IT

CASSANI, Giovanni, Corso Garibaldi 26, I-27100 Pavia, IT

(74) ĐAKONOVIĆ, Vido, Bajova 9, Cetinje, 81250, ME

- (57) Upotreba eukariotskog ekspres ionog vektora koji sa drži sekvencu nukleotid a šifrovanu za human I dugi pentraksin PTX3 protein pod kontrolom efektivnog promotera, kao i se kvencu nukleotidašifrovanu za selektovani marker, koji suštinski ima se kvencu SEQ ID I za transformi sa njerekombinantne ljudske host ćelije koja već može da eksprimira humani dugi pentraksin PTX3 protein, gde je rekombinantna ljudska host ćelija rekombinantni klon 293F/PTX 3/2F12 deponovanu ECACC pod broj em 08011001.
 Preostalo patentnih zahtjeva 7.

(51) C 07D 209/42^{2006.01} A 61K 31/403^{2006.01} (11) 01658 (13) B

(21) P-2013-141

(22) 04. 01. 2013

(30) 201200033 05. 01. 2012 FR

(86) EP/13150296.5/04. 01. 2013

(87) EP 2612850/10. 07. 2013/2013/28

EP 2612850/18. 09. 2013/2013/38

(54) me **Delta kristalni oblik argininske soli perindoprila, postupak za njegovu proizvodnju i farmaceutske smeše koje ga sadrže**
 en **Delta crystalline form of the arginine salt of perindopril, a process for its preparation, and pharmaceutical compositions containing it**

(73) Les Laboratoires Servier, 35, rue de Verdun, 92284 Suresnes Cedex, FR

(72) Linol, Julie, 76770 Malaunay, FR

Laurent, Stéphane, 76190 Valliquerville, FR

Grenier, Arnaud, 76110 Breaute, FR

Mathieu, Sébastien, 76290 Montivillers, FR

(74) JUSIĆ, Jasna, Crnogorskih Serdara bb, Podgorica, 81000, ME

(57) Delta kristalni oblik L-argininske soli perindoprila, formule (I) :

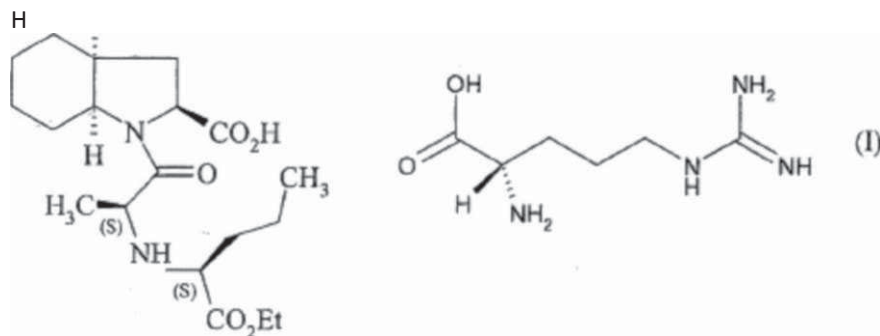

naznačen time što su pikovi RX difrakcije na prašku, mereni na difraktometru na bakarnoj antikatodi, koji su izraženi kao Braggov ugao 2 teta (°), sledeći: 4,3 11,0 11,1 13,2 14,6 16,0 i 21,9.
 Preostalo patentnih zahtjeva 15.

- (51) **B 65 B 27 / 10**^{2006.01} **B 65 B 65 / 00**^{2006.01} (11) **01569** (13) **B**
B 23 D 36 / 00^{2006.01} **B 21 B 15 / 00**^{2006.01}
- (21) P-2013-145
(22) 13. 04. 2012
(30) 20110017354 07. 10. 2011 GB
(86) EP/12164147.6/13. 04. 2012
(87) EP 2578502/10. 04. 2013/2013/15
EP 2578502/04. 12. 2013/2013/49
- (54) me **POSTUPAK I UREĐAJ ZA PROIZVODNJU ŠIPKI ISJEČENIH NA ZADATU DUŽINU U VALJAONICI ČELIKA**
en **Method and apparatus for producing cut to length bars in a steel mill**
- (73) Pong, David Teng, Apt 6A Tower One, No. 1 Po Shan Road, Hong Kong SAR, CN
(72) Pong, David Teng, Apt 6A Tower One, No. 1 Po Shan Road, Hong Kong SAR, CN
(74) RADULOVIĆ, S. Božidar, Jovana Tomaševića 9/III-1, Podgorica, 81000, ME

- (57) Postupak za proizvodnju čeličnih šipki (23) sečenih na dužinu po nalogu kupca, koji metod obuhvata faze: proizvodnju čelične šipke (12) kontinuirane dužine od strane valjaonice (11), sečenje te čelične šipke (12) kontinuirane dužine na dužine jednake dužini šipke (23) prema narudžbini kupca održavajući proizvodnju čelične šipke (12) kontinuirane dužine proizvedene od strane valjaonice (11), i uvezivanje šipki (23) dužine poručene od strane kupca radi otpusta iz valjaonice (11) upotrebom jedne od dve jedinice (24a, 24b) za uvezivanje postavljene tako da primi i uveže isečene šipke (23), gde najmanje jedna od navedenih jedinica (24a) za uvezivanje ima više mašina (27a, 28a, 29a) za uvezivanje, n a z n a č e n t i m e, što mašina (27a) za uvezivanje najbliža kraju jedinice (24a) za uvezivanje u koju se radi vezivanja ubacuju šipke (23) dužine poručene od strane kupca ostaje aksijalno stacionarna nezavisno od dužine šipki (23) prema narudžbini kupca, a gde je najmanje jedna od ostalih mašina (28a, 29a) za uvezivanje jedinice (24a) za uvezivanje aksijalno pomerljiva.

Preostalo patentnih zahtjeva 12.

(51) **07D4704/**^{2006.01} **61K31437/**^{2006.01} (11) **01573** (13) **B**
07D51900/^{2006.01} **61P2528/**^{2006.01}

(21) 2013-142
 (22) 11. 05. 2010
 (30) 09160059 12. 05. 2009 EP
 (86) EP/10721696.2/11. 05. 2010
 EP/PCT/EP2010/002910/11. 05. 2010
 (87) WO 2010130424/18. 11. 2010/2010/46
 EP 2430022/21. 03. 2012/2012/12
 EP 2430022/20. 11. 2013/2013/47

(54) me **DERIVATI 1,2,4-TRIAZOLO[4,3-a]PIRIDINA I NJIHOVA UPOTREBA U TRETMANU ILI PREVENCIJI NEUROLOŠKIH I PSIHIJATRIJSKIH POREMEĆAJA**
 en **1,2,4-Triazolo[4,3-a]pyridine derivatives and their use for the treatment or prevention of neurological and psychiatric disorders**

(73) Janssen Pharmaceuticals, Inc., 1125 Trenton-Harbourton Road, Titusville, NJ 08560, US
 Adnex Pharma SA, 12 Chemin des Aulx, 1228 Plan-les-Ouates, CH

(72) CID-NÚÑEZ, José, María,
 Janssen-Cilag, S.A., Calle Jarama 75, Poligono Industrial, 45007 Toledo, ES
 OEHLRICH, Daniel, Janssen Pharmaceutica NV, Turnhoutseweg 30, 2340 Beerse, BE
 TRABANCO-SUÁREZ, Andrés, Avelino,
 Janssen-Cilag, S.A., Calle Jarama 75, Poligono Industrial, 45007 Toledo, ES
 TRESADERN, Gary, John,
 Janssen-Cilag, S.A., Calle Jarama 75, Poligono Industrial, 45007 Toledo, ES
 VEGA RAMIRO, Juan, Antonio,
 Janssen-Cilag, S.A., Calle Jarama 75, Poligono Industrial, 45007 Toledo, ES
 MACDONALD, Gregor, James, Janssen Pharmaceutica NV, Turnhoutseweg 30, 2340 Beerse, BE

(74) RADULOVIĆ, Božidar, Studentska bb, Podgorica, 81000, ME

(57) Jedinjenje formule (I)

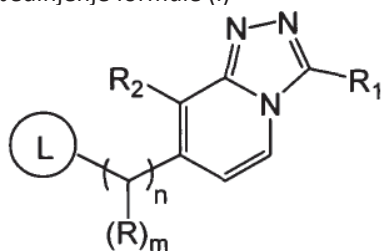

(I)

ili njegov stereohemijski izomerni oblik gde n je odabrano od grupe koja se sastoji od 0, 1 i 2; m je odabrano od grupe koja se sastoji od 0, 1 i 2; R je odabrano od metil ili trifluorometil; R¹ je odabrano od grupe koja se sastoji od vodonik, C₁₋₆ alkil; (C₁₋₃ alkiloksi)- C₁₋₃ alkil; [(C₁₋₃ alkiloksi)C₁₋₃ alkiloksi]C₁₋₃ alkil; C₁₋₃ alkil supstituisan sa jednim ili više nezavisno odabranih halo supstituenata; nesupstituisani fenil; nesupstituisani benzil; benzil supstituisan sa 1, 2 ili 3 supstituenta nezavisno odabranih od grupe koja se sastoji od halo, C₁₋₃ alkil, C₁₋₃ alkiloksi, C₁₋₃ alkiloksiC₁₋₃ alkil, hidroksiC₁₋₃ alkil, cijano, hidroksil, amino, C(=O)R', C(=O)OR', C(=O)NR'R'', mono- ili di(C₁₋₃ alkil) amino, morfolinil, (C₃₋₇ cikloalkil)C₁₋₃ alkiloksi, trifluorometil i trifluorometoksi, gde su R' i R'' nezavisno odabrani od vodonik i C₁₋₆ alkil; (benziloksi)C₁₋₃ alkil; nesupstituisani C₃₋₇ cikloalkil; C₃₋₇ cikloalkil supstituisan sa C₁₋₃ alkil supstituisan sa jednim ili više nezavisno odabranih halo supstituenata; (C₃₋₇ cikloalkil)C₁₋₃ alkil; [(C₃₋₇ cikloalkil)C₁₋₃ alkiloksi]C₁₋₃ alkil; (C₃₋₇ cikloalkil)C₁₋₃ alkiloksi; 4-(2,3,4,5- tetrahydro-benzo[f][1, 4]oksazepin)metil; Het¹; Het¹C₁₋₃ alkil; Het²; i Het²C₁₋₃ alkil; R² je odabrano iz grupe koja se sastoji od cijano; halo; C₁₋₃ alkil supstituisan sa jednim ili više nezavisno odabranih halo supstituenata; C₁₋₃ alkiloksi supstituisan sa jednim ili više nezavisno odabranih halo supstituenata; C₁₋₃ alkil; C₃₋₇ cikloalkil; i (C₃₋₇ cikloalkil)C₁₋₃ alkil;



je N-koji sadrži heteroprsten odabran od grupe koja se sastoji od (L-a), (L-b), (L-c), (L-d), (L-e), (L-f), (L-g) i (L-h) dole

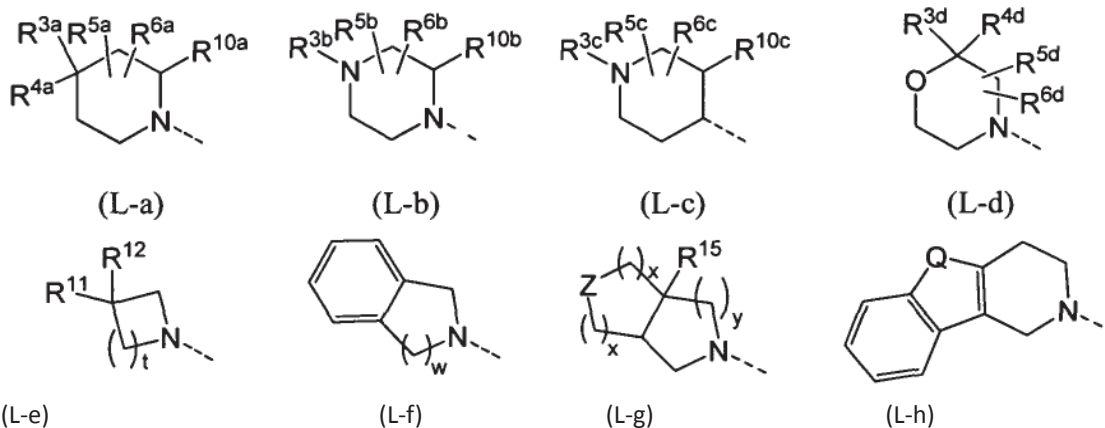

gde R^{3a} je odabrano iz grupe koja se sastoji od C_{1-3} alkil; C_{1-3} alkil supstituisan sa jednim ili više nezavisno odabranih halo supstituenata; nesupstituisani C_{3-7} cikloalkil; C_{3-7} cikloalkil supstituisan sa 1 ili 2 supstituenta nezavisno odabranih od C_{1-3} alkil, C_{1-3} alkil supstituisan sa jednim ili više nezavisno odabranih halo supstituenata; ili hidroksil; nesupstituisani fenil; fenil supstituisan sa 1, 2 ili 3 supstituenta nezavisno odabranih od grupe koja se sastoji od halo, C_{1-3} alkil, hidroksi C_{1-3} alkil, C_{1-3} alkil supstituisan sa jednim ili više nezavisno odabranih halo supstituenata, cijano, hidroksil, amino, karboksil, C_{1-3} alkiloksi- C_{1-3} alkil, C_{1-3} alkiloksi, C_{1-3} alkiloksi supstituisan sa jednim ili više nezavisno odabranih halo supstituenata, C_{1-3} alkilkarbonil, mono- i di(C_{1-3} alkil)amino, i morfolinil; nesupstituisani (fenil) C_{1-3} alkil; (fenil) C_{1-3} alkil gde fenil i C_{1-3} alkil deo supstituenta mogu svaki biti nezavisno supstituisani sa 1, 2 ili 3 supstituenta nezavisno odabranih od grupe koja se sastoji od halo, C_{1-3} alkil, hidroksi C_{1-3} alkil, C_{1-3} alkil supstituisan sa jednim ili više nezavisno odabranih halo supstituenata, cijano, hidroksil, amino, karboksil, C_{1-3} alkiloksi- C_{1-3} alkil, C_{1-3} alkiloksi, C_{1-3} alkiloksi supstituisan sa jednim ili više nezavisno odabranih halo supstituenata, C_{1-3} alkilkarbonil, mono- ili di(C_{1-3} alkil)amino, morfolinil i (C_{3-7} cikloalkil) C_{1-3} alkiloksi; nesupstituisani feniloksi; feniloksi supstituisan sa 1, 2 ili 3 supstituenta nezavisno odabranih od grupe koja se sastoji od halo, C_{1-3} alkil, C_{1-3} alkil supstituisan sa jednim ili više nezavisno odabranih halo supstituenata, C_{1-3} alkiloksi, i C_{1-3} alkiloksi supstituisan sa jednim ili više nezavisno odabranih halo supstituenata; nesupstituisani feniloksi(C_{1-3} alkil)oksi; nesupstituisani (fenil C_{1-3} alkil)oksi; fenil(C_{1-3} alkil)oksi gde je fenil deo supstituenta supstituisan sa 1, 2, ili 3 supstituenta nezavisno odabranih od grupe koja se sastoji od halo, C_{1-3} alkil, C_{1-3} alkil supstituisanih sa jednim ili više nezavisno odabranih halo supstituenata, C_{1-3} alkiloksi, i C_{1-3} alkiloksi supstituisanih sa jednim ili više nezavisno odabranih halo supstituenata; nesupstituisani fenilamino; fenilamino supstituisan sa 1 ili 2 nezavisno odabrana halo supstituenta; (fenil C_{1-3} alkil)amino; (fenilamino)(C_{1-3} alkil); (C_{3-7} cikloalkil) C_{1-3} alkil; [fenil(C_{3-7} cikloalkil)] C_{1-3} alkil; Het¹; Het²; Het²oksi; Het²metiloksi; Het³; i fenil sa dva vicinalna supstituenta koji uzeti zajedno formiraju bivalentni radikal formule -N=CH-NH- (a), -CH=CH-NH- (b), ili -O-CH₂-CH₂-NH- (c); R^{4a} je odabrano iz grupe koja se sastoji od vodonik; halogen; trifluorometil; trifluorometoksi; hidroksil; C_{1-3} alkil; C_{1-3} alkiloksi; hidroksi C_{1-3} alkil; hidroksil- C_{1-3} alkiloksi; fluoro C_{1-3} alkil; fluoro C_{1-3} alkiloksi; cijano; nesupstituisani fenil; i fenil supstituisan sa 1 ili 2 supstituenta nezavisno odabranih od grupe koja se sastoji od halo, C_{1-3} alkiloksi, hidroksi C_{1-3} alkil, trifluorometil i trifluorometoksi; ili $CR^{3a}R^{4a}$ formira radikal formule (d), (e), (f), (g) ili (h);

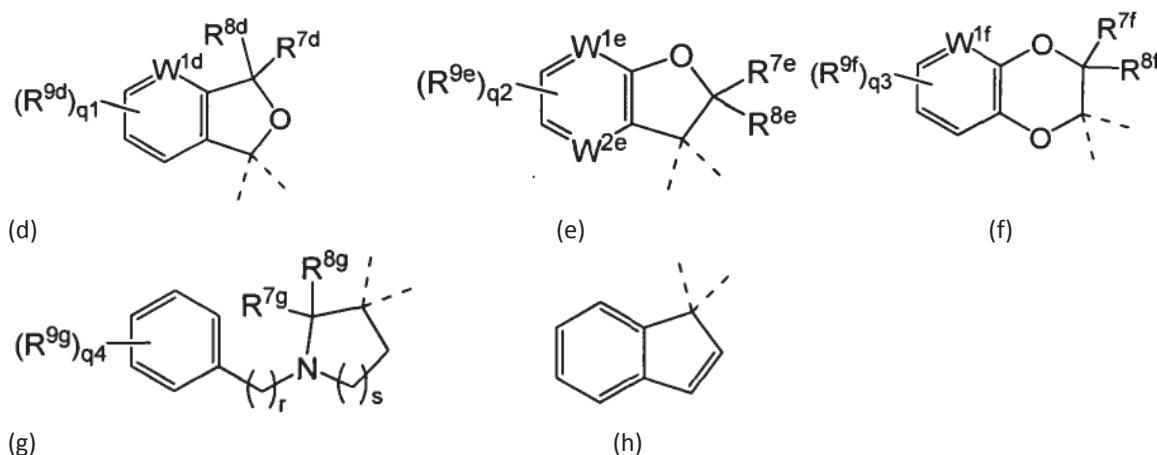

gde je svako W^{1d} , W^{1e} , W^{2e} i W^{1f} nezavisno odabrano od CH i N; svako R^{7d} , R^{7e} , R^{7f} , R^{7g} , R^{8d} , R^{8e} , R^{8f} , R^{8g} je nezavisno

odbrano od vodonik, metil i fluoro; ili svako CR^{7d}R^{8d}, CR^{7e}R^{8e}, CR^{7f}R^{8f}, CR^{7g}R^{8g} formira karbonil grupu; svako R^{9d}, R^{9e}, R^{9f}, i R^{9g} je fluoro; svako ql, q2, q3 ili q4 je nezavisno odabrano od 0, 1 i 2; r je 0 ili 1; s je 0 ili 1; svako R^{3b} i R^{3c} je odabrano od grupe koja se sastoji od C₁₋₃alkil; C₁₋₃alkil supstituisan sa jednim ili više nezavisno odabranih halo supstituenata; nesupstituisani fenil; fenil supstituisan sa 1, 2 ili 3 supstituenta nezavisno odabranih od grupe koja se sastoji od halo, C₁₋₃alkil, hidroksiC₁₋₃alkil, C₁₋₃alkil supstituisan sa jednim ili više nezavisno odabranih halo supstituenata, cijano, hidroksil, amino, karboksil, C₁₋₃alkiloksiC₁₋₃alkil, C₁₋₃alkiloksi, C₁₋₃alkiloksi supstituisan sa jednim ili više nezavisno odabranih halo supstituenata, C₁₋₃alkilkarbonil, mono- i di(C₁₋₃alkil) amino i morfolinil; nesupstituisani (fenil)C₁₋₃alkil; (fenil)C₁₋₃alkil gde fenil i C₁₋₃alkil deo supstituenta mogu svaki biti nezavisno supstituisani sa 1, 2 ili 3 supstituenta nezavisno odabrana od grupe koja se sastoji od halo, C₁₋₃alkil, hidroksiC₁₋₃alkil, C₁₋₃alkil supstituisan sa jednim ili više nezavisno odabranih halo supstituenata, cijano, hidroksil, amino, karboksil, C₁₋₃alkiloksiC₁₋₃alkil, C₁₋₃alkiloksi, C₁₋₃alkiloksi supstituisan sa jednim ili više nezavisno odabranih halo supstituenata, C₁₋₃alkilkarbonil, mono- ili di(C₁₋₃alkil)amino, morfolinil, C₃₋₇cikloalkil, (C₃₋₇cikloalkil)C₁₋₃alkil, i (C₃₋₇cikloalkil)-C₁₋₃alkiloksi; nesupstituisani (feniloksi)C₁₋₃alkil; (feniloksi)C₁₋₃alkil supstituisan sa 1 ili 2 supstituenta nezavisno odabrana od grupe koja se sastoji od halo, C₁₋₃alkil, C₁₋₃alkil supstituisan sa jednim ili više nezavisno odabranih halo supstituenata, C₁₋₃alkiloksi, i C₁₋₃alkiloksi supstituisan sa jednim ili više nezavisno odabranih halo supstituenata; (fenilamino)(C₁₋₃alkil); fenil sa dva vicinalna supstituenta koji uzeti zajedno formiraju bivalentni radikal formule (a), (b) ili (c) kao što je prethodno definisano; Het¹; Het²; Her³; nesupstituisani C₃₋₇cikloalkil; C₃₋₇cikloalkil supstituisan sa 1 ili 2 supstituenta nezavisno odabrana od C₁₋₃alkil, C₁₋₃alkil supstituisan sa jednim ili više nezavisno odabranih halo supstituenata, ili hidroksil; (C₃₋₇cikloalkil) C₁₋₃alkil; i [fenil(C₃₋₇cikloalkil)]C₁₋₃alkil; R^{3d} i R^{4d} su svako nezavisno odabrani od grupe koja se sastoji od vodonik i C₁₋₃alkil; svako R^{5a}, R^{5b}, R^{5c}, R^{5d}, R^{6a}, R^{6b}, R^{6c} i R^{6d} su nezavisno odabrani od grupe koja se sastoji od vodonik i C₁₋₃alkil; ili svaki par R^{5a}R^{6a}, R^{5b}R^{6b}, R^{5c}R^{6c}, R^{5d}R^{6d} su supstituenti na istom atomu ugljenika i svaki CR^{5a}R^{6a}, CR^{5b}R^{6b}, CR^{5c}R^{6c}, CR^{5d}R^{6d} zajedno formiraju (C=O) ili C₃₋₇cikloalkiliden radikal; svako R^{10a}, R^{10b} i R^{10c} je odabrano od H, C₁₋₃alkil i C₁₋₃alkiloksi; gde, u (L-e), kada je t 1 ili 2, R¹¹ je vodonik i R¹² je odabrano od supstituenta odabranog od grupe koja se sastoji od fenil, feniloksi i fenilamino, koje može svako po potrebi biti supstituisano sa 1 ili 2 halo supstituenta; ili kada je t 1 ili 3, onda CR¹¹R¹² formira radikal formule (i) ili formule (j)

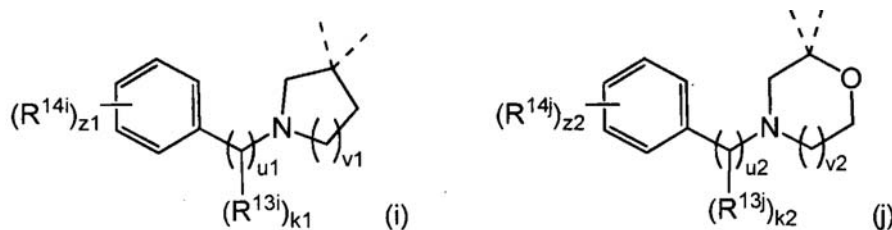

gde svako R¹³ⁱ i R^{13j} je nezavisno odabrano od metil i trifluorometil; svako R¹⁴ⁱ ili R^{14j} je fluoro; svako u₁ i u₂ je nezavisno 0, 1 ili 2; v₁ je odabrano iz grupe od 0, 1 i 2; v₂ je odabrano iz grupe od 1 i 2; svako z₁ i z₂ je nezavisno odabrano od grupe od 0, 1 i 2; svako k₁ i k₂ je nezavisno odabrano od grupe od 0, 1 i 2; gde, u (L-f) w je 1 ili 2; gde u (L-g) Z je CR¹⁶R¹⁷ i R¹⁵ je vodonik gde je svako x 0 i y je 1; ili Z je CR¹⁶R¹⁷ i R¹⁵ je odabrano od grupe koja se sastoji od, vodonik, metil i fenil kada je svako x 0 i y je 2; (L-g) je (L-g'') kada je Z NR¹⁶

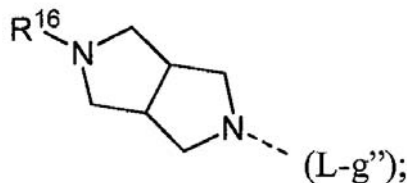

gde su R¹⁶ i R¹⁷ svaki nezavisno odabrani od grupe koja se sastoji od vodonik; nesupstituisani fenil; i fenil supstituisan sa 1, 2 ili 3 halo supstituenta; gde u (L-h), Q je O ili N-R¹⁸, gde je R¹⁸ odabrano od vodonik i C₁₋₃alkil; gde svaki Het¹ je zasićeni heterociklični radikal odabran od pirolidinil; piperidinil; piperazinil; i morfolinil; od kojih svaki može po potrebi biti supstituisan sa 1 ili 2 supstituenta nezavisno odabrana od grupe koja se sastoji od C₁₋₆alkil, halo, C₁₋₃alkil supstituisan sa jednim ili više nezavisno odabranih halo supstituenta, nesupstituisani fenil; ili fenil supstituisan sa 1, 2 ili 3 supstituenta nezavisno odabrana od grupe koja se sastoji od halo, trifluorometil, i trifluorometoksi; i svaki Het² je aromatični heterociklični radikal odabran od piridinil i pirimidinil; od kojih je svaki nesupstituisan ili supstituisan sa 1 ili 2 supstituenta odabrana iz grupe koja se sastoji od halo; C₁₋₃alkil; C₁₋₃alkiloksi; i C₁₋₃alkil supstituisan sa jednim ili više nezavisno odabranih halo supstituenata; svaki Het³ je heterociklični radikal odabran od 1,3-tiazolil po potrebi supstituisan sa C₁₋₃alkil; nesupstituisani benzofuranil; nesupstituisani 3,4-dihidro-2H-hromenil; i supstituisani 1H-indolil; svaki halo je odabran od grupe koja se sastoji od fluoro, hloro, bromo i jodo; i njihovih farmaceutski prihvatljivih soli ili solvata. Preostalih patentnih zahtjeva je 14.

- (51) **C 07D 207/273**^{2006.01} **C 07D 209/54**^{2006.01} (11) **01579** (13) **B**
A 61K 31/4015^{2006.01} **A 61P 5/00**^{2006.01}
A 61P 15/12^{2006.01} **A 61P 19/10**^{2006.01}
- (21) P-2013-64
(22) 06. 08. 2008
(30) 2007205966 07. 08. 2007 JP
2007299658 19. 11. 2007 JP
(86) EP/08792430.4/06. 08. 2008
JP/PCT/JP2008/064500/06. 08. 2008
(87) WO 2009/020234 /12. 02. 2009/2009/07
EP 2176220/21. 04. 2010/2010/16
EP 2176220/27. 03. 2013/2013/13
(54) me **Derivati pirolidin-2-ona kao modulatori androgenskih receptora**
en **Pyrrolidin-2-one derivatives as androgen receptor modulators**
(73) Takeda Pharmaceutical Company Limited,
1-1, Doshomachi 4-chome Chuo-ku Osaka-shi, Osaka 541-0045, JP
(72) HASUOKA, Atsushi,
c/o Takeda Pharmaceutical Company Limited, Fujisawa, Kanagawa 251-8555, JP
26-1, Muraoka-Higashi 2-chome
(74) AOD "ĆUPIĆ", Dalmatinska 10, Podgorica, 81000, ME

(57) Jedinjenje formule (I)

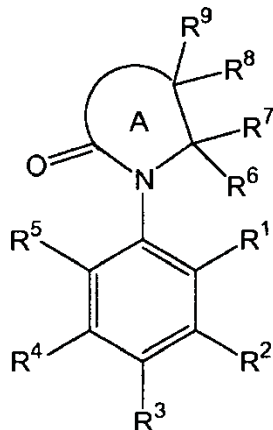

u kojoj

R¹ je atom vodonika, atom halogena ili alkil grupa sa 1 do 6 ugljenika, po izboru sa supstuentom (supstuentima);

R² je atom halogena, alkil grupa sa 1 do 6 ugljenika izboru sa supstuentom (supstuentima) ili alkoksi grupa sa 1 do 6 ugljenika koji po izboru imaju supstuent(e);

R³ je cijano grupa;

R⁴ je atom vodonika ili atom halogena;

R⁵ je atom vodonika;

R⁶ je atom vodonika;

R⁷ je alkil grupa sa 1 do 6 ugljenika sa po izboru supstuentom (supstuentima) ili n aralkil grupa koja po izboru sadrži supstuent(e);

R⁸ je atom vodonika, alkil grupa sa 1 do 6 ugljenika, po izboru sa supstuentom (supstuentima) ili C₃₋₆ cikloalkil grupa koja po izboru sadrži supstuent(e);

R⁹ je hidroksi grupa; i

Prsten A je pirolidinski ring koji po izboru ima 1 ili 2 supstuenta odabrana od 1) atoma halogena, 2) alkil grupe koja po izboru sadrži hidroksi grupu odabrana iz grupe koju čine metil, etil, propil, izopropil, butil, izobutil, sec-butil, terc-butil, pentil, heksil, hidroksimetil i 1-hidroksi-1-metiletil, 3) alkenil grupa odabrana iz grupe koju čine vinil, alil i 2-metilprop-2-en-1-il i 4) aralkil grupa, ili pirolidinski ring koji formira spiro vezu sa C₃₋₆ cikloalkanom, ili njegova so.

Patent sadrži još 19 patentnih zahtjeva.

- (51) **A 61K 31/485**^{2006.01} **A 61K 9/22**^{2006.01} (11) **01580** (13) **B**
A 61K 9/32^{2006.01}
- (21) P-2013-67
(22) 24. 08. 2007
(30) 840244 P 25. 08. 2006 US
(86) EP/ 11157006.5/24. 08. 2007
(87) EP 2399579/28. 12. 2011/2011/52
EP 2399579/03. 04. 2013/2013/14
EP 2399579/24. 07. 2013/2013/30
- (54) me **FARMACEUTSKI DOZNI OBLICI**
en **PHARMACEUTICAL DOSAGE FORMS**
- (73) Purdue Pharma LP, One Stamford Forum, 201 Tresser Boulevard, Stamford, CT 06901, US
(72) Mannion, Richard Owen, 3860 Green Ridge Road, Furlong, PA 18925, US
Huang, Haiyong Hugh, 33 Ketley Place, Princeton, NJ 08540, US
McKenna, William Henry, 10 Longmeadow Road, Yonkers, NY 10704, US
O'Donnell, Edward, P., 38 Chestnut Court, Basking Ridge, NJ 07920, US
(74) LUTOVAC, Branislav, Bulevar Ivana Crnojevića 93, Podgorica, 81000, ME
- (57) Čvrst oralni farmaceutski dozni oblik sa produženim oslobađanjem, koji sadrži formulaciju matrice sa produženim oslobađanjem, a formulacija matrice sa produženim oslobađanjem sadrži kompoziciju koja sadrži bar jedan aktivni agens i najmanje jedan polietilen oksid koji na osnovu reoloških merenja ima približnu molekulsku težinu od najmanje 1 ,000,000; i gde kompozicija sadrži bar oko 80 ma s.% polietilen oksida koji na osnovu reoloških merenja ima približnu molekulu lsku težinu bar 1 ,000,000; u obliku tablete ili zrnaca, pri čemu ova tableta ili pojedinačno znce može da se zgnječi bez kidanja, naznačen time, što debljina tablete ili pojedinačnog zrnca posle ovog gnječenja, nije veća od oko 60% debljine te tablete ili pojedinačnog zrnca pre nego što su zgnječeni , pri čemu pomenuta zgnječena ili nezgnječena tableta ili zgnječena ili nezgnječena zrnca imaju brzinu rastvaranja in vitro, merenu u aparatu USP Apparatus 1 (sa korpom), pri 100 o/min, u 900 ml simuliranog želudačnog fluida bez enzima (SŽF), koji sadrži 40% ili 0% etanola na 37° C, koja je između 5 i 40 ma s.% oslobođenog aktivnog agensa posle 0.5 sati.
Patent sadrži još 25 patentnih zahtjeva.

- (51) **A 61K 39/395**^{2006.01} **A 61P 35/00**^{2006.01} (11) **01591** (13) **B**
- (21) P-2014-2
- (22) 21. 02. 2006
- (30) 655277P 23. 02. 2005 US
- (86) EP/06735838.2/21. 02. 2006
US/PCT/US2006/006334
- (87) WO 2006/091693/31. 08. 2006/2006/35
EP 1850874/07. 11. 2007/2007/45
EP 1850874/16. 10. 2013/2013/42
- (54) me **PRODUŽAVANJE VREMENA PROGRESIJE BOLESTI ILI PREŽIVLJAVANJA KOD**
en **PACIJENATA OBOLELIH OD KANCERA JAJNIKA KORIŠĆENJEM PERTUZUMABA**
EXTENDING TIME TO DISEASE PROGRESSION OR SURVIVAL IN OVARIAN CANCER
PATIENTS USING PERTUZUMAB
- (73) Genentech, Inc., 1 DNA Way, South San Francisco CA 94080-4990, US
- (72) DERYNCK, Mika K., 27 Hilltop Road, San Mateo, California 94402, US
KELSEY, Stephen M., 360 14th Street, Montara, California 94037, US
- (74) RADULOVIĆ, S. Božidar, Studentska bb, Lamela 3/18, Podgorica, 81000, ME

- (57) Pertuzumab za upotrebu u postupku produženja vremena do progresije bolesti (TTP) ili preživljavanja kod pacijenta obolelog od kancera, metod koji se sastoji u davanju pertuzumaba pacijentu u količini koja dovodi do produženja TTP-a ili preživljavanja pacijenta, gde je pacijent oboleo od kancera koji je kancer jajnika.

Patent sadrži još 17 patentnih zahtjeva.

- (51) C 07D 513/04^{2006.01} C 07D 519/00^{2006.01} (11) 01592 (13) B
 C 07D 513/12^{2006.01} A 61K 31/437^{2006.01}
 A 61K 31/519^{2006.01}
- (21) P-2013-70
 (22) 24. 06. 2008
 (30) PCT/GB2007/002390 26. 06. 2007 GB
 (86) EP/08775774.6/24. 06. 2008
 GB/PCT/GB2008/002194/24. 06. 2008
 (87) WO 2009/001089/31. 12. 2008/2009/01
 EP 2170906/07. 04. 2010/2010/14
 EP 2170906/03. 04. 2013/2013/14
- (54) me **FUZIONISANI DERIVATI TIAZOLA KAO INHIBITORI KINAZE**
 en **FUSED THIAZOLE DERIVATIVES AS KINASE INHIBITORS**
- (73) UCB Pharma, S.A., 60, allée de la Recherche, 1070 Brussels, BE
 (72) ALEXANDER, Rikki Peter, UCB Celltech, 208 Bath Road, Slough, Berkshire SL1 3WE, GB
 AUJLA, Pavandeep Singh, UCB Celltech, 208 Bath Road, Slough, Berkshire SL1 3WE, GB
 CRÉPY, Karen Viviane Lucile, UCB Celltech, 208 Bath Road, Slough, Berkshire SL1 3WE, GB
 FOLEY, Anne Marie, UCB Celltech, 208 Bath Road, Slough, Berkshire SL1 3WE, GB
 FRANKLIN, Richard Jeremy, UCB Celltech, 208 Bath Road, Slough, Berkshire SL1 3WE, GB
- (74) RADULOVIĆ, S. Božidar, Jovana Tomaševića 9/III-1, Podgorica, 81000, ME

- (57) Jedinjenje, naznačeno time, da je predstavljeno sa formulom (I), ili njegova farmaceutski prihvatljiva so ili solvat:

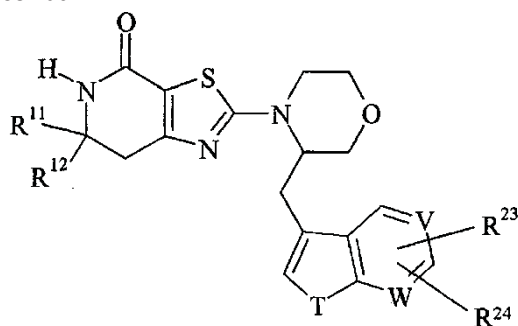

(I)

gde R¹¹ predstavlja vodonik ili C₁₋₆ alkil; R¹² predstavlja C₁₋₆ alkil; T predstavlja kiseonik ili N-R²⁵; V predstavlja ugljenik; W predstavlja ugljenik; R²³ predstavlja vodonik, halogen, cijano, nitro, C₁₋₆ alkil, hidroksi(C₁₋₆)alkil, trifluorometil, aril(C₁₋₆)alkil, oksazolinil, triazolil, hidroksi, C₁₋₆ alkoksi, difluorometoksi, trifluorometoksi, C₃₋₇ cikloalkoksi, C₃₋₇ cikloalkil(C₁₋₆)alkoksi, morfolinil(C₁₋₆)alkoksi, ariloksi, aril(C₁₋₆)alkoksi, C₁₋₆ alkiltio, C₁₋₆ alkilsulfonil, arilsulfonil, arilsulfonil, C₁₋₆ alkilsulfoniloksi, amino, azetidil, morfolinil, C₂₋₆ alkilkarbonilamino, C₂₋₆ alkilkarbonilaminometil, C₂₋₆ alkoksikarbonilamino, [(C₂₋₆)alkoksikarbonil][(C₁₋₆)alkil]amino, C₁₋₆ alkilsulfonilamino, C₂₋₆ alkilkarbonil, C₂₋₆ alkilkarbonil oksim, C₂₋₆ alkilkarbonil O-(metil)oksim, trifluorometilkarbonil, karboksi, C₂₋₆ alkoksikarbonil, aminokarbonil, C₁₋₆ alkilaminokarbonil, [hidroksi(C₁₋₆)-alkil]aminokarbonil, [di(C₁₋₆)alkilamino(C₁₋₆)alkil]aminokarbonil, di(C₁₋₆)alkilaminokarbonil, [(C₁₋₆)alkil][cijano(C₁₋₆)alkil]aminokarbonil, [(C₁₋₆)alkil][hidroksi(C₁₋₆)-alkil]aminokarbonil, [(C₁₋₆)alkoksi(C₁₋₆)alkil][(C₁₋₆)alkil]aminokarbonil, [di(C₁₋₆)alkilamino(C₁₋₆)alkil][(C₁₋₆)alkil]aminokarbonil, C₃₋₇ cikloalkil(C₁₋₆)alkilaminokarbonil, aril(C₁₋₆)alkilaminokarbonil, heteroarilaminokarbonil, heteroaril(C₁₋₆)alkilaminokarbonil, azetidilkarbonil, hidroksiazetidilkarbonil, aminoazetidilkarbonil, C₂₋₆ alkoksikarbonilaminoazetidilkarbonil, pirolidinilkarbonil, (C₁₋₆)alkilpirolidinilkarbonil, C₁₋₆ alkoksi(C₁₋₆)alkilpirolidinilkarbonil, di(C₁₋₆)alkilaminopiroldinilkarbonil, tiazolidinilkarbonil, oksotiazolidinilkarbonil, piperidinilkarbonil, (C₁₋₆)-alkilpiperazinilkarbonil, morfolinilkarbonil, C₁₋₆ alkilsulfonil, C₁₋₆ alkilsulfonilmetil ili di(C₁₋₆)alkilaminosulfonil; R²⁴ predstavlja vodonik; a R²⁵ predstavlja C₁₋₆ alkil; a pomenute heteroarilne grupe su izabrane iz furila, benzofurila, dibenzofurila, tienila, benzotienila, pirolila, indolila, pirololo[2,3-b]piridinila, pirololo[3,2-c]piridinila, pirazolila, pirazolo[1,5-a]piridinila, indazolila, oksazolila, benzoksazolila, izoksazolila, tiazolila, benzotiazolila, izotiazolila, imidazolila, benzimidazolila, imidazo[1,2-a]piridinila, imidazo[4,5-b]piridinila, imidazo[1,2-a]pirimidinila, imidazo[1,2-a]pirazinila, oksadiazolila, tiadiazolila, triazolila, benzotriazolila, tetrazolila, piridinila, kinolinila, izokinolinila, piridazinila, kinolinila, pirimidinila, pirazinila, kinoksalinila i hromenila.

Patent sadrži još 18 patentnih zahtjeva.

- (51) **C 07D 473/04**^{2006.01} **A 61K 31/522**^{2006.01} (11) **01593** (13) **B**
A 61P 3/10^{2006.01}
- (21) P-2013-77
(22) 26. 07. 2006
(30) 102005035891 30. 07. 2005 DE
(86) EP/06777973.6/26. 07. 2006
EP/PCT/EP2006/064657/26. 07. 2006
(87) WO 2007/014886/08. 02. 2007/2007/06
EP 1912990/23. 04. 2008/2008/17
EP 1912990/26. 06. 2013/2013/26
- (54) me **HIDROHLORIDI I HIDRATI 1-[(3-CIJANOPIRIDIN-2-IL)METIL]-3-METIL-7-(2-BUTIN-1-IL)-8-(3-AMINOPIPERIDIN-1-IL)KSANTINA, NJIHOVO DOBIJANJE I NJIHOVA PRIMENA KAO LIJEKOVA**
en **HYDROCHLORIDES AND HYDRATES OF 1-[(3-CYANOPYRIDIN-2-YL)METHYL]-3-METHYL-7-(2-BUTYN-1-YL)-8-(3-AMINOPIPERIDIN-1-YL)XANTHINE, THEIR PREPARATION AND THEIR USE AS MEDICAMENTS**
- (73) Boehringer Ingelheim International GmbH, Binger Strasse 173, 55216 Ingelheim am Rhein, DE
(72) PFRENGLE, Waldemar, Wittlingerweg 14, 88400 Biberach, DE
SIEGER, Peter, Klingenäcker 7, 88441 Mittelbiberach, DE
(74) RADULOVIĆ, S. Božidar, Jovana Tomaševića 9/III-1, Podgorica, 81000, ME
- (57) Hidrohloridna so 1-[(3-cijano-piridin-2-il)metil]-3-metil-7-(2-butin-1-il)-8-(3-amino-piperidin-1-il)-ksantina.
Patent sadrži još 14 patentnih zahtjeva.

(51) C 07D 487 / 08^{2006.01}

(11) 01594

(13) B

(21) P-2011-17

(22) 27. 02. 2006

(30) 20050658791P 04. 03. 2005 US

(86) EP/09158939.0/27. 02. 2006

(87) EP 2112153 /28. 10. 2009/2009/44

EP 2112153 /10. 11. 2010/2010/45

(54) me **POSTUPAK SMANJENJA ALFA, BETA NEZASIĆENIH KETONA U OPIOIDNIM KOMPOZICIJAMA**en **Method of reducing alpha, beta- unsaturated ketones in opioid compositions**

(73) EURO-CELTIQUE S.A., 2, avenue Charles de Gaulle, 1653 Luxembourg, LU

(72) Kupper, Robert Joe, 755 Major Potter Road, East Greenwich, RI 02818, US

(74) LUTOVAC, Branislav, Bulevar Ivana Crnojevića 93, Podgorica, 81000, ME

- (57) Postupak za smanjenje količine α , β -nezasićenih ketona u opioidnoj analgetičkoj kompoziciji koji se sastoji od hidrogenizacije polazne opioidne analgetičke kompozicija koja ima nečistoće α , β -nezasićenih ketona sa diimidom, jedinjenjem koje daje diimid ili njihovom kombinacijom u pogodnom rastvaraču, da bi se dobila rezultujuća opioidna analgetička kompozicija koja ima nivo α , β -nezasićenih ketona manji od polazne kompozicije, a gde je opioidni analgetik jedinjenje formule (III):

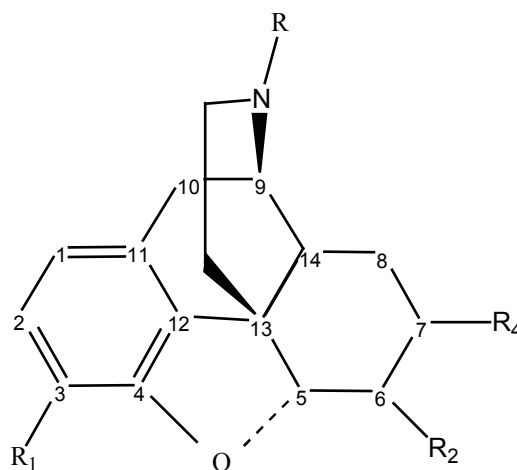

(III)

gde R je izabran iz grupe koju čine vodonik; C_{1-8} alkil; C_{3-6} cikloalkil; (C_{3-6})cikloalkil(C_{1-3})alkil; fenil(C_{1-3})alkil; i fenil(C_{1-3})alkil supstituisan sa 1-3 člana grupe koju čine C_{1-8} alkil, trifluorometil, nitro, dialkilamino i cijano; R_1 je izabran iz grupe koju čine vodonik; C_{1-8} alkil; C_{3-6} cikloalkil; C_{1-8} alkoksi; C_{3-6} cikloalkoksi; 2-(4-morfolinil)etil; benziloksikarbonil; (R_8)₃C(O)-; fenil(C_{1-3})alkil; i fenil(C_{1-3})alkil supstituisan sa 1-3 člana grupe koju čine C_{1-8} alkil, trifluorometil, nitro, dialkilamino i cijano; R_2 je izabran iz grupe koju čine vodonik; okso; hidroksil; C_{1-8} alkil; C_{1-8} alkoksi; C_{3-6} cikloalkil; i C_{3-6} cikloalkoksi; i R_4 je vodonik; hidroksil; alkoksi; C_{1-8} alkil supstituisan sa 1-3 člana grupe koju čine C_{1-8} alkil, hidroksil, cijano, nitro i dialkilamino; svaki R_8 je nezavisno vodonik, C_{1-4} alkil, C_{3-6} cikloalkil, fenil ili benzil ili njegova farmaceutski prihvatljiva so.

Preostalo patentnih zahtjeva 8.

- (51) C 07D 401/06²⁰⁰⁶⁰¹⁰¹ A 61P 35/00²⁰⁰⁶⁰¹⁰¹ (11) 01595 (13) B
 A 61K 31/454²⁰⁰⁶⁰¹⁰¹
- (21) P-2013-85
 (22) 17. 10. 2006
 (30) 20050021244 19. 10. 2005 GB
 (86) EP/06794783.8/17. 10. 2006
 GB/PCT/GB2006/003838/17. 10. 2006
 (87) WO 2007045844/26. 04. 2007/2007/17
 EP 1954690/13. 08. 2008/2008/33
 EP 1954690/15. 05. 2013/2013/20
- (54) me **BENZAMIDINSKA JEDINJENJA KOJA SU KORISNA KAO INHIBITORI HISTONSKE DEACETILAZE**
 en **BENZAMIDE COMPOUNDS USEFUL AS HISTONE DEACETYLASE INHIBITORS**
- (73) AstraZeneca AB, 151 85 Södertälje, SE
 (72) ANDREWS, David, Michael,
 AstraZeneca R & D Alderley, Alderley Park, Macclesfield Cheshire SK10 4TG, GB
 STOKES, Elaine Sophie Elizabeth, Macclesfield Cheshire SK10 4TG, GB
 TURNER, Andrew, AstraZeneca R & D Alderley, Alderley Park, Macclesfield Cheshire SK10 4TG, GB
 WARING, Michael, James,
 AstraZeneca R & D Alderley, Alderley Park, Macclesfield Cheshire SK10 4TG, GB
 (74) RADULOVIĆ, S. Božidar, Jovana Tomaševića 9/III-1, Podgorica, 81000, ME

- (57) Jedinjenje, naznačeno time, da je predstavljeno sa formulom (IA)

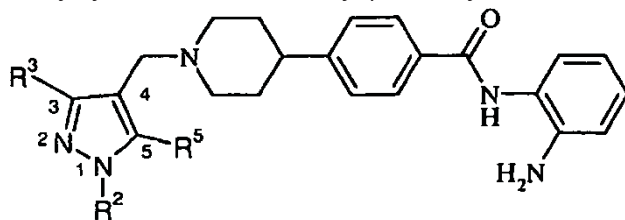

(IA)

gde R², R³ i R⁵ su nezavisno izabrani iz vodonika ili metila; ili neka njegova farmaceutski prihvatljiva so.
 Preostalo patentnih zahtjeva 12.

(51) C07D417/14^{2006.01} C07D401/12^{2006.01} (11) 01596 (13) B
 C07D401/14^{2006.01} C07D403/14^{2006.01}
 C07D409/14^{2006.01} C07D413/14^{2006.01}
 C07D417/12^{2006.01}

(21) P-2013-86
 (22) 18. 02. 2005
 (30) 20040546213P 20. 02. 2004 US
 (86) EP/05714457.8/18. 02. 2005
 CA/PCT/CA2005/000208/18. 02. 2005
 (87) WO 2005/080388/01. 09. 2005/35/2005
 EP 1718608/08. 11. 2006/2006/45
 EP 1718608/17. 07. 2013/2013/29

(54) me **VIRUSNI POLIMERAZNI INHIBITORI**
 en **VIRAL POLYMERASE INHIBITORS**

(73) Boehringer Ingelheim International GmbH, Binger Strasse 173, 55216 Ingelheim am Rhein, DE

(72) TSANTRIZOS, Youla, S., 2100 Cunard Street, Laval, Québec H7S 2G5, CA
 CHABOT, Catherine, 2100 Cunard Street, Laval, Québec H7S 2G5, CA
 BEAULIEU, Pierre, 2100 Cunard Street, Laval, Québec H7S 2G5, CA
 BROCHU, Christian, 2100 Cunard Street, Laval, Québec H7S 2G5, CA
 POIRIER, Martin, 2100 Cunard Street, Laval, Québec H7S 2G5, CA
 STAMMERS, Timothy, A., 2100 Cunard Street, Laval, Québec H7S 2G5, CA
 THAVONEKHAM, Bounkham, 2100 Cunard Street, Laval, Québec H7S 2G5, CA
 RAN COURT, Jean, 2100 Cunard Street, Laval, Québec H7S 2G5, CA

(74) RADULOVIĆ, S. Božidar, Jovana Tomaševića 9/III-1, Podgorica, 81000, ME

(57) Jedinjenje, odabrano među

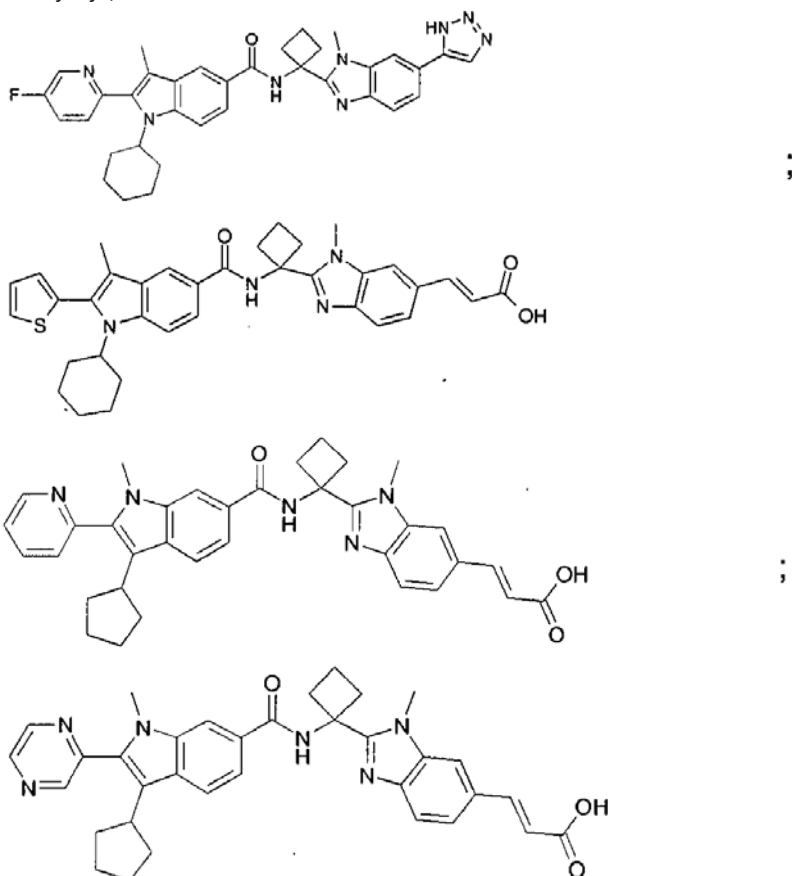

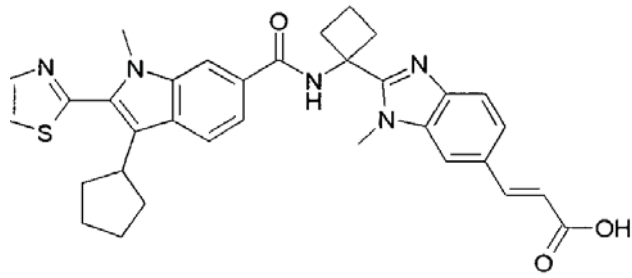

;

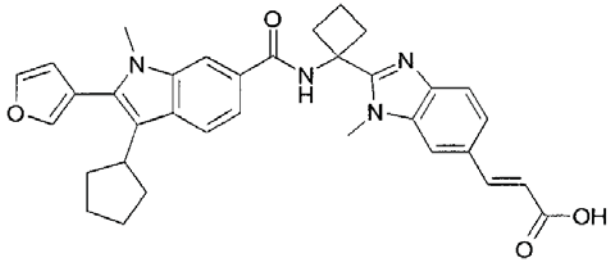

;

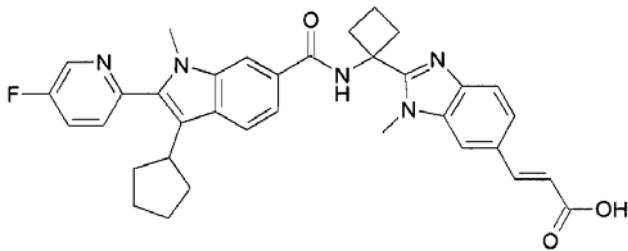

;

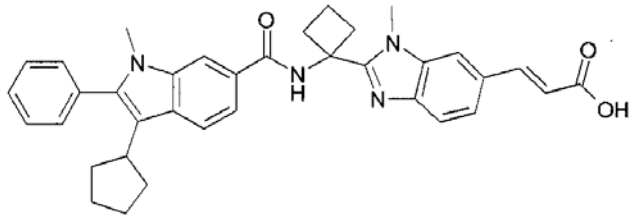

;

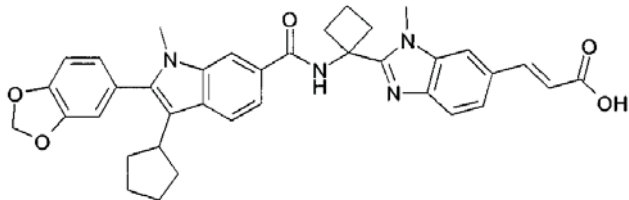

;

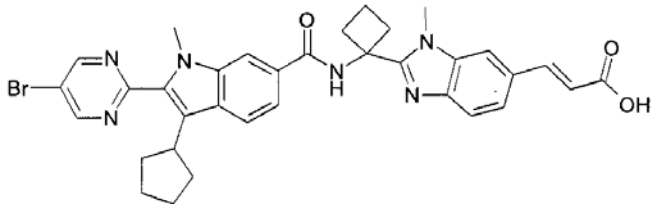

;

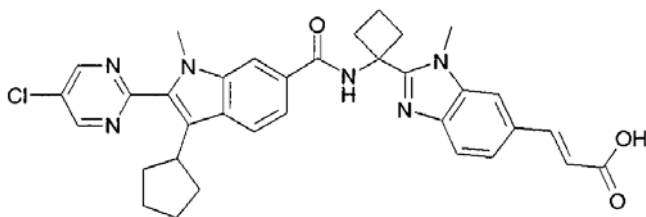

;

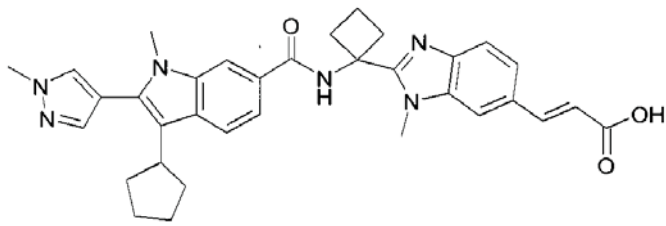

;

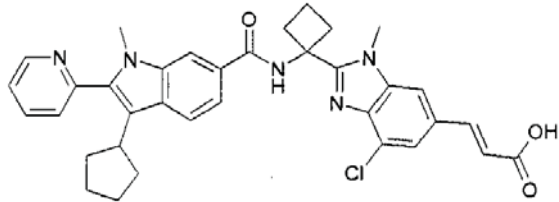

;

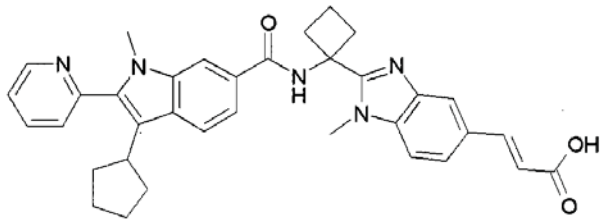

;

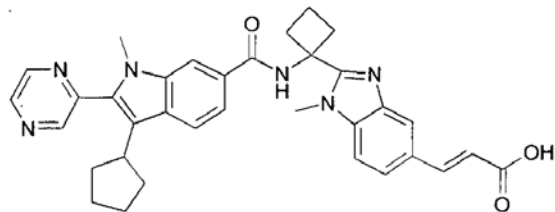

;

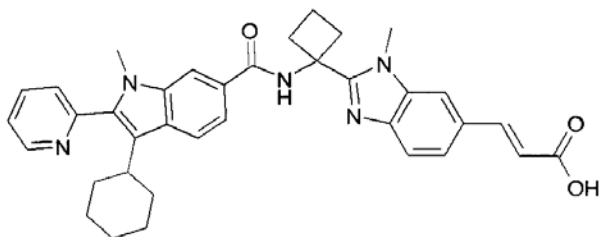

;

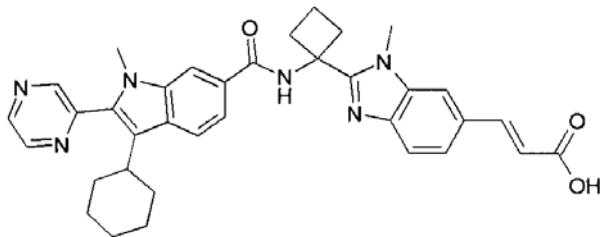

;

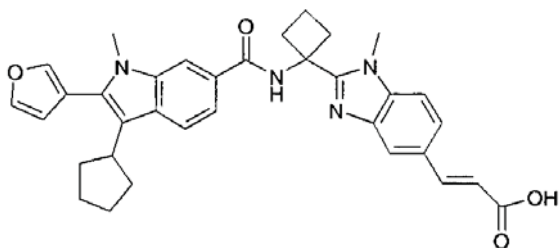

;

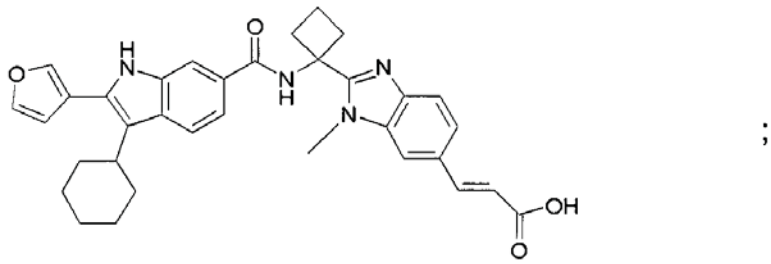

;

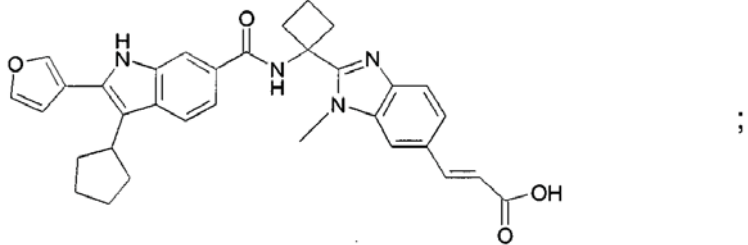

;

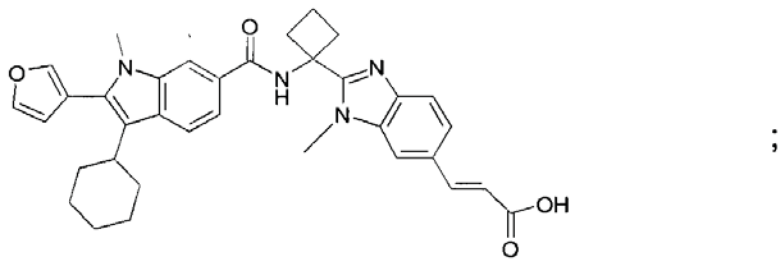

;

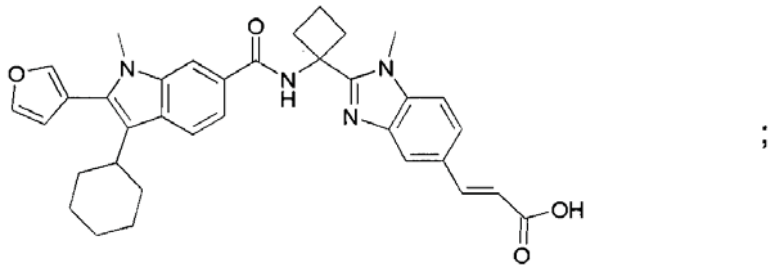

;

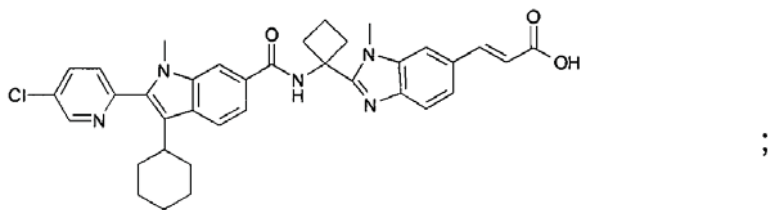

;

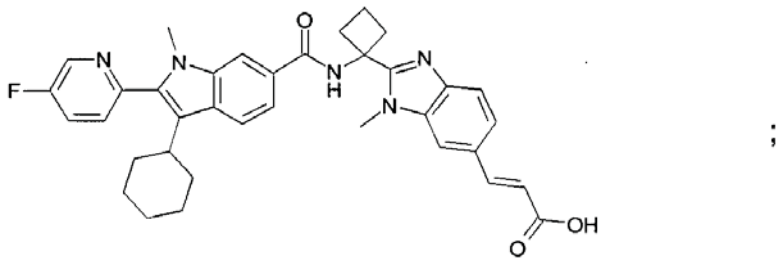

;

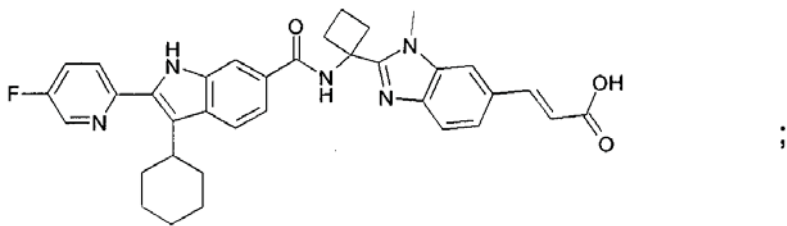

;

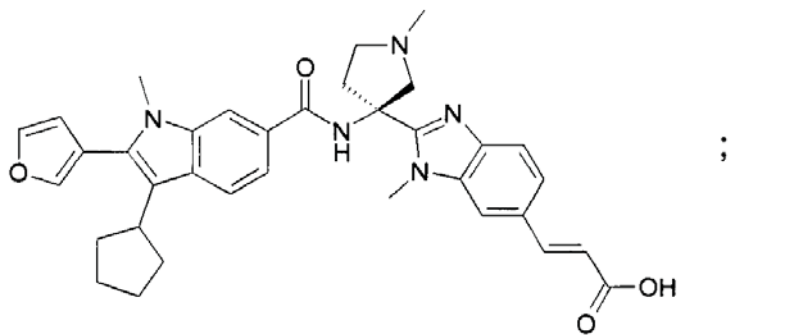
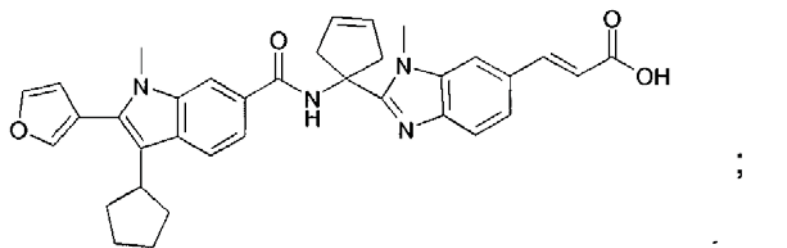
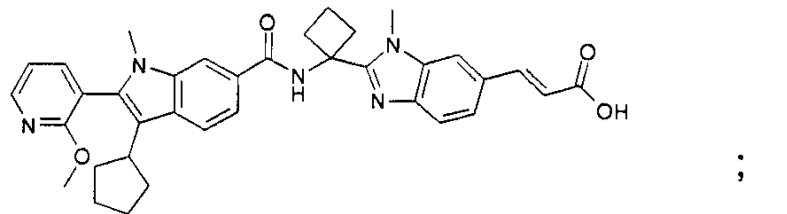
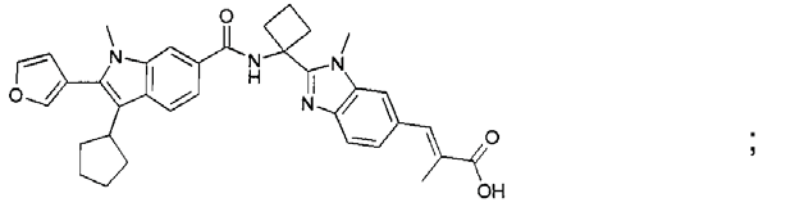
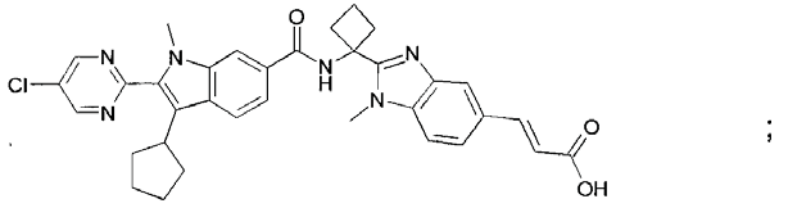
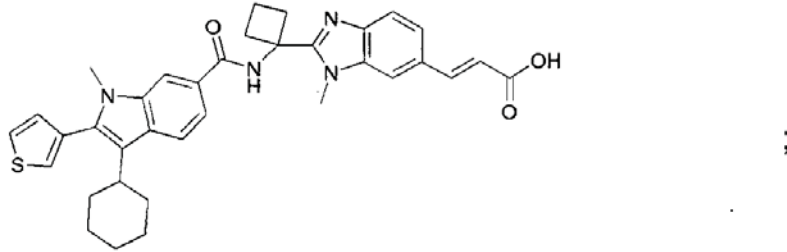
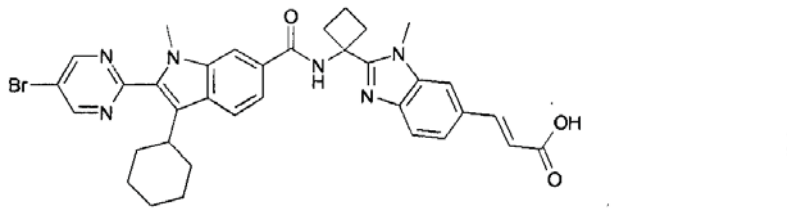

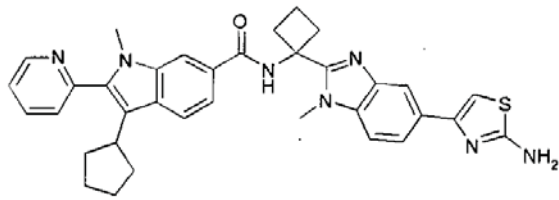

;

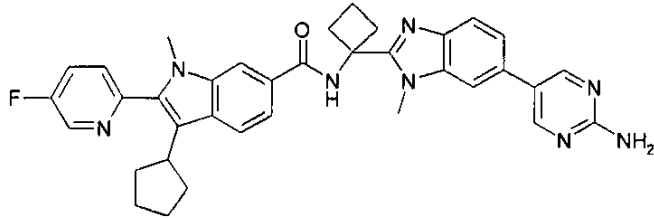

;

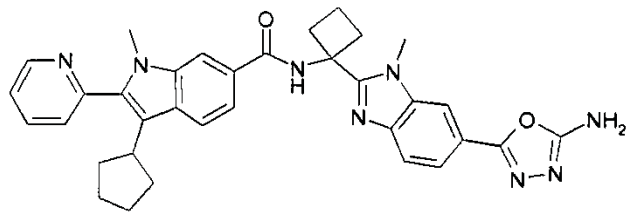

;

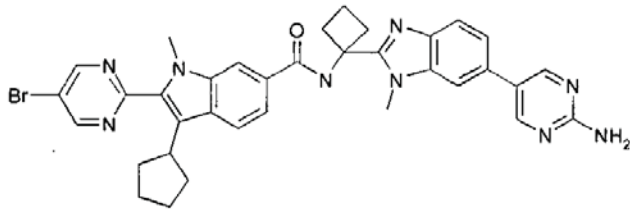

;

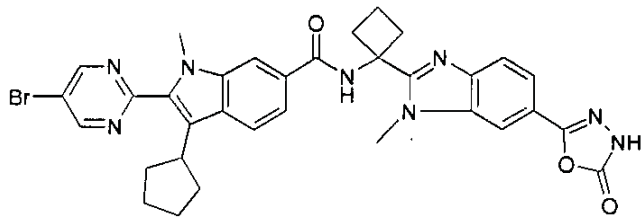

;

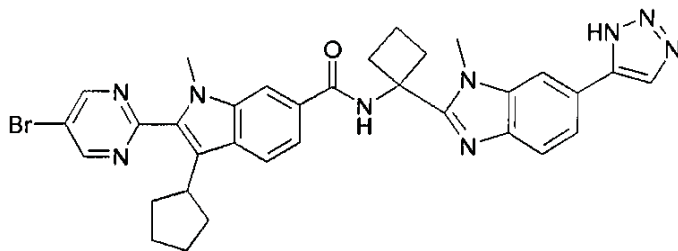

;

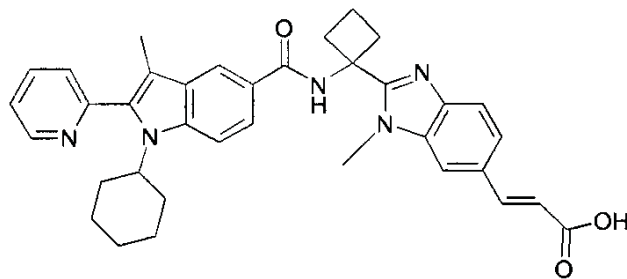

;

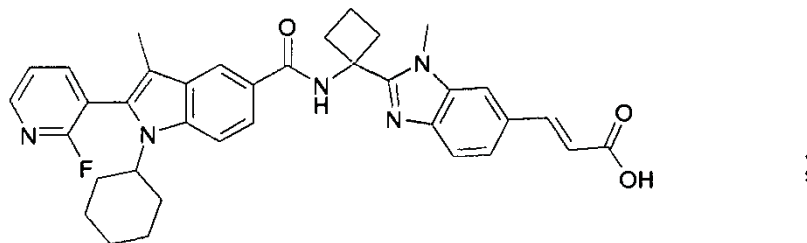
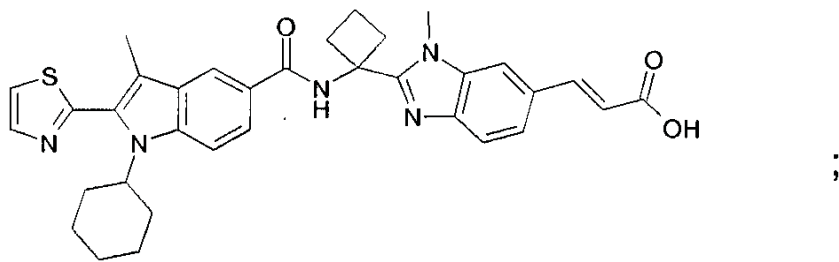
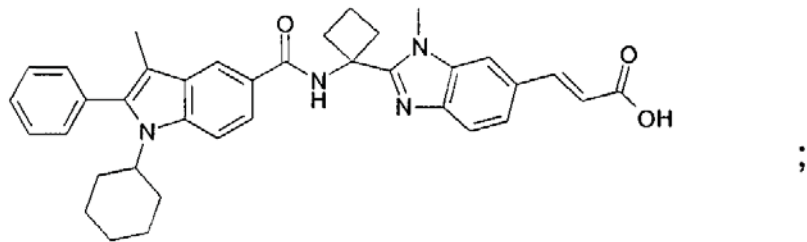
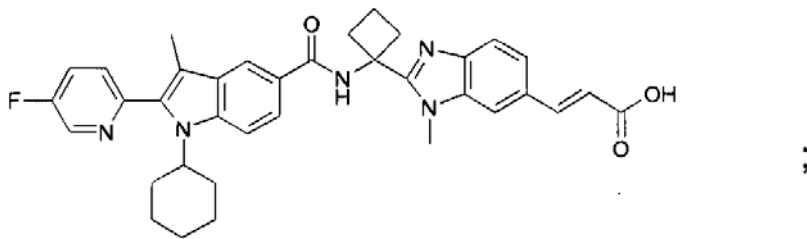
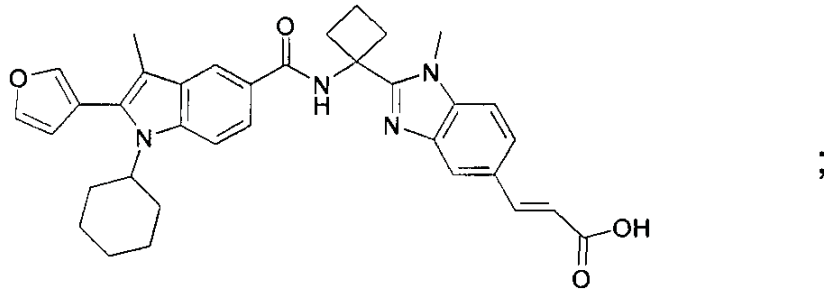
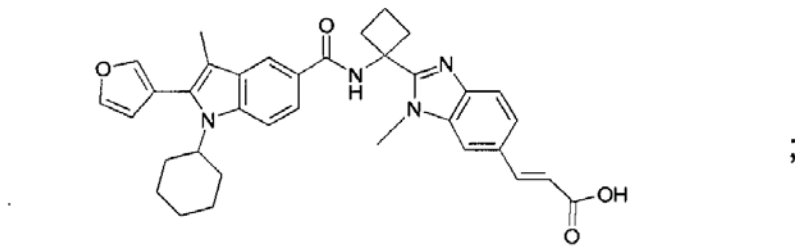

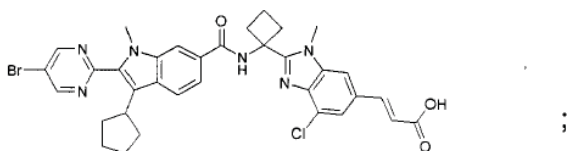
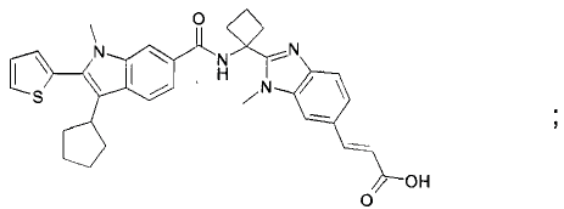
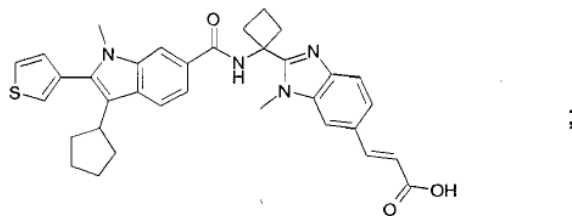
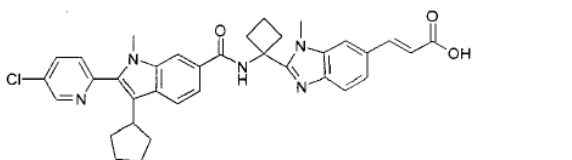
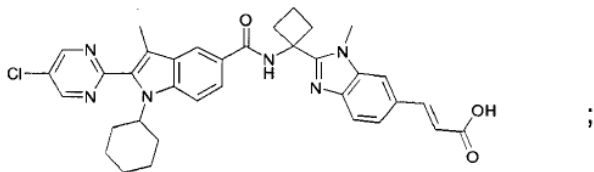
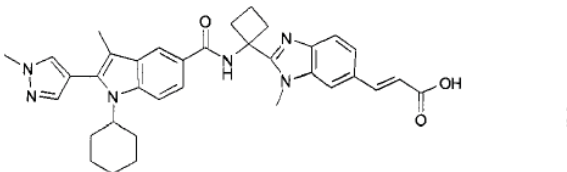
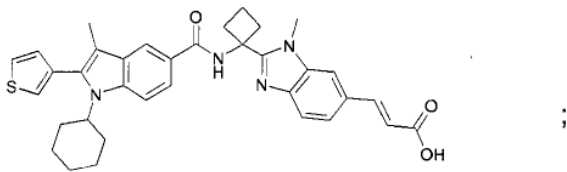

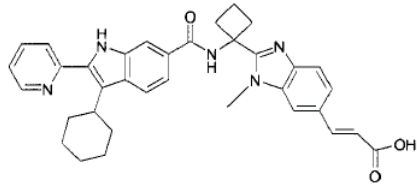

;

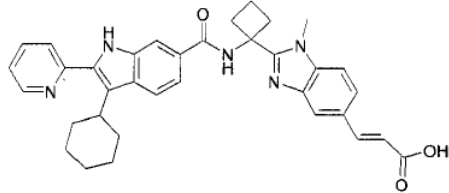

;

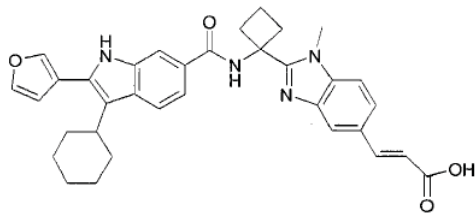

;

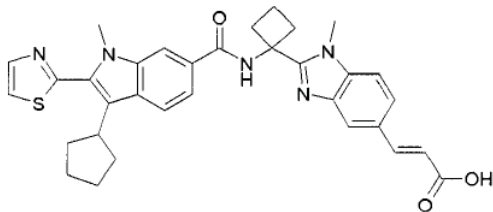

;

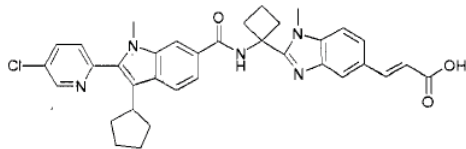

;

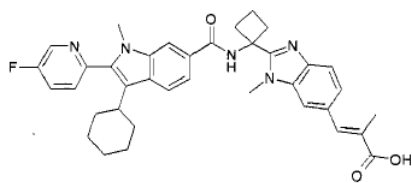

;

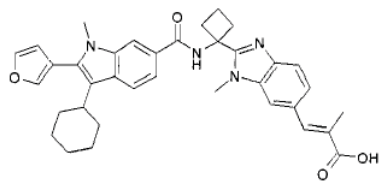

;

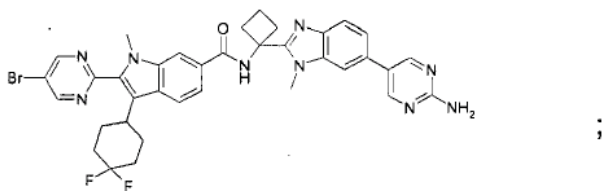
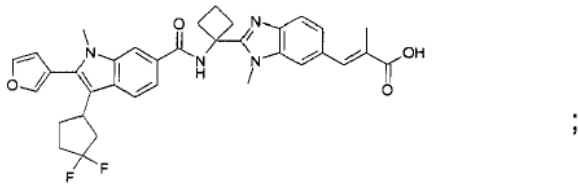
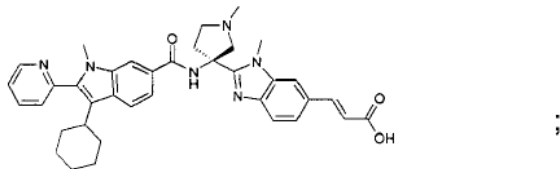
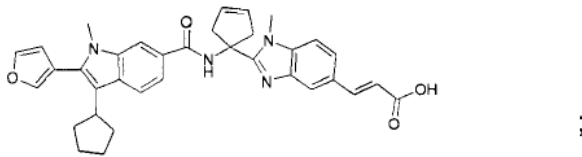
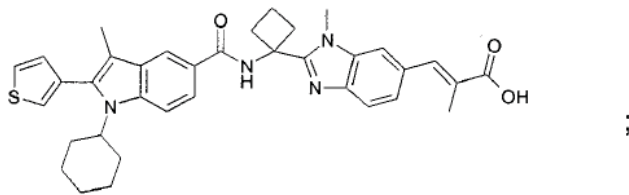
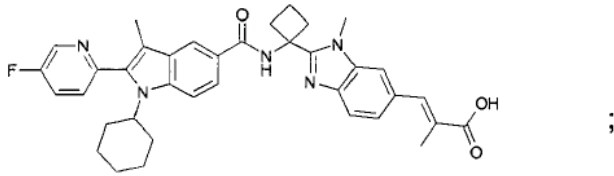
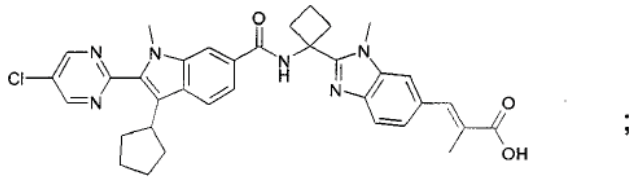

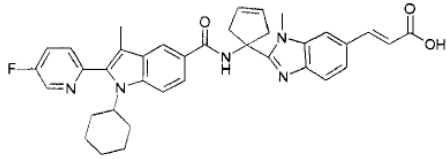

;

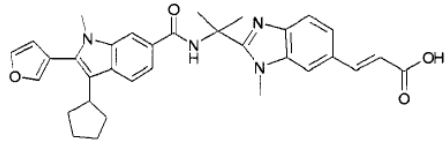

;

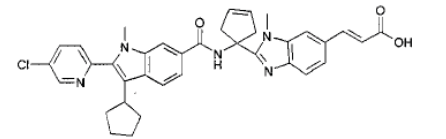

;

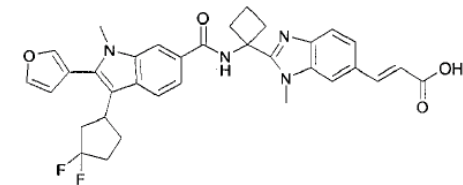

;

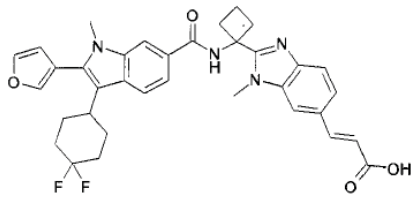

;

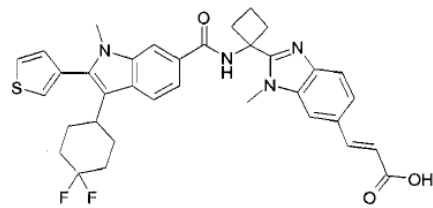

;

i

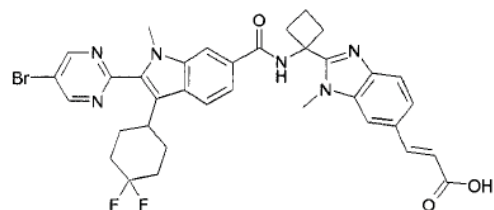

;

ili njegova so ili ester.
Preostalo patentnih zahtjeva 31.

- (51) **A 61K 38/08**²⁰⁰⁶⁰¹⁰¹ **A 61P 25/02**²⁰⁰⁶⁰¹⁰¹ (11) **01597** (13) **B**
A 61K 31/517²⁰⁰⁶⁰¹⁰¹ **A 61P 25/06**²⁰⁰⁶⁰¹⁰¹
 (21) P-2013-88
 (22) 23. 12. 2005
 (30) 20040907332 24. 12. 2004 AU
 (86) EP/05821524.5/23. 12. 2005
 AU/PCT/AU2005/001975/23. 12. 2005
 (87) WO 2006/066361 /29. 06. 2006/2006/26
 EP 1830869 /12. 09. 2007/2007/37
 EP 1830869 /22. 05. 2013/2013/21
 (54) me **POSTUPAK LIJEČENJA ILI PROFILAKSE**
 en **METHOD OF TREATMENT OR PROPHYLAXIS**
 (73) Spinifex Pharmaceuticals Pty Ltd,
 South Yarra Corporate Centre Suite T18, Level 1, 122 Toorak Road, South Yarra, VIC 3141, AU
 (72) SMITH, Maree, Therese, 31 Chiswick Road, Bardon, QLD 4065, AU
 WYSE, Bruce, Douglas, 25 Clara Street, Corinda, QLD 4075, AU
 (74) RADULOVIĆ, S. Božidar, Jovana Tomaševića 9/III-1, Podgorica, 81000, ME

- (57) Upotreba efikasne količine antagoniste AT₂ receptora, koji je opciono u obliku jedinjenja koje se sastoji od farmaceutski prihvatljivog nosača i/ili rastvarača, u proizvodnji leka za lečenje, prevenciju ili ublažavanje neuropatskog bola kod ispitanika; naznačeno time što je antagonista AT₂ receptora odabran od jedinjenja predstavljenih pomoću formule (I):

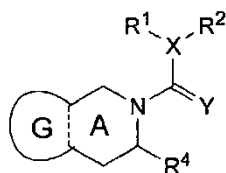

(I)

naznačena time što: su R¹ i R² nezavisno odabrani od sledećeg: H, benzil, supstituisani benzil, fenil, supstituisani fenil, C₁₋₆ alkil, supstituisani C₁₋₆ alkil, C₃₋₆ cikloalkil, supstituisani C₃₋₆ cikloalkil, i heteroaril, pod uslovom da ni R¹ ni R² nisu vodonik, je R⁴ odabran od sledećeg: karboksilat, karboksilna kiselina, sulfat, fosfat, sulfonamid, fosfonamid ili amid, je X odabran od sledećeg: CH, azot, sumpor ili kiseonik pod uslovom da kada je X sumpor ili kiseonik jedan od R¹ ili R² nedostaje, je Y odabran od sledećeg: sumpor, kiseonik ili N-R^N, gde je R^N odabran od sledećeg: H, C₁₋₆ alkil, supstituisani C₁₋₆ alkil, aril, supstituisani aril, benzil, supstituisani benzil, C₁₋₄ alkilaril, supstituisani C₁₋₄ alkilaril, OH, ili NH₂, je G petočlani ili šestočlani, homoaromatični ili nezasićeni, supstituisani ili nesupstituisani, heterociklični prsten koji uključuje, ali bez ograničenja na, sledeće sisteme prstenova:

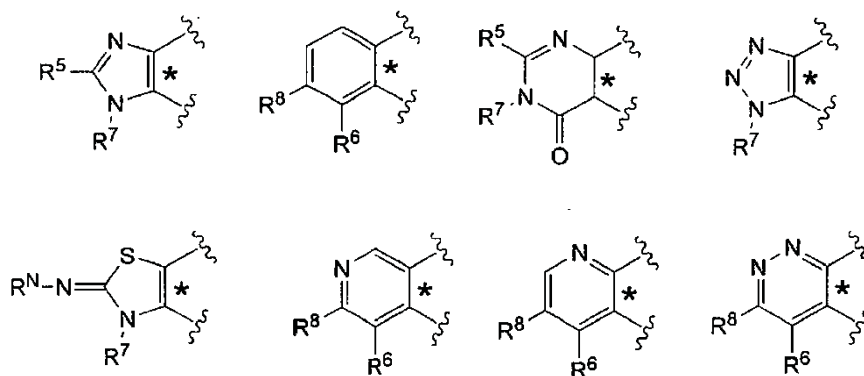

gde simbol „*“ označava vezu koju dele fuzirani prstenovi „A“ i „G“, je R⁵ odabran od sledećeg: H, C₁₋₆ alkil, fenil, supstituisani fenil, supstituisani C₁₋₆ alkil, C₁₋₆ alkoksi, ili supstituisani C₁₋₆ alkoksi, su R⁶ i R⁸ nezavisno odabrani od sledećeg: H, C₁₋₆ alkil, supstituisani C₁₋₆ alkil, C₁₋₆ alkoksi, supstituisani C₁₋₆ alkoksi, fenil, feniloksi, benzil, benziloksi, benzilamino, bifenil, supstituisani bifenil, bifeniloksi, supstituisani bifeniloksi, naftil, supstituisani naftil, pod uslovom da jedan od R⁶ ili R⁸ nije vodonik, i je R⁷ odabran od sledećeg: fenil, supstituisani fenil, benzil, supstituisani benzil, bifenil, supstituisani bifenil, bifenilmetilen, supstituisani bifenilmetilen, naftil, supstituisani naftil, naftilmetilen, i supstituisani naftilmetilen, ili njegova farmaceutski kompatibilna so. Preostalo patentnih zahtjeva 16.

(51) C07D401/14^{2006.01} A61K31/444^{2006.01} (11) 01598 (13) B

(21) P-2013-90

(22) 26. 08. 2009

(30) 20080218851 27. 08. 2008 JP

20080269099 17. 10. 2008 JP

(86) EP/09788053.8/26. 08. 2009

JP/PCT/JP2009/065279/26. 08. 2009

(87) WO 2010024451 /04. 03. 2010/2010/09

EP 2318390/11. 05. 2011/2011/19

EP 2318390/01. 05. 2013/2013/18

(54) me **JEDINJENJA PIROLA**
en **PYRROLE COMPOUNDS**

(73) Takeda Pharmaceutical Company Limited,

1-1, Doshomachi-4-chome, Chuo-ku, Osaka-shi, Osaka 541-0045, JP

(72) NISHIDA, Haruyuki,

c/o TAKEDA PHARMACEUTICAL COMPANY LIMITED, Osaka-shi Osaka 532-8686, JP

17-85, Jusohonmachi 2-chome, Yodogawa-ku

ARIKAWA, Yasuyoshi, c/o Takeda Pharmaceutical Company Limited, Osaka-shi Osaka 532-8686, JP

17-85, Jusohonmachi 2-chome, Yodogawa-ku

FUJIMORI, Ikuo,

c/o TAKEDA PHARMACEUTICAL COMPANY LIMITED 17-85, Osaka-shi Osaka 532-8686, JP

Jusohonmachi 2-chome Yodogawa-ku

(74) ČUPIĆ, Branislav, Dalmatinska 10, Podgorica, 81000, ME

(57) Jedinjenje formule (I)

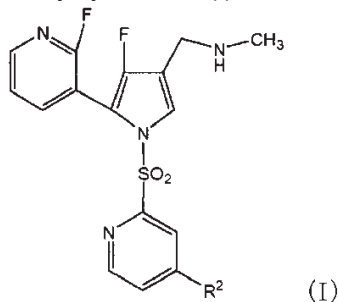

u kojoj R² je atom halogena, C₁₋₆ alkil grupa po izboru supstituisana halogenom ili C₁₋₆ alkoksi grupa po izboru supstituisana halogenom, ili njegova so.

Preostalo patentnih zahtjeva 8.

(51) C 07 D 401 / 04^{2006.01}

(11) 01599

(13) B

(21) P-2013-91

(22) 11. 08. 2005

(30) 20040019365 14. 08. 2004 EP

20050001611 27. 01. 2005 EP

(86) EP/05771218.4/11. 08. 2005

EP/PCT/EP2005/008734/11. 08. 2005

(87) WO 2006/018220/23. 02. 2006/08/2006

EP 1778668/02. 05. 2007/2007/18

EP 1778668/03. 07. 2013/2013/27

(54) me **POSTUPAK ZA DOBIJANJE DIHIDROPTERIDINONA**
en **METHOD FOR THE PRODUCTION OF DIHYDROPTERIDINONES**

(73) Boehringer Ingelheim International GmbH, Binger Strasse 173, 55216 Ingelheim am Rhein, DE

(72) LINZ, Guenter, Eschenweg 6, 88441 MITTELBIERACH, DE
KRAEMER, Gerd F., Auenweg 38a, 88436 EBERHARDZELL, DE
GUTSCHERA, Ludwig, Irisweg 31, 89079 ULM, DE
ASCHE, Geert, Baid 17, 88400 Biberach, DE

(57) Postupak za dobijanje dihidropteridinona opšte formule (I)

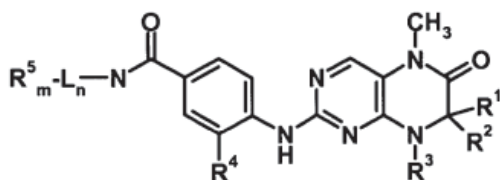

(I)

pri čemu R¹, R² koji mogu biti dentični ili različiti, označavaju vodonik ili opciono supstituisani C₁-C₆-alkil, ili R¹ i R² zajedno označavaju 2- do 5- član i alkil most koji može sadržati 1 do 2 heteroatoma, R³ označava vodonik ili radikal koji je izabran iz grupe koja se sastoji od opciono supstituisanog C₁-C₁₂-alkila, C₂-C₁₂-alkenila, C₂-C₁₂-alkinila i C₆-C₁₄-arila, ili radikal koji je izabran iz grupe koja se sastoji od opciono supstituisanog i/ili premošćenog C₃-C₁₂-cikloalkila, C₃-C₁₂-cikloalkenila, C₇-C₁₂-policikloalkila, C₇-C₁₂-policikloalkenila, C₅-C₁₂-spiro-cikloalkila, C₃-C₁₂-heterocikloalkila kojisadrži od 1 do 2 heteroatoma, i C₃-C₁₂-heterocikloalkenila kojisadrži od 1 do 2 heteroatoma, ili R¹ i R³ ili R² i R³ zajedno označavaju zasićeni ili nezasićeni C₃-C₄-alkil most koji može opciono sadržati 1 heteroatom, R⁴ označava radikal koji je izabran iz grupe koja se sastoji od vodonika, -CN, hidroksi, -NR⁶R⁷ i halogena, ili radikal koji je izabran iz grupe koja se sastoji od opciono supstituisanog C₁-C₆-alkila, C₂-C₆-alkenila, C₂-C₆-alkinila, C₁-C₅-alkiloksi, C₂-C₅-alkeniloksi, C₂-C₅-alkiniloksi, C₁-C₆-alkiltio, C₁-C₆-alkilsulfokso i C₁-C₆-alkilsulfonila, L označava linker kojije izabran iz grupe koja se sastoji od opciono supstituisanog C₂-C₁₀-alkila, C₂-C₁₀-alkenila, C₆-C₁₄-arila, -C₂-C₄-alkil-C₆-C₁₄-arila, -C₆-C₁₄-aril-C₁-C₄-alkila, opciono premošćenog C₃-C₁₂-cikloalkila i heteroarila koji opciono sadrži 1 ili 2 atomaazota, n označava 0 ili 1 m označava 1 ili 2 R⁵ označava radikal koji je izabran iz grupe koja se sastoji od opciono supstituisanog morfolinila, piperidinila, piperazinila, piperazinilkarbonila, pirolidinila, tropenila, R⁸ -diketometilpiperazinila, sulfoksomorfolinila, sulfonilmorfolinila, tiomorfolinila, -NR⁸ R⁹ i azacikloheptila, R⁶, R⁷ koji mogu biti identični ili različiti, označavaju vodonik ili C₁-C₄-alkil, i R⁸, R⁹ označavaju nesupstitui i sa neazotne supstituentena R⁵, koji mogu biti identični ili različiti, bilo vodonik ili radikal koji je izabran iz grupe koja se sastoji od C₁-C₆-alkila, -C₁-C₄-alkil-C₃-C₁₀-cikloalkila, C₃-C₁₀-cikloalkila, C₆-C₁₄-arila, -C₁-C₄-alkil-C₆-C₁₄-arila, piranila, piridinila, pirimidinila, C₁-C₄-alkiloksikarbonila, C₆-C₁₄-arilkarbonila, C₁-C₄-alkilkarbonila, C₆-C₁₄-arilmetiloksikarbonila, C₆-C₁₄-arilsulfonila, C₁-C₄-alkilsulfonila i C₆-C₁₄-aril-C₁-C₄-alkilsulfonila, naznačen time, što jedinjenje je formule (II)

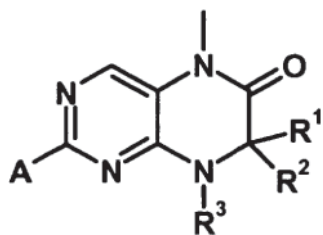

(II)

Pričemu R¹ do R³ imaju gore navede naznačenja i A je odlazeća grupa, reaguje sa jedinjenjem formule (III)

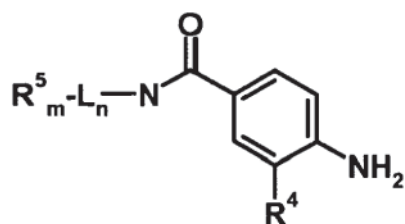

(III)

i m, n mogu imati gore navedena značenja.
Preostalo patentnih zahtjeva 14.

u prisustvu organskih sulfonskih kiselina, pričemu R⁴, R⁵, L

- (51) **C 12N 15/113**^{2006.01} **A 61K 31/7088**^{2006.01} (11) **O 1600** (13) **B**
C 12Q 1/68^{2006.01}
- (21) P-2013-93
(22) 26. 02. 2009
(30) 20080003570 27. 02. 2008 EP
20080031835P 27. 02. 2008 US
20080033340P 03. 03. 2008 US
PCT/EP2009/051986 19. 02. 2009 WO
(86) EP/09714079.2/26. 02. 2009
EP/PCT/EP2009/05190/26. 02. 2009
(87) WO 2009106367/03. 09. 2009/2009/36
EP 2260101/15. 12. 2010/2010/50
EP 2260101/29. 05. 2013/2013/22
- (54) me **MIKRORNK (MIRNK) MIR-21 ZA DIJAGNOZU I TERAPEUTSKE SVRHE**
en **MICRORNA (MIRNA) MIR-21 FOR DIAGNOSTIC AND THERAPEUTIC PURPOSES**
- (73) Julius-Maximilians-Universität Würzburg, Sanderring 2, 97070 Würzburg, DE
(72) THUM, Thomas, Leutfresserweg 24, 97082 Würzburg, DE
BAUERSACHS, Johann, Zürnstrasse 15, 97074 Würzburg, DE
ENGELHARDT, Stefan, Winterleitenweg 33, 97082 Würzburg, DE
GROSS, Carina, Huttenstr. 24a, 97072 Würzburg, DE
(74) RADULOVIĆ, S. Božidar, Jovana Tomaševića 9/III-1, Podgorica, 81000, ME
- (57) Jedinjenje, naznačeno time, da sadrži modifikovani oligonukleotid koji obuhvata 12 do 30 spojenih nukleozida, pri čemu modifikovani oligonukleotid ima nukleobaznu sekvencu koja je komplementarna sa miR-21 ili njenim prekursorom, za upotrebu u tretmanu, prevenciji ili dijagnozi fibroze u nekom subjektu. Preostali patentni zahtjevi 14.

- (51) **C 07D 233/54**^{2006.01} **A 61K 31/417**^{2006.01} (11) **01601** (13) **B**
A 61P 25/04^{2006.01}
- (21) P-2013-97
(22) 14. 03. 2005
(30) 20040553342P 15. 03. 2004 US
(86) EP/10182349.0/14. 03. 2005
(87) EP 2298744 /23. 03. 2011/2011/12
EP 2298744 /10. 08. 2011/2011/32
EP 2298744 /26. 06. 2013/2013/26
- (54) me **MODULATORI OPIOIDNOG RECEPTORA**
en **OPIOID RECEPTOR MODULATORS**
- (73) Janssen Pharmaceutica NV, Turnhoutseweg 30, 2340 Beerse, BE
(72) Breslin, Henry, J., 1974 Muhlenburg Drive, Lansdale, PA 19446, US
Cai, Chaozhong, 129 Banbury Avenue, N. Wales, PA 19454, US
He, Wei, 2002 Kestral Circle, Audubon, PA 19403, US
Kavash, Robert, W., 148 N. Keswick Avenue, Glenside, PA 19038, US
(74) RADULOVIĆ, S. Božidar, Jovana Tomaševića 9/III-1, Podgorica, 81000, ME

(57) Jedinjenje Formule (I)

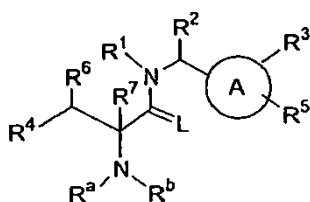

Formula (I)

pri čemu : R¹ je izabran iz grupe koju čine vodonik, C₁₋₆ alkil, cikloalkil, heterociklil, aril(C₁₋₆)alkil, i heteroaril(C₁₋₆)alkil; pri čemu kada je R¹ fenil(C₁₋₆)alkil, fenil je proizvoljno fuzioniran na heterociklil ili cikloalkil; pri čemu kada R¹ je C₁₋₂alkil, navedeni C₁₋₂alkil je opciono supstituisan sa jednim do dva supstituenta nezavisno izabrana iz grupe koju čine C₁₋₆alkoksi, aril, cikloalkil, heterociklil, hidroksi, cijano, amino, C₁₋₆alkilamino, (C₁₋₆alkil)₂amino, trifluorometil, i karboksi; i dalje, pri čemu kada R² je C₃₋₆alkil, navedeni C₃₋₆alkil je opciono supstituisan s jednim do tri supstituenta nezavisno izabrana iz grupe koju čine C₁₋₆alkoksi, aril, cikloalkil, heterociklil, hidroksi, cijano, amino, C₁₋₆alkilamino, (C₁₋₆alkil)₂amino, trifluorometil, i karboksi; pri čemu cikloalkil i heterociklil od C₁₋₂alkila i C₃₋₆alkila su opciono supstituisani sa jednim do dva supstituenta nezavisno izabrana iz grupe koju čine C₁₋₆alkil, hidroksi(C₁₋₆)alkil, C₁₋₆alkoksi, hidroksi, cijano, amino, C₁₋₆alkilamino, (C₁₋₆alkil)₂amino, trifluorometil, karboksi, aril(C₁₋₆)alkoksikarbonil, C₁₋₆alkoksikarbonil, aminokarbonil, C₁₋₆alkilaminokarbonil, (C₁₋₆alkil)₂aminokarbonil, i aminosulfonil; dalje, pri čemu cikloalkil i heterociklil od R¹ su opciono supstituisani sa jednim do dva supstituenta nezavisno izabrana iz grupe koju čine C₁₋₆alkil, hidroksi(C₁₋₆)alkil, C₁₋₆alkoksi, hidroksi, cijano, amino, C₁₋₆alkilamino, (C₁₋₆alkil)₂amino, trifluorometil, karboksi, aril(C₁₋₆)alkoksikarbonil, C₁₋₆alkoksikarbonil, aminokarbonil, C₁₋₆alkilaminokarbonil, (C₁₋₆alkil)₂aminokarbonil, i aminosulfonil; i dalje, pri čemu arilni i heteroarilni deo od R¹ supstituenata aril(C₁₋₆)alkila i heteroaril(C₁₋₆)alkila, su opciono supstituisani sa jednim do tri R¹¹ supstituenta nezavisno izabrana iz grupe koju čine C₁₋₆alkil; hidroksi(C₁₋₆)alkil; C₁₋₆alkoksi; C₆₋₁₀aril(C₁₋₆)alkil; C₆₋₁₀aril(C₁₋₆)alkoksi; C₆₋₁₀aril; heteroaril opciono supstituisan sa jednim do dva supstituenta nezavisno izabrana iz grupe koju čine C₁₋₄alkil, C₁₋₄alkoksi, i karboksi; cikloalkil; heterociklil; C₆₋₁₀ariloksi; heteroariloksi; cikloalkiloksi; heterocikliloksi; amino; C₁₋₆alkilamino; (C₁₋₆alkil)₂amino; C₃₋₆cikloalkilaminokarbonil; hidroksi(C₁₋₆)alkilaminokarbonil; C₆₋₁₀arilaminokarbonil gde je C₅₋₁₀aril opciono supstituisan sa karboksi ili C₁₋₄alkoksikarbonilom; heterociklilkarbonil; karboksi; C₁₋₆alkoksikarbonil; C₁₋₆alkoksikarboniloksi; C₁₋₆alkilkarbonil; C₁₋₆alkilkarbonilamino; aminokarbonil; C₁₋₆alkilaminokarbonil; (C₁₋₆alkil)₂aminokarbonil; cijano; halogen; trifluorometil; trifluorometoksi; i hidroksi; obezbeđujući da je ne više od jedan R¹¹ supstituent izabran iz grupe koju čine C₆₋₁₀aril(C₁₋₆)alkil; C₆₋₁₀aril(C₁₋₆)alkoksi; C₆₋₁₀aril; heteroaril opciono supstituisan sa jednim do dva supstituenta nezavisno izabrana iz grupe koju čine C₁₋₄alkil, C₁₋₄alkoksi, i karboksi; cikloalkil; heterociklil; C₆₋₁₀ariloksi; heteroariloksi; cikloalkiloksi; C₆₋₁₀arilaminokarbonil pri čemu C₆₋₁₀aril je opciono supstituisan sa karboksi ili C₁₋₄alkoksikarbonilom; heterociklilkarbonil, te heterocikliloksi; R² je vodonik, C₁₋₈alkil, hidroksi(C₁₋₈)alkil, C₆₋₁₀aril(C₁₋₆)alkoksi(C₁₋₆)alkil, ili C₆₋₁₀aril(C₁₋₈)alkil; pri čemu C₆₋₁₀aril grupa u supstituentima R² koji sadrže C₆₋₁₀aril je opciono supstituisana sa jednim do dva supstituenta nezavisno izabrana iz grupe koju čine C₁₋₆alkil, C₁₋₆alkoksi, hidroksi, amino, C₁₋₆alkilamino, (C₁₋₆alkil)₂amino, aminokarbonil, C₁₋₆alkilaminokarbonil, (C₁₋₆alkil)₂aminokarbonil, cijano, fluoro, hloro, tiromo, trifluorometil, i trifluorometoksi; i pri čemu C₁₋₆alkil i C₁₋₆alkoksi supstituenti arila su opciono supstituisani sa hidroksi, amino, C₁₋₆alkilamino, (C₁₋₆alkil)₂amino, ili arilom; A je izabran iz grupe koja se satoji od sistema

prstena a-1, a-2, a-3, i a-4, opciono supstituisan sa R³ i R⁵:

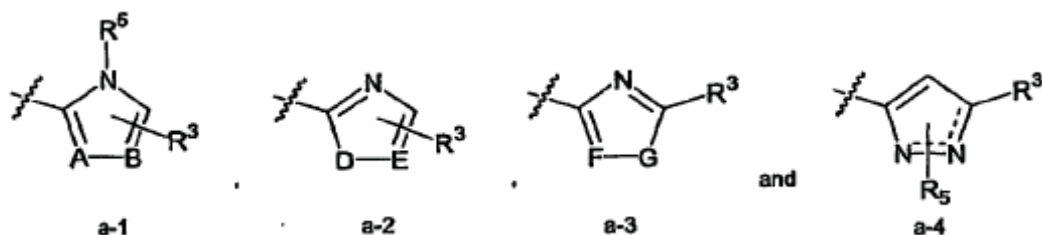

pri čemu A-B je izabran iz grupe koja se sastoji od N-C, C-N i C-C; D-E je izabran iz grupe koja se sastoji od O-C i S-C; F-G je izabran iz grupe koja se sastoji od N-O i C-O; R³ je jedan do dva supstituenta nezavisno izabrana iz grupe koju čine C₁₋₆alkil, aril, aril(C₁₋₆)alkil, aril(C₂₋₆)alkenil, aril(C₂₋₆)alkenil, heteroaril, heteroaril(C₁₋₆)alkil, heteroaril(C₂₋₆)alkenil, heteroaril(C₂₋₆)alkinil, amino, C₁₋₆alkilamino, (C₁₋₆alkil)₂amino, arilamino, heteroarilamino, ariloksi, heteroariloksi, trifluorometil, i halogen; pri čemu aril, heteroaril, i aril i heteroaril od aril(C₁₋₆)alkila, aril(C₂₋₆)alkenila, aril(C₂₋₆)alkinila, heteroaril(C₁₋₆)alkila, heteroaril(C₂₋₆)alkenila, heteroaril(C₂₋₆)alkinila, arilamino, heteroarilamino, ariloksi, i heteroariloksi, su opciono supstituisani sa jednim do pet fluoro supstituenta ili jednim do tri supstituenta nezavisno izabrana iz grupe koju čine C₁₋₆alkil, hidroksi(C₁₋₆)alkil, C₁₋₆alkoksi, C₆₋₁₀aril(C₁₋₆)alkil, C₆₋₁₀aril(C₁₋₆)alkoksi, C₆₋₁₀aril, C₆₋₁₀ariloksi, heteroaril(C₁₋₆)alkil, heteroaril(C₁₋₆)alkoksi, heteroaril, heteroariloksi, C₆₋₁₀arilamino, heteroarilamino, amino, C₁₋₆alkilamino, (C₁₋₆alkil)₂amino, karboksi(C₁₋₆)alkilamino, karboksi, C₁₋₆alkilkarbonil, C₁₋₆alkoksikarbonil, C₁₋₆alkilkarbonilamino, aminokarbonil, C₁₋₆alkilaminokarbonil, (C₁₋₆alkil)₂aminokarbonil, karboksi(C₁₋₆)alkilaminokarbonil, cijano, halogen, trifluorometil, trifluorometoksi, hidroksi, C₁₋₆alkilsulfonil, i C₁₋₆alkilsulfonilamino; obeybeđujući da ne više od jednog takvog supstituenta na arilnom ili heteroarilnom delu od R³ je izabran iz grupe koju čine C₆₋₁₀aril(C₁₋₆)alkil, C₆₋₁₀aril(C₁₋₆)alkoksi, C₆₋₁₀aril, C₆₋₁₀ariloksi, heteroaril(C₁₋₆)alkil, heteroaril(C₁₋₆)alkoksi, heteroaril, heteroariloksi, C₆₋₁₀arilamino, heteroarilamino; i pri čemu C₁₋₆alkil i C₁₋₆alkil od aril(C₁₋₆)alkila i heteroaril(C₁₋₆)alkila su opciono supstituisani sa supstituentom izabranim iz grupe koju čine hidroksi, karboksi, C₁₋₄alkoksikarbonil, amino, C₁₋₆alkilamino, (C₁₋₆alkil)₂amino, aminokarbonil, (C₁₋₄)alkilaminokarbonil, di(C₁₋₄)alkilaminokarbonil, aril, heteroaril, arilamino, heteroarilamino, ariloksi, heteroariloksi, aril(C₁₋₄)alkoksi, i heteroaril(C₁₋₄)alkoksi; R⁴ je C₆₋₁₀aril ili heteroaril izabran iz grupe koju čine furil, tienil, pirolil, oksazolil, tiazolil, imidazolil, pirazolil, piridinil, pirimidinil, pirazinil, indolil, izoindolil, indolinil, benzofuril, benzotienil, benzimidazolil, benzotiazolil, benzoksazolil, hinolizinil, hinolinil, izohinolinil i hinazolil; pri čemu je R⁴ opciono supstituisan sa jednim do tri R⁴¹ supstituenta nezavisno izabrana iz grupe koju čine (C₁₋₆)alkil opciono supstituisan sa amino, C₁₋₆alkilamino, ili (C₁₋₆alkil)amino; (C₁₋₆)alkoksi; fenil(C₁₋₆)alkoksi; fenil(C₁₋₆)alkilkarboniloksi pri čemu je C₁₋₆alkil je opciono supstituisan sa amino; ne fuzionirani 5-člani-heteroaril(C₁₋₆)alkilkarboniloksi; ne fuzionirani 5-člani-heteroaril; hidroksi; halogen; amino-sulfonil; formilamino; aminokarbonil; C₁₋₆alkilaminokarbonil pri čemu (C₁₋₆)alkil je opciono supstituisan sa amino, C₁₋₆alkilamino ili (C₁₋₆alkil)₂amino; (C₁₋₆alkil)₂aminokarbonil pri čemu svaki (C₁₋₆)alkil je opciono supstituisan sa amino, C₁₋₆alkilamino ili (C₁₋₆alkil)₂amino; heterociklilkarbonil pri čemu heterociklil je 5-7 člani prsten koji sadrži azot i navedeni heterociklil je spojen na karbonil ugljenika preko atoma azota; karboksi; ili cijano; i pri čemu fenilni deo od fenil(C₁₋₆)alkilkarboniloksi je opciono supstituisan sa (C₁₋₆)alkil (C₁₋₆)alkoksi, halogen, cijano, amino, ili hidroksi; obezbeđujući da ne više od jedan R⁴¹ je C₁₋₆alkil supstituisan sa C₁₋₆alkilamino ili (C₁₋₆alkil)₂amino; aminosulfonil; formilamino; aminokarbonil; C₁₋₆alkilaminokarbonil; (C₁₋₆alkil)₂aminokarbonil; heterociklilkarbonil; hidroksi; karboksi; ili fenil- ili supstituent koji sadrži heteroaril-; R⁵ je supstituent na atomu azota od prstena A izabran iz grupe koju čine vodonik i C₁₋₄alkil; R⁶ je vodonik ili C₁₋₆alkil; R⁷ je vodonik ili C₁₋₆alkil; R^a i R^b su nezavisno izabrani iz grupe koju čine vodonik, C₁₋₆alkil, i C₁₋₆alkoksikarbonil; alternativno, kada R^a i R^b, svaki od njih, nisu vodonik, R^a i R^b su proizvoljno uzeti zajedno sa azotom na koji su oba spojeni da oblikuju pet do osam člani monociklični prsten; L je izabran iz grupe koju čine O, S, i N(R^d) pri čemu je R^d vodonik ili C₁₋₄alkil; i njihovi farmaceutski prihvatljivi enantiomeri, diastereomeri, racemati i soli.

Preostalo patentnih zahtjeva 14.

- (51) **A 61K 9 /16**^{2006.01} **A 61K 9 /20**^{2006.01} (11) **01602** (13) **B**
A 61K 9 /28^{2006.01} **A 61K 9 /50**^{2006.01}
- (21) P-2013-99
(22) 23. 08. 2010
(30) 20090000950 24. 08. 2009 DK
20090236223P 24. 08. 2009 US
(86) EP/10805414.9/23. 08. 2010
DK/PCT/DK2010/050216/23. 08. 2010
(87) WO 2011/023194 /03. 03. 2011/2011/09
EP 2470166 /04. 07. 2012/2012/27
EP 2470166 /14. 08. 2013/2013/33
(54) me **NOVE KOMPOZICIJE 1-[2 -(2,4-DIMETIL-FENILSULFANIL)-FENIL]PIPERAZINA**
en **NEW COMPOSITIONS OF 1-[2-(2,4-DIMETHYL-PHENYLSULFANYL)-**
PHENYL]PIPERAZINE
(73) H. Lundbeck A/S,Ottiliavej 9,2500 Valby,DK
(72) HØJER, Astrid-Maria,Ingvar Hjorts Vej 14,DK-2830 Virum,DK
DREWES, Pernille, Gundorf,Askimvej 15,DK-2830 Virum,DK
KATEB, Jens,Köpenhamnsvägen 9b,S-21743 Malmö, SE
(74) RADULOVIĆ, S. Božidar,Jovana Tomaševića 9/III-1,Podgorica,81000,ME
- (57) Farmaceutska kompozicija za oralnu primenu koja obuhvata jedinjenje 1-[2-(2,4-dimetil-fenilsulfanil)-fenil]piperazin i njegove farmaceutski prihvatljive adicione soli sa kiselinama pri čemu je ta kompozicija prilagođena da se pomenuto jedinjenje ne oslobađa u želucu.
Preostalo patentnih zahtjev 12.

(51) C 07D 401 /04^{2006.01}

(11) 01603

(13) B

(21) P-2013-105

(22) 02. 03. 2005

(30) 20040004973 03. 03. 2004 EP

20040106359 07. 12. 2004 EP

(86) EP/05716889.0/02. 03. 2005

EP/PCT/EP2005/050931/02. 03. 2005

(87) WO 2005/085225/15. 09. 2005/37/2005

EP 1723135/22. 11. 2006/2006/47

EP 1723135/19. 06. 2013/2013/25

(54) me **NOVI HIDROKSI-6-HETEROARILFENANTRIDINI I NJIHOVA PRIMJENA KAO PDE4 INHIBITORI**
 en **NOVEL HYDROXY-6-HEROARYLPHENANTHRIDINES AND THEIR USE AS PDE4 INHIBITORS**

(73) Takeda GmbH,Byk-Gulden-Strasse 2,78467 Konstanz, DE

(72) KAUTZ, Ulrich,Prof.-Schmider-Str. 12,78476 Allensbach, DE

SCHMIDT, Beate,Allensbacher Str. 5,78476 Allensbach, DE

FLOCKERZI, Dieter,Ackerweg 26,78476 Allensbach, DE

HATZELMANN, Armin,Alter Wall 3,78467 Konstanz, DE

ZITT, Christof,Mainaustr. 209 D,78464 Konstanz, DE

BARSIG, Johannes,Am alten Sägewerk 14,78467 Konstanz, DE

MARX, Degenhard,Obere Reute 15,78345 Moos, DE

KLEY, Hans-Peter,Hafnerstrasse 12,78476 Allensbach, DE

(74) RADULOVIĆ, S. Božidar,Jovana Tomaševića 9/III-1,Podgorica,81000,ME

(57) Jedinjenje formule I

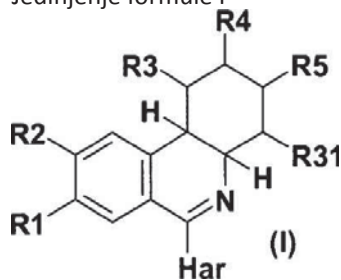

u kojoj

R1 je 1-2C-alkoksi, 2,2-difluoroetoksi, ili potpuno ili pretežno fluoromsupstituisan1-2C-alkoksi,

R2 je 1-2C-alkoksi, 2,2-difluoroetoksi, ili potpuno ili pretežno fluoromsupstituisan1-2C-alkoksi,

R3 jevodonik,

R31 jevodonik,

R4 je -O-R41, gde

R41 jevodonik,

R5 jevodonik,

Har jeopciono supstituisan sa R6 i/ili R7 ijepiridinil, izoksazolil, imidazolil, tiazolil, oksazolil, pirimidinil, pirazinililipiridazinil radikal, gde

R6 je 1-4C-alkil, 1-4C-alkoksi, piridililimorfolin-4-il,

R7 je 1-4C-alkoksi,

ili so, N-oksidili so N-oksidaovog jedinjenja.

Preostalo patentnih zahtjevaa 29.

(51) C 07D 401/12^{2006.01} A 61K 31/415^{2006.01} (11) 01604 (13) B
 A 61P 11/00^{2006.01} A 61P 29/00^{2006.01}

(21) P-2013-108

(22) 02. 10. 2009

(30) 20080018033 02. 10. 2008 GB

(86) EP/09736271.9/02. 10. 2009
 GB/PCT/GB2009/051303/02. 10. 2009

(87) WO 2010/038085/08. 04. 2010/2010/14

EP 2350047/03. 08. 2011/2011/31

EP 2350047/26. 06. 2013/2013/26

(54) me **INHIBITORI P38 MAP KINAZE**
 en **P38 MAP KINASE INHIBITORS**

(73) Respivert Limited, 50-100 Holmers Farm Way High Wycombe Buckinghamshire, HP12 4EG, GB

(72) ITO, Kazuhiro, Respivert Limited, Imperial College BioIncubator, London SW7 2AZ, GB

Level 1, Bessemer Building, Imperial College

STRONG, Peter, Respivert Limited, Imperial College BioIncubator, London SW7 2AZ, GB

Level 1, Bessemer Building, Imperial College

RAPEPORT, William, Garth, Respivert Limited, Imperial College BioIncubator, London SW7 2AZ, GB

Level 1, Bessemer Building, Imperial College

KING-UNDERWOOD, John, Moorend Cottage, Worcestershire GL19 3PW, GB

School Lane, Pendock

WILLIAMS, Jonathan, Gareth,

Sygnature Chemical Services Ltd, Biocity Nottingham, Pennyfoot Street, Nottingham NG1 1GF, GB

ONIONS, Stuart, Thomas,

Sygnature Chemical Services Ltd, Biocity Nottingham, Pennyfoot Street, Nottingham NG1 1GF, GB

MURRAY, Peter, John, c/o Respivert Limited, Imperial College BioIncubator, London SW7 2AZ, GB

Level 1, Bessemer Building, Imperial College

CHARRON, Catherine, Elisabeth,

c/o Respivert Limited, Imperial College BioIncubator, London SW7 2AZ, GB

Level 1, Bessemer Building, Imperial College

(74) RADULOVIĆ, S. Božidar, Studentska bb, Podgorica, 81000, ME

(57) Jedinjenje, naznačeno time, što ima formulu (I)

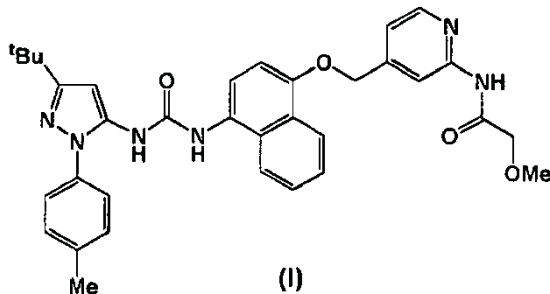

ili njegova farmaceutski prihvatljiva so ili solvat, uključujući sve njegove tautomere.
 Preostalih patentnih zahtjeva 10.

- (51) **F 16D63/00**^{2006.01} **F 16D57/00**^{2006.01} (11) **01605** (13) **B**
B 60T 1 / 10^{2006.01}
- (21) P-2013-110
(22) 15. 08. 2008
(30) 20070005658 16. 08. 2007 TR
(86) EP/08803069.7/15. 08. 2008
EP/PCT/EP2008/060778/15. 08. 2008
(87) WO 2009/022017 /19. 02. 2009/08/2009
EP 2188544 /26. 05. 2010/2010/21
EP 2188544 /14. 08. 2013/2013/33
(54) me **Uređaj za kočenje i metod kočenja**
en **Braking device and method**
(73) Erke Erke Arastirmalari Ve Mühendislik A.S.,
Halkali Merkez Mah. Basın Ekspres Yolu, No. 5/A, Kat.5, 34303 KUCUKCEKMECE,, Istanbul, TR
(72) ÖZTÜRK, Mustafa Naci,
Halkali Merkez Mah., Basın Ekspres Yolu, No: 5/A, K.cekmece,34303 Istanbul, TR
ÖZTÜRK, Mustafa Naci,
Halkali Merkez Mah., Basın Ekspres Yolu, No: 5/A, Kat.5, Kucukcekmece,,34303 Istanbul, TR
(74) RAULOVIĆ, S. Božidar, Jovana Tomaševića 9/III-1, Podgorica, 81000, ME

- (57) Metod kočenja pomoću uređaja za kočenje koji se sastoji od tijela (4) i kolijevke (11, 12), sastoji se od koraka kako slijedi: tijelo (4) se podržava kolijevkom (11, 12) tako da je tijelo (4) ograničeno da se rotira oko prve osovine (1), druge osovine (2) i treće osovine (3), gdje je prva osovina (1) u odnosu na drugu osovinu (2) pozicionirana pod uglom nagiba θ , obje prva i treća osovina (1, 3) se rotiraju oko druge osovine (2), a rotacija tijela (4) oko treće osovine (3) uzrokuje povećanje ugla nagiba θ ; rotiranje tijela (4) oko prve osovine (1) sa jednim ili više izvora pokretačke sile (10); gdje
a) druga osovina (2) se koristi kao osovina kočenja na koju je primijenjena pokretačka sila koja sadrži kretanje koje treba zakočiti, a treća osovina (3) se koristi kao osovina slobodnog kretanja oko koje je dozvoljeno rotiranje, ili
b) treća osovina (3) se koristi kao osovina kočenja na koju je primijenjena pokretačka sila koja sadrži kretanje koje treba zakočiti, a druga osovina (2) se koristi kao osovina slobodnog kretanja oko koje je dozvoljeno rotiranje
gdje, kada se kretanje koje treba zakočiti primijeni na osovinu kočenja, obrtna snaga se primjenjuje na tijelo (4) i rotira ga oko osovine kočenja, gdje, kao rezultat rotacije tijela (4) oko prve osovine (1) i obrtne sile primijenjene na tijelo (4) oko osovine kočenja, tijelo (4) počinje da se takođe rotira oko osovine slobodnog kretanja, a ovo kretanje se naziva precesija, istovremeno, rotacija tijela (4) oko obje, prve osovine (1) i osovine slobodnog kretanja, sačinjava obrtnu silu kočenja oko osovine kočenja u suprotnom smjeru od smjera kretanja koje treba zakočiti, naznačen time da se metod dalje sastoji od sljedećih koraka: slučaj a) spajanje treće osovine (3) na izvor pokretačke sile koja se sastoji od kretanja koje treba zakočiti u svrhu ubrzanja rotacije tijela (4) oko treće osovine (3), te slučaj b) spajanje druge osovine (2) na izvor pokretačke sile koja se sastoji od kretanja koje treba zakočiti u svrhu ubrzanja rotacije tijela (4) oko druge osovine (2).
Preostalo patentnih zahtjeva 6.

- (51) **C 07D 403/12**^{2006.01} **A 61K 31/55**^{2006.01} (11) **01606** (13) **B**
A 61P 9/55^{2006.01}
- (21) P-2013-114
(22) 28. 06. 2010
(30) 20090221708P 30. 06. 2009 US
(86) EP/10728558.7/28. 06. 2010
US/PCT/US2010/040125/28. 06. 2010
(87) WO 2011002696/06. 01. 2011/2011/01
EP 2448933/09. 05. 2012/2012/19
EP 2448933/28. 08. 2013/2013/35
- (54) me **TRANS-4-[[[(5S)-5-[[[3,5-BIS(TRIFLUORMETIL)FENIL]METIL](2-METIL-2H-TETRAZOL-5-IL)AMINO]-2,3,4,5-TETRAHIDRO-7,9-DIMETIL-1H-1-BENZAZEPIN-1-IL]METIL]CIKLOHEKSANKARBOKSILNA KISELINA**
en **TRANS-4-[[[(5S)-5-[[[3,5-BIS(TRIFLUOROMETHYL)PHENYL]METHYL](2-METHYL-2H-TETRAZOL-5-YL)AMINO]-2,3,4,5-TETRAHYDRO-7,9-DIMETHYL-1H-1-BENZAZEPIN-1-YL]METHYL]-CYCLOHEXANECARBOXYLIC ACID**
- (73) Eli Lilly and Company, Lilly Corporate Center, Indianapolis, IN 46285, US
(72) CHEN, Xinchao, Eli Lilly And Company, Lilly Corporate Center, Indianapolis, Indiana 46285, US
FRANK, Scott, Alan, Eli Lilly And Company, Lilly Corporate Center, Indianapolis, Indiana 46285, US
REMICK, David, Michael,
Eli Lilly And Company, Lilly Corporate Center, Indianapolis, Indiana 46285, US
PEDERSEN, Steven, Wayne,
Eli Lilly And Company, Lilly Corporate Center, Indianapolis, Indiana 46285, US
(74) ČUPIĆ, Branislav, Dalmatinska 10, Podgorica 10, 81000, ME
- (57) Spoj, naznačen time što je *trans-4-[[[(5S)-5-[[[3,5-bis(trifluormetil)fenil]metil](2-metil-2H-tetrazol-5-il)amino]-2,3,4,5-tetrahidro-7,9-dimetil-1H-1-benzazepin-1-il]metil]cikloheksankarboksilna kiselina*, hidrat, ili farmaceutski prihvatljiva sol navedenog spoja
Preostalo patentnih zahtjeva 21.

- (51) **C 07D 401 / 04**^{2006.01} (11) **01607** (13) **B**
 (21) P-2013-120
 (22) 29. 06. 2006
 (30) 20050696224P 30. 06. 2005 US
 (86) EP/11175056.8/29. 06. 2006
 US/PCT/US2006/026210/29. 06. 2006
 (87) WO 2007/005972/11. 01. 2007/02/2007
 EP 2380887 /26. 10. 2011/2011/43
 EP 2380887 /07. 08. 2013/2013/32
 (54) me **POSTUPAK DOBIJANJA SPOJEVA 4-AMINO-2-(2,6-DIOKSOPIPERIDIN-3-IL)IZOINDOLIN-3-ONA**
 en **Processes for the preparation of 4-amino-2-(2,6-dioxopiperidin-3-yl)isoindoline-1,3-dione compounds**
 (73) Celgene Corporation, 86 Morris Avenue, Summit, NJ 07901, US
 (72) Muller, George W., P.O. Box 3688, Rancho Santa Fe, CA California 92067, US
 Saindane, Manohar, T., 716 Ladson Court, Decatur, GA Georgia 30033, US
 Ge, Chuansheng, 9 Breckenridge Court, Belle Mead, NJ New Jersey 08502, US
 Chen, Roger, 110 Christie Street, Edison, NJ New Jersey 08820, US
 Chen, Roger, 110 Christie Street, Edison, NJ New Jersey 08820, US
 (74) AOD ČUPIĆ, Dalmatinska 10, Podgorica, 81000, ME

(57) Postupak dobivanja spoja Formule (I):

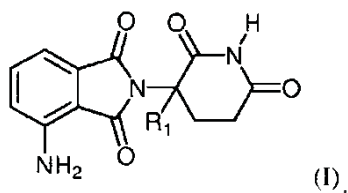

ili njegove farmaceutski prihvatljive soli, solvata, polimorfa ili stereoizomera, naznačen time što se sastoji u koraku cikliziranja spoja Formule (II) ili (IIA):

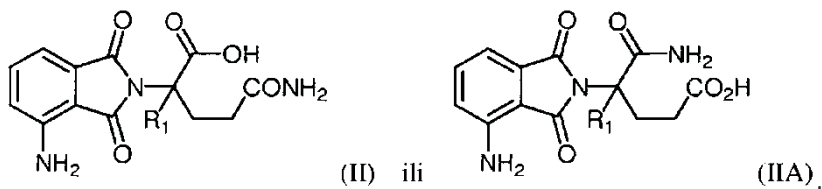

ili njegove soli s ciklizirajućim sredstvom Formule (V):

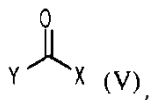

gdje je R¹ H, F, benzil, (C₁-C₈)alkil, (C₂-C₈)alkenil ili (C₂-C₈)alkinil; a svaki od X i Y je neovisno nesupstituirani ili supstituirani imidazolil, benzimidazolil ili benzotriazolil.

Preostalo patentnih zahtjeva 16.

- (51) **A 23B 7 /02**^{2006.01} **A 23B 7 /03**^{2006.01} (11) **01608** (13) **B**
A 23L 1 /217^{2006.01} **A 23L 1 /31**^{2006.01}
A 23L 1 /325^{2006.01} **A 23L 1 /212**^{2006.01}
A 23B 4 /03^{2006.01} **A 23L 1 /216**^{2006.01}
- (21) P-2013-125
(22) 22. 12. 2010
(30) 10000072 07. 01. 2010 EP
(86) EP/10015938.3/22. 12. 2010
(87) EP 2294925 /16. 03. 2011/2011/11
EP 2294925 /16. 10. 2013/2013/42
(54) me **Mješavina čipsa**
en **Chip mixture**
(73) Zweifel Pomy-Chips AG,8957 Spreitenbach, CH
(72) Blumenthal, Marco,5400 Baden, CH
(74) ĆOSOVIĆ, L. Dejan,ul. 13 Jul br. 1,Budva,85310,ME
- (57) Metod za proizvodnju suvog proizvoda koji predstavlja prehrambeni proizvod u obliku komadića , karakterisan time da je u koraku završnog sušenja proizvod prve vrste, sa sadržajem vlage od najmanje 5% težinskih , a najviše 15% težinskih , dehidratisan na temperaturi ispod 80°C, po mogućnosti ispod 60°C, a naročito na sobnoj temperaturi , bar delimično pomoćuproizvoda druge vrste, gde je proizvod druge vrste prehrambeni proizvod.
Preostalo patentnih zahtjeva 14.

- (51) **A 61K 31/44**^{2006.01} **A 61K 31/4412**^{2006.01} (11) **01609** (13) **B**
A 61K 31/519^{2006.01} **A 61K 31/4985**^{2006.01}
A 61K 31/53^{2006.01} **A 61K 31/506**^{2006.01}
A 61K 31/5025^{2006.01} **A 61P 9/12**²⁰⁰⁶⁰¹⁰¹
- (21) P-2013-129
(22) 12. 04. 2006
(30) 20050103147 19. 04. 2005 EP
(86) EP/11168764.6/12. 04. 2006
EP/PCT/EP2006/061557/12. 04. 2006
(87) WO 2006/111495/26. 10. 2006/43/2006
EP 2366393/21. 09. 2011/2011/38
EP 2366393/07. 08. 2013/2013/32
(54) me **Roflumilast za liječenje pulmonarne hipertenzije**
en **Roflumilast for the treatment of pulmonary hypertension**
(73) Takeda GmbH, Byk-Gulden-Strasse 2, 78467 Konstanz, DE
(72) Beume, Rolf, Bohlstrasse 13, 78465 Konstanz, DE
Hatzelmann, Armin, Alter Wall 3, 78467 Konstanz, DE
Marx, Degenhard, Obere Reute 15, 78345 Moos, DE
Schudt, Christian, Schützenstrasse 20, 78462 Konstanz, DE
Tenor, Hermann, St.-Gebhard-Str. 38, 78467 Konstanz, DE
Eddahibi, Saadia, 19 Rue Francois-Joseph Bouille, 92260 Fontenay-aux-Roses, FR
Adnot, Serge, 38, Avenue des Sapins, 94100 Saint Maur des Fossés, FR
(74) RADULović, S. Božidar, Jovana Tomaševića 9/III-1, Podgorica, 81000, ME
- (57) Primena jedinjenja odabranog iz grupe koja se sastoji od Roflumilasta, farmaceutski prihvatljive soli Roflumilasta, Roflumilast-N-Oksida i farmaceutski prihvatljive soli Roflumilast-N-Oksida za proizvodnju farmaceutske kompozicije za preventivno lečenje pulmonarne hipertenzije.
Preostalo patentnih zahtjeva 11.

- (51) **B05B 11/00**^{2006.01} **A61M15/00**^{2006.01} (11) **01610** (13) **B**
G06M3/02^{2006.01}
- (21) P-2013-133
(22) 14. 08. 2006
(30) 20051039921 24. 08. 2005 DE
(86) EP/11009899.3/14. 08. 2006
EP/PCT/EP2006/008029/14. 08. 2006
(87) WO 2007/022898/01. 03. 2007/09/2007
EP 2436453/04. 04. 2012/2012/14
EP 2436453/02. 10. 2013/2013/40
(54) me **Atomizer koji sadrži brojač i blokadu daljeg aktiviranja**
en **Atomiser comprising a counter and an end of operation lock**
(73) BOEHRINGER INGELHEIM INTERNATIONAL GMBH, Binger Str. 173,55216 Ingelheim am Rhein, DE
(72) Thoemmes, Ralf,
Boehringer Ingelheim GmbH, CD Patents, Binger Strasse 173,55216 Ingelheim am Rhein, DE
Westmeier, Birgit,
Boehringer Ingelheim GmbH, CD Patents, Binger Strasse 173,55216 Ingelheim am Rhein, DE
Metzger, Burkhard P.,
Boehringer Ingelheim GmbH, CD Patents, Binger Strasse 173,55216 Ingelheim am Rhein, DE
Geser, Johannes,
Boehringer Ingelheim GmbH, CD Patents, Binger Strasse 173,55216 Ingelheim am Rhein, DE
(74) RADULOVIĆ, S. Božidar, Jovana Tomaševića 9/III-1, Podgorica, 81000, ME

- (57) Atomizer (1) za fluid (2), sa kontejnerom (3) sa fluidom (2) koji se prvenstveno može umetnuti i koji se još poželjnije može zamjeniti, sa brojačkom napravom (23) za brojanje aktiviranja atomizera (1) i/ili broja kontejnera (3) koji se mogu umetnuti i prvenstveno sa dijelom (18) kućišta koji može biti montiran na atomizeru (1) ili se može skinuti sa njega, radi umetanja i/ili zamjene kontejnera (3), i pri čemu je prvenstveno brojačka naprava (23) ili bar prvi brojač (31) brojačke naprave (23) za brojanje aktiviranja atomizera (1) naročito postavljen na dijelu (18) kućišta i izveden je tako da je atomizer (1) blokiran protiv dalje upotrebe i/ili protiv skidanja aktuelnog kontejnera (3) ili umetanja novog kontejnera (3), kada se dostigne ili kada se pređe određeni broj aktiviranja atomizera (1), što se naziva prvim blokiranim stanjem, naznačen time, što je brojačka naprava (23) izvedena tako da je atomizer (1) blokiran protiv skidanja aktuelnog kontejnera (3) kada se dostigne određeni broj umetnutih kontejnera (3), što takođe važi i kada se dostigne ili pređe izvestan broj aktiviranja atomizera (1) sa aktuelnim kontejnerom (3), što se takođe naziva drugim blokiranim stanjem.
Preostalo još 14 patentnih zahtjeva.

(51) **A 61K 31/47**^{2006.01} **A 61P 31/04**^{2006.01} (11) **01611** (13) **B**
C 07D 215/22^{2006.01}

- (21) P-2013-134
 (22) 31. 07. 2006
 (30) 200501071159 03. 08. 2005 EP
 (86) EP/06778081.7/31. 07. 2006
 EP/PCT/EP2006/064856/31. 07. 2006
 (87) WO 2007/014940/08. 02. 2007/06/2007
 EP 1912647/23. 04. 2008/2008/17
 EP 1912647/11. 09. 2013/2013/37

(54) me **KINOLINSKI DERIVATI KAO ANTIBAKTERIJSKI AGENSI**
 en **QUINOLINE DERIVATIVES AS ANTIBACTERICAL AGENTS**

- (73) Janssen Pharmaceutica NV, Turnhoutseweg 30, 2340 Beerse, BE
 (72) ANDRIES, Koenraad Jozef Lodewijk Marcel,
 c/o Janssen Pharmaceutica N.V., Turnhoutseweg 30, B-2340 Beerse, BE
 KOUL, Anil, c/o Janssen Pharmaceutica N.V., Turnhoutseweg 30, B-2340 Beerse, BE
 GUILLEMONT, Jérôme, Emile, Georges,
 JohnsonR&D Johnson Pharma., a Div. of Janssen-Cilag, Campus de Maigremont FR
 - BP 615 F-27106 Val de Reuil Cedex'
 PASQUIER, Elisabeth, Thérèse, Jeanne,
 JohnsonR&DJohnson Pharma., a Div. of Janssen-Cilag, Campus de Maigremont FR
 - BP 615 F-27106 Val de Reuil Cedex'
 LANÇOIS, David, Francis, Alain,
 JohnsonR&DJohnson Pharma., a Div. of Janssen-Cilag, Campus de Maigremont FR
 - BP 615 F-27106 Val de Reuil Cedex'

(74) RADULOVIĆ, S. Božidar, Jovana Tomaševića 9/III-1, Podgorica, 81000, ME

(57) Upotreba jedinjenja, naznačena time, što se pomenuto jedinjenje koristi za proizvodnju leka za tretman bakterijske infekcije, pri čemu pomenuto jedinjenje ima Formulu (Ia) i (Ib)

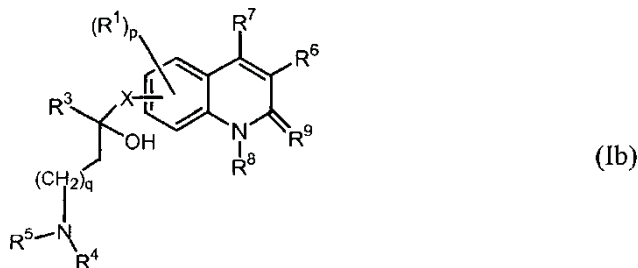
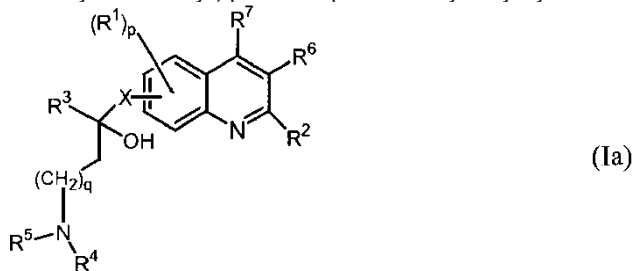

njegovih farmaceutski prihvatljivih kiselih ili baznih adicijonih soli, kvaternarnih amina, stereohemijski izomernih formi, tautomernih formi ili N-oksidnih formi, gde

R¹ je vodonik, halo, haloalkil, cijano, hidroksi, Ar, Het, alkil, alkiloksi, alkiltio, alkiloksialkil, alkiltioalkil, Ar-alkil ili di(Ar)alkil;

p je celi broj jednak 1, 2 ili 3;

R² je vodonik; alkil; hidroksi; merkapto; alkiloksi ponekad supstituisan sa amino ili mono ili di(alkil)amino ili sa radikalom sa formulom

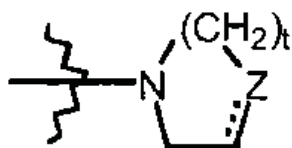

gde Z je CH₂, CH-R¹⁰, O, S, N-R¹⁰, a t je celi broj jednak 1 ili 2, pri čemu isprekidana linija predstavlja moguću vezu; alkiloksialkiloksi; alkiltio; mono ili di(alkil)amino gde alkil može ponekad da bude supstituisan sa jednim ili dva supstituenta od kojih je svaki nezavisno izabran iz alkiloksi ili Ar ili Het ili morfolinila ili 2-oksopirrolidinila; Ar; Het ili radikal sa formulom

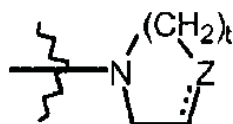

gde Z je CH₂, CH-R¹⁰, O, S, N-R¹⁰; t je celi broj jednak 1 ili 2; pri čemu isprekidana linija označava moguću vezu;

R³ je alkil, Ar, Ar-alkil, Het ili Het-alkil;

q je celi broj jedna nuli, 1, 2, 3 ili 4;

X je direktna veza ili CH₂;

R⁴ i R⁵ svaki nezavisno su vodonik, alkil ili benzil; ili

R⁴ i R⁵ zajedno i uključujući N na kojeg su spojeni mogu da formiraju radikal izabran iz grupe imidazolila, triazolila, piperidinila, piperazinila i tiomorfolinila;

R⁶ je vodonik ili neki radikal sa formulom

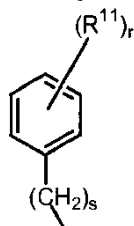

gde s je celi broj jednak nuli, 1, 2, 3 ili 4; r je celi broj jednak 1, 2, 3, 4 ili 5; a R¹¹ je vodonik, halo, haloalkil, hidroksi, Ar, alkil, alkiloksi, alkiltio, alkiloksialkil, alkiltioalkil, Ar-alkil ili di(Ar)alkil; ili dva susedna R¹¹ radikala mogu da, zajedno fenilnim prstenom na kojeg su spojeni, formiraju naftil;

R⁷ je vodonik, alkil, Ar ili Het;

R⁸ je vodonik ili alkil;

R⁹ je okso; ili

R⁸ i R⁹ zajedno formiraju radikal -CH=CH-N=;

R¹⁰ je vodonik, alkil, hidroksil, aminokarbonil, mono- ili di(alkil)aminokarbonil, Ar, Het, alkil supstituisan sa jednim ili dva Het, alkil supstituisan sa jednim ili dva Ar, Het-C(=O)-, Ar-C(=O)-;

alkil je ravan ili razgranat zasićeni ugljovodonik koji ima od 1 do 6 atoma ugljenika; ili je ciklički zasićeni ugljovodonik koji ima od 3 do 6 atoma ugljenika; ili je ciklički zasićeni ugljovodonik koji ima od 3 do 6 atoma ugljenika koji su spojeni na ravan ili razgranat zasićeni ugljovodonik koji ima od 1 do 6 atoma ugljenika; pri čemu svaki atom ugljenika može da ponekad bude supstituisan sa hidroksi, alkiloksi ili okso;

Ar je homocikal izabran iz grupe fenila, naftila, acenaftila, tetrahidronaftila, a svaki od njih je ponekad supstituisan sa 1, 2 ili 3 supstituenta, a svaki supstituent je nezavisno izabran iz grupe hidroksi, halo, cijano, nitro, amino, mono- ili di-alkilamino, alkila, haloalkila, alkiloksi, haloalkiloksi, karboksila, alkiloksikarbonila, alkilkarbonila, aminokarbonila, morfolinila i mono- ili di-alkilaminokarbonila;

Het je monociklički heterocikal izabran iz grupe N-fenoksipiperidinila, piperidinila, pirolila, pirazolila, imidazolila, furanila, tienila, oksazolila, izoksazolila, tiazolila, izotiazolila, triazolila, piridinila, pirimidinila, pirazinila i piridazinila; ili biciklički heterocikal izabran iz grupe kinolinila, izokinolinila, 1,2,3,4-tetrahidroizokinolinila, kinoksalinila, indolila, indazolila, benzimidazolila, benzoksazolila, benzizoksazolila, benzotiazolila, benzizotiazolila, benzofuranila, benzotienila, 2,3-dihidrobenzo[1,4]dioksinila ili benzo[1,3]dioksolila; a svaki monociklički i biciklički heterocikal može ponekad da bude supstituisan na atomu ugljenika sa 1, 2 ili 3 supstituenta, a svaki supstituent je nezavisno izabran iz grupe halo, hidroksi, alkila ili alkiloksi;

halo je supstituent izabran iz grupe fluoro, hloro, bromo i jodo; i

haloalkil je ravan ili razgranat zasićeni ugljovodonik koji ima od 1 do 6 atoma ugljenika ili je ciklički zasićeni ugljovodonik koji ima od 3 do 6 atoma ugljenika ili je ciklički zasićeni ugljovodonik koji ima od 3 do 6 atoma ugljenika koji su spojeni na ravan ili razgranat zasićeni ugljovodonik koji ima od 1 do 6 atoma ugljenika; pri čemu jedan ili više atoma ugljenika je supstituisano sa jednim ili više halo atoma; gde

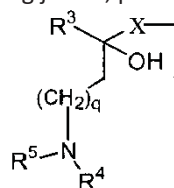

radikal može takođe da se nalazi na poziciji 4 u kinolinskom prstenu; i pod uslovom da je pomenuta bakterijska infekcija drugačija od infekcije sa Mycobacteria.

Preostalih patentnih zahtjeva je 24.

(51) C07D239/46^{2006.01}

(11) 01612

(13) B

(21) P-2013-136

(22) 24. 05. 2006

(30) 20050104531 26. 05. 2005 EP

20050685993P 31. 05. 2005 US

(86) EP/06755299.2/24. 05. 2006

EP/PCT/EP2006/062606/24. 05. 2006

(87) WO 2006/125809/30. 11. 2006

EP 1888537/20. 02. 2008/2008/08

EP 1888537/11. 09. 2013/2013/37

(54) me **PROCES ZA PRIPREMU 4-[(1,6-DIHIDRO-6-OKSO-2-PIRIMIDINIL)AMINO**
BENZONITRILAen **PROCESS FOR PREPARING 4-[(1,6-DIHYDRO-6-OXO-2-PYRIMIDINYL)AMINO**
BENZONITRILE

(73) Janssen R&D Ireland, Eastgate Village, Eastgate, Little Island, County Cork, IE

(72) SCHILS, Didier, Philippe, Robert, Chaussée de Charleroi 31, B-1471 Loupoigne, BE

STAPPERS, Alfred, Elisabeth, Werkendam 41, B-2360 Oud-Turnhout, BE

RADULOVIĆ, S. Božidar, Jovana Tomaševića 9/III-1,

(57) Postupak za pripremu jedinjenja sa formulom

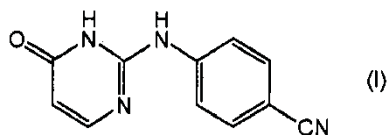

naznačen time, što se pomenuto jedinjenje sa formulom (I) priprema uz pomoć dealkoksikarbonilovanja estera 4-okso-1,6-dihidro-pirimidinil karboksilne kiseline sa formulom (II):

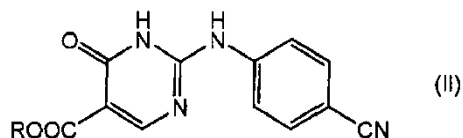

gde R je C₁₋₄ alkil.

Preostalo patentnih zahtjeva 17.

(51) **A 01 N 25 / 16**^{2006.01} **A 01 N 25 / 30**^{2006.01} (11) **01613** (13) **B**
A 01 N 59 / 12^{2006.01} **A 61 K 47 / 06**^{2006.01}
A 61 P 31 / 02^{2006.01} **A 01 P 1 / 00**^{2006.01}

(21) P-2013-139

(22) 30. 10. 2008

(30) 20070283787 31. 10. 2007 JP

(86) EP/08844363.5/30. 10. 2008

EP/PCT/EP2008/009180/30. 10. 2008

(87) WO 2009/056322/07. 05. 2009/19/2009

EP 2207419/21. 07. 2010/2010/29

EP 2207419/16. 10. 2013/2013/42

(54) me **STABILIZATOR PJENE ZA STERILIZACIONU KOMPOZICIJU**
en **FOAM STABILIZER FOR A STERILIZATION COMPOSITION**

(73) Mundipharma International Limited,

Mundipharma House 14 Par-la-Ville Road P.O. Box HM 2332, Hamilton HMJX, BM

(72) CHIKAKO, Udagawa, 18-16, Asahigaoka, Kawachinagano-shi, Osaka 586-0084, JP

YOSHIE, Kono, 4-16 Kyobashi 2-chome, Chuo-ku, Tokyo 104-8002, JP

TAKAKO, Okamoto, 790, Morooka-cho, Kouhoku-ku, Yokohama-shi Kanagawa 222-8567, JP

(74) LUTOVAC, Branislav, Bulevar Crnojevića 93, Podgorica, 81000, ME

(57) Kompozicija za sterilizaciju koja sadrži povidon jod, nejonsku površinski aktivnu supstancu i površinski aktivnu supstancu tipa organosulfata, gde je količina koja se meša povidon joda 4 do 10 (tež./V)%, odnos mešanja između površinski aktivne supstance tipa organosulfata i nejonske površinski aktivne supstance je od 50:1 do 2:1 i ukupni sadržaj dve površinski aktivne supstance je 0.4 do 14 (tež./V)% u odnosu na ukupnu količinu kompozicije.

Preostalo patentnih zahtjeva 4.

- (51) **A 61K 9 /08**^{2006.01} **A 61K 9 /10**^{2006.01} (11) **01614** (13) **B**
A 61K 47 /10^{2006.01} **A 61K 47 /14**^{2006.01}
A 61K 31 /44^{2006.01}
- (21) P-2013-140
(22) 18. 11. 2009
(30) 20080116789P 21. 11. 2008 US
(86) EP/09760395.5/18. 11. 2009
US/PCT/US2009/064908/18. 11. 2009
(87) WO 2010/059667 /27. 05. 2010/21/2010
EP 2358355 /24. 08. 2011/2011/34
EP 2358355 /06. 11. 2013/2013/45
- (54) me **Farmaceutska kompozicija snažnog HCV inhibitora za oralnu primjenu**
en **Pharmaceutical composition of a patent HCV inhibitor for oral administration**
- (73) Boehringer Ingelheim International GmbH, Binger Strasse 173, 55216 Ingelheim am Rhein, DE
(72) CHEN, Feng-Jing, Boehringer Ingelheim Pharmaceuticals Inc., Ridgefield, Connecticut 06877, US
900 Ridgebury Road, P.O. Box 368
GEL, Juan Francisco, Avenida del Libertador 7208, Buenos Aires C1429BMS, AR
VILLAGRA, Maria Fernanda, Avenida del Libertador 7208, Buenos Aires C1429BMS, AR
(74) RADULOVIĆ, S. Božidar, Jovana Tomaševića 9/III-1, Podgorica, 81000, ME

- (57) Tečna farmaceutska kompozicija koja sadrži:
(a) manje od ili jednako 4.6% po težini Jedinjenja (1), ili njegovu farmaceutsku prihvatljivu so:

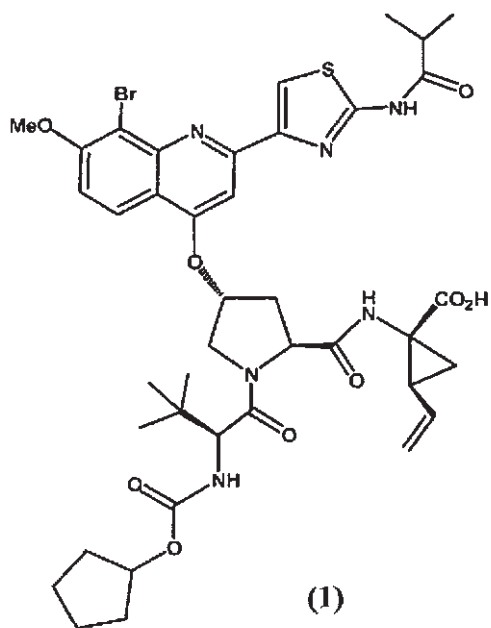

- (b) najmanje jednu 10% do 30% po težini površinski aktivnu supstancu; i
(c) najmanje jedan 60% do 90% po težini farmaceutski prihvatljivi rastvarač;
pri čemu je težinski odnos površinske aktivne supstance u odnosu na Jedinjenje (1) ili njegovu farmaceutsku prihvatljivu so veći od ili jednak 2.7; i pri čemu je kompozicija suštinski bez lipida, i pri čemu kompozicijski oblici u vidu čiste disperzije imaju srednju veličinu čestice manju od 1 μm nakon razblaživanja u simuliranoj želudačnoj tečnosti.

Preostalo patentnih zahtjeva 15.

- (51) **A 61K 9 /20**^{2006.01} **A 61K 31 /4184**^{2006.01} (11) **01615** (13) **B**
A 61K 31 /4422^{2006.01} **A 61P 9 /00**^{2006.01}
A 61P 9 /04^{2006.01} **A 61P 9 /08**^{2006.01}
A 61P 9 /10^{2006.01} **A 61P 9 /12**^{2006.01}
A 61P 3 /10^{2006.01} **A 61P 25 /28**^{2006.01}
- (21) P-2013-147
(22) 29. 10. 2005
(30) 20040026234 05. 11. 2004 EP
(86) EP/05810652.7/29. 10. 2005
WO/PCT/2005EP/11596
(87) WO 2006/048208/11. 05. 2006/19/2006
EP 1814527 /08. 08. 2007/2007/32
EP 1814527 /18. 12. 2013/2013/51
(54) me **Dvoslojna tableta koja sadrži telmisartan i amlodipin**
en **Bilayer tablet comprising telmisartan and amlodipine**
(73) Boehringer Ingelheim International GmbH, Binger Strasse 173, 55216 Ingelheim am Rhein, DE
(72) EISENREICH, Wolfram, Kirchstr. 16/1, 89081 Ulm, DE
(74) RADULović, S. Božidar, Jovana Tomaševića 9/III-1, Podgorica, 81000, ME
- (57) Farmaceutska tableta koja sadrži prvi sloj od telmisartana u rastvorljivoj matrici tablete koja sadrži bazni agens koji je izabran između hidroksida alkalnih metala, baznih aminokiselina i meglumina, vodorastvorni razređivač i, opcionalno, druge ekscipijense i adjuvanse i drugi sloj od amlodipina u dezintegrišućoj ili erodirajućoj matrici tablete
Preostalo patentnih zahtjeva 12.

- (51) **A 61K 31/47**^{2006.01} **A 61P 31/04**^{2006.01} (11) **01616** (13) **B**
C 07D 215/22^{2006.01} **C 07D 215/18**^{2006.01}
- (21) P-2013-65
 (22) 31. 07. 2006
 (30) 20050107164 03. 08. 2005 EP
 (86) EP/06778083.3/31. 07. 2006
 WO/PCT/EP2006/064858/31. 07. 2006
 (87) WO 2007/014941/08. 02. 2007/2007/06
 EP 1912648/23. 04. 2008/2008/17
 EP 1912648/10. 04. 2013/2013/15
- (54) me **KINOLINSKI DERIVATI KAO ANTIBAKTERIJSKI AGENSI**
 en **QUINOLINE DERIVATIVES AS ANTIBACTERIAL AGENTS**
- (73) Janssen Pharmaceutica NV, Turnhoutseweg 30, 2340 Beerse, BE
 (72) GUILLEMONT, J. E. G.,
 Johnson & Johnson Pharmaceut., Research & Development, F-27106 Val de Reuil Cedex, FR
 Campus de Maigremont, BP 615
 PASQUIER, E. T. J.,
 Johnson & Johnson Pharmaceut., Research & Development, F-27106 Val de Reuil Cedex, FR
 Campus de Maigremont, BP 615
 LANÇOIS, David Francis Alain,
 Johnson & Johnson Pharmaceut., Research & Development, F-27106 Val de Reuil Cedex, FR
 Campus de Maigremont, BP 615
 ANDRIES, Koenraad Jozef Lodewijk Marcel,
 c/o Janssen Pharmaceutica N.V., Turnhoutseweg 30, B-2340 Beerse, BE
 KOUL, Anil, c/o Janssen Pharmaceutica N.V., Turnhoutseweg 30, B-2340 Beerse, BE
 BACKX, Leo Jacobus Jozef, c/o Janssen Pharmaceutica N.V., Turnhoutseweg 30, B-2340 Beerse, BE
 MEERPOEL, Lieven, c/o Janssen Pharmaceutica N.V., Turnhoutseweg 30, B-2340 Beerse, BE
- (74) RADULOVIĆ, S. Božidar, Jovana Tomaševića 9/III-1, Podgorica, 81000, ME
- (57) Upotreba jedinjenja za proizvodnju leka za tretman bakterijske infekcije koja je uzrokovana sa *Staphylococci*, *Enterococci* ili *Streptococci*, naznačena time, da pomenuto jedinjenje ima formulu (I)

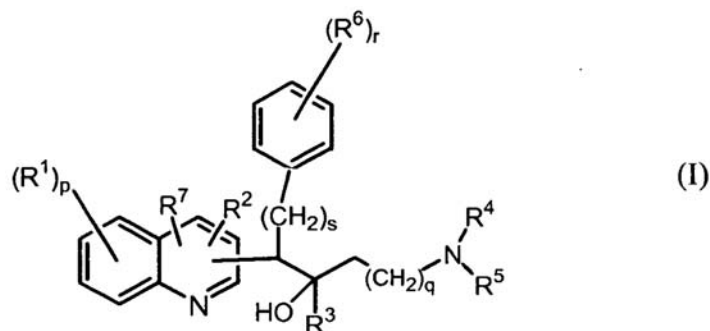

farmaceutski prihvatljiva kisela ili bazna adicione so, kvaternarni amin, stereoemijski izomerna forma, tautomerna forma i N-oksidna forma, gde: R¹ je vodonik, halo, haloalkil, cijano, hidroksi, Ar, Het, a lkil, alkiloksi, alkiltio, alkiloksialkil, alkiltioalkil, Ar-alkil ili di(Ar)alkil; p je celi broj jednak na 1, 2 ili 3; s je celi broj jednak nuli, 1, 2, 3 ili 4; R² je vodonik; halo; alkil; hidroksi; merkpto; alkiloksi ponekad supstituisan sa amino ili mono ili

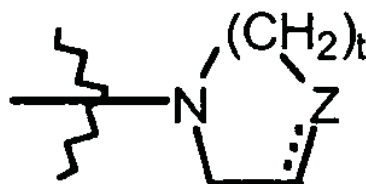

di(alkil)amino ili radikal sa formulom
 gde Z je CH₂, CH-R⁸, O, S, N-R⁸, a t je celi broj jednak 1 ili 2, a tačkasta linija predstavlja moguću vezu; alkiloksialkiloksi; alkiltio; mono ili di(alkil)amino gde alkil može ponekad da bude supstituisan sa jednim ili dva supstituenta svaki nezavisno izabran iz alkiloksi ili Ar ili Het ili morfolinila ili 2- oksopirolidinila; Ar; Het ili radikal sa formulom

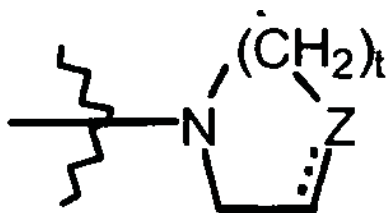

gde Z je CH_2 , CH-R^8 , O, S, N-R^8 ; t je celi broj jednak 1 ili 2; a tačkasta linija predstavlja moguću vezu; R^3 je alkil, Ar, Ar-alkil, Het ili Het-alkil; q je celi broj jednak nuli, 1, 2, 3 ili 4; R^4 i R^5 svaki nezavi sno su vodonik, alkil ili benzil; ili R^4 i R^5 zajedno sa N na kojeg su spojeni mogu da formiraju radikal koji je izabran iz grupe koja obuhvata pirolidinil, 2-pirolinil, 3-pirolinil, pirolil, imidazolidinil, pirazolidinil, 2-imidazolinil, 2-pirazolinil, imidazolil, pirazolil, triazolil, piperidinil, piridinil, piperazinil, piridazinil, pirimidinil, pirazinil, triazinil, morfolinil i tiomorfolinil, a svaki pomenuti prsten može ponekad da bude supstituisan sa alkilom, halo, haloalkilom, hidroksi, alkiloksi, amino, mono- ili dialkilamino, alkiltio, alkiloksialkilom, alkiltioalkilom i pirimidinilom; R^6 je vodonik, halo, haloalkil, hidroksi, Ar, alkil, alkiloksi, alkiltio, alkiloksialkil, alkiltioalkil, Ar-alkil ili di(Ar)alkil; ili dva susedna R^6 radikala mogu zajedno sa fenilnim prstenom, na kojeg su spojeni, da formiraju naftil; r je celi broj jednak 1, 2, 3, 4 ili 5; i R^7 je vodonik, alkil, Ar ili Het; R^8 je vodonik, alkil, hidroksil, aminokarbonil, mono- ili di(alkil)aminokarbonil, Ar, Het, alkil supstituisan sa jednim ili dva Het, alkil supstituisan sa jednim ili dva Ar, Het-C(=O)- ili Ar-C(=O)-; alkil je ravan ili razgranat zasićen ugljovodonički radikal koji ima od 1 do 6 atoma ugljenika; ili je ciklički zasićen ugljovodonički radikal koji ima od 3 do 6 atoma ugljenika; ili je ciklički zasićeni ugljovodonički radikal koji ima od 3 do 6 atoma ugljenika spojen na ravan ili razgranat zasićeni ugljovodonički Radikal koji ima od 1 do 6 atoma ugljenika; gde svaki atom ugljenika može ponekad da bude supstituisan sa hidroksi, alkiloksi ili oksa; Ar je homocikal koji je izabran iz grupe fenila, naftila, acenaftila, tetrahidronaftila, a svaki je ponekad supstituisan sa 1, 2 ili 3 supstituenta, a svaki supstituenat je nezavisno izabran iz grupe hidroksi, halo, cijana, nitro, amino, mono- ili dialkilamino, alkila, haloalkila, alkiloksi, haloalkiloksi, karboksila, alkiloksikarbonila, alkilkarbonila, aminokarbonila, morfolinila i mono- ili dialkilaminokarbonila; Het je monociklički heterocikal koji je izabran iz grupe N-fenoksipiperidinila, piperidinila, pirolila, pirazolila, imidazolila, furan ila, tienila, oksazolila, izoksazolila, tiazolila, izotiazolila, triazolila, piridinila, pirimidinila, pirazinila i piridazinila; ili je biciklički heterocikal koji je izabran iz grupe kinolinila, izokinolinila, 1,2,3,4-tetrahidrozokinolinila, kinoksalinila, indolila, indazolila, benzimidazolila, benzoksazolila, benzizoksazolila, benzotiazolila, benzizotiazolila, benzofuranila, benzotienila, 2,3 -dihidrobenzo[1,4]dioksinila ili benzo[1,3]dioksolila; a svaki monociklički i biciklički heterocikal može ponekad da bude supstituisan na atomu ugljenika sa 1, 2 ili 3 supstituenta, a svaki supstituenat je nezavisno izabran iz grupe halo, hidroksi, alkila ili alkiloksi; halo je supstituenat koji je izabran iz grupe fluoro, hloro, hromo i jodo, a haloalkil je ravan ili razgranat zasićeni ugljovodonički radikal koji ima od 1 do 6 atoma ugljenika ili je ciklički zasićeni ugljovodonički radikal koji ima od 3 do 6 atoma ugljenika ili je ciklički zasićeni ugljovodonički radikal koji ima od 3 do 6 atoma ugljenika spojen na ravan ili razgranat zasićen ugljovodonički radikal koji ima od 1 do 6 atoma ugljenika; gde jedan ili dva atoma uglje-

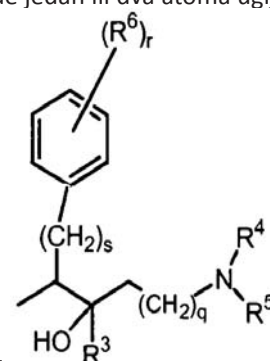

nika je supstituisano sa jednim ili više halo atoma; pod uslovom da kada je radikal pozicioniran na poziciji 3 u kinolinskom ostatku; R^7 je pozicioniran na poziciji 4 kinolinskog ostatka, a R^2 je pozicioniran na poziciji 2 u kinolinskom ostatku i predstavlja vodonik, hidroksi, merkpto, alkiloksi, alkiloksialkiloksi, alkiltio, mono ili di(alkil)amino ili radikal sa formulom

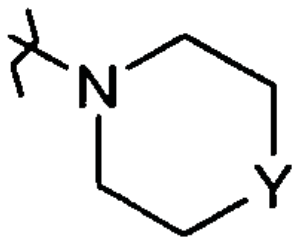

gde Y je CH₂, O, S, NH ili N-alkil; tada s je 1, 2, 3 ili 4.
Patent sadrži još 19 patentnih zahtjeva.

- (51) **A 61K 31/505**^{2006.01} **A 61P 31/18**^{2006.01} (11) **01617** (13) **B**
- (21) P-2013-66
- (22) 19. 01. 2007
- (30) 06100677 20. 01. 2006 EP
- (86) EP/07712053.3/19. 01. 2007
WO/PCT/EP2007/050516
- (87) WO 2007082922/26. 07. 2007/2007/30
EP 1981506/22. 10. 2008/2008/43
EP 1981506/27. 03. 2013/2013/13
- (54) me **DUGOTRAJNO TRETIRANJE HIV-INFEKCIJE S TCM278**
en **LONG TERM TREATMENT OF HIV- INFECTION WITH TCM278**
- (73) Janssen R&D Ireland, Eastgate Village, Eastgate, Little Island, County Cork, IE
- (72) BAERT, Lieven, Elvire, Colette, Jozef Van Walleggemstraat 11, B-8200 Brugge 2, BE
KRAUS, Guenter, De Billemontstraat 13, B-2860 Sint-Katelijne-Waver, BE
VAN 'T KLOOSTER, Gerben Albert Eleutherius, Ruitersboslaan 70, NL-4837 CK Breda, NL
- (74) RADULOVIĆ, S. Božidar, Jovana Tomaševića 9-III/1, Podgorica, 81000, ME
- (57) Korišćenje parenteralne formulacije koja sadrži antivirusnu efikasnu količinu TMC278 ili njegove farmaceutski prihvatljive kisele adicijske soli, te nosač, za proizvodnju medikamenta za tretiranje HIV-a, naznačeno time što medikament može da se primeni intermitentno supkutanom ili intramuskularnom primenom u vremenskim intervalima koji su u rasponu od dve sedmice do jedne godine. Patent sadrži još 27 patentnih zahtjeva.

(51) C 07C 231/20^{2006.01} C 07C 237/22^{2006.01} (11) 01618 (13) B
 C 07C 237/06^{2006.01} C 07C 237/52^{2006.01}

(21) P-2013-71

(22) 06. 11. 2009

(30) 08105749 07. 11. 2008 EP

(86) EP/09799015.4/06. 11. 2009

EP/PCT/EP2009/007962/06. 11. 2009

(87) WO 2010/052011/14. 05. 2010/2010/19

EP 2352721/10. 08. 2011/2011/32

EP 2352721/27. 03. 2013/2013/13

(54) me **NOVI PROCES ZA DOBIJANJE DERIVATA AMINOKISELINA**
 en **NOVEL PROCESS FOR THE PREPARATION OF AMINO ACID DERIVATIVES**

(73) UCB Pharma GmbH, Alfred-Nobel-Strasse 10, 40789 Monheim, DE

(72) BOUVY, Didier, UCB Pharma S.A., 60 Allée de la Recherche, B-1070 Brussels, BE

MERSCHAERT, Alain, UCB Pharma S.A., 60 Allée de la Recherche, B-1070 Brussels, BE

PINILLA, Véronique, UCB Pharma S.A., 60 Allée de la Recherche, B-1070 Brussels, BE

HAMANN, Joerg, Auguststrasse 45, 50733 Köln, DE

KANZLER, Ralf, Duerer Strasse 23, 51371 Leverkusen, DE

THOMAS, Antoine, 144, Rue du Bois, F-59800 Lille, BE

(74) RADULOVIĆ, S. Božidar, Jovana Tomaševića 9/III-1, Podgorica, 81000, ME

- (57) Proces za proizvodnju najmanje 95% optički čistog (R)-2-acetamido-N-benzil-3-metoksipropion-amida (I), naznačen time što podrazumeva sledeće korake: (a) razdvajanje 2-acetamido-N-benzil-3-metoksipropion-amida (II) na (R)-2-acetamido-N-benzil-3-metoksipropion-amid (I) i (S)-2-acetamido-N-benzil-3-metoksipropionamid (III);

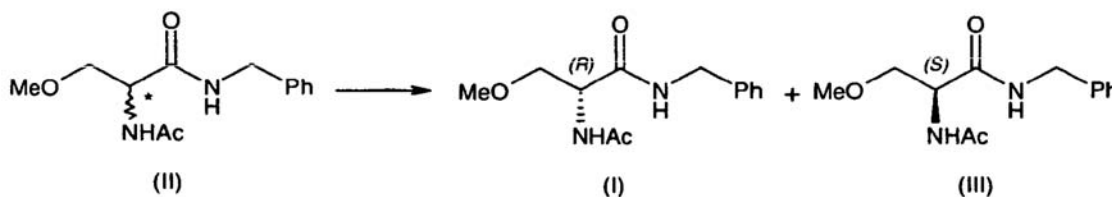

- (b) racemizaciju (S)-2-acetamido-N-benzil-3-metoksipropion-amida (III) koji je tako dobijen u 2-acetamido-N-benzil-3-metoksipropion-amid (II); i (e) dalje razdvajanje navedenog 2-acetamido-N-benzil-3-metoksipropion-amida (II) u jedinjenje sa formulom (I) i jedinjenje sa formulom (III).

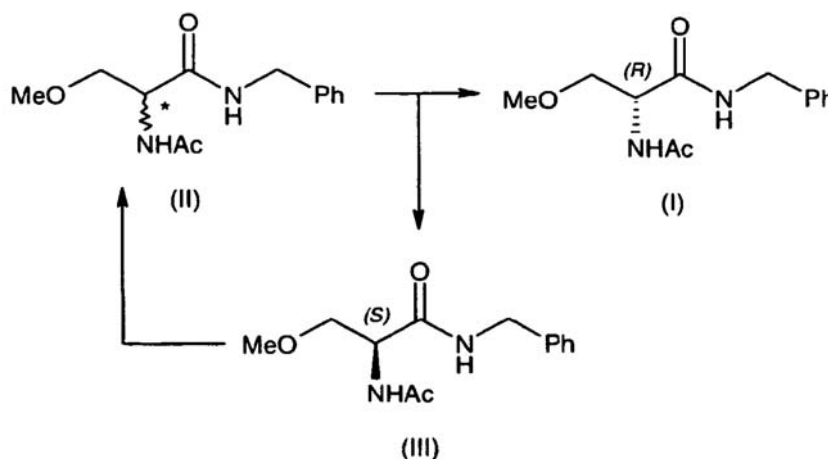

Patent sadrži još 22 patentna zahtjeva.

(51) C 07D 241 / 04^{2006.01} A 61K 31 / 495^{2006.01} (11) 01619 (13) B
 A 61P 25 / 18^{2006.01}

(21) P-2013-74

(22) 19. 02. 2010

(30) 154067P 20. 02. 2009 US

(86) EP/ 10744028.1/19. 02. 2010

WO/PCT/SE2010/050191

(87) WO 2010/096011 /26. 08. 2010/2010/34

EP 2398780/28. 12. 2011/2011/52

EP 2398780/17. 04. 2013/2013/16

(54) me **DERIVATI CIKLOPROPIL AMIDA KOJI CILJAJU HISTAMINSKI H3 RECEPTOR**
 en **CYCLOPROPYL AMIDE DERIVATIVES TARGETING THE HISTAMINE H3 RECEPTOR**

(73) AstraZeneca AB, 151 85 Södertälje, SE

(72) GRIFFIN, Andrew,

AstraZeneca R&D Montreal, 7171 Frederick-Banting, Ville St. Laurent, Montreal, Québec H4S 1Z9, CA

(74) RADULOVIĆ, S. Božidar, Jovana Tomaševića 9/III-1, Podgorica, 81000, ME

(57) Jedinjenje formule I, ili njegovi enantiomeri ili diastereomeri, ili farmaceutski prihvatljive soli formule I ili njihovi enantiomeri ili diastereomeri, ili njihove smeše:

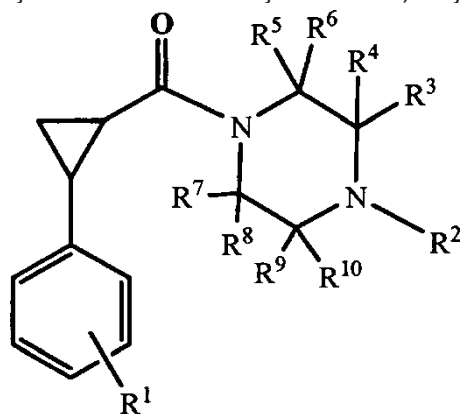

I

naznačeno time da: R¹ je aril, heteroaril, -C₁-C₆alkil-C₁-C₃alkoksi, -C₁-C₆alkil-hidroksi, -C₁-C₆alkil-C(=O)-NR¹¹R¹², -S(=O)₂NR¹¹R¹², heterocikal, cijano, haloalkil, -C(=O)NR¹¹R¹², alkoksi, ili halogen; R² je C₁-C₆alkil ili C₃-C₆cikloalkil; R³, R⁴, R⁵, R⁶, R⁷, R⁸, R⁹, i R¹⁰ su svaki nezavisno izabrani od H i C₁-C₃alkila; i R¹¹ i R¹² su svaki nezavisno izabrani od H, -C₁-C₆alkila, -C₁-C₃alkil-C₁-C₃alkoksi, 5-članog heterocikloalkila koji sadrži barem jedan heteroatom izabran od O i N, 6-članog heterocikloalkila koji sadrži barem jedan heteroatom izabran od O i N, -(C₁-C₃alkil)-(5-člani heteroaril koji sadrži barem jedan heteroatom izabran od O i N), -(C₁-C₃alkil)-(6-člani heteroaril koji sadrži barem jedan heteroatom izabran od O i N), haloalkil, ili R¹¹, R¹² i azot na koji su vezani udružuju se i grade heterocikloalkil izabran od piperidina, morfolina, piperidina, i piperazina, gde je pomenuti heterocikloalkil po izboru supstituisan sa najmanje jednim supstituentom izabranim iz -C₁-C₃alkila i -C₁-C₆alkil-C₁-C₃alkoksi; i pod pretpostavkom da: i) barem jedan od R³, R⁴, R⁵, R⁶, R⁷, R⁸, R⁹, i R¹⁰ je C₁-C₃alkil; ii) formula I nije

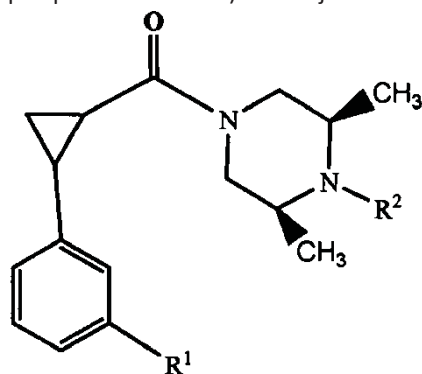

kada R¹ je -C(=O)NR¹¹R¹² grupa meta-vezana na fenil, R² je izopropil, te R¹¹ i R¹² su H; i iii) formula I nije u cis konfiguraciji na ciklopropanu.

Patent sadrži još 14 patentnih zahtjeva.

- (51) **C 07D 403 / 12**^{2006.01} **C 07D 417 / 12**^{2006.01} (11) **01620** (13) **B**
C 07D 401 / 12^{2006.01} **A 61K 31 / 5377**^{2006.01}
- (21) P-2014-3
(22) 23. 08. 2005
(30) 0419235 28. 08. 2004 GB
0502544 08. 02. 2005 GB
(86) EP/05773278.6/23. 08. 2005
GB/PCT/GB2005/003257
(87) WO 2006/024823/09. 03. 2006/2006/10
EP 1809624/25. 07. 2007/2007/30
EP 1809624/20. 11. 2013/2013/47
(54) me **PIRIMIDIN SULFONAMIDNI DERIVATI KAO MODULATORI HEMOKINSKIH**
RECEPTORA
en **PYRIMIDINE SULPHONAMIDE DERIVATIVES AS CHEMOKINE RECEPTOR**
MODULATORS
(73) AstraZeneca AB, 151 85 Södertälje, SE
(72) CHESHIRE, David, Ranulf,
C/o AstraZeneca IP, AstraZeneca R&D Alderley, Alderley Park, Macclesfield, Cheshire, SK10 4TG, GB
COX, Rhona, Jane, AstraZeneca R&D Mölndal, SE 431 83 Mölndal, SE
MEGHANI, Premji,
C/o AstraZeneca IP, AstraZeneca R&D Alderley, Alderley Park, Macclesfield, Cheshire, SK10 4TG, GB
PRESTON, Cherylin, Francis,
C/o AstraZeneca IP, AstraZeneca R&D Alderley, Alderley Park, Macclesfield, Cheshire, SK10 4TG, GB
SMITH, Neal, Michael,
C/o AstraZeneca IP, AstraZeneca R&D Alderley, Alderley Park, Macclesfield, Cheshire, SK10 4TG, GB
STONEHOUSE, Jeffrey, Paul,
C/o AstraZeneca IP, AstraZeneca R&D Alderley, Alderley Park, Macclesfield, Cheshire, SK10 4TG, GB
(74) RADULOVIĆ, S. Božidar, Studentska bb, Lamela 3/18, Podgorica, 81000, ME

- (57) Jedinjenje sa formulom (1)

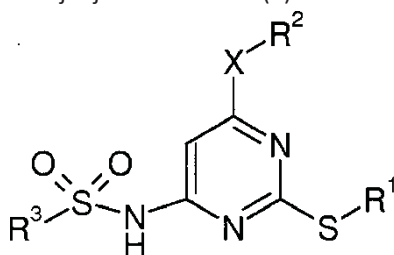

(1)

naznačeno time što R¹ je C₁₋₈alkil supstituisan sa fenilom koji je po izboru supstituisan sa 1, 2 ili 3 supstituenta koji su nezavisno izabrani od fluoro, hloro, bromo, metoksi, metila i trifluorometila; X je -CH₂-, veza, kiseonik, sumpor, sulfoksid, ili sulfon; R² je C₃₋₇karbociklil, po izboru supstituisan sa 1, 2 ili 3 supstituenta koji su nezavisno izabrani od: fluoro, -OR⁴, -NR⁵R⁶, -CONR⁵R⁶, -COOR⁷, -NR⁸COR⁹, -SR¹⁰, -SO₂R¹⁰, -SO₂NR⁵R⁶, -NR⁸SO₂R⁹; ili R² je 3-8 člani prsten koji po izboru sadrži 1, 2 ili 3 atoma izabranih od O, S, -NR⁸ i gde je prsten po izboru supstituisan sa 1, 2 ili 3 supstituenta koji su nezavisno izabrani od C₁₋₃alkila, fluoro, -OR⁴, -NR⁵R⁶, -CONR⁵R⁶, -COOR⁷, -NR⁸COR⁹, -SR¹⁰, -SO₂R¹⁰, -SO₂NR⁵R⁶, -NR⁸SO₂R⁹; ili R² je fenil ili monociklični ili biciklični heteroarilni prsten koji sadrži 5 do 10 atoma u prstenu od kojih 1, 2, 3 ili 4 atoma u prstenu je izabrano od azota, sumpora ili kiseonika; svaki od kojih je po izboru supstituisan sa 1, 2 ili 3 supstituenta koji su nezavisno izabrani od halo, cijano, nitro, -OR⁴, -NR⁵R⁶, -CONR⁵R⁶, -NR⁸COR⁹, -SO₂NR⁵R⁶, -NR⁸SO₂R⁹, C₁₋₆alkila i trifluorometila; ili R² je grupa izabrana od C₁₋₈alkila, C₂₋₆alkenila ili C₂₋₆alkinila pri čemu je grupa supstituisana sa 1, 2 ili 3 supstituenta koji su nezavisno izabrani od hidroksi, amino, C₁₋₆alkoksi, C₁₋₆alkilamino, di(C₁₋₆alkil)amino, N-(C₁₋₆alkil)-N-(fenil)amino, N-C₁₋₆alkilkarbamoil, N,N-di(C₁₋₆alkil)karbamoil, N-(C₁₋₆alkil)-N-(fenil)karbamoil, karboksi, fenoksikarbonil, -NR⁸COR⁹, -SO₂R¹⁰, -SO₂NR⁵R⁶, -NR⁸SO₂R⁹ i -CONR⁵R⁶; R³ je trifluorometil ili grupa -NR⁵R⁶, ili R³ je fenil, naftil, monociklični ili biciklični heteroarilni prsten koji sadrži 5 do 10 atoma u prstenu od kojih 1, 2, 3 ili 4 atoma u prstenu je izabrano od azota, sumpora ili kiseonika pri čemu heteroprsten može da bude delimično ili potpuno zasićen i jedan ili više atoma ugljenika u prstenu mogu da grade karbonilnu grupu, te gde je svaka fenilna ili heteroarilna grupa po izboru supstituisana sa 1, 2 ili 3 supstituenta koji su nezavisno izabrani od halo, cijano, nitro, fenila, heteroarila, -OR⁴, -NR⁵R⁶, -CONR⁵R⁶, -COR⁷-, -COR²⁰-, -COOR⁷, -NR⁸COR⁹, -SR¹⁰, -SO₂R¹⁰, -SO₂NR⁵R⁶, -NR⁸SO₂R⁹, trifluorometila ili C₁₋₆alkila [po izboru dodatno supstituisan sa 1, 2 ili 3 supstituenta koji su nezavisno izabrani od halo, cijano, nitro, -OR²⁰, -COOR²⁰, -COR²⁰, NR¹⁸R¹⁹, -CONR¹⁸R¹⁹, -NR¹⁸COR¹⁹, -SO₂R²⁰, -SO₂NR¹⁸R¹⁹,

NR¹⁸SO₂R¹⁹, fenila ili monocikličnog ili bicikličnog heteroarilnog prstena koji sadrži 5 do 10 atoma u prstenu od kojih 1, 2, 3 ili 4 atoma u prstenu je izabrano od azota, sumpora ili kiseonika, pri čemu heteroprsten može da bude delimično ili potpuno zasićen; i pri čemu svaka fenilna ili heteroarilna grupa je po izboru supstituisana sa 1, 2 ili 3 supstituenta koji su nezavisno izabrani od halo, cijano, nitro, -OR²⁰, -NR⁵R⁶, -CONR⁵R⁶, -COR⁷, -COOR⁷, -NR⁸COR⁹, -SR¹⁰, -SO₂R¹⁰, -SO₂NR⁵R⁶, -NR⁸SO₂R⁹, heteroarila, C₁₋₆alkila (po izboru dodatno supstituisan sa 1, 2 ili 3 supstituenta koji su nezavisno izabrani od halo, cijano, nitro, -OR²⁰, -COOR²⁰, COR²⁰, NR¹⁸R¹⁹, -CONR¹⁸R¹⁹, NR¹⁸COR¹⁹, SO₂R²⁰, -SO₂NR¹⁸R¹⁹, NR¹⁸SO₂R¹⁹, ili R³ je grupa izabrana od C₃₋₇karbociklila, C₁₋₈alkila, C₂₋₆alkenila i C₂₋₆alkinila pri čemu je grupa po izboru supstituisana sa 1, 2 ili 3 supstituenta koji su nezavisno izabrani od halo, -OR⁴, -NR⁵R⁶, -CONR⁵R⁶, -COR⁷, -COOR⁷, -NR⁸COR⁹, -SR¹⁰, -SO₂R¹⁰, -SO₂NR⁵R⁶, -NR⁸SO₂R⁹, fenila ili monocikličnog ili bicikličnog heteroarilnog prstena koji sadrži 5 do 10 atoma u prstenu od kojih 1, 2, 3 ili 4 atoma u prstenu je izabrano od azota, sumpora ili kiseonika, pri čemu heteroprsten može da bude delimično ili potpuno zasićen; te gde je svaka fenilna ili monociklična ili biciklična heteroarilna grupa po izboru supstituisana sa 1, 2 ili 3 supstituenta koji su nezavisno izabrani od halo, cijano, nitro, -OR⁴, -NR⁵R⁶, -CONR⁵R⁶, -COR⁷, -COOR⁷, -NR⁸COR⁹, -SR¹⁰, -SO₂R¹⁰, -SO₂NR⁵R⁶, -NR⁸SO₂R⁹, C₁₋₆alkila, ili trifluorometila; R⁴ je vodonik ili grupa izabrana od C₁₋₆alkila i fenila, pri čemu je grupa po izboru supstituisana sa 1 ili 2 supstituenta koji su nezavisno izabrani od halo, fenila, -OR¹¹ i -NR¹²R¹³; R⁵ i R⁶ su nezavisno vodonik ili grupa izabrana od C₁₋₆alkila i fenila i monocikličnog ili bicikličnog heteroarilnog prstena, koji sadrži 5 do 10 atoma u prstenu od kojih 1, 2, 3 ili 4 atoma u prstenu je izabrano od azota, sumpora ili kiseonika, pri čemu heteroprsten može da bude delimično ili potpuno zasićen; pri čemu je grupa po izboru supstituisana sa 1, 2 ili 3 supstituenta koji su nezavisno izabrani od halo, fenila, -OR¹⁴, -NR¹⁵R¹⁶, -COOR¹⁴, -CONR¹⁵R¹⁶, -NR¹⁵COR¹⁶, -SO₂R¹⁰, -SO₂NR¹⁵R¹⁶ i NR¹⁵SO₂R¹⁶; ili R⁵ i R⁶ zajedno sa atomom azota na koji su spojeni formiraju 4- do 7-člani zasićeni heterociklični prstenski sistem koji po izboru sadrži dodatni heteroatom odabran od kiseonika, -SO_(n)- (gde n = 0, 1 ili 2) i atoma azota, u kojem je prsten po izboru supstituisan sa 1, 2 ili 3 supstituenta koji su nezavisno izabrani od fenila, monocikličnog ili bicikličnog heteroarilnog prstena koji sadrži 5 do 10 atoma u prstenu od kojih 1, 2, 3 ili 4 atoma u prstenu je izabrano od azota, sumpora ili kiseonika; -OR¹⁴, -COR²⁰, -COOR¹⁴, -NR¹⁵R¹⁶, -CONR¹⁵R¹⁶, -NR¹⁵COR¹⁶, -SO₂R¹⁰, -SO₂NR¹⁵R¹⁶, NR¹⁵SO₂R¹⁶ ili C₁₋₆alkila (po izboru dodatno supstituisan sa 1 ili 2 ili 3 supstituenta koji su nezavisno izabrani od halo, -NR¹⁵R¹⁶ i -OR¹⁷ ili cijano, nitro, -OR²⁰, -COOR²⁰, -COR²⁰, -NR¹⁸R¹⁹, -CONR¹⁸R¹⁹, -NR¹⁸COR¹⁹, -SO₂R²⁰, -SO₂NR¹⁸R¹⁹, NR¹⁸SO₂R¹⁹ grupe); R¹⁰ je vodonik ili grupa izabrana od C₁₋₆alkila ili fenila, pri čemu je grupa po izboru supstituisana sa 1, 2 ili 3 supstituenta koji su nezavisno izabrani od halo, fenila, -OR¹⁷ i -NR¹⁵R¹⁶; te svaki od R⁷, R⁸, R⁹, R¹¹, R¹², R¹³, R¹⁴, R¹⁵, R¹⁶, R¹⁷ je nezavisno vodonik, C₁₋₆alkil ili fenil; R¹⁸, R¹⁹, i R²⁰ su vodonik ili grupa izabrana od C₁₋₆alkila ili monocikličnog ili bicikličnog heteroarilnog prstena koji sadrži 5 do 10 atoma u prstenu od kojih 1, 2, 3 ili 4 atoma u prstenu je izabrano od azota, sumpora ili kiseonika (pri čemu heteroprsten može da bude delimično ili potpuno zasićen) ili fenila, pri čemu je grupa po izboru supstituisana sa 1, 2 ili 3 supstituenta koji su nezavisno izabrani od halo, nitro, -CN, -OR⁴, -NR⁸R⁹, -CONR⁸R⁹, -COR⁷, -COOR⁷, NR⁸COR⁹, -SR¹⁰, -SO₂R¹⁰, -SO₂NR⁸R⁹, -NR⁸SO₂R⁹, C₁₋₆alkila ili monocikličnog ili bicikličnog heteroarilnog prstena, koji sadrži 5 do 10 atoma u prstenu od kojih 1, 2, 3 ili 4 atoma u prstenu je izabrano od azota, sumpora ili kiseonika; ili njihova farmaceutski prihvatljiva so, solvat ili *in vivo* hidrolizirajući estar.

Patent sadrži još 24 patentna zahtjeva.

(51) C 07D 487 / 04^{2006.01} A 61K 31 / 519^{2006.01} (11) 01621 (13) BA 61P 9 / 00^{2006.01}

(21) P-2013-131

(22) 29. 01. 2010

(30) 20090020720 30. 01. 2009 JP

(86) EP/ 10703532.1/29. 01. 2010
JP/PCT/JP2010/051651/29. 01. 2010

(87) WO 2010/087515 /05. 08. 2010/31/2010

EP 2384327 /09. 11. 2011/2011/45

EP 2384327 /31. 07. 2013/2013/31

(54) me **JEDINJENJE SA KONDENZOVANIM PRSTENOM I NJEGOVA UPOTREBA**
en **FUSED RING COMPOUND AND USE THEREOF**(73) Takeda Pharmaceutical Company Limited,
1-1, Doshomachi 4-chome, Chuo-ku, Osaka-shi, Osaka 541-0045, JP(72) MAEKAWA, Tsuyoshi,
c/o TAKEDA PHARMACEUTICAL COMPANY LIMITED, 26-1, Fujisawa, Kanagawa 251-8555, JP
Muraoka-Higashi 2-chomeIGAWA, Hideyuki,
c/o TAKEDA PHARMACEUTICAL COMPANY LIMITED, Fujisawa, Kanagawa 251-8555, JP
26-1, Muraoka-Higashi 2-chome

(74) ČUPIĆ, Branislav, Dalmatinska 10, Podgorica, 81000, ME

(57) Jedinjenje predstavljeno formulom (I):

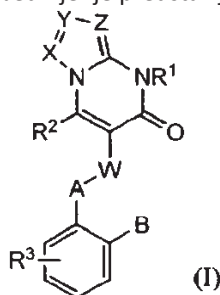

gde,

R¹ je atom vodonika, po izboru supstituisan C₁₋₆ alkil, po izboru supstituisana 3- do 10-člana nearomatična ciklična grupa ili po izboru supstituisana 5- ili 6-člana aromatična ciklična grupa, R² je atom vodonika, po izboru supstituisan C₁₋₆ alkil, po izboru supstituisan C₁₋₆ alkoksi, po izboru supstituisan C₁₋₆ alkiltio, po izboru supstituisan C₁₋₆ alkilsulfinil ili po izboru supstituisan C₁₋₆ alkilsulfonil, R³ je atom vodonika, atom halogena, po izboru supstituisan C₁₋₆ alkil ili po izboru supstituisan C₁₋₆ alkoksi, X, Y i Z svaki su nezavisno atom azota ili CR⁴ pri čemu R⁴ je atom vodonika, atom halogena, po izboru supstituisan C₁₋₆ alkil, po izboru supstituisan C₁₋₆ alkoksi ili po izboru supstituisan C₃₋₆ cikloalkil, W je po izboru supstituisan C₁₋₄ alkilen, -O-W'-, -W'-O-, -N(Ra)-W'- ili -W'-N(Ra)- pri čemu W' je veza ili po izboru supstituisan C₁₋₄ alkilen, Ra je atom vodonika, po izboru supstituisan C₁₋₆ alkil ili po izboru supstituisan C₃₋₆ cikloalkil, A je po izboru supstituisan 5- ili 6-člani dvovalentni aromatični prsten, i B je acil ili po izboru supstituisana 3- do 10-člana heterociklična grupa, pod uslovom da kada B je karboksi, karbamoil ili tetrazolil, onda R¹ nije atom vodonika, ili njegova so.

Preostalih patentnih zahtjeva 21.

- (51) C 07C 327/56^{2006.01} A 61K 31/16^{2006.01} (11) 01644 (13) B
 A 61P 35/00^{2006.01}
- (21) P-2013-124
 (22) 20. 06. 2005
 (30) 20040582596P 23. 06. 2004 US
 20050681368P 16. 05. 2005 US
 (86) EP/05762347.2/20. 06. 2005
 US/PCT/US2005/021642/20. 06. 2005
 (87) WO 2006/009940/26. 01. 2006/04/2006
 EP 1781604/09. 05. 2007/2007/19
 EP 1781604/07. 08. 2013/2013/32
- (54) me **BIS(TIO-HIDRAZID AMIDNE) SOLI ZA TRETMAN KANCERA**
 en **BIS(THIO-HYDRAZIDE AMIDE) SALTS FOR TREATMENT OF CANCERS**
- (73) Synta Pharmaceuticals Corp., 45 Hartwell Avenue, Lexington, MA 02421, US
 (72) KOSTIK, Elena, 32 School Street, Arlington, MA 02474, US
 VAGHEFI, Farid, 14 Marshall Street, Watertown, MA 02472, US
 LIANG, Guiqing, 26 Minuteman Drive, Concord, MA 01742, US
 KOYA, Keizo, 234 Bonad Road, Chestnut Hill, MA 02467, US
 SUN, Lijun, 148 Depot Road, Harvard, MA 01451, US
 TATSUTA, Noriaki, 60 Fifer lane, Lexington, MA 02420, US
 CHEN, Shoujun, 22 Reeves Road, Bedford, MA 01730, US
 INOUE, Takayo, 18 Winship Street, Malden Massachusetts 02148, US
 XIA, Zhi-Qiang, 634 Massachusetts Avenue, Acton, MA 01720, US
 (74) RADULOVIĆ, S. Božidar, Jovana Tomaševića 9/III-1, Podgorica, 81000, ME

(57) Jedinjenje formule (II):

$2M^+$ ili M^{2+}

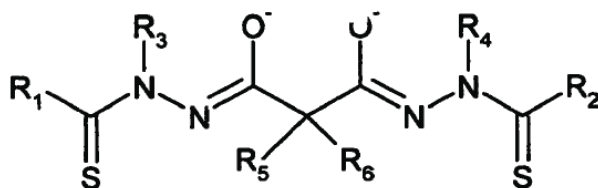

naznačeno time, što: R_1 i R_2 svaki nezavisno predstavlja supstituisanu ili nesupstituisanu fenil grupu, naznačenu time, što supstituente predstavljaju C1-C4 alkil, C1-C4 alkoksi, C1-C4 haloalkil, C1-C4 haloalkoksi, fenil, benzil, piridil, -OH, -NH₂, -F, -Cl, -Br, -I, -NO₂ ili -CN radikali; R_3 i R_4 svaki nezavisno predstavlja metil ili etil grupu; R_5 predstavlja -H; R_6 predstavlja -H ili metil grupu; M^+ predstavlja farmaceutski prihvatljiv monovalentni katjon, a M^{2+} predstavlja farmaceutski prihvatljiv dvovalentni katjon.
 Preostalo patentnih yahtjeva 23.

(51) **C 07D 211/40**^{2006.01} **C 07D 207/12**^{2006.01} (11) **01645** (13) **B**
C 07D 295/18^{2006.01}

(21) P-2014-4

(22) 20. 08. 2008

(30) 957181P 22. 08. 2007 US

(86) EP/08788694.1/20. 08. 2008
 WO/PCT/GB2008/050723

(87) WO 2009/024823/26. 02. 2009/2009/09

EP 2195293/16. 06. 2010/2010/24

EP 2195293/16. 10. 2013/2013/42

(54) me **DERIVATI CIKLOPROPIL AMIDA**
 en **CYCLOPTOPYL AMIDE DERIVATIVES**

(73) AstraZeneca AB, 151 85 Södertälje, SE

(72) ARNOLD, James, 96 Toledo Way, Apartment 305, San Francisco, California 94123, US

BRUGEL, Todd, Andrew,

AstraZeneca R&D Wilmington, 1800 Concord Pike, PO Box 15437, Wilmington, Delaware 19850-5437, US

EDWARDS, Phil, 1921 Marlboro Road, Kennett Square, Pennsylvania 19348, US

GRIFFIN, Andrew,

AstraZeneca R&D Montréal, 7171 Frédérick Banting, Saint Laurent, Québec H4S 1Z9, CA

GROBLEWSKI, Thierry,

AstraZeneca R&D Montréal, 7171 Frédérick Banting, Saint Laurent, Québec H4S 1Z9, CA

LABRECQUE, Denis,

AstraZeneca R&D Montréal, 7171 Frédérick Banting, Saint Laurent, Québec H4S 1Z9, CA

THRONER, Scott,

AstraZeneca R&D Wilmington, 1800 Concord Pike, PO Box 15437, Wilmington, Delaware 19850-5437, US

WESOLOWSKI, Steven,

AstraZeneca R&D Wilmington, 1800 Concord Pike, PO Box 15437, Wilmington, Delaware 19850-5437, US

Brown, Dean, Astra Zeneca R&D Boston, 35 Gatehouse Drive, Waltham, Massachusetts 02451, US

(74) RADULOVIĆ, Božidar, Studentska bb, Lamela 3/18, Podgorica, 81000, ME

(57) Jedinjenje sa formulom I, ili njegovi dijastereomeri ili enantiomeri, ili farmaceutski prihvatljive soli prema formuli I ili njezini dijastereomeri ili enantiomeri, ili njihove smeše:

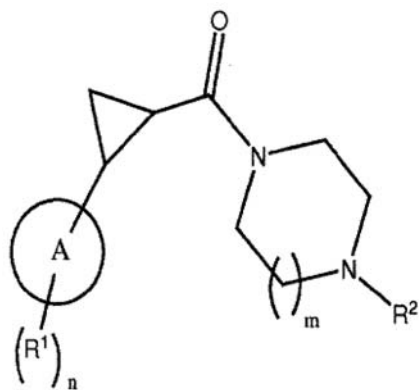

I

naznačeno time što A je aril, heteroaril, cikloalkil, ili heterocikloalkil; m je 1 ili 2; n je 1, 2, 3, 4, ili 5; svaki R¹ je nezavisno H, aril, heteroaril, arilalkil, heteroarilalkil, cikloalkil, heterocikloalkilalkil, C₁-C₆alkil, C₂-C₆alkenil, C₃-C₆cikloalkenil, C₂-C₆alkinil, alkoksialkil, hidroksialkil, aminoalkil, aminokarbonilalkil, heterociklus, arilalkenil, cikloalkenilalkil, heterocikloalkil, cijano, alkilsulfmil, haloalkil, NR⁴R⁵, -NR⁶C(=O)R³, -C(=O)NR⁴R⁵, alkoksi, halogen, alkilkarbonil, ili hidroksi (-OH); R² je C₃-C₈cikloalkil ili C₁-C₆alkil; R³ je H, C₁-C₆alkil, C₁-C₆alkoksi, -NHC₁-C₆alkil, ili -N(C₁-C₆alkil)₂, ili R³ i N iz -NR⁶C(=O)R³ grupa udružuju se da grade 4, 5, ili 6-člani heterociklični prsten koji ima najmanje jedan heteroatom izabran od O i N; R⁴ i R⁵ su svaki nezavisno izabrani iz H i C₁-C₆alkil; i R⁶ je H ili odsutan; pod uslovom da kada i) N i R³ se udružuju R⁶ je odsutan. Patent sadrži još 17 patentnih zahtjeva.

- (51) **C 07C 237/24**^{2006.01} **C 07D 207/04**^{2006.01} (11) **01646** (13) **B**
A 61K 31/165^{2006.01}
- (21) P-2014-11
(22) 16. 10. 2006
(30) 730996P 27. 10. 2005 US
(86) EP/06809114.9/16. 10. 2006
IB/PCT/IB2006/002977/16. 10. 2006
(87) WO 2007/049123/03. 05. 2007/2007/18
EP 1951660/06. 08. 2008/2008/32
EP 1951660/11. 12. 2013/2013/50
- (54) me **ANTAGONISTI HISTAMINSKIH -3 RECEPTORA**
en **HISTAMINE-3 RECEPTOR ANTAGONISTS**
- (73) Pfizer Products Inc., Eastern Point Road, Groton, CT 06340, US
(72) WAGER, Travis, T.,
Pfizer Global Research and Development, Eastern Point Road, Groton, CT 06340, US
CHANDRASEKARAN, Ramalakshmi, Yegna,
Pfizer Global Research & Development, Eastern Point Road, Groton, CT 06340, US
BUTLER, Todd, William,
Pfizer Global Research and Development, Eastern Point Road, Groton, CT 06340, US
(74) AOD "ČUPIĆ", Dalmatinska 10, Podgorica, 81000, ME

(57) Jedinjenje formule I

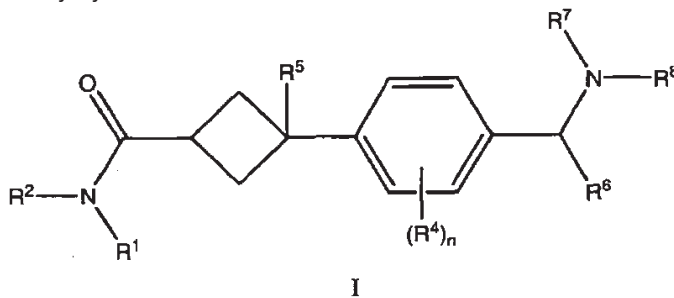

ili njegov stereoizomer, geometrijski izomer ili tautomerni oblik, ili farmaceutski prihvatljiva so jedinjenja formule I ili njegovog stereoizomera, geometrijskog izomera ili tautomernog oblika, gde : R¹ i R² je svaki nezavisno odabran iz grupe koju čine vodonik; C₁-C₈ alkil po izboru supstituisan sa 1 do 4 halogena; C₁-C₄ alkil grupa po izboru supstituisana supstuentom odabranim iz grupe koju čine OH, jedan do četiri C₁-C₄ alkila, C₃-C₇ cikloalkil, C₁-C₄ dialkilamino, C₆-C₁₄ aril po izboru supstituisan halogenom i po izboru supstituisan sa C₆-C₁₀ ariloksi po izboru supstituisan jednim do dva halogena, i 5-10-člani heteroaril po izboru supstituisan C₆-C₁₀ aril grupom i po izboru supstituisan jednom do tri C₁-C₄ alkil grupe; C₃-C₇ cikloalkil; C₆-C₁₄ aril; -(C₀-C₃)alkil-O-(C₁-C₃)alkil po izboru supstituisan (C₁-C₃)alkilom ; -(C₁-C₃)alkil-C(=O)O-(C₁-C₃)alkil; 3-8-člani heterocikloalkil po izboru supstituisan jednom ili više C₁-C₄ alkil-karbonil grupa; C₆-C₁₀ arilsulfonyl po izboru supstituisan jednim ili više C₁-C₂ alkila; 5-10-člani heteroaril; i C₆-C₁₄ aril-C₀-C₄ alkilen-O-C₀-C₄ alkil, gde je svaki C₀-C₄ alkil i svaki C₀-C₄ alkilen po izboru supstituisan jednim do četiri C₁-C₄ alkila; ili po izboru R¹ i R², zajedno sa azotom za koji su vezani, obrazuju 4-, 5-, 6-, ili 7-člani zasićen ili nezasićen alifatični prsten, pri čemu je jedan od ugljenika u alifatičnom prstenu po izboru zamenjen sa O, S, NR³, ili CO, i gde je dati prsten po izboru kondenzovan sa C₆-C₁₀ arilenom i po izboru je supstituisan na ugljeniku u prstenu supstuentom odabranim iz grupe koju čine -OH, 5-10-člani heteroaril po izboru supstituisan jednim ili više halogena i po izboru supstituisan jednim ili više C₁-C₂ alkila, C₁-C₄ alkoksi po izboru supstituisan jednim ili više C₁-C₂ alkoksi i po izboru supstituisan jednim ili više C₁-C₄ dialkilaminokarbonila, i jedan ili dva C₁-C₄ alkila po izboru i nezavisno supstituisan jednim ili više C₁-C₂ alkoksi; gde R³ je vodonik; C₁-C₈ alkil po izboru supstituisan sa 1 do 4 halogena; 5-10-člani heteroaril po izboru supstituisan supstuentom odabranim iz grupe koju čine halogen, C₁-C₄ alkil, C₁-C₂ alkoksi, C₆-C₁₀ aril, C₁-C₄ alkilaminokarbonil, i cijano; C₁-C₄ alkil grupa po izboru supstituisana supstuentom odabranim iz grupe koju čine C₁-C₂alkoksikarbonil, 5-10-člani heteroaril po izboru supstituisan jednim ili više C₁-C₂ alkila, jedna do četiri C₁-C₄ alkila, C₃-C₇ cikloalkil, i C₆-C₁₄ aril; C₆-C₁₀ aril po izboru supstituisan jednim ili dva C₁-C₂ alkila; C₁-C₄ alkilkarbonil; ili C₆-C₁₄ aril-C₀-C₄ alkilen-O-C₀-C₄ alkil, pri čemu svaki C₀-C₄ alkil i svaki C₀-C₄ alkilen je po izboru supstituisan jednim do četiri C₁-C₄ alkila; R⁴ je nezavisno odabran iz grupe koju čine vodonik, C₁-C₄ alkil, C₁-C₄ alkoksil, halogen, nitril, -SO₂C₁-C₄, -SO₂NHC₁-C₄, i -C(=O)NHC₁-C₄; n je 0, 1, 2, 3, ili 4; R⁵ je OH, -O (C₁-C₃)alkil, halogen ili vodonik; R⁶ je vodonik, C₁-C₄ alkil po izboru supstituisan sa 1 do 4 halogena, ili C₃-C₇ cikloalkil-C₀-C₄ alkil; R⁷ je vodonik, C₁-C₈ alkil po izboru supstituisan sa 1 do 4 halogena, ili C₃-C₇ cikloalkil-C₀-C₄ alkil, gde svaki C₀-C₄ je po izboru supstituisan sa jedan do četiri C₁-C₄ alkila i; R⁸ je vodonik, C₁-C₈ alkil po izboru supstituisan

sa 1 do 4 halogena, ili C₃-C₇ cikloalkil-C₀-C₄ alkil; ili po izboru R⁷ i R⁸, zajedno sa azotom za koji su vezani, formiraju 4-, 5-, 6-, ili 7-člani heterociklični prsten gde je dati heterociklični prsten po izboru supstituisan jednim ili dva C₁-C₄ alkila; i gde jedan od ugljenika u heterocikličnom prstenu koji je odvojen sa najmanje dva atoma od datog azota u datom heterocikličnom prstenu, je po izboru zamenjen sa O, S, NR⁹, ili C=O, gde R⁹ je vodonik, C₁-C₈ alkil po izboru supstituisan sa 1 do 4 halogena, ili C₃-C₇ cikloalkil-C₀-C₄ alkil, i pri čemu svaki C₀-C₄ alkil je po izboru supstituisan sa jedan do četiri C₁-C₄ alkila.
Patent sadrži još 14 patentnih zahtjeva.

- (51) **B 65D 41/46**^{2006.01} **B 65D 41/62**^{2006.01} (11) **01647** (13) **B**
(21) P-2014-19
(22) 28. 09. 2010
(86) EP/10460040.8/28. 09. 2010
(87) EP 2444334 /25. 04. 2012/2012/17
EP 2444334 /27. 11. 2013/2013/48
(54) me **Zaštitna kapica za boce**
en **Safety bottle cap**
(73) CEDC International sp. z.o.o., ul. Kowanowska 48, 64-600 Oborniki Wielkopolskie, PL
(72) Klopocki, Marek, ul. Zmudzka 7, 81-554 Gdynia, PL
(74) ĐAKONOVIĆ, Vido, Vojvode Boža br. 1, Cetinje, 81250, ME

- (57) Zaštitna kapica za boce koja sadrži plastično telo (2) koje se sastoji od dva dijela koji su međusobno spojeni pomoću mnoštva mostića (3) koji se mogu pokidati, pri čemu gornji dio tijela (2) sadrži zaptivni element (4), koji treba da se uvede u otvor na vrhu grlića boce, zaptivnu ivicu (5), mnoštvo periferno raspoređenih spoljnih rebara (7), i donji dio tijela (2) u obliku zasječenog kontrolnog prstena koji se može pokidati, a koji sadrži zaštitnu kariku (10) koja je usmjerena pod uglom prema unutrašnjosti prstena, pri čemu karika (10) zahvata i uskače u odgovarajući prstenasti žljeb koji je izveden na spoljnoj površini vrha grlića boce, i pri čemu gornji dio tijela (2) ima mnoštvo unutrašnjih rebara (6), raspoređenih periferno na unutrašnjoj strani tela (2), koja dodiruju spoljnu perifernu površinu vrha grlića boce naznačena time što je metalni poklopac (1) spojen sa plastičnim telom, što kontrolni prsten dalje sadrži jezičak (11) za otkidanje kontrolnog prstena, koji na svom donjem dijelu ima mostiće (12) koji se mogu pokidati, a koji spajaju jezičak sa donjim dijelom kontrolnog prstena i i što gornji deo tela (2) na svojom donjem perifernom rubu ima prstenasti ispust (8) koji se pruža spolja u radijalnom smeru preko konture metalnog poklopca (1).

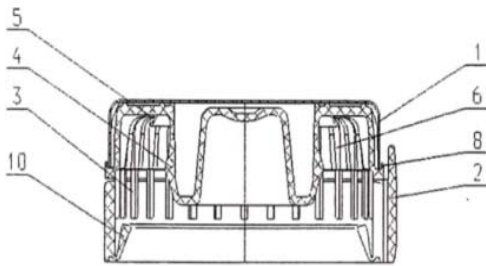

Patent sadrži još 6 patentnih zahtjeva.

- (51) **A 61K 31/44**^{2006.01} **A 61K 31/277**^{2006.01} (11) **01648** (13) **B**
A 61K 31/4439^{2006.01} **A 61K 31/437**^{2006.01}
A 61K 31/343^{2006.01} **A 61K 31/502**^{2006.01}
A 61K 31/366^{2006.01} **A 61K 31/22**^{2006.01}
A 61K 31/40^{2006.01} **A 61K 31/405**^{2006.01}
A 61K 31/505^{2006.01} **A 61K 31/352**^{2006.01}
A 61K 31/453^{2006.01} **A 61P 11/00**^{2006.01}
A 61K 45/06^{2006.01}
- (21) P-2014-9
(22) 03. 07. 2007
(30) 06116625 05. 07. 2006 EP
(86) EP/ 11164516.4/03. 07. 2007
(87) EP 2359826/24. 08. 2011/2011/34
EP 2359826/30. 10. 2013/2013/44
(54) me **Kombinacija inhibitora HMG-COA reduktaze rosuvastatina sa inhibitorom fosfodiesteraze 4, kao što je roflumilast, roflumilast-N-oksidi za liječenje inflamatornih plućnih oboljenja**
en **Combination of HMG-COA reductase inhibitor rosuvastatin with a phosphodiesterase 4 inhibitor, such as roflumilast, roflumilast N-oxide for the treatment of inflammatory pulmonary diseases**
- (73) Takeda GmbH, Byk-Gulden-Strasse 2, 78467 Konstanz, DE
(72) Wollin, Stefan-Lutz, Mälzergasse 3, 88339, Bad Waldsee, DE
Wohlsen, Andrea, Steubenring 6, 53175, Bonn, DE
Braun, Clemens, Obere Au 7, 88400 Biberach, DE
Marx, Degenhard, Obere Reute 15, 78345, Moos, DE
(74) RADULOVIĆ, S. Božidar, Studentska bb, Lamela 3/18, Podgorica, 81000, ME
- (57) Farmaceutska kompozicija koja sadrži farmaceutsku formulaciju koja uključuje količinu PDE4 inhibitora, količinu inhibitora HMG-CoA reduktaze i bar jednu farmaceutsku prihvatljivu pomoćnu supstancu, gde je PDE4 inhibitor odabran iz grupe koja se sastoji od ROFLUMILASTA, farmaceutske prihvatljive soli ROFLUMILASTA, ROFLUMILAST-N-oksida i farmaceutske prihvatljive soli ROFLUMILAST-N-oksida, inhibitor HMG-CoA reduktaze je ROSUVASTATIN ili njegova farmaceutski prihvatljiva so, gde prva količina i druga količina zajedno obuhvataju efikasnu količinu za preventivni ili lekoviti tretman inflamatornog plućnog oboljenja.
Patent sadrži još 33 patentna zahtjeva.

- (51) **C 07D 489/12**^{2006.01} **A 61K 31/485**^{2006.01} (11) **01665** (13) **B**
A 61P 25/04^{2006.01}
 (21) P-2014-12
 (22) 30. 07. 2009
 (30) 226119P 16. 07. 2009 US
 84764P 30. 07. 2008 US
 (86) EP/09789036.2/30. 07. 2009
 US/PCT/US2009/004391/30. 07. 2009
 (87) WO 2010/014229/04. 02. 2010/2010/05
 EP 2326651/01. 06. 2011/2011/22
 EP 2326651/27. 11. 2013/2013/48
 (54) me **ANALOZI BUPRENORFINA**
 en **BUPRENORPHINE ANALOGS**
 (73) Purdue Pharma LP, One Stamford Forum 201 Tresser Boulevard, Stamford, CT 06901, US
 (72) KYLE, Donald, J., 29 Weatherfield Drive, Newtown, PA 18940, US
 GOEHRING, R., Richard, 315 Manor Drive, Dublin, PA 18917, US
 FUNDYTUS, Marian, E., 52 Fawn Hollow Road, Burlington, NJ 08016, US
 (74) LUTOVAC, Branislav, Bilevar Ivana Crnojevića 93, Podgorica, 81000, ME

(57) Jedinjenje formule III:

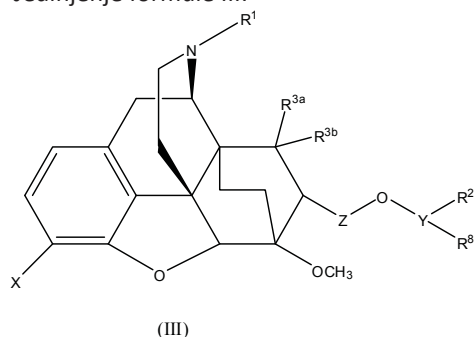

u kojoj R¹ je izabran od -(C₁-C₁₀)alkil, -(C₂-C₁₂)alkenil, -(C₂-C₁₂)alkinil, -(C₃-C₁₂)cikloalkil, -(C₄-C₁₂)cikloalkenil, ((C₃-C₁₂)cikloalkil)-(C₁-C₆)alkil-, ((C₄-C₁₂)cikloalkenil)-(C₁-C₆)alkil-, (5- do 12-člani)aril, ((5- do 12-člani)aril)-(C₁-C₆)alkil-, (5- do 12-člani)heteroaril, i -(3- do 12-člani)heterocikl, od kojih svaki može biti opciono supstituisan sa 1, 2, ili 3 supstituenta nezavisno izabranih iz grupe koju čine -(C₁-C₆)alkil, OH, halo, -C(halo)₃, -CH(halo)₂, -CH₂(halo), NH₂, -NH(C₁-C₆)alkil, CN, SH, -(5- do 12-člani)karbociklični prsten, -(5- do 12-člani)heterocikl, fenil, i benzil; R² i R⁸ su svaki nezavisno vodonik, -(C₁-C₁₀)alkil, -(C₂-C₁₂)alkenil, -(C₂-C₁₂)alkinil, -(C₃-C₁₂)cikloalkil, -(C₃-C₁₂)cikloalkil)-(C₁-C₆)alkil-, -(C₄-C₁₂)cikloalkenil, -(C₆-C₁₄)bicikloalkil, -(C₈-C₂₀)tricikloalkil, -(C₇-C₁₄)bicikloalkenil, -(C₈-C₂₀)tricikloalkenil, -(5- do 12-člani)aril, ((5- do 12-člani)aril)-(C₁-C₆)alkil-, -(7- do 12-člani)biciklični sistem prstena, -(7- do 12-člani)biciklični aril, -(5- do 12-člani)heteroaril, -(3- do 12-člani)heterocikl, ili -(7- do 12-člani) bicikloheterocikl; od kojih svaki opciono supstituisan sa jednim ili dva supstituenta nezavisno izabrana iz grupe koju čine OH, (=O), halo, C(halo)₃, CH(halo)₂, CH₂(halo), -(C₁-C₆)alkil, halo(C₁-C₆)alkil-, -(C₂-C₆)alkenil, -(C₂-C₆)alkinil, hidroksi(C₁-C₆)alkil-, fenil, benzil, NH₂, -NH(C₁-C₆)alkil, CN, SH, OR⁴, CONR⁵R⁶ i COOR⁷; R^{3a} i R^{3b} su svaki nezavisno izabrani od vodonika, -(C₁-C₆)alkil, -(C₂-C₆)alkenil, -(C₂-C₆)alkinil, OH, hidroksi(C₁-C₆)alkil-, -C(halo)₃, -CH(halo)₂, i -CH₂(halo), ili zajedno obrazuju (=O); R⁴ je izabran od -(C₁-C₆)alkil, -(C₂-C₆)alkenil, -(C₂-C₆)alkinil, -C(halo)₃, hidroksi(C₁-C₆)alkil-, -(C₃-C₁₂)cikloalkil, -(C₆-C₁₄)bicikloalkil, -(C₈-C₂₀)tricikloalkil, -(C₄-C₁₂)cikloalkenil, -(C₇-C₁₄)bicikloalkenil, -(C₈-C₂₀)tricikloalkenil, -(5- do 12-člani)aril, -(5- do 12-člani)heteroaril, -(3- do 12-člani)heterocikl, i -(7- do 12-člani)bicikloheterocikl; R⁵ i R⁶ su svi nezavisno -(C₁-C₆)alkil, -(C₃-C₈)cikloalkil, ((C₃-C₈)cikloalkil)-(C₁-C₆)alkil-, ili zajedno sa azotovim atomom za koji su vezani obrazuju (4- do 8- člani)heterocikl; R⁷ je izabran od vodonika, -(C₁-C₆)alkil, -(C₂-C₆)alkenil, -(C₂-C₆)alkinil, -(C₃-C₁₂)cikloalkil, -(C₄-C₁₂)cikloalkenil, ((C₃-C₁₂)cikloalkil)-(C₁-C₆)alkil-, i ((C₄-C₁₂)cikloalkenil)-(C₁-C₆)alkil-; X je izabran od (C₁-C₆)alkoksi i OH; Z je CH₂; je (CH₂)_n-CH ili direktna veza, uz uslov da kada je Y direktna veza tada R⁸ nije prisutan; n je ceo broj 0, 1, 2, 3, 4, 5 ili 6; ili njegova farmaceutski prihvatljiva so, estar ili solvat; i gde je bar jedan od R² ili R⁸ -(C₁-C₁₀)alkil, -(C₂-C₁₂)alkenil, -(C₂-C₁₂)alkinil, -(C₃-C₁₂)cikloalkil, fenil-(C₁-C₆)alkil, -(C₄-C₁₂)cikloalkenil, -(C₆-C₁₄)bicikloalkil, -(C₈-C₂₀)tricikloalkil, -(C₇-C₁₄)bicikloalkenil, -(C₈-C₂₀) tricikloalkenil, -(5- do 12-člani)aril, ((5- do 12-člani)aril)-(C₁-C₆)alkil-, -(5- do 12-člani)heteroaril, -(3- do 12-člani)heterocikl ili -(7- do 12-člani)bicikloheterocikl; od kojih je svaki opciono supstituisan sa jednim ili dva supstituenta nezavisno izabrana iz grupe koju čine OH, (=O), halo, -C(halo)₃, -CH(halo)₂, -CH₂(halo), -(C₁-C₆)alkil, halo(C₁-C₆)alkil-, -(C₂-C₆)alkenil, -(C₂-C₆)alkinil, hidroksi(C₁-C₆)alkil-, fenil, benzil, NH₂, -NH(C₁-C₆)alkil, CN, SH, OR⁴, CONR⁵R⁶ i COOR⁷.

Patent sadrži još 31 patentni zahtjev.

- (51) **B09B3/00**^{2006.01} **A61K9/70**^{2006.01} (11) **01666** (13) **B**
A61K9/16^{2006.01} **A61K31/485**^{2006.01}
- (21) P-2014-16
(22) 15. 02. 2005
(30) 547196P 23. 02. 2004 US
(86) EP/09004191.4/15. 02. 2005
(87) EP 2074989/01. 07. 2009/2009/27
EP 2074989/20. 11. 2013/2013/47
(54) me **OPIOIDNI TRANSDERMALNI PREPARAT OTPORAN NA ZLOUPOTREBU**
en **ABUSE RESISTANCE OPIOID TRANSDERMAL DELIVERY DEVICE**
(73) EURO-CELTIQUE S.A., 2, avenue Charles de Gaulle, 1653 Luxembourg, LU
(72) Reidenberg, Bruce, 1 Stonycrest Road, Rye, NY 10580, US
Shevchuk, Ihor, 11 Shelburne Road, Yonkers, NY 10710, US
Tavares, Lino, 86 South Glen Road, Kinnelon, NJ 07405, US
Long, Kevin, 3 Hidden Hills Road, Oak Ridge, NJ 07438, US
Maskiewicz, Richard, 30555 Los Altos Drive, Redlands, CA 92373, US
Shameem, Mohammed, 4 Surim Court, Nanuet, NY 10954, US
(74) LUTOVAC, Branislav, Bulevar Ivana Crnojevića 93, Podgorica, 81000, ME

- (57) Transdermalni preparat koji se sastoji od: sloja polimernog matriksa koga čini opioidni agonist pomešan sa mikrosferama koje sadrže opioidni antagonist, pri čemu se opioidni antagonist ne oslobađa kada se preparat primenjuje lokalno, i gde su mikrosfere srednje veličine od 1 do 300 µm u prečniku.
Patent sadrži još 15 patentnih zahtjeva.

(51) C 07D 473/04^{2006.01} A 61K 31/522^{2006.01} (11) 01667 (13) B

(21) P-2014-21

(22) 02. 11. 2005

(30) 102004054054 05. 11. 2004 DE

(86) EP/10181043.0/02. 11. 2005

(87) EP 2287164 /23. 02. 2011/2011/08

EP 2287164 /22. 01. 2014/2014/04

(54) me **Postupak za dobijanje hiralnog 8-(3-amino-piperidin-1-il)-ksantina**
en **Process for the manufacture of chiral 8-(3-aminopiperidin-1-yl)-xanthines**

(73) BOEHRINGER INGELHEIM INTERNATIONAL GMBH, Binger Str. 173,55216 Ingelheim am Rhein, DE

(72) Pfrengle, Waldemar, Wittlingerweg. 14,88400, Biberach, DE

Pachur, Thorsten, Geschwister-Rommer-Weg 8,88400 Biberach, DE

Nicola, Thomas, Stauferring 3,55218, Ingelheim, DE

Duran, Adil, Kastanienweg 8,88400, Rissegg, DE

(74) RADULOVIĆ, Božidar, Studentska bb, Lamela 3/18, Podgorica, 81000, ME

(57) Postupak za dobijanje lijeka koji sadrži primjenu jedinjenja opšte formule (I)

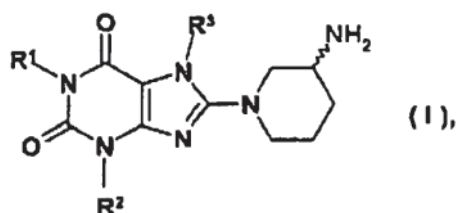

ili njegovog enantiomera ili soli u kojoj je R^1 je fenilkarbonilmetil, benzil, naftilmetil, piridinilmetil, pirimidinilmetil, hinolinilmetil, izohinolinilmetil, hinazolinilmetil, hinoksalinilmetil, naftiridinilmetil ili fenantridinilmetil grupa u kojoj je aromatična ili heteroaromatična grupa uvijek mono- ili disupstituisana sa R_a , pri čemu supstituenti mogu biti isti ili različiti i R_a je atom vodonika, fluora, hlora ili broma ili cijano, metil, trifluorometil, etil, fenil, metoksi, difluorometoksi, trifluorometoksi ili etoksi grupa, ili dva R_a radikala koji kada su vezani za susjedne atome ugljenika mogu takođe biti $-O-CH_2-O-$ ili $-O-CH_2-CH_2-O-$ grupa, R^2 je metil, etil, propil, izopropil, ciklopropil ili fenil grupa i R^3 je 2-buten-1-il, 3-metil-2-buten-1-il, 2-butin-1-il, 2-fluorobenzil, 2-hlorobenzil, 2-bromobenzil, 2-jodobenzil, 2-metilbenzil, 2-(trifluorometil)benzil ili 2-cijanobenzil grupa, koje se dobija postupkom koji sadrži slijedeće korake sinteze: a) reakciju jedinjenja opšte formule (III)

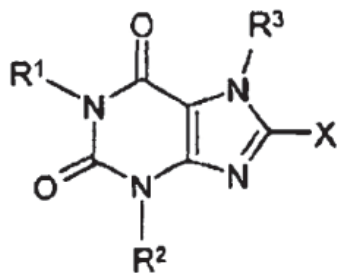

u kojoj je X odlazeća grupa koja je izabrana iz grupe halogena ili sulfonskih estara i svaki R^1 do R^3 je definisan kao što je gore navedeno, sa 3-(ftalimido)piperidinom ili njegovim enantiomerom, b) deprotekciju tako dobio jedinjenja opšte formule (II)

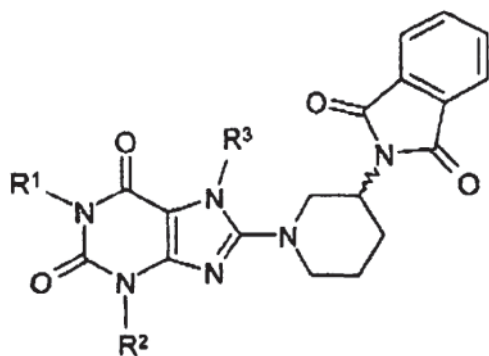

u kojoj je svaki R¹ do R³ definisan kao što je gore navedeno i c) opciono prevođenje u fiziološki prihvatljivu so; i eventualno jednog ili više inertnih nosača i/ili razređivača.
Patent sadrži još 14 patentnih zahtjeva.

- (51) **61K31513/** ^{2006.01} **61K3144/** ^{2006.01} (11) **01668** (13) **B**
61K31131/ ^{2006.01} **61P310/** ^{2006.01}
- (21) P-2014-14
(22) 13. 09. 2006
(30) 717558P 14. 09. 2005 US
747273P 15. 05. 2006 US
(86) EP/06803523.7/13. 09. 2006
WO/PCT/US2006/035708
(87) WO 2007/033266/22. 03. 2007/2007/12
EP 1931350/18. 06. 2008/2008/25
EP 1931350/20. 11. 2013/2013/47
(54) me **ADMINISTRACIJA INHIBITORA DIPEPTIDIL PEPTIDAZE**
en **ADMINISTRATION OF DIPEPTIDYL PEPTIDASE INHIBITORS**
(73) Takeda Pharmaceutical Company Limited,
1-1, Doshomachi 4-chome Chuo-ku Osaka-shi, Osaka 541-0045, JP
(72) CHRISTOPHER, Ronald, J, 1059 Snipe Court, Carlsbad, California 92011, US
COVINGTON, Paul, 3116 Braemar Lane, Wilmington, North Carolina 28409, US
(74) RADULOVIĆ, S. Božidar, Studentska bb, Lamela 3/18, Podgorica, 81000, ME

- (57) Farmaceutska kompozicija formulisana kao pojedinačna dozna forma, naznačena time, što takva pojedinačna dozna forma sadrži između 5 mg i 250 mg Jedinjenja I, gde pomenuto Jedinjenje I ima formulu

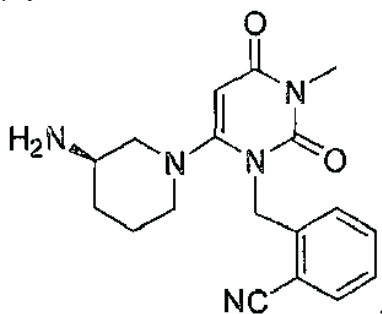

uz iznimku sledećih kompozicija: (a) farmaceutska kompozicija formulisana za oralnu administraciju koja sadrži 10 do 100 mg Jedinjenja I, 105 mg monohidrata limunske kiseline, 18 mg natrijum hidroksida, agensa za ukus i vode do 100 ml; i (b) farmaceutska kompozicija formulisana za intravenoznu administraciju koja sadrži 5 do 10 mg Jedinjenja I, 1.05 mg monohidrata limunske kiseline, 0.18 mg natrijum hidroksida, dovoljne količine monohidrata dekstroze da pomenuta formulacija bude izotonična, i vode do 1 ml.
Patent sadrži još 47 patentnih zahtjeva.

- (51) C 07D 205 / 04^{2006.01} C 07D 401 / 14^{2006.01} (11) 01693 (13) B
 C 07D 403 / 12^{2006.01} C 07D 405 / 12^{2006.01}
 C 07D 405 / 14^{2006.01} C 07D 409 / 12^{2006.01}
 C 07D 409 / 14^{2006.01} C 07D 413 / 12^{2006.01}
 C 07D 413 / 14^{2006.01} C 07D 417 / 12^{2006.01}
 C 07D 417 / 14^{2006.01} C 07D 495 / 04^{2006.01}
 A 61K 31 / 496^{2006.01} A 61P 29 / 00^{2006.01}
 A 61P 25 / 00^{2006.01}

(21) P-2014-26

(22) 22. 04. 2010

(30) 171649P 22. 04. 2009 US

171658P 22. 04. 2009 US

(86) EP/ 10716205.9/22. 04. 2010

US/PCT/US2010/032082/22. 04. 2010

(87) WO 2010/124108/28. 10. 2010/2010/43

EP 2421825 /29. 02. 2012/2012/09

EP 2421825 /01. 01. 2014/2014/01

(54) me **AZETIDINIL DIAMIDI KAO INHIBITORI MONOACILGLICEROL LIPAZE**
 en **AZETIDINYL DIAMIDES AS MONOACYLGLYCEROL LIPASE INHIBITORS**

(73) Janssen Pharmaceutica N.V., Turnhoutseweg 30, 2340 Beerse, BE

(72) BIAN, Haiyan, 109 York Drive, Princeton NJ 08540, US

CHEVALIER, Kristen, M., 407 Nottingham Lane, Collegeville PA 19426, US

CONNOLLY, Peter, J., Welsh&Mckean Roads, Spring House PA 19477, US

FLORES, Christopher, M., Welsh&Mckean Roads, Spring House PA 19477, US

LIN, Shu-chen, 4895 Redfield Road, Doylestown PA 18902, US

LIU, Li, 271 Fox Chase Lane, Doylestown PA 18901, US

MABUS, John, 9131 Rosewood Drive, East Greenville PA 18041, US

MACIELAG, Mark, J., Welsh&Mckean Roads, Spring House PA 19477, US

MCDONNELL, Mark, E., 1280 Sumneytown Pike, Lansdale PA 19446, US

PITIS, Philip, M., 108 Sunrise Drive, North Wales PA 19454, US

ZHANG, Sui-po, 665 Stockton Drive, Exton PA 19341, US

ZHANG, Yue-mei, Welsh&Mckean Roads, Spring House PA 19477, US

ZHU, Bin, Welsh&Mckean Roads, Spring House PA 19477, US

CLEMENTE, Jose, 665 Stockton Drive, Exton PA 19341, US

(74) RADULOVIĆ, S. Božidar, Studentska bb, Lamela 3/18, Podgorica, 81000, ME

(57) Jedinjenje Formule (1)

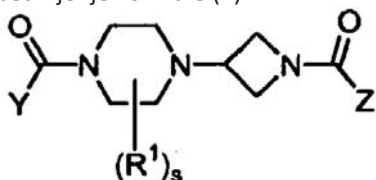

Formula (I)

pri čemu su Y i Z nezavisno izabrani od a) ili b) tako da je jedan od Y i Z izabran iz grupe a) i drugi je izabran iz grupe b); Grupa a) je i) supstituisani C₆₋₁₀ aril ii) C₃₋₈ cikloalkil opciono supstituisan sa jednim do dva fluora supstituenta, iii) trifluorometil, ili iv) heteroaril izabran iz grupe koju čine tienil, furanil, tiazolil, izotiazolil, oksazolil, pirolil, pirimidinil, izoksazolil, benzotienil, tieno[3,2-b]tiofen-2-il, pirazolil, triazolil, tetrazolil, i [1,2,3]tiadiazolil; pri čemu je C₆₋₁₀ aril supstituisan sa; i heteroaril je opciono supstituisan sa; jednim supstituentom izabranim iz grupe koju čine fluora, hlora, broma, C₁₋₄ alkil, C₁₋₄ alkoksi, cijana, C₁₋₄ alkilkarbonilamino, i trifluorometil; Grupa b) je i) C₆₋₁₀ aril; ii) heteroaril izabran iz grupe koju čine tiazolil, piridinil, indolil, indazolil, benzoksazolil, benzotiazolil, benzofuranil, benzotienil, 1H-pirololo[3,2-b]piridin-5-il, 1H-tieno[2,3-pirazol-5-il, 1H-pirololo[2,3-b]piridin-5-il, 1H-pirazolo[3,4-b]piridin-5-il, furo[2,3-b]piridin-2-il, hinolinil, hinazolinil, furanil, [1,2,3]triazolil, tienil, oksazolil, [1,3,4]oksadiazol-2-il, pirolil, pirazolil, i benzimidazolil; iii) 2,3-dihidro-1H-indolil; iv) 2,3 difenil-indolil; v) difenil-imidazolil; vi) 1-(2,4-dihlorofenil)-4,5,6,7-tetrahidro-1H-indazol-3-il; vii) 3-(4-hlorofenil)-4,5,6,7-tetrahidro-indazol-2-il; viii) 1-(4-fluorofenil)-1H-pirololo[3,2-b]piridin-6-il; ili ix) difenil-1H-pirazol-3-il; pri čemu je svaki fenil opciono supstituisan sa jednim do dva hlora supstituenta; i pri čemu je navedeni pirazolil opciono supstituisan sa jednim metil supstituentom; pri čemu su C₆₋₁₀ aril, 2,3-dihidro-1H-indolil, i heteroaril od Grupe b) opciono nezavisno supstituisani sa jednim do dva supstituenta izabrana iz grupe koju čine broma, hlora, fluora, joda, C₁₋₄ alkil, C₁₋₄ alkoksi, i trifluorometil; i supstituisani su sa jednim dodatnim supstituentom izabranim iz grupe koju čine i) C₆₋₁₀ aril; ii) heteroaril izabran iz grupe koju čine pirimidinil, tienil, hinolinil, piridi-

nil, izoksazolil, tiazolil, benzimidazolil, pirolil, furanil, pirimidinil, i pirazolil; ili iii) 5,6-dihidro-4H-ciklopentapirazol-2-il; pri čemu su navedeni heteroaril i 5,6-dihidro-4H-ciklopentapirazol-2-il opciono supstituisani sa jednim fenil supstituentom, i navedeni fenil supstituent je opciono supstituisan sa jednim do dva hlora supstituenta ili trifluorometilom; i pri čemu su fenil od C₆₋₁₀arila i heteroaril opciono nezavisno supstituisani sa jednim do dva supstituenta izabrana iz grupe koju čine C₁₋₄alkoksikarbonilamino; C₁₋₄alkil; cijanometil; C₁₋₄alkoksi; jedan do tri fluora ili hlora supstituenta; trifluorometil; trifluorometoksi; trifluorometiltio; C₁₋₄alkilkarbonil; C₁₋₄alkoksikarbonil; C₁₋₄alkoksikarbonil(C₂₋₄)alkenil; cijano(C₂₋₄)alkenil; (2-cijano)etilaminokarbonil; cijano; karboksi; aminokarbonil; C₁₋₄alkilaminokarbonil; di(C₁₄alkil)aminokarbonil; formil; nitro; bromo; hidroksi; di(C₁₄alkil)aminosulfonil; C₁₋₄alkilsulfonil; di(C₁₄alkil)aminosulfonil; morfolin-4-ilsulfonil; -OCH₂O- vezan na susednim atomima ugljenika; i NR^cR^d; pri čemu R^c je hidrogen ili C₁₋₆alkil i pri čemu R^d je hidrogen, C₁₋₆alkil, cijano(C₁₄)alkil, C₃₋₈cikloalkil, C₁₋₆alkilkarbonil, C₁₋₆alkoksikarbonil, C₃₋₈cikloalkilkarbonil, C₃₋₈cikloalkil(C₁₋₄)alkil, aminokarbonil, di(C₁₄alkil)aminokarbonil, C₆₋₁₀arilkarbonil; di(C₁₄alkil)aminosulfonil, i C₁₄alkilsulfonil; s je 0, 1 ili 2; pod uslovom da kada je s 2, R¹ je nezavisno izabran iz grupe koju čine fenil, C₁₋₃alkil, i C₆₋₁arii(C₁₋₃)alkil; kada je s 1, R¹ je C₆₋₁₀aril, C₁₋₃alkil, benziloksimetil, hidroksi(C₁₃)alkil, aminokarbonil, karboksi, trifluorometil, spirofuzionisani ciklopropil, 3-okso, ili arii(C₁₋₃)alkil; ili, kada s je 2 i R¹ je C₁₋₃alkil, C₁₋₃alkil supstituenti su uzeti sa piperizinil prstena da se formira 3,8-diaza-biciklo[3.2.1]oktanil ili 2,5-diaza-biciklo[2.2.2]oktanil sistem prstena; pod uslovom da jedinjenje formule (I) je različit od jedinjenja pri čemu je Y 3-hlorobenzotien-2-il, Z je 4-bifenil, i s je 0; jedinjenje pri čemu je Y 3-hlorotien-2-il, Z je 4-bifenil, i s je 0; jedinjenje pri čemu je Y 2-cijanofenil, Z je 4-bifenil, i s je 0; jedinjenje pri čemu je Y 5-metil-izoksazol-3-il, Z je 4-bifenil, i s je 0; jedinjenje pri čemu je Y tiazol-2-il, Z je 5-(4-hlorofenil)oksazol-4-il, i s je 0; jedinjenje pri čemu je Y tiazol-2-il, Z je 3-fenil -1H-pirazol-4-il, i s je 0; jedinjenje pri čemu je Y tiazol-2-il, Z je 5-(2-fluoropiridin-3-ii)-1Hbenzimidazol-2-il, i s je 0; jedinjenje pri čemu je Y tiazol-4-il, Z je 1-fenil-5-trifluorometil-pirazol-4-il, i s je 0; jedinjenje pri čemu je Y pirimidin-2-il, Z je 4-bifenil, i s je 0; jedinjenje pri čemu je Y tiazol-4-il, Z je 4-bifenil, s je 1, i R¹ je 3-fenil; i enantiomeri, diastereomeri, solvati i farmaceutski prihvatljive soli od njih.

Patent sadrži još 20 patentnih zahtjeva.

- (51) **C 07D 239/54**^{2006.01} (11) **01709** (13) **B**
 (21) P-2014-22
 (22) 03. 08. 2010
 (30) 231464P 05. 08. 2009 US
 (86) EP/10740817.1/03. 08. 2010
 US/PCT/US2010/044274
 (87) WO 2011/017342/10. 02. 2011/2011/06
 EP 2462124 /13. 06. 2012/2012/24
 EP 2462124 /08. 01. 2014/2014/02
 (54) me **MEZOJONSKI PESTICIDI**
 en **MESOIONIC PESTICIDES**
 (73) E. I. du Pont de Nemours and Company, Wilmington, DE 19898, US
 (72) ZHANG, Wenming, Newark Delaware 19702, US
 HOLYOKE JR, Caleb, William, Newark Delaware 19711, US
 HUGHES, Kenneth Andrew, Rising Sun, MD 21911, US
 LAHM, George, P., Wilmington Delaware 19808, US
 PAHUTSKI JR, Thomas, Francis, Elkton Maryland 21921, US
 TONG, My-Hanh, Thi, Bear Delaware 19701, US
 XU, Ming, Newark Delaware 19702, US
 (74) POPOVIĆ, Miladin, Đoka Miraševića 21/III, Podgorica, 81000, ME

(57) Jedinjenje formule 1, njegov N-oksidi ili so,

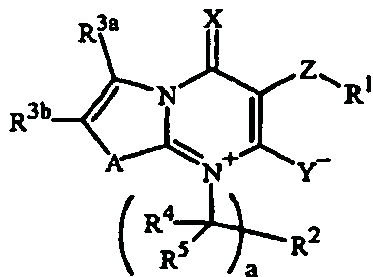

1

u kojima X je O ili S; Y je O ili S; A je O, S, NR^{3e} ili C(R^{3c})=C(R^{3d}), uz uslov da je C(R^{3c})=C(R^{3d}) grupa orijentisana tako da je atom ugljenika koji je vezan za R^{3d} vezan direktno za pirimidinijum prsten formule 1; Z je direktna veza, O, S(O)_n, NR⁶, C(R⁷)₂O, OC(R⁷)₂, C(=X¹), C(=X¹)E, EC(=X¹), C(=NOR⁸) ili C(=NN(R⁶)₂); X¹ je O, S ili NR⁹; E je O, S ili NR^{9a}; R¹ je 3- do 10-člani prsten ili 7- do 11-člani sistem prstena, pri čemu svaki prsten ili sistem prstena sadrži članove prstena koji su izabrani od atoma ugljenika i do 4 heteroatoma nezavisno izabrana od maksimalno 2 O, maksimalno 2 S i maksimalno 4 N, gde su maksimalno 3 atoma ugljenika koji su članovi prstena nezavisno izabrani od C(=O) i C(=S) i članovi prstena atomi sumpora su nezavisno izabrani od S(=O)u(=NR²⁴)_z, pri čemu je svaki prsten ili sistem prstena izborno supstituisan sa do 5 supstituenata nezavisno izabrana od R¹⁴; R² je H, halogen, cijano, hidroksi, amino, nitro, OCN, SCN, CHO, C(=O)OH, C(=O)NH₂, C(=S)NH₂, SO₂NH₂, C(=O)R¹⁰, C(=O)OR¹⁸, NHR¹⁸, NR¹⁸R¹⁹, C(=O)NR²¹R¹⁹, C(=S)NR²¹R¹⁹, SO₂NR²¹R¹⁹, OC(=O)R^{2a}, OC(=O)OR¹⁸, OC(=O)NR²¹R¹⁹, N(R²¹)C(=O)R²¹, N(R²¹)C(=O)OR¹⁹, N(R²¹)C(=O)NR²¹R²², OSO₂R¹⁸, OSO₂NR²¹R²², NR²¹SO₂R¹⁸, NR²¹SO₂NR²¹R²² ili Si(R¹⁸R¹⁹R²⁰); ili C1-C8 alkil, C2-C8 alkenil, C2-C8 alkinil, C3-C10 cikloalkil, C4-C10 alkilcikloalkil, C4-C10 cikloalkilalkil, C6-C14 cikloalkilcikloalkil, C5-C10 alkilcikloalkilalkil, C3-C8 cikloalkenil, C1-C8 alkoksi, C3-C8 cikloalkoksi, C4-C10 cikloalkilalkoksi, C2-C8 alkeniloksi, C2-C8 alkiniloksi, C1-C8 alkiltio, C1-C8 alkilsulfinil, C1-C8 alkilsulfonyl, C3-C8 cikloalkiltio, C3-C8 cikloalkilsulfinil, C3-C8 cikloalkilsulfonyl, C4-C10cikloalkilalkiltio, C4-C10 cikloalkilalkilsulfinil, C4-C10 cikloalkilalkilsulfonyl, C2-C8 alkeniltio, C2-C8 alkenilsulfinil, C2-C8 alkenilsulfonyl, C2-C8 alkiniltio, C2-C8 alkinilsulfinil ili C2-C8 alkinilsulfonyl, pri čemu je svaki nesupstituisan ili supstituisan sa najmanje jednim supstituentom nezavisno izabranim iz grupe koju čine halogen, cijano, nitro, CHO, C(=O)OH, C(=O)NH₂, C(=O)R¹⁰, C(=O)OR¹¹, C(=O)NR¹²R¹³, OR¹¹, S(O)nR¹⁰, SO₂NR¹²R¹³ i Si(R¹⁰)₃; ili 3- do 10-člani prsten ili 7- do 11-člani sistem prstena, pri čemu svaki prsten ili sistem prstena sadrži članove prstena koji su izabrani od atoma ugljenika i do 4 heteroatoma nezavisno izabrana od maksimalno 2 O, maksimalno 2 S i maksimalno 4 N, gde su maksimalno 3 atoma ugljenika koji su članovi prstena nezavisno izabrani od C(=O) i C(=S) i članovi prstena atomi sumpora su nezavisno izabrani od S(=O)u(=NR²⁴)_z, pri čemu je svaki prsten ili sistem prstena izborno supstituisan sa do 5 supstituenata nezavisno izabrana od R¹⁵; R^{3a}, R^{3b}, R^{3c} i R^{3d} su ne-

zavisno H, halogen, cijano, hidroksi, amino, nitro, SF₅, OCN, SCN, CHO, C(=O)OH, C(=O)NH₂, C(=S)NH₂, SO₂NH₂, C(=O)R¹⁸, C(=O)OR¹⁸, NHR¹⁸, NR¹⁸R¹⁹, C(=O)NR²¹R¹⁹, C(=S)NR²¹R¹⁹, SO₂NR²¹R¹⁹, OC(=O)R²¹, OC(=O)OR¹⁸, OC(=O)NR²¹R¹⁹, N(R²¹)C(=O)R²¹, N(R²¹)C(=O)OR¹⁹, N(R²¹)C(=O)NR²¹R²², OSO₂R¹⁸, OSO₂NR²¹R²², NR²¹SO₂R¹⁸, NR²¹SO₂NR²¹R²², Si(R¹⁸R¹⁹R²⁰) ili Z¹Q[†]; ili C1-C8 alkil, C2-C8 alkenil, C2-C8 alkinil, C3-C10 cikloalkil, C4-C10 alkilcikloalkil, C4-C10 cikloalkilalkil, C6-C14 cikloalkilcikloalkil, C5-C10 alkilcikloalkilalkil, C3-C8 cikloalkenil, C1-C8 alkoksi, C3-C8 cikloalkoksi, C4-C10 cikloalkilalkoksi, C2-C8 alkeniloksi, C2-C8 alkiniloksi, C1-C8 alkiltio, C1-C8 alkilsulfinil, C1-C8 alkilsulfonyl, C3-C8 cikloalkiltio, C3-C8 cikloalkilsulfinil, C3-C8 cikloalkilsulfonyl, C4-C10 cikloalkilalkiltio, C4-C10 cikloalkilalkilsulfinil, C4-C10 cikloalkilalkilsulfonyl, C2-C8 alkeniltio, C2-C8 alkenilsulfinil, C2-C8 alkenilsulfonyl, C2-C8 alkiniltio, C2-C8 alkinilsulfinil ili C2-C8 alkinilsulfonyl, pri čemu je svaki nesupstituisan ili supstituisan sa najmanje jednim supstituentom koji je nezavisno izabran od R¹⁷; ili R^{3a} i R^{3b}, ili R^{3b} i R^{3c}, ili R^{3c} i R^{3d} su uzeti zajedno sa susednim atomima ugljenika za koje su vezani tako da formiraju 5- do 7-člani karbocikličan ili heterocikličan prsten, pri čemu svaki prsten sadrži članove prstena izabrane od atoma ugljenika i do 3 heteroatoma nezavisno izabrana od maksimalno 2 O, maksimalno 2 S i maksimalno 3 N, gde su do 2 člana prstena atoma ugljenika izabrana od C(=O) i C(=S) i članovi prstena atomi sumpora su nezavisno izabrani od S(=O)n, pri čemu je svaki prsten izborno supstituisan sa do 3 supstituenta nezavisno izabrana iz grupe koju čine halogen, cijano, hidroksi, amino, nitro, C(=O)OH, C(=O)NH₂, SO₂NH₂, C1-C4 alkil, C1-C4 haloalkil, C2-C4 alkenil, C2-C4 haloalkenil, C2-C4 alkinil, C2-C4 haloalkinil, C3-C7 cikloalkil, C3-C7 halocikloalkil, C4-C8 alkilcikloalkil, C4-C8 haloalkilcikloalkil, C4-C8 cikloalkilalkil, C4-C8 halocikloalkilalkil, C1-C6 alkoksi, C1-C6 haloalkoksi, C2-C6 alkoksikarbonil, C2-C6 haloalkoksikarbonil, C2-C6 alkilkarbonil i C2-C6 haloalkilkarbonil; R^{3e} je H, hidroksi, amino, CHO, C(=O)NH₂, C(=S)NH₂, SO₂NH₂, C(=O)R¹⁸, C(=O)OR¹⁸, NHR¹⁸, NR¹⁸R¹⁹, C(=O)NR²¹R¹⁹, C(=S)NR²¹R¹⁹, SO₂NR²¹R¹⁹, OC(=O)R²¹, OC(=O)OR¹⁸, OC(=O)NR²¹R¹⁹, N(R²¹)C(=O)R²¹, N(R²¹)C(=O)OR¹⁹, N(R²¹)C(=O)NR²¹R²², OSO₂R¹⁸, OSO₂NR²¹R²², NR²¹SO₂R¹⁸, NR²¹SO₂NR²¹R²², Si(R¹⁸R¹⁹R²⁰) ili Z¹Q[†]; ili C1-C8 alkil, C2-C8 alkenil, C2-C8 alkinil, C3-C10 cikloalkil, C4-C10 alkilcikloalkil, C4-C10 cikloalkilalkil, C6-C14 cikloalkilcikloalkil, C5-C10 alkilcikloalkilalkil, C3-C8 cikloalkenil, C1-C8 alkoksi, C3-C8 cikloalkoksi, C4-C10 cikloalkilalkoksi, C2-C8 alkeniloksi, C2-C8 alkiniloksi, C1-C8 alkilsulfinil, C1-C8 alkilsulfonyl, C3-C8 cikloalkilsulfinil, C3-C8 cikloalkilsulfonyl, C4-C10 cikloalkilalkilsulfinil, C4-C10 cikloalkilalkilsulfonyl, C2-C8 alkenilsulfinil, C2-C8 alkenilsulfonyl, C2-C8 alkinilsulfinil ili C2-C8 alkinilsulfonyl, pri čemu je svaki nesupstituisan ili supstituisan sa najmanje jednim supstituentom koji je nezavisno izabran od R¹⁷; ili R^{3e} i R^{3b} su uzeti zajedno sa susednim atomima ugljenika za koje su vezani tako da formiraju 5- do 7-člani karbocikličan ili heterocikličan prsten, pri čemu svaki prsten sadrži članove prstena izabrane od atoma ugljenika i do 3 heteroatoma nezavisno izabrana od maksimalno 2 O, maksimalno 2 S i maksimalno 3 N, gde su do 2 člana prstena atoma ugljenika izabrana od C(=O) i C(=S) i članovi prstena atomi sumpora su nezavisno izabrani od S(=O)n, pri čemu je svaki prsten izborno supstituisan sa do 3 supstituenta nezavisno izabrana iz grupe koju čine halogen, cijano, hidroksi, amino, nitro, OCN, SCN, CHO, C(=O)OH, C(=O)NH₂, C(=S)NH₂ ili SO₂NH₂; ili C1-C6 alkil, C2-C6 alkenil, C2-C6 alkinil, C3-C8 cikloalkil, C4-C8 alkilcikloalkil, C4-C8 cikloalkilalkil, C6-C12 cikloalkilcikloalkil, C5-C8 alkilcikloalkilalkil, C3-C6 cikloalkenil, C1-C6 alkoksi, C3-C6 cikloalkoksi, C4-C8 cikloalkilalkoksi, C2-C6 alkeniloksi ili C2-C6 alkiniloksi, pri čemu je svaki nesupstituisan ili supstituisan sa najmanje jednim supstituentom nezavisno izabranim iz grupe koju čine halogen, cijano, nitro, CHO, C(=O)OH, C(=O)NH₂, C(=O)R¹⁰, C(=O)OR¹¹, C(=O)NR¹²R¹³, OR¹¹, S(O)nR¹⁰, SO₂NR¹²R¹³ i Si(R¹⁰)₃; ili R⁴ i R⁵ su uzeti zajedno sa atomom ugljenika za koji su vezani tako da formiraju 3- do 7-člani prsten koji sadrži članove prstena izabrane od atoma ugljenika i do 2 heteroatoma nezavisno izabrana od jednog O, jednog S i do 2 N, gde su do 2 člana prstena atoma ugljenika izabrana od C(=O) i C(=S) i atom sumpora član prstena je izabran od S, S(O) ili S(O)₂, pri čemu je navedeni prsten izborno supstituisan sa do 4 supstituenta nezavisno izabrana iz grupe koju čine halogen, cijano i C1-C4 alkil; svaki R⁶ je nezavisno H; ili C1-C6 alkil, C2-C6 alkenil, C2-C6 alkinil, C3-C8 cikloalkil, C4-C8 alkilcikloalkil, C4-C8 cikloalkilalkil, C6-C10 cikloalkilcikloalkil, C5-C10 alkilcikloalkilalkil, C3-C6 cikloalkenil, C2-C6 alkilkarbonil ili C2-C6 alkoksikarbonil, pri čemu je svaki nesupstituisan ili supstituisan sa najmanje jednim supstituentom nezavisno izabranim iz grupe koju čine halogen, cijano, nitro, CHO, C(=O)OH, C(=O)NH₂, C(=O)R¹⁰, C(=O)OR¹¹, C(=O)NR¹²R¹³, OR¹¹, S(O)nR¹⁰, SO₂NR¹²R¹³ i Si(R¹⁰)₃; ili dva R⁶ supstituenta su uzeta zajedno sa atomom azota za koji su vezani tako da formiraju 3- do 7-člani prsten koji sadrži članove prstena izabrane od atoma ugljenika i do 2 heteroatoma nezavisno izabrana od jednog O, jednog S i do 2 N, gde su do 2 člana prstena atoma ugljenika izabrana od C(=O) i C(=S) i atom sumpora član prstena je izabran od S, S(O) ili S(O)₂, pri čemu je navedeni prsten izborno supstituisan sa do 4 supstituenta nezavisno izabrana iz grupe koju čine halogen, cijano i C1-C4 alkil; svaki R⁷ i R⁸ je nezavisno H; ili C1-C6 alkil, C2-C6 alkenil, C2-C6 alkinil, C3-C8 cikloalkil, C4-C8 alkilcikloalkil,

C4-C8 cikloalkilalkil, C6-C10 cikloalkilcikloalkil, C5-C10 alkilcikloalkilalkil, C3-C6 cikloalkenil, C2-C6 alkilkarbonil ili C2-C6 alkoksikarbonil, pri čemu je svaki nesupstituisan ili supstituisan sa najmanje jednim supstituentom nezavisno izabranim iz grupe koju čine halogen, cijano, nitro, CHO, C(=O)OH, C(=O)NH₂, C(=O)R¹⁰, C(=O)OR¹¹, C(=O)NR¹²R¹³, OR¹¹, S(O)nR¹⁰, SO₂NR¹²R¹³ i Si(R¹⁰)₃; svaki R⁹ je nezavisno C1-C6 alkil, C2-C6 alkenil, C2-C6 alkinil, C3-C8 cikloalkil, C4-C8 alkilcikloalkil, C4-C8 cikloalkilalkil, C6-C10 cikloalkilcikloalkil, C5-C10 alkilcikloalkilalkil, C3-C6 cikloalkenil, C2-C6 alkilkarbonil ili C2-C6 alkoksikarbonil, pri čemu je svaki nesupstituisan ili supstituisan sa najmanje jednim supstituentom nezavisno izabranim iz grupe koju čine halogen, cijano, nitro, CHO, C(=O)OH, C(=O)NH₂, C(=O)R¹⁰, C(=O)OR¹¹, C(=O)NR¹²R¹³, OR¹¹, S(O)nR¹⁰, SO₂NR¹²R¹³ i Si(R¹⁰)₃; svaki R^{9a} je nezavisno H; ili C1-C6 alkil, C2-C6 alkenil, C2-C6 alkinil, C3-C8 cikloalkil, C4-C8 alkilcikloalkil, C4-C8 cikloalkilalkil, C6-C10 cikloalkilcikloalkil, C5-C10 alkilcikloalkilalkil, C3-C6 cikloalkenil, C2-C6 alkilkarbonil ili C2-C6 alkoksikarbonil, pri čemu je svaki nesupstituisan ili supstituisan sa najmanje jednim supstituentom nezavisno izabranim iz grupe koju čine halogen, cijano, nitro, CHO, C(=O)OH, C(=O)NH₂, C(=O)R¹⁰, C(=O)OR¹¹, C(=O)NR¹²R¹³, OR¹¹, S(O)nR¹⁰, SO₂NR¹²R¹³ i Si(R¹⁰)₃; svaki R¹⁰ i R¹¹ je nezavisno C1-C6 alkil, C2-C6 alkenil, C2-C6 alkinil, C3-C8 cikloalkil, C4-C8 alkilcikloalkil, C4-C8 cikloalkilalkil, C6-C10 cikloalkilcikloalkil, C5-C10 alkilcikloalkilalkil ili C3-C6 cikloalkenil, pri čemu je svaki nesupstituisan ili supstituisan sa najmanje jednim supstituentom nezavisno izabranim iz grupe koju čine halogen, cijano, nitro, CHO, C(=O)OH, C(=O)NH₂, C1-C4 alkoksi, C1-C4 haloalkoksi, C1-C4 alkiltio, C1-C4 alkilsulfinil, C1-C4 alkilsulfonyl, C1-C4 haloalkiltio, C1-C4 haloalkilsulfonyl, C1-C4 haloalkilsulfonyl, C1-C4 alkilamino, C2-C8 dialkilamino, C3-C6 cikloalkilamino, C2-C4 alkoksialkil, C2-C4 alkilkarbonil, C2-C6 alkoksikarbonil, C2-C6 alkilkarboniloksi, C2-C6 alkilkarboniltio, C2-C6 alkilaminokarbonil, C3-C8 dialkilaminokarbonil i C3-C6 trialkilsilil; ili fenil ili 5- ili 6-člani heteroaromatični prsten, pri čemu je svaki nesupstituisan ili supstituisan sa najmanje jednim supstituentom nezavisno izabranim iz grupe koju čine C1-C6 alkil, C1-C6 haloalkil, C2-C6 alkenil, C2-C6 alkinil, C3-C8 cikloalkil, C4-C8 alkilcikloalkil, C4-C8 cikloalkilalkil, C6-C10 cikloalkilcikloalkil, C5-C10 alkilcikloalkilalkil, C3-C6 cikloalkenil, halogen, cijano, nitro, CHO, C(=O)OH, C(=O)NH₂, C1-C4 alkoksi, C1-C4 haloalkoksi, C1-C4 alkiltio, C1-C4 alkilsulfinil, C1-C4 alkilsulfonyl, C1-C4 haloalkiltio, C1-C4 haloalkilsulfonyl, C1-C4 haloalkilsulfonyl, C1-C4 alkilamino, C2-C8 dialkilamino, C3-C6 cikloalkilamino, C2-C4 alkoksialkil, C2-C4 alkilkarbonil, C2-C6 alkoksikarbonil, C2-C6 alkilkarboniloksi, C2-C6 alkilkarboniltio, C2-C6 alkilaminokarbonil, C3-C8 dialkilaminokarbonil i C3-C6 trialkilsilil; svaki R¹² i R¹³ je nezavisno C1-C6 alkil, C2-C6 alkenil, C2-C6 alkinil, C3-C8 cikloalkil, C4-C8 alkilcikloalkil, C4-C8 cikloalkilalkil, C6-C10 cikloalkilcikloalkil, C5-C10 alkilcikloalkilalkil ili C3-C6 cikloalkenil, pri čemu je svaki nesupstituisan ili supstituisan sa najmanje jednim supstituentom nezavisno izabranim iz grupe koju čine halogen, cijano, nitro, CHO, C(=O)OH, C(=O)NH₂, C1-C4 alkoksi, C1-C4 haloalkoksi, C1-C4 alkiltio, C1-C4 alkilsulfinil, C1-C4 alkilsulfonyl, C1-C4 haloalkiltio, C1-C4 haloalkilsulfonyl, C1-C4 haloalkilsulfonyl, C1-C4 alkilamino, C2-C8 dialkilamino, C3-C6 cikloalkilamino, C2-C4 alkoksialkil, C2-C4 alkilkarbonil, C2-C6 alkoksikarbonil, C2-C6 alkilkarboniloksi, C2-C6 alkilkarboniltio, C2-C6 alkilaminokarbonil, C3-C8 dialkilaminokarbonil i C3-C6 trialkilsilil; ili fenil ili 5- ili 6-člani heteroaromatični prsten, pri čemu je svaki nesupstituisan ili supstituisan sa najmanje jednim supstituentom nezavisno izabranim iz grupe koju čine C1-C6 alkil, C1-C6 haloalkil, C2-C6 alkenil, C2-C6 alkinil, C3-C8 cikloalkil, C4-C8 alkilcikloalkil, C4-C8 cikloalkilalkil, C6-C10 cikloalkilcikloalkil, C5-C10 alkilcikloalkilalkil, C3-C6 cikloalkenil, halogen, cijano, nitro, CHO, C(=O)OH, C(=O)NH₂, C1-C4 alkoksi, C1-C4 haloalkoksi, C1-C4 alkiltio, C1-C4 alkilsulfinil, C1-C4 alkilsulfonyl, C1-C4 haloalkiltio, C1-C4 haloalkilsulfonyl, C1-C4 haloalkilsulfonyl, C1-C4 alkilamino, C2-C8 dialkilamino, C3-C6 cikloalkilamino, C2-C4 alkoksialkil, C2-C4 alkilkarbonil, C2-C6 alkoksikarbonil, C2-C6 alkilkarboniloksi, C2-C6 alkilkarboniltio, C2-C6 alkilaminokarbonil, C3-C8 dialkilaminokarbonil i C3-C6 trialkilsilil; ili R¹² i R¹³ su uzet zajedno sa atomom azota za koji su vezani tako da formiraju 3- do 7-člani prsten koji sadrži članove prstena izabrane od atoma ugljenika i do 2 heteroatoma nezavisno izabrana od jednog O, jednog S i do 2 N, gde su do 2 člana prstena atoma ugljenika izabrana od C(=O) i C(S) i atom sumpora član prstena je izabran od S, S(O) ili S(O)₂, pri čemu je navedeni prsten izborno supstituisan sa do 4 supstituenta nezavisno izabrana iz grupe koju čine halogen, cijano i C1-C4 alkil; svaki R¹⁴ je nezavisno halogen, cijano, hidroksi, amino, nitro, SF₅, OCN, SCN, CHO, C(=O)OH, C(=O)NH₂, C(=S)NH₂, SO₂NH₂, C(=O)R¹⁸, C(=O)OR¹⁸, NHR¹⁸, NR¹⁸R¹⁹, C(=O)NR²¹R¹⁹, C(=O)NR²¹NR²²R²³, C(=S)NR²¹R¹⁹, SO₂NR²¹R¹⁹, OC(=O)R²¹, OC(=O)OR¹⁸, OC(=O)NR²¹R¹⁹, N(R²¹)C(=O)R²¹, N(R²¹)C(=O)OR¹⁹, N(R²¹)C(=O)NR²¹R²², OSO₂R¹⁸, OSO₂NR²¹R²², NR²¹SO₂R¹⁸, NR²¹SO₂NR²¹R²², Si(R¹⁸R¹⁹R²⁰), C(=NR²¹)R²², C(=NOR²¹)R²², C(=NNR²¹R²²)R²³, (=NN(C(=O)R¹⁹)R²¹)R²², C(=NN(C(=O)OR¹⁹)R²¹)R²², ON=CR²¹R²², ONR²¹R²², S(=O)(=NR²¹)R²², SO₂NR²¹C(=O)NR²²R²³, P(=X²)R¹⁸R¹⁹, OP(=X²)R¹⁸R¹⁹, OP(=X²)(OR¹⁸)R¹⁹, OP(=X²)(OR¹⁸)OR¹⁹, N=CR²¹R²², NR²¹N=CR²²R²³, NR²¹NR²²R²³, NR²¹C(=X²)NR²²R²³, NR²¹C(=NR²¹)NR²²R²³, NR²¹NR²¹C(=X²)NR²²R²³, NR²¹NR²¹SO₂NR²²R²³, Z¹Q^t ili Z¹QⁱZ¹Q^t; ili C1-C8 alkil, C2-C8 alkenil, C2-C8 alkinil, C3-C10 cikloalkil, C4-C10 alkilcikloalkil, C4-C10 cikloalkilalkil, C6-C14 cikloalkilcikloalkil, C5-C10 alkilcikloalkilalkil, C3-C8 cikloalkenil, C1-C8 alkoksi, C3-C8 cikloalkoksi, C4-C10 cikloalkilalkoksi, C2-C8 alkeniloksi, C2-C8 alkiniloksi, C1-C8 alkiltio, C1-C8 alkilsulfinil, C1-C8 alkilsulfonyl, C3-C8 cikloalkiltio, C3-C8 cikloalkilsulfinil, C3-C8 cikloalkilsulfonyl, C4-C10 cikloalkilalkiltio, C4-C10 cikloalkilalkilsulfonyl, C4-C10 cikloalkilalkilsulfonyl, C2-C8 alkeniltio, C2-C8 alkenilsulfinil, C2-C8 alkenilsulfonyl,

C2-C8 alkiniltio, C2-C8 alkinilsulfinil ili C2-C8 alkinilsulfonil, pri čemu je svaki nesupstituisan ili supstituisan sa najmanje jednim supstituentom koji je nezavisno izabran od R^{17} ; ili dva R^{14} supstituenta na susednim atomima u prstenu su uzeta zajedno sa susednim atomima u prstenu tako da formiraju 5- do 7-člani karbocikličan ili heterocikličan prsten, pri čemu svaki prsten sadrži članove prstena izabrane od atoma ugljenika i do 3 heteroatoma nezavisno izabrana od maksimalno 2 O, maksimalno 2 S i maksimalno 3 N, gde su do 2 člana prstena atoma ugljenika izabrana od $C(=O)$ i $C(=S)$ i članovi prstena atomi sumpora su nezavisno izabrani od $S(=O)_n$, pri čemu je svaki prsten izborno supstituisan sa do 3 supstituenta nezavisno izabrana iz grupe koju čine halogen, cijano, hidroksi, amino, nitro, $C(=O)OH$, $C(=O)NH_2$, SO_2NH_2 , C1-C4 alkil, C1-C4 haloalkil, C2-C4 alkenil, C2-C4 haloalkenil, C2-C4 alkinil, C2-C4 haloalkinil, C3-C7 cikloalkil, C3-C7 halocikloalkil, C4-C8 alkilcikloalkil, C4-C8 haloalkilcikloalkil, C4-C8 cikloalkilalkil, C4-C8 halocikloalkilalkil, C1-C6 alkoksi, C1-C6 haloalkoksi, C2-C6 alkoksikarbonil, C2-C6 haloalkoksikarbonil, C2-C6 alkilkarbonil i C2-C6 haloalkilkarbonil; svaki X^2 je nezavisno O ili S; svaki Z^1 je nezavisno direktna veza, O, $S(O)_n$, NR^6 , $C(R^7)_2$, $C(R^7)=C(R^7)$, $C=C$, $C(R^7)O$, $OC(R^7)_2$, $C(=X^1)$, $C(=X^1)E$, $EC(=X^1)$, $C(=NOR^8)$ ili $C(=NN(R^6)_2)$; svaki Q^1 je nezavisno 3- do 10-člani prsten ili 7- do 11-člani sistem prstena, pri čemu svaki prsten ili sistem prstena sadrži članove prstena koji su izabrani od atoma ugljenika i do 4 heteroatoma nezavisno izabrana od maksimalno 2 O, maksimalno 2 S i maksimalno 4 N, gde su maksimalno 3 atoma ugljenika koji su članovi prstena nezavisno izabrani od $C(=O)$ i $C(=S)$ i članovi prstena atomi sumpora su nezavisno izabrani od $S(=O)_u(=NR^{24})_z$, pri čemu je svaki prsten ili sistem prstena izborno supstituisan sa do 4 supstituenta nezavisno izabrana iz grupe koju čine halogen, cijano, nitro, CHO , $C(=O)OH$, $C(=O)NH_2$, $C(=O)R^{10}$, $C(=O)OR^{11}$, $C(=O)NR^{12}R^{13}$, OR^{11} , $S(O)nR^{10}$, $SO_2NR^{12}R^{13}$, $Si(R^{10})_3$ i R^{16} ; svaki Q^t je nezavisno 3- do 10-člani prsten ili 7- do 11-člani sistem prstena, pri čemu svaki prsten ili sistem prstena sadrži članove prstena koji su izabrani od atoma ugljenika i do 4 heteroatoma nezavisno izabrana od maksimalno 2 O, maksimalno 2 S i maksimalno 4 N, gde su maksimalno 3 atoma ugljenika koji su članovi prstena nezavisno izabrani od $C(=O)$ i $C(=S)$ i članovi prstena atomi sumpora su nezavisno izabrani od $S(=O)_u(=NR^{24})_z$, pri čemu je svaki prsten ili sistem prstena izborno supstituisan sa do 5 supstituenata nezavisno izabrana iz grupe koju čine halogen, cijano, nitro, CHO , $C(=O)OH$, $C(=O)NH_2$, $C(=O)R^{10}$, $C(=O)OR^{11}$, $C(=O)NR^{12}R^{13}$, $C(=O)NR^{21}NR^{22}R^{23}$, OR^{11} , $S(O)nR^{10}$, $SO_2NR^{12}R^{13}$, $S(=O)(=NR^{21})R^{22}$, $Si(R^{10})_3$ i R^{16} ; svaki R^{15} je nezavisno halogen, cijano, hidroksi, amino, nitro, SF_5 , OCN , SCN , CHO , $C(=O)OH$, $C(=O)NH_2$, $C(=S)NH_2$, SO_2NH_2 , $C(=O)R^{18}$, $C(=O)OR^{18}$, NHR^{18} , $NR^{18}R^{19}$, $C(=O)NR^{21}R^{19}$, $C(=O)NR^{21}NR^{22}R^{23}$, $C(=S)NR^{21}R^{19}$, $SO_2NR^{21}R^{19}$, $S(=O)(=NR^{21})R^{22}$, $OC(=O)R^{21}$, $OC(=O)OR^{18}$, $OC(=O)NR^{21}R^{19}$, $N(R^{21})C(=O)R^{21}$, $N(R^{21})C(=O)OR^{19}$, $N(R^{21})C(=O)NR^{21}R^{22}$, OSO_2R^{18} , $OSO_2NR^{21}R^{22}$, $NR^{21}SO_2R^{18}$, $NR^{21}SO_2NR^{21}R^{22}$, $Si(R^{18}R^{19}R^{20})$ ili Z^1Q^t ; ili C1-C8 alkil, C2-C8 alkenil, C2-C8 alkinil, C3-C10 cikloalkil, C4-C10 alkilcikloalkil, C4-C10 cikloalkilalkil, C6-C14 cikloalkilcikloalkil, C5-C10 alkilcikloalkilalkil, C3-C8 cikloalkenil, C1-C8 alkoksi, C3-C8 cikloalkoksi, C4-C10 cikloalkilalkoksi, C2-C8 alkeniloksi, C2-C8 alkiniloksi, C1-C8 alkiniltio, C1-C8 alkilsulfinil, C1-C8 alkilsulfonil, C3-C8 cikloalkiltio, C3-C8 cikloalkilsulfinil, C3-C8 cikloalkilsulfonil, C4-C10 cikloalkilalkiltio, C4-C10 cikloalkilalkilsulfinil, C4-C10 cikloalkilalkilsulfonil, C2-C8 alkeniltio, C2-C8 alkenilsulfinil, C2-C8 alkenilsulfonil, C2-C8 alkiniltio, C2-C8 alkinilsulfinil ili C2-C8 alkinilsulfonil, pri čemu je svaki nesupstituisan ili supstituisan sa najmanje jednim supstituentom koji je nezavisno izabran od R^{17} ; ili dva R^{15} supstituenta na susednim atomima u prstenu su uzeta zajedno sa susednim atomima u prstenu tako da formiraju 5- do 7-člani karbocikličan ili heterocikličan prsten, pri čemu svaki prsten sadrži članove prstena izabrane od atoma ugljenika i do 3 heteroatoma nezavisno izabrana od maksimalno 2 O, maksimalno 2 S i maksimalno 3 N, gde su do 2 člana prstena atoma ugljenika izabrana od $C(=O)$ i $C(=S)$ i članovi prstena atomi sumpora su nezavisno izabrani od $S(=O)_n$, pri čemu je svaki prsten izborno supstituisan sa do 3 supstituenta nezavisno izabrana iz grupe koju čine halogen, cijano, hidroksi, amino, nitro, $C(=O)OH$, $C(=O)NH_2$, SO_2NH_2 , C1-C4 alkil, C1-C4 haloalkil, C2-C4 alkenil, C2-C4 haloalkenil, C2-C4 alkinil, C2-C4 haloalkinil, C3-C7 cikloalkil, C3-C7 halocikloalkil, C4-C8 alkilcikloalkil, C4-C8 haloalkilcikloalkil, C4-C8 cikloalkilalkil, C4-C8 halocikloalkilalkil, C1-C6 alkoksi, C1-C6 haloalkoksi, C2-C6 alkoksikarbonil, C2-C6 haloalkoksikarbonil, C2-C6 alkilkarbonil i C2-C6 haloalkilkarbonil; svaki R^{16} je nezavisno C1-C6 alkil, C2-C6 alkenil, C2-C6 alkinil, C3-C8 cikloalkil, C4-C8 alkilcikloalkil, C4-C8 cikloalkilalkil, C6-C10 cikloalkilcikloalkil, C5-C10 alkilcikloalkilalkil ili C3-C6 cikloalkenil, pri čemu je svaki nesupstituisan ili supstituisan sa najmanje jednim supstituentom nezavisno izabranim iz grupe koju čine halogen, cijano, nitro, CHO , $C(=O)OH$, $C(=O)NH_2$, C1-C4 alkoksi, C1-C4 haloalkoksi, C1-C4 alkiniltio, C1-C4 alkilsulfinil, C1-C4 alkilsulfonil, C1-C4 haloalkiltio, C1-C4 haloalkilsulfinil, C1-C4 haloalkilsulfonil, C1-C4 alkilamino, C2-C8 dialkilamino, C3-C6 cikloalkilamino, C2-C4 alkoksialkil, C2-C4 alkilkarbonil, C2-C6 alkoksikarbonil, C2-C6 alkilkarboniloksi, C2-C6 alkilkarboniltio, C2-C6 alkilaminokarbonil, C3-C8 dialkilaminokarbonil i C3-C6 trialkilsilil; ili fenil ili 5- ili 6-člani heteroaromatični prsten, pri čemu je svaki nesupstituisan ili supstituisan sa najmanje jednim supstituentom nezavisno izabranim iz grupe koju čine C1-C6 alkil, C2-C6 alkenil, C2-C6 alkinil, C3-C8 cikloalkil, C4-C8 alkilcikloalkil, C4-C8 cikloalkilalkil, C6-C10 cikloalkilcikloalkil, C5-C10 alkilcikloalkilalkil, C3-C6 cikloalkenil, halogen, cijano, nitro, CHO , $C(=O)OH$, $C(=O)NH_2$, C1-C4 alkoksi, C1-C4 haloalkoksi, C1-C4 alkiniltio, C1-C4 alkilsulfinil, C1-C4 alkilsulfonil, C1-C4 haloalkiltio, C1-C4 haloalkilsulfinil, C1-C4 haloalkilsulfonil, C1-C4 alkilamino, C2-C8 dialkilamino, C3-C6

cikloalkilamino, C2-C4 alkoksialkil, C2-C4 alkilkarbonil, C2-C6 alkoksikarbonil, C2-C6 alkilkarboniloksi, C2-C6 alkilkarboniltio, C2-C6 alkilaminokarbonil, C3-C8 dialkilaminokarbonil i C3-C6 trialkilsilil; svaki R^{17} je nezavisno halogen, cijano, nitro, OH, CHO, C(=O)OH, C(=O)NH₂, C(=O)R¹⁰, C(=O)OR¹¹, C(=O)NR¹²R¹³, OR¹¹, S(O)nR¹⁰, SO₂NR¹²R¹³, Si(R¹⁰)₃ ili Z¹Q^t; svaki R^{18} , R^{19} i R^{20} je nezavisno Q^t; ili C1-C6 alkil, C2-C6 alkenil, C2-C6 alkinil, C3-C8 cikloalkil, C4-C8 alkilcikloalkil, C4-C8 cikloalkilalkil, C6-C10 cikloalkilcikloalkil, C5-C10 alkilcikloalkilalkil ili C3-C6 cikloalkenil, pri čemu je svaki nesupstituisan ili supstituisan sa najmanje jednim supstituentom koji je nezavisno izabran od R^{17} ; svaki R^{21} je nezavisno Q^t ili H; ili C1-C6 alkil, C2-C6 alkenil, C2-C6 alkinil, C3-C8 cikloalkil, C4-C8 alkilcikloalkil, C4-C8 cikloalkilalkil, C6-C10 cikloalkilcikloalkil, C5-C10 alkilcikloalkilalkil ili C3-C6 cikloalkenil, pri čemu je svaki nesupstituisan ili supstituisan sa najmanje jednim supstituentom koji je nezavisno izabran od R^{17} ; svaki R^{22} i R^{23} je nezavisno Q^t ili H; ili C1-C6 alkil, C2-C6 alkenil, C2-C6 alkinil, C3-C8 cikloalkil, C4-C8 alkilcikloalkil, C4-C8 cikloalkilalkil, C6-C10 cikloalkilcikloalkil, C5-C10 alkilcikloalkilalkil ili C3-C6 cikloalkenil, pri čemu je svaki nesupstituisan ili supstituisan sa najmanje jednim supstituentom koji je nezavisno izabran od R^{17} ; ili R^{22} i R^{23} su uzet zajedno sa atomom azota za koji su vezani tako da formiraju 3- do 7-člani prsten koji sadrži članove prstena izabrane od atoma ugljenika i do 2 heteroatoma nezavisno izabrana od jednog O, jednog S i do 2 N, gde su do 2 člana prstena atoma ugljenika izabrana od C(=O) i C(=S) i atom sumpora član prstena je izabran od S, S(O) ili S(O)₂, pri čemu je navedeni prsten izorno supstituisan sa do 4 supstituenta nezavisno izabrana iz grupe koju čine halogen, cijano i C1-C4 alkil; svaki R^{24} je nezavisno H, cijano, OCN, SCN, CHO, C(=O)OH, C(=O)NH₂, C(=S)NH₂, SO₂NH₂, C(=O)R¹⁸, C(=O)OR¹⁸, NHR¹⁸, NR¹⁸R¹⁹, C(=O)NR²¹R¹⁹, C(=S)NR²¹R¹⁹, SO₂NR²¹R¹⁹, OC(=O)R²¹, OC(=O)OR¹⁸, OC(=O)NR²¹R¹⁹, N(R²¹)C(=O)R²¹, N(R²¹)C(=O)OR¹⁹, N(R²¹)C(=O)NR²¹R²², OSO₂R¹⁸, OSO₂NR²¹R²², NR²¹SO₂R¹⁸, NR²¹SO₂NR²¹R²², Si(R¹⁸R¹⁹R²⁰) ili Z¹Q^t; ili C1-C8 alkil, C2-C8 alkenil, C2-C8 alkinil, C3-C10 cikloalkil, C4-C10 alkilcikloalkil, C4-C10 cikloalkilalkil, C6-C14 cikloalkilcikloalkil, C5-C10 alkilcikloalkilalkil, C3-C8 cikloalkenil, C1-C8 alkoksi, C3-C8 cikloalkoksi, C4-C10 cikloalkilalkoksi, C2-C8 alkeniloksi, C2-C8 alkiniloksi, C1-C8 alkiltio, C1-C8 alkilsulfinil, C1-C8 alkilsulfonyl, C3-C8 cikloalkiltio, C3-C8 cikloalkilsulfinil, C3-C8 cikloalkilsulfonyl, C4-C10 cikloalkilalkiltio, C4-C10 cikloalkilalkilsulfinil, C4-C10 cikloalkilalkilsulfonyl, C2-C8 alkeniltio, C2-C8 alkenilsulfinil, C2-C8 alkenilsulfonyl, C2-C8 alkiniltio, C2-C8 alkinilsulfinil ili C2-C8 alkinilsulfonyl, pri čemu je svaki nesupstituisan ili supstituisan sa najmanje jednim supstituentom koji je nezavisno izabran od R^{17} ; a je 1, 2 ili 3; svaki n je nezavisno 0, 1 ili 2; i u i z u svakom slučaju S(=O)u(=NR²⁴)_z su nezavisno 0, 1 ili 2, uz uslov da je zbir u i z u svakom slučaju S(=O)u(=NR²⁴)_z jednak 0, 1 ili 2; uz uslov da (i) kada je A jednako O, S, NCH₃ ili C(R^{3c})=C(R^{3d}), R^{3c} je H ili F, i R^{3d} je H, F, CF₂H ili CF₃, tada se najmanje jedan od R^{3a} ili R^{3b} razlikuje od H; i (ii) jedinjenje formule 1 se razlikuje od

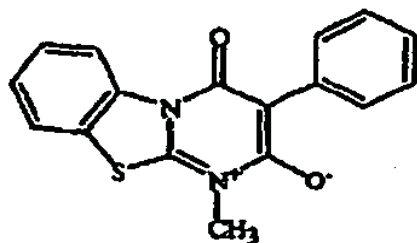

Patent sadrži još 13 patentnih zahtjeva.

- (51) **A 61K 31/4453**^{2006.01} **A 61P 25/16**^{2006.01} (11) **01713** (13) **B**
A 61P 25/28^{2006.01}
 (21) P-2013-98
 (22) 30. 03. 2006
 (30) 20050290727 01. 04. 2005 EP
 20050668618P 06. 04. 2005 US
 (86) EP/06744466.1/30. 03. 2006
 IB/PCT/IB2006/000739/30. 03. 2006
 (87) WO 2006/103546 /05. 10. 2006/2006/40
 EP 1863487 /12. 12. 2007/2007/50
 EP 1863487 /29. 05. 2013/2013/22
 (54) me **LIJEČENJE SIMPTOMA PARKINSONOVE BOLESTI SA ALKILAMIN HISTAMINOM BEZ**
IMIDAZOLA-H3 RECEPTORA UGANDA
 en **TREATMENT OF SYMPTOMS OF PARKINSON'S DISEASE WITH NON-IMIDAZOLE**
ALKYLAMINES HISTAMINE H3-RECEPTOR LIGANDS
 (73) BIOPROJET,30, rue des Francs-Bourgeois,75003 Paris, FR
 (72) SCHWARTZ, Jean-Charles,9, villa Seurat,F-75014 Paris, FR
 LECOMTE, Jeanne-Marie,30, rue des Francs Bourgeois,F-75003 Paris, FR
 (74) LUTOVAC, Branislav,Bulevar Ivana Crnojevića 93,Podgorica,81000,ME

(57) Jedinjenje ima opštu formulu (IIa):

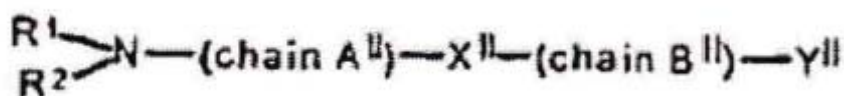

(IIa)

pri čemu: R¹ R² zajedno sa azotom formiraju atom na koji je povezan zasićeni prsten koji sadrži azot



gde je m u opsegu od 2 do 8, R^{a-b} je slobodni atom vodonika ili linearna ili razgranata alkilna grupa koja sadrži od 1 do 6 atoma ugljenika i lanac A^{II} izabran iz nerazgranate alkilne grupe -(CH₂)_{n₁₁} - pri čemu je n₁₁ je 3; grupa X^{II} je -O-; lanac B^{II} je nerazgranati alkil koji se sastoji od 3 atoma ugljenika; i grupa Y^{II} predstavlja fenilnu grupu, nesupstituisana ili mono ili polisupstituisana jednim ili više identičnih ili različitih supstituenata selektovanih iz halogenih atoma, OCF₃, CHO, CF₃, SO₂N(alkil), NO₂, S(aril), SCH₂(fenil), nerazgranatog ili razgranatog alkena, nerazgranatog ili razgranatog alkina sa opcijom supstitucije sa trialkilsilil radikalom; -O(alkil), -O(aril), -CH₂CN, keton, aldehid, sulfon, acetal, alkohol, linearna ili razgranata alkilna grupa koja sadrži od 1 do 6 atoma ugljenika, -CH=CH-CHO, -C(alkil)=N-OH, -C(alkil)=N-O(alkil), -CH=NOH, -CH=NO(alkyl), -C(alkyl)=NH-NH-CONH₂, an 0-phenyl ili -OCH₂(phenyl) group, -C(cycloalkyl)=NOH, -C(cycloalkyl)=N-O(alkyl); kao i njihove farmakološki prihvatljive soli, njihovi hidrati, njihove hidratizane soli, polimorfne kristalne strukture ovih jedinjenja i njihovih optičkih izomera, racemates, diastereoisomera i enantiomera, za korišćenje u lečenju preterane dnevne pospanosti, povezana sa Parkinsonovom bolešću ili opstruktivne apneje. Patent sadrži još 15 patentnih zahtjeva.

- (51) **A 47J 31/36**^{2006.01} **B 65D85/804**^{2006.01} (11) **01715** (13) **B**
 (21) P-2014-7
 (22) 30. 12. 2009
 (30) 20090163008 17. 06. 2009 EP
 (86) EP/12174373.6/30. 12. 2009
 (87) EP 2510843/17. 10. 2012/2012/42
 EP 2510843/23. 10. 2013/2013/43
 (54) me **Sistem, kapsula i postupak za pripremanje pića**
 en **System, capsule and method for preparing a beverage**
 (73) Koninklijke Douwe Egberts B.V., Vleutensevaart 35,3532 AD Utrecht, NL
 (72) Kamerbeek, Ralf, Ten Veldestraat 59,3454 EJ De Meern, NL
 Flamand, John Henri, Meulunterseweg 72,6741 HP Lunteren, NL
 Post van Loon, Angenita Dorothea, Weerschijnvlinder 11,3544 DT Utrecht, NL
 Koeling, Hendrik Cornelis, Harderwijkade 11,3826 BE Amersfoort, NL
 Biesheuvel, Arend Cornelis Jacobus, Raadhuislaan 7,4251 VS Werkendam, NL
 (74) ĐAKONOVIĆ, Vido, Vojvode Boža br. 1, Cetinje, 81250, ME

- (57) Otvorena kapsula (2) za pripremanje unapred određene količine pića podesnog za konzumaciju korišćenjem proizvoda koji se može ekstrahovati, koja sadrži: u suštini kruti obodni zid (6), dno (7) koje zatvara obodni zid na prvom kraju (8), i poklopac (9) koji sadrži fleksibilni perforirani i/ili porozni materijal u vidu lista koji zatvara obodni zid na drugom, otvorenom kraju (10) koji se nalazi nasuprot dna, pri čemu obodni zid (6), dno (7) i poklopac (9) okružuju unutrašnji prostor (11) koji sadrži proizvod koji se može ekstrahovati, pri čemu je otvorena kapsula (2) naznačena time što poklopac (9) sadrži nepropusnu spoljašnju obodnu oblast (30) i izlaznu oblast (32) koja je okružena pomenutom nepropusnom spoljašnjom obodnom oblasti (30), pri čemu se nepropusna spoljašnja obodna oblast (30) pruža od obodnog zida (6) radialno prema unutrašnjosti, tako da se pri upotrebi pripremljeno piće ispusta iz kapsule aktivnim potiskivanjem pripremljenog pića kroz izlaznu oblast (32).

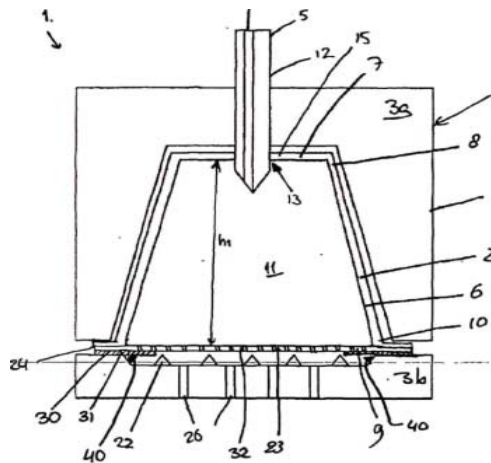

Patent sadrži još 15 patentnih zahtjeva.

- (51) **A 61K 9 /70**^{2006.01} **A 61K 31 /565**^{2006.01} (11) **01716** (13) **B**
- (21) P-2014-15
- (22) 10. 12. 2004
- (30) 03078881 12. 12. 2003 EP
- (86) EP/09173898.9/10. 12. 2004
- (87) EP 2138169 /30. 12. 2009/2009/53
EP 2138169 /06. 11. 2013/2013/45
- (54) me **Transdermalni sistem dostave hormona bez upotrebe pojačivača penetracije**
en **Transdermal delivery system of hormones without penetration enhancers**
- (73) Bayer Intellectual Property GmbH, Alfred-Nobel-Strasse 10, 40789 Monheim, DE
- (72) Langguth, Thomas, Am Goethepark 2 B, 07751 Jena, DE
Dittgen, Michael, Heidenberg 35, 99510 Apolda, DE
Bracht, Stefan, Staerkstr. 29, 16548 Glienicke Nordbahn, DE
Huber, Petra, Lindwurmstrasse 72, 80337 München, DE
Schenk, Dirk, Hochlandstrasse 5, 83623 Dietramszell, DE
- (74) RADULOVIĆ, S. Božidar, Studentska bb, Lamela 3/18, Podgorica, 81000, ME
- (57) Komplet hemikalija, naznačen time, što obuhvata 1 do 11 doznih jedinica koje su namenjene tretmanu tokom perioda od 12 sedmica i koji je formulisan u formi za transdermalnu dostavu Gestodena, pri čemu pomenuta dozna jedinica sadrži kompoziciju za transdermalnu dostavu koja obuhvata sloj za lek koji sadrži Gestoden i neki nosilac koji je izabran iz grupe koja obuhvata poliizobutilene, polibutene, poliizoprene, polistirene, stiren izopren stiren blok-polimere, stiren butadien stiren blok-polimere i njihove mešavine, gde pomenuti sloj za lek rastvara Gestoden ne više od 3% po težini samog sloja za lek i gde pomenuti Gestoden je prisutan u količini koja se kreće u rasponu od između 0.5 i 3% po težini samog sloja za lek.
- Patent sadrži još 11 patentnih zahtjeva.

- (51) **C 07K 16/46**^{2006.01} **C 07K 16/24**^{2006.01} (11) **01717** (13) **B**
A 61K 39/395^{2006.01} **A 61K 35/00**^{2006.01}
A 61K 37/08^{2006.01} **A 61P 11/06**^{2006.01}
- (21) P-2014-20
(22) 14. 10. 2008
(30) 07291259 15. 10. 2007 EP
37128P 17. 03. 2008 US
(86) EP/08839958.9/14. 10. 2008
US/PCT/US2008/079787/14. 10. 2008
(87) WO 2009/052081 /23. 04. 2009/2009/17
EP 2205640 /14. 07. 2010/2010/28
EP 2205640 /20. 11. 2013/2013/47
- (54) me **ANTITELA KOJA VEŽU IL-4 I/ILI IL-13 I NJIHOVE UPOTREBE**
en **ANTIBODIES THAT BIND IL-4 AND/OR IL-13 AND THEIR USES**
- (73) SANOFI, 54, rue La Boétie, 75008 Paris, FR
(72) RAO, Ercole,
c/o Sanofi-Aventis Deutschland GmbH, Industriepark Hoechst, 65926 Frankfurt Am Main, DE
MIKOL, Vincent, c/o Sanofi-Aventis, 174 avenue de France, F-75013 Paris, FR
LI, Danxi, 5 Pauma Valley Court, Skillman, NJ 08558, US
KRUIP, Jochen,
c/o Sanofi-Aventis Deutschland GmbH, Industriepark Hoechst, 65926 Frankfurt Am Main, DE
DAVISON, Matthew,
c/o sanofi-aventis U.S., 55 Corporate Drive, Bridgewater, New Jersey 08807, US
(74) RADULOVIĆ, Božidar, Studentska bb, Lamela 3/18, Podgorica, 81000, ME

(57) Bispecifično antitelo ili fragment bispecifičnog antitela koji se specifično veže na IL-13 i IL-4, naznačen time, što pomenuto bispecifično antitelo ili fragment bispecifičnog antitela sadrži dva laka lanca sa strukturom N-VL_{hB-B13}-linker-VL_{hB-D4-8} CL-C i dva teška lanca sa strukturom N-VH_{hB-B13}-linker-VH_{hB-D4-8}-CH1-CH2-CH3-C, pri čemu VL_{hB-B13} obuhvata amino-kiselinsku sekvencu SEQ ID BR: 1, u kojoj VL_{hB-D4-3} obuhvata amino-kiselinsku sekvencu SEQ ID BR: 3, gde VH_{hB-B13} obuhvata amino-kiselinsku sekvencu SEQ ID BR: 2, gde VH_{hB-D4-8} obuhvata amino-kiselinsku sekvencu SEQ ID BR: 5, i gde svaki linker je peptidni linker koji ima amino-kiselinsku sekvencu koja obuhvata sekvencu SEQ ID BR: 6.

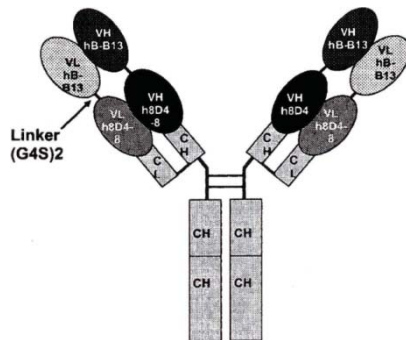

Patent sadrži još 6 patentnih zahtjeva.

(51) **A 61K 9 /107**^{2006.01} **A 61K 9 /48**^{2006.01} (11) **01718** (13) **B**
A 61K 31 /427^{2006.01} **A 61K 47 /10**^{2006.01}
A 61K 47 /12^{2006.01} **A 61K 47 /14**^{2006.01}
A 61K 47 /44^{2006.01}

(21) P-2014-23

(22) 01. 07. 2010

(30) 20090223507P 07. 07. 2009 US

(86) EP/ 10731685.3/01. 07. 2010
US/PCT/US2010/040734

(87) WO 2011/005646/13. 01. 2011/2011/02

EP 2451438/16. 05. 2012/2012/20

EP 2451438/26. 02. 2014/2014/09

EP 2451438/09. 04. 2014/2014/15

(54) me **Farmaceutska kompozicija za inhibitor proteaze virusnog Hepatitis C**
en **Pharmaceutical composition for a hepatitis C viral protease inhibitor**

(73) Boehringer Ingelheim International GmbH, Binger Strasse 173, 55216 Ingelheim am Rhein, DE

(72) CHEN, Feng-Jing,

Boehringer Ingelheim Pharmaceuticals Inc., Ridgefield Connecticut 06877-0368, US
900 Ridgebury Road, P.O. Box 368

SCHWABE, Robert J.,

Boehringer Ingelheim Pharmaceuticals Inc., Ridgefield Connecticut 06877-0368, US
900 Ridgebury Road, P.O. Box 368

(74) RADULOVIĆ, S. Božidar, Studentska bb, Lamela 3/18, Podgorica, 81000, ME

(57) Tečna farmaceutska kompozicija koja sadrži: (a) jedinjenje formule (1):

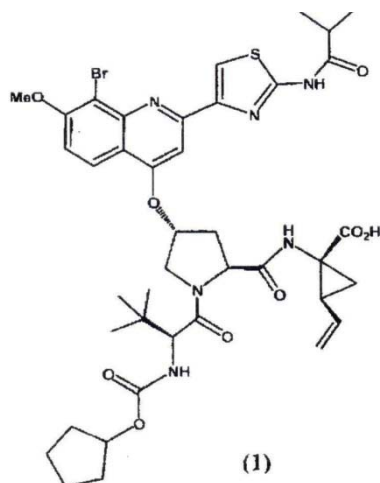

iii njegovu farmaceutski prihvatljivu so; (b) jedan iii više farmaceutskih prihvatljivih lipida; i (c) jednu iii više farmaceutski prihvatljivih hidrofilnih površinski aktivnih supstanci.

Patent sadrži još 11 patentnih zahtjeva.

- (51) **A 61K 31/18**^{2006.01} **A 61P 37/06**^{2006.01} (11) **01719** (13) **B**
- (21) P-2014-24
- (22) 06. 10. 2010
- (30) 09172364 06. 10. 2009 EP
- (86) EP/10761018.0/06. 10. 2010
EP/PCT/EP2010/064921/06. 10. 2010
- (87) WO 2011/042466/14. 04. 2011/2011/15
EP 2485723/15. 08. 2012/2012/33
EP 2485723/11. 12. 2013/2013/50
- (54) me **INHIBITORI CXCR1/2 KAO ADJUVANSI U TRANSPLANTACIJI PANKREASNIH OSTRVACA**
en **INHIBITORS OF CXCR1/2 AS ADJUVANTS IN THE TRANSPLANT OF PANCREATIC ISLETS**
- (73) Dompé S.p.A., Località Campo di Pile snc, 67100 L'Aquila AQ, IT
- (72) PIEMONTE, Lorenzo, Diabetes Research Institute (HSR-DRI), 20132 Milano, IT
-San Raffaele Scientific Institute, Via Olgettina 60'
DAFFONCHIO, Luisa, c/o Dompé S.p.A., Località Campo di Pile snc, I-67100 L`Aquila AQ, IT
ALLEGRETTI, Marcello, c/o Dompé S.p.A., Località Campo di Pile snc, I-67100 L`Aquila AQ, IT
- (74) RADULOVIĆ, S. Božidar, Studentska bb, Lamela 3/18, Podgoricca, 81000, ME

- (57) Inhibitor CXCR1 i/ili CXCR2 za upotrebu kao adjuvantni medikament za transplantaciju pankreasnih ostrvaca kod pacijenata koji boluju od dijabetesa Tipa 1.
Patent sadrži još 7 patentnih zahtjeva.

- (51) **C 07K 14/18**^{2006.01} **C 12N 15/867**^{2006.01} (11) **01720** (13) **B**
- (21) P-2014-29
(22) 22. 07. 2010
(30) 228491 P 24. 07. 2009 US
(86) EP/10737715.2/22. 07. 2010
WO/PCT/US2010/042870
(87) WO 2011/011584/27. 01. 2011/2011/04
EP 2456786/30. 05. 2012/2012/22
EP 2456786/08. 01. 2014/2014/02
- (54) me **LENTIVIRALNI VEKTORI PSEUDOTIPIZIRANI SA OMOTAČEM OD
GLIKOBELANČEVINE IZ SINDBIS-VIRUSA**
en **LENTIVIRAL VECTORS PSEUDOTYPED WITH A SINDBIS VIRUS ENVELOPE
GLYCOPROTEIN**
- (73) Immune Design Corp, 1616 Eastlake Ave. E., Suite 310, Seattle, WA 98102, US
(72) ALLEN, James, M., 1616 Eastlake Ave. E., Suite 310, Seattle, WA 98102, US
VAN HOEVEN, Neal, S., 1616 Eastlake Ave. E., Suite 310, Seattle, WA 98102, US
LI, Jin Zhong, 1616 Eastlake Ave. E., Suite 310, Seattle, WA, 98102, US
SLOAN, Derek, D., 1616 Eastlake Ave. E., Suite 310, Seattle, WA 98102, US
DUBENSKY, Thomas W., Jr., 1616 Eastlake Ave. E., Suite 310, Seattle, WA 98102, US
(74) RADULOVIĆ, S. Božidar, Studentska bb, lamela 3/18, Podgorica, 81000, ME
- (57) Čestice lentiviralnog vektora, naznačene time, što obuhvataju:
(a) omotač koji se sastoji od
(i) E2 glikobelančevine iz Sindbis-virusa sa SEQ ID BR: 1 gde 160X je odsutna ili je neka amino-kiselina koja je različita od glutaminske kiseline, ili od varijante SEQ ID BR: 1 koja ima najmanje 80% identičnosti sa SEQ ID BR: 1 i gde 160X je odsutna ili je neka amino-kiselina koja je različita od glutaminske kiseline, koja je sposobna da inficira dendrite; pri čemu E2 nije deo fuzione belančevine sa E3 iz Sindbis-virusa; i
(b) genom lentiviralnog vektora koji obuhvata jednu ili više sekvenci od interesa.

Patent sadrži još 22 patentna zahtjeva.

- (51) **C 07D 215/48**^{2006.01} **C 07D 401/12**^{2006.01} (11) **01748** (13) **B**
C 07D 407/12^{2006.01} **C 07D 409/12**^{2006.01}
C 07D 413/12^{2006.01} **C 07D 417/12**^{2006.01}
A 61K 31/4709^{2006.01} **A 61P 31/10**^{2006.01}
- (21) P-2014-36
(22) 28. 12. 2010
(30) 09180895 29. 12. 2009 EP
(86) EP/10798129.2/28. 12. 2010
EP/PCT/EP2010/070793/28. 12. 2010
(87) WO 2011/080266/07. 07. 2011/27/2011
EP 2519504/07. 11. 2012/2012/45
EP 2519504/19. 03. 2014/2014/12
- (54) me **NOVI DERIVATI SEKUNDARNOG 8- HIDROKSIHINOLIN-7 KARBOKSAMIDA**
en **NEW SECONDARY 8-HYDROXYQUINOLINE-7-CARBOXAMIDE DERIVATIVES**
- (73) Polichem SA, 50, Val Fleuri, 1526 Luxembourg, LU
(72) GAGLIARDI, Stefania, Via Passirano 24, I-20059 Vimercate (MB), IT
DEL SORDO, Simone, Piazza Carlo Alberto dalla Chiesa 22, I-24047 Treviglio (BG), IT
MAILLAND, Federico, Strada Regina 10, CH-6900 Lugano, CH
LEGORA, Michela, Via Castellazzo 1/B, I-22070 Appiano Gentile (CO), IT
(74) Advokatsko Ortačko Društvo "ĆUPIĆ", Dalmatinska 10, Podgorica, 81000, ME
- (57) Jedinjenje odabrano iz grupe koju čine: 8- hidroksi-N-(1,1-dioksidotetrahidrotien-3-il)hinolin-7-karboksamid; 8- hidroksi-N-(tetrahidro-2H-piran-4-il)hinolin-7-karboksamid; 8- hidroksi-N-(4-morfolinofenil)hinolin-7-karboksamid; 8- hidroksi-N-(tiazol-2-il)hinolin-7-karboksamid; 8- hidroksi-N-(izoksazol-3-il)hinolin-7-karboksamid; 8- hidroksi-N-((5-metilpirazin-2-il)metil)hinolin-7-karboksamid; 8- hidroksi-N-((1-metil-1H-imidazol-2-il)metil)hinolin-7-karboksamid; 8- hidroksi-N-((4-feniltiazol-2-il)metil)hinolin-7-karboksamid; 8- hidroksi-N-(piridin-4-ilmetil)hinolin-7-karboksamid; 8- hidroksi-N-(2,3-dihidrobenzo[b][1,4]dioksin-6-il)hinolin-7-karboksamid; 8- hidroksi-N-(4-(dimetilamino)benzil)hinolin-7-karboksamid; 8- hidroksi-N-(4-bromobenzil)hinolin-7-karboksamid; 8- hidroksi-N-(benzo[d]tiazol-2-ilmetil)hinolin-7-karboksamid; 8- hidroksi-N-(4-morfolinobenzil)hinolin-7-karboksamid; 8- hidroksi-N-((4-metiltiazol-2-il)metil)hinolin-7-karboksamid; 8- hidroksi-N-(piridin-2-ilmetil)hinolin-7-karboksamid; 8- hidroksi-N-(4-(1H-1,2,4-triazol-1-il)fenil)hinolin-7-karboksamid; 8- hidroksi-N-((5-metilisoksazol-3-il)metil)hinolin-7-karboksamid.
Patent sadrži još 1 patentni zahtjev.

(51) **A 61K 45/06**^{2006.01} **C 07D 211/58**^{2006.01} (11) **01749** (13) **B**
C 07D 401/06^{2006.01} **A 61P 29/02**^{2006.01}
A 61P 25/04^{2006.01} **A 61K 31/4468**^{2006.01}

(21) P-2012-103

(22) 31. 10. 2007

(30) 20060855826P 01. 11. 2006 US

(86) EP/07825628.6/31. 10. 2007

IB/PCT/IB2007/003411/31. 10. 2007

(87) WO 2008/053352/08. 05. 2008/30/2008

EP 2079485/22. 07. 2009/2009/30

EP 2079485/13. 06. 2012/2012/24

(54) me **JEDINJENJA FENILPROPIONAMIDA I NJIHOVA UPOTREBA**
en **PHENYLPROPIONAMIDE COMPOUNDS AND THE USE THEREOF**

(73) Purdue Pharma LP, One Stamford Forum 201 Tresser Boulevard, Stamford, CT 06901, US

(72) ZHOU, Xiaoming, 22 Dogwood Drive, Plainsboro, NJ 08523, US

(74) LUTOVAC, Branislav,

Bulevar Ivana Crnojevića 93, 81000 Podgorica, Bulevar Ivana Crnojevića 93, Podgorica, 81000, ME

(57) Jedinjenje formule IA:

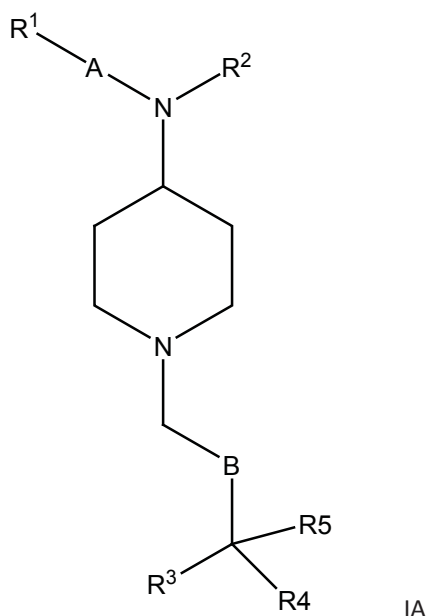

gde A je aril, ili heteroaril; R¹ je: H ili halo; ili -O-C₁₋₆ alkil, koji je opciono supstituisan; ili -NR⁶R⁷, gde svaki od R⁶ i R⁷ je nezavisno izabran iz grupe koju čine H, ili C₁₋₆ alkil, C₂₋₆ alkenil, i C₂₋₆ alkinil; od kojih je svaki opciono supstituisan, R² je C₁₋₆ alkil, C₂₋₆ alkenil, C₂₋₆ alkinil, -C(=O)C₁₋₆ alkil, -C(=O)C₂₋₆ alkenil, -C(=O)C₂₋₆ alkinil, -S(=O)C₁₋₆ alkil, -S(=O)C₂₋₆ alkenil, -S(=O)C₂₋₆ alkinil, SO₂C₁₋₆ alkil, SO₂C₂₋₆ alkenil, SO₂C₂₋₆ alkinil, -CO₂C₁₋₆ alkil, -CO₂C₂₋₆ alkenil, ili -CO₂C₂₋₆ alkinil, od kojih je dvaki opciono supstituisan; gde opciono supstituisani znači da je grupa opciono supstituisana sa jednim ili više supstituenata, poželjno 1, 2, ili 3 supstituenta, nezavisno izabranih iz grupe koju čine halo, halo(C₁₋₆) alkil, halo₂(C₁₋₆) alkil, halo₃(C₁₋₆) alkil, aril, heteroaril, cikloalkil, heterocikloalkil, C₁₋₆ alkil, C₂₋₆ alkenil, C₂₋₆ alkinil, aril(C₁₋₆) alkil, aril(C₂₋₆) alkenil, aril(C₂₋₆) alkinil, cikloalkil(C₁₋₆) alkil, heterociklo(C₁₋₆) alkil, hidroksil(C₁₋₆) alkil, amino(C₁₋₆) alkil, karboksi(C₁₋₆) alkil, aloksi(C₁₋₆) alkil, nitro, amino, ureido, cijano, alkilkarbonilamino, hidroksil, tiol, alkilkarboniloksi, azido, aloksi, karboksi, aminokarbonil, i C₁₋₆ alkiltiol, a poželjno supstituisan je sa halo, halo(C₁₋₆) alkil, halo₂(C₁₋₆) alkil, halo₃(C₁₋₆) alkil, hidroksil(C₁₋₆) alkil, amino(C₁₋₆) alkil, hidroksil, nitro, C₁₋₆ alkil, C₁₋₆ aloksi i amino, B je (CH₂)_m gde je m celi broj od 0 do 12, i poželjno 1, 2 ili 3;

R³ i R⁴ svaki nezavisno su izabrani iz grupe koju čine aril i heteroaril;

R⁵ je H, C₁₋₆ alkil, -C(=O)NHC₁₋₆ alkil, -C(=O)N(C₁₋₆ alkil)₂, ili alkilaminokarbonil;

i njegove farmaceutski prihvatljive soli i solvati.

- (51) **A 61K 31/4704**^{2006.01} **A 61P 11/00**^{2006.01} (11) **15/2014** (13) **B**
A 61P 11/06^{2006.01} **A 61P 11/08**^{2006.01}
- (21) P-2013-117
(22) 18. 02. 2010
(30) 2009382020 18. 02. 2009 EP
(86) EP/ 10711830.9/18. 02. 2010
EP/PCT/EP2010/001026/18. 02. 2010
(87) WO 2010/094483/26. 08. 2010/34/2010
EP 2398473/28. 12. 2011/2011/52
EP 2398473/24. 07. 2013/2013/30
(54) me **5-(2-{{[6-(2, 2-DIFLUORO-2-FENILETOKSI)HEKSIL]AMINO}-1-HIDROKSJETIL)-8-HIDROKSIKI NOLIN-2-(1 H)-ON ZA LEČENJE PLUĆNE FUNKCIJE**
en **5-(2-{{[6-(2, 2-difluoro-2-phenylethoxy)hexyl]amino}-1-hydroxyethyl)-8-hydroxyquinolin-2-(1H)-one for the treatment of lung function**
- (73) Almirall S.A., Ronda del General Mitre, 151, 08022 Barcelona, ES
(72) RUF, Thorsten, C/ Laureà Miró 408-410, E-08980 Sant Feliu de Llobregat (Barcelona), ES
MASSANA MONTEJO, Eric,
C/ Laureà Miró 408-410, E-08980 Sant Feliu de Llobregat (Barcelona), ES
(74) ĐAKONOVIĆ, Vido, Bajova 9, Cetinje, 81250, ME
- (57) Jedinjenje koje je 5-(2-{{[6-(2,2-difluoro-2-feniletoksi)heksil]amino}-1-hidroksietil)-8-hidroksikinolin-2(1H)-on u obliku racemata, stereoisomera ili smjese stereoisomera. ili farmaceutski prihvatljive soli ili njenog solvata, za korišćenje putem inhalacije u normalizaciji plućne funkcije kod ljudskog pacijenta koji pati od astme, hronične opstruktivne bolesti pluća (HOBP), mišićne distrofije ili gastroezofagealnog refluksa, naznačeno time, što pacijent prije administriranja jedinjenja ima FEV1 manji od 90% predviđenog normalnog FEV1 za datog pacijenta, i što se predviđeni normalni FEV1 izračunava pomoću sljedećih formula:
Muškarci: 4,3 V - 0,029 D - 2,49 Žene: 3,95 V - 0.025 D - 2,6
pri čemu je V = visina (izražena u metrima) i D = dob (izražena u godinama).
Preostalo patentnih zahtjeva 2.

- (51) **C 07K 16/18**^{2006.01} (11) **01758** (13) **B**
- (21) P-2013-132
- (22) 13. 07. 2007
- (30) 20060014730 14. 07. 2006 EP
20060020765 02. 10. 2006 EP
20070943289P 11. 06. 2007 US
20070943499P 12. 06. 2007 US
- (86) EP/07840408.4/13. 07. 2007
US/PCT/US2007/073504/13. 07. 2007
- (87) WO 2008/011348/24. 01. 2008/04/2008
EP 2046833/15. 04. 2009/2009/16
EP 2046833/21. 08. 2013/2013/34
- (54) me **HUMANIZIRANO PROTUTIJELO PROTIV AMILOIDA BETA**
en **HUMANIZED ANTIBODY AGAINST AMYLOID BET A**
- (73) AC Immune S.A., EPFL -PSE, Building B, 1015 Lausanne, CH
Genentech, Inc., 1 DNA Way, South San Francisco CA 94080-4990, US
- (72) PFEIFER, Andrea, Rte de Fenil 16A, 1806 St- L gier, CH
PIHLGREN, Maria, Rue du Centre 42A, 1025 St. Sulpice, CH
MUHS, Andreas, Av. des Cerisiers 39b, 1009 Pully, CH
WATTS, Ryan, 524 Yale Drive, San Mateo, CA 94402, US
- (74) AOD  UPIĆ, Dalmatinska 10, Podgorica, 81000, ME
- (57) Humanizirano protutijelo, ili njegov fragment, koje prepoznaje i ve e se na β -amiloidni protein, nazna eno time  to navedeno humanizirano protutijelo, ili njegov fragment, sadr i:
- i) varijabilno podru je te kog lanca (HCVR), koje ima aminokiselinski slijed SEQ ID NO: 15, i
 - ii) varijabilno podru je lakog lanca (LCVR), koje ima aminokiselinski slijed SEQ ID NO: 12.

(51) C07D213/75^{2006.01} A61K31/44^{2006.01} (11) 01759 (13) B
 A61P1/00^{2006.01} A61P11/06^{2006.01}
 A61P19/02^{2006.01} A61P25/28^{2006.01}
 A61P29/00^{2006.01}

(21) P-2011-28

(22) 28. 01. 2008

(30) 20070887981P 02. 02. 2007 US

(86) EP/08702358.6/28. 01. 2008
 IB/PCT/IB2008/000249/28. 01. 2008

(87) WO 2008/093236/07. 08. 2008/32/2008

EP 2114888/11. 11. 2009/2009/46

EP 2114888/10. 11. 2010/2010/45

(54) me **TRICIKLIČNA JEDINJENJA I NJIHOVA UPOTREBA KAO MODULATORA**
GLUKOKORTIKOIDNIH RECEPTORA
 en **TRICYCLIC COMPOUNDS AND THEIR USE AS GLUCOCORTICOID RECEPTOR**
MODULATORS

(73) Pfizer Products Inc., Eastern Point Road, Groton, CT 06340, US

(72) CHENG, Hengmiao,
 Agouron Pharmaceuticals, Inc. A Pfizer Company San Diego, California 92121, US
 10777 Science Center Drive
 HU, Xiao, Pfizer Global Research and Development Chesterfield, Missouri 63017, US
 700 Chesterfield Parkway West

JEROME, Kevin, DeWayne,
 Pfizer Global Research and Development Chesterfield, Missouri 63017, US
 700 Chesterfield Parkway West

OBUKOWICZ, Mark, Gerard,
 Pfizer Global Research and Development Chesterfield, Missouri 63017, US
 700 Chesterfield Parkway West

OLSON, Lisa, 4 Circle Drive, Hopkinton, Massachusetts 01748, US

RUCKER, Paul, Vincent, 2390 Rising Glen Way, Apt. 101, Carlsbad, California 92008, US

WEBBER, Ronald, Keith, Pfizer Global Research and Development Chesterfield, Missouri 63017, US
 700 Chesterfield Parkway West

Advokatsko Ortačko Društvo ČUPIĆ, Dalmatinska 10, 81000 Podgorica,

(57) Jedinjenje formule 1:

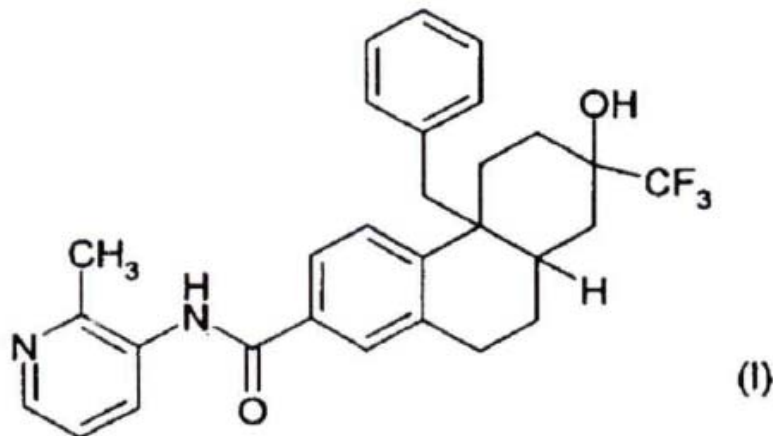

ili njegova so.

Patent sadrži još 6 patentnih zahtjeva.

- (51) **A01N25/04**^{2006.01} **A01N47/44**^{2006.01} (11) **01760** (13) **B**
A01P3/00^{2006.01}
 (21) P-2014-40
 (22) 22. 08. 2012
 (30) PCT/EP2011/064397 22. 08. 2011 WO
 (86) EP/12181421.4/22. 08. 2012
 (87) EP 2561753/27. 02. 2013/2013/09
 EP 2561753/19. 03. 2014/2014/12
 (54) me **Koncentrat vodene suspenzije koji obuhvata so dodecilgvanidina sa kiselinom**
 en **Aqueous suspension concentrate comprising an acid salt of dodecylguanidine**
 (73) Agriphar S.A., Rue de Renory 26/1, 4102 Ougrée, BE
 (72) Pirotte, Alan, Cour de l'Abbaye 7, 6660 Houffalize, BE
 (74) RADULOVIĆ, S. Božidar, Studentska bb, Lamela 3/18, Podgorica, 81000, ME

- (57) Kompozicija koncentrata suspenzije koja obuhvata, izraženo po masi u odnosu na ukupnu masu kompozicije:
 a) 40 do 80% čestica dodecilgvanidina ili soli dodecilgvanidina sa kiselinom strukture (1),

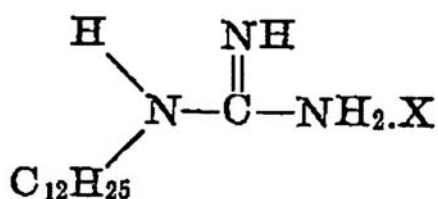

(1)

u kojoj X predstavlja kiseli ostatak monokarboksilne kiseline, dikarboksilne kiseline ili mineralne kiseline, b) 0 do 10% jedinjenja protiv zamrzavanja, c) 1 do 10% agensa za vlaženje i / ili d) dispergujućeg agensa, e) 0 do 5% agensa protiv penušanja, f) vodu kao ostatak, n a z n a č e n a t i m e, što je srednji prečnik čestica (d_{50}) najmanje 7 μm , a manje od 20 μm .
 Patent sadrži još 13 patentni zahtjev.

- (51) **A 61K 39/145**^{2006.01} **C 12Q 1/70**^{2006.01} (11) **01772** (13) **B**
- (21) P-2011-32
- (22) 09. 09. 2005
- (30) 20040255471 09. 09. 2004 EP
- (86) EP/05795012.3/09. 09. 2005
IB/PCT/IB2005/003266/09. 09. 2005
- (87) WO 2006/027698/16. 03. 2006/11/2006
EP 1789084/30. 05. 2007/2007/22
EP 1789084/17. 11. 2010/2010/46
- (54) me **Smanjenje potencijalnih jatrogenih rizika povezanih sa vakcinama protiv gripa**
en **Decreasing potential iatrogenic risks associated with influenza vaccines**
- (73) Novartis Vaccines and Diagnostics GmbH, Emil-von-Behring-Strasse 76, 35041 Marburg, DE
- (72) GREGERSEN, Jens-Peter, Chiron Behring GmbH & Co., Emil-von-Behring-Str. 76, 35041 Marburg, DE
RADULOVIĆ, S. Božidar, Jovana Tomaševića 9/III-1, 81000 Podgorica,
- (57) Postupak za pripremanje vakcina protiv gripa od virusa gripa koji se uzgaja u kulturi Vero ćelijske linije, obuhvata fazu u kojoj se inokulum vakcionalnog soja virusa za umnožavanje virusa i/i li vakcina i/ ili kultura testira na prisustvo infektivnog agensa koji može da se razvija u navedenoj ćelijskoj liniji, ali se ne razvija u embrioniranim kokošijim jajima, pri čemu je pomenuti infektivni agens jedan ili više sledećih patogena: *Pneumovirinae*, Metapneumovirusi iz familije *Paramyxoviridae*; *Rubulavirusi* iz familije *Paramyxoviridae*; *Coronaviridae*; *Rhinovirusi* iz familije *Picornaviridae*; Varičela zoster virus; BK poliomavirus; JC poliomavirus; Ehovirus; koksaki virusi Enterovirusa IZ familije *Picornaviridae*; Rotavirus; Svinjski picomavirusi; Parvovirusi; Circovirusi; bakterija *Chlamydia*; *Reoviridae* sisara.
Preostalo patentnih zahtjeva 5.

- (51) **A 61K 31/47**^{2006.01} **A 61P 31/04**^{2006.01} (11) **01783** (13) **B**
A 61K 31/4709^{2006.01} **C 07D 215/22**^{2006.01}
C 07D 215/36^{2006.01} **C 07D 401/04**^{2006.01}
C 07D 405/04^{2006.01} **C 07D 401/06**^{2006.01}
- (21) P-2014-25
(22) 06. 06. 2006
(30) 05105023 08. 06. 2005 EP
296918 08. 12. 2005 US
(86) EP/06763532.6/06. 06. 2006
EP/PCT/EP2006/062934/06. 06. 2006
(87) WO 2006/131519/14. 12. 2006/2006/50
EP 1901743/26. 03. 2008/2008/13
EP 1901743/25. 12. 2013/2013/52
(54) me **DERIVATI HINOLINA KAO ANTI-BAKTERIJSKI AGENSI**
en **QUINOLINE DERIVATIVES AS ANTIBACTERIAL AGENTS**
(73) Janssen Pharmaceutica NV, Turnhoutseweg 30, 2340 Beerse, BE
(72) ANDRIES, Koenraad, Jozef, Lodewijk, Marcel,
c/o Janssen Pharmaceutica N.V., Turnhoutseweg 30, B-2340 Beerse, BE
KOUL, Anil, c/o Janssen Pharmaceutica N.V., Turnhoutseweg 30, B-2340 Beerse, BE
GUILLEMONT, Jérôme, Emile, Georges,
Johnson & Johnson Pharmaceut., Research and Development, 27106 Val de Reuil, FR
Campus Maigremont BP615
PASQUIER, Elisabeth, Thérèse, Jeanne,
Johnson & Johnson Pharmaceut., Research and Development, 27106 Val de Reuil, FR
Campus Maigremont BP615
LANÇOIS, David, Francis, Alain,
Johnson & Johnson Pharmaceut., Research and Development, 27106 Val de Reuil, FR
Campus Maigremont BP615
(74) RADULOVIĆ, S. Božidar, Studentska bb, Lamela 3/18, Podgorica, 81000, ME

(57) Upotreba jedinjenja za proizvodnju medikamenta za tretiranje bakterijske infekcije koja je izazvana stafilokokima, enterokokima ili streptokokima, naznačena time što je navedeno jedinjenje jedinjenje sledeće formule

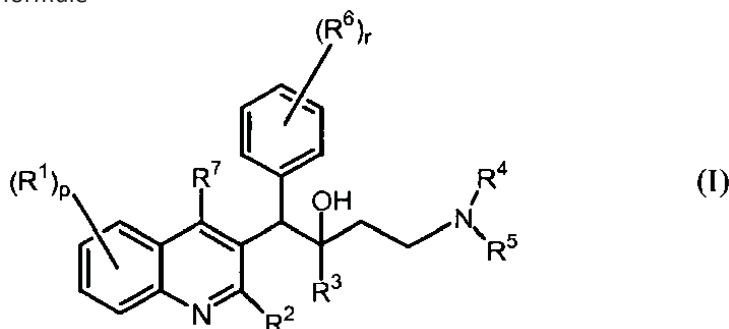

neka njegova farmaceutski prihvatljiva kiselina ili bazična adicijska so, neka njegova stereohemijska izomerna forma ili neka njegova forma *N*-oksida, gde R¹ je vodonik, halo, polihaloC₁₋₆ alkil, C₁₋₆ alkil, hidroksiC₁₋₆ alkil, C₁₋₆ alkiloksi, Ar ili Het; p je ceo broj koji je jednak 1 ili 2; R² je C₁₋₆ alkiloksi, C₁₋₆ alkiloksiC₁₋₆ alkiloksi ili C₁₋₆ alkiltio; R³ je C₁₋₆ alkil, Ar, Het ili Het¹; R⁴ i R⁵ su svaki nezavisno vodonik, C₁₋₆ alkil ili benzil, ili R⁴ i R⁵ zajedno i uključujući N za kojega su vezani mogu da obrazuju neki radikal odabran iz grupe koju sačinjavaju pirolidinil, 2-pirolinil, 3-pirolinil, pirolil, imidazolidinil, pirazolidinil, 2-imidazolinil, 2-pirazolinil, imidazolil, pirazolil, triazolil, piperidinil, piridinil, piperazinil, piridazinil, pirimidinil, pirazinil, triazinil, morfolinil i tiomorfolinil, a svaki od navedenih prstena može proizvoljno da bude supstituisan s C₁₋₆ alkil, halo, polihaloC₁₋₆ alkil, hidroksi, hidroksiC₁₋₆ alkil, C₁₋₆ alkiloksi, amino, mono- ili di(C₁₋₆ alkil)amino, C₁₋₆ alkiltio, C₁₋₆ alkiloksiC₁₋₆ alkil, C₁₋₆ alkiltioC₁₋₆ alkil ili pirimidinil; R⁶ je vodonik, halo, polihaloC₁₋₆ alkil, C₁₋₆ alkil, C₁₋₆ alkiloksi, C₁₋₆ alkiltio, ili dva susedna R⁶ radikala mogu da se povežu i obrazuju dvovaljani radikal formule -CH=CH-CH=CH-; r je ceo broj koji je jednak 1 ili 2; R⁷ je vodonik, C₁₋₆ alkil, Ar, Het ili Het¹; Ar je neki homocikl odabran iz grupe koju sačinjavaju fenil, naftil, acenaftil, 1,2-dihidro-acenaftil, tetrahidronaftil, svaki homocikl može proizvoljno da bude supstituisan s 1, 2 ili 3 supstituenta, a svaki supstituent je nezavisno odabran iz grupe koju sačinjavaju hidroksi, halo, cijano, nitro, amino, mono- ili di(C₁₋₆ alkil) amino, C₁₋₆ alkil, polihaloC₁₋₆ alkil, hidroksiC₁₋₆ alkil, C₁₋₆ alkiloksi, polihaloC₁₋₆ alkiloksi, C₁₋₆ alkiloksiC₁₋₆ alkil, karbonil, C₁₋₆ alkiloksikarbonil, aminokarbonil, morfolinil te mono- ili di(C₁₋₆ alkil)aminokarbonil; Het je neki monoklički heterocikl odabran iz grupe koju sačinjavaju *N*-fenoksipiperidinil, piperidinil, pirolil, pirazolil, imidazolil, furanil, tienil, oksazolil, izoksazolil, tiazolil, izotiazolil, piridinil, pirimidinil, pirazinil i piridazinil; a svaki mocičklički heterocikl može da bude supstituisan s 1, 2 ili 3 supstituenta, a svaki supstituent je nezavisno odabran iz

grupe koju sačinjavaju halo, hidroksi, C₁₋₆alkil, polihaloC₁₋₆alkil, hidroksiC₁₋₆alkil, C₁₋₆alkiloksi, C₁₋₆alkiloksiC₁₋₆alkil ili Ar-C(=O)-; Het¹ je neki biciklički heterocikl odabran iz grupe koju sačinjavaju hinolinil, hinoksalinil, indolil, benzimidazolil, benzoksazolil, benzizoksazolil, benzotiazolil, benzizotiazolil, benzofuranil, benzotienil, 2,3-dihidrobenzo[1,4]dioksinil ili benzo[1,3]dioksolil; svaki biciklički heterocikl može da bude proizvoljno supstituisan s 1, 2 ili 3 supstituenta, a svaki supstituent je nezavisno odabran iz grupe koju sačinjavaju halo, hidroksi, C₁₋₆alkil, polihaloC₁₋₆alkil, hidroksiC₁₋₆alkil, C₁₋₆alkiloksi, C₁₋₆alkiloksiC₁₋₆alkil ili Ar-C(=O)-; te pod uslovom da to nije jedinjenje (αS, βR)-6-bromo-α-[2-(dimetilamino) etil]-2-metoksi-α-1-naftalenil-β-fenil-3-hinolinetanol, neka njegova farmaceutski prihvatljiva kiselina ili bazična adicijska so ili neka njegova forma N-oksida.

Patent sadrži još 37 patentnih zahtjeva.

(51) **A 61J 7/00**^{2006.01}
A 61J 1/03^{2006.01}

B 65D 83/04^{2006.01}

(11) **01784**

(13) **B**

(21) P-2014-32

(22) 14. 11. 2009

(30) 20081059672 26. 11. 2008 DE

20081059674 26. 11. 2008 DE

20081059675 26. 11. 2008 DE

(86) EP/09759880.9/14. 11. 2009

PCT/EP2009/008123/14. 11. 2009

(87) WO 2010/060546/03. 06. 2010/2010/22

EP 2370045/05. 10. 2011/2011/40

EP 2370045/01. 01. 2014/2014/01

(54) me **ULOŽAK, DOZATOR ZA LEKOVE - ZA DOZE LEKOVA U KRUTOM STANJU, KAO I**
PRAKTIČNI PRIMERI KORIŠĆENJA ULOŠKA I DOZATORA ZA LEKOVE
 en **CARTRIDGE, PHARMACEUTICAL DISPENSER FOR SOLID PHARMACEUTICAL**
PORTIONS AND APPLICATIONS OF SAID CARTRIDGE AND SAID PHARMACEUTICAL
DISPENSER

(73) Bayer Intellectual Property GmbH, Alfred-Nobel-Strasse 10, 40789 Monheim, DE

(72) LEIFELD, Sabine, Pestalozzistrasse 40, 13187 Berlin, DE

REINHOLD, Tom, Feldstiege 4, 48161 Münster, DE

FILLER, Sven, Freiburger Strasse 30, 16515 Oranienburg, DE

KARLA, Uwe, Goethestrasse 3, 16348 Wandlitz, DE

WEBER, Peter, Lengenlocher Strasse 27, 72213 Altensteig, DE

VOEGE, Nina, Eerste Jan van der Heijdenstraat 62, NL-1072 TX Amsterdam, NL

JARVIS, Nat, Schulstrasse 6, 71083 Herrenberg, DE

HOLCH, Benjamin, Wöhrtrasse 11, 72202 Nagold, DE

WHITTAKER, James, Veerstraat 79-3, NL-1075 SP Amsterdam, NL

(74) RADULOVIĆ, S. Božidar, Studentska bb, Lamela 3/18, Podgorica, 81000, ME

- (57) Unutar dozatora za tablete (1) za doze lekova u krutom stanju (T) primenjivi i sa spremištem za prihvatanje doza lekova (T) opremljeni uložak (900), naznačen time što uložak poseduje (900) uređaj za odvajanje (910), namenjen za ispuštanje unapred definisanih doza lekova (T) i koji obuhvata pomerajući uređaj (940) za odvajanje unapred definisane doze lekova (T) iz spremišta i ispuštanje iz dozatora za lekove (1), zbog čega je uređaj za odvajanje (910) osmišljen za uspostavu aktivne veze s jednim od uređaja za aktivisanje (14, 220, 224, 226; 15, 210; 230) predviđenim unutar dozatora za lekove (1) za uređaj za odvajanje (910) i zbog čega doze lekova (T) kod odvajanja, kao i

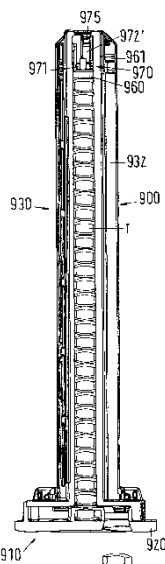

Fig. 4

Patent sadrži još 12 patentnih zahtjeva.

(51) C 12N 15/13^{2006.01} C 12N 5/10^{2006.01} (11) 01785 (13) B
 C 07K 16/10^{2006.01} C 07K 14/145^{2006.01}
 A 61K 39/395^{2006.01} A 61K 39/205^{2006.01}
 A 61P 31/14^{2006.01} G 01N 33/53^{2006.01}

(21) P-2014-30

(22) 02. 02. 2006

(30) 649512P 02. 02. 2005 US

(86) EP/06720126.9/02. 02. 2006

WO/PCT/US2006/003644/02. 02. 2006

(87) WO 2006/084006/10. 08. 2006/2006/32

EP 1851315/07. 11. 2007/2007/45

EP 1851315/25. 12. 2013/2013/52

(54) me **HUMANA ANTITIJELA PROTIV BJESNILA I NJIHOVE UPOTREBE**
 en **HUMAN ANTIBODIES AGAINST RABIES AND USES THEREOF**

(73) Centers for Disease Control and Prevention,

National Ctr. Infectious Diseases 1600 Clifton Road, N.E. MSE51, Atlanta, GA 30333, US

University of Massachusetts, 225 Franklin Street, 12th Floor, Boston, MA 02110, US

(72) THOMAS, William D., Jr., 75 Birch St, Dedham, MA 02026-2630, US

AMBROSINO, Donna, 241 Perkins St Unit H101, Jamaica Plain, MA 02130-4043, US

MANDELL, Robert, 70766 335th St, Collins, IA 50055-8027, US

SCHONHOFF, Susan, 2 Marlou Terrace, Jamaica Plain, Massachusetts 02130, US

BABCOCK, Gregory J., 9 Azalea Lane, Marlborough, Massachusetts 01752, US

RUPPRECHT, Charles, 647 Michelle Court, Lawrenceville, Georgia 30044, US

(74) RADULOVIĆ, S. Božidar, Studentska bb, Lamela 3/18, Podgorica, 81000, ME

- (57) Izolovano humano antitelo, ili njegov deo koji veže antigen, naznačeno time, što se veže na G-belančevinu iz virusa besnila i inhibira sposobnost pomenutog virus da inficira ćelije, i koje sadrži CDR3 iz varijabilnog regiona iz teškog lanca sa sekvencom SEQ ID BR: 5, CDR3 iz varijabilnog regiona iz lakog lanca sa sekvencom SEQ ID BR: 8, CDR2 iz varijabilnog regiona iz teškog lanca sa sekvencom SEQ ID BR: 4, CDR2 iz varijabilnog regiona iz lakog lanca sa sekvencom SEQ ID BR: 7, CDR1 iz varijabilnog regiona iz teškog lanca sa sekvencom SEQ ID BR: 3, i CDR1 iz varijabilnog regiona iz lakog lanca sa sekvencom SEQ ID BR: 6.
 Patent sadrži još 19 patentnih zahtjeva.

- (51) **C 07K 16/28**^{2006.01} **C 12N 15/13**^{2006.01} (11) **01786** (13) **B**
- (21) P-2014-35
- (22) 14. 08. 2007
- (30) 822362P 14. 08. 2006 US
- (86) EP/07840953.9/14. 08. 2007
US/PCT/US2007/075932/14. 08. 2007
- (87) WO 2008/022152/21. 02. 2008/2008/08
EP 2059536/20. 05. 2009/2009/21
EP 2059536/08. 01. 2014/2014/02
- (54) me **OPTIMIZOVANA ANTITELA USMERENA NA CD19**
en **OPTIMIZED ANTIBODIES THAT TARGET CD19**
- (73) Xencor, Inc., 111 W. Lemon Avenue, Monrovia, CA 91016, US
- (72) BERNETT, Matthew J., 222 E. Olive Ave. 3, Monrovia, California 91016, US
CHU, Seung Yup, 4613 Larwin Avenue, Cypress, California 90630, US
DESJARLAIS, John R., 1030 N. Michigan Avenue, Pasadena, California 91104, US
KARKI, Sher Bahadur, 2833 Providence Way, Pomona, CA 91767, US
LAZAR, Gregory Alan, 750 Arcadia Avenue, 6, Arcadia, California 91007, US
PONG, Erik WeiKing, 9415 Lemon Avenue, Temple City, California 91780, US
RICHARDS, John O., 893 San Marcus Lane, Duarte, California 91010, US
ZHUKOVSKY, Eugene Alexander,
1124 N. Kings Road, Apt. 203, West Hollywood, California 90069, US
- (74) RADULović, S. Božidar, Studentska bb, Lamela 3/18, Podgorica, 81000, Me
- (57) Antitelo koje se vezuje za CD19 naznačeno time što sadrži: težak lanac CDR1, težak lanac CDR2, i težak lanac CDR3 prikazan u SEQ ID NO: 40; te laki lanac CDR1, laki lanac CDR2, i laki lanac CDR3 prikazan u SEQ ID NO: 58, pri čemu je numeracija određena prema Kabat-u.
Patent sadrži još 11 patentnih zahtjeva.

- (51) **A 61K 31/522**^{2006.01} **A 61K 31/4985**^{2006.01} (11) **01787** (13) **B**
A 61P 3/10^{2006.01} **A 61P 9/04**^{2006.01}
- (21) P-2014-37
(22) 03. 05. 2007
(30) 06009203 04. 05. 2006 EP
(86) EP/07728723.3/03. 05. 2007
EP/PCT/EP2007/054270/03. 05. 2007
(87) WO 2007/128761/15. 11. 2007/46/2007
EP 2015754/21. 01. 2009/2009/04
EP 2015754/09. 04. 2014/2014/15
- (54) me **PRIMENA DPP-IV INHIBITORA**
en **USES OF DPP-IV INHIBITORS**
- (73) Boehringer Ingelheim International GmbH, Binger Strasse 173, 55216 Ingelheim am Rhein, DE
(72) DUGI, Klaus, Hietzsigstrasse 3, 01324 Dresden, DE
HIMMELSBACH, Frank, Ahornweg 16, 88441 Mittelbiberach, DE
MARK, Michael, Hugo-Haering-Strasse 50, 88400 Biberach, DE
(74) RADULOVIĆ, S. Božidar, Studentska bb, Lamela 3/18, Podgorica, 81000, ME
- (57) Primjena DPP IV inhibitora za dobijanje lijeka za smanjenje rizika od makrovaskularnih komplikacija kod pacijenta kod koga je dijagnostikovao predijabetes ili manifestovani dijabetes tipa 2, pri čemu je DPP IV inhibitor 1-[(4-metil-hinazolin-2-il)metil]-3-metil-7-(2-butin-1-il)-8-(3-(R)-amino-piperidin-1-il)-ksantin ili njegova terapeutski aktivna so.
Patent sadrži još 4 patentna zahtjeva.

- (51) C 07K 16/24^{2006.01} A 61K 47/48^{2006.01} (11) 01809 (13) B
C 12N 15/13^{2006.01} C 07K 14/54^{2006.01}
C 12N 15/63^{2006.01} C 12N 5/16^{2006.01}
A 61K 39/395^{2006.01} A 61P 43/00^{2006.01}
- (21) P-2014-33
(22) 16. 11. 2005
(30) 20040025569 19. 11. 2004 GB
(86) EP/05803526.2/16. 11. 2005
GB/PCT/GB2005/004392/16. 11. 2005
(87) WO 2006/054059/26. 05. 2006/21/2006
EP 1814915/08. 08. 2007/2007/32
EP 1814915/08. 01. 2014/2014/02
- (54) me **NEUTRALIŠUĆA ANTITELA KOJA IMAJU SPECIFIČNOST PREMA HUMANOM IL-17**
en **NEUTRALISING ANTIBODIES HAVING SPECIFICITY FOR HUMAN IL-17**
- (73) UCB Pharma S.A., Allée de la Recherche 60, 1070 Brussels, BE
(72) ADAMS, Ralph, UCB Celltech, 208 Bath Road, Slough, Berkshire SL1 3WE, GB
POPPLEWELL, Andrew George, UCB Celltech, 208 Bath Road, Slough, Berkshire SL1 3WE, GB
RAPECKI, Stephen Edward, UCB Celltech, 208 Bath Road, Slough, Berkshire SL1 3WE, GB
TICKLE, Simon Peter, UCB Celltech, 208 Bath Road, Slough, Berkshire SL1 3WE, GB
(74) RADULOVIĆ, S. Božidar, Studentska bb, Lamela 3/18, Podgorica, 81000, ME
- (57) Neutrališuće antitelo koje ima specifičnost prema humanom IL-17, naznačeno time što ima teški lanac koji sadrži sekvencu gH11 (ID BR. SEK:11) i laki lanac koji sadrži sekvencu gL3 (ID BR. SEK:13). Patent sadrži još 18 patentnih zahtjeva.

- (51) **C07K 16/10**^{2006.01} **A61K 39/395**^{2006.01} (11) **01810** (13) **B**
A61K 39/00^{2006.01} **A61P 31/14**^{2006.01}
- (21) P-2014-34
(22) 13. 02. 2008
(30) 902432P 21. 02. 2007 US
(86) EP/08725537.8/13. 02. 2008
US/PCT/US2008/001922/13. 02. 2008
(87) WO 2008/108918/12. 09. 2008/37/2008
EP 2125889/02. 12. 2009/2009/49
EP 2125889/15. 01. 2014/2014/03
(54) me **HUMANA ANTITELA PROTIV VIRUSA HEPATITISA C (HCV) I NJIHOVA UPOTREBA**
en **HUMAN ANTIBODIES AGAINST HEPATITIS C VIRUS (HCV) USES THEREOF**
(73) University of Massachusetts, 225 Franklin Street, 12th Floor, Boston, MA 02110, US
(72) BROERING, Teresa, 74 Parkman St., no. 3, Brookline, MA 02446, US
SLOAN, Susan, 2 Marlou Terrace, Jamaica Plain, MA 02130, US
BABCOCK, Gregory, J., 38 Muir Way, Marlborough, MA 01752, US
AMBROSINO, Donna, 241 Perkins St., H101, Jamaica Plain, MA 02139, US
THOMAS, William D., Jr., 75 Birch St., Dedham, MA 02026, US
(74) RADULOVIĆ, S. Božidar, Studentska bb, Lamela 3/18, Podgorica, 81000, Me
- (57) Izolovano humano monoklonsko antitelo, ili njegov deo koji veže antigen, naznačeno time, što pomenuto antitelo, ili njegov deo koji veže antigen, obuhvata:
(a) varijabilne regione iz teškog i lakog lanca koje imaju sekvence SEQ ID BR: 1 i 2; ili
(b) CDR3 sekvencu za varijabilni region iz teškog lanca SEQ ID BR: 9, CDR3 sekvencu za varijabilni region iz lakog lanca SEQ ID BR: 18, CDR2 sekvencu za varijabilni region iz teškog lanca SEQ ID BR: 8, CDR2 sekvencu za varijabilni region iz lakog lanca SEQ ID BR: 17, CDR1 sekvencu za varijabilni region iz teškog lanca SEQ ID BR: 7 i CDR1 sekvencu za varijabilni region iz lakog lanca SEQ ID BR: 16.
Patent sadrži još 13 patentnih zahtjeva.

- (51) **C 07C 217/80**^{2006.01} (11) **01812** (13) **B**
- (21) P-2014-50
- (22) 14. 10. 2010
- (30) 20090382212 16. 10. 2009 EP
- (86) EP/10765586.2/14. 10. 2010
EP/PCT/EP2010/006283/14. 10. 2010
- (87) WO 2011/045059/21. 04. 2011/16/2011
EP 2488497/22. 08. 2012/2012/34
EP 2488497/12. 03. 2014/2014/11
- (54) me **POSTUPAK ZA DOBIJANJE 2-[(3,5-DIFLUORO-3'-METOKSI-1 , 1'-BIFENIL-4-IL)AMINO]NIKOTINSKE KISELINE**
en **PROCESS FOR MANUFACTURING 2-[(3,5-DIFLUORO-3'-METHOXY-1,1'-BIPHENYL-4-YL)AMINO]NICOTINIC ACID**
- (73) Almirall S.A., Ronda del General Mitre, 151, 08022 Barcelona, ES
- (72) BOIX BERNARDINI, Maria, Carmen, C/ Laureá Mir 408-410, E-08980 Sant Feliu de Llobregat, ES
- (74) ĐAKONOVIĆ, Vido, Vojvode Boža br. 1, Cetinje, 81250, ME
- (57) Postupak za dobijanje 2-[(3,5-difluoro-3'-metoksi-1 , 1'-bifenil-4-il)amino]nikotinske kiseline, koji sadrži korake:
- pribavljanje 3,5-difluoro-3'-metoksibifenil-4-amina,
 - dobijanje i izolaciju aminijum soli 3,5-difluoro-3'-metoksibifenil-4-amina, i
 - sljedeću reakciju aminijum soli 3,5-difluoro-3'-metoksibifenil-4-amina dobijene u b) da bi se dobila 2-[(3,5-difluoro-3'-metoksi-1 , 1'-bifenil-4-il)amino]nikotinska kiselina.
- Patent sadrži još 14 patentnih zahtjeva.

(51) C 07D 471/04^{2006.01} A 61K 31/519^{2006.01} (11) 01813 (13) B
 A 61P 35/00^{2006.01}

(21) P-2014-28
 (22) 29. 06. 2006
 (30) 0507032 01. 07. 2005 FR
 (86) EP/08017944.3/29. 06. 2006
 (87) EP 2020410/04. 02. 2009/2009/06
 EP 2020410/18. 12. 2013/2013/51

(54) me **Derivati pirido[2,3-d]pirimidina, njihovo dobijanje, njihova primjena u terapiji**
 en **Pyrido[2,3-d]pyrimidine derivatives, process for their preparation and their**
therapeutical use

(73) SANOFI, 54, rue La Boétie, 75008 Paris, FR
 (72) Bourrie, Bernard, 678 Rue Colline, 34980 Saint Gely du Fesc, FR
 Casellas, Pierre, 10 Rue Carl von Linné, 34090 Montpellier, FR
 Jegham, Samir, 206 Rue des Asphodèles, 34980 Montpellier, FR
 Muneaux, Claude, Chemin Perayrols, 34270 Les Matelles, FR
 Perreaut, Pierre, 110 Allée des Peupliers, 34980 Saint Clément de Rivière, FR
 (74) AOD "ČUPIĆ", Dalmatinska 10, Podgorica, 81000, ME

(57) Jedinjenje koje odgovara formuli (I):

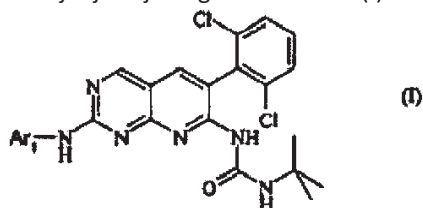

naznačeno time što Ar₁ je odabrano od:

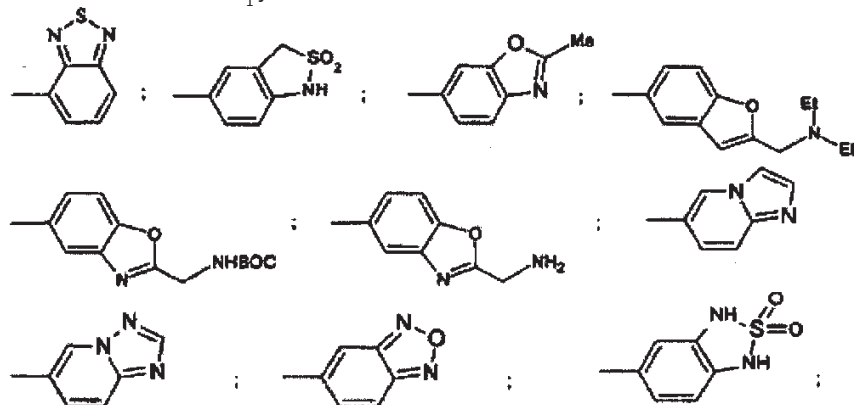

Patent sadrži još 10 patentnih zahtjeva.

(51) **C 07D 487 / 04**^{2006.01}

(11) **01814**

(13) **B**

(21) P-2014-39

(22) 22. 01. 2007

(30) 06290154 25. 01. 2006 EP

(86) EP/07700505.6/22. 01. 2007

IB/PCT/IB2007/000142/22. 01. 2007

(87) WO 2007/085930/02. 08. 2007/31/2007

EP 1981889/22. 10. 2008/2008/43

EP 1981889/15. 01. 2014/2014/03

(54) me **CITOTOKSIČNI AGENSI KOJI SADRŽE NOVE DERIVATE TOMAIMICINA I NJIHOVA TERAPEUTSKA PRIMJENA**
 en **CYTOTOXIC AGENTS COMPRISING NEW TOMAYMYCIN DERIVATIVES AND THEIR THERAPEUTIC USE**

(73) SANOFI, 54, rue La Boétie, 75008 Paris, FR

(72) GAUZY, Laurence, c/o Sanofi-aventis, Pat. Dept., 174, avenue de France, 75013 Paris, FR

ZHAO, Robert, 128 Sidney Street, Cambridge, Massachusetts 02139, US

DENG, Yonghong, 128 Sidney Street, Cambridge, Massachusetts 02139, US

LI, Wei, 128 Sidney Street, Cambridge, Massachusetts 02139, US

BOUCHARD, Hervé, c/o Sanofi-aventis, Pat. Dept., 174, avenue de France, 75013 Paris, FR

CHARI, Ravi, V.J., 128 Sidney Street, Cambridge, Massachusetts 02139, US

COMMERCON, Alain, c/o Sanofi-aventis, Pat. Dept., 174, avenue de France, 75013 Paris, FR

(74) AOD, ČUPIĆ, Dalmatinska 10, Podgorica, 81000, ME

(57) Jedinjenje odabrano od:

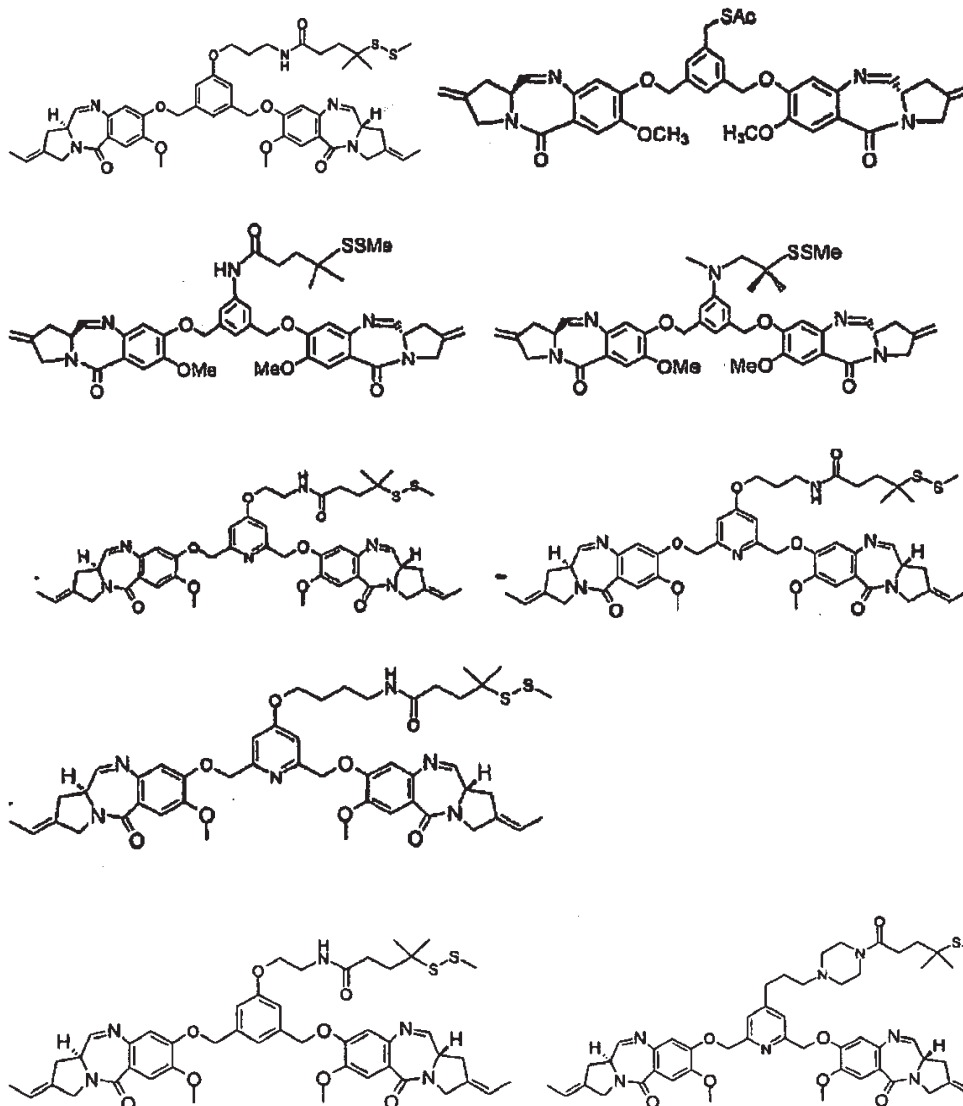

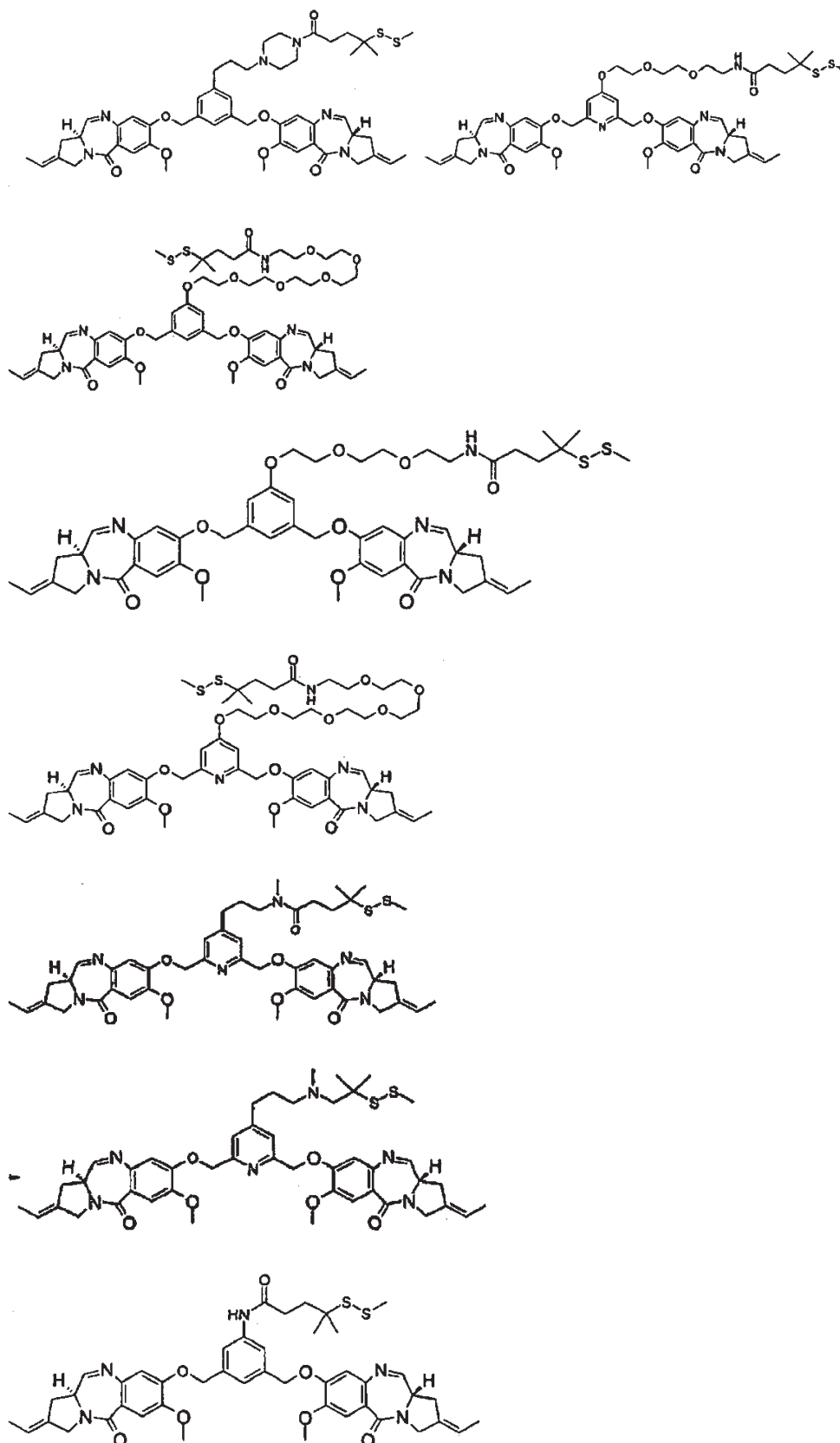

kao i odgovarajući merkapto derivati, ili njihove farmaceutski prihvatljive soli, hidrati ili hidratisane soli ili polimorfne kristalne strukture ovih jedinjenja ili njihovi optički izomeri, racemati, diastereomeri ili enantiomeri Patent sadrži još 14 patentnih zahtjeva.

- (51) **A 61K 47/10**^{2006.01} **A 61K 47/14**^{2006.01} (11) **01815** (13) **B**
A 61K 31/519^{2006.01} **A 61K 9/00**^{2006.01}
- (21) P-2014-41
(22) 29. 07. 2010
(30) 0903742 30. 07. 2009 FR
(86) EP/ 10762950.3/29. 07. 2010
FR/PCT/FR2010/051611/29. 07. 2010
(87) WO 2011/012816/03. 02. 2011/05/2011
EP 2459221 /06. 06. 2012/2012/23
EP 2459221 /22. 01. 2014/2014/04
- (54) me **FARMACEUTSKA FORMULACIJA**
en **FORMULATION PHARMACEUTIQUE**
- (73) SANOFI; ,54, rue La Boétie,,75008 Paris,, FR
(72) BURNOUF, Jean-Pierre; ,
c/o Sanofi-Aventis, Département Brevets, 174 Avenue de France,F-75013 Paris, FR
BENARD, Tsiala; ,
c/o Sanofi-Aventis, Département Brevets, 174 Avenue de France,F-75013 Paris, FR
(74) Advokatsko Ortačko Društvo "ĆUPIĆ",Dalmatinska 10,,Podgorica,81000,ME

(57) Farmaceutska formulacija koja sadrži jedinjenje formule (I):

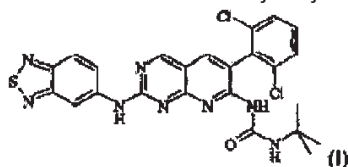

u vidu baze ili u vidu soli neke farmaceutski prihvatljive kiseline rastvorene u smeši:

- etanola i
- surfaktanta koji sadrži smešu polietoksilovanih mono- i diestara of 12-hidroksi stearinske kiseline formule:

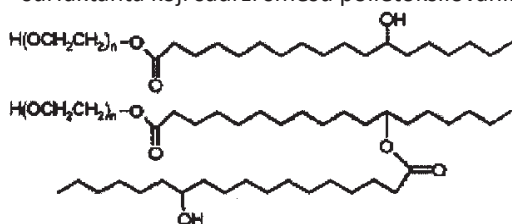

gde je n ceo broj u opsegu od 15 do 16, pri težinskom odnosu surfaktant/etanol u opsegu od 25/75 do 80/20. Patent sadrži još 15 patentnih zahtjeva.

- (51) **A 61K 51/04**^{2006.01} **G 01N 33/60**^{2006.01} (11) **01819** (13) **B**
- (21) P-2014-31
- (22) 27. 10. 2009
- (30) 08291013 28. 10. 2008 EP
- (86) EP/09760593.5/27. 10. 2009
IB/PCT/IB2009/007562/27. 10. 2009
- (87) WO 2010/049819/06. 05. 2010/2010/18
EP 2349352/03. 08. 2011/2011/31
EP 2349352/25. 12. 2013/2013/52
- (54) me **UPOTREBA 7-HLORO-N,N,5-TRIMETIL-4-OKSO-3-FENIL-3,5-DIHIDRO-4H-PIRIDAZINO[4,5-B]INDOL-1- ACETAMIDA KAO BIOMARKERA NIVOA PERIFERNIH BENZODIAZEPINSKIH RECEPTORA**
en **USE OF 7-CHLORO-N,N,5-TRIMETHYL-4-OXO-3-PHENYL-3,5-DIHYDRO-4H-PYRIDAZINO[4,5-B]INDOLE-1-ACETAMIDE AS A BIOMARKER OF PERIPHERAL BENZODIAZEPINE RECEPTOR LEVELS**
- (73) SANOFI, 54, rue La Boétie, 75008 Paris, FR
Commissariat à l'Énergie Atomique et aux Énergies Alternatives,
Bâtiment "Le Ponant D" 25, rue Leblanc, 75015 Paris, FR
- (72) BENAVIDES, Jesus,
c/o Sanofi-Aventis, Patent Department, 174 Avenue de France, F-75013 Paris, FR
BOUTIN, Hervé, 8 Hawphom drive, Manchester M191GX, GB
CASTEL, Marie-Noëlle,
c/o Sanofi-Aventis, Patent Department, 174 Avenue de France, F-75013 Paris, FR
DAMONT, Annelaure, 13 rue de la tour, F-78117 Châteaufort, FR
DOLLE, Frédéric, 10 allée de Villeneuve, F-91940 Gometz-le-Châtel, FR
HANTRAYE, Philippe, 8 Allée Jean François de la Pérouse, F-91420 Morangis, FR
MARGUET, Frank, c/o Sanofi-Aventis, Patent Department, 174 Avenue de France, F-75013 Paris, FR
ROONEY, Thomas, c/o Sanofi-Aventis, Patent Department, 174 Avenue de France, F-75013 Paris, FR
RIVRON, Luc, c/o Sanofi-Aventis, Patent Department, 174 Avenue de France, F-75013 Paris, FR
TAVITIAN, Bertrand, 186 rue de Vaugirard, F-75015 Paris, FR
THOMINIAUX, Cyrille, 12 rue de la République, F-78470 Saint Rémy les Chevreuse, FR
- (74) "AOD" ČUPIĆ, Dalmatinska 10, Podgorica, 81000, ME
- (57) Upotreba radioobeleženog 7-hloro-*N,N,5*-trimetil-4-okso-3-fenil-3,5-dihidro-4*H*piridazino[4,5-*b*]indol-1-acetamida kao biomarkera za detekciju, kod pojedinca, nivoa perifernog benzodiazepinskog receptora (PBR) poveznog sa normalnim i patološkim stanjima, naznačena time, što je radioobeleživač izabran od ugljenika-11, radioaktivnog izotopa halogena i radioaktivnog izotopa metala.
Patent sadrži još 24 patentnih zahtjeva.

- (51) **A 61K 38/17**^{2006.01} **A 61K 38/26**^{2006.01} (11) **01820** (13) **B**
C 07K 14/605^{2006.01} **A 61P 3/04**^{2006.01}
A 61P 3/10^{2006.01}
- (21) P-2014-78
(22) 15. 12. 2010
(30) 288888 P 22. 12. 2009 US
352576 P 08. 06. 2010 US
(86) EP/10801033.1/15. 12. 2010
US/PCT/US2010/060390/15. 12. 2010
(87) WO 2011/087672/21. 07. 2011/2011/29
EP 2515928/31. 10. 2012/2012/44
EP 2515928/18. 06. 2014/2012/25
(54) me **PEPTIDNI ANALOG OKSINTOMODULINA**
en **OXYNTOMODULIN PEPTIDE ANALOGUE**
(73) Eli Lilly and Company, Lilly Corporate Center, Indianapolis, IN 46285, US
(72) ALSINA-FERNANDEZ, Jorge,
Eli Lilly And Company, Lilly Corporate Center, Indianapolis, IN 46285, US
KOHN, Wayne, David, Eli Lilly And Company, Lilly Corporate Center, Indianapolis, IN 46285, US
(74) Advokatsko Ortačko Društvo "ĆUPIĆ", Dalmatinska 10, 81000 Podgorica, ME
- (57) Peptidni analog oksintomodulina, naznačen time što ima aminokiselinski slijed: His-(Aib)-Gln-Gly-Thr-Phe-Thr-Ser-Asp-Tyr-Ser-Lys-Tyr-Leu-Asp-Ser-Lys-Lys-Aia-G In-Giu-Phe-Val-Gln-Trp-Leu-Leu-Asn-(Aib)-Gly-Arg-Asn-Arg-Asn-Asn-Tle-Ala-Xaa₃₈-Xaa₃₉ (SEQ ID NO: 5) gdje je Xaa₃₈ Cys, Cys-PEG, ili je odsutan; Xaa₃₉ je Cys, Cys-PEG, ili je odsutan; i gdje je C-terminalna aminokiselina izborno amidirana
Patent sadrži još 12 patentnih zahtjeva.

OBJAVA UPISA PROMJENA
PUBLICATION OF RECORD OF CHANGES

OBJAVA PRENOSA PATENTA PUBLICATION OF PATENT ASSIGNMENT		
RegistarSKI broj patenta (11)	IME NOSIOCA PATENTA NAME OF THE OWNER OF PATENT (73)	IME NOSIOCA PATENTA NAME OF THE OWNER OF PATENT (73)
01586	ALSTOM Zweite Verwaltungs-GmbH, Boveristrasse 22, 68309 Mannheim DE	ALSTOM Technology Ltd, Brown Boveri Strasse 7, CH-5400 Baden CH
01056	Bayer Pharma Aktiengesellschaft, Müllerstrasse 178, 13353 Berlin DE	Bayer Intellectual Property GmbH, Alfred-Nobel-Strasse 10, 40789 Monheim am Rhein DE
01714	Ofer Zeev, Na Fiserce br. 10, 16000 Prag, CZ	PTP GROUP LIMITED, 15 Agiou Pavlou Street, Ledra House, Agios Andreas, 1105 Nicosia, CY
00913	BAYER HealthCare AG, 51368 Leverkusen DE	Bayer Schering Pharma Aktiengesellschaft, Müllerstrasse 178, 13353 Berlin DE
00913	Bayer Pharma AG Müllerstrasse 178, 13353 Berlin, DE	Bayer Intellectual Property GmbH, Alfred-Nobel-Straße 10, 40789 Monheim DE
00091	Bristol-Myers Squibb Company, 345 Park Avenue New York, NY 10154 US	AstraZeneca AB, SE-151 85, Södertälje SE
00226	Medarex, Inc. 707 State Road, Princeton, NJ 08540 US	Medarex, L.L.C. Route 206 and Province Line Road, Princeton, NJ 08540 US
00427	ISTITUTO DI RICERCHE DI BIOLOGIA MOLECOLARE P. ANGELETTI S.p.A., Via Pontina Km. 30.600, I-00040 Pomezia (Rome) IT	MSD ITALIA S.r.l., Via Vitorchiano 151, 00189 Rome IT
00066	AVENTIS PHARMACEUTICALS INC. 55 Corporate Drive, Bridgewater, NJ 08807 US	HMR Pharma Inc. 3711 Kennett Pike, Suite 200, Greenville, Delaware 19807 US
00066	HMR Pharma Inc. 3711 Kennett Pike, Suite 200, Greenville, Delaware 19807 US	AVENTIS HOLDINGS INC. 3711 Kennett Pike, Suite 200, Greenville, Delaware 19807 US
00066	AVENTIS HOLDINGS INC. 3711 Kennett Pike, Suite 200, Greenville, Delaware 19807 US	AVENTISUB II INC. 3711 Kennett Pike, Suite 200, Greenville, Delaware 19807 US

OBJAVA PROMJENE ADRESE
PUBLICATION OF CHANGE OF ADDRESS

Registarski broj patenta (11)	IME NOSIOCA PATENTA NAME OF THE OWNER OF PATENT (73)	IME NOSIOCA PATENTA NAME OF THE OWNER OF PATENT (73)
01721	Acorda Therapeutics, Inc., 15 Skyline Drive, Hawthorne, NY 10531 US	Acorda Therapeutics, Inc., 420 Saw Mill River Road, Ardsley, NY 10502 US
00091	Bristol-Myers Squibb Company, P.O. Box 4000, Route 206 and Provinceline Road, Princeton, NJ 08543-4000 US	Bristol-Myers Squibb Company, 345 Park Avenue New York, New York 10154 US

OBJAVA PROMJENE IMENA I ADRESE
PUBLICATION OF CHANGE OF NAME AND ADDRESS

Registarski broj patenta (11)	IME NOSIOCA PATENTA NAME OF THE OWNER OF PATENT (73)	IME NOSIOCA PATENTA NAME OF THE OWNER OF PATENT (73)
01586	ALSTOM Power Boiler Service GmbH, Am Bahnhof 11, D-08496 Neumark DE	ALSTOM Zweite Verwaltungs-GmbH, Boveristrasse 22, 68309 Mannheim DE

OBJAVA PROMJENE IMENA NOSIOCA PATENTA
PUBLICATION OF CHANGE OF NAME OF THE OWNER OF PATENT

Registarski broj patenta (11)	IME NOSIOCA PATENTA NAME OF THE OWNER OF PATENT (73)	IME NOSIOCA PATENTA NAME OF THE OWNER OF PATENT (73)
01056	Bayer Schering Pharma Aktiengesellschaft Müllerstrasse 178, 13353 Berlin DE	Bayer Pharma Aktiengesellschaft, Müllerstrasse 178, 13353 Berlin DE
00476	RIB LOC AUSTRALIA PTY. LTD. 587 Grand Junction Road, Gepps Cross, S.A. 5094 AU	SEKISUI RIB LOC AUSTRALIA PTY. LTD. 587 Grand Junction Road, Gepps Cross, S.A. 5094 AU
00477	RIB LOC AUSTRALIA PTY. LTD. 587 Grand Junction Road, Gepps Cross, S.A. 5094 AU	SEKISUI RIB LOC AUSTRALIA PTY. LTD. 587 Grand Junction Road, Gepps Cross, S.A. 5094 AU
00478	RIB LOC AUSTRALIA PTY. LTD. 587 Grand Junction Road, Gepps Cross, S.A. 5094 AU	SEKISUI RIB LOC AUSTRALIA PTY. LTD. 587 Grand Junction Road, Gepps Cross, S.A. 5094 AU
00913	Bayer Schering Pharma Aktiengesellschaft, Müllerstrasse 178, 13353 Berlin, DE	Bayer Pharma AG, Müllerstrasse 178, 13353 Berlin, DE

00524	NYCOMED GmbH, Byk-Gulden-Straße 2, 78467 Konstanz DE	Takeda GmbH, Byk-Gulden-Straße 2, 78467 Konstanz DE
00525	NYCOMED GmbH, Byk-Gulden-Straße 2, 78467 Konstanz DE	Takeda GmbH, Byk-Gulden-Straße 2, 78467 Konstanz DE



ŽIGOVI

TRADEMARKS

Službeni glasnik Zavoda za intelektualnu svojinu Crne Gore
Official Gazette of the Montenegrin Intellectual Property Office

15 / 2014



Zavod za intelektualnu svojinu Crne Gore
ul. Rimski trg br. 46,
81000 Podgorica,
Crna Gora



**MEĐUNARODNI KODOVI ZA IDENTIFIKACIJU BIBLIOGRAFSKIH
PODATAKA O ŽIGOVIMA PREMA WIPO ST 60**
RECOMMENDATION CONCERNING BIBLIOGRAFIC DATA RELATING TO
TRADEMARKS- WIPO-ST. 60

CRNOGORSKI	MDK	ENGLESKI
REGISTRARSKI BROJ	111	NUMBER OF THE REGISTRATION
DATUM REGISTRACIJE	151	DATE OF THE REGISTRATION
OČEKIVANI DATUM PRESTANKA VAŽENJA ŽIGA	181	EXPECTED EXPIRATION DATE OF THE REGISTRATION
BROJ PRIJAVE	210	NUMBER OF THE APPLICATION
DATUM PODNOŠENJA PRIJAVE	220	DATE OF FILING OF THE APPLICATION
PODACI O IZLOŽBENOM PRAVU PRVENSTVA	230	DATA CONCERNING EXHIBITIONS
PODACI O PRAVU PRVENSTVA NA OSNOVU PARISKE KONVENCIJE	300	DATA RELATING TO PRIORITU UNDER THE PARIS CONVENTION
DATUM OBJAVLJIVANJA PRIJAVE	442	DATA OF PUBLICATION OF APPLICATION
SPISAK ROBA I USLUGA PREMA NIČANSKOJ KLASIFIKACIJI ROBA I USLUGA	511	LIST OF GOODS AND SERVICES ACCORDING THE NICE CLASSIFICATION OF GOODS AND SERVICE
IZJAVA PODNOSIOCA PRIJAVE DA NE TRAŽE EKSKLUZIVNO PRAVO ZA POJEDINE NEDINSTIKTIVNE ELEMENTE ZNAKA	526	DISCLAIMER
IZGLED ZNAKA	540	REPRODUCTION OF THE MARK
NAZNAKA O PRIRODI ILI VRSTI ZNAKA	550	INDICATION RELATING TO THE NATURE OR KIND OF MARK
INFORMACIJA O ZATRAŽENIM BOJAMA NA ZNAKU	591	INFORMATION CONCERNING THE COLORS CLAIMED
PODACI O PODNOSIOCU PRIJAVE	731	NAME AND ADRESS OF THE APPLICANT
IME I ADRESA NOSIOCA ŽIGA	732	NAME AND ADDRESS OF THE HOLDER OF THE REGISTRATION
INFORMACIJA O ZATRAŽENIM BOJAMA NA ZNAKU	591	INFORMATION CONCERNING THE COLORS CLAIMED
PODACI O PODNOSIOCU PRIJAVE	731	NAME AND ADRESS OF THE APPLICANT
IME I ADRESA NOSIOCA ŽIGA	732	NAME AND ADDRESS OF THE HOLDER OF THE REGISTRATION
IME I ADRESA PUNOMOĆNIKA	740	NAME AND ADDRESS OF THE REPRESENTATIVE



OBAVJEŠTENJE NOTICE

Obavještavamo korisnike da se od 7-og broja Crnogorskog glasnika za intelektualnu svojinu koji se objavljuje na web stranici Zavoda za intelektualnu svojinu Crne Gore, u elektronskoj formi, odnosno od 20.12.2011 godine (Glasnik broj 7/2011) uvodi objava prijave za registraciju žiga. Stupanjem na snagu Pravilnika o postupku za priznanje, promjenama, obnovi i međunarodnoj registraciji žiga ("Sl. list CG" broj 55/11) stekli su se uslovi da Zavod postupa u skladu sa odredbom člana 29 stav 1 Zakona o žigu i uredne prijave, za koje nije utvrđen razlog za odbijanje registracije iz člana 28 ovog zakona, objavi u Službenom glasilu.

Od dana objavljivanja prijave u Službenom glasilu, shodno odredbi člana 30 stav 1 Zakona o žigu, pravna i fizička lica ili udruženja proizvođača roba ili usluga, pružaoci usluga, trgovci i potrošači mogu, u roku od 90 dana od datuma objavljivanja prijave, dostaviti Zavodu obrazloženo mišljenje u pisanoj formi o apsolutnim razlozima za odbijanje registracije iz člana 6 Zakona o žigu.

U roku od 90 dana od dana objavljivanja prijave u Službenom glasilu, nosilac ranijeg žiga ili sticalac licence, na osnovu ovlašćenja nosioca žiga, mogu zbog razloga iz čl. 7 i 8 Zakona o žigu, u roku od 90 dana od dana objavljivanja prijave, shodno odredbi člana 31 stav 1 i 2 Zakona o žigu podnijeti Zavodu Prigovor za odbijanje registracije žiga.



(210) **2011-45** (442) **20.09.2014.**
(220) 1/31/2011
(731) **BONGRAIN S.A.** 42 RUE RIEUSSEC, 78220 VIROFLAY FR

MONAŠKI

(540)
(550) I
(740) Lutovac Branislav, Bulevar Crnojevića 93, Podgorica ME
(511) **Klasa 29:** mlijeko,sir i mliječni proizvodi,jestiva ulja i masti

(210) **2011-594** (442) **20.09.2014.**
(220) 12/5/2011
(731) **APATINSKA PIVARA** APATIN DOO, TRG OSLOBOĐENJA 5, APATIN RS



(540)
(550) I
(740) Božović Vesko, Rimski trg 50/11, Podgorica ME
(511) **Klasa 32:** pivo

(210) **2011-734** (442) **20.09.2014.**
(220) 12/29/2011
(731) **MEGA DISPOSABLES S.A.** 148 DEKELIAS STREET, 136 78 AHARNES GR

MEGAFORM

(540)
(550) I, V
(740) Radulović Božidar, Jovana Tomaševića 9/III, Podgorica ME
(511) **Klasa 05:** pelene za inkotinenciju

- (210) **2011-93** (442) **20.09.2014.**
(220) 2/25/2011
(731) **MARFING ALIMENTOS S.A.** AV. CHEDID JAFET, 222-BLOCO A-5 ANDAR-ED.
MILLENNIUM VILA OLIMPIA-04551-065-SAO PAULO SP BR

PENA BRANCA

- (540)
(550) I
(740) Čejović Vladimir, 13. jula 21, Podgorica ME
(511) **Klasa 29:** meso, riba, živina i divljač; mesne prerađevine; konzervisano, zamrznuto, sušeno i kuvano voće i povrće; želei, džemovi, kompoti; jaja; mlijeko i mlječni proizvodi; jestiva ulja i masti

-
- (210) **2011-94** (442) **20.09.2014.**
(220) 2/25/2011
(731) **MARFING ALIMENTOS S.A.** AV. CHEDID JAFET, 222-BLOCO A-5 ANDAR-ED.
MILLENNIUM VILA OLIMPIA-04551-065-SAO PAULO SP BR

MABELLA

- (540)
(550) I
(740) Čejović Vladimir, 13. jula 21, Podgorica ME
(511) **Klasa 29:** meso, riba, živina i divljač; mesne prerađevine; konzervisano, zamrznuto, sušeno i kuvano voće i povrće; želei, džemovi, kompoti; jaja; mlijeko i mlječni proizvodi; jestiva ulja i masti

-
- (210) **2012-159** (442) **20.09.2014.**
(220) 3/19/2012
(731) **CROSSCARE LIMITED**, BROOMHILL ROAD, TALLAGHT, DUBLIN 24 IE
(540) REDUCE THE HOURS OF CRYING
(550) I
(740) Popović Miladin, Đoka Miraševića 21/III, Podgorica ME
(511) **Klasa 05:** preparati za smanjenje intolerancije na laktozu kod dojenčadi, dodatak ishrani koji se dodaje u mlijeko bebama

-
- (210) **2012-180** (442) **20.09.2014.**
(220) 4/10/2012

- (731) **Raychem HTS Limited**, Victoria Road, Leeds, West Yorkshire LS11 5 GB
(540) FROSTGUARD
(550) I, V
(740) AOD "Ćupić", Dalmatinska 10, Podgorica ME
(511) **Klasa 11:** aparati za grijanje, elementi za grijanje, električni grejni kablovi, djelovi i oprema za navedenu robu.
-

- (210) **2012-201** (442) **20.09.2014.**
(220) 4/17/2012
(731) **SAVILLS PLC**, 20 GROSVENOR HILL BERKELEY SQUARE, W1K 3HQ LONDON GB
(540) SAVILLS
(550) I
(740) Čejović Vladimir, 13. jula 21, Podgorica ME
(511) **Klasa 35:** kompjuterizovano upravljanje bazama podataka (upravljanje objektima) sve u vezi ustupanja korišćenja imovine, planiranje reklamnih usluga u vezi sa nepokretnostima, savjetodavne usluge u vezi poreza na nepokretnosti, revizorske usluge koje se odnose na imovinu, usluge reklamiranja imovine, aukcijske usluge
Klasa 36: usluge agencije za nekretnine, izbor i nabavka nekretnina, usluge posredovanja kod hipoteke, usluge osiguranja strukturnih finansija, usluge investiranja u nekretnine, usluge izdavanja i nabavke nekretnina, usluge procjene imovine, usluge upravljanja zemljom i imanjem, finansijske usluge, usluge finansijskog planiranja, usluge upravljanja fondovima, usluge posredovanja u vezi sa zaduženjima, usluge posredovanja u vezi sa kreditima, usluge procjene osiguranja od požara, usluge osiguranja imovine i pripadajućih joj sadržaja
Klasa 37: usluge razvoja nekretnina, usluge nadgledanja građevina, usluge ugradnje i održavanja cjevovoda, usluge u vezi ustupanja korišćenja imovine, savjetodavne usluge, usluge izgradnje, održavanja i popravke
Klasa 42: geodetske usluge, usluge koje se tiču vrednovanja, procjene, istraživanja i izvještaja
-

- (210) **2012-202** (442) **20.09.2014.**
(220) 4/17/2012
(731) **SAVILLS PLC**, 20 GROSVENOR HILL BERKELEY SQUARE, W1K 3HQ LONDON GB
(540) SAVILLS
(550) I
(740) Čejović Vladimir, 13. jula 21, Podgorica ME
(511) **Klasa 35:** kompjuterizovano upravljanje bazama podataka (upravljanje objektima) sve u vezi ustupanja korišćenja imovine, planiranje reklamnih usluga u vezi sa nepokretnostima, savjetodavne usluge u vezi poreza na nepokretnosti, revizorske usluge koje se odnose na imovinu, usluge reklamiranja imovine, aukcijske usluge
Klasa 36: usluge agencije za nekretnine, usluge u pregovaranju pri iznajmljivanju i izdavanju nekretnina, usluge izbora i nabavke nekretnina, usluge posredovanja kod hipoteke, usluge osiguranja strukturnih finansija, usluge investiranja u nekretnine, usluge prodaje, izdavanja i nabavke nekretnina, usluge procjene imovine, usluge procjene koje se tiču nadgledanja građevina, usluge upravljanja zemljom i imanjem, finansijske usluge, usluge finansijskog planiranja, usluge upravljanja fondovima, usluge posredovanja u vezi sa zaduženjima, usluge posredovanja u vezi sa kreditima, usluge procjene osiguranja od požara, usluge osiguranja imovine i pripadajućih joj sadržaja, usluge upravljanja imovinom, usluge ujedinjenja i obezbjeđenja imovine

Klasa 37: usluge razvoja nekretnina, usluge nadgledanja građevina, usluge ugradnje i održavanja cjevovoda, usluge u vezi ustupanja korišćenja imovine, savjetodavne usluge, usluge izgradnje, održavanja i popravke

Klasa 42: geodetske usluge, usluge koje se tiču vrednovanja, procjene, istraživanja i izvještaja

(210) **2012-257**

(442) **20.09.2014.**

(220) 6/4/2012

(731) **ANETA IVANOVIĆ**, KRUŠEDOLSKA 1, BEOGRAD RS

(540) PRAVE RIJEČI

(550) I

(511) **Klasa 09:** aparati za snimanje, prenos ili reprodukciju zvuka ili slika, diskovi za snimanje, kompakt diskovi, DVD-i, diskovi i trake, magnetski i optički nosači podataka, zvučni i video snimci, nasnimljeni diskovi, elektronske knjige i izdanja, multi medijalni snimci i izdanja, elektronske igrice, aparati za zabavu koji se koriste sa ili imaju ugrađen TV ekran ili video monitor, automati za video igrice koji se koriste sa TV ili kompjuterom, automati za izlazne video igrice koje se koriste sa TV, električni ili elektronski aparati za zabavu koji se pokreću novcem ili žetonom, softveri za kompjuterske igrice, programi i trake, prethodno snimljene video trake, kinematografski filmovi i igrani crtani filmovi, filmske trake, filmovi, kompjuterski softveri i programi, aparati i instrumenti za komunikaciju, telefoni, mobilni telefoni, aparati za mobilne telefone, koji se koriste bez upotrebe ruke (hands-free), igrice za mobilne telefone, naočare, podloge za kompjuterskog miša

Klasa 38: emitovanje, emitovanje putem televizije, satelitske i kablovske televizijske, radio emitovanja, komunikacije preko telefona, interaktivne telefonske usluge, usluge slanja telefonskih poruka, komunikacijske usluge putem radio talasa, telefona, interneta, svetske globalne mreže (World Wide Web), kablovske, satelitske, mikrotalasne i električne mreže, telefonija za usluge glasanja i za zabavu

Klasa 41: obrazovne usluge i usluge razonode sve u vezi sa televizijom, bioskopom, radijom, i pozorištem, produkcija i prezentacija radio i televizijskog programa, filmova, šou programa, obrazovanje putem ili u vezi sa televizijom i radijem, razonoda putem ili u vezi sa televizijom i radijem, organizacija takmičenja (obrazovanje ili zabava), interaktivna telefonska takmičenja, izdavaštvo, produkcija kinematografskih filmova, šou programa, radio i televizijskih programa, obezbeđivanje obrazovanja ili zabave putem radio, televizije, satelita, kablovske, telefonske, svetske globalne mreže ili internet mreže, organizacija šou programa, iznajmljivanje zvučnih zapisa ili prethodno snimljenih šou filmova programa, radio i televizijskih izvođenja, produkcija video traka, video diskova ili digitalnih univerzalnih diskova (DVD-i), radio zabava, televizijska zabava, bioskopska zabava, pozorišna zabava, zabavni programi u kojim ucesnici igraju razne igre, televizijske usluge zabave koje uključuju učešće publike preko telefona, usluge interaktivne zabave putem mobilnih telefona, igrice zasnovane na internetu, obezbeđivanje digitalnih audio ili digitalnih video snimaka, koje nisu za preuzimanje, obezbeđivanje onlajn elektronskih izdanja

(210) **2012-261**

(442) **20.09.2014.**

(220) 6/7/2012

(731) **CIMAB S.A.** CALLE 206 NO.1926 E/19 Y 21 ATABEY, PLAYA, LA HABANA CU

(540) CIMAvax-EGF

(550) I

(740) Čejović Vladimir, 13. jula 21, Podgorica ME

(511) **Klasa 05:** farmaceutski i veterinarski preparati, sanitarni preparati za upotrebu u medicini,

dijetetske supstance prilagođene za upotrebu u medicini, hrana za bebe, flasteri, materijali za zavijanje, materijali za plombiranje zuba, zubarska smola, dezinfekciona sredstva, preparati za uništavanje štetočina, fungicidi, herbicidi

(210) **2012-267** (442) **20.09.2014.**

(220) 6/13/2012

(731) **MONSTER ENERGY COMPANY** (A DELAWARE CORPORATION), 1 MONSTER WAY, CORONA, CALIFORNIA 92879 US

(540) MONSTER REHABITUATE

(550) I

(740) Radulović Božidar, Jovana Tomaševića 9/III, Podgorica ME

(511) **Klasa 05:** dodaci za ishranu u tečnom obliku

Klasa 30: gotovi čaj, ledeni čaj i čaj (napici od čaja), gotovi aromatizovani čaj, ledeni čaj i čaj (napici od čaja)

Klasa 32: bezalkoholna pića

(210) **2012-279** (442) **20.09.2014.**

(220) 6/22/2012

(731) **DŽEK POT DOO**, RIMSKI TRG 50, PODGORICA ME



(540)

(550) I

(740) Božović Vesko, Rimski trg 50/11, Podgorica ME

(511) **Klasa 28:** igre i igračke, opremu za različite sportove i igre, karte za igru

Klasa 35: oglašavanje, vođenje poslova, poslovno upravljanje i kancelarijski poslovi

Klasa 41: obrazovne usluge, pripremanje obuke, razonoda, sportske i kulturne aktivnosti

(210) **2012-291** (442) **20.09.2014.**

(220) 6/25/2012

(731) **SAILUNCO.LTD**, THE WEST OF JIANGSHAN MIDDLE ROAD, ECONOMIC & TECHNOLOGICAL DEVELOPMENT ZONE (HI-TECH INDUSTRIAL PARK) QINGDAO CN

ICE BLAZER

(540)

(550) I

(740) Ćosović Dejan, 13. jula 1/5, Budva ME

(511) **Klasa 12:** unutrašnje gume za pneumatike, gume za točkove vozila, površinski slojevi guma za vozila (za pokretne trake - kaiševe), površinski slojevi guma za vozila (za traktore), gume za bicikle, pokrivači za pneumatske gume, pneumatske gume, pune gume za točkove vozila, lepljive gumene zakrpe za popravku unutrašnjih guma, automobilske gume, bicikli, šinska vozila koja se pokreću ručno, naprave za porinuće ili navlačenje vozila, žicare i

uspinjače

(210) **2012-293** (442) **20.09.2014.**

(220) 6/25/2012

(731) **JUMEIRAH INTERNATIONAL LLC**, AL SUFOUH AREA, PO BOX 73137, DUBAI AE

Jumeirah

(540)

(550) I

(740) Jusić Jasna, Crnogorskih serdara bb, Podgorica ME

(511) **Klasa 16:** papir i proizvodi od papira, karton i proizvodi od kartona, knjižice, flajeri, pamfleti, kalendari, karte, obrasci, čestitke, pozivnice, etikete, pisma, bilteni, blokovi, kancelarijski blokovi, upijači, memorandum i albumi sa vjeridbenim slikama, dnevnic, dosijei, indeksni dosijei, razglednice, poster, karte (ulaznice, vozne karte i slično), blokovi za pisanje, papir za pisanje, štampane stvari, novine, časopisi koji izlaze periodično, knjige, knjigovezački materijal, štampane publikacije, žurnali, magazini, katalozi, knjižice, brošure, racuni, pisaci i kancelarijski materijal (izuzev namještaja), olovke, hemijske olovke, flomasteri, patent olovke, hemijske olovke sa kuglicom na vrhu pisaljke, pritiskivač za hartiju, gumice, fotografije

Klasa 43: usluge hotelskog i privremenog smještaja i rezervacije, usluge rezervacije i informacije s tim u vezi, iznajmljivanje stolica, stolova, stolnjaka i salveta, staklarije i sala za sastanke za konferencije, sastanke, izložbe, obuke, radionice, poslovne sajmove, kongrese i predavanja, ugostiteljske usluge, usluge dobavljanja hrane, usluge snabdijevanja hranom i pićem (bezalkoholnim), usluge restorana i restorana sa samoposluživanjem, restorana sa hranom za ponijeti, kafea, kafea, bifea, usluge dobavljanja u vezi sa snabdijevanjem hranom i pićem (bezalkoholnim), usluge pripremanja hrane i pića (bezalkoholnog), usluge obezbijedivanja vrtića za djecu

(210) **2012-297** (442) **20.09.2014.**

(220) 6/26/2012

(731) **PHILIP MORRIS BRANDS SARL**, QUAI JEANRENAUD 3 NEUCHATEL, 2000 CH

MERIT



(540)

(550) I, F

(511) **Klasa 34:** duvan, sirov ili prerađen, proizvodi od duvana, naročito cigare, cigarete, cigarilosi/male cigarete, duvan za uvijanje cigareta, duvan za lule, duvan za žvakanje, duvan za šmrkanje, kretek, snus (mokri duvanski prah kao duvanski proizvod), zamena za duvan (za nemedicinsku upotrebu), proizvodi za pušače, naročito: papir za cigarete i lule, filteri za cigarete, kutije za duvan (od neplemenitih metala), kutije za cigarete i pepeljare (od neplemenitih metala), lule, ručni aparati/spravice za uvijanje cigareta, upaljači, šibice

(210) **2012-305** (442) **20.09.2014.**
(220) 6/28/2012
(731) **HORT SECURITY SYSTEMS DOO**, I PROLETERSKA BB BUDVA ME
(540) Xort-security systems
(550)
(511) **Klasa 37:** postavljanje električnih instalacija, ugradnja i održavanje alarmnih sistema protiv provala

(210) **2012-308** (442) **20.09.2014.**
(220) 6/29/2012
(731) **CRISPIN CIDER COMPANY**, 1213 SOUTH AUBURN STREET, SUITE A 95713 COLFAX, CALIFORNIA US
(540) CRISPIN
(550) I
(740) Čejović Vladimir, 13. jula 21, Podgorica ME
(511) **Klasa 38:** cider (alkoholno piće na bazi voća)

(210) **2012-309** (442) **20.09.2014.**
(220) 6/29/2012
(300) 85/550648 23.02.2012. US
(731) **CRISPIN CIDER COMPANY**, 1213 SOUTH AUBURN STREET, SUITE A 95713 COLFAX, CALIFORNIA US
(540) FOX BARREL
(550) I
(740) Čejović Vladimir, 13. jula 21, Podgorica ME
(511) **Klasa 38:** cider (alkoholno piće na bazi voća)

(210) **2012-310** (442) **20.09.2014.**
(220) 6/29/2012
(731) **CRISPIN CIDER COMPANY**, 1213 SOUTH AUBURN STREET, SUITE A 95713 COLFAX, CALIFORNIA US
(540) BROWNS LANE
(550) I
(740) Čejović Vladimir, 13. jula 21, Podgorica ME
(511) **Klasa 38:** cider (alkoholno piće na bazi voća)

(210) **2012-320** (442) **20.09.2014.**
(220) 7/12/2012
(731) **AGRO GROUP D.O.O.** KOZARAČKA 30, STARI AERODROM, 81000 PODGORICA ME
(540) BONELA
(550) I
(740) Lutovac Branislav, Bulevar Crnojevića 93, Podgorica ME
(511) **Klasa 35:** oglašavanje, vođenje poslova, poslovno upravljanje, kancelarijski poslovi, usluge maloprodajnih radnji u vezi prehrambenih proizvoda, voća, povrća i sokova

(210) **2012-321** (442) **20.09.2014.**
(220) 7/12/2012

(731) **AGRO GROUP D.O.O.** KOZARAČKA 30, STARI AERODROM, 81000 PODGORICA ME

(540) BONELLA

(550) I

(740) Lutovac Branislav, Bulevar Crnojevića 93, Podgorica ME

(511) **Klasa 35:** oglašavanje, vođenje poslova, poslovno upravljanje, kancelarijski poslovi, usluge maloprodajnih radnji u vezi prehrambenih proizvoda, voća, povrća i sokova

(210) **2012-337** (442) **20.09.2014.**

(220) 7/31/2012

(731) **NISSAN JIDOSHA KABUSHIKI KAISHA** (ALSO TRADING AS NISSAN MOTOR CO.LTD.), NO.2, TAKARA-CHO, KANGARA-KU, YOKOHAMA-SHI, KANAGAWA-KEN JP



(540)

(550) I

(740) Čejović Vladimir, 13. jula 21, Podgorica ME

(511) **Klasa 12:** robe iz klase 12 sa prioritetom prijave jp br. 2012-015938: motori i strojevi za suvozemna vozila, prenosni sistemi i zupčanici za suvozemna vozila. robe iz klase 12 sa prioritetom prijave jp br. 2012-015939: brodovi/čamci, samim tim i njihovi djelovi i oprema, alarmi protiv krađe za automobile. robe iz klase 12 sa prioritetom prijave jp br. 2012-015940: automobili, kamioni, autobusi, viljuškari, motorna vozila nad dva točka i bicikla, a time i njihovi djelovi i oprema, kolica, traktori, ijepljive gumene fleke za popravku unutrašnjih guma ili spoljašnjih guma. robe iz klase 12 bez prioriteta: električna vozila uključujući i električne automobile, vagone, kamionete, vozila koja se koriste u sportske svrhe, rekreativna vozila (rv), sportski automobili, trkački automobili, kamioni, tegleći traktori (traktori), i njihovi strukturalni djelovi i oprema, lokomotive, osovine za vozila, amortizeri za automobile, ovjesni amortizeri za vozila, kočnice za vozila, motori na naizmjeničnu/direktnu struju za kopnena vozila, svi uključeni u međunarodnu klasu 12

(210) **2012-341** (442) **20.09.2014.**

(220) 8/1/2012

(731) **DOO TIMES OUT BAR**, BULEVAR REVOLUCIJE BB KULA A, BAR ME

(540) MONTENEGA

(550) V

(511) **Klasa 03:** sapuni, parfimerija, kozmetika

(210) **2012-342** (442) **20.09.2014.**

(220) 8/2/2012

(731) **LUKA VUČKOVIĆ**, STARI GRAD BB, BUDVA ME

HOTEL
Mozart

(540)

(550) I

(511) **Klasa 30:** kolači i poslastice, sladoledi**Klasa 43:** usluge obezbeđenja hrane i pića, privremeni smjestaj(210) **2012-343**(442) **20.09.2014.**

(220) 8/2/2012

(731) **LUKA VUČKOVIĆ**, STARI GRAD BB, BUDVA ME

caffe
Mozart

(540)

(550) I

(511) **Klasa 30:** kolači i poslastice, sladoledi**Klasa 43:** usluge obezbeđenja hrane i pića, privremeni smjestaj(210) **2012-344**(442) **20.09.2014.**

(220) 8/2/2012

(731) **LUKA VUČKOVIĆ**, STARI GRAD BB, BUDVA ME

restaurant
Mozart

(540)

(550) I

(511) **Klasa 30:** kolači i poslastice, sladoledi**Klasa 43:** usluge obezbeđenja hrane i pića, privremeni smjestaj(210) **2012-345**(442) **20.09.2014.**

(220) 8/2/2012

(731) **LUKA VUČKOVIĆ**, STARI GRAD BB, BUDVA ME



(540)

(550) I

(511) **Klasa 30:** kolači i poslastice, sladoledi**Klasa 43:** usluge obezbeđenja hrane i pića, privremeni smjestaj(210) **2012-346**(442) **20.09.2014.**

(220) 8/6/2012

(731) **GENERAL MOTORS LLC**, 300 RENAISSANCE CENTER, DETROIT, MICHIGAN 48265-3000 US

(540) STS

(550) I, V

(740) Radulović Božidar, Jovana Tomaševića 9/III, Podgorica ME

(511) **Klasa 12:** motorna vozila i djelovi za njih(210) **2012-353**(442) **20.09.2014.**

(220) 8/14/2012

(731) **ANTARES-MNE D.O.O.-HERCEG NOVI**, KUMBOR BB, HERCEG NOVI ME**Sun Union** 

(540)

(550) I

(511) **Klasa 11:** uređaji za rasvjetu, grijanje, proizvodnju pare, kuvanje, hlađenje, sušenje, ventilaciju, vodosnadbjevanje u sanitarne svrhe**Klasa 37:** ugradnja, popravka, instalacione usluge(210) **2012-354**(442) **20.09.2014.**

(220) 8/14/2012

(731) **GORSKA SLUŽBA SPASA CRNE GORE**, KAPINO POLJE BB, 81400 NIKŠIĆ ME



(540)

(550) I

(511)

Klasa 39: organizacija transporta povrijeđenih i oboljelih osoba sa planina i drugih nepristupačnih mjesta

Klasa 41: obuka, stručno osposobljavanje, organizovanje i izvođenje obuke i školovanje kadrova iz oblasti specijalističkih planinarskih aktivnosti, organizuje polaganja i dodjelu stručnih zvanja po pravilniku GSS, organizuje i priprema aktivnosti i mjere u svrhu održanja pripravnosti za spašavanje, te trajno organizuje osposobljavanje i uvježbavanje svojih članova za otklanjanje nesreća u planinama, jamama, skijalištima, urbanim prostorima i drugim nepristupačnim mjestima, obuka prve pomoći

Klasa 44: medicinske usluge, usluge prve pomoći prilikom spašavanja

Klasa 45: sigurnosne usluge za zaštitu imovine i lica, spašavanje ljudi i imovine u planinama, jamama, pećinama, na skijalištima, urbanim sredinama i ostalim nepristupačnim terenima, organizuje i izvodi potragu i spašavanje iz lavina i sprovodi preventivne mjere u vezi sa opasnošću od sniježnih lavina, učestvuje u sistemu traganja i spašavanja za nestalim letilicama u planinskom području i drugim nepristupačnim mjestima, učestvuje u sistemu spašavanja kod masovnih prirodnih nesreća

(210) 2012-355

(442) 20.09.2014.

(220) 8/14/2012

(731) **TSVESTAN STEFANOV LUKANOV**, PRAVETS, J.K.SEVER, BL. 210. FLOOR 3 APT. 22. BG



(540)

(550) I

(740) Đakonović Vido, Bajova 9, Cetinje ME

(511) **Klasa 07:** aspiratori, električne mešalice, elektro-mehaničke mašine za pripremu napitaka, blenderi (električne mešalice) za kućne potrebe, bojleri, mašine za sečenje hleba, kompresori za frižidere, mašine za pranje posuđa, mašine za sušenje, mašine za meso, električni kućni uređaji, električni procesori za hranu, električne prese za voće za kućne

potrebe, električni uređaji za mlevenje/drobljenje za kućne potrebe, električne ručne mašine za bušenje, električne kuhinjske mašine, električni noževi, električni aparati i mašine za čišćenje, mašine za ljuštenje, mašine za ispiranje, električne makaze, mašine za šivenje, vakumski čistači, mašine za pranje, električni aparati za zavarivanje, električne mašine za brisanje za domaće potrebe

Klasa 11: instalacije za osvetljenje, zagrevanje, proizvodnju pare, pečenje, hlađenje, sušenje, ventilaciju, instalacije za erkondišn, instalacije za ventilaciju vozila, oprema za ventilaciju za instalacije za erkondišn, uređaji za pečenje za domaće potrebe, kamini, električne mašine za kafu, oprema za grejanje, električni radijatori, tepsije, aparati za pečenje, rerne za pečenje, frizeri (uređaji za hlađenje), električne prese za kuvanje, električni uređaji za prženje, električni i bojleri na gas, roštilji, aparati za ventilaciju, aparati za kolače, električno posude za kuvanje, električni kotlovi, mikrotalasne peći, ploče za pripremu kolača, fenovi za kosu, aparati za hlađenje napitaka, aparati za pečenje kafe, aparati za pečenje voća, aparati za ventilaciju i osveživanje, aparati i mašine za zamrzavanje, uređaji i instalacije za zamrzavanje, frižideri i komore za zamrzavanje

Klasa 35: agencije za uvoz-izvoz, organizacija izložbi u komercijalne i reklamne svrhe, sistematizacija i kompilacija informacija u kompjuterskim bazama podataka, biznis-menadžment i organizacija konsultacija, akcionarstvo, direktno pismeno reklamiranje, javno reklamiranje, računovodstvo, knjigovodstvo, komercijalno-informativne agencije, biznis-menadžment asistencija, pretraživanje u kompjuterskim bazama podataka, komercijalna ili za industrijski menadžment asistencija

(210) **2012-356**

(442) **20.09.2014.**

(220) 8/14/2012

(731) **DEUTSCHE TELECOM AG**, FRIEDRICH-EBERT-ALLEE 140 53113 BONN DE

(540) MyWallet

(550) I

(740) Popović Miladin, Đoka Miraševića 21/III, Podgorica ME

(511) **Klasa 09:** naučni, pomorski, geodetski, fotografski, kinematografski, optički aparati, aparati za mjerenje, signalizaciju, kontrolu (inspekciju), spašavanje života i aparati i instrumenti za podučavanje, aparati i instrumenti za sprovođenje, prekid, transformaciju, akumulaciju, regulisanje ili kontrolu električne energije, aparati za snimanje, prenos, obradu i reprodukciju zvuka, slike ili podataka, magnetni nosioci podataka, računске mašine, hardver za obradu podataka, računari, CD-ovi, DVD-jevi i drugi digitalni mediji za snimanje, računarski softver, elektronskim putem snimljeni podaci (koji se mogu preuzeti), elektronske publikacije (koje se mogu preuzeti)

Klasa 35: reklamiranje, poslovni menadžment, poslovna administracija, prikupljanje, sistematizacija, kompilacija i ekonomska analiza poslovnih podataka i informacija uskladištenih u računarskim bazama podataka, maloprodajne usluge (takođe putem interneta i drugih komunikacionih mreža), u vezi sa robama iz klasa 9 i 16

Klasa 36: osiguranje, finansijski poslovi, monetarni poslovi, poslovi u vezi sa nekretninama

Klasa 38: telekomunikacije, usluge novinske agencije, iznajmljivanje telekomunikacione opreme, informacije o telekomunikacijama

Klasa 42: naučne i tehnološke usluge i istraživanje i dizajniranje u vezi sa tim, usluge industrijske analize i istraživanja, dizajniranje i razvijanje računarskog hardvera, softvera i baza podataka, održavanje softvera, tehničke konsultacije u vezi sa uslugama uključenim u ovu klasu, računarske usluge u vezi sa skladištenjem elektronskih podataka, iznajmljivanje računara i računarske opreme, dizajniranje veb sajtova za druge

(210) **2012-357** (442) **20.09.2014.**
(220) 8/20/2012
(731) **JOSEPH COMPANY INTERNATIONAL, INC.** 1711 LANGLEY AVENUE IRVINE, CA 92614 US
(540) MICROCOOL
(550) I
(740) Čejović Vladimir, 13. jula 21, Podgorica ME
(511) **Klasa 21:** posuda za napitke ili hranu s hermetički zatvorenom jedinicom za izmjenu toplote koji je trajno smješten unutar navedene posude te je u dodiru s hranom ili napitkom

(210) **2012-358** (442) **20.09.2014.**
(220) 8/20/2012
(731) **JOSEPH COMPANY INTERNATIONAL, INC.** 1711 LANGLEY AVENUE IRVINE, CA 92614 US
(540) WEST COAST CHILL
(550) I
(740) Čejović Vladimir, 13. jula 21, Podgorica ME
(511) **Klasa 32:** energetski i sportski napici koji sadrže dijetetske i prehrambene dodatke, vitamine i bilje

(210) **2012-359** (442) **20.09.2014.**
(220) 8/20/2012
(731) **SYSTEMAX INC.** 11 HARBOR PARK DRIVE, PORT WASHINGTON, NEW YORK 11050 US

The logo for Systemax features the word "Systemax" in a bold, sans-serif font. The letters "S", "y", "e", "m", "a", and "x" are in a dark grey color, while the letters "s", "t", "e", "m", "a", and "x" are in a lighter grey color. A thin, curved line arches over the top of the letters "y", "e", "m", and "a".

(540)
(550) I
(740) Radulović Božidar, Jovana Tomaševića 9/III, Podgorica ME
(511) **Klasa 09:** toneri i mastila za multifunkcionalne elektronske uređaje za upotrebu prilikom kopiranja, štampanja, skeniranja, video snimanja ili prenosa dokumenata i slika, kompjuteri, notebuk kompjuteri, tablet kompjuteri, kompjuterski periferni uređaji, kompjuterski dodaci, naročito, miš, tastature, torbe za nošenje kompjutera, kompjuterski softver, oprema za kućni bioskop, oprema za fotografisanje, mobilni telefoni i dodatna oprema, telefoni i dodatna oprema, video oprema, audio oprema, prenosni elektronski uređaji, proizvodi za kućne kancelarije, oprema za obradu slika, mrežni sigurnosni uređaji sa fajervolom, prenosne komponente za čuvanje podataka, pretvarači, uređaji za napajanje i adapteri, mrežni medija plejeri, video igre i softveri za video igre, oprema i dodaci za video igre, CD-ovi, DVD-ovi, CD i DVD snimači, baterije, TV i multifunkcionalni elektronski uređaji za upotrebu prilikom kopiranja, štampanja, skeniranja, video snimanja i/ ili prenosa dokumenata i slika, a naročito je uključeno sledeće: žice, kablovi, priključni kablovi, konektori, spojni priključni kablovi, jednostruki utikači, adapteri koji se koriste za povezivanje kompjutera na drugi kompjuter ili koji su deo bilo koje kompjuterske mreže (bez obzira da li takav kabal, priključni kabal, spojni priključni kabal, adapter ili neki drugi takav uređaj sadrži mikroprocesor ili bilo kakvu memoriju), uključujući električne žice za upotrebu u telekomunikacijskoj industriji, žice, kablove i priključne kablove od optičkog vlakna, telekomunikacijski adapteri, interkonekcijski

kablovi od optičkog vlakna, telekomunikacijski konektori, utikači, jednostruki utikači i blokovi za povezivanje, telekomunikacijski uređaji koji ponavljaju, preoblikuju ili reformatiraju signale iz terminala podataka i kontrolora, telekomunikacijske konzole, držači i spojnice za učvršćivanje i podržavanje kablovske i telekomunikacijske opreme, sve distribuirano kao jedna celina, koja takođe uključuje kompjutersko i ostalo umrežavanje, telekomunikacijske i prenosne uređaje i opremu, kao što su Wi-Fi, WLAN i MLAN oprema, kao i senzore, priključne tačke i opremu za povezivanje za ugradnju automatizovanih sistema, kao i drugi proizvodi koji uključuju ali nisu ograničeni na telekomunikacijske ormare i distribucijske tačke privatnih korisnika, kao što su ali ne isključivo stalci, kućišta, ormari, napajanja i utičnice koje se koriste sa ili za kablove ili priključne kablove, lokalni priključni kablovi, kablovi i ožičenje potrebno za dobijanje električne energije iz zidne utičnice ili za spajanje jednog kompjutera sa mišem, štampačem, tastaturom, monitorom ili diskom ili CD snimačem

Klasa 16: rezači papira i kancelarijski materijal, heftalica, papir za kopiranje, papir za izradu koverti, papir za pisma, papiri sa memorandumom, papir za beleške, papir, spajalice.

Klasa 20: radni stolovi, stolice, nemetalni zidni nosači za LCD i plazma televizore, nemetalni nosači za zvučnike, stalci za televizore, nameštaj koji služi za smeštanje multimedijalnih uređaja, okretni stalci za televizore, kancelarijski namještaj, kompjuterski namještaj, plastične i drvene kutije koje se koriste za čuvanje i transport

Klasa 35: onlajn usluge maloprodajnih radnji u oblasti elektronike široke potrošnje, kompjutera, kompjuterskih perifernih uređaja, opreme za kompjutere, kompjuterskog softvera, radio uređaja, satelitskih radio uređaja i odnosne opreme, opreme za kućni bioskop, fotografske opreme, mobilnih telefona i dodatne opreme, telefona i dodatne opreme, kućnih potrepština i bele tehnike, faks uređaja, video opreme, audio opreme, prenosnih elektronskih uređaja i odnosne opreme, proizvoda za kućne kancelarije, opreme za obradu slika, mrežnih sigurnosnih uređaja sa fajervolom, prenosnih komponenti za čuvanje podataka, konvertora i adaptera, mrežnih medija plejera, mastila i tonera, elektronskih muzičkih instrumenata, uređaja za zaštitu od struje, video igara i softvera za video igre, opreme i dodataka za video igre, nameštaja za medijske i elektronske uređaje, CD-ova, DVD-ova, CD i DVD snimača, baterija, audio opreme za automobile, digitalnih okvira za fotografije

Klasa 39: usluge skladišta, naročito skladištenje, distribucija, preuzimanje, pakovanje i dostava kućnih, stambenih, poslovnih i komercijalnih proizvoda

Klasa 42: usluge produžene garancije, naročito servisni ugovori za kompjutersku i elektroniku široke potrošnje, konsultantske usluge koje se odnose na upravljanje, podržavanje, servisiranje i poboljšanje poslovanja i kritičnih tačaka sistema (IT rešenja za poslovanja, saveti potrošačima o integraciji i dizajnu sistema koji sadrže predloge za poboljšanje efikasnosti), usluge omogućavanja puštanja u rad i puštanje u rad, koje se odnose na konfigurisanje (u rasponu od konfigurisanja RAID servera do nadogradnje memorije za presonalni računar), i na kompjuterski softver za praćenje i upravljanje informacijama u vezi kompjuterskim hardverskim resursima, i na softverski imaging (obezbeđivanje konfigurisanja operativnog sistema i aplikacija u skladu sa specifičnim mrežnim potrebama klijenata), i na sveobuhvatne usluge instaliranja kompjuterskog hardvera, softvera i mrežne opreme, uz mogućnost saradnje sa klijentovim postojećim ISP i bilo kojim drugim licem u cilju obezbeđivanja neometanog Internet pristupa, e-mail usluga i drugih IP usluga, usluge upravljanja informatičkim sistemima koje se odnose na pružanje usluge IT konfiguracije kao što su konfiguracija i instalacija softvera, konfiguracija i instalacija hardvera i instalacija i konfiguracija mrežne opreme, i na usluge IT podrške, naročito projektovanje, nadogradnja i provera mreže, kao i na informativne, savetodavne i konsultantske usluge koje se odnose na sve gore navedene usluge, usluge zaštite životne sredine, naročito, tehničke konsultacije

u oblasti ponovne upotrebe dobara i odlaganja otpada

(210) **2012-361** (442) **20.09.2014.**

(220) 8/23/2012

(731) **JACK DANIEL'S PRPERTIES, INC.** 4040 CIVIC CENTER DRIVE, SUITE 528, SAN RAFAEL, CALIFORNIA 94903 US



(540)

(550) I

(740) AOD "Ćupić", Dalmatinska 10, Podgorica ME

(511) **Klasa 33:** alkoholna pića, uključujući žestoka pića

(210) **2012-362** (442) **20.09.2014.**

(220) 8/24/2012

(731) **MERCK SHARP & DOHME CORP.** ONE MERCK DRIVE, WHITEHOUSE STATION, NEW JERSEY 08889 US

VYNFINIT

(540)

(550) I

(740) AOD "Ćupić", Dalmatinska 10, Podgorica ME

(511) **Klasa 05:** farmaceutski preparati

(210) **2012-363** (442) **20.09.2014.**

(220) 8/24/2012

(731) **HEMOFARM A.D.** FARMACEUTSKO-HEMIJSKA INDUSTRIJA VRŠAC, BEOGRADSKI PUT BB, 26300 VRŠAC RS

(540) SIGENE

(550) I

(511) **Klasa 05:** farmaceutski i veterinarski preparati, sanitarni preparati za medicinsku upotrebu, dijetetske supstance prilagođene za upotrebu u medicini, hrana za bebe, flasteri, materijali za zavijanje, materijali za plombiranje zuba, zubarska smola, dezinfekciona sredstva, preparati za uništavanje štetočina, fungicidi, herbicidi

(210) **2012-364** (442) **20.09.2014.**

(220) 8/24/2012

(300) 85/551, 360 23.02.2012 US

(731) **JOSEPH COMPANY INTERNATIONAL, INC**, 1711 LANGLEY AVENUE IRVINE, CA 92614 US



(540)

(550) I

(740) Čejović Vladimir, 13. jula 21, Podgorica ME

(511) **Klasa 32:** energetski i sportski napici koji sadrže dijetetske i prehrambene dodatke, vitamine i bilje

(210) **2012-365** (442) **20.09.2014.**

(220) 8/28/2012

(731) **HOP LUN BRANDS LIMITED**, 5TH FLOOR, BEAUX LANE HOUSE, MERCER STREET LOWER, DUBLIN, 2 IE



(540)

(550) I

(740) AOD "Ćupić", Dalmatinska 10, Podgorica ME

(511) **Klasa 25:** odjeća, obuća, pokrivala za glavu, donje rublje, kupaće gaće/kostimi i odjeća za spavanje

(210) **2012-366** (442) **20.09.2014.**

(220) 8/28/2012

(731) **JOSEPH COMPANY INTERNATIONAL, INC.** 1711 LANGLEY AVENUE, IRVINE, CALIFORNIA 92614 US

(540) CHILL CAN

(550) I

(740) Čejović Vladimir, 13. jula 21, Podgorica ME

(511) **Klasa 21:** posuda za napitke ili hranu s hermetički zatvorenom jedinicom za izmjenu toplote koji je trajno smješten unutar navedene posude te je u dodiru s hranom ili napitkom

(210) **2012-367** (442) **20.09.2014.**

(220) 8/31/2012

(731) **PHILIP MORRIS PRODUCTS S.A.** QUAI JEANRENAUD 3, NEUCHATEL, 2000 CH

VIŠE OD OČEKIVANOG

(540)

(550) I

(740) Kojić Ivana, Serdara Jola Piletića bb, Podgorica ME

(511) **Klasa 34:** duvan, sirov ili prerađen, proizvodi od duvana, naročito cigare, cigarete, cigarilosi/male cigarete, duvan za uvijanje cigareta, duvan za lule, duvan za žvakanje, duvan za šmrkanje, kretek, snus (mokri duvanski prah kao duvanski proizvod), zamena za duvan (za nemedicinsku upotrebu), proizvodi za pušače, naročito: papir za cigarete i lule, filteri za cigarete, kutije za duvan (od neplemenitih metala), kutije za cigarete i pepeljare (od neplemenitih metala), lule, ručni aparati/spravice za uvijanje cigareta, upaljači, šibice

(210) **2012-368**

(442) **20.09.2014.**

(220) 9/3/2012

(731) **D.O.O. POLAR CLEAN HEMIJSKA TIVAT**, PORTOMONTENEGRO VILLAGE, ZGRADA OZANA, OBALA BB 85320 TIVAT ME



(540)

(550) I

(511) **Klasa 37:** pranje, pranje veša, šišćenje odjeće, peglanje odjeće, peglanje lana

(210) **2012-369**

(442) **20.09.2014.**

(220) 9/3/2012

(731) **W.L. GORE & ASSOCIATES, INC.** 555 PAPER MILL ROAD, P.O. BOX 9329, NEWARK DE 19714 US



(540)

(550) I

(740) Čejović Vladimir, 13. jula 21, Podgorica ME

(511) **Klasa 09:** zaštitna odjeća uključujući zaštitnu odjeću protiv nezgoda

Klasa 24: tekstili i tekstilni slojevi uključeni u ovu klasu

Klasa 25: odjeća, obuća, pokrivala za glavu, rukavice

(210) **2012-370**

(442) **20.09.2014.**

(220) 9/4/2012

(731) **CINEPLEXX INTERNATIONAL GMBH, BEČ AT**



(540)

(550) I

(511) **Klasa 35:** poslovno upravljanje vezano za poslovanje bioskopa

Klasa 41: razonoda, poslovanje bioskopa, bioskopska film i video produkcija, bioskopske prezentacije

Klasa 43: usluge koje se pružaju u kafeima, kafeterijama, restoranima, bar servisima, bifeima

(210) **2012-371**

(442) **20.09.2014.**

(220) 9/6/2012

(731) **KICKERS INDUSTRIAL BV, CLAUDE DEBUSSYLAAN 24, 1082 MD AMSTERDAM NL**

(540) KICKERS

(550) I

(740) Čejović Vladimir, 13. jula 21, Podgorica ME

(511) **Klasa 18:** koža i imitacija kože, i proizvodi izrađeni od ovih materijala koji nisu uključeni u druge klase, prtljag, koferi, putne torbe, školske torbe, naprtnjače, toaletne torbice, kežual torbe, koferi za šminku, kaiševi, aktentašne, ručne torbe, velike putne torbe, sportske torbe, ruksaci, tašne, novčanici, kišobrani i suncobrani, štapovi za hodanje

(210) **2012-372**

(442) **20.09.2014.**

(220) 9/10/2012

(731) **BROWN-FORMAN POLSKA SP.Z.O.O. A POLISH LIMITED COMPANY PL**



(540)

MAXIMUS

(550) I

(740) AOD "Ćupić", Dalmatinska 10, Podgorica ME

(511) **Klasa 33:** alkoholna pića, uključujući žestoka pića

(210) **2012-373**

(442) **20.09.2014.**

(220) 9/10/2012

(731) **MATTEL**, INC. 333 CONTINETAL BOULEVARD, EL SEGUNDO, CALIFORNIA 90245-5012 US

(540) MONSTER HIGH

(550) I

(740) Lutovac Branislav, Bulevar Crnojevića 93, Podgorica ME

(511) **Klasa 03:** sredstva za bijeljenje i druge supstance za upotrebu u pranju, preparati za čišćenje, poliranje, ribanje, abrazivna sredstva, sapuni, parfimerija, eterična ulja, kozmetika, losioni za kosu, proizvodi za njegu zuba

Klasa 28: igre i igračke, gimnastički i sportski artikli koji nisu obuhvaćeni drugim klasama, ukrasi za jelke

Klasa 41: obrazovne usluge, pripremanje obuke, razonoda, sportske i kulturne aktivnosti

(210) **2012-374**

(442) **20.09.2014.**

(220) 9/10/2012

(731) **MATTEL**, INC. 333 CONTINETAL BOULEVARD, EL SEGUNDO, CALIFORNIA 90245-5012 US

(540) HOT WHEELS

(550) I

(740) Lutovac Branislav, Bulevar Crnojevića 93, Podgorica ME

(511) **Klasa 03:** sredstva za bijeljenje i druge supstance za upotrebu u pranju, preparati za čišćenje, poliranje, ribanje, abrazivna sredstva, sapuni, parfimerija, eterična ulja, kozmetika, losioni za kosu, proizvodi za njegu zuba

Klasa 28: igre i igračke, gimnastički i sportski artikli koji nisu obuhvaćeni drugim klasama, ukrasi za jelke

Klasa 41: obrazovne usluge, pripremanje obuke, razonoda, sportske i kulturne aktivnosti

(210) **2012-377**

(442) **20.09.2014.**

(220) 9/11/2012

(731) **LUTRIJA CRNE GORE A.D.**, RIMSKI TRG BR.50, 81000 PODGORICA ME



(540)

(550) I

(740) Božović Vesko, Rimski trg 50/11, Podgorica ME

(511) **Klasa 35:** oglašavanje, vođenje poslova, poslovno upravljanje i kancelarijski poslovi

Klasa 38: telekomunikacije

Klasa 41: obrazovne usluge, pripremanje obuke, razonoda, sportske i kulturne aktivnosti

(210) **2012-378** (442) **20.09.2014.**

(220) 9/11/2012

(731) **DAIKIN INDUSTRIES, LTD.** UMEDA CENTER BUILDING, 4-12, NAKAZAKI-NISHI 2-CHOME, KITA-KU, OSAKA JP



VARIABLE REFRIGERANT TEMPERATUI

(540)

(550) I

(740) Radulović Božidar, Jovana Tomaševića 9/III, Podgorica ME

(511) **Klasa 11:** aparati i instalacije za klimatizaciju, aparati i instalacije za prečišćavanje vazduha, aparati i instalacije za ventilaciju, aparati i instalacije za hlađenje vazduha, aparati i instalacije za grijanje vazduha, aparati i instalacije za povećavanje vlažnosti vazduha, aparati i instalacije za smanjenje vlažnosti vazduha, grijači vode, dijelovi i oprema za svu gore pomenutu robu

(210) **2012-379** (442) **20.09.2014.**

(220) 9/11/2012

(731) **MAJA BOGOJEVIĆ,** CRNOGORSKIH SERDARA BB, 81000 PODGORICA ME



(540)

(550) I

(511) **Klasa 41:** obrazovne usluge, pripremanje obuke, razonoda, sportske i kulturne aktivnosti
Klasa 42: naučne i tehnološke usluge i istraživanje i projektovanje u vezi navedenih usluga, usluge industrijske analize i istraživanja, projektovanje i razvoj kompjuterskog hardvera i softvera.

(210) **2012-381** (442) **20.09.2014.**

(220) 9/13/2012

(731) **TEHNO PLUS DOO,** CETINJSKI PUT BR. 36, 81000 PODGORICA ME



(540)

(550) I

(511) **Klasa 07:** mašine i mašinski alati, motori i pogonske mašine (osim za suvozemna vozila), mašinske spojnice i transmisioni elementi (osim za suvozemna vozila), poljoprivredne sprave osim onih kojima se ručno upravlja, inkubatori za jaja

Klasa 09: aparati i instrumenti naučni, pomorski, geodetski, fotografski, kinematografski, optički, za vaganje, merenje, signalizaciju, kontrolu (inspekciju), spašavanje i nastavu, aparati i instrumenti za provođenje, prekid, transformaciju, akumulaciju, regulisanje ili kontrolu električne energije, aparati za snimanje, prenos i reprodukovanje zvuka ili slike, magnetni nosioci podataka, diskovi za snimanje, automatske mašine i mehanizmi za aparate koji se pokreću novcem ili žetonom, registar kase, računске mašine, oprema za obradu podataka i kompjuteri, aparati za gašenje požara

Klasa 11: aparati za osvetljavanje, grejanje, proizvodnju pare, kuvanje, hlađenje, sušenje, ventilaciju, snabdevanje vodom i za sanitarne svrhe

(210) **2012-382**

(442) **20.09.2014.**

(220) 9/13/2012

(731) **TEHNO PLUS DOO**, CETINJSKI PUT BR. 36, 81000 PODGORICA ME



(540)

(550) I

(511) **Klasa 07:** mašine i mašinski alati, motori i pogonske mašine (osim za suvozemna vozila), mašinske spojnice i transmisioni elementi (osim za suvozemna vozila), poljoprivredne sprave osim onih kojima se ručno upravlja, inkubatori za jaja

Klasa 09: aparati i instrumenti naučni, pomorski, geodetski, fotografski, kinematografski, optički, za vaganje, merenje, signalizaciju, kontrolu (inspekciju), spašavanje i nastavu, aparati i instrumenti za provođenje, prekid, transformaciju, akumulaciju, regulisanje ili kontrolu električne energije, aparati za snimanje, prenos i reprodukovanje zvuka ili slike, magnetni nosioci podataka, diskovi za snimanje, automatske mašine i mehanizmi za aparate koji se pokreću novcem ili žetonom, registar kase, računске mašine, oprema za obradu podataka i kompjuteri, aparati za gašenje požara

Klasa 09: aparati i instrumenti naučni, pomorski, geodetski, fotografski, kinematografski, optički, za vaganje, merenje, signalizaciju, kontrolu (inspekciju), spašavanje i nastavu, aparati

i instrumenti za provođenje, prekid, transformaciju, akumulaciju, regulisanje ili kontrolu električne energije, aparati za snimanje, prenos i reprodukovanje zvuka ili slike, magnetni nosioci podataka, diskovi za snimanje, automatske mašine i mehanizmi za aparate koji se pokreću novcem ili žetonom, registar kase, računске mašine, oprema za obradu podataka i kompjuteri, aparati za gašenje požara

Klasa 11: aparati za osvetljavanje, grejanje, proizvodnju pare, kuvanje, hlađenje, sušenje, ventilaciju, snabdevanje vodom i za sanitarne svrhe

(210) **2012-383**

(442) **20.09.2014.**

(220) 9/13/2012

(731) **TEHNO PLUS DOO**, CETINJSKI PUT BR. 36, 81000 PODGORICA ME



(540)

(550) I

(511) **Klasa 07:** mašine i mašinski alati, motori i pogonske mašine (osim za suvozemna vozila), mašinske spojnice i transmisioni elementi (osim za suvozemna vozila), poljoprivredne sprave osim onih kojima se ručno upravlja, inkubatori za jaja (objašnjenje klasa 07 uključuje uglavnom mašine, mašinske alate, motore i mašine, ova klasa uključuje posebno:- delove motora i mašina (svih vrsta), električne mašine i aparate za čišćenje. ova klasa ne uključuje posebno, specijalne mašine i mašinske alate (nalaze u drugim klasama), ručne alate i sprave kojima se ručno upravlja (klasa 08), motore i mašine za kopnena vozila (klasa 12)

Klasa 09: aparati i instrumenti naučni, pomorski, geodetski, fotografski, kinematografski, optički, za vaganje, merenje, signalizaciju, kontrolu (inspekciju), spašavanje i nastavu, aparati i instrumenti za provođenje, prekid, transformaciju, akumulaciju, regulisanje ili kontrolu električne energije, aparati za snimanje, prenos i reprodukovanje zvuka ili slike, magnetni nosioci podataka, diskovi za snimanje, automatske mašine i mehanizmi za aparate koji se pokreću novcem ili žetonom, registar kase, računске mašine, oprema za obradu podataka i kompjuteri, aparati za gašenje požara (objašnjenje ova klasa uključuje posebno, aparate i instrumente za naučna ispitivanja u laboratorijama, aparate i instrumente za kontrolu brodova, kao i aparate i instrumente za vršenje prenosa i razvoda, sledeće električne aparate i instrumente: (a) izvesne elektrotermičke sprave i aparate, kao što su električni aparati za lemljenje, ravnjanje, peglanje a ako nisu električni, pripadaju klasi 08, (b) aparate i sprave, ukoliko nisu električni, mogli bi pripadati različitim klasama, tj. električno grajana odeća, električni upaljači za automobile, uglomeri, kancelarijske mašine sa perforiranim karticama, aparati za razonodu koji koriste spoljni ekran ili monitor, svi kompjuterski programi i softveri bez obzira na medijum na koji su snimljeni ili način diseminacije tj. softver snimljen na magnetnim nosačima podataka ili učitani sa udaljene kompjuterske mreže, ova klasa ne uključuje posebno, sledeće električne aparate i instrumente, (a) elektromehaničke aparate za kuhinju (rezalice i miksera za hranu, voćne prese, električne mlinove za kafu, itd) i izvesne druge aparate i instrumente koje pokreće električni motor (klasa 07), (b) električne briače i šišače (ručne naprave) (klasa 08), (c) električne četkice za zube i češljeve (klasa 21), (d)

električne aparate za zagrevanje prostora ili tečnosti, za kuvanje, ventilaciju, itd, (klasa 11), časovnike i satove i druge instrumente za merenje vremena (klasa 14), kontrolne satove (klasa 14)

Klasa 11: aparati za osvetljavanje, grejanje, proizvodnju pare, kuvanje, hlađenje, sušenje, ventilaciju, snabdevanje vodom i za sanitarne svrhe, (objašnjenje ova klasa uključuje posebno, erkondišan aparate, grejače kreveta, posude za toplu vodu, bojlere, električne ili ne-električne, električno grejane jastuke i ćebad, koji nisu za medicinsku upotrebu, električne kazane, električne sprave za kuvanje, ova klasa ne uključuje posebno: aparate za proizvodnju pare (kao delove mašina) (klasa 07), električno grejanu odeću (klasa 09)

(210) **2012-384**

(442) **20.09.2014.**

(220) 9/13/2012

(731) **TEHNO PLUS DOO**, CETINJSKI PUT BR. 36, 81000 PODGORICA ME



(540)

(550) I

(511) **Klasa 07:** mašine i mašinski alati, motori i pogonske mašine (osim za suvozemna vozila), mašinske spojnice i transmisioni elementi (osim za suvozemna vozila), poljoprivredne sprave osim onih kojima se ručno upravlja, inkubatori za jaja

Klasa 09: aparati i instrumenti naučni, pomorski, geodetski, fotografski, kinematografski, optički, za vaganje, merenje, signalizaciju, kontrolu (inspekciju), spašavanje i nastavu, aparati i instrumenti za provođenje, prekid, transformaciju, akumulaciju, regulisanje ili kontrolu električne energije, aparati za snimanje, prenos i reprodukovanje zvuka ili slike, magnetni nosioci podataka, diskovi za snimanje, automatske mašine i mehanizmi za aparate koji se pokreću novcem ili žetonom, registar kase, računске mašine, oprema za obradu podataka i kompjuteri, aparati za gašenje požara.

Klasa 11: aparati za osvetljavanje, grejanje, proizvodnju pare, kuvanje, hlađenje, sušenje, ventilaciju, snabdevanje vodom i za sanitarne svrhe

(210) **2012-385**

(442) **20.09.2014.**

(220) 9/14/2012

(731) **INTERNATIONAL TRADEMARK AGENCY LTD**, Global Gaeway 8, Rue de la Perle, Mahe Seychelles

AXIS

(540)

(550) I

(511) **Klasa 07:** Mašine i mašinski alati; motori i pogonske mašine (osim za suvozemna vozila); mašinske spojnice i transmisioni elementi (osim za suvozemna vozila); poljoprivredne sprave osim onih kojima se ručno upravlja; inkubatori zajaja; automatske mašine za prodaju

Klasa 09: električni aparati i instrumenti za ulaz, obradu, prenos, skladištenje i izlaz podataka; kompjuterska oprema za obradu; kompjuteri i mini kompjuteri; hardver, periferni uređaji i procesori svi za upotrebu zajedno sa kompjuterima, kamerama, mrežnim video proizvodima i štampačima; kućišta za kamere; sočiva za kamere; oprema za napajanje, džojstik uređaji, osvetljivači (koji nisu za medicinsku upotrebu), kablovi i konektori, instalacioni displeji sve za upotrebu zajedno sa kamerama, mrežnim video proizvodima i instalacijama za nadzor; printer serveri, serveri za pohranjivanje podataka; serveri za kamere, video koderi; kontrolori štampača, konverteri protokola, multiplekseri, kompjuterske interfejs table; table sa štampanim kolima; čipovi (integrisana kola); elektronski uređaji za upotrebu u kombinaciji sa kompjuterima ili kao integralni delovi kompjutera ili u kompjuterskim mrežama, kompjuterski programi i softver; softver za video upravljanje; aparati za snimanje, primanje, prenos ili reprodukciju zvuka ili slika, prenos ili reprodukciju informacija i slika preko globalne mreže i/ili preko drugih mreža; aparati za video nadzor; kamere, digitalne kamere, mrežne kamere, IP-kamere ili we6 kamere; video rekorderi i video plejeri; mrežni video proizvodi; aparati za kontrolu pristupa; instalacije za kontrolu pristupa; aparati za sigurnosni nadzor; električne i elektronske instalacije za video nadzor; elektronski časopisi i publikacije (koje se mogu skinuti sa mreže); marketinški materijal, tehničke informacije i prezentacije na CD-y/ DVD-y; koji nisu za sisteme za upravljanje informacijama kao što su upravljanje odnosima sa dobavljačima, poslovna inteligencija, logistika, materijalno upravljanje, reinženjering i upravljanje poslovnim procesima; koji nisu za automatsku integraciju podataka ili razmenu podataka o poslovnim procesima

Klasa 35: ugovaranje poslovnih i finansijskih kontakata, takođe preko interneta; distribucija robe u reklamne svrhe; promocija robe i usluga za druge; obezbeđenje onlajn baze podataka sa komercijalnim informacijama za pretragu, takođe preko interneta; poslovne usluge, naime, obezbeđenje kompjuterskih baza podataka u vezi sa kupovinom ili prodajom različitih vrsta robe i usluga u ime drugih; usluge maloprodaje u polju digitalnih kamera, mrežnih kamera i we6 kamera, IP-kamera, video koderi, video dekoderi, aparata za kontrolu pristupa, kompjutera, kompjuterskih programa, softvera za video upravljanje, perifernih uređaja i opreme za kamere i kompjutere; usluge distribucije, uključujući poslove veleprodaje u vezi sa digitalnim kamerama, mrežnim kamerama, we6 kamerama, IP-kamerama, video koderima, video dekoderima, aparatima za kontrolu pristupa, kompjuterima, kompjuterskim programima, softverom za video upravljanje, perifernim uređajima i opremom za kamere i kompjutere; organizovanje izložbi u komercijalne svrhe, usluge nabavke za druge (kupovina robe i usluga za druge firme), komercijalna administracija licenciranja; koje nisu za sisteme za upravljanje informacijama kao što su upravljanje odnosima sa dobavljačima, poslovna

inteligencija, logistika, materijalno upravljanje, reinženjering i upravljanje poslovnim procesima; koje nisu za automatsku integraciju podataka ili razmenu podataka o poslovnim procesima

Klasa 41: podučavanje/obrazovanje; organizovanje uputstava/instrukcija; organizovanje i vođenje konferencija, kongresa, seminara, radionica i simpozijuma; uputstva, praktični trening (demonstracije); objavljivanje tekstova koji nisu reklamni tekstovi; obezbeđenje on-lajn elektronskih publikacija (koje se mogu skinuti sa mreže); obrazovne akademije; sertifikovanje obrazovnih nagrada i nagrada iz obuke; objavljivanje knjiga; koje nisu za sisteme za upravljanje informacijama kao što su upravljanje odnosima sa dobavljačima, poslovna inteligencija, logistika, materijalno upravljanje, reinženjering i upravljanje poslovnim procesima; koje nisu za automatsku integraciju ili razmenu podataka o poslovnim procesima

Klasa 42: tehnička ekspertiza; razvoj elektronskih aparata za nadzor; kompjuterske konsalting usluge u vezi sa dizajnom programa za mikroprocesore, kompjutersku infrastrukturu, kompjuterski hardver, kompjuterski softver, osavremenjivanje kompjuterskih programa za obradu teksta, videa, slika i podataka; konsultantske aktivnosti u obliku testiranja i konsultacija za razvoj novih proizvoda i razvoj novih proizvoda; konsultacije i istraživanje u oblasti video nadzora, aparata za kontrolu pristupa, video tehnika, tehnika za kamere, procesiranje slika, sistemsku integraciju i snimljene kompjuterske programe; razvoj kompjuterskih sistema, dizajn i razvoj proizvoda (hardver i softver) za druge u oblasti video nadzora, aparata za kontrolu pristupa, kompjutera, softvera, obrade slika, video i tehnika za kamere; inženjering; obezbeđenje tehničkog znanja; industrijski dizajn, kompjutersko programiranje, analize kompjuterskog sistema; dizajn softvera; održavanje i podrška softveru, osavremenjavanje softvera; odobravanje pristupnog vremena bazama podataka; hostovanje kompjuterskih sajtova (we6 sajtova); održavanje i kreiranje we6 sajtova za druge; koje nisu za sisteme za upravljanje informacijama kao što su upravljanje odnosima sa dobavljačima, poslovna inteligencija, logistika, materijalno upravljanje, reinženjering i upravljanje poslovnim procesima; koje nisu za automatsku integraciju podataka ili razmenu podataka o poslovnim procesima

Klasa 45: usluge u vezi sa elektronskim nadzorom, alarmima protiv provalnika, sigurnošću, sigurnosnim alarmima, sigurnosnim sistemima i sistemima za kontrolu pristupa u sigurnosne svrhe; usluge kompjuterizovanog nadzora u vezi sa provalom i ulaskom; iznajmljivanje aparata za sigurnosni nadzor; licenciranje softvera, licenciranje znanja; licenciranje intelektualne svojine: koje nisu za sisteme za upravljanje informacijama kao što su upravljanje odnosima sa dobavljačima, poslovna inteligencija, logistika, materijalno upravljanje, reinženjering i upravljanje poslovnim procesima; koje nisu za automatsku integraciju podataka ili razmenu podataka o poslovnim procesima

(210) **2012-386**

(442) **20.09.2014.**

(220) 9/19/2012

(731) **AMERICAN INTERNATIONAL GROUP, INC.** 180 MAIDEN LANE, NEW YORK, NY 10038 US



(540)

(550) I

(740) AOD "Ćupić", Dalmatinska 10, Podgorica ME

(511) **Klasa 36:** osiguranje, finansijski poslovi, monetarni poslovi, poslovi s nekretninama, usluge preuzimanja rizika osiguranja iz područja nesreće i zdravlja, automobilskog i rekreacijskog vozila, vazduhoplovstva, prekida poslovanja, upravljanja krizama u poslovanju, odgovornosti direktora i službenika, invalidnosti, dobrobiti zaposlenih, odgovornosti zaposlenih na praksi, ekološke odgovornosti, grešaka i propusta, u slučaju otkaza, lojalnosti i kriminala, fiducijarne odgovornosti, prevare, opšte odgovornosti, domovinske bezbjednosti i terorizama, krađe identiteta, otmice i otkupnine/ucjene, osiguranja života, hipotekarne garancije, sigurnosti mreže i privatnosti, odgovornosti za proizvod, profesionalne odgovornosti, imovine i nezgoda, reosiguranja, jamca, trgovačkog kredita i političkog rizika, putovanja, i nadoknade za radnike, usluge upravljanja finansijskim rizicima, osiguranje renti, izdavanje i upravljanje anuitetima, finansijska uprava penzijskim planovima, usluge investicijskih savjetnika, upravljanje investicijama, ulaganje u zajednički investicijski fond, usluge ustupanja hipoteka na nekretninama, upravljanje nekretninama/usluge investiranja, usluge rata kredita, usluge posredovanja u osiguranju i agencijske usluge u području polovnih aviona

(210) **2012-387**(442) **20.09.2014.**

(220) 9/19/2012

(731) **AMERICAN INTERNATIONAL GROUP, INC.** 180 MAIDEN LANE, NEW YORK, NY 10038 US



(540)

(550) I

(740) AOD "Ćupić", Dalmatinska 10, Podgorica ME

(511) **Klasa 36:** osiguranje, finansijski poslovi, monetarni poslovi, poslovi s nekretninama, usluge preuzimanja rizika osiguranja iz područja nesreće i zdravlja, automobilskog i rekreacijskog vozila, vazduhoplovstva, prekida poslovanja, upravljanja krizama u poslovanju, odgovornosti direktora i službenika, invalidnosti, dobrobiti zaposlenih, odgovornosti zaposlenih na praksi, ekološke odgovornosti, grešaka i propusta, u slučaju otkaza, lojalnosti i kriminala, fiducijarne odgovornosti, prevare, opšte odgovornosti, domovinske bezbjednosti i terorizama, krađe identiteta, otmice i otkupnine/ucjene, osiguranja života, hipotekarne garancije, sigurnosti mreže i privatnosti, odgovornosti za proizvod, profesionalne odgovornosti, imovine i nezgoda, reosiguranja, jamca, trgovačkog kredita i političkog rizika, putovanja, i nadoknade za radnike, usluge upravljanja finansijskim rizicima, osiguranje renti, izdavanje i upravljanje

anuitetima, finansijska uprava penzijskim planovima, usluge investicijskih savjetnika, upravljanje investicijama, ulaganje u zajednički investicijski fond, usluge ustupanja hipoteka na nekretninama, upravljanje nekretninama/usluge investiranja, usluge rata kredita, usluge posredovanja u osiguranju i agencijske usluge u području polovnih aviona

(210) **2012-388**

(442) **20.09.2014.**

(220) 9/20/2012

(731) **WM.WRIGLEY JR. COMPANY**, 1132 WEST BLACKHAWK STREET, CHICAGO, ILLNOIS 60642 US



(540)

(550) I

(740) Čejović Vladimir, 13. jula 21, Podgorica ME

(511) **Klasa 30:** konditorski proizvodi, bombone, dražeje peperminta, mali okrugli bomboni (drops)i pastile

(210) **2012-390**

(442) **20.09.2014.**

(220) 9/21/2012

(300) 16396 29.06.2012. 31.08.2012. LI

(731) **MOTOROLA TRADEMARK HOLDINGS**, LLC, 600 NORTH US HIGHWAY 45, LIBERTYVILLE, IL 60048 US

(540) SMARTACTIONS

(550) I

(740) Čejović Vladimir, 13. jula 21, Podgorica ME

(511) **Klasa 09:** Kompjuterski softver i aplikacije za kompjuterski softver za upravljanje mobilnim telefonima, pametnim telefonima (smartphones) i drugim mobilnim uređajima, softver i aplikacijsko programski interfejs (API) za upotrebu u prilagođavanju postavki, optimiziranju snage, automatizaciji zadataka, i personalizaciji korisničkog iskustva na mobilne telefone, pametne telefone (smartphones) i druge mobilne uređaje na temelju korisničkog konteksta, okoline, aktivnosti, modaliteta, ponašanja, mjesta i vremena

(210) **2012-391**

(442) **20.09.2014.**

(220) 9/24/2012

(731) **GANT AB**, P.O. BOX 27021, 102 51 STOCKHOLM SE

(540) GANT

(550) I

(511) **Klasa 03:** sredstva za beljenje i druge spustance za upotrebu u perionicama, preparati za čišćenje, poliranje, ribanje i nagrizanje, sapuni, parfimerija, eterična ulja, kozmetika, losioni za kosu, paste za zube

Klasa 09: aparati i instrumenti naučni, pomorski, geodetski, fotografski, kinematografski, optički, za vaganje, merenje, signalizaciju, kontrolu (inspekciju), spašavanje i nastavu, aparati i instrumenti za provođenje, prekid, transformaciju, akumulaciju, regulisanje ili kontrolu električne energije, aparati za snimanje, prenos i reprodukovanje zvuka ili slike, magnetni nosioci podataka, diskovi za snimanje, automatske mašine i mehanizmi za aparate koji se pokreću novcem ili žetonom, registar kase, računске mašine, oprema za obradu podataka i kompjuteri, aparati za gašenje požara

Klasa 14: dragoceni metali i njihove legure i proizvodi od dragocenih metala ili sa prevlakom od njih, koji nisu uključeni u druge klase, nakit, bižuterija, drago kamenje, časovničarski i hronometrijski instrumenti

Klasa 35: oglašavanje, vođenje poslova, poslovno upravljanje, kancelarijski poslovi

(210) **2012-392**

(442) **20.09.2014.**

(220) 9/24/2012

(731) **ALKALOID AD-SKOPLJE**, BUL. ALEKSANDAR MAKEDONSKI 12, 1000 SKOPLJE RM



(540)

(550) I, F

(740) Popović Miladin, Đoka Miraševića 21/III, Podgorica ME

(511) **Klasa 29:** sušeno voće, sušeno sjeme

Klasa 30: musli, smješe žitarica

(210) **2012-393**

(442) **20.09.2014.**

(220) 9/24/2012

(731) **ALKALOID AD-SKOPLJE**, BUL. ALEKSANDAR MAKEDONSKI 12, 1000 SKOPLJE RM



(540)

(550) I, F.

(740) Popović Miladin, Đoka Miraševića 21/III, Podgorica ME

(511) **Klasa 29:** Sušeno voće, sušeno sjeme**Klasa 30:** musli, smješe žitarica(210) **2012-394**(442) **20.09.2014.**

(220) 9/24/2012

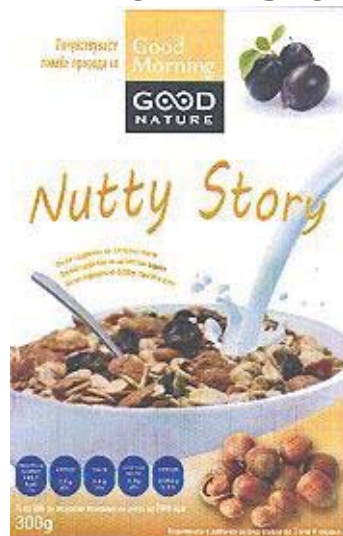
(731) **ALKALOID AD-SKOPLJE**, BUL. ALEKSANDAR MAKEDONSKI 12, 1000 SKOPLJE RM

(540)

(550) I, F

(740) Popović Miladin, Đoka Miraševića 21/III, Podgorica ME

(511) **Klasa 29:** Sušeno voće, sušeno sjeme**Klasa 30:** musli, smješe žitarica(210) **2012-395**(442) **20.09.2014.**

(220) 9/24/2012

(731) **ALKALOID AD-SKOPLJE**, BUL. ALEKSANDAR MAKEDONSKI 12, 1000 SKOPLJE RM

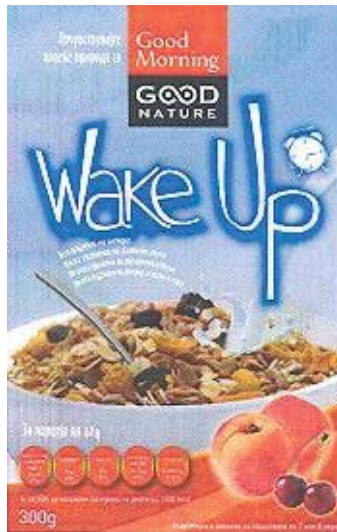

(540)

(550) I, F

(740) Popović Miladin, Đoka Miraševića 21/III, Podgorica ME

(511) **Klasa 29:** Sušeno voće, sušeno sjeme**Klasa 30:** musli, smješe žitarica(210) **2012-397**(442) **20.09.2014.**

(220) 9/26/2012

(731) **GLAXO GROUP LIMITED**, 980 GREAT WEST ROAD, BRENTFORD, MIDDLESEX, TW89GS
GB

(540) RELVAR

(550) I

(740) Lutovac Branislav, Bulevar Crnojevića 93, Podgorica ME

(511) **Klasa 05:** farmaceutski i medicinski preparati i supstance, a sve za prevenciju, liječenje i/ili ublažavanje respiratornih oboljenja i poremećaja(210) **2012-398**(442) **20.09.2014.**

(220) 9/26/2012

(731) **GLAXO GROUP LIMITED**, 980 GREAT WEST ROAD, BRENTFORD, MIDDLESEX, TW89GS
GB

(540) REVINTY

(550) I

(740) Lutovac Branislav, Bulevar Crnojevića 93, Podgorica ME

(511) **Klasa 05:** farmaceutski i medicinski preparati i supstance(210) **2012-399**(442) **20.09.2014.**

(220) 9/26/2012

(731) **GLAXO GROUP LIMITED**, 980 GREAT WEST ROAD, BRENTFORD, MIDDLESEX, TW89GS
GB

(540) ELLIPTA

(550) I

(740) Lutovac Branislav, Bulevar Crnojevića 93, Podgorica ME

(511) **Klasa 05:** farmaceutski preparati i supstance za liječenje i ublažavanje respiratornih tegoba, i inhalatori sa farmaceutskim preparatima za liječenje i ublažavanje respiratornih

poremećaja

Klasa 10: medicinski i hirurški aparati i instrumenti, a naročito inhalatori, i djelovi i oprema za naprijed navedenu robu

(210) **2012-400** (442) **20.09.2014.**

(220) 9/26/2012

(731) **GLAXO GROUP LIMITED**, 980 GREAT WEST ROAD, BRENTFORD, MIDDLESEX, TW89GS GB

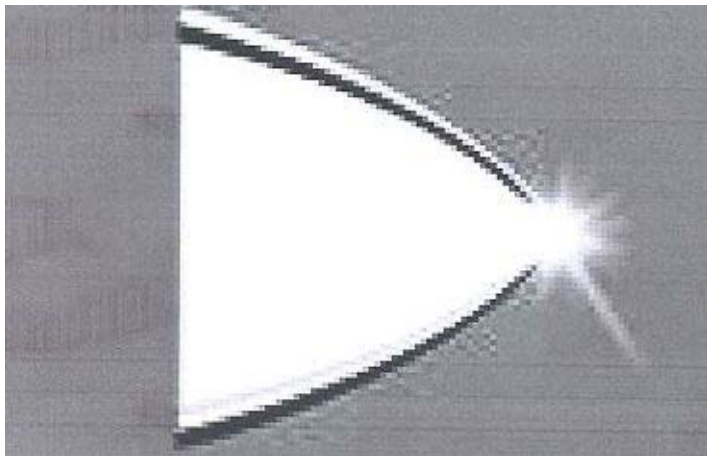

(540)

(550) I, F

(740) Popović Miladin, Đoka Miraševića 21/III, Podgorica ME

(511) **Klasa 05:** farmaceutski i medicinski preparati i supstance za ljudsku upotrebu, ljepljivi zavoji za medicinske svrhe

Klasa 10: hirurški, medicinski, zubarski i veterinarski aparati, oprema i instrumenti, jastučići i zavoji za grijanje za terapijsko liječenje, aparati za terapiju grijanjem

(210) **2012-401** (442) **20.09.2014.**

(220) 10/1/2012

(300) 85/585, 622 30.032012. US

(731) **LENOVO (BEIJING) LIMITED**, NO.6 CHUANGYE ROAD, SHANGDI INFORMATION INDUSTRY BASE, HAIDIAN DISTRICT, BEIJING 100085 CN

(540) YOGA

(550) I, V

(740) AOD "Ćupić", Dalmatinska 10, Podgorica ME

(511) **Klasa 09:** kompjuteri, naime prenosivi kompjuteri i tablete, uključujući softer i periferije za iste

(210) **2012-433** (442) **20.09.2014.**

(220) 10/30/2012

(300) 85/614269 02.05.2012. US

(731) **GENERAL MOTORS LLC**, 300 RENAISSANCE CENTER, DETROIT, MICHIGAN 48265-3000 US

(540) DURALIFE

(550) I

(740) Radulović Božidar, Jovana Tomaševića 9/III, Podgorica ME

(511) **Klasa 12:** kočioni diskovi za suvozemna putnička vozila

(210) **2012-434** (442) **20.09.2014.**
(220) 10/30/2012
(300) 85/614269 02.05.2012 US
(731) **CHRYSLER GROUP LLC**, 1000 CHRYSLER DRIVE, AUBURN HILLS, MICHIGAN 48326 US
(540) CHEROKE
(550) I, V
(740) Radulović Božidar, Jovana Tomaševića 9/III, Podgorica ME
(511) **Klasa 12:** motorna vozila i djelovi za njih

(210) **2012-435** (442) **20.09.2014.**
(220) 10/31/2012
(731) **VOITH GMBH**, SANKT POLTENER STRASSE 43, 89522 HEIDENHEIM DE
(540) VOITH
(550) I
(740) Lutovac Branislav, Bulevar Crnojevića 93, Podgorica ME
(511) **Klasa 07:** vodene turbine, generatori, hidroenergetska oprema, fransisove, peltonove i kaplanove turbine, kaplanovečevne turbine, pumpneturbine, akumulacione turbine, akumulacione pumpe, radijalne semi-aksijalne i aksijalne pumpe, zaustavni ventili, naime ventili, kuglični ventili, propusni ventili, Voith-Schneider propeleri, prenosni sistemi za menjače, kvačila i kočnice za mašine i za vazдушna i vodena vozila, elektromehanički pogonski sistemi, pogoni za upotrebu otpadne toplote iz motora sa unutrašnjim sagorevanjem, motori, hibridni prenosni sistemi, pramci, turbošaržeri, kompresori za vazduh, obrtni pretvarači, prenosne osovine i kardanske osovine, Hirth ozubljenja, aktuatori i kontrolni sistemi za turbo mašineriju, pumpe, ventili, mašinerija za proizvodnju i obradu papira, kartona, tabli od papirne mase, netkani tekstil, i djelovi za istu

Klasa 09: mjerni, regulacioni i kontrolni sistemi, električne kontrolne jedinice, sistemi za kontrolu procesa, naime elektronski i električni uređaji za prenos procedura ili signala, merni instrumenti, kontrolori, kontrolni aparati, vučni pretvarači

Klasa 11: sistemi za hlađenje, pogoni za obradu vode, mašine za hlađenje, ventilaciju i sušenje

Klasa 12: menjači, usporivači (retarder) i prigušivacitorzionih vibracija, hibridni pogoni za autobuse, nezavisni sistemi vešanja i krute osovine za autobuse, pogonski sistemi za šinska vozila, kao što su turbo prenosnici, finalni pogoni i diferencijali sa automatskim zaključavanjem, locomotive, brodska kormila, stabilizacioni sistemi za brodove, prednji djelovi za agregate

Klasa 24: podloge za oblikovanje papira ili tkanine, čoje za oblikovanje papira ili tkanine, podloge za presovanje papira ili tkanine, čoje za presovanje papira ili tkanine

Klasa 35: Poslovno upravljanje, kancelarijski poslovi, privremeno zapošljavanje

Klasa 36: osiguranje, upravljanje nepokretnostima

Klasa 37: servisiranje, održavanje, popravlanje i čišćenje zgrada i industrijskih pogona, iznajmljivanje mašina za čišćenje, usluge instaliranja, održavanja i popravlanja mašinerije

Klasa 38: usluge u vezi sa telekomunikacijom

Klasa 39: transport, pakovanje i skladištenje robe

Klasa 40: obrada materijala

Klasa 41: obrazovanje, obezbeđivanje obuke, zabava

Klasa 42: naučne i tehnološke usluge, kao i usluge istraživanja i projektovanja u vezi sa njima,

usluge industrijskih analiza i istraživanja, projektovanje i razvoj računarskog hardvera i sofvera

Klasa 43: usluge obezbeđivanja hrane i pića

Klasa 44: usluge poljoprivrede, hortikulture i šumarstva

Klasa 45: usluge obezbeđenja za zaštitu imovine i lica

(210) **2012-436** (442) **20.09.2014.**

(220) 10/31/2012

(731) **KRAFT FOODS DEUTSCHLAND HOLDING GMBH**, LANGEMARCKSTRASSE 4-20, 28199 BREMEN DE

(540) SWEET BREAK

(550) I

(740) AOD "Ćupić", Dalmatinska 10, Podgorica ME

(511) **Klasa 30:** kafa, ekstrakti kafe, zamjene za kafu, kakao, čokolada, napitci od kakaoa, napitci od čokolade i napitci od kafe i preparati za takve napitke, čaj, pekarski proizvodi, biskviti, peciva i konditorski proizvodi, naročito šećerni i čokoladni konditorski proizvodi, proizvodi od tijesta, proizvodi od žitarica, jestivi led

(210) **2012-437** (442) **20.09.2014.**

(220) 11/1/2012

(731) **AKCIONARSKO DRUŠTVO ZA TURIZAM, UGOSTITELJSTVO, SAOBRAĆAJ I TRGOVINU INTOURS PODGORICA**, TRG GOLOOTOČKIH ŽŽRTAVA B.B. 81000 PODGORICA ME



(540)

(550) I, F

(511) **Klasa 35:** reklamiranje i oglašavanje korisnika usluga autobuske stanice

Klasa 39: prijem i otpremu putnika, autobusa i prtljaga u međumjesnom i međunarodnm linijskom i slobodnom drumskom saobraćaju, prodaju autobuskih karata, usluge rezervacije i čuvanje mjesta u autobusu, koje putnik ima pravo koristitič, primanje prtljaga na čuvanje (garderoba), osiguranje parking prostora za autobuse i automobile, u skladu sa svojim mogućnostima, pružanje informacije putnicima o redu vožnje putem razglasa, telefona i usmeno, djelatnost turističke agencije, evidenciju o redu vožnje, posredovanje kod prijema i otpreme pošiljki putnika

(210) **2012-439** (442) **20.09.2014.**

(220) 11/2/2012

(731) **MONSOON ACCESSORIZE LIMITED**, NOTTING HILL VILLAGE 1 NICHOLAS ROAD
LONDON W11 4AN GB

(540) ACCESSORIZE

(550) I, V

(511) **Klasa 03:** sapuni za ličnu upotrebu, šamponi, parfemi, toaletne vode, kolonjske vode, kozmetika, nemedicinski toaletni preparati za održavanje i negu kože, tela i kože glave, preparati za depilaciju, nemedicinski preparati za kosu, paste za zube, eterična ulja, anti-perspiranti, preparati za kupanje i tuširanje, ulja za kupanje, soli za kupanje, puder u prahu, ulja za aromaterapiju, mirisi, karmini, sjaj za usne, melem za usne, olovka za usne, lažni nokti, proizvodi i preparati za čišćenje, ukrašavanje, negu i tretman noktiju

Klasa 09: aparati za negu kose na gas, katalitičko sagorevanje ili električnu energiju, prese za kosu, prese za ispravljanje kose, vikleri i vikleri za kosu, delovi navedenih uređaja, električne pegle, vage za domaćinstvo i lica, mašine za računanje, futrole za džepne kalkulatore, električni kablovi, električni utikači, električni prekidači, delovi navedenih proizvoda, optički aparati i instrumenti, optička stakla i sočiva, naočare, naočare za sunce, okviri, sočiva, futrole, trake i lančići za naočare, kontaktna sočiva, futrole za mobilne telefone i maske, fotografski aparati i instrumenti, instrumenti i sve za prijem, prenos, snimanje i reprodukciju zvuka, vizuelnih slika i video snimaka, kompjuteri, kompjuterski programi i kompjuterske igre, nasnimljene ili prazne video kasete, CD-ovi, DVD-evi, kasete i trake, memorijski čipovi i USB-ovi

Klasa 14: Nakit i imitacije nakita, minduše, ogrlice, narukvice, lančići za nogu, broševi, prstenje, drago kamenje, ručni satovi i satovi, kristali za body art, nakit, nakit za telo, nakit za telo napravljen od kristala, kristalne tetovaže, plemeniti metali i njihove legure i proizvodi od plemenitih metala ili sa njihovom prevlakom, drago kamenje, delovi i pribor za sve navedene robe

Klasa 18: torbe, cegeri, tašne, torbe na rame, torbe za kupovinu, sportske torbe, torbice za oko struka, torbe i kutije za nošenje opreme za bebe, odojčad, decu i trudnice, kozmetičke torbice, prtljag, putne torbe, rančevi, školske torbe, akten tašne, novčanici, futrole za kreditne kartice, proizvodi izrađeni od kože ili imitacije kože, kišobrani i suncobrani, odeća za pse i mačke, ogrlice, povoci, torbe i ćebad za pse i mačke

Klasa 20: nameštaj, ogledala, okviri za slike, ekrani i uređaji za prikazivanje, ormani, kutije, kreveti i kanabei, zidne table, ekrani, police, regali i stalci, vreće za spavanje, tacne, stolovi, stolice, oprema za skladištenje, oprema za prodajne prostore, kuke i kvake, ornamenti i plakete

Klasa 21: pribor i kutije za domaćinstvo i kuhinju, staklo, porcelan, grnčarija i posude, posude za kuvanje, lonci, šerpe i posude, posude za pećnicu, roštilji, električni roštilji, ne-električni ručni mikseri, žžica za mućenje, mikseri, brusilice i mlinovi, ne-električni filteri za kafu, brusilice za kafu, cediljke za kafu i aparati za kafu, lončići za kafu i ručni aparati za kafu, lončići za čaj, cediljke za čaj i cediljke, daske za sečenje hleba, otvarači za boce i konzerve, otvarači za flaše i buteljke, prenosni hladnjači, kible za led i hladnjaci za vino, ne-električne voćne prese i cediljke za voće, presa za beli luk, kulinarski kalupi, separatori za jaja, sita i cediljke, cediljke sa stalkom, oprema sa pečenje, soda sifoni, ne-električne mašine za sladoled, regali i ploče za sušenje, poslužavnici, posude za piće, šolje, čaše, tanjiri, bokali, boce, tegle, pljoske, vakuum boce, boce za ulje i sirće, termički izolovane kutije za hranu i piće, kutije za ručak, piknik korpe i piknik torbe, vaze, nakit i predmeti za dekoraciju, svećnjaci, korpe za upotrebu u domaćinstvu, korpe za odpatke, četke, češljevi, mopovi i pjalice, prese za pantalone i četkice za zube

Klasa 25: komadi odeće, pokrivala za glavu, mašne, kupaći kostimi, odeća za plažu, obuća, pidžame, donji veš, rublje, sportska odeća, odeća za kišu, cipele, čizme, patike, rukavice, beretke, rukavice, šalovi, kape, kačketi, čarape, marama, ponča i kaiševi

Klasa 26: ukrasi za kosu, proizvodi za kosu, šnale za kosu, trake za kosu, pletenice, trake, čipke, vezovi i bedževi, dugmadi, kukice, čiode i jastučići, trake i pletenice, veštačko cveće

Klasa 35: oglašavanje, organizacija, rad i nadzor programa lojalnosti i prodaje i promotivnih podsticajnih šema, promotivnih usluga, poslovni konsalting, poslovne informacije, upravljanje računarskim bazama podataka, kompilacija informacija na kompjuterskim bazama podataka, savetodavne i konsultantske usluge u vezi sa bazom podataka menadžmenta i marketinga, analiza podataka, poslovna istraživanja i analiza, organizovanje izložbi ili sajмова za komercijalne ili reklamne svrhe, maloprodajne usluge povezane sa publikacijama, kancelarijski materijal, CD-ovi, DVD-ovi, magnetni nosioci podataka, diskovi za nasnimavanje, video igre, kompjuterske igre, muzički i audio vizuelni radovi koji su dostupni preko interneta, kao i preko drugih računarskih i elektronskih komunikacionih mreža, ili preko bežične tehnologije, računari i računarski softveri, telefoni i telekomunikacije, igračke, igre i sportska oprema, proizvodi za gradenje i uređivanje kuća iz programa 'uradi-sam', baštenske biljke i roba i oprema za bašte, električna i elektronska oprema za domaćinstva, šporeti, ringle, roštilji, frižideri, zamrzivači, frižider-zamrzivači, mikrotalasne pećnice, mašine za pranje veša, mašine za sušenje veša, usisivači, mašine za pranje sudova, hladnjaci za vino, grejači vode, kotlovi, kompaktori za otpatke, klima-uređaji, mašine za ručnu upotrebu, ručni alat, optička roba, kamere i fotografska roba. nakit, satovi, proizvodi za kupatilo i grejanje, odeća, kape, obuća, modni dodaci, kože i imitacije kože. tašne i prtljag, oprema za putovanja i dodaci, nameštaj. kućne posude i pribor, posude i proizvodi od stakla, nameštaj. tekstil, galanterija, naperi, kozmetika, proizvodi i usluge za zdravlje i lepotu. hrana i pića (alkoholna i bezalkoholna), hrana za kućne ljubimce, oprema i proizvodi za kućne ljubimce, duvanski proizvodi i pribor za pušače, aparati za negu kose na gas, katalitičko sagorevanje ili električnu energiju, prese za kosu, prese za ispravljanje kose, vikleri i vikleri za kosu; delovi navedenih uređaja; električne pegle, vage za domaćinstvo i lica; mašine za računanje, futrole za džepne kalkulatore; električni kablovi, električni utikači, električni prekidači: delovi navedenih proizvoda; optički aparati i instrumenti; optička stakla i sočiva; naočare; naočare za sunce; okviri; sočiva; futrole; trake i lančići za naočare; kontaktna sočiva; futrole za mobilne telefone i maske: fotografski aparati i instrumenti, instrumenti i sve za prijem, prenos, snimanje i reprodukciju zvuka, vizuelnih slika i video snimaka, kompjuteri, kompjuterski programi i kompjuterske igre, električni aparati za sušenje kose i prilozi, kao što su dizne ili difuzori za njih, stajajući ventilatori i grejalice na duvanje. aparati i uređaji za prečišćavanje, omekšavanje i filtriranje vode u domaćinstvu, aparati za prečišćavanje i vlaženje vazduha, delovi navedenih proizvoda, električnih uređaja za pravljenje jogurta, električni aparati za kafu, kapučino i espresso mašine, električno posuđe za kuvanje. aparati za roštilj, posebno tosteri i aparati za pečenje, fenovi za sušenje za kose na gas kao i na katalitičko sagorevanje i delovi navedenih dobara

(210) **2012-440**

(442) **20.09.2014.**

(220) 11/2/2012

(731) **BASF SE**, CARL-BOSCH-STRABE 38 D-67056 LUDWIGSHAFEN AM RHEIN DE

(540) PASSAT

(550) I

(740) Stanković Mugoša Ana, Trg Republike 13, Podgorica ME

(511) **Klasa 01:** hemikalije koje se koriste u poljoprivredi, hortikulturi i šumarstvu, naročito

preparati za jačanje biljaka, hemijski i/ili biološki preparati za kontrolu stresa kod biljaka, preparati za regulisanje rasta biljaka, hemijski preparati za tretiranje sjemena, površinski-aktivna sredstva, prirodne ili vještačke hemikalije koje se koriste kao seksualni mamci ili agensi za zbunjivanje insekata

Klasa 05: preparati za uništavanje i suzbijanje štetočina, insekticidi, fungicidi

Klasa 31: poljoprivredni proizvodi, proizvodi hortikulture i proizvodi šumarstva koji sadrže pesticide, sjemenje tretirano hemijskim i/ili biološkim proizvodima, žitarice, sjemenje i vegetativni djelovi biljaka koji nisu obuhvaćeni drugim klasama, herbicidi, pesticidi

(210) **2012-441**

(442) **20.09.2014.**

(220) 11/2/2012

(731) **MONSOON ACCESSORIZE LIMITED**, NOTTING HILL VILLAGE 1 NICHOLAS ROAD LONDON W11 4 AN GB

(540) MONSOON

(550) I, V

(511) **Klasa 03:** sapuni za ličnu upotrebu, šamponi, parfemi, toaletne vode, kolonjske vode, kozmetika, nemedicinski toaletni preparati za održavanje i negu kože, tela i kože glave, preparati za depilaciju, nemedicinski preparati za kosu, paste za zube, eterična ulja, anti-perspiranti, preparati za kupanje i tuširanje, ulja za kupanje, soli za kupanje, puder u prahu, ulja za aromaterapiju, mirisi, karmini, sjaj za usne, melem za usne, olovka za usne, lažni nokti, proizvodi i preparati za čišćenje, ukrašavanje, negu i tretman noktiju

Klasa 09: aparati za negu kose na gas, katalitičko sagorevanje ili električnu energiju, prese za kosu, prese za ispravljanje kose, vikleri i vikleri za kosu, delovi navedenih uređaja, električne pegle, vage za domaćinstvo i lica, mašine za računanje, futrole za džepne kalkulatore, električni kablovi, električni utikači, električni prekidači, delovi navedenih proizvoda, optički aparati i instrumenti, optička stakla i sočiva, naočare, naočare za sunce, okviri, sočiva, futrole, trake i lančići za naočare, kontaktna sočiva, futrole za mobilne telefone i maske, fotografski aparati i instrumenti, instrumenti i sve za prijem, prenos, snimanje i reprodukciju zvuka, vizuelnih slika i video snimaka, kompjuteri, kompjuterski programi i kompjuterske igre, nasnimljene ili prazne video kasete, CD-ovi, DVD-evi, kasete i trake, memorijski čipovi i USB-ovi

Klasa 14: nakit i imitacije nakita, minduše, ogrlice, narukvice, lančići za nogu, broševi, prstenje, drago kamenje, ručni satovi i satovi, kristali za body art, nakit, nakit za telo, nakit za telo napravljen od kristala, kristalne tetovaže, plemeniti metali i njihove legure i proizvodi od

Klasa 18: torbe, cegeri, tašne, torbe na rame, torbe za kupovinu, sportske torbe, torbice za oko struka, torbe i kutije za nošenje opreme za bebe, odojčad, decu i trudnice, kozmetičke torbice, prtljag, putne torbe, rančevi, školske torbe, akten tašne, novčanici, futrole za kreditne kartice, proizvodi izrađeni od kože ili imitacije kože, kišobrani i suncobrani, odeća za pse i mačke, ogrlice, povoci, torbe i ćebad za pse i mačke

Klasa 20: nameštaj, ogledala, okviri za slike, ekrani i uređaji za prikazivanje, ormani, kutije, kreveti i kanabei, zidne table, ekrani, police, regali i stalci, vreće za spavanje, tacne, stolovi, stolice, oprema za skladištenje, oprema za prodajne prostore, kuke i kvake, ornamenti i plakete

Klasa 21: pribor i kutije za domaćinstvo i kuhinju, staklo, porcelan, grnčarija i posude, posude za kuvanje, lonci, šerpe i posude, posude za pećnicu, roštilji, električni roštilji, ne-električni ručni mikseri, žica za mućenje, mikseri, brusilice i mlinovi, ne-električni filteri za kafu, brusilice za kafu, cediljke za kafu i aparati za kafu, lončići za kafu i ručni aparati za kafu, lončići za čaj, cediljke za čaj i cediljke, daske za sečenje hleba, otvarači za boce i konzerve, otvarači

za flaše i buteljke, prenosni hladnjači, kible za led i hladnjaci za vino, ne-električne voćne prese i cediljke za voće, presa za beli luk, kulinarski kalupi, separatori za jaja, sita i cediljke, cediljke sa stalkom, oprema sa pečenje, soda sifoni, ne-električne mašine za sladoled, regali i ploče za sušenje, poslužavnici, posude za piće, šolje, čaše, tanjiri, bokali, boce, tegle, pljoske, vakuum boce, boce za ulje i sirće, termički izolovane kutije za hranu i piće, kutije za ručak, piknik korpe i piknik torbe, vaze, nakit i predmeti za dekoraciju, svećnjaci, korpe za upotrebu u

Klasa 25: komadi odeće, pokrivala za glavu, mašne, kupaći kostimi, odeća za plažu, obuća, pidžame, donji veš, rublje, sportska odeća, odeća za kišu, cipele, čizme, patike, rukavice, beretke, rukavice, šalovi, kape. kačketi, čarape, marama, ponča i kaiševi

Klasa 26: ukrasi za kosu, proizvodi za kosu, šnale za kosu, trake za kosu, pletenice, trake, čipke, vezovi i bedževi, dugmadi, kukice, čiode i jastučići, trake i pletenice, veštačko cveće

Klasa 35: oglašavanje, organizacija, rad i nadzor programa lojalnosti i prodaje i promotivnih podsticajnih šema, promotivnih usluga, poslovni konsalting. poslovne informacije, upravljanje računarskim bazama podataka, kompilacija informacija na kompjuterskim bazama podataka, savetodavne i konsultantske usluge u vezi sa bazom podataka menadžmenta i marketinga, analiza podataka, poslovna istraživanja i analiza, organizovanje izložbi ili sajмова za komercijalne ili reklamne svrhe, maloprodajne usluge povezane sa publikacijama. kancelarijski materijal, CD-ovi, DVD-ovi, magnetni nosioci podataka, diskovi za nasnimavanje, video igre, kompjuterske igre, muzički i audio vizuelni radovi koji su dostupni preko interneta, kao i preko drugih računarskih i elektronskih komunikacionih mreža, ili preko bežične tehnologije, računari i računarski softveri, telefoni i telekomunikacije, igračke, igre i sportska oprema, proizvodi za gradenje i uređivanje kuća iz programa 'uradi-sam', baštenske biljke i roba i oprema za bašte, električna i elektronska oprema za domaćinstva, šporeti, ringle, roštilji, frižideri. zamrzivači, frižider-zamrzivači, mikrotalasne pećnice, mašine za pranje veša, mašine za sušenje veša, usisivači, mašine za pranje sudova, hladnjaci za vino, grejači vode, kotlovi, kompaktori za otpatke. klima-uređaji, mašine za ručni upotrebu, ručni alat, optička roba, kamere i fotografska roba. nakit, satovi, proizvodi za kupatilo i grejanje, odeća, kape, obuća, modni dodaci, kože i imitacije kože. tašne i prtljag, oprema za putovanja i dodaci, nameštaj. kućne posude i pribor, posude i proizvodi od stakla, nameštaj. tekstil, galanterija, naperi, kozmetika, proizvodi i usluge za zdravlje i lepotu. hrana i pića (alkoholna i bezalkoholna), hrana za kućne ljubimce, oprema i proizvodi za kućne ljubimce, duvanski proizvodi i pribor za pušaće, aparati za negu kose na gas, katalitičko sagorevanje ili električnu energiju, prese za kosu, prese za ispravljanje kose, vikleri i vikleri za kosu; delovi navedenih uređaja; električne pegle, vage za domaćinstvo i lica; mašine za računanje, futrole za džepne kalkulatore; električni kablovi, električni utikači, električni prekidači: delovi navedenih proizvoda; optički aparati i instrumenti; optička stakla i sočiva; naočare; naočare za sunce; okviri; sočiva; futrole; trake i lančići za naočare; kontaktna sočiva; futrole za mobilne telefone i maske: fotografski aparati i instrumenti, instrumenti i sve za prijem, prenos, snimanje i reprodukciju zvuka, vizuelnih slika i video snimaka, kompjuteri, kompjuterski programi i kompjuterske igre, električni aparati za sušenje kose i prilozi, kao što su dizne ili difuzori za njih, stajajući ventilatori i grejalice na duvanje. aparati i uređaji za prečišćavanje, omekšavanje i filtriranje vode u domaćinstvu, aparati za prečišćavanje i vlaženje vazduha, delovi navedenih proizvoda, električnih uređaja za pravljenje jogurta, električni aparati za kafu, kapučino i espresso mašine, električno posuđe za kuvanje. aparati za roštilj, posebno tosteri i aparati za pečenje, fenovi za sušenje za kose na gas kao i na katalitičko sagorevanje i delovi navedenih dobara.

(220) 11/5/2012

(731) **FARMACEVTSKA XEMISKA KOZMETIČKA INDUSTRIJA ALKALOID AD-SKOPLJE**, BUL. ALEKSANDAR MAKEDONSKI BR.12, 1000 SKOPLJE RM

(540) ALKALOID

(550) I, V

(740) Popović Miladin, Đoka Miraševića 21/III, Podgorica ME

(511) **Klasa 01:** hemijski proizvodi za industriju, nauku, fotografsku djelatnost, hortikulturu, poljoprivredu i šumarstvo, sirova veštačka smola, sirova plastika, đubrivo za zemlju, mješavine za gašenje požara, preparati za kaljenje, zavarivanje i lemljenje metala, hemijski proizvodi za konzervisanje hrane, sredstva za štavljenje kože, ljepila (ljepljive supstance) namijenjene za industriju

Klasa 03: preparati za bijeljenje i ostale materije za pranje rublja, preparati za čišćenje, poliranje, odmaščivanje i struganje, sapuni, parfimerijski proizvodi, eterična ulja, kozmetički proizvodi, losioni za kosu, proizvodi za njegu zuba

Klasa 05: farmaceutski i veterinarski proizvodi, higijenski proizvodi za upotrebu u medicini, dijetalne materije za medicinske potrebe, hrana za odojčad, flasteri, materijal za previjanje, materijali za plombiranje zuba i za zubne otiske, dezinfekciona sredstva, proizvodi za uništavanje životinjskih štetočina, fungicidi, herbicidi

Klasa 29: meso, riba, živina i divljač, mesni ekstrakti, konzervirano, sušeno i kuvano voće i povrće, želei, džemovi, kompoti, jaja, mlijeko i mliječni proizvodi, jestiva ulja i masti

Klasa 30: kafa, čaj, kakao, šećer, riža, tapioka, sago, zamjene za kafu, brašno i proizvodi od žitarica, hleb, kolači, poslastice, bomboni, sladoled, med, sirup od melase, kvasac, prašak za pecivo, so, senf, sirće, prelive, razni začini, led za hlađenje

Klasa 31: poljoprivredni, povrtlarski, šumski proizvodi i bobice, koji nisu obuhvaćeni drugim razredima, žive životinje, svježe voće i povrće, sjeme, prirodne biljke i cvijeće, hrana za životinje, slad.

(210) **2012-443**

(442) **20.09.2014.**

(220) 11/5/2012

(731) **FARMACEVTSKA XEMIJSKA KOZMETIČKA INDUSTRIJA ALKALOID-AD-SKOPLJE**, BUL. ALEKSANDAR MAKEDONSKI BR.12, 1000 SKOPLJE RM

(540) ALKALOID

(550) I, V

(740) Popović Miladin, Đoka Miraševića 21/III, Podgorica ME

(511) **Klasa 01:** hemijski proizvodi za industriju, nauku, fotografsku djelatnost, hortikulturu, poljoprivredu i šumarstvo, sirova veštačka smola, sirova plastika, đubrivo za zemlju, mješavine za gašenje požara, preparati za kaljenje, zavarivanje i lemljenje metala, hemijski proizvodi za konzervisanje hrane, sredstva za štavljenje kože, ljepila (ljepljive supstance) namijenjene za industriju

Klasa 03: preparati za bijeljenje i ostale materije za pranje rublja, preparati za čišćenje, poliranje, odmaščivanje i struganje, sapuni, parfimerijski proizvodi, eterična ulja, kozmetički proizvodi, losioni za kosu, proizvodi za njegu zuba

Klasa 05: farmaceutski i veterinarski proizvodi, higijenski proizvodi za upotrebu u medicini, dijetalne materije za medicinske potrebe, hrana za odojčad, flasteri, materijal za previjanje, materijali za plombiranje zuba i za zubne otiske, dezinfekciona sredstva, proizvodi za uništavanje životinjskih štetočina, fungicidi, herbicidi

Klasa 29: meso, riba, živina i divljač, mesni ekstrakti, konzervirano, sušeno i kuvano voće i

povrće, želei, džemovi, kompoti, jaja, mlijeko i mliječni proizvodi, jestiva ulja i masti

Klasa 30: kafa, čaj, kakao, šećer, riža, tapioka, sago, zamjene za kafu, brašno i proizvodi od žitarica, hleb, kolači, poslastice, bomboni, sladoled, med, sirup od melase, kvasac, prašak za pecivo, so, senf, sirće, prelive, razni začini, led za hlađenje

Klasa 31: poljoprivredni, povrtlarski, šumski proizvodi i bobice, koji nisu obuhvaćeni drugim razredima, žive životinje, svježe voće i povrće, sjeme, prirodne biljke i cvijeće, hrana za životinje, slad.

(210) **2012-444** (442) **20.09.2014.**

(220) 11/6/2012

(731) **MERIDA INDUSTRY CO.LTD.** 116, MEEI GAANG ROAD, MEEI GAANG TSUEN, TA TSUEN, CHANG HWA HSIEN, TAIWAN, R.O.C. TW

MERIDA

(540)

(550) I

(740) Lutovac Branislav, Bulevar Crnojevića 93, Podgorica ME

(511) **Klasa 12:** bicikli, bicikli na rasklapanje, električni bicikli i električni bicikli na sklapanje, i strukturni djelovi za iste, dodatni pribor za bicikle, bicikle na sklapanje, električne bicikle i električne bicikle na sklapanje, uključujući pokrivače za sjedišta, torbe i bisage za bicikle, blatobrane, štitnike za lance, zvonca, remene za pedale i štipaljke (klipsere) za pedale, korpe prilagođene za bicikle, prtljažnike za bicikle, amortizere za bicikle, motore za električne bicikle, korpe za bicikle za držanje

(210) **2012-445** (442) **20.09.2014.**

(220) 11/6/2012

(731) **MERIDA INDUSTRY CO.LTD.** 116, MEEI GAANG ROAD, MEEI GAANG TSUEN, TA TSUEN, CHANG HWA HSIEN, TAIWAN, R.O.C. TW



(540)

(550) I

(740) Lutovac Branislav, Bulevar Crnojevića 93, Podgorica ME

(511) **Klasa 12:** bicikli, bicikli na rasklapanje, električni bicikli i električni bicikli na sklapanje, i strukturni djelovi za iste, dodatni pribor za bicikle, bicikle na sklapanje, električne bicikle i električne bicikle na sklapanje, uključujući pokrivače za sjedišta, torbe i bisage za bicikle,

blatobrane, štitnike za lance, zvonca, remene za pedale i štikaljke (klipsere) za pedale, korpe prilagođene za bicikle, prtljažnike za bicikle, amortizere za bicikle, motore za električne bicikle, korpe za bicikle za držanje

(210) **2012-446**

(442) **20.09.2014.**

(220) 11/6/2012

(731) **JT INTERNATIONAL S.A.** 1, RUE DE LA GABELLE, 1211 GENEVA 26 CH



(540)

(550) I

(740) Čejović Vladimir, 13. jula 21, Podgorica ME

(511) **Klasa 34:** duvan, prerađen ili neprerađen, duvan za pušenje, duvan za lule, duvan za ručno uvijanje, duvan za žvakanje, snus duvan, cigarete, cigare, cigarilosi, supstance za pušenje koje se prodaju odvojeno ili miješane sa duvanom, a koje nisu za medicinske svrhe ili u svrhe liječenja, duvan za ušmrkavanje, artikli za pušače uključeni u klasu 34, papir za cigarete, tube za cigarete i šibice

(210) **2012-447**

(442) **20.09.2014.**

(220) 11/6/2012

(731) **JT INTERNATIONAL S.A.** 1, RUE DE LA GABELLE, 1211 GENEVA 26 CH



(540)

(550) I

(740) Čejović Vladimir, 13. jula 21, Podgorica ME

(511) **Klasa 34:** duvan, prerađen ili neprerađen, duvan za pušenje, duvan za lule, duvan za ručno uvijanje, duvan za žvakanje, snus duvan, cigarete, cigare, cigarilosi, supstance za pušenje koje se prodaju odvojeno ili miješane sa duvanom, a koje nisu za medicinske svrhe ili u svrhe liječenja, duvan za ušmrkavanje, artikli za pušače uključeni u klasu 34, papir za cigarete, tube za cigarete i šibice

(210) **2012-448** (442) **20.09.2014.**

(220) 11/7/2012

(731) **DINERS CLUB INTERNATIONAL LTD.** 2500 LAKE COOK ROAD, RIVERWOODS, IL 60015 US

(540) CARTE BLANCHE

(550) I

(740) AOD "Ćupić", Dalmatinska 10, Podgorica ME

(511) **Klasa 36:** finasijske usluge, usluge kreditnih kartica

(210) **2012-449** (442) **20.09.2014.**

(220) 11/12/2012

(731) **DR. SVETLANA PEJIĆ-GERIĆ** PR SPECIJALISTIČKA ORDINACIJA ZA OPŠTU MEDICINU PROTEKAL, DR. IVE POPOVIĆA ĐANIJA 3A, 11040 BEOGRAD RS

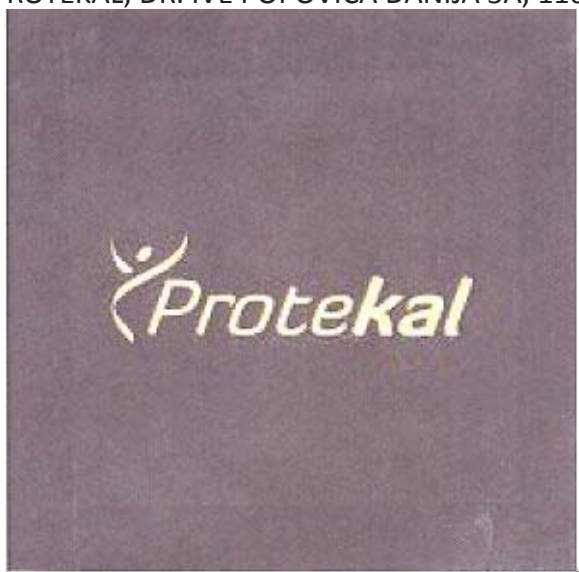

(540)

(550) I

(511) **Klasa 05:** farmaceutski i veterinarski preparati, sanitarni preparati za medicinsku upotrebu, dijetetske supstance prilagođene za upotrebu u medicini, hrana za bebe, flasteri, materijali za zavijanje, materijali za plombiranje zuba, zubarska smola, dezinfekciona sredstva, preparati za uništavanje štetočina, fungicidi, herbicidi

Klasa 42: naučne i tehnološke usluge i istraživanje i projektovanje u vezi navedenih usluga, usluge industrijske analize i istraživanja, projektovanje u razvoj kompjuterskog hardvera i softvera

Klasa 44: medicinske usluge, veterinarske usluge, higijenska zaštita i njega ljepote za ljude ili životinje, agrikulturne, hortikulturne i šumarske usluge

(210) **2012-450** (442) **20.09.2014.**

(220) 11/13/2012

(731) **ORTAČKO ADVOKATSKO DRUŠTVO BOJOVIĆ DAŠIĆ KOJOVIĆ**, UL. DOBRAČINA 38, BEOGRAD RS



(540)

(550) I

(511) **Klasa 16:** hartija, karton i proizvodi od njih, koji nisu uključeni u druge klase, štampane stvari, kancelarijski materijal, pisaće mašine i kancelarijski pribor (izuzev nameštaja), materijali za obuku i nastavu (izuzev aparata)

Klasa 35: oglašavanje, vođenje poslova, poslovno upravljanje, kancelarijski poslovi

Klasa 45: pravne usluge, sve vrste usluga iz oblasti konsaltinga i zaštite prava intelektualne svojine

(210) **2012-451**

(442) **20.09.2014.**

(220) 11/13/2012

(731) **ORTAČKO ADVOKATSKO DRUŠTVO BOJOVIĆ DAŠIĆ KOJOVIĆ, UL. DOBRAČINA 38, BEOGRAD RS**

(540) BDK

(550) I, V

(511) **Klasa 16:** hartija, karton i proizvodi od njih, koji nisu uključeni u druge klase, štampane stvari, kancelarijski materijal, pisaće mašine i kancelarijski pribor (izuzev nameštaja), materijali za obuku i nastavu (izuzev aparata)

Klasa 35: oglašavanje, vođenje poslova, poslovno upravljanje, kancelarijski poslovi

Klasa 45: pravne usluge, sve vrste usluga iz oblasti konsaltinga i zaštite prava intelektualne svojine

(210) **2012-452**

(442) **20.09.2014.**

(220) 11/14/2012

(731) **EAU ECARLATE S.A.S. 28 RUE DE RESISTANCE, ZAC DE LA CROIX BLANCHE, 91707 SANTE GENEVIAVE DES BOIS CEDEX FR**

(540) SEPTIFOS

(550) I, T, F

(740) Lutovac Branislav, Bulevar Crnojevića 93, Podgorica ME

(511) **Klasa 01:** hemijski proizvodi koji se upotrebljavaju u industriji, hemijski proizvodi za čišćenje i održavanje odvodnih cijevi, neprerađene plastične materije, materije za štavljenje, ljepljive supstance koje se upotrebljavaju u industriji, hemijski proizvodi za održavanje septičkih rezervoara, za septičke jame i za uklanjanje kamenca, hemikalije za tretiranje vode, đubriva, baštenska đubriva, stajska đubriva, komposti, preparati za sprečavanje promjena u metalu, ljepljive supstance, materijali za filtriranje (mineralne supstance), katalizatori i

biohemijski katalizatori, biološki aktivatori za septičke rezervoare, biorazgradive materije za razlaganje otpada u septičkim jamama

Klasa 03: sredstva za bijeljenje i druge supstance za upotrebu u pranju, preparati za čišćenje, poliranje, ribanje, uklanjanje kamenca i abrazivna sredstva, sapuni, rastvori za ribanje, sredstva za uklanjanje mrlja, deterdženti, sapuni, dezodoransi, preparati za njegu i čišćenje septičkih rezervoara

Klasa 05: preparati za uništavanje štetočina, fungicidi, sredstva za uklanjanje kamenca, dezinfekciona sredstva za hemijske toalete, dezinfekciona sredstva za higijenske svrhe

(210) **2012-453** (442) **20.09.2014.**

(220) 11/16/2012

(731) **PHARMACEUTICAL CHEMICAL COSMETIC INDUSTRY ALKALOID AD-SKOPLJE**, BUL. ALEKSANDAR MAKEDONSKI 12, 1000 SKOPLJE RM



(540)

(550) I

(740) Popović Miladin, Đoka Miraševića 21/III, Podgorica ME

(511) **Klasa 03:** kolonjska voda, prirodni sprej

(210) **2012-454** (442) **20.09.2014.**

(220) 11/16/2012

(731) **PHARMACEUTICAL CHEMICAL COSMETIC INDUSTRY ALKALOID AD-SKOPLJE**, BUL. ALEKSANDAR MAKEDONSKI 12, 1000 SKOPLJE RM

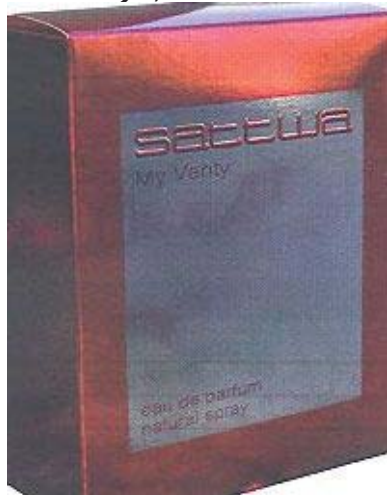

(540)

(550) I, F, T,

(740) Popović Miladin, Đoka Miraševića 21/III, Podgorica ME

(511) **Klasa 03:** kolonjska voda, prirodni sprej

(210) **2012-455**

(442) **20.09.2014.**

(220) 11/16/2012

(731) **PHARMACEUTICAL CHEMICAL COSMETIC INDUSTRY ALKALOID AD-SKOPLJE**, BUL. ALEKSANDAR MAKEDONSKI 12, 1000 SKOPLJE RM

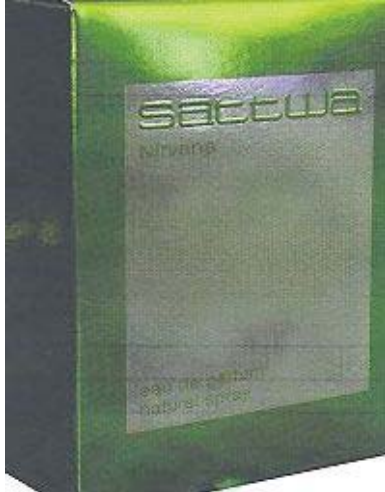

(540)

(550) I, F, T

(740) Popović Miladin, Đoka Miraševića 21/III, Podgorica ME

(511) **Klasa 03:** kolonjska voda, prirodni sprej

(210) **2012-456**

(442) **20.09.2014.**

(220) 11/16/2012

(731) **PHARMACEUTICAL CHEMICAL COSMETIC INDUSTRY ALKALOID AD-SKOPLJE**, BUL. ALEKSANDAR MAKEDONSKI 12, 1000 SKOPLJE RM



(540)

(550) I, F, T

(740) Popović Miladin, Đoka Miraševića 21/III, Podgorica ME

(511) **Klasa 03:** kolonjska voda, prirodni sprej

(210) **2012-457**

(442) **20.09.2014.**

(220) 11/19/2012

(731) **VICTORIA'S SECRET STORIES BRAND MANAGEMENT, INC, FOUR LIMITED**
PARKWAZ REZNOLDSBURG OHIO 43068 US

(540) LOVE PINK

(550) I, V

(740) Popović Miladin, Đoka Miraševića 21/III, Podgorica ME

(511) **Klasa 03:** proizvodi za ličnu njegu i parfimerijski proizvodi, naime, ekstrakt parfema, parfem, kolonjska voda, toaletna voda, parfimisani sprej za tijelo, osvježivač za tijelo u vidu spreja, sprej za tijelo, piling za tijelo, pjena za kupanje, gel za tuširanje, kupka za tijelo, sapun za tijelo, puter za tijelo, krema za tijelo, losion za tijelo, puder za tijelo, losion za ruke i krema za ruke, kozmetika, naime, korektor za područje ispod očiju, sijenke za oči, ajlajneri, maskara, šminka za naglašavanje očiju, lak za nokte, puder za lice, rumenilo, podloga za šminku i korektori, tečna podloga, nemedicinski preparati za njegu usana, karmini, balzam za usne, sredstvo za povećanje volumena usana, sjaj za usne, prajmer za usne, olovka za usne, kreme za usne, prajmer za lice, hidrantna krema u boji, hranljive kreme, losioni za kožu, sredstva za uklanjanje šminke, kreme za lice, kreme za čišćenje, gelovi za čišćenje, tonici za lice, hidrantne kreme, kreme za tretman očiju, pilinzi za lice, sredstva za matiranje kože, puderi za bronziranje za kožu i lice, usavršavajući puderi, svjetlucajući puderi, kozmetički komplet šminke koji se sastoji od sjenki za oči, karmina, sjajeva za usne, bronzera, olovaka za usne, maskare, rumenila i laka za nokte

Klasa 18: ručne torbe, torbe za sve namjene, velike torbe, putne torbe, torbe za nošenje preko ramena, tašne, clutch torbe, poštanske torbe, torbe za pelene, večernje ručne torbe, torbe koje se nose oko ručnog zgloba, vreće za stvari, torbe za pse, torbice koje se nose oko struka, rančevi, atletske torbe, torbe za teretanu, mali koferi, kompjuterske torbe, aktentašne, torbe za prtljag, vreće za odjeću za putovanje, putnički koferi, torbe za plažu, torbe za kupovinu, torbice, novčanici, futrole za ključeve, futrole za kreditne kartice, kozmetičke futrole i torbe koje se prodaju prazne, kišobrani, suncobrani, korice za pasoše, novčanici za metalni novac, korice za čekove i kaiševi

Klasa 25: sportski brushalteri, pantalone, košulje, šortsevi, majice, majice bez rukava, bluze, majice na bretele, farmerice, jakne, kaputi, haljine, odela, suknje, šortsevi, atletska odjeća, svadbena odjeća, neformalna odjeća, svečana odjeća, formalna odjeća, odjeća za teretanu, odjeća za trudnice, sportska odjeća, odjeća za zaštitu od sunca, haljine za plažu, odjeća za plažu, saronzi, odjeća za plivanje, steznici za oblikovanje tijela, bodiji, brushalteri, korseti, kamisoli, mideri, pojasevi za čarape, steznici, gaćice, slipovi (donji veš), gaće, potkošulje, donje rublje, prsluci, bejzbol kape, šeširi, trake za glavu, sportske kape, slamnati šeširi, šeširi za sunce, kostimi, kape za plivanje, atletska obuća, obuća za plažu, neformalna obuća, večernja obuća, obuća za vježbanje, papuče, čarape, rukavice, rukavice bez prstiju, ogrtači, čarape i pletena trikotaža, dokoljenice, hulahopke, ženske čarape, ženske najlonske čarape, bademantili, žensko donje rublje, odjeća za odmor, negližei, spavaćice, noćne košulje, pidžame, odjeća za spavanje, jednodjelne bluze sa gaćicama (žensko donje rublje) i šalovi, marama

Klasa 35: usluge maloprodajnih trgovina, online usluge maloprodajnih trgovina i usluge porudžbina koje se šalju preko pošte, sve u oblasti odjeće uključujući žensko donje rublje i intimni veš, kožne robe, modne dodatke, nakit, obuću, kozmetiku, proizvode za ličnu njegu, naočare, prtljag i proizvode za kuću

(210) **2012-458**

(442) **20.09.2014.**

(220) 11/19/2012

(731) **VICTORIA`S SECRET STORIES BRAND MANAGEMENT, INC`**, FOUR LIMITED
PARKWAZ REZNOLDSBURG OHIO 43068 US

(540) VICTORIA`S SECRET PINK

(550) I, V

(740) Popović Miladin, Đoka Miraševića 21/III, Podgorica ME

(511) **Klasa 03:** proizvodi za ličnu njegu i parfimerijski proizvodi, naime, ekstrakt parfema, parfem, kolonjska voda, toaletna voda, parfimisani sprej za tijelo, osvježivač za tijelo u vidu spreja, sprej za tijelo, piling za tijelo, pjena za kupanje, gel za tuširanje, kupka za tijelo, sapun za tijelo, puter za tijelo, krema za tijelo, losion za tijelo, puder za tijelo, losion za ruke i krema za ruke, kozmetika, naime, korektor za područje ispod očiju, sijenke za oči, ajlajneri, maskara, šminka za naglašavanje očiju, lak za nokte, puder za lice, rumenilo, podloga za šminku i korektori, tečna podloga, nemedicinski preparati za njegu usana, karmini, balzam za usne, sredstvo za povećanje volumena usana, sjaj za usne, prajmer za usne, olovka za usne, kreme za usne, prajmer za lice, hidrantna krema u boji, hranljive kreme, losioni za kožu, sredstva za uklanjanje šminke, kreme za lice, kreme za čišćenje, gelovi za čišćenje, tonici za lice, hidrantne kreme, kreme za tretman očiju, pilinzi za lice, sredstva za matiranje kože, puderi za bronziranje za kožu i lice, usavršavajući puderi, svjetlucajući puderi, kozmetički komplet šminke koji se sastoji od sjenki za oči, karmina, sjajeva za usne, bronzera, olovaka za usne, maskare, rumenila i laka za nokte

Klasa 18: Ručne torbe, torbe za sve namjene, velike torbe, putne torbe, torbe za nošenje preko ramena, tašne, clutch torbe, poštanske torbe, torbe za pelene, večernje ručne torbe, torbe koje se nose oko ručnog zgloba, vreće za stvari, torbe za pse, torbice koje se nose oko struka, rančevi, atletske torbe, torbe za teretanu, mali koferi, kompjuterske torbe, aktentašne, torbe za prtljag, vreće za odjeću za putovanje, putnički koferi, torbe za plažu, torbe za kupovinu, torbice, novčanici, futrole za ključeve, futrole za kreditne kartice, kozmetičke futrole i torbe koje se prodaju prazne, kišobrani, suncobrani, korice za pasoše, novčanici za metalni novac, korice za čekove i kaiševi

Klasa 25: Sportski brushalteri, pantalone, košulje, šortsevi, majice, majice bez rukava, bluze, majice na bretele, farmerice, jakne, kaputi, haljine, odelo, suknje, šortsevi, atletska odjeća, svadbena odjeća, neformalna odjeća, svečana odjeća, formalna odjeća, odjeća za teretanu, odjeća za trudnice, sportska odjeća, odjeća za zaštitu od sunca, haljine za plažu, odjeća za plažu, saronzi, odjeća za plivanje, steznici za oblikovanje tijela, bodiji, brushalteri, korseti, kamisoli, mideri, pojasevi za čarape, steznici, gaćice, slipovi (donji veš), gaće, potkošulje, donje rublje, prsluci, bejzbol kape, šeširi, trake za glavu, sportske kape, slamnati šeširi, šeširi za sunce, kostimi, kape za plivanje, atletska obuća, obuća za plažu, neformalna obuća, večernja obuća, obuća za vježbanje, papuče, čarape, rukavice, rukavice bez prstiju, ogrtači, čarape i pletena trikotaža, dokoljenice, hulahopke, ženske čarape, ženske najlonske čarape, bademantili, žensko donje rublje, odjeća za odmor, negližei, spavaćice, noćne košulje, pidžame, odjeća za spavanje, jednodjelne bluze sa gaćicama (žensko donje rublje) i šalovi, marama

Klasa 35: usluge maloprodajnih trgovina, online usluge maloprodajnih trgovina i usluge porudžbina koje se šalju preko pošte, sve u oblasti odjeće uključujući žensko donje rublje i intimni veš, kožne robe, modne dodatke, nakit, obuću, kozmetiku, proizvode za ličnu njegu, naočare, prtljag i proizvode za kuću

(210) **2012-459**

(442) **20.09.2014.**

(220) 11/19/2012

(731) **VICTORIA`S SECRET STORIES BRAND MANAGEMENT, INC`**, FOUR LIMITED

PARKWAZ REZNOLDSBURG OHIO 43068 US

(540) VICTORIA`S SECRET

(550) I, V

(740) Popović Miladin, Đoka Miraševića 21/III, Podgorica ME

(511) **Klasa 03:** Proizvodi za ličnu njegu i parfimerijski proizvodi, naime, ekstrakt parfema, parfem, kolonjska voda, toaletna voda, parfimisani sprej za tijelo, osvježivač za tijelo u vidu spreja, sprej za tijelo, piling za tijelo, pjena za kupanje, gel za tuširanje, kupka za tijelo, sapun za tijelo, puter za tijelo, krema za tijelo, losion za tijelo, puder za tijelo, losion za ruke i krema za ruke, kozmetika, naime, korektor za područje ispod očiju, sijenke za oči, ajlajneri, maskara, šminka za naglašavanje očiju, lak za nokte, puder za lice, rumenilo, podloga za šminku i korektori, tečna podloga, nemedicinski preparati za njegu usana, karmini, balzam za usne, sredstvo za povećanje volumena usana, sjaj za usne, prajmer za usne, olovka za usne, kreme za usne, prajmer za lice, hidrantna krema u boji, hranljive kreme, losioni za kožu, sredstva za uklanjanje šminke, kreme za lice, kreme za čišćenje, gelovi za čišćenje, tonici za lice, hidrantne kreme, kreme za tretman očiju, pilinzi za lice, sredstva za matiranje kože, puderi za bronziranje za kožu i lice, usavršavajući puderi, svjetlucajući puderi, kozmetički komplet šminke koji se sastoji od sjenki za oči, karmina, sjajeva za usne, bronzera, olovaka za usne, maskare, rumenila i laka za nokte

Klasa 18: Ručne torbe, torbe za sve namjene, velike torbe, putne torbe, torbe za nošenje preko ramena, tašne, clutch torbe, poštanske torbe, torbe za pelene, večernje ručne torbe, torbe koje se nose oko ručnog zgloba, vreće za stvari, torbe za pse, torbice koje se nose oko struka, rančevi, atletske torbe, torbe za teretanu, mali koferi, kompjuterske torbe, aktentašne, torbe za prtljag, vreće za odjeću za putovanje, putnički koferi, torbe za plažu, torbe za kupovinu, torbice, novčanici, futrole za ključeve, futrole za kreditne kartice, kozmetičke futrole i torbe koje se prodaju prazne, kišobrani, suncobrani, korice za pasoše, novčanici za metalni novac, korice za čekove i kaiševi

Klasa 25: Sportski brushalteri, pantalone, košulje, šortsevi, majice, majice bez rukava, bluže, majice na bretele, farmerice, jakne, kaputi, haljine, odela, suknje, šortsevi, atletska odjeća, svadbena odjeća, neformalna odjeća, svečana odjeća, formalna odjeća, odjeća za teretanu, odjeća za trudnice, sportska odjeća, odjeća za zaštitu od sunca, haljine za plažu, odjeća za plažu, saronzi, odjeća za plivanje, steznici za oblikovanje tijela, bodiji, brushalteri, korseti, kamisoli, mideri, pojasevi za čarape, steznici, gaćice, slipovi (donji veš), gaće, potkošulje, donje rublje, prsluci, bejzbol kape, šeširi, trake za glavu, sportske kape, slamnati šeširi, šeširi za sunce, kostimi, kape za plivanje, atletska obuća, obuća za plažu, neformalna obuća, večernja obuća, obuća za vježbanje, papuče, čarape, rukavice, rukavice bez prstiju, ogrtači, čarape i pletena trikotaža, dokoljenice, hulahopke, ženske čarape, ženske najlonske čarape, bademantili, žensko donje rublje, odjeća za odmor, negližei, spavačice, noćne košulje, pidžame, odjeća za spavanje, jednodjelne bluže sa gaćicama (žensko donje rublje) i šalovi, marame

Klasa 35: usluge maloprodajnih trgovina, online usluge maloprodajnih trgovina i usluge porudžbina koje se šalju preko pošte, sve u oblasti odjeće uključujući žensko donje rublje i intimni veš, kožne robe, modne dodatke, nakit, obuću, kozmetiku, proizvode za ličnu njegu, naočare, prtljag i proizvode za kuću

(210) **2012-460**

(442) **20.09.2014.**

(220) 11/20/2012

(731) **ELI LILLY AND COMPANY**, LILLY CORPORATE CENTER, INDIANAPOLIS, INDIANA 46285 US

(540) PONTEVIA

(550) I, V

(740) Radulović Božidar, Jovana Tomaševića 9/III, Podgorica ME

(511) **Klasa 05:** farmaceutski preparati, naročito, farmaceutski preparati za dijagnozu i lečenje poremećaja upotrebe alkohola, Alchajmerove bolesti, anksioznih poremećaja, ateroskleroze, autoimunih bolesti i poremećaja, krvnih poremećaja, poremećaja i bolesti kostiju i skeleta, raka, kardiovaskularnih bolesti, poremećaja i oboljenja centralnog nervnog sistema, poremećaja holesterola, cistične fibroze, demencije, dermatoloških oboljenja i poremećaja, dijabetesa, dislipidemije, endokrinih bolesti i poremećaja, gastrointestinalnih bolesti i poremećaja, hormonskih poremećaja i bolesti, zapaljenja i inflamatornih bolesti i poremećaja, poremećaja i bolesti bubrega, oboljenja i poremećaja jetre, metaboličkih bolesti i poremećaja, migrena, mišićnih bolesti i poremećaja, neurodegenerativnih bolesti i poremećaja, neuroloških oboljenja i poremećaja, gojaznosti, bola, bolesti i poremećaja pankreasa, psihijatrijskih poremećaja, bolesti i poremećaja reproduktivnog sistema, poremećaja sna, uroloških poremećaja, antidepresivi

(210) **2012-461**

(442) **20.09.2014.**

(220) 11/20/2012

(731) **VOČAR d.o.o.** 76 207 Gornji Rahić 112, Brčko BA

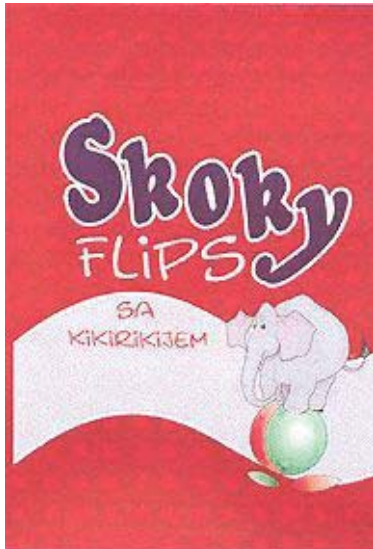

(540)

(550) I, F

(740) Radulović Božidar, Jovana Tomaševića 9/III, Podgorica ME

(511) **Klasa 30:** proizvodi od žitarica, a naročito slani proizvodi na bazi kukuruznog griza sa mješavinom mljevenog kikirikija

(210) **2012-462**

(442) **20.09.2014.**

(220) 11/20/2012

(731) **VICTORIA'S SECRET STORIES BRAND MANAGEMENT, INC.**, FOUR LIMITED
PARKWAY REZNOLDSBURG OHIO 43068 US



(540)

(550) I, F

(740) Popović Miladin, Đoka Miraševića 21/III, Podgorica ME

(511) **Klasa 03:** proizvodi za ličnu njegu i parfimerijski proizvodi, naime, ekstrakt parfema, parfem, kolonjska voda, toaletna voda, parfimisani sprej za tijelo, osvježivač za tijelo u vidu spreja, sprej za tijelo, piling za tijelo, pjena za kupanje, gel za tuširanje, kupka za tijelo, sapun za tijelo, puter za tijelo, krema za tijelo, losion za tijelo, puder za tijelo, losion za ruke i krema za ruke, kozmetika, naime, korektor za područje ispod očiju, sijenke za oči, ajlajneri, maskara, šminka za naglašavanje očiju, lak za nokte, puder za lice, rumenilo, podloga za šminku i korektori, tečna podloga, nemedicinski preparati za njegu usana, karmini, balzam za usne, sredstvo za povećanje volumena usana, sjaj za usne, prajmer za usne, olovka za usne, kreme za usne, prajmer za lice, hidrantna krema u boji, hranjive kreme, losioni za kožu, sredstva za uklanjanje šminke, kreme za lice, kreme za čišćenje, gelovi za čišćenje, tonici za lice, hidrantne kreme, kreme za tretman očiju, pilinzi za lice, sredstva za matiranje kože, puderi za bronziranje za kožu i lice, usavršavajući puderi, svjetlucajući puderi, kozmetički komplet šminke koji se sastoji od sjenki za oči, karmina, sjajeva za usne, bronzera, olovaka za usne, maskare, rumenila i laka za nokte

Klasa 18: ručne torbe, torbe za sve namjene, velike torbe, putne torbe, torbe za nošenje preko ramena, tašne, clutch torbe, poštanske torbe, torbe za pelene, večernje ručne torbe, torbe koje se nose oko ručnog zgloba, vreće za stvari, torbe za pse, torbice koje se nose oko struka, rančevi, atletske torbe, torbe za teretanu, mali koferi, kompjuterske torbe, aktentašne, torbe za prtljag, vreće za odjeću za putovanje, putnički koferi, torbe za plažu, torbe za kupovinu, torbice, novčanici, futrole za ključeve, futrole za kreditne kartice, kozmetičke futrole i torbe koje se prodaju prazne, kišobrani, suncobrani, korice za pasoše, novčanici za metalni novac, korice za čekove i kaiševi

Klasa 25: sportski brushalteri, pantalone, košulje, šortsevi, majice, majice bez rukava, bluze, majice na bretele, farmerice, jakne, kaputi, haljine, odela, suknje, šortsevi, atletska odjeća, svadbena odjeća, neformalna odjeća, svečana odjeća, formalna odjeća, odjeća za teretanu, odjeća za trudnice, sportska odjeća, odjeća za zaštitu od sunca, haljine za plažu, odjeća za plažu, saronzi, odjeća za plivanje, steznici za oblikovanje tijela, bodiji, brushalteri, korseti, kamisoli, mideri, pojasevi za čarape, steznici, gaćice, slipovi (donji veš), gaće, potkošulje, donje rublje, prsluci, bejzbol kape, šeširi, trake za glavu, sportske kape, slamnati šeširi, šeširi za sunce, kostimi, kape za plivanje, atletska obuća, obuća za plažu, neformalna obuća, večernja obuća, obuća za vježbanje, papuče, čarape, rukavice, rukavice bez prstiju, ogrtači, čarape i pletena trikotaža, dokoljenice, hulahopke, ženske čarape, ženske najlonske čarape, bademantili, žensko donje rublje, odjeća za odmor, negliže, spavaćice, noćne košulje,

pidžame, odjeća za spavanje, jednodjelne bluze sa gaćicama (žensko donje rublje) i šalovi, marama

Klasa 35: usluge maloprodajnih trgovina, online usluge maloprodajnih trgovina i usluge porudžbina koje se šalju preko pošte, sve u oblasti odjeće uključujući žensko donje rublje i intimni veš, kožne robe, modne dodatke, nakit, obuću, kozmetiku, proizvode za ličnu njegu, naočare, prtljag i proizvode za kuću

(210) **2012-463** (442) **20.09.2014.**

(220) 11/20/2012

(731) **VICTORIA'S SECRET STORIES BRAND MANAGEMENT, INC.**, FOUR LIMITED
PARKWAZ REZNOLDSBURG OHIO 43068 US



(540)

(550) I, F

(740) Popović Miladin, Đoka Miraševića 21/III, Podgorica ME

(511) **Klasa 03:** proizvodi za ličnu njegu i parfimerijski proizvodi, naime, ekstrakt parfema, parfem, kolonjska voda, toaletna voda, parfimisani sprej za tijelo, osvježivač za tijelo u vidu spreja, sprej za tijelo, piling za tijelo, pjena za kupanje, gel za tuširanje, kupka za tijelo, sapun za tijelo, puter za tijelo, krema za tijelo, losion za tijelo, puder za tijelo, losion za ruke i krema za ruke, kozmetika, naime, korektor za područje ispod očiju, sijenke za oči, ajlajneri, maskara, šminka za naglašavanje očiju, lak za nokte, puder za lice, rumenilo, podloga za šminku i korektori, tečna podloga, nemedicinski preparati za njegu usana, karmini, balzam za usne, sredstvo za povećanje volumena usana, sjaj za usne, prajmer za usne, olovka za usne, kreme za usne, prajmer za lice, hidrantna krema u boji, hranljive kreme, losioni za kožu, sredstva za uklanjanje šminke, kreme za lice, kreme za čišćenje, gelovi za čišćenje, tonici za lice, hidrantne kreme, kreme za tretman očiju, pilinzi za lice, sredstva za matiranje kože, puderi za bronziranje za kožu i lice, usavršavajući puderi, svjetlucajući puderi, kozmetički komplet šminke koji se sastoji od sjenki za oči, karmina, sjajeva za usne, bronzera, olovaka za usne, maskare, rumenila i laka za nokte

Klasa 18: ručne torbe, torbe za sve namjene, velike torbe, putne torbe, torbe za nošenje preko ramena, tašne, clutch torbe, poštanske torbe, torbe za pelene, večernje ručne torbe, torbe koje se nose oko ručnog zgloba, vreće za stvari, torbe za pse, torbice koje se nose oko struka, rančevi, sportske torbe, torbe za teretanu, mali koferi, kompjuterske torbe, aktentašne, torbe za prtljag, vreće za odjeću za putovanje, putnički koferi, torbe za plažu, torbe za kupovinu, torbice, novčanici, futrole za ključeve, futrole za kreditne kartice, kozmetičke futrole i torbe koje se prodaju prazne, kišobrani, suncobrani, korice za pasoše, novčanici za metalni novac, korice za čekove i kaiševi

Klasa 25: sportski brushalteri, pantalone, košulje, šortsevi, majice, majice bez rukava, bluze, majice na bretele, farmerice, jakne, kaputi, haljine, odela, suknje, šortsevi, atletska odjeća, svadbena odjeća, neformalna odjeća, svečana odjeća, formalna odjeća, odjeća za teretanu, odjeća za trudnice, sportska odjeća, odjeća za zaštitu od sunca, haljine za plažu, odjeća za plažu, saronzi, odjeća za plivanje, steznici za oblikovanje tijela, bodiji, brushalteri, korseti, kamisoli, mideri, pojasevi za čarape, steznici, gaćice, slipovi (donji veš), gaće, potkošulje, donje rublje, prsluci, bejzbol kape, šeširi, trake za glavu, sportske kape, slamnati šeširi, šeširi za sunce, kostimi, kape za plivanje, atletska obuća, obuća za plažu, neformalna obuća, večernja obuća, obuća za vježbanje, papuče, čarape, rukavice, rukavice bez prstiju, ogrtači, čarape i pletena trikotaža, dokoljenice, hulahopke, ženske čarape, ženske najlonske čarape, bademantili, žensko donje rublje, odjeća za odmor, negližei, spavaćice, noćne košulje, pidžame, odjeća za spavanje, jednodjelne bluze sa gaćicama (žensko donje rublje) i šalovi, marame

Klasa 35: usluge maloprodajnih trgovina, online usluge maloprodajnih trgovina i usluge porudžbina koje se šalju preko pošte, sve u oblasti odjeće uključujući žensko donje rublje i intimni veš, kožne robe, modne dodatke, nakit, obuću, kozmetiku, proizvode za ličnu njegu, naočare, prtljag i proizvode za kuću

(210) **2012-464**

(442) **20.09.2014.**

(220) 11/20/2012

(731) **HENRI BENDEL INC.** 666 FIFTH AVENUE 4TH FLOOR, NEW YORK NY 10103 US

(540) HENRI BENDEL

(550) I, F

(740) Popović Miladin, Đoka Miraševića 21/III, Podgorica ME

(511) **Klasa 14:** plemeniti metali i njihove legure i proizvodi od tih metala ili obloženi tim metalima, koji nisu obuhvaćeni drugim razredima, pravi i lažni nakit, drago kamenje, časovničarski proizvodi i hronometrijski instrumenti

Klasa 18: koža, imitacije kože, proizvodi od tih materijala koji nisu obuhvaćeni drugim razredima, životinjske kože, koferi i torbe, kišobrani, suncobrani i štapovi za hodanje, bičevi i sedlarsko remenarski proizvodi

Klasa 35: oglašavanje i reklamiranje, vođenje komercijalnih poslova, komercijalna administracija, kancelarisjki poslovi

(210) **2012-465**

(442) **20.09.2014.**

(220) 11/20/2012

(731) **FARMACEUTSKA HEMIJSKA KOZMETIČKA INDUSTRIJA ALKALOID AD-SKOPLJE**, BUL. ALEKSANDAR MAKEDONSKI 12, 1000 SKOPLJE RM



(540)

(550) I, F

(740) Popović Miladin, Đoka Miraševića 21/III, Podgorica ME

(511) **Klasa 30:** čajevi(210) **2012-466**(442) **20.09.2014.**

(220) 11/22/2012

(300) 85/727676 12.09.2012 US

(731) **EBAY INC.**(DELAWARE CORPORATION), 2145 HAMILTON AVE. SAN JOSE, CA95125 US

(540)

(550) I, F

(740) Radulović Božidar, Jovana Tomaševića 9/III, Podgorica ME

(511) **Klasa 35:** usluge onlajn trgovanja, naročito, organizovanje on-line pijaca za prodavce i kupce robe i usluga, usluge onlajn trgovanja u kojima prodavci postavljaju proizvode ili usluge koji se nude na prodaju i kupovinu ili se licitacija vrši putem interneta u cilju olakšavanja prodaje robe i usluga, za druge, putem računarske mreže, pružanje povratnih informacija i vrednovanje robe i usluga prodavaca, vrednosti i cena robe i usluga prodavaca, uspešnosti kupaca i prodavaca, isporuke i ukupnog iskustva u trgovanju u vezi sa tim, obezbeđivanje onlajn uputstva koje se može pretraživati, a koje se se odnosi na oglašavanje, i koji sadrži robu i usluge onlajn prodavaca, obezbeđivanje onlajn baze podataka koja se može pretraživati a koja se odnosi na vrednovanje prodavaca i kupaca, usluge oglašavanja i reklamiranja, poslovne usluge, naročito obezbeđivanje veb sajtova koje pružaju korisniku mogućnost da stvori prilagođenu veb stranicu koja sadrži informacije definisane od strane korisnika u oblasti prava intelektualne svojine i pravila koja se odnose na zaštitu intelektualne svojine, kako bi se pomoglo učesnicima u programu u vezi sa upitima i zahtevima koji se odnose na upotrebu intelektualne svojine od strane drugih na onlajn pijaci

(210) **2012-467**(442) **20.09.2014.**

(220) 11/22/2012

(731) **COMPAGNIE GERVAIS DANONE**, 17, BOULEVARD HAUSSMANN, 75009 PARIS FR

(540) ACTIREGULARIS

(550) I

(740) Čejović Vladimir, 13. jula 21, Podgorica ME

(511) **Klasa 29:** mlijeko, mlijeko u prahu, želatinirano, začinjeno i lupano mlijeko, mliječni proizvodi, naime, mliječni dezerti, jogurti, pića od jogurta, svježi sir, obična ili začinjena pića koja se uglavnom sastoje od mlijeka ili mliječnih proizvoda, mliječni napici sačinjeni uglavnom od mlijeka, mliječni napici koji sadrže voće, fermentizovani obični ili začinjeni mliječni proizvodi

(210) **2012-468**

(442) **20.09.2014.**

(220) 11/23/2012

(731) **NOBEL ILAC SANAYII VE TICARET ANONIM SIRKETI**, INKILAP MAH. AKCAKOCA SK. NO, UMRANIYE, ISTANBUL TR

(540) ANZIBEL

(550) I

(740) Božović Vesko, Rimski trg 50/11, Podgorica ME

(511) **Klasa 05:** farmaceutski proizvodi

(210) **2012-469**

(442) **20.09.2014.**

(220) 11/23/2012

(731) **NOBEL ILAC SANAYII VE TICARET ANONIM SIRKETI**, INKILAP MAH. AKCAKOCA SK. NO, UMRANIYE, ISTANBUL TR

(540) LORDES

(550) I

(740) Božović Vesko, Rimski trg 50/11, Podgorica ME

(511) **Klasa 05:** farmaceutski proizvodi

(210) **2012-470**

(442) **20.09.2014.**

(220) 11/23/2012

(731) **NOBEL ILAC SANAYII VE TICARET ANONIM SIRKETI**, INKILAP MAH. AKCAKOCA SK. NO, UMRANIYE, ISTANBUL TR

(540) BEFRON

(550) I

(740) Božović Vesko, Rimski trg 50/11, Podgorica ME

(511) **Klasa 05:** farmaceutski proizvodi

(210) **2012-471**

(442) **20.09.2014.**

(220) 11/23/2012

(731) **NOBEL ILAC SANAYII VE TICARET ANONIM SIRKETI**, INKILAP MAH. AKCAKOCA SK. NO, UMRANIYE, ISTANBUL TR

(540) DEKSALGIN

(550) I

(740) Božović Vesko, Rimski trg 50/11, Podgorica ME

(511) **Klasa 05:** farmaceutski proizvodi

(210) **2012-472**

(442) **20.09.2014.**

(220) 11/23/2012

- (731) **NOBEL ILAC SANAYII VE TICARET ANONIM SIRKETI**, INKILAP MAH. AKCAKOCA SK. NO, UMRANIYE, ISTANBUL TR
- (540) TYLOL
- (550) I
- (740) Božović Vesko, Rimski trg 50/11, Podgorica ME
- (511) **Klasa 05:** farmaceutski proizvodi

- (210) **2012-473** (442) **20.09.2014.**
- (220) 11/26/2012
- (731) **VELTEX AD**, CIJEVNA BB, 81000 PODGORICA ME



- (540)
- (550) I
- (511) **Klasa 29:** meso, riba, živina i divljač, mesne prerađevine, konzervisano, zamrznuto, sušeno i kuvano voće i povrće, želei, džemovi, kompoti, jaja, mleko i mlečni proizvodi, jestiva ulja i masti
- Klasa 30:** kafa, čaj, kakao, šećer, pirinač, tapioka, sago, zamena kafe, brašno i proizvodi od žitarica, hleb, kolači i poslastice, sladoledi, med, melasa, kvasac, prašak za pecivo, so, senf, sirće, sosovi (kao dodaci), začini, led

- (210) **2012-474** (442) **20.09.2014.**
- (220) 11/27/2012
- (731) **SPOTLESS PUNCH LIMITED**, A U.K.COMPANY, SUITE B, FIRST FLOOR, KNOWLES HOUSE, CROMWELL ROAD, REDHILL, SURREY RH1 1RT GB



- (540)
- (550) I
- (740) Lutovac Branislav, Bulevar Crnojevića 93, Podgorica ME
- (511) **Klasa 03:** impregnirane obrađene sintetičke netkane rupičaste maramice od celuloze, koje se koriste pri pranju, sredstva za osvježavanje rublja, omekšivači, sredstva za privlačenje prljavštine i boja, sredstva za bijeljenje i druge supstance za upotrebu u pranju, sredstva za čišćenje, poliranje, odmaščivanje i abrazivna sredstva
- Klasa 21:** pribor za čišćenje, krpe za čišćenje

(210) **2012-475** (442) **20.09.2014.**

(220) 11/27/2012

(731) **PUNCH INDUSTRIES**, AN UNLIMITED IRISH COMPANY, MACRO II, UNIT 4, PLATO BUSINES PARK, DAMASTOWN, DUBLIN 15 IE

(540) DOKAZ OSTAJE NA MARAMICI!

(550) I

(740) Lutovac Branislav, Bulevar Crnojevića 93, Podgorica ME

(511) **Klasa 03:** impregnirane obrađene sintetičke netkane rupičaste maramice od celuloze, koje se koriste pri pranju, sredstva za osvježavanje rublja, omekšivači, sredstva za privlačenje prljavštine i boja, sredstva za bijeljenje i druge supstance za upotrebu u pranju, sredstva za čišćenje, poliranje, odmašćivanje i abrazivna sredstva

Klasa 21: pribor za čišćenje, krpe za čišćenje

(210) **2012-476** (442) **20.09.2014.**

(220) 11/27/2012

(731) **PUNCH INDUSTRIES**, AN UNLIMITED IRISH COMPANY, MACRO II, UNIT 4, PLATO BUSINES PARK, DAMASTOWN, DUBLIN 15 IE

(540) THE PROOF IS ON THE SHEET!

(550) I

(740) Lutovac Branislav, Bulevar Crnojevića 93, Podgorica ME

(511) **Klasa 03:** impregnirane obrađene sintetičke netkane rupičaste maramice od celuloze, koje se koriste pri pranju, sredstva za osvježavanje rublja, omekšivači, sredstva za privlačenje prljavštine i boja, sredstva za bijeljenje i druge supstance za upotrebu u pranju, sredstva za čišćenje, poliranje, odmašćivanje i abrazivna sredstva

Klasa 21: pribor za čišćenje, krpe za čišćenje

(210) **2012-478** (442) **20.09.2014.**

(220) 11/27/2012

(731) **SAPONIA** KEMIJSKA, PREHRAMBENA, I FARMACUTSKA INDUSTRIJA D.D. OSIJEK, MATIJE GUPCA 2, OSIJEK HR



(540)

(550) I

(740) Radulović Božidar, Jovana Tomaševića 9/III, Podgorica ME

(511) **Klasa 03:** sredstva za njegu zuba, zubne paste

Klasa 21: četkice za zube

(210) **2012-479** (442) **20.09.2014.**

(220) 11/27/2012

(731) **SAPONIA** KEMIJSKA, PREHRAMBENA, I FARMACUTSKA INDUSTRIJA D.D.OSIJEK, MATIJE GUPCA 2, OSIJEK HR



(540)

(550) I

(740) Radulović Božidar, Jovana Tomaševića 9/III, Podgorica ME

(511) **Klasa 03:** sredstva za njegu zuba, zubne paste

Klasa 21: četkice za zube

(210) **2012-480**

(442) **20.09.2014.**

(220) 11/27/2012

(731) **ROTHMANS OF PALL MALL LIMITED**, ZAEHLERWEG 4 ZUG CH 6300 CH

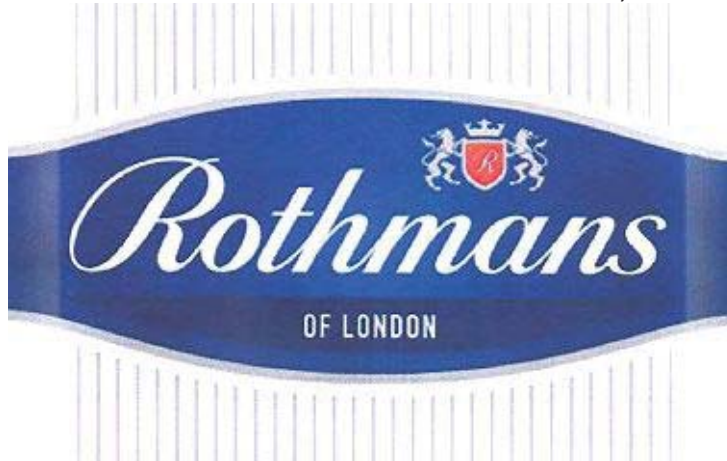

(540)

(550) I

(740) Popović Miladin, Đoka Miraševića 21/III, Podgorica ME

(511) **Klasa 34:** cigarete, duvan, duvanski proizvodi, upaljači, šibice, artikli za pušače

(210) **2012-481**

(442) **20.09.2014.**

(220) 11/28/2012

(731) **PODRAVKA D.D.** ANTE STARČEVIĆA 32 48000 KOPRIVNICA HR

(540) VEGETA

(550) I

(740) Popović Miladin, Đoka Miraševića 21/III, Podgorica ME

(511) **Klasa 16:** papir, karton i proizvodi od tih materijala koji nijesu obuhvaćeni drugim klasama štamparski proizvodi, proizvodi za uvezivanje knjiga, fotografije, pribor za pisanje, ljepila (ljepljive materije za papirnate proizvode ili za kućne potrebe), slikarski pribor, kistovi, pisaće mašine i kancelarijski pribor (osim namještaja), oprema za nastavu i obuku (osim aparata), plastični materijali za ambalažu (koji nijesu obuhvaćeni drugim klasama), štamparska slova, klišeji

Klasa 29: meso, riba, živina i divljač, mesni ekstrakti, konzervirano, sušeno i kuvano voće i povrće, želeji, džemovi, kompoti, jaja, mlijeko i mliječni proizvodi, jestiva ulja i masti

Klasa 30: kafa, čaj, kakao, šećer, riža, tapioka, sago, zamjene za kafu, brašno i proizvodi od žitarica, hleb, kolači, poslastice, bomboni, sladoled, med, sirup od melase, kvasac, prašak za pecivo, so, senf, sirće, prelive, začini, razni začini, led za hlađenje

Klasa 31: poljoprivredni, povrtlarski, šumski proizvodi i bobice, koji nijesu obuhvaćeni drugim klasama, žive životinje, svježe voće i povrće, sjeme, prirodne biljke i cvijeće, hrana za životinje, slad

Klasa 35: oglašavanje i reklamiranje, vođenje komercijalnih poslova, komercijalna administracija, kancelarijski poslovi

Klasa 41: obuka, stručno osposobljavanje, razonoda, sportske i kulturne djelatnosti

Klasa 42: naučne i tehnološke usluge kao i pripadajuće usluge istraživanja i koncepcije, usluge industrijskih analiza i istraživanja, koncepcija i razvoj računara i računarskih programa / hardvera i softvera/

Klasa 43: usluge obezbjeđivanja hrane i pića, privremeno primanje na stan

(210) **2012-482** (442) **20.09.2014.**

(220) 11/29/2012

(731) **SOTHEBY'S**, 34-35 NEW BOND STREET, LONDON W1A 2AA GB

(540) SOTHEBY'S INTERNATIONAL REALTY

(550) I

(740) Čejović Vladimir, 13. jula 21, Podgorica ME

(511) **Klasa 36:** osiguranje, finansijski poslovi, monetarni poslovi, upravljanje nekretninama, usluge u posredovanju nekretninama

(210) **2012-483** (442) **20.09.2014.**

(220) 11/30/2012

(731) **THE HERSHEY COMPANY**, 100 CRYSTAL A DRIVE, HERSHAY, PA 17033 US



(540)

(550) I

(511) **Klasa 30:** kafa, čaj, kakao i zamena kafe, pirinač, tapioka i sago, brašno i proizvodi od žitarica, hleb, kolači i poslastice, sladoledi, šećer, med, melasa, kvasac, prašak za pecivo, so, senf, sirće, sosovi (kao začini), začini, led, čokolada, proizvodi od čokolade, bombone, slatke štangice, poslastičarski proizvodi, kakao proizvodi, kolačići, biskviti, čokolada za kuvanje, komadići, kriške i komadi za pečenje slatkiša, čokoladna instant smeša (za hladne i vruće napitke), slatki prelive za sladoled i za deserte, torte, kolači, sladoled, smrznuti slatkiši

(210) **2012-484** (442) **20.09.2014.**

(220) 11/30/2012

(731) **LA SENZA CORPORATION**, 1608 ST. REGIS BOULEVARD DORVAL QUEBEC H9P 1 H6

CA

(540) LA SENZA

(550) I

(740) Popović Miladin, Đoka Miraševića 21/III, Podgorica ME

(511) **Klasa 03:** preparati za bijeljenje i druge supstance za upotrebu u perionicama, preparati za čišćenje, poliranje, odmašćivanje i abrazivni preparati, sapuni, parfimerija, eterična ulja, kozmetika, losioni za kosu, paste za zube

(210) **2012-485**(442) **20.09.2014.**

(220) 11/30/2012

(731) **LEE KUM KEE COMPANY LIMITED**, 2-4 DAI FAT STREET, TAI PO INDUSTRIAL ESTATE, TAI PO, NEW TERRITORIES, HONG KONG CN

(540) LEE KUM KEE

(550) I

(740) AOD "Ćupić", Dalmatinska 10, Podgorica ME

(511) **Klasa 29:** meso, riba, živina i divljač, mesne prerađevine, konzervirano, smrznuto, sušeno i kuvano voće i povrće, želei, džemovi, kompoti, jaja, mlijeko i mliječni proizvodi, jestiva ulja i masti, piletina u prahu, aromatizovana piletina u prahu, pileći buljon u prahu, koncentrat buljona, preparati za pravljenje supe, baze (kocke) za supu i buljoni supe, supe, baze (kocke) za supu, mješavine supe, buljon, susamovo ulje, ulje čilija, namirnice, koncentrat ili preparati napravljeni od ili koji sadrže čili ili ekstrakte čilija, pasta od škampa, namirnice, koncentrat, paste ili preparati od mesa, ribe, živine, morskih plodova, školjki i/ili ljuskara, namirnice, koncentrat, paste ili preparati sačinjeni od ili koji sadrže sušene ribe ili ekstrakte ribe, škampe, morske račiće, školjke, dagnje, ostrige i/ili školjke kapice, plodovi mora koji se prodaju kao komponenta ili kao sastojak koncentrata, paste, sosova ili začina

Klasa 30: sosovi, dodaci gotovim jelima, sredstva za poboljšanje ukusa, začini, so, senf, sirće, soja sosovi, sos od ostriga, aromatizovani sos od ostriga, preparati, paste i koncentrat za pravljenje sosova, kuvanje, mariniranje ili za upotrebu kao dodaci jelima, sosovi za kuvanje, unaprijed upakovani sosovi za pripremanje ili kuvanje hrane i obroka ili za upotrebu kao dodaci jelima, sosovi za umakanje, preparati, sosovi, paste i koncentrat koji sadrže pastu od čilija, sos od čilija ili čili u prahu, voćni sosovi (izizimajući sos od brusnice i sos od jabuke), sos od paradajza, mljeveni bijeli luk za upotrebu kao sredstvo za poboljšanje ukusa ili dodatak jelima, mljeveni đumbir za upotrebu kao sredstvo za poboljšanje ukusa ili dodatak jelima, sosovi načinjeni od morskih plodova ili koji sadrže morske plodove, ekstrakte morskih plodova ili sušene morske plodove, kecap, prelive za salatu, marinade, sosovi, dodaci gotovim jelima, sredstva za poboljšanje ukusa, začini, so, senf, sirće, soja sosovi, sos od ostriga, aromatizovani sos od ostriga, preparati, paste i koncentrat za pravljenje sosova, kuvanje, mariniranje ili za upotrebu kao dodaci jelima, sosovi za kuvanje, unaprijed upakovani sosovi za pripremanje ili kuvanje hrane i obroka ili za upotrebu kao dodaci jelima, sosovi za umakanje, preparati, sosovi, paste i koncentrat koji sadrže pastu od čilija, sos od čilija ili čili u prahu, voćni sosovi (izizimajući sos od brusnice i sos od jabuke), sos od paradajza, mljeveni bijeli luk za upotrebu kao sredstvo za poboljšanje ukusa ili dodatak jelima, mljeveni đumbir za upotrebu kao sredstvo za poboljšanje ukusa ili dodatak jelima, sosovi načinjeni od morskih plodova ili koji sadrže morske plodove, ekstrakte morskih plodova ili sušene morske plodove, kecap, prelive za salatu, marinade

(210) **2012-486**(442) **20.09.2014.**

(220) 11/30/2012

(731) **LEE KUM KEE COMPANY LIMITED**, 2-4 DAI FAT STREET, TAI PO INDUSTRIAL ESTATE, TAI PO, NEW TERRITORIES, HONG KONG CN

李錦記

(540)

(550) I

(740) AOD "Ćupić", Dalmatinska 10, Podgorica ME

(511) **Klasa 29:** meso, riba, živina i divljač, mesne prerađevine, konzervirano, smrznuto, sušeno i kuvano voće i povrće, želei, džemovi, kompoti, jaja, mlijeko i mliječni proizvodi, jestiva ulja i masti, piletina u prahu, aromatizovana piletina u prahu, pileći buljon u prahu, koncentrat buljona, preparati za pravljenje supe, baze (kocke) za supu i buljoni supe, supe, baze (kocke) za supu, mješavine supe, buljon, susamovo ulje, ulje čilija, namirnice, koncentrat ili preparati napravljeni od ili koji sadrže čili ili ekstrakte čilija, pasta od škampa, namirnice, koncentrat, paste ili preparati od mesa, ribe, živine, morskih plodova, školjki i/ili ljuskara, namirnice, koncentrat, paste ili preparati sačinjeni od ili koji sadrže sušene ribe ili ekstrakte ribe, škampe, morske račiće, školjke, dagnje, ostrige i/ili školjke kapice, plodovi mora koji se prodaju kao komponenta ili kao sastojak koncentrata, paste, sosova ili začina, sosovi, dodaci gotovim jelima, sredstva za poboljšanje ukusa, začini, so, senf, sirće, soja sosovi, sos od ostriga, aromatizovani sos od ostriga, preparati, paste i koncentrat za pravljenje sosova, kuvanje, mariniranje ili za upotrebu kao dodaci jelima, sosovi za kuvanje, unaprijed upakovani sosovi za pripremanje ili kuvanje hrane i obroka ili za upotrebu kao dodaci jelima, sosovi za umakanje, preparati, sosovi, paste i koncentrat koji sadrže pastu od cilija, sos od čilija ili čili u prahu, voćni sosovi (izizimajući sos od brusnice i sos od jabuke), sos od paradajza, mljeveni bijeli luk za upotrebu kao sredstvo za poboljšanje ukusa ili dodatak jelima, mljeveni đumbir za upotrebu kao sredstvo za poboljšanje ukusa ili dodatak jelima, sosovi načinjeni od morskih plodova ili koji sadrže morske plodove, ekstrakte morskih plodova ili sušene morske plodove, kecap, prelive za salatu, marinade

(210) **2012-487**

(442) **20.09.2014.**

(220) 11/30/2012

(731) **DINERS CLUB INTERNATIONAL LTD.** 2500 LAKE COOK ROAD, RIVEWOODS, IL 60015 US

(540) DINERS CLUB SUPERIOR

(550) I

(740) AOD "Ćupić", Dalmatinska 10, Podgorica ME

(511) **Klasa 36:** finasijske usluge, usluge kreditnih kartica

(210) **2012-488**

(442) **20.09.2014.**

(220) 11/30/2012

(731) **HOME BOX OFFICE, INC.** A DELAWARE CORPORATION, 1100 AVENUE OF THE AMERICAS, NEW YORK, NY 10036 US

(540) IT'S HBO, ANYWHERE. ANYTIME.

(550) I

(740) Čejović Vladimir, 13. jula 21, Podgorica ME

(511) **Klasa 38:** usluge mobilnih medija u smislu elektronskog prenosa, emitovanja i dovođenja audio, video i multimedijalnog zabavnog sadržaja uključujući tekst, podatke, slike, audio, video i audiovizuelne fajlove putem interneta, bežične komunikacije, elektronskih mreža za komunikaciju i kompjuterskih mreža

(210) **2012-489** (442) **20.09.2014.**

(220) 12/3/2012

(731) **HERSHEY CANADA, INC.** 5750 EXPLORER DRIVE, SUITE 500, MISSISSAUGA, ONTERIO L4W 0B1 CA



BROOKSIDE

(540)

(550) I

(511) **Klasa 29:** grickalice na bazi sušenog voća, kombinacija grickalica koja se sastoji uglavnom od prerađenih oraha, semenki, sušenog voća i koja takođe uključuje čokoladu, kombinacija grickalica koja se sastoji uglavnom od prerađenih oraha, semenki i sušenog voća, grickalice na bazi voća, čips od sušenog voća, čips od voća, voćni jogurt, voćni filovi za pekarske proizvode, voćni praškovi za pekarske proizvode, surutka od limuna, pomorandže i maline kao filovi za pekarske proizvode

Klasa 30: kafa, čaj, kakao i zamena kafe, pirinač, tapioka i sago, brašno i proizvodi od žitarica, hleb, kolači i poslastice, sladoledi, šećer, med, melasa, kvasac, prašak za pecivo, so, senf, sirće, sosovi (kao začini), začini, led, čokolada, proizvodi od čokolade, bombone, slatke štangice, poslastičarski proizvodi, kakao proizvodi, kolačići, biskviti, čokolada za kuvanje, komadići, kriške i komadi za pečenje slatkiša, čokoladna instant smeša (za hladne i vruće napitke), slatki prelive za sladoled i za deserte, torte, kolači, sladoled, smrznuti slatkiši

(210) **2012-490** (442) **20.09.2014.**

(220) 12/3/2012

(731) **ACTERRNA D.O.O.** CARA DUŠANA 28, BEOGRAD, SRBIJA RS

(540) FERROVIN

(550) I

(511) **Klasa 03:** sredstva za beljenje i druge spustance za upotrebu u perionicama, preparati za čišćenje, poliranje, ribanje i nagrizanje, sapuni, parfimerija, eterična ulja, kozmetika, losioni za kosu, paste za zube

Klasa 05: farmaceutski i veterinarski preparati, sanitarni preparati za medicinsku upotrebu, dijetetske supstance prilagođene za upotrebu u medicini, hrana za bebe, flasteri, materijali za zavijanje, materijali za plombiranje zuba, zubarska smola, dezinfekciona sredstva, preparati za uništavanje štetočina, fungicidi, herbicidi

Klasa 10: hirurški, medicinski, zubarski i veterinarski aparati i instrumenti, veštački udovi, oči i

zubi, ortopedski artikli, hirurški materijali za zašivanje

(210) **2012-491** (442) **20.09.2014.**

(220) 12/3/2012

(731) **FARMACEUTSKA HEMIJSKA KOZMETIČKA INDUSTRIJA ALKALOID AD-SKOPLJE**, BUL. ALEKSANDAR MAKEDONSKI BR.12 1000 SKOPLJE RM

(540) Cffetin sc

(550) I

(740) Popović Miladin, Đoka Miraševića 21/III, Podgorica ME

(511) **Klasa 05:** farmaceutski preparati

(210) **2012-492** (442) **20.09.2014.**

(220) 12/4/2012

(731) **PUNCH INDUSTRIES**, AN UNLIMITED IRISH COMPANY, MACRO II, UNIT 4, PLATO BUSINESS PARK, DAMASTOWN, DUBLIN 15 IE

**Colour
Catcher**
HVATAČ BOJA

(540)

(550) I

(740) Lutovac Branislav, Bulevar Crnojevića 93, Podgorica ME

(511) **Klasa 03:** impregnirane obrađene sintetičke netkane rupičaste maramice od celuloze, koje se koriste pri pranju, sredstva za osvježavanje rublja, omekšivači, sredstva za privlačenje prljavštine i boja, sredstva za bijeljenje i druge supstance za upotrebu u pranju, sredstva za čišćenje, poliranje, odmaščivanje i abrazivna sredstva

Klasa 21: pribor za čišćenje, krpe za čišćenje

(210) **2012-493** (442) **20.09.2014.**

(220) 12/4/2012

(731) **BURBERRY LIMITED**, HORSEFERRY HOUSE, HORSEFERRY ROAD, LONDON SW1P 2AW GB

(540) BURBERRY

(550) I

(740) Lutovac Branislav, Bulevar Crnojevića 93, Podgorica ME

(511) **Klasa 03:** nemedicinski toaletni preparati, kozmetika, sredstva za kupanje i tuširanje, sredstva za njegu tijela i kože, sredstva za zube i za kosu, sredstva za njegu noktiju, lak za nokte, vještački nokti, sapuni, antiperspiranti, dezodoransi, parfemi, kolonska voda, eau de toilette i toaletna voda, eterična ulja, ulje za masažu, potpuri, sredstva za osvježavanje prostorije i tamjan, sredstva za čišćenje i njegu proizvoda od kože i proizvoda koji nisu od kože

Klasa 09: naočari za sunce, naočari sa dioptrijom, optičke naočari, odgovarajući okviri i sočiva

za naprijed navedenu robu, futrole i držači za naprijed navedenu robu, djelovi i pribor za svu naprijed navedenu robu, futrole i držači za prenosive elektronske uređaje, mobilne telefone, prenosive audio i video sisteme i kompjutere, podloge za miševe, futrole za kamere, mobilni telefoni, prenosivi elektronski uređaji, oprema za mobilne telefone, uključujući futrole i zaštitne folije, priveske i uzice za mobilne telefone, maske za mobilne telefone

Klasa 14: ručni satovi, satovi i djelovi, oprema i kutije za svu naprijed navedenu robu, kaiševi i narukvice za satove, nakit, imitacija nakita, igle za kravate, kopče za kravate i dugmad za manžetne, proizvodi od plemenitih metala ili presvučeni njima, uključujući priveske za ključeve, priveske, bedževe, ukrase za cipele, kutije i futrole za nakit, modeli i figure od plemenitog metala

Klasa 18: proizvodi od kože ili imitacije kože, torbe, kovčezi, mali koferi, koferi, putne torbe, zaštitne navlake za odijela, putni neseseri, torbe za bebi opremu, nosiljke za bebe, pojasevi za hodanje beba, rančevi, sacel tašne, velike putne torbe, ručne torbe, torbe koje se nose preko ramena, futrole za kamere, torbe za kupovinu, torbe za kupovinu sa točkovima ikolica, tašne, vrećice, novčanici, futrole za ključeve, futrole za platne kartice, tašnice, naljepnice, naljepnice i oznake za prtljag, kutije i torbe za kozmetiku (neopremljene), futrole za pribor za manikir, putne torbice za nakit, kišobrani, suncobrani, odjeća za kućne ljubimce, pokrivači za konje, ogrlice i povodci za životinje

Klasa 25: odjeća, obuća, pokrivala za glavu, kaiševi

Klasa 35: usluge prodaje na malo i prodaje na veliko odjeće, obuće, pokrivala za glavu, torbi, malih proizvoda od kože i imitacije kože, modnih detalja, proizvoda za domaćinstvo, parfema, toaletnih proizvoda i kozmetike, satova, nakita, naočara i naočara za sunce

(210) **2012-494**

(442) **20.09.2014.**

(220) 12/4/2012

(731) **BURBERRY LIMITED**, HORSEFERRY HOUSE, HORSEFERRY ROAD, LONDON SW1P 2AW GB

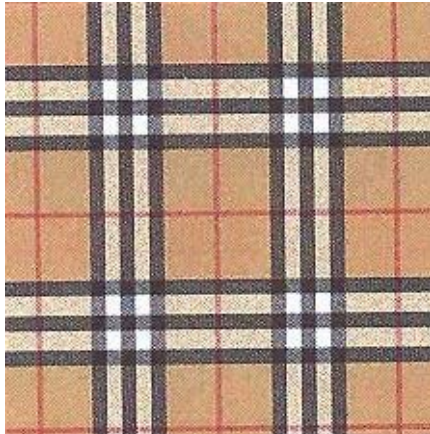

(540)

(550) I

(740) Lutovac Branislav, Bulevar Crnojevića 93, Podgorica ME

(511) **Klasa 03:** nemedicinski toaletni preparati, kozmetika, sredstva za kupanje i tuširanje, sredstva za njegu tijela i kože, sredstva za zube i za kosu, sredstva za njegu noktiju, lak za nokte, vještački nokti, sapuni, antiperspiranti, dezodoransi, parfemi, kolonska voda, eau de toilette i toaletna voda, eterična ulja, ulje za masažu, potpuri, sredstva za osvježavanje prostorije i tamjan, sredstva za čišćenje i njegu proizvoda od kože i proizvoda koji nisu od kože

Klasa 09: naočari za sunce, naočari sa dioptrijom, optičke naočari, odgovarajući okviri i sočiva

za naprijed navedenu robu, futrole i držači za naprijed navedenu robu, djelovi i pribor za svu naprijed navedenu robu, futrole i držači za prenosive elektronske uređaje, mobilne telefone, prenosive audio i video sisteme i kompjutere, podloge za miševe, futrole za kamere, mobilni telefoni, prenosivi elektronski uređaji, oprema za mobilne telefone, uključujući futrole i zaštitne folije, priveske i uzice za mobilne telefone, maske za mobilne telefone

Klasa 14: ručni satovi, satovi i djelovi, oprema i kutije za svu naprijed navedenu robu, kaiševi i narukvice za satove, nakit, imitacija nakita, igle za kravate, kopče za kravate i dugmad za manžetne, proizvodi od plemenitih metala ili presvučeni njima, uključujući priveske za ključeve, priveske, bedževe, ukrase za cipele, kutije i futrole za nakit, modeli i figure od plemenitog metala.

Klasa 18: proizvodi od kože ili imitacije kože, torbe, kovčezi, mali koferi, koferi, putne torbe, zaštitne navlake za odijela, putni neseseri, torbe za bebi opremu, nosiljke za bebe, pojasevi za hodanje beba, rančevi, sacel tašne, velike putne torbe, ručne torbe, torbe koje se nose preko ramena, futrole za kamere, torbe za kupovinu, torbe za kupovinu sa točkovima ikolica, tašne, vrećice, novčanici, futrole za ključeve, futrole za platne kartice, tašnice, naljepnice, naljepnice i oznake za prtljag, kutije i torbe za kozmetiku (neopremljene), futrole za pribor za manikir, putne torbice za nakit, kišobrani, suncobrani, odjeća za kućne ljubimce, pokrivači za konje, ogrlice i povodci za životinje

Klasa 25: odjeća, obuća, pokrivala za glavu, kaiševi

(210) **2012-495**

(442) **20.09.2014.**

(220) 12/4/2012

(731) **BURBERRY LIMITED**, HORSEFERRY HOUSE, HORSEFERRY ROAD, LONDON SW1P 2AWGB



(540)

(550) I

(740) Lutovac Branislav, Bulevar Crnojevića 93, Podgorica ME

(511) **Klasa 03:** nemedicinski toaletni preparati, kozmetika, sredstva za kupanje i tuširanje, sredstva za njegu tijela i kože, sredstva za zube i za kosu, sredstva za njegu noktiju, lak za nokte, vještački nokti, sapuni, antiperspiranti, dezodoransi, parfemi, kolonska voda, eau de toilette i toaletna voda, eterična ulja, ulje za masažu, potpuri, sredstva za osvježavanje prostorije i tamjan, sredstva za čišćenje i njegu proizvoda od kože i proizvoda koji nisu od kože

Klasa 09: naočari za sunce, naočari sa dioptrijom, optičke naočari, odgovarajući okviri i sočiva za naprijed navedenu robu, futrole i držači za naprijed navedenu robu, djelovi i pribor za svu naprijed navedenu robu, futrole i držači za prenosive elektronske uređaje, mobilne telefone,

prenosive audio i video sisteme i kompjutere, podloge za miševe, futrole za kamere, mobilni telefoni, prenosivi elektronski uređaji, oprema za mobilne telefone, uključujući futrole i zaštitne folije, priveske i uzice za mobilne telefone, maske za mobilne telefone

Klasa 14: ručni satovi, satovi i djelovi, oprema i kutije za svu naprijed navedenu robu, kaiševi i narukvice za satove, nakit, imitacija nakita, igle za kravate, kopče za kravate i dugmad za manžetne, proizvodi od plemenitih metala ili presvučeni njima, uključujući priveske za ključeve, priveske, bedževe, ukrase za cipele, kutije i futrole za nakit, modeli i figure od plemenitog metala

Klasa 18: proizvodi od kože ili imitacije kože, torbe, kovčezi, mali koferi, koferi, putne torbe, zaštitne navlake za odijela, putni neseseri, torbe za bebi opremu, nosiljke za bebe, pojasevi za hodanje beba, rančevi, sacel tašne, velike putne torbe, ručne torbe, torbe koje se nose preko ramena, futrole za kamere, torbe za kupovinu, torbe za kupovinu sa točkovima ikolica, tašne, vrećice, novčanici, futrole za ključeve, futrole za platne kartice, tašnice, naljepnice, naljepnice i oznake za prtljag, kutije i torbe za kozmetiku (neopremljene), futrole za pribor za manikir, putne torbice za nakit, kišobrani, suncobrani, odjeća za kućne ljubimce, pokrivači za konje, ogrlice i povodci za životinje

Klasa 25: odjeća, obuća, pokrivala za glavu, kaiševi

(210) **2012-496**

(442) **20.09.2014.**

(220) 12/4/2012

(731) **INTERNATIONAL GREAT BRANDS LLC**, DEFOREST AVENUE, EAST HANOVER, NJ 07936 US



(540)

(550) I

(740) AOD "Ćupić", Dalmatinska 10, Podgorica ME

(511) **Klasa 30:** pekarski proizvodi, poslastice i slatkiši, biskviti (slani ili slatki), galette, vafli, kolači, hleb, dvopek, čokolada i konditorski proizvodi, svi gore navedeni proizvodi koji nisu posebno namjenjeni za bebe, djecu i dojenčad

(210) **2012-497**

(442) **20.09.2014.**

(220) 12/4/2012

(731) **INTERNATIONAL GREAT BRANDS LLC**, 100, DEFOREST AVENUE, EAST HANOVER, NJ 07936 US

(540) ELVITA

(550) I

(740) AOD "Ćupić", Dalmatinska 10, Podgorica ME

(511) **Klasa 30:** pekarski proizvodi, poslastice i slatkiši, biskviti (slani ili slatki), galete, vafli, kolači, hleb, dvopek, čokolada i konditorski proizvodi, svi gore navedeni proizvodi koji nisu posebno namjenjeni za bebe, djecu i dojenčad

(210) **2012-498** (442) **20.09.2014.**

(220) 12/4/2012

(731) **IRONWOOD PHARMACEUTICALS, INC.** 301 BINNEY STREET CAMBRIDGE MASSACHUSETTS 02142 US

(540) KOHCTELLA

(550) I, V

(740) Popović Miladin, Đoka Miraševića 21/III, Podgorica ME

(511) **Klasa 05:** farmaceutske preparati za upotrebu kod lečenja hronične konstipacije, sindroma razdražljivog creva, poremećaja gastrointestinalnog motiliteta i drugih gastrointestinalnih poremećaja

(210) **2012-499** (442) **20.09.2014.**

(220) 12/5/2012

(300) 85/656368 20.06 2012. US

(731) **GENERAL MOTORS LLC**, 300 RENAISSANCE CENTER, DETROIT, MICHIGAN 48265-3000 US

(540) DOCKSPOT

(550) I, V,

(740) Radulović Božidar, Jovana Tomaševića 9/III, Podgorica ME

(511) **Klasa 09:** aparati za bežični prenos energije za indukciono punjenje prenosnih elektronskih uređaja

(210) **2012-500** (442) **20.09.2014.**

(220) 12/7/2012

(731) **CHATTEM INC.** 1715 WEST 38TH STREET, CHATTANOOGA, TENNESSE 37409 US

(540) ICY HOT

(550) I, V,

(740) Radulović Božidar, Jovana Tomaševića 9/III, Podgorica ME

(511) **Klasa 05:** analgetski melemi, sredstva protiv bolova za lokalnu upotrebu

Klasa 10: obloge protiv bolova za lokalnu upotrebu, za ublažavanje bola i za terapijske svrhe, tople obloge sa hemijskom aktivacijom za terapijske svrhe, gaze koje greju i gaze koje se greju za terapijske svrhe, kao i pomoćni i terapijski kompresivni zavoji i kompresivne gaze, zavoji i gaze za zglobove, pomagala za učvršćivanje udova i zglobova za medicinsku upotrebu

(210) **2012-501** (442) **20.09.2014.**

(220) 12/7/2012

(731) **CHATTEM INC.** 1715 WEST 38TH STREET, CHATTANOOGA, TENNESSE 37409 US



(540)

(550) I, V

(740) Radulović Božidar, Jovana Tomaševića 9/III, Podgorica ME

(511) **Klasa 05:** analgetski melemi, sredstva protiv bolova za lokalnu upotrebu

Klasa 10: obloge protiv bolova za lokalnu upotrebu, za ublažavanje bola i za terapijske svrhe, tople obloge sa hemijskom aktivacijom za terapijske svrhe, gaze koje greju i gaze koje se greju za terapijske svrhe, kao i pomoćni i terapijski kompresivni zavoji i kompresivne gaze, zavoji i gaze za zglobove, pomagala za učvršćivanje udova i zglobova za medicinsku upotrebu

(210) **2012-502**

(442) **20.09.2014.**

(220) 12/7/2012

(731) **GILDAN ACTIVEWEAR SRL**, NEWTON, CHRIST CHURCH BB17047 BB

(540) GILDAN

(550) I, V

(740) Radulović Božidar, Jovana Tomaševića 9/III, Podgorica ME

(511) **Klasa 25:** muška, ženska, za mlade i dečija odeća, naime, haljine, golf majice, polo majice, košulje, majice sa kragom, košulje s okovratnikom s kratkim rebastim rubovima, gornji delovi odeće sa kapuljačom, naročito duksevi sa kapuljačom, majice sa kapuljačom, vetrovke, pantalone za vetar, odeća za trčanje, pantalone za trčanje, šorcevi za trčanje, setovi odeće za trčanje, kombinezoni, tkane haljine, tkani šorcevi, tkani gornji delovi odeće, naročito tkane polo majice, majice bez rukava, jednodelna odela za igru i dvodelna odela za igru, naročito setovi koji se sastoje od pantalona i košulje, pantalone sa tregerima, pantalone, teksas farmerke, košulje, kompleti koji se sastoje od šorca i majice, suknje, haljine-majice, sportske majice, džemper, donji delovi trenerke, dukserice, majice na bretele, majice, rolke, odeća za spavanje, naročito, jednodelna dečija odeća za spavanje, pidžame i spavaćice, čarape, sokne, potkošulje, veš, ženski i muški veš, naročito bokserice, uzane bokserice, muške gaće, gaće, ženske gaćice, bikini gaće, gaće sa niskim strukom, gaće sa visokim strukom

(210) **2012-503**

(442) **20.09.2014.**

(220) 12/7/2012

(300) 11137247 23.08.2012. CTM

(731) **DEUTSCHE BORSE AG**, MERGENTHALERALLEE 61 65670 ESCHBORN DE

(540) C7

(550) I, V

(740) Popović Miladin, Đoka Miraševića 21/III, Podgorica ME

(511) **Klasa 16:** štampane stvari i štampane publikacije, naročito finansijski izvještaji, brošure, obavještenja, registri i prospekti iz oblasti finansija, finansijskih usluga i usluga kliring-agencija

Klasa 36: finansijski poslovi, naročito finansijske usluge kliring-agencija, usluge finansijskog kliringa i poravnanja, naročito kliring i poravnanje finansijskih transakcija za druge, usluge upravljanja finansijskim rizikom u vezi sa investicijama, bankarske usluge, obezbjeđivanje

onlajn elektronskih baza podataka iz oblasti usluga kliring-agencija, usluge finansijskog kliringa i poravnanja, naročito kliring i poravnanje finansijskih transakcija za druge, usluge upravljanja finansijskim rizikom u vezi sa investicijama, bankarske usluge

(210) **2012-504** (442) **20.09.2014.**

(220) 12/7/2012

(300) 11137353 23.08.2012. CTM

(731) **DEUTSCHE BORSE AG**, MERGENTHALERALLEE 61 65670 ESCHBORN DE

(540) T7

(550) I, V

(740) Popović Miladin, Đoka Miraševića 21/III, Podgorica ME

(511) **Klasa 16:** štampane stvari i štampane publikacije, naročito finansijski izvještaji, brošure, obavještenja, registri i prospekti iz oblasti finansija, finansijskih usluga i usluga kliring-agencija

Klasa 36: finansijski poslovi, naročito finansijske usluge kliring-agencija, usluge finansijskog kliringa i poravnanja, naročito kliring i poravnanje finansijskih transakcija za druge, usluge upravljanja finansijskim rizikom u vezi sa investicijama, bankarske usluge, obezbjeđivanje onlajn elektronskih baza podataka iz oblasti usluga kliring-agencija, usluge finansijskog kliringa i poravnanja, naročito kliring i poravnanje finansijskih transakcija za druge, usluge upravljanja finansijskim rizikom u vezi sa investicijama, bankarske usluge

(210) **2012-506** (442) **20.09.2014.**

(220) 12/10/2012

(731) **THE HERSHEY COMPANY**, 100 CRISTAL A DRIVE, HERSHEY, PA 17033 US



(540)

(550) I, F

(511) **Klasa 30:** kafa, čaj, kakao i zamena kafe, pirinač, tapioka i sago, brašno i proizvodi od žitarica, hleb, kolači i poslastice, sladoledi na bazi vode, šećer, med, melasa, kvasac, prašak za pecivo, so, senf, sirće, sosovi (kao začini), začini, led, čokolada: proizvodi od čokolade, bombone, slatke štangice, poslastičarski proizvodi, kakao proizvodi, kolačići, biskviti, čokolada za kuvanje, komadići, kriške i komadi za pečenje slatkiša, čokoladna instant smeša (za hladne i vruće napitke), slatki prelive za sladoled i za deserte, torte, kolači, sladoled, smrznuti slatkiši

(210) **2012-507** (442) **20.09.2014.**

(220) 12/10/2012

(731) **BRITISH AMERICAN TOBACCO (BRANDS) INC.** 2711 CENTERVILLE ROAD SUITE 300 WILMINGTON DELAWARE 19808 US

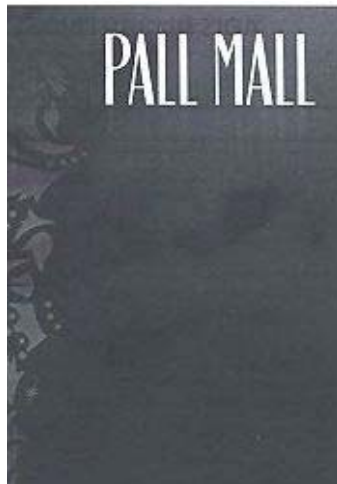

(540)

(550) I, F

(740) Popović Miladin, Đoka Miraševića 21/III, Podgorica ME

(511) **Klasa 34:** cigarete, duvan, proizvodi od duvana, upaljači, šibice, artikli za pušače(210) **2012-508**(442) **20.09.2014.**

(220) 12/13/2012

(300) 2012 10944 27.06.2012. UA

(731) **JAPAN TOBACCO INC.** 2-2-1 TORANOMON, MINATO-KU, TOKYO JP

(540) CHILL OUT

(550) I

(740) Čejović Vladimir, 13. jula 21, Podgorica ME

(511) Kasa 34: cigarete

(210) **2012-509**(442) **20.09.2014.**

(220) 12/14/2012

(731) **WESTEN UNION HOLDINGS, INC.** 12500 E.BELFORD AVE.M21A2 ENGLEWOOD, COLORADO 80112 US

(540) WU

(550) I, V

(740) Popović Miladin, Đoka Miraševića 21/III, Podgorica ME

(511) **Klasa 36:** osiguranje, finasijski poslovi, monetarni poslovi, upravljanje nekretninama(210) **2012-510**(442) **20.09.2014.**

(220) 12/14/2012

(731) **BALTIKA BREWERIES.** 3, 6TH VERKHNY PEREULOK, SAINT-PETERSBURG-194292 RU

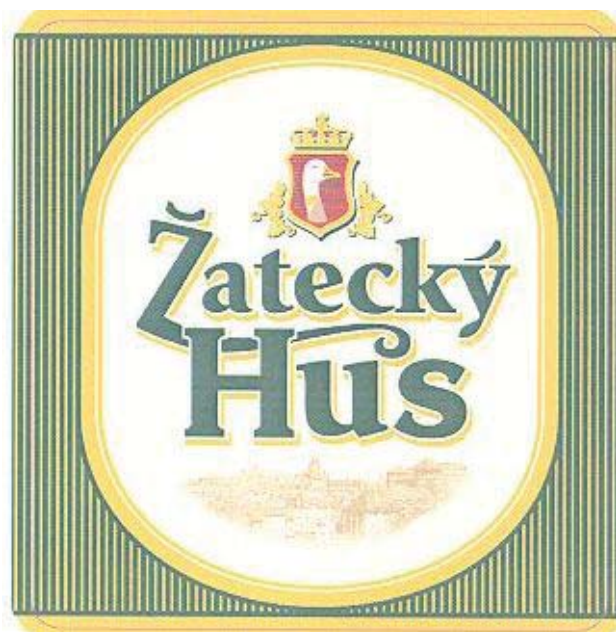

(540)

(550) I

(511) **Klasa 32:** pivo proizvedeno dodavanjem hmelja iz grada Žatec i regiona Žatec u Republici Češkoj, bezalkoholno pivo proizvedno dodavanjem hmelja iz grada Žžatec i regiona Žžatec u Republici Češkoj

(210) **2012-511**(442) **20.09.2014.**

(220) 12/14/2012

(731) **BALTIKA BREWERIES.** 3, 6TH VERKHNY PEREULOK, SAINT-PETERSBURG-194292 RU

(540) ZATECKY HUS

(550) I

(511) **Klasa 32:** pivo proizvedeno dodavanjem hmelja iz grada Žatec i regiona Žatec u Republici Češkoj, bezalkoholno pivo proizvedno dodavanjem hmelja iz grada Žžatec i regiona Žžatec u Republici Češkoj

(210) **2012-512**(442) **20.09.2014.**

(220) 12/14/2012

(731) **OTSUKA PHARMACEUTICAL CO.LTD,** 2-9 KANDA-TSUKASAMACHI, CHIYODA-KU, TOKYO JP

(540) JINARC

(550) I

(740) Popović Miladin, Đoka Miraševića 21/III, Podgorica ME

(511) **Klasa 05:** farmaceutski preparati(210) **2012-513**(442) **20.09.2014.**

(220) 12/18/2012

(731) **OTSUKA PHARMACEUTICAL CO.LTD,** 2-9 KANDA-TSUKASAMACHI, CHIYODA-KU, TOKYO JP

(540) JINARQ

(550) I

(740) Popović Miladin, Đoka Miraševića 21/III, Podgorica ME

(511) **Klasa 05:** farmaceutski preparati

(210) **2012-514**

(442) **20.09.2014.**

(220) 12/19/2012

(731) **KOVING DOO**, PARISKE KOMUNE BR.24 11070 NOVI BEOGRAD RS

(540) VINGCARD

(550) I

(740) Božović Vesko, Rimski trg 50/11, Podgorica ME

(511) **Klasa 06:** kasice za novac od metala, sefovi, prstenovi od metala, zaptivni prstenovi od metala, šarke od metala, zavrtnji od metala, obodi, bandaži od metala (zaptivne zatege, venci ili spojke), kase (sefovi) za gotovinu, kase (sefovi) za gotovinu, ključevi, nosači ključeva od metala, kutije od metala za čuvanje stvari, brave od metala, osim električnih, brave od metala (koje nisu električne), opruge za brave, kvake od metala, karike od metala za kvake, reze, zavrtnji za brave, mašine i mašinski alati, motori i pogonske mašine (osim za suvozemna vozila), mašinske spojnice i transmisioni elementi (osim za suvozemna vozila), poljoprivredne sprave osim onih kojima se ručno upravlja, inkubatori za jaja, automatske mašine za prodaju, električni aparati i instrumenti za ulaz, obradu, prenos, skladištenje i izlaz podataka, kompjuterska oprema za obradu, kompjuteri i mini kompjuteri, hardver, periferni uređaji i procesori svi za upotrebu zajedno sa kompjuterima, kamerama, mrežnim video proizvodima i štampačima, kućišta za kamere, sočiva za kamere, oprema za napajanje, džojstik uređaji, osvetljivači (koji nisu za medicinsku upotrebu), kablovi i konektori, instalacioni displeji sve za upotrebu zajedno sa kamerama, mrežnim video proizvodima i instalacijama za nadzor, printer serveri, serveri za pohranjivanje podataka, serveri za kamere, video koderi, kontrolori štampača, konverteri protokola, multiplekseri, kompjuterske interfejs table, table sa štampanim kolima, čipovi (integrisana kola), elektronski uređaji za upotrebu u kombinaciji sa kompjuterima ili kao integralni delovi kompjutera ili u kompjuterskim mrežama, kompjuterski programi i softver, softver za video upravljanje, aparati za snimanje, primanje, prenos ili reprodukciju zvuka ili slika, prenos ili reprodukciju informacija i slika preko globalne mreže i/ili preko drugih mreža, aparati za video nadzor, kamere, digitalne kamere, mrežne kamere, IP-kamere ili web kamere, video rekorderi i video plejeri, mrežni video proizvodi, aparati za kontrolu pristupa, instalacije za kontrolu pristupa, aparati za sigurnosni nadzor, električne i elektronske instalacije za video nadzor, elektronski časopisi i publikacije (koje se mogu skinuti sa mreže), marketinški materijal, tehničke informacije i prezentacije na CD-u/DVD-u, koji nisu za sisteme za upravljanje informacijama kao što su upravljanje odnosima sa dobavljačima, poslovna inteligencija, logistika, materijalno upravljanje, reinženjering i upravljanje poslovnim procesima, koji nisu za automatsku integraciju podataka ili razmenu podataka o poslovnim procesima

Klasa 35: ugovaranje poslovnih i finansijskih kontakata, takođe preko interneta, distribucija robe u reklamne svrhe, promocija robe i usluga za druge, obezbeđenje onlajn baze podataka sa komercijalnim informacijama za pretragu, takođe preko interneta, poslovne usluge, naime, obezbeđenje kompjuterskih baza podataka u vezi sa kupovinom ili prodajom različitih vrsta robe i usluga u ime drugih, usluge maloprodaje u polju digitalnih kamera, mrežnih kamera i web kamera, IP-kamera, video koderi, video dekoderi, aparata za kontrolu pristupa, kompjutera, kompjuterskih programa, softvera za video upravljanje, perifernih uređaja i opreme za kamere i kompjutere, usluge distribucije, uključujući poslove veleprodaje u vezi sa digitalnim kamerama, mrežnim kamerama, web kamerama, IP-kamerama, video koderima, video dekoderima, aparatima za kontrolu pristupa, kompjuterima, kompjuterskim programima, softverom za video upravljanje, perifernim uređajima i opremom za kamere i kompjutere, organizovanje izložbi u komercijalne svrhe, usluge nabavke za druge (kupovina robe i usluga za druge firme), komercijalna administracija licenciranja, koje nisu za sisteme za upravljanje

informacijama kao što su upravljanje odnosima sa dobavljačima, poslovna inteligencija, logistika, materijalno upravljanje, reinženjering i upravljanje poslovnim procesima, koje nisu za automatsku integraciju podataka ili razmenu podataka o poslovnim procesima. tehnička ekspertiza, razvoj elektronskih aparata za nadzor, kompjuterske konsalting usluge u vezi sa dizajnom programa za mikroprocesore, kompjutersku infrastrukturu, kompjuterski hardver, kompjuterski softver, osavremenjivanje kompjuterskih programa za obradu teksta, videa, slika i podataka, konsultantske aktivnosti u obliku testiranja i konsultacija za razvoj novih proizvoda i razvoj novih proizvoda, konsultacije i istraživanje u oblasti video nadzora, aparata za kontrolu pristupa, video tehnika, tehnika za kamere, procesiranje slika, sistemsku integraciju i snimljenje kompjuterske programe, razvoj kompjuterskih sistema, dizajn i razvoj proizvoda (hardver i softver) za druge u oblasti video nadzora, aparata za kontrolu pristupa, kompjutera, softvera, obrade slika, video i tehnika za kamere, inženjering, obezbeđenje tehničkog znanja, industrijski dizajn, kompjutersko programiranje, analize kompjuterskog sistema, dizajn softvera, održavanje i podrška softveru, osavremenjivanje softvera, odobravanje pristupnih vremena bazama podataka, hostovanje kompjuterskih sajtova (web sajtova), održavanje i kreiranje web sajtova za druge, koje nisu za sisteme za upravljanje informacijama kao što su upravljanje odnosima sa dobavljačima, poslovna inteligencija, logistika, materijalno upravljanje, reinženjering i upravljanje poslovnim procesima, koje nisu za automatsku integraciju podataka ili razmenu podataka o poslovnim procesima. usluge u vezi sa elektronskim nadzorom, alarmima protiv provalnika, sigurnošću, sigurnosnim alarmima, sigurnosnim sistemima i sistemima za kontrolu pristupa u sigurnosne svrhe, usluge kompjuterizovanog nadzora u vezi sa provalom i ulaskom, iznajmljivanje aparata za sigurnosni nadzor, licenciranje softvera, licenciranje znanja, licenciranje intelektualne svojine, koje nisu za sisteme za upravljanje informacijama kao što su upravljanje odnosima sa dobavljačima, poslovna inteligencija, logistika, materijalno upravljanje, reinženjering i upravljanje poslovnim procesima koje nisu za automatsku integraciju podataka ili razmenu podataka o poslovnim procesima

Klasa 42: usluge u vezi sa elektronskim nadzorom, alarmima protiv provalnika, sigurnošću, sigurnosnim alarmima, sigurnosnim sistemima i sistemima za kontrolu pristupa u sigurnosne svrhe, usluge kompjuterizovanog nadzora u vezi sa provalom i ulaskom, iznajmljivanje aparata za sigurnosni nadzor, licenciranje softvera, licenciranje znanja, licenciranje intelektualne svojine, koje nisu za sisteme za upravljanje informacijama kao što su upravljanje odnosima sa dobavljačima, poslovna inteligencija, logistika, materijalno upravljanje, reinženjering i upravljanje poslovnim procesima koje nisu za automatsku integraciju podataka ili razmenu podataka o poslovnim procesima

(210) **2012-515** (442) **20.09.2014.**

(220) 12/19/2012

(731) **GENZYME CORPORATION(MASSACHUSETTS CORPORATION),** 500
KENDALL STREET, CAMBRIDGE, MASSACHUSETTS 02142 US

(540) CIMVERIZ

(550) I

(740) Radulović Božidar, Jovana Tomaševića 9/III, Podgorica ME

(511) **Klasa 05:** farmaceutski preparati za tretiranje Goseove bolesti

(210) **2012-516** (442) **20.09.2014.**

(220) 12/19/2012

(300) 85657604 21.06.2012 US

(731) **GENZYIME CORPRATION(MASSACHUSETTS CORPORATION)**, 500
KENDALL STREET, CAMBRIDGE, MASSACHUSETTS 02142 US

(540) CIMUTOTE

(550) I, V

(740) Radulović Božidar, Jovana Tomaševića 9/III, Podgorica ME

(511) **Klasa 05:** farmaceutski preparati za tretiranje Goseove bolesti

(210) **2012-517** (442) **20.09.2014.**

(220) 12/19/2012

(300) 85657583 21.06.2012 US

(731) **GENZYIME CORPRATION (MASSACHUSETTS CORPORATION)**, 500
KENDALL STREET, CAMBRIDGE, MASSACHUSETTS 02142 US

(540) CERDELGA

(550) I, V

(740) Radulović Božidar, Jovana Tomaševića 9/III, Podgorica ME

(511) **Klasa 05:** farmaceutski preparati za tretiranje Goseove bolesti

(210) **2012-518** (442) **20.09.2014.**

(220) 12/20/2012

(731) **WM.WRIDLEY JR.COMPANY**, 1132 WEST BLACHAWK STREET, CHICAGO, ILLINOIS
60642 US

(540) ASCENT

(550) I

(740) Čejović Vladimir, 13. jula 21, Podgorica ME

(511) **Klasa 05:** žvakaća guma i dražeje od pepermint

(210) **2012-519** (442) **20.09.2014.**

(220) 12/20/2012

(731) **COMPAGNIE GERIVAIS DANONE** (A FRENCH CORPORATION), 17, BOULEVARD
HAUSSMANN, 75009 PARIS FR

(540) AKTIVIA

(550) I

(740) Čejović Vladimir, 13. jula 21, Podgorica ME

(511) **Klasa 29:** mlijeko, mlijeko u prahu, želatinirano, začinjeno i lupano mlijeko, mliječni proizvodi, naime, mliječni dezerti, jogurti, pića od jogurta, svježi sir, obična ili začinjena pića koja se uglavnom sastoje od mlijeka ili mliječnih proizvoda, mliječni napici sačinjeni uglavnom od mlijeka, mliječni napici koji sadrže voće, fermentizovani obični ili začinjeni mliječni proizvodi

Klasa 30: kakao, čokolada, napici na bazi kakaoa, napici na bazi čokolade, šećer, naduvani pirinač, proizvodi napravljeni od žitarica, žitarice za doručak, kolačići (slatki ili začinjeni), oblande, vafle, kolači, poslastice, svi ovi proizvodi su ili obični i/ili obloženi i/ili aromatizovani. konditorski proizvodi, jestivi led, jestivi led uglavnom napravljen od jogurta, sladoledi, vodeni led (jestivi led), smrznuti jogurti (jestivi led), aromatizovani led

Klasa 32: negazirana i gazirana voda (mineralna ili nemineralna), sokovi od voća ili povrća, pića od voća ili povrća, limunade, soda, sorbet pića, preparati za pića, sirupi za pića, bezalkoholni ekstrakti od voća ili povrća, bezalkoholna pića

(210) **2012-520** (442) **20.09.2014.**

(220) 12/21/2012

(731) **MOBILETRON ELECTRONICS CO.LTD**, NO.39, SEC.3, JHONGCING RD.DAYA DIST. TAICHUNG CITY 428, TAYWAN(R.O.C.) TW

MOBILETRON

(540)

(550) I, F

(740) Đakonović Vido, Bajova 9, Cetinje ME

(511) **Klasa 07:** držači četkica, pneumatski alati, akumulatorski alati i električni alati, naime udarni ključevi za vijke, ključevi za vijke, ključevi sa skakavicom, odvijači, odvijači sa automatskim punjenjem, pištolj za zakivanje, pištolji sa vrelo lepljenje, pištolji za heftanje, osim za hiruršku i kancelarijsku upotrebu, pištolji za eksere za drvo, pištolji za podmazivanje, čekićne hušilice, čekićni odvijač, zakivni čekić, čekići, hušilice, udarne hušilice, hrusilice, električne heftalice, testere, cirkularne testere, uhodne testere, motorne testere, rotacione brusilice, velike makaze, mašine za poliranje, oštraci noževa, makaze, hrusne trake i diskovi za električne rotacione hrusilice, svrdla za električne alate, svrdla za odvijače, klešta i bušilice, okasta svrdla za odvijače, ključeve i hušilice, okca za odvijače, ključeve i bušilice, dodaci za električne alate, naime okca za odvijače, ključeve i hušilice, i okasta svrdla za odvijače, ključeve i bušilice, delovi mašinski, naime, lanci za motorne testere, stezna čeljust, šila, ručni električni uređaji za poliranje za domaćinstvo i industrijske potrebe

Klasa 09: RVC (regulisano upravljanje naponom) adapteri, senzori zapreminski protok vazduha (MAF), senzor apsolutnog pritiska izduvne grane (MAP), senzori za kiseonik, senzori za radilicu, senzori bregaste osovine, senzori za sistem protiv blokiranja kočnica (ABS), sigurnosna oprema za vozilo, naime, elektronski uređaji za kontrolu pritiska u gumama, rezervni senzori, kamere, elektronski alarmi za divljač, elektronski uređaji za kontrolu vibracije, udara, kretanja, ugla, temperature i napona, elektronski sistem za kontrolu pritiska u gumama koji se sastoji od digitalnih prijemnika i monitora za prijem i praćenje signala za nadzora pritiska u gumama, temperature guma, i napona akumulatora, kamere sa uređajem sa spregnutim nabojem, predajnici, antene, elektronske skretnice za priključivanje antena i prijemnika, priključni kablovi, elektronski provodnici i stezaljke za creva, sistem za nadzor retrovizora koji se sastoji od kamera sa uređajem sa spregnutim nabojem, monitori za retrovizor, upravljačke kutije, električni kablovi i vodovi, baterije, mikrofoni i zvučnici, radarski detektori predmeta za upotrebu na vozilima, mašine za balansiranje guma za kopnena vozila, sistem za globalno pozicioniranje (GPS), audio oprema za vozila, naime, stereo uređaji, zvučnici, pojačala, ekvilizatori, skretnice i kućišta za zvučnike

Klasa 12: elektronika za vozila, naime, elektronski moduli za paljenje, razvodnici paljenja, elektronski kontroleri motora, ispravljači, diode, trojne diode, regulatori napona, reduktori napona, remontna kola, električni kalemi, kalemi davača, svećice, upaljači za cigare i elektronske upravljačke uređaje za upravljanje elektronskim delovima vozila, vozila, aparatura z.a kretanje kopnom, vazduhom ili vodom, automobilski delovi i komponente

(210) **2012-521** (442) **20.09.2014.**

(220) 12/21/2012

(731) **RABBIT RECORDS D.O.O.** BOKEŠKA 10.PODGORICA ME



(540)

(550) I, F

(511) **Klasa 09:** aparati za snimanje, prijenos, reprodukciju zvuka ili slika, magnetni nosači podataka, diskovi za snimanje, kompaktni diskovi, DVD i drugi numerički nosači za snimanje, kompaktni audio-video diskovi [diskovi], kompaktni optički diskovi [diskovi], muzičke datoteke koje se mogu preuzimati

Klasa 16: štamparski proizvodi, fotografije, albumi, čestitke s muzikom, časopisi [periodični], časopisi [revije], knjige

Klasa 35: oglašavanje i reklamiranje, vođenje komercijalnih poslova

(210) **2012-522**

(442) **20.09.2014.**

(220) 12/21/2012

(731) **TEVA PHARMACEUTICALS EUROPE B.V.** COMPUTERWEG 10 3542DR UTRECHT NL

(540) XEPTORAL

(550) I, V

(740) Popović Miladin, Đoka Miraševića 21/III, Podgorica ME

(511) **Klasa 05:** farmaceutski preparati za sprječavanje i liječenje imunitetskih reakcija na presađene organe i za liječenje autoimunih poremećaja

(210) **2012-523**

(442) **20.09.2014.**

(220) 12/21/2012

(731) **TEVA PHARMACEUTICALS EUROPE B.V.** COMPUTERWEG 10 3542DR UTRECHT NL

(540) VANQUORAL

(550) I, V

(740) Popović Miladin, Đoka Miraševića 21/III, Podgorica ME

(511) **Klasa 05:** farmaceutski preparati za sprječavanje i liječenje imunitetskih reakcija na presađene organe i za liječenje autoimunih poremećaja

(210) **2012-524**

(442) **20.09.2014.**

(220) 12/24/2012

(731) **FARMACEUTSKA HEMIJSKA KOZMETIČKA INDUSTRIJA ALKALOID AD-SKOPLJE**, BUL. ALEKSANDAR MAKEDONSKI 12, 1000 SKOPLJE RM



(540)

(550) I, F

(740) Popović Miladin, Đoka Miraševića 21/III, Podgorica ME

(511) **Klasa 03:** tonik za lice sa kolagenom i D-pantenol(210) **2012-525**(442) **20.09.2014.**

(220) 12/24/2012

(731) **FARMACEUTSKA HEMIJSKA KOZMETIČKA INDUSTRIJA ALKALOID AD-SKOPLJE**, BUL. ALEKSANDAR MAKEDONSKI 12, 1000 SKOPLJE RM

(540)

(550) I, F

(740) Popović Miladin, Đoka Miraševića 21/III, Podgorica ME

(511) **Klasa 03:** mlijeko za lice sa kolagenom i D-pantenol(210) **2012-526**(442) **20.09.2014.**

(220) 12/27/2012

(731) **13-JUL-PLANTAŽE AD**, PODGORICA ME

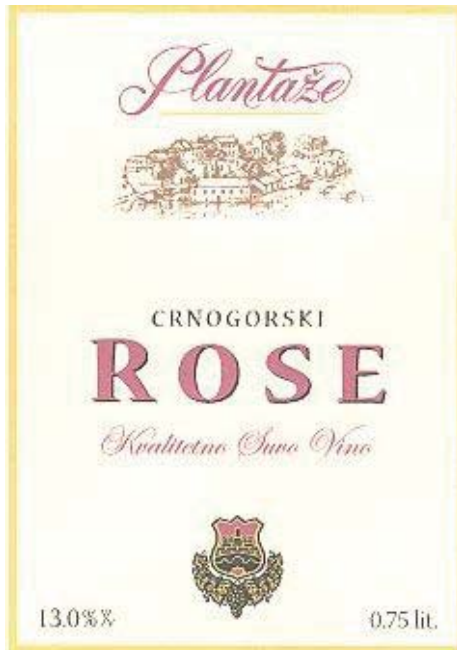

(540)

(550) I

(511) **Klasa 33:** alkoholna pića (izuzev piva)(210) **2012-527**(442) **20.09.2014.**

(220) 12/27/2012

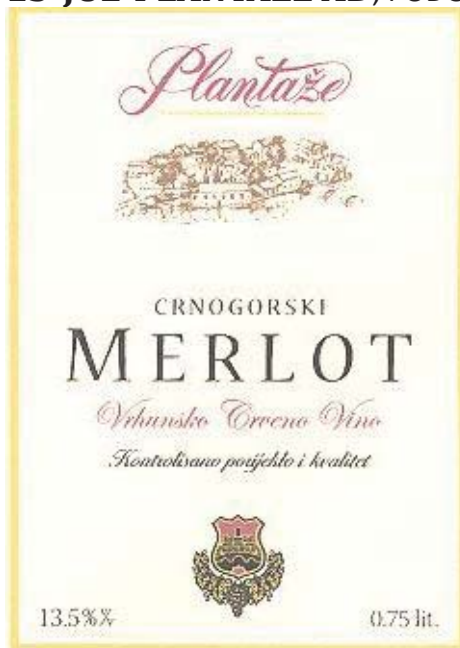
(731) **13-JUL-PLANTAŽE AD**, PODGORICA ME

(540)

(550) I

(511) **Klasa 33:** alkoholna pića (izuzev piva)(210) **2012-528**(442) **20.09.2014.**

(220) 12/27/2012

(731) **13-JUL-PLANTAŽE AD**, PODGORICA ME

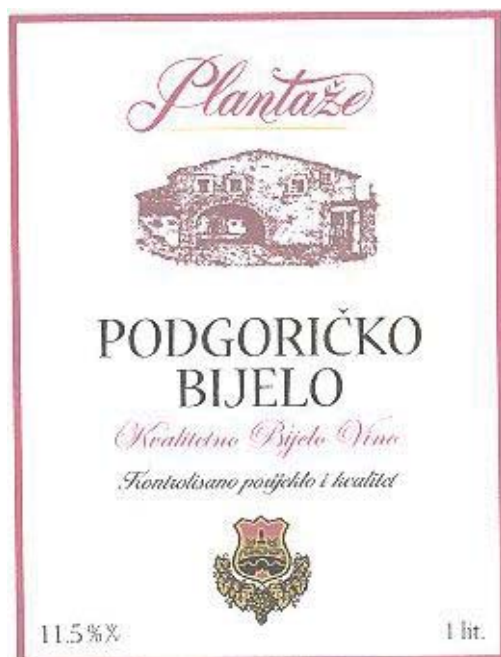

(540)

(550) I

(511) **Klasa 33:** alkoholna pića (izuzev piva)(210) **2012-530**(442) **20.09.2014.**

(220) 12/31/2012

(731) **MERCK SHARP & DOHME CORP**, ONE MERCK DRIVE, WHITEHOUSE STATION, NEW JERSEY 08889 US

(540) REDITWIST

(550) I

(740) Čejović Vladimir, 13. jula 21, Podgorica ME

(511) **Klasa 05:** farmaceutski preparati koji se isporučuju u unaprijed popunjenim injektivnim uređajima**Klasa 10:** Injektivni uređaji za medicinske svrhe(210) **2012-531**(442) **20.09.2014.**

(220) 12/31/2012

(731) **MERCK SHARP & DOHME CORP**, ONE MERCK DRIVE, WHITEHOUSE STATION, NEW JERSEY 08889 US

(540) SYMTWIST

(550) I

(740) Čejović Vladimir, 13. jula 21, Podgorica ME

(511) **Klasa 05:** farmaceutski preparati koji se isporučuju u unaprijed popunjenim injektivnim uređajima**Klasa 10:** injektivni uređaji za medicinske svrhe(210) **2012-532**(442) **20.09.2014.**

(220) 12/31/2012

(731) **EATON TECHNOLOGIES IP GMBH & CO.KG**, MITTELSTRASSE 5-5A, 12529 SCHOENEFELD DE

(540) INTERNORMEN

(550) I, V

(740) Radulović Božidar, Jovana Tomaševića 9/III, Podgorica ME

(511) **Klasa 09:** sistemi za praćenje stanja fluida, monitori za stanje fluida za merenje parametara hidraulične tečnosti i ulja, prenosivi monitori stanja fluida za praćenje stanja hidraulične tečnosti i maziva, sistem za praćenje čvrstih kontaminanata u fluidima, sistem za praćenje prisustva metalnih čestica u fluidima, sistemi za praćenje stanja fluida za praćenje zagušenosti filtera merenjem diferencijalnog pritiska, električni monitori za utvrđivanje prisustva gljivične infekcije u grožđu, senzori za čvrste kontaminante, senzori za praćenje prisustva vode u ulju, ugradni monitori za stacionarne sisteme za kontinualno ili periodično praćenje hidrauličnih sistema i sistema za podmazivanje, indeksni merači, sistem za merenje sposobnosti filtriranja za tečne namirnice, kao što su sokovi, pivo i vino: sistem za zagrevanje i hlađenje tečnosti za podmazivanje za generatorske vetrenjače, senzori za metalne čestice, senzori za viskoznost, senzori za dielektričnost, elektronski senzori za zagušenje, senzori za temperaturu, senzori za vodu, ugradni merni sistemi, merni sistemi za korišćenje uz vezu sa internetom i merni sistemi za korišćenje bez veze sa internetom, laserski brojači čestica, sistemi za uzimanje uzoraka iz boca, sistemi za višestruke analize, softver za odabir filtera, softver za simulaciju filtera za hidrauličke i sisteme za podmazivanje

Klasa 11: filtrirajuće posude, elementi filtera, filterske jedinice za filtriranje, punjenje ili ispiranje hidrauličkih sistema, sistema za servisiranje ulja ili sistema za podmazivanje, oprema za prečišćavanje ulja, sistemi za filtriranje i podmazivanje za podmazivanje zupčanika sa filtracijom i dezaeracijom maziva, prenosive jedinice za filtriranje bez veze sa internetom, stacionarne jedinice za filtriranje, sistemi za prečišćavanje fluida, filteri za hidrauličnu tečnost, filteri za tečnost za podmazivanje

(210) **2013-1**

(442) **20.09.2014.**

(220) 1/4/2013

(731) **THE HERSHEY COMPANY**, A CORPORATION ORGANIZED UNDER THE LAWS OF DELAWARE, 100 CRYSTAL A DRIVE, HERSHEY, PA 17033 US

HERSHEY'S

(540)

(550) I, F

(511) **Klasa 30:** kafa, čaj, kakao i zamena kafe, pirinač, tapioka i sago, brašno i proizvodi od žitarica, hleb, kolači i poslastice, sladoledi na bazi vode, šećer, med, melasa, kvasac, prašak za pecivo, so, senf, sirće, sosovi (kao začini), začini, led, čokolada, proizvodi od čokolade, bombone, slatke štanglice, poslastičarski proizvodi, kakao proizvodi, kolačići, biskviti, čokolada za kuvanje, komadići, kriške i komadi za pečenje slatkiša, čokoladna instant smeša (za hladne i vruće napitke), čokoladni prelive, bezalkoholni čokoladni liker, orasi prelive čokoladom, aromatizovani sirupi, naime čokoladni sirupi, sirupi od jagode, sirupi od karamele, sirupi od braon šećera i putera (butterscotch), sirupi sa puterom od kikirikija, slatki prelive za sladoled i za deserte, torte, kolači, sladoled, poslastice na bazi sladoleda, smrznuti slatkiši, nemlečni i bezalkoholni napici bazirani na čokoladi, pločice od žitarica

(210) **2013-10**

(442) **20.09.2014.**

(220) 1/15/2013

(731) **RETAIL RAYALTY COMPANY**(NEVADA CORPRATION), 101 CONVENTION CENTER DRIVE, LAS VEGAS, NEVADA 89109 US

(540) AERIE

(550) I, V

(740) Radulović Božidar, Jovana Tomaševića 9/III, Podgorica ME

(511) **Klasa 03:** kozmetika, toaletni proizvodi, proizvodi za ličnu njegu

Klasa 14: nakit i satovi

Klasa 18: torbe, ruksaci, kišobrani, novčanici, tašne

Klasa 25: odjeća, obuća, pokrivala za glavu

Klasa 35: usluge maloprodaje i usluge onlajn maloprodaje koje se odnose na kozmetiku, toaletne proizvode, proizvode za ličnu njegu, parfeme, nakit i satove, torbe, ruksake, kišobrane, novčanike, tašne, odjeću, akcesoare, obuću, pokrivala za glavu i naočare

(210) **2013-11** (442) **20.09.2014.**

(220) 1/15/2013

(731) **RETAIL ROYALTY COMPANY** (NEVADA CORPRATION), 101 CONVENTION CENTER DRIVE, LAS VEGAS, NEVADA 89109 US

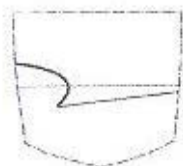

(540)

(550) I, F

(740) Radulović Božidar, Jovana Tomaševića 9/III, Podgorica ME

(511) **Klasa 25:** pantalone, farmerke, šorcevi, suknje

(210) **2013-12** (442) **20.09.2014.**

(220) 1/15/2013

(731) **RETAIL ROYALTY COMPANY** (NEVADA CORPRATION), 101 CONVENTION CENTER DRIVE, LAS VEGAS, NEVADA 89109 US

(540) AMERICAN EAGLE

(550) I, V

(740) Radulović Božidar, Jovana Tomaševića 9/III, Podgorica ME

(511) **Klasa 03:** kozmetika, toaletni proizvodi, proizvodi za ličnu njegu

Klasa 14: nakit i satovi

Klasa 25: odjeća, obuća, pokrivala za glavu

Klasa 35: usluge maloprodaje i usluge onlajn maloprodaje koje se odnose na kozmetiku, toaletne proizvode, proizvode za ličnu njegu, parfeme, nakit i satove, torbe, ruksake, kišobrane, novčanike, tašne, odjeću, akcesoare, obuću, pokrivala za glavu i naočare

(210) **2013-13** (442) **20.09.2014.**

(220) 1/15/2013

(731) **RETAIL ROYALTY COMPANY** (NEVADA CORPRATION), 101 CONVENTION CENTER DRIVE, LAS VEGAS, NEVADA 89109 US

(540) AEO

(550) I, V

(740) Radulović Božidar, Jovana Tomaševića 9/III, Podgorica ME

(511) **Klasa 03:** kozmetika, toaletni proizvodi, proizvodi za ličnu njegu

Klasa 14: nakit i satovi

Klasa 18: torbe, ruksaci, kišobrani, novčanici, tašne

Klasa 25: odjeća, obuća, pokrivala za glavu

Klasa 35: usluge maloprodaje i usluge onlajn maloprodaje koje se odnose na kozmetiku, toaletne proizvode, proizvode za ličnu njegu, parfeme, nakit i satove, torbe, ruksake, kišobrane, novčanike, tašne, odjeću, akcesoare, obuću, pokrivala za glavu i naočare

(210) **2013-14**

(442) **20.09.2014.**

(220) 1/15/2013

(731) **RETAIL ROYALTY COMPANY** (NEVADA CORPRATION), 101 CONVENTION CENTER DRIVE, LAS VEGAS, NEVADA 89109 US

(540) PRETTY GOES WITH EVERYTHING

(550) I, V

(740) Radulović Božidar, Jovana Tomaševića 9/III, Podgorica ME

(511) **Klasa 03:** parfemi, toaletni proizvodi za negu i čišćenje kose i kože kozmetika

Klasa 25: odjeća, obuća, pokrivala za glavu

Klasa 35: usluge maloprodaje i usluge onlajn maloprodaje koje se odnose na kozmetiku, toaletne proizvode, proizvode za ličnu njegu, parfeme, nakit i satove, torbe, ruksake, kišobrane, novčanike, tašne, odjeću, akcesoare, obuću, pokrivala za glavu i naočare

(210) **2013-15**

(442) **20.09.2014.**

(220) 1/15/2013

(731) **RETAIL ROYALTY COMPANY** (NEVADA CORPRATION), 101 CONVENTION CENTER DRIVE, LAS VEGAS, NEVADA 89109 US

(540) AE

(550) I, V

(740) Radulović Božidar, Jovana Tomaševića 9/III, Podgorica ME

(511) **Klasa 03:** kozmetika, toaletni proizvodi, proizvodi za ličnu njegu

Klasa 14: nakit i satovi

Klasa 25: odjeća, obuća, pokrivala za glavu

Klasa 35: usluge maloprodaje i usluge onlajn maloprodaje koje se odnose na kozmetiku, toaletne proizvode, proizvode za ličnu njegu, parfeme, nakit i satove, torbe, ruksake, kišobrane, novčanike, tašne, odjeću, akcesoare, obuću, pokrivala za glavu i naočare

(210) **2013-16**

(442) **20.09.2014.**

(220) 1/15/2013

(731) **RETAIL ROYALTY COMPANY** (NEVADA CORPRATION), 101 CONVENTION CENTER DRIVE, LAS VEGAS, NEVADA 89109 US

(540) AMERICAN EAGLE OUTFITTERS

(550) I, V

(740) Radulović Božidar, Jovana Tomaševića 9/III, Podgorica ME

(511) **Klasa 03:** kozmetika, toaletni proizvodi, proizvodi za ličnu njegu

Klasa 14: nakit i satovi

Klasa 18: torbe, ruksaci, kišobrani, novčanici, tašne

Klasa 25: odjeća, obuća, pokrivala za glavu

Klasa 35: usluge maloprodaje i usluge onlajn maloprodaje koje se odnose na kozmetiku, toaletne proizvode, proizvode za ličnu njegu, parfeme, nakit i satove, torbe, ruksake, kišobrane, novčanike, tašne, odjeću, akcesoare, obuću, pokrivala za glavu i naočare

(210) **2013-17** (442) **20.09.2014.**

(220) 1/15/2013

(731) **RETAIL ROYALTY COMPANY** (NEVADA CORPORATION), 101 CONVENTION CENTER DRIVE, LAS VEGAS, NEVADA 89109 US



(540)

(550) I, V

(740) Radulović Božidar, Jovana Tomaševića 9/III, Podgorica ME

(511) **Klasa 03:** kozmetika, toaletni proizvodi, proizvodi za ličnu njegu

Klasa 14: nakit i satovi

Klasa 18: torbe, ruksaci, kišobrani, novčanici, tašne

Klasa 25: odjeća, obuća, pokrivala za glavu

Klasa 35: usluge maloprodaje i usluge onlajn maloprodaje koje se odnose na kozmetiku, toaletne proizvode, proizvode za ličnu njegu, parfeme, nakit i satove, torbe, ruksake, kišobrane, novčanike, tašne, odjeću, akcesoare, obuću, pokrivala za glavu i naočare

(210) **2013-170** (442) **20.09.2014.**

(220) 5/7/2013

(731) **APPLE INC.** 1 INFINITE LOOP, CUPERTINO, CALIFORNIA 95014 US

MULTI-TOUCH

(540)

(550) I

(740) AOD "Ćupić", Dalmatinska 10, Podgorica ME

(511) **Klasa 09:** ručni mobilni digitalni elektronski uređaji sa elektronskom poštom, digitalni prenos podataka, audio plejeri, video plejeri, ručni kompjuteri, personalni digitalni asistenti, elektronski organizatori, elektronski notesi, telefonske i kompjuterske igre, funkcije kamere i

računarski softveri za upotrebu sa navedenim uređajima

(210) **2013-171** (442) **20.09.2014.**

(220) 5/7/2013

(731) **NISSAN JIDOSHA KABUSHIKI KAISHA** (ALSO TRADING AS NISSAN MOTOR CO.LTD), NO.2 TAKARACHO KANAGAWA-KU YOKOHAMA-SHI KANAGAWA-KEN JP

SENTRA

(540)

(550) I, V

(740) Popović Miladin, Đoka Miraševića 21/III, Podgorica ME

(511) **Klasa 12:** automobili, karavani, teretnjaci, kombiji, terenska vozila (SUV vozila), autobusi, rekreativna vozila (RV), sportski automobili, trkački automobili, kamioni, viljuškari, i traktori za vucu (traktori), i strukturni dijelovi i oprema za iste, traktori, protiv-provalni alarmi za vozila, samoljepljive gumene zakrpe za popravku unutrašnjih i spoljašnjih guma, sve uključeno u međunarodnu klasu 12

(210) **2013-172** (442) **20.09.2014.**

(220) 5/8/2013

(300) US 17.12.2012 85804346

(731) **THE GILLETTE COMPANY**, ONE GILLETTE PARK, BOSTON, MA 02127 US

FLEXBALL

(540)

(550) I

(740) Lutovac Branislav, Bulevar Crnojevića 93, Podgorica ME

(511) **Klasa 08:** brijači i nožici za brijače, automati (dozeri), kasete, držači i ulošci koji su svi posebno dizajnirani za i sadrže, nožice za brijače, djelovi i oprema za naprije navedenu robu

(210) **2013-173** (442) **20.09.2014.**

(220) 5/8/2013

(300) 011332566 09.11.2012. CTM

(731) **STIEFEL LABORATORIES**, INC. CORPORATION SERVICE COMPANY, 2711 CENTERVILLE ROAD, SUITE 400, WILMINGTON, DELAWARE 19808 US

PHYSIOGEL BIOMIMIC TECHNOLOGY

(540)

(550) I

(740) Lutovac Branislav, Bulevar Crnojevića 93, Podgorica ME

(511) **Klasa 03:** Preparati za njegu kože, kose i skalpa, šamponi, preparati za pranje, gelovi, pjene, dezodoransi, sapuni, puderi, losioni, kreme, ulja, masti u međunarodnoj klasi 03

(210) **2013-174** (442) **20.09.2014.**

(220) 5/8/2013

(300) 2645403 12.12.2012. GB

(731) **GLAXO GROUP LIMITED**, 980 GREAT WEST ROAD BRENTFORD MIDDLESEX TW8 9GS GB

HIGH DEFINITION

(540)

(550) I, V

(740) Popović Miladin, Đoka Miraševića 21/III, Podgorica ME

(511) **Klasa 03:** preparati za bijeljenje i ostale materije za pranje rublja, preparati za čišćenje, poliranje, odmašćivanje i struganje, sapuni, parfimerijski proizvodi, eterična ulja, kozmetički proizvodi, losioni za kosu, proizvodi za njegu zuba, naročito nemedicinski toaletni preparati, paste za zube, tečnosti za ispiranje usta i osvježivaci daha, preparati za oralnu njegu, gelovi za zube, preparati za izbjeljivanje, preparati za poliranje zuba, preparati i akceleratori za izbjeljivanje zuba, kozmetički preparati za uklanjanje mrlja

Klasa 05: farmaceutski i veterinarski proizvodi, higijenski proizvodi za upotrebu u medicini, dijetalne materije za medicinske potrebe, hrana za bebe, flasteri, materijal za previjanje, materijali za plombiranje zuba i za zubne otiske, dezinfekciona sredstva, proizvodi za uništavanje životinjskih štetočina, fungicidi, herbicidi, naročito medicinski preparati za oralnu njegu, medicinski preparati za poliranje zuba, medicinski preparati za posvjetljivanje zuba, medicinske tečnosti za ispiranje usta, medicinski preparati za izbjeljivanje, medicinske žvakaće gume i pastile za dentalnu higijenu

Klasa 10: hirurški, medicinski zubarski i veterinarski, aparati i instrumenti, vještački udovi, oči i zubi, ortopedski proizvodi, hirurški pribor za zašivanje rana, naročito aparati za oralnu njegu, fleksibilne i stomatološke posude za jednokratnu upotrebu

Klasa 21: pribor i posude za domaćinstvo ili za kuhinju, češljeve i sunđere, četke (osim kičica), materijali za četke, pribor za čišćenje, žica za struganje parketa, sirovo ili poluobradeno staklo (osim građevinskog stakla), stakleni proizvodi, porculansko i keramičko posuđe koje nije obuhvaćeno drugim klasama, naročito četkice za zube, čačkalice, zubni konac, četke i sunđeri, držači i aplikatori za njih

(210) **2013-175**

(442) **20.09.2014.**

(220) 5/8/2013

(731) **TRIZON HOLDINGS LIMITED**, PO BOX 957, OFFSHORE INCORPORATIONS CENTRE, ROAD TOWN, TORTOLA BRITISH VIRGIN ISLANDS GB

SETAI

(540)

(550) I

(511) **Klasa 35:** Onlajn, kataloške i maloprodajne usluge naime koje se odnose na posteljine, svijeće, namještaj i dekorativne predmete, muziku, proizvode za ljepotu i ličnu njegu, kozmetiku, odjeću i dodatke, nakit i parfeme

Klasa 36: usluge upravljanja nekretninama i brokerske usluge, razvoj nekretnina

Klasa 43: usluge hotela i restorana

(210) **2013-176**

(442) **20.09.2014.**

(220) 5/10/2013

(731) **SONDCO IP LIMITED**, UNIT A, BROOK PARK EAST SHIREBROOK NG20 8 RY GB

(540) SONDICO

(550) I,

(740) Popović Miladin, Đoka Miraševića 21/III, Podgorica ME

(511) **Klasa 25:** odjeća, obuća, pokrivala za glavu, odjeća za spavanje, modna odjeća, ležerna odjeća, sportske cipele, patike, čizme, planinske cipele, kopačke, cipele, obuća za bicikliste, vodootporna odjeća, odjeća za sve vremenske uslove, termo odjeća, lagana odjeća, kaputi, odjeća za vježbanje, sportska odjeća, šorcevi za surfovanje, zaštitna odjeća za surfovanje, odjeća za skijanje, jakne, vjetrovke, puloveri, pantalone, košulje, majice, kabanice, kecelje, kombinezoni/pantalone satregerima, šalovi, kaiševi [odjeća], kožni kaiševi, rukavice, šeširi, balaklava, čarape, čarape za fudbal, donje rublje, dokoljenice, kombinezoni za skijanje na vodi, sportski dresovi, odjeća za fudbal, dresovi za fudbal, termo i kompresijska odjeća, replike dresova za fudbal, zaštitna odjeća [osim za zaštitu od nezgode ili povrede], zaštitne rukavice [osim za zaštitu od nezgode ili povrede], sportska pokrivala za glavu [osim kacige], zaštitna obuća [osim za zaštitu od nezgode ili povrede], sportska odjeća, sportske uniforme, odjeća za jahanje, klinovi za kopačke [cipele], povezi za ruku [odjeća]

Klasa 28: igre i igračke, gimnastički i sportski predmeti, oprema i aparati koji nijesu uključeni u druge klase, aparati i oprema za vježbanje i fitnes, lopte, lopte za fudbal, loptice za badminton, štapovi za golf, palice, štapovi, i reketi, štitnici za koljena za sportsku upotrebu, štitnici za noge prilagođeni za sportsku upotrebu, štitnici za potkoljenice [sportski predmeti], štitnici za laktove (sportski predmeti), štitnici za kukove posebno napravljeni za sportsku upotrebu [djelovi sportske odjeće], štitnici za potkoljenice za sportsku upotrebu, štitnici za ručne zglobove za sportsku upotrebu, štitnici za pesnicesportski predmeti], štitnici za šake prilagođeni za sportsku upotrebu, rukavice, viziri, maske, štitnici za tijelo, štitnici za ruke, štitnici za podlaktice i štitnici za potkoljenice, golmanske rukavice za upotrebu u fudbalu, pumpe za lopte za igru, aparati i oprema za igrališta, ukrasi za božićne jelke, karte za igru, klizaljke, skejtbordi, torbe za sportsku opremu, oprema za ribolov, torbe, navlaka i držači za sportske predmete, golovi za američki fudbal ili fudbal, aparati za vježbanje za upotrebu u vezi sa fudbalom, mreže za gol u fudbalu, stative, zviždaljke, djelovi i pribor u ovoj klasi za sve gore navedene robe

(210) **2013-177**

(442) **20.09.2014.**

(220) 5/10/2013

(731) **SONDCO IP LIMITED**, UNIT A, BROOK PARK EAST SHIREBROOK NG20 8 RY GB



(540)

(550) I, F

(740) Popović Miladin, Đoka Miraševića 21/III, Podgorica ME

(511) **Klasa 25:** odjeća, obuća, pokrivala za glavu, odjeća za spavanje, modna odjeća, ležerna

odjeća, sportske cipele, patike, čizme, planinske cipele, kopačke, cipele, obuća za bicikliste, vodootporna odjeća, odjeća za sve vremenske uslove, termo odjeća, lagana odjeća, kaputi, odjeća za vježbanje, sportska odjeća, šorcevi za surfovanje, zaštitna odjeća za surfovanje, odjeća za skijanje, jakne, vjetrovke, puloveri, pantalone, košulje, majice, kabanice, kecelje, kombinezoni/pantalone satregerima, šalovi, kaiševi [odjeća], kožni kaiševi, rukavice, šeširi, balaklava, čarape, čarape za fudbal, donje rublje, dokoljenice, kombinezoni za skijanje na vodi, sportski dresovi, odjeća za fudbal, dresovi za fudbal, termo i kompresijska odjeća, replike dresova za fudbal, zaštitna odjeća [osim za zaštitu od nezgode ili povrede], zaštitne rukavice [osim za zaštitu od nezgode ili povrede], sportska pokrivala za glavu [osim kacige], zaštitna obuća [osim za zaštitu od nezgode ili povrede], sportska odjeća, sportske uniforme, odjeća za jahanje, klinovi za kopačke [cipele], povezi za ruku [odjeća]

Klasa 28: igre i igračke, gimnastički i sportski predmeti, oprema i aparati koji nijesu uključeni u druge klase, aparati i oprema za vježbanje i fitnes, lopte, lopte za fudbal, loptice za badminton, štapovi za golf, palice, štapovi, i reketi, štitnici za koljena za sportsku upotrebu, štitnici za noge prilagođeni za sportsku upotrebu, štitnici za potkoljenice [sportski predmeti], štitnici za laktove (sportski predmeti), štitnici za kukove posebno napravljeni za sportsku upotrebu [djelovi sportske odjeće], štitnici za potkoljenice za sportsku upotrebu, štitnici za ručne zglobove za sportsku upotrebu, štitnici za pesnicesportski predmeti], štitnici za šake prilagođeni za sportsku upotrebu, rukavice, viziri, maske, štitnici za tijelo, štitnici za ruke, štitnici za podlaktice i štitnici za potkoljenice, golmanske rukavice za upotrebu u fudbalu, pumpe za lopte za igru, aparati i oprema za igrališta, ukrasi za božićne jelke, karte za igru, klizaljke, skejtbordi, torbe za sportsku opremu, oprema za ribolov, torbe, navlaka i držači za sportske predmete, golovi za američki fudbal ili fudbal, aparati za vježbanje za upotrebu u vezi sa fudbalom, mreže za gol u fudbalu, stative, zviždaljke, djelovi i pribor u ovoj klasi za sve gore navedene robe

(210) **2013-178** (442) **20.09.2014.**

(220) 5/13/2013

(300) 63443/2012 12.11.2012. CH

(731) **Philip Morris Brands Sarl**, Quai Jeanrenaud 3, Neuchatel, 2000 CH

JAVAFLAV

(540)

(550) I

(511) **Klasa 34:** duvan, sirov ili prerađen, duvanski proizvodi, naročito cigare, cigarete, cigarilosi, duvan za uvijanje cigareta, duvan za lule, duvan za žvakanje, duvan za šmrkanje, kretek, snus (duvan u prahu), zamena za duvan (za nemedicinsku upotrebu), artikli za pušače, naročito papir za cigarete i lule, filteri za cigarete, kutije za duvan, tabakere (kutije za cigarete) i pepeljare, lule, ručni aparati /spravice za uvijanje cigareta, upaljači, šibice

(210) **2013-179** (442) **20.09.2014.**

(220) 5/13/2013

(731) **BASF AGRO B.V.ARMHEM (NL)**, ZWEIGNIEDERLASSUNG ZURICH, IM TIERGARTEN 7 ZURICH CH

SCALA

(540)

(550) I

(740) Stanković Mugoša Ana, Trg Republike 13, Podgorica ME

(511) **Klasa 01:** hemikalije koje se koriste u poljoprivredi, hortikulturi i šumarstvu, naročito preparati za jačanje biljaka, hemijski i/ili biološki preparati za kontrolu stresa kod biljaka, preparati za regulisanje rasta biljaka, hemijski preparati za tretiranje sjemena, površinski-aktivna sredstva, prirodne ili vještačke hemikalije koje se koriste kao seksualni mamci ili agensi za zbunjivanje insekata

Klasa 05: preparati za uništavanje i suzbijanje štetočina, insekticidi, fungicidi, herbicidi, pesticidi

(210) 2013-18

(442) **20.09.2014.**

(220) 1/15/2013

(731) **RETAIL ROYALTY COMPANY** (NEVADA CORPRATION), 101 CONVENTION CENTER DRIVE, LAS VEGAS, NEVADA 89109 US

(540) LIVE YOUR LIFE

(550) I, V

(740) Radulović Božidar, Jovana Tomaševića 9/III, Podgorica ME

(511) **Klasa 25:** odjeća, obuća, pokrivala za glavu

Klasa 35: usluge maloprodaje i usluge onlajn maloprodaje koje se odnose na kozmetiku, toaletne proizvode, proizvode za ličnu njegu, parfeme, nakit i satove, torbe, ruksake, kišobrane, novčanike, tašne, odjeću, akcesoare, obuću, pokrivala za glavu i naočare

(210) **2013-180**

(442) **20.09.2014.**

(220) 5/14/2013

(731) **SIMPLONTRADE D.O.O.** UL. 8.MARTA BR.55 PODGORICA ME



(540)

(550) I

(511) **Klasa 35:** oglašavanje i reklamiranje, vođenje komercijalnih poslova, komercijalna administracija, kancelarijski poslovi

Klasa 36: osiguranje, finansijski poslovi, monetarni poslovi, upravljanje nekretninama

(210) **2013-181**

(442) **20.09.2014.**

(220) 5/16/2013

(731) **DIAGEO BRANDS B.V.** MOLENWERF 10-12, 1014, BG AMSTERDAM NL

RED LABEL

(540)

(550) I

(511) **Klasa 33:** alkoholna pića (izuzev piva)

(210) **2013-182** (442) **20.09.2014.**

(220) 5/16/2013

(731) **TEVA PHARMACEUTICAL EUROPE B.V.** COMPUTERWEG 10 3542 DR UTRECHT
NL

(540) CIQORIN

(550) I

(740) Popović Miladin, Đoka Miraševića 21/III, Podgorica ME

(511) **Klasa 05:** farmaceutski preparati za sprečavanje i liječenje imutetskih reakcija na presađene organe i za liječenje autoimunih poremećaja

(210) **2013-183** (442) **20.09.2014.**

(220) 5/17/2013

(731) **HONDA MOTORS CO.LTD**, 1-1, MINAMI-AOYAMA 2-CHOME, MINATO-KU TOKYO
107-8556, JP

MONTESA

(540)

(550) I

(740) Lutovac Branislav, Bulevar Crnojevića 93, Podgorica ME

(511) **Klasa 12:** motocikli i djelovi i oprema za njih

(210) **2013-184** (442) **20.09.2014.**

(220) 5/20/2013

(731) **INTERNATIONAL TRADE MARK AGENCY DOO**, PARISKE KOMUNE 24, BEOGRAD
RS

(540) ONE&ONLY

(550) I

(511) **Klasa 35:** oglašavanje, vođenje poslova, poslovno upravljanje, kancelarijski poslovi

Klasa 39: organizovanje putovanja

Klasa 41: usluge koje pružaju sve vrste edukacije lica, organizovanje i vođenje seminara, konferencija i kongresa

Klasa 42: usluge smeštaja, hotelske, ugostiteljske i barske usluge, catering usluge za snabdevanje hranom i/ili pićem, usuge rezervacija hotelskih soba

Klasa 43: usluge hotela, odmarališta, motela, usluge privremenog smeštaja, usluge putnih agencija u vezi sa rezervacijom hotelskog smeštaja, specijalizovane hotelske usluge kao deo programa za stalne goste hotela, usluge restorana, barova i koktel barova, usluge snek barova, obezbeđivanje kapaciteta za održavanje proslava i društvenih događaja za specijalne prilike, catering za potrebe snabdevanja hrane i pića, obezbeđivanje kapaciteta za konferencije, izložbe i sastanke, iznajmljivanje konferencijskih sala

(210) **2013-185** (442) **20.09.2014.**

(220) 5/20/2013

(731) **INTERNATIONAL TRADE MARK AGENCY DOO**, PARISKE KOMUNE 24, BEOGRAD
RS

ONE&ONLY HOTELS & RESORT

(540)

(550) I

(511) **Klasa 35:** oglašavanje, vođenje poslova, poslovno upravljanje, kancelarijski poslovi

Klasa 39: organizovanje putovanja

Klasa 41: usluge koje pružaju sve vrste edukacije lica, organizovanje i vođenje seminara, konferencija i kongresa

Klasa 42: usluge smeštaja, hotelske, ugostiteljske i barske usluge, catering usluge za snabdevanje hranom i/ili pićem, usuge rezervacija hotelskih soba

Klasa 43: usluge hotela, odmarališta, motela, usluge privremenog smeštaja, usluge putnih agencija u vezi sa rezervacijom hotelskog smeštaja, specijalizovane hotelske usluge kao deo programa za stalne goste hotela, usluge restorana, barova i koktel barova, usluge snek barova, obezbeđivanje kapaciteta za održavanje proslava i društvenih događaja za specijalne prilike, catering za potrebe snabdevanja hrane i pića, obezbeđivanje kapaciteta za konferencije, izložbe i sastanke, iznajmljivanje konferencijskih sala

(210) **2013-186** (442) **20.09.2014.**

(220) 5/20/2013

(731) **INTERNATIONAL TRADE MARK AGENCY DOO**, PARISKE KOMUNE 24, BEOGRAD
RS

ONE AND ONLY HOTELS & RES

(540)

(550) I

(511) **Klasa 35:** oglašavanje, vođenje poslova, poslovno upravljanje, kancelarijski poslovi

Klasa 39: organizovanje putovanja

Klasa 41: usluge koje pružaju sve vrste edukacije lica, organizovanje i vođenje seminara, konferencija i kongresa

Klasa 42: usluge smeštaja, hotelske, ugostiteljske i barske usluge, catering usluge za snabdevanje hranom i/ili pićem, usuge rezervacija hotelskih soba

Klasa 43: usluge hotela, odmarališta, motela, usluge privremenog smeštaja, usluge putnih agencija u vezi sa rezervacijom hotelskog smeštaja, specijalizovane hotelske usluge kao deo programa za stalne goste hotela, usluge restorana, barova i koktel barova, usluge snek barova, obezbeđivanje kapaciteta za održavanje proslava i društvenih događaja za specijalne prilike, catering za potrebe snabdevanja hrane i pića, obezbeđivanje kapaciteta za konferencije, izložbe i sastanke, iznajmljivanje konferencijskih sala

(210) **2013-187**(442) **20.09.2014.**

(220) 5/23/2013

(731) **INTERNATIONAL TRADE MARK AGENCY DOO**, PARISKE KOMUNE 24, BEOGRAD RS,

ONE AND ONLY

(540)

(550) I

(511) **Klasa 39:** organizovanje putovanja**Klasa 41:** usluge koje pružaju sve vrste edukacije lica, organizovanje i vođenje seminara, konferencija i kongresa**Klasa 42:** usluge hotela, odmarališta, motela, usluge privremenog smeštaja, usluge putnih agencija u vezi sa rezervacijom hotelskog smeštaja, specijalizovane hotepske usluge kao deo programa za stalne goste hotela, usluge restorana, barova i koktel barova, usluge snek barova, obezbeđivanje kapaciteta za održavanje proslava i društvenih događaja za specijalne prilike, catering za potrebe snabdevanja hrane i pića, obezbeđivanje kapaciteta za konferencije, izložbe i sastanke, iznajmljivanje konferencijskih sala**Klasa 43:** usluge hotela, odmarališta, motela, usluge privremenog smeštaja, usluge putnih agencija u vezi sa rezervacijom hotelskog smeštaja, specijalizovane hotepske usluge kao deo programa za stalne goste hotela, usluge restorana, barova i koktel barova, usluge snek barova, obezbeđivanje kapaciteta za održavanje proslava i društvenih događaja za specijalne prilike, catering za potrebe snabdevanja hrane i pića, obezbeđivanje kapaciteta za konferencije, izložbe i sastanke, iznajmljivanje konferencijskih sala(210) **2013-188**(442) **20.09.2014.**

(220) 5/23/2013

(731) **ALLERGAN, INC.** 2525 DUPONT DRIVE IRVINE, CA 92612 US

SKINMEDICA

(540)

(550) I

(740) Popović Miladin, Đoka Miraševića 21/III, Podgorica ME

(511) **Klasa 03:** preparati za njegu kože i uljepšavanje tijela i lica, naročito, sredstva za čišćenje lica, kreme i losioni za vlaženje kože, kreme i losioni za toniranje, teksturu i učvršćivanje kože, kreme za posle sunčanja, kreme za obnavljanje kože oštećene na suncu, kreme za ublažavanje znakova starenja kože, kreme za ublažavanje staračkih pjega, preparati za sunčanje, piling kreme, hemijski rastvori za piling kože, kreme za učvršćivanje kože, hidratne kreme i tonici, sprejevi za telo i lice, kreme i serumi za područje oko očiju, maske za lice**Klasa 05:** farmaceutski i kozmetički preparati, naročito, medicinska sredstva za čišćenje kože, tonici, preparati za vlaženje kože, preparati za podmladivanje kože, kreme za rehidraciju i losioni za lice i telo(210) **2013-189**(442) **20.09.2014.**

(220) 5/23/2013

(731) **ALLERGAN, INC.** 2525 DUPONT DRIVE IRVINE, CA 92612 US

BIOMETA

(540)

(550) I, V

(740) Popović Miladin, Đoka Miraševića 21/III, Podgorica ME

(511) **Klasa 03:** kozmetičke kreme za njegu kože, nemedicinske kreme i losioni za njegu kože, nemedicinski preparati za njegu kože, naročito, kreme, losioni, gelovi, tonici, sredstva za čišćenje i pilinzi

(210) **2013-19** (442) **20.09.2014.**

(220) 1/15/2013

(731) **RETAIL ROYALTY COMPANY** (NEVADA CORPORATION), 101 CONVENTION CENTER DRIVE, LAS VEGAS, NEVADA 89109 US



(540)

(550) I, V

(740) Radulović Božidar, Jovana Tomaševića 9/III, Podgorica ME

(511) **Klasa 25:** pantalone, farmerke, šorcevi

(210) **2013-190** (442) **20.09.2014.**

(220) 5/23/2013

(731) **ALLERGAN**, INC. 2525 DUPONT DRIVE IRVINE, CA 92612 US

TNS

(540)

(550) I, V

(740) Popović Miladin, Đoka Miraševića 21/III, Podgorica ME

(511) **Klasa 03:** nemedicinski preparati za njegu kože, naročito, kreme za tkivo kože oko očiju, sprejevi za tijelo, kreme za podmladivanje i poboljšanje kože, kreme protiv starenja kože, i kreme za toniranje, teksturu i učvršćivanje kože, kozmetičke kreme i losioni, naročito, preparati za njegu i podmladivanje kože, i pakovanja za njegu kože koja sadrže jedan ili kombinaciju nemedicinskih preparata za njegu kože, koja prodaju i distribuiraju dermatolozi, ljekari koji liječe dermatološka oboljenja, ili spa centri i banje koje pružaju spa usluge i tretmane za njegu kože

(210) 2013-221 (442) **20.09.2014.**

(220) 5/23/2013

(731) **ALLERGAN**, INC. 2525 DUPONT DRIVE IRVINE, CA 92612 US

LYTERA

(540)

(550) I, V

(740) Popović Miladin, Đoka Miraševića 21/III, Podgorica ME

(511) **Klasa 03:** kozmetički preparati za sunčanje, kozmetika i kozmetički preparati, ne-medicinski preparati za njegu kože, naročito, kreme i serumi za posvjetljivanje kože, izbjeljivači kože, preparati za izbjeljivanje kože

(210) **2013-192** (442) **20.09.2014.**

(220) 5/23/2013

(731) **PFIZER INC.** 235 EAST 42ND STREET, NEW YORK, NY 10017 US

ELELYSO

(540)

(550) I

(511) **Klasa 05:** farmaceutske proizvodi koji se koriste za liječenje lizosomskih bolesti nakupljanja,

(210) **2013-193** (442) **20.09.2014.**

(220) 5/23/2013

(300) 2013000051 07.03.2013. SM

(731) **INTEL CORPRATION**, 2200 MISSION COLLEGE BOULEVARD, SC4-203, 95052-8119
SANTA CLARA, CA US

IRIS

(540)

(550) I

(511) **Klasa 09:** integrisana kola, kompleti kompjuterskih čipova, grafičke kartice, kompleti HD grafičkih čipova

(210) **2013-194** (442) **20.09.2014.**

(220) 5/24/2013

(731) **INTERNATIONAL GREAT BRANDS LLC**, 100 DEFOREST AVENUE, EAST HANOVER,
NEW JERSEY 07936 US

PHILADELPHIA

(540)

(550) I

(740) AOD "Ćupić", Dalmatinska 10, Podgorica ME

(511) **Klasa 29:** mlijeko i mliječni proizvodi, krem sir, sir i proizvodi bazirani na siru

Klasa 30: peciva, pekarski proizvodi i konditorski proizvodi, jestivi led, sladoled, smrznute poslastice, prelive za salate, sosovi (začini)

(210) **2013-195** (442) **20.09.2014.**

(220) 5/24/2013

(731) **GENERAL MOTORS LLC**, 300 RENAISSANCE CENTER, DETROIT, MICHIGAN 48265-
3000 US

CHEVROLET

(540)

(550) I

(740) Radulović Božidar, Jovana Tomaševića 9/III, Podgorica ME

(511) **Klasa 36:** osiguranje i finansijski poslovi, uključujući finansiranje vozila i druge robe, lizing sa opcijom otkupa vozila, hipotekarni poslovi, usluge zajmovnih i kreditnih linija, usluge procene rizika u osiguranju, usluge elektronskog transfera sredstava, usluge kreditnih i debitnih kartica.

Klasa 39: usluge transporta i skladištenja, najam vozila i ostale robe

(210) **2013-196**

(442) **20.09.2014.**

(220) 5/24/2013

(731) **GENERAL MOTORS LLC**, 300 RENAISSANCE CENTER, DETROIT, MICHIGAN 48265-3000 US



(540)

(550) I

(740) Radulović Božidar, Jovana Tomaševića 9/III, Podgorica ME

(511) **Klasa 36:** osiguranje i finansijski poslovi, uključujući finansiranje vozila i druge robe, lizing sa opcijom otkupa vozila, hipotekarni poslovi, usluge zajmovnih i kreditnih linija, usluge procene rizika u osiguranju, usluge elektronskog transfera sredstava, usluge kreditnih i debitnih kartica.

Klasa 39: usluge transporta i skladištenja, najam vozila i ostale robe

(210) **2013-197**

(442) **20.09.2014.**

(220) 5/27/2013

(731) **EYGN LIMITED**, ONE MONTAGE PLACE EAST BAY STREET, NASSAU BM



(540)

(550) I

(511) **Klasa 35:** oglašavanje, usluge promocije, usluge regrutovanja kadrova, usluge knjigovodstva i finansijske kontrole poslovanja, usluge poreskog savjetovanja, obračuna poreza, računovodstva, finansijske kontrole poslovanja i poslovnog savjetovanja, usluge oglašavanja putem Interneta, usluge vođenja poslova, poslovno upravljanje, usluge savjetovanja, konsaltinga i informisanja u poslovanju, obezbeđivanje poslovnih informacija, kancelarijski poslovi, ispitivanje javnog mnjenja, istraživanje tržišta, usluge poslovnog i tržišnog istraživanja, poslovna ispitivanja u vezi sa finansijskim uslugama, ispitivanja tržišta, analiza ispitivanja tržišta, obrada podataka, organizovanje prezentacija u poslovne, komercijalne i privredne svrhe, konsultacije u poslovnom upravljanju, pomoć u poslovnom upravljanju, usluge savetjovanja u poslovnim transakcijama, usluge poslovnih modela, usluge poslovnog restrukturiranja, konsalting usluge u oblasti upravljanja intelektualnom svojinom, kadrovske usluge, konsalting u upravljanju kadrovima, sistematizacija informacija u računarske baze podataka, kompjutersko upravljanje podacima, uključuje sve navedene usluge koje se pružaju elektronskim putem ili onlajn iz računarske baze podataka ili preko Interneta, usluge informisanja, savjetovanja i konsaltinga u vezi sa gore navedenim uslugama

Klasa 36: finansijski poslovi, usluge upravljanja, pomoći, savjetovanja, konsaltinga, informisanja i istraživanja u finansijama, usluge poreskog savjetovanja, usluge poreskih i carinskih konsultacija, usluge poreskog računovodstva, usluge savjetovanja u vezi sa poreskim učinkom, finansijske prekogranične savjetodavne usluge, usluge određivanja cijena transfera i poreski efikasnog upravljanja lancem snabdevanja, usluge u vezi sa nesposobnošću plaćanja, investicione usluge, usluge procjene vrijednosti, korporativne finansijske usluge, korporativni finansijski konsalting, procjena vrijednosti korporativne imovine, finansijske procjene nepokretne i pokretne imovine, finansijske analize i konsultacije, naime, restrukturiranje kompanija u stečaju, konsultacije u vezi sa osiguranjem, naime, usluge savjetovanja i regulatorne podrške za osiguranje, usluge procjene intelektualne svojine, agencije za nekretnine i usluge upravljanja nepokretnostima, novčani (monetarni) poslovi, poslovi vezani za nepokretnosti, usluge u vezi sa nepokretnostima, uključujući procjenu nepokretnosti, osiguranje, obezbeđivanje finansijskih informacija, usluge savetovanja u vezi sa kapitalnim investicijama, usluge kapitalizacije, uključuje sve navedene usluge koje se pružaju elektronskim putem ili onlajn iz računarske baze podataka ili preko Interneta, finansijska analiza, kliring (finansijski), finansijsko sponzorisavanje, upravljanje imovinom u korist drugih, finansijske procjene (osiguranja, bankarsva, nepokretnosti), usluge poslovne likvidacije (finansijske), finansijske usluge u vezi sa novčanim (monetarnim) poslovima, informacione, savjetodavne i konsultantske usluge u vezi sa navedenim uslugama

(210) **2013-198**

(442) **20.09.2014.**

(220) 5/27/2013

- (731) **ZAKRYTOE AKTSIONERNOE OBSHESTVO KOMPANIA MAY**, DOM 1 A,
OZERNAYA FRYAZINO MOSKOVSKOY OBL.141190 RF

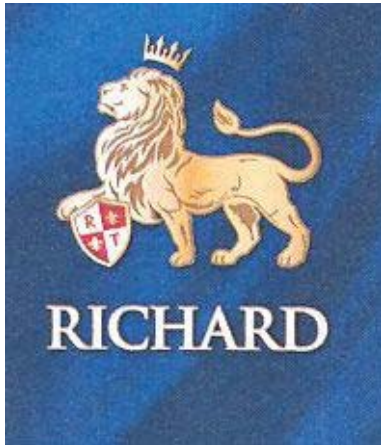

(540)

(550) I

(740) Popović Miladin, Đoka Miraševića 21/III, Podgorica ME

- (511) **Klasa 30:** čaj, uključujući i čaj od listova biljaka, čaj u kesicama, instant čaj, aromatizovani čaj, voćni, biljni i cvjetni čaj, čaj s ostalim dodacima, ledeni čaj, napici na bazi čaja

(210) **2013-199**

(442) **20.09.2014.**

(220) 5/27/2013

- (731) **ZAKRYTOE AKTSIONERNOE OBSHESTVO KOMPANIA MAY**, DOM 1 A,
OZERNAYA FRYAZINO MOSKOVSKOY OBL.141190 RF

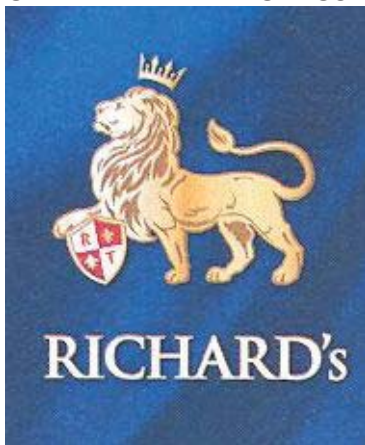

(540)

(550) I

(740) Popović Miladin, Đoka Miraševića 21/III, Podgorica ME

- (511) **Klasa 30:** čaj, uključujući i čaj od listova biljaka, čaj u kesicama, instant čaj, aromatizovani čaj, voćni, biljni i cvjetni čaj, čaj s ostalim dodacima, ledeni čaj, napici na bazi čaja

(210) **2013-2**

(442) **20.09.2014.**

(220) 1/10/2013

- (731) **OPEN ENGLISH LLC**, EDIFICIO TORRES DE LAS AMERICAS, TORRE A PISO 15 PUNTA
PACIFICA, APARTADO POSTAL 0832-0588 PA



(540)

(550) I

(740) Čejović Vladimir, 13. jula 21, Podgorica ME

(511) **Klasa 41:** usluge obrazovanja i jezičke nastave, posebno, vođenje neformalnih onlajn programa za učenje jezika i dostavu materijala, usluge obrazovanja, naime, obezbjeđivanje kurseva na srednjoškolskom nivou i distribuiranje materijala u vezi sa ovim kursevima, obezbjeđujući sredstva za obrazovnu i jezičku nastavu

(210) **2013-200**(442) **20.09.2014.**

(220) 5/27/2013

(731) **ZAKRYTOE AKTSIONERNOE OBSHESTVO KOMPANIA MAY**, DOM 1 A, OZERNAYA FRYAZINO MOSKOVSKOY OBL.141190 RF



(540)

(550) I

(740) Popović Miladin, Đoka Miraševića 21/III, Podgorica ME

(511) **Klasa 30:** čaj, uključujući i čaj od listova biljaka, čaj u kesicama, instant čaj, aromatizovani čaj, voćni, biljni i cvjetni čaj, čaj s ostalim dodacima, ledeni čaj, napici na bazi čaja

(210) **2013-201**(442) **20.09.2014.**

(220) 5/28/2013

(731) **ADVANCE MAGAZINE PUBLISHERS INC.**A NEW YORK CORPORATION, 4 TIMES SQUARE, NEW YORK NY 10036 US

DETAILS

(540)

(550) I

(740) AOD "Ćupić", Dalmatinska 10, Podgorica ME

(511) **Klasa 16:** štampani materijal, štampane publikacije, knjige, časopisi, periodične publikacije.

Klasa 41: razonoda, obrazovanje, nastava i obučavanje, obezbjeđivanje objekata za razonodu i rekreaciju, usluge u oblasti sporta i igara, organizovanje takmičenja, usluge kazina i igara na sreću, obezbjeđivanje objekata za zabavu, usluge u oblasti rekreacije, usluge kabarea, usluge noćnih klubova, usluge diskoteka, organizovanje, vođenje i obezbjeđivanje objekata za koncerte, zabave, te filmske, muzičke, plesne, dramske i pozorišne zabave i događaji, izdavaštvo, fotografske usluge, usluge snimanja, pružanje savjeta, pomoći i informacija koje se odnose na sve gore navedeno, pružanje elektronskih informacija i usluga razonode putem globalne ili ne-globalne računarske mreže

Klasa 42: obezbjeđivanje pristupa globalnim ili ne-globalni računarskim mrežama radi informisanja o pitanjima u nespecijalizovanim oblastima, uključujući i razonodu, filmove, televiziju, modu, zdravlje i fitnes

(210) **2013-202** (442) **20.09.2014.**

(220) 5/28/2013

(731) **ADVANCE MAGAZINE PUBLISHERS INC.**A NEW YORK CORPORATION, 4 TIMES SQUARE, NEW YORK NY 10036 US

ARCHITECTURAL DIGEST

(540)

(550) I

(740) AOD "Ćupić", Dalmatinska 10, Podgorica ME

(511) **Klasa 09:** softver, CD-ROM-ovi, audio i video kasete, elektronske, optičke i digitalne publikacije, optički aparati i proizvodi, uključujući pomagala za oči-naočare za vid i naočare za sunce

Klasa 16: štampani materijal, štampane publikacije, knjige, časopisi, periodične publikacije

Klasa 41: razonoda, obrazovanje, nastava i obučavanje, obezbjeđivanje objekata za razonodu i rekreaciju, usluge u oblasti sporta i igara, organizovanje takmičenja, usluge kazina i igara na sreću, obezbjeđivanje objekata za zabavu, usluge u oblasti rekreacije, usluge kabarea, usluge noćnih klubova, usluge diskoteka, organizovanje, vođenje i obezbjeđivanje objekata za koncerte, zabave, te filmske, muzičke, plesne, dramske i pozorišne zabave i događaji, izdavaštvo, fotografske usluge, usluge snimanja, pružanje savjeta, pomoći i informacija koje se odnose na sve gore navedeno, pružanje elektronskih informacija i usluga razonode putem globalne ili ne-globalne računarske mreže

Klasa 42: obezbjeđivanje pristupa globalnim ili ne-globalni računarskim mrežama radi informisanja o pitanjima ili iz nespecijalizovanih oblasti, uključujući i uređenje interijera eksterijera, dekora i arhitekture

(210) **2013-203** (442) **20.09.2014.**

(220) 5/28/2013

(731) **ADVANCE MAGAZINE PUBLISHERS INC.**A NEW YORK CORPORATION, 4 TIMES SQUARE, NEW YORK NY 10036 US

AD

(540)

(550) I

(740) AOD "Ćupić", Dalmatinska 10, Podgorica ME

(511) **Klasa 09:** softver, CD-ROM-ovi, audio i video kasete, elektronske, optičke i digitalne publikacije, optički aparati i proizvodi, uključujući pomagala za oči-naočare za vid i naočare za sunce

Klasa 16: štampani materijal, štampane publikacije, knjige, časopisi, periodične publikacije

Klasa 41: razonoda, obrazovanje, nastava i obučavanje, obezbjeđivanje objekata za razonodu i rekreaciju, usluge u oblasti sporta i igara, organizovanje takmičenja, usluge kazina i igara na sreću, obezbjeđivanje objekata za zabavu, usluge u oblasti rekreacije, usluge kabarea, usluge noćnih klubova, usluge diskoteka, organizovanje, vođenje i obezbjeđivanje objekata za koncerte, zabave, te filmske, muzičke, plesne, dramske i pozorišne zabave i događaji, izdavaštvo, fotografske usluge, usluge snimanja, pružanje savjeta, pomoći i informacija koje se odnose na sve gore navedeno, pružanje elektronskih informacija i usluga razonode putem globalne ili ne-globalne računarske mreže

Klasa 42: obezbjeđivanje pristupa globalnim ili ne-globalni računarskim mrežama radi informisanja o pitanjima ili iz nespecijalizovanih oblasti, uključujući i uređenje interijera i eksterijera, dekora i arhitekture

Klasa 43: usluge obezbjeđivanja hrane i pića, privremeni smještaj, smješta] i briga za životinje, usluge hotela, barova, kafea, restorana i usluge noćnih klubova (obezbjeđivanje hrane), obezbjeđivanje hrane i pića, katen'ng, usluge obdaništa i jaslica, iznajmljivanje stolica, stolova, pribora za jelo i ugostiteljske opreme, organizacija, obezbjeđivanje rezervacija, informacija, savjeta i pomoći u vezi sa gore navedenim

(210) **2013-204**

(442) **20.09.2014.**

(220) 5/28/2013

(731) **ADVANCE MAGAZINE PUBLISHERS INC.**A NEW YORK CORPORATION, 4 TIMES SQUARE, NEW YORK NY 10036 US

Lucky

(540)

(550) I

(511) **Klasa 09:** softver; CD-ROM-ovi; audio i video kasete; elektronske, optičke i digitalne publikacije; optički aparati i proizvodi, uključujući pomagala za oči-naočare za vid i naočare za sunce

Klasa 16: štampani materijal, štampane publikacije, knjige, časopisi, periodične publikacije

Klasa 41: razonoda, obrazovanje, nastava i obučavanje; obezbjeđivanje objekata za razonodu i rekreaciju; usluge u oblasti sporta i igara; organizovanje takmičenja; usluge kazina i igara na sreću; obezbjeđivanje objekata za zabavu, usluge u oblasti rekreacije; usluge kabarea; usluge noćnih klubova; usluge diskoteka, organizovanje, vođenje i obezbjeđivanje objekata za koncerte, zabave, te filmske, muzičke, plesne, dramske i pozorišne zabave i događaji; izdavaštvo; fotografske usluge; usluge snimanja; pružanje savjeta, pomoći i informacija koje se odnose na sve gore navedeno; pružanje elektronskih informacija i usluga razonode putem globalne ili ne-globalne računarske mrež.

Klasa 42: obezbjeđivanje pristupa globalnim ili ne-globalni računarskim mrežama radi informisanja o pitanjima u nespecijalizovanim oblastima, uključujući i razonodu, filmove, televiziju, modu, ljepotu, zdravlje, fitnes i hranu

(210) **2013-205** (442) **20.09.2014.**

(220) 5/28/2013

(731) **ADVANCE MAGAZINE PUBLISHERS INC.**A NEW YORK CORPORATION, 4 TIMES SQUARE, NEW YORK NY 10036 US

domino

(540)

(550) I

(740) AOD "Ćupić", Dalmatinska 10, Podgorica ME

(511) **Klasa 09:** softver, CD-ROM-ovi, audio i video kasete, elektronske, optičke i digitalne publikacije, optički aparati i proizvodi, uključujući pomagala za oči-naočare za vid i naočare za sunce

Klasa 16: štampani materijal, štampane publikacije, knjige, časopisi, periodične publikacije

Klasa 41: razonoda, obrazovanje, nastava i obučavanje, obezbjeđivanje objekata za razonodu i rekreaciju, usluge u oblasti sporta i igara, organizovanje takmičenja, usluge kazina i igara na sreću, obezbjeđivanje objekata za zabavu, usluge u oblasti rekreacije, usluge kabarea, usluge noćnih klubova, usluge diskoteka, organizovanje, vođenje i obezbjeđivanje objekata za koncerte, zabave, te filmske, muzičke, plesne, dramske i pozorišne zabave i događaji, izdavaštvo, fotografske usluge, usluge snimanja, pružanje savjeta, pomoći i informacija koje se odnose na sve gore navedeno, pružanje elektronskih informacija i usluga razonode putem globalne ili ne-globalne računarske mreže

Klasa 42: obezbjeđivanje pristupa globalnim ili ne-globalni računarskim mrežama radi informisanja o pitanjima u nespecijalizovanim oblastima, uključujući i razonodu, filmove, televiziju, modu, zdravlje i fitnes

(210) **2013-206** (442) **20.09.2014.**

(220) 5/29/2013

(731) **SEIM & FLER SH.P.K.** RR.SIRI KODRA, PALLATI A&A, N.1.TIRANA AL

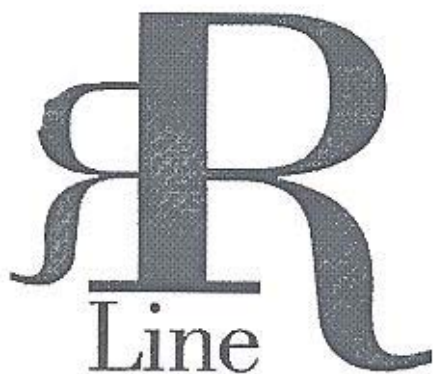

(540)

(550) I

(740) Božović Vesko, Rimski trg 50/11, Podgorica ME

(511) **Klasa 03:** šamponi, losioni za kosu, kreme za kosu, melemi za kosu, gelovi za kosu, boje za kosu, puderi za izbjeljivanje, kreme za jačanje kose, losioni za oporavak kose, kreme za oporavak kose, preparati za trajno kovrdžanje kose, preparati za izbjeljivanje kose, preparati za talasastu kosu, preparati za uklanjanje boje, farbe za kosu, esencijalna ulja, parfemi, kozmetika, sapuni, kreme, kreme za tijelo, kreme za lice, sredstvo za čišćenje lica i uklanjanje šminke, gelovi za tuširanje, ulje i krema za sunčanje

(210) **2013-207**(442) **20.09.2014.**

(220) 5/29/2013

(731) **FRESH & CO.DOO**, IVANA GORANA KOVACICA 3 24000 SUBOTICA RS

SU-VOĆE

(540)

(550) I, V

(740) Popović Miladin, Đoka Miraševića 21/III, Podgorica ME

(511) **Klasa 32:** nezalkoholni napici od voća, voćni napici, voćni sirupi i drugi preparati za pravljenje voćnih napitaka

(210) **2013-208**(442) **20.09.2014.**

(220) 5/29/2013

(300) 1816-2012 17.12.2012 RS

(731) **BIKRAM CHOUDHURY**, 115000 W.OLYMPIC BLVD.SUITE 150, 90064 LOS ANGELES US

BIKRAM YOGA

(540)

(550) I

(511) **Klasa 09:** prethodno snimljeni magnetni nosači podataka, prethodno snimljeni diskovi, prethodno snimljeni kompakt diskovi, prethodno snimljeni DVD i drugi prethodno snimljeni digitalni nosači podataka, audio-video datoteke (fajlovi) koje se mogu preuzimati (daunloudovati), elektronske publikacije koje se mogu preuzimati (daunloudovati)

Klasa 16: hartija, karton i proizvodi od njih, koji nijesu uključeni u druge klase, štampane stvari, knjigovezački materijal, fotografije, kancelarijski materijal, ljepila za kancelarijske i kućne potrebe, umjetnički materijali, kičice, pisaće mašine i kancelarijski pribor (izuzev namještaja), materijal za obuku i nastavu (izuzev aparata), plastični materijal za pakovanje (koji nije uključen u druge klase), štamparska slova, klišeji

Klasa 41: obrazovne usluge, pripremanje obuke, razonoda, sportske i kulturne aktivnosti, naročito priprema (organizovanje) i vođenje časova, seminara, konferencija i obuka nastavnika u oblasti nastave joge, filozofije joge, joga teorije i prakse, alopatskih sistema za vježbanje, integracije medicinskih i joga sistema, joga terapija, marketinga nastave joge, fizičke kondicije, meditacije, mentalnog treninga i discipline, i zdravlja, i distribucija materijala za kurseve u vezi sa navedenim

(210) **2013-209** (442) **20.09.2014.**

(220) 5/31/2013

(731) **HEMOFARM A.D.** FARMACEUTSKO-HEMIJSKA INDUSTRIJA VRŠAC, BEOGRADSKI PUT 26300, VRŠAC RS

HEMOFARM

(540)

(550) I, V

(740) Popović Miladin, Đoka Miraševića 21/III, Podgorica ME

(511) **Klasa 03:** sredstva za beljenje i druge spustance za upotrebu u perionicama, preparati za čišćenje, poliranje, ribanje i nagrizanje, sapuni, parfimerija, eterična ulja, kozmetika, losioni za kosu, paste za zube, farmaceutski, veterinarski i sanitarni preparati, dietetske spustance prilagođene za upotrebu u medicini, hrana za bebe, flasteri, materijali materijali za zavijanje, materijali za plombiranje zuba, zubarska smola, dezinfekciona sredstva, preparati za uništavanje štetočina, fungicidi, herbicidi

Klasa 05: zavijanje, materijali za plombiranje zuba, zubarska smola, dezinfekciona sredstva, preparati za uništavanje štetočina, fungicidi, herbicidi,

Klasa 35: oglašavanje, vođenje poslova, poslovno upravljanje, kancelarijski poslovi, usluge u vezi sa prometom robe

(210) **2013-210** (442) **20.09.2014.**

(220) 5/31/2013

(731) **HEMOFARM A.D.** FARMACEUTSKO-HEMIJSKA INDUSTRIJA VRŠAC, BEOGRADSKI PUT 26300 VRŠAC RS



(540)

(550) I, V

(740) Popović Miladin, Đoka Miraševića 21/III, Podgorica ME

(511) **Klasa 03:** sredstva za beljenje i druge spustance za upotrebu u perionicama, preparati za

čišćenje, poliranje, ribanje i nagrizanje, sapuni, parfimerija, eterična ulja, kozmetika, losioni za kosu, paste za zube

Klasa 05: farmaceutski, veterinarski i sanitarni preparati, dietetske spustance prilagođene za upotrebu u medicini, hrana za bebe, flasteri, materijali za zavijanje, materijali za plombiranje zuba, zubarska smola, dezinfekciona sredstva, preparati za uništavanje štetočina, fungicidi, herbicidi,

Klasa 35: oglašavanje, vođenje poslova, poslovno upravljanje, kancelarijski poslovi, usluge u vezi sa prometom robe

(210) **2013-211** (442) **20.09.2014.**

(220) 5/31/2013

(731) **INTERNATIONAL TRADE MARK AGENCY DOO**, PARISKE KOMUNE 24 BEOGRAD
RS

HILTON

(540)

(550) I

(511) **Klasa 35:** oglašavanje, vođenje poslova, poslovno upravljanje, kancelarijski poslovi

Klasa 39: organizovanje putovanja

Klasa 41: usluge koje pružaju sve vrste edukacije lica, organizovanje i vođenje seminara, konferencija i kongresa.

Klasa 42: usluge smeštaja, hotelske, ugostiteljske i barske usluge, catering usluge za snabdevanje hranom i/ili pićem, usluge rezervacija hotelskih soba, 43: usluge hotela, odmarališta, motela, usluge privremenog smeštaja, usluge putnih agencija u vezi sa rezervacijom hotelskog smeštaja, specijalizovane hotelske usluge kao deo programa za stalne goste hotela, usluge restorana, barova i koktel barova, usluge sneg barova, obezbeđivanje kapaciteta za održavanje proslava i društvenih događaja za specijalne prilike, catering za potrebe snabdevanja hrane i pića, obezbeđivanje kapaciteta za konferencije, izložbe i sastanke, iznajmljivanje konferencijskih sala

(210) **2013-212** (442) **20.09.2014.**

(220) 5/31/2013

(731) **INTERNATIONAL TRADE MARK AGENCY DOO**, PARISKE KOMUNE 24 BEOGRAD
RS

HILTON HOTELS & RESORTS

(540)

(550) I

(511) **Klasa 35:** oglašavanje, vođenje poslova, poslovno upravljanje, kancelarijski poslovi

Klasa 39: organizovanje putovanja

Klasa 41: usluge koje pružaju sve vrste edukacije lica, organizovanje i vođenje seminara, konferencija i kongresa

Klasa 42: usluge smeštaja, hotelske, ugostiteljske i barske usluge, catering usluge za snabdevanje hranom i/ili pićem, usluge rezervacija hotelskih soba, 43: usluge hotela, odmarališta, motela, usluge privremenog smeštaja, usluge putnih agencija u vezi sa rezervacijom hotelskog smeštaja, specijalizovane hotelske usluge kao deo programa za stalne goste hotela, usluge restorana, barova i koktel barova, usluge sneg barova, obezbeđivanje kapaciteta za održavanje proslava i društvenih događaja za specijalne prilike, catering za potrebe

snabdevanja hrane i pića, obezbeđivanje kapaciteta za konferencije, izložbe i sastanke, iznajmljivanje konferencijskih sala

(210) **2013-213** (442) **20.09.2014.**

(220) 6/3/2013

(731) **THE PROCTER & GAMBLE COMPANY**, ONE PROCTER & GAMBLE PLAZA, CINCINITI, OHIO 45202 US

PODS

(540)

(550) I

(740) Lutovac Branislav, Bulevar Crnojevića 93, Podgorica ME

(511) **Klasa 03:** sredstva za bijeljenje i druge supstance za upotrebu u pranju veša, preparati za čišćenje, poliranje, ribanje, abrazivna sredstva, sapuni, parfimerija, eterična ulja, kozmetika, losioni za kosu, proizvodi za njegu zuba

Klasa 05: farmaceutski i veterinarski preparati, sanitarni preparati za upotrebu u medicini, dijetetske supstance prilagođene za upotrebu u medicini, hrana za bebe, flasteri, materijali za zavijanje, materijali za plombiranje zuba, zubarska smola, dezinfekciona sredstva, preparati za uništavanje štetočina, fungicidi, herbicidi

Klasa 11: aparati za osvjetljavanje, grijanje, proizvodnju pare, kuvanje, hlađenje, sušenje, ventilaciju, snabdijevanje vodom i za sanitarne svrhe

(210) **2013-214** (442) **20.09.2014.**

(220) 6/3/2013

(731) **MERKUR GAMING GMBH**, BORSIGSTRASSE 26, 32312, LUBBECKE DE

Merkur Gaming

(540)

(550) I, V

(740) Prelević Dragan, ulica Slobode 74, Podgorica ME

(511) **Klasa 09:** muzički „Juke-box“-ovi i djelovi za automatske mašine koje se na njih odnose; mašine za automatsko distribuiranje novca; automatske mašine za prebrojavanje i razmjenu novca; mehanizmi za aparate koji rade na kovanice; softver računarskih igara; softver za igre koje se koriste na svim informatičkim platformama, uključujući konzole za elektronsku zabavu i igrice; računarske igre (programi za-); operativni programi za električne i elektronske igrice, razonodu i/ili zabavu; automatske mašine za lutriju; računarski softver za igranje igara na internetu; online igrice (softver); računarski softver u formi aplikacije za mobilne uređaje i računare; aparati za prebrojavanje namijenjeni za mašine koje rade na kovanice i djelovi opreme koja se na njih odnosi; aparati za snimanje, prenos, obradu ili reprodukciju podataka, uključujući zvuk ili slike, uključujući djelove opreme koja se na

njih odnosi, osim radio aparata, televizijskih prijemnika, aparata od velike vrijednosti, video rekordera, telefonskih aparata, faks mašina i telefonskih sekretarica; hardver i softver za kazino igre ili zabavne igre u zabavnim klubovima, slot mašine ili mašine za igre video lutrije ili igre na sreću putem putem interneta; električni, elektronski, optički ili automatski aparati, za identifikaciju nosilaca podataka, ličnih karata, kreditnih kartica, novčanica i kovanica; električni, elektronski ili optički alarmi ili sistemi za nadzor, uključujući video kamere i aparate za prenos i obradu slika; oprema za obradu podataka i kompjuteri, uključujući aparate za obradu podataka i kompjutere kao komponente za mreže podataka i djelove koji olakšavaju komunikaciju podataka na netu; električni kablovi; p.c. ploče, instalacija ugradnih p.c. ploča (električne komponente) i kombinacije istih, instalacija i djelovi opreme koji su uključeni u klasu 9

Klasa 28: igre; igračke; aparati za igranje za novac (uključujući igre (mašine) za novac u zabavnim klubovima namijenjene za zabavne centre (uključeno u klasu 28); aparati za video igre na novac; video igre prilagođene upotrebi ekrana ili eksternih monitora; dodatna oprema za kazina, posebno rulet stolovi i rulet točkovi; automatske mašine za igre kojese pokreću novcem i mašine za igre, posebno za zabavne klubove, sa ili bez plaćanja premije; elektronski ili elektrotehnički aparati za igru, mašine za igru i slot mašine koje se pokreću kovanicama, žetonima, novčanicama, tiketima ili putem elektronskog, magnetnog ili biometrijskog nosača podataka, posebno za komercijalnu upotrebu u kazinima i zabavnim centrima, sa ili bez plaćanja premije; mašine za igru koje se pokreću na novac i/ili elektronski aparati za igru koji se pokreću na novac (mašine), sai ili bez premije; kućišta prilagođena za mašine sa igrama, aparati za igre i automatske mašine za igre koje rade na novac, sa žetonima, tiketima ili putem elektronskog, magnetnog ili biometrijskog nosača podataka, posebno za komercijalnu upotrebu u kazinima i zabavnim centrima, sa ili bez plaćanja premije; mašine za igre sa video formatom; aparati za izvlačenje za igre na premije i lutriju, izvlačenja ili tombole; metalna, plastična i/ili drvena kućišta za automatske mašine na novac; aparati za igre (uključujući video igre) za upotrebu pored prilagođenih, samo sa monitorima ili eksternim ekranima; elektro-pneumatske mašine i električne mašine na tastere (mašine za igre); stolovi za igre, posebno za stoni fudbal, bilijar, akcijske igre; horseshoe i spear igrice (materijali sa kojima se igra); električni, elektronski ili elektromehanički aparati za bingo igre, lutriju ili video-lutriju i za pravila klađenja koja postoje na netu ili ne; LCD konzole za igre; automatske mašine za igre; uključujući sve gore navedene automatske mašine, mašine i aparate koji funkcionišu na netu; aparati i uređaji koji prihvataju ili čuvaju novac, kao dodatna oprema za automatske mašine na koje se odnosi klasa 28

(210) **2013-215**

(442) **20.09.2014.**

(220) 6/4/2013

(731) **LES PUBLICATIONS CONDE NAST S.A.** 56A, RUE DU FAUBOURG SAINT-HONORE, F-75008 PARIS FR



(540)

(550) I

(740) AOD "Ćupić", Dalmatinska 10, Podgorica ME

(511) **Klasa 09:** softver, CD-ROM-ovi, audio i video kasete, elektronske, optičke i digitalne publikacije, optički aparati i proizvodi

Klasa 16: štampani materijal, štampane publikacije, knjige, časopisi, periodične publikacije

Klasa 41: fazonoda, obrazovanje, nastava i obučavanje, obezbjeđivanje objekata za razonodu i rekreaciju, usluge u oblasti sporta i igara, organizovanje takmičenja, usluge kazina i igara na sreću, obezbjeđivanje objekata za zabavu, usluge u oblasti rekreacije, usluge kabarea, usluge noćnih klubova, usluge diskoteka, organizovanje, vođenje i obezbjeđivanje objekata za koncerte, zabave, te filmske, muzičke, plesne, dramske i pozorišne zabave i događaji, izdavaštvo, fotografske usluge, usluge snimanja, pružanje savjeta, pomoći i informacija koje se odnose na sve gore navedeno, pružanje elektronskih informacija i usluga razonode putem globalne ili ne-globalne računarske mreže

Klasa 42: obezbjeđivanje pristupa globalnim ili ne-globalni računarskim mrežama radi informisanja o pitanjima u nespécializovanim oblastima, uključujući i razonodu, filmove, televiziju, modu, ljepotu, zdravlje, fitnes i hranu

Klasa 43: usluge obezbjeđivanja hrane i pića, privremeni smještaj, smještaj i briga za životinje, usluge hotela, barova, kafea, restorana i usluge noćnih klubova (obezbjeđivanje hrane), obezbjeđivanje hrane i pića, catering, usluge obdaništa i jaslica, iznajmljivanje stolica, stolova, pribora za jelo i ugostiteljske opreme, organizacija, obezbjeđivanje rezervacija, informacija, savjeta i pomoći u vezi sa gore navedenim

(210) **2013-216** (442) **20.09.2014.**

(220) 6/5/2013

(731) **GENERAL MOTORS LLC**, 300 RENAISSANCE CENTER, DETROIT, MICHIGAN 48265-3000 US



(540)

(550) F

(740) Radulović Božidar, Jovana Tomaševića 9/III, Podgorica ME

(511) **Klasa 12:** dizel motori za suvozemna vozila

(210) **2013-217** (442) **20.09.2014.**

(220) 6/6/2013

(300) 30 2012 063 022.7/38 07.12.2012 DE

(731) **DEUTCHE TELEKOM AG**, FRIDRICH-EBERT-ALLEE 140 53113 BONN DE

TeraStream

(540)

(550) I, V

(740) Popović Miladin, Đoka Miraševića 21/III, Podgorica ME

(511) **Klasa 09:** aparati i instrumenti naučni, pomorski, geodetski, fotografski, kinematografski, optički, za vaganje, merenje, signalizaciju, kontrolu (inspekciju), spašavanje i nastavu, aparati i instrumenti za provođenje, razvođenje, transformaciju, akumulaciju, regulaciju

ili kontrolu elektriciteta, aparati za snimanje, prenos, obradu i reprodukciju zvuka, slika ili podataka, magnetni nosači podataka, mehanizmi za aparate koji se pokreću novcem ili žetonom, računске mašine, oprema i kompjuteri za obradu podataka, CD-ovi, DVD-jevi i drugi digitalni nosači podataka svih vrsta (koji su uključeni u klasu 09), kompjuterski softver, elektronski uskladišteni podaci (koji se mogu preuzimati), elektronske publikacije (koje se mogu preuzimati)

Klasa 35: reklamiranje, poslovni menadžment, poslovna administracija, prikupljanje, sistematizacija, kompilacija i analiza poslovnih podataka i informacija uskladištenih u računarskim bazama podataka, maloprodajne usluge (uključujući i one putem interneta i drugih komunikacionih mreža), u vezi sa robama iz klasa 09 i 16

Klasa 38: telekomunikacije, usluge novinskih agencija, iznajmljivanje telekomunikacione opreme, informacije o telekomunikacijama

Klasa 41: obrazovne usluge, pripremanje obuke, razonoda, organizovanje sportskih i kulturnih aktivnosti

Klasa 42: naučne i tehnološke usluge i istraživanje i dizajniranje u vezi sa tim, usluge industrijske analize i istraživanja, dizajniranje i razvijanje računarskog hardvera, softvera i baza podataka, održavanje kompjuterskog softvera, tehničke konsultacije u vezi sa uslugama uključenim u ovu klasu, računarske usluge u vezi sa skladištenjem elektronskih podataka, iznajmljivanje opreme za obradu podataka, dizajniranje veb sajtova za druge

(210) **2013-218** (442) **20.09.2014.**

(220) 6/10/2013

(300) 85801238 12.12.2012. US

(731) **ABBVIE INC.** 1 N. WWAUKEGEN ROAD NORTH CHICAGO IL 60064 US

(540) PEOPLE. PASSION. POSSIBILITIES.

(550) I, V

(740) Popović Miladin, Đoka Miraševića 21/III, Podgorica ME

(511) **Klasa 16:** pamfleti, brošure, bilteni i knjige koje se odnose na zdravstvene teme

Klasa 44: pružanje medicinskih informacija, naime, informacija u vezi sa medicinskim stanjima, tretmanima i proizvodima za pacijente i zdravstvene radnike, medicinsko savjetovanje, naime, davanje savjeta zdravstvenim radnicima u pogledu medicinskih stanja i liječenja

(210) **2013-219** (442) **20.09.2014.**

(220) 6/10/2013

(731) **GULBAHAR TOBACCO INTERNATIONAL FZE**, P.O.BOX JEBEL ALI FREE ZONE DUBAI AE



(540)

(550) I, F

(740) Popović Miladin, Đoka Miraševića 21/III, Podgorica ME

(511) **Klasa 34:** duvan, cigarete, pribor za pušače, šibice

-
- (210) **2013-220** (442) **20.09.2014.**
(220) 6/10/2013
(731) **RED BULL GMBH**, AM BRUNNEN 1, 5330 FUSCHL AM SEE AU

OKREPLJUJE DUH I TELO

- (540)
(550) I, F
(511) **Klasa 32:** bezalkoholna pića, osvježavajuća pića, energetska pića, napitci od surutke, hipertonična i hipotonična pića (koja koriste sportisti i/ili za potrebe sportista), izotonična pića, piva, pivo od slada, pivo od pšenice, tamno (porter) pivo, svijetlo (ale) pivo, tamno (stout) pivo, lager pivo, mineralna voda, voda za piće i gazirana voda, voćni napitci i voćni sokovi, bezalkoholni napitci od povrća i voća i bezalkoholni voćni ekstrakti, sirupi i drugi preparati za proizvodnju pića i sirup za limunadu, pjenušajuće tablete i praškovi za napitke, bezalkoholni aperitivi i kokteli, šerbeti, smutiji (smoothies)

-
- (210) **2013-221** (442) **20.09.2014.**
(220) 6/11/2013
(731) **EYGN LIMITED**, ONE MONTAGUE PLACE EAST BAY STREET, NASSAU BM



- (540)
(550) I
(511) **Klasa 35:** oglašavanje, usluge promocije, usluge regrutovanja kadrova, usluge knjigovodstva i finansijske kontrole poslovanja, usluge poreskog savjetovanja, obračuna poreza, računovodstva, finansijske kontrole poslovanja i poslovnog savjetovanja, usluge oglašavanja putem Interneta, usluge vođenja poslova, poslovno upravljanje, usluge savjetovanja, konsaltinga i informisanja u poslovanju, obezbeđivanje poslovnih informacija, kancelarijski poslovi, ispitivanje javnog mnjenja, istraživanje tržišta, usluge poslovnog i tržišnog istraživanja, poslovna ispitivanja u vezi sa finansijskim uslugama, ispitivanja tržišta, analiza ispitivanja tržišta, obrada podataka, organizovanje prezentacija u poslovne, komercijalne i privredne svrhe, konsultacije u poslovnom upravljanju, pomoć u poslovnom upravljanju, usluge savjetovanja u poslovnim transakcijama, usluge poslovnih modela,

usluge poslovnog restrukturiranja, konsalting usluge u oblasti upravljanja intelektualnom svojinom, kadrovske usluge, konsalting u upravljanju kadrovima, sistematizacija informacija u računarske baze podataka, kompjutersko upravljanje podacima, uključuje sve navedene usluge koje se pružaju elektronskim putem ili onlajn iz računarske baze podataka ili preko Interneta, usluge informisanja, savjetovanja i konsaltinga u vezi sa gore navedenim uslugama

Klasa 36: finansijski poslovi, usluge upravljanja, pomoći, savjetovanja, konsaltinga, informisanja i istraživanja u finansijama, usluge poreskog savjetovanja, usluge poreskih i carinskih konsultacija, usluge poreskog računovodstva, usluge savjetovanja u vezi sa poreskim učinkom, finansijske prekogranične savjetodavne usluge, usluge određivanja cijena transfera i poreski efikasnog upravljanja lancem snabdijevanja, usluge u vezi sa nesposobnošću plaćanja, investicione usluge, usluge procjene vrijednosti, korporativne finansijske usluge, korporativni finansijski konsalting, procjena vrijednosti korporativne imovine, finansijske procjene nepokretne i pokretne imovine, finansijske analize i konsultacije, naime, restrukturiranje kompanija u stečaju, konsultacije u vezi sa osiguranjem, naime, usluge savjetovanja i regulatorne podrške za osiguranje, usluge procjene intelektualne svojine, agencije za nekretnine i usluge upravljanja nepokretnostima, novčani (monetarni) poslovi, poslovi vezani za nepokretnosti, usluge u vezi sa nepokretnostima, uključujući procjenu nepokretnosti, obezbjeđivanje finansijskih informacija, osiguranje, obezbjeđivanje finansijskih informacija, investicione usluge, usluge procjene, novčani (monetarni) poslovi, usluge savjetovanja u vezi sa kapitalnim investicijama, usluge kapitalizacije, uključuje sve navedene usluge koje se pružaju elektronskim putem ili onlajn iz računarske baze podataka ili preko Interneta, finansijska analiza, kliring (finansijski), finansijsko sponzorisanje, upravljanje imovinom u korist drugih, finansijske procjene (osiguranja, bankarstva, nepokretnosti), usluge poslovne likvidacije (finansijske); finansijske usluge u vezi sa novčanim (monetarnim) poslovima, informacione, savjetodavne i konsultantske usluge u vezi sa navedenim uslugama

(210) **2013-223**

(442) **20.09.2014.**

(220) 6/12/2013

(731) **THE GILLETTE COMPANY**, BOSTON, MASSACHUSETTS 02127 US

QUENCH

(540)

(550) I

(740) Lutovac Branislav, Bulevar Crnojevića 93, Podgorica ME

(511) **Klasa 08:** brijači i nožici za brijače, automati (dozeri), kasete, držači i ulošci koji su svi posebno dizajnirani za i sadrže, nožice za brijače, djelovi i oprema za naprijed navedenu robu

(210) **2013-224**

(442) **20.09.2014.**

(220) 6/12/2013

(731) **FARMACEUTSKA HEMISKA KOZMETIČKA INDUSTRIJA ALKALOID AD-SKOPLJE**, BUL. ALEKSANDAR MAKEDONSKI BR.12 1000 SKOPLJE RM



(540)

(550) I

(740) Popović Miladin, Đoka Miraševića 21/III, Podgorica ME

(511) **Klasa 03:** šampon i penušava kupka za djecu(210) **2013-225**(442) **20.09.2014.**

(220) 6/12/2013

(731) **FARMACEUTSKA HEMISKA KOZMETIČKA INDUSTRIJA ALKALOID AD-SKOPLJE**, BUL. ALEKSANDAR MAKEDONSKI BR.12 1000 SKOPLJE RM

(540)

(550) I

(740) Popović Miladin, Đoka Miraševića 21/III, Podgorica ME

(511) **Klasa 03:** hidratantno mlijeko za njegu dječije kože(210) **2013-227**(442) **20.09.2014.**

(220) 6/12/2013

(731) **GALDERMA S.A.** ZUGERSTRASSE 8 CH-6330 CHAM CH

The logo for GALDERMA features the word "GALDERMA" in a blue, sans-serif font. The letter "D" is significantly larger and is contained within a solid blue square, which is positioned centrally behind the other letters.

(540)

(550) I

(740) Lutovac Branislav, Bulevar Crnojevića 93, Podgorica ME

(511) **Klasa 03:** kozmetički preparati

Klasa 05: farmaceutski preparati i supstance

Klasa 10: medicinski aparati

(210) **2013-228**

(442) **20.09.2014.**

(220) 6/13/2013

(731) **ALLTECH**, INC, 3031 CATNIP HILL PIKE, NICHOLASVILLE, KENTUCKY 40356 US

ALLTECH

(540)

(550) I

(511) **Klasa 01:** bakterije i enzimi mliječnih kisjelina za proizvodnju životinjske i stočne hrane, organski zakisjeljivači za vodu za piće, enzimi koji pomažu varenju za upotrebu u proizvodnji životinjske hrane, zakisjeljivači za upotrebu u proizvodnji stočne hrane, mlijeko i zamjene za mlijeko, inhibitori buđi za stočnu hranu, hemijski dodaci za upotrebu u proizvodnji alkoholnih proizvoda, bakterijski inhibitori za upotrebu u proizvodnji alkoholnih proizvoda i za sterilizaciju opreme za proizvodnju alkohola

Klasa 05: ne-medicinski aditivi životinjskoj ishrani za upotrebu kao nutricionistički suplementi, nutricionistički dodaci za životinjsku i stočnu hranu, dodaci životinjskoj prehrani, naime, enzimi za upotrebu u životinjskoj ishrani za pomoć u varenju, hranljivi suplementi za stoku i ljubimce, inhibitori buđi za održavanje životinjske hrane, smješe za osvježavanje stočnih kućišta

Klasa 31: životinjske namirnice, životinjska hrana, miješana životinjska hrana, kvasac za životinjsku upotrebu, kvasac za upotrebu kao životinjska hrana

(210) **2013-229**

(442) **20.09.2014.**

(220) 6/13/2013

(731) **ALLTECH**, INC. 3031 CATNIP HILL PIKE, NICHOLASVILLE, KENTUCKY 40356 US

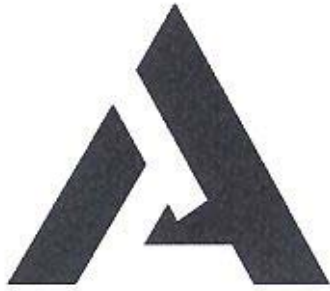

(540)

(550) I

(511) **Klasa 01:** bakterije i enzimi mliječnih kiselina za proizvodnju životinjske i stočne hrane, organski zakisjeljivači za vodu za piće, enzimi koji pomažu varenju za upotrebu u proizvodnji životinjske hrane, zakisjeljivači za upotrebu u proizvodnji stočne hrane, mlijeko i zamjene za mlijeko, inhibitori buđi za stočnu hranu, hemijski dodaci za upotrebu u proizvodnji alkoholnih proizvoda, bakterijski inhibitori za upotrebu u proizvodnji alkoholnih proizvoda i za sterilizaciju opreme za proizvodnju alkohola

Klasa 05: ne-medicinski aditivi životinjskoj ishrani za upotrebu kao nutricionistički suplementi, nutricionistički dodaci za životinjsku i stočnu hranu, dodaci životinjskoj prehrani, naime, enzimi za upotrebu u životinjskoj ishrani za pomoć u varenju, hranljivi suplementi za stoku i ljubimce, inhibitori buđi za održavanje životinjske hrane, smješe za osvježavanje stočnih kućišta

Klasa 31: životinjske namirnice, životinjska hrana, miješana životinjska hrana, kvasac za životinjsku upotrebu, kvasac za upotrebu kao životinjska hrana

(210) **2013-230**(442) **20.09.2014.**

(220) 6/17/2013

(731) **BASF CORPORATION**, 100 PARK AVENUE FLORHAM PARK, NJ 07932 US

INVIDUON

(540)

(550) I

(740) Stanković Mugoša Ana, Trg Republike 13, Podgorica ME

(511) **Klasa 01:** biološki preparati koji se koriste u poljoprivredi, hortikulturi i šumarstvu, posebno đubriva u poljoprivredi i hortikulturi, korisne bakterije i dodaci zemljištu

Klasa 05: preparati za uništavanje i suzbijanje štetočina, insekticidi, fungicidi, herbicidi, pesticidi, nematocidi, nematode za kontrolu insekata, biološka sredstva za kontrolu

Klasa 31: poljoprivredni proizvodi, proizvodi hortikulture i proizvodi šumarstva, posebno sjemenje tretirano biološkim proizvodima, žitarice, sjemenje i vegetativni dijelovi biljaka, prekrivači za biljke od slame i gnojiva, koji nisu obuhvaćeni drugim klasama

(210) **2013-231**(442) **20.09.2014.**

(220) 6/17/2013

(731) **BASF CORPORATION**, 100 PARK AVENUE FLORHAM PARK, NJ 07932 US

SERIFEL

(540)

(550) I

(740) Stanković Mugoša Ana, Trg Republike 13, Podgorica ME

(511) Klasa 01: biološki preparati koji se koriste u poljoprivredi, hortikulturi i šumarstvu, posebno đubriva u poljoprivredi i hortikulturi, korisne bakterije i dodaci zemljištu

Klasa 05: preparati za uništavanje i suzbijanje štetočina, insekticidi, fungicidi, herbicidi, pesticidi, nematicidi, nematode za kontrolu insekata, biološka sredstva za kontrolu

Klasa 31: poljoprivredni proizvodi, proizvodi hortikulture i proizvodi šumarstva, posebno sjemenje tretirano biološkim proizvodima, žitarice, sjemenje i vegetativni djelovi biljaka, prekrivači za biljke od slame i gnojiva, koji nisu obuhvaćeni drugim klasama

(210) **2013-232**

(442) **20.09.2014.**

(220) 6/17/2013

(731) **BASF CORPORATION**, 100 PARK AVENUE FLORHAM PARK, NJ 07932 US

VELONDIS

(540)

(550) I

(740) Stanković Mugoša Ana, Trg Republike 13, Podgorica ME

(511) **Klasa 01:** biološki preparati koji se koriste u poljoprivredi, hortikulturi i šumarstvu, posebno đubriva u poljoprivredi i hortikulturi, korisne bakterije i dodaci zemljištu

Klasa 05: preparati za uništavanje i suzbijanje štetočina, insekticidi, fungicidi, herbicidi, pesticidi, nematicidi, nematode za kontrolu insekata, biološka sredstva za kontrolu

Klasa 31: poljoprivredni proizvodi, proizvodi hortikulture i proizvodi šumarstva, posebno sjemenje tretirano biološkim proizvodima, žitarice, sjemenje i vegetativni djelovi biljaka, prekrivači za biljke od slame i gnojiva, koji nisu obuhvaćeni drugim klasama

(210) **2013-233**

(442) **20.09.2014.**

(220) 6/17/2013

(731) **BASF CORPORATION**, 100 PARK AVENUE FLORHAM PARK, NJ 07932 US

TEQUALIS

(540)

(550) I

(740) Stanković Mugoša Ana, Trg Republike 13, Podgorica ME

(511) **Klasa 01:** biološki preparati koji se koriste u poljoprivredi, hortikulturi i šumarstvu, posebno đubriva u poljoprivredi i hortikulturi, korisne bakterije i dodaci zemljištu

Klasa 05: preparati za uništavanje i suzbijanje štetočina, insekticidi, fungicidi, herbicidi,

pesticidi, nematicidi, nematode za kontrolu insekata, biološka sredstva za kontrolu

Klasa 31: poljoprivredni proizvodi, proizvodi hortikulture i proizvodi šumarstva, posebno sjemenje tretirano biološkim proizvodima, žitarice, sjemenje i vegetativni dijelovi biljaka, prekrivači za biljke od slame i gnojiva, koji nisu obuhvaćeni drugim klasama

(210) **2013-234**

(442) **20.09.2014.**

(220) 6/17/2013

(731) **NEWELL RUBBERMAID EUROPE LLC**, 3 GLENLAKE PARKWAY ATLANTA GA 30328 US

DYMO

(540)

(550) I

(740) Popović Miladin, Đoka Miraševića 21/III, Podgorica ME

(511) **Klasa 07:** mašine i alatne mašine, motori (osim motora za kopnena vozila), spojnice, transmisioni uređaji (osim onih za kopnena vozila), poljoprivredne sprave osim onih koje se pokreću ručno, inkubatori za jaja, automatske mašine, naročito ručne mašine za štampanje etiketa, mašine za utiskivanje u plastiku, metal i slično, ketridži sa vrstama slova (za štampanje), ručni aparati za etiketiranje, ručni aparati za pravljenje etiketa/utiskivači

Klasa 09: naučni, nautički, geodetski, fotografski, kinematografski i optički aparati i instrumenti kao i aparati i instrumenti za vaganje, mjerenje, signalizaciju, kontrolu (inspekciju), za pomoć (spašavanje) i za obuku, aparati i instrumenti za vođenje, distribuciju, transformisanje, akumuliranje, podešavanje ili upravljanje električne struje, aparati za snimanje, prijenos, reprodukciju zvuka ili slika, magnetni nosači podataka, diskovi za snimanje, kompaktni diskovi, DVD i drugi numerički nosači za snimanje, mehanizmi za uređaje koji se pokreću uz prethodno ubacivanje novca ili žetona, registarske blagajne, računari, oprema za obradu podataka i kompjuteri, uređaji za gašenje požara, kompjuterski programi [softveri], naročito elektronski aparati za etiketiranje i elektronski štampač etiketa, softver za etiketiranje za mašine za štampanje etiketa, kompjuterski štampači za štampanje etiketa, elektronski aparat za pecatiranje datuma i vremena, komplet za etiketiranje koji se sastoji od elektronskog aparata za etiketiranje i traka, kasete i ketridži, koji sadrže trake, blanko naljepnice, naljepnice sa adresama, naljepnice sa podacima o isporukama, papirne oznake, papirne oznake sa cijenama i identifikacione papirne oznake za upotrebu sa elektronskim mašinama za etiketiranje, kasete i ketridži sa vrstama slova za korišćenje sa elektronskim mašinama za etiketiranje

Klasa 16: papir, karton i proizvodi od tih materijala koji nisu obuhvaćeni drugim klasama, štamparski proizvodi, proizvodi za uvezivanje knjiga, fotografije, pribor za pisanje, ljepila (ljepljive materije za papirnate proizvode ili za kućne potrebe), slikarski pribor, kistovi, pisače mašine i kancelarijski pribor (osim namještaja), oprema za nastavu i obuku (osim aparata), plastični materijali za ambalažu (koji nisu obuhvaćeni drugim klasama), štamparska slova, klišeji, naročito blanko nalepnice za štampanje, trake sa nalepticama, trake za utiskivanje, elektronski brisač (kancelarijski materijal), kasete i ketridži, koji sadrže trake, blanko naljepnice, naljepnice sa adresama, naljepnice sa podacima o isporukama, papirne oznake, papirne oznake sa cijenama i identifikacione papirne oznake za upotrebu sa elektronskim mašinama za etiketiranje, papirne oznake, papirne oznake sa cijenama i identifikacione

papirne oznake, priručnici

(210) **2013-235** (442) **20.09.2014.**

(220) 6/18/2013

(731) **BONGRAIN S.A.** A FRENCH SOCIETE ANONYME, 42 RUE RIEUSSEC, 78220 VIROFLAY FR



(540)

(550) I

(740) Lutovac Branislav, Bulevar Crnojevića 93, Podgorica ME

(511) **Klasa 29:** mlijeko, sir i mliječni proizvodi, jestiva ulja i masti

(210) **2013-236** (442) **20.09.2014.**

(220) 6/21/2013

(300) EU BR.011447786 od 21.12.2012

(731) **LRC PRODUCTS LIMITED**, 103-105 BATH ROAD SLOUGH, SL1 3UH GB

SCHOLL EXPRESS PEDI

(540)

(550) I

(740) Popović Miladin, Đoka Miraševića 21/III, Podgorica ME

(511) **Klasa 05:** sanitarni preparati za medicinsku upotrebu, medicinski preparati za njegu stopala, tijela i kože, kreme za hidrataciju (medicinske), kreme za hidrataciju [farmaceutske], gelovi za hidrataciju [farmaceutski], losioni za hidrataciju [farmaceutski], losioni za hidrataciju tijela [farmaceutski], losioni za hidrataciju kože [farmaceutski], kreme za hidrataciju kože [farmaceutske], medicinske kreme, gelovi, losioni, ulja, balzami, puderi, talkovi i sprejevi za stopala, tijelo i kožu, medicinski, sanitarni ili dezinfekcioni preparati za tretman stopala, tijela i kože, medicinski i terapijski preparati i dodaci za kupke u obliku soli, ulja i sredstava za potapanje, medicinska ili dezinfekciona sredstava za potapanje u obliku tableta, medicinski ili farmaceutski preparati protiv znojenja, medicinske tečnosti za masažu, medicinski toaletni preparati, medicinski ili farmaceutski preparati za žuljeve i promrzline, ulošci i jastučići koji pripadaju klasi 5 za prevenciju upale prstiju na nogama i zadebljanja žuljeva, medicinski preparati za liječenje uraslih noktiju na nogama, medicinski ulošci i umeci za cipele, materijali za zavijanje, flasteri, prstenasti flasteri, prstenovi za žuljeve, ljepljivi flasteri, materijali za previjanje, zavoji, preparati za dezinfekciju, antiseptički proizvodi, anti-gljivične supstance, materijali natopljeni sa ili koji sadrže anti-gljivične supstance, zavoji za rane, ulošci, fungicidi, herbicidi

Klasa 08: ručni kućni alati i pribor za manikir ili pedikir, ručni alati za uklanjanje zadebljale kože, ručni alati za piling kože, grickalice za nokte, turpije, makazice, pincete, djelovi i pribor za

svu gore navedenu robu

Klasa 10: ortopedski, ortotičko-protetički, pedikirski i aparati i instrumenti za njegu stopala, materijali za ušivanje, instrumenti, oprema i aparati za liječenje i njegu stopala i kože, jastučići za njegu stopala, pomagala za korekciju stopala, uključujući i podupirače za svod stopala, aparati za razdvajanje i ispravljanje prstiju na nogama, zaštitni aparati protiv nastanka zadebljanja na žuljevima i protiv upale nožnih prstiju, elektronski uređaji koji se koriste za uklanjanje zadebljale kože, elektronski uređaji koji se koriste za piling kože, elektronske turpije za stopala, jastučići za pete i potpetice, zaštita za metatarzalne jagodice na stopalima, ulošci za čizme, prstenovi za stopala i podupirači, ulošci za cipele, ortopedski ulošci, ulošci za jednokratnu upotrebu, mirišljavi ulošci za ortopedsku obuću, kompresivne čarape, kompresivne čarape razričite čvrstoće, medicinske čarape za potporu, ortopedske i terapijske čarape, čarape za medicinske, hirurške i / ili profilaktičke svrhe, medicinske i hirurške čarape, čarape za proširene vene, aparati za vežbanje stopala, ortopedski proizvodi, instrumenti i aparati za stavljanje zavoja, aparati za fiksiranje prstiju na rukama i nogama, elastični zavoji za zglobove, elastične dokoljenice, elastični zavoji za koljena, elastični zavoji, zavoji za struk, zavoji za ortopedske svrhe, aparati za mjerenje, ispitivanje i uzimanje otisaka stopala, masažeri za tijelo, električni masažeri, masažeri za stopala, terapijski aparati i uređaji za masažu i / ili kupanje, djelovi i pribor za svu gore navedenu robu

(210) **2013-237**

(442) **20.09.2014.**

(220) 6/25/2013

(731) **COLGATE-PALMOLIVE COMPANY**, 300 PARK AVENUE, NEW YORK, NY 10022 US

COLGATE 360°
INTERDENTAL

(540)

(550) I

(740) AOD "Ćupić", Dalmatinska 10, Podgorica ME

(511) **Klasa 21:** četkice za zube

(210) **2013-238**

(442) **20.09.2014.**

(220) 6/25/2013

(731) **PONTI S.P.A.** VIA E. FERRARI 7, GHEMME IT

PONTI

(540)

(550) I

(511) **Klasa 29:** konzervisano, smrznuto, sušeno i kuvano voće i povrće, želei, džemovi, kompoti, jestiva ulja i masti

Klasa 30: so, senf, sirće, sosevi (kao začini), začini

(210) **2013-239**

(442) **20.09.2014.**

(220) 6/25/2013

(731) **TWENTIETH CENTRY FOX FILM CORPRATION**, 10201WEST PICO BOULEVARD, LOS ANGELES, CALIFORNIA 90035 US

FOX SPORTS 3

(540)

(550) I

(511) **Klasa 38:** telekomunikacije, usluge televizijskog emitovanja i televizijskog prenosa, usluge radio emitovanja

Klasa 41: obrazovanje, pružanje obuke, zabava, sportske i kulturne aktivnosti, proizvodnja i distribucija televizijskih programa, igranih filmova i audio-vizuelne zabave, usluge zabave u vidu televizijskog programa, pružanje onlajn informacija u oblasti televizije, igrani filmovi i video zabava putem interneta, pružanje televizijskog programa, igranih filmova i video-zabave putem wireless uređaja, usluge zabave u vidu video-zapisa koji se ne mogu preuzimati i slika koje prikazuju televizijske emisije i zabavu, koje se prenose putem internet i mreža wireless komunikacije, usluge zabave, naime, pružanje onlajn kompjuterskih igrica, onlajn dnevnic, naime, blogovi koje karakterišu lični podaci i mišljenja, organizovanje zabavnih i kulturnih manifestacija, zabava u vidu takmičenja, nadmetanja i igara

(210) **2013-240**(442) **20.09.2014.**

(220) 6/25/2013

(731) **TWENTIETH CENTRY FOX FILM CORPRATION**, 10201WEST PICO BOULEVARD, LOS ANGELES, CALIFORNIA 90035 US

FOX SPORTS 2

(540)

(550) I

(511) **Klasa 38:** telekomunikacije, usluge televizijskog emitovanja i televizijskog prenosa, usluge radio emitovanja

Klasa 41: obrazovanje, pružanje obuke, zabava, sportske i kulturne aktivnosti, proizvodnja i distribucija televizijskih programa, igranih filmova i audio-vizuelne zabave, usluge zabave u vidu televizijskog programa, pružanje onlajn informacija u oblasti televizije, igrani filmovi i video zabava putem interneta, pružanje televizijskog programa, igranih filmova i video-zabave putem wireless uređaja, usluge zabave u vidu video-zapisa koji se ne mogu preuzimati i slika koje prikazuju televizijske emisije i zabavu, koje se prenose putem internet i mreža wireless komunikacije, usluge zabave, naime, pružanje onlajn kompjuterskih igrica, onlajn dnevnic, naime, blogovi koje karakterišu lični podaci i mišljenja, organizovanje zabavnih i kulturnih manifestacija, zabava u vidu takmičenja, nadmetanja i igara

(210) **2013-241**(442) **20.09.2014.**

(220) 6/25/2013

(731) **FRESH & CO.D.O.O.** IVANA GORANA KOVAČIĆA 24000 SUBOTICA RS

SU-voće

(540)

(550) I

(740) Popović Miladin, Đoka Miraševića 21/III, Podgorica ME

(511) **Klasa 32:** bezalkoholni napici od voća, voćni napici, voćni sirupi i drugi preparati za pravljenje voćnih napitaka

(210) **2013-242**

(442) **20.09.2014.**

(220) 6/26/2013

(731) **FADI F.M.YOUNIS**, MARŠALA TITA 24, 85000 BAR ME

(540) MARBLE

(550) I

(511) **Klasa 34:** duvan, koji je prerađen ili neprerađen, duvan za pušenje, duvan za lule, duvan za savijanje, duvan za žvakanje, duvan za sisanje, cigarete, cigare, cigarilosi, supstance za pušenje koje se prodaju odvojeno ili izmiješane sa duvanom, i koje nijesu za medicinsku ili svrhu liječenja, burmut, arti kli za pušače uključeni u klasu 34, papir za cigarete, fišeci za cigarete i šibice

(210) **2013-243**

(442) **20.09.2014.**

(220) 6/26/2013

(731) **PHILIP MORRIS BRANDS SARL**, QUAI JEANRENAUD 3, NEUCHATEL, 2000 CH



(540)

(550) I

(511) **Klasa 34:** duvan, sirov ili prerađen, proizvodi od duvana, uključujući cigare, cigarete, cigarilosi, duvan za uvijanje cigareta, duvan za lule, duvan za žvakanje, duvan za šmrkanje, kretek, snus, zamena za duvan (za nemedicinsku upotrebu), proizvodi za pušače, naročito papir za cigarete i lule, filteri za cigarete, kutije za duvan, kutije za cigarete i pepeljare, lule, ručni aparati/spravice za uvijanje, cigareta, upaljači, šibice

(210) **2013-244** (442) **20.09.2014.**

(220) 6/26/2013

(731) **PHILIP MORRIS BRANDS SARL**, QUAI JEANRENAUD 3, NEUCHATEL, 2000 CH

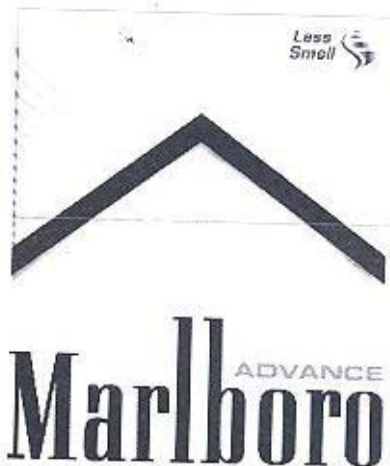

(540)

(550) I

(511) **Klasa 34:** duvan, sirov ili prerađen, proizvodi od duvana, uključujući cigare, cigarete, cigarilosi, duvan za uvijanje cigareta, duvan za lule, duvan za žvakanje, duvan za šmrkanje, kretek, snus, zamena za duvan (za nemedicinsku upotrebu), proizvodi za pušače, naročito papir za cigarete i lule, filteri za cigarete, kutije za duvan, kutije za cigarete i pepeljare, lule, ručni aparati/spravice za uvijanje, cigareta, upaljači, šibice

(210) **2013-245** (442) **20.09.2014.**

(220) 6/26/2013

(731) **GRENDENE S.A.** AV.PIMENTEL GOMES, 214, BAIRRO:EXPECTATIVA 62040-050 SOBRAL-CE BR



Dreamed by melissa

(540)

(550) I

(511) **Klasa 25:** ženska i dječija obuća, naime sandale, obuća za plažu, papuče za kupanje i čizme

(210) **2013-246**(442) **20.09.2014.**

(220) 6/27/2013

(731) **MONTRES ANTIMA SA**, A SWITZERLAND CORPORATION, THEODOR KOCHER-STRASSE
11, 2502 BIENNE CH

(540)

(550) I

(511) **Klasa 14:** satovi(210) **2013-247**(442) **20.09.2014.**

(220) 6/27/2013

(731) **MONTRES ANTIMA SA**, A SWITZERLAND CORPORATION, THEODOR KOCHER-STRASSE
11, 2502 BIENNE CH

ZODIAC

(540)

(550) I

(511) **Klasa 14:** satovi(210) **2013-248**(442) **20.09.2014.**

(220) 6/27/2013

(731) **FOSSIL GROUP**, INC A DELAWARE CORPRATION, 901.S CENTRAL EXPRESSWAY,
RICHARDSON, TEXAS 75080 US

(540)

(550) I, F

(511) **Klasa 09:** naočare za sunce i naočare za vid, zaštitne futrole za nošenje posebno prilagođene za lične elektronske futrole za naočare

Klasa 18: kožni privesci, ručne torbe, novčanici za sitan novac, cegeri, tašne, novčanici za papirni novac, novčanici, rančevi, akten tašne, torbe za nošenje opreme, sportske torbe, atletske torbe, putne torbe, ručni prtljag, prazni futrole (etui) za kravate, kišobrani

Klasa 25: odeća, dodaci za odeću, obuća, pokrivala za glavu, kaiševi, marame, rukavice bez prstiju, rukavice, šeširi

Klasa 35: maloprodajne usluge i online maloprodajne usluge u vezi sa satovima, nakitom, naočarima za sunce, privescima za ključeve, ručnim torbama, novčanicima za sitan novac, cegerima, tašnama, novčanicima za papirni novčanicima, obućom, maramama, šeširima, rukavicama bez prstiju, rukavicama, odećom, modnim dodacima, proizvodima od kože i dodacima za odeću

(210) **2013-249**

(442) **20.09.2014.**

(220) 6/27/2013

(731) **FOSSIL GROUP**, INC A DELAWARE CORPORATION, 901.S CENTRAL EXPRESSWAY, RICHARDSON, TEXAS 75080 US



(540)

(550) I, F

(511) **Klasa 14:** satovi i nakit

(210) **2013-250**

(442) **20.09.2014.**

(220) 6/27/2013

(731) **FOSSIL GROUP**, INC A DELAWARE CORPORATION, 901.S CENTRAL EXPRESSWAY, RICHARDSON, TEXAS 75080 US

FOSSIL

(540)

(550) I, F

(511) **Klasa 25:** odeća, dodaci za odeću, obuća, pokrivala za glavu, kaiševi, marame, rukavice bez prstiju, rukavice, šeširi

Klasa 35: maloprodajne usluge i online maloprodajne usluge u vezi sa satovima, nakitom, naočarima za sunce, privescima za ključeve, ručnim torbama, novčanicima za sitan novac, cegerima, tašnama, novčanicima za papirni novčanicima, obućom, maramama, šeširima, rukavicama bez prstiju, rukavicama, odećom, modnim dodacima, proizvodima od kože i dodacima za odeću

(210) **2013-251**

(442) **20.09.2014.**

(220) 6/27/2013

(731) **FOSSIL GROUP, INC** A DELAWARE CORPORATION, 901.S CENTRAL EXPRESSWAY, RICHARDSON, TEXAS 75080 US

MICHELE

(540)

(550) I, F

(511) **Klasa 14:** satovi i nakit

(210) **2013-252**

(442) **20.09.2014.**

(220) 6/27/2013

(731) **13 JUL-PLANTAŽE A.D.** PODGORICA ME



(540)

(550) I

(511) **Klasa 33:** alkoholna pića (izuzev piva)

(210) **2013-253**

(442) **20.09.2014.**

(220) 6/27/2013

(731) **13 JUL-PLANTAŽE A.D.** PODGORICA ME



(540)

(550) I

(511) **Klasa 33:** alkoholna pića (izuzev piva)

(210) **2013-254** (442) **20.09.2014.**

(220) 6/27/2013

(731) **13 JUL-PLANTAŽE A.D.** PODGORICA ME



(540)

(550) I

(511) **Klasa 33:** alkoholna pića (izuzev piva)

(210) **2013-255** (442) **20.09.2014.**

(220) 7/1/2013

(731) **DENSO CORPORATION**, 1-1 SHOWA-CHO, KARIYA-CITY, AICHI-PREF JP

DENSO

(540)

(550) I

(740) AOD "Ćupić", Dalmatinska 10, Podgorica ME

(511) **Klasa 35:** računovodstvo, poslovni konstanting (profesionalni), pomoć kod poslovnog menadžmenta, poslovno istraživanje, prikupljanje informacija u kompjuterske baze podataka, analiza cijena koštanja, pretraživanje podataka iz kompjuterskih fajlova za druge, rasturanje reklamnog materijala, usluge stručnjaka za efikasnost, marketinška istraživanja, marketinške studije, usluge modela (manekenki/manekena) za reklame i promocije, onlajn oglašavanje na računarskoj mreži, prezentacija robe na medijima za komunikaciju u maloprodajne svrhe, oglašavanje, prodajne promocije za druge, sistematizacija podataka u kompjuterske baze podataka, poreska priprema, maloprodajne usluge il usluga veleprodaje, agencije za zapošljavanje, agencije za uvoz i izvoz

Klasa 42: računarsko programiranje, iznajmljivanje računara, konsalting u vezi računarskih softvera, kompjuterski dizajn softvera, kompjuterski sistem dizajn, kompjuterska analiza sistema, konsalting u oblasti računarskog hardvera, inženjering, industrijski dizajn, održavanje računarskih softvera, ispitivanje materijala, mašinska istraživanja, meteorološke informacije, fizika (istraživanje), projektne studije (tehničke), iznajmljivanje računarskih softvera, istraživanja i razvoj za druge, tehnička istraživanja, ispitivanje isptavnosti vozila,

vremenska prognoza, savjetodavne usluge u vezi intelektualne svojine, usiuge u sudskim sporovima, licenciranje kod intelektualne svojine, inženjerski crteži, dijagnostička ispitivanja ili usluge dijagnostičkog analiziranja u vezi djelova vozila, motora, elektronskih aparata, telekomunikacijskih aparata, industrijskih mašina ili aparata za domaćinstvo

(210) **2013-256**

(442) **20.09.2014.**

(220) 7/1/2013

(731) **BOSNALIJEK**, FARMACEUTSKA I HEMIJSKA INDUSTRIJA, D.D. JUKIĆEVA 53, 71000 SARAJEVO BA

CHOLROSIN

(540)

(550) I

(740) Radulović Božidar, Jovana Tomaševića 9/III, Podgorica ME

(511) **Klasa 05:** farmaceutski proizvodi

(210) **2013-257**

(442) **20.09.2014.**

(220) 7/4/2013

(731) **WORLD VISION INTERNATIONAL**, 800 WEST CHESTNUT AVENUE, 91016 MONROVIA, CALIFORNIA US



(540)

(550) I

(740) Đakonović Vido, Bajova 9, Cetinje ME

(511) **Klasa 09:** film za veliko platno i slajdovi, prethodno snimljene audio i video kasete, kompakt diskovi, DVD diskovi i časopisi i bilteni koji se mogu preuzeti koji se odnose na pomoć gladnima, pomoć siromašnima, medicinsku pomoć, projekte za čistu vodu, prevenciju bolesti, beskućništvo, razvoj domaćinstva, pomoć izbeglicama, sponzorisane dece, humanitarnu pomoć, ekonomski razvoj i razvoj zajednice, ljudska prava, socijalnu pravdu, mir i sukobe, nasilje u porodici, prava djece, hrišćanstvo, religiju, i duhovnost

Klasa 16: brošure, bilteni, pamfleti, kratke vijesti i časopisi u oblastima za pomoć gladnima, pomoć siromašnima, medicinsku pomoć, projekte za čistu vodu, sprečavanje bolesti, beskućništvo, razvoj domaćinstva, pomoć izbeglicama, sponzorisane dece, humanitarnu pomoć, ekonomski razvoj i razvoj zajednice, ljudska prava, socijalnu pravdu, mir i sukobe, nasilje u porodici, prava djece, hrišćanstvo, religiju, i duhovnost

(210) **2013-258**

(442) **20.09.2014.**

(220) 7/4/2013

(731) **ZHENGZHOU YUTONG GROUP CO.LTD.** NO.8 CHANGCHUN ROAD, HI-TECH

INDUSTRIAL PARK, ZHENGZHOU CH

YUTON

(540)

(550) I

(740) Đakonović Vido, Bajova 9, Cetinje ME

(511) **Klasa 07:** mašine za bušenje, mešalice, valjci za puteve, parni valjci, mašine za mešanje, mašine za izbeljivanje, vibracione mašine, mašine za mešanje betona, mašine za pravljenje bitumena, buldožeri, kopači, mehanički, bageri, mašine za katranisanje, mašine za postavljanje šina, mašine za pravljenje puteva, mašine za gradnju pruga, kopači (mašine), hidraulični klipovi (mašine), mašine za pomeranje zemlje, plugovi za kopanje rovova, kopači sa kašikom (mašine), mašine i mašinerija koji se upotrebljavaju za izvođenje zemljanih radova u oblasti građevinarstva, mostogradnje i gradnje puteva, vibratori za beton (mašine), mašine za utovar i istovar, dizalice, kranovi (aparati za podizanje), starteri (elektropokretači) za motore i mašine, klipovi za ublažavanje udara (delovi mašina), ublaživači udara (amortizeri) za mašine, mašine za čišćenje puteva (samohotke), pulverizatori otpadnih voda, aparati za pranje, instalacije za pranje vozila, električne mašine i aparati za čišćenje, razvrstavači, odstranjivači smeća (mašine), razvrstavači, odstranjivači smeća, razvrstavači, odstranjivači smeća, mašine za presovanje đubreta, mašine za presovanje đubreta, ploveći bageri, mašine za sortiranje za industriju

(210) **2013-259**

(442) **20.09.2014.**

(220) 7/5/2013

(731) **SHURJOINT PIPING PRODUCTS, INC.** 3F, 130 XINHU 3RD ROAD, TAIPEI, TAIWAN CN

SHURJOINT

(540)

(550) I

(740) AOD "Ćupić", Dalmatinska 10, Podgorica ME

(511) **Klasa 06:** Metalne cijevi i tube, spojnice za metalne cijevi, koljena za metalne cijevi, djelovi za montažu metalnih cijevi, zglobovi, vodovi, obujmice, reduciri i stalci za metalne cijevi, prirubnice od metala, adapteri za prirubnice, metalni ventili (koji nisu djelovi mašina), metalni poklopci za cijevi, metalni zaptivači, metalne alke za cijevi, alke od metala za pričvršćivanje cijevi, metalne grane za cjevovode, metalni usisni difuzori, metalne izdubljene cjediljke, metalne stege za grede

(210) **2013-260**

(442) **20.09.2014.**

(220) 7/8/2013

(731) **PHARMANOVA D.O.O.** DRUŠTVO ZA PROIZVODNJU FARMACEUTSKIH PROIZVODA, OBRENOVAC, INDUSTRIJSKA 8 RS

CALDEOSS

(540)

(550) I

(740) Kojić Ivana, Serdara Jola Piletića bb, Podgorica ME

(511) **Klasa 05:** farmaceutski preparati

(210) **2013-261**

(442) **20.09.2014.**

(220) 7/8/2013

(731) **PAYLESS SHOESOURCE WORLDWIDE, INC.** JAUHAWK TOWRES, 700 SW JACKSON STREET SUITE 202, TOPEKA, KS 66603 US



(540)

(550) I, F

(511) **Klasa 25:** obuća

Klasa 35: prikupljanje za račun drugih, obuće, odeće, tašni, torbi, i ranaca (isključujući transport istih), omogućavajući kupcima da razgledaju i kupe ove robe, takve usluge koje se pružaju takođe od strane maloprodajnih radnji, putem elektronskih medija, na primer, putem web strana

(210) **2013-262**

(442) **20.09.2014.**

(220) 7/8/2013

(731) **PAYLESS SHOESOURCE WORLDWIDE, INC.** JAUHAWK TOWRES, 700 SW JACKSON STREET SUITE 202, TOPEKA, KS 66603 US

PAYLESS SHOESOURCE

(540)

(550) I, F

(511) **Klasa 25:** obuća

Klasa 35: prikupljanje za račun drugih, obuće, odeće, tašni, torbi, i ranaca (isključujući transport istih), omogućavajući kupcima da razgledaju i kupe ove robe, takve usluge koje se pružaju takođe od strane maloprodajnih radnji, putem elektronskih medija, na primer, putem web strana

(210) **2013-263**

(442) **20.09.2014.**

(220) 7/8/2013

(731) **OKF CORPRATION**, 714, BOKJEUNG-DONG, SUJEUNG-GU, SUNGNAM CITY, GYEONGGI-

DO 461-200 KR



ALOE VERA KING

(540)

(550) I, F

(740) Radulović Božidar, Jovana Tomaševića 9/III, Podgorica ME

(511) **Klasa 32:** sokovi od povrća za pića, voćni sokovi, sokovi koji sadrže Aloe, voćni sirupi za pića, sirupi za pića, pića od prerađenog povrća i voća, bezalkoholni voćni nektari, gazirana voda, bezalkoholna pića koja sadrže voćne sokove, mineralna voda, pića od povrća, sokovi od Aloe Vera

(210) **2013-264**(442) **20.09.2014.**

(220) 7/9/2013

(731) **KAHLUA AG**, C/O TESTATORIS AG, TOPFERSTRASSE 5, 6004 LUCERANE CH

(540)

(550) T

(740) Lutovac Branislav, Bulevar Crnojevića 93, Podgorica ME

(511) **Klasa 33:** alkoholna pića (izuzev piva)(210) **2013-265**(442) **20.09.2014.**

(220) 7/9/2013

(731) **STARBUCKS CORPORATION** D/B/A STARBUCKS COFFEE COMPANY, 2401 UTAH AVENUE SOUTH, SEATTLE, WASHINGTON 98134 US

READY BREW

(540)

(550) I

(511) **Klasa 30:** kafa i bez-alkoholna pića na bazi kafe

(210) **2013-266** (442) **20.09.2014.**

(220) 7/9/2013

(731) **STARBUCKS CORPORATION** D/B/A STARBUCKS COFFEE COMPANY, 2401 UTAH AVENUE SOUTH, SEATTLE, WASHINGTON 98134 US

STARBUCKS WILLOW BLEND

(540)

(550) I

(511) **Klasa 30:** pića pravljena od kafe, kafa, kafa u zrnu, mljevena kafa

(210) **2013-267** (442) **20.09.2014.**

(220) 7/9/2013

(731) **STARBUCKS CORPORATION** D/B/A STARBUCKS COFFEE COMPANY, 2401 UTAH AVENUE SOUTH, SEATTLE, WASHINGTON 98134 US

STARBUCKS VIA

(540)

(550) I

(511) **Klasa 30:** mljevena i cijela zrna kafe, kakao, čaj (biljni i ne-biljni), kafa, čaj, kakao i espresso pića i pića na bazi kafe i/ili espresa, pića na bazi čaja, čokolade u prahu i vanile, sosovi kao dodaci pićima, čokoladni sirup, sirupi s aromom kao dodaci pićima, peciva uključujući i mafine, suvi kolači, biskviti, kolačići, peciva i hljebovi, sendviči, granola, gotove kafe, gotovi čajevi, sladoled i smrznuti konfekcije, čokolada, slatkiši i konfekcije

(210) **2013-268** (442) **20.09.2014.**

(220) 7/9/2013

(731) **STARBUCKS CORPORATION** D/B/A STARBUCKS COFFEE COMPANY, 2401 UTAH AVENUE SOUTH, SEATTLE, WASHINGTON 98134 US

PIKE PLACE

(540)

(550) I

(511) **Klasa 30:** kafa, kafa u zrnu, mljevena kafa, instant kafa, ekstrakti i esencije kafe, preparati i pića na bazi kafe, preparati i pića na bazi espresa, ledena kafa, vještačka kafa, ekstrakti i esencije i preparati i pića na bazi vještačke kafe

(210) **2013-269** (442) **20.09.2014.**

(220) 7/9/2013

(731) **STARBUCKS CORPORATION** D/B/A STARBUCKS COFFEE COMPANY, 2401 UTAH AVENUE SOUTH, SEATTLE, WASHINGTON 98134 US

STARBUCKS BLONDE

(540)

(550) I

(511) **Klasa 30:** pića pravljena od kafe, kafa, kafa u zrnu, mljevena kafa(210) **2013-270**(442) **20.09.2014.**

(220) 7/9/2013

(731) **STARBUCKS CORPORATION** D/B/A STARBUCKS COFFEE COMPANY, 2401 UTAH AVENUE SOUTH, SEATTLE, WASHINGTON 98134 US

KOMODO DRAGON BLEND

(540)

(550) I

(511) **Klasa 30:** pića pravljena od kafe, kafa, kafa u zrnu, mljevena kafa(210) **2013-271**(442) **20.09.2014.**

(220) 7/9/2013

(731) **STARBUCKS CORPORATION** D/B/A STARBUCKS COFFEE COMPANY, 2401 UTAH AVENUE SOUTH, SEATTLE, WASHINGTON 98134 US

STARBUCKS VERANDA BLEND

(540)

(550) I

(511) **Klasa 30:** pića pravljena od kafe, kafa, kafa u zrnu, mljevena kafa(210) **2013-272**(442) **20.09.2014.**

(220) 7/9/2013

(731) **NEVLADINO UDRUŽENJE UDRUŽENJE BERANDA BERANE**, UL. MILJANA VUKOVA 23A BERANE ME

(540)

(550) I

(511) **Klasa 41:** obavljanje kulturno društvene djelatnosti u okviru koje se obučavaju osobe u raznim kulturnim i sportskim aktivnostima koje manifestacija predviđa

(210) **2013-273**

(442) **20.09.2014.**

(220) 7/10/2013

(731) **BASF SE**, CARL-BOSCH-STRASSE 38 LUDWIGHAFEN AM RHEIN DE

LIVELTA

(540)

(550) I

(740) Stanković Mugoša Ana, Trg Republike 13, Podgorica ME

(511) **Klasa 01:** hemikalije koje se koriste u poljoprivredi, hortikulturi i šumarstvu, naročito preparati za jačanje biljaka, hemijski i/ili biološki preparati za kontrolu stresa kod biljaka, preparati za regulisanje rasta biljaka, hemijski preparati za tretiranje sjemena, površinski-aktivna sredstva, prirodne ili vještačke hemikalije koje se koriste kao seksualni mamci ili agensi za zbunjivanje insekata

Klasa 05: preparati za uništavanje i suzbijanje štetočina, insekticidi, fungicidi, herbicidi, pesticidi

(210) **2013-274**

(442) **20.09.2014.**

(220) 7/11/2013

(731) **SAMSUNG ELECTRONICS CO.LTD.** 129, SAMSUNG-RO, YEONGTONG-GU, SUWON-SI, GYEONGGI-DO KP

S View Cover

(540)

(550) I

(740) Lutovac Branislav, Bulevar Crnojevića 93, Podgorica ME

(511) **Klasa 09:** računarski softver za kodiranje i dekodiranje glasovnih i zvučnih signala, softver za unapređenje analognog i digitalnog zvuka za obradu, snimanje, beleženje, prijem, prenos, generisanje i arhiviranje glasovnih i audio signala, datoteka i zvukova, audio pojačala, audio zvučnici, prazne USB fleš memorijske jedinice, ugradni bežični audio i video prijemnici i elektronske priključne (doking) stanice koje se koriste sa uređajima za čitanje elektronskih knjiga, tablet računarima, mp3 plejerima, mp4 plejerima, mobilnim telefonima i smart (pametnim) telefonima, kamkorderi, softver za kompjutere i mobilne uređaje namijenjen za personalizovanje vidžeta i aplikacija za mobilnu telefoniju, softver za računarske aplikacije za mobilne telefone, prenosne plejere i ručne (handheld) računare, a naročito softver koji se koristi za prepoznavanje govora, softver za računarske igre, monitori za računare, habovi (čvorišta), preklopnici (svičevi) i ruteri za računarske mreže, računarski softver ugrađen u prenosne telefone i/ili prenosne računare koji omogućava korisnicima da igraju i preuzimaju

elektronske igrice, preslušavaju i preuzimaju melodije za mobilne telefone i muziku, i pregledaju i preuzimaju skrinsejvere i pozadine za ekran, računarski softver za kontrolu kućnih aparata, računarski softver za instant tekstualnu komunikaciju, slanje i prijem elektronske pošte i kontakt podataka, šerovanje (dijeljenje) rasporeda i drugih sadržaja, računarski softver za upravljanje i sistematizaciju različitih digitalnih čitalačkih sadržaja, a naročito digitalnih elektronskih knjiga, digitalnih elektronskih novina, stručnih radova, i digitalnih elektronskih časopisa, računarski softver za upravljanje ličnim podacima, računarski softver za emitovanje, šerovanje i upravljanje multimedijalnim sadržajima, računarski softver za kupovinu, preuzimanje, emitovanje ili preslušavanje muzike, računarski softver za kupovinu, pretplatu, preuzimanje, emitovanje i preslušavanje digitalnih čitalačkih sadržaja, a naročito digitalnih elektronskih knjiga, digitalnih elektronskih novina, stručnih radova, digitalnih elektronskih časopisa i elektronskih igara, računarski softver za sisteme sa sadržajima o putovanjima namijenjene za pružanje ili pribavljanje obavještenja u vezi sa putovanjima i za informacije koje se odnose na hotele, znamenitosti, muzeje, sredstva javnog prevoza, restorane i druge informacije o putovanjima i transportu, računarski softver za upotrebu pri snimanju, sistematizaciji, emitovanju, rukovanju i pregledu i radu sa tekstualnim, audio, video datotekama, i računarskim programima za igrice u vezi sa televizijom, računarima, muzičkim plejerima, video plejerima, plejerima multimedijalnih sadržaja i mobilnim telefonima, računarski softver za upotrebu pri traženju, pretraživanju i kupovini softvera iz elektronskih baza podataka, računarski softver za upotrebu sa satelitskim i GPS navigacionim sistemima za navigaciju, određivanja rute i planiranje putovanja, i elektronsko mapiranje, računarski softver koji predlaže najpogodnije aplikacije koje koriste digitalnu olovku (pen-input tehnologiju) za mobilne uređaje, računarski softver za pristup internetu i različitim aplikacijama, računarski softver namijenjen za pregledanje i preuzimanje elektronskih mapa, računarski softver namijenjen za uređivanje dnevnih aktivnosti, imenika, kalendara, beležaka i multimedijalnih sadržaja sačuvanih na mobilnim uređajima, računarski softver namijenjen za autorizaciju, objavljivanje, učitavanje, preuzimanje, prenos, prijem, uređivanje, ekstrakciju, kodiranje, dekodiranje, reprodukciju, memorisanje, organizovanje, postavljanje, prikazivanje, označavanje (tagovanje), blogovanje i/ili šerovanje elektronskih sadržaja i podataka preko interneta, lokalne (LAN)

(210) **2013-275**

(442) **20.09.2014.**

(220) 7/11/2013

(731) **WIX-FILTRON SP.Z.** O.O. WROCLAWSKA 145 STR, GOSTYN, 63-800 PL

FILTRON

(540)

(550) I

(511) **Klasa 07:** filteri, filter kertridži, aparati i material za filtriranje, posebno za motore s unutrašnjim sagorijevanjem, filteri (kao djelovi mašina ili motora)

Klasa 12: vozila, aparati za kretanje po zemlji, vazduhu ili vodi, uređaji protiv zagađenja za motore i njihove mašine

(210) **2013-276** (442) **20.09.2014.**

(220) 7/11/2013

(300) 011497625 17.01.2013. CTM

(731) **MARRIOTT INTERNATIONAL, INC,** 10400 FERNWOOD ROAD, BETHESDA, MARYLAND 20817 US

MOXY

(540)

(550) I

(511) **Klasa 35:** usluge franšiza, odnosno, pružanje pomoći u upravljanju poslovima kod osnivanja i vođenja hotela, usluge poslovnog upravljanja, odnosno, upravljanja i vođenja hotela

Klasa 45: obezbjeđivanje zabavnih, sportskih i kulturnih aktivnosti, organizovanje konferencija i izložbi za kulturne i obrazovne svrhe, usluge kazina, usluge igara na sreću, usluge kabarea, usluge noćnih klubova, organizovanje prodaje karata i obavljanje rezervacija za šou programe i druge zabavne događaje, usluge zdravstvenih i fitnes klubova, odnosno, pružanje usluga, obezbjeđivanje prostora, podučavanje i obezbjeđivanje opreme za potrebe fitnesa i fizičke vježbe, pružanje usluga, obezbjeđivanje prostora, podučavanje i obezbjeđivanje opreme za potrebe tenisa, bazena za plivanje, rekreativnih aktivnosti, vožnje bicikla, golfa, vodenih sportova, jahanja konja, skijanja, odlaska na plažu i društvenih funkcija, usluge golf klubova, golf terena i podučavanje u igranju golfa, usluge planiranja vjenčanja, usluge planiranja i upravljanja događajima

Klasa 43: hotelske usluge, usluge za restorane, dostavu hrane, barove i foajee, usluge odmarališta i smještaja, obezbjeđivanje objekata opšte namjene za sastanke, konferencije i izložbe, obezbjeđivanje prostora za bankete i društvene svrhe za posebne prilike, i usluge rezervacija za hotelski smještaj

(210) **2013-277** (442) **20.09.2014.**

(220) 7/16/2013

(731) **ZHENGZHOU YUTONG BUS CO.LTD.** YUTONG ROAD, GUANCHENG DISTRICT, ZHENGZHOU CN

YUTON

(540)

(550) I

(740) Đakonović Vido, Bajova 9, Cetinje ME

(511) **Klasa 12:** viljuškari, vozila za dizanje, kamioni za posipanje, prskanje, motorni autobusi, motorna vozila, kamioni, kola za prevoz municije (vozila), karavani, prikolice (vozila), kola

za creva za polivanje, traktori, vagoni, motorne trokolice, električna vozila, teretna kombi vozila, hladnjače, vojna vozila za transport, sportska kola, kolica sa nagibom (tzv. karts vozila), tramvaji, vozila za kretanje po zemlji, vazduhu, vodi, šinama, kola, motorna kola, automobili, vozila za mešanje betona, ambulatna vozila, vozila za kampovanje, kuće na točkovima na motorni pogon, vozila za snijeg, vozila na daljinsko upravljanje koja nisu igračke, osovine za vozila, kola za spavanje, mjenjačke kutije za kopnena vozila, šasije (školjke) za vozila, uređaji za prenos, pojačavanje i redukciju obrtnog momenta za kopnena vozila, kamioni cisterne, vozila za transport i postavljanje kablova, vozila za prenos alata i opreme, vozila za smještaj i transport pribora i sredstava za čišćenje, vozila za kretanje po vodi, vozila sa vazдушnim jastucima, amortizeri za ublažavanje udara za vozila, nosači prtljaga za vozila (gepek), nosači točkova za vozila, centralni rotirajući dio točka vozila, šasije za vozila, branici (vozila), kočnice za vozila, vrata za vozila, opruge za suspenziju za vozila, naplatci (felne) za točkove vozila, sjedišta za vozila, tapacirunzi za vozila

Klasa 37: održavanje i popravka motornih vozila, pranje vozila, servisne stanice za vozila (dopunjavanje gorivom i održavanje), čišćenje vozila, usluge pomoći popravke za pokvarena vozila, vulkanizacija guma, popravka

(210) **2013-278**

(442) **20.09.2014.**

(220) 7/16/2013

(731) **MIDIS GROUP LTD.** GENEVA PLACE, WATERFRONT DRIVE, ROAD TOWN, TORTOLA VG

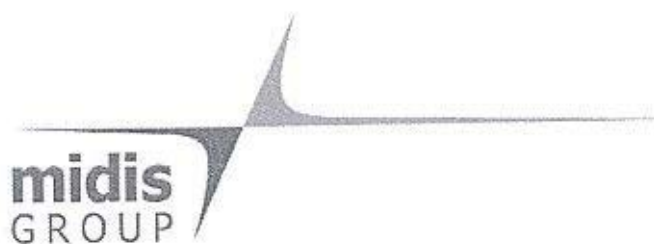

(540)

(550) I

(740) Đakonović Vido, Bajova 9, Cetinje ME

(511) **Klasa 09:** elektronske komponente i periferni uređaji, računari i računarski uređaji, magnetni nosači podataka, diskovi za snimanje, oprema za obradu podataka i računari

Klasa 35: povezivanje, za treća lica, raznovrsne robe specifično računarskih softvera i programa, omogućavanje potrošačima da lakše vide i kupe robu, pružanje savjeta i pomoći poslovnim licima u pogledu uspostavljanja i održavanja poslovanja, oglašavanje, poslovno upravljanje, poslovna administracija, kancelarijske funkcije

Klasa 42: usluge koje se odnose na računarske sisteme, umrežavanje, softver i profesionalne usluge, rješenja za sajt i napajanje (kao neprekidno napajanje (UPS), generatori električne energije, akumulatori i punjači, visoki podovi, bezbednosni sistemi i sistemi zaštite od požara, upravljački uređaji za klimatizaciju i sve mašine za električno napajanje), naučne i tehnološke usluge i istraživanje i projektovanje koji se odnosi na njih, industrijska analiza i istraživačke usluge, projektovanje i razvoj kompjuterskog hardvera i softvera

(210) **2013-279**

(442) **20.09.2014.**

(220) 7/16/2013

(731) **DINERS CLUB INTERNATIONAL LTD.** 2500 LAKE COOK ROAD, RIVERWOODS, IL

60015 US

PROTECTBUY

(540)

(550) I

(740) AOD "Ćupić", Dalmatinska 10, Podgorica ME

(511) **Klasa 36:** finansijske usluge, naročito bankarske usluge, usluge kreditnih kartica, usluge debitnih kartica i transakcije na prodajnim mjestima, finansijske savjetodavne usluge koje se odnose na bezbjedonosnu metodologiju za šifrovanje informacija o plaćanju i podataka u vezi s tim, usluge identifikacije kupca i prodavca za finansijske transakcije

(210) **2013-280**(442) **20.09.2014.**

(220) 7/16/2013

(731) **DINERS CLUB INTERNATIONAL LTD.** 2500 LAKE COOK ROAD, RIVERWOODS, IL 60015 US



(540)

(550) I

(740) AOD "Ćupić", Dalmatinska 10, Podgorica ME

(511) **Klasa 36:** finansijske usluge, naročito bankarske usluge, usluge kreditnih kartica, usluge debitnih kartica i transakcije na prodajnim mjestima, finansijske savjetodavne usluge koje se odnose na bezbjedonosnu metodologiju za šifrovanje informacija o plaćanju i podataka u vezi s tim, usluge identifikacije kupca i prodavca za finansijske transakcije

(210) **2013-281**(442) **20.09.2014.**

(220) 7/16/2013

(731) **BCARDI & COMPANY LIMITED**, 5 AEULESTRASSE, 9490 VADUZ LI

BOMBAY SAPPHIRE

(540)

(550) I

(740) Radulović Božidar, Jovana Tomaševića 9/III, Podgorica ME

(511) **Klasa 33:** alkoholna pića (osim piva)

(210) **2013-282**(442) **20.09.2014.**

(220) 7/16/2013

(731) **GENERAL MOTORS LLC**, 300 RENAISSANCE CENTER, DETROIT, MICHIGAN 48265-3000 US



(540)

(550) I

(740) Radulović Božidar, Jovana Tomaševića 9/III, Podgorica ME

(511) **Klasa 33:** alkoholna pića (osim piva)(210) **2013-283**(442) **20.09.2014.**

(220) 7/16/2013

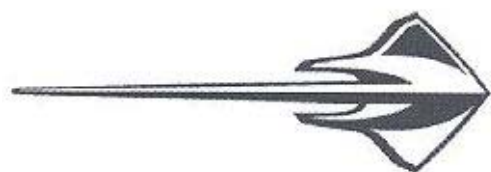
(731) **GENERAL MOTORS LLC**, 300 RENAISSANCE CENTER, DETROIT, MICHIGAN 48265-3000 US

(540)

(550) I

(740) Radulović Božidar, Jovana Tomaševića 9/III, Podgorica ME

(511) **Klasa 33:** alkoholna pića (osim piva)(210) **2013-284**(442) **20.09.2014.**

(220) 7/18/2013

(731) **BRITISH AMERICAN TOBACCO (BRANDS) INC.** 2711 CENTERVILLE ROAD SUITE 300 WILMINGTON DELAWARE 19808 US

PURPLE

(540)

(550) I

(740) Popović Miladin, Đoka Miraševića 21/III, Podgorica ME

(511) **Klasa 34:** cigarete, duvan, proizvodi od duvana, upaljači, šibice, artikli za pušače(210) **2013-285**(442) **20.09.2014.**

(220) 7/19/2013

(731) **HONDA MOTORS CO**, LTD, 1-1, 2-CHOME, MINAMI-AOYAMA, MINATO-KU, TOKYO JP



(540)

(550) I

(511) **Klasa 12:** vozila, aparati za kretanje po kopnu, vazduhu ili vodi pribor za gore navedenu robu

(210) **2013-286**

(442) **20.09.2014.**

(220) 7/19/2013

(731) **HONDA MOTORS CO**, LTD, 1-1, 2-CHOME, MINAMI-AOYAMA, MINATO-KU, TOKYO JP

CIVIC Type-R

(540)

(550) I

(511) **Klasa 12:** vozila, aparati za kretanje po kopnu, vazduhu ili vodi pribor za gore navedenu robu

(210) **2013-287**

(442) **20.09.2014.**

(220) 7/19/2013

(731) **HONDA MOTORS CO**, LTD, 1-1, 2-CHOME, MINAMI-AOYAMA, MINATO-KU, TOKYO JP



(540)

(550) I

(511) **Klasa 12:** vozila, aparati za kretanje po kopnu, vazduhu ili vodi pribor za gore navedenu robu

Klasa 37: građevinsko konstruisanje, popravljanje, usluge instaliranja

(210) **2013-288** (442) **20.09.2014.**
(220) 7/19/2013
(731) **HONDA MOTORS CO**, LTD, 1-1, 2-CHOME, MINAMI-AOYAMA, MINATO-KU, TOKYO JP

VTEC

(540)
(550) I
(511) **Klasa 12:** vozila, aparati za kretanje po zemlji, vazduhu ili vodi, kao i njihovi delovi, a naročito motori za motorna vozila, i sporedni delovi za gore opisane proizvode koji spadaju u međunarodnu klasu 12

(210) **2013-289** (442) **20.09.2014.**
(220) 7/19/2013
(731) **HONDA MOTORS CO**, LTD, 1-1, 2-CHOME, MINAMI-AOYAMA, MINATO-KU, TOKYO JP



(540)
(550) I
(511) **Klasa 12:** vozila, aparati za kretanje po kopnu, vazduhu ili vodi pribor za gore navedenu robu

(210) **2013-290** (442) **20.09.2014.**
(220) 7/19/2013
(731) **HONDA MOTORS CO**, LTD, 1-1, 2-CHOME, MINAMI-AOYAMA, MINATO-KU, TOKYO JP

CITY

(540)
(550) I
(511) **Klasa 12:** automobili

(210) **2013-291** (442) **20.09.2014.**

(220) 7/19/2013

(731) **HONDA MOTORS CO**, LTD, 1-1, 2-CHOME, MINAMI-AOYAMA, MINATO-KU, TOKYO JP

FR-V

(540)

(550) I

(511) **Klasa 12:** vozila, aparati za kretanje po zemlji, vazduhu i vodi i oprema za napred navedenu robu

(210) **2013-292**

(442) **20.09.2014.**

(220) 7/19/2013

(731) **HONDA MOTORS CO**, LTD, 1-1, 2-CHOME, MINAMI-AOYAMA, MINATO-KU, TOKYO JP

HONDA CITY

(540)

(550) I

(511) **Klasa 12:** vozila, aparati za kretanje po zemlji, vazduhu i vodi i oprema za napred navedenu robu

(210) **2013-293**

(442) **20.09.2014.**

(220) 7/19/2013

(731) **HONDA MOTORS CO**, LTD, 1-1, 2-CHOME, MINAMI-AOYAMA, MINATO-KU, TOKYO JP

THE POWER OF DREAMS

(540)

(550) I

(511) **Klasa 12:** vozila, aparati za kretanje po zemlji, vazduhu i vodi i oprema za napred navedenu robu,

(210) **2013-294**

(442) **20.09.2014.**

(220) 7/19/2013

(731) **HONDA MOTORS CO**, LTD, 1-1, 2-CHOME, MINAMI-AOYAMA, MINATO-KU, TOKYO JP

JAZZ

(540)

(550) I

(511) **Klasa 12:** vozila, aparati za kretanje po zemlji, vazduhu i vodi i oprema za napred navedenu robu

(210) **2013-295**

(442) **20.09.2014.**

(220) 7/19/2013

(731) **HONDA MOTORS CO**, LTD, 1-1, 2-CHOME, MINAMI-AOYAMA, MINATO-KU, TOKYO JP

CR-V

(540)

(550) I

(511) **Klasa 12:** vozila, aparati za kretanje po zemlji, vazduhu i vodi i oprema za napred navedenu robu

(210) **2013-296**

(442) **20.09.2014.**

(220) 7/19/2013

(731) **FARMACEVTSKA HEMISKA KOZMETIČKA INDUSTRIJA ALKALOID AD -SKOPLJE**, BUL. ALEKSANDAR MAKEDONSKI 12, 1000 SKOPLJE RM



(540)

(550) I

(740) Popović Miladin, Đoka Miraševića 21/III, Podgorica ME

(511) **Klasa 03:** tonik

(210) **2013-297**

(442) **20.09.2014.**

(220) 7/19/2013

(731) **DRAŠKO VUČINIĆ**, ROGAMI BB, PODGORICA ME

VINO KNJAZ

(540)

(550) I

(511) **Klasa 33:** alkoholna pića (vino od grožđa)

(210) **2013-298**

(442) **20.09.2014.**

(220) 7/19/2013

(731) **DRAŠKO VUČINIĆ**, ROGAMI BB, PODGORICA ME

KNJAZ

(540)

(550) I

(511) **Klasa 33:** alkoholna pića (vino od grožđa)(210) **2013-299**(442) **20.09.2014.**

(220) 7/22/2013

(731) **ĐUKANOVIĆ GORAN**, BAJOVA 156 CETINJE ME

(540)

(550) I

(511) **Klasa 35:** oglašavanje, vođenje poslova, poslovno upravljanje**Klasa 39:** organizovanje putovanja**Klasa 40:** obrađivanje materijala**Klasa 41:** obrazovne usluge, pripremanje obuke, razonoda, sportske i kulturne aktivnosti(210) **2013-3**(442) **20.09.2014.**

(220) 1/10/2013

(731) **ZENTIVA GROUP**, A.S. U KABELOVNY 130, 102 37 PRAHA 10, DOLNI MECHOLUPY CZ

(540) ZENTIVA

(550) I, V

(740) Radulović Božidar, Jovana Tomaševića 9/III, Podgorica ME

(511) **Klasa 10:** hirurški, medicinski, zubarski i veterinarski aparati i instrumenti, veštački udovi, oči i zubi, ortopedski članci, materijali za ušivanje(210) **2013-302**(442) **20.09.2014.**

(220) 7/23/2013

(731) **AGIP LLC** (DELAWARE LIMITED LIABILITY COMPANY), 800 CONNECTICUT AVENUE, NORWALK, CONNECTICUT 06854 US

Агода

(540)

(550) I

(740) AOD "Ćupić", Dalmatinska 10, Podgorica ME

(511) **Klasa 39:** organizovanje putničkih tura, usluge putničkih agencija, naročito usluge rezervacije i bukinga prevoza, usluge putničkih buking agencija, i usluge pružanja putničkih informacija

Klasa 43: usluge putničkih agencija, naročito usluge rezervacije i bukinga privremenog smeštaja

(210) **2013-303**

(442) **20.09.2014.**

(220) 7/24/2013

(300) 85835756 01.29.2013 US

(731) **AMGEN INC.**(DELAWARE CORPORATION), ONE AMGEN CENTER DRIVE, THOUSAND OAKS, CALIFORNIA 91320-1799 US

BLINCYTO

(540)

(550) I

(740) Radulović Božidar, Jovana Tomaševića 9/III, Podgorica ME

(511) **Klasa 05:** farmaceutski proizvodi

(210) **2013-304**

(442) **20.09.2014.**

(220) 7/24/2013

(300) 85835762 01.29.2013 US

(731) **AMGEN INC.**(DELAWARE CORPORATION), ONE AMGEN CENTER DRIVE, THOUSAND OAKS, CALIFORNIA 91320-1799 US

GANVADO

(540)

(550) I

(740) Radulović Božidar, Jovana Tomaševića 9/III, Podgorica ME

(511) **Klasa 05:** farmaceutski proizvodi

(210) **2013-305**

(442) **20.09.2014.**

(220) 7/24/2013

(300) 85835774 01.29.2013 US

(731) **AMGEN INC.**(DELAWARE CORPORATION), ONE AMGEN CENTER DRIVE, THOUSAND OAKS, CALIFORNIA 91320-1799 US

SOLYMBIC

(540)

(550) I

(740) Radulović Božidar, Jovana Tomaševića 9/III, Podgorica ME

(511) **Klasa 05:** farmaceutske proizvodi

(210) **2013-306**

(442) **20.09.2014.**

(220) 7/24/2013

(731) **HYUNDAI HAEVY INDUSTRIES CO.LTD.** (A KOREAN CORPORATION), 1000, BANGEOJINSUNHWAN-DORO, DONG-GU, ULSAN KR



(540)

(550) I, F

(740) Radulović Božidar, Jovana Tomaševića 9/III, Podgorica ME

(511) **Klasa 12:** traktori, pogonski motori, viljuškari, traktori za poljoprivredne svrhe, putnički brodovi, brodovi za podvodno bušenje, brodovi za naftu, naime, tankeri za naftu brodovi za kontejnere, teretni brodovi, brodovi, vozila za kretanje po vazduhu, dijelovi i pribor za vazduhoplove

(210) **2013-307**

(442) **20.09.2014.**

(220) 7/24/2013

(731) **SHULTON, INC.** ONE PROCTER & GAMBLE PLAZA, CINCINNATI, OHIO 45202 US



(540)

(550) I

(740) Lutovac Branislav, Bulevar Crnojevića 93, Podgorica ME

(511) **Klasa 03:** sprejevi za tijelo

(210) **2013-308**

(442) **20.09.2014.**

(220) 7/25/2013

(731) **ZLATIBORAC DOO** BEOGRAD, UL. MOJKOVAČKA 58, BEOGRAD RS

ПЛАНИНСКА

(540)

(550) V

(740) Prelević Dragan, ulica Slobode 74, Podgorica ME

(511) **Klasa 29:** suvo meso

(210) **2013-309**

(442) **20.09.2014.**

(220) 7/25/2013

(731) **ZLATIBORAC DOO** BEOGRAD, UL. MOJKOVAČKA 58, BEOGRAD RS

КРАЉЕВСКА

(540)

(550) I, V

(740) Prelević Dragan, ulica Slobode 74, Podgorica ME

(511) **Klasa 29:** suvo meso

(210) **2013-310**

(442) **20.09.2014.**

(220) 7/29/2013

(731) **BRITISH AMERICAN TOBACCO (BRANDS) INC.** 2711 CENTERVILLE ROAD SUITE
300 WILMINGTON DELAWARE 19808 US



(540)

(550) I, F

(740) Popović Miladin, Đoka Miraševića 21/III, Podgorica ME

(511) **Klasa 34:** cigarete, duvan, proizvodi od duvana, upaljači, šibice, artikli za pušače

(210) **2013-311**

(442) **20.09.2014.**

(220) 7/30/2013

(731) **MT&CE COMPANY LTD.** 11 KYRIACOU MATSI AVE. NIKIS CENTER, OFFICE, OFFICE NR.303, 1082 NICOSIA CY

SUMER

(540)

(550) I, V

(740) Radulović Božidar, Jovana Tomaševića 9/III, Podgorica ME

(511) **Klasa 34:** duvan, artikli za pušače, šibice

(210) **2013-312**

(442) **20.09.2014.**

(220) 7/30/2013

(731) **THE GILLETTE COMPANY,** ONE GILLETTE PARK, BOSTON, MASSACHUSETTS 02127 US

ARCTIC ICE

(540)

(550) I

(740) Lutovac Branislav, Bulevar Crnojevića 93, Podgorica ME

(511) **Klasa 03:** sredstva za bijeljenje i druge supstance za upotrebu u pranju veša, preparati za čišćenje, poliranje, ribanje, abrazivna sredstva, sapuni, parfimerija, eterična ulja, kozmetika,

losioni za kosu, proizvodi za njegu zuba

(210) **2013-313** (442) **20.09.2014.**

(220) 7/30/2013

(731) **THE GILLETTE COMPANY**, ONE GILLETTE PARK, BOSTON, MASSACHUSETTS 02127
US

COOL WAVE

(540)

(550) I

(740) Lutovac Branislav, Bulevar Crnojevića 93, Podgorica ME

(511) **Klasa 03:** sredstva za bijeljenje i druge supstance za upotrebu u pranju veša, preparati za čišćenje, poliranje, ribanje, abrazivna sredstva, sapuni, parfimerija, eterična ulja, kozmetika, losioni za kosu, proizvodi za njegu zuba

(210) **2013-314** (442) **20.09.2014.**

(220) 7/30/2013

(731) **UNITED PARCEL SERVICE OF AMERICA**, INC A DELAWARE CORPRATION, 55
GLENLAKE PARKWAY N.E.ATLANTA, GEORGIA 30328 US

CEMELOG

(540)

(550) I

(740) AOD "Ćupić", Dalmatinska 10, Podgorica ME

(511) **Klasa 39:** transport, slanje i isporuka robe, logističke usluge, skladištenje, sortiranje robe, distribucija, pakovanje, čuvanje i vraćanje u vezi sa transportom, slanjem i isporukom robe, špedicija, slanje dokumenata i prijem i isporuka dokumenata za druge, praćenje dokumenata i robe u transportu, konsultantske usluge u polju logistike

Klasa 42: obezbjeđivanje onlajn softvera za upotrebu u organizaciji i upravljanje slanjem, isporukom, transportom i skladištenjem/čuvanjem pošiljki

(210) **2013-315** (442) **20.09.2014.**

(220) 7/30/2013

(731) **PHARMACEUTICAL CHEMICAL COSMETIC INDUSTRY ALKALOID AD
SKOPLJE**, BUL. ALEKSANDAR MAKEDONSKI 12, 1000 SKOPLJE RM

GastroGuard

(540)

(550) I

(740) Popović Miladin, Đoka Miraševića 21/III, Podgorica ME

(511) **Klasa 05:** lijekovi za poremećaje povezane za kiselinama

(210) **2013-316**(442) **20.09.2014.**

(220) 8/1/2013

(731) **B & H FOTO & ELECTRONIC CORP.** A NEW YORK COPORATION, 420 NINTH AVENUE, NEW YORK, NY 10001 US(540) **B & H**

(550) I

(740) Đakonović Vido, Bajova 9, Cetinje ME

(511) **Klasa 35:** nuđenje na prodaju i prodaja robe u maloprodaji i veleprodaji, uključujući internet veb-stranu, poručivanje kataloga na adresu, telefonsko poručivanje, i maloprodajni objekat, opreme, komponenata, rezervnih delova, i pribora za fotografiju, videografiju, film, audio-video produkciju i prezentaciju, audio snimanje, audio produkcija, audio i video emitovanje, multimedijalne sadrže, rasvetu, projekciju, televiziju, snimanje zvuka i slike, emitovanje zvuka i slike, prenosivu ličnu razonodu, kućne medije za razonodu, kompjutere, čuvanje podataka, digitalnu obradu slike, optiku, uređaje za nadzor, i dvoglede i teleskopi, oglašavanje u gore pomenutim oblastima

(210) **2013-317**(442) **20.09.2014.**

(220) 8/1/2013

(300) 51539/2013 06.02.2013 CH

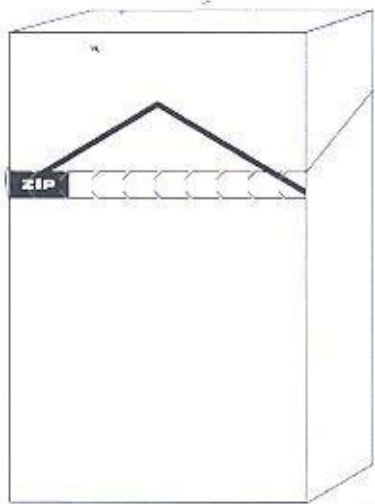
(731) **PHILIP MORRIS BRANDS SARL**, QUAI JEANRENAUD 3 NEUCHATEL, 2000 CH

(540)

(550) I, F

(511) **Klasa 34:** duvan, sirov ili prerađen, proizvodi od duvana, naročito cigare, cigarete, cigarilosi, duvan za uvijanje cigareta, duvan za lule, duvan za žvakanje, duvan za šmrkanje, kretek, snus, zamena za duvan (za nemedicinsku upotrebu), proizvodi za pušače, naročito papir za cigarete i lule, filteri za cigarete, kutije za duvan, kutije za cigarete i pepeljare, lule, ručni aparati/spravice za uvijanje, cigareta, upaljači, šibice

(210) **2013-318**(442) **20.09.2014.**

(220) 8/1/2013

(731) **PREFERRED GUEST, INC.** ONE STARPOINT, STAMFORD, CONNECTICUT 06902 US**SPG**

(540)

(550) I

(740) Lutovac Branislav, Bulevar Crnojevića 93, Podgorica ME

(511) **Klasa 36:** usluge vezane za nepokretnosti, a naročito usluge posredovanja u vezi sa nepokretnostima, sticanje nepokretnosti, podjela udjela u nepokretnostima, a naročito upravljanje i organizovanje u pogledu prava svojine nad nepokretnostima, stambenim objektima, apartmanima, investiranje u nepokretnosti, upravljanje nepokretnostima, usluge tajmšeringa i zakupa nekretnina i ostale nepokretne imovine, uključujući stambene objekte i apartmane.

(210) **2013-319**

(442) **20.09.2014.**

(220) 8/1/2013

(731) **PLANIKA MONTENEGRO DOO**, NOVAKA MILOŠEVA 22 PODGORICA ME



(540)

(550) I

(511) **Klasa 25:** odjeća, obuća i pokrivala za glavu, uvoz i maloprodaja obuće, odjeće i pokrivala za glavu

(210) **2013-320**

(442) **20.09.2014.**

(220) 8/1/2013

(731) **PLANIKA MONTENEGRO DOO**, NOVAKA MILOŠEVA 22 PODGORICA ME



(540)

(550) I

(511) **Klasa 25:** odjeća, obuća i pokrivala za glavu, uvoz i maloprodaja obuće, odjeće i pokrivala za glavu

(210) **2013-321**

(442) **20.09.2014.**

(220) 8/2/2013

(731) **CHIPITA INDUSTRIAL AND COMERCIAL COMPANY S.A.:(D.T. CHIPITA S.A.)**,
12TH KM NATIONAL ROAD ATHENS-LAMIA, METAMORPHOSIS GR

7DAYS Borseto

(540)

(550) I

(740) Đakonović Vido, Bajova 9, Cetinje ME

(511) **Klasa 29:** konzervisano i sušeno voće i povrće (suvo grožđe, grožđica bez koštica, ribizle), kristalizirano voće (kandirani limun i kora pomorandže), urme, koštunjavi proizvodi, proizvodi od krompira svih vrsta i formi (čips-listići, čips-pločice, štapići, pahuljice, pomfrit), smrznuto voće, zamrznuto voće, voćni čips, voćni žele, grickalice na bazi voća, džemovi, džem od đumbira, marmelada, kikiriki puter, kompoti, namazi za kriške hleba (lešnik ili nugat ili vanila ili sa drugim ukusom), jestiva ulja i masnoće

Klasa 30: kakao proizvodi, vanila proizvodi, pšenično brašno, brašno za hranu, brašno i proizvodi od žitarica (osim namirnica za životinje), pločice od žitarica, žitarice napravljene za ljudsku ishranu (ovsene pahuljice i pahuljice od drugih žitarica), kukuruzne pahuljice, kokice, namirnice bogate skrobom, pripremljene pekarske mješavine za hleb, kolače, testa za kolače, palačinke, smesa za testo za tortu, prašak za krem za tortu, jestivi ukrasi za torte, pirinčani kolačići, grickalice na bazi pirinča, arome za torte, hleb, zemičke, hlebne mrvice, sve vrste proizvoda od hleba (listići, pločice, štapići), kifle, oblande, okrugle oblande, napunjene kremom od lešnika ili nugat ili kakao kremom ili vanilom, švajcarske kifle (rolati), kroasani, slatka čajna testa (magdalene), dvopek-štrudla, kolačići, biskviti, testo i slatkiši, slatkiši od koštunjavog voća, kakao ili čokoladna baza, čokoladni (premaz), ploče i filovi od čokolade, čokolada punjena koštunjavim i/ili cerealnim proizvodima i/ili voćem, pirinčem, pralinama, marcipanom

(210) **2013-322**(442) **20.09.2014.**

(220) 8/2/2013

(731) **NIKON CORPORATION**, 12-1, YURAKUCHO 1-CHOME CHIYODA-KU TOKYO JP

Nikon

(540)

(550) I.F

(511) **Klasa 01:** hemijski proizvodi koji se upotrebljavaju u industriji, nauci, fotografiji, kao i u poljoprivredi, hortikulturi i šumarstvu, neprerađene veštačke smole, neprerađene plastične materije, đubriva, smeše za gašenje vatre, preparati za kaljenje i zavarivanje, hemijske supstance za očuvanje namirnica, materije za štavljenje, lepljive supstance koje se upotrebljavaju u industriji, lepkovi za plastiku koji nisu za kancelarijsku ili upotrebu u domaćinstvu, preparati za regulaciju rasta biljaka, đubriva, keramičke glazure, git za premazivanje, više masne kiseline, obojeni metali, nemetalni minerali, hemijska jedinjenja za razvijanje, izradu i uvećavanje fotografija, reagensni papir koji nije za medicinsku upotrebu, veštački zaslađivači, brašno i skrob za industrijsku upotrebu, pulpa, papir za šeme, fotografski papir, fotografski osetljive supstance, fotografske suve ploče, fotografski razvijajući, prah za blic, foto fiksatori, neosvetljeni foto filmovi, kinematografski filmovi (trake), osetljivi ali

neosvetljeni, rendgenski filmovi, osetljivi ali neosvetljeni, smeše za gašenje vatre, tečnost za kočnice, hemijski aditivi za ulja

Klasa 11: aparati za osvetljavanje, grejanje, proizvodnju pare, kuvanje, hlađenje, sušenje, ventilaciju, snabdevanje vodom i za sanitarne svrhe, setovi za kupatila -wc šolje i daske, setovi za kupatila, aparati za sušenje (za hemijsku obradu), rekuperatori (za hemijsku obradu), pame mašine (za hemijsku obradu), isparivači (za hemijsku obradu), uređaji za destilaciju (za hemijsku obradu), izmenjivači toplote (za hemijsku obradu), aparati za sušenje (za proizvodnju tekstila), sterilizatori mleka, uređaji za pravljenje hleba (koji se upotrebljavaju u industriji), mašine za sušenje šperploče, industrijske peći, nuklearni reaktori, aparati za sušenje za žetvu, aparati za sušenje stočne hrane, bojleri (koji nisu delovi primarnog pokretača, motora), klima uređaji koji se upotrebljavaju u industriji, rashladne mašine i uređaji, sušaci veša (električni, koji se upotrebljavaju u industriji), mašine i aparati koji se upotrebljavaju u kozmetičkim salonima ili berbernicama (ne uključujući frizerske stolice), oprema za kuvanje koja se upotrebljava u industriji, industrijski aparati i instalacije za sušenje posuda, aparati za dezinfekciju posuda koji se upotrebljavaju u industriji, slavine, ventili za kontrolu nivoa u tankovima, slavine, rezervoari za tretman otpadnih voda (koji se upotrebljavaju u industriji), septičke jame (koje se upotrebljavaju u industriji), insineratori otpada koji se upotrebljavaju u industriji, insineratori otpada koji se upotrebljavaju u domaćinstvu, solarni grejači vode, aparati za prečišćavanje vode, električne lampe i ostali aparati za osvetljavanje, elektrotermički kućni uređaji (koji se ne upotrebljavaju za ulepšavanje i higijenu, elektrotermički kućni uređaji koji se upotrebljavaju za ulepšavanje i higijenu, zaptivači za slavine za vodu, gasni bojleri (koji se upotrebljavaju u domaćinstvu), ne-električni grejači za kuvanje (koji se upotrebljavaju u domaćinstvu), kuhinjske radne ploče sa ugrađenim sudoperama, kuhinjske sudopere, ledomati (koji se upotrebljavaju u domaćinstvu, neprenosivi), frižideri sa zamrzivačem (koji se upotrebljavaju u domaćinstvu), filteri za česme u domaćinstvu, stone papirne lampe (Andon), prenosive papirne lampe (Chochin), gasne lampe, uljne lampe, petrolejske svetiljke, posude za zagrevanje (ne-električne), džepni grejači (ne-električni), japanski džepni grejači napunjeni gorivom, boce za toplu vodu (za grejanje nogu u krevetu), rezervoari za tretman otpadnih voda koji se upotrebljavaju u domaćinstvu, septičke jame koje se upotrebljavaju u domaćinstvu, pakovanja za grejanje ili hlađenje napunjena hemijskim supstancama koje reaguju kada je to potrebno, wc šolje sa mlazevima vode za pranje, zidni držači dezinfekcionih sredstava za toalete, wc šolje, daske za wc šolje u japanskom stilu, oprema za kupatila; peći koje se upotrebljavaju u domaćinstvu (ne-električne); postrojenja za desalinizaciju; tankovi za vodu pod pritiskom; instalacije za saune; instalacije za klimatizaciju; električni aparati za kafu; ovlaživači; LED lampe; džepne lampe; električni tosteri

Klasa 24: tekstil i tekstilni proizvodi koji nisu obuhvaćeni drugim klasama, prekrivači za krevete, prekrivači za stolove, tkanine (koje nisu porubne trake za tatami prostirke), tkanina za porubne trake za tatami prostirke, pletene tkanine, filc i netkana tekstilna vlakna, voštano platno, gumirano vodootporno platno, gumirano platno, materijal za filtriranje od tekstila, tkana tekstilna roba za ličnu upotrebu, mreže za komarce, čaršavi za krevet, futoni i jorgani, navlake za futon i jorgane (posteljina), navlake za futon (nenapunjen futon), jastučnice, ćebad, stone salvete od tekstila, krpe za sudove, tuš zavese, baneri i zastave koje nisu od papira, tekstilne presvlake za wc dasku, zidne tapiserije od tekstila, zavese, stolnjaci koji nisu od papira, draperije (teške zavese), pokrovi (čaršavi za pokrivanje umrlih), pokrovi za oblačenje umrlih za sahranu (Kvokatabira kimono), japanski platneni paravani sa crveno-belim prugama (Kohaku-maku), japanski platneni paravani sa cmo-belim prugama (Kuroshiro-maku), prekrivači za bilijarske stolove, oglasni platneni panoi, natpisi od tekstila,

kožne tkanine, tkanine od vinila, etikete od platna, ubrusi od tekstila, tekstilne maramice

Klasa 30: kafa, čaj, kakao, i zamena kafe, pirinač, tapioka i sago, brašno i proizvodi od žitarica, hleb, kolači i poslastice, sladoledi, šećer, med, melasa, kvasac, prašak za pecivo, so, senf, sirće, sosovi (kao dodaci), začini, led, vezivni agensi za sladoled, omekšivači za meso, za upotrebu u domaćinstvu, preparati za učvršćivanje mućene pavlake (šlaga), aromatični preparati za hranu (koji nisu esencijalna ulja), slatke zemičke, sendviči, zemičke na pari punjene mlevenim mesom (kineski manjuh), hamburgeri (sendviči), pice, hot dogovi (sendviči), pite od mesa, testo od sojinog zrna (dodatak), Worcester sos, umaci za meso, kečap, soja sos, sirćetne mješavine, začinski soja sos (Soba4suyu), prelive za salatu, beli sos, majonez, sosevi za roštiljsko meso, šećer u kocki, fruktoza (koja se upotrebljava u kuvanju), kristal šećer (koji nije poslastica), maltoza (koja se upotrebljava u kuvanju), glukoza za kulinarsku namenu, skrobni sirup u prahu (koji se upotrebljava u kuvanju), skrobni sirup (koji se upotrebljava u kuvanju), kuhinjska so pomešana sa semenom susama, kuhinjska so, pržena i mlevena semena susama, celerova so, umami začini, smeše za sladoled, smeše za šerbet, nepržena zrna kafe, kineske punjene knedle (Gyoza, kuvane), kineske punjene knedle (Shumai, kuvane), suši, pržene kuglice od testa pomešane sa komadićima hobotnice (Takoyaki), lanc paketi koji se sastoje od pirinča, sa dodatkom mesa, ribe ili povrća, ravioli, kvasac u prahu (suvi kvasac), Koji (fermentisani sladni pirinač), instant poslastičarske smese, sosevi za testenine, nus proizvodi od pirinca za jelo (sediment koji ostaje nakon pasiranja sake-a), oljušteni ovas, oljušteni ječam, gluten za jelo

(210) **2013-325**

(442) **20.09.2014.**

(220) 8/7/2013

(731) **DOO ZA PROIZVODNJU, PROMET I USLUGE, EXPORT-IMPORT KOLUM,**
UL. GOJKA GARČEVIĆA BR.1/17 NIKŠIĆ ME

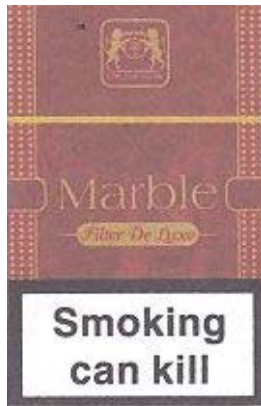

(540)

(550) I

(511) **Klasa 34:** cigarete

(210) **2013-326**

(442) **20.09.2014.**

(220) 8/7/2013

(731) **BOGRAIN S.A.**A FRESH SOCIETE ANONYME, 42 RUE RIEUSSEC, 78220 VIROFLAY FR



(540)

(550) I

(740) Lutovac Branislav, Bulevar Crnojevića 93, Podgorica ME

(511) **Klasa 29:** sir(210) **2013-327**(442) **20.09.2014.**

(220) 8/7/2013

(731) **ADRIATIC MARINAS doo**, Obala b.b. 85320 Tivat ME

PORTO

(540)

(550) V

(511) **Klasa 36:** osiguranje; finansijski poslovi; novčani (monetarni) poslovi; poslovi vezani za nepokretnosti**Klasa 39:** transportne usluge; pakovanje i skladištenje robe; organizovanje putovanja**Klasa 41:** obrazovne usluge; pripremanje obuke; razonoda; sportske i kulturne aktivnosti**Klasa 43:** usluge obezbeđivanja hrane i pića; privremeni smeštaj**Klasa 44:** medicinske usluge; veterinarske usluge; higijenska zaštita i nega lepote za ljude ili životinje; agrikulturne, hortikulturne i šumarske usluge(210) **2013-328**(442) **20.09.2014.**

(220) 8/12/2013

(731) **HEMOFARM A.D.**FARMACEUTSKO-HEMIJSKA INDUSTRIJA VRŠAC, BEOGRADSKI PUT BB 26300 VRŠAC, RS

DEMETRIN

(540)

(550) I

(511) **Klasa 05:** farmaceutski proizvodi(210) **2013-329**(442) **20.09.2014.**

(220) 8/12/2013

(731) **GRENDENE S.A.** AV. PIMENTEL GOMES, 214, BAIRRO.EXPECTATIVA 62040-125 SOBRALCE, BR,

 The logo for 'ZAKY' features a stylized butterfly-like symbol to the left of the word 'ZAKY' in a bold, sans-serif font. The entire logo is enclosed in a thin, wavy border.

(540)

(550) I

(511) **Klasa 25:** ženska obuća, sandale, obuća za plažu, papuče za kupanje, zakrpe na prednjem dijelu cipela, čizme, ravne cipele, papuče, klompe, sandale (japanke) i obuća za tenis

(210) **2013-330**(442) **20.09.2014.**

(220) 8/12/2013

(731) **HONGTA TOBACCO (GROUP)CO.LTD.** NO.118, HONGTA AVENUE, HONGTA DISTRICT, YUHI, YUNNAN CN

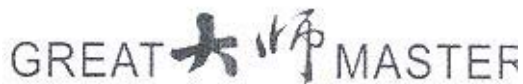
 The logo for 'GREAT MASTER' features the word 'GREAT' in a serif font, followed by the Chinese characters '大师' (Dàshī) in a stylized font, and the word 'MASTER' in a serif font.

(540)

(550) I

(740) Radulović Božidar, Jovana Tomaševića 9/III, Podgorica ME

(511) **Klasa 34:** duvan, duvan za žvakanje, cigare, cigarete koje sadrže zamjene duvana za nemedicinske potrebe, cigarete, cigarilosi (male cigare), trave za pušenje, šmrkanje (duvan za šmrkanje), rezani duvan, otpaci duvana, vrhovi od ćilibara za muštikle za cigare ili cigarete, duvan (vrećice za duvan), vrhovi cigarete (čibuci), lule, cigare (sjeckalice za cigare), kutije za cigare, kutije za cigarete, cigarnici (držači cigara), džepne sprave za savijanje cigareta, cigaretnici (držači cigareta), usnici za muštikle za cigarete, četkice za čišćenje lula (pribor za lule), stalci za duvanske lule, ćupovi za duvan, kutije za šmrkanje, pepeljare za pušače, pljuvaonice za duvanske korisnike, kutije za cigare opremljene ovlaživačem, šibice, stalci za šibice, kutije za šibice, upaljači za pušače, kontejneri plina za upaljače za cigare, kremen za upaljače, butagas držač za upotrebu kod upaljača, butagas (za potrebe pušenja), filteri za cigarete, blokovi (svežnjevi) cigaret papira, papir, upijajući za lule, papir za cigarete, kompleti filterskih vlakana za cigarete

(210) **2013-332**(442) **20.09.2014.**

(220) 8/14/2013

(731) **GAP (ITM) INC.** 2 FOLSOM STREET, SAN FRANCISCO, CALIFORNIA US

 The logo for 'GAP' is a stylized, bold, dark blue letter 'G' with a thick stroke.

(540)

(550) I

(740) Lutovac Branislav, Bulevar Crnojevića 93, Podgorica ME

(511) **Klasa 25:** odjeća, obuća, pokrivala za glavu

-
- (210) **2013-333** (442) **20.09.2014.**
(220) 8/14/2013
(731) **STANLEY BLACK & DECKER, INC.** 1000 STANLEY DRIVE NEW BRITAIN CONNECTICUT
06053 US

STANLEY

- (540)
(550) I, F
(740) Popović Miladin, Đoka Miraševića 21/III, Podgorica ME
(511) **Klasa 08:** ručni alati i sprave sa ručnim pokretanjem, pribor za jelo, hladno oružje, mehaničke i elektronske sprave za brijanje, ručni alati, naročito, šila, graničnici za stolarski sto, burgija, produžetak svrdla, kliješta za armaturu, bušilice, pištolji za silikon, šila za označavanje rupe za bušenje, aparat za označavanje linije kredom, kutija, motovilo za označavanje linija i linija od krede, dljeta, stege, kombinovane stege, ručne testere, lučne testere, odbojnici za umivaonike, poluge za razvaljivanje, matrice za centriranje, turpije, alat za zaptivanje, bonseci, čekići, ručne bušilice, ručni cirkular za sječenje, sjekirice, imbus ključevi, maljevi, držač ručne testere prilikom rezanja, kliješta za sječenje, brusilice za koso rezanje, sprave za izradu okvira, kliješta za vađenje eksera, setovi eksera, ključevi za zatezanje navrtanja, glodalica, kliješta, džepni noževi, pajseri, bušaci, noževi za gitovanje, turpije, gedore, drške i ključevi za gedore, alati za vađenje eksera, pištolj za zakivke, testere, pribor za testere, strugači, šrafčigeri, dodaci za šrafčigere, oštrila, velike makaze, makaze za lim, utičnice, setovi utičnica, alat za glačanje drvenih površina, makaze, opružni stezaci, uglomjeri, pištolji za heftanje, ravnatelji površina, heftalice, noževi kao dio alata, stege, višegaone stege, noževi za tapete, kliješta za skidanje izolacije sa žica, testere za drvo, mjerni instrumenti pri obradi drveta, ključevi za vijke, setovi ključeva za vijke, pajseri, dodaci za ručne alate, naime sjeciva za ručne testere, diskovi za glačanje, sjeciva za struganje, oprema za oštrenje sjeciva naime kamen za oštrenje, pomagalo za oštrilo i bijelo vazelinsko ulje (višenamjenski ručni alat sastavljen od jedne ili više u nastavku navedenih alatki, naime, špicasta kliješta, otvarač konzervi i /ili flaša, 1/4 odvrtac ili navrtac, rezač žice, Phillips šrafčiger, pljosnati šrafčiger, zvjezdasti, testera za drvo, makaze i nazubljeni nož

-
- (210) **2013-334** (442) **20.09.2014.**
(220) 8/19/2013
(731) **13. JUL PLANTAŽE A.D.** PODGORICA ME

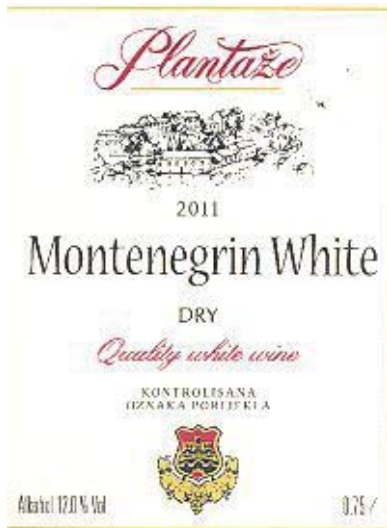

(540)

(550) I

(511) **Klasa 33:** alkoholna pića (izuzev piva)(210) **2013-335**(442) **20.09.2014.**

(220) 8/19/2013

(731) **13-JUL PLANTAŽE A.D.** PODGORICA ME

(540)

(550) I

(511) **Klasa 33:** alkoholna pića (izuzev piva)(210) **2013-336**(442) **20.09.2014.**

(220) 8/19/2013

(731) **DIEGO BRANDS B.V.** MOLENWERF 10-12, 1014 BG AMSTERDAM NL

DOUBLE BLACK

(540)

(550) I

(511) **Klasa 33:** alkoholna pića (izuzev piva)

(210) **2013-337** (442) **20.09.2014.**

(220) 8/20/2013

(731) **HENKEL CORPORATION**, ONE HENKEL WAY, ROCKY HILL, 06067 CT US

SUPER BOND

(540)

(550) I

(511) **Klasa 01:** adhesivi koji se koriste u industriji

Klasa 16: adhesivi za kancelarijske, kućne i uradi sam svrhe

(210) **2013-338** (442) **20.09.2014.**

(220) 8/20/2013

(731) **HYUNDAI MOTOR COMPANY**, 231, YANGJAE-DONG SEICHO-GU, SEOUL, 137-938
KR

GRANDEUR

(540)

(550) I

(740) Popović Miladin, Đoka Miraševića 21/III, Podgorica ME

(511) **Klasa 28:** tricikli za djecu [igračke], konjići, muzički instrumenti igračke, lopte za igranje, igračke, kocke za igranje, trotineti [igračke], leteći diskovi [igračke], sobe za lutke, flašice za lutke, odjeća za lutke, kuće za lutke, krevet za lutke, plišani medvjedići, pištolji igračke, papirne igračke, plišane igračke, plastične igračke, maske igračke, gumene igračke, metalne igračke, igračke iznenađenja [noviteti], marionete, igračke od ratana, zvečke [igračke], igračke na daljinsko upravljanje [osim onih koje su prilagođene za upotrebu sa televizijskim prijemnicima], maneken lutke, maskote lutke, mobilne [igračke], drvene igračke, setovi igračaka, marionete, hodalice za bebe [igračke], modeli vozila za djecu

(210) **2013-341** (442) **20.09.2014.**

(220) 8/22/2013

(731) **13-JUL PLANTAŽE A.D.** PODGORICA ME



(540)

(550) I

(511) **Klasa 33:** alkoholna pića (izuzev piva)(210) **2013-342**(442) **20.09.2014.**

(220) 8/22/2013

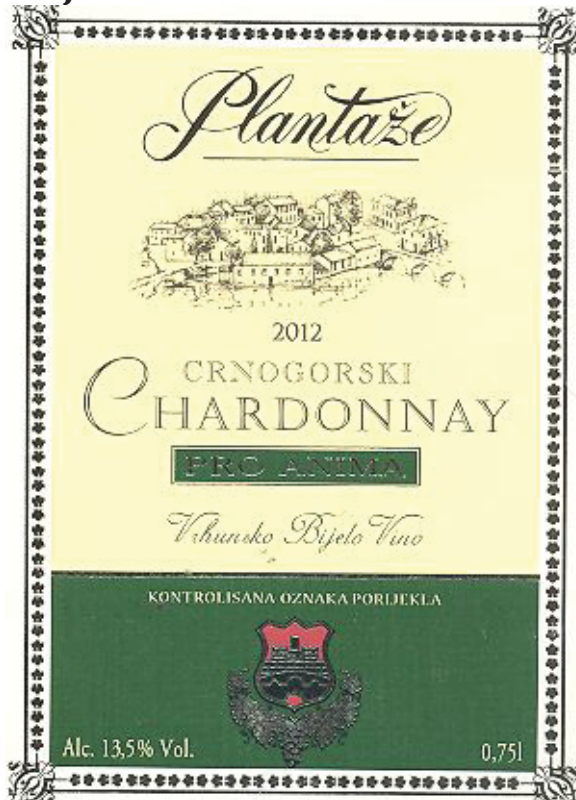
(731) **13-JUL PLANTAŽE A.D. PODGORICA ME**

(540)

(550) I

(511) **Klasa 33:** alkoholna pića (izuzev piva)

(210) **2013-343**

(442) **20.09.2014.**

(220) 8/23/2013

(731) **BEATS ELECTRONICS.LLC** (DELAWARE LIMITED LIABILITY COMPANY), 1601 CLOVERFIELD BLVD, SUITE 5000N, SANTA MONICA, CA 90404 US

BEATSAUDIO

(540)

(550) I

(740) Radulović Božidar, Jovana Tomaševića 9/III, Podgorica ME

(511) **Klasa 09:** zvučnici za automobile, medija plejeri za automobile, digitalni audio plejeri za automobile, mobilni telefoni, laptop kompjuteri

(210) **2013-344**

(442) **20.09.2014.**

(220) 8/23/2013

(731) **BEATS ELECTRONICS.LLC** (DELAWARE LIMITED LIABILITY COMPANY), 1601 CLOVERFIELD BLVD, SUITE 5000N, SANTA MONICA, CA 90404 US

BEATS

(540)

(550) I

(740) Radulović Božidar, Jovana Tomaševića 9/III, Podgorica ME

(511) **Klasa 09:** slušalice, slušalice koje se stavljaju u uši, zvučnici, audio zvučnici, audio kablovi, zvučnici za automobile, medija plejeri za automobile, digitalni audio plejeri za automobile, mobilni telefoni, laptop kompjuteri

Klasa 25: odeća, obuća, pokrivala za glavu

(210) **2013-345**

(442) **20.09.2014.**

(220) 8/23/2013

(731) **BEATS ELECTRONICS.LLC** (DELAWARE LIMITED LIABILITY COMPANY), 1601 CLOVERFIELD BLVD, SUITE 5000N, SANTA MONICA, CA 90404 US

BEATS BY DR. DRE

(540)

(550) I

(740) Radulović Božidar, Jovana Tomaševića 9/III, Podgorica ME

(511) **Klasa 09:** slušalice, slušalice koje se stavljaju u uši, zvučnici, audio zvučnici, audio kablovi,

zvučnici za automobile, medija plejeri za automobile, digitalni audio plejeri za automobile, mobilni telefoni, laptop kompjuteri

Klasa 25: odeća, obuća, pokrivala za glavu

(210) **2013-346**

(442) **20.09.2014.**

(220) 8/23/2013

(731) **BEATS ELECTRONICS.LLC** (DELAWARE LIMITED LIABILITY COMPANY), 1601 CLOVERFIELD BLVD, SUITE 5000N, SANTA MONICA, CA 90404 US

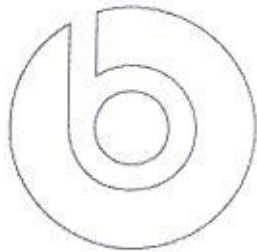

(540)

(550) I

(740) Radulović Božidar, Jovana Tomaševića 9/III, Podgorica ME

(511) **Klasa 09:** slušalice, slušalice koje se stavljaju u uši, zvučnici, audio zvučnici, audio kablovi, zvučnici za automobile, medija plejeri za automobile, digitalni audio plejeri za automobile, mobilni telefoni, laptop kompjuteri

Klasa 25: odeća, obuća, pokrivala za glavu

(210) **2013-347**

(442) **20.09.2014.**

(220) 8/26/2013

(731) **NEXT GROUP PLC**, DESFORD ROAD ENDERBY LEICESTER LEICESTERSHIRE LE 19 4AT GB

NEXT

(540)

(550) I

(740) Popović Miladin, Đoka Miraševića 21/III, Podgorica ME

(511) **Klasa 09:** aparati i instrumenti naučni, nautički, geodetski, fotografski, kinematografski, optički, za signalizaciju, kontrolu (inspekciju), za pomoć (spašavanje) i za obuku, mehanizmi za uređaje koji se pokreću uz prethodno ubacivanje novca ili žetona, registar kase, računске mašine, uređaji za gašenje požara, naočare za sunce i naočare

Klasa 14: plemeniti metali i njihove legure i proizvodi od tih metala ili obloženi tim metalima, koji nisu obuhvaćeni drugim klasama, nakit, drago kamenje, časovničarski i hronometrijski instrumenti.

Klasa 18: koža i imitacije kože, proizvodi od tih materijala koji nisu obuhvaćeni drugim klasama, životinjske kože, krzno, koferi i putne torbe, kišobrani, suncobrani i štapovi za hodanje, bičevi, saračka i sedlarska oprema

Klasa 25: odjeća, obuća, pokrivala za glavu

Klasa 35: oglašavanje, vođenje poslova, poslovno upravljanje, kancelarijski poslovi, usluge maloprodaje, uključujući i usluge maloprodaje ponudene putem opšte prodaje i u radnji odjeće, putem kataloga koji se poručuje putem pošte, onlajn, putem televizijskog kanala, putem mobilnog telefona i direktnim marketingom, sve u vezi sa prodajom odjeće, pokrivala

za glavu i obuće, nakitom, satovima, modnim dodacima, proizvodima za domaćinstvo, peškirimama, posteljinom, tekstilom, namještajem, uređajima za rasvjetu, igračkama, električnim proizvodima, kozmetikom, nemedicinskim toaletnim preparatima, naočarima, torbicama za nošenje, robama od kože, ručnim torbama, sportskim torbama, putnim torbama, kesama za kupovinu, torbama za toaletni pribor, torbama za nošenje preko ramena, ceđerima, torbama za dokumenta i dječjim torbama, posuđem, bojama, tapetama, zidnim naljepnicama i bordurama, slikama, okvirima za slike, električnim proizvodima, kamerama, pružanje informacija i savjeta u vezi sa uslugama maloprodaje koje se odnose na gore navedene robe, savjetovanje u vezi sa vođenjem poslova uključujući pružanje podrške i savjeta u upravljanju maloprodajnim radnjama u oblasti gore navedenih roba

(210) **2013-348** (442) **20.09.2014.**

(220) 8/26/2013

(731) **MILLENNIUM PHARMACEUTICALS, INC**, 40 LANDSDOWNE STREET CAMBRIDGE MASSACHUSETTS 02139 US

ADCETRIS

(540)

(550) I

(740) Popović Miladin, Đoka Miraševića 21/III, Podgorica ME

(511) **Klasa 05:** farmaceutski preparati za ljudsku upotrebu, farmaceutski preparati za liječenje i prevenciju raka

(210) **2013-349** (442) **20.09.2014.**

(220) 8/27/2013

(731) **GLOSARIJ D.O.O.** VOJISLAVLJEVIĆA 76 PODGORICA ME

MYRIN®

(540)

(550) I

(511) **Klasa 05:** farmaceutski i veterinarski proizvodi, higijenski proizvodi za upotrebu u medicini dijetetska hrana i supstance prilagođene za medicinsku ili veterinarsku upotrebu, hrana za bebe, flasteri, materijali za previjanje, materijali za plombiranje zuba, zubni vosak, preparati za dezinfekciju, preparati za uništavanje štetina fungicide, herbicidi

(210) **2013-350** (442) **20.09.2014.**

(220) 8/27/2013

(731) **GLOSARIJ D.O.O.** VOJISLAVLJEVIĆA 76 PODGORICA ME

SATURIL®

(540)

(550) I

(511) **Klasa 05:** farmaceutski i veterinarski proizvodi, higijenski proizvodi za upotrebu u medicini dijetetska hrana i supstance prilagođene za medicinsku ili veterinarsku upotrebu, hrana za bebe, flasteri, materijali za previjanje, materijali za plombiranje zuba, zubni vosak,

preparati za dezinfekciju, preparati za uništavanje štecina fungicide, herbicidi

(210) **2013-351** (442) **20.09.2014.**

(220) 8/29/2013

(731) **JOHNSON & JOHNSON** (NEW JERSEY CORPRATION), ONE JOHNSON & JOHNSON PLAZA, NEW BRUNSWICK, NEW JERSEY US

DELICA

(540)

(550) I, V

(740) Radulović Božidar, Jovana Tomaševića 9/III, Podgorica ME

(511) **Klasa 10:** lancete i uređaji za uzrokovanje koji koriste lancete, koji se koriste sa uređajima za praćenje koncentracije glukoze u krvi

(210) **2013-353** (442) **20.09.2014.**

(220) 8/29/2013

(731) **TRAVELHOUSE**, CETINJSKI PUT 16, PODGORICA ME



(540)

(550) I

(511) **Klasa 39:** transportne usluge, pakovanje i skladištenje robe, organizovanje putovanja

Klasa 43: usluge obezbeđivanja hrane i pića, privremeni smeštaj

(210) **2013-355** (442) **20.09.2014.**

(220) 9/2/2013

(300) 40-2013-0055195 16.08.2013.

(731) **HYUNDAI MOTOR COMPANY**, 231, YANGJAE-DONG SEOCHO-GU, SEUL.137-938 KR

SANTA FE

(540)

(550) I, F

(740) Popović Miladin, Đoka Miraševića 21/III, Podgorica ME

(511) **Klasa 28:** tricikli za djecu [igračke], konjići, muzički instrumenti igračke, lopte za igranje, kocke za igranje, trotineti [igračke], leteći diskovi [igračke], sobe za lutke, flašice za lutke, odjeća za lutke, kuće za lutke, krevet za lutke, plišani medvjedići, pištolji igračke, papirne igračke, plišane igračke, plastične igračke, maske igračke, gumene igračke, metalne igračke, igračke iznenađenja [noviteti], marionete, igračke od ratana, zvečke [igračke], igračke na daljinsko upravljanje [osim onih koje su prilagođene za upotrebu sa televizijskim prijemnicima], maneken lutke, maskote lutke, mobilne [igračke], drvene igračke, setovi igračaka, marionete, hodalice za bebe [igračke], modeli vozila za djecu

(210) **2013-357**

(442) **20.09.2014.**

(220) 9/2/2013

(731) **ŽARKO KOPITOVIĆ**, ĐOKA MIRAŠEVIĆA 19, 81000 PODGORICA ME

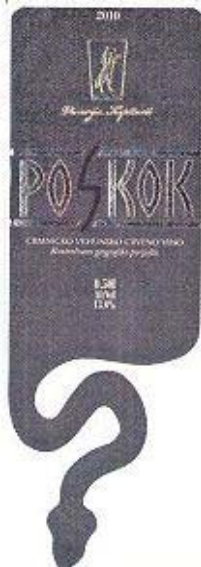

(540)

(550) I, F

(511) **Klasa 33:** alkoholna pića (izuzev piva)

Klasa 35: oglašavanje i reklamiranje, vođenje komercijalnih poslova, komercijalna administracija, kancelarijski poslovi

Klasa 43: usluge obezbeđivanja hrane i pića

(210) **2013-358**

(442) **20.09.2014.**

(220) 9/2/2013

(731) **ŽARKO KOPITOVIĆ**, ĐOKA MIRAŠEVIĆA 19, 81000 PODGORICA ME

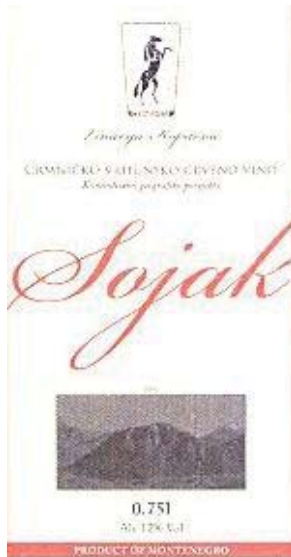

(540)

(550) I, F

(511) **Klasa 33:** alkoholna pića (izuzev piva)**Klasa 35:** oglašavanje i reklamiranje, vođenje komercijalnih poslova, komercijalna administracija, kancelarijski poslovi**Klasa 43:** usluge obezbeđivanja hrane i pića(210) **2013-359**(442) **20.09.2014.**

(220) 9/2/2013

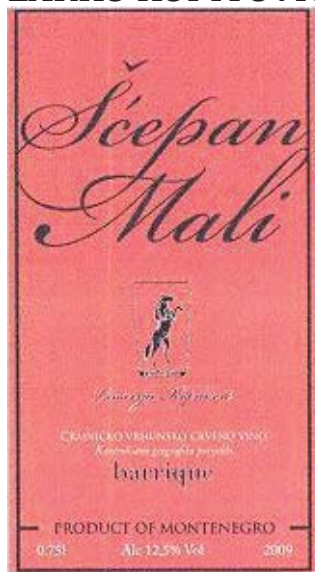
(731) **ŽARKO KOPITOVIĆ**, ĐOKA MIRAŠEVIĆA 19, 81000 PODGORICA ME

(540)

(550) I, F

(511) **Klasa 33:** alkoholna pića (izuzev piva)**Klasa 35:** oglašavanje i reklamiranje, vođenje komercijalnih poslova, komercijalna administracija, kancelarijski poslovi**Klasa 43:** usluge obezbeđivanja hrane i pića(210) **2013-360**(442) **20.09.2014.**

(220) 9/2/2013

(731) **3M COMPANY**, A CORPRATION OF THE STATE OF DELAWARE, 3M CENTER, 2501 HUDSON

ROAD, ST.PAUL, MINNESOTA 55144 US

COMMAND

(540)

(550) I

(511) **Klasa 01:** ljepila i materijali za lijepljenje

Klasa 16: ljepljive trake za svrhu montaže u domaćinstvu i kancelariji, trake za montažu za upotrebu u domaćinstvu i kancelarijskom prostoru

(210) **2013-361**

(442) **20.09.2014.**

(220) 9/3/2013

(731) **STARWOOD HOTELS & RESORTS WORLDWIDW**, INC.(A MARYLAND CORPRATION), ONE STARPOINT, STAMFORD, CONNECTICUT 06902 US



RETREAT & SPA

(540)

(550) I

(740) Lutovac Branislav, Bulevar Crnojevića 93, Podgorica ME

(511) **Klasa 36:** usluge vezane za nepokretnosti, a naročito usluge posredovanja u vezi sa nepokretnostima, sticanje nepokretnosti, podela udela u nepokretnostima, a naročito upravljanje i organizovanje u pogledu prava svojine nad nepokretnostima, stambenim objektima, apartmanima, investiranje u nepokretnosti, upravljanje nepokretnostima, usluge tajmšeringa i zakupa nekretnina i ostale nepokretne imovine, uključujući stambene objekte i apartmane

Klasa 43: hoteli, odmarališta, restorani, barovi, čekaonice, usluge rezervacije hotelskih soba, rezervacije sala za sastanke, konferencije

(210) **2013-362**

(442) **20.09.2014.**

(220) 9/4/2013

(731) **NOVARTIS AG**, 4002 BASEL CH

SEDACORON

(540)

(550) I

(511) **Klasa 05:** farmaceutski preparati za ljudsku upotrebu

(210) **2013-364** (442) **20.09.2014.**

(220) 9/5/2013

(731) **CRNOGORSKI TELEKOM AD PODGORICA**, MOSKOVSKA 29, PODGORICA ME



(540)

(550) I

(511) **Klasa 09:** naučni, nautički, geodetski, fotografski, kinematografski i optički aparati i instrumenti kao i aparati i instrumenti za vaganje, mjerenje, signalizaciju, kontrolu (inspekciju), za pomoć (spašavanje) i za obuku, aparati i instrumenti za vođenje, distribuciju, transformisanje, akumuliranje, podešavanje ili upravljanje električne struje, aparati za snimanje, prijenos, reprodukciju zvuka ili slika, magnetni nosači podataka, diskovi za snimanje, kompaktni diskovi, DVD i drugi numerički nosači za snimanje, mehanizmi za uređaje koji se pokreću uz prethodno ubacivanje novca ili žetona, registarske blagajne, računari, oprema za obradu podataka i kompjuteri, uređaji za gašenje požara, kompjuterski programi [softveri]

Klasa 16: papir, karton i proizvodi od tih materijala koji nisu obuhvaćeni drugim klasama, štamparski proizvodi, proizvodi za uvezivanje knjiga, fotografije, pribor za pisanje, ljepila (ljepljive materije za papirnate proizvode ili za kućne potrebe), slikarski pribor, kistovi, pisaće mašine i kancelarijski pribor (osim namještaja), oprema za nastavu i obuku (osim aparata), plastični materijali za ambalažu (koji nisu obuhvaćeni drugim klasama), štamparska slova, klišeji

Klasa 35: oglašavanje i reklamiranje, vođenje komercijalnih poslova, komercijalna administracija, kancelarijski poslovi

Klasa 36: osiguranje, finansijski poslovi, monetarni poslovi, upravljanje nekretninama

Klasa 37: izgradnja, popravke, usluge postavljanja (instaliranja)

Klasa 38: telekomunikacije

Klasa 41: obuka, stručno osposobljavanje, razonoda, sportske i kulturne djelatnosti

Klasa 42: naučne i tehnološke usluge kao i pripadajuće usluge istraživanja i koncepcije, usluge industrijskih analiza i istraživanja, koncepcija i razvoj računara i računarskih programa / hardvera i softvera/

(210) **2013-365** (442) **20.09.2014.**

(220) 9/5/2013

(731) **CRNOGORSKI TELEKOM AD PODGORICA**, MOSKOVSKA 29, PODGORICA ME

pick
n
play

(540)

(550) I

(511) **Klasa 09:** naučni, nautički, geodetski, fotografski, kinematografski i optički aparati i instrumenti kao i aparati i instrumenti za vaganje, mjerenje, signalizaciju, kontrolu (inspekciju), za pomoć (spašavanje) i za obuku, aparati i instrumenti za vođenje, distribuciju, transformisanje, akumuliranje, podešavanje ili upravljanje električne struje, aparati za snimanje, prijenos, reprodukciju zvuka ili slika, magnetni nosači podataka, diskovi za snimanje, kompaktni diskovi, DVD i drugi numerički nosači za snimanje, mehanizmi za uređaje koji se pokreću uz prethodno ubacivanje novca ili žetona, registarske blagajne, računari, oprema za obradu podataka i kompjuteri, uređaji za gašenje požara, kompjuterski programi [softveri]

Klasa 16: papir, karton i proizvodi od tih materijala koji nisu obuhvaćeni drugim klasama, štamparski proizvodi, proizvodi za uvezivanje knjiga, fotografije, pribor za pisanje, ljepila (ljepljive materije za papirnate proizvode ili za kućne potrebe), slikarski pribor, kistovi, pisaće mašine i kancelarijski pribor (osim namještaja), oprema za nastavu i obuku (osim aparata), plastični materijali za ambalažu (koji nisu obuhvaćeni drugim klasama), štamparska slova, klišeji

Klasa 35: oglašavanje i reklamiranje, vođenje komercijalnih poslova, komercijalna administracija, kancelarijski poslovi

Klasa 36: osiguranje, finansijski poslovi, monetarni poslovi, upravljanje nekretninama

Klasa 37: izgradnja, popravke, usluge postavljanja (instaliranja)

Klasa 38: telekomunikacije

Klasa 41: obuka, stručno osposobljavanje, razonoda, sportske i kulturne djelatnosti

Klasa 42: naučne i tehnološke usluge kao i pripadajuće usluge istraživanja i koncepcije, usluge industrijskih analiza i istraživanja, koncepcija i razvoj računara i računarskih programa / hardvera i softvera/.

(210) 2013-366

(442) 20.09.2014.

(220) 9/5/2013

(731) CRNOGORSKI TELEKOM AD PODGORICA, MOSKOVSKA 29, PODGORICA ME

NRG

(540)

(550) I

(511) **Klasa 09:** naučni, nautički, geodetski, fotografski, kinematografski i optički aparati i instrumenti kao i aparati i instrumenti za vaganje, mjerenje, signalizaciju, kontrolu (inspekciju), za pomoć (spašavanje) i za obuku, aparati i instrumenti za vođenje, distribuciju, transformisanje, akumuliranje, podešavanje ili upravljanje električne struje, aparati za snimanje, prijenos, reprodukciju zvuka ili slika, magnetni nosači podataka, diskovi za snimanje, kompaktni diskovi, DVD i drugi numerički nosači za snimanje, mehanizmi za uređaje koji se pokreću uz prethodno ubacivanje novca ili žetona, registarske blagajne, računari, oprema za obradu podataka i kompjuteri, uređaji za gašenje požara, kompjuterski programi [softveri]

Klasa 16: papir, karton i proizvodi od tih materijala koji nisu obuhvaćeni drugim klasama, štamparski proizvodi, proizvodi za uvezivanje knjiga, fotografije, pribor za pisanje, ljepila (ljepljive materije za papirnate proizvode ili za kućne potrebe), slikarski pribor, kistovi, pisaće mašine i kancelarijski pribor (osim namještaja), oprema za nastavu i obuku (osim aparata), plastični materijali za ambalažu (koji nisu obuhvaćeni drugim klasama), štamparska slova, klišeji

Klasa 35: oglašavanje i reklamiranje, vođenje komercijalnih poslova, komercijalna administracija, kancelarijski poslovi

Klasa 36: osiguranje, finansijski poslovi, monetarni poslovi, upravljanje nekretninama

Klasa 37: izgradnja, popravke, usluge postavljanja (instaliranja)

Klasa 38: telekomunikacije

Klasa 41: obuka, stručno osposobljavanje, razonoda, sportske i kulturne djelatnosti

Klasa 42: naučne i tehnološke usluge kao i pripadajuće usluge istraživanja i koncepcije, usluge industrijskih analiza i istraživanja, koncepcija i razvoj računara i računarskih programa / hardvera i softvera/.

(210) **2013-367**

(442) **20.09.2014.**

(220) 9/5/2013

(731) **CRNOGORSKI TELEKOM AD PODGORICA, MOSKOVSKA 29, PODGORICA ME**



(540)

(550) I

(511) **Klasa 09:** naučni, nautički, geodetski, fotografski, kinematografski i optički aparati i instrumenti kao i aparati i instrumenti za vaganje, mjerenje, signalizaciju, kontrolu (inspekciju), za pomoć (spašavanje) i za obuku, aparati i instrumenti za vođenje, distribuciju, transformisanje, akumuliranje, podešavanje ili upravljanje električne struje, aparati za snimanje, prijenos, reprodukciju zvuka ili slika, magnetni nosači podataka, diskovi za snimanje, • kompaktni diskovi, DVD i drugi numerički nosači za snimanje, mehanizmi za uređaje koji se pokreću uz prethodno ubacivanje novca ili žetona, registarske blagajne, računari, oprema za obradu podataka i kompjuteri, uređaji za gašenje požara, kompjuterski programi [softveri]

Klasa 16: papir, karton i proizvodi od tih materijala koji nisu obuhvaćeni drugim klasama, štamparski proizvodi, proizvodi za uvezivanje knjiga, fotografije, pribor za pisanje, ljepila

(jjepljive materije za papirnate proizvode ili za kućne potrebe), slikarski pribor, kistovi, pisaće mašine i kancelarijski pribor (osim namještaja), oprema za nastavu i obuku (osim aparata), plastični materijali za ambalažu (koji nisu obuhvaćeni drugim klasama), štamparska slova, klišeji

Klasa 35: oglašavanje i reklamiranje, vođenje komercijalnih poslova, komercijalna administracija, • kancelarijski poslovi

Klasa 36: osiguranje, finansijski poslovi, monetarni poslovi, upravljanje nekretninama

Klasa 37: izgradnja, popravke, usluge postavljanja (instaliranja)

Klasa 38: telekomunikacije

Klasa 41: obuka, stručno osposobljavanje, razonoda, sportske i kulturne djelatnosti

Klasa 42: naučne i tehnološke usluge kao i pripadajuće usluge istraživanja i koncepcije, usluge industrijskih analiza i istraživanja, koncepcija i razvoj računara i računarskih programa / hardvera i softvera/

(210) **2013-368** (442) **20.09.2014.**

(220) 9/5/2013

(731) **BRISTOL-MYERS SQUIBB COMPANY** (A DELAWARE CORPRATION), 345 PARK AVENUE, NEW YORK, NY 10154 US

ELIQUIS

(540)

(550) I

(740) AOD "Ćupić", Dalmatinska 10, Podgorica ME

(511) **Klasa 05:** farmaceutski preparati za ljudsku upotrebu

(210) **2013-369** (442) **20.09.2014.**

(220) 9/5/2013

(731) **THE CONCENTRATE MANUFACTURING COMPANY OF IRELAND**, CORNER HOUSE, 20 PARLIAMENT STREET, HAMILTON BM

7UP

(540)

(550) I

(511) **Klasa 32:** mineralne i gazirane vode i druga bezalkoholna pića, pića od voća i voćni sokovi, sirupi i drugi preparati za pravljenje pića

(210) **2013-370** (442) **20.09.2014.**

(220) 9/5/2013

(731) **BAYER HEALTHCARE LLC**, 100 BAYER ROAD, PITTSBURG, PENNSYLVANIA 15205 US

LIBREVIA

(540)

(550) I

(511) **Klasa 05:** veterinarski preparati

(210) **2013-371**

(442) **20.09.2014.**

(220) 9/5/2013

(731) **BAYER HEALTHCARE LLC**, 100 BAYER ROAD, PITTSBURG, PENNSYLVANIA 15205 US

QUELLIN

(540)

(550) I

(511) **Klasa 05:** veterinarski preparati

(210) **2013-372**

(442) **20.09.2014.**

(220) 9/6/2013

(731) **THE CONCENTRATE MANUFACTURING COMPANY OF IRELAND**, CORNER HOUSE, 20 PARLIAMENT STREET, HAMILTON BM



(540)

(550) I

(511) **Klasa 32:** mineralne i gazirane vode i druga bezalkoholna pića, pića od voća i voćni sokovi, sirupi i drugi preparati za pravljenje pića

(210) **2013-373**

(442) **20.09.2014.**

(220) 9/6/2013

(731) **PLANTAGE CONFECIAO E COMERCIO DE ROUPAS LTDA.** RUA GENERAL BRUCE, 551 SAO CRISTOVAO, 20.921-030 RIO DE JANEIRO, RJ BR



(540)

(550) I

(511) **Klasa 25:** odjeća i sportska odjeća, naime, kišni mantili, šalovi, kaiševi, trake, kaputi, jakne, haljine, bluze, majice, majice bez rukava, pantalone, košulje, suknje, kombinezoni, šorcevi, donji veš, džemper, brushalteri, bikiniji, marama za plažu, ponco ogrtači, bolero prsluci, tunike, topovi, obuća uopšte, naime, papuče, čizme, cipele, sandale, patike.

(210) **2013-374**(442) **20.09.2014.**

(220) 9/9/2013

(731) **THE SPORTSMEN OF MONTENEGRO DOO**, BULEVAR REVOLUCIJE 80, PODGORICA ME



(540)

(550) I

(511) **Klasa 16:** fotografije, štampane stvari

Klasa 25: sportska odjeća, elegantna odjeća, sportska obuća, elegantna obuća, kape šeširi

Klasa 28: društvene igre, kompjuterske igre, igre u vidu mobilne aplikacije, akcione igračke (super heroji), lopte

Klasa 32: pivo, voda, sportski napici, sokovi

Klasa 41: sportsko usavršavanje i obuka sportski seminari sportska takmičenja

(210) **2013-375** (442) **20.09.2014.**

(220) 9/11/2013

(731) **MIODRAG MILIĆ**, UL. ARHONTA PETRA 12, PODGORICA, DUŠAN LEKIĆ, UL. PIPERSKA BB PODGORICA ME

20 CLASS A CIGARETTES



(540)

(550) I, F

(511) **Klasa 34:** cigarete, kutije za cigarete, papir za cigarete

(210) **2013-376** (442) **20.09.2014.**

(220) 9/11/2013

(731) **MIODRAG MILIĆ**, UL. ARHONTA PETRA 12, PODGORICA, DUŠAN LEKIĆ, UL. PIPERSKA BB PODGORICA ME

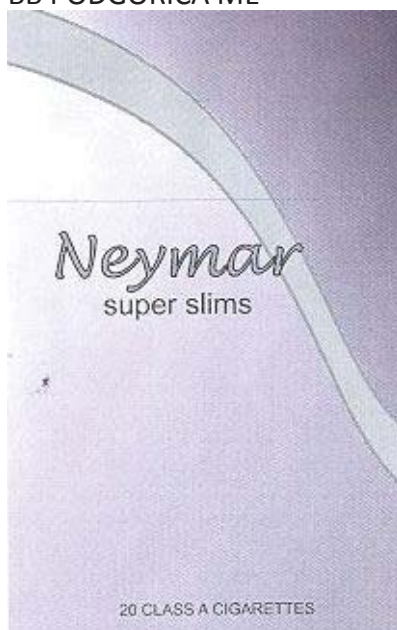

(540)

(550) I, F

(511) **Klasa 34:** cigarete, kutije za cigarete, papir za cigarete

(210) **2013-378** (442) **20.09.2014.**

(220) 9/11/2013

(731) **AMGEN INC.**(DELAWARE CORPORATION), ONE AMGEN CENTER DRIVE, THOUSAND OAKS, CALIFORNIA 910320-1799 US

DEPTARGIS

(540)

(550) I, V

(740) Radulović Božidar, Jovana Tomaševića 9/III, Podgorica ME

(511) **Klasa 05:** farmaceutski preparati

(210) **2013-379** (442) **20.09.2014.**

(220) 9/16/2013

(731) **J.K.ANSELL LIMITED**, PLOT NO.G-35 & 36, MIDC INDUSTRIAL AREA, WALUJ, AURANGABAD-431 136 IN

(540) KAMA SUTRA

(550) V

(511) **Klasa 10:** hirurški, medicinski, zubarski i veterinarski aparati i instrumenti, veštački udovi, oči i zubi, ortopedski artikli, hirurški materijali za zašivanje, specijalan nameštaj za medicinsku upotrebu, higijenski gumeni proizvodi, potporni zavoji

(210) **2013-380** (442) **20.09.2014.**

(220) 9/16/2013

(731) **EISAI R&D MANAGEMENT CO.LTD**, NO.6-10, KOISHIKAWA 4-CHOME, BUNKYO-KU, TOKYO JP

HALAVEN

(540)

(550) I, V

(740) Radulović Božidar, Jovana Tomaševića 9/III, Podgorica ME

(511) **Klasa 05:** farmaceutski preparati i supstance

(210) **2013-381** (442) **20.09.2014.**

(220) 9/17/2013

(731) **EXXON MOBIL CORPRATION**, 5959 LAS COLINAS BOULEVARD, IRVING, TEHAS 75039-2298 US

(540) ENERGY LIVES HERE

(550) I

(740) Ćosović Dejan, 13. jula 1/5, Budva ME

(511) **Klasa 01:** hemijski proizvodi koji se upotrebljavaju u industriji, nauci, fotografiji, poljoprivredi, hortikulturi i šumarstvu, neprerađene vještačke smole i neprerađene plastične materije, đubriva, smjese za gašenje vatre, preparati za kaljenje i zavarivanje, hemijske supstance za očuvanje namirnica, materije za štavljenje, ljepljive materije za upotrebu u industriji

Klasa 04: industrijska ulja i masti, sredstva za podmazivanje, materije za upijanje, vlaženje i vezivanje prašine, goriva (uključujući motorna tečna goriva) i materija za osvetljenje, svijeće i fitilji za rasvjetu

Klasa 16: matarijal za oglašavanje, brošure, štampane stvari

Klasa 35: usluge korporativnog oglašavanja

Klasa 41: usluge obuke, stručnog osposobljavanja, razonode, sportske i kulturne djelatnosti, uključujući naročito korporativno oglašavanje i javna saopštavanja u vezi sa petrolejskom industrijom i hemijskom industrijom

(210) **2013-382**

(442) **20.09.2014.**

(220) 9/17/2013

(731) **BOSNAEXPRES D.D.** USORSKA 21, 74203 MATUZIĆI, DOBOJ JUG BA



(540)

(550) I

(740) Ćosović Dejan, 13. jula 1/5, Budva ME

(511) **Klasa 18:** koža, imitacija kože, proizvodi od tih materijala koji nisu obuhvaćeni drugim klasama, životinjske kože, kovčezi i torbe, kišobrani, suncobrani i štapovi za hodanje, bičevi, saračka i sedlarska oprema

Klasa 24: tkanine i tekstilni proizvodi koji nisu obuhvaćeni drugim razredima, pokrivači za krevete i stolove

Klasa 25: odeća, obuća, pokrivala za glavu

(210) **2013-383**

(442) **20.09.2014.**

(220) 9/17/2013

(731) **TAVFIK GENERAL TRADING L.L.C.** OFFICE NO.104.AL HUDA BUILDING, DIERA, DUBAI AE

ROYAL PALACE

(540)

(550) I

(740) Radulović Božidar, Jovana Tomaševića 9/III, Podgorica ME

(511) **Klasa 34:** duvan i artikli za njih

(210) **2013-385**

(442) **20.09.2014.**

(220) 9/17/2013

(731) **TDR D.O.O.** OBALA VLADIMIRA NAZORA 1.52210 ROVINJ HR

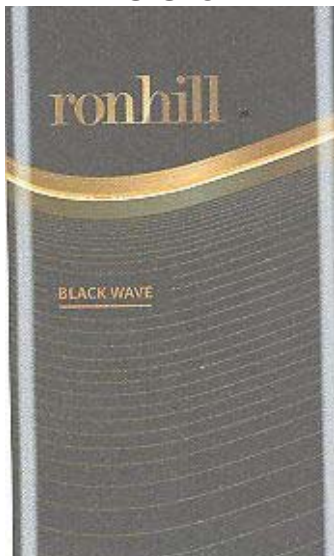

(540)

(550) I

(740) Vukotić Petar, Novaka Miloševa, Podgorica ME

(511) **Klasa 34:** duvan sirov i prerađen, proizvodi od duvana, cigare, cigarete, filter, cigarete, cigarilosi, artikli za pušače, upaljači, šibice

Klasa 35: usluge u vezi sa prometom robe, posebno usluge u prometu duvana i duvanskih proizvoda, oglašavanje, vođenje poslova, poslovno upravljanje, kancelarijski poslovi, komercijalno zastupanje, propagandne i reklamne usluge, marketing, usluge istraživanja tržišta, usluge promocije, posebno promovisanje ili reklamiranje kulturnih i zabavnih događaja, sportskih takmičenja i modnih revija, organizovanje i vođenje sajмова i izložbi u reklamne i komercijalne svrhe, naprijed navedene usluge koje pripadaju ovoj klasi koje se obavljaju putem interneta, davanje i širenje informacija u vezi sa gore navedenim uslugama

(210) **2013-386**

(442) **20.09.2014.**

(220) 9/17/2013

(731) **TDR D.O.O.** OBALA VLADIMIRA NAZORA 1.52210 ROVINJ HR



(540)

(550) I

(740) Vukotić Petar, Novaka Miloševa, Podgorica ME

(511) **Klasa 34:** duvan sirov i prerađen, proizvodi od duvana, cigare, cigarete, filter, cigarete, cigarilosi, artikli za pušače, upaljači, šibice

Klasa 35: usluge u vezi sa prometom robe, posebno usluge u prometu duvana i duvanskih proizvoda, oglašavanje, vođenje poslova, poslovno upravljanje, kancelarijski poslovi, komercijalno zastupanje, propagandne i reklamne usluge, marketing, usluge istraživanja tržišta, usluge promocije, posebno promovisanje ili reklamiranje kulturnih i zabavnih događaja, sportskih takmičenja i modnih revija, organizovanje i vođenje sajмова i izložbi u reklamne i komercijalne svrhe, naprijed navedene usluge koje pripadaju ovoj klasi koje se obavljaju putem interneta, davanje i širenje informacija u vezi sa gore navedenim uslugama.

(210) **2013-387**

(442) **20.09.2014.**

(220) 9/17/2013

(731) **TUMBLR**, INC. 35 EAST 21ST STREET, 6TH FLOOR NEW YORK, NY 10010 US

(540) TUMBLR

(550) I

(740) Popović Miladin, Đoka Miraševića 21/III, Podgorica ME

(511) **Klasa 09:** kompjuterski softver koji omogućava učitavanje, preuzimanje, pristup, objavljivanje, prikazivanje, blogovanje, povezivanje, dijeljenje ili na drugi način pružanje elektronskih medija ili informacija putem kompjutera, interneta i drugih komunikacionih mreža, kompjuterski aplikacioni softver za mobilne komunikacione uređaje, naime, softver koji omogućava učitavanje, preuzimanje, pristup, objavljivanje, prikazivanje, blogovanje, povezivanje, dijeljenje ili na drugi način pružanje elektronskih medija ili informacija putem kompjuterskih i komunikacionih mreža, elektronske publikacije koje se mogu preuzimati, naime, časopisi koji imaju sadržaj namijenjen određenim korisnicima iz oblasti od opšteg interesa, softveri za kompjutere koji se mogu preuzimati, prenosive ručne digitalne elektronske uređaje za komunikaciju, mobilne komunikacione uređaje, i žične i bežične komunikacione uređaje za društveno umrežavanje, softver u vidu mobilne aplikacije koji se može preuzeti za korišćenje na kompjuterima, prenosivim ručnim digitalnim elektronskim uređajima za komunikaciju, mobilnim komunikacionim uređajima, i žičnim i bežičnim komunikacionim uređajima za stvaranje, dijeljenje i objavljivanje sadržaja i blogova na Internetu, alati za razvoj kompjuterskih softvera, kompjuterski softver koji se koristi kao aplikacija za programski interfejs (API) za upotrebu za razvoj drugih aplikacionih softvera

Klasa 35: usluge oglašavanja i marketinga koje se pružaju putem indirektnih metoda marketinških komunikacija, naime, društvenih medija, marketinga na internet pretraživačima, marketinškog upitnika, Internet marketinga, mobilnog marketinga, blogovanja i drugih oblika komunikacionih kanala, pasivnih, za dijeljenje ili virusnih, usluge oglašavanja i mrežnog servisa, naime, promovisanje usluga drugih pružajući kreiranjem web stranica koje sadrže linkove do drugih web stranica, on-line oglašavanje i marketinške usluge za druge

Klasa 38: kompjuterske usluge, naime, pružanje on-line sadržaja za istovremenu interakciju između i među korisnicima kompjutera, mobilnih i ručnih kompjutera, i žičnih i bežičnih uređaja za komunikaciju u oblastima od opšteg interesa, telekomunikacione usluge, naime, elektronski prenos poruka, teksta, multimedijalnog sadržaja, muzike, video zapisa, audio zapisa, animacije i slika putem globalne kompjuterske mreže, pružanje online komunikacionih veza koje prenose korisnike web stranica na druge web stranice, usluge ravnopravnog dijeljenja fotografija, naime, elektronski prenos digitalnih foto datoteka među korisnicima interneta, isporuka digitalne muzike elektronskim putem

Klasa 41: usluge elektronskog objavljivanja, naime, objavljivanje onlajn radova drugih putem elektronskih medija, multimedijalnih sadržaja, video zapisa, filmova, slika, prikaza, tekstova, fotografija, sadržaja koji su objavljeni na sajtovima (UGC) i relevantnim informacijama putem interneta i drugih komunikacionih mreža u oblastima od opšteg interesa, on-line

objavljivanje blogova za druge, usluge elektronskog objavljivanja, naime, objavljivanje tekstualnih i grafičkih radova za druge koji sadrže informacije iz oblasti zabave, obrazovanja, društvenih pitanja, politike, kulturnih pitanja, ekonomskih pitanja, pitanja naučnog i od opšteg interesa, objavljivanje elektronskih publikacija, on-line žurnali, naime, blogovi koji sadrže teme od opšteg interesa, uređenje, organizovanje, vođenje i priređivanje društvenih zabavnih događaja

Klasa 42: usluge pružanja on-line softvera, koji se ne mogu preuzimati, za društveno umrežavanje i dijeljenje medija i upotrebu putem Interneta, usluge hostovanja koje omogućavaju pristup softveru preko interneta (application service provider - ASP) uključujući softver koji omogućava ili olakšava otpremanje, učitavanje, preuzimanje, protok, postavljanje, prikazivanje, blogovanje, povezivanje, deljenje ili na drugi način omogućava pristup elektronskim medijima ili informacijama putem komunikacionih mreža, omogućavanje privremenog korišćenja softvera koji se ne mogu preuzimati u svrhu društvenog povezivanja, kreiranja virtuelnih zajednica, i prenošenja audio zapisa, video zapisa, muzike, fotografskih prikaza, teksta, grafike i podataka, omogućavanje usluga veb sajtova koje uključuju i tehnologiju koja omogućava korisnicima učitavanje i dijeljenje video zapisa, muzike, fotografija, teksta, grafike i podataka, održavanje blogova za druge, pružanje usluga korisnicima online zajednica sa svrhom dijeljenja informacija, fotografija, muzike, audio i video sadržaja, dobijanja povratnih informacija od svojih vršnjaka, formiranja virtuelnih zajednica, i angažovanja u društvenim mrežama

Klasa 45: usluge društvenih mreža bazirane na Internetu koje dozvoljavaju korisnicima da komuniciraju i dijele, skladište, šalju, vide, i preuzimaju tekstove, slike, audio i video sadržaj, i drugi multimedijalni materijal, usluge online društvenog umrežavanja, pružanje usluga društvenih mreža putem veb sajtova u svrhu zabave

(210) **2013-388** (442) **20.09.2014.**

(220) 9/17/2013

(731) **PHARMACEUTICAL CHEMICAL COSMETIC INDUSTRY ALKALOID AD-SKOPLJE**, BUL. ALEKSANDAR MAKEDONSKI 12, 1000 SKOPLJE RM

(540) RISSAR

(550) I

(740) Popović Miladin, Đoka Miraševića 21/III, Podgorica ME

(511) **Klasa 05:** farmaceutski preparati

(210) **2013-389** (442) **20.09.2014.**

(220) 9/19/2013

(731) **JANOME SEWING MACHINE COMPANY LIMITED**, 1463 HAZAMA-MACHI, HACHIOJI-SHI, TOKYO JP

(540) JANOME

(550) I, V

(740) Popović Miladin, Đoka Miraševića 21/III, Podgorica ME

(511) **Klasa 07:** mašine za šivenje, mašine i alati za obradu metala, tekstilne mašine i aparati, mašine za pranje posuđa, mašine za pranje veša, usisavači, električni mikseri za hranu

(210) **2013-390** (442) **20.09.2014.**

(220) 9/20/2013

(731) **NU MARK LLC**, 6601 WEST BROAD STREET RICHMOND, VA 23230 US

(540) MARKTEN

(550) I, V

(740) Popović Miladin, Đoka Miraševića 21/III, Podgorica ME

(511) **Klasa 09:** baterije za električne cigarete, elektronske cigarete, električne cigare, elektronske cigare, električne cigarilose, elektronske cigarilose, električne lule, elektronske lule i vaporizere za duvan, duvanske proizvode i zamene za duvan, akumulatori za električne cigarete, elektronske cigarete, električne cigare, elektronske cigare, električne cigarilose, elektronske cigarilose, električne lule, i elektronske lule, i vaporizere za duvan, duvanske proizvode i zamene za duvan, punjači za baterije, punjači, adapteri za kola, i kablovi za električne cigarete, elektronske cigarete, električne cigare, elektronske cigare, električne cigarilose, elektronske cigarilose, električne lule, i elektronske lule, i vaporizere za duvan, duvanske proizvode i zamene za duvan, elektronski i električni delovi, komponente, i pribor za električne cigarete, elektronske cigarete, električne cigare, elektronske cigare, električne cigarilose, elektronske cigarilose, električne lule, i elektronske lule, i vaporizere za duvan, duvanske proizvode i zamene za duvan

Klasa 34: duvanski proizvodi, prerađen ili neprerađen duvan, artikli za pušače, duvan, naročito duvan za pušenje, bezdimni duvan, i duvan za žvakanje, duvanski proizvodi, naročito cigare, cigarete, i cigarilosi, duvanski proizvodi, naročito, nikotinske pastile napravljane od duvana za oralnu upotrebu, lule, snus, zamene za duvan, koje se ne koriste za medicinske i lekovite svrhe, zamene za duvanske proizvode, naročito cigare i cigarete koje sadrže zamene za duvan, koje se ne koriste za medicinske i lekovite svrhe, električne cigarete, elektronske cigarete, električne cigare, elektronske cigare, električni cigarilosi, elektronski cigarilosi, električne lule, i elektronske lule, tečnosti, ampule, i patrone za električne cigarete, elektronske cigarete, elektronske cigare, elektronske cigarilose, i električne lule, tečnost koja se može dopunjavati za elektronske cigarete i elektronsku opremu za pušenje, dopunjive patrone za elektronske cigarete i elektronsku opremu za pušenje, atomizeri i kartomizeri za elektronske cigarete i elektronsku opremu za pušenje, vaporizeri za duvan, duvanske proizvode i zamene za duvan, delovi, komponente, i pribor za elektronske cigarete i elektronsku opremu za pušenje, i vaporizere za duvan, duvanske proizvode i zamene za duvan, kutijice i kutije specijalno prilagođene za držanje gore navedene robe, postolja/stalci posebno prilagođeni za gore navedenu robu, delovi i rezervni delovi za gore navedenu robu

(210) **2013-391**

(442) **20.09.2014.**

(220) 9/20/2013

(300) 11682201 22.03.2013. EU

(731) **Nu Mark LLC**, 6601 West Broad Street Richmond, VA 23230 US



(540)

(550) I, F

(740) Popović Miladin, Đoka Miraševića 21/III, Podgorica ME

(511) **Klasa 09:** baterije za električne cigarete, elektronske cigarete, električne cigare, elektronske cigare, električne cigarilose, elektronske cigarilose, električne lule, elektronske lule, i vaporizere za duvan, duvanske proizvode i zamene za duvan, akumulatori za električne cigarete, elektronske cigarete, električne cigare, elektronske cigare, električne cigarilose, elektronske cigarilose, električne lule i elektronske lule, i vaporizere za duvan, duvanske proizvode i zamene za duvan, punjači za baterije, punjači, adapteri za kola, i kablovi za električne cigarete, elektronske cigarete, električne cigare, elektronske cigare, električne cigarilose, elektronske cigarilose, električne lule, i elektronske lule, i vaporizere za duvan, duvanske proizvode i zamene za duvan, elektronski i električni delovi, komponente, i pribor za električne cigarete, elektronske cigarete, električne cigare, elektronske cigare, električne cigarilose, elektronske cigarilose, električne lule, i elektronske lule, i vaporizere za duvan, duvanske proizvode i zamene za duvan

Klasa 34: duvanski proizvodi, prerađen ili neprerađen duvan, artikli za pušače, duvan, naročito duvan za pušenje, bezdimni duvan, i duvan za žvakanje, duvanski proizvodi, naročito cigare, cigarete, i cigarilosi, duvanski proizvodi, naročito, nikotinske pastile napravljane od duvana za oralnu upotrebu, lule, snus, zamene za duvan, koje se ne koriste za medicinske i lekovite svrhe, zamene za duvanske proizvode, naročito cigare i cigarete koje sadrže zamene za duvan, koje se ne koriste za medicinske i lekovite svrhe, električne cigarete, elektronske cigarete, električne cigare, elektronske cigare, električni cigarilosi, elektronski cigarilosi, električne lule, i elektronske lule, tečnosti, ampule, i patrone za električne cigarete, elektronske cigarete, elektronske cigare, elektronske cigarilose, i električne lule, tečnost koja se može dopunjavati za elektronske cigarete i elektronsku opremu za pušenje, dopunjive patrone za elektronske cigarete i elektronsku opremu za pušenje, atomizeri i kartomizeri za elektronske cigarete i elektronsku opremu za pušenje, vaporizeri za duvan, duvanske proizvode i zamene za duvan, delovi, komponente, i pribor za elektronske cigarete i elektronsku opremu za pušenje, i vaporizere za duvan, duvanske proizvode i zamene za duvan, kutijice i kutije specijalno prilagođene za držanje gore navedene robe, postolja/stalci posebno prilagođeni za gore navedenu robu, delovi i rezervni delovi za gore navedenu robu

(210) **2013-392**

(442) **20.09.2014.**

(220) 9/20/2013

(300) EU br.11682218 od 22.03.2013

(731) **NU MARK LLC**, 6601 WEST BROAD STREET RICHMOND, VA 23230 US



(540)

(550) I, F

(740) Popović Miladin, Đoka Miraševića 21/III, Podgorica ME

(511) **Klasa 09:** baterije za električne cigarete, elektronske cigarete, električne cigare, elektronske cigare, električne cigarilose, elektronske cigarilose, električne lule, elektronske lule, i vaporizere za duvan, duvanske proizvode i zamene za duvan, akumulatori za električne cigarete, elektronske cigarete, električne cigare, elektronske cigare, električne cigarilose, elektronske cigarilose, električne lule, i elektronske lule, i vaporizere za duvan, duvanske proizvode i zamene za duvan, punjači za baterije, punjači, adapteri za kola, i kablovi za električne cigarete, elektronske cigarete, električne cigare, elektronske cigare, električne cigarilose, elektronske cigarilose, električne lule i elektronske lule, i vaporizere za duvan, duvanske proizvode i zamene za duvan, elektronski i električni delovi, komponente, i pribor za električne cigarete, elektronske cigarete, električne cigare, elektronske cigare, električne cigarilose, elektronske cigarilose, električne lule, i elektronske lule, i vaporizere za duvan, duvanske proizvode i zamene za duvan

Klasa 34: duvanski proizvodi, prerađen ili neprerađen duvan, artikli za pušače, duvan, naročito duvan za pušenje, bezdimni duvan, i duvan za žvakanje, duvanski proizvodi, naročito cigare, cigarete, i cigarilosi, duvanski proizvodi, naročito, nikotinske pastile napravljane od duvana za oralnu upotrebu, lule, snus, zamene za duvan, koje se ne koriste za medicinske i lekovite svrhe, zamene za duvanske proizvode, naročito cigare i cigarete koje sadrže zamene za duvan, koje se ne koriste za medicinske i lekovite svrhe, električne cigarete, elektronske cigarete, električne cigare, elektronske cigare, električni cigarilosi, elektronski cigarilosi, električne lule, i elektronske lule, tečnosti, ampule i patrone za električne cigarete, elektronske cigarete, elektronske cigare, elektronske cigarilose, i električne lule, tečnost koja se može dopunjavati za elektronske cigarete i elektronsku opremu za pušenje, dopunjive patrone za elektronske cigarete i elektronsku opremu za pušenje, atomizeri i kartomizeri za elektronske cigarete i elektronsku opremu za pušenje, vaporizeri za duvan, duvanske proizvode i zamene za duvan, delovi, komponente, i pribor za elektronske cigarete i elektronsku opremu za pušenje, i vaporizere za duvan, duvanske proizvode i zamene za duvan, kutijice i kutije specijalno prilagođene za držanje gore navedene robe, postolja/stalci posebno prilagođeni za gore navedenu robu, delovi i rezervni delovi za gore navedenu robu

(210) **2013-395**

(442) **20.09.2014.**

(220) 9/26/2013

(731) **CYBORG PROJECT SPOLKA Z ORANICZONA ODPOWIEDZIALNOSCIA SP.K.** AL.JANA PAWLA II 23 00-854 WARSZAWA PO

cyborg

(540)

(550) I, V

(740) Đakonović Vido, Bajova 9, Cetinje ME

(511) **Klasa 16:** papir, karton i proizvodi napravljeni od kartona, koji nisu obuhvaćeni drugim klasama, ambalaža, papir ili karton, kontejneri za pakovanje, vreće, štampani materijali, poster, poster od papira ili kartona, podloge za pisanje, brošure, zastave, papir, formulari i štampani materijali, kalendari, kalendari sa listovima na spirali i sL, katalogi, koverta, kancelarijski materijal nalepnice, samolepive nalepnice, nalepnice za adrese, indeksi, sveske, blokčići, katabzi, koverta, razglednice, brošure, mape, olovke, pribor za pisanje uključujući: olovke, markere, setove za pisanje, kancelarijski materijal znake od papira ili kartona, fascikle, korice, kancelarijske potrepštine, knjige, marke, markere za knjige, štampane publikacije, časopise, instrukcione i obrazovne materijate, lepkove za kancelarijske potrebe i u domaćinstvu, materijale za umetnike, uključujući materijale za crtanje, slikanje i izradu modela

Klasa 32: bezalkoholni napici, uključujući osvežavajuća pića, energetska napici, sportski napici, osvežavajući napici hiper i hipotonični (za upotrebu i/ili kako preporučuju atletičari), šumeće tablete i praškovi za pića, kokteli, bezalkoholni aperitivi, bezalkoholni napici koji sadrže med limunadu, bezalkoholni napici od slada, mineralna voda, gazirana voda, stona voda, soda, šerbet, voćni napici, voćni sokovi, biljni sokovi, osvežavajuća pića na bazi voća i povrća, voćni nektari, sirupi, esencije i drugi preparati za pravljenje napitaka, pivo, pivo od slada

Klasa 35: oglašavanje, uključujući promociju proizvoda i usluga, takmičenja i sportski događaji, raspodela reklamnog materijala - uzorci, štampane stvari, pamfleti, brošure, reklamiranje poštom, oglašavanje u štampi, televizijsko oglašavanje, radio oglašavanje, oglašavanje na reklamnim panelima, oglašavanje na kompjuterskoj mreži, diseminacija oglašavanja, raspodela proizvoda u svrhu oglašavanja, statističke kombinacije, agencije, javni odnosi, organizaciono savetovanje, poslovno upravljanje, poslovna administracija, organizovanje trgovačkih sajmova i izbjbi u komercijalne svrhe ili za potrebe oglašavanja, sakupljanje za druge raznovrsnih proizvoda da se kupcima omogući razgledanje i kupovina ovih proizvoda, usluge prodaje proizvoda u oblasti sportske opreme, uključujući bicikle, daske za jedrenje, paraglajdere i sportsku odeću i opremu, pronalaženje sponzora, marketinško istraživanje, ispitivanje javnog mnjenja, marketinško istraživanje, istraživanje u oblasti poslovnog konsaltinga, saveti za organizovanje i vođenje poslovanja, savetodavne usluge u poslovanju, savetovanje o personalnom poslovnom upravljanju, konsultativne usluge u poslovnom upravljanju, airtsorsing

(210) **2013-396**

(442) **20.09.2014.**

(220) 9/26/2013

(731) **EXXON MOBIL CORPRATION**, A CORPORATION ARGANIZED AND EXISTING UNDER THE LAWS OF THE STATE OF NEW JERSEY US

MOBIL

(540)

(550) I

(740) AOD "Ćupić", Dalmatinska 10, Podgorica ME

(511) **Klasa 01:** antifriz, hemijski preparati, naime rastvori za odmašćivanje i čišćenje, rashladne tečnosti, kočione tečnosti, tečnosti za odleđivanje šofer-šajbne

Klasa 03: tečnosti za čišćenje šofer-šajbni

(210) **2013-397**

(442) **20.09.2014.**

(220) 9/26/2013

(731) **MERCK SHARP & DOHME CORP.** ONE MERCK DRIVE, WHITEHOUSE STATION, NEW JERSEY 08889 US



(540)

(550) I

(740) AOD "Ćupić", Dalmatinska 10, Podgorica ME

(511) **Klasa 05:** farmaceutski preparati

(210) **2013-398**

(442) **20.09.2014.**

(220) 9/26/2013

(731) **JACK DANIEL'S PROPERTIES, INC,** A DELAWARE, USA CORPRATION US

JACK DANIEL

(540)

(550) I

(740) AOD "Ćupić", Dalmatinska 10, Podgorica ME

(511) **Klasa 33:** alkoholna pića , uključujući žestoka pića

(210) **2013-399**

(442) **20.09.2014.**

(220) 9/26/2013

(731) **JACK DANIEL'S PROPERTIES, INC,** A DELAWARE, USA CORPRATION US

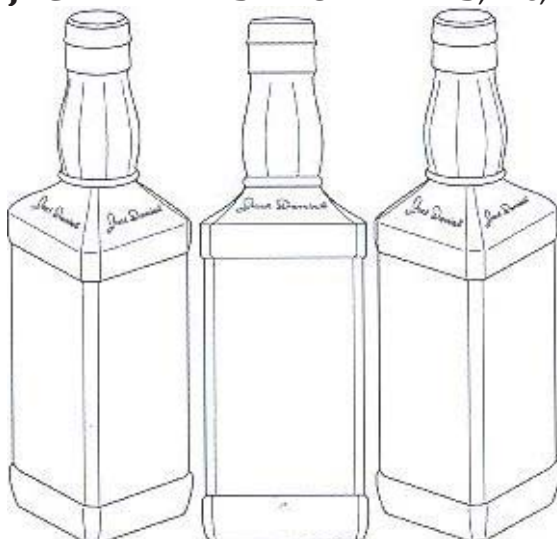

(540)

(550) I

(740) AOD "Ćupić", Dalmatinska 10, Podgorica ME
(511) **Klasa 33:** alkoholna pića , uključujući žestoka pića

(210) 2013-4 (442) **20.09.2014.**
(220) 1/10/2013
(731) **CHEVRON INTELLECTUAL PROPERTY LLC** (DELAWARE LIMITED LIABILITY COMPANY), 6001 BOLLINGER CANYON ROAD, SAN RAMON, CALIFORNIA 94583 US

**TECHIRON
WORKS**

(540)
(550) I, F
(740) Radulović Božidar, Jovana Tomaševića 9/III, Podgorica ME
(511) **Klasa 01:** aditivi za benzin i aditivi za motorna goriva
Klasa 04: motorna goriva

(210) **2013-400** (442) **20.09.2014.**
(220) 9/27/2013
(731) **NOVARTIS AG**, 4002 BASEL CH

HERZ ASS

(540)
(550) I
(511) **Klasa 05:** farmaceutski preparati za ljudsku upotrebu, naime analgetici, antiinflamatorni lekovi i antipiretici

(210) **2013-401** (442) **20.09.2014.**
(220) 9/27/2013
(731) **NOVARTIS AG**, 4002 BASEL CH

DOLOROFEN

(540)
(550) I
(511) **Klasa 05:** farmaceutski preparati za ljudsku upotrebu

(210) **2013-402** (442) **20.09.2014.**
(220) 9/27/2013
(731) **NOVARTIS AG**, 4002 BASEL CH

PROCTE-COR

(540)

(550) I

(511) **Klasa 05:** farmaceutski preparati za ljudsku upotrebu(210) **2013-404**(442) **20.09.2014.**

(220) 9/30/2013

(731) **BELUPO LJEKOVI I KOZMETIKA D.D. ULICA DANICA 5 KOPRIVNICA HR**

SONA

(540)

(550) I, V

(740) Popović Miladin, Đoka Miraševića 21/III, Podgorica ME

(511) **Klasa 05:** farmaceutski proizvodi(210) **2013-405**(442) **20.09.2014.**

(220) 9/30/2013

(731) **BELUPO LJEKOVI I KOZMETIKA, ULICA DANICA 5 KOPRIVNICA HR**

AFLODERM

(540)

(550) I, V

(740) Popović Miladin, Đoka Miraševića 21/III, Podgorica ME

(511) **Klasa 05:** farmaceutski proizvodi(210) **2013-406**(442) **20.09.2014.**

(220) 10/1/2013

(731) **PODRAVKA-LAGRIS A.S. DOLNI LHOTA 39, PSČ 76323 CZ**

(540)

(550) I, F

(740) Popović Miladin, Đoka Miraševića 21/III, Podgorica ME

(511) **Klasa 29:** meso, riba, živina i divljač, mesni ekstrakti, konzervirano, sušeno i kuvano voće i povrće, želei, džemovi, kompoti, jaja, mlijeko i mliječni proizvodi, jestiva ulja i masti**Klasa 30:** kafa, čaj, kakao, šećer, riža, tapioka, sago, zamjene za kafu, brašno i proizvodi od žitarica, hljeb, kolači, poslastice, bomboni, sladoled, med, sirup od melase, kvasac, prašak za pecivo, so, senf, sirće, prelive, začini, razni začini, led za hlađenje**Klasa 31:** poljoprivredni, povrtlarski, šumski proizvodi i bobice, koji nijesu obuhvaćeni drugim klasama, žive životinje, svježe voće i povrće, sjeme, prirodne biljke i cvijeće, hrana za

životinje, slad

(210) **2013-407** (442) **20.09.2014.**

(220) 10/2/2013

(731) **MILENKO ČABARKAPA**, JOLA PILETIĆA 6. PODGORICA ME

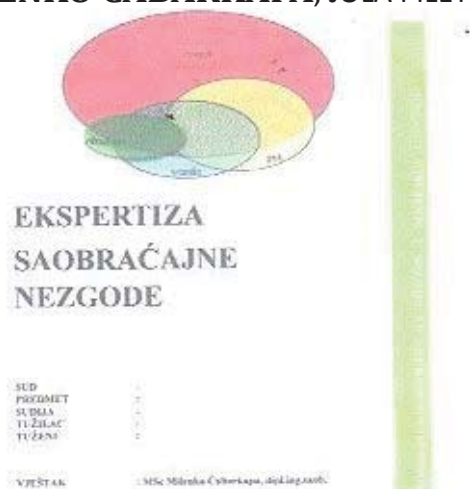

(540)

(550) I

(511) **Klasa 42:** naučne i tehnološke usluge i istraživanja i projektovanje u vezi navedenih usluga. **Klasa 45:** pravne usluge

(210) **2013-408** (442) **20.09.2014.**

(220) 10/2/2013

(731) **FK BUDUĆNOST AD**, VAKA ĐUROVIĆA 2, 81000 PODGORICA ME



(540)

(550) I, F

(511) **Klasa 41:** akademije [obuka] informacije o razonodi informacije u vezi rekreacije iznajmljivanje sportske opreme [osim vozila], iznajmljivanje sportskih terena, iznajmljivanje stadiona, igre (usluge hala i dvorana za igre), kampovi za sportsko usavršavanje, lični treneri (usluge ličnih trenera) [fitnes], organizovanje i vođenje konferencija, organizovanje i vođenje kongresa, organizovanje i vođenje radionica za stručno osposobljavanje, organizovanje i vođenje razgovora organizovanje i vođenje seminara, organizovanje izložba u kulturne i obrazovne svrhe, organizovanje javnih konkursa [obrazovanje ili rasonoda] sportska oprema (stavljane na raspolaganje sportske opreme), sportska takmičenja (mjerjenje vremena

na sportskim takmičenjima), sportska takmičenja (organizovanje sportskih takmičenja) sportska usavršavanja (sportski kampovi za usavršavanje u sportu) stadioni (iznajmljivanje stadiona), treniranje [fizička vježba]

(210) **2013-409**

(442) **20.09.2014.**

(220) 10/2/2013

(731) **FK BUDUĆNOST AD**, VAKA ĐUROVIĆA 2, 81000 PODGORICA ME



(540)

(550) I, F

(511) **Klasa 41:** akademije [obuka] informacije o razonodi informacije u vezi rekreacije iznajmljivanje sportske opreme [osim vozila], iznajmljivanje sportskih terena, iznajmljivanje stadiona, igre (usluge hala i dvorana za igre), kampovi za sportsko usavršavanje, lični treneri (usluge ličnih trenera) [fitnes], organizovanje i vođenje konferencija, organizovanje i vođenje kongresa, organizovanje i vođenje radionica za stručno osposobljavanje, organizovanje i vođenje razgovora organizovanje i vođenje seminara, organizovanje izložba u kulturne i obrazovne svrhe, organizovanje javnih konkursa [obrazovanje ili razonoda] sportska oprema (stavljanje na raspolaganje sportske opreme), sportska takmičenja (mjerenje vremena na sportskim takmičenjima), sportska takmičenja (organizovanje sportskih takmičenja) sportska usavršavanja (sportski kampovi za usavršavanje u sportu) stadioni (iznajmljivanje stadiona), treniranje [fizička vježba]

(210) **2013-410**

(442) **20.09.2014.**

(220) 10/3/2013

(731) **THE BODY SHOP INTERNATIONAL PLC**, WATERSMEAD, LITTLEHAMPTON WEST SUSSEX, BN17 6LS GB

THE BODY SHOP

(540)

(550) I, F

(740) Popović Miladin, Đoka Miraševića 21/III, Podgorica ME

(511) **Klasa 03:** kozmetika i proizvodi za njegu kože, naime, podloga, korektor, maskara, sjenka za oči, olovke za oči i / ili obrve, ruž za usne, olovka za usne, balzam za usne, puder za lice, bronzer, rumenilo, ovlaživači, odstranjivač šminke, nemedicinski puder za tijelo, sapuni za kožu, gel za kupanje, ulja za kupanje, soli za kupanje, kuglice za kupanje, i preparati sa mehurićima za kupanje, nemedicinski preparati za njegu kože, naime, losioni, kreme, sredstva za čišćenje kože, pilinzi, maske i toneri, preparati za njegu kose i oblikovanje kose, naime, šamponi, regeneratori, završni sprej, i gelovi, dezodoransi za ličnu upotrebu, preparati za samopotamnjivanje, ulja i losioni za zaštitu od sunca, preparati za brijanje, paste za zube, parfemi, toaletna voda, eterična ulja za ličnu upotrebu, parfemska ulja, preparati za njegu noktiju, lak za nokte, kamen za glačanje kože, pamučni štapići i vuneni tamponi za nemedicinske svrhe svi za upotrebu na tijelu, aromatični sobni mirisi, mirisni štapići, potpuri i kesice sa mirišljivim prahom, kozmetičke maramice sa puderom, maramice natopljene losionima, kompleti i poklon setovi koji sadrže preparate za njegu kože i / ili kose

Klasa 21: četke za kosu, sunđeri za tijelo, lufa sunđeri, držači za svijeće ne od dragocjenih metala, tegle, posude i držači za aromu ne od dragocjenih metala, češalice za leđa, atomizeri, kutije za puder, posude za sapun, držači za četkice, cjedila za čaj, kozmetički aplikatori i dodaci, naime četke za lice/tijelo, četke za šminku, četke i češljevi za oči, aplikatori za pjenu, sunđeri za šminku i puferi za puder

Klasa 35: maloprodajne usluge, online maloprodajne usluge, usluge- telešopa iz kuće, i kupovine iz kuće u vezi sa proizvodima za ljepotu, kozmetikom, toaletom, preparatima za njegu kože, preparatima za njegu kose, mirisi, i proizvodima za ličnu njegu, kompjuterizovane usluge on line poručivanja u vezi sa proizvodima za ljepotu, kozmetikom, preparatima za njegu kože, mirisima, i povezanim proizvodima

(210) **2013-411**

(442) **20.09.2014.**

(220) 10/3/2013

(731) **THE BODY SHOP INTERNATIONAL PLC**, WATERSMEAD, LITTLEHAMPTON WEST SUSSEX, BN17 6LS GB



(540)

(550) I, F

(740) Popović Miladin, Đoka Miraševića 21/III, Podgorica ME

(511) **Klasa 03:** kozmetika i proizvodi za njegu kože, naime, podloga, korektor, maskara, sjenka za oči, olovke za oči i / ili obrve, ruž za usne, olovka za usne, balzam za usne, puder za lice, bronzer, rumenilo, ovlaživači, odstranjivač šminke, nemedicinski puder za tijelo, sapuni za kožu, gel za kupanje, ulja za kupanje, soli za kupanje, kuglice za kupanje, i preparati sa mehurićima za kupanje, nemedicinski preparati za njegu kože, naime, losioni, kreme, sredstva za čišćenje kože, pilinzi, maske i toneri, preparati za njegu kose i oblikovanje kose, naime, šamponi, regeneratori, završni sprej, i gelovi, dezodoransi za ličnu upotrebu, preparati za samopotamnjivanje, ulja i losioni za zaštitu od sunca, preparati za brijanje, paste za zube, parfemi, toaletna voda, eterična ulja za ličnu upotrebu, parfemska ulja, preparati za njegu noktiju, lak za nokte, kamen za glačanje kože, pamučni štapići i vuneni tamponi za nemedicinske svrhe svi za upotrebu na tijelu, aromatični sobni mirisi, mirisni štapići, potpuri i kesice sa mirišljivim prahom, kozmetičke maramice sa puderom, maramice natopljene losionima, kompleti i poklon setovi koji sadrže preparate za njegu kože i / ili kose

Klasa 21: četke za kosu, sunđeri za tijelo, lufa sunđeri, držači za svijeće ne od dragocjenih metala, tegle, posude i držači za aromu ne od dragocjenih metala, češalice za leđa, atomizeri, kutije za puder, posude za sapun, držači za četkice, cjedila za čaj, kozmetički aplikatori i dodaci, naime četke za lice/tijelo, četke za šminku, četke i češljevi za oči, aplikatori za pjenu, sunđeri za šminku i puferi za puder

Klasa 35: maloprodajne usluge, online maloprodajne usluge, usluge- telešopa iz kuće, i kupovine iz kuće u vezi sa proizvodima za ljepotu, kozmetikom, toaletom, preparatima za njegu kože, preparatima za njegu kose, mirisi, i proizvodima za ličnu njegu, kompjuterizovane usluge on line poručivanja u vezi sa proizvodima za ljepotu, kozmetikom, preparatima za njegu kože, mirisima, i povezanim proizvodima

(210) **2013-412**

(442) **20.09.2014.**

(220) 10/3/2013

(731) **THE BODY SHOP INTERNATIONAL PLC**, WATERSMEAD, LITTLEHAMPTON WEST SUSSEX, BN17 6LS GB

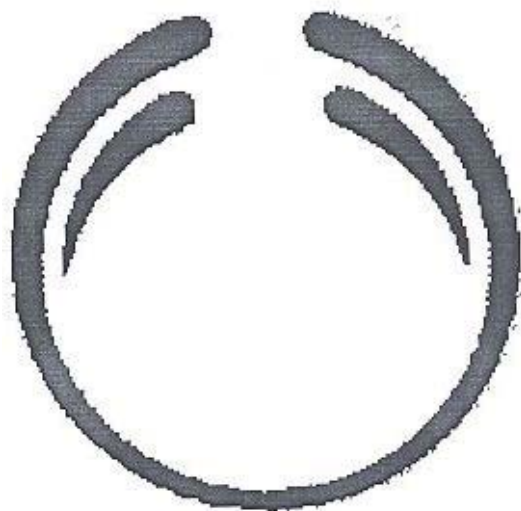

(540)

(550) I, F

(740) Popović Miladin, Đoka Miraševića 21/III, Podgorica ME

(511) **Klasa 03:** kozmetika i proizvodi za njegu kože, naime, podloga, korektor, maskara, sjenka za oči, olovke za oči i / ili obrve, ruž za usne, olovka za usne, balzam za usne, puder za lice, bronzer, rumenilo, ovlaživači, odstranjivač šminke, nemedicinski puder za tijelo, sapuni za kožu, gel za kupanje, ulja za kupanje, soli za kupanje, kuglice za kupanje, i preparati sa mehurićima za kupanje, nemedicinski preparati za njegu kože, naime, losioni, kreme, sredstva za čišćenje kože, pilinzi, maske i toneri, preparati za njegu kose i oblikovanje kose, naime, šamponi, regeneratori, završni sprej, i gelovi, dezodoransi za ličnu upotrebu, preparati za samopotamnjivanje, ulja i losioni za zaštitu od sunca, preparati za brijanje, paste za zube, parfemi, toaletna voda, eterična ulja za ličnu upotrebu, parfemska ulja, preparati za njegu noktiju, lak za nokte, kamen za glačanje kože, pamučni štapići i vuneni tamponi za nemedicinske svrhe svi za upotrebu na tijelu, aromatični sobni mirisi, mirisni štapići, potpuri i kesice sa mirišljavim prahom, kozmetičke maramice sa puderom, maramice natopljene losionima, kompleti i poklon setovi koji sadrže preparate za njegu kože i / ili kose

Klasa 21: četke za kosu, sunđeri za tijelo, lufa sunđeri, držači za svijeće ne od dragocjenih metala, tegle, posude i držači za aromu ne od dragocjenih metala, češalice za leđa, atomizeri, kutije za puder, posude za sapun, držači za četkice, cjedila za čaj, kozmetički aplikatori i dodaci, naime četke za lice/tijelo, četke za šminku, četke i češljevi za oči, aplikatori za pjenu, sunđeri za šminku i puferi za puder

Klasa 35: maloprodajne usluge, online maloprodajne usluge, usluge- telešopa iz kuće, i kupovine iz kuće u vezi sa proizvodima za ljepotu, kozmetikom, toaletom, preparatima za njegu kože, preparatima za njegu kose, mirisi, i proizvodima za ličnu njegu, kompjuterizovane usluge on line poručivanja u vezi sa proizvodima za ljepotu, kozmetikom, preparatima za njegu kože, mirisima, i povezanim proizvodima

(210) **2013-413**

(442) **20.09.2014.**

(220) 10/3/2013

(731) **THE BODY SHOP INTERNATIONAL PLC**, WATERSMEAD, LITTLEHAMPTON WEST SUSSEX, BN17 6LS GB

(540)

LOVE YOUR BODY

(550) I, F

(740) Popović Miladin, Đoka Miraševića 21/III, Podgorica ME

(511) **Klasa 09:** kodirane ili magnetne kartice za popuste, kodirane ili magnetne kartice za lojalnost

Klasa 16: kartice za popuste (drugačije od kodiranih ili magnetnih), kartice za lojalnost (drugačije od kodiranih ili magnetnih)

Klasa 35: organizovanje, rukovanje i nadziranje šema lojalnosti potrošača

Klasa 36: izdavanje tokena od vrednosti u odnosu na lojalnost potrošača

(210) **2013-414**

(442) **20.09.2014.**

(220) 10/4/2013

(731) **INDUSTRIJA PIVA I SOKOVA TREBJESA AD NIKŠIĆ, UL. NJEGOŠEVA BR.18 NIKŠIĆ ME**



(540)

(550) I

(740) Božović Vesko, Rimski trg 50/11, Podgorica ME

(511) **Klasa 32:** pivo, mineralne i sodne vode i druga bezalkoholna pića, pića od voća i voćni sokovi, sirupi i drugi preparati za proizvodnju pića

Klasa 35: oglašavanje, vođenje poslova, poslovno upravljanje, kancelarijski poslovi, obuhvata usluge koje pružaju lica ili organizacije u pomoći u radu ili upravljanju preduzećima i u vođenju poslova preduzeća, usluge koje pružaju preduzeća koja se bave oglašavanjem (reklamiranjem), tako što, za račun drugih lica, komuniciraju sa javnošću (reklama) putem prenosa bilo kakvih informacija o proizvodima i uslugama omogućavajući potrošačima prigodan pogled na te proizvode i usluge, usluge koje se sastoje od upisivanja, uređivanja, obrade, prerade ili sistematizacije pisanih informacija i zapisa, usluge reklamnih agencija, distribuciju prospekata i uzoraka direktno ili poštom, izradu i korišćenje matematičkih i statističkih podataka, organizovanje sajмова i izložbi u komercijalne ili reklamne svrhe

(210) **2013-416**

(442) **20.09.2014.**

(220) 10/9/2013

(731) **ABBOTT MEDICAL OPTICS INC. 1700 E.ST. ANDREW PLACE SANTA ANA CALIFORNIA 92705 US**

(540) BLINK CONTACTS

(550) I, V

(740) Popović Miladin, Đoka Miraševića 21/III, Podgorica ME

(511) **Klasa 05:** oftalmoloski preparati naime rastvori za podmazivanje i ponovno ovlaživanjež

(210) **2013-420**

(442) **20.09.2014.**

(220) 10/15/2013

(731) **PHARMACEUTICAL CHEMICAL COSMETIC INDUSTRY ALAKLOID-AD SKOPLJE**, BUL. ALEKSANDAR MAKEDONSKI 12, 1000 SKOPLJE RM



(540)

(550) I, F

(740) Popović Miladin, Đoka Miraševića 21/III, Podgorica ME

(511) **Klasa 03:** hidratantno mlijeko za tijelo s bademovim uljem, kamilicom i D-pantenolom

(210) **2013-421**

(442) **20.09.2014.**

(220) 10/15/2013

(731) **PHARMACEUTICAL CHEMICAL COSMETIC INDUSTRY ALAKLOID-AD SKOPLJE**, BUL. ALEKSANDAR MAKEDONSKI 12, 1000 SKOPLJE RM

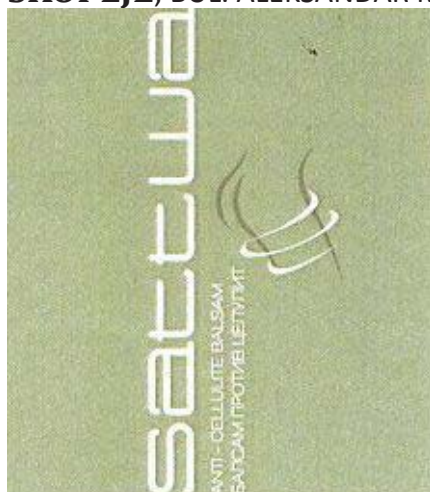

(540)

(550) I, F

(740) Popović Miladin, Đoka Miraševića 21/III, Podgorica ME

(511) **Klasa 03:** anticelulit balsam

(210) **2013-422**

(442) **20.09.2014.**

(220) 10/16/2013

(731) **HONDA MOTOR CO.LTD**, 1-1, MINAMI-AOYAMA 2-CHOME, MINATO-KU, TOKYO 107-8556 JP



(540)

(550) I

(740) Lutovac Branislav, Bulevar Crnojevića 93, Podgorica ME

(511) **Klasa 12:** motocikli i djelovi i oprema za njih(210) **2013-423**(442) **20.09.2014.**

(220) 10/16/2013

(731) **NOVARTIS AG**, 4002 BASEL CH

PROFEDOL

(540)

(550) I

(511) **Klasa 05:** farmaceutski preparati, naime analgetici, antiinflamatorni lekovi i antipiretici(210) **2013-424**(442) **20.09.2014.**

(220) 10/18/2013

(731) **MCG Montenegro** doo Budva, Jadranski put 31 ME,

DOM XXI

(540)

(550) I, V, F

(511) **Klasa 36:** građevinski objekti (upravljanje građevinskim objektima) imovina (upravljanje imovinom) iznajmljivanje kancelarija (nekretnine) nekretnine (davanje u zakup nekretnina) [lizing] nekretnine (upravljanje nekretninama) stanarine (naplata stanarina) stanovi (iznajmljivanje stanova) upravljanje građevinskim objektima upravljanje imovinom upravljanje nekretninama**Klasa 37:** građevinski radovi (nadzor građevinskih radova) informaije o graditeljstvu informacije o popravkama izgradnja (oglasi o izgradnji) izgradnja izgradnja štandova i prodavaonica izolovanje (usluga izolovanja) [građevinski radovi]**Klasa 42:** arhitektura, inženjering, izgradnja, (izgradnja građevinskih planova) planovi, (izrada građevinskih planova), savjeti o gradnji(210) **2013-425**(442) **20.09.2014.**

(220) 10/22/2013

(731) **E.I.DUPONT DE NEMOURS AND COMPANY**, 1007 MARKET STREET, WILMINGTON, DE 19898 US

EXPRESSSUN

(540)

(550) I

(740) Mladen Čolović, Podgorica, Crnogorskih Serdara bb,

(511) **Klasa 01:** geni tolerantni na herbicide koji se koriste u proizvodnji poljoprivrednih sjemena

(210) **2013-426**

(442) **20.09.2014.**

(220) 10/22/2013

(300) 2013714232 25.04.2013. RU

(731) **FASHION ONE TELEVISION LLC**, 820 MERIDIAN AVE, SUITE 100, MIAMI BEACH, FL, 33139 US

Fashion One

(540)

(550) I

(511) **Klasa 38:** televizijsko emitovanje

Klasa 41: televizijski programi za zabavu

(210) **2013-427**

(442) **20.09.2014.**

(220) 10/23/2013

(731) **RECKITT BENCKISER N.V.** SIRIUSDREEF 14 2132 WT HOOFDDORP NL

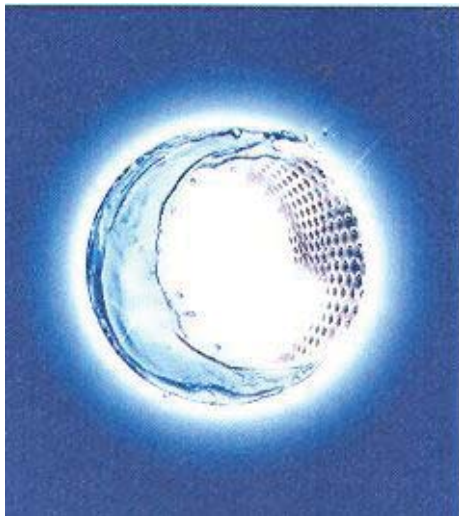

(540)

(550) I, F

(740) Popović Miladin, Đoka Miraševića 21/III, Podgorica ME

(511) **Klasa 01:** preparati za omekšavanje vode

Klasa 03: preparati za bijeljenje i ostale supstance za upotrebu u perionicama, deterdženti, sapuni, stirak za veš, plavilo za veš, preparati za perionice, preparati za pranje za hemijske čistione, sredstva za čišćenje tepiha, šamponi, preparati za dekalifikovanje i uklanjanje kamenca za kućne potrebe, omekšivači za tkanine, dodaci za pranje, preparati za uklanjanje fleka

Klasa 11: aparati za dekalifikaciju vode i uklanjanje kamenca, aparati za filtriranje vode, aparati za mekšanje vode, filteri za vodu, omekšivači za vodu, patrone za filtere za prečišćavanje i omekšavanje vode za kućnu upotrebu, filteri za prečišćavanje otpadnih voda

(210) **2013-428** (442) **20.09.2014.**

(220) 10/24/2013

(731) **BIOGEN IDEC MA INC.**(MASSACHUSTTS CORPRATION), 14 CAMBRIDGE CENTER, CAMBRIDGE, MASSACHUSETTS 02124 US



(540)

(550) I, F

(740) Radulović Božidar, Jovana Tomaševića 9/III, Podgorica ME

(511) **Klasa 05:** farmaceutski preparati za tretman neuroloških poremećaja

(210) **2013-429** (442) **20.09.2014.**

(220) 10/28/2013

(731) **MERCK SHARP & DOHME CORP.** ONE MERCK DRIVE, WHITEHOUSE STATION, NEW JERSEZ 08889, US

VYFONIT

(540)

(550) I

(740) AOD "Ćupić", Dalmatinska 10, Podgorica ME

(511) **Klasa 05:** farmaceutski preparati

(210) **2013-431** (442) **20.09.2014.**

(220) 10/28/2013

(731) **KAYLA FOODS INTL**(BARBADOS) INC. 27 PINE ROAD, BELLEVILLE, ST MICHAEL, BB11113, BARBADOS, W.I. BB

YOGEN FRÜZ

(540)

(550) I

(511) **Klasa 30:** zamrznute poslastice, zamrznuti jogurt

(210) **2013-432**

(442) **20.09.2014.**

(220) 10/29/2013

(731) **13 JUL-PLANTAŽE A.D.,** PODGORICA ME

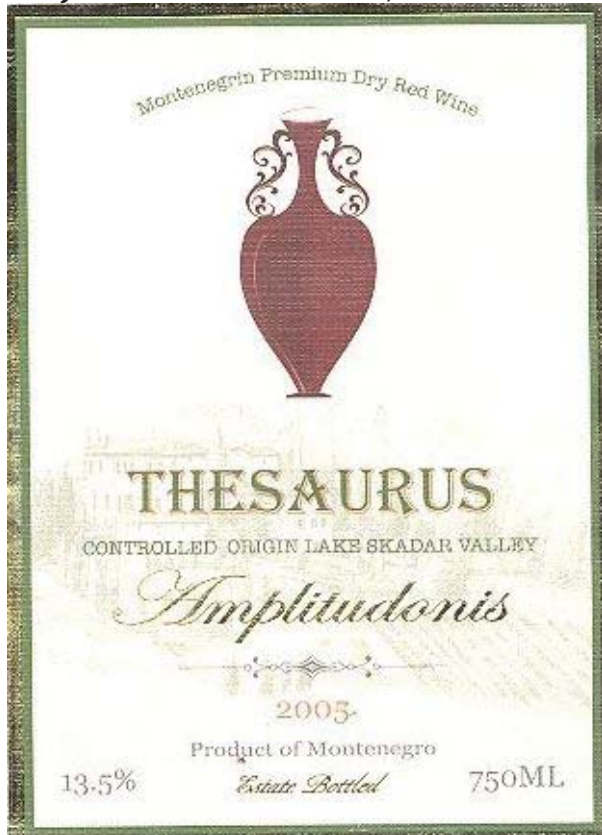

(540)

(550) I

(511) **Klasa 33:** alkoholna pića (izuzev piva)

(210) **2013-433**

(442) **20.09.2014.**

(220) 10/29/2013

(731) **13 JUL-PLANTAŽE A.D.,** PODGORICA ME

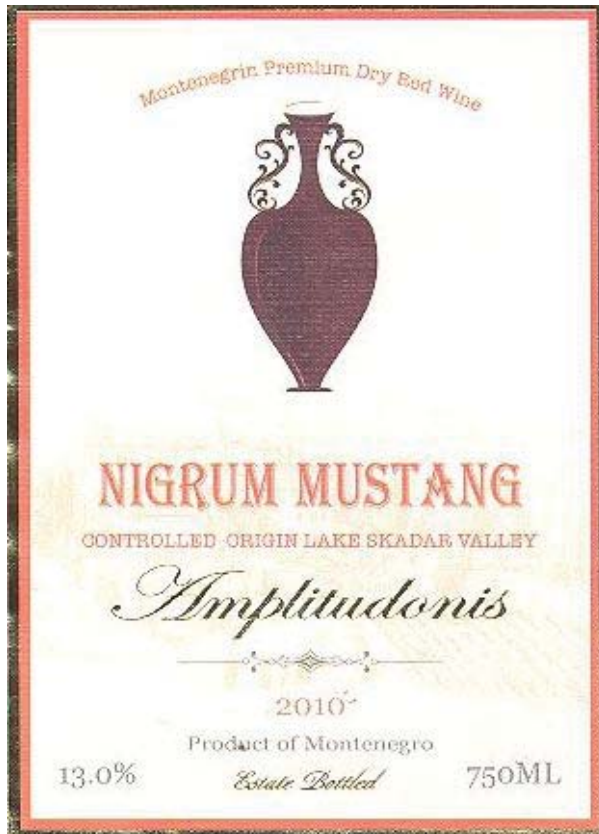

(540)

(550) I

(511) **Klasa 33:** alkoholna pića (izuzev piva)

(210) **2013-434**

(442) **20.09.2014.**

(220) 10/29/2013

(731) **13 JUL-PLANTAŽE A.D.,** PODGORICA ME

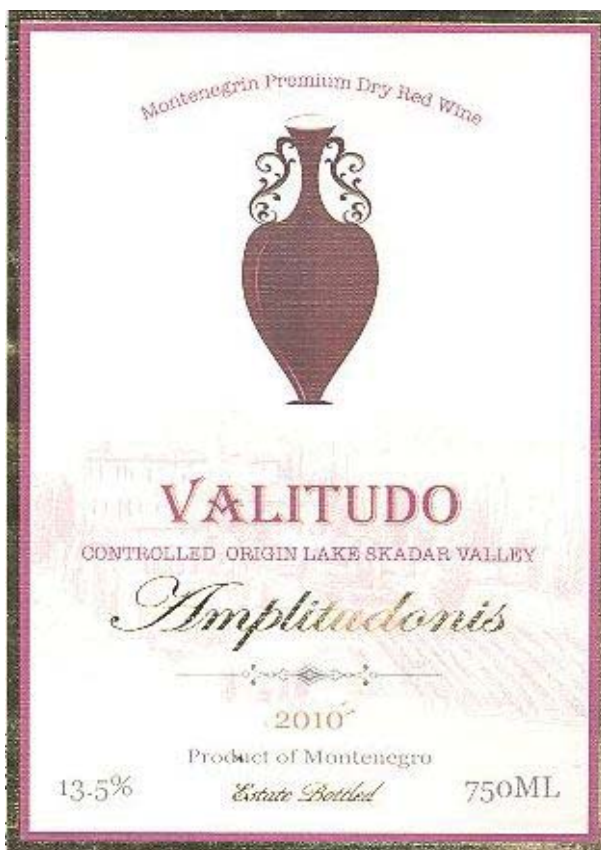

(540)

(550) I

(511) **Klasa 33:** alkoholna pića (izuzev piva)

(210) **2013-435**

(442) **20.09.2014.**

(220) 10/29/2013

(731) **13 JUL-PLANTAŽE A.D.,** PODGORICA ME

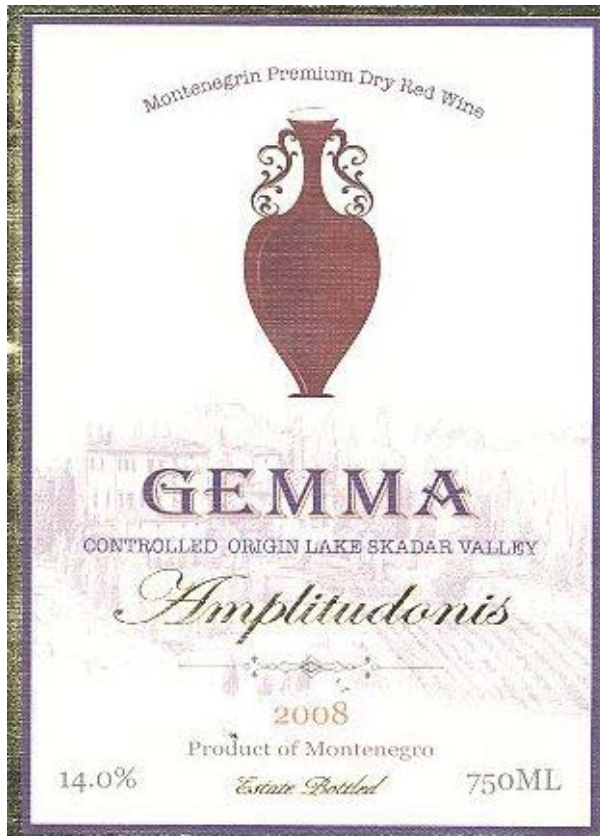

(540)

(550) I

(511) **Klasa 33:** alkoholna pića (izuzev piva)(210) **2013-436**(442) **20.09.2014.**

(220) 10/29/2013

(731) **CELGENE CORPRATION**, 86 MORRIS AVENUE, SUMMIT, NEW JERSEY 07901 US

Отезла

(540)

(550) I

(740) Jusić Jasna, Crnogorskih serdara bb, Podgorica ME

(511) **Klasa 05:** farmaceutske preparati, naime, lijekovi koji inhibiraju citokin; farmaceutske preparati koji podešavaju imuni sistem; farmaceutske preparati za liječenje hroničnih inflamatornih bolesti, ankilozirajućeg spondilitisa, psorijaze, psorijatičnog artritisa i kancera(210) **2013-437**(442) **20.09.2014.**

(220) 10/29/2013

(731) **ACTAVIS GROUP PTC EHF**. REZKJAVIKURVEGI 76-78, 220 HAFNARFJORDUR IS

ACTAWELL

(540)

(550) I

(740) Jusić Jasna, Crnogorskih serdara bb, Podgorica ME

(511) **Klasa 05:** farmaceutski preparati i supstance

(210) **2013-438**

(442) **20.09.2014.**

(220) 11/4/2013

(731) **ALEKSANDAR MILIČIĆ**, BULEVAR REVOLUCIJE 64, 81000 PODGORICA ME



(540)

(550) I

(511) **Klasa 35:** oglašavanje, vođenje poslova, poslovno upravljanje, kancelarijski poslovi

Klasa 36: osiguranje, finansijski poslovi, novčani (monetarni) poslovi, poslovi vezani za nepokretnosti

Klasa 41: obrazovne usluge, pripremanje obuke, razonoda, sportske i kulturne aktivnosti

(210) **2013-439**

(442) **20.09.2014.**

(220) 11/4/2013

(731) **PHILIP MORRIS PRODUCTS S.A.** QUAI JEANRENAUD 3, NEUCHATEL 2000 CH

LOFT BLUE

(540)

(550) I

(740) Rončević Milena, Bulevar Svetog Petra Cetinjskog 130/VII, Podgorica ME

(511) **Klasa 34:** duvan, sirov ili prerađen, duvanski proizvodi, naročito cigare, cigarete, cigarilosi/male cigarete, duvan za uvijanje cigareta, duvan za lule, duvan za žvakanje, duvan za šmrkanje, kretek, snus (duvan u prahu), zamena za duvan (za nemedicinsku upotrebu), artikli za pušače, naročito papir za cigarete i lule, filteri za cigarete, kutije za duvan (od neplemenitih metala), tabakere (kutije za cigarete) i pepeljare (od neplemenitih metala), lule, ručni aparati/spravice za uvijanje cigareta, upaljači, šibice

(210) **2013-440**

(442) **20.09.2014.**

(220) 11/4/2013

(731) **PHILIP MORRIS PRODUCTS S.A.** QUAI JEANRENAUD 3, NEUCHATEL 2000 CH

LOFT SEA BLUE

(540)

(550) I

(740) Rončević Milena, Bulevar Svetog Petra Cetinjskog 130/VII, Podgorica ME

(511) **Klasa 34:** duvan, sirov ili prerađen, duvanski proizvodi, naročito cigare, cigarete, cigarilosi/male cigarete, duvan za uvijanje cigareta, duvan za lule, duvan za žvakanje, duvan za šmrkanje, kretek, snus (duvan u prahu), zamena za duvan (za nemedicinsku upotrebu), artikli za pušače, naročito papir za cigarete i lule, filteri za cigarete, kutije za duvan (od neplemenitih metala), tabakere (kutije za cigarete) i pepeljare (od neplemenitih metala), lule, ručni aparati/sprave za uvijanje cigareta, upaljači, šibice

(210) **2013-441**

(442) **20.09.2014.**

(220) 11/6/2013

(731) **SAMSUNG ELECTRONIC CO.LTD**, 129, SAMSUNG-RO YEONTONG-GU SUWON-SI GYEONGGI-DO RK



(540)

(550) I

(740) Popović Miladin, Đoka Miraševića 21/III, Podgorica ME

(511) **Klasa 35:** administriranje programa lojalnosti koji se nude prodavcima, prodajnim organizacijama i distributerima uz davanje podsticaja, nagradili bodova i rabata

(210) **2013-442**

(442) **20.09.2014.**

(220) 11/6/2013

(731) **DRAFTFCB, INC**, 100 WEST 33RD STREET, NEW YORK, NY 10001 US

FCB

(540)

(550) I

(740) AOD "Ćupić", Dalmatinska 10, Podgorica ME

(511) **Klasa 35:** usluge agencija za oglašavanje, usluge oglašavanja, marketinške i promotivne usluge, usluge odnosa sa javnošću, marketing događaja (event-marketing), priprema i plasiranje reklama, medijske usluge, kupovina medijskog prostora i medijsko plasiranje, analiza i istraživanje tržišta, usluge ispitivanja javnog mnjenja, usluge direktnog marketinga, usluge unapređenja prodaje (sales promotion), poslovne savjetodavne usluge u vezi sa

sponzorstvom i franšizingom, usluge poslovnog menadžmenta i savjetovanja, usluge poslovnog informisanja i istraživanja, poslovne savjetodavne usluge

(210) **2013-443** (442) **20.09.2014.**

(220) 11/6/2013

(731) **DRAFTFCB, INC**, 100 WEST 33RD STREET, NEW YORK, NY 10001 US

FOOTE, CONE & BELDING

(540)

(550) I

(740) AOD "Ćupić", Dalmatinska 10, Podgorica ME

(511) **Klasa 35:** usluge agencija za oglašavanje, usluge oglašavanja, marketinške i promotivne usluge, usluge odnosa sa javnošću, marketing događaja (event-marketing), priprema i plasiranje reklama, medijske usluge, kupovina medijskog prostora i medijsko plasiranje, analiza i istraživanje tržišta, usluge ispitivanja javnog mnjenja, usluge direktnog marketinga, usluge unapređenja prodaje (sales promotion), poslovne savjetodavne usluge u vezi sa sponzorstvom i franšizingom, usluge poslovnog menadžmenta i savjetovanja, usluge poslovnog informisanja i istraživanja, poslovne savjetodavne usluge

(210) **2013-444** (442) **20.09.2014.**

(220) 11/7/2013

(731) **DOO ZA VAZDUŠNI SAOBRAČAJ, TURIZAM I USLUGE "AIRSERBIA"**, AERODROMSKA 11, 81000 PODGORICA ME



(540)

(550) I

(511) **Klasa 36:** usluge izdavanja putnih čekova ili kreditnih pisama od strane posrednika ili putnih agencija

Klasa 39: usluge iznajmljivanja prevoznih sredstava. usluge obavještanja o cijeni i načinu prevoza i voznom redu

(210) **2013-445** (442) **20.09.2014.**

(220) 11/7/2013

(731) **HOLT`SCOMPANZ** (DELAWARE CORPRATION), 1105 N.MARKET STREET, SUITE 1300, WILMINGTON, DELAWARE 19801 US

LA AROMA DEL CARIBE

(540)

(550) I

(740) Radulović Božidar, Jovana Tomaševića 9/III, Podgorica ME

(511) **Klasa 34:** cigare(210) **2013-446**(442) **20.09.2014.**

(220) 11/7/2013

(731) **HOLT`SCOMPANZ** (DELAWARE CORPRATION), 1105 N.MARKET STREET, SUITE 1300, WILMINGTON, DELAWARE 19801 US

PARADISO

(540)

(550) I

(740) Radulović Božidar, Jovana Tomaševića 9/III, Podgorica ME

(511) **Klasa 34:** cigare(210) **2013-447**(442) **20.09.2014.**

(220) 11/8/2013

(731) **KIA MOTORS CORPRATION**, 231, YANGJAE-DONG, SEOCHO-GU, SEUL KR

(540)

(550) I

(740) Sekulić Vuk, Bulevar Despota Stefana 1a, Beograd SR

(511) **Klasa 12:** automobili, kamioni, autobusi na motorni pogon, minibusevi, automobili sa pogonom na četiri točka, kombiji, mini kombiji, vozila namenjena za sportske namene, motori za suvozemna vozila, pogonski motori za suvozemna vozila, ručke za vrata automobila, vazdušni jastuci za automobile, vetrobranski brisači, navlake za automobilske motore, vazdušne pumpe za automobile, pokazivači smera za automobile, protiv zaslepljujući uređaji za automobile, retrovizori za automobile, branici za automobile, automobilske šasije (karoserije), vetrobranska stakla, bezbednosna sedišta za decu, za automobile, upravljači (volani) za automobile, pragovi za automobile, točkovi za automobile, presvlake za sedišta za automobile, sigurnosni pojasevi za vozila, vozila na električni pogon, strukturni delovi i oprema za automobile

(210) **2013-449**(442) **20.09.2014.**

(220) 11/11/2013

(731) **TEAVANA CORPRATION**, SUITE 1438, 3630 PEACHTREE ROAD, NE, 30326 ATLANTA, GEORGIA US

TEAVANA

(540)

(550) I

(740) Jusić Jasna, Crnogorskih serdara bb, Podgorica ME

(511) **Klasa 43:** restorani, kafići, kafeterije, snek barovi, čajni barovi i kuće čaja, sobe čaja, usluge restorana sa hranom za ponijeti, katering usluge, usluge pravljenja hrane po ugovoru, priprema hrane i pića

(210) **2013-450**

(442) **20.09.2014.**

(220) 11/11/2013

(731) **TEAVANA CORPRATION**, SUITE 1438, 3630 PEACHTREE ROAD, NE, 30326 ATLANTA, GEORGIA US



(540)

(550) I

(740) Jusić Jasna, Crnogorskih serdara bb, Podgorica ME

(511) **Klasa 30:** čajevi i mješavine čaja, slatkiši, naime mentol bombone sa ukusom čaja, med u obliku kašike, napici na bazi biljnog čaja, napici i koncentрати na bazi čaja i biljnog čaja, sa ukusom voća, smrznute poslastice sa ukusom čaja, biljnog čaja i voća, kakao, biljni i čaj koji nije od bilja, čaj, kakao i napici, napici napravljeni na bazi čokolade u prahu i napici napravljeni na bazi vanile, sosevi koji se dodaju napicima, čokoladni sirup, sirupi sa ukusima koji se dodaju napicima, čaj koji je spreman za piće, sladoled i smrznute poslastice, naime sladoled, smrznuto mleko, smrznuti jogurt, smrznuti dezerti na bazi soje, bombone i poslastice, naime, čokolada, šećer, bombone sa bademom, i smrznute poslastice, pekarski proizvodi, naime, mafini, korneti, biskviti, keksi, peciva i hlebovi, hranljive štanglice, naime, hranljive štanglice na bazi žitarica, i hranljive štanglice na bazi ovasa, šećer, začini, med, agava, sirupi sa ukusima za pravljenje napitaka

Klasa 35: poslovna administracija, poslovno upravljanje, franšizing, naime, pružanje tehničke pomoću u uspostavljanju i radu restorana, kafica, kuća čaja, i snek barova, maloprodajne usluge u oblasti: kafe, čaja, kakaoa, upakovane i gotove hrane, električnih i neelektričnih aparata u vezi sa čajem, predmeta za kuću, kuhinjskog pribora, staklenog posuda, poklona, tanjira, činija, kutija za čuvanje hrane, skulptura, figurica, dekorativnih ukrasa, odeće, sveća, tamjana, mirisa za kuću, proizvoda za ličnu higijenu, muzičkih zapisa i knjiga, distribucija na veliko, veleprodajni objekti i usluge naručivanja na veliko u oblasti: kafe, čaja, kakaoa,

upakovane i gotove hrane, električnih i neelektričnih aparata u vezi sa čajem, predmeta za kuću, kuhinjskog pribora, staklenog posuda, poklona, tanjira, činija, kutija za čuvanje hrane, skulptura, figurica, dekorativnih ukrasa, odeće, sveća, tamjana, mirisa za kuću, proizvoda za ličnu higijenu, muzičkih zapisa i knjiga, usluge naručivanja poštom i usluge naručivanja poštom preko kataloga, usluge onlajn naručivanja putem računara, usluge onlajn prodaje na malo putem računara preko direktnog posredovanja od strane prodavaca ka krajnjim korisnicima, usluge onlajn naručivanja i usluge onlajn prodaje na malo sve u oblasti: kafe, čaja, kakaoa, upakovane i gotove hrane, električnih i neelektričnih aparata u vezi sa čajem, predmeta za kuću, kuhinjskog pribora, staklenog posuda, poklona, tanjira, činija, kutija za čuvanje hrane, skulptura, figurica, dekorativnih ukrasa, odeće, sveća, tamjana, mirisa za kuću, proizvoda za ličnu higijenu, muzičkih zapisa i knjiga, usluge u vezi sa kompjuterizovanim onlajn listama poklona i usluge naručivanja lista poklona

Klasa 43: restorani, kafići, kafeterije, snek barovi, čajni barovi i kuće čaja, sobe čaja, usluge restorana sa hranom za ponijeti, catering usluge, usluge pravljenja hrane po ugovoru, priprema hrane i pića

(210) **2013-451**

(442) **20.09.2014.**

(220) 11/11/2013

(731) **TEAVANA CORPRATION**, SUITE 1438, 3630 PEACHTREE ROAD, NE, 30326 ATLANTA, GEORGIA US

TEAVANA

(540)

(550) I

(740) Jusić Jasna, Crnogorskih serdara bb, Podgorica ME

(511) **Klasa 30:** čajevi i mješavine čaja, slatkiši, naime mentol bombone sa ukusom čaja, med u obliku kašike, napici na bazi biljnog čaja, napici i koncentрати na bazi čaja i biljnog čaja, sa ukusom voća, smrznute poslastice sa ukusom čaja, biljnog čaja i voća, kakao, biljni i čaj koji nije od bilja, čaj, kakao i napici, napici napravljeni na bazi čokolade u prahu i napici napravljeni na bazi vanile, sosevi koji se dodaju napicima, čokoladni sirup, sirupi sa ukusima koji se dodaju napicima, čaj koji je spreman za piće, sladoled i smrznute poslastice, naime sladoled, smrznuto mleko, smrznuti jogurt, smrznuti dezerti na bazi soje, bombone i poslastice, naime, čokolada, šećer, bombone sa bademom, i smrznute poslastice, pekarski proizvodi, naime, mafini, korneti, biskviti, keksi, peciva i hlebovi, hranljive štanglice, naime, hranljive štanglice na bazi žitarica, i hranljive štanglice na bazi ovasa, šećer, začini, med, agava, sirupi sa ukusima za pravljenje napitaka

Klasa 35: poslovna administracija, poslovno upravljanje, franšizing, naime, pružanje tehničke pomoću u uspostavljanju i radu restorana, kafica, kuća čaja, i snek barova, maloprodajne usluge u oblasti: kafe, čaja, kakaoa, upakovane i gotove hrane, električnih i neelektričnih aparata u vezi sa čajem, predmeta za kuću, kuhinjskog pribora, staklenog posuda, poklona, tanjira, činija, kutija za čuvanje hrane, skulptura, figurica, dekorativnih ukrasa, odeće, sveća, tamjana, mirisa za kuću, proizvoda za ličnu higijenu, muzičkih zapisa i knjiga, distribucija na veliko, veleprodajni objekti i usluge naručivanja na veliko u oblasti: kafe, čaja, kakaoa, upakovane i gotove hrane, električnih i neelektričnih aparata u vezi sa čajem, predmeta za kuću, kuhinjskog pribora, staklenog posuda, poklona, tanjira, činija, kutija za čuvanje hrane, skulptura, figurica, dekorativnih ukrasa, odeće, sveća, tamjana, mirisa za kuću, proizvoda za ličnu higijenu, muzičkih zapisa i knjiga, usluge naručivanja poštom i usluge naručivanja poštom preko kataloga, usluge onlajn naručivanja putem računara, usluge onlajn prodaje na malo putem računara preko direktnog posredovanja od strane prodavaca ka krajnjim

korisnicima, usluge onlajn naručivanja i usluge onlajn prodaje na malo sve u oblasti: kafe, čaja, kakaoa, upakovane i gotove hrane, električnih i neelektričnih aparata u vezi sa čajem, predmeta za kuću, kuhinjskog pribora, staklenog posuda, poklona, tanjira, činija, kutija za čuvanje hrane, skulptura, figurica, dekorativnih ukrasa, odeće, sveća, tamjana, mirisa za kuću, proizvoda za ličnu higijenu, muzičkih zapisa i knjiga, usluge u vezi sa kompjuterizovanim onlajn listama poklona i usluge naručivanja lista poklona

(210) **2013-452** (442) **20.09.2014.**

(220) 11/11/2013

(731) **NVO "UDRUŽENJE STUDENATA EKONOMIJE I MENADŽMENTA AIESEC CRNA GORA"**, UL, JOVANA TOMAŠEVIĆA 37, 81000, PODGORICA ME



(540) |

(550) I

(511) **Klasa 41:** obrazovne usluge, pripremanje obuke, razonoda, sportske i kulturne aktivnosti

(210) **2013-453** (442) **20.09.2014.**

(220) 11/14/2013

(731) **HEMOFARM AD FARMACEUTSKO-HEMIJSKA INDUSTRIJA VRŠAC**, BEOGRADSKI PUT BB, 26300 VRŠAC, RS

(540) **REXIT**

(550) I

(740) Sekulić Vuk, Bulevar Despota Stefana 1a, Beograd SR

(511) **Klasa 05:** farmaceutski i veterinarski preparati, sanitarni preparati za medicinsku upotrebu, dijetetske supstance prilagođene za upotrebu u medicini, hrana za bebe, flasteri, materijali za zavijanje, materijali za plombiranje zuba, zubarska smola, dezinfekciona sredstva, preparati za uništavanje štetočina, fungicidi, herbicidi

(210) **2013-454** (442) **20.09.2014.**

(220) 11/14/2013

(731) **PHARMACEUTICAL CHEMICAL COSMETIC INDUSTRZ ALKALOID AD SKOPLJE**, BUL. ALEKSANDAR MAKEDONSKI 12, 1000 SKOPLJE RM



(540) |

(550) I, V

(740) Popović Miladin, Đoka Miraševića 21/III, Podgorica ME

(511) **Klasa 03:** vlažne maramice

(210) 2013-455

(442) 20.09.2014.

(220) 11/14/2013

(731) PHARMACEUTICAL CHEMICAL COSMETIC INDUSTRZ ALKALOID AD SKOPLJE, BUL. ALEKSANDAR MAKEDONSKI 12, 1000 SKOPLJE RM



(540)

(550) I, V

(740) Popović Miladin, Đoka Miraševića 21/III, Podgorica ME

(511) **Klasa 03:** vlažne maramice

(210) 2013-456

(442) 20.09.2014.

(220) 11/15/2013

(731) **TELENOR** D.O.O. RIMSKI TRG BR.4 PODGORICA ME

(540)

(550) I

(511) **Klasa 35:** oglašavanje, poslovna istraživanja, lijepljenje oglasa, širenje reklamnog sadržaja, prezentacija robe, oglašavanje putem pošte, poslovna istraživanja (ispitivanja), reklamiranje, televizijske reklame, oglašavanje preko televizije, marketinška istraživanja, ispitivanje javnog mnjenja, sakupljanje informacija u kompjutersku bazu podataka, sistematizacija informacija u kompjutersku bazu podataka, reklamiranje na informatičkoj mreži, iznajmljivanje vremena za reklamiranje u svim sredstvima komunikacije, potrošači (pružanje komercijalnih savjeta i informacija potrošačima), savjeti za potrošače, usluge telekomunikacija, reklamni filmovi, marketing

Klasa 38: telekomunikacije, informacija o telekomunikacijama, usluge elektronskog biltena (telekomunikacione usluge), emitovanje televizijskih programa, emitovanje radio programa, telefonske komunikacije, prenos poruka i slika preko kompjutera, elektronska pošta, prenos faksimilom

Klasa 41: obrazovne usluge, pripremanje obuke, razonoda, kulturne aktivnosti, zabava, organizovanje zabavnih ili vaspitnih takmičenja, obrazovne usluge, podučavanje, savjetodavne usluge, nastava, obuka, produkcija radio i televizijskih programa, produkcija predstava, zabava preko televizije, informacije, obrazovne, ispiti iz oblasti obrazovanja, informacije iz oblasti zabave i razonode, organizovanje izložbi za kulturne ili obrazovne potrebe, izvođenje nastupa u živo, izvođenje predstava u živo, treninzi, demonstracije, priprema (organizovanje) i vođenje seminara, produkcija video filmova, priprema (organizovanje) i vođenje radionica za obuku, elektronsko izdavaštvo, elektronske publikacije (usluge iskorišćavanja elektronskih publikacija koje se ne mogu kopirati), profesionalna orijentacija (obrazovanje i saveti pri obuci), priprema (organizovanje) i vođenje koncerata

(210) **2013-457** (442) **20.09.2014.**

(220) 11/15/2013

(731) **BEATSELECTRONICS**, LLC DELAWARE LIMITED LIABILITY COMPANY, 1601 CLOVERFIELD BLVD, SUITE 5000N, SANTA MONICA, CA 90404 US

SOLO

(540)

(550) I, V

(740) Radulović Božidar, Jovana Tomaševića 9/III, Podgorica ME

(511) **Klasa 09:** slušalice, slušalice koje se stavljaju u uši, zvučnici, audio zvučnici, audio kablovi, zvučnici za automobile, medija plejeri za automobile, digitalni audio plejeri za automobile, mobilni telefoni, laptop kompjuteri

(210) **2013-458** (442) **20.09.2014.**

(220) 11/15/2013

(300) 9 T1307878D, 17.05.2013. SG 38 T1308063J, 21.05.2013. SG

(731) **MOTOROLA TRADEMARK HOLDINGS**, LLC, 600 NORTH US HIGHWAY 45, LIBERTYVILLE, IL 60048 US

MOTO

(540)

(550) I

(740) Jusić Jasna, Crnogorskih serdara bb, Podgorica ME

(511) **Klasa 09:** telefoni, mobilni telefoni, pametni telefoni, tablet računari, računari, ručni i mobilni digitalni elektronski uređaji za bežičnu komunikaciju, radio telefoni, pejdžeri, ručne radio stanice, radio predajnici, radio prijemnici, radio primopredajnici, elektronski planeri i dodatna oprema za sljedeće robe, naime, slušalice sa mikrofonom, slušalice, mikrofoni, zvučnici, kofer za nošenje, zaštitne kutije i navlake, zaštitne ili dekorativne futrole, kopče za kačenje na kaiš, nosači za elektronske uređaje, postolja i konzole za mobilne telefone, tablete, ručne računare i ručne i mobilne digitalne elektronske uređaje za bežičnu komunikaciju, kablovi i konektori i tastature, radio bazne stanice, prekidači, ruteri, računari, računarski softver i programi koji se koriste za prenos ili reprodukciju ili prijem zvuka, slika, video zapisa ili podataka putem telekomunikacijske mreže ili sistema između terminala i za bolje i lakše korištenje i pristup računarskim i telefonskim mrežama, računarski softver za upravljanje bazom podataka za opšte namjene, računarski softver za elektronsko poslovanje koji omogućava korisniku u oblasti elektronskih poslovnih transakcija bezbjedno slanje narudžbenica i plaćanja putem globalne računarske mreže ili telekomunikacione

mreže, računarski softver za obuku i podršku proizvodima kao što su računari i mobilni telefoni u oblasti komunikacija, računarski softver sa korisnim alatima pomoću kojih se održava rad računara, softver za računarske igrice za slušalice mobilnog telefona, računarski softver i programi za muziku, filmove, animacije, elektronske knjige, igrice u oblasti opšte zabave, računarski softver za distribuciju informativnog i interaktivnog multimedijalnog sadržaja koji se sastoji od teksta, slika, video i zvučnog sadržaja namijenjenog korisnicima u oblasti telekomunikacija, računarski softver i programi za upravljanje i rad bežičnih telekomunikacionih uređaja, računarski softver za pristup, pretraživanje, označavanje i ponovno vraćanje informacija i podataka sa globalnih računarskih mreža i globalnih komunikacijskih mreža i za pretraživanje i navigaciju po mrežnim sajtovima na pomenutim mrežama, računarski softver za slanje i primanje kratkih poruka i elektronske pošte i za filtriranje netekstualnih informacija iz podataka, analogni i digitalni radio primopredajnici ili prijemnici za podatke, glas, sliku i video komunikaciju, modemi, uređaji za globalno pozicioniranje, baterije, punjači za baterije, adapteri i antene, fotoaparati, digitalni fotoaparati, digitalne video kamere, nosivi računarski periferali, lični nosivi i razmjenjivi elektronski moduli, naime lični identifikatori za telefone, mobilne telefone, pametne telefone, tablete, računare i ručne i mobilne elektronske uređaje za bežičnu komunikaciju

Klasa 38: telekomunikacije, usluge bežične i digitalne komunikacije, televizijsko emitovanje, elektronske glasovne poruke, video konferencije, elektronski prenos glasa, video zapisa, slika, poruka i podataka, slanje tekstualnih poruka, obezbjeđivanje pristupa telekomunikacionoj mreži, nadziranje i upravljanje mrežom, planiranje telekomunikacione mreže, radijsko emitovanje, obezbjeđivanje telekomunikacionih veza sa globalnom računarskom mrežom, obezbjeđivanje pristupa globalnoj računarskoj informacionoj mreži za više korisnika preko računara i ručnih i mobilnih digitalnih elektronskih uređaja za bežičnu komunikaciju, iznajmljivanje i lizing telekomunikacionih mreža i telekomunikacionih aparata, naime, baznih stanica koje se sastoje od antena i antenskih stubova, predajnika, prijemnika, obrađivača signala, mikrotalasnih radio veza, kablovskih veza, dovoda električne struje i kućišta, kontrolora elektronskih baznih stanica, usmjerenih antena, mikrotalasnih radija, telefonskih razmjena, prenosne opreme za korištenje u komunikacijama, pristupnih čvorova, uređaja za prebacivanje za telekomunikacione namjene, servera, rutera, kartica sa podacima, modema, multipleksera, električnih kablova i optičkih kablova

(210) **2013-459** (442) **20.09.2014.**

(220) 11/18/2013

(731) **HEMOFARM A.D.** FARMACEUTSKO-HEMIJSKA INDUSTRIJA VRŠAC, BEOGRADSKI PUT BB, 26300 VRŠAC SR

TREFERO

(540)

(550) I

(740) Sekulić Vuk, Bulevar Despota Stefana 1a, Beograd SR

(511) **Klasa 05:** farmaceutski i veterinarski preparati, sanitarni preparati za medicinsku upotrebu, dijetetske supstance prilagođene za upotrebu u medicini, hrana za bebe, flasteri, materijali za zavijanje, materijali za plombiranje zuba, zubarska smola, dezinfekciona sredstva, preparati za uništavanje štetočina, fungicidi, herbicidi

(210) **2013-460** (442) **20.09.2014.**

(220) 11/18/2013

(731) **HEMOFARM A.D.** FARMACEUTSKO-HEMIJSKA INDUSTRIJA VRŠAC, BEOGRADSKI PUT

BB, 26300 VRŠAC SR

TAITA

(540)

(550) I

(740) Sekulić Vuk, Bulevar Despota Stefana 1a, Beograd SR

(511) **Klasa 05:** farmaceutske proizvodi za humanu upotrebu na bazi supstance duloksetin, koji se naročito koriste u terapiji depresije, generalizovanog anksioznog poremećaja, bola kod dijabetične neuropatije

(210) **2013-461**

(442) **20.09.2014.**

(220) 11/19/2013

(731) **PHILIP MORRIS PRODUCTS S.A.** QUAI JEANRENAUD 3, NEUCHATEL 2000 CH



(540)

(550) I, F

(740) Rončević Milena, Bulevar Svetog Petra Cetinjskog 130/VII, Podgorica ME

(511) **Klasa 34:** duvan, sirov ili prerađen, duvanski proizvodi, naročito cigare, cigarete, cigarilosi/male cigarete, duvan za uvijanje cigareta, duvan za lule, duvan za žvakanje, duvan za šmrkanje, kretek, snus (duvan u prahu), zamena za duvan (za nemedicinsku upotrebu), artikli za pušače, naročito papir za cigarete i lule, filteri za cigarete, kutije za duvan (od neplemenitih metala), tabakere (kutije za cigarete) i pepeljare (od neplemenitih metala), lule, ručni aparati/spravice za uvijanje cigareta, upaljači, šibice

(210) **2013-462**

(442) **20.09.2014.**

(220) 11/19/2013

(731) **PHILIP MORRIS PRODUCTS S.A.** QUAI JEANRENAUD 3, NEUCHATEL 2000 CH



(540)

(550) I, F

(740) Rončević Milena, Bulevar Svetog Petra Cetinjskog 130/VII, Podgorica ME

(511) **Klasa 34:** duvan, sirov ili prerađen, duvanski proizvodi, naročito cigare, 'cigarete, cigarilosi/male cigarete, duvan za uvijanje cigareta, duvan za lule, duvan za žvakanje, duvan za šmrkanje, kretek, snus (duvan u prahu), zamena za duvan (za nemedicinsku upotrebu), artikli za pušače, naročito papir za cigarete i lule, filteri za cigarete, kutije za duvan (od neplemenitih metala), tabakere (kutije za cigarete) i pepeljare (od neplemenitih metala),

lule, ručni aparati/spravice za uvijanje cigareta, upaljači, šibice

(210) **2013-463** (442) **20.09.2014.**

(220) 11/19/2013

(731) **SAPONIA** KEMIJSKA, PREHRABENA, I FARMACEUTSKA INDUSTRIJA D.D. MATIJE GUPCA 2, OSIJEK HR

B-SAFE

(540)

(550) I, V

(740) Radulović Božidar, Jovana Tomaševića 9/III, Podgorica ME

(511) **Klasa 03:** sapuni, tekući sapuni, kreme za njegu kože ruku nakon pranja, kreme za njegu kože ruku prije pranja, zaštitna krema za njegu kože ruku

(210) **2013-464** (442) **20.09.2014.**

(220) 11/19/2013

(731) **SAPONIA** KEMIJSKA, PREHRABENA, I FARMACEUTSKA INDUSTRIJA D.D. MATIJE GUPCA 2, OSIJEK HR



(540)

(550) I, V

(740) Radulović Božidar, Jovana Tomaševića 9/III, Podgorica ME

(511) **Klasa 03:** sapuni, tekući sapuni, kreme za njegu kože ruku nakon pranja, kreme za njegu kože ruku prije pranja, zaštitna krema za njegu kože ruku

(210) **2013-465** (442) **20.09.2014.**

(220) 11/19/2013

(731) **PZ CUSSONS INTERNATIONAL LIMITED**, MANCHESTER BUSINESS PARK, 3500 AVIATOR WAZ, MANSHESTER, M22 5TG GB

(540) **MORNING FRESH**

(550) V

(740) Anđelić Branislav, Svetozara Markovića 12, Podgorica ME

(511) **Klasa 03:** preparati za beljenje, čišćenje, poliranje, ispiranje i ribanje, sredstva za skidanje kamenca, preparati za pranje veša, deterdženti, tečnosti za pranje sudova, preparati za pranje sudova u mašini uključujući tečnosti, praškove i tablete, tečni deterdženti za pranje

posuđa, pribora za jelo i / ili drugih artikala za upotrebu pri služenju i konzumiranju hrane i pića

(210) **2013-466** (442) **20.09.2014.**

(220) 11/19/2013

(731) **VISA INTERNATIONAL SERVICE ASSOCIATION**, 900 METRO CENTER BOULEVARD, FOSTER CITZ, CALIFORNIA, 94404 US

**VISA. EVERYWHERE YOU
WANT TO BE**

(540)

(550) I

(740) Jusić Jasna, Crnogorskih serdara bb, Podgorica ME

(511) **Klasa 36:** finansijske usluge, usluge osiguranja, bankarske usluge, usluge kreditnih kartica i debitnih kartica, usluge punjenja kartica, usluge kartica za plaćanja unaprijed, usluge smart kartica, elektronske kreditne i platne transakcije, elektronski transfer sredstava, usluge obrade plaćanja, usluge autentičnosti i verifikacija transakcija, zamjena za gotovinu uslugama kreditnih i debitnih kartica, usluge mjenjačnice, usluge online bankarstva, usluge platnog računa, usluge pristupa depozitu i automatizovanih šalter mašina, usluge unovčavanja čekova i isplata gotovine, širenje finansijskih informacija putem globalne računarske mreže i finansijskog sponzorstva sportskih takmičenja, događaja, aktivnosti, i igara

(210) **2013-467** (442) **20.09.2014.**

(220) 11/19/2013

(731) **HELLENICA COSMETIC PRODUCTS EXPLOITATION S.A.** 7, Chimaras str.151 25 Maroussi, Athens GR

SEVENTEEN / HELLENICA

(540)

(550) I

(740) Jusić Jasna, Crnogorskih serdara bb, Podgorica ME

(511) **Klasa 03:** sapuni, šamponi, preparati za njegu kose, farbe za kosu, tonici za kosu, losioni, preparati za oblikovanje kose, ulja, talk, puder za šminku, preparati za šminku, tečni puder, kreme za lice, kreme za tijelo, lak za nokte, ruž za usne, parfemi, kolonjske vode, dezodoransi i antiperspiranti, kreme i gelovi za bijanje, preparati za sunčanje, preparati protiv bora, kozmetika

(210) **2013-468** (442) **20.09.2014.**

(220) 11/21/2013

(731) **SOFA-BED** D.O.O. DZORDŽA WAŠINGTONA 3/21 PODGORICA ME



SOFA·BED

(540)

(550) I, V

(511) **Klasa 35:** oglašavanje i reklamiranje, vođenje komercijalnih poslova, komercijalna administracija, kancelarijski poslovi(210) **2013-470**(442) **20.09.2014.**

(220) 11/25/2013

(731) **MARIO VUJIČIĆ**, GIGE IGNJATOVIĆA 7, BEOGRAD RS

(540)

(550) I

(740) Jusić Jasna, Crnogorskih serdara bb, Podgorica ME

(511) **Klasa 29:** meso, riba, živina i divljač, mesne prerađevine, konzervisano, sušeno i kuvano voće i povrće, želei, džemovi, kompoti, jaja, mlijeko i mliječni proizvodi, jestiva ulja i masti**Klasa 30:** kafa, čaj, kakao, šećer, pirinač, tapioka, sago, zamjena kafe, brašno i proizvodi od žitarica, hljeb, kolači, poslastice, sladoledi, med, melasa, kvasac, prašak za pecivo, so, senf, sirće, sosovi (kao začini), začini, led**Klasa 32:** pivo, mineralne i sodne vode i druga bezalkoholna pića, pića od voća i voćni sokovi, sirupi i drugi preparati za proizvodnju pića**Klasa 43:** usluge obezbjeđivanja hrane i pića, privremeni smeštaj(210) **2013-472**(442) **20.09.2014.**

(220) 11/27/2013

(731) **THE PROCTER & GAMBLE COMPANY**, ONE PROCTER & GAMBLE PLAZA CINCINNATI, OHIO 45202 US

UNSTOPABLES

(540)

(550) I

(740) Lutovac Branislav, Bulevar Crnojevića 93, Podgorica ME

(511) **Klasa 03:** sredstva za bijeljenje i druge supstance za upotrebu u pranju veša, preparati za njegu, tretman i uljepšavanje tkanina, omekšivači, oplemenjivači tkanina, preparati za čišćenje, poliranje, ribanje, abrazivna sredstva, mirišljava voda za kućnu upotrebu i za upotrebu na tkaninama, eterična ulja, preparati za nadimljavanje koji se oslobađaju u

vazduh, atmosferu ili na tkanine u obliku dima, pare ili gasa, preparati za parfemisanje ili aromatizovanje vazduha

Klasa 05: osvježivači vazduha, preparati za pročišćavanje vazduha, sobni osvježivači vazduha, dezodoransi za tkanine i vazduh, preparati za uklanjanje neprijatnih mirisa

Klasa 11: aparati i instrumenti koji se za koriste za aromatizaciju, pročišćavanje i osvježavanje atmosfere, djelovi i oprema za svu navedenu robu, jedinice za aroma-terapiju i pročišćavanje vazduha na baterije ili na struju i ulošci koji se ubacuju u ove jedinice, samostalni neparfimisani uređaji za dezodoraciju koji ne ispuštaju supstance i filteri za frižidere i ostale male prostore

(210) **2013-473**

(442) **20.09.2014.**

(220) 11/27/2013

(731) **PARAMOUNT PICTURES CORPORATION**, 5555 MELROSE AVENUE, HOLLYWOOD, CALIFORNIA 90038 US

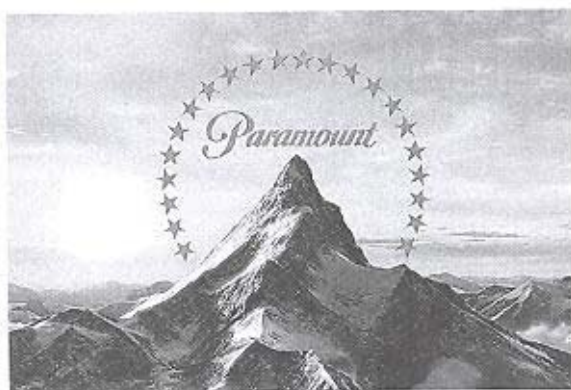

(540)

(550) I

(740) Lutovac Branislav, Bulevar Crnojevića 93, Podgorica ME

(511) **Klasa 09:** igrani filmovi, filmske trake, videodiskovi, video kasete, laserski diskovi i digitalni video diskovi (DVD), CD-ROM-ovi i svi drugi medijski formati koji sadrže igre, igrani filmovi, sportske i televizijske serije, šou programi, rialiti programi, animacije, snimljene magnetofonske trake sa zvucima i / ili slikama, zvučni zapisi, fonografski zapisi i kompakt diskovi, aparati za zabavu koji se koriste sa televizijskim risiverima, kompjuteri, kompjuterski programi, interaktivni kompjuterski sistemi, kompjuterske igre i kompjuterizovani zabavni programi, bežična oprema i dodaci za mobilne telefone, maske za mobilne telefone, melodije koje se mogu preuzeti, muzika, mp3, grafika, igre i video zapisi za bežične mobilne komunikacione uređaje, omogućavanje bežične transmisije upload-ovanja i preuzimanja melodija, glasa, muzike, mp3, grafika, igara i video zapisa, informacija, i novosti preko globalne kompjuterske mreže do bežičnih mobilnih komunikacionih uređaja, glasanje i prijem glasa i pisanih poruka preko bežičnih mobilnih komunikativnih uređaja.

Klasa 41: usluge zabave, proizvodnje, pripreme, izlaganja, distribucije i iznajmljivanja televizijskih i radio programa i filmova, animirani filmovi i zvučna i video snimanja bilo da su ili ne preko interaktivnijih medija, uključujući internet, proizvodnja zabavnih programa u živo, proizvodnja televizijskih zabavnih programa, TV snimanje muzičkih programa, izdavanje knjiga, magazina i periodike, proizvodnja i iznajmljivanje obrazovnih i nastavnih materijala, organizacija, proizvodnja i prezentacija događaja za obrazovne, kulturne ili zabavne svrhe, bilo da je ili ne preko interaktivnih media, organizacija, produkcija i prezentacija- takmičenja, nadmetanja, igara, kvizova, izložbi, sportskih događaja, šou programa, putujućih programa,

javnih priredbi, pozorišnih predstava, koncerata, nastupa uživo i događaja uz prisustvo publike, organizacija interaktivnih igara, produkcija sms-kviz programa, zabava i obrazovanje, sve gore navedene usluge koje se takođe mogu prenositi preko globalne kompjuterske mreže i drugih (interaktivnih) komunikacionih mreža, uključujući i internet

(210) **2013-474** (442) **20.09.2014.**

(220) 11/28/2013

(731) **HEMOFARM A.D.**FARMCEUTSKO-HEMIJSKA INDUSTRIJA VRŠAC, BEOGRADSKI PUT BB, 26300 VRŠAC RS

IRBENIDA

(540)

(550) I

(740) MSA IP Milojević Sekulić, Bulevar Despota Stefana 1a, Beograd SR

(511) **Klasa 05:** farmaceutski i veterinarski preparati, sanitarni preparati za medicinsku upotrebu, dijetetske supstance za upotrebu u medicini, hrana za bebe, flasteri, materijali za zavijanje, materijali za plombiranje zuba, zubarska smola, dezinfekciona sredstva, preparati za uništavanje štetočina, fungicidi, herbicidi

(210) **2013-475** (442) **20.09.2014.**

(220) 11/28/2013

(731) **HEMOFARM A.D.**FARMACEUTSKO-HEMIJSKA INDUSTRIJA VRŠAC, BEOGRADSKI PUT BB, 26300 VRŠAC RS

TRODON

(540)

(550) I

(740) MSA IP Milojević Sekulić, Bulevar Despota Stefana 1a, Beograd SR

(511) **Klasa 05:** farmaceutski i veterinarski preparati, sanitarni preparati za medicinsku upotrebu, dijetetske supstance za upotrebu u medicini, hrana za bebe, flasteri, materijali za zavijanje, materijali za plombiranje zuba, zubarska smola, dezinfekciona sredstva, preparati za uništavanje štetočina, fungicidi, herbicidi

(210) **2013-476** (442) **20.09.2014.**

(220) 12/5/2013

(731) **ASAHI-THAI ALLOY CO.LTD**, 9/23 MOO 7 SUKSAWAT ROAD, BANGJAK, PRAPADAENG, SAMUTPRAKARN10130 TH

SANWA

(540)

(550) I

(740) Radoičić Radmila, Moskovska 93, Podgorica ME

(511) **Klasa 11:** slavine, vodovodne instalacije, ventili za slavine i vodovodne instalacije

(210) **2013-477**

(442) **20.09.2014.**

(220) 12/5/2013

(731) **BEATS ELECTRONICS**, LLC(DELAWARE LIMITED LIABILITY COMPANY, 1601 CLOVERFIELD BVLD, SUITE 5000N, SANTA MONICA, CA90404 US

BEATS PILL

(540)

(550) I

(740) Radulović Božidar, Jovana Tomaševića 9/III, Podgorica ME

(511) **Klasa 09:** slušalice, slušalice koje se stavljaju u uši, zvučnici, audio zvučnici, audio kablovi, zvučnici za automobile, medija plejeri za automobile, digitalni audio plejeri za automobile, mobilni telefoni, laptop kompjuteri

(210) **2013-478**

(442) **20.09.2014.**

(220) 12/9/2013

(731) **MULLIRI I VJETAR SH.P.K**, BERXULL RRUGA DYTESORE TIRANE-DURRES, 100M PRANE URES LIMUTHIT, GODINE DY KATESHE, TIRANE AL



(540)

(550) I

(740) Đakonović Vido, Bajova 9, Cetinje ME

(511) **Klasa 30:** kafa, čaj, kakao i zamjena kafe, pirinač, tapioca i sago, brašno i proizvodi od žitarica, hleb, kolači i poslastice, sladoledi, šećer, med, melasa, kvasac, prašak za pecivo, so, senf, sirće, sosovi (kao začini), začini, led

(210) **2013-479**

(442) **20.09.2014.**

(220) 12/9/2013

(731) **POLLI PROM** D.O.O. VOJISLAVA ILIĆA 44/6 11000 BEOGRAD RS

POLINA

-Piletina fina-

(540)

(550) I

(740) Lutovac Branislav, Bulevar Crnojevića 93, Podgorica ME

(511) **Klasa 29:** meso, živina i divljač, mesne prerađevine**Klasa 35:** vođenje poslova, poslovno upravljanje(210) **2013-480**(442) **20.09.2014.**

(220) 12/9/2013

(300) 2548512 14.06.2013. IN

(731) **SHULTON, INC.** ONE PROCTER & GAMBLE PLAZA, CINCINNATI, OHIO 45202 US

MANTASTIC

(540)

(550) I

(740) Lutovac Branislav, Bulevar Crnojevića 93, Podgorica ME

(511) **Klasa 03:** antiperspiranti i dezodoransi, preparati za brijanje uključujući kreme za brijanje, losione za brijanje i gelove za brijanje, preparati za njegu kože posle brijanja, parfemi, mirisi, sprejevi za tijelo, sapuni, sredstva za pranje ruku, lica i tijela i druga sredstva za ličnu higijenu, preparati za čišćenje, njegu, tretman i uljepšavanje kože, kože glave i kose(210) **2013-481**(442) **20.09.2014.**

(220) 12/11/2013

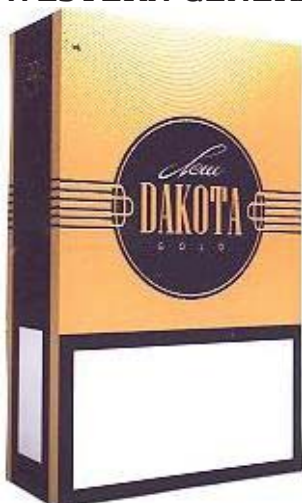
(731) **WESTERN GENERAL EUROPE DOO**, MILUTINA VUČINIĆA 43, PODGORICA ME

(540)

(550) I

(511) **Klasa 34:** duvan, pribor za pušače, šibice

Klasa 35: oglašavanje i reklamiranje, vođenje komercijalnih poslova, komercijalna administracija, kancelarijski poslovi, izvoz duvana

(210) **2013-482** (442) **20.09.2014.**

(220) 12/11/2013

(731) **NIPPON KAYAKU KABUSHIKI KAISHA**, 11-2, FUJIMI 1-CHOME, CHIYODA-KU, TOKYO JP

Lastet

(540)

(550) I

(740) MSA IP Milojević Sekulić, Bulevar Despota Stefana 1a, Beograd SR

(511) **Klasa 05:** farmaceutski preparati, lekovi za medicinsku upotrebu, lekovi za ljudsku upotrebu, lekovi za lečenje tumora, sredstva za suzbijanje tumora, antikancerogeni lekovi, dijagnostička sredstva za medicinsku upotrebu

(210) **2013-483** (442) **20.09.2014.**

(220) 12/12/2013

(731) **CANON KABUSHIKI KAISHA**, 30-2, SHIMOMARUKO 3-CHOME, OHTA-KU, TOKYO JP

MREAL

(540)

(550) I

(740) Ćosović Dejan, 13. jula 1/5, Budva ME

(511) **Klasa 09:** aparati i instrumenti naučni, pomorski, geodetski, fotografski, kinematografski, optički, za vaganje, merenje, signalizaciju, kontrolu (inspekciju), spašavanje i nastavu, aparati i instrumenti za provođenje, prekid, transformaciju, akumulaciju, regulisanje ili kontrolu električne energije, aparati za snimanje, prenos i reprodukovanje zvuka ili slike, magnetni nosači podataka, diskovi za snimanje, kompakt diskovi, DVD i drugi digitalni nosači podataka, mehanizmi za aparate koji se pokreću novcem ili žetonom, registar kase, računске mašine, oprema za obradu podataka, računah, računski softver, aparati za gašenje požara, softver za aparate za arkadne video igre, sistemi kombinovane stvarnosti koji cine nosač displeja koji se postavlja na glavu, kontroler i operativni softver, nosači displeja koji se postavljaju na glavu za sisteme kombinovane stvarnosti, kontrolori za sisteme kombinovane stvarnosti, operativni softver za sisteme kombinovane stvarnosti

Klasa 35: oglašavanje, vođenje poslova, poslovno upravljanje, kancelarijski poslovi, pružanje usluga savjetovanja u vezi sa poslovanjem, potrošačima i upravljanjem u vezi sa izgradnjom sistema kombinovane stvarnosti

Klasa 37: građevinsko konstruisanje, popravlanje, usluge instaliranja (postavljanja), instalacija, održavanje i popravka sistema kombinovane stvarnosti koje čine nosač displeja koji se postavlja na glavu, kontroler i operativni softver i pružanje konsultantskih usluga s tim u vezi, pružanje informacija u vezi sa instalacijom, održavanjem i popravkom sistema kombinovane stvarnosti koje čine nosač displeja koji se postavlja na glavu, kontroler i operativni softver

Klasa 42: Naučne i tehnološke usluge kao i usluge istraživanja i projektovanja u vezi sa njima, usluge industrijskih analiza i istraživanja, projektovanje i razvoj računarskog hardvera i softvera, pružanje informacija i konsultacija u vezi sa projektovanjem sistema kombinovane stvarnosti, projektovanje sistema kombinovane stvarnosti i njihovih komponenti, projektovanje sistema za proizvodnju automobila, projektovanje telekomunikacijskih mašina i aparata i elektronskih mašina i aparata, projektovanje kompjuterskog softvera,

programiranje kompjutera ili održavanje kompjuterskog softvera za sisteme kombinovane stvarnosti i pružanje konsultantskih usluga s tim u vezi, analiza sistema kombinovane stvarnosti, projektovanje, programiranje ili održavanje kompjuterskih sistema i pružanje savjetodavnih usluga, tehničko savjetovanje u vezi sa performansama, radom itd. mašina i aparata u sistemima kombinovane stvarnosti, tehničko savjetovanje u vezi sa performansama, radom itd. kompjutera, automobila i drugih mašina koje zahtijevaju visok nivo ličnog znanja, vještine ili iskustva operatera da bi se osigurala dovoljna preciznost u upravljanju takvim mašinama, obezbjeđivanje kompjuterskih programa koji se koriste u sistemima kombinovane stvarnosti, iznajmljivanje kompjuterskih programa koji se koriste u sistemima kombinovane stvarnosti, obezbjeđivanje kompjuterskih programa i povezanih usluga savjetovanja, testiranje, ispitivanje ili istraživanje sistema kombinovane stvarnosti, testiranje i istraživanje kompjuterskih programa koji se koriste u sistemima kombinovane stvarnosti, kalibracija (mjerenje), testiranje i istraživanje kompjuterskih programa

(210) **2013-484**

(442) **20.09.2014.**

(220) 12/12/2013

(731) **CANON KABUSHIKI KAISHA**, 30-2, SHIMOMARUKO 3-CHOME, OHTA-KU, TOKYO JP

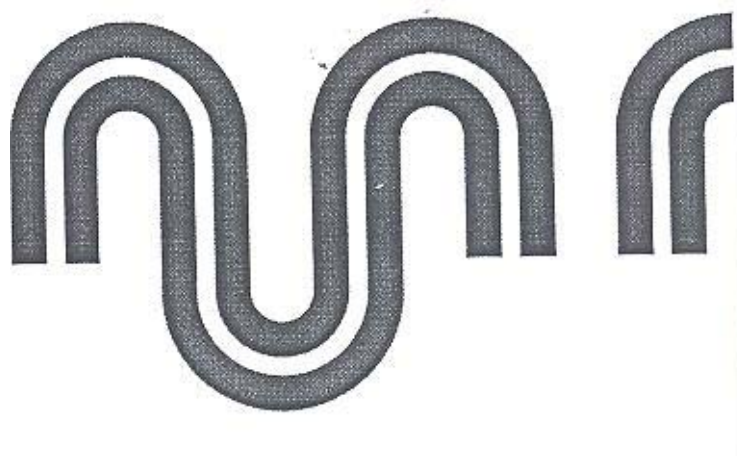

(540)

(550) I

(740) Čosović Dejan, 13. jula 1/5, Budva ME

(511) **Klasa 09:** aparati i instrumenti naučni, pomorski, geodetski, fotografski, kinematografski, optički, za vaganje, merenje, signalizaciju, kontrolu (inspekciju), spašavanje i nastavu, aparati i instrumenti za provođenje, prekid, transformaciju, akumulaciju, regulisanje ili kontrolu električne energije, aparati za snimanje, prenos i reprodukovanje zvuka ili slike, magnetni nosači podataka, diskovi za snimanje, kompakt diskovi, DVD i drugi digitalni nosači podataka, mehanizmi za aparate koji se pokreću novcem ili žetonom, registar kase, računске mašine, oprema za obradu podataka, računah, računski softver, aparati za gašenje požara, softver za aparate za arkadne video igre, sistemi kombinovane stvarnosti koji cine nosač displeja koji se postavlja na glavu, kontroler i operativni softver, nosači displeja koji se postavljaju na glavu za sisteme kombinovane stvarnosti, kontrolori za sisteme kombinovane stvarnosti, operativni softver za sisteme kombinovane stvarnosti

Klasa 35: oglašavanje, vođenje poslova, poslovno upravljanje, kancelarijski poslovi, pružanje usluga savjetovanja u vezi sa poslovanjem, potrošačima i upravljanjem u vezi sa izgradnjom sistema kombinovane stvarnosti

Klasa 37: građevinsko konstruisanje, popravlanje, usluge instaliranja (postavljanja), instalacija, održavanje i popravka sistema kombinovane stvarnosti koje čine nosač displeja koji se postavlja na glavu, kontroler i operativni softver i pružanje konsultantskih usluga s tim u vezi,

pružanje informacija u vezi sa instalacijom, održavanjem i popravkom sistema kombinovane stvarnosti koje čine nosač displeja koji se postavlja na glavu, kontroler i operativni softver

Klasa 42: naučne i tehnološke usluge kao i usluge istraživanja i projektovanja u vezi sa njima, usluge industrijskih analiza i istraživanja, projektovanje i razvoj računarskog hardvera i softvera, pružanje informacija i konsultacija u vezi sa projektovanjem sistema kombinovane stvarnosti, projektovanje sistema kombinovane stvarnosti i njihovih komponenti, projektovanje sistema za proizvodnju automobila, projektovanje telekomunikacijskih mašina i aparata i elektronskih mašina i aparata, projektovanje kompjuterskog softvera, programiranje kompjutera ili održavanje kompjuterskog softvera za sisteme kombinovane stvarnosti i pružanje konsultantskih usluga s tim u vezi, analiza sistema kombinovane stvarnosti, projektovanje, programiranje ili održavanje kompjuterskih sistema i pružanje savjetodavnih usluga, tehničko savjetovanje u vezi sa performansama, radom itd. mašina i aparata u sistemima kombinovane stvarnosti, tehničko savjetovanje u vezi sa performansama, radom itd. kompjutera, automobila i drugih mašina koje zahtijevaju visok nivo ličnog znanja, vještine ili iskustva operatera da bi se osigurala dovoljna preciznost u upravljanju takvim mašinama, obezbjeđivanje kompjuterskih programa koji se koriste u sistemima kombinovane stvarnosti, iznajmljivanje kompjuterskih programa koji se koriste u sistemima kombinovane stvarnosti, obezbjeđivanje kompjuterskih programa i povezanih usluga savjetovanja, testiranje, ispitivanje ili istraživanje sistema kombinovane stvarnosti, testiranje i istraživanje kompjuterskih programa koji se koriste u sistemima kombinovane stvarnosti, kalibracija (mjerenje), testiranje i istraživanje kompjuterskih programa

(210) **2013-485**

(442) **20.09.2014.**

(220) 12/12/2013

(731) **BARILLA G.E R.**FRATELLI-SOCIETA PER AZIONI, VIA MANTOVA 166, PARMA IT



(540)

(550) I

(740) Čolović Mladen, Crnogorskih serdara bb, Podgorica ME

(511) **Klasa 30:** kafa, čaj, kako, šećer, riža, tapioka, sago, vještačka kafa, brašno i proizvodi na bazi žitarica, hljeb, zamjena za hljeb i ostali proizvodi od hljeba, užina na bazi žitarica, biskviti, tijesto i slatkiši, biskviti sa čokoladnim prelivom i punjeni čokoladom, čokolade i proizvodi na bazi čokolade ili proizvodi koji sadrže čokoladu, pekarski proizvodi, užine i slatke užine, preparati za pravljenje torti, pice i preparati za pice, sladoled, med, melasa, kvasac, prašak za pecivo, so, senf, sirće, sosevi (začini), začini, led

- (210) **2013-486** (442) **20.09.2014.**
(220) 12/12/2013
(731) **BARILLA G.E R.**FRATELLI-SOCIETA PER AZIONI, VIA MANTOVA 166, PARMA IT

PAN DI STELLE

- (540)
(550) I
(740) Čolović Mladen, Crnogorskih serdara bb, Podgorica ME
(511) **Klasa 30:** kafa, čaj, kako, šećer, riža, tapioka, sago, vještačka kafa, brašno i proizvodi na bazi žitarica, hljeb, zamjena za hljeb i ostali proizvodi od hljeba, užina na bazi žitarica, biskviti, tijesto i slatkiši, biskviti sa čokoladnim prelivom i punjeni čokoladom, čokolade i proizvodi na bazi čokolade ili proizvodi koji sadrže čokoladu, pekarski proizvodi, užine i slatke užine, preparati za pravljenje torti, pice i preparati za pice, sladoled, med, melasa, kvasac, prašak za pecivo, so, senf, sirće, sosevi (začini), začini, led

-
- (210) **2013-488** (442) **20.09.2014.**
(220) 12/12/2013
(731) **DUKLEY-LOUNGE BEACH** DOO, JADRANSKI PUT BB BUDVA ME



DUKLEY
BEACH
LOUNGE

- (540)
(550) I, F
(511) **Klasa 43:** barovi, kafane (kafeterije), kafane-restorani, restorani, restorani sa samoposluživanjem, restorani za brzo i stalno posluživanje, ugostitelji (usluge kateringa)

-
- (210) **2013-489** (442) **20.09.2014.**
(220) 12/12/2013
(731) **ASTRA MONTENEGRO INVESTMENT ASSOCIATION** DOO, ROZINE BB BUDVA ME



(540)

(550) I, F

(511) **Klasa 36:** agencije za nekretnine, agencije za stanove [nepokretna imovina], građevinski objekti (upravljanje građevinskim objektima), imovina (upravljanje imovinom), informacije (finansijska obaveštenja), iznajmljivanje kancelarija [nekretnine], iznajmljivanje stanova, kapital (ulaganje kapitala), kompenzacijski poslovi [menjanje], nekretnine (agencije za nekretnine), nekretnine (davanje u zakup nekretnina), nekretnine (procena nekretnina), nekretnine (upravljanje nekretninama), posredovanje u nekretninama, procena nekretnina, stanarine (naplata stanarina), stanovi (iznajmljivanje stanova), upravljanje građevinskim objektima, upravljanje imovinom, upravljanje nekretninama

Klasa 37: građevinski radovi (nadzor građevinskih radova), informacije o graditeljstvu, informacije o popravkama, izgradnja (oglasi o izgradnji) izgradnja izgradnja štandova i prodavaonica, izolovanje (usluge izolovanja) [građevinski radovi], krovopokrivači (usluge krovopokrivača), nadzor građevinskih radova [vođenje], rušenje građevinskih objekata, zidanje ciglom, zidarski radovi

Klasa 42: arhitektura, inženjering, izgradnja (izrada građevinskih planova), planovi (izrada građevinskih planova), saveti o gradnji

(210) **2013-490**(442) **20.09.2014.**

(220) 12/16/2013

(731) **ASUSTEK COMPUTER INCORPORATION**, A LIMITED LIABILITY COMPANY INCORPORATED AND EXISTING UNDER THE LAWS OF THE REPUBLIC OF CHINA (TAIWAN)

IN SEARCH OF
INCREDIBLE

(540)

(550) I

(740) AOD "Ćupić", Dalmatinska 10, Podgorica ME

(511) **Klasa 09:** laptop računari, prenosivi računari, kompjuterski miš, slušalice, stereo pojačala, mikrofoni, zvučni sistemi koji sadrže daljinske upravljače, pojačala, zvučnike i komponente istih, ekranski monitori računara, centralni procesor računara, kompakt disk plejeri, kompjuterski kontrolisane radne stanice za unos podataka, personalni računari, računarski terminali, oprema za pristup internetu, matične ploče, grafičke kartice, zvučne kartice (računarski djelovi), čitači elektronskih knjiga, mobilni telefoni, personalni digitalni asistenti

(pda), mrežni serveri, projektori sa svjetlećim diodama (led), ip (internet protocol) kamere, računarski hardver, laptop računarske torbice, torbe posebno prilagođene za nošenje tablet računara, torbe posebno prilagođene za nošenje laptop i notebook računara, zaštitne torbice specijalno prilagođene za personalne digitalne asistente (pda), torbice za mobilne telefone, periferije za računare

(210) **2013-491** (442) **20.09.2014.**

(220) 12/18/2013

(731) **BIOFARMA PHARMACEUTICAL INDUSTRY CO. INC.** AKPMAR MAH OSMANGAZI
CAD.NO 156 SANCAKEPE INSTANBUL TR

CIPRO

(540)

(550) I, V

(740) Kovačević Aleksandar, Kružni Put bb, Cetinje ME

(511) **Klasa 05:** farmaceutski i veterinarski preparati, sanitarni preparati za medicinsku upotrebu, dijetetske supstance prilagođene za upotrebu u medicini, hrana za bebe, flasteri, materijali za zavijanje, materijali za plombiranje zuba, zubarska smola, dezinfekciona sredstva, preparati za uništavanje štetočina, fungicidi, herbicidi, objašnjenje klasa 05 uključuje uglavnom farmaceutske i druge preparate za medicinsku upotrebu, ova klasa uključuje posebno, sanitarne preparate za ličnu higijenu, osim toaletnih, dezodoranse koji nisu za ličnu upotrebu, cigarete bez duvana za medicinske svrhe, ova klasa ne uključuje posebno, sanitarne preparate za toalete (klasa 03), dezodoranse za ličnu upotrebu (klasa 03), potporne zavoje (klasa 10)

(210) **2013-492** (442) **20.09.2014.**

(220) 12/18/2013

(731) **BIOFARMA PHARMACEUTICAL INDUSTRY CO. INC.** AKPMAR MAH OSMANGAZI
CAD.NO 156 SANCAKEPE INSTANBUL TR

RICUS

(540)

(550) I, V

(740) Kovačević Aleksandar, Kružni Put bb, Cetinje ME

(511) **Klasa 05:** farmaceutski i veterinarski preparati, sanitarni preparati za medicinsku upotrebu, dijetetske supstance prilagođene za upotrebu u medicini, hrana za bebe, flasteri, materijali za zavijanje, materijali za plombiranje zuba, zubarska smola, dezinfekciona sredstva, preparati za uništavanje štetočina, fungicidi, herbicidi, objašnjenje klasa 05 uključuje uglavnom farmaceutske i druge preparate za medicinsku upotrebu, ova klasa uključuje posebno, sanitarne preparate za ličnu higijenu, osim toaletnih, dezodoranse koji nisu za ličnu upotrebu, cigarete bez duvana za medicinske svrhe, ova klasa ne uključuje posebno, sanitarne preparate za toalete (klasa 03), dezodoranse za ličnu upotrebu (klasa 03), potporne zavoje (klasa 10)

(210) **2013-493** (442) **20.09.2014.**

(220) 12/18/2013

(300) 00003012847 05.07.2013. GB

(731) **BRITISH AMERICAN TOBACCO (BRANDS) INC.** 2711 CENTERVILLE ROAD SUITE

300 WILMINGTON DELAWARE 19808 US

MORE TO EVERY MOMENT

(540)

(550) I, V

(740) Popović Miladin, Đoka Miraševića 21/III, Podgorica ME

(511) **Klasa 34:** cigarete, duvan, proizvodi od duvana, upaljači, šibice, artikli za pušače

(210) **2013-494**

(442) **20.09.2014.**

(220) 12/23/2013

(731) **JAVNA USTANOVA SLUŽBENI LIST CRNE GORE**, NOVAKA MILOŠEVA 10/I
PODGORICA ME

СЛУЖБЕНИ ЛИСТ
ЦРНЕ ГОРЕ

Internet: <http://www.sluzbenilist.me>

e-mail: mlb@sluzbenilist.me

(540)

(550) I

(511) **Klasa 35:** oglašavanje, oglašavanje nevažećim javnih isprava, objavljivanje javnih konkursa i oglasa, akata o upisu u sudske i druge registre i drugih oglasa, javnih poziva i drugih obavještenja

Klasa 41: izdavanje tekstova i knjiga, izdavanje Službenog lista, izdavanje i prodaja zbirki propisa, komentara propisa, zbirki sudskih odluka, obrazaca, knjiga i stručnih časopisa, umnožavanje i prodaja/snimljenih, zvučnih, video i kompjuterskih zapisa i slično

(210) **2013-495**

(442) **20.09.2014.**

(220) 12/23/2013

(731) **JAVNA USTANOVA SLUŽBENI LIST CRNE GORE**, NOVAKA MILOŠEVA 10/I
PODGORICA ME

СЛУЖБЕНИ ЛИСТ
ЦРНЕ ГОРЕ
- ОПШТИНСКИ ПРОПИСИ -

Internet: <http://www.sluzbenilist.me>

e-mail: mlb@sluzbenilist.me

(540)

(550) I

(511) **Klasa 35:** oglašavanje, oglašavanje nevažećim javnih isprava, objavljivanje javnih konkursa i oglasa, akata o upisu u sudske i druge registre i drugih oglasa, javnih poziva i drugih obavještenja

Klasa 41: izdavanje tekstova i knjiga, izdavanje Službenog lista, izdavanje i prodaja zbirki propisa, komentara propisa, zbirki sudskih odluka, obrazaca, knjiga i stručnih časopisa, umnožavanje

i prodaja/snimljenih, zvučnih, video i kompjuterskih zapisa i slično

(210) **2013-496** (442) **20.09.2014.**

(220) 12/23/2013

(731) **ABBOTT POINT OF CARE INC.** 400 COLLEGE ROAD EAST PRINCETON, NEW JERSEY 08540 US

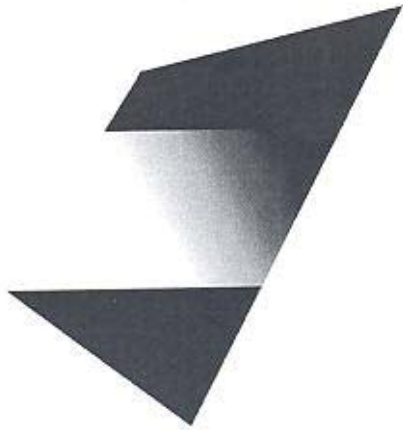

(540)

(550) I

(740) Popović Miladin, Đoka Miraševića 21/III, Podgorica ME

(511) **Klasa 09:** računarski softver i hardver za medicinske dijagnostičke instrumente, računarski softver i hardver za instrumente za testiranje krvi, softver i hardver za organizaciju podataka u oblasti testiranja krvi, softver i hardver za organizaciju podataka za medicinske dijagnostičke instrumente, softver i hardver za organizaciju podataka u oblasti upravljanja komunikacijom između podataka kod softvera za organizaciju podataka i hardvera za analizu krvi, računarski softver i hardver za daljinsko praćenje instrumenata za testiranje krvi, računarski softver i hardver za daljinsko praćenje medicinskih dijagnostičkih instrumenata

Klasa 10: instrumenti za analizu krvi i sistemi za upotrebu kod medicinske dijagnostike, patrone koje sadrže reagense za upotrebu kod prenosivih aparata za analizu krvi

Klasa 42: pružanje usluga tehničke podrške za medicinske dijagnostičke instrumente i za računarski softver i hardver u vezi sa njima, pružanje usluga tehničke podrške za računarski softver u oblasti medicinske dijagnostike, pružanje usluga operativnog monitoringa za medicinske dijagnostičke instrumente, daljinsko praćenje medicinskih dijagnostičkih sistema, pružanje daljinskog elektronskog praćenja i rešavanja problema kod medicinskih dijagnostičkih instrumenata, obezbeđivanje internet-sofverske platforme za organizaciju podataka, praćenje i analizu u oblasti medicinske dijagnostike, obezbeđivanje uslužnog softvera (SAAS) iz oblasti medicinske dijagnostike, aplikacije, softver i internet-stranice za organizaciju, upravljanje, razvoj i održavanje u vezi sa instrumentima i sistemima za medicinsku dijagnostiku, računarske usluge, naime, daljinsko upravljanje podacima kod medicinskih dijagnostičkih instrumenata, računarske usluge, naime, daljinsko upravljanje medicinskim dijagnostičkim sistemima, računarske usluge, naime, praćenje i izveštavanje o performansama i greškama kod medicinskih dijagnostičkih instrumenata, pružanje on-line internet okruženja sa tehnologijom koja omogućava korisnicima da dele podatke iz oblasti medicinske dijagnostike, pružanje privremenog korišćenja softvera i aplikacija koji se ne mogu preuzeti, za praćenje medicinskih dijagnostičkih instrumenata i za upravljanje podacima kod medicinskih dijagnostičkih instrumenata

(210) **2013-497**

(442) **20.09.2014.**

(220) 12/23/2013

(731) **LF, LLC**, A DELAWARE LIMITED LIABILITY COMPANY, 1000 LOWE'S BOULEVARD
MOORESVILLE, NORTH CAROLINA 28117 US

(540) **LOWE'S**

(550) I

(740) Jusić Jasna, Crnogorskih serdara bb, Podgorica ME

(511) **Klasa 16:** knjige i časopisi koji sadrže ideje, metode i instrukcije koje se odnose na uradi sam popravku kuća, gradnju, dekoraciju, baštovanstvo, pejzažnu arhitekturu i aktivnosti koje su u vezi sa tim

Klasa 35: usluge sakupljanja na jednom mestu raznih vrsta roba (isključujući njihov transport) za račun drugih lica, omogućavajući potrošačima da na najpogodniji način razgledaju i nabave robu koja je u vezi sa uslugama outlet prodavnica koje sadrže razne vrste uređaja, građevinski materijal, opremu za osvetljavanje i električnu opremu materijale za krovove, kućni nameštaj, predmete koji se koriste za uradi sam popravku/poboljšanje kuća, alate, električnu opremu za spoljnu upotrebu, predmete za obezbeđivanje, zaštitu kuća, materijale za uređivanje zemljišta, usluge sakupljanja na jednom mestu raznih vrsta roba (isključujući njihov transport) za račun drugih lica, omogućavajući potrošačima da na najpogodniji način razgledaju i nabave robu iz oblasti cvečarstva

Klasa 36: usluge obezbeđivanja produžene garancije za uređaje i proizvode koji se koriste za uradi sam popravku/poboljšanje kuća, usluge u vezi kreditnih kartica, usluge osnivanja dobrotvornih fondova

Klasa 37: usluge instalacije, opravke i re-modelovanja uređaja, građevinskog materijala, svetlosne i električne opreme, vodovodne opreme, materijala za krovove, kućnog nameštaja, predmeta koji se koriste za uradi sam popravku/poboljšavanje kuća, predmeta za obezbeđivanje sigurnosti kuća, materijala za uređenje krajolika, iznajmljivanje građevinske opreme i alata, usluge mešanja boja

Klasa 40: usluge sečenja drvene grade, užadi, lanaca, mini roletni i užadi za kupce, usluge povezivanja cevi za kupce

Klasa 41: usluge obrazovanja, naime, vođenje klinika i radionica koje se odnose na instalaciju i opravku uređaja, građevinskog materijala, svetlosne i električne opreme, vodovodne opreme, materijale za krovove, kućnog nameštaja, predmeta koji se koriste za uradi sam popravku/poboljšavanje kuća, predmeta koji služe za obezbeđivanje sigurnosti kuća i distribucija pisanog materijala koji je u vezi sa tim

Klasa 42: usluge konsultacija i dizajna za građevinske materijale, svetlosnu i električnu opremu, vodovodnu opremu, materijale za krovove, nameštaj za kuće, za predmete koji se odnose na uradi sam popravku/poboljšanje kuća, za obezbeđivanje, zaštitu kuća, usluge slaganja boja putem kompjutera, usluge konsultacije i dizajniranja u vezi sa uređenjem zelenih površina

Klasa 45: usluge registrovanja brakova

(210) **2013-498**

(442) **20.09.2014.**

(220) 12/23/2013

(731) **HONEYWELL INTERNATIONAL INC.**(A DELAWARE CORPORATION), 101 COLUMBIA
ROAD, MORRISTOWN, NEW JERSEY, 07962 US

(540) **HOWARD LEIGHT**

(550)

(550) I

(740) Jusić Jasna, Crnogorskih serdara bb, Podgorica ME

(511) **Klasa 10:** zapašaći za uši za blokiranje buke, otporni na zvuk i smanjenje buke

(210) **2013-499**

(442) **20.09.2014.**

(220) 12/24/2013

(731) **SODILAC**, A FRENCH SOCIETE PAR ACTIONS SIMPLIFIEE, 68, RUE DE VILLIERS, 92300 LEVALLOIS-PERRET FR

MODILAC

(540)

(550) I

(740) Lutovac Branislav, Bulevar Crnojevića 93, Podgorica ME

(511) **Klasa 05:** farmaceutski preparati, dijetetska hrana i supstance prilagođene upotrebi u medicini, hrana za bebe, mlijeko u prahu i mlijeko za bebe i odojčad, hranjivi i dijetetski dodaci ishrani za ljudsku upotrebu, naročito za bebe i odojčad, napici sa dodatkom vitaminima i mineralima, hranjivi napici

Klasa 29: mlijeko i mliječni proizvodi, naročito mlijeko obogaćeno vitaminima, aromatizovano mlijeko, mliječne poslastice, jogurti, jestiva ulja i masti, puter, sirevi, sosovi od sira, mliječni napici (u kojima preovlađuje mlijeko)

Klasa 30: kakao, brašno i proizvodi od žitarica, hleb, peciva i poslastice, sladoledi, sosovi (kao začini), sosovi od sira

Klasa 32: mineralne i sodne vode i druga bezalkoholna pića, voćni napici i voćni sokovi, sirupi i drugi preparati za proizvodnju pića

Klasa 32: mineralne i sodne vode i druga bezalkoholna pića, voćni napici i voćni sokovi, sirupi i drugi preparati za proizvodnju pića

(210) **2013-5**

(442) **20.09.2014.**

(220) 1/11/2013

(731) **CHINA TOBACCO GUANGDONG INDUSTRIAL CO.LTD**, 8TH-16TH FLOOR, NO.186, LINHEXIHENG ROAD, TIANHE, GUANGZHOU CN

(540) SHUANGXI

(550) I, V

(740) Đakonović Vido, Bajova 9, Cetinje ME

(511) **Klasa 34:** cigarete, cigare, duvan, cigarete koje sadrže zamjenu za duvan, ne za medicinske svrhe, tabakere, muštikle, pepeljare za pušaće, šibice, upaljači za pušaće, filteri za cigarete, papir za cigarete.

(210) **2013-500**

(442) **20.09.2014.**

(220) 12/24/2013

(731) **NBA PROPERTIES**, INC. OLYMPIC TOWER-645 FIFTH AVENUE NEW YORK, NY 10022 US



(540)

(550) I

(740) Popović Miladin, Đoka Miraševića 21/III, Podgorica ME

(511) **Klasa 25:** odjeća, naročito čarape, obuća, cipele za košarku, patike za košarku, majice sa kratkim rukavima, košulje, polo majice, dukserice, donji dijelovi trenerki, pantalone, majice na bretele, džemperi, kratke pantalone, pidžame, sportske majice, ragbi majice, vunene majice, kaiševi, kravate, spavaćice, šeširi, kape, viziri, trenerke za zagrijavanje, donji dijelovi trenerki za zagrijavanje, dresovi za zagrijavanje/majice za vježbanje ubačaja, jakne, vjetrovke, jakne sa kapuljačom, kaputi, portikle za bebe koje nisu od papira, znojnice za glavu, znojnice za zglobove, kecelje, donji veš, bokzerski šortsevi, sportske pantalone, štitnici za uši, rukavice, rukavice sa spojenim prstima, šalovi, tkane i štrikane majice, vunena odjeća, haljine, haljine i uniforme za navijačice, odjeća za plivanje, kostimi za kupanje, kupaći kostimi, bikini, tankini, gaćice za plivanje, gaćice za kupanje, kratke pantalone za surfovanje, ronilačka odijela, marama za plažu, pokrivači za kupaći kostim, ogrtači za kupaći kostim, sandale, sandale za plažu, šeširi za plažu, viziri za sunce, kape za plivanje, kape za kupanje, nova pokrivala za glavu sa perikama

Klasa 28: igračke, igre i sportski predmeti, naročito košarkaške lopte, loptice za golf, lopte za igralište, sportske lopte, gumene lopte i lopte od pjenastih materija koje jako odskaču, plišane lopte za igru, plastične lopte za igru, mrežice za košarku, table za košarku, minijaturne table za košarku, pumpe za naduvavanje košarkaških lopti kao i igle njima namijenjene, štapovi za golf, torbe za golf, nastavci za štapove za golf, oprema za golf, naročito, alat za popravku divota (busena trave izbačenih štapom za golf), kupice na koje se stavlja lopta, markeri za lopte, navlake za torbe za golf, futrole za glave golf štapova, rukavice za golf, futrole za golf lopte, posebna zelena staza za golf, peškiri za golf, stalci za bilijarske štapove, kugle za bilijar, futrole za bilijarske kugle, pikado ormari, elektronske stone košarkaške igrice, stone košarkaške iglice, košarkaške društvene igrice, akcione igrice koje se zasnivaju na vještini, društvene igrice za odrasle i djecu, ostale informacijske igrice i mašine za elektronske video arkadne uređaje, košarkaška oprema koji se sastoji od mrežice i pištaljke, lutke, dekorativne lutke, kolekcionarske lutke, akcione igračke, akcione igračke sa vunenim glavama, punjene igračke, plišane igračke, slagalice, lego kocke, ukrasi za Božićnu jelku i Božićne čarape, vozila za igru u obliku automobila, kamiona, vozova i kombija, svi sa temom košarke, nove igračke od pjene u obliku prstiju i trofeja, igračke trofeji, karte za igranje, igrice sa kartama, igračke koje proizvode buku, igračke za kućne ljubimce, igračke za plažu, naročito, lopte za plažu, lopte na naduvavanje, kantice za igru, lopatice za igru, igračke za pijesak, kutije za pijesak za igru, igračke za prskanje vodom, oprema za bazen, naročito pojasevi za plivanje, pojasevi za bazen, igračke za splavanje na vodi, pojasevi od plene, kolutovi za plivanje, kolutovi za

bazen, kolutovi od pjene, daske za plivanje, daske za surfovanje, peraja za plivanje, peraja za surfovanje, mišići na naduvavanje i kolutovi za pomoć pri plivanju u rekreativne svrhe, odbojkaška oprema koja se sastoji od lopte, mrežice, trake koje označavaju teren i pištaljke, i vaterpolo oprema koja se sastoji od lopte, mrežice i pištaljke, dekorativne igračke od tkanine koje se puštaju da lete na vjetru

Klasa 41: usluge razonode i obrazovanja u oblasti direktnog televizijskog i radio prenosa iz oblasti košarke i prikazivanje uživo košarkaških utakmica i egzibicija, produkcija i distribucija radio i televizijskih prenosa košarkaških utakmica, košarkaških događaja i programa, vođenje i organizovanje košarkaških škola i kampova, škola i kampova za trenere, škola i kampova za plesne timove i košarkaške događaje, usluge razonode putem ličnog pojavljivanja kao kostimiranih maskota ili plesnih timova na košarkaškim utakmicama i egzibicijama, školama, kampovima, promocijama, i ostalim događajima vezanim za košarku, posebnim događanjima i zabavama, usluge kluba obožavatelja/navijača, usluge razonode, naročito one koje pružaju web stranice putem video prijenosa multimedijских sadržaja u svojstvu televizijskih najvažnijih događaja, interaktivnih televizijskih najvažnijih događaja, video snimaka, snimanja video prijenosa, interaktivnih video izbora najvažnijih događaja, radio programa, radijskih najvažnijih događaja i audio snimanja u području košarke, pružanje vijesti i informacija u smislu statističkih i ostalih podataka u oblasti košarke, on-line igrice koje se ne mogu preuzimati, naročito kompjuterske igrice, video igrice, interaktivne video igrice, akcione igrice koje zahtjevaju veštinu, arkadne igrice, društvene igrice za odrasle i djecu, igre na tablama, slagalice, i ostale igrice, usluge elektronskog objavljivanja, naročito, izdavanje magazina, vodica, biltena, bojanki, i rasporeda on-line utakmica drugih putem interneta, sve u oblasti košarke, obezbjeđivanje on-line kompjuterskih baza podataka u oblasti košarke,

(210) **2013-501** (442) **20.09.2014.**

(220) 12/24/2013

(300) 86/007, 264 11.07.2013. US

(731) **BIOGEN IDEC MA INC.**(MASSACHUSETTS CORPRATION), 14 CAMBRIDGE CENTER, CAMBRIDGE, MASSACHUSTTS 02142 US

ZINBRYTA

(540)

(550) I

(740) Radulović Božidar, Jovana Tomaševića 9/III, Podgorica ME

(511) **Klasa 05:** farmaceutski preparati za tretman neuroloških poremećaja

(210) **2013-502** (442) **20.09.2014.**

(220) 12/30/2013

(731) **TBL LICENSING LLC**, 200 DOMAIN DRIVE, STRATHAM, NEW HAMPSHIRE 03885 US



(540)

(550) I, V

(740) Radulović Božidar, Jovana Tomaševića 9/III, Podgorica ME

(511) **Klasa 25:** odjeća, obuća, pokrivala za glavu

(210) **2013-503**

(442) **20.09.2014.**

(220) 12/30/2013

(731) **TBL LICENSING LLC**, 200 DOMAIN DRIVE, STRATHAM, NEW HAMPSHIRE 03885 US

TIMBERLAND PRO

(540)

(550) I, V

(740) Radulović Božidar, Jovana Tomaševića 9/III, Podgorica ME

(511) **Klasa 25:** odjeća, obuća, pokrivala za glavu

(210) **2013-505**

(442) **20.09.2014.**

(220) 12/30/2013

(731) **SOLO DOO**, UL. BRAĆE RIBARA 46, 81000 PODGORICA ME

SOLO

(540)

(550) I

(511) **Klasa 16:** listovi (papirni proizvodi za toaletnu upotrebu), maramice od papira, salvete od papira, toalet papir, toaletni ubrusi od papira

(210) **2013-506**

(442) **20.09.2014.**

(220) 12/30/2013

(731) **LOTTE CONFECTINARY CO.LTD.** (YANGPYEONG-DONG 5-GA), 10, YANGPYEONG-RO 21-GIL, YEONGDEUNGPO-GU, SEUL, KR

PEPERO

(540)

(550) I

(740) AOD "Ćupić", Dalmatinska 10, Podgorica ME

(511) **Klasa 30:** perece sa badenom i čokoladom, žvakaće gume, ne u medicinske svrhe, bombone, čokolade, karamel, sladoled, ledene poslastice, šećer, hleb, pirinčani kolači, biskviti, čokoladne bombone, čips (proizvodi od cerealija), poslastičarski proizvodi, krekeri, pite

(210) **2013-507**

(442) **20.09.2014.**

(220) 12/31/2013

(300) 86003372 05.07.2013. US

(731) **BEATS ELECTRONICS**, LLC (DELAWARE LIMITED LIABILITY COMPANY), 1601 CLOVERFIELD BLVD, SUITE 500N, SANTA MONICA, CA90404 US

REMOTETALK

(540)

(550) I

(740) Radulović Božidar, Jovana Tomaševića 9/III, Podgorica ME

(511) **Klasa 09:** slušalice, slušalice koje se stavljaju u uši, mikrofoni, kablovi za daljinske mikrofone, energetske kablovi i kablovi za prenos zvuka i slike

(210) **2013-508**

(442) **20.09.2014.**

(220) 12/31/2013

(300) 86003374 05. 07.2013. US

(731) **BEATS ELECTRONICS**, LLC (DELAWARE LIMITED LIABILITY COMPANY), 1601 CLOVERFIELD BLVD, SUITE 500N, SANTA MONICA, CA90404 US

BEATS ACOUSTIC ENGINE

(540)

(550) I, V

(740) Radulović Božidar, Jovana Tomaševića 9/III, Podgorica ME

(511) **Klasa 09:** slušalice i slušalice koje se stavljaju u uši, futrole za slušalice i slušalice koje se stavljaju u uši, audio zvučnici, mikrofoni, audio oprema, naročito medija plejeri, prenosivi medija plejeri, medija plejeri za automobile, mobilni telefoni, pametni telefoni, personalni digitalni pomoćnici, ručni elektronski uređaji, elektronski tableti, kao i slušalice za sve njih, kompjuteri, kompjuterski softver za obradu i puštanje digitalnih muzičkih fajlova

(210) **2013-510**

(442) **20.09.2014.**

(220) 12/31/2013

(731) **SHULTON**, INC. ONE PROCTER & GAMBLE PLAZA, CINCINATI, OHIO 45202 US

TIMBER

(540)

(550) I

(740) Lutovac Branislav, Bulevar Crnojevića 93, Podgorica ME

(511) **Klasa 03:** preparati za njegu kože posle brijanja, antiperspiranti i dezodoransi za ličnu upotrebu, sapuni za kupanje, sprejevi za tijelo, kupke za tijelo, preparati za njegu kose, preparati za brijanje

(210) **2013-6**

(442) **20.09.2014.**

(220) 1/11/2013

(300) 011296399 26.10.2012. CTM

(731) **THE PROCTER & GAMBLE COMPANY** ONE PROCTER & GAMBLE PLAZA, CINCINNATI, OHIO 45202 US

(540) MOUNTAIN SPRING

(550) I

(740) Lutovac Branislav, Bulevar Crnojevića 93, Podgorica ME

(511) **Klasa 03:** sredstva za bijeljenje i druge supstance za upotrebu pri pranju, preparati za čišćenje, poliranje, ribanje, abrazivna sredstva, sapuni za upotrebu u domaćinstvu

(210) **2013-7**

(442) **20.09.2014.**

(220) 1/15/2013

(731) **UNILEVER N.V.** WEENA 455 3013 AL ROTTERDAM NL

(540) TRICHAZOLE ACTIVES

(550) I, V

(740) Popović Miladin, Đoka Miraševića 21/III, Podgorica ME

(511) **Klasa 03:** sapuni, parfimerija, eterična ulja, dezodoransi i antiperspiranti, proizvodi za njegu kose, preparati za bojenje kose, preparati za farbanje kose, losioni za kosu, preparati za talasanje kose, šamponi, balzami, sprejevi za kosu, puder za kosu, prelive za kosu, lakovi za kosu, pjene za kosu, sjajevi za kosu, gelovi za kosu, ovlaživači kose, tečnost za kosu, tretmani za očuvanje kose, tretmani za isušivanje kose, ulja za kosu, tonik za kosu, kreme za kosu, preparati za kupanje i/ili za tuširanje, ne medicinski toaletni preparati, preparati za njegu kože, kozmetika

(210) **2013-8**

(442) **20.09.2014.**

(220) 1/15/2013

(731) **AKTIEBOLAGET ELECTROLUX, S:** T GORANSGATAN 143, SE-145 45 STOCKHOLM SE

(540) ELECTROLUX ULTRACOLLECTION

(550) I

(740) AOD "Ćupić", Dalmatinska 10, Podgorica ME

(511) **Klasa 07:** usisivači, djelovi i pribor za iste

(210) **2014-10**

(442) **20.09.2014.**

(220) 1/21/2014

(731) **AKTSIONERNO DROUJESTVO BULGARTABAC HOLDING,** 62 GRAF IGNATIEV STR.1000 SOFIA BG



(540)

(550) I

(740) Anđelić Branislav, Svetozara Markovića 12, Podgorica ME

(511) **Klasa 16:** papir, karton i proizvodi od tih materijala koji nisu obuhvaćeni drugim klasama, štampane stvari, materijali za potrebe knjigovezaca, fotografije, kancelarijski pribor, lepkovi za upotrebu u kancelariji ili domaćinstvu, materijali za umetnike, četkice za slikanje, pišaće mašine i kancelarijski rekviziti (osim nameštaja), materijali za podučavanje i nastavni materijali (osim aparata), plastični materijali za pakovanje (koji nisu obuhvaćeni drugim klasama), slova za štampanje, štamparski klišeji

Klasa 34: duvan, sirov, prerađen ili obraden, proizvodi od duvana, cigarete, cigare i cigarilosi, filteri za cigarete, papir za cigarete / cigaret papir, proizvodi za pisace, šibice, upaljači za pušaće i pepeljare od neplemenitog materijala

Klasa 35: oglašavanje, poslovni menadžment, poslovna administracija, kancelarijske usluge

(210) **2014-100** (442) **20.09.2014.**

(220) 3/11/2014

(731) **HEMOFARM A.D.** FARMACEUTSKO-HEMIJSKA INDUSTRIJA VRŠAC, BEOGRADSKI PUT BB, 26300 VRŠAC RS

ALTRAK

(540)

(550) I

(740) MSA IP Milojević Sekulić, Bulevar Despota Stefana 1a, Beograd SR

(511) **Klasa 05:** farmaceutski i veterinarski preparati, sanitarni preparati za medicinsku upotrebu, dijetetske supstance prilagođene za upotrebu u medicini, hrana za bebe, flasteri, materijali za zavijanje, materijali za plombiranje zuba, zubarska smola, dezinfekciona sredstva, preparati za uništavanje štetočina, fungicidi, herbicidi

(210) **2014-101** (442) **20.09.2014.**

(220) 3/11/2014

(731) **HEMOFARM A.D.** FARMACEUTSKO-HEMIJSKA INDUSTRIJA VRŠAC, BEOGRADSKI PUT BB, 26300 VRŠAC RS

ENTRYKA

(540)

(550) I

(740) MSA IP Milojević Sekulić, Bulevar Despota Stefana 1a, Beograd SR

(511) **Klasa 05:** farmaceutski i veterinarski preparati, sanitarni preparati za medicinsku upotrebu, dijetetske supstance prilagođene za upotrebu u medicini, hrana za bebe, flasteri, materijali za zavijanje, materijali za plombiranje zuba, zubarska smola, dezinfekciona sredstva, preparati za uništavanje štetočina, fungicidi, herbicidi

(210) **2014-102** (442) **20.09.2014.**

(220) 3/11/2014

(731) **HEMOFARM A.D.** FARMACEUTSKO-HEMIJSKA INDUSTRIJA VRŠAC, BEOGRADSKI PUT BB, 26300 VRŠAC RS

PARAVANO

(540)

(550) I

(740) MSA IP Milojević Sekulić, Bulevar Despota Stefana 1a, Beograd SR

(511) **Klasa 05:** farmaceutske i veterinarske preparate, sanitarni preparati za medicinsku upotrebu, dijetetske supstance prilagođene za upotrebu u medicini, hrana za bebe, flasteri, materijali za zavijanje, materijali za plombiranje zuba, zubarska smola, dezinfekciona sredstva, preparati za uništavanje štetočina, fungicidi, herbicidi

(210) **2014-103** (442) **20.09.2014.**

(220) 3/11/2014

(731) **HEMOFARM A.D.** FARMACEUTSKO-HEMIJSKA INDUSTRIJA VRŠAC, BEOGRADSKI PUT BB, 26300 VRŠAC RS

DISIA

(540)

(550) I

(740) MSA IP Milojević Sekulić, Bulevar Despota Stefana 1a, Beograd SR

(511) **Klasa 05:** farmaceutske i veterinarske preparate, sanitarni preparati za medicinsku upotrebu, dijetetske supstance prilagođene za upotrebu u medicini, hrana za bebe, flasteri, materijali za zavijanje, materijali za plombiranje zuba, zubarska smola, dezinfekciona sredstva, preparati za uništavanje štetočina, fungicidi, herbicidi

(210) **2014-104** (442) **20.09.2014.**

(220) 3/11/2014

(731) **HEMOFARM A.D.** FARMACEUTSKO-HEMIJSKA INDUSTRIJA VRŠAC, BEOGRADSKI PUT BB, 26300 VRŠAC RS

IDIKA

(540)

(550) I

(740) MSA IP Milojević Sekulić, Bulevar Despota Stefana 1a, Beograd SR

(511) **Klasa 05:** farmaceutske i veterinarske preparate, sanitarni preparati za medicinsku upotrebu, dijetetske supstance prilagođene za upotrebu u medicini, hrana za bebe, flasteri, materijali za zavijanje, materijali za plombiranje zuba, zubarska smola, dezinfekciona sredstva, preparati za uništavanje štetočina, fungicidi, herbicidi

(210) **2014-105** (442) **20.09.2014.**

(220) 3/11/2014

(731) **HEMOFARM A.D.** FARMACEUTSKO-HEMIJSKA INDUSTRIJA VRŠAC, BEOGRADSKI PUT BB, 26300 VRŠAC RS

SIVERIO

(540)

(550) I

(740) MSA IP Milojević Sekulić, Bulevar Despota Stefana 1a, Beograd SR

(511) **Klasa 05:** farmaceutske i veterinarske preparate, sanitarni preparati za medicinsku upotrebu, dijetetske supstance prilagođene za upotrebu u medicini, hrana za bebe, flasteri, materijali za zavijanje, materijali za plombiranje zuba, zubarska smola, dezinfekciona sredstva, preparati za uništavanje štetočina, fungicidi, herbicidi

(210) **2014-106** (442) **20.09.2014.**

(220) 3/11/2014

(731) **HEMOFARM A.D.** FARMACEUTSKO-HEMIJSKA INDUSTRIJA VRŠAC, BEOGRADSKI PUT BB, 26300 VRŠAC RS

ELUMELA

(540)

(550) I

(740) MSA IP Milojević Sekulić, Bulevar Despota Stefana 1a, Beograd SR

(511) **Klasa 05:** farmaceutski i veterinarski preparati, sanitarni preparati za medicinsku upotrebu, dijetetske supstance prilagođene za upotrebu u medicini, hrana za bebe, flasteri, materijali za zavijanje, materijali za plombiranje zuba, zubarska smola, dezinfekciona sredstva, preparati za uništavanje štetočina, fungicidi, herbicidi

(210) **2014-107** (442) **20.09.2014.**

(220) 3/11/2014

(731) **BEATS ELECTRONICS, LLC** (DELAWARE LIMITED LIABILITY COMPANY), 1601 CLOVERFIELD BLVD, SUITE 5000N, SANTA MONICA, CA90404 US

POWERBEATS

(540)

(550) I

(740) Radulović Božidar, Jovana Tomaševića 9/III, Podgorica ME

(511) **Klasa 09:** slušalice, slušalice koje se stavljaju u uši, zvučnici, audio zvučnici, audio kablovi, audio zvučnici za automobile, medija plejeri za automobile, digitalni audio plejeri za automobile, mobilni telefoni, laptop kompjuteri

(210) **2014-108** (442) **20.09.2014.**

(220) 3/12/2014

(731) **ACTAVIS GROUP PTC EHF**, REYKJAVIKURVEGI 76-78, 220 HAFNARFJORDUR IS

LACTACARE

(540)

(550) I

(740) Jusić Jasna, Crnogorskih serdara bb, Podgorica ME

(511) **Klasa 05:** farmaceutski preparati i supstance, probiotski preparati i dodaci ishrani

(210) **2014-109** (442) **20.09.2014.**

(220) 3/13/2014

(731) **13 JUL PLANTAŽE A.D.** PODGORICA ME

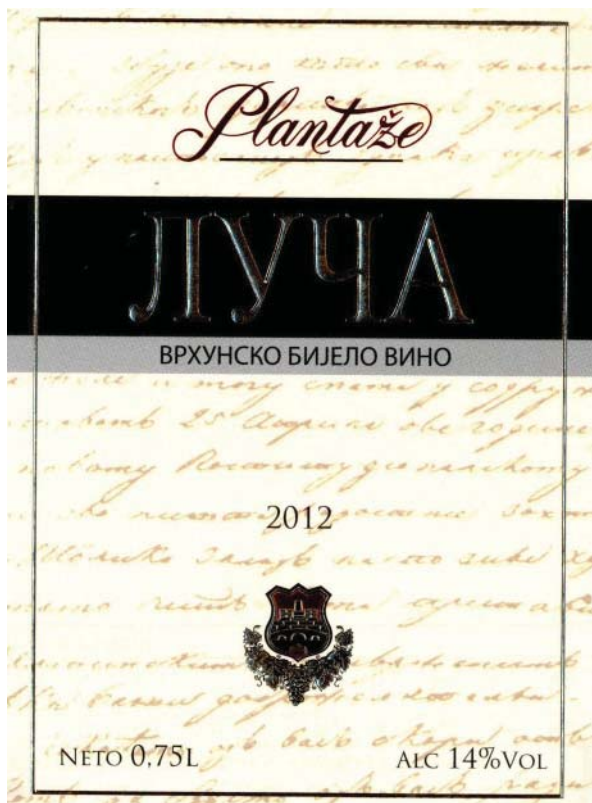

(540)

(550) I

(511) **Klasa 33:** alkoholna pića (izuzev piva)(210) **2014-11**(442) **20.09.2014.**

(220) 1/23/2014

(731) **BOSNALIJEK**, FARMACEUTSKA I HEMIJSKA INDUSTRIJA, DIONIČKO DRUŠTVO, JUKIĆEVA
53, 71000 SARAJEVO BA

LYSOBACT SPRAY

(540)

(550) I

(740) Radulović Božidar, Jovana Tomaševića 9/III, Podgorica ME

(511) **Klasa 05:** farmaceutski proizvodi(210) **2014-110**(442) **20.09.2014.**

(220) 3/13/2014

(731) **13 JUL PLANTAŽE A.D.** PODGORICA ME

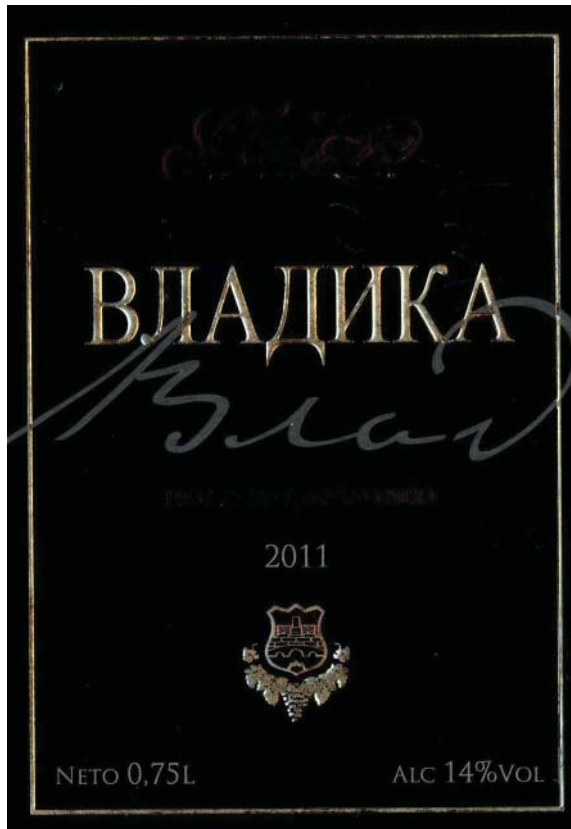

(540)

(550) I

(511) **Klasa 33:** alkoholna pića (izuzev piva)(210) **2014-111** (442) **20.09.2014.**

(220) 3/13/2014

(731) **BEATS ELECTRONICS, LLC** (DELAWARE LIMITED LIABILITY COMPANY), 1601 CLOVERFIELD BLVD, SUITE 5000N, SANTA MONICA, CA 90404 US

BEATS PRO

(540)

(550) I, V

(740) Radulović Božidar, Jovana Tomaševića 9/III, Podgorica ME

(511) **Klasa 09:** slušalice, slušalice koje se stavljaju u uši, zvučnici, audio zvučnici, audio kablovi, audio zvučnici za automobile, medija plejeri za automobile, digitalni audio plejeri za automobile, mobilni telefoni, laptop kompjuteri(210) **2014-12** (442) **20.09.2014.**

(220) 1/24/2014

(731) **KING POINT ENTERPRISE CO.LTD.** 15FL.-6, NO.110, SAN DUO 4TH ROAD, LING YA DIST.KAOHSIUNG CITY, TAIWAN, R.O.C.



(540)

(550) I

(740) Lutovac Branislav, Bulevar Crnojevića 93, Podgorica ME

(511) **Klasa 06:** metalni zavrtnji, neelektrični automati za zatvaranje vrata, metalna oprema za vrata, kvake za vrata od metala, zvekiri, neelektrični otvarači za vrata, metalni stoperi za vrata, metalna oprema za gradnju, metalna oprema za namještaj, metalna oprema za prozore, gvoždarska roba široke potrošnje, šarke od metala, kuke (gvoždarska roba), ključevi, kvake od metala, neelektrične brave od metala, ekseri, navrtke od metala, zakivci od metala, vijci od metala, alke sa vijkom, federi (gvoždarska roba), podloške od metala

(210) **2014-13**

(442) **20.09.2014.**

(220) 1/27/2014

(731) **ABBVIE INC.** 1 NORTH WAUKEGAN ROAD NORTH CHICAGO IL 60064 US



(540)

(550) I, F

(740) Popović Miladin, Đoka Miraševića 21/III, Podgorica ME

(511) **Klasa 05:** Pulmonarni surfaktant,

(210) **2014-14**

(442) **20.09.2014.**

(220) 1/28/2014

(731) **BEATS ELECTRONICS, LLC** (DELAWARE LIMITED LIABILITY COMPANY), 1601 CLOVERFILED BLVD, SUITE 5000N, SANTA MONICA, CA 90404 US

TOUR

(540)

(550) I, V

(740) Radulović Božidar, Jovana Tomaševića 9/III, Podgorica ME

(511) **Klasa 09:** slušalice, slušalice koje se stavljaju u uši, zvučnici, audio zvučnici, audio kablovi, audio zvučnici za automobile, medija plejeri za automobile, digitalni audio plejeri za automobile, mobilni telefoni, laptop kompjuteri

(210) **2014-15**

(442) **20.09.2014.**

(220) 1/29/2014

(731) **EUROCLEAR PLC**, BAARERMATTE, CH 6340 BAAR CH

EUROCLEAR EASYWAY

(540)

(550) I, V

(740) Popović Miladin, Đoka Miraševića 21/III, Podgorica ME

(511) **Klasa 09:** softver za elektronsku obradu podataka i elektronski prenos sredstava, podataka i dokumenta u vezi sa finansijskim uslugama

Klasa 35: upravljanje finansijskim informacijama iz baza podataka za kupovinu, prodaju, promet, staranje i upravljanje hartijama od vrijednosti

Klasa 36: bankarstvo i finansijske usluge, usluge kreditiranja, finansiranja i investiranja, usluge kolateralnih informacija, usluge kolateralnog upravljanja i druge usluge obezbjeđivanja i objedinjavanja, usluge post trgovine (kliring i saldiranje), upravljanje i čuvanje hartija od vrijednosti, pružanje finansijskih informacija iz baza podataka za kupovinu, prodaju, promet, staranje i upravljanje hartijama od vrijednosti

(210) **2014-17**

(442) **20.09.2014.**

(220) 1/29/2014

(731) **KENTUCKY FRIED CHIKEN INTERNATIONAL HOLDINGS INC.** 1441 GARDINER LANE, LOUISVILLE, KENTUCKY 40213 US



(540)

(550) I

(740) Jusić Jasna, Crnogorskih serdara bb, Podgorica ME

(511) **Klasa 29:** meso, riba, živina i divljač, mesne prerađevine, konzervisano, smrznuto, sušeno i kuvano voće i povrće, želei, džemovi, kompoti, jaja, mlijeko i mliječni proizvodi, jestiva ulja i masti

Klasa 30: kafa, čaj, kakao i zamjena kafe, pirinač, tapioca i sago, brašno i proizvodi od žitarica, hljeb, kolači, poslastice, sladoledi, šećer, med, melasa, kvasac, prašak za pecivo, so, senf, sirće, sosevi (kao začini) začini, led

Klasa 43: usluge obezbjeđivanja hrane i pića, usluge privremenog smještaja

(210) **2014-18**

(442) **20.09.2014.**

(220) 1/30/2014

(731) **PPG INDUSTRIES OHIO, INC.** A CORPORATION ORGANIZED AND EXISTING UNDER THE LAWS OF THE STATE OF DELAWARE, 3800 WEST 143RD STREET CLEVELAND, STATE OF OHIO 44111 US

AUTOLUX

(540)

(550) I

(740) MSA IP Milojević Sekulić, Bulevar Despota Stefana 1a, Beograd SR

(511) **Klasa 02:** mješavine za premazivanje u obliku boja

(210) **2014-19**

(442) **20.09.2014.**

(220) 1/30/2014

(731) **EUROCLEAR SA/NV**, 1 BOULEVARD DU ROI ALBERT 11 1210 BRUSSELS BE

COLLATERAL HIGHWAY

(540)

(550) I

(740) Popović Miladin, Đoka Miraševića 21/III, Podgorica ME

(511) **Klasa 09:** softver za elektronsku obradu podataka i elektronski prenos sredstava,

podataka i dokumenata u vezi sa finansijskim uslugama

Klasa 35: upravljanje finansijskim informacijama iz baza podataka za kupovinu, prodaju, promet, staranje i upravljanje hartijama od vrijednosti

Klasa 36: bankarstvo i finansijske usluge, pružanje finansijskih informacija iz baza podataka za kupovinu, prodaju, promet, staranje i upravljanje hartijama od vrijednosti

(210) **2014-2** (442) **20.09.2014.**

(220) 1/14/2014

(731) **BONATTI** D.O.O. BULEVAR VOJVODE MISICA 41, 11000 BEOGRAD RS

BONATTI

(540)

(550) I

(740) AOD "Ćupić", Dalmatinska 10, Podgorica ME

(511) **Klasa 18:** koža i imitacija kože, proizvodi izrađeni od ovih materijala koji nisu uključeni u druge klase, životinjska koža, koferi i putne torbe, torbe, kišobrani, suncobrani i štapovi za hodanje, bičevi, saračka i sedlarska roba

Klasa 24: tekstil i tekstilni proizvodi koji nisu obuhvaćeni drugim klasama, prekrivači za krevete i stolove

Klasa 25: odjeća, obuća, pokrivala za glavu

(210) **2014-20** (442) **20.09.2014.**

(220) 1/30/2014

(731) **JFI GLOBAL PURCHASING LIMITED**, 2ND FLOOR, ITC BUILDING, WERRENS, ST.MICHAEL BB

JOE FRESH

(540)

(550) I

(740) Jusić Jasna, Crnogorskih serdara bb, Podgorica ME

(511) **Klasa 03:** kozmetika

Klasa 25: odjeća, obuća, pokrivala za glavu

Klasa 35: usluge maloprodajnih objekata

(210) **2014-21** (442) **20.09.2014.**

(220) 2/3/2014

(731) **FALCON GROUP** DOO, DAJBABE BB PODGORICA ME



(540)

(550) I, F

(511) **Klasa 29:** meso, riba, živina, i divljač, mesni ekstrakti, konzervirano, sušeno i kuvano voće i povrće, želei, džemovi, kompoti, jaja, mlijeko, mliječni proizvodi, jestiva ulja i masti

Klasa 30: kafa, čaj, kakao, šećer, riža, tapioka, sago, zamjene za kafu, brašno, proizvodi od žitarica, hleb, kolači, poslastice, bomboni, sladoled, med, sirup od melase, kvasac, prašak za pecivo, so, senf, sirće, prelive, začini, razni začini, led za hlađenje

Klasa 31: poljoprivredni, povrtlarski, šumski proizvodi i bobice, koji nisu obuhvaćeni drugim klasama, žive životinje, svježe voće i povrće, sjeme, prirodne biljke i cvijeće, hrana za životinje, slad

(210) **2014-22**(442) **20.09.2014.**

(220) 2/3/2014

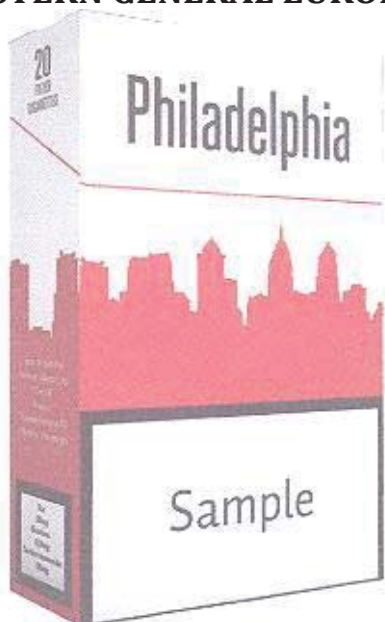
(731) **WESTERN GENERAL EUROPE DOO**, MILUTINA VUČINIČA BR.43 PODGORICA ME

(540)

(550) I, F

(511) **Klasa 34:** duvan, pribor za pušače, šibice

Klasa 35: oglašavanje, reklamiranje, vođenje komercijalnih poslova, komercijalna administracija, kancelarijski poslovi, izvoz duvana

(210) **2014-23**(442) **20.09.2014.**

(220) 2/3/2014

(731) **PPG INDUSTRIES OHIO, INC.**A CORPORATION ORGANIZED AND EXISTING UNDER THE LAWS OF THE STATE OF DELAWARE, 3800 WEST 143RD STREET CLEVELAND, STATE OF

OHIO 44111 US

VALUE-PRO

(540)

(550) I

(740) MSA IP Milojević Sekulić, Bulevar Despota Stefana 1a, Beograd SR

(511) **Klasa 02:** mješavine za premazivanje u obliku boja

(210) **2014-24**

(442) **20.09.2014.**

(220) 2/3/2014

(731) **AMGEN INC.**(DELAWARE CORPRATION), ONE AMGEN CENTER DRIVE, THOUSAND OAKS, CALIFORNIA 91320-1799 US

REPATHA

(540)

(550) I

(740) Radulović Božidar, Jovana Tomaševića 9/III, Podgorica ME

(511) **Klasa 05:** farmaceutski preparati

(210) **2014-25**

(442) **20.09.2014.**

(220) 2/3/2014

(300) 86/174, 517 24.01.2014 US

(731) **AMGEN INC.** (DELAWARE CORPORATION), ONE AMGEN CENTER DRIVE, THOUSAND OAKS, CALIFORNIA 91320-1799 US

ELUCIAM

(540)

(550) I, V

(740) Radulović Božidar, Jovana Tomaševića 9/III, Podgorica ME

(511) **Klasa 05:** farmaceutski preparati

(210) **2014-26**

(442) **20.09.2014.**

(220) 2/3/2014

(731) **AMGEN INC.** (DELAWARE CORPRATION), ONE AMGEN CENTER DRIVE, THOUSAND OAKS, CALIFORNIA 91320-1799 US

ZEROUNT

(540)

(550) I, V

(740) Radulović Božidar, Jovana Tomaševića 9/III, Podgorica ME

(511) **Klasa 05:** farmaceutski preparati

(210) **2014-27**

(442) **20.09.2014.**

(220) 2/4/2014

(731) **DOO "CO2PRINT"**, DŽORDŽA WAŠINGTONA 3/7, ULAZ 2, BR. STANA 5. PODGORICA ME



(540)

(550) I

(511) **Klasa 09:** naučni, nautički, geodetski, fotografski, kinematografski i optički aparati i instrumenti kao i aparati i instrumenti za vaganje, mjerenje, signalizaciju, kontrolu (inspekciju), za pomoć (spašavanje) i za obuku, aparati i instrumenti za vođenje, distribuciju, transformisanje, akumuliranje, podešavanje ili upravljanje električne struje, aparati za snimanje, prijenos, reprodukciju zvuka ili slika, magnetni nosači podataka, diskovi za snimanje, kompaktni diskovi, DVD i drugi numerički nosači za snimanje, mehanizmi za uređaje koji se pokreću uz prethodno ubacivanje novca ili žetona, registarske blagajne, računari, oprema za obradu podataka i kompjuteri, uređaji za gašenje požara, kompjuterski programi [softveri]

Klasa 41: obuka, stručno osposobljavanje, razonoda, sportske i kulturne djelatnosti

Klasa 42: naučne i tehnološke usluge kao i pripadajuće usluge istraživanja i koncepcije, usluge industrijskih analiza i istraživanja, koncepcija i razvoj računara i računarskih programa / hardvera i softvera/

(210) **2014-28**

(442) **20.09.2014.**

(220) 2/4/2014

(731) **PHARMACEUTICAL CHEMICAL COSMETIC INDUSTRY ALKLOID AD-SKOPLJE**, BUL. ALEKSANDAR MAKEDONSKI 12, 1000 SKOPLJE RM

Premama Duo

(540)

(550) I

(740) Popović Miladin, Đoka Miraševića 21/III, Podgorica ME

(511) **Klasa 05:** multivitaminske/multimineralne tablete za trudnice

(210) **2014-29** (442) **20.09.2014.**

(220) 2/5/2014

(731) **NOVARTIS AG**, 4002 BASEL CH

SUREPAL

(540)

(550) I

(740) MSA IP Milojević Sekulić, Bulevar Despota Stefana 1a, Beograd SR

(511) **Klasa 05:** farmaceutski preparati za ljudsku upotrebu

Klasa 10: injekcioni uređaji za farmaceutske preparate

(210) **2014-3** (442) **20.09.2014.**

(220) 1/16/2014

(731) **JADE GENERAL TRADING LLC**, P.O.BOX 31461, DUBAI AE



(540)

(550) I

(740) Radulović Božidar, Jovana Tomaševića 9/III, Podgorica ME

(511) **Klasa 34:** duvan, artikli za pušaće, šibice

(210) **2014-30** (442) **20.09.2014.**

(220) 2/5/2014

(731) **THE GILLETTE COMPANY**, ONE GILLETTE PARK, BOSTON, MA02127 US

DURACOMFORT

(540)

(550) I

(740) Lutovac Branislav, Bulevar Crnojevića 93, Podgorica ME

(511) **Klasa 08:** nožići za brijače koji se prodaju kao integrisani sastavni djelovi uložaka za brijače

(210) **2014-31** (442) **20.09.2014.**

(220) 2/5/2014

(731) **FLY STAR** DOO PODGORICA, AERODROM GOLUBOVCI BB, PODGORICA ME



(540)

(550) I, F

(740) Ivanović Đorđe, Moskovska 89/V, Podgorica ME

(511) **Klasa 12:** vozila za kretanje po vazduhu, putnički autobusi, avioni, dostavna vozila, kombi vozila, helikopteri, kola, automobili

Klasa 16: hartija i proizvodi od hartije, karton i proizvodi od kartona, kancelarijski pribor, pribor za pisanje, štampane stvari, reklamni materijal, časopisi, periodična izdanja, knjige, fotografije, razglednice, brošure, poster, mape, uverenja, karte, red letenja, cenovnik

Klasa 25: odeća, obuća, pokrivala za glavu

Klasa 39: transportne usluge, pakovanje i skladištenje robe, organizovanje putovanja

Klasa 43: usluge rezervacija smeštaja putnika, catering hrane i pića

Klasa 25: odeća, obuća, pokrivala za glavu

(210) **2014-32**

(442) **20.09.2014.**

(220) 2/5/2014

(731) **FLY STAR** DOO PODGORICA, AERODROM GOLUBOVCI BB, PODGORICA ME



(540)

(550) I, F

(740) Ivanović Đorđe, Moskovska 89/V, Podgorica ME

(511) **Klasa 12:** vozila za kretanje po vazduhu, putnički autobusi, avioni, dostavna vozila, kombi vozila, helikopteri, kola, automobili

Klasa 16: hartija i proizvodi od hartije, karton i proizvodi od kartona, kancelarijski pribor, pribor za pisanje, štampane stvari, reklamni materijal, časopisi, periodična izdanja, knjige,

fotografije, razglednice, brošure, poster, mape, uverenja, karte, red letenja, cenovnik

Klasa 25: odeća, obuća, pokrivala za glavu

Klasa 39: transportne usluge, pakovanje i skladištenje robe, organizovanje putovanja

Klasa 43: usluge rezervacija smeštaja putnika, katering hrane i pića

(210) **2014-37** (442) **20.09.2014.**

(220) 2/6/2014

(731) **SENSORMATIC ELECTRONICS**, LLC, 1501 YAMATO ROAD, BOCA RATON, FLORIDA 33431, US

AMERICAN
DYNAMICS

(540)

(550) I

(740) AOD "Ćupić", Dalmatinska 10, Podgorica ME

(511) **Klasa 09:** uređaji za snimanje, prenos ili reprodukovanje zvuka i slike (uključujući uređaje za obradu podataka, komunikaciju i kopiranje, kao i spoljašnju računarsku opremu), magnetni i optički nosioci podataka, kao i računarski programi koji su na njima snimljeni, elektronske objave koje se mogu preuzeti preko računarskih mreža i snimiti na magnetne i optičke medije, kartice sa magnetnim/optičkim čitačima, antene, satelitske antene, pojačavači i odgovarajući djelovi, kamere, pomoćna oprema za kamere, IP video koderi, mrežni video rekorderi, sistemi za upravljanje video zapisima, hibridna rješenja za snimanje video zapisa, rješenja za skladištenje, rješenja za matrične preklopnike, Quad uređaji i multiplekseri, kao i monitori, računarska oprema i programi za kontrolu pristupa, upravljanje događajima, televizija zatvorenog kola, video kamere/kupole, digitalni video nadzor, snimanje digitalnih video zapisa i njihova kontrola, sistemi za praćenje i kontrolu osnovnih sredstava, analiza video zapisa, nadzor prodajnih mjesta i integrisani elektronski bezbjednosni sistemi.

(210) **2014-38** (442) **20.09.2014.**

(220) 2/6/2014

(731) **SENSORMATIC ELECTRONICS**, LLC, 1501 YAMATO ROAD, BOCA RATON, FLORIDA 33431, US



(540)

(550) I

(740) AOD "Ćupić", Dalmatinska 10, Podgorica ME

(511) **Klasa 09:** uređaji za snimanje, prenos ili reprodukovanje zvuka i slike (uključujući uređaje

za obradu podataka, komunikaciju i kopiranje, kao i spoljašnju računarsku opremu), magnetni i optički nosioci podataka, kao i računarski programi koji su na njima snimljeni, elektronske objave koje se mogu preuzeti preko računarskih mreža i snimiti na magnetne i optičke medije, kartice sa magnetnim/optičkim čitačima, antene, satelitske antene, pojačavači i odgovarajući djelovi, kamere, pomoćna oprema za kamere, IP video koderi, mrežni video rekorderi, sistemi za upravljanje video zapisima, hibridna rješenja za snimanje video zapisa, rješenja za skladištenje, rješenja za matrične preklopnike, Quad uređaji i multiplekseri, kao i monitori, računarska oprema i programi za kontrolu pristupa, upravljanje događajima, televizija zatvorenog kola, video kamere/kupole, digitalni video nadzor, snimanje digitalnih video zapisa i njihova kontrola, sistemi za praćenje i kontrolu osnovnih sredstava, analiza video zapisa, nadzor prodajnih mjesta i integrisani elektronski bezbjednosni sistemi.

(210) **2014-39** (442) **20.09.2014.**

(220) 2/6/2014

(731) **TYCO SAFETY PRODUCTS CANADA LTD.** 3301 LANGSTAFF ROAD, CONCORD, ONTARIO L4K 4L2 CA

DSC

(540)

(550) I

(740) AOD "Ćupić", Dalmatinska 10, Podgorica ME

(511) **Klasa 09:** bezbjednosni i alarmni sistemi, kao i prateća oprema i komponente, naime, detektori prisustva gasa i monitori, detektori udara i monitori, PIR detektori, detektori prisustva dima i izbijanja požara i monitori, detektori toplote i monitori, kao i detektori pokreta i monitori, štampano kolo, elektronski kontrolni moduli, kontrolni paneli, numeričke tastature, uređaji za bežičnu kontrolu, uređaji za bežično zaključavanje, lični alarmi za skretanje pažnje i zaštitu od napada, električni kontakti za vrata i prozore, senzori i punjači baterija, oprema centralne stanice za nadzor, naime, automatske telefonske sekretarice, alarmni prijemnici za identifikovanje poziva i dekodiranje signala alarma i nadzora, izlazni uređaji, naime, terminali za prikaz video zapisa i štampači, kao i računarski programi za daljinsko programiranje alarmnih panela, sistemi i uređaji za kontrolu pristupa, naime, monitori i kontrole pristupa, predajnici i prijemnici glasa i signala, oprema za međusobne veze, voki-toki, TV interkom, monitori za prikaz, računarski programi za alarmne i bezbjednosne sisteme

(210) **2014-4** (442) **20.09.2014.**

(220) 1/16/2014

(300) 47576 18.11.2013. TT

(731) **INTEL CORPRATION**, 2200 MISSION COLLEGE BOULEVARD, SANTA CLARA, CALIFORNIA, 95052-8119 US

INTEL REALSENSE

(540)

(550) I

(740) Jusić Jasna, Crnogorskih serdara bb, Podgorica ME

(511) **Klasa 09:** računari, ručni računari, mini računari, računarski hardver, računarski softver,

hardver i softver za prepoznavanje glasa, softver za pretvaranje glasa u tekst, softverske aplikacije koje se aktiviraju glasom, softver za prepoznavanje znakova, računarski softver u oblasti prirodnih jezika, govora, govornika, jezika, prepoznavanja glasa, i prepoznavanja glasa prema profilu glasa, hardver i softver za sisteme za 3d kamere koje se koriste za praćenje pogleda i prepoznavanje pokreta, aparati za elektronsko obezbeđenje i aparati za nadzor, sigurnosni softver i hardver koji koristi tehnologiju praćenja pogleda i praćenja pokreta, celularni telefoni, mobilni telefoni, smartfoni, prenosiivi i ručni elektronski lični organizatori, aparati i potrošački elektronski uređaji, televizori, digitalni muzički plejeri, dvd plejeri, rekorderi, pisači i rezači, lični digitalni uređaji, digitalne kamere i digitalni rekorderi, proizvodi za kućni bioskop, video igre, zvučni drajveri, video drajveri, video kamere, grafičke karte, grafičke procesorske jedinice (gpu), grafički čipsetovi, vizuelni procesori, vizuelni koprocesori, dodatni uređaji, softver i hardver, računarski softver za upravljanje ličnim informacijama, softver za upravljanje bazama podataka, softver za sinhronizaciju baza podataka, integrisana kola, integrisana memorijska kola, čipovi sa integrisanim kolima, računarski čipsetovi, poluprovodnički procesori, čipovi sa poluprovodničkim procesorima, čipovi sa poluprovodnicima, mikroprocesori, štampane ploče sa kolima, štampana kola, ploče sa integrisanim kolima, štampane ploče sa kolima i električne ploče sa kolima, elektronske ploče sa kolima, računarske matične ploče, računarske memorije, operativni sistemi, mikrokontrolori, uređaji za obradu podataka, centralne procesorske jedinice (epu), poluprovodnički memorijski uređaji, poluprovodničke memorije i poluprovodničke memorijske jedinice, procesori koji se mogu programirati uz pomoć softvera, digitalni i optički mikroprocesori, računarski periferni uređaji, video ploče sa kolima, audio ploče sa kolima, audio -video ploče sa kolima, video grafički akceleratori, akceleratori za multimediju video procesori, ploče sa videoprocessorima, memorije sa podacima, računarski hardver, računarski čipovi i mikroprocesori optimizovani za elektronski sigurnosni nadzor, algoritamski softverski programi za rad i kontrolu računara, softver za sisteme za rad računara, sistemske ekstenzije za računar, alati i uslužni programi u oblasti aplikativnog softvera za povezivanje ličnih računara, mreža, aparata za telekomunikacije i aplikacija za globalnu računarsku mrežu, kompjuterizovane telekomunikacije i mrežna oprema koja se sastoji od softvera za operativne sisteme, računarski hardver i softver za poboljšanje i pružanje transfera, prenosa, prijema, obrade i digitalizovanja u realnom vremenu audio i video grafičkih informacija, računarski firmver, računarski softver za operativne sisteme, računarski uslužni softver i drugi računarski softver koji se koristi za održavanje i rukovanje računarskim sistemima, računarske instalacije, memorijske ploče, uređaji za čuvanje podataka, USB memorije, fleš memorije, memorijski stikovi, sigurnosni sistemi za računarski hardver i softver, zaštitni zidovi, serverski hardver za mrežni pristup za stvaranje i održavanje zaštitnih zidova, računarski hardver i računarski softver za rad servera za stvaranje i održavanje zaštitnih zidova na virtuelnoj privatnoj mreži (vpn), softver za obezbeđivanje sigurnosti računarskih mreža, softver za kontrolu i sigurnost pristupa, računarski hardver i softver koji se koristi za zaštitu računarskih mreža od krađe podataka ili štete nanijete od strane neovlašćenih korisnika, komponente za računare, računarske ploče za akceleraciju zvuka, računarske akceleratorne ploče za glas, podatke, slike i video zapise, fleš memorijske ploče i fleš memorijske kartice, oprema za telekomunikacije i računarske mreže, naime, sistemi za obradu i upravljanje, aparati i instrumenti za telekomunikacije, računarski ruteri, čvorišta, serveri i skretnice, računarski hardver i softver za razvoj, održavanje, i upotrebu lokalnih i računarskih mreža za široko područje, set top boks, elektronski kontrolni uređaji za interfejs i kontrolu računara i globalnih računarskih i telekomunikacionih mreža sa televizijskim i kablovskim programima i opremom, aparati za testiranje i programiranje integrisanih kola, računarski periferni memorijski aparati i uređaji, računarski server sa fiksnom funkcijom,

hardver za umrežavanje računara, računarski hardver i softver za stvaranje, olakšavanje i upravljanje daljinskim pristupom ka i komunikaciju sa lokalnim mrežama (lans), virtuelnim privatnim mrežama (vpn), mrežama za široko područje (wans) i globalnim računarskim mrežama, softver za upravljanje ruterima, skretnicama, čvorištima i serverima, računarski softver i hardver koji se koristi za pružanje pristupa velikom broju korisnika globalnoj računarskoj informacionoj mreži za pretraživanje, preuzimanje, prenos, rukovanje i širenje širokog spektra informacija, računarski softverski alati za olakšavanje rada softverskim aplikacijama trećih strana, računarski hardver i softver za bežične mrežne komunikacije, elektronske publikacije koje se mogu preuzeti sa globalne mreže u vidu biltena, knjiga, magazina, časopisa, brošura i uputstava iz oblasti elektronike, poluprovodnika, integrisanih elektronskih aparata i uređaja, računara, telekomunikacija, zabave, telefonije, i žične i bežične telekomunikacije, sastavni delovi i oprema za svu gore navedenu robu, priručnici sa uputstvima koji se prodaju zajedno sa gore navedenom robom i elektronski priručnici sa uputstvima koji se mogu preuzeti sa globalne računarske mreže, aparati i instrumenti naučni, pomorski, geodetski, fotografski, kinematografski, optički, za vaganje, mejerjenje, signalizaciju, kontrolu (inspekciju), spašavanje i nastavu, aparati i instrumenti za provođenje, prekid, transformaciju, akumulaciju, regulisanje ili kontrolu električne energije, aparati za snimanje, prenos i reprodukovanje zvuka ili slike, magnetni nosači podataka, diskovi za snimanje, kompakt diskovi, DVD i drugi digitalni nosači podataka, mehanizmi za aparate koji se pokreću novcem ili žetonom, registar kase, računске mašine, oprema za obradu podataka, račun, računarski softver, aparati za gašenje požara

(210) **2014-41**

(442) **20.09.2014.**

(220) 2/7/2014

(731) **SOCIETE DES PRODUITS NESTLE S.A.** 1800 VEVEY CH



(540)

(550) I

(740) Lutovac Branislav, Bulevar Crnojevića 93, Podgorica ME

(511) **Klasa 30:** jestivi led i preparati za pravljenje jestivog leda, sladoledi na bazi vode, sorbe, zaleđene poslastice, zaleđeni kolači i torte, zaleđeni jogurt

(210) **2014-43**

(442) **20.09.2014.**

(220) 2/7/2014

(731) **ALEKSANDRIJA MONTE DOO**, BIJELA BB HERCEG NOVI ME



(540)

(550) I, F

(511) **Klasa 29:** kiseli kupus, krastavci ukiseljeni, povrće konzervirano, supe, voće konzervirano, čips (prženi krompiri)

Klasa 30: brašno i proizvodi od žitarica, hljeb, kolači, poslastice, bomboni, sladoled i to: beskvasni hljeb, biskviti (suvi kolači), bomboni, brašno, čajni kolačići (minjoni), čokolada, dvopek (prepečenac), fabrika brašna (proizvodi fabrike brašna), glazure za kolače, hljeb, hljebne mrvice, kakao (proizvodi od kakaoa), keks (pettits beure), kolači, kolačići (šaćasti kolačići), vafel, kolačići od badema, krekeri, makaroni, marcipan (kolač od badema), mesne pite, pecivo (sitno fino pecivo), pecivo, pizza, praline, prehrambena tjestenina, pršenicne klice za ljudsku ishranu, pšenično brašno za ljudsku prehranu, rezanci, rezanci za supe, sendviči, sendviči od sira, slastičarski proizvodi, slatkiši, suvi kolačići, špageti, tjesto za kolače, tjestenina, tjestenina za prehranu, torte, tortilje, ukrasi za kolače (jestivi), vafel proizvodi, voćni kolači, žitarice (pahulje od sušenih žitarica), puslice od badema (poslastica), krekeri, pite od pirinča, brza hrana na bazi žitarica

Klasa 31: poljoprivredni, povrtlarski proizvodi koji nisu obuhvaćeni drugim klasifikacijama, svježe voće i povrće, sjemena, i to: krompiri, kukuruz, luk svježi, ovas (zob), pasulj u svježem stanju, pšenica, raž, sjeme, spanać (svježi), tikvice, voće svježe, zrna (žitarice), krastavci svježi, svježe povrće, boranija (svježa), praziluk (svjež)

(210) **2014-44**(442) **20.09.2014.**

(220) 2/7/2014

(731) **FARMACEUTSKO-HEMIJSKA INDUSTRIJA ZDRAVLJE AD**, VLAJKOVA 199, 16000 LESKOVAC, RS

ROSACTA

(540)

(550) I, V

(740) Popović Miladin, Đoka Miraševića 21/III, Podgorica ME

(511) **Klasa 05:** farmaceutski preparati i supstance(210) **2014-45**(442) **20.09.2014.**

(220) 2/11/2014

(731) **VISA INTERNATIONAL SERVICE ASSOCIATION**, 900 METRO CENTER BOULEVARD, FOSTER CITY, CALIFORNIA 94404 US

Visa. Svugdje gdje želite da budete

(540)

(550) I

(740) Čolović Mladen, Crnogorskih serdara bb, Podgorica ME

(511) **Klasa 36:** finansijske usluge, usluge osiguranja, bankarske usluge, usluge kreditnih kartica, usluge debitnih kartica, usluge punjenja kartica, usluge kartica za plaćanje unaprijed, usluge smart kartica, elektronske kreditne i platne transakcije, elektronski transfer sredstava, usluge obrade plaćanja, usluge autentifikacije i verifikacija transakcija, zamjena za gotovinu uslugama kreditnih i debitnih kartica, usluge mjenjačnice, usluge onlajn bankarstva, usluge platnog računa, usluge pristupa depozitu i automatizovanih šalter mašina, usluge unovčavanja čekova i isplate gotovine, širenje finansijskih infomacija putem globalne računarske mreže i finansijskog sponzorstva sportskih takmičenja, događaja, aktivnosti, i igara

(210) **2014-46**

(442) **20.09.2014.**

(220) 2/11/2014

(731) **TAVFIK GENERAL TRADING** L.L.C. OFFICE NO.104, AL HUDA BUILDING, DIERA, DUBAI AE

MASTER

(540)

(550) I, V

(740) Radulović Božidar, Jovana Tomaševića 9/III, Podgorica ME

(511) **Klasa 34:** duvan, cigarete, cigare, filteri (cigarete) i šibice

(210) **2014-47**

(442) **20.09.2014.**

(220) 2/14/2014

(731) **UNIVERSAL PROTEIN SUPPLEMENTS CORPORATION** D/B/A UNIVERSAL NUTRITION, 3 TERMINAL ROAD, NEW BRUNSWICK, NEW JERSEY 08901 US



(540)

(550) I

(740) Ćosović Dejan, 13. jula 1/5, Budva ME

(511) **Klasa 05:** dodaci ishrani

Klasa 25: odjeća, pokrivala za glavu i prateća oprema (proizvodi) za proizvode iz klase 25

Klasa 35: usluge maloprodaje putem interneta

(210) **2014-48**

(442) **20.09.2014.**

(220) 2/14/2014

(300) 00003019811 28.08.2013. GB

(731) **BRITISH AMERICAN TOBACCO (BRANDS) INC.** 2711 CENTREVILLE ROAD SUITE 300 WILMINGTON DELAWARE 19808 US



(540)

(550) I, F

(740) Popović Miladin, Đoka Miraševića 21/III, Podgorica ME

(511) **Klasa 34:** cigarete, duvan, proizvodi od duvana, upaljači šibice artikli za pušače

(210) **2014-49**

(442) **20.09.2014.**

(220) 2/14/2014

(731) **PT INDOFOOD SUKSES MAKMUR TBK**, SUDIRMAN PLAZA, INDOFOOD TOWER 27TH/FI.JI.JEND.SUDIRMAN KAV.76-78, JAKARTA SELATAN ID

Indofood

(540)

(550) I

(740) Jusić Jasna, Crnogorskih serdara bb, Podgorica ME

(511) **Klasa 30:** makarone, rezanci, tjestenina, Vermiceli rezanci, pšenicno brašno, kečap (sosevi), čili (sos), majonez, senf, dvopek, sosevi (dodaci jelima), začini, soja sos, čaj, paradajz sos

(210) **2014-5**

(442) **20.09.2014.**

(220) 1/17/2014

(731) **THE PROCTER & GAMBLE COMPANY**, ONE PROCTER & GAMBLE PLAZA, CINCINATI,

OHIO 45202 US

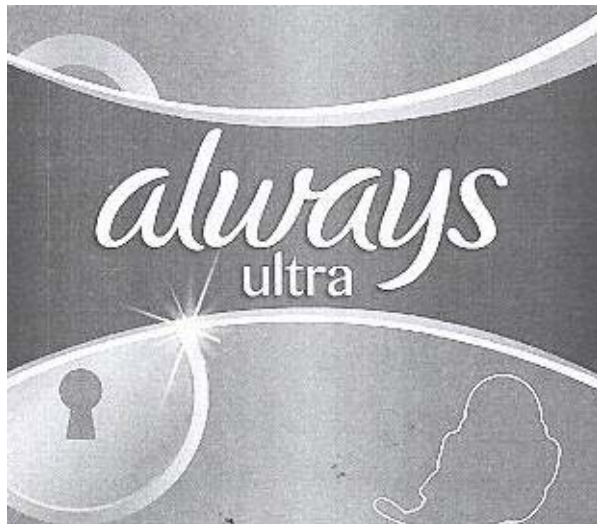

(540)

(550) I

(740) Lutovac Branislav, Bulevar Crnojevića 93, Podgorica ME

(511) **Klasa 05:** ženski higijenski proizvodi kao što su dnevni ulošci, higijenski ulošci i tamponi, higijenske gaćice, interlabijalni ulošci za žensku higijenu, gaćice za žensku higijenu, pelene i ulošci za inkontinenciju, gaćice za inkontinenciju

(210) **2014-50**(442) **20.09.2014.**

(220) 2/14/2014

(731) **MOCLER S.P.A.** VIA STENDHAL 47, 20144 MILANO IT

MONCLER

(540)

(550) I

(740) Jusić Jasna, Crnogorskih serdara bb, Podgorica ME

(511) **Klasa 03:** parfemi, toaletna voda, lični dezodoransi, mirisi, preparati za osvježavanje vazduha, mirišljave vrećice za čuvanje posteljine, esencijalna ulja za ličnu upotrebu, kana (kozmetička boja), sjenke za oči, kozmetičke olovke, podloga za šminku, puderi za lice, puder u talku, ruževi, karmini, maškare, preparati za sunčanje, lak za nokte, maske za lice, pilinzi za lice, kreme za lice, kreme za tijelo, kozmetičke kreme, kozmetički preparati za mršavljenje, anti-celulit kreme (za kozmetičku upotrebu), sprejevi za kosu, losioni za kosu, odstranjivači boje za kosu, preparati za bojenje kose, farba za kosu, preparati za ispiranje kose, preparati za posvjetljivanje kose, balzami za kosu, omekšivači za kosu, preparati za trajno uvijanje kose, pjene i gelovi za kosu, preparati za depilaciju, sapuni za ruke, sapuni, sapuni za lice, kreme za čišćenje kože, losioni za čišćenje kože, gel za tuširanje, pjenušava kupka, ulja za kupanje, kuglice za kupku, nemedicinske soli za kupku, losioni za tijelo, balzami za brijanje, krema za brijanje, sapun za brijanje, losioni za poslije brijanja, šamponi za kosu, preparati za ispiranje usta, ne u medicinske svrhe, pasta za zube, štirk, perači sapun, preparati za uklanjanje fleka, preparati za čišćenje, preparati za uklanjanje rđe, šamponi za tepihe, natopljene krpe za čišćenje, brusni papir, kamen za stopala, puder za poliranje, preparati za poliranje cipela, vosak za cipele, kreme za kožu, preparati za izbjeljivanje kože

(210) **2014-51**(442) **20.09.2014.**

(220) 2/17/2014

(731) **ALBISEH** D.O.O. PRVOMAJSKA 4A 85310 BUDVA ME

(540)

(550) I.F

(511) **Klasa 03:** preparati za bijeljenje i ostale materije za pranje rublja, preparati za čišćenje, poliranje, odmaščivanje i struganje, sapuni, parfimerijski proizvodi, eterična ulja, kozmetički proizvodi, losioni za kosu, proizvodi za njegu zuba, dezodoranse (parfimerija), proizvode za osvježavanje (parfemisanje) prostorija

Klasa 14: plemeniti metali i njihove legure i proizvodi od tih metala ili obloženi tim metalima, koji nisu obuhvaćeni drugim klasama, pravi i lažni nakit, drago kamenje, časovničarski proizvodi i hronometrijski instrumenti, pravi i lažni nakit, dugmad za manžetne, igle za kravate, narukvice (nakit)

Klasa 16: papir, karton i proizvodi od tih materijala koji nisu obuhvaćeni drugim klasama, štamparski proizvodi, proizvodi za uvezivanje knjiga, fotografije, pribor za pisanje, ljepila (ljepljive materije za papirnate proizvode ili za kućne potrebe), slikarski pribor, kistovi, pisaće mašine i kancelarijski pribor (osim namještaja), oprema za nastavu i obuku (osim aparata), plastični materijali za ambalažu (koji nisu obuhvaćeni drugim klasama), štamparska slova, klišeji, plastične folije, torbe i vrećice od plastičnog materijala, za ambalažu

Klasa 18: koža, imitacije kože, proizvodi od tih materijala koji nisu obuhvaćeni drugim klasama, životinjske kože, koferi i torbe, kišobrani, suncobrani i štapovi za hodanje, bičevi i sedlarsko remenarski proizvodi, novčanici, torbe (kožna galanterija)

Klasa 20: namještaj, ogledala, okviri, proizvodi koji nijesu obuhvaćeni drugim klasama, od drveta, plute, trske, šiblja, roga, kosti, slonovače, kitove kosti, školjki, ćilibara, sedefa, morske pjene (štive), zamjena svih tih materijala ili plastični proizvodi

Klasa 21: pribor i posude za domaćinstvo ili za kuhinju, češljeve i sunđere, četke (osim kicica), materijali za četke, pribor za čišćenje, žica za struganje parketa, sirovo ili polu obrađeno staklo (osim građevinskog stakla), stakleni proizvodi, porculansko i keramičko posude koje nije obuhvaćeno drugim klasama, kristalni proizvodi

Klasa 24: tkanine i tekstilni proizvodi koji nijesu obuhvaćeni drugim klasama, pokrivači za krevete i stolove

Klasa 25: odjeća, obuća, pokrivala za glavu, bluze [radničke bluze], bodi [žensko donje rublje], boe [okovratnici od perja ili krzna], cipele, čizme, dokoljenice [odjevni predmeti], džemperi [puloveri], đonovi [đonovi], esparto cipele ili sandale [obuća od platna i špage] ešarpe [šalovi] francuske kape, gaćice, grudnjaci i haljine, haljine na tregere, imitacija kože (odjeća od imitacije kože), jakna ili košulja od platna ili serža za mornare, kabanice, kape za glavu, kape, okrugle, kapuljače, (odjevni predmeti) kaputi, kombinezoni, [odjeća] koprenice, odjeća [mali velovi], košulje, košulje s kratkim rukavima, kožna odjeća, kratke bluze, kratke

čarape [sokne], kratki kaputi [sakoi], kravate, krzna, [odjevni predmeti od krzna], krzneni ogrtači [kaputi] krzneni šalovi, [ženski šalovi od krzna] kupaći kostimi, kupanje (cipele za kupanje), kupanje (kapice za kupanje), kupanje (ogrtači za kupanje), kupanje (sandale za kupanje), lente [široki pojasevi], manžetne [odjevni predmeti], marame za pokrivanje vrata, marame, salovi(fulari), marame, salovi za glavu, mufovi (odjevni predmeti), muske gaće, muške kupaće gaće, muški ogrtači, narukvice, vunene [pletene] nazuvci, grijači nogu, obuća, obuća za plažu, obuća za skijanje, odjeća, odjeća (džepovi za odjeću), odjeća (gornja odjeća), [ogrtači], odjevni predmeti odore, [uniforme], ogrtači [odjevni predmeti], papuče, pantalone, pelerine, pelerine s kapuljačom, plaža, (obuća za plažu), plaža, (odjeća za plažu), podsuknje, pojasevi, [odjevni predmeti], pokrivači za uši [odjevni predmet], Pončo, [vrsta ogrtača], postave, sašivene [dio odjeće], potkošulje, potkošulje za žene, potpetice, prsluci uz tijelo puloveri, puloveri bez rukava rublje (donje rublje za upijanje znoja) rublje (donje rublje) rukavice [odjevni predmeti] sandale, sare, [gornji dio čizama], šari [ženski odjevni predmeti] sarong [odjevni predmeti], slipovi [donji veš] sportska obuća, sportske cipele, sportske gaćice, steznici, steznici od struka do kukova [donje rublje za žene], suknje, suknje-pantalone, šeširi, tee-shirts [majice, toge rake za glavu [odjevni predmeti], tergeri, trikoi (odjevni predmeti), trikotažni odjevni predmeti, turbani, vindjake(kratki sportski kaputi sa kapuljačom), ženske kape, ženske potkošulje, žerseji (odjevni predmeti)

Klasa 33: alkoholna pića

Klasa 35: oglašavanje i reklamiranje, vođenje komercijalnih poslova, komercijalna administracija, kancelarijski poslovi, usluge koje se odnose na registraciju, prijepis, sastavljanje, kompilaciju ili sistematizaciju pisanih saopštenja i zapisa kao i obradu ili kompilaciju matematičkih ili statističkih podataka, usluge agencija za oglašavanje kao i usluge distribuiranja prospekata direktno ili poštom ili distribuiranje uzoraka, oglašavanje u vezi s drugim uslugama kao što su usluge u vezi bankarskih zajmova i oglašavanja putem radija, sortiranje za račun drugih osoba, raznih proizvoda (ne uključuje njihov prevoz) radi omogućavanja potrošaču njihovog lakšeg razgledanja i kupovine, ove usluge se mogu pružati u okviru prodavnica na malo, trgovina na veliko, posredstvom prodajnih kataloga, dopisno ili elektronskim putem, na primjer posredstvom weba ili putem telefona

(210) **2014-53** (442) **20.09.2014.**

(220) 2/20/2014

(731) **PHARMACEUTICAL CHEMICAL COSMETIC INDUSTRY ALKALOID AD-SKOPLJE**, BUL. ALEKSANDAR MAKEDONSKI 12, 1000 SKOPLJE RM



(540)

(550) I

(740) Popović Miladin, Đoka Miraševića 21/III, Podgorica ME

(511) **Klasa 03:** vlažne maramice sa kamilice

(210) **2014-54**

(442) **20.09.2014.**

(220) 2/21/2014

(731) **JOHN PAUL MITCHELL SYSTEMS**, 20705 CENTRE POINTE PARKWAY SANTA CLARITA, CA 91350 US

PAUL MITCHELL

(540)

(550) I

(740) Lutovac Branislav, Bulevar Crnojevića 93, Podgorica ME

(511) **Klasa 03:** preparati za njegu kose i kože, a naročito šamponi, šamponi za bebe, kolor šamponi, sapuni, regeneratori, preparati za hidrataciju, ispiranje i raščeljavanje, i nemedicinski tretman kose, preparati u spreju (mist preparati), sprejevi za toplotnu zaštitu, regeneratori u spreju, gelovi za kosu, gelovi u spreju, pjene za oblikovanje i učvršćivanje kose, losioni, serumi za oblikovanje kose, sprejevi za oblikovanje kose, gelovi za oblikovanje kose, losioni za oblikovanje kose, kreme za ispravljanje kose, lakovi za kosu, pomade, preparati za oblikovanje frizure, sjaj za kosu u spreju, sjaj za kosu u kapima, voskovi, preparati za bojenje, kolorisanje, i nijansiranje kose, polutrajne i trajne boje za kosu, sredstva za izbjeljivanje, preparati za jačanje kose, sredstva za trajno kovrdžanje kose, preparati za njegu kože, a naročito tečni sapuni, čvrsti sapuni, gelovi za brijanje

(210) **2014-55**

(442) **20.09.2014.**

(220) 2/21/2014

(731) **GOOGLE INC.** 1600 AMPHITHEATRE PARKWAY, MOUNTAIN VIEW, CALIFORNIA 94043 US

DOUBLECLICK

(540)

(550) I

(740) AOD "Ćupić", Dalmatinska 10, Podgorica ME

(511) **Klasa 35:** omogućavanje onlajn razmjena i onlajn aukcija za kupovinu ili prodaju oglašavanja, usluge u oblasti oglašavanja radi spajanja odgovarajućih prodavaca i kupaca oglašavanja, radi praćenja učinka oglašavanja, radi upravljanja, distribucije i postavljanja oglašavanja, radi analiziranja podataka o oglašavanju, raportiranja podataka o oglašavanju, radi optimizovanja učinka oglašavanja, konsultantske usluge u oblasti oglašavanja i marketinga, komercijalne informativne usluge, uključujući vođenje oglašavanja putem davanja izvještaja, usmjeravanje oglašavanja na određene ciljne grupe, upravljanje elektronski pohranjenim oglašavanjem, usluge konsaltinga u oblasti oglašavanja putem digitalnih medija

Klasa 42: kompjuterske usluge, uključujući usluge provajdera aplikacionog servisa (ASP) koji sadrži softver za administraciju onlajn razmjena i onlajn aukcija za kupovinu i prodaju oglašavanja, za spajanje odgovarajućih kupaca i prodavaca oglašavanja, za praćenje učinka

oglašavanja, za upravljanje, distribuciju i postavljanje oglašavanja, za analiziranje podataka o oglašavanju, za izvještavanje o podacima o oglašavanju, i za optimizovanje učinka oglašavanja, kompjuterske usluge za kupovinu onlajn oglasnog prostora

(210) **2014-56** (442) **20.09.2014.**

(220) 2/21/2014

(731) **CLAVIN KLEIN TRADEMARK TRUST**, DELAWARE BUSINESS TRUST (WILMINGTON TRUST COMPANY, TRUSTEE) RODNEY SQUARE NORTH, 1100 NORTH MARKET STREET, WILMINGTON, DELAWARE 19890, C/O CLAVIN KLEIN, INC. 205 WEST 39 STREET, NEW YORK, NY 10018 US

Calvin Klein

(540)

(550) I

(740) Jusić Jasna, Crnogorskih serdara bb, Podgorica ME

(511) **Klasa 03:** kozmetika i mirisi, preparat za izbjeljivanje, parfemi, noćna krema, puder za tijelo, šampon, dezodorans, krema za tijelo, gel za tuširanje, mirisi, dekorativni mirisni aranžmani, karmini, sjenka za oči, korektor, rumenilo, ajlajner, puder u prahu za lice, krema za obraze, dnevni losion, granule za čišćenje lica, preparati za čišćenje i hidrataciju, losioni za tijelo, lak za nokte, kolonjska voda, sapun, preparati za hidrataciju kože, kupka za tijelo, balzam za kosu, učvršćivač za kosu, krema za sunčanje, kuglice za kupku, olovka za usne, maskara, puder u prahu, puder za potamnijavanje, olovka za obrve, puder za osvjetljavanje lica, sredstvo za čišćenje lica, krema za oči (za ispod očiju), osvježivač za lice, kuglice za kupku, gel za noge i stopala (koji hladi), odstranjivač laka za nokte, uljna kupka, krema za mekšanje kože, krema za ruke, afterševj, balzam za poslije brijanja, pjena, gel za oblikovanje, sjaj za usne, podloga za šminku, kompaktni puder, preparat za uklanjanje šminke, završni puder za lice, korektor u olovci za prekrivanje nedostataka na licu, tonik/osvježivač za lice, piling za lice i maska za lice, preparat za glačanje kože lica, piling za tijelo, preparat za pranje tijela

Klasa 09: optika, okviri za naočare, naočare za sunce

Klasa 14: nakit, plemeniti metali, ručni satovi, satovi, nakit (prsteni, minđuše, narukvice, stilizovane narukvice, broševi, ogrlice, ogrlice koje stoje usko uz vrat, amajlije, privjesci, medaljoni, menžetne, šnale za kravatu, igle za kravatu, značke, igle za marame, prsteni za marame, šnale za marame, bižuterija i polu-dragi nakit)

Klasa 18: kožni aksesoar, od kože i od imitacije kože, ručne torbe, novčanici, torbice za ključeve, torbice za sitniš, kozmetičke torbe i vrećice, torbe/povezi za nošenje dokumenata, torbe -navlake za odijela, sanduci, koferi, kišobrani, povezi za novac, putne torbe, cegeri, aktovke i torbe za spine, torbe za prtljag, manje putne torbe za jedno noćenje, novčanici za kreditne kartice, novčanici za vizit kartice, toaletne torbice (koje se prodaju prazne), futrole za tablet i ostale mobilne elektronske uređaje, kaiševi

Klasa 25: ženska odjeća, muška odjeća, odjeća za dječake i djevojčice, odjeća, obuća, pokrivala za glavu uključujući (ali ne samo), kombinezoni, majice, bluze, jakne, kupaći kostimi, pantalone, šorcevi, trenerke, donji djelovi trenerke i duksevi, bermude, farmerice, odijela, večernji sakoi i formalna odjeća, pletene majice, kravate i ostali okovratnici, čarape/hulahopke, šeširi/kape, jakne, džemperu, suknje, kaputi, kaputi ukrašeni krznom, krzna, prsluci,

majice kratkih rukava, odjeća za tenis i golf: haljine, majice, suknje, pantalone, šorcevi i ostala odjeća, biciklistička odjeća i odjeća za jogu, majice, trik-majice, suknje, šorcevi, jakne, pantalone za plažu i plivanje, odjeća za kišu, kabanice, pončoi, ogrtači, trik-majice/potkošulje, obuća: cipele, patike za aktivno bavljenje sportom, patike, čizme, papuče, sakoi, pantalone, ogrtači, čarape, rukavice, haljine, kaputi postavljeni krznom i jakne postavljene krznom, šalovi/marame, sportske jakne, (samo donji veš), donji veš/odjeća za spavanje za muškarce i dječake, uključujući: donji veš, odjeću za spavanje, udobna svakodnevna odjeća uključujući (ali ne samo): gaćice, bokserice, sportski (atletski) donji veš, pletena sportska odjeća, majice kratkih rukava, trik-majice, potkošulje, osnovni donji veš i ogrtači, pletena i tkana odjeća za spavanje, majice za spavanje, gornji djelovi pidžama, donji djelovi pidžama, jutarnje jakne, smoking ogrtači, ogrtači za spavanje, ogrtači, pletena i tkana udobna svakodnevna odjeća, udobne svakodnevne pantalone i majice, udobne svakodnevne jakne, donji veš/odjeća za spavanje za žene i djevojčice , uključujući: intimna odjeća i odjeća za spavanje, udobna svakodnevna odjeća, uska odjeća, sve vrste veša, grudnjaci, steznici, podvezice, jednodjelni veš, korseti, jednodjelne unihopke za cijelo tijelo, steznici, elastične gaćice sa niskim strukom, sportski grudnjak, topovi sa grudnjakom, trik-majice, steznici za struk, grudnjak za isticanje grudi, trikoi i trikoi sa nogavicama, dnevna odjeća uključujući (ali ne samo), suknja-pantalone, bikiniji, gaćice sa niskim strukom, gaćice, elastične gaćice, kombinezon bluze, kombinezon trik-majice, kombinezon ženske košulje, kombinezon suknja-pantalone, večernji kombinezoni, porodiljski kombinezoni, elastične gaćice, princeza kombinezoni, prozirne podsuknje, kombinezoni bez bretela, kombinezon odijela, kombinezoni krojeni po mjeri, polu kombinezoni, podsuknje, podsuknja gaće, elastični grudnjak, ženske košulje, negližei, trik-majice, top sa grudnjakom, trik-majice, grudnjaci bez žica i korpica, široke gaće, pod-pantalone, dnevna odjeća, udobna svakodnevna odjeća, odjeća za spavanje, uska odjeća uključujući (ali ne samo) spavaćice, dugačke spavaćice, košulje za spavanje, pidžame, kratke pidžame, bebi-dol pidžame, pidžame kratkih rukava, kostimi za francusku sobaricu, dimije pidžame, kombinezon suknja-pantalone, udobne pidžame, kombinezon bermude, šorcevi za spavanje, kućne haljine, jakne za spavanje, kaftani, kombinezoni, negližei, bade-mantili, ogrtači, kimono, kućni ogrtači, plažne toge, plažni omotači, jutarnji ogrtači, podnevni ogrtači, kobinezon ogrtači, Kabuki ogrtači, udobni ogrtači, mantija ogrtači, topovi sa grudnjakom, kratke majice, helanke

Klasa 35: usluge oglašavanja i poslovne usluge, usluge oglašavanja i usluge promovisanja, tj. razvijanje koncepta i ideja, organizovanje snimanja za oglase i reklame uključujući izbor fotografa, talenta, pomoćnog osoblja (stilista, frizer, itd.), izviđanje lokacije, proizvodnja takvog materijala i razvoj i dalje plasiranje (magazini, bilbordi, kiosci, TV, kablovska, itd.), usluge maloprodaje, uključujući dizajn i dekor prodavnica, prodajne robe

Klasa 42: usluge dizajna u vezi sa licenciranjem, obezbjeđivanje skica, tkanina, obrada i vezanje informacija i materijala

(210) **2014-57**

(442) **20.09.2014.**

(220) 2/21/2014

(731) **CALVIN KLEIN TRADEMARK TRUST**, DELAWARE BUSINESS TRUST (WILMINGTON TRUST COMPANY, TRUSTEE), 1100 NORTH MARKET STREET, WILMINGTON, DELAWARE 19890, C/O CALVIN KLEIN, INC.205 WEST 39 STREET, NEW YORK, NY 10018 US

ck

(540)

(550) I

(740) Jusić Jasna, Crnogorskih serdara bb, Podgorica ME

(511) **Klasa 03:** kozmetika i mirisi, preparat za izbjeljivanje, parfemi, noćna krema, puder za tijelo, šampon, dezodorans, krema za tijelo, gel za tuširanje, mirisi, dekorativni mirisni aranžmani, karmini, sjenka za oči, korektor, rumenilo, ajlajner, puder u prahu za lice, krema za obraze, dnevni losion, granule za čišćenje lica, preparati za čišćenje i hidrataciju, losioni za tijelo, lak za nokte, kolonjska voda, sapun, preparati za hidrataciju kože, kupka za tijelo, balzam za kosu, učvršćivač za kosu, krema za sunčanje, kuglice za kupku, olovka za usne, maškara, puder u prahu, puder za potamnjenje, olovka za obrve, puder za osvjetljavanje lica, sredstvo za čišćenje lica, krema za oči (za ispod očiju), osvježivač za lice, kuglice za kupku, gel za noge i stopala (koji hladi), odstranjivač laka za nokte, uljna kupka, krema za mekšanje kože, krema za ruke, afteršejv, balzam za poslije brijanja, pjena, gel za oblikovanje, sjaj za usne, podloga za šminku, kompaktni puder, preparat za uklanjanje šminke, završni puder za lice, korektor u olovci za prekrivanje nedostataka na licu, tonik/osvježivač za lice, piling za lice i maska za lice, preparat za glačanje kože lica, piling za tijelo, preparat za pranje tijela

Klasa 09: optika, okviri za naočare, naočare za sunce

Klasa 14: nakit, plemeniti metali, ručni satovi, satovi, nakit (prsteni, minđuše, narukvice, stilizovane narukvice, broševi, ogrlice, ogrlice koje stoje usko uz vrat, amajlije, privjesci, medaljoni, menžetne, šnale za kravatu, igle za kravatu, značke, igle za maramu, prsteni za maramu, šnale za maramu, bižuterija i polu-dragi nakit)

Klasa 18: kožni aksesoar, od kože i od imitacije kože, ručne torbe, novčanici, torbice za ključeve, torbice za sitniš, kozmetičke torbe i vrećice, torbe/povezi za nošenje dokumenata, torbe -navlake za odijela, sanduci, koferi, kišobrani, povezi za novac, putne torbe, cegeri, aktovke i torbe za spise, torbe za prtljag, manje putne torbe za jedno noćenje, novčanici za kreditne kartice, novčanici za vizit kartice, toaletne torbice (koje se prodaju prazne), futrole za tablet i ostale mobilne elektronske uređaje, kaiševi

Klasa 25: ženska odjeća, muška odjeća, odjeća za dječake i djevojčice, odjeća, obuća, pokrivala za glavu uključujući (ali ne samo), kombinezoni, majice, bluze, jakne, kupaći kostimi, pantalone, šorcevi, trenerke, donji djelovi trenerke i duksevi, bermude, farmerice, odijela, večernji sakoi i formalna odjeća, pletene majice, kravate i ostali okovratnici, čarape/hulahopke, šeširi/kape, jakne, džempereri, suknje, kaputi, kaputi ukrašeni krznom, krzna, prsluci, majice kratkih rukava, odjeća za tenis i golf, haljine, majice, suknje, pantalone, šorcevi i ostala odjeća, biciklistička odjeća i odjeća za jogu, majice, trik-majice, suknje, šorcevi, jakne, pantalone za plažu i plivanje, odjeća za kišu, kabanice, pončoi, ogrtači, trik-majice/potkošulje, obuća: cipele, patike za aktivno bavljenje sportom, patike, čizme, papuče, sakoi, pantalone, ogrtači, čarape, rukavice, haljine, kaputi postavljeni krznom i jakne postavljene krznom, šalovi/maramu, sportske jakne, (samo donji veš), donji veš/odjeća za spavanje za muškarce i dječake, uključujući donji veš, odjeću za spavanje, udobna svakodnevna odjeća uključujući (ali ne samo), gaćice, bokserice, sportski (atletski) donji veš, pletena sportska odjeća, majice kratkih rukava, trik-majice, potkošulje, osnovni donji veš i ogrtači, pletena i tkana odjeća za spavanje, majice za spavanje, gornji djelovi pidžama, donji djelovi pidžama, jutarnje jakne,

smoking ogrtači, ogrtači za spavanje, ogrtači, pletena i tkana udobna svakodnevna odjeća, udobne svakodnevne pantalone i majice, udobne svakodnevne jakne, donji veš/odjeća za spavanje za žene i djevojčice, uključujući: intimna odjeća i odjeća za spavanje, udobna svakodnevna odjeća, uska odjeća, sve vrste veša, grudnjaci, steznici, podvezice, jednodjelni veš, korseti, jednodjelne unihopke za cijelo tijelo, steznici, elastične gaćice sa niskim strukom, sportski grudnjak, topovi sa grudnjakom, trik-majice, steznici za struk, grudnjak za isticanje grudi, trikoi i trikoi sa nogavicama, dnevna odjeća uključujući (ali ne samo): suknja-pantalone, bikiniji, gaćice sa niskim strukom, gaćice, elastične gaćice, kombinezon bluze, kombinezon trik-majice, kombinezon ženske košulje, kombinezon suknja-pantalone, večernji kombinezoni, porodiljski kombinezoni, elastične gaćice, princeza kombinezoni, prozirne podsuknje, kombinezoni bez bretela, kombinezon odijela, kombinezoni krojeni po mjeri, polu kombinezoni, podsuknje, podsuknja gaće, elastični grudnjak, ženske košulje, negliže, trik-majice, top sa grudnjakom, trik-majice, grudnjaci bez žica i korpica, široke gaće, pod-pantalone, dnevna odjeća, udobna svakodnevna odjeća, odjeća za spavanje, uska odjeća uključujući (ali ne samo) spavaćice, dugačke spavaćice, košulje za spavanje, pidžame, kratke pidžame, bebi-dol pidžame, pidžame kratkih rukava, kostimi za francusku sobaricu, dimije pidžame, kombinezon suknja-pantalone, udobne pidžame, kombinezon bermude, šorcevi za spavanje, kućne haljine, jakne za spavanje, kaftani, kombinezoni, negliže, bade-mantili, ogrtači, kimono, kućni ogrtači, plažne toge, plažni omotači, jutarnji ogrtači, podnevni ogrtači, kombinezon ogrtači, Kabuki ogrtači, udobni ogrtači, mantija ogrtači, topovi sa grudnjakom, kratke majice, helanke

Klasa 35: usluge oglašavanja i poslovne usluge, usluge oglašavanja i usluge promovisanja, tj. razvijanje koncepta i ideja, organizovanje snimanja za oglase i reklame uključujući izbor fotografa, talenta, pomoćnog osoblja (stilista, frizer, itd.), izviđanje lokacije, proizvodnja takvog materijala i razvoj i dalje plasiranje (magazini, bilbordi, kiosci, TV, kablovska, itd.), usluge maloprodaje, uključujući dizajn i dekor prodavnica, prodajne robe

Klasa 42: usluge dizajna u vezi sa licenciranjem, obezbjeđivanje skica, tkanina, obrada i vezanje informacija i materijala

(210) **2014-58**

(442) **20.09.2014.**

(220) 2/24/2014

(731) **TACO BELL CORP.** 1 CLEN BELL WAY, IRVINE, CALIFORNIA 92618 US

LIVE MÁS

(540)

(550) I

(740) Jusić Jasna, Crnogorskih serdara bb, Podgorica ME

(511) **Klasa 29:** meso, riba, živina i divljač, mesne prerađevine, konzervisano, zamrznuto, sušeno i kuvano voće i povrće, želei, džemovi, kompoti, jaja, mlijeko i mlječni proizvodi, jestiva ulja i masti

Klasa 30: kafa, čaj, kakao i zamjena za kafu, pirinač, tapioka i sago, brašno i proizvodi od žitarica, hljeb, kolači i poslastice, sladoledi, šećer, med, melasa, kvasac, prašak za pecivo, so, senf, sirće, sosovi (kao dodaci), začini, led

Klasa 43: usluge obezbjeđivanja hrane i pića, privremeni smještaj

(210) **2014-59**

(442) **20.09.2014.**

(220) 2/24/2014

(731) **TACO BELL CORP.** 1 CLEN BELL WAY, IRVINE, CALIFORNIA 92618 US



(540)

(550) I

(740) Jusić Jasna, Crnogorskih serdara bb, Podgorica ME

(511) **Klasa 29:** meso, riba, živina i divljač, mesne prerađevine, konzervisano, zamrznuto, sušeno i kuvano voće i povrće, želei, džemovi, kompoti, jaja, mlijeko i mlječni proizvodi, jestiva ulja i masti

Klasa 30: kafa, čaj, kakao i zamjena za kafu, pirinač, tapioka i sago, brašno i proizvodi od žitarica, hljeb, kolači i poslastice, sladoledi, šećer, med, melasa, kvasac, prašak za pecivo, so, senf, sirće, sosovi (kao dodaci), začini, led

Klasa 43: usluge obezbjeđivanja hrane i pića, privremeni smještaj

(210) **2014-6**

(442) **20.09.2014.**

(220) 1/17/2014

(731) **V-MARINA** DOO, IVA ANDRIĆA 34, 81000 PODGORICA ME



(540)

(550) I

(511) **Klasa 30:** kolači, torte i sladoled

(210) **2014-60** (442) **20.09.2014.**

(220) 2/24/2014

(731) **TACO BELL CORP.** 1 CLEN BELL WAY, IRVINE, CALIFORNIA 92618 US



(540)

(550) I

(740) Jusić Jasna, Crnogorskih serdara bb, Podgorica ME

(511) **Klasa 29:** meso, riba, živina i divljač, mesne prerađevine, konzervisano, zamrznuto, sušeno i kuvano voće i povrće, želei, džemovi, kompoti, jaja, mlijeko i mlječni proizvodi, jestiva ulja i masti

Klasa 30: kafa, čaj, kakao i zamjena za kafu, pirinač, tapioka i sago, brašno i proizvodi od žitarica, hljeb, kolači i poslastice, sladoledi, šećer, med, melasa, kvasac, prašak za pecivo, so, senf, sirće, sosovi (kao dodaci), začini, led

Klasa 43: usluge obezbjeđivanja hrane i pića, privremeni smještaj

(210) **2014-61** (442) **20.09.2014.**

(220) 2/24/2014

(731) **TACO BELL CORP.** 1 CLEN BELL WAY, IRVINE, CALIFORNIA 92618 US

TACO BELL

(540)

(550) I

(740) Jusić Jasna, Crnogorskih serdara bb, Podgorica ME

(511) **Klasa 29:** meso, riba, živina i divljač, mesne prerađevine, konzervisano, zamrznuto, sušeno i kuvano voće i povrće, želei, džemovi, kompoti, jaja, mlijeko i mlječni proizvodi, jestiva ulja i masti

Klasa 30: kafa, čaj, kakao i zamjena za kafu, pirinač, tapioka i sago, brašno i proizvodi od žitarica, hljeb, kolači i poslastice, sladoledi, šećer, med, melasa, kvasac, prašak za pecivo, so, senf, sirće, sosovi (kao dodaci), začini, led

Klasa 43: usluge obezbjeđivanja hrane i pića, privremeni smještaj

(210) **2014-62** (442) **20.09.2014.**

(220) 2/24/2014

(731) **PIZZA HUT INTERNATIONAL, LLC,** 7100 CORPORATE DRIVE, PLANO, TEXAS 75024

US

MAKE IT GREAT

(540)

(550) I

(740) Jusić Jasna, Crnogorskih serdara bb, Podgorica ME

(511) **Klasa 43:** usluge restorana(210) **2014-63**(442) **20.09.2014.**

(220) 2/25/2014

(731) **KENDA RUBBER INDUSTRIAL CO.LTD.** NO.146, SEC.1, CHUNG SHAN RD.YUANLIN TOWNSHIP, CHANGHUA COUNTY, TAIWAN (R.O.C.)

ACENDA

(540)

(550) I

(740) Đakonović Vido, Bajova 9, Cetinje ME

(511) **Klasa 12:** gume, unutrašnje gume za pneumatske točkove, bandaži (felne) za pneumatike, zakrpe za popravku guma, automobilske gume, gume za bicikle, gume za motorcikle, unutrašnje gume, zakrpe za popravku unutrašnjih guma, šare za protektiranje guma, klinovi za zimske gume, klinovi protiv klizanja za gume vozila(210) **2014-64**(442) **20.09.2014.**

(220) 2/25/2014

(731) **HONGTA TOBACCO (GROUP) CO.LTD.** NO.118, HONGTA AVENUE, HONGTA DISTRICT, YUXI, YUNNAN CN

玉漠

(540)

(550) I

(740) Radulović Božidar, Jovana Tomaševića 9/III, Podgorica ME

(511) **Klasa 34:** elektronske cigarete za upotrebu kao alternativa tradicionalnih cigareta,

elektronske cigarete, patrone za dopunjavanje elektronske cigarete za prodaju prazne, duvan za žvakanje, duvan u prahu, naime, za kihanje, burmut, cigarete koje sadrže zamjene duvana za nemedicinske potrebe

(210) **2014-65** (442) **20.09.2014.**

(220) 2/25/2014

(731) **HONGTA TOBACCO** (GROUP) CO.LTD. NO.118, HONGTA AVENUE, HONGTA DISTRICT, YUXI, YUNNAN CN

Ashima

(540)

(550) I

(740) Radulović Božidar, Jovana Tomaševića 9/III, Podgorica ME

(511) **Klasa 34:** elektronske cigarete za upotrebu kao alternativa tradicionalnih cigareta, elektronske cigarete, patrone za dopunjavanje elektronske cigarete za prodaju prazne, duvan za žvakanje, duvan u prahu, naime, za kihanje, burmut, cigarete koje sadrže zamjene duvana za nemedicinske potrebe

(210) **2014-66** (442) **20.09.2014.**

(220) 2/25/2014

(731) **HONGTA TOBACCO** (GROUP) CO.LTD. NO.118, HONGTA AVENUE, HONGTA DISTRICT, YUXI, YUNNAN CN

Hongtashan

(540)

(550) I

(740) Radulović Božidar, Jovana Tomaševića 9/III, Podgorica ME

(511) **Klasa 34:** elektronske cigarete za upotrebu kao alternativa tradicionalnih cigareta, elektronske cigarete, patrone za dopunjavanje elektronske cigarete za prodaju prazne, duvan za žvakanje, duvan u prahu, naime, za kihanje, burmut, cigarete koje sadrže zamjene duvana za nemedicinske potrebe

(210) **2014-67** (442) **20.09.2014.**

(220) 2/26/2014

(731) **CRNOGORSKI TELEKOM AD**, MOSKOVSKA 29 PODGORICA ME

SMART HOME

(540)

(550) I

(511) **Klasa 09:** naučni, nautički, geodetski, fotografski, kinematografski i optički aparati i instrumenti kao i aparati i instrumenti za vaganje, mjerenje, signalizaciju, kontrolu (inspekciju), za pomoć (spašavanje) i za obuku, aparati i instrumenti za vođenje, distribuciju,

transformisanje, akumuliranje, podešavanje ili upravljanje električne struje, aparati za snimanje, prijenos, reprodukciju zvuka ili slika, magnetni nosači podataka, diskovi za snimanje, kompaktni diskovi, DVD i drugi numerički nosači za snimanje, mehanizmi za uređaje koji se pokreću uz prethodno ubacivanje novca ili žetona, registarske blagajne, računari, oprema za obradu podataka i kompjuteri, uređaji za gašenje požara, kompjuterski programi [softveri]

Klasa 16: papir, karton i proizvodi od tih materijala koji nisu obuhvaćeni drugim klasama, štamparski proizvodi, proizvodi za uvezivanje knjiga, fotografije, pribor za pisanje, ljepila (ljepljive materije za papirnate proizvode ili za kućne potrebe), slikarski pribor, kistovi, pisaće mašine i kancelarijski pribor (osim namještaja), oprema za nastavu i obuku (osim aparata), plastični materijali za ambalažu (koji nisu obuhvaćeni drugim klasama), štamparska slova, klišeji

Klasa 35: oglašavanje i reklamiranje, vođenje komercijalnih poslova, komercijalna administracija, kancelarijski poslovi

Klasa 36: osiguranje, finansijski poslovi, monetarni poslovi, upravljanje nekretninama

Klasa 37: izgradnja, popravke, usluge postavljanja (instaliranja)

Klasa 38: telekomunikacije

Klasa 41: obuka, stručno osposobljavanje, razonoda, sportske i kulturne djelatnosti

Klasa 42: naučne i tehnološke usluge kao i pripadajuće usluge istraživanja i koncepcije, usluge industrijskih analiza i istraživanja, koncepcija i razvoj računara i računarskih programa / hardvera i softvera/

(210) **2014-68** (442) **20.09.2014.**

(220) 2/26/2014

(731) **CRNOGORSKI TELEKOM AD**, MOSKOVSKA 29 PODGORICA ME

SMART HOME

(540)

(550) I

(511) **Klasa 09:** naučni, nautički, geodetski, fotografski, kinematografski i optički aparati i instrumenti kao i aparati i instrumenti za vaganje, mjerenje, signalizaciju, kontrolu (inspekciju), za pomoć (spašavanje) i za obuku, aparati i instrumenti za vođenje, distribuciju, transformisanje, akumuliranje, podešavanje ili upravljanje električne struje, aparati za snimanje, prijenos, reprodukciju zvuka ili slika, magnetni nosači podataka, diskovi za snimanje, kompaktni diskovi, DVD i drugi numerički nosači za snimanje, mehanizmi za uređaje koji se pokreću uz prethodno ubacivanje novca ili žetona, registarske blagajne, računari, oprema za obradu podataka i kompjuteri, uređaji za gašenje požara, kompjuterski programi [softveri]

Klasa 16: papir, karton i proizvodi od tih materijala koji nisu obuhvaćeni drugim klasama, štamparski proizvodi, proizvodi za uvezivanje knjiga, fotografije, pribor za pisanje, ljepila (ljepljive materije za papirnate proizvode ili za kućne potrebe), slikarski pribor, kistovi, pisaće mašine i kancelarijski pribor (osim namještaja), oprema za nastavu i obuku (osim aparata), plastični materijali za ambalažu (koji nisu obuhvaćeni drugim klasama), štamparska slova, klišeji

Klasa 35: oglašavanje i reklamiranje, vođenje komercijalnih poslova, komercijalna administracija, kancelarijski poslovi

Klasa 36: osiguranje, finansijski poslovi, monetarni poslovi, upravljanje nekretninama

Klasa 37: izgradnja, popravke, usluge postavljanja (instaliranja)

Klasa 38: telekomunikacije

Klasa 41: obuka, stručno osposobljavanje, razonoda, sportske i kulturne djelatnosti

Klasa 42: naučne i tehnološke usluge kao i pripadajuće usluge istraživanja i koncepcije, usluge industrijskih analiza i istraživanja, koncepcija i razvoj računara i računarskih programa / hardvera i softvera/

(210) **2014-70**

(442) **20.09.2014.**

(220) 4/27/2014

(731) **INTERNATIONAL GREAT BRANDS LLC**, 100 DEFOREST AVE EAST HANOVER NEW JERSEY 07936 US



(540)

(550) I, F

(740) Popović Miladin, Đoka Miraševića 21/III, Podgorica ME

(511) **Klasa 29:** mliječni proizvodi, mliječni namazi, krem sirevi, sirevi, proizvodi na bazi sira, simi namazi, kremasti namaz od sira (fromage frais), mlijeko i mliječni proizvodi, mlečni napici (gdje mlijeko preovlađuje), jogurt, smrznuti jogurt, mliječni frapei, slag, dezerti i preparati za pravljenje dezerata napravljeni od mliječnih proizvoda, želei, kupovi (trifles), namazi, jestiva ulja i masti

Klasa 30: prelive za salatu, sosovi (žalini), sladoled, smrznute poslastice, dečeilni musevi (poslastice), pudinzi, kolači, biskviti, majonez, začini

(210) **2014-71**

(442) **20.09.2014.**

(220) 3/3/2014

(731) **Azmont Investment** DOO, Braće Grakalića br.94, Meljine, Herceg Novi ME
PORTONOVI

(540)

(550) I, V

(511) **Klasa 03:** preparati za bijeljenje i ostale materije za pranje rublja; preparati za čišćenje, poliranje, odmašćivanje i struganje; sapuni; parfimerijski proizvodi, eterična ulja, kozmetički proizvodi, losioni za kosu; proizvodi za njegu zuba.

Klasa 04: industrijska ulja i masti; sredstva za podmazivanje; proizvodi za upijanje, vlaženje i vezivanje prašine; goriva (uključujući benzin za motore) i rasvjetne materije; svijeće, fitilje za rasvjetu.

Klasa 05: farmaceutski i veterinarski proizvodi; higijenski proizvodi za upotrebu u medicini; dijetalne materije za medicinske potrebe, hrana za bebe; flasteri, materijal za previjanje; materijali za plombiranje zuba i za zubne otiske; dezinfekciona sredstva; proizvodi za uništavanje životinjskih štetočina; fungicidi, herbicidi.

- Klasa 08:** ručni alati i sprave sa ručnim pokretanjem; pribor za jelo; hladno oružje;
- Klasa 14:** plemeniti metali i njihove legure i proizvodi od tih metala ili obloženi tim metalima, koji nisu obuhvaćeni drugim klasama; pravi i lažni nakit, drago kamenje; časovničarski proizvodi i hronometrijski instrumenti.
- Klasa 16:** papir, karton i proizvodi od tih materijala koji nisu obuhvaćeni drugim klasama; štamparski proizvodi; proizvodi za uvezivanje knjiga; fotografije; pribor za pisanje; ljepila (ljepljive materije za papirnate proizvode ili za kućne potrebe); slikarski pribor; kistovi; pisaće mašine i kancelarijski pribor (osim namještaja); oprema za nastavu i obuku (osim aparata); plastični materijali za ambalažu (koji nisu obuhvaćeni drugim klasama); štamparska slova; klišeji.
- Klasa 18:** koža, imitacije kože, proizvodi od tih materijala koji nisu obuhvaćeni drugim klasama; životinjske kože; koferi i torbe; kišobrani, suncobrani i štapovi za hodanje; bičevi i sedlarsko remenarski proizvodi.
- Klasa 21:** pribor i posuđe za domaćinstvo ili za kuhinju; češljeve i sunđere; četke (osim kičica); materijali za četke; pribor za čišćenje; žica za struganje parketa; sirovo ili polu obrađeno staklo (osim građevinskog stakla); stakleni proizvodi, porculansko i keramičko posuđe koje nije obuhvaćeno drugim klasama.
- Klasa 22:** konopci, užad, mreže, šatori, cerade, jedra, vreće (koji nisu obuhvaćeni drugim klasama) materijal za punjenje madraca (nabijanje) (osim gume i plastike); sirovi vlaknasti, tekstilni, materijali.
- Klasa 24:** tkanine i tekstilni proizvodi koji nijesu obuhvaćeni drugim klasama; pokrivači za krevete i stolove.
- Klasa 26:** čipka, vez, vrpce i gajtane; dugmad, kopče i petlje, špenadle (duple igle) i igle; vještačko cvijeće.
- Klasa 27:** tepisi, prostirači, strunjače, linoleumi i ostali pokrivači za podove; zidne tapete koje nijesu od tekstila.
- Klasa 28:** igre i igračke; gimnastički i sportski predmeti koji nisu obuhvaćeni drugim klasama; ukrasi za božićne jelke.
- Klasa 29:** meso, riba, živina i divljač; mesni ekstrakti; konzervirano, sušeno i kuvano voće i povrće; želei, džemovi, kompoti.
- Klasa 30:** kafa, čaj, kakao, šećer, riža, tapioka, sago, zamjene za kafu; brašno i proizvodi od žitarica, hleb, kolači, poslastice, bomboni, sladoled; med, sirup od melase; kvasac, prašak za pecivo; so, senf; sirce, prelive začini, razni začini, led za hlađenje.
- Klasa 32:** pivo; mineralne i gazirane vode i ostala bezalkoholna pića; pića od voća i voćni sokovi; sirupi i ostali preparati za pripremanje napitaka.
- Klasa 33:** alkoholna pića (osim piva).
- Klasa 34:** duvan; pribor za pušače; šibice.
- Klasa 35:** oglašavanje i reklamiranje; vođenje komercijalnih poslova; komercijalna administracija; kancelarijski poslovi.
- Klasa 36:** osiguranje; finansijski poslovi; monetarni poslovi; upravljanje nekretninama.
- Klasa 37:** izgradnja; popravke; usluge postavljanja (instaliranja).
- Klasa 41:** obuka; stručno osposobljavanje; razonoda; sportske i kulturne djelatnosti.
- Klasa 42:** naučne i tehnološke usluge kao i pripadajuće usluge istraživanja i koncepcije usluge industrijskih analiza i istraživanja; koncepcija i razvoj računara i računarskih programa / hardvera i softvera/.
- Klasa 43:** usluge obezbjeđivanja hrane i pića; privremeno primanje na stan.

Klasa 44: medicinske usluge; veterinarske usluge; higijenska njega i njega ljepote za ljude ili za životinje; usluge poljoprivrede, povrtlarstva i šumarstva.

(210) **2014-72**

(442) **20.09.2014.**

(220) 3/3/2014

(731) **Azmont Investment** DOO, Braće Grakalića br.94, Meljine, Herceg Novi ME

PORTO NOVI

(540)

(550) I, V

(511) **Klasa 03:** preparati za bijeljenje i ostale materije za pranje rublja; preparati za čišćenje, poliranje, odmaščivanje i struganje; sapuni; parfimerijski proizvodi, eterična ulja, kozmetički proizvodi, losioni za kosu; proizvodi za njegu zuba.

Klasa 04: industrijska ulja i masti; sredstva za podmazivanje; proizvodi za upijanje, vlaženje i vezivanje prašine; goriva (uključujući benzin za motore) i rasvjetne materije; svijeće, fitilje za rasvjetu.

Klasa 05: farmaceutski i veterinarski proizvodi; higijenski proizvodi za upotrebu u medicini; dijetalne materije za medicinske potrebe, hrana za bebe; flasteri, materijal za previjanje; materijali za plombiranje zuba i za zubne otiske; dezinfekciona sredstva; proizvodi za uništavanje životinjskih štetočina; fungicidi, herbicidi.

Klasa 08: ručni alati i sprave sa ručnim pokretanjem; pribor za jelo; hladno oružje;

Klasa 14: plemeniti metali i njihove legure i proizvodi od tih metala ili obloženi tim metalima, koji nisu obuhvaćeni drugim klasama; pravi i lažni nakit, drago kamenje; časovničarski proizvodi i hronometrijski instrumenti.

Klasa 16: papir, karton i proizvodi od tih materijala koji nisu obuhvaćeni drugim klasama; štamparski proizvodi; proizvodi za uvezivanje knjiga; fotografije; pribor za pisanje; ljepila (ljepljive materije za papirnate proizvode ili za kućne potrebe); slikarski pribor; kistovi; pisaće mašine i kancelarijski pribor (osim namještaja); oprema za nastavu i obuku (osim aparata); plastični materijali za ambalažu (koji nisu obuhvaćeni drugim klasama); štamparska slova; klišeji.

Klasa 18: koža, imitacije kože, proizvodi od tih materijala koji nisu obuhvaćeni drugim klasama; životinjske kože; koferi i torbe; kišobrani, suncobrani i štapovi za hodanje; bičevi i sedlarsko remenarski proizvodi.

Klasa 21: pribor i posuđe za domaćinstvo ili za kuhinju; češljeve i sunđere; četke (osim kičica); materijali za četke; pribor za čišćenje; žica za struganje parketa; sirovo ili polu obrađeno staklo (osim građevinskog stakla); stakleni proizvodi, porculansko i keramičko posuđe koje nije obuhvaćeno drugim klasama.

Klasa 22: konopci, užad, mreže, šatori, cerade, jedra, vreće (koji nisu obuhvaćeni drugim klasama) materijal za punjenje madraca (nabijanje) (osim gume i plastike); sirovi vlaknasti, tekstilni, materijali.

Klasa 24: tkanine i tekstilni proizvodi koji nijesu obuhvaćeni drugim klasama; pokrivači za krevete i stolove.

Klasa 26: čipka, vez, vrpce i gajtane; dugmad, kopče i petlje, špenadle (duple igle) i igle; vještačko cvijeće.

Klasa 27: tepisi, prostirači, strunjače, linoleumi i ostali pokrivači za podove; zidne tapete koje nijesu od tekstila.

Klasa 28: igre i igračke; gimnastički i sportski predmeti koji nisu obuhvaćeni drugim klasama;

ukrasi za božićne jelke.

Klasa 28: meso, riba, živina i divljač; mesni ekstrakti; konzervirano, sušeno i kuvano voće i povrće; želei, džemovi, kompoti.

Klasa 30: kafa, čaj, kakao, šećer, riža, tapioka, sago, zamjene za kafu; brašno i proizvodi od žitarica, hleb, kolači, poslastice, bomboni, sladoled; med, sirup od melase; kvasac, prašak za pecivo; so, senf; sirce, prelivni začini, razni začini led za hlađenje.

Klasa 32: pivo; mineralne i gazirane vode i ostala bezalkoholna pića; pića od voća i voćni sokovi; sirupi i ostali preparati za pripremanje napitaka.

Klasa 33: alkoholna pića (osim piva).

Klasa 34: duvan; pribor za pušače; šibice.

Klasa 35: oglašavanje i reklamiranje; vođenje komercijalnih poslova; komercijalna administracija; kancelarijski poslovi.

Klasa 36: osiguranje; fi nansijski poslovi; monetarni poslovi; upravljanje nekretninama.

Klasa 37: izgradnja; popravke; usluge postavljanja (instaliranja).

Klasa 41: obuka; stručno osposobljavanje; razonoda; sportske i kulturne djelatnosti.

Klasa 42: naučne i tehnološke usluge kao i pripadajuće usluge istraživanja i koncepcije usluge industrijskih analiza i istraživanja; koncepcija i razvoj računara i računarskih programa / hardvera i softvera/.

Klasa 43: usluge obezbjeđivanja hrane i pića; privremeno primanje na stan.

Klasa 44: medicinske usluge; veterinarske usluge; higijenska njega i njega ljepote za ljude ili za životinje; usluge poljoprivrede, povrtlarstva i šumarstva.

(210) **2014-73**

(442) **20.09.2014.**

(220) 3/3/2014

(731) **Azmont Investment** DOO, Braće Grakalića br.94, Meljine, Herceg Novi ME



PORTONOVİ

MONTENEGRO

(540)

(550) I, V

(511) **Klasa 03:** preparati za bijeljenje i ostale materije za pranje rublja; preparati za čišćenje, poliranje, odmaščivanje i struganje; sapuni; parfimerijski proizvodi, eterična ulja, kozmetički proizvodi, losioni za kosu; proizvodi za njegu zuba.

Klasa 04: industrijska ulja i masti; sredstva za podmazivanje; proizvodi za upijanje, vlaženje i vezivanje prašine; goriva (uključujući benzin za motore) i rasvjetne materije; svijeće, fitilje za rasvjetu.

Klasa 05: farmaceutski i veterinarski proizvodi; higijenski proizvodi za upotrebu u medicini; dijetalne materije za medicinske potrebe, hrana za bebe; flasteri, materijal za previjanje; materijali za plombiranje zuba i za zubne otiske; dezinfekciona sredstva; proizvodi za uništavanje životinjskih štetočina; fungicidi, herbicidi.

Klasa 08: ručni alati i sprave sa ručnim pokretanjem; pribor za jelo; hladno oružje;

Klasa 14: plemeniti metali i njihove legure i proizvodi od tih metala ili obloženi tim metalima, koji nisu obuhvaćeni drugim klasama; pravi i lažni nakit, drago kamenje; časovničarski proizvodi i hronometrijski instrumenti.

Klasa 16: papir, karton i proizvodi od tih materijala koji nisu obuhvaćeni drugim klasama; štamparski proizvodi; proizvodi za uvezivanje knjiga; fotografije; pribor za pisanje; ljepila (ljepljive materije za papirnate proizvode ili za kućne potrebe); slikarski pribor; kistovi; pisače mašine i kancelarijski pribor (osim namještaja); oprema za nastavu i obuku (osim aparata); plastični materijali za ambalažu (koji nisu obuhvaćeni drugim klasama); štamparska slova; klišeji.

Klasa 18: koža, imitacije kože, proizvodi od tih materijala koji nisu obuhvaćeni drugim klasama; životinjske kože; koferi i torbe; kišobrani, suncobrani i štapovi za hodanje; bičevi i sedlarsko remenarski proizvodi.

Klasa 21: pribor i posuđe za domaćinstvo ili za kuhinju; češljeve i sunđere; četke (osim kičica); materijali za četke; pribor za čišćenje; žica za struganje parketa; sirovo ili polu obrađeno staklo (osim građevinskog stakla); stakleni proizvodi, porculansko i keramičko posuđe koje nije obuhvaćeno drugim klasama.

Klasa 22: konopci, užad, mreže, šatori, cerade, jedra, vreće (koji nisu obuhvaćeni drugim klasama) materijal za punjenje madraca (nabijanje) (osim gume i plastike); sirovi vlaknasti, tekstilni, materijali.

Klasa 24: tkanine i tekstilni proizvodi koji nijesu obuhvaćeni drugim klasama; pokrivači za krevete i stolove.

Klasa 26: čipka, vez, vrpce i gajtane; dugmad, kopče i petlje, špenadle (duple igle) i igle; vještačko cvijeće.

Klasa 27: tepisi, prostirači, strunjače, linoleumi i ostali pokrivači za podove; zidne tapete koje nijesu od tekstila.

Klasa 28: igre i igračke; gimnastički i sportski predmeti koji nisu obuhvaćeni drugim klasama; ukrasi za božićne jelke.

Klasa 29: meso, riba, živina i divljač; mesni ekstrakti; konzervirano, sušeno i kuvano voće i povrće; želei, džemovi, kompoti.

Klasa 30: kafa, čaj, kakao, šećer, riža, tapioka, sago, zamjene za kafu; brašno i proizvodi od žitarica, hleb, kolači, poslastice, bomboni, sladoled; med, sirup od melase; kvasac, prašak za pecivo; so, senf; sirce, prelive začini, razni začini, led za hlađenje.

Klasa 32: pivo; mineralne i gazirane vode i ostala bezalkoholna pića; pića od voća i voćni sokovi; sirupi i ostali preparati za pripremanje napitaka.

Klasa 33: alkoholna pića (osim piva).

Klasa 34: duvan; pribor za pušače; šibice.

Klasa 35: oglašavanje i reklamiranje; vođenje komercijalnih poslova; komercijalna administracija; kancelarijski poslovi.

Klasa 36: osiguranje; finansijski poslovi; monetarni poslovi; upravljanje nekretninama.

Klasa 37: izgradnja; popravke; usluge postavljanja (instaliranja).

Klasa 41: obuka; stručno osposobljavanje; razonoda; sportske i kulturne djelatnosti.

Klasa 42: naučne i tehnološke usluge kao i pripadajuće usluge istraživanja i koncepcije usluge industrijskih analiza i istraživanja; koncepcija i razvoj računara i računarskih programa / hardvera i softvera/.

Klasa 43: usluge obezbjeđivanja hrane i pića; privremeno primanje na stan.

Klasa 44: medicinske usluge; veterinarske usluge; higijenska njega i njega ljepote za ljude ili za životinje; usluge poljoprivrede, povrtlarstva i šumarstva.

(210) **2014-74** (442) **20.09.2014.**

(220) 3/3/2014

(731) **PODRAVKA PREHRAMBENA INDUSTRIJA** D.D. ANTE STARČEVIĆA 32 48000 KOPRIVNICA HR



(540)

(550) I, F

(740) Popović Miladin, Đoka Miraševića 21/III, Podgorica ME

(511) **Klasa 05:** hrana za odojčad

Klasa 29: meso i proizvodi od mesa - naročito mesne kašice, konzervirano, sušeno i kuvano voće i povrće naročito kašice, kompoti, mliječni napici u kojima mlijeko prevladava, namazi obuhvaćeni ovim razredom

Klasa 30: čaj, čokolada (pića od čokolade), kakao (pića od kaka), keksi, vafli, brašno i proizvodi od žitarica naročito pahuljice od sušenih žitarica i žitne pločice, sladoled

Klasa 32: voćni sokovi, pića (koncentrati i sastojci za pripremu pića)

(210) **2014-76** (442) **20.09.2014.**

(220) 3/4/2014

(731) **VLADAN ŽUGIĆ**, SVETOG PETRA CETINJSKOG 89, 81000 PODGORICA ME



(540)

(550) I, F

(511) **Klasa 35:** oglašavanje, vođenje poslova, poslovno upravljanje, kancelarijski poslovi

Klasa 41: obrazovne usluge pripremanje obuke razonoda

Klasa 43: sportske i kulturne aktivnosti, usluge obezbjeđivanja hrane i pića privremeni smještaj

(210) **2014-77** (442) **20.09.2014.**

(220) 3/4/2014

(731) **BEATS ELECTRONICS**, LLC (DELAWARE LIMITED LIABILITY COMPANY), 1601 CLOVERFIELD BLVD, SUITE 5000N, SANTA MONICA, CA 90404 US

POWERBEATS BY DR. DRE

(540)

(550) I, V

(740) Radulović Božidar, Jovana Tomaševića 9/III, Podgorica ME

(511) **Klasa 09:** slušalice, slušalice koje se stavljaju u uši, zvučnici, audio zvučnici, audio kablovi, audio zvučnici za automobile, medija plejeri za automobile, digitalni audio plejeri za automobile, mobilni telefoni, laptop kompjuteri

(210) **2014-78** (442) **20.09.2014.**

(220) 3/4/2014

(731) **IGLA SHPK**, KOMUNA VAQARR, GODINA 2 KATESHE, PRANE SHKOLLES VELLEZERIT KAJTAZI TIRANE, AL



(540)

(550) I, F

(740) Đakonović Vido, Bajova 9, Cetinje ME

(511) **Klasa 34:** duvan, prerađen ili neprerađen, duvanski proizvodi, zamjene za duvan koje nisu za upotrebu u medicini ili za liječenje, artikli i pribor za pušaće i za duvan, šibice, upaljači

(210) **2014-79** (442) **20.09.2014.**

(220) 3/5/2014

(731) **MERCK SHARP & DOHME CORP.** ONE MERCK DRIVE, WHITEHOUSE STATION, NEW JERSEY 08889 US

JEGZO

(540)

(550) I

(740) AOD "Ćupić", Dalmatinska 10, Podgorica ME

(511) **Klasa 05:** farmaceutski preparati

(210) **2014-80** (442) **20.09.2014.**

(220) 3/5/2014

(731) **MERCK SHARP & DOHME CORP.** ONE MERCK DRIVE, WHITEHOUSE STATION, NEW JERSEY 08889 US

PAZAMBRO

- (540)
(550) I
(740) AOD "Ćupić", Dalmatinska 10, Podgorica ME
(511) **Klasa 05:** farmaceutske preparati
-

- (210) **2014-81** (442) **20.09.2014.**
(220) 3/5/2014
(731) **MERCK SHARP & DOHME CORP.** ONE MERCK DRIVE, WHITEHOUSE STATION, NEW JERSEY 08889 US
-

TACIVIEN

- (540)
(550) I
(740) AOD "Ćupić", Dalmatinska 10, Podgorica ME
(511) **Klasa 05:** farmaceutske preparati
-

- (210) **2014-82** (442) **20.09.2014.**
(220) 3/11/2014
(731) **HEMOFARM A.D.** FARMACEUTSKO-HEMIJSKA INDUSTRIJA VRŠAC, BEOGRADSKI PUT BB, 26300 VRŠAC RS
-

- (540) **QUIBIA**
(550) I
(740) MSA IP Milojević Sekulić, Bulevar Despota Stefana 1a, Beograd SR
(511) **Klasa 05:** farmaceutske i veterinarske preparati, sanitarni preparati za medicinsku upotrebu, dijetetske supstance prilagođene za upotrebu u medicini, hrana za bebe, flasteri, materijali za zavijanje, materijali za plombiranje zuba, zubarska smola, dezinfekciona sredstva, preparati za uništavanje štetočina, fungicidi, herbicidi
-

- (210) **2014-83** (442) **20.09.2014.**
(220) 3/11/2014
(731) **HEMOFARM A.D.** FARMACEUTSKO-HEMIJSKA INDUSTRIJA VRŠAC, BEOGRADSKI PUT BB, 26300 VRŠAC RS
-

- (540) **XEPAR**
(550) I
(740) MSA IP Milojević Sekulić, Bulevar Despota Stefana 1a, Beograd SR
(511) **Klasa 05:** farmaceutske i veterinarske preparati, sanitarni preparati za medicinsku upotrebu, dijetetske supstance prilagođene za upotrebu u medicini, hrana za bebe, flasteri, materijali za zavijanje, materijali za plombiranje zuba, zubarska smola, dezinfekciona sredstva, preparati za uništavanje štetočina, fungicidi, herbicidi
-

- (210) **2014-84** (442) **20.09.2014.**
(220) 3/11/2014

(731) **HEMOFARM A.D.** FARMACEUTSKO-HEMIJSKA INDUSTRIJA VRŠAC, BEOGRADSKI PUT BB, 26300 VRŠAC RS

(540) **ABIOLA**

(550) I

(740) MSA IP Milojević Sekulić, Bulevar Despota Stefana 1a, Beograd SR

(511) **Klasa 05:** farmaceutski i veterinarski preparati, sanitarni preparati za medicinsku upotrebu, dijetetske supstance prilagođene za upotrebu u medicini, hrana za bebe, flasteri, materijali za zavijanje, materijali za plombiranje zuba, zubarska smola, dezinfekciona sredstva, preparati za uništavanje štetočina, fungicidi, herbicidi

(210) **2014-85**

(442) **20.09.2014.**

(220) 3/11/2014

(731) **HEMOFARM A.D.** FARMACEUTSKO-HEMIJSKA INDUSTRIJA VRŠAC, BEOGRADSKI PUT BB, 26300 VRŠAC RS

(540) **QUIBIR**

(550) I

(740) MSA IP Milojević Sekulić, Bulevar Despota Stefana 1a, Beograd SR

(511) **Klasa 05:** farmaceutski i veterinarski preparati, sanitarni preparati za medicinsku upotrebu, dijetetske supstance prilagođene za upotrebu u medicini, hrana za bebe, flasteri, materijali za zavijanje, materijali za plombiranje zuba, zubarska smola, dezinfekciona sredstva, preparati za uništavanje štetočina, fungicidi, herbicidi

(210) **2014-86**

(442) **20.09.2014.**

(220) 3/11/2014

(731) **HEMOFARM A.D.** FARMACEUTSKO-HEMIJSKA INDUSTRIJA VRŠAC, BEOGRADSKI PUT BB, 26300 VRŠAC RS

(540) **KYARA**

(550) I

(740) MSA IP Milojević Sekulić, Bulevar Despota Stefana 1a, Beograd SR

(511) **Klasa 05:** farmaceutski i veterinarski preparati, sanitarni preparati za medicinsku upotrebu, dijetetske supstance prilagođene za upotrebu u medicini, hrana za bebe, flasteri, materijali za zavijanje, materijali za plombiranje zuba, zubarska smola, dezinfekciona sredstva, preparati za uništavanje štetočina, fungicidi, herbicidi

(210) **2014-87**

(442) **20.09.2014.**

(220) 3/11/2014

(731) **HEMOFARM A.D.** FARMACEUTSKO-HEMIJSKA INDUSTRIJA VRŠAC, BEOGRADSKI PUT BB, 26300 VRŠAC RS

(540) **SPIRTOS**

(550) I

(740) MSA IP Milojević Sekulić, Bulevar Despota Stefana 1a, Beograd SR

(511) **Klasa 05:** farmaceutski i veterinarski preparati, sanitarni preparati za medicinsku upotrebu, dijetetske supstance prilagođene za upotrebu u medicini, hrana za bebe, flasteri, materijali za zavijanje, materijali za plombiranje zuba, zubarska smola, dezinfekciona sredstva, preparati za uništavanje štetočina, fungicidi, herbicidi

(210) **2014-88**

(442) **20.09.2014.**

(220) 3/11/2014

(731) **HEMOFARM A.D.** FARMACEUTSKO-HEMIJSKA INDUSTRIJA VRŠAC, BEOGRADSKI PUT BB, 26300 VRŠAC RS

(540) **MALARDA**

(550) I

(740) MSA IP Milojević Sekulić, Bulevar Despota Stefana 1a, Beograd SR

(511) **Klasa 05:** farmaceutski i veterinarski preparati, sanitarni preparati za medicinsku upotrebu, dijetetske supstance prilagođene za upotrebu u medicini, hrana za bebe, flasteri, materijali za zavijanje, materijali za plombiranje zuba, zubarska smola, dezinfekciona sredstva, preparati za uništavanje štetočina, fungicidi, herbicidi

(210) **2014-89**

(442) **20.09.2014.**

(220) 3/11/2014

(731) **HEMOFARM A.D.** FARMACEUTSKO-HEMIJSKA INDUSTRIJA VRŠAC, BEOGRADSKI PUT BB, 26300 VRŠAC RS

(540) **YARAMERA**

(550) I

(740) MSA IP Milojević Sekulić, Bulevar Despota Stefana 1a, Beograd SR

(511) **Klasa 05:** farmaceutski i veterinarski preparati, sanitarni preparati za medicinsku upotrebu, dijetetske supstance prilagođene za upotrebu u medicini, hrana za bebe, flasteri, materijali za zavijanje, materijali za plombiranje zuba, zubarska smola, dezinfekciona sredstva, preparati za uništavanje štetočina, fungicidi, herbicidi

(210) **2014-90**

(442) **20.09.2014.**

(220) 3/11/2014

(731) **HEMOFARM A.D.** FARMACEUTSKO-HEMIJSKA INDUSTRIJA VRŠAC, BEOGRADSKI PUT BB, 26300 VRŠAC RS

(540) **PALAWRA**

(550) I

(740) MSA IP Milojević Sekulić, Bulevar Despota Stefana 1a, Beograd SR

(511) **Klasa 05:** farmaceutski i veterinarski preparati, sanitarni preparati za medicinsku upotrebu, dijetetske supstance prilagođene za upotrebu u medicini, hrana za bebe, flasteri, materijali za zavijanje, materijali za plombiranje zuba, zubarska smola, dezinfekciona sredstva, preparati za uništavanje štetočina, fungicidi, herbicidi

(210) **2014-91**

(442) **20.09.2014.**

(220) 3/11/2014

(731) **HEMOFARM A.D.** FARMACEUTSKO-HEMIJSKA INDUSTRIJA VRŠAC, BEOGRADSKI PUT BB, 26300 VRŠAC RS

(540) **FARNOS**

(550) I

(740) MSA IP Milojević Sekulić, Bulevar Despota Stefana 1a, Beograd SR

(511) **Klasa 05:** farmaceutski i veterinarski preparati, sanitarni preparati za medicinsku upotrebu, dijetetske supstance prilagođene za upotrebu u medicini, hrana za bebe, flasteri, materijali za zavijanje, materijali za plombiranje zuba, zubarska smola, dezinfekciona sredstva, preparati za uništavanje štetočina, fungicidi, herbicidi

(210) **2014-92** (442) **20.09.2014.**
(220) 3/11/2014
(731) **HEMOFARM A.D.** FARMACEUTSKO-HEMIJSKA INDUSTRIJA VRŠAC, BEOGRADSKI PUT
BB, 26300 VRŠAC RS
(540) **JARAMERA**
(550) I
(740) MSA IP Milojević Sekulić, Bulevar Despota Stefana 1a, Beograd SR
(511) **Klasa 05:** farmaceutski i veterinarski preparati, sanitarni preparati za medicinsku
upotrebu, dijetetske supstance prilagođene za upotrebu u medicini, hrana za bebe, flasteri,
materijali za zavijanje, materijali za plombiranje zuba, zubarska smola, dezinfekciona
sredstva, preparati za uništavanje štetočina, fungicidi, herbicidi

(210) **2014-93** (442) **20.09.2014.**
(220) 3/11/2014
(731) **HEMOFARM A.D.** FARMACEUTSKO-HEMIJSKA INDUSTRIJA VRŠAC, BEOGRADSKI PUT
BB, 26300 VRŠAC RS
(540) **PALAVRA**
(550) I
(740) MSA IP Milojević Sekulić, Bulevar Despota Stefana 1a, Beograd SR
(511) **Klasa 05:** farmaceutski i veterinarski preparati, sanitarni preparati za medicinsku
upotrebu, dijetetske supstance prilagođene za upotrebu u medicini, hrana za bebe, flasteri,
materijali za zavijanje, materijali za plombiranje zuba, zubarska smola, dezinfekciona
sredstva, preparati za uništavanje štetočina, fungicidi, herbicidi

(210) **2014-94** (442) **20.09.2014.**
(220) 3/11/2014
(731) **HEMOFARM A.D.** FARMACEUTSKO-HEMIJSKA INDUSTRIJA VRŠAC, BEOGRADSKI PUT
BB, 26300 VRŠAC RS
(540) **DARANDA**
(550) I
(740) MSA IP Milojević Sekulić, Bulevar Despota Stefana 1a, Beograd SR
(511) **Klasa 05:** farmaceutski i veterinarski preparati, sanitarni preparati za medicinsku
upotrebu, dijetetske supstance prilagođene za upotrebu u medicini, hrana za bebe, flasteri,
materijali za zavijanje, materijali za plombiranje zuba, zubarska smola, dezinfekciona
sredstva, preparati za uništavanje štetočina, fungicidi, herbicidi

(210) **2014-95** (442) **20.09.2014.**
(220) 3/11/2014
(731) **HEMOFARM A.D.** FARMACEUTSKO-HEMIJSKA INDUSTRIJA VRŠAC, BEOGRADSKI PUT
BB, 26300 VRŠAC RS
(540) **BARIOS**
(550) I
(740) MSA IP Milojević Sekulić, Bulevar Despota Stefana 1a, Beograd SR
(511) **Klasa 05:** farmaceutski i veterinarski preparati, sanitarni preparati za medicinsku
upotrebu, dijetetske supstance prilagođene za upotrebu u medicini, hrana za bebe, flasteri,
materijali za zavijanje, materijali za plombiranje zuba, zubarska smola, dezinfekciona
sredstva, preparati za uništavanje štetočina, fungicidi, herbicidi

-
- (210) **2014-96** (442) **20.09.2014.**
(220) 3/11/2014
(731) **HEMOFARM A.D.** FARMACEUTSKO-HEMIJSKA INDUSTRIJA VRŠAC, BEOGRADSKI PUT BB, 26300 VRŠAC RS
(540) **INSTRICA**
(550) I
(740) MSA IP Milojević Sekulić, Bulevar Despota Stefana 1a, Beograd SR
(511) **Klasa 05:** farmaceutski i veterinarski preparati, sanitarni preparati za medicinsku upotrebu, dijetetske supstance prilagođene za upotrebu u medicini, hrana za bebe, flasteri, materijali za zavijanje, materijali za plombiranje zuba, zubarska smola, dezinfekciona sredstva, preparati za uništavanje štetočina, fungicidi, herbicidi

-
- (210) **2014-97** (442) **20.09.2014.**
(220) 3/11/2014
(731) **HEMOFARM A.D.** FARMACEUTSKO-HEMIJSKA INDUSTRIJA VRŠAC, BEOGRADSKI PUT BB, 26300 VRŠAC RS
(540) **INSTRIKA**
(550) I
(740) MSA IP Milojević Sekulić, Bulevar Despota Stefana 1a, Beograd SR
(511) **Klasa 05:** farmaceutski i veterinarski preparati, sanitarni preparati za medicinsku upotrebu, dijetetske supstance prilagođene za upotrebu u medicini, hrana za bebe, flasteri, materijali za zavijanje, materijali za plombiranje zuba, zubarska smola, dezinfekciona sredstva, preparati za uništavanje štetočina, fungicidi, herbicidi

-
- (210) **2014-98** (442) **20.09.2014.**
(220) 3/11/2014
(731) **HEMOFARM A.D.** FARMACEUTSKO-HEMIJSKA INDUSTRIJA VRŠAC, BEOGRADSKI PUT BB, 26300 VRŠAC RS
(540) **ALTRACK**
(550) I
(740) MSA IP Milojević Sekulić, Bulevar Despota Stefana 1a, Beograd SR
(511) **Klasa 05:** farmaceutski i veterinarski preparati, sanitarni preparati za medicinsku upotrebu, dijetetske supstance prilagođene za upotrebu u medicini, hrana za bebe, flasteri, materijali za zavijanje, materijali za plombiranje zuba, zubarska smola, dezinfekciona sredstva, preparati za uništavanje štetočina, fungicidi, herbicidi

-
- (210) **2014-99** (442) **20.09.2014.**
(220) 3/11/2014
(731) **HEMOFARM A.D.** FARMACEUTSKO-HEMIJSKA INDUSTRIJA VRŠAC, BEOGRADSKI PUT BB, 26300 VRŠAC RS
(540) **ADEMOLA**
(550) I
(740) MSA IP Milojević Sekulić, Bulevar Despota Stefana 1a, Beograd SR
(511) **Klasa 05:** farmaceutski i veterinarski preparati, sanitarni preparati za medicinsku upotrebu, dijetetske supstance prilagođene za upotrebu u medicini, hrana za bebe, flasteri, materijali za zavijanje, materijali za plombiranje zuba, zubarska smola, dezinfekciona

sredstva, preparati za uništavanje štetočina, fungicidi, herbicidi

- (210) **2008-413** (442) **20.09.2014.**
 (220) 25/08/2008
 (731) **STUDIO MODERNA SA**, VIA PRETORIO SA, 6900 LUGANO CH

TOP SHOP TV

- (540)
 (550) I
 (740) Otašević Đuro, Serdara Jola Piletića bb, 81000 Podgorica ME
 (511) **Klasa 38:** usluge emitovanja
Klasa 41: produkcija i distribucija radio i televizijskog programa preko televizora, radija, satelita, telefona, bežičnog i običnog telefona, digitalnog telefona i globalne komunikacijske mreže.

- (210) **2011-74** (442) **20.09.2014.**
 (220) 14.02.2011.
 (732) **JOHNSON & JOHNSON (NEW JERSEY CORPORATION)**, ONE JOHNSON & JOHNSON PLAZA, NEW BRUNSWICK, NEW JERSEY, US

CLEAN & CLEAR

- (540)
 (550) I
 (740) Božidar Radulović, Jovana Tomaševića 9/III-1, Podgorica ME
 (511) **Klasa 03:** Nemedicinska kozmetika; balzami za usne, sjajevi za usne i puderi.

- (210) **2012-389** (442) **20.09.2014.**
 (220) 20.09.2012.
 (732) **ODEON TURIZM ISLETMECİLİĞİ A.Ş.**, CUMHURİYET CAD. NO: 281 HARBIYE ŞİŞLİ İSTANBUL, TR



- (540)
 (550) I,F

(740) Milena Rončević, Bulevar Svetog Petra Cetinjskog 130/VII, Podgorica ME

(511) **Klasa 39:** saobraćaj, pakovanje i skladištenje robe; prevoz lica i stvari, naročito u drumskom, željezničkom, pomorskom i vazdušnom saobraćaju; portir usluge; transport novca i dragocenosti, usluge tur operatera, usluge menadžimenta destinacija, usluge pružanja zemaljskog servisa uključujući pružanje prijema, transfera, smještaja i usluge turističkih vodiča koji govore maternje jezike gostiju, dodatne ture i usluge povratnog putovanja, organizacija putovanja, rezervacija i raspored putovanja, ekskurzije i krstarenja, organizacija transportnih usluga; iznajmljivanje ronilačkih odijela, organizacija, rezervacija i raspored ekskurzija, izleti i obilasci, konsultantske usluge u vezi sa putovanjem i sprovođenje putnika, iznajmljivanje, rezervacije i stavljanje na raspolaganje vazduhoplova; zakup, rezervacija i stavljanje na raspolaganje brodova, posebno veslačkih i motornih čamaca, jedrenjaka i kanua, iznajmljivanje, rezervacija i stavljanje na raspolaganje motornih vozila, bicikala i konja, dostava paketa, organizacija putovanja, odmora i tura razgledanja znamenitosti, usluge turističke agencije (uključeno u ovu klasu), posebno konsultacije i rezervacije putnih usluga, pružanje informacija o putovanjima, organizacija prevoza i putovanja, usluge rezervisanja putovanja (uključene u ovu klasu), informacije o putovanju na Internetu, naročito o rezervacijama u turizmu i sektoru poslovnih putovanja (onlajn turističke agencije); isporuka, otprema i distribucija novina i časopisa, konsultacije u vezi putovanja putem telefonskog centra (kol centar) i hotlajna, uključujući poslovna putovanja i oblast logistike, transporta i skladištenja; transportne usluge, odnosno konsultacije u vezi sa praćenjem putničkih ili teretnih vozila koja koriste računare ili globalno-pozicioni sistem (GPS); informacije o saobraćaju

Klasa 43: agencije za smještaj (hotelski, pansionski), smještaj (privremeno iznajmljivanje), rezervacije privremenog smještaj, barske usluge, kafići, kafeterije, ugostiteljstvo (hrana i piće), obdaništa (jaslice), starački domovi, turističke kuće, hotelske rezervacije, pansioni, moteli, iznajmljivanje sala za sastanke, iznajmljivanje privremenih smještaja, rezervisanje privremenog smještaja, restorani, restorani za samoposluživanje, snek-barovi

(210) **2014-354**

(442) **20.09.2014.**

(220) 29.07.2014.

(731) **ZEKOVIĆ M. SRETEN**, "GIPOS" IV/II/2, 81250 CETINJE ME

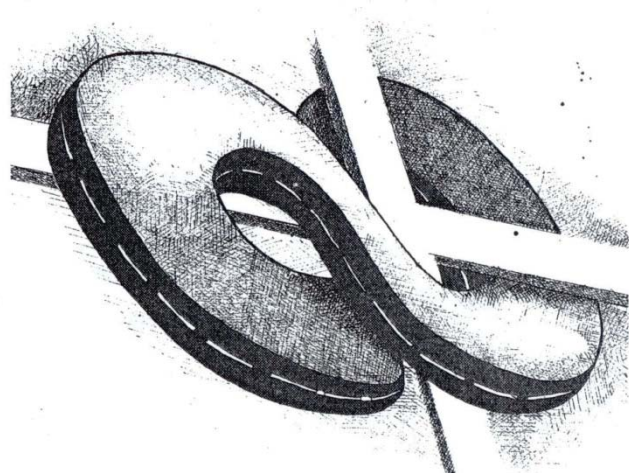

(540)

(550) I, F

(511) **Klasa 16:** publikacije, časopisi, novine, knjige, papir i karton i proizvodi od ovih materijala,

plakati

Klasa 41: objavljivanje tekstova, knjiga, publikacija, časopisa i novina, izdavanje knjiga, publikacija, časopisa i novina, kulturne aktivnosti

(111) 11005

(151) 13.06.2014.

(210) **2012-147**

(442) **20.12.2013.**

(220) 08.03.2012.

(732) **Euro-pro Operating LLC** (Delaware Limited Liability Company), 180 Wells Avenue, Suite 200, Newton, Massachusetts 02459 US

(540) SHARK

(550) I

(740) Radulović Božidar, Jovana Tomaševića 9/III, Podgorica ME

(511) **Klasa 07:** Mašine i mašinski alati, motori i pogonske mašine (osim za suvozemna vozila), mašinske spojnice i transmisioni elementi (osim za suvozemna vozila), poljoprivredne sprave osim onih kojima se ručno upravlja, inkubatori za jaja, automatske mašine za prodaju, usisivači i višenamenske mašine za čišćenje na paru za upotrebu u domaćinstvu.

Klasa 09: Pegle na paru za upotrebu u domaćinstvu, električne pegle za upotrebu u domaćinstvu.

(111) 11111

(151) 26.07.2011.

(210) **2011-382**

(442) **20.12.2013.**

(220) 26.07.2011.

(732) **GLOSARIJ DOO**, VOJISAVLJEVIĆA 76, PODGORICA ME

LITAK®

(540)

(550) I

(511) **Klasa 05:** Farmaceutski preparat.

(111) 11211

(151) 08.07.2014.

(210) **2012-76**

(442) **20.12.2013.**

(220) 08.02.2012.

(732) **BOSNALIJEK**, DD. JUKIĆEVA 53, SARAJEVO BA

ARGEDIN

(540)

(550) I, V

(740) Radulović Božidar, Jovana Tomaševića 9/III, Podgorica ME

(511) **Klasa 05:** Farmaceutski proizvodi.

(111) 11214

(151) 08.07.2014.

(210) **2012-80**

(442) **20.12.2013.**

(220) 13.02.2012.

(732) **PODRAVKA** D.D. ANTE STARČEVIĆA 32, KOPRIVNICA HR



(540)

(550) I, F

(740) Radulović Božidar, Jovana Tomaševića 9/III, Podgorica ME

(511) **Klasa 30:** Mješavina za pohanje, umaci.

(111) 11215

(151) 08.07.2014

(210) **2012-81**

(442) **20.12.2013.**

(220) 13.02.2012.

(732) **NISSAN JIDOSHA KABUSHIKI KAISHA** (ALSO TRADING AS NISSAN MOTOR CO.LTD.), NO.2 TAKARACHO, KANAGAWA-KU, YOKOHAMA-SHI, KANAGAWA-KEN JP



(540)

(550) I

(740) Popović Miladin, Đoka Miraševića 21/III, Podgorica ME

(511) **Klasa 01:** Hemijski proizvodi koji se upotrebljavaju u industriji, neprerađene vještačke smole, neprerađene plastične materije, smjese za gašenje požara, preparati za kaljenje i zavarivanje, materije za štavljenje, ljepljive supstance koje se upotrebljavaju u industriji, materijali (hemijski proizvodi) za oblaganje stakla, smjese (hemijski proizvodi) za popravku vjetrobrana, preparati (hemijski proizvodi) za odstranjivanje, zaptivači (hemijski proizvodi) za zaptivanje površina, materijali (hemijski proizvodi) za oblaganje radi osvjetljavanja i zaštite površine djelova vozila (šasije, točka, gume), materijali (hemijski proizvodi) koji su otporni na vodu za prozore, zakisjeljena voda za punjenje akumulatora, aditivi (hemijski proizvodi-) za ulja, aditivi, hemijski proizvodi za rashladni uređaj klime, aditivi, hemijski proizvodi za motorno gorivo, tečnost za kočnice automobila, rashladne tečnosti za motore vozila,

tečnost za servo upravljače kod automobila, epoksid za lijepljenje i punjenje kod opravki i održavanja automobila, hemijski preparati za popravku i održavanje automobila, brizgaljke za čišćenje goriva, transmisiona tečnosti za automobile, aditivi za hladnjake za sprječavanje rđe, anistatički preparati, izuzev onih za upotrebu u domaćinstvu.

Klasa 02: Boje, firnajzi, lakovi, sredstva za zaštitu od rđe, materije za bojenje, sredstva za nagrizanje, metali u obliku listova i praha za slikare, dekoratere, štampare i umjetnike. Podloga za šasije automobila, masti za zaštitu od rđe za vozila, prajmeri, premazi za zaptivanje, podloga za površine koje će se farbati, preparati protiv rđe.

Klasa 03: Preparati za čišćenje, poliranje, ribanje i nagrizanje, parfimerija, eterična ulja, kozmetika, losioni za kosu, tečnosti za čišćenje vjetrobrana, tečnosti za čišćenje djelova vozila, vosak za poliranje, preparati za sjaj i preparati za zaštitu spoljne površine automobila, antistatički preparati za upotrebu u domaćinstvima, parfemi, kolonjska voda, preparati za čišćenje automobila, preparati za uklanjanje rđe, preparati za uklanjanje naljepnica i boje, preparati za čišćenje prilikom uklanjanja zaptivača.

Klasa 04: Industrijska ulja i masti, maziva, jedinjenja za skupljanje prašine vlaženjem i vezivanjem, goriva (uključujući motorna tečna goriva) i materije za osvetljavanje, masti i maziva za vozila, motorna ulja, ulja za kočnice za automobile, ulje za servo upravljače za automobile, transmisiona maziva za automobil, mast za podmazivanje, ricinusovo ulje za tehničke svrhe.

Klasa 05: Farmaceutski i veterinarski preparati, sanitarni preparati za medicinsku upotrebu, dezodoransi, izuzev za ličnu upotrebu, kutije za Prvu pomoć, pune.

(111) 11216

(151) 08.07.2014.

(210) **2012-82**

(442) **20.12.2013.**

(220) 13.02.2012.

(732) **NISSAN JIDOSHA KABUSHIKI KAISHA** (ALSO TRADING AS NISSAN MOTOR CO.LTD.), NO.2 TAKARACHO, KANAGAWA-KU, YOKOHAMA-SHI, KANAGAWA-KEN JP



(540)

(550) I

(740) Popović Miladin, Đoka Miraševića 21/III, Podgorica ME

(511) **Klasa 06:** Obični metali i njihove legure, bravarski proizvodi, mali metalni gvoždarski proizvodi, proizvodi od običnih metala koji nijesu uključeni u druge klase, čepovi za boce napravljeni od metala, kutije i držači za kartice (od metala), ploče za identifikaciju od metala, privezak za ključeve (kao nakit ili kao privezak) od ne-dragocenih metala, skulpture i figure (figurice) automobila napravljene od običnog metala, kutije za alate od metala (prazne).

Klasa 08: Ručni alati i sprave (kojima se ručno upravlja), pribor za jelo, set za manikir, set za pedikir, sječiva (ručni alati), kliješta za zanoktice, pincete za zanoktice, rezači, alati za sječenje (ručni alati), alati za porublivanje (ručni alati), turpije (alati), alati za poliranje nok-

tiju, električni i ne-električni, čekici (ručni alati), ručna bušilica (ručni alati), puferi i makaže za nokte, električni i ne-električni, turpije za nokte i kliješta, krckalice za orahe, makaže, šrafčigeri, kutije za brijanje, srebrnina (noževi, viljuške i kašike), ključevi za matice (ručni alati), stono posuđe (noževi, viljuške i kašike), ključevi (ručni alati).

Klasa 14: Dragocjeni metali i njihove legure i proizvodi od dragocjenih metala ili sa prevlakom od njih, koji nijesu uključeni u druge klase, časovničarski i hronometrijski instrumenti, čepovi za boce od dragocjenih metala, novčići za sakupljanje, dugmad za košulje, satovi i časovnici, privjesci za ključeve (nakit ili lančić) od dragocjenih metala, broševi (nakit), kopče za kravate od dragocjenih metala, ukrasni novi bedževi (dugmad).

Klasa 16: Hartija, karton i proizvodi od njih, koji nijesu uključeni u druge klase, štampane stvari, fotografije, kancelarijski materijal, držači za pasoše, omoti za knjige, kutije za poslovne kartice napravljene od kartona, držači za poslovne kartice (od ne-dragocjenih metala), kalendari, podmetači za čaše od papira, desktop držači za poslovne kartice, dnevници, kese za poklone, graficke umjetničke reprodukcije, kese za ručak, držači memoranduma, spajalice za novac, blokčići za bilješke, jastučići od papira, mjerači papira, držači za olovke i hemijske olovke, čaše za držanje olovaka, olovke, hemijske olovke, foto albumi (koje se odnose i na knjige za uspomene), poster, štampani lozovi (ne igračke), naljepnice, naljepnice i crteži za gravuru, blokčići za pisanje, držači za blokčiće/rokovnike, sveske, držači za blokčiće, fascikle sa rajsferšlusom, trake za držanje ključeva.

Klasa 18: Koža i imitacija kože, i proizvodi izradeni od ovih materijala a koji nijesu uključeni u druge klase, koferi i putne torbe, suncobrani i štapovi za hodanje, torbe za kompjutere napravljene od kože, ruksaci, aktin-tašne, kutije za kartice i držači, torbe za kovani novac, koje nijesu napravljene od dragocjenog metala, fascikle, napravljene od kože, privjesci za ključeve i futrole napravljene od kože, etikete za prtljag, spajalice za novac (od kože), etikete sa imenom od kože, etikete za prtljag, bilježnice, napravljene od kože, držači za bilježnice, napravljene od kože, ručne torbe, kišobrani, novčanici, fascikle sa rajsferšlusom (od kože), industrijske posude za pakovanje, nesereri (ne popunjeni).

Klasa 20: Namještaj, ogledala, okviri za slike, proizvodi (koji nijesu obuhvaćeni drugim klasama) od drveta, plute, trske, rogoza, vrbovog pruća, roga, kosti, slonovače, kitove kosti, ćilibara, sedefa, morske pjene i zamjene svih ovih materijala, ili od plastike, čepovi za boce, ne od metala, otvarači za boce, nemetalni, stolice, ventilatori za ličnu upotrebu, ne električni, ramovi za slike, skulpture i figure (figurice) automobila napravljene od smole, jastuci (namještaj), madraci, kutije za alat (ne od metala).

Klasa 21: Kućne ili kuhinjske sprave i posude, staklarija, porcelan i grnčarija koja nije uključena u druge klase, čepovi za boce napravljene od metala, čaše od porcelana, roštilji za kampovanje, podmetači za čaše, ne od papira i drugačiji od stonog platna, rashladne torbe, dekorativni poslužavnici napravljene od kristala, staklarija za upotrebu u domaćinstvima, izolovane posude za piće, japanski štapici, držači za tetrapak boce (posude), korpe za piknik (opremljene), uključujući posude, bokali, prenosivi rashladni uređaji, boce od nerđajućeg čelika za višekratnu upotrebu, statue i figure (figurice) napravljene od stakla, toaletne torbe, opremljene, šolje za putovanja, visoke čaše bez postolja (sudovi za pijeње) napravljene od stakla, termos, napravljene od ne-dragocjenog metala, vaze.

Klasa 24: Tekstil i tekstilni proizvodi, koji nijesu obuhvaćeni drugim klasama, blokčići za krevete i stolove, podmetači (stolnjaci i salvete), peškiri za golf, blokčići, peškiri, baneri, zastave, ne od papira, blokčići za namještaj od tekstila, salvete od tekstila, tkanine (izuzev traka za porub kod tatami prostirki).

Klasa 25: Odjeća, obuća, pokrivala za glavu, kaiševi (odjeća), kape, marame od kašmira, replika delova trkačkog vozila Formule 1, naime rukavice vozača, replika delova trkačkog vozila

Formule 1, naime trkačkog odijela, rukavice, majice za golf, šeširi, jakne, pletena odjeća, ženske bluze, kožne jakne, kravate, jakne sa kapuljačom, zaštitna radna odjeća (izuzev one za zaštitu od nezgode i povrede), marame, šalovi, majice, cipele, višeslojne jakne, viziri za sunce (pokrivala za glavu), džemper, dukserice.

Klasa 26: Čipka i vez, trake i gajtani, dugmad, kopče i petlje, špenadle i igle, ukrasni novi bedževi (dugmad), broševi (dodaci odjeći), kopče (dodaci odjeći), kopče (cipele), kratki konop za ključeve, naočare za sunce, prenosiva elektronika, male flaše, bedževi.

Klasa 27: Tepisi, asure, prostirke i otirači, linoleum i drugi materijali za pokrivanje podova, blokčići za zidove (netekstilni), prostirke za prekrivanje prtljavnika automobila, patosnice za automobile, tepisi, prostirke za pod, prostirke, asure.

Klasa 28: Igre i igračke, gimnastički i sportski artikli koji nijesu obuhvaćeni drugim klasama, replika delova trkačkog vozila Formule 1, naime kontrolne table (igračka), replika delova trkačkog vozila Formule 1, naime rukavice vozača, daljinski upravljač za vozila igračke na baterije, alatka za opravku (dodatak za golf), replika delova trkačkog vozila Formule 1, naime sprave za prenos brzine preko ekrana (igračka), replika delova trkačkog vozila Formule 1, naime mini kacige (igračka), replika delova trkačkog vozila Formule 1, naime mini nosne membrane (igračka), replika delova trkačkog vozila Formule 1, naime mini upravljači (igračka), replika delova trkačkog vozila Formule 1, naime upravljači (igračka), loptice za golf, kupice za golf na koje se stavlja lopta, svjetlosne i zvučne igračke, vozila u minijaturnim kockastim kalupima, mala vozila (igračke), komplet za sastavljanje modela igračke, plišane igračke, kopije modela vozila, vozila igračke za vožnju na njima, skije, punjene igračke, igračke u formi kopije kaciga, igrice u boji, šah, igra dame (set za igru), karte za igranje, mašine za igranje i aparati, oprema za bilijar.

Klasa 30: Poslastice, čokolada, poslastice od nane, čaj, pića (na bazi čokolade), pića (na bazi kafe), pića (na bazi čaja), biskviti, bombone, kafa, kafa (nepržena), kolačići.

Klasa 33: Alkoholna pića (izuzev piva), Alkoholna pića koja sadrže voće, pića (destilovana), rakija, kokteli, žestoka alkoholna pića, vodka, viski, vino.

Klasa 34: Artikli za pušače, pepeljare za pušače, upaljači za pušače, kutije za cigare, kutije za cigarete.

(111) 11217

(151) 04.07.2014.

(210) **2012-83**

(442) **20.12.2013.**

(220) 13.02.2012.

(732) **NISSAN JIDOSHA KABUSHIKI KAISHA** (ALSO TRADING AS NISSAN MOTOR CO.LTD.), NO.2 TAKARACHO, KANAGAWA-KU, YOKOHAMA-SHI, KANAGAWA-KEN JP



(540)

(550) I

(740) Popović Miladin, Đoka Miraševića 21/III, Podgorica ME

(511) **Klasa 35:** Usluge maloprodaje i veleprodaje različitih roba, naime automobila, njihovih djelova i opreme (isključujući njihov transport), usluge reklamiranja i publiciteta za automobile, promovisanje u svijesti javnosti električnih motornih vozila i promjena u načinu života koje oni proizvode, pružanje korisnicima proizvoda usluge veb-sajtova koji pružaju informacije o električnim automobilima i informacije koje se odnose na kupovinu takvih automobila, zastupništva u oblasti motornih vozila, pružanje informacija u vezi sa električnim vozilima, naime, potrošačke informacije o proizvodu i poređenje cijena, promovisanje roba i usluga drugih kroz administriranje podsticajnih nagradnih programa koji uključuju distribuciju EV (električnih vozila) i kreditiranje kilometara vožnje, informacione usluge, odnosno, pružanje informacija u oblasti poređenja cijena na polju benzina.

Klasa 37: Popravljanje ili održavanje automobila, električnih vozila uključujući električne automobile, karavane, kamione, kombije, terenska (SUV) vozila, autobuse, rekreativna vozila, sportske automobile, trkačke automobile, vagonete, viljuškare, i traktore za vuču (traktore), i strukturnih djelova i opreme za njih, pružanje informacija u vezi sa popravljanjem ili održavanjem automobila, električnih vozila uključujući električne automobile, karavane, kamione, kombije, terenska (SUV) vozila, autobuse, rekreativna vozila, sportske automobile, trkačke automobile, vagonete, viljuškare, i traktore za vuču (traktore), i strukturnih djelova i opreme za njih, popravljanje ili održavanje mašina i instrumenata za mjerenje ili testiranje, popravljanje ili održavanje mašina i aparata za distribuciju električne energije i kontrolu, popravljanje ili održavanje rotacionih konvertora, popravljanje ili održavanje modifikatora faze, popravljanje ili održavanje punjača, popravljanje ili održavanje baterija i ćelija, popravljanje ili održavanje motora sa unutrašnjim sagorijevanjem, popravljanje ili održavanje djelova motora sa unutrašnjim sagorijevanjem, popravljanje ili održavanje anlasera za motore i mašine, ne za kopnena vozila, popravljanje ili održavanje djelova AC motora i DC motora, popravljanje ili održavanje Ac generatora i DC generatora, popravljanje ili održavanje agregata, popravljanje ili održavanje električnih žica i kablova, popravljanje ili održavanje telekomunikacionih uređaja i aparata, popravljanje ili održavanje telefonskih aparata, popravljanje ili održavanje djelova i dodatne opreme za telekomunikacione mašine i aparate, popravljanje ili održavanje telematskih aparata za vozila, popravljanje ili održavanje aparata za automatsko obavještanje o završetku punjenja, popravljanje ili održavanje navigacionih sistema za vozila, popravljanje ili održavanje elektronskih mašina, aparata, i njihovih djelova, popravljanje ili održavanje sistema na daljinsku kontrolu, popravljanje ili održavanje elektroda, popravljanje ili održavanje magnetnih jezgra, popravljanje ili održavanje otpornosti žica, pružanje usluga pomoći na putu, naročito odgovaranje na telefonske pozive za pomoć pored puta, brzo mijenjanje guma, hitno snabdijevanje gorivom, punjenje baterija i hitno snabdijevanje baterijama, pružanje informacija o stanju vozila, naime status punjenja, potrebno vrijeme za potpuno punjenje, isključen status, napunjen, pružanje informacija o stanju vozila, naime status punjenja, potrebno vrijeme za potpuno punjenje, isključen status, napunjen, pružanje informacija o stanju vozila, naime, podsjećanje vozača da uključi vozilo radi punjenja baterija, usluge održavanja vozila, naime, pružanje elektronskih upozorenja putem interneta koja obavještaavaju vlasnike vozila o terminu za održavanje vozila.

Klasa 38: Usluge komunikacija putem mobilnih telefona, komunikacija putem kompjuterskih terminala, komunikacija putem telefona, iznajmljivanje/lizing komunikacione opreme, uključujući telefone, faks mašine, informacije o komunikacionim podacima (uključujući informacije putem kabla i radio komunikacionih mreža), komunikacija putem e-maila, informacije o komunikacionim mrežama putem kompjuterskih terminala, komunikacija putem VAN mreže, pružanje telekomunikacionih veza na globalnoj kompjuterskoj mreži, pružanje pristupa korisnicima globalno pozicioniranim signalima za navigacijske svrhe, pružanje ko-

risnicima pristup internetu, komunikacija podacima sa slovima, slikama i zvucima putem e-maila i komputera, pružanje korisnicima pristup globalnoj kompjuterskoj mreži, telematska pomoć preko servisnog i alarmnog centra za transport i saobraćaj za povezivanje poziva u svrhu intervencije i pomoći osobama i vozilima u slučaju nezgode, kvara ili krađe, pružanje usluga za povezivanje i pristup elektronskim komunikacionim mrežama za prenos i preuzimanje ili prijem audio, video ili multimedijalnog sadržaja, pružanje pristupa digitalnoj muzici na Internetu, telekomunikacije, naime primanje, koordiniranje i prosleđivanje poziva na daljinu o stanju vozila, telekomunikacije, naime primanje, koordiniranje i prosleđivanje udaljenih hitnih poziva, prijenos teksta, glasa i alarmnih poruka i signala, mera, zvuka, slika, videa, položaja, kretanja i stanja podataka između kopnenih vozila kao i između mašina/motora/baterija i mašina i raznih centara za obradu podataka i telematskih sistema, telefona ili personalnih računara, telekomunikacione usluge, naime, elektronski prijenos podataka za vlasnike vozila i vozače, u vezi sa postojećim podacima koji asistiraju u praćenju ukradenog vozila, pomoćni kompjuterski prijenos signala mehanizma za zaključavanje vozila, telematske usluge, naime, usluge nadgledanja energije, naime, pregled ili snimanje vremena ili nivoa upotrebe i kontrolisanje struje koju koriste izabrani uređaji putem telematskih sistema, telematske usluge, naime, usluge nadgledanja energije za druge, naime, pregled ili snimanje vremena ili nivoa upotrebe i kontrolisanje struje koju koriste izabrani uređaji putem telematskih sistema, telekomunikacije, naime, prijenos podataka, naime, informacije vezane za put i vožnju putem telematskih sistema, komunikacija putem telematskih sistema, naime, informacije u vezi sa prikazom puta i vožnjom. Telekomunikacije, naime, prijenos podataka, naime, opšte informacije kao što su informacije u vezi sa automobilom, saobraćajem i stanjem na putu, putem telematskih sistema, telekomunikacije, naime, prijenos podataka i aplikativnog softvera, telekomunikacione usluge, naime, elektronski prijenos glasovnih poruka i podataka.

Klasa 39: Informacije u vezi sa transportom, prevoz automobila, brodski prevoz, posredovanje u prevozu, usluge iznajmljivanja i lizinga vozila, pomoć u slučajevima kvara na motornom vozilu, uključujući i vuču i transport, transport putnika putem, morem i vazduhom, informacione usluge, naime, pružanje informacija o vremenu, vesti, informacije o saobraćaju, informacije u vezi sa dolascima letova i odlascima, GPS (Global Positioning' Sistem-globalni sistem za pozicioniranje) navigacione usluge, naime, pružanje prognoziranja vozačima smerica u vezi sa najboljom rutom, navigacione usluge putem Interneta i pomoć pri postavljanju destinacije, GPS (Global Positioning Sistem -globalni sistem za pozicioniranje) navigacione usluge, naime, glasovno rutiranje i pomoć na licu mesta i pružanje praktičnih usluga preko komponenti integrisanih u motornom vozilu, naime, predajnici, prijemnici, mikroprocesori, softver, mobilni telefoni, i električna striktura sve u interakciji sa globalnim sistemom za pozicioniranje i satelitskom tehnologijom i korisničkim servisnim centrom, obezbeđivanje mesta za punjenje vozila električnom energijom, usluge parkinga za vozila, iznajmljivanje vozila, pružanje informacija u vezi lokacije i dostupnosti benzinskih stanica, pružanje informacija u vezi lokacije i dostupnosti mesta za električno punjenje vozila.

Klasa 41: Obrazovne usluge, pripremanje obuke, razonoda, sportske i kulturne aktivnosti, planiranje, promocija, rukovanje i održavanje trka motornih vozila, sve usluge u vezi sa razonodom, sponzorske aktivnosti u vezi sa trkama motornih vozila, obezbeđivanje on-line magazina iz oblasti automobilizma, mode, razonode i stila, on-line publikacija elektronskih magazina, uputstvo za vožnju vozila, uputstvo za vožnju vozila, naime, pružanje informacija o ekonomičnoj vožnji, obezbeđivanje digitalne muzike (koja se ne može preuzeti) na Internetu.

Klasa 42: Usluge informisanja o vremenu, hosting on-line društvenog vebajta koji pruža informacije o električnim vozilima za vlasnike električnih vozila, sistem on-line usluga za up-

ravljanje koji omogućava korisnicima da na daljinu vide, nadgledaju, programiraju, rukuju i kontrolišu sisteme baterija i air-condition sisteme u električnim vozilima, daljinski nadzor i snabdevanje rezultatima nivoa napunjenosti automobilske baterije, obezbeđivanje inspekcijskog programa za polovna vozila, usluge trgovine motornim vozilima, hitne usluge i usluge obezbeđivanja na putum naime, daljinsko zaključavanje i otključavanje vrata, detekcija i obaveštavanje vlasnika vozila o istom, nadziranje punjenja baterije i obaveštavanje vozača o statusu punjenja. Nadziranje sistema električne energije koji se koristi u kopnenim vozilima, nadziranje sistema električne energije koji se koristi u kopnenim vozilima.

Klasa 45: Obezbeđivanje vebajtova koji pružaju informacije o promenama načina života proizašlim iz upotrebe električnih automobila, daljinski set i početno punjenje baterije i air-condition u električnom vozilu, usluge pružanja hitne pomoći na putu, naročito odgovaranje na pozive za hitnu pomoć za putnike koji su povredeni ili bolesni, usluge nadgledanja vozila u svrhu bezbednosti, naime, automatsko obaveštavanje o raspoređenosti vazdušnih jastuka, usluge automatskog obaveštavanja o sudaru i obaveštavanja operatera o abnormalnom statusu vozila, usluge pružanja hitne pomoći i bezbednosti na putu, naime, praćenje ukradenih vozila, detekcija i obaveštavanje vlasnika vozila o istom, upravljanje vozačima tinejdžerima, naime, nadgledanje, praćenje i upozoravanje vlasnika motornih vozila iz bezbednosnih i sigurnosnih razloga o tome da li je vozač tinejdžer prekoračio ograničenje brzine ili napustio prethodno ograničenu geografsku oblast korišćenjem globalnog sistema za pozicioniranje, domarske usluge za druge koje se sastoje u pravljenju rezervacija na daljinu za punjenje električnih vozila, a koje se pružaju preko telefona, putem e-maila ili tekstualnom porukom, domarske usluge za druge koje se sastoje u nameštanju na daljinu air-conditiona u vozilima, i koje se pružaju preko telefona, putem e-maila ili tekstualnom porukom, pravljenje rezervacija na mestima za električno punjenje vozila, domarske usluge za druge koje se sastoje iz pravljenja zatraženih ličnih aranžmana i rezervacija i pružanja informacija potrošačima kako bi zadovoljili licne potrebe, a sve se pružaju putem telefona, putem e-maila ili tekstualne poruke.

(111) 11218

(151) 04.07.2014.

(210) **2012-84**

(442) **20.12.2013.**

(220) 13.02.2012.

(732) **NISSAN JIDOSHA KABUSHIKI KAISHA** (ALSO TRADING AS NISSAN MOTOR CO.LTD.), NO.2 TAKARACHO, KANAGAWA-KU, YOKOHAMA-SHI, KANAGAWA-KEN JP



(540)

(550) I

(740) Popović Miladin, Đoka Miraševića 21/III, Podgorica ME

(511) **Klasa 36:** Usluge osiguranja od automobilskih nesreća, usluge posredovanja pri zakupu-kupovini, usluge vezane za kreditne i gotovinske kartice, usluge pružanja finansijskih informacija, usluge finansiranja u vezi automobila, krediti na rate, izdavanje kreditnih kartica, procena polovnih automobila, osiguranje motornih vozila, pružanje sveobuhvatnih

osiguravajućih/garantnih ugovora za motorna vozila i njihove delove.

(111) 11205

(151) 08.07.2014.

(210) **2012-69**

(442) **20.12.2013.**

(220) 31.01.2012.

(300) 85454957 24.10.2011. US

(732) **FORD MOTOR COMPANY**, ONE AMERICAN ROAD, DEARBORN, MICHIGAN 48126 US

Ford Go Further

(540)

(550) I

(740) Popović Miladin, Đoka Miraševića 21/III, Podgorica ME

(511) **Klasa 12:** Motorna vozila, naime automobili, kamioni, kombiji, terenska vozila (sport utility vehicles-SUV), i njihovi sastavni delovi i motori.

(111) 11206

(151) 08.07.2014.

(210) **2012-70**

(442) **20.12.2013.**

(220) 31.01.2012.

(300) 85454955 24.10.2011. US

(732) **FORD MOTOR COPANY**, ONE AMERICAN ROAD, DEARBORN, MICHIGAN 48126 US

Ford Go Further

(540)

(550) I

(740) Popović Miladin, Đoka Miraševića 21/III, Podgorica ME

(511) **Klasa 35:** Usluge veleprodajne i maloprodajne distribucije novih i polovnih motornih vozila, njihovih delova i opreme, usluge promovisanja prodaje tuđih roba i usluga u automobilske industriji deljenjem promotivnih materijala i informacija o proizvodima putem onlajn globalne računarske mreže, kroz distribuciju štampanog materijala, audio i video snimaka, televizijskih i radio snimaka, onlajn oglašavanja, i promotivnih takmičenja, maloprodajne usluge u oblasti automobila, njihovih delova i opreme, usluge ovlašćene prodaje automobila na maloprodajnom nivou (ovlašćeni dileri).

(111) 11207

(151) 08.07.2014.

(210) **2012-71**

(442) **20.12.2013.**

(220) 02.02.2012.

(732) **JT INTERNATIONAL S.A.** 1, RUE DE LA GABELLE 1211, GENEVA 26 CH

RAW BEAUTY

(540)

(550) I

(740) Čejović Vladimir, 13. jula 21, Podgorica ME

(511) **Klasa 34:** Duvan, prerađen ili neprerađen, duvan za pušenje, duvan za lule, duvan za ručno uvijanje, duvan za žvakanje, snus duvan, cigarete, cigare, cigarilosi, supstance za pušenje koje se prodaju odvojeno ili miješane sa duvanom, a koje nisu za medicinske svrhe ili u svrhe liječenja, duvan za ušmrkavanje, artikli za pušače uključeni u klasu 34, papir za cigarete, tube za cigarete i šibice.

(111) 11212

(151) 08.07.2014.

(210) **2012-78**

(442) **20.12.2013.**

(220) 09.02.2012.

(732) **TOYOTA JIDOSHA KABUSHIKI KAISHA** (ASLO TRADING AS TOYOTA MOTOR CORPORATION), 1, TOYOTA -CHO, TOYOTA-CHI, AICHI-KEN JP

THE POWER OF H

(540)

(550) I

(740) Čejović Vladimir, 13. jula 21, Podgorica ME

(511) **Klasa 12:** Automobili i njihovi strukturni djelovi.

(111) 11088

(151) 13.06.2014.

(210) **2012-146**

(442) **20.12.2013.**

(220) 08.03.2012.

(732) **EURO-PRO OPERATING LLC** (DELAWARE LIMITED LIABILITY COMPANY), 180 WELLS AVENUE, SUITE 200, NEWTON, MASSACHUSETTS 02459 US

(540) EURO-PRO

(550) I

(740) Radulović Božidar, Jovana Tomaševića 9/III, Podgorica ME

(511) **Klasa 07:** Mašine i mašinski alati, motori i pogonske mašine (osim za suvozemna vozila), mašinske spojnice i transmisioni elementi (osim za suvozemna vozila), poljoprivredne

sprave osim onih kojima se ručno upravlja, inkubatori za jaja, automatske mašine za prodaju, usisivači, šivaće mašine, višenamenske mašine za čišćenje na paru i kuhinjski električni uređaji, naročito, blenderi za hranu za upotrebu u domaćinstvu, mikseri, seckalice, aparati za ceđenje voća i sokovnici i uređaji za obradu hrane.

Klasa 09: Aparati i instrumenti naučni, pomorski, geodetski, fotografski, kinematografski, optički, za vaganje, merenje, signalizaciju, kontrolu (inspekciju), spašavanje i nastavu, aparati i instrumenti za provođenje, prekid, transformaciju, akumulaciju, regulisanje ili kontrolu električne energije, aparati za snimanje, prenos i reprodukovanje zvuka ili slike, magnetni nosači podataka, diskovi za snimanje, kompakt diskovi, DVD i drugi digitalni nosači podataka, mehanizmi za aparate koji se pokreću novcem ili žetonom, registar kase, računске mašine, oprema za obradu podataka, računari, računarski softver, aparati za gašenje požara, pegle na paru i električne pegle za upotrebu u domaćinstvu.

Klasa 11: Aparati za osvetljavanje, grejanje, proizvodnju pare, kuvanje, hladenje, sušenje, ventilaciju, snabdevanje vodom i za sanitarne svrhe, uređaji za precišćavanje vazduha za upotrebu u domaćinstvu i uređaji za povećavanje vlažnosti vazduha, aparati za prženje i grilovanje.

Klasa 21: Kućne ili kuhinjske sprave i posude (ne od dragocenih metala ili sa prevlakom od njih), češljevi i sunđer, četke (izuzev kičica), materijali za pravljenje četki, pribor za čišćenje, čelčna vuna, neprerađeno ili poluprerađeno staklo (osim stakla koje se koristi u građevinarstvu), staklarija, porcelan i grnčarija koja nije uključena u druge klase, posude za kuvanje, naročito tiganji za prženje, metalne šerpe za kuvanje, lonci i poklopci, posude za pečenje.

(111) 11208

(151) 08.07.2014.

(210) **2012-72**

(442) **20.12.2013.**

(220) 02.02.2012.

(732) **JT INTERNATIONAL S.A.** 1, RUE DE LA GABELLE 1211, GENEVA 26 CH

SOBRANIE LIQUID GOLD

(540)

(550) I

(740) Čejović Vladimir, 13. jula 21, Podgorica ME

(511) **Klasa 34:** Duvan, prerađen ili neprerađen, duvan za pušenje, duvan za lule, duvan za ručno uvijanje, duvan za žvakanje, snus duvan, cigarete, cigare, cigarilosi, supstance za pušenje koje se prodaju odvojeno ili miješane sa duvanom, a koje nisu za medicinske svrhe ili u svrhe liječenja, duvan za ušmrkavanje, artikli za pušače uključeni u klasu 34, papir za cigarete, tube za cigarete i šibice.

(111) 11085

(151) 13.06.2014.

(210) **2012-21**

(442) **20.12.2013.**

(220) 13.01.2012.

(732) **DC COMICS**, 1700 Broadway New York, NY 10019 US



**DC
ENTERTAINMENT**

(540)

(550) I

(740) Popović Miladin, Đoka Miraševića 21/III, Podgorica ME

(511) **Klasa 03:** Sredstva za bijeljenje i druge spustance za upotrebu u perionicama, preparati za čišćenje, poliranje, ribanje i nagrizanje, sapuni, parfimerija, eterična ulja, kozmetika, losioni za kosu, paste za zube, posebno kozmetika, naime ruž za usne, sjaj za usne i ne-medicinski melem za usne, maskara, lak za nokte, puder za lice, krema za lice, losion za telo i gel za telo, puder za telo, ulje za kupanje, gel za kupanje i ne-medicinske soli za kupanje, krema i losion za ruke, krema i losion za telo, preparat za suncanje, naime krema i losion, krema za brijanje i losion posle brijanja, losioni za čišćenje kože i ne-medicinske kupke za kupanje, dezodorans za telo, kolonjska voda i parfem, sapuni, naime, tečni sapun za kupanje, sapun u gelu i tvrdi sapun, pasta za zube, deterdžent u obliku sapuna, naime, tečni i u obliku praška, omekšivač veša, dezodorans u obliku sapuna, sapun za kožu, i šampon i balzam.

Klasa 09: Aparati i instrumenti naučni, pomorski, geodetski, fotografski, kinematografski, optički, za vaganje, merenje, signalizaciju, kontrolu (inspekciju), spašavanje i nastavu, aparati i instrumenti za provođenje, prekid, transformaciju, akumulaciju, regulisanje ili kontrolu električne energije, aparati za snimanje, prenos i reprodukovanje zvuka ili slike, magnetni nosioci podataka, diskovi za snimanje, automatske mašine i mehanizmi za aparate koji se pokreću novcem ili žetonom, registar kase, računске mašine, oprema za obradu podataka i kompjuteri, aparati za gašenje požara, posebno filmovi u kojima je tematika komedija, drama, akcija, avantura i/ili animacija i filmovi za emitovanje na televiziji u kojima je tematika komedija, drama, akcija, avantura i/ili animacija, audio video diskovi, i digitalni višenamenski diskovi (DVD) koji sadrže muziku, komediju, dramu, akciju, avanturu i/ili animaciju, stereo slušalice, baterije, bežični telefoni, CD plejeri, kompjuterski CD ROM diskovi koji sadrže igre, telefon i/ili radio pejdžeri, kompakt disk plejeri, radio, podloge za miša, naočare za vid, naočare za sunce i futrole za njih, oprema za igre koja se prodaje kao jedinica za igranje grupnih, računarskih igrica u zatvorenom prostiru, softver koji se može preuzimati za korišćenje u igranju online računarskih igrica, softver za računarske igrice koji se može preuzimati, softver za računarske igrice za korišćenje na mobilnim telefonima, programi za video i računarske igrice, kertridži za video igrice, računarske i video igrice koje su dizajnirane za hardverske platforme, naime, konzole za igrice i personalne računare, CD-ROM-ovi i digitalni višenamenski diskovi (DVD) za računarske igrice i računarski programi, naime, softver koji povezuje digitalizovane video i audio medije na globalnu računarsku mrežu, audio-vizuelni medijski sadržaji koji se mogu preuzimati iz oblasti zabave koji prikazuju animirane filmove, televizijske serije, komedije, i drame, računarski softver, naime, računarski softver za kontinuirano emitovanje audio-vizuelnih medijskih sadržaja preko interneta, računarski softver za kontinuirano emitovanje i skladištenje audio-vizuelnih medijskih sadržaja, audio i

video plejeri koji se mogu preuzimati za medijske sadržaje sa multimedijalnim i interaktivnim funkcijama, softver za video pretragu i pravljenje zabeleški, softver za zaštitu sadržaja, softver za upravljanje bazama podataka, softver za sinhronizaciju baza podataka, računarski programi za pristup, nasumično pretraživanje i precizno pretraživanje online baza podataka, softveri koji omogućavaju korisnicima da igraju i programiraju audio, video, tekstualne i multimedijalne sadržaje zabavnog karaktera, softver za računarske aplikacije za kontinuirano emitovanje i skladištenje audio-vizuelnih medijskih sadržaja, softver za računarske aplikacije za kontinuirano emitovanje audio-vizuelnih medijskih sadržaja preko interneta, računarski softver koji se može preuzimati za kontinuirano emitovanje audio-vizuelnih medijskih sadržaja preko interneta, računarski softver koji se može preuzimati za kontinuirano emitovanje i skladištenje audio-vizuelnih medijskih sadržaja, publikacije koje se mogu preuzimati u obliku knjiga koje sadrže likove iz animiranih filmova, akcionih avantura, komedija i/ili drama, stripovi, knjige za decu, priručnici za igrice, časopisi koji sadrže likove iz animiranih filmova, akcionih avantura, komedija i/ili dramskih filmova, bojanke, dečije interaktivne knjige i časopisi iz oblasti zabave, oprema za mobilne telefone, naime oprema za slušalice, futrole za mobilni telefon i maske za mobilni telefon, kodirane magnetne kartice, naime, telefonske kartice, kreditne kartice, gotovinske kartice, debitne kartice i magnetne kartice, i dekorativni magneti.

Klasa 14: Dragoceni metali i njihove legure i proizvodi od dragocenih metala ili sa prevlakom od njih, koji nisu uključeni u druge klase, nakit, bižuterija, drago kamenje, časovničarski i hronometrijski instrumenti. posebno satovi (časovnici), ručni satovi, nakit, naime narukvice, narukvice oko članka, broševi, lanci, amajlije, manžetne, minduše, značke, ogrlice, ukrasne igle, privesci i prstenje, šnale za kaiševe.

Klasa 16: Hartija, karton i proizvodi od njih, koji nisu uključeni u druge klase, štampane stvari, knjigovezački materijal, fotografije, kancelarijski materijal, lepila za kancelarijske i kućne potrebe, umetnički materijali, kičice, pisaće mašine i kancelarijski rekviziti (izuzev nameštaja), materijali za obuku i nastavu (izuzev aparata), plastični materijal za pakovanje (koji nije uključen u druge klase), štamparska slova, klišei, posebno štampane stvari i proizvodi od papira, naime knjige koje sadrže likove iz animiranih filmova, akcionih avantura, komedija i/ili dramskih filmova, stripovi, knjige za decu, uputstva za video igrice, časopisi koji sadrže likove iz animiranih filmova, akcionih avantura, komedija i/ili dramskih filmova, bojanke, interaktivne knjige za decu, kancelarijski materijal, papir za pisanje, koverta, sveske, dnevници, beležnice, čestitke, kolekcionarske karte, litografije, hemijske olovke, olovke, pernice za njih, gumice, bojice, flomasteri, olovke u boji, pribor za slikanje, krede i table, dekorativne nalepnice, preslikači, poster, lepljive plastične folije sa papirom koji se može skinuti za montiranje slika u dekorativne svrhe, montirane i/ili nemontirane fotografije, pokrivala za knjige, markeri za knjige, kalendari, ukrasni papir za pakovanje, pokloni od papira i dekoracije od papira, naime, papirne salvete, papirni podmetači, krep papir, pozivnice, papirni stolnjaci, papirni ukrasi za torte, štampane aplikacije za vez ili tkanine, štampane aplikacije za kostime, pidžame, dukserice i majice.

Klasa 18: Koža i imitacija kože, proizvodi izradeni od ovih materijala koji nisu uključeni u druge klase, životinjska koža, koferi i putne torbe, kišobrani, suncobrani i štapovi za hodanje, bičevi, saračka i sedlarska roba, posebno atletske torbe, rančevi za bebe, rančevi, torbe za plažu, torbe za knjige, torbe za pelene, velike sportske torbe, torbe za teretanu, velike ručne tašne, male torbice za novac, torbice za nošenje oko struka, ruksaci, sportske torbe za nošenje oko struka, torbe za kupovinu, kišobrani, novčanici, modni detalji napravljeni od kože, naime novčanici, ručne tašne i kaiševi.

Klasa 25: Odeća, obuća, pokrivala za glavu, odeća za muškarce, žene i decu-naime, majice, majice kratkih rukava, dukserice, trenerke za trčanje, pantalone, gaće, šorcevi, majice bez

rukava, odeća za kišu, dečije krpene portikle, suknje, bluze, haljine, tregeri, veste, jakne, kaputi, kišni kaputi, odela za sneg, kravate, kućne haljine, šeširi, kape, štitnici za sunce, rukavice, remeni (kaiševi), marama, odeća za spavanje, pidžame, žensko rublje, donji veš, čizme, cipele, patike, sandale, sokne, kratke sokne, čarape-papučice, kupaće gaćice i kostimi i maske za maskenbal i Noc Veštica prodavani u vezi sa istim.

Klasa 28: Igre i igračke, gimnastički i sportski artikli koji nisu obuhvaćeni drugim klasama, ukrasi za jelke, igračke i sportski proizvodi, uključujući igre i igračke-naime, akcijske figurice i dodaci za iste, setovi za igranje za akcijske figurice, nameštaj za igračke, plišane igračke, baloni, igračke za kupanje u kadi, igračke za jahanje na njima, oprema prodavana kao celina za igranje kartaških igara, igračke vozila, lutke, leteći diskovi, jedinice elektronske ručne igre, igrača oprema prodavana kao celina za igranje stonih igara, kartaških igara, manipulativnih igara, igara u salonu i igara sa metama akcijskog tipa, samostojeće igrace mašine sa video izlazom, slagalice i manipulativne puzle, papirnate maske za lice, skejtbordovi, klizaljke za led, igračke koje prskaju vodu, lopte-naime, lopte za igralište, fudbalske lopte, bejzbol lopte, košarkaške lopte, rukavice za bejzbol, plovci za plivanje za rekreativnu upotrebu, plutajuće table za plivanje za rekreativnu upotrebu, table za surfovanje, table za plivanje za rekreativnu upotrebu, peraje za plivanje, igračke posude i posude za pečenje, igračke banke, igračke snežne kugle, papirnati šeširi za zabave, i ukrasi za jelku.

Klasa 41: Obrazovne usluge, pripremanje obuke, razonoda, sportske i kulturne aktivnosti, usluge razonode, naime, pružanje video igrice online, pružanje kompjuterskih igrice online, pružanje privremenog korišćenja video igrice koje se ne mogu preuzeti (downloadovati), usluge produkcije softvera za video i kompjuterske igrice, usluge razonode u pogledu živih nastupa, komedija, drama, animiranih, i reality televizijskih serija, produkcija živih nastupa, komedija, drama, animiranih i reality televizijskih serija, distribucija i prikazivanje živih nastupa, komedija, drama i animiranih bioskopskih filmova, produkcija živih nastupa, komedija, drama i animiranih bioskopskih filmova, pozorišne predstave kako animirane tako i uživo, internet usluge koje pružaju informacije putem elektronske globalne kompjuterske mreže u oblasti razonode a posebno u vezi sa igricama, muzikom, filmovima, i televizijom, usluge pružanja web stranica koji sadrže filmske klipove (isecke), fotografije i druge multimedijalne materijale, usluge pružanja vesti o trenutnim događajima i razonodi, i informacija u vezi sa obrazovanjem i kulturnim događajima, putem globalne kompjuterske mreže, i pružanje informacija za razonodu i konkretna razonoda putem elektronske globalne komunikacione mreže a u vidu živih nastupa, komedija, drama i animiranih programa i produkcije živih nastupa, komedija, drama i animiranih filmova za distribuciju putem globalne kompjuterske mreže, usluge pružanja kompjuterske igrice kojoj se može pristupiti putem telekomunikacione mreže, i pružanje usluga elektronskog izdavaštva, naime, online izdavanje tekstova i grafičkih radova drugih koji sadrže članke, priče, scenarija, stripove, strategijske vodiče, fotografije i vizuelne materijale, usluge zabavnih parkova, usluge vožnji u zabavnim parkovima, živi ili unapred snimljeni nastupi i/ili filmovi, usluge informisanja o razonodi i/ili rekreaciji, usluge klubova za razonodu.

(111) 11222

(151) 04.07.2014.

(210) **2012-89**

(442) **20.12.2013.**

(220) 13.02.2012.

(732) **NISSAN JIDOSHA KABUSHIKI KAISHA** (ALSO TRADING AS NISSAN MOTOR CO.LTD.), NO.2 TAKARACHO, KANAGAWA-KU, YOKOHAMA-SHI, KANAGAWA-KEN JP

I N F I N I T I

(540)

(550) I

(740) Popović Miladin, Đoka Miraševića 21/III, Podgorica ME

(511) **Klasa 36:** Finansijske usluge, uključujući finansijske usluge u vezi automobila, usluge kreditiranja, usluge iznajmljivanja, usluge posredovanja pri zakupu-kupovini, usluge kreditiranja uz stavljanje hipoteke na kuću, usluge kreditiranja obrtnog kapitala, usluge iznajmljivanja opreme, usluge prodaje i kupovine hartija od vrednosti pokrivenih imovinom (ABS) i računa potraživanja, usluge prodaje i osiguranja, sve gore navedene usluge isključujući usluge vezane za kreditne kartice, usluge vezane za debitne kartice i usluge u vezi placanja.

(111) 11221

(151) 04.07.2014.

(210) **2012-88**

(442) **20.12.2013.**

(220) 13.02.2012.

(732) **NISSAN JIDOSHA KABUSHIKI KAISHA** (ALSO TRADING AS NISSAN MOTOR CO.LTD.), NO.2 TAKARACHO, KANAGAWA-KU, YOKOHAMA-SHI, KANAGAWA-KEN JP

I N F I N I T I

(540)

(550) I

(740) Popović Miladin, Đoka Miraševića 21/III, Podgorica ME

(511) **Klasa 35:** Usluge maloprodaje i veleprodaje različitih roba, naime automobila, njihovih djelova i opreme (isključujući njihov transport), usluge reklamiranja i publiciteta za automobile, promovisanje u svijesti javnosti električnih motornih vozila i promjena u načinu života koje oni proizvode, pružanje korisnicima proizvoda usluge veb-sajtova koji pružaju informacije o električnim automobilima i informacije koje se odnose na kupovinu takvih automobila, zastupništva u oblasti motornih vozila, pružanje informacija u vezi sa električnim vozilima, naime, potrošačke informacije o proizvodu i poređenje cijena, promovisanje roba i usluga drugih kroz administriranje podsticajnih nagradnih programa koji uključuju distribuciju EV (električnih vozila) i kreditiranje kilometara vožnje, informacione usluge, odnosno, pružanje informacija u oblasti poređenja cijena na polju benzina.

Klasa 37: Popravljanje ili održavanje automobila, električnih vozila uključujući električne automobile, karavane, kamione, kombije, terenska (SUV) vozila, autobuse, rekreativna vozila,

sportske automobile, trkačke automobile, vagonete, viljuškare, i traktore za vuču (traktore), i strukturnih djelova i opreme za njih, pružanje informacija u vezi sa popravljanjem ili održavanjem automobila, električnih vozila uključujući električne automobile, karavane, kamione, kombije, terenska (SUV) vozila, autobuse, rekreativna vozila, sportske automobile, trkačke automobile, vagonete, viljuškare, i traktore za vuču (traktore), i strukturnih djelova i opreme za njih, popravlanje ili održavanje mašina i instrumenata za mjerenje ili testiranje, popravlanje ili održavanje mašina i aparata za distribuciju električne energije i kontrolu, popravlanje ili održavanje rotacionih konvertora, popravlanje ili održavanje modifikatora faze, popravlanje ili održavanje punjača, popravlanje ili održavanje baterija i ćelija, popravlanje ili održavanje motora sa unutrašnjim sagorijevanjem, popravlanje ili održavanje djelova motora sa unutrašnjim sagorijevanjem, popravlanje ili održavanje anlasera za motore i mašine, ne za kopnena vozila, popravlanje ili održavanje djelova AC motora i DC motora, popravlanje ili održavanje Ac generatora i DC generatora, popravlanje ili održavanje agregata, popravlanje ili održavanje električnih žica i kablova, popravlanje ili održavanje telekomunikacionih uređaja i aparata, popravlanje ili održavanje telefonskih aparata, popravlanje ili održavanje djelova i dodatne opreme za telekomunikacione mašine i aparate, popravlanje ili održavanje telematskih aparata za vozila, popravlanje ili održavanje aparata za automatsko obavješćavanje o završetku punjenja, popravlanje ili održavanje navigacionih sistema za vozila, popravlanje ili održavanje elektronskih mašina, aparata, i njihovih djelova, popravlanje ili održavanje sistema na daljinsku kontrolu, popravlanje ili održavanje elektroda, popravlanje ili održavanje magnetnih jezgra, popravlanje ili održavanje otpornosti žica, pružanje usluga pomoći na putu, naročito odgovaranje na telefonske pozive za pomoć pored puta, brzo mijenjanje guma, hitno snabdijevanje gorivom, punjenje baterija i hitno snabdijevanje baterijama, pružanje informacija o stanju vozila, naime status punjenja, potrebno vrijeme za potpuno punjenje, isključen status, napunjen, pružanje informacija o stanju vozila, naime status punjenja, potrebno vrijeme za potpuno punjenje, isključen status, napunjen, pružanje informacija o stanju vozila, naime, podsjećanje vozača da uključi vozilo radi punjenja baterija, usluge održavanja vozila, naime, pružanje elektronskih upozorenja putem interneta koja obavješćavaju vlasnike vozila o terminu za održavanje vozila.

Klasa 38: Usluge komunikacija putem mobilnih telefona, komunikacija putem kompjuterskih terminala, komunikacija putem telefona, Iznajmljivanje/lizing komunikacione opreme, uključujući telefone, faks mašine, informacije o komunikacionim podacima (uključujući informacije putem kabla i radio komunikacionih mreža), komunikacija putem e-maila, informacije o komunikacionim mrežama putem kompjuterskih terminala, komunikacija putem VAN mreže, pružanje telekomunikacionih veza na globalnoj kompjuterskoj mreži, pružanje pristupa korisnicima globalno pozicioniranim signalima za navigacijske svrhe, pružanje korisnicima pristup internetu, komunikacija podacima sa slovima, slikama i zvucima putem e-maila i kompjutera, pružanje korisnicima pristup globalnoj kompjuterskoj mreži, telematska pomoć preko servisnog i alarmnog centra za transport i saobraćaj za povezivanje poziva u svrhu intervencije i pomoći osobama i vozilima u slučaju nezgode, kvara ili krađe, pružanje usluga za povezivanje i pristup elektronskim komunikacionim mrežama za prenos i preuzimanje ili prijem audio, video ili multimedijalnog sadržaja, pružanje pristupa digitalnoj muzici na Internetu, telekomunikacije, naime primanje, koordiniranje i prosledivanje poziva na daljinu o stanju vozila, telekomunikacije, naime primanje, koordiniranje i prosledivanje udaljenih hitnih poziva, prijenos teksta, glasa i alarmnih poruka i signala, mera, zvuka, slika, videa, položaja, kretanja i stanja podataka između kopnenih vozila kao i između mašina/motora/baterija i mašina i raznih centara za obradu podataka i telematskih sistema, telefona ili personalnih računara, Telekomunikacione usluge, naime, elektronski prijenos podataka za vlasnike vozila i vozače, u vezi sa postojećim podacima koji asistiraju u praćenju ukrad-

enog vozila, pomoćni kompjuterski prijenos signala mehanizma za zaključavanje vozila, telematske usluge, naime, usluge nadgledanja energije, naime, pregled ili snimanje vremena ili nivoa upotrebe i kontrolisanje struje koju koriste izabrani uređaji putem telematskih sistema, telematske usluge, naime, usluge nadgledanja energije za druge, naime, pregled ili snimanje vremena ili nivoa upotrebe i kontrolisanje struje koju koriste izabrani uređaji putem telematskih sistema, telekomunikacije, naime, prijenos podataka, naime, informacije vezane za put i vožnju putem telematskih sistema, komunikacija putem telematskih sistema, naime, informacije u vezi sa prikazom puta i vožnjom, telekomunikacije, naime, prijenos podataka, naime, opšte informacije kao što su informacije u vezi sa automobilom, saobraćajem i stanjem na putu, putem telematskih sistema, telekomunikacije, naime, prijenos podataka i aplikativnog softvera, telekomunikacione usluge, naime, elektronski prijenos glasovnih poruka i podataka.

Klasa 39: Informacije u vezi sa transportom, prevoz automobila, brodski prevoz, posredovanje u prevozu, usluge iznajmljivanja i lizinga vozila, pomoć u slučajevima kvara na motornom vozilu, uključujući i vucu i transport, transport putnika putem, morem i vazduhom, informacione usluge, naime, pružanje informacija o vremenu, vesti, informacije o saobraćaju, informacije u vezi sa dolascima letova i odlascima, GPS (Global Positioning Sistem-globalni sistem za pozicioniranje) navigacione usluge, naime, pružanje prognoziranja vozačima smernica u vezi sa najboljom rutom, navigacione usluge putem Interneta i pomoć pri postavljanju destinacije, GPS (Global Positioning Sistem globalni sistem za pozicioniranje) navigacione usluge, naime, glasovno rutiranje i pomoć na licu mesta i pružanje praktičnih usluga preko komponenti integrisanih u motornom vozilu, naime, predajnici, prijemnici, mikroprocesori, softver, mobilni telefoni, i električna striktura sve u interakciji sa globalnim sistemom za pozicioniranje i satelitskom tehnologijom i korisničkim servisnim centrom, obezbeđivanje mesta za punjenje vozila električnom energijom, usluge parkinga za vozila, iznajmljivanje vozila, pružanje informacija u vezi lokacije i dostupnosti benzinskih stanica, pružanje informacija u vezi lokacije i dostupnosti mesta za električno punjenje vozila.

Klasa 41: Obrazovne usluge, pripremanje obuke, razonoda, sportske i kulturne aktivnosti, planiranje, promocija, rukovanje i održavanje trka motornih vozila, sve usluge u vezi sa razonodom, sponzorske aktivnosti u vezi sa trkama motornih vozila, obezbeđivanje on-line magazina iz oblasti automobilizma, mode, razonode i stila, on-line publikacija elektronskih magazina. Uputstvo za vožnju vozila, uputstvo za vožnju vozila, naime, pružanje informacija o ekonomičnoj vožnji, obezbeđivanje digitalne muzike (koja se ne može preuzeti) na Internetu.

Klasa 42: Usluge informisanja o vremenu, hosting on-line društvenog veb sajta koji pruža informacije o električnim vozilima za vlasnike električnih vozila, sistem on-line usluga za upravljanje koji omogućava korisnicima da na daljinu vide, nadgledaju, programiraju, rukuju i kontrolišu sisteme baterija i air-condition sisteme u električnim vozilima, daljinski nadzor i snabdevanje rezultatima nivoa napunjenosti automobilske baterije, obezbeđivanje inspekcijskog programa za polovna vozila, usluge trgovine motornim vozilima, hitne usluge i usluge obezbeđivanja na putu naime, daljinsko zaključavanje i otključavanje vrata, detekcija i obaveštavanje vlasnika vozila o istom, nadziranje punjenja baterije i obaveštavanje vozača o statusu punjenja, nadziranje sistema električne energije koji se koristi u kopnenim vozilima, nadziranje sistema električne energije koji se koristi u kopnenim vozilima.

Klasa 45: Obezbeđivanje veb sajta koji pružaju informacije o promenama načina života proizašlim iz upotrebe električnih automobila, daljinski set i početno punjenje baterije i air-condition u električnom vozilu, usluge pružanja hitne pomoći na putu, naročito odgovaranje na pozive za hitnu pomoć za putnike koji su povredeni ili bolesni, usluge nadgledanja vozila u svrhu bezbednosti, naime, automatsko obaveštavanje o rasporedenosti vazдушnih jastuka,

usluge automatskog obaveštavanja o sudaru i obaveštavanja operatera o abnormalnom statusu vozila, usluge pružanja hitne pomoći i bezbednosti na putu, naime, praćenje ukradenih vozila, detekcija i obaveštavanje vlasnika vozila o istom, upravljanje vozačima tinejdžerima, naime, nadgledanje, praćenje i upozoravanje vlasnika motornih vozila iz bezbednosnih i sigurnosnih razloga o tome da li je vozač tinejdžer prekoračio ograničenje brzine ili napustio prethodno ograničenu geografsku oblast korišćenjem globalnog sistema za pozicioniranje, domarske usluge za druge koje se sastoje u pravljenju rezervacija na daljinu za punjenje električnih vozila, a koje se pružaju preko telefona, putem e-maila ili tekstualnom porukom, domarske usluge za druge koje se sastoje u nameštaju na daljinu air-conditiona u vozilima, i koje se pružaju preko telefona, putem e-maila ili tekstualnom porukom, pravljenje rezervacija na mestima za električno punjenje vozila, domarske usluge za druge koje se sastoje iz pravljenja zatraženih ličnih aranžmana i rezervacija i pružanja informacija potrošačima kako bi zadovoljili licne potrebe, a sve se pružaju putem telefona, putem e-maila ili tekstualne poruke.

(111) 11089

(151) 13.06.2014.

(210) **2012-147**

(442) **20.12.2013.**

(220) 08.03.2012.

(732) **Euro-pro Operating LLC** (Delaware Limited Liability Company), 180 Wells Avenue, Suite 200, Newton, Massachusetts 02459 US

(540) SHARK

(550) I

(740) Radulović Božidar, Jovana Tomaševića 9/III, Podgorica ME

(511) **Klasa 07:** Mašine i mašinski alati, motori i pogonske mašine (osim za suvozemna vozila), mašinske spojnice i transmisioni elementi (osim za suvozemna vozila), poljoprivredne sprave osim onih kojima se ručno upravlja, inkubatori za jaja, automatske mašine za prodaju, usisivači i višenamenske mašine za čišćenje na paru za upotrebu u domaćinstvu.

Klasa 09: Pegle na paru za upotrebu u domaćinstvu, električne pegle za upotrebu u domaćinstvu.

(111) 11213

(151) 08.07.2014.

(210) **2012-79**

(442) **20.12.2013.**

(220) 13.02.2012.

(732) **PODRAVKA** D.D. ANTE STARČEVIĆA 32, KOPRIVNICA HR



(540) Prevod Znak

(550) I, F

(740) Radulović Božidar, Jovana Tomaševića 9/III, Podgorica ME

(511) **Klasa 30:** Mješavina za pripremu pečenja, začini za pripremu pečenja,

(111) 11000

(151) 13.06.2014.

(210) **2012-133**

(442) **20.12.2013.**

(220) 01.03.2012.

(732) **JOHNSON&JOHNSON** (NEW JERSEY CORPORATION), ONE JOHNSON&JOHNSON PLAZA, NEW BRUNSWICK, NEW JERSEY US

(540) CLEAN & CLEAR

(550) I

(740) Radulović Božidar, Jovana Tomaševića 9/III, Podgorica ME

(511) **Klasa 03:** Kozmetički i toaletni proizvodi za negu kože i kose, sredstva za pranje tela, proizvodi za čišćenje, skrab za lice.

Klasa 05: Medicinski proizvodi za čišćenje kože, medicinska sredstva za pranje lica i tela, i medicinski skrab za lice i telo, medicinske trake za nos za tretiranje mitisera, medicinski flasteri za akne, preparati za tretiranje akni, medicinski proizvodi za skupljanje tkiva, medicinska sredstva za davanje vlažnosti koži i za čišćenje kože.

Klasa 16: Ubrusi za jednokratnu upotrebu koji nisu impregnirani hemijskim proizvodima ili jedinjenjima za upotrebu kao kozmetički upijajući listovi za upijanje masnoce sa lica.

Klasa 21: Uređaji za ekfolijaciju i čišćenje, naročito, ručni Uređaji sa baterijskim napajanjem koji se koriste za čišćenje i ekfolijaciju kože, jastučići za ekfolijaciju lica.

(111) 11223

(151) 04.07.2014.

(210) **2012-90**

(442) **20.12.2013.**

(220) 13.02.2012.

(732) **NISSAN JIDOSHA KABUSHIKI KAISHA** (ALSO TRADING AS NISSAN MOTOR CO.LTD.), NO.2 TAKARACHO, KANAGAWA-KU, YOKOHAMA-SHI, KANAGAWA-KEN JP

INFINITI

(540)

(550) I

(740) Popović Miladin, Đoka Miraševića 21/III, Podgorica ME

(511) **Klasa 07:** Mlazni motori, osim za suvozemna vozila, motori, osim za suvozemna vozila, električni motori, osim za suvozemna vozila, turbine, osim za suvozemna vozila, delovi za motore za suvozemna vozila, naime, izduvni lonac, segmenti klipa, prstenovi za podmazivanje, kaiševi, blokovi cilindra, dna motorske kućice, prilagođene presvlake, zamajci, kućišta zamajca, glave cilindra, poklopci ventila, poklopci motora, klipovi, klipni prstenovi, radilice i električni regulatori, remenice kolenastog vratila, izduvne grane, grane za usisavanje vazduha, grane za vodu, pumpe za gorivo, pumpe za vodu, pumpe za ubrizgavanje goriva, injektori za pumpe, kontrolori vremena ubrizgavanja goriva, filteri za gorivo, filteri za vazduh, filteri za ulje, prečistači vazduha, mehanički i električni regulatori, ventilatori sistema za hladenje, hladnjaci za ulje, ventili, starteri, starteri motora, svećice, klinasti kaiš, kablovi visokog napona, kontaktne tacke, izduvne cevi, dihtunzi, radijatori, kompleti zaptivača, isparivaci, karburatori, Uređaji za paljenje, magneti za paljenje, i delovi za svu gore navedenu robu obuhvaćenu klasom 7, super punjači, turbo punjači, turbo punjači za auspuhe, kompresori za vazduh, turbo kompresori, motori jednosmerne struje, generatori jednosmerne struje, motori naizmenične struje, generatori naizmenične struje, električni generatori, kompresori vazduha, pumpe za podmazivanje, hidraulične pumpe, pumpe za vazduh, pumpe za ulje, pumpe za gorivo, hidraulične pumpe, električni generatori, kontrolni ventili za pumpe, alternatori, vazdušni kondenzatori, i delovi za svu gore navedenu robu obuhvaćenu klasom 7, automatski nosači, mašine i aparati za rukovanje teretom, konvejeri, pneumatski transporteri, dizalice, i delovi za svu gore navedenu robu obuhvaćenu klasom 7.

(111) 11196

(151) 08.07.2014.

(210) **2012-56**(442) **20.12.2013.**

(220) 25.01.2012.

(732) **LES MILLS INTERNATIONAL LIMITED**, 22 CENTRE STREET, AUCKLAND NZ

BODYCOMBAT

(540)

(550) I

(740) Ćupić Branislav, Dalmatinska 10, Podgorica ME

(511) **Klasa 41:** Usluge rekreacije i treninga, sportske aktivnosti, usluge obrazovanja, kreiranje i vođenje časova i programa vježbi uz muziku, usluge teretana, usluge klubova vezanih za zdrav život, usluge sportskih klubova, usluge fitnes klubova, usluge vježbi sa instruktorom, usluge savjetovanja i treniranja, usluge pružanja prostora za vježbanje, usluge sportskih vježbi sa instruktorom, usluge treniranja i obuke, usluge informacija, savjeta i konsultacija u vezi sa nekim ili svim navedenim uslugama, objava štampanog materijala i elektronskih medija, uključujući objavu muzičkih i video zapisa u digitalnom formatu vezanih za programe i treninge fitnes klubova i klubova vezanih za zdrav život.

(111) 11197

(151) 08.07.2014.

(210) **2012-55**

(442) **20.12.2013.**

(220) 25.01.2012.

(732) **LES MILLS INTERNATIONAL LIMITED**, 22 CENTRE STREET, AUCKLAND NZ

LES MILLS

(540)

(550) I

(740) Ćupić Branislav, Dalmatinska 10, Podgorica ME

(511) **Klasa 41:** Usluge rekreacije i treninga, sportske aktivnosti, usluge obrazovanja, kreiranje i vođenje časova i programa vježbi uz muziku, usluge teretana, usluge klubova vezanih za zdrav život, usluge sportskih klubova, usluge fitnes klubova, usluge vježbi sa instruktorom, usluge savjetovanja i treniranja, usluge pružanja prostora za vježbanje, usluge sportskih vježbi sa instruktorom, usluge treniranja i obuke, usluge informacija, savjeta i konsultacija u vezi sa nekim ili svim navedenim uslugama, objava štampanog materijala i elektronskih medija, uključujući objavu muzičkih i video zapisa u digitalnom formatu vezanih za programe i treninge fitnes klubova i klubova vezanih za zdrav život.

(111) 11209

(151) 08.07.2014.

(210) **2012-73**

(442) **20.12.2013.**

(220) 02.02.2012.

(732) **JT INTERNATIONAL S.A.** 1, RUE DE LA GABELLE 1211, GENEVA 26 CH

SUSPENDED BELIEF

(540)

(550) I

(740) Čejović Vladimir, 13. jula 21, Podgorica ME

(511) **Klasa 34:** Duvan, prerađen ili neprerađen, duvan za pušenje, duvan za lule, duvan za ručno uvijanje, duvan za žvakanje, snus duvan, cigarete, cigare, cigarilosi, supstance za pušenje koje se prodaju odvojeno ili miješane sa duvanom, a koje nisu za medicinske svrhe ili u svrhe liječenja, duvan za ušmrkavanje, artikli za pušače uključeni u klasu 34, papir za cigarete, tube za cigarete i šibice.

(111) 11210

(151) 08.07.2014.

(210) **2012-74**

(442) **20.12.2013.**

(220) 02.02.2012.

(732) **JT INTERNATIONAL S.A.** 1, RUE DE LA GABELLE 1211, GENEVA 26 CH

SOBRANIE MODERN HERITAGE

(540)

(550) I

(740) Čejović Vladimir, 13. jula 21, Podgorica ME

(511) **Klasa 34:** Duvan, prerađen ili neprerađen, duvan za pušenje, duvan za lule, duvan za ručno uvijanje, duvan za žvakanje, snus duvan, cigarete, cigare, cigarilosi, supstance za pušenje koje se prodaju odvojeno ili miješane sa duvanom, a koje nisu za medicinske svrhe ili u svrhe liječenja, duvan za ušmrkavanje, artikli za pušače uključeni u klasu 34, papir za cigarete, tube za cigarete i šibice.

(111) 11220

(151) 04.07.2014.

(210) **2012-86**

(442) **20.12.2013.**

(220) 13.02.2012.

(732) **NISSAN JIDOSHA KABUSHIKI KAISHA** (ALSO TRADING AS NISSAN MOTOR CO.LTD.), NO.2 TAKARACHO, KANAGAWA-KU, YOKOHAMA-SHI, KANAGAWA-KEN JP

I N F I N I T I

(540)

(550) I

(740) Popović Miladin, Đoka Miraševića 21/III, Podgorica ME

(511) **Klasa 01:** Hemijski proizvodi koji se upotrebljavaju u industriji, neprerađene vještačke smole, neprerađene plastične materije, smješe za gašenje požara, preparati za kaljenje i zavarivanje, materije za štavljenje, ljepljive supstance koje se upotrebljavaju u industriji,

materijali (hemijski proizvodi) za oblaganje stakla, smjese (hemijski proizvodi) za popravku vjetrobrana, preparati (hemijski proizvodi) za odstranjivanje, zaptivači (hemijski proizvodi) za zaptivanje površina, materijali (hemijski proizvodi) za oblaganje radi osvjtljavanja i zaštite površine djelova vozila (šasije, točka, gume), materijali (hemijski proizvodi) koji su otporni na vodu za prozore, zakisjeljena voda za punjenje akumulatora, aditivi (hemijski proizvodi-) za ulja, aditivi, hemijski proizvodi za rashladni uređaj klime, aditivi, hemijski proizvodi za motorno gorivo, tečnost za kočnice automobila, rashladne tečnosti za motore vozila, tečnost za servo upravljače kod automobila, epoksid za lijepljenje i punjenje kod opravki i održavanja automobila, hemijski preparati za popravku i održavanje automobila, brizgaljke za čišćenje goriva, transmisione tečnosti za automobile, aditivi za hladnjake za sprječavanje rde, anistatički preparati, izuzev onih za upotrebu u domaćinstvu.

Klasa 02: Boje, firnajzi, lakovi, sredstva za zaštitu od rđe, materije za bojenje, sredstva za nagrižanje, metali u obliku listova i praha za slikare, dekoratere, štampare i umjetnike. Podloga za šasije automobila, masti za zaštitu od rđe za vozila, prajmeri, premazi za zaptivanje, podloga za površine koje će se farbati, preparati protiv rđe.

Klasa 03: Preparati za čišćenje, poliranje, ribanje i nagrižanje, parfimerija, eterična ulja, kozmetika, losioni za kosu, tečnosti za čišćenje vjetrobrana, tečnosti za čišćenje djelova vozila, vosak za poliranje, preparati za sjaj i preparati za zaštitu spoljne površine automobila, antistatički preparati za upotrebu u domaćinstvima, parfemi, kolonjska voda, preparati za čišćenje automobila, preparati za uklanjanje rđe, preparati za uklanjanje naljepnica i boje, preparati za čišćenje prilikom uklanjanja zaptivača.

Klasa 04: Industrijska ulja i masti, maziva, jedinjenja za skupljanje prašine vlaženjem i vezivanjem, goriva (uključujući motorna tečna goriva) i materije za osvjtljavanje, masti i maziva za vozila, motorna ulja, ulja za kočnice za automobile, ulje za servo upravljače za automobile, transmisiona maziva za automobil, mast za podmazivanje, ricinusovo ulje za tehničke svrhe.

Klasa 05: Farmaceutski i veterinarski preparati, sanitarni preparati za medicinsku upotrebu, dezodoransi, izuzev za ličnu upotrebu, kutije za Prvu pomoć, pune.

(111) 10996

(151) 08.07.2014.

(210) **2012-130**

(442) **20.12.2013.**

(220) 29.02.2012.

(732) **PETROL. SLOVENSKA ENERGETSKA DRUŽBA** D.D. LJUBLJANA, DUNAJSKA C.50, 1527 LJUBLJANA SI



(540)

(550) I

(740) Popović Miladin, Đoka Miraševića 21/III, Podgorica ME

(511) **Klasa 16:** Hartija, karton i proizvodi od njih, koji nisu uključeni u druge klase, štampane stvari, knjigovezački materijal, fotografije, kancelarijski materijal, lepkovi za kancelarijske i kućne potrebe, umetnički materijali, kičice, pisaće mašine i kancelarijski pribor (izuzev

nameštaja), materijali za obuku i nastavu (izuzev aparata), plastični materijal za pakovanje (koji nije uključen u druge klase), štamparska slova, klišeji.

Klasa 18: Koža i imitacija kože, proizvodi izradeni od ovih materijala koji nisu uključeni u druge klase, životinjska koža, krzno, koferi i putne torbe, kišobrani i suncobrani, štapovi za hodanje, bičevi, saračka i sedlarska roba.

Klasa 25: Odeća, obuća, pokrivala za glavu.

Klasa 28: Igre i igračke, gimnastički i sportski artikli koji nisu obuhvaćeni drugim klasama, ukrasi za jelke.

Klasa 29: Meso, riba, živina i divljač, mesne prerađevine, konzervisano, zamrznuto sušeno i kuvano voće i povrće, želei, džemovi, kompoti, jaja, mleko i mlečni proizvodi, jestiva ulja i masti.

Klasa 30: Kafa, čaj, kakao i zamena kafe, pirinač, tapioca i sago, brašno i proizvodi od žitarica, hleb, kolači i poslastice, sladoledi, šećer, med, melasa, kvasac, prašak za pecivo, so, senf, sirće, sosovi (kao dodaci), začini, led.

Klasa 32: Pivo, mineralne i sodne vode i druga bezalkoholna pića, voćni napici i voćni sokovi, sirupi i drugi preparati za proizvodnju pića.

Klasa 33: Alkoholna pića (izuzev piva).

Klasa 35: Oglašavanje, vođenje poslova, poslovno upravljanje, kancelarijski poslovi.

Klasa 43: Usluge obezbeđivanja hrane i pića, privremeni smeštaj.

(111) 11172

(151) 02.07.2014.

(210) **2012-110**

(442) **20.12.2013.**

(220) 22.02.2012.

(732) **AVON PRODUCTS, INC** WORLD HEADQUARTERS, 1345 AVENUE OF THE AMERICAS, NEW YORK, NY 10105-0196 US

(540) Budite najbolji uz najbolje

(550) I

(740) Ćupić Branislav, Dalmatinska 10, Podgorica ME

(511) **Klasa 35:** Oglašavanje, vođenje poslova, vođenje administracije, kancelarijski poslovi, usluge distribucije, usluge maloprodaje u radnjama, prodaja od vrata do vrata, direktno savjetovanje putem nezavisnih predstavnika prodaje, i to telefonom, kataloškom prodajom i putem globalne kompjuterske mreže, a sve u vezi sa njegovom ljepote, odjećom, toaletnim preparatima, kozmetikom, nakitom, proizvodima lične njege, nutritivnim dodacima, opremom za vježbanje i fitnesa, sportskom opremom, knjigama, snimljenim video i audio trakama, CD-ova i poklona, usluge promotivnih i reklamnih kampanja na polju angažovanja nezavisnih predstavnika prodaje.

Klasa 41: Obrazovanje, usluge treninga, zabave, sportskih i kulturnih aktivnosti, usluge poslovnog obrazovanja i usluge treninga za razvoj i postizanje odgovarajućeg vodstva, usluge edukativno-poslovnog programa za izvršne direktore, zaposlene, saradnike i agente, usluge poslovnog treninga, savjetodavne usluge poslovnog treninga, edukativne usluge putem pružanja nastave, seminara, konferencija i radionica na polju maloprodaje i trgovine proizvodima i distribucije materijala za treninge u vezi sa istim, obrazovne usluge putem održavanja konferencija, nastave, seminara i radionica na polju zdravlja, ishrane, fitnesa, finansija, vježbi, stila, frizura i/ili ljepote.

(111) 11195

(151) 08.07.2014.

(210) **2012-57**

(442) **20.12.2013.**

(220) 25.01.2012.

(732) **LES MILLS INTERNATIONAL LIMITED**, 22 CENTRE STREET, AUCKLAND NZ

BODYSTEP

(540)

(550) I

(740) Ćupić Branislav, Dalmatinska 10, Podgorica ME

(511) **Klasa 41:** Usluge rekreacije i treninga, sportske aktivnosti, usluge obrazovanja, kreiranje i vođenje časova i programa vježbi uz muziku, usluge teretana, usluge klubova vezanih za zdrav život, usluge sportskih klubova, usluge fitnes klubova, usluge vježbi sa instruktorom, usluge savjetovanja i treniranja, usluge pružanja prostora za vježbanje, usluge sportskih vježbi sa instruktorom, usluge treniranja i obuke, usluge informacija, savjeta i konsultacija u vezi sa nekim ili svim navedenim uslugama, objava štampanog materijala i elektronskih medija, uključujući objavu muzičkih i video zapisa u digitalnom formatu vezanih za programe i treninge fitnes klubova i klubova vezanih za zdrav život.

(111) 11224

(151) 04.07.2014.

(210) **2010-63**

(442) **20.06.2012**

(220) 15.03.2010

(732) **BROADBAND MONTENEGRO BBM.DOO**, BULEVAR REVOLUCIJE 66, PODGORICA ME



(540)

(550) I

(511) **Klasa 35:** Oglašavanje, vođenje poslova, poslovno upravljanje, kancelarijski poslovi .

Klasa 37: Građevinsko konstruisanje, popravlanje, usluge instaliranja (instalacione usluge).

Klasa 38: Telekomunikacije.

Klasa 39: Transportne usluge, pakovanje i skladištenje robe, organizovanje putovanja.

Klasa 42: Naučne i tehnološke usluge i istraživanje i projektovanje u vezi navedenih usluga, usluge industrijske analize i istraživanja, projektovanje i razvoj kompjuterskog hardvera i softvera, pravne usluge.

Klasa 43: Usluge obezbjeđivanja hrane i pića, privremeni smještaj.

(111) 11137

(151) 25.06.2014.

(210) **2012-33**

(442) **20.12.2013.**

(220) 24.01.2012.

(732) **VIACOM INTERNATIONAL INC.** 1515 BROADWAY, NEW YORK, NY 10036 US



(540)

(550) I

(740) Lutovac Branislav, Bulevar Crnojevića 93, Podgorica ME

(511) **Klasa 38:** Radio-difuzne i telekomunikacijske usluge, kablovske i satelitske usluge prenosa, wireless usluge za mobilne telefone, omogućavanje download-ovanja melodija, muzike, mp3, grafika, igrice, slika i informacija za bežične mobilne uređaje, pružanje bežičnog prenosa pri upload-vanju i download-ovanju melodija, glasova, muzike, mp3, grafika, igrice, slika, informacija i novosti preko globalne kompjuterske mreže do mobilnog uređaja sa bežičnom komunikacijom, glasanje preko mobilnog uređaja sa bežičnom komunikacijom, slanje i primanje glasova preko mobilnog, slanje i primanje zvučnih i tekstualnih poruka između mobilnih uređaja sa bežičnom komunikacijom, omogućavanje glasanja online preko interneta ili uređaja za bežičnu komunikaciju, internet usluge koje podrazumijevaju usluge komunikacije, uglavnom transmisije strimovanih zvukova i zvučno-vizuelnih snimaka preko interneta.

Klasa 41: Zabava, proizvodnja, priprema, izlaganje, distribucija i iznajmljivanje tv i radio programa i filmova, animiranih filmova, zvučnih i video snimaka kroz interaktivne i neinteraktivne medije, među kojima je internet, produkcija zabave uživo, produkcija tv zabave, muzički tv programi, objavljivanje knjiga, časopisa i mjesečnika, proizvodnja i izdavanje obrazovnih i nastavnih sredstava, organizacija, proizvodnja i prezentacija događaja u obrazovne, kulturne ili zabavne svrhe, kroz interaktivne i neinteraktivne medije, organizacija, produkcija i prezentacija takmičenja, igara, kvizova, izložbi, sportskih događaja, predstava, putujućih predstava, organizovanih događaja, pozorišnih izvođenja, koncerata, predstava uživo, događaja sa učešćem publike, organizacija interaktivnih igara, proizvodnja sms-kviz programa, zabava i obrazovanje, sve navedene usluge takodje prenijete preko globalne kompjuterske mreže i drugih (interaktivnih) komunikacijskih mreža, uključujući internet.

(111) 11167

(151) 02.07.2014.

210) **2012-108**(442) **20.12.2013.**

(220) 21.02.2012.

(732) **PETROLEO BRASILEIRO** S.A.-PETROBRAS, AVENIDA REPUBLICA DO CHILE, 65 CENTRO-CEP, 20.031-912, RIO DE JANEIRO, RJ BR

(540) PETROBRAS

(550) I, V

(740) Radulović Božidar, Jovana Tomaševića 9/III, Podgorica ME

(511) **Klasa 01:** Hemijski proizvodi za upotrebu u industriji, naročito motorna ulja i aditivi za benzin, fertilajzeri za upotrebu u poljoprivredi i domaćinstvu, hemikalije za upotrebu u proizvodnji boja i premaza kao i smola a sve sa namenom u proizvodnji inženjerskih plastika.**Klasa 04:** Butani, aromatski petrolejski ekstrakti ulja za industrijsku upotrebu, prirodni gas, benzin, rafinerijsko rezidualno benzinsko gorivo, naročito metan, etan, etilen, propani i kombinacije istih, gorivno ulje, dizel ulja i goriva, goriva za mlazne (jet) motore, lož ulja za grejanje, emulzivno gorivo za industrijske mašine, nehemijski aditivi koji su po svojoj prirodi sintetički bazni lubrikanti za upotrebu u proizvodnji lubrikanata za različite svrhe, lubrikanti, industrijska ulja, naročito mešavine ugljenih-mineralnih ulja, baznih ulja, ulja za cilindre dizel motora, ulja za osovine-vretena, ulje za gasne turbine, ulje za upotrebu u elektrici i ulje od škrljaca.**Klasa 35:** Oglašavanje, poslovno upravljanje, poslovna administracija, kancelarijsko poslovanje, usluge agencija za uvoz i izvoz na polju uljnih-naftnih proizvoda, proizvoda uljnih-naftnih rafinerija i dalje obrađenih rafinerijskih proizvoda, usluge maloprodaje u vezi sa uljnim-naftnim proizvodima, proizvodima rafinerija i dalje obrađenih proizvoda rafinerija.**Klasa 37:** Usluge servisa, usluge servisiranja vozila, uključujući punjenje gorivom, pranje i čišćenje vozila, podmazivanje vozila, održavanje vozila i održavanje i popravka automobila.**Klasa 39:** Transportne usluge, pakovanje i skladištenje robe, usluge organizovanja putovanja, transport proizvoda kamionom i brodom, skladištenje ulja-nafte i gasa, prenos ulja-nafte i gasa putem cevovoda.**Klasa 40:** Obrada materijala, naročito obrada sirovih mineralnih ulja u rafinerijama, proizvodnja paleta i linija proizvoda u oblasti mineralnih ulja a po porudžbini i specifikacijama drugih, rafinisanje ulja-nafte i goriva, naročito obrada stena koje sadrže petrolej, naročito škrljaca.**Klasa 42:** Usluge istraživanja naftnih nalazišta, usluge razvoja u oblasti nafte, naročito usluge bušenja, postavljanja bušotina i testiranja u vezi sa naftom i uljem-naftom iz uljanih škrljaca.

(111) 10997

(151) 04.07.2014.

(210) **2011-452**(442) **20.06.2013**

(220) 15.9.2011

(732) **E.MISHAN & SONS, INC(NEW YORK CORPORATON)**, 230 FIFTH AVENUE, SUITE 800, NEW YORK, NY 10001 US

(540)

(550) I

(740) Čejović Vladimir, 13. jula 21, Podgorica (ME)

(511) **Klasa 10:** ortopedske trake za koljena, ortopedski zavoj za članke, ortopedski zavoj za vrat, ortopedski zavoj za ručne zglobove, ortopedski zavoj za ramena, ortopedski pojasi za leđa, ortopedski ulošci za cipele, ortopedski podvezi, podupirači za leđa, članke, vrat i ramena koji se koriste u medicinske potrebe, ortopedski steznici za koljena, ortopedski rastezljivi podupirači za koljena, steznici za leđa koji se koriste za medicinske svrhe, medicinski uređaji i instrumenti, terapijski galvanski uređaji, medicinski uređaji za magnetnu terapiju koji spadaju u klasu 10.

(111) 11219

(151) 04.07.2014.

(210) **2012-85**

(442) **20.12.2013.**

(220) 13.02.2012.

(732) **NISSAN JIDOSHA KABUSHIKI KAISHA** (ALSO TRADING AS NISSAN MOTOR CO.LTD.), NO.2 TAKARACHO, KANAGAWA-KU, YOKOHAMA-SHI, KANAGAWA-KEN JP



(540)

(550) I

(740) Popović Miladin, Đoka Miraševića 21/III, Podgorica ME

(511) **Klasa 07:** Mlazni motori, osim za suvozemna vozila, motori, osim za suvozemna vozila, električni motori, osim za suvozemna vozila, turbine, osim za suvozemna vozila, delovi za motore za suvozemna vozila, naime, izduvni lonac, segmenti klipa, prstenovi za podmazivanje, kaiševi, blokovi cilindra, dna motorske kućice, prilagođene presvlake, zamajci, kućišta zamajca, glave cilindra, poklopci ventila, poklopci motora, klipovi, klipni prstenovi, radilice i električni regulatori, remenice kolenastog vratila, izduvne grane, grane za usisavanje vazduha, grane za vodu, pumpe za gorivo, pumpe za vodu, pumpe za ubrizgavanje goriva, injektori za pumpe, kontrolori vremena ubrizgavanja goriva, filteri za gorivo, filteri za vazduh, filteri za ulje, prečistači vazduha, mehanički i električni regulatori, ventilatori sistema za hladenje, hladnjaci za ulje, ventili, starteri, starteri motora, svećice, klinasti kaiš, kablovi visokog napona, kontaktne tačke, izduvne cevi, dihtunzi, radijatori, kompleti zaptivača, isparivači, karburatori, Uređaji za paljenje, magneti za paljenje, i delovi za svu gore navedenu robu obuhvaćenu klasom 7, super punjači, turbo punjači, turbo punjači za auspuhe, kompresori za vazduh, turbo kompresori, motori jednosmerne struje, generatori jednosmerne struje, motori naizmjenične struje, generatori naizmjenične struje, električni generatori, kompresori vazduha, pumpe za podmazivanje, hidraulične pumpe, pumpe za vazduh, pumpe za ulje, pumpe za gorivo, hidraulične pumpe, električni generatori, kontrolni ventili za pumpe, alternatori, vazdušni kondenzatori, i delovi za svu gore navedenu robu obuhvaćenu klasom 7, automatski nosači, mašine i aparati za rukovanje teretom, konvejeri, pneumatski transporteri, dizalice, i delovi za svu gore navedenu robu obuhvaćenu klasom 7.

(111) 11136

(151) 25.06.2014.

(210) **2012-34**

(442) **20.12.2013.**

(220) 24.01.2012.

(732) **GOOGLE INC.** 1600 AMPHITHEATRE PARKWAY, MOUNTAIN VIEW, CA 94043, US

ZAGAT

(540)

(550) I

(740) Čupić Branislav, Dalmatinska 10, Podgorica ME

(511) **Klasa 09:** Aparati i instrumenti naučni, pomorski, geodetski, fotografski, kinematografski, optički, za vaganje, mjerenje, signalizaciju, kontrolu (inspekciju), pomoć (spasavanje) i nastavu, aparati i instrumenti za provođenje, prekidanje, transformisanje, akumuliranje, regulisanje ili kontrolu električne energije, aparati za snimanje, prenos ili reprodukovanje zvuka ili slike, magnetski nosioci podataka, kompakt diskovi, DVD diskovi i drugi digitalni mediji za snimanje, mehanizmi za aparate koji se pokreću novcem ili žetonom, registar-kase, računске mašine, oprema za obradu podataka, kompjuteri, kompjuterski softver, uključujući kompjuterski softver koji se može preuzimati elektronskim putem (daunlodovati).

Klasa 20: Namještaj, ogledala, ramovi, proizvodi (koji nisu obuhvaćeni drugim klasama) od drveta, plute, trske, rogoza, pruća, roga, kosti, slonovače, kitove kosti, školjke, ćilibara, sedefa, sepiolita, i zamjena svih ovih materijala, ili od plastike, ploče i table (osim metalnih).

Klasa 25: Odjeća, obuća i pokrivala glave.

Klasa 35: Oglašavanje, usluge poslovnih imenika, poslovni menadžment, poslovna administracija, kancelarijski poslovi.

Klasa 41: Obrazovne usluge, obučavanje, razonoda, sportske i kulturne aktivnosti, pružanje on-lajn elektronskih publikacija.

Klasa 42: Naučne i tehnološke usluge i istraživanje i projektovanje u vezi navedenih usluga, usluge industrijske analize i istraživanja, projektovanje i razvoj kompjuterskog hardvera i softvera, uključujući softver koji se ne može preuzimati elektronskim putem.

Klasa 45: Lične i društvene usluge koje pružaju drugi radi zadovoljavanja potreba pojedinaca, usluge društvenih onlajn mreža.

(111) 11168

(151) 02.07.2014.

(210) **2012-95**

(442) **20.12.2013.**

(220) 14.02.2012.

(732) **BIOFARMA**, 50 RUE CARONT, 92284 SURESNES CEDEX, FRANCE FR

PREXANOR

(540)  insertovati profilom

(550) I

(740) Radulović Božidar, Jovana Tomaševića 9/III, Podgorica ME

(511) **Klasa 05:** Kardiovaskularni farmaceutski proizvodi.

(111) 10998

(151) 08.07.2014.

(210) **2012-131**

(442) **20.12.2013.**

(220) 29.02.2012.

(732) **PETROL, SLOVENSKA ENERGETSKA DRUŽBA** D.D. LJUBLJANA, Dunajska C.50, 1527 Ljubljana SI

HIP SHOP

(540)

(550) I

(740) Popović Miladin, Đoka Miraševića 21/III, Podgorica ME

(511) **Klasa 16:** Hartija, karton i proizvodi od njih, koji nisu uključeni u druge klase, štampane stvari, knjigovezački materijal, fotografije, kancelarijski materijal, lepkovi za kancelarijske i kućne potrebe, umetnički materijali, kičice, pisaće mašine i kancelarijski pribor (izuzev nameštaja), materijali za obuku i nastavu (izuzev aparata), plastični materijal za pakovanje (koji nije uključen u druge klase), štamparska slova, klišeji.

Klasa 18: Koža i imitacija kože, proizvodi izradeni od ovih materijala koji nisu uključeni u druge klase, životinjska koža, krzno, koferi i putne torbe, kišobrani i suncobrani, štapovi za hodanje, bičevi, saračka i sedlarska roba.

Klasa 25: Odeća, obuća, pokrivala za glavu.

Klasa 28: Igre i igračke, gimnastički i sportski artikli koji nisu obuhvaćeni drugim klasama, ukrasi za jelke.

Klasa 29: Meso, riba, živina i divljač, mesne prerađevine, konzervisano, zamrznuto sušeno i kuvano voće i povrće, želei, džemovi, kompoti, jaja, mleko i mlečni proizvodi, jestiva ulja i masti.

Klasa 30: Kafa, čaj, kakao i zamena kafe, pirinač, tapioca i sago, brašno i proizvodi od žitarica, hleb, kolači i poslastice, sladoledi, šećer, med, melasa, kvasac, prašak za pecivo, so, senf, sirće, sosovi (kao dodaci), začini, led.

Klasa 32: Pivo, mineralne i sodne vode i druga bezalkoholna pića, voćni napici i voćni sokovi, sirupi i drugi preparati za proizvodnju pića.

Klasa 33: Alkoholna pića (izuzev piva).

Klasa 35: Oglašavanje, vođenje poslova, poslovno upravljanje, kancelarijski poslovi.

Klasa 43: Usluge obezbeđivanja hrane i pića, privremeni smeštaj.

(111) 11194

(151) 08.07.2014.

(210) **2012-58**

(442) **20.12.2013.**

(220) 25.01.2012.

(732) **LES MILLS INTERNATIONAL LIMITED**, 22 CENTRE STREET, AUCKLAND NZ

BODYATTACK

(540)

(550) I

(740) Ćupić Branislav, Dalmatinska 10, Podgorica ME

(511) **Klasa 41:** Usluge rekreacije i treninga, sportske aktivnosti, usluge obrazovanja, kreiranje i vođenje časova i programa vježbi uz muziku, usluge teretana, usluge klubova vezanih za zdrav život, usluge sportskih klubova, usluge fitnes klubova, usluge vježbi sa instruktorom, usluge savjetovanja i treniranja, usluge pružanja prostora za vježbanje, usluge sportskih vježbi sa instruktorom, usluge treniranja i obuke, usluge informacija, savjeta i konsultacija u vezi sa nekim ili svim navedenim uslugama, objava štampanog materijala i elektronskih medija, uključujući objavu muzičkih i video zapisa u digitalnom formatu vezanih za programe i treninge fitnes klubova i klubova vezanih za zdrav život.

(111) 10966

(151) 30.05.2014.

(210) **2012-124**

(442) **20.12.2013.**

(220) 24.02.2012.

(732) **Merck Sharp&Dohme Corp.** One Merck Drive, Whitehouse Station, New Jersey 08889 US

(540) TESLITA

(550) I

(740) Ćupić Branislav, Dalmatinska 10, Podgorica ME

(511) **Klasa 05:** Farmaceutski preparati za prevenciju i liječenje dijabetesa.

(111) 11153

(151) 08.07.2014.

(210) **2012-107**

(442) **20.12.2013.**

(220) 21.02.2012.

(732) **MERCK SHARP&DOHME CORP. ONE MERCK DRIVE, WHITEHOUSE STATION, NEW JERSEY 08889 US**

(540) JUVICOR

(550) I

(740) Ćupić Branislav, Dalmatinska 10, Podgorica ME

(511) **Klasa 05:** Farmaceutski preparati za ljudsku upotrebu.

(111) 11198

(151) 08.07.2014.

(210) **2012-54**

(442) **20.12.2013.**

(220) 25.01.2012.

(732) **ALKALOID AD** SKOPLJE, BUL. ALEKSANDAR MAKEDONSKI 12, SKOPLJE MK



(540)

(550) I

(740) Popović Miladin, Đoka Miraševića 21/III, Podgorica ME

(511) **Klasa 03:** Noćna krema sa matičnim ćelijama jabuke i maslinovim uljem.

(111) 11143

(151) 25.06.2014.

(210) **2012-24**

(442) **20.12.2013.**

(220) 18.01.2012.

(732) **NBA PROPERTIES, INC.** OLYMPIC TOWER BLDG. 645 FIFTH AVENUE, NEWYORK, NY 10022 US



(540)

(550) I

(740) Popović Miladin, Đoka Miraševića 21/III, Podgorica ME

(511) **Klasa 28:** Igračke, igre i sportske stvari, naime košarkaške lopte, loptice za golf, lopte za igralište, sportske lopte, gumene lopte i penaste lopte, plišane lopte za igru, plastične lopte za igru, mrežice za košarku, table za košarku, minijaturne table za košarku, pumpe i igle za naduvavanje košarkaških lopti, štapovi za golf, torbe za golf, podmetači za golf, oprema za golf, naime, alat za popravku golf terena, kupice na koje se stavlja lopta, markeri lopti, torbe za golf opremu, pokrivala za glave golf štapova, rukavice za golf, kutije za golf lopte, elektronske table za košarkaške igrice na tabli, table za košarkaške igrice, košarkaške igrice, akcione igrice, društvene igrice za odrasle i decu, trivia informacione igrice i elektronske video arkada igrice, košarkaška torbica koja se sastoji od mrežice i zviždaljke, lutke, dekorativne

lutke, lutke za kolekciju, akcione figure za igru, akcione figure karikature, punjene igračke, nove plišane igračke sa perikom, puzzle, montažni blokovi za igre, ukrasi za Božićnu jelku i Božićne čarape, vozila za igru u obliku automobila, kamiona, vozova i kombija, svi sa temom košarke, nove penaste igračke u obliku prsta ili trofeja, igrački trofeji, karte za igru, igrice sa kartama, igračke koje prave zvuk, igračke za kućne ljubimce, igračke za plažu, naime lopte za plažu, lopte na naduvavanje, kantice za igru, lopatice za igru, igračke za pesak, kutijice za pesak, gumene igračke za vodu, oprema za bazen, naime plivačka oprema za plutanje, oprema za plutanje u bazenu, igračke za splavarenje na vodi, penasta oprema za plutanje, gume za plivanje, gume za plivanje u bazenu, penaste gume, daske za plivanje, daske za surfovanje, peraja za plivanje, peraja za surfovanje, mišići za plutanje i krila za pomoć pri plivanju u rekreativne svrhe, odbojkaške torbice za igru koje se sastoje od lopte, mrežice, sporednih stvari i zviždaljke, i vaterpolo torbice za igru koje se sastoje od lopte, mrežice i zviždaljke, dekorativne igračke od tkanine koje se puštaju da lete na vetru.

Klasa 41: Razonoda i obrazovne usluge u smislu televizijskih događaja i radio programa u polju košarke i prikazivanja uživo košarkaških igara i košarkaških priredbi, usluge produkcije i distribucije radio i televizijskih šou programa o košarkaškim igrama, košarkaškim događajima i programima iz oblasti košarke, usluge vođenja i organizovanja košarkaških klinika i kampova, klinika i kampova za trenere, klinika i kampova za plesne timove i košarkaške igre, usluge rasonode u vidu ličnog pojavljivanja u kostimiziranim maskotama ili u plesnim timovima na košarkaškim igrama i priredbama, klinikama, kampovima, promocijama i drugim događajima, specijalnim događajima i žurkama vezanim za košarku, usluge kluba obožavalaca, usluge rasonode, naime one koje pružaju veb-sajt predstavljanje multimedijjskih sadržaja u vidu najvažnijih televizijskih događaja, interaktivnih najvažnijih televizijskih događaja, video snimaka, video strim snimaka, interaktivnih video izbora najvažnijih događaja, radio programa, najvažnijih radijskih događaja i audio snimaka u polju košarke, usluge obezbeđivanja vesti i informacija u vidu statistika i drugih stvari u polju košarke, onlajn igrice koje se ne mogu preuzimati, naime kompjuterske igrice, video igrice, interaktivne video igrice, akcione igrice, arkadne igrice, društvene igrice za odrasle i decu, igre na tabli, puzzle, trivia igrice, usluge elektronskog izdavaštva, naime, izdavanje magazina, vodiča, biltena, bojanki i igrice kod kojih se igrači određuju putem interneta, sve u vezi sa košarkom, usluge obezbeđivanja onlajn kompjuterske baze podataka u polju košarke.

(111) 11141

(151) 25.06.2014.

(210) **2012-25**

(442) **20.12.2013.**

(220) 18.01.2012.

(732) **NBA PROPERTIES, INC**, OLYMPIC TOWER BLDG. 645 FIFTH AVENUE, NEWYORK, NY 10022 US



(540)

(550) I

(740) Popović Miladin, Đoka Miraševića 21/III, Podgorica ME

(511) **Klasa 25:** Odeća, naime čarape, obuća, cipele za košarku, patike za košarku, majice, košulje, polo majice, dukserice, donji delovi trenerke, pantalone, majice na bretele, džemperi, kratke pantalone, pidžame, sportske majice, ragbi majice, vunene majice, kaiševi, kravate, spavacice, šeširi, kape, štitnici na kacketima, trenerke, donji delovi trenerki, dresovi, jakne, vetrovke, kišne krznene jakne, kaputi, portikle za bebe ne od papira, trake za glavu, narukvice, kecelje, donje rublje, bokserice, široke pantalone, štitnici za uši, rukavice, bokzerske rukavice, šalovi, pletene i štrikane majice, trikotažne haljine, haljine, dresovi i uniforme za navijacice, odeća za plivanje, odela za kupanje, kupaći kostimi, bikini, tamkini kupaći kostimi, gacice za plivanje, gacice za kupanje, šorcevi za surfovanje, šorcevi za kupanje, marama za plažu, pokrivala za kupaći kostim, ogrtači za kupaći kostim, sandale, sandale za plažu, šeširi za plažu, štitnici za sunce, kape za plivanje, kape za kupanje, nova pokrivala za glavu sa prikačenim umecima.

Klasa 28: Igračke, igre i sportske stvari, naime košarkaške lopte, loptice za golf, lopte za igralište, sportske lopte, gumene lopte i penaste lopte, plišane lopte za igru, plastične lopte za igru, mrežice za košarku, table za košarku, minijaturne table za košarku, pumpe i igle za naduvavanje košarkaških lopti, štapovi za golf, torbe za golf, podmetači za golf, oprema za golf, naime, alat za popravku golf terena, kupice na koje se stavlja lopta, markeri lopti, torbe za golf opremu, pokrivala za glave golf štapova, rukavice za golf, kutije za golf lopte, elektronske table za košarkaške igrice na tabli, table za košarkaške igrice, košarkaške igrice, akcione igrice, društvene igrice za odrasle i decu, trivia informacione igrice i elektronske video arka-da igrice, košarkaška torbica koja se sastoji od mrežice i zviždaljke, lutke, dekorativne lutke, lutke za kolekciju, akcione figure za igru, akcione figure karikature, punjene igračke, nove plišane igračke sa perikom, puzzle, montažni blokovi za igre, ukrasi za Božićnu jelku i Božićne čarape, vozila za igru u obliku automobila, kamiona, vozova i kombija, svi sa temom košarke, nove penaste igračke u obliku prsta ili trofeja, igrački trofeji, karte za igru, igrice sa kartama, igračke koje prave zvuk, igračke za kućne ljubimce, igračke za plažu, naime lopte za plažu, lopte na naduvavanje, kantice za igru, lopatice za igru, igračke za pesak, kutijice za pesak, gumene igračke za vodu, oprema za bazen, naime plivačka oprema za plutanje, oprema za plutanje u bazenu, igračke za splavanje na vodi, penasta oprema za plutanje, gume za plivanje, gume za plivanje u bazenu, penaste gume, daske za plivanje, daske za surfovanje, peraja za plivanje, peraja za surfovanje, mišici za plutanje i krila za pomoć pri plivanju u rekreativne svrhe, odbojkaške torbice za igru koje se sastoje od lopte, mrežice, sporednih stvari i zviždaljke, i vaterpolo torbice za igru koje se sastoje od lopte, mrežice i zviždaljke,

dekorativne igračke od tkanine koje se puštaju da lete na.

Klasa 41: Razonoda i obrazovne usluge u smislu televizijskih događaja i radio programa u polju košarke i prikazivanja uživo košarkaških igara i košarkaških priredbi, usluge produkcije i distribucije radio i televizijskih šou programa o košarkaškim igrama, košarkaškim događajima i programima iz oblasti košarke, usluge vođenja i organizovanja košarkaških klinika i kampova, klinika i kampova za trenere, klinika i kampova za plesne timove i košarkaške igre, usluge rasonode u vidu ličnog pojavljivanja u kostimiziranim maskotama ili u plesnim timovima na košarkaškim igrama i priredbama, klinikama, kampovima, promocijama i drugim događajima, specijalnim događajima i žurkama vezanim za košarku, usluge kluba obožavalaca, usluge rasonode, naime one koje pružaju vebsajt predstavljanje multimedijjskih sadržaja u vidu najvažnijih televizijskih događaja, interaktivnih najvažnijih televizijskih događaja, video snimaka, video strim snimaka, interaktivnih video izbora najvažnijih događaja, radio programa, najvažnijih radijskih događaja i audio snimaka u polju košarke, usluge obezbeđivanja vesti i informacija u vidu statistika i drugih stvari u polju košarke, onlajn igrice koje se ne mogu preuzimati, naime kompjuterske igrice, video igrice, interaktivne video igrice, akcione igrice, arkadne igrice, društvene igrice za odrasle i decu, igre na tabli, puzle, trivia igrice, usluge elektronskog izdavaštva, naime, izdavanje magazina, vodiča, biltena, bojanki i igrice kod kojih se igrači određuju putem interneta, sve u vezi sa košarkom, usluge obezbeđivanja onlajn kompjuterske baze podataka u polju košarke.

(111) 11132

(151) 02.07.2014.

(210) **2012-41**

(442) **20.12.2013.**

(220) 24.01.2012.

(732) **JT INTERNATIONAL S.A**, 1, RUE DE LA GABELLE, 1211 GENEVA 26 CH



(540) 

(550) I

(740) Čejović Vladimir, 13. jula 21, Podgorica ME

(511) **Klasa 34:** Duvan, prerađen ili neprerađen, duvan za pušenje, duvan za lule, duvan za ručno uvijanje, duvan za žvakanje, snus duvan, cigarete, cigare, cigarilosi, supstance za pušenje koje se prodaju odvojeno ili miješane sa duvanom, a koje nisu za medicinske svrhe ili u svrhe liječenja, duvan za ušmrkavanje, artikli za pušače uključeni u klasu 34, papir za cigarete, tube za cigarete i šibice.

(111) 11077

(151) 01.07.2014.

(210) **2012-13**

(442) **20.12.2013.**

(220) 12.01.2012.

(732) **UNILEVER N.V.** WEENA 455 3013 AL ROTTERDAM NL



(540)

(550) I

(740) Popović Miladin, Đoka Miraševića 21/III, Podgorica ME

(511) **Klasa 03:** Sapun, medicinski sapun, preparati za čišćenje, parfimerija, eterična ulja, dezodoransi i anti-perspiranti, preparati za negu kose, šamponi i balzami, farbe za kosu, preparati za oblikovanje frizura, nemedicinski toaletni preparati, preparati za kupanje i tuširanje, preparati za negu kože, ulja, kreme i losioni za kožu, preparati za brijanje, preparati za korišćenje prije brijanja i posle brijanja, kolonjska voda, preparati za depilaciju, preparati za potamnjivanje i preparati za zaštitu od sunca, kozmetički preparati, šminka i preparati za skidanje šminke, vazelin, preparati za negu usana, puder u prahu, vata za kozmetičke namjene, pamučni štapići za kozmetičke namjene, maramice, jastučići ili maramice impregnirane ili natopljene losionom za čišćenje ili kozmetičkim losionom, maske za lice, pakovanja za lice.

(111) 10958

(151) 30.05.2014.

(210) **2011-328**

(442) **20.06.2013**

(220) 29.6.2011

(732) **THE PROCTER & GAMBLE COMPANY**, ONE PROCTER & GAMBLE PLAZA, CINCINNATI, OHIO 45202 US



(540)

(550) I

(740) Lutovac Branislav, Bulevar Crnojevića 93, Podgorica (ME)

(511) **Klasa 03:** Sredstva za bijeljenje i druge supstance za upotrebu kod pranja veša; preparati za čišćenje, poliranje, nagrizajuća sredstva, abrazivna sredstva; omekšivači tkanina; sapuni; parfimerija, eterična ulja, kozmetika, losioni za kosu; proizvodi za njegu zuba.

(111) 10944

(151) 30.05.2014.

(210) **2011-353**

(442) **20.06.2013**

(220) 12.7.2011

(732) **DUVANSKI KOMBINAT, AD, U STEČAJU**, PODGORICA, NASELJE KRUŠEVAC BB
PODGORICA, ME



(540) _____

(550) I

(511) **Klasa 34:** duvan; artikli za pušenje; šibice.

(111) 11121

(151) 02.07.2014.

(210) **2012-128**

(442) **20.12.2013.**

(220) 27.02.2012.

(732) **GENERAL MOTORS LLC** (kompanija organizovana po propisima države Delaware),
300 Renaissance Center, Detroit, Michigan 48265-3000 US

(540) STINGRAY

(550) I

(740) Radulović Božidar, Jovana Tomaševića 9/III, Podgorica ME

(511) **Klasa 12:** Automobili.

(111) 11142

(151) 25.06.2014.

(210) **2012-23**

(442) **20.12.2013.**

(220) 18.01.2012.

(732) **NBA PROPERTIES, INC.** OLYMPIC TOWER BLDG. 645 FIFTH AVENUE, NEWYORK, NY
10022 US



(540)

(550) I

(740) Popović Miladin, Đoka Miraševića 21/III, Podgorica ME

(511) **Klasa 41:** Razonoda i obrazovne usluge u smislu televizijskih događaja i radio programa u polju košarke i prikazivanja uživo košarkaških igara i košarkaških priredbi, usluge produkcije i distribucije radio i televizijskih šou programa o košarkaškim igrama, košarkaškim događajima i programima iz oblasti košarke, usluge vođenja i organizovanja košarkaških klinika i kampova, klinika i kampova za trenere, klinika i kampova za plesne timove i košarkaške igre, usluge rasonode u vidu ličnog pojavljivanja u kostimiziranim maskotama ili u plesnim timovima na košarkaškim igrama i priredbama, klinikama, kampovima, promocijama i drugim događajima, specijalnim događajima i žurkama vezanim za košarku, usluge kluba obožavalaca, usluge rasonode, naime one koje pružaju vebajst predstavlanje multimedijjskih sadržaja u vidu najvažnijih televizijskih događaja, interaktivnih najvažnijih televizijskih događaja, video snimaka, video strim snimaka, interaktivnih video izbora najvažnijih događaja, radio programa, najvažnijih radijskih događaja i audio snimaka u polju košarke, usluge obezbeđivanja vesti i informacija u vidu statistika i drugih stvari u polju košarke, onlajn igrice koje se ne mogu preuzimati, naime kompjuterske igrice, video igrice, interaktivne video igrice, akcione igrice, arkadne igrice, društvene igrice za odrasle i decu, igre na tabli, puzle, trivia igrice, usluge elektronskog izdavaštva, naime, izdavanje magazina, vodiča, biltena, bojanke i igrice kod kojih se igrači određuju putem interneta, sve u vezi sa košarkom, usluge obezbeđivanja onlajn kompjuterske baze podataka u polju košarke.

(111) 11200

(151) 08.07.2014.

(210) **2012-60**

(442) **20.12.2013.**

(220) 25.01.2012.

(732) **LES MILLS INTERNATIONAL LIMITED**, 22 CENTRE STREET, AUCKLAND NZ

BODYJAM

(540)

(550) I

(740) Čupić Branislav, Dalmatinska 10, Podgorica ME

(511) **Klasa 41:** Usluge rekreacije i treninga, sportske aktivnosti, usluge obrazovanja, kreiranje i vođenje časova i programa vježbi uz muziku, usluge teretana, usluge klubova vezanih za zdrav život, usluge sportskih klubova, usluge fitnes klubova, usluge vježbi sa instruktorom, usluge savjetovanja i treniranja, usluge pružanja prostora za vježbanje, usluge sportskih vježbi sa instruktorom, usluge treniranja i obuke, usluge informacija, savjeta i konsultacija u vezi sa nekim ili svim navedenim uslugama, objava štampanog materijala i elektronskih medija, uključujući objavu muzičkih i video zapisa u digitalnom formatu vezanih za programe i treninge fitnes klubova i klubova vezanih za zdrav život.

(111) 11079

(151) 01.07.2014.

(210) **2012-15**

(442) **20.12.2013.**

(220) 12.01.2012.

(732) **UNILEVER N.V.** WEENA 455 3013 AL ROTTERDAM NL



(540)

(550) I

(740) Popović Miladin, Đoka Miraševića 21/III, Podgorica ME

(511) **Klasa 03:** Sapun, medicinski sapun, preparati za čišćenje, parfimerija, eterična ulja, dezodoransi i anti-perspiranti, preparati za negu kose, šamponi i balzami, farbe za kosu, preparati za oblikovanje frizura, nemedicinski toaletni preparati, preparati za kupanje i tuširanje, preparati za negu kože, ulja, kreme i losioni za kožu, preparati za brijanje, preparati za korišćenje prije brijanja i posle brijanja, kolonjska voda, preparati za depilaciju, preparati za potamnjivanje i preparati za zaštitu od sunca, kozmetički preparati, šminka i preparati za skidanje šminke, vazelin, preparati za negu usana, puder u prahu, vata za kozmetičke namjene, pamučni štapići za kozmetičke namjene, maramice, jastučići ili maramice impregnirane ili natopljene losionom za čišćenje ili kozmetičkim losionom, maske za lice, pakovanja za lice.

(111) 11078

(151) 13.01.2012.

(210) **2012-14**

(442) **20.12.2013.**

(220) 12.01.2012.

(732) **UNILEVER N.V.** WEENA 455 3013 AL ROTTERDAM NL

POND'S

(540)

(550) I

(740) Popović Miladin, Đoka Miraševića 21/III, Podgorica ME

(511) **Klasa 05:** Farmaceutski preparati, dezinfekciona sredstva i antiseptici, dezodoransi i preparati za osvježavanje vazduha, sanitarni proizvodi i preparati, zubarska smola, zavoji, flasteri, materijali za zavijanje, medicinski preparati za kožu i kosu, medicinski preparati za usne, preparati za lečenje i/ili ublažavanje opekotina, vazelin za medicinske namene, dijetetske supstance za medicinsku upotrebu, biljni preparati za medicinske namene, biljni dodaci i biljni ekstrakti, medicinski biljni napici, vitamini, minerali, dodaci ishrani.

(111) 11123

(151) 25.06.2014.

(210) **2011-418**

(442) **20.06.2013**

(220) 18.8.2011

(732) **LYXOR LTD**, ZOLLSTRASSE 16, FL-9494 SCHAAN, LI



(540)

(550) I

(511) **Klasa 36:** finansijske usluge, pružanje finansijskih informacija, finansijski derivati, usluge u vezi sa valutama, robom (kao što je zlato, srebro i nafta), berzanski indeksi, trgovanje akcijama preko interneta i fiksna i bežična komunikaciona sredstva i mreže, usluge posredovanja u vezi sa finansijskim proizvodima, agencije za brokerske usluge u trgovanju hartijama od vrednosti na domaćem i inostranom tržištu hartija od vrednosti i u transakcijama na proviziju na domaćem i inostranom tržištu hartija od vrednosti i fjučersa, razmena strane valute preko interneta, pružanje informacija i finansijskih podataka u vezi sa razmenom valute i upravljenjem investicionim portfolijima, obezbeđenje gotovog novca i transakcija za razmenu valute preko globalne komunikacione mreže, pružanje informacije o razmeni valute preko globalne komunikacione mreže.

(111) 11110

(151) 25.06.2014.

(210) **2012-7**

(442) **20.12.2013.**

(220) 12.01.2012.

(732) **JT INTERNATIONAL S.A**, 1, RUE DE LA GABELLE, 1211 GENEVA 26 CH

SOBRANIE CONTOUR

(540)

(550) I

(740) Čejović Vladimir, 13. jula 21, Podgorica ME

(511) **Klasa 34:** Duvan, prerađen ili neprerađen, duvan za pušenje, duvan za lule, duvan za ručno uvijanje, duvan za žvakanje, snus duvan, cigarete, cigare, cigarilosi, supstance za pušenje koje se prodaju odvojeno ili miješane sa duvanom, a koje nisu za medicinske svrhe ili u svrhe liječenja, duvan za ušmrkavanje, artikli za pušače uključeni u klasu 34, papir za cigarete, tube za cigarete i šibice.

(111) 11151

(151) 02.07.2014.

(210) **2012-112**

(442) **20.12.2013.**

(220) 22.02.2012.

(732) **FARMACEUTSKA HEMISKA KOZMETIČKA INDUSTRIJA ALKALOID AD-**
SKOPLJE, BUL. ALEKSANADAR MAKEDONSKI BR. 12, SKOPLJE MK

(540) BECUTAN

(550) I

(740) Popović Miladin, Đoka Miraševića 21/III, Podgorica ME

(511) **Klasa 03:** dječji sapun sa ekstraktom kamilice i d-pantenolom.

(111) 11152

(151) 02.07.2014.

(210) **2012-111**

(442) **20.12.2013.**

(220) 22.02.2012.

(732) **DELTA AIR LINES**, INC, 1030 DELTA BOULEVARD ATLANTA, GEORGIA US

(540) SKY PRIORITY

(550) I

(740) Popović Miladin, Đoka Miraševića 21/III, Podgorica ME

(511) **Klasa 39:** Usluge transporta u vazdušnom saobraćaju i usluge transporta u vazdušnom saobraćaju koje obezbeđuju program za dodatne nagrade i stimulaciju za frekventna vazdušna putovanja, usluge tranzitnih salona za odmor i relaksaciju putnika, usluge specijalizovanih povlašćenih vazduhoplovnih servisa sa odeljenjem za rezervacije, usluge unapređivanja procesa čekiranja na aerodromu, usluge ubrzavanja procedura za pozive na čekanju, usluge čekiranja sa pravom prvenstva, usluge čekiranja za posebno privilegovane putnike, usluge namenskog servisnog centra i usluge VIP prolaza (club lanes), usluge posebnih prioriteta i ubrzanja bezbednosne obrade, usluge ubrzavanja procedura izlaska i vazduhoplovnih servisa za ukrcavanje, usluge unapređivanja smeštaja na rezervisanim i ner-

ezervisanim sedištima, usluge unapređivanja ličnog prostora uz poseban zabavni program, usluge računarskog povezivanja u vazdušnom saobraćaju, usluge unapređivanja služenja obroka i usluge vrednosnih vaučera za elitne putnike, usluge isporuke prioriternog prtljaga, usluge povećanog i poboljšanog korisničkog servisa za elitne putnike u međunarodnoj klasi 39.

(111) 11129

(151) 02.07.2014

(210) **2012-38**

(442) **20.12.2013.**

(220) 24.01.2012.

(732) **JT INTERNATIONAL S.A**, 1, RUE DE LA GABELLE, 1211 GENEVA 26 CH



(540)

(550) I

(740) Čejović Vladimir, 13. jula 21, Podgorica ME

(511) **Klasa 34:** Duvan, prerađen ili neprerađen, duvan za pušenje, duvan za lule, duvan za ručno uvijanje, duvan za žvakanje, snus duvan, cigarete, cigare, cigarilosi, supstance za pušenje koje se prodaju odvojeno ili miješane sa duvanom, a koje nisu za medicinske svrhe ili u svrhe liječenja, duvan za ušmrkavanje, artikli za pušače uključeni u klasu 34, papir za cigarete, tube za cigarete i šibice.

(111) 10968

(151) 13.06.2014.

(210) **2012-134**

(442) **20.12.2013.**

(220) 02.03.2012.

(732) **YANMAR CO. LTD.** 1-9, Tsurunicho, Kita-ku, Osaka JP

(540) YANMAR

(550) I

(740) Ćupić Branislav, Dalmatinska 10, Podgorica ME

(511) **Klasa 04:** Mineralna ulja i maziva za industrijsku upotrebu (ne za gorivo), ne-mineralna ulja i maziva za industrijsku upotrebu (osim za goriva), goriva, voskovi (sirovi materijal), čvrsta maziva, sirovo ulje ili rafinisano ulje, industrijsko ulje, motorno ulje, lubrikanti, dizel ulje za sagorijevanje, lako ulje, ulje za motore sa unutrašnjim sagorijevanjem, ulje za sagorijevanje.

Klasa 07: Generatori struje sa sistemima za iskorišćenje otpadne toplote, poljoprivredne alatke (osim onih kojima se ručno upravlja), poljoprivredne mašine kao što su kombajni, rasađivač pirinča, vezači, pokretne vršalice, aparati i uređaji za razdvajanje opne od zrna pirinča,

motorni orači, sjekači za grmlje, rasađivači i sijačice za povrće, kosačice, motori i pogonske mašine (osim za suvozemna vozila), djelovi i oprema za sve vrste motora i pogonske mašine svih vrsta (osim za suvozemna vozila), dizel motori, benzinski motori, motori za plovila, kompresori za plovila, ležaj osovine klipa, klipovi, osovine klipa, karike, klipni prsteni, filteri za gorivo, pumpe, pumpe-mašine, gasne toplotne pumpe, generatori struje kao što su dizel generatori, benzinski generator, gasni generator, građevinske mašine i aparati, mašine i alati za utovar-istovar, djelovi i oprema za iste, građevinske mašine, ekskavatori, utovarivači, kopačice, buldožeri, nosači, plugovi za snijeg, potopivi uređaji za čišćenje ribarskih mreža, automatski odstranjivači ljuske za pirinač, sorter po bojama, odvijlač kamenčića sa pirinča, abrazivni aparat za poliranje pirinča, separator zrna pirinča, čistač zrna pirinča, mašine za razvrstavanje po debljini, mašine za razvrstavanje po usjeku, pomoćni dodaci za mlinove.

Klasa 11: Klima uređaji, gasne toplotne pumpe–sistemi klima, uređaja, bojleri, uređaji i instalacije za rashladivanje, kućišta za rashladivanje, aparati za sušenje stočne hrane, izmjenjivaci toplote, pokretni uređaji za osvjetljavanje.

Klasa 12: Motorizovani nosači za sve terene, motori i stojevi za suvozemna vozila, plovila kao što su jahte i pecaroški brodovi i njihovi djelovi i oprema, traktori i traktori za poljoprivredu.

Klasa 16: Kutije od papira ili kartona, papir za pakovanje, kese koverta, vrećice za pakovanje od papira ili plastike.

Klasa 37: Usluge za instalaciju i popravku opreme za grijanje, usluge instalacije i popravke klima uređaja.

(111) 11255

(151) 22.07.2014.

(210) **2012-149**

(442) **20.12.2013.**

(220) 12.03.2012.

(732) **RIBNICA COMMERCE D.O.O, ZELENKA BB, PODGORICA ME**



(550) I

(511) **Klasa 35:** Uvoz sledeće robe: Sektor prehrane, konzervisana tunjevina pekarski proizvodi sokovi korniflexi konzervisano povrće maslinovo i jestivo ulje brašno suvo voće i povrće, Sektor sitnih kućanskih aparata i predmeta za opštu upotrebu, kućanski aparati (pegle, fenovi, kafemati, depilatori, kuvala za vodu, radijatori, tosteri, sokovnici), predmeti za opštu upotrebu (čaše, šolje, lonci, tanjiri, escajg), Sektor profesionalne opreme za trgovinske i ugostiteljske objekte, oprema za markete i trgovine: (rashladne vitrine, ormari, mesoreznice, kafemati, metalne police) oprema za ugostiteljske objekte i hotele (profesionalne kuhinje, pica peći, konvektomati, mikseri, hamburger prese).

(111) 10965

(151) 22.07.2014.

(210) **2012-150**

(442) **20.12.2013.**

(220) 12.03.2012.

(732) **RIBNICA COMMERCE D.O.O, ZELENKA BB, PODGORICA ME**



(550) I

(511) **Klasa 35:** Uvoz sledeće robe: Sektor prehrane, konzervisana tunjevina pekarski proizvodi

sokovi kornifleksi konzervisano povrće maslinovo i jestivo ulje brašno suvo voće i povrće, Sektor sitnih kućanskih aparata i predmeta za opštu upotrebu, kućanski aparati (pegle, fenovi, kafemati, depilatori, kuvala za vodu, radijatori, tosteri, sokovnici), predmeti za opštu upotrebu (čaše, šolje, lonci, tanjiri, escajg), Sektor profesionalne opreme za trgovinske i ugostiteljske objekte, oprema za markete i trgovine: (rashladne vitrine, ormari, mesoreznice, kafemati, metalne police) oprema za ugostiteljske objekte i hotele (profesionalne kuhinje, pica peći, konvektomati, mikseri, hamburger prese).

(111) 11256

(151) 22.07.2014.

(210) **2012-68**

(442) **20.12.2013.**

(220) 30.01.2012.

(732) **D.O.O UDAČA**, GORIČANI BB, GOLUBOVCI, PODGORICA ME



(540)

(550) I

(511) **Klasa 35:** Oglašavanje, vođenje poslova, razonoda, kancelarijski poslovi.

Klasa 41: Obrazovne usluge, pripremanje obuke, razonoda, sportske i kulturne aktivnosti.

Klasa 42: Naučne i tehnološke usluge i istraživanje i prorojektovanje u vezi navedenih usluga, usluge industrijske analize i istraživanja, projektovanje i razvoj kompjuterskog hardvera i softvera.

(111) 10967

(151) 30.05.2014.

(210) **2012-129**

(442) **20.12.2013.**

(220) 28.02.2012.

(732) **SKKR ALDINA**, Korać Mirsad, Miladina Radulovića 103, Novi Pazar RS



(540)

(550) I

(511) **Klasa 25:** odjeća, obuća, pokrivala za glavu, pantalone, košulje, jakne, majice, donji veš, čarape, kape, kačketi, šeširi, cipele, čizme, sandale, papuče, patike.

(111) 111333

(151) 02.07.2014.

(210) **2012-42**

(442) **20.12.2013.**

(220) 24.01.2012.

(732) **JT INTERNATIONAL S.A**, 1, RUE DE LA GABELLE, 1211 GENEVA 26 CH



(540)

(550) I

(740) Čejović Vladimir, 13. jula 21, Podgorica ME

(511) **Klasa 34:** Duvan, prerađen ili neprerađen, duvan za pušenje, duvan za lule, duvan za ručno uvijanje, duvan za žvakanje, snus duvan, cigarete, cigare, cigarilosi, supstance za pušenje koje se prodaju odvojeno ili miješane sa duvanom, a koje nisu za medicinske svrhe ili u svrhe liječenja, duvan za ušmrkavanje, artikli za pušaće uključeni u klasu 34, papir za cigarete, tube za cigarete i šibice.

(111) 11147

(151) 25.06.2014.

(210) **2012-10**

(442) **20.12.2013.**

(220) 12.01.2012.

(300) 2011 07732 02.11.2011. RO

(732) **JT INTERNATIONAL S.A**, 1, RUE DE LA GABELLE, 1211 GENEVA 26 CH

SOBRANIE SUPREME

(540)

(550) I

(740) Čejović Vladimir, 13. jula 21, Podgorica ME

(511) **Klasa 34:** Duvan, prerađen ili neprerađen, duvan za pušenje, duvan za lule, duvan za

ručno uvijanje, duvan za žvakanje, snus duvan, cigarete, cigare, cigarilosi, supstance za pušenje koje se prodaju odvojeno ili miješane sa duvanom, a koje nisu za medicinske svrhe ili u svrhe liječenja, duvan za ušmrkavanje, artikli za pušače uključeni u klasu 34, papir za cigarete, tube za cigarete i šibice.

(111) 10991

(151) 30.05.2014.

(210) **2012-103**

(442) **20.12.2013.**

(220) 20.02.2012.

(732) **ADIDAS INTERNATIONAL MARKETING BV**, HOODOORDDREEF 9A, 1101 BA AMSTERDAM ZO NL

(540) STAN SMITH

(550) I, V

(740) Radulović Božidar, Jovana Tomaševića 9/III, Podgorica ME

(511) **Klasa 25:** Obuća za slobodno vrijeme, atletska obuća.

(111) 11112

(151) 25.06.2014.

(210) **2012-64**

(442) **20.12.2013.**

(220) 26.01.2012.

(300) 2012-000382 06.01.2012. JP

(732) **NIKON CORPORATION**, 12-1, YURAKUCHO 1-CHOME, CHIYODA-KU, TOKYO JP



(540)

(550) I

(740) Popović Miladin, Đoka Miraševića 21/III, Podgorica ME

(511) **Klasa 09:** Kamere, digitalne kamere, sočiva za kamere, baterije i punjači za baterije za kamere i digitalne kamere, daljinski upravljači za kamere i digitalne kamere, futrole za kamere i digitalne kamere, kaiševi za kamere i digitalne kamere, kompjuterski softver, futrole posebno napravljene za fotografske aparate i instrumente, filteri za ultraljubičaste zrake, za fotografiju, filteri (za fotografiju), blicevi (za fotografiju), baterijske lampe (za fotografiju), izbacivači blende (za fotografiju), blende (za fotografiju), slajdovi (za fotografiju), kalem (za fotografiju), postolja za fotografske aparate, transparencije (za fotografiju), viziri, fotografski, tripodi za kamere, epidijaskopi, mobilni telefoni, celularni telefoni, pametni telefoni, zaštitne folije (filmovi) za digitalne kamere.

(111) 11118

(151) 25.06.2014.

(210) **2012-144**

(442) **20.12.2013.**

(220) 07.03.2012.

(732) **ALLOY RODS GLOBAL, INC.** 1105 N.MARKET STREET, SUITE 1300, WILMINGTON DEL-AWARE 19899-8985 US

(540) DUAL SHIELD

(550) I

(740) Popović Miladin, Đoka Miraševića 21/III, Podgorica ME

(511) **Klasa 09:** Elektrode za elektro lučno zavarivanje i aparati za električno lučno zavarivanje i njihovi djelovi.

(111) 10943

(151) 30.05.2014.

(210) **2011-352**

(442) **20.06.2013**

(220) 12.7.2011

(732) **DUVANSKI KOMBINAT, AD, U STEČAJU,** PODGORICA, NASELJE KRUŠEVAC BB PODGORICA, ME

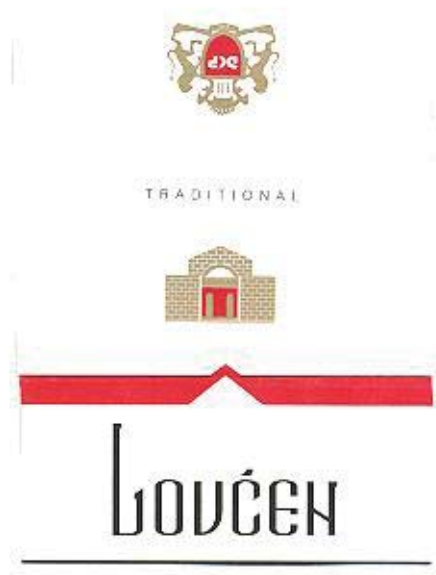

(540)

(550) I

(511) **Klasa 34:** duvan; artikli za pušenje; šibice.

(111) 11122

(151) 25.06.2014.

(210) **2012-77**

(442) **20.12.2013.**

(220) 09.02.2012.

(732) **WM. WRIGLEY JR. COMPANY,** 410 NORTH MICHIGAN AVENUE, CHICAGO, IL 60611 US



(540)

(550) I

(740) Čejović Vladimir, 13. jula 21, Podgorica ME

(511) **Klasa 30:** Konditorski proizvodi, žvakaće gume, žvakaće gume od kojih mogu da se prave veliki baloni, bombone, dražeje pepermint, mali okrugli bomboni (drops) i pastile.

(111) 11086

(151) 01.07.2014.

(210) **2012-8**

(442) **20.12.2013.**

(220) 12.01.2012.

(300) 2011 07730 02.11.2011. RO

(732) **JT INTERNATIONAL S.A.**, 1, RUE DE LA GABELLE, 1211 GENEVA 26 CH

DISCERN

(540)

(550) I

(740) Čejović Vladimir, 13. jula 21, Podgorica ME

(511) **Klasa 34:** Duvan, prerađen ili neprerađen, duvan za pušenje, duvan za lule, duvan za ručno uvijanje, duvan za žvakanje, snus duvan, cigarete, cigare, cigarilosi, supstance za pušenje koje se prodaju odvojeno ili miješane sa duvanom, a koje nisu za medicinske svrhe ili u svrhe liječenja, duvan za ušmrkavanje, artikli za pušače uključeni u klasu 34, papir za cigarete, tube za cigarete i šibice.

(111) 11003

(151) 13.06.2014.

(210) **2012-137**

(442) **20.12.2013.**

(220) 05.03.2012.

(300) 2011 08898 20.12.2011. RO

(732) **JT International S.A.**, 1, rue de la Gabele 1211 Geneva 26 CH

(540) SOBRANIE SUPREMACY

(550) I

(740) Čejović Vladimir, 13. jula 21, Podgorica ME

(511) **Klasa 34:** Duvan, prerađen ili neprerađen, duvan za pušenje, duvan za lule, duvan za

ručno uvijanje, duvan za žvakanje, snus duvan, cigarete, cigare, cigarilosi, supstance za pušenje koje se prodaju odvojeno ili miješane sa duvanom, a koje nisu za medicinske svrhe ili u svrhe liječenja, duvan za ušmrkavanje, artikli za pušače uključeni u klasu 34, papir za cigarete, tube za cigarete i šibice.

(111) 10957

(151) 30.05.2014.

(210) **2010-58**

(442) **20.06.2012**

(220) 10.03.2010

(732) CHERY AUTOMOBILE CO.LTD, 8 CHANGCHUN ROAD, ECONOMY I TECHNOLOGY DEVELOPMENT ZONE WUHU CITY, ANHUI PROVINCE CN

TIGGO

(540)

(550) I

(740) Đakonović Vido, Bajova 9, Cetinje (ME)

(511) **Klasa 12:** Vazdušni jastuci [sigurnosni uređaji za automobile], pumpe za vazduh [dodatna oprema za vozila], bolnička kola, uređaji protiv zasjenjivanja za vozila, uređaji protiv krađe za vozila, karoserije i šasije za automobile, automobilske gume, automobili, osovine za vozila, trake za glavčine točkova, djelovi kočnica za vozila, kočione pedale za vozila, kočnice za vozila, autobusi, motorna vozila, kvačila za kopnena vozila, klipnjače za kopnena vozila, koje nisu djelovi motora i pogonskih mašina, konvertori za kopnena vozila, kućišta radilice i komponente terenskih vozila, koji nisu pogonski motor, pokazivači pravca za vozila, vrata za vozila, pogonski motori za kopnena vozila, električna vozila, lančanik slobodnog hoda za kopnena vozila, prenosnici brzine za kopnena vozila, sistem prenosnika za kopnena vozila, poklopci za motore na vozilima, poklopci za vozila, sirene za vozila, glavčine za točkove vozila, motori za upravljanje kopnenim vozilima, propulzioni mehanizmi za kopnena vozila, redukcionni prenosnici za kopnena vozila, alarm opomene za vožnju u rikverc, točkovi vozila, amortized za automobile, volani za vozila, konvertori obrtnog momenta za kopnena vozila, torzione poluge za vozila, prenosni lanci za kopnena vozila, prenosna vratila za kopnena vozila, prenosnici za kopnena vozila, turbine za kopnena vozila, stalni trap automobila, kamioni, kombiji i kamioneti, opruge za vješanje vozila, prozori za vozila, bicikli, motorcikli, vozila za prevoz kopnom, vazduhom, vodom ili železnicom.

Klasa 37: Održavanje i popravka motornih vozila, podmazivanje vozila, pranje vozila, poliranje vozila, zaštita vozila od rđe, stanice za servisiranje vozila (pumpe za gorivo i održavanje), popravka šara na gumama, vulkaniziranje i popravka guma, restauracija mašina koje su pohabane ili delimično uništene, instaliranje i popravka alarma protiv provala.

(111) 11083

(151) 13.06.2014.

(210) **2012-19**

(442) **20.12.2013.**

(220) 13.01.2012.

(732) **ABBOTT MEDICAL OPTICS INC.** 1700 E.ST. ANDREW PLACE, SANTA ANA, CALIFORNIA 92705-4933 US

UNFOLDER

(540)

(550) I

(740) Popović Miladin, Đoka Miraševića 21/III, Podgorica ME

(511) **Klasa 10:** Hirurški, medicinski, zubarski i veterinarski aparati i instrumenti, vještački udovi, oči i zubi, ortopedski artikli, hirurški materijali za zašivanje, naročito hirurški ručni alati, medicinski aparati i instrumenti, naime, sistem za implantaciju intraokularnog sočiva.

(111) 11127

(151) 02.07.2014.

(210) **2012-36**

(442) **20.12.2013.**

(220) 24.01.2012.

(732) **JT INTERNATIONAL S.A**, 1, RUE DE LA GABELLE, 1211 GENEVA 26 CH



(540)

(550) I

(740) Čejović Vladimir, 13. jula 21, Podgorica ME

(511) **Klasa 34:** Duvan, prerađen ili neprerađen, duvan za pušenje, duvan za lule, duvan za ručno uvijanje, duvan za žvakanje, snus duvan, cigarete, cigare, cigarilosi, supstance za pušenje koje se prodaju odvojeno ili miješane sa duvanom, a koje nisu za medicinske svrhe ili u svrhe liječenja, duvan za ušmrkavanje, artikli za pušače uključeni u klasu 34, papir za cigarete, tube za cigarete i šibice.

(111) 11128

(151) 02.07.2014.

(210) **2012-37**

(442) **20.12.2013.**

(220) 24.01.2012.

(732) **JT INTERNATIONAL S.A**, 1, RUE DE LA GABELLE, 1211 GENEVA 26 CH



(540)

(550) I

(740) Čejović Vladimir, 13. jula 21, Podgorica ME

(511) **Klasa 34:** Duvan, prerađen ili neprerađen, duvan za pušenje, duvan za lule, duvan za ručno uvijanje, duvan za žvakanje, snus duvan, cigarete, cigare, cigarilosi, supstance za pušenje koje se prodaju odvojeno ili miješane sa duvanom, a koje nisu za medicinske svrhe ili u svrhe liječenja, duvan za ušmrkavanje, artikli za pušače uključeni u klasu 34, papir za cigarete, tube za cigarete i šibice.

(111) 11140

(151) 25.06.2014.

(210) **2012-26**

(442) **20.12.2013.**

(220) 19.01.2012.

(732) **SHIMANO** INC. 3-77 OIMATSU-CHO, SAKAI-KU, SAKAI CITY OSAKA JP

HG-EV

(540)

(550) I

(740) Popović Miladin, Đoka Miraševića 21/III, Podgorica ME

(511) **Klasa 12:** Električne bicikle, bicikle, delovi i oprema za bicikle, naime, glavčine, unutrašnje glavčine menjača, glavčine dinamama za bicikle, glavčine za brzo otpuštanje poluge menjača, otp usne poluge menjača, poluge za menjanje brzina, prednji prenosni mehanizmi, zadnji prenosni mehanizmi, vođice lanca, pomoćni zupčanici za menjanje brzina (skretači lanca), zupčanici, dizalice za bicikle, lanci za bicikle, sajle, obrtaljke, komplet obrtaljka, prednji lančanici za točak, pedale za bicikle, klipseri (korpice za stopala), poluge kočnica, prednje kočnice, zadnje kočnice, sajle za kočnice, kočne papuče, obruči, točkovi, lanci za kočenje, klipovi za kočenje, donje sponje, nosači za sedišta, mehanizmi za brzo otpuštanje nosača sedišta, glavni delovi za sklapanje rama viljuški, amortizeri, upravljači, drške upravljača, ručice upravljača, krajevi drške upravljača, uporišta sedišta, sedišta, prenosni mehanizmi kojima upravlja kompjuter, pokazivači pozicije brzine bicikla.

(111) 11150

(151) 25.06.2014.

(210) **2012-2**

(442) **20.12.2013.**

(220) 09.01.2012.

(732) **RODRIGO MIGUELL FONT**, AVINGUDA DE VALLVIDRERA 44, BARCELONA ES

(540)

(550) I

(740) Radulović Božidar, Jovana Tomaševića 9/III, Podgorica ME

(511) **Klasa 12:** Vozila, uređaji za kretanje po zemlji, po vodi ili po zraku, posebno, komponente, dodatna oprema i rezervni dijelovi za vozila, spojke i prijenosni uređaji za kopnena vozila, komponente za rashladne sistave, ispušne lonce, amortizacijske sustave, motore ili strojeve (mehaničke), prijenosne i upravljačke komponente za vozila.

(111) 11113

(151) 25.06.2014.

210) **2012-45**(442) **20.12.2013.**

(220) 24.01.2012.

(732) **REVLON CONSUMER PRODUCTS CORPORATION** (A DELAWARE CORPORATION), 237 PARK AVENUE, NEW YORK, NY 10017 US

REVLON

(540)

(550) I

(740) Čejović Vladimir, 13. jula 21, Podgorica ME

(511) **Klasa 03:** Sredstva za bijeljenje i druge supstance za upotrebu u perionicama, preparati za čišćenje, poliranje, ribanje i nagrizanje, sapuni, parfimerija, eterična ulja, kozmetika, losioni za kosu, paste za zube.

(111) 11080

(151) 13.06.2014.

(210) **2012-16**(442) **20.12.2013.**

(220) 12.01.2012.

(732) **UNILEVER N.V.** WEENA 455 3013 AL ROTTERDAM NL

POND'S

(540)

(550) I

(740) Popović Miladin, Đoka Miraševića 21/III, Podgorica ME

(511) **Klasa 03:** Sapun, medicinski sapun, preparati za čišćenje, parfimerija, eterična ulja, dezodoransi i anti-perspiranti, preparati za negu kose, šamponi i balzami, farbe za kosu, preparati za oblikovanje frizura, nemedicinski toaletni preparati, preparati za kupanje i tuširanje, preparati za njegu kože, ulja, kreme i losioni za kožu, preparati za brijanje, preparati za korišćenje prije brijanja i posle brijanja, kolonjska voda, preparati za depilaciju, preparati za potamnivanje i preparati za zaštitu od sunca, kozmetički preparati, šminka i preparati za skidanje šminke, vazelin, preparati za njegu usana, puder u prahu, vata za kozmetičke namjene, pamučni štapići za kozmetičke namjene, maramice, jastučići ili maramice impregnirane ili natopljene losionom za čišćenje ili kozmetičkim losionom, maske za lice, pakovanja za lice.

(111) 11114

(151) 25.06.2014.

(210) **2012-46**

(442) **20.12.2013.**

(220) 24.01.2012.

(732) **REVLON CONSUMER PRODUCTS CORPORATION** (A DELAWARE CORPORATION), 237 PARK AVENUE, NEW YORK, NY 10017 US

CHARLIE

(540)

(550) I

(740) Čejović Vladimir, 13. jula 21, Podgorica ME

(511) **Klasa 03:** Sredstva za bijeljenje i druge supstance za upotrebu u perionicama, preparati za čišćenje, poliranje, ribanje i nagrizanje, sapuni, parfimerija, eterična ulja, kozmetika, losioni za kosu, paste za zube.

(111) 11148

(151) 25.06.2014.

(210) **2012-9**

(442) **20.12.2013.**

(220) 12.01.2012.

(300) 2011 07731 02.11.2011. RO

(732) **JT INTERNATIONAL S.A**, 1, RUE DE LA GABELLE, 1211 GENEVA 26 CH

ELEVATE

(540)

(550) I

(740) Čejović Vladimir, 13. jula 21, Podgorica ME

(511) **Klasa 34:** Duvan, prerađen ili neprerađen, duvan za pušenje, duvan za lule, duvan za ručno uvijanje, duvan za žvakanje, snus duvan, cigarete, cigare, cigarilosi, supstance za pušenje koje se prodaju odvojeno ili miješane sa duvanom, a koje nisu za medicinske svrhe ili u svrhe liječenja, duvan za ušmrkavanje, artikli za pušače uključeni u klasu 34, papir za cigarete, tube za cigarete i šibice.

(111) 11130

(151) 02.07.2014

(210) **2012-39**

(442) **20.12.2013.**

(220) 24.01.2012.

(732) **JT INTERNATIONAL S.A**, 1, RUE DE LA GABELLE, 1211 GENEVA 26 CH



(540)

(550) I

(740) Čejović Vladimir, 13. jula 21, Podgorica ME

(511) **Klasa 34:** Duvan, prerađen ili neprerađen, duvan za pušenje, duvan za lule, duvan za ručno uvijanje, duvan za žvakanje, snus duvan, cigarete, cigare, cigarilosi, supstance za pušenje koje se prodaju odvojeno ili miješane sa duvanom, a koje nisu za medicinske svrhe ili u svrhe liječenja, duvan za ušmrkavanje, artikli za pušače uključeni u klasu 34, papir za cigarete, tube za cigarete i šibice.

(111) 11005

(151) 13.06.2014.

(210) **2012-145**

(442) **20.12.2013.**

(220) 08.03.2012.

(732) **Japan Tobacco Inc.** 2-2-1 Toranomom, Minato-ku Tokio JP

(540) WINSTON FREE XSTYLE

(550) I

(740) Čejović Vladimir, 13. jula 21, Podgorica ME

(511) **Klasa 34:** Duvan, prerađen ili neprerađen, duvan za pušenje, duvan za lule, duvan za ručno uvijanje, duvan za žvakanje, snus duvan, cigarete, cigare, cigarilosi, supstance za pušenje koje se prodaju odvojeno ili miješane sa duvanom, a koje nisu za medicinske svrhe ili u svrhe liječenja, duvan za ušmrkavanje, artikli za pušače uključeni u klasu 34, papir za cigarete, tube za cigarete i šibice.

(111) 11117

(151) 25.06.2014.

(210) **2012-65**

(442) **20.12.2013.**

(220) 27.01.2012.

(732) **FOUR ROSES DISTILLERY LLC**, 1224 BONDS MILL ROAD, LAWRENCEBURG, KENTUCKY 40342 US



(540)

(550) I

(740) Čejović Vladimir, 13. jula 21, Podgorica ME

(511) **Klasa 33:** Viski.

(111) 11149

(151) 25.06.2014.

(210) **2012-3**

(442) **20.12.2013.**

(220) 10.01.2012.

(732) **SHIMANO INC.** 3-77 OIMATSCU-CHO, SAKAI CITY, OSAKA JP

SHIMANO DOC

(540)

(550) I

(740) Popović Miladin, Đoka Miraševića 21/III, Podgorica ME

(511) **Klasa 09:** Računari za bicikle, merači utroška energije za bicikle.

Klasa 12: Električne bicikle, bicikle, delovi i oprema za bicikle, naime, glavčine, unutrašnje glavčine menjača, glavčine dinama za bicikle, glavčine za brzo otpuštanje poluge menjača, otp usne poluge menjača, poluge za menjanje brzina, prednji prenosni mehanizmi, zadnji prenosni mehanizmi, vođice lanca, pomoćni zupčanici za menjanje brzina (skretači lanca), zupčanici, dizalice za bicikle, lanci za bicikle, sajle, obrtaljke, komplet obrtaljka, prednji

lančanicu za točak, pedale za bicikle, klipseri (korpice za stopala), poluge kočnica, prednje kočnice, zadnje kočnice, sajle za kočnice, kočne papuče, obruči, točkovi, lanci za kočenje, klipovi za kočenje, donje spona, nosači za sedišta, mehanizmi za brzo otpuštanje nosača sedišta, glavni delovi za sklapanje rama viljuški, amortizeri, upravljači, drške upravljača, ručice upravljača, krajevi drške upravljača, uporišta sedišta, sedišta, prenosni mehanizmi kojima upravlja kompjuter, pokazivači pozicije brzine bicikla.

(111) 11126

(151) 02.07.2014.

(210) **2012-35**

(442) **20.12.2013.**

(220) 24.01.2012.

(300) 11*1290 07.10.2011. LT

(732) **JT INTERNATIONAL S.A**, 1,RUE DE LA GABELLE, 1211 GENEVA 26 CH



(540)

(550) I

(740) Čejović Vladimir, 13. jula 21, Podgorica ME

(511) **Klasa 34:** Duvan, prerađen ili neprerađen, duvan za pušenje, duvan za lule, duvan za ručno uvijanje, duvan za žvakanje, snus duvan, cigarete, cigare, cigarilosi, supstance za pušenje koje se prodaju odvojeno ili miješane sa duvanom, a koje nisu za medicinske svrhe ili u svrhe liječenja, duvan za ušmrkavanje, artikli za pušače uključeni u klasu 34, papir za cigarete, tube za cigarete i šibice.

(111) 11084

(151) 13.06.2014.

(210) **2012-20**

(442) **20.12.2013.**

(220) 13.01.2012.

(732) **DC COMICS**, 1700 BROADWAY NEW YORK, NY 10019 US



(540)

(550) I

(740) Popović Miladin, Đoka Miraševića 21/III, Podgorica ME

(511) **Klasa 03:** Sredstva za beljenje i druge supstance za upotrebu u perionicama, preparati za čišćenje, poliranje, ribanje i nagrizanje, sapuni, parfimerija, eterična ulja, kozmetika, losioni za kosu, paste za zube, posebno kozmetika, naime ruž za usne, sjaj za usne i ne-medicinski melem za usne, maskara, lak za nokte, puder za lice, krema za lice, losion za telo i gel za telo, puder za telo, ulje za kupanje, gel za kupanje i ne-medicinske soli za kupanje, krema i losion za ruke, krema i losion za telo, preparat za sunčanje, naime krema i losion, krema za brijanje i losion posle brijanja, losioni za čišćenje kože i ne-medicinske kupke za kupanje, dezodorans za telo, kolonjska voda i parfem, sapuni, naime, tečni sapun za kupanje, sapun u gelu i tvrdi sapun, pasta za zube, deterdžent u obliku sapuna, naime, tečni i u obliku praška, omekšivač veša, dezodorans u obliku sapuna, sapun za kožu, i šampon i balzam.

Klasa 09: Aparati i instrument naučni, pomorski, geodetski, fotografski, kinematografski, optički, za vaganje, merenje, signalizaciju, kontrolu (inspekciju), spasavanje i nastavu, aparati i instrumenti za provodenje, prekid, transformaciju, akumulaciju, regulisanje ili kontrolu električne energije, aparati za snimanje, prenos i reprodukovanje zvuka ili slike, magnetni nosioci podataka, diskovi za snimanje, automatske mašine i mehanizmi za aparate koji se pokreću novcem ili žetonom, registar kase, računске mašine, oprema za obradu podataka i kompjuteri, aparati za gašenje požara, posebno filmovi u kojima je tematika komedija, drama, akcija, avantura i/ili animacija i filmovi za emitovanje na televiziji u kojima je tematika komedija, drama, akcija, avantura i/ili animacija, audio video diskovi, i digitalni višenamenski diskovi (DVD) koji sadrže muziku, komediju, dramu, akciju, avanturu i/ili animaciju, stereo slušalice, baterije, bežični telefoni, CD plejeri, kompjuterski CD ROM diskovi koji sadrže igre, telefon i/ili radio pejdžeri, kompakt disk plejeri, radio, podloge za miša, naočare za vid, naočare za sunce i futrole za njih, oprema za igre koja se prodaje kao jedinica za igranje grupnih, računarskih igrica u zatvorenom prostiru, softver koji se može preuzimati za korišćenje u igranju online računarskih igrica, softver za računarske igrice koji se može preuzimati, softver za računarske igrice za korišćenje na mobilnim telefonima, programi za video i računarske igrice, kertridži za video igrice, računarske i video igrice koje su dizajnirane za hardverske platforme, naime, konzole za igrice i personalne računare, CD-ROM-ovi i digitalni višenamenski diskovi (DVD) za računarske igrice i računarski programi, naime, softver koji povezuje digitalizovane video i audio medije na globalnu računarsku mrežu, audio-vizuelni medijski sadržaji koji se mogu preuzimati iz oblasti zabave koji prikazuju animirane filmove, televizijske serije, komedije, i drame, računarski softver, naime, računarski softver za kontinuirano emitovanje audio-vizuelnih medijskih sadržaja preko interneta, računarski softver za kontinuirano emitovanje i skladištenje audio-vizuelnih medijskih sadržaja, audio i video plejeri koji se mogu preuzimati za medijske sadržaje samultimedijalnim i interaktivnim

funkcijama, softver za video pretragu i pravljenje zabeleški, softver za zaštitu sadržaja, softver za upravljanje bazama podataka, softver za sinhronizaciju baza podataka, računarski programi za pristup, nasumično pretraživanje i precizno pretraživanje online baza podataka, softveri koji omogućavaju korisnicima da igraju i programiraju audio, video, tekstualne i multimedijalne sadržaje zabavnog karaktera, softver za računarske aplikacije za kontinuirano emitovanje i skladištenje audio-vizuelnih medijskih sadržaja, softver za računarske aplikacije za kontinuirano emitovanje audio-vizuelnih medijskih sadržaja preko interneta, računarski softver koji se može preuzimati za kontinuirano emitovanje audio-vizuelnih medijskih sadržaja preko interneta, računarski softver koji se može preuzimati za kontinuirano emitovanje i skladištenje audio-vizuelnih medijskih sadržaja, publikacije koje se mogu preuzimati u obliku knjiga koje sadrže likove iz animiranih filmova, akcionih avantura, komedija i/ili drama, stripovi, knjige za decu, priručnici za igrice, časopisi koji sadrže likove iz animiranih filmova, akcionih avantura, komedija i/ili dramskih filmova, bojanke, dečije interaktivne knjige i časopisi iz oblasti zabave, oprema za mobilne telefone, naime oprema za slušalice, futrole za mobilni telefon i maske za mobilni telefon, kodirane magnetne kartice, naime, telefonske kartice, kreditne kartice, gotovinske kartice, debitne kartice i magnetne kartice, i dekorativni magneti.

Klasa 14: Dragoceni metali i njihove legure i proizvodi od dragocenih metala ili sa prevlakom od njih, koji nisu uključeni u druge klase, nakit, bižuterija, drago kamenje, časovničarski i hronometrijski instrumenti. posebno satovi (časovnici), ručni satovi, nakit, naime narukvice, narukvice oko članka, broševi, lanci, amajlije, manžetne, minduše, značke, ogrlice, ukrasne igle, privesci i prstenje, šnale za kaiševe.

Klasa 16: Hartija, karton i proizvodi od njih, koji nisu uključeni u druge klase, štampane stvari, knjigovezački materijal, fotografije, kancelarijski materijal, lepila za kancelarijske i kućne potrebe, umetnički materijali, kičice, pisaće mašine i kancelarijski rekviziti (izuzev nameštaja), materijali za obuku i nastavu (izuzev aparata), plastični materijal za pakovanje (koji nije uključen u druge klase), štamparska slova, klišei, posebno štampane stvari i proizvodi od papira, naime knjige koje sadrže likove iz animiranih filmova, akcionih avantura, komedija i/ili dramskih filmova, stripovi, knjige za decu, uputstva za video igrice, časopisi koji sadrže likove iz animiranih filmova, akcionih avantura, komedija i/ili dramskih filmova, bojanke, interaktivne knjige za decu, kancelarijski materijal, papir za pisanje, koverta, sveske, dnevници, beležnice, čestitke, kolekcionarske karte, litografije, hemijske olovke, olovke, pernice za njih, gumice, bojice, flomasteri, olovke u boji, pribor za slikanje, krede i table, dekorativne nalepnice, preslikači, poster, lepljive plastične folije sa papirom koji se može skinuti za montiranje slika u dekorativne svrhe, montirane i/ili nemontirane fotografije, pokrivala za knjige, markeri za knjige, kalendari, ukrasni papir za pakovanje, pokloni od papira i dekoracije od papira, naime, papirne salvete, papirni podmetači, krep papir, pozivnice, papirni stolnjaci, papirni ukrasi za torte, štampane aplikacije za vez ili tkanine, štampane aplikacije za kostime, pidžame, dukserice i majice.

Klasa 18: Koža i imitacija kože, proizvodi izradeni od ovih materijala koji nisu uključeni u druge klase, životinjska koža, koferi i putne torbe, kišobrani, suncobrani i štapovi za hodanje, bičevi, saračka i sedlarska roba, posebno atletske torbe, rančevi za bebe, rančevi, torbe za plažu, torbe za knjige, torbe za pelene, velike sportske torbe, torbe za teretanu, velike ručne tašne, male torbice za novae, torbice za nošenje oko struka, ruksaci, sportske torbe za nošenje oko struka, torbe za kupovinu, kišobrani, novčanici, modni detalji napravljeni od kože, naime novčanici, ručne tašne i kaiševi.

Klasa 25: Odeća, obuća, pokrivala za glavu, odeća za muškarce, žene i decu - naime, majice, majice kratkih rukava, dukserice, trenerke za trčanje, pantalone, gaće, šorcevi, majice bez rukava, odeća za kišu, dečije krpene portikle, suknje, bluze, haljine, treneri, veste, jakne,

kaputi, kišni kaputi, odela za sneg, kravate, kućne haljine, šeširi, kape, štitnici za sunce, rukavice, remeni (kaiševi), marama, odeća za spavanje, pidžame, žensko rublje, donji veš, čizme, cipele, patike, sandale, sokne, kratke sokne, čarape-papučice, kupaće gaćice i kostimi i maske za maskenbal i Noć Veštica prodavani u vezi sa istim.

Klasa 28: Igre i igračke, gimnastički i sportski artikli koji nisu obuhvaćeni drugim klasama, ukrasi za jelke, igračke i sportski proizvodi, uključujući igre i igračke - naime, akcijske figurice i dodaci za iste, setovi za igranje za akcijske figurice, nameštaj za igračke, plišane igračke, baloni, igračke za kupanje u kadi, igračke za jahanje na njima, oprema prodavana kao celina za igranje kartaških igara, igračke vozila, lutke, leteći diskovi, jedinice elektronske ručne igre, igraća oprema prodavana kao celina za igranje stonih igara, kartaških igara, manipulativnih igara, igara u salonu i igara sa metama akcijskog tipa, samostojeće igraće mašine sa video izlazom, slagalice i manipulative puzzle, papirnate maske za lice, skejtboardovi, klizaljke za led, igračke koje prskaju vodu, lopte - naime, lopte za igralište, fudbalske lopte, bejzbol lopte, košarkaške lopte, rukavice za bejzbol, plovci za plivanje za rekreativnu upotrebu, plutajuće table za plivanje za rekreativnu upotrebu, table za surfovanje, table za plivanje za rekreativnu upotrebu, peraje za plivanje, igračke posuđe i posude za pečenje, igračke banke, igračke snežne kugle, papirnati šeširi za zabave, i ukrasi za jelku.

Klasa 41: Obrazovne usluge, pripremanje obuke, razonoda, sportske i kulturne aktivnosti, usluge razonode, naime, pružanje video igrice online, pružanje kompjuterskih igrica online, pružanje privremenog korišćenja video igrice koje se ne mogu preuzeti (downloadovati), usluge produkcije softvera za video i kompjuterske igrice, usluge razonode u pogledu živih nastupa, komedija, drama, animiranih, i reality televizijskih serija, produkcija živih nastupa, komedija, drama, animiranih i reality televizijskih serija, distribucija i prikazivanje živih nastupa, komedija, drama i animiranih bioskopskih filmova, produkcija živih nastupa, komedija, drama i animiranih bioskopskih filmova, pozorišne predstave kako animirane tako i uživo, internet usluge koje pružaju informacije putem elektronske globalne kompjuterske mreže u oblasti razonode a posebno u vezi sa igricama, muzikom, filmovima, i televizijom, usluge pružanja web stranica koji sadrže filmske klipove (isečke), fotografije i druge multimedijalne materijale, usluge pružanja vesti o trenutnim događajima i razonodi, i informacija u vezi sa obrazovanjem i kulturnim događajima, putem globalne kompjuterske mreže, i pružanje informacija za razonodu i konkretna razonoda putem elektronske globalne komunikacione mreže a u vidu živih nastupa, komedija, drama i animiranih programa i produkcije živih nastupa, komedija, drama i animiranih filmova za distribuciju putem globalne kompjuterske mreže, usluge pružanja kompjuterske igrice kojoj se može pristupiti putem telekomunikacione mreže, i pružanje usluga elektronskog izdavaštva, naime, online izdavanje tekstova i grafičkih radova drugih koji sadrže članke, price, scenarija, stripove, strategijske vodiče, fotografije i vizuelne materijale, usluge zabavnih parkova, usluge vožnji u zabavnim parkovima, živi ili unapred snimljeni nastupi i/ili filmovi, usluge informisanja o razonodi i/ili rekreaciji, usluge klubova za razonodu.

(111) 11156

(151) 25.06.2014.

210) **2012-53**

(442) **20.12.2013.**

(220) 25.01.2012.

(732) **ALKALOID AD** SKOPLJE, BUL. ALEKSANDAR MAKEDONSKI 12, SKOPLJE MK



(540)

(550) I

(740) Popović Miladin, Đoka Miraševića 21/III, Podgorica ME

(511) **Klasa 03:** Dnevna krema sa matičnim ćelijama jabuke i maslinovim uljem.

(111) 11144

(151) 25.06.2014.

(210) **2012-22**

(442) **20.12.2013.**

(220) 16.01.2012.

(732) **SHIMANO INC**, 3-77 Oimatsu-cho, Sakai-ku, Sakai City, Osaka JP



(540)

(550) I

(740) Popović Miladin, Đoka Miraševića 21/III, Podgorica ME

(511) **Klasa 12:** Djelovi za bicikle, naime, periferni dio točka na koji je priložena guma (felne), točkovi, spone (žice) točka.

(111) 11145

(151) 25.06.2014.

(210) **2012-12**

(442) **20.12.2013.**

(220) 12.01.2012.

(732) **JT INTERNATIONAL S.A.** 1, RUE DE LA GABELLE, 1211 GENEVA 26 CH

CONTRAST

(540)

(550) I

(740) Čejović Vladimir, 13. jula 21, Podgorica ME

(511) **Klasa 34:** Duvan, prerađen ili neprerađen, duvan za pušenje, duvan za lule, duvan za ručno uvijanje, duvan za žvakanje, snus duvan, cigarete, cigare, cigarilosi, supstance za pušenje koje se prodaju odvojeno ili miješane sa duvanom, a koje nisu za medicinske svrhe ili u svrhe liječenja, duvan za ušmrkavanje, artikli za pušače, papir za cigarete, tube za cigarete i šibice.

(111) 11001

(151) 13.06.2014.

(210) **2012-135**

(442) **20.12.2013.**

(220) 05.03.2012.

(300) 2011 08899 20.12.2011. RO

(732) **JT International** S.A. 1, rue de la Gabele 1211 Geneva 26 CH

(540) SOBRANIE ULTIMO

(550) I

(740) Čejović Vladimir, 13. jula 21, Podgorica ME

(511) **Klasa 34:** Duvan, prerađen ili neprerađen, duvan za pušenje, duvan za lule, duvan za ručno uvijanje, duvan za žvakanje, snus duvan, cigarete, cigare, cigarilosi, supstance za pušenje koje se prodaju odvojeno ili miješane sa duvanom, a koje nisu za medicinske svrhe ili u svrhe liječenja, duvan za ušmrkavanje, artikli za pušače uključeni u klasu 34, papir za cigarete, tube za cigarete i šibice.

(111) 11146

(151) 25.06.2014.

(210) **2012-11**

(442) **20.12.2013.**

(220) 12.01.2012.

(300) 1591/2011 04.11.2011. RS

(732) **JT INTERNATIONAL** S.A. 1, RUE DE LA GABELLE, 1211 GENEVA 26 CH

REFINE

(540)

(550) I

(740) Čejović Vladimir, 13. jula 21, Podgorica ME

(511) **Klasa 34:** Duvan, prerađen ili neprerađen, duvan za pušenje, duvan za lule, duvan za

ručno uvijanje, duvan za žvakanje, snus duvan, cigarete, cigare, cigarilosi, supstance za pušenje koje se prodaju odvojeno ili miješane sa duvanom, a koje nisu za medicinske svrhe ili u svrhe liječenja, duvan za ušmrkavanje, artikli za pušače, papir za cigarete, tube za cigarete i šibice.

(111) 11134

(151) 25.06.2014.

(210) **2012-43**

(442) **20.12.2013.**

(220) 24.01.2012.

(732) **JT INTERNATIONAL S.A**, 1, RUE DE LA GABELLE, 1211 GENEVA 26 CH



(540) _____

(550) I

(740) Čejović Vladimir, 13. jula 21, Podgorica ME

(511) **Klasa 34:** Duvan, prerađen ili neprerađen, duvan za pušenje, duvan za lule, duvan za ručno uvijanje, duvan za žvakanje, snus duvan, cigarete, cigare, cigarilosi, supstance za pušenje koje se prodaju odvojeno ili miješane sa duvanom, a koje nisu za medicinske svrhe ili u svrhe liječenja, duvan za ušmrkavanje, artikli za pušače uključeni u klasu 34, papir za cigarete, tube za cigarete i šibice.

(111) 11157

(151) 25.06.2014.

(210) **2012-96**

(442) **20.12.2013.**

(220) 15.02.2012.

(732) **NISSAN JIDOSHA KABUSHIKI KAISHA** (ALSO TRADING AS NISSAN MOTOR CO.LTD.), NO.2 TAKARACHO, KANAGAWA-KU, YOKOHAMA-SHI, KANAGAWA-KEN JP

SHIFT_

(540)

(550) I

(740) Popović Miladin, Đoka Miraševića 21/III, Podgorica ME

(511) **Klasa 12:** Brodovi/čamci i djelovi i oprema za iste, automobili, električna vozila uključujući električne automobile, karavani, teretnjaci, kombiji, terenska vozila (SUV vozila), autobusi, rekreativna vozila (RV), sportski automobili, trkački automobili, kamioni, viljuškari, i traktori za vucu (traktori), i strukturni djelovi i oprema za iste, motorna vozila na dva točka, bicikli i djelovi i oprema za iste, kolica, auto-kiperi, auto-gurači, aparat za vuču automobila, traktori (mašine za vuču), motori i mašine za kopnena vozila, osovine za vozila, prijenosnici snage i zupčanici za mašine, amortizeri, kočnice, motori na naizmjeničnu struju/jednosmernu struju, za kopnena vozila, protiv-provalni alarmi za vozila, samolepljive gumene zakrpe za popravku unutrašnjih i spoljašnjih guma, sve uključeno u međunarodnu klasu 12.

Klasa 37: Popravljanje ili održavanje automobila, električnih vozila uključujući električne automobile, karavane, teretnjake, kombije, terenska vozila (SUV vozila), autobuse, rekreativna vozila (RV), sportske automobile, trkačke automobile, kamione, viljuškare, i traktore za vuču (traktore), i strukturnih djelova i opreme za iste, pružanje informacija o popravljanju ili održavanju automobila, električnih vozila uključujući električne automobile, karavana, teretnjaka, kombija, terenskih vozila (SUV vozila), autobusa, rekreativnih vozila (RV), sportskih automobila, trkačkih automobila, kamiona, viljuškara, i traktora za vuču (traktora), i strukturnih djelova i opreme za iste, popravljanje ili održavanje mašina i instrumenata za mjerenje ili testiranje, popravljanje ili održavanje mašina i aparata za distribuciju ili kontrolu električne energije, popravljanje ili održavanje rotacionih konvertora, popravljanje ili održavanje modifikatora faze.

(111) 11090

(151) 13.06.2014.

(210) **2012-67**

(442) **20.12.2013.**

(220) 30.01.2012.

(732) **MSD INTERNATIONAL HOLDINGS GMBH**, WEYSTRASSE 20, CH-6000 LUCERNE 6 CH

REDITABS

(540)

(550) I

(740) Ćupić Branislav, Dalmatinska 10, Podgorica ME

(511) **Klasa 05:** Farmaceutski preparati.

(111) 11202

(151) 08.07.2014.

(210) **2012-62**

(442) **20.12.2013.**

(220) 25.01.2012.

(732) **LES MILLS INTERNATIONAL LIMITED**, 22 CENTRE STREET, AUCKLAND NZ

BODYVIVE

(540)

(550) I

(740) Čupić Branislav, Dalmatinska 10, Podgorica ME

(511) **Klasa 41:** Usluge rekreacije i treninga, sportske aktivnosti, usluge obrazovanja, kreiranje i vođenje časova i programa vježbi uz muziku, usluge teretana, usluge klubova vezanih za zdrav život, usluge sportskih klubova, usluge fitnes klubova, usluge vježbi sa instruktorom, usluge savjetovanja i treniranja, usluge pružanja prostora za vježbanje, usluge sportskih vježbi sa instruktorom, usluge treniranja i obuke, usluge informacija, savjeta i konsultacija u vezi sa nekim ili svim navedenim uslugama, objava štampanog materijala i elektronskih medija, uključujući objavu muzičkih i video zapisa u digitalnom formatu vezanih za programe i treninge fitnes klubova i klubova vezanih za zdrav život.

(111) 11203

(151) 08.07.2014.

210) **2012-63**

(442) **20.12.2013.**

(220) 25.01.2012.

(732) **LES MILLS INTERNATIONAL LIMITED, 22 CENTRE STREET, AUCKLAND NZ**

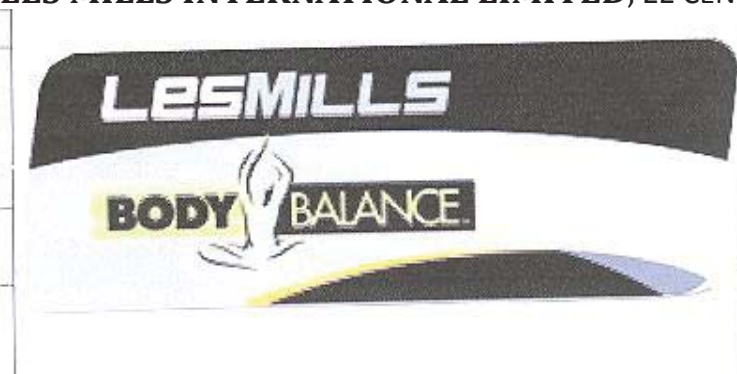

(540)

(550) I

(740) Čupić Branislav, Dalmatinska 10, Podgorica ME

(511) **Klasa 41:** Usluge rekreacije i treninga, sportske aktivnosti, usluge obrazovanja, kreiranje i vođenje časova i programa vježbi uz muziku, usluge teretana, usluge klubova vezanih za zdrav život, usluge sportskih klubova, usluge fitnes klubova, usluge vježbi sa instruktorom, usluge savjetovanja i treniranja, usluge pružanja prostora za vježbanje, usluge sportskih vježbi sa instruktorom, usluge treniranja i obuke, usluge informacija, savjeta i konsultacija u vezi sa nekim ili svim navedenim uslugama, objava štampanog materijala i elektronskih medija, uključujući objavu muzičkih i video zapisa u digitalnom formatu vezanih za programe i treninge fitnes klubova i klubova vezanih za zdrav život.

(111) 11204

(151) 08.07.2014.

210) **2012-66**

(442) **20.12.2013.**

(220) 30.01.2012.

(732) **MIKASA CORPORATION**, A CORPORATION ORGANIZED UNDER THE LAW OF JAPAN, LOCATED AT NO.11-2, 3-CHOME, KUSUNOKI-CHO, NISHI KU, HIROSHIMA-SHI, HIROSHIMA-KEN JP

MIKASA

(540)

(550) I

(740) Ćupić Branislav, Dalmatinska 10, Podgorica ME

(511) **Klasa 28:** Sportska oprema.

(111) 10994

(151) 30.05.2014.

(210) **2012-100**

(442) **20.12.2013.**

(220) 20.02.2012.

(732) **ADIDAS INTERNATIONAL MARKETING BV**, HOODOORDDREEF 9A, 1101 BA AMSTERDAM ZO NL

(540) FIT FOAM

(550) I, V

(740) Radulović Božidar, Jovana Tomaševića 9/III, Podgorica ME

(511) **Klasa 25:** Obuća, odjeća.

(111) 11087

(151) 13.06.2014.

(210) **2012-141**

(442) **20.12.2013.**

(220) 05.03.2012.

(732) **NANYANG BROTHERS TOBACCO COMPANY LIMITED**, 9 TSING YEUNG CIRCUIT, TUEN MUN, NEW TERRITORIES, HONG KONG HK



(540)

(550) I

(740) Otašević Đuro, Serdara Jola Piletića bb, Podgorica ME

(511) **Klasa 34:** Cigarete, duvan, artikli za pušače, šibice.

(111) 10959

(151) 30.05.2014.

(210) **2011-379**

(442) **20.06.2013**

(220) 25.7.2011

(732) **DAIMLER AG**, MERCEDESSTRASSE 137 70327 STUTTGART, DE**COMPACTSPACE**

(540)

(550) I

(511) **Klasa 12:** Motorna vozila i njihovi djelovi.

(111) 10990

(151) 30.05.2014.

(210) **2012-104**(442) **20.12.2013.**

(220) 20.02.2012.

(732) **ADIDAS INTERNATIONAL MARKETING BV**, HOODOORDDREEF 9A, 1101 BA AMSTERDAM ZO NL

(540) POWERWEB

(550) I, V

(740) Radulović Božidar, Jovana Tomaševića 9/III, Podgorica ME

(511) **Klasa 25:** Obuća, odjeća.

(111) 11131

(151) 02.07.2014.

(210) **2012-40**(442) **20.12.2013.**

(220) 24.01.2012.

(732) **JT INTERNATIONAL S.A**, 1, RUE DE LA GABELLE, 1211 GENEVA 26 CH

(540)

(550) I

(740) Čejović Vladimir, 13. jula 21, Podgorica ME

(511) **Klasa 34:** Duvan, prerađen ili neprerađen, duvan za pušenje, duvan za lule, duvan za ručno uvijanje, duvan za žvakanje, snus duvan, cigarete, cigare, cigarilosi, supstance za pušenje koje se prodaju odvojeno ili miješane sa duvanom, a koje nisu za medicinske svrhe ili u svrhe liječenja, duvan za ušmrkavanje, artikli za pušače uključeni u klasu 34, papir za cigarete, tube za cigarete i šibice.

(111) 11135

(151) 02.07.2014.

(210) **2012-44**

(442) **20.12.2013.**

(220) 24.01.2012.

(300) 11-1289 07.10.2011.

LV

(732) **JT INTERNATIONAL S.A**, 1, RUE DE LA GABELLE, 1211 GENEVA 26 CH

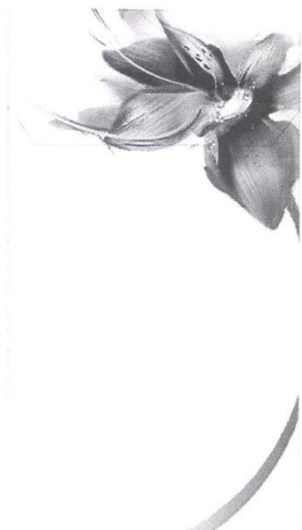

(540)

(550) I

(740) Čejović Vladimir, 13. jula 21, Podgorica ME

(511) **Klasa 34:** Duvan, prerađen ili neprerađen, duvan za pušenje, duvan za lule, duvan za ručno uvijanje, duvan za žvakanje, snus duvan, cigarete, cigare, cigarilosi, supstance za pušenje koje se prodaju odvojeno ili miješane sa duvanom, a koje nisu za medicinske svrhe ili u svrhe liječenja, duvan za ušmrkavanje, artikli za pušače uključeni u klasu 34, papir za cigarete, tube za cigarete i šibice.

(111) 10960

(151) 30.05.2014.

(210) **2011-287**

(442) **20.12.2013.**

(220) 16.06.2011.

(732) **TEVA PHARMACEUTICAL INDUSTRIES LTD.** SCIENC BASED INDUSTRIES CAMPUS, HAR HOTZVIM, P.O. BOX 1142, JERUSALIM, 921010 IL

TACNI

(540)

(550) I

(740) Popović Miladin, Đoka Miraševića 21/III, Podgorica ME

(511) **Klasa 05:** Imunosupresanti za pacijente nakon transplatancije čvrstih organa i u slučaju akutnog odbacivanja.

(111) 10999

(151) 13.06.2014.

(210) **2012-125**

(442) **20.12.2013.**

(220) 24.02.2012.

(732) **BUSINESS WIRE**, Inc. 44 Montgomery Street, 39th Flor, San Francisko, California 94104
US

BUSINESS WIRE

(540)

(550) I

(740) Ćupić Branislav, Dalmatinska 10, Podgorica ME

(511) **Klasa 09:** Elektronski bilteni, saopštenja i vijesti (novosti).

Klasa 38: Elektronski prenos poruka i slika, podataka i dokumenata, preko kompjuterskog terminala, interneta, satelitskog i bežičnog prenosa, elektronska pošta, faksimilni prenos.

Klasa 41: Objavljivanje (izdavanje) biltena, saopštenja i vijesti (novosti).

(111) 11002

(151) 13.06.2014.

(210) **2012-136**

(442) **20.12.2013.**

(220) 05.03.2012.

(300) 2011 08897 20.12.2011. RO

(732) **JT International** S.A. 1,rue de la Gabele 1211 Geneva 26 CH

(540) SOBRANIE DISTINCT

(550) I

(740) Ćejović Vladimir, 13. jula 21, Podgorica ME

(511) **Klasa 34:** Duvan, prerađen ili neprerađen, duvan za pušenje, duvan za lule, duvan za ručno uvijanje, duvan za žvakanje, snus duvan, cigarete, cigare, cigarilosi, supstance za pušenje koje se prodaju odvojeno ili miješane sa duvanom, a koje nisu za medicinske svrhe ili u svrhe liječenja, duvan za ušmrkavanje, artikli za pušaće uključeni u klasu 34, papir za cigarete, tube za cigarete i šibice.

(111) 11115

(151) 25.06.2014.

(210) **2012-32**

(442) **20.12.2013.**

(220) 23.01.2012.

(732) **PRINGLE OF SCOTLAND LIMITED**, QUARTER ONE, 15 LAURISTON PLACE, EDINBURG, EH3 9EP SCOTLAND UK

PRINGLE

(540)
(550) I
(740) Čejović Vladimir, 13. jula 21, Podgorica ME
(511) **Klasa 25:** Odjeća, obuća, pokrivala za glavu.

(111) 111116
(151) 25.06.2014.
(210) **2012-1** (442) **20.12.2013.**
(220) 05.01.2012.
(732) **THE GOODYEAR TIRE&RUBBER COMPANY**, 1144 EAST MARKET STREET, AK-
RON, OHIO 44316 US

ULTRAGRIP

(540)
(550) I
(740) Čejović Vladimir, 13. jula 21, Podgorica ME
(511) **Klasa 12:** Gume.

(111) 11081
(151) 13.06.2014.
(210) **2012-17** (442) **20.12.2013.**
(220) 12.01.2012.
(732) **UNILEVER N.V.** WEENA 455 3013 AL ROTTERDAM NL

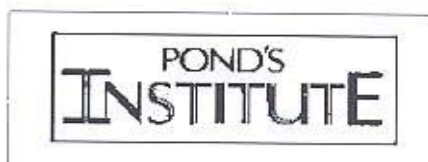

(540)
(550) I
(740) Popović Miladin, Đoka Miraševića 21/III, Podgorica ME
(511) **Klasa 44:** Usluge salona ljepote, frizerske usluge, usluge manikira i pedikira, aromaterapi-

ja, usluge sunčanja, usluge sauna, solarijuma i masaža, pružanje informacija i savjetodavne usluge vezane za zdravlje, dijete, vježbe, način života, zdravstvenu zaštitu, njegu ljepote, njegu kože, parfimeriju, dezodoranse, ishranu i ličnu higijenu.

(111) 10993

(151) 30.05.2014.

(210) **2012-101**

(442) **20.12.2013.**

(220) 20.02.2012.

(732) **ADIDAS INTERNATIONAL MARKETING BV**, HOODOORDDREEF 9A, 1101 BA AMSTERDAM ZO NL

(540) NASTASE

(550) I, V

(740) Radulović Božidar, Jovana Tomaševića 9/III, Podgorica ME

(511) **Klasa 25:** Obuća, odjeća.

(111) 11138

(151) 25.06.2014.

(210) **2012-31**

(442) **20.12.2013.**

(220) 23.01.2012.

(732) **MEGA DISPOSABLES S.A.** 148 DEKELIAS STREET, 136 78 AHARNES GR

BABYCARE BY MEGA

(540)

(550) I

(740) Radulović Božidar, Jovana Tomaševića 9/III, Podgorica ME

(511) **Klasa 03:** Vlažne maramice.

(111) 10995

(151) 30.05.2014.

(210) **2012-99**

(442) **20.12.2013.**

(220) 20.02.2012.

(732) **ADIDAS INTERNATIONAL MARKETING BV**, HOODOORDDREEF 9A, 1101 BA AMSTERDAM ZO NL

(540) geoFIT

(550) I

(740) Radulović Božidar, Jovana Tomaševića 9/III, Podgorica ME

(511) **Klasa 25:** Obuća, odjeća.

(111) 10992

(151) 13.06.2014.

(210) **2012-102**(442) **20.12.2013.**

(220) 20.02.2012.

(732) **ADIDAS INTERNATIONAL MARKETING BV**, HOODOORDDREEF 9A, 1101 BA AMSTERDAM ZO NL

(540) MICOACH

(550) I, V

(740) Radulović Božidar, Jovana Tomaševića 9/III, Podgorica ME

(511) **Klasa 25:** Obuća, odjeća.

(111) 11119

(151) 25.06.2014.

(210) **2012-143**(442) **20.12.2013.**

(220) 07.03.2012.

(732) **Alloy Rods Global, Inc.** 1105 N. Market Street, Suite 1300, Wilmington Delaware 19899-8985 US

(540)

(550) I

(740) Popović Miladin, Đoka Miraševića 21/III, Podgorica ME

(511) **Klasa 09:** Šipke za zavarivanje.

(111) 11082

(151) 01.07.2014

(210) **2012-18**(442) **20.12.2013.**

(220) 12.01.2012.

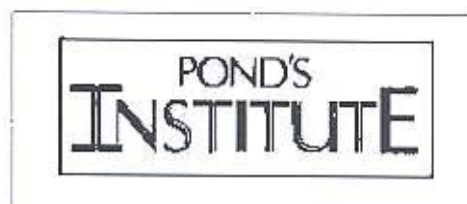
(732) **UNILEVER N.V.** WEENA 455 3013 AL ROTTERDAM NL

(540)

(550) I

- (740) Popović Miladin, Đoka Miraševića 21/III, Podgorica ME
- (511) **Klasa 03:** Sapun, medicinski sapun, preparati za čišćenje, parfimerija, eterična ulja, dezodoransi i anti-perspiranti, preparati za negu kose, šamponi i balzami, farbe za kosu, preparati za oblikovanje frizura, nemedicinski toaletni preparati, preparati za kupanje i tuširanje, preparati za njegu kože, ulja, kreme i losioni za kožu, preparati za brijanje, preparati za korišćenje prije brijanja i posle brijanja, kolonjska voda, preparati za depilaciju, preparati za potamnjivanje i preparati za zaštitu od sunca, kozmetički preparati, šminka i preparati za skidanje šminke, vazelin, preparati za njegu usana, puder u prahu, vata za kozmetičke namjene, pamučni štapići za kozmetičke namjene, maramice, jastučići ili maramice impregnirane ili natopljene losionom za čišćenje ili kozmetičkim losionom, maske za lice, pakovanja za lice.

(111) 10988

(151) 30.05.2014.

(210) **2012-106**

(442) **20.12.2013.**

(220) 21.02.2012.

(732) **MERCK SHARP&DOHME CORP. ONE MERCK DRIVE, WHITEHOUSE STATION, NEW JERSEY 08889 US**

(540) JACORIN

(550) I

(740) Ćupić Branislav, Dalmatinska 10, Podgorica ME

(511) **Klasa 05:** Farmaceutski preparati za ljudsku upotrebu.

(111) 10956

(151) 30.05.2014.

(210) **2011-326**

(442) **20.06.2013**

(220) 28.6.2011

(732) **THE PROCTER & GAMBLE COMPANY, ONE PROCTER & GAMBLE PLAZA, CINCINNATI, OHIO 45202 US**

LENOR MAGNEFIQUE

(540) I

(550) I

(740) Lutovac Branislav, Bulevar Crnojevića 93, Podgorica (ME)

(511) **Klasa 03:** Sredstva za bijeljenje i druge supstance za upotrebu kod pranja veša; preparati za njegu, tretiranje i uljepšavanje tkanina; preparati za čišćenje, poliranje, ribanje i nagrižanje; preparati za nadimljavanje za emitovanje u vazduh, atmosferu ili na tkanine u obliku dima, isparenja ili gasa

(111) 10946

(151) 30.05.2014.

(210) **2011-401**

(442) **20.06.2013**

(220) 9.8.2011

(732) **MEC AUTO D.O.O, LAMELA II-STARI AERODROM, PODGORICA ME**



(540)

(550) I

(511) **Klasa 35:** Sakupljanje u korist drugih, citavog niza roba (uključujući i njihov uvoz i transport) prodaju originalnih rezervnih dijelova omogućavajući klijentima da zgodno razgledaju i kupuju ovu robu (MBORIGINAL, MAHLE, MONROE, RUVILLE, SACHS, KWP, VALEO, TRW, SKF, SN R, PAYEN, HUTCHINSON, FAG-INA, FRAM, DELPHI, CLEAN, AIRTEX, HANSE PREASE...); takve usluge mogu se pružiti prodavnicama na veliko i malo, rasprodajama, porudžbinama postom preko kataloga ili putem elektronskih medija, na primer preko web site-a ili televizijskih programa za kupovinu; Usluge koje se sastoje od registracije, transkripcije, kompezacije ili sistematizacije pisanih saopštenja i registracija i takodje kompilacije matematičkih ili statističkih podataka;

(111) 10945

(151) 30.05.2014.

(210) **2011-404**(442) **20.06.2013**

(220) 9.8.2011

(732) **MEC AUTO DOO**, LAMELA II STARI AERODROM, PODGORICA ME

(540)

(550) I

(511) **Klasa 35:** Sakupljanje u korist drugih, citavog niza roba (uključujući i njihov uvoz i transport) prodaju originalnih rezervnih dijelova omogućavajući klijentima da zgodno razgledaju i kupuju ovu robu (MBORIGINAL, MAHLE, MONROE, RUVILLE, SACHS, KWP, VALEO, TRW, SKF, SN R, PAYEN, HUTCHINSON, FAG-INA, FRAM, DELPHI, CLEAN, AIRTEX, HANSE PREASE...); takve usluge mogu se pružiti prodavnicama na veliko i malo, rasprodajama, porudžbinama postom preko kataloga ili putem elektronskih medija, na primer preko web site-a ili televizijskih programa za kupovinu; Usluge koje se sastoje od registracije, transkripcije, kompezacije ili sistematizacije pisanih saopštenja i registracija i takodje kompilacije matematičkih ili statističkih podataka;

(111) 11155

(151) 25.06.2014

(210) **2012-30**(442) **20.12.2013.**

(220) 23.01.2012.

(732) **MEGA DISPOSABLES S.A.** 148 DEKELIAS STREET, 136 78 AHARNES GR



(540)

(550) I

(740) Radulović Božidar, Jovana Tomaševića 9/III, Podgorica ME

(511) **Klasa 05:** Higijenski ulošci.

(111) 11091

(151) 13.06.2012.

(210) **2012-75**

(442) **20.12.2013.**

(220) 02.02.2012.

(732) **ABBOTT MEDICAL OPTICS** INC. 1700 E.ST. ANDREW PLACE, SANTA ANA, CA 92705
US



(540)

(550) I

(740) Popović Miladin, Đoka Miraševića 21/III, Podgorica ME

(511) **Klasa 10:** Hirurški, medicinski, zubarski i veterinarski aparati i instrumenti, veštački udovi, oči i zubi, ortopedski artikli, hirurški materijali za zašivanje, naročito, hirurški ručni alati, medicinski aparati i instrumenti, naime, sistem za implantaciju i stavljanje intraokularnog sočiva.

(111) 11154

(151) 22.07.2014.

(210) **2011-273**

(442) **20.03.2013**

(220) 2.6.2011

(732) **EASTERN COMPANY**,S.A.E, P.O. BOX 1543 CAIRO,450 ALAHRAM STREET GIZA EG



(540)

(550) I

(740) Radulović Božidar, Jovana Tomaševića 9/III, Podgorica (ME)

(511) **Klasa 34:** Sirovi i prerađeni duvan, cigarete, duvan sa medom (moassel).

(111) 11120

(151) 25.06.2014.

(210) **2012-142**

(442) **20.12.2013.**

(220) 06.03.2012.

(732) **SK HOLDING CO.** LTD. 99 Seorin-dong Jongro-gu, Seul KR



(540)

(550) I

(740) Popović Miladin, Đoka Miraševića 21/III, Podgorica ME

(511) **Klasa 09:** Poluprovodnici, silikonski vaferi, integrisana kola, memorijske kartice, poluprovodnički čipovi, poluprovodničke memorije, poluprovodnički memorijski uređaj, aparati instrumenti naučni, pomorski, geodetski, fotografski, kinematografski, optički, za vaganje, mjerenje, signalizaciju, kontrolu (inspekciju), spašavanje i nastavu, aparati i instrumenti za provođenje, prekid, transformaciju, akumulaciju, regulisanje ili kontrolu elektriciteta, aparati za snimanje, prenos ili reprodukovanje zvuka ili slike, magnetni nosači podataka, diskovi za snimanje, kompakt diskovi, DVD-ovi i drugi digitalni medijumi za snimanje, mehanizmi za aparate koji se pokreću novcem ili žetonom, registar kase, računске mašine, oprema za obradu podataka, računari, računarski softver, aparati za gašenje požara.

(111) 10989

(151) 30.05.2014.

(210) **2012-105**

(442) **20.12.2013.**

(220) 20.02.2012.

(732) **ADIDAS INTERNATIONAL MARKETING BV**, HOODOORDDREEF 9A, 1101 BA AMSTERDAM ZO NL

(540) FORMOTION

(550) I, V

(740) Radulović Božidar, Jovana Tomaševića 9/III, Podgorica ME

(511) **Klasa 25:** Obuća, odjeća.

(111) 10961

(151) 30.05.2014.

(210) **2011-390**

(442) **20.06.2013**

(220) 2.8.2011

(732) **PHILIP MORRIS BRANDS SARL**, QUAI JEANRENAUD 3, NEUCHATEL, 2000, CH



(540)

(550) I

(511) **Klasa 34:** Duvan, sirov ili prerađen; duvanski proizvodi, naročito cigare, cigarete, cigarilosi/male cigarete, duvan za uvijanje cigareta, duvan za lule, duvan za žvakanje, duvan za šmrkanje, kretek, snus (duvan u prahu), zamena za duvan (za nemedicinsku upotrebu); artikli za pušače, naročito papir za cigarete i lule, filteri za cigarete, kutije za duvan (od neplemenitih metala), tabakere (kutije za cigarete) i pepeljare (od neplemenitih metala), lule, ručni aparati/spravice za uvijanje cigareta, upaljači; šibice. /

(111) 10834

(151) 11.04.2014.

(210) **2011-324**

(442) **20.06.2013**

(220) 28.6.2011

(732) **THE PROCTER & GAMBLE COMPANY**, ONE PROCTER & GAMBLE PLAZA, CINCINNATI, OHIO 45202 US

CLAIROL HERBAL ESSENCE

(540)

(550) I

(740) Lutovac Branislav, Bulevar Crnojevića 93, Podgorica (ME)

(511) **Klasa 03:** Sapuni, parfimerija, eterična ulja, kozmetički preparati, losioni za kosu, preparati za čišćenje, njegu i uljepšavanje kože, kože glave i kose, proizvodi za oblikovanje frizure, preparati za nijansiranje, blajhanje, farbanje i kolorisanje kose.

(111) 10837

(151) 11.04.2014.

(210) **2011-443**

(442) **20.06.2013**

(220) 5.9.2011

(732) **THE PROCTER & GAMBLE COMPANY**, ONE PROCTER & GAMBLE PLAZA, CINCINNATI, OHIO 45202 US



Naturella

(540)

(550) I

(740) Lutovac Branislav, Bulevar Crnojevića 93, Podgorica (ME)

(511) **Klasa 05:** Proizvodi za žensku higijenu, naročito maxi ulošci, mini ulošci, dnevni ulošci i tamponi; ulošci za inkontinenciju; dnevni ulošci za inkontinenciju.

(111) 10836

(151) 11.04.2014.

(210) **2011-338**

(442) **20.06.2013**

(220) 1.7.2011

(732) **THE PROCTER & GAMBLE COMPANY**, ONE PROCTER & GAMBLE PLAZA, CINCINNATI, OHIO 45202, US

SASSOON

(540)

(550) I

(740) Lutovac Branislav, Bulevar Crnojevića 93, Podgorica (ME)

(511) **Klasa 03:** Sapuni, parfimerija, esencijalna ulja, kozmetika, losioni za kosu, preparati za čišćenje, njegu, tretiranje i uljepšavanje kože, kože glave i kose, uključujući šampone, regeneratore, pjene, gelove i lakove za kosu; sredstva za bijeljenje, farbanje i kolorisanje kose.

Klasa 11: Fenovi za kosu i djelovi i oprema za njih.

Klasa 21: Četke (osim kičica) i češljevi (uključujući električne i one koje se pokreću baterijama) kao i djelovi i pribor za iste.

Klasa 41: Frizerske škole.

Klasa 42: Usluge frizerskih salona.

(111) 10832

(151) 28.03.2014.

(210) **2011-361**

(442) **20.06.2013**

(220) 18.7.2011

(732) **CUMMINS FILTRATION INC.**, 500 JACKSON STREET, COLUMBUS, INDIANA, US



(540)

(550) I

(740) Popović Miladin, Đoka Miraševića 21/III, Podgorica (ME)

(511) **Klasa 07:** Mašine i mašinski alati; motori i pogonske mašine (osim za suvozemna vozila); djelovi i dodaci za motore i pogonske mašine; mašinske spojnice i transmisioni elementi (osim za suvozemna vozila); poljoprivredne sprave osim onih kojima se ručno upravlja; inkubatori za jaja; pogonske mašine za sagorijevanje na dizel i benzin i njihovi djelovi; pogonske mašine za sagorijevanje; Generatori struje i njihovi djelovi; filteri za ulje; filteri za ulje, benzin, dizel gorivo i vazduh za motore i pogonske mašine; Uređaji protiv zagađenja za motore, pogonske mašine i industrijske instalacije; turbokompresori i djelovi toga; filteri za gorivo i strukturalni djelovi toga; filteri za vazduh i ulje i strukturalni djelovi toga; filteri za vazduh i ulje za mehaničke svrhe; filteri za hidraulične tečnosti za mehaničke svrhe; filteri za ulje, benzin, vazduh i gorivo za motore i mašinske pogone za suvozemna i nautička vozila; kani-

steri i kućišta za sve navedene filtere; aparati, uređaji i filteri za smanjenje emisije izduvnih gasova i smanjene buke kod korišćenja pogonskih mašina.

(111) 09021

(151) 11.04.2014.

(210) **2011-365**

(442) **20.06.2013**

(220) 18.7.2011

(732) **BERLIN-CHEMIE AG**, GLIENICKER WEG 125, D-12489, BERLIN, DE

SILTION

(540)

(550) I

(740) Radulović Božidar, Jovana Tomaševića 9/III, Podgorica (ME)

(511) **Klasa 05:** Farmaceutski proizvodi, dijetetske supstance prilagodjene za upotrebu u medicine.

(111) 09028

(151) 21.11.2013.

(210) **2011-366**

(442) **20.06.2013**

(220) 18.7.2011

(732) **BERLIN-CHEMIE AG**, GLIENICKER WEG 125, D-12489, BERLIN, DE

ZITON

(540)

(550) I

(740) Radulović Božidar, Jovana Tomaševića 9/III, Podgorica (ME)

(511) **Klasa 05:** Farmaceutski proizvodi, dijetetske supstance prilagođene za upotrebu u medicine.

(111) 10779

(151) 30.01.2014.

(210) **2011-466**

(442) **20.03.2013**

(220) 26.9.2011

(732) **JUB-H D.D.DOL** PRI LJUBLJANI 28, LJUBLJANA SI

TAKRIL

(540)

(550) I

(740) Radulović Božidar, Jovana Tomaševića 9/III, Podgorica (ME)

(511) **Klasa 2:** Akrilni podni premaz u različitim tonovima.

(111) 10844

(151) 11.04.2014.

(210) **2011-425**

(442) **20.06.2013**

(220) 22.8.2011

(732) **ALKALOID AD SKOPLJE**, BUL. ALEKSANDAR MAKEDONSKI 12, SKOPLJE MK



(540)

(550) I

(740) Popović Miladin, Đoka Miraševića 21/III, Podgorica (ME)

(511) **Klasa 03:** Polivitaminska dnevna krema.

(111) 10835

(151) 11.04.2014.

(210) **2011-316**

(442) **20.06.2013**

(220) 28.6.2011

(732) **THE PROCTER & GAMBLE COMPANY**, ONE PROCTER & GAMBLE PLAZA, CINCINNATI, OHIO 45202 US

FRESH BALANCE

(540)

(550) I

(740) Lutovac Branislav, Bulevar Crnojevića 93, Podgorica (ME)

(511) **Klasa 03:** Sapuni, parfimerija, eterična ulja, kozmetički preparati, losioni za kosu, preparati za čišćenje, njegu i uljepšavanje kože, kože glave i kose, proizvodi za oblikovanje frizure, preparati za nijansiranje, blajhanje, farbanje i kolorisanje kose.

(111) 09557

(151) 16.12.2013.

(210) **2011-397**

(442) **20.06.2013**

(220) 5.8.2011

(732) **GENERAL MOTORS LLC**, 300 RENAISSANCE CENTER DETROIT, MICHIGAN 48265-3000 US

CADILLAC CUE

(540)

(550) I

(740) Radulović Božidar, Jovana Tomaševića 9/III, Podgorica (ME)

(511) **Klasa 09:** Elektronski modul interfejsa koji se prodaje kao sastavni dio motornog vozila za kretanje po zemlji za žični i bežični interfejs ručnih elektronskih uređaja; softver za mobilne telefone koji korisnicima omogućava sposobnost daljinske kontrole funkcija motornog vozila, uključujući, zaključavanje i otključavanje vrata vozila, paljenje ili gašenje motora vozila; daljinsku kontrolu statusa operativnog sistema motornog vozila, uključujući, vijek motornog ulja, nivo goriva, pritisak u gumama, stanje akumulatora i da se konektuju sa kol centrom radi pomoći.

(111) 10312

(151) 24.12.2013

(210) **2011-448**

(442) **20.06.2013**

(220) 9.9.2011

(732) **SHELL BRANDS INTERNATIONAL AG**, BAARERMATTE, 6340 BAAR, CH

TACTIC

(540)
(550) I
(740) Čejović Vladimir, 13. jula 21, Podgorica (ME)
(511) **Klasa 04:** Ulja; masti; maziva; goriva.

(111) 10881
(151) 23.04.2014.
(210) **2010-187** (442) **20.06.2012**
(220) 03.06.2010
(300) BA Z 1014513A 28.01.2010
(732) KWIZDA HOLDING GMBH, DR.KARL LUEGER-RING 6, A-1010 WIEN AT

FLUPIX

(540)
(550) I
(740) Čejović Vladimir, 13. jula 21, Podgorica (ME)
(511) **Klasa 05:** Farmaceutski i veterinarski proizvodi higijenski proizvodi za upotrebu u medicini dijetetske supstance prilagođene za upotrebu u medicini, hrana za bebe flasteri, materijali za previjanje materijali za plombiranje zuba, zubarska smola sredstva za dezinfekciju proizvodi za uništavanje životinjskih štetočina fungicidi, herbicidi.

(111) 10880
(151) 09.07.2014.
(210) **2011-677** (442) **20.12.2013.**
(220) 21.12.2011.
(732) **SCHERING CORPORATION**, 2000 GALLOPING HILL ROAD, KENILWORTH, NEW JERSEY 07033 US

PURESEA

(540)
(550) I
(740) Ćupić Branislav, Dalmatinska 10, Podgorica ME
(511) **Klasa 05:** Farmaceutski preparati.

(111) 10879
(151) 10.07.2014.

(210) 2011-182

(442) 20.12.2013.

(220) 12.04.2011.

(732) **FINLANDIA VODKA WORLDWIDE LTD**, PORKKALANKATU 24, 00180 HELSINKI FI

(540)

(550) I

(740) Čupić Branislav, Dalmatinska 10, Podgorica ME

(511) **Klasa 25:** Alkoholna pića, uključujući žestoka pića.

(111) 10833

(151) 07.04.2014.

(210) 2010-361

(442) 20.03.2013

(220) 13.10.2010.

(732) **AGENCIJA ZA ZAŠTITU ŽIVOTNE SREDINE**, ul. IV Proleterske br. 19, Podgorica ME

(540)

(550) I

(740)

(511) **Klasa 35:** oglašavanje; vodjenje poslova; poslovno upravljanje; kancelarijski poslovi.

(111) 10969

(151) 09.07.2014.

(210) **2011-593**

(442) **20.12.2013.**

(220) 05.12.2011.

(732) **APATINSKA PIVARA** APATIN DOO, TRG OSLOBOĐENJA 5, APATIN RS



(540) a Ničanskoj klasifikaciji:

(550) I

(740) Božović Vesko, Rimski trg 50/11, Podgorica ME

(511) **Klasa 32:** Bezalkoholno piće od biljnih ekstrata.

(111) 10922

(151) 09.07.2014.

(210) **2011-571**

(442) **20.12.2013.**

(220) 23.11.2011.

(732) **MAKPROGRES** DOO, ILIDENSKA BB, 2310 VINICA MK



(540)

(550) I

(740) Radulović Božidar, Jovana Tomaševića 9/III, Podgorica ME

(511) **Klasa 29:** Meso, riba, živina i divljač, mesne prerađevine, konzervisano, smrznuto, sušeno i kuvano voće i povrće, želei, džemovi, kompoti, jaja, mlijeko i mlječni proizvodi, jestiva ulja i masti.

Klasa 30: kafa, čaj, kakao, šećer, pirinač, tapioka, sago, zamjena kafe, brašno i proizvodi od žitarica, hljeb, kolači, poslastice, sladoledi, med, melasa, kvasac, prašak za pecivo, so, senf, sirće, sosovi (kao začini), začini, led.

Klasa 31: poljoprivredni, vrtlarski i šumarski proizvodi i zrnevlje koji nisu uključeni u druge klase, žive životinje, svježe voće i povrće, sjeme, prirodne biljke i cvijeće, hrana za životinje, slad.

(111) 10923

(151) 09.07.2014.

(210) **2011-661**

(442) **20.12.2013.**

(220) 16.12.2011.

(732) **SIX CONTINENTS HOTELS, INC, 3 RAVINIA DRIVE, ATLANTA GEORGIA US**

HOLIDAY INN

(540)

(550) I

(740) Mihailović Vojislav, Hilendarska 5, Beograd (SR)

(511) **Klasa 43:** Hotelske usluge, usluge motela, usluge obezbeđivanja smeštaja, usluge priremenog smeštaja, usluge rezervacije za hotelski smeštaj i za druge vrste smeštaja, usluge informacija o odmoru i planiranju u vezi sa smeštajem, usluge barova, usluge koktel odmarališta i organizovanja i održavanja koktela i usluge noćnih barova, usluge kafea, restorana i snek barova, usluge kateringa za obezbeđenje hrane i pića, usluge obezbeđivanja prostora za održavanje konferencija, sastanaka i izložbi, usluge prijave i odjave u hotelima, usluge elektronskih informacija koje se odnose na hotele, savetodavne usluge i usluge konsultacije koje se odnose na gore navedeno.

(111) 10976

(151) 09.07.2014.

(210) **2011-650**

(442) **20.12.2013.**

(220) 15.12.2011.

(732) **EUROPAPERESS HOLDING D.O.O. KORANSKA 2, ZAGREB HR**

REVIIJA ZA ZDRAVLJE I DUG ŽIVOT
DOKTOR
U KUĆI

(540)

(550) I

(740) Lutovac Branislav, Bulevar Crnojevića 93, Podgorica ME

(511) **Klasa 09:** naučni, nautički, geodetski, fotografski, kinematografski i optički aparati i instrumenti kao i aparati i instrumenti za vaganje, mjerenje, signalizaciju, kontrolu (inspekciju), za pomoć (spašavanje) i za obuku, aparati i instrumenti za vođenje, distribuiranje, transformiranje, akumuliranje, podešavanje ili upravljanje električne struje, aparati za sni-

manje, prenos, reprodukciju zvuka ili slika, magnetne podloge za snimanje, akustične ploče, automati i mehanizmi za automatske uređaje koji se pokreću uz prethodno ubacivanje metalnih novčića, registarske kase, računari, oprema za obradu podataka i računara, uređaji za gašenje požara, a pogotovo elektronske publikacije.

Klasa 16: Papir, karton i proizvodi od tih materijala koji nisu obuhvaćeni drugim klasama, a pogotovo novine, časopisi, magazini, publikacije, knjige, štamparski proizvodi, proizvodi za uvezivanje knjiga, fotografije, pribor za pisanje, ljepila (ljepljive tvari za papirne proizvode ili za domaćinstvo), slikarski pribor, kistovi, pisaće mašine i kancelarijski pribor (osim namještaja), oprema za nastavu i obuku (osim aparata), plastični materijali za ambalažu (koji nisu obuhvaćeni drugim razredima), štamparska slova, klišei.

Klasa 35: oglašavanje i reklamiranje, vodenje komercijalnih poslova, komercijalna administracija, kancelarijski poslovi.

Klasa 38: Telekomunikacije.

Klasa 41: Obuka, stručno osposobljavanje, razonoda, sportske i kulturne djelatnosti.

(111) 10977

(151) 09.07.2014.

(210) **2011-651**

(442) **20.12.2013.**

(220) 15.12.2011.

(732) **EUROPAPRESS HOLDING** D.O.O. KORANSKA 2, ZAGREB HR

GLORIA GLAM

(540)

(550) I

(740) Lutovac Branislav, Bulevar Crnojevića 93, Podgorica ME

(511) **Klasa 09:** Naučni, nautički, geodetski, fotografski, kinematografski i optički aparati i instrumenti kao i aparati i instrumenti za vaganje, mjerenje, signalizaciju, kontrolu (inspekciju), za pomoć (spašavanje) i za obuku, aparati i instrumenti za vođenje, distribuiranje, transformiranje, akumuliranje, podešavanje ili upravljanje električne struje, aparati za snimanje, prenos, reprodukciju zvuka ili slika, magnetne podloge za snimanje, akustične ploče, automati i mehanizmi za automatske uređaje koji se pokreću uz prethodno ubacivanje metalnih novčića, registarske kase, računari, oprema za obradu podataka i računara, uređaji za gašenje požara, a pogotovo elektronske publikacije.

Klasa 16: Papir, karton i proizvodi od tih materijala koji nisu obuhvaćeni drugim klasama, a pogotovo novine, časopisi, magazini, publikacije, knjige, štamparski proizvodi, proizvodi za uvezivanje knjiga, fotografije, pribor za pisanje, ljepila (ljepljive tvari za papirne proizvode ili za domaćinstvo), slikarski pribor, kistovi, pisaće mašine i kancelarijski pribor (osim namještaja), oprema za nastavu i obuku (osim aparata), plastični materijali za ambalažu (koji nisu obuhvaćeni drugim razredima), štamparska slova, klišei.

Klasa 35: Oglašavanje i reklamiranje, vodenje komercijalnih poslova, komercijalna administracija, kancelarijski poslovi.

Klasa 38: Telekomunikacije.

Klasa 41: Obuka, stručno osposobljavanje, razonoda, sportske i kulturne djelatnosti.

(111) 10978

(151) 09.07.2014.

(210) **2011-652**

(442) **20.12.2013.**

(220) 15.12.2011.

(732) **EUROPAPRESS HOLDING** D.O.O. KORANSKA 2, ZAGREB HR

GLAM

(540)

(550) I

(740) Lutovac Branislav, Bulevar Crnojevića 93, Podgorica ME

(511) **Klasa 09:** naučni, nautički, geodetski, fotografski, kinematografski i optički aparati i instrumenti kao i aparati i instrumenti za vaganje, mjerenje, signalizaciju, kontrolu (inspekciju), za pomoć (spašavanje) i za obuku, aparati i instrumenti za vođenje, distribuiranje, transformiranje, akumuliranje, podešavanje ili upravljanje električne struje, aparati za snimanje, prenos, reprodukciju zvuka ili slika, magnetne podloge za snimanje, akustične ploče, automati i mehanizmi za automatske uređaje koji se pokreću uz prethodno ubacivanje metalnih novčića, registarske kase, računari, oprema za obradu podataka i računara, uređaji za gašenje požara, a pogotovo elektronske publikacije.

Klasa 16: Papir, karton i proizvodi od tih materijala koji nisu obuhvaćeni drugim klasama, a pogotovo novine, časopisi, magazini, publikacije, knjige, štamparski proizvodi, proizvodi za uvezivanje knjiga, fotografije, pribor za pisanje, ljepila (ljepljive tvari za papirne proizvode ili za domaćinstvo), slikarski pribor, kistovi, pisaće mašine i kancelarijski pribor (osim namještaja), oprema za nastavu i obuku (osim aparata), plastični materijali za ambalažu (koji nisu obuhvaćeni drugim razredima), štamparska slova, klišeji.

Klasa 35: Oglašavanje i reklamiranje, vodenje komercijalnih poslova, komercijalna administracija, kancelarijski poslovi.

Klasa 38: Telekomunikacije.

Klasa 41: Obuka, stručno osposobljavanje, razonoda, sportske i kulturne djelatnosti.

(111) 11044

(151) 09.07.2014.

210) **2011-215**

(442) **20.12.2013.**

(220) 04.05.2011.

(732) **DOMPE S.P.A.** LOCALITA CAMPO DI PILE SNC,67100 L'AQUILA AQ IT

MIOTENS

(540)

(550) I

(740) Popović Miladin, Đoka Miraševića 21/III, Podgorica ME

(511) **Klasa 05:** Farmaceutski i veterinarski preparati, sanitarni preparati za medicinsku upotrebu, dijetetske supstance prilagođene za upotrebu u medicini, hrana za bebe, flasteri, materijali za zavijanje, materijali za plombiranje zuba, zubarska smola, dezinfekciona sredstva, preparati za uništavanje štetočina, fungicidi, herbicidi.

(111) 11045

(151) 09.07.2014.

(210) **2011-587**

(442) **20.12.2013.**

(220) 02.12.2011.

(732) **LG LIFE SCIENCES, LTD.** 92, SINMUNNO 2-GA JONGNO-GU SEUL KR

FACTIVE

(540)

(550) I

(740) Popović Miladin, Đoka Miraševića 21/III, Podgorica ME

(511) **Klasa 05:** Farmaceutski i medicinski preparati i supstance.

(111) 11181

(151) 09.07.2014.

(210) **2011-203**

(442) **20.12.2013.**

(220) 27.04.2011.

(732) **REMEDICA LTD,** AHARNON STR, IPSONAS INDUSTRIAL ESTATE, LIMASSOL CY

Mycoril

(540)

(550) I

(511) **Klasa 05:** Farmaceutski i veterinarski preparati, sanitarni preparati za medicinsku upotrebu, dijetetske supstance prilagođene za upotrebu u medicini, hrana za bebe, flasteri, materijali za zavijanje, materijali za plombiranje zuba, zubarske smole, dezinfekciona sredstva, preparati za uništavanje štetočina, fungicidi, herbicidi, sanitarni preparati za upotrebu u medicini i za ličnu higijenu, dezodoransi koji nisu za ljudsku upotrebu, cigarete bez duvana za medicinske svrhe.

(111) 11188

(151) 09.07.2014.

(210) **2011-204**

(442) **20.12.2013.**

(220) 27.04.2011.

(732) **REMEDICA LTD,** AHARNON STR, IPSONAS INDUSTRIAL ESTATE, LIMASSOL CY

Imuprin

(540)

(550) I

(511) **Klasa 05:** Farmaceutski i veterinarski preparati, sanitarni preparati za medicinsku upotrebu, dijetetske supstance prilagođene za upotrebu u medicini, hrana za bebe, flasteri, materijali za zavijanje, materijali za plombiranje zuba, zubarske smole, dezinfekciona sredstva, preparati za uništavanje štetočina, fungicidi, herbicidi, sanitarni preparati za upotrebu u medicini i za ličnu higijenu, dezodoransi koji nisu za ljudsku upotrebu, cigarete bez duvana za medicinske svrhe.

(111) 11189

(151) 09.07.2014.

(210) **2011-205**

(442) **20.12.2013.**

(220) 27.04.2011.

(732) **REMEDICA LTD**, AHARNON STR, IPSONAS INDUSTRIAL ESTATE, LIMASSOL CY

Cyclovax

(540)

(550) I

(511) **Klasa 05:** Farmaceutski i veterinarski preparati, sanitarni preparati za medicinsku upotrebu, dijetetske supstance prilagođene za upotrebu u medicini, hrana za bebe, flasteri, materijali za zavijanje, materijali za plombiranje zuba, zubarske smole, dezinfekciona sredstva, preparati za uništavanje štetočina, fungicidi, herbicidi, sanitarni preparati za upotrebu u medicini i za ličnu higijenu, dezodoransi koji nisu za ljudsku upotrebu, cigarete bez duvana za medicinske svrhe.

(111) 11190

(151) 09.07.2014.

(210) **2011-206**

(442) **20.12.2013.**

(220) 27.04.2011.

(732) **REMEDICA LTD**, AHARNON STR, IPSONAS INDUSTRIAL ESTATE, LIMASSOL CY

Clavomid

(540)

(550) I

(511) **Klasa 05:** Farmaceutski i veterinarski preparati, sanitarni preparati za medicinsku upotrebu, dijetetske supstance prilagođene za upotrebu u medicini, hrana za bebe, flasteri, materijali za zavijanje, materijali za plombiranje zuba, zubarske smole, dezinfekciona sredstva, preparati za uništavanje štetočina, fungicidi, herbicidi, sanitarni preparati za upotrebu u medicini i za ličnu higijenu, dezodoransi koji nisu za ljudsku upotrebu, cigarete bez duvana za medicinske svrhe.

(111) 11191

(151) 09.07.2014.

(210) **2011-207**

(442) **20.12.2013.**

(220) 27.04.2011.

(732) **REMEDICA LTD**, AHARNON STR, IPSONAS INDUSTRIAL ESTATE, LIMASSOL CY

Aremed

(540)

(550) I

(511) **Klasa 05:** Farmaceutski i veterinarski preparati, sanitarni preparati za medicinsku upotrebu, dijetetske supstance prilagođene za upotrebu u medicini, hrana za bebe, flasteri,

materijali za zavijanje, materijali za plombiranje zuba, zubarske smole, dezinfekciona sredstva, preparati za uništavanje štetočina, fungicidi, herbicidi, sanitarni preparati za upotrebu u medicini i za ličnu higijenu, dezodoransi koji nisu za ljudsku upotrebu, cigarete bez duvana za medicinske svrhe.

(111) 10896

(151) 20.06.2014.

(210) **2012-152**

(442) **20.12.2013.**

(220) 12.03.2012.

(300) CTM 12.01.2012. 10557346

(732) **THE PROCTER&GAMBLE COMPANY**, THE PROCTER&GAMBLE PLAZA, CINCINNATI, OHIO 45202 US

гачунара



(540)

(550) I

(740) Lutovac Branislav, Bulevar Crnojevića 93, Podgorica ME

(511) **Klasa 03:** Sredstva za bijeljenje i druge supstance za upotrebu kod pranja veša, preparati za čišćenje, poliranje, ribanje i nagrizanje, sapuni.

(111) 10897

(151) 20.06.2014.

(210) **2012-155**

(442) **20.12.2013.**

(220) 14.03.2012.

(732) **JOHNSON CONTROLS HYBRID AND RECYCLING GMBH**, AM LEINEUFER 51, 30419, HANNOVER DE

(540) VARTA

(550) I

(740) Popović Miladin, Đoka Miraševića 21/III, Podgorica ME

(511) **Klasa 09:** Industrijske baterije.

(111) 10898

(151) 20.06.2014.

(210) **2012-156**

(442) **20.12.2013.**

(220) 14.03.2012.

(732) **JOHNSON CONTROLS HYBRID AND RECYCLING GMBH**, AM LEINEUFER 51,

30419, HANNOVER DE



(540)

(550) I

(740) Popović Miladin, Đoka Miraševića 21/III, Podgorica ME

(511) **Klasa 09:** Industrijske baterije.

(111) 10901

(151) 20.06.2014.

(210) **2012-157**

(442) **20.12.2013.**

(220) 16.03.2012.

(732) **MSD CONSUMER CARE, INC.** 3030 JACKSON AVENUE, MEMPHIS, TENNESSEE 38151 US

(540) SOLARCAINE

(550) I

(740) Čupić Branislav, Dalmatinska 10, Podgorica ME

(511) **Klasa 05:** Farmaceutski preparati.

(111) 10899

(151) 20.06.2014.

210) **2012-158**

(442) **20.12.2013.**

(220) 19.03.2012.

(732) **CROSSCARE LIMITED**, BROOMHILL ROAD, TALLAGHT, DUBLIN 24 IE

(540) COLIEF

(550) I

(740) Popović Miladin, Đoka Miraševića 21/III, Podgorica ME

(511) **Klasa 05:** Preparati za smanjenje intolerancije na laktozu kod dojenčadi, dodatak ishrani koji se dodaje u mlijeko bebama.

(111) 10900

(151) 20.06.2014.

(210) **2012-160**

(442) **20.12.2013.**

(220) 20.03.2012.

(732) **ABBOT LABORATORIES**, 100 ABBOTT PARK ROAD, ABBOT PARK, ILLINOIS 60064 US

(540) ABBVIE

(550) I

(740) Popović Miladin, Đoka Miraševića 21/III, Podgorica ME

(511) **Klasa 05:** Farmaceutski preparati, veterinarski preparati, sanitarni preparati za upotrebu u medicini, dijeteske supstance prilagođene za upotrebu u medicini.

Klasa 42: usluge medicinskog istraživanja, usluge naučnog i tehnološkog istraživanja u vezi sa njima.

(111) 10902

(151) 20.06.2014.

(210) **2012-161**

(442) **20.12.2013.**

(220) 27.03.2012.

(732) **FEDERAL-MOGUL PRODUCTS, INC.** 26555 NORTHWESTERN HIGHWAY, SOUTHFIELD, MICHIGAN 48033 US

(540) WAGNER

(550) I

(740) Radulović Božidar, Jovana Tomaševića 9/III, Podgorica ME

(511) **Klasa 12:** kočnice, kočione pločice, kočione papučice, kočine obloge, kočioni rotori, kočioni bubnjevi, kočioni blokovi, kočioni hardver, kvačila i obloge za kvačila, hidraulika kočnica i kvačila.

(111) 10947

(151) 03.07.2014.

(210) **2012-162**

(442) **20.12.2013.**

(220) 28.03.2012.

(732) **BAYER AKTIENGESELLSCHAFT**, KAISER-WILHELM-ALLEE, 51373 LEVERKUSEN DE

(540) CANES-NAIL

(550) I

(740) Čejović Vladimir, 13. jula 21, Podgorica ME

(511) **Klasa 03:** Kozmetika.

Klasa 05: Farmaceutski preparati, sanitarni preparati za upotrebu u medicini, flasteri, materijali za zavijanje, dezinfekciona sredstva.

Klasa 08: Strugalice.

(111) 10930

(151) 03.07.2014.

(210) **2012-165**

(442) **20.12.2013.**

(220) 02.04.2012.

(732) **D.O.O ŠIMŠIĆ-MONTIMILK** ZA PROIZVODNJU I USLUGE, LAZINE BB DANILOVGRAD ME



(540)

(550) I

(511) **Klasa 29:** Jaja, mlijeko i mliječni proizvodi.

(111) 10979

(151) 21.07.2014.

(210) **2012-167**(442) **20.12.2013.**

(220) 04.04.2012.

(732) **THE COCA-COLA COMPANY**, ONE COCA-COLA PLAZA, ATLANTA, GEORGIA 30313 US

(540)

(550) I

(740) Popović Miladin, Đoka Miraševića 21/III, Podgorica ME

(511) **Klasa 21:** Kućne ili kuhinjske sprave i posude, češljevi i sunđeri, četke (izuzev kičica), materijali za pravljenje četki, pribor za čišćenje, čelična vuna, neprerađeno ili poluprerađeno staklo (osim stakla koje se koristi u građevinarstvu), staklarija, porcelan i grnčanja koja nije uključena u druge klase.**Klasa 32:** Pivo, mineralne i sodne vode i druga bezalkoholna pića, voćni napici i voćni sokovi, sirupi i drugi preparati za proizvodnju pića.

(111) 10931

(151) 03.07.2014.

(210) **2012-173**(442) **20.12.2013.**

(220) 05.04.2012.

(732) **EXXON MOBIL CORPORATION**, 5959 LAS COLINAS BOULEVARD, IRVING, TEXAS

75039-2298 US

(540) DTE

(550) I

(740) Ćupić Branislav, Dalmatinska 10, Podgorica ME

(511) **Klasa 04:** Ulje i maziva za podmazivanje.

(111) 10980

(151) 21.07.2014.

(210) **2012-175**

(442) **20.12.2013.**

(220) 06.04.2012.

(732) **THE COCA-COLA COMPANY**, ONE COCA-COLA PLAZA, ATLANTA, GEORGIA 30313 US



(540) _____

(550) I

(740) Popović Miladin, Đoka Miraševića 21/III, Podgorica ME

(511) **Klasa 06:** Obični metali i njihove legure, metalni građevinski materijali, metalne prenosive konstrukcije, materijali od metala za željezničke šine, neelektrični kablovi i žice od običnog metala, bravarski proizvodi, mali metalni gvoždarski proizvodi, cevčice i cevi od metala, sefovi, proizvodi od običnih metala koji nisu uključeni u druge klase, rude.

Klasa 16: Hartija, karton i proizvodi od njih, koji nijesu uključeni u druge klase, štampane stvari, knjigovezački materijal, fotografije, kancelarijski materijal, lepkovi za kancelarijske i kućne potrebe, umetnički materijali, kičice, pisaće mašine i kancelarijski pribor (izuzev nameštaja), materijali za obuku i nastavu (izuzev aparata), plastični materijal za pakovanje (koji nije uključen u druge klase), štamparska slova, klišei.

Klasa 21: Kućne ili kuhinjske sprave i posude, češljevi i sunđeri, četke (izuzev kičica), materijali za pravljenje četki, pribor za čišćenje, čelična vuna, neprerađeno ili poluprerađeno staklo (osim stakla koje se koristi u građevinarstvu), staklarija, porcelan i grnčarija koja nije uključena u druge klase.

Klasa 25: Odeća, obuća, pokrivala za glavu.

Klasa 28: Igre i igračke, gimnastički i sportski artikli koji nijesu obuhvaćeni drugim klasama, ukrasi za jelke.

Klasa 32: Pivo, mineralne i sodne vode i druga bezalkoholna pića, voćni napici i voćni sokovi, sirupi i drugi preparati za proizvodnju pića.

Klasa 41: Obrazovne usluge, pripremanje obuke, razonoda, sportske i kulturne aktivnosti.

(111) 10948

(151) 03.07.2014.

(210) **2012-176**

(442) **20.12.2013.**

(220) 09.04.2012.

(732) **ALKALOID AD** SKOPLJE, BUL. ALEKSANDAR MAKEDONSKI 12, SKOPLJE MK



(540) _____

(550) I

(740) Popović Miladin, Đoka Miraševića 21/III, Podgorica ME

(511) **Klasa 03:** Šampon i penušava kupka za djecu.

(111) 10949

(151) 03.07.2014.

(210) **2012-177**

(442) **20.12.2013.**

(220) 09.04.2012.

(732) **ALKALOID AD** SKOPLJE, BUL. ALEKSANDAR MAKEDONSKI 12, SKOPLJE MK

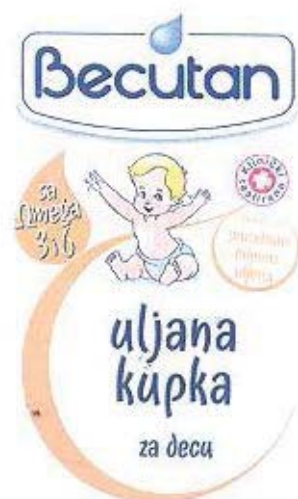

(540)

(550) I

(740) Popović Miladin, Đoka Miraševića 21/III, Podgorica ME

(511) **Klasa 03:** Uljana kupka za djecu.

(111) 11009

(151) 20.06.2014.

(210) 2012-179

(442) 20.12.2013.

(220) 10.04.2012.

(732) **SVJETLOST-MONT**, BULEVAR REVOLUCIJE G-12, BAR ME

(540)

(550) I, V, T

(740) VIS LEGIS D.O.O. POSLOVNI CENTAR G-9, BAR ME

(511) **Klasa 39:** Transportne usluge, pakovanje i skladištenje robe, organizovanje putovanja.**Klasa 41:** Obrazovne usluge, pripremanje obuke, razonoda, sportske i kulturne aktivnosti.**Klasa 43:** Usluge obezbeđivanja hrane i pića, privremeni smeštaj.

(111) 10981

(151) 21.07.2014.

(210) 2012-183

(442) 20.12.2013.

(220) 12.04.2012.

(732) **THE COCA-COLA COMPANY**, ONE COCA-COLA PLAZA, ATLANTA, GEORGIA 30313 US

(540)

(550) I

(740) Popović Miladin, Đoka Miraševića 21/III, Podgorica ME

(511) **Klasa 16:** Hartija, karton i proizvodi od njih, koji nijesu uključeni u druge klase, štampane stvari, knjigovezački materijal, fotografije, kancelarijski materijal, lepkovi za kancelarijske i kućne potrebe, umetnički materijali, kičice, pisaće mašine i kancelarijski pribor (izuzev namještaja), materijali za obuku i nastavu (izuzev aparata), plastični materijal za pakovanje (koji nije uključen u druge klase), štamparska slova, klišeji.

Klasa 25: Odeća, obuća, pokrivala za glavu.

Klasa 28: Igre i igračke, gimnastički i sportski artikli koji nijesu obuhvaćeni drugim klasama, ukrasi za jelke.

Klasa 29: Meso, riba, živina i divljač, mesne prerađevine, konzervisano, zamrznuto, sušeno i kuvano voće i povrće, želei, džemovi, kompoti, jaja, mleko i mlečni proizvodi, jestiva ulja i masti.

Klasa 30: Kafa, čaj, kakao, šećer, pirinač, tapioka, sago, zamena kafe, brašno i proizvodi od žitarica, hleb, kolači i poslastice, sladoledi, med, melasa, kvasac, prašak za pecivo, so, senf, sirće, sosovi (kao dodaci), začini, led.

Klasa 32: Pivo, mineralne i sodne vode i druga bezalkoholna pića, voćni napici i voćni sokovi, sirupi i drugi preparati za proizvodnju pića.

Klasa 41: Obrazovne usluge, pripremanje obuke, razonoda, sportske i kulturne aktivnosti.

(111) 10950

(151) 03.07.2014.

(210) **2012-184**

(442) **20.12.2013.**

(220) 12.04.2012.

(732) **ALKALOID AD** Skoplje, Bul. Aleksandar Makedonski 12, Skoplje MK



(540) **ni klasifikacija**

(550) T

(740) Popović Miladin, Đoka Miraševića 21/III, Podgorica ME

(511) **Klasa 03:** Krema za njegu masne i problematične kože.

(111) 10951

(151) 20.06.2014.

(210) **2012-185**

(442) **20.12.2013.**

(220) 12.04.2012.

(732) **ALKALOID AD** Skoplje, Bul. Aleksandar Makedonski 12, Skoplje MK



(540)

(550) T

(740) Popović Miladin, Đoka Miraševića 21/III, Podgorica ME

(511) **Klasa 03:** Krema za njegu masne i problematične kože.

(111) 10904

(151) 20.06.2014.

(210) **2012-186**(442) **20.12.2013.**

(220) 12.04.2012.

(732) **ALKALOID AD** Skoplje, Bul. Aleksandar Makedonski 12, Skoplje MK

(540)

(550) T

(740) Popović Miladin, Đoka Miraševića 21/III, Podgorica ME

(511) **Klasa 03:** Mleko za tijelo za normalnu do suve kože.

(111) 10952

(151) 20.06.2014.

(210) **2012-187**(442) **20.12.2013.**

(220) 12.04.2012.

(732) **ALKALOID AD** Skoplje, Bul. Aleksandar Makedonski 12, Skoplje MK

(540) _____

(550) T

(740) Popović Miladin, Đoka Miraševića 21/III, Podgorica ME

(511) **Klasa 03:** Podloga za šminku za kombinovanu i masnu kožu.

(111) 10903

(151) 20.06.2014.

(210) **2012-188**(442) **20.12.2013.**

(220) 12.04.2012.

(732) **ALKALOID AD-SKOPLJE, BUL. ALEKSANDAR MAKEDONSKI 12, SKOPLJE MK**

(540)

(550) T

(740) Popović Miladin, Đoka Miraševića 21/III, Podgorica ME

(511) **Klasa 03:** Podloga za šminku za kombinovanu i masnu kožu.

(111) 10932

(151) 03.07.2014.

(210) **2012-189**(442) **20.12.2013.**

(220) 12.04.2012.

(732) **Engel&Volkers Marken GmbH&Co.KG**, Dorfstrabe 34a, 22113 Oststeinbek-Havighorst DE

(540) ENGEL & VÖLKERS

(550) I, V

(740) Radulović Božidar, Jovana Tomaševića 9/III, Podgorica ME

(511) **Klasa 35:** Komercijalne informacije i saveti za potrošače u vezi sa vozilima za kretanje po vodi, posebno novih i polovnih čamaca/brodova, kao i jahti, pripremanje ugovora za treća lica u vezi sa sticanjem/kupovinom i prodajom čamaca/brodova i jahti, organizovanje ugovora za treća lica u vezi sa zakupom čarter jahti i čarter čamaca/brodova.**Klasa 39:** Iznajmljivanje čamaca/ brodova i jahti, organizovanje najma čamaca/brodova i jahti, tzv. čartering jahti, brokerski poslovi u vezi sa plovilima.

(111) 11012

(151) 07.07.2014.

(210) **2012-194**(442) **20.12.2013.**

(220) 12.04.2012.

(732) **JT International S.A.** 1, rue de la Gabelle, 1211 Geneva 26 CH

(540) Glamour

(550) I

(740) Čejović Vladimir, 13. jula 21, Podgorica ME

(511) **Klasa 34:** Duvan, prerađen ili neprerađen, duvan za pušenje, duvan za lule, duvan za ručno uvijanje, duvan za žvakanje, snus duvan, cigarete, cigare, cigarilosi, supstance za pušenje koje se prodaju odvojeno ili miješane sa duvanom, a koje nisu za medicinske svrhe ili u svrhe liječenja, duvan za ušmrkavanje, artikli za pušače uključeni u klasu 34, papir za cigarete, tube za cigarete i šibice.

(111) 10982

(151) 21.07.2014.

(210) **2012-197**(442) **20.12.2013.**

(220) 17.04.2012.

(732) **THE COCA-COLA COMPANY**, ONE COCA-COLA PLAZA, ATLANTA, GEORGIA 30313 US

(540)

(550) I

(740) Popović Miladin, Đoka Miraševića 21/III, Podgorica ME

(511) **Klasa 16:** Hartija, karton i proizvodi od njih, koji nijesu uključeni u druge klase, štampane stvari, knjigovezački materijal, fotografije, kancelarijski materijal, lepkovi za kancelarijske i kućne potrebe, umetnički materijali, kičice, pisaće mašine i kancelarijski pribor (izuzev na-

meštaja), materijali za obuku i nastavu (izuzev aparata), plastični materijal za pakovanje (koji nije uključen u druge klase), štamparska slova, klišeji.

Klasa 25: Odeća, obuća, pokrivala za glavu.

Klasa 28: Igre i igračke, gimnastički i sportski artikli koji nijesu obuhvaćeni drugim klasama, ukrasi za jelke.

Klasa 29: Meso, riba, živina i divljač, mesne prerađevine, konzervisano, zamrznuto, sušeno i kuvano voće i povrće, želei, džemovi, kompoti, jaja, mleko i mlečni proizvodi, jestiva ulja i masti.

Klasa 30: Kafa, čaj, kakao, šećer, pirinač, tapioka, sago, zamena kafe, brašno i proizvodi od žitarica, hleb, kolači i poslastice, sladoledi, med, melasa, kvasac, prašak za pecivo, so, senf, sirće, sosovi (kao dodaci), začini, led.

Klasa 30: Kafa, čaj, kakao, šećer, pirinač, tapioka, sago, zamena kafe, brašno i proizvodi od žitarica, hleb, kolači i poslastice, sladoledi, med, melasa, kvasac, prašak za pecivo, so, senf, sirće, sosovi (kao dodaci), začini, led.

Klasa 41: Obrazovne usluge, pripremanje obuke, razonoda, sportske i kulturne aktivnosti.

(111) 10983

(151) 21.07.2014.

(210) **2012-198**

(442) **20.12.2013.**

(220) 17.04.2012.

(732) **THE COCA-COLA COMPANY**, ONE COCA-COLA PLAZA, ATLANTA, GEORGIA 30313 US



(540) _____

(550) I

(740) Popović Miladin, Đoka Miraševića 21/III, Podgorica ME

(511) **Klasa 16:** Hartija, karton i proizvodi od njih, koji nijesu uključeni u druge klase, štampane stvari, knjigovezački materijal, fotografije, kancelarijski materijal, lepkovi za kancelarijske i kućne potrebe, umetnički materijali, kičice, pisaće mašine i kancelarijski pribor (izuzev nameštaja), materijali za obuku i nastavu (izuzev aparata), plastični materijal za pakovanje (koji nije uključen u druge klase), štamparska slova, klišeji.

Klasa 25: Odeća, obuća, pokrivala za glavu.

Klasa 28: Igre i igračke, gimnastički i sportski artikli koji nijesu obuhvaćeni drugim klasama, ukrasi za jelke.

Klasa 29: Meso, riba, živina i divljač, mesne prerađevine, konzervisano, zamrznuto, sušeno i kuvano voće i povrće, želei, džemovi, kompoti, jaja, mleko i mlečni proizvodi, jestiva ulja i masti.

Klasa 30: Kafa, čaj, kakao, šećer, pirinač, tapioka, sago, zamena kafe, brašno i proizvodi od žitarica, hleb, kolači i poslastice, sladoledi, med, melasa, kvasac, prašak za pecivo, so, senf, sirće, sosovi (kao dodaci), začini, led.

Klasa 32: Pivo, mineralne i sodne vode i druga bezalkoholna pića, voćni napici i voćni sokovi, sirupi i drugi preparati za proizvodnju pića.

Klasa 41: Obrazovne usluge, pripremanje obuke, razonoda, sportske i kulturne aktivnosti.

(111) 10905

(151) 07.07.2014.

(210) **2012-206**

(442) **20.12.2013.**

(220) 20.04.2012.

(732) **FARMACEUTSKO-HEMIJSKA INDUSTRIJA ZDRAVLJE AD**, VLAJKOVA 199, LE-SKOVAC RS

(540) ANZOVIP

(550) I

(740) Popović Miladin, Đoka Miraševića 21/III, Podgorica ME

(511) **Klasa 05:** Farmaceutski i veterinarski preparati, sanitarni proizvodi za upotrebu u medicini, dijetetska hrana i supstance prilagođene za upotrebu u medicini i veterinarsku upotrebu, hrana za bebe, dijetetski dodaci (dodaci ishrani) za ljude i životinje, flasteri, materijali za zavijanje, materijali za plombiranje zuba, zubarska smola, dezinfekciona sredstva, preparati za unštavanje stetocina, fungicidi, herbicidi.

(111) 10908

(151) 20.06.2014.

(210) **2012-207**

(442) **20.12.2013.**

(220) 20.04.2012.

(300) 85/451808 20.10.2011.

US

(732) **INTERNATIONAL TRUCK INTELLECTUAL PROPERTY COMPANY**, 4201 WINFILED ROAD, WARRENVILLE, ILLINOIS 60555 US

(540) PUREPAC LOG SUPPORT

(550) I

(740) Čupić Branislav, Dalmatinska 10, Podgorica ME

(511) **Klasa 35:** Marketinške usluge u vezi rezervnih djelova za vojna vozila.

Klasa 36: Garantni programi koji pružaju garancije za proizvode koje su proizvela druga lica, naime rezervni djelovi za vojna vozila.

(111) 10953

(151) 20.06.2014.

(210) **2012-210**

(442) **20.12.2013.**

(220) 23.04.2012.

(732) **ALKALOID AD-SKOPLJE**, Bul. Aleksandar Makedonski 12, 1000 Skoplje MK



(540) _____

(550) I

(740) Popović Miladin, Đoka Miraševića 21/III, Podgorica ME

(511) **Klasa 03:** Losion za čišćenje masne i problematične kože.

(111) 10909

(151) 07.07.2014.

(210) **2012-211**

(442) **20.12.2013.**

(220) 23.04.2012.

(732) **BR INTERNATIONAL HOLDING INC.** C/O P.O.BOX 261031, JEBEL ALI, DUBAI AE

(540) BUSINESS ROYAL

(550) I

(740) Popović Miladin, Đoka Miraševića 21/III, Podgorica ME

(511) **Klasa 34:** Duvan, artikli za pušače, šibice, cigarete, cigarilosi, cigare, upaljači za pušače, burmut, lule za duvan, kese za duvan, duvan za žvakanje, papir za cigarete, filteri za cigarete.

(111) 11040

(151) 21.07.2014.

(210) **2012-212**

(442) **20.12.2013.**

(220) 24.04.2012.

(732) **INDUSTRIJA PIVA I SOKOVA TREBJESA AD** NIKŠIĆ, NJEGOŠEVA BR.18. NIKŠIĆ ME

(540)

(550) I

(740) Božović Vesko, Rimski trg 50/11, Podgorica ME

(511) **Klasa 32:** Pivo, mineralne i sodne vode i druga bezalkoholna pića, pića od voća i voćni sokovi, sirupi i drugi preparati za proizvodnju pića.

Klasa 35: Oglašavanje, vođenje poslova, poslovno upravljanje, kancelarijski poslovi, obuhvata usluge koje pružaju lica ili organizacije u pomoći u radu ili upravljanju preduzećima i u vođenju poslova preduzeća, usluge koje pružaju preduzeća koja se bave oglašavanjem (reklamiranjem), tako što, za račun drugih lica, komuniciraju sa javnošću (reklama) putem prenosa bilo kakvih informacija o proizvodima i uslugama omogućavajući potrošačima prigodan pogled na te proizvode i usluge, usluge koje se sastoje od upisivanja, uređivanja, obrade, prerade ili sistematizacije pisanih informacija i zapisa, usluge reklamnih agencija, distribuciju prospekata i uzoraka direktno ili poštom, izradu i korišćenje matematičkih i statističkih podataka, organizovanje sajmova i izložbi u komercijalne ili reklamne svrhe.

(111) 10910

(151) 07.07.2012.

(210) **2012-213**

(442) **20.12.2013.**

(220) 26.04.2012.

(732) **STIEFEL LABORATORIES, INC. CORPORATION SERVICE COMPANY, 2711 CENTERVILLE ROAD, SUITE 400, WILMINGTON, DELAWARE 19808 US**

(540) ISOTREXIN

(550) I

(740) Lutovac Branislav, Bulevar Crnojevića 93, Podgorica ME

(511) **Klasa 05:** Farmaceutski preparati i supstance za liječenje dermatoloških oboljenja, stanja i poremećaja.

(111) 10911

(151) 07.07.2014.

(210) **2012-217**

(442) **20.12.2013.**

(220) 27.04.2012.

(732) **NBA PROPERTIES, INC. OLIMPIC TOWER BLDG. 645 FIFTH AVENUE NEW YORK, NY 10022 US**



(540)

(550) I

(740) Popović Miladin, Đoka Miraševića 21/III, Podgorica ME

(511) **Klasa 25:** Odjeća, obuća, pokrivala za glavu.

Klasa 28: Igre i igračke, gimnastički i sportski artikli koji nijesu obuhvaćeni drugim klasama, ukrasi za jelke.

Klasa 41: Obrazovne usluge, pripremanje obuke, razonoda, sportske i kulturne aktivnosti.

(111) 10912

(151) 07.07.2014.

(210) **2012-218**

(442) **20.12.2013.**

(220) 27.04.2012.

(732) **ALKALOID AD** -SKOPLJE, BUL.ALEKSANDAR MAKEDONSKI BR.12, 1000 SKOPLJE MK

(540) Nježno još od prvog dodira

(550) I

(740) Popović Miladin, Đoka Miraševića 21/III, Podgorica ME

(511) **Klasa 03:** Sapuni, kozmetika, preparati za negu zuba.

Klasa 05: Higijenski proizvodi za medicinsku upotrebu.

Klasa 35: Reklamiranje.

(111) 10914

(151) 07.07.2014.

(210) **2012-219**

(442) **20.12.2013.**

(220) 30.04.2012.

(732) **GOOGLE INC.** 1600 AMPHITHEATRE PARKWAY, MOUNTAIN VIEW, CA 94043 US

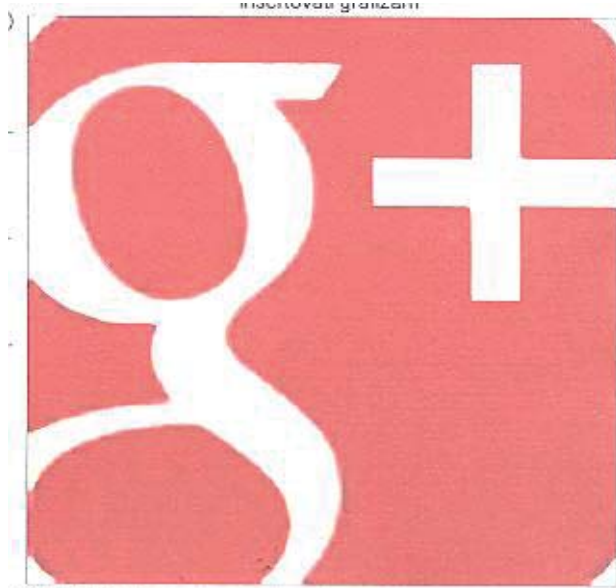

(540)

(550) I

(740) Čupić Branislav, Dalmatinska 10, Podgorica ME

(511) **Klasa 09:** Kompjuterski softver za objavljivanje i razmjenu digitalnih medija i informacija preko globalnih kompjuterskih i komunikacionih mreža, programski alati za razvoj kompjuterskog softvera, kompjuterski softver koji se koristi kao programski interfejs aplikacije (API), kompjuterski softver za kreiranje indeksa informacija, indeksa vebajtova i indeksa drugih informacionih resursa.

Klasa 38: Telekomunikacione usluge, naročito, usluge elektronskog prenosa podataka i digitalnih poruka preko globalnih kompjuterskih i komunikacionih mreža, pružanje usluga onlajn

foruma, čet soba (chat rooms) i elektronskih oglasnih tabli za prenos poruka među korisnicima u nespecijalizovanim oblastima, usluge digitalnog multimedijalnog emitovanja preko Interneta, naročito, postavljanje, prikazivanje i elektronski prenos podataka, audio i video sadržaja, obezbjeđivanje pristupa kompjuterskim bazama podataka u nespecijalizovanim oblastima.

Klasa 41: Usluge onlajn časopisa, naročito, blogova korisnički-definisanog sadržaja sa komentarima u oblasti društva, kulture i političkih vijesti, usluge elektronskog izdavaštva, naročito, objavljivanje digitalnih medija u formi elektronskih časopisa preko globalnih kompjuterskih i komunikacionih mreža sa komentarima u oblasti društva, kulture i političkih vijesti, usluge u oblasti rasonode, naročito obezbjeđivanje privremene upotrebe interaktivnih igara za jednog ili više igrača koje se ne mogu preuzeti (non-downloadable) a koje se igraju preko globalnih kompjuterskih i komunikacionih mreža.

Klasa 42: Omogućavanje privremenog korišćenja onlajn softvera koji se ne može preuzeti (non-downloadable) za objavljivanje i razmjenu digitalnih medija i informacija preko globalnih kompjuterskih i komunikacionih mreža, omogućavanje privremenog korišćenja onlajn programskih alata za razvoj softvera koji se ne mogu preuzeti (non-downloadable), omogućavanje privremenog korišćenja onlajn softvera koji se ne može preuzeti (non-downloadable) koji se koristi kao programski interfejs aplikacije (API), omogućavanje privremenog korišćenja onlajn softvera koji se ne može preuzeti (non-downloadable) za kreiranje indeksa informacija, indeksa veb-sajtova i indeksa drugih informacionih resursa, usluge tehničke podrške, naročito, onlajn rješavanje problema kompjuterskog softvera za korisnike kompjuterskih programa koji se ne mogu preuzimati (non-downloadable), usluge hostinga na mreži za druge za organizovanje i održavanje sastanaka, društvenih događaja i interaktivnih tekstualnih, audio i video diskusija, pružanje onlajn mrežnog okruženja sa tehnologijom koja omogućava korisnicima da razmjenjuju podatke.

Klasa 45: Usluge onlajn društvenih mreža.

(111) 10915

(151) 07.07.2014.

(210) **2012-220**

(442) **20.12.2013.**

(220) 30.04.2012.

(732) **GOOGLE INC.** 1600 AMPHITHEATRE PARKWAY, MOUNTAIN VIEW, CA 94043 US

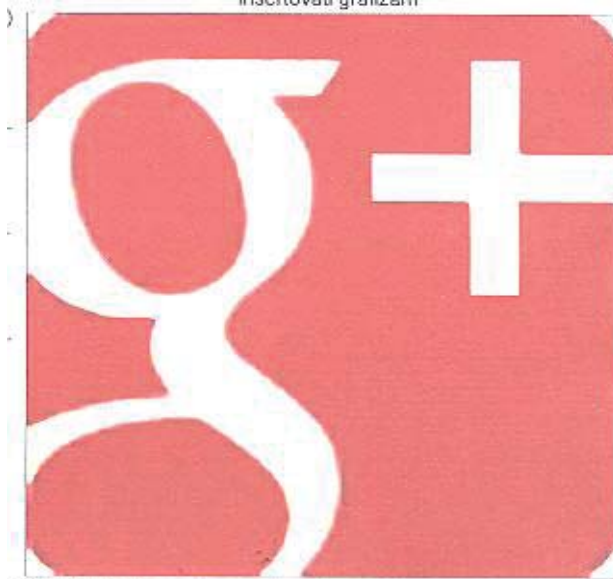

(540)
(550) I

(740) Ćupić Branislav, Dalmatinska 10, Podgorica ME

(511) **Klasa 35:** Promocija, oglašavanje i marketing brendova, proizvoda, usluga i onlajn vebsaj-tova fizičkih lica, privrednih subjekata i neprofitnih organizacija, usluge istraživanja tržišta i informativne usluge.

(111) 10954

(151) 20.06.2014.

(210) **2012-222**

(442) **20.12.2013.**

(220) 03.05.2012.

(732) **BAYER CONSUMER CARE AG**, PETER MERIAN STR. 84, 4052 BASEL CH

(540) BEPANSCAR

(550) I

(740) Ćejović Vladimir, 13. jula 21, Podgorica ME

(511) **Klasa 05:** Farmaceutski preparati.

(111) 10916

(151) 07.07.2014.

(210) **2012-223**

(442) **20.12.2013.**

(220) 04.05.2012.

(732) **THE ABSOLUT COMPANY AKTIEBOLAG**, S-117 97 Stockholm SE

(540) ABSOLUT

(550) I

(740) Lutovac Branislav, Bulevar Crnojevića 93, Podgorica ME

(511) **Klasa 33:** Alkoholna pića (izuzev piva).

(111) 10917

(151) 07.07.2014.

(210) **2012-224**

(442) **20.12.2013.**

(220) 04.05.2012.

(732) **IOCHPE-MAXION S/A**, RUA LUIGI GALVANI, 145, 13 ANDAR, 04575-020 SAO PAULO BR



(540)

(550) I

(740) Ćupić Branislav, Dalmatinska 10, Podgorica ME

(511) **Klasa 12:** Djelovi za suvozemna vozila, naime točkovi. šasije, uzdužne grede (lonžeroni), poprečne grede (stringeri), presovani djelovi i kovani djelovi, naime, konstrukcijski djelovi za kamione, autobuse, kombije, traktore i terenska vozila.

(111) 10918

(151) 03.07.2014.

(210) **2012-225**

(442) **20.12.2013.**

(220) 04.05.2012.

(732) **IOCHPE-MAXION S/A**, RUA LUIGI GALVANI,145, 13 ANDAR, 04575-020 SAO PAULO BR

(540) MAXION

(550) I

(740) Ćupić Branislav, Dalmatinska 10, Podgorica ME

(511) **Klasa 12:** Djelovi za suvozemna vozila. naime točkovi, šasije, uzdužne grede (lonžeroni), poprečne grede (stringeri), presovani djelovi i kovani djelovi, naime, konstrukcijski djelovi za kamione, autobuse, kombije, traktore i terenska vozila.

(111) 10984

(151) 21.07.2014.

(210) **2012-231**

(442) **20.12.2013.**

(220) 08.05.2012.

(732) **THE COCA-COLA COMPANY** ONE COCA COLA PLAZA, ATLANTA, GEORGIA 30313 US

(540) AQUARIUS

(550) I

(740) Popović Miladin, Đoka Miraševića 21/III, Podgorica ME

(511) **Klasa 32:** Pivo, svijetlo pivo i cmo pivo, mineralne i sodne vode i druga bezalkoholna pića, sirupi i drugi preparati za proizvodnju pića.

(111) 10985

(151) 21.07.2014.

(210) **2012-232**

(442) **20.12.2013.**

(220) 08.05.2012.

(732) **THE COCA-COLA COMPANY** ONE COCA COLA PLAZA, ATLANTA, GEORGIA 30313 US

(540) FANTA

(550) I

(740) Popović Miladin, Đoka Miraševića 21/III, Podgorica ME

(511) **Klasa 30:** Sladoledi i preparati za njihovo spravljanje.

Klasa 32: Šerbeti i preparati za njihovo spravljanje.

(111) 10986

(151) 21.07.2014.

(210) **2012-233**

(442) **20.12.2013.**

(220) 08.05.2012.

(732) **THE COCA-COLA COMPANY** ONE COCA COLA PLAZA, ATLANTA, GEORGIA 30313 US



(540)

(550) I

(740) Popović Miladin, Đoka Miraševića 21/III, Podgorica ME

(511) **Klasa 30:** Sladoledi i preparati za njihovo spravljanje.

Klasa 32: Šerbeti i preparati za njihovo spravljanje.

(111) 11041

(151) 21.07.2014.

(210) **2012-238**

(442) **20.12.2013.**

(220) 14.05.2012.

(732) **SWISSOTEL MANAGEMENT GMBH**, BALZ-ZIMMERMANNSTRASSE 7 8302 KLOTEN
CH

(540) SWISSOTEL

(550) I

(740) Popović Miladin, Đoka Miraševića 21/III, Podgorica ME

(511) **Klasa 35:** Poslovno upravljanje hotelima, konsalting za poslovno i hotelsko upravljanje koji je u vezi sa franšizingom, usluge maloprodaje, veleprodaje i prodaje, sastavljanje poštanskih lista, usluge porudžbine putem pošte i telefonom i usluge porudžbine putem drugih telekomunikacionih medija, direktno poštansko oglašavanje, poslovno savjetovanje i poslovno upravljanje, oglašavanje, usluge prikazivanja roba i druge usluge reklamiranja prodaje, analize tržišta i istraživanja tržišta, oglašavanje i reklamiranje prodaje u vezi sa hotelskim uslugama, sticanje i kupovina roba u ime drugih, aranžiranje izloga prodavnica, konsalting u vezi sa svim gore navedenim uslugama i svim drugim uslugama obuhvaćenim ovom klasom.

(111) 10924

(151) 20.06.2014.

(210) **2012-239**

(442) **20.12.2013.**

(220) 15.05.2012.

(732) **ALKALOID AD-SKOPLJE**, BUL. ALEKSANDAR MAKEDONSKI BR. 12. SKOPLJE MK

(540) ZYGLIP

(550) I

(740) Popović Miladin, Đoka Miraševića 21/III, Podgorica ME

(511) **Klasa 05:** Hipolipemik.

(111) 10925

(151) 03.07.2014.

(210) **2012-240**(442) **20.12.2013.**

(220) 17.05.2012.

(732) **FARMACEUTSKO-HEMIJSKA INDUSTRIJA ZDRAVLJE AD**, VLAJKOVA 199, LE-SKOVAC RS

(540) KOLBRIT

(550) I

(740) Popović Miladin, Đoka Miraševića 21/III, Podgorica ME

(511) **Klasa 05:** Farmaceutski i veterinarski preparati, sanitarni proizvodi za upotrebu u medicini, dijetetska hrana i supstance prilagođene za upotrebu u medicini ili veterinarsku upotrebu, hrana za bebe, dijetetski dodaci (dodaci ishrani) za ljude i životinje, flasteri, materijali za zavijanje, materijali za plombiranje zuba, zubarska smola, dezinfekciona sredstva, preparati za uništavanje štetocina, fungicidi, herbicidi.

(111) 10933

(151) 20.06.2014.

(210) **2012-241**(442) **20.12.2013.**

(220) 18.05.2012.

(732) **FREMANTLE MEDIA LIMITED 1 STEPHEN STREET**, LONDON W1T 1AL UK, SIMCO LIMITED 9 DERRY STREET, LONDON W8 5 HY UK

(540) X FACTOR

(550) I

(740) Popović Miladin, Đoka Miraševića 21/III, Podgorica ME

(511) **Klasa 09:** Kinematografski filmovi, crtani filmovi, dijafilmovi, filmovi, magnetni zapisi, optički zapisi, magnetno-optički zapisi, zapisi na čvrstim podlogama, audio-vizuelni aparati za nastavu, aparati za zabavu adaptirani za upotrebu priključenjem na televizore, elektronske knjige i publikacije, elektronske igrice, interaktivne igrice adaptirane za upotrebu uz televizore, električni i video aparati i instrumenti za zabavu, multimedijalni diskovi i publikacije, multimedijalni zapisi i publikacije, laserski čitljivi diskovi, video diskovi i publikacije, kompjuterski softver, kompjuterski programi, kompjuterske igrice, softveri za interaktivne igrice za kompjutere, mobilne telefone i uređaje kojima se manualno rukuje, digitalni zapisi, mediji za cuvanje ili snimanje zvuka i/ili video zapisa i/ili podataka i/ili informacija, aparati i instrumenti za snimanje i/ili reprodukovanje zvuka i/ili video zapisa i/ili informacija, hologrami, flopi diskovi, zvučni zapisi, presnimljeni diskovi, snimljeni diskovi, kompakt diskovi, gramofonske ploče, audio kasete, kasete, video kasete, laserski diskovi, kompakt diskovi-interaktivni CD ROM-ovi, digitalni video diskovi (DVD), aparati i instrumenti za komunikaciju, telefoni, mobilni telefoni, punjači, punjači za mobilne telefone, hands-free aparati za mobilne telefone, igrice za mobilne telefone, karaoke mašine, delovi i oprema za svu gorenavedenu robu, digitalne igrice, igrice za mobilne telefone, DVD igrice.**Klasa 38:** Emitovanje, emitovanje televizijskog programa, emitovanje radio programa, emitovanje programa satelitske televizije, emitovanje programa kablovske televizije, telefonske komunikacije, interaktivne telefonske usluge, usluge telefonskih poruka, komunikacijske usluge putem radio talasa, telefona, Interneta, svetskog pretraživača, kablovskim putem, putem satelita, mikrotalasa i električnih mreža, telefonija.**Klasa 41:** Usluge obrazovanja i razonode u formi televizijskih programa, radio programa, kablovskih, satelitskih i Internet programa, produkcija i prezentacija radio i televizijskog programa, kinematografskih filmova, predstava, video programa, DVD programa, kablovskih programa, satelitskih programa i/ili Internet programa, usluge organizovanja predstava, iznajmljivanje zvučnih zapisa i prethodno snimljenih predstava, filmova, radio i televizijskih

performansa, produkcija video kasete i video diskova, usluge zabave putem radija, usluge zabave putem televizije, usluge zabave putem bioskopa, usluge zabave putem pozorišta, zabavne emisije koje uključuju igru (takmičenje), usluge razonode putem televizije koje uključuju i učestvovanje gledalaca putem telefona, interaktivna razonoda uz upotrebu mobilnog telefona, usluge omogućavanja igranja igrice putem Interneta (on-line), usluge organizovanja lota i igara na sreću, usluge pružanja zabave putem igrice, usluge igre, usluge klađenja, usluge opklada, usluge kazina, usluge organizovanja igara sa kartama i kazino turnira, takmičenja, nadmetanja, igara i/ili događaja, lutrija, omogućavanje bilo koje gore navedene usluge na mobilnim telefonima putem mreže mobilne telefonije, satelitskom komunikacijom, mikrotalasima ili drugim elektronskim, digitalnim i analognim medijom, uživo, elektronski, putem kompjuterske mreže, putem interneta, online ili putem televizijskog medija, organizovanje, produkcija i prezentacija događaja u obrazovne, kulturne ili zabavne svrhe, organizovanje, produkcija, upravljanje i prezentacija takmičenja, nadmetanja, igara, predstava koje uključuju igru, kvizova, dana zabave, izložbi, predstava, parada na točkovima (roadshows), predstava na podijumima, rejvova, pozorišnih performansa, koncerata, performansa uživo i događaja u kojima se može učestvovati, usluge organizovanja i proizvodnje video klipova putem mobilne telefonije ili kompjuterske mreže za zabavu i/ili u obrazovne svrhe.

(111) 10926

(151) 20.06.2014.

(210) **2012-245**

(442) **20.12.2013.**

(220) 30.05.2012.

(732) **ALKALOID AD** SKOPLJE, BUL. ALEKSANDAR MAKEDONSKI 12, SKOPLJE MK

(540) AME

(550) I, V

(740) Popović Miladin, Đoka Miraševića 21/III, Podgorica ME

(511) **Klasa 03:** Sredstva za bijeljenje i druge supstance za upotrebu u perionicama, preparati za čišćenje, poliranje, ribanje i nagrizanje, sapuni, parfimerija, eterična ulja, kozmetika, losioni za kosu, paste za zube.

(111) 10927

(151) 20.06.2014.

(210) **2012-246**

(442) **20.12.2013.**

(220) 30.05.2012.

(732) **ALKALOID AD** SKOPLJE, BUL. ALEKSANDAR MAKEDONSKI 12, SKOPLJE MK

(540) ASSO

(550) I, V

(740) Popović Miladin, Đoka Miraševića 21/III, Podgorica ME

(511) **Klasa 03:** Sredstva za bijeljenje i druge supstance za upotrebu u perionicama, preparati za čišćenje, poliranje, ribanje i nagrizanje, sapuni, parfimerija, eterična ulja, kozmetika, losioni za kosu, paste za zube.

(111) 10928

(151) 20.06.2014.

(210) **2012-247**

(442) **20.12.2013.**

(220) 30.05.2012.

(732) **ALKALOID AD** SKOPLJE, BUL. ALEKSANDAR MAKEDONSKI 12, SKOPLJE MK

(540) BLACK-UP

(550) I, V

(740) Popović Miladin, Đoka Miraševića 21/III, Podgorica ME

(511) **Klasa 03:** Sredstva za bijeljenje i druge supstance za upotrebu u perionicama, preparati za čišćenje, poliranje, ribanje i nagrizanje, sapuni, parfimerija, eterična ulja, kozmetika, losioni za kosu, paste za zube.

(111) 10929

(151) 20.06.2014.

(210) **2012-248**

(442) **20.12.2013.**

(220) 30.05.2012.

(732) **ALKALOID AD** SKOPLJE, BUL. ALEKSANDAR MAKEDONSKI 12, SKOPLJE MK

(540) SLIM-MIX

(550) I, V

(740) Popović Miladin, Đoka Miraševića 21/III, Podgorica ME

(511) **Klasa 05:** Čaj od ljekovitog bilja.

(111) 11008

(151) 22.07.2014.

(210) **2012-163**

(442) **20.12.2013.**

(220) 28.03.2012.

(732) **TOA KAB USHIKI KAISHA(TOA CORPORATION)**, 2-1, MINATOJIMANAKAMCHI 7-CHOME, CHUO-KU, KOBE-SHI, HYOGO-KEN JP

(540) TOA

(550) I

(740) Popović Miladin, Đoka Miraševića 21/III, Podgorica ME

(511) **Klasa 09:** Aparati i instrumenti naučni, pomorski, geodetski, fotografski, kinematografski, optički, za vaganje, za mjerenje, signalizaciju, kontrolu (inspekciju), spasavanje i nastavu, aparati i instrumenti za provođenje, prekid, transformaciju, akumulaciju, regulisanje ili kontrolu električne energije, aparati za snimanje, prenos i reprodukovanje zvuka ili slike, magnetni nosači podataka, diskovi za snimanje, kompakt diskovi, DVD i drugi digitalni nosači podataka, mehanizmi za aparate koji se pokreću novcem ili žetonom, register kase, računarske mašine, oprema za obradu podataka, računari, računarski softver, aparati za gašenje požara, naročito: antene, antenski pojačivači, slušalice, bežični prijemnici, bežični predajnici, punjači za baterije, mikrofoni, infracrveni komunikacioni sistemi, razglasi, oprema za razglase i zvučne sisteme, stalci za uređaje i aparate za ozvučenje, pojačala, regulatori za zvučnik, stalaže za zvučne uređaje i aparate, stalaže za uređaje i aparate za video nadzor, monitori za zvučnu opremu, transformatori, procesori zvučnog signala, zvučne miksete, kutije za skladištenje uređaja i aparata za emitovanje na stalažama i u ormanima, razvodne table za uređaje i aparate za emitovanje na stalažama i u ormanima, ventilacioni paneli za upotrebu na stalažama i u ormanima za uređaje i aparate za emitovanje, audio plejeri, uređaji za snimanje i premotavanje zvuka, uređaji za prenos i prijem zvučnog signala, programatori za električne uređaje, nosači zvuka, memorijske kartice za snimanje zvuka, razvodnici za električnu opremu, strujni napajajući, kontrolne table za razglasni sistem, priključci za zvučni signal, regulatori zvučnog signala, konvertori zvučnog signala, mjerači impedanse, prigušivači, zvučnici i sastavni djelovi, megafoni, predajnici i prijemnici zvuka putem mreža, mrežni zvučni uređaji, interfon sistemi, interfon centrale, interfon stanice, konferencijski sistemi, električne oglasne table, oprema za emitovanje signala za uzbunu, sistemi za video nadzor, priključci za video signal, uređaji za prenos i prijem video signala, prekidači za monitore,

uređaji za kompenzaciju video signala, objektivni za kamere video nadzora, kontrolne table za rukovanje video opremom, regulatori za opremu video nadzora, kamere za video nadzor, maske za kamere video nadzora, uređaji za prenos sinhronizovanog video signala, električni spojevi za kamere video nadzora, hard disk jedinice, digitalni video rekorderi, kućišta za kamere video nadzora, video monitori, konvertori video signala, uređaji za snimanje putem mreže, instalacioni držači za audio uređaje i video uređaje, baterije, uređaji za distribuciju signala, priključci za audio signal i video signal, kompjuterski softver, snimljen, kompjuterski softver koji se može preuzimati, kompjuterski softver za potrebe snimanja, pojačavanja, reprodukcija i prenošenja zvukova, kablovi za audio i video signal.

(111) 11253

(151) 23.07.2014.

(210) **2012-172**

(442) **20.12.2013.**

(220) 05.04.2012.

(732) **BASF SE**, CARL-BOSCH-STRASSE 38, LUDWIGSHAFEN AM RHEIN DE

(540) TECTANET

(550) I

(740) Stanković Mugoša Ana, Trg Republike 13, Podgorica ME

(511) **Klasa 05:** Preparati za uništavanje i suzbijanje štetočina, fungicidi, herbicidi, pesticidi.

(111) 10955

(151) 22.07.2014.

(210) **2012-174**

(442) **20.12.2013.**

(220) 05.04.2012.

(300) 61133/2011 05.10.2011. CH

(732) **JT INTERNATIONAL S.A.** 1, RUE DE LA GABELE, 1211 GENEVA 26 CH



(540)

(550) I

(740) Čejović Vladimir, 13. jula 21, Podgorica ME

(511) **Klasa 34:** Duvan, prerađen ili neprerađen, duvan za pušenje, duvan za lule, duvan za ručno uvijanje, duvan za žvakanje, snus duvan, cigarete, cigare, cigarilosi, supstance za pušenje koje se prodaju odvojeno ili miješane sa duvanom, a koje nisu za medicinske svrhe ili u svrhe liječenja, duvan za ušmrkavanje, artikli za pušače uključeni u klasu 34, papir za cigarete, tube za cigarete i šibice.

(111) 11010

(151) 22.07.2014.

(210) **2012-190**

(442) **20.12.2013.**

(220) 12.04.2012.

(732) **Engel&Volkers Marken GmbH&Co.KG**, Dorfstrabe 34a, 22113 Oststeinbek-Havighorst DE

E&V

(540)

(550) I, V

(740) Radulović Božidar, Jovana Tomaševića 9/III, Podgorica ME

(511) **Klasa 35:** Komercijalne informacije i saveti za potrošače u vezi sa vozilima za kretanje po vodi, posebno novih i polovnih čamaca/brodova, kao i jahti, pripremanje ugovora za treća lica u vezi sa sticanjem/kupovinom i prodajom čamaca/brodova i jahti, organizovanje ugovora za treća lica u vezi sa zakupom čarter jahti i čarter čamaca/brodova.

Klasa 39: Iznajmljivanje čamaca/ brodova i jahti, organizovanje najma čamaca/brodova i jahti, tzv. čartering jahti, brokerski poslovi u vezi sa plovilima.

(111) 11011

(151) 22.07.2014.

(210) **2012-192**

(442) **20.12.2013.**

(220) 12.04.2012.

(732) **S.C.Johnson & Son**, Inc, 1525 Howe Street, Racine, Wisconsin 53403-22036 US



(540)

(550) I

(740) Čejović Vladimir, 13. jula 21, Podgorica ME

(511) **Klasa 03:** Preparati za čišćenje, poliranje, ribanje i nagrizanje, sredstva za bijeljenje i druge supstance za upotrebu na tkaninama, maramice za jednokratnu upotrebu impregnirane hemikalijama ili jedinjenjima za upotrebu u domaćinstvu, preparati za uklanjanje laka, preparati u obliku voska za upotrebu na završenim i nezavršenim površinama, preparati za

uklanjanje voska, preparati za otpušavanje odvoda, preparati za poliranje cipela, kreme za cipele, preparati za čišćenje cipela, sapuni, deterdženti.

Klasa 05: Sredstva za uklanjanje mikroba i sredstva za dezinfekciju.

Klasa 21: Kuhinjski i pribor za domaćinstva za čišćenje, poliranje, ribanje, nagrizanje i voskiranje, sunđer, četke, krpe, odjeća za čišćenje, odjeća impregnirana rastvorom za čišćenje.

(111) 11013

(151) 22.07.2014.

(210) **2012-195**

(442) **20.12.2013.**

(220) 12.04.2012.

(732) **POSLOVNI CENTAR MERCATOR** d.d, Dunajska cesta 107, 1000 Ljubljana SI

(540) RODA

(550) I

(740) Radulović Božidar, Jovana Tomaševića 9/III, Podgorica ME

(511) **Klasa 03:** Preparati za izbjeljivanje i druge supstance za upotrebu u perionicama, preparati za čišćenje, poliranje, ribanje i nagrizanje, sapuni, parfimerija, eterična ulja, kozmetika, losioni za kosu, paste za zube.

Klasa 25: Odjeća, obuća, pokrivala za glavu.

Klasa 28: Igre i igračke, gimnastičke i sportski artikli koji nisu uključeni u druge klase, ukrasi za jelke.

Klasa 29: Meso, riba, živina i divljač, mesne prerađevine, konzervisano, smrznuto, sušeno i kuvano voće i povrće, želei, džemovi, kompoti, jaja, mlijeko i mliječni proizvodi, jestiva ulja i masti.

Klasa 30: Kafa, čaj, kakao, šećer, pirinač, tapioka, sago, zamena kafe, brašno i proizvodi od žitarica, hljeb, kolači i poslastice, sladoledi, med, melasa, kvasac, prašak za pecivo, so, senf, sirće, umaci (začini), začini, led za osveženje.

Klasa 31: Poljoprivredni, hortikulturalni i proizvodi u šumarstvu i žitarice koji nisu uključeni u druge klase, žive životinje, svježe voće i povrće, sjemenke, prirodne biljke i cvijeće, hrana za životinje, slad.

Klasa 32: Pivo, mineralna i gazirana voda i druga bezalkoholna pića, voćni napitci i voćni sokovi, sirupi i drugi preparati za pravljenje pića.

Klasa 33: Alkoholna pića (osim piva).

Klasa 34: duvan, proizvodi pušače, šibice.

Klasa 35: Oglašavanje, poslovni menadžment, poslovna administracija, kancelarijski poslovi.

Klasa 39: Saobraćaj, skladištenje i pakovanje robe, organizovanje putovanja.

Klasa 43: Usluge obezbeđivanja hrane i pića, privremeni smeštaj.

(111) 11258

(151) 23.07.2014.

(210) **2012-196**

(442) **20.12.2013.**

(220) 12.04.2012.

(300) 201171328 14.10.2011.

SI

(732) **POSLOVNI CENTAR MERCATOR** d.d, Dunajska cesta 107, 1000 Ljubljana SI



(540)

(550) I, G

(740) Radulović Božidar, Jovana Tomaševića 9/III, Podgorica ME

(511) **Klasa 03:** Preparati za izbjeljivanje i druge supstance za upotrebu u perionicama, preparati za čišćenje, poliranje, ribanje i nagrizanje, sapuni, parfimerija, eterična ulja, kozmetika, losioni za kosu, paste za zube.**Klasa 25:** Odjeća, obuća, pokrivala za glavu.**Klasa 28:** Igre i igračke, gimnastičke i sportski artikli koji nisu uključeni u druge klase, ukrasi za jelke.**Klasa 29:** Meso, riba, živina i divljač, mesne prerađevine, konzervisano, smrznuto, sušeno i kuvano voće i povrće, želei, džemovi, kompoti, jaja, mlijeko i mliječni proizvodi, jestiva ulja i masti.**Klasa 30:** Kafa, čaj, kakao, šećer, pirinač, tapioka, sago, zamena kafe, brašno i proizvodi od žitarica, hljeb, kolači i poslastice, sladoledi, med, melasa, kvasac, prašak za pecivo, so, senf, sirće, umaci (začini), začini, led za osveženje.**Klasa 31:** Poljoprivredni, hortikulturalni i proizvodi u šumarstvu i žitarice koji nisu uključeni u druge klase, žive životinje, svježe voće i povrće, sjemenke, prirodne biljke i cvijeće, hrana za životinje, slad.**Klasa 32:** Pivo, mineralna i gazirana voda i druga bezalkoholna pića, voćni napitci i voćni sokovi, sirupi i drugi preparati za pravljenje pića.**Klasa 33:** Alkoholna pića (osim piva).**Klasa 34:** duvan, proizvodi pušače, šibice.**Klasa 35:** Oglašavanje, poslovni menadžment, poslovna administracija, kancelarijski poslovi.**Klasa 39:** Saobraćaj, skladištenje i pakovanje robe, organizovanje putovanja.**Klasa 43:** Usluge obezbeđivanja hrane i pića, privremeni smeštaj.

(111) 11225

(151) 22.07.2014.

(210) **2012-203**(442) **20.12.2013.**

(220) 18.04.2012.

(732) **NIKE INTERNATIONAL LTD.** A BERMUDA COMPANY ONE BOWERMAN DRIVE, BEAVERTON, OR 97005-6453 US

(540) MERCURIAL

(550) I

(740) Čejović Vladimir, 13. jula 21, Podgorica ME

(511) **Klasa 25:** Obuća, odjeća, pokrivala za glavu.**Klasa 28:** Sportska oprema, naime, fudbalske lopte, štitnici za cjevanice, zaštitni jastučići za igranje fudbala, torbe specijalno prilagođene za nošenje sportske opreme i sportskih lopti.

(111) 11014

(151) 22.07.2014.

(210) **2012-204**

(442) **20.12.2013.**

(220) 18.04.2012.

(732) **PREDRAG KOVAČEVIĆ**, SAVSKA 14, PODGORICA ME



MOGUL CRNA GORA

(540) _____

(550) I

(511) **Klasa 01:** Hemijski proizvodikoji se upotrebljavaju u industriji, nauci, fotografiji, poljoprivredi, hortikulturi i šumarstvu, neprerađene nevestačke smole, neprerađene neplastične materije, đubriva, smješe za gašenje vatre, preparati za kaljenje i zavarivanje, hemijske supstance za očuvanje namirnica, materije za štavljenje, ljepljive supstance koje se upotrebljavaju u industriji.

Klasa 03: Sredstva za bijeljenje i druge supstance za upotrebu u perionicama, preparati za čišćenje, poliranje, ribanje i nagrizanje, sapuni, parfimerija, eterična ulja, kozmetika, losioni za kosu, paste za zube.

Klasa 04: Industrijska ulja i masti, maziva, goriva (uključujući i motorna tečna goriva) i materije za osvjtljavanje, svijeće i fitilji za osvjtljavanje, jedinjenja za skupljanje prašine vlaženjem i vezivanjem.

Klasa 05: Farmaceutski i veterinarski preparati, sanitarni preparati za medicinsku upotrebu, djetetske supstance prilagođene za upotrebu u medicini, hrana za bebe, flasteri, materijali za zavijanje, materijali za plombiranje zuba, zubarska smola, dezinfekciona sredstva, preparati za uništavanje štetocina, fungicidi, herbicidi.

Klasa 07: Mašine i mašinski alati, motori i pogonske mašine (osim za suvozemna vozila), mašinske spojnice i transmisioni elementi (osim za suvozemna vozila), poljoprivredne sprave osim onih kojima se ručnou pravlja, inkubator za jaja.

Klasa 09: Aparati i instrumenti naučni, pomorski, geodetski, fotografski, kinematografski, optički, za vaganje, mjerenje, signalizaciju, kontrolu (inspekciju), spasavanje i nastavu, kontrolu električne energije, aparati za snimanje, prenos i reprodukovanje zvuka i slike, magnetni nosioci podataka, diskovi za snimanje, automatske mašine i mehanizmi za aparate koji se pokreću novcem ili žetonom, registar kase, računске mašine, oprema za obradu podataka i kompjuteri, aparati za gašenje požara, aparati i instrumenti za provođenje, prekid, transformaciju, akumulaciju, regulisanje.

Klasa 12: Vozila, aparati zakretanje po zemlji, vazduhu ili vodi.

Klasa 35: Oglašavanje, vođenje poslova, poslovno upravljanje, kancelarijski poslovi.

Klasa 39: Transportne usluge, pakovanje i skladištenje robe, organizovanje putovanja.

(111) 11229

(151) 22.07.2014.

(210) **2012-205**

(442) **20.12.2013.**

(220) 19.04.2012.

(732) **CANON KABUSHIKI KAISHA**, 30-2, Shimomaruko 3-chome, Ohta-ku, Tokyo JP



(540)

(550) I

(740) Čosović Dejan, 13. jula 1/5, Budva ME

(511) **Klasa 02:** Boje, firnajzi, lakovi, sredstva za zaštitu od rđe i truljenja drveta, materije za bojenje, sredstva za nagrizanje, sirove prirodne smole, metali u obliku listova i praha za slikare, dekoratere, štampare i umetnike, mastilo za inkdžet štampače, fotokopir mašine, telefakse, kasete sa mastilom (uključujući kasete sa mastilom opremljene glavom za štampanje) za inkdžet štampače, fotokopir mašine, telefakse, tonerza laserske štampače, fotokopir mašine, telefakse, kasete sa tonerom za laserske štampače, fotokopir mašine, telefakse.

Klasa 09: Aparati i instrumenti naučni, pomorski, geodetski, fotografski, kinematografski, optički, za vaganje, merenje, signalizaciju, kontrolu (inspekciju), spašavanje i nastavu, aparati i instrumenti za provođenje, prekid, transformaciju, akumulaciju, regulisanje ili kontrolu električne energije, aparati za snimanje, prenos i reprodukovanje zvuka ili slike, magnetni nosači podataka, diskovi za snimanje, kompakt diskovi, DVD i drugi digitalni nosači podataka, mehanizmi za aparate koji se pokreću novcem ili žetonom, registar kase, računске mašine, oprema za obradu podataka, računari, računarski softver, aparati za gašenje požara, kamere, digitalne kamere, video kamkorderi, elektronske računске mašine, fotokopir mašine, telefaksi, skeneri, laserski štampači, inkdžet štampači, delovi i pribor za navedene proizvode, to jest, baterije, punjači za baterije, adapteri za automobilske akumulatore, adapteri naizmenične struje, kućišta za kamere, digitalne kamere, video kamkordere, remeni za kamere, digitalne kamere, video kamkordere, torbe za kamere, digitalne kamere, video kamkordere, tronošci, računarski softver za digitalne kamere, video kamkordere, inkdžet štampače, laserske štampače, fotokopir mašine, telefakse, skeneri.

(111) 11023

(151) 22.07.2014.

(210) **2012-214**

(442) **20.12.2013.**

(220) 26.04.2012.

(732) **TOYOTA JIDOSHA KABUSHIKI KAISHA** (ALSO TRADING AS TOYOTA MOTOR CORPORATION), 1, TOYOTA-CHO, TOYOTA-SHI, AICHI-KEN JP

(540) PROACE

(550) I

(740) Čejović Vladimir, 13. jula 21, Podgorica ME

(511) **Klasa 12:** Automobili i njihovi strukturalni delovi.

(111) 11027

(151) 22.07.2014.

(210) **2012-215**

(442) **20.12.2013.**

(220) 26.04.2012.

(732) **WM.WRIGLEY JR. COMPANY**, 1132 WEST BLACKHAWK STEET, CHICAGO, ILLINOIS 60642 US

(540) BREATHE IN.MOVE ON.

(550) I

(740) Čejović Vladimir, 13. jula 21, Podgorica ME

(511) **Klasa 30:** Konditorski proizvodi, naime žvakaće gume, žvakaće gume od kojih mogu da se prave veliki baloni, bombone i dražeje peperminta.

(111) 11227

(151) 22.07.2014.

(210) **2012-228**

(442) **20.12.2013.**

(220) 04.05.2012.

(732) **E.L.DU PONT DE NEMOURS AND COMPANY**, 1007 MARKET STREET, WILMINGTON, DE 19898 US

(540) HOMEKS

(550) I

(740) Čejović Vladimir, 13. jula 21, Podgorica ME

(511) **Klasa 09:** Zaštitna odjeća.

Klasa 16: Papir i stvari napravljene od papira, uključujući papirne filtere.

Klasa 17: Električni izolacioni materijal, savitljive cijevi i crijeva.

Klasa 22: Ručno napravljena vlakna, vlakna i savitljivi tabak sličan papiru, materijali od sirovog vlaknastog tekstila.

Klasa 23: Pređe i konci napravljeni od tekstilnih materijala.

Klasa 24: Tkanine, obložene tkanine i slojevite tkanine.

Klasa 25: Odjeća.

(111) 10987

(151) 22.07.2014.

(210) **2012-234**

(442) **20.12.2013.**

(220) 08.05.2012.

(732) **THE COCA-COLA COMPANY** ONE COCA COLA PLAZA, ATLANTA, GEORGIA 30313 US



(540)

(550) I

(740) Popović Miladin, Đoka Miraševića 21/III, Podgorica ME

(511) **Klasa 32:** Svijetlo pivo, tamno pivo i crno pivo, mineralne i sodne vode i druga bezalkoholna pića, sirupi i drugi preparati za proizvodnju pića.

(111) 11228

(151) 22.07.2014.

(210) **2012-235**

(442) **20.12.2013.**

(220) 09.05.2012.

(732) **AKTIEBOLAGET ELECTROLUX**, S:T GORANSGATAN 143, SE-105 45 STOCKHOLM SE



(540)

(550) I

(740) Čupić Branislav, Dalmatinska 10, Podgorica ME

(511) **Klasa 07:** Usisivači, crijeva za usisivače, usisni nastavci i pribori za usisivače, cijevi kao djelovi mašina.

(111) 11226

(151) 22.07.2014.

(210) **2012-243**

(442) **20.12.2013.**

(220) 23.05.2012.

(732) **MARS, INCORPORATED**, 6885 ELM STREET, MCLEAN, VA 22101-3883 US

(540) LEFT TWIX.RIGHT TWIX.PICK A SIDE.

(550) I

(740) Čejović Vladimir, 13. jula 21, Podgorica ME

(511) **Klasa 29:** Meso, riba, živina i divljač, mesne prerađevine, konzervisano, zamrznuto, sušeno i kuvano voće i povrće, želei, džemovi, kompoti, jaja, mlijeko i mliječni proizvodi, mliječni proizvodi, mliječni napici, proizvodi pripremljeni za konzumiranje i koji se sastoje uglavnom od gore navedenih proizvoda.

Klasa 30: Kafa, čaj, kakao i vještačka kafa, pirinač, tapioka i sago, brašno i proizvodi od žitarica, hljeb, kolači i poslastice, ledene poslastice, šećer, med, melasa, kvasac, prašak za pecivo, so, senf, sirće, sosovi (kao dodaci), začini, led, zamjene kafe, čokolada za piće, table od žitarica, tjestenina, rezanci, biskviti, kolači, čokolada, sladoled, smrznuti slatkiši, pesto, bilje, proizvodi pripremljeni za konzumiranje i koji se sastoje uglavnom od gore navedenih proizvoda.

(111) 11022

(151) 22.07.2014.

(210) **2012-244**

(442) **20.12.2013.**

(220) 23.05.2012.

(732) **PEPSICO, INC.** 700 ANDERSON HILL ROAD, PURCHASE, NY 10577 US



(540)

(550) I

(740) Čejović Vladimir, 13. jula 21, Podgorica ME

(511) **Klasa 29:** Meso, riba, živina i divljač, mesne prerađevine, konzervisano, zamrznuto, suše-

no i kuvano voće i povrće, želei, džemovi, kompoti, jaja, mlijeko i mliječni napitci proizvodi, jestiva ulja i masti.

Klasa 30: Kafa, čaj, kakao i zamjena kafe, pirinač, tapioka i sago, brašno i proizvodi od žitarica, hljeb, kolači i poslastice, sladoledi, šećer, med, melasa, kvasac, prašak za pecivo, so, senf, sirće, sosovi (kao dodaci), začini, led.

(111) 11026

(151) 22.07.2014.

(210) **2012-200**

(442) **20.12.2013.**

(220) 17.04.2012.

(732) **WM.WRIGLEY JR. COMPANY**, 410 NORTH MICHIGAN AVENUE, CHICAGO, IL 60611
US

(540) WINTERFRESH POLAR ICE

(550) I

(740) Čejović Vladimir, 13. jula 21, Podgorica ME

(511) **Klasa 30:** Konditorski proizvodi, žvakaće gume, žvakaće gume od kojih mogu da se prave veliki baloni, bombone, dražeje pepermintna, mali okrugli bomboni (drops) i pastile.

(111) 11275

(151) 23.07.2014.

(210) **2011-134**

(442) **20.06.2013**

(220) 15.3.2011

(732) **NOVARTIS AG**, 4002 BASEL, CH

LADIOMIL

(540)

(550) I

(740) Radulović Božidar, Jovana Tomaševića 9/III, Podgorica (ME)

(511) **Klasa 05:** Farmaceutski preparati.

(111) 10942

(151) 30.05.2014.

(210) **2011-453**

(442) **20.06.2013**

(220) 19.9.2011

(732) **J&J COMPANY DOO**, BOTUN BB, PODGORICA, ME



(540)

(550) I

(511) **Klasa 29:** Konzervisano, zamrznuto, sušeno i kuvano voće i povrće,; mlijeko u prahu.**Klasa 30:** šećer, kakao, pirinac; so; mljevena paprika, susam, kokos brašno.**Klasa 31:** Kikiriki u ljusci, kikiriki oljušteni, badem, lješnik, kukuruz kokičar, pistači, pšenica, pasulj, orah, bundevina sjemenka, suncorkretova sjemenka.

(111) 10831

(151) 25.03.2014.

(210) **2011-509**

(220) 14.10.2011.

(300) 902197 09. 05.2008. IR

(732) **SUOLAKIVENKATU 1**, 00810 HELSINKI FI

CLASSIC

(540)

(550) I

(740) Čejović Vladimir, 13. jula 21, Podgorica ME

(511) **Klasa 06:** rofilisani limovi, krovovi od čelika i njihovi djelovi, limeni opšivi, limovi, talasasti limovi, slemenjače, rebra, lajsne, punila, sljemene kape, oluci, obrađene ivice, žljebovi, sistemi za odvod kišnica, olovne vođice za krovove; šrafovi, okuke, zatege i drugi predmeti za pričvršćavanje; merdevine, branici za snijeg, krovni mostovi i drugi bezbjedonosni predmeti za krovove, fasade od lima; proizvodi za fasade.**Klasa 19:** Nemetalni krovovi, podloge, slemenjače, lajsne za krovove, olovne vođice za krovove, punila i zaptivci, proizvodi za fasade.**Klasa 37:** Instalacije i opravka krovova i fasada.

(111) 10936

(151) 03.07.2014.

(210) **2012-311**

(220) 29.06.2012

(300) 865347 16.03.2005 IR

(732) **TALLY WEIJI HOLDING AG**, VIADUKTSTRASSE 42,4051 BASEL CH

(540) TOTALLY SEXY

(550) I

(511) **Klasa 03:** Sapuni; parfimerija, eterična ulja, kozmetika, losioni za kosu; paste za zube;

kreme, losioni, pilinzi, šminka, lak za nokte, šamponi, kupka i gel za tuširanje, preparati za njegu kose.

Klasa 14: Dragocjeni metali i njihove legure i proizvodi izrađeni od njih ili sa prevlakom koji nisu obuhvaćeni drugim klasama; nakit, drago kamenje; časovnici i hronometrijski instrumenti; pribor za sve gore navedene robe uključene u ovu klasu.

Klasa 18: Koža i imitacije kože, i proizvodi od tih materijala koji nijesu obuhvaćeni drugim klasama; životinjske kože, krzna; kovčezi i putne torbe; kišobrani, suncobran i štapovi za hodanje; sedlarska roba; ručne torbe, torbe, tašne, ulošci za ključeve, tašne i novčanici od svih vrsta kože i imitacije kože.

Klasa 25: Odjeća, obuća; pokrivala za glavu, svi gore pomenuti proizvodi od kože, tekstila i drugih materijala; kaiševi, kopče.

(111) 11043

(151) 05.06.2014.

(210) **2011-122**

(442) **20.12.2013.**

(220) 11.03.2011.

(732) **DOMPE S.P.A.** LACOLITA CAMPO DI PILE SNC, 67100 L AQUILA AQ IT

FLUIFORT

(540)

(550) I

(740) Popović Miladin, Đoka Miraševića 21/III, Podgorica ME

(511) **Klasa 05:** Farmaceutski i veterinarski preparati, sanitarni preparati za medicinsku upotrebu, dijetetske supstance prilagođene za upotrebu u medicini, hrana za bebe, flasteri, materijali za zavijanje, materijali za plombiranje zuba, zubarska smola, dezinfekciona sredstva, preparati za uništavanje štetočina, fungicidi, herbicidi.

(111) 11042

(151) 05.06.2014.

(210) **2011-121**

(442) **20.12.2013.**

(220) 11.03.2011.

(732) **DOMPE S.P.A.** LACOLITA CAMPO DI PILE SNC, 67100 L AQUILA AQ IT

ARTROSILENE

(540)

(550) I

(740) Popović Miladin, Đoka Miraševića 21/III, Podgorica ME

(511) **Klasa 05:** Farmaceutski i veterinarski preparati, sanitarni preparati za medicinsku upotrebu, dijetetske supstance prilagođene za upotrebu u medicini, hrana za bebe, flasteri, materijali za zavijanje, materijali za plombiranje zuba, zubarska smola, dezinfekciona sredstva, preparati za uništavanje štetočina, fungicidi, herbicidi.

(111) 10964

(151) 23.05.2014.

(210) **2011-601**

(442) **20.12.2013.**

(220) 07.12.2011.

(732) **BORIS RAŠKOVIĆ, JOVANA TOMAŠEVIĆA 9/3 PODGORICA ME**

MIRO PEROVIĆ, SERDARA JOLA PILETIĆA 28/1 PODGORICA ME

Naljepiti izgled znaka a verbalni znak ostampati



(540)

(550) I

(511) **Klasa 29:** Meso, riba, živina i divljač, mesne prerađevine, konzervisano, zamrznuto. sušeno i kuvano voće i povrće, želei, džemovi, kompoti, jaja, mlijeko i mliječni proizvodi, jestiva ulja i masti, pića na bazi mlijeka (u kojima mlijeko preovladava).

Klasa 30: Kafa, čaj, kakao, šećer, pirinač, tapioka, sago, zamjena kafe, brašno i proizvodi od žitarica, hljeb, kolači i poslastice, sladoled, med, melasa, kvasac, prašak za pecivo, so, senf, sirće, sosovi (kao dodaci), začini, led, pića od kakaoa, kafe ili na bazi čokolade.

Klasa 32: Pivo, mineralne i sodne vode i druga bezalkoholna pića, pića od voća i voćni sokovi, sirupi i drugi preparati za proizvodnju pića, bezalkoholna pića, pića od mlijeka (u kojima mlijeko preovladava), pića sa kafom, kakaom ili čokoladom.

(111) 11050

(151) 06.06.2014.

(210) **2011-697**

(442) **20.12.2013.**

(220) 21.12.2011.

(732) **COLGATE PALMOLIVE COMPANY, A DELAWARE CORPORATION, 300 PARK AVENUE, NEW YORK, NY 10022 US**

ACTION

(540)

(550) I

(740) Kojić Ivana, Serdara Jola Piletića bb, Podgorica ME

(511) **Klasa 03:** Sredstva za pranje (izuzev sapuna svih vrsta), sredstva za bijeljenje i ispiranje, sredstva za čišćenje i poliranje (izuzev onih koja su namijenjena koži i izuzev sapuna svih vrsta).

(111) 11049

(151) 06.06.2014.

(210) **2011-696**

(442) **20.12.2013.**

(220) 21.12.2011.

(732) **COLGATE PALMOLIVE COMPANY**, A DELAWARE CORPORATION, 300 PARK AVENUE, NEW YORK, NY 10022 US

PAIC

(540)

(550) I

(740) Kojić Ivana, Serdara Jola Piletića bb, Podgorica ME

(511) **Klasa 03:** Parfimerija, sapuni i toaletni preparati za ličnu upotrebu.

(111) 11048

(151) 06.06.2014.

(210) **2011-695**

(442) **20.12.2013.**

(220) 21.12.2011.

(732) **COLGATE PALMOLIVE COMPANY**, A DELAWARE CORPORATIN, 300 PARK AVENUE, NEW YORK, NY 10022 US

OLA

(540)

(550) I

(740) Kojić Ivana, Serdara Jola Piletića bb, Podgorica ME

(511) **Klasa 03:** Sredstva za bijeljenje i druge supstance za pranje, sredstva za čišćenje, poliranje, uklanjanje masti i brušenje, sapuni, parfimerija, eterična ulja, kozmetički proizvodi, losioni za kosu, preparati za njegu zuba.

(111) 11047

(151) 06.06.2014.

(210) **2011-693**

(442) **20.12.2013.**

(220) 21.12.2011.

(732) **COLGATE PALMOLIVE COMPANY**, A DELAWARE CORPORATION, 300 PARK AVENUE, NEW YORK, NY 10022 US

VEL

(540)

(550) I

(740) Kojić Ivana, Serdara Jola Piletića bb, Podgorica ME

(511) **Klasa 03:** Sredstva za bijeljenje i druge supstance za pranje, sredstva za čišćenje, poliranje, uklanjanje masti i brušenje, sapuni, parfimerija, eterična ulja, kozmetički proizvodi, losioni za kosu, preparati za njegu zuba.

(111) 11046

(151) 06.06.2014.

(210) **2011-694**

(442) **20.12.2013.**

(220) 21.12.2011.

(732) **COLGATE PALMOLIVE COMPANY**, A DELAWARE CORPORATION, 300 PARK AVENUE, NEW YORK, NY 10022 US

DYNAMO

(540)

(550) I

(740) Kojić Ivana, Serdara Jola Piletića bb, Podgorica ME

(511) **Klasa 03:** Sredstva za bijeljenje i druge supstance za pranje, sredstva za čišćenje, poliranje, uklanjanje masti i brušenje, sapuni, parfimerija, eterična ulja, kozmetički proizvodi, losioni za kosu, preparati za njegu zuba.

(111) 11051

(151) 09.06.2014.

(210) **2011-680**

(442) **20.12.2013.**

(220) 21.12.2011.

(732) **PHAMANOVA DOO**, INDUSTRIJSKA 8, OBRENOVAC RS

BABYTIME

(540)

(550) I

(740) Kojić Ivana, Serdara Jola Piletića bb, Podgorica ME

(511) **Klasa 05:** Farmaceutski preparati.

(111) 11052

(151) 09.06.2014.

(210) **2011-681**

(442) **20.12.2013.**

(220) 21.12.2011.

(732) **PHAMANOVA DOO**, INDUSTRIJSKA 8, OBRENOVAC RS

SIRUP
OD BELOG SLEZA



(540)

(550) I

(740) Kojić Ivana, Serdara Jola Piletića bb, Podgorica ME

(511) **Klasa 05:** Sirup od bijelog sleza.

(111) 11053

(151) 09.06.2014.

(210) **2011-682**

(442) **20.12.2013.**

(220) 21.12.2011.

(732) **PHAMANOVA DOO**, INDUSTRIJSKA 8, OBRENOVAC RS

SIRUP
OD JAGORČEVINE



(540)

(550) I

(740) Kojić Ivana, Serdara Jola Piletića bb, Podgorica ME

(511) **Klasa 05:** Sirup od jagorčevine.

(111) 11037

(151) 02.06.2014.

(210) **2011-612**

(442) **20.12.2013.**

(220) 12.12.2011.

(732) **13 JUL-PLANTAŽE A.D.** PODGORICA ME



(540)

(550) I

(511) **Klasa 33:** Alkoholna pića (izuzev piva).

(111) 11036

(151) 02.06.2014.

(210) **2011-611**(442) **20.12.2013.**

(220) 12.12.2011.

(732) **13 JUL-PLANTAŽE A.D. PODGORICA ME**

(540)

(550) I

(511) **Klasa 33:** Alkoholna pića (izuzev piva).

(111) 11035

(151) 02.06.2014.

(210) **2011-610**(442) **20.12.2013.**

(220) 12.12.2011.

(732) **13 JUL-PLANTAŽE A.D. PODGORICA ME**



(540) klasifikaciji:

(550) I

(511) **Klasa 33:** Alkoholna pića (izuzev piva).

(111) 11034

(151) 02.06.2014.

(210) **2011-609**

(442) **20.12.2013.**

(220) 12.12.2011.

(732) **13 JUL-PLANTAŽE A.D. PODGORICA ME**

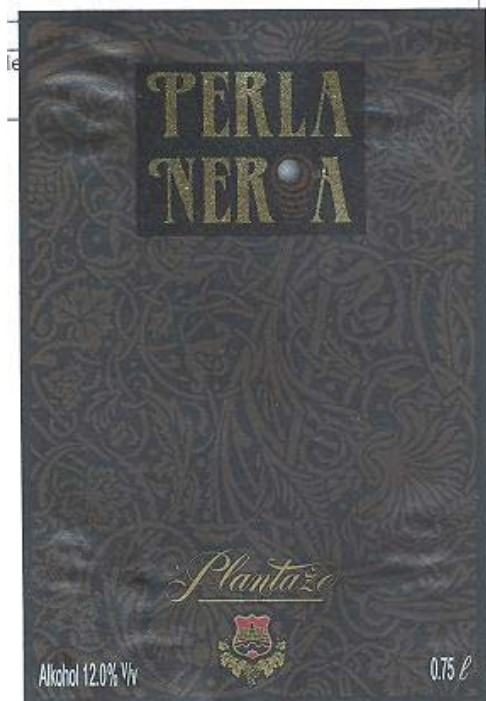

(540) klasifikaciji:

(550) I

(511) **Klasa 33:** Alkoholna pića (izuzev piva).

(111) 11033

(151) 02.06.2014.

(210) **2011-608**(442) **20.12.2013.**

(220) 12.12.2011.

(732) **13 JUL-PLANTAŽE A.D. PODGORICA ME****Ničanskoj klasifikaciji:**

(540) 3 | 12 | 14 | 15 | 16 | 17 | 18 | 19 | 20 | 21 | 22 | 23 | 24

(550) I

(511) **Klasa 33:** Alkoholna pića (izuzev pivo).

(111) 11032

(151) 02.06.2014.

(210) **2011-607**(442) **20.12.2013.**

(220) 12.12.2011.

(732) **13 JUL-PLANTAŽE A.D. PODGORICA ME**

Strast koja traje

(540)

(550) I

(511) **Klasa 33:** Alkoholna pića (izuzev piva).**Klasa 35:** Oglašavanje, vođenje poslova, poslovno upravljanje, kancelarijski poslovi.

(111) 11031

(151) 02.06.2014.

(210) **2011-606**(442) **20.12.2013.**

(220) 12.12.2011.

(732) **13 JUL-PLANTAŽE A.D. PODGORICA ME**

Ukus koji se pamti

(540)

(550) I

(511) **Klasa 33:** Alkoholna pića (izuzev piva).

Klasa 35: Oglašavanje, vođenje poslova, poslovno upravljanje, kancelarijski poslovi.

(111) 11059

(151) 09.06.2014.

(210) **2011-626**

(442) **20.12.2013.**

(220) 13.12.2011.

(732) **HUHTAMAKI FINANCE** B.V. A DUTCH CORPORATION JUPITERSTRAAT 102 2132 HE
HOOFDDORP NL

JOLLY RANCHER

(540)

(550) I

(740) Popović Miladin, Đoka Miraševića 21/III, Podgorica ME

(511) **Klasa 30:** Slatkiši, poslastice, gume za žvakanje, smrznute poslastice naime, vocni sladoledi, zacinjeni led, sladoledi, sladoledi na štapić, poslastice od sladoleda, smrznuti jogurt, smrznuti jogurt na štapić, šerbet.

(111) 11058

(151) 09.06.2014.

(210) **2011-560**

(442) **20.12.2013.**

(220) 15.11.2011.

(732) **HERSHEY CHOCOLATE&CONFECTIONERY COPRORATION**, 100 CRYSTAL A
DRIVE HERSHEY PENNSYLVANIA 17033 US

ICE BREAKERS

(540)

(550) I

(740) Popović Miladin, Đoka Miraševića 21/III, Podgorica ME

(511) **Klasa 30:** Kafa, čaj, kakao, šećer, pirinač, tapioka, sago, zamjena kafe, brašno i proizvodi od žitarica, hleb, kolači i poslastice, sladoledi, med, melasa, kvasac, prašak za pecivo, so, senf, sirće, sosovi (kao dodaci), začini, led, a naročito slatkiši, bombone, gume za žvakanje i bombone od mente.

(111) 11076

(151) 10.06.2014.

(210) **2011-245**

(442) **20.12.2013.**

(220) 20.05.2011.

(732) **MATICA CRNOGORSKA**, BEOGRADSKA 24 C PODGORICA ME



MATICA
crnogorska

(540)

(550) I

(511) **Klasa 41:** Obrazovne usluge, pripremanje obuke, razonoda, sportske i kulturne aktivnosti.

(111) 11029

(151) 02.06.2014.

(210) **2011-657**

(442) **20.12.2013.**

(220) 15.12.2011.

(732) **NINE WEST DEVELOPMENT COPORATION**, 1007 ORANGE SREET, SUITE 225, WILMINGTON, DELAWARE 19801 US

LOVE FURY KISS

(540)

(550) I

(740) Čejović Vladimir, 13. jula 21, Podgorica ME

(511) **Klasa 03:** Sredstva za bijeljenje i druge supstance za upotrebu u perionicama, preparati za čišćenje, poliranje, ribanje i nagrizanje, sapuni, parfimerija, eterična ulja, kozmetika, losioni za kosu, paste za zube, parfemi, toaletna voda, kolonska voda, mirisni sprejevi, sapuni, sredstva za čišćenje kože, losioni za kožu i kreme, hidrantne kreme, losioni i ulja za sunčanje, kozmetički proizvodi, naime, puderi za lice i tijelo, podloga za šminku, sjaj za tijelo, sjaj za lice, karmin, olovke za usne, rumenilo, sjenka za oči, krema za područje oko očiju, ajlajner, maskara i olovke za obrve, gel za tuširanje, soli za kupanje, prozvodi za njegu kose, naime šampon i regenerator.

(111) 11054

(151) 09.06.2014.

(210) **2011-636**

(442) **20.12.2013.**

(220) 14.12.2011.

(300) 62736 19.05.2011. RS

(732) **GALENIKA** A.D. BATAJNIČKI DRUM BB, 11080 BEOGRAD RS

KVINAP PLUS
КВИНАП ПЛУС

(540)

(550) I

(740) Kovačević Aleksandar, Kružni put bb, Cetinje ME

(511) **Klasa 05:** Farmaceutski preparati.

(111) 11055

(151) 09.06.2014.

(210) **2011-637**

(442) **20.12.2013.**

(220) 14.12.2011.

(300) 62732 19.05.2011. RS

(732) **GALENIKA** A.D. BATAJNIČKI DRUM BB, 11080 BEOGRAD RS

KVINAP
КВИНАП

(540)

(550) I

(740) Kovačević Aleksandar, Kružni put bb, Cetinje ME

(511) **Klasa 05:** Farmaceutski preparati.

(111) 11056

(151) 09.06.2014.

(210) **2011-638**

(442) **20.12.2013.**

(220) 14.12.2011.

(300) 62497 25.03.2011. RS

(732) **GALENIKA** A.D. BATAJNIČKI DRUM BB, 11080 BEOGRAD RS

GALOSART PLUS
ГАЛОСАРТ ПЛУС

(540)
(550) I
(740) Kovačević Aleksandar, Kružni put bb, Cetinje ME
(511) **Klasa 05:** Farmaceutski preparati.

(111) 11057
(151) 09.06.2014.
(210) **2011-642** (442) **20.12.2013.**
(220) 14.12.2011.
(732) **GALENIKA A.D. BATAJNIČKI DRUM BB, 11080 BEOGRAD RS**

LANOPROGAL
ЛАНПРОГАЛ

(540)
(550) I
(740) Kovačević Aleksandar, Kružni put bb, Cetinje ME
(511) **Klasa 05:** Farmaceutski preparati.

(111) 11075
(151) 11.06.2014.
(210) **2011-698** (442) **20.12.2013.**
(220) 21.12.2011.
(732) **COLGATE PALMOLIVE COMPANY, A DELAWARE CORPRATION, 300 PARK AVENUE, NEW YORK, NY 10022 US**

SOFLAN

(540)
(550) I
(740) Kojić Ivana, Serdara Jola Piletića bb, Podgorica ME
(511) **Klasa 03:** Deterdženti za fine tkanine, sredstva za bijeljenje i druge supstance za pranje, sredstva za čišćenje, poliranje, uklanjanje masti i brušenje, sapuni, parfimerija, eterična ulja, kozmetički proizvodi, losioni za kosu, preparati za njegu zuba.

(111) 11074

(151) 11.06.2014.

(210) **2011-706**

(442) **20.12.2013.**

(220) 21.12.2011.

(732) **COLGATE PALMOLIVE COMPANY**, A DELAWARE CORPORATION, 300 PARK AVENUE, NEW YORK, NY 10022 US



(540)

(550) I

(740) Kojić Ivana, Serdara Jola Piletića bb, Podgorica ME

(511) **Klasa 03:** Pasta za zube i voda za ispiranje usta.

(111) 11073

(151) 11.06.2014.

(210) **2011-705**

(442) **20.12.2013.**

(220) 21.12.2011.

(732) **COLGATE PALMOLIVE COMPANY**, A DELAWARE CORPORATION, 300 PARK AVENUE, NEW YORK, NY 10022 US



(540)

(550) I

(740) Kojić Ivana, Serdara Jola Piletića bb, Podgorica ME

(511) **Klasa 03:** Pasta za zube i voda za ispiranje usta.

(111) 11072

(151) 11.06.2014.

(210) **2011-704**

(442) **20.12.2013.**

(220) 21.12.2011.

(732) **COLGATE PALMOLIVE COMPANY**, A DELAWARE CORPORATION, 300 PARK AVENUE, NEW YORK, NY 10022 US



(540)

(550) I
(740) Kojić Ivana, Serdara Jola Piletića bb, Podgorica ME
(511) **Klasa 03:** Pasta za zube i voda za ispiranje usta.

(111) 11071
(151) 11.06.2014.
(210) **2011-703** (442) **20.12.2013.**
(220) 21.12.2011.
(732) **COLGATE PALMOLIVE COMPANY**, A DELAWARE CORPORATION, 300 PARK AVENUE, NEW YORK, NY 10022 US

GERMDEFENSE

(540)
(550) I
(740) Kojić Ivana, Serdara Jola Piletića bb, Podgorica ME
(511) **Klasa 03:** Pasta za zube i voda za ispiranje usta.

(111) 10974
(151) 26.05.2014.
(210) **2011-603** (442) **20.12.2013.**
(220) 09.12.2011.
(300) 2584822 16.06.2011. GB
(732) **BRITISH AMERICAN TOBACCO (BRANDS) INC.** 2711 CENTERVILLE ROAD, SUITE 300, WILMINGTON, DELAWARE 19808 US



(540)
(550) I
(740) Popović Miladin, Đoka Miraševića 21/III, Podgorica ME
(511) **Klasa 34:** Cigarete, duvan, proizvodi od duvana, upaljači, šibice, artikli za pušače.

(111) 10975
(151) 26.05.2014.
(210) **2011-604** (442) **20.12.2013.**

(220) 09.12.2011.

(300) 2584821 16.06. 2011. GB

(732) **BRITISH AMERICAN TOBACCO (BRANDS) INC.** 2711 CENTERVILLE ROAD, SUITE 300, WILMINGTON, DELAWARE 19808 US

(540)

(550) I

(740) Popović Miladin, Đoka Miraševića 21/III, Podgorica ME

(511) **Klasa 34:** Cigarete, duvan, proizvodi od duvana, upaljači, šibice, artikli za pušače.

(111) 11105

(151) 13.06.2014.

(210) **2011-709**(442) **20.12.2013.**

(220) 21.12.2011.

(732) **COLGATE PALMOLIVE COMPANY**, A DELAWARE CORPORATION, 300 PARK AVENUE, NEW YORK, NY 10022 US

(540)

(550) I

(740) Kojić Ivana, Serdara Jola Piletića bb, Podgorica ME

(511) **Klasa 03:** Pasta za zube i voda za ispiranje usta.

(111) 11106

(151) 13.06.2014.

(210) **2011-710**(442) **20.12.2013.**

(220) 21.12.2011.

(732) **COLGATE PALMOLIVE COMPANY**, A DELAWARE CORPORATION, 300 PARK AVENUE, NEW YORK, NY 10022 US

COLGATE

(540)

(550) I

(740) Kojić Ivana, Serdara Jola Piletića bb, Podgorica ME

(511) **Klasa 30:** Žvakaća guma i tablete za žvakanje.

(111) 11107

(151) 13.06.2014.

(210) **2011-711**

(442) **20.12.2013.**

(220) 21.12.2011.

(732) **COLGATE PALMOLIVE COMPANY**, A DELAWARE CORPORATION, 300 PARK AVENUE, NEW YORK, NY 10022 US

SOUPLINE

(540)

(550) I

(740) Kojić Ivana, Serdara Jola Piletića bb, Podgorica ME

(511) **Klasa 03:** Pasta za zube i voda za ispiranje usta.

(111) 11103

(151) 13.06.2014.

(210) **2011-707**

(442) **20.12.2013.**

(220) 21.12.2011.

(732) **COLGATE PALMOLIVE COMPANY**, A DELAWARE CORPORATION, 300 PARK AVENUE, NEW YORK, NY 10022 US



(540)

(550) I

(740) Kojić Ivana, Serdara Jola Piletića bb, Podgorica ME

(511) **Klasa 03:** Pasta za zube i voda za ispiranje usta.

(111) 11104

(151) 13.06.2014.

(210) **2011-708**(442) **20.12.2013.**

(220) 21.12.2011.

(732) **COLGATE PALMOLIVE COMPANY**, A DELAWARE CORPORATION, 300 PARK AVENUE, NEW YORK, NY 10022 US

(540)

(550) I

(740) Kojić Ivana, Serdara Jola Piletića bb, Podgorica ME

(511) **Klasa 03:** Pasta za zube i voda za ispiranje usta.

(111) 11109

(151) 16.06.2014.

(210) **2011-201**(442) **20.12.2013.**

(220) 26.04.2011.

(732) **MEDOCHEMIE LTD.** CONSTANTINOUPOLEOS STREET 3011, LIMASSOL CY

RILCAPTON

(540)

(550) I

(740) Popović Miladin, Đoka Miraševića 21/III, Podgorica ME

(511) **Klasa 05:** farmaceutski proizvodi.

(111) 11108

(151) 16.06.2014.

(210) **2011-200**(442) **20.12.2013.**

(220) 26.04.2011.

(732) **MEDOCHEMIE LTD.** CONSTANTINOUPOLEOS STREET 3011, LIMASSOL CY

AZEPTIL

(540)

(550) I

(740) Popović Miladin, Đoka Miraševića 21/III, Podgorica ME

(511) **Klasa 05:** Farmaceutski proizvodi.

(111) 11185

(151) 30.06.2014.

(210) **2011-645**

(442) **20.12.2013.**

(220) 14.12.2011.

(732) **TEVA OPERATINS POLAND** SP.Z.O.O, EMILII PLATER 53 00-113 WARSZAWA PL

AVIOMARIN

(540)

(550) I

(740) Popović Miladin, Đoka Miraševića 21/III, Podgorica ME

(511) **Klasa 05:** Farmaceutski preparati za lijekove koji se koriste za prevenciju i liječenje mučnine, povraćanja i vrtoglavice.

(111) 11180

(151) 30.06.2014.

(210) **2011-641**

(442) **20.12.2013.**

(220) 14.12.2011.

(300) 62498 25.03.2011. RS

(732) **GALENKA** A.D. BATAJNIČKI DRUM BB, 11080 BEOGRAD RS

FOSINOP ФОСИНОП

(540)

(550) I

(740) Kovačević Aleksandar, Kružni put bb, Cetinje ME

(511) **Klasa 05:** Farmaceutski preparati.

(111) 11179

(151) 30.06.2014.

(210) **2011-639**

(442) **20.12.2013.**

(220) 14.12.2011.

(300) 62499 25.03.2011. RS

(732) **GALENKA** A.D. BATAJNIČKI DRUM BB, 11080 BEOGRAD RS

NEBIGAL
НЕБИГАЛ

(540)
(550) I
(740) Kovačević Aleksandar, Kružni put bb, Cetinje ME
(511) **Klasa 05:** Farmaceutski preparati.

(111) 11173
(151) 30.06.2014.
(210) **2011-630** (442) **20.12.2013.**
(220) 14.12.2011.
(300) 63265 13.10.2011. RS
(732) **GALENIKA** A.D. BATAJNIČKI DRUM BB, 11080 BEOGRAD RS

SCILOPRAM
СЦИЛОПРАМ

(540)
(550) I
(740) Kovačević Aleksandar, Kružni put bb, Cetinje ME
(511) **Klasa 05:** Farmaceutski preparati.

(111) 11174
(151) 30.06.2014.
(210) **2011-631** (442) **20.12.2013.**
(220) 14.12.2011.
(300) 62703 10.05.2011. RS
(732) **GALENIKA** A.D. BATAJNIČKI DRUM BB, 11080 BEOGRAD RS

LEFLOGAL
ЛЕФЛОГАЛ

(540)
(550) I

(740) Kovačević Aleksandar, Kružni put bb, Cetinje ME

(511) **Klasa 05:** Farmaceutski preparati.

(111) 11175

(151) 30.06.2014.

(210) **2011-632**

(442) **20.12.2013.**

(220) 14.12.2011.

(300) 62735 19.05.2011. RS

(732) **GALENIKA** A.D. BATAJNIČKI DRUM BB, 11080 BEOGRAD RS

TELUKA
TEJYKA

(540)

(550) I

(740) Kovačević Aleksandar, Kružni put bb, Cetinje ME

(511) **Klasa 05:** Farmaceutski preparati.

(111) 11176

(151) 30.06.2014.

(210) **2011-633**

(442) **20.12.2013.**

(220) 14.12.2011.

(300) 62733 19.05.2011.RS

(732) **GALENIKA** A.D. BATAJNIČKI DRUM BB, 11080 BEOGRAD RS

ELEPHOGAL
ЕЛЕФОГАЛ

(540)

(550) I

(740) Kovačević Aleksandar, Kružni put bb, Cetinje ME

(511) **Klasa 05:** Farmaceutski preparati.

(111) 11177

(151) 30.06.2014.

(210) **2011-634**

(442) **20.12.2013.**

(220) 14.12.2011.

(300) 62731 19.05.2011. RS

(732) **GALENIKA** A.D. BATAJNIČKI DRUM BB, 11080 BEOGRAD RS

LINDOMEM
ЛИНДОМЕМ

(540)

(550) I

(511) **Klasa 05:** Farmaceutski preparati.

(111) 11178

(151) 30.06.2014.

(210) **2011-635**

(442) **20.12.2013.**

(220) 14.12.2011.

(300) 62734 19.05.2011. RS

(732) **GALENIKA** A.D. BATAJNIČKI DRUM BB, 11080 BEOGRAD RS

PARIZOL
ПАРИЗОЛ

(540)

(550) I

(740) Kovačević Aleksandar, Kružni put bb, Cetinje ME

(511) **Klasa 05:** Farmaceutski preparati.

(111) 11192

(151) 02.07.2014.

(210) **2011-671**

(442) **20.12.2013.**

(220) 20.12.2011.

(732) **UNILEVER N.V.** WEENA 455 3013 AL ROTTERDAM NL



(540)

(550) I

(740) Popović Miladin, Đoka Miraševića 21/III, Podgorica ME

(511) **Klasa 03:** Deterdženti, preparati i supstance, sve za pranje rublja, preparati za omekšavanje rublja, preparati za izbjeljivanje, preparati za čišćenje, poliranje, odmaščivanje i abrazivni preparati, preparati za pranje sudova, sapuni, za pranje ruku, preparatima impregnirani ubrusi supstance za čišćenje i poliranje.

(111) 09820

(151) 23.07.2014.

(210) **2011-65**

(442) **20.04.2014.**

(220) 2/8/2011

(732) **BOSNALIJEK, FARMACEUTSKA I HEMIJSKA INDUSTRIJA, DD**, JUKIĆEVA 53, 71000 SARAJEVO BA

RODAVAN N

(540)

(550) I

(740) Radulović Božidar, Jovana Tomaševića 9/III, Podgorica ME

(511) **Klasa 05:** Farmaceutski proizvodi.

(111) 11276

(151) 23.07.2014.

(210) **2011-730**

(442) **20.12.2013.**

(220) 28.12.2011.

(732) **CRNOGORSKO SERTIFIKACIONO TIJELO D.O.O.** BULEVAR SV. PETRA CETINJSKOG 91, PODGORICA ME



(540)

(550) I

(511) **Klasa 35:** Oglašavanje, vođenje poslova, poslovno upravljanje, kancelarijski poslovi.**Klasa 42:** Naučne i tehnološke usluge i istraživanje i projektovanje u vezi navedenih usluga, usluge industrijske analize i istraživanje.

(111) 09221

(151) 11.12.2013.

(210) **2011-126**(442) **20.06.2013**

(220) 11.3.2011

(732) **SEBA DIS TICARET VE NAKLIYAT A.S.**, SAMANDIRA CADDESİ, NO.18
BUYUKBAKKALKOY-MALTEPE-INSTANBUL, TR

(540)

(550) I

(740) Čupić Branislav, Dalmatinska 10, Podgorica (ME)

(511) **Klasa 34:** Cigarete, duvan, artikli za pušače, šibice.

(111) 09224

(151) 11.12.2013.

(210) **2011-111**(442) **20.06.2013**

(220) 7.3.2011

(732) **MAGNUM INDUSTRIA DA AMAZONIA S.A.**, AVENIDA CUIUBA, 1.500, DISTRITO
INDUSTRIAL, CEP 69075-060, MANAUS, AM BR



(540)

(550) I

(740) Čejović Vladimir, 13. jula 21, Podgorica (ME)

(511) **Klasa 14:** satovi i njihovi djelovi, nakit i bižuterija.

(111) 09225

(151) 11.12.2013.

(210) **2011-128**(442) **20.06.2013**

(220) 11.3.2011

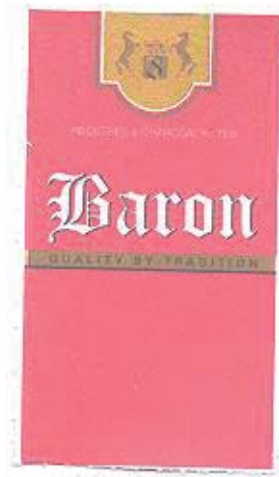
(732) **SEBA DIS TICARET VE NAKLIYAT A.S.**, SAMANDIRA CADDESİ, NO. 18
BUYUKBAKKALKOY-MALTEPE-INSTANBUL, TR

(540)

(550) I

(740) Čupić Branislav, Dalmatinska 10, Podgorica (ME)

(511) **Klasa 34:** Cigarete, duvan, artikli za pušače, šibice.

(111) 09232

(151) 11.12.2013.

(210) **2011-145**(442) **20.06.2013**

(220) 24.3.2011

(732) **AMGEN INC.**, ONE AMGEN CENTER DRIVE THOUSAND OAKS, CALIFORNIA 91320-1799, US

STROSTEO

(540)

(550) I

(740) Radulović Božidar, Jovana Tomaševića 9/III, Podgorica (ME)

(511) **Klasa 05:** Farmaceutski preparati.

(111) 09230

(151) 11.12.2013.

(210) **2011-146**

(442) **20.06.2013**

(220) 25.3.2011

(732) **ABBOTT LABORATORIES**, ABBOTT PARK, ILLINOIS 60064 US

CELL-DYN

(540)

(550) I

(740) Popović Miladin, Đoka Miraševića 21/III, Podgorica (ME)

(511) **Klasa 05:** Farmaceutski preparati, medicinski dijagnostički reagensi, dijagnostički preparati za kliničku i medicinsko laboratorijsku upotrebu.

Klasa 10: Hirurški i medicinski aparati i instrumenti, medicinski dijagnostički aparati i instrumenti.

(111) 09226

(151) 11.12.2013.

(210) **2011-147**

(442) **20.06.2013**

(220) 25.3.2011

(732) **SCHERING CORPORATION**, 2000 Galloping Hill Road, New Jersey 07033, US

M-M-RVAXPRO

(540)

(550) I

(740) Ćupić Branislav, Dalmatinska 10, Podgorica (ME)

(511) **Klasa 05:** Farmaceutski preparati, naročito za ljudsku upotrebu.

(111) 09233

(151) 11.12.2013.

(210) **2011-136**

(442) **20.06.2013**

(220) 18.3.2011

(732) **VULCABRAS-AZALEIA-RS**, CALCADOS E ARTIGOS ESPORTIVOS S.A, RUA DR. LEGEN-DRE, 34, PAROBE, RIO GRANDE DO SUL BRAZIL, 95630-000, BR

OLK

(540)

(550) I

(740) Popović Miladin, Đoka Miraševića 21/III, Podgorica (ME)

(511) **Klasa 25:** Odjeća, obuća i pokrivala za glavu.

(111) 09241

(151) 11.12.2013.

(210) **2011-133**

(442) **20.06.2013**

(220) 15.3.2011

(732) **KWIZDA HOLDING GMBH**, DR.KARL LUEGER-RING 6,A-1010 WIEN, AT

VERAGOL

(540)

(550) I

(740) Čejović Vladimir, 13. jula 21, Podgorica (ME)

(511) **Klasa 05:** Farmaceutski i veterinarski preparati; sanitarni preparati za medicinske svrhe; dijetetske supstance prilagođene za upotrebu u medicini, hrana za bebe; flasteri, materijali za zavijanje; materijali za plombiranje zuba; zubarska smola; dezinfekciona sredstva; preparati za uništavanje štetočina; fungicidi, herbicidi.

(111) 09270

(151) 11.12.2013

(210) **2011-129**

(442) **20.06.2013**

(220) 14.3.2011

(732) **AKZO NOBEL COATINGS INTERNATIONAL B.V.**, VELPERWEG 76, 6824 BM ARNHEM, THE NL

INTERNATIONAL

(540)

(550) I

(740) Ćupić Branislav, Dalmatinska 10, Podgorica (ME)

(511) **Klasa 02:** Boje, firnajzi, emajl; lakovi; materije za bojenje; tempere; crni lakovi; preparati i substance za sušenje boja i lakova; sredstva za zaštitu od truljenja drva; sredstva za bojenje drva; sredstva protiv rđe; farbe za sprečavanje razvoja organizama; razređivači za gore navedenu robu; osnovni premaz boja.

(111) 09251

(151) 11.12.2013.

(210) **2011-130**

(442) **20.06.2013**

(220) 14.3.2011

(732) **CONVATEC INC.**, 200 HEADQUARTERS PARK DRIVE, SKILLMAN, NJ08558,US

REALIZE THE POSSIBILITIES

(540)

(550) I

(740) Ćupić Branislav, Dalmatinska 10, Podgorica (ME)

(511) **Klasa 16:** Štampani materijal, a naročito bilteni, brošure, pamfleti, informativni listići, prikazi i poster i iz oblasti tretmana ostomije, njege kože i obrade rana.

Klasa 44: Usluge davanja medicinskih informacija, a naročito davanje informacija ljekarima, zdravstvenim radnicima i pacijentima na temu tretmana ostomije, njege kože i obrade rana.

(111) 09245

(151) 11.12.2013.

(210) **2011-131**

(442) **20.06.2013**

(220) 14.3.2011

(732) **SANOFI**, 54 Rue La Boetie,75008 PARIS. FR

(540)

(550) I

(740) Popović Miladin, Đoka Miraševića 21/III, Podgorica (ME)

(511) **Klasa 05:** Farmaceutski proizvodi, dietetski dodaci, funkcionalna hrana (pola hrana, pola lijek), prehrambeni dodaci, za medicinsku i ljudsku upotrebu.

(111) 09283

(151) 11.12.2013.

(210) **2011-120**

(442) **20.06.2013**

(220) 11.3.2011

(732) **BELUPO LJEKOVI I KOZMETIKA D.D.**, DANICA 5 48000 KOPRIVNICA HR

GLIKA

(540)

(550) I

(740) Popović Miladin, Đoka Miraševića 21/III, Podgorica (ME)

(511) **Klasa 05:** Farmaceutski proizvodi.

(111) 09271

(151) 11.12.2013.

(210) **2011-125**

(442) **20.06.2013**

(220) 11.3.2011

(732) **RUBYCON CORPORATION**, 1938-1 NISHI MINOWA INA-SHI, NAGANO-KEN, JP

Rubycon

(540)

(550) I

(740) Čupić Branislav, Dalmatinska 10, Podgorica (ME)

(511) **Klasa 09:** Kondezatori, otpornici i drugi električni djelovi.

(111) 09284

(151) 11.12.2013.

(210) **2011-63**

(442) **20.06.2013**

(220) 7.2.2011

(732) **GROUPON, INC**, 600 WEST CHICAGO AVENUE, CHICAGO, ILLINOIS 60654 US

GROUPON

(540)

(550) I

(740) Ćupić Branislav, Dalmatinska 10, Podgorica (ME)

(511) **Klasa 35:** Promovisanje roba i usluga za druge obezbjeđivanjem vebajtova koje karakterišu kuponi, rabati, obavještenja o uporednim cjenama proizvoda, procjene proizvoda, linkovi ka vebajtovima drugih maloprodajnih subjekata i informacije o popustima.

(111) 09313

(151) 11.12.2013.

(210) **2011-43**

(442) **20.06.2013**

(220) 31.1.2011

(732) **BONGRAIN S.A.**, 42 RUE RIEUSSEC, 78220 VIROFLAY, FR



(540)

(550) I

(740) Lutovac Branislav, Bulevar Crnojevića 93, Podgorica (ME)

(511) **Klasa 29:** Mlijeko, sir i mliječni proizvodi; jestiva ulja i masti.

(111) 09315

(151) 11.12.2013.

(210) **2011-25**

(442) **20.06.2013**

(220) 20.1.2011

(732) **NOVARTIS AG**, 4002 BASEL CH

BRINERDIN

(540)

(550) I

(740) Radulović Božidar, Jovana Tomaševića 9/III, Podgorica (ME)

(511) **Klasa 05:** Farmaceutski preparati.

(111) 09316

(151) 11.12.2013.

(210) **2011-219**

(442) **20.06.2013**

(220) 6.5.2011

(732) **TDR DOO**, OBALA VLADIMIRA NAZORA BR.1 52210 ROVINJ, HR

uz pomoć računara



(540)

(550) I

(740) Vukotić Petar, Novaka Miloševa, Podgorica (ME)

(511) **Klasa 34:** duvan sirov i prerađen. proizvodi od duvana, cigare, cigarete, filter, cigarete, cigarilosi, artikli za pušače, upaljači, šibice.

Klasa 35: usluge u vezi sa prometom robe, Dosebno usluge u prometu duvana i duvan skin proizvoda; oglašavanje: vodenje poslova; poslovno upravljanje; kancelarijski poslovi; komercijalno zastupanje; propagandne i reklamne usluge; marketing; usluge istraživanja tržišta; usluge promocije, posebno promovisanje ili reklamiranje kulturnih i zabavnih događaja, sportskih tajcmicenja i niodnih revija; organizovanje i vođenje sajrnova i izložbi u reklamne i komercijaine svrhe; naprijed navedene usluge koje pripadaju ovoj klasi ko)č se obavljaju putem intemeta; davanje i širenje informacija u vezi sa gore navedenim uslugama.

(111) 09317

(151) 11.12.2013.

(210) **2011-220**

(442) **20.06.2013**

(220) 6.5.2011

(732) **TDR DOO**, OBALA VLADIMIRA NAZORA BR.1 52210 ROVINJ, HR



(540)

(550) I

(740) Vukotić Petar, Novaka Miloševa, Podgorica (ME)

(511) **Klasa 34:** duvan sirov i prerađen. proizvodi od duvana, cigare, cigarete, filter, cigarete, cigarilosi, artikli za pušaće, upaljači, šibice.

Klasa 35: usluge u vezi sa prometom robe, Dosebno usluge u prometu duvana i duvan skin proizvoda; oglašavanje: vodenje poslova; poslovno upravljanje; kancelarijski poslovi; komercijalno zastupanje; propagandne i reklamne usluge; marketing; usluge istraživanja tržišta; usluge promocije, posebno promovisnje ili reklamiranje kulturnih i zabavnih događaja, sportskih tajcmicjenja i niodnih revija; organizovanje i vođenje sajrnova i izložbi u reklamne i komercijaine svrhe; naprijed navedene usluge koje pripadaju ovoj klasi ko)č se obavljaju putem intemeta; davanje i širenje informacija u vezi sa gore navedenim uslugama.

(111) 09345

(151) 11.12.2013.

(210) **2011-112**

(442) **20.06.2013**

(220) 8.3.2011

(300) 77-756951 11.06.2009. US

(732) **GENERAL MOTORS LLC**, 300 RENASSANCE CENTER, CITY OF DETROIT, STATE OF MICHIGAN 48265-3000 US

CHEVROLET TRAX

(540)

(550) I

(740) Popović Miladin, Đoka Miraševića 21/III, Podgorica (ME)

(511) **Klasa 12:** Motorna vozila i njihovi djelovi (osim uređaja protiv krađa za vozila).

(111) 09346

(151) 11.12.2013.

(210) **2011-586**

(442) **20.03.2013**

(220) 1.12.2011

(732) **MEGA DISPOSABLES S.A.**, 148 DEKELIASB ST.,13671 AHARNAI GR

BABYLINO

(540)

(550) I

(740) Čejović Vladimir, 13. jula 21, Podgorica (ME)

(511) **Klasa 05:** Pelene.

(111) 09347

(151) 11.12.2013.

(210) **2011-118**

(442) **20.06.2013**

(220) 10.3.2011

(732) **SUMITOMO CHEMICAL CO.LTD**, 27-1, SHINKAWA 2-CHOME, CHUO-KU TOKYO 104-8260 JP

APACHE

(540)

(550) I

(740) Mugoša Stanković Ana, Trg Republike 13, Podgorica (ME)

(511) **Klasa 01:** Hemijski proizvodi koji se koriste u proizvodnji insekticida, fungicida i herbicida;

Klasa 05: Insekticidi, fungicidi, herbicidi, i preparati za uništavanje gamadi i korova.

(111) 09352

(151) 11.12.2013.

(210) **2011-119**

(442) **20.06.2013**

(220) 10.3.2011

(732) **SUMITOMO CHEMICAL CO., LTD**, 27-1, SHINKAWA 2-CHOME, CHUO-KU TOKYO 104-8260 JP

DANTOP

(540)

(550) I

(740) Mugoša Stanković Ana, Trg Republike 13, Podgorica (ME)

(511) **Klasa 01:** Hemijski proizvodi koji se koriste u proizvodnji insekticida, fungicida i herbicida;

Klasa 05: Insekticidi, fungicidi, herbicidi, i preparati za uništavanje gamadi i korova.

(111) 09353

(151) 11.12.2013.

(210) **2011-110**

(442) **20.06.2013**

(220) 7.3.2011

(732) **ASTRA ZENECA AB**., SE-151 85 SODERTALJE, SE

MARCAIN

(540)

(550) I

(740) Božović Vesko, Rimski trg 50/11, Podgorica (ME)

(511) **Klasa 05:** Farmaceutski preparati i supstance.

(111) 09378

(151) 11.12.2013.

(210) **2011-183**

(442) **20.06.2013**

(220) 12.4.2011

(732) **SCERING CORPRATION**, 2000 GALLOPING HILL ROAD, KENILWORTH, NEW JERSEY 07033, US



(540)

(550) I

(740) Čupić Branislav, Dalmatinska 10, Podgorica (ME)

(511) **Klasa 05:** vakcine za ljudsku upotrebu.

(111) 09377

(151) 11.12.2013.

(210) **2011-184**

(442) **20.06.2013**

(220) 12.4.2011

(732) **SCERING CORPRATION**, 2000 GALLOPING HILL ROAD, KENILWORTH, NEW JERSEY 07033, US

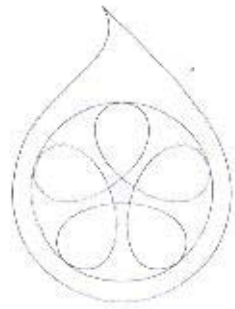

(540)

(550) I

(740) Čupić Branislav, Dalmatinska 10, Podgorica (ME)

(511) **Klasa 05:** Vakcina za ljudsku upotrebu.

(111) 09389

(151) 11.12.2013.

(210) **2011-244**(442) **20.06.2013**

(220) 19.5.2011

(732) **DUNHILL TOBACCO OF LONDON LIMITED**, GLOBE HOUSE 4 TEMPLE LONDON WC2R 2 PG UK, GB

DUNHILL MASTER BLEND

(540)

(550) I

(740) Popović Miladin, Đoka Miraševića 21/III, Podgorica (ME)

(511) **Klasa 34:** Cigarete; cigare; cigarilosi; duvan za lule; duvan za uvijanje; duvan za pušenje; duvan za žvakanje i duvan.

(111) 09391

(151) 11.12.2013.

(210) **2011-187**(442) **20.06.2013**

(220) 14.4.2011

(732) **SCHERING CORPRATION**, 2000 GALLOPING HILL ROAD, KENILWORTH, NEW JERSEY 07033, US

ZOLINZA

(540)

(550) I

(740) Čupić Branislav, Dalmatinska 10, Podgorica (ME)

(511) **Klasa 05:** Farmaceutski preparati za liječenje raka.

(111) 09550

(151) 12.12.2013.

(210) **2011-194**

(442) **20.06.2013**

(220) 21.4.2011

(732) **BERLIN-CHEMIE AG**, GLIENICKER WEG 125, D-12489 BERLIN, DE

MIG

(540)

(550) I

(740) Radulović Božidar, Jovana Tomaševića 9/III, Podgorica (ME)

(511) **Klasa 05:** Farmaceutski proizvodi, dijetetske supstance prilagođene za upotrebu u medicini.

(111) 09734

(151) 16.12.2013.

(210) **2011-238**

(442) **20.06.2013**

(220) 17.5.2011

(732) **ALKALOID AD SKOPLJE**, BUL.ALEKSANDAR MAKEDONSKI 12, 1000 SKOPLJE REPUBLIKA MAKEDONIJA, MK



(540) _____

(550) I

(740) Popović Miladin, Đoka Miraševića 21/III, Podgorica (ME)

(511) **Klasa 03:** Dečja vitaminska mast.

(111) 09756

(151) 17.12.2013.

(210) **2011-188**

(442) **20.06.2013**

(220) 18.4.2011

(732) **THE PROCTER & GAMBLE COMPANY**, ONE PROCTER & GAMBLE PLAZA, CINCINNATI, OHIO 45202, US

(540)

(550) I

(740) Lutovac Branislav, Bulevar Crnojevića 93, Podgorica (ME)

(511) **Klasa 03:** Preparati za njegu kože.

(111) 09757

(151) 17.12.2013.

(210) **2011-231**(442) **20.06.2013**

(220) 16.5.2011

(732) **PHARMACEUTICAL CHEMICAL COSMETICS INDUSTRY ALKALOID AD SKOPLJE**, BIL. ALEKSANDAR MAKEDONSKI 12 1000 SKOPLJE MK

(540)

(550) I

(740) Popović Miladin, Đoka Miraševića 21/III, Podgorica (ME)

(511) **Klasa 03:** Sapuni; parfimerija, eterična ulja, kozmetika, losioni za kosu, paste za zube.**Klasa 05:** Farmaceutski preparati; dietetske supstance prilagođene za medicinsku upotrebu, hrana za bebe; flasteri, materijali za zavijanje;**Klasa 16:** Pelene za bebe, kartoni i robe napravljene od ovih materijala, koji nisu uključeni u

druge klase;

(111) 09758

(151) 20.12.2013.

(210) **2011-208**

(442) **20.06.2013**

(220) 28.4.2011

(732) **SAMSONITE IP HOLDING S.a.r.l.**, 13-15 AVENUE DE LA LIBERTE.L-1931 LUXEMBURG, LU

Samsnite

(540)

(550) I

(740) Popović Miladin, Đoka Miraševića 21/III, Podgorica (ME)

(511) **Klasa 09:** Torbe za nošenje za prenosive računare; torbe sa točkovima specijalno prilagođene za držanje prenosivih računara; zaštitne navlake za prenosive računare; zaštitne torbe za prenosive računare; električne pegle za putovanja; konvertor električne struje; kompleti konvertora električne struje i adaptera; pegle na paru; pegla na paru za odeću; dvogledi i futrole za dvoglede; naočari i naočari za sunce; futrole za naočari; torbe za nošenje foto, video, audio, elektronske i kompjuterske opreme; futrole za telefone, kaiševi za fotografsku i video opremu koji se kače oko vrata i ramena; torbe za kamere; tronošci za fotografsku i video opremu; alarmi na baterije koji se aktiviraju pokretom protiv krađe prtljaga, vage

Klasa 18: Putni koferi, vreće za nošenje stvari za sve namene, putne torbe, kolica, rančevi, vreće za nošenje stvari, vreće za nošenje stvari na točkove, sportske torbe, meke torbe sa držačima, ruksaci, uprtnjače, mali koferi, torbe za nošenje knjiga, rančevi, aktovke, akten-tašne, torbe za kupovinu, torbe za nošenje preko ramena, Boston torbe (torbe sa dve ručke), kaiševi za prtljag, etikete za prtljag, identifikacione oznake, držači za novae, novčanici, bezbednosne kese, novčanici za račune, damske tašnice, tašnice za držanje sitnine, večernje torbice, torbe za rame, ručne torbe, futrole za kreditne kartice, futrole za ključeve, torbe koje se nose oko struka, torbice za toaletni pribor koje se prodaju prazne, organizatori za toaletni pribor koji se prodaju prazni, kutije za toaletni pribor koje se prodaju prazne, torbice za pribor za brijanje koje se prodaju prazne, male torbe za putovanja, kozmetičke torbe koje se prodaju prazne, torbe za donji veš koje se prodaju prazne, navlake za odeću, torbe za odeću, kišobrani, torbe za cipele naročito za putovanja; torbe za pelene; remenice za kaiševe za prtljag, koje se prodaju kao sastavni deo putnog kofera, umeci za putni kofer, naime, torbice za pakovanje.

Klasa 35: Usluge maloprodaje u vezi sa predmetima koji se tiču putnih kofera i srodnih predmeta za putovanja i pribora; onlajn usluge maloprodaje putnih kofera koji se tiču naime putnih kofera i pribora za putovanja.

(111) 09759

(151) 17.12.2013.

(210) **2011-229**

(442) **20.06.2013**

(220) 13.5.2011

(732) **THE PROCTER & GAMBLE COMPANY**, ONE PROCTER & GAMBLE PLAZA, CINCINNATI, OHIO 45202 US

MYSTERIEUSE

(540)

(550) I

(740) Lutovac Branislav, Bulevar Crnojevića 93, Podgorica (ME)

(511) **Klasa 03:** Sredstva za pranje i beljenje i druge supstance za upotrebu u domaćinstvu; sredstva za čišćenje, poliranje, odmaščivanje i abrazivna sredstva; sredstva za čišćenje, negu i ulepšavanje pribora za jelo i posuda; sapuni za upotrebu u domaćinstvu.

(111) 09761

(151) 17.12.2013.

(210) **2011-222**

(442) **20.06.2013**

(220) 10.5.2011

(732) **PROCTER & GAMBLE BUSINESS SERVICER CANADA COMPANY**, SUITE 800,1959 UPPER WATER STREET,P,O BOX 997, HALIFAX,NOVA SCOTIA B3J2X2, CA

CROSSACTION

(540)

(550) I

(740) Lutovac Branislav, Bulevar Crnojevića 93, Podgorica (ME)

(511) **Klasa 21:** Četkice za zube, četkice za desni i djelovi i oprema za iste, električne četkice za zube; četke i materijal za pravljenje četki, čačkalice za zube, materijal i instrumenti za čišćenje i poliranje prirodnih ili vještačkih zuba, patrone, držači i tacne za upotrebu u domaćinstvu i kupatilu, koji nisu od plemenitih metala.

(111) 09760

(151) 17.12.2013.

(210) **2011-223**

(442) **20.06.2013**

(220) 10.5.2011

(732) **THE PROCTER & GAMBLE COMPANY**, ONE PROCTER & GAMBLE PLAZA. CINCINNATI, OHIO 45202 US

MICRO CAPSULES

(540)

(550) I

(740) Lutovac Branislav, Bulevar Crnojevića 93, Podgorica (ME)

(511) **Klasa 03:** Sredstva za pranje i beljenje, i druge supstance za upotrebu kod pranja veša; preparati za čišćenje, poliranje, nagrizajuća sredstva, abrazivna sredstva; sredstva za omekšavanje i oplemenjivanje tkanina; sapuni; parfimerija, eterična ulja, kozmetika, losioni za kosu; proizvodi za negu zuba, ništa od napred navedene robe u obliku kapsula.

(111) 09762

(151) 17.12.2013.

(210) **2009-412**

(442) **20.03.2012**

(220) 03.06.2009

(732) **ALKALOID AD SKOPLJE;** BULEVAR ALEKSANDAR MAKEDONSKI 12, 1000 SKOPLJE MK

ANALGIN

(540)

(550) I

(740) Božović Vesko, Rimski trg, 50/11, Podgorica (ME)

(511) **Klasa 05:** Farmaceutski preparati.

(111) 09786

(151) 17.12.2013.

(210) **2011-178**

(442) **20.06.2013**

(220) 11.4.2011

(732) **THE PROCTER & GAMBLE COMPANY,** ONE PROCTER & GAMBLE PLAZA, CINCINNATI, OHIO 45202, US

PROSPETIMEA NATURII

(540)

(550) I

(740) Lutovac Branislav, Bulevar Crnojevića 93, Podgorica (ME)

(511) **Klasa 03:** Sredstva za pranje i beljenje i druga sredstva za upotrebu u pranju veša; preparati za čišćenje, poliranje, nagrizajuća sredstva, abrazivna sredstva; sapuni; deterdženti, sredstva za uklanjanje krečnih naslaga i kamenca; sva naprijed navedena roba sa ili bez dezinfikujuće komponente.

Klasa 05: Sredstva za dezinfekciju, sterilizaciju i antibakterijska sredstva, sve za upotrebu u domaćinstvu.

(111) 09787

(151) 17.12.2013.

(210) **2011-189**

(442) **20.06.2013**

(220) 18.4.2011

(732) **THE PROCTER & GAMBLE COMPANY**, ONE PROCTER & GAMBLE PLAZA, CINCINNATI, OHIO 45202, US

OLAY

(540)

(550) I

(740) Lutovac Branislav, Bulevar Crnojevića 93, Podgorica (ME)

(511) **Klasa 03:** Preparati za njegu kože.

(111) 09819

(151) 28.12.2013.

(210) **2011-246**

(442) **20.06.2013**

(220) 20.5.2011

(732) **RATIOPHARM GMBH**, GRAF-ARCO-STR.3 89079 ULM DE

EPORATIO

(540)

(550) I

(740) Lutovac Branislav, Bulevar Crnojevića 93, Podgorica (ME)

(511) **Klasa 05:** Farmaceutski i veterinarski preparati; sanitarni preparati za medicinske svrhe; dijetetske supstance prilagodjene za upotrebu u medicini, hrana za bebe; flasteri, materijali za zavijanje; materijali za plombiranje zuba, zubarska smola; dezinfekciona sredstva; preparati za uništavanje štetočina; fungicidi, herbicidi.

(111) 10460

(151) 28.12.2013.

(210) **2011-212**

(442) **20.06.2013**

(220) 4.5.2011

(732) **APPLE INC.**, 1 INFINITE LOOP, CUPERTINO, 95014 CALIFORNIA, US

APP STORE

(540)

(550) I

(740) Ćupić Branislav, Dalmatinska 10, Podgorica (ME)

(511) **Klasa 09:** Računari, računarski hardver, računarski periferni uređaji; mikroprocesori, memorijske ploče, monitori, displeji, tastature, kablovi, modemi, štampači, disk drajvovi, adapted, adapterske karte, konektori i drajveri; hard drajvovi; uređaji za čuvanje podataka; računarske mašine za igranje; prazni računarski memorijski medijumi; magnetni nosači podataka; audio diskovi, video diskovi, kompakt diskovi, CD-ROM-ovi, DVD-ovi; čipovi, diskovi i trake sa nasnimljenim ili za snimanje računarskih programa i softvera; memorije sa direktnim pristupom (RAM); čitačke memorije (ROM); memorijski uređaji bez pokretnih dijelova; podloge za miša; baterije; punjači; punjači za električne baterije; kamere; video kamere; ručni računari, tablet računari, personalni digitalni asistenti (PDA); elektronski organizatori, elektronske sveske; mobilni digitalni elektronski uređaji, GPS uređaji; ručni digitalni elektronski uređaji i softver za navedeno; elektronske ručne jedinice za bežični prijem, čuvanje i/ili prenos podataka i poruka, i elektronski uređaji koji omogućavaju korisniku da prati ili upravlja ličnim informacijama; elektronska komunikaciona oprema i instrumenti; telekomunikacioni aparati i instrumenti; telefoni; videofoni; ručni i mobilni digitalni elektronski uređaji za slanje i prijem telefonskih poziva, faksova, elektronske pošte i drugih digitalnih podataka; MP3 i drugi audio plejeri digitalnog formata; digitalni audio i video rekorderi i plejeri; rekorderi i plejeri za audio i video kasete, kompakt diskove, DVD-ove i digitalne audio trake; aparati za snimanje i reprodukciju zvuka; slušalice, stereo slušalice; zvučnici, stereo zvučnici, audio zvučnici; stereo uređaji; radio uređaji, radio odašiljači i prijemnici; pojačala; električni fonografi, gramofoni; aparati za snimanje i reprodukciju traka; aparati za snimanje; mikrofoni; audio, video, i digitalni mikseri; audio aparati za automobile; računarski softver; računarski softver za autorizaciju, preuzimanje, prenos, prijem, montažu, ekstrakciju, kodiranje, dekodiranje, prikazivanje, čuvanje i uređivanje teksta, grafika, slika, audio fajlova, video fajlova, elektronskih igara i elektronskih publikacija; računarski izvršni softver za mobilne telefone, prenosive media plejere i ručne računare; računarski softver za pretraživanje, pregled, kupovinu i preuzimanje elektronskih igara i softverskih aplikacija; softver za računarske operativne sisteme; softver za sinhronizaciju podataka; softver za razvoj aplikacija; računarski programi za upravljanje ličnim podacima; softver za upravljanje bazom podataka; softver za prepoznavanje znakova (karaktera); softver za elektronsku poštu i poruke; softver za mobilne telefone; računarski programi za pristup, pregled i pretragu onlajn baza podataka; kompjuterske i elektronske igrice; elektronske publikacije koje se mogu preuzeti; uputstva za upotrebu u elektronski, mašinski ili kompjuterski čitljivoj formi koja se koriste za i koja su prodana zajedno sa gore navedenom robom; navlake, torbe i futrole za svu gore navedenu robu; pribor, dijelovi i oprema za svu gore navedenu robu.

Klasa 35: Oglašavanje; poslovno upravljanje; vodenje poslova; kancelarijsko poslovanje; usluge trgovine na malo; promovisanje roba i usluga drugih; organizovanje i vodenje komercijalnih, trgovinskih i poslovnih konferencija, sajmova i izložbi; izrada za druge indeksa onlajn informacija, sajtova i drugih resursa dostupnih na globalnim računarskim mrežama; pružanje poslovnih i komercijalnih informacija preko računarskih i globalnih komunikacionih mreža;

kompilacije direktorijuma za publikovanje na Internetu i drugim elektronskim, računarskim i komunikacionim mrežama; upravljanje kompjuterizovanim bazama podataka i fajlovima; usluge obrade podataka; usluge pretplate, naročito obezbjeđivanje pretplate za tekstove, podatke, slike, audio i video sadržaje, igre i multimedijalne sadržaje, dobijene preko Interneta i drugih elektronskih i komunikacionih mreža; uređivanje sadržaja informacija dobijenih preko globalne računarske mreže i drugih elektronskih i komunikacionih mreža, u skladu sa željama korisnika; usluge obavještanja, savjetovanja i konsultovanja u vezi sa svim gore navedenim.

Klasa 42: Naučne i tehnološke usluge i istraživanje i projektovanje u vezi navedenih usluga; usluge industrijske analize i istraživanja; projektovanje i razvoj računarskog hardvera i softvera; instalacija, ažuriranje, održavanje i popravka softvera; usluge tehničke podrške, naročito otkrivanje smetnji kod računarskog hardvera, računarskih perifernih uređaja, računarskog softvera i korisničkih elektronskih uređaja; savjetodavne usluge u vezi sa izborom, ugradnjom i korišćenjem računarskog hardvera, softvera i korisničkih elektronskih sistema; obnavljanje računarskih podataka; računarsko programiranje; usluge podrške i savjetovanja u vezi sa razvojem računarskih sistema, baza podataka i aplikacija; obezbeđivanje pretraživača za dobijanje podataka preko komunikacijskih mreža; obezbeđivanje privremenog korišćenja računarskog softvera i onlajn instalacija da bi se omogućilo korisnicima da pristupe i preuzmu računarski softver; savjetodavne usluge u vezi računarskog hardvera i softvera; iznajmljivanje hardverskih i softverskih aparata i opreme; informacije koje se odnose na računarski hardver ili softver dobijene onlajn sa globalne računarske mreže ili Interneta; kreiranje i održavanje web-sajtova; dizajn i razvoj web-sajtova; hostovanje web-sajtova drugih subjekata; usluge davanja aplikacijskih usluga (ASP) praćene kompjuterskim softverom; kreiranje i razvoj baze podataka; usluge obavještanja, savjetovanja i konsultovanja u vezi sa svim gore navedenim.

(111) 10464

(151) 28.12.2013.

(210) **2011-239**

(442) **20.06.2013**

(220) 17.5.2011

(732) **CP KELCO U.S INC**, 1000 PARKWOOD CIRCLE.ATLANTA, GEORGIA US

CP KELCO

(540)

(550) I

(740) Popović Miladin, Đoka Miraševića 21/III, Podgorica (ME)

(511) **Klasa 01:** Hemijski aditivi koji se koriste u proizvodnji u oblasti agrohemije, proizvodnje ulja, farmacije, proizvoda za ličnu higijenu, papira i proizvodnje hrane.

(111) 10466

(151) 28.12.2013.

(210) **2011-142**

(442) **20.06.2013**

(220) 23.3.2011

(732) **E.I.DU PONT DE NEMOURS AND COMPANY**, 1007 MARKET STREET, WILMIN-

GTON, DE 19898, US

ARIGO

(540)
(550) I
(740) Čejović Vladimir, 13. jula 21, Podgorica (ME)
(511) **Klasa 05:** Herbicidi.

(111) 10467
(151) 28.12.2013.
(210) **2011-148** (442) **20.06.2013**
(220) 28.3.2011
(732) **DIAGEO BRANDS B.V.**, MOLENWERF 10 -12,1014 BG AMSTERDAM, NL

GOLD LABEL RESERVE

(540)
(550) I
(740) Čejović Vladimir, 13. jula 21, Podgorica (ME)
(511) **Klasa 33:** Alkoholna pića (izuzev piva).

(111) 10471
(151) 28.12.2013.
(210) **2011-149** (442) **20.06.2013**
(220) 28.3.2011
(732) **KSIN LUXEMBOURG ILS.AR.L.**, 1, RUE DES GLACIS, L-1628, LUXEMBOURG, LU



(540)
(550) I
(740) Čejović Vladimir, 13. jula 21, Podgorica (ME)
(511) **Klasa 04:** Lubrikanti.

Klasa 09: Šivaće mašine: mašine za vez; nosači mašina za pletenje; kontrolni kablovi za mašine, stojeve ili motore; kontrolni mehanizmi za mašine, strojeve ili motore; mašine za siječenje; mašine za krpljenje; motori, koji nijesu za kopnena vozila; remenici ventilatora za motore i

strojeve; ventilatori za motore i strojeve; alati koji nijesu za kopnena vozila; štitnici (djelovi mašina); vođice mašina; alati koji se drže u ruci ali se ne pokreću ručno; mašine za porubljanje; poklopci (djelovi mašina); kućišta (djelovi mašina); mašine za peglanje; mašine za pletenje; mašine za pravljenje čipke; mašine za obradu kože; razboji; pumpe za podmazivanje; podmazivači (djelovi mašina); mašine za tekstilu industriju; motori koji nijesu za kopnena vozila; pogonske pedale za šivaće mašine; rotacione parne prese (pegle), prenosive za tkanine; makaze električne; prigušivači za motore i strojeve; klizne vođice za mašine za pletenje; klizači za mašine za pletenje; prese za glačanje; opruge (djelovi mašina); postolja za mašine; starteri za izradu spoljnih navoja; mašine za šavove; stolovi za mašine; strojevi za izradu spoljnih navoja; mašine za štepanje; mašine za skraćivanje; razboji za tkanje; kalemi za šivaće mašine; papučice za šivaće mašine; papučice za mašine za vez.

Klasa 09: Elektronski kontrolni aparati za šivaće mašine; mjere (etaloni); trake za mjerenje; električni kablovi; kompakt diskovi; kompjuterski softver; nasnimljeni kompjuterski programi; krojačke mjere; elektronske publikacije koje se mogu daunloudovati; električne ravne pegle; električne parne prese električne prese za peglanje.

Klasa 26: Igle za ručno šivenje i igle za mašinsko šivenje; čipka i vez; trake (pantiljke); gajtani; dugmad; naprstci za šivenje; kopče; petlje; igle (osim nakita); i kompleti šivaćeg pribora.

(111) 10472

(151) 28.12.2013.

(210) **2011-213**

(442) **20.06.2013**

(220) 4.5.2011

(300) 30 11 2010 BR.830802207

(732) **COMPANHIA NITRO QUIMICA BRASILERIA**, A BRAZILIAN COMPANY, AV. DR. JOSE ARTUR NOVA, 951, SAO MIGUEL PAULISTA, SAO PAULO, SP, BR



(540)

(550) I

(740) Radulović Božidar, Jovana Tomaševića 9/III, Podgorica (ME)

(511) **Klasa 13:** Nitroceluloza.

(111) 10473

(151) 28.12.2013.

(210) **2011-214**

(442) **20.06.2013**

(220) 4.5.2011

(300) 30 11 2010 BR. 830802215 BR

(732) **COMPANHIA NITRO QUIMICA BRASILEIRA**, A BRAZILIAN COMPANY, AV. DR. JOSE ARTUR NOVA, 951, SAO MIGUEL PAULISTA, SAO PAULO, SP, BR.

The logo for ECOCCELL is displayed in a stylized, outlined font. The letters 'E', 'C', 'O', 'C', 'E', and 'L' are connected, while the 'L' is slightly separated from the 'E'. The 'L' has a unique shape with a small loop at the top.

(540)

(550) I

(740) Radulović Božidar, Jovana Tomaševića 9/III, Podgorica (ME)

(511) **Klasa 13:** Nitroceluloza.

(111) 10678

(151) 10.01.2014.

(210) **2011-197**

(442) **20.06.2013**

(220) 26.4.2011

(732) **MEDOCHEMIE LTD.**, CONSTANTINOUPOLEOS STREET 3011 LIMASSOL. KIPAR, MT

MEDOCLAV

(540)

(550) I

(740) Popović Miladin, Đoka Miraševića 21/III, Podgorica (ME)

(511) **Klasa 05:** Farmaceutski proizvodi.

(111) 10699

(151) 15.01.2014.

(210) **2011-160**

(442) **20.06.2013**

(220) 31.3.2011

(732) **PHARMANOVA D.O.O.**, INDUSTRIJSKA 8, OBRENOVAC RS

ALEFOSS

(540)

(550) I

(740) Lutovac Branislav, Bulevar Crnojevića 93, Podgorica (ME)

(511) **Klasa 05:** Farmaceutski preparati.

(111) 10709

(151) 17.01.2014.

(210) **2011-162**

(442) **20.06.2013**

(220) 31.3.2011

(732) **PREMIJER MONTENEGRO D.O.O.**, V. BOŽOVIĆA BR.9, PODGORICA ME



(540)

(550) I

(511) **Klasa 36:** Novčani (monetrani poslovi).

Klasa 41: Priređivanje igara na sreću, razonoda.

(111) 10710

(151) 17.01.2014.

(210) **2011-250**

(442) **20.06.2013**

(220) 20.5.2011

(732) **WESTINGHOUSE ELECTRIC CORPORATION**, 51 WEST 52ND STREET NEW YORK, NEW YORK 10019, US



(540)

(550) I

(740) Radulović Božidar, Jovana Tomaševića 9/III, Podgorica (ME)

(511) **Klasa 07:** Mašine i mašinski alati; motori i pogonske mašine (osim za suvozemna vozila); mašinske spojnice i transmisioni elementi (osim za suvozemna vozila); poljoprivredne sprave; inkubatori za jaja.

(111) 10711

(151) 17.01.2014.

(210) **2011-252**

(442) **20.06.2013**

(220) 20.5.2011

(732) **WESTINGHOUSE ELECTRIC CORPORATION (DELAWARE CORPORATION)**, 51 WEST 52ND STREET NEW YORK, NEW YORK 10019, US



(540)

(550) I

(740) Radulović Božidar, Jovana Tomaševića 9/III, Podgorica (ME)

(511) **Klasa 11:** Aparati za osvjtljavanje, grijanje, proizvodnju pare, kuvanje, hlađenje, sušenje, ventilaciju, snabdijevanje vodom i za sanitarne svrhe.

(111) 10718

(151) 22.01.2014.

(210) **2011-202**(442) **20.06.2013**

(220) 26.4.2011

(732) **GENERAL MOTORS LLC**, 300 RENAISSANCE CENTER, DETROIT, MICHIGAN 48265-3000, US

CHEVROLET ORLANDO

(540)

(550) I

(740) Radulović Božidar, Jovana Tomaševića 9/III, Podgorica (ME)

(511) **Klasa 12:** motorna vozila za kretanje po zemlji, odnosno automobili, terenska vozila, teretna i monovolumenska vozila.

(111) 10720

(151) 22.01.2014.

(210) **2011-240**(442) **20.06.2013**

(220) 17.5.2011

(732) **GENERAL MOTORS LLC**, 300 RENAISSANCE CENTER DETROIT, MICHIGAN 48265-3000, US

(540)

(550) I

(740) Radulović Božidar, Jovana Tomaševića 9/III, Podgorica (ME)

(511) **Klasa 12:** Dijelovi i komponente za automobile koje se ugrađuju u motorna vozila za kretanje po zemlji namjenjeni smanjivanju emisije CO₂ i povećanju ekonomije goriva, naime, motori, transmisije, vješanje, pogonsko vratilo, kočnice, gume, točkovi, prednji i bočni nastavci poda karoserije, modul kontrole goriva, spojler, aero paneli, prekrivači za maske, vazdušne blende na maskama, usmjerivači za vazduh, prednji spojler.

(111) 10719

(151) 22.01.2014.

(210) **2011-241**

(442) **20.06.2013**

(220) 17.5.2011

(732) **GENERAL MOTORS LLC**, 300 RENAISSANCE CENTER DETROIT, MICHIGAN 48265-3000, US

The logo for 'ecologic' features the word in a bold, lowercase, sans-serif font. Below the letters 'o' and 'l' is a stylized, wavy graphic element that resembles a leaf or a wave.

(540)

(550) I

(740) Radulović Božidar, Jovana Tomaševića 9/III, Podgorica (ME)

(511) **Klasa 12:** Dijelovi i komponente za automobile koje se ugrađuju u motorna vozila za kretanje po zemlji namjenjeni smanjivanju emisije CO₂ i povećanju ekonomije goriva, naime, motori, transmisije, vješanje, pogonsko vratilo, kočnice, gume, točkovi, prednji i bočni nastavci poda karoserije, modul kontrole goriva, spojler, aero paneli, prekrivači za maske, vazdušne blende na maskama, usmjerivači za vazduh, prednji spojler.

(111) 10721

(151) 22.01.2014.

(210) **2011-174**

(442) **20.06.2013**

(220) 8.4.2011

(732) **GENERAL MOTORS LLC**, KOMPANIJA ORGANIZOVANA PO PRPISIMA DRŽAVE DELAWARE, 300 RENAISSANCE CENTER, DETROIT, MICHIGAN 48265-3000, US

CHEVROLET TRACKER

(540)

(550) I

(740) Radulović Božidar, Jovana Tomaševića 9/III, Podgorica (ME)

(511) **Klasa 12:** Motorna vozila i djelovi za njih (izuzev uređaja protiv krađe vozila).

(111) 10722

(151) 22.01.2014.

(210) **2011-251**

(442) **20.06.2013**

(220) 20.5.2011

(732) **WESTINHOUSE ELECTRIC CORPORATION (DELAWARE CORPORATION)**, 51 WEST 52ND STREET NEW YORK, NEW YORK 10019, US

(540)

(550) I

(740) Radulović Božidar, Jovana Tomaševića 9/III, Podgorica (ME)

(511) **Klasa 09:** Aparati i instrumenti naučni, pomorski, geodetski, električni, fotografski, kinematografski, optički, za vaganje, mjerenje, signalizaciju, kontrolu (inspekciju), spasavanje i nastavu; aparati i instrumenti za sprovođenje, uključivanje, pretvaranje, akumuliranje, regulisanje i kontrolu struje; aparati za snimanje, prenos i reprodukovanje zvuka ili slike; magnetni nosioci podataka, diskovi za snimanje; automatske mašine i mehanizmi za aparate koji se pokreću novcem ili žetonom; registar kase, računске mašine, oprema za obradu podataka i kompjuteri; aparati za gašenje požara.

(111) 10746

(151) 24.01.2014.

(210) **2011-232**(442) **20.06.2013**

(220) 16.5.2011

(732) **SHIMANO INC**, 3-77 OIMATSUCHO, SAKAI-KU SAKAI CITY, OSAKA JP

(540)

(550) I

(740) Popović Miladin, Đoka Miraševića 21/III, Podgorica (ME)

(511) **Klasa 09:** Električne žice za bicikla.

(111) 10747

(151) 24.01.2014.

(210) **2011-190**(442) **20.06.2013**

(220) 18.4.2011

(732) **CHLORIDE GROUP LIMITED**, EBURY GATE, 23 LOWER BELGRAVE STREET, LONDON SW1W 0NR, GB

CHLORIDE

(540)

(550) I

(740) Radulović Božidar, Jovana Tomaševića 9/III, Podgorica (ME)

(511) **Klasa 09:** Električne baterije; punjači električnih baterija; aparati za napajanje električnom energijom, aparati za neprekidno napajanje električnom energijom (UPS aparati) i kompjuterski programi koji se uz njih koriste; aparati za ispitivanje u elektrici, moduli za zaštitu od prevelikog napona, indikatori nestanka struje, aparati za regulaciju električne energije, aparati za praćenje strujnih vodova i napajanje električnom energijom, aparati za regulaciju električne energije, konvertori, invertori, regulatori ripla, aparati za prekidanje električne energije, transformatori, linijski filteri za električnu energiju, ublaživači strujnih udara, svijetleći znaci, alarmi, alarmi protiv krađe, protivpožarni alarmi, aparati za protivpožarnu kontrolu, aparati za detekciju požara, aparati za protivprovalne alarme, generatori buke i detektori koji se uz njih koriste, aparati za kontrolu pristupa; dijelovi svih gore pomenutih proizvoda.

(111) 10758

(151) 28.01.2014.

(210) **2011-150**(442) **20.06.2013**

(220) 28.3.2011

(732) **JT INTERNATIONAL S.A.**, 1, RUE DE LA GABELE, 1211 GENEVA 26, CH

(540)

(550) I

(740) Čejović Vladimir, 13. jula 21, Podgorica (ME)

(511) **Klasa 34:** Duvan, koji je prerađen ili neprerađen; duvan za pušenje, duvan za lule, duvan za savijanje, duvan za žvakanje, duvan za sisanje; cigarete, cigare, cigarilosi; supstance za pušenje koje se prodaju odvojeno ili izmiješane sa duvanom, i koje nijesu za medicinsku ili svrhu liječenja; burmut; artikli za pušače uključeni u klasu 34; papir za cigarete, fišeci za cigarete i šibice.

(111) 10759

(151) 28.01.2014.

(210) **2011-195**

(442) **20.06.2013**

(220) 21.4.2011

(732) **WYETH LLC**, A COMPANY ORGANIZED UNDER THE LAWS OF DELAWARE, FIVE GIRALDA FARMS, MADISON, NEW JERSEY 07940, US

CONBRIZA

(540)

(550) I

(740) Čejović Vladimir, 13. jula 21, Podgorica (ME)

(511) **Klasa 05:** Farmaceutski preparati uključujući preparate za liječenje stanja menopauze i postmenopauze i prevenciju i liječenje osteoporoze.

(111) 10760

(151) 28.01.2014.

(210) **2011-211**

(442) **20.06.2013**

(220) 29.4.2011

(732) **STARBUCKS CORPORATION d/b/a STARBUCKS COFFEE COMPANY**, 2401 UTAH AVENUE SOUTH, SEATTLE, WASHINGTON 98134 US



(540)

(550) I

(740) Čejović Vladimir, 13. jula 21, Podgorica (ME)

(511) **Klasa 30:** Mljevena kafa i kafa u zrnu, kakao, čaj (biljni i onaj koji nije biljni), napici od kafe, čaja, kakaoa, espressa, i napici napravljeni na bazi kafe i/ili espressa, napici na bazi čaja, čokolade u prahu i vanile; sosovi koji se dodaju napicima; čokoladni sirup, sirupi raznih uku-

sa koji se dodaju napicima, pekarski proizvodi uključujući mafine, kornete, kekse, kolačiće, peciva i hlebove, sendviče, musli, kafa za ponijeti, čaj za ponijeti, sladoled i smrznute poslastice; čokolada, slatkiši i poslastice.

Klasa 35: Poslovno upravljanje; poslovni menadžment; franšizing, naime usluge tehničke pomoći u uspostavljanju i/ili upravljanju restoranima, kaficima, kućama kafe i snek-barovima; usluge maloprodaje u vezi: kafe, čaja, kakao, zapakovane i pripremljene hrane, električnih aparata, aparata koji nijesu na struju, kućnih potrepština, kuhinjskog posuđa, satova, ručnih satova, kuhinjskih tajmera, štoperica, nakita, knjiga, muzičkih zapisa, podloga za miševе, novčanika, lisnica, velikih torbi, torbica, aktovki, torbi za knjige, putnih torbi i kišobrana, svi napravljeni od platna, plastike ili kože, privesaka za ključeve od kože, odjeće, kapa i šešira, igračkа, uključujući medvedice, punjene igračke, plišane igračke, lutke i dodatke za njih, Božićne ukrase; veleprodajna distribucija, veleprodajne radnje i usluge naručivanja na veliko sve u vezi: kafe, čaja, kakao, zapakovane i pripremljene hrane, električnih aparata, aparata koji nisu na struju, kućnih potrepština, kuhinjskog posuđa, satova, ručnih satova, kuhinjskih tajmera, štoperica, nakita, knjiga, muzičkih zapisa, podloga za miševе, novčanika, lisnica, velikih torbi, torbica, aktovki, torbi za knjige, putnih torbi i kišobrana, svi napravljeni od platna, plasike ili kože, privesaka za ključeve od kože, odjeće, kapa i šešira, igračkа, uključujući medvedice, punjene igračke, plišane igračke, lutke i dodatke za njih, Božićnih ukrasa; kompjuterizovane on-line usluge naručivanja putem pošte i usluge naručivanja putem pošte preko kataloga, kompjuterizovane on-line usluge naručivanja, kompjuterizovane on-line usluge maloprodaje, on-line usluge naručivanja i on-line usluge maloprodajnih radnji, sve u vezi sa: kafom, čajem, kakaom, zapakovanom i pripremljenom hranom, električnim aparatima, aparatima koji nisu na struju, kućnim potrepštinama, kuhinjskim posuđem, satovima, ručnim satovima, kuhinjskim tajmerima, štopericama, nakitom, knjigama, muzičkim zapisima, podlogama za miševе, novčanicima, lisnicama, velikim torbama, torbicama, aktovkama, torbama za knjige, putnim torbama i kišobranima, svi napravljeni od platna, plastike ili kože, privescima za ključeve od kože, odjećom, kapama i šeširima, igračkа, uključujući medvedice, punjene igračke, plišane igračke, lutke i dodatke za njih, Božićnim ukrasima; kompjuterizovane on-line usluge zapisivanja i naručivanja poklona.

Klasa 43: Usluge restorana, kafea, kafeterije, snek bara, kafe bara i kuće kafe, usluge restorana koji služe hranu za poneti; usluge keteringa; usluge dostave kafe kancelarijama; usluge pripremanja hrane po ugovoru; pripremanje hrane; pripremanje i prodaja hrane i napitaka za ponijeti.

(111) 10761

(151) 28.01.2014.

(210) **2011-227**

(442) **20.06.2013**

(220) 11.5.2011

(300) 009706326 02.02.2011. EU

(732) **DIAGEO BRANDS B.V.**, MOLENWERF 10-12,1014 BG AMSTERDAM, NL

JOHNNIE WALKER PLATINUM LABEL

(540)

(550) I

(740) Čejović Vladimir, 13. jula 21, Podgorica (ME)

(511) **Klasa 33:** Alkoholna pića (osim piva).

(111) 10762

(151) 28.01.2014.

(210) **2011-217**

(442) **20.06.2013**

(220) 5.5.2011

(732) **APPLE INC.**, 1 INFINITE LOOP, CUPERTINO, CA 95014, US

THUNDERBOLT

(540)

(550) I

(740) Čejović Vladimir, 13. jula 21, Podgorica (ME)

(511) **Klasa 09:** Računari, računarski periferni uređaji, računarski terminali; računarski hardver; mašine za kompjuterske igre, mikroprocesori, memorijske ploče, monitori, displeji, tastature, kablovi, modemi, štampači, disk drajvovi, adapteri, kartice za adaptere, konektori i drajveri; nepopunjeni mediji za skladištenje kompjuterskog sadržaja; magnetni nosači podataka; kompjuterski softver; kompjuterski softver za kreiranje, preuzimanje, prenos, prijem, uređivanje, izvlačenje, kodiranje, dekodiranje, prikazivanje, čuvanje i organizovanje teksta, grafike, slike, i elektronskih publikacija; kompjuterski softver i firmver, naime, operativni sistemi, programi za sinhronizaciju podataka i programi aplikacija za razvijanje pomoćnih alatki za lične i ručne računare; kompjuterski hardver i softver za pružanje integrisane telefonske komunikacije sa kompjuterskim globalnim informacionim mrežama; prethodno snimljeni kompjuterski programi za lično upravljanje informacijama, softver za upravljanje bazama podataka, softver za prepoznavanje znakova, softver za upravljanje telefonijom, softver za elektronsku poštu i slanje poruka, pejdžing softver, softver za mobilni telefon; softver za sinhronizaciju baza podataka, kompjuterski programi za pristup, pregled i pretraživanje on-line baza podataka, kompjuterski softver za preusmeravanje poruka, elektronske pošte preko interneta, i / ili drugih podataka na jedan ili više elektronskih ručnih uređaja iz prodavnice podataka na ili u vezi sa ličnim računarima ili serverima; kompjuterski softver za sinhronizaciju podataka između daljinskih stanica ili uređaja i fiksnih stanica ili daljinskih

stanica ili uređaja; elektronske publikacije koje se mogu preuzeti kao što su knjige, drame, pamfleti, brošure, bilteni, dnevne novine, magazini, i časopisi o širokom spektru tema od opšteg interesa; ručni digitalni elektronski uređaji i odgovarajući softver; MP3 i drugi audio plejeri u digitalnom formatu; ručni računari, tablet računari, lični digitalni asistenti, elektronski organizatori, elektronske sveske; mobilni digitalni elektronski uređaji, uređaji za globalni sistem pozicioniranja (GPS), telefoni; ručni i mobilni digitalni elektronski uređaji za slanje i primanje telefonskih poziva, faksova, elektronske pošte i drugih digitalnih podataka; bežični telefoni; mobilni telefoni; djelovi i pribor za mobilne telefone; faks mašine, telefonske sekretarice, kamere, uređaji za prenos videa preko telefona, softver i hardver za pronalaženje informacija preko telefona; elektronske ručne jedinice za bežični prijem, skladištenje i / ili prenos podataka i poruka, i elektronski uređaji koji omogućavaju korisniku da prate i upravljaju ličnim podacima; elektronska komunikaciona oprema i instrumenti; telekomunikacioni aparati i instrumenti; fontovi, slogovi, štamparski dizajni i simboli u obliku snimljenih podataka; čipovi, diskovi i trake koje sadrže ili su za snimanje kompjuterskih programa i softvera; ram memorija, rom memorija; solid state memorijski aparat; kompjuterske i elektronske igre; uputstva za rukovanje u obliku koji se može čitati elektronskim putem, putem mašina ili putem računara za upotrebu sa, i koji se prodaju zajedno sa svom gore navedenom robom; aparati za skladištenje podataka; hard drajvovi; minijaturni hard disk drajvovi za skladištenje podataka; audio-video diskovi, čitači kompakt diskova, i digitalni višenamjenski diskovi; podloge za miša; baterije; punjive baterije; punjači; punjači za električne baterije; slušalice; stereo slušalice; slušalice koje se stavljaju direktno u ušni kanal; stereo zvučnici; audio zvučnici; audio zvučnici za kućnu upotrebu; zvučnici za monitore; zvučnici za računare; zvučni sistemi za lični stereo; radio prijemnici, pojačala, aparati za snimanje i reprodukciju zvuka, električni fonografi, gramofoni, stereo uređaji za visoko kvalitetnu reprodukciju zvuka, magnetofoni i aparati za reprodukciju, zvučnici, jedinice sa više zvučnika, mikrofoni; digitalni audio i video uređaji; uređaji za snimanje i reprodukciju zvuka, uređaji za snimanje i reprodukciju pokretnih slika, uređaji za reprodukciju kompakt diskova, uređaji za snimanje i reprodukciju digitalnih višenamjenskih diskova, uređaji za snimanje i reprodukciju digitalnih audio kaseti; digitalni uređaji za reprodukciju muzike i/ili pokretnih slika; radio aparati; video kamere; audio, video, i digitalni mikseri; radio predajnici; zvučni uređaji za automobile; računarska oprema za upotrebu sa svom gore navedenom robom; elektronski aparati sa multimedijalnim funkcijama za upotrebu sa svom gore navedenom robom; elektronski aparati sa interaktivnim funkcijama za upotrebu sa svom gore navedenom robom; pribor, djelovi, oprema i aparati za testiranje za svu gore navedenu robu; djelovi i oprema za svu gore navedenu robu; pokrivači, torbe i futrole prilagodene ili oblikovane da sadrže svu gore navedenu robu, od kože, imitacije kože, tkanine, ili tekstilnih materijala.

(111) 10763

(151) 28.01.2014.

(210) **2011-221**

(442) **20.06.2013**

(220) 10.5.2011

(732) **INTERVET INTERNATIONAL B.V.**, WIM DE KORVERSTRAAT 35, 5831 AN BOXMEER, NL

RABDOMUN

(540)

(550) I

(740) Čejović Vladimir, 13. jula 21, Podgorica (ME)

(511) **Klasa 05:** Ljekovi i farmaceutski preparati za veterinarsku upotrebu

(111) 10764

(151) 28.01.2014.

(210) **2011-171**

(442) **20.06.2013**

(220) 6.4.2011

(732) **KICKERS INTERNATIONAL BV**, CLAUDE DEBUSSYLAAN 24, 1082 MD AMSTREDAM, THE NL

KICKERS

(540)

(550) I

(740) Čejović Vladimir, 13. jula 21, Podgorica (ME)

(511) **Klasa 25:** Odjeća, obuća, pokrivala za glavu.

(111) 10765

(151) 28.01.2014.

(210) **2011-169**

(442) **20.06.2013**

(220) 4.4.2011

(732) **AUSTRIA TABAK GMBH**, KOPPSTRASSE 166, A-1160 WIEN, AT

uz pomoć računara



(540)

(550) I

(740) Čejović Vladimir, 13. jula 21, Podgorica (ME)

(511) **Klasa 34:** Duvan, koji je prerađen ili neprerađen; duvan za pušenje, duvan za lule, duvan za savijanje, duvan za žvakanje; duvan za sisanje; cigarete, cigare, cigarilosi; supstance za pušenje koje se prodaju odvojeno ili izmiješane sa duvanom, i koje nijesu za medicinsku ili svrhu liječenja; burmut;

(111) 10795

(151) 04.02.2014.

(210) **2011-137**

(442) **20.06.2013**

(220) 22.3.2011

(732) **IT TECHNOLOGIES SERVICES S.A.**, WICKHAMS CAY, TRIDENT CHAMBERS, ROAD TOWN, TORTOLA, VG

ELECTIS

(540)

(550) I

(740) Radulović Božidar, Jovana Tomaševića 9/III, Podgorica (ME)

(511) **Klasa 05:** Poljoprivredni pesticidi.

(111) 10796

(151) 04.02.2014.

(210) **2011-38**

(442) **20.06.2013**

(220) 31.1.2011

(732) **SOCIETE DES PRODUITS NESTLE S.A.**, 1800 VEVEY, CH

MOJITO

(540)

(550) I

(740) Lutovac Branislav, Bulevar Crnojevića 93, Podgorica (ME)

(511) **Klasa 30:** Sladoled

(111) 10797

(151) 05.02.2014.

(210) **2011-254**

(442) **20.06.2013**

(220) 24.5.2011

(732) **PHARMA SWISS SA**, BUNDESPLATZ 1,6300 ZUG, CH

MOFETAN

(540)

(550) I

(740) Radulović Božidar, Jovana Tomaševića 9/III, Podgorica (ME)

(511) **Klasa 05:** Farmaceutski preparati-lijekovi.

(111) 10798

(151) 07.02.2014.

(210) **2009-552**

(442) **20.03.2012**

(220) 09.09.2009

(300) 20.11.2007 947320 IR

(732) **ATLAS SPOLKA Z O O**; UL SWIETEJ TERESY OD DZIECIATKA JEZUS 105, PL-91-222 LODZ, PL



(540)

(550) I

(740) Čejović Vladimir, advokat, 13. jul 21, Podgorica (ME)

(511) **Klasa 01:** Hemijski proizvodi koji se upotrebljavaju u industriji, nauci i fotografiji, kao i u poljoprivredi, hortikulturi i šumarstvu; neprerađene vještačke smole; neprerađene plastične materije; đubriva; smješe za gašenje vatre; preparati za kaljenje i zavarivanje; hemijske supstance za očuvanje namirnica; materije za štavljenje; adhezivi koji se upotrebljavaju u industriji.

Klasa 02: Boje, firnajzi, lakovi; sredstva za zaštitu drveta od rđe i truljenja; materije za bojenje; sredstva za nagrizanje; sirove prirodne smole; metali u obliku listova i praha za slikare, dekoratere, štampare i umjetnike.

Klasa 17: Guma, gutaperka, kaučuk, azbest, liskun i proizvodi napravnjeni od ovih materijala koji nijesu uključeni u druge klase; polupreradeni plastični proizvodi; materijali za podbijanje, zaptivanje i izolovanje; savitljive nemetalne cevi.

Klasa 19: Građevinski materijali (nemetalni); čvrste nemetalne cijevi za građevine; asfalt; crna smola i bitumen, nemetalne prenosne građevine; spomenici koji nijesu od metala.

(111) 10799

(151) 07.02.2014.

(210) **2011-164**

(442) **20.06.2013**

(220) 1.4.2011

(732) **CHIQUITA BRANDS L.L.C.**, 250 EAST FIFTH STREET, CINCINNATI, OHIO 45202 US



(540)

(550) I

(740) Popović Miladin, Đoka Miraševića 21/III, Podgorica (ME)

(511) **Klasa 29:** Konzervisano, sušeno, kuvano voće i povrće.

Klasa 31: Svježe voće i povrće

(111) 10800

(151) 07.02.2014.

(210) **2011-216**

(442) **20.06.2013**

(220) 5.5.2011

(732) **GLAXOSMITH KLINE BIOLOGICALS SA**, RUE DE L, INSTITUT 89, B-1330 RIXENSART BE

POLIORIX

(540)

(550) I

(740) Popović Miladin, Đoka Miraševića 21/III, Podgorica (ME)

(511) **Klasa 05:** Farmaceuski preparati i supstance za ljudsku upotrebu, vakcine

(111) 10801

(151) 07.02.2014.

(210) **2011-163**

(442) **20.06.2013**

(220) 1.4.2011

(732) **CHIGUITA BRANDS L.C.C.**, 250 EAST FIFTH STREET, CINCINNATI, OHIO 45202 US



(540)

(550) I

(740) Popović Miladin, Đoka Miraševića 21/III, Podgorica (ME)

(511) **Klasa 29:** Konzervisano, sušeno, kuvano voće i povrće.

Klasa 31: Svježe voće i povrće

(111) 10802

(151) 07.02.2014.

(210) **2011-191**

(442) **20.06.2013**

(220) 18.4.2011

(732) **VLASINKA D.O.O.**, BATAJNICKI DRUM 14-16, BEOGRAD-ZEMUN RS



(540)

(550) I

(740) Popović Miladin, Đoka Miraševića 21/III, Podgorica (ME)

(511) **Klasa 25:** Kućne ili kuhinjske sprave i posude; češljevi i suđeri; četke (izuzev kičica); materijali za pravljenje četki; artikli koji se koriste pri čišćenju; čelična vuna; neprerađeno ili polupreradađeno staklo (osim stakla koje se koristi u građevinarstvu); staklarija, porcelan i grnčarija koja nije uključena u druge klase.

Klasa 32: Piva; mineralne i sodne vode i druga bezalkoholna pica; voćna pica i voćni sokovi; sirupi i drugi preparati za pravljenje pica

(111) 10766

(151) 28.01.2014.

(210) **2011-185**

(442) **20.06.2013**

(220) 13.4.2011

(732) **GOODYEAR DUNLOP TYRES UK LIMITED**, TYRE FORT 88-98, WINGFOOT WAY, BIRMINGHAM B24 9 HY, UK, GB

SPORT MAXX

(540)

(550) I

(740) Čejović Vladimir, 13. jula 21, Podgorica (ME)

(511) **Klasa 12:** Gume.

(111) 10767

(151) 28.01.2014.

(210) **2011-186**

(442) **20.06.2013**

(220) 13.4.2011

(732) **GOODYEAR DUNLOP TYRES UK LIMITED**, TYRE FORT 88-98, WINGFOOT WAY, BIRMINGHAM B24 9 HY, UK, GB

SPORT MAXX RACE

(540)

(550) I

(740) Čejović Vladimir, 13. jula 21, Podgorica (ME)

(511) **Klasa 12:** Gume.

(111) 10768

(151) 28.01.2014.

(210) **2011-230**

(442) **20.06.2013**

(220) 13.5.2011

(732) **THE PROCTER & GAMBLE COMPANY**, ONE PROCTER & GAMBLE PLAZA, CINCINNATI, OHIO 45202 US



(540)

(550) I

(740) Lutovac Branislav, Bulevar Crnojevića 93, Podgorica (ME)

(511) **Klasa 03:** Sredstva za pranje i beljenje i druge supstance za upotrebu u domaćinstvu; sredstva za čišćenje, poliranje, odmaščivanje i abrazivna sredstva; sredstva za čišćenje, negu i ulepšavanje pribora za jelo i posuda; sapuni za upotrebu u domaćinstvu.

(111) 10780

(151) 30.01.2014.

(210) **2011-552**(442) **20.06.2013**

(220) 10.11.2011

(732) **J. & P. COATS, LIMITED**, 1 GEORGE SQUARE, GLASGOW G2 1AL SCOTLAND UK

(540)

(550) I

(740) Popović Miladin, Đoka Miraševića 21/III, Podgorica (ME)

(511) **Klasa 23:** prediva i konci za tekstilnu upotrebu;

(111) 10781

(151) 30.01.2014.

(210) **2011-242**(442) **20.06.2013**

(220) 19.5.2011

(732) **HONGTA TOBACCO (GROUP) CO.LTD**, NO.118, HONGTA AVENUE, HONGTA DISTRICT, YUXI, YUNNAN, CN;



(540)

(550) I

(740) Ćupić Branislav, Dalmatinska 10, Podgorica (ME)

(511) **Klasa 34:** Cigarete; duvan; cigare; filteri za cigarete; kutije za cigarete; pepeljare za pušače; šibice; upaljači za pušače; papir za cigarete; lule za duvan.

(111) 10782

(151) 30.01.2014.

(210) **2011-243**

(442) **20.06.2013**

(220) 19.5.2011

(732) **HONGTA TOBACCO (GROUP) CO.LTD.**, NO.118, HONGTA AVENUE, HONGTA DISTRICT, YUXI, YUNNAN, CN



(540)

(550) I

(740) Ćupić Branislav, Dalmatinska 10, Podgorica (ME)

(511) **Klasa 34:** Cigarete; duvan; cigare; filteri za cigarete; kutije za cigarete; pepeljare za pušače; šibice; upaljači za pušače; papir za cigarete; lule za duvan.

(111) 10784

(151) 31.01.2014.

(210) **2011-228**

(442) **20.06.2013**

(220) 13.5.2011

(732) **STERISOL AB**, BOX 149 592 23 VADSTENA SE

STERISOL

(540)

(550) I

(740) Ćupić Branislav, Dalmatinska 10, Podgorica (ME)

(511) **Klasa 03:** Sapuni, uključujući tečne sapune i šampone za kosu; paste za čišćenje; parfimerija, eterična ulja, kozmetika uključujući kozmetičke kreme, losioni za kosu; preparati za njegu zuba.

Klasa 05: Farmaceutski i sanitarni preparati za ličnu higijenu; flasteri za medicinsku svrhu, materijali za zavijanje; dezinfekciona sredstva u svrhu održavanja higijene; medicinski melemi; proizvodi za tretiranje rana, zaštitu kože i njegu kose.

(111) 10787

(151) 13.02.2014.

(210) **2011-170**

(442) **20.06.2013**

(220) 6.4.2011

(732) **CHURCH & DWIGHT CO. INC**, 469 NORTH CO HARRISON STREET, PRINCETON, NEW JERSEY 08543, US

(540)

(550) I

(740) Čejović Vladimir, 13. jula 21, Podgorica (ME)

(511) **Klasa 10:** Kondomi, aparati za masažu; rukavice za masažu; seksualna pomagala za odrasle, naime, lični vibratori, vibrirajuće prstenje, stimulacioni uređaji za pomoć u seksualnom uzbuđenju i seksualnim performansima, lični masažeri na baterije.

(111) 10788

(151) 03.02.2014.

(210) **2011-248**

(442) **20.06.2013**

(220) 20.5.2011

(732) **CRNAGORACOOP AD-U STEČAJU**, LANDŽA BB DANILOVGRAD, ME



(540)

(550) I

(511) **Klasa 30:** Keksi.

(111) 10789

(151) 03.02.2014.

(210) **2011-249**(442) **20.06.2013**

(220) 20.5.2011

(732) **CRNAGORACOOP AD-U STEČAJU**, LANDŽA BB DANILOVGRAD, ME

(540)

(550) I

(511) **Klasa 30:** Keksi.

(111) 10790

(151) 04.02.2014.

(210) **2011-193**(442) **20.06.2013**

(220) 19.4.2011

(732) **GIGA-BITE TECHNOLOGY CO.LTD.**, NO.6, BAU CHIANG RD. HSIN-TIEN, TAIPEI 231, TW

Booktop

(540)

(550) I

(740) Radulović Božidar, Jovana Tomaševića 9/III, Podgorica (ME)

(511) **Klasa 09:** Kompjuteri, laptop kompjuteri, kompjuterski periferni uređaji.

(111) 10791

(151) 04.02.2014.

(210) **2011-135**

(442) **20.06.2013**

(220) 16.3.2011

(732) **DEUTCHE TELEKOM AG**, FRIEDRICH-EBERT-ALLEE 140 53113 BONN DE



(540)

(550) I

(740) Popović Miladin, Đoka Miraševića 21/III, Podgorica (ME)

(511) **Klasa 35:** Oglašavanje; vođenje poslova; poslovno upravljanje; kancelarijski poslovi

Klasa 38: Telekomunikacije

Klasa 41: Obrazovne usluge; pripremanje obuke; razonoda; sportske i kulturne aktivnosti.

Klasa 45: Pravne usluge; usluge obezbjeđenja radi zaštite imovine i lica; individualne i društvene usluge koje pružaju drugi, radi zadovoljavanja potreba pojedinaca

(111) 10792

(151) 04.02.2014.

(210) **2011-92**

(442) **20.06.2013**

(220) 25.2.2011

(732) **PANASONIC CORPORATION**, 1006,OAZA KADOMA,KADOMA-SHI, OSAKA 571-8501, JP

Panasonic

(540)

(550) I

(740) Radulović Božidar, Jovana Tomaševića 9/III, Podgorica (ME)

(511) **Klasa 01:** Hemijski proizvodi za industriju, nauku, ratarstvo, povrtlarstvo i šumarstvo; sirova vještačka smola, sirova plastika; đubrivo za zemlju; mješavine za gašenje požara; preparati za kaljenje, zavarivanje i lemljenje metala; hemijski proizvodi za konzervisanje hrane; sredstva za štavljenje kože; ljepila (ljepljive tvari) namijenjene za industriju.

Klasa 02: Boje, lakovi i glazure; zaštite od rđe te od propadanja i truljenja drveta; tvari za bojenje; nagrizajuće tvari; prirodne sirove smole; metali u listovima i u prahu za slikare, dekoratere, štampare i umjetnike.

Klasa 03: Preparati za bijeljenje i ostale tvari za pranje rublja; preparati za čišćenje, poliranje, odmaščivanje i struganje; sapuni; parfimerijski proizvodi, eterična ulja, kozmetički proizvodi, losioni za kosu; proizvodi za njegu zuba.

Klasa 04: Industrijska ulja i masti; sredstva za podmazivanje; proizvodi za upijanje, vlaženje i vezanje prašine; goriva (uključujući benzin za motore) i rasvjetne tvari; svijeće, fitilji za rasvjetu..

Klasa 05: Farmaceutski i veterinarski proizvodi; higijenski proizvodi za upotrebu u medicini; dijetne tvari za medicinske potrebe, hrana za dojenčad; flasteri, materijal za previjanje; materijali za plombiranje zuba i za zubne otiske; dezinfekciona sredstva; proizvodi za uništavanje životinjskih štetočina; fungicidi, herbicidi.

Klasa 06: Obični metali i njihove legure; metalni građevinski materijali; metalne prenosive konstrukcije; metalni materijali za sine; metalna užad i neelektrične metalne žice; metalni bravarski proizvodi i sitni metalni predmeti; metalne cijevi; metalne blagajne; metalni proizvodi koji nisu obuhvaćeni drugim klasama; rude.

Klasa 07: Mašine i alatne mašine; motori (osim motora za kopnena vozila); spojke, prenosni uređaji (osim onih za kopnena vozila); poljoprivredne naprave osim onih koji se pokreću ručno; inkubatori za jaja

Klasa 08: Ručni alati i sprave s ručnim pokretanjem; noževi, viljuške i kašike; hladno oružje; mehaničke i električne sprave za brijanje.

Klasa 09: Naučni, nautički, geodetski instrumenti kao i aparati i instrumenti za vaganje, mjerenje signalizaciju, kontrolu (inspekciju), za pomoć (spašavanje) i za obuku; aparati i instrumenti za vodenje, distribuiranje, transformisanje, akumuliranje, podešavanje ili upravljanje električne struje; aparati za snimanje, prenos, reprodukciju zvuka ili slike; magnetne podloge za snimanje, akustične ploče; automati i mehanizmi za automatske uređaje koji se pokreću uz prethodno ubacivanje kovanica; registarske blagajne, računari, oprema za obradu podataka i računala; uređaji za gašenje požara.

Klasa 10: Hirurški, medicinski, zubarski i veterinarski aparati i instrumenti, vještački udovi, oči i zubi; ortopedski proizvodi; pribor za šivanje rana.

- Klasa 11:** Uređaji za rasvjetu, grijanje, proizvodnju pare, kuvanje, hlađenje, sušenje, ventilaciju, vodosnabdijevanje i sanitarna oprema.
- Klasa 12:** Vozila; uređaji za kretanje po zemlji, po vodi ili po vazduhu.
- Klasa 14:** Plemeniti metali i njihove legure i proizvodi od tih materijala ili obloženi tim metalima, koji nisu obuhvaćeni drugim klasama; pravi i lažni nakit, drago kamenje; časovničarski proizvodi i hronometrički instrumenti.
- Klasa 16:** Papir, karton i proizvodi od tih materijala koji nisu obuhvaćeni drugim klasama; štamparski proizvodi; proizvodi za uvezivanje knjiga; pribor za pisanje; ljepljiva tvari za papirnatu proizvodnju ili za domaćinstvo); slikarski pribor; kistovi; pisaće mašine i kancelarijski pribor (osim namještaja); oprema za nastavu i obuku (osim aparata); plastični materijali za ambalažu (koji nisu obuhvaćeni drugim klasama); štamparska slova; i klišeji.
- Klasa 17:** Guma, gutaperka, biljna smola, azbest, liskun i proizvodi od tih materijala koji nisu obuhvaćeni drugim klasama; proizvodi od poluobrađene plastike; materijali za hermetičko zatvaranje, za brtvljenje i za izolaciju; nemetalne savitljive cijevi..
- Klasa 19:** Nemetalni građevinski materijali; krute nemetalne cijevi za gradnju; asfalt, katran i bitumen (smola); nemetalne prenosive konstrukcije; i nemetalni spomenici.
- Klasa 20:** Namještaj, ogledala, okviri; proizvodi koji nisu obuhvaćeni drugim klasama, od drveća, plute, trske, vrbovog pruća, roga, kosti, slonovače, kitove kosti, kornjačevine, školjki, ćilibara, sedefa, morske pjene i zamjena svih tih materijala ili plastični proizvodi.
- Klasa 21:** Pribor i posude za domaćinstvo ili za kuhinju (koji nisu od plemenitih metala niti su presvućeni metalom); češljevi i sunđer; četke (osim kistova); materijali za četke; pribor za čišćenje; žica za struganje parketa; sirovo ili poluobrađeno staklo (osim građevinskog stakla); stakleni proizvodi, porculanski i keramički proizvodi koji nisu obuhvaćeni drugim klasama.
- Klasa 24:** Tkanine i tekstilni proizvodi koji nisu obuhvaćeni drugim klasama; pokrivači za krevete i stolove.
- Klasa 27:** Sagovi, prostirači, strunjače, linoleumi i ostali pokrivači za podove; netekstilne zidne tapete.
- Klasa 28:** Igre i igračke; gimnastički i sportski predmeti koji nisu obuhvaćeni drugim klasama; ukrasi za novogodišnje jelke.
- Klasa 35:** Oglašavanje i reklamiranje; vođenje komercijalnih poslova; komercijalna administracija i kancelarijski poslovi.
- Klasa 36:** Osiguranje; finansijski poslovi; monetarni poslovi i upravljanje nekretninama.
- Klasa 37:** Izgradnja; popravke; usluge postavljanja.
- Klasa 40:** Obrada materijala.
- Klasa 41:** Obuka; stručno osposobljavanje; razonoda; sportske i kulturne djelatnosti.
- Klasa 42:** Naučne i tehnološke usluge kao i pripadajuće usluge istraživanja i koncepcije; usluge industrijskih analiza i istraživanja, koncepcija i razvoj računara i računarskih programa.
- Klasa 43:** Usluge obezbjeđivanja hrane i pica; privremeni smještaj.
- Klasa 44:** Medicinske usluge; veterinarske usluge; higijenska njega i njega ljepote za ljude za životinje; poljoprivredne, povrtlarske i šumarske usluge.
- Klasa 45:** Pravne usluge; Lične i društvene usluge namijenjene za zadovoljenje ljudskih potreba; usluge sigurnosti za zaštitu imovine i ljudi.

(111) 10794

(151) 04.02.2014.

(210) **2011-138**

(442) **20.06.2013**

(220) 22.3.2011

(732) **IT TECHNOLOGIES SERVICES S.A.**, WICKHAMS CAY, TRIDENT CHAMBERS, ROAD TOWN, TORTOLA, VG

DEMITAN

(540)

(550) I

(740) Radulović Božidar, Jovana Tomaševića 9/III, Podgorica (ME)

(511) **Klasa 05:** Poljoprivedni pesticidi.

(111) 10793

(151) 04.02.2014.

(210) **2011-139**

(442) **20.06.2013**

(220) 22.3.2011

(732) **GOWAN COMPANY,LLC**, 370 S MAIN STREET, YUMA, ARIZONA 85364, US

IMIDAN

(540)

(550) I

(740) Radulović Božidar, Jovana Tomaševića 9/III, Podgorica (ME)

(511) **Klasa 05:** Poljoprivedni pesticidi.

(111) 10859

(151) 11.04.2014.

(210) **2011-614**

(442) **20.12.2013.**

(220) 12.12.2011.

(732) **WOLVERINE INTERNATIONAL**, L.P. (A CAYMAN ISLANDS CORPRATION), 4TH FLOOR, SCOTIA CENTRE P.O. BOX 268 GRAND CAYMAN KY1-1104 KY

CUSHE

(540)

(550) I

(740) Čupić Branislav, Dalmatinska 10, Podgorica ME

(511) **Klasa 25:** Odjeća, obuća, pokrivala za glavu.

(111) 10858

(151) 11.04.2014.

(210) **2011-615**

(442) **20.12.2013.**

(220) 12.12.2011.

(732) **WOLVERINE INTERNATIONAL**, L.P.(A CAYMAN ISLAND CORPRATION), 4TH FLOOR, SCOTIA CENTRE P.O. BOX 268 GRAND CAYMAN KY1-1104 KY

SHUCOON

(540)

(550) I

(740) Ćupić Branislav, Dalmatinska 10, Podgorica ME

(511) **Klasa 25:** Odjeća, obuća, pokrivala za glavu.

(111) 10860

(151) 11.04.2014.

(210) **2011-531**

(442) **20.12.2013.**

(220) 03.11.2011.

(732) **NBA PROPERTIES, INC.** OLYMPIC TOWER BLDG. 645 FIFTH AVENUE, NEW YORK, NY 10022 US



(540)

(550) I

(740) Popović Miladin, Đoka Miraševića 21/III, Podgorica ME

(511) **Klasa 25:** Odeća, naime čarape, obuća, cipele za košarku, patike za košarku, majice, košulje, polo majice, dukserice, donji delovi trenerke, pantalone, majice na bretele, džemperi, kratke pantalone, pidžame, sportske majice, ragbi majice, vunene majice, kaiševi, kravate, spavaćice, šeširi, kape, štitnici na kačketima, trenerke, donji delovi trenerki, dresovi, jakne, vetrovke, kišne krznene jakne, kaputi, portikle za bebe ne od papira, trake za glavu, narukvice, kecelje, donje rublje, bokserice, široke pantalone, štitnici za uši, rukavice, bokzerske rukavice, šalovi, pletene i štrikane majice, trikotažne haljine, haljine, dresovi i uniforme za navijačice, odeća za plivanje, odela za kupanje, kupaci kostimi, bikini, tamkini kupaći kostimi, gaćice za plivanje, gaćice za kupanje, šorcevi za surfovanje, šorcevi za kupanje, marame za plažu, pokrivala za kupaći kostim, ogrtači za kupaći kostim, sandale, sandale za plažu, šeširi za plažu, štitnici za sunce, kape za plivanje, kape za kupanje, nova pokrivala za glavu sa prikačenim umecima.

Klasa 28: Igračke, igre i sportske stvari, naime košarkaške lopte, loptice za golf, lopte za igralište, sportske lopte, gumene lopte i penaste lopte, plišane lopte za igru, plastične lopte za igru, mrežice za košarku, table za košarku, minijaturne table za košarku, pumpe i igle za nadu-

vavanje košarkaških lopti, štapovi za golf, torbe za golf, podmetači za golf, oprema za golf, naime, alat za popravku golf terena, kupice na koje se stavlja lopta, markeri lopti, torbe za golf opremu, pokrivala za glave golf štapova, rukavice za golf, kutije za golf lopte, elektronske table za košarkaške igrice na tabli, table za košarkaške igrice, košarkaške igrice, akcione igrice, društvene igrice za odrasle i decu, trivia informacione igrice i elektronske video arka-da igrice, košarkaška torbica koja se sastoji od mrežice i zviždaljke, lutke, dekorativne lutke, lutke za kolekciju, akcione figure za igru, akcione figure karikature, punjene igračke, nove plišane igračke sa perikom, puzle, montažni blokovi za igre, ukrasi za Božićnu jelku i Božićne čarape, vozila za igru u obliku automobila, kamiona, vozova i kombija, svi sa temom košarke, nove penaste igračke u obliku prsta ili trofeja, igrački trofeji, karte za igru, igrice sa kartama, igračke koje prave zvuk, igračke za kućne ljubimce, igračke za plažu, naime lopte za plažu, lopte na naduvavanje, kantice za igru, lopatice za igru, igračke za pesak, kutijice za pesak, gumene igračke za vodu, oprema za bazen, naime plivačka oprema za plutanje, oprema za plutanje u bazenu, igračke za splavanje na vodi, penasta oprema za plutanje, gume za plivanje, gume za plivanje u bazenu, penaste gume, daske za plivanje, daske za surfovanje, peraja za plivanje, peraja za surfovanje, mišići za plutanje i krila za pomoć pri plivanju u rekreativne svrhe, odbojkaške torbice za igru koje se sastoje od lopte, mrežice, sporednih stvari i zviždaljke, i vaterpolo torbice za igru koje se sastoje od lopte, mrežice i zviždaljke, dekorativne igračke od tkanine koje se puštaju da lete na vetru.

Klasa 41, Razonoda i obrazovne usluge u smislu televizijskih događaja i radio programa u polju košarke i prikazivanja uživo košarkaških igara i košarkaških priredbi, usluge produkcije i distribucije radio i televizijskih sou programa o košarkaškim igrama, košarkaškim događajima i programima iz oblasti košarke, usluge vođenja i organizovanja košarkaških klinika i kampova, klinika i kampova za trenere, klinika i kampova za plesne timove i košarkaške igre, usluge rasonode u vidu ličnog pojavljivanja u kostimiziranim maskotama ili u plesnim timovima na košarkaškim igrama i priredbama, klinikama, kampovima, promocijama i drugim događajima, specijalnim događajima i žurkama vezanim za košarku, usluge kluba obožavalaca, usluge rasonode, naime one koje pružaju vebsajt predstavljanje multimedijских sadržaja u vidu najvažnijih televizijskih događaja, interaktivnih najvažnijih televizijskih događaja, video snimaka, video strim snimaka, interaktivnih video izbora najvažnijih događaja, radio programa, najvažnijih radijskih događaja i audio snimaka u polju košarke, usluge obezbeđivanja vesti i informacija u vidu statistika i drugih stvari u polju košarke, onlajn igrice koje se ne mogu preuzimati, naime kompjuterske igrice, video igrice, interaktivne video igrice, akcione igrice, arkadne igrice, društvene igrice za odrasle i decu, igre na tabli, puzle, trivia igrice, usluge elektronskog izdavaštva, naime, izdavanje magazina, vodiča, biltena, bojanki i igrica kod kojih se igrači određuju putem interneta, sve u vezi sa košarkom, usluge obezbeđivanja onlajn kompjuterske baze podataka u polju košarke

(111) 10863

(151) 11.04.2014.

(210) **2011-532**

(442) **20.12.2013.**

(220) 03.11.2011.

(732) **NBA PROPERTIS, INC**, OLYMPIC TOWER BLDG. 645 FIFTH AVENUE, NEW YORK, NY 10022 US



(540)

(550) I

(740) Popović Miladin, Đoka Miraševića 21/III, Podgorica ME

(511) **Klasa 25:** Odeća, naime čarape, obuća, cipele za košarku, patike za košarku, majice, košulje, polo majice, dukserice, donji delovi trenerke, pantalone, majice na bretele, džemperi, kratke pantalone, pidžame, sportske majice, ragbi majice, vunene majice, kaiševi, kravate, spavačice, šeširi, kape, štitnici na kačketima, trenerke, donji delovi trenerki, dresovi, jakne, vetrovke, kišne krznene jakne, kaputi, portikle za bebe ne od papira, trake za glavu, narukvice, kecelje, donje rublje, bokserice, široke pantalone, štitnici za uši, rukavice, bokzerske rukavice, šalovi, pletene i štrikane majice, trikotažne haljine, haljine, dresovi i uniforme za navijačice, odeća za plivanje, odela za kupanje, kupaci kostimi, bikini, tamkino kupaci kostimi, gaćice za plivanje, gaćice za kupanje, šorcevi za surfovanje, šorcevi za kupanje, marama za plažu, pokrivala za kupaci kostim, ogrtači za kupaci kostim, sandale, sandale za plažu, šeširi za plažu, štitnici za sunce, kape za plivanje, kape za kupanje, nova pokrivala za glavu sa prikačenim umecima.

Klasa 28: Igračke, igre i sportske stvari, naime košarkaške lopte, loptice za golf, lopte za igralište, sportske lopte, gumene lopte i penaste lopte, plišane lopte za igru, plastične lopte za igru, mrežice za košarku, table za košarku, minijaturne table za košarku, pumpe i igle za naduvavanje košarkaških lopti, štapovi za golf, torbe za golf, podmetači za golf, oprema za golf, naime, alat za popravku golf terena, kupice na koje se stavlja lopta, markeri lopti, torbe za golf opremu, pokrivala za glave golf štapova, rukavice za golf, kutije za golf lopte, elektronske table za košarkaške igrice na tabli, table za košarkaške igrice, košarkaške igrice, akcione igrice, društvene igrice za odrasle i decu, trivia informacione igrice i elektronske video arkađne igrice, košarkaška torbica koja se sastoji od mrežice i zviždaljke, lutke, dekorativne lutke, lutke za kolekciju, akcione figure za igru, akcione figure karikature, punjene igračke, nove plišane igračke sa perikom, puzzle, montažni blokovi za igre, ukrasi za Božićnu jelku i Božićne čarape, vozila za igru u obliku automobila, kamiona, vozova i kombija, svi sa temom košarke, nove penaste igračke u obliku prsta ili trofeja, igrački trofeji, karte za igru, igrice sa kartama, igračke koje prave zvuk, igračke za kućne ljubimce, igračke za plažu, naime lopte za plažu, lopte na naduvavanje, kantice za igru, lopatice za igru, igračke za pesak, kutijice za pesak, gumene igračke za vodu, oprema za bazen, naime plivačka oprema za plutanje, oprema za plutanje u bazenu, igračke za splavanje na vodi, penasta oprema za plutanje, gume za plivanje, gume za plivanje u bazenu, penaste gume, daske za plivanje, daske za surfovanje, peraja za plivanje, peraja za surfovanje, mišići za plutanje i krila za pomoć pri plivanju u rekreativne svrhe, odbojkaške torbice za igru koje se sastoje od lopte, mrežice, sporednih stvari i zviždaljke, i vaterpolo torbice za igru koje se sastoje od lopte, mrežice i zviždaljke,

dekorativne igračke od tkanine koje se puštaju da lete na vetru.

Klasa 41: Razonoda i obrazovne usluge u smislu televizijskih događaja i radio programa u polju košarke i prikazivanja uživo košarkaških igara i košarkaških priredbi, usluge produkcije i distribucije radio i televizijskih sou programa o košarkaškim igrama, košarkaškim događajima i programima iz oblasti košarke, usluge vođenja i organizovanja košarkaških klinika i kampova, klinika i kampova za trenere, klinika i kampova za plesne timove i košarkaške igre, usluge rasonode u vidu ličnog pojavljivanja u kostimiziranim maskotama ili u plesnim timovima na košarkaškim igrama i priredbama, klinikama, kampovima, promocijama i drugim događajima, specijalnim događajima i žurkama vezanim za košarku, usluge kluba obožavalaca, usluge rasonode, naime one koje pružaju vebisajt predstavljanje multimedijjskih sadržaja u vidu najvažnijih televizijskih događaja, interaktivnih najvažnijih televizijskih događaja, video snimaka, video strim snimaka, interaktivnih video izbora najvažnijih događaja, radio programa, najvažnijih radijskih događaja i audio snimaka u polju košarke, usluge obezbeđivanja vesti i informacija u vidu statistika i drugih stvari u polju košarke, onlajn igrice koje se ne mogu preuzimati, naime kompjuterske igrice, video igrice, interaktivne video igrice, akcione igrice, arkadne igrice, društvene igrice za odrasle i decu, igre na tabli, puzle, trivia igrice, usluge elektronskog izdavaštva, naime, izdavanje magazina, vodiča, biltena, bojanki i igrice kod kojih se igrači određuju putem interneta, sve u vezi sa košarkom, usluge obezbeđivanja onlajn kompjuterske baze podataka u polju košarke.

(111) 10862

(151) 11.04.2014.

(210) **2011-533**

(442) **20.12.2013.**

(220) 03.11.2011.

(732) **NBA PROPERTIES, INC.** OLYMPIC TOWER BLDG. 645 FIFTH AVENUE, NEW YORK, NY 10022 US



(540) _____

(550) I

(740) Popović Miladin, Đoka Miraševića 21/III, Podgorica ME

(511) **Klasa 25:** Odeća, naime čarape, obuća, cipele za košarku, patike za košarku, majice, košulje, polo majice, dukserice, donji delovi trenerke, pantalone, majice na bretele, džemper, kratke pantalone, pidžame, sportske majice, ragbi majice, vunene majice, kaiševi, kravate, spavaćice, šeširi, kape, štitnici na kačketima, trenerke, donji delovi trenerki, dresovi, jakne, vetrovke, kišne krznene jakne, kaputi, portikle za bebe ne od papira, trake za glavu, narukvice, kecelje, donje rublje, bokserice, široke pantalone, štitnici za uši, rukavice, bokerske rukavice, šalovi, pletene i štrikane majice, trikotažne haljine, haljine, dresovi i

uniforme za navijačice, odeća za plivanje, odela za kupanje, kupaci kostimi, bikini, tamkini kupaći kostimi, gaćice za plivanje, gaćice za kupanje, šorcevi za surfovanje, šorcevi za kupanje, marama za plažu, pokrivala za kupaći kostim, ogrtači za kupaći kostim, sandale, sandale za plažu, šeširi za plažu, štitnici za sunce, kape za plivanje, kape za kupanje, nova pokrivala za glavu sa prikačenim umecima.

Klasa 28: Igračke, igre i sportske stvari, naime košarkaške lopte, loptice za golf, lopte za igralište, sportske lopte, gumene lopte i penaste lopte, plišane lopte za igru, plastične lopte za igru, mrežice za košarku, table za košarku, minijaturne table za košarku, pumpe i igle za naduvavanje košarkaških lopti, štapovi za golf, torbe za golf, podmetači za golf, oprema za golf, naime, alat za popravku golf terena, kupice na koje se stavlja lopta, markeri lopti, torbe za golf opremu, pokrivala za glave golf štapova, rukavice za golf, kutije za golf lopte, elektronske table za košarkaške igrice na tabli, table za košarkaške igrice, košarkaške igrice, akcione igrice, društvene igrice za odrasle i decu, trivia informacione igrice i elektronske video arka-da igrice, košarkaška torbica koja se sastoji od mrežice i zviždaljke, lutke, dekorativne lutke, lutke za kolekciju, akcione figure za igru, akcione figure karikature, punjene igračke, nove plišane igračke sa perikom, puzle, montažni blokovi za igre, ukrasi za Božićnu jelku i Božićne čarape, vozila za igru u obliku automobila, kamiona, vozova i kombija, svi sa temom košarke, nove penaste igračke u obliku prsta ili trofeja, igrački trofeji, karte za igru, igrice sa kartama, igračke koje prave zvuk, igračke za kućne ljubimce, igračke za plažu, naime lopte za plažu, lopte na naduvavanje, kantice za igru, lopatice za igru, igračke za pesak, kutijice za pesak, gumene igračke za vodu, oprema za bazen, naime plivačka oprema za plutanje, oprema za plutanje u bazenu, igračke za splavanje na vodi, penasta oprema za plutanje, gume za plivanje, gume za plivanje u bazenu, penaste gume, daske za plivanje, daske za surfovanje, peraja za plivanje, peraja za surfovanje, mišići za plutanje i krila za pomoć pri plivanju u rekreativne svrhe, odbojkaške torbice za igru koje se sastoje od lopte, mrežice, sporednih stvari i zviždaljke, i vaterpolo torbice za igru koje se sastoje od lopte, mrežice i zviždaljke, dekorativne igračke od tkanine koje se puštaju da lete na vetru.

Klasa 41: Razonoda i obrazovne usluge u smislu televizijskih događaja i radio programa u polju košarke i prikazivanja uživo košarkaških igara i košarkaških priredbi, usluge produkcije i distribucije radio i televizijskih sou programa o košarkaškim igrama, košarkaškim događajima i programima iz oblasti košarke, usluge vođenja i organizovanja košarkaških klinika i kampova, klinika i kampova za trenere, klinika i kampova za plesne timove i košarkaške igre, usluge rasonode u vidu ličnog pojavljivanja u kostimiziranim maskotama ili u plesnim timovima na košarkaškim igrama i priredbama, klinikama, kampovima, promocijama i drugim događajima, specijalnim događajima i žurkama vezanim za košarku, usluge kluba obožavalaca, usluge rasonode, naime one koje pružaju veb-sajt predstavljanje multimedijjskih sadržaja u vidu najvažnijih televizijskih događaja, interaktivnih najvažnijih televizijskih događaja, video snimaka, video strim snimaka, interaktivnih video izbora najvažnijih događaja, radio programa, najvažnijih radijskih događaja i audio snimaka u polju košarke, usluge obezbeđivanja vesti i informacija u vidu statistika i drugih stvari u polju košarke, onlajn igrice koje se ne mogu preuzimati, naime kompjuterske igrice, video igrice, interaktivne video igrice, akcione igrice, arkadne igrice, društvene igrice za odrasle i decu, igre na tabli, puzle, trivia igrice, usluge elektronskog izdavaštva, naime, izdavanje magazina, vodiča, biltena, bojanki i igrice kod kojih se igrači određuju putem interneta, sve u vezi sa košarkom, usluge obezbeđivanja onlajn kompjuterske baze podataka u polju košarke.

(111) 10861

(151) 11.04.2014.

(210) **2011-534**

(442) **20.12.2013.**

(220) 03.11.2011.

(732) **NBA PROPERTIES, INC.**, OLYMPIC TOWER BLDG. 645 FIFTH AVENUE, NEW YORK, NY 10022 US

(540)

(550) I

(740) Popović Miladin, Đoka Miraševića 21/III, Podgorica ME

(511) **Klasa 25:** Odeća, naime čarape, obuća, cipele za košarku, patike za košarku, majice, košulje, polo majice, dukserice, donji delovi trenerke, pantalone, majice na bretele, džemperi, kratke pantalone, pidžame, sportske majice, ragbi majice, vunene majice, kaiševi, kravate, spavaćice, šeširi, kape, štitnici na kačketima, trenerke, donji delovi trenerki, dresovi, jakne, vetrovke, kišne krznene jakne, kaputi, portikle za bebe ne od papira, trake za glavu, narukvice, kecelje, donje rublje, bokserice, široke pantalone, štitnici za uši, rukavice, bokerske rukavice, šalovi, pletene i štrikane majice, trikotažne haljine, haljine, dresovi i uniforme za navijačice, odeća za plivanje, odela za kupanje, kupaci kostimi, bikini, tamkini kupaći kostimi, gaćice za plivanje, gaćice za kupanje, šorcevi za surfovanje, šorcevi za kupanje, marame za plažu, pokrivala za kupaći kostim, ogrtači za kupaći kostim, sandale, sandale za plažu, šeširi za plažu, štitnici za sunce, kape za plivanje, kape za kupanje, nova pokrivala za glavu sa prikačenim umecima.

Klasa 28: Igračke, igre i sportske stvari, naime košarkaške lopte, loptice za golf, lopte za igralište, sportske lopte, gumene lopte i penaste lopte, plišane lopte za igru, plastične lopte za igru, mrežice za košarku, table za košarku, minijaturne table za košarku, pumpe i igle za naduvavanje košarkaških lopti, štapovi za golf, torbe za golf, podmetači za golf, oprema za golf, naime, alat za popravku golf terena, kupice na koje se stavlja lopta, markeri lopti, torbe za golf opremu, pokrivala za glave golf štapova, rukavice za golf, kutije za golf lopte, elektronske table za košarkaške igrice na tabli, table za košarkaške igrice, košarkaške igrice, akcione igrice, društvene igrice za odrasle i decu, trivia informacione igrice i elektronske video arka-da igrice, košarkaška torbica koja se sastoji od mrežice i zviždaljke, lutke, dekorativne lutke, lutke za kolekciju, akcione figure za igru, akcione figure karikature, punjene igračke, nove plišane igračke sa perikom, puzle, montažni blokovi za igre, ukrasi za Božićnu jelku i Božićne čarape, vozila za igru u obliku automobila, kamiona, vozova i kombija, svi sa temom košarke, nove penaste igračke u obliku prsta ili trofeja, igrački trofeji, karte za igru, igrice sa kartama, igračke koje prave zvuk, igračke za kućne ljubimce, igračke za plažu, naime lopte za plažu, lopte na naduvavanje, kantice za igru, lopatice za igru, igračke za pesak, kutijice za pesak, gumene igračke za vodu, oprema za bazen, naime plivačka oprema za plutanje, oprema za plutanje u bazenu, igračke za splavanje na vodi, penasta oprema za plutanje, gume za plivanje, gume za plivanje u bazenu, penaste gume, daske za plivanje, daske za surfovanje, peraja za plivanje, peraja za surfovanje, mišići za plutanje i krila za pomoć pri plivanju u rekreativne svrhe, odbojkaške torbice za igru koje se sastoje od lopte, mrežice, sporednih

stvari i zviždaljke, i vaterpolo torbice za igru koje se sastoje od lopte, mrežice i zviždaljke, dekorativne igračke od tkanine koje se puštaju da lete na vetru.

Klasa 41: Razonoda i obrazovne usluge u smislu televizijskih događaja i radio programa u polju košarke i prikazivanja uživo košarkaških igara i košarkaških priredbi, usluge produkcije i distribucije radio i televizijskih sou programa o košarkaškim igrama, košarkaškim događajima i programima iz oblasti košarke, usluge vođenja i organizovanja košarkaških klinika i kampova, klinika i kampova za trenere, klinika i kampova za plesne timove i košarkaške igre, usluge rasonode u vidu ličnog pojavljivanja u kostimiziranim maskotama ili u plesnim timovima na košarkaškim igrama i priredbama, klinikama, kampovima, promocijama i drugim događajima, specijalnim događajima i žurkama vezanim za košarku, usluge kluba obožavalaca, usluge rasonode, naime one koje pružaju vebsajt predstavljanje multimedijjskih sadržaja u vidu najvažnijih televizijskih događaja, interaktivnih najvažnijih televizijskih događaja, video snimaka, video strim snimaka, interaktivnih video izbora najvažnijih događaja, radio programa, najvažnijih radijskih događaja i audio snimaka u polju košarke, usluge obezbeđivanja vesti i informacija u vidu statistika i drugih stvari u polju košarke, onlajn igrice koje se ne mogu preuzimati, naime kompjuterske igrice, video igrice, interaktivne video igrice, akcione igrice, arkadne igrice, društvene igrice za odrasle i decu, igre na tabli, puzle, trivia igrice, usluge elektronskog izdavaštva, naime, izdavanje magazina, vodiča, biltena, bojanki i igrice kod kojih se igrači određuju putem interneta, sve u vezi sa košarkom, usluge obezbeđivanja onlajn kompjuterske baze podataka u polju košarke.

(111) 10864

(151) 15.05.2014.

(210) **2011-543**

(442) **20.12.2013.**

(220) 09.11.2011.

(732) **GOOGLE INC**, 1600 AMPHITHEATRE PARKWAY, MOUNTAIN VIEW, CA 94043 US

ANDROID

(540)

(550) I

(740) Ćupić Branislav, Dalmatinska 10, Podgorica ME

(511) **Klasa 11:** Uređaji za osvjtljavanje, grijanje, proizvodnju pare, kuvanje, hlađenje, sušenje, ventilaciju, snabdjevanje vodom i sanitarne svrhe, sijalice, mikrotalasne rerne, frižideri, zamrzivači, električni aparati, šporeti za kuvanje, rerne za kuvanje, električne peći, električne lampe, plafonske lampe i lusteri, zidne lampe, mašine za sušenje veša, klima uređaji, električni grijači, električni ventilatori, plafonski ventilatori, peći.

Klasa 16: Hartija, karton i proizvodi od ovih materijala, koji nisu obuhvaćeni drugim klasama, štampane stvari, knjigovezački materijal, fotografije, kancelarijski materijal, ljepila za kancelarijsku ili kućnu upotrebu, materijali za umjetnike, kičice, pisaće mašine i kancelarijski pribor (izuzev namještaja), materijal za nastavu i obuku (izuzev aparata), plastični materijali za pakovanje (koji nisu obuhvaćeni drugim klasama), štamparska slova, klišei, knjige, časopisi, bilteni, priručnici, sveske, blokovi za bilješke, pera, čestitke, sličice, dckali, ljepljive

poruke, rokovnici i adresari, olovke, patent-olovke, rezači za olovke, korektori, razglednice, ljepkovi, futrole za olovke, spjalice, heftalice, municija za heftalice, klipbordi, kompleti za pisači sto, poster, podsjetnici, pritiskivači za hartiju, kalendari, omoti za knjige.

Klasa 25: Odjeća, naročito košulje, majice sa kratkim rukavima, šeširi, kape, dječija odjeća, obuća, pokrivala za glavu.

Klasa 28: Igre, igračke, gimnastički i sportski artikli koji nisu obuhvaćeni drugim klasama, ukrasi za jelku, kolekcionarske igračke-figure, arkadne igrice, stone igre, društvene igre, igre sa kartama, loptice za igre, video igre koje se pokreću novcem ili žetonom, ručne jedinice za igranje elektronskih igara, akcione figure, edukativne igračke, vozila-igračke, plišane igračke, roboti-igračke, zmajevi i oprema za zmajevе, vodene igračke, igračke na navijanje, lutke i oprema za lutke, leteći diskovi (frisbiji), igračke koje govore, muzički instrumenti-igračke, alati-igračke, kocke za igranje, maske-igračke, marionete, karte za igranje.

Klasa 35: Oглашavanje, poslovni menadžment, poslovna administracija, kancelarijski poslovi, online maloprodajne usluge

Klasa 38: Telekomunikacije, prenos podataka putem globalne kompjuterske mreže, striming audio, video i audio-vizuelnih materijala putem globalne kompjuterske mreže,

Klasa 41: Obrazovne usluge, obučavanje, razonoda, sportske i kulturne aktivnosti, obezbjeđivanje onlajn resursa i vodiča za razvoj softvera, obezbjeđivanje onlajn žurnala, naročito blogova u oblasti razvoja softvera, onlajn usluge u vezi igara, usluge u vezi igara za mobilne uredaje.

Klasa 42: Naučne i tehnološke usluge i istraživanje i projektovanje u vezi navedenih usluga, usluge industrijske analize i istraživanja, projektovanje i razvoj kompjuterskog hardvera i softvera, kompjuterske usluge, snabdjevanje aplikacionim uslugama (application service provider, ASP), naročito hosting kompjuterskih softverskih aplikacija.

(111) 10865

(151) 15.05.2014.

(210) **2011-544**

(442) **20.12.2013.**

(220) 09.11.2011.

(732) **GOOGLE INC.** 1600 AMPHITHEATRE PARKWAY, MOUNTAIN VIEW, CA 94043 US

ANDROID

(540)

(550) I

(740) Ćupić Branislav, Dalmatinska 10, Podgorica ME

(511) **Klasa 09:** Aparati i instrumenti naučni, pomorski, geodetski, fotografski, kinematografski, optički, za vaganje, mjerenje, signalizaciju, kontrolu (inspekciju), pomoć (spasavanje) i nastavu, aparati i instrumenti za provođenje, prekidanje, transformisanje, akumuliranje, regulisanje ili kontrolu elektricne energije, aparati za snimanje, prenos ili reprodukovanje zvuka ili slike, magnetski nosioci podataka, diskovi za snimanje, automatske prodajne mašine i mehanizmi za aparate koji se pokreću novcem ili žetonom, registar-kase, računске mašine, oprema za obradu podataka i kompjuteri, aparati za gašenje požara, kompjuterski

softver, kompjuterski hardver, mobilni telefoni, mobilni perifemi uređaji, kompjuteri, televizori, tablet kompjuteri, noutbuk kompjuteri, laptop kompjuteri, čipovi za integrisana kola, mikročipovi, torbe za kamere, torbe za kamkodere, termostati, televizori, radio aparati, telefoni, daljinski upravljači za radio, televizore i stereo uređaje, konzole za video igrice, DVD plejeri, video rekorderi, digitalni video rekorderi, MP3 plejeri, audio pojačala, kompjuterski serveri, printeri, skeneri, fotokopir aparati, kompjuterski monitori, faks uređaji, mrežni ruteri, tastature, kompjuterski miševi, eksterni kompjuterski hard diskovi, kamkoderi, kamere, kalkulatori, GPS navigacioni uređaji, audio komponente, slušalice, audio zvučnici, audio i video prijemnici, personalni digitalni asistenti (PDA), set-top uređaji, sistemi za kućni bioskop, video projektori, filmski projektori, sigurnosni alarmi, detektori vatre i dima, detektori radara, audio i video oprema za vozila, punjači baterija, adapteri (strujni), telefonske sekretarice, kompleti slušalica sa mikrofonom, električni prekidači za svjetlo.

Klasa 11: Uređaji za osvjetljavanje, grijanje, proizvodnju pare, kuvanje, hlađenje, sušenje, ventilaciju, snabdjevanje vodom i sanitarne svrhe, sijalice, mikrotalasne rerne, frižideri, zamrzivači, električni aparati, šporeti za kuvanje, rerne za kuvanje, električne peći, električne lampe, plafonske lampe i lusteri, zidne lampe, mašine za sušenje veša, klima uređaji, električni grijači, električni ventilatori, plafonski ventilatori, peći.

Klasa 16: Hartija, karton i proizvodi od ovih materijala, koji nisu obuhvaćeni drugim klasama, štampane stvari, knjigovezački materijal, fotografije, kancelarijski materijal, ljepila za kancelarijsku ili kućnu upotrebu, materijali za umjetnike, kičice, pisaće mašine i kancelarijski pribor (izuzev nameštaja), materijal za nastavu i obuku (izuzev aparata), plastični materijali za pakovanje (koji nisu obuhvaćeni drugim klasama), štamparska slova, klišei, knjige, časopisi, bilteni, priručnici, sveske, blokovi za bilješke, pera, čestitke, sličice, dekalni, ljepljive poruke, rokovnici i adresari, olovke, patent-olovke, rezači za olovke, korektori, razglednice, ljepkovi, futrole za olovke, spjalice, heftalice, municija za heftalice, klipbordi, kompleti za pisači sto, posted, podsjetnici, pritiskivači za hartiju, kalendrad, omoti za knjige.

Klasa 25: Odjeća, naročito košulje, majice sa kratkim rukavima, šeširi, kape, dječija odjeća, obuća, pokrivala za glavu.

Klasa 28: Igre, igračke, gimnastički i sportski artikli koji nisu obuhvaćeni drugim klasama, ukrasi za jelku, kolekcionarske igračke-figure, arkadne igrice, stone igre, društvene igre, igre sa kartama, loptice za igre, video igre koje se pokreću novcem ili žetonom, ručne jedinice za igranje elektronskih igara, akcione figure, edukativne igračke, vozila-igračke, plišane igračke, roboti-igračke, zmajevi i oprema za zmajeve, vodene igračke, igračke na navijanje, lutke i oprema za lutke, leteći diskovi (frisbiji), igračke koje govore, muzički instrumenti-igračke, alati-igračke, kocke za igranje, maske-igračke, marionete, karte za igranje.

Klasa 35: Oglašavanje, poslovni menadžment, poslovna administracija, kancelarijski poslovi, online maloprodajne usluge.

Klasa 38: Telekomunikacije, prenos podataka putem globalne kompjuterske mreže, striming audio, video i audio-vizuelnih materijala p'item globalne kompjuterske mreže.

Klasa 41: Obrazovne usluge, obučavanje, razonoda, sportske i kulturne aktivnosti, obezbjeđivanje onlajn resursa i vodiča za razvoj softvera, obezbjeđivanje onlajn žurnala, naročito blogova u oblasti razvoja softvera, onlajn usluge u vezi igara, usluge u vezi igara za mobilne uređaje.

Klasa 42: Naučne i tehnološke usluge i istraživanje i projektovanje u vezi navedenih usluga, usluge industrijske analize i istraživanja, projektovanje i razvoj kompjuterskog hardvera i softvera, kompjuterske usluge, snabdjevanje aplikacionim uslugama (application service provider, ASP), naročito hosting kompjuterskih softverskih aplikacija.

(111) 10866

(151) 15.05.2014.

(210) **2011-613**

(442) **20.12.2013.**

(220) 12.12.2011.

(732) **TAMRON CO. LTD.** 1385, HASUNUMA, MINUMA-KU, SAITIMA-SHI, SAITIMA-KEN JP

TAMRON

(540)

(550) I

(740) Lutovac Branislav, Bulevar Crnojevića 93, Podgorica ME

(511) **Klasa 09:** Aparati i instrumenti naučni, pomorski, geodetski, fotografski, kinematografski, optički, zavaganje, merenje, signalizaciju, kontrolu (inspekciju), spasavanje i nastavu, aparati i instrumenti za provođenje, isključivanje, transformisanje, akumuliranje, regulisanje ili kontrolisanje električne energije, aparati za snimanje, prenos i reprodukovanje zvuka ili slike, magnetni nosioci podataka, diskovi za snimanje, automatske mašine i mehanizmi za aparate koji se pokreću novcem ili žetonom, registarkase, računске mašine, oprema za obradu podataka i kompjuteri, aparati za gašenje požara, a naročito optički uređaji i komponente za ulazno/izlazne uređaje (uključujući skenere, kopir aparate, faks mašine i štampače), uređaji za snimanje (uključujući optičke medije), ekrani, posebno projektovana ogledala za primenu u laserskoj tehnologiji, polarizovani razdvajači snopova, prizme, tanki zaštitni filmovi i prevlake, optički motori za LCD projektore, uređaji za laserske optičke sisteme, dihroidna ogledala, dihroidne prizme, objektivske jedinice za digitalne kamere, objektivske jedinice za video kamere, objektivske jedinice za kamere na mobilnim telefonima, optički aparati i instrumenti uključujući probne ploče za provjeru preciznosti površine sočiva, fotoaparati sa ugradjenim optičkim zumom, digitalni fotoaparati, fotoaparati srednjeg formata, CCTV kamere, druge kamere, objektiv i sočiva, uključujući i fotografske objektivne, objektivne za CCTV kamere, objektivne za video kamere, objektivne za kamere na mobilnim telefonima, asferna sočiva, sferna sočiva, projekcijska sočiva, sočiva za motorizovani zum, vari-fokalna sočiva, sočiva fiksnog fokusa za nadzor, zamenjiva sočiva za digitalne fotoaparate i druge fotoaparate, sočiva za nadzorne kamere, sočiva za automatizacija u industriji, objektivne sa uvećavajućim zumom, širokougaone objektivne, teleobjektivne, makro objektivne, sočiva sa fiksnom fokalnom dužinom, infracrvene objektivne, filteri (fotografski), tele-konvertori, fotografske kapuljače, jednonožni stalci, torbe za fotoaparate za nošenje preko ramena, torbice za fotoaparate, futrole za fotoaparate, poklopci za objektivne, adapteri za montažu, filmske pregrade, tražila, drugi djelovi i pribor za digitalne fotoaparate i druge fotoaparate, kinematografski aparati i instrumenti, interferometri, sferometri, farbe za livenje, plastične livene komponente, naočari za oči, kontaktna sočiva, mašine i aparati za telekomunikaciju i njihovi djelovi i pribor, infracrvene kamere, objektivske jedinice za infracrvene kamere, kamere za vozila, sočiva za kamere za vozila, objektivske jedinice za kamere za vozila, panoramske kamere, optički sistemi za osvetljenja na vozilima, kamere za daleko infracrveno područje, zamjenjiva sočiva za kamere za daleko infracrveno područje, objektivske jedinice za daleko infracrveno područje, sočiva za daleko infracrveno područje, kupola kamere, riblje oko objektivni.

(111) 10867

(151) 15.05.2014.

(210) **2011-658**

(442) **20.12.2013.**

(220) 15.12.2011.

(732) **AATELLAS DEUTCHLAND GMBH**, GEORG BRAUCHLE RING 64-66, MUNCHEN DE

RIBOMUSTIN

(540)

(550) I

(740) Popović Miladin, Đoka Miraševića 21/III, Podgorica ME

(511) **Klasa 05:** Farmaceutski, veterinarski i sanitarni proizvodi za medicinske svrhe, farmaceutski proizvodi dostupni samo na recept, naime citostatički (rast ćelija, inhibiranje kancera) preparati za medicinske svrhe.

Klasa 16: Štampane stvari, kancelarijski materijal, materijal za obuku i nastavu (izuzev aparata).

Klasa 41: Obrazovne usluge i pripremanje obuke.

Klasa 42: Naučne i tehnološke usluge i istraživanje i projektovanje u vezi sa navedenim uslugama.

Klasa 44: Farmaceutske usluge uključujući pravljenje recepata, farmaceutske i medicinske savjetodavne usluge, usluge dijagnostikovanja, usluge medicinskog liječenja.

(111) 10868

(151) 15.05.2014.

(210) **2011-659**

(442) **20.12.2013.**

(220) 15.12.2011.

(732) **ASTELLAS DEUTSCHLAND GMBH**, GEORG BRAUCHLE RING 64-66 MUNCHEN DE



(540)

(550) I

(740) Popović Miladin, Đoka Miraševića 21/III, Podgorica ME

(511) **Klasa 05:** Farmaceutski, veterinarski i sanitarni proizvodi za medicinske farmaceutski proizvodi dostupni samo na recept, naime citostatički (rast ćelija, inhibiranje kancera) preparati za medicinske svrhe.

Klasa 16: Štampane stvari, kancelarijski materijal, materijal za obuku i nastavu (izuzev aparata).

Klasa 41: Obrazovne usluge i pripremanje obuke.

Klasa 42: Naučne i tehnološke usluge i istraživanje i projektovanje u vezi sa navedenim uslugama.

Klasa 44: Farmaceutske usluge uključujući pravljenje recepata, farmaceutske i medicinske sav-

jetodavne usluge, usluge dijagnostikovanja, usluge medicinskog liječenja.

(111) 10869

(151) 15.05.2014.

(210) **2011-660**

(442) **20.12.2013.**

(220) 16.12.2011.

(732) **ALKALOID AD** SKOPLJE, BUL. ALEKSANAR MAKEDONSKI 12, SKOPLJE RM



(540)

(550) I

(740) Popović Miladin, Đoka Miraševića 21/III, Podgorica ME

(511) **Klasa 05:** Dječija pasta za zube.

(111) 10870

(151) 15.05.2014.

(210) **2011-618**

(442) **20.12.2013.**

(220) 12.12.2011.

(732) **JOHNSON CONTROLS TECHNOLOGY COMPANY**, 915 EAST 32ND STREET CITY OF HOLLAND STATE OF MICHIGAN 49423 US

POWERFRAME

(540)

(550) I

(740) Popović Miladin, Đoka Miraševića 21/III, Podgorica ME

(511) **Klasa 09:** Baterije, provodne mreže za baterije i punjači baterija.

(111) 10871

(151) 15.05.2014.

(210) **2011-196**

(442) **20.12.2013.**

(220) 26.04.2011.

(732) **MEDOCHEMIE LTD.** CONSTANTINOUPOLEOS STREET 3011, LIMASSOL CY

MOXILEN

(540)

(550) I

(740) Popović Miladin, Đoka Miraševića 21/III, Podgorica ME

(511) **Klasa 05:** Farmaceutski proizvodi.

(111) 10872

(151) 15.05.2014.

(210) **2011-198**

(442) **20.12.2013.**

(220) 26.04.2011.

(732) **MEDOCHEMIE LTD.** CONSTANTINOUPOLEOS STREET 3011, LIMASSOL CY

ARNETIN

(540)

(550) I

(740) Popović Miladin, Đoka Miraševića 21/III, Podgorica ME

(511) **Klasa 05:** Farmaceutski proizvodi.

(111) 10873

(151) 15.05.2014.

(210) **2011-199**

(442) **20.12.2013.**

(220) 26.04.2011.

(732) **MEDOCHEMIE LTD.** CONSTANTINOUPOLEOS STREET 3011, LIMASSOL CY

MABRON

(540)

(550) I

(740) Popović Miladin, Đoka Miraševića 21/III, Podgorica ME

(511) **Klasa 05:** Farmaceutski proizvodi.

(111) 10875

(151) 16.05.2014.

(210) **2011-541**

(442) **20.12.2013.**

(220) 08.11.2011.

(732) **JX NIPPON OIL&ENERGY CORPORATION**, 6-3 OTEMACHI 2-CHOME, HIUDAKU, TOKYO 100-8162 JP

ENEOS

(540)

(550) I

(740) Radulović Božidar, Jovana Tomaševića 9/III, Podgorica ME

(511) **Klasa 01:** Tečnost za prenosnike snage.

Klasa 04: Mašinsko i motorno ulje, goriva, tečna goriva, industrijska ulja, mineralna ulja i masti za industrijsku upotrebu (ne za gorivo), nemineralna ulja i masti za industrijsku upotrebu (ne za gorivo), mazivna ulja, industrijska maziva, tečnost za prenosnike snage.

(111) 10876

(151) 16.05.2014

(210) **2011-542**

(442) **20.12.2013.**

(220) 08.11.2011.

(732) **JX NIPPON OIL&ENERGY CORPRATION**, 6-3 OTEMACHI 2-CHOME, CHIUDAKU, TOKYO 100-8162 JP

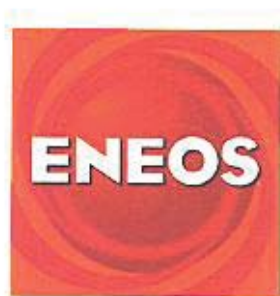

(540)

(550) I

(740) Radulović Božidar, Jovana Tomaševića 9/III, Podgorica ME

(511) **Klasa 01:** Tečnost za prenosnike snage.

Klasa 04: Mašinsko i motorno ulje, goriva, tečna goriva, industrijska ulja, mineralna ulja i masti za industrijsku upotrebu (ne za gorivo), nemineralna ulja i masti za industrijsku upotrebu (ne za gorivo), mazivna ulja, industrijska maziva, tečnost za prenosnike snage.

(111) 10877

(151) 16.05.2014.

(210) **2011-616**

(442) **20.12.2013.**

(220) 12.12.2011.

(732) **DURMUS YASAR VE OGULLARI BOYA VERNIK VE RECINE FABRIKALARI ANONIM SIRKETI**, SANAYI CADDESİ, NO.37, BORNOVA IZMIR TR



(540)

(550) I

(740) Popović Miladin, Đoka Miraševića 21/III, Podgorica ME

(511) **Klasa 01:** Hemijski proizvodi koji se upotrebljavaju u industriji, nauci i fotografiji, kao i u poljoprivredi, hortikulturi i šumarstvu, neprerađene vještačke smole, neprerađene plastične materije, đubriva, smješe za gašenje požara, preparati za kaljenje i zavarivanje, hemijske supstance za očuvanje namirnica, materije za šavljenje, ljepljive supstance koje se upotrebljavaju u industriji.

Klasa 02: Boje, firnajzi, lakovi, sredstva za zaštitu od rđe i truljenja drveta, materije za bojenje, sredstva za nagrizanje, sirove prirodne smole, metali u obliku listova i praha za slikare, dekoratere, štampare i umjetnike.

(111) 10878

(151) 16.05.2014.

(210) **2011-617**(442) **20.12.2013.**

(220) 12.12.2011.

(732) **DYO BOYA FABRIKALARI** SANAYI VE TICARET ANONIM SIRKETI, SEHIT FETHI BEY CADDESI NO.120 IZMIR TR

DEWILUX

(540)

(550) I

(740) Popović Miladin, Đoka Miraševića 21/III, Podgorica ME

(511) **Klasa 01:** Hemijski proizvodi koji se upotrebljavaju u industriji, nauci i fotografiji, kao i u poljoprivredi, hortikulturi i šumarstvu, neprerađene vještačke smole, neprerađene plastične materije, đubriva, smješe za gašenje požara, preparati za kaljenje i zavarivanje, hemijske supstance za očuvanje namirnica, materije za šavljenje, ljepljive supstance koje se upotrebljavaju u industriji.

Klasa 02: Boje, firnajzi, lakovi, sredstva za zaštitu od rđe i truljenja drveta, materije za bojenje, sredstva za nagrizanje, sirove prirodne smole, metali u obliku listova i praha za slikare, dekoratere, štampare i umjetnike.

(111) 10883

(151) 24.04.2014.

(210) **2011-627**(442) **20.12.2013.**

(220) 13.12.2011.

(732) **FASHIONET AG**, GARTENSTRASSE 70 CH-4052 BASEL CH

FASHIONET

(540)

(550) I

(740) Popović Miladin, Đoka Miraševića 21/III, Podgorica ME

(511) **Klasa 35:** Administrativne usluge u vezi sa transportom, skladištenjem, otpremanjem, distribucijom, namještanjem i pakovanjem odjevnih predmeta i modnih dodataka.

Klasa 39: Transport, skladištenje, otpremanje, distribucija, namještanje i pakovanje odjevnih predmeta i modnih dodataka.

(111) 10884

(151) 29.04.2014.

(210) **2011-692**

(442) **20.12.2013.**

(220) 21.12.2011.

(732) **COLGATE PALMOLIVE COMPANY**, A DELAWARE CORPORATION, 300 PARK AVENUE, NEW YORK, NY 10022 US

KOLYNOS FLUOR

(540)

(550) I

(740) Kojić Ivana, Serdara Jola Piletića bb, Podgorica ME

(511) **Klasa 03:** Paste i praškovi za čišćenje zuba, preparati za negu zuba i desni, kremovi za brijanje.

Klasa 05: Antiseptički rastvori i dezinfekciona sredstva koja ubijaju klice.

Klasa 21: Četkice za zube.

(111) 10886

(151) 29.04.2014.

(210) **2011-699**

(442) **20.12.2013.**

(220) 21.12.2011.

(732) **COLGATE PALMOLIVE COMPANY**, A DELAWARE CORPORATION, 300 PARK AVENUE, NEW YORK, NY 10022 US

COLGATE FRESH CONFIDENCE

(540)

(550) I

(740) Kojić Ivana, Serdara Jola Piletića bb, Podgorica ME

(511) **Klasa 03:** Zubna pasta i sredstva za pranje zuba.

(111) 10885

(151) 29.04.2014.

(210) **2011-700**(442) **20.12.2013.**

(220) 21.12.2011.

(732) **COLGATE PALMOLIVE COMPANY**, A DELAWARE CORPORATION, 300 PARK AVENUE, NEW YORK, NY 10022 US

(540)

(550) I

(740) Kojić Ivana, Serdara Jola Piletića bb, Podgorica ME

(511) **Klasa 03:** Pasta za zube i voda za ispiranje usta.

(111) 10887

(151) 29.04.2014.

(210) **2011-701**(442) **20.12.2013.**

(220) 21.12.2011.

(732) **COLGATE PALMOLIVE COMPANY**, A DELAWARE CORPORATION, 300 PARK AVENUE, NEW YORK, NY 10022 US

PAX

(540)

(550) I

(740) Kojić Ivana, Serdara Jola Piletića bb, Podgorica ME

(511) **Klasa 03:** Sredstva za bijeljenje i druge supstance za pranje, sredstva za čišćenje, poliranje, uklanjanje masti i brušenje, sapuni, parfimerija, eterična ulja, kozmetički proizvodi, losioni za kosu, preparati za njegu zuba.

(111) 10888

(151) 29.04.2014.

(210) **2011-702**(442) **20.12.2013.**

(220) 21.12.2011.

(732) **COLGATE PALMOLIVE COMPANY**, A DELAWARE CORPORATION, 300 PARK AVENUE, NEW YORK, NY 10022 US**COLGATE HERBAL**

(540)

(550) I

(740) Kojić Ivana, Serdara Jola Piletića bb, Podgorica ME

(511) **Klasa 03:** Zubna pasta i tečnost za ispiranje usta.

(111) 10889

(151) 29.04.2014.

(210) **2011-683**(442) **20.12.2013.**

(220) 21.12.2011.

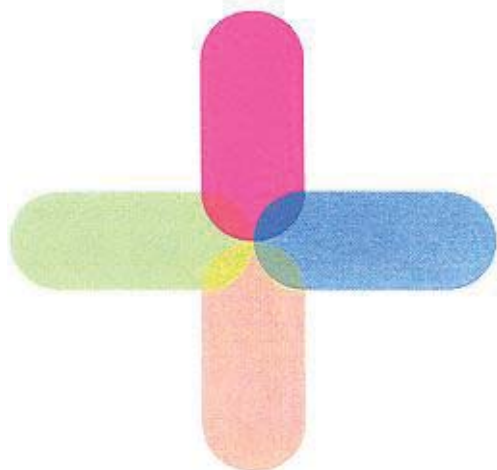
(732) **PHAMANOVA DOO**, INDUSTRIJSKA 8, OBRENOVAC RS

(540)

(550) I

(740) Kojić Ivana, Serdara Jola Piletića bb, Podgorica ME

(511) **Klasa 03:** Sredstva za beljenje i druge supstance za upotrebu u perionicama, preparati za čišćenje, poliranje, ribanje i nagrizanje, sapuni, parfimerija, eterična ulja, kozmetika, losioni za kosu, paste za zube.**Klasa 05:** Farmaceutski i veterinarski preparati, sanitarni preparati za medicinsku upotrebu, dijetetske supstance prilagođene za upotrebu u medicini, hrana za bebe, flasteri, materijali za zavijanje, materijali za plombiranje zuba, zubarska smola, dezinfekciona sredstva, preparati za uništavanje štetočina, fungicidi, herbicidi.**Klasa 30:** Kafa, čaj, kakao, šećer, pirinač, tapioka, sago, zamena kafe, brašno i proizvodi od žitarica, hleb, kolači, poslastice, sladoledi, med, melasa, kvasac, prašak za pecivo, so, senf, sirće, sosovi (kao začini), začini, led.**Klasa 32:** Pivo, mineralne i sodne vode i druga bezalkoholna pića, pića od voća i voćni sokovi, sirupi i drugi preparati za proizvodnju pića.**Klasa 42:** Naučne i tehnološke usluge i istraživanje i projektovanje u vezi navedenih usluga,

usluge industrijske analize i istraživanja, projektovanje i razvoj kompjuterskog hardvera i softvera.

(111) 10890

(151) 29.04.2014.

(210) **2011-15**

(442) **20.12.2013.**

(220) 13.01.2011.

(732) **HERCULES INCORPORATED**, HERCULES PLAZA, 1313 NORTH MARKET STREET, WILMINGTON, DELAWARE 19894-001 US

CULMINAL

(540)

(550) I

(740) Ćupić Branislav, Dalmatinska 10, Podgorica ME

(511) **Klasa 01:** Hemijski proizvodi i hemijske kompozicije koje se koriste u proizvodnji boja, premaza i industrijskih ljepila, hemijski proizvodi i hemijske kompozicije koje se koriste u proizvodnji proizvoda za građevinarstvo, kao što su maker, gips, keramika, smjese za popunjavanje, supstance za popunjavanje, cement za pločice, i cement, polimeri koji se rastvaraju u vodi, metilceluloza i etri celuloze koji se koriste u industriji, polimeri koji se rastvaraju u vodi, metilceluloza i etri celuloze koji se koriste u proizvodnji boja, premaza i industrijskim ljepilima, polimeri koji se rastvaraju u vodi, metilceluloza i etri celuloze koji se koriste u proizvodnji proizvoda za građevinarstvo, kao što su malter, gips, keramika, materijal za ispunu, supstance za popunjavanje, cement za pločice, i cement, hemijski proizvodi i hemijske kompozicije koje se koriste kao reološki modifikatori, vezivni materijali, emulgatori, pomoćne supstance za ravnomjerno upijanje vlage, stabilizator, pomoćne supstance za suspenziju, i zaštitni koloidi, polimeri koji se rastvaraju u vodi, metilceluloza i etri celuloze koji se koriste kao reološki modifikatori, vezivni materijali, emulgatori, pomoćne supstance za ravnomjerno upijanje vlage, stabilizator, zaštitni koloidi.

(111) 10891

(151) 29.04.2014.

(210) **2011-686**

(442) **20.12.2013.**

(220) 21.12.2011.

(732) **TIKKURILA DOO**, HAJDUK VELJKOVA BB, ŠABAC RS

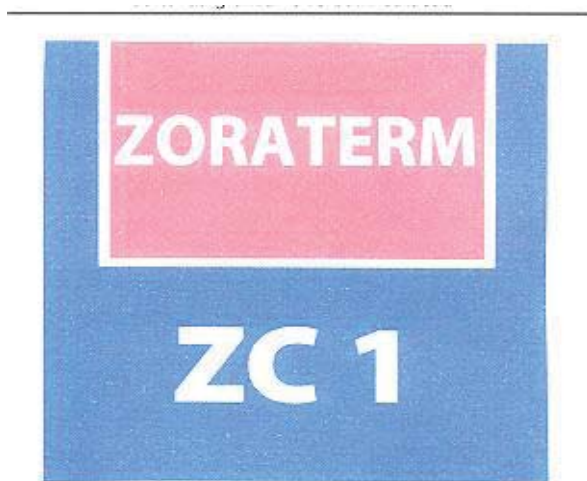

(540)

(550) I

(740) Kojić Ivana, Serdara Jola Piletića bb, Podgorica ME

(511) **Klasa 01:** Hemijski proizvodi koji se upotrebljavaju u industriji, nauci, fotografiji, poljoprivredi i šumarstvu, neprerađene veštačke smole, neprerađene plastične materije, đubriva, smeše za gašenje vatre, preparati za kaljenje i zavarivanje, hemijske supstance za konzervisanje namirnica, materije za štavljenje, lepljive supstance koje se upotrebljavaju u industriji.

Klasa 02: Boje, firnajzi, lakovi, sredstva za zaštitu od rđe i truljenja drveta, materije za bojenje, sredstva za nagrizanje, sirove prirodne smole, metali u obliku listova i praha za slikare, dekoratere, štampare i umetnike.

Klasa 03: Sredstva za beljenje i druge supstance za upotrebu u perionicama, preparati za čišćenje, poliranje, ribanje i nagrizanje, sapuni, parfimerija, eterična ulja, kozmetika, losioni za kosu, paste za zube.

(111) 10892

(151) 29.04.2014.

(210) **2011-687**(442) **20.12.2013.**

(220) 21.12.2011.

(732) **TIKKURILA DOO**, HAJDUK VELJKOVA BB, ŠABAC RS

(540)

(550) I

(740) Kojić Ivana, Serdara Jola Piletića bb, Podgorica ME

(511) **Klasa 01:** Hemijski proizvodi koji se upotrebljavaju u industriji, nauci, fotografiji, poljoprivredi i šumarstvu, neprerađene veštačke smole, neprerađene plastične materije, đubriva,

smeše za gašenje vatre, preparati za kaljenje i zavarivanje, hemijske supstance za konzervisanje namirnica, materije za štavljenje, lepljive supstance koje se upotrebljavaju u industriji.

Klasa 02: Boje, firnajzi, lakovi, sredstva za zaštitu od rđe i truljenja drveta, materije za bojenje, sredstva za nagrizanje, sirove prirodne smole, metali u obliku listova i praha za slikare, dekoratere, štampare i umetnike.

(111) 10893

(151) 29.04.2014.

(210) **2011-689**

(442) **20.12.2013.**

(220) 21.12.2011.

(732) **TIKKURILA DOO**, HAJDUK VELJKOVA BB, ŠABAC RS

Linea plus

(540)

(550) I

(740) Kojić Ivana, Serdara Jola Piletića bb, Podgorica ME

(511) **Klasa 01:** Hemijski proizvodi koji se upotrebljavaju u industriji, nauci, fotografiji, poljoprivredi i šumarstvu, neprerađene veštačke smole, neprerađene plastične materije, đubriva, smeše za gašenje vatre, preparati za kaljenje i zavarivanje, hemijske supstance za konzervisanje namirnica, materije za štavljenje, lepljive supstance koje se upotrebljavaju u industriji.

Klasa 02: Boje, firnajzi, lakovi, sredstva za zaštitu od rđe i truljenja drveta, materije za bojenje, sredstva za nagrizanje, sirove prirodne smole, metali u obliku listova i praha za slikare, dekoratere, štampare i umetnike.

(111) 10894

(151) 29.04.2014.

(210) **2011-648**

(442) **20.12.2013.**

(220) 15.12.2011.

(732) **ASTEX PHARMACEUTICALS, INC**, 4140 DUBLIN BLVD. SUITE 200, DUBLIN, CALIFORNIA 94568 US

DACOGEN

(540)

(550) I

(740) Lutovac Branislav, Bulevar Crnojevića 93, Podgorica ME

(511) **Klasa 05:** Farmaceutski proizvodi za liječenje raka imunoloških poremećaja.

(111) 10895

(151) 29.04.2014.

(210) **2011-649**

(442) **20.12.2013.**

(220) 15.12.2011.

(732) **SANYANG INDUSTRY CO. LTD**, 3 CHUNG HUA ROAD, HUKOU, HSINCHU, TAIWAN R.O.C. TW



(540)

(550) I

(740) Lutovac Branislav, Bulevar Crnojevića 93, Podgorica ME

(511) **Klasa 12:** Vozila, automobili, motocikli, ATV vozila, kolica za starije osobe, električni motocikli, sportski motocikli, električni skuteri, električni bicikli, motocikli za vodu, delovi i oprema sa svu napred navedenu robu.

Klasa 37: Održavanje i popravka vozila, održavanje i popravka automobila, održavanje i popravka motocikala, pranje automobila, pranje motocikala, zaštita automobila od rdje, zaštita motocikala od rdje, podmazivanje automobila, podmazivanje motocikala, čišćenje automobila, čišćenje motocikala, usluge servisnih stanica za automobile, usluge servisnih stanica za motocikle, vulkaniziranje automobilskih guma, vulkaniziranje guma za motocikle, ugradnja, održavanje i popravka mašina iz oblasti automobila, ugradnja, održavanje i popravka mašina iz oblasti motocikala.

(111) 10906

(151) 29.04.2014.

(210) **2011-115**

(442) **20.12.2013.**

(220) 09.03.2011.

(732) **BOSNALIJEK**, FARMACEUTSKA I HEMIJSKA INDUSTRIJA DD, JUKIĆEVA 53, SARAJEVO BA

METROZOL

(540)

(550) I

(740) Radulović Božidar, Jovana Tomaševića 9/III, Podgorica ME

(511) **Klasa 05:** Farmaceutski proizvodi.

(111) 10907

(151) 09.05.2014.

(210) **2011-116**

(442) **20.12.2013.**

(220) 09.03.2011.

(732) **BOSNALIJEK**, FARMACEUTSKA I HEMIJSKA INDUSTRIJA DD, JUKIĆEVA 53, SARAJEVO BA

DOXAT

(540)

(550) I

(740) Radulović Božidar, Jovana Tomaševića 9/III, Podgorica ME

(511) **Klasa 05:** Farmaceutski proizvodi.

(111) 10913

(151) 09.05.2014.

(210) **2011-181**

(442) **20.12.2013.**

(220) 12.04.2011.

(732) **BOSNALIJEK DD**, JUKIĆEVA 53, 71000 SARAJEVO BA

ESBESUL

(540)

(550) I

(740) Radulović Božidar, Jovana Tomaševića 9/III, Podgorica ME

(511) **Klasa 05:** Farmaceutski proizvodi.

(111) 10919

(151) 09.05.2014.

(210) **2011-666**

(442) **20.12.2013.**

(220) 16.12.2011.

(732) **PERNOD RICARD USA**, LLC, 100 MANHATTANVILLE ROAD, PURCHASE, NEW YORK 10577 US

Seagram

(540)

(550) I, F

(740) Mihailović Vojislav, Hilandarska 5, Beograd (SR)

(511) **Klasa 33:** Alkoholna pića, prije svega viski.

(111) 10920

(151) 09.05.2014.

(210) **2011-506**

(442) **20.12.2013.**

(220) 14.10.2011.

(732) **OCTAPHARMA AG**, SEIDENSTRASSE 2 8853 LACHEN CH

Human Albumin 5% Octapharma

(540)

(550) I

(740) Ćupić Branislav, Dalmatinska 10, Podgorica ME

(511) **Klasa 05:** Farmaceutski proizvodi, naime proizvodi izvedeni od krvne plazme, naročito albumin.

(111) 10921

(151) 09.05.2014.

(210) **2011-507**

(442) **20.12.2013.**

(220) 14.10.2011.

(732) **OCTAPHARMA AG**, SEIDENSTRASSE 2 8853 LACHEN CH

Human Albumin 20% Octapharma

(540)

(550) I

(740) Ćupić Branislav, Dalmatinska 10, Podgorica ME

(511) **Klasa 05:** Farmaceutski proizvodi, naime proizvodi izvedeni od krvne plazme, naročito albumin.

(111) 10934

(151) 13.05.2014.

(210) **2011-678**

(442) **20.12.2013.**

(220) 21.12.2011.

(732) **UNIVERSAL CITY STUDIOS LLC**, (A DELAWARE LIMITED LIABILITY COMPANY), 100 UNIVERSAL CITY PLAZY, UNIVERSAL CITY, CALIFORNIA 91608 US



(540)

(550) I, F

(740) Radulović Božidar, Jovana Tomaševića 9/III, Podgorica ME

(511) **Klasa 09:** Aparati i instrumenti naučni, pomorski, geodetski, električni, fotografski, kinematografski, optički, za vaganje, merenje, signalizaciju, kontrolu (inspekciju), spasavanje i nastavu, aparati i instrumenti za sprovođenje, uključivanje, pretvaranje, akumuliranje, regulisanje i kontrolu struje, aparati za snimanje, prenos i reprodukovanje zvuka ili slike, magnetni nosioci podataka, diskovi za snimanje, automatske mašine i mehanizmi za aparate koji se pokreću novcem ili žetonom, register kase, računске mašine, oprema za obradu podataka i kompjuteri, aparati za gašenje požara.

Klasa 41: Obrazovne usluge, pripremanje obuke, razonoda, sportske i kulturne aktivnosti.

(111) 10935

(151) 13.05.2014.

(210) **2011-679**

(442) **20.12.2013.**

(220) 21.12.2011.

(732) **UNIVERSAL CITY STUDIOS LLC**, (A DELAWARE LIMITED LIABILITY COMPANY), 100 UNIVERSAL CITY PLAZY, UNIVERSAL CITY, CALIFORNIA 91608 US



(540)

(550) I, F

(740) Radulović Božidar, Jovana Tomaševića 9/III, Podgorica ME

(511) **Klasa 09:** Aparati i instrumenti naučni, pomorski, geodetski, električni, fotografski, kinematografski, optički, za vaganje, merenje, signalizaciju, kontrolu (inspekciju), spasavanje i nastavu, aparati i instrumenti za sprovođenje, uključivanje, pretvaranje, akumuliranje, regulisanje i kontrolu struje, aparati za snimanje, prenos i reprodukovanje zvuka ili slike, magnetni nosioci podataka, diskovi za snimanje, automatske mašine i mehanizmi za aparate koji se pokreću novcem ili žetonom, register kase, računске mašine, oprema za obradu podataka i kompjuteri, aparati za gašenje požara.

Klasa 41: Obrazovne usluge, pripremanje obuke, razonoda, sportske i kulturne aktivnosti.

(111) 10938

(151) 13.05.2014.

(210) **2011-643**

(442) **20.12.2013.**

(220) 14.12.2011.

(732) **JOHNSON CONTROLS TECHNOLOGY COMPANY**, 915 EAST 32ND STREET CITY OF HOLLAND STATE OF MICHIGAN 49423 US



(540) _____

(550) I

(740) Popović Miladin, Đoka Miraševića 21/III, Podgorica ME

(511) **Klasa 09:** Baterije, provodne mreže za baterije i punjači baterija.

(111) 10937

(151) 13.05.2014.

(210) **2011-644**

(442) **20.12.2013.**

(220) 14.12.2011.

(732) **JONHSON CONTROLS TECHNOLOGY COMPANY**, 915 EAST 32ND STREET CITY OF HOLLAND STATE OF MICHIGAN 49423 US



(540)

(550) I

(740) Popović Miladin, Đoka Miraševića 21/III, Podgorica ME

(511) **Klasa 09:** Baterije, provodne mreže za baterije i punjači baterija.

(111) 10939

(151) 13.05.2014.

(210) **2011-732**

(442) **20.12.2013.**

(220) 29.12.2011.

(732) **DP BEVERAGES LIMITED**, PO BOX 309GT UGLAND HO USE SOUTH CHURCH STREET, GEORGE TOWN KY

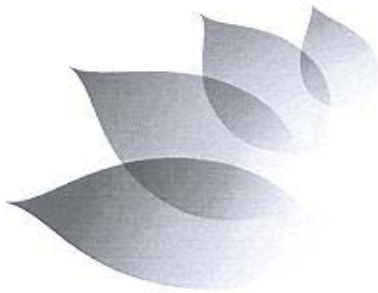

(540)

(550) I

(740) Popović Miladin, Đoka Miraševića 21/III, Podgorica ME

(511) **Klasa 30:** Kafa, čaj, kakao, šećer, pirinač, tapioka, sago, zamena kafe, brašno i proir žitari-
ca, hleb, kolači i poslastice, sladoledi, med, melasa, kvasac, pre pecivo, so, senf, sirće, sosovi
(kao dodaci), začini, led.

Klasa 32: Piva, mineralne i sodne vode i ostala bezalkoholna pića, voćna pića sokovi, sirupi i drugi preparati za proizvodnju pića.

(111) 10940

(151) 13.05.2014.

(210) **2011-733**(442) **20.12.2013.**

(220) 29.12.2011.

(732) **DP BEVERAGES LIMITED**, PO BOX 309GT UGLAND HOUSE SOUTH CHURCH STREET,
GEORGE TOWN KY**FUZE TEA**

(540)

(550) I

(740) Popović Miladin, Đoka Miraševića 21/III, Podgorica ME

(511) **Klasa 30:** Kafa, čaj, kakao, šećer, pirinač, tapioka, sago, zamena kafe, brašno i proir žitari-
ca, hleb, kolači i poslastice, sladoledi, med, melasa, kvasac, pre pecivo, so, senf, sirće, sosovi
(kao dodaci), začini, led.**Klasa 32:** Piva, mineralne i sodne vode i ostala bezalkoholna pića, voćna pića sokovi, sirupi i
drugi preparati za proizvodnju pića.

(111) 10962

(151) 19.05.2014.

(210) **2011-628**(442) **20.12.2013.**

(220) 14.12.2011.

(732) **13 JUL-PLANTAŽE A.D.** PODGORICA ME

(540)

50.0% vol

1 lit.

(550) I

(511) **Klasa 33:** Alkoholna pića (izuzev piva).

(111) 10963

(151) 19.05.2014.

(210) **2011-620**(442) **20.12.2013.**

(220) 12.12.2011.

(732) **13 JUL-PLANTAŽE A.D.** PODGORICA ME



(540)

(550) I

(511) **Klasa 33:** Alkoholna pića (izuzev piva).

(111) 10970

(151) 26.05.2014.

(210) **2011-751**(442) **20.12.2013.**

(220) 30.12.2011.

(732) **THE COCA-COLA COMPANY**, ONE COCA-COLA PLAZA, ATLANTA, GEORGIA 30313 US

(540)

(550) I

(740) Popović Miladin, Đoka Miraševića 21/III, Podgorica ME

(511) **Klasa 16:** Hartija, karton i proizvodi od njih, koji nijesu uključeni u druge klase, štamparske stvari, knjigovezački materijal, fotografije, kancelarijski materijal, ljepila za kancelarijske i kućne potrebe, umjetnički materijali, kičice, pisaće mašine i kancelarijski rekviziti (izuzev namještaja), materijali za obuku i nastavu (izuzev aparata), plastični materijal za pakovanje (koji nije uključen u druge klase), štamparska slova, klišeji.

Klasa 21: Kućne ili kuhinjske sprave i posude, češljevi i sunđeri, četke (izuzev kičica), materijali za pravljenje četki, artikli koji se koriste pri čišćenju, čelična vuna, neprerađeno ili poluprerado staklo (osim stakla koje se koristi u građevinarstvu), staklarija, porcelan i grnčarija koja nije uključena u druge klase.

Klasa 25: Odjeća, obuća, pokrivala za glavu.

Klasa 28: Igre i igračke, gimnastički i sportski artikli koji nijesu obuhvaćeni drugim klasama, ukrasi za jelke.

Klasa 32: Piva, mineralne i sodne vode i ostala bezalkoholna pića, voćna pića i voćni sokovi, sirupi i drugi preparati za proizvodnju pića.

Klasa 41: Obrazovne usluge, pripremanje obuke, razonoda, sportske i kulturne aktivnosti.

(111) 10971

(151) 26.05.2014.

(210) **2011-752**

(442) **20.12.2013.**

(220) 30.12.2011.

(732) **THE COCA-COLA COMPANY**, ONE COCA-COLA PLAZA, ATLANTA, GEORGIA 30313 US



(540)

(550) I

(740) Popović Miladin, Đoka Miraševića 21/III, Podgorica ME

(511) **Klasa 32:** Piva, mineralne i sodne vode i ostala bezalkoholna pića, voćna pića i voćni sokovi, sirupi i drugi preparati za proizvodnju pića.

(111) 10972

(151) 26.05.2014.

(210) **2011-753**

(442) **20.12.2013.**

(220) 30.12.2011.

(732) **THE COCA-COLA COMPANY**, ONE COCA-COLA PLAZA, ATLANTA, GEORGIA 30313 US



(540)

(550) I

(740) Popović Miladin, Đoka Miraševića 21/III, Podgorica ME

(511) **Klasa 16:** Hartija, karton i proizvodi od njih, koji nijesu uključeni u druge klase, štamparske stvari, knjigovezački materijal, fotografije, kancelarijski materijal, ljepljiva za kancelarijske i kućne potrebe, umjetnički materijali, kičice, pisaće mašine i kancelarijski rekviziti (izuzev namještaja), materijali za obuku i nastavu (izuzev aparata), plastični materijal za pakovanje

(koji nije uključen u druge klase), štamparska slova, kliše.

Klasa 21: Kućne ili kuhinjske sprave i posude, češljevi i sunđeri, četke (izuzev kičica), materijali za pravljenje četki, artikli koji se koriste pri čišćenju, čelična vuna, neprerađeno ili polupreradađeno staklo (osim stakla koje se koristi u građevinarstvu), staklarija, porcelan i grnčarija koja nije uključena u druge klase.

Klasa 25: Odjeća, obuća, pokrivala za glavu.

Klasa 28: Igre i igračke, gimnastički i sportski artikli koji nijesu obuhvaćeni drugim klasama, ukrasi za jelke.

Klasa 32: Piva, mineralne i sodne vode i ostala bezalkoholna pića, voćna pića i voćni sokovi, sirupi i drugi preparati za proizvodnju pića.

Klasa 41: Obrazovne usluge, pripremanje obuke, razonoda, sportske i kulturne aktivnosti.

(111) 10973

(151) 26.05.2014.

(210) **2011-754**

(442) **20.12.2013.**

(220) 30.12.2011.

(732) **THE COCA-COLA COMPANY**, ONE COCA-COLA PLAZA, ATLANTA, GEORGIA 30313 US



(540)

(550) I

(740) Popović Miladin, Đoka Miraševića 21/III, Podgorica ME

(511) **Klasa 16:** Hartija, karton i proizvodi od njih, koji nijesu uključeni u druge klase, štamparske stvari, knjigovezački materijal, fotografije, kancelarijski materijal, ljepila za kancelarijske i kućne potrebe, umjetnički materijali, kičice, pisaće mašine i kancelarijski rekviziti (izuzev namještaja), materijali za obuku i nastavu (izuzev aparata), plastični materijal za pakovanje (koji nije uključen u druge klase), štamparska slova, kliše.

Klasa 21: Kućne ili kuhinjske sprave i posude, češljevi i sunđeri, četke (izuzev kičica), materijali za pravljenje četki, artikli koji se koriste pri čišćenju, čelična vuna, neprerađeno ili polupreradađeno staklo (osim stakla koje se koristi u građevinarstvu), staklarija, porcelan i grnčarija koja nije uključena u druge klase.

Klasa 25: Odjeća, obuća, pokrivala za glavu.

Klasa 28: Igre i igračke, gimnastički i sportski artikli koji nijesu obuhvaćeni drugim klasama, ukrasi za jelke.

Klasa 32: Piva, mineralne i sodne vode i ostala bezalkoholna pića, voćna pića i voćni sokovi, sirupi i drugi preparati za proizvodnju pića.

Klasa 41: Obrazovne usluge, pripremanje obuke, razonoda, sportske i kulturne aktivnosti.

(111) 11006

(151) 28.05.2014.

(210) 2011-235

(442) 20.12.2013.

(220) 17.05.2011.

(732) **ALKALOID AD** SKOPLJE, BUL. ALEKSANDAR MAKEDONSKI 12, SKOPLJE MK

(540)

(550) I

(740) Popović Miladin, Đoka Miraševića 21/III, Podgorica ME

(511) **Klasa 03:** Šamponi.

(111) 11007

(151) 28.05.2014.

(210) 2011-236

(442) 20.12.2013.

(220) 17.05.2011.

(732) **ALKALOID AD** SKOPLJE, BUL. ALEKSANDAR MAKEDONSKI 12, SKOPLJE MK

(540) _____

(550) I

(740) Popović Miladin, Đoka Miraševića 21/III, Podgorica ME

(511) **Klasa 03:** Šamponi.

(111) 11015

(151) 28.05.2014.

(210) **2011-646**(442) **20.12.2013.**

(220) 14.12.2011.

(732) **HENRI-LLOYD LIMITED**, SMITHFOLD LANE, WORSLEY, MANCHESTER, M280GP GB

HENRI  **LLOYD**

(540)

(550) I

(740) Radulović Božidar, Jovana Tomaševića 9/III, Podgorica ME

(511) **Klasa 25:** Nepromočiva ili vodootporna odjeća, odela za preživljavanje, jakne, pantalone, kombinezon-pantalone, vjetrovke, krznene jakne, zaštitna odjela i jakne, kaputi, pokrivala za glavu, košulje, obuća, čarape, marama, kravate, pletena odjeća, prsluci, sigurnosni proizvodi za moreplovstvo, naročito kaiševi i sigurnosna užad.

(111) 11016

(151) 28.05.2014.

(210) **2011-726**(442) **20.12.2013.**

(220) 27.12.2011.

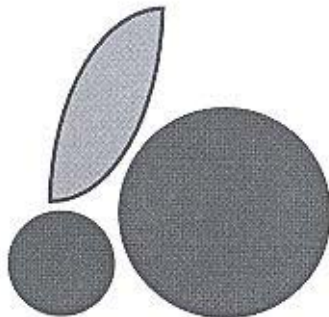
(732) **ZEKO.ME** D.O.O. MOSKOVSKA BB, PODGORICA ME

"ZEKO.ME"

(540)

(550) I

(511) **Klasa 42:** Projektovanje i razvoj kompjuterskog hardvera i softvera.

(111) 11017

(151) 28.05.2014.

(210) **2011-712**(442) **20.12.2013.**

(220) 22.12.2011.

(732) **THE COCA-COLA COMPANY**, ONE COCA-COLA PLAZA, ATLANTA, GA 30313 US



(540)

(550) I

(740) Popović Miladin, Đoka Miraševića 21/III, Podgorica ME

(511) **Klasa 32:** Piva, mineralne i sodne vode i ostala bezalkoholna pića, pića od voća i voćni sokovi, sirupi i drugi preparati za proizvodnju pića.

(111) 11018

(151) 28.05.2014.

(210) **2011-511**

(442) **20.12.2013.**

(220) 17.10.2011.

(732) **THE COCA-COLA COMPANY**, ONE COCA-COLA PLAZA, ATLANTA, GEORGIA 30313 US

FRUITIZZ

(540)

(550) I

(740) Popović Miladin, Đoka Miraševića 21/III, Podgorica ME

(511) **Klasa 32:** Piva, mineralne i sodne vode i ostala bezalkoholna pića, voćna pića i voćni sokovi, sirupi i drugi preparati za proizvodnju pića.

(111) 11019

(151) 28.05.2014.

(210) **2011-724**

(442) **20.12.2013.**

(220) 26.12.2011.

(732) **VIDKRITE AKTSIONERNE TOVARISTVO ISKRA**, UL. VULETSKA 14, 79066 LVIV UA



(540)

(550) I

(740) Ćupić Branislav, Dalmatinska 10, Podgorica ME

(511) **Klasa 11:** Aparati za osvjetljavanje, grijanje, proizvodnju pare, kuvanje, hlađenje, sušenje, ventilaciju, snabdjevanje vodom i sanitame svrhe.

Klasa 21: Kućne ili kuhinjske sprave i posude (koje nisu od dragocjenih metala ili sa prevlakama od njih), češljevi i sušeri, četke (izuzev kičica), materijali za pravljenje četki, artikli koji se koriste pri čišćenju, čelična vuna, neprerađeno ili poluprerađeno staklo (osim stakla koje se koristi u građevinarstvu), staklarija, porcelan, grnčarija i lončarija koja nije obuhvaćena drugim klasama.

(111) 11020

(151) 28.05.2014.

(210) **2011-237**

(442) **20.12.2013.**

(220) 17.05.2011.

(732) **ALKALOID AD** SKOPLJE, BUL. ALEKSANDAR MAKEDONSKI 12, SKOPLJE MK



(540)

(550) I

(740) Popović Miladin, Đoka Miraševića 21/III, Podgorica ME

(511) **Klasa 03:** Šamponi.

(111) 11021

(151) 28.05.2014.

(210) **2011-713**

(442) **20.12.2013.**

(220) 22.12.2011.

(732) **ASCOM NETWORK TESTING AB**, SKELLEFTEHAMNVAGEN 206, 936 35 URSVIKEN SE

TEMS

(540)

(550) I

(740) Čejović Vladimir, 13. jula 21, Podgorica ME

(511) **Klasa 09:** Ispitna oprema za analizu/pronalaženje grešaka (kvarova) u digitalnim mobilnim telefonskim mrežama (radio interfejs).

(111) 11024

(151) 30.05.2014.

(210) **2011-725**

(442) **20.12.2013.**

(220) 26.12.2011.

(732) **GENERAL MOTORS LLC**, 300 RENAISSANCE CENTER, DETROIT, MICHIGAN 48265-3000 US

XTS

(540)

(550) I, V

(740) Radulović Božidar, Jovana Tomaševića 9/III, Podgorica ME

(511) **Klasa 12:** Motorna vozila.

(111) 11025

(151) 30.05.2014.

(210) **2011-647**

(442) **20.12.2013.**

(220) 14.12.2011.

(732) **ŽITO PREHRAMBENA INDUSTRIJA**, D.D. ŠMARTINSKA CESTA 154, 1000 LJUBLJANA SI



(540)

(550) I

(740) Radulović Božidar, Jovana Tomaševića 9/III, Podgorica ME

(511) **Klasa 05:** Ljekovite trave i ljekoviti čajevi.

Klasa 30: Čajevi.

(111) 11028

(151) 02.06.2014.

(210) **2011-625**(442) **20.12.2013.**

(220) 13.12.2011.

(732) **JAMES SOMMERS**, AN INDIVIDUAL OF THE UNITED STATES, 7095 HOLLYWOOD BLVD.
90028 LOS ANGELES US**WILDFOX**

(540)

(550) I

(740) Čejović Vladimir, 13. jula 21, Podgorica ME

(511) **Klasa 25:** Odjeća, pokrivala za glavu, obuća.

(111) 11030

(151) 02.06.2014.

(210) **2011-527**(442) **20.12.2013.**

(220) 31.10.2011.

(732) **VISA INTERNATIONAL SERVICE ASSOCIATION**, 900 METRO CENTER BOULE-
VARD, FOSTER CITY, CALIFORNIA, 94404 US**V.ME**

(540)

(550) I

(740) Čejović Vladimir, 13. jula 21, Podgorica ME

(511) **Klasa 09:** Kompjuterski softver za obradu elektronskog plaćanja i prenos sredstava drugima i od drugih, softver koji se može preuzeti koji omogućava postavljanje, povezivanje, prikazivanje, prikazivanje, označavanje, blogovanje, dijeljenje ili pružanje elektronskih medija ili informacija preko interneta na drugi način, magnetno-kodirane kartice i kartice sa integrisanim kolima za finansijske aplikacije, mašinski čitljive, platne kartice sa bar kodovima, aparati za očitavanje magnetno-kodiranih kartica i kartica sa integrisanim kolima.**Klasa 35:** Obrada podataka i upravljanje bazama podataka u oblasti bankarstva, pružanje online kompjuterskog veb sajta koji obezbjeđuje podatke o finansijskim transakcijama, promotivni podsticaji, popusti, takmičenja i klađenja, pružanje analitičkih podataka koji se odnose na polje bankarskih i finansijskih usluga, pružanje sigurnog, on-line pristupa interfejsu za korisnike interneta za upotrebu u preuzimanju i analiziranju finansijskih informacija, pružanje informacija o proizvodima u cilju oglašavanja i prodaje.**Klasa 36:** Finansijske usluge, bankarstvo, plaćanje računa, usluge kreditnih kartica, usluge debitnih kartica, usluge pripejd kartica, elektronski platni promet, usluge transfera novca, usluge plaćanja u elektronskoj trgovini, usluge mjesta prodaje i mjesta transakcije, usluge transakcijskih ovlašćenja i poravnanja, usluge obrade elektronskog platnog prometa, usluge autentifikacije i verifikacije platnog prometa, usluge elektronskog prenosa sredstava, pružanje finansijskih usluga preko bežične mreže, uređaji za globalnu kompjutersku mrežu i mobilnu komunikaciju, formiranje namjenskih računa koji se koriste za kupovinu roba i usluga na internetu, usluge za olakšano plaćanje sa osobe na osobu, sigurne elektronske tran-

sakcije preko interneta kako bi se olakšala elektronska trgovina, usluge plaćanja računa sa daljine, informacije o plaćanju usluga o upravljanju, širenje finansijskih informacija putem globalne računarske mreže, bežične mreže i mobilnih komunikacijskih uređaja.

Klasa 38: Telekomunikacione usluge, koje omogućavaju siguran elektronski prenos informacija o nalogu i srodne informacije u oblasti finansijskih usluga, elektronski prenos računa i plaćanje takvih računa putem kompjuterskih terminala povezanih sa mrežama i internetom, obezbjeđivanje pristupa sajtovima trećim licima tako što se korisnicima omogućava da se prijave kroz univerzalno korisničko ime i lozinku preko interneta i drugih komunikacionih mreža.

Klasa 42: Obezbeđivanje sistema zasnovanog na mreži i onlajn portala za analizu finansijskih podataka, obezbjeđivanje veb sajta koji sadrži tehnologiju koja omogućava korisnicima da kreiraju lični onlajn servis informacija, obezbjeđivanje sistema zasnovanog na mreži za prikazivanje i dijeljenje lokacije korisnika da pronađe, locira i uzajamno djeluje sa drugima, obezbjeđivanje sistema zasnovanog na mreži koji omogućavaju korisnicima da obavljaju sigurne transakcije plaćanja u elektronskoj trgovini.

(111) 11060

(151) 11.06.2014.

(210) **2011-737**

(442) **20.12.2013.**

(220) 30.12.2011.

(732) **CORPORATION HABANOS**, S.A. AVENIDA 3RA NO.2006, ENTRE 20 Y 22, MIRAMAR, PLAYA CIUDAD DE LA HABANA CU



(540)

(550) I

(740) Stanković Mugoša Ana, Trg Republike 13, Podgorica ME

(511) **Klasa 34:** Duvan, uključujući cigare, cigarete, cigarilose, rezani duvan za lule, artikli za pušaće, uključujući pepeljare, nožice za cigare, kutije za šibice, kutije za cigare, šibice.

(111) 11061

(151) 11.06.2014.

(210) **2011-738**

(442) **20.12.2013.**

(220) 30.12.2011.

(732) **CORPORATION HABANOS**, S.A. AVENIDA 3RA NO.2006, ENTRE 20 Y 22, MIRAMAR, PLAYA CIUDAD DE LA HABANA CU



(540)

(550) I

(740) Stanković Mugoša Ana, Trg Republike 13, Podgorica ME

(511) **Klasa 34:** Duvan, uključujući cigare, cigarete, cigarilose, rezani duvan za lule, artikli za pušače, uključujući pepeljare, nožiče za cigare, kutije za šibice, kutije za cigare, šibice.

(111) 11062

(151) 11.06.2014.

(210) **2011-739**

(442) **20.12.2013.**

(220) 30.12.2011.

(732) **CORPORATION HABANOS**, S.A. AVENIDA 3RA NO.2006, ENTRE 20 Y 22, MIRAMAR, PLAYA CIUDAD DE LA HABANA CU



(540)

(550) I

(740) Stanković Mugoša Ana, Trg Republike 13, Podgorica ME

(511) **Klasa 34:** Duvan, uključujući cigare, cigarete, cigarilose, rezani duvan za lule, artikli za pušače, uključujući pepeljare, nožiče za cigare, kutije za šibice, kutije za cigare, šibice.

(111) 11063

(151) 11.06.2014.

(210) **2011-740**

(442) **20.12.2013.**

(220) 30.12.2011.

(732) **CORPORATION HABANOS**, S.A. AVENIDA 3RA NO.2006, ENTRE 20 Y 22, MIRAMAR, PLAYA CIUDAD DE LA HABANA CU

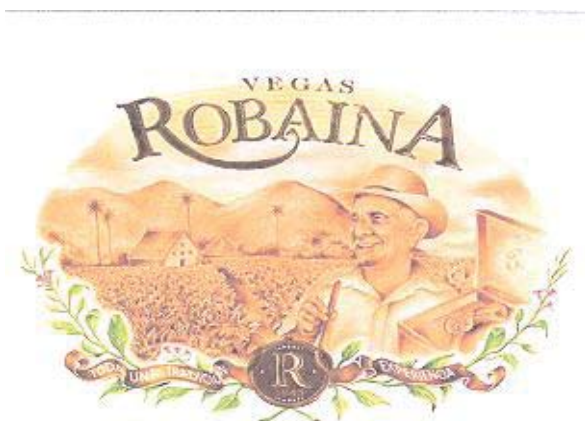

(540)

(550) I

(740) Stanković Mugoša Ana, Trg Republike 13, Podgorica ME

(511) **Klasa 34:** Duvan, uključujući cigare, cigarete, cigarilose, rezani duvan za lule, artikli za pušače, uključujući pepeljare, nožice za cigare, kutije za šibice, kutije za cigare, šibice.

(111) 11064

(151) 11.06.2014.

(210) **2011-741**

(442) **20.12.2013.**

(220) 30.12.2011.

(732) **CORPORATION HABANOS**, S.A. AVENIDA 3RA NO.2006, ENTRE 20 Y 22, MIRAMAR, PLAYA CIUDAD DE LA HABANA CU

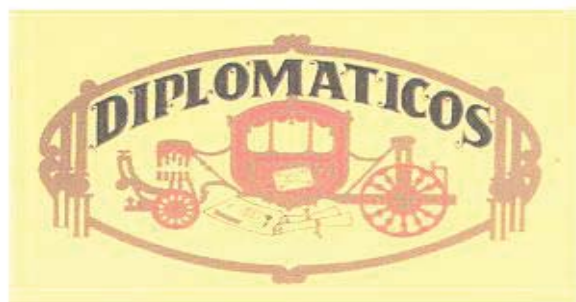

(540)

(550) I

(740) Stanković Mugoša Ana, Trg Republike 13, Podgorica ME

(511) **Klasa 34:** Duvan, uključujući cigare, cigarete, cigarilose, rezani duvan za lule, artikli za pušače, uključujući pepeljare, nožice za cigare, kutije za šibice, kutije za cigare, šibice.

(111) 11065

(151) 11.06.2014.

(210) **2011-742**

(442) **20.12.2013.**

(220) 30.12.2011.

(732) **CORPORATION HABANOS**, S.A. AVENIDA 3RA NO.2006, ENTRE 20 Y 22, MIRAMAR, PLAYA CIUDAD DE LA HABANA CU

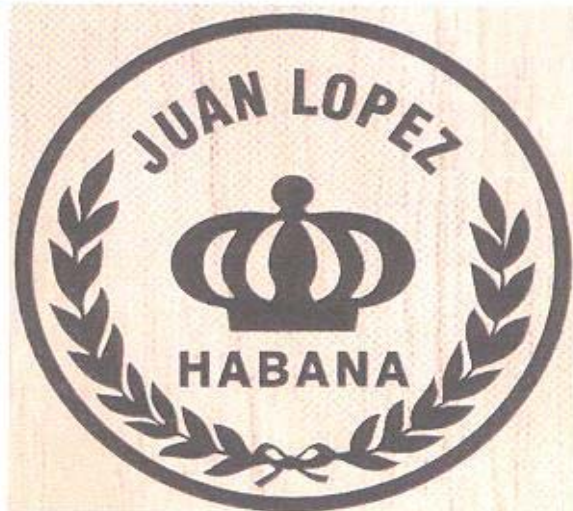

(540) _____

(550) I

(740) Stanković Mugoša Ana, Trg Republike 13, Podgorica ME

(511) **Klasa 34:** Duvan, uključujući cigare, cigarete, cigarilose, rezani duvan za lule, artikli za pušače, uključujući pepeljare, nožice za cigare, kutije za šibice, kutije za cigare, šibice.

(111) 11066

(151) 11.06.2014.

(210) **2011-743**

(442) **20.12.2013.**

(220) 30.12.2011.

(732) **CORPORATION HABANOS**, S.A. AVENIDA 3RA NO.2006, ENTRE 20 Y 22, MIRAMAR, PLAYA CIUDAD DE LA HABANA CU



(540)

(550) I

(740) Stanković Mugoša Ana, Trg Republike 13, Podgorica ME

(511) **Klasa 34:** Duvan, uključujući cigare, cigarete, cigarilose, rezani duvan za lule, artikli za pušače, uključujući pepeljare, nožice za cigare, kutije za šibice, kutije za cigare, šibice.

(111) 11067

(151) 11.06.2014.

(210) **2011-744**

(442) **20.12.2013.**

(220) 30.12.2011.

(732) **CORPORATION HABANOS**, S.A. AVENIDA 3RA NO.2006, ENTRE 20 Y 22, MIRAMAR,

PLAYA CIUDAD DE LA HABANA CU



(540)

(550) I

(740) Stanković Mugoša Ana, Trg Republike 13, Podgorica ME

(511) **Klasa 34:** Duvan, uključujući cigare, cigarete, cigarilose, rezani duvan za lule, artikli za pušače, uključujući pepeljare, nožiče za cigare, kutije za šibice, kutije za cigare, šibice.

(111) 11068

(151) 11.06.2014.

(210) **2011-745**

(442) **20.12.2013.**

(220) 30.12.2011.

(732) **CORPORATION HABANOS**, S.A. AVENIDA 3RA NO.2006, ENTRE 20 Y 22, MIRAMAR, PLAYA CIUDAD DE LA HABANA CU



(540)

(550) I

(740) Stanković Mugoša Ana, Trg Republike 13, Podgorica ME

(511) **Klasa 34:** Duvan, uključujući cigare, cigarete, cigarilose, rezani duvan za lule, artikli za pušače, uključujući pepeljare, nožiče za cigare, kutije za šibice, kutije za cigare, šibice.

(111) 11069

(151) 11.06.2014.

(210) **2011-746**

(442) **20.12.2013.**

(220) 30.12.2011.

(732) **CORPORATION HABANOS**, S.A. AVENIDA 3RA NO.2006, ENTRE 20 Y 22, MIRAMAR, PLAYA CIUDAD DE LA HABANA CU

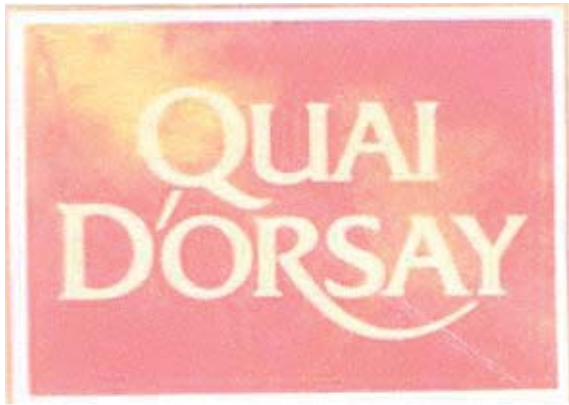

(540)

(550) I

(740) Stanković Mugoša Ana, Trg Republike 13, Podgorica ME

(511) **Klasa 34:** Duvan, uključujući cigare, cigarete, cigarilose, rezani duvan za lule, artikli za pušače, uključujući pepeljare, nožice za cigare, kutije za šibice, kutije za cigare, šibice.

(111) 11070

(151) 11.06.2014.

(210) **2011-747**

(442) **20.12.2013.**

(220) 30.12.2011.

(732) **CORPORATION HABANOS**, S.A. AVENIDA 3RA NO.2006, ENTRE 20 Y 22, MIRAMAR, PLAYA CIUDAD DE LA HABANA CU



(540)

(550) I

(740) Stanković Mugoša Ana, Trg Republike 13, Podgorica ME

(511) **Klasa 34:** Duvan, uključujući cigare, cigarete, cigarilose, rezani duvan za lule, artikli za pušače, uključujući pepeljare, nožice za cigare, kutije za šibice, kutije za cigare, šibice.

(111) 11193

(151) 02.07.2014.

(210) **2011-731**

(442) **20.12.2013.**

(220) 28.12.2011.

(732) **WM.WRIGLEY JR.COMPANY**, 410 NORTH MICHIGAN AVENUE, CHICAGO, IL 60611 US

EVOLUTION

(540)

(550) I

(740) Čejović Vladimir, 13. jula 21, Podgorica ME

(511) **Klasa 30:** Konditorski proizvodi, žvakaće gume, žvakaće gume od kojih mogu da se prave veliki baloni, bombone, dražeje pepermint, mali okrugli bomboni (drops) i pastile.

(111) 11092

(151) 12.06.2014.

(210) **2011-619**(442) **20.12.2013.**

(220) 12.12.2011.

(732) **HTC CORPRATION** (A TAIWANESE COMPANY), NO. 23, XINGHUA ROAD, TAOYUAN CITY, TAOYUAN COUNTRY 330, TAIWAN, R.O.C. TW

(540)

(550) I

(740) Čejović Vladimir, 13. jula 21, Podgorica ME

(511) **Klasa 09:** Mobilni telefoni, smartfoni, bežični telefoni, bežični uređaji, prenosivi kompjuteri i lični digitalni asistenti, kompjuterski hardver i softver za mobilne, prenosive i bežične uređaje, korisnički interfejs softver, kompjuterski hardver i softver za korisnički interfejsing, telekomunikacije i telekomunikacijske usluge, kompjuterski hardver i softver za prenošenje i prijem glasa, slike, podataka, audio, video i multimedijalnog sadržaja, bežični modemi, slušalice, slušalice sa funkcijom bežičnog prenosa, kablovi za konekciju, držači, nosači, maske, baterije, adapteri, punjači, futrole, punjači za vozila, držači za vozila, daljinski upravljači, tastature, mikrofoni, zvučnici, kožne torbice za mobilne telefone.**Klasa 37:** Dijagnostika, popravka, održavanje i konsultantske usluge za mobilne telefone, smartfone, bežične telefone, bežične uređaje, prenosive kompjutere, lične digitalne asistente, dijagnostika, popravka, održavanje i konsultantske usluge za bežične modeme, slušalice, slušalice sa funkcijom bežičnog prenosa, kablovima za konekciju, držačima, nosačima, maskama, baterijama, adapterima, punjačima, futrolama, punjačima za vozila, držačima za vozila, daljinskim upravljačima, tastaturama, mikrofonomima, zvučnicima, kožnim torbicama za mobilne telefone.

(111) 11093

(151) 13.06.2014.

(210) **2011-718**(442) **20.12.2013.**

(220) 22.12.2011.

(732) **GARAGE INTERNATIONAL LUX SARL**, 1 ALLEE SCHEFFER, SUITE 2.05.1, L-2520, LUXEMBOURG LU

GRG BY GARAGE

(540)

(550) I

(740) Čejović Vladimir, 13. jula 21, Podgorica ME

(511) **Klasa 03:** Parfimerija, eterična ulja, kozmetika.**Klasa 18:** Torbe, naprtnjače.**Klasa 25:** Odjeća, obuća, pokrivala za glavu.**Klasa 35:** Usluge maloprodajnih objekata u vezi sa parfimerijom, eteričnim uljima, kozmetikom, torbama, naprtnjačama, odjećom, obućom, pokrivalima za glavu.

(111) 11094

(151) 12.06.2014.

(210) **2011-605**(442) **20.12.2013.**

(220) 09.12.2011.

(732) **FOUR ROSES DISTILLERY LLC**, 1224 BONDS MILL ROAD, LAWRENCEBURG, KENTUCKY 40342 US

FOUR ROSES

(540)

(550) I

(740) Čejović Vladimir, 13. jula 21, Podgorica ME

(511) **Klasa 33:** Viski.

(111) 11158

(151) 25.06.2014.

(210) **2011-735**(442) **20.12.2013.**

(220) 30.12.2011.

(732) **CORPORATION HABANOS**, S.A. AVENIDA 3RA NO.2006, ENTRE 20 Y 22, MIRAMAR, PLAYA CIUDAD DE LA HABANA CU

(540)

(550) I

(740) Stanković Mugoša Ana, Trg Republike 13, Podgorica ME

(511) **Klasa 34:** Duvan, uključujući cigare, cigarete, cigarilose, rezani duvan za lule, artikli za pušače, uključujući pepeljare, nožice za cigare, kutije za šibice, kutije za cigare, šibice.

(111) 11159

(151) 25.06.2014.

(210) **2011-736**

(442) **20.12.2013.**

(220) 30.12.2011.

(732) **CORPORATION HABANOS**, S.A. AVENIDA 3RA NO.2006, ENTRE 20 Y 22, MIRAMAR, PLAYA CIUDAD DE LA HABANA CU



(540)

(550) I

(740) Stanković Mugoša Ana, Trg Republike 13, Podgorica ME

(511) **Klasa 34:** Duvan, uključujući cigare, cigarete, cigarilose, rezani duvan za lule, artikli za pušače, uključujući pepeljare, nožice za cigare, kutije za šibice, kutije za cigare, šibice.

(111) 11160

(151) 25.06.2014.

(210) **2011-714**

(442) **20.12.2013.**

(220) 22.12.2011.

(732) **GARAGE INTERNATIONAL LUX SARL**, 1 ALLEE SCHEFFER, SUITE 2.05.1, L-2520, LUXEMBOURG LU

GARAGE

(540)

(550) I

(740) Čejović Vladimir, 13. jula 21, Podgorica ME

(511) **Klasa 03:** Parfimerija, eterična ulja, kozmetika.

Klasa 18: Torbe, naprtnjače.

Klasa 35: Usluge maloprodajnih objekata u vezi sa parfimerijom, eteričnim uljima, kozmetikom, torbama, naprtnjačama, odjećom, obućom, pokrivalima za glavu.

(111) 11161

(151) 25.06.2014.

(210) **2011-715**(442) **20.12.2013.**

(220) 22.12.2011.

(732) **GARAGE INTERNATIONAL LUX SARL**, 1 ALLEE SCHEFFER, SUITE 2.05.1, L-2520, LUXEMBOURG LU**GARAGE**

(540)

(550) I

(740) Čejović Vladimir, 13. jula 21, Podgorica ME

(511) **Klasa 03:** Parfimerija, eterična ulja, kozmetika.**Klasa 18:** Torbe, naprtnjače.**Klasa 35:** Usluge maloprodajnih objekata u vezi sa parfimerijom, eteričnim uljima, kozmetikom, torbama, naprtnjačama, odjećom, obućom, pokrivalima za glavu.

(111) 11162

(151) 25.06.2014.

(210) **2011-716**(442) **20.12.2013.**

(220) 22.12.2011.

(732) **GARAGE INTERNATIONAL LUX SARL**, 1 ALLEE SCHEFFER, SUITE 2.05.1, L-2520, LUXEMBOURG LU

GARAGE

(540)

(550) I

(740) Čejović Vladimir, 13. jula 21, Podgorica ME

(511) **Klasa 03:** Parfimerija, eterična ulja, kozmetika.**Klasa 18:** Torbe, naprtnjače.**Klasa 35:** Usluge maloprodajnih objekata u vezi sa parfimerijom, eteričnim uljima, kozmetikom, torbama, naprtnjačama, odjećom, obućom, pokrivalima za glavu.

(111) 11163

(151) 25.06.2014.

(210) **2011-717**(442) **20.12.2013.**

(220) 22.12.2011.

(732) **GARAGE INTERNATIONAL LUX SARL**, 1 ALLEE SCHEFFER, SUITE 2.05.1, L-2520,

LUXEMBOURG LU

GRG

(540)

(550) I

(740) Čejović Vladimir, 13. jula 21, Podgorica ME

(511) **Klasa 03:** Parfimerija, eterična ulja, kozmetika.**Klasa 18:** Torbe, naprtnjače.**Klasa 25:** Odjeća, obuća, pokrivala za glavu.**Klasa 35:** Usluge maloprodajnih objekata u vezi sa parfimerijom, eteričnim uljima, kozmetikom, torbama, naprtnjačama, odjećom, obućom, pokrivalima za glavu.

(111) 11164

(151) 25.06.2014.

(210) **2011-719**(442) **20.12.2013.**

(220) 22.12.2011.

(732) **GARAGE INTERNATIONAL LUX SARL**, 1 ALLEE SCHEFFER, SUITE 2.05.1, L-2520, LUXEMBOURG LU**DYNAMITE**

(540)

(550) I

(740) Čejović Vladimir, 13. jula 21, Podgorica ME

(511) **Klasa 18:** Torbe, naprtnjače.**Klasa 25:** Odjeća, obuća, pokrivala za glavu.**Klasa 35:** Usluge maloprodajnih objekata u vezi sa parfimerijom, eteričnim uljima, kozmetikom, torbama, naprtnjačama, odjećom, obućom, pokrivalima za glavu.

(111) 11165

(151) 25.06.2014.

(210) **2011-720**(442) **20.12.2013.**

(220) 22.12.2011.

(732) **GARAGE INTERNATIONAL LUX SARL**, 1 ALLEE SCHEFFER, SUITE 2.05.1, L-2520, LUXEMBOURG LU

(540)

(550) I

(740) Čejović Vladimir, 13. jula 21, Podgorica ME

(511) **Klasa 18:** Torbe, naprtnjače.**Klasa 25:** Odjeća, obuća, pokrivala za glavu.

Klasa 35: Usluge maloprodajnih objekata u vezi sa parfimerijom, eteričnim uljima, kozmetikom, torbama, naprtnjačama, odjećom, obućom, pokrivalima za glavu.

(111) 11166

(151) 25.06.2014.

(210) **2011-721**

(442) **20.12.2013.**

(220) 22.12.2011.

(732) **GARAGE INTERNATIONAL LUX SARL**, 1 ALLEE SCHEFFER, SUITE 2.05.1, L-2520, LUXEMBOURG LU

(540)

(550) I

(740) Čejović Vladimir, 13. jula 21, Podgorica ME

(511) **Klasa 03:** Parfimerija, eterična ulja, kozmetika.

Klasa 18: Torbe, naprtnjače.

Klasa 35: Usluge maloprodajnih objekata u vezi sa parfimerijom, eteričnim uljima, kozmetikom, torbama, naprtnjačama, odjećom, obućom, pokrivalima za glavu.

(111) 11182

(151) 30.06.2014.

(210) **2011-672**

(442) **20.12.2013.**

(220) 20.12.2011.

(732) **RUSSELL BRANDS, LLC**, ONE FRUIT OF THE LOOM DRIVE, BOWLING GREEN, KENTUCKY 42103 US

(540)

(550) I

(740) Čejović Vladimir, 13. jula 21, Podgorica ME

(511) **Klasa 18:** Torbe, sportske torbe, atletske torbe, trake za upotrebu u sportu, novčanici i tašne, putne torbe, putne vreće i rančevi.

Klasa 25: Odjeća, obuća, pokrivala za glavu, sportska odjeća, sportska obuća, pokrivala za glavu za upotrebu u sportu.

Klasa 28: Torbe prilagođene za nošenje sportskih artikala, gimnastički i sportski artikli i oprema.

Klasa 35: Maloprodajne usluge u vezi sa prodajom torbi, sportskih torbi, atletskih torbi, traka za upotrebu u sportu, novčanika i tašni, putnih torbi, putnih vreća i rančeva, odjeće, obuće, pokrivala za glavu, sportske odjeće, sportske obuće, pokrivala za glavu za upotrebu u sportu, torbi prilagođenih za nošenje sportskih artikala, gimnastičkih i sportskih artikala i opreme, usluge u vezi reklamnih torbi, sportskih torbi, atletskih torbi, traka za upotrebu u sportu, novčanika i tašni, putnih torbi, putnih vreća i rančeva, odjeće, obuće, pokrivala za glavu, sportske odjeće, sportske obuće, pokrivala za glavu za upotrebu u sportu, torbi prilagođenih za nošenje sportskih artikala, gimnastičkih i sportskih artikala i opreme.

(111) 11183

(151) 30.06.2014.

(210) **2011-673**

(442) **20.12.2013.**

(220) 20.12.2011.

(732) **RUSSELL BRANDS, LLC, ONE FRUIT OF THE LOOM DRIVE, BOWLING GREEN, KENTUCKY 42103 US**



(540)

(550) I

(740) Čejović Vladimir, 13. jula 21, Podgorica ME

(511) **Klasa 18:** Torbe, sportske torbe, atletske torbe, trake za upotrebu u sportu, novčanici i tašne, putne torbe, putne vreće i rančevi.

Klasa 25: Odjeća, obuća, pokrivala za glavu, sportska odjeća, sportska obuća, pokrivala za glavu za upotrebu u sportu.

Klasa 28: Torbe prilagođene za nošenje sportskih artikala, gimnastički i sportski artikli i oprema.

Klasa 35: Maloprodajne usluge u vezi sa prodajom torbi, sportskih torbi, atletskih torbi, traka za upotrebu u sportu, novčanika i tašni, putnih torbi, putnih vreća i rančeva, odjeće, obuće, pokrivala za glavu, sportske odjeće, sportske obuće, pokrivala za glavu za upotrebu u sportu, torbi prilagođenih za nošenje sportskih artikala, gimnastičkih i sportskih artikala i opreme, usluge u vezi reklamnih torbi, sportskih torbi, atletskih torbi, traka za upotrebu u sportu, novčanika i tašni, putnih torbi, putnih vreća i rančeva, odjeće, obuće, pokrivala za glavu, sportske odjeće, sportske obuće, pokrivala za glavu za upotrebu u sportu, torbi prilagođenih za nošenje sportskih artikala, gimnastičkih i sportskih artikala i opreme.

(111) 11184

(151) 30.06.2014.

(210) 2011-674

(442) 20.12.2013.

(220) 20.12.2011.

(732) **RUSSELL BRANDS**, LLC, ONE FRUIT OF THE LOOM DRIVE, BOWLING GREEN, KENTUCKY 42103 US

(540)

(550) I

(740) Čejović Vladimir, 13. jula 21, Podgorica ME

(511) **Klasa 18:** Torbe, sportske torbe, atletske torbe, trake za upotrebu u sportu, novčanici i tašne, putne torbe, putne vreće i rančevi.**Klasa 25:** Odjeća, obuća, pokrivala za glavu, sportska odjeća, sportska obuća, pokrivala za glavu za upotrebu u sportu.**Klasa 28:** Torbe prilagođene za nošenje sportskih artikala, gimnastički i sportski artikli i oprema.**Klasa 35:** Maloprodajne usluge u vezi sa prodajom torbi, sportskih torbi, atletskih torbi, traka za upotrebu u sportu, novčanika i tašni, putnih torbi, putnih vreća i rančeva, odjeće, obuće, pokrivala za glavu, sportske odjeće, sportske obuće, pokrivala za glavu za upotrebu u sportu, torbi prilagođenih za nošenje sportskih artikala, gimnastičkih i sportskih artikala i opreme, usluge u vezi reklamnih torbi, sportskih torbi, atletskih torbi, traka za upotrebu u sportu, novčanika i tašni, putnih torbi, putnih vreća i rančeva, odjeće, obuće, pokrivala za glavu, sportske odjeće, sportske obuće, pokrivala za glavu za upotrebu u sportu, torbi prilagođenih za nošenje sportskih artikala, gimnastičkih i sportskih artikala i opreme.

(111) 11186

(151) 30.06.2014.

(210) 2011-688

(442) 20.12.2013.

(220) 21.12.2011.

(732) **TIKKURILA DOO**, HAJDUK VELJKOVA BB, ŠABAC RS

(540)

(550) I

(740) Kojić Ivana, Serdara Jola Piletića bb, Podgorica ME

(511) **Klasa 01:** Hemijski proizvodi koji se upotrebljavaju u industriji, nauci, fotografiji, poljoprivredi i šumarstvu, neprerađene veštačke smole, neprerađene plastične materije, đubriva, smeše za gašenje vatre, preparati za kaljenje i zavarivanje, hemijske supstance za konzervisanje namirnica, materije za štavljenje, lepljive supstance koje se upotrebljavaju u industriji.

Klasa 02: Boje, firnajzi, lakovi, sredstva za zaštitu od rđe i truljenja drveta, materije za bojenje, sredstva za nagrizanje, sirove prirodne smole, metali u obliku listova i praha za slikare, dekoratere, štampare i umetnike.

(111) 11187

(151) 30.06.2014.

(210) **2011-722**

(442) **20.12.2013.**

(220) 22.12.2011.

(300) 1,542,87 09.10.2010.

CA

(732) **COLLIERS INTERNATIONAL PRPERTY CONSULTANTS, INC.** 1209 ORANGE STREET WILMINGTON, DELAWARE 19801 US

ACCELERATING SUCCESS

(540)

(550) I

(740) Čejović Vladimir, 13. jula 21, Podgorica ME

(511) **Klasa 16:** Štampane i elektronske publikacije, naime časopisi, bilteni i brošure, koji uglavnom sadrže članke o opštim temama u vezi sa nepokretnom imovinom, nekretninama, komercijalnom imovinom, stambenim objektima, industrijskom svojinom, zgradama i firmama. Štampanim edukativnim materijalima, naime, udžbenicima, vodičima, radnim svjeskama, radnim materijalima, formularima, procjenama i uputstvima za upotrebu, blokovima za bilježenje, blokovima za pisanje, instrumentima za pisanje.

Klasa 35: Pružanje usluga istraživanja tržišta i analize usluga u vezi sa nepokretnom imovinom, nekretninama, komercijalnom svojinom, rezidencijalnim objektima, industrijskom svojinom, zgradama i firmama. Aukcijske usluge.

Klasa 36: Pružanje konsultantskih, agencijskih i brokerskih usluga drugima u vezi sa izgradnjom nekretnina, planiranjem nekretnina, upravljanjem projektima vezanim za nekretnine, investicijama u nekretnine, rukovođenjem nekretninama, finansijskim uslugama u vezi sa nekretninama, upravljanjem nekretninama, procjenom poreza na nekretnine, marketingom nekretnina, prodajom i kupovinom nekretnina, izdavanjem i iznajmljivanjem nekretnina, procjenom i vrjednovanjem nekretnina i posredovanjem u poslovima s nekretninama. Pružanje konsultantskih, agencijskih i brokerskih usluga drugima u vezi sa izgradnjom, planiranjem, upravljanjem projektima, investicijama, rukovođenjem, upravljanjem, prodajom i kupovinom nekretnina, izdavanjem i iznajmljivanjem, procjenom i vrjednovanjem i preuzimanjem i spajanjem komercijalne svojine, rezidencijalnih objekata, industrijske svojine, zgrada i firmi.



INDEKS NOSILACA ŽIGOVA
INDEX OF THE HOLDER OF THE REGISTRATION

(732)	(111)	(210)
13 JUL-PLANTAŽE A.D.	10962	2011-628
13 JUL-PLANTAŽE A.D.	10963	2011-620
13 JUL-PLANTAŽE A.D.	11031	2011-606
13 JUL-PLANTAŽE A.D.	11032	2011-607
13 JUL-PLANTAŽE A.D.	11033	2011-608
13 JUL-PLANTAŽE A.D.	11034	2011-609
13 JUL-PLANTAŽE A.D.	11035	2011-610
13 JUL-PLANTAŽE A.D.	11036	2011-611
13 JUL-PLANTAŽE A.D.	11037	2011-612
AATELLAS DEUTCHLAND GMBH	10867	2011-658
ABBOT LABORATORIES	10900	2012-160
ABBOTT LABORATORIES	09230	2011-146
ABBOTT MEDICAL OPTICS INC.	11083	2012-19
ABBOTT MEDICAL OPTICS	11091	2012-75
ADIDAS INTERNATIONAL MARKETING BV	10989	2012-105
ADIDAS INTERNATIONAL MARKETING BV	10990	2012-104
ADIDAS INTERNATIONAL MARKETING BV	10991	2012-103
ADIDAS INTERNATIONAL MARKETING BV	10992	2012-102
ADIDAS INTERNATIONAL MARKETING BV	10993	2012-101
ADIDAS INTERNATIONAL MARKETING BV	10994	2012-100
ADIDAS INTERNATIONAL MARKETING BV	10995	2012-99
AGENCIJA ZA ZAŠTITU ŽIVOTNE SREDINE	10833	2010-361
AKTIEBOLAGET ELECTROLUX	11228	2012-235
AKZO NOBEL COATINGS INTERNATIONAL B.V.	09270	2011-129
ALKALOID AD SKOPLJE	09734	2011-238
ALKALOID AD SKOPLJE	09762	2009-412
ALKALOID AD	10844	2011-425
ALKALOID AD	10869	2011-660
ALKALOID AD	10903	2012-188
ALKALOID AD	10904	2012-186
ALKALOID AD	10912	2012-218
ALKALOID AD	10924	2012-239
ALKALOID AD	10926	2012-245
ALKALOID AD	10927	2012-246
ALKALOID AD	10928	2012-247
ALKALOID AD	10929	2012-248

(732)	(111)	(210)
ALKALOID AD	10948	2012-176
ALKALOID AD	10949	2012-177
ALKALOID AD	10950	2012-184
ALKALOID AD	10951	2012-185
ALKALOID AD	10952	2012-187
ALKALOID AD	10953	2012-210
ALKALOID AD	11006	2011-235
ALKALOID AD	11007	2011-236
ALKALOID AD	11020	2011-237
ALKALOID AD	11156	2012-53
ALKALOID AD	11198	2012-54
ALLOY RODS GLOBAL	11118	2012-144
Alloy Rods Global	11119	2012-143
AMGEN INC.	09232	2011-145
APATINSKA PIVARA	10969	2011-593
APPLE INC.	10460	2011-212
APPLE INC.	10762	2011-217
ASCOM NETWORK TESTING AB	11021	2011-713
ASTELLAS DEUTSCHLAND GMBH	10868	2011-659
ASTEX PHARMACEUTICALS	10894	2011-648
ASTRA ZENECA AB	09353	2011-110
ATLAS SPOLKA Z O O	10798	2009-552
AUSTRIA TABAK GMBH	10765	2011-169
AVON PRODUCTS	11172	2012-110
BASF SE	11253	2012-172
BAYER AKTIENGESELLSCHAFT	10947	2012-162
BAYER CONSUMER CARE AG	10954	2012-222
BELUPO LJEKOVI I KOZMETIKA D.D.	09283	2011-120
BERLIN-CHEMIE AG	09021	2011-365
BERLIN-CHEMIE AG	09028	2011-366
BERLIN-CHEMIE AG	09550	2011-194
BIOFARMA	11168	2012-95
BONGRAIN S.A.	09313	2011-43
BORIS RAŠKOVIĆ, MIRO PEROVIĆ	10964	2011-601
BOSNALIJEK	09820	2011-65
BOSNALIJEK	10906	2011-115
BOSNALIJEK	10907	2011-116
BOSNALIJEK	10913	2011-181
BOSNALIJEK	11211	2012-76

(732)	(111)	(210)
BR INTERNATIONAL HOLDING	10909	2012-211
BRITISH AMERICAN TOBACCO (BRANDS) INC.	10974	2011-603
BRITISH AMERICAN TOBACCO (BRANDS) INC.	10975	2011-604
BROADBAND MONTENEGRO BBM	11224	2010-63
BUSINESS WIRE	10999	2012-125
CANON KABUSHIKI KAISHA	11229	2012-205
CHERY AUTOMOBILE CO.LTD	10957	2010-58
CHIGUITA BRANDS L.C.C.	10801	2011-163
CHIQUITA BRANDS L.L.C.	10799	2011-164
CHLORIDE GROUP LIMITED	10747	2011-190
CHURCH & DWIGHT CO. INC	10787	2011-170
COLGATE PALMOLIVE COMPANY	10884	2011-692
COLGATE PALMOLIVE COMPANY	10885	2011-700
COLGATE PALMOLIVE COMPANY	10886	2011-699
COLGATE PALMOLIVE COMPANY	10887	2011-701
COLGATE PALMOLIVE COMPANY	10888	2011-702
COLGATE PALMOLIVE COMPANY	11046	2011-694
COLGATE PALMOLIVE COMPANY	11047	2011-693
COLGATE PALMOLIVE COMPANY	11048	2011-695
COLGATE PALMOLIVE COMPANY	11049	2011-696
COLGATE PALMOLIVE COMPANY	11050	2011-697
COLGATE PALMOLIVE COMPANY	11071	2011-703
COLGATE PALMOLIVE COMPANY	11072	2011-704
COLGATE PALMOLIVE COMPANY	11073	2011-705
COLGATE PALMOLIVE COMPANY	11074	2011-706
COLGATE PALMOLIVE COMPANY	11075	2011-698
COLGATE PALMOLIVE COMPANY	11103	2011-707
COLGATE PALMOLIVE COMPANY	11104	2011-708
COLGATE PALMOLIVE COMPANY	11105	2011-709
COLGATE PALMOLIVE COMPANY	11106	2011-710
COLGATE PALMOLIVE COMPANY	11107	2011-711
COLLIERS INTERNATIONAL PRPERTY CONSULTANTS	11187	2011-722
COMPANHIA NITRO QUIMICA BRASILEIRA	10473	2011-214
COMPANHIA NITRO QUIMICA BRASILERIA	10472	2011-213
CONVATEC INC.	09251	2011-130
CORPORATION HABANOS	11060	2011-737
CORPORATION HABANOS	11061	2011-738
CORPORATION HABANOS	11062	2011-739
CORPORATION HABANOS	11063	2011-740

(732)	(111)	(210)
CORPORATION HABANOS	11064	2011-741
CORPORATION HABANOS	11065	2011-742
CORPORATION HABANOS	11066	2011-743
CORPORATION HABANOS	11067	2011-744
CORPORATION HABANOS	11068	2011-745
CORPORATION HABANOS	11069	2011-746
CORPORATION HABANOS	11070	2011-747
CORPORATION HABANOS	11158	2011-735
CORPORATION HABANOS	11159	2011-736
CP KELCO U.S INC	10464	2011-239
CRNAGORACOOP AD-U STEČAJU	10788	2011-248
CRNAGORACOOP AD-U STEČAJU	10789	2011-249
CRNOGORSKO SERTIFIKACIONO TIJELO	11276	2011-730
CROSSCARE LIMITED	10899	2012-158
CUMMINS FILTRATION INC.	10832	2011-361
D.O.O ŠIMŠIĆ-MONTIMILK	10930	2012-165
D.O.O UDAČA	11256	2012-68
DAIMLER AG	10959	2011-379
DC COMICS	11084	2012-20
DC COMICS	11085	2012-21
DELTA AIR LINES	11152	2012-111
DEUTCHE TELEKOM AG	10791	2011-135
DIAGEO BRANDS B.V.	10467	2011-148
DIAGEO BRANDS B.V.	10761	2011-227
DOMPE S.P.A.	11042	2011-121
DOMPE S.P.A.	11043	2011-122
DOMPE S.P.A.	11044	2011-215
DP BEVERAGES LIMITED	10939	2011-732
DP BEVERAGES LIMITED	10940	2011-733
DUNHILL TOBACCO OF LONDON LIMITED	09389	2011-244
DURMUS YASAR	10877	2011-616
DUVANSKI KOMBINAT, AD, U STEČAJU	10943	2011-352
DUVANSKI KOMBINAT, AD, U STEČAJU	10944	2011-353
DYO BOYA FABRIKALARI	10878	2011-617
E.I.DU PONT DE NEMOURS AND COMPANY	10466	2011-142
E.L.DU PONT DE NEMOURS AND COMPANY	11227	2012-228
E.MISHAN & SONS, INC(NEW YORK CORPORATON)	10997	2011-452
EASTERN COMPANY	11154	2011-273
Engel&Volkers Marken GmbH&Co.KG	10932	2012-189

(732)	(111)	(210)
Engel&Volkers Marken GmbH&Co.KG	11010	2012-190
EUROPAPERESS HOLDING	10976	2011-650
EUROPAPRESS HOLDING	10977	2011-651
EUROPAPRESS HOLDING	10978	2011-652
Euro-pro Operating LLC	11005	2012-147
EURO-PRO OPERATING LLC	11088	2012-146
Euro-pro Operating LLC	11089	2012-147
EXXON MOBIL CORPORATION	10931	2012-173
FARMACEUTSKA HEMISKA KOZMETIČKA INDUSTRIJA ALKALOID AD	11151	2012-112
FARMACEUTSKO-HEMIJSKA INDUSTRIJA ZDRAVLJE AD	10905	2012-206
FARMACEUTSKO-HEMIJSKA INDUSTRIJA ZDRAVLJE AD	10925	2012-240
FASHIONET AG	10883	2011-627
FEDERAL-MOGUL PRODUCTS	10902	2012-161
FINLANDIA VODKA WORLDWIDE LTD	10879	2011-182
FORD MOTOR COMPANY	11205	2012-69
FORD MOTOR COPANY	11206	2012-70
FOUR ROSES DISTILLERY LLC	11094	2011-605
FOUR ROSES DISTILLERY LLC	11117	2012-65
FREMANTLEMEDIA LIMITED 1 STEPHEN STREET	10933	2012-241
GALENKA	11054	2011-636
GALENKA	11055	2011-637
GALENKA	11056	2011-638
GALENKA	11057	2011-642
GALENKA	11173	2011-630
GALENKA	11174	2011-631
GALENKA	11175	2011-632
GALENKA	11176	2011-633
GALENKA	11177	2011-634
GALENKA	11178	2011-635
GALENKA	11179	2011-639
GALENKA	11180	2011-641
GARAGE INTERNATIONAL LUX SARL	11093	2011-718
GARAGE INTERNATIONAL LUX SARL	11160	2011-714
GARAGE INTERNATIONAL LUX SARL	11161	2011-715
GARAGE INTERNATIONAL LUX SARL	11162	2011-716
GARAGE INTERNATIONAL LUX SARL	11163	2011-717
GARAGE INTERNATIONAL LUX SARL	11164	2011-719
GARAGE INTERNATIONAL LUX SARL	11165	2011-720

(732)	(111)	(210)
GARAGE INTERNATIONAL LUX SARL	11166	2011-721
GENERAL MOTORS LLC	09345	2011-112
GENERAL MOTORS LLC	09557	2011-397
GENERAL MOTORS LLC	10718	2011-202
GENERAL MOTORS LLC	10719	2011-241
GENERAL MOTORS LLC	10720	2011-240
GENERAL MOTORS LLC	10721	2011-174
GENERAL MOTORS LLC	11024	2011-725
GENERAL MOTORS LLC	11121	2012-128
GIGA-BITE TECHNOLOGY CO.LTD.	10790	2011-193
GLAXOSMITH KLINE BIOLOGICALS SA	10800	2011-216
GLOSARIJ DOO	11111	2011-382
GOODYEAR DUNLOP TYRES UK LIMITED	10766	2011-185
GOODYEAR DUNLOP TYRES UK LIMITED	10767	2011-186
GOOGLE INC	10864	2011-543
GOOGLE INC	10865	2011-544
GOOGLE	10914	2012-219
GOOGLE	10915	2012-220
GOOGLE	11136	2012-34
GOWAN COMPANY,LLC	10793	2011-139
GROUPON, INC	09284	2011-63
HENRI-LLOYD LIMITED	11015	2011-646
HERCULES INCORPORATED	10890	2011-15
HERSHEY CHOCOLATE&CONFECTIONERY COPRORATION	11058	2011-560
HONGTA TOBBACCO (GROUP) CO.LTD	10781	2011-242
HONGTA TOBBACCO (GROUP) CO.LTD	10782	2011-243
HTC CORPRATION	11092	2011-619
HUHTAMAKI FINANCE	11059	2011-626
INDUSTRIJA PIVA I SOKOVA TREBJESA AD	11040	2012-212
INTERNATIONAL TRUCK INTELLECTUAL PROPERTY COMPANY	10908	2012-207
INTERVET INTERNATIONAL B.V.	10763	2011-221
IOCHPE-MAXION S/A	10917	2012-224
IOCHPE-MAXION S/A	10918	2012-225
IT TECHNOLOGIES SERVICES S.A.	10794	2011-138
IT TECHNOLOGIES SERVICES S.A.	10795	2011-137
J&J COMPANY DOO	10942	2011-453
J. & P. COATS, LIMITED	10780	2011-552
JAMES SOMMERS	11028	2011-625

(732)	(111)	(210)
Japan Tobacco	11005	2012-145
JOHNSON CONTROLS HYBRID AND RECYCLING GMBH	10897	2012-155
JOHNSON CONTROLS HYBRID AND RECYCLING GMBH	10898	2012-156
JOHNSON CONTROLS TECHNOLOGY COMPANY	10870	2011-618
JOHNSON CONTROLS TECHNOLOGY COMPANY	10937	2011-644
JOHNSON CONTROLS TECHNOLOGY COMPANY	10938	2011-643
JOHNSON&JOHNSON	11000	2012-133
JT INTERNATIONAL S.A.	10758	2011-150
JT INTERNATIONAL	10955	2012-174
JT International	11001	2012-135
JT International	11002	2012-136
JT International	11003	2012-137
JT International	11012	2012-194
JT INTERNATIONAL	11086	2012-8
JT INTERNATIONAL	11110	2012-7
JT INTERNATIONAL	11126	2012-35
JT INTERNATIONAL	11127	2012-36
JT INTERNATIONAL	11128	2012-37
JT INTERNATIONAL	11129	2012-38
JT INTERNATIONAL	11130	2012-39
JT INTERNATIONAL	11131	2012-40
JT INTERNATIONAL	11132	2012-41
JT INTERNATIONAL	111333	2012-42
JT INTERNATIONAL	11134	2012-43
JT INTERNATIONAL	11135	2012-44
JT INTERNATIONAL	11145	2012-12
JT INTERNATIONAL	11146	2012-11
JT INTERNATIONAL	11147	2012-10
JT INTERNATIONAL	11148	2012-9
JT INTERNATIONAL	11207	2012-71
JT INTERNATIONAL	11208	2012-72
JT INTERNATIONAL	11209	2012-73
JT INTERNATIONAL	11210	2012-74
JUB-H D.D.DOL	10779	2011-466
JX NIPPON OIL&ENERGY CORPORATION	10875	2011-541
JX NIPPON OIL&ENERGY CORPRATION	10876	2011-542
KICKERS INTERNATIONAL BV	10764	2011-171
KSIN LUXEBOURG II.S.AR.L.	10471	2011-149
KWIZDA HOLDING GMBH	09241	2011-133

(732)	(111)	(210)
KWIZDA HOLDING GMBH	10881	2010-187
LES MILLS INTERNATIONAL LIMITED	11194	2012-58
LES MILLS INTERNATIONAL LIMITED	11195	2012-57
LES MILLS INTERNATIONAL LIMITED	11196	2012-56
LES MILLS INTERNATIONAL LIMITED	11197	2012-55
LES MILLS INTERNATIONAL LIMITED	11200	2012-60
LES MILLS INTERNATIONAL LIMITED	11202	2012-62
LES MILLS INTERNATIONAL LIMITED	11203	2012-63
LG LIFE SCIENCES	11045	2011-587
LYXOR LTD	11123	2011-418
MAGNUM INDUSTRIA DA AMAZONIA S.A.	09224	2011-111
MAKPROGRES	10922	2011-571
MARS, INCORPORATED	11226	2012-243
MATICA CRNOGORSKA	11076	2011-245
MEC AUTO D.O.O	10946	2011-401
MEC AUTO DOO	10945	2011-404
MEDOCHEMIE LTD	10871	2011-196
MEDOCHEMIE LTD.	10678	2011-197
MEDOCHEMIE LTD.	10872	2011-198
MEDOCHEMIE LTD.	10873	2011-199
MEDOCHEMIE LTD.	11108	2011-200
MEDOCHEMIE LTD.	11109	2011-201
MEGA DISPOSABLES S.A.	09346	2011-586
MEGA DISPOSABLES	11138	2012-31
MEGA DISPOSABLES	11155	2012-30
MERCK SHARP&DOHME CORP. ONE MERCK DRIVE	10988	2012-106
MERCK SHARP&DOHME CORP. ONE MERCK DRIVE	11153	2012-107
Merck Sharp&Dohme Corp.	10966	2012-124
MIKASA CORPORATION	11204	2012-66
MSD CONSUMER CARE	10901	2012-157
MSD INTERNATIONAL HOLDINGS GMBH	11090	2012-67
NANYANG BROTHERS TOBACCO COMPANY LIMITED	11087	2012-141
NBA PROPERTIES	10860	2011-531
NBA PROPERTIES	10862	2011-533
NBA PROPERTIES	10863	2011-532
NBA PROPERTIES	10911	2012-217
NBA PROPERTIES	11141	2012-25
NBA PROPERTIES	11142	2012-23
NBA PROPERTIES	11143	2012-24

(732)	(111)	(210)
NBA PROPERTIS	10861	2011-534
NIKE INTERNATIONAL	11225	2012-203
NIKON CORPORATION	11112	2012-64
NINE WEST DEVELOPMENT COPORATION	11029	2011-657
NISSAN JIDOSHA KABUSHIKI KAISHA	11157	2012-96
NISSAN JIDOSHA KABUSHIKI KAISHA	11215	2012-81
NISSAN JIDOSHA KABUSHIKI KAISHA	11216	2012-82
NISSAN JIDOSHA KABUSHIKI KAISHA	11217	2012-83
NISSAN JIDOSHA KABUSHIKI KAISHA	11218	2012-84
NISSAN JIDOSHA KABUSHIKI KAISHA	11219	2012-85
NISSAN JIDOSHA KABUSHIKI KAISHA	11220	2012-86
NISSAN JIDOSHA KABUSHIKI KAISHA	11221	2012-88
NISSAN JIDOSHA KABUSHIKI KAISHA	11222	2012-89
NISSAN JIDOSHA KABUSHIKI KAISHA	11223	2012-90
NOVARTIS AG	09315	2011-25
NOVARTIS AG	11275	2011-134
OCTAPHARMA AG	10920	2011-506
OCTAPHARMA AG	10921	2011-507
PANASONIC CORPORATION	10792	2011-92
PEPSICO	11022	2012-244
PERNOD RICARD USA	10919	2011-666
PETROL, SLOVENSKA ENERGETSKA DRUŽBA	10998	2012-131
PETROL. SLOVENSKA ENERGETSKA DRUŽBA	10996	2012-130
PETROLEO BRASILEIRO	11167	2012-108
PHAMANOVA DOO	10889	2011-683
PHAMANOVA DOO	11051	2011-680
PHAMANOVA DOO	11052	2011-681
PHAMANOVA DOO	11053	2011-682
PHARMA SWISS SA	10797	2011-254
PHARMACEUTICAL CHEMICAL COSMETICS INDUSTRY ALKALOID AD SKOPLJE	09757	2011-231
PHARMANOVA D.O.O.	10699	2011-160
PHILIP MORRIS BRANDS SARL	10961	2011-390
PODRAVKA	11213	2012-79
PODRAVKA	11214	2012-80
POSLOVNI CENTAR MERCATOR	11013	2012-195
POSLOVNI CENTAR MERCATOR	11258	2012-196
PREDRAG KOVAČEVIĆ	11014	2012-204
PREMIJER MONTENEGRO D.O.O.	10709	2011-162

(732)	(111)	(210)
PRINGLE OF SCOTLAND LIMITED	11115	2012-32
PROCTER & GAMBLE BUSINESS SERVICER CANADA COMPANY	09761	2011-222
RATIOPHARM GMBH	09819	2011-246
REMEDICA LTD	11181	2011-203
REMEDICA LTD	11188	2011-204
REMEDICA LTD	11189	2011-205
REMEDICA LTD	11190	2011-206
REMEDICA LTD	11191	2011-207
REVLON CONSUMER PRODUCTS CORPORATION	11113	2012-45
REVLON CONSUMER PRODUCTS CORPORATION	11114	2012-46
RIBNICA COMMERCE	10965	2012-150
RIBNICA COMMERCE	11255	2012-149
RODRIGO MIGUELL FONT	11150	2012-2
RUBYCON CORPORATION	09271	2011-125
RUSSELL BRANDS	11182	2011-672
RUSSELL BRANDS	11183	2011-673
RUSSELL BRANDS	11184	2011-674
S.C.Jonhson & Son	11011	2012-192
SAMSONITE IP HOLDING S.a.r.l.	09758	2011-208
SANOFI	09245	2011-131
SANYANG INDUSTRY CO. LTD	10895	2011-649
SCERING CORPRATION	09377	2011-184
SCERING CORPRATION	09378	2011-183
SCHERING CORPORATION	10880	2011-677
SCHERING CORPRATION	09226	2011-147
SCHERING CORPRATION	09391	2011-187
SEBA DIS TICARET VE NAKLIYAT A.S.	09221	2011-126
SEBA DIS TICARET VE NAKLIYAT A.S.	09225	2011-128
SHELL BRANDS INTERNATIONAL AG	10312	2011-448
SHIMANO INC	10746	2011-232
SHIMANO INC	11144	2012-22
SHIMANO	11140	2012-26
SHIMANO	11149	2012-3
SIX CONTINENTS HOTELS	10923	2011-661
SK HOLDING CO.	11120	2012-142
SKKR ALDINA	10967	2012-129
SOCIETE DES PRODUITS NESTLE S.A.	10796	2011-38
STARBUCKS CORPORATION d/b/a STARBUCKS COFFEE COMPANY	10760	2011-211

(732)	(111)	(210)
STERISOL AB	10784	2011-228
STIEFEL LABORATORIES	10910	2012-213
SUMITOMO CHEMICAL CO.LTD	09347	2011-118
SUMITOMO CHEMICAL CO.LTD	09352	2011-119
SUOLAKIVENKATU 1	10831	2011-509
SVJETLOST-MONT	11009	2012-179
SWISSOTEL MANAGEMENT GMBH	11041	2012-238
TALLY WEIJI HOLDING AG	10936	2012-311
TAMRON CO. LTD.	10866	2011-613
TDR DOO	09316	2011-219
TDR DOO	09317	2011-220
TEVA OPERATINS POLAND	11185	2011-645
TEVA PHARMACEUTICAL INDUSTRIES LTD	10960	2011-287
THE ABSOLUT COMPANY AKTIEBOLAG	10916	2012-223
THE COCA-COLA COMPANY	10970	2011-751
THE COCA-COLA COMPANY	10971	2011-752
THE COCA-COLA COMPANY	10972	2011-753
THE COCA-COLA COMPANY	10973	2011-754
THE COCA-COLA COMPANY	10979	2012-167
THE COCA-COLA COMPANY	10980	2012-175
THE COCA-COLA COMPANY	10981	2012-183
THE COCA-COLA COMPANY	10982	2012-197
THE COCA-COLA COMPANY	10983	2012-198
THE COCA-COLA COMPANY	10984	2012-231
THE COCA-COLA COMPANY	10985	2012-232
THE COCA-COLA COMPANY	10986	2012-233
THE COCA-COLA COMPANY	10987	2012-234
THE COCA-COLA COMPANY	11017	2011-712
THE COCA-COLA COMPANY	11018	2011-511
THE GOODYEAR TIRE&RUBBER COMPANY	11116	2012-1
THE PROCTER & GAMBLE COMPANY	09756	2011-188
THE PROCTER & GAMBLE COMPANY	09759	2011-229
THE PROCTER & GAMBLE COMPANY	09760	2011-223
THE PROCTER & GAMBLE COMPANY	09786	2011-178
THE PROCTER & GAMBLE COMPANY	09787	2011-189
THE PROCTER & GAMBLE COMPANY	10768	2011-230
THE PROCTER & GAMBLE COMPANY	10834	2011-324
THE PROCTER & GAMBLE COMPANY	10835	2011-316
THE PROCTER & GAMBLE COMPANY	10836	2011-338

(732)	(111)	(210)
THE PROCTER & GAMBLE COMPANY	10837	2011-443
THE PROCTER & GAMBLE COMPANY	10956	2011-326
THE PROCTER & GAMBLE COMPANY	10958	2011-328
THE PROCTER&GAMBLE COMPANY	10896	2012-152
TIKKURILA DOO	10891	2011-686
TIKKURILA DOO	10892	2011-687
TIKKURILA DOO	10893	2011-689
TIKKURILA DOO	11186	2011-688
TOA KAB USHIKI KAISHA(TOA CORPORATION)	11008	2012-163
TOYOTA JIDOSHA KABUSHIKI KAISHA	11023	2012-214
TOYOTA JIDOSHA KABUSHIKI KAISHA	11212	2012-78
UNILEVER N.V.	11077	2012-13
UNILEVER N.V.	11078	2012-14
UNILEVER N.V.	11079	2012-15
UNILEVER N.V.	11080	2012-16
UNILEVER N.V.	11081	2012-17
UNILEVER N.V.	11082	2012-18
UNILEVER N.V.	11192	2011-671
UNIVERSAL CITY STUDIOS LLC	10934	2011-678
UNIVERSAL CITY STUDIOS LLC	10935	2011-679
VIACOM INTERNATIONAL	11137	2012-33
VIDKRITE AKTSIONERNE TOVARISTVO ISKRA	11019	2011-724
VISA INTERNATIONAL SERVICE ASSOCIATION	11030	2011-527
VLASINKA D.O.O.	10802	2011-191
VULCABRAS-AZALEIA-RS	09233	2011-136
WESTINGHOUSE ELECTRIC CORPORATION	10710	2011-250
WESTINGHOUSE ELECTRIC CORPORATION	10711	2011-252
WESTINHOUSE ELECTRIC CORPORATION	10722	2011-251
WM. WRIGLEY JR. COMPANY	11122	2012-77
WM.WRIGLEY JR. COMPANY	11026	2012-200
WM.WRIGLEY JR. COMPANY	11027	2012-215
WM.WRIGLEY JR.COMPANY	11193	2011-731
WOLVERINE INTERNATIONAL	10858	2011-615
WOLVERINE INTERNATIONAL	10859	2011-614
WYETH LLC	10759	2011-195
YANMAR CO.	10968	2012-134
ZEKO.ME	11016	2011-726
ŽITO PREHRAMBENA INDUSTRIJA	11025	2011-647

INDEKS BROJEVA ŽIGOVA
INDEX OF THE TRADEMARK NUMBERS

(210)	(111)	(210)	(111)	(210)	(111)
2009-412	09762	2011-162	10709	2011-221	10763
2009-552	10798	2011-163	10801	2011-222	09761
2010-58	10957	2011-164	10799	2011-223	09760
2010-63	11224	2011-169	10765	2011-227	10761
2010-187	10881	2011-170	10787	2011-228	10784
2010-361	10833	2011-171	10764	2011-229	09759
2011-15	10890	2011-174	10721	2011-230	10768
2011-25	09315	2011-178	09786	2011-231	09757
2011-38	10796	2011-181	10913	2011-232	10746
2011-43	09313	2011-182	10879	2011-235	11006
2011-63	09284	2011-183	09378	2011-236	11007
2011-65	09820	2011-184	09377	2011-237	11020
2011-92	10792	2011-185	10766	2011-238	09734
2011-110	09353	2011-186	10767	2011-239	10464
2011-111	09224	2011-187	09391	2011-240	10720
2011-112	09345	2011-188	09756	2011-241	10719
2011-115	10906	2011-189	09787	2011-242	10781
2011-116	10907	2011-190	10747	2011-243	10782
2011-118	09347	2011-191	10802	2011-244	09389
2011-119	09352	2011-193	10790	2011-245	11076
2011-120	09283	2011-194	09550	2011-246	09819
2011-121	11042	2011-195	10759	2011-248	10788
2011-122	11043	2011-196	10871	2011-249	10789
2011-125	09271	2011-197	10678	2011-250	10710
2011-126	09221	2011-198	10872	2011-251	10722
2011-128	09225	2011-199	10873	2011-252	10711
2011-129	09270	2011-200	11108	2011-254	10797
2011-130	09251	2011-201	11109	2011-273	11154
2011-131	09245	2011-202	10718	2011-287	10960
2011-133	09241	2011-203	11181	2011-316	10835
2011-134	11275	2011-204	11188	2011-324	10834
2011-135	10791	2011-205	11189	2011-326	10956
2011-136	09233	2011-206	11190	2011-328	10958
2011-137	10795	2011-207	11191	2011-338	10836
2011-138	10794	2011-208	09758	2011-352	10943
2011-139	10793	2011-211	10760	2011-353	10944
2011-142	10466	2011-212	10460	2011-361	10832
2011-145	09232	2011-213	10472	2011-365	09021
2011-146	09230	2011-214	10473	2011-366	09028
2011-147	09226	2011-215	11044	2011-379	10959
2011-148	10467	2011-216	10800	2011-382	11111
2011-149	10471	2011-217	10762	2011-390	10961
2011-150	10758	2011-219	09316	2011-397	09557
2011-160	10699	2011-220	09317	2011-401	10946

(210)	(111)	(210)	(111)	(210)	(111)
2011-404	10945	2011-626	11059	2011-693	11047
2011-418	11123	2011-627	10883	2011-694	11046
2011-425	10844	2011-628	10962	2011-695	11048
2011-443	10837	2011-630	11173	2011-696	11049
2011-448	10312	2011-631	11174	2011-697	11050
2011-452	10997	2011-632	11175	2011-698	11075
2011-453	10942	2011-633	11176	2011-699	10886
2011-466	10779	2011-634	11177	2011-700	10885
2011-506	10920	2011-635	11178	2011-701	10887
2011-507	10921	2011-636	11054	2011-702	10888
2011-509	10831	2011-637	11055	2011-703	11071
2011-511	11018	2011-638	11056	2011-704	11072
2011-527	11030	2011-639	11179	2011-705	11073
2011-531	10860	2011-641	11180	2011-706	11074
2011-532	10863	2011-642	11057	2011-707	11103
2011-533	10862	2011-643	10938	2011-708	11104
2011-534	10861	2011-644	10937	2011-709	11105
2011-541	10875	2011-645	11185	2011-710	11106
2011-542	10876	2011-646	11015	2011-711	11107
2011-543	10864	2011-647	11025	2011-712	11017
2011-544	10865	2011-648	10894	2011-713	11021
2011-552	10780	2011-649	10895	2011-714	11160
2011-560	11058	2011-650	10976	2011-715	11161
2011-571	10922	2011-651	10977	2011-716	11162
2011-586	09346	2011-652	10978	2011-717	11163
2011-587	11045	2011-657	11029	2011-718	11093
2011-593	10969	2011-658	10867	2011-719	11164
2011-601	10964	2011-659	10868	2011-720	11165
2011-603	10974	2011-660	10869	2011-721	11166
2011-604	10975	2011-661	10923	2011-722	11187
2011-605	11094	2011-666	10919	2011-724	11019
2011-606	11031	2011-671	11192	2011-725	11024
2011-607	11032	2011-672	11182	2011-726	11016
2011-608	11033	2011-673	11183	2011-730	11276
2011-609	11034	2011-674	11184	2011-731	11193
2011-610	11035	2011-677	10880	2011-732	10939
2011-611	11036	2011-678	10934	2011-733	10940
2011-612	11037	2011-679	10935	2011-735	11158
2011-613	10866	2011-680	11051	2011-736	11159
2011-614	10859	2011-681	11052	2011-737	11060
2011-615	10858	2011-682	11053	2011-738	11061
2011-616	10877	2011-683	10889	2011-739	11062
2011-617	10878	2011-686	10891	2011-740	11063
2011-618	10870	2011-687	10892	2011-741	11064
2011-619	11092	2011-688	11186	2011-742	11065
2011-620	10963	2011-689	10893	2011-743	11066
2011-625	11028	2011-692	10884	2011-744	11067

(210)	(111)	(210)	(111)	(210)	(111)
2011-745	11068	2012-53	11156	2012-110	11172
2011-746	11069	2012-54	11198	2012-111	11152
2011-747	11070	2012-55	11197	2012-112	11151
2011-751	10970	2012-56	11196	2012-124	10966
2011-752	10971	2012-57	11195	2012-125	10999
2011-753	10972	2012-58	11194	2012-128	11121
2011-754	10973	2012-60	11200	2012-129	10967
2012-1	11116	2012-62	11202	2012-130	10996
2012-2	11150	2012-63	11203	2012-131	10998
2012-3	11149	2012-64	11112	2012-133	11000
2012-7	11110	2012-65	11117	2012-134	10968
2012-8	11086	2012-66	11204	2012-135	11001
2012-9	11148	2012-67	11090	2012-136	11002
2012-10	11147	2012-68	11256	2012-137	11003
2012-11	11146	2012-69	11205	2012-141	11087
2012-12	11145	2012-70	11206	2012-142	11120
2012-13	11077	2012-71	11207	2012-143	11119
2012-14	11078	2012-72	11208	2012-144	11118
2012-15	11079	2012-73	11209	2012-145	11005
2012-16	11080	2012-74	11210	2012-146	11088
2012-17	11081	2012-75	11091	2012-147	11005
2012-18	11082	2012-76	11211	2012-147	11089
2012-19	11083	2012-77	11122	2012-149	11255
2012-20	11084	2012-78	11212	2012-150	10965
2012-21	11085	2012-79	11213	2012-152	10896
2012-22	11144	2012-80	11214	2012-155	10897
2012-23	11142	2012-81	11215	2012-156	10898
2012-24	11143	2012-82	11216	2012-157	10901
2012-25	11141	2012-83	11217	2012-158	10899
2012-26	11140	2012-84	11218	2012-160	10900
2012-30	11155	2012-85	11219	2012-161	10902
2012-31	11138	2012-86	11220	2012-162	10947
2012-32	11115	2012-88	11221	2012-163	11008
2012-33	11137	2012-89	11222	2012-165	10930
2012-34	11136	2012-90	11223	2012-167	10979
2012-35	11126	2012-95	11168	2012-172	11253
2012-36	11127	2012-96	11157	2012-173	10931
2012-37	11128	2012-99	10995	2012-174	10955
2012-38	11129	2012-100	10994	2012-175	10980
2012-39	11130	2012-101	10993	2012-176	10948
2012-40	11131	2012-102	10992	2012-177	10949
2012-41	11132	2012-103	10991	2012-179	11009
2012-42	11133	2012-104	10990	2012-183	10981
2012-43	11134	2012-105	10989	2012-184	10950
2012-44	11135	2012-106	10988	2012-185	10951
2012-45	11113	2012-107	11153	2012-186	10904
2012-46	11114	2012-108	11167	2012-187	10952

(210)	(111)
2012-188	10903
2012-189	10932
2012-190	11010
2012-192	11011
2012-194	11012
2012-195	11013
2012-196	11258
2012-197	10982
2012-198	10983
2012-200	11026
2012-203	11225
2012-204	11014
2012-205	11229
2012-206	10905
2012-207	10908
2012-210	10953
2012-211	10909
2012-212	11040
2012-213	10910
2012-214	11023
2012-215	11027
2012-217	10911
2012-218	10912
2012-219	10914
2012-220	10915
2012-222	10954
2012-223	10916
2012-224	10917
2012-225	10918
2012-228	11227
2012-231	10984
2012-232	10985
2012-233	10986
2012-234	10987
2012-235	11228
2012-238	11041
2012-239	10924
2012-240	10925
2012-241	10933
2012-243	11226
2012-244	11022
2012-245	10926
2012-246	10927
2012-247	10928
2012-248	10929
2012-311	10936

INDEKS PO KLASAMA NIČANSKE KLASIFIKACIJE ROBA I USLUGA
INDEX ACCORDING TO THE NICE CLASSIFICATION OF GOODS AND SERVICES

Klasa 01	10792	11074	09028	10900
09347	10834	11075	09226	10901
09352	10835	11077	09230	10905
10464	10836	11079	09232	10906
10792	10844	11080	09241	10907
10798	10884	11082	09245	10910
10875	10885	11084	09283	10912
10876	10886	11085	09315	10913
10877	10887	11093	09346	10920
10878	10888	11103	09347	10921
10890	10889	11104	09352	10924
10891	10891	11105	09353	10925
10892	10896	11106	09377	10929
10893	10903	11107	09378	10947
11014	10904	11113	09391	10954
11167	10912	11114	09550	10960
11186	10926	11138	09757	10966
11215	10927	11151	09762	10988
11220	10928	11156	09819	11000
	10936	11160	09820	11011
Klasa 02	10947	11161	10466	11014
09270	10948	11162	10678	11025
10779	10949	11163	10699	11042
10792	10950	11166	10759	11043
10798	10951	11192	10763	11044
10877	10952	11198	10784	11045
10878	10953	11215	10792	11051
10891	10956	11220	10793	11052
10892	10958	11258	10794	11053
10893	11000		10795	11054
11186	11006	Klasa 04	10797	11055
11215	11007	10312	10800	11056
11220	11011	10471	10837	11057
11229	11013	10792	10867	11078
	11014	10875	10868	11090
Klasa 03	11020	10876	10869	11108
09734	11029	10931	10871	11109
09756	11046	10968	10872	11111
09757	11047	11014	10873	11153
09759	11048	11167	10880	11155
09760	11049	11215	10881	11168
09786	11050	11220	10884	11173
09787	11071		10889	11174
10768	11072	Klasa 05	10894	11175
10784	11073	09021	10899	11176

11177	10747	10836	09757	11216
11178	10762	10864	10792	
11179	10790	10968	10864	Klasa 19
11180	10792	11019	10865	10792
11181	10865	11088	10867	10798
11185	10866		10868	10831
11188	10870	Klasa 12	10968	
11189	10897	09345	10970	Klasa 20
11190	10898	10718	10972	10792
11191	10914	10719	10973	11136
11211	10933	10720	10976	11216
11215	10934	10721	10977	
11220	10935	10766	10978	Klasa 21
11253	10937	10767	10980	09761
11275	10938	10792	10981	10792
	10976	10895	10982	10836
Klasa 06	10977	10902	10983	10884
10792	10978	10917	10996	10970
10831	10999	10918	10998	10972
10980	11005	10957	11000	10973
11216	11008	10959	11084	10979
	11014	10968	11085	10980
Klasa 07	11021	11014	11187	11000
10710	11030	11023	11216	11011
10792	11084	11024	11227	11019
10832	11085	11116		11088
10968	11088	11121	Klasa 17	11216
11005	11089	11140	10792	
11014	11092	11144	10798	Klasa 22
11088	11112	11149	11227	11227
11089	11118	11150		
11219	11119	11157	Klasa 18	Klasa 23
11223	11120	11205	09758	10780
11228	11136	11212	10936	11227
	11149		10996	
Klasa 08	11227	Klasa 13	10998	Klasa 24
10471	11229	10472	11084	10792
10792		10473	11085	11216
10947	Klasa 10		11093	11227
11216	09230	Klasa 14	11160	
	10787	09224	11161	Klasa 25
Klasa 09	10792	10792	11162	09233
09271	10997	10936	11163	10764
09557	11083	11084	11164	10802
09758	11091	11085	11165	10858
10460		11216	11166	10859
10471	Klasa 11		11182	10860
10722	10711	Klasa 16	11183	10861
10746	10792	09251	11184	

10862	10792	11226	10940	09317
10863	11216	11258	10964	09389
10864			10969	10758
10865	Klasa 28	Klasa 30	10970	10765
10879	10792	10760	10971	10781
10911	10860	10788	10972	10782
10936	10861	10789	10973	10909
10967	10862	10796	10979	10943
10970	10863	10889	10980	10944
10972	10864	10922	10981	10955
10973	10865	10939	10983	10961
10980	10911	10940	10984	10974
10981	10970	10942	10985	10975
10982	10972	10964	10986	11001
10983	10973	10981	10987	11002
10989	10980	10982	10996	11003
10990	10981	10982	10998	11005
10991	10982	10983	11013	11012
10992	10983	10985	11017	11013
10993	10996	10986	11018	11060
10994	10998	10996	11040	11061
10995	11013	10998	11258	11062
10996	11084	11013		11063
10998	11085	11022	Klasa 33	11064
11013	11141	11025	10467	11065
11015	11143	11026	10761	11066
11028	11182	11027	10916	11067
11084	11183	11058	10919	11068
11085	11184	11059	10962	11069
11093	11204	11122	10963	11070
11115	11216	11193	10996	11086
11136	11225	11213	10998	11087
11141	11258	11214	11013	11110
11163		11216	11031	11126
11164	Klasa 29	11226	11032	11127
11165	09313	11258	11033	11128
11182	10799		11034	11129
11183	10801	Klasa 31	11035	11130
11184	10922	10799	11036	11131
11216	10930	10801	11037	11132
11225	10942	10922	11094	11133
11227	10964	10942	11117	11134
11258	10981	11013	11216	11135
	10982	11258	11258	11145
Klasa 26	10983			11146
10471	10996	Klasa 32	Klasa 34	11147
11216	10998	10802	09221	11148
	11013	10889	09225	11154
Klasa 27	11022	10939	09316	11158

11159
11207
11208
11209
11210
11216
11258

Klasa 35

09284
09316
09317
09758
10460
10760
10791
10792
10833
10864
10865
10883
10908
10912
10915
10932
10945
10946
10965
10976
10977
10978
10996
10998
11010
11013
11014
11030
11031
11032
11040
11041
11093
11136
11160
11161
11162
11163
11164
11165

11166
11167
11172
11182
11183
11184
11187
11206
11217
11221
11224
11255
11256
11258
11276

Klasa 36

10709
10792
10908
11030
11123
11187
11218
11222

Klasa 37

10792
10831
10895
10957
10968
11092
11157
11167
11217
11221
11224

Klasa 38

10791
10864
10865
10914
10933
10976
10977
10978
10999

11030
11137
11217
11221
11224

Klasa 39

10883
10932
11009
11010
11013
11014
11152
11167
11217
11221
11224
11258

Klasa 40

10792
11167

Klasa 41

10709
10791
10792
10836
10860
10861
10862
10863
10864
10865
10867
10868
10911
10914
10933
10934
10935
10970
10972
10973
10976
10977
10978
10980

10981
10982
10983
10999
11009
11076
11084
11085
11136
11137
11141
11142
11143
11172
11194
11195
11196
11197
11200
11202
11203
11217
11221
11256

Klasa 42

10792
10836
10864
10865
10867
10868
10889
10900
10914
11016
11030
11136
11167
11217
11221
11224
11256
11276

Klasa 43

10760
10792
10923

10996
10998
11009
11013
11224
11258

Klasa 44

09251
10792
10867
10868
11081

Klasa 45

10791
10792
10914
11136
11217
11221

OBJAVA ISPRAVKI CORRECTIONS

U „Crnogorskom glasniku intelektualne svojine“ broj 13. od 20.12.2013. godine objavljeni su pogrešni podaci za prijavu žiga **2012-87**

Pogrešni podaci

(210) **2012-87** (442) **20.12.2013.**
(220) 13.02.2012.

(731) **NISSAN JIDOSHA KABUSHIKI KAISHA** (ALSO TRADING AS NISSAN MOTOR CO.LTD.), NO.2 TAKARACHO, KANAGAWA-KU, YOKOHAMA-SHI, KANAGAWA-KEN JP

I N F I N I T I

(540)

(550) I

(740) Popović Miladin, Đoka Miraševića 21/III, Podgorica ME

(511) **Klasa 06:** Obični metali i njihove legure, bravarski proizvodi, mali metalni gvoždarski proizvodi, proizvodi od običnih metala koji nijesu uključeni u druge klase, čepovi za boce napravljeni od metala, kutije i držači za kartice (od metala), ploče za identifikaciju od metala, privezak za ključeve (kao nakit ili kao privezak) od ne-dragocenih metala, skulpture i figure (figurice) automobila napravljene od običnog metala, kutije za alate od metala (prazne).

Klasa 08: Ručni alati i sprave (kojima se ručno upravlja), pribor za jelo, set za manikir, set za pedikir, sječiva (ručni alati), kliješta za zanoktice, pincete za zanoktice, rezači, alati za sječenje (ručni alati), alati za porubljivanje (ručni alati), turpije (alati), alati za poliranje noktiju, električni i ne-električni, čekici (ručni alati), ručna bušilica (ručni alati), puferi i makaze za nokte, električni i ne-električni, turpije za nokte i kliješta, krckalice za orahe, makaze, šrafčigeri, kutije za brijanje, srebrnina (noževi, viljuške i kašike), ključevi za matice (ručni alati), stono posude (noževi, viljuške i kašike), ključevi (ručni alati).

Klasa 14: Dragocjeni metali i njihove legure i proizvodi od dragocjenih metala ili sa prevlakom od njih, koji nijesu uključeni u druge klase, časovničarski i hronometrijski instrumenti, čepovi za boce od dragocjenih metala, novčići za sakupljanje, dugmad za košulje, satovi i časovnici, privjesci za ključeve (nakit ili lancic) od dragocjenih metala, broševi (nakit), kopče za kravate od dragocjenih metala, ukrasni novi bedževi (dugmad).

Klasa 16: Hartija, karton i proizvodi od njih, koji nijesu uključeni u druge klase, štampane stvari, fotografije, kancelarijski materijal, držači za pasoše, omoti za knjige, kutije za poslovne kartice napravljene od kartona, držači za poslovne kartice (od ne-dragocjenih metala), kalendari, podmetači za čaše od papira, desktop držači za poslovne kartice, dnevnic, kese za poklone, graficke umjetničke reprodukcije, kese za ručak, držači memorandum, spajalice za novac, blokčići za bilješke, jastučići od papira, mjerači papira, držači za olovke i hemijske olovke, čaše za držanje olovaka, olovke, hemijske olovke, foto albumi (koje se odnose i na knjige za uspomene), poster, štampani lozovi (ne igračke), naljepnice, naljepnice i crteži za gravuru, blokčići za pisanje, držači za blokčice/rokovnike, sveske, držači za blokčice, fascikle sa rajsferslusom, trake za držanje ključeva.

Klasa 18: Koža i imitacija kože, i proizvodi izradeni od ovih materijala a koji nijesu uključeni u druge klase, koferi i putne torbe, suncobrani i štapovi za hodanje, torbe za kompjutere napravljene od kože, ruksaci, aktn-tašne, kutije za kartice i držači, torbe za kovani novac, koje nijesu napravljene od dragocjenog metala, fascikle, napravljene od kože, privjesci za ključeve i futrole napravljeni od kože, etikete za prtljag, spajalice za novac (od kože), etikete sa imenom od kože, etikete za prtljag, bilježnice, napravljene od kože, držači za bilježnice, napravljeni od kože, ručne torbe, kišobrani, novčanici, fascikle sa rajšferšlusom (od kože), industrijske posude za pakovanje, nesereri (ne popunjeni).

Klasa 20: Namještaj, ogledala, okviri za slike, proizvodi (koji nijesu obuhvaćeni drugim klasama) od drveta, plute, trske, rogoza, vrbovog pruca, roga, kosti, slonovace, kitove kosti, cilibara, sedefa, morske pjene i zamjene svih ovih materijala, ili od plastike, čepovi za boce, ne od metala, otvarači za boce, nemetalni, stolice, ventilatori za ličnu upotrebu, ne električni, ramovi za slike, skulpture i figure (figurice) automobila napravljene od smole, jastuci (namještaj), madraci, kutije za alat (ne od metala).

Klasa 21: Kućne ili kuhinjske sprave i posude, staklarija, porcelan i grnčarija koja nije uključena u druge klase, čepovi za boce napravljeni od metala, čaše od porcelana, roštilji za kampionanje, podmetači za čaše, ne od papira i drugaciji od stonog platna, rashladne torbe, dekorativni poslužavnici napravljeni od kristala, staklarija za upotrebu u domaćinstvima, izolovane posude za piće, japanski štapici, držači za tetrapak boce (posude), korpe za piknik (opremljene), uključujući posude, bokali, prenosivi rashladni uređaji, boce od nerđajućeg čelika za višekratnu upotrebu, statue i figure (figurice) napravljene od stakla, toaletne torbe, opremljene, šolje za putovanja, visoke čaše bez postolja (sudovi za pijenje) napravljene od stakla, termos, napravljeni od ne-dragocjenog metala, vaze.

Klasa 24: Tekstil i tekstilni proizvodi, koji nijesu obuhvaćeni drugim klasama, blokčići za krevete i stolove, podmetači (stolnjaci i salvete), peškiri za golf, blokčići, peškiri, baneri, zastave, ne od papira, blokčići za namještaj od tekstila, salvete od tekstila, tkanine (izuzev traka za porub kod tatami prostirki).

Klasa 25: Odjeća, obuća, pokrivala za glavu, kaiševi (odjeća), kape, marame od kašmira, replika delova trkačkog vozila Formule 1, naime rukavice vozača, replika delova trkačkog vozila Formule 1, naime trkačkog odijela, rukavice, majice za golf, šeširi, jakne, pletena odjeća, ženske bluze, kožne jakne, kravate, jakne sa kapuljačom, zaštitna radna odjeća (izuzev one za zaštitu od nezgode i povrede), marame, šalovi, majice, cipele, višeslojne jakne, viziri za sunce (pokrivala za glavu), džemper, dukserice.

Klasa 26: Čipka i vez, trake i gajtani, dugmad, kopče i petlje, špenadle i igle, ukrasni novi bedževi (dugmad), broševi (dodaci odjeći), kopce (dodaci odjeći), kopče (cipele), kratki konop za ključeve, naočare za sunce, prenosiva elektronika, male flaše, bedževi.

Klasa 27: Tepisi, asure, prostirke i otirači, linoleum i drugi materijali za pokrivanje podova, blokčići za zidove (netekstilni), prostirke za prekrivanje prtljažnika automobila, patosnice za automobile, tepisi, prostirke za pod, prostirke, asure.

Klasa 28: Igre i igračke, gimnastički i sportski artikli koji nijesu obuhvaćeni drugim klasama, igračke na baterije, alatka za opravku (dodatak za golf), replika delova trkačkog vozila Formule 1, naime sprave za prenos brzine preko ekrana (igračka), replika delova trkačkog vozila Formule 1, naime mini kacige (igračka), replika delova trkačkog vozila Formule 1, naime mini nosne membrane (igračka), replika delova trkačkog vozila Formule 1, naime mini upravljači (igračka), replika delova trkačkog vozila Formule 1, naime upravljači (igračka), loptice za golf, kupice za golf na koje se stavlja lopta, svjetlosne i zvucne igračke, vozila u minijaturnim kockastim kalupima, mala vozila (igračke), komplet za sastavljanje modela igračke, plišane igračke, kopije modela vozila, vozila igračke za vožnju na njima, skije, punjene igračke, igračke u formi kopije kaciga, igrice u boji,

šah, igra dame (set za igru), karte za igranje, mašine za igranje i aparati, oprema za bilijar, replika delova trkačkog vozila Formule 1, naime kontrolne table (igračka), replika delova trkačkog vozila Formule 1, naime rukavice vozača, daljinski upravljač za vozila.

Klasa 30: Poslastice, čokolada, poslastice od nane, čaj, pića (na bazi čokolade), pića (na bazi kafe), pića (na bazi čaja), biskviti, bombone, kafa, kafa (nepržena), kolačići.

Klasa 34: Artikli za pušače, pepeljare za pušače, upaljači za pušače, kutije za cigare, kutije za cigarete.

Ispravni podaci

(210) **2012-87** (442) **20.12.2013.**

(220) 13.02.2012.

(731) **NISSAN JIDOSHA KABUSHIKI KAISHA** (ALSO TRADING AS NISSAN MOTOR CO.LTD.), NO.2 TAKARACHO, KANAGAWA-KU, YOKOHAMA-SHI, KANAGAWA-KEN JP

I N F I N I T I

(540)

(550) I

(740) Popović Miladin, Đoka Miraševića 21/III, Podgorica ME

(511) **Klasa 06:** Obični metali i njihove legure, bravarski proizvodi, mali metalni gvoždarski proizvodi, proizvodi od običnih metala koji nijesu uključeni u druge klase, čepovi za boce napravljeni od metala, kutije i držači za kartice (od metala), ploče za identifikaciju od metala, privezak za ključeve (kao nakit ili kao privezak) od ne-dragocenih metala, skulpture i figure (figurice) automobila napravljene od običnog metala, kutije za alate od metala (prazne).

Klasa 08: Ručni alati i sprave (kojima se ručno upravlja), pribor za jelo, set za manikir, set za pedikir, sječiva (ručni alati), kliješta za zanoktice, pincete za zanoktice, rezači, alati za sječenje (ručni alati), alati za porublivanje (ručni alati), turpije (alati), alati za poliranje noktiju, električni i ne-električni, čekici (ručni alati), ručna bušilica (ručni alati), puferi i makaze za nokte, električni i ne-električni, turpije za nokte i kliješta, krckalice za orahe, makaze, šrafcižeri, kutije za brijanje, srebrnina (noževi, viljuške i kašike), ključevi za matice (ručni alati), stono posude (noževi, viljuške i kašike), ključevi (ručni alati).

Klasa 14: Dragocjeni metali i njihove legure i proizvodi od dragocenih metala ili sa prevlakom od njih, koji nijesu uključeni u druge klase, časovničarski i hronometrijski instrumenti, čepovi za boce od dragocenih metala, novčići za sakupljanje, dugmad za košulje, satovi i časovnici, privjesci za ključeve (nakit ili lancic) od dragocenih metala, broševi (nakit), kopče za kravate od dragocenih metala, ukrasni novi bedževi (dugmad).

Klasa 16: Hartija, karton i proizvodi od njih, koji nijesu uključeni u druge klase, štamparske stvari, fotografije, kancelarijski materijal, držači za pasoše, omoti za knjige, kutije za poslovne kartice napravljene od kartona, držači za poslovne kartice (od ne-dragocenih metala), kalendari, podmetači za čaše od papira, desktop držači za poslovne kartice, dnevници, kese za poklone, graficke umjetničke reprodukcije, kese za ručak, držači memoranduma, spajalice za novac, blokčići

za bilješke, jastučići od papira, mjerači papira, držači za olovke i hemijske olovke, čaše za držanje olovaka, olovke, hemijske olovke, foto albumi (koje se odnose i na knjige za uspomene), posteri, štampani lozovi (ne igračke), naljepnice, naljepnice i crteži za gravuru, blokčići za pisanje, držači za blokčiće/rokovnike, sveske, držači za blokčiće, fascikle sa rajsferšlusom, trake za držanje ključeva.

Klasa 18: Koža i imitacija kože, i proizvodi izradeni od ovih materijala a koji nijesu uključeni u druge klase, koferi i putne torbe, suncobrani i štapovi za hodanje, torbe za kompjutere napravljene od kože, ruksaci, akti-tašne, kutije za kartice i držači, torbe za kovani novac, koje nijesu napravljene od dragocjenog metala, fascikle, napravljene od kože, privjesci za ključeve i futrole napravljene od kože, etikete za prtljag, spajalice za novac (od kože), etikete sa imenom od kože, etikete za prtljag, bilježnice, napravljene od kože, držači za bilježnice, napravljene od kože, ručne torbe, kišobrani, novčanici, fascikle sa rajsferšlusom (od kože), industrijske posude za pakovanje, nesereri (ne popunjeni).

Klasa 20: Namještaj, ogledala, okviri za slike, proizvodi (koji nijesu obuhvaćeni drugim klasama) od drveta, plute, trske, rogoza, vrbovog pruca, roga, kosti, slonovace, kitove kosti, cilibara, sedefa, morske pjene i zamjene svih ovih materijala, ili od plastike, čepovi za boce, ne od metala, otvarači za boce, nemetalni, stolice, ventilatori za ličnu upotrebu, ne električni, ramovi za slike, skulpture i figure (figurice) automobila napravljene od smole, jastuci (namještaj), madraci, kutije za alat (ne od metala).

Klasa 21: Kućne ili kuhinjske sprave i posude, staklarija, porcelan i grnčarija koja nije uključena u druge klase, čepovi za boce napravljene od metala, čaše od porcelana, roštilji za kam-povanje, podmetači za čaše, ne od papira i drugaciji od stonog platna, rashladne torbe, dekorativni poslužavnici napravljene od kristala, staklarija za upotrebu u domaćinstvima, izolovane posude za piće, japanski štapici, držači za tetrapak boce (posude), korpe za piknik (opremljene), uključuju-ći posude, bokali, prenosivi rashladni uređaji, boce od nerđajućeg čelika za višekratnu upotrebu, statue i figure (figurice) napravljene od stakla, toaletne torbe, opremljene, šolje za putovanja, visoke čaše bez postolja (sudovi za pijenje) napravljene od stakla, termos, napravljene od ne-dragocjenog metala, vaze.

Klasa 24: Tekstil i tekstilni proizvodi, koji nijesu obuhvaćeni drugim klasama, blokčići za krevete i stolove, podmetači (stolnjaci i salvete), peškiri za golf, blokčići, peškiri, baneri, zastave, ne od papira, blokčići za namještaj od tekstila, salvete od tekstila, tkanine (izuzev traka za porub kod tatami prostirki).

Klasa 25: Odjeća, obuća, pokrivala za glavu, kaiševi (odjeća), kape, marame od kašmira, replika delova trkačkog vozila Formule 1, naime rukavice vozača, replika delova trkačkog vozila Formule 1, naime trkačkog odijela, rukavice, majice za golf, šeširi, jakne, pletena odjeća, ženske bluze, kožne jakne, kravate, jakne sa kapuljačom, zaštitna radna odjeća (izuzev one za zaštitu od nezgode i povrede), marame, šalovi, majice, cipele, višeslojne jakne, viziri za sunce (pokrivala za glavu), džemper, dukserice.

Klasa 26: Čipka i vez, trake i gajtani, dugmad, kopče i petlje, špenadle i igle, ukrasni novi bedževi (dugmad), broševi (dodaci odjeći), kopce (dodaci odjeći), kopče (cipele), kratki konop za ključeve, naočare za sunce, prenosiva elektronika, male flaše, bedževi.

Klasa 27: Tepisi, asure, prostirke i otirači, linoleum i drugi materijali za pokrivanje podova, blokčići za zidove (netekstilni), prostirke za prekrivanje prtljažnika automobila, patosnice za automobile, tepisi, prostirke za pod, prostirke, asure.

Klasa 28: Igre i igračke, gimnastički i sportski artikli koji nijesu obuhvaćeni drugim klasama, igračke na baterije, alatka za opravku (dodatak za golf), replika delova trkačkog vozila Formule 1, naime sprave za prenos brzine preko ekrana (igračka), replika delova trkačkog vozila Formule 1, naime mini kacige (igračka), replika delova trkačkog vozila Formule 1, naime mini nosne membrane (igračka), replika delova trkačkog vozila Formule 1, naime mini upravljači (igračka), replika

delova trkačkog vozila Formule 1, naime upravljači (igračka), loptice za golf, kupice za golf na koje se stavlja lopta, svjetlosne i zvučne igračke, vozila u minijaturnim kockastim kalupima, mala vozila (igračke), komplet za sastavljanje modela igračke, plišane igračke, kopije modela vozila, vozila igračke za vožnju na njima, skije, punjene igračke, igračke u formi kopije kaciga, igrice u boji, šah, igra dame (set za igru), karte za igranje, mašine za igranje i aparati, oprema za bilijar, replika delova trkačkog vozila Formule 1, naime kontrolne table (igračka), replika delova trkačkog vozila Formule 1, naime rukavice vozača, daljinski upravljač za vozila.

Klasa 30: Poslastice, čokolada, poslastice od nane, čaj, pića (na bazi čokolade), pića (na bazi kafe), pića (na bazi čaja), biskviti, bombone, kafa, kafa (nepržena), kolačići.

Klasa 33: Alkoholna pića (izuzev piva); Alkoholna pića koja sadrže voće; pića, (destilovana); rakija; kokteli, žestoka alkoholna pića; vodka, viski, vino.

Klasa 34: Artikli za pušače, pepeljare za pušače, upaljači za pušače, kutije za cigare, kutije za cigarete.

U „Crnogorskom glasniku intelektualne svojine“ broj 13. od 20.12.2013. godine objavljeni su pogrešni podaci za prijavu žiga **2012-113**

Pogrešni podaci

(210) **2012-113** (442) **20.12.2013.**
(220) 23.02.2012.

(731) **GOODY'S S.A.** SOCIETE ANONYME OF CATERING SERVICES 10, ZIRIDI STREET, MAROUSSI, ATTICA 151 23 GR

(540) FLOCAFE

(550) I

(740) Čupić Branislav, Dalmatinska 10, Podgorica ME

(511) **Klasa 30:** Kafa, čaj, kakao, šećer, pirinač, tapioka, sago, zamjena kafe, brašno i proizvodi od žitarica, hleb, kolači, poslastice, sladoledi, med, melasa, kvasac, prašak za pecivo, so, senf, sirće, sosovi (kao začini), začini, led.

Klasa 43: Usluge obezbjeđivanja hrane i pića, usluge restorana uključujući restorane brze hrane, organizacija i vođenje restorana, usluge kateringa, organizacija prijema.

Ispravni podaci

(210) **2012-113** (442) **20.12.2013.**
(220) 23.02.2012.

(731) **GOODY'S S.A.** SOCIETE ANONYME OF CATERING SERVICES 10, ZIRIDI STREET, MAROUSSI, ATTICA 151 23 GR



(540)

(550) I

(740) Ćupić Branislav, Dalmatinska 10, Podgorica ME

(511) **Klasa 30:** Kafa, čaj, kakao, šećer, pirinač, tapioka, sago, zamjena kafe, brašno i proizvodi od žitarica, hleb, kolači, poslastice, sladoledi, med, melasa, kvasac, prašak za pecivo, so, senf, sirće, sosovi (kao začini), začini, led.

Klasa 43: Usluge obezbjeđivanja hrane i pića, usluge restorana uključujući restorane brze hrane, organizacija i vođenje restorana, usluge kateringa, organizacija prijema.

U „Crnogorskom glasniku intelektualne svojine“ broj 13. od 20.12.2013. godine objavljeni su pogrešni podaci za prijavu žiga **2012-114**

Pogrešni podaci(210) **2012-114** (442) **20.12.2013.**

(220) 23.02.2012.

(731) **GOODY'S S.A.** Societe Anonyme of Catering Services 10, Ziridi street, Maroussi, Attica 151 23 GR

(540) FLOCAFE

(550) I

(740) Ćupić Branislav, Dalmatinska 10, Podgorica ME

(511) **Klasa 30:** Kafa, čaj, kakao, šećer, pirinač, tapioka, sago, zamjena kafe, brašno i proizvodi od žitarica, hleb, kolači, poslastice, sladoledi, med, melasa, kvasac, prašak za pecivo, so, senf, sirće, sosovi (kao začini), začini, led.

Klasa 43: Usluge obezbjeđivanja hrane i pića, usluge restorana uključujući restorane brze hrane, organizacija i vođenje restorana, usluge kateringa, organizacija prijema.

Ispravni podaci(210) **2012-114** (442) **20.12.2013.**

(220) 23.02.2012.

(731) **GOODY'S S.A.** Societe Anonyme of Catering Services 10, Ziridi street, Maroussi, Attica 151 23 GR



(540)

(550) I

(740) Ćupić Branislav, Dalmatinska 10, Podgorica ME

(511) **Klasa 30:** Kafa, čaj, kakao, šećer, pirinač, tapioka, sago, zamjena kafe, brašno i proizvodi od žitarica, hleb, kolači, poslastice, sladoledi, med, melasa, kvasac, prašak za pecivo, so,

senf, sirće, sosovi (kao začini), začini, led.

Klasa 43: Usluge obezbjeđivanja hrane i pića, usluge restorana uključujući restorane brze hrane, organizacija i vođenje restorana, usluge kateringa, organizacija prijema.

U „Crnogorskom glasniku intelektualne svojine“ broj 13. od 20.12.2013. godine objavljeni su pogrešni podaci za prijavu žiga **2012-115**

Pogrešni podaci

(210) **2012-115** (442) **20.12.2013.**
(220) 23.02.2012.

(731) **GOODY'S S.A.** Societe Anonyme of Catering Services 10, Ziridi street, Maroussi, Attica 151 23 GR

(540) GOODY'S

(550) I

(740) Čupić Branislav, Dalmatinska 10, Podgorica ME

(511) **Klasa 16:** Hartija, karton i proizvodi od njih, koji nisu uključeni u druge klase, štampane stvari, knjigovezački materijal, fotografije, kancelarijski materijal, ljepila za kancelarijske i kućne potrebe, umjetnički materijali, kičice, pisaće mašine i kancelarijski rekviziti (izuzev namještaja), materijali za obuku i nastavu (izuzev aparata), plastični materijali za pakovanje (koji nisu uključeni u druge klase), karte za igru, štamparska slova, klišeji.

Klasa 29: Meso, riba, živina i divljač, mesne prerađevine, konzervisano, sušeno i kuvano voće i povrće, želei, džemovi, kompoti, jaja, mlijeko i mliječni proizvodi, jestiva ulja i masti.

Klasa 30: Kafa, čaj, kakao, šećer, pirinač, tapioka, sago, zamjena kafe, brašno i proizvodi od žitarica, hleb, kolači, poslastice, sladoledi, med, melasa, kvasac, prašak za pecivo, so, senf, sirće, sosovi (kao začini), začini,

Klasa 43: Usluge obezbjeđivanja hrane i pića, usluge restorana uključujući restorane brze hrane, organizacija i vođenje restorana, usluge kateringa, organizacija prijema.

Ispravni podaci

(210) **2012-115** (442) **20.12.2013.**
(220) 23.02.2012.

(731) **GOODY'S S.A.** Societe Anonyme of Catering Services 10, Ziridi street, Maroussi, Attica 151 23 GR



(540)

(550) I

(740) Čupić Branislav, Dalmatinska 10, Podgorica ME

(511) **Klasa 16:** Hartija, karton i proizvodi od njih, koji nisu uključeni u druge klase, štampane stvari, knjigovezački materijal, fotografije, kancelarijski materijal, ljepila za kancelarijske i kućne potrebe, umjetnički materijali, kičice, pisaće mašine i kancelarijski rekviziti (izuzev

namještaja), materijali za obuku i nastavu (izuzev aparata), plastični materijali za pakovanje (koji nisu uključeni u druge klase), karte za igru, štamparska slova, klišeji.

Klasa 29: Meso, riba, živina i divljač, mesne prerađevine, konzervisano, sušeno i kuvano voće i povrće, želei, džemovi, kompoti, jaja, mlijeko i mliječni proizvodi, jestiva ulja i masti.

Klasa 30: Kafa, čaj, kakao, šećer, pirinač, tapioka, sago, zamjena kafe, brašno i proizvodi od žitarica, hleb, kolači, poslastice, sladoledi, med, melasa, kvasac, prašak za pecivo, so, senf, sirće, sosovi (kao začini), začini,

Klasa 43: Usluge obezbjeđivanja hrane i pića, usluge restorana uključujući restorane brze hrane, organizacija i vođenje restorana, usluge kateringa, organizacija prijema.

U „Crnogorskom glasniku intelektualne svojine“ broj 13. od 20.12.2013. godine objavljeni su pogrešni podaci za prijavu žiga **2012-116**

Pogrešni podaci

(210) **2012-116** (442) **20.12.2013.**
(220) 23.02.2012.

(731) **Kawasho Foods Corporation**, 7-1, Otemachi 2-chome, Chiyoda-ku, Tokyo
JP

(540) Geisha

(550) I

(740) Ćupić Branislav, Dalmatinska 10, Podgorica ME

(511) **Klasa 29:** Meso, riba, živina, divljač, voće i povrće, u konzervama, u flašama na drugi način konzervirano.

Ispravni podaci

(210) **2012-116** (442) **20.12.2013.**
(220) 23.02.2012.

(731) **Kawasho Foods Corporation**, 7-1, Otemachi 2-chome, Chiyoda-ku, Tokyo
JP

GEISHA



(540)

(550) I

(740) Ćupić Branislav, Dalmatinska 10, Podgorica ME

(511) **Klasa 29:** Meso, riba, živina, divljač, voće i povrće, u konzervama, u flašama na

drugi način konzervirano.

U „Crnogorskom glasniku intelektualne svojine“ broj 13. od 20.12.2013. godine objavljeni su pogrešni podaci za prijavu žiga **2012-148**

Pogrešni podaci

- (210) **2012-148** (442) **20.12.2013.**
 (220) 08.03.2012.
 (731) **KONSTA DOO**, Đjenovići bb, Herceg Novi ME



- (540)
 (550) I

(511) **Klasa 14:** Dragoceni metali i njihove legure i proizvodi od dragocenih metala ili sa prevlakom od njih, koji nisu uključeni u druge klase, nakit, drago kamenje, časovničarski i hronometrijski instrumenti.

Klasa 16: Hartija, karton i proizvodi od njih, koji nisu uključeni u druge klase.

Klasa 18: Koža i imitacija kože, proizvodi izrađeni od ovih materijala koji nisu uključeni u druge klase, životinjska koža, krzno, koferi i putne torbe, kišobrani, suncobrani i štapovi za hodanje, bičevi, saračka i sedlarska oprema.

Klasa 20: Nameštaj, ogledala, okviri za slike.

Klasa 21: Kućne ili kuhinjske sprave i posude češljevi i sunđereri, četke (izuzev kičica), materijali za pravljenje četki, artikli koji se koriste pri čišćenju, čelična vuna, neprerađeno ili polupreradađeno staklo (osim stakla koje se koristi u građevinarstvu), staklarija, porcelan, fajans, grnčarija i lončarija koja nije uključena u druge klase.

Klasa 25: Odeća, obuća, pokrivala za glavu.

Klasa 26: Čipka i vez, trake (pantljike) i gajtani, dugmad, kopče i petlje, špenadle i igle, veštačko cveće.

Klasa 28: Igre i igračke.

Ispravni podaci

- (210) **2012-148** (442) **20.12.2013.**
 (220) 08.03.2012.
 (731) **KONSTA DOO**, Đjenovići bb, Herceg Novi ME



(540)

(550) I

(511) **Klasa 14:** Dragoceni metali i njihove legure i proizvodi od dragocenih metala ili sa prevlakom od njih, koji nisu uključeni u druge klase, nakit, drago kamenje, časovničarski i hronometrijski instrumenti.

Klasa 16: Hartija, karton i proizvodi od njih, koji nisu uključeni u druge klase. Štampane stvari, knjigovezački materijal, fotografije, kancelarijski materijal, lepila za kancelarijske i kućne potrebe, umetnički materijali, kičice, pisaće mašine i kancelarijski rekviziti (izuzev nameštaja), materijali za obuku i nastavu (izuzev aparata), plastični materijal za pakovanje (koji nije uključen u druge klase, štamparska slova, klišeji.

Klasa 18: Koža i imitacija kože, proizvodi izrađeni od ovih materijala koji nisu uključeni u druge klase, životinjska koža, krzno, koferi i putne torbe, kišobrani, suncobrani i štapovi za hodanje, bičevi, saračka i sedlarska oprema.

Klasa 20: Nameštaj, ogledala, okviri za slike. proizvodi (koji nisu obuhvaćeni drugim klasama) od drveta, plute, trske, rogoza, vrbovog pruća, roga, kosti, slonovače, kitove kosti, školjki, ćilibara, sedefa, morske pene i zamene svih ovih materijala, ili od plastike.

Klasa 21: Kućne ili kuhinjske sprave i posude češljevi i sunđeri, četke (izuzev kičica), materijali za pravljenje četki, artikli koji se koriste pri čišćenju, čelična vuna, neprerađeno ili polupreradeno staklo (osim stakla koje se koristi u građevinarstvu), staklarija, porcelan, fajans, grnčarija i lončarija koja nije uključena u druge klase.

Klasa 24: Tekstil i tekstilni proizvodi koji nisu obuhvaćeni drugim klasama, prekrivači za krevete i stolove.

Klasa 25: Odeća, obuća, pokrivala za glavu.

Klasa 26: Čipka i vez, trake (pantljike) i gajtani, dugmad, kopče i petlje, špenadle i igle, veštačko cveće.

Klasa 28: Igre i igračke, gimnastički i sportski artikli koji nisu obuhvaćeni drugim klasama, ukrasi za jelke.

U „Crnogorskom glasniku intelektualne svojine“ broj 14. od 20.04.2014. godine objavljeni su

pogrešni podaci za prijavu žiga **2013-92**

Pogrešni podaci



(540)

Ispravni podaci

NATRODALE

(540)

U „Crnogorskom glasniku intelektualne svojine“ broj 14. od 20.04.2014. godine objavljeni su pogrešni podaci za prijavu žiga **2013-93**

Pogrešni podaci



(540)

Ispravni podaci



(540)

U „Crnogorskom glasniku intelektualne svojine“ broj 14. od 20.04.2014. godine objavljeni su pogrešni podaci za prijavu žiga **2013-29**

Pogrešni podaci

(731) **KRAFT FOODS SCHWEIY HOLDING GMBH**, CHOLLERSTRASSE 4, 6301 ZUG CH

Ispravni podaci

(731) **KRAFT FOODS SCHWEIZ HOLDING GMBH**, CHOLLERSTRASSE 4, 6301 ZUG CH

U „Crnogorskom glasniku intelektualne svojine“ broj 14. od 20.04.2014. godine objavljeni su pogrešni podaci za prijavu žiga **2013-30**

Pogrešni podaci

(731) **KRAFT FOODS SCHWEIY HOLDING GMBH**, CHOLLERSTRASSE 4, 6301 ZUG CH

Ispravni podaci

(731) **KRAFT FOODS SCHWEIZ HOLDING GMBH**, CHOLLERSTRASSE 4, 6301 ZUG CH

U „Crnogorskom glasniku intelektualne svojine“ broj 14. od 20.04.2014. godine objavljeni su pogrešni podaci za prijavu žiga **2013-33**

Pogrešni podaci

(731) **KRAFT FOODS SCHWEIY HOLDING GMBH**, CHOLLERSTRASSE 4, 6301 ZUG CH

Ispravni podaci

(731) **KRAFT FOODS SCHWEIZ HOLDING GMBH**, CHOLLERSTRASSE 4, 6301 ZUG CH

U „Crnogorskom glasniku intelektualne svojine“ broj 14. od 20.04.2014. godine objavljeni su pogrešni podaci za prijavu žiga **2011-346**

Pogrešni podaci

(731) **BROWN-FORMAN POLSKA SP.Z.O.O A POLISH LIMITED COMPANY**, GANDHIEGO 3, WARSZAWA, 02-645 PL

Ispravni podaci

(731) **BROWN-FORMAN POLSKA SP.Z.O.O A POLISH LIMITED COMPANY**, POSTEPU 21D, 02-676 WARŠAVA PL

U „Crnogorskom glasniku intelektualne svojine“ broj 14. od 20.04.2014. godine objavljeni su pogrešni podaci za prijavu žiga **2012-313**

Pogrešni podaci

(731) **KABUSHIKI KAISHA HITACHI SEISAKUSHO** (D.B.A.HITACHI, LTD), 6-6, MARU-NOICHI 1-CHOME, CHIYODA-KU, TOKYO JP

Ispravni podaci

(731) **KABUSHIKI KAISHA HITACHI SEISAKUSHO** (D.B.A.HITACHI, LTD), 6-6, MARUNOUCHI 1-CHOME, CHIYODA-KU, TOKYO JP

U „Crnogorskom glasniku intelektualne svojine“ broj 14. od 20.04.2014. godine objavljeni su pogrešni podaci za prijavu žiga **2012-314**

Pogrešni podaci

(731) **KABUSHIKI KAISHA HITACHI SEISAKUSHO** (D.B.A.HITACHI, LTD), 6-6, MARU-NOICHI 1-CHOME, CHIYODA-KU, TOKYO JP

Ispravni podaci

(731) **KABUSHIKI KAISHA HITACHI SEISAKUSHO** (D.B.A.HITACHI, LTD), 6-6, MARUNOUCHI 1-CHOME, CHIYODA-KU, TOKYO JP

U „Crnogorskom glasniku intelektualne svojine“ broj 14. od 20.04.2014. godine objavljeni su pogrešni podaci za prijavu žiga **2013-158**

Pogrešni podaci

(210) **2013-158** (442) **20.04.2014.**
(220) 4/17/2013

(731) **ICENTAR D.O.O.PODGORICA**, UL.RADOJA BAKIĆA BB, PODGORICA ME

ICENTAR

(540)

(550) I, V

(511) **Klasa 09:** Aparati i instrumenti naučni, pomorski, geodetski, fotografski, kinematografski, optički, za vaganje, merenje, signalizaciju, kontrolu (inspekciju), spasavanje i nastavu; aparati i instrumenti za provođenje, prekid, transformaciju, akumulaciju, regulisanje ili kontrolu električne energije; aparati za snimanje, prenos i reprodukovanje zvuka ili slike; magnetni nosioci podataka, diskovi za snimanje; automatske mašine i mehanizmi za aparate koji se pokreću novcem ili žetonom; registar kase, računске mašine, oprema za obradu podataka i kompjuteri; aparati za gašenje požara.

Klasa 35: Oglašavanje; vođenje poslova; poslovno upravljanje; kancelarijski poslovi.

Klasa 36: Osiguranje; finansijski poslovi; novčani (monetarni) poslovi; poslovi vezani za nepokretnosti.

Klasa 37: Građevinsko konstruisanje; popravljanje; usluge instaliranja (instalacione usluge).

Klasa 41: Obrazovne usluge; pripremanje obuke; razonoda; sportske i kulturne aktivnosti.

Klasa 42: Naučne i tehnološke usluge i istraživanje i projektovanje u vezi navedenih usluga; usluge industrijske analize i istraživanja; projektovanje i razvoj kompjuterskog hardvera i softvera.

Ispravni podaci

(210) **2013-158** (442) **20.04.2014.**

(220) 4/17/2013

(731) **ICENTAR D.O.O.PODGORICA**, UL.RADOJA BAKIĆA BB, PODGORICA ME

ICENTAR

(540)

(550) I, V

(511) **Klasa 09:** Aparati i instrumenti naučni, pomorski, geodetski, fotografski, kinematografski, optički, za vaganje, merenje, signalizaciju, kontrolu (inspekciju), spasavanje i nastavu; aparati i instrumenti za provođenje, prekid, transformaciju, akumulaciju, regulisanje ili kontrolu električne energije; aparati za snimanje, prenos i reprodukovanje zvuka ili slike; magnetni nosioci podataka, diskovi za snimanje; automatske mašine i mehanizmi za aparate koji se pokreću novcem ili žetonom; registar kase, računске mašine, oprema za obradu podataka i kompjuteri;

aparati za gašenje požara.

Klasa 35: Oglašavanje; vođenje poslova; poslovno upravljanje; kancelarijski poslovi.

Klasa 36: Osiguranje; finansijski poslovi; novčani (monetarni) poslovi; poslovi vezani za nepokretnosti.

Klasa 37: Građevinsko konstruisanje; popravlanje; usluge instaliranja (instalacione usluge).

Klasa 38: Telekomunikacije.

Klasa 41: Obrazovne usluge; pripremanje obuke; razonoda; sportske i kulturne aktivnosti.

Klasa 42: Naučne i tehnološke usluge i istraživanje i projektovanje u vezi navedenih usluga; usluge industrijske analize i istraživanja; projektovanje i razvoj kompjuterskog hardvera i softvera.

U „Crnogorskom glasniku intelektualne svojine“ broj 14. od 20.04.2014. godine objavljeni su pogrešni podaci za prijavu žiga **2013-155**

Pogrešni podaci

(511) **Klasa 03:** Preparati za bjeljenje i druge supstance za upotrebu u praonicama; preparati za čišćenje, poliranje, ribanje i nagrizanje; sapuni; parfimerija, eterična ulja, kozmetika, losioni za kosu; sredstva za njegu zuba; abrazivni papir; abrazivna sredstva; ljepila za pričvršćivanje lažnih trepavica; ljepila za pričvršćivanje vještačke kose; ljepila u kozmetičke svrhe; losioni za posle brijanja; preparati za osvježavanje vazduha; bademovo mlijeko u kozmetičke svrhe; bademovo ulje; bademov sapun; preparati od aloe-vere u kozmetičke svrhe; alunit (sredstvo koje zateže); čilibar (parfem); amonijak (isparljiva alkalija) (deterdžent); antiperspirantni sapuni; antiperspiranti (toaletna sredstva); antistatički preparati za kućnu upotrebu; aromaticna sredstva (eterična ulja); sredstva koja zatežu u kozmetičke svrhe; Badian esencija (esencija od zvjezdastog anisa); melemi osim u medicinske svrhe; baze za cvjetne parfeme; soli za kupke, ne u medicinske svrhe; boje za farbanje brade; maske za njegu ljepote; Bergamotova ulja; sredstva za bjeljenje (odstranjivanje boja) u kozmetičke svrhe; soli za bjeljenje; soda bikarbona za bjeljenje; sprejevi za osvježavanje daha; tralice za osvježavanje daha; arome za kolace (eterična ulja); okrugli sapuni; komprimovani vazduh u konzervama u svrhe čišćenja i brisanja prašine; metalni karbidi (abrazivna sredstva); kreda za čišćenje; preparati za čišćenje; mlijeko za čišćenje u toaletne svrhe; krpe impregnirane sa deterdžentom za čišćenje; vosak za obućare; hemijska sredstva za oživljavanje boja u kućne svrhe (rublje); preparati za uklanjanje boja; sredstva za bojenje u toaletne svrhe; korund (abrazivno sredstvo), kozmetičke kreme; boje u kozmetičke svrhe; kozmetički pribor; kozmetičke olovke; kozmetički preparati za kupke; kozmetički preparati za trepavice; kozmetički preparati za njegu kože; kozmetički preparati za mršavljenje; kozmetika; kozmetika za životinje; pamucni štapići u kozmetičke svrhe; vata u kozmetičke svrhe; dekorativne naljepnice u kozmetičke svrhe; odmaščivaci osim za upotrebu u proizvodnji; gelovi za izbjeljivanje zuba; sredstva za njegu zuba; sredstva za poliranje zubne proteze; deodorantski sapuni; deodoranti za ljude ili životinje; deodoranti za kućne ljubimce; sredstva za depilaciju; vosak za depilaciju; deterdženti osim za upotrebu u proizvodnim procesima i u medicinske svrhe; abrazivna sredstva u formi dijamanta; dezinfekcioni sapun; preparati za tuširanje za ličnu higijenu ili u deodorantske svrhe (toaletna sredstva); preparati za suvo pranje; šamponi za suvo pranje; agensi za sušenje za mašine za sudove; kolonjske vode; šmirgla; brusna tkanina; brusni papir; eterična ulja od kedrovine; eterična ulja od citrusa; eterična ulja od limuna; eterične esencije; eterična ulja; ekstrakti cvjetova (parfemi); kozmetika za obrve; olovke za obrve; omekšivači za rublje; vještačke trepavice; vještački nokti; arome za napitke (eterična ulja); vosak za podove; sredstva za odstranjivanje podnog voska (preparati za ribanje); preparati za neutralisanje dima (parfemi); preparati za postizanje sjaja; ulje Gaultheria-e;

Geraniol; krpe za stakla; masnoce u kozmetičke svrhe; preparati za brušenje; boje za kosu; losioni za kosu; lakovi za kosu; preparati za talase u kosi; heliotropin; kana (kozmetička boja); vodonik peroksid u kozmetičke svrhe; kadulje; jononi (parfimerija); ulje jasmína; javelle (žavel) voda; mirišljavi štapići; preparati za skidanje laka; izbjeljivaci za rublje; vešplav (plavilo za rublje); impregnacija rublja; preparati za rublje; preparati za potapanje veša; štirak za veš; vosak za veš; ulje lavande; vodiča od lavande; preparati za izbjeljivanje kože; sredstva za zaštitu kože (politure); sjajevi za usne; karmini; losioni u kozmetičke svrhe; šminka; puderi za šminkanje; preparati za šminkanje; preparati za skidanje šminke; maskare; gelovi za masažu, ne u medicinske svrhe; medicinski sapun; esencije mente (eterična ulja); menta za parfimeriju; sredstva za ispiranje usta, ne u medicinske svrhe; mošus (parfimerija); vosak za brkove; naljepnice za nokte; preparati za njegu noktiju; lakovi za nokte; neutralizatori za trajnu ondulaciju; tečnosti za podove koje sprecavaju klizanje; neklizajući vosak za podove; terpentinsko ulje za odmašćivanje; ulja u svrhe čišćenja; ulja u kozmetičke svrhe; ulja za parfeme i mirise; ulja u toaletne svrhe; preparati za skidanje farbe; paste za kaiševе za oštrenje brijanja; parfimerija; parfemi; vazelin u kozmetičke svrhe; politure za namještaj i podove; kreme za poliranje; papir za poliranje; preparati za poliranje; sredstva za poliranje na bazi vještačkog oksida gvoždja; kamen za poliranje; vosak za poliranje; pomade u kozmetičke svrhe; potpuri (mirisi); preparati za čišćenje zubnih proteza; preparati za otpušavanje vodovodnih cijevi; preparati za sjaj listova na biljkama; kamen za pete; kora Quillajaceae za pranje; ružino ulje; preparati za uklanjanje rde; vrećice za parfimisanje posteljine; safrol; šmirgle; papir za šmirglanje; preparati za skidanje kamenca za kućnu upotrebu; mirisne vodiče; mirišljivo drvo; rastvori za ribanje; šamponi; šamponi za kućne ljubimce; preparati za brijanje; sapun za brijanje; kamen za brijanje (zatvaranje pora); preparati za davanje sjaja (politura); krema za cipele; sjaj za cipele; vosak za cipele; obučarski vosak; silicijumkarbid (abraziv); kreme za bjeljenje kože; preparati za glacanje (štirak); kamen za glacanje; sapun; sapun za osvježavanje boja na tekstilu; sapun protiv znojenja stopala; lužina sode; sredstva za odstranjivanje fleka; impregnacije od štirka za rublje; preparati za sunčanje (kozmetika); preparati za zaštitu od sunca; vošak za krojace; talk, u toaletne svrhe; terpeni (eterična ulja); maramice impregnirane kozmetičkim losionima; toaletne vode; toaletna sredstva; Tripoli kamen za poliranje; terpentin za odmašćivanje; preparati za skidanje laka; vulkanski pepeo za čišćenje; preparati za čišćenje tapeta; soda za pranje; vosak za kožu; bjelila; tečnosti za čišćenje vjetrobrana. Klasa 5: Farmaceutski i veterinarski preparati; sanitarni preparati u medicinske svrhe; dijetetska hrana i supstance prilagođene za upotrebu u medicini ili veterinarsku upotrebu, hrana za bebe; dijetetski dodaci za ljude i životinje; flasteri, materijali za zavijanje; materijali za plombiranje zuba, zubarski vosak; dezinfekciona sredstva; preparati za uništavanje štetočina; fungicidi, herbicidi; upijajuća vata (tupferi); akaricidi; acetati u farmaceutske svrhe; kiseline u farmaceutske svrhe; akonitin; ljepljive trake u medicinske svrhe; ljepljivi flasteri; ljepila za zubne proteze; adjuvansi u medicinske svrhe; preparati za osvježavanje vazduha; preparati za prečišćavanje vazduha; dijetetski dodaci na bazi albumina; naminice sa albuminom u medicinske svrhe; preparati sa albuminom u medicinske svrhe; alkohol u farmaceutske svrhe; aldehidi u farmaceutske svrhe; algicidi; dijetetski dodaci na bazi alginata; alginati u farmaceutske svrhe; alkalni jodid u farmaceutske svrhe; alkaloidi u medicinske svrhe; legure plemenitih metala u zubarske svrhe; preparati aloe vere u farmaceutske svrhe; aluminijum acetat u farmaceutske svrhe; amino kiseline u medicinske svrhe; amino kiseline u veterinarske svrhe; anestetici; analgetici; kora angosture u medicinske svrhe; sredstva za pranje životinja; anti-reumatske narukvice; anti-reumatsko prstenje; preparati protiv stvaranja mokracne kiseline; antibiotici; antikriptogamni preparati; antioksidantne tablete; antiparazitske ogrlice za životinje; antiparazitski preparati; antiseptička vata; antiseptici; tablete za smanjenje apetita; sredstva za smanjenje apetita u medicinske svrhe; sredstva protiv glavobolje; aseptična vata; čaj za astmaticare; gaćice za bebe; pelene za bebe; bakterijski otrovi; bakterijski preparati u medicinske i veterinarske svrhe; medijum bakterioloških kultura; bakteriološki preparati u medicinske i veterinarske svrhe; melemi u medicinske

svrhe; balsamični preparati u medicinske svrhe; zavoji; kore drveta u farmaceutske svrhe; preparati za kupke, medicinski; soli za kupke u medicinske svrhe; trake-držači za sanitarne uloške; soda bikarbona u farmaceutske svrhe; biocidi; biološki preparati u medicinske svrhe; biološki preparati u veterinarske svrhe; biološke kulture tkiva u medicinske svrhe; biološke kulture tkiva u veterinarske svrhe; preparati bizmuta u farmaceutske svrhe; subnitrat bizmuta u farmaceutske svrhe; krv u medicinske svrhe; krvna plazma; cement za kosti u hirurške i ortopedske svrhe; narukvice u medicinske svrhe; tuferi za dojenje; brom u farmaceutske svrhe; bronhodilatatori preparati; jastučići za cukljeve; nusproizvodi dobijeni preradom žitarica u dijetetske ili medicinske svrhe; kapsule u farmaceutske svrhe; pastile u farmaceutske svrhe; kalomel; kamfor u medicinske svrhe; ulje kamfora u medicinske svrhe; bombone u medicinske svrhe; bombone, medicinske; kapsule za medikamente; karbolineum (paraziticidi); kazeinski dijetetski dodaci; ricinusovo ulje u medicinske svrhe; sredstva za pranje stoke; kausticne olovke; kaustici u farmaceutske svrhe; kedrovina koja se koristi za odbijanje insekata; estri celuloze u farmaceutske svrhe; etri celuloze u farmaceutske svrhe; cement za životinjska kopita; ugalj u farmaceutske svrhe; hemijski provodnici za elektrokardiografske elektrode; hemijska kontraceptivna sredstva; hemijski preparati u medicinske svrhe; hemijski preparati u farmaceutske svrhe; hemijski preparati za dijagnostiku trudnoće; hemijski preparati za lečenje phylloxera-e; hemijski preparati u veterinarske svrhe; hemijski preparati za tretiranje budi; hemijski preparati za tretiranje žitaricnog sneta; hemijski reagensi u medicinske i veterinarske svrhe; hemijsko-farmaceutski preparati; žvake u medicinske svrhe; preparati protiv promrzlina; hinolin u medicinske svrhe; hloroform; cinchona u medicinske svrhe; kokain; ulje jetre bakalara; kolodijum u farmaceutske svrhe; collvrium; komprese; kora conduranga u medicinske svrhe; preparati za čišćenje sočiva; sprejovi za hlađenje u medicinske svrhe; sredstva protiv žuljeva i kurjih očiju; prstenasti flasteri za žuljeve i kurje oci na stopalima; pamuk u medicinske svrhe; vinski streš u farmaceutske svrhe; kreozot u farmaceutske svrhe; kora krotona; kulture mikroorganizama u medicinske i veterinarske svrhe; kurare; esencije u farmaceutske svrhe; abrazivna sredstva za zube; zubni amalgami; zubni amalgami od zlata; zubni cementi; materijali za uzimanje zubnih otisaka; zubni lakovi; zubne smole; deodoranti za odjecu i tekstil; deodoranti, osim za ljude ili životinje; sredstva za čišćenje; deterdženti u medicinske svrhe; hleb za dijabetičare, adaptiran za medicinske svrhe; dijagnostički preparati u medicinske svrhe; pelene za kućne ljubimce; dijastaza u medicinske svrhe; dijetetska vlakna; dijetetski dodaci za životinje; dijetetski napici prilagođeni za medicinske svrhe; dijetetska hrana prilagođena za medicinske svrhe; dijetetske substance, prilagođene za medicinske svrhe; digestivi u farmaceutske svrhe; digitalin; ulje mirodije u medicinske svrhe; dezinfekciona sredstva za hemijske toalete; dezinfekciona sredstva u higijenske svrhe; losioni za pse; sredstva za pranje pasa; preparati za tuširanje u medicinske svrhe; medicinski zavoji; lijekovi u medicinske svrhe;

Ispravni podaci

(511) **Klasa 03:** Preparati za bjeljenje i druge supstance za upotrebu u praonicama; preparati za čišćenje, poliranje, ribanje i nagrizanje; sapuni; parfimerija, eterična ulja, kozmetika, losioni za kosu; sredstva za njegu zuba; abrazivni papir; abrazivna sredstva; ljepila za pričvršćivanje lažnih trepavica; ljepila za pričvršćivanje vještačke kose; ljepila u kozmetičke svrhe; losioni za posle brijanja; preparati za osvježavanje vazduha; bademovo mlijeko u kozmetičke svrhe; bademovo ulje; bademov sapun; preparati od aloe-vere u kozmetičke svrhe; alunit (sredstvo koje zateže); ćilibar (parfem); amonijak (isparljiva alkalija) (deterdžent); antiperspirantni sapuni; antiperspiranti (toaletna sredstva); antistatički preparati za kućnu upotrebu; aromatična sredstva (eterična ulja); sredstva koja zatežu u kozmetičke svrhe; Badian esencija (esencija od zvjezdastog anisa); melemi osim u medicinske svrhe; baze za cvjetne parfeme; soli za kupke, ne u medicinske svrhe; boje za farbanje brade; maske za njegu ljepote; Bergamotova ulja; sredstva za bjeljenje (odstranjivanje boja) u kozmetičke svrhe; soli za bjeljenje; soda bikarbona za bjeljenje; sprejevi za osvježavanje

daha; tračice za osvježavanje daha; arome za kolače (eterična ulja); okrugli sapuni; komprimovani vazduh u konzervama u svrhe čišćenja i brisanja prašine; metalni karbidi (abrazivna sredstva); kreda za čišćenje; preparati za čišćenje; mlijeko za čišćenje u toaletne svrhe; krpe impregnirane sa deterdžentom za čišćenje; vosak za obučare; hemijska sredstva za ožvljavanje boja u kućne svrhe (rublje); preparati za uklanjanje boja; sredstva za bojenje u toaletne svrhe; korund (abrazivno sredstvo), kozmetičke kreme; boje u kozmetičke svrhe; kozmetički pribor; kozmetičke olovke; kozmetički preparati za kupke; kozmetički preparati za trepavice; kozmetički preparati za njegu kože; kozmetički preparati za mršavljenje; kozmetika; kozmetika za životinje; pamučni štapići u kozmetičke svrhe; vata u kozmetičke svrhe; dekorativne naljepnice u kozmetičke svrhe; odmašćivači osim za upotrebu u proizvodnji; gelovi za izbjeljivanje zuba; sredstva za njegu zuba; sredstva za poliranje zubne proteze; deodorantski sapuni; deodoranti za ljude ili životinje; deodoranti za kućne ljubimce; sredstva za depilaciju; vosak za depilaciju; deterdženti osim za upotrebu u proizvodnim procesima i u medicinske svrhe; abrazivna sredstva u formi dijamanata; dezinfekcioni sapun; preparati za tuširanje za ličnu higijenu ili u deodorantske svrhe (toaletna sredstva); preparati za suvo pranje; šamponi za suvo pranje; agensi za sušenje za mašine za sudove; kolonjske vode; šmirgla; brusna tkanina; brusni papir; eterična ulja od kedrovine; eterična ulja od citrusa; eterična ulja od limuna; eterične esencije; eterična ulja; ekstrakti cvjetova (parfemi); kozmetika za obrve; olovke za obrve; omekšivači za rublje; vještačke trepavice; vještački nokti; arome za napitke (eterična ulja); vosak za podove; sredstva za odstranjivanje podnog voska (preparati za ribanje); preparati za neutralisanje dima (parfemi); preparati za postizanje sjaja; ulje Gaultheria-e; Geraniol; krpe za stakla; masnoće u kozmetičke svrhe; preparati za brušenje; boje za kosu; losioni za kosu; lakovi za kosu; preparati za talase u kosi; heliotropin; kana (kozmetička boja); vodonik peroksid u kozmetičke svrhe; kadulje; jononi (parfimerija); ulje jasmina; javelle (žavel) voda; mirišljavi štapići; preparati za skidanje laka; izbjeljivači za rublje; vešplav (plavilo za rublje); impregnacija rublja; preparati za rublje; preparati za potapanje veša; štirak za veš; vosak za veš; ulje lavande; vodica od lavande; preparati za izbjeljivanje kože; sredstva za zaštitu kože (politure); sjajevi za usne; karmini; losioni u kozmetičke svrhe; šminka; puderi za šminkanje; preparati za šminkanje; preparati za skidanje šminke; maskare; gelovi za masažu, ne u medicinske svrhe; medicinski sapun; esencije mente (eterična ulja); menta za parfimeriju; sredstva za ispiranje usta, ne u medicinske svrhe; mošus (parfimerija); vosak za brkove; naljepnice za nokte; preparati za njegu noktiju; lakovi za nokte; neutralizatori za trajnu ondulaciju; tečnosti za podove koje sprečavaju klizanje; neklizajući vosak za podove; terpentinsko ulje za odmašćivanje; ulja u svrhe čišćenja; ulja u kozmetičke svrhe; ulja za parfeme i mirise; ulja u toaletne svrhe; preparati za skidanje farbe; paste za kaiševе za oštrenje brijanja; parfimerija; parfemi; vazelin u kozmetičke svrhe; politure za namještaj i podove; kreme za poliranje; papir za poliranje; preparati za poliranje; sredstva za poliranje na bazi vještackog oksida gvoždja; kamen za poliranje; vosak za poliranje; pomade u kozmetičke svrhe; potpuri (mirisi); preparati za čišćenje zubnih proteza; preparati za otpušavanje vodovodnih cjevi; preparati za sjaj listova na biljkama; kamen za pete; kora Quillajaceae za pranje; ružino ulje; preparati za uklanjanje rđe; vrećice za parfimisanje posteljine; safrol; šmirgle; papir za šmirglanje; preparati za skidanje kamenca za kućnu upotrebu; mirisne vodice; mirišljivo drvo; rastvori za ribanje; šamponi; šamponi za kućne ljubimce; preparati za brijanje; sapun za brijanje; kamen za brijanje (zatvaranje pora); preparati za davanje sjaja (politura); krema za cipele; sjaj za cipele; vosak za cipele; obučarski vosak; silicijumkarbid (abraziv); kreme za bjeljenje kože; preparati za glačanje (štirak); kamen za glačanje; sapun; sapun za osvježavanje boja na tekstilu; sapun protiv znojenja stopala; lužina sode; sredstva za odstranjivanje fleka; impregnacije od štirka za rublje; preparati za sunčanje (kozmetika); preparati za zaštitu od sunca; vosak za krojače; talk, u toaletne svrhe; terpeni (eterična ulja); maramice impregnirane kozmetičkim losionima; toaletne vode; toaletna sredstva; Tripoli kamen za poliranje; terpentin za odmašćivanje; preparati za skidanje laka; vulkanski pepeo za čišćenje; preparati za čišćenje tapeta; soda za pranje; vosak

za kožu; bjelila; tečnosti za čišćenje vjetrobrana.

Klasa 05: Farmaceutski i veterinarski preparati; sanitarni preparati u medicinske svrhe; dijetetska hrana i supstance prilagođene za upotrebu u medicini ili veterinarsku upotrebu, hrana za bebe; dijetetski dodaci za ljude i životinje; flasteri, materijali za zavijanje; materijali za plombiranje zuba, zubarski vosak; dezinfekciona sredstva; preparati za uništavanje štetočina; fungicidi, herbicidi; upijajuća vata (tupferi); akaricidi; acetati u farmaceutske svrhe; kiseline u farmaceutske svrhe; akonitin; ljepljive trake u medicinske svrhe; ljepljivi flasteri; ljepila za zubne proteze; adjuvansi u medicinske svrhe; preparati za osvježavanje vazduha; preparati za prečišćavanje vazduha; dijetetski dodaci na bazi albumina; namirinice sa albuminom u medicinske svrhe; preparati sa albuminom u medicinske svrhe; alkohol u farmaceutske svrhe; aldehidi u farmaceutske svrhe; algicidi; dijetetski dodaci na bazi alginata; alginati u farmaceutske svrhe; alkalni jodid u farmaceutske svrhe; alkaloidi u medicinske svrhe; legure plemenitih metala u zubarske svrhe; preparati aloe vere u farmaceutske svrhe; aluminijum acetat u farmaceutske svrhe; amino kiseline u medicinske svrhe; amino kiseline u veterinarske svrhe; anestetici; analgetici; kora angosture u medicinske svrhe; sredstva za pranje životinja; anti-reumatske narukvice; anti-reumatsko prstenje; preparati protiv stvaranja mokraćne kiseline; antibiotici; antikriptogamni preparati; antioksidantne tablete; antiparazitske ogrlice za životinje; antiparazitski preparati; antiseptička vata; antiseptici; tablete za smanjenje apetita; sredstva za smanjenje apetita u medicinske svrhe; sredstva protiv glavobolje; aseptična vata; čaj za astmatičare; gaćice za bebe; pelene za bebe; bakterijski otrovi; bakterijski preparati u medicinske i veterinarske svrhe; medijum bakterioloških kultura; bakteriološki preparati u medicinske i veterinarske svrhe; melemi u medicinske svrhe; balsamični preparati u medicinske svrhe; zavoji; kore drveta u farmaceutske svrhe; preparati za kupke, medicinski; soli za kupke u medicinske svrhe; trake-držači za sanitarne uloške; soda bikarbona u farmaceutske svrhe; biocidi; biološki preparati u medicinske svrhe; biološki preparati u veterinarske svrhe; biološke kulture tkiva u medicinske svrhe; biološke kulture tkiva u veterinarske svrhe; preparati bizmuta u farmaceutske svrhe; subnitrat bizmuta u farmaceutske svrhe; krv u medicinske svrhe; krvna plazma; cement za kosti u hirurške i ortopedske svrhe; narukvice u medicinske svrhe; tuferi za dojenje; brom u farmaceutske svrhe; bronhodilatorni preparati; jastučići za čukljeve; nusproizvodi dobijeni preradom žitarica u dijetetske ili medicinske svrhe; kapsule u farmaceutske svrhe; pastile u farmaceutske svrhe; kalomel; kamfor u medicinske svrhe; ulje kamfora u medicinske svrhe; bombone u medicinske svrhe; bombone, medicinske; kapsule za medikamente; karbolineum (parazitocidi); kazeinski dijetetski dodaci; ricinusovo ulje u medicinske svrhe; sredstva za pranje stoke; kaustične olovke; kaustici u farmaceutske svrhe; kedrovina koja se koristi za odbijanje insekata; estri celuloze u farmaceutske svrhe; etri celuloze u farmaceutske svrhe; cement za životinjska kopita; ugallj u farmaceutske svrhe; hemijski provodnici za elektrokardiografske elektrode; hemijska kontraceptivna sredstva; hemijski preparati u medicinske svrhe; hemijski preparati u farmaceutske svrhe; hemijski preparati za dijagnostiku trudnoće; hemijski preparati za lečenje phylloxera-e; hemijski preparati u veterinarske svrhe; hemijski preparati za tretiranje buđi; hemijski preparati za tretiranje žitaričnog sneta; hemijski reagensi u medicinske ili veterinarske svrhe; hemijsko-farmaceutski preparati; žvake u medicinske svrhe; preparati protiv promrzlina; hinolin u medicinske svrhe; hloroform; cinchona u medicinske svrhe; kokain; ulje jetre bakalara; kolodijum u farmaceutske svrhe; collyrium; komprese; kora conduranga u medicinske svrhe; preparati za čišćenje sočiva; sprejovi za hlađenje u medicinske svrhe; sredstva protiv žuljeva i kurjih očiju; prstenasti flasteri za žuljeve i kurje oči na stopalima; pamuk u medicinske svrhe; vinski streš u farmaceutske svrhe; kreozot u farmaceutske svrhe; kora krotona; kulture mikroorganizama u medicinske i veterinarske svrhe; kurare; esencije u farmaceutske svrhe; abrazivna sredstva za zube; zubni amalgami; zubni amalgami od zlata; zubni cementi; materijali za uzimanje zubnih otisaka; zubni lakovi; zubne smole; deodoranti za odjeću i tekstil; deodoranti, osim za ljude ili životinje; sredstva za čišćenje; deterdženti u medicinske svrhe;

hleb za dijabetičare, adaptiran za medicinske svrhe; dijagnostički preparati u medicinske svrhe; pelene za kućne ljubimce; dijestaza u medicinske svrhe; dijetetska vlakna; dijetetski dodaci za životinje; dijetetski napici prilagođeni za medicinske svrhe; dijetetska hrana prilagođena za medicinske svrhe; dijetetske substance, prilagođene za medicinske svrhe; digestivi u farmaceutske svrhe; digitalin; ulje mirođije u medicinske svrhe; dezinfekciona sredstva za hemijske toalete; dezinfekciona sredstva u higijenske svrhe; losioni za pse; sredstva za pranje pasa; preparati za tuširanje u medicinske svrhe; medicinski zavoji; lijekovi u medicinske svrhe; eliksiri (farmaceutski preparati); enzimski dijetetski dodaci; enzimski preparati u medicinske svrhe; enzimski preparati u veterinarske svrhe; enzimi u medicinske svrhe; enzimi u veterinarske svrhe; ergot u farmaceutske svrhe; estri u farmaceutske svrhe; etri u farmaceutske svrhe; eukaliptol u farmaceutske svrhe; eukaliptus u farmaceutske svrhe; sredstva za čišćenje crijeva; ekstrakt hmelja u farmaceutske svrhe; sredstva za ispiranje očiju; povezi za oči u medicinske svrhe; antipiretici; komorač u medicinske svrhe; fermenti u farmaceutske svrhe; kutije prve pomoći, opremljene; riblji obroci u medicinske svrhe; sumporno brašno u farmaceutske svrhe; papir za hvatanje muva; preparati za uništavanje muva; ljepak za muve; hrana za bebe; aldehid mravje kiseline u farmaceutske svrhe; melemi za promrzline u farmaceutske svrhe; štapići za kađenje; preparati za kađenje u medicinske svrhe; fungicidi; galna kiselina u farmaceutske svrhe; gumena smola (Gamboge) u medicinske svrhe; gasovi u medicinske svrhe; gaze za previjanje; želatin u medicinske svrhe; gorčica u medicinske svrhe; germicidi; glukozni dijetetski dodaci; glukoza u medicinske svrhe; glicerin u medicinske svrhe; glicerfosfati; masti u medicinske svrhe; masti u veterinarske svrhe; gvajakol u farmaceutske svrhe; guma u medicinske svrhe; Gurjun (gurjon, gurjan); balzam u medicinske svrhe; olovke protiv glavobolje; hematogen; hemoglobin; preparati za hemoroide; hemostatične olovke; biljni čajevi u medicinske svrhe; herbicidi; hormoni u medicinske svrhe; hidrastini; hidrastinini; hidratizirani hloral u farmaceutske svrhe; vodonik peroksid u medicinske svrhe; mirišljavi preparati za odbijanje insekata; repelanti; insekticidi; jodidi u farmaceutske svrhe; jod u farmaceutske svrhe; jodoform; irska mahovina u medicinske svrhe; izotopi u medicinske svrhe; jalapa; jujub, u medicinske svrhe; mliječno brašno za bebe; laktoza u farmaceutske svrhe; preparati za uništavanje larvi; laksativi; olovna voda; dijetetski lecitinski dodaci; lecitin u medicinske svrhe; pijavice u medicinske svrhe; sredstva za utrljavanje (liniment); dijetetski dodaci od lanenog sjemena; laneno sjeme u farmaceutske svrhe; obroci od lanenog sjemena u farmaceutske svrhe; dijetetski dodatak od ulja lanenog sjemena; lan u medicinske svrhe; gospino bilje u farmaceutske svrhe; losioni u farmaceutske svrhe; losioni u veterinarske svrhe; lozengete u farmaceutske svrhe; lupulin u farmaceutske svrhe; magnezijum u farmaceutske svrhe; slad u farmaceutske svrhe; mliječni napici sa sladom u medicinske svrhe; kora mangrova u farmaceutske svrhe; obroci u farmaceutske svrhe; medicinski preparati u svrhe mršavljenja; medicinski alkohol; medicinski napici; medicinski preparati za rast kose; medicinsko bilje; medicinske infuzije; medicinsko blato; medicinska ulja; medicinsko korenje; medicinski čajevi; medicinske kutije, prenosive, opremljene; medicinska sredstva za ublažavanje konstipacije; medicinska sredstva u dentalne svrhe; medicinska sredstva za ljude; medicinska sredstva u veterinarske svrhe; vodica od matičnjaka u farmaceutske svrhe; mentol; živini melemi; mliječni fermenti u farmaceutske svrhe; bademovo mlijeko u farmaceutske svrhe; mliječna mast; mineralni dodaci u hrani; soli mineralne vode; mineralne vode u medicinske svrhe; menta u farmaceutske svrhe; vosak za kalupe za zubare; jaka pamučna tkanina u medicinske svrhe (moleskin); papir protiv moljaca; preparati protiv moljaca; sredstva za ispiranje usta u medicinske svrhe; blato za kupatila; gorušica u farmaceutske svrhe; ulje gorušice u medicinske svrhe; melemi od gorušice; kora terminalia myrobalan u farmaceutske svrhe; pelene za inkontinente osobe; narkotici; sredstva za nerve; dodaci u ishrani; nutritivne supstance za mikroorganizme; ulje terpentina u farmaceutske svrhe; masti u farmaceutske svrhe; opijati; opijum; opodeldok masti; preparati za opoterapiju; kiseoničke kupke; kiseonik u medicinske svrhe; gaćice koje absorbuju, za inkontinentne; ulošci (sanitarni); papir za meleme od gorušice;

paraziticidi; biserni prah u medicinske svrhe; pektin u farmaceutske svrhe; pepsini u farmaceutske svrhe; peptoni u farmaceutske svrhe; lični seksualni lubrikanti; pesticidi; vazelin u medicinske svrhe; farmaceutski preparati; farmaceutski preparati za negu kože; farmaceutski preparati protiv peruti; fenol u farmaceutske svrhe; fosfati u farmaceutske svrhe; otrovi; dijetetski dodaci od polena; pomade u medicinske svrhe; porcelan za zubne proteze; kalijumove soli u medicinske svrhe; vruće (kašne) obloge; prah kantarida; preparati za kožna zadebljanja; preparati za uništavanje gljivica truleži; preparati za uništavanje miševa; preparati za uništavanje štetočina; preparati za smanjenje seksualne aktivnosti; preparati za tretiranje opekotina; preparati od kreča u farmaceutske svrhe; preparati sa elementima u tragovima za upotrebu kod ljudi i životinja; preparati za olakšanje kod izbijanja (rasta) zuba; dijetetski dodaci sa propolisom; propolis u farmaceutske svrhe; proteinski dijetetski dodaci; proteinski dodaci za životinje; prah pyrethrum-a; quassia u medicinske svrhe; biljka quebracho u medicinske svrhe; kinin u medicinske svrhe; radioaktivne supstance u medicinske svrhe; radiološke kontrastne supstance u medicinske svrhe; radijum u medicinske svrhe; otrov za pacove; reagensni papir u medicinske i veterinarske svrhe; lijekovi protiv znojenja stopala; lijekovi protiv znojenja; sredstva za odbijanje pasa; koren rabarbare u farmaceutske svrhe; dijetetski dodaci od matičnog mliječa; matični mliječ u farmaceutske svrhe; kaučuk za dentalne svrhe; soli u medicinske svrhe; soli za kupke sa mineralnom vodom; sanitarni ulošci; sanitarne gaćice; sanitarni tamponi; sanitarni peškiri; sarsaparilla u medicinske svrhe; lopatice u hirurške svrhe; morska voda za medicinske kupke; sedativi; sperma za vještačku oplodnju; seroterapeutski lijekovi; sikativi (agensi za isušivanje) u medicinske svrhe; pilule za mršavljenje; preparati za uništavanje puževa golača; mirišljave soli; bilje za pušenje u medicinske svrhe; natrijumove soli u medicinske svrhe; preparati za sterilizaciju tla; rastvori za kontaktna sočiva; rastvarači za odstranjivanje ljepljivih flastera; soporifici; skrob za dijetetske ili u farmaceutske svrhe; matične ćelije u medicinske svrhe; matične ćelije u veterinarske svrhe; preparati za sterilizaciju; steroidi; štapići od gospinog bilja u farmaceutske svrhe; strihnin; preparati stiptika; šećer u medicinske svrhe; sulfonamidi (lekovi); sumporni štapići (dezinfekciona sredstva); obloge za opekotine od sunca; preparati za opekotine od sunca u farmaceutske svrhe; supozitorije; hirurške obloge i materijali; hirurški implantati (živa tkiva); hirurška tkiva; sirupi u farmaceutske svrhe; tablete za potamnjivanje; streš u farmaceutske svrhe; materijal za punjenje zuba; terapijski preparati za kupke; termalna voda; timol u farmaceutske svrhe; tinkture joda; tinkture u medicinske svrhe; tkiva impregnirana farmaceutskim losionima; ekstrakti duvana (insekticidi); bezduvanske cigarete u medicinske svrhe; tonici (lekovi); terpentini u farmaceutske svrhe; vakcine; vaginalna ispiranja; sredstva za izbacivanje glisti; preparati za uništavanje štetočina; supstance koje izazivaju plikove (vezikanti); veterinarski preparati; hemijska sredstva za tretiranje bolesti kod vina; vitaminski preparati; sunđeri za tretiranje rana; vatiranje u medicinske svrhe; olovke za bradavice; dijetetski dodaci sa pšeničnim klicama; dijetetski dodaci sa kvascem; kvasac u farmaceutske svrhe.

U „Crnogorskom glasniku intelektualne svojine“ broj 14. od 20.04.2014. godine objavljeni su pogrešni podaci za prijavu žiga **2012-332**

Pogrešni podaci

- (210) **2012-332** (442) **20.04.2014.**
 (220) 7/26/2012
 (731) **DRAŠKO VUČINIĆ**, ROGAMI BB, PODGORICA ME
 (540) ZENATA
 (550) I
 (511) **Klasa 33:** alkoholna pića (vino i rakija od grozđa);

Ispravni podaci

- (210) **2012-332** (442) **20.04.2014.**
(220) 7/26/2012
(731) **DRAŠKO VUČINIĆ**, ROGAMI BB, PODGORICA ME
(540) ZENTA
(550) I
(511) **Klasa 33:** alkoholna pića (vino i rakija od grozđa);

U „Crnogorskom glasniku intelektualne svojine“ broj 14. od 20.04.2014. godine objavljeni su pogrešni podaci za prijavu žiga **2012-317**

Pogrešni podaci

(731) **R & A BAILY & CO**, NANGOR HOUSE, WESTERN ESTATE, NANGOR ROAD, DUBLIN 12 IE

Ispravni podaci

(731) **R & A Bailey & Co**, NANGOR HOUSE, WESTERN ESTATE, NANGOR ROAD, DUBLIN 12 IE





DIZAJN

DESIGNS

Službeni glasnik Zavoda za intelektualnu svojinu Crne Gore
Official Gazette of the Montenegrin Intellectual Property Office

15 / 2014



Zavod za intelektualnu svojinu Crne Gore
ul. Rimski trg br. 46,
81000 Podgorica,
Crna Gora

**MEĐUNARODNI KODOVI ZA IDENTIFIKACIJU BIBLIOGRAFSKIH
PODATAKA O DIZAJNU PREMA WIPO CT.80**
RECOMMENDATION CONCERNING BIBLIOGRAPHIC DATA RELATING TO
INDUSTRIAL DESIGNS WIPO CT.80

CRNOGORSKI	MDK	ENGLESKI
Registarski broj	11	Number of registration
Datum registracije	15	Date of the registration
Očekivani datum isteka registracije	18	Expected expiration date of the registration
Broj prijave	21	Number of the application
Datum podnošenja prijave	22	Date of filing of the application
Podaci o izložbenom pravu prvenstva	23	Exhibition priority data
Broj prijavljenih dizajna	28	Number of industrial designs included in the application
Podaci o pravu prvenstva na osnovu Pariske konvencije	30	Data relating to priority under the Paris Convention
Klasa i podklasa Lokarnske klasifikacije	51	Class and subclass of the Locarno Classification
Naziv dizajna	54	Title of the industrial design
Prikaz	55	Reproduction of the industrial design (e.g., drawing, photograph) and explanations relating to the reproduction
Ime autora dizajna	72	Name of the creator
Ime i adresa nosioca prava	73	Name and address of the owner
Ime i adresa punomoćnika	74	Name and address of the representative

OBJAVE DIZAJNA
PUBLICATION OF DESIGNS(11) **00093**

(21) D-2012-19

(22) 24.08.2012.

(28) 2

(30) 002009100-0001 15.03.2012.

002009100-0002 15.03.2012.

(54) **GRAFIČKI SIMBOL**

(72) Sylvia Vitale Rotta (Italian), Team Créatif, 89 rue de Miromesnil, 75008, Paris FR

Olivier Dognon (French), Team Créatif, 89 rue de Miromesnil, 75008, Paris FR

Coralie Deloffre (French), Team Créatif, 89 rue de Miromesnil, 75008, Paris FR

Pascal Marcos (French), Team Créatif, 89 rue de Miromesnil, 75008, Paris FR

Thierry Vial Paillet (French), Team Créatif, 89 rue de Miromesnil, 75008, Paris FR

Roland Chappuy (French), Team Créatif, 89 rue de Miromesnil, 75008, Paris FR

(73) Mars, Incorporated 6885 Elm Street, McLean, VA 22101-3883 US

(74) Jusić Jasna, Crnogorskih serdara bb, Podgorica ME

(55)

(51) **32-00**

(15) 20.06.2014.

(18) 24.08.2017.



1.1

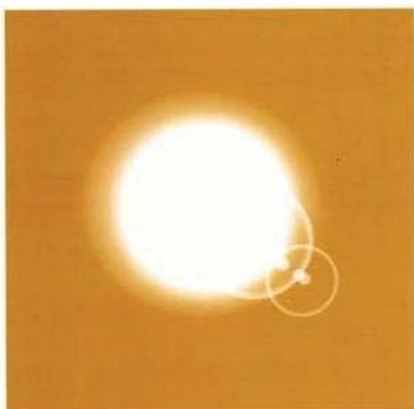

2.1

(11) **00115**
(21) D-2012-16
(22) 10.07.2012.
(28) 2

(51) **09-01**
(15) 20.06.2014.
(18) 10.07.2017.

(54) **BOCA**

(73) Industrija piva i sokova Pivara „TREBJESA“ AD-Nikšić, Njegoševa 18, Nikšić ME

(74) Božović Vesko, Rimski trg 50/11, Podgorica ME

(55)



1.1



1.2



1.3



2.1



2.2



2.3

INDEKS NOSILACA DIZAJNA
INDEX OF INDUSTRIAL DESIGNS OWERS

(73)	(51)	(21)	(22)	(11)
Industrija piva i sokova Pivara „TREBJESA“ AD-Nikšić	09-01	D-2012-16	10.07.2012.	00115
Mars, Incorporated	32-00	D-2012-19	20.06.2014.	00093

INDEX BROJEVA DIZAJNA
INDEX OF INDUSTRIAL DESIGNS NUMBERS

(11)	(21)
------	------

00093 D-2012-19

00115 D-2012-16

INDEKS PO KLASAMA I PODKLASAMA LOKARNSKE KLASIFIKACIJE
INDEX ACCORDING TO CLASSES SUBCLASSEN THE LOCARNO
CLASSIFICATION

(21)	(11)
------	------

D-2012-16 00115

D-2012-19 00093

OBJAVE OBNOVE VAŽENJA INDUSTRIJSKOG DIZAJNA
PUBLICATION OF INDUSTRIAL DESIGN RENEWAL

Registarski broj dizajna CG (11)	Ime i adresa nosioca industrijskog dizajna (73)	Datum do kojeg važi obnova industrijskog dizajna (18)
00033 PP (10257)	BSTG, Drahtwaren Produktions-und Handels-GmbH FN 79259h Köglstrasse 11, 4017 Linz, AT	21.05.2019.
00057	Deutsche Telekom AG, Friedrich-Ebert-Allee 140, 53113 Bonn DE	02.04.2019.



INFORMATOR

INFORMATION

Službeni glasnik Zavoda za intelektualnu svojinu Crne Gore
Official Gazette of the Montenegrin Intellectual Property Office

15 / 2014



Zavod za intelektualnu svojinu Crne Gore
ul. Rimski trg br. 46,
81000 Podgorica,
Crna Gora

INTELEKTUALNA SVOJINA

AUTORSKO PRAVO I SRODNA PRAVA

INDUSTRIJSKA SVOJINA

- * Patenti
- * Žigovi
- * Industrijski dizajn
- * Oznake geografskog porijekla roba i usluga
- * Topografija integriranih kola

AUTORSKO PRAVO

(Koje se odnosi na duhovne tvorevine)

- Kao što su naročito:
- * Književna djela
(pisana, govorna, kompjuterski programi)
 - * Muzička djela
 - * Dramska i dramsko-muzička djela
 - * Koreografska i pantomimska djela
 - * Djela likovnih umjetnosti iz područja slikarstva, vajarstva i arhitekture
 - * Djela primjenjenih umjetnosti
 - * Fotografiska djela
 - * Kinematografska djela
 - * Prevodi, obrade i druge prerade djela
 - * Zbirke autorskih djela, podataka ili druge građe

SRODNA PRAVA

- Koja se odnose:
- * Izvođenja umjetnika izvođača
 - * Fonograme
 - * Emitovanja radija I televizije

CIP - Каталогizacija u publikaciji
Централна народна библиотека Црне Горе, Цетиње

347.77/78(497.16)

CRNOGORSKI glasnik intelektualne svojine : Službeni glasnik
Zavoda za Intelektualnu svojinu Crne Gore = Journal of intel-
lectual properti in Montenegro = Official Gazete of the Intellec-
tual Property Office of Montenegro / glavni i odgovorni urednik
Novak Adžić - 2014, br.14 - 820. - Podgorica (Bulevar Revolucije
9) : Zavod za intelektualnu svojinu Crne Gore, 2010. - 30 cm

Tromjesečno.

ISSN 1800-8003 = Crnogorski glasnik intelektualne svojine
(Podgorica)

COBISS.CG-ID 15168784

