



# CRNOGORSKI GLASNIK INTELEKTUALNE SVOJINE

INTELLECTUAL PROPERTY GAZETTE OF MONTENEGRO

Službeni glasnik Zavoda za intelektualnu svojinu Crne Gore  
Official Gazette of the Montenegrin Intellectual Property Office

# 12/2013



Zavod za intelektualnu svojinu Crne Gore  
ul. Rimski trg br. 46,  
81000 Podgorica,  
Crna Gora

# CRNOGORSKI GLASNIK INTELEKTUALNE SVOJINE

Godina IV

Datum objavljivanja: 20. 06. 2013. god.

*Izdavač:*

ZAVOD ZA INTELEKTUALNU  
SVOJINU CRNE GORE  
Rimski trg br. 46,  
81000 Podgorica, Crna Gora

*Za izdavača:*

Novak Adžić, direktor

*Glavni i odgovorni urednik:*

Novak Adžić

*Urednički odbor:*

Novak Adžić, Predrag Malbaša,  
Dušanka Perović, Milica Savić,  
Gordana Tripković

*Tehnički urednik:*

Predrag Malbaša

*Prevod:*

Gordana Tripković

*Dizajn:*

Aleksandar-Saša Samardžić

OVAJ BROJ SLUŽBENOG GLASNIKA OBJAVLJEN JE U ELEKTRONSKOJ FORMI

Crnogorski glasnik intelektualne svojine službeno je glasilo Zavoda za intelektualnu svojinu Crne Gore. U Glasniku se objavljuju sve relevantnim zakonima i pravilnicima propisane informacije iz postupka dodjele prava industrijskog vlasništva, informacije o dodijeljenim pravima te o kasnijim promjenama u vezi s tim pravima, kao i ostale službene informacije.

The Montenegrinan intellectual property gazette is the official gazette of the State Intellectual Property Office of the Montenegro. The Gazette publishes all the information, prescribed by the relevant laws and regulations, relating to the industrial property granting procedure concerning granted rights and subsequent changes made in connection with such right, as well as other official information.

## SADRŽAJ

DVOSLOVNE OZNAKE ZEMALJA, TERITORIJA I MEĐUNARODNIH ORGANIZACIJA  
TWO LETTER CODE COUNTRIES, TERRITORIES AND INTERNATIONAL ORGANIZATIONS ..... 947

**PATENTI**

**PATENTS ..... 949**

MEĐUNARODNI KODOVI ZA IDENTIFIKACIJU BIBLIOGRAFSKIH PODATAKA O PATENTIMA

PREMA WIPO STANDARDU ST. 9

RECOMMENDATION CONCERNING BIBLIOGRAFIC DATA ON AND RELATING TO

PATENTS- WIPO-ST. 9..... 951

OBAVJEŠTENJE

NOTICE ..... 953

OBJAVE PRIJAVA PATENATA

PUBLICATION OF PATENT APPLICATIONS..... 955

INDEKS NOSILACA PATENTA

PATENT OWNER INDEX ..... 987

INDEKS BROJEVA PRIJAVA PATENATA

APPLICANTS NUMBER INDEX ..... 991

INDEKS OBJAVLJENIH PRIJAVA PATENATA PREMA MKP

INDEX OF PATENT APPLICANTS ACCORDINT TO IPC ..... 993

OBJAVE ZAHTJEVA ZA PROŠIRENJE EVROPSKIH PRIJAVA PATENATA

PUBLICATION OF REQUEST FOR THE EXTENSION OF THE EFFECTS OF EUROPEAN PATENT

APPLICATIONS ..... 995

INDEKS BROJEVA ZAHTJEVA ZA PROŠIRENJE EVROPSKIH PRIJAVA PATENTA

INDEX ON NUMBER OF REQUESTS FOR EXTENSION ON EUROPEAN PATENT APPLICATIONS . 1155

INDEKS KLASIFIKACIJSKIH OZNAKA BROJEVA ZAHTJEVA ZA PROŠIRENJE EVROPSKIH

PRIJAVA PATENTA PREMA MKP

INDEX ON CLASSIFICATION MARKS ON REQUESTS FOR EXTENSION OF EUROPEAN PATENT

APPLICATION IN ACCORDANCE WITH THE INTERNATIONAL PATENT CLASSIFICATION .. 1205

INDEKS PODNOSITELJA ZAHTJEVA ZA PROŠIRENJE EVROPSKIH PRIJAVA PATENTA

INDEX ON NUMBER OF APPLICATIONS FOR EXTENSION OF EUROPEAN PATENT

APPLICATION ..... 1319

OBJAVA POVUČENIH ZAHTJEVA ZA PROŠIRENJE EVROPSKIH PRIJAVA PATENTA

PUBLICATION OF WITHDRAWN REQUESTS FOR EXTENSION OF EUROPEAN PATENT

APPLICATION ..... 1401

OBJAVA PROŠIRENIH EVROPSKIH PATENATA

PUBLICATION OF EXTENDED EUROPEAN PATENTS..... 1403

**ŽIGOVI**

**TRADEMARKS..... 1465**

MEĐUNARODNI KODOVI ZA IDENTIFIKACIJU BIBLIOGRAFSKIH PODATAKA O ŽIGOVIMA

PREMA WIPO ST 60

RECOMMENDATION CONCERNING BIBLIOGRAFIC DATA RELATING TO

TRADEMARKS- WIPO-ST. 60 ..... 1467

OBAVJEŠTENJE	
NOTICE .....	1469
OBJAVA PRIJAVA ŽIGOVA	
PUBLICATION OF TRADEMARK APPLICATIONS .....	1471
OBJAVA ŽIGOVA	
PUBLICATION OF TRADEMARKS .....	1591
INDEKS NOSILACA ŽIGOVA	
INDEX OF THE HOLDER OF THE REGISTRATION .....	1605
INDEKS BROJEVA ŽIGOVA	
INDEX OF THE TRADEMARK NUMBERS .....	1607
INDEKS PO KLASAMA NIČANSKE KLASIFIKACIJE ROBA I USLUGA	
INDEX ACCORDING TO THE NICE CLASSIFICATION OF GOODS AND SERVICES .....	1609
OBJAVA ISPRAVKI	
CORRECTIONS.....	1611
OBJAVA UPISA U REGISTAR ŽIGOVA CRNE GORE	
PUBLICATION OF THE ENTRY TRADEMARK REGISTER MONTENEGRO .....	1623
OBJAVA UPISA PROMJENA U REGISTAR ŽIGOVA	
PUBLICATION OF RECORD OF CHANGES TO THE TRADEMARK REGISTER .....	1627
<b>DIZAJN</b>	
<b>DESIGNS .....</b>	<b>1629</b>
MEĐUNARODNI KODOVI ZA IDENTIFIKACIJU BIBLIOGRAFSKIH PODATAKA O DIZAJNU PREMA WIPO CT.80	
RECOMMENDATION CONCERNING BIBLIOGRAPHIC DATA RELATING TO INDUSTRIJAL DESIGNS WIPO CT.80 .....	1631
OBJAVE DIZAJNA	
PUBLICATION OF DESIGNS.....	1633
INDEKS NOSILACA DIZAJNA	
INDEX OF INDUSTRIAL DESIGN OWNERS .....	1691
INDEKS BROJEVA DIZAJNA	
INDEX OF INDUSTRIAL DESIGN NUMBERS.....	1693
INDEKS PO KLASAMA I PODKLASAMA LOKARNSKE KLASIFIKACIJE	
INDEX ACCORDING TO CLASSES SUBCLASSES THE LOCARNO CLASSIFICATION .....	1695
OBJAVE OBNOVE VAŽENJA INDUSTRIJSKOG DIZAJNA	
PUBLICATION OF INDUSTRIAL DESIGN RENEWAL .....	1697
<b>INFORMATOR</b>	
<b>INFORMATION.....</b>	<b>1699</b>
Snežana Džuverović:	
MEĐUNARODNA SARADNJA Zavoda za intelektualnu svojinu Crne Gore u periodu januar – jun 2013.god.....	1701

**DVOSLOVNE OZNAKE ZEMALJA, TERITORIJA I MEĐUNARODNIH  
ORGANIZACIJA  
(prema WIPO standardu ST. 3)**

<b>AD</b>	Andora	<b>CF</b>	Centralna Afrička Republika	<b>GB</b>	Velika Britanija
<b>AE</b>	Ujedinjeni Arapski Emirati	<b>CG</b>	Kongo	<b>GC</b>	Patentna kancelarija Savjeta za saradnju država Arapskog Zaliva (GCC)
<b>AF</b>	Afganistan	<b>CH</b>	Švajcarska	<b>GD</b>	Grenada
<b>AG</b>	Antigva i Barbuda	<b>CI</b>	Obala Bjelokosti	<b>GE</b>	Gruzija
<b>AI</b>	Angvila	<b>CK</b>	Kukova ostrva	<b>GG</b>	Guernsey
<b>AL</b>	Albanija	<b>CL</b>	Čile	<b>GH</b>	Gana
<b>AM</b>	Armenija	<b>CM</b>	Kamerun	<b>GI</b>	Gibraltar
<b>AN</b>	Holandski Antili	<b>CN</b>	Kina	<b>GL</b>	Grenland
<b>AO</b>	Angola	<b>CO</b>	Kolumbija	<b>GM</b>	Gambija
<b>AP</b>	Afrička regionalna organizacija za industrijsko vlasništvo (ARIPO)	<b>CR</b>	Kostarika	<b>GN</b>	Gvineja
<b>AR</b>	Argentina	<b>CU</b>	Kuba	<b>GQ</b>	Ekvatorska Gvineja
<b>AT</b>	Austrija	<b>CV</b>	Kabo Verde	<b>GR</b>	Grčka
<b>AU</b>	Australija	<b>CY</b>	Kipar	<b>GS</b>	Južna Džordžija i Ostrva Južni Sendvič
<b>AW</b>	Aruba	<b>CZ</b>	Češka Republika	<b>GT</b>	Gvatemala
<b>AZ</b>	Azerbejdžan	<b>DE</b>	Njemačka	<b>GW</b>	Gvineja-Bisao
<b>BA</b>	Bosna i Hercegovina	<b>DJ</b>	Džibuti	<b>GY</b>	Gvajana
<b>BB</b>	Barbados	<b>DK</b>	Danska	<b>HK</b>	Hongkong – Posebna administrativna regija
<b>BD</b>	Bangladeš	<b>DM</b>	Dominika	<b>HN</b>	NR Kine Honduras
<b>BE</b>	Belgija	<b>DO</b>	Dominikanska Republika	<b>HR</b>	Hrvatska
<b>BF</b>	Burkina Faso	<b>DZ</b>	Alžir	<b>HT</b>	Haiti
<b>BG</b>	Bugarska	<b>EA</b>	Evroazijska patentna organizacija (EAPO)	<b>HU</b>	Mađarska
<b>BH</b>	Bahrein	<b>EC</b>	Ekvador	<b>IB</b>	Međunarodna kancelarija Svjetske organizacije za intelektualno vlasništvo (WIPO)
<b>BI</b>	Burundi	<b>EE</b>	Estonija	<b>ID</b>	Indonezija
<b>BJ</b>	Benin	<b>EG</b>	Egipat	<b>IE</b>	Irska
<b>BM</b>	Bermudi	<b>EH</b>	Zapadna Sahara	<b>IL</b>	Izrael
<b>BN</b>	Brunej Darussalam	<b>EM</b>	Kancelarija za harmonizaciju Unutrašnjeg tržišta (žigovi i dizajn) (OHIM)	<b>IM</b>	Ostrvo Man
<b>BO</b>	Bolivija	<b>EP</b>	Evropska patentna kancelarija (EPO)	<b>IN</b>	Indija
<b>BR</b>	Brazil	<b>ER</b>	Eritreja	<b>IQ</b>	Irak
<b>BS</b>	Bahami	<b>ES</b>	Španija	<b>IR</b>	Iran (Islamska Republika)
<b>BT</b>	Butan	<b>ET</b>	Etiopija	<b>IS</b>	Island
<b>BV</b>	Ostrvo Buve	<b>FI</b>	Finska	<b>IT</b>	Italija
<b>BW</b>	Bocvana	<b>FJ</b>	Fidži	<b>JE</b>	Džersi
<b>BX</b>	Kancelarija za intelektualno vlasništvo Beneluksa (BOIP)	<b>FK</b>	Foklandska ostrva (Malvini)	<b>JM</b>	Jamajka
<b>BY</b>	Bjelorusija	<b>FO</b>	Farska Ostrva	<b>JO</b>	Jordan
<b>BZ</b>	Belize	<b>FR</b>	Francuska		
<b>CA</b>	Kanada	<b>GA</b>	Gabon		
<b>CD</b>	Demokratska Republika Kongo				

<b>JP</b>	Japan	<b>NA</b>	Namibija	<b>SY</b>	Sirijska Arapska Republika
<b>KE</b>	Kenija	<b>NE</b>	Niger	<b>SZ</b>	Svazi
<b>KG</b>	Kirgistan	<b>NG</b>	Nigerija	<b>TC</b>	Turska i Kajkoska Ostrva
<b>KH</b>	Kambodža	<b>NI</b>	Nikaragva	<b>TD</b>	Čad
<b>KI</b>	Kiribati	<b>NL</b>	Holandija	<b>TG</b>	Togo
<b>KM</b>	Komori	<b>NO</b>	Norveška	<b>TH</b>	Tajland
<b>KN</b>	Sveti Kristofor i Nevis	<b>NP</b>	Nepal	<b>TJ</b>	Tadžikistan
<b>KP</b>	Demokratska Narodna Republika Koreja	<b>NR</b>	Nauru	<b>TL</b>	Istočni Timor
<b>KR</b>	Republika Koreja	<b>NZ</b>	Novi Zeland	<b>TM</b>	Turkmenistan
<b>KW</b>	Kuvajt	<b>OA</b>	Afrička organizacija za intelektualno vlasništvo (OAPI)	<b>TN</b>	Tunis
<b>KY</b>	Kajmanska Ostrva	<b>OM</b>	Oman	<b>TO</b>	Tonga
<b>KZ</b>	Kazahstan	<b>PA</b>	Panama	<b>TR</b>	Turska
<b>LA</b>	Narodna Demokratska Republika Laos	<b>PE</b>	Peru	<b>TT</b>	Trinidad i Tobago
<b>LB</b>	Libanon	<b>PG</b>	Papuanska Nova Gvineja	<b>TV</b>	Tuvalu
<b>LC</b>	Sveta Lucija	<b>PH</b>	Filipini	<b>TW</b>	Tajvan, Kineska Pokrajina
<b>LI</b>	Lihtenštajn	<b>PK</b>	Pakistan	<b>TZ</b>	Ujedinjena Republika Tanzanija
<b>LK</b>	Šri Lanka	<b>PL</b>	Poljska	<b>UA</b>	Ukrajina
<b>LR</b>	Liberija	<b>PT</b>	Portugal	<b>UG</b>	Uganda
<b>LS</b>	Lesoto	<b>PW</b>	Palau	<b>US</b>	Sjedinjene Američke Države
<b>LT</b>	Litva	<b>PY</b>	Paragvaj	<b>UY</b>	Urugvaj
<b>LU</b>	Luksemburg	<b>QA</b>	Katar	<b>UZ</b>	Uzbekistan
<b>LV</b>	Latvija	<b>QZ</b>	Kancelarija Zajednice za biljne sorte (Evropska Unija) (CPVO)	<b>VA</b>	Sveta Stolica (Vatikan)
<b>LY</b>	Libijska Arapska Džamahirija	<b>RO</b>	Rumunija	<b>VC</b>	Sveti Vincent i Grenadini
<b>MA</b>	Maroko	<b>RS</b>	Srbija	<b>VE</b>	Venecuela
<b>MC</b>	Monako	<b>RU</b>	Ruska Federacija	<b>VG</b>	Britanska Djevičanska Ostrva
<b>MD</b>	Republika Moldavija	<b>RW</b>	Ruanda	<b>VN</b>	Vijetnam
<b>ME</b>	Crna Gora	<b>SA</b>	Saudijska Arabija	<b>VU</b>	Vanuatu
<b>MG</b>	Madagaskar	<b>SB</b>	Solomonska Ostrva	<b>WO</b>	Svjetska organizacije za intelektualno vlasništvo (WIPO) (Međunarodna kancelarija)
<b>MK</b>	Bivša Jugoslovenska Republika Makedonija	<b>SC</b>	Sejšeli	<b>WS</b>	Samoa
<b>ML</b>	Mali	<b>SD</b>	Sudan	<b>XN</b>	Nordijski institut za patente (NPI)
<b>MM</b>	Mianmar	<b>SE</b>	Švedska	<b>YE</b>	Jemen
<b>MN</b>	Mongolija	<b>SG</b>	Singapur	<b>ZA</b>	Južnoafrička Republika
<b>MO</b>	Makao	<b>SH</b>	Sveta Jelena	<b>ZM</b>	Zambija
<b>MP</b>	Sjeverna Marijanska Ostrva	<b>SI</b>	Slovenija	<b>ZW</b>	Zimbabve
<b>MR</b>	Mauritanija	<b>SK</b>	Slovačka		
<b>MS</b>	Montserrat	<b>SL</b>	Sijera Leone		
<b>MT</b>	Malta	<b>SM</b>	San Marino		
<b>MU</b>	Mauricijus	<b>SN</b>	Senegal		
<b>MV</b>	Maldivi	<b>SO</b>	Somalija		
<b>MW</b>	Malavi	<b>SR</b>	Surinam		
<b>MX</b>	Meksiko	<b>ST</b>	Sveti Toma i Princip		
<b>MY</b>	Malezija	<b>SV</b>	Salvador		
<b>MZ</b>	Mozambik				



# PATENTI

## PATENTS

Službeni glasnik Zavoda za intelektualnu svojinu Crne Gore  
Official Gazette of the Montenegrin Intellectual Property Office

# 12/2013



Zavod za intelektualnu svojinu Crne Gore  
ul. Rimski trg br. 46,  
81000 Podgorica,  
Crna Gora





**MEĐUNARODNI KODOVI ZA IDENTIFIKACIJU BIBLIOGRAFSKIH PODATAKA O PATENTIMA PREMA WIPO STANDARDU ST. 9**  
**RECOMMENDATION CONCERNING BIBLIOGRAFIC DATA ON AND RELATING TO PATENTS- WIPO-ST. 9**

CRNOGORSKI	MDK	ENGLSKI
IDENTIFIKATOR DOKUMENTA	<b>10</b>	IDENTIFICATION OF THE PATENT
BROJ DOKUMENTA	<b>11</b>	NUMBER OF THE PATENT
VRST DOKUMENTA	<b>13</b>	KIND-OF-DOCUMENT CODE ACCORDING TO WIPO STANDARD
BROJ PRIJAVE	<b>21</b>	NUMBER(S) ASSIGNED TO THE APPLICATION(S)
DATUM PODNOŠENJA PRIJAVE	<b>22</b>	DATE(S) OF FILING THE APPLICATION(S)
DATUM IZLAGANJA NA MEĐUNARODNOJ IZLOŽBI	<b>23</b>	DATE OF EXHIBITING AT THE INTERNATIONAL EXHIBITION
PODACI O PRAVU PRVJENSTVA	<b>30</b>	PRIORITY DATA
DATUM OBJAVLJIVANJA PRIJAVE	<b>43</b>	PUBLICATION DATE OF THE UNEXAMINED APPLICATION
DATUM OBJAVLJIVANJA PATENTA	<b>45</b>	PUBLICATION DATE OF REGISTERED PATENT
MEĐUNARODNA KLASIFIKACIJA PATENATA	<b>51</b>	INTERNATIONAL PATENT CLASSIFICATION CODE
NAZIV PRONALASKA	<b>54</b>	TITLE OF THE INVENTION
APSTRAKT ILI PATENTNI ZAHTJEV	<b>57</b>	ABSTRACT OR CLAIM
BROJ OSNOVNE PRIJAVE (ILI PATENTA) ZA KOJI SE PODNOSI DOPUNSKA PRIJAVA	<b>61</b>	NUMBER OF THE EARLIER APPLICATION (OR PATENT) TO WHICH THE PRESENT DOCUMENT IS AN ADDITION
BROJ PRVOBITNE PRIJAVE IZ KOJE JE PRIJAVA IZDOJENA	<b>62</b>	NUMBER OF THE EARLIER APPLICATION FROM WHICH THE PRESENT DOCUMENT HAS BEEN DIVIDED UP
IME PODNOSIOCA PRIJAVE	<b>71</b>	NAME OF THE APPLICANT
IME PRONALAZAČA	<b>72</b>	NAME OF THE INVENTOR
IME NOSIOCA PATENTA	<b>73</b>	NAME OF THE OWNER OF PATENT
IME PUNOMOĆNIKA	<b>74</b>	NAME OF THE REPRESENTATIVE
BROJ I DATUM PODNOŠENJA MEĐUNARODNE PRIJAVE	<b>86</b>	NUMBER AND FILING DATE OF THE INTERNATIONAL APPLICATION
BROJ I DATUM MEĐUNARODNE OBJAVE	<b>87</b>	NUMBER AND DATE OF THE PUBLICATION OF THE INTERNATIONAL APPLICATION

VRSTA DOKUMENTA		TYPES OF DOCUMENTS
OBJAVA PRIJAVA PATENATA	<b>A</b>	PUBLICATION OF PATENT APPLICATIONS
REGISTROVANI PATENTI	<b>B</b>	REGISTERED PATENTS



**OBAVJEŠTENJE**  
NOTICE

Obavještavamo korisnike da se od 6-og broja Crnogorskog glasnika za intelektualnu svojinu koji se objavljuje na web stranici Zavoda za intelektualnu svojinu Crne Gore, u elektronskoj formi, odnosno od 10.10.2011 godine (Glasnik broj 6/2011) uvode promjene u objavi patentnih dokumenata.

Tako, objavljena prijava patenta (dokument A) sadrži i broj pod kojim je patent upisan u Registar patenata, (međunarodni kod 11 – broj dokumenta), koji je do sada bio objavljivan u svakom narednom broju Crnogorskog glasnika za intelektualnu svojinu. Kako Zavoda za intelektualnu svojinu Crne Gore, ispituje samo formalne uslove za priznavanje patenta, izmjenu uvodimo da bi svi podaci o priznatom patentu bili u istom broju Crnogorskog glasnika za intelektualnu svojinu, a ujedno i pojednostavili put do dodjele isprave, sve u skladu sa članom 40 Zakona o patenima ("Sl. list CG" broj 66/2008 i 40/2010).



(51) **A61K 39/04**(11) **01250**(13) **A**

(21) P-2010-62

(22) 09.10.2008.

(30) 60/979,822 13.10.2007. US

61/094,552 05.09.2008. US

(86) PCT/US2008/079425 09.10.2008.

(87) WO 2009/049097 16.04.2009.

(54) **(ME) SMJEŠEZA PODSTICANJE IMUNOG ODGOVORA PREMA MYCOBACTERIUM AVIUM SUBSPECIES PARATUBERCULOSIS**

(EN) COMPOSITIONS FOR ELICITING AN IMMUNE RESPONSE AGAINST MYCOBACTERIUM AVIUM SUBSPECIES PARATUBERCULOSIS

(73) CORNELL UNIVERSITY, 395 Pine Tree Road, Suite 310 Ithaca, NY 14850 (US)

(72) CHANG, Yung-Fu; 204 Christopher Lane Ithaca, NY 14850 (US)

(74) Čejović Vladimir, 13. jula 21, Podgorica (ME)

(57) Ovim pronalaskom obezbjeđene su smješe i postupci za stimulisanje imunog odgovora prema Mycobacterium avium subspecies paratuberculosis (MAP). Smješe obuhvataju rekombinantni polipeptid koji od svog N-kraja do svog C-kraja sadrži : C-terminalni fragment MAP proteina Map3527. amino kiselinsku sekvencu Map1519 proteina, a zatim slijedi N-terminalni dio Map3527. Postupak obuhvata primjenjivanje smješe životinji u količini efektivnoj da stimuliše imunoloski odgovor prema MAP bakteriji. Postupak je koristan za svaku životinju koja je osjetljiva na infekciju MAP, ali je naročito koristan za preživare.

Figure 1A



- (51) **C07D 213/61**  
**C07D 213/89**  
**A61K 31/44**  
**A61P 11/00**

- (11) **01243**  
 (13) **A**

- (21) P-2011-150  
 (22) 04.02.2010.  
 (30) 09001660.1 06.02.2009. EP  
 (86) PCT/EP2010/000676 04.02.2010.  
 (87) WO 2010/089107 12.08.2010.

(54) (ME) **(1-FENIL-2-PIRIDIN-4-IL) ETIL ESTRI BENZOVE KISJELINE KAO INHIBITORI FOSFODIESTERAZE**

(EN) BENZOIC ACID (1-PHENYL-2-PYRIDIN-4-YL) ETHYL ESTERS AS PHOSPHODIESTERASE INHIBITORS

(73) CHIESI FARMACEUTICI S.P.A.; Via Palermo, 26/A I-43100 Parma (IT)

(72) AMARI, Gabriele; Via Palermo, 26/A I-43100 Parma (IT)

ARMANI, Elisabetta; Via Palermo, 26/A I-43100 Parma (IT)

DELCANALE, Maurizio; Via Palermo, 26/A I-43100 Parma (IT)

(74) Radulović Božidar, Jovana Tomaševića 9/III, Podgorica (ME)

- (57) Predmetni pronalazak odnosi se na inhibitore enzima fosfodiesteraze 4 (PDE 4). Preciznije, predmetni pronalazak odnosi se na jedinjenja koja su derivati fenil-2-piridinil alkil alkohola, postupke za dobijanje takvih jedinjenja, preparate koji ih sadrže, kombinacije takvih jedinjenja i njihove terapeutske upotrebe (I), gdje je n = 0 ili 1; R1 i R2 mogu da budu isti ili različiti, a izabrani su iz grupe koja se sastoji od: linearnih i račvastih C<sub>1</sub>-C<sub>6</sub> alkil grupa; OR3 gdje je R3 C<sub>1</sub>-C<sub>6</sub> alkil grupa opciono supstituisana jednom ili većim brojem C<sub>3</sub>-C<sub>7</sub> cikoalkil grupa: i -HNSO<sub>4</sub>R4 gdje je R4 C<sub>1</sub>-C<sub>4</sub> alkil grupa opciono supstituisana jednim ili većim brojem halogenih atoma ili C1-C4 alkil grupom, gdje je najmanje jedan od R1 i R2 HNSO<sub>4</sub>R4. Druge promjenljive imaju značenje delnisanano u patentnim zahtjevima.

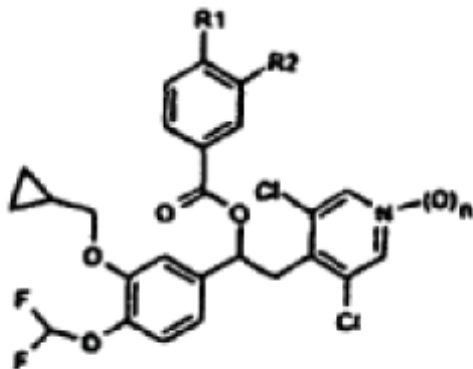

(I)

(51) **F03B 17/00**

(11) **01247**

(13) **A**

(21) P-2011-152

(22) 19.01.2010.

(30) 1200900059 13.02.2009. OA

(86) PCT/OA2010/000001 19.01.2010.

(87) WO 2010/093267 19.08.2010.

(54) **(ME) SISTEM ZA PUMPANJE I METOD**

**(EN) PUMPING SYSTEM AND METHOD**

(73) DJERASSEM, Le Bemadjiel; BP: 5413 N'Djamena (TD)

(72) DJERASSEM, Le Bemadjiel; BP: 5413 N'Djamena (TD)

(74) Ćupić Branislav, Dalmatinska 10, Podgorica (ME)

(57) Ovaj pronalazak se odnosi na metode i sisteme za pumpanje ili prenos fluida i za kontinuiranu i autonomnu proizvodnju energije. On je sačinjen od zatvorenih termodinamičkih sistema raspoređenih u serijama. Pronalazak se zasniva na otkriću principa autonomnog serijskog pritiskivanja/depresije i kompresije. To je širenje nekog gasa koje snabdijeva rad neophodan za pumpanje ili prenos tečnosti iz jednog pregratka u drugi.

- (51) **C12P 7/64**  
**C12N 5/04**  
**C12N 5/02**
- (11) **01242**  
(13) **A**
- (21) P-2011-154  
(22) 19.11.2009.  
(30) 09-040167 21.04.2009. CO  
(86) PCT/IB2009/007517 19.11.2009.  
(87) WO 2010/122372 28.10.2010.
- (54) (ME) **POSTUPAK ZA MULTIPLIKACIJU ĆELIJSKOG TKIVA JATROPHA CURCAS**  
(EN) METHOD FOR CELLULAR TISSUE MULTIPLICATION FROM JATROPHA CURCAS
- (73) 1. EMPRESAS PÚBLICAS DE MEDELLIN E.S.P.; Carrera 58 N° 42-125 Edificio Inteligente Sotano, 2 Medellin (CO)  
2. UNIVERSIDAD DE ANTIOQUIA ; Calle 67 Número 53-108 Medellin (CO)
- (72) ATEHORTUA GARCES, Lucia; Calle 17 No. 40 B-76 Apto 215 Medellín Antioquia (CO)  
CORREA CORDOBA, Sandra, Marcela; Carrera 18B No. 11-21 Girardota Antioquia (CO)
- (74) Popović Miladin, Đoka Miraševića 21/III, Podgorica (ME)
- (57) Metoda iz predočenog pronalaska podrazumijeva: Dobijanje eksplanta iz sjemena *Jatropha curcas*; postavljanje eksplanta izvedenog iz sjemena *Jatropha curcas* u kultivacioni medijum; raskidanje intercelularnih veza u tkivu eksplanta gdje eksplanti generišu pojedinačne ćelije; inkubiranje kultivacionog medijuma tokom određenog vremena sa generisanim pojedinačnim ćelijama koje su umnožene; i, ekstrakciju ulja iz ćelija koje su umnožene od pojedinačnih ćelija izdvojenih iz eksplanta izvedenih iz sjemena *Jatropha curcas*.



(51) C02F 1/68

(11) 01249

(13) A

(21) P-2012-5

(22) 18.01.2012.

(30) 61/469,548 30.03.2011. (US)

13/136,458 01.08.2011. (US)

(54) (ME) **ODRŽIVI LOW-COST METOD I SISTEM ZA PREČIŠĆAVANJE VODENIH TIJELA ZAGAĐENIH BAKTERIJAMA I MIKROALGAMA**

(EN) SUSTAINABLE METHOD AND SYSTEM FOR TREATING WATER BODIES AFFECTED BY BACTERIA AND MICROALGAE AT LOW COST

(73) CRYSTAL LAGOONS CORPORATION LLC; A corporation organized under the laws of Delaware, Domiciled at 1692 Coastal Highway, Lewes, Delaware (US)

(72) FISCHMANN, T., Fernando; Avenida Kennedy 8830 Vitacura, Santiago (CL)

(74) ADVOKATSKA KANCELARIJA "VUJAČIĆ", Radoičić Radmila, Moskovska 93, Podgorica (ME)

(57) Izložen je održivi low-cost metod za prečišćavanje i održavanje vodenih tijela za rekreativnu upotrebu sa malom gustinom. Sistem ovog pronalaska generalno obuhvata najmanje jedan bazen, najmanje jedan koordinacioni uređaj, najmanje jedno sredstvo za aplikaciju hemikalija, najmanje jedno neintruzivno mobilno usisno sredstvo i najmanje jedan filtracioni uređaj. Koordinacioni uređaj može primati informacije u vezi parametara kvaliteta vode koji se kontrolišu, i može vremenski aktivirati procese neophodne za usklađivanje parametara kvaliteta vode u okviru njihovih određenih granica. Objavljeni metodi i sistem filtriraju samo malu frakciju ukupne mase vode, do 200 puta manje na dan od količine koju filtriraju konvencionalni filtracioni sistemi bazena za plivanje. Izloženi metodi i sistem takođe koriste manje hemikalija, do 200 puta manje nego kod konvencionalnih sistema za prečišćavanje vode bazena za plivanje. Metodi i sistem ovog pronalaska mogu se koristiti za prečišćavanje rekreativnih vodenih tijela zagađenih bakterijama i mikroalgama i pružaju održive metode za proizvodnju vode koja zadovoljava bakteriološke i fizičko-hemijske uslove za rekreacione vode, kao što propisuju državne regulatorne agencije kao što je EPA - Agencija za zaštitu čovjekove okoline, za kupanje pri punom tjelesnom kontaktu.

Figure 1

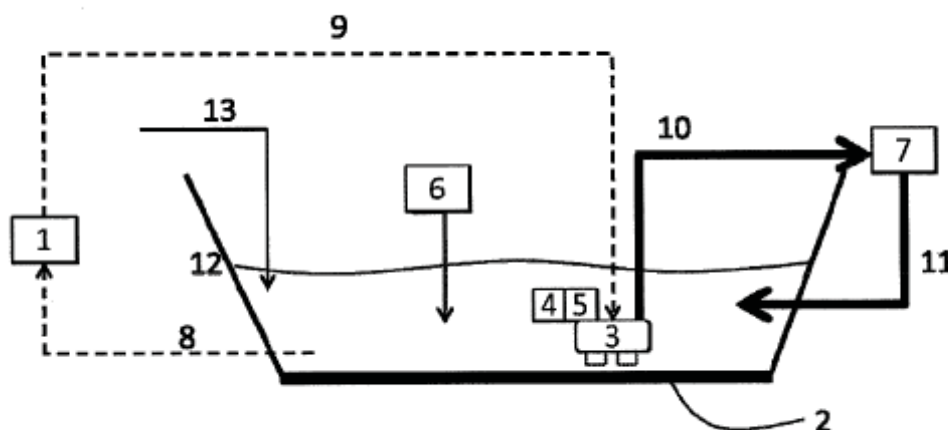

(51) **C07D 493/10** (11) **01285**  
**A61K 31/357** (13) **A**  
**A61P 3/10**  
**C07H 15/18**

(21) P-2011-45

(22) 17.08.2009

(30) 61/092,470 28.08.2008 US

61/227,212 21.07.2009 US

(86) PCT/IB2009/053626 17.08.2009

(87) WO/2010/023594 04.03.2010

(54) (ME) **DERIVATI DIOKSA-BICIKL(3.2.1.)OKTAN-2,3,4-TRIOLA**

(EN) **DIOXA-BICYCLO[3.2.1.]OCTANE-2,3,4-TRIOL DERIVATIVES**

(73) PFIZER INC.; 235 East 42nd Street New York, New York 10017 (US)

(72) MASCITTI, Vincent; Pfizer Global Research and Development Eastern Point Road Groton, Connecticut 06340 (US)

COLLMAN, Benjamin, Micah; Pfizer Global Research and Development Eastern Point Road Groton, Connecticut 06340 (US)

(74) Čupić Branislav, Dalmatinska 10, Podgorica (ME)

(57) Opisana su jedinjenja formule (I) i njihove upotrebe i njihove upotrebe za tretman bolesti, stanja i/ili poremećaja posredovanih inhibitorima transportera natijuma-glukoz (naročito inhibitorima SGLT2).

**FIG. 9**

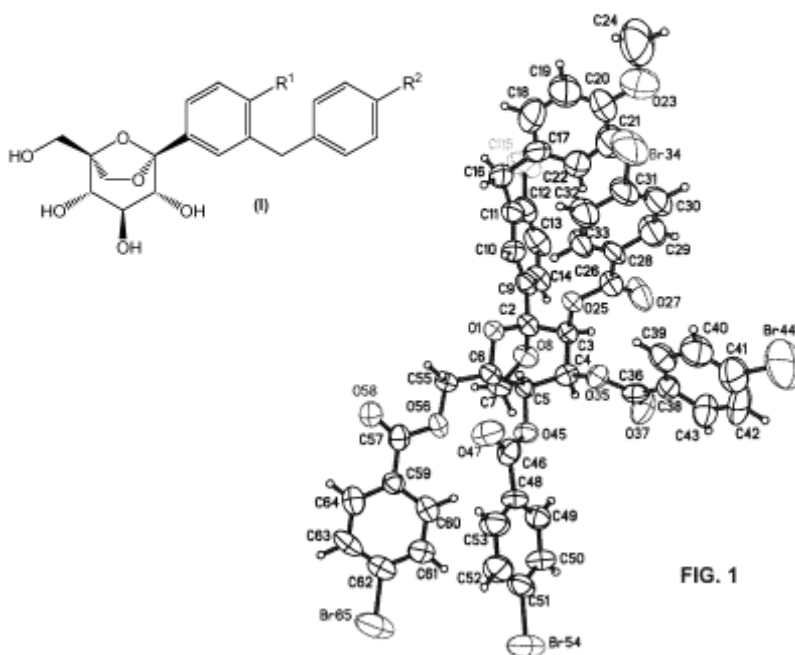
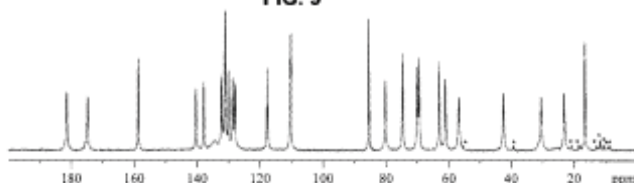

**FIG. 1**

- (51) **C07D 249/12** (11) **01294**
- C07D 235/28** (13) **A**
- (21) P-2010-100
- (22) 26.11.2008
- (30) 60/990,574 27.11.2007 US
- 61/094,388 04.09.2008 US
- (86) PCT/US2008/084988 26.11.2008
- (87) WO/2009/070740 04.06.2009
- (54) (ME) **NOVA JEDINJENJA I KOMPOZICIJE I METODE UPOTREBE**  
(EN) **NOVEL COMPOUNDS AND COMPOSITIONS AND METHODS OF USE**
- (73) ARDEA BIOSCIENCES INC.; 4939 Directors Place, San Diego, California 92121 (US)
- (72) QUART, Barry D.; 3273 Violet Ridge Encinitas, California 92024 (US)
- GIRARDET, Jean-luc; 16763 Santa Corina Court San Diego, California 92127 (US)
- GUNIC, Esmir; 8952 Capcano Road San Diego, California 92129 (US)
- YEH, Li-Tain; 6 Dos Rios Irvine, California 92602 (US)
- (74) Kojić Ivana, Serdara Jola Piletića bb, Podgorica, ME
- (57) Ovde su opisana jedinjenja korisna pri modulaciji nivoa urinske kiseline u krvi, formulacije koje ih sadrže i metode koje ih primjenjuju. U nekim oblicima, ovde opisana jedinjenja se upotrebljavaju u liječenju ili prevenciji poremećaja vezanih za neuobičajene nivoe urinske kiseline.

FIGURE 1  
Serum uric acid (mg/dL) levels 0, 3, 7 and 14 days after administering 4-(2-(5-bromo-4-(4-cyclopropyl-naphthalen-1-yl)-4H-1,2,4-triazol-3-ylthio)acetamido)-3-chlorobenzoic acid, potassium salt in humans at doses of 300mg, 400mg or 500mg b.i.d.

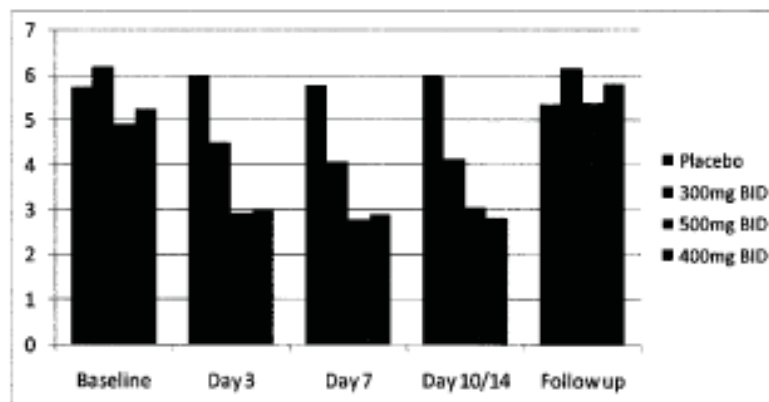

(51) **A47B 97/08**

**A47C 17/54**

(21) P-2010-186

(22) 03.11.2010.

(54) (ME) **PLAFONSKI KREVET**

(EN) BED ON THE CEILING

(73) Vujković Dejan, Dobrota, Kotor, (ME)

(72) Vujković Dejan, Dobrota bb, Kotor, (ME)

(57) Pronalazak se odnosi na samo pričvršćivanje metalne konstrukcije kreveta na plafon ili naslanjanje djelova na vrh plakara zbog iskorišćenosti prostora koji je u toku dana Slobodan a noću iskorišten za spavanje.

(11) **01276**

(13) **A**

- (51) **C07K 16/28** (11) **01281**  
(13) **A**
- (21) P-2010-215  
(22) 23.12.1999  
(30) 60/113,647 23.12.1998 US  
(86) PCT/US1999/030895 23.12.1999  
(87) WO/2000/037504 29.06.2000
- (54) (ME) **HUMANA MONOKLONALNA ANTITIJELA ZA CTLA-4**  
(EN) HUMAN MONOCLONAL ANTIBODIES TO CTLA-4
- (73) PFIZER INC. [US/US]; 235 East 42nd Street, New York, NY 10017 (US) (For All Designated States Except US).; AMGEN FREMONT INC., 6701 KAISER DRIVE, FREMONT, CA 94555, US
- (72) HANSON, Douglas, Charles; 3 Acorn Drive Niantic, CT 06357 (US)  
NEVEU, Mark, Joseph; 18 Greenbriar Court Mystic, CT 06355 (US)  
MUELLER, Eileen, Elliot; 4 Butterwick Lane Old Lyme, CT 06371 (US)  
HANKE, Jeffrey, Herbert; 1 Jefferson Circle Reading, MA 01867 (US)  
GILMAN, Steven, Christopher; 118 Sill Lane Old Lyme, CT 06371 (US)  
DAVIS, C., Geoffrey; 1132 Vancouver Avenue Burlingame, CA 94010 (US)  
CORVALAN, Jose, Ramon; 125 Williams Lane Foster City, CA 94404 (US)
- (74) Ćupić Branislav, Dalmatinska 10, Podgorica (ME)
- (57) U saglasnosti sa ovim pronalaskom, obezbjeđena su potpuna humana monoklonalna antitela protiv humanog citotoksičnog T<sup>~</sup> limfocitnog antigena 4 (CTLA-4). Nukleotidne sekvence koje kodiraju i amino kiselinske sekvence koje obuhvataju teških i lakih lanaca imunoglobulin molekule, naročito susjodne teških i lakih lanaca sekvence koje se protežu preko komple-mentarnih određujućih regiona (CDRs), specifično od unutar FR1 i/ili CDR1 do CDR3 i/ili unutar FR4 su ovime obezbijedjeni. Dalje su obezbijedjena antitela koja imaju slične oso-bine vezivanja i antitela (ili drugi antaonisti) koji imaju slične funkcionalnosti kao antitela opisana ovde.

(51) **C07D 213/75**  
**A61K 31/44**  
**A61P 29/00**

(11) **01272**  
 (13) **A**

(21) P-2010-221

(22) 14.07.2009

(30) 61/084,095 28.07.2008 US

(86) PCT/IB2009/053044 14.07.2009

(87) WO/2010/013158 04.02.2010

(54) (ME) **JEDINJENJA FENANTRENONA, KOMPOZICIJE I POSTUPCI**  
 (EN) PHENANTHRENONE COMPOUNDS, COMPOSITIONS AND METHODS

(73) PFIZER INC.; 235 East 42nd Street New York, New York 10017

(72) RUCKER, Paul Vincent; 4307 Sierra Morena Avenue Carlsbad, California 92010 (US)

(74) Ćupić Branislav, Dalmatinska 10, Podgorica (ME)

(57) Ovaj pronalazak se odnosi na jedinjenja Formule I: ili njihove sole, koje su modulatori glulukokortikoidnog recept. Jedinjenj i soli iz pronalazak su korisna u tretmanu stanja prouzrokovanih aktivnošću glulukokortikoidnihreceptora.

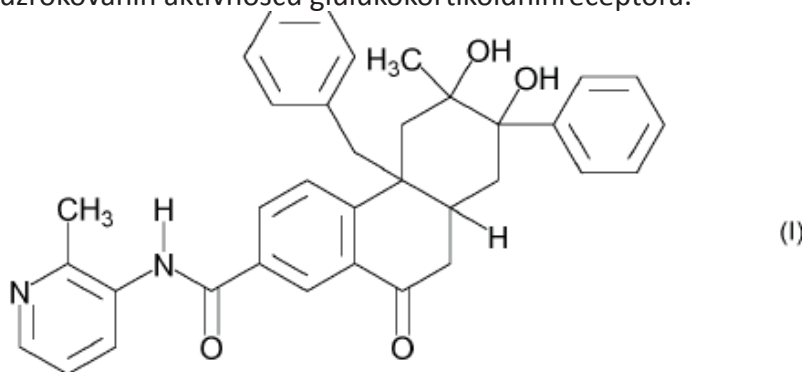

- (51) **C07D 401/12**  
**A61K 31/501**  
**A61K 31/506**  
**A61P 35/00**  
**C07D 401/14**  
**C07D 403/12**  
**C07D 413/14**  
**C07D 471/04**
- (11) **01290**  
(13) **A**
- (21) P-2011-6  
(22) 16.07.2009  
(30) 61/081,900 18.07.2008 US  
(86) PCT/EP2009/059138 16.07.2009  
(87) WO/2010/007120 21.01.2010
- (54) (ME) **DERIVATI PIRIDAZINA KAO INHIBITORI AKTIVNOSTI SMO**  
(EN) PYRIDAZINE DERIVATIVES AS SMO INHIBITORS
- (73) NOVARTIS AG; Lichtstrasse 35 CH-4056 Basel (CH)
- (72) HE, Feng; China Novartis Institutes for BioMedical Research Co., Ltd. No. 8 Building Lane 898 Halei Road Zhangjiang Hi-Tech Park, Pudong New Area Shanghai 201203 (CN)  
PEUKERT, Stefan; Novartis Institutes for BioMedical Research, Inc. 250 Massachusetts Avenue Cambridge, Massachusetts 02139 (US)  
MILLER-MOSLIN, Karen; Novartis Institutes for BioMedical Research, Inc. 250 Massachusetts Avenue Cambridge, Massachusetts 02139 (US)  
YUSUFF, Naeem; Novartis Institutes for BioMedical Research, Inc. 250 Massachusetts Avenue Cambridge, Massachusetts 02139 (US)  
CHEN, Zhuoliang; Novartis Institutes for BioMedical Research, Inc. 250 Massachusetts Avenue Cambridge, Massachusetts 02139 (US)  
LAGU, Bharat; Novartis Institutes for BioMedical Research, Inc. 250 Massachusetts Avenue Cambridge, Massachusetts 02139 (US)
- (74) Čejović Vladimir, 13. jula 21, Podgorica (ME)
- (57) Ovaj pronalazak se, u širem smislu, odnosi na nova jedinjenja koja su povezana sa dijagnostikom i liječenjem patologija u čijoj se osnovi nalazi Hedgehog signalni put, kao što su između ostalog, formiranje tumora, kanceri, neoplazije i nemaligni hiperproliferativni poremećaji. Ovaj pronalazak opisuje nova jedinjenja, nove kompozicije, postupke za njihovu upotrebu, kao i postupke za njihovo dobijanje, gdje takva jedinjenja imaju farmakološku upotrebu, kao terapijska sredstva čiji mehanizmi delovanja uključuju postupke za inhibiciju tumorogeneze, rasta tumora i preživljavanja tumora, korišćenjem sredstava koji inhibiraju Hedgehog i Smo signalne puteve.

- (51) **A61K 31/343** (11) **01280**  
**A61K 9/28** (13) **A**  
**A61P 9/10**
- (21) P-2011-19  
(22) 03.08.2009  
(30) 08290761.9 07.08.2008 EP  
61/087,803 11.08.2008 US  
(86) PCT/IB2009/006831 03.08.2009  
(87) WO/2010/015939 11.02.2010
- (54) (ME) **UPOTREBA DRONEDARONA ZA IZRADU MEDIKAMENTA ZA PREVENCIJU ŠLOGA ILI PROLAZNOG ISHEMIČNOG NAPADA**  
(EN) USE OF DRONEDARONE FOR THE PREPARATION OF A MEDICAMENT FOR THE PREVENTION OF STROKE OR TRANSIENT ISCHEMIC ATTACK
- (73) SANOFI-AVENTIS; 174 Avenue de France F-75013 Paris (FR)  
(72) GAUDIN, Christophe; c/o Sanofi-Aventis Patent Department 174 avenue de France F-75013 Paris (FR)  
HAMDANI, Nacéra; c/o Sanofi-Aventis Patent Department 174 avenue de France F-75013 Paris (FR)  
RADZIK, Davide; c/o Sanofi-Aventis Patent Department 174 avenue de France F-75013 Paris (FR)  
VAN EICKELS, Martin; C/o Sanofi-aventis Deutschland GmbH 65926 Frankfurt (DE)
- (74) Ćupić Branislav, Dalmatinska 10, Podgorica (ME)  
(57) Upotreba dronedarona za izradu medikamenta za prevenciju šloga ili prolaznog ishemičnog napada.



(51) **C07D 417/14** (11) **01284**  
**A61K 31/4439** (13) **A**  
**A61P 35/00**

(21) P-2011-21

(22) 08.09.2009

(30) 08164104.5 10.09.2008 EP

61/096,674 12.09.2008 US

(86) PCT/EP2009/061644 08.09.2009

(87) WO/2010/029082 18.03.2010

(54) (ME) **ORGANSKA JEDINJENJA**

(EN) ORGANIC COMPOUNDS

(73) NOVARTIS AG; Lichtstrasse 35 CH-4056 Basel (CH)

(72) CARAVATTI, Giorgio; Novartis Pharma AG Werk Klybeck Postfach CH-4002 Basel (CH)

FAIRHURST, Robin Alec; Novartis Horsham Research Centre Wimblehurst Road Horsham Sussex RH12 5AB (GB)

FURET, Pascal; Novartis Pharma AG Werk Klybeck Postfach CH-4002 Basel (CH)

GUAGNANO, Vito; Novartis Pharma AG Werk Klybeck Postfach CH-4002 Basel (CH)

IMBACH, Patricia; Novartis Pharma AG Werk Klybeck Postfach CH-4002 Basel (CH)

(74) Čejović Vladimir, 13. jula 21, Podgorica (ME)

(57) Dati pronalazak odnosi se na jedinjenje (I) ili njegovu so, gdje su supstituenti definisani u opisu, na kompozicije i na upotrebu jedinjenja u liječenju oboljenja koje se može poboljšati inhibiranjem fosfatidilinozitol 3-kinasa.

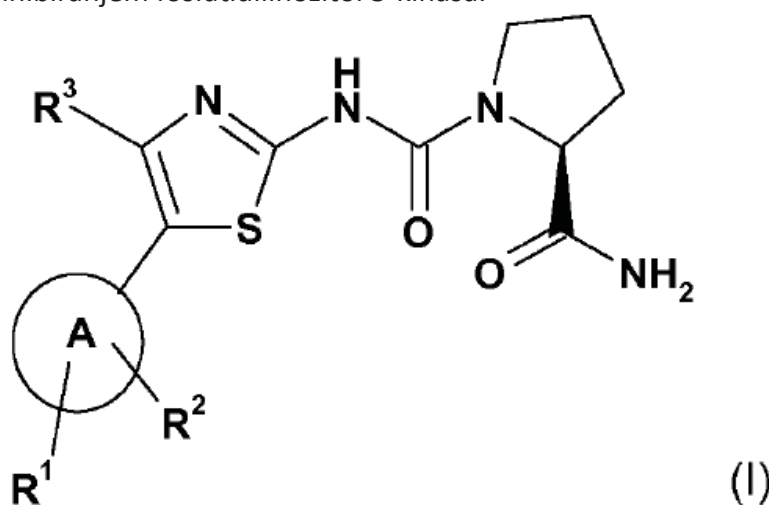

- (51) **C07D 487/04**  
**A61K 31/519**  
**A61P 37/00**
- (11) **01269**  
(13) **A**
- (21) P-2011-22  
(22) 10.08.2009.  
(30) 61/090,371 20.08.2008 US  
(86) PCT/IB2009/053514 10.08.2009.  
(87) WO/2010/020905 25.02.2010
- (54) (ME) **JEDINJENJA PIROLO (2,3-D) PIRIMIDINA**  
(EN) PYRROLO[2,3-D]PYRIMIDINE COMPOUNDS
- (73) Zoetis LLC; 100 Campus Drive, Florham Park, New Jersey 07932, US
- (72) BERLINSKI, Pamela Jo; Pfizer Global Research and Development 7000 Portage Road Kalamazoo, MI 49001 (US)  
BIRCHMEIER, Matthew Joseph; Pfizer Global Research and Development 7000 Portage Road Kalamazoo, MI 49001 (US)  
BOWMAN, Jerry Wayne; Pfizer Global Research and Development 7000 Portage Road Kalamazoo, MI 49001 (US)  
GONZALES, Andrea Joy; Pfizer Global Research and Development 7000 Portage Road Kalamazoo, MI 49001 (US)  
KAMERLING, Steven Glenn; Pfizer Global Research and Development 7000 Portage Road Kalamazoo, MI 49001 (US)  
MANN, Donald Wayne; Pfizer Global Research and Development 50 Pequot Avenue New London, CT 06320 (US)  
MITTON-FRY, Mark Joseph; Pfizer Global Research and Development Eastern Point Road Groton, CT 06340 (US)
- (74) Ćupić Branislav, Dalmatinska 10, Podgorica (ME)
- (57) Ovde su opisana jedinjenja pirolo{2,3-d}pirimidina, njihova upotreba kao inhibitora Janus Kinaze (JAK), farmaceutske kompozicije koje sadrže ova jedinjenja i postupke za dobijanje ovih jedinjenja.

- (51) **C12N 7/08** (11) **01270**  
**A61K 39/215** (13) **A**
- (21) P-2011-23  
 (22) 07.08.2009.  
 (30) 61/087,228 08.08.2008 US  
 (86) PCT/US2009/053085 07.08.2009.  
 (87) WO/2010/017440 11.02.2010
- (54) (ME) **CJEPIVA PROTIV ZARAZNOG BRONHITISA DOBIVENA IZ SOJEVA VIRUSA SLIČNOG IB-QX**  
 (EN) INFECTIOUS BRONCHITIS VACCINES DERIVED FROM IB-QX-LIKE STRAINS
- (73) Zoetis W LLC; 100 Campus Drive, Florham Park, New Jersey 07932, US  
 (72) GEERLIGS, Harmen, Jacob; R. Van Rijnstraat 111 NL-1382 AR Weesp (NL)  
 MEINDERS, Cindy, Aleida, Maria; Hartekruidpad 7 NL-1313 JJ Almere (NL)  
 BOELM, Geert, Jan; Hoflaan 37 NL-6715 AG Ede (NL)  
 STUURMAN, Bastiana, Geertruida, Elisabeth; Kaukasusstraat 8 NL-3446 DJ Woerden (NL)
- (74) Čupić Branislav, Dalmatinska 10, Podgorica (ME)
- (57) Ovaj izum odnosi se na viruse koji uzrokuju zarazni bronhitis (IB), dobijene iz nedavno identifikiranog genotipa virusa IB, poznatog kao IB-QX, ili na viruse genetski srodne IB-QX, koje se u ovoj specifikaciji navodi kao viruse slične IB-QX. Virusi IB prema ovom izumu mogu biti živi i atenuirani ili inaktivirani. Zive, atenuirane viruse IB prema ovom izumu može se dobiti serijskim pasažama virusa sličnih IB-QX. Viruse IB prema ovom izumu može se, između ostalog, upotrijebiti za cijepljenje protiv virusa IB-QX i virusa sličnih IB-QX. Do sada su se poznati cjepivni sojevi virusa IB pokazali kao nedjelotvorni u zaštiti protiv zaraznog bronhitisa kojeg uzrokuju virus IB-QX i virusi slični IB-QX.

(51) **C07D 453/02**  
**A61K 31/439**  
**A61P 11/00**

(11) **01283**

(13) **A**

(21) P-2011-24

(22) 21.07.2009.

(30) 08162066.8 08.08.2008 EP

(86) PCT/EP2009/005272 21.07.2009.

(87) WO/2010/015324 11.02.2010

(54) (ME) **DERIVATI KVINUKLIDIN KARBONATA I NJHOVI LJEKOVITI PREPARATI**  
(EN) QUINUCLIDINE CARBONATE DERIVATIVES AND MEDICINAL COMPOSITION THEREOF

(73) CHIESI FARMACEUTICI S.P.A.; Via Palermo, 26/A I-43100 Parma (IT)

(72) AMARI, Gabriele; Via Palermo, 26/A I-43100 Parma (IT)

DELCANALE, Maurizio; Via Palermo 26/A I-43100 Parma (IT)

(74) Radulović Božidar, Jovana Tomaševića 9/III, Podgorica (ME)

(57) Predmetni pronalazak se odnosi na derivate kvinuklidin karbonata, koji djeluju kao antagonist muskarinskog receptora. na postupke za dobijanje takvih derivata, na preparate koji ih sadrže i na terapijsku primjenu takvih preparata.

- (51) **C07D 487/04** (11) **01282**  
**A61K 31/519** (13) **A**  
**A61P 35/00**
- (21) P-2011-25  
(22) 20.08.2009  
(30) 61/091,037 22.08.2008 US  
(86) PCT/EP2009/060793 20.08.2009  
(87) WO/2010/020675 25.02.2010
- (54) (ME) **JEDINJENJA PIROLOPIRIMIDINA KAO INHIBITORI CDK**  
(EN) **PYRROLOPYRIMIDINE COMPOUNDS AS CDK INHIBITORS**
- (73) NOVARTIS AG, Lichtstrasse 35 CH-4056 Basel (CH)  
(72) ASTEX THERAPEUTICS, 436 Cambridge Science Park Milton Road Cambridge CB4 0QA (GB)  
(74) BESONG, Gilbert; Astex Therapeutics Ltd. 436 Cambridge Science Park Milton Road Cambridge CB4 0QA (GB)  
BRAIN, Christopher Thomas; Novartis Institutes for BioMedical Research, Inc. 250 Massachusetts Avenue Cambridge, Massachusetts 02139 (US)  
BROOKS, Clinton A.; 3274 Ridgecrest Rd. Smyrna, Georgia 30080 (US)  
CONGREVE, Miles Stuart; 11A Orchard Road Melbourn Royston SG8 6HL (GB)  
DAGOSTIN, Claudio; 1 Hillfield Road Comberton CB23 7DB (GB)  
HE, Guo; Novartis Institutes for BioMedical Research, Inc. 250 Massachusetts Avenue Cambridge, Massachusetts 02139 (US)  
HOU, Ying; Novartis Institutes for BioMedical Research, Inc. 250 Massachusetts Avenue Cambridge, Massachusetts 02139 (US)  
HOWARD, Steven; Astex Therapeutics Ltd. 436 Cambridge Science Park Milton Road Cambridge CB4 0QA (GB)  
LI, Yue; China Novartis Institutes for BioMedical Research Co., Ltd. No. 8 Building Lane 898 Halei Road Zhangjiang Hi-Tech Park, Pudong New Area Shanghai, 201203 (CN)  
LU, Yipin; Novartis Institutes for BioMedical Research, Inc. 400 Technology Square Cambridge, Massachusetts 02139 (US)  
MORTENSON, Paul; Astex Therapeutics Ltd. 436 Cambridge Science Park Milton Road Cambridge CB4 0QA (GB)  
SMITH, Troy; Novartis Institutes for BioMedical Research, Inc. 250 Massachusetts Avenue Cambridge, Massachusetts 02139 (US)  
SUNG, Moo; Novartis Institutes for BioMedical Research, Inc. 250 Massachusetts Avenue Cambridge, Massachusetts 02139 (US)  
WOODHEAD, Steven; Astex Therapeutics Ltd. 436 Cambridge Science Park Milton Road Cambridge CB4 0QA (GB)  
WRONA, Wojciech; Novartis Institutes for BioMedical Research, Inc. 250 Massachusetts Avenue Cambridge, Massachusetts 02139 (US)
- (74) Čejović Vladimir, 13. jula 21, Podgorica (ME)
- (57) Prikazana jedinjenja se odnose na liječenja i terapije poremećaja povezanih sa protein kinazom. Takođe postoji potreba za jedinjenjima koja se mogu koristiti za liječenje ili prevenciju ili poboljšanje jednog ili više simptoma kancera, odbacivanja transplantata, i autoimunih bolesti. Osim toga, postoji potreba za metodama za moduliranje aktivnosti protein kinaza, kao što su CDK1, CDK2, CDK4, CDK5, CDK6, CDK7, CDK8 i CDK9, primjenom jedinjenja koja su ovde data.

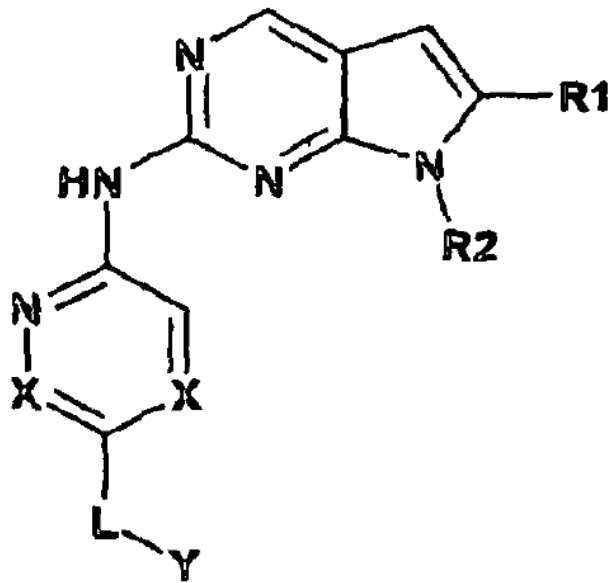

(51) **A61K 39/39**

(13) **01271**

(21) **A**

(22) P-2011-33

(30) 2008904261 19.08.2008 AU

61/092,091 27.08.2008 US

(86) PCT/US2009/054285 19.08.2009

(87) WO/2010/022135 25.02.2010

(54) (ME) **IMUNOLOŠKA KOMPOZICIJA**

(EN) IMMUNOLOGICAL COMPOSITION

(73) Zoetis W LLC; 100 Campus Drive, Florham Park, New Jersey 07932, US

(72) LEHRBACH, Philip, Ralph; 5 Fiona Avenue Wahroonga, New South Wales 2076 (AU)

CHESHIRE, William, John; 19 Glenbrook Road Glenbrook, New South Wales 2773 (AU)

XIN, Zhixian; 25 Seabrook Crescent Doonside, New South Wales 2767 (AU)

(74) Ćupić Branislav, Dalmatinska 10, Podgorica (ME)

(57) Ovaj pronalazak se odnosi na imunološke kompozicije koje uključuju sullblipo-ciklodckstrin (SL-CD) i saponin ili Quil A i opciono najmanje jedan antigen. Pronalazak se odnosi na postupke i imunološke kompozicije koje uključuju najmanje jedan antigen, koji može da bude veterinarski antigen. Veterinarski antigen u postupcima i imunološkim kompozicijama iz pronalaska može da bude goveđi antigen. Pronalazak se odnosi na postupke i imunološke kompozicije koje uključuju virus goveđe efemeralne groznice (BEFV), goveđi herpes virus 1 (1BR) ili virus plavog jezika (BTV). Pronalazak uključuje postupke za pojačavanje imunog odgovora u odnosu na BEFV, IBR ili BTV kod životinje koji uključuje primjenu na životinji kompozicije iz pronalaska. U pronalasku, poseban imuni odgovor je zaštitni imuni odgovor. Pronalazak uključuje postupak za izradu imunološke kompozicije koja uključuje dodavanje Quil A u virus.

- (51) **C07D 401/12**  
**A61K 31/444**  
**A61P 35/00**  
**C07D 401/14**
- (11) **01291**  
(13) **A**
- (21) P-2011-37  
(22) 31.08.2009  
(30) 61/093,666 02.09.2008 US  
61/225,660 15.07.2009 US  
(86) PCT/EP2009/061205 03.08.2009  
(87) WO/2010/026124 11.03.2010
- (54) (ME) **DERIVATI PRIKOLINAMIDA KAO INHIBITORI KINAZE**  
(EN) PICOLINAMIDE DERIVATIVES AS KINASE INHIBITORS
- (73) NOVARTIS AG; Lichtstrasse 35 CH-4056 Basel (CH)  
(72) BURGER, Matthew, T.; Novartis Vaccines and Diagnostics, Inc. 4560 Horton Street Emeryville, California 94608-2916 (US)  
HAN, Wooseok; Novartis Vaccines and Diagnostics, Inc. 4560 Horton Street Emeryville, California 94608-2916 (US)  
LAN, Jiong; Novartis Vaccines and Diagnostics, Inc. 4560 Horton Street Emeryville, California 94608-2916 (US)  
NISHIGUCHI, Gisele; Novartis Vaccines and Diagnostics, Inc. 4560 Horton Street Emeryville, California 94608-2916 (US)
- (74) Čejović Vladimir, 13. jula 21, Podgorica (ME)
- (57) Predstavljena su nova jedinjenja pikolinamida, kompozicije i načini inhibicije PIM (Provirus Integration of Maloney) kinaze povezane sa tumorigenezom kod ljudi ili životinjskih subjekata. U izvođenjima, jedinjenja i kompozicije su efikasni u inhibiranju aktivnosti bar jedne PIM kinaze. Nova jedinjenja i kompozicije mogu se koristiti bilo samostalno bilo u kombinaciji sa bar jednim dodatnim sredstvom za tretman poremećaja posredovanog serin/treonin kinazom ili receptornom tirozin kinazom, kao što je kancer.



- (51) **C07D 231/40**  
**A61K 31/4155**  
**A61K 31/4178**  
**A61K 31/4427**  
**A61K 31/497**  
**A61K 31/506**  
**A61P 3/00**  
**C07D 401/12**  
**C07D 403/12**  
**C07D 513/**
- (11) **01274**  
(13) **A**
- (21) P-2011-44  
(22) 28.08.2009  
(30) 61/096,056 11.09.2008 US  
61/232,578 10.08.2009 US  
(86) PCT/IB2009/053773 28.08.2009  
(87) WO/2010/029461 18.03.2010

(54) (ME) **HETEROARILI DERIVATI AMIDA I NJIHOVA UPOTREBA KAO GLUKOKINAZNIH AKTIVATORA**

(EN) HETEROARYLS AMIDE DERIVATIVES AND THEIR USE AS GLUCOKINASE ACTIVATORS

- (73) PFIZER INC., 235 East 42nd Street New York, New York 10017 (US)  
(72) BENBOW, John William; 211 Harland Road Norwich, Connecticut 06360 (US)  
LOU, Jihong; 10636 Senda Acuario San Diego, California 92130 (US)  
PFEFFERKORN, Jeffrey Allen; Pfizer Global Research & Development Eastern Point Road Groton, Connecticut 06340 (US)  
TU, Meihua Mike; Pfizer Global Research & Development Eastern Point Road Groton, Connecticut 06340 (US)
- (74) Ćupić Branislav, Dalmatinska 10, Podgorica (ME)
- (57) Ovaj pronalazak daje jedinjenja Formule (1A) koja djeluju kao aktivatori glukokinaza; njegove farmaceutske kompozicije; i postupke za tretiranje bolesti, poremećaja ili stanja posredovanih sa glukokinazom. X, Y, Z, R<sup>1</sup>, R<sup>2</sup>, R<sup>3</sup>, i R<sup>4</sup>su opisani u njemu.

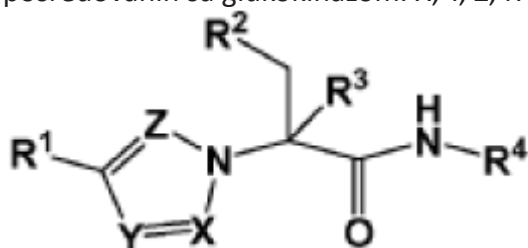

- (51) **C07D 413/04**  
**A61K 35/00**  
**A61K 31/5377**
- (11) **01292**  
(13) **A**
- (21) P-2011-50  
(22) 15.09.2009  
(30) 61/097,580 17.09.2008 US  
(86) PCT/US2009/056918 15.09.2009  
(87) WO 2010/033481 25.03.2010
- (54) (ME) **SOLI N-(6-(CIS-2,6-DIMETRILMORFOLIN-4-IL)PIRIDIN -3-IL)-2-METIL-4-(TRIFLUOROMETOKSI)(1,1-BEFENIL)-3-KARBOKSAMIDA**  
(EN) SALTS OF N-[6-CIS-2,6-DIMETHYLMORPHOLIN-4YL]PYRIDINE-3YL]-2-METHYL-4'-(TRIFLUOROMETHOXY)[1,1'-BIPHENYL]-3-CARBOXAMIDE
- (73) NOVARTIS AG; Lichtstrasse 35 CH-4056 Basel (CH)  
(72) BAJWA, Joginder Singh; 50 Linwood Avenue Elmwood Park, New Jersey 07407 (US)  
DE LA CRUZ, Marilyn; 27 Porsche Drive Matawan, New Jersey 07747 (US)  
DODD, Stephanie Kay; 83 Pleasant Street Ayer, Massachusetts 01432 (US)  
WAYKOLE, Liladhar Murlidhar; 11 Putters Road Succasunna, New Jersey 07876 (US)  
WU, Raeann; 2423 Rachel Terrace Pine Brook, New Jersey 07058 (US)
- (74) Čejović Vladimir, 13. jula 21, Podgorica (ME)
- (57) Soli N-SOLI N-(6-(CIS-2,6-DIMETRILMORFOLIN-4-IL)PIRIDIN -3-IL)-2-METIL-4-(TRIFLUOROMETOKSI) (1,1-BEFENIL)-3-KARBOKSAMIDA su dobijene i opisane u ovom tekstu

(51) **C07D 493/18**  
**C07H 19/01**

(11) **01289**

(13) **A**

(21) P-2011-51

(22) 15.09.2009

(30) 08/05062 16.09.2008 FR

(86) PCT/FR2009/051729 15.09.2009

(87) WO/2010/031953 25.03.2010

(54) (ME) **POSTUPAK ZA DOBIJANJE 1,6:2,3-DIANHIDRO- $\beta$ -D-MANOPIRANOZE**  
(EN) **METHOD FOR PREPARING 1,6:2,3-DIANHYDRO-BETA-D-MANNOPYRANOSE**

(73) SANOFI-AVENTIS; avenue de France F-75013 Paris (FR)

(72) GROSSI, Pierre, Jean; c/o Sanofi-Aventis Département Brevets 174 Avenue de France F-75013 Paris (FR)

HOFF, Christian; c/o Sanofi-Aventis Département Brevets 174 Avenue de France F-75013 Paris (FR)

ROVERA, Jean-Claude; c/o Sanofi-Aventis Département Brevets 174 Avenue de France F-75013 Paris (FR)

SOLE, Raphaël; c/o Sanofi-Aventis Département Brevets 174 Avenue de France F-75013 Paris (FR)

(74) Ćupić Branislav, Dalmatinska 10, Podgorica (ME)

(57) Postupak za dobijanje 1,6:2,3-dianhidro- $\beta$ -d-manopiranoze, karakterističan po tome što obuhvata etapu kristalizacije jedinjenja c: gdje r predstavlja alkil grupu i r predstavlja jedan agens za aktiviranje, u smješi alkohol/alkoksid u anhidrovanim uslovima.

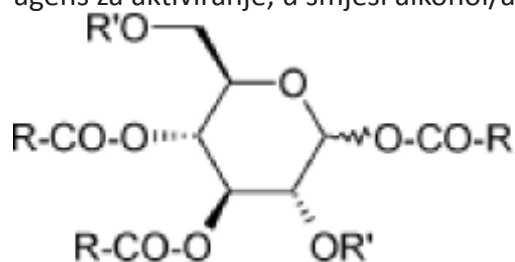

- (51) **H04L 12/28** (11) **01278**  
**H04L 12/46** (13) **A**
- (21) P-2011-52  
 (22) 31.08.2009
- (30) 2046/DEL/2008 29.08.2008 IN  
 (86) PCT/IN2009/000475 31.08.2009  
 (87) WO/2010/035280 01.04.2010
- (54) **(ME) POSTUPAK I SISTEM ZA INTEGRISANJE VIŠE SERVISA ZA UPRAVLJANJE U ZGRADAMA I SERVISA ZA AUTOMATIZACIJU U KUĆAMA SA VIŠE RAZLIČITIH TELEKOMUNIKACIONIH SERVISA ZA RAD U NEUTRALNOJ PRISTUPNOJ MREŽI**  
**(EN) INTEGRATING PLURALITY OF BUILDING MANAGEMENT SERVICES AND HOME AUTOMATION SERVICES WITH PLURALITY OF MULTI-PLAY SERVICES ON NEUTRAL ACCESS NETWORK OPERATION BASIS**
- (73) HARI, Shanker Singh; C-96, Sector 33 NOIDA 201 301 UP (IN)  
 (72) HARI, Shanker Singh; C-96, Sector 33 NOIDA 201 301 UP (IN)  
 (74) Popović Miladin, Đoka Miraševića 21/III, Podgorica (ME)
- (57) Opisan je sistem sa jednim vlaknom za različite telekomunikacione servise. Sistem sadrži jedno vlakno za prenos jednog ili više servisa baziranih na sledećim: globalni sistem za mobilne (GSM) komunikacije, podela koda višestrukim pristupom (engl. Code Division Multiple Access) (CDMA), globalna interoperabilnost za mikrotalasni pristup (engl. Worldwide Interoperability for Microwave Access) (Wimax), globalni sistem za pozicioniranje (GPS), implementiranih na jednom ili više od sledećih: asinhroni transfer mod (ATM), multipleksiranje sa vremenskom podjelom (TDM), Transmission Control Protocol-Internet Protocol(TCP/IP), radio frekvencije (PvF), multipleksiranje sa podjelom po talasnim dužinama (engl. Wavelength Division Multiplexing) (WDM) ili gusto multipleksiranje sa podjelom po talasnim dužinama (engl. Dense Wavelength Division Multiplexing) (DWDM), i hardverski povezan kompjuterski programabilni uređaj povezan na to jedno vlakno da bi se kreiralo mnoštvo tunela unutar pomenutog jednog vlakna i da bi se kreiralo mnoštvo kola unutar pomenutog tunela.

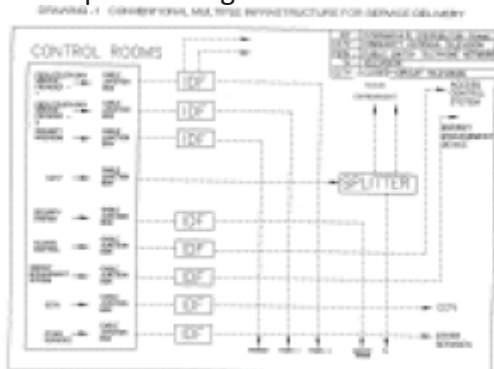

- (51) **A61K 9/0**  
**A61K 47/24**  
**A61K 47/34**  
**A61K 9/50**
- (11) **01288**  
(13) **A**
- (21) P-2011-159  
(22) 05.02.2010  
(30) P0900072 06.02.2009 HU  
(86) PCT/HU2010/000015 05.02.2010  
(87) 05.02.2010 12.08.2010
- (54) (ME) **TRANSDERMALNI FARMACEUTSKI PREPARATI**  
(EN) TRANSDERMAL PHARMACEUTICAL PREPARATIONS
- (73) EGIS GYÓGYSZERGYÁR NYILVÁNOSAN MŰKÖDŐ RÉSZVÉNYTÁRSASÁG; Keresztúri út 30-38, H-1106, Hungary (HU)  
(72) MIKULÁSIK, Endre; Kossuth Lajos U. 60 H-8924 Alsónemesapáti (HU)  
FAZEKAS, Patrik; Berki u. 74 H-9900 Körmend (HU)  
(74) Radulović Božidar, Jovana Tomaševića 9/III, Podgorica (ME)  
(57) Predmetni pronalazak se odnosi na polučvrsti transdermalni farmaceutski preparat sa pojačanom stabilnošću i biološkom dostupnošću, u kojem su čestice obložene isparljivom komponentom silikonskog ulja, te je tako dobijena suspenzija dispergovana u gel ili krem bazi.

(51) **C07D 277/56**  
**A61K 38/55**  
**C07K 5/08**

(11) **01277**

(13) **A**

(21) P-2011-164

(22) 22.03.2010

(30) 61/180,561 22.05.2009 US

61/162,196 20.03.2009 US

(86) PCT/US2010/028126 22.03.2010

(87) WO/2010/108172 23.09.2010

(54) (ME) **KRISTALNI TRIPEPTIDNI EPOKSI KETONSKI INHIBITORI PROTEAZE**  
(EN) **CRYSTALLINE TRIPEPTIDE EPOXY KETONE PROTEASE INHIBITORS**

(73) ONYX THERAPEUTICS, INC.; 249 E. Grand Avenue South San Francisco, CA 94080 (US)

(72) PHIASIVONGSA, Pasit; 2712 Saint Regis Avenue Brentwood, CA 94513 (US)

SEHL, Louis, C.; 403 Alameda de la Pulgas Redwood City, CA 94062 (US)

(74) Radulović Božidar, Jovana Tomaševića 9/III, Podgorica (ME)

(57) Predmetni pronalazak odnosi se na kristalna tripeptidna keto epoksidna jedinjenja, postupke za njihovo dobijanje i srodne farmaceutske preparate.

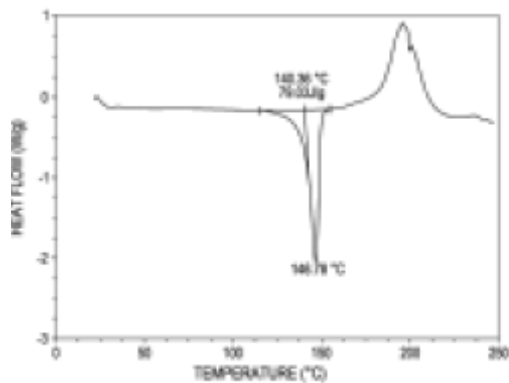

FIGURE 1

(51) **B65D 6/18**(11) **01287**(13) **A**

(21) P-2011-170

(22) 15.04.2009

(86) PCT/EP2009/002760 15.04.2009

(87) WO/2010/118758 21.10.2010

(54) (ME) **KONTEJNER SA PREKLOPIVIM BOČNIM ZIDOVIMA**

(EN) CONTAINER HAVING FOLDING SIDE WALL

(73) IFCO SYSTEMS GMBH; Zugspitzstr. 7 82049 Pullach (DE)

(72) DEKKERS, Hendrik; Mandjesstraat 2 FIN-8011 RM Zwolle (NL)

(74) Čupić Branislav, Dalmatinska 10, Podgorica (ME)

(57) Pronalazak se odnosi na kontejner (1) sa sklopivim bočnim zidovima i šarnirnim vezama (7) koje gotovo u potpunosti sprečavaju izvijanje osnove (2) čak i pod opterećenjem. Kontejner (1) se može proizvesti izuzetno jednostavno i jeftino, s obzirom da se zahvaljujući naročitoj šarnirnoj vezi (7). osnova (2) može proizvoditi metodom brizganja u kalup. bez upotrebe alata sa naležećim površinama. te je omogućeno korišćenje jednostavnih alata.

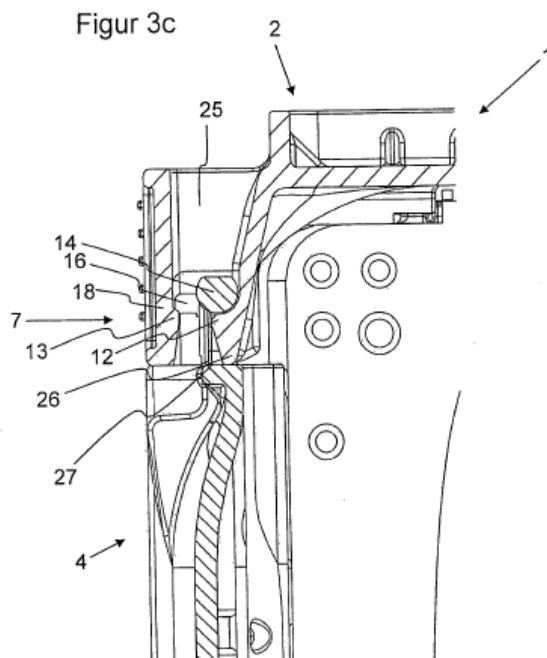

- (51) **B25B 11/00**  
**B62D 65/06**  
**B65G 7/12**  
**B65G 49/06**  
**B66C 1/02**

- (11) **01293**  
 (13) **A**

- (21) P-2011-174  
 (22) 05.05.2010  
 (30) 0907781.9 06.05.2009 (GB)  
 (86) PCT/GB2010/000885 05.05.2010  
 (87) WO 2010/128282 11.11.2010.

- (54) (ME) **UREĐAJ ZA PODIZANJE (TERETA)**  
 (EN) LIFTING DEVICE

(73) BELRON HUNGARY KFT - ZUG BRANCH; Gotthardstrasse 20 CH-6304 Zug (CH)

(72) FINCK, William; 31 Doddinghurst Road Brentwood Essex CM15 9EP (GB)

(74) Popović Miladin, Đoka Miraševića 21/III, Podgorica (ME)

- (57) Predmetni pronalazak odnosi se na uređaj za podizanje tereta koji sadrži duguljastu noseću ručicu na kojoj je postavljen vakuumski sklop za pozicioniranje, pomoću koga se predmetni uređaj fiksira za teret koji se podiže. Vakuumski sklop za pozicioniranje sadrži vakuumske pozicionere koji se na nosećoj ručici nalaze na dovoljnom podužnom rastojanju jedan od drugog kako bi korisniku uređaja omogućili čvrsto držanje ručice u zoni između pomenutih vakuumskih pozicionera. Predmetni uređaj nastavlja dalje da se pruža u podužnom pravcu noseće ručice, na stranu suprotno od položaja vakuumskog sklopa za pozicioniranje i ka dršci uređaja koja je u podužnom pravcu odmaknuta od položaja pomenutog vakuumskog sklopa za pozicioniranje i koja je u odnosu na ravan noseće ručice savijena nagore i postavljena na suprotnoj strani uređaja od strane na kojoj se nalaze vakuumske pozicioneri.

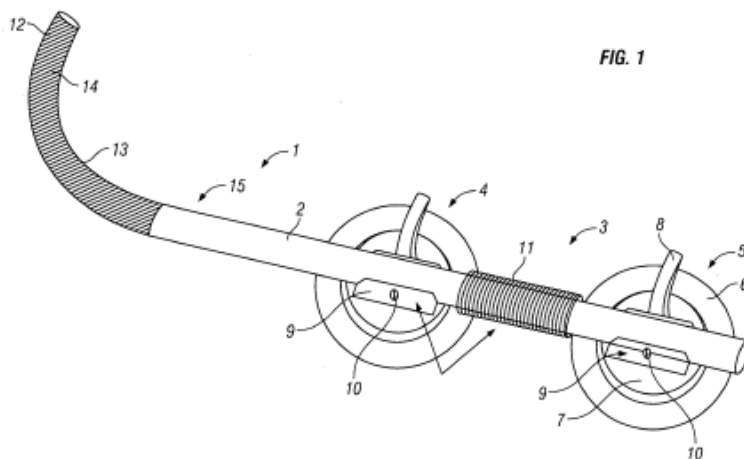

FIG. 1



- (51) **C07K 14/785** (11) **01279**  
**A61K 38/00** (13) **A**
- (21) P-2011-197
- (22) 31.05.2010
- (30) 09162052.6 05.06.2009 EP
- (86) PCT/EP2010/003293 31.05.2010
- (87) WO/2010/139442 09.12.2010
- (54) (ME) **Poboljšani rekonstituisani preparat surfaktanta koji sadrži analoge surfaktantnog proteina B (SP-B) i surfaktantnog proteina C (SP-C)**  
(EN) IMPROVED RECONSTITUTED SURFACTANT COMPOSITION CONTAINING ANALOGS OF SURFACTANT PROTEIN B (SP-B) AND SURFACTANT PROTEIN C (SP-C)
- (73) CHIESI FARMACEUTICI S.P.A.; Via Palermo 26/A I-43100 Parma (IT)
- (72) PIVETTI, Fausto; Chiesi Farmaceutici S.p.A. Via Palermo, 26A I-43100 Parma (IT)  
BOCCHI, Monica; Chiesi Farmaceutici S.p.A. Via Palermo, 26A I-43100 Parma (IT)  
SOLIANI RASCHINI, Annamaria; Chiesi Farmaceutici S.p.A. Via Palermo, 26A I-43100 Parma (IT)
- (74) Radulović Božidar, Jovana Tomaševića 9/III, Podgorica (ME)
- (57) Predmetni pronalazak odnosi se na rekonstituisani plućni surfaktant koji sadrži lipidni nosilac, kombinaciju polipeptidnog analoga nativnog surfaktantnog proteina SP-C sa tačno određenim polipeptidnim analogom nativnog surfaktantnog proteina SP-B. Predmetni pronalazak takođe je usmjeren na njihove farmaceutske preparate i na njihovu upotrebu za liječenje ili profdaksu RDS i drugih respiratornih poremećaja.

(51) F03B13/00

(11) 01275

(13) A

(21) P-2013-19

(22) 14.02.2013.

(54) (ME) **MINI ELEKTRIČNA CENTRALA**

(EN) MINI ELECTRIC POWER PLANT

(73) Milan Bojović, Njegoševa 4, Žabljak, ME

(72) Milan Bojović, Njegoševa 4, Žabljak, ME

Zoran Savović, Đuro Perović 25, Lovćenac, SR

(57) Novo konstruktivno rešenje u oblasti električnih centrala za proizvodnju električne energije, a koje obezbeđuje: ekonomičnu proizvodnju, nezavisnu proizvodnju od drugih izvora energije, pouzdanost u radu, jeftina izrada, jednostavna upotreba i ekološki čisto.

Konstrukcija se sastoji u tome : na postolje ( konstrukciju) postavi i poveže baterija 12V 1, regulator napona 2, pretvarač 3, punjač 4, baterija 12V 5, regulator napona 6, pretvarač 7, punjač 8, pomoćni relej 9, kontaktor 10, mrežna utičnica 220V 11.

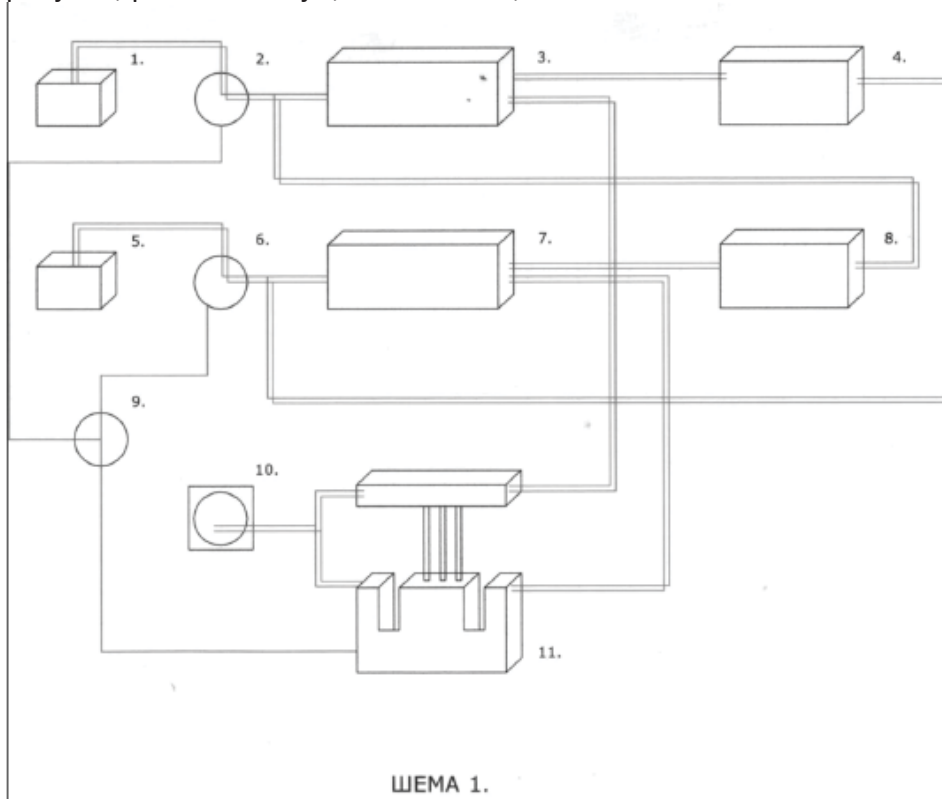

- (51) **C04B 41/50** (11) **01286**  
**C04B 41/52** (13) **A**  
**C04B 41/87**  
**C04B 41/89**
- (21) P-2011-202  
(22) 19.06.2009  
(30) 2009/000028 02.02.2009 IT  
(86) PCT/IB2009/006002 19.06.2009  
(87) WO/2010/146410 23.12.2010
- (54) (ME) **FOTOKATALITIČKI KERAMIČKI MATERIJAL I METOD NJEGOVE PROIZVODNJE**  
(EN) PHOTOCATALYTIC CERAMIC ARTICLE AND METHOD FOR ITS PRODUCTION
- (73) GRANITIFIANDRE S.p.A., Via Radici Nord, 112 Castellarano (IT)  
(72) PELLICELLI, Giovanni; C/o Granitifiandre S.p.A. Via Radici Nord, 112 I-42014 Castellarano (IT)  
TUCCI, Antonella; C/o Centro Ceramico - Consorzio Univ. per la Ricerca e Sperimentazione Via Martelli, 26/A I-40138 Bologna (IT)  
RAMBALDI, Elisa; C/o Centro Ceramico - Consorzio Univ. per la Ricerca e Sperimentazione Via Martelli, 26/A I-40138 Bologna (IT)
- (74) Čejović Vladimir, 13. jula 21, Podgorica (ME)
- (57) Metod za proizvodnju obrađenog materijala; Metod se sastoji od faze koja uključuje nanošenje prvog gornjeg sloja TiO<sub>2</sub> praha sa specifičnom površinom koja se kreće od 5 do 20 m<sup>2</sup>/g na površini proizvoda sa keramičkom osnovom na kojoj je drugi sloj neorganskog adheziva prethodno nanesen na način kojim se dobija poluproizvod; i faze zagrijavanja, tokom kojeg se poluproizvod zagrijava.



**INDEKS NOSILACA PATENTA**  
**PATENT OWNER INDEX**

(73)	(51)	(21)
ARDEA BIOSCIENCES INC.	C07D 249/12 C07D 235/28	P-2010-100
BELRON HUNGARY KFT - ZUG BRANCH	B25B 11/00 B62D 65/06 B65G 7/12 B65G 49/06 B66C 1/02	P-2011-174
CHIESI FARMACEUTICI S.P.A.	C07D 213/61 C07D 213/89 A61K 31/44 A61P 11/00	P-2011-150
CHIESI FARMACEUTICI S.P.A.	C07D 453/02 A61K 31/439 A61P 11/00	P-2011-24
CHIESI FARMACEUTICI S.P.A.	C07K 14/785 A61K 38/00	P-2011-197
CORNELL UNIVERSITY	A61K 39/04	P-2010-62
CRYSTAL LAGOONS CORPORATION LLC	C02F 1/68	P-2012-5
DJERASSEM	F03B 17/00	P-2011-152
EGIS GYÓGYSZERGYÁR NYILVÁNOSAN MŰKÖDŐ RÉSZVÉNYTÁRSASÁG	A61K 9/0 A61K 47/24 A61K 47/34 A61K 9/50	P-2011-159
EMPRESAS PÚBLICAS DE MEDELLIN E.S.P. UNIVERSIDAD DE ANTIOQUIA	C12P 7/64 C12N 5/04 C12N 5/02	P-2011-154
GRANITIFIANDRE S.p.A.	C04B 41/50 C04B 41/52 C04B 41/87 C04B 41/89	P-2011-202

HARI	H04L 12/28 H04L 12/46	P-2011-52
IFCO SYSTEMS GMBH	B65D 6/18	P-2011-170
Milan Bojović	F03B13/00	P-2013-19
NOVARTIS AG	C07D 401/12 A61K 31/501 A61K 31/506 A61P 35/00 C07D 401/14 C07D 403/12 C07D 413/14 C07D 471/04	P-2011-6
NOVARTIS AG	C07D 417/14 A61K 31/4439 A61P 35/00	P-2011-21
NOVARTIS AG	C07D 487/04 A61K 31/519 A61P 35/00	P-2011-25
NOVARTIS AG	C07D 401/12 A61K 31/444 A61P 35/00 C07D 401/14	P-2011-37
NOVARTIS AG	C07D 413/04 A61K 35/00 A61K 31/5377	P-2011-50
ONYX THERAPEUTICS, INC.	C07D 277/56 A61K 38/55 C07K 5/08	P-2011-164
PFIZER INC.	C07D 493/10 A61K 31/357 A61P 3/10 C07H 15/18	P-2011-45
PFIZER INC.	C07D 213/75 A61K 31/44 A61P 29/00	P-2010-221

PFIZER INC.	C07D 231/40 A61K 31/4155 A61K 31/4178 A61K 31/4427 A61K 31/497 A61K 31/506 A61P 3/00 C07D 401/12 C07D 403/12 C07D 513/	P-2011-44
PFIZER INC. AMGEN FREMONT INC.	C07K 16/28	P-2010-215
SANOFI-AVENTIS	A61K 31/343 A61K 9/28 A61P 9/10	P-2011-19
SANOFI-AVENTIS	C07D 493/18 C07H 19/01	P-2011-51
Vujković Dejan	A47B 97/08 A47C 17/54	P-2010-186
Zoetis LLC	C07D 487/04 A61K 31/519 A61P 37/00	P-2011-22
Zoetis W LLC	C12N 7/08 A61K 39/215	P-2011-23
Zoetis W LLC	A61K 39/39	P-2011-33





**INDEKS BROJEVA PRIJAVA PATENATA**  
**APPLICANTS NUMBER INDEX**

(21)	(51)	(21)	(51)
P-2010-62	A61K 39/04	P-2011-44	C07D 231/40
P-2010-100	C07D 249/12 C07D 235/28		A61K 31/4155 A61K 31/4178 A61K 31/4427 A61K 31/497 A61K 31/506 A61P 3/00 C07D 401/12 C07D 403/12 C07D 513/
P-2010-186	A47B 97/08 A47C 17/54	P-2011-45	C07D 493/10 A61K 31/357 A61P 3/10 C07H 15/18
P-2010-215	C07K 16/28	P-2011-50	C07D 413/04 A61K 35/00 A61K 31/5377
P-2010-221	C07D 213/75 A61K 31/44 A61P 29/00	P-2011-51	C07D 493/18 C07H 19/01
P-2011-6	C07D 401/12 A61K 31/501 A61K 31/506 A61P 35/00 C07D 401/14 C07D 403/12 C07D 413/14 C07D 471/04	P-2011-52	H04L 12/28 H04L 12/46
P-2011-19	A61K 31/343 A61K 9/28 A61P 9/10	P-2011-150	C07D 213/61 C07D 213/89 A61K 31/44 A61P 11/00
P-2011-21	C07D 417/14 A61K 31/4439 A61P 35/00	P-2011-152	F03B 17/00
P-2011-22	C07D 487/04 A61K 31/519 A61P 37/00	P-2011-154	C12P 7/64 C12N 5/04 C12N 5/02
P-2011-23	C12N 7/08 A61K 39/215	P-2011-159	A61K 9/0 A61K 47/24 A61K 47/34 A61K 9/50
P-2011-24	C07D 453/02 A61K 31/439 A61P 11/00	P-2011-164	C07D 277/56 A61K 38/55 C07K 5/08
P-2011-25	C07D 487/04 A61K 31/519 A61P 35/00	P-2011-170	B65D 6/18
P-2011-33	A61K 39/39		
P-2011-37	C07D 401/12 A61K 31/444 A61P 35/00 C07D 401/14		

(21)	(51)
------	------

P-2011-174	B25B 11/00 B62D 65/06 B65G 7/12 B65G 49/06 B66C 1/02
P-2011-197	C07K 14/785 A61K 38/00
P-2011-202	C04B 41/50 C04B 41/52 C04B 41/87 C04B 41/89
P-2012-5	C02F 1/68
P-2013-19	F03B13/00

**INDEKS OBJAVLJENIH PRIJAVA PATENATA PREMA MKP**  
**INDEX OF PATENT APPLICANTS ACCORDINT TO IPC**

(51)	(21)	(51)	(21)
A47B 97/08	P-2010-186	A61K 9/28	P-2011-19
A47C 17/54	P-2010-186	A61K 9/50	P-2011-159
A61K 31/343	P-2011-19	A61P 11/00	P-2011-150
A61K 31/357	P-2011-45	A61P 11/00	P-2011-24
A61K 31/4155	P-2011-44	A61P 29/00	P-2010-221
A61K 31/4178	P-2011-44	A61P 3/00	P-2011-44
A61K 31/439	P-2011-24	A61P 3/10	P-2011-45
A61K 31/44	P-2010-221	A61P 35/00	P-2011-21
A61K 31/44	P-2011-150	A61P 35/00	P-2011-25
A61K 31/4427	P-2011-44	A61P 35/00	P-2011-37
A61K 31/4439	P-2011-21	A61P 35/00	P-2011-6
A61K 31/444	P-2011-37	A61P 37/00	P-2011-22
A61K 31/497	P-2011-44	A61P 9/10	P-2011-19
A61K 31/501	P-2011-6	B25B 11/00	P-2011-174
A61K 31/506	P-2011-44	B62D 65/06	P-2011-174
A61K 31/506	P-2011-6	B65D 6/18	P-2011-170
A61K 31/519	P-2011-22	B65G 49/06	P-2011-174
A61K 31/519	P-2011-25	B65G 7/12	P-2011-174
A61K 31/5377	P-2011-50	B66C 1/02	P-2011-174
A61K 35/00	P-2011-50	C02F 1/68	P-2012-5
A61K 38/00	P-2011-197	C04B 41/50	P-2011-202
A61K 38/55	P-2011-164	C04B 41/52	P-2011-202
A61K 39/04	P-2010-62	C04B 41/87	P-2011-202
A61K 39/215	P-2011-23	C04B 41/89	P-2011-202
A61K 39/39	P-2011-33	C07D 213/61	P-2011-150
A61K 47/24	P-2011-159	C07D 213/75	P-2010-221
A61K 47/34	P-2011-159	C07D 213/89	P-2011-150
A61K 9/0	P-2011-159	C07D 231/40	P-2011-44

(51)	(21)	(51)	(21)
C07D 235/28	P-2010-100	F03B 13/00	P-2013-19
C07D 249/12	P-2010-100	H04L 12/28	P-2011-52
C07D 277/56	P-2011-164	H04L 12/46	P-2011-52
C07D 401/12	P-2011-37		
C07D 401/12	P-2011-44		
C07D 401/12	P-2011-6		
C07D 401/14	P-2011-37		
C07D 401/14	P-2011-6		
C07D 403/12	P-2011-44		
C07D 403/12	P-2011-6		
C07D 413/04	P-2011-50		
C07D 413/14	P-2011-6		
C07D 417/14	P-2011-21		
C07D 453/02	P-2011-24		
C07D 471/04	P-2011-6		
C07D 487/04	P-2011-22		
C07D 487/04	P-2011-25		
C07D 493/10	P-2011-45		
C07D 493/18	P-2011-51		
C07D 513/	P-2011-44		
C07H 15/18	P-2011-45		
C07H 19/01	P-2011-51		
C07K 14/785	P-2011-197		
C07K 16/28	P-2010-215		
C07K 5/08	P-2011-164		
C12N 5/02	P-2011-154		
C12N 5/04	P-2011-154		
C12N 7/08	P-2011-23		
C12P 7/64	P-2011-154		
F03B 17/00	P-2011-152		

**OBJAVE ZAHTJEVA ZA PROŠIRENJE EVROPSKIH PRIJAVA PATENATA**  
**PUBLICATION OF REQUEST FOR THE EXTENSION OF THE EFFECTS OF**  
**EUROPEAN PATENT APPLICATIONS**

<p>(51) MKP  <b>C12N 9/16 (2006.01)</b>  <b>C12N 15/67 (2006.01)</b>  <b>C12N 9/14 (2006.01)</b>  <b>A61K 48/00 (2006.01)</b>  <b>C12N 15/68 (2006.01)</b>  <b>C12N 15/864 (2006.01)</b>  (86) EP2011059678 10.06.2011  (96) 11724246.1 17.04.2013  (87) WO2011154520, 10.06.2011  (97) 2579900, 17.04.2013 en  (54) VECTORS AND SEQUENCES FOR THE TREATMENT OF DISEASES  (71) Laboratorios del. Dr. Esteve, S.A., Avda Mare de Deu de Montserrat 221, 08041 Barcelona, ES  Universitat Autònoma De Barcelona, Edifici A - Campus Universitari s/n Bellaterra, 08193 Barcelona, ES  (72) BOSCH TUBERT, Fátima, C/ La Lluna nº 92, E-08290 Cerdanyola del Valles, ES  AYUSO LÓPEZ, Eduard, Urb Ribes Blaves 6/90, E-08640 Olesa de Montserrat, ES  RUZO MATÍAS, Albert, C/ Rossello nº 110 2º 2ª, E-08036 Barcelona, ES</p>	<p>(97) <b>2579900 *</b></p>	<p>(51) MKP  <b>A01N 43/00 (2006.01)</b>  <b>A61P 33/00 (2006.01)</b>  (86) US2011030930 01.04.2011  (96) 11714200.0 06.02.2013  (87) WO2011123773, 01.04.2011  2552201, 06.02.2013 en  (54) PARASITICIDAL COMPOSITIONS COMPRISING MULTIPLE ACTIVE AGENTS, METHODS AND USES THEREOF  (71) Merial Limited, 3239 Satellite Blvd., Duluth, GA 30096, US  (72) ROSENTEL, Jr., Joseph K., 10675 Branham Fields Road, Johns Creek GA 30097, US  TEJWANI, Monica, 47 Putnam Road, Monmouth Junction NJ 08852, US  DAS-NANDY, Arima, 243 Washington Crossing Pennington Road, Titusville NJ 08560, US</p>	<p>(97) <b>2552201 *</b></p>
<p>(51) MKP  <b>A01N 47/36 (2006.01)</b>  <b>C07D 417/06 (2006.01)</b>  <b>C07D 277/20 (2006.01)</b>  <b>A01N 47/18 (2006.01)</b>  <b>A01P 7/02 (2006.01)</b>  <b>C07D 401/14 (2006.01)</b>  <b>C07D 277/32 (2006.01)</b>  <b>A01P 7/04 (2006.01)</b>  <b>A01N 43/78 (2006.01)</b>  <b>C07D 401/04 (2006.01)</b>  <b>A01P 5/00 (2006.01)</b>  <b>C07D 417/14 (2006.01)</b>  (86) JP2011065285 04.07.2011  (96) 11803550.0 15.05.2013  (87) WO2012005216, 04.07.2011  (97) 2591673, 15.05.2013 en  (54) PEST CONTROL AGENT  (71) Meiji Seika Pharma Co., Ltd., 4-16, Kyobashi 2-chome Chuo-ku, Tokyo 104-8002, JP  Gifu University, 1-1, Yanagido, Gifu-shi Gifu 501-1193, JP  (72) KAGABU, Shinzo, c/o Gifu University 1-1, Yanagido, Gifu-shi Gifu 501-1193, JP  MITOMI, Masaaki, c/o Meiji Seika Pharma Co. Ltd. 760 Morooka-cho Kohoku-ku, Yokohama-shi Kanagawa 222-8567, JP  KITSUDA, Shigeki, c/o Meiji Seika Pharma Co. Ltd. 760 Morooka-cho Kohoku-ku, Yokohama-shi Kanagawa 222-8567, JP  NOMURA, Masahiro, c/o Meiji Seika Pharma Co. Ltd. 760 Morooka-cho Kohoku-ku, Yokohama-shi Kanagawa 222-8567, JP  NAKAMURA, Satoshi, c/o Meiji Seika Pharma Co. Ltd. 760 Morooka-cho Kohoku-ku, Yokohama-shi Kanagawa 222-8567, JP  YAMAMOTO, Kazumi, c/o Meiji Seika Pharma Co. Ltd. 760 Morooka-cho Kohoku-ku, Yokohama-shi Kanagawa 222-8567, JP</p>	<p>(97) <b>2591673 *</b></p>	<p>(51) MKP  <b>A61L 2/00 (2006.01)</b>  (86) US2011043614 12.07.2011  (96) 11738541.9 22.05.2013  (87) WO2012009299, 12.07.2011  (97) 2593144, 22.05.2013 en  (54) IMPROVED METHODS FOR THE STERILIZATION OF BENDAMUSTINE  (71) Cephalon, Inc., 41 Moores Road P.O. Box 4011, Frazer, PA 19355, US  (72) LABELL, Rachel Y., 561 N. Sandy Hill Road, Coatesville Pennsylvania 19320, US  PATEL, Piyush R., 716 Scott Lane, Wallingford Pennsylvania 19086, US</p>	<p>(97) <b>2593144 *</b></p>
<p>(51) MKP  <b>F16H 48/30 (2012.01)</b>  (86) IB2011001637 14.07.2011  (96) 11760544.4 22.05.2013  (87) WO2012007829, 14.07.2011  (97) 2593696, 22.05.2013 en  (54) AXLE ASSEMBLY WITH TORQUE DISTRIBUTION DRIVE MECHANISM  (71) E-AAM Driveline Systems AB, Nohabgatan 18-A, 461 53 Trollhattan, SE  (72) STEN, Erik, Vallmovagen 1c, S-461 43 Trollhattan, SE</p>	<p>(97) <b>2593696 *</b></p>	<p>(51) MKP  <b>B29C 45/00 (2006.01)</b>  <b>B29L 31/04 (2006.01)</b>  <b>B29C 45/04 (2006.01)</b>  <b>B29C 45/56 (2006.01)</b>  (96) 11195888.0 22.08.2012  (97) 2489491, 22.08.2012 de  (54) Method and device for producing ball bearing rings  (71) NP Poschmann GmbH, Zur Heide 33, 59929 Brilon, DE  (72) Baukloh, Horst, Südstr. 8, 58540 Meinerzhagen, DE</p>	<p>(97) <b>2489491</b></p>
<p>(51) MKP  <b>C12Q 1/70 (2006.01)</b>  (86) IB2011001048 19.04.2011  (96) 11738473.5 27.02.2013  (87) WO2011132078, 19.04.2011  (97) 2561104, 27.02.2013 en  (54) DIAGNOSIS OF VIRAL INFECTIONS BY DETECTION OF GENOMIC AND INFECTIOUS VIRAL DNA BY MOLECULAR COMBINING  (71) Genomic Vision, 80-84 rue des Meuniers, 92220 Bagneux, FR  (72) MAHIET, Charlotte, 7 Padfield Road Camberwell, London SE5 9AA, GB  SALVAIRE, Fabrice, 7 rue Jean Baillet, F-95870 Bezons, FR  CONSEILLER, Emmanuel, 10 rue de Plélo, F-75015 Paris, FR  BARRADEAU, Sébastien, Apt. 2A 145 rue Pelleport, F-75020 Paris, FR</p>	<p>(97) <b>2561104 *</b></p>	<p>(51) MKP  <b>A01N 43/00 (2006.01)</b>  <b>A61P 33/00 (2006.01)</b>  (86) US2011030930 01.04.2011  (96) 11714200.0 06.02.2013  (87) WO2011123773, 01.04.2011  2552201, 06.02.2013 en  (54) PARASITICIDAL COMPOSITIONS COMPRISING MULTIPLE ACTIVE AGENTS, METHODS AND USES THEREOF  (71) Merial Limited, 3239 Satellite Blvd., Duluth, GA 30096, US  (72) ROSENTEL, Jr., Joseph K., 10675 Branham Fields Road, Johns Creek GA 30097, US  TEJWANI, Monica, 47 Putnam Road, Monmouth Junction NJ 08852, US  DAS-NANDY, Arima, 243 Washington Crossing Pennington Road, Titusville NJ 08560, US</p>	<p>(97) <b>2552201 *</b></p>

- (51) MKP  
**A61M 5/315 (2006.01)** (97) **2579923 \***  
**A61M 5/24 (2006.01)**
- (86) EP2011059575 09.06.2011  
(96) 11724222.2 17.04.2013  
(87) WO2011154489, 09.06.2011  
(97) 2579923, 17.04.2013 en  
(54) DRIVE MECHANISM FOR A DRUG DELIVERY DEVICE AND DRUG DELIVERY DEVICE  
(71) Sanofi-Aventis Deutschland GmbH, Brüningstraße 50, 65929 Frankfurt, DE  
(72) HEALD, Michael, 22 Wells Avenue, Crewe, Cheshire CW1 5RZ, GB
- 
- (51) MKP  
**C07C 215/60 (2006.01)** (97) **2563757 \***
- (86) EP2011054565 24.03.2011  
(96) 11710495.0 06.03.2013  
(87) WO2011134724, 24.03.2011  
(97) 2563757, 06.03.2013 en  
(54) METHOD FOR PREPARING RITODRINE HYDROCHLORIDE  
(71) Lundbeck Pharmaceuticals Italy S.p.A., Quarta Strada, 2, 35129 Padova, IT  
(72) ZANON, Jacopo, Santa Croce 1653, I-30135 Venezia, IT  
LIBRALON, Giovanna, Via Ca'Onorai 27, I-35015 Galliera Veneta, IT  
DE FAVERI, Carla, Via dei Colli 28, I-31010 Farra di Soligo, IT  
HUBER, Florian Anton Martin, Via Zardo 5, I-36050 Bolzano Vicentino, IT
- 
- (51) MKP  
**C12N 5/077 (2010.01)** (97) **2576767 \***  
**C12N 5/073 (2010.01)**
- (86) EP2011002653 30.05.2011  
(96) 11723878.2 10.04.2013  
(87) WO2011151043, 30.05.2011  
(97) 2576767, 10.04.2013 en  
(54) PROCESS FOR DIFFERENTIATING STEM CELLS OF THE AMNIOTIC MEMBRANE  
(71) Trauma Care Consult (TCC) Traumatologische Forschung Gemeinnützige Gesellschaft MBH, Gonzagagasse 11/25, 1010 Wien, AT  
Bio-Products&Bio-Engineering AG, Schottenring 10, 1010 Wien, AT  
(72) EIBL, Johann, Gustav-Tschermak-Gasse 2, A-1180 Wien, AT  
REDL, Heinz, Windmuehlgasse 7, A-1060 Vienna, AT
- 
- (51) MKP  
**A61P 13/08 (2006.01)** (97) **2564849 \***  
**A61P 13/10 (2006.01)**  
**C07D 401/14 (2006.01)**  
**A61K 31/496 (2006.01)**  
**C07D 213/65 (2006.01)**  
**A61K 31/4545 (2006.01)**  
**A61P 43/00 (2006.01)**  
**A61P 13/00 (2006.01)**  
**C07D 213/80 (2006.01)**  
**A61P 29/00 (2006.01)**  
**A61P 25/04 (2006.01)**  
**A61P 19/00 (2006.01)**  
**C07D 413/14 (2006.01)**  
**C07D 401/12 (2006.01)**
- (86) JP2011060332 27.04.2011  
(96) 11775089.3 06.03.2013  
(87) WO2011136308, 27.04.2011  
(97) 2564849, 06.03.2013 en  
(54) PROPHYLACTIC OR THERAPEUTIC AGENT FOR DISEASES ASSOCIATED WITH PAINS IN URINARY ORGANS  
(71) Astellas Pharma Inc., 3-11, Nihonbashi-Honcho 2-chome Chuo-ku, Tokyo 103-8411, JP  
(72) SOMEYA, Akiyoshi, c/o Astellas Pharma Inc. 3-11 Nihonbashi-Honcho 2-chome Chuo-ku, Tokyo 103-8411, JP  
HAYASHIDA, Hiroko, c/o Astellas Pharma Inc. 3-11 Nihonbashi-Honcho 2-chome Chuo-ku, Tokyo 103-8411, JP  
KODA, Mai, c/o Astellas Pharma Inc. 3-11 Nihonbashi-Honcho 2-chome Chuo-ku, Tokyo 103-8411, JP  
TANAHASHI, Masayuki, c/o Astellas Pharma Inc. 3-11 Nihonbashi-Honcho 2-chome Chuo-ku, Tokyo 103-8411, JP  
YOSHIOKA, Katsuro, c/o Astellas Pharma Inc. 3-11 Nihonbashi-Honcho 2-chome Chuo-ku, Tokyo 103-8411, JP
- 
- (51) MKP  
**A61K 38/10 (2006.01)** (97) **2593124 \***  
**A61K 38/08 (2006.01)**  
**A61P 3/00 (2006.01)**  
**A61P 35/00 (2006.01)**  
**A61K 38/16 (2006.01)**  
**A61K 39/395 (2006.01)**  
**A61P 3/10 (2006.01)**
- (86) US2011043596 11.07.2011  
(96) 11807357.6 22.05.2013  
(87) WO2012009289, 11.07.2011  
(97) 2593124, 22.05.2013 en  
(54) INNOVATIVE DISCOVERY OF THERAPEUTIC, DIAGNOSTIC, AND ANTIBODY COMPOSITIONS RELATED TO PROTEIN FRAGMENTS OF ASPARTYL-TRNA SYNTHETASES  
(71) aTyr Pharma, Inc., 3545 John Hopkins Court, Suite 250, San Diego, CA 92121, US  
Pangu Biopharma Limited, Edinburgh Tower, 18/F The Landmark 15 Queen's Road Central, Hong Kong, CN  
GREENE, Leslie, Ann, 13941 Davenport Avenue, San Diego CA 92129, US  
CHIANG, Kyle, P., 1615 Debann Road, Cardiff CA 92007, US  
HONG, Fei, 12646 Spindletop Road, San Diego CA 92129, US  
VASSEROT, Alain, P., 6421 La Paloma Street, Carlsbad CA 92009, US  
LO, Wing-Sze, RM 815 Sui Ming House Siu Sai Wan Estate Chai Wan, Hong Kong, CN  
WATKINS, Jeffrey, D., 3442 Fortuna Ranch Road, Encinitas CA 92024, US  
QUINN, Cheryl, L., 408 North 1st Street No.706, Minneapolis MN 55401, US  
MENDLEIN, John, D., 1550 Neptune Avenue, Encinitas CA 92024, US
- 
- (51) MKP  
**A61P 7/02 (2006.01)** (97) **2585079 \***  
**A61K 31/727 (2006.01)**
- (86) EP2011060612 24.06.2011  
(96) 11729952.9 01.05.2013  
(87) WO2011161234, 24.06.2011  
(97) 2585079, 01.05.2013 en  
(54) SEMULOPARIN FOR THE EXTENDED PREVENTION OF A MORTALITY AND/OR MORBIDITY EVENT IN A PATIENT HAVING UNDERGONE HIP FRACTURE SURGERY  
(71) Aventis Pharma S.A., 20, avenue Raymond Aron, 92160 Antony, FR  
(72) DESTREE, Dominique, c/o Sanofi Patent Department 174 avenue de France, F-75013 Paris, FR  
LAWSON, Francesca, c/o Sanofi-Aventis US. Inc. 1041 Route 202-206 Mail Code: D-303A, Bridgewater, NJ 08807, US
- 
- (51) MKP  
**C02F 1/52 (2006.01)** (97) **2592054**
- (96) 11188758.4 15.05.2013  
(97) 2592054, 15.05.2013 en  
(54) Aqueous suspensions of calcium carbonate-comprising materials with low deposit built up  
(71) Omya Development AG, Baslerstrasse 42, 4665 Oftringen, CH  
(72) Buri, Matthias, Mätteliweg 20, 4852 Rothrist, CH  
Rentsch, Samuel, Burgpark 2, 4663 Aarburg, CH  
Gane, Patrick A.C., Studenweg 8, 4852 Rothrist, CH

(51) MKP  
**A61P 31/18 (2006.01)** (97) **2552480 \***  
**A61K 39/21 (2006.01)**  
(86) EP2011054654 25.03.2011  
(96) 11709973.9 06.02.2013  
(87) WO2011117408, 25.03.2011  
(97) 2552480, 06.02.2013 en  
(54) HIV VACCINE  
(71) GlaxoSmithKline Biologicals S.A., rue de l'Institut, 89, 1330 Rixensart, BE  
(72) BOURGUIGNON, Patricia, GlaxoSmithKline Biologicals sa rue de l'Institut 89, B-1330 Rixensart, BE  
KOUTSOUKOS, Marguerite Christine, GlaxoSmithKline Biologicals s.a. rue de l'Institut 89, B-1330 Rixensart, BE  
LORIN, Clarisse, GlaxoSmithKline Biologicals s.a. rue de l'Institut 89, B-1330 Rixensart, BE  
MCNALLY, Lisa, GlaxoSmithKline 980 Great West Road, Bredford Middlesex TW8 9GS, GB  
VOSS, Gerald Hermann, GlaxoSmithKline Biologicals s.a. rue de l'Institut 89, B-1330 Rixensart, BE

(51) MKP  
**C07F 17/02 (2006.01)** (97) **2580224 \***  
(86) IB2011052536 10.06.2011  
(96) 11729738.2 17.04.2013  
(87) WO2011154923, 10.06.2011  
(97) 2580224, 17.04.2013 en  
(54) METHOD OF SYNTHESIS OF FERROQUINE BY CONVERGENT REDUCTIVE AMINATION  
(71) SANOFI, 54, rue de la Boétie, 75008 Paris, FR  
(72) FEREY, Vincent, c/o Sanofi Département Brevets 174 Avenue de France, F-75013 Paris, FR  
MATEOS-CARO, Julia, c/o Sanofi Département Brevets 174 Avenue de France, F-75013 Paris, FR  
MONDIERE, Régis, c/o Sanofi Département Brevets 174 Avenue de France, F-75013 Paris, FR  
VAYRON, Philippe, c/o Sanofi Département Brevets 174 Avenue de France, F-75013 Paris, FR  
VIGNE, Sylvie, c/o Sanofi Département Brevets 174 Avenue de France, F-75013 Paris, FR

(51) MKP  
**A61M 5/20 (2006.01)** (97) **2538996 \***  
(86) EP2011052304 16.02.2011  
(96) 11703890.1 02.01.2013  
(87) WO2011101382, 16.02.2011  
(97) 2538996, 02.01.2013 en  
(54) AUTO - INJECTOR WITH NEEDLE SHROUD AND NEEDLE PROTECTION CAP  
(71) Sanofi-Aventis Deutschland GmbH, Brüningstraße 50, 65929 Frankfurt, DE  
(72) KEMP, Thomas Mark, 3 Forresters Cottages High Steet, Ashwell SG7 5NW, GB  
BARROW-WILLIAMS, Timothy Donald, 1 Grange Street, St. Albans Herts AL3 5NA, GB  
EKMAN, Matthew, 59 Ecton Avenue, Macclesfield Cheshire SK10 1RD, GB

(51) MKP  
**F24F 12/00 (2006.01)** (97) **2539642 \***  
**E06B 7/10 (2006.01)**  
**F24F 13/18 (2006.01)**  
**F24F 11/00 (2006.01)**  
(86) SI2011000011 23.02.2011  
(96) 11715777.6 02.01.2013  
(87) WO2011105969, 23.02.2011  
(97) 2539642, 02.01.2013 en  
(54) VENTILATION DEVICE  
(71) Mik, D.o.o., Celjska cesta 55, 3212 Vojnik, SL  
(72) NOVAK, Peter, Pod kostanji 8, 1000 Ljubljana, SI

(51) MKP  
**C07D 413/04 (2006.01)** (97) **2563765 \***  
**A61P 3/00 (2006.01)**  
**C07D 231/54 (2006.01)**  
**A61K 31/416 (2006.01)**  
**C07D 487/08 (2006.01)**  
**C07D 263/56 (2006.01)**  
**A61K 31/496 (2006.01)**  
**C07D 417/04 (2006.01)**  
**A61P 9/00 (2006.01)**  
**C07D 307/81 (2006.01)**  
**A61K 31/4365 (2006.01)**  
**C07D 263/58 (2006.01)**  
**A61K 31/4355 (2006.01)**  
**C07D 498/04 (2006.01)**  
(86) JP2011060616 26.04.2011  
(96) 11722184.6 06.03.2013  
(87) WO2011136385, 26.04.2011  
(97) 2563765, 06.03.2013 en  
(54) BICYCLIC COMPOUND DERIVATIVES AND THEIR USE AS ACC INHIBITORS.  
(71) Takeda Pharmaceutical Company Limited, 1-1 Doshomachi 4-chome Chuo-ku, Osaka-shi, Osaka 541-0045, JP  
(72) YAMASHITA, Tohru, c/o TAKEDA PHARMACEUTICAL COMPANY LIMITED 17-85 Jusohonmachi 2-chome Yodogawa-ku, Osaka-shi Osaka 532-8686, JP  
KAMATA, Makoto, c/o TAKEDA PHARMACEUTICAL COMPANY LIMITED 17-85 Jusohonmachi 2-chome Yodogawa-ku, Osaka-shi Osaka 532-8686, JP  
HIROSE, Hideki, c/o TAKEDA PHARMACEUTICAL COMPANY LIMITED 17-85 Jusohonmachi 2-chome Yodogawa-ku, Osaka-shi Osaka 532-8686, JP  
MURAKAMI, Masataka, c/o TAKEDA PHARMACEUTICAL COMPANY LIMITED 17-85 Jusohonmachi 2-chome Yodogawa-ku, Osaka-shi Osaka 532-8686, JP  
FUJIMOTO, Takuya, c/o TAKEDA PHARMACEUTICAL COMPANY LIMITED 17-85 Jusohonmachi 2-chome Yodogawa-ku, Osaka-shi Osaka 532-8686, JP  
IKEDA, Zenichi, c/o TAKEDA PHARMACEUTICAL COMPANY LIMITED 17-85 Jusohonmachi 2-chome Yodogawa-ku, Osaka-shi Osaka 532-8686, JP  
YASUMA, Tsuneo, c/o TAKEDA PHARMACEUTICAL COMPANY LIMITED 17-85 Jusohonmachi 2-chome Yodogawa-ku, Osaka-shi Osaka 532-8686, JP  
FUJIMORI, Ikuo, c/o TAKEDA PHARMACEUTICAL COMPANY LIMITED 17-85 Jusohonmachi 2-chome Yodogawa-ku, Osaka-shi Osaka 532-8686, JP  
MIZOJIRI, Ryo, c/o TAKEDA PHARMACEUTICAL COMPANY LIMITED 17-85 Jusohonmachi 2-chome Yodogawa-ku, Osaka-shi Osaka 532-8686, JP  
YUKAWA, Tomoya, c/o TAKEDA PHARMACEUTICAL COMPANY LIMITED 17-85 Jusohonmachi 2-chome Yodogawa-ku, Osaka-shi Osaka 532-8686, JP

(51) MKP  
**C09J 189/00 (2006.01)** (97) **2576697 \***  
**C08L 97/02 (2006.01)**  
**C08L 79/02 (2006.01)**  
**C08L 89/00 (2006.01)**  
(86) US2011038132 26.05.2011  
(96) 11726549.6 10.04.2013  
(87) WO2011150203, 26.05.2011  
(97) 2576697, 10.04.2013 en  
(54) PROTEIN ADHESIVE FORMULATIONS WITH AMINE-EPICHLOROHYDRIN AND ISOCYANATE ADDITIVES  
HERCULES INCORPORATED, 500 Hercules Road, Wilmington, DE 19808, US  
(71) ALLEN, Anthony, J., 6918 Avalon Lane, Madison WI 53719, US  
(72) WESCOTT, James, M., 305 Worthington Court, Waunakee WI 53597, US  
VARNELL, Daniel, F., 1103 Bardell Drive, Wilmington DE 19808, US  
EVANS, Michael, A., 406 South Woodward Avenue, Wilmington DE 19805, US

- (51) MKP  
**A61K 31/437 (2006.01)** (97) **2594555 \***  
**A61K 31/498 (2006.01)**  
**C07D 231/40 (2006.01)**  
**C07D 277/20 (2006.01)**  
**A61K 31/4178 (2006.01)**  
**A61P 29/00 (2006.01)**  
**C07D 405/14 (2006.01)**  
**A61K 31/341 (2006.01)**  
**A61K 31/55 (2006.01)**  
**C07D 307/68 (2006.01)**  
**A61K 31/427 (2006.01)**  
**A61P 43/00 (2006.01)**  
**C07D 207/34 (2006.01)**  
**A61K 31/5383 (2006.01)**  
**C07D 277/42 (2006.01)**  
**A61K 31/426 (2006.01)**  
**A61P 35/00 (2006.01)**  
**A61K 31/415 (2006.01)**  
**A61P 3/10 (2006.01)**  
**C07D 403/12 (2006.01)**  
(86) JP2011065148 01.07.2011  
(96) 11800989.3 22.05.2013  
(87) WO2012002527, 01.07.2011  
(97) 2594555, 22.05.2013 en  
(54) HETEROCYCLIC COMPOUND, AND p27 KIP1 DEGRADATION INHIBITOR  
(71) ASKA Pharmaceutical Co., Ltd., 5-1, Shibaura 2-chome Minato-ku, Tokyo 108-8532, JP  
(72) UCHIDA, Hiroshi, c/o ASKA Pharmaceutical Co. Ltd. Kawasaki Research Center 5-36-1 Shimosakunobe Takatsu-ku, Kawasaki-shi Kanagawa 213-8522, JP  
ASAGARASU, Akira, c/o ASKA Pharmaceutical Co. Ltd. Kawasaki Research Center 5-36-1 Shimosakunobe Takatsu-ku, Kawasaki-shi Kanagawa 213-8522, JP  
MATSUI, Teruaki, c/o ASKA Pharmaceutical Co. Ltd. 5-1 Shibaura 2-chome Minato-ku, Tokyo 108-8532, JP
- 
- (51) MKP  
**A61P 3/10 (2006.01)** (97) **2566854 \***  
**A61K 31/4164 (2006.01)**  
**C07D 233/22 (2006.01)**  
**A61K 31/421 (2006.01)**  
**C07D 263/16 (2006.01)**  
**C07D 263/14 (2006.01)**  
**C07D 231/14 (2006.01)**  
**A61P 31/12 (2006.01)**  
(86) US2011035211 04.05.2011  
(96) 11778269.8 13.03.2013  
(87) WO2011140232, 04.05.2011  
(97) 2566854, 13.03.2013 en  
(54) DESAZADESFERROTHIOCIN AND DESAZADESFERROTHIOCIN POLYETHER ANALOGUES AS METAL CHELATION AGENTS  
(71) Shire LLC, 9200 Brookfield Court, Suite 108, Florence KY 41042, US  
(72) MALECHA, James, W., 2729 Debbie Court, San Carlos CA 94070, US
- 
- (51) MKP  
**A61K 31/00 (2006.01)** (97) **2571900 \***  
**C07K 14/56 (2006.01)**  
**A61K 38/21 (2006.01)**  
**A61K 38/26 (2006.01)**  
**C07K 14/575 (2006.01)**  
**C07K 16/18 (2006.01)**  
**C07K 16/28 (2006.01)**  
**A61K 47/48 (2006.01)**  
(86) EP2011058298 20.05.2011  
(96) 11720310.9 27.03.2013  
(87) WO2011144751, 20.05.2011  
(97) 2571900, 27.03.2013 en  
(54) IMPROVED ANTI-SERUM ALBUMIN BINDING VARIANTS  
(71) Glaxo Group Limited, Glaxo Wellcome House Berkeley Avenue Greenford, Middlesex UB6 0NN, GB  
(72) DE ANGELIS, Elena, Domantis Limited 315 Cambridge Science Park Cambridge, Cambridgeshire CB4 0WG, GB  
ENEVER, Carolyn, Domantis Limited 315 Cambridge Science Park Cambridge, Cambridgeshire CB4 0WG, GB  
LIU, Haiqun, Domantis Limited 315 Cambridge Science Park Cambridge, Cambridgeshire CB4 0WG, GB  
SCHON, Oliver, Domantis Limited 315 Cambridge Science Park Cambridge, Cambridgeshire CB4 0WG, GB  
PUPECKA-SWIDER, Malgorzata, Domantis Limited 315 Cambridge Science Park Cambridge, Cambridgeshire CB4 0WG, GB
- 
- (51) MKP  
**C07K 16/30 (2006.01)** (97) **2550296 \***  
(86) EP2011001198 10.03.2011  
(96) 11708201.6 30.01.2013  
(87) WO2011116885, 10.03.2011  
(97) 2550296, 30.01.2013 en  
(54) MONOCLONAL ANTIBODIES FOR TREATMENT OF CANCER  
(71) GANYMED Pharmaceuticals AG, Freiligrathstrasse 12, 55131 Mainz, DE  
Johannes- Gutenberg-Universität Mainz, Saarstrasse 21, 55122 Mainz, DE  
(72) SAHIN, Ugur, Philipp-von-Zabern-Platz 1, 55116 Mainz, DE  
TÜRECI, Özlem, Philipp-von-Zabern-Platz 1, 55116 Mainz, DE  
KOSLOWSKI, Michael, Am Ried 23, 85764 Oberschleißheim, DE  
MITNACHT-KRAUS, Rita, Taunusstrasse 45, 61169 Friedberg, DE
- 
- (51) MKP  
**A47K 5/12 (2006.01)** (97) **2560530 \***  
(86) AT2011000202 21.04.2011  
(96) 11722276.0 27.02.2013  
(87) WO2011130768, 21.04.2011  
(97) 2560530, 27.02.2013 de  
(54) STAND FOR A LIQUID DISPENSER  
(71) Hagleitner, Hans Georg, Lindenallee 11, 5700 Zell am See, AT  
(72) Hagleitner, Hans Georg, Lindenallee 11, 5700 Zell am See, AT
- 
- (51) MKP  
**A61K 31/495 (2006.01)** (97) **2585440 \***  
**C07D 403/10 (2006.01)**  
**C07D 401/12 (2006.01)**  
**C07D 241/08 (2006.01)**  
**A61P 25/28 (2006.01)**  
**C07D 401/10 (2006.01)**  
(86) EP2011060712 27.06.2011  
(96) 11729962.8 01.05.2013  
(87) WO2012000933, 27.06.2011  
(97) 2585440, 01.05.2013 en  
(54) 3-AMINO-5,6-DIHYDRO-1H-PYRAZIN-2-ONE DERIVATIVES USEFUL FOR THE TREATMENT OF ALZHEIMER'S DISEASE AND OTHER FORMS OF DEMENTIA  
(71) Janssen Pharmaceutica, N.V., Turnhoutseweg 30, 2340 Beerse, BE  
(72) TRABANCO-SUÁREZ, Andrés Avelino, c/o Janssen-Cilag S.A. Calle Jarama 75 Poligono Industrial, E-45007 Toledo, ES  
DELGADO-JIMÉNEZ, Francisca, c/o Janssen-Cilag S.A. Calle Jarama 75 Poligono Industrial, E-45007 Toledo, ES  
TRESADERN, Gary, John, c/o Janssen-Cilag S.A. Calle Jarama 75 Poligono Industrial, E-45007 Toledo, ES



- (51) MKP  
**C07C 271/20 (2006.01)** (97) **2569276 \***  
**C07C 237/06 (2006.01)**  
**C12N 15/11 (2006.01)**  
**C07D 249/04 (2006.01)**  
**C07C 229/30 (2006.01)**  
**C12N 15/88 (2006.01)**  
**A61K 48/00 (2006.01)**  
**C07D 233/60 (2006.01)**  
**C07C 217/08 (2006.01)**  
**C07C 327/06 (2006.01)**  
**C07C 217/46 (2006.01)**  
**A61K 49/04 (2006.01)**  
**C07C 229/12 (2006.01)**  
**A61K 47/48 (2006.01)**  
(86) GB2011000723 12.05.2011  
(96) 11731455.9 20.03.2013  
(87) WO2011141705, 12.05.2011  
(97) 2569276, 20.03.2013 en  
(54) NOVEL CATIONIC LIPIDS AND METHODS OF USE THEREOF  
(71) Protiva Biotherapeutics Inc., 100-8900 Glenlyon Parkway, Burnaby, British Columbia V5J 5J8, CA  
(72) HEYES, James, 47-870 West 7th Avenue, Vancouver, British Columbia V5Z 4C1, CA  
WOOD, Mark, 205-801 Klahanie Drive, Port Moody, British Columbia V3H 5K4, CA  
MARTIN, Alan, 708-688 Abbott Street, Vancouver, British Columbia V6B 0B9, CA

- (51) MKP  
**A63G 27/00 (2006.01)** (97) **2591835 \***  
(86) RU2011000688 08.09.2011  
(96) 11809945.6 15.05.2013  
(87) WO2012011852, 08.09.2011  
(97) 2591835, 15.05.2013 en  
(54) OBSERVATION WHEEL  
(71) Gnezdilov, Vladimir Alexeevich, Ul Aviatsionnaya 79-295, Moscow 123182, RU  
(72) Gnezdilov, Vladimir Alexeevich, Ul Aviatsionnaya 79-295, Moscow 123182, RU

- (51) MKP  
**B01D 63/04 (2006.01)** (97) **2559477**  
**B01D 65/00 (2006.01)**  
(96) 11006673.5 20.02.2013  
(97) 2559477, 20.02.2013 de  
(54) Device for filtering and separating flow media with hollow fibre membrane elements  
(71) TIG Automation GmbH, Bötelkamp 38, 22529 Hamburg, DE  
(72) Arbeiter, Udo, Wassertalsweg 8, 21218 Seevetal, DE

- (51) MKP  
**A61K 38/17 (2006.01)** (97) **2563382 \***  
**A61K 38/16 (2006.01)**  
**A61K 39/395 (2006.01)**  
**A61P 29/00 (2006.01)**  
**A61P 3/00 (2006.01)**  
**A61P 35/00 (2006.01)**  
(86) US2011034207 27.04.2011  
(96) 11777984.3 06.03.2013  
(87) WO2011139801, 27.04.2011  
(97) 2563382, 06.03.2013 en  
(54) INNOVATIVE DISCOVERY OF THERAPEUTIC, DIAGNOSTIC, AND ANTIBODY COMPOSITIONS RELATED TO PROTEIN FRAGMENTS OF THREONYL TRNA SYNTHETASES  
(71) aTyr Pharma, Inc., 3545 John Hopkins Court, Suite 250, San Diego, CA 92121, US  
Pangu Biopharma Limited, Edinburgh Tower, 18/F The Landmark 15 Queen's Road Central, Hong Kong, CN  
(72) GREENE, Leslie Ann, 13941 Davenport Avenue, San Diego, California 92129, US  
CHIANG, Kyle, P., 943 Torrance Street Apt. 6, San Diego, California 92103, US  
HONG, Fei, 7979 Caminito Dia 2, San Diego, California 92122, US  
VASSEROT, Alain, P., 6421 La Paloma Street, Carlsbad, California 92009, US  
LO, Wing-Sze, RM 815 Sui Ming House Siu Sai Wan Estate, Chai Wan Hong Kong, CN  
WATKINS, Jeffrey, D., 3442 Fortuna Ranch Road, Encinitas, California 92024, US  
MENDLEIN, John, D., 1550 Neptune Avenue, Encinitas, California 92024, US  
QUINN, Cheryl, L., 5392 Renaissance Avenue, San Diego, California 92122, US

- (51) MKP  
**G06F 19/00 (2011.01)** (97) **2550613 \***  
(86) EP2010001882 25.03.2010  
(96) 10712334.1 30.01.2013  
(87) WO2011116791, 25.03.2010  
(97) 2550613, 30.01.2013 de  
(54) METHOD AND RECORDING MACHINE FOR RECORDING HEALTH-RELATED INFORMATION  
(71) Normamed S.A., Rue Jean-Pierre Brasseur 22, 1258 Luxembourg, LU  
(72) TESMER, Karl, Via Albonago 28b, CH-6962 Viganello, CH

- (51) MKP  
**A61M 5/178 (2006.01)** (97) **2455120**  
**H02K 7/18 (2006.01)**  
**H02K 35/00 (2006.01)**  
(96) 10191801.9 23.05.2012  
(97) 2455120, 23.05.2012 en  
(54) Medical device comprising mechanical-electrical transducing means  
(71) Sanofi-Aventis Deutschland GmbH, Brüningstraße 50, 65929 Frankfurt, DE  
(72) Pommereau, Christian, c/o Sanofi-Aventis Deutschland GmbH, 65926 Frankfurt am Main, DE

- (51) MKP  
**E05F 3/10 (2006.01)** (97) **2426300**  
(96) 10187458.4 07.03.2012  
(97) 2426300, 07.03.2012 en  
(54) Door closer, particularly for glass doors  
(71) Gosio Dianora, Via Della Fonte 9c, 25075 Nave (Brescia), IT  
(72) Bacchetti, Luciano, Via della fonte 9/C, 25075, Nave (BS), IT

- (51) MKP  
**A61K 39/395 (2006.01)** (97) **2569336 \***  
**A61K 45/06 (2006.01)**  
**A61P 35/00 (2006.01)**  
**C12Q 1/68 (2006.01)**  
**C07K 16/28 (2006.01)**  
(86) US2011036521 13.05.2011  
(96) 11720711.8 20.03.2013  
(87) WO2011143614, 13.05.2011  
(97) 2569336, 20.03.2013 en  
(54) ENHANCED DEATH RECEPTOR AGONISTS  
(71) Amgen Inc., One Amgen Center Drive M/S 28-2-C, Thousand Oaks, CA 91320, US  
(72) GRAVES, Jonathan David, 42 Stults Road, Belmont, MA 02478, US  
KORDICH, Jennifer Joy, 3015 255th Avenue SE, Sammamish, Washington 98075, US  
COTTRELL, Susan Ellen, 522 NE 84th Street, Seattle, Washington 98115, US  
HUANG, Chang-Pin, 20321 Greenwood Avenue North, Shoreline, Washington 98133, US

- (51) MKP  
**A61K 9/28 (2006.01)** (97) **2542220 \***  
**A61K 31/275 (2006.01)**  
**A61K 45/06 (2006.01)**  
**A61K 9/00 (2006.01)**  
**A61K 31/198 (2006.01)**  
**A61P 25/16 (2006.01)**  
**A61K 9/20 (2006.01)**  
(86) FI2011000013 03.03.2011  
(96) 11709446.6 09.01.2013  
(87) WO2011107653, 03.03.2011  
(97) 2542220, 09.01.2013 en  
(54) USE OF LEVODOPA, CARBIDOPA AND ENTACAPONE FOR TREATING PARKINSON'S DISEASE  
(71) Orion Corporation, Orionintie 1, 02200 Espoo, FI  
(72) ROURU, Juha, Tammilehdonkuja 5 H 24, FI-20900 Turku, FI  
KUOPPAMÄKI, Mikko, Katteluksentie 9, FI-21120 Raisio, FI  
ELLMEN, Juha, Impivaarantie 8 A, FI-20320 Turku, FI  
MÄNNISTÖ, Pekka, Harmaapaadenties 5 A, FI-00930 Helsinki, FI

- (51) MKP  
**C40B 30/06 (2006.01)** (97) **2582813 \***  
**C12N 15/62 (2006.01)**  
**C12N 15/10 (2006.01)**  
(86) EP2011003022 17.06.2011  
(96) 11726355.8 24.04.2013  
(87) WO2011157448, 17.06.2011  
(97) 2582813, 24.04.2013 en  
(54) METHODS OF GENERATING AND SCREENING FOR LYTIC CHIMERIC POLYPEPTIDES  
(71) Hyglos Invest GmbH, Am Neuland 1, 82347 Bernried, DE  
(72) SCHERZINGER, Anna, Zugspitzstrasse 11a, 82347 Bernried, DE  
LEOPOLDSEDER, Sonja, Am Meisteranger 30, 82362 Weilheim, DE  
BUCHBERGER, Bernd, Wiesenstr. 7, 93197 Zeitlarn/Laub, DE

- (51) MKP  
**A61M 5/34 (2006.01)** (97) **2552521 \***  
**A61M 5/31 (2006.01)**  
**A61M 5/00 (2006.01)**  
(86) EP2011054418 23.03.2011  
(96) 11709721.2 06.02.2013  
(87) WO2011117282, 23.03.2011  
(97) 2552521, 06.02.2013 en  
(54) DEDICATED NEEDLE ASSEMBLY  
(71) Sanofi-Aventis Deutschland GmbH, Brüningstraße 50, 65929 Frankfurt, DE  
(72) CROSS, John David, 34 Station Road Long Buckby, Northampton Northamptonshire NN6 7QB, GB  
BOYD, Malcolm Stanley, 28 Whitehead Drive, Wellsbourne Warwickshire CV35 9PW, GB  
DE SAUSMAREZ LINTELL, Daniel Thomas, 6 Smithy Lane Church Lawford, Rugby, Warwickshire CV23 9EQ, GB  
YOUNG, Alasdair George, Bakehouse Cottage 50 West Street, Chipping Norton Oxfordshire OX7 5ER, GB

- (51) MKP  
**A61K 39/395 (2006.01)** (97) **2569013 \***  
**C12P 21/08 (2006.01)**  
**C12N 5/07 (2010.01)**  
**C12N 5/16 (2006.01)**  
(86) US2011036535 13.05.2011  
(96) 11781385.7 20.03.2013  
(87) WO2011143624, 13.05.2011  
(97) 2569013, 20.03.2013 en  
(54) HUMANIZED AND CHIMERIC MONOCLONAL ANTIBODIES TO CD47  
(71) The Board of Trustees of the Leland Stanford Junior University, 1705 El Camino Real, Palo Alto, CA 94306, US  
LIU, Jie, 3119 Stockton Place, Palo Alto, California 94303, US  
WEISSMAN, Irving L., 747 Santa Ynez Street, Stanford, California 94305, US  
MAJETI, Ravindra, Stanford Institute for Stem Cell Bio and Regenerative Medicine 1050 Arastradero Road Building A, Stanford, California 94304, US

- (51) MKP  
**A61M 5/24 (2006.01)** (97) **2560707 \***  
(86) EP2011056481 21.04.2011  
(96) 11716249.5 27.02.2013  
(87) WO2011131782, 21.04.2011  
(97) 2560707, 27.02.2013 en  
(54) CODED FASTENER ASSEMBLY  
(71) Sanofi-Aventis Deutschland GmbH, Brüningstraße 50, 65929 Frankfurt, DE  
(72) AVERY, Richard, James, Vincent, 28 Nursery Close Mickleton, Chipping Campden Gloucestershire GL55 6TX, GB  
DRAPER, Paul, 2 Clyde Avenue, Evesham Worcestershire WR11 3, GB  
JAMES, Aled, Meredydd, 5 Moorefield Avenue Knowle, Solihull West Midlands B93 9RE, GB

- (51) MKP  
**D21H 21/14 (2006.01)** (97) **2576637 \***  
**D21H 17/35 (2006.01)**  
**C08F 10/10 (2006.01)**  
**C08F 10/08 (2006.01)**  
(86) US2011039368 07.06.2011  
(96) 11727064.5 10.04.2013  
(87) WO2011156313, 07.06.2011  
(97) 2576637, 10.04.2013 en  
(54) CREPING RELEASE AGENTS  
(71) Hercules Incorporated, 500 Hercules Road, Wilmington, DE 19808, US  
(72) DILKUS, Christopher, P., 219 Laurel Avenue, Woodylyne NJ 08107, US

- (51) MKP  
**A61B 5/08 (2006.01)** (97) **2579824 \***  
**A61M 16/00 (2006.01)**  
**A61F 5/56 (2006.01)**  
(86) CA2011000669 08.06.2011  
(96) 11791778.1 17.04.2013  
(87) WO2011153622, 08.06.2011  
(97) 2579824, 17.04.2013 en  
(54) A METHOD AND DEVICE(S) FOR DIAGNOSIS AND/OR TREATMENT OF SLEEP APNEA AND RELATED DISORDERS  
(71) YRT Limited, 506-141 Wellington Crescent, Winnipeg, Manitoba R3M 3X3, CA  
(72) YOUNES, Magdy, 506-141 Wellington Crescent, Winnipeg Manitoba R3M 3X3, CA

- (51) MKP  
**A61K 47/48 (2006.01)** (97) **2588124 \***  
**A61K 38/18 (2006.01)**  
**A61K 38/17 (2006.01)**  
**A61K 9/48 (2006.01)**  
**A61P 35/00 (2006.01)**  
**A61K 31/7105 (2006.01)**  
(86) US2011042832 01.07.2011  
(96) 11801506.4 08.05.2013  
(87) WO2012003466, 01.07.2011  
(97) 2588124, 08.05.2013 en  
(54) SINGLE-WALLED CARBON NANOTUBE/SIRNA COMPLEXES AND METHODS RELATED THERETO  
(71) Ensysce Biosciences, Inc., 20333 S.H. 249, Suite 600, Houston, TX 77070, US  
(72) KIRKPATRICK, D. Lynn, 326 E. Cowan Drive, Houston, Texas 77007, US  
WEISS, Michelle K., 5239 Caversham Drive, Houston, Texas 77096, US

- (51) MKP  
**A61K 31/197 (2006.01)** (97) **2567700 \***  
**A61K 31/714 (2006.01)**  
**A61K 31/198 (2006.01)**  
**A61K 33/06 (2006.01)**  
**A61K 9/08 (2006.01)**  
**A61K 31/525 (2006.01)**  
**A61K 31/4188 (2006.01)**  
**A61K 33/30 (2006.01)**  
**A61K 31/4415 (2006.01)**  
**A61K 47/12 (2006.01)**  
**A61K 31/51 (2006.01)**  
**A61K 31/455 (2006.01)**  
**A61P 7/00 (2006.01)**  
**A61K 31/19 (2006.01)**  
**A61K 31/7004 (2006.01)**  
**A61K 31/375 (2006.01)**  
**A61K 33/20 (2006.01)**  
(86) JP2011060899 02.05.2011  
(96) 11777492.7 13.03.2013  
(87) WO2011138973, 02.05.2011  
(97) 2567700, 13.03.2013 en  
(54) VITAMIN-CONTAINING NUTRITION INFUSION FOR ADMINISTRATION THROUGH PERIPHERAL VEIN  
(71) Ajinomoto Co., Inc., 15-1, Kyobashi 1-chome Chuo-ku, Tokyo 104-8315, JP  
(72) ABIKO, Kazuhiro, c/o AJINOMOTO PHARMACEUTICALS CO. LTD. 649-1, Miyakami Shimizu-ku, Shizuoka-shi Shizuoka 424-0911, JP  
KATSURA, Toshiyuki, c/o AJINOMOTO PHARMACEUTICALS CO. LTD. 649-1, Miyakami Shimizu-ku, Shizuoka-shi Shizuoka 424-0911, JP

- (51) MKP  
**A61K 31/167 (2006.01)** (97) **2594262 \***  
**A61K 45/00 (2006.01)**  
**A61K 31/192 (2006.01)**  
**A61K 9/70 (2006.01)**  
(86) JP2011065762 11.07.2011  
(96) 11806725.5 22.05.2013  
(87) WO2012008395, 11.07.2011  
(97) 2594262, 22.05.2013 en  
(54) SUBSTRATE OF THREE-LAYER STRUCTURE AND WATER-CONTAINING ADHESIVE PATCH INCLUDING SAME  
(71) Teikoku Seiyaku Co., Ltd., 567 Sanbonmatsu, Higashikagawa-shi, Kagawa 769-2695, JP  
Toyobo Co., Ltd., 2-8 Dojima Hama 2-chome Kita-ku, Osaka-shi Osaka 530-8230, JP  
(72) SHIRAI, Sadanobu, c/o TEIKOKU SEIYAKU CO. LTD. 567 Sanbonmatsu, Higashikagawa-shi Kagawa 769-2695, JP  
INAZUKI, Masahiro, c/o TEIKOKU SEIYAKU CO. LTD. 567 Sanbonmatsu, Higashikagawa-shi Kagawa 769-2695, JP  
ISHIGURE, Miho, c/o TEIKOKU SEIYAKU CO. LTD. 567 Sanbonmatsu, Higashikagawa-shi Kagawa 769-2695, JP  
ISODA, Hideo, c/o TOYO BOSEKI KABUSHIKI KAISHA 1-1, Katata 2-chome, Otsu-shi Shiga 520-0292, JP  
SAKAMOTO, Hiroyuki, c/o TOYO BOSEKI KABUSHIKI KAISHA 1-1, Katata 2-chome, Otsu-shi Shiga 520-0292, JP  
KOIDA, Takashi, c/o TOYO BOSEKI KABUSHIKI KAISHA 2-8, Dojima Hama 2-chome Kita-ku, Osaka-shi Osaka 530-8230, JP  
SAKAGUCHI, Hiroyasu, c/o TOYO BOSEKI KABUSHIKI KAISHA 2-8, Dojima Hama 2-chome Kita-ku, Osaka-shi Osaka 530-8230, JP

- (51) MKP  
**A61P 31/04 (2006.01)** (97) **2544711 \***  
**A61K 39/09 (2006.01)**  
(86) EP2011053485 08.03.2011  
(96) 11706840.3 16.01.2013  
(87) WO2011110570, 08.03.2011  
(97) 2544711, 16.01.2013 en  
(54) TREATMENT OF STREPTOCOCCAL INFECTIONS  
(71) GlaxoSmithKline Biologicals S.A., rue de l'Institut, 89, 1330 Rixensart, BE  
(72) DENOEL, Philippe, GlaxoSmithKline Biologicals s.a. Rue de l'Institut 89, B-1330 Rixensart, BE  
HERMAND, Philippe Vincent, GlaxoSmithKline Biologicals s.a. Rue de l'Institut 89, B-1330 Rixensart, BE  
LABBE, Steve, GlaxoSmithKline Biologicals Canada 525 Cartier Boulevard West Laval, Quebec H7V 3S8, CA  
POOLMAN, Jan, GlaxoSmithKline Biologicals s.a. Rue de l'Institut 89, B-1330 Rixensart, BE  
RIOUX, Stephane, GlaxoSmithKline Biologicals s.a. Rue de l'Institut 89, B-1330 Rixensart, BE

- (51) MKP  
**A61P 15/00 (2006.01)** (97) **2547681 \***  
**A61K 31/5517 (2006.01)**  
**C07D 487/04 (2006.01)**  
(86) GB2011000381 18.03.2011  
(96) 11709771.7 23.01.2013  
(87) WO201114109, 18.03.2011  
(97) 2547681, 23.01.2013 en  
(54) TOSYLATE SALT OF CYCLOPROPANECARBOXYLIC ACID 4-(6-CHLORO-3-METHYL-4,10-DIHYDRO-3H-2,3,4,9-TETRABENZO[F]AZULENE-9-CARBONYL)-2-FLUOROBENZYLAMIDE  
(71) Vantia Limited, 1 Venture Road, Southampton Science Park Chilworth Hampshire SO16 7NP, GB  
(72) BATT, Andrzej, Roman, Vantia Limited 1 Venture Road Chilworth, Southampton SO16 7NP, GB  
HANDY, RachelLouisa Charlotte, Vantia Limited 1 Venture Road Chilworth, Southampton SO16 7NP, GB  
ROE, Michael Bryan, Vantia Limited 1 Venture Road Chilworth, Southampton SO16 7NP, GB  
PEAL, Valerie Elizabeth, Willowbrook Technology Park Llandogo Road St Mellons, Cardiff CF30EF UK, GB  
GIBBS, Timothy John Kenhardt, Park Place Research Ltd Willowbrook Technology Park Llandogo Road St Mellons, Cardiff CF3 0EF, GB  
CHURCHLEY, David Raymond, Pharmaterials Ltd UnitB 5 Boulton Road, Reading RG2 0NH, GB

- (51) MKP  
**F02D 41/34 (2006.01)** (97) **2556232 \***  
**F02P 7/077 (2006.01)**
- (86) EP2011055503 08.04.2011  
(96) 11715191.0 13.02.2013  
(87) WO2011124679, 08.04.2011  
(97) 2556232, 13.02.2013 en  
(54) INJECTION CONTROL METHOD  
(71) Delphi Technologies Holding S.à.r.l., Avenue de Luxembourg, 4940 Bascharage, LU  
(72) GUERRASSI, Nouredine, 14 Haute Rue, F-41350 Vineuil, FR  
ALLEZY, Pierre, 42 rue du Chateau, F-41370 Talcy, FR
- 
- (51) MKP  
**F02F 3/28 (2006.01)** (97) **2556235 \***  
**F02F 7/00 (2006.01)**
- (86) TR2011000076 05.04.2011  
(96) 11721137.5 13.02.2013  
(87) WO2011126464, 05.04.2011  
(97) 2556235, 13.02.2013 en  
(54) HIGH SPEED ENGINE  
(71) Ozdamar, Hasan Basri, Organize Sanayi Bolgesi 14. Cadde No. 19, 38070 Kayseri, TR  
(72) Ozdamar, Hasan Basri, Organize Sanayi Bolgesi 14. Cadde No. 19, 38070 Kayseri, TR
- 
- (51) MKP  
**H04M 9/08 (2006.01)** (97) **2568695 \***
- (86) CN2011081180 24.10.2011  
(96) 11864133.1 13.03.2013  
(87) WO2013007070, 24.10.2011  
(97) 2568695, 13.03.2013 en  
(54) METHOD AND DEVICE FOR SUPPRESSING RESIDUAL ECHO  
(71) Goertek Inc., No. 268 Dong Fang Road Hi-Tech Industry Development District, Wei Fang, Shandong 261031, CN  
(72) LOU, Shasha, No. 268 Dongfang Road Hi-Tech Industry Development District Weifang, Shandong 261031, CN  
LI, Bo, No. 268 Dongfang Road Hi-Tech Industry Development District Weifang, Shandong 261031, CN  
LIU, Song, No. 268 Dongfang Road Hi-Tech Industry Development District Weifang, Shandong 261031, CN
- 
- (51) MKP  
**F41H 11/02 (2006.01)** (97) **2556325 \***  
**F41H 13/00 (2006.01)**
- (86) KR2010006156 10.09.2010  
(96) 10849531.8 13.02.2013  
(87) WO2011126184, 10.09.2010  
(97) 2556325, 13.02.2013 en  
(54) HIGH-ENERGY LASER SYSTEM INTERCEPTING A TARGET AND METHOD THEREOF  
(71) Korea Advanced Institute Of Science And Technology, 373-1 Guseong-dong Yuseong-gu, Daejeon 305-701, KR  
(72) KONG, Hong Jin, 107-402 Hanbit Apt. Eoeun-dong Yuseong-gu, Daejeon 305-755, KR  
SHIN, Jae Sung, Korea Advanced Institute of Science 373-1 Guseong-dong Yuseong-gu, Daejeon 305-701, KR  
PARK, Sang Woo, Korea Advanced Institute of Science 373-1 Guseong-dong Yuseong-gu, Daejeon 305-701, KR  
SHIM, Kang Sup, Korea Advanced Institute of Science 373-1 Guseong-dong Yuseong-gu, Daejeon 305-701, KR  
CHA, Seong Woo, Korea Advanced Institute of Science 373-1 Guseong-dong Yuseong-gu, Daejeon 305-701, KR
- 
- (51) MKP  
**A61K 31/4422 (2006.01)** (97) **2585051 \***  
**A61K 9/20 (2006.01)**  
**A61K 31/401 (2006.01)**
- (86) EP2011060584 23.06.2011  
(96) 11727178.3 01.05.2013  
(87) WO2011161223, 23.06.2011  
(97) 2585051, 01.05.2013 en  
(54) PHARMACEUTICAL ORAL DOSAGE FORMS COMPRISING LERCANIDIPINE AND ENALAPRIL AND THEIR PHARMACEUTICALLY ACCEPTABLE SALTS  
(71) Krka Tovarna Zdravil, D.D., Novo Mesto, Smarjeska cesta 6, 8501 Novo Mesto, SI  
(72) SEDMAK, Gregor, Palmejeva 30, 1000 Ljubljana, SI  
TURK, Urska, Kostialova 44a, 8000 Novo mesto, SI  
BUKOVEC, Polona, Regrca vas 37a, 8000 Novo mesto, SI
- 
- (51) MKP  
**G06F 3/01 (2006.01)** (97) **2555703 \***  
**A61B 5/11 (2006.01)**  
**A61B 3/113 (2006.01)**  
**A61B 19/00 (2006.01)**
- (86) IB2011051397 01.04.2011  
(96) 11722883.3 13.02.2013  
(87) WO2011125007, 01.04.2011  
(97) 2555703, 13.02.2013 en  
(54) ROBOTIZED SURGERY SYSTEM WITH IMPROVED CONTROL  
(71) Sofar SPA, Via Firenze 40, 20060 Trezzano Rosa (MI), IT  
RUIZ MORALES, Emilio, Via Bronzino 3, I-20133 Milano, IT  
BRASSET, Damien, Via Libertà 29-2, I-20874 Busnago (MB), IT  
INVERNIZZI, Paolo, Via Generale Govone 52, I-20152 Milano, IT
- 
- (51) MKP  
**B65D 19/24 (2006.01)** (97) **2585379 \***  
**B65D 19/28 (2006.01)**  
**B21D 9/05 (2006.01)**
- (86) CA2011050372 20.06.2011  
(96) 11797435.2 01.05.2013  
(87) WO2011160224, 20.06.2011  
(97) 2585379, 01.05.2013 en  
(54) SECTIONAL METAL PALLET FORMED FROM CORRIGATED METAL TUBES  
(71) Novellis, Inc., 191 Evans Avenue, Toronto, ON M8Z 1J5, CA  
(72) STRIZKI, Thomas Charles, 18630 County Road 1, Berthoud Colorado 80513, US
- 
- (51) MKP  
**A01P 13/00 (2006.01)** (97) **2582245 \***  
**A01N 43/90 (2006.01)**  
**A01N 43/40 (2006.01)**
- (86) US2011040682 16.06.2011  
(96) 11728977.7 24.04.2013  
(87) WO2011159884, 16.06.2011  
(97) 2582245, 24.04.2013 en  
(54) SYNERGISTIC HERBICIDAL COMPOSITION CONTAINING CLOPYRALID AND FLORASULAM  
(71) Dow AgroSciences LLC, 9330 Zionsville Road, Indianapolis, IN 46268, US  
(72) BECKER, Joerg, Eichendorffstr. 16, D-83043 Bad Aibling, DE
- 
- (51) MKP  
**A61F 2/00 (2006.01)** (97) **2547266 \***  
**A61B 17/00 (2006.01)**  
**A61B 17/06 (2006.01)**
- (86) US2011028290 14.03.2011  
(96) 11710612.0 23.01.2013  
(87) WO2011115876, 14.03.2011  
(97) 2547266, 23.01.2013 en  
(54) SURGICAL INSTRUMENT AND METHOD FOR THE TREATMENT OF URINARY INCONTINENCE  
(71) Ethicon, Inc., P.O. Box 151 Route 22, Somerville, NJ 08876, US  
(72) YOUNG, John, 48 Ashton Drive, Staten Island, NY 10312, US  
NASTASI, Frank A., 1100 Grand Street Apt. 401, Hoboken, NJ 07030, US  
LIBERATORE, Jessica, 10 Yellowbrook Road, Marlboro, NJ 07746, US

(51) MKP  
**G01N 33/68 (2006.01)** (97) **2568294**  
 (96) 12195913.4 13.03.2013  
 (97) 2568294, 13.03.2013 en  
 (54) Risk Factors and Prediction of Myocardial Infarction  
 (71) BG Medicine, Inc., 610N Lincoln Street, Waltham, MA 02451, US  
 (72) The designation of the inventor has not yet been filed , null, null, null

(51) MKP  
**A61L 27/38 (2006.01)** (97) **2566529 \***  
 (86) US2011035058 03.05.2011  
 (96) 11722655.5 13.03.2013  
 (87) WO2011140137, 03.05.2011  
 (97) 2566529, 13.03.2013 en  
 (54) SMOOTH MUSCLE CELL CONSTRUCTS  
 (71) Tengion, Inc., 2900 Potshop Lane, Suite 100, East Norriton, PA 19403, US  
 (72) LUDLOW, John, W., 100 Rivercreek Place, Carrboro NC 27510, US  
 JAYO, Manuel, J., 2534 Warwick Road, Winston Salem NC 27104, US  
 BASU, Joydeep, 435 Mica Court, Winston-salem NC 27103, US  
 BERTRAM, Limothy, A., 423 Torrington Lane, Winston-salem NC 27104, US  
 GENHEIMER, Christopher, W., 4013 Ballard Farm Road, Colfax NC 27235, US  
 GUTHRIE, Kelly, I., 3415 Thoresby Court, Winston-salem NC 27104, US  
 ILAGAN, Roger, M., 2022 Sinclair Trace, Burlington NC 27215, US  
 JAIN, Deepak, 559 Sun Creek Drive, Winston-salem NC 27104, US  
 KNIGHT, Oluwatoyin, A., 3919 Heatherview Lane, Winston-salem NC 27127, US  
 PAYNE, Richard, 934 Franklin St., Winston-salem NC 27101, US  
 QUINLAN, Sarah, F., 1521 Kenwalt Drive, Clemmons NC 27012, US  
 RAPOPORT, H., Scott, Arriatera Etorbidea 69 2D, E-48600 Sopolana Vizkaya, ES  
 SANGHA, Namrata, D., 320 Stonebrook Lane, Winston-salem NC 27104, US  
 SHOKES, Jacob, E., 267 Quik Silver Drive, Winston-Salem NC 27127, US  
 BURNETTE, Teresa, B., 3507 Woodview Dr., High Point NC 27265, US  
 BOYD, Sarah, A., 118a Walnut Cove Drive, Mooresville NC 28117, US  
 HALBERSTADT, Craig, R., 2115 Cherrywood Dr., Clemmons NC 27012, US  
 JUSTEWICZ, Dominic, M., 310 W. Fourth St. No.1604, Winston-salem NC 27101, US  
 RIVERA, Elias, A., 1805 Wild Fern Dr., Oak Ridge NC 27310, US  
 SHARP, Wendy, 409 Biscayne Street, Winston-salem NC 27104, US

(51) MKP  
**C07D 513/10 (2006.01)** (97) **2547685 \***  
**A61K 31/429 (2006.01)**  
**A61P 25/28 (2006.01)**  
**A61K 31/424 (2006.01)**  
**C07D 498/10 (2006.01)**  
**C07D 498/20 (2006.01)**  
 (86) US2011028417 14.03.2011  
 (96) 11710372.1 23.01.2013  
 (87) WO2011115938, 14.03.2011  
 (97) 2547685, 23.01.2013 en  
 (54) SPIRO-TETRACYCLIC RING COMPOUNDS AS BETA - SECRETASE MODULATORS  
 (71) Amgen Inc., One Amgen Center Drive, Thousand Oaks, California 91320-1799, US  
 (72) CHENG, Yuan, 5329 Via Jacinto, Newburry Park CA 91320, US  
 WHITE, Ryan, 34 Willow Avenue Unit 1, Somerville MA 02144, US  
 AMEGADZIE, Albert, 15242 B Campus Park Drive, Moorpark CA 93021, US  
 BROWN, James, 4438 Appleglen Court, Moorpark California 93021, US  
 CHENG, Alan, C., 122 Stillings Avenue, San Francisco CA 94131, US  
 DIMAURO, Erin, F., 250 Chestnut Street, Cambridge MA 02139, US  
 DINEEN, Thomas, 36 Waterhouse Street, Somerville MA 02144, US  
 GORE, Vijay Keshav, 8 Del Rey, Irvine CA 92612, US  
 HUMAN, Jason, Brooks, 944 Dorchester Avenue Unit 19, Boston MA 02125, US  
 JUDD, Ted, 610 Geranium Lane Unit A, Simi Valley CA 93065, US  
 KREIMAN, Charles, 36 Springfield Street, Belmont MA 02478, US  
 LIU, Qingyian, 4631 Paseo Girasol, Camarillo CA 93012, US  
 LOPEZ, Patricia, 22644 Saticoy Street, West Hills CA 91307, US  
 MA, Vu, Van, 356 Countryside Road, Oak Park CA 91377, US  
 MARX, Isaac, 159 Pemberton Street 1, Cambridge CA 02140, US  
 MINATTI, Ana, Elena, 2219 3rd Street unit 6, Santa Monica CA 90405, US  
 NGUYEN, Hanh, Nho, 185 Brattle Street, Arlington MA 02474, US  
 PARAS, Nick, A., 3632 26th Street, San Francisco CA 94110, US  
 PATEL, Vinod, F., 3 Mossy Lane, Acton MA 01720, US  
 QIAN, Wenyuan, 3872 Fountain Street, Camarillo CA 93012, US  
 WEISS, Matthew, 99 Revere Street, Boston Massachusetts 02114, US  
 XUE, Qiufen, 5018 Via Mesita, Newbury Park California 91320, US  
 ZHENG, Xiao Mei, 19 Allison Way, Natick Massachusetts 01760, US  
 ZHONG, Wenge, 2921 Venezia Lane, Thousand Oaks California 91362, US  
 EPSTEIN, Oleg, 44 Trowbridge Street, Belmont, MA 02478, US

(51) MKP  
**G01F 15/06 (2006.01)** (97) **2558821 \***  
**G01D 4/00 (2006.01)**  
 (86) AT2011000186 15.04.2011  
 (96) 11719994.3 20.02.2013  
 (87) WO2011127514, 15.04.2011  
 (97) 2558821, 20.02.2013 de  
 (54) APPARATUS FOR MONITORING AND/OR CONTROLLING ENERGY AND WATER MANAGEMENT  
 (71) Ploder, Edwin, Murfeld 14, 8850 Murrau, AT  
 (72) Ploder, Edwin, Murfeld 14, 8850 Murrau, AT

- (51) MKP  
**B01D 53/62 (2006.01)** (97) **2571805 \***  
**C01B 3/04 (2006.01)**  
**C01B 3/06 (2006.01)**  
**C04B 5/00 (2006.01)**  
(86) IB2011052217 20.05.2011  
(96) 11729711.9 27.03.2013  
(87) WO2011145080, 20.05.2011  
(97) 2571805, 27.03.2013 en  
(54) A PROCESS FOR THE PRODUCTION OF HYDROGEN, THE SEQUESTRATION OF CARBON DIOXIDE AND THE PRODUCTION OF BUILDING MATERIALS STARTING FROM SLAGS AND/OR INDUSTRIAL ASHES  
(71) A.S.I.U. S.p.A., Via Isonzo 21-23, 57025 Piombino (LI), IT  
(72) PLESCIA, Paolo, Via Tespi 38, I-00125 Roma (RM), IT  
BARBARESE, Enrico, Via Repubblica 37, I-57021 Campiglia Marittima (LI), IT  
PINNA, Maurizio, Via Curiel 11, I-57025 Piombino (LI), IT

- (51) MKP  
**A61K 39/395 (2006.01)** (97) **2544719 \***  
(86) US2011028172 11.03.2011  
(96) 11754195.3 16.01.2013  
(87) WO2011112978, 11.03.2011  
(97) 2544719, 16.01.2013 en  
(54) CD37-BINDING MOLECULES AND IMMUNOCONJUGATES THEREOF  
(71) Immunogen, Inc., 830 Winter Street, Waltham, MA 02451, US  
(72) DECKERT, Jutta, 16 Eaton Road, Lexington Massachusetts 02420, US  
PARK, Peter, 25 Webster Ave, 301, Somerville Massachusetts 02143, US  
TAVARES, Daniel, 27 Sylvester Road, Natick Massachusetts 01760, US  
RUI, Lingyun, 11 Arrowhead Road, Weston Massachusetts 02493, US

- (51) MKP  
**F15B 3/00 (2006.01)** (97) **2539592 \***  
(86) IB2011050724 22.02.2011  
(96) 11714104.4 02.01.2013  
(87) WO2011104662, 22.02.2011  
(97) 2539592, 02.01.2013 en  
(54) INTENSIFIER OF HYDRAULIC POWER WITH RELY WITH MAINTENANCE OF THE REACHED POSITION AND FORCE  
(71) Rozzi De Hieronymis, Carlo Maria, Via Cuppio 4/2, 40043 Marzabotto (Bologna), IT  
(72) Rozzi De Hieronymis, Carlo Maria, Via Cuppio 4/2, 40043 Marzabotto (Bologna), IT

- (51) MKP  
**H01F 1/047 (2006.01)** (97) **2550666 \***  
**B22F 1/00 (2006.01)**  
(86) IB2011051112 17.03.2011  
(96) 11758892.1 30.01.2013  
(87) WO2011117783, 17.03.2011  
(97) 2550666, 30.01.2013 en  
(54) COMPOSITION FOR PRODUCING MAGNETIC OR MAGNETIZABLE MOLDINGS, AND PROCESS FOR PRODUCING THE SAME  
(71) BASF SE, null, 67056 Ludwigshafen, DE  
(72) BLETTNER, Carsten, Hochzeitpfad 13, 67098 Bad Dürkheim, DE  
KACZUN, Jürgen, In den Backhauswiesen 15, 67157 Wachenheim, DE  
KRESS, Ria, Gartenstr. 5, 67063 Ludwigshafen, DE  
WIEBELHAUS, Dag, Pfarrhausstr. 15, 67435 Neustadt, DE

- (51) MKP  
**C07D 403/04 (2006.01)** (97) **2547673 \***  
**A61K 31/505 (2006.01)**  
**A61P 11/00 (2006.01)**  
(86) US2011028433 15.03.2011  
(96) 11710375.4 23.01.2013  
(87) WO2011115943, 15.03.2011  
(97) 2547673, 23.01.2013 en  
(54) A SUBSTITUTED PYRIMIDINE AS A PROSTAGLANDIN D2 RECEPTOR ANTAGONIST  
(71) Aventis Pharmaceuticals Inc., 55 Corporate Drive, Bridgewater, NJ 08822, US  
(72) HARRIS, Keith John, Sanofi-Aventis U.S. 1041 Route 202-206 Mail Code: D-303A Bridgewater, New Jersey 08807, US  
AGUIAR, Joacy C., Sanofi-Aventis U.S. 1041 Route 202-206 Mail Code: D-303A Bridgewater, New Jersey 08807, US  
SHUM, Patrick Wai-Kwok, Sanofi-Aventis U.S. 1041 Route 202-206 Mail Code: D-303A Bridgewater, New Jersey 08807, US  
ZHAO, Zhicheng, Sanofi-Aventis U.S. 1041 Route 202-206 Mail Code: D-303A Bridgewater, New Jersey 08807, US  
POLI, Gregory B., Sanofi-Aventis U.S. 1041 Route 202-206 Mail Code: D-303A Bridgewater, New Jersey 08807, US  
STOKLOSA, Gregory T., Sanofi-Aventis U.S. 1041 Route 202-206 Mail Code: D-303A Bridgewater, New Jersey 08807, US  
CHOI-SLEDESKI, Yong-Mi, Sanofi-Aventis U.S. 1041 Route 202-206 Mail Code: D-303A Bridgewater, New Jersey 08807, US  
REILING, Stephan, Sanofi-Aventis U.S. 1041 Route 202-206 Mail Code: D-303A Bridgewater, New Jersey 08807, US

- (51) MKP  
**C07K 16/28 (2006.01)** (97) **2558499 \***  
(86) US2011032641 15.04.2011  
(96) 11730120.0 20.02.2013  
(87) WO2011130603, 15.04.2011  
(97) 2558499, 20.02.2013 en  
(54) ANTI-VLA-4 ANTIBODIES  
(71) Biogen Idec MA Inc., 14 Cambridge Center, Cambridge, MA 02142, US  
(72) LUGOVSKOY, Alexey, A., 24 Center Street, Woburn MA 01801-2931, US  
TAYLOR, Frederick, R., 98 Gulliver Street, Milton MA 02186, US  
MCLACHLAN, Karen, 948 Valley Ave, Solana Beach CA 92075, US

- (51) MKP  
**A24B 3/12 (2006.01)** (97) **2571385 \***  
(86) US2011035592 06.05.2011  
(96) 11783958.9 27.03.2013  
(87) WO2011146264, 06.05.2011  
(97) 2571385, 27.03.2013 en  
(54) METHOD FOR PREPARING TOBACCO EXTRACT FOR ELECTRONIC SMOKING DEVICES  
(71) Global Vapor Trademarks Incorporated, 1030 Northeast 28th Avenue, Pompano Beach, FL 33062, US  
(72) O'CONNELL, Thomas, 283 Atlantic Isle, Sunny Isles Beach FL 33160, US

- (51) MKP  
**G09B 23/28 (2006.01)** (97) **2559020 \***  
(86) US2011022249 24.01.2011  
(96) 11763188.7 20.02.2013  
(87) WO2011123185, 24.01.2011  
(97) 2559020, 20.02.2013 en  
(54) HEART COMPRESSION SIMULATION DEVICE  
(71) May, Daniel C., 3741 West Butterfly Lane, Tucson, AZ 85742, US  
(72) MAY, Daniel, C., 3741 West Butterfly Lane, Tucson, AZ 85742, US  
BRAMLETT, Larry, 13136 N. Desert Flora Lane, Marana, AZ 85658, US

- (51) MKP  
**B26D 3/08 (2006.01)** (97) **2560799 \***  
**B26B 5/00 (2006.01)**  
**B28D 1/22 (2006.01)**
- (86) IB2011051674 18.04.2011  
(96) 11720878.5 27.02.2013  
(87) WO2012020330, 18.04.2011  
(97) 2560799, 27.02.2013 fr  
(54) CARRIAGE FOR CUTTING A SHEET OF GYPSUM BOARD, CUTTING KIT AND METHOD FOR IMPLEMENTING SAME  
(71) Mallet, Benoît, 10 rue des Bas de Ferrières, 27190 Ferrieres Haut Clocher, FR  
(72) Mallet, Benoît, 10 rue des Bas de Ferrières, 27190 Ferrieres Haut Clocher, FR
- 
- (51) MKP  
**B63B 25/00 (2006.01)** (97) **2468622**
- (96) 11191582.3 27.06.2012  
(97) 2468622, 27.06.2012 en  
(54) Storage system  
(71) Åsa Westin desingner, Skolvägen 2, 18770 Täby, SE  
(72) Westin, Åsa, Skolvägen 2, 187 70 TÄBY, SE
- 
- (51) MKP  
**A61K 31/4985 (2006.01)** (97) **2585466 \***  
**C07D 487/04 (2006.01)**  
**A61P 35/00 (2006.01)**
- (86) US2011041547 23.06.2011  
(96) 11728164.2 01.05.2013  
(87) WO2011163430, 23.06.2011  
(97) 2585466, 01.05.2013 en  
(54) POLYMORPHS OF OSI-906  
(71) OSI Pharmaceuticals, LLC, 1 Bioscience Park Drive, Farmingdale, NY 11735, US  
(72) CASTELHANO, Arlindo, L., OSI Pharmaceuticals LLC 140 East Hanover Avenue, Cedar Knolls, NJ 07927, US  
ENGERS, David, A., SSCI, a division of Aptuit Inc. 3065 Kent Avenue, West Lafayette, IN 47906, US  
HANKO, Jason, A., SSCI, a division of Aptuit Inc. 3065 Kent Avenue, West Lafayette, IN 47906, US  
RECHKA, Josef, A., OSI Pharmaceuticals LLC 1 Bioscience Park Drive, Farmingdale, NY 11735, US  
TENG, Jing, SSCI, a division of Aptuit Inc. 3065 Kent Avenue, West Lafayette, IN 47906, US  
YANG, Yonglai, SSCI, a division of Aptuit Inc. 3065 Kent Avenue, West Lafayette, IN 47906, US
- 
- (51) MKP  
**A61M 5/20 (2006.01)** (97) **2544739 \***  
**A61M 5/24 (2006.01)**
- (86) EP2011053159 03.03.2011  
(96) 11709046.4 16.01.2013  
(87) WO2011110466, 03.03.2011  
(97) 2544739, 16.01.2013 en  
(54) AUTO-INJECTOR  
(71) Sanofi-Aventis Deutschland GmbH, Brüningstraße 50, 65929 Frankfurt, DE  
(72) KEMP, Thomas Mark, 3 Forresters Cottages High Steet, Ashwell SG7 5NW, GB  
JENNINGS, Douglas, 73 Redwing Rise Royston, Herts SG8 7XU, GB  
SCUDAMORE, Peter, 90 Macaulay Ave Great Shelford, Cambridge CB22 5AF, GB  
EKMAN, Matthew, 59 Ecton Avenue Macclesfield, Cheshire SK10 1RD, GB
- 
- (51) MKP  
**A61K 31/55 (2006.01)** (97) **2558450 \***  
**C07D 405/14 (2006.01)**  
**C07D 403/12 (2006.01)**  
**A61P 35/00 (2006.01)**  
**C07D 405/12 (2006.01)**  
**C07D 249/08 (2006.01)**
- (86) EP2011055840 13.04.2011  
(96) 11715682.8 20.02.2013  
(87) WO2011128381, 13.04.2011  
(97) 2558450, 20.02.2013 en  
(54) TRIAZOLE COMPOUNDS AS KSP INHIBITORS  
(71) Novartis AG, Lichtstrasse 35, 4056 Basel, CH  
(72) ABRAMS, Tinya, Novartis Vaccines and Diagnostics Inc. 4560 Horton Street, Emeryville, CA 94608-2916, US  
BARSANTI, Paul, A., Novartis Vaccines and Diagnostics Inc. 4560 Horton Street, Emeryville, CA 94608-2916, US  
DING, Yu, Novartis Vaccines and Diagnostics Inc. 4560 Horton Street, Emeryville, CA 94608-2916, US  
DUHL, David, Novartis Vaccines and Diagnostics Inc. 4560 Horton Street, Emeryville, CA 94608-2916, US  
HAN, Wooseok, Novartis Vaccines and Diagnostics Inc. 4560 Horton Street, Emeryville, CA 94608-2916, US  
HU, Cheng, Novartis Vaccines and Diagnostics Inc. 4560 Horton Street, Emeryville, CA 94608-2916, US  
PAN, Yue, Novartis Vaccines and Diagnostics Inc. 4560 Horton Street, Emeryville, CA 94608-2916, US
- 
- (51) MKP  
**A61K 31/538 (2006.01)** (97) **2582667 \***  
**A61K 31/404 (2006.01)**  
**C07D 209/34 (2006.01)**  
**A61K 31/428 (2006.01)**  
**A61K 31/4704 (2006.01)**  
**C07D 215/227 (2006.01)**  
**C07D 277/68 (2006.01)**  
**C07D 498/04 (2006.01)**  
**C07D 265/36 (2006.01)**  
**A61K 31/5383 (2006.01)**
- (86) EP2011060177 20.06.2011  
(96) 11726768.2 24.04.2013  
(87) WO2011161030, 20.06.2011  
(97) 2582667, 24.04.2013 de  
(54) HETEROCYCLIC SUBSTITUTED METHOXYPHENYL DERIVATIVES HAVING AN OXO GROUP, METHOD FOR PRODUCING SAME, AND USE THEREOF AS GPR40 RECEPTOR MODULATORS  
(71) SANOFI, 54, rue de la Boétie, 75008 Paris, FR  
(72) KEIL, Stefanie, c/o Sanofi-Aventis Deutschland GmbH, 65926 Frankfurt am Main, DE  
DEFOSSA, Elisabeth, c/o Sanofi-Aventis Deutschland GmbH, 65926 Frankfurt am Main, DE  
DIETRICH, Viktoria, c/o Sanofi-Aventis Deutschland GmbH, 65926 Frankfurt am Main, DE  
STENGELIN, Siegfried, c/o Sanofi-Aventis Deutschland GmbH, 65926 Frankfurt am Main, DE  
HERLING, Andreas, c/o Sanofi-Aventis Deutschland GmbH, 65926 Frankfurt am Main, DE  
HASCHKE, Guido, c/o Sanofi-Aventis Deutschland GmbH, 65926 Frankfurt am Main, DE  
KLABUNDE, Thomas, c/o Sanofi-Aventis Deutschland GmbH, 65926 Frankfurt am Main, DE
-

- (51) MKP  
**A61P 11/06 (2006.01)** (97) **2586772 \***  
**A61P 11/02 (2006.01)**  
**C07D 217/18 (2006.01)**  
**A61P 37/08 (2006.01)**  
**A61K 31/472 (2006.01)**  
**C07D 217/20 (2006.01)**  
**A61P 43/00 (2006.01)**  
**A61P 17/04 (2006.01)**  
(86) JP2011064208 22.06.2011  
(96) 11798156.3 01.05.2013  
(87) WO2011162274, 22.06.2011  
(97) 2586772, 01.05.2013 en  
(54) ISOQUINOLINE DERIVATIVE  
(71) Taisho Pharmaceutical Co., Ltd., 24-1, Takada 3-chome  
Toshima-ku, Tokyo 170-8633, JP  
(72) TAKAYAMA Tetsuo, c/o TAISHO PHARMACEUTICAL CO.  
LTD. 24-1 Takada 3-chome Toshima-ku, Tokyo 170-8633, JP  
KAWAMURA Madoka, c/o TAISHO PHARMACEUTICAL CO.  
LTD. 24-1 Takada 3-chome Toshima-ku, Tokyo 170-8633, JP  
WAKASUGI Daisuke, c/o TAISHO PHARMACEUTICAL CO.  
LTD. 24-1 Takada 3-chome Toshima-ku, Tokyo 170-8633, JP  
NISHIKAWA Rie, c/o TAISHO PHARMACEUTICAL CO. LTD.  
24-1 Takada 3-chome Toshima-ku, Tokyo 170-8633, JP  
SEKIGUCHI Yoshinori, c/o TAISHO PHARMACEUTICAL CO.  
LTD. 24-1 Takada 3-chome Toshima-ku, Tokyo 170-8633, JP
- 
- (51) MKP  
**A61K 39/395 (2006.01)** (97) **2566890 \***  
**A61K 39/00 (2006.01)**  
**C12P 21/06 (2006.01)**  
**C07K 16/00 (2006.01)**  
**C07H 21/04 (2006.01)**  
(86) US2011034820 02.05.2011  
(96) 11778108.8 13.03.2013  
(87) WO2011139974, 02.05.2011  
(97) 2566890, 13.03.2013 en  
(54) ANTI-PAI-1 ANTIBODIES AND METHODS OF USE THEREOF  
(71) AbbVie Inc., 1 North Waukegan Road, North Chicago, IL  
60064, US  
(72) ELVIN, John, Milstein Building Granta Park, Cambridge CB21  
6GH, GB  
DUFFNER, Patrick, Segantinistrasse 50, CH-8049 Zurich, CH  
NEWTON, Philip, Milstein Building Granta Park, Cambridge  
CB21 6GH, GB
- 
- (51) MKP  
**A01N 37/18 (2006.01)** (97) **2582237 \***  
(86) US2011040673 16.06.2011  
(96) 11728976.9 24.04.2013  
(87) WO2011159879, 16.06.2011  
(97) 2582237, 24.04.2013 en  
(54) SYNERGISTIC HERBICIDAL COMPOSITIONS CONTAINING  
PROPYZAMIDE AND AMINOPYRALID  
(71) Dow AgroSciences LLC, 9330 Zionsville Road, Indianapolis, IN  
46268, US  
(72) MANN, Richard, 1828 South 550 East, Franklin IN 46131, US  
DE GAUJAC, Xavier, 12 Chemin du Clos, F-06530  
Peymeinade, FR
- 
- (51) MKP  
**A61M 5/24 (2006.01)** (97) **2579930 \***  
**A61M 5/315 (2006.01)**  
(86) EP2011059573 09.06.2011  
(96) 11727671.7 17.04.2013  
(87) WO2011154488, 09.06.2011  
(97) 2579930, 17.04.2013 en  
(54) DRUG DELIVERY DEVICE WITH DRIVE MEMBER HAVING  
INDICATION ELEMENTS  
(71) Sanofi-Aventis Deutschland GmbH, Brüningstraße 50, 65929  
Frankfurt, DE  
(72) SMITH, Christopher, James, 4 Elm Drive, Holmes Chapel  
Cheshire CW4 7QG, GB  
HORLOCK, Mark, Philip, 18 Mayfield Close, Timperley,  
Cheshire WA15 7TE, GB  
BUTLER, Stephen, David, 25 High Hill South Staffords,  
Essington, Staffordshire WV11 2DP, GB
- 
- (51) MKP  
**D02J 3/10 (2006.01)** (97) **2566401 \***  
**A61B 17/04 (2006.01)**  
**D02J 3/02 (2006.01)**  
**A61B 17/08 (2006.01)**  
(86) US2011035270 04.05.2011  
(96) 11778310.0 13.03.2013  
(87) WO2011140282, 04.05.2011  
(97) 2566401, 13.03.2013 en  
(54) LASER CUTTING SYSTEM AND METHODS FOR CREATING  
SELF-RETAINING SUTURES  
(71) Ethicon, LLC, Road 183 KM 8.3 Hato Industrial Area, San  
Lorenzo, PR 00754, US  
(72) GROSS, Jeffrey, M., 1100 Garden View Road, 200, Encinitas,  
CA 92024, US  
D'AGOSTINO, William, L., 19 Douglas Drive, Hamden  
Connecticut 06518, US  
DRUBETSKY, Lev, 2948 Waterford Place, Coquitlam British  
Columbia V3E 2S9, CA  
NAIMAGON, Alexander, 11-8711 General Currie Road,  
Richmond BC V6Y 1M3, CA  
CONNER, Jacob, D., 2241 E. Kearney St., Springfield Missouri  
65803, US  
WHITWORTH, Kevin, R., 2241 E. Kearney St., Springfield  
Missouri 65803, US  
WOOLSEY, Ryan, T., 2241 E. Kearney St., Springfield Missouri  
65803, US  
DICKEY, Fred, M., 850 W. Highland St., Springfield Missouri  
65807, US
- 
- (51) MKP  
**A61K 31/56 (2006.01)** (97) **2542245 \***  
(86) US2011027177 04.03.2011  
(96) 11751415.8 09.01.2013  
(87) WO2011109704, 04.03.2011  
(97) 2542245, 09.01.2013 en  
(54) ANTIMICROBIAL CATIONIC STEROIDS AND METHODS  
OF USE  
(71) The Trustees Of The University Of Pennsylvania, Center  
for Technology Transfer 3160 Chestnut Street Suite 200,  
Philadelphia, PA 19104-6283, US  
(72) FEIN, David, E., 2020 Ballantine Lane, Warrington, PA 18976,  
US  
BUCKI, Robert, 836 S 51st Street, Philadelphia, PA 19143, US  
JANMEY, Paul, A., 110 Idlewild Lane, Media, PA 19063, US  
DIAMOND, Scott, L., 610 Yale Road, Bala Cynwyd, PA 19004,  
US
- 
- (51) MKP  
**C07D 487/04 (2006.01)** (97) **2547683 \***  
(86) CZ2011000021 15.03.2011  
(96) 11718244.4 23.01.2013  
(87) WO2011113399, 15.03.2011  
(97) 2547683, 23.01.2013 en  
(54) METHOD OF PREPARING SITAGLIPTIN  
(71) Zentiva, K.S., U Kabelovny 130, 102 37 Praha 10, CZ  
(72) RICHTER, Jindrich, Hurka 173, 530 02 Pardubice, CZ  
JIRMAN, Josef, U Hranic 4, 100 00 Praha 10, CZ
- 
- (51) MKP  
**A61K 31/425 (2006.01)** (97) **2582709 \***  
**C07D 513/04 (2006.01)**  
(86) EP2011060122 17.06.2011  
(96) 11725479.7 24.04.2013  
(87) WO2011157827, 17.06.2011  
(97) 2582709, 24.04.2013 de  
(54) AZOLOPYRIDIN-3-ONE DERIVATIVES AS INHIBITORS OF  
LIPASES AND PHOSPHOLIPASES  
(71) SANOFI, 54 rue La Boétie, 75008 Paris, FR  
(72) PETRY, Stefan, c/o Sanofi-Aventis Deutschland GmbH, 65926  
Frankfurt am Main, DE  
TENNAGELS, Norbert, c/o Sanofi-Aventis Deutschland GmbH,  
65926 Frankfurt am Main, DE  
BARINGHAUS, Karl-Heinz, c/o Sanofi-Aventis Deutschland  
GmbH, 65926 Frankfurt am Main, DE



- (51) MKP  
**C07D 487/04 (2006.01)** (97) **2545055 \***  
**A61P 3/00 (2006.01)**  
**A61P 25/00 (2006.01)**  
**A61K 31/4985 (2006.01)**  
(86) EP2011053445 08.03.2011  
(96) 11707172.0 16.01.2013  
(87) WO2011110545, 08.03.2011  
(97) 2545055, 16.01.2013 en  
(54) IMIDAZO [1, 2 -A]PYRAZINE DERIVATIVES AND THEIR USE FOR THE PREVENTION OR TREATMENT OF NEUROLOGICAL, PSYCHIATRIC AND METABOLIC DISORDERS AND DISEASES  
(71) Janssen Pharmaceutica, N.V., Turnhoutseweg 30, 2340 Beerse, BE  
(72) BARTOLOMÉ-NEBREDA, José, Manuel, Janssen-Cilag S.A. Calle Jarama 75 Poligono Industrial, E-45007 Toledo, ES  
CONDE-CEIDE, Susana, Janssen-Cilag S.A. Calle Jarama 75 Poligono Industrial, E-45007 Toledo, ES  
MACDONALD, Gregor, James, Janssen Pharmaceutica NV Turnhoutseweg 30, B-2340 Beerse, BE  
PASTOR-FERNÁNDEZ, Joaquin, C/Hierbabuena 37 Urbanización La Hacienda Cobisa, E-45111 Toledo, ES  
VAN GOOL, Michiel, Luc, Maria, Janssen-Cilag S.A. Calle Jarama 75 Poligono Industrial, E-45007 Toledo, ES  
MARTÍN-MARTÍN, María, Luz, Janssen-Cilag S.A. Calle Jarama 75 Poligono Industrial, E-45007 Toledo, ES  
VANHOOF, Greta, Constantia, Peter, Janssen Pharmaceutica NV Turnhoutseweg 30, B-2340 Beerse, BE
- 
- (51) MKP  
**A61M 5/20 (2006.01)** (97) **2538997 \***  
(86) EP2011052305 16.02.2011  
(96) 11703891.9 02.01.2013  
(87) WO2011101383, 16.02.2011  
(97) 2538997, 02.01.2013 en  
(54) FORCE TRANSMISSION ARRANGEMENT FOR AUTO-INJECTOR  
(71) Sanofi-Aventis Deutschland GmbH, Brüningstraße 50, 65929 Frankfurt, DE  
(72) EKMAN, Matthew, 59 Ecton Avenue, Macclesfield Cheshire SK10 1RD, GB  
BARROW-WILLIAMS, Timothy Donald, 1 Grange Street, St. Albans Herts AL3 5NA, GB  
KEMP, Thomas Mark, 3 Forresters Cottages High Steet, Ashwell SG7 5NW, GB
- 
- (51) MKP  
**C02F 1/68 (2006.01)** (97) **2565165**  
**C02F 103/42 (2006.01)**  
(96) 11179541.5 06.03.2013  
(97) 2565165, 06.03.2013 en  
(54) Remineralization of desalinated and of fresh water by dosing of a calcium carbonate solution in soft water  
(71) Omya Development AG, Baslerstrasse 42, 4665 Oftringen, CH  
(72) Poffet, Martine, Wohlenstrasse 29, 3043 Uetligen, CH  
Skovby, Michael, Wampfenstrasse 52, 8706 Meilen, CH  
Pohl, Michael, H.-v.-Tuerlin Strasse 11, 9500 Villach, AT
- 
- (51) MKP  
**C09J 163/10 (2006.01)** (97) **2576717 \***  
**C09J 11/04 (2006.01)**  
**C09J 9/02 (2006.01)**  
(86) CA2011000599 26.05.2011  
(96) 11785937.1 10.04.2013  
(87) WO2011147016, 26.05.2011  
(97) 2576717, 10.04.2013 en  
(54) CONDUCTIVE ADHESIVE  
(71) Turbosonic Inc., 550 Parkside Drive Suite A-14, Waterloo, Ontario N2L 5V4, CA  
(72) McGRATH, Paul, 42-7284 Bellshire Gate, Mississauga Ontario L5N 8F4, CA

- (51) MKP  
**A61M 5/20 (2006.01)** (97) **2585142 \***  
(86) EP2011060502 22.06.2011  
(96) 11729949.5 01.05.2013  
(87) WO2012000871, 22.06.2011  
(97) 2585142, 01.05.2013 en  
(54) AUTO-INJECTOR  
(71) Sanofi-Aventis Deutschland GmbH, Brüningstraße 50, 65929 Frankfurt, DE  
(72) EKMAN, Matthew, 59 Ecton Avenue, Macclesfield Cheshire SK10 1RD, GB  
BRERETON, Simon Francis, 75 De Freville Avenue, Cambridge CB4 1HP, GB  
KEMP, Thomas Mark, 3 Forresters Cottages High Steet, Ashwell Cheshire SG7 5NW, GB
- 
- (51) MKP  
**A61P 11/06 (2006.01)** (97) **2585047 \***  
**A61K 9/00 (2006.01)**  
**A61K 9/14 (2006.01)**  
**A61K 31/439 (2006.01)**  
**A61P 11/08 (2006.01)**  
(86) EP2011058804 30.05.2011  
(96) 11724158.8 01.05.2013  
(87) WO2011160920, 30.05.2011  
(97) 2585047, 01.05.2013 en  
(54) DRY POWDER FORMULATION COMPRISING AN ANTIMUSCARINIC DRUG  
(71) Chiesi Farmaceutici S.p.A., Via Palermo, 26/A, 43100 Parma, IT  
(72) SCHIARETTI, Francesca, c/o CHIESI FARMACEUTICI S.p.A. Via Palermo 26/A, I-43100 Parma, IT
- 
- (51) MKP  
**C12N 9/96 (2006.01)** (97) **2591099 \***  
**A61K 38/48 (2006.01)**  
**A61K 38/36 (2006.01)**  
(86) US2011043597 11.07.2011  
(96) 11738538.5 15.05.2013  
(87) WO2012006633, 11.07.2011  
(97) 2591099, 15.05.2013 en  
(54) CHIMERIC CLOTTING FACTORS  
(71) BIOGEN IDEC HEMOPHILIA INC., 9 Fourth Avenue, Waltham, MA 02451, US  
(72) SALAS, Joe, 9 D' Angelo Road, Wayland MA 01778, US  
PETERS, Robert, 51 Newfield Street, West Roxbury MA 02132, US  
BITONTI, Alan, 32 Carlton Drive, Acton MA 01720, US
- 
- (51) MKP  
**A63B 55/00 (2006.01)** (97) **2575978 \***  
**A63B 55/04 (2006.01)**  
**A63B 55/06 (2006.01)**  
(86) US2011038234 26.05.2011  
(96) 11787456.0 10.04.2013  
(87) WO2011150274, 26.05.2011  
(97) 2575978, 10.04.2013 en  
(54) GOLF BAG BANNER  
(71) Drenaline Products, LLC, 9400 Old Cedar Ave South, 335, Bloomington, Minnesota 55425, US  
HIGH, Randal, 9400 Old Cedar Ave. South 335, Bloomington Minnesota 55425, US  
BUCKLEY, Joel, 15645 24th Ave North Unit D, Plymouth Minnesota 55447, US
- 
- (51) MKP  
**G08C 17/02 (2006.01)** (97) **2539875 \***  
**G06F 3/038 (2013.01)**  
(86) FR2012050233 02.02.2012  
(96) 12707853.3 02.01.2013  
(87) WO2012153019, 02.02.2012  
(97) 2539875, 02.01.2013 fr  
(54) METHOD AND DEVICE FOR CONTROLLING AT LEAST ONE APPARATUS BY MEANS OF AT LEAST ONE OTHER APPARATUS, AND SYSTEM IMPLEMENTING SUCH A DEVICE  
(71) Archos, 12 Rue Ampère Z.I., 91430 Igny, FR  
(72) CARON, François, 2 Square Vivaldi, 78150 Le Chesnay, FR  
DE COURVILLE, Marc, 10 Impasse Reille, 75014 Paris, FR  
MALLART, Raul, 34 rue de Picpus, 75012 Paris, FR

- (51) MKP  
**C12N 5/07 (2010.01)** (97) **2590671 \***  
**A61K 39/00 (2006.01)**  
**C12P 21/08 (2006.01)**  
**C12N 5/16 (2006.01)**  
(86) US2011043297 08.07.2011  
(96) 11804385.0 15.05.2013  
(87) WO2012006490, 08.07.2011  
(97) 2590671, 15.05.2013 en  
(54) DUAL VARIABLE DOMAIN IMMUNOGLOBULINS AND USES THEREOF  
(71) Abbott Laboratories, 100 Abbott Park Road, Abbott Park, IL 60064, US  
(72) GHAYUR, Tariq, 1014 Washington Street, Holliston, MA 01746, US  
LIU, Junjian, 14 Crimson Drive, Shrewsbury, MA 01545, US
- 
- (51) MKP  
**G07F 11/44 (2006.01)** (97) **2263638**  
**G07F 17/00 (2006.01)**  
**A61J 7/00 (2006.01)**  
(96) 10164868.1 22.12.2010  
(97) 2263638, 22.12.2010 en  
(54) Dispensing canister for delivery of solid medications  
(71) Talyst Inc., 13555 Southeast 36th Street, Suite 150, Bellevue, WA 98006, US  
(72) Clarke, Darcy, 9830 S 262 Pl Kent, Washington 98030, US  
Bumb, Kameron, 8622 Leitz Avenue SE Snoqualmie, Washington 98065, US  
Wathen, Geoffrey, 227 NW 29th Street Corvallis, Oregon 97330, US
- 
- (51) MKP  
**C07D 409/14 (2006.01)** (97) **2552909 \***  
**C07D 413/14 (2006.01)**  
**C07D 417/14 (2006.01)**  
**A61K 31/506 (2006.01)**  
**C07D 417/04 (2006.01)**  
**C07D 403/04 (2006.01)**  
**A61P 25/00 (2006.01)**  
**C07D 403/14 (2006.01)**  
**A61P 3/10 (2006.01)**  
(86) IB2011000664 29.03.2011  
(96) 11719879.6 06.02.2013  
(87) WO2011121418, 29.03.2011  
(97) 2552909, 06.02.2013 en  
(54) 4 - AMINOPYRIMIDINE DERIVATIVES AND THEIR AS AS ADENOSINE A2A RECEPTOR ANTAGONISTS  
(71) Palobiofarma, S.L., C/Porvenir 42 Pol.Ind.Sur, Sector F, 08450 Llinars del Vallès, ES  
(72) CAMACHO GOMEZ, Juan Alberto, C/ Porvenir 42 - Pol.Ind.Sur Sector F, E-08450 Llinars Del Vallès, Barcelone, ES  
CASTRO-PALOMINO LARIA, Julio Cesar, C/ Porvenir 42 - Pol. Ind.Sur Sector F, E-08450 Llinars Del Vallès, Barcelone, ES
- 
- (51) MKP  
**A61P 11/00 (2006.01)** (97) **2585457 \***  
**A61K 31/439 (2006.01)**  
**C07D 453/02 (2006.01)**  
(86) EP2011058801 30.05.2011  
(96) 11724157.0 01.05.2013  
(87) WO2011160918, 30.05.2011  
(97) 2585457, 01.05.2013 en  
(54) ALKALOID AMINOESTER DERIVATIVES AND MEDICINAL COMPOSITION THEREOF  
(71) Chiesi Farmaceutici S.p.A., Via Palermo, 26/A, 43100 Parma, IT  
(72) AMARI, Gabriele, c/o Chiesi Farmaceutici S.p.A. Via Palermo 26/A, I-43100 Parma, IT  
RICCABONI, Mauro, c/o Chiesi Farmaceutici S.p.A. Via Palermo 26/A, I-43100 Parma, IT  
CALIGIURI, Antonio, c/o Chiesi Farmaceutici S.p.A. Via Palermo 26/A, I-43100 Parma, IT
- 
- (51) MKP  
**H02M 5/257 (2006.01)** (97) **2395643**  
(96) 11162279.1 14.12.2011  
(97) 2395643, 14.12.2011 de  
(54) Method for adjusting an AC power controller  
(71) AEG Power Solutions B.V., Weerenweg 29, 1161 AH Zwanenburg, NL  
(72) Hesse, Christian, Sellenweg 19, 59581, Warstein, DE  
Schaffarra, Christian, Maximilian-Kolbe-Str. 4, 59602, Rùthen, DE
- 
- (51) MKP  
**F16H 57/08 (2006.01)** (97) **2569556 \***  
(86) US2011036264 12.05.2011  
(96) 11781275.0 20.03.2013  
(87) WO2011143439, 12.05.2011  
(97) 2569556, 20.03.2013 en  
(54) EXERCISE CYCLE WITH PLANETARY GEAR SYSTEM AND ROLLING RECOILED LATERAL MOTION SYSTEM  
(71) Relay Fitness Group, 3189 Airway Avenue Suite F, Costa Mesa, CA 92626, US  
(72) VUJICIC, Marko, 6771 BreeLand Drive., Huntington Beach CA 92647, US  
CHILES, Mark, 5635 Greenbriar Drive., Yorba Linda CA 92887, US  
WALLACE, Greg, 26662 Calle Alcalá, Mission Viejo CA 92691, US
- 
- (51) MKP  
**A61P 27/02 (2006.01)** (97) **2575793 \***  
**A61K 31/198 (2006.01)**  
**A61K 31/00 (2006.01)**  
(86) IB2011000965 06.05.2011  
(96) 11726946.4 10.04.2013  
(87) WO2011151685, 06.05.2011  
(97) 2575793, 10.04.2013 en  
(54) N-ACETYL-DL-LEUCINE, NEUROPROTECTIVE AND RETINOPROTECTIVE MEDICAMENT  
(71) Rekik, Raouf, Tanit Medical Avenue du Japon-Mont Plaisir, 1073 Tunis, TN  
(72) Rekik, Raouf, Tanit Medical Avenue du Japon-Mont Plaisir, 1073 Tunis, TN
- 
- (51) MKP  
**H04N 5/765 (2006.01)** (97) **2581908 \***  
**H04N 5/85 (2006.01)**  
**G11B 20/10 (2006.01)**  
**H04N 5/91 (2006.01)**  
(86) JP2011000496 28.01.2011  
(96) 11745463.7 17.04.2013  
(87) WO2011155098, 28.01.2011  
(97) 2581908, 17.04.2013 en  
(54) REPRODUCTION DEVICE, RECORDING MEDIUM, REPRODUCTION METHOD, PROGRAM  
(71) Panasonic Corporation, 1006, Oaza Kadoma, Kadoma-shi Osaka 571-8501, JP  
(72) TANAKA, Keiichi, c/o Panasonic Corporation IPROC 7F Twin 21 OBP Panasonic Tower 2-1-61, Shiromi, Chuo-ku, Osaka-shi, Osaka 540-6207, JP  
OTO, Hidetaka, c/o Panasonic Corporation IPROC 7F Twin 21 OBP Panasonic Tower 2-1-61, Shiromi, Chuo-ku, Osaka-shi, Osaka 540-6207, JP

- (51) MKP  
**A01N 51/00 (2006.01)** (97) **2590508 \***  
**A01N 25/30 (2006.01)**  
**A01N 43/40 (2006.01)**  
**A01N 47/18 (2006.01)**  
(86) JP2011065747 05.07.2011  
(96) 11735924.0 15.05.2013  
(87) WO2012005371, 05.07.2011  
(97) 2590508, 15.05.2013 en  
(54) WATER-BASED PESTICIDAL SUSPENSION  
(71) Ishihara Sangyo Kaisha, Ltd., 3-15 Edobori 1-chome Nishi-ku, Osaka-shi, Osaka 550-0002, JP  
(72) AWAZU, Takao, c/o Ishihara Sangyo Kaisha Ltd. Chuo Kenkyusho 3-1, Nishi-shibukawa 2-chome, Kusatsu-shi Shiga 525-0025, JP  
SANO, Mitsuo, c/o Ishihara Sangyo Kaisha Ltd. Chuo Kenkyusho 3-1, Nishi-shibukawa 2-chome, Kusatsu-shi Shiga 525-0025, JP  
NAKAGAWA, Akira, c/o Ishihara Sangyo Kaisha Ltd. Chuo Kenkyusho 3-1, Nishi-shibukawa 2-chome, Kusatsu-shi Shiga 525-0025, JP

- (51) MKP  
**E21B 10/32 (2006.01)** (97) **2553206 \***  
(86) GB2011050623 28.03.2011  
(96) 11718145.3 06.02.2013  
(87) WO2011121341, 28.03.2011  
(97) 2553206, 06.02.2013 en  
(54) DOWNHOLE TOOL  
(71) Pedem Limited, Badentoy Road, Badentoy Industrial Estate Portlethen Aberdeenshire AB12 4YA, GB  
(72) SHEARS, Carl, 28 Morningfield Mews, Aberdeen AB15 4ER, GB

- (51) MKP  
**F25D 23/02 (2006.01)** (97) **2439366**  
**E05F 11/54 (2006.01)**  
**E05B 17/00 (2006.01)**  
(96) 11183358.8 11.04.2012  
(97) 2439366, 11.04.2012 en  
(54) Device for opening sliding doors for cold rooms  
(71) Dervet S.r.l., Via De Gasperi, 25, 26025 Pandino (CR), IT  
(72) Milanesi, Paolo, Via Bonzi, 1, 26020 MADIGNANO (CR), IT

- (51) MKP  
**B66B 11/04 (2006.01)** (97) **2560912 \***  
(86) IB2011053760 14.09.2011  
(96) 11781863.3 27.02.2013  
(87) WO2012143765, 14.09.2011  
(97) 2560912, 27.02.2013 en  
(54) DEVICE FOR SAVING ENERGY DURING VERTICAL AND HORIZONTAL MOTIONS  
(71) Jezek, Giorgio, Via Ponte Alto 45 A, 38050 Cognola di Trento, IT  
(72) Jezek, Giorgio, Via Ponte Alto 45 A, 38050 Cognola di Trento, IT

- (51) MKP  
**A61K 31/425 (2006.01)** (97) **2544541 \***  
**A01N 43/54 (2006.01)**  
**A61K 31/505 (2006.01)**  
(86) US2011027589 08.03.2011  
(96) 11753944.5 16.01.2013  
(87) WO2011112609, 08.03.2011  
(97) 2544541, 16.01.2013 en  
(54) COMBINATION THERAPY FOR TREATING BREAST CANCER  
(71) Genzyme Corporation, 500 Kendall Street, Cambridge, MA 02142, US  
(72) HARPER, Jay, 10 Lathrop Street, Salem MA 01970, US  
LONNING, Scott, Michael, 337 Olivia Drive, Northbridge MA 01534, US  
HSU, Frank, James, 14 Fisher Avenue, Wellesley MA 02482, US

- (51) MKP  
**A61K 31/4704 (2006.01)** (97) **2560649 \***  
**A61K 31/404 (2006.01)**  
**A61K 31/443 (2006.01)**  
(86) US2011033687 22.04.2011  
(96) 11718596.7 27.02.2013  
(87) WO2011133951, 22.04.2011  
(97) 2560649, 27.02.2013 en  
(54) PHARMACEUTICAL COMPOSITIONS AND ADMINISTRATIONS THEREOF  
(71) Vertex Pharmaceuticals Incorporated, 130 Waverly Street, Cambridge, MA 02139, US  
(72) VAN GOOR, Fredrick, F., 832 Ormond Court, San Diego, CA 92109, US  
ALARGOVA, Rossitza, Gueorguieva, 148 Newton Street, Apt. 4, Brighton, MA 02135, US  
ALCACIO, Tim, Edward, 2276 Fenton Parkway, 304, San Diego, CA 92108, US  
AREKAR, Sneha, G., 26 Waverly Street, Apt. 209, Brighton, MA 02135, US  
JOHNSTON, Steven, C., 22 Page Road, Lichtfield, NH 03052, US  
KADIYALA, Irina, Nikolaevna, 40 Hagen Road, Newton, MA 02457, US  
KESHAVARZ-SHOKRI, Ali, 4285 Corte Langostino, San Diego, CA 92130, US  
KRAWIEC, Mariusz, 46 Littlefield Lane, Marlborough, MA 01752, US  
LEE, Elaine, Chungmin, 303 Third Street Apt.316, Cambridge, MA 02142, US  
MEDEK, Ales, 14 Lockland Road, Winchester, MA 01890, US  
MUDUNURI, Praveen, 7 Charlesbank Way, Apt. A, Waltham, MA 02453, US  
SULLIVAN, Mark, Jeffrey, 103 Howe Street, Framingham, MA 01702, US  
ZAMAN, Noreen, Tasneem, 1 Magnolia Drive, Acton, MA 01720, US  
ZHANG, Beili, 4505 Shorepointe Way, San Diego, CA 92130, US  
ZHANG, Yuegang, 15 Fairfield Road, Wayland, MA 01778, US  
ZLOKARNIK, Gregor, 2754 Palomino Circle, La Jolla, CA 92037, US

- (51) MKP  
**C09J 167/06 (2006.01)** (97) **2576140 \***  
**C08G 69/44 (2006.01)**  
**C08G 63/676 (2006.01)**  
**C08G 63/52 (2006.01)**  
**B24D 3/28 (2006.01)**  
**B24D 3/20 (2006.01)**  
(86) FR2011051213 27.05.2011  
(96) 11726913.4 10.04.2013  
(87) WO2011148111, 27.05.2011  
(97) 2576140, 10.04.2013 fr  
(54) ADHESIVE COMPOSITION CONTAINING A WATER-SOLUBLE OR WATER-DISPERSIBLE UNSATURATED POLYESTER AND AN ETHYLENE-UNSATURATED MONOMER, AND USES THEREOF  
(71) SAINT-GOBAIN RECHERCHE, 39 quai Lucien Lefranc, 93300 Aubervilliers, FR  
(72) JASINSKA, Lidia, Ul. Wladyslawa Cieszyńskiego 17/6, PL-80809 Gdansk, PL  
KONING, Cornelis Eme, Sperwerdreef 7, NL-6446 DJ Brunssum, NL  
ARNAUD, Alix, 57 Avenue de la République, F-92120 Montrouge, FR  
HOUGA, Clément, 4 rue Pierre Le Frapper, F-78800 Houilles, FR

- (51) MKP  
**C12N 15/10 (2006.01)** (97) **2558577 \***  
 (86) DK2011000031 16.04.2011  
 (96) 11720372.9 20.02.2013  
 (87) WO2011127933, 16.04.2011  
 (97) 2558577, 20.02.2013 en  
 (54) BI-FUNCTIONAL COMPLEXES AND METHODS FOR MAKING AND USING SUCH COMPLEXES  
 (71) Nuevolution A/S, Rønnegade 8, 5., 2100 Copenhagen 0, DK  
 (72) GOULIAEV, Alex, Haahr, Brøndsted 223, DK-3670 Veksø Sjøælland, DK  
 FRANCH, Thomas, Tjørnevej 26, DK-3070 Snekkersten, DK  
 GODSKESEN, Michael, Anders, Plantagekrogen 8, DK-2950 Vedbæk, DK  
 JENSEN, Kim, Birkebæk, Voldumvej 30C, DK-2610 Rødovre, DK

- (51) MKP  
**A61M 5/315 (2006.01)** (97) **2566539 \***  
**A61M 5/24 (2006.01)**  
 (86) EP2011056994 03.05.2011  
 (96) 11716592.8 13.03.2013  
 (87) WO2011138295, 03.05.2011  
 (97) 2566539, 13.03.2013 en  
 (54) DRIVE MECHANISM WITH A LOW FRICTION COATING FOR A DRUG DELIVERY DEVICE  
 (71) Sanofi-Aventis Deutschland GmbH, Brüningstraße 50, 65929 Frankfurt, DE  
 (72) JUGL, Michael, c/o Sanofi-Aventis Deutschland GmbH, 65926 Frankfurt am Main, DE  
 SENDATZKI, Günther, c/o Sanofi-Aventis Deutschland GmbH, 65926 Frankfurt am Main, DE  
 TEUCHER, Axel, c/o Sanofi-Aventis Deutschland GmbH, 65926 Frankfurt am Main, DE

- (51) MKP  
**B65D 39/00 (2006.01)** (97) **2590869 \***  
**B65D 51/24 (2006.01)**  
 (86) EP2011050896 24.01.2011  
 (96) 11701094.2 15.05.2013  
 (87) WO2011089245, 24.01.2011  
 (97) 2590869, 15.05.2013 en  
 (54) CONTAINER STOPPER WITH A DECORATIVE LAYER  
 (71) Nomacor LLC, 400 Vintage Park Drive, Zebulon, NC 27597, US  
 (72) BOST, Damon James, 3514 Bluebonnet Dr, Wake Forest North Carolina 27587, US  
 COOPER, James Edward, 5906 Pine Street, Bailey North Carolina 27807, US  
 DAVIS, Lindsay Herman, 10708 Summerton Place, Raleigh North Carolina 27614, US  
 KIRCH, Marco Josef Otto, 220 Caniff Lane, Cary North Carolina 27519, US  
 MILLER, Darell James, 112 Hickory Glen Lane, Holly Springs North Carolina 27540, US  
 KESKAR, Nisha Amol, 4432 Overglen Avenue, Wake Forest NC 27587, US

- (51) MKP  
**C07D 239/34 (2006.01)** (97) **2476670**  
**A61K 31/513 (2006.01)**  
 (96) 11000089.0 18.07.2012  
 (97) 2476670, 18.07.2012 en  
 (54) Stable solid salts of ambrisentan  
 (71) Zentiva, K.S., U Kabelovny 130, 102 37 Praha 10, CZ  
 Sanofi-Aventis Deutschland GmbH, Industriepark Höchst, Geb. K 801, 65926 Frankfurt am Main, DE  
 (72) Nagel, Norbert, Flughafenstrasse 50, 64546 Mörfelden-Walldorf, DE  
 Baumgartner, Bruno, Rossdörfer Strasse 22, 64287 Darmstadt, DE  
 Bröckelmann, Martin, Wildhubenweg 11, 65428 Rüsselsheim, DE  
 Radl, Stanislav, Ohnicova 127, 250 84 Praha-Kvetnice, CZ  
 Klecan, Ondrej, Na Cihelne 1335, 282 01 Cesky Brod, CZ  
 Ridvan, Ludek, Bratislavská 11, 102 00 Praha 10, CZ  
 Dammer, Ondrej, Dobriv 170, 338 44 Dobriv, CZ

- (51) MKP  
**B65D 85/76 (2006.01)** (97) **2544966 \***  
 (86) FR2011000120 07.03.2011  
 (96) 11714348.7 16.01.2013  
 (87) WO2011110754, 07.03.2011  
 (97) 2544966, 16.01.2013 fr  
 (54) PORTIONABLE PACKAGING FOR A FOOD PRODUCT  
 (71) BONGRAIN S.A., 42, Rue Rieussec, 78223 Viroflay, FR  
 (72) BONNIN, Yves, 12 Chemin de Bazemont, F-78580 Maule, FR  
 RAVELET, Sébastien, 7 rue Jaroslava Flogara, 63900 Brno, CZ

- (51) MKP  
**C12N 9/00 (2006.01)** (97) **2566516 \***  
**A61K 39/39 (2006.01)**  
**A61K 38/16 (2006.01)**  
**A61K 38/43 (2006.01)**  
**A61P 37/00 (2006.01)**  
**A61K 39/395 (2006.01)**  
 (86) US2011034840 02.05.2011  
 (96) 11778120.3 13.03.2013  
 (87) WO2011139988, 02.05.2011  
 (97) 2566516, 13.03.2013 en  
 (54) INNOVATIVE DISCOVERY OF THERAPEUTIC, DIAGNOSTIC, AND ANTIBODY COMPOSITIONS RELATED TO PROTEIN FRAGMENTS OF SERYL-TRNA SYNTHETASES  
 (71) aTyr Pharma, Inc., 3545 John Hopkins Court, Suite 250, San Diego, CA 92121, US  
 Pangu Biopharma Limited, Edinburgh Tower, 18/F The Landmark 15 Queen's Road Central, Hong Kong, CN  
 (72) GREENE, Leslie Ann, 13941 Davenport Avenue, San Diego California 92129, US  
 CHIANG, Kyle P., 943 Torrance Street, Apt. 6, San Diego California 92103, US  
 HONG, Fei, 7979 Caminito Dia, 2, San Diego California 92122, US  
 VASSEROT, Alain P., 6421 La Paloma Street, Carlsbad California 92009, US  
 LO, Wing-Sze, RM 815 Sui Ming House Siu Sai Wan Estate Chai Wan, Hong Kong, HK  
 WATKINS, Jeffry D., 3442 Fortuna Ranch Road, Encinitas California 92024, US  
 MENDLEIN, John D., 1550 Neptune Avenue, Encinitas California 92024, US  
 QUINN, Cheryl L., 5392 Renaissance Avenue, San Diego California 92122, US

- (51) MKP  
**A61K 31/5517 (2006.01)** (97) **2576557 \***  
**C07D 487/04 (2006.01)**  
**A61P 31/10 (2006.01)**  
 (86) EP2011059058 01.06.2011  
 (96) 11723445.0 10.04.2013  
 (87) WO2011154298, 01.06.2011  
 (97) 2576557, 10.04.2013 en  
 (54) NOVEL ANTIFUNGAL 5,6-DIHYDRO-4-[(DIFLUOROETHYL)PHENYL]-4H-PYRROLO[1,2-a][1,4]BENZODIAZEPINE AND 4-[(DIFLUOROETHYL)PHENYL]-6H-PYRROLO[1,2-a][1,4]BENZODIAZEPINE DERIVATIVES  
 (71) Janssen Pharmaceutica, N.V., Turnhoutseweg 30, 2340 Beerse, BE  
 (72) MEERPOEL, Lieven, c/o Janssen Pharmaceutica NV Turnhoutseweg 30, B-2340 Beerse, BE  
 MAES, Louis, Jules, Roger, Marie, c/o University of Antwerp Prinsstraat 13, B-2000 Antwerp, BE  
 DE WIT, Kelly, c/o University of Antwerp Prinsstraat 13, B-2000 Antwerp, BE

(51) MKP  
**A61P 35/00 (2006.01)** (97) **2566869 \***  
**C07D 495/04 (2006.01)**  
**C07D 498/04 (2006.01)**  
**C07D 487/04 (2006.01)**  
**A61K 31/498 (2006.01)**  
(86) US2011035596 06.05.2011  
(96) 11731170.4 13.03.2013  
(87) WO2011140488, 06.05.2011  
(97) 2566869, 13.03.2013 en  
(54) PYRIDONE AND AZA-PYRIDONE COMPOUNDS AND METHODS OF USE  
(71) Gilead Connecticut, Inc., 333 Lakeside Drive, Foster City, CA 94404, US  
Genentech, Inc., 1 DNA Way, South San Francisco, CA 94080, US  
(72) BARBOSA, Antonio, J., M., 127 Watertown Road P.O.Box Box 196, Middlebury, CT 06762, US  
BLOMGREN, Peter, A., 20 James Road, North Branford CT 06471, US  
CURRIE, Kevin, S., 9 Overlook Drive, North Branford CT 06471, US  
KRISHNAMOORTHY, Ravi, 72A Devonshire Drive, Guilderland NY 12084, US  
KROPF, Jeffrey, E., 203 Greens Farm Road, Branford CT 06405, US  
LEE, Seung H., 109 Stannard Avenue, Branford CT 06405, US  
MITCHELL, Scott A., 13 Morris Road, East Haven CT 06513, US  
ORTWINE, Daniel, 138 Cortona Drive, San Ramon CA 94582, US  
SCHMITT, Aaron, C., 32 Linden Avenue, Hamden CT 06518, US  
WANG, Xiaojing, 736 Bounty Drive 3604, Foster City CA 94404, US  
XU, Jianjun, 211 Devonshire Lane, Madison CT 06443, US  
YOUNG, Wendy, 502 Cornell Avenue, San Mateo CA 94402, US  
ZHANG, Honglu, 101 Bleeker Road Apt 10, Guilderland NY 12084, US  
ZHAO, Zhongdong, 8 Old Barn Lane, Guilford CT 06437, US  
ZHICHKIN, Pavel E., 19-B Clermont Street, Delmar NY 12054, US

(51) MKP  
**C12N 15/09 (2006.01)** (97) **2576773 \***  
**C07K 14/11 (2006.01)**  
**C12N 15/86 (2006.01)**  
**C12N 7/02 (2006.01)**  
(86) EP2011059284 06.06.2011  
(96) 11727412.6 10.04.2013  
(87) WO2011151470, 06.06.2011  
(97) 2576773, 10.04.2013 en  
(54) METHODS AND HELPER VIRUSES FOR THE GENERATION OF RNA VIRUS  
(71) Avir Green Hills Biotechnology Research Development Trade AG, Forsthausgasse 11, 1200 Vienna, AT  
(72) MUSTER, Thomas, Eckperggasse 40/6, A-1180 Vienna, AT  
EGOROV, Andrej, Leipziger Strasse 58/8, A-1200 Vienna, AT  
WOLSCHEK, Markus, Pflugg. 8/22, A-1090 Vienna, AT

(51) MKP  
**A61K 38/47 (2006.01)** (97) **2593131 \***  
**A61P 25/28 (2006.01)**  
**A61P 25/00 (2006.01)**  
(86) US2011041925 25.06.2011  
(96) 11799036.6 22.05.2013  
(87) WO2011163649, 25.06.2011  
2593131, 22.05.2013 en  
(54) METHODS AND COMPOSITIONS FOR CNS DELIVERY OF IDURONATE-2-SULFATASE  
(71) Shire Human Genetic Therapies, Inc., 700 Main Street, Cambridge, MA 02139, US  
(72) ZHU, Gaozhong, 680 South Avenue, Unit 15, Weston MA 02493, US  
LOWE, Kris, 16 Sachem Street, Boston MA 02120, US  
SHAHROKH, Zahra, 5 Terrace Road, Weston MA 02493, US  
CHRISTIAN, James, 36 Gordon Circle, Grafton MA 01519, US  
FAHRNER, Rick, 6 Beechwood Circle, Boxford MA 01921, US  
PAN, Jing, 868 Depot Road, Boxborough MA 01719, US  
WRIGHT, Teresa, Leah, 39 Earl Street, Lexington MA 02142, US  
CALIAS, Pericles, 39 Swains Pond Avenue, Melrose MA 02176, US

(51) MKP  
**A61M 5/32 (2006.01)** (97) **2588162 \***  
**A61M 5/20 (2006.01)**  
(86) EP2011060322 21.06.2011  
(96) 11726441.6 08.05.2013  
(87) WO2012000838, 21.06.2011  
(97) 2588162, 08.05.2013 en  
(54) SAFETY DEVICE FOR A PRE-FILLED SYRINGE AND INJECTION DEVICE  
(71) Sanofi-Aventis Deutschland GmbH, Brüningstraße 50, 65929 Frankfurt, DE  
(72) ROBERTS, Gareth, Glendale Pen-y-cae Road Ruabon, Wrexham LL14 6EB, GB  
OWEN, Sioned, Berllan Bach, Prion Denbigh LL16 4 SE, GB  
EKMAN, Matthew, 59 Ecton Avenue, Macclesfield, Cheshire SK10 1RD, GB

(51) MKP  
**A61P 15/10 (2006.01)** (97) **2546255 \***  
**A61K 31/55 (2006.01)**  
**A61P 13/02 (2006.01)**  
**C07D 498/04 (2006.01)**  
**A61P 43/00 (2006.01)**  
**A61P 3/04 (2006.01)**  
**C07D 487/04 (2006.01)**  
**A61P 13/00 (2006.01)**  
(86) JP2011055759 11.03.2011  
(96) 11753475.0 16.01.2013  
(87) WO2011111817, 11.03.2011  
(97) 2546255, 16.01.2013 en  
(54) BENZAZEPINE COMPOUND  
(71) Astellas Pharma Inc., 3-11, Nihonbashi-Honcho 2-chome Chuo-ku, Tokyo 103-8411, JP  
(72) KOSHIO, Hiroyuki, c/o Astellas Pharma Inc. 3-11 Nihonbashi-Honcho 2-chome Chuo-ku, Tokyo 103-8411, JP  
ASAI, Norio, c/o Astellas Pharma Inc. 3-11 Nihonbashi-Honcho 2-chome Chuo-ku, Tokyo 103-8411, JP  
TAKAHASHI, Taisuke, c/o Astellas Pharma Inc. 3-11 Nihonbashi-Honcho 2-chome Chuo-ku, Tokyo 103-8411, JP  
SHIMIZU, Takafumi, c/o Astellas Pharma Inc. 3-11 Nihonbashi-Honcho 2-chome Chuo-ku, Tokyo 103-8411, JP  
NAGAI, Yasuhito, c/o Astellas Pharma Inc. 3-11 Nihonbashi-Honcho 2-chome Chuo-ku, Tokyo 103-8411, JP  
KAWABATA, Keiko, c/o Astellas Pharma Inc. 3-11 Nihonbashi-Honcho 2-chome Chuo-ku, Tokyo 103-8411, JP  
THOR, Karl Bruce, 801 Capitola Drive, Durham, North Carolina 27703, US

- (51) MKP  
**A61P 7/04 (2006.01)** (97) **2563403 \***  
**A61K 47/48 (2006.01)**  
**A61K 38/36 (2006.01)**
- (86) GB2011000663 28.04.2011  
(96) 11719041.3 06.03.2013  
(87) WO2011135308, 28.04.2011  
(97) 2563403, 06.03.2013 en
- (54) CONJUGATED BLOOD COAGULATION FACTOR VIIA  
(71) Cantab Biopharmaceuticals Patents Limited, Palazzo Pietro Stiges 103 Strait Street, Valletta VLT 1436, MT  
Polytherics Limited, The London Biotechnology Innovation Centre 2 Royal College Street Camden, London, NW1 0TU, GB  
(72) HENRY, William, Cantab Biopharmaceuticals Limited 155 Cambridge Science Park Milton Road, Cambridge CB4 0GN, GB
- 
- (51) MKP  
**A61P 25/04 (2006.01)** (97) **2585069 \***  
**A61P 25/02 (2006.01)**  
**A61K 31/513 (2006.01)**  
**A61K 31/53 (2006.01)**
- (86) US2011041981 27.06.2011  
(96) 11730505.2 01.05.2013  
(87) WO2012006004, 27.06.2011  
(97) 2585069, 01.05.2013 en
- (54) PROKINETICIN 1 RECEPTOR ANTAGONISTS FOR THE TREATMENT OF PAIN  
(71) Janssen Pharmaceutica, N.V., Turnhoutseweg 30, 2340 Beerse, BE  
(72) FLORES, Christopher, M., 1125 Trenton-harbourton Road, Titusville, NJ 08560, US  
WADE, Paul, 564 North 17th Street, Philadelphia, PA 19130-3921, US
- 
- (51) MKP  
**A61K 9/10 (2006.01)** (97) **2571488 \***  
**A61K 31/19 (2006.01)**  
**A61K 47/18 (2006.01)**
- (86) EP2011058087 18.05.2011  
(96) 11720479.2 27.03.2013  
(87) WO2011144677, 18.05.2011  
(97) 2571488, 27.03.2013 en
- (54) PHARMACEUTICAL COMPOSITION OF IBUPROFEN FOR INJECTION  
(71) Spain Pharma, S.A., C/ Cólquide 6, Portal 2, 28230 Las Rozas (Madrid), ES  
(72) ORTÚZAR ANDÉCHAGA, Ignacio, Cólquide 6 portal 2, E-28230 Las Rozas (Madrid), ES  
ORTÚZAR GUTIÉRREZ, Mario, Cólquide 6 portal 2, E-28230 Las Rozas (Madrid), ES
- 
- (51) MKP  
**A61K 31/47 (2006.01)** (97) **2547658 \***  
**C07D 215/56 (2006.01)**  
**A61P 11/00 (2006.01)**
- (86) US2011029276 21.03.2011  
(96) 11711419.9 23.01.2013  
(87) WO2011116397, 21.03.2011  
(97) 2547658, 23.01.2013 en
- (54) SOLID FORMS OF N-[2,4-BIS(1,1-DIMETHYLETHYL)-5-HYDROXYPHENYL]-1,4-DIHYDRO-4-OXOQUINOLINE-3-CARBOXAMIDE  
(71) Vertex Pharmaceuticals Incorporated, 130 Waverly Street, Cambridge, MA 02139, US  
(72) AREKAR, Sneha, G., 26 Waverly Street, Apt. 209, Brighton, MA 02135, US  
JOHNSTON, Steven, C., 22 Page Road, Litchfield, NH 03052, US  
KRAWIEC, Mariusz, 46 Littlefield Lane, Marlborough MA 01752, US  
MEDEK, Ales, 14 Lockland Road, Winchester MA 01890, US  
MUDUNURI, Praveen, 7 Charlesbank Way, Apt. A, Waltham, MA 02453, US  
SULLIVAN, Mark, Jeffrey, 103 Howe Street, Framingham MA 01702, US
- 
- (51) MKP  
**C01G 7/00 (2006.01)** (97) **2580162 \***  
**C22B 11/06 (2006.01)**  
**C22B 3/26 (2006.01)**
- (86) FI2011050532 07.06.2011  
(96) 11791989.4 17.04.2013  
(87) WO2011154603, 07.06.2011  
(97) 2580162, 17.04.2013 en
- (54) METHOD FOR RECOVERING GOLD BY SOLVENT EXTRACTION  
(71) Outotec OYJ, Riihitontuntie 7, 02200 Espoo, FI  
(72) PAATERO, Erkki, Merikannontie 7 C 46, FI-00260 HELSINKI, FI  
HAAPALAINEN, Mika, Liinakkotie 13, FI-28430 Pori, FI
- 
- (51) MKP  
**C07K 16/18 (2006.01)** (97) **2542580 \***  
**G01N 33/564 (2006.01)**  
**G01N 33/68 (2006.01)**
- (86) EP2011001090 04.03.2011  
(96) 11708716.3 09.01.2013  
(87) WO2011107291, 04.03.2011  
(97) 2542580, 09.01.2013 en
- (54) ANTIBODIES AGAINST PHOSPHORYLCHOLINE IN COMBINATION THERAPY WITH BIOLOGIC AGENTS  
(71) Medirista Biotechnologies AB, Drottningholmsvägen 1, 112 42 Stockholm, SE  
(72) FROSTEGÅRD, Johan, Drottningholmsvägen 1 5th floor, S-112 42 Stockholm, SE
- 
- (51) MKP  
**C07D 213/64 (2006.01)** (97) **2563762 \***
- (86) EP2011056588 26.04.2011  
(96) 11717250.2 06.03.2013  
(87) WO2011134963, 26.04.2011  
(97) 2563762, 06.03.2013 de
- (54) METHOD FOR PRODUCING SUBSTITUTED PYRIDIN-2-ONE  
(71) Bayer Intellectual Property GmbH, Alfred-Nobel-Strasse 10, 40789 Monheim, DE  
(72) KRÜGER, Joachim, Zeppenheimer Weg 71, 40489 Düsseldorf, DE  
GROSSBACH, Danja, Kluckstr. 1, 42329 Wuppertal, DE  
PAULSEN, Holger, Dietrich-Bonhoeffer-Strasse 19, 40724 Hilden, DE  
KROH, Walter, Breuerweg 18, 42115 Wuppertal, DE
- 
- (51) MKP  
**H02J 7/00 (2006.01)** (97) **2567445 \***
- (86) EP2011002250 05.05.2011  
(96) 11723246.2 13.03.2013  
(87) WO2011138038, 05.05.2011  
(97) 2567445, 13.03.2013 en
- (54) BIPOLAR OVERVOLTAGE BATTERY PULSER AND METHOD  
(71) Aanensen, Ove T., Hyllebakken 2, 4622 Kristiansand, NO  
Valand, Dag Arild, Im Ellig 7, 53343 Wachtberg, DE  
(72) Aanensen, Ove T., Hyllebakken 2, 4622 Kristiansand, NO  
Valand, Dag Arild, Im Ellig 7, 53343 Wachtberg, DE
- 
- (51) MKP  
**A61P 17/14 (2006.01)** (97) **2582355 \***  
**A61K 31/727 (2006.01)**  
**A61Q 7/00 (2006.01)**  
**A61K 45/06 (2006.01)**  
**A61K 8/73 (2006.01)**  
**A61K 31/337 (2006.01)**  
**A61K 31/506 (2006.01)**  
**A61K 31/58 (2006.01)**
- (86) US2011040470 15.06.2011  
(96) 11743385.4 24.04.2013  
(87) WO2011159770, 15.06.2011  
(97) 2582355, 24.04.2013 en
- (54) METHODS AND COMPOSITIONS FOR PROMOTING HAIR GROWTH  
(71) Momenta Pharmaceuticals, Inc., 675 West Kendall Street, Cambridge, MA 02142, US  
(72) ZHOU, He, 128 Cross Street, Malden, MA 02148, US  
COCHRAN, Edward, 54 West Street, Marshfield, MA 02050, US

(51) MKP  
**A61K 9/26 (2006.01)** (97) **2538928 \***  
**A61K 31/485 (2006.01)**  
(86) US2011025914 23.02.2011  
(96) 11705797.6 02.01.2013  
(87) WO2011106416, 23.02.2011  
(97) 2538928, 02.01.2013 en  
(54) ABUSE-RESISTANT FORMULATIONS  
(71) Cima Labs Inc., 7325 Aspen Lane, Brooklyn Park, Minnesota 55428, US  
(72) HAMED, Ehab, 9206 Holly Lane North, Maple Grove Minnesota 55311, US  
KRALING, Carrie, 319 Vincent Avenue North, Minneapolis Minnesota 55405, US

(51) MKP  
**A61K 39/21 (2006.01)** (97) **2547697 \***  
**C07K 14/16 (2006.01)**  
(86) EP2011001606 21.03.2011  
(96) 11714488.1 23.01.2013  
(87) WO2011113618, 21.03.2011  
(97) 2547697, 23.01.2013 en  
(54) IMMUNE THERAPY  
(71) Vaxxit Srl, Via dei Valeri 1, 00184 Roma, IT  
(72) ENSOLI, Barbara, Via Capo Sottile 25, 00139 Roma, IT

(51) MKP  
**C07D 487/04 (2006.01)** (97) **2566867 \***  
**A61P 29/00 (2006.01)**  
**A61K 31/519 (2006.01)**  
**A61P 35/00 (2006.01)**  
(86) EP2011056158 18.04.2011  
(96) 11714581.3 13.03.2013  
(87) WO2011134831, 18.04.2011  
(97) 2566867, 13.03.2013 en  
(54) PYRAZOLE COMPOUNDS AS JAK INHIBITORS  
(71) Cellzome Limited, Chesterford Research Park, Little Chesterford Cambridgeshire CB10 1XL, GB  
(72) HARRISON, Richard, John, 30 Chalmers Road, Cambridge CB1 3SX, GB  
OXENFORD, Sally, 70 Millmead Way, Hertford, Herts SG14, 3 YH, GB  
HOBSON, Andrew, 77 Riverside Place, Cambridge CB5 8JF, GB  
RAMSDEN, Nigel, Sparrows Lodge Green Lane Fowlmere Royston, Herts SG8 7QP, GB  
MILLER, Warren, 21 Grebe Court, Cambridge UK CB58FR, GB

(51) MKP  
**A61K 31/4409 (2006.01)** (97) **2560630 \***  
**A61K 9/28 (2006.01)**  
**A61K 31/4425 (2006.01)**  
**A61K 9/48 (2006.01)**  
**A61K 31/438 (2006.01)**  
**A61K 9/20 (2006.01)**  
**A61K 31/47 (2006.01)**  
**A61K 9/50 (2006.01)**  
**A61K 31/395 (2006.01)**  
**A61K 9/02 (2006.01)**  
**A61K 31/7036 (2006.01)**  
**A61K 31/4965 (2006.01)**  
**A61K 9/00 (2006.01)**  
**A61K 31/133 (2006.01)**  
**A61K 45/06 (2006.01)**  
(86) IB2011051566 12.04.2011  
(96) 11755438.6 27.02.2013  
(87) WO2011132114, 12.04.2011  
(97) 2560630, 27.02.2013 en  
(54) TUBERCULOSIS DRUG BASED ON 4-THIOUREIDO-IMINOMETHYLPYRIDINIUM PERCHLORATE: METHOD OF PREPARATION AND TREATMENT  
(71) Joint Stock Company "Pharmasyntez", Patent Attorney RF Fedorov D.V. Office 3 Dom 23 ul. Krasnogvardeyskaya, Irkutsk 664007, RU  
(72) GUSHCHIN, Aleksander Sergeevich, Gushchin A.S. kv.20 d. 5A ul. Mayakovskogo, Irkutsk 664005, RU  
VINOGRADOVA, Tatiana Ivanovna, Vinogradova T.I. kv. 41 d. 21 ul. Maxima Gorkogo, Tosno 181010, RU  
YABLONSKIY, Petr Kazimirovich, Yablonskiy P.K. kv.125 d. 11 Kostromskoy prospekt, Saint Petersburg 194354, RU  
BATYUNIN, Gennady Andreevich, Batyunin G.A. kv.10 d. 48 ul. 5-oy Armii, Irkutsk 664025, RU  
ZABOLOTNYH, Natalya Vyacheslavovna, Zabolotnykh N.V. kv.5 d. 13 ul. Pskovskaya, Saint Petersburg 191036, RU  
VASILIEVA, Svetlana Nikolaevna, Vasilieva S.N. kv.133 d. 13 ul. Olgi Forsh, Saint Petersburg 195269, RU  
MALIGIN, Alexey Vladimirovich, Maligin A.V. kv.56 d. 23A ul. Shakhtyorskaya, Irkutsk 664014, RU

(51) MKP  
**D01D 1/02 (2006.01)** (97) **2471983**  
**D01F 6/60 (2006.01)**  
**C08G 69/32 (2006.01)**  
(96) 11177599.5 04.07.2012  
(97) 2471983, 04.07.2012 en  
(54) Method For Preparing Meta-Aramid Fibers  
(71) Zhong, Zhou, Room 1101-1103 Tongda Building N°. 1 Lane 600 Tianshang Road, ChangNing District Shanghai, CN  
(72) Zhong, Zhou, Room 1101-1103 Tongda Building N°. 1 Lane 600 Tianshang Road, ChangNing District Shanghai, CN

(51) MKP  
**F25B 43/02 (2006.01)** (97) **2500677**  
(96) 12157699.5 19.09.2012  
(97) 2500677, 19.09.2012 en  
(54) Oil separator and refrigerating cycle apparatus using the same  
(71) Panasonic Healthcare Co., Ltd., 2131-1 Minamigata Toon-shi., Ehime 791-0395, JP  
(72) Tadano, Rikio, c/o Intellectual Property H.Q., SANYO ELECTRIC CO., LTD. 5-5, Keihanondori 2-chome, Moriguchi-shi, Osaka 5708677, JP  
Satou, Hiroyuki, c/o Intellectual Property H.Q., SANYO ELECTRIC CO., LTD. 5-5, Keihanondori 2-chome, Moriguchi-shi, Osaka 5708677, JP  
Kobayashi, Susumu, c/o Intellectual Property H.Q., SANYO ELECTRIC CO., LTD. 5-5, Keihanondori 2-chome, Moriguchi-shi, Osaka 5708677, JP  
Yamawaki, Hiroshi, c/o Intellectual Property H.Q., SANYO ELECTRIC CO., LTD. 5-5, Keihanondori 2-chome, Moriguchi-shi, Osaka 5708677, JP

- (51) MKP  
**A61P 37/00 (2006.01)** (97) **2580196 \***  
**C07D 401/12 (2006.01)**  
**C07D 223/12 (2006.01)**  
**C07D 211/56 (2006.01)**  
**A61P 17/06 (2006.01)**  
**A61K 31/45 (2006.01)**  
**A61P 29/00 (2006.01)**  
**A61K 31/55 (2006.01)**  
**A61K 31/4523 (2006.01)**  
(86) GB2011000863 08.06.2011  
(96) 11725490.4 17.04.2013  
(87) WO2011154696, 08.06.2011  
(97) 2580196, 17.04.2013 en  
(54) ANTI-INFLAMMATORY AGENTS  
(71) Cambridge Enterprise Ltd., The Old Schools Trinity Lane, Cambridge Cambridgeshire CB2 1TN, GB  
BOEHRINGER INGELHEIM INTERNATIONAL GMBH, Binger Str. 173, 55216 Ingelheim am Rhein, DE  
(72) GRAINGER, David, John, Department of Medicine Cambridge University Box 157 Addenbrookes Hospital, Hills Road Cambridge CB2 2QQ, GB  
FOX, David John, Department of Chemistry University of Warwick Gibbet Hill Road, Coventry CV4 7AL, GB

- (51) MKP  
**A61K 31/437 (2006.01)** (97) **2576548 \***  
**C07D 471/04 (2006.01)**  
**A61P 9/00 (2006.01)**  
**A61P 15/00 (2006.01)**  
(86) EP2011058433 24.05.2011  
(96) 11722786.8 10.04.2013  
(87) WO2011147810, 24.05.2011  
(97) 2576548, 10.04.2013 en  
(54) THE USE OF sGC STIMULATORS, sGC ACTIVATORS, ALONE AND COMBINATIONS WITH PDE5 INHIBITORS FOR THE TREATMENT OF SYSTEMIC SCLEROSIS (SSc).  
(71) Bayer Intellectual Property GmbH, Alfred-Nobel-Strasse 10, 40789 Monheim, DE  
(72) HIRTH-DIETRICH, Claudia, Stockmannsmühle 127, 42115 Wuppertal, DE  
SANDNER, Peter, Julius-Lucas-Weg 59, 42113 Wuppertal, DE  
STASCH, Johannes-Peter, Alfred-Nobel-Str.109, 42651 Solingen, DE  
KNORR, Andreas, Trillser Graben 10, 40699 Erkrath, DE  
VON DEGENFELD, Georges, Friedrich-Weskott-Str. 10, 51373 Leverkusen, DE  
HAHN, Michael, Rietherbach 42D, 40764 Langenfeld, DE  
FOLLMANN, Markus, Ringstr. 61, 42489 Wülfrath, DE

- (51) MKP  
**C07K 14/195 (2006.01)** (97) **2590993 \***  
(86) EP2011061623 08.07.2011  
(96) 11743207.0 15.05.2013  
(87) WO2012004384, 08.07.2011  
(97) 2590993, 15.05.2013 en  
(54) POLYPEPTIDES  
(71) Affibody AB, Gunnar Asplunds Allé 24, 171 63 Solna, SE  
(72) EKBLAD, Caroline, Huldrevägen 23, S-132 39 Saltsjö-Boo, SE  
ABRAHMSÉN, Lars, Vereliusvägen 17, S-168 53 Bromma, SE

- (51) MKP  
**A23L 1/236 (2006.01)** (97) **2386209**  
**A23L 1/09 (2006.01)**  
(96) 11003001.2 16.11.2011  
(97) 2386209, 16.11.2011 de  
(54) Natural sweetener  
(71) Jungbunzlauer Austria AG, Zweigniederlassung Anwendungstechnik Ladenburg Dr. Albert-Reinmann-Str. 18, 68526 Ladenburg, DE  
(72) Scholten, Claudia, Stephanienufer 3, 68163 Mannheim, DE  
Jantschewski, Vitalij, Ahornstrasse 56, 68542 Heddesheim, DE  
Seemann, Matthias, Zedernstrasse 2, 68542 Heddesheim, DE

- (51) MKP  
**A61M 5/315 (2006.01)** (97) **2455121**  
(96) 10191800.1 23.05.2012  
(97) 2455121, 23.05.2012 en  
(54) Cartridge holder and drug delivery device  
(71) Sanofi-Aventis Deutschland GmbH, Brüningstraße 50, 65929 Frankfurt, DE  
(72) Helmer, Michael, c/o Sanofi-Aventis Deutschland GmbH, 65926 Frankfurt am Main, DE

- (51) MKP  
**H04L 12/28 (2006.01)** (97) **2594082 \***  
**H04Q 3/00 (2006.01)**  
(86) FR2011051568 04.07.2011  
(96) 11741638.8 22.05.2013  
(87) WO2012010764, 04.07.2011  
(97) 2594082, 22.05.2013 fr  
(54) CONTINUITY OF THE AVAILABILITY OF A COMMUNICATION SERVICE  
(71) Softathome, 81 Avenue François Arago, 92000 Nanterre, FR  
(72) BADUEL, Guy, 12 Rue du Maréchal Juin, F-95180 Menucourt, FR  
MAKOWSKI, Wojciech, 15 rue de Saint Germain, F-78230 Le Pecq, FR

- (51) MKP  
**C07K 14/435 (2006.01)** (97) **2542569 \***  
**A61K 38/16 (2006.01)**  
**C12N 15/62 (2006.01)**  
(86) EP2011053309 04.03.2011  
(96) 11706287.7 09.01.2013  
(87) WO201107591, 04.03.2011  
(97) 2542569, 09.01.2013 en  
(54) CHIMERIC INHIBITOR MOLECULES OF COMPLEMENT ACTIVATION  
(71) Rigshospitalet, Blegdamsvej 9, 2100 Copenhagen Ø, DK  
Københavns Universitet, Nørregade 10 P.O. Box 2177, 1017 Copenhagen K, DK  
Syddansk Universitet, Campusvej 55, 5230 Odense M, DK  
(72) GARRED, Peter, Folevænget 8, 2920 Charlottenlund, DK  
GLUE, Tina Hummelshøj, Telefonvej 4g, 1.th., 2860 Søborg, DK  
SKJØDT, Mikkel-Ole, Ingemannsvej 22, 3.th., 1964 Frederiksberg C, DK

- (51) MKP  
**A01H 5/00 (2006.01)** (97) **2563113 \***  
**C12N 15/29 (2006.01)**  
**C12N 15/82 (2006.01)**  
(86) US2011034202 27.04.2011  
(96) 11777981.9 06.03.2013  
(87) WO2011139798, 27.04.2011  
(97) 2563113, 06.03.2013 en  
(54) MODIFIED PYR/PYL RECEPTORS ACTIVATED BY ORTHOGONAL LIGANDS  
(71) The Regents of the University of California, 1111 Franklin Street, 12th Floor, Oakland, CA 94607-5200, US  
(72) CUTLER, Sean R., 5115 Chequers Court, Riverside California 92507, US  
PARK, Sang-Youl, 235 Green Oaks Drive, Riverside California 92507, US

- (51) MKP  
**B65D 19/28 (2006.01)** (97) **2555990 \***  
**B65G 1/02 (2006.01)**  
(86) EP2011001742 07.04.2011  
(96) 11713477.5 13.02.2013  
(87) WO2011124383, 07.04.2011  
(97) 2555990, 13.02.2013 de  
(54) SUPPORT FRAME FOR RACKS  
(71) Tegometall International AG, Industriestrasse, 8574 Lengwil, CH  
(72) BOHNACKER, Ulrich, Am Herrensberg 5, CH-8559 Fruthwilen, CH



(51) MKP  
**A23L 1/216 (2006.01)** (97) **2566351 \***  
**A23L 1/18 (2006.01)**  
**A23L 1/164 (2006.01)**  
(86) IB2012050562 08.02.2012  
(96) 12710787.8 13.03.2013  
(87) WO2012114221, 08.02.2012  
(97) 2566351, 13.03.2013 en  
(54) FOOD PRODUCT COMPRISING A MIXTURE OF SLICES OF POTATOES COOKED IN OIL AND CORNS PUFFED UP WHEN HEATED  
(71) Perini, Oscar, Via dei Colli 52, 38015 Lavis (Trento), IT  
(72) Perini, Oscar, Via dei Colli 52, 38015 Lavis (Trento), IT

---

(51) MKP  
**C02F 1/32 (2006.01)** (97) **2575901 \***  
**A61L 2/00 (2006.01)**  
(86) US2011039301 06.06.2011  
(96) 11726583.5 10.04.2013  
(87) WO2011156281, 06.06.2011  
(97) 2575901, 10.04.2013 en  
(54) DEVICE FOR VIRAL INACTIVATION OF LIQUID MEDIA  
(71) Genzyme Corporation, 500 Kendall Street, Cambridge, MA 02142, US  
(72) DHANASEKHARAN, Muthukumar, 11 Seton Drive, Shrewsbury MA 01545-5468, US

---

(51) MKP  
**C09K 101/00 (2006.01)** (97) **2588564 \***  
**C09K 17/40 (2006.01)**  
**C09K 17/00 (2006.01)**  
**B09C 1/00 (2006.01)**  
**C09K 17/50 (2006.01)**  
**A01C 1/00 (2006.01)**  
(86) HU2011000058 22.06.2011  
(96) 11800252.6 08.05.2013  
(87) WO2012001435, 22.06.2011  
(97) 2588564, 08.05.2013 en  
(54) CELL FOR CONDITIONING AND IMPROVING OF SOIL, AS WELL AS PROCESS FOR PRODUCTION AND ALLOCATION TO THE SOIL OF IT  
(71) Endrödi, László, Középtemető u. 11., 1239 Budapest, HU  
(72) Endrödi, László, Középtemető u. 11., 1239 Budapest, HU

---

(51) MKP  
**C07D 413/12 (2006.01)** (97) **2542537 \***  
**C07D 498/04 (2006.01)**  
**A61K 31/395 (2006.01)**  
**C07D 267/22 (2006.01)**  
**C07D 403/12 (2006.01)**  
**C07D 417/12 (2006.01)**  
**A61P 29/00 (2006.01)**  
**C07D 245/06 (2006.01)**  
**C07D 281/18 (2006.01)**  
**C07D 413/10 (2006.01)**  
**C07D 487/04 (2006.01)**  
**A61P 37/00 (2006.01)**  
(86) EP2011000976 28.02.2011  
(96) 11706184.6 09.01.2013  
(87) WO2011107248, 28.02.2011  
(97) 2542537, 09.01.2013 en  
(54) NOVEL COMPOUNDS FOR MODULATION OF ORPHAN NUCLEAR RECEPTOR RAR-RELATED ORPHAN RECEPTOR-GAMMA (ROR GAMMA, NR1F3) ACTIVITY AND FOR THE TREATMENT OF CHRONIC INFLAMMATORY AND AUTOIMMUNE DISEASE  
(71) Phenex Pharmaceuticals AG, Donnersbergweg 1, 67059 Ludwigshafen, DE  
(72) KINZEL, Olaf, Schlierbacher Landstrasse 15, 69118 Heidelberg, DE  
STEENECK, Christoph, Schulstrasse 8, 69221 Dossenheim, DE  
KLEYMANN, Gerald, Leopoldshöher Strasse 7, 32107 Bad Salzufen, DE  
ALBERS, Michael, Schwabenstr. 6A, 68239 Mannheim-Seckenheim, DE  
HOFFMANN, Thomas, Gebrüder Grimm Allee 19, 68519 Viernheim, DE  
KREMOSER, Claus, Gugenmusweg 20, 69121 Heidelberg, DE  
PEROVIC-OTTSTADT, Sanja, Im Niederfeld 13, 65462 Ginsheim-Gustavsburg, DE  
SCHLÜTER, Thomas, Wieblinger Weg 33/5, 69123 Heidelberg, DE

---

(51) MKP  
**A61P 31/18 (2006.01)** (97) **2593120 \***  
**A61K 38/08 (2006.01)**  
(86) AU2011000878 14.07.2011  
(96) 11806135.7 22.05.2013  
(87) WO2012006667, 14.07.2011  
(97) 2593120, 22.05.2013 en  
(54) METHOD OF TREATMENT OF HIV OR AIDS  
(71) Adistem Ltd, 5/F, CNT Tower 338 Hennessey Road Wanchai, Hong Kong, CN  
(72) PASPALIARIS, Vasilis, 1985 Malvern Road, Malvern East Victoria 3145, AU

---

(51) MKP  
**C07D 471/04 (2006.01)** (97) **2588197 \***  
**A61P 3/10 (2006.01)**  
**A61K 31/437 (2006.01)**  
**A61P 9/00 (2006.01)**  
(86) US2011042700 30.06.2011  
(96) 11732540.7 08.05.2013  
(87) WO2012003392, 30.06.2011  
(97) 2588197, 08.05.2013 en  
(54) FUSED HETEROCYCLIC COMPOUNDS AS ION CHANNEL MODULATORS  
(71) Gilead Sciences, Inc., 333 Lakeside Drive, Foster City, CA 94404, US  
(72) KOBAYASHI, Tetsuya, 1362 Arleen Avenue, Sunnyvale, California 94087, US  
KOLTUN, Dmitry, 1075 Grebe Street, Foster City, California 94404, US  
NOTTE, Gregory, 21 Otay Avenue, San Mateo, California 94403, US  
PARKHILL, Eric, 559 Lincoln Way 2, San Francisco, California 94122, US  
ZABLOCKI, Jeff, 1910 Noel Drive, Los Altos, California 94024, US

---

- (51) MKP  
**C07C 233/58 (2006.01)** (97) **2588446 \***  
**C07D 333/58 (2006.01)**  
**A61K 31/167 (2006.01)**  
**C07D 307/30 (2006.01)**  
**C07C 233/60 (2006.01)**  
**C07D 333/38 (2006.01)**  
**C07C 233/59 (2006.01)**
- (86) EP2011061128 01.07.2011  
(96) 11729412.4 08.05.2013  
(87) WO2012001148, 01.07.2011  
(97) 2588446, 08.05.2013 en
- (54) NOVEL CALCIUM SALTS OF COMPOUND AS ANTI-INFLAMMATORY, IMMUNOMODULATORY AND ANTI-PROLIFERATORY AGENTS
- (71) 4SC AG, Am Klopferspitz 19a, 82152 Planegg-Martinsried, DE  
(72) AMMENDOLA, Aldo, Max-Bruch-Str. 4c, 82166 Gräfelfing, DE  
DIEDERICHS, Julia, Ehrengutstr. 14, 80469 München, DE  
LEBAN, Johann, Kopernikusweg 5, 82152 Planegg-Martinsried, DE  
VITT, Daniel, Obere Bahnhofstr. 7a, 82110 Germering, DE
- 
- (51) MKP  
**A61K 39/00 (2006.01)** (97) **2575846 \***  
**A61K 38/00 (2006.01)**  
**C12P 21/06 (2006.01)**  
**C12P 21/04 (2006.01)**
- (86) US2011037904 25.05.2011  
(96) 11787324.0 10.04.2013  
(87) WO2011150061, 25.05.2011  
(97) 2575846, 10.04.2013 en
- (54) INSULIN-LIKE GROWTH FACTOR 1 RECEPTOR BINDING PEPTIDES
- (71) Janssen Biotech, Inc., 800/850 Ridgeview Drive, Horsham, PA 19044, US  
(72) DIEM, Michael, 145 King Of Prussia Road, Radnor, PA 19087, US  
O'NEIL, Karen, 145 King Of Prussia Road, Radnor, PA 19087, US
- 
- (51) MKP  
**A61P 25/00 (2006.01)** (97) **2569303 \***  
**A61K 31/4709 (2006.01)**  
**C07D 401/14 (2006.01)**  
**C07D 495/04 (2006.01)**  
**C07D 403/04 (2006.01)**  
**C07D 407/14 (2006.01)**
- (86) US2011035819 10.05.2011  
(96) 11731171.2 20.03.2013  
(87) WO2011143145, 10.05.2011  
(97) 2569303, 20.03.2013 en
- (54) SUBSTITUTED N-ALKYL AND N-ACYL TETRAHYDRO-ISOQUINOLINE DERIVATIVES, PREPARATION AND THERAPEUTIC USE THEREOF
- (71) SANOFI, 54, rue de la Boétie, 75008 Paris, FR  
(72) GAO, Zhongli, c/o Sanofi-Aventis U.S. 1041 Route 202-206 BWD-303A, Bridgewater, New Jersey 08807, US  
HARTUNG, Ryan, c/o Sanofi-Aventis U.S. 1041 Route 202-206 BWD-303A, Bridgewater, New Jersey 08807, US
- 
- (51) MKP  
**C07K 7/62 (2006.01)** (97) **2548883 \***
- (86) ES2011070153 09.03.2011  
(96) 11752896.8 23.01.2013  
(87) WO2011110716, 09.03.2011  
(97) 2548883, 23.01.2013 en
- (54) PEPTIDE COMPOUNDS THAT CAN BE USED AS ANTIBACTERIAL AGENTS
- (71) Universidad de Barcelona, Centro de Patentes de la UB Baldiri Reixac, 4, 08028 Barcelona, ES  
(72) RABANAL ANGLADA, Francesc, Torres Vilaró 56, E-08859 Begues, ES  
CAJAL VISA, Yolanda, Torres Vilaró 56, E-08859 Begues, ES  
GARCIA SUBIRATS, Maria, Conca 18, 2n 2a, E-08026 Barcelona, ES  
RODRÍGUEZ NÚÑEZ, Montserrat, Penedès 117, 5è 1a, E-08820 El Prat de Llobregat, ES
- 
- (51) MKP  
**A23K 1/12 (2006.01)** (97) **2557940 \***  
**A61P 33/00 (2006.01)**  
**A23K 1/16 (2006.01)**  
**A61K 31/575 (2006.01)**  
**A61P 1/00 (2006.01)**  
**A61K 36/54 (2006.01)**  
**A23K 1/14 (2006.01)**
- (86) AT2011000152 28.03.2011  
(96) 11714212.5 20.02.2013  
(87) WO2011127499, 28.03.2011  
(97) 2557940, 20.02.2013 de
- (54) ANIMAL FEED ADDITIVE HAVING AN ANTIMICROBIAL AND GROWTH-PROMOTING EFFECT
- (71) Neufeld, Klaus, Sattelbach 13, 2532 Heiligenkreuz, AT  
(72) Neufeld, Klaus, Sattelbach 13, 2532 Heiligenkreuz, AT
- 
- (51) MKP  
**A61K 31/4406 (2006.01)** (97) **2558126 \***  
**A61K 31/519 (2006.01)**  
**A61K 45/06 (2006.01)**  
**A61K 31/5377 (2006.01)**  
**A61K 31/18 (2006.01)**
- (86) EP2011055917 14.04.2011  
(96) 11714553.2 20.02.2013  
(87) WO2011128407, 14.04.2011  
(97) 2558126, 20.02.2013 en
- (54) SUBSTITUTED 2,3-DIHYDROIMIDAZO[1,2-C]QUINAZOLINE-CONTAINING COMBINATIONS
- (71) Bayer Intellectual Property GmbH, Alfred-Nobel-Strasse 10, 40789 Monheim, DE  
(72) LIU, Ningshu, Limonenstr 28, 12203 Berlin, DE
- 
- (51) MKP  
**A61M 5/315 (2006.01)** (97) **2579925 \***  
**A61M 5/24 (2006.01)**
- (86) EP2011059565 09.06.2011  
(96) 11725715.4 17.04.2013  
(87) WO2011154481, 09.06.2011  
(97) 2579925, 17.04.2013 en
- (54) MEDICATION DELIVERY DEVICE
- (71) Sanofi-Aventis Deutschland GmbH, Brüningstraße 50, 65929 Frankfurt, DE  
(72) SMITH, Christopher, James, 4 Elm Drive Cheshire, Holmes Chapel CW4 7QG, GB  
HEALD, Michael, 22 Wells Avenue, Crewe, Cheshire CW1 5RZ, DE  
BUTLER, Stephen, David, 25 High Hill South Staffords Essington, Staffordshire WV11 2DP, GB  
HORLOCK, Mark, Philip, 18 Mayfield Close, Timperley Cheshire WA15 7TE, GB
- 
- (51) MKP  
**G11B 20/10 (2006.01)** (97) **2479754**
- (96) 11275073.2 25.07.2012  
(97) 2479754, 25.07.2012 en
- (54) Circuits and methods for data detection using multiple detectors, storage device
- (71) LSI Corporation, 1621 Barber Lane MS D-106, Milpitas, CA 95035, US  
(72) Annampedu, Viswanath, 5173 Arrowhead Drive, Schnecksville, PA 18078, US
-

- (51) MKP  
**A61K 31/23 (2006.01)** (97) **2471528**  
**A61K 9/00 (2006.01)**  
(96) 10197296.6 04.07.2012  
(97) 2471528, 04.07.2012 en  
(54) A preparation method for suspension of cetyl myristate and/or cetyl palmitate  
(71) Deva Holding Anonim Sirketi, Patent Law Department Halkali Merkez Mah. Basın Ekspres Cad. No: 1,34303, Kucukcekmece/Istanbul, TR  
(72) HAAS, Philipp Daniel, DEVA HOLDING ANONIM SIRKETI Halkali Merkez Mah.,Ba, 34303, ISTANBUL, TR  
FIRAT, Omer Faruk, R&D DEVA HOLDING ANONIM SIRKETI Halkali Merkez Mah, 34303, ISTANBUL, TR  
KANDEMİR, Levent, R&D DEVA HOLDING ANONIM SIRKETI Halkali Merkez Mah, 34303, ISTANBUL, TR  
KOC, Fikret, R&D DEVA HOLDING ANONIM SIRKETI Halkali Merkez Mah, 34303, ISTANBUL, TR  
SIVASLIGIL, Ramazan, R&D DEVA HOLDING ANONIM SIRKETI Halkali Merkez Mah, 34303, ISTANBUL, TR

- (51) MKP  
**H02M 3/06 (2006.01)** (97) **2548282 \***  
**H02J 7/00 (2006.01)**  
(86) US2011027717 09.03.2011  
(96) 11710938.9 23.01.2013  
(87) WO2011115797, 09.03.2011  
(97) 2548282, 23.01.2013 en  
(54) CELL BALANCING SYSTEM  
(71) Electronvault Inc., 17287 Skyline Boulevard Pmb 42, Woodside, CA 94062, US  
(72) FERBER, Robert, R. Jr., 245 Allen Road, Woodside CA 94062, US

- (51) MKP  
**A61P 9/00 (2006.01)** (97) **2563780 \***  
**A61K 31/4535 (2006.01)**  
**C07D 451/06 (2006.01)**  
**C07D 451/04 (2006.01)**  
**A61P 25/28 (2006.01)**  
**C07D 409/14 (2006.01)**  
**A61P 3/10 (2006.01)**  
**A61K 31/46 (2006.01)**  
**C07D 451/02 (2006.01)**  
**A61P 25/00 (2006.01)**  
**A61P 3/04 (2006.01)**  
(86) GB2011000345 10.03.2011  
(96) 11709770.9 06.03.2013  
(87) WO2011135276, 10.03.2011  
(97) 2563780, 06.03.2013 en  
(54) 3, 3 -DISUBSTITUTED- ( 8 -AZA - BICYCLO [3.2.1]OCT-8 -YL) -[5- (1H - PYRAZOL - 4 -YL) -THIOPHEN-3 -YL] METHANONES AS INHIBITORS OF 11 (BETA) -HSD1  
(71) THE UNIVERSITY OF EDINBURGH, Old College, South Bridge Edinburgh EH8 9YL, GB  
(72) WEBSTER, Scott, Peter, Endocrinology Unit Centre for Cardiovascular Science The Queen's Medical Research Institute University of Edinburgh 47 Little France Crescent, Edinburgh EH16 4TJ, GB  
SECKL, Jonathan, Robert, Endocrinology Unit Centre for Cardiovascular Science The Queen's Medical Research Institute University of Edinburgh 47 Little France Crescent, Edinburgh EH16 4TJ, GB  
WALKER, Brian, Robert, Endocrinology Unit Centre for Cardiovascular Science The Queen's Medical Research Institute University of Edinburgh 47 Little France Crescent, Edinburgh EH16 4TJ, GB  
WARD, Peter, 3 Lowlands Road, Pinner, Middlesex HA5 1TY, GB  
PALLIN, Thomas, David, Argenta Discovery 2009 Ltd. 8/9 Spire Green Centre Flex Meadow, Harlow, Essex CM 19 5TR, GB  
DYKE, Hazel, Joan, Edenderry House Bracken Close, Storrington West Sussex RH20 3HT, GB  
PERRIOR, Trevor, Robert, Brook Farm Barn Lackford, Bury St Edmunds, Suffolk IP28 6HL, GB

- (51) MKP  
**C07K 16/46 (2006.01)** (97) **2550297 \***  
(86) GB2011050613 25.03.2011  
(96) 11730048.3 30.01.2013  
(87) WO2011117653, 25.03.2011  
(97) 2550297, 30.01.2013 en  
(54) DISULFIDE STABILIZED DVD-LG MOLECULES  
(71) UCB Pharma, S.A., 60, allée de la Recherche, 1070 Brussels, BE  
(72) HEYWOOD, Sam, Philip, UCB Celltech 208 Bath Road, Slough Berkshire SL1 3WE, GB  
HUMPHREYS, David, Paul, UCB Celltech 208 Bath Road, Slough Berkshire SL1 3WE, GB

- (51) MKP  
**A61K 39/29 (2006.01)** (97) **2547695 \***  
**C07K 14/47 (2006.01)**  
**C07K 14/02 (2006.01)**  
(86) EP2011001168 09.03.2011  
(96) 11707355.1 23.01.2013  
(87) WO2011113546, 09.03.2011  
(97) 2547695, 23.01.2013 en  
(54) TUMOR VACCINATION INVOLVING A HUMORAL IMMUNE RESPONSE AGAINST SELF-PROTEINS  
(71) Biontech AG, Hölderlinstrasse 8, 55131 Mainz, DE  
Universitätsmedizin der Johannes Gutenberg-Universität Mainz, Langenbeckstraße 1, 55131 Mainz, DE  
(72) KLAMP, Thorsten, Albinstrasse 11, 55116 Mainz, DE  
SAHIN, Ugur, Philipp-von-Zabern-Platz 1, 55116 Mainz, DE  
TÜRECI, Özlem, Philipp-von-Zabern-Platz 1, 55116 Mainz, DE  
KOSLOWSKI, Michael, Autogenstrasse 50, 65933 Frankfurt/Main, DE  
HILLER, Thomas, An der Allee 82, 55122 Mainz, DE  
SCHUMACHER, Jens, Keplerstrasse 54, 69120 Heidelberg, DE

- (51) MKP  
**C12P 21/06 (2006.01)** (97) **2556163 \***  
**H01J 49/00 (2006.01)**  
**C12Q 1/00 (2006.01)**  
(86) US2011031637 07.04.2011  
(96) 11766759.2 13.02.2013  
(87) WO2011127322, 07.04.2011  
(97) 2556163, 13.02.2013 en  
(54) HIGH MANNANOSE GLYCANS  
(71) Momenta Pharmaceuticals, Inc., 675 West Kendall Street, Cambridge, MA 02142, US  
(72) COLLINS, Brian, E., 30 Country Club Drive, Arlington, MA 02474, US  
DUFFNER, Jay, 29 Lawton Road, Shirley, MA 01464, US  
BOSQUES, Carlos, J., 40 Brattle Street 7, Arlington, MA 02476, US  
BULIK, Dorota, A., 240 Hawthorne Street, Malden, MA 02148, US  
MYETTE, James, 33 Winthrop Street, Waltham, MA 02453, US  
MEADOR, James, 38 Gryzboska Circle, Framingham, MA 01702, US

- (51) MKP  
**H01L 31/04 (2006.01)** (97) **2559071 \***  
(86) EP2011055701 12.04.2011  
(96) 11715465.8 20.02.2013  
(87) WO2011128331, 12.04.2011  
(97) 2559071, 20.02.2013 de  
(54) SOLAR INSTALLATION WITH ARTIFICIAL LIGHT SOURCE  
(71) Rabold, Ludwig, Hauptstrasse 157, 8142 Wundschuh, AT  
(72) Rabold, Ludwig, Hauptstrasse 157, 8142 Wundschuh, AT

- (51) MKP  
**A61K 9/06 (2006.01)** (97) **2560615 \***  
**A61K 9/08 (2006.01)**  
**A61K 31/425 (2006.01)**  
**A61K 9/00 (2006.01)**  
**A61K 9/48 (2006.01)**  
(86) US2011033145 20.04.2011  
(96) 11716784.1 27.02.2013  
(87) WO2011133611, 20.04.2011  
(97) 2560615, 27.02.2013 en  
(54) THIAZOLIDINEDIONE ANALOGUES  
(71) Metabolic Solutions Development Company LLC, 161 East Michigan Avenue, 4th Floor, Kalamazoo, MI 49007, US  
(72) COLCA, Gerard, R., 125 South Kalamazoo Mall 604, Kalamazoo, MI 49007, US  
GADWOOD, Robert, C., 5232 Stonehenge Drive, Portage, MI 49024, US  
PARKER, Timothy, 1521 Timberlane Drive, Portage, MI 49024, US

- (51) MKP  
**B08B 7/04 (2006.01)** (97) **2582472 \***  
(86) US2011039711 09.06.2011  
(96) 11796201.9 24.04.2013  
(87) WO2011159541, 09.06.2011  
(97) 2582472, 24.04.2013 en  
(54) SYSTEM FOR PRODUCING AND DISTRIBUTING AN OZONATED FLUID  
(71) Food Safety Technology LLC, 13714 A. Street, Omaha, Nebraska 68144, US  
(72) LYNN, Daniel, W., 13714 A. Street, Omaha Nebraska 68144, US

- (51) MKP  
**A61K 39/02 (2006.01)** (97) **2544708 \***  
(86) EP2011053400 07.03.2011  
(96) 11709065.4 16.01.2013  
(87) WO2011110531, 07.03.2011  
(97) 2544708, 16.01.2013 en  
(54) CONJUGATION PROCESS OF BACTERIAL POLYSACCHARIDES TO CARRIER PROTEINS  
(71) GlaxoSmithKline Biologicals S.A., rue de l'Institut, 89, 1330 Rixensart, BE  
(72) BIEMANS, Ralph Leon, GlaxoSmithKline Biologicals S.A. Rue de l'Institut 89, B-1330 Rixensart, BE  
DUVIVIER, Pierre, GlaxoSmithKline Biologicals S.A. Rue de l'Institut 89, B-1330 Rixensart, BE  
GAVARD, Ollivier Francis Nicolas, GlaxoSmithKline Biologicals S.A. Rue de l'Institut 89, B-1330 Rixensart, BE

- (51) MKP  
**A61K 31/337 (2006.01)** (97) **2542232 \***  
**A61K 31/70 (2006.01)**  
**A61K 31/185 (2006.01)**  
**A61K 31/336 (2006.01)**  
(86) US2010055100 02.11.2010  
(96) 10859382.3 09.01.2013  
(87) WO2012099557, 02.11.2010  
(97) 2542232, 09.01.2013 en  
(54) FATTY ACID INHIBITORS  
(71) Complexa, Inc., 100 Technology Drive, Suite 400, Pittsburgh, PA 15219, US  
(72) BRANCHAUD, Bruce, 3873 Monroe Street, Eugene OR 94705, US

- (51) MKP  
**C03B 9/16 (2006.01)** (97) **2576462 \***  
**B65D 1/02 (2006.01)**  
**C03B 9/325 (2006.01)**  
(86) EP2011002659 30.05.2011  
(96) 11728580.9 10.04.2013  
(87) WO2011151047, 30.05.2011  
(97) 2576462, 10.04.2013 en  
(54) PROCESS AND EQUIPMENT FOR THE FABRICATION OF GLASS CONTAINERS WITH INTERNALLY THREADED NECK  
(71) Owens-Brockway Glass Container INC., One Michael Owens Way, Perrysburg, OH 43551, US  
(72) VILLARET DE CHAUVIGNY, Benoît, 71 av. Valioud, F-69110 Sinte Foy les Lyon, FR  
BRIGNOLO, Gino, Giovanni, Via Andrea Costa N 14 C, I-20090 Trezzano sul Naviglio, IT  
MORETTIN, Ambrogio, Via Friuli 23, I-30020 Cinto Caomaggiore, IT  
CAMPODONICO, Federico, Via Nizza 1/4, I-16145 Genova, IT  
PERRONE, Dalmazio, Quarto Superiore 44, I-Asti, IT

- (51) MKP  
**A61P 13/00 (2006.01)** (97) **2552910 \***  
**A61P 13/02 (2006.01)**  
**A61K 31/53 (2006.01)**  
**C07D 409/12 (2006.01)**  
(86) GB2011000500 31.03.2011  
(96) 11714079.8 06.02.2013  
(87) WO2011121308, 31.03.2011  
(97) 2552910, 06.02.2013 en  
(54) NEW POLYMORPH  
(71) Vantia Limited, 1 Venture Road Southampton Science Park Chilworth, Southampton, Hampshire SO16 7NP, GB  
(72) KJELLSTRÖM, Johan, Henrik, Ferring Pharmaceuticals A/S Late Stage Development Global Pharmaceutical R&D Kay Fiskers Plads 11, DK-2300 Copenhagen S, DK  
JOHANSON, Björn, Erik, Vimpelgatan 35, S-211 14 malmö, SE  
VILHELMSEN, Thomas, Bygaden 8 Karlstrup, DK-2690 Karlslunde, DK

- (51) MKP  
**A23L 1/00 (2006.01)** (97) **2540169 \***  
**A61K 8/64 (2006.01)**  
(86) ES2011070118 24.02.2011  
(96) 11719583.4 02.01.2013  
(87) WO2011104410, 24.02.2011  
(97) 2540169, 02.01.2013 en  
(54) NANOPARTICLES FOR THE ENCAPSULATION OF COMPOUNDS, PREPARATION THEREOF AND USE OF SAME  
(71) Universidad de Navarra, Avda. Pío XII, 53, 31008 Pamplona - Navarra, ES  
Centro Nacional De Tecnología Y Seguridad Alimentaria. Laboratorio Dei Ebro, Carretera NA-134, km. 50, 31570 San Adrian, Navarra, ES  
(72) AGÜEROS BAZO, Maite, ICT (D.P.I) Avda. Pío XII 53, E-31008 Pamplona - Navarra, ES  
ESPARZA CATALÁN, Irene, ICT (D.P.I) Avda. Pío XII 53, E-31008 Pamplona - Navarra, ES  
GONZÁLEZ FERRERO, Carolina, CNTA, Ctra. NA-134 Km 50, E-31570 San Adrián - Navarra, ES  
GONZÁLEZ NAVARRO, Carlos Javier, CNTA, Ctra. NA-134 Km 50, E-31570 San Adrián - Navarra, ES  
IRACHE GARRETA, Juan Manuel, ICT (D.P.I) Avda. Pío XII 53, E-31008 Pamplona - Navarra, ES  
ROMO HUALDE, Ana, CNTA, Ctra. NA-134 Km 50, E-31570 San Adrián - Navarra, ES

- (51) MKP  
**F04B 13/00 (2006.01)** (97) **2547909 \***  
(86) IT2011000074 16.03.2011  
(96) 11721379.3 23.01.2013  
(87) WO2011114365, 16.03.2011  
(97) 2547909, 23.01.2013 en  
(54) DOSING PUMP WITH CONTROL DEVICE OF THE PISTON STROKE  
(71) Etatron D.S. SpA., Via dei Ranuncoli 53 Loc. S. Palomba, 00134 Roma, IT  
(72) PROIETTI DE MARCHIS, Roberto, Via dell' Assunzione n.59, 00168 Roma, IT

(51) MKP  
**A61K 9/00 (2006.01)** (97) **2571517 \***  
**A61K 38/00 (2006.01)**  
**A61K 38/28 (2006.01)**  
**A61K 31/00 (2006.01)**  
**A61K 9/08 (2006.01)**  
(86) EP2011058079 18.05.2011  
(96) 11720115.2 27.03.2013  
(87) WO2011144673, 18.05.2011  
(97) 2571517, 27.03.2013 en  
(54) LONG - ACTING FORMULATIONS OF INSULINS  
(71) SANOFI, 54, rue de la Boétie, 75008 Paris, FR  
(72) BECKER, Reinhard, c/o Sanofi-Aventis Deutschland GmbH, 65926 Frankfurt am Main, DE  
FRICK, Annke, c/o Sanofi-Aventis Deutschland GmbH, 65926 Frankfurt am Main, DE  
BODERKE, Peter, c/o Sanofi-Aventis Deutschland GmbH, 65926 Frankfurt am Main, DE  
FUERST, Christiane, c/o Sanofi-Aventis Deutschland GmbH, 65926 Frankfurt am Main, DE  
MUELLER, Werner, c/o Sanofi-Aventis Deutschland GmbH, 65926 Frankfurt am Main, DE  
TERTSCH, Katrin, c/o Sanofi-Aventis Deutschland GmbH, 65926 Frankfurt am Main, DE  
WERNER, Ulrich, c/o Sanofi-Aventis Deutschland GmbH, 65926 Frankfurt am Main, DE  
LOOS, Petra, c/o Sanofi-Aventis Deutschland GmbH, 65926 Frankfurt am Main, DE  
SCHOETTLE, Isabell, c/o Sanofi-Aventis Deutschland GmbH, 65926 Frankfurt am Main, DE

(51) MKP  
**E04B 1/348 (2006.01)** (97) **2578760 \***  
**B28B 7/22 (2006.01)**  
**B28B 19/00 (2006.01)**  
(86) ES2010000306 25.08.2010  
(96) 10759687.6 10.04.2013  
(87) WO2011151475, 25.08.2010  
(97) 2578760, 10.04.2013 en  
(54) PROCEDURE FOR MANUFACTURING OF COMPACT MODULES FOR CONSTRUCTION  
(71) Medrán López, Francisco, C/ Málaga 17, 14460 Dos Torres (Córdoba), ES  
(72) Medrán López, Francisco, C/ Málaga 17, 14460 Dos Torres (Córdoba), ES

(51) MKP  
**A61K 38/46 (2006.01)** (97) **2538968 \***  
**C07K 1/16 (2006.01)**  
(86) DK2011050054 23.02.2011  
(96) 11705806.5 02.01.2013  
(87) WO2011103877, 23.02.2011  
(97) 2538968, 02.01.2013 en  
(54) PROCESS FOR PRODUCTION AND PURIFICATION OF RECOMBINANT LYOSOMAL ALPHA-MANNOSIDASE  
(71) Zymenex A/S, Roskildevej 12 C, 3400 Hilleroed, DK  
(72) FOGH, Jens, Bjergagervej 37, 3540 Lyngbe, DK  
ANDERSSON, Claes, Tallåsvägen 5, 187 43 Täby, SE  
WEIGELT, Cecilia, Banérgatan 27, 1 tr., 115 22 Stockholm, SE  
HYDÉN, Pia, Dalgången 6, 182 74 Stocksund, SE  
REUTERWALL, Helena, Ripstigen 6, 1 tr., 170 74 Solna, SE  
NILSSON, Stefan, Geijersgatan 35B, 752 31 Uppsala, SE

(51) MKP  
**A61P 35/00 (2006.01)** (97) **2552415 \***  
**A61K 31/555 (2006.01)**  
**A61K 31/337 (2006.01)**  
**A61K 9/14 (2006.01)**  
(86) US2011030209 28.03.2011  
(96) 11763292.7 06.02.2013  
(87) WO2011123395, 28.03.2011  
(97) 2552415, 06.02.2013 en  
(54) METHODS OF TREATING CANCER  
(71) Abraxis BioScience, LLC, 11755 Wilshire Boulevard, Suite 2100, Los Angeles, California 90025, US  
(72) DESAI, Neil, P., 11755 Wilshire Boulevard, Suite 2100, Los Angeles, California 90025, US  
SOON-SHIONG, Patrick, 149 South Barrington Avenue 311, Los Angeles, CA 90049, US

(51) MKP  
**A61P 11/00 (2006.01)** (97) **2475373 \***  
**A61K 35/42 (2006.01)**  
**A61K 38/44 (2006.01)**  
(86) EP2010005159 24.08.2010  
(96) 10760903.4 18.07.2012  
(87) WO2011029525, 24.08.2010  
(97) 2475373, 18.07.2012 en  
(54) A THERAPEUTIC COMBINATION COMPRISING A PULMONARY SURFACTANT AND ANTIOXIDANT ENZYMES  
(71) Chiesi Farmaceutici S.p.A., Via Palermo, 26/A, 43100 Parma, IT  
(72) DANI, Carlo, Chiesi Farmaceutici S.p.A. Via Palermo 26/A, I-43100 Parma, IT

(51) MKP  
**G01N 33/68 (2006.01)** (97) **2577318 \***  
**C12Q 1/68 (2006.01)**  
**G01N 33/15 (2006.01)**  
**C12N 5/0735 (2010.01)**  
(86) US2011037179 19.05.2011  
(96) 11787151.7 10.04.2013  
(87) WO2011149762, 19.05.2011  
(97) 2577318, 10.04.2013 en  
(54) METHOD OF NOCICEPTOR DIFFERENTIATION OF HUMAN EMBRYONIC STEM CELLS AND USES THEREOF  
(71) Memorial Sloan-Kettering Cancer Center, 1275 York Avenue, New York, NY 10065, US  
(72) STUDER, Lorenz, 345 East 68th Street Apt. 4fg, New York, NY 10065, US  
CHAMBERS, Stuart, M., 1275 York Ave. Rrl-945 Box 256, New York, NY 10021, US

(51) MKP  
**C04B 28/18 (2006.01)** (97) **2571828 \***  
**H01L 35/22 (2006.01)**  
**H01L 35/32 (2006.01)**  
(86) EP2011006139 07.12.2011  
(96) 11807858.3 27.03.2013  
(87) WO2012089295, 07.12.2011  
(97) 2571828, 27.03.2013 de  
(54) STRUCTURAL ELEMENT FOR GENERATING THERMOELECTRIC POWER AND METHOD FOR THE PRODUCTION THEREOF  
(71) Aiysh, Jehad, Yorckstrasse 10, 58097 Hagen, DE  
(72) Aiysh, Jehad, Yorckstrasse 10, 58097 Hagen, DE

(51) MKP  
**A61M 5/32 (2006.01)** (97) **2588168 \***  
**A61M 5/28 (2006.01)**  
**A61M 5/50 (2006.01)**  
(86) EP2011060319 21.06.2011  
(96) 11726439.0 08.05.2013  
(87) WO2012000835, 21.06.2011  
(97) 2588168, 08.05.2013 en  
(54) SAFETY DEVICE FOR A PRE-FILLED SYRINGE AND INJECTION DEVICE  
(71) Sanofi-Aventis Deutschland GmbH, Brüningstraße 50, 65929 Frankfurt, DE  
(72) ROBERTS, Gareth, Glendale Pen-y-cae Road Ruabon, Wrexham LL14 6EB, GB  
WARD, Chris, 31 Princes Avenue Prestatyn, Denbighshire LL19 8RW, GB  
EKMAN, Matthew, 59 Ecton Avenue Cheshire Macclesfield, Cheshire SK10 1RD, GB

- (51) MKP  
**C12Q 1/68 (2006.01)** (97) **2593561 \***
- (86) EP2011062050 14.07.2011  
 (96) 11735636.0 22.05.2013  
 (87) WO2012007546, 14.07.2011  
 (97) 2593561, 22.05.2013 en
- (54) METHODS AND KITS FOR THE DIAGNOSIS OF PROSTATE CANCER
- (71) Fundació Institut de Recerca Hospital Universitari Vall d'Hebron, Fundació Privada, Passeig Vall d'Hebron, 119-129, 08035 Barcelona, ES
- (72) DOLL, Andreas, Fundació Institut De Recerca Hospital Universitari Vall D'hebron Fundació Privada Passeig Vall d'Hebron 119-129, E-08035 Barcelona, ES  
 RIGAU RESINA, Marina, Fundació Institut De Recerca Hospital Universitari Vall D'hebron Fundació Privada Passeig Vall d'Hebron 119-129, E-08035 Barcelona, ES  
 ABAL POSADA, Miguel, Fundació Institut De Recerca Hospital Universitari Vall D'hebron Fundació Privada Passeig Vall d'Hebron 119-129, E-08035 Barcelona, ES  
 MOROTE ROBLES, Juan, Fundació Institut De Recerca Hospital Universitari Vall D'hebron Fundació Privada Passeig Vall d'Hebron 119-129, E-08035 Barcelona, ES  
 REVENTÓS PUIGJANER, Jaume, Fundació Institut De Recerca Hospital Universitari Vall D'hebron Fundació Privada Passeig Vall d'Hebron 119-129, E-08035 Barcelona, ES
- 

- (51) MKP  
**A61K 31/41 (2006.01)** (97) **2538787 \***  
**A01N 43/64 (2006.01)**
- (86) US2011025661 22.02.2011  
 (96) 11745417.3 02.01.2013  
 (87) WO2011103546, 22.02.2011  
 (97) 2538787, 02.01.2013 en
- (54) TRIAZOLONES AS FATTY ACID SYNTHASE INHIBITORS
- (71) GlaxoSmithKline LLC, One Franklin Plaza 200 North 16th Street, Philadelphia, PA 19102, US
- (72) ADAMS, Nicholas, D., 1250 South Collegeville Road, Collegeville PA 19426, US  
 AQUINO, Christopher, Joseph, Five Moore Drive, Research Triangle Park NC 27709, US  
 CHAUDHARI, Amita, M., 1250 South Collegeville Road, Collegeville PA 19426, US  
 GHERGUROVICH, Jonathan, M., 1250 South Collegeville Road, Collegeville PA 19426, US  
 KIESOW, Terence, John, 1250 South Collegeville Road, Collegeville PA 19426, US  
 PARRISH, Cynthia, A., 1250 South Collegeville Road, Collegeville PA 19426, US  
 REIF, Alexander, Joseph, 1250 South Collegeville Road, Collegeville PA 19426, US  
 WIGGALL, Kenneth, 1250 South Collegeville Road, Collegeville PA 19426, US
- 

- (51) MKP  
**C07C 29/09 (2006.01)** (97) **2576486 \***  
**B01J 21/18 (2006.01)**  
**C07B 41/00 (2006.01)**  
**C07C 45/42 (2006.01)**  
**C07C 51/093 (2006.01)**
- (86) US2011038334 27.05.2011  
 (96) 11787494.1 10.04.2013  
 (87) WO2011150329, 27.05.2011  
 (97) 2576486, 10.04.2013 en
- (54) CARBOCATALYSTS FOR CHEMICAL TRANSFORMATIONS
- (71) Graphea, Inc., 1624 Headway Circle, Austin, TX 78754, US
- (72) BIELAWSKI, Christopher W., 3105 S. I-35 2070, Austin Texas 78741, US  
 DREYER, Daniel R., 7121 Hart Lane Apt. 1097, Austin Texas 78731, US  
 JIA, Hong-Peng, JIA, Hongpeng Hongwen Road Yard 43 Building 45 APT-21 Jintai District Baoji, Shaanxi 721004, CN
- 

- (51) MKP  
**C07D 453/02 (2006.01)** (97) **2585458 \***  
**A61P 11/00 (2006.01)**  
**A61K 31/439 (2006.01)**  
**C07D 413/06 (2006.01)**  
**A61K 31/4025 (2006.01)**
- (86) EP2011058802 30.05.2011  
 (96) 11725021.7 01.05.2013  
 (87) WO2011160919, 30.05.2011  
 (97) 2585458, 01.05.2013 en
- (54) ALKALOID AMINOESTER DERIVATIVES AND MEDICINAL COMPOSITION THEREOF
- (71) Chiesi Farmaceutici S.p.A., Via Palermo, 26/A, 43100 Parma, IT
- (72) AMARI, Gabriele, c/o Chiesi Farmaceutici S.p.a. Via Palermo 26/A, I-43100 Parma, IT  
 RICCABONI, Mauro, c/o Chiesi Farmaceutici S.p.a. Via Palermo 26/A, I-43100 Parma, IT
-

- (51) MKP  
**A61K 31/404 (2006.01)** (97) **2560650 \***  
**A61K 31/443 (2006.01)**  
**A61K 31/4704 (2006.01)**
- (86) US2011033689 22.04.2011  
(96) 11718597.5 27.02.2013  
(87) WO2011133953, 22.04.2011  
(97) 2560650, 27.02.2013 en
- (54) PHARMACEUTICAL COMPOSITIONS AND ADMINISTRATIONS THEREOF
- (71) Vertex Pharmaceuticals Incorporated, 130 Waverly Street, Cambridge, MA 02139, US
- (72) VAN GOOR, Fredrick, F., 832 Ormond Court, San Diego, CA 92109, US  
ALARGOVA, Rossitza, Gueorguieva, 148 Newton Street, Apt.4, Brighton, MA 02135, US  
ALCACIO, Tim, Edward, 2276 Fenton Parkway, 304, San Diego, CA 92108, US  
AREKAR, Sneha, G., 26 Waverly Street, Apt. 209, Brighton, MA 02135, US  
BINCH, Hayley, Marie, 1406 Flair Encinitas Drive, Encinitas, CA 92024, US  
BOTFIELD, Martyn, Curtis, 47 Walden Terrace, Concord, MA 01742, US  
FANNING, Lev, Tyler Dewey, 115 Dole Way, San Marcos, CA 92078, US  
GROOTENHUIS, Peter, Diederik Jan, 4801 Riding Ridge Road, San Diego, CA 92130, US  
HURLEY, Dennis, James, 1513 Black Walnut Drive, San Marcos, CA 92078, US  
JOHNSTON, Steven, C., 22 Page Road, Lichtfield, NH 03052, US  
KADIYALA, Irina, Nikolaevna, 40 Hagen Road, Newton, MA 02457, US  
KAUSHIK, Ritu, Rohit, 24 Church Street, Apt. 23, Watertown, MA 02472, US  
KESHAVARZ-SHOKRI, Ali, 4285 Corte Langostino, San Diego, CA 92130, US  
KRAWIEC, Mariusz, 46 Littlefield Lane, Marlborough, MA 01752, US  
LEE, Elaine, Chungmin, 303 Third Street, Apt. 316, Cambridge, MA 02142, US  
LUI SI, Brian, 26 Carriage House Lane, Mansfield, MA 02048, US  
MEDEK, Ales, 14 Lockland Road, Winchester, MA 01890, US  
MUDUNURI, Praveen, 7 Charlesbank Way, Apt. A, Waltham, MA 02453, US  
NUMA, Mehdi, 3106 Jemez Drive, San Diego, CA 92117, US  
SHETH, Urvi Jagdishbhai, 9316 Babauta Road, 71, San Diego, CA 92129, US  
SILINA, Alina, 7160 Shoreline Drive, 4308, San Diego, CA 92122, US  
SULLIVAN, Mark Jeffrey, 103 Howe Street, Framingham, MA 01702, US  
VERWIJS, Marinus Jacobus, 4 Carter Drive, Framingham, MA 01701, US  
YANG, Xiaoqing, 4526 Vereda Mar de Ponderosa, San Diego, CA 92130, US  
YOUNG, Christopher Ryan, 42 Francis Street Unit 1, Waltham, MA 02451, US  
ZAMAN, Noreen Tasneem, 1 Magnolia Drive, Acton, MA 01720, US  
ZHANG, Beili, 4505 Shorepointe Way, San Diego, CA 92130, US  
ZHANG, Yuegang, 15 Fairfield Road, Wayland, MA 01778, US  
ZLOKARNIK, Gregor, 2754 Palomino Circle, La Jolla, CA 92037, US

- (51) MKP  
**A61K 31/403 (2006.01)** (97) **2538924 \***  
**A61P 9/12 (2006.01)**  
**A61K 9/20 (2006.01)**  
**A61K 45/06 (2006.01)**
- (86) IB2010051616 14.04.2010  
(96) 10717277.7 02.01.2013  
(87) WO2011104588, 14.04.2010  
(97) 2538924, 02.01.2013 en
- (54) SOLID PHARMACEUTICAL FORMULATIONS OF RAMIPRIL AND AMLODIPINE BESYLATE, AND THEIR PREPARATION
- (71) Sanofi-Aventis Deutschland GmbH, Brüningstraße 50, 65929 Frankfurt am Main, DE
- (72) JAISWAL, Nilesh, c/o Sanofi Synthelabo India Ltd GIDC Plot L 121 Phase III A Verna Industrial Estate, Goa 403 722, IN  
KHULLAR, Praveen, c/o Sanofi Synthelabo India Ltd GIDC Plot L 121 Phase III A Verna Industrial Estate, Goa 403 722, IN  
KULKARNI, Amol, c/o Sanofi Synthelabo India Ltd GIDC Plot L 121 Phase III A Verna Industrial Estate, Goa 403 722, IN  
PRAJAPATI, Dilip, c/o Sanofi Synthelabo India Ltd GIDC Plot L 121 Phase III A Verna Industrial Estate, Goa 403 722, IN

- (51) MKP  
**C01F 11/18 (2006.01)** (97) **2552835 \***
- (86) EP2011054994 31.03.2011  
(96) 11711354.8 06.02.2013  
(87) WO2011121065, 31.03.2011  
(97) 2552835, 06.02.2013 en
- (54) PROCESS FOR OBTAINING PRECIPITATED CALCIUM CARBONATE
- (71) Omya Development AG, Baslerstrasse 42, 4665 Oftringen, CH  
(72) POHL, Michael, H.-v.-Tuerlin Strasse 11, A-9500 Villach, AT  
RAINER, Christian, Treffnerstrasse 62f, A-9500 Villach, AT  
PRIMOSCH, Gernot, Jungnickelstrasse 5/II/47, A-9500 Villach, AT

- (51) MKP  
**C07D 249/14 (2006.01)** (97) **2582683 \***
- (86) US2011040398 14.06.2011  
(96) 11796324.9 24.04.2013  
(87) WO2011159732, 14.06.2011  
(97) 2582683, 24.04.2013 en
- (54) TREATMENT OF GOUT AND HYPERURICEMIA
- (71) Ardea Biosciences, Inc., 4939 Directors Place, San Diego, CA 92121, US
- (72) MINER, Jeffrey, 4572 Pauling Avenue, San Diego, CA 92122, US  
QUART, Barry, D., 3273 Violet Ridge, Encinitas, CA 92024, US  
GIRARDET, Jean-luc, 16763 Santa Corina Court, San Diego, CA 92127, US

(51) MKP  
**A61P 3/00 (2006.01)** (97) **2563380 \***  
**A61K 39/395 (2006.01)**  
**A61P 29/00 (2006.01)**  
**A61P 35/00 (2006.01)**  
**A61K 38/16 (2006.01)**  
**A61K 38/17 (2006.01)**  
(86) US2011033988 26.04.2011  
(96) 11777925.6 06.03.2013  
(87) WO2011139714, 26.04.2011  
(97) 2563380, 06.03.2013 en  
(54) INNOVATIVE DISCOVERY OF THERAPEUTIC, DIAGNOSTIC, AND ANTIBODY COMPOSITIONS RELATED TO PROTEIN FRAGMENTS OF CYSTEINYL-TRNA SYNTHETASE  
(71) aTyr Pharma, Inc., 3545 John Hopkins Court, Suite 250, San Diego, CA 92121, US  
Pangu Biopharma Limited, Edinburgh Tower, 18/F The Landmark 15 Queen's Road Central, Hong Kong, CN  
(72) GREENE, Leslie Ann, 13941 Davenport Avenue, San Diego, CA 92129, US  
CHIANG, Kyle, P., 943 Torrance Street Apt. 6, San Diego, CA 92103, US  
HONG, Fei, 7979 Caminito Dia 2, San Diego, CA 92122, US  
VASSEROT, Alain, P., 6421 La Paloma Street, Carlsbad, CA 92009, US  
LO, Wing-Sze, RM 815 Sui Ming House Siu Sai Wan Estate, Chai Wan Hong Kong, CN  
WATKINS, Jeffry, D., 3442 Fortuna Ranch Road, Encinitas, CA 92024, US  
MENDLEIN, John, D., 1550 Neptune Avenue, Encinitas, CA 92024, US  
QUINN, Cheryl, L., 5392 Renaissance Avenue, San Diego, CA 92122, US

(51) MKP  
**A61K 9/20 (2006.01)** (97) **2568968 \***  
(86) EP2011057567 10.05.2011  
(96) 11718748.4 20.03.2013  
(87) WO2011141489, 10.05.2011  
(97) 2568968, 20.03.2013 en  
(54) MANUFACTURING OF ACTIVE-FREE GRANULES AND TABLETS COMPRISING THE SAME  
(71) Euro-Celtique S.A., 2, avenue Charles de Gaulle, 1653 Luxembourg, LU  
(72) HAYES, Geoffrey, Gerard, Mundipharma Research Limited 191 Cambridge Science Park Milton Road, Cambridge Cambridgeshire CB4 0GW, GB  
MOHAMMAD, Hassan, Mundipharma Research Limited 191 Cambridge Science Park Milton Road, Cambridge Cambridgeshire CB4 0GW, GB  
TAMBER, Harjit, Mundipharma Res 191 Cambridge Science Park Milton Road, Cambridge Cambridgeshire CB4 0GW, GB  
WALDEN, Malcolm, Mundipharma Research Limited 191 Cambridge Science Park Milton Road, Cambridge Cambridgeshire CB4 0GW, GB

(51) MKP  
**A61K 39/395 (2006.01)** (97) **2547365 \***  
**C07K 16/22 (2006.01)**  
**C07K 16/18 (2006.01)**  
**C07K 16/28 (2006.01)**  
(86) US2011028659 16.03.2011  
(96) 11715322.1 23.01.2013  
(87) WO2011116090, 16.03.2011  
(97) 2547365, 23.01.2013 en  
(54) ANTI-NERVE GROWTH FACTOR (NGF) ANTIBODY COMPOSITIONS  
(71) Abbott Research B.V., Meeuwenlaan 4 P.O.Box 365, 8000 AJ Zwolle, NL  
(72) FRAUNHOFER, Wolfgang, 6290 Murifield Drive, Gurnee, IL 60031, US  
CHARI, Ravi, 76 Harley Drive, Apt. 2, Worcester, MA 01616, US  
KUMAR, Vineet, 126 Courtyard Lane, Storrs, CT 06268, US  
SAEDLER, Rainer, Rheindammstrasse 30, 68163 Mannheim, DE  
SIEDLER, Michael, 86 Marlborough St. 9, Boston, MA 02116, US  
STINE, William, B., 18 Quail Hollow Drive, Shrewsbury, MA 01545, US  
WEBER, Carsten, Rietburgstr. 29, 67133 Maxdorf, DE

(51) MKP  
**C07K 14/00 (2006.01)** (97) **2566514 \***  
**A61K 39/395 (2006.01)**  
(86) US2011034815 02.05.2011  
(96) 11778107.0 13.03.2013  
(87) WO2011139973, 02.05.2011  
(97) 2566514, 13.03.2013 en  
(54) METHODS OF INHIBITING FIBROSIS USING ANTI-PAI-1 ANTIBODIES  
(71) AbbVie Inc., 100 Abbott Park Road, Abbott Park, IL 60064, US  
(72) ANDERSON, Ian, 1155 23rd Street, Washington District of Columbia 20037, US  
COYLE, Anthony, 12 Union Park, Boston Massachusetts 02118, US  
NOBLE, Nancy, 391 Chipeta Way Room E111, Salt Lake City Utah 84108, US

(51) MKP  
**A61M 5/32 (2006.01)** (97) **2588167 \***  
(86) EP2011060318 21.06.2011  
(96) 11726438.2 08.05.2013  
(87) WO2012000834, 21.06.2011  
(97) 2588167, 08.05.2013 en  
(54) SAFETY DEVICE FOR A PRE-FILLED SYRINGE AND INJECTION DEVICE  
(71) Sanofi-Aventis Deutschland GmbH, Brüningstraße 50, 65929 Frankfurt, DE  
(72) ROBERTS, Gareth, Glendale Pen-y-cae Road Ruabon, Wrexham LL14 6EB, GB  
OWEN, Sioned, Berlan Bach Denbigh, Prion Denbigh LL16 4SE, GB  
EKMAN, Matthew, 59 Ecton Avenue, Macclesfield, Cheshire SK10 1RD, GB

(51) MKP  
**C01B 25/14 (2006.01)** (97) **2569263 \***  
**C07D 213/63 (2006.01)**  
**C07B 45/00 (2006.01)**  
**C07D 211/84 (2006.01)**  
**C07C 327/44 (2006.01)**  
**C07D 211/72 (2006.01)**  
**C07C 325/02 (2006.01)**  
**C07D 241/06 (2006.01)**  
**C07D 213/06 (2006.01)**  
**C07D 239/93 (2006.01)**  
**C07D 207/24 (2006.01)**  
**C07D 209/30 (2006.01)**  
(86) EP2012051864 03.02.2012  
(96) 12702531.0 20.03.2013  
(87) WO2012104415, 03.02.2012  
(97) 2569263, 20.03.2013 en  
(54) A THIONATION PROCESS AND A THIONATING AGENT  
(71) Vironova AB, Gävlegatan 22, 113 30 Stockholm, SE  
(72) PETERSSON, Birgitta, Mellanbergsvägen 11, S-126 42 Hägersten, SE  
HASIMBEGOVIC, Vedran, Råsundavägen 75, S-169 57 Solna, SE  
SVENSSON, Per, H., Fatburs Brunnsgata 18, S-118 28 Stockholm, SE  
BERGMAN, Jan, Lekgränd 5, S-163 46 Spånga, SE

(51) MKP  
**F25J 3/00 (2006.01)** (97) **2545334 \***  
(86) US2011027968 10.03.2011  
(96) 11754107.8 16.01.2013  
(87) WO2011112854, 10.03.2011  
(97) 2545334, 16.01.2013 en  
(54) PROCESS FOR DILUTE PHASE INJECTION OR DRY ALKALINE MATERIALS  
(71) ADA-ES, Inc., 9135 S. Ridgeline Blvd. Suite 200, Highlands Ranch, CO 80129, US  
(72) DILLON, Martin, A., 10372 Beas Lane, Conifer CO 80433, US  
FILIPPELLI, Gregory, M., 3 Franklin Tree Court, Catonsville MD 21228, US



(51) MKP  
**G01N 33/18 (2006.01)** (97) **2591357 \***  
**G01N 33/49 (2006.01)**  
**G01N 33/50 (2006.01)**  
(86) US2011043595 11.07.2011  
(96) 11804482.5 15.05.2013  
(87) WO2012006632, 11.07.2011  
(97) 2591357, 15.05.2013 en  
(54) LUNG CANCER BIOMARKERS AND USES THEREOF  
(71) Somalogic, Inc., 2945 Wilderness Place, Boulder, CO 80301, US  
(72) WILCOX, Sheri, 806 Neon Forest Circle, Longmont Colorado 80504, US  
AYERS, Deborah, 1045 E 19th Ave, Broomfield Colorado 80020, US  
JANJIC, Nebojsa, 6973 Carter Trail, Boulder Colorado 80301, US  
GOLD, Larry, 1033 5th Street, Boulder Colorado 80302, US  
RIEL-MEHAN, Michael, 845 W. Linden St., Louisville Colorado 80027, US  
JARVIS, Thale, 2265 Dartmouth Avenue, Boulder Colorado 80305, US

---

(51) MKP  
**C22B 1/00 (2006.01)** (97) **2576850 \***  
**C22B 11/00 (2006.01)**  
(86) EP2010064678 01.10.2010  
(96) 10760350.8 10.04.2013  
(87) WO2011150984, 01.10.2010  
(97) 2576850, 10.04.2013 en  
(54) METHOD FOR RECOVERING NOBLE METALS AND OTHER BYPRODUCTS FROM ORE  
(71) Belakovs, Voldemars, Negoveanu Street 13-9, 550308 Sibiu, RO  
Costache, Nicolae, Sos. Oltenitei, Nr. 234, Bl. 58, Sc. A, Et. 5, Ap. 23, Sec. 4, 041329 Bucuresti, RO  
Crestin, Dumitru, 26 Johannes K. Kepler, sector 2, 020346 Bucuresti, RO  
Banu, Geanina Silvana, Polux street 7, building G14 Entrance D, App. 63, 100113 Ploiesti, Prahova County, RO  
(72) Belakovs, Voldemars, Negoveanu Street 13-9, 550308 Sibiu, RO  
Costache, Nicolae, Sos. Oltenitei, Nr. 234, Bl. 58, Sc. A, Et. 5, Ap. 23, Sec. 4, 041329 Bucuresti, RO  
Crestin, Dumitru, 26 Johannes K. Kepler, sector 2, 020346 Bucuresti, RO  
Banu, Geanina Silvana, Polux street 7, building G14 Entrance D, App. 63, 100113 Ploiesti, Prahova County, RO

---

(51) MKP  
**A61P 35/00 (2006.01)** (97) **2563368 \***  
**A61K 31/53 (2006.01)**  
**C07D 403/04 (2006.01)**  
(86) IB2011051829 27.04.2011  
(96) 11723129.0 06.03.2013  
(87) WO2011135520, 27.04.2011  
(97) 2563368, 06.03.2013 en  
(54) PIPERAZINOTRIAZINES AS PI3K INHIBITORS FOR USE IN THE TREATMENT ANTIPROLIFERATIVE DISORDERS  
(71) University of Basel, Unictetra, Technology Transfer, Schützenmattstrasse 16, 4003 Basel, CH  
(72) CMILJANOVIC, Vladimir, Hohe Winde-Strasse 120, CH-4059 Basel, CH  
CMILJANOVIC, Natasa, Davidsrain 4, CH-4056 Basel, CH  
GIESE, Bernd, Boulevard de Péroilles 15, CH-1700 Fribourg, CH  
WYMAN, Matthias, Bühlstrasse 44, CH-3012 Bern, CH

(51) MKP  
**A23C 19/09 (2006.01)** (97) **2544549 \***  
**A23C 19/06 (2006.01)**  
**A23L 1/00 (2006.01)**  
**A23J 3/26 (2006.01)**  
(86) DK2011050081 14.03.2011  
(96) 11709321.1 16.01.2013  
(87) WO2011110184, 14.03.2011  
(97) 2544549, 16.01.2013 en  
(54) A RETICULATE DAIRY BASED PRODUCT  
(71) Arla Foods Amba, Sønderhøj 14, 8260 Viby J, DK  
(72) CARØE, Christina, Højmoosevej 4, DK-8382 Hinnerup, DK  
KRISTENSEN, Jens Jørgen Søgaard, Sydgaden 57 Snejbjerg, DK-7400 Herning, DK  
KØBKE, Kathrine, Kirkedalen 18, DK-8660 Skanderborg, DK  
JENSEN, Klaus Juhl, Høgemosevej 8 Ølsted, DK-8380 Trige, DK  
KNUDSEN, Lisbeth Bjerre, H.C. Ørstedesvej 4, DK-8260 Viby J, DK

(51) MKP  
**A61M 5/00 (2006.01)** (97) **2552511 \***  
(86) EP2011054649 25.03.2011  
(96) 11711846.3 06.02.2013  
(87) WO2011117404, 25.03.2011  
(97) 2552511, 06.02.2013 en  
(54) ELECTRO-MECHANICAL DRUG DELIVERY DEVICE  
(71) Sanofi-Aventis Deutschland GmbH, Brüningstraße 50, 65929 Frankfurt, DE  
(72) WIMPENNY, Steven, 12 Greatheed Road Leamington Spa, Warwickshire CV31 3QH, GB  
O'HARE, Aidan Michael, 18 Thickethorne Kenilworth, Warwickshire CV8 2AF, GB  
YATES, Barry, 1 Towers Close Kenilworth, Warwickshire CV8 1, GB  
DAY, Shane Alistair, 25 Sheres Dyche Warwick, Warwickshire CV34 6BX, GB

(51) MKP  
**A61L 26/00 (2006.01)** (97) **2555804 \***  
**A61L 15/42 (2006.01)**  
**A61L 15/58 (2006.01)**  
**A61L 24/04 (2006.01)**  
**A61L 15/22 (2006.01)**  
**A61L 24/00 (2006.01)**  
(86) EP2011055418 07.04.2011  
(96) 11712579.9 13.02.2013  
(87) WO2011124640, 07.04.2011  
(97) 2555804, 13.02.2013 en  
(54) HEMOSTATIC SPONGE  
(71) Baxter International Inc., One Baxter Parkway, Deerfield, IL 60015, US  
Baxter Healthcare S.A., Thurgauerstrasse 130, 8152 Glattpark (Opfikon), CH  
(72) HEDRICH, Hans Christian, Engerthstrasse 171/18, A-1020 Vienna, AT  
HOEFINGHOFF, Joris, Guglgasse 8/2/38, A-1110 Vienna, AT

- (51) MKP  
**C07D 519/00 (2006.01)** (97) **2571883 \***  
**A61K 31/519 (2006.01)**  
**C07D 487/04 (2006.01)**
- (86) US2011036452 13.05.2011  
(96) 11728970.2 27.03.2013  
(87) WO2011146336, 13.05.2011  
(97) 2571883, 27.03.2013 en  
(54) MACROCYCLIC COMPOUNDS AS TRK KINASE INHIBITORS
- (71) Array Biopharma, Inc., 3200 Walnut Street, Boulder, CO 80301, US  
(72) ANDREWS, Steven, Wade, c/o Array BioPharma Inc. 3200 Walnut Street, Boulder, CO 80301, US  
CONDROSKI, Kevin, Ronald, c/o Array BioPharma Inc. 3200 Walnut Street, Boulder, CO 80301, US  
HAAS, Julia, c/o Array BioPharma Inc. 3200 Walnut Street, Boulder, CO 80301, US  
JIANG, Yutong, c/o Array BioPharma Inc. 3200 Walnut Street, Boulder, CO 80301, US  
KOLAKOWSKI, Gabrielle, R., c/o Array BioPharma Inc. 3200 Walnut Street, Boulder, CO 80301, US  
SEO, Jeongbeob, c/o Array BioPharma Inc. 3200 Walnut Street, Boulder, CO 80301, US  
YANG, Hong-Woon, c/o Array BioPharma Inc. 3200 Walnut Street, Boulder, CO 80301, US  
ZHAO, Qian, c/o Array BioPharma Inc. 3200 Walnut Street, Boulder, CO 80301, US
- 
- (51) MKP  
**E04B 7/22 (2006.01)** (97) **2423402**  
**E04C 2/288 (2006.01)**  
**E04B 1/14 (2006.01)**  
**E04B 1/80 (2006.01)**
- (96) 11179370.9 29.02.2012  
(97) 2423402, 29.02.2012 fr  
(54) Highly insulated prefabricated element  
(71) Alpha beton SPRL, Rue John Cockerill 13, 4780 Saint-Vith, BE  
(72) Linden, Udo, An der Hoehe 9, 4780 Saint-Vith, BE
- 
- (51) MKP  
**B65D 83/44 (2006.01)** (97) **2576423 \***  
**B65D 83/16 (2006.01)**  
**B67D 1/12 (2006.01)**  
**B67D 1/08 (2006.01)**  
**B65D 83/18 (2006.01)**  
**G01F 11/08 (2006.01)**  
**B67D 1/04 (2006.01)**  
**B65D 83/14 (2006.01)**  
**B65D 83/60 (2006.01)**  
**B67D 1/02 (2006.01)**
- (86) NL2011050369 27.05.2011  
(96) 11724814.6 10.04.2013  
(87) WO2011152717, 27.05.2011  
(97) 2576423, 10.04.2013 en  
(54) METHOD AND APPARATUS FOR DISPENSING BEVERAGES, ESPECIALLY CARBONATED BEVERAGES  
(71) Heineken Supply Chain B.V., 2e Weteringplantsoen 21, 1017 ZD Amsterdam, NL  
(72) LANDMAN, Bernardus Cornelis Johannes, Noordeinde 373, NL-2771 WR Boskoop, NL  
LINDMAYER, István Stephen, Homokhegy u. 12., H-7228 Döbrököz, HU
- 
- (51) MKP  
**A61B 17/3205 (2006.01)** (97) **2582309 \***
- (86) EP2011060111 17.06.2011  
(96) 11725476.3 24.04.2013  
(87) WO2011157824, 17.06.2011  
(97) 2582309, 24.04.2013 de  
(54) SURGICAL INSTRUMENT  
(71) MTW-Endoskopie W. Haag KG, Goldsbergstrasse 18, 46487 Wesel, DE  
(72) HAAG, Wolfgang, Melkweg 7, 46487 Wesel, DE
- 
- (51) MKP  
**E06B 3/58 (2006.01)** (97) **2460970**  
**E06B 3/54 (2006.01)**  
**E06B 3/56 (2006.01)**  
**E06B 3/64 (2006.01)**  
**E06B 3/48 (2006.01)**
- (96) 11192119.3 06.06.2012  
(97) 2460970, 06.06.2012 en  
(54) A sectional door panel comprising a window assembly and a method of assembling said panel  
(71) Nassau Door A/S, Kroagervej 2, 5750 Ringe, DK  
(72) Nielsen, Steffen Pram, Elleholmvej 65, 5250 Odense SV, DK
- 
- (51) MKP  
**G07C 9/00 (2006.01)** (97) **2469478**
- (96) 10196097.9 27.06.2012  
(97) 2469478, 27.06.2012 en  
(54) Access control in location tracking system  
(71) 9Solutions Oy, Teknologiantie 2, 90590 Oulu, FI  
(72) Herrala, Sami, Ylänkötie 8, 90650, Oulu, FI
- 
- (51) MKP  
**C07D 401/14 (2006.01)** (97) **2569304 \***  
**A61P 25/28 (2006.01)**  
**A61P 25/24 (2006.01)**  
**A61K 31/407 (2006.01)**  
**A61P 25/18 (2006.01)**  
**C07D 491/107 (2006.01)**  
**C07D 471/10 (2006.01)**  
**A61P 25/16 (2006.01)**  
**A61K 31/438 (2006.01)**  
**A61K 31/4439 (2006.01)**
- (86) US2011035824 10.05.2011  
(96) 11731172.0 20.03.2013  
(87) WO2011143148, 10.05.2011  
(97) 2569304, 20.03.2013 en  
(54) SUBSTITUTED N-HETEROARYL SPIROLACTAM BIPYRROLIDINES, PREPARATION AND THERAPEUTIC USE THEREOF  
(71) SANOFI, 54, rue de la Boétie, 75008 Paris, FR  
(72) GAO, Zhongli, c/o sanofi-aventis U.S. 1041 Route 202-206 BWD-303A, Bridgewater, New Jersey 08807, US  
HALL, Daniel, c/o sanofi-aventis U.S. 1041 Route202-206 BWD-303A, Bridgewater, New Jersey 08807, US  
STEFANY, David, c/o sanofi-aventis U.S. 1041 Route 202-206 BWD-303A, Bridgewater, New Jersey 08807, US
- 
- (51) MKP  
**A61M 5/24 (2006.01)** (97) **2571553 \***  
**A61M 5/34 (2006.01)**
- (86) EP2011057957 17.05.2011  
(96) 11721494.0 27.03.2013  
(87) WO2011144604, 17.05.2011  
(97) 2571553, 27.03.2013 en  
(54) NEEDLE ASSEMBLY FOR DRUG DELIVERY DEVICES  
(71) Sanofi-Aventis Deutschland GmbH, Brüningstraße 50, 65929 Frankfurt, DE  
(72) JUJL, Michael, c/o Sanofi-Aventis Deutschland GmbH, 65926 Frankfurt am Main, DE  
TEUCHER, Axel, c/o Sanofi-Aventis Deutschland GmbH, 65926 Frankfurt am Main, DE
- 
- (51) MKP  
**G01F 23/00 (2006.01)** (97) **2539673 \***
- (86) EP2012052908 21.02.2012  
(96) 12708269.1 02.01.2013  
(87) WO2012113776, 21.02.2012  
(97) 2539673, 02.01.2013 de  
(54) DEVICE FOR MEASURING LIQUID FILLING LEVELS  
(71) Gaslock GmbH, Hombrucher Weg 19, 58638 Iserlohn, DE  
(72) LIENENKAMP, Jörg, Alte Strasse 102, 58452 Witten, DE

- (51) MKP  
**A61K 31/616 (2006.01)** (97) **2566472 \***  
**A61K 9/50 (2006.01)**  
**A61K 9/16 (2006.01)**  
**A61K 9/52 (2006.01)**  
**A61K 9/20 (2006.01)**  
**A61K 31/138 (2006.01)**  
(86) IE2011000027 05.05.2011  
(96) 11720589.8 13.03.2013  
(87) WO2011138772, 05.05.2011  
(97) 2566472, 13.03.2013 en  
(54) A PHARMACEUTICAL COMPOSITION COMPRISING ASPIRIN AND BISOPROLOL  
(71) CAL INTERNATIONAL LIMITED, 6 Northbrook Road, Dublin 6, IE  
(72) DONEGAN, Ann, Brookdale Coleville Road, Clonmel, County Tipperary, IE  
CLOSS, Stephen, Paul, 55 Cranborne Crescent, Brooklin, Ontario, CA  
MALLAPPA, Danashankar, 1350 Spring Garden Court, Mississauga, Ontario L5N 8K5, CA

- (51) MKP  
**G06F 17/30 (2006.01)** (97) **2498191**  
(96) 12157185.5 12.09.2012  
(97) 2498191, 12.09.2012 en  
(54) Feature conversion device, similar information search apparatus provided therewith, coding parameter generation method, and computer program  
(71) Denso IT Laboratory, Inc., Shibuya Cross Tower 28th Floor 2-15-1, Shibuya Shibuya-ku, Tokyo 150-0002, JP  
(72) Anbai, Mitsuru, c/o Denso IT Laboratory, Inc. Shibuya cross tower 28th floor, 2-15-1, Shibuya, Shibuya-ku, Tokyo, Tokyo 150-0002, JP  
Yoshida, Yuichi, c/o Denso IT Laboratory, Inc. Shibuya cross tower 28th floor, 2-15-1, Shibuya, Shibuya-ku, Tokyo, Tokyo 150-0002, JP

- (51) MKP  
**A01N 47/36 (2006.01)** (97) **2579720 \***  
**A01N 47/30 (2006.01)**  
(86) JP2011063625 08.06.2011  
(96) 11728964.5 17.04.2013  
(87) WO2011158843, 08.06.2011  
(97) 2579720, 17.04.2013 en  
(54) HERBICIDAL COMPOSITION  
(71) Ishihara Sangyo Kaisha, Ltd., 3-15 Edobori 1-chome Nishi-ku, Osaka-shi, Osaka 550-0002, JP  
(72) KIKUGAWA, Hiroshi, c/o Ishihara Sangyo Kaisha Ltd. Chuo Kenkyusho 3-1, Nishi-shibukawa 2-chome, Kusatsu-shi Shiga 525-0025, JP  
KEZUKA, Tomoaki, c/o Ishihara Sangyo Kaisha Ltd. 3-15, Edobori 1-chome Nishi-ku, Osaka-shi Osaka 525-0025, JP  
YAMADA, Ryu, c/o Ishihara Sangyo Kaisha Ltd. Chuo Kenkyusho 3-1, Nishi-shibukawa 2-chome, Kusatsu-shi Shiga 525-0025, JP  
TERADA, Takashi, c/o Ishihara Sangyo Kaisha Ltd. Chuo Kenkyusho 3-1, Nishi-shibukawa 2-chome, Kusatsu-shi Shiga 525-0025, JP

- (51) MKP  
**A61F 2/04 (2013.01)** (97) **2584999 \***  
(86) EP2011056785 28.04.2011  
(96) 11716422.8 01.05.2013  
(87) WO2011160875, 28.04.2011  
(97) 2584999, 01.05.2013 en  
(54) ORTHOTOPIC ARTIFICIAL BLADDER PROSTHESIS  
(71) Sambusseti, Antonio, Via San Predengo, 13, 26100 Cremona, IT  
(72) Sambusseti, Antonio, Via San Predengo, 13, 26100 Cremona, IT

- (51) MKP  
**C07D 401/06 (2006.01)** (97) **2566849 \***  
**C07D 401/12 (2006.01)**  
**A61P 9/10 (2006.01)**  
**C07D 413/12 (2006.01)**  
**A61K 31/4709 (2006.01)**  
**A61K 31/47 (2006.01)**  
**C07D 215/26 (2006.01)**  
**A61P 25/28 (2006.01)**  
**C07D 401/14 (2006.01)**  
(86) HU2011000043 06.05.2011  
(96) 11752335.7 13.03.2013  
(87) WO2011148208, 06.05.2011  
(97) 2566849, 13.03.2013 en  
(54) 8-HYDROXY-QUINOLINE DERIVATIVES  
(71) "Avidin" Kutató, Fejlesztés És Kereskedelmi Korlátolt Felelősségű Társaság, Közép fasor 52., 6726 Szeged, HU  
Ubichem Kutató Korlátolt Felelősségű Társaság, Illatos út 33, 1097 Budapest, HU  
(72) Puskás, László, Magdolna u. 17., H-6726 Szeged, HU  
Szabó, Csaba, Szent István útja 19-25, II/28., H-9021 Győr, HU  
Kanizsai, Iván, Nemestakács utca 47., H-6725 Szeged, HU  
Gyuris, Mária, Párizsi krt. 25., H-6724 Szeged, HU  
Madácsi, Ramóna, Ady Endre út 5., H-6414 Pirtó, HU  
Ózsvári, Béla, Vedres utca 14/B, 9/26., H-6726 Szeged, HU  
Fehér, Liliána, Makkoserd sor 34/A, 2/3., H-6724 Szeged, HU  
Tamás, Gábor, Szentháromság u. 4., H-6722 Szeged, HU

- (51) MKP  
**H01F 41/14 (2006.01)** (97) **2577686 \***  
**H01F 10/00 (2006.01)**  
(86) NZ2011000087 27.05.2011  
(96) 11786965.1 10.04.2013  
(87) WO2011149366, 27.05.2011  
(97) 2577686, 10.04.2013 en  
(54) MAGNETIC NANOCCLUSERS  
(71) Institute Of Geological And Nuclear Sciences Limited, 30 Gracefield Road Gracefield Lower Hutt 5010, Wellington, NZ  
KENNEDY, John Vedamuthu, C/- 30 Gracefield Road Gracefield, Lower Hutt 5010, NZ  
(72) MARKWITZ, Andreas, C/- 30 Gracefield Road Gracefield, Lower Hut 5010, NZ

- (51) MKP  
**B60N 2/50 (2006.01)** (97) **2552744 \***  
(86) GB2010001520 11.08.2010  
(96) 10749481.7 06.02.2013  
(87) WO2011121261, 11.08.2010  
(97) 2552744, 06.02.2013 en  
(54) LOAD RESPONSIVE SEAT/ BED  
(71) CORCOST LIMITED, 22 Great Close, Cawood North Yorkshire YO8 3UG, GB  
(72) CORCORAN, Steven, 22 Great Close Cawood, Selby, North Yorkshire YO8 3UG, GB

- (51) MKP  
**F24J 1/00 (2006.01)** (97) **2564126 \***  
(86) US2011034365 28.04.2011  
(96) 11722224.0 06.03.2013  
(87) WO2011139849, 28.04.2011  
(97) 2564126, 06.03.2013 en  
(54) THERMAL SIGNALING OR MARKING DEVICE  
(71) Cyalume Technologies, Inc, 96 Windsor Street, West Springfield, MA 01089, US  
(72) PALMER, Stephen L., 4391 Cameron Road, Cameron, CA 95682, US  
PALMER, William R., 3026 Whitetail Drive, Rescue, CA 95672, US

- (51) MKP  
**A61K 38/47 (2006.01)** (97) **2588132 \***  
**A61P 25/28 (2006.01)**  
**A61P 25/00 (2006.01)**
- (86) US2011041927 25.06.2011  
(96) 11799038.2 08.05.2013  
(87) WO2011163651, 25.06.2011  
(97) 2588132, 08.05.2013 en
- (54) METHODS AND COMPOSITIONS FOR CNS DELIVERY OF -GALACTOCEREBROSIDASE
- (71) Shire Human Genetic Therapies, Inc., 700 Main Street, Cambridge, MA 02139, US
- (72) SALAMAT-MILLER, Nazila, 80 College Avenue, Arlington MA 02474, US  
TAYLOR, Katherine, 472 Appleton Street, Arlington MA 02476, US  
MANNING, Ken, 213 Central Street, Framingham MA 01701, US  
ZHU, Gaozhong, 680 South Avenue, Unit 15, Weston MA 02493, US  
CAMPOLIETO, Paul., 3595 Red Hill Road, Charlottesville, Virginia 22903, US  
SHAHROKH, Zahra., 5 Terrace Road., Weston, Massachusetts 02493, US  
MCCAULEY, Thomas., 85 Gore Street., Cambridge, Massachusetts 02141, US  
CALIAS, Pericles., 39 Swains Pond Road., Melrose, Massachusetts 02176, US

- (51) MKP  
**A61K 9/00 (2006.01)** (97) **2568960 \***
- (86) IN2011000313 04.05.2011  
(96) 11780312.2 20.03.2013  
(87) WO2011141926, 04.05.2011  
(97) 2568960, 20.03.2013 en
- (54) LIQUID FORMULATION OF POLYPEPTIDES CONTAINING AN FC DOMAIN OF AN IMMUNOGLOBULIN
- (71) Intas Biopharmaceuticals Limited, Plot No: 423/P/A/GIDC Sarkhej-Bavla Highway Moraiya, Tal.: Sanand Ahmedabad - 382 210, Gujarat, IN
- (72) TUNGA, Binita Shrivastava, C-402 Sanskar Apartment Opposite To Karnavati Club S.G. Highway, Ahmedabad 380 015, Gujarat, IN  
SHARMA, Sachin, 69, Block - C2 Gurudwarawali Gali Swarn Park Nangloi, Delhi 110 041, IN  
DUA, Rajiv, Bungalow No.8 K-S. Irani Road Bhingar (camp), Ahmednagar 414 002, IN  
DUTTA, Sourabh, C/o. Rathindra Nath Dutta E-463 Greater Kailash Part - II, New Delhi 110 048, IN  
MALLUBHOTLA, Hanuman, C-14 A Amaltas Apartments Behind Fun Republic Satellite, Ahmedabad 380 015, Gujarat, IN  
PANDEY, Vijaykant, R-208, Venus Parkland, Vejalpur-Jivraj Road, Near Vejalpur Police Station, Vejalpur, Ahmedabad 380051 Gujarat, IN  
CHHATBAR, Chandresh, C-402, Anurag Residency, Near IOC Petrol Pump., Memnagar, Ahmedabad 380052, Gujarat, IN

- (51) MKP  
**C07K 16/30 (2006.01)** (97) **2552964 \***  
**C07K 16/40 (2006.01)**  
**A61K 39/395 (2006.01)**  
**C07K 16/28 (2006.01)**
- (86) EP2011055104 01.04.2011  
(96) 11711591.5 06.02.2013  
(87) WO2011121110, 01.04.2011  
(97) 2552964, 06.02.2013 en
- (54) CROSS-SPECIES-SPECIFIC PSMAxCD3 BISPECIFIC SINGLE CHAIN ANTIBODY
- (71) Amgen Research (Munich) GmbH, Staffelseestrasse 2, 81477 München, DE
- (72) KUFER, Peter, c/o Amgen Research (Munich) GmbH Staffelseestr. 2, 81477 München, DE  
KISCHEL, Roman, c/o Amgen Research (Munich) GmbH Staffelseestrasse 2, 81477 München, DE  
RAU, Doris, c/o Amgen Research (Munich) GmbH Staffelseestrasse 2, 81477 München, DE  
HOFFMANN, Patrick, c/o Amgen Research (Munich) GmbH Staffelseestrasse 2, 81477 München, DE  
LUTTERBUESE, Ralf, c/o Amgen Research (Munich) GmbH Staffelseestrasse 2, 81477 München, DE  
KLINGER, Matthias, c/o Amgen Research (Munich) GmbH Staffelseestrasse 2, 81477 München, DE  
STEIGER, Carola, c/o Amgen Research (Munich) GmbH Staffelseestrasse 2, 81477 München, DE  
FLUHR, Petra, c/o Amgen Research (Munich) GmbH Staffelseestrasse 2, 81477 München, DE  
HAUSMANN, Susanne, c/o Amgen Research (Munich) GmbH Staffelseestrasse 2, 81477 München, DE  
MANGOLD, Susanne, c/o Amgen Research (Munich) GmbH Staffelseestrasse 2, 81477 München, DE  
SCHALLER, Evelyne, c/o Amgen Research (Munich) GmbH Staffelseestrasse 2, 81477 München, DE  
RAUM, Tobias, c/o Amgen Research (Munich) GmbH Staffelseestr. 2, 81477 Munich, DE

- (51) MKP  
**A63F 3/06 (2006.01)** (97) **2569735 \***  
**G07F 17/32 (2006.01)**  
**G06K 19/07 (2006.01)**
- (86) FR2011050952 27.04.2011  
(96) 11723512.7 20.03.2013  
(87) WO2011141659, 27.04.2011  
(97) 2569735, 20.03.2013 fr
- (54) PAYMENT CARD COMPRISING AN ELECTRONIC GAME CHIP
- (71) UINT, Route de l'Orme des Merisiers Parc des Algorithmes Bâtiment Aristote, 91190 Saint-Aubin, FR
- (72) BLOT, Philippe, 7, chemin de la Fontaine de Launay, F-78640 Neauphle le Château, FR  
MOBETIE, Didier, 70 rue de Montreuil, F-78000 Versailles, FR  
RENAUD, Jean-Charles, 6 rue du Bois Abel Hameau de Soucy, F-91640 Fontenay les Briis, FR  
BOUHANNA, Eric, 153 bis rue de la Porte Jaune, F-92380 Garches, FR

- (51) MKP  
**A61M 5/48 (2006.01)** (97) **2585134 \***  
**A61M 5/32 (2006.01)**  
**A61M 5/20 (2006.01)**  
**A61M 5/315 (2006.01)**
- (86) EP2011060506 22.06.2011  
(96) 11726829.2 01.05.2013  
(87) WO2012000874, 22.06.2011  
(97) 2585134, 01.05.2013 en
- (54) AUTO-INJECTOR WITH INJECTION DAMPER
- (71) Sanofi-Aventis Deutschland GmbH, Brüningstraße 50, 65929 Frankfurt, DE
- (72) HOURMAND, Yannick, 14 The Elms, Haslingfield CB23 1ND, GB  
BARROW-WILLIAMS, Timothy, Donald, 1 Grange Street, St. Albans Hertfordshire AL3 5NA, GB  
EKMAN, Matthew, 59 Ecton Avenue, Macclesfield Cheshire SK10 1RD, GB

(51) MKP  
**A61K 31/704 (2006.01)** (97) **2558477 \***  
**C07H 17/04 (2006.01)**  
(86) EP2010003118 20.05.2010  
(96) 10724281.0 20.02.2013  
(87) WO2011127948, 20.05.2010  
(97) 2558477, 20.02.2013 en  
(54) ANALOGUES OF ETOPOSIDE FOR THE TREATMENT OF TUMOURS  
(71) CellAct Pharma GmbH, Otto-Hahn-Strasse 15, 44227 Dortmund, DE  
(72) UTKU, Nalan, Zietenstrasse 25, 53173 Bonn, DE

(51) MKP  
**A01N 43/90 (2006.01)** (97) **2578084 \***  
**C07D 491/052 (2006.01)**  
**C07D 493/04 (2006.01)**  
**A01P 7/04 (2006.01)**  
**A01N 47/18 (2006.01)**  
**A01N 55/00 (2006.01)**  
**C07F 7/18 (2006.01)**  
(86) JP2011061730 23.05.2011  
(96) 11786585.7 10.04.2013  
(87) WO2011148886, 23.05.2011  
(97) 2578084, 10.04.2013 en  
(54) NOXIOUS ORGANISM CONTROL AGENT  
(71) Meiji Seika Pharma Co., Ltd., 4-16, Kyobashi 2-chome Chuo-ku, Tokyo 104-8002, JP  
(72) GOTO Kimihiko, c/o Meiji Seika Pharma Co. Ltd. 760 Morooka-cho Kohoku-ku, Yokohama-shi Kanagawa 222-8567, JP  
HORIKOSHI Ryo, c/o Meiji Seika Pharma Co. Ltd. 760 Morooka-cho Kohoku-ku, Yokohama-shi Kanagawa 222-8567, JP  
OYAMA Kazuhiko, c/o Meiji Seika Pharma Co. Ltd. 760 Morooka-cho Kohoku-ku, Yokohama-shi Kanagawa 222-8567, JP  
FUKUDA Yoshimasa, c/o Meiji Seika Pharma Co. Ltd. 760 Morooka-cho Kohoku-ku, Yokohama-shi Kanagawa 222-8567, JP  
NAKANISHI Nozomu, c/o Meiji Seika Pharma Co. Ltd. 760 Morooka-cho Kohoku-ku, Yokohama-shi Kanagawa 222-8567, JP  
TANI Masato, c/o Meiji Seika Pharma Co. Ltd. 788 Kayama, Odawara-shi Kanagawa 250-0852, JP  
MINOWA Nobuto, c/o Meiji Seika Pharma Co. Ltd. 760 Morooka-cho Kohoku-ku, Yokohama-shi Kanagawa 222-8567, JP  
MITOMI Masaaki, c/o Meiji Seika Pharma Co. Ltd. 760 Morooka-cho Kohoku-ku, Yokohama-shi Kanagawa 222-8567, JP  
OMURA Satoshi, 3-12 Okamoto 3-chome Setagaya-ku, Tokyo 157-0076, JP  
SUNAZUKA Toshiaki, Lune Funabashi 405 353-6 Gyodacho, Funabashi-shi Chiba 273-0043, JP  
TOMODA Hiroshi, 71-11-211 Shimoishihara 3-chome, Chofu-shi Tokyo 182-0035, JP

(51) MKP  
**A61B 5/151 (2006.01)** (97) **2590565 \***  
(86) EP2011061542 07.07.2011  
(96) 11730011.1 15.05.2013  
(87) WO2012004359, 07.07.2011  
(97) 2590565, 15.05.2013 en  
(54) BLOOD SAMPLE COLLECTION  
(71) Sanofi-Aventis Deutschland GmbH, Brüningstraße 50, 65929 Frankfurt, DE  
(72) RICHTER, Frank, c/o Sanofi-Aventis Deutschland GmbH, 65926 Frankfurt am Main, DE  
MACARTHUR, Ross, 22 Barlow Way, Sandbach, Cheshire CW11 1PB, GB

(51) MKP  
**C12P 1/02 (2006.01)** (97) **2571995 \***  
**C12P 7/00 (2006.01)**  
(86) US2011037020 18.05.2011  
(96) 11784182.5 27.03.2013  
(87) WO2011146634, 18.05.2011  
(97) 2571995, 27.03.2013 en  
(54) SYSTEM AND METHOD OF PRODUCING VOLATILE ORGANIC COMPOUNDS FROM FUNGI  
(71) Strobel, Gary A., 2107 Fairway Drive, Bozeman, MT 59715, US  
Tomscheck, Angela R., 5808 South Regal Street, Apt. 55, Spokane, WA 99223, US  
(72) Strobel, Gary A., 2107 Fairway Drive, Bozeman, MT 59715, US  
Tomscheck, Angela R., 5808 South Regal Street, Apt. 55, Spokane, WA 99223, US

(51) MKP  
**G06F 7/70 (2006.01)** (97) **2553568 \***  
(86) US2011030689 31.03.2011  
(96) 11763423.8 06.02.2013  
(87) WO2011123616, 31.03.2011  
(97) 2553568, 06.02.2013 en  
(54) SYSTEMS AND METHODS FOR AIRCRAFT FLIGHT TRACKING AND ANALYSIS  
(71) Cloudahoy, Inc., 11 Hathaway Road, Lexington, MA 02420, US  
(72) SHAVIT, Tsachi, Chuck, 11 Hathway Rd., Lexington, MA 02420, US

(51) MKP  
**A61K 39/395 (2006.01)** (97) **2563393 \***  
(86) US2011033934 26.04.2011  
(96) 11775500.9 06.03.2013  
(87) WO2011137114, 26.04.2011  
(97) 2563393, 06.03.2013 en  
(54) SPARC BINDING ANTIBODIES AND USES THEREOF  
(71) Abraxis BioScience, LLC, 11755 Wilshire Boulevard Suite 2000, Los Angeles, CA 90025, US  
(72) TRIEU, Vuong, 4003 Jim Bowie Boulevard, Agoura Hills California 91301, US  
LIU, Xiping, 6035 Camellia Avenue, Temple City California 91780, US  
DESAL, Neil, 11755 Wilshire Boulevard Suite 2000, Los Angeles California 90025, US

- (51) MKP  
**A01N 43/90 (2006.01)** (97) **2575473 \***  
**A61K 31/519 (2006.01)**
- (86) US2011037718 24.05.2011  
(96) 11787236.6 10.04.2013  
(87) WO2011149921, 24.05.2011  
(97) 2575473, 10.04.2013 en
- (54) SOLUBLE GUANYLATE CYCLASE ACTIVATORS
- (71) Merck Sharp & Dohme Corp., 126 East Lincoln Avenue, Rahway, NJ 07065-0907, US
- (72) RAGHAVAN, Subharkha, 126 East Lincoln Avenue, Rahway, New Jersey 07065-0907, US  
STELMACH, John, E., 126 East Lincoln Avenue, Rahway, New Jersey 07065-0907, US  
SMITH, Cameron, J., 126 East Lincoln Avenue, Rahway, New Jersey 07065-0907, US  
LI, Hong, 126 East Lincoln Avenue, Rahway, New Jersey 07065-0907, US  
WHITEHEAD, Alan, 126 East Lincoln Avenue, Rahway, New Jersey 07065-0907, US  
WADDELL, Sherman, T., 126 East Lincoln Avenue, Rahway, New Jersey 07065-0907, US  
CHEN, Yi-Heng, 126 East Lincoln Avenue, Rahway, New Jersey 07065-0907, US  
MIAO, Shouwu, 126 East Lincoln Avenue, Rahway, New Jersey 07065-0907, US  
ORNOSKI, Olga, A., 126 East Lincoln Avenue, Rahway, New Jersey 07065-0907, US  
GARFUNKLE, Joie, 126 East Lincoln Avenue, Rahway, New Jersey 07065-0907, US  
LIAO, Xibin, 126 East Lincoln Avenue, Rahway, New Jersey 07065-0907, US  
CHANG, Jiang, 126 East Lincoln Avenue, Rahway, New Jersey 07065-0907, US  
HAN, Xiaoqing, 126 East Lincoln Avenue, Rahway, New Jersey 07065-0907, US  
GUO, Jian, 126 East Lincoln Avenue, Rahway, New Jersey 07065-0907, US  
GROEPER, Jonathan, A., 126 East Lincoln Avenue, Rahway, New Jersey 07065-0907, US  
BROCKUNIER, Linda, L., 126 East Lincoln Avenue, Rahway, New Jersey 07065-0907, US  
ROSAUER, Keith, 126 East Lincoln Avenue, Rahway, New Jersey 07065-0907, US  
PARMEE, Emma, R., 770 Sumneytown Pike, West Point, Pennsylvania 19486, US

- (51) MKP  
**A61K 31/437 (2006.01)** (97) **2582699 \***  
**A61P 35/00 (2006.01)**  
**C07D 519/00 (2006.01)**  
**C07D 471/04 (2006.01)**
- (86) EP2011059806 14.06.2011  
(96) 11725437.5 24.04.2013  
(87) WO2011157688, 14.06.2011  
(97) 2582699, 24.04.2013 en
- (54) SUBSTITUTED TRIAZOLOPYRIDINES
- (71) Bayer Intellectual Property GmbH, Alfred-Nobel-Strasse 10, 40789 Monheim, DE
- (72) SCHULZE, Volker, Emil-Czekowski-Str. 5, 16562 Hohen Neuendorf OT Bergfelde, DE  
KOSEMUND, Dirk, Klutstr. 14, 12587 Berlin, DE  
SCHIROK, Hartmut, Pestalozzistr. 39a, 40764 Langenfeld, DE  
BADER, Benjamin, Hillmannstr. 14, 13467 Berlin, DE  
LIENAU, Philip, Jahnstr. 13, 10967 Berlin, DE  
WENGMER, Antje Margret, Borkumstr. 12 e, 13189 Berlin, DE  
BRIEM, Hans, Emser Str. 3, 10719 Berlin, DE  
HOLTON, Simon, Lauterstr 27, 12159 Berlin, DE  
SIEMEISTER, Gerhard, Reimerswalder Steig 26, 13503 Berlin, DE  
PRECHTL, Stefan, Kanzowstr. 5a, 10439 Berlin, DE  
KOPPITZ, Marcus, Scharnhorststr. 28, 10115 Berlin, DE  
STÖCKIGT, Dettlef, Clara-Zetkin-Strasse 27, 14471 Potsdam, DE  
PRIEN, Olaf, Salzachstrasse 56C, 14129 Berlin, DE

- (51) MKP  
**A47L 7/04 (2006.01)** (97) **2592986 \***  
**A47L 5/14 (2006.01)**
- (86) DK2011000078 07.07.2011  
(96) 11806314.8 22.05.2013  
(87) WO2012006997, 07.07.2011  
(97) 2592986, 22.05.2013 en
- (54) A DISCHARGE VALVE FOR VACUUM CLEANERS
- (71) Nilfisk-Advance A/S, Sognevej 25, 2605 Brøndby, DK
- (72) LAURIDSEN, Jan, Himmerlandsgade 39, DK-9560 Hadsund, DK  
LYKKE, Hans, Ulrik, Bækkevej 7, DK-8930 Randers NØ, DK

- (51) MKP  
**B65D 21/06 (2006.01)** (97) **2520505**  
**B65D 43/02 (2006.01)**
- (96) 12005141.2 07.11.2012  
(97) 2520505, 07.11.2012 en
- (54) Material handling device lid
- (71) CANADA POST CORPORATION, 2701 Riverside Drive, Suite N1110, Ottawa, Ontario K1A 0B1, CA
- (72) Ulmer, John, B432-2701 Riverside Drive, Ottawa ON, K1A 0B1, CA  
Li, Hongqiao, 5750-50th Street, Edmonton Alberta, T6B 2Z8, CA  
McTavish, Kevin, 5750-50th Street, Edmonton Alberta, T6B 2Z8, CA

- (51) MKP  
**A01N 47/28 (2006.01)** (97) **2542086 \***
- (86) US2011026752 01.03.2011  
(96) 11751234.3 09.01.2013  
(87) WO2011109441, 01.03.2011  
(97) 2542086, 09.01.2013 en
- (54) COMPOUNDS AND THERAPEUTIC USES THEREOF
- (71) Myrex, Inc., 305 Chipeta Way, Salt Lake City, UT 84108, US  
WILLARDSEN, Adam, J., 305 Chipeta Way, Salt Lake City UT 84108, US  
LOCKMAN, Jeffrey, W., 305 Chipeta Way, Salt Lake City UT 84108, US  
MURPHY, Brett, R., 305 Chipeta Way, Salt Lake City UT 84108, US  
JUDD, Weston, R., 305 Chipeta Way, Salt Lake City UT 84108, US  
KIM, In Chul, 305 Chipeta Way, Salt Lake City UT 84108, US  
KIM, Se-Ho, 305 Chipeta Way, Salt Lake City UT 84108, US  
ZIGAR, Daniel, Feodore, 305 Chipeta Way, Salt Lake City UT 84108, US  
YAGER, Kraig, M., 305 Chipeta Way, Salt Lake City UT 84108, US  
FLEISCHER, Tracey, C., 305 Chipeta Way, Salt Lake City UT 84108, US  
TERRY-LORENZO, Ryan, T., 305 Chipeta Way, Salt Lake City UT 84108, US  
BONIFACE, J. Jay, 305 Chipeta Way, Salt Lake City UT 84108, US  
PARKER, Daniel, P., 305 Chipeta Way, Salt Lake City UT 84108, US  
MCALEXANDER, Ian, A., 305 Chipeta Way, Salt Lake City UT 84108, US  
BURSAVICH, Matthew, Gregory, 305 Chipeta Way, Salt Lake City UT 84108, US  
DASTRUP, David, M., 305 Chipeta Way, Salt Lake City UT 84108, US

- (51) MKP  
**G10L 19/00 (2006.01)** (97) **2355556**  
**H04S 7/00 (2006.01)**  
**H04S 5/02 (2006.01)**
- (96) 10192906.5 10.08.2011  
(97) 2355556, 10.08.2011 en
- (54) User interface apparatus
- (71) Roland Corporation, 2036-1, Nakagawa, Hosoe-cho Kita-ku Hamamatsu, Shizuoka 431-1304, JP
- (72) Sato, Kenji, 2036-1 Nakagawa, Hosoe-cho Kita-ku, Hamamatsu Shizuoka 431-1304, JP  
Hagino, Takaaki, 2036-1 Nakagawa, Hosoe-cho Kita-ku, Hamamatsu Shizuoka 431-1304, JP

- (51) MKP  
**A61B 19/08 (2006.01)** (97) **2579799 \***  
 (86) DK2011050205 10.06.2011  
 (96) 11791959.7 17.04.2013  
 (87) WO2011154010, 10.06.2011  
 (97) 2579799, 17.04.2013 en  
 (54) INTERVENTIONAL DRAPE COMPRISING A PATIENT INTERVENTIONAL DRAPE AND A BARRIER DRAPE  
 (71) USABCD A/S, c/o Incuba Science Park - Skejby Brendstrupgaardsvej 102, 8200 Aarhus N, DK  
 (72) SLOTH, Erik, Adelvej 14, DK-8240 Risskov, DK  
 BENDTSEN, Thomas Fichtner, Hellerupvej 3, DK-8000 Århus C, DK  
 KNUDSEN, Lars, Agrivej 6, DK-8240 Risskov, DK

- (51) MKP  
**C07K 14/705 (2006.01)** (97) **2585480 \***  
**C07K 14/435 (2006.01)**  
 (86) EP2011060666 24.06.2011  
 (96) 11727457.1 01.05.2013  
 (87) WO2011161260, 24.06.2011  
 (97) 2585480, 01.05.2013 en  
 (54) ANTICANCER FUSION PROTEIN  
 (71) Adamed sp. z o.o., Pienków 149, 05-152 Czosnów k/ Warszawy, PL  
 (72) PIECZYKOLAN, Jerzy Szczepan, Gorajec - Zastawie 47, PL-22-463 Radeckznica, PL  
 PAWLAK, Sebastian Dominik, ul. Majakowskiego 3/2, PL-01-420 Warszawa, PL  
 ZEREK, Bartłomiej Maciej, ul. Po udniowa 45/4, PL-97-200 D browa, PL  
 LEMKE, Krzysztof Kazimierz, ul. Batalionów Ch opskich 2A, PL-81-452 Gdynia, PL

- (51) MKP  
**A61K 45/06 (2006.01)** (97) **2590654 \***  
**A61K 39/395 (2006.01)**  
**A61P 35/00 (2006.01)**  
**A61K 31/63 (2006.01)**  
**A61K 31/498 (2006.01)**  
**A61K 31/517 (2006.01)**  
**A61K 31/7088 (2006.01)**  
 (86) US2011043401 08.07.2011  
 (96) 11731617.4 15.05.2013  
 (87) WO2012006552, 08.07.2011  
 (97) 2590654, 15.05.2013 en  
 (54) COMBINATIONS OF KINASE INHIBITORS FOR THE TREATMENT OF CANCER  
 (71) Exelixis, Inc., 210 East Grand Avenue, South San Francisco, CA 94080, US  
 SANOFI, 54, rue de la Boétie, 75008 Paris, FR  
 Vanderbilt University, Office Of Technology Transfer 305 Kirkland Hall, Nashville, Tennessee 37240, US  
 (72) ARTEAGA, Carlos, L., 6231 Bresslyn Rd, Nashville TN 37205-3107, US  
 AFTAB, Dana, T., 736 Tamarack Drive, San Rafael CA 94903, US  
 BLANC, Veronique, 14 rue Moreau, F-75012 Paris, FR  
 CHAKRABARTY, Anindita, 2140 Acklen Ave Apt 11, Nashville TN 37212-3518, US  
 CHIRON-BLONDEL, Marielle, 13 rue Castagnary, F-75015 Paris, FR  
 NICOLAZZI, Celine, 28 avenue Louis Luc, F-94600 Choisy Le Roi, FR  
 RINEHART, Cammie, 4402 Soper Avenue, Nashville TN 37204, US  
 VINCENT, Loic, 18 impasse Bougainville, F-91000 Evry, FR

- (51) MKP  
**H04L 12/64 (2006.01)** (97) **2591579 \***  
**H04L 12/28 (2006.01)**  
 (86) FR2011051567 04.07.2011  
 (96) 11741637.0 15.05.2013  
 (87) WO2012004503, 04.07.2011  
 (97) 2591579, 15.05.2013 fr  
 (54) METHOD OF SELF-CONFIGURATION OF A DOMESTIC GATEWAY IN THE PRESENCE OF VARIOUS EXTERNAL NETWORKS, AND GATEWAY IMPLEMENTING SUCH A METHOD  
 (71) Softathome, 81 Avenue François Arago, 92000 Nanterre, FR  
 (72) ROSSEEL, Jan, Vuggelberg 11, B-3270 Scherpenheuvel-Zichem, BE

- (51) MKP  
**F27D 99/00 (2010.01)** (97) **2547974 \***  
**F27B 1/10 (2006.01)**  
**F27B 1/00 (2006.01)**  
**F27B 1/08 (2006.01)**  
**C04B 2/12 (2006.01)**  
 (86) IB2010051146 17.03.2010  
 (96) 10717772.7 23.01.2013  
 (87) WO2011114187, 17.03.2010  
 (97) 2547974, 23.01.2013 en  
 (54) KILN FOR THE PRODUCTION OF CALCIUM OXIDE  
 (71) Cimprogetti S.p.A., Via Pasubio, 5, 24044 Dalmine (BG), IT  
 (72) FERRI, Vincenzo, c/o CIMPROGETTI S.p.A. Via Pasubio 5, I-24044 Dalmine (bergamo), IT  
 COLLARINI, Oliviero, c/o CIMPROGETTI S.p.A. Via Pasubio 5, I-24044 Dalmine (bergamo), IT

- (51) MKP  
**C07K 14/62 (2006.01)** (97) **2552471 \***  
**A61K 38/26 (2006.01)**  
**A61K 38/16 (2006.01)**  
**C07K 14/47 (2006.01)**  
**C07K 14/605 (2006.01)**  
**A61K 38/30 (2006.01)**  
 (86) US2011029501 23.03.2011  
 (96) 11711424.9 06.02.2013  
 (87) WO201119657, 23.03.2011  
 (97) 2552471, 06.02.2013 en  
 (54) NOVEL PEPTIDES AND METHODS FOR THEIR PREPARATION AND USE  
 (71) ELI LILLY AND COMPANY, Lilly Corporate Center, Indianapolis, IN 46285, US  
 (72) ALSINA-FERNANDEZ, Jorge, Eli Lilly And Company Lilly Corporate Center, Indianapolis, Indiana 46285, US  
 BOKVIST, Krister Bengt, Eli Lilly And Company Lilly Corporate Center, Indianapolis, Indiana 46285, US  
 GUO, Lili, Eli Lilly And Company Lilly Corporate Center, Indianapolis, Indiana 46285, US  
 MAYER, John Philip, Eli Lilly And Company Lilly Corporate Center, Indianapolis, Indiana 46285, US

- (51) MKP  
**C07K 14/78 (2006.01)** (97) **2563809 \***  
**A61K 9/00 (2006.01)**  
**A61K 38/18 (2006.01)**  
**A61K 47/22 (2006.01)**  
**C07K 14/47 (2006.01)**  
 (86) EP2011056622 27.04.2011  
 (96) 11716269.3 06.03.2013  
 (87) WO2011134979, 27.04.2011  
 (97) 2563809, 06.03.2013 en  
 (54) STABLE AQUEOUS MIA/CD-RAP FORMULATIONS  
 (71) Scil Technology GmbH, Fraunhoferstrasse 5, 82152 Martinsried, DE  
 (72) HELLERBRAND, Klaus, St.-Georg-Strasse 24, 82272 Moorenweis (Eismerszell), DE  
 SIGL, Rainer, Gröbenbachweg 45, 82178 Puchheim, DE

- (51) MKP  
**A61L 27/38 (2006.01)** (97) **2544726 \***  
(86) US2011027609 08.03.2011  
(96) 11711177.3 16.01.2013  
(87) WO2011112626, 08.03.2011  
(97) 2544726, 16.01.2013 en  
(54) CELL-SCAFFOLD CONSTRUCTS  
(71) Tengion, Inc., 2900 Potshop Lane, Suite 100, East Norriton, PA 19403, US  
(72) LUDLOW, John, W., 100 Rivercreek Place, Carrboro NC 27510, US  
GUTHRIE, Kelly, I., 3415 Thoresby Court, Winston-salem NC 27104, US  
JOHNSON, Kenny, 117 Rose Arbor Lane, Mocksville NC 27028, US  
BRUCE, Andrew, T., 315 Ridge Drive, Lexington NC 27295, US
- 
- (51) MKP  
**A61M 5/315 (2006.01)** (97) **2549915 \***  
**A61B 5/00 (2006.01)**  
(86) EP2011054283 22.03.2011  
(96) 11709138.9 30.01.2013  
(87) WO2011117212, 22.03.2011  
(97) 2549915, 30.01.2013 en  
(54) DEVICE AND METHOD FOR DETERMINING INFORMATION RELATED TO A MEDICAL DEVICE  
(71) Sanofi-Aventis Deutschland GmbH, Brüningstraße 50, 65929 Frankfurt, DE  
(72) SCHABBACH, Michael, Sanofi-Aventis Deutschland GmbH, 65926 Frankfurt am Main, DE  
KOHLL, Amit, Sanofi-Aventis Département Brevets 174 Avenue de France, F-75013 Paris, FR
- 
- (51) MKP  
**C02F 1/50 (2006.01)** (97) **2594532**  
(86) 12075130.0 22.05.2013  
(97) 2594532, 22.05.2013 de  
(54) Method and arrangement for hygienisation of water in a swimming pool system or swimming or bathing area  
(71) Martin Bergmann Umwelttechnik, Am Zeisig 8, 09322 Penig, DE  
(72) Triller, Wolfgang, Hämmerlingstrasse 35 C, 12555 Berlin, DE  
Bergmann, Martin, Am Zeisig 8, 09322 Penig, DE  
Llian, Jens, Warthaer Strasse 6, 01157 Dresden, DE
- 
- (51) MKP  
**B05C 11/115 (2006.01)** (97) **2563524 \***  
**B05C 9/10 (2006.01)**  
**B01F 5/04 (2006.01)**  
**B01F 15/02 (2006.01)**  
(86) CA2011000480 21.04.2011  
(96) 11774228.8 06.03.2013  
(87) WO2011134059, 21.04.2011  
(97) 2563524, 06.03.2013 en  
(54) APPARATUS FOR MIXING AND DISPENSING MULTIPLE FLOWABLE COMPONENTS  
(71) Integra Adhesives Inc., 4-33759 Morey Avenue, Abbotsford, British Columbia V2S 7S2, CA  
(72) TURNER, Douglas C., 2041 Sierra Place, Abbotsford, British Columbia V2S 2W5, CA
- 
- (51) MKP  
**A23J 1/14 (2006.01)** (97) **2566346 \***  
**A23J 3/14 (2006.01)**  
**A23L 1/305 (2006.01)**  
**A23L 2/66 (2006.01)**  
**A23J 3/16 (2006.01)**  
(86) CA2011000529 09.05.2011  
(96) 11777058.6 13.03.2013  
(87) WO2011137524, 09.05.2011  
(97) 2566346, 13.03.2013 en  
(54) PRODUCTION OF SOLUBLE PROTEIN SOLUTIONS FROM PULSES  
(71) Burcon Nutrascience (MB) Corp., 1388 Waller Avenue, Winnipeg, Manitoba R3T 1P9, CA  
(72) SEGALL, Kevin I., 31 Dunbar Crescent, Winnipeg, Manitoba R3P 0W6, CA  
SCHWEIZER, Martin, 117 Haig Avenue, Winnipeg, Manitoba R2M 0E3, CA
- 
- (51) MKP  
**H04B 7/00 (2006.01)** (97) **2564514 \***  
(86) US2011033288 20.04.2011  
(96) 11775450.7 06.03.2013  
(87) WO2011137007, 20.04.2011  
(97) 2564514, 06.03.2013 en  
(54) SYSTEM AND METHOD FOR CONTROLLING WLAN AND BLUETOOTH COMMUNICATIONS  
(71) Qualcomm Atheros, Inc., 1700 Technology Drive, San Jose, CA 95110, US  
(72) TSAO, Wei-Sung, 962 Scorpion Place, Fremont, CA 94539, US  
PETRUS, Paul, 3574 Olsen Drive, San Jose, CA 95117, US
- 
- (51) MKP  
**G10D 3/18 (2006.01)** (97) **2593935 \***  
(86) HR2011000026 17.06.2011  
(96) 11751628.6 22.05.2013  
(87) WO2012007774, 17.06.2011  
(97) 2593935, 22.05.2013 en  
(54) ERGONOMIC CHINREST FOR VIOLINS/VIOLAS USING A NEW METHOD OF ATTACHMENT ONTO THE BODY OF AN INSTRUMENT AS WELL AS THE METHOD OF PRODUCING THE ERGONOMIC SURFACE OF THE CHINREST  
(71) GEO3D d.o.o., Antuna Mihanovica 6, 42000 Varazdin, HR  
(72) MESEK, Darko, Zrinskih i Frankopana 21, 42000 Varazdin, HR  
HANZEK, Mato, Ivana Gorana Kovacica 27/I, 42000 Varazdin, HR  
NOVAK, Zlatan, Vladimira Nazora 6, 40305 Nedelisce, Puscine, HR
- 
- (51) MKP  
**A61M 5/24 (2006.01)** (97) **2550043 \***  
**A61M 5/28 (2006.01)**  
**A61M 5/32 (2006.01)**  
(86) EP2011054422 23.03.2011  
(96) 11709722.0 30.01.2013  
(87) WO2011117284, 23.03.2011  
(97) 2550043, 30.01.2013 en  
(54) MEDICATED MODULE WITH USER SELECTION  
(71) Sanofi-Aventis Deutschland GmbH, Brüningstraße 50, 65929 Frankfurt, DE  
(72) CROSS, John David, 34 Station Road Long Buckby, Northampton Northamptonshire NN6 7QB, GB  
BOYD, Malcolm Stanley, 28 Whitehead Drive, Wellsbourne Warwickshire CV35 9PW, GB  
YOUNG, Alasdair George, Bakehouse Cottage 50 West Street Chipping Norton, Oxfordshire OX7 5ER, GB  
REKAYA, Naceur, 8 The Old Stone Yard 74 Rugby Road Leamington Spa, Warwickshire CV32 6DQ, GB  
DAVIES, James Alexander, 7 Old School Mews Cubbington Road, Leamington Spa Warwickshire CV32 7XB, GB  
WIMPENNY, Steven, 12 Greatheed Road Leamington Spa, Warwickshire CV31 6ES, GB  
DE SAUSMAREZ LINTELL, Daniel Thomas, 6 Smithy Lane Church Lawford, Rugby Warwickshire CV23 9EQ, GB  
BILTON, Simon Lewis, Flat 3 15 Clarendon Square, Leamington Spa Warwickshire CV32 5QT, GB
- 
- (51) MKP  
**G06F 17/30 (2006.01)** (97) **2550607 \***  
(86) US2011029534 23.03.2011  
(96) 11714614.2 30.01.2013  
(87) WO2011119676, 23.03.2011  
(97) 2550607, 30.01.2013 en  
(54) CLOUD-BASED WEB CONTENT FILTERING  
(71) Reversinglabs Corporation, 169 Msgr. O'Brian Highway Apt. 802, Cambridge, MA 02141, US  
(72) VUKSAN, Mario, 169 Monsignor O'Brien Highway. Apt. 802, Cambridge MA 02141, US  
NOVOSELAC, Vedran, Gradiste, 33273 Bosutska 6a, HR  
MATIJASEVIC, Mario, Stefaniceva 4, 10000 Zagreb, HR



- (51) MKP  
**A61K 47/26 (2006.01)** (97) **2552482 \***  
**A61K 39/395 (2006.01)**
- (86) IB2011051373 31.03.2011  
(96) 11715612.5 06.02.2013  
(87) WO2011121560, 31.03.2011  
(97) 2552482, 06.02.2013 en  
(54) STABILIZED ANTIBODY PREPARATIONS AND USES THEREOF  
(71) Université de Genève, 24 rue du Général-Dufour, 1211 Genève 4, CH  
(72) GURNY, Robert, 7 rue Calvin, 1204 Geneva, CH  
SCAPOZZA, Leonardo, Chemin Pré Marétan 4, 1274 Grens, CH  
WESTERMAIER, Yvonne, Via Vitgé 10, 7017 Flims, CH  
VEURINK, Marieke, Rue St-Léger 5, 1205 Geneve, CH
- 
- (51) MKP  
**A61K 39/395 (2006.01)** (97) **2552961 \***  
**C07K 16/24 (2006.01)**
- (86) US2011030469 30.03.2011  
(96) 11763357.8 06.02.2013  
(87) WO2011123507, 30.03.2011  
(97) 2552961, 06.02.2013 en  
(54) HUMANIZED IL-25 ANTIBODIES  
(71) Janssen Biotech, Inc., 800/850 Ridgeview Drive, Horsham, PA 19044, US  
(72) ALMAGRO, Juan, Carlos, 44 Harvard Avenue, no. 5, Brookline, MA 02446, US  
BRANIGAN, Patrick, 145 King Of Prussia Road, Radnor, PA 19087, US  
KANE, Colleen, 145 King Of Prussia Road, Radnor, PA 19087, US  
STROHL, William, 145 King Of Prussia Road, Radnor, PA 19087, US  
TAUDTE, Susann, 145 King Of Prussia Road, Radnor, PA 19087, US  
TORNETTA, Mark, 145 King Of Prussia Road, Radnor, PA 19087, US  
WHEELER, John, 145 King Of Prussia Road, Radnor, PA 19087, US
- 
- (51) MKP  
**A61K 31/165 (2006.01)** (97) **2563355 \***  
**C07C 231/24 (2006.01)**  
**C07C 237/06 (2006.01)**  
**C07C 309/04 (2006.01)**
- (86) EP2011055309 06.04.2011  
(96) 11714958.3 06.03.2013  
(87) WO2011134763, 06.04.2011  
(97) 2563355, 06.03.2013 en  
(54) PROCESS FOR THE PRODUCTION OF RALFINAMIDE METHANESULFONATE SALTS OR THEIR R-ENANTIOMERS  
(71) Newron Pharmaceuticals S.p.A., Via L. Ariosto, 21, 20091 Bresso (MI), IT  
(72) GIORDANO, Claudio, Via Carlo Ottavio Cornaggia 1, I-20123 Milano, IT  
WALDVOGEL, Erwin, Reinacherstrasse 18, CH-4147 Aesch, CH

- (51) MKP  
**C07H 19/16 (2006.01)** (97) **2569325 \***  
**A61K 31/7076 (2006.01)**  
**C07H 19/167 (2006.01)**  
**A61P 27/02 (2006.01)**  
**C07H 19/00 (2006.01)**
- (86) US2011030009 25.03.2011  
(96) 11760319.1 20.03.2013  
(87) WO2011119969, 25.03.2011  
(97) 2569325, 20.03.2013 en  
(54) METHOD OF REDUCING INTRAOCULAR PRESSURE IN HUMANS USING N6 - CYCLOPENTYLADENOSINE (CPA), CPA DERIVATIVES OR PRODRUGS THEREOF  
(71) Inotek Pharmaceuticals Corporation, 131 Hartwell Avenue 1st Floor, Suite 105, Lexington, MA 02421, US  
(72) KIM, Norman, N., 2 Honeysuckle Road, Westford MA 01886, US  
MCVICAR, William, K., 31Powers Road, Sudbury MA 01776, US  
MCCAULEY, Thomas, G., 85 Gore Street, Cambridge MA 02141, US  
JAGTAP, Prakash, 486 Sharpners Pond Road, N. Andover MA 01845, US
- 
- (51) MKP  
**E06B 3/273 (2006.01)** (97) **2476853**  
**E06B 3/263 (2006.01)**
- (96) 11009336.6 18.07.2012  
(97) 2476853, 18.07.2012 de  
(54) Connecting section for windows, doors and façades as well as method for producing the same  
(71) Jansen AG, Industriestrasse 34, 9463 Oberriet, CH  
(72) Rüttimann, Philipp, Fähnernerweg 6, 9453 Eichberg, CH
- 
- (51) MKP  
**C07D 413/14 (2006.01)** (97) **2569305 \***  
**C07D 403/14 (2006.01)**  
**C07D 401/14 (2006.01)**  
**A61K 31/4709 (2006.01)**  
**A61P 25/00 (2006.01)**
- (86) US2011035835 10.05.2011  
(96) 11731174.6 20.03.2013  
(87) WO2011143155, 10.05.2011  
(97) 2569305, 20.03.2013 en  
(54) SUBSTITUTED N-HETEROARYL TETRAHYDRO-ISOQUINOLINE DERIVATIVES, PREPARATION AND THERAPEUTIC USE THEREOF  
(71) SANOFI, 54 rue La Boétie, 75008 Paris, FR  
(72) GAO, Zhongli, c/o sanofi-aventis U.S. 1041 Route 202-206 BWD-303A, Bridgewater, New Jersey 08807, US  
HARTUNG, Ryan, c/o sanofi-aventis U.S. 1041 Route 202-206 BWD-303A, Bridgewater, New Jersey 08807, US

- (51) MKP  
**C07K 16/20 (2006.01)** (97) **2576614 \***  
**A61K 38/17 (2006.01)**  
**C07K 14/74 (2006.01)**  
**A61P 35/00 (2006.01)**  
**A61K 39/395 (2006.01)**  
**G01N 33/68 (2006.01)**  
**C07K 7/00 (2006.01)**
- (86) US2011037699 24.05.2011  
(96) 11787229.1 10.04.2013  
(87) WO2011149909, 24.05.2011  
(97) 2576614, 10.04.2013 en  
(54) CLASS I MHC PHOSPHOPEPTIDES FOR CANCER IMMUNOTHERAPY AND DIAGNOSIS
- (71) Phosimmune Inc., 970 Old Ballard Road, Charlottesville, VA 22901-9457, US  
(72) SHABANOWITZ, Jeffrey, 3130 Rocks Farm Ct., Charlottesville Virginia 22903, US  
NORRIS, Andrew, 37 Bunker Boulevard, Palmyra Virginia 22963, US  
CUMMINGS, Kara L., 2752 Gatewood Circle, Charlottesville Virginia 22911, US  
ENGELHARD, Victor H., 3656 Pinemeadow Way, Crozet Virginia 22932, US  
ZARLING, Angela, 1425 Lacebark Terr., Charlottesville Virginia 22903, US  
OBENG, Rebecca C., 1208 Cherry Ave, Charlottesville Virginia 22903, US  
QIAN, Jie, 265 Davidson Avenue Suite 101, Somerset, NJ 08873, US  
COBBOLD, Mark, 91 Tennal Road, Birmingham B32 2JB, GB  
COTTINE, Jennifer, 251-10 Colonnade Dr., Charlottesville Virginia 22903, US  
ENGLISH, Ann M., 19 Overlook Cir., Palmyra Virginia 22963, US  
HUNT, Donald F., 970 Old Ballard Road, Charlottesville Virginia 22901, US

- (51) MKP  
**B01J 20/32 (2006.01)** (97) **2589430**  
**C02F 1/56 (2006.01)**  
**C02F 103/28 (2006.01)**  
**B01J 20/04 (2006.01)**  
**C02F 1/28 (2006.01)**  
**C02F 11/14 (2006.01)**  
**C02F 1/66 (2006.01)**
- (96) 11187987.0 08.05.2013  
(97) 2589430, 08.05.2013 en  
(54) Surface-treated calcium carbonate and its use in water purification and for the dewatering of sludges and sediments
- (71) Omya Development AG, Baslerstrasse 42, 4665 Oftringen, CH  
(72) Daniel E. Gerard, Rheinfelderstrasse 12, 4058 Basel, CH  
Hans Georg Hartan, Langstraat 1, 47625 Kevelaer, DE  
Joachim Schoelkopf, Buechbühlstrasse 3, 8956 Killwangen, CH  
Michael Skovby, Wampflenstrasse 52, 8706 Meilen, CH  
Patrick A.C. Gane, Studenweg 8, 4852 Rothrist, CH

- (51) MKP  
**C07D 401/14 (2006.01)** (97) **2588472 \***
- (86) EP2011061035 30.06.2011  
(96) 11728293.9 08.05.2013  
(87) WO2012001120, 30.06.2011  
(97) 2588472, 08.05.2013 en  
(54) RUPATADINE SALT AS AN ANTIHISTAMINIC AGENT
- (71) J. Uriach y Compania S.A., Av. Cami Reial, 51-57, 08184 Palau-solità i Plegamans (Barcelona), ES  
(72) CUGCELLER GONZÁLEZ, Elena, Joan Miró 2, E-08190 Sant Cugat del Vallès - Barcelona, ES  
BELLOC PASCUAL, Jordi, Navas de Tolosa 338 3r4t, E-08027 Barcelona, ES

- (51) MKP  
**G01B 9/02 (2006.01)** (97) **2564153 \***  
**G02B 21/00 (2006.01)**
- (86) FR2011050900 19.04.2011  
(96) 11721347.0 06.03.2013  
(87) WO2011135231, 19.04.2011  
(97) 2564153, 06.03.2013 fr  
(54) OPTICAL DEVICE AND METHOD FOR INSPECTING STRUCTURED OBJECTS
- (71) Nanotec Solution, 237, chemin Puech du Teil, 30900 Nîmes, FR  
(72) FRESQUET, Gilles, 5324 Rue des Ormeaux, F-30190 Garrigues Sainte Eulalie, FR

- (51) MKP  
**A61K 9/20 (2006.01)** (97) **2568965 \***  
**A61K 9/16 (2006.01)**
- (86) EP2011057568 10.05.2011  
(96) 11718749.2 20.03.2013  
(87) WO2011141490, 10.05.2011  
(97) 2568965, 20.03.2013 en  
(54) COMBINATION OF ACTIVE LOADED GRANULES WITH ADDITIONAL ACTIVES
- (71) Euro-Celtique S.A., 2, avenue Charles de Gaulle, 1653 Luxembourg, LU  
(72) MOHAMMAD, Hassan, Mundipharma Research Limited 191 Cambridge Science Park Milton Road, Cambridge Cambridgeshire CB4 0GW, GB  
WALDEN, Malcolm, Mundipharma Research Limited 191 Cambridge Science Park Milton Road, Cambridge Cambridgeshire CB4 0GW, GB  
HAYES, Geoffrey, Gerard, Mundipharma Research Limited 191 Cambridge Science Park Milton Road, Cambridge Cambridgeshire CB4 0GW, GB  
TAMBER, Harjit, Mundipharma Research Limited 191 Cambridge Science Park Milton Road, Cambridge Cambridgeshire CB4 0GW, GB

- (51) MKP  
**A61K 31/425 (2006.01)** (97) **2544542 \***  
**A01N 43/78 (2006.01)**
- (86) US2011027580 08.03.2011  
(96) 11753938.7 16.01.2013  
(87) WO2011112602, 08.03.2011  
(97) 2544542, 16.01.2013 en  
(54) ANALGESIC COMPOUNDS, COMPOSITIONS, AND USES THEREOF
- (71) Galleon Pharmaceuticals, Inc., 213 Witmer Road, Horsham, PA 19044, US  
(72) MANNION, James, C., 2 Clydesdale Court, Plainsboro NJ 08536, US  
DAX, Scott, L., 3 Quail Drive, Landenberg PA 19350, US

- (51) MKP  
**A61K 9/16 (2006.01)** (97) **2471386**  
**A23L 1/30 (2006.01)**  
**A61K 9/20 (2006.01)**  
**A61K 9/48 (2006.01)**  
**A61K 31/23 (2006.01)**  
**A61K 9/00 (2006.01)**
- (96) 10197297.4 04.07.2012  
(97) 2471386, 04.07.2012 en  
(54) Cetyl myristate and/or cetyl palmitate suspension formulations
- (71) Deva Holding Anonim Sirketi, Patent Law Department Halkali Merkez Mah. Basın Ekspres Cad. No: 1,34303, Kucukcekmece/Istanbul, TR  
(72) Haas, Philipp Daniel, R&D DEVA HOLDING ANONIM SIRKETI Halkali Merkez Mah., Basın Ekspres Caddesi No: 1, Patent Law Department, Kat:5, Kucukcekmece, 34303, ISTANBUL, TR  
Firat, Omer Faruk, R&D DEVA HOLDING ANONIM SIRKETI Halkali Merkez Mah., Basın Ekspres Caddesi No: 1, Patent Law Department, Kat:5, Kucukcekmece, 34303, ISTANBUL, TR  
Kandemir, Levent, R&D DEVA HOLDING ANONIM SIRKETI Halkali Merkez Mah., Basın Ekspres Caddesi No: 1, Patent Law Department, Kat:5, Kucukcekmece, 34303, ISTANBUL, TR  
Koc, Fikret, R&D DEVA HOLDING ANONIM SIRKETI Halkali Merkez Mah., Basın Ekspres Caddesi No: 1, Patent Law Department, Kat:5, Kucukcekmece, 34303, ISTANBUL, TR  
Sivasligil, Ramazan, R&D DEVA HOLDING ANONIM SIRKETI Halkali Merkez Mah., Basın Ekspres Caddesi No: 1, Patent Law Department, Kat:5, Kucukcekmece, 34303, ISTANBUL, TR

(51) MKP  
**A61K 9/00 (2006.01)** (97) **2552448 \***  
**A61K 31/498 (2006.01)**  
**A61P 17/00 (2006.01)**  
**A61K 9/06 (2006.01)**  
(86) EP2011054597 25.03.2011  
(96) 11709960.6 06.02.2013  
(87) WO2011117378, 25.03.2011  
(97) 2552448, 06.02.2013 en  
(54) IMPROVED METHODS AND COMPOSITIONS FOR SAFE AND EFFECTIVE TREATMENT OF TELANGIECTASIA  
(71) Galderma Research & Development, 2400 Route des Colles Les Templiers, 06410 Biot, FR  
(72) GRAEBER, Michael, 30103 Palm Court, Lawrenceville NJ08648, US  
LOESCHE, Christian, 1 Place des Cines, F-06560 Valbonne, FR  
FREIDENREICH, Philip, 347 Michael Road, Yardley PA 19067, US  
LIU, Yin, 19 Reed Dr. North Princeton Junction, New Jersey, NJ 08550, US  
LEONI, Matthew James, 1 Rockhill Dr., Hampton NJ 08827, US

(51) MKP  
**B01J 37/02 (2006.01)** (97) **2576048 \***  
**B01J 19/24 (2006.01)**  
**B01J 8/18 (2006.01)**  
**B01J 21/18 (2006.01)**  
(86) US2011038327 27.05.2011  
(96) 11787491.7 10.04.2013  
(87) WO2011150325, 27.05.2011  
(97) 2576048, 10.04.2013 en  
(54) GRAPHENE OXIDE AND GRAPHITE OXIDE CATALYSTS AND SYSTEMS  
(71) Graphea, Inc., 1624 Headway Circle, Austin, TX 78754, US  
(72) BIELAWSKI, Christopher, W., 3105 S. I-35 2070, Austin Texas 78741, US  
DREYER, Daniel, R., 7121 Hart Lane Apt. 1097, Austin Texas 78731, US

(51) MKP  
**C03C 23/00 (2006.01)** (97) **2547631 \***  
**C03C 17/00 (2006.01)**  
(86) US2011029026 18.03.2011  
(96) 11711221.9 23.01.2013  
(87) WO2011116302, 18.03.2011  
(97) 2547631, 23.01.2013 en  
(54) CURING COATINGS ON GLASS CONTAINERS  
(71) Owens-Brockway Glass Container Inc., One Michael Owens Way, Perrysburg, OH 43551-2999, US  
(72) REMINGTON, Michael, P., Jr., 1936 Dority Road, Toledo OH 43615, US  
HOWSE, Terrence, K., G., 4243 West Bancroft Apt. 103W Toledo, OH 43615, US

(51) MKP  
**E02D 31/02 (2006.01)** (97) **2354326**  
**E02B 3/10 (2006.01)**  
(96) 10197209.9 10.08.2011  
(97) 2354326, 10.08.2011 en  
(54) Anti-flooding device  
(71) Techne Grado Studio Associato di Ingegneria Geologia, Campo dei Patriarchi 5, 34073 Grado (GO), IT  
(72) Marocco, Michele, Via del Sole, 69, 34073 Grado (GO), IT

(51) MKP  
**H01J 37/32 (2006.01)** (97) **2518763**  
**H01L 21/677 (2006.01)**  
**H01L 21/687 (2006.01)**  
**H01L 21/67 (2006.01)**  
**C23C 16/509 (2006.01)**  
**C23C 16/458 (2006.01)**  
(96) 12165448.7 31.10.2012  
(97) 2518763, 31.10.2012 en  
(54) A grounding assembly for vacuum processing apparatus  
(71) Orbotech LT Solar, LLC, 17 Great Oaks Boulevard, San Jose, California 95119, US  
(72) Stevens, Craig Lyle, 188 Brown Gables Rd., Ben Lomond, CA 95005, US  
Blonigan, Wendell Thomas, 8137 War Glory Place, Pleasanton, CA 94566, US

(51) MKP  
**C08G 63/08 (2006.01)** (97) **2585091 \***  
**A61K 9/52 (2006.01)**  
**A61K 47/34 (2006.01)**  
**A61P 35/00 (2006.01)**  
**A61K 38/08 (2006.01)**  
(86) JP2011064992 23.06.2011  
(96) 11731522.6 01.05.2013  
(87) WO2011162413, 23.06.2011  
(97) 2585091, 01.05.2013 en  
(54) SUSTAINED-RELEASE FORMULATION  
(71) Takeda Pharmaceutical Company Limited, 1-1 Doshomachi 4-chome Chuo-ku, Osaka-shi, Osaka 541-0045, JP  
(72) FUTO, Tomomichi, c/o TAKEDA PHARMACEUTICAL COMPANY LIMITED 17-85, Jusohonmachi 2-chome Yodogawa-ku, Osaka-shi Osaka 532-0024, JP  
TAIRA, Hikaru, c/o TAKEDA PHARMACEUTICAL COMPANY LIMITED 17-85 Jusohonmachi 2-chome Yodogawa-ku, Osaka-shi Osaka 532-0024, JP  
MIZUKAMI, Seitaro, c/o TAKEDA PHARMACEUTICAL COMPANY LIMITED 17-85, Jusohonmachi 2-chome Yodogawa-ku, Osaka-shi Osaka 532-0024, JP  
MURATA, Naoyuki, c/o TAKEDA PHARMACEUTICAL COMPANY LIMITED 17-85, Jusohonmachi 2-chome Yodogawa-ku, Osaka-shi Osaka 532-0024, JP

(51) MKP  
**B03C 7/12 (2006.01)** (97) **2576071 \***  
**B03C 7/00 (2006.01)**  
(86) IB2011001055 13.05.2011  
(96) 11729164.1 10.04.2013  
(87) WO2011151690, 13.05.2011  
(97) 2576071, 10.04.2013 en  
(54) A METHOD AND A DEVICE FOR SEPARATING PARTICLES OF A DETERMINED SYNTHETIC MATERIAL FROM PARTICLES OF DIFFERENT SYNTHETIC MATERIALS  
(71) Cassani, Stefano, 51 Via Casola Canina, 40026 Imola, Bologna, IT  
(72) Cassani, Stefano, 51 Via Casola Canina, 40026 Imola, Bologna, IT

(51) MKP  
**B67D 3/00 (2006.01)** (97) **2542498 \***  
(86) US2011026690 01.03.2011  
(96) 11751205.3 09.01.2013  
(87) WO2011109401, 01.03.2011  
(97) 2542498, 09.01.2013 en  
(54) SAFETY CAN  
(71) Justrite Manufacturing Company, L.L.C., 2454 Dempster Street, Suite 300, Des Plaines, IL 60016-5315, US  
Carter, Glen, 14 Western Avenue Heights, Mattoon, Illinois 61938, US  
Goddard, Mark, 5386 Ncr 1450 E, Charleston, Illinois 61920, US  
(72) CARTER, Glen, 14 Western Avenue Heights, Mattoon, IL 61938, US  
GODDARD, Mark, 5386 Ncr 1450 E., Charleston, IL 61920, US

- (51) MKP  
**C07D 487/04 (2006.01)** (97) **2576560 \***  
**A61K 31/4985 (2006.01)**
- (86) EP2011058713 27.05.2011  
(96) 11725886.3 10.04.2013  
(87) WO2011151259, 27.05.2011  
(97) 2576560, 10.04.2013 en  
(54) SUBSTITUTED IMIDAZOPYRAZINES
- (71) Bayer Intellectual Property GmbH, Alfred-Nobel-Strasse 10, 40789 Monheim, DE
- (72) KLAR, Ulrich, Isegrimsteig 8a, 13503 Berlin, DE  
KOPPITZ, Marcus, Scharnhorststr. 28, 10115 Berlin, DE  
JAUTELAT, Rolf, Zur Pumpstation 35, 42781 Haan, DE  
KOSEMUND, Dirk, Klutstr. 14, 12587 Berlin, DE  
BOHLMANN, Rolf, Kuehler Weg 6a, 14055 Berlin, DE  
BADER, Benjamin, Hillmannstr. 14, 13467 Berlin, DE  
LIENAU, Philip, Jahnstrasse 13, 10967 Berlin, DE  
SIEMEISTER, Gerhard, Reimerswalder Steig 26, 13503 Berlin, DE  
SCOTT, William, 210 Saddle Hill Drive, 06437 Guilford, US

- (51) MKP  
**G01N 33/574 (2006.01)** (97) **2558864 \***
- (86) US2011032721 15.04.2011  
(96) 11716153.9 20.02.2013  
(87) WO2011130654, 15.04.2011  
(97) 2558864, 20.02.2013 en  
(54) FOXO3A AS PREDICTIVE BIOMARKER FOR PI3K/AKT KINASE PATHWAY INHIBITOR EFFICACY
- (71) Genentech, Inc., 1 DNA Way, MS49, South San Francisco, CA 94080-4990, US
- (72) PUNNOOSE, Elizabeth, c/o Genentech Inc. 1 DNA Way, South San Francisco California 94080-4990, US

- (51) MKP  
**C07K 14/415 (2006.01)** (97) **2590996 \***  
**C12N 15/82 (2006.01)**
- (86) EP2011004565 06.07.2011  
(96) 11767621.3 15.05.2013  
(87) WO2012004013, 06.07.2011  
(97) 2590996, 15.05.2013 en  
(54) GLUCOSINOLATE TRANSPORTER PROTEIN AND USES THEREOF
- (71) Bayer CropScience NV, J.E. Mommaertsiaan 14, 1831 Diegem, BE  
University of Copenhagen, Postbox 2177 Norregade 10, 1017 Copenhagen K, DK
- (72) DENOLF, Peter, Schonenberg 6, B-9620 Velzeke, BE  
OPSOMER, Christiane, Dudenhofenlaan 121, B-8620 Nieuwpoort, BE  
HALKIER, Barbara, Ann, Nansensgade 43 1tv, DK-1366 Copenhagen K., DK  
NOUR-ELDIN AUIS, Hussam, Hassan, Gernersgade 39 2th, DK-1319 Copenhagen K., DK  
ANDERSEN, Tonni, Grube, Nordre Fasanvej 185 1.th, DK-2000 Frederiksberg, DK  
MADSEN, Svend, Roesen, Haraldsgade 92 1.th, DK-2100 Copenhagen Ø, DK  
JØRGENSEN, Morten, Egevang, Dalslandsgade 8H 5., DK-2300 Copenhagen S, DK

- (51) MKP  
**A61K 31/7042 (2006.01)** (97) **2568988 \***  
**A61K 9/20 (2006.01)**  
**A61P 3/10 (2006.01)**
- (86) US2011036038 11.05.2011  
(96) 11721616.8 20.03.2013  
(87) WO2011143296, 11.05.2011  
(97) 2568988, 20.03.2013 en  
(54) PHARMACEUTICAL FORMULATIONS COMPRISING 1 - (BETA-D-GLUCOPYRANOSYL) - 2 - THIENYLMETHYLBENZENE DERIVATIVES AS INHIBITORS OF SGLT
- (71) Janssen Pharmaceutica, N.V., Turnhoutseweg 30, 2340 Beerse, BE
- (72) WANG, Wenhua, 329 Crittenden Drive, New Hope PA 18940, US  
OUTWIN, Todd, 209 Hunter Way, Chalfont PA 18914, US  
JOSEPH, Thomas C., 1936 Fernbrook Avenue, Oakford PA 19503, US

- (51) MKP  
**A61K 9/22 (2006.01)** (97) **2564838 \***  
**A61P 25/24 (2006.01)**  
**A61K 47/02 (2006.01)**  
**A61K 47/32 (2006.01)**  
**A61K 31/495 (2006.01)**  
**A61K 47/34 (2006.01)**  
**A61K 9/32 (2006.01)**
- (86) JP2011060483 28.04.2011  
(96) 11775157.8 06.03.2013  
(87) WO2011136376, 28.04.2011  
(97) 2564838, 06.03.2013 en  
(54) ENTERIC TABLET
- (71) Takeda Pharmaceutical Company Limited, 1-1 Doshomachi 4-chome Chuo-ku, Osaka-shi, Osaka 541-0045, JP
- (72) MISAKI, Masafumi, c/o TAKEDA PHARMACEUTICAL COMPANY LIMITED 17-85 Jusohonmachi 2-chome Yodogawa-ku, Osaka-shi Osaka 532-8686, JP  
TSUSHIMA, Yuki, c/o TAKEDA PHARMACEUTICAL COMPANY LIMITED 17-85 Jusohonmachi 2-chome Yodogawa-ku, Osaka-shi Osaka 532-8686, JP  
NIWA, Masahiro, c/o TAKEDA PHARMACEUTICAL COMPANY LIMITED 17-85 Jusohonmachi 2-chome Yodogawa-ku, Osaka-shi Osaka 532-8686, JP

- (51) MKP  
**A61K 31/74 (2006.01)** (97) **2566487 \***
- (86) US2011035147 04.05.2011  
(96) 11778244.1 13.03.2013  
(87) WO2011140194, 04.05.2011  
(97) 2566487, 13.03.2013 en  
(54) OPHTHALMIC COMPOSITION
- (71) SENJU USA, INC., 21700 Oxnard Street, Suite 1070, Woodland Hills, CA 91367, US
- (72) INOUE, Jun, c/o Senju Usa Inc 21700 Oxnard Street Suite 1070, Woodland Hills, CA 91367, US  
SHAH, Tapan, c/o Senju Usa Inc. 21700 Oxnard Street Suite 1070, Woodland Hills, CA 91367, US

- (51) MKP  
**C07K 1/00 (2006.01)** (97) **2555801 \***  
**A61K 45/00 (2006.01)**
- (86) US2011031641 07.04.2011  
(96) 11766762.6 13.02.2013  
(87) WO2011127325, 07.04.2011  
(97) 2555801, 13.02.2013 en  
(54) SELECTION AND USE OF HOST CELLS FOR PRODUCTION OF GLYCOPROTEINS
- (71) Momenta Pharmaceuticals, Inc., 675 West Kendall Street, Cambridge, MA 02142, US
- (72) COLLINS, Brian, E., 30 Country Club Drive, Arlington, MA 02474, US  
DUFFNER, Jay, 29 Lawton Road, Shirley, MA 01464, US  
FARUTIN, Victor, 113 Fayette Street, Watertown, MA 02472, US  
BHATNAGAR, Naveen, 2 Bishop Drive, Framingham, MA 01720, US  
THIRUNEELAKANTAPILLAI, Lakshmanan, 7 Oceanview Drive Apt. 505, Boston, MA 02125, US  
BOSQUES, Carlos, J., 40 Brattle Street 7, Arlington, MA 02476, US  
KAUNDINYA, Ganesh, 215 Concord Road, Bedford, MA 01730, US

- (51) MKP  
**A61G 7/057 (2006.01)** (97) **2474292**
- (86) 11193503.7 11.07.2012  
(97) 2474292, 11.07.2012 en  
(54) Apparatus with inflatable mattress
- (71) MKS Innovatech S.r.l., Via Simone D'Orsenigo, 5, 20135 Milano, IT
- (72) Gelmetti, Nicola, Via Paiari, 52, 37017 Lazise (VR), IT  
Martinelli, Fabio, Via Mozart, 1, 37029 San Pietro in Cariano (VR), IT

- (51) MKP  
**B65D 1/04 (2006.01)** (97) **2576361 \***  
**B65D 3/04 (2006.01)**  
**F04D 13/00 (2006.01)**  
(86) NL2011050368 27.05.2011  
(96) 11723745.3 10.04.2013  
(87) WO2011152716, 27.05.2011  
(97) 2576361, 10.04.2013 en  
(54) DISPENSING UNIT AND METHOD FOR DISPENSING A LIQUID UNDER PRESSURE  
(71) Heineken Supply Chain B.V., 2e Weteringplantsoen 21, 1017 ZD Amsterdam, NL  
(72) LINDMAYER, István Stephen, Homokhegy u. 12., H-7228 Döbrököz, HU

- (51) MKP  
**C12Q 1/42 (2006.01)** (97) **2553117 \***  
**G01N 33/569 (2006.01)**  
**C12Q 1/28 (2006.01)**  
(86) US2011030166 28.03.2011  
(96) 11714460.0 06.02.2013  
(87) WO2011123386, 28.03.2011  
(97) 2553117, 06.02.2013 en  
(54) METHODS FOR DETECTING RAMAN SCATTERING USING AROMATIC COMPOUNDS COMPRISING PHOSPHATE AND AT LEAST ONE NON-LASER LIGHT SOURCE  
(71) Sword Diagnostics, Inc., 3440 South Dearborn Street, Suite 260, Chicago IL 60616, US  
(72) KUNDU, Samar, Kumar, 1313 Oxford Court, Libertyville, IL 60048, US  
GINSBURGH, Charles, Lester, 1514 Plum Lane, Westmont, IL 60559, US  
SIEGEL, Neal, Arthur, 652 North Gorham Road, Morris, IL 60450, US

- (51) MKP  
**C07D 265/30 (2006.01)** (97) **2580201 \***  
(86) IB2011001330 10.06.2011  
(96) 11736154.3 17.04.2013  
(87) WO2011154827, 10.06.2011  
(97) 2580201, 17.04.2013 en  
(54) TRANSITION METAL-CATALYZED PROCESSES FOR THE PREPARATION OF N-ALLYL COMPOUNDS AND USE THEREOF  
(71) Rhodes Technologies, 498 Washington Street, Coventry, RI 02816, US  
(72) GIGUERE, Joshua, R., 17 Harding Street, Sharon MA 02067, US  
MCCARTHY, Keith, E., 10Wolcott Lane, Old Lyme CT 06371, US  
REISCH, Helge, A., 36 Wells Street, Westerly RI 02891, US  
SANDOVAL, Sergio, 34 Scenic Drive, West Warwick RI 02893, US  
STYMIEST, Jake, L., 41 Howard Hill Road, Foster RI 02825, US

- (51) MKP  
**A61K 31/426 (2006.01)** (97) **2590930 \***  
**A61K 31/421 (2006.01)**  
**C07D 213/65 (2006.01)**  
**C07D 305/06 (2006.01)**  
**C07D 213/64 (2006.01)**  
**A61K 31/192 (2006.01)**  
**C07C 255/54 (2006.01)**  
**A61K 31/381 (2006.01)**  
**C07C 59/72 (2006.01)**  
**A61K 31/34 (2006.01)**  
**A61K 31/4439 (2006.01)**  
(86) EP2011061336 05.07.2011  
(96) 11729315.9 15.05.2013  
(87) WO2012004270, 05.07.2011  
(97) 2590930, 15.05.2013 de  
(54) SPIROCYCLICALLY SUBSTITUTED 1,3-PROPANE DIOXIDE DERIVATIVES, METHODS FOR THE PRODUCTION THEREOF AND USE OF THE SAME AS MEDICAMENT  
(71) SANOFI, 174, Avenue de France, 75013 Paris, FR  
(72) KEIL, Stefanie, c/o Sanofi-Aventis Deutschland GmbH Patentabteilung Industriepark Höchst Gebäude K 801, 65926 Frankfurt am Main, DE  
DEFOSSA, Elisabeth, c/o Sanofi-Aventis Deutschland GmbH Patentabteilung Industriepark Höchst Gebäude K 801, 65926 Frankfurt am Main, DE  
DIETRICH, Viktoria, c/o Sanofi-Aventis Deutschland GmbH Patentabteilung Industriepark Höchst Gebäude K 801, 65926 Frankfurt am Main, DE  
STENGELIN, Siegfried, c/o Sanofi-Aventis Deutschland GmbH Patentabteilung Industriepark Höchst Gebäude K 801, 65926 Frankfurt am Main, DE  
HERLING, Andreas, c/o Sanofi-Aventis Deutschland GmbH Patentabteilung Industriepark Höchst Gebäude K 801, 65926 Frankfurt am Main, DE  
HASCHKE, Guido, c/o Sanofi-Aventis Deutschland GmbH Patentabteilung Industriepark Höchst Gebäude K 801, 65926 Frankfurt am Main, DE  
KLABUNDE, Thomas, c/o Sanofi-Aventis Deutschland GmbH Patentabteilung Industriepark Höchst Gebäude K 801, 65926 Frankfurt am Main, DE

- (51) MKP  
**C07C 225/16 (2006.01)** (97) **2542544 \***  
**C07C 311/08 (2006.01)**  
**C07F 5/02 (2006.01)**  
**C07D 307/83 (2006.01)**  
**C07C 311/07 (2006.01)**  
**A61P 9/00 (2006.01)**  
**C07C 217/22 (2006.01)**  
**A61K 31/43 (2006.01)**  
(86) FR2011050420 01.03.2011  
(96) 11712941.1 09.01.2013  
(87) WO2011107705, 01.03.2011  
(97) 2542544, 09.01.2013 fr  
(54) KETOBENZOFURAN DERIVATIVES, METHOD FOR SYNTHESISING SAME, AND INTERMEDIATES  
(71) SANOFI, 54, rue de la Boétie, 75008 Paris, FR  
(72) BAILLY, Frédéric, c/o Sanofi-Aventis Département Brevets 174 Avenue de France, F-75013 Paris, FR  
GRIMAUD, Bernard, c/o Sanofi-Aventis Département Brevets 174 Avenue de France, F-75013 Paris, FR  
MALEJONOCK, Irina, c/o Sanofi-Aventis Département Brevets 174 Avenue de France, F-75013 Paris, FR  
VAYRON, Philippe, c/o Sanofi-Aventis Département Brevets 174 Avenue de France, F-75013 Paris, FR

- (51) MKP  
**A61M 5/24 (2006.01)** (97) **2460551**  
**A61M 5/315 (2006.01)**  
(96) 10193752.2 06.06.2012  
(97) 2460551, 06.06.2012 en  
(54) Drug delivery device with locking arrangement for dose button  
(71) Sanofi-Aventis Deutschland GmbH, Brüningstraße 50, 65929 Frankfurt, DE  
(72) Teucher, Axel, c/o Sanofi-Aventis Deutschland GmbH Industriepark Höchst, 65926 Frankfurt am Main, DE

- (51) MKP  
**A61K 8/27 (2006.01)** (97) **2550067 \***  
**A61K 8/46 (2006.01)**  
**A61Q 11/00 (2006.01)**  
**A61K 8/34 (2006.01)**  
(86) EP2011054291 22.03.2011  
(96) 11709141.3 30.01.2013  
(87) WO2011117216, 22.03.2011  
(97) 2550067, 30.01.2013 en  
(54) NOVEL USE  
(71) Glaxo Group Limited, Glaxo Wellcome House Berkeley Avenue Greenford, Middlesex UB6 0NN, GB  
(72) AITKEN, Gail, Cameron, GlaxoSmithKline St. George's Avenue, Weybridge Surrey KT13 0DE, GB  
CHURCHLEY, David, Raymond, GlaxoSmithKline St. George's Avenue, Weybridge Surrey KT13 0DE, GB

- (51) MKP  
**C07J 71/00 (2006.01)** (97) **2566877 \***  
(86) US2011035402 05.05.2011  
(96) 11778372.0 13.03.2013  
(87) WO2011140375, 05.05.2011  
(97) 2566877, 13.03.2013 en  
(54) METHODS OF REDUCING SYMPTOMS IN SUBJECTS USING SINGLE DOSAGE FORMS WITH TAPERING RELEASE RATES  
(71) Teva Women's Health, Inc., 400 Chestnut Ridge Road, Woodcliff Lake, NJ 07677, US  
(72) DILIBERTI, Charles, E., 350 Park Street, Montclair, NJ 07043, US  
MAHASHABDE, Anu, 13 Village Road, Kendall Park, NJ 08824, US

- (51) MKP  
**A01N 43/42 (2006.01)** (97) **2560490 \***  
**A61K 31/44 (2006.01)**  
(86) US2010031954 21.04.2010  
(96) 10850372.3 27.02.2013  
(87) WO2011133150, 21.04.2010  
(97) 2560490, 27.02.2013 en  
(54) COMPOSITIONS COMPRISING ENZYME-CLEAVABLE PRODRUGS OF ACTIVE AGENTS AND INHIBITORS THEREOF  
(71) Signature Therapeutics, Inc., 75 Shoreway Road, Suite D, San Carlos, CA 94070, US  
(72) JENKINS, Thomas, E., 75 Shoreway Road Suite D., San Carlos, CA 94070, US  
HUSFELD, Craig, O., 75 Shoreway Road Suite D., San Carlos, CA 94070, US  
SEROOGY, Julie, D., 75 Shoreway Road Suite D., San Carlos, CA 94070, US  
WRAY, Jonathan, W., 75 Shoreway Road Suite D., San Carlos, CA 94070, US

- (51) MKP  
**A61P 27/06 (2006.01)** (97) **2552932 \***  
**A61P 9/10 (2006.01)**  
**C07H 19/16 (2006.01)**  
**A61P 29/00 (2006.01)**  
**C07H 19/167 (2006.01)**  
**A61K 31/7076 (2006.01)**  
**A61P 27/02 (2006.01)**  
(86) US2011029929 25.03.2011  
(96) 11760282.1 06.02.2013  
(87) WO2011119919, 25.03.2011  
(97) 2552932, 06.02.2013 en  
(54) ADENOSINE COMPOUNDS AND THEIR USE THEREOF  
(71) Inotek Pharmaceuticals Corporation, 131 Hartwell Avenue 1st Floor, Suite 105, Lexington, MA 02421, US  
(72) JAGTAP, Prakash, 486 Sharpners Pond Road, N. Andover, MA 01845, US

- (51) MKP  
**C09D 11/00 (2006.01)** (97) **2548928 \***  
**C09B 63/00 (2006.01)**  
**C09B 67/20 (2006.01)**  
(86) JP2011001473 14.03.2011  
(96) 11755882.5 23.01.2013  
(87) WO2011114691, 14.03.2011  
(97) 2548928, 23.01.2013 en  
(54) PIGMENT COMPOSITION  
(71) Taisho Pharmaceutical Co., Ltd., 24-1, Takada 3-chome Toshima-ku, Tokyo 170-8633, JP  
(72) NAKAJIMA, Toshiki, c/o TAISHO PHARMACEUTICAL CO. LTD. 24-1 Takada 3-chome Toshima-ku, Tokyo 170-8633, JP  
URABE, Masakiyo, c/o TAISHO PHARMACEUTICAL CO. LTD. 24-1 Takada 3-chome Toshima-ku, Tokyo 170-8633, JP  
NUMAO, Mariko, c/o TAISHO PHARMACEUTICAL CO. LTD. 24-1 Takada 3-chome Toshima-ku, Tokyo 170-8633, JP  
IKEDA, Masatoshi, c/o TAISHO PHARMACEUTICAL CO. LTD. 24-1 Takada 3-chome Toshima-ku, Tokyo 170-8633, JP  
YAMABE, Kenji, c/o TAISHO PHARMACEUTICAL CO. LTD. 24-1 Takada 3-chome Toshima-ku, Tokyo 170-8633, JP

- (51) MKP  
**G06F 15/16 (2006.01)** (97) **2577485 \***  
(86) US2011038195 26.05.2011  
(96) 11787437.0 10.04.2013  
(87) WO2011150244, 26.05.2011  
(97) 2577485, 10.04.2013 en  
(54) STREAMING MEDIA DELIVERY COMPOSITE  
(71) Ineoquest Technologies, Inc., 170 Forbes Boulevard, Mansfield, MA 02048, US  
(72) TODD, Marc, A., 22 Ames Road, Foxboro MA 02035, US  
WELCH, James, 29 Meadow Haven, Mashpee MA 02649, US  
BIRCH, Lynn, 23 Lancashire Drive, Mansfield MA 02048, US  
SHEAHAN, Matthew, 23 Bird Road, Mansfield MA 02048, US

- (51) MKP  
**C07K 14/705 (2006.01)** (97) **2552953 \***  
(86) US2011030950 01.04.2011  
(96) 11763516.9 06.02.2013  
(87) WO2011123785, 01.04.2011  
(97) 2552953, 06.02.2013 en  
(54) FRIZZLED-BINDING AGENTS AND USES THEREOF  
(71) OncoMed Pharmaceuticals, Inc., 800 Chesapeake Drive, Redwood City, CA 94063, US  
(72) GURNEY, Austin, L., 946 Diamond Street, San Francisco CA 94114, US

- (51) MKP  
**A61P 27/02 (2006.01)** (97) **2555776 \***  
**A61P 27/06 (2006.01)**  
**A61K 31/7076 (2006.01)**  
**A61K 31/085 (2006.01)**  
**A61K 31/5377 (2006.01)**  
(86) US2011029012 18.03.2011  
(96) 11757065.5 13.02.2013  
(87) WO2011116292, 18.03.2011  
(97) 2555776, 13.02.2013 en  
(54) COMBINATION COMPOSITIONS OF ADENOSINE A1 AGONISTS AND NON-SELECTIVE BETA-ADRENERGIC RECEPTOR BLOCKERS FOR REDUCING INTRAOCULAR PRESSURE  
(71) Inotek Pharmaceuticals Corporation, 131 Hartwell Avenue 1st Floor, Suite 105, Lexington, MA 02421, US  
(72) KIM, Norman, N., 2 Honeysuckle Road, Westford MA 01886, US  
MCVICAR, William, K., 31 Powers Road, Subdury MA 01776, US  
MCCAULEY, Thomas, G., 85 Gore Street, Cambridge MA 02141, US

(51) MKP  
**C07K 14/475 (2006.01)** (97) **2558489 \***  
**A61K 38/00 (2006.01)**  
(86) FR2011050811 08.04.2011  
(96) 11719346.6 20.02.2013  
(87) WO2011128561, 08.04.2011  
(97) 2558489, 20.02.2013 fr  
(54) ROBO1-FC FUSION PROTEIN AND USE THEREOF FOR TREATING TUMOURS  
(71) SANOFI, 54, rue de la Boétie, 75008 Paris, FR  
(72) BLANCHE, Francis, c/o SANOFI-AVENTIS Departement Brevets 174 avenue de France, F-75013 Paris, FR  
CAMERON, Béatrice, c/o SANOFI-AVENTIS Departement Brevets 174 avenue de France, F-75013 Paris, FR  
DABDOUBI, Tarik, c/o SANOFI-AVENTIS Departement Brevets 174 avenue de France, F-75013 Paris, FR  
DOL-GLEIZES, Frédérique, c/o SANOFI-AVENTIS Departement Brevets 174 avenue de France, F-75013 Paris, FR  
FONS, Pierre, c/o SANOFI-AVENTIS Departement Brevets 174 avenue de France, F-75013 Paris, FR  
HERAULT, Jean-Pascal, c/o SANOFI-AVENTIS Departement Brevets 174 avenue de France, F-75013 Paris, FR  
PRADES, Catherine, c/o SANOFI-AVENTIS Departement Brevets 174 avenue de France, F-75013 Paris, FR

(51) MKP  
**B09B 3/00 (2006.01)** (97) **2550118 \***  
(86) IL2011000263 17.03.2011  
(96) 11715615.8 30.01.2013  
(87) WO2011117864, 17.03.2011  
(97) 2550118, 30.01.2013 en  
(54) COMPOSITIONS OF MATTER AND USES THEREOF IN THE TREATMENT OF WASTE MATERIALS  
(71) Agrobics Ltd, P.O. Box 437, 20200 Shfaram, IL  
(72) SABBAAH, Isam, Elfawar 249/13, 20200 Shfaram, IL  
MASSALHA, Nedal, P.O.B. 235, 16910 Daboria, IL  
SALIBA, Ahlam, Abu Zaid St., 20200 Shfaram, IL

(51) MKP  
**A61M 5/32 (2006.01)** (97) **2550047 \***  
(86) EP2011054419 23.03.2011  
(96) 11712214.3 30.01.2013  
(87) WO2011117283, 23.03.2011  
(97) 2550047, 30.01.2013 en  
(54) NEEDLE ASSEMBLY  
(71) Sanofi-Aventis Deutschland GmbH, Brüningstraße 50, 65929 Frankfurt, DE  
(72) CROSS, John David, 34 Station Road Long Buckby Northampton, Northamptonshire NN6 7QB, GB  
BOYD, Malcolm Stanley, 28 Whitehead Drive Wellsbourne, Warwickshire CV35 9PW, GB  
YOUNG, Alasdair George, Bakehouse Cottage 50 West Street Chipping Norton, Oxfordshire OX7 5ER, GB  
REKAYA, Naceur, 8 The Old Stone Yard 74 Rugby Road Leamington Spa, Warwickshire CV32 5DQ, GB

(51) MKP  
**C07C 61/40 (2006.01)** (97) **2552881 \***  
(86) EP2011053694 11.03.2011  
(96) 11712195.4 06.02.2013  
(87) WO2011120778, 11.03.2011  
(97) 2552881, 06.02.2013 en  
(54) NOVEL POLYMORPHS AND SALTS  
(71) Chiesi Farmaceutici S.p.A., Via Palermo, 26/A, 43100 Parma, IT  
(72) PIVETTI, Fausto, Chiesi Farmaceutici S.p.A. Via Palermo 26/A, I-43100 Parma, IT  
DELCANALE, Maurizio, Chiesi Farmaceutici S.p.A. Via Palermo 26/A, I-Parma 43100, IT  
GIAFFREDA, Stefano Luca, Chiesi Farmaceutici S.p.A. Via Palermo 26/A, I-43100 Parma, IT  
CURZI, Marco, Chiesi Farmaceutici S.p.A. Via Palermo 26/A, I-43100 Parma, IT

(51) MKP  
**B65G 67/08 (2006.01)** (97) **2508451**  
**B65G 41/00 (2006.01)**  
(96) 12163470.3 10.10.2012  
(97) 2508451, 10.10.2012 en  
(54) Cargo handling system  
(71) Precision Automation and Robotics India Ltd., Narhe Works S/ NO 38/2 Village Narhe Off Pune Sinhgad Road, Pune 411041 MAH, IN  
(72) Date, Ranjit, 38/2, Narhe, Tal - Haveli, 411 041 Pune, Maharashtra, IN  
Oza, Govind, 38/2, Narhe, Tal - Haveli, 411 041 Pune, Maharashtra, IN

(51) MKP  
**A61C 19/02 (2006.01)** (97) **2494884**  
**A45C 13/26 (2006.01)**  
(96) 12157947.8 05.09.2012  
(97) 2494884, 05.09.2012 de  
(54) Container for storing and transporting dental casts, models, etc.  
(71) Speiko - Dr. Speier GmbH, Haferlandweg 12, 48155 Münster, DE  
(72) Kreutzer, Stefan, Burgwall 6, 48165 Münster, DE

(51) MKP  
**A61K 38/46 (2006.01)** (97) **2588130 \***  
(86) US2011041924 25.06.2011  
(96) 11799035.8 08.05.2013  
(87) WO2011163648, 25.06.2011  
(97) 2588130, 08.05.2013 en  
(54) CNS DELIVERY OF THERAPEUTIC AGENTS  
(71) Shire Human Genetic Therapies, Inc., 700 Main Street, Cambridge, MA 02139, US  
(72) SHAHROKH, Zahra, 5 Terrace Road, Weston MA 02493, US  
CALIAS, Pericles, 39 Swains Pond Avenue, Melrose MA 02166, US  
MCCAULEY, Thomas, 85 Gore Street, Cambridge MA 02141, US  
POWELL, Jan., 560 Old Marlborough Road., Concord MA 01742, US  
PAN, Jing., 868 Depot Road., Boxborough, MA 01719, US  
PFEIFER, Richard., 243 Silver Street., North Granby, CT 06060, US  
CHARNAS, Lawrence., 49 Mill Street., Natick, MA 01760, US  
WRIGHT, Teresa Leah., 39 Earl Street., Lexington, MA 02142, US

(51) MKP  
**C01B 17/04 (2006.01)** (97) **2550236 \***  
(86) EP2011001058 03.03.2011  
(96) 11708404.6 30.01.2013  
(87) WO2011116876, 03.03.2011  
(97) 2550236, 30.01.2013 de  
(54) DEVICE AND METHOD FOR CONDENSING, SEPARATING, AND STORING LIQUID SULFUR IN A CLAUS PLANT  
(71) ThyssenKrupp Uhde GmbH, Friedrich-Uhde-Strasse 15, 44141 Dortmund, DE  
(72) THIELERT, Holger, Westewikstr. 38, 44379 Dortmund, DE

- (51) MKP  
**A61P 31/04 (2006.01)** (97) **2557082 \***  
**C07D 501/46 (2006.01)**  
**A61K 31/546 (2006.01)**  
**C07D 519/06 (2006.01)**
- (86) JP2011058498 04.04.2011  
(96) 11765867.4 13.02.2013  
(87) WO2011125967, 04.04.2011  
(97) 2557082, 13.02.2013 en  
(54) CEPHEM COMPOUND HAVING CATECHOL GROUP  
(71) Shionogi & Co., Ltd., 1-8, Doshomachi 3-chome Chuo-ku, Osaka-shi, Osaka 541-0045, JP  
(72) HISAKAWA, Shinya, c/o Shionogi & Co., Ltd. 1-1, Futaba-cho 3-chome, Toyonaka-shi Osaka 561-0825, JP  
HASEGAWA, Yasushi, c/o Shionogi & Co., Ltd. 1-1, Futaba-cho 3-chome, Toyonaka-shi Osaka 561-0825, JP  
AOKI, Toshiaki, c/o Shionogi & Co., Ltd. 1-1, Futaba-cho 3-chome, Toyonaka-shi Osaka 561-0825, JP  
KUSANO, Hiroki, c/o Shionogi & Co., Ltd. 1-1, Futaba-cho 3-chome, Toyonaka-shi Osaka 561-0825, JP  
SANO, Masayuki, c/o Shionogi & Co., Ltd. 1-1, Futaba-cho 3-chome, Toyonaka-shi Osaka 561-0825, JP  
SATO, Jun, c/o Shionogi & Co., Ltd. 1-1, Futaba-cho 3-chome, Toyonaka-shi Osaka 561-0825, JP  
YAMAWAKI, Kenji, c/o Shionogi & Co., Ltd. 1-1, Futaba-cho 3-chome, Toyonaka-shi Osaka 561-0825, JP
- 
- (51) MKP  
**H01R 24/62 (2011.01)** (97) **2583360 \***  
**H01R 13/6581 (2011.01)**
- (86) US2011041290 21.06.2011  
(96) 11728163.4 24.04.2013  
(87) WO2011163260, 21.06.2011  
(97) 2583360, 24.04.2013 en  
(54) EXTERNAL CONTACT PLUG CONNECTOR  
(71) Apple Inc., 1 Infinite Loop, MS 169-3IPL, Cupertino, CA 95014, US  
(72) GOLKO, Albert, J, 1 Infinite Loop, MS 305-1DR, Cupertino, CA 95014, US  
BRIGHAM, Arthur, Stanley, 1 Infinite Loop, MS 169-3IPL, Cupertino, CA 95014, US  
CHEN, Roger, 1 Infinite Loop, MS 169-3IPL, Cupertino, CA 95014, US  
YANG, Alice, 1 Infinite Loop, MS 169-3IPL, Cupertino, CA 95014, US
- 
- (51) MKP  
**B29C 41/00 (2006.01)** (97) **2593321 \***  
**B29C 41/04 (2006.01)**  
**B60K 15/03 (2006.01)**
- (86) EP2011062048 14.07.2011  
(96) 11731377.5 22.05.2013  
(87) WO2012007544, 14.07.2011  
(97) 2593321, 22.05.2013 en  
(54) TANK TO CONTAIN FUEL AND RELATIVE PRODUCTION METHOD  
(71) Polymtec Engineering AG, Mauren (FL), Succursale Di Lugano, Viale Stefano Francini 1, 6901 Lugano, CH  
(72) GÖKCEN, Mehmet Celal, Bahnhofstrasse 4a, 76137 Karlsruhe, DE
- 
- (51) MKP  
**B26B 5/00 (2006.01)** (97) **2560797 \***  
**B26B 29/06 (2006.01)**  
**B28D 1/22 (2006.01)**
- (86) IB2011051675 18.04.2011  
(96) 11720879.3 27.02.2013  
(87) WO2011132133, 18.04.2011  
(97) 2560797, 27.02.2013 fr  
(54) GUIDE FOR GUIDING THE CUTTING OF A PIECE OF PLASTERBOARD, AND KIT AND METHOD FOR THE IMPLEMENTATION THEREOF  
(71) Mallet, Benoît, 10 rue des Bas de Ferrières, 27190 Ferrieres Haut Clocher, FR  
(72) Mallet, Benoît, 10 rue des Bas de Ferrières, 27190 Ferrieres Haut Clocher, FR
- 
- (51) MKP  
**B32B 27/08 (2006.01)** (97) **2585297 \***  
**B32B 27/36 (2006.01)**  
**B65D 77/20 (2006.01)**  
**B32B 27/32 (2006.01)**
- (86) DK2011000063 16.06.2011  
(96) 11797635.7 01.05.2013  
(87) WO2011160627, 16.06.2011  
(97) 2585297, 01.05.2013 en  
(54) A SHEET, A METHOD OF MAKING AND USING A SHEET AS A LID FOR PACKAGES  
(71) Danapak Flexibles A/S, Strudsbergsvej 3, 4200 Slagelse, DK  
(72) JOHANSEN, Peter, Munkebjergvej 3, 2. sal, DK-5000 Odense C, DK
- 
- (51) MKP  
**A61B 6/06 (2006.01)** (97) **2564786**
- (96) 11462013.1 06.03.2013  
(97) 2564786, 06.03.2013 en  
(54) Method for automatic contour filter positioning for medical X-ray imaging  
(71) General Electric Company, 1 River Road, Schenectady, NY 12345, US  
(72) Ujvári, Tamás, Akron str. 2, 2040 Budaörs, HU
- 
- (51) MKP  
**A61K 31/195 (2006.01)** (97) **2569277 \***  
**C07C 229/38 (2006.01)**
- (86) EP2011057390 09.05.2011  
(96) 11720740.7 20.03.2013  
(87) WO2011141409, 09.05.2011  
(97) 2569277, 20.03.2013 de  
(54) SUBSTITUTED 8-ALKOXY-2-AMINOTETRALIN DERIVATIVES, AND USE THEREOF  
(71) Bayer Intellectual Property GmbH, Alfred-Nobel-Strasse 10, 40789 Monheim, DE  
(72) HÜBSCH, Walter, Wildsteig 22, 42113 Wuppertal, DE  
HAHN, Michael, Rietherbach 42D, 40764 Langenfeld, DE  
VAKALOPOULOS, Alexandros, Heinrich-Heine-Str. 79a, 40721 Hilden, DE  
LI, Volkhart, Min-Jian, Im Wiesengrund 40, 42553 Velbert, DE  
WUNDER, Frank, Schwarzer Weg 251, 42117 Wuppertal, DE  
STASCH, Johannes-Peter, Alfred-Nobel-Str. 109, 42651 Solingen, DE  
SCHLEMMER, Karl-Heinz, Wildsteig 22a, 42113 Wuppertal, DE  
STOLL, Friederike, Remscheid Str. 22, 40215 Düsseldorf, DE  
LINDNER, Niels, Bodelschwingweg 4, 42115 Wuppertal, DE
- 
- (51) MKP  
**A61M 5/20 (2006.01)** (97) **2585136 \***
- (86) EP2011060729 27.06.2011  
(96) 11727479.5 01.05.2013  
(87) WO2012000941, 27.06.2011  
(97) 2585136, 01.05.2013 en  
(54) NEEDLE SAFETY ARRANGEMENT AND METHOD FOR OPERATING IT  
(71) Sanofi-Aventis Deutschland GmbH, Brüningstraße 50, 65929 Frankfurt, DE  
(72) BRERETON, Simon, Francis, 75 De Freville Avenue, Cambridge Cambridgeshire CB4 1HP, GB  
EKMAN, Matthew, 59 Ecton Avenue Cheshire, Macclesfield Cheshire SK10 1RD, GB
- 
- (51) MKP  
**C08G 69/16 (2006.01)** (97) **2558517 \***  
**C08L 77/00 (2006.01)**  
**C08K 7/00 (2006.01)**  
**C08K 3/00 (2006.01)**
- (86) EP2011055760 13.04.2011  
(96) 11715209.0 20.02.2013  
(87) WO2011128352, 13.04.2011  
(97) 2558517, 20.02.2013 de  
(54) METHOD FOR PRODUCING MODIFIED POLYAMIDE 6  
(71) Wingspeed AG, Maispracherstr. 2, 4312 Magden, CH  
(72) DÜRR, Georg, Wingspeed AG Maispracherstr. 2, CH-4312 Magden, CH  
HERBST, Alexander, Wintersingerstrasse 9, CH-4312 Magden, CH



(51) MKP  
**C07F 5/02 (2006.01)** (97) **2560978 \***  
**A61K 31/155 (2006.01)**  
**A61K 31/69 (2006.01)**  
**A61K 49/00 (2006.01)**  
(86) US2011033223 20.04.2011  
(96) 11716786.6 27.02.2013  
(87) WO2011133653, 20.04.2011  
(97) 2560978, 27.02.2013 en  
(54) INHIBITORS OF ARGINASE AND THEIR THERAPEUTIC APPLICATIONS  
(71) Mars, Incorporated, 6885 Elm Street, McLean, VA 22101, US  
(72) VAN ZANDT, Michael, c/o MARS INCORPORATED 6885 Elm Street, McLean, Virginia 22101, US  
GOLEBIOWSKI, Adam, c/o MARS INCORPORATED 6885 Elm Street, McLean, Virginia 22101, US  
JI, Min, Koo, c/o MARS INCORPORATED 6885 Elm Street, McLean, Virginia 22101, US  
WHITEHOUSE, Darren, c/o MARS INCORPORATED 6885 Elm Street, McLean, Virginia 22101, US  
RYDER, Todd, c/o MARS INCORPORATED 6885 Elm Street, McLean, Virginia 22101, US  
BECKETT, Paul, c/o MARS INCORPORATED 6885 Elm Street, McLean, Virginia 22101, US

(51) MKP  
**A63F 9/00 (2006.01)** (97) **2566591 \***  
**A63F 9/08 (2006.01)**  
(86) HU2010000051 05.05.2010  
(96) 10723283.7 13.03.2013  
(87) WO2011138623, 05.05.2010  
(97) 2566591, 13.03.2013 en  
(54) SPATIAL LOGICAL AND SKILL IMPROVEMENT GAME, PARTICULARLY A LABYRINTH GAME  
(71) ART & SMART EGG KFT., Péterfia utca 25., 4026 Debrecen, HU  
(72) ZAGYVAI, Andras, Szerb utca 15., H-1056 Budapest, HU

(51) MKP  
**A61K 39/395 (2006.01)** (97) **2558497 \***  
**A61P 3/10 (2006.01)**  
**C07K 16/28 (2006.01)**  
(86) US2011032333 13.04.2011  
(96) 11715374.2 20.02.2013  
(87) WO2011130417, 13.04.2011  
(97) 2558497, 20.02.2013 en  
(54) HUMAN FGF RECEPTOR AND BETA-KLOTTHO BINDING PROTEINS  
(71) Amgen Inc., One Amgen Center Drive, Thousand Oaks, California 91320-1799, US  
(72) FACHINI, Roger, 119 Lear Circle, Thousand Oaks, California 91360-5344, US  
FOLTZ, Ian, 2108 Knightswood Place, Burnaby British Columbia V5A 4B9, CA  
HAN, Seog Joon, 2645 Fall Creek Court, Simi Valley, California 93063, US  
HARRIS, Susie Miki, 197 Los Vientos Drive, Newbury Park, California 91320, US  
HU, Shaw-Fen Sylvia, 986 Lynnmere Drive, Thousand Oaks, California 91360, US  
KING, Chadwick Terence, 1325 Moody Avenue, North Vancouver British Columbia V7L 3T5, CA  
LI, Yang, 1142 Cuesta Drive, Mountain View, California 94040, US  
LU, Ji, 1874 Brush Oak Court, Thousand Oaks, California 91320, US  
MICHAELS, Mark Leo, 5007 Texhoma Avenue, Encino, California 91316, US  
SUN, Jeonghoon, 4340 Camino De La Rosa, Thousand Oaks, California 91320, US

(51) MKP  
**A61K 39/395 (2006.01)** (97) **2563381 \***  
**A61K 38/17 (2006.01)**  
**A61K 38/16 (2006.01)**  
**A61P 35/00 (2006.01)**  
**A61P 3/00 (2006.01)**  
**A61P 29/00 (2006.01)**  
(86) US2011034205 27.04.2011  
(96) 11777982.7 06.03.2013  
(87) WO2011139799, 27.04.2011  
(97) 2563381, 06.03.2013 en  
(54) INNOVATIVE DISCOVERY OF THERAPEUTIC, DIAGNOSTIC, AND ANTIBODY COMPOSITIONS RELATED TO PROTEIN FRAGMENTS OF ISOLEUCYL TRNA SYNTHETASES  
(71) aTyr Pharma, Inc., 3545 John Hopkins Court, Suite 250, San Diego, CA 92121, US  
Pangu Biopharma Limited, Edinburgh Tower, 18/F The Landmark 15 Queen's Road Central, Hong Kong, CN  
(72) GREENE, Leslie, Ann, 13941 Davenport Avenue, San Diego, California 92129, US  
CHIANG, Kyle, P., 943 Torrance Street Apt. 6, San Diego, California 92103, US  
HONG, Fei, 7979 Caminito Dia 2, San Diego, California 92122, US  
VASSEROT, Alain, P., 6421 La Paloma Street, Carlsbad, California 92009, US  
LO, Wing-Sze, RM 815 Sui Ming House Siu Sai Wan Estate, Chai Wan Hong Kong, CN  
WATKINS, Jeffrey, D., 3442 Fortuna Ranch Road, Encinitas, California 92024, US  
MENDLEIN, John, D., 1550 Neptune Avenue, Encinitas, California 92024, US  
QUINN, Cheryl, L., 5392 Renaissance Avenue, San Diego, California 92122, US

- (51) MKP  
**A61K 31/337 (2006.01)** (97) **2562155 \***  
**A61K 31/40 (2006.01)**  
**A61K 31/415 (2006.01)**  
**A61K 31/341 (2006.01)**  
**A61K 31/4015 (2006.01)**  
**A61K 31/416 (2006.01)**  
**A61K 31/357 (2006.01)**  
**A61K 31/4035 (2006.01)**  
**A61K 31/36 (2006.01)**  
**A61K 31/404 (2006.01)**  
**C07C 259/06 (2006.01)**  
**A61K 31/381 (2006.01)**  
**A61K 31/4045 (2006.01)**  
**A61K 31/166 (2006.01)**  
**A61K 31/397 (2006.01)**  
**A61K 31/407 (2006.01)**  
**A61K 31/351 (2006.01)**  
**A61K 31/403 (2006.01)**  
**A61K 31/343 (2006.01)**  
**A61K 31/402 (2006.01)**  
(86) JP2011059737 20.04.2011  
(96) 11772045.8 27.02.2013  
(87) WO2011132712, 20.04.2011  
(97) 2562155, 27.02.2013 en  
(54) NOVEL HYDROXAMIC ACID DERIVATIVE  
(71) Taisho Pharmaceutical Co., Ltd., 24-1, Takada 3-chome  
Toshima-ku, Tokyo 170-8633, JP  
Toyama Chemical Co., Ltd., 2-5 Nishishinjuku 3-Chome,  
Shinjuku-ku Tokyo 160-0023, JP  
(72) TAKASHIMA, Hajime, c/o Taisho Pharmaceutical Co. Ltd. 24-1  
Takada 3-chome Toshima-ku, Tokyo 170-8633, JP  
TSURUTA, Risa, c/o Taisho Pharmaceutical Co. Ltd. 24-1  
Takada 3-chome Toshima-ku, Tokyo 170-8633, JP  
YABUUCHI, Tetsuya, c/o Taisho Pharmaceutical Co. Ltd. 24-1  
Takada 3-chome Toshima-ku, Tokyo 170-8633, JP  
OKA, Yusuke, c/o Taisho Pharmaceutical Co. Ltd. 24-1 Takada  
3-chome Toshima-ku, Tokyo 170-8633, JP  
URABE, Hiroki, c/o Taisho Pharmaceutical Co. Ltd. 24-1  
Takada 3-chome Toshima-ku, Tokyo 170-8633, JP  
SUGA, Yoichiro, c/o Taisho Pharmaceutical Co. Ltd. 24-1  
Takada 3-chome Toshima-ku, Tokyo 170-8633, JP  
TAKAHASHI, Masato, c/o Taisho Pharmaceutical Co. Ltd. 24-1  
Takada 3-chome Toshima-ku, Tokyo 170-8633, JP  
UNEUCHI, Fumito, c/o Taisho Pharmaceutical Co. Ltd. 24-1  
Takada 3-chome Toshima-ku, Tokyo 170-8633, JP  
KOTSUBO, Hironori, c/o Toyama Chemical Co. Ltd. Toyama  
Works 4-1 Shimookui 2-chome, Toyama-shi, Toyama 930-  
8508, JP  
SHOJI, Muneo, c/o Toyama Chemical Co. Ltd. Toyama Works  
4-1 Shimookui 2-chome, Toyama-shi, Toyama 930-8508, JP  
KAWAGUCHI, Yasuko, c/o Toyama Chemical Co. Ltd. Toyama  
Works 4-1 Shimookui 2-chome, Toyama-shi, Toyama 930-  
8508, JP

- (51) MKP  
**H02M 7/06 (2006.01)** (97) **2479880**  
**H01F 29/00 (2006.01)**  
(96) 11151910.4 25.07.2012  
(97) 2479880, 25.07.2012 de  
(54) Power supply assembly for rectification  
(71) AEG Power Solutions B.V., Weerenweg 10, 1161 AH  
Zwanenburg, NL  
(72) Wallmeier, Dr. Peter, Tilsiter Straße 59, 59556 Lippstadt, DE  
Düppe Gregor, Beethovenstraße 13, 59581 Warstein, DE  
Malberg, Paul, Uhländstrasse 23, 59609 Anröchte, DE

- (51) MKP  
**A61F 13/15 (2006.01)** (97) **2548540**  
**B26D 7/18 (2006.01)**  
(96) 12176967.3 23.01.2013  
(97) 2548540, 23.01.2013 en  
(54) Differential speed shafted machines and uses therefor,  
including discontinuous and continuous side by side bonding  
(71) Curt G. Joa, Inc., 100 Crocker Avenue, Sheboygan Falls,  
Wisconsin 53085, US  
(72) McCabe, John A, 1141 Partridge Run, Sheboygan Falls., WI  
Wisconsin 53085, US  
Andrews, Robert E, N7488 Sunset Circle Drive, Sheboygan.,  
WI Wisconsin 53083, US

- (51) MKP  
**C12M 1/107 (2006.01)** (97) **2361673**  
**F16M 11/00 (2006.01)**  
**B01F 15/00 (2006.01)**  
**B01F 7/00 (2006.01)**  
**A01C 3/02 (2006.01)**  
(96) 11154905.1 31.08.2011  
(97) 2361673, 31.08.2011 de  
(54) Apparatus  
(71) Thürwächter GmbH & Co.KG, Martinszeller Strasse 21, 87477  
Sulzberg, DE  
(72) Thürwächter, Paul, Thürwächter GmbH&Co.KG Martinszeller  
Straße 21, 87477, Sulzberg, DE

- (51) MKP  
**C07D 405/14 (2006.01)** (97) **2588467 \***  
**C07D 401/12 (2006.01)**  
**C07D 401/14 (2006.01)**  
**C07D 413/14 (2006.01)**  
(86) US2011042525 30.06.2011  
(96) 11730534.2 08.05.2013  
(87) WO2012003274, 30.06.2011  
(97) 2588467, 08.05.2013 en  
(54) HETEROCYCLIC COMPOUNDS AND THEIR USE AS  
INHIBITORS OF PI3K ACTIVITY  
(71) Amgen Inc., One Amgen Center Drive, Thousand Oaks,  
California 91320-1799, US  
(72) BUI, Minna Hue Thanh, 2445 25th Avenue, Oakland, California  
94601, US  
FISHER, Benjamin, 1020 Yates Way 313, San Mateo,  
California 94403, US  
HAO, Xiaolin, 637 Sandy Hook Court, Foster City, California  
94404, US  
LUCAS, Brian, 133 10th Avenue, San Francisco, California  
94118, US

- (51) MKP  
**A61K 31/41 (2006.01)** (97) **2556059 \***  
**C07D 257/04 (2006.01)**  
(86) EP2011055451 07.04.2011  
(96) 11712864.5 13.02.2013  
(87) WO2011124655, 07.04.2011  
(97) 2556059, 13.02.2013 en  
(54) IMPROVED PROCESS FOR PREPARING VALSARTAN  
(71) KRKA, d.d., Novo mesto, Smarjeska cesta 6, 8501 Novo  
mesto, SI  
(72) ZUPANCIC, Silvo, Zupnca 4b, 8000 Novo mesto, SI

- (51) MKP  
**B05D 5/08 (2006.01)** (97) **2579996 \***  
**B05D 7/02 (2006.01)**  
**B05D 7/24 (2006.01)**  
(86) US2011036097 11.05.2011  
(96) 11731554.9 17.04.2013  
(87) WO2011143329, 11.05.2011  
(97) 2579996, 17.04.2013 en  
(54) LUBRICITY VESSEL COATING, COATING PROCESS AND  
APPARATUS  
(71) SiO2 Medical Products, Inc., 2250 Riley Street, Auburn, AL  
36832, US  
(72) FELTS, John, T., 2624 Calhoun Street, Alameda California  
94501, US  
FISK, Thomas, E., 955 North Night Heron Drive, Green Valley  
Arizona 85614, US  
ABRAMS, Robert, S., 21 Marian Avenue, Albany New York  
12203, US  
FERGUSON, John, 797 Greenwood Drive, Auburn Alabama  
36832, US  
FREEDMAN, Jonathan, R., 2213 Brenton Lane, Auburn  
Alabama 36830, US  
PANGBORN, Robert, J., 2215 North Lakeshore Drive, Harbor  
Springs Michigan 49740, US  
SAGONA, Peter, J., 161 Ridgeview Drive, Pottstown  
Pennsylvania 19465, US

(51) MKP  
**A61L 27/60 (2006.01)** (97) **2575908 \***  
**A61L 27/44 (2006.01)**  
**A61L 27/04 (2006.01)**  
**A61K 47/48 (2006.01)**  
**A61L 27/24 (2006.01)**  
(86) US2011039497 07.06.2011  
(96) 11730136.6 10.04.2013  
(87) WO2011156410, 07.06.2011  
(97) 2575908, 10.04.2013 en  
(54) CONJUGATED POLYMERIC MATERIAL AND USES THEREOF  
(71) The Curators Of The University Of Missouri, 615 Locust Street Building 3rd Floor, Columbia, MO 65211, US  
(72) HARRIS, Anthony, c/o The Curators Of The University Of Missouri 615 Locust St. Bldg., 3rd Floor, Columbia, MO 65211, US  
THOMPSON, Jonathan, c/o The Curators Of The University Of Missouri 615 Locust St. Bldg., 3rd Floor, Columbia, MO 65211, US  
RONE, Rebecca, c/o The Curators Of The University Of Missouri 615 Locust St. Bldg., 3rd Floor, Columbia, MO 65211, US  
GRANT, Sheila, c/o The Curators Of The University Of Missouri 615 Locust St. Bldg., 3rd Floor, Columbia, MO 65211, US  
GRANT, David, c/o The Curators Of The University Of Missouri 615 Locust St. Bldg., 3rd Floor, Columbia, MO 65211, US

---

(51) MKP  
**A61K 39/09 (2006.01)** (97) **2544710 \***  
**A61P 43/00 (2006.01)**  
**A61K 39/385 (2006.01)**  
(86) EP2010061963 17.08.2010  
(96) 10742846.8 16.01.2013  
(87) WO2011110241, 17.08.2010  
(97) 2544710, 16.01.2013 en  
(54) IMMUNOGENIC COMPOSITION COMPRISING S. PNEUMONIAE POLYSACCHARIDES CONJUGATED TO CARRIER PROTEINS  
(71) GlaxoSmithKline Biologicals S.A., rue de l'Institut, 89, 1330 Rixensart, BE  
(72) BIEMANS, Ralph Leon, GlaxoSmithKline Biologicals s.a. Rue de l'Institut 89, B-1330 Rixensart, BE  
DUVIVIER, Pierre, GlaxoSmithKline Biologicals s.a. Rue de l'Institut 89, B-1330 Rixensart, BE  
GAVARD, Ollivier Francis Nicolas, GlaxoSmithKline Biologicals s.a. Rue de l'Institut 89, B-1330 Rixensart, BE  
POOLMAN, Jan, GlaxoSmithKline Biologicals s.a. Rue de l'Institut 89, B-1330 Rixensart, BE

---

(51) MKP  
**B23Q 1/76 (2006.01)** (97) **2433742**  
**B23Q 1/38 (2006.01)**  
(86) 11182319.1 28.03.2012  
(97) 2433742, 28.03.2012 de  
(54) Rest for hydrostatically supporting a workpiece of a machine tool  
(71) WFL Millturn Technologies GmbH & Co. KG, Wahingerstrasse 36, 4030 Linz, AT  
(72) Wimmer, Karl, Höhenstraße 26, 4048 Puchenu, AT  
Dr. Pernkopf, Friedrich, Emil-Futter-Straße 4/1, 4040 Linz, AT

---

(51) MKP  
**G06Q 10/00 (2012.01)** (97) **2455895**  
(86) 10191615.3 23.05.2012  
(97) 2455895, 23.05.2012 en  
(54) A device for supporting a user in selecting clothes  
(71) DNA Interactif Fashion, 't Hoge 49, 8500 Kortrijk, BE  
(72) Fijen, Huub, DNA Interactif Fashion 't Hoge 49, 8500 KORTRIJK, BE

(51) MKP  
**A01N 25/04 (2006.01)** (97) **2563115 \***  
(86) US2011033837 26.04.2011  
(96) 11718836.7 06.03.2013  
(87) WO2011139647, 26.04.2011  
(97) 2563115, 06.03.2013 en  
(54) STABILIZED AGRICULTURAL OIL DISPERSIONS  
(71) Dow AgroSciences, LLC, 9330 Zionsville Road, Indianapolis, IN 46268, US  
(72) WU, Dan, 498 Arbor Drive, Carmel, Indiana 46032, US  
QIN, Kuide, 13179 Lamana Place, Westfield, IN 46074, US  
KEENEY, Franklin, 12304 Windsor Drive, Carmel, IN 46033, US  
Ll. Mei, 13679 Cunningham Drive, Westfield, IN 46074, US

---

(51) MKP  
**A41C 3/12 (2006.01)** (97) **2568847 \***  
**A44C 25/00 (2006.01)**  
(86) US2011036107 11.05.2011  
(96) 11781221.4 20.03.2013  
(87) WO2011143336, 11.05.2011  
(97) 2568847, 20.03.2013 en  
(54) GARMENT AND BRASSIERE ACCESSORY  
(71) De Sousa, Michelle E., 16101 Parque Lane, Naples, FL 34110, US  
De Sousa, Jose De Jesus, 16101 Parque Lane, Naples, FL 34110, US  
(72) De Sousa, Michelle E., 16101 Parque Lane, Naples, FL 34110, US  
De Sousa, Jose De Jesus, 16101 Parque Lane, Naples, FL 34110, US

---

(51) MKP  
**F28D 15/00 (2006.01)** (97) **2577210 \***  
**H01L 23/34 (2006.01)**  
(86) US2011037369 20.05.2011  
(96) 11722698.5 10.04.2013  
(87) WO2011149780, 20.05.2011  
(97) 2577210, 10.04.2013 en  
(54) HEAT AND ENERGY EXCHANGE  
(71) Forced Physics Llc, 8001 Irvine Center Ste 400, Irvine, California 92618, US  
(72) DAVIS, Scott, 1734 Seagull Court 305, Reston Virginia 20194, US

---

(51) MKP  
**A61P 25/28 (2006.01)** (97) **2588198 \***  
**A61K 31/4415 (2006.01)**  
**A61K 31/519 (2006.01)**  
**A61K 31/714 (2006.01)**  
(86) GB2010051557 17.09.2010  
(96) 10755230.9 08.05.2013  
(87) WO2012001336, 17.09.2010  
(97) 2588198, 08.05.2013 en  
(54) TREATMENT OF COGNITIVE DISORDERS  
(71) Isis Innovation Limited, Ewert House Ewert Place Summertown, Oxford, Oxfordshire OX2 7SG, GB  
(72) SMITH, Anthony David, Department of Pharmacology Mansfield Road, Oxford Oxfordshire OX1 3QT, GB  
REFSUM, Helga Margareta, University of Oxford Department of Physiology Anatomy&Genetics Le Gros Clark Building, Oxford Oxfordshire OX13QX, GB

---

(51) MKP  
**B23Q 1/76 (2006.01)** (97) **2415557**  
**B24B 41/06 (2012.01)**  
(86) 11176496.5 08.02.2012  
(97) 2415557, 08.02.2012 de  
(54) Device and method for reducing deviations in shape and/or position, in particular the run out of a workpiece  
(71) WFL Millturn Technologies GmbH & Co. KG, Wahingerstrasse 36, 4030 Linz, AT  
(72) Wimmer, Karl, Höhenstraße 26, 4048 Puchenu, AT

- (51) MKP  
**A61K 31/47 (2006.01)** (97) **2542078 \***  
**A01N 43/42 (2006.01)**  
(86) US2011026879 02.03.2011  
(96) 11751295.4 09.01.2013  
(87) WO2011109526, 02.03.2011  
(97) 2542078, 09.01.2013 en  
(54) TREATMENT OF LUPUS NEPHRITIS USING LAQUINIMOD  
(71) Teva Pharmaceutical Industries Ltd., 5 Basel Street P.O. Box 3190, 49131 Petach-Tikva, IL  
(72) HAVIV, Asi, Kvut Shiller(gan Shlomo), 76802, IL  
**TARCIC. Nora, Migdal David 29/1. Modiin. IL**

- (51) MKP  
**A61P 37/00 (2006.01)** (97) **2558474 \***  
**A61P 29/00 (2006.01)**  
**A61K 31/5383 (2006.01)**  
**C07D 498/04 (2006.01)**  
(86) US2011032291 13.04.2011  
(96) 11730116.8 20.02.2013  
(87) WO2011130390, 13.04.2011  
(97) 2558474, 20.02.2013 en  
(54) 2, 4-PYRIMIDINEDIAMINE COMPOUNDS AND PRODRUGS THEREOF AND THEIR USES  
(71) Rigel Pharmaceuticals, Inc., 1180 Veterans Boulevard, South San Francisco, CA 94080, US  
(72) YU, Jiaxin, 628 Chestnut Street, San Carlos CA 94070, US  
**CLOUGH, Jeffrey, 3520 Bay Road, Redwood City CA 94063, US**  
**SINGH, Rajinder, 1832 Hillman Avenue, Belmont CA 94002, US**

- (51) MKP  
**A47F 5/13 (2006.01)** (97) **2579747 \***  
(86) EP2011002841 09.06.2011  
(96) 11733992.9 17.04.2013  
(87) WO2011154145, 09.06.2011  
(97) 2579747, 17.04.2013 de  
(54) SALES TABLE  
(71) Tegometall International AG, Industriestrasse, 8574 Lengwil, CH  
(72) BOHNACKER, Ulrich, Am Herrensberg 5, CH-8559 Fruthwilen, CH

- (51) MKP  
**A61P 25/24 (2006.01)** (97) **2547649 \***  
**A61K 31/165 (2006.01)**  
**C07C 231/12 (2006.01)**  
**C07C 233/18 (2006.01)**  
(86) CN2011071910 17.03.2011  
(96) 11755679.5 23.01.2013  
(87) WO2011113362, 17.03.2011  
(97) 2547649, 23.01.2013 en  
(54) AGOMELATINE HYDROCHLORIDE HYDRATE AND PREPARATION THEREOF  
(71) Les Laboratoires Servier, 35, rue de Verdun, 92284 Suresnes Cedex, FR  
(72) SHAN, Hanbin, No. 24, Dongfangxincun Gaoan, Jiangxi 330800, CN  
**YUAN, Zhedong, Room 201, No. 14, Lane 58 Aomen Road, Shanghai 200060, CN**  
**ZHU, Xueyan, Room 602, No. 78, Lane 283 Yangcheng Road, Zhabei District, Shanghai 200436, CN**  
**ZHANG, Peng, No. 826, Zhangheng Road Pudong New Area, Shanghai 201203, CN**  
**PAN, Hongjuan, Room 801, No. 21, Lane 150 Qingshan Road, Minhang District, Shanghai 201103, CN**  
**YU, Xiong, Room 107, No. 32, Duolun Road Hongkou District, Shanghai 200081, CN**

- (51) MKP  
**B61D 19/02 (2006.01)** (97) **2558344 \***  
**E05F 15/18 (2006.01)**  
**E05D 15/06 (2006.01)**  
(86) US2011025221 17.02.2011  
(96) 11769231.9 20.02.2013  
(87) WO2011129918, 17.02.2011  
(97) 2558344, 20.02.2013 en  
(54) MAGNETIC-ASSISTED LINEAR BEARING  
(71) Ricon Corp., 7900 Nelson Road, Panorama City, CA 91402, US  
(72) EVANS, Simon, 58 Washford Road, Hilton Derbyshire DE65 5HN, GB

- (51) MKP  
**A61M 35/00 (2006.01)** (97) **2579831 \***  
**A61B 19/02 (2006.01)**  
**A61J 1/05 (2006.01)**  
(86) US2011036265 12.05.2011  
(96) 11792843.2 17.04.2013  
(87) WO2011156082, 12.05.2011  
(97) 2579831, 17.04.2013 en  
(54) DISPENSER AND METHODS OF USE  
(71) Fern Innovations IP, LLC, 15960 Barnstomer Court, Wellington, FL 33414, US  
(72) FERN, Steven, J, 15960 Barnstomer Court, Wellington, FL 33414, US

- (51) MKP  
**C07J 19/00 (2006.01)** (97) **2563803 \***  
**A61K 31/585 (2006.01)**  
**C07J 71/00 (2006.01)**  
**A61P 35/00 (2006.01)**  
(86) EP2011056566 26.04.2011  
(96) 11716407.9 06.03.2013  
(87) WO2011134954, 26.04.2011  
(97) 2563803, 06.03.2013 en  
(54) ANTICANCER STEROIDAL LACTONES UNSATURATED IN POSITION 7 (8)  
(71) Pharma Mar S.A., Avda. de los Reyes, 1 Polígono Industrial La Mina-Norte, 28770 Colmenar Viejo Madrid, ES  
(72) FERNÁNDEZ RODRÍGUEZ, Rogelio, Pharma Mar S.A. Avda. de los Reyes 1. Polígono Industrial La Mina-Norte, E-28770 Colmenar Viejo - Madrid, ES  
**REYES BENÍTEZ, José Fernando, Pharma Mar S.A. Avda. de los Reyes 1. Polígono Industrial La Mina-Norte, E-28770 Colmenar Viejo - Madrid, ES**  
**FRANCESCH SOLLOSO, Andrés, Pharma Mar S.A. Avda. de los Reyes 1. Polígono Industrial La Mina-Norte, E-28770 Colmenar Viejo - Madrid, ES**  
**CUEVAS MARCHANTE, María del Carmen, Pharma Mar S.A. Avda. de los Reyes 1. Polígono Industrial La Mina-Norte, E-28770 Colmenar Viejo - Madrid, ES**

- (51) MKP  
**A61K 31/553 (2006.01)** (97) **2571503 \***  
**A61K 31/555 (2006.01)**  
(86) US2011036701 16.05.2011  
(96) 11781422.8 27.03.2013  
(87) WO2011143669, 16.05.2011  
(97) 2571503, 27.03.2013 en  
(54) COMPOSITIONS AND METHODS FOR TREATING NEOPLASIA, INFLAMMATORY DISEASE AND OTHER DISORDERS  
(71) Dana-Farber Cancer Institute, Inc., 450 Brookline Avenue, Boston, MA 02215, US  
(72) BRADNER, James, Elliott, 9 Rollins Court, Cambridge, MA 02139, US  
**QI, Jun, 54 Linden Street Apt. 1, Malden, MA 02148, US**

(51) MKP  
**C07D 487/04 (2006.01)** (97) **2576558 \***  
 (86) US2011037633 24.05.2011  
 (96) 11724855.9 10.04.2013  
 (87) WO2011149861, 24.05.2011  
 (97) 2576558, 10.04.2013 en  
 (54) PROCESS FOR THE PREPARATION OF 5-SUBSTITUTED-8-  
 ALKOXY[1,2,4]TRIAZOLO[1,5-C]PYRIMIDIN-2-AMINES  
 (71) Dow AgroSciences LLC, 9330 Zionsville Road, Indianapolis, IN 46268,  
 US  
 (72) BOTT, Craig, 2787 E. Elm Rd., Clare, MI 48617, US  
 HAMILTON, Christopher, 3708 East Acorn Lane, Midland, MI 48642,  
 US  
 ROTH, Gary, 1250 East Stewart Road, Midland, MI 48640, US

(51) MKP  
**F02D 41/22 (2006.01)** (97) **2556231 \***  
 (86) EP2011055506 08.04.2011  
 (96) 11714521.9 13.02.2013  
 (87) WO2011124680, 08.04.2011  
 (97) 2556231, 13.02.2013 en  
 (54) DIAGNOSIS DEVICE AND METHOD USING AN IN-  
 CYLINDER PRESSURE SENSOR IN AN INTERNAL  
 COMBUSTION ENGINE  
 (71) Delphi Technologies Holding S.à.r.l., Avenue de Luxembourg,  
 4940 Bascharage, LU  
 (72) GUERRASSI, Noureddine, 14 Haute Rue, F-41350 Vineuil, FR  
 ALLEZY, Pierre, 42 Rue Du Chateau, F-41370 Talcy, FR

(51) MKP  
**A47K 10/36 (2006.01)** (97) **2560536 \***  
 (86) AT2011000201 21.04.2011  
 (96) 11722709.0 27.02.2013  
 (87) WO2011130767, 21.04.2011  
 (97) 2560536, 27.02.2013 de  
 (54) PAPER DISPENSER  
 (71) Hagleitner, Hans Georg, Lindenallee 11, 5700 Zell am See, AT  
 (72) Hagleitner, Hans Georg, Lindenallee 11, 5700 Zell am See, AT

(51) MKP  
**A61K 31/555 (2006.01)** (97) **2582369 \***  
**A61K 31/282 (2006.01)**  
**A61K 33/24 (2006.01)**  
**A61K 31/337 (2006.01)**  
**A61K 45/06 (2006.01)**  
**A61K 31/167 (2006.01)**  
**A61P 35/00 (2006.01)**  
 (86) IB2011052628 16.06.2011  
 (96) 11738298.6 24.04.2013  
 (87) WO2011158206, 16.06.2011  
 (97) 2582369, 24.04.2013 en  
 (54) AN ANTITUMORAL COMBINATION COMPRISING  
 OMBRABULIN, A TAXANE DERIVATIVE AND A PLATINUM  
 DERIVATIVE  
 (71) SANOFI, 54, rue de la Boétie, 75008 Paris, FR  
 (72) COHEN, Patrick, c/o Sanofi Patent Department 174 avenue de  
 France, F-75013 Paris, FR  
 OPREA, Ileana Corina, c/o Sanofi Patent Department 174  
 avenue de France, F-75013 Paris, FR

(51) MKP  
**A61K 31/7076 (2006.01)** (97) **2552931 \***  
**A61K 31/7072 (2006.01)**  
**C07F 9/6558 (2006.01)**  
**C07H 19/044 (2006.01)**  
**C07F 9/655 (2006.01)**  
**C07H 19/04 (2006.01)**  
**A61P 31/14 (2006.01)**  
**A61K 31/664 (2006.01)**  
**C07H 19/10 (2006.01)**  
**C07H 19/06 (2006.01)**  
**C07F 9/24 (2006.01)**  
**C07F 7/18 (2006.01)**  
**C07H 19/24 (2006.01)**  
**C07F 9/6561 (2006.01)**  
**C07H 19/052 (2006.01)**  
 (86) US2011030762 31.03.2011  
 (96) 11714466.7 06.02.2013  
 (87) WO2011123668, 31.03.2011  
 (97) 2552931, 06.02.2013 en  
 (54) STEREOSELECTIVE SYNTHESIS OF PHOSPHORUS  
 CONTAINING ACTIVES  
 (71) Gilead Pharmasset LLC, Gilead Sciences, Inc. 333 Lakeside  
 Drive, Foster City, CA 94404, US  
 (72) ROSS, Bruce, S., 8 Keppel Road, Plainsboro, NJ 08536, US  
 SOFIA, Michael, Joseph, 3066 Antler Drive, Doylestown, PA  
 18901, US  
 PAMULAPATI, Ganapati, Reddy, 4608 Hunters Glen Drive,  
 Plainsboro, NJ 08536, GB  
 RACHAKONDA, Suguna, 1272 Sharonbrook Drive, Twinsburg,  
 OH 44087, US  
 ZHANG, Hai-Ren, 8680 Manahan Drive, Ellicott City, MD  
 21043, US

(51) MKP  
**A61K 47/30 (2006.01)** (97) **2544689 \***  
**A61K 9/20 (2006.01)**  
**A61K 31/498 (2006.01)**  
**A61K 31/4965 (2006.01)**  
**A61K 31/395 (2006.01)**  
**A61P 31/14 (2006.01)**  
 (86) US2011027511 08.03.2011  
 (96) 11753907.2 16.01.2013  
 (87) WO2011112558, 08.03.2011  
 (97) 2544689, 16.01.2013 en  
 (54) SOLID COMPOSITIONS  
 (71) Abbott Laboratories, Department 032G/AP6A-1 100 Abbott  
 Park Road, Abbott Park, Illinois 60064-6008, US  
 (72) LIEPOLD, Bernd, Birkenweg 44, 29221 Dossenheim, DE  
 ROSENBLATT, Karin, Eichelbergstrasse 17, 68163 Mannheim,  
 DE  
 HÖLIG, Peter, Hopfengarten 11, 63607 Waechtersbach, DE  
 GOKHALE, Rajeev, 2250 Hanlong Road, Libertyville IL 60048,  
 US  
 PRASAD, Leena, 2309 W 21st Street Unit 2, Chicago IL  
 60608, US  
 MILLER, Jonathan, 1228 Meade Drive, Lindenhurst IL 60046,  
 US  
 SCHMITT, Eric, A., 319 Evergreen Court, Libertyville IL 60048,  
 US  
 MORRIS, John, B., 1451 Churchill Lane, Grayslake IL 60030,  
 US

(51) MKP  
**A01H 5/10 (2006.01)** (97) **2542048 \***  
 (86) US2011027035 03.03.2011  
 (96) 11751362.2 09.01.2013  
 (87) WO2011109624, 03.03.2011  
 (97) 2542048, 09.01.2013 en  
 (54) ULTRA-LOW TRYPSIN INHIBITOR SOYBEAN  
 (71) Schillinger Genetics, Inc., 4401 Westown Parkway Uite 225,  
 West Des Moines, IA 50266, US  
 (72) SCHILLINGER, John A., 34469 Maffitt Lake Road, Cumming  
 Iowa 50061, US

- (51) MKP  
**A61M 5/315 (2006.01)** (97) **2552519 \***  
 (86) EP2011054986 31.03.2011  
 (96) 11711562.6 06.02.2013  
 (87) WO2011121061, 31.03.2011  
 (97) 2552519, 06.02.2013 en  
 (54) PISTON ROD ASSEMBLY FOR A DRUG DELIVERY DEVICE  
 (71) Sanofi-Aventis Deutschland GmbH, Brüningstraße 50, 65929 Frankfurt, DE  
 (72) HELMER, Michael, c/o Sanofi-Aventis Deutschland GmbH, 65926 Frankfurt am Main, DE  
 EISENGARTHEN, Christoph, Wörrstädter Str. 5, 55278 Dexheim, DE  
 HUTHMACHER, Winfried, Valentin-Senger-Str. 19, 60389 Frankfurt, DE  
 MOSEBACH, Carsten, Frauenlobstraße 11, 55118 Mainz, DE  
 ZEIMETZ, Leo, Amselweg 4, 64572 Büttelborn, DE

- (51) MKP  
**A01N 33/02 (2006.01)** (97) **2568806 \***  
 (86) US2011036311 12.05.2011  
 (96) 11781299.0 20.03.2013  
 (87) WO2011143469, 12.05.2011  
 (97) 2568806, 20.03.2013 en  
 (54) THERAPEUTIC REGIMENS  
 (71) Radius Health, Inc., 201 Broadway, 6th Floor, Cambridge, MA 02139, US  
 (72) O'DEA, Louis, 566 Main Street, Hingham MA 02043-3127, US  
 LYTTLE, C., Richard, 120 Edgehill Road, Bala Cynwyd PA 19004, US  
 GUERRIERO, Jonathan, 399 Pond Street, Braintree MA 02184, US

- (51) MKP  
**C07C 405/00 (2006.01)** (97) **2495235**  
**C07D 307/935 (2006.01)**  
 (96) 11157027.1 05.09.2012  
 (97) 2495235, 05.09.2012 en  
 (54) Process for the synthesis of prostaglandins and intermediates thereof  
 (71) Newchem S.p.A., Via De Amicis, 47, 20123 Milano, IT  
 Mariani, Edoardo, c/o NEWCHEM S.p.A. Via De Amicis, 47, 20123 Milano, IT  
 Orru', Gianmauro, c/o NEWCHEM S.p.A. Via De Amicis, 47, 20123 Milano, IT  
 Montorsi, Mauro, c/o NEWCHEM S.p.A. Via De Amicis, 47, 20123 Milano, IT  
 Andrioli, Erika, c/o NEWCHEM S.p.A. Via De Amicis, 47, 20123 Milano, IT  
 Bandini, Marco, c/o UNIVERSITA' DI BOLOGNA Via Zamboni, 33, 40126 Bologna, IT  
 Contento, Michele, c/o UNIVERSITA' DI BOLOGNA Via Zamboni, 33, 40126 Bologna, IT  
 Tolomelli, Alessandra, c/o UNIVERSITA' DI BOLOGNA Via Zamboni, 33, 40126 Bologna, IT

- (51) MKP  
**C07K 19/00 (2006.01)** (97) **2591006 \***  
**A61K 47/42 (2006.01)**  
**C07K 16/46 (2006.01)**  
 (86) US2011043599 11.07.2011  
 (96) 11738539.3 15.05.2013  
 (87) WO2012006635, 11.07.2011  
 (97) 2591006, 15.05.2013 en  
 (54) PROCESSABLE SINGLE CHAIN MOLECULES AND POLYPEPTIDES MADE USING SAME  
 (71) BIOGEN IDEC HEMOPHILIA INC., 9 Fourth Avenue, Waltham, MA 02451, US  
 (72) SALAS, Joe, 9 D'Angelo Road, Wayland MA 01778, US  
 PETERS, Robert, 51 Newfield Street, West Roxbury MA 02132, US

- (51) MKP  
**G01N 33/68 (2006.01)** (97) **2545384 \***  
 (86) EP2011001167 09.03.2011  
 (96) 11707354.4 16.01.2013  
 (87) WO2011110341, 09.03.2011  
 (97) 2545384, 16.01.2013 en  
 (54) METHOD FOR DETERMINING THE CONCENTRATION OF A PEPTIDE  
 (71) JPT Peptide Technologies GmbH, Volmerstrasse (UTZ) 5, 12489 Berlin, DE  
 (72) ZERWECK, Johannes, Dahmestrasse 93, 12526 Berlin, DE  
 SCHUTKOWSKI, Mike, Am Glockenstuhl 27, 06268 Querfurt, DE  
 WENSCHUH, Holger, Glasbergerstrasse 29, 12555 Berlin, DE

- (51) MKP  
**C02F 1/00 (2006.01)** (97) **2465822**  
**C02F 1/52 (2006.01)**  
 (96) 11193156.4 20.06.2012  
 (97) 2465822, 20.06.2012 de  
 (54) Separator to separate fat from water and method for separating fat from water  
 (71) ACO Severin Ahlmann GmbH & Co. KG, Am Ahlmannkai, 24768 Rendsburg, DE  
 (72) Dr. Paluchowski, Dariusz, Kirchplatz 2, 36404 Vacha, DE  
 Brinkhoff, Alexander, Am Ofenstein 33, 99187 Eisenach, DE  
 Fulenstein, Marco, Breitenstraße 19, 36251 Bad Hersfeld, DE

- (51) MKP  
**B05B 7/04 (2006.01)** (97) **2554273**  
 (96) 11176306.6 06.02.2013  
 (97) 2554273, 06.02.2013 en  
 (54) Atomizing nozzle device and use of the same  
 (71) Omya Development AG, Baslerstrasse 42, 4665 Oftringen, CH  
 (72) Saunders, George, 1946 Forest Dale Rd., Brandon, VT Vermont 05733, US  
 Kittredge, Ryan, 718 Shady Hollow Lane, Milford, OH Ohio 45150, US

- (51) MKP  
**A01N 43/42 (2006.01)** (97) **2560491 \***  
**A61K 31/44 (2006.01)**  
 (86) US2011031844 08.04.2011  
 (96) 11772435.1 27.02.2013  
 (87) WO2011133346, 08.04.2011  
 (97) 2560491, 27.02.2013 en  
 (54) PERIPHERAL OPIOID AGONISTS AND PERIPHERAL OPIOID ANTAGONISTS  
 (71) Signature Therapeutics, Inc., 75 Shoreway Road, Suite D, San Carlos, CA 94070, US  
 (72) JENKINS, Thomas, E., 75 Shoreway Road Suite D, San Carlos, California 94070, US  
 HUSFELD, Craig, O., 75 Shoreway Road Suite D, San Carlos, California 94070, US

- (51) MKP  
**A61K 8/26 (2006.01)** (97) **2552384 \***  
**A61K 8/24 (2006.01)**  
**A61Q 11/00 (2006.01)**  
 (86) EP2011054770 29.03.2011  
 (96) 11712227.5 06.02.2013  
 (87) WO2011120943, 29.03.2011  
 (97) 2552384, 06.02.2013 en  
 (54) NOVEL COMPOSITION  
 (71) Glaxo Group Limited, Glaxo Wellcome House Berkeley Avenue Greenford, Middlesex UB6 0NN, GB  
 (72) LIPPERT, Frank, c/o GlaxoSmithKline St. George's Avenue, Weybridge Surrey KT13 0DE, GB  
 LUCAS, Robert, Anthony, GlaxoSmithKline St. George's Avenue, Weybridge Surrey KT13 0DE, GB

(51) MKP  
**B65D 5/24 (2006.01)** (97) **2559627**  
**B65D 5/20 (2006.01)**  
(96) 12180944.6 20.02.2013  
(97) 2559627, 20.02.2013 de  
(54) Folding carton or the like, blank for forming a folding carton and process for erecting the folding carton  
(71) Van Genechten Packaging N.V., Raadsheerenstraat 2, 2300 Turnhout, BE  
(72) Rampott, Walter, Buchenberger Weg 18, 87439 Kempten, DE  
Rädler, Christiane, Steufzgerstraße 23, 87435 Kempten, DE  
de Winter, Hannes, Sniederspad 27, 2980 Halle-Zoersel, BE

(51) MKP  
**H01R 4/58 (2006.01)** (97) **2583356 \***  
(86) US2011041127 20.06.2011  
(96) 11796594.7 24.04.2013  
(87) WO2011160138, 20.06.2011  
(97) 2583356, 24.04.2013 en  
(54) DUAL ORIENTATION CONNECTOR WITH SIDE CONTACTS  
(71) Apple Inc., 1 Infinite Loop, MS 169-3IPL, Cupertino, CA 95014, US  
(72) SCHMIDT, Mathias, 1 Infniti Loop, MS 305-1DR, Cupertino, CA 95014, US  
GOLKO, Albert, J., 1 Infniti Loop, MS 305-1DR, Cupertino, CA 95014, US  
JOL, Eric, 1 Infniti Loop, MS 305-1PH, Cupertino, CA 95014, US

(51) MKP  
**A61P 29/00 (2006.01)** (97) **2590974 \***  
**C07D 471/04 (2006.01)**  
**A61K 31/517 (2006.01)**  
(86) EP2011061393 06.07.2011  
(96) 11730637.3 15.05.2013  
(87) WO2012004299, 06.07.2011  
(97) 2590974, 15.05.2013 en  
(54) TETRAHYDRO-PYRIDO-PYRIMIDINE DERIVATIVES  
(71) Novartis AG, Lichtstrasse 35, 4056 Basel, CH  
(72) COOKE, Nigel Graham, Novartis Pharma AG Postfach, CH-4002 Basel, CH  
FERNANDES GOMES DOS SANTOS, Paulo, Novartis Pharma AG Werk Klybeck Postfach, CH-4002 Basel, CH  
GRAVELEAU, Nadege, Novartis Pharma AG Postfach, CH-4002 Basel, CH  
HEBACH, Christina, Novartis Pharma AG Postfach, CH-4002 Basel, CH  
HÖGENAUER, Klemens, Novartis Pharma AG Postfach, CH-4002 Basel, CH  
HOLLINGWORTH, Gregory, Novartis Pharmaceuticals UK Limited Horsham Research Centre Wimbleshurst Road, Horsham Sussex RH12 5AB, GB  
SMITH, Alexander Baxter, Novartis Pharma AG Postfach, CH-4002 Basel, CH  
SOLDERMANN, Nicolas, Novartis Pharma AG Werk Klybeck Postfach, CH-4002 Basel, CH  
STOWASSER, Frank, Novartis Pharma AG Postfach, CH-4002 Basel, CH  
STRANG, Ross, Novartis Pharma AG Postfach, CH-4002 Basel, CH  
TUFILLI, Nicola, Novartis Pharma AG Postfach, CH-4002 Basel, CH  
VON MATT, Anette, Novartis Pharma AG Postfach, CH-4002 Basel, CH  
WOLF, Romain, Novartis Pharma AG Postfach, CH-4002 Basel, CH  
ZECRI, Frédéric, Novartis Institutes for BioMedical Research Inc. 100 Technology Square, Cambridge Massachusetts 02139, US

(51) MKP  
**A61M 5/24 (2006.01)** (97) **2579924 \***  
**A61M 5/315 (2006.01)**  
(86) EP2011059563 09.06.2011  
(96) 11724628.0 17.04.2013  
(87) WO2011154480, 09.06.2011  
(97) 2579924, 17.04.2013 en  
(54) A DRIVE ASSEMBLY FOR A MEDICATION DELIVERY DEVICE AND MEDICATION DELIVERY DEVICE  
(71) Sanofi-Aventis Deutschland GmbH, Brüningstraße 50, 65929 Frankfurt, DE  
(72) HORLOCK, Mark, Philip, 18 Mayfield Close Cheshire Timperley, Cheshire WA15 7TE, GB

(51) MKP  
**A61K 31/517 (2006.01)** (97) **2579878 \***  
**A61P 35/02 (2006.01)**  
**A61K 31/52 (2006.01)**  
(86) US2011040051 10.06.2011  
(96) 11725852.5 17.04.2013  
(87) WO2011156759, 10.06.2011  
(97) 2579878, 17.04.2013 en  
(54) METHODS OF TREATING HEMATOLOGICAL DISORDERS WITH QUINAZOLINONE COMPOUNDS IN SELECTED PATIENTS  
(71) Gilead Calistoga LLC, 333 Lakeside Drive, Foster City, CA 94404, US  
(72) LANNUTTI, Brian, 333 Lakeside Drive, Foster City, CA 94404, US  
MILLER, Langdon, 333 Lakeside Drive, Foster City, CA 94404, US  
WEBB, Heather, 333 Lakeside Drive, Foster City, CA 94404, US

(51) MKP  
**G01N 33/50 (2006.01)** (97) **2578678 \***  
**C12Q 1/02 (2006.01)**  
**C07K 14/435 (2006.01)**  
**C12N 5/10 (2006.01)**  
**C07K 14/82 (2006.01)**  
**A01K 67/027 (2006.01)**  
**A61P 35/00 (2006.01)**  
**G01N 33/15 (2006.01)**  
**C12N 15/09 (2006.01)**  
(86) JP2011062876 31.05.2011  
(96) 11789954.2 10.04.2013  
(87) WO2011152554, 31.05.2011  
(97) 2578678, 10.04.2013 en  
(54) METHOD FOR PRODUCING TUMOR CELL  
(71) Eisai R&D Management Co., Ltd., 6-10, Koishikawa 4-chome Bunkyo-ku, Tokyo 112-8088, JP  
(72) AKAGI, Tsuyoshi, KAN Research Institute Inc. Kobe MI R&D Center 6-7-3 Minatojima-minamimachi Chuo-ku, Kobe-shi Hyogo 650-0047, JP  
SASAI, Ken, KAN Research Institute Inc. Kobe MI R&D Center 6-7-3 Minatojima-minamimachi Chuo-ku, Kobe-shi Hyogo 650-0047, JP

(51) MKP  
**E04F 11/032 (2006.01)** (97) **2505736**  
(86) 12161180.0 03.10.2012  
(97) 2505736, 03.10.2012 en  
(54) Winding staircase  
(71) Cerioni, Sandro, Via Santa Lucia, 5, 60037 Monte San Vito (AN), IT  
(72) Cerioni, Sandro, Via Santa Lucia, 5, 60037 Monte San Vito (AN), IT

- (51) MKP  
**A61P 3/10 (2006.01)** (97) **2566499 \***  
**A61P 35/00 (2006.01)**  
**A61K 38/17 (2006.01)**  
**C07K 14/525 (2006.01)**  
**A61K 39/395 (2006.01)**  
**A61P 29/00 (2006.01)**
- (86) US2011035251 04.05.2011  
(96) 11778297.9 13.03.2013  
(87) WO2011140267, 04.05.2011  
(97) 2566499, 13.03.2013 en  
(54) INNOVATIVE DISCOVERY OF THERAPEUTIC, DIAGNOSTIC, AND ANTIBODY COMPOSITIONS RELATED TO PROTEIN FRAGMENTS OF P38 MULTI-TRNA SYNTHETASE COMPLEX
- (71) aTyr Pharma, Inc., 3545 John Hopkins Court, Suite 250, San Diego, CA 92121, US  
(72) GREENE, Leslie, Ann, 13941 Davenport Avenue, San Diego California 92129, US  
CHIANG, Kyle, P., 943 Torrance Street Apt. 6, San Diego California 92103, US  
VASSEROT, Alain, P., 6421 La Paloma Street, Carlsbad California 92009, US  
WATKINS, Jeffrey, D., 3442 Fortuna Ranch Road, Encinitas California 92024, US  
MENDLEIN, John, D., 1550 Neptune Avenue, Encinitas California 92024, US  
QUINN, Cheryl, L., 11227 Cedar Pointe Drive South, Minnetonka Minnesota 55305, US

- (51) MKP  
**F04D 29/40 (2006.01)** (97) **2542784 \***  
**F04D 7/04 (2006.01)**  
**F15D 1/04 (2006.01)**
- (86) AU2011000225 01.03.2011  
(96) 11750076.9 09.01.2013  
(87) WO2011106829, 01.03.2011  
(97) 2542784, 09.01.2013 en  
(54) PUMP INTAKE DEVICE
- (71) Weir Minerals Australia Ltd, 1 Marden Street, Artarmon, New South Wales 2064, AU  
(72) WALKER, Craig Ian, 14 Grevillea Avenue, Warriewood, New South Wales 2102, AU

- (51) MKP  
**A61P 3/00 (2006.01)** (97) **2579867 \***  
**A61K 31/23 (2006.01)**
- (86) US2011040234 13.06.2011  
(96) 11796261.3 17.04.2013  
(87) WO2011159634, 13.06.2011  
(97) 2579867, 17.04.2013 en  
(54) TRIHEPTANOIN DIET FOR ADULT POLYGLUCOSAN BODY DISEASE (APBD) TREATMENT
- (71) Baylor Research Institute, 3310 Live Oak Street, Suite 501, Dallas, TX 75204, US  
(72) SCHIFFMANN, Raphael, 2125 Hillcroft Drive, Rockwall, TX 75087, US  
MOCHEL, Fanny, 10299 Kilamey Drive, Dallas, TX 75218, US

- (51) MKP  
**C12Q 1/68 (2006.01)** (97) **2556167 \***
- (86) EP2011055651 11.04.2011  
(96) 11713793.5 13.02.2013  
(87) WO2011124725, 11.04.2011  
(97) 2556167, 13.02.2013 en  
(54) RAD51C AS A HUMAN CANCER SUSCEPTIBILITY GENE
- (71) Hanenberg, Helmut, Im Benrader Feld 56, 47804 Krefeld, DE  
Heinrich-Heine-Universität Düsseldorf, Universitätsstrasse 1, 40225 Düsseldorf, DE  
Universität zu Köln, Albertus-Magnus-Platz, 50923 Köln, DE  
NIEDERACHER, Dieter, Grüner Weg 28, 41468 Neuss, DE  
SCHECKENBACH, Kathrin, Schulstr. 15, Solingen 42653, DE  
SCHMUTZLER, Rita, Frauenklinik Universitätsklinikum Köln Kerpener Str. 34, 50931 Köln, DE  
MEINDL, Alfons, Frauenklinik der TU München Klinikum Rechts der Isar Ismaninger Str. 22, 81675 München, DE  
WIEK, Constanze, Liebfrauenstrasse 13, 40591 Düsseldorf, DE  
ERVEN, Verena, Krahkampweg 41, 40221 Düsseldorf, DE  
FREUND, Marcel, Birkenstrasse 71, 40233 Düsseldorf, DE

- (51) MKP  
**A61K 31/436 (2006.01)** (97) **2558082 \***  
**A61P 35/00 (2006.01)**  
**A61K 31/496 (2006.01)**  
**A61K 31/00 (2006.01)**
- (86) EP2011055908 14.04.2011  
(96) 11714304.0 20.02.2013  
(87) WO2011128405, 14.04.2011  
(97) 2558082, 20.02.2013 en  
(54) COMBINATION OF ORGANIC COMPOUNDS
- (71) Novartis AG, Lichtstrasse 35, 4056 Basel, CH  
(72) GRAUS-PORTA, Diana, Novartis Pharma AG Postfach, CH-4002 Basel, CH  
SHI, Michael, Novartis Pharmaceuticals Corporation One Health Plaza, East Hanover New Jersey 07936, US  
EVANS, Dean Brent, Neusatzweg 20, CH-4106 Therwil, CH

- (51) MKP  
**A61K 39/395 (2006.01)** (97) **2558498 \***  
**A01K 67/027 (2006.01)**  
**A61P 37/02 (2006.01)**  
**C07K 16/28 (2006.01)**  
**A61P 35/00 (2006.01)**  
**C07K 14/705 (2006.01)**
- (86) US2011032355 13.04.2011  
(96) 11730118.4 20.02.2013  
(87) WO2011130434, 13.04.2011  
(97) 2558498, 20.02.2013 en  
(54) ANTIBODIES THAT BIND HUMAN CD27 AND USES THEREOF
- (71) Celldex Therapeutics, Inc., 119 Fourth Avenue, Needham, MA 02494-2725, US  
(72) KELER, Tibor, 30 Park Road, Ottsville, PA 18942, US  
MARSH, Henry, C., 297 Summer Avenue, Reading, MA 01867, US  
HE, Lizhen, 1675 Ridgeview Drive, Allentown, PA 18104, US  
VITALE, Laura, A., 5574 Bittersweet Lane, Doylestown, PA 18902, US  
THOMAS, Lawrence, J., 1 Fox Ridge Road, Easton, MA 02375, US

- (51) MKP  
**A61M 5/178 (2006.01)** (97) **2555812 \***  
**A61M 39/22 (2006.01)**  
**A61M 5/145 (2006.01)**
- (86) US2011031192 05.04.2011  
(96) 11766576.0 13.02.2013  
(87) WO2011127020, 05.04.2011  
(97) 2555812, 13.02.2013 en  
(54) SYSTEMS, DEVICES, METHODS FOR DELIVERING HYDROGEL COMPOSITIONS WITH SELF-PURGING TO PREVENT CLOGGING
- (71) Neomend, Inc., 60 Technology Drive, Irvine, California 92618, US  
(72) BARKER, Peter, 31175 Old River Road, Bonsall, California 92003-5104, US  
MEZGER, William Jerome, 31741 Contijo Way, Trabuco Canyon, California 92679-3614, US

- (51) MKP  
**A61K 31/05 (2006.01)** (97) **2484350**  
**A61K 47/48 (2006.01)**  
**A61K 9/00 (2006.01)**
- (96) 11153452.5 08.08.2012  
(97) 2484350, 08.08.2012 de  
(54) Pharmaceutical preparation containing a complex of a salt of propofol and a cyclodextrin
- (71) Roewer, Norbert, Univ.-Prof. Dr. med., Nikolausstrasse 20, 97082 Würzburg, DE  
Broscheit, Jens, Dr. med., Kerzenleite 35, 97209 Würzburg, DE  
(72) Roewer, Norbert, Univ.-Prof. Dr. med., Nikolausstrasse 20, 97082 Würzburg, DE  
Broscheit, Jens, Dr. med., Kerzenleite 35, 97209 Würzburg, DE



- (51) MKP  
**H04L 9/00 (2006.01)** (97) **2556622 \***  
**H04K 1/00 (2006.01)**  
 (86) SE2011050206 23.02.2011  
 (96) 11766232.0 13.02.2013  
 (87) WO2011126425, 23.02.2011  
 (97) 2556622, 13.02.2013 en  
 (54) METHOD TO ENCRYPT INFORMATION THAT IS TRANSFERRED BETWEEN TWO COMMUNICATION UNITS  
 (71) Exformation Communication AB, Stefan Hagbard Tykövägen 10, 181 61 Lidingö, SE  
 (72) HAGBARD, Stefan, Tykövägen 10, S-181 61 Lidingö, SE

- (51) MKP  
**A61K 31/4709 (2006.01)** (97) **2569308 \***  
**C07D 409/14 (2006.01)**  
**A61P 11/00 (2006.01)**  
 (86) EP2011002376 13.05.2011  
 (96) 11720386.9 20.03.2013  
 (87) WO2011141180, 13.05.2011  
 (97) 2569308, 20.03.2013 en  
 (54) NEW CYCLOHEXYLAMINE DERIVATIVES HAVING 2 ADRENERGIC AGONIST AND M3 MUSCARINIC ANTAGONIST ACTIVITIES  
 (71) Almirall S.A., Ronda del General Mitre, 151, 08022 Barcelona, ES  
 (72) PRAT QUINONES, Maria, C/ Laureà Miró 408-410, E-08980 Sant Feliu de Llobregat Barcelona, ES  
 FONQUERNA POU, Silvia, C/ Laureà Miró 408-410, E-08980 Sant Feliu de Llobregat Barcelona, ES  
 PUIG DURAN, Carlos, C/ Laureà Miró 408-410, E-08980 Sant Feliu de Llobregat Barcelona, ES  
 LUMERAS AMADOR, Wenceslao, C/ Laureà Miró 408-410, E-08980 Sant Feliu de Llobregat Barcelona, ES  
 AIGUADE BOSCH, Jose, C/ Laureà Miró 408-410, E-08980 Sant Feliu de Llobregat Barcelona, ES  
 CATURLA JAVALOYES, Juan Francisco, C/Laureà Miró, 408-410, 08980 Sant Feliu de Llobregat, Barcelona, ES

- (51) MKP  
**F03D 7/02 (2006.01)** (97) **2558717 \***  
 (86) EP2011055625 11.04.2011  
 (96) 11713784.4 20.02.2013  
 (87) WO2011128291, 11.04.2011  
 (97) 2558717, 20.02.2013 de  
 (54) WIND ENERGY INSTALLATION AZIMUTH OR PITCH DRIVE  
 (71) Wobben Properties GmbH, Dreekamp 5, 26605 Aurich, DE  
 (72) RÖER, Jochen, Eichhörnchenweg 12, 27777 Ganderkesee, DE

- (51) MKP  
**G01S 11/14 (2006.01)** (97) **2550542 \***  
**G01S 1/82 (2006.01)**  
**G01S 1/76 (2006.01)**  
**G01S 5/18 (2006.01)**  
 (86) IB2011001091 23.03.2011  
 (96) 11728932.2 30.01.2013  
 (87) WO2011117739, 23.03.2011  
 (97) 2550542, 30.01.2013 en  
 (54) ROBUST ULTRASONIC INDOOR POSITIONING SYSTEM WITH HIGH ACCURACY  
 (71) University Of Oslo, Box 1061 Blindern, 0316 Oslo, NO  
 (72) HOLM, Sverre, Daeliveien 1, N-1383 Asker, NO

- (51) MKP  
**F03D 1/06 (2006.01)** (97) **2561218 \***  
 (86) EP2011065116 01.09.2011  
 (96) 11751897.7 27.02.2013  
 (87) WO2012031976, 01.09.2011  
 (97) 2561218, 27.02.2013 de  
 (54) REMOVABLE ROTOR BLADE TIP  
 (71) Wobben Properties GmbH, Dreekamp 5, 26605 Aurich, DE  
 (72) OLTHOFF, Gerhard, Erster Dwarsweg 13, 26607 Aurich, DE

- (51) MKP  
**H01H 85/30 (2006.01)** (97) **2574217 \***  
 (86) HR2011000008 16.03.2011  
 (96) 11718478.8 03.04.2013  
 (87) WO2011114176, 16.03.2011  
 (97) 2574217, 03.04.2013 en  
 (54) FUSE LINK STATUS INDICATOR FOR A LOW-VOLTAGE HIGH-POWER FUSE  
 (71) Kopicic, Nikola, Davorina Bazjanca 25, 10000 Zagreb, HR  
 Kopicic, Davor, Mirka Viriusa 12, 10000 Zagreb, HR  
 (72) Kopicic, Nikola, Davorina Bazjanca 25, 10000 Zagreb, HR  
 Kopicic, Davor, Mirka Viriusa 12, 10000 Zagreb, HR

- (51) MKP  
**F04D 13/12 (2006.01)** (97) **2585720 \***  
**F04F 10/02 (2006.01)**  
 (86) IB2010055124 11.11.2010  
 (96) 10803498.4 01.05.2013  
 (87) WO2012001466, 11.11.2010  
 (97) 2585720, 01.05.2013 en  
 (54) HYDRAULIC PUMP WITH COMMUNICATING VESSELS  
 (71) Masciarelli, Giuseppe, 11 Mulham Place, Toronto ON M9A 4V9, CA  
 (72) Masciarelli, Giuseppe, 11 Mulham Place, Toronto ON M9A 4V9, CA

- (51) MKP  
**A61P 25/36 (2006.01)** (97) **2588094 \***  
**A61P 25/04 (2006.01)**  
**A61K 9/00 (2006.01)**  
**A61K 31/135 (2006.01)**  
**A61K 31/137 (2006.01)**  
**A61K 9/12 (2006.01)**  
 (86) GB2011051230 29.06.2011  
 (96) 11729456.1 08.05.2013  
 (87) WO2012001411, 29.06.2011  
 (97) 2588094, 08.05.2013 en  
 (54) PHARMACEUTICAL COMPOSITIONS FOR SUBLINGUAL DELIVERY OF OPIOIDS  
 (71) Londonpharma Ltd., Innovation Centre Norwich Research Park Colney Lane, Norwich NR4 7UH, GB  
 (72) SAMS, Martin James, c/o LondonPharma Limited Innovation Centre Norwich Research Park Colney Lane, Norwich NR4 7UH, GB  
 HIGH, Juliet Victoria, c/o LondonPharma Limited Innovation Centre Norwich Research Park Colney Lane, Norwich NR4 7UH, GB  
 JAMIESON, Paul Andrew, c/o LondonPharma Limited Innovation Centre Norwich Research Park Colney Lane, Norwich NR4 7UH, GB  
 ROSS, Calvin John, - deceased, GB

- (51) MKP  
**A01N 55/08 (2006.01)** (97) **2552216 \***  
 (86) US2011030455 30.03.2011  
 (96) 11763354.5 06.02.2013  
 (87) WO2011123502, 30.03.2011  
 (97) 2552216, 06.02.2013 en  
 (54) DERIVATIVES OF 1-AMINO-2-CYCLOPROPYLETHYLBORONIC ACID  
 (71) Millennium Pharmaceuticals, Inc., 40 Landsdowne Street, Cambridge, MA 02139, US  
 (72) FLEMING, Paul, E., 38 Fairview Road, Weston, MA 02493, US  
 LI, Jing, 2223 Ayreshire Drive, Lansdale, PA 19446, US

- (51) MKP  
**C12P 21/02 (2006.01)** (97) **2585607 \***  
**A61K 39/395 (2006.01)**  
**C07K 16/00 (2006.01)**
- (86) US2011041633 23.06.2011  
(96) 11798923.6 01.05.2013  
(87) WO2011163478, 23.06.2011  
(97) 2585607, 01.05.2013 en  
(54) DUAL VARIABLE DOMAIN IMMUNOGLOBULINS AND USES THEREOF  
(71) Abbott Laboratories, 100 Abbott Park Rd., Abbott Park, IL 60064, US  
(72) GHAYUR, Tariq, 1014 Washington Street, Holliston MA 01746, US  
LIU, Junjian, 14 Crimson Drive, Shrewsbury MA 01545, US  
JAKWAY, James, J., 9 Morse Road, Berlin MA 01503, US  
TALANIAN, Robert, V., 33 Candleberry Lane, Harvard MA 01451, US  
BENATUIL, Lorenzo, 33 Mohawk Drive, Northborough MA 01532, US
- 
- (51) MKP  
**G06Q 20/00 (2012.01)** (97) **2553642 \***  
(86) AU2011000377 31.03.2011  
(96) 11761840.5 06.02.2013  
(87) WO2011120098, 31.03.2011  
(97) 2553642, 06.02.2013 en  
(54) METHODS AND SYSTEMS FOR VERIFYING TRANSACTIONS  
(71) Isignthis Ltd, Sea Meadow House Blackburne Highway Road Town, Tortola, VG  
(72) KARANTZIS, Nickolas, John, 13 Miller Street, Richmond, VIC 3121, AU
- 
- (51) MKP  
**C07D 241/18 (2006.01)** (97) **2585437 \***  
**C07D 401/04 (2006.01)**  
**A61P 9/12 (2006.01)**  
**A61K 31/444 (2006.01)**  
**C07D 213/70 (2006.01)**  
**A61P 9/00 (2006.01)**  
**A61P 19/06 (2006.01)**  
**A61K 31/4965 (2006.01)**  
**A61K 31/44 (2006.01)**  
(86) US2011040585 15.06.2011  
(96) 11796396.7 01.05.2013  
(87) WO2011159839, 15.06.2011  
(97) 2585437, 01.05.2013 en  
(54) THIOACETATE COMPOUNDS, COMPOSITIONS AND METHODS OF USE  
(71) Ardea Biosciences, Inc., 4939 Directors Place, San Diego, CA 92121, US  
(72) OUK, Samedy, 10790 Dabney Drive Apt 2., San Diego, CA 92121, US  
VERNIER, Jean-michel, 5150 Sea Mist, San Diego, CA 92121, US  
GUNIC, Esmir, 8952 Capcano Road, San Diego, CA 92129, US  
CHEN, Chixu, 11618 Aspenview Drive, San Diego, CA 92128, US
- 
- (51) MKP  
**A01N 43/36 (2006.01)** (97) **2575459 \***  
**A61K 31/40 (2006.01)**  
**A61K 31/35 (2006.01)**  
(86) US2011039166 03.06.2011  
(96) 11790509.1 10.04.2013  
(87) WO2011153495, 03.06.2011  
(97) 2575459, 10.04.2013 en  
(54) CANCER TREATMENT WITH WORTMANNIN ANALOGS  
(71) Oncothyreon Inc., 2601 Fourth Avenue, Suite 500, Seattle, WA 98121, US  
(72) PETERSON, Scott, 15003 225th Ave Ne, Woodinville, WA 98077, US  
HAUSMAN, Diana, F., 2339 Federal Ave E., Seattle, WA 98102, US  
KIRKMAN, Robert, 4439 95th Avenue, Yarrow Point, WA 98004, US
- 
- (51) MKP  
**C07D 409/14 (2006.01)** (97) **2544684 \***  
**A61K 31/4375 (2006.01)**  
**C07D 417/14 (2006.01)**  
**C07D 401/06 (2006.01)**  
**C07D 211/66 (2006.01)**  
**A61K 31/4436 (2006.01)**  
**C07D 407/14 (2006.01)**  
**C07D 407/06 (2006.01)**  
**C07D 417/06 (2006.01)**  
**A61K 31/4439 (2006.01)**  
**C07D 409/06 (2006.01)**  
**A61K 31/444 (2006.01)**  
**A61P 19/02 (2006.01)**  
(86) US2011027699 09.03.2011  
(96) 11708663.7 16.01.2013  
(87) WO2011112685, 09.03.2011  
(97) 2544684, 16.01.2013 en  
(54) 4,4-DISUBSTITUTED PIPERIDINE DERIVATIVES USEFUL AS INHIBITORS OF DIPEPTIDYL PEPTIDASE-1 (DPP-1)  
(71) Janssen Pharmaceutica, N.V., Turnhoutseweg 30, 2340 Beerse, BE  
(72) DECORTE, Bart, L., 1590 Winding Road, Southampton PA 18966, US  
DESJARLAIS, Renee, L., 11 Cornwall Circle, Saint Davids PA 19087, US  
HUANG, Yifang, 303 Walden Lane, Lansdale PA 19446, US  
PARKER, Michael, H., 3587 Gray Fox Drive, Chalfont PA 18914, US  
HLASTA, Dennis, J., 5008 Davis Drive, Doylestown PA 18902, US
- 
- (51) MKP  
**A61K 31/58 (2006.01)** (97) **2575822 \***  
**A61K 47/06 (2006.01)**  
**A61K 47/10 (2006.01)**  
**A61K 47/36 (2006.01)**  
**A61K 9/06 (2006.01)**  
(86) EP2011002369 13.05.2011  
(96) 11719487.8 10.04.2013  
(87) WO2011147536, 13.05.2011  
(97) 2575822, 10.04.2013 en  
(54) TOPICAL PHARMACEUTICAL COMPOSITIONS COMPRISING MOMETASONE FUROATE  
(71) Almira S.A., Ronda del General Mitre, 151, 08022 Barcelona, ES  
(72) EVERS, Fritjof, Wohltofer Strasse 21, 21465 Reinbek, DE  
MALLWITZ, Henning, Falkenweg 9c, 21244 Buchholz/N., DE  
MEYER, Ricarda, Mühlenweg 16, 21271 Hanstedt, DE  
WILLERS, Christoph, Scholtzstrasse 3, 21465 Reinbek, DE
- 
- (51) MKP  
**B60R 13/10 (2006.01)** (97) **2532556**  
(86) 12168180.3 12.12.2012  
(97) 2532556, 12.12.2012 en  
(54) Registration Plate Holder  
(71) Modeltek SNC di Salvarani - Vacondio - Masi, Via Anna Frank, 3, 42012 Campagnola Emilia (Reggio Emilia), IT  
(72) Salvarani, Massimiliano, MODELTEK SNC DI SALVARANI - VACONDIO - MASI 3, Via Anna Frank, 42012 Campagnola Emilia (Reggio Emilia), IT
- 
- (51) MKP  
**A61K 31/765 (2006.01)** (97) **2563374 \***  
**A61P 31/22 (2006.01)**  
(86) IB2011001919 08.07.2011  
(96) 11754919.6 06.03.2013  
(87) WO2012004669, 08.07.2011  
(97) 2563374, 06.03.2013 en  
(54) POLYETHYLENE GLYCOL COMPOSITIONS FOR CONTROLLING RELAPSE OF HERPES LABIALIS, HERPES GENITALIS, AND HERPES ZOSTER  
(71) Devirex AG, Sagenstrasse 4c, 6318 Walchwil, CH  
(72) VITINS, Peter, Gheidweg 1, CH-5452 Oberohrdorf, CH  
LANGENAUER, Marcel, Enerholzstrasse 10, CH-4712 Laupersdorf, CH  
SCHERER, Paul, Martin, Sagenstrasse 4c, CH-6318 Walchwil, CH
-

(51) MKP  
**B65D 71/70 (2006.01)** (97) **2569030 \***  
**A61M 5/00 (2006.01)**  
**B65B 3/00 (2006.01)**  
(86) EP2011057698 12.05.2011  
(96) 11719813.5 20.03.2013  
(87) WO2011141549, 12.05.2011  
(97) 2569030, 20.03.2013 en  
(54) WORKPIECE CARRIER FOR TRANSPORTING AND/OR STORING COMPONENTS OF DRUG DELIVERY DEVICES  
(71) Sanofi-Aventis Deutschland GmbH, Brüningsstraße 50, 65929 Frankfurt, DE  
(72) JOSEF, Clemens, c/o Sanofi-Aventis Deutschland GmbH, 65926 Frankfurt am Main, DE  
SIMON, Christian, c/o Sanofi-Aventis Deutschland GmbH, 65926 Frankfurt am Main, DE  
BODE, Andreas, c/o Sanofi-Aventis Deutschland GmbH, 65926 Frankfurt am Main, DE  
POMMERAU, Christian, c/o Sanofi-Aventis Deutschland GmbH, 65926 Frankfurt am Main, DE

(51) MKP  
**C07D 215/38 (2006.01)** (97) **2588455 \***  
**C07D 519/00 (2006.01)**  
**C07D 215/14 (2006.01)**  
**C07D 417/04 (2006.01)**  
**C07D 405/04 (2006.01)**  
**C07D 401/12 (2006.01)**  
**A61K 31/47 (2006.01)**  
**C07D 215/18 (2006.01)**  
**C07D 487/04 (2006.01)**  
**C07D 215/48 (2006.01)**  
**C07D 215/227 (2006.01)**  
**C07D 215/06 (2006.01)**  
**C07D 413/04 (2006.01)**  
**C07D 401/04 (2006.01)**  
**A61P 31/18 (2006.01)**  
(86) US2011042881 01.07.2011  
(96) 11738339.8 08.05.2013  
(87) WO2012003498, 01.07.2011  
(97) 2588455, 08.05.2013 en  
(54) 2-QUINOLINYL-ACETIC ACID DERIVATIVES AS HIV ANTIVIRAL COMPOUNDS  
(71) Gilead Sciences, Inc., 333 Lakeside Drive, Foster City, CA 94404, US  
(72) BABAUGLU, Kerim, 2209 Wentz Church Road, Lansdale, PA 19446, US  
BJORNSON, Kyla, 2721 South Norfolk Street, Apt. 207, San Mateo, CA 94403, US  
GUO, Hongyan, 1743 Maxine Avenue, San Mateo, CA 94401, US  
HALCOMB, Randall, L., 892 Gull Avenue, Foster City, CA 94404, US  
LINK, John, O., 74 Prospect Avenue, San Francisco, CA 94110, US  
LIU, Hongtao, 10320 Orange Avenue, Cupertino, CA 95014, US  
MITCHELL, Michael, L., 108 Crossing Court, Hayward, CA 94544, US  
SUN, Jianyu, 4137 Castlewood Crescent, Burnaby, British Columbia V5G 2M1, CA  
VIVIAN, Randall, W., 1430 Via Vista, San Mateo, CA 94404, US  
XU, Lianhong, 970 Blair Court, Palo Alto, CA 94303, US  
TAYLOR, James, 100 State Street, San Mateo, CA 94401, US

(51) MKP  
**A61K 35/36 (2006.01)** (97) **2574663**  
**C12M 3/08 (2006.01)**  
(86) 12197925.6 03.04.2013  
(97) 2574663, 03.04.2013 en  
(54) Method for preparing tissue, particularly adipose tissue  
(71) Lipogems International SRL, Via Santa Maria alla Porta n.9, 20100 Milano, IT  
(72) Tremolada, Carlo, via Spadolini 9a, I-20100 Milano, IT

(51) MKP  
**A61K 31/00 (2006.01)** (97) **2552429 \***  
**A61K 31/4433 (2006.01)**  
**A61K 45/06 (2006.01)**  
**A61K 31/496 (2006.01)**  
**A61K 31/46 (2006.01)**  
**A61K 31/4725 (2006.01)**  
**A61K 31/427 (2006.01)**  
**A61K 31/4545 (2006.01)**  
**A61K 31/4178 (2006.01)**  
**A61K 31/351 (2006.01)**  
**A61K 31/506 (2006.01)**  
**A61K 31/4402 (2006.01)**  
**A61K 31/472 (2006.01)**  
**A61P 31/18 (2006.01)**  
**A61K 31/499 (2006.01)**  
(86) IB2011051370 30.03.2011  
(96) 11715752.9 06.02.2013  
(87) WO2011121558, 30.03.2011  
(97) 2552429, 06.02.2013 en  
(54) COMBINATION THERAPY COMPRISING A CCR5 ANTAGONIST, A HIV-1 PROTEASE INHIBITOR AND A PHARMACOKINETIC ENHANCER  
(71) Phivco-1 LLC, Corporation Service Company 2711 Centerville Road, Suite 400, Wilmington, Delaware 19808, US  
(72) TRESSLER, Randall, Lee, Pfizer Inc. 235 East 42nd Street, New York, New York 10017, US  
VALDEZ, Hernan, Pfizer Inc. 235 East 42nd Street, New York, New York 10017, US

(51) MKP  
**A61K 38/36 (2006.01)** (97) **2590668 \***  
(86) US2011043569 11.07.2011  
(96) 11804476.7 15.05.2013  
(87) WO2012006624, 11.07.2011  
(97) 2590668, 15.05.2013 en  
(54) FACTOR IX POLYPEPTIDES AND METHODS OF USE THEREOF  
(71) BIOGEN IDEC HEMOPHILIA INC., 9 Fourth Avenue, Waltham, MA 02451, US  
(72) PIERCE, Glenn, 14 Cambridge Center, Cambridge MA 02142, US  
TRUOX, Samantha, 101 Longfellow Road, Sudbury MA 01776, US  
PETERS, Robert, T., 51 New Field Street, West Roxbury MA 02132, US  
JIANG, Haiyan, 3 Bayberry Ln, Belmont MA 02478, US

(51) MKP  
**H05K 1/11 (2006.01)** (97) **2583361 \***  
**H01R 13/66 (2006.01)**  
**H01R 27/00 (2006.01)**  
**H01R 13/6582 (2011.01)**  
**H01R 13/03 (2006.01)**  
**H01R 29/00 (2006.01)**  
**H01R 13/627 (2006.01)**  
**H01R 13/24 (2006.01)**  
**H01R 13/642 (2006.01)**  
(86) US2011041286 21.06.2011  
(96) 11728504.9 24.04.2013  
(87) WO2011163256, 21.06.2011  
(97) 2583361, 24.04.2013 en  
(54) EXTERNAL CONTACT PLUG CONNECTOR  
(71) Apple Inc., 1 Infinite Loop, MS 169-3IPL, Cupertino, CA 95014, US  
(72) GOLKO, Albert J., 1 Infinite Loop MS 305-1DR, Cupertino, CA 95014, US  
BRIGHAM, Arthur Stanley, 1 Infinite Loop MS 169-3IPL, Cupertino, CA 95014, US  
MCDONALD, Anwyl Myron, 1 Infinite Loop MS 169-3IPL, Cupertino, CA 95014, US  
LEE, Daniel Zisuk, 1 Infinite Loop MS 169-3IPL, Cupertino, CA 95014, US  
CARTER, Troy Alexander, 1 Infinite Loop MS 169-3IPL, Cupertino, CA 95014, US  
Marin, Jose A., 1 Infinite Loop MS 169-3IPL, Cupertino, CA 95014, US  
KOH, Paul Bongkyu, 1 Infinite Loop MS 169-3IPL, Cupertino, CA 95014, US

- (51) MKP  
**C07K 14/47 (2006.01)** (97) **2452948 \***  
**C07K 16/30 (2006.01)**  
**C07K 14/435 (2006.01)**  
**G01N 33/574 (2006.01)**  
**C07K 16/18 (2006.01)**  
**A61K 39/395 (2006.01)**  
**A61P 35/04 (2006.01)**
- (86) CN2010075896 11.08.2010  
(96) 10796746.5 16.05.2012  
(87) WO2011003369, 11.08.2010  
(97) 2452948, 16.05.2012 en  
(54) NEW TUMOR MARKER  
(71) Tsinghua University, Qing Hua Yuan, Haidian District Beijing 100084, CN  
Protgen Ltd., Room B-421, Zhong Guan Cun Biomedical Park 5 Shangdi Kaitou Road, Haidian District, Beijing 100085, CN  
(72) LUO, Yongzhang, Qing Hua Yuan Haidian District, Beijing 100084, CN  
SONG, Xiaomin, Qing Hua Yuan Haidian District, Beijing 100084, CN  
WANG, Xiaofeng, Qing Hua Yuan Haidian District, Beijing 100084, CN  
ZHUO, Wei, Qing Hua Yuan Haidian District, Beijing 100084, CN  
CHANG, Guodong, Room B-421 Zhong Guan Cun Biomedical Park No.5 Shangdi Kaituo Road Haidian District, Beijing 100085, CN  
FU, Yan, Qing Hua Yuan Haidian District, Beijing 100084, CN

- (51) MKP  
**A61K 31/135 (2006.01)** (97) **2568977 \***  
**A61K 9/20 (2006.01)**
- (86) US2011035770 09.05.2011  
(96) 11720364.6 20.03.2013  
(87) WO2011143120, 09.05.2011  
(97) 2568977, 20.03.2013 en  
(54) ALCOHOL-RESISTANT METOPROLOL-CONTAINING EXTENDED- RELEASE ORAL DOSAGE FORMS  
(71) Cima Labs Inc., 7325 Aspen Lane, Brooklyn Park, Minnesota 55428, US  
(72) HAMED, Ehab, 9206 Holly Lane North, Maple Grove Minnesota 55311, US

- (51) MKP  
**B01D 39/08 (2006.01)** (97) **2593206 \***  
**B01D 39/20 (2006.01)**  
**B01D 39/16 (2006.01)**
- (86) US2011043988 14.07.2011  
(96) 11751975.1 22.05.2013  
(87) WO2012009521, 14.07.2011  
(97) 2593206, 22.05.2013 en  
(54) FILTRATION MEDIA AND APPLICATIONS THEREOF  
(71) PPG Industries Ohio, Inc., 3800 West 143rd Street, Cleveland, OH 44111, US  
(72) VELPARI, Vedagiri, 230 Old Haymaker Road, Monroeville Pennsylvania 15146, US  
MENG, Jian, 3740 Tea Olive Drive, Gastonia North Carolina 28056, US  
GILMORE, Dennis, 290 California Terrace, Pasadena California 91105, US  
MARSH, Timothy, E., 2750 Hunters Circle Apt. 531, Allison Park Pennsylvania 15101, US  
WATSON, James, 444 Terrapin Lane, Lake Wylie South Carolina 29710, US  
HELLRING, Stuart, 130 Oak Park Place, Pittsburgh Pennsylvania 15243, US  
WESTBROOK, Paul, A., 112 Santa Clara Drive, Shelby North Carolina 28152, US

- (51) MKP  
**F26B 5/04 (2006.01)** (97) **2589303 \***  
**B65D 33/01 (2006.01)**  
**B65D 81/00 (2006.01)**  
**A23L 3/015 (2006.01)**  
**A01F 25/14 (2006.01)**  
**B65D 30/00 (2006.01)**  
**B65D 33/00 (2006.01)**  
**B65D 33/16 (2006.01)**  
**B65D 81/20 (2006.01)**
- (86) IB2010053034 02.07.2010  
(96) 10803983.5 08.05.2013  
(87) WO2011013016, 02.07.2010  
(97) 2589303, 08.05.2013 en  
(54) WATER EQUILIBRIUM VARIABLE PRESSURE DRIED FOODS, PROCESSING METHOD, DEVICE AND PACKAGE THEREOF  
(71) Wu, Dinan, 4 1-9 Wenmingdonglu3 Houbin Sanmenxia, Henan 472000, CN  
(72) WU, Yuanming, 4 109 Wenmingdonglu3 Houbin Sanmenxia, Henan 472000, CN

- (51) MKP  
**A61P 11/00 (2006.01)** (97) **2580195 \***  
**A61P 11/06 (2006.01)**  
**A61K 31/40 (2006.01)**  
**C07D 207/12 (2006.01)**  
**A61P 11/08 (2006.01)**
- (86) EP2011002893 13.06.2011  
(96) 11735781.4 17.04.2013  
(87) WO2011157387, 13.06.2011  
(97) 2580195, 17.04.2013 en  
(54) CRYSTAL FORM OF GLYCOPYRRONIUM CHLORIDE  
(71) Chiesi Farmaceutici S.p.A., Via Palermo, 26/A, 43100 Parma, IT  
(72) PIVETTI, Fausto, c/o Chiesi Farmaceutici S.p.A. Via Palermo 26/A, I-43100 Parma, IT  
BOCCHI, Monica, c/o Chiesi Farmaceutici S.p.A. Via Palermo 26/A, I-43100 Parma, IT  
VIGANO', Enrico, c/o Chiesi Farmaceutici S.p.A. Via Palermo 26/A, I-43100 Parma, IT  
LANDONIO, Ernesto, c/o Chiesi Farmaceutici S.p.A. Via Palermo 26/A, I-43100 Parma, IT

- (51) MKP  
**C07D 213/51 (2006.01)** (97) **2560956 \***  
**C07D 277/34 (2006.01)**
- (86) US2011032822 18.04.2011  
(96) 11716155.4 27.02.2013  
(87) WO2011133442, 18.04.2011  
(97) 2560956, 27.02.2013 en  
(54) NOVEL SYNTHESIS FOR THIAZOLIDINEDIONE COMPOUNDS  
(71) Metabolic Solutions Development Company LLC, 161 East Michigan Avenue, 4th Floor, Kalamazoo, MI 49007, US  
(72) ZELLER, James, R., 9113 North 116th Way, Scottsdale AZ 85259, US  
TANIS, Steven, P., 1750 Oriole Ct., Carlsbad CA 92011, US  
LARSEN, Scott, D., 13638 Cantabery Ct., South Lyon MI 48178, US  
PARKER, Timothy, 1521 Timberlane Drive, Portage, MI 49024, US

- (51) MKP  
**C07K 16/18 (2006.01)** (97) **2563813 \***
- (86) US2011034672 29.04.2011  
(96) 11775670.0 06.03.2013  
(87) WO2011137395, 29.04.2011  
(97) 2563813, 06.03.2013 en  
(54) ANTI-C5A ANTIBODIES AND METHODS FOR USING THE ANTIBODIES  
(71) Alexion Pharmaceuticals, Inc., 352 Knotter Drive, Cheshire, CT 06410, US  
(72) ROTHER, Russell P., 10325 Forest Meadow Drive, Oklahoma City, OK 73151, US  
SHERIDAN, Douglas L., 92 Limewood Avenue C5, Branford, CT 06405, US  
TAMBURINI, Paul P., 80 Devonshire Way, Kensington, CT 06037, US  
ZHANG, Yuchun, 440 Budding Ridge Road, Cheshire, CT 06410, US

(51) MKP  
**C01B 13/11 (2006.01)** (97) **2582621 \***  
**B01J 19/08 (2006.01)**  
**B01J 19/00 (2006.01)**  
(86) US2011039756 09.06.2011  
(96) 11796204.3 24.04.2013  
(87) WO2011159544, 09.06.2011  
(97) 2582621, 24.04.2013 en  
(54) OZONATED LIQUID DISPENSING UNIT  
(71) Food Safety Technology LLC, 13714 A. Street, Omaha, Nebraska 68144, US  
(72) LYNN, Daniel W., 13714 A. Street, Omaha Nebraska 68144, US

(51) MKP  
**A61K 9/20 (2006.01)** (97) **2590631 \***  
**A61K 31/7072 (2006.01)**  
**A61K 9/28 (2006.01)**  
**A61K 31/155 (2006.01)**  
(86) US2011042988 06.07.2011  
(96) 11736495.0 15.05.2013  
(87) WO2012006298, 06.07.2011  
(97) 2590631, 15.05.2013 en  
(54) FORMULATION FOR CO-THERAPY TREATMENT OF DIABETES  
(71) Janssen Pharmaceutica, N.V., Turnhoutseweg 30, 2340 Beerse, BE  
(72) DELAET, Urbain, Alfons Clementina, Turnhoutseweg 30, B-2340 Beerse, BE  
FAURE, Anne, Turnhoutseweg 30, B-2340 Beerse, BE  
HEYNS, Philip, Erna Hortentia Gilbert, Turnhoutseweg 30, B-2340 Beerse, BE  
JANS, Eugene, Maria Jozef, Turnhoutseweg 30, B-2340 Beerse, BE  
RAILKAR, Aniruddha, 1214 Joseph Road, Ambler PA 19002, US

(51) MKP  
**C07D 403/04 (2006.01)** (97) **2545047 \***  
**C07D 403/14 (2006.01)**  
**A61K 31/4184 (2006.01)**  
**A61P 25/28 (2006.01)**  
**C07D 401/04 (2006.01)**  
**A61K 31/454 (2006.01)**  
**A61P 31/04 (2006.01)**  
**A61K 31/4709 (2006.01)**  
**A61P 35/00 (2006.01)**  
**A61K 31/5377 (2006.01)**  
**A61P 29/00 (2006.01)**  
**C07D 405/10 (2006.01)**  
**A61P 25/18 (2006.01)**  
**C07D 403/10 (2006.01)**  
**A61P 1/04 (2006.01)**  
(86) EP2011053576 10.03.2011  
(96) 11707182.9 16.01.2013  
(87) WO2011110613, 10.03.2011  
(97) 2545047, 16.01.2013 en  
(54) HETEROCYCLIC INHIBITORS OF GLUTAMINYL CYCLASE (QC, EC 2.3.2.5)  
(71) Probiodrug AG, Weinbergweg 22, 06120 Halle/Saale, DE  
(72) HEISER, Ulrich, Franz-Schubert-Strasse 5, 06108 Halle / Saale, DE  
GAERTNER, Ulf-Torsten, Johannesplatz 5, 06110 Halle / Saale, DE  
DEMUTH, Hans-Ulrich, Am Waldrand 13a, 06120 Halle / Saale, DE

(51) MKP  
**H02K 21/18 (2006.01)** (97) **2249466**  
(96) 10003144.2 10.11.2010  
(97) 2249466, 10.11.2010 de  
(54) Disc motor with electromagnetic drive  
(71) Kutzke, Arthur, Hainholzstrasse 3, 18435 Stralsund, DE  
(72) Kutzke, Arthur, Hainholzstrasse 3, 18435 Stralsund, DE

(51) MKP  
**A01P 13/00 (2006.01)** (97) **2555615 \***  
**A01P 3/00 (2006.01)**  
**A01N 43/40 (2006.01)**  
**A01N 25/32 (2006.01)**  
(86) US2011025160 17.02.2011  
(96) 11704911.4 13.02.2013  
(87) WO2011103240, 17.02.2011  
(97) 2555615, 13.02.2013 en  
(54) SYNERGISTIC HERBICIDE/FUNGICIDE COMPOSITION CONTAINING A PYRIDINE CARBOXYLIC ACID AND A FUNGICIDE  
(71) Dow AgroSciences LLC, 9330 Zionsville Road, Indianapolis, IN 46268, US  
(72) SATCHIVI, Norbert, 3100 Cherub Court, Westfield, IN 46074, US  
SCHMITZER, Paul, 7960 North Whittier Place, Indianapolis, IN 46250, US

(51) MKP  
**A61P 35/00 (2006.01)** (97) **2547691 \***  
**C07K 7/06 (2006.01)**  
**A61K 39/00 (2006.01)**  
(86) EP2011053996 16.03.2011  
(96) 11708860.9 23.01.2013  
(87) WO2011113872, 16.03.2011  
(97) 2547691, 23.01.2013 en  
(54) COMPOSITION OF TUMOR-ASSOCIATED PEPTIDES AND RELATED ANTI-CANCER VACCINE FOR THE TREATMENT OF GASTRIC CANCER AND OTHER CANCERS  
(71) Immatics Biotechnologies GmbH, Paul-Ehrlich-Strasse 15, 72076 Tübingen, DE  
(72) FRITSCHKE, Jens, Im Schoenblick 48, 72076 Tuebingen, DE  
WEINSCHENK, Toni, Im Morgenrain 15, 73773 Aichwald, DE  
WALTER, Steffen, Steinenbergstrasse 2, 72764 Reutlingen, DE  
LEWANDROWSKI, Peter, Burgstrasse 14, 72070 Tuebingen-Hirschau, DE  
SINGH, Harpreet, Bei den Pferdestaellen 9, 72072 Tuebingen, DE

(51) MKP  
**B60P 1/02 (2006.01)** (97) **2484550**  
(96) 10191215.2 08.08.2012  
(97) 2484550, 08.08.2012 en  
(54) Vehicle  
(71) ES Smede & Maskinservice ApS, Veggerslevvej 11, 8500 Grenaa, DK  
(72) Wulff, Olaf, ES Smede & Maskinservice ApS Sangstrupvej 1 Voldby, 8500, Grenaa, DK

(51) MKP  
**A61K 39/00 (2006.01)** (97) **2542571 \***  
**A61P 25/28 (2006.01)**  
**A61P 37/04 (2006.01)**  
**A61K 39/395 (2006.01)**  
**C07K 16/18 (2006.01)**  
**C07K 14/47 (2006.01)**  
**C12N 15/13 (2006.01)**  
**G01N 33/53 (2006.01)**  
(86) CA2011000238 03.03.2011  
(96) 11750124.7 09.01.2013  
(87) WO2011106885, 03.03.2011  
(97) 2542571, 09.01.2013 en  
(54) OLIGOMER-SPECIFIC AMYLOID BETA EPI TOPE AND ANTIBODIES  
(71) The University of British Columbia, 103 - 6190 Agronomy Road, Vancouver, BC V6T 1Z3, CA  
(72) CASHMAN, Neil R., 3793 West King Edward Ave, Vancouver, British Columbia V6S 1M8, CA

- (51) MKP  
**A61K 9/00 (2006.01)** (97) **2471385**  
**A23L 1/30 (2006.01)**  
**A61K 31/23 (2006.01)**  
**A61K 9/16 (2006.01)**  
(96) 10197295.8 04.07.2012  
(97) 2471385, 04.07.2012 en  
(54) Cetyl myristate and/or cetyl palmitate suspension formulations  
(71) Deva Holding Anonim Sirketi, Patent Law Department  
Halkali Merkez Mah. Basın Ekspres Cad. No: 1,34303,  
Kucukcekmece/Istanbul, TR  
(72) Haas, Philipp Daniel, R&D DEVA HOLDING ANONIM SIRKETI  
Halkali Merkez Mah., Basın Ekspres Caddesi No: 1, Patent Law  
Department, Kat:5, Kucukcekmece, 34303, ISTANBUL, TR  
Firat, Omer Faruk, R&D DEVA HOLDING ANONIM SIRKETI  
Halkali Merkez Mah., Basın Ekspres Caddesi No: 1, Patent Law  
Department, Kat:5, Kucukcekmece, 34303, ISTANBUL, TR  
Kandemir, Levent, R&D DEVA HOLDING ANONIM SIRKETI  
Halkali Merkez Mah., Basın Ekspres Caddesi No: 1, Patent Law  
Department, Kat:5, Kucukcekmece, 34303, ISTANBUL, TR  
Koc, Fikret, R&D DEVA HOLDING ANONIM SIRKETI Halkali  
Merkez Mah., Basın Ekspres Caddesi No: 1, Patent Law  
Department, Kat:5, Kucukcekmece, 34303, ISTANBUL, TR  
Sivasligil, Ramazan, R&D DEVA HOLDING ANONIM SIRKETI  
Halkali Merkez Mah., Basın Ekspres Caddesi No: 1, Patent Law  
Department, Kat:5, Kucukcekmece, 34303, ISTANBUL, TR
- 
- (51) MKP  
**A01N 43/38 (2006.01)** (97) **2566327 \***  
**A61K 31/405 (2006.01)**  
(86) US2011035336 05.05.2011  
(96) 11778334.0 13.03.2013  
(87) WO2011140324, 05.05.2011  
(97) 2566327, 13.03.2013 en  
(54) INDOLES  
(71) GlaxoSmithKline LLC, One Franklin Plaza 200 North 16th  
Street, Philadelphia, PA 19102, US  
(72) BRACKLEY, James, 1250 South Collegeville Road,  
Collegeville PA 19426, US  
BURGESS, Joelle, Lorraine, 1250 South Collegeville Road,  
Collegeville PA 19426, US  
GRANT, Seth, 1250 South Collegeville Road, Collegeville PA  
19426, US  
JOHNSON, Neil, 1250 South Collegeville Road, Collegeville  
PA 19426, US  
KNIGHT, Steven, D., 1250 South Collegeville Road,  
Collegeville PA 19426, US  
LaFRANCE, Louis, 1250 South Collegeville Road, Collegeville  
PA 19426, US  
MILLER, William, H., 1250 South Collegeville Road,  
Collegeville PA 19426, US  
NEWLANDER, Kenneth, 1250 South Collegeville Road,  
Collegeville PA 19426, US  
ROMERIL, Stuart, 1250 South Collegeville Road, Collegeville  
PA 19426, US  
ROUSE, Meagan, B., 1250 South Collegeville Road,  
Collegeville PA 19426, US  
TIAN, Xinrong, 1250 South Collegeville Road, Collegeville PA  
19426, US  
VERMA, Sharad, Kumar, 1250 South Collegeville Road,  
Collegeville PA 19426, US
- 
- (51) MKP  
**A61K 9/50 (2006.01)** (97) **2588090 \***  
(86) EP2011061140 01.07.2011  
(96) 11732405.3 08.05.2013  
(87) WO2012001156, 01.07.2011  
(97) 2588090, 08.05.2013 en  
(54) PHARMACEUTICAL ORAL DOSAGE FORMS COMPRISING  
DABIGATRAN ETEXILATE AND ITS PHARMACEUTICALLY  
ACCEPTABLE SALTS  
(71) Krka Tovarna Zdravil, D.D., Novo Mesto, Smarjeska cesta 6,  
8501 Novo Mesto, SI  
(72) KROSELJ, Vesna, Gasparljeva 10, 1000 Ljubljana, SI
- 
- (51) MKP  
**A61B 17/06 (2006.01)** (97) **2544599 \***  
(86) US2011027130 04.03.2011  
(96) 11710588.2 16.01.2013  
(87) WO2011112433, 04.03.2011  
(97) 2544599, 16.01.2013 en  
(54) SUTURE PACKAGES PROVIDING UNCONSTRAINED  
DISPENSING OF SUTURES AND METHODS THEREFOR  
(71) Ethicon, Inc, U.S. Route 22, Somerville, NJ 08876-0151, US  
(72) CERWIN, Robert, J., 404 Cafferty Road, Pipersville PA  
18947, US  
MCHUGH KAROW, Meredith, 211 East Mill Road, Hatboro PA  
19040, US  
PARKER, Raymond, 4191 Greenspire Lane, New Hope PA  
18938, US
- 
- (51) MKP  
**A61L 27/20 (2006.01)** (97) **2547372 \***  
**C12R 1/02 (2006.01)**  
**A61L 26/00 (2006.01)**  
(86) DE2011000269 15.03.2011  
(96) 11718257.6 23.01.2013  
(87) WO2011113423, 15.03.2011  
(97) 2547372, 23.01.2013 de  
(54) MULTI-PHASE BACTERIALLY-SYNTHESIZED-  
NANOCELLULOSE BIOMATERIALS AND METHOD FOR  
PRODUCING SAME  
(71) Friedrich-Schiller-Universität Jena, Fürstengraben 1, 07743  
Jena, DE  
(72) HESSLER, Nadine, Denkmalsweg 3, 96529 Mengersgereuth-  
Hämmern, DE  
SULTANOVA, Barno, Massiv Yalangach 100A-23, 10025  
Tashkent, UZ  
KLEMM, Dieter, Am Waldschlößchen 7, 99425 Weimar, DE
- 
- (51) MKP  
**G06F 1/16 (2006.01)** (97) **2577418 \***  
**H04L 12/28 (2006.01)**  
(86) US2011000993 02.06.2011  
(96) 11727562.8 10.04.2013  
(87) WO2011152868, 02.06.2011  
(97) 2577418, 10.04.2013 en  
(54) DOCKING STATION WITH REDUNDANT COMMUNICATION  
PATH  
(71) Savant Systems LLC., 886 Main Street, Osterville, MA 02655,  
US  
(72) MADONNA, Robert, P., 32 Wianno Avenue, Osterville MA  
02655, US  
NOONAN, Michael, E., 7 Rolling Ridge Lane, Sandwich MA  
02563, US  
SILVA, Michael, C., 6 Fairfield Drive, East Sandwich MA  
02537, US
- 
- (51) MKP  
**E02B 3/00 (2006.01)** (97) **2582881 \***  
**B65D 88/36 (2006.01)**  
(86) IL2011000492 21.06.2011  
(96) 11740987.0 24.04.2013  
(87) WO2011161675, 21.06.2011  
(97) 2582881, 24.04.2013 en  
(54) FLOATING DEVICE AND METHOD OF USING THE SAME  
(71) Top-It-Up Ltd., 32 Ben-Gurion Street, 47321 Ramat-HaSharon,  
IL  
(72) BIRGER, Zeev, 32 Ben Gurion Street, 47321 Ramat-  
HaSharon, IL
-

(51) MKP  
**A61M 5/20 (2006.01)** (97) **2585137 \***  
**A61M 5/00 (2006.01)**  
**A61M 5/32 (2006.01)**  
(86) EP2011060730 27.06.2011  
(96) 11727480.3 01.05.2013  
(87) WO2012000942, 27.06.2011  
(97) 2585137, 01.05.2013 en  
(54) AUTO-INJECTOR  
(71) Sanofi-Aventis Deutschland GmbH, Brüningstraße 50, 65929 Frankfurt, DE  
(72) HOURMAND, Yannick, 14 The Elms, Haslingfield CB23 1ND, GB  
BARROW-WILLIAMS, Timothy Donald, 1 Grange Street, St. Albans Hertfordshire AL3 5NA, GB  
EKMAN, Matthew, 59 Ecton Avenue Cheshire, Macclesfield Cheshire SK10 1RD, GB

(51) MKP  
**C12N 15/82 (2006.01)** (97) **2566318 \***  
**A01H 5/10 (2006.01)**  
**C07K 14/415 (2006.01)**  
**A01H 1/06 (2006.01)**  
(86) EP2011002183 02.05.2011  
(96) 11720377.8 13.03.2013  
(87) WO2011137998, 02.05.2011  
(97) 2566318, 13.03.2013 en  
(54) BRASSICA PLANTS WITH ALTERED ARCHITECTURE  
(71) Bayer CropScience NV, J.E. Mommaertsiaan 14, 1831 Diegem, BE  
(72) BOTS, Marc, Landjuweelstraat 32, 9050 Ledeborg, BE  
LAGA, Benjamin, Rakestraat 4, 8750 Wingene, BE  
DEN BOER, Bart, Wilgenstraat 21, 9820 Merelbeke, BE

(51) MKP  
**A61M 5/315 (2006.01)** (97) **2579928 \***  
(86) EP2011059567 09.06.2011  
(96) 11724422.8 17.04.2013  
(87) WO2011154483, 09.06.2011  
(97) 2579928, 17.04.2013 en  
(54) DRIVE ASSEMBLY, DRIVE COMPONENT AND DRUG DELIVERY DEVICE  
(71) Sanofi-Aventis Deutschland GmbH, Brüningstraße 50, 65929 Frankfurt, DE  
(72) SMITH, Christopher, James, 4 Elm Drive Cheshire, Holmes Chapel CW4 7QG, GB  
BUTLER, Stephen, David, 25 High Hill South Staffords Essington, Staffordshire WV11 2DP, GB  
HORLOCK, Mark, Philip, 18 Mayfield Close Cheshire Timperley, Cheshire WA15 7TE, GB

(51) MKP  
**B01F 5/04 (2006.01)** (97) **2571610 \***  
**B03D 3/06 (2006.01)**  
**B01D 21/01 (2006.01)**  
(86) CA2011000601 20.05.2011  
(96) 11782825.1 27.03.2013  
(87) WO2011143768, 20.05.2011  
(97) 2571610, 27.03.2013 en  
(54) METHOD AND DEVICE FOR IN-LINE INJECTION OF FLOCCULENT AGENT INTO A FLUID FLOW OF MATURE FINE TAILINGS  
(71) Suncor Energy Inc., Suncor Energy Centre West Tower 22nd Floor P.O. Box 2844 150 - 6 Avenue S.W., Calgary, Alberta T2P 3E3, CA  
(72) REVINGTON, Adrian, Peter, 506 105 Loutit Road, Fort McMurray Alberta T9K 2N5, CA  
MARTIN, William, Matthew, 182 KennedyCrescent, Fort McMurray Alberta T9K 1M8, CA  
EASTWOOD, Jamie, 182 Bird Crescent, Fort McMurray Alberta T9H 4T3, CA

(51) MKP  
**B09B 3/00 (2006.01)** (97) **2587145 \***  
**F23G 5/00 (2006.01)**  
**F23G 5/04 (2006.01)**  
(86) RU2010000347 22.06.2010  
(96) 10853754.9 01.05.2013  
(87) WO2011162632, 22.06.2010  
(97) 2587145, 01.05.2013 en  
(54) METHOD FOR THE POLLUTION-FREE THERMAL PROCESSING OF SOLID MUNICIPAL WASTE AND PLANT FOR CARRYING OUT SAID METHOD  
(71) Obchestvo S Ogranichennoj Otvetstvennostju Promishlennaja Kompanija "Tehnologija Metallov", Ul. Kosareva 63-486, Chelyabinsk 454129, RU  
(72) GOLUBEV, Anatolij Anatoljevich, ul. K.Marksa 73-38, Chelyabinsk 454091, RU  
GUDIM, Jurij Alexandrovich, ul. Kommunisticheskaya 5-7, Chelyabinsk 454017, RU

(51) MKP  
**A61K 31/498 (2006.01)** (97) **2444068**  
**A61K 9/06 (2006.01)**  
**A61K 47/14 (2006.01)**  
**A61K 47/32 (2006.01)**  
**A61K 9/00 (2006.01)**  
(96) 11185810.6 25.04.2012  
(97) 2444068, 25.04.2012 en  
(54) Brimonidine gel composition  
(71) Galderma S.A., Zugerstrasse 8, 6330 Cham, CH  
(72) Buge, Jean-Christophe, 60 CHEMIN VALLON BARLA LE VAL D'AZUR BAT A, 06200 NICE, FR  
Nadau Fourcade, Karine, « Les Restanques de Vaugrenier » 1214 Avenue de Vaugrenier, 06270 VILLENEUVE LOUBET, FR  
Meunier, Cyril, 9, place du Château, 06250 MOUGINS, FR

(51) MKP  
**C07D 401/14 (2006.01)** (97) **2545037 \***  
**A61K 31/496 (2006.01)**  
**A61K 31/4418 (2006.01)**  
**A61P 9/00 (2006.01)**  
**C07D 401/12 (2006.01)**  
**A61K 31/4436 (2006.01)**  
**C07D 417/12 (2006.01)**  
**A61P 29/00 (2006.01)**  
**C07D 213/75 (2006.01)**  
**A61K 31/44 (2006.01)**  
**A61K 31/4545 (2006.01)**  
**A61P 25/00 (2006.01)**  
**A61K 31/4439 (2006.01)**  
**C07D 409/12 (2006.01)**  
**A61P 25/28 (2006.01)**  
(86) EP2011053574 10.03.2011  
(96) 11708026.7 16.01.2013  
(87) WO2011110612, 10.03.2011  
(97) 2545037, 16.01.2013 en  
(54) INHIBITORS OF PROTEIN KINASES  
(71) Ingenium Pharmaceuticals GmbH, Fraunhoferstrasse 13, 82152 Martinsried, DE  
(72) HEISER, Ulrich, Franz-Schubert-Strasse 5, 06108 Halle / Saale, DE  
NIESTROJ, André J., Thaelmannplatz 1, 06193 Sennewitz, DE  
ZEITLMANN, Lutz, Juttastrasse 15, 80636 Muenchen, DE

(51) MKP  
**H02J 7/14 (2006.01)** (97) **2586114 \***  
(86) US2011000994 02.06.2011  
(96) 11726530.6 01.05.2013  
(87) WO2011162798, 02.06.2011  
(97) 2586114, 01.05.2013 en  
(54) HANDHELD ROTATIONALLY RECHARGEABLE ELECTRONIC APPARATUS  
(71) Budziszek, Bobby Lee, 30 Livingston Place, Middletown, RI 02842, US  
McMaster, Collin James, 5 Prairie Place, Elma, WA 98541, US  
(72) Budziszek, Bobby Lee, 30 Livingston Place, Middletown, RI 02842, US  
McMaster, Collin James, 5 Prairie Place, Elma, WA 98541, US

- (51) MKP  
**A61K 31/44 (2006.01)** (97) **2575461 \***  
**A01N 43/40 (2006.01)**
- (86) US2011037775 24.05.2011  
(96) 11787265.5 10.04.2013  
(87) WO2011149963, 24.05.2011  
(97) 2575461, 10.04.2013 en
- (54) SUBSTITUTED-6-METHYLNICOTINAMIDES AS MGLURS POSITIVE ALLOSTERIC MODULATORS
- (71) Vanderbilt University, Center for Technology Transfer and Commercialization 305 Kirkland Hall 2201 West End Avenue, Nashville, TN 37240, US
- (72) CONN, P., Jeffrey, 9012 Grey Point Ct., Brentwood, TN 37027, US  
LINDSLEY, Craig, W., 401 Briery Court, Brentwood, TN 37027, US  
STAUFFER, Shaun, R., 9500 Wexcroft Drive, Brentwood, TN 37027, US  
ZHOU, Ya, 406 Avoca Ave. Woodside Apt. B-3, Nashville, TN 37203, US  
MANKA, Jason, 1147 Shelton Ave., Nashville, TN 37216, US  
MACDONALD, Gregor, James, c/o Janssen Pharmaceutica NV Turnhoutseweg 30, B-2340 Beerse, BE  
BARTOLOME-NEBREDA, Jose, Manuel, c/o Janssen-Cilag S.A. Calle Jarama, 75 Piliqona Industrial, E-45007 Toledo, ES
- 
- (51) MKP  
**A47K 5/12 (2006.01)** (97) **2560531 \***
- (86) AT2011000203 21.04.2011  
(96) 11722277.8 27.02.2013  
(87) WO2011130769, 21.04.2011  
(97) 2560531, 27.02.2013 de
- (54) DISPENSER
- (71) Hagleitner, Hans Georg, Lindenallee 11, 5700 Zell am See, AT
- (72) Hagleitner, Hans Georg, Lindenallee 11, 5700 Zell am See, AT
- 
- (51) MKP  
**A01N 43/02 (2006.01)** (97) **2563122 \***  
**A01N 43/22 (2006.01)**  
**A61K 31/38 (2006.01)**
- (86) US2011034024 27.04.2011  
(96) 11775513.2 06.03.2013  
(87) WO2011137135, 27.04.2011  
(97) 2563122, 06.03.2013 en
- (54) CHEMICAL COMPOUNDS
- (71) Glaxosmithkline LLC, One Franklin Plaza 200 North 16th Street, Philadelphia, PA 19102, US
- (72) AQUINO, Christopher, Joseph, GlaxoSmithKline c/o Global Patents Five Moore Drive C.2111.2F PO Box 13398, Research Triangle Park, North Carolina 27709, US  
COLLINS, Jon, Loren, GlaxoSmithKline c/o Global Patents Five Moore Drive C.2111.2F PO Box 13398, Research Triangle Park, North Carolina 27709, US  
COWAN, David, John, GlaxoSmithKline c/o Global Patents Five Moore Drive PO Box 13398, Research Triangle Park, North Carolina 27709, US  
WU, Yulin, GlaxoSmithKline c/o Global Patents Five Moore Drive C.2111.2F PO Box 13398, Research Triangle Park, North Carolina 27709, US
- 
- (51) MKP  
**H04R 25/00 (2006.01)** (97) **2571571 \***  
**A61N 1/36 (2006.01)**
- (86) IB2011052170 18.05.2011  
(96) 11738041.0 27.03.2013  
(87) WO2011145061, 18.05.2011  
(97) 2571571, 27.03.2013 en
- (54) MULTI-ELECTRODE CHANNEL CONFIGURATIONS
- (71) Cochlear Limited, 1 University Avenue, Macquarie University, NSW 2109, AU
- (72) SMITH, Zachary M., c/o IP Department Cochlear Limited 1 University Avenue Macquarie University, New South Wales 2109, AU  
HONERT, Christopher van den, c/o IP Department Cochlear Limited 1 University Avenue Macquarie University, New South Wales 2109, AU
- 
- (51) MKP  
**G21F 9/30 (2006.01)** (97) **2586034 \***  
**G21F 9/02 (2006.01)**
- (86) IT2011000211 21.06.2011  
(96) 11739196.1 01.05.2013  
(87) WO2011161709, 21.06.2011  
(97) 2586034, 01.05.2013 en
- (54) PROCESS FOR THE DETRITIATION OF SOFT HOUSEKEEPING WASTE AND PLANT THEREOF
- (71) ENEA - Agenzia Nazionale Per Le Nuove Tecnologie, L'Energia e Lo Sviluppo Economico Sostenibile, Lungotevere Thaon di Revel 76, 00196 Roma, IT  
Commissariat à l'Énergie Atomique et aux Énergies Alternatives, Bâtiment "Le Ponant D" 25, rue Leblanc, 75015 Paris, FR
- (72) GHIRELLI, Nicolas, 23 Rue C. Kaloustian Résidence Vallon Florette Bat G2, F-13013 Marseille, FR  
TOSTI, Silvano, Via della Sorgente 6, I- 00044 Frascati (RM), IT  
TRABUC, Pierre, 75 Avenue des Faurys, F-13770 Venelles, FR  
BORGOGNONI, Fabio, Via Montessori 13, I -60035 lesi (AN), IT  
LIGER, Karine, 123 Rue des Cédres, F-84120 Pertuis, FR  
SANTUCCI, Alessia, Via Casilina 13, I-00030 Colonna (RM), IT  
LEFEBVRE, Xavier, 51, Mattock Way, Abingdon, OX14 2PQ, GB
- 
- (51) MKP  
**A61K 31/4725 (2006.01)** (97) **2572717 \***  
**A61P 13/10 (2006.01)**  
**A61K 9/10 (2006.01)**  
**A61P 43/00 (2006.01)**  
**A61K 47/32 (2006.01)**  
**A61P 13/00 (2006.01)**  
**A61P 11/06 (2006.01)**  
**A61K 47/30 (2006.01)**  
**A61P 11/00 (2006.01)**  
**A61P 1/00 (2006.01)**
- (86) JP2011061376 18.05.2011  
(96) 11783576.9 27.03.2013  
(87) WO2011145642, 18.05.2011  
(97) 2572717, 27.03.2013 en
- (54) PHARMACEUTICAL COMPOSITION CONTAINING SOLIFENACIN
- (71) Astellas Pharma Inc., 3-11, Nihonbashi-Honcho 2-chome Chuo-ku, Tokyo 103-8411, JP
- (72) YOSHIOKA Tatsunobu, c/o Astellas Pharma Inc. 3-11 Nihonbashi-Honcho 2-chome Chuo-ku, Tokyo 103-8411, JP  
MURAI Makoto, c/o Astellas Pharma Inc. 3-11 Nihonbashi-Honcho 2-chome Chuo-ku, Tokyo 103-8411, JP  
TASAKI Hiroaki, c/o Astellas Pharma Inc. 3-11 Nihonbashi-Honcho 2-chome Chuo-ku, Tokyo 103-8411, JP
- 
- (51) MKP  
**F17C 13/06 (2006.01)** (97) **2546556 \***  
**F16J 13/08 (2006.01)**
- (86) ES2011000070 10.03.2011  
(96) 11752887.7 16.01.2013  
(87) WO2011110707, 10.03.2011  
(97) 2546556, 16.01.2013 en
- (54) HERMETIC SEALING SYSTEM FOR CONTAINERS
- (71) Forpogui, S.L., Carrer Migdia n° 22 Entresuelo 2º, 43500 Tortosa, ES
- (72) GUINART PALLARES, José Ramon, c/Masia, s/nº, E-43520 Roquetes - Tarragona, ES  
POY BARBERA, Alejandro, c/Masia, s/nº, E-43520 Roquetes - Tarragona, ES
- 
- (51) MKP  
**A47B 87/02 (2006.01)** (97) **2505100**
- (86) 12161813.6 03.10.2012  
(97) 2505100, 03.10.2012 en
- (54) Modular furnishing element and assembly comprising a composition with such furnishing element
- (71) Molteni & C. S.p.A., Via Rossini 50, 20033 Giussano, MONZA E BRIANZA, IT
- (72) MOLTENI, Carlo, c/o MOLTENI & C. S.p.A. VIA ROSSINI, 50, I-20033 Giussano, MONZA E BRIANZA, IT



(51) MKP  
**G01N 33/487 (2006.01)** (97) **2550530 \***  
 (86) US2011029318 22.03.2011  
 (96) 11712389.3 30.01.2013  
 (87) WO2011119533, 22.03.2011  
 (97) 2550530, 30.01.2013 en  
 (54) RESIDUAL COMPENSATION FOR A BIOSENSOR  
 (71) Bayer HealthCare LLC, 555 White Plains Road, Tarrytown, NY 10591, US  
 (72) WU, Huan-Ping, 14374 Shoreline Dr., Granger, Indiana 46530, US  
 HARRISON, Bern, 29470 County Road 1, Granger, Indiana 46530, US  
 MAURER, Eric, 3345 Stone Briar Dr., South Bend, Indiana 46628, US

(51) MKP  
**B03C 3/06 (2006.01)** (97) **2552591 \***  
**B03C 3/16 (2006.01)**  
 (86) CA2011000327 29.03.2011  
 (96) 11761860.3 06.02.2013  
 (87) WO2011120137, 29.03.2011  
 (97) 2552591, 06.02.2013 en  
 (54) ELECTROSTATIC PRECIPITATOR WITH DUAL ENERGY ZONE DISCHARGE ELECTRODES  
 (71) Turbosonic Inc., 550 Parkside Drive Suite A-14, Waterloo, Ontario N2L 5V4, CA  
 (72) ALLAN, Robert A., 126 Pinhurst Crescent, Kitchener Ontario N2N 1E4, CA  
 VAN EVERDINGEN, Egbert, 145 Simeon Street, Kitchener Ontario N2H 1S7, CA

(51) MKP  
**A61K 9/20 (2006.01)** (97) **2556824**  
**A61K 31/165 (2006.01)**  
**A61K 9/00 (2006.01)**  
 (96) 12179774.0 13.02.2013  
 (97) 2556824, 13.02.2013 fr  
 (54) Solid pharmaceutical composition for buccal administration of agomelatine  
 (71) Les Laboratoires Servier, 35, rue de Verdun, 92284 Suresnes Cedex, FR  
 (72) Tharrault, François, 13, rue des Pruniers, 45000 ORLEANS, FR  
 Poirier, Cécile, 138, rue du Faubourg Saint Jean, 45000 ORLEANS, FR  
 Fonknechten, Gilles, Route de la Californie, 45240 LIGNY LE RIBAUT, FR  
 Pean, Jean-Manuel, 2 bis rue Adolphe Crespin, 45000 ORLEANS, FR

(51) MKP  
**B41N 6/00 (2006.01)** (97) **2514601**  
 (96) 12164490.0 24.10.2012  
 (97) 2514601, 24.10.2012 en  
 (54) An apparatus for providing bubble-less sealing of flexo-printing photopolymers on sleeves coated by an adhesive strip  
 (71) Biesse Equipment Solutions S.r.l., Via Cartesio, 7, 20018 Sedriano (MI), IT  
 (72) Gatti, Roberto, c/o BIESSSE EQUIPMENT SOLUTIONS S.r.l. Via Cartesio, 7, 20018 Sedriano (MI), IT

(51) MKP  
**A61K 31/437 (2006.01)** (97) **2590987 \***  
**A61P 9/00 (2006.01)**  
**C07D 519/00 (2006.01)**  
 (86) EP2011061306 05.07.2011  
 (96) 11745710.1 15.05.2013  
 (87) WO2012004259, 05.07.2011  
 (97) 2590987, 15.05.2013 de  
 (54) RING-FUSED 4 -AMINOPYRIMIDINES AND USE THEREOF AS STIMULATORS OF SOLUBLE GUANYLATE CYCLASES  
 (71) Bayer Intellectual Property GmbH, Alfred-Nobel-Strasse 10, 40789 Monheim, DE  
 (72) FOLLMANN, Markus, Rosmarinweg 28, 50859 Köln, DE  
 STASCH, Johannes-Peter, Alfred-Nobel-Str.109, 42651 Solingen, DE  
 REDLICH, Gorden, Schadowstraße 50, 44799 Bochum, DE  
 ACKERSTAFF, Jens, Schliemannstrasse 15, 10437 Berlin, DE  
 GRIEBENOW, Nils, Kurfürstenstr. 39, 41541 Dormagen, DE  
 KNORR, Andreas, Trillser Graben 10, 40699 Erkrath, DE  
 WUNDER, Frank, Schwarzer Weg 251, 42117 Wuppertal, DE  
 LI, Volkhart Min-Jian, Im Wiesengrund 40, 42553 Velbert, DE

(51) MKP  
**A61K 39/39 (2006.01)** (97) **2566515 \***  
**A61K 38/43 (2006.01)**  
**C12N 9/00 (2006.01)**  
**A61P 37/00 (2006.01)**  
**A61K 39/395 (2006.01)**  
**A61K 38/16 (2006.01)**  
 (86) US2011034838 02.05.2011  
 (96) 11778118.7 13.03.2013  
 (87) WO2011139986, 02.05.2011  
 (97) 2566515, 13.03.2013 en  
 (54) INNOVATIVE DISCOVERY OF THERAPEUTIC, DIAGNOSTIC, AND ANTIBODY COMPOSITIONS RELATED TO PROTEIN FRAGMENTS OF ARGINYLYL-TRNA SYNTHETASES  
 (71) aTyr Pharma, Inc., 3545 John Hopkins Court, Suite 250, San Diego, CA 92121, US  
 Pangu Biopharma Limited, Edinburgh Tower, 18/F The Landmark 15 Queen's Road Central, Hong Kong, CN  
 (72) GREENE, Leslie Ann, 13941 Davenport Avenue, San Diego California 92129, US  
 CHIANG, Kyle P., 943 Torrance Street, Apt. 6, San Diego California 92103, US  
 HONG, Fei, 7979 Caminito Dia 2, San Diego California 92122, US  
 VASSEROT, Alain P., 6421 La Paloma Street, Carlsbad California 92009, US  
 LO, Wing-Sze, RM 815 Sui Ming House Siu Sai Wan Estate Chai Wan, Hong Kong, HK  
 WATKINS, Jeffry D., 3442 Fortuna Ranch Road, Encinitas California 92024, US  
 MENDLEIN, John D., 1550 Neptune Avenue, Encinitas California 92024, US  
 QUINN, Cheryl L., 5392 Renaissance Avenue, San Diego California 92122, US

(51) MKP  
**B03D 101/02 (2006.01)** (97) **2547453 \***  
**C22B 26/00 (2006.01)**  
**B03D 1/01 (2006.01)**  
**C22B 26/20 (2006.01)**  
 (86) EP2011053983 16.03.2011  
 (96) 11708477.2 23.01.2013  
 (87) WO2011113866, 16.03.2011  
 (97) 2547453, 23.01.2013 en  
 (54) FROTH FLOTATION PROCESS FOR THE SEPARATION OF SILICATES AND ALKALINE EARTH METAL CARBONATES USING A COLLECTOR COMPRISING AT LEAST ONE HYDROPHOBICALLY MODIFIED POLYALKYLENEIMINE  
 (71) Omya Development AG, Baslerstrasse 42, 4665 Oftringen, CH  
 (72) GANE, Patrick, A., C., Studenweg 8, CH-4852 Rothrist, CH  
 BURI, Matthias, Mätteliweg 20, CH-4852 Rothrist, CH  
 RENTSCH, Samuel, Höheweg 1, CH-4663 Aarburg, CH  
 SÖTEMANN, Jörg, Italiener Straße 35, A-9500 Villach, AT

- (51) MKP  
**A61K 8/19 (2006.01)** (97) **2566583 \***  
**A61K 8/67 (2006.01)**  
**A61Q 19/00 (2006.01)**  
**A61Q 19/08 (2006.01)**  
**A61K 8/98 (2006.01)**  
(86) IB2011001488 05.05.2011  
(96) 11739160.7 13.03.2013  
(87) WO2011138687, 05.05.2011  
(97) 2566583, 13.03.2013 en  
(54) USE OF CELLULAR EXTRACTS FOR SKIN REJUVENATION  
(71) Regenics AS, Nycoveien 2, 0485 Oslo, NO  
(72) GAMMELSAETER, Runhild, Maridalsveien 37, NO-0175 Oslo, NO  
REMMERREIT, Jan, Halkjelsgatta 7, NO-6100 Volda, NO
- 
- (51) MKP  
**G07F 9/02 (2006.01)** (97) **2553665 \***  
(86) EP2011054983 31.03.2011  
(96) 11711352.2 06.02.2013  
(87) WO2011121059, 31.03.2011  
(97) 2553665, 06.02.2013 en  
(54) VENDING APPARATUS AND METHOD FOR PROVIDING TRAINING FOR A MEDICINAL PRODUCT OR MEDICAL DEVICE OR COMBINATION PRODUCT  
(71) Sanofi-Aventis Deutschland GmbH, Brüningstraße 50, 65929 Frankfurt, DE  
(72) BODE, Andreas, c/o Sanofi-Aventis Deutschland GmbH, 65926 Frankfurt am Main, DE  
HEGER, Serpil, c/o Sanofi-Aventis Deutschland GmbH, 65926 Frankfurt am Main, DE  
STROSSENREUTHER, Laurin, c/o Sanofi-Aventis Deutschland GmbH, 65926 Frankfurt am Main, DE
- 
- (51) MKP  
**C07K 16/00 (2006.01)** (97) **2576616 \***  
(86) US2011037826 25.05.2011  
(96) 11787290.3 10.04.2013  
(87) WO2011149999, 25.05.2011  
(97) 2576616, 10.04.2013 en  
(54) METHOD FOR PREPARING ANTIBODIES HAVING IMPROVED PROPERTIES  
(71) Merck Sharp & Dohme Corp., 126 East Lincoln Avenue, Rahway, NJ 07065-0907, US  
(72) STADHEIM, Terrance, A., 21 Lafayette Street, Suite 200, Lebanon New Hampshire 03766, US  
ZHA, Dongxing, 21 Lafayette Street, Suite 200, Lebanon New Hampshire 03766, US  
LIU, Liming, 770 Sumneytown Pike, West Point Pennsylvania 19486, US
- 
- (51) MKP  
**G01M 5/00 (2006.01)** (97) **2583076 \***  
**G01M 11/08 (2006.01)**  
(86) IT2011000203 16.06.2011  
(96) 11740730.4 24.04.2013  
(87) WO2011158273, 16.06.2011  
(97) 2583076, 24.04.2013 en  
(54) SYSTEM FOR MEASURING AND MONITORING THE STRAIN ON OBJECTS STRESSED BY EXTERNAL FORCES  
(71) Persi Del Marmo, Paolo, Via Marche 84, 00187 Roma, IT  
(72) Persi Del Marmo, Paolo, Via Marche 84, 00187 Roma, IT
- 
- (51) MKP  
**G01N 33/487 (2006.01)** (97) **2590550 \***  
**A61B 5/1486 (2006.01)**  
**A61B 5/157 (2006.01)**  
**A61B 5/151 (2006.01)**  
**A61B 5/00 (2006.01)**  
(86) EP2011061536 07.07.2011  
(96) 11730654.8 15.05.2013  
(87) WO2012004354, 07.07.2011  
(97) 2590550, 15.05.2013 en  
(54) ALLOWING MEASUREMENTS TO BE MADE OF A BLOOD SAMPLE  
(71) Sanofi-Aventis Deutschland GmbH, Brüningstraße 50, 65929 Frankfurt, DE  
(72) RICHTER, Frank, c/o Sanofi-Aventis Deutschland GmbH, 65926 Frankfurt am Main, DE  
MACARTHUR, Ross, 22 Barlow Way, Sandbach Cheshire CW11 1PB, GB
- 
- (51) MKP  
**A47L 13/20 (2006.01)** (97) **2544576 \***  
**A47L 13/256 (2006.01)**  
**A47L 13/44 (2006.01)**  
(86) CH2011000042 07.03.2011  
(96) 11709622.2 16.01.2013  
(87) WO2011109917, 07.03.2011  
(97) 2544576, 16.01.2013 de  
(54) WIPING PLATE HAVING AN ASSOCIATED WIPING CLOTH FOR PICKING UP THE WIPING CLOTH IN A HANDS-FREE MANNER  
(71) Edi Baur AG Bürstenfabrik, Im Schrännenbrunnen 1, 8320 Fehraltdorf, CH  
(72) BAUR, Edi, Unterhäslerstrasse 11, CH-8312 Winterberg, CH  
DÜTSCH, Andreas, Birkenstrasse 7, CH-9525 Lenggenwil, CH
- 
- (51) MKP  
**H01R 13/52 (2006.01)** (97) **2544313 \***  
(86) JP2011055008 25.02.2011  
(96) 11750788.9 09.01.2013  
(87) WO2011108679, 25.02.2011  
(97) 2544313, 09.01.2013 en  
(54) CONNECTOR AND CONNECTION DEVICE FOR ELECTRONIC EQUIPMENT  
(71) EX Company Limited, 6-2 Kukodori 4-chome, Matsuyama-shi, Ehime 791-0054, JP  
(72) YUDATE Shinya, c/o EX Company Limited 6-2 Kukodori 4-chome, Matsuyama-shi Ehime 791-0054, JP  
OZAKI Masanobu, c/o EX Company Limited 6-2 Kukodori 4-chome, Matsuyama-shi Ehime 791-0054, JP
- 
- (51) MKP  
**A01N 43/90 (2006.01)** (97) **2540719 \***  
**A61P 33/10 (2006.01)**  
**A01P 7/02 (2006.01)**  
**C07D 491/052 (2006.01)**  
**C07D 451/06 (2006.01)**  
(86) JP2011054173 24.02.2011  
(96) 11747466.8 02.01.2013  
(87) WO2011105506, 24.02.2011  
(97) 2540719, 02.01.2013 en  
(54) CYCLIC AMINE COMPOUND AND MITICIDE  
(71) Nippon Soda Co., Ltd., 2-1, Ohtemachi 2-chome Chiyoda-ku, Tokyo 100-8165, JP  
(72) HAMAMOTO Isami, c/o Odawara Research Center Nippon Soda Co. Ltd. 345 Takada, Odawara-shi Kanagawa 250-0280, JP  
KOIZUMI Keiji, c/o Odawara Research Center Nippon Soda Co. Ltd. 345 Takada, Odawara-shi Kanagawa 250-0280, JP  
KAWAGUCHI Masahiro, c/o Odawara Research Center Nippon Soda Co. Ltd. 345 Takada, Odawara-shi Kanagawa 250-0280, JP  
TANIGAWA Hisashi, c/o Odawara Research Center Nippon Soda Co. Ltd. 345 Takada, Odawara-shi Kanagawa 250-0280, JP  
NAKAMURA Takehiko, c/o Odawara Research Center Nippon Soda Co. Ltd. 345 Takada, Odawara-shi Kanagawa 250-0280, JP  
KOBAYASHI Tomomi, c/o Odawara Research Center Nippon Soda Co. Ltd. 345 Takada, Odawara-shi Kanagawa 250-0280, JP
-

- (51) MKP  
**A61M 5/24 (2006.01)** (97) **2560708 \***  
 (86) EP2011056482 21.04.2011  
 (96) 11716250.3 27.02.2013  
 (87) WO2011131783, 21.04.2011  
 (97) 2560708, 27.02.2013 en  
 (54) CODED CARTRIDGE ASSEMBLY  
 (71) Sanofi-Aventis Deutschland GmbH, Brüningstraße 50, 65929 Frankfurt, DE  
 (72) AVERY, Richard, James, Vincent, 28 Nursery Close Mickleton, Chipping Campden Gloucestershire GL55 6TX, GB
- 
- (51) MKP  
**A61K 47/08 (2006.01)** (97) **2588141 \***  
**A61K 39/395 (2006.01)**  
**A61K 9/08 (2006.01)**  
 (86) US2011042838 01.07.2011  
 (96) 11801508.0 08.05.2013  
 (87) WO2012003470, 01.07.2011  
 (97) 2588141, 08.05.2013 en  
 (54) ANTIBODY FORMULATIONS  
 (71) MedImmune, LLC, One MedImmune Way, Gaithersburg, MD 20878, US  
 (72) DIMITROVA, Mariana, N., 3849 Triton Lane, Frederick, MD 21704, US  
 MODY, Neil, 22400 Brick Haven Way, Clarksburg, MD 20871, US
- 
- (51) MKP  
**C07K 16/10 (2006.01)** (97) **2591000 \***  
**A61P 31/12 (2006.01)**  
 (86) US2011043463 08.07.2011  
 (96) 11731618.2 15.05.2013  
 (87) WO2012006596, 08.07.2011  
 (97) 2591000, 15.05.2013 en  
 (54) ANTI-HUMAN RESPIRATORY SYNCYTIAL VIRUS (RSV) ANTIBODIES AND METHODS OF USE  
 (71) Crucell Holland B.V., Archimedesweg 4, 2333 CN Leiden, NL  
 (72) WILLIAMSON, Robert, Anthony, 5329 Chelsea Street, La Jolla CA 92037, US  
 WADIA, Jehangir, 10686 Passerine Way, San Diego CA 92121, US  
 PASCUAL, Gabriel, 3324 Camino Eastbluff, 160, La Jolla CA 92037, US  
 KEOGH, Elissa, 7999 Caminito Dia 2, San Diego CA 92122, US
- 
- (51) MKP  
**G01N 33/68 (2006.01)** (97) **2558867 \***  
 (86) EP2011056056 15.04.2011  
 (96) 11714563.1 20.02.2013  
 (87) WO2011128448, 15.04.2011  
 (97) 2558867, 20.02.2013 en  
 (54) METHOD FOR DIFFERENTIALLY QUANTIFYING NATURALLY PROCESSED HLA-RESTRICTED PEPTIDES FOR CANCER, AUTOIMMUNE AND INFECTIOUS DISEASES IMMUNOTHERAPY DEVELOPMENT  
 (71) Immatics Biotechnologies GmbH, Paul-Ehrlich-Strasse 15, 72076 Tübingen, DE  
 (72) WEINSCHENK, Toni, Im Morgenrain 15, 73773 Aichwald, DE  
 FRITSCHKE, Jens, Im Schoenblick 48, 72076 Tuebingen, DE
- 
- (51) MKP  
**C07D 277/82 (2006.01)** (97) **2542541 \***  
 (86) US2011026989 03.03.2011  
 (96) 11708371.7 09.01.2013  
 (87) WO2011109596, 03.03.2011  
 (97) 2542541, 09.01.2013 en  
 (54) SYNTHESIS OF CHIRALLY PURIFIED SUBSTITUTED BENZOTHIAZOLE DIAMINES  
 (71) KNOPP NEUROSCIENCES, 2100 Wharton Street, Suite 615, Pittsburg, PA 15203, US  
 (72) GREENFIELD, Scott, Jeffrey, 14 McMillen Place, Delmar NY 12054, US  
 GIBB, Cameron, Seath, 37 Lansgate Court, Durham, NC 27713, US  
 GADIKOTA, Rajendra, Kumar, Reddy, Villa 70, Ashoka-A-la Maison Dhoolapalli Road, Kompalli Hyderabad 500 014, IN

- (51) MKP  
**A61K 47/42 (2006.01)** (97) **2575804 \***  
**A61P 35/00 (2006.01)**  
**A61K 9/14 (2006.01)**  
**A61K 31/337 (2006.01)**  
 (86) US2011037462 20.05.2011  
 (96) 11790193.4 10.04.2013  
 (87) WO2011153010, 20.05.2011  
 (97) 2575804, 10.04.2013 en  
 (54) METHODS OF TREATMENT OF PANCREATIC CANCER  
 (71) Abraxis BioScience, LLC, 11755 Wilshire Boulevard Suite 2100, Los Angeles, CA 90025, US  
 (72) DESAI, Neil, P., 11755 Wilshire Boulevard, Suite 2100, Los Angeles CA 90025, US  
 SOON-SHIONG, Patrick, 149 South Barrington Avenue, 311, Los Angeles CA 90049, US
- 
- (51) MKP  
**A61M 5/32 (2006.01)** (97) **2585140 \***  
**A61M 5/20 (2006.01)**  
**A61M 5/00 (2006.01)**  
 (86) EP2011060504 22.06.2011  
 (96) 11729285.4 01.05.2013  
 (87) WO2012000872, 22.06.2011  
 (97) 2585140, 01.05.2013 en  
 (54) AUTO-INJECTOR  
 (71) Sanofi-Aventis Deutschland GmbH, Brüningstraße 50, 65929 Frankfurt, DE  
 (72) HOURMAND, Yannick, 14 The Elms, Haslingfield CB23 1ND, GB  
 BARROW-WILLIAMS, Timothy Donald, 1 Grange Street, St. Albans Hertfordshire AL3 5NA, GB  
 EKMAN, Matthew, 59 Ecton Avenue, Macclesfield Cheshire SK10 1RD, GB
- 
- (51) MKP  
**A61K 31/47 (2006.01)** (97) **2575814 \***  
 (86) US2011037457 20.05.2011  
 (96) 11724493.9 10.04.2013  
 (87) WO2011146901, 20.05.2011  
 (97) 2575814, 10.04.2013 en  
 (54) PHARMACEUTICAL COMPOSITIONS AND ADMINISTRATIONS THEREOF  
 (71) Vertex Pharmaceuticals Incorporated, 130 Waverly Street, Cambridge, MA 02139, US  
 (72) VAN GOOR, Fredrick, F., 832 Ormond Court, San Diego, CA 92109, US  
 BURTON, William, Lawrence, 5345 Toscana Way 528, San Diego, CA 92122, US  
 HUANG, Chien-jung, 1540 Tennis Match Way, Encinitas, CA 92024, US  
 NEGULESCU, Paul, Adrian, 386 Serpentine Drive, Del Mar, CA 92014, US  
 YU, Haihui, 6183 Quail Run St., San Diego, CA 92130-5780, US
- 
- (51) MKP  
**F03G 7/00 (2006.01)** (97) **2582916 \***  
**F01B 23/02 (2006.01)**  
**F01B 9/02 (2006.01)**  
**B60W 20/00 (2006.01)**  
 (86) US2011040477 15.06.2011  
 (96) 11796349.6 24.04.2013  
 (87) WO2011159774, 15.06.2011  
 (97) 2582916, 24.04.2013 en  
 (54) COMPRESSED AIR ENGINE  
 (71) HB Spider, LLC, 4448 South Avilla Street, Reeds, MO 64859, US  
 (72) HUFF, Christopher, M., 4448 Avilla Street, Reeds, MO 64859, US  
 BLOCK, Danny, Lee, 3551 State Hwy 37, Reeds, MO 64859, US

- (51) MKP  
**C07C 235/40 (2006.01)** (97) **2547645 \***  
**C07C 69/74 (2006.01)**  
**C07C 51/487 (2006.01)**  
**C07C 61/06 (2006.01)**  
(86) EP2011053957 16.03.2011  
(96) 11709692.5 23.01.2013  
(87) WO2011113859, 16.03.2011  
(97) 2547645, 23.01.2013 en  
(54) PROCESSES AND INTERMEDIATES FOR PREPARING A MACROCYCLIC PROTEASE INHIBITOR OF HCV  
(71) Janssen Pharmaceuticals, Inc., 1125 Trenton-Harbourton Road, Titusville, NJ 08560, US  
(72) ORMEROD, Dominic, John, Jan Van Cuyckstraat 24, 2320 Hoogstraten, BE  
DEPRÉ, Dominique, Paul, Michel, Rue René Ménada 81, 1320 Hamme-Mille, BE  
HORVATH, Andras, Dokter Paul Janssenlaan 16, 2300 Turnhout, BE

- (51) MKP  
**A61K 9/48 (2006.01)** (97) **2471514**  
**A61K 9/16 (2006.01)**  
**A61K 9/20 (2006.01)**  
**A61K 31/23 (2006.01)**  
(96) 10197293.3 04.07.2012  
(97) 2471514, 04.07.2012 en  
(54) Controlled moisture content of cetyl myristate and/or cetyl palmitate granules or formulations  
(71) Deva Holding Anonim Sirketi, Patent Law Department Halkali Merkez Mah. Basın Ekspres Cad. No: 1,34303, Kucukcekmece/Istanbul, TR  
(72) HAAS, Philipp Daniel, DEVA HOLDING ANONIM SIRKETI Halkali Merkez Mah.,Ba, 34303, ISTANBUL, TR  
FIRAT, Omer Faruk, R&D DEVA HOLDING ANONIM SIRKETI Halkali Merkez Mah, 34303, ISTANBUL, TR  
KANDEMİR, Levent, R&D DEVA HOLDING ANONIM SIRKETI Halkali Merkez Mah, 34303, ISTANBUL, TR  
KOC, Fikret, R&D DEVA HOLDING ANONIM SIRKETI Halkali Merkez Mah, 34303, ISTANBUL, TR  
SIVASLIGIL, Ramazan, R&D DEVA HOLDING ANONIM SIRKETI Halkali Merkez Mah, 34303, ISTANBUL, TR

- (51) MKP  
**B65D 77/04 (2006.01)** (97) **2566777 \***  
**B65D 8/04 (2006.01)**  
**B65D 77/06 (2006.01)**  
(86) EP2011056553 26.04.2011  
(96) 11717245.2 13.03.2013  
(87) WO2011134949, 26.04.2011  
(97) 2566777, 13.03.2013 en  
(54) CONTAINER FOR LIQUIDS  
(71) Eurokeg B.V., Takelaarsweg 10, 1786 PR Den Helder, NL  
(72) HANSEN, Hubert, Joseph, Frans, Zwarte Pad 2, NL-1069 MN Amsterdam, NL  
VEENENDAAL, Jan, Dirk, Mr. J. Henderikxstraat 79, NL-1788 AZ Den Helder, NL  
VEENENDAAL, Jan, Mr. J. Henderikxstraat 69, NL-1788 AZ Den Helder, NL

- (51) MKP  
**B01D 53/64 (2006.01)** (97) **2555851 \***  
**B01D 53/34 (2006.01)**  
**B01D 53/02 (2006.01)**  
(86) US2011031638 07.04.2011  
(96) 11766760.0 13.02.2013  
(87) WO2011127323, 07.04.2011  
(97) 2555851, 13.02.2013 en  
(54) METHODS FOR REMOVAL OF MERCURY FROM FLUE GAS  
(71) Calgon Carbon Corporation, 500 Calgon Drive, Pittsburgh, PA 15205, US  
Pollack, Nicholas R., 105 Boggs Avenue, Moon, Pennsylvania 15108, US  
(72) POLLACK, Nicholas R., 105 Boggs Avenue, Moon, Pennsylvania 15108, US  
HAYDEN, Richard A., 348 Lee Avenue, Pittsburgh, Pennsylvania 15237, US

- (51) MKP  
**A61K 31/445 (2006.01)** (97) **2544685 \***  
**A61K 9/20 (2006.01)**  
(86) DE2011000242 09.03.2011  
(96) 11730880.9 16.01.2013  
(87) WO2011110166, 09.03.2011  
(97) 2544685, 16.01.2013 de  
(54) SOLID PHARMACEUTICAL COMPOSITION, COMPRISING DONEPEZIL HYDROCHLORIDE OF THE CRYSTALLINE POLYMORPHOUS FORM I  
(71) STADA ARZNEIMITTEL AG, Stadastrasse 2-18, 61118 Bad Vilbel, DE  
(72) STUPAR, Biljana, Lipa 14 (nasalje Hemograd), 26300 Vrsac, RS  
VUKOVIC, Stasa, Lipa 16 (nasalje Hemograd), 26300 Vrsac, RS  
BOZIC, Jovana, Sterijina 15/5, 26300 Vrsac, RS

- (51) MKP  
**C07K 16/40 (2006.01)** (97) **2563911 \***  
**C07K 19/00 (2006.01)**  
**C12N 15/113 (2010.01)**  
**G01N 33/68 (2006.01)**  
**A61K 38/43 (2006.01)**  
**C12N 9/00 (2006.01)**  
**C12N 15/52 (2006.01)**  
(86) US2011034387 28.04.2011  
(96) 11778025.4 06.03.2013  
(87) WO2011139853, 28.04.2011  
(97) 2563911, 06.03.2013 en  
(54) INNOVATIVE DISCOVERY OF THERAPEUTIC, DIAGNOSTIC, AND ANTIBODY COMPOSITIONS RELATED TO PROTEIN FRAGMENTS OF ALANYL TRNA SYNTHETASES  
(71) aTyr Pharma, Inc., 3545 John Hopkins Court, Suite 250, San Diego, CA 92121, US  
Pangu Biopharma Limited, Edinburgh Tower, 18/F The Landmark 15 Queen's Road Central, Hong Kong, CN  
(72) GREENE, Leslie Ann, 13941 Davenport Avenue, San Diego California 92129, US  
CHIANG, Kyle, P., 943 Torrance Street Apt. 6, San Diego California 92103, US  
HONG, Fei, 7979 Caminito Dia, 2, San Diego California 92122, US  
VASSEROT, Alain, P., 6421 La Paloma Street, Carlsbad California 92009, US  
LO, Wing-Sze, RM 815 Sui Ming House Siu Sai Wan Estate Chai Wan, Hong Kong, CN  
WATKINS, Jeffrey, D., 3442 Fortuna Ranch Road, Encinitas California 92024, US  
MENDLEIN, John, D., 1550 Neptune Avenue, Encinitas California 92024, US  
QUINN, Cheryl, L., 5392 Renaissance Avenue, San Diego California 92122, US

- (51) MKP  
**C08J 3/22 (2006.01)** (97) **2573130 \***  
**C08L 77/00 (2006.01)**  
**C08K 3/22 (2006.01)**  
**B29B 9/12 (2006.01)**  
(86) JP2011061672 20.05.2011  
(96) 11783662.7 27.03.2013  
(87) WO2011145730, 20.05.2011  
(97) 2573130, 27.03.2013 en  
(54) MASTERBATCH PELLETS, PROCESS FOR PRODUCING SAME, AND POLYAMIDE RESIN COMPOSITION CONTAINING THE MASTERBATCH PELLETS  
(71) Asahi Kasei Chemicals Corporation, 1-105, Kanda Jinbocho Chiyoda-ku, Tokyo 101-8101, JP  
(72) TERADA, Kazunori, 1-105 Kanda Jinbocho Chiyoda-ku, Tokyo 101-8101, JP

(51) MKP  
**C09J 167/06 (2006.01)** (97) **2576141 \***  
**C08G 63/676 (2006.01)**  
**C08G 63/52 (2006.01)**  
**B24D 3/28 (2006.01)**  
**B24D 3/20 (2006.01)**  
(86) FR2011051214 27.05.2011  
(96) 11726914.2 10.04.2013  
(87) WO2011148112, 27.05.2011  
(97) 2576141, 10.04.2013 fr  
(54) ADHESIVE COMPOSITION CONTAINING A CARBOXYLIC-ACID-TERMINATED UNSATURATED POLYESTER AND USES THEREOF  
(71) SAINT-GOBAIN RECHERCHE, 39 quai Lucien Lefranc, 93300 Aubervilliers, FR  
(72) JASINSKA, Lidia, Ul. Wladyslawa Cieszynskiego 17/6, PL-80809 Gdansk, PL  
KONING, Cornelis Eme, Sperwerdreef 7, NL-6446 DJ Brunssum, NL  
ARNAUD, Alix, 57 Avenue de la République, F-92120 Montrouge, FR  
HOUGA, Clément, 4 rue Pierre Le Frapper, F-78800 Houilles, FR

(51) MKP  
**A61M 5/24 (2006.01)** (97) **2460552**  
**A61M 5/315 (2006.01)**  
(86) 10193754.8 06.06.2012  
(97) 2460552, 06.06.2012 en  
(54) Drug delivery device with locking arrangement for dose button  
(71) Sanofi-Aventis Deutschland GmbH, Brünigstraße 50, 65929 Frankfurt, DE  
(72) Teucher, Axel, c/o Sanofi-Aventis Deutschland GmbH Industriepark Höchst, 65926 Frankfurt am Main, DE

(51) MKP  
**E21B 47/00 (2012.01)** (97) **2558681 \***  
(86) US2011031968 11.04.2011  
(96) 11769381.2 20.02.2013  
(87) WO2011130176, 11.04.2011  
(97) 2558681, 20.02.2013 en  
(54) PRODUCTION LOGGING PROCESSES AND SYSTEMS  
(71) Marathon Oil Company, 5555 San Felipe, Houston, TX 77056-2799, US  
(72) SNIDER, Philip M., 12102 Rocky Lake Drive, Houston Texas 77070, US

(51) MKP  
**A61M 1/14 (2006.01)** (97) **2585489 \***  
**C07K 14/705 (2006.01)**  
**C07K 17/02 (2006.01)**  
(86) EP2011060130 17.06.2011  
(96) 11726415.0 01.05.2013  
(87) WO2011161017, 17.06.2011  
(97) 2585489, 01.05.2013 en  
(54) NEW MEDIUM, DEVICES AND METHODS  
(71) JJK Medical Ltd., 11-15 Seaton Place, Saint Helier, Channel Islands JE4 0HQ, GB  
(72) AXELSSON, Jonas, Odengatan 6 2 tr, S-114 24 Stockholm, SE

(51) MKP  
**B32B 27/08 (2006.01)** (97) **2552689 \***  
**B32B 27/36 (2006.01)**  
**C08G 63/08 (2006.01)**  
(86) US2010062062 23.12.2010  
(96) 10849172.1 06.02.2013  
(87) WO2011123165, 23.12.2010  
(97) 2552689, 06.02.2013 en  
(54) BIAXIALLY ORIENTED POLYLACTIC ACID FILM WITH REDUCED NOISE LEVEL  
(71) Toray, Plastics (America), Inc., 50 Belver Avenue, North Kingstown, RI 02852-7500, US  
(72) DOU, Shichen, 31 Cedar Pond Drive Apt 11, Warwick RI 02886, US  
LEE, Mark, S., 153 Mount View Avenue, North Kingstown RI 02852, US  
PAULINO, Claudio, M., 66 Straw Lane, South Kingstown RI 02879, US  
YOKOTA, Nao, 80 Fleetwood Drive, Saundertown RI 02874, US  
CHANG, Keunsuk, P., 31 Mayflower Court, North Kingstown RI 02852-7500, US

(51) MKP  
**G01M 3/32 (2006.01)** (97) **2569611 \***  
**G01N 15/08 (2006.01)**  
**C23C 16/00 (2006.01)**  
**G01N 33/00 (2006.01)**  
(86) US2011036358 12.05.2011  
(96) 11722664.7 20.03.2013  
(87) WO2011143509, 12.05.2011  
(97) 2569611, 20.03.2013 en  
(54) VESSEL OUTGASSING INSPECTION METHODS  
(71) SiO2 Medical Products, Inc., 2250 Riley Street, Auburn, AL 36832, US  
(72) FELTS, John T., 2624 Calhoun Street, Alameda California 94501, US  
FISK, Thomas E., 955 North Night Heron Drive, Green Valley Arizona 85614, US  
ABRAMS, Robert S., 21 Marian Avenue, Albany New York 12203, US  
FERGUSON, John, 797 Greenwood Drive, Auburn Alabama 36832, US  
FREEDMAN, Jonathan R., 2213 Brenton Lane, Auburn Alabama 36830, US  
PANGBORN, Robert J., 2215 North Lakeshore Drive, Harbor Springs Michigan 49740, US  
SAGONA, Peter J., 161 Ridgeview Drive, Pottstown Pennsylvania 19465, US

(51) MKP  
**A01N 43/42 (2006.01)** (97) **2575464 \***  
**C07D 291/00 (2006.01)**  
**A61K 31/44 (2006.01)**  
(86) US2011039085 03.06.2011  
(96) 11790471.4 10.04.2013  
(87) WO2011153444, 03.06.2011  
(97) 2575464, 10.04.2013 en  
(54) NEW FORMS OF RIFAXIMIN AND USES THEREOF  
(71) Salix Pharmaceuticals, Ltd., 8510 Colonnade Center Drive, Raleigh, NC 27615, US  
(72) WU, Yiduo, 3205 Bowfield Way, West Lafayette, IN 47906, US  
PARENT, Stephan, D., 2120 Cumulus Ct., West Lafayette, IN 47906, US  
SCHULTHEISS, Nathan, Carl, 5403 Timber Shade Dr., Kingwood, TX 77345, US  
BEVILL, Melanie, Janelle, 343 Buchanan Dr., West Lafayette, IN 47906, US  
VLAHOVA, Petinka, 1041 Shootingstar Ct., West Lafayette, IN 47906, US  
HOUSTON, Travis, L., 3240 Hendrickson Lane, Lafayette, IN 47909, US

- (51) MKP  
**G06F 19/24 (2011.01)** (97) **2390811**  
 (96) 11167497.4 30.11.2011  
 (97) 2390811, 30.11.2011 en  
 (54) Identification of ribosomal DNA sequences  
 (71) Tata Consultancy Services Limited, Nirmal Building, 9th Floor Nariman Point Maharashtra, 400021 Mumbai, IN  
 (72) Mande, Sharmila S., Bio-Sciences R&D Division, TCS Innovation Labs, Hyderabad, Tata Consultancy Services Limited, 1 Software Units Layout, Madhapur, Hyderabad 500081 Andhra Pradesh, IN  
 Haque, Mohammed Monzoorul, Bio-Sciences R&D Division, TCS Innovation Labs, Hyderabad, Tata Consultancy Services Limited, 1 Software Units Layout, Madhapur, Hyderabad 500081 Andhra Pradesh, IN  
 Ghosh, Tarini Shankar, Bio-Sciences R&D Division, TCS Innovation Labs, Hyderabad, Tata Consultancy Services Limited, 1 Software Units Layout, Madhapur, Hyderabad 500081 Andhra Pradesh, IN  
 Chadram, Sudha, Bio-Sciences R&D Division, TCS Innovation Labs, Hyderabad, Tata Consultancy Services Limited, 1 Software Units Layout, Madhapur, Hyderabad 500081 Andhra Pradesh, IN  
 Chennareddy, Venkata Siva Kumar Reddy, Bio-Sciences R&D Division, TCS Innovation Labs, Hyderabad, Tata Consultancy Services Limited, 1 Software Units Layout, Madhapur, Hyderabad 500081 Andhra Pradesh, IN
- 
- (51) MKP  
**H01M 4/96 (2006.01)** (97) **2548257 \***  
**G21B 3/00 (2006.01)**  
**H01M 14/00 (2006.01)**  
**C01B 3/00 (2006.01)**  
**H01M 8/22 (2006.01)**  
**H01M 4/94 (2006.01)**  
**H01M 4/86 (2006.01)**  
 (86) US2011028889 17.03.2011  
 (96) 11712377.8 23.01.2013  
 (87) WO2011116236, 17.03.2011  
 (97) 2548257, 23.01.2013 en  
 (54) ELECTROCHEMICAL HYDROGEN-CATALYST POWER SYSTEM  
 (71) Blacklight Power, Inc., 493 Old Trenton Road, Cranbury, NJ 08512, US  
 (72) MILLS, Randell, L., 27 Rosedale Road, Princeton NJ 08540, US
- 
- (51) MKP  
**C07D 211/46 (2006.01)** (97) **2556056 \***  
**C07D 413/14 (2006.01)**  
**C07D 413/04 (2006.01)**  
**C07D 413/06 (2006.01)**  
**C07D 405/12 (2006.01)**  
**A61K 31/495 (2006.01)**  
**C07D 401/12 (2006.01)**  
**A61K 31/445 (2006.01)**  
**C07D 405/14 (2006.01)**  
**A61P 3/10 (2006.01)**  
**C07D 401/14 (2006.01)**  
**A61K 31/454 (2006.01)**  
**C07D 401/04 (2006.01)**  
**C07D 417/14 (2006.01)**  
 (86) US2011031243 05.04.2011  
 (96) 11715123.3 13.02.2013  
 (87) WO2011127051, 05.04.2011  
 (97) 2556056, 13.02.2013 en  
 (54) MODULATORS OF THE GPR119 RECEPTOR AND THE TREATMENT OF DISORDERS RELATED THERETO  
 (71) Arena Pharmaceuticals, Inc., 6166 Nancy Ridge Drive, San Diego, CA 92121, US  
 (72) JONES, Robert M., 10937 Corte luz del Sol, San Diego California 92130, US  
 HAN, Sangdon, 9953 Fieldthorn Street, San Diego California 92127, US  
 BUZARD, Daniel J., 14494 Janal Way, San Diego California 92129, US  
 LEHMANN, Juerg, 9840 La Tortola Court, San Diego California 92129, US  
 NARAYANAN, Sanju, 10616 Marbury Avenue, San Diego California 92126, US  
 YUE, Dawei, 11353 Nahama Lane, San Diego California 92130, US
- 
- (51) MKP  
**A61K 35/12 (2006.01)** (97) **2443231 \***  
**C12N 5/10 (2006.01)**  
**C12N 5/0735 (2010.01)**  
**C12N 15/12 (2006.01)**  
**C12N 5/074 (2010.01)**  
 (86) US2010039222 18.06.2010  
 (96) 10790286.8 25.04.2012  
 (87) WO2010148334, 18.06.2010  
 (97) 2443231, 25.04.2012 en  
 (54) GENERATION OF INDUCED PLURIPOTENT STEM CELLS FROM CORD BLOOD  
 (71) The Salk Institute for Biological Studies, 10010 North Torrey Pines Road, La Jolla, CA 92037, US  
 Center Of Regenerative Medicine Of Barcelona, Spain, Dr. Alguader 88 7th Floor, 08003 Barcelona, ES  
 (72) GIORGETTI, Alessandra, Carrer de Mallorca 492 5<sup>a</sup>4a, E-08013 Barcelona, ES  
 IZPISUA BELMONTE, Juan Carlos, 8435 Avenieda de las Ondas, La Jolla California 92037, US
- 
- (51) MKP  
**A61K 38/00 (2006.01)** (97) **2542254 \***  
**A61K 38/16 (2006.01)**  
 (86) US2011024583 11.02.2011  
 (96) 11761468.5 09.01.2013  
 (87) WO2011100585, 11.02.2011  
 (97) 2542254, 09.01.2013 en  
 (54) SECONDARY STRUCTURE STABILIZED NMDA RECEPTOR MODULATORS AND USES THEREOF  
 (71) Northwestern University, 633 Clark Street, Evanston, IL 60208, US  
 (72) MOSKAL, Joseph., 801 Central Street, Evanstown, IL 60201, US  
 KHAN, Amin., 2 East Oak Street. Apt. 2201, Chicago, IL 60611, US
-

- (51) MKP  
**C07D 498/20 (2006.01)** (97) **2547686 \***  
**A61K 31/537 (2006.01)**  
**C07D 498/10 (2006.01)**  
**A61K 31/5386 (2006.01)**  
**C07D 513/10 (2006.01)**  
**C07D 513/20 (2006.01)**  
**A61P 25/28 (2006.01)**  
**A61K 31/547 (2006.01)**  
(86) US2011028401 14.03.2011  
(96) 11714873.4 23.01.2013  
(87) WO2011115928, 14.03.2011  
(97) 2547686, 23.01.2013 en  
(54) AMINO -DIHYDROOXAZINE AND AMINO -  
DIHYDROTHIAZINE SPIRO COMPOUNDS AS BETA -  
SECRETASE MODULATORS AND THEIR MEDICAL USE  
(71) Amgen Inc., One Amgen Center Drive, Thousand Oaks,  
California 91320-1799, US  
(72) CHEN, Jian, J., 5448 Castillo De Rosa, Camrillo CA 91320, US  
ZHONG, Wenge, 2921 Venezia Lane, Thousand Oaks CA  
91362, US  
YANG, Bryant, 637 Warrendale Avenue, Simi Valley CA 93065,  
US  
QIAN, Wenyuan, 3872 Fountain Street, Camarillo CA 93012,  
US  
LOPEZ, Patricia, 22644 Saticoy Street, Woodland Hills CA  
91307, US  
WHITE, Ryan, 34 Willow Avenue Unit 1, Somerville MA 02144,  
US  
WEISS, Matthew, 99 Revere Street, Boston MA 02114, US  
JUDD, Ted, 610 Geranium Lane Unit A, Simi Valley CA 93065,  
US  
POWERS, Timothy, 31230 Bailard Road, Malibu CA 09265, US  
CHENG, Yuan, 5329 Via Jacinto, Newbury Park CA 91320, US  
DINEEN, Thomas, 36 Waterhouse Street, Somerville MA  
02144, US  
EPSTEIN, Oleg, 44 Trowbridge Street, Belmont MA 02478, US  
LOW, Jonathan, 18644 Clark Street, 5, Tarzana CA 91356, US  
MARX, Isaac, 159 Pemberton Street 1, Cambridge MA 02140,  
US  
MINATTI, Ana Elena, 2219 3rd Street Unit 6, Santa Monica CA  
90405, US  
PARAS, Nick, A., 3632 36th Street, San Francisco CA 94110,  
US  
POTASHMAN, Michele, 19 Clary Street, Cambridge MA  
02139, US
- 
- (51) MKP  
**G01N 33/548 (2006.01)** (97) **2560003 \***  
**G01N 33/53 (2006.01)**  
(86) JP2011059150 13.04.2011  
(96) 11768878.8 20.02.2013  
(87) WO2011129357, 13.04.2011  
(97) 2560003, 20.02.2013 en  
(54) COMPLEX OF LABELED PROBE AND WATER-SOLUBLE  
CARRIER  
(71) EIKEN KAGAKU KABUSHIKI KAISHA, 4-19-9, Taito, Taito-ku,  
Tokyo 110-8408, JP  
Advanced Life Science Institute, Inc., 2-10-23, Maruyamadai,  
Wako-shi, Saitama 351-0112, JP  
(72) OHIRO Yoshiyuki, c/o NOGI JIGYOSHO EIKEN KAGAKU  
KABUSHIKI KAISHA 143 Nogi Nogi-machi, Shimotsuga-gun,  
Tochigi 329-0114, JP  
TAKAYASU Susumu, c/o NOGI JIGYOSHO EIKEN KAGAKU  
KABUSHIKI KAISHA 143 Nogi Nogi-machi, Shimotsuga-gun,  
Tochigi 329-0114, JP
- 
- (51) MKP  
**C12Q 1/60 (2006.01)** (97) **2580346 \***  
(86) FR2011051316 09.06.2011  
(96) 11735470.4 17.04.2013  
(87) WO2011154662, 09.06.2011  
(97) 2580346, 17.04.2013 fr  
(54) METHOD FOR DETECTING COMPOUNDS THAT  
MODULATE THE CHOLESTEROL METABOLISM  
(71) SANOFI, 54 rue La Boétie, 75008 Paris, FR  
(72) DUMAS, Bruno, c/o Sanofi Département Brevets 174 avenue  
de France, F-75013 Paris, FR  
MAURY, Isabelle, c/o Sanofi Département Brevets 174 avenue  
de France, F-75013 Paris, FR
- 
- (51) MKP  
**A01K 1/00 (2006.01)** (97) **2590501 \***  
**A01K 1/01 (2006.01)**  
(86) DK2011050266 07.07.2011  
(96) 11733558.8 15.05.2013  
(87) WO2012003837, 07.07.2011  
(97) 2590501, 15.05.2013 en  
(54) APPARATUS AND METHOD FOR HANDLING A SEAL IN A  
SLURRY DUCT  
(71) MT Højgaard A/S, Vestermarksvej 3, 8800 Viborg, DK  
(72) MIKKELSEN, Jens Bang, Myrupvej 13, DK-4700 Næstved, DK
- 
- (51) MKP  
**A61P 29/00 (2006.01)** (97) **2566474 \***  
**A61K 31/337 (2006.01)**  
**A61K 9/107 (2006.01)**  
**A61K 9/10 (2006.01)**  
(86) US2011034586 29.04.2011  
(96) 11778055.1 13.03.2013  
(87) WO2011139899, 29.04.2011  
(97) 2566474, 13.03.2013 en  
(54) NON-AQUEOUS TAXANE PRO-EMULSION FORMULATIONS  
AND METHODS OF MAKING AND USING THE SAME  
(71) Teikoku Pharma USA, Inc., 1718 Ringwood Avenue, San Jose,  
CA 95131, US  
(72) NABETA, Kiichiro, 2-23-30-201 Kaminoge, Setagaya-ku Tokyo  
158-0093, JP
- 
- (51) MKP  
**C12Q 1/68 (2006.01)** (97) **2588630 \***  
(86) US2011042823 01.07.2011  
(96) 11801503.1 08.05.2013  
(87) WO2012003462, 01.07.2011  
(97) 2588630, 08.05.2013 en  
(54) MOLECULAR GENETIC APPROACH TO TREATMENT AND  
DIAGNOSIS OF ALCOHOL AND DRUG DEPENDENCE  
(71) University of Virginia Patent Foundation, 250 West Main Street,  
Suite 300, Charlottesville, VA 22902, US  
(72) JOHNSON, Bankole A., 2857 Carters Mountain Road,  
Charlottesville, VA 22902, US
- 
- (51) MKP  
**C12M 1/02 (2006.01)** (97) **2505634**  
**C12M 1/00 (2006.01)**  
**B01F 11/00 (2006.01)**  
(96) 11425082.2 03.10.2012  
(97) 2505634, 03.10.2012 en  
(54) A solid state fermentation plant  
(71) Technelep srl, Via Valsesia, 50, 20152 Milano, IT  
(72) Bobbiesi, Giuseppe, Via Valsesia, n°50, 20152 Milano, IT  
Bobbiesi, Marco, Via Valsesia, n°50, 20152 Milano, IT
- 
- (51) MKP  
**A61M 5/32 (2006.01)** (97) **2588173 \***  
**A61M 5/50 (2006.01)**  
(86) EP2011060320 21.06.2011  
(96) 11728613.8 08.05.2013  
(87) WO2012000836, 21.06.2011  
(97) 2588173, 08.05.2013 en  
(54) SAFETY DEVICE FOR A PRE-FILLED SYRINGE AND  
INJECTION DEVICE  
(71) Sanofi-Aventis Deutschland GmbH, Brüningstraße 50, 65929  
Frankfurt, DE  
(72) ROBERTS, Gareth, Glendale Pen-y-cae Road Ruabon,  
Wrexham LL14 6EB, GB  
WARD, Chris, 31 Princes Avenue Denbighshire, Prestatyn  
Denbighshire LL19 8RW, GB  
EKMAN, Matthew, 59 Ecton Avenue Cheshire, Macclesfield  
Cheshire SK10 1RD, GB
-

- (51) MKP  
**B65D 83/44 (2006.01)** (97) **2576387 \***  
**B67D 1/12 (2006.01)**  
**G01F 11/08 (2006.01)**  
**B65D 83/18 (2006.01)**  
**B65D 83/16 (2006.01)**  
**G01F 11/04 (2006.01)**  
**B65D 83/60 (2006.01)**  
**B65D 83/14 (2006.01)**  
**B67D 1/02 (2006.01)**  
**B67D 1/04 (2006.01)**  
(86) NL2011050367 27.05.2011  
(96) 11724813.8 10.04.2013  
(87) WO2011152715, 27.05.2011  
(97) 2576387, 10.04.2013 en  
(54) METHOD AND APPARATUS FOR DISPENSING BEVERAGES, ESPECIALLY CARBONATED BEVERAGES  
(71) Heineken Supply Chain B.V., 2e Weteringplantsoen 21, 1017 ZD Amsterdam, NL  
(72) LANDMAN, Bernardus Cornelis Johannes, Noordeinde 373, NL-2771 WR Boskoop, NL  
LINDMAYER, István Stephen, Homokhegy u. 12., H-7228 Döbrököz, HU
- 
- (51) MKP  
**F16L 51/03 (2006.01)** (97) **2569568 \***  
(86) HR2011000017 10.05.2011  
(96) 11728047.9 20.03.2013  
(87) WO2011141758, 10.05.2011  
(97) 2569568, 20.03.2013 en  
(54) IN-LINE PRESSURE BALANCED EXPANSION JOINT FOR PIPING AND DUCTING SYSTEMS WITH CIRCULAR CROSS SECTION AND INTERNALLY LOCATED TIE RODS  
(71) Numikon D.O.O, Dragutina Golika 63, 10000 Zagreb, HR  
Pipetech, Jocic, Haegelerstrasse 75, 5400 Baden, CH  
Innospin AG, Jurastrasse 58, 5430 Wettingen, CH  
(72) IVANCIC, Zdravko, Bistrec 31 Lug Samoborski, 10432 Bregana, HR  
JOCIC, Misa, Im Eichtal 4, CH-5400 Baden, CH
- 
- (51) MKP  
**A61K 47/10 (2006.01)** (97) **2575784 \***  
**A61K 9/14 (2006.01)**  
**A61K 31/4184 (2006.01)**  
**A61K 9/48 (2006.01)**  
(86) EP2011002764 01.06.2011  
(96) 11727396.1 10.04.2013  
(87) WO2011151087, 01.06.2011  
(97) 2575784, 10.04.2013 en  
(54) ORAL DOSAGE FORMS OF BENDAMUSTINE  
(71) Astellas Deutschland GmbH, Georg-Brauchle-Ring 64-66, 80992 München, DE  
(72) COLLEDGE, Jeffrey, Astellas Pharma Europe B.V. P.O. Box 108, 2350 AC Leiderdorp, NL  
OLTHOFF, Margaretha, Astellas Pharma Europe BV P.O. Box 108, NL-2350 AC Leiderdorp, NL
- 
- (51) MKP  
**C07D 213/81 (2006.01)** (97) **2593434 \***  
**A61K 31/4412 (2006.01)**  
**C07D 413/12 (2006.01)**  
**A61K 31/4439 (2006.01)**  
**C07D 401/12 (2006.01)**  
**A61P 25/00 (2006.01)**  
**A61K 31/443 (2006.01)**  
**A61K 31/444 (2006.01)**  
(86) IB2011001705 15.07.2011  
(96) 11755436.0 22.05.2013  
(87) WO2012007836, 15.07.2011  
(97) 2593434, 22.05.2013 en  
(54) PYRIDINE COMPOUNDS AS SODIUM CHANNEL BLOCKERS  
(71) Purdue Pharma LP, One Stamford Forum 201 Tresser Boulevard, Stamford, CT 06901-3431, US  
(72) KYLE, Donald, J., 173 N. Main Street, Yardley PA 19067, US  
NI, Chiyou, 5 Ford Court, Princeton, NJ 08540, US  
PARK, Minnie, 22, Warwick Road, Princeton Junction, NJ 08550, US  
TAFESSE, Laykea, 11 Abington Lane, Robbinsville NJ 08691, US
- 
- (51) MKP  
**A61P 35/00 (2006.01)** (97) **2563400 \***  
**A61K 47/48 (2006.01)**  
**A61P 27/02 (2006.01)**  
(86) EP2011056824 29.04.2011  
(96) 11716429.3 06.03.2013  
(87) WO2011135067, 29.04.2011  
(97) 2563400, 06.03.2013 en  
(54) MODIFIED BINDING PROTEINS INHIBITING THE VEGF-A RECEPTOR INTERACTION  
(71) Molecular Partners AG, Wagistrasse 14, 8952 Schlieren, CH  
(72) BINZ, Hans Kaspar, Bachstrasse 27, CH-8903 Birmensdorf, CH  
FORRER, Patrik, Rainackerstrasse 17, CH-8953 Dietikon, CH  
STUMPP, Michael Tobias, Chratzstrasse 6, CH-8954 Geroldswil, CH
- 
- (51) MKP  
**C08J 3/11 (2006.01)** (97) **2591042 \***  
**B29C 65/48 (2006.01)**  
**C08J 5/12 (2006.01)**  
**C09J 127/06 (2006.01)**  
**C09J 155/02 (2006.01)**  
(86) DK2011050267 08.07.2011  
(96) 11732352.7 15.05.2013  
(87) WO2012003838, 08.07.2011  
(97) 2591042, 15.05.2013 en  
(54) GLUE COMPOSITION COMPRISING THE SOLVENT N-ACETYLMORPHOLINE  
(71) Nordcoll A/S, Egeskovvej 12, 3490 Kvistgaard, DK  
(72) JENSEN, Mikael, Nordvestvej 4, DK-3400 Hillerød, DK
- 
- (51) MKP  
**A61P 9/00 (2006.01)** (97) **2576547 \***  
**A61P 15/00 (2006.01)**  
**A61K 31/437 (2006.01)**  
**C07D 471/04 (2006.01)**  
(86) EP2011058431 24.05.2011  
(96) 11720806.6 10.04.2013  
(87) WO2011147809, 24.05.2011  
(97) 2576547, 10.04.2013 de  
(54) SUBSTITUTED 5-FLUORO-1H-PYRAZOLOPYRIDINES AND USE THEREOF  
(71) Bayer Intellectual Property GmbH, Alfred-Nobel-Strasse 10, 40789 Monheim, DE  
(72) FOLLMANN, Markus, Ringstr. 61, 42489 Wülfrath, DE  
STASCH, Johannes-Peter, Alfred-Nobel-Str.109, 42651 Solingen, DE  
REDLICH, Gorden, Schadowstraße 50, 44799 Bochum, DE  
ACKERSTAFF, Jens, Schliemannstrasse 15, 10437 Berlin, DE  
GRIEBENOW, Nils, Kurfürstenstr. 39, 41541 Dormagen, DE  
KROH, Walter, Breuerweg 18, 42115 Wuppertal, DE  
KNORR, Andreas, Trillser Graben 10, 40699 Erkrath, DE  
BECKER, Eva-Maria, Düsselers Höhe 22, 42327 Wuppertal, DE  
WUNDER, Frank, Schwarzer Weg 251, 42117 Wuppertal, DE  
LI, Volkhart Min-Jian, Im Wiesengrund 40, 42553 Velbert, DE  
HARTMANN, Elke, Holunderweg 97, 42111 Wuppertal, DE  
MITTENDORF, Joachim, Wildsteig 30A, 42113 Wuppertal, DE  
SCHLEMMER, Karl-Heinz, Wildsteig 22 a, 42113 Wuppertal, DE  
JAUTELAT, Rolf, Zur Pumpstation 35, 42781 Haan, DE  
BIERER, Donald, Horst 9, 42781 Haan, DE
-



(51) MKP  
**E04B 1/74 (2006.01)** (97) **2576209 \***  
**B27N 7/00 (2006.01)**  
**E04F 13/00 (2006.01)**  
**B60R 13/02 (2006.01)**  
**B32B 5/28 (2006.01)**  
**D06M 13/402 (2006.01)**  
**C08J 7/06 (2006.01)**  
**B32B 21/10 (2006.01)**  
(86) FR2011051073 13.05.2011  
(96) 11725166.0 10.04.2013  
(87) WO2011148075, 13.05.2011  
(97) 2576209, 10.04.2013 fr  
(54) MAT OF POLYMER FIBRES CONTAINING AN ACETOACETAMIDE, AND ITS USE.  
(71) Saint-Gobain Adfors, 517, Avenue de la Boisse, 73000 Chambéry, FR  
(72) BLANCHARD, Benjamin, 17 rue Auguste Méry, F-95150 Taverny, FR  
JAFFRENOU, Boris, 33 rue des Alouettes, F-75019 Paris, FR  
CHUDA, Katarzyna, 10 rue des Frères Chausson, 92600 Asnières sur Seine, FR

(51) MKP  
**A61K 31/506 (2006.01)** (97) **2571885 \***  
**C07D 487/14 (2006.01)**  
(86) US2011036814 17.05.2011  
(96) 11721691.1 27.03.2013  
(87) WO2011146488, 17.05.2011  
(97) 2571885, 27.03.2013 en  
(54) METHOD FOR PURIFYING A FUSED PYRROLOCARBAZOLE DERIVATIVE  
(71) Cephalon, Inc., 41 Moores Road P.O. Box 4011, Frazer, PA 19355, US  
Cephalon France, 20 Rue Charles Martigny, 94701 Maisons-Alfort Cedex, FR  
(72) ALLWEIN, Shawn P., 395 Township Line Road, Downingtown, Pennsylvania 19335, US  
GRANDEURY, Arnaud, 50 Rue Principale, F-68510 Helfrantzkirch, FR  
PIACENZA, Guy, 75 rue de Général Leclerc, F-94000 Créteil, FR  
ROSE, Sébastien, 130 rue du Vert Galant Trois Etots, F-60190 Cernoy, FR

(51) MKP  
**C10C 3/14 (2006.01)** (97) **2563878 \***  
(86) US2011033960 26.04.2011  
(96) 11777914.0 06.03.2013  
(87) WO2011139698, 26.04.2011  
(97) 2563878, 06.03.2013 en  
(54) PELLETIZING ASPHALT  
(71) Gala Industries, Inc., 181 Pauley Street, Eagle Rock, VA 24085, US  
(72) WRIGHT, Roger B., 457 Middlebrook Road, Staunton, VA 24401, US  
BOLTON, John, 1757 Ball Park Road, Eagle Rock, VA 24085, US

(51) MKP  
**A61K 31/47 (2006.01)** (97) **2566329 \***  
**A01N 43/42 (2006.01)**  
(86) US2011035126 04.05.2011  
(96) 11778241.7 13.03.2013  
(87) WO2011140183, 04.05.2011  
(97) 2566329, 13.03.2013 en  
(54) PROCESS FOR SYNTHESIZING OXIDIZED LACTAM COMPOUNDS  
(71) Alkermes Pharma Ireland Limited, Connaught House 1 Burlington Road, Dublin 4, IE  
(72) REMENAR, Julius, F., 9 Eaton Road, Framingham MA 01701, US  
BLUMBERG, Laura, Cook, 37 Mill Street, Lincoln MA 01773, US  
ZEIDAN, Tarek, A., 296 Lexington Street, Watertown MA 02472, US

(51) MKP  
**C12N 9/64 (2006.01)** (97) **2550363 \***  
**A01K 67/027 (2006.01)**  
**C12N 15/85 (2006.01)**  
**C07K 16/46 (2006.01)**  
(86) US2012026416 24.02.2012  
(96) 12716101.6 30.01.2013  
(87) WO2012141798, 24.02.2012  
(97) 2550363, 30.01.2013 en  
(54) ADAM6 MICE  
(71) REGENERON PHARMACEUTICALS, INC., 777 Old Saw Mill River Road, Tarrytown, NY 10591, US  
(72) MACDONALD, Lynn, 16 Gedney Way, White Plains, NY 10605, US  
STEVENS, Sean, 355 Berry Street, No. 413, San Francisco, CA 94158, US  
MURPHY, Andrew, J., 10 Newton Court, Croton-on-Hudson, NY 10520, US

(51) MKP  
**A61K 38/08 (2006.01)** (97) **2593125 \***  
**A61K 39/395 (2006.01)**  
**A61P 3/10 (2006.01)**  
**A61K 38/10 (2006.01)**  
**A61P 35/00 (2006.01)**  
**A61K 38/16 (2006.01)**  
**A61P 3/00 (2006.01)**  
(86) US2011043756 12.07.2011  
(96) 11816759.2 22.05.2013  
(87) WO2012021247, 12.07.2011  
(97) 2593125, 22.05.2013 en  
(54) INNOVATIVE DISCOVERY OF THERAPEUTIC, DIAGNOSTIC, AND ANTIBODY COMPOSITIONS RELATED TO PROTEIN FRAGMENTS OF GLYCYL-TRNA SYNTHETASES  
(71) aTyr Pharma, Inc., 3545 John Hopkins Court, Suite 250, San Diego, CA 92121, US  
Pangu Biopharma Limited, Edinburgh Tower, 18/F The Landmark 15 Queen's Road Central, Hong Kong, CN  
(72) GREENE, Leslie, Ann, 13941 Davenport Avenue, San Diego California 92129, US  
CHIANG, Kyle, P., 1615 Debann Road, Cardiff CA 92007, US  
HONG, Fei, 12646 Spindletop Road, San Diego California 92129, US  
VASSEROT, Alain, P., 6421 La Paloma Street, Carlsbad California 92009, US  
LO, Wing-Sze, RM 815, Sui Ming House Siu Sai Wan Estate Chai Wan, Hong Kong, CN  
WATKINS, Jeffry, D., 3442 Fortuna Ranch Road, Encinitas California 92014, US  
QUINN, Cheryl, L., 408 North 1st Street No.706, Minneapolis MN 55401, US  
MENDLEIN, John, D., 1550 Neptune Avenue, Encinitas California 92024, US

- (51) MKP  
**C12N 5/071 (2010.01)** (97) **2569418 \***
- (86) US2011036347 12.05.2011  
(96) 11722663.9 20.03.2013  
(87) WO2011143499, 12.05.2011  
(97) 2569418, 20.03.2013 en
- (54) BIOACTIVE RENAL CELLS
- (71) Tengion, Inc., 2900 Potshop Lane, Suite 100, East Norriton PA 19403, US
- (72) ILAGAN, Roger, M., 2022 Sinclair Trace, Burlington NC 27215, US  
KELLER, Russell, W., 742 Hertford Road, Winston-Salem NC 27104, US  
PRESNELL, Sharon, C., 705 River Grove Court, Lewisville NC 27023, US  
CHOUDHURY, Sumana, 125 Picardy Court, Kernersville NC 27284, US  
BRUCE, Andrew, T., 315 Ridge Drive, Lexington NC 27295, US  
GENHEIMER, Christopher, W., 4013 Ballard Farm Road, Colfax NC 27235, US  
COX, Bryan, R., 370 Glendare Court, Unit M, Winston-Salem NC 27104, US  
GUTHRIE, Kelly, I., 3415 Thoresby Court, Winston-Salem NC 27104, US  
BASU, Joydeep, 435 Mica Court, Winston-Salem NC 27103, US  
WALLACE, Shay, M., 4757 Farm Bell Ct., Winston-Salem NC 27127, US  
WERDIN, Eric, S., 393 Lewisville Trails Rd., Lewisville NC 27023, US  
KNIGHT, Oluwatoyin, A., 3919 Heatherview Lane, Winston-Salem NC 27127, US  
SANGHA, Namrata, D., 320 Stonebrook Lane, Winston-Salem NC 27104, US  
LUDLOW, John, W., 100 Rivercreek Place, Carrboro NC 27510, US  
HALBERSTADT, Craig, R., 2115 Cherrywood Dr., Clemmons NC 27012, US  
PAYNE, Richard, 934 Franklin Street, Winston-Salem NC 27101, US  
ROBINS, Neil, F., Jr., 1111-5 Barbara Ann Circle, Winston-Salem NC 27103, US  
MCCOY, Darrell, 7047 Windrift Court, Clemmons NC 27012, US  
JAIN, Deepak, 559 Sun Creek Drive, Winston-Salem NC 27104, US  
JAYO, Manuel, J., 2534 Warwick Road, Winston-Salem NC 27104, US  
RIVERA, Elias, A., 1805 Wild Fern Dr., Oak Ridge NC 27310, US  
SPENCER, Thomas, 1849 Hunters Forest Drive, Winston-Salem NC 27103, US  
WATTS, Benjamin, 1221 Doyle Cromer Road, King NC 27021, US

- (51) MKP  
**H05K 9/00 (2006.01)** (97) **2485573**
- (96) 12153632.0 08.08.2012  
(97) 2485573, 08.08.2012 en
- (54) Container box made of carbon fiber for electronic equipment
- (71) Aeronautical Service S.r.l., Via Monte Cadria 67, 00054 Fiumicino (RM), IT
- (72) Bordignon, Cristiano, c/o AERONAUTICAL SERVICE S.r.l. Via Monte Cadria 67, I-00054 FIUMICINO (RM), IT

- (51) MKP  
**A61K 39/00 (2006.01)** (97) **2547360 \***
- (86) US2011028487 15.03.2011  
(96) 11756841.0 23.01.2013  
(87) WO2011115970, 15.03.2011  
(97) 2547360, 23.01.2013 en
- (54) SYSTEM AND METHOD OF PREPARING AND STORING ACTIVATED MATURE DENDRITIC CELLS
- (71) The Trustees of The University of Pennsylvania, Center for Technology Transfer 3160 Chestnut Street, Suite 200, Philadelphia, PA 19104-6283, US
- (72) CZERNIECKI, Brian, J., 77 Chews Landing Road, Haddonfield, NJ 08033, US  
KOLDOVSKY, Ursula, 604 Mallard Terrace, Wayne, PA 19087, US  
XU, Shuwen, 42 Overlook Circle, Garnet Valley, PA 19060, US  
KOSKI, Gary, K., 4585 Granger Road, Akron, OH 44333, US

- (51) MKP  
**A61K 39/395 (2006.01)** (97) **2579894 \***
- (86) US2011039381 07.06.2011  
(96) 11792989.3 17.04.2013  
(87) WO2011156324, 07.06.2011  
(97) 2579894, 17.04.2013 en
- (54) CGRP ANTIBODIES
- (71) Eli Lilly and Company, Lilly Corporate Center, Indianapolis, IN 46285, US
- (72) ALLAN, Barrett, c/o Eli Lilly and Company P. O. Box 6288, Indianapolis Indiana 46206-6288, US  
BENSCHOP, Robert Jan, c/o Eli Lilly and Company P. O. Box 6288, Indianapolis, Indiana 46206-6288, US  
CHAMBERS, Mark Geoffrey, c/o Eli Lilly and Company P. O. Box 6288, Indianapolis Indiana 46206-6288, US  
DARLING, Ryan James, c/o Eli Lilly and Company P. O. Box 6288, Indianapolis Indiana 46206-6288, US

- (51) MKP  
**A23C 19/068 (2006.01)** (97) **2568817 \***
- (86) RO2010000019 25.11.2010  
(96) 10850920.9 20.03.2013  
(87) WO2011142684, 25.11.2010  
(97) 2568817, 20.03.2013 en
- (54) METHOD OF OBTAINING FRESH SPUN CHEESE
- (71) Ece, Abdulvahit, Str. Vascozei bl.2A ap.2 Lupeni, 335600 Jud. Hunedoara, RO
- (72) MORARIU, Louisa-Karina, Str. Vascozei bl.2A ap.2 Lupeni, R-335600 Jud. Hunedoara, RO

- (51) MKP  
**A23L 1/30 (2006.01)** (97) **2471387**  
**A61K 31/23 (2006.01)**  
**A61K 9/00 (2006.01)**  
**A61K 9/16 (2006.01)**
- (96) 10197298.2 04.07.2012  
(97) 2471387, 04.07.2012 en
- (54) Cetyl myristate and/or cetyl palmitate suspension formulations
- (71) Deva Holding Anonim Sirketi, Patent Law Department Halkali Merkez Mah. Basin Ekspres Cad. No: 1,34303, Kucukcekmece/Istanbul, TR
- (72) Haas, Philipp Daniel, R&D DEVA HOLDING ANONIM SIRKETI Halkali Merkez Mah., Basin Ekspres Caddesi No:1, Patent Law Department, Kat:5, Kucukcekmece, 34303, ISTANBUL, TR  
Firat, Omer Faruk, R&D DEVA HOLDING ANONIM SIRKETI Halkali Merkez Mah., Basin Ekspres Caddesi No:1, Patent Law Department, Kat:5, Kucukcekmece, 34303, ISTANBUL, TR  
Kandemir, Levent, R&D DEVA HOLDING ANONIM SIRKETI Halkali Merkez Mah., Basin Ekspres Caddesi No:1, Patent Law Department, Kat:5, Kucukcekmece, 34303, ISTANBUL, TR  
Koc, Fikret, R&D DEVA HOLDING ANONIM SIRKETI Halkali Merkez Mah., Basin Ekspres Caddesi No:1, Patent Law Department, Kat:5, Kucukcekmece, 34303, ISTANBUL, TR  
Sivasligil, Ramazan, R&D DEVA HOLDING ANONIM SIRKETI Halkali Merkez Mah., Basin Ekspres Caddesi No:1, Patent Law Department, Kat:5, Kucukcekmece, 34303, ISTANBUL, TR

(51) MKP  
**A61K 31/44 (2006.01)** (97) **2584900 \***  
**A01N 43/42 (2006.01)**  
(86) US2011041876 24.06.2011  
(96) 11799007.7 01.05.2013  
(87) WO2011163617, 24.06.2011  
(97) 2584900, 01.05.2013 en  
(54) COMBINATION THERAPY WITH CRYOSURGERY AND  
LOW DOSAGE STRENGTH IMIQUIMOD TO TREAT ACTINIC  
KERATOSIS  
(71) Medicis Pharmaceutical Corporation, 7720 North Dobson  
Road, Scottsdale, AZ 85256, US  
(72) NORDSIEK, Michael, T., 208 Grouse Lane, Wayne PA 19087,  
US  
LEVY, Sharon, F., 404 East Mount Airy Avenue, Philadelphia  
PA 19119, US  
LEE, James, Hurn-joung, 3m Center P.o. Box 33427, St. Paul  
MN 55133-3427, US  
KULP, James, H., 104 Crosspointe Drive, West Chester PA,  
US  
MENG, Tze-chiang, 1115 Trappers Court, Lino Lakes MN  
55038, US  
WU, Jason, J., 608 Trephanny Lane, Wayne PA 19087, US  
BABILON, Robert, 510 Fancy Hill Road, Boyertown PA 19512,  
US  
BALAJI, Kodumudi, S., 1521 Ide Drive, Lansdale PA 19446,  
US  
BAHM, Valyn, S., 210 Dylan Lane, Phoenixville PA, US

(51) MKP  
**G06M 1/16 (2006.01)** (97) **2570149**  
**A61M 15/00 (2006.01)**  
**G06M 1/24 (2006.01)**  
(96) 12195433.3 20.03.2013  
(97) 2570149, 20.03.2013 en  
(54) Counter  
(71) EURO-CELTIQUE S.A., 2, avenue Charles de Gaulle, 1653  
Luxembourg, LU  
(72) Bacon, Raymond, Steep Farm Steep, Petersfield, Hampshire  
GU32 2DB, GB  
McDerment, Iain, 7 Moat Lane Melbourn, Royston,  
Hertfordshire SG8 6EH, GB

(51) MKP  
**H04N 7/00 (2011.01)** (97) **2569939 \***  
**H04N 7/15 (2006.01)**  
**H04N 7/14 (2006.01)**  
(86) US2011036257 12.05.2011  
(96) 11722955.9 20.03.2013  
(87) WO2011143434, 12.05.2011  
(97) 2569939, 20.03.2013 en  
(54) SYSTEMS AND METHODS FOR SCALABLE COMPOSITION  
OF MEDIA STREAMS FOR REAL-TIME MULTIMEDIA  
COMMUNICATION  
(71) Blue Jeans Network, Inc., 3000 Lakeside Drive, Santa Clara,  
CA 95054, US  
(72) PERIYANNAN, Alagu, 3152 Ross Road, Palo Alto CA 94303,  
US  
ANAND, Raghavan, 2650 Keystone Avenue 113, Santa Clara  
95051, US  
GRUPENHOFF, Michael, 3314 Saint Michael Drive, Palo Alto  
CA 94306, US  
KALLURI, Ravi, Kiran, 3287 Cantamar Court, San Jose CA  
95135, US  
WEBER, Emmanuel, 4512 Carnaby Court, San Jose CA  
95136, US

(51) MKP  
**A61K 31/519 (2006.01)** (97) **2585055 \***  
**A61P 7/06 (2006.01)**  
**A61K 31/5377 (2006.01)**  
**A61K 31/4439 (2006.01)**  
**A61K 31/198 (2006.01)**  
**A61K 45/06 (2006.01)**  
**A61K 31/506 (2006.01)**  
**A61K 31/427 (2006.01)**  
**A61K 31/426 (2006.01)**  
(86) EP2011060331 21.06.2011  
(96) 11726444.0 01.05.2013  
(87) WO2011161099, 21.06.2011  
(97) 2585055, 01.05.2013 de  
(54) USE OF STIMULATORS AND ACTIVATORS OF SOLUBLE  
GUANYLATE CYCLASE FOR TREATING SICKLE-CELL  
ANEMIA AND CONSERVING BLOOD SUBSTITUTES  
(71) Bayer Intellectual Property GmbH, Alfred-Nobel-Strasse 10,  
40789 Monheim, DE  
(72) STASCH, Johannes-Peter, Alfred-Nobel-Str. 109, 42651  
Solingen, DE  
BECKER, Eva-Maria, Düsseler Höhe 22, 42327 Wuppertal, DE  
TRÜBEL, Hubert, Lante 23, 42281 Wuppertal, DE  
HIMMEL, Herbert, Kahrstr. 23, 45128 Essen, DE

(51) MKP  
**C07D 495/04 (2006.01)** (97) **2588483 \***  
(86) HU2010000148 21.12.2010  
(96) 10807537.5 08.05.2013  
(87) WO2011077173, 21.12.2010  
(97) 2588483, 08.05.2013 en  
(54) IMPROVED PROCESS FOR PREPARING A  
PHARMACEUTICAL COMPOUND  
(71) EGIS GYÓGSZERGYÁR Nyilvánosan Működő  
Részvénytársaság, Keresztúri út 30-38, 1106 Budapest, HU  
(72) PORCS-MAKKAY, Márta, Bem József u. 21, H-2013 Pomáz,  
HU  
GREGOR, Tamás, Vágóhíd u. 7., H-2141 Csömör, HU  
VOLK, Balázs, Pilisi u. 54, H-1106 Budapest, HU  
NÉMETH, Gábor, Benko u 3., H-1147 Budapest, HU  
BARKÓCZY, József, Szirom u. 4-6, H-1016 Budapest, HU  
NYULASI, Bálint, Gombköt u.2, H-8500 Pápa, HU  
MEZEI, Tibor, Borz u. 4., H-1221 Budapest, HU  
RUZSICS, György, Bokay János u. 56., 1083 Budapest, HU  
PANDUR, Angéla, Deák Ferenc u. 24., H-2235 Mende, HU  
SZILÁGYI, Erika, Régi vásártér u. 7., H-2194 Tura, HU  
NAGY, Kálmán, Turista u. 2/A, H-1025 Budapest, HU  
SLÉGEL, Péter, Eötvös u. 31., H-1067 Budapest, HU  
MOLNÁR,Enik, Titkár u. 16., H-1030 Érd, HU  
DEBRECZENI, József, Harang u. 19... H-1037 Budapest, HU

(51) MKP  
**G06F 17/15 (2006.01)** (97) **2539468 \***  
**C12Q 1/68 (2006.01)**  
**G06F 19/10 (2011.01)**  
(86) US2011026098 24.02.2011  
(96) 11748075.6 02.01.2013  
(87) WO2011106541, 24.02.2011  
(97) 2539468, 02.01.2013 en  
(54) DIAGNOSTIC METHODS INVOLVING LOSS OF  
HETEROZYGOSITY  
(71) Myriad Genetics, Inc., 320 Wakara Way, Salt Lake City, UT  
84108, US  
Abkevich, Victor, 320 Wakara Way, Salt Lake City, Utah 84108,  
US  
Timms, Kirsten, 320 Wakara Way Salt Lake City, Salt Lake  
City, Utah 84108, US  
Gutin, Alexander, 320 Wakara Way, Salt Lake City, Utah  
84108, US  
(72) ABKEVICH, Victor, 320 Wakara Way, Salt Lake City Utah  
84108, US  
TIMMS, Kirsten, 320 Wakara Way, Salt Lake City Utah 84108,  
US  
GUTIN, Alexander, 320 Wakara Way, Salt Lake City Utah  
84108, US

- (51) MKP  
**A61B 17/00 (2006.01)** (97) **2550048 \***  
**B01L 3/02 (2006.01)**  
**A61M 5/46 (2006.01)**  
**A61M 5/315 (2006.01)**  
**A61M 5/20 (2006.01)**  
**A61M 5/32 (2006.01)**  
**A61M 5/19 (2006.01)**  
(86) IL2011000268 22.03.2011  
(96) 11716310.5 30.01.2013  
(87) WO2011117867, 22.03.2011  
(97) 2550048, 30.01.2013 en  
(54) DEVICES FOR INJECTING A SUBSTANCE AND METHODS THEREFOR  
(71) Omrix Biopharmaceuticals Ltd., Bldg.14 Weizmann Science Park P.O. Box 619, Rehovot 76106, IL  
(72) MERON, Moti, 19 Avoka Street, Herzliah 46352, IL  
NUR, Israel, House No. 277, Moshav Timmorim 79860, IL  
ATLAS, Roee, P.O. Box 213, Givatayim 53101, IL

- (51) MKP  
**C07D 409/06 (2006.01)** (97) **2539326 \***  
**C07D 249/12 (2006.01)**  
**A61K 31/4196 (2006.01)**  
**C07D 403/06 (2006.01)**  
**C07D 413/14 (2006.01)**  
**C07D 417/06 (2006.01)**  
**C07D 409/14 (2006.01)**  
**C07D 413/06 (2006.01)**  
**C07D 401/06 (2006.01)**  
**A61P 9/00 (2006.01)**  
(86) EP2011052781 25.02.2011  
(96) 11704637.5 02.01.2013  
(87) WO2011104322, 25.02.2011  
(97) 2539326, 02.01.2013 de  
(54) BISARYL-BONDED ARYLTRIAZOLONES AND USE THEREOF  
(71) Bayer Intellectual Property GmbH, Alfred-Nobel-Strasse 10, 40789 Monheim, DE  
(72) FÜRSTNER, Chantal, Arnoldstr. 33, 45478 Mülheim/Ruhr, DE  
KELDENICH, Jörg, Damaschkeweg 49, 42113 Wuppertal, DE  
DELBECK, Martina, Müllerweg 10, 42579 Heiligenhaus, DE  
KOLKHOF, Peter, Falkenberg 121, 42113 Wuppertal, DE  
KRETSCHMER, Axel, Am Acker 23, 42113 Wuppertal, DE  
PLUSCHKELL, Ingo, Krampenhof 4, 44879 Bochum, DE  
POOK, Elisabeth, Im Lehmbruch 24, 42109 Bochum, DE  
SCHMECK, Carsten, Carl-Friedrich-Goerdeler-Str. 24, 45472 Mülheim/Ruhr, DE  
TRÜBEL, Hubert, Lante 23, 42281 Wuppertal, DE

- (51) MKP  
**A61P 35/00 (2006.01)** (97) **2588468 \***  
**C07D 519/00 (2006.01)**  
**A61K 31/4743 (2006.01)**  
**C07D 401/12 (2006.01)**  
**A61P 29/00 (2006.01)**  
**C07D 487/04 (2006.01)**  
(86) US2011042499 30.06.2011  
(96) 11730844.5 08.05.2013  
(87) WO2012003262, 30.06.2011  
(97) 2588468, 08.05.2013 en  
(54) HETEROCYCLIC COMPOUNDS AND THEIR USE AS INHIBITORS OF PI3K ACTIVITY  
(71) Amgen Inc., One Amgen Center Drive, Thousand Oaks, California 91320-1799, US  
(72) LUCAS, Brian, 133 10th Avenue, San Francisco, California 94118, US

- (51) MKP  
**C07K 1/107 (2006.01)** (97) **2569326 \***  
**A61P 31/20 (2006.01)**  
**A61P 35/00 (2006.01)**  
**A61P 31/18 (2006.01)**  
**A61P 31/16 (2006.01)**  
**C07K 14/47 (2006.01)**  
**C07K 7/06 (2006.01)**  
**C07K 14/715 (2006.01)**  
**A61P 37/00 (2006.01)**  
(86) US2011036010 11.05.2011  
(96) 11720697.9 20.03.2013  
(87) WO2011143280, 11.05.2011  
(97) 2569326, 20.03.2013 en  
(54) PEPTIDE-BASED INHIBITOR OF INTERLEUKIN-10 OR INTERFERON-GAMMA SIGNALING  
(71) The U.S.A. as represented by the Secretary, Department of Health and Human Services, Office of Technology Transfer National Institutes of Health 6001 Executive Boulevard, Suite 325 Msc 7600, Bethesda, MD 20892-7660, US  
(72) TARASOVA, Nadya I., 103 Pipe Meadow Way, Frederick Maryland 21702, US  
TRINCHIERI, Giorgio, 9809 Hall Road Potomac, MD 20854, US  
YOUNG, Howard A., 14520 Stonebridge Vw Dr. North Potomac, MD 20878, CN  
STEWART, C. Andrew, 6E Patrick Street Apt. 2, Frederick MD 21701, CN  
CARDONE, Marco A., 1400 Baker Place W. Apt. 44 Frederick, MD 21702, US  
PERANTONI, Alan O., 150 Irishtown Rd. Fairfield, Pennsylvania 17320, US

- (51) MKP  
**A61L 2/00 (2006.01)** (97) **2571534 \***  
(86) US2011037405 20.05.2011  
(96) 11784351.6 27.03.2013  
(87) WO2011146878, 20.05.2011  
(97) 2571534, 27.03.2013 en  
(54) ULTRAVIOLET DISINFECTING DEVICE FOR FOOD AND BEVERAGE DISPENSERS  
(71) Automatic Bar Controls, Inc., 790 Eubanks Drive, Vacaville, CA 95688, US  
(72) HECHT, Thomas R., 225 Creekside Way, Winters, California 95694, US  
MARTINDALE, Richard A., 135 Dobbins Street, Vacaville, California 95688, US

- (51) MKP  
**A61K 31/496 (2006.01)** (97) **2585066 \***  
**C07D 401/12 (2006.01)**  
(86) US2011041830 24.06.2011  
(96) 11798995.4 01.05.2013  
(87) WO2011163594, 24.06.2011  
(97) 2585066, 01.05.2013 en  
(54) PRODRUGS OF NH-ACIDIC COMPOUNDS: ESTER, CARBONATE, CARBAMATE AND PHOSPHONATE DERIVATIVES  
(71) Alkermes Pharma Ireland Limited, Connaught House 1 Burlington Road, Dublin 4, IE  
(72) BLUMBERG, Laura, Cook, 37 Mill Street, Lincoln MA 01773, US  
REMENAR, Julius, F., 9 Eaton Road, Framingham MA 01701, US  
ALMARRSON, Orn, 22 Farmington Drive, Shrewsbury MA 01545, US  
ZEIDAN, Tarek, A., 296 Lexington Street, Watertown MA 02472, US

- (51) MKP  
**C12N 5/02 (2006.01)** (97) **2569631 \***  
**C12N 5/00 (2006.01)**  
**G01N 33/53 (2006.01)**  
(86) US2011035944 10.05.2011  
(96) 11781153.9 20.03.2013  
(87) WO2011143232, 10.05.2011  
(97) 2569631, 20.03.2013 en  
(54) MARKERS FOR ACUTE KIDNEY INJURY  
(71) Austin Health, 145 Studley Road, Heideberg, VIC 3084, AU  
Brownstein, Michael, 6515 Old Farm Lane, Rockville, Maryland  
20852, US  
Intrinsic Lifesciences LLC, 505 Coast boulevard South Suite  
102, La Jolla, California 92037, US  
(72) WESTERMAN, Mark, 5904 Mt. La Platta Drive, San Diego, CA  
92117, US  
BELLOMO, Rinaldo, 18 Otterington Grove, Ivanhoe, Victoria  
3084, AU  
PROWLE, John, Flat 3 Brixton Hill, London SW2 1JE, GB  
BROWNSTEIN, Michael, 6515 Old Farm Lane, Rockville, MD  
20852, US

- (51) MKP  
**A61K 39/395 (2006.01)** (97) **2558124 \***  
(86) US2011032581 14.04.2011  
(96) 11769624.5 20.02.2013  
(87) WO2011130572, 14.04.2011  
(97) 2558124, 20.02.2013 en  
(54) POLYSACCHARIDE COMPOSITIONS AND METHODS  
OF USE FOR THE TREATMENT AND PREVENTION OF  
DISORDERS ASSOCIATED WITH PROGENITOR CELL  
MOBILIZATION  
(71) Momenta Pharmaceuticals, Inc., 675 West Kendall Street,  
Cambridge, MA 02142, US  
(72) SUNDARAM, Mallikarjun, 25 Penny Lane, Flemington NJ  
08812, US  
KISHIMOTO, Takashi, Kei, 46 Coolidge Avenue, Lexington MA  
02420, US  
ROY, Sucharita, 7 Shakespeare Road, Tyngsboro MA 01879,  
US  
ZHOU, He, 160 Pleasant Street, apt. 207, Malden, MA 02148,  
US  
SCHULTES, Birgit, 12 Monadnock Road, Arlington, MA 02476,  
US

- (51) MKP  
**A61P 31/18 (2006.01)** (97) **2552902 \***  
**A61K 31/4439 (2006.01)**  
**C07D 401/06 (2006.01)**  
(86) CA2011000320 28.03.2011  
(96) 11761856.1 06.02.2013  
(87) WO2011120133, 28.03.2011  
(97) 2552902, 06.02.2013 en  
(54) NON-NUCLEOSIDE REVERSE TRANSCRIPTASE  
INHIBITORS  
(71) Merck Canada Inc., 16711 Trans-Canada Highway, Kirkland,  
QC H94 3L1, CA  
(72) BURCH, Jason, 2645 Brewster Avenue, Redwood City  
California 94062, US  
COTE, Bernard, 113 Lucien Theriault, Notre-Dame-de-l'Île-  
Perrot Québec J7V 7P2, CA  
NGUYEN, Natalie, 5037 Rue Resther, Montreal Québec H2J  
2V9, CA  
LI, Chun, Sing, 296 Rue Matisse, Dollard-Des-Ormeaux  
Québec H9A 3J6, CA  
ST-ONGE, Miguel, 177, 8e Avenue, Vaudreuil-Dorion Québec  
J7T 3B3, CA  
GAUVREAU, Danny, 815 Bouchard Street, Saint-Lazare  
Québec J7T 3J1, CA

- (51) MKP  
**B65D 83/44 (2006.01)** (97) **2566782 \***  
(86) US2011035386 05.05.2011  
(96) 11778362.1 13.03.2013  
(87) WO2011140361, 05.05.2011  
(97) 2566782, 13.03.2013 en  
(54) OVER PRESSURE RELEASE VALVE  
(71) Joseph Company International, Inc., 1711 Langley Avenue,  
Irvine, CA 92614, US  
(72) CULL, David, 214/1 Moo 9 Prachautit Soi 16 Ratburana,  
Bangkok 10140, TH  
SILLINCE, Mark, 14 Cowdray Drive Rustington, West Sussex  
BN16 3SJ, GB

- (51) MKP  
**A47K 10/38 (2006.01)** (97) **2394551**  
(96) 10305621.4 14.12.2011  
(97) 2394551, 14.12.2011 fr  
(54) Paper roll dispenser comprising a base and at least one  
first door and one second door mounted on the base of the  
dispenser  
(71) SCA TISSUE FRANCE, 60, avenue de l'Europe, 92270 Bois-  
Colombes, FR  
(72) Denis, Yoann, Domaine de la Roseraie 16 56 Quai de l'III,  
67600, Selestat, FR  
Pommier, Nicolas, 9A rue du Rhin, 68740, Balgau, FR  
Marietta-Tondin, Julien, 15b rue du Maréchal Joffre, 67390,  
Marckolsheim, FR  
Jehl, Jean-Louis, 7 rue de Calviac, 67390, Artolsheim, FR

- (51) MKP  
**A61K 47/38 (2006.01)** (97) **2564875 \***  
**A61K 9/08 (2006.01)**  
**A61K 47/42 (2006.01)**  
**A61K 47/10 (2006.01)**  
**A61K 47/36 (2006.01)**  
**A61K 47/34 (2006.01)**  
**A61K 49/04 (2006.01)**  
**A61K 47/26 (2006.01)**  
(86) JP2011060384 28.04.2011  
(96) 11775117.2 06.03.2013  
(87) WO2011136336, 28.04.2011  
(97) 2564875, 06.03.2013 en  
(54) LIQUID PREPARATION FOR ORAL ADMINISTRATION  
WHICH CAN BE USED IN CT COLONOGRAPHY, AND  
COMPOSITION FOR IMAGING OF DIGESTIVE TRACT  
(71) Ajinomoto Co., Inc., 15-1, Kyobashi 1-chome Chuo-ku, Tokyo  
104-8315, JP  
(72) MITSUSHIMA Toru, 793 Utsutsumi, Kamogawa-shi Chiba 296-  
0035, JP

- (51) MKP  
**A61P 35/00 (2006.01)** (97) **2575850 \***  
**C07K 14/47 (2006.01)**  
**A61K 39/00 (2006.01)**  
**A61K 45/06 (2006.01)**  
**A61K 38/04 (2006.01)**  
(86) EP2011059121 01.06.2011  
(96) 11722825.4 10.04.2013  
(87) WO2011151403, 01.06.2011  
(97) 2575850, 10.04.2013 en  
(54) IMPROVED CANCER THERAPY BASED ON TUMOR  
ASSOCIATED ANTIGENS DERIVED FROM CYCLIN D1  
(71) Immatics Biotechnologies GmbH, Paul-Ehrlich-Strasse 15,  
72076 Tübingen, DE  
(72) SINGH, Harpreet, Bei den Pferdestaellen 9, 72072 Tuebingen,  
DE  
WEINSCHENK, Toni, Im Morgenrain 15, 73773 Aichwald, DE  
WALTER, Steffen, Steinenbergstrasse 2, 72764 Reutlingen,  
DE

- (51) MKP  
**B01D 53/22 (2006.01)** (97) **2588217 \***  
**C10L 3/10 (2006.01)**
- (86) EP2011058636 26.05.2011  
(96) 11722404.8 08.05.2013  
(87) WO2012000727, 26.05.2011  
(97) 2588217, 08.05.2013 de
- (54) PROCESS FOR SEPARATION OF GASES  
(71) Evonik Fibres GmbH, Gewerbepark 4, 4861 Schörfing am Attersee, AT
- (72) UNGERANK, Markus, Münzbacherstraße 22, A-4320 Perg, AT  
BAUMGARTEN, Goetz, Reinhard-Freericks-Str. 20, 45721 Haltern am See, DE  
PRISKE, Markus, Am Königshof 13, 40472 Düsseldorf, DE  
ROEGL, Harald, Mühlbachgasse 20, A-4702 Wallern an der Trattnach, AT

- (51) MKP  
**A61M 5/24 (2006.01)** (97) **2579926 \***  
**A61M 5/315 (2006.01)**
- (86) EP2011059576 09.06.2011  
(96) 11724223.0 17.04.2013  
(87) WO2011154490, 09.06.2011  
(97) 2579926, 17.04.2013 en
- (54) DRIVE MECHANISM FOR A DRUG DELIVERY DEVICE  
(71) Sanofi-Aventis Deutschland GmbH, Brüningstraße 50, 65929 Frankfurt, DE
- (72) HEALD, Michael, 22 Wells Avenue, Crewe, Cheshire CW1 5RZ, GB  
BUTLER, Stephen, David, 25 High Hill, Essington, South Staffordshire WV11 2DP, GB  
HORLOCK, Mark, Philip, 18 Mayfield Close, Timperley Aberdeenshire WA15 7TE, GB

- (51) MKP  
**A61K 31/404 (2006.01)** (97) **2560651 \***  
**A61K 31/4704 (2006.01)**  
**A61K 31/443 (2006.01)**
- (86) US2011033693 22.04.2011  
(96) 11718598.3 27.02.2013  
(87) WO2011133956, 22.04.2011  
(97) 2560651, 27.02.2013 en
- (54) PHARMACEUTICAL COMPOSITIONS AND ADMINISTRATIONS THEREOF  
(71) Vertex Pharmaceuticals Incorporated, 130 Waverly Street, Cambridge, MA 02139, US
- (72) VAN GOOR, Fredrick, F., 832 Ormond Court, San Diego, CA 92109, US  
ALARGOVA, Rossitza, Gueorguieva, 148 Newton Street, Apt. 4, Brighton, MA 02135, US  
ALCACIO, Tim, Edward, 2276 Fenton Parkway, 304, San Diego, CA 92108, US  
BINCH, Hayley, Marie, 1406 Flair Encinitas Drive, Encinitas, CA 92024, US  
BOTFIELD, Martyn, Curtis, 47 Walden Terrace, Concord, MA 01742, US  
FANNING, Lev Tyler, Dewey, 115 Dole Way, San Marcos, CA 92078, US  
GROOTENHUIS, Peter Diederik, Jan, 4801 Riding Ridge Road, San Diego, CA 92130, US  
HURLEY, Dennis, James, 1513 Black Walnut Drive, San Marcos, CA 92078, US  
KADIYALA, Irina, Nikolaevna, 40 Hagen Road, Newton, MA 02457, US  
KAUSHIK, Ritu, Rohit, 24 Church Street, Apt. 23, Watertown, MA 02472, US  
KESHAVARZ-SHOKRI, Ali, 4285 Corte Langostino, San Diego, CA 92130, US  
KRAWIEC, Mariusz, 46 Littlefield Lane, Marlborough, MA 01752, US  
LEE, Elaine, Chungmin, 303 Third Street, Apt. 316, Cambridge, MA 02142, US  
LUIZI, Brian, 26 Carriage House Lane, Mansfield, MA 02048, US  
MEDEK, Ales, 14 Lockland Road, Winchester, MA 01890, US  
NUMA, Mehdi, 3106 Jemez Drive, San Diego, CA 92117, US  
SHETH, Urvi, Jagdishbhai, 9316 Babauta Road, 71, San Diego, CA 92129, US  
SILINA, Alina, 7160 Shoreline Drive, 4308, San Diego, CA 92122, US  
VERWIJS, Marinus, Jacobus, 4 Carter Drive, Framingham, MA 01701, US  
YANG, Xiaoqing, 4526 Vereda Mar de Ponderosa, San Diego, CA 92130, US  
YOUNG, Christopher Ryan, 42 Francis Street Unit 1, Waltham, MA 02451, US  
ZAMAN, Noreen, Tasneem, 1 Magnolia Drive, Acton, MA 01720, US  
ZHANG, Beili, 4505 Shorepointe Way, San Diego, CA 92130, US  
ZHANG, Yuegang, 15 Fairfield Road, Wayland, MA 01778, US  
ZLOKARNIK, Gregor, 2754 Palomino Circle, La Jolla, CA 92037, US

- (51) MKP  
**G01V 1/48 (2006.01)** (97) **2577359 \***
- (86) EP2011058743 27.05.2011  
(96) 11721784.4 10.04.2013  
(87) WO2011147970, 27.05.2011  
(97) 2577359, 10.04.2013 en
- (54) METHOD AND SYSTEM FOR DETERMINING THE RIGIDITY OF A GEOLOGICAL LAYER  
(71) Uretek S.r.l., Via Dosso del Duca 16, 37021 Bosco Chiesanuova (Verona), IT
- (72) MULARGIA, Francesco, Via Avesella 3, I-40121 Bologna, IT  
CASTELLARO, Silvia, Via Asseggiano 234/A, I-30174 Venezia, IT  
PASTOR, Mariapia, Via Dosso del Duca 18, I-37021 Bosco Chiesanuova (VR), IT  
VINCO, Gianluca, Via Ardizzone 27, I-37023 Grezzana (VR), IT

(51) MKP  
**B65D 47/20 (2006.01)** (97) **2560532 \***  
**A47K 5/12 (2006.01)**  
**B65D 47/32 (2006.01)**  
**B05B 11/00 (2006.01)**  
**B65D 51/16 (2006.01)**  
**A47K 5/13 (2006.01)**  
**G01F 11/08 (2006.01)**  
(86) AT2011000197 21.04.2011  
(96) 11722707.4 27.02.2013  
(87) WO2011130763, 21.04.2011  
(97) 2560532, 27.02.2013 de  
(54) REFILLING UNIT COMPRISING A CONTAINER  
(71) Hagleitner, Hans Georg, Lindenallee 11, 5700 Zell am See, AT  
(72) Hagleitner, Hans Georg, Lindenallee 11, 5700 Zell am See, AT

(51) MKP  
**A61K 31/505 (2006.01)** (97) **2547672 \***  
**A61P 11/00 (2006.01)**  
**C07D 403/04 (2006.01)**  
(86) US2011028427 15.03.2011  
(96) 11710373.9 23.01.2013  
(87) WO2011115940, 15.03.2011  
(97) 2547672, 23.01.2013 en  
(54) SUBSTITUTED PYRIMIDINES AS PROSTAGLANDIN D2 RECEPTOR ANTAGONISTS  
(71) Aventis Pharmaceuticals Inc., 55 Corporate Drive, Bridgewater, NJ 08807, US  
(72) HARRIS, Keith J., c/o sanofi-aventis U.S. 1041 Route 202-206 Mail Code: BWD-303A Bridgewater, New Jersey 08807, US  
AGUIAR, Joacy C., c/o sanofi-aventis U.S. 1041 Route 202-206 Mail Code: BWD-303A Bridgewater, New Jersey 08807, US  
SHUM, Patrick Wai-Kwok, c/o sanofi-aventis U.S. 1041 Route 202-206 Mail Code: BWD-303A Bridgewater, New Jersey 08807, US  
ZHAO, Zhicheng, c/o sanofi-aventis U.S. 1041 Route 202-206 Mail Code: BWD-303A Bridgewater, New Jersey 08807, US  
POLI, Gregory B., c/o sanofi-aventis U.S. 1041 Route 202-206 Mail Code: BWD-303A Bridgewater, New Jersey 08807, US  
STOKLOSA, Gregory, c/o sanofi-aventis U.S. 1041 Route 202-206 Mail Code: BWD-303A Bridgewater, New Jersey 08807, US  
CHOI-SLEDESKI, Yong-Mi, c/o sanofi-aventis U.S. 1041 Route 202-206 Mail Code: BWD-303A Bridgewater, New Jersey 08807, US  
REILING, Stephan, c/o sanofi-aventis U.S. 1041 Route 202-206 Mail Code: BWD-303A Bridgewater, New Jersey 08807, US  
STEFANY, David, c/o sanofi-aventis U.S. 1041 Route 202-206 Mail Code: BWD-303A Bridgewater, New Jersey 08807, US  
GARDNER, Charles, c/o sanofi-aventis U.S. 1041 Route 202-206 Mail Code: BWD-303A Bridgewater, New Jersey 08807, US

(51) MKP  
**B29C 53/82 (2006.01)** (97) **2580046 \***  
**B29C 69/00 (2006.01)**  
**B29C 53/70 (2006.01)**  
(86) NL2011050413 08.06.2011  
(96) 11726220.4 17.04.2013  
(87) WO2011155835, 08.06.2011  
(97) 2580046, 17.04.2013 en  
(54) METHOD AND DEVICE FOR MANUFACTURING COMPOSITE PRODUCTS COMPRISING A PLANAR PORTION  
(71) Airborne International B.V., Laan van Ypenburg 70-78, 2497 GB 's-Gravenhage, NL  
(72) KREMERS, Marcus Antonius Ivonne, Stoombootweg 41, NL-1035 TT Amsterdam, NL

(51) MKP  
**A61K 31/4184 (2006.01)** (97) **2575785 \***  
**A61K 9/28 (2006.01)**  
**A61K 9/16 (2006.01)**  
**A61K 9/48 (2006.01)**  
**A61K 9/20 (2006.01)**  
**A61K 47/10 (2006.01)**  
**A61K 9/14 (2006.01)**  
(86) EP2011002763 01.06.2011  
(96) 11727917.4 10.04.2013  
(87) WO2011151086, 01.06.2011  
(97) 2575785, 10.04.2013 en  
(54) ORAL DOSAGE FORMS OF BENDAMUSTINE AND THERAPEUTIC USE THEREOF  
(71) Astellas Deutschland GmbH, Georg-Brauchle-Ring 64-66, 80992 München, DE  
(72) PATZAK, Ulrich, c/o Astellas Pharma Europe B.V. Patent Department Elisabethhof 19, NL-2353 EW Leiderdorp, NL  
OUATAS, Taoufik, c/o Astellas Pharma Europe B.V. Patent Department Elisabethhof 19, NL-2353 EW Leiderdorp, NL

(51) MKP  
**C07D 413/06 (2006.01)** (97) **2576543 \***  
**A61K 31/5377 (2006.01)**  
**A61K 31/4025 (2006.01)**  
**C07D 403/12 (2006.01)**  
**C07D 413/14 (2006.01)**  
**C07D 413/12 (2006.01)**  
**A61K 31/496 (2006.01)**  
**A61K 31/454 (2006.01)**  
**C07D 401/12 (2006.01)**  
**A61P 25/00 (2006.01)**  
(86) EP2011058633 26.05.2011  
(96) 11723422.9 10.04.2013  
(87) WO2011147910, 26.05.2011  
(97) 2576543, 10.04.2013 en  
(54) PYRAZOLE COMPOUNDS AS SIGMA RECEPTOR INHIBITORS  
(71) Laboratorios del Dr. Esteve S.A., Avda. Mare de Deu de Montserrat, 221, 08041 Barcelona, ES  
(72) GARCÍA LÓPEZ, Mónica, Gran Vía de les Corts Catalanes 911, 2n 1º, E-08018 Barcelona, ES  
TORRENS JOVER, Antoni, Carrer del Raco 8 - 2º 2ª, E-08221 Terrasa - Barcelona, ES  
DÍAZ FERNÁNDEZ, José Luis, Cadí 21, E-08240 Manresa - Barcelona, ES  
CAAMAÑO MOURE, Ana María, Raíña 16 - 1º, E-15705 Santiago de Compostela - A Coruña, ES

(51) MKP  
**A61M 5/32 (2006.01)** (97) **2588165 \***  
(86) EP2011060316 21.06.2011  
(96) 11726436.6 08.05.2013  
(87) WO2012000832, 21.06.2011  
(97) 2588165, 08.05.2013 en  
(54) SAFETY DEVICE FOR A PRE-FILLED SYRINGE, INJECTION DEVICE AND INJECTION KIT  
(71) Sanofi-Aventis Deutschland GmbH, Brüningstraße 50, 65929 Frankfurt, DE  
(72) EKMAN, Matthew, 59 Ecton Avenue, Macclesfield, Cheshire SK10 1RD, GB  
SMITH, Christopher James, 4 Elm Drive, Holmes Chapel, Cheshire CW4 7QG, DE  
BAKER, Troy, 4 Lon Y Parc, St Asaph, Denbighshire LL17 0PJ, GB  
WILSON, Graham, 41 Birch Ridge, Flint, Flintshire CH6 5YR, GB  
ROBERTS, Gareth, Glendale Pen-y-cae Road Ruabon, Wrexham LL14 6EB, GB  
SLEMMEN, John, 34 Empress Road Liscard Wallasey Wirral, Merseyside CH44 0AP, GB

- (51) MKP  
**A61K 8/55 (2006.01)** (97) **2572700 \***  
**A61Q 7/00 (2006.01)**  
**A61Q 5/00 (2006.01)**  
(86) KR2011003652 17.05.2011  
(96) 11783754.2 27.03.2013  
(87) WO2011145872, 17.05.2011  
(97) 2572700, 27.03.2013 en  
(54) COMPOSITION FOR PREVENTING HAIR-LOSS OR STIMULATING HAIR GROWTH  
(71) Biopid Corporation, 343-1 Sancheon-ri Sinbuk-eup, Chuncheon-si, Gangwon-do 200-822, KR  
(72) CHOI, Seong Hyun, 343-1 Sancheon-ri Sinbuk-eup, Chuncheon-si Gangwon-do 200-822, KR

- (51) MKP  
**C12Q 1/00 (2006.01)** (97) **2542687 \***  
**G01N 33/487 (2006.01)**  
**A61K 38/00 (2006.01)**  
**A61P 5/26 (2006.01)**  
**G01N 33/483 (2006.01)**  
**A61P 3/00 (2006.01)**  
(86) US2011026761 01.03.2011  
(96) 11751240.0 09.01.2013  
(87) WO2011109448, 01.03.2011  
(97) 2542687, 09.01.2013 en  
(54) INVOLVEMENT OF ANDROGEN/ANDROGEN RECEPTOR PATHWAY IN FABRY DISEASE  
(71) Baylor Research Institute, 3310 Live Oak Street, Suite 501, Dallas, TX 75204, US  
(72) SHEN, Jinsong, 208 Tuscany Court, Allen, TX 75013, US  
SCHIFFMANN, Raphael, 2125 Hillcroft Drive, Rockwall, TX 75087, US  
MENG, Xingli, 208 Tuscany Court, Allen, TX 75013, US

- (51) MKP  
**G01N 33/487 (2006.01)** (97) **2577303 \***  
(86) US2011039382 07.06.2011  
(96) 11752665.7 10.04.2013  
(87) WO2011156325, 07.06.2011  
(97) 2577303, 10.04.2013 en  
(54) UNDERFILL MANAGEMENT SYSTEM FOR A BIOSENSOR  
(71) Bayer HealthCare LLC, 555 White Plains Road, Tarrytown, NY 10591, US  
(72) WU, Ping, 14374 Shoreline Dr., Granger Indiana 46530, US  
MAURER, Eric, 121 South Walnut St., 45869 New Bremen, US

- (51) MKP  
**C09C 1/02 (2006.01)** (97) **2565236**  
**D21H 17/00 (2006.01)**  
(96) 11179572.0 06.03.2013  
(97) 2565236, 06.03.2013 en  
(54) Self-binding pigment hybrid  
(71) Omya Development AG, Baslerstrasse 42, 4665 Oftringen, CH  
(72) Gantenbein, Daniel, Vogesenstrasse 27, 4056 Basel, CH  
Schoelkopf, Joachim, Buechbühlstrasse 3, 8956 Killwangen, CH  
Gane, Patrick A.C., Studenweg 8, 4852 Rothrist, CH

- (51) MKP  
**A61K 39/395 (2006.01)** (97) **2575879 \***  
**A61P 35/00 (2006.01)**  
**C07K 16/28 (2006.01)**  
(86) EP2011059139 01.06.2011  
(96) 11722828.8 10.04.2013  
(87) WO2011151412, 01.06.2011  
(97) 2575879, 10.04.2013 en  
(54) NOVEL ANTI-CMET ANTIBODY  
(71) Pierre Fabre Medicament, 45, Place Abel Gance, 92100 Boulogne-Billancourt, FR  
(72) GOETSCH, Liliane, 15 route de Cluses, F-74130 Ayzé, FR  
WURCH, Thierry, 7 route des Etoiles Le Clos Bellevue, F-74140 Machilly, FR  
BES, Cédric, 12 boulevard des Acanthes, F-30250 Villevieille, FR

- (51) MKP  
**C07K 14/535 (2006.01)** (97) **2547699 \***  
(86) EP2011001331 17.03.2011  
(96) 11709881.4 23.01.2013  
(87) WO2011113601, 17.03.2011  
(97) 2547699, 23.01.2013 en  
(54) METHOD FOR OBTAINING BIOLOGICALLY ACTIVE RECOMBINANT HUMAN G-CSF  
(71) Biogenerix GmbH, Graf-Arco-Strasse 3, 89079 Ulm, DE  
(72) HINDERER, Walter, Dekan-Schuster-Strasse 25, 63110 Rodgau, DE  
SCHECKERMANN, Christian, Sägegasse 1c, 79238 Ehrenkirchen, DE

- (51) MKP  
**A61M 1/16 (2006.01)** (97) **2563343 \***  
**A61M 1/36 (2006.01)**  
**A61K 9/50 (2006.01)**  
(86) IB2011000891 26.04.2011  
(96) 11729678.0 06.03.2013  
(87) WO2011135429, 26.04.2011  
(97) 2563343, 06.03.2013 en  
(54) APPARATUS AND KIT FOR ENCAPSULATING AT LEAST ONE COMPOUND FOR THERAPEUTIC AND/OR DIAGNOSTIC USE IN ERYTHROCYTES  
(71) EryDel S.p.A., Via Sasso 36, Urbino, IT  
(72) MAMBRINI, Giovanni, c/o Erydel S.p.A. Via Sasso 36, 61029 Urbino, IT  
SERAFINI, Sonja, c/o Erydel S.p.A. Via Sasso 36, 61029 Urbino, IT

- (51) MKP  
**C01F 11/18 (2006.01)** (97) **2447213**  
**C09C 1/02 (2006.01)**  
(96) 10188840.2 02.05.2012  
(97) 2447213, 02.05.2012 en  
(54) Production of high purity precipitated calcium carbonate  
(71) Omya Development AG, Baslerstrasse 42, 4665 Oftringen, CH  
(72) Tavakkoli, Bahman, Zauchenweg 8, 9722 Puch, AT  
Sötemann, Jörg, Italiener Strasse 35, 9500 Villach, AT  
Pohl, Michael, H.-v.-Tuerlin Strasse 11, 9500 Villach, AT  
Schmölzer, Thomas, Hauptschulstrasse 6/6, 9523 Landskron, AT

- (51) MKP  
**E05D 15/06 (2006.01)** (97) **2455573**  
**E06B 3/46 (2006.01)**  
(96) 11167273.9 23.05.2012  
(97) 2455573, 23.05.2012 en  
(54) Device for suspension fastening of pocket doors positionable in openings smaller than the door  
(71) ECLISSE SRL, Via Sernaglia, 76, 31053 Pieve di Soligo TV, IT  
(72) De Faveri, Luigi, Via Vittoria, 114, 31020, Refrontolo TV, IT



- (51) MKP  
*C07D 211/16 (2006.01)* (97) **2576507 \***  
*C07D 403/04 (2006.01)*  
*C07D 211/62 (2006.01)*  
*C07D 205/04 (2006.01)*  
*A61K 31/4468 (2006.01)*  
*C07D 211/54 (2006.01)*  
*C07D 409/12 (2006.01)*  
*C07D 207/12 (2006.01)*  
*A61P 25/00 (2006.01)*  
*C07D 211/58 (2006.01)*  
*C07D 413/12 (2006.01)*  
*C07D 211/46 (2006.01)*  
*C07D 405/12 (2006.01)*  
*C07D 207/14 (2006.01)*  
*C07D 401/12 (2006.01)*  
(86) IB2011052458 06.06.2011  
(96) 11729733.3 10.04.2013  
(87) WO2011151808, 06.06.2011  
(97) 2576507, 10.04.2013 en  
(54) HEXAFLUOROISOPROPYL CARBAMATE DERIVATIVES, THEIR PREPARATION AND THEIR THERAPEUTIC APPLICATION  
(71) SANOFI, 54, rue de la Boétie, 75008 Paris, FR  
(72) BARTSCH, Régine, c/o Sanofi Patent Department 174 avenue de France, F-75013 Paris, FR  
CHEURET, Dorothee, c/o Sanofi Patent Department 174 avenue de France, F-75013 Paris, FR  
EVEN, Luc, c/o Sanofi Patent Department 174 avenue de France, F-75013 Paris, FR  
HOORNAERT, Christian, c/o Sanofi Patent Department 174 avenue de France, F-75013 Paris, FR  
JEUNESSE, Jean, c/o Sanofi Patent Department 174 avenue de France, F-75013 Paris, FR  
MARGUET, Frank, c/o Sanofi Patent Department 174 avenue de France, F-75013 Paris, FR

- (51) MKP  
*A61K 31/403 (2006.01)* (97) **2569296 \***  
*C07D 403/10 (2006.01)*  
*C07D 401/10 (2006.01)*  
*A61P 25/00 (2006.01)*  
(86) US2011035847 10.05.2011  
(96) 11731176.1 20.03.2013  
(87) WO2011143163, 10.05.2011  
(97) 2569296, 20.03.2013 en  
(54) SUBSTITUTED N-PHENYL SPIROLACTAM BIPYRROLIDINES, PREPARATION AND THERAPEUTIC USE THEREOF  
(71) SANOFI, 54 rue La Boétie, 75008 Paris, FR  
(72) GAO, Zhongli, c/o sanofi-aventis U.S. 1041 Route 202-206 BWD-303A, Bridgewater New Jersey 08807, US  
HALL, Daniel, c/o sanofi-aventis U.S. 1041 Route 202-206 BWD-303A, Bridgewater New Jersey 08807, US  
STEFANY, David, c/o sanofi-aventis U.S. 1041 Route 202-206 BWD-303A, New Jersey 08807, US

- (51) MKP  
*A61P 35/04 (2006.01)* (97) **2540728 \***  
*C07D 495/04 (2006.01)*  
*C07D 519/00 (2006.01)*  
*A61K 31/5377 (2006.01)*  
*A61P 43/00 (2006.01)*  
*A61P 35/02 (2006.01)*  
*A61P 35/00 (2006.01)*  
*A61K 31/541 (2006.01)*  
*A61K 31/519 (2006.01)*  
(86) JP2011053303 16.02.2011  
(96) 11744685.6 02.01.2013  
(87) WO2011102399, 16.02.2011  
(97) 2540728, 02.01.2013 en  
(54) HETEROCYCLIC COMPOUND  
(71) Takeda Pharmaceutical Company Limited, 1-1 Doshomachi 4-chome Chuo-ku, Osaka-shi, Osaka 541-0045, JP  
(72) HOMMA, Misaki, c/o Takeda Pharmaceutical Company Limited 26-1 Muraoka-Higashi 2-chrome, Fujisawa; Kanagawa 251-0012, JP  
MIYAZAKI, Toru, c/o Takeda Pharmaceutical Company Limited 26-1 Muraoka-Higashi 2-chrome, Fujisawa; Kanagawa 251-0012, JP  
OGURO, Yuya, c/o Takeda Pharmaceutical Company Limited 26-1 Muraoka-Higashi 2-chrome, Fujisawa; Kanagawa 251-0012, JP  
KURASAWA, Osamu, c/o Takeda Pharmaceutical Company Limited 26-1 Muraoka-Higashi 2-chrome, Fujisawa; Kanagawa 251-0012, JP

- (51) MKP  
*A61K 9/28 (2006.01)* (97) **2555754 \***  
*A61K 9/16 (2006.01)*  
*A61K 9/20 (2006.01)*  
*C07D 405/12 (2006.01)*  
*C07D 405/14 (2006.01)*  
*C07D 213/75 (2006.01)*  
(86) US2011031588 07.04.2011  
(96) 11714625.8 13.02.2013  
(87) WO2011127290, 07.04.2011  
(97) 2555754, 13.02.2013 en  
(54) SOLID FORMS OF 3-(6-(1-(2,2-DIFLUOROBENZO[D][1,3]DIOXOL-5-YL)CYCLOPROPANECARBOXAMIDO)-3-METHYLPYRIDIN-2-YL)BENZOIC ACID  
(71) Vertex Pharmaceuticals Incorporated, 130 Waverly Street, Cambridge, MA 02139, US  
(72) KESHAVARZ-SHOKRI, Ali, 4285 Corte Langostino, San Diego CA 92130, US  
ZHANG, Beili, 4505 Shorepointe Way, San Diego CA 92130, US  
KRAWIEC, Mariusz, 46 Littlefield Lane, Marlborough MA 01752, US

- (51) MKP  
*A61K 31/439 (2006.01)* (97) **2585459 \***  
*A61P 11/00 (2006.01)*  
*C07D 453/02 (2006.01)*  
(86) EP2011060131 17.06.2011  
(96) 11728800.1 01.05.2013  
(87) WO2011161018, 17.06.2011  
(97) 2585459, 01.05.2013 en  
(54) ALKALOID AMINOESTER DERIVATIVES AND MEDICINAL COMPOSITIONS THEREOF  
(71) Chiesi Farmaceutici S.p.A., Via Palermo, 26/A, 43100 Parma, IT  
(72) AMARI, Gabriele, c/o CHIESI FARMACEUTICI S.P.A. Via Palermo 26/A, I-43100 Parma, IT  
RICCABONI, Mauro, c/o CHIESI FARMACEUTICI S.P.A. Via Palermo 26/A, I-43100 Parma, IT  
BOSSOLO, Stefano, Via Palermo 26/A, I-43100 Parma, IT

- (51) MKP  
**C07D 471/04 (2006.01)** (97) **2545052 \***  
**A61K 31/437 (2006.01)**  
**A61P 29/00 (2006.01)**  
**A61P 11/00 (2006.01)**  
**A61P 35/00 (2006.01)**  
**C07D 519/00 (2006.01)**  
**A61P 35/02 (2006.01)**  
**A61P 19/00 (2006.01)**
- (86) US2011028194 11.03.2011  
(96) 11709600.8 16.01.2013  
(87) WO2011112995, 11.03.2011  
(97) 2545052, 16.01.2013 en  
(54) IMIDAZOPYRIDINES SYK INHIBITORS  
(71) Gilead Connecticut, Inc., 333 Lakeside Drive, Foster City, CA 94404, US  
(72) BLOMGREN, Peter, 333 Lakeside Drive, Foster City, CA 94404, US  
CURRIE, Kevin, S, 333 Lakeside Drive, Foster City, CA 94404, US  
KROPF, Jeffrey, E., 333 Lakeside Drive, Foster City, CA 94404, US  
LEE, Seung, H., 333 Lakeside Drive, Foster City, CA 94404, US  
MITCHELL, Scott, A., 333 Lakeside Drive, Foster City, CA 94404, US  
SCHMITT, Aaron, C., 333 Lakeside Drive, Foster City, CA 94404, US  
XU, Jianjun, 333 Lakeside Drive, Foster City, CA 94404, US  
ZHAO, Zhongdong, 333 Lakeside Drive, Foster City, CA 94404, US
- 
- (51) MKP  
**A61K 31/422 (2006.01)** (97) **2566452 \***  
**A61K 9/00 (2006.01)**  
**A61K 31/497 (2006.01)**  
**A61K 31/404 (2006.01)**
- (86) DE2011001022 03.05.2011  
(96) 11738393.5 13.03.2013  
(87) WO2011137894, 03.05.2011  
(97) 2566452, 13.03.2013 de  
(54) MELTING TABLET COMPRISING A TRIPTANE OR ATYPICAL NEUROLEPTIC  
(71) STADA ARZNEIMITTEL AG, Stadastrasse 2-18, 61118 Bad Vilbel, DE  
(72) VUKOVIC, Stasa, Lipa 16 (nasalje Hemograd), 26300 Vrsac, RS  
STUPAR, Biljana, Lipa 14 (nasalje Hemograd), 26300 Vrsac, RS  
MIHAJLOVIC, Tijana, Svetozara Miletica 90, 26300 Vrsac, RS
- 
- (51) MKP  
**C40B 40/06 (2006.01)** (97) **2545211 \***  
**C40B 50/06 (2006.01)**
- (86) US2011027392 07.03.2011  
(96) 11753873.6 16.01.2013  
(87) WO2011112511, 07.03.2011  
(97) 2545211, 16.01.2013 en  
(54) METHODS AND ALGORITHMS FOR SELECTING POLYNUCLEOTIDES FOR SYNTHETIC ASSEMBLY  
(71) Centocor Ortho Biotech Inc., 800/850 Ridgeview Drive, Horsham, PA 19044, US  
(72) PARDINAS, Jose, 3210 Merryfield Row, San Diego, CA 92121, US  
ZHAO, Shanrong, 3210 Merryfield Row, San Diego, CA 92121, US
- 
- (51) MKP  
**G10L 21/02 (2013.01)** (97) **2555189 \***
- (86) CN2011082993 25.11.2011  
(96) 11843100.6 06.02.2013  
(87) WO2012069020, 25.11.2011  
(97) 2555189, 06.02.2013 en  
(54) METHOD AND DEVICE FOR SPEECH ENHANCEMENT, AND COMMUNICATION HEADPHONES WITH NOISE REDUCTION  
(71) Goertek Inc., No. 268 Dongfang Road, Hi-Tech Industry District Weifang, Shandong 261031, CN  
(72) ZHAO, Jian, NO.268 Dongfang Road Hi-Tech Industry Development District, Weifang Shandong 261031, CN  
LIU, Song, NO.268 Dongfang Road Hi-Tech Industry Development District, Weifang Shandong 261031, CN  
LI, Bo, NO.268 Dongfang Road Hi-Tech Industry Development District, Weifang Shandong 261031, CN  
HUA, Yang, NO.268 Dongfang Road Hi-Tech Industry Development District, Weifang Shandong 261031, CN
- 
- (51) MKP  
**A61L 31/04 (2006.01)** (97) **2555809 \***  
**A61K 9/16 (2006.01)**  
**A61L 27/20 (2006.01)**
- (86) EP2011001736 07.04.2011  
(96) 11714227.3 13.02.2013  
(87) WO2011124380, 07.04.2011  
(97) 2555809, 13.02.2013 en  
(54) CHITOSAN BEADS AND FILLER COMPRISING SUCH BEADS  
(71) Merz Pharma GmbH & Co. KGaA, Eckenheimer Landstrasse 100, 60318 Frankfurt am Main, DE  
(72) KIEHM, Kevin, Landgraf-Philipp-Strasse 44, 60431 Frankfurt am Main, DE  
HAUPTMEIER, Bernhard, Neue Weinbergstr. 10, 63571 Gelnhausen, DE  
BODERKE, Peter, Bockenheimer Str. 3, 65824 Schwalbach, DE
- 
- (51) MKP  
**G02B 27/34 (2006.01)** (97) **2557450 \***  
**F41G 1/34 (2006.01)**
- (86) RU2011000727 23.09.2011  
(96) 11806000.3 13.02.2013  
(87) WO2012091622, 23.09.2011  
(97) 2557450, 13.02.2013 en  
(54) OPTICAL SIGHT (VARIANTS)  
(71) RusOpticalSystem Ltd., Prospekt Krasnoi Armii 212 V Sergiev Posad, Moskovskaya obl. 141300, RU  
(72) BLAGOV, Pavel Andreevich, ul. Osipenko 4-105, Sergiev Posad Moskovskaya obl. 141300, RU  
TSIVILEV, Evgeny Viktorovich, ul. Moskovskaya 15-1, Sergiev Posad Moskovskaya obl. 141300, RU
- 
- (51) MKP  
**A01H 5/00 (2006.01)** (97) **2575431 \***  
**C12N 15/82 (2006.01)**
- (86) US2011038684 01.06.2011  
(96) 11726013.3 10.04.2013  
(87) WO2011153186, 01.06.2011  
(97) 2575431, 10.04.2013 en  
(54) TRANSGENIC BRASSICA EVENT MON 88302 AND METHODS OF USE THEREOF  
(71) Monsanto Technology LLC, 800 North Lindbergh Blvd., St. Louis, MO 63167, US  
(72) BROWN, Andrew, J., 800 North Lindbergh Blvd., St. Louis, MO 63167, US  
BYRNE, James, F., 800 North Lindbergh Blvd., St. Louis, MO 63167, US  
COLE, Robert, H., 800 North Lindbergh Blvd., St. Louis, MO 63167, US  
CROWLEY, James, H., 800 North Lindbergh Blvd., St. Louis, MO 63167, US  
MIKLOS, John, A., 800 North Lindbergh Blvd., St. Louis, MO 63167, US  
RIPLEY, Robert, C., 800 North Lindbergh Blvd., St. Louis, MO 63167, US  
SEIFERT-HIGGINS, Simone, 800 North Lindbergh Blvd., St. Louis, MO 63167, US  
XIE, Jiali, 800 North Lindbergh Blvd., St. Louis, MO 63167, US

(51) MKP  
**A61K 38/18 (2006.01)** (97) **2538962 \***  
**A61P 27/02 (2006.01)**  
(86) EP2011052543 21.02.2011  
(96) 11704455.2 02.01.2013  
(87) WO2011101478, 21.02.2011  
(97) 2538962, 02.01.2013 en  
(54) USE OF TRANSFORMING GROWTH FACTOR - BETA 1 (TGF- 1) INHIBITOR PEPTIDES FOR THE TREATMENT OF CORNEAL FIBROSIS AND/OR HAZE  
(71) Proyecto de Biomedicina Cima, S.L., Avda. Pío XII, 22 Oficina 1, 31008 Pamplona - Navarra, ES  
Digna Biotech, S.L., Avenida Pío XII, 22. Oficina 2, 31008 Pamplona Navarra, ES  
(72) DOTOR DE LAS HERRERÍAS, Javier, ICT (D.P.I.) Avda. Pio XII nº 53, E-31008 Pamplona - Navarra, ES  
MALDONADO LÓPEZ, Miguel José, ICT (D.P.I.) Avda. Pío XIII 53, E-31008 Pamplona - Navarra, ES

(51) MKP  
**A61K 47/10 (2006.01)** (97) **2563351 \***  
**A61K 47/32 (2006.01)**  
**A61K 31/12 (2006.01)**  
(86) EP2011056836 29.04.2011  
(96) 11717608.1 06.03.2013  
(87) WO2011135073, 29.04.2011  
(97) 2563351, 06.03.2013 de  
(54) ADHESIVE SLOW-RELEASE FORMULATIONS FOR THE LOCAL ADMINISTRATION OF CURCUMIN  
(71) Orphanidis Pharma Research GmbH, Wilhelminenstrasse 91/1lf, 1160 Vienna, AT  
(72) OBWALLER, Andreas, Dr. Eberleg. 10/5/12. A-1100 Vienna. AT

(51) MKP  
**C07C 51/02 (2006.01)** (97) **2383249**  
**C07C 51/44 (2006.01)**  
**C07C 51/46 (2006.01)**  
(96) 11164481.1 02.11.2011  
(97) 2383249, 02.11.2011 en  
(54) Processes for producing adipic acid from fermentation broths containing diammonium adipate  
(71) BioAmber S.A.S., 1250 Rene-Levesque Boulevard, West Suite 4110, Montreal H3B 4W8, CA  
(72) Fruchey, Olan S., 13 Greenbrier Avenue, Hurricane, WV 25526, US  
Keen, Brian T., 108 Hughes Drive, Pinch, WV 25156, US  
Albin, Brooke A., 1026 Gordon Drive, Charleston, WV 25303, US  
Clinton, Nye A., 16 Christopher Drive, Hurricane, WV 25526, US  
Dombek, Bernard D., 1620 Woodvale Drive, Charleston, WV 25314, US  
Manzer, Leo E., 328 Cassell Court, Wilmington, DE 19803, US  
Dunuwila, Dilum, 394 Franklin Avenue, Princeton, NJ 08540, US

(51) MKP  
**C02F 3/34 (2006.01)** (97) **2557129**  
**C09C 1/02 (2006.01)**  
**C02F 1/68 (2006.01)**  
(96) 11177031.9 13.02.2013  
(97) 2557129, 13.02.2013 en  
(54) Surface-treated calcium carbonate for binding and bioremediating hydrocarbon-containing compositions  
(71) Omya Development AG, Baslerstrasse 42, 4665 Oftringen, CH  
(72) Di Maiuta, Nicola, Amselweg 8, 4528 Zuchwil, CH  
Schwarzentruber, Patrick, Untere Lättenstrasse 193, 5245 Habsburg, CH  
Skovby, Michael, Wampflenstrasse 52, 8706 Meilen, CH

(51) MKP  
**A61M 15/00 (2006.01)** (97) **2570148**  
**G06M 1/24 (2006.01)**  
**G06M 1/16 (2006.01)**  
(96) 12195429.1 20.03.2013  
(97) 2570148, 20.03.2013 en  
(54) Counter  
(71) EURO-CELTIQUE S.A., 2, avenue Charles de Gaulle, 1653 Luxembourg, LU  
(72) Bacon, Raymond, Steep Farm Steep, Petersfield, Hampshire GU32 2DB, GB  
McDerment, Iain, 7 Moat Lane Melbourn, Royston, Hertfordshire SG8 6EH, GB

(51) MKP  
**C07D 473/00 (2006.01)** (97) **2542552 \***  
**A61K 31/437 (2006.01)**  
**A61P 29/00 (2006.01)**  
**A61P 9/00 (2006.01)**  
**C07D 487/04 (2006.01)**  
**A61K 31/52 (2006.01)**  
**C07D 471/04 (2006.01)**  
**A61K 31/4985 (2006.01)**  
(86) US2011026974 03.03.2011  
(96) 11709244.5 09.01.2013  
(87) WO2011109587, 03.03.2011  
(97) 2542552, 09.01.2013 en  
(54) SUBSTITUTED AZA-BICYCLIC IMIDAZOLE DERIVATIVES USEFUL AS TRPM8 RECEPTOR MODULATORS  
(71) Janssen Pharmaceutica, N.V., Turnhoutseweg 30, 2340 Beerse, BE  
(72) PLAYER, Mark, R., 80 Page Lane, Phoenixville, PA 19460, US  
CALVO, Raul, 72 Orchard Court, Royersford PA 19468, US  
CHEN, Jinsheng, 11 Fairwind Lane, Exton PA 19341, US  
MEEGALLA, Sanath, 3822 Highland Drive, Garnet Valley PA 19060, US  
PARKS, Daniel, 26 Berkley Drive, Downingtown PA 19335, US  
PARSONS, William, 29 Grayson Drive, Belle Mead NJ 08502, US  
BALLENTINE, Scott, 1985 Armstrong Drive, Lansdale PA 19446, US  
BRANUM, Shawn, 1808 B Merlot Drive, Easton PA 18045, US

(51) MKP  
**C07D 413/14 (2006.01)** (97) **2569309 \***  
**C07D 413/04 (2006.01)**  
**A61K 31/4245 (2006.01)**  
(86) EP2011057019 03.05.2011  
(96) 11716947.4 20.03.2013  
(87) WO2011141325, 03.05.2011  
(97) 2569309, 20.03.2013 de  
(54) HYDROXYALKYL BENZYL PYRAZOLES, AND USE THEREOF FOR THE TREATMENT OF HYPERPROLIFERATIVE AND ANGIOGENIC DISEASES  
(71) Bayer Intellectual Property GmbH, Alfred-Nobel-Strasse 10, 40789 Monheim, DE  
(72) HÄRTER, Michael, Ernst-Ludwig-Kirchner-Str. 56, 51375 Leverkusen, DE  
BECK, Hartmut, Ursula-von-Reibnitz-Straße 69, 42287 Wuppertal, DE  
SÜßMEIER, Frank, Baubergerstr.5, 80992 München, DE  
GRESCHAT-SCHADE, Susanne, Im Collmoor 6a, 49419 Wagenfeld, DE  
ELLINGHAUS, Peter, Auf der Obstwiese 3, 49324 Melle, DE  
UNTERSCHHEMMANN, Kerstin, Am Vogelherd 15, 45239 Essen, DE  
THIERAUCH, Karl-Heinz, Hochwildpfad 45, 14169 Berlin, DE  
SCHUHMACHER, Joachim, Lipkenskothen 31, 42113 Wuppertal, DE

- (51) MKP  
**A61K 31/522 (2006.01)** (97) **2582703 \***  
**A61P 29/00 (2006.01)**  
**C07D 519/00 (2006.01)**  
**C07D 487/04 (2006.01)**  
(86) EP2011002917 14.06.2011  
(96) 11724975.5 24.04.2013  
(87) WO2011157397, 14.06.2011  
(97) 2582703, 24.04.2013 en  
(54) HETEROARYL IMIDAZOLONE DERIVATIVES AS JAK INHIBITORS  
(71) Almirall S.A., Ronda del General Mitre, 151, 08022 Barcelona, ES  
(72) EASTWOOD, Paul Robert, C/Laureà Miró 408-410 08980 Sant Feliu de Llobregat, Barcelona, ES  
GONZALEZ RODRIGUEZ, Jacob, C/Laureà Miró 408-410 08980 Sant Feliu de Llobregat, Barcelona, ES  
GOMEZ CASTILLO, Elena, C/Laureà Miró 408-410 08980 Sant Feliu de Llobregat, Barcelona, ES  
BACH TAÑA, Jordi, C/Laureà Miró 408-410 08980 Sant Feliu De Llobregat, Barcelona, ES

- (51) MKP  
**A61P 35/02 (2006.01)** (97) **2563360 \***  
**A61P 35/00 (2006.01)**  
**A61K 31/404 (2006.01)**  
**A61K 31/407 (2006.01)**  
(86) US2011031256 05.04.2011  
(96) 11766596.8 06.03.2013  
(87) WO2011127058, 05.04.2011  
(97) 2563360, 06.03.2013 en  
(54) BIOMARKERS FOR MDM2 INHIBITORS FOR USE IN TREATING DISEASE  
(71) The Regents of The University of Michigan, 1600 Huron Parkway 2nd Floor, Ann Arbor, Michigan 48109, US  
(72) WANG, Shaomeng, 9343 Yorkshire Drive, Saline Michigan 48176, US  
MALEK, Sami, 4794 Polo Fields Drive, Ann Arbor Michigan 48103, US  
LONG, Jianting, 1974 Traver Road Apartment 205, Ann Arbor, Michigan 48105, US  
OUILLETTE, Peter, 6212 Hickory Ridge Court, Ypsilanti Michigan 48197, US

- (51) MKP  
**A61K 38/47 (2006.01)** (97) **2588131 \***  
**A61P 25/28 (2006.01)**  
**A61P 25/00 (2006.01)**  
(86) US2011041922 25.06.2011  
(96) 11799034.1 08.05.2013  
(87) WO2011163647, 25.06.2011  
(97) 2588131, 08.05.2013 en  
(54) METHODS AND COMPOSITIONS FOR CNS DELIVERY OF HEPARAN N-SULFATASE  
(71) Shire Human Genetic Therapies, Inc., 700 Main Street, Cambridge, MA 02169, US  
(72) NATOLI, Farah, 106 Pond Street, Georgetown MA 01833, US  
ZHU, Gaozhong, 680 South Avenue, Unit 15, Weston MA 02493, US  
TEREW, Jennifer, 225 Commonwealth Avenue, Concord MA 01742, US  
JIANG, Yuan, 42 Forest Street, Londonderry NH 03053, US  
TSUNG, Jamie, 7 Carlton Road, Wellesley MA 02482, US  
SHAHROKH, Zahra, 5 Terrace Road, Weston MA 02493, US  
VERNAGLIA, Brian, 19 Sargent Road, Winchester MA 01890, US  
PAN, Jing, 868 Depot Road, Boxborough MA 01719, US  
PFEIFER, Richard, 243 Silver Street, North Granby CT 06060, US  
CALIAS, Pericles, 39 Swains Pond Avenue, Melrose MA 02176, US

- (51) MKP  
**A61K 31/497 (2006.01)** (97) **2590653 \***  
(86) US2011043391 08.07.2011  
(96) 11804416.3 15.05.2013  
(87) WO2012006544, 08.07.2011  
(97) 2590653, 15.05.2013 en  
(54) 5-CHLORO-4-HYDROXY-1-METHYL-2-OXO-N-PHENYL-1,2-DIHYDROQUINOLINE-3-CARBOXAMIDE, SALTS AND USES THEREOF  
(71) Teva Pharmaceutical Industries Ltd., 5 Basel Street P.O. Box 3190, 49131 Petah Tiqva, IL  
(72) FRISTEDT, Ulf, Tomas, Byalagsgatan 54, S-256 56 Helsingborg, SE

- (51) MKP  
**H01L 31/04 (2006.01)** (97) **2544243 \***  
**B32B 3/30 (2006.01)**  
**B32B 27/30 (2006.01)**  
**B32B 27/00 (2006.01)**  
(86) JP2011055118 04.03.2011  
(96) 11750831.7 09.01.2013  
(87) WO2011108722, 04.03.2011  
(97) 2544243, 09.01.2013 en  
(54) TRANSPARENT CONDUCTIVE SUBSTRATE FOR SOLAR CELL, METHOD FOR MANUFACTURING THE SUBSTRATE, AND SOLAR CELL USING THE SUBSTRATE  
(71) JX Nippon Oil & Energy Corporation, 6-3, Otemachi 2-chome, Chiyoda-ku Tokyo 100-8162, JP  
Tokyo Institute of Technology, 2-12-1, Ookayama Meguro-ku, Tokyo 152-8550, JP  
(72) TAKEZOE Hideo, c/o Tokyo Institute of Technology 2-12-1 Ookayama Meguro-ku, Tokyo 152-8550, JP  
KOO, Won Hoe, c/o Tokyo Institute of Technology 2-12-1 Ookayama Meguro-ku, Tokyo 152-8550, JP  
NISHIMURA Suzushi, c/o JX Nippon Oil&Energy Corporation 8 Chidori-cho Naka-ku, Yokohama-shi Kanagawa 231-0815, JP  
SEKI Takashi, c/o JX Nippon Oil&Energy Corporation 8 Chidori-cho Naka-ku, Yokohama-shi Kanagawa 231-0815, JP  
TORIYAMA Shigetaka, c/o JX Nippon Oil&Energy Corporation 8 Chidori-cho Naka-ku, Yokohama-shi Kanagawa 231-0815, JP  
JEONG, Soon Moon, c/o JX Nippon Oil&Energy Corporation 8 Chidori-cho Naka-ku, Yokohama-shi Kanagawa 231-0815, JP  
FUKUDA Maki, c/o JX Nippon Oil&Energy Corporation 8 Chidori-cho Naka-ku, Yokohama-shi Kanagawa 231-0815, JP  
FUKUSHIMA Madoka, c/o JX Nippon Oil&Energy Corporation 8 Chidori-cho Naka-ku, Yokohama-shi Kanagawa 231-0815, JP  
MASUYAMA Satoshi, c/o JX Nippon Oil&Energy Corporation 8 Chidori-cho Naka-ku, Yokohama-shi Kanagawa 231-0815, JP

- (51) MKP  
**C07K 16/22 (2006.01)** (97) **2588138 \***  
**A61K 39/395 (2006.01)**  
**A61P 27/02 (2006.01)**  
(86) US2011042787 01.07.2011  
(96) 11734224.6 08.05.2013  
(87) WO2012003437, 01.07.2011  
(97) 2588138, 08.05.2013 en  
(54) TREATMENT OF VASCULARIZED PIGMENT EPITHELIAL DETACHMENT WITH ANTI-VEGF THERAPY  
(71) Genentech, Inc., 1 DNA Way, South San Francisco, CA 94080, US  
(72) ABRAHAM, M.D., Prema, 13179 Baker Park Road, Rapid City, South Dakota 57702, US

- (51) MKP  
**A47C 1/14 (2006.01)** (97) **2592971 \***  
**A47C 1/022 (2006.01)**  
**A47C 17/04 (2006.01)**  
**A47C 3/025 (2006.01)**  
(86) NO2011000209 15.07.2011  
(96) 11743377.1 22.05.2013  
(87) WO2012008852, 15.07.2011  
(97) 2592971, 22.05.2013 en  
(54) A SITTING ARRANGEMENT  
(71) Ekornes ASA, Industrivegen 1, 6222 Ikornnes, NO  
(72) SOLHEIM, Albert, Strandvegen 1, N-6222 Ikornnes, NO

(51) MKP  
**C07D 498/04 (2006.01)** (97) **2539322 \***  
**A61K 31/40 (2006.01)**  
**C07D 401/04 (2006.01)**  
**A61P 27/06 (2006.01)**  
**C07D 209/96 (2006.01)**  
**A61P 25/28 (2006.01)**  
**C07D 491/10 (2006.01)**  
**C07D 513/04 (2006.01)**  
**C07D 471/04 (2006.01)**  
**C07D 487/04 (2006.01)**  
(86) US2011025912 23.02.2011  
(96) 11706719.9 02.01.2013  
(87) WO2011106414, 23.02.2011  
(97) 2539322, 02.01.2013 en  
(54) INHIBITORS OF BETA-SECRETASE  
(71) Vitae Pharmaceuticals, Inc., 502 West Office Center Drive, Fort Washington, PA 19034, US  
(72) DILLARD, Lawrence W., 496 Kings Road, Yardley Pennsylvania 19067, US  
YUAN, Jing, 537 Candlemaker Way, Lansdale Pennsylvania 19446, US  
LEFATHERIS, Karina, 92 Richmond Drive, Skillman New Jersey 08558, US  
VENKATRAMAN, Shankar, 114 Country Lane, Lansdale Pennsylvania 19446, US  
WU, Guosheng, 549 Palmer Farm Drive, Yardley Pennsylvania 19067, US  
JIA, Lanqi, 22 Beaver Hill Road, Horsam Pennsylvania 19044, US  
XU, Zhenrong, 3224 Riding Court, Chalfont Pennsylvania 18914, US  
CACATIAN, Salvacion, 169 Front Street, Conshohocken Pennsylvania 19428, US  
MORALES-RAMOS, Angel, 2310 Buckeye Circle, Blue Bell Pennsylvania 19422, US  
SINGH, Suresh, 4 Adams Road, Kendall Park New Jersey 08824, US  
ZHENG, Yajun, 605 Giffen Court, Hockessin Delaware 19707, US

(51) MKP  
**B32B 33/00 (2006.01)** (97) **2576218 \***  
(86) US2011039141 03.06.2011  
(96) 11790499.5 10.04.2013  
(87) WO2011153482, 03.06.2011  
(97) 2576218, 10.04.2013 en  
(54) DISCONTINUOUS SHORT FIBER PREFORM AND FIBER-REINFORCED ALUMINUM BILLET AND METHODS OF MANUFACTURING THE SAME  
(71) Triton Systems, Inc., 200 Turnpike Road, Chelmsford, MA 01824, US  
(72) KARG, Karin, M., 19 Caughey St. Unit 2, Waltham, Massachusetts 02451, US  
NEUTRA, Justin, Andreas, 206 Roxbury Road, Marlborough, New Hampshire 03455, US  
PARNELL, Jeff, 70 Boston Road Apt B-104, Chelmsford, Massachusetts 01824, US  
GORMAN, James, J., 654 Hill Road, Boxborough, Massachusetts 01719, US

(51) MKP  
**F01N 3/20 (2006.01)** (97) **2503122**  
(96) 11159223.4 26.09.2012  
(97) 2503122, 26.09.2012 en  
(54) Reagent dosing pump assembly  
(71) Delphi Technologies Holding S.à.r.l., Avenue de Luxembourg, 4940 Bascharage, LU  
(72) Wright, Keith, 6 Kinross Close Walderslade, Chatham, Kent ME5 7RS, GB  
Cooke, Michael, 52 Burnt Oak Terrace, Gillingham, Kent ME7 1DR, GB  
Needham, David, 77 High Street Lenham, Maidstone, Kent ME17 2LA, GB  
Hardy, Martin, 71 Cedar Grove Hempstead, Gillingham, Kent ME7 3QZ, GB

(51) MKP  
**C07D 401/12 (2006.01)** (97) **2583967 \***  
**A61P 9/12 (2006.01)**  
**A61P 13/12 (2006.01)**  
**A61P 43/00 (2006.01)**  
**A61K 31/5377 (2006.01)**  
**A61P 9/00 (2006.01)**  
(86) JP2011063735 15.06.2011  
(96) 11795784.5 24.04.2013  
(87) WO2011158880, 15.06.2011  
(97) 2583967, 24.04.2013 en  
(54) CRYSTAL OF AMIDE COMPOUND  
(71) Takeda Pharmaceutical Company Limited, 1-1 Doshomachi 4-chome Chuo-ku, Osaka-shi, Osaka 541-0045, JP  
(72) KITAYAMA, Masato, c/o TAKEDA PHARMACEUTICAL COMPANY LIMITED 17-85, Jusohonmachi 2-chome Yodogawa-ku, Osaka-shi Osaka 532-8686, JP

(51) MKP  
**B65D 85/30 (2006.01)** (97) **2566771 \***  
**B65D 81/107 (2006.01)**  
**B65D 81/127 (2006.01)**  
**B65D 25/06 (2006.01)**  
**B65D 81/02 (2006.01)**  
**B65D 85/20 (2006.01)**  
(86) EP2011056995 03.05.2011  
(96) 11719507.3 13.03.2013  
(87) WO2011138296, 03.05.2011  
(97) 2566771, 13.03.2013 en  
(54) CONTAINER FOR HANDLING AND TRANSPORTING CYLINDERS  
(71) Sanofi-Aventis Deutschland GmbH, Brüningstraße 50, 65929 Frankfurt, DE  
(72) KIBAT, Paul-Gerhard, c/o Sanofi-Aventis Deutschland GmbH, 65926 Frankfurt am Main, DE  
SCHARF, Matthias, c/o Sanofi-Aventis Deutschland GmbH, 65926 Frankfurt am Main, DE  
JUHNKE, Hanno, c/o Sanofi-Aventis Deutschland GmbH, 65926 Frankfurt am Main, DE  
GROESCHKE, Jasmin, c/o Sanofi-Aventis Deutschland GmbH, 65926 Frankfurt am Main, DE  
BERNHARDT, Rainer, c/o Sanofi-Aventis Deutschland GmbH, 65926 Frankfurt am Main, DE  
SPENGLER, Jan-Peter, c/o Sanofi-Aventis Deutschland GmbH, 65926 Frankfurt am Main, DE  
SCHRACK, Michael, Schwalbenstr. 16, 72124 Pliezhausen, DE  
ZECKAL, Olaf, Ortsstr. 14, 69469 Weinheim, DE

(51) MKP  
**A61G 7/057 (2006.01)** (97) **2465480**  
(96) 11193540.9 20.06.2012  
(97) 2465480, 20.06.2012 en  
(54) Inflatable mattress  
(71) MKS Innovatech S.r.l., Via Simone D'Orsenigo, 5, 20135 Milano, IT  
(72) Gelmetti, Nicola, Via Paiari, 52, 37017 Lazise (VR), IT  
Martinelli, Fabio, Via Mozart, 1, 37029 San Pietro in Cariano (VR), IT

- (51) MKP  
**A61P 1/00 (2006.01)** (97) **2544690 \***  
**C07D 239/26 (2006.01)**  
**A61K 31/505 (2006.01)**  
**A61K 31/506 (2006.01)**  
**C07D 403/02 (2006.01)**  
**A61P 25/00 (2006.01)**
- (86) US2011027111 04.03.2011  
(96) 11753832.2 16.01.2013  
(87) WO2011112428, 04.03.2011  
(97) 2544690, 16.01.2013 en  
(54) ARYLVINYLACYCLOALKANE COMPOUNDS FOR CONSTIPATION
- (71) Targacept Inc., 200 East First Street, Suite 300, Winston-Salem, NC 27106, US  
(72) TOLER, Steven M., 4256 Saddlewood Forest Drive, Winston-Salem North Carolina 27106, US  
HOSFORD, David A., 3412 Cottonwood Drive, Durham North Carolina 27707, US  
LIPPIELLO, Patrick M., 1233 Arboretum Drive, Lewisville North Carolina 27023, US  
DUNBAR, Geoffrey Charles, 300 Chadbourne Drive, Winston-Salem North Carolina 27104, US  
CALDWELL, William Scott, 1270 Yorkshire Road, Winston-Salem North Carolina 27106, US  
HAMEDANI, Parviz, 4 Hillview Drive, Califon New Jersey 07830, US  
BENCHERIF, Merouane, 104 Brampton Court, Winston-Salem North Carolina 27106, US

- (51) MKP  
**C07D 405/12 (2006.01)** (97) **2569297 \***  
**A61P 25/00 (2006.01)**  
**C07D 401/12 (2006.01)**  
**A61K 31/351 (2006.01)**  
**A61K 31/4439 (2006.01)**
- (86) US2011035842 10.05.2011  
(96) 11731175.3 20.03.2013  
(87) WO2011143161, 10.05.2011  
(97) 2569297, 20.03.2013 en  
(54) SUBSTITUTED N-HETEROCYCLOALKYL BIPYRROLIDINYLPHENYL AMIDE DERIVATIVES, PREPARATION AND THERAPEUTIC USE THEREOF
- (71) SANOFI, 54, rue de la Boétie, 75008 Paris, FR  
(72) GAO, Zhongli, c/o sanofi-aventis U.S. 1041 Route 202-206 BWD-303A, Bridgewater New Jersey 08807, US

- (51) MKP  
**B02C 18/24 (2006.01)** (97) **2500100**
- (96) 12159842.9 19.09.2012  
(97) 2500100, 19.09.2012 de  
(54) Drive device and work machine device
- (71) Desch Antriebstechnik GmbH & Co. KG, Kleinbahnstrasse 21, 59759 Arnsberg, DE  
(72) Geilker, Uwe, Steinbergstraße 32, 59757 Arnsberg, DE  
Plattfaut, Bernhard, Am Fuhrbach 2, 59069 Hamm, DE  
Winiarski, Udo, Zur Mailinde 16a, 58802 Balve, DE

- (51) MKP  
**A61P 25/04 (2006.01)** (97) **2585068 \***  
**A61K 31/513 (2006.01)**  
**A61P 25/02 (2006.01)**  
**A61K 31/53 (2006.01)**
- (86) US2011041979 27.06.2011  
(96) 11730504.5 01.05.2013  
(87) WO2012006003, 27.06.2011  
(97) 2585068, 01.05.2013 en  
(54) PROKINETICIN 1 RECEPTOR ANTAGONISTS FOR THE TREATMENT OF PAIN
- (71) Janssen Pharmaceutica, N.V., Turnhouseweg 30, 2340 Beerse, BE  
(72) FLORES, Christopher, M., 1125 Trenton-harbourton Road, Titusville, NJ 08560, US  
WADE, Paul, 564 North 17th Street, Philadelphia, PA 19130-3921, US

- (51) MKP  
**C09B 63/00 (2006.01)** (97) **2548927 \***  
**C09B 67/20 (2006.01)**
- (86) JP2011001467 14.03.2011  
(96) 11755880.9 23.01.2013  
(87) WO2011114689, 14.03.2011  
(97) 2548927, 23.01.2013 en  
(54) PIGMENT COMPOSITION
- (71) Taisho Pharmaceutical Co., Ltd., 24-1, Takada 3-chome Toshima-ku, Tokyo 170-8633, JP  
NAKAJIMA, Toshiki, c/o TAISHO PHARMACEUTICAL CO. LTD. 24-1 Takada 3-chome Toshima-ku, Tokyo 170-8633, JP  
URABE, Masakiyo, c/o TAISHO PHARMACEUTICAL CO. LTD. 24-1 Takada 3-chome Toshima-ku, Tokyo 170-8633, JP  
NUMAO, Mariko, c/o TAISHO PHARMACEUTICAL CO. LTD. 24-1 Takada 3-chome Toshima-ku, Tokyo 170-8633, JP  
TADA, Hiroki, c/o TAISHO PHARMACEUTICAL CO. LTD. 24-1 Takada 3-chome Toshima-ku, Tokyo 170-8633, JP  
YAMABE, Kenji, c/o TAISHO PHARMACEUTICAL CO. LTD. 24-1 Takada 3-chome Toshima-ku, Tokyo 170-8633, JP

- (51) MKP  
**G01C 21/36 (2006.01)** (97) **2472228**
- (96) 10197424.4 04.07.2012  
(97) 2472228, 04.07.2012 de  
(54) System for collecting the geolocations of addresses
- (71) Deutsche Post AG, Charles-de-Gaulle-Strasse 20, 53113 Bonn, DE  
(72) Boris, Paul, Clemens-August-Str. 47, 53115 Bonn, DE  
Verena, Wild, Burbacher Str. 53, 53129 Bonn, DE  
Keith, Ulrich, Kinkelstrasse 14, 53227 Bonn-Oberkassel, DE

- (51) MKP  
**A61K 31/407 (2006.01)** (97) **2590978 \***  
**C07D 477/14 (2006.01)**  
**C07D 403/06 (2006.01)**  
**A61P 31/04 (2006.01)**  
**C07D 487/04 (2006.01)**
- (86) US2011040883 17.06.2011  
(96) 11796509.5 15.05.2013  
(87) WO2011160020, 17.06.2011  
(97) 2590978, 15.05.2013 en  
(54) CARBAPENEM ANTIBACTERIALS WITH GRAM-NEGATIVE ACTIVITY
- (71) FOB Synthesis, Inc., 3400 Cobb International Boulevard, Kennesaw, GA 30152, US  
(72) CHOI, Woo-Baeg, 6300 Riverside Road, Sandy Springs GA 30328, US  
KIM, Deog-Il, 1850 Mallard Lake Dr., Marietta GA 30068, US  
GRUSZECKA-KOWALIK, Ewa, 1174 Davis Place Nw, Atlanta GA 30318, US  
JOO, Hyung-Yeul, 3400 Cobb International Blvd., Kennesaw GA 30152, US  
LIU, Shuangpei, 1972 Kimberly Village Lane 1, Marietta GA 30067, US  
MAO, Shuli, 3819 Chattahoochee Summit Drive, Atlanta GA 30339, US  
LI, Yongfeng, 1078 Princeton Walk NE, Marietta GA 30068, US

- (51) MKP  
**A61K 9/20 (2006.01)** (97) **2549984 \***  
**A61K 31/485 (2006.01)**
- (86) EP2011054463 23.03.2011  
(96) 11716189.3 30.01.2013  
(87) WO2011117306, 23.03.2011  
(97) 2549984, 30.01.2013 en  
(54) DOUBLE-LAYER PHARMACEUTICAL FORMULATIONS CONTAINING OPIOID AGONISTS AND ANTAGONISTS
- (71) Molteni L. E C. Dei Fratelli Alitti Societa' Di Esercizio S.P.A., Strada Statale 67 Tosco-Romagnola Localita Granatieri, 50018 Scandicci, IT  
(72) ANGELI, Roberto, Via dell'Acciaio 44, I-50018 Scandicci, IT  
RAFFAELI, William, Via Giarabub 30, I-47923 Rimini, IT  
RIGAMONTI, Maria Adele, Via Locchi 90, I-50145 Firenze, IT

- (51) MKP  
**C07D 209/10 (2006.01)** (97) **2567698**  
**C07K 14/72 (2006.01)**  
**G01N 33/53 (2006.01)**  
**A61K 31/405 (2006.01)**
- (96) 11180467.0 13.03.2013  
(97) 2567698, 13.03.2013 en  
(54) GPR 17 agonists and screening assay  
(71) Rheinische Friedrich-Wilhelms-Universität Bonn, Regina-Pacis-Weg 3, 53113 Bonn, DE  
(72) Kostenis, Evi, Auf der Kaiserfuhr 14, 53127 Bonn, DE  
Spinrath, Andreas, Erika-Mann-Strasse 21, 80636 München, DE  
Hennen, Stephanie, Waldesruh 49, 54439 Saarburg, DE  
Peters, Lucas, Austraße 36, 53604 Bad Honnef, DE  
Müller, Christa E., Buschstr. 52, 53113 Bonn, DE  
Akkari, Rhalid, 6 Rue de la Distillerie, 93500 Pantin, FR  
Baqi, Younis, Köslinstr. 11, 53123 Bonn, DE  
Ritter, Kirsten, Buchaer Strasse 12b, 07745 Jena, DE
- 
- (51) MKP  
**C07D 407/04 (2006.01)** (97) **2576510 \***  
**C07D 498/08 (2006.01)**  
**C07D 417/06 (2006.01)**  
**C07D 409/04 (2006.01)**  
**A61K 31/4412 (2006.01)**  
**C07D 413/06 (2006.01)**  
**A61P 35/00 (2006.01)**  
**C07D 401/04 (2006.01)**  
**C07D 279/02 (2006.01)**  
**C07D 401/06 (2006.01)**  
**C07D 401/12 (2006.01)**  
**C07D 407/06 (2006.01)**  
**C07D 498/20 (2006.01)**  
**C07D 211/40 (2006.01)**  
**C07D 471/20 (2006.01)**
- (86) US2011039184 03.06.2011  
(96) 11726581.9 10.04.2013  
(87) WO2011153509, 03.06.2011  
(97) 2576510, 10.04.2013 en  
(54) PIPERIDINONE DERIVATIVES AS MDM2 INHIBITORS FOR THE TREATMENT OF CANCER  
(71) Amgen Inc., One Amgen Center Drive M/S 28-2-C, Thousand Oaks, CA 91320, US  
(72) BARTBERGER, Michael David, 4471 Ventura Canyon Avenue D-105, Sherman Oaks, California 91423, US  
GONZALEZ BUENROSTRO, Ana, 419 Turner Terrace Apt. 9, San Mateo, California 94401, US  
BECK, Hilary Plake, 416 Portofino Drive 306, San Carlos, California 94070, US  
CHEN, Xiaohui, 970 Blair Court, Palo Alto, California 94303, US  
CONNORS, Richard Victor, 935 Crespi Drive, Pacifica, California 94044, US  
DEIGNAN, Jeffrey, 500 29th Street, San Francisco, California 94131, US  
DUQUETTE, Jason, 460 Bayview Avenue, Millbrae, California 94030, US  
EKSTEROWICZ, John, 1845 Church Street, San Francisco, California 94131, US  
FISHER, Benjamin, 1020 Yates Way Apt. 313, San Mateo, California 94403, US  
FOX, Brian Matthew, 124 Swallowtail Court, Brisbane, California 94005, US  
FU, Jiasheng, 221 Pelican Court, Foster City, California 94404, US  
FU, Zice, 788 Santa Maria Lane, Foster City, California 94404, US  
GONZALEZ LOPEZ DE TURISO, Felix, 10 De Sabla Road Apt. 509, San Mateo, California 94402, US  
GRIBBLE, JR., Michael William, 949 Capp Street Apt. 22, San Francisco, California 94110, US  
GUSTIN, Darin James, 433 Kehoe Avenue, Half Moon Bay, California 94019, US  
HEATH, Julie Anne, 6 Ivy Drive, Orinda, California 94563, US  
HUANG, Xin, 16 Abbott Road, Wellesly, Massachusetts 02481, US  
JIAO, Xianyun, 2603 All View Way, Belmont, California 94002, US  
JOHNSON, Michael, 409 Clipper Street, San Francisco, California 94114, US  
KAYSER, Frank, 4150 17th Street Apt. 25, San Francisco, California 94114, US  
KOPECKY, David John, 548 Brannan Street 200, San Francisco, California 94107, US  
LAI, Sujen, 1439 Floribunda Avenue 15, Burlingame, California 94010, US  
LI, Yihong, 821 Taylor Boulevard, Millbrae, California 94030, US  
LI, Zhihong, 467 Anita Drive, Millbrae, California 94030, US  
LIU, Jiwen, 250 Trysail Court, Foster City, California 94404, US  
LOW, Jonathan Dante, 18644 Clark Street 5, Tarzana, California 91356, US  
LUCAS, Brian Stuart, 133 10th Avenue, San Francisco, California 94118, US  
MA, Zhihua, 733 Celestial Lane, Foster City, California 94404, US  
MCGEE, Lawrence, 39 Big Sur Way, Pacifica, California 94044, US  
MCINTOSH, Joel, 540 Fremont Avenue, Pacifica, California 94044, US  
MCMINN, Dustin, 1065 Grand Teton, Pacifica, California 94044, US  
MEDINA, Julio Cesar, 1407 Cedar Street, San Carlos, California 94070, US  
MIHALIC, Jeffrey Thomas, 300 3rd Street 523, San Francisco, California 94107, US  
OLSON, Steven Howard, 406 Green Hills Drive, Millbrae, California 94030, US  
REW, Yosup, 828 Juno Lane, Foster City, California 94404, US  
ROVETO, Philip Marley, 500 29th Street, San Francisco, California 94131, US  
SUN, Daqing, 804 Cortez Lane, Foster City, California 94404, US  
WANG, Xiaodong, 821 Taylor Boulevard, Millbrae, California 94030, US  
WANG, Yingcai, 860 Helen Drive, Millbrae, California 94030, US  
YAN, Xuelei, 1013 Catamaran Street, 3, Foster City, California 94404, US  
YU, Ming, 42 Williams Lane, Foster City, California 94404, US  
ZHU, Jiang, 747 Coastland Drive, Palo Alto, California 94303, US
-

- (51) MKP  
**E04D 1/30 (2006.01)** (97) **2539519 \***  
**E04D 15/00 (2006.01)**  
**E04D 1/34 (2006.01)**  
(86) US2011026550 28.02.2011  
(96) 11748245.5 02.01.2013  
(87) WO2011106793, 28.02.2011  
(97) 2539519, 02.01.2013 en  
(54) CLOSURE STRIP  
(71) Marco Industries, Inc., 9410 East 54th Street, Tulsa, Oklahoma 74145, US  
(72) POLUMBUS, Mark D., 1804 South Dogwood Place, Broken Arrow, Oklahoma 74012, US

- (51) MKP  
**A61J 1/05 (2006.01)** (97) **2433608**  
**A61J 1/14 (2006.01)**  
**A61J 1/20 (2006.01)**  
**A61J 1/12 (2006.01)**  
(96) 11156309.4 28.03.2012  
(97) 2433608, 28.03.2012 de  
(54) Blood plasma collection bottle  
(71) Deutsche Gesellschaft für Humanplasma mbH, Elisabeth-Selbert-Strasse 11, 40764 Langenfeld, DE  
(72) Rettinghaus, Reinhard, Alfred-Keller-Strasse 64, 53721 Siegburg, DE  
Franzaring, Hubert, Kotzterter Stöcken 3, 42719 Solingen, DE  
Schulz, Jürgen, Dr., Schulstrasse 8, 21266 Jesterburg, DE  
Taborski, Uwe, Dr., Wilhelm-Leuschner-Strasse 34, 61231 Bad Nauheim, DE

- (51) MKP  
**A61K 31/50 (2006.01)** (97) **2563365 \***  
(86) US2011033605 22.04.2011  
(96) 11772778.4 06.03.2013  
(87) WO2011133882, 22.04.2011  
(97) 2563365, 06.03.2013 en  
(54) CERTAIN AMINO-PYRIDAZINES, COMPOSITIONS THEREOF, AND METHODS OF THEIR USE  
(71) Cytokinetics, Inc., 280 East Grand Avenue, South San Francisco, CA 94080, US  
(72) ASHCRAFT, Luke W., 668 Carolina Street, San Francisco, California 94107, US  
BERGNES, Gustave, c/o Cytokinetics, Inc. 280 East Grand Avenue South San Francisco, CA 94080, US  
COLLIBEE, Scott, c/o Cytokinetics, Inc. 280 East Grand Avenue South San Francisco, CA 94080, US  
CHUANG, Chihyuan, c/o Cytokinetics, Inc. 280 East Grand Avenue South San Francisco, CA 94080, US  
GARDINA, Jeff, 280 East Grand Avenue, South San Francisco, California 94080, US  
MORGAN, Bradley P., c/o Cytokinetics, Inc. 280 East Grand Avenue South San Francisco, CA 94080, US  
MUCI, Alex R., c/o Cytokinetics, Inc. 280 East Grand Avenue South San Francisco, CA 94080, US  
QIAN, Xiangping, c/o Cytokinetics, Inc. 280 East Grand Avenue South San Francisco, CA 94080, US  
WARRINGTON, Jeffrey, 1936 Playa Street, San Mateo, California 94403, US  
YANG, Zhe, c/o Cytokinetics, Inc. 280 East Grand Avenue South San Francisco, CA 94080, US  
LU, Pu-Ping, c/o Cytokinetics, Inc. 280 East Grand Avenue South San Francisco, CA 94080, US  
ROMERO, Antonio, 1309 Newbridge Avenue, San Mateo, California 94401, US

- (51) MKP  
**H04N 7/15 (2006.01)** (97) **2569937 \***  
**H04N 7/14 (2006.01)**  
(86) US2011036247 12.05.2011  
(96) 11721197.9 20.03.2013  
(87) WO2011143427, 12.05.2011  
(97) 2569937, 20.03.2013 en  
(54) SYSTEMS AND METHODS FOR REAL-TIME MULTIMEDIA COMMUNICATION ACROSS MULTIPLE STANDARDS AND PROPRIETARY DEVICES  
(71) Blue Jeans Network, Inc., 3000 Lakeside Drive, Santa Clara, CA 95054, US  
(72) PERIYANNAN, Alagu, 3152 Ross Road, Palo Alto CA 94303, US  
RAMAKRISHNAN, Krish, 21225 Comer Drive, Saratoga CA 95070, US

- (51) MKP  
**B65H 19/22 (2006.01)** (97) **2550218 \***  
**B65H 19/26 (2006.01)**  
(86) IB2011051221 23.03.2011  
(96) 11719886.1 30.01.2013  
(87) WO2011117827, 23.03.2011  
(97) 2550218, 30.01.2013 en  
(54) A CORE FEEDING DEVICE IN A REWINDING MACHINE FOR THE PRODUCTION OF ROLLS  
(71) Studio Duebi S.A.S., Via Pittini 14, 51011 Buggiano (PT), IT  
(72) BERTOLI BARSOTTI, Giovanni, Via Fico 10, 55020 Fabbriche di Vallico (LU), IT

- (51) MKP  
**C07K 16/24 (2006.01)** (97) **2591001 \***  
**C07K 16/28 (2006.01)**  
(86) EP2011061557 07.07.2011  
(96) 11731331.2 15.05.2013  
(87) WO2012004367, 07.07.2011  
(97) 2591001, 15.05.2013 en  
(54) AGONISTIC ANTIBODY TO CD27  
(71) BioNovion Holding B.V., Oss Life Sciences Park, RE1129 Molenweg 79, 5349 AC Oss, NL  
(72) VAN EENENNAAM, Hans, N.V. Organon P.O. Box 20, NL-5340 BH Oss, NL  
MULDER, Winfried Robert, N.V. Organon P.O. Box 20, NL-5340 BH Oss, NL  
BORST, Jannetje Geertruida, Prinsengracht 52, NL-1015 DW Amsterdam, NL  
VERAAR, Aartje Maria Elizabeth, Overtoom 332-3hg, 1054 JE Amsterdam, NL  
VINK, Paul Maria Frederikus, N.V. Organon P.O. Box 20, NL-5340 BH Oss, NL



(51) MKP  
**C07D 403/04 (2006.01)** (97) **2556071 \***  
**A61K 31/5377 (2006.01)**  
**A61P 35/00 (2006.01)**  
**C07D 413/14 (2006.01)**  
(86) CA2011000386 06.04.2011  
(96) 11764988.9 13.02.2013  
(87) WO2011123946, 06.04.2011  
(97) 2556071, 13.02.2013 en  
(54) KINASE INHIBITORS AND METHOD OF TREATING CANCER WITH SAME  
(71) University Health Network, 190 Elizabeth Street, Toronto, ON M5G 2C4, CA  
(72) SAMPSON, Peter Brent, 1320 Ridgebank Drive, Oakville Ontario L6M 4A5, CA  
LIU, Yong, 65 Forest Manor Road Apt. 1413, North York Ontario M2J 1M5, CA  
LI, Sze-Wan, B326 Beverly Street, Toronto Ontario M5T 3L2, CA  
FORREST, Bryan T., 9 Fairview Avenue, Toronto Ontario M6P 3A2, CA  
PAULS, Heinz W., 460 Fourth Line, Oakville Ontario L6L 5A4, CA  
EDWARDS, Louise G., 871 Chippenham Drive, Mississauga Ontario L5H 3S6, CA  
FEHER, Miklos, 481 Rosewell Avenue Suite 213, Toronto Ontario M4R 2J1, CA  
PATEL, Narendra Kumar B., 1102, 360 Pitfield Road, Scarborough Ontario M1S 3E6, CA  
LAUFER, Radoslaw, 2145 Meadowglen Drive, Oakville Ontario L6M 4C8, CA  
PAN, Guohua, 182 Trelawn Avenue, Oakville Ontario L6J 4R2, CA

(51) MKP  
**G01N 33/50 (2006.01)** (97) **2547789 \***  
**G01N 33/68 (2006.01)**  
**C12Q 1/68 (2006.01)**  
(86) EP2011054025 17.03.2011  
(96) 11709920.0 23.01.2013  
(87) WO2011113888, 17.03.2011  
(97) 2547789, 23.01.2013 en  
(54) METHODS AND USES RELATING TO THE IDENTIFICATION OF COMPOUND INVOLVED IN PAIN AS WELL AS METHODS OF DIAGNOSING ALGESIA  
(71) SANOFI, 54, rue de la Boétie, 75008 Paris, FR  
(72) GEBAUER, Mathias, c/o Sanofi-Aventis Deutschland GmbH, 65926 Frankfurt am Main, DE  
MICHAELIS, Martin, Unterlindau 72, 60323 Frankfurt, DE  
DING-PFENNIGDORFF, Danping, c/o Sanofi-Aventis Deutschland GmbH, 65926 Frankfurt am Main, DE  
SCHULTE, Anke, M., c/o Sanofi-Aventis Deutschland GmbH, 65926 Frankfurt am Main, DE  
ZIEMEK, Daniel, 53 Barnard Ave, Watertown MA 02472, US  
METZ-WEIDMANN, Christiane, c/o Sanofi-Aventis Deutschland GmbH, 65926 Frankfurt am Main, DE

(51) MKP  
**G02B 6/42 (2006.01)** (97) **2577372 \***  
**H01R 13/40 (2006.01)**  
**G02B 6/38 (2006.01)**  
(86) US2011038533 31.05.2011  
(96) 11723215.7 10.04.2013  
(87) WO2011153132, 31.05.2011  
(97) 2577372, 10.04.2013 en  
(54) HYBRID OPTICAL CONNECTOR  
(71) Apple Inc., 1 Infinite Loop, MS 169-3IPL, Cupertino, CA 95014, US  
(72) SLOEY, Jason, 1 Infinite Loop MS 169-31 PL, Cupertino, CA 95014, US  
GOLKO, AI, 1 Infinite Loop MS 169-31 DR, Cupertino, CA 95014, US  
JOL, Eric, 1 Infinite Loop MS 169-31 PH, Cupertino, CA 95014, US  
SPRAGGS, Ian, 1 Infinite Loop MS 169-31 PH, Cupertino, CA 95014, US

(51) MKP  
**A61K 31/496 (2006.01)** (97) **2588086 \***  
**A61K 9/20 (2006.01)**  
(86) EP2011060949 29.06.2011  
(96) 11734043.0 08.05.2013  
(87) WO2012001074, 29.06.2011  
(97) 2588086, 08.05.2013 en  
(54) PHARMACEUTICAL COMPOSITIONS COMPRISING 4-AMINO-5-FLUORO-3-[6-(4-METHYLPYPERAZIN-1-YL)-1H-BENZIMIDAZOL-2-YL]-1H-QUINOLIN-2-ONE LACTATE MONOHYDRATE.  
(71) Novartis AG, Lichtstrasse 35, 4056 Basel, CH  
(72) THAKUR, Jeewan, Novartis Pharma AG Postfach, CH-4002 Basel, CH  
QIU, Zhihui, YuShan Lu 100 Nong Bldg 28-1901 PuDong New District, Shanghai 200135, CN

(51) MKP  
**A61P 1/16 (2006.01)** (97) **2566505 \***  
**A61K 38/45 (2006.01)**  
(86) US2011035500 06.05.2011  
(96) 11720265.5 13.03.2013  
(87) WO2011140429, 06.05.2011  
(97) 2566505, 13.03.2013 en  
(54) DELIVERY OF CHOLESTERYL ESTER TO STEROIDOGENIC TISSUES  
(71) Alphacore Pharma LLC, 333 Parkland Plaza, Ann Arbor, MI 48103, US  
(72) AUERBACH, Bruce. J., 2425 Meadowridge Court, Ann Arbor Michigan 48105, US  
HOMAN, Reynold, 2607 Tessmer Road, Ann Arbor Michigan 48103, US  
KRAUSE, Brian, 1984 Encore Ct., Ann Arbor Michigan 48103, US

(51) MKP  
**A61K 35/36 (2006.01)** (97) **2571975 \***  
**C12M 3/08 (2006.01)**  
(86) IB2011052204 20.05.2011  
(96) 11727294.8 27.03.2013  
(87) WO2011145075, 20.05.2011  
(97) 2571975, 27.03.2013 en  
(54) DEVICE AND A METHOD FOR PREPARING TISSUE, PARTICULARLY ADIPOSE TISSUE.  
(71) Lipogems International SRL, Via Santa Maria alla Porta n.9, 20100 Milano, IT  
(72) TREMOLADA, Carlo, Via Spadolini 9a, 20141 Milano, IT

(51) MKP  
**F24J 2/51 (2006.01)** (97) **2578379**  
**B29C 49/00 (2006.01)**  
**B29C 49/04 (2006.01)**  
**F24J 2/04 (2006.01)**  
**F24J 2/20 (2006.01)**  
**F24J 2/52 (2006.01)**  
**F24J 2/34 (2006.01)**  
**F24J 2/46 (2006.01)**  
(96) 11008055.3 10.04.2013  
(97) 2578379, 10.04.2013 en  
(54) Solar thermal solutions using blow moulding technologies  
(71) Sumika Polymer Compounds (France) SA, Zone Industrielle du Bois de Leuze 5 Avenue Marie Curie, 13310 Saint Martin de Crau, FR  
EXCELL CORPORATION, 3-15 Kyobashi 2-chome Chuo-Ku, Tokyo, JP  
(72) Bollaert, Franck, 25, rue Raoul Follereau, 30000 Nimes, FR  
Nishio, Hideaki, 40, Blake House Gunwharf Quays, Portsmouth PO1 3 TH, GB  
Nakagawa, Gota, 3-9-3 Higashikomagata Sumida Ward, Tokyo, JP

- (51) MKP  
**A61K 38/16 (2006.01)** (97) **2566495 \***  
**A61K 39/395 (2006.01)**  
**A61P 3/10 (2006.01)**  
**A61P 35/00 (2006.01)**  
**A61P 29/00 (2006.01)**  
**C07K 14/525 (2006.01)**
- (86) US2011035053 03.05.2011  
(96) 11778205.2 13.03.2013  
(87) WO2011140132, 03.05.2011  
(97) 2566495, 13.03.2013 en
- (54) INNOVATIVE DISCOVERY OF THERAPEUTIC, DIAGNOSTIC, AND ANTIBODY COMPOSITIONS RELATED TO PROTEIN FRAGMENTS OF PHENYLALANYL-ALPHA-TRNA SYNTHETASES
- (71) aTyr Pharma, Inc., 3545 John Hopkins Court, Suite 250, San Diego, CA 92121, US  
Pangu Biopharma Limited, Edinburgh Tower, 18/F The Landmark 15 Queen's Road Central, Hong Kong, CN
- (72) GREENE, Leslie, Ann, 13941 Davenport Avenue, San Diego CA 92129, US  
CHIANG, Kyle, P., 943 Torrance Street Apt. 6, San Diego CA 92103, US  
HONG, Fei, 7979 Caminito Dia 2, San Diego CA 92122, US  
VASSEROT, Alain, P., 6421 La Paloma Street, Carlsbad CA 92009, US  
LO, Wing-Sze, RM 815 Sui Ming House Siu Sai Wan Estate Chai Wan, Hong Kong, CN  
WATKINS, Jeffry, D., 3442 Fortuna Ranch Road, Encinitas CA 92024, US  
MENDLEIN, John, D., 1550 Neptune Avenue, Encinitas CA 92024, US  
QUINN, Cheryl, L., 5392 Renaissance Avenue, San Diego CA 92122, US

- (51) MKP  
**A61K 31/438 (2006.01)** (97) **2590985 \***  
**C07D 491/10 (2006.01)**  
**A61P 13/02 (2006.01)**  
**C07D 498/10 (2006.01)**
- (86) EP2011061690 08.07.2011  
(96) 11746494.1 15.05.2013  
(87) WO2012004400, 08.07.2011  
(97) 2590985, 15.05.2013 en
- (54) NOVEL SPIROHETEROCYCLIC COMPOUNDS AS MGLU5 ANTAGONISTS
- (71) Recordati Ireland Limited, Raheens East, Ringaskiddy County Cork, IE
- (72) LEONARDI, Amedeo, Via A. Poliziano 16, I-20154 Milano, IT  
MOTTA, Gianni, Corso Marconi 32/1, I-20030 Barlassina, IT  
RIVA, Carlo, Via V. Walder 10, I-21100 Varese, IT  
GUARNERI, Luciano, Via Canova 18, I-20024 Garbagnate Milanese, IT  
GRAZIANI, Davide, Via Tavazzano 16, I-20155 Milano, IT  
DE TOMA, Carlo, Via Bodoni 7/1, I-20155 Milano, IT  
KARAMFILOVA, Katia Dimitrova, Via Tonale 57, I-20099 Sesto San Giovanni, IT

- (51) MKP  
**C12Q 1/68 (2006.01)** (97) **2593562 \***
- (86) EP2011062049 14.07.2011  
(96) 11736042.0 22.05.2013  
(87) WO2012007545, 14.07.2011  
(97) 2593562, 22.05.2013 en
- (54) METHODS AND KITS FOR THE DIAGNOSIS OF PROSTATE CANCER
- (71) Fundació Institut de Recerca Hospital Universitari Vall d'Hebron, Fundació Privada, Passeig Vall d'Hebron, 119-129, 08035 Barcelona, ES
- (72) DOLL, Andreas, Fundació Institut De Recerca Hospital Universitari Vall D'hebron Fundació Privada Passig Vall d'Hebron 119-129, E-08035 Barcelona, ES  
RIGAU RESINA, Marina, Fundació Institut De Recerca Hospital Universitari Vall D'hebron Fundació Privada Passig Vall d'Hebron 119-129, E-08035 Barcelona, ES  
MOROTE ROBLES, Juan, Fundació Institut De Recerca Hospital Universitari Vall D'hebron Fundació Privada Passig Vall d'Hebron 119-129, E-08035 Barcelona, ES  
ABAL POSADA, Miguel, Fundació Institut De Recerca Hospital Universitari Vall D'hebron Fundació Privada Passig Vall d'Hebron 119-129, E-08035 Barcelona, ES  
REVENTÓS PUIGJANER, Jaume, Fundació Institut De Recerca Hospital Universitari Vall D'hebron Fundació Privada Passig Vall d'Hebron 119-129, E-08035 Barcelona, ES

- (51) MKP  
**A61K 31/16 (2006.01)** (97) **2560486 \***  
**A01N 37/18 (2006.01)**
- (86) US2011031846 08.04.2011  
(96) 11772437.7 27.02.2013  
(87) WO2011133348, 08.04.2011  
(97) 2560486, 27.02.2013 en
- (54) COMPOSITIONS COMPRISING ENZYME-CLEAVABLE AMPHETAMINE PRODRUGS AND INHIBITORS THEREOF
- (71) Signature Therapeutics, Inc., 75 Shoreway Road, Suite D, San Carlos, CA 94070, US
- (72) JENKINS, Thomas E., 75 Shoreway Road Suite D, San Carlos, California 94070, US  
HUSFELD, Craig O., 75 Shoreway Road Suite D, San Carlos, California 94070, US  
SEROOGY, Julie D., 75 Shoreway Road Suite D, San Carlos, California 94070, US  
WRAY, Jonathan W., 75 Shoreway Road Suite D, San Carlos, California 94070, US

- (51) MKP  
**G01N 33/53 (2006.01)** (97) **2576838 \***  
**C12N 15/12 (2006.01)**  
**C12Q 1/68 (2006.01)**
- (86) US2011039174 03.06.2011  
(96) 11790515.8 10.04.2013  
(87) WO2011153501, 03.06.2011  
(97) 2576838, 10.04.2013 en
- (54) METHODS FOR IMPROVING INFLAMMATORY BOWEL DISEASE DIAGNOSIS
- (71) Nestec S.A., Avenue Nestlé 55, 1800 Vevey, CH
- (72) PRINCEN, Fred, 610 Kirkwood Place, La Jolla, California 92037, US  
SINGH, Sharat, PMB 69, P.O. Box 5000, Rancho Santa Fe California 92067, US

(51) MKP  
**C12N 15/53 (2006.01)** (97) **2593558 \***  
**C12N 9/02 (2006.01)**  
**C12N 9/04 (2006.01)**  
**C12P 17/12 (2006.01)**  
**C12P 21/02 (2006.01)**  
(86) IN2011000469 14.07.2011  
(96) 11767779.9 22.05.2013  
(87) WO2012007965, 14.07.2011  
(97) 2593558, 22.05.2013 en  
(54) ENZYME FOR THE PRODUCTION OF OPTICALLY PURE 3 - QUINUCLIDINOL  
(71) Cadila Healthcare Limited, Zydus Tower Satellite Cross Roads, Ahmedabad 380 015, Gujarat, IN  
(72) JOSHI, Rupal, CADILA HEALTHCARE LIMITED Zydus Tower Satellite Cross Road, Ahmedabad 380 015 Gujarat, IN  
NAIR, Anita, CADILA HEALTHCARE LIMITED Zydus Tower Satellite Cross Road, Ahmedabad 380 015 Gujarat, IN  
RAMRAKHIANI, Anita, CADILA HEALTHCARE LIMITED Zydus Tower Satellite Cross Road, Ahmedabad 380 015 Gujarat, IN  
MENDIRATTA, Sanjeev Kumar, CADILA HEALTHCARE LIMITED Zydus Tower Satellite Cross Road, Ahmedabad 380 015 Gujarat, IN  
TRIVEDI, Umang, CADILA HEALTHCARE LIMITED Zydus Tower Satellite Cross Road, Ahmedabad 380 015 Gujarat, IN

(51) MKP  
**B05B 11/00 (2006.01)** (97) **2585151 \***  
**A61M 15/00 (2006.01)**  
(86) EP2011059088 01.06.2011  
(96) 11723447.6 01.05.2013  
(87) WO2011160932, 01.06.2011  
(97) 2585151, 01.05.2013 en  
(54) NEBULIZER  
(71) Boehringer Ingelheim International GmbH, Binger Straße 173, 55216 Ingelheim, DE  
(72) HERRMANN, Frank, Boehringer Ingelheim GmbH Corporate Patents Binger Str. 173, 55216 Ingelheim Am Rhein, DE  
KRENZ, Holger, Boehringer Ingelheim GmbH Corporate Patents Binger Str. 173, 55216 Ingelheim Am Rhein, DE  
ENDERT, Guido, Bayreuther Str. 52 a, 42115 Wuppertal, DE  
WERGEN, Horst, Bayreuther Str. 52 a, 42115 Wuppertal, DE

(51) MKP  
**G01N 33/574 (2006.01)** (97) **2542893 \***  
(86) US2011026968 03.03.2011  
(96) 11707332.0 09.01.2013  
(87) WO2011109584, 03.03.2011  
(97) 2542893, 09.01.2013 en  
(54) BIOLOGICAL MARKERS PREDICTIVE OF ANTI-CANCER RESPONSE TO INSULIN-LIKE GROWTH FACTOR-1 RECEPTOR KINASE INHIBITORS  
(71) OSI Pharmaceuticals, LLC, 1 Bioscience Park Drive, Farmingdale, NY 11735, US  
(72) BUCK, Elizabeth, A., Osi Pharmaceuticals Inc. Broadhollow Bioscience Park 1 Bioscience Park Drive, Farmingdale, NY 11735, US  
BARR, Sharon, M., Osi Pharmaceuticals Inc. Broadhollow Bioscience Park 1 Bioscience Park Drive, Farmingdale, NY 11735, US  
MIGLARESE, Mark, R., Ose Pharmaceuticals Inc. 420 Saw Mill River Road, Ardsley, NY 10502, US

(51) MKP  
**E04F 13/08 (2006.01)** (97) **2580402 \***  
**E04B 2/90 (2006.01)**  
(86) IE2011000030 08.06.2011  
(96) 11729765.5 17.04.2013  
(87) WO2011154929, 08.06.2011  
(97) 2580402, 17.04.2013 en  
(54) A STRUCTURAL INFILL WALL PANEL MODULE  
(71) Kingspan Holdings (IRL) Limited, Dublin Road, Kingscourt County Cavan, IE  
(72) CAROLAN, James, Drumpeak, Kingscourt County Cavan, IE  
FLYNN, Gregory, Teach Mhuilinn Rathdaniel, Collon County Louth, IE

(51) MKP  
**F41H 5/04 (2006.01)** (97) **2518434**  
(96) 12164710.1 31.10.2012  
(97) 2518434, 31.10.2012 en  
(54) Protective composite structure with low radar visibility having integrated attack signaling system  
(71) Aeronautical Service S.r.l., Via Monte Cadria 67, 00054 Fiumicino (RM), IT  
(72) Bordignon, Cristiano, c/o Aeronautical Service S.r.l. Via Monte Cadria 67, I-00054 Fiumicino (RM), IT

(51) MKP  
**F16J 15/02 (2006.01)** (97) **2567072 \***  
**F01D 11/00 (2006.01)**  
**F01D 25/24 (2006.01)**  
**F02C 7/28 (2006.01)**  
(86) US2011034075 27.04.2011  
(96) 11777941.3 13.03.2013  
(87) WO2011139741, 27.04.2011  
(97) 2567072, 13.03.2013 en  
(54) BRUSH RING SEAL  
(71) Elliott Company, 901 North Fourth Street, Jeannette, PA 15644, US  
(72) MINDOCK, III, Michael, Arthen, 687 Arrow Road, New Ringgold, Pennsylvania 19760, US

(51) MKP  
**G01N 33/487 (2006.01)** (97) **2577301 \***  
(86) EP2011002738 01.06.2011  
(96) 11727916.6 10.04.2013  
(87) WO2011154114, 01.06.2011  
(97) 2577301, 10.04.2013 de  
(54) METHOD FOR PRODUCING A BILIPID LAYER, AND MICROSTRUCTURE AND MEASURING ASSEMBLY  
(71) Albert-Ludwigs-Universität Freiburg, Fahrenbergplatz, 79085 Freiburg, DE  
(72) BEHREND, Jan, Im Kreuzacker 10, 79252 Stegen, DE  
BAAKEN, Gerhard, Schützenallee 64, 79102 Freiburg, DE

(51) MKP  
**A61P 31/14 (2006.01)** (97) **2593439 \***  
**A61K 31/522 (2006.01)**  
**C07D 239/54 (2006.01)**  
(86) US2011044283 15.07.2011  
(96) 11739236.5 22.05.2013  
(87) WO2012009699, 15.07.2011  
(97) 2593439, 22.05.2013 en  
(54) PROCESS FOR PREPARING ANTIVIRAL COMPOUNDS  
(71) Abbvie Inc., 1 North Waukegan Road, North Chicago, IL 60064, US  
(72) SHEKHAR, Shashank, 2101 St. Johns Avenue, Highland Park Illinois 60035, US  
FRANCZYK, Thaddeus S., 18630 W. Lazy Acre, Lake Villa Illinois 60046, US  
BARNES, David M., 15895 88th Street, Bristol Wisconsin 53104, US  
DUNN, Travis B., 6647 Foxworth Lane, Gurnee Illinois 60031, US  
HAIGHT, Anthony R., 40381 Reed Ct., Wadsworth Illinois 60083, US  
CHAN, Vincent S., 412 Lee Street Apt. 3, Evanston Illinois 60202, US

- (51) MKP  
**A61K 31/4355 (2006.01)** (97) **2585462 \***  
**A61K 31/437 (2006.01)**  
**C07D 471/04 (2006.01)**  
**A61K 31/5025 (2006.01)**  
**C07D 473/28 (2006.01)**  
**A61K 31/519 (2006.01)**  
**A61K 31/4985 (2006.01)**  
**A61K 31/4427 (2006.01)**  
**C07D 487/04 (2006.01)**  
**A61K 31/52 (2006.01)**  
**C07D 498/04 (2006.01)**  
**A61P 25/18 (2006.01)**
- (86) US2011041443 22.06.2011  
(96) 11728745.8 01.05.2013  
(87) WO2011163355, 22.06.2011  
(97) 2585462, 01.05.2013 en  
(54) FUSED HETEROCYCLIC COMPOUNDS AS PHOSPHODIESTERASES (PDES) INHIBITORS  
(71) Takeda Pharmaceutical Company Limited, 1-1 Doshomachi 4-chome Chuo-ku, Osaka-shi, Osaka 541-0045, JP  
(72) TANIGUCHI, Takahiko, c/o Takeda Pharmaceutical Company Limited 26-1, Muraoka-Higashi 2-chome, Fujisawa, Kanagawa 251-0012, JP  
YOSHIKAWA, Masato, c/o TAKEDA PHARMACEUTICAL COMPANY LIMITED 26-1, Muraoka-Higashi 2-chome, Fujisawa, Kanagawa 251-0012, JP  
MIURA, Kasei, c/o TAKEDA PHARMACEUTICAL COMPANY LIMITED 26-1, Muraoka-Higashi 2-chome, Fujisawa, Kanagawa 251-0012, JP  
HASUI, Tomoaki, c/o TAKEDA PHARMACEUTICAL COMPANY LIMITED 26-1, Muraoka-Higashi 2-chome, Fujisawa, Kanagawa 251-0012, JP  
HONDA, Eiji, c/o TAKEDA PHARMACEUTICAL COMPANY LIMITED 26-1, Muraoka-Higashi 2-chome, Fujisawa, Kanagawa 251-0012, JP  
IMAMURA, Keisuke, c/o TAKEDA PHARMACEUTICAL COMPANY LIMITED 26-1, Muraoka-Higashi 2-chome, Fujisawa Kanagawa 251-0012, JP  
KAMATA, Makoto, c/o TAKEDA PHARMACEUTICAL COMPANY LIMITED 26-1, Muraoka-Higashi 2-chome, Fujisawa Kanagawa 251-0012, JP  
KAMISAKI, Haruhi, c/o TAKEDA PHARMACEUTICAL COMPANY LIMITED 26-1 Muraoka-Higashi 2-chome, Fujisawa Kanagawa 251-0012, JP  
QUINN, John, F., 133 Jay Street, Albany NY 12210, US  
RAKER, Joseph, 35 Cherry Avenue, Delmar, NY 12054, US  
CAMARA, Fatoumata, c/o ALBANY MOLECULAR RESEARCH INC. 26 Corporate Circle P.O. Box 15098, Albany, NY 12212-5098, US  
WANG, Yi, 3 Emandan Lane, Hockessin DE 19707, US

- (51) MKP  
**A61K 9/00 (2006.01)** (97) **2560612 \***  
**A61K 9/16 (2006.01)**  
**A61K 9/50 (2006.01)**
- (86) IB2011051736 20.04.2011  
(96) 11722553.2 27.02.2013  
(87) WO2011132167, 20.04.2011  
(97) 2560612, 27.02.2013 en  
(54) METHOD FOR PREPARING PHARMACEUTICAL COMPOSITIONS INTENDED FOR ORAL ADMINISTRATION COMPRISING ONE OR MORE ACTIVE INGREDIENTS AND THE COMPOSITIONS COMPRISING SAME  
(71) SANOFI, 54, rue de la Boétie, 75008 Paris, FR  
(72) LESOT, Axelle, c/o sanofi-aventis Patent Department 174 avenue de France, F-75013 Paris, FR  
LEYDET, Damia, c/o sanofi-aventis Patent Department 174 avenue de France, F-75013 Paris, FR  
MOUSSEL, Arnaud, c/o sanofi-aventis Patent Department 174 avenue de France, F-75013 Paris, FR

- (51) MKP  
**G07C 9/00 (2006.01)** (97) **2577616 \***
- (86) NL2011050395 03.06.2011  
(96) 11725218.9 10.04.2013  
(87) WO2011152729, 03.06.2011  
(97) 2577616, 10.04.2013 en  
(54) A METHOD OF AUTHORIZING A PERSON, AN AUTHORIZING ARCHITECTURE AND A COMPUTER PROGRAM PRODUCT  
(71) Ubiqu B.V., Kerstant van den Bergelaan 13b, 3054 EM Rotterdam, NL  
(72) GORANOV, Boris Petrov Dokov, Kerstant van den Bergelaan 13b, NL-3054 EM Rotterdam, NL

- (51) MKP  
**A61K 31/433 (2006.01)** (97) **2555775 \***  
**A61P 27/06 (2006.01)**  
**A61K 31/7076 (2006.01)**  
**A61K 31/382 (2006.01)**  
**A61P 27/02 (2006.01)**  
**A61K 31/542 (2006.01)**
- (86) US2011029010 18.03.2011  
(96) 11757063.0 13.02.2013  
(87) WO2011116290, 18.03.2011  
(97) 2555775, 13.02.2013 en  
(54) COMBINATION COMPOSITIONS OF ADENOSINE A1 AGONISTS AND CARBONIC ANHYDRASE INHIBITORS FOR REDUCING INTRAOCULAR PRESSURE  
(71) Inotek Pharmaceuticals Corporation, 131 Hartwell Avenue 1st Floor, Suite 105, Lexington, MA 02421, US  
(72) KIM, Norman, N., 2 Honeysuckle Road, Westford MA 01886, US  
MCVICAR, William, K., 31 Powers Road, Sudbury MA 01776, US  
MCCAULEY, Thomas, G., 85 Gore Street, Cambridge MA 02141, US

- (51) MKP  
**G01N 23/04 (2006.01)** (97) **2561340 \***
- (86) CA2011000474 21.04.2011  
(96) 11771450.1 27.02.2013  
(87) WO2011130845, 21.04.2011  
(97) 2561340, 27.02.2013 en  
(54) METHOD AND SYSTEM FOR USE IN PERFORMING SECURITY SCREENING  
(71) Optosecurity Inc., 505 Blvd. du Parc Technologique, Québec, QC G1P 4S9, CA  
(72) PERRON, Luc, 1127 de la Chatelaine, Charlesbourg, Québec G2L 1A1, CA

- (51) MKP  
**F24J 2/32 (2006.01)** (97) **2580538 \***  
**H01L 31/058 (2006.01)**  
**H01L 31/052 (2006.01)**  
**F24J 2/34 (2006.01)**  
**F24J 2/50 (2006.01)**  
**F24J 2/54 (2006.01)**  
**F24J 2/05 (2006.01)**  
**F24J 2/26 (2006.01)**  
**F24J 2/14 (2006.01)**
- (86) AT2011000235 23.05.2011  
(96) 11724516.7 17.04.2013  
(87) WO2011153561, 23.05.2011  
(97) 2580538, 17.04.2013 de  
(54) COMBINED SOLAR COLLECTOR  
(71) Ferschitz, Reinold, Telering 15, 2460 Bruck an der Leitha, AT  
(72) Ferschitz, Reinold, Telering 15, 2460 Bruck an der Leitha, AT

(51) MKP  
**A61P 3/10 (2006.01)** (97) **2554183**  
**A61K 47/10 (2006.01)**  
**A61K 38/28 (2006.01)**  
**A61K 47/18 (2006.01)**  
**A61K 38/26 (2006.01)**  
**A61K 9/00 (2006.01)**  
(96) 12190525.1 06.02.2013  
(97) 2554183, 06.02.2013 de  
(54) Pharmaceutical composition comprising a GLP-1-agonist, an insulin, and methionine  
(71) Sanofi-Aventis Deutschland GmbH, Brüningstraße 50, 65929 Frankfurt, DE  
(72) Hagendorf, Annika, c/o Sanofi-Aventis Deutschland GmbH, 65926 Frankfurt am Main, DE  
Hauck, Gerrit, c/o Sanofi-Aventis Deutschland GmbH, 65926 Frankfurt am Main, DE  
Müller, Werner, c/o Sanofi-Aventis Deutschland GmbH, 65926 Frankfurt am Main, DE  
Schoettle, Isabell, c/o Sanofi-Aventis Deutschland GmbH, 65926 Frankfurt am Main, DE  
Siefke-Henzler, Verena, c/o Sanofi-Aventis Deutschland GmbH, 65926 Frankfurt am Main, DE  
Tertsch, Katrin, c/o Sanofi-Aventis Deutschland GmbH, 65926 Frankfurt am Main, DE

(51) MKP  
**A61P 35/02 (2006.01)** (97) **2593479 \***  
**C07K 16/28 (2006.01)**  
**A61K 39/395 (2006.01)**  
(86) EP2011062133 15.07.2011  
(96) 11732464.0 22.05.2013  
(87) WO2012007576, 15.07.2011  
(97) 2593479, 22.05.2013 en  
(54) SUPERIOR EFFICACY OF CD37 ANTIBODIES IN CLL BLOOD SAMPLES  
(71) Boehringer Ingelheim International GmbH, Binger Strasse 173, 55216 Ingelheim am Rhein, DE  
(72) STILGENBAUER, Stephan, Universitaetsklinikum Ulm Klinik für Innere Medizin III Albert-Einstein-Allee 23, 89081 Ulm, DE  
ZENZ, Thorsten, Nationales Centrum für Tumorerkrankungen (NCT) Heidelberg und Deutsches Krebsforschungszentrum (DKFZ) Im Neuenheimer Feld 460, 69120 Heidelberg, DE  
HEIDER, Karl-Heinz, Boehringer Ingelheim GmbH Corporate Patents Binger Strasse 173, 55216 Ingelheim Am Rhein, DE

(51) MKP  
**A61P 17/02 (2006.01)** (97) **2575840 \***  
**A61K 36/47 (2006.01)**  
**A61K 36/61 (2006.01)**  
(86) IB2011001137 25.05.2011  
(96) 11731068.0 10.04.2013  
(87) WO2011148257, 25.05.2011  
(97) 2575840, 10.04.2013 en  
(54) KIT OF PARTS FOR TREATING AND/OR PREVENTING CUTANEOUS ULCERS  
(71) Logi, Roberto, Via Sant 'Ilario a Colombaia, 2, 50124 Firenze, IT  
(72) Logi, Roberto, Via Sant 'Ilario a Colombaia, 2, 50124 Firenze, IT

(51) MKP  
**C07D 401/12 (2006.01)** (97) **2588471 \***  
**A61K 31/4375 (2006.01)**  
**C07D 471/04 (2006.01)**  
**C07D 491/107 (2006.01)**  
**C07D 409/14 (2006.01)**  
**A61K 31/4709 (2006.01)**  
**C07D 405/14 (2006.01)**  
**A61P 29/00 (2006.01)**  
**C07D 413/14 (2006.01)**  
**C07D 401/14 (2006.01)**  
**A61P 35/00 (2006.01)**  
(86) US2011042539 30.06.2011  
(96) 11734209.7 08.05.2013  
(87) WO2012003283, 30.06.2011  
(97) 2588471, 08.05.2013 en  
(54) HETEROCYCLIC COMPOUNDS AND THEIR USE AS INHIBITORS OF PI3K ACTIVITY  
(71) Amgen Inc., One Amgen Center Drive, Thousand Oaks, California 91320-1799, US  
(72) DRANSFIELD, Paul, John, 178 Allison Street, San Francisco, California 94112, US  
GONZALEZ LOPEZ DE TURISO, Felix, 10 De Sabla Road 509, San Mateo, California 94402, US  
KOHNS, Todd, J., 818 North Delaware Street 412, San Mateo, California 94401, US  
PATTAROPONG, Vatee, 1408 El Camino Real Unit 1, Burlingame, California 94010, US  
SIMARD, Jillian, L., 2584 Bush Street, San Francisco, California 94115, US

(51) MKP  
**A47F 11/06 (2006.01)** (97) **2560525 \***  
(86) HU2011000034 19.04.2011  
(96) 11723603.4 27.02.2013  
(87) WO2011132005, 19.04.2011  
(97) 2560525, 27.02.2013 en  
(54) EQUIPMENT FOR DISPLAYING INFORMATION CARRIERS, ESPECIALLY FOR ADVERTISING PURPOSES  
(71) Flyvision Kft., Szabadság u. 50/A, 2040 Budaörs, HU  
(72) GTÓZY, András, Kastély U. 70., 2045 Törökálmt, HU

(51) MKP  
**A61K 31/519 (2006.01)** (97) **2545057 \***  
**C07D 487/04 (2006.01)**  
**A61P 11/00 (2006.01)**  
**A61P 1/00 (2006.01)**  
(86) GB2011050478 10.03.2011  
(96) 11709795.6 16.01.2013  
(87) WO2011110859, 10.03.2011  
(97) 2545057, 16.01.2013 en  
(54) PYRIMIDINE DERIVATIVES AND THEIR USE IN THE TREATMENT OF RESPIRATORY DISEASES SUCH AS COPD  
(71) Chiesi Farmaceutici S.p.A., Via Palermo, 26/A, 43100 Parma, IT  
(72) EDWARDS, Christine, c/o Pulmagen Therapeutics (Inflammation) Limited Fulmer Hall Windmill Road Fulmer, Slough Berkshire SL3 6HD, GB  
KULAGOWSKI, Janusz, c/o Pulmagen Therapeutics (Inflammation) Limited Fulmer Hall Windmill Road Fulmer, Slough Berkshire SL3 6HD, GB  
FINCH, Harry, c/o Pulmagen Therapeutics (Inflammation) Limited Fulmer Hall Windmill Road Fulmer, Slough Berkshire SL3 6HD, GB

- (51) MKP  
**C07D 209/58 (2006.01)** (97) **2539320 \***  
**C07D 209/94 (2006.01)**  
**C07D 241/24 (2006.01)**  
**C07D 209/52 (2006.01)**  
**C07D 403/06 (2006.01)**
- (86) EP2010063656 16.09.2010  
(96) 10762614.5 02.01.2013  
(87) WO2011103932, 16.09.2010  
(97) 2539320, 02.01.2013 en  
(54) A PROCESS FOR THE PREPARATION OF SUBSTITUTED PROLYL PEPTIDES AND SIMILAR PEPTIDOMIMETICS  
(71) Vereniging Voor Christelijk Hoger Onderwijs, Wetenschappelijk Onderzoek En Patiëntenzorg, De Boelelaan 1105, 1081 HV Amsterdam, NL  
(72) RUIJTER, Eelco, Klaproosweide 52, NL-3448JH Woerden, NL  
ORRU, Romano, Saturnusstraat 6, NL-2024 GJ Haarlem, NL  
ZNABET, Anass, Burgemeester van de Pollstraat 126-II, NL-1064 AZ Amsterdam, NL  
POLAK, Marloes, Kroeskarperlaan 45, NL-2215 XN Voorhout, NL  
TURNER, Nicholas, 35 Old Broadway, Manchester Greater Manchester M20 3DN, GB
- 
- (51) MKP  
**C07D 217/04 (2006.01)** (97) **2542530 \***  
**C07D 401/12 (2006.01)**
- (86) US2011027118 04.03.2011  
(96) 11708373.3 09.01.2013  
(87) WO2011109675, 04.03.2011  
(97) 2542530, 09.01.2013 en  
(54) PROCESS FOR THE PREPARATION OF 2-(CYCLOHEXYLMETHYL)-N-[(2S)-1-METHYLPYRROLIDIN-2-YL]ETHYL]-1, 2, 3, 4-TETRAHYDROISOQUINOLINE-7-SULFONAMIDE  
(71) SANOFI, 54, rue de la Boétie, 75008 Paris, FR  
(72) ELENBAAS, Steven, c/o sanofi-aventis 1041 Route 202-206 Mail Code D-303A, Bridgewater, New Jersey 08807, US
- 
- (51) MKP  
**E04H 12/08 (2006.01)** (97) **2593619 \***  
**E04H 12/34 (2006.01)**  
**F03D 11/04 (2006.01)**
- (86) DK2011050262 04.07.2011  
(96) 11730554.0 22.05.2013  
(87) WO2012007000, 04.07.2011  
(97) 2593619, 22.05.2013 en  
(54) METHOD OF ASSEMBLING A TUBULAR BUILDING STRUCTURE BY USING SCREW SOCKETS  
(71) Andresen Towers A/S, Lindholm Havnevej 33, 5800 Nyborg, DK  
(72) ANDRESEN, Tom, Skovallén 19, 5250 Odense SV, DK
- 
- (51) MKP  
**C08J 7/12 (2006.01)** (97) **2481769**  
**A47J 36/04 (2006.01)**
- (96) 11193056.6 01.08.2012  
(97) 2481769, 01.08.2012 en  
(54) Article suitable for contact with foodstuffs and process for realizing the same  
(71) Tescoma S.P.A., Via Traversa Caduti Del Lavoro 3, 25046 Cazzago San Martino (BS), IT  
(72) Vaculik, Jiri, c/o TESCOMA S.P.A. VIA TRAVERSA CADUTI DEL LAVORO 3, 25046 CAZZAGO SAN MARTINO (BS), CZ
- 
- (51) MKP  
**C21D 9/52 (2006.01)** (97) **2576849 \***  
**C22C 38/04 (2006.01)**  
**C22C 38/02 (2006.01)**  
**C21D 1/20 (2006.01)**  
**C21D 9/58 (2006.01)**
- (86) FR2011000167 23.03.2011  
(96) 11719592.5 10.04.2013  
(87) WO2011151532, 23.03.2011  
(97) 2576849, 10.04.2013 fr  
(54) PROFILED WIRE MADE OF HYDROGEN-EMBRITTELEMENT-RESISTANT STEEL HAVING HIGH MECHANICAL PROPERTIES  
(71) Arcelormittal Wire France, 25 Avenue de Lyon BP 96, 01000 Bourg en Bresse, FR  
(72) FOISSEY, Sylvain, 6 rue de Bressy, F-01800 Meximieux, FR  
BERTOUT, Christophe, 249 Avenue de Macon, F-01440 Viriat, FR  
PERROUD, Xavier, Chemin de la Côtère, F-01800 Mollon, FR
- 
- (51) MKP  
**D02J 3/00 (2006.01)** (97) **2563240 \***  
**D01F 6/06 (2006.01)**  
**A61L 17/00 (2006.01)**  
**A61B 17/064 (2006.01)**
- (86) US2011034660 29.04.2011  
(96) 11778070.0 06.03.2013  
(87) WO2011139916, 29.04.2011  
(97) 2563240, 06.03.2013 en  
(54) HIGH-DENSITY SELF-RETAINING SUTURES, MANUFACTURING EQUIPMENT AND METHODS  
(71) Ethicon, LLC, Road 183 KM 8.3 Hato Industrial Area, San Lorenzo, PR 00754, US  
(72) GROSS, Jeffrey, M., 1100 Garden View Road, 200, Encinitas, CA 92024, US  
DRUBETSKY, Lev, 2948 Waterford Place, Coquitlam British Columbia V3E 2S9, CA  
NAIMAGON, Alexander, 11-8711 General Currie Road, Richmond British Columbia V6Y 1M3, CA  
D'AGOSTINO, William, L., 19 Douglas Drive, Hamden Connecticut 06518, US
- 
- (51) MKP  
**C07D 311/78 (2006.01)** (97) **2576535 \***
- (86) US2011039159 03.06.2011  
(96) 11790504.2 10.04.2013  
(87) WO2011153488, 03.06.2011  
(97) 2576535, 10.04.2013 en  
(54) COMBINATION CANCER THERAPIES WITH WORTMANNIN ANALOGS  
(71) Oncothyreon Inc., 2601 Fourth Avenue, Suite 500, Seattle, WA 98121, US  
(72) PETERSON, Scott, 15003 225th Ave NE, Woodinville, WA 98077, US  
HAUSMAN, Diana, F., 2339 Federal Ave E., Seattle, WA 98102, US  
KIRKMAN, Robert, 4439 95th Avenue, Yarrow Point, WA 98004, US
- 
- (51) MKP  
**C09K 11/77 (2006.01)** (97) **2417216 \***  
**C01B 33/00 (2006.01)**  
**C09K 11/06 (2006.01)**
- (86) EP2010001663 17.03.2010  
(96) 10713558.4 15.02.2012  
(87) WO2010115503, 17.03.2010  
(97) 2417216, 15.02.2012 de  
(54) MODIFICATION OF LAYERED SILICATES FOR LUMINESCENCE ACTIVATION  
(71) Inbio Prof. Jürgen Büddefeld Dr. Peter Klauth Prof. Manfred Rietz Gbr, Ringstrasse 3, 47239 Duisburg, DE  
(72) KLAUTH, Peter, Alter Sportplatz 17, 41189 Mönchengladbach, DE  
RIETZ, Manfred, Anton-Aretz-Strasse 1, 41812 Erkelenz, DE  
BÜDDEFELD, Jürgen, Ringstrasse 3, 47239 Duisburg, DE  
KYNAST, Ulrich, Nelkenweg 4, 48565 Steinfurt, DE  
LEZHNINA, Marina, Bütkamp 1-2, 48565 Steinfurt, DE
-

- (51) MKP  
**B42D 15/00 (2006.01)** (97) **2560824 \***  
 (86) US2011031966 11.04.2011  
 (96) 11772441.9 27.02.2013  
 (87) WO2011133352, 11.04.2011  
 (97) 2560824, 27.02.2013 en  
 (54) OPTICALLY WRITABLE HOLOGRAPHIC MEDIA  
 (71) LaserCard Corporation, 1875 N. Shoreline Boulevard,  
 Mountain View, CA 94043, US  
 (72) DYBALL, Christopher, J., 239 Mirada Road, Half Moon Bay CA  
 94019, US

- (51) MKP  
**B62D 11/10 (2006.01)** (97) **2570332**  
**B62D 11/04 (2006.01)**  
**B66F 9/075 (2006.01)**  
 (96) 12179090.1 20.03.2013  
 (97) 2570332, 20.03.2013 en  
 (54) An improved traction axle for work machines  
 (71) OTO S.p.A., Via D. Marchesi 4 Zona Industriale Rondello,  
 42022 Boretto, Reggio Emilia, IT  
 (72) Chezzi, Aleardo, Via Firenze 9, 42022 BORETTO, REGGIO  
 EMILIA, IT  
 Anesi, Andrea, Via Ponchielli 22, 42049 SANT'ILARIO  
 D'ENZA, REGGIO EMILIA, IT

- (51) MKP  
**G10L 13/08 (2013.01)** (97) **2579249 \***  
 (86) CN2011081452 27.10.2011  
 (96) 11864132.3 10.04.2013  
 (87) WO2013020329, 27.10.2011  
 (97) 2579249, 10.04.2013 en  
 (54) PARAMETER SPEECH SYNTHESIS METHOD AND SYSTEM  
 (71) Goertek Inc., No. 268 Dong Fang Road Hi-Tech Industry  
 Development District, Wei Fang, Shandong 261031, CN  
 (72) WU, Fengliang, No. 268 Dongfang Road, Hi-Tech Industry  
 Development District Weifang, Shandong 261031, CN  
 ZHI, Zhenhua, No. 268 Dongfang Road, Hi-Tech Industry  
 Development District Weifang, Shandong 261031, CN

- (51) MKP  
**A61K 35/36 (2006.01)** (97) **2582791 \***  
**A61F 2/10 (2006.01)**  
**C12N 5/071 (2010.01)**  
**C12Q 1/68 (2006.01)**  
**C12N 5/077 (2010.01)**  
 (86) US2011040937 17.06.2011  
 (96) 11796538.4 24.04.2013  
 (87) WO2011160055, 17.06.2011  
 (97) 2582791, 24.04.2013 en  
 (54) HAIR FOLLICLE NEOGENESIS  
 (71) The Henry M. Jackson Foundation for the Advancement  
 of Military Medicine, Inc., 1401 Rockville Pike Suite 600,  
 Rockville, MD 20852, US  
 (72) THANGAPAZHAM, Rajesh, 622 Denham Road, Rockville, MD  
 20851, US  
 DARLING, Thomas, N., 2 Lochness Court, Rockville, MD  
 20850, US  
 LI, Shaowei, 8147 Inverness Ridge Road, Potomac, MD  
 20854, US

- (51) MKP  
**H01M 2/02 (2006.01)** (97) **2572394 \***  
 (86) US2011037244 19.05.2011  
 (96) 11784278.1 27.03.2013  
 (87) WO2011146774, 19.05.2011  
 (97) 2572394, 27.03.2013 en  
 (54) EXTERNAL PROCESSING ACCESSORY FOR MOBILE  
 DEVICE  
 (71) Mophie, Inc., 2850 Red Hill Avenue Suite 128, Santa Ana, CA  
 92705, US  
 (72) HUANG, Daniel, 20 Buellton, Irvine, California 92602, US

- (51) MKP  
**C12N 15/113 (2010.01)** (97) **2576782 \***  
**A61K 31/713 (2006.01)**  
**A61P 27/02 (2006.01)**  
 (86) GB2011051007 27.05.2011  
 (96) 11723600.0 10.04.2013  
 (87) WO2011148193, 27.05.2011  
 (97) 2576782, 10.04.2013 en  
 (54) SIRNA AND THEIR USE IN METHODS AND COMPOSITIONS  
 FOR THE TREATMENT AND/OR PREVENTION OF EYE  
 CONDITIONS  
 (71) Sylentis S.A.U., Plaza del Descubridor Diego de Ordás no. 3  
 Planta 5, 28003 Madrid, ES  
 (72) LOPEZ-FRAGA, Marta, c/o Sylentis S.A. Santiago Grisolia 2  
 Tres Cantos, E-28770 Madrid, ES  
 JIMENEZ, Ana Isabel, c/o Sylentis S.A. Santiago Grisolia 2  
 Tres Cantos, E-28770 Madrid, ES  
 VALCAREL, Tamara Martinez, c/o Sylentis S.A. Santiago  
 Grisolia 2 Tres Cantos, E-28770 Madrid, ES

- (51) MKP  
**A01N 1/02 (2006.01)** (97) **2578082 \***  
 (86) ES2011070375 24.05.2011  
 (96) 11745806.7 10.04.2013  
 (87) WO2011148024, 24.05.2011  
 (97) 2578082, 10.04.2013 en  
 (54) COMPOSITION FOR THE COLD STORAGE OF ORGANS  
 (71) Digna Biotech, S.L., Avenida Pío XII, 22. Oficina 2, 31008  
 Pamplona Navarra, ES  
 Proyecto de Biomedicina Cima, S.L., Avda. Pío XII, 22 Oficina  
 1, 31008 Pamplona - Navarra, ES  
 (72) CHANG, Haisul C.Y., lct (d.p.i.) Avda. Pío XII 53, E-31008  
 Pamplona - Navarra, ES  
 FERNÁNDEZ GALLEGU, Victor, lct (d.p.i.) Avda. Pío XII 53,  
 E-31008 Pamplona - Navarra, ES  
 IÑIGUEZ MARTÍNEZ, María, lct (d.p.i.) Avda. Pío XII 53,  
 E-31008 Pamplona - Navarra, ES  
 LÓPEZ NOVOA, Jose Miguel, lct (d.p.i.) Avda. Pío XII 53,  
 E-31008 Pamplona - Navarra, ES  
 PRIETO VALTUEÑA, Jesús María, lct (d.p.i.) Avda. Pío XII 53,  
 E-31008 Pamplona - Navarra, ES  
 RUIZ ECHEVERRÍA, Juan, lct (d.p.i.) Avda. Pío XII 53,  
 E-31008 Pamplona - Navarra, ES

- (51) MKP  
**A61M 5/00 (2006.01)** (97) **2585141 \***  
**A61M 5/32 (2006.01)**  
**A61M 5/20 (2006.01)**  
 (86) EP2011060505 22.06.2011  
 (96) 11729594.9 01.05.2013  
 (87) WO2012000873, 22.06.2011  
 (97) 2585141, 01.05.2013 en  
 (54) AUTO-INJECTOR  
 (71) Sanofi-Aventis Deutschland GmbH, Brüningstraße 50, 65929  
 Frankfurt, DE  
 (72) HOURMAND, Yannick, 14 The Elms, Haslingfield CB23 1ND,  
 GB  
 BARROW-WILLIAMS, Timothy Donald, 1 Grange Street, St.  
 Albans Hertfordshire AL3 5NA, GB  
 EKMAN, Matthew, 59 Ecton Avenue, Macclesfield Cheshire  
 SK10 1RD, GB

- (51) MKP  
**A61M 5/315 (2006.01)** (97) **2579927 \***  
 (86) EP2011059562 09.06.2011  
 (96) 11724421.0 17.04.2013  
 (87) WO2011154479, 09.06.2011  
 (97) 2579927, 17.04.2013 en  
 (54) DRIVE MECHANISM FOR A DRUG DELIVERY DEVICE AND  
 DRUG DELIVERY DEVICE  
 (71) Sanofi-Aventis Deutschland GmbH, Brüningstraße 50, 65929  
 Frankfurt, DE  
 (72) BUTLER, Stephen, David, 25 High Hill South Staffords,  
 Essington WV11 2DP, GB  
 HORLOCK, Mark, Philip, 18 Mayfield Close Cheshire,  
 Timperley WA15 7TE, GB

- (51) MKP  
**C07D 205/04 (2006.01)** (97) **2588450 \***  
**C07D 493/04 (2006.01)**  
**C07D 213/64 (2006.01)**  
**A61P 31/18 (2006.01)**  
**C07D 231/12 (2006.01)**  
**C07D 213/73 (2006.01)**  
**C07D 211/48 (2006.01)**  
**C07D 295/073 (2006.01)**  
**C07D 233/58 (2006.01)**  
**C07D 215/04 (2006.01)**  
**C07D 213/65 (2006.01)**  
**C07D 311/20 (2006.01)**  
**C07D 241/12 (2006.01)**  
**C07D 309/10 (2006.01)**  
**C07D 239/34 (2006.01)**  
(86) US2011042880 01.07.2011  
(96) 11738878.5 08.05.2013  
(87) WO2012003497, 01.07.2011  
(97) 2588450, 08.05.2013 en  
(54) NAPHT- 2 -YLACETIC ACID DERIVATIVES TO TREAT AIDS  
(71) Gilead Sciences, Inc., 333 Lakeside Drive, Foster City, CA 94404, US  
(72) BABAOGLU, Kerim, 2209 Wentz Church Road, Lansdale, PA 19446, US  
BJORNSON, Kyla, 2721 South Norfolk Street, Apt. 207, San Mateo, CA 94403, US  
GUO, Hongyan, 1743 Maxine Avenue, San Mateo, CA 94401, US  
HALCOMB, Randall, L., 892 Gull Avenue, Foster City, CA 94404, US  
LINK, John, O., 74 Prospect Avenue, San Francisco, CA 94110, US  
MCFADDEN, Ryan, 1171 Compass Lane 213, Foster City, CA 94404, US  
MITCHELL, Michael, L., 108 Crossing Court, Hayward, CA 94544, US  
ROETHLE, Paul A., 675 Guerrero Street, San Francisco, CA 94110, US  
TRENKLE, James, D., 585 Ninth Street Unit 636, Oakland, CA 94607, US  
VIVIAN, Randall, W., 1430 Via Vista, San Mateo, CA 94404, US  
XU, Lianhong, 970 Blair Court, Palo Alto, CA 94303, US  
LIU, Hongtao, 10320 Orange Avenue, Cupertino, CA 95014, US  
TAYLOR, James, 100 State Street, San Mateo, CA 94401, US  
HRVATIN, Paul, 120 A Street, South San Francisco CA 94080, US  
BACON, Elizabeth, 1218 Floribunda Ave., Apt. 8, Burlingame, CA 94010, US
- 
- (51) MKP  
**A61P 43/00 (2006.01)** (97) **2560942 \***  
**A61K 31/19 (2006.01)**  
**C07C 57/58 (2006.01)**  
**A61P 25/28 (2006.01)**  
(86) EP2011056224 19.04.2011  
(96) 11723282.7 27.02.2013  
(87) WO2011131661, 19.04.2011  
(97) 2560942, 27.02.2013 en  
(54) 1-(2-FLUOROBIPHENYL-4-YL)-ALKYL CARBOXYLIC ACID DERIVATIVES FOR THE THERAPY OF TRANSTHYRETIN AMYLOIDOSIS  
(71) Chiesi Farmaceutici S.p.a., Via Palermo, 26/A, 43100 Parma, IT  
(72) IMBIMBO, Bruno Pietro, c/o Chiesi Farmaceutici S.p.a. Via Palermo 26/A, I-43100 Parma, IT  
VILLETTI, Gino, c/o Chiesi Farmaceutici S.p.a. Via Palermo 26/A, I-43100 Parma, IT  
BERNI, Rodolfo, c/o Chiesi Farmaceutici S.p.a. Via Palermo 26/A, I-43100 Parma, IT
- 
- (51) MKP  
**B25G 3/12 (2006.01)** (97) **2555907 \***  
**F16M 13/04 (2006.01)**  
**F16C 11/10 (2006.01)**  
**G05G 1/10 (2006.01)**  
(86) CA2011000348 30.03.2011  
(96) 11764972.3 13.02.2013  
(87) WO2011123930, 30.03.2011  
(97) 2555907, 13.02.2013 en  
(54) ADJUSTABLE HANDLE ASSEMBLY WITH LOCKING MECHANISM  
(71) Shape WLB Inc., 3220 1ère Rue Suite 507, St-Hubert, Québec J3Y 8Y5, CA  
(72) VALLIÈRES, Charles, 2284 Ethel Est, Carignan, Québec J3L 4J4, CA  
GIRARD, Mylène, 2284 Ethel Est, Carignan, Québec J3L 4J4, CA
- 
- (51) MKP  
**E05B 13/00 (2006.01)** (97) **2550418 \***  
**E05B 47/00 (2006.01)**  
(86) SE2011050322 23.03.2011  
(96) 11759799.7 30.01.2013  
(87) WO2011119097, 23.03.2011  
(97) 2550418, 30.01.2013 en  
(54) SELECTIVELY DISENGAGEABLE AND COUPLABLE HANDLE WITH MOTOR  
(71) Assa Oem AB, Box 371, 631 05 Eskilstuna, SE  
(72) CALLEBERG, Johan, Landsvägsgatan 14, SE-413 04 Göteborg, SE
- 
- (51) MKP  
**A23L 1/30 (2006.01)** (97) **2471384**  
**A61K 31/23 (2006.01)**  
**A61K 9/00 (2006.01)**  
(96) 10197294.1 04.07.2012  
(97) 2471384, 04.07.2012 en  
(54) Suspension formulations of cetyl myristate and/or cetyl palmitate  
(71) Deva Holding Anonim Sirketi, Patent Law Department Halkali Merkez Mah. Basin Ekspres Cad. No: 1,34303, Kucukcekmece/Istanbul, TR  
(72) Haas, Philipp Daniel, R&D DEVA HOLDING ANONIM SIRKETI Halkali Merkez Mah., Basin Ekspres Caddesi No:1, Patent Law Department, Kat:5, Kucukcekmece, 34303, ISTANBUL, TR  
Firat, Omer Faruk, R&D DEVA HOLDING ANONIM SIRKETI Halkali Merkez Mah., Basin Ekspres Caddesi No:1, Patent Law Department, Kat:5, Kucukcekmece, 34303, ISTANBUL, TR  
Kademit, Levent, R&D DEVA HOLDING ANONIM SIRKETI Halkali Merkez Mah., Basin Ekspres Caddesi No:1, Patent Law Department, Kat:5, Kucukcekmece, 34303, ISTANBUL, TR  
Koc, Fikret, R&D DEVA HOLDING ANONIM SIRKETI Halkali Merkez Mah., Basin Ekspres Caddesi No:1, Patent Law Department, Kat:5, Kucukcekmece, 34303, ISTANBUL, TR  
Sivasligil, Ramazan, R&D DEVA HOLDING ANONIM SIRKETI Halkali Merkez Mah., Basin Ekspres Caddesi No:1, Patent Law Department, Kat:5, Kucukcekmece, 34303, ISTANBUL, TR
- 
- (51) MKP  
**E05F 3/00 (2006.01)** (97) **2580416 \***  
**E05F 3/04 (2006.01)**  
(86) EP2011002287 09.05.2011  
(96) 11719770.7 17.04.2013  
(87) WO2011157326, 09.05.2011  
(97) 2580416, 17.04.2013 de  
(54) MOUNTING ARRANGEMENT FOR A DOOR ACTUATOR  
(71) Dorma GmbH&Co. KG, Dorma Platz 1, 58256 Ennepetal, DE  
(72) SALUTZKI, Thomas, Zu den Tannen 9, 58456 Witten, DE  
HELLWIG, Alexander, Leibnitzstrasse 53, 58256 Ennepetal, DE
-



(51) MKP  
**A61P 11/00 (2006.01)** (97) **2555785 \***  
**A61K 35/74 (2006.01)**  
(86) IT2011000104 07.04.2011  
(96) 11721384.3 13.02.2013  
(87) WO2011125086, 07.04.2011  
(97) 2555785, 13.02.2013 en  
(54) USE OF STREPTOCOCCUS SALIVARIUS IN THE TREATMENT OF CHRONIC INFECTIONS OF THE RESPIRATORY TRACT  
(71) D.M.G. Italia Srl, Via Laurentina Km 26,700, 00040 Pomezia (RM), IT  
(72) STEFANI, Stefania, Universita' Degli Studi Di Catania Dip. di Scienze Bio-Mediche Sez. Microbiologia Via Androne 81, I-95124 Catania (CT), IT  
TIBERI, Licia, Via Laurentina Km 26,700, I-00040 Pomezia (RM), IT  
SANTAGATI, Maria., Universita' Degli Studi Di Catania Dip. di Scienze Bio-Mediche Sez. Microbiologia Via Androne 81, I-95124 Catania (CT), IT

(51) MKP  
**C12N 15/82 (2006.01)** (97) **2580336 \***  
(86) EP2011002894 07.06.2011  
(96) 11727919.0 17.04.2013  
(87) WO2011154158, 07.06.2011  
(97) 2580336, 17.04.2013 en  
(54) METHODS AND MEANS TO MODIFY A PLANT GENOME AT A NUCLEOTIDE SEQUENCE COMMONLY USED IN PLANT GENOME ENGINEERING  
(71) Bayer CropScience NV, J.E. Mommaertslaan 14, 1831 Diegem, BE  
(72) D'HALLUIN, Kathleen, Hooiland 48, B-9030 Mariakerke, BE

(51) MKP  
**C07D 498/00 (2006.01)** (97) **2593463 \***  
(86) US2011043769 12.07.2011  
(96) 11807418.6 22.05.2013  
(87) WO2012009388, 12.07.2011  
(97) 2593463, 22.05.2013 en  
(54) FORMULATIONS OF RIFAXIMIN AND USES THEREOF  
(71) Salix Pharmaceuticals, Ltd., 8510 Colonnade Center Drive, Raleigh, NC 27615, US  
(72) SELBO, Jon, 5798 Augusta Blvd., West Lafayette IN 47906, US  
TENG, Jing, 2501 Soldiers Home Rd. Apt. 32b, West Lafayette, IN 47906, US  
KABIR, Mohammed, A., 703 Unison Ct., Cary NC 27519, US  
GOLDEN, Pam, 5 Fontana Ct., Durham NC 27713, US

(51) MKP  
**A63B 22/04 (2006.01)** (97) **2558169 \***  
(86) US2011032651 15.04.2011  
(96) 11769650.0 20.02.2013  
(87) WO2011130607, 15.04.2011  
(97) 2558169, 20.02.2013 en  
(54) IMPACT ABSORBING EXERCISE DEVICE  
(71) Lepore, Marianne, 7 Gaslight Lane, Framingham, MA 01702, US  
(72) Lepore, Marianne, 7 Gaslight Lane, Framingham, MA 01702, US

(51) MKP  
**E04F 13/00 (2006.01)** (97) **2576166 \***  
**B32B 21/10 (2006.01)**  
**B27N 7/00 (2006.01)**  
**B32B 5/28 (2006.01)**  
**B60R 13/02 (2006.01)**  
**E04B 1/74 (2006.01)**  
**D06M 13/402 (2006.01)**  
**C08J 7/06 (2006.01)**  
(86) FR2011051074 13.05.2011  
(96) 11725167.8 10.04.2013  
(87) WO2011148076, 13.05.2011  
(97) 2576166, 10.04.2013 fr  
(54) MAT OF POLYMER FIBRES CONTAINING A DIHYDRAZIDE, AND USE THEREOF  
(71) Saint-Gobain Adfors, 517, Avenue de la Boisse, 73000 Chambéry, FR  
(72) BLANCHARD, Benjamin, 17 rue Auguste Méry, F-95150 Taverny, FR  
JAFFRENNOU, Boris, 33 rue des Alouettes, F-75010 Paris, FR  
CHUDA, Katarzyna, 10 rue des Frères Chausson, 92600 Asnieres sur Seine, FR

(51) MKP  
**A61K 31/55 (2006.01)** (97) **2569434 \***  
**C12N 15/13 (2006.01)**  
**A61K 31/7088 (2006.01)**  
(86) US2011036672 16.05.2011  
(96) 11781413.7 20.03.2013  
(87) WO2011143660, 16.05.2011  
(97) 2569434, 20.03.2013 en  
(54) COMPOSITIONS AND METHODS FOR TREATING LEUKEMIA  
(71) Dana-Farber Cancer Institute, Inc., 450 Brookline Avenue, Boston, MA 02215, US  
COLD SPRING HARBOR LABORATORY, 1 Bungtown Road, Cold Spring Harbor, NY 11724, US  
(72) BRADNER, James, Elliott, 9 Rollins Court, Cambridge, MA 02139, US  
ZUBER, Johannes, 1 Bungtown Road, Cold Spring Harbor, NY 11724-2202, US  
SHI, Junwei, 1 Bungtown Road, Cold Spring Harbor, NY 11724-2202, US  
VAKOC, Christopher, R., 1 Bungtown Road, Cold Spring Harbor, NY 11724-2202, US

(51) MKP  
**F16H 25/20 (2006.01)** (97) **2481537**  
**B26D 7/08 (2006.01)**  
**B26D 1/143 (2006.01)**  
**B26D 7/00 (2006.01)**  
(96) 12153344.2 01.08.2012  
(97) 2481537, 01.08.2012 de  
(54) Cutting machine for food  
(71) Gebr. Graef GmbH & Co. KG, Donnerfeld 6, 59757 Arnsberg, DE  
(72) Bergmann, Christoph, In der Esmecke 41, 59846 Sundern, DE  
Hellmann, Frank, Im Eichenring 26A, 59519 Möhnese-Günne, DE  
Hagenhoff, Klaus, Zu den Gärten 26, 59755 Arnsberg, DE

- (51) MKP  
**A61K 31/53 (2006.01)** (97) **2544672 \***  
**A61P 35/00 (2006.01)**  
**A61K 31/4985 (2006.01)**  
**A61K 31/00 (2006.01)**
- (86) US2011027673 09.03.2011  
(96) 11708662.9 16.01.2013  
(87) WO2011112666, 09.03.2011  
(97) 2544672, 16.01.2013 en  
(54) COMBINATION ANTI-CANCER THERAPY  
(71) OSI Pharmaceuticals, LLC, 1 Bioscience Park Drive, Farmingdale, NY 11735, US
- (72) BARR, Sharon, OSI Pharmaceuticals Inc. Broadhollow Bioscience Park 1 Bioscience Park Drive, Farmingdale, NY 11735, US  
BUCK, Elizabeth, A., OSI Pharmaceuticals Inc. Broadhollow Bioscience Park 1 Bioscience Park Drive, Farmingdale, NY 11735, US  
EPSTEIN, David, M., OSI Pharmaceuticals Inc. Broadhollow Bioscience Park 1 Bioscience Park Drive, Farmingdale, NY 11735, US  
GOKHALE, Prafulla, C., Superior, CO, US  
MIGLARESE, Mark, R., OSI Pharmaceuticals Inc. 420 Saw Mill River Road, Ardsley, NY 10502, US

- (51) MKP  
**H05K 1/14 (2006.01)** (97) **2561741 \***  
**H05K 7/20 (2006.01)**
- (86) EP2011056260 19.04.2011  
(96) 11718323.6 27.02.2013  
(87) WO2011131686, 19.04.2011  
(97) 2561741, 27.02.2013 en  
(54) A THERMALLY CONTROLLED ASSEMBLY  
(71) Napatech A/S, Tobaksvej 23A, 2860 Søborg, DK  
(72) EK, Claus, Hestetangsvej 6, DK-3520 Farum, DK  
STOREMOEN, Christoffer, Krusågade 13, st.tv., DK-1719 Copenhagen V, DK

- (51) MKP  
**A61M 5/32 (2006.01)** (97) **2588169 \***  
**A61M 5/28 (2006.01)**
- (86) EP2011060321 21.06.2011  
(96) 11726440.8 08.05.2013  
(87) WO2012000837, 21.06.2011  
(97) 2588169, 08.05.2013 en  
(54) INJECTION DEVICE WITH NEEDLE SHIELD  
(71) Sanofi-Aventis Deutschland GmbH, Brüningstraße 50, 65929 Frankfurt, DE  
(72) ROBERTS, Gareth, Glendale Pen-y-cae Road Ruabon, Wrexham LL14 6EB, GB  
WARD, Chris, 31 Princes Avenue, Prestatyn, Denbighshire LL19 8RW, GB  
EKMAN, Matthew, 59 Ecton Avenue, Macclesfield, Cheshire SK10 1RD, GB

- (51) MKP  
**G06F 3/01 (2006.01)** (97) **2561424 \***  
**G06Q 30/00 (2012.01)**
- (86) US2011033576 22.04.2011  
(96) 11718590.0 27.02.2013  
(87) WO2011133860, 22.04.2011  
(97) 2561424, 27.02.2013 en  
(54) SYSTEMS AND METHODS FOR PROVIDING HAPTIC EFFECTS  
(71) Immersion Corporation, 30 Rio Robles, San Jose, CA 95134, US  
Birnbaum, David M., 311 Oak Street, 327, Oakland, California 94607, US  
Grant, Danny A., 1784 De Lunebourg, Laval, Québec H7M 2A1, CA  
Ramstein, Christophe, 818 Union Street, San Francisco, California 94019, US  
Ullrich, Christopher J., 227 Palomares Avenue, Ventura, California 93003, US
- (72) BIRNBAUM, David, M., 311 Oak Street, 327, Oakland, California 94607, US  
GRANT, Danny, A., 1784 De Lunebourg, Laval, Québec H7M 2A1, CA  
RAMSTEIN, Christophe, 818 Union Street, San Francisco, California 94019, US  
ULLRICH, Christopher, J., 227 Palomares Avenue, Ventura, California 93003, US

- (51) MKP  
**A61K 31/222 (2006.01)** (97) **2549985 \***  
**A61K 9/20 (2006.01)**  
**A61K 9/50 (2006.01)**  
**A61K 9/16 (2006.01)**
- (86) IN2011000189 22.03.2011  
(96) 11725530.7 30.01.2013  
(87) WO2011117884, 22.03.2011  
(97) 2549985, 30.01.2013 en  
(54) STABLE PHARMACEUTICAL COMPOSITIONS COMPRISING FESOTERODINE  
(71) Cadila Healthcare Limited, Zydus Tower Satellite Cross Roads, Ahmedabad 380 015 Gujarat, IN  
(72) ROY, Sunilendu Bhushan, Zydus Tower Satellite Cross Road, Ahmedabad 380 015 Gujarat, IN  
KULKARNI, Sushrut Krishnaji, Zydus Tower Satellite Cross Road, Ahmedabad 380 015 Gujarat, IN  
DHIRAJBHAI, Pranav Jogani, Zydus Tower Satellite Cross Road, Ahmedabad 380 015 Gujarat, IN  
KUMAR, Ajay Handa, Zydus Tower Satellite Cross Road, Ahmedabad 380 015 Gujarat, IN

- (51) MKP  
**A47G 23/02 (2006.01)** (97) **2564732 \***  
**A47F 5/02 (2006.01)**  
**A47G 19/00 (2006.01)**
- (86) RU2011000268 25.04.2011  
(96) 11775359.0 06.03.2013  
(87) WO2011136699, 25.04.2011  
(97) 2564732, 06.03.2013 en  
(54) DEVICE FOR THE ROTATION OF OBJECTS (EMBODIMENTS). SET FOR THE ROTATION OF OBJECTS  
(71) Bushkovskiy, Evgeniy Vladimirovich, Pr. Koroleva, 47-1-30, St. Petersburg 197371, RU  
(72) Bushkovskiy, Evgeniy Vladimirovich, Pr. Koroleva, 47-1-30, St. Petersburg 197371, RU

- (51) MKP  
**B01D 35/02 (2006.01)** (97) **2580425 \***  
**G01N 33/28 (2006.01)**  
**E21B 43/10 (2006.01)**  
**E21B 43/08 (2006.01)**  
**E21B 47/00 (2012.01)**  
(86) CA2011000699 13.06.2011  
(96) 11791792.2 17.04.2013  
(87) WO2011153636, 13.06.2011  
(97) 2580425, 17.04.2013 en  
(54) WELLBORE SCREEN WITH TRACER FOR FLUID DETECTION  
(71) Absolute Completion Technologies Ltd., No. 302, 600 Crowfoot Crescent NW, Calgary, Alberta T3G 0B4, CA  
Resman AS, Stiklestadveien 1, 7041 Trondheim, NO  
(72) WOICESHYN, Glenn, Edward, 302, 600 Crowfoot Crescent NW, Calgary Alberta T3G 0B4, CA  
NYHAVN, Fridtjof, c/o Stiklestadveien 1, N-7041 Trondheim, NO
- 
- (51) MKP  
**B32B 3/10 (2006.01)** (97) **2590815 \***  
(86) US2011043281 08.07.2011  
(96) 11804379.3 15.05.2013  
(87) WO2012006484, 08.07.2011  
(97) 2590815, 15.05.2013 en  
(54) SIDE NOTCH PAPER  
(71) Azzar, James, Douglas, 208 Pioneer Club Road S.E., East Grand Rapids Michigan 49506, US  
(72) Azzar, James, Douglas, 208 Pioneer Club Road S.E., East Grand Rapids Michigan 49506, US
- 
- (51) MKP  
**A61K 31/5025 (2006.01)** (97) **2569315 \***  
**A61P 35/00 (2006.01)**  
**C07D 487/04 (2006.01)**  
**C07D 471/04 (2006.01)**  
(86) US2011036573 16.05.2011  
(96) 11721679.6 20.03.2013  
(87) WO2011143646, 16.05.2011  
(97) 2569315, 20.03.2013 en  
(54) FUSED BICYCLIC KINASE INHIBITORS  
(71) OSI Pharmaceuticals, LLC, 1 Bioscience Park Drive, Farmingdale, NY 11735, US  
(72) LI, An-Hu, Osi Pharmaceuticals LLC 1 Bioscience Park Drive, Farmingdale, NY 11735, US  
MULVIHILL, Mark, J., Osi Pharmaceuticals LLC 1 Bioscience Park Drive, Farmingdale, NY 11735, US  
STEINIG, Arno, G., Osi Pharmaceuticals LLC 1 Bioscience Park Drive, Farmingdale, NY 11735, US
- 
- (51) MKP  
**A61K 9/14 (2006.01)** (97) **2575769 \***  
(86) DK2011050046 17.02.2011  
(96) 11704177.2 10.04.2013  
(87) WO2011100975, 17.02.2011  
(97) 2575769, 10.04.2013 en  
(54) STABILIZED TACROLIMUS COMPOSITION  
(71) Veloxis Pharmaceuticals A/S, Bøge Allé 5, 2. th., 2970 Hørsholm, DK  
(72) SKAK, Nikolaj, Guldregnvænget 11, DK-2830 Virum, DK  
HANSEN, Liselotte, Hjortespringparken 17, DK-2730 Herlev, DK
- 
- (51) MKP  
**F17C 13/00 (2006.01)** (97) **2500619**  
**F17C 13/06 (2006.01)**  
(96) 12159155.6 19.09.2012  
(97) 2500619, 19.09.2012 de  
(54) Originality guarantee for compressed gas bottles  
(71) Messer GasPack GmbH, Gahlingspfad 31, 47803 Krefeld, DE  
(72) Kriese, Alexander, Braitnerstrasse 30, 2500 Baden bei Wien, AT
- 
- (51) MKP  
**A61K 31/737 (2006.01)** (97) **2588087 \***  
**A61K 31/7008 (2006.01)**  
**A61K 9/20 (2006.01)**  
(86) EP2011060782 28.06.2011  
(96) 11737910.7 08.05.2013  
(87) WO2012000971, 28.06.2011  
(97) 2588087, 08.05.2013 de  
(54) COMPOSITIONS WITH A HIGH ACTIVE INGREDIENT FRACTION OF PHARMACEUTICALLY ACTIVE SUBSTANCES  
(71) Mepha Schweiz AG, Dornacherstrasse 114 Postfach 445, 4147 Aesch, CH  
(72) ENSSLIN, Simon, Friedrichplatz 7a, 79618 Rheinfelden, DE
- 
- (51) MKP  
**F24J 2/04 (2006.01)** (97) **2474794**  
**F24J 2/52 (2006.01)**  
(96) 11150314.0 11.07.2012  
(97) 2474794, 11.07.2012 de  
(54) Seal board  
(71) FibreCem Holding AG, Eternitstrasse 3, 8867 Niederurnen, CH  
(72) Sele, Thomas, Letzanaweg 3, 9495 Triesen, CH
- 
- (51) MKP  
**E04F 10/04 (2006.01)** (97) **2571723 \***  
**E04H 15/06 (2006.01)**  
**B60P 3/34 (2006.01)**  
(86) GB2011050945 18.05.2011  
(96) 11722146.5 27.03.2013  
(87) WO2011144936, 18.05.2011  
(97) 2571723, 27.03.2013 en  
(54) DEPLOYABLE SHELTER STRUCTURE  
(71) Belron Hungary Kft - Zug Branch, Gotthardstrasse 20, 6304 Zug, CH  
(72) FINCK, William, 31 Doddinghurst Road Brentwood, Essex CM15 9EP, GB
- 
- (51) MKP  
**A61K 38/11 (2006.01)** (97) **2571511 \***  
**A61P 3/10 (2006.01)**  
**A61P 3/04 (2006.01)**  
(86) IB2011052156 17.05.2011  
(96) 11725971.3 27.03.2013  
(87) WO2011145051, 17.05.2011  
(97) 2571511, 27.03.2013 en  
(54) NEW USES OF OXYTOCIN-LIKE MOLECULES AND RELATED METHODS  
(71) Université de Genève, 24 rue du Général-Dufour, 1211 Genève 14, CH  
(72) ROHNER-JEANRENAUD, Françoise, 6 chemin des Piverts, CH-1226 Thonex, CH  
DEBLON, Nicolas, 162 route de l'Eculaz, F-74390 Reignier, FR
- 
- (51) MKP  
**C10M 161/00 (2006.01)** (97) **2587920 \***  
**C02F 1/50 (2006.01)**  
**A61K 31/44 (2006.01)**  
**A61L 2/18 (2006.01)**  
**A61K 31/785 (2006.01)**  
**A01P 1/00 (2006.01)**  
**A01N 43/40 (2006.01)**  
**B27K 3/50 (2006.01)**  
(86) EP2011060874 29.06.2011  
(96) 11728629.4 08.05.2013  
(87) WO2012001028, 29.06.2011  
(97) 2587920, 08.05.2013 en  
(54) ANTIMICROBIAL COMBINATIONS OF PYRION COMPOUNDS WITH POLYETHYLENIMINES  
(71) Janssen Pharmaceutica, N.V., Turnhoutseweg 30, 2340 Beerse, BE  
(72) BYLEMANS, Dany Leopold Jozefien, Janssen Pharmaceutica NV Turnhoutseweg 30, B-2340 Beerse, BE  
DE BOLLE, Miguel F.C., Janssen Pharmaceutica NV Turnhoutseweg 30, B-2340 Beerse, BE

- (51) MKP  
**A61K 39/395 (2006.01)** (97) **2568996 \***  
**A61P 37/00 (2006.01)**  
**A61K 38/17 (2006.01)**  
**A61K 38/16 (2006.01)**  
**A61P 35/00 (2006.01)**  
**A61P 29/00 (2006.01)**
- (86) US2011036326 12.05.2011  
(96) 11781304.8 20.03.2013  
(87) WO2011143482, 12.05.2011  
(97) 2568996, 20.03.2013 en  
(54) INNOVATIVE DISCOVERY OF THERAPEUTIC, DIAGNOSTIC, AND ANTIBODY COMPOSITIONS RELATED TO PROTEIN FRAGMENTS OF PHENYLALANYL-BETA-TRNA SYNTHETASES
- (71) aTyr Pharma, Inc., 3545 John Hopkins Court, Suite 250, San Diego, CA 92121, US  
Pangu Biopharma Limited, Edinburgh Tower, 18/F The Landmark 15 Queen's Road Central, Hong Kong, CN
- (72) GREENE, Leslie, Ann, 13941 Davenport Avenue, San Diego, California 92129, US  
CHIANG, Kyle, P., 943 Torrance Street, Apt. 6, San Diego, California 92103, US  
HONG, Fei, 7979 Caminito Dia, 2, San Diego, California 92122, US  
VASSEROT, Alain, P., 6421 La Paloma Street, Carlsbad, California 92009, US  
LO, Wing-Sze, RM 815 Sui Ming House Siu Sai Wan Estate Chai Wan, Hong Kong, CN  
WATKINS, Jeffrey, D., 3442 Fortuna Ranch Road, Encinitas, California 92024, US  
QUINN, Cheryl, L., 11227 Cedar Pointe Drive South, Minnetonka, Minnesota 55305, US  
XU, Zhiwen, Rm 7165 IAS HKUST-Scripps R&D Laboratory Hong Kong University of Science&Technology, Hong Kong, CN  
MENDLEIN, John, D., 1550 Neptune Avenue, Encinitas, California 92024, US
- 
- (51) MKP  
**C07D 237/08 (2006.01)** (97) **2588453 \***  
**A61K 31/44 (2006.01)**  
**A61P 35/00 (2006.01)**  
**C07D 401/14 (2006.01)**  
**C07D 213/56 (2006.01)**  
**C07D 401/12 (2006.01)**  
**C07D 403/12 (2006.01)**  
**C07D 279/12 (2006.01)**
- (86) US2011042215 28.06.2011  
(96) 11733945.7 08.05.2013  
(87) WO2012003189, 28.06.2011  
(97) 2588453, 08.05.2013 en  
(54) COMPOSITIONS AND METHODS FOR MODULATING THE WNT SIGNALING PATHWAY
- (71) IRM LLC, 131 Front Street P.O. Box HM 2899, Hamilton HM LX, BM  
Novartis AG, Lichtstrasse 35, 4056 Basel, CH
- (72) CHENG, Dai, Genomics Institute of the Novartis Research Foundation 10675 John Jay Hopkins Drive, San Diego, California 92121, US  
ZHANG, Guobao, Genomics Institute of the Novartis Research Foundation 10675 John Jay Hopkins Drive, San Diego, CA 92121, US  
HAN, Dong, Genomics Institute of the Novartis Research Foundation 10675 John Jay Hopkins Drive, San Diego, California 92121, US  
GAO, Wenqi, Genomics Institute of the Novartis Research Foundation 10675 John Jay Hopkins Drive, San Diego, California 92121, US  
PAN, Shifeng, Genomics Institute of the Novartis Research Foundation 10675 John Jay Hopkins Drive, San Diego, California 92121, US  
SHEN, Lichun, Novartis Pharmaceuticals Corporation One Health Plaza, East Hanover, New Jersey 07936, US  
LELETI, Rajender Reddy, Novartis Pharmaceuticals Corporation One Health Plaza, East Hanover, New Jersey 07936, US
- 
- (51) MKP  
**A61P 43/00 (2006.01)** (97) **2508184**  
**A61P 35/00 (2006.01)**  
**A61K 31/4985 (2006.01)**  
**A61K 31/501 (2006.01)**  
**A61K 31/5377 (2006.01)**  
**C07D 471/04 (2006.01)**
- (96) 11161248.7 10.10.2012  
(97) 2508184, 10.10.2012 en  
(54) Pyridopyrazine derivatives and their use  
(71) Æterna Zentaris GmbH, Weismüllerstraße 50, 60314 Frankfurt am Main, DE  
(72) GERLACH, Matthias, Pfarrgasse 1, 63636 Brachtal, DE
- 
- (51) MKP  
**A61K 31/28 (2006.01)** (97) **2545064 \***  
**C07F 13/00 (2006.01)**
- (86) EP2011001077 04.03.2011  
(96) 11706765.2 16.01.2013  
(87) WO2011110315, 04.03.2011  
(97) 2545064, 16.01.2013 en  
(54) CARBON MONOXIDE RELEASING RHENIUM COMPOUNDS FOR MEDICAL USE
- (71) University of Zürich, Raemistrasse 71, 8006 Zürich, CH  
(72) ZOBİ, Fabio, Himmerriweg 6, CH-8052 Zürich, CH  
ALBERTO, Roger, St. Georgenstrasse 54, CH-8400 Winterthur, CH  
KROMER, Lukas, Unterer Deutweg 49, CH-8400 Winterthur, CH
- 
- (51) MKP  
**A61K 39/395 (2006.01)** (97) **2538976 \***  
**C07K 16/00 (2006.01)**
- (86) US2011026079 24.02.2011  
(96) 11748067.3 02.01.2013  
(87) WO2011106528, 24.02.2011  
(97) 2538976, 02.01.2013 en  
(54) FOLATE RECEPTOR 1 ANTIBODIES AND IMMUNOCONJUGATES AND USES THEREOF
- (71) Immunogen, Inc., 830 Winter Street, Waltham, MA 02451, US  
(72) AB, Olga, 26 Bayberry Circle, Millis Massachusetts 02054, US  
TAVARES, Daniel, 27 Sylvester Road, Natick Massachusetts 01760, US  
RUI, Lingyun, 11 Arrowhead Road, Weston Massachusetts 02493, US  
PAYNE, Gillian, 21 Oakvale Road, Waban Massachusetts 02468, US  
GOLDMAKHER, Viktor S., 74 Pelham Street, Newton Massachusetts 02459, US
- 
- (51) MKP  
**A61K 39/395 (2006.01)** (97) **2563397 \***
- (86) US2011034797 02.05.2011  
(96) 11775704.7 06.03.2013  
(87) WO2011137441, 02.05.2011  
(97) 2563397, 06.03.2013 en  
(54) SPARC BINDING APTAMERS AND USES THEREOF
- (71) Abraxis BioScience, LLC, 11755 Wilshire Boulevard Suite 2000, Los Angeles, CA 90025, US  
Motamed, Kouros, 25 Palatine, Apt. 433, Irvine, California 92612, US  
Dai, Yanshan, 11755 Wilshire Boulevard, Suite 2000, Los Angeles, California 90025, US  
Trieu, Vuong, 3965 North Ceanothus Place, h, Calabasas, California 91302, US  
Desai, Neil, 11755 Wilshire Boulevard, Suite 2000, Los Angeles, California 90025, US  
(72) MOTAMED, Kouros, 25 Palatine, Apt. 433, Irvine, CA 92612, US  
DAI, Yanshan, 11755 Wilshire Boulevard Suite 2000, Los Angeles, CA 90025, US  
TRIEU, Yuong, 3965 North Ceanothus Place, no. h, Calabasas, CA 91302, US  
DESAI, Neil, 11755 Wilshire Boulevard Suite 2000, Los Angeles, CA 90025, US

(51) MKP  
**C22C 38/44 (2006.01)** (97) **2591134 \***  
**C22C 38/58 (2006.01)**  
**C21D 8/02 (2006.01)**  
**C22C 38/42 (2006.01)**  
**C22C 38/00 (2006.01)**  
(86) FR2011000394 05.07.2011  
(96) 11751621.1 15.05.2013  
(87) WO2012004473, 05.07.2011  
(97) 2591134, 15.05.2013 fr  
(54) AUSTENITIC-FERRITIC STAINLESS STEEL HAVING IMPROVED MACHINABILITY  
(71) Arcelormittal Investigación y Desarrollo SL, CL/Chavarrí, 6, 48910 Sestao, Bizkaia, ES  
Ugitech, Avenue Paul Girod, 73000 Ugine, FR  
(72) PEULTIER, Jérôme, 9 rue Saint Georges, F-71300 Autun, FR  
FANICA, Amélie, Les Blignys, F-71390 Cersot, FR  
RENAUDOT, Nicolas, 8 chemin des Galibouds, F-73200 Albertville, FR  
BOURGIN, Christophe, 59 avenue de Tarentaise, F-73200 Albertville, FR  
CHAUVEAU, Eric, Eden Parc 19 avenue Victor Hugo, F-73200 Albertville, FR  
MANTEL, Marc, 458 route de L'araignée, F-73200 Mercury, FR

(51) MKP  
**A61B 17/295 (2006.01)** (97) **2552329 \***  
(86) US2011029560 23.03.2011  
(96) 11713913.9 06.02.2013  
(87) WO2011119685, 23.03.2011  
(97) 2552329, 06.02.2013 en  
(54) SURGICAL CUTTING AND SEALING INSTRUMENT WITH REDUCED FIRING FORCE  
(71) Ethicon Endo-Surgery, Inc., 4545 Creek Road, Cincinnati, OH 45242, US  
(72) HUNT, John, V., 3654 Moorhill Drive, Cincinnati OH 45241, US  
LAIRD, Robert, J., 3407 Gray Fox Trail, Morrow OH 45152, US  
VAKHARIA, Omar, J., 2243 Sussex Avenue, Cincinnati OH 45230, US  
TIMM, Richard, W., 3405 Monteith Avenue, 1, Cincinnati OH 45208, US  
MONSON, Gavin, M., 5966 Reily Millville Road, Oxford OH 45056, US  
THOMPSON, Suzanne, E., 7500 Susan Springs Drive, West Chester OH 45069, US

(51) MKP  
**A23L 1/035 (2006.01)** (97) **2563164 \***  
**A23L 1/302 (2006.01)**  
**A61K 9/107 (2006.01)**  
**A23L 1/30 (2006.01)**  
(86) US2011000538 22.03.2011  
(96) 11713391.8 06.03.2013  
(87) WO2011119228, 22.03.2011  
(97) 2563164, 06.03.2013 en  
(54) NANOEMULSION INCLUDING SUCROSE FATTY ACID ESTER  
(71) VIRUN, INC., 21118 Commerce Pointe Drive, Walnut, CA 91789, US  
(72) BROMLEY, Philip, J., 520 East Wilshire Avenue, Fullerton, CA 92832, US

(51) MKP  
**H02K 21/18 (2006.01)** (97) **2290792**  
**H02K 29/00 (2006.01)**  
**H02K 21/14 (2006.01)**  
(96) 10008281.7 02.03.2011  
(97) 2290792, 02.03.2011 de  
(54) Magnetic turbine  
(71) Kutzke, Arthur, Hainholzstrasse 3, 18435 Stralsund, DE  
Kutzke, Arthur, Hainholzstrasse 3, 18435 Stralsund, DE

(51) MKP  
**C07D 493/04 (2006.01)** (97) **2542555 \***  
(86) JP2010070414 10.11.2010  
(96) 10788151.8 09.01.2013  
(87) WO2011108155, 10.11.2010  
(97) 2542555, 09.01.2013 en  
(54) PROCESS FOR PRODUCING PYRIPYROPENE DERIVATIVES  
(71) Meiji Seika Pharma Co., Ltd., 4-16, Kyobashi 2-chome Chuo-ku, Tokyo 104-8002, JP  
(72) FUKUDA, Yoshimasa, c/o Meiji Seika Pharma Co. 760 Morooka-cho Kohoku-ku, Yokohama-shi Kanagawa 222-8567, JP  
ANDO, Takashi, c/o Meiji Seika Pharma Co. 760 Morooka-cho Kohoku-ku, Yokohama-shi Kanagawa 222-8567, JP  
GOTO, Kimihiko, c/o Meiji Seika Pharma Co. 760 Morooka-cho Kohoku-ku, Yokohama-shi Kanagawa 222-8567, JP  
NAKANISHI, Nozomu, c/o Meiji Seika Pharma Co. 760 Morooka-cho Kohoku-ku, Yokohama-shi Kanagawa 222-8567, JP  
WATANABE, Takashi, c/o Meiji Seika Pharma Co. 760 Morooka-cho Kohoku-ku, Yokohama-shi Kanagawa 222-8567, JP  
KURIHARA, Kenichi, c/o Meiji Seika Pharma Co. 760 Morooka-cho Kohoku-ku, Yokohama-shi Kanagawa 222-8567, JP  
MINOWA, Nobuto, c/o Meiji Seika Pharma Co. 760 Morooka-cho Kohoku-ku, Yokohama-shi Kanagawa 222-8567, JP  
MITOMI, Masaaki, c/o Meiji Seika Pharma Co. 760 Morooka-cho Kohoku-ku, Yokohama-shi Kanagawa 222-8567, JP

(51) MKP  
**H01L 31/00 (2006.01)** (97) **2548243 \***  
**H01M 8/02 (2006.01)**  
**H01M 10/42 (2006.01)**  
**H01M 2/20 (2006.01)**  
**H01G 9/20 (2006.01)**  
(86) US2011027463 08.03.2011  
(96) 11708955.7 23.01.2013  
(87) WO2011115774, 08.03.2011  
(97) 2548243, 23.01.2013 en  
(54) MODULAR INTERCONNECTION SYSTEM  
(71) Electronvault Inc., 17287 Skyline Boulevard Pmb 42, Woodside, CA 940062, US  
(72) FERBER, Robert R. Jr., 245 Allen Road, Woodside CA 94062, US

(51) MKP  
**A61M 5/315 (2006.01)** (97) **2579929 \***  
(86) EP2011059577 09.06.2011  
(96) 11724424.4 17.04.2013  
(87) WO2011154491, 09.06.2011  
(97) 2579929, 17.04.2013 en  
(54) DRIVE MECHANISM FOR A DRUG DELIVERY DEVICE AND DRUG DELIVERY DEVICE  
(71) Sanofi-Aventis Deutschland GmbH, Brüningstraße 50, 65929 Frankfurt, DE  
(72) HILES, John, c/o Sanofi-Aventis Deutschland GmbH, 65926 Frankfurt am Main, DE

(51) MKP  
**A61P 35/00 (2006.01)** (97) **2545038 \***  
**C07D 215/22 (2006.01)**  
**A61K 31/47 (2006.01)**  
(86) US2011028035 11.03.2011  
(96) 11709589.3 16.01.2013  
(87) WO2011112896, 11.03.2011  
(97) 2545038, 16.01.2013 en  
(54) HYDRATED CRYSTALLINE FORMS OF N-[3-FLUORO-4-((6-(METHYLOXY)-7-[(3-MORPHOLIN-4-YLPROPYL)OXY]-QUINOLIN-4-YL)OXY)PHENYL]-N'-(4-FLUOROPHENYL)CYCLOPROPANE-1,1-DICARBOXAMIDE  
(71) Exelixis, Inc., 210 East Grand Avenue, South San Francisco, CA 94080, US  
(72) CANNON, Hilary, 7 Larch Avenue St Ippolyts, Hitchin Hertfordshire SG4 7SL, GB  
KANG, Feirong, 210 East Grand Ave., South San Francisco CA 94083-0511, US  
VOGT, Frederick, G., 210 East Grand Ave., South San Francisco CA 94083-0511, US

- (51) MKP  
**A47C 1/024 (2006.01)** (97) **2555733 \***  
**A47C 1/029 (2006.01)**  
**A61G 5/14 (2006.01)**
- (86) GB2010001541 12.08.2010  
(96) 10749482.5 13.02.2013  
(87) WO2011124871, 12.08.2010  
(97) 2555733, 13.02.2013 en  
(54) SELF LOCKING MODULAR ARTICULATED FRAME  
(71) CORCOST LIMITED, 22 Great Close, Cawood, North Yorkshire YO8 3UG, GB  
(72) CORCORAN, Steven, 22 Great Close Cawood, Selby North Yorkshire YO8 3UG, GB
- 
- (51) MKP  
**B65G 57/18 (2006.01)** (97) **2581332**
- (96) 11184862.8 17.04.2013  
(97) 2581332, 17.04.2013 en  
(54) Procedure and mobile device for stacking wooden logs onto a pallet with raised sides  
(71) Winkl, Peter, Feistritz 10, 9143 St. Michael ob Bleiburg, AT Siegel, Rudolf, Maitratten 21, 9563 Gnesau, AT  
(72) Winkl, Peter, Feistritz 10, 9143 St. Michael ob Bleiburg, AT Siegel, Rudolf, Maitratten 21, 9563 Gnesau, AT
- 
- (51) MKP  
**C07D 261/18 (2006.01)** (97) **2539323 \***  
**A61K 31/506 (2006.01)**  
**C07D 213/81 (2006.01)**  
**A61K 31/165 (2006.01)**  
**C07D 239/28 (2006.01)**  
**A61K 31/505 (2006.01)**  
**C07D 271/10 (2006.01)**  
**C07D 401/12 (2006.01)**  
**C07D 239/557 (2006.01)**  
**C07D 405/12 (2006.01)**  
**C07D 211/62 (2006.01)**  
**C07C 237/24 (2006.01)**  
**C07D 207/277 (2006.01)**  
**C07D 233/90 (2006.01)**  
**A61K 31/44 (2006.01)**
- (86) EP2011052512 21.02.2011  
(96) 11705858.6 02.01.2013  
(87) WO2011104203, 21.02.2011  
(97) 2539323, 02.01.2013 de  
(54) COMPOUNDS AS BRADYKININ B1 ANTAGONISTS  
(71) Boehringer Ingelheim International GmbH, Binger Strasse 173, 55216 Ingelheim am Rhein, DE  
(72) HAUDEL, Norbert, Boehringer Ingelheim GmbH Corporate Patents Binger Strasse 173, 55216 Ingelheim am Rhein, DE  
CECI, Angelo, Boehringer Ingelheim GmbH Corporate Patents Binger Strasse 173, 55216 Ingelheim am Rhein, DE  
DOODS, Henri, Boehringer Ingelheim GmbH Corporate Patents Binger Strasse 173, 55216 Ingelheim am Rhein, DE  
KONETZKI, Ingo, Boehringer Ingelheim GmbH Corporate Patents Binger Strasse 173, 55216 Ingelheim am Rhein, DE  
MACK, Juergen, Boehringer Ingelheim GmbH Corporate Patents Binger Strasse 173, 55216 Ingelheim am Rhein, DE  
PRIEPKE, Henning, Boehringer Ingelheim GmbH Corporate Patents Binger Strasse 173, 55216 Ingelheim am Rhein, DE  
SCHULER-METZ, Annette, Boehringer Ingelheim GmbH Corporate Patents Binger Strasse 173, 55216 Ingelheim am Rhein, DE  
WALTER, Rainer, Boehringer Ingelheim GmbH Corporate Patents Binger Strasse 173, 55216 Ingelheim am Rhein, DE  
WIEDENMAYER, Dieter, Boehringer Ingelheim GmbH Corporate Patents Binger Strasse 173, 55216 Ingelheim am Rhein, DE
- 
- (51) MKP  
**A01N 35/00 (2006.01)** (97) **2542058 \***
- (86) US2011026310 25.02.2011  
(96) 11751116.2 09.01.2013  
(87) WO2011109248, 25.02.2011  
(97) 2542058, 09.01.2013 en  
(54) EFFECTIVE SENSITIZING DOSE OF A GELLED IMMUNOMODULATING TOPICAL COMPOSITION  
(71) Hapten Pharmaceuticals, LLC, 20 Nassau St. Suite 210, Princeton, NJ 08542, US  
(72) LEVIS, William, R., 151 West 17th Street, New York NJ 10011, US  
KAPLAN, Leonard, L., 1 Minute Man Court, East Brunswick NJ 08816, US  
CALLAHAN, John, G., 212 Quakerbridge Court, Moorestown NJ 08057, US
- 
- (51) MKP  
**A61K 31/337 (2006.01)** (97) **2575774 \***  
**A61K 31/16 (2006.01)**  
**A61K 31/7068 (2006.01)**  
**A61K 9/14 (2006.01)**  
**A61P 35/00 (2006.01)**  
**A61K 47/42 (2006.01)**
- (86) US2011037450 20.05.2011  
(96) 11792867.1 10.04.2013  
(87) WO2011156119, 20.05.2011  
(97) 2575774, 10.04.2013 en  
(54) COMBINATION THERAPY METHODS FOR TREATING PROLIFERATIVE DISEASES  
(71) Abraxis BioScience, LLC, 11755 Wilshire Boulevard Suite 2100, Los Angeles, CA 90025, US  
(72) DESAI, Neil, P., 11755 Wilshire Boulevard Suite 2100, Los Angeles, CA 90025, US  
SOON-SHIONG, Patrick, 149 South Barrington Avenue 311, Los Angeles, CA 90049, US
- 
- (51) MKP  
**A61M 5/24 (2006.01)** (97) **2560709 \***  
**A61M 5/31 (2006.01)**  
**A61M 5/315 (2006.01)**  
**A61M 5/00 (2006.01)**
- (86) EP2011056473 21.04.2011  
(96) 11717237.9 27.02.2013  
(87) WO2011131776, 21.04.2011  
(97) 2560709, 27.02.2013 en  
(54) CARTRIDGE ASSEMBLY HAVING SHARED FASTENING MEANS AND DRUG DELIVERY DEVICE  
(71) Sanofi-Aventis Deutschland GmbH, Brüningstraße 50, 65929 Frankfurt, DE  
(72) OSMAN, Thomas, Frederick, 30 Willes Road, Leamington Spa Warwickshire CV31 1, GB  
AVERY, Richard, James, Vincent, 28 Nursery Close Mickleton, Chipping Campden Gloucestershire GL55 6TX, GB  
BUTLER, Joseph, 6 Hadfield Close Clifton, Rugby Warwickshire CV23 0DL, GB  
JAMES, Aled, Meredydd, 5 Moorefield Avenue, Knowle West Midlands B93 9RE, GB
- 
- (51) MKP  
**A61K 9/16 (2006.01)** (97) **2497464**  
**A61K 9/48 (2006.01)**  
**A61K 31/506 (2006.01)**
- (96) 12156117.9 12.09.2012  
(97) 2497464, 12.09.2012 en  
(54) Pharmaceutical composition of imatinibe methanesulphonate and a process for its manufacture  
(71) Adamed SP. Z O.O., Pienków 149, 05-152 Czosnow k/ Warszawy, PL  
(72) Ilczuk, Jerzy Adam, Aleja Armii Krajowej 32/25, 05-200 Wolomin, PL  
Komsta-Leszczczyk, Izabela Sylwia, ul. Taldykina 8/3, 78-301 Swidwin, PL
-

(51) MKP  
**A61K 31/4965 (2006.01)** (97) **2560653 \***  
 (86) US2011033614 22.04.2011  
 (96) 11772782.6 27.02.2013  
 (87) WO2011133888, 22.04.2011  
 (97) 2560653, 27.02.2013 en  
 (54) CERTAIN AMINO-PYRIMIDINES, COMPOSITIONS THEREOF, AND METHODS FOR THEIR USE  
 (71) Cytokinetics, Inc., 280 East Grand Avenue, South San Francisco, CA 94080, US  
 (72) YANG, Zhe, c/o Cytokinetics, Inc. 280 East Grand Avenue South San Francisco, CA 94080, US  
 MUCI, Alex R., c/o Cytokinetics, Inc. 280 East Grand Avenue South San Francisco, CA 94080, US  
 WARRINGTON, Jeffrey, 1936 Playa Street, San Mateo, California 94403, US  
 BERGNES, Gustave, c/o Cytokinetics, Inc. 280 East Grand Avenue South San Francisco, CA 94080, US  
 MORGAN, Bradley P., c/o Cytokinetics, Inc. 280 East Grand Avenue South San Francisco, CA 94080, US  
 CHUANG, Chihyuan, c/o Cytokinetics, Inc. 280 East Grand Avenue South San Francisco, CA 94080, US  
 ROMERO, Antonio, 1309 Newbridge Avenue, San Mateo, California 94401, US  
 COLLIBEE, Scott, c/o Cytokinetics, Inc. 280 East Grand Avenue South San Francisco, CA 94080, US  
 QIAN, Xiangping, c/o Cytokinetics, Inc. 280 East Grand Avenue South San Francisco, CA 94080, US  
 LU, Pu-Ping, c/o Cytokinetics, Inc. 280 East Grand Avenue South San Francisco, CA 94080, US

(51) MKP  
**A61K 39/00 (2006.01)** (97) **2575867 \***  
 (86) EP2011002747 03.06.2011  
 (96) 11723884.0 10.04.2013  
 (87) WO2011151078, 03.06.2011  
 (97) 2575867, 10.04.2013 en  
 (54) NOVEL INTERFERON-ALPHA-PRODUCING BONE MARROW DENDRITIC CELLS  
 (71) Bavarian Nordic A/S, Hejreskovvej 10A, 3490 Kvistgaard, DK  
 (72) O'KEEFFE, Meredith, 10 Hudson Grove, Melbourne, VIC 3055, AU  
 HOCHREIN, Hubertus, Haffstrasse 134, 81825 Munich, DE

(51) MKP  
**H04L 9/06 (2006.01)** (97) **2545674 \***  
**H04L 29/06 (2006.01)**  
 (86) US2011027821 10.03.2011  
 (96) 11754044.3 16.01.2013  
 (87) WO2011112767, 10.03.2011  
 (97) 2545674, 16.01.2013 en  
 (54) ONE VAULT VOICE ENCRYPTION  
 (71) SRA International, Inc., 4350 Fair Lakes Court, Fairfax, VA 22033, US  
 (72) GRAHAM, Andrew, 617 W. State Street, North Aurora IL 60542, US  
 KOPEC, Michael, 133 Inland Road, Warminster PA 18974, US

(51) MKP  
**C07K 14/605 (2006.01)** (97) **2585482 \***  
**A61P 5/48 (2006.01)**  
**A61K 38/26 (2006.01)**  
 (86) DK2011000072 24.06.2011  
 (96) 11741514.1 01.05.2013  
 (87) WO2011160633, 24.06.2011  
 (97) 2585482, 01.05.2013 en  
 (54) GLUCAGON ANALOGUES  
 (71) Zealand Pharma A/S, Smedeland 36, 2600 Glostrup, DK  
 (72) RIBER, Ditte, Degnemose Allé 64, DK-2700 Brønshøj, DK  
 MEIER, Eddi, Bringebakken 88, DK-3500 Værløse, DK

(51) MKP  
**A61K 39/085 (2006.01)** (97) **2566507 \***  
 (86) EP2011057111 04.05.2011  
 (96) 11724567.0 13.03.2013  
 (87) WO2011138361, 04.05.2011  
 (97) 2566507, 13.03.2013 en  
 (54) CAPSULAR GRAM-POSITIVE BACTERIA BIOCONJUGATE VACCINES  
 (71) Glycovaxyn AG, Grabenstrasse 3, 8952 Schlieren, CH  
 (72) WACKER, Michael, Dahlienstrasse 17, CH-8103 Unterengstringen, CH  
 KOWARIK, Michael, Goldbrunnenstrasse 57, CH-8055 Zurich, CH  
 WETTER, Michael, Fellenbergstrasse 277, CH-8047 Zurich, CH

(51) MKP  
**A01N 43/42 (2006.01)** (97) **2575463 \***  
**A61K 31/44 (2006.01)**  
**A01N 43/38 (2006.01)**  
**A01N 43/40 (2006.01)**  
 (86) US2011037849 25.05.2011  
 (96) 11787299.4 10.04.2013  
 (87) WO2011150016, 25.05.2011  
 (97) 2575463, 10.04.2013 en  
 (54) APOPTOSIS-INDUCING AGENTS FOR THE TREATMENT OF CANCER AND IMMUNE AND AUTOIMMUNE DISEASES  
 (71) Abbvie Inc., 1 North Waukegan Road, North Chicago, IL 60064, US  
 (72) TAO, Zhi-Fu, 1532 Vineyard Drive, Gurnee, Illinois 60031, US  
 WANG, Xilu, 34056 Sulkey Drive, Grayslake, Illinois 60030, US  
 SOUERS, Andrew, J., 901 Hinman Apt. 3A, Evanston, Illinois 60202, US  
 CATRON, Nathaniel, D., 305 Lakeside Drive, Vernon Hills, Illinois 60061, US  
 SULLIVAN, Gerard, 1212 Tulip Tree Court, Lake Villa, Illinois 60046, US

(51) MKP  
**A61B 17/072 (2006.01)** (97) **2547267 \***  
 (86) US2011027504 08.03.2011  
 (96) 11710934.8 23.01.2013  
 (87) WO2011115780, 08.03.2011  
 (97) 2547267, 23.01.2013 en  
 (54) STAPLE CARTIDGE  
 (71) Ethicon Endo-Surgery, Inc., 4545 Creek Road, Cincinnati, OH 45242, US  
 (72) BEDI, James, J., 7567 Fawnmeadow Lane, Cincinnati OH 45241, US

(51) MKP  
**A23G 4/06 (2006.01)** (97) **2560501 \***  
 (86) EP2011056127 18.04.2011  
 (96) 11718962.1 27.02.2013  
 (87) WO2011131618, 18.04.2011  
 (97) 2560501, 27.02.2013 en  
 (54) SLOW-RELEASE DIETARY FORMULATIONS  
 (71) Perfetti Van Melle S.p.A., Via XXV Aprile, 7, 20020 Lainate (Milano), IT  
 (72) COLLE, Roberto, c/o PERFETTI VAN MELLE S.P.A. Via XXV Aprile 7, I-20020 Lainate (MI), IT  
 DELEO, Maurizio, c/o PERFETTI VAN MELLE S.P.A. Via XXV Aprile 7, I-20020 Lainate (MI), IT  
 SALMOIRAGHI, Guglielmo, c/o PERFETTI VAN MELLE S.P.A. Via XXV Aprile 7, I-20020 Lainate (MI), IT  
 WALZL, Martin, c/o PERFETTI VAN MELLE S.P.A. Via XXV Aprile 7, I-20020 Lainate (MI), IT

- (51) MKP  
**A61P 35/00 (2006.01)** (97) **2582689 \***  
**A61K 31/505 (2006.01)**  
**C07D 401/04 (2006.01)**  
(86) EP2011003025 17.06.2011  
(96) 11726356.6 24.04.2013  
(87) WO2011157450, 17.06.2011  
(97) 2582689, 24.04.2013 en  
(54) NEW POLYMORPHIC FORM OF IMATINIB BASE AND PREPARATION OF SALTS THEREOF  
(71) KRKA, D.D., Novo Mesto, Smarjeska cesta 6, 8501 Novo mesto, SI  
(72) BENKIC, Primoz, Masera-Spasicева ulica 7, 1000 Ljubljana, SI  
TIHI, Jaroslav, Ulica Slavka Gruma 36, 8000 Novo mesto, SI  
PECAVAR Anica, Gotna vas 18, 8000 Novo mesto, SI  
GERMAN Tamara, Seidlova 64, 8000 Novo mesto, SI  
VRECER Franc, Potok 5b, 8351 Straza pri Novem mestu, SI  
VAJS Anamarija, Ulica Pie in Pina Mlakarja 22, 8000 Novo mesto, SI  
**SKRABANJA Vida, Zupnca 4b, 8000 Novo mesto, SI**

- (51) MKP  
**A61P 19/02 (2006.01)** (97) **2582391 \***  
**A61P 19/00 (2006.01)**  
**A61K 39/395 (2006.01)**  
**A61P 29/00 (2006.01)**  
(86) US2011040819 17.06.2011  
(96) 11796483.3 24.04.2013  
(87) WO2011159976, 17.06.2011  
(97) 2582391, 24.04.2013 en  
(54) ARTHRITIS TREATMENT  
(71) XBiotech, Inc, 1055 West Hastings Street, Suite 300, Vancouver, British Columbia V6E 2E9, CA  
(72) SIMARD, John, 8201 East Riverside Drive Bldg. 4, Suite 100, Austin, TX 78744, US

- (51) MKP  
**A61K 39/02 (2006.01)** (97) **2588137 \***  
**A61K 39/385 (2006.01)**  
**C07K 14/245 (2006.01)**  
(86) EP2011060839 28.06.2011  
(96) 11727505.7 08.05.2013  
(87) WO2012001004, 28.06.2011  
(97) 2588137, 08.05.2013 en  
(54) FIMH VACCINE AGAINST URINARY TRACT INFECTIONS (UTI)  
(71) Sigma-Tau Industrie Farmaceutiche Riunite S.P.A., Viale Shakespeare 47, 00144 Rome, IT  
(72) DE SANTIS, Rita, Via Casa Serena 56, I-00040 Pomezia (RM), IT  
**MINENKOVA, Olga, Via Fontana delle Cannetacce 13, I-00040 Montecompati (RM), IT**

- (51) MKP  
**C12N 5/10 (2006.01)** (97) **2581442 \***  
**C12N 5/078 (2010.01)**  
**A61K 31/122 (2006.01)**  
**C12N 5/071 (2010.01)**  
**A61P 43/00 (2006.01)**  
(86) JP2011063537 13.06.2011  
(96) 11795711.8 17.04.2013  
(87) WO2011158806, 13.06.2011  
(97) 2581442, 17.04.2013 en  
(54) PROCESS FOR PRODUCTION OF HEMATOPOIETIC STEM CELL  
(71) Nissan Chemical Industries, Ltd., 7-1 Kanda-Nishiki-cho 3-chome, Chiyoda-ku Tokyo 101-0054, JP  
National University Corporation Chiba University, 1-33, Yayoi-cho Inage-ku, Chiba-shi Chiba 263-8522, JP  
(72) NISHINO, Taito, c/o Nissan Chemical Industries Ltd. 7-1 Kanda-Nishiki-cho 3-chome Chiyoda-ku, Tokyo 101-0054, JP  
IWAMA, Atsushi, c/o Graduate School of Medicine National University Corporation Chiba University 8-1 Inohana 1-chome Chuo-ku, Chiba-shi Chiba 260-8670, JP

- (51) MKP  
**C12N 15/64 (2006.01)** (97) **2558580 \***  
(86) EP2011001884 14.04.2011  
(96) 11719763.2 20.02.2013  
(87) WO2011107299, 14.04.2011  
(97) 2558580, 20.02.2013 en  
(54) METHOD FOR THE MANUFACTURE OF RECOMBINANT DSPA ALPHA1  
(71) H. Lundbeck A/S, Ottiliavej 9, 2500 Valby-Copenhagen, DK  
(72) KOPS, Oliver, Meisenweg 15, 52078 Aachen, DE  
LESCHIK, Damian, Danziger Str. 48, 42897 Remscheid, DE  
SCHÜTTLER, Achim, Am Blockhaus 20, 52074 Aachen, DE  
SEMBRIES, Sabine, Rückertstrasse 4, 10627 Berlin, DE  
PUNGOR, Erno, 250 Castenada Drive, Milbrae CA 94030, US  
McCAMAN, Michael, 506 Hillock Place, Encinitas CA 92024, US  
GROB, Thilo, Erwin-Rentschler-Strasse 21, 88471 Laupheim, DE  
KOHNE, Frank, Erwin-Rentschler-Strasse 21, 88471 Laupheim, DE  
MEIJER, Jeroen, Paasheuvelweg 30, 1105 BJ Amsterdam, NL  
**NIESSEN, Jos, Paasheuvelweg 30, 1105 BJ Amsterdam, NL**

- (51) MKP  
**A61K 31/44 (2006.01)** (97) **2560489 \***  
**A01N 43/42 (2006.01)**  
(86) US2010031953 21.04.2010  
(96) 10850371.5 27.02.2013  
(87) WO2011133149, 21.04.2010  
(97) 2560489, 27.02.2013 en  
(54) COMPOSITIONS COMPRISING ENZYME-CLEAVABLE OPIOID PRODRUGS AND INHIBITORS THEREOF  
(71) Signature Therapeutics, Inc., 75 Shoreway Road, Suite D, San Carlos, CA 94070, US  
(72) JENKINS, Thomas, E., 75 Shoreway Road Suite D., San Carlos, CA 94070, US  
HUSFELD, Craig, O., 75 Shoreway Road Suite D., San Carlos, CA 94070, US  
SEROOGY, Julie, D., 75 Shoreway Road Suite D., San Carlos, CA 94070, US  
WRAY, Jonathan, W., 75 Shoreway Road Suite D., San Carlos, CA 94070, US

- (51) MKP  
**C07D 277/00 (2006.01)** (97) **2576524 \***  
(86) US2011037752 24.05.2011  
(96) 11787250.7 10.04.2013  
(87) WO2011149945, 24.05.2011  
(97) 2576524, 10.04.2013 en  
(54) USE OF METFORMIN IN COMBINATION WITH A GLUCOKINASE ACTIVATOR AND COMPOSITIONS COMPRISING METFORMIN AND A GLUCOKINASE ACTIVATOR  
(71) TransTech Pharma, Inc, 4170 Mendenhall Oaks Parkway, High Point, North Carolina 27265, US  
(72) MJALLI, Adnan M.M., 6421 Ashton Park Drive, Oak Ridge, North Carolina 27310, US  
**VALCARCE-LÓPEZ, Maria Carmen, 1785 Deer Run Court, Oak Ridge, North Carolina 27310, US**

- (51) MKP  
**A61K 38/19 (2006.01)** (97) **2582385 \***  
**C07K 7/64 (2006.01)**  
**C07K 14/525 (2006.01)**  
(86) EP2010006408 20.10.2010  
(96) 10771018.8 24.04.2013  
(87) WO2011160664, 20.10.2010  
(97) 2582385, 24.04.2013 en  
(54) TREATMENT OF VASCULAR COMPLICATIONS OF DIABETES  
(71) Apeptico Forschung und Entwicklung GmbH, Mariahilferstrasse 136, 1150 Wien, AT  
(72) FISCHER, Bernhard, Wilhelminenstrasse 95/C/17, A-1160 Wien, AT  
LUCAS, Rudolf, Frits van den Berghelaan 83, B-2630 Aartselaar, BE



(51) MKP  
**C07F 3/02 (2006.01)** (97) **2547687 \***  
**C07D 405/06 (2006.01)**  
**C07F 3/00 (2006.01)**  
(86) EP2011053865 15.03.2011  
(96) 11708836.9 23.01.2013  
(87) WO2011113820, 15.03.2011  
(97) 2547687, 23.01.2013 en  
(54) A PROCESS USING GRIGNARD REAGENTS  
(71) BASF SE, null, 67056 Ludwigshafen, DE  
(72) DOCHNAHL, Maximilian, Bassermannstr. 35, 68165 Mannheim, DE  
KEIL, Michael, Fontanestr.4, 67251 Freinsheim, DE  
GEBHARDT, Joachim, Pegauer Str. 51, 67157 Wachenheim, DE  
VOGELBACHER, Uwe Josef, Rheinecke 22, 67071 Ludwigshafen, DE  
MENGES, Frederik, Uzering 53, 69198 Schriesheim, DE  
RACK, Michael, Hildastr. 11/1, 69214 Eppelheim, DE  
RENNER, Jens, Balthasar-Neumann-Str. 17, 67246 Dirmstein, DE  
WOLF, Bernd, Halbergstr. 4, 67136 Fußgönheim, DE

---

(51) MKP  
**G01V 1/16 (2006.01)** (97) **2567260 \***  
**G01V 1/38 (2006.01)**  
(86) NO2011000147 06.05.2011  
(96) 11777623.7 13.03.2013  
(87) WO2011139159, 06.05.2011  
(97) 2567260, 13.03.2013 en  
(54) OCEAN BOTTOM SEISMIC CABLE RECORDING APPARATUS  
(71) Magseis AS, Gaustadalallén 21, 0349 Oslo, NO  
(72) GATEMAN, Jan, Bjerkelundsveien 104a, N-1357 Bekkestua, NO  
GIMSE, Ivar, Midtåsen 28, N-1166 Oslo, NO

---

(51) MKP  
**C07K 16/32 (2006.01)** (97) **2575880 \***  
**A61P 35/00 (2006.01)**  
**A61K 39/395 (2006.01)**  
(86) EP2011058772 27.05.2011  
(96) 11723427.8 10.04.2013  
(87) WO2011147982, 27.05.2011  
(97) 2575880, 10.04.2013 en  
(54) MONOCLONAL ANTIBODIES AGAINST HER2 EPITOPE  
(71) Genmab A/S, Bredgade 34 E, 1260 Copenhagen K, DK  
(72) GOEIJ, Bart de, Yalelaan 60, NL-3584 CM Utrecht, NL  
BRINK, Edward N. van den, Yalelaan 60, NL-3584 CM Utrecht, NL  
HAIJ, Simone, Yalelaan 60, NL-3584 CM Utrecht, NL  
RIEDL, Thilo, Yalelaan 60, NL-3584 CM Utrecht, NL  
HOET, René, Van Speyk 126, NL-5831 LG Boxmeer, NL  
BAADSGAARD, Ole, Tuborg Sundpark 10 1.tv., DK-2900 Hellerup, DK  
SATIJN, David, Yalelaan 60, NL-3584 CM Utrecht, NL  
WINKEL, Jan van de, Yalelaan 60, NL-3584 CM Utrecht, NL  
PARREN, Paul, Yalelaan 60, NL-3584 CM Utrecht, NL

---

(51) MKP  
**A01N 33/26 (2006.01)** (97) **2563117 \***  
(86) US2011033905 26.04.2011  
(96) 11775497.8 06.03.2013  
(87) WO2011137103, 26.04.2011  
(97) 2563117, 06.03.2013 en  
(54) FORMULATIONS AND USES OF 2-HYDROXY-5-PHENYLAZOBENZOIC ACID DERIVATIVES FOR THE TREATMENT OF MALES  
(71) Salix Pharmaceuticals, Ltd., 8510 Colonnade Center Drive, Raleigh, NC 27615, US  
(72) FORBES, William, 1008 Heydon Court, Raleigh, NC 27614, US  
BORTEY, Enoch, 225 Ocoee Falls Drive, Chapel Hill, NC 27517, US  
JOHNSON, Lorin, 195-A Bryant Street, Palo Alto, CA 94301, US

(51) MKP  
**A61F 13/02 (2006.01)** (97) **2491905**  
(96) 12157257.2 29.08.2012  
(97) 2491905, 29.08.2012 en  
(54) Adhesive Bandage  
(71) Johnson & Johnson Consumer Companies Inc., Grandview Road, Skillman, NJ 08558, US  
(72) Chan, Jennifer Wing-Yee, 1123 Rhoads Drive, Belle Mead, NJ New Jersey 08502, US  
Eknoian, Michael W., 10 Ellsworth Drive, Warren, NJ New Jersey 07059, US  
Reddy, Megha, 1304 Wessex Place, Princeton, NJ New Jersey 08540, US  
Rizzo, Carmine Michael, 234 Birchwood Drive, Cliffwood Beach, NJ New Jersey 07735, US  
Petersack, Vincent John, 3 Carriage Drive, Eastampton, NJ New Jersey 08060, US

---

(51) MKP  
**F21S 8/02 (2006.01)** (97) **2416060**  
**F21V 21/22 (2006.01)**  
(96) 11006335.1 08.02.2012  
(97) 2416060, 08.02.2012 en  
(54) Modular lighting apparatus  
(71) Palazzoli S.p.A., Via Palazzoli, 31, 25128 Brescia, IT  
(72) Alfano, Franco, Via Gerolamo da Cremona 65, 26100 Cremona, IT

---

(51) MKP  
**A61P 3/10 (2006.01)** (97) **2575856 \***  
**A61K 38/16 (2006.01)**  
**A61K 38/10 (2006.01)**  
**A61K 38/08 (2006.01)**  
**A61K 39/395 (2006.01)**  
**A61P 35/00 (2006.01)**  
**A61P 29/00 (2006.01)**  
(86) US2011038240 26.05.2011  
(96) 11787458.6 10.04.2013  
(87) WO2011150279, 26.05.2011  
(97) 2575856, 10.04.2013 en  
(54) INNOVATIVE DISCOVERY OF THERAPEUTIC, DIAGNOSTIC, AND ANTIBODY COMPOSITIONS RELATED TO PROTEIN FRAGMENTS OF GLUTAMINYL-TRNA SYNTHETASES  
(71) aTyr Pharma, Inc., 3545 John Hopkins Court, Suite 250, San Diego, CA 92121, US  
Pangu Biopharma Limited, Edinburgh Tower, 18/F The Landmark 15 Queen's Road Central, Hong Kong, CN  
GREENE, Leslie, Ann, 13941 Davenport Avenue, San Diego California 92129, US  
CHIANG, Kyle, P., 1615 Debann Road, Cardiff, CA 92007, US  
HONG, Fei, 12646 Spindletop Road, San Diego California 92129, US  
VASSEROT, Alain, P., 6421 La Paloma Street, Carlsbad California 92009, US  
LO, Wing-Sze, RM 815 Sui Ming House Siu Sai Wan Estate Chai Wan, Hong Kong, CN  
WATKINS, Jeffrey, D., 3442 Fortuna Ranch Road, Encinitas California 92024, US  
QUINN, Cheryl, L., 408 North 1st street No. 706, Minneapolis, MN 55401, US  
MENDLEIN, John, D., 1550 Neptune Avenue, Encinitas California 92024, US

- (51) MKP  
**G06F 19/18 (2011.01)** (97) **2582847 \***  
**C12N 15/11 (2006.01)**  
**C12Q 1/68 (2006.01)**  
**C12N 5/09 (2010.01)**
- (86) US2011040953 17.06.2011  
(96) 11796544.2 24.04.2013  
(87) WO2011160063, 17.06.2011  
(97) 2582847, 24.04.2013 en  
(54) METHODS AND MATERIALS FOR ASSESSING LOSS OF HETEROZYGOSITY
- (71) Myriad Genetics, Inc., 320 Wakara Way, Salt Lake City, UT 84108, US  
Abkevich, Victor, 320 Wakara Way, Salt Lake City, Utah 84108, US  
Gutin, Alexander, 320 Wakara Way, Salt Lake City, Utah 84108, US  
Timms, Kirsten, 320 Wakara Way Salt Lake City, Salt Lake City, Utah 84108, US  
Lanchbury, Jerry, 320 Wakara Way, Salt Lake City, UT 84108, US
- (72) ABKEVICH, Victor, 320 Wakara Way , Salt Lake City, UT 84108, US  
GUTIN, Alexander, 320 Wakara Way , Salt Lake City, UT 84108, US  
TIMMS, Kirsten, 320 Wakara Way , Salt Lake City, UT 84108, US  
LANCHBURY, Jerry, 320 Wakara Way , Salt Lake City, UT 84108. US
- 
- (51) MKP  
**A61K 31/724 (2006.01)** (97) **2575892 \***  
**A61K 9/00 (2006.01)**  
**A61K 47/40 (2006.01)**  
**A61K 47/48 (2006.01)**  
**A61K 47/12 (2006.01)**
- (86) NL2011050366 26.05.2011  
(96) 11723744.6 10.04.2013  
(87) WO2011149349, 26.05.2011  
(97) 2575892, 10.04.2013 en  
(54) 2-IMINOBIOTIN FORMULATIONS AND USES THEREOF
- (71) Neurophyxia B.V., , Onderwijsboulevard 219, 5223 DE 's-Hertogenbosch, NL
- (72) LEUFKENS, Paul Willem Theresia Josef, c/o Neurophyxia B.V. Onderwijsboulevard 219. NL-5223 DE 's-Hertogenbosch. NL
- 
- (51) MKP  
**C11D 3/00 (2006.01)** (97) **2569406 \***
- (86) US2011036503 13.05.2011  
(96) 11781371.7 20.03.2013  
(87) WO2011143602, 13.05.2011  
(97) 2569406, 20.03.2013 en  
(54) POLYMER-CONTAINING CLEANING COMPOSITIONS AND METHODS OF PRODUCTION AND USE THEREOF
- (71) The Sun Products Corporation, 60 Danbury Road, Wilton, CT 06897, US
- (72) NEKMARD, Farid, 25 Route 46 West, Lodi, New Jersey 07644, US  
KOMESVARAKUL, Napaporn, 78 Shelton Avenue, Shelton, Connecticut 06484, US  
VARGABARAGH, Orsolya, 36 Meadow Lake Drive, Shelton, Connecticut 06484, US  
SUN, Guanglin, 513 Woodside Lane, Branchburg, New Jersey 08876. US
- 
- (51) MKP  
**E04C 2/54 (2006.01)** (97) **2580406 \***  
**B28B 23/00 (2006.01)**  
**E04C 2/06 (2006.01)**
- (86) EP2011059591 09.06.2011  
(96) 11730596.1 17.04.2013  
(87) WO2011154498, 09.06.2011  
(97) 2580406, 17.04.2013 en  
(54) COMPOSITE PANEL BASED ON CEMENTITIOUS MORTAR WITH PROPERTIES OF TRANSPARENCY
- (71) ITALCEMENTI S.p.A., Via G. Camozzi, 124, 24121 Bergamo, IT
- (72) CANGIANO, Stefano, Via A. Moro 73, I-24060 Torre de Roveri, IT  
CARMINATI, Aronne, Via Europa 16, I-24030 Medolago, IT
- 
- (51) MKP  
**A61K 31/33 (2006.01)** (97) **2544679 \***
- (86) US2011027927 10.03.2011  
(96) 11754087.2 16.01.2013  
(87) WO2011112828, 10.03.2011  
(97) 2544679, 16.01.2013 en  
(54) PDE10 INHIBITORS AND RELATED COMPOSITIONS AND METHODS
- (71) Omeros Corporation, 1420 Fifth Avenue, Suite 2600, Seattle, WA 98101, US
- (72) CUTSHALL, Neil, S., 3817 165th Avenue SE, Snohomish Washington 98290, US  
GAGE, Jennifer, Lynn., 15318 62nd Place NE, Kenmore Washington 98028, US  
WHEELER, Thomas, Neil., 8605 Wood Lawn Drive, Raleigh North Carolina 27613, US  
LITTLE, Thomas, L., 18619 NE 100th Court, Redmond Washington 98052. US
- 
- (51) MKP  
**A23K 1/18 (2006.01)** (97) **2557941 \***  
**A23K 1/16 (2006.01)**  
**A61P 1/14 (2006.01)**  
**A61P 1/04 (2006.01)**  
**A61P 1/12 (2006.01)**  
**A61P 33/00 (2006.01)**
- (86) AT2011000148 24.03.2011  
(96) 11714211.7 20.02.2013  
(87) WO2011127496, 24.03.2011  
(97) 2557941, 20.02.2013 de  
(54) ANIMAL FEED ADDITIVE HAVING AN ANTIMICROBIAL AND GROWTH-PROMOTING EFFECT
- (71) Neufeld, Klaus, Sattelbach 13, 2532 Heiligenkreuz, AT
- (72) Neufeld, Klaus, Sattelbach 13, 2532 Heiligenkreuz, AT
- 
- (51) MKP  
**F22B 1/00 (2006.01)** (97) **2574199 \***  
**F01K 25/00 (2006.01)**
- (86) US2011034986 03.05.2011  
(96) 11719947.1 03.04.2013  
(87) WO2011140080, 03.05.2011  
(97) 2574199, 03.04.2013 en  
(54) METHOD FOR REUTILIZING CO2 FROM COMBUSTED CARBONACEOUS MATERIAL
- (71) Powerdyne, Inc., 4740 Von Karman Avenue Suite 300, Newport Beach, California 92660, US
- (72) HIRSON, Geoffrey, 208 Grand Canal, Newport Beach California 92662, US  
SHOUSE, Gus F., 2525 Ocean Boulevard Suite H1 Corona Del Mar, California 92625, US
- 
- (51) MKP  
**A61P 9/00 (2006.01)** (97) **2588454 \***  
**A61K 31/44 (2006.01)**  
**C07D 213/85 (2006.01)**
- (86) EP2011060735 27.06.2011  
(96) 11737909.9 08.05.2013  
(87) WO2012000945, 27.06.2011  
(97) 2588454, 08.05.2013 de  
(54) SUBSTITUTED DICYANOPYRIDINES AND USE THEREOF
- (71) Bayer Intellectual Property GmbH, Alfred-Nobel-Strasse 10, 40789 Monheim, DE
- (72) VAKALOPOULOS, Alexandros, Heinrich-Heine-Str. 79a, 40721 Hilden, DE  
MEIBOM, Daniel, In den Birken 62b, 42113 Wuppertal, DE  
NELL, Peter, 1142 Moore Road, 94062 Woodside, US  
SÜßMEIER, Frank, Baubergerstr. 5, 80992 München, DE  
ALBRECHT-KÜPPER, Barbara, Heidestr. 9, 42489 Wülfrath, DE  
ZIMMERMANN, Katja, Bockumer Str. 370b, 40489 Düsseldorf, DE  
KELDENICH, Joerg, Damaschkeweg 49, 42113 Wuppertal, DE  
SCHNEIDER, Dirk, Bodelschwingweg 39, 42115 Wuppertal, DE  
KRENZ, Ursula, Am Kloster 33, 42799 Leichlingen, DE
-

(51) MKP  
**A61J 3/10 (2006.01)** (97) **2543502 \***  
**B30B 11/02 (2006.01)**  
 (86) JP2011054927 03.03.2011  
 (96) 11750757.4 09.01.2013  
 (87) WO2011108648, 03.03.2011  
 (97) 2543502, 09.01.2013 en  
 (54) TABLET MANUFACTURING METHOD  
 (71) Taisho Pharmaceutical Co., Ltd., 24-1, Takada 3-chome  
 Toshima-ku, Tokyo 170-8633, JP  
 (72) ANDO, Shinji, c/o TAISHO PHARMACEUTICAL CO. LTD. 24-1  
 Takada 3-chome Toshima-ku, Tokyo 170-8633, JP  
 YOSHIDA, Kenji, c/o TAISHO PHARMACEUTICAL CO. LTD.  
 24-1 Takada 3-chome Toshima-ku, Tokyo 170-8633, JP  
 UEDA, Takuji, c/o TAISHO PHARMACEUTICAL CO. LTD. 24-1  
 Takada 3-chome Toshima-ku, Tokyo 170-8633, JP

(51) MKP  
**A61K 31/55 (2006.01)** (97) **2565190 \***  
**C07D 333/68 (2006.01)**  
**A61P 3/12 (2006.01)**  
**A61K 31/496 (2006.01)**  
**A61K 31/4535 (2006.01)**  
**C07D 409/12 (2006.01)**  
**A61K 31/5377 (2006.01)**  
**A61K 31/4436 (2006.01)**  
**A61P 43/00 (2006.01)**  
**A61K 31/4025 (2006.01)**  
**A61P 13/12 (2006.01)**  
**A61K 31/381 (2006.01)**  
**A61P 9/00 (2006.01)**  
 (86) JP2011060261 27.04.2011  
 (96) 11775050.5 06.03.2013  
 (87) WO2011136269, 27.04.2011  
 (97) 2565190, 06.03.2013 en  
 (54) TETRAHYDROBENZOTHIOPHENE COMPOUND  
 (71) Astellas Pharma Inc., 3-11, Nihonbashi-Honcho 2-chome  
 Chuo-ku, Tokyo 103-8411, JP  
 (72) HACHIYA, Shunichiro, c/o Astellas Pharma Inc. 3-11  
 Nihonbashi-Honcho 2-chome Chuo-ku, Tokyo 103-8411, JP  
 MIURA, Masanori, c/o Astellas Pharma Inc. 3-11 Nihonbashi-  
 Honcho 2-chome Chuo-ku, Tokyo 103-8411, JP  
 IMAMURA, Yoshimasa, c/o Astellas Pharma Inc. 3-11  
 Nihonbashi-Honcho 2-chome Chuo-ku, Tokyo 103-8411, JP  
 KAGA, Daisuke, c/o Astellas Pharma Inc. 3-11 Nihonbashi-  
 Honcho 2-chome Chuo-ku, Tokyo 103-8411, JP  
 SATO, Ippei, c/o Astellas Pharma Inc. 3-11 Nihonbashi-Honcho  
 2-chome Chuo-ku, Tokyo 103-8411, JP  
 MORITOMO, Hiroyuki, c/o Astellas Pharma Inc. 3-11  
 Nihonbashi-Honcho 2-chome Chuo-ku, Tokyo 103-8411, JP  
 KATO, Koji, c/o Astellas Pharma Inc. 3-11 Nihonbashi-Honcho  
 2-chome Chuo-ku, Tokyo 103-8411, JP  
 TERAJ, Kazuhiro, c/o Astellas Pharma Inc. 3-11 Nihonbashi-  
 Honcho 2-chome Chuo-ku, Tokyo 103-8411, JP  
 TERADA, Yoh, c/o Astellas Pharma Inc. 3-11 Nihonbashi-  
 Honcho 2-chome Chuo-ku, Tokyo 103-8411, JP

(51) MKP  
**A61K 31/437 (2006.01)** (97) **2569314 \***  
**C07D 471/04 (2006.01)**  
**A61P 35/00 (2006.01)**  
 (86) US2011036572 16.05.2011  
 (96) 11721678.8 20.03.2013  
 (87) WO2011143645, 16.05.2011  
 (97) 2569314, 20.03.2013 en  
 (54) FUSED BICYCLIC KINASE INHIBITORS  
 (71) OSI Pharmaceuticals, LLC, 1 Bioscience Park Drive,  
 Farmingdale, NY 11735, US  
 (72) MULVIHILL, Mark, J., OSI Pharmaceuticals LLC 1 Bioscience  
 Park Drive, Farmingdale, NY 11735, US  
 STEINIG, Arno, G., OSI Pharmaceuticals LLC 1 Bioscience  
 Park Drive, Farmingdale, NY 11735, US  
 CREW, Andrew, Philip, OSI Pharmaceuticals LLC 1 Bioscience  
 Park Drive, Farmingdale, NY 11735, US  
 JIN, Meizhong, OSI Pharmaceuticals LLC 1 Bioscience Park  
 Drive, Farmingdale, NY 11735, US  
 KLEINBERG, Andrew, OSI Pharmaceuticals LLC 1 Bioscience  
 Park Drive, Farmingdale, NY 11735, US  
 LI, An-Hu, OSI Pharmaceuticals LLC 1 Bioscience Park Drive,  
 Farmingdale, NY 11735, US  
 WANG, Jing, OSI Pharmaceuticals LLC 1 Bioscience Park  
 Drive, Farmingdale, NY 11735, US

(51) MKP  
**C07F 11/00 (2006.01)** (97) **2556078 \***  
**C08F 4/72 (2006.01)**  
 (86) DE2011000348 31.03.2011  
 (96) 11722991.4 13.02.2013  
 (87) WO2011120508, 31.03.2011  
 (97) 2556078, 13.02.2013 de  
 (54) CATALYSTS FOR ALKYNE METATHESIS  
 (71) Studiengesellschaft Kohle MbH, Kaiser-Wilhelm-Platz 1, 45470  
 Mülheim an der Ruhr, DE  
 (72) FÜRSTNER, Alois, Arnoldstrasse 33, 45478 Mülheim an der  
 Ruhr, DE  
 HEPPEKAUSEN, Johannes, Dimbeck 22, 45470 Mülheim an der  
 Ruhr, DE  
 HICKMANN, Volker, Kantstrasse 23, 67125 Dannstadt, DE  
 STADE, Robert, Kuhlendahl 2, 45470 Mülheim an der Ruhr,  
 DE

(51) MKP  
**A61K 9/00 (2006.01)** (97) **2575871 \***  
**A61P 37/04 (2006.01)**  
**A61K 39/145 (2006.01)**  
 (86) EP2011059167 02.06.2011  
 (96) 11724181.0 10.04.2013  
 (87) WO2011151431, 02.06.2011  
 (97) 2575871, 10.04.2013 en  
 (54) ORAL VACCINE COMPRISING AN ANTIGEN AND A TOLL-  
 LIKE RECEPTOR AGONIST  
 (71) GlaxoSmithKline Biologicals S.A., rue de l'Institut, 89, 1330  
 Rixensart, BE  
 (72) OUAKED, Nadia, GlaxoSmithKline Biologicals North America  
 525 Blvd Cartier West, Laval, Québec H7V 3S8, CA  
 PLANTE, Martin, GlaxoSmithKline Biologicals North America  
 525 Blvd Cartier West, Laval, Québec H7V 3S8, CA  
 LAROCQUE, Daniel, GlaxoSmithKline Biologicals North  
 America 525 Blvd Cartier West, Laval, Québec H7V 3S8, CA  
 MALLETT, Corey Patrick, GlaxoSmithKline Biologicals North  
 America 525 Blvd Cartier West, Laval, Québec H7V 3S8, CA

(51) MKP  
**A61K 31/192 (2006.01)** (97) **2575797 \***  
**A61P 31/00 (2006.01)**  
 (86) EP2011058956 31.05.2011  
 (96) 11727661.8 10.04.2013  
 (87) WO2011151330, 31.05.2011  
 (97) 2575797, 10.04.2013 en  
 (54) 1-(2-FLUOROBIPHENYL-4-YL)-  
 CYCLOPROPANECARBOXYLIC ACID DERIVATIVES FOR  
 THE THERAPY OF PRION DISEASES  
 (71) Chiesi Farmaceutici S.p.A., Via Palermo, 26/A, 43100 Parma,  
 IT  
 (72) IMBIMBO, Bruno, Pietro, c/o Chiesi Farmaceutici S.p.A. Via  
 Palermo 26/A, I-43100 Parma, IT  
 VILLETTI, Gino, c/o Chiesi Farmaceutici S.p.A. Via Palermo  
 26/A, I-43100 Parma, IT  
 POLI, Giorgio, c/o Chiesi Farmaceutici S.p.A. Via Palermo  
 26/A, I-43100 Parma, IT

(51) MKP  
**A61F 6/14 (2006.01)** (97) **2585010 \***  
 (86) US2011041444 22.06.2011  
 (96) 11798840.2 01.05.2013  
 (87) WO2011163356, 22.06.2011  
 (97) 2585010, 01.05.2013 en  
 (54) METHODS OF TREATING CONDITIONS ASSOCIATED WITH  
 OVERACTIVE BLADDER  
 (71) Mahashabde, Anu, 13 Village Road, Kendall Park, New Jersey  
 08824, US  
 Tsao, Jiaxiang, 4 Morgan Court, Nanuet, NY 10954, US  
 (72) Mahashabde, Anu, 13 Village Road, Kendall Park, New Jersey  
 08824, US  
 Tsao, Jiaxiang, 4 Morgan Court, Nanuet, NY 10954, US

- (51) MKP  
**C07K 16/28 (2006.01)** (97) **2591003 \***  
**A61K 39/395 (2006.01)**  
**A61P 35/00 (2006.01)**
- (86) EP2011003312 04.07.2011  
(96) 11730907.0 15.05.2013  
(87) WO2012003956, 04.07.2011  
(97) 2591003, 15.05.2013 en  
(54) CANCER THERAPY USING CLDN6 TARGET-DIRECTED ANTIBODIES IN VIVO  
(71) GANYMED Pharmaceuticals AG, Freiligrathstrasse 12, 55131 Mainz, DE  
Johannes- Gutenberg-Universität Mainz, Saarstrasse 21, 55122 Mainz, DE  
(72) SAHIN, Ugur, Philipp-von-Zabern-Platz 1, 55116 Mainz, DE  
TÜRECI, Özlem, Philipp-von-Zabern-Platz 1, 55116 Mainz, DE  
KOSLOWSKI, Michael, Am Ried 23, 85764 Oberschleißheim, DE  
WALTER, Korden, Hüglerstrasse 3, 65203 Wiesbaden, DE  
KREUZBERG, Maria, Freiherr-vom-Stein Strasse 1, 55131 Mainz, DE  
LUXEN, Sylvia, U6 17, 68161 Mannheim, DE
- 
- (51) MKP  
**A61K 31/437 (2006.01)** (97) **2585439 \***  
**C07D 471/04 (2006.01)**  
**C07D 401/12 (2006.01)**  
**A61K 31/517 (2006.01)**  
**A61P 9/00 (2006.01)**  
**C07D 239/84 (2006.01)**
- (86) EP2011060445 22.06.2011  
(96) 11729591.5 01.05.2013  
(87) WO2011161159, 22.06.2011  
(97) 2585439, 01.05.2013 en  
(54) HETEROCYCLIC COMPOUNDS, THEIR PREPARATION AND THEIR THERAPEUTIC APPLICATION  
(71) Fovea Pharmaceuticals, Institut de la Vision 17 Rue Moreau, 75012 Paris, FR  
(72) MIDDLEMISS, David, Fovea Pharmaceuticals Department Brevets Institut de la Vision 17 Rue Moreau, F-75012 Paris, FR  
LERICHE, Caroline, Fovea Pharmaceuticals Department Brevets Institut de la Vision 17 Rue Moreau, F-75012 Paris, FR
- 
- (51) MKP  
**C12P 7/62 (2006.01)** (97) **2545179 \***  
**C08L 67/04 (2006.01)**  
**C08G 63/89 (2006.01)**
- (86) SG2011000094 10.03.2011  
(96) 11753698.7 16.01.2013  
(87) WO2011112154, 10.03.2011  
(97) 2545179, 16.01.2013 en  
(54) PRODUCTION OF POLYHYDROXYALKANOATES  
(71) G5 International Holdings Pte Ltd, 169 Kaki Bukit Avenue 1, 01-00 Shun Li Industrial Park, Singapore 416019, SG  
(72) IVANOV, Volodymyr, N1, Cee, Ntu 50 Nanyang Avenue, Singapore 639798, SG  
ONG, Tet Siong, Blk 117C Rivervale Drive 10-50, Singapore 543117, SG
- 
- (51) MKP  
**A01C 1/04 (2006.01)** (97) **2478755**  
**A01G 1/00 (2006.01)**
- (96) 11000533.7 25.07.2012  
(97) 2478755, 25.07.2012 en  
(54) Dry organic additivated clod and process for its preparation  
(71) Biocart S.r.l., Zona Industriale, 85050 Tito Scalo (PZ), IT  
(72) Colangelo, Antonio, c/o Biocart S.r.l. Zona Industriale, 85050 Tito Scalo (PZ), IT
- 
- (51) MKP  
**A61K 39/00 (2006.01)** (97) **2590672 \***
- (86) US2011039200 04.06.2011  
(96) 11836777.0 15.05.2013  
(87) WO2012057877, 04.06.2011  
(97) 2590672, 15.05.2013 en  
(54) COMBINATIONS OF ANTI-S1P ANTIBODIES AND SPHINGOLIPID PATHWAY INHIBITORS  
(71) Lpath, Inc., 4025 Sorrento Valley Blvd., San Diego, CA 92121, US  
(72) SABBADINI, Roger, A., 12509 Del Sol Road, Lakeside, CA 92040, US
- 
- (51) MKP  
**G06K 19/077 (2006.01)** (97) **2569737 \***  
**G06K 19/073 (2006.01)**
- (86) IB2011052041 09.05.2011  
(96) 11727292.2 20.03.2013  
(87) WO2011141864, 09.05.2011  
(97) 2569737, 20.03.2013 en  
(54) MEMORY CARD CARRIER, THE METHOD OF FIRST DATA STORAGE INTO THE MEMORY CARD  
(71) Logomotion, s.r.o., Winterova 15, 921 01 Piestany, SK  
(72) FLOREK, Miroslav, Ing. Miroslav Florek Sedmokraskova 4, 821 01 Bratislava, SK  
MASARYK, Michal, Ing. Michal Masaryk PhD. Medzilaborecká 7, 821 01 Bratislava, SK
- 
- (51) MKP  
**A61K 31/337 (2006.01)** (97) **2575803 \***  
**A61K 47/42 (2006.01)**  
**A61K 9/14 (2006.01)**  
**A61P 35/04 (2006.01)**
- (86) US2011037449 20.05.2011  
(96) 11790192.6 10.04.2013  
(87) WO2011153009, 20.05.2011  
(97) 2575803, 10.04.2013 en  
(54) METHODS OF TREATING BLADDER CANCER  
(71) Abraxis BioScience, LLC, 11755 Wilshire Boulevard Suite 2100, Los Angeles, CA 90025, US  
(72) DESAI, Neil, P., 11755 Wilshire Boulevard, Suite 2100, Los Angeles CA 90025, US  
SOON-SHIONG, Patrick, 149 South Barrington Avenue, 311, Los Angeles CA 90049, US
- 
- (51) MKP  
**A61P 11/00 (2006.01)** (97) **2545056 \***  
**A61P 1/00 (2006.01)**  
**A61K 31/519 (2006.01)**  
**C07D 487/04 (2006.01)**
- (86) GB2011050477 10.03.2011  
(96) 11709794.9 16.01.2013  
(87) WO2011110858, 10.03.2011  
(97) 2545056, 16.01.2013 en  
(54) PYRIMIDINE DERIVATIVES AND THEIR USE IN THE TREATMENT OF RESPIRATORY DISEASES SUCH AS COPD  
(71) CHIESI FARMACEUTICI S.p.A., Via Palermo, 30, 43100 Parma, IT  
(72) EDWARDS, Christine, c/o Pulmagen Therapeutics (Inflammation) Limited Fulmer Hall Windmill Road Fulmer, Sough Berkshire SL3 6HD, GB  
KULAGOWSKI, Janusz, c/o Pulmagen Therapeutics (Inflammation) Limited Fulmer Hall Windmill Road Fulmer, Slough Berkshire SL3 6HD, GB  
FINCH, Harry, c/o Pulmageen Therapeutics (Inflammation) Limited Fulmer Hall Windmill Road Fulmer, Slough Berkshire SL3 6HD, GB
-

(51) MKP  
**A61K 9/06 (2006.01)** (97) **2552449 \***  
**A61K 31/498 (2006.01)**  
**A61P 17/00 (2006.01)**  
**A61K 9/00 (2006.01)**  
(86) EP2011054596 25.03.2011  
(96) 11710199.8 06.02.2013  
(87) WO2011117377, 25.03.2011  
(97) 2552449, 06.02.2013 en  
(54) COMPOSITIONS COMPRISING BRIMONIDINE FOR THE TREATMENT OF ERYTHEMA  
(71) Galderma Research & Development, 2400 Route des Colles Les Templiers, 06410 Biot, FR  
(72) GRAEBER, Michael, 30103 Palm Court, Lawrenceville NJ08648, US  
LOESCHE, Christian, 1 Place des Cines, F-06560 Valbonne, FR  
FREIDENREICH, Philip, 347 Michael Road, Yardley PA 19067, US  
LIU, Yin, 19 Reed Dr. North Princeton Junction, New Jersey, NJ 08550, US  
LEONI, Matthew James, 1 Rockhill Dr., Hampton NJ08827, US

(51) MKP  
**B60T 8/40 (2006.01)** (97) **2569193 \***  
**B60T 8/48 (2006.01)**  
(86) EP2011057602 11.05.2011  
(96) 11720749.8 20.03.2013  
(87) WO2011141507, 11.05.2011  
(97) 2569193, 20.03.2013 en  
(54) METHOD FOR ADJUSTING THE PLAY IN A HYDRAULIC BRAKE SYSTEM, IN PARTICULAR FOR A MOTOR VEHICLE  
(71) Continental Teves AG & Co. oHG, Guerickestraße 7, 60488 Frankfurt, DE  
(72) GRONAU, Ralph, Joh. Pinzier-Str. 7, 35083 Wetter, DE

(51) MKP  
**A61K 47/34 (2006.01)** (97) **2575890 \***  
(86) EP2011059000 31.05.2011  
(96) 11725383.1 10.04.2013  
(87) WO2011151355, 31.05.2011  
(97) 2575890, 10.04.2013 en  
(54) ANTIPSYCHOTIC INJECTABLE DEPOT COMPOSITION  
(71) Laboratorios Farmacéuticos Rovi, S.A., C/ Julián Camarillo 35, 28037 Madrid, ES  
(72) GUTIERRO ADURIZ, Ibon, c/ Julián Camarillo 35, E-28037 Madrid, ES  
GÓMEZ OCHOA, María Teresa, c/ Julián Camarillo 35, E-28037 Madrid, ES

(51) MKP  
**A61P 9/12 (2006.01)** (97) **2542560 \***  
**C07F 9/26 (2006.01)**  
**A61K 31/683 (2006.01)**  
**C07F 9/20 (2006.01)**  
**C07F 9/14 (2006.01)**  
(86) US2011027232 04.03.2011  
(96) 11751437.2 09.01.2013  
(87) WO2011109731, 04.03.2011  
(97) 2542560, 09.01.2013 en  
(54) ARYLFLUOROPHOSPHATE INHIBITORS OF INTESTINAL APICAL MEMBRANE SODIUM/PHOSPHATE CO-TRANSPORT  
(71) Duophos, 301 Briar Meadow Avenue, Friendswood, TX 77546, US  
(72) PEERCE, Brian, 301 Briar Meadow Avenue, Friendswood, TX 77546, US  
SLOMOWITZ, Larry, 1865 Alberni Street, Vancouver, BC V6H 3H9, CA

(51) MKP  
**B44C 1/00 (2006.01)** (97) **2463114**  
**B44C 5/04 (2006.01)**  
**B44D 5/10 (2006.01)**  
**B44C 1/22 (2006.01)**  
(96) 11192391.8 13.06.2012  
(97) 2463114, 13.06.2012 en  
(54) Method for processing a brushed, glazed or mirror plate and plant for the obtainment thereof.  
(71) Metal Riv S.r.l., Località Cavaterre, 4, 37020 Brentino Belluno - Verona, IT  
(72) Brunelli, Loredana, Località Cavaterre, 4, 37020 Brentino Belluno - Verona, IT  
Bonini, Giuseppe, Località Cavaterre, 4, 37020 Brentino Belluno - Verona, IT  
Bonini, Andrea, Località Cavaterre 4, 37020 Rivalta di Brentino Belluno Verona, IT  
Bonini, Alessio, Via Benaco, 46, 37067 Salionze di Valeggio sul Mincio - Verona, IT

(51) MKP  
**C09K 17/52 (2006.01)** (97) **2558548 \***  
**A01G 7/00 (2006.01)**  
(86) IB2011000789 11.04.2011  
(96) 11724742.9 20.02.2013  
(87) WO2011128752, 11.04.2011  
(97) 2558548, 20.02.2013 en  
(54) BIODEGRADABLE MATERIALS FOR SOIL MULCHING BASED ON AQUEOUS MIXTURES OF POLYSACCHARIDES AND PLANT WASTE FIBERS AND METHODS FOR THEIR APPLICATION  
(71) Malinconico, Mario, Via Giacinto Gigante 2, 80136 Napoli, IT  
(72) Malinconico, Mario, Via Giacinto Gigante 2, 80136 Napoli, IT

(51) MKP  
**C07K 16/36 (2006.01)** (97) **2582728 \***  
**A61K 47/48 (2006.01)**  
(86) EP2011059917 15.06.2011  
(96) 11725095.1 24.04.2013  
(87) WO2011157741, 15.06.2011  
(97) 2582728, 24.04.2013 en  
(54) HUMAN ANTIBODY DRUG CONJUGATES AGAINST TISSUE FACTOR  
(71) Genmab A/S, Bredgade 34 E, 1260 Copenhagen K, DK  
SATIJN, David, Yalelaan 60, NL-3584 CM Utrecht, NL  
VERPLOEGEN, Sandra, Yalelaan 60, NL-3584 CM Utrecht, NL  
BLEEKER, Wim, Yalelaan 60, NL-3584 CM Utrecht, NL  
LISBY, Steen, Stockflethsvej 5, DK-2000 Frederiksberg, DK  
WINKEL, Jan van de, Yalelaan 60, NL-3584 CM Utrecht, NL  
BERKEL, Patrick van, Derde Westerparklaan 321, 3544 NH Utrecht, NL  
PARREN, Paul, Yalelaan 60, NL-3584 CM Utrecht, NL

(51) MKP  
**C07K 16/28 (2006.01)** (97) **2580243 \***  
(86) EP2011059507 08.06.2011  
(96) 11726381.4 17.04.2013  
(87) WO2011154453, 08.06.2011  
(97) 2580243, 17.04.2013 en  
(54) ANTIBODIES AGAINST HUMAN CD38  
(71) Genmab A/S, Bredgade 34 E, 1260 Copenhagen K, DK  
WEERS, Michel de, Yalelaan 60, NL-3584 CM Utrecht, NL  
WALSETH, Tim, 1952 Midland Hills Road, Roseville Minnesota 55113, US  
WINKEL, Jan van de, Yalelaan 60, NL-3584 CM Utrecht, NL  
VINK, Tom, Yalelaan 60, NL-3584 CM Utrecht, NL  
PARREN, Paul, Yalelaan 60, NL-3584 CM Utrecht, NL

- (51) MKP  
**F24J 2/38 (2006.01)** (97) **2543879**  
**F24J 2/54 (2006.01)**  
**F03G 6/06 (2006.01)**
- (96) 11005986.2 09.01.2013  
(97) 2543879, 09.01.2013 en  
(54) Solar generator apparatus with cable-controlled tracking  
(71) TOPPER SUN ENERGY TECHNOLOGY CO., LTD., 458-9, Sinsing Road Hukou Township, Hsinchu County 303, TW Luo, Chia Ching, 458-9, Sinsing Road Hukou Township, Hsinchu County 303, TW  
(72) Luo, Chia Ching, 458-9, Sinsing Road, Hukou Township Hsinchu County 303, TW
- 
- (51) MKP  
**A61P 3/04 (2006.01)** (97) **2558105 \***  
**A61K 31/56 (2006.01)**
- (86) US2011032156 12.04.2011  
(96) 11715645.5 20.02.2013  
(87) WO2011130302, 12.04.2011  
(97) 2558105, 20.02.2013 en  
(54) METHOD OF TREATING OBESITY USING ANTIOXIDANT INFLAMMATION MODULATORS  
(71) Reata Pharmaceuticals, Inc., 2801 Gateway Drive, Suite 150, Irving, TX 75063-2648, US  
(72) MEYER, Colin, J., c/o Reata Pharmaceuticals Inc. 2801 Gateway Dr. Suite 150, Irving, TX 75063-2648, US
- 
- (51) MKP  
**A61M 15/06 (2006.01)** (97) **2542285 \***  
**A24F 47/00 (2006.01)**
- (86) DK2011050067 04.03.2011  
(96) 11750219.5 09.01.2013  
(87) WO2011107104, 04.03.2011  
(97) 2542285, 09.01.2013 en  
(54) AN INHALATOR  
(71) LK Investment APS, Humlehaven 2, 3050 Humlebaek, DK  
(72) KNUDSEN, Carsten, Leonhard, Rønnevej 70, DK-3730 Neksø, DK
- 
- (51) MKP  
**C02F 3/28 (2006.01)** (97) **2460771**
- (96) 10193829.8 06.06.2012  
(97) 2460771, 06.06.2012 en  
(54) An anaerobic reactor for psychrophilic and/or mesophilic wastewater treatment  
(71) National University of Ireland, Galway, University Road, Galway, IE  
(72) O'Flaherty, Vincent, 4 Forest Hill, Moycullen, County Galway, IE  
Hughes, Dermot, 37 Long Walk, Galway, IE
- 
- (51) MKP  
**C03B 9/38 (2006.01)** (97) **2560925 \***
- (86) US2011033444 21.04.2011  
(96) 11717885.5 27.02.2013  
(87) WO2011133781, 21.04.2011  
(97) 2560925, 27.02.2013 en  
(54) GLASSWARE MOLD COOLING AIR SUPPLY  
(71) Owens-Brockway Glass Container Inc., One Michael Owens Way, Perrysburg, OH 43551, US  
(72) NEWSOM, Daniel, L., 429 N. Church Street, Oak Harbor, OH 43449, US  
GARNES, Richard, H., 2379 St. James Wood Blvd., Toledo, OH 43617, US
- 
- (51) MKP  
**F04B 1/04 (2006.01)** (97) **2412976**  
**F02M 59/10 (2006.01)**
- (96) 11175789.4 01.02.2012  
(97) 2412976, 01.02.2012 en  
(54) Intermediate drive assembly  
(71) Delphi Technologies Holding S.à.r.l., Avenue de Luxembourg, 4940 Bascharage, LU  
(72) Wenger, Marco, Flat 18, Herron Court, 82 Westmoreland Road, Bromley, Kent BR2 0QX, GB  
Garland, Paul, 39 Holmside, Gillingham, Kent ME7 4BQ, GB  
Avery, Stephen, 8 Grove Park Avenue, Sittingbourne, Kent ME10 1YH, GB
- 
- (51) MKP  
**B01D 11/02 (2006.01)** (97) **2578285**  
**C10G 1/04 (2006.01)**
- (96) 12160938.2 10.04.2013  
(97) 2578285, 10.04.2013 en  
(54) Analogue ionic liquids for the separation and recovery of hydrocarbons from particulate matter  
(71) The Penn State Research Foundation, 200 Innovation Boulevard, University Park, PA 16802, US  
(72) Painter, Paul, P.O. Box 64, Boalsburg, PA 16827, US  
Williams, Phil, 117 N. Gill Street, Apt. 1, State College, PA 16801, US  
Mannebach, Ehren, 794 Country Club Lane, Fon du Lac, WI 54935, US  
Lupinsky, Aron, 137 S. Butz Street, State College, PA, US
- 
- (51) MKP  
**C07K 16/28 (2006.01)** (97) **2585110 \***  
**A61K 39/395 (2006.01)**
- (86) US2011041517 22.06.2011  
(96) 11798880.8 01.05.2013  
(87) WO2011163412, 22.06.2011  
(97) 2585110, 01.05.2013 en  
(54) ANTIBODIES TO THE C3D FRAGMENT OF COMPLEMENT COMPONENT 3  
(71) The Regents of the University of Colorado, A Body Corporate, 1800 Grant Street, 8th Floor, Denver, CO 80203, US  
(72) HOLERS, V., Michael, 4825E. 1st Avenue, Denver, CO 80220, US  
THURMAN, Joshua, M., 2 Red Fox Lane, Greenwood Village, CO 80111, US  
KULIK, Liudmila, 14934 East Hampden Circle, D5, Aurora, CO 80014, US
- 
- (51) MKP  
**C12N 15/55 (2006.01)** (97) **2561069 \***  
**A61K 38/46 (2006.01)**  
**C12N 9/20 (2006.01)**
- (86) US2011033699 23.04.2011  
(96) 11772834.5 27.02.2013  
(87) WO2011133960, 23.04.2011  
(97) 2561069, 27.02.2013 en  
(54) LYSOSOMAL STORAGE DISEASE ENZYME  
(71) Synageva BioPharma Corp., 128 Spring Street, Suite 520, Lexington, MA 02421, US  
(72) QUINN, Anthony, 107 Manet Road, Chestnut Hill Massachusetts 02467, US  
HARVEY, Alex J., 106 Fox Trace, Athens Georgia 30606, US
- 
- (51) MKP  
**A61P 17/00 (2006.01)** (97) **2594263 \***  
**A61K 9/70 (2006.01)**  
**A61K 31/545 (2006.01)**
- (86) KR2011005061 11.07.2011  
(96) 11807003.6 22.05.2013  
(87) WO2012008718, 11.07.2011  
(97) 2594263, 22.05.2013 en  
(54) PATCH FOR TREATING AND ALLEVIATING SYMPTOMS OF SKIN DISEASES ACCOMPANIED BY EFFUSION OF BLOOD PROTEINS  
(71) Biopid Corporation, 343-1 Sancheon-ri Sinbuk-eup, Chuncheon-si, Gangwon-do 200-822, KR  
(72) CHOI, Seong Hyun, 343-1 Sancheon-ri Sinbuk-eup, Chuncheon-si, Gangwon-do 200-822, KR
-

(51) MKP  
**B44C 1/17 (2006.01)** (97) **2558305 \***  
 (86) FR2011050871 15.04.2011  
 (96) 11730381.8 20.02.2013  
 (87) WO2011128603, 15.04.2011  
 (97) 2558305, 20.02.2013 fr  
 (54) METHOD AND DEVICE FOR THE MANUFACTURE OF GLAZING COMPRISING A DECORATIVE FILM AND GLAZING COMPRISING A DECORATIVE FILM  
 (71) Saint-Gobain Glass France, 18 avenue d'Alsace, 92400 Courbevoie, FR  
 (72) VERRAT-DEBAILLEUL, Adèle, 14 allée de la Montagne, F-60150 Villers Sur Coudun, FR  
 LEFEVRE, Pascal, 29 rue Victor Hugo, F-02300 Viry Noureuil, FR  
 FROISSARD, Loïc, 4 rue Soeur Thérèse Massin, F-60200 Compiègne, FR

(51) MKP  
**A61K 31/551 (2006.01)** (97) **2585467 \***  
**C07D 487/04 (2006.01)**  
**A61K 31/519 (2006.01)**  
**A61K 31/55 (2006.01)**  
**A61P 11/00 (2006.01)**  
 (86) US2011041688 23.06.2011  
 (96) 11729018.9 01.05.2013  
 (87) WO2011163518, 23.06.2011  
 (97) 2585467, 01.05.2013 en  
 (54) PYRAZOLO [1, 5 -A]PYRIMIDINES AS ANTIVIRAL AGENTS  
 (71) Gilead Sciences, Inc., 333 Lakeside Drive, Foster City, CA 94404, US  
 (72) BABAUGLU, Kerim, 2209 Wentz Church Road, Lansdale, Pennsylvania 19446, US  
 BOOJAMRA, Constantine, G., 1 Worth Street, San Francisco California 94114, US  
 EISENBERG, Eugene, J., 236 Club Drive, San Carlos California 94070, US  
 HUI, Hon Chung, 853 Woodside Way 229, San Mateo California 94401, US  
 MACKMAN, Richard, L., 360 Ashton Avenue, Milbrae California 94030, US  
 PARRISH, Jay, P., 760 Bair Island Road 106, Redwood City California 94063, US  
 SANGI, Michael, 7 College Ave. Apt. 7, Oakland California 94618, US  
 SAUNDERS, Oliver, L., 8811 East Herndon Ave, Clovis, California 93619, US  
 SIEGEL, Dustin, 758 Bounty Dr. Apt. 5803, Foster City California 94404, US  
 SPERANDIO, David, 3804 Nathan Way, Palo Alto California 94303, US  
 YANG, Hai, 32 Jody Court, San Mateo California 94402, US

(51) MKP  
**A61K 31/4465 (2006.01)** (97) **2564837 \***  
**A61K 47/34 (2006.01)**  
**C07D 211/20 (2006.01)**  
**A61P 25/24 (2006.01)**  
**A61K 47/02 (2006.01)**  
**A61K 47/32 (2006.01)**  
**A61K 9/32 (2006.01)**  
**A61K 9/22 (2006.01)**  
 (86) JP2011060478 28.04.2011  
 (96) 11775154.5 06.03.2013  
 (87) WO2011136373, 28.04.2011  
 (97) 2564837, 06.03.2013 en  
 (54) ENTERIC TABLET  
 (71) Takeda Pharmaceutical Company Limited, 1-1 Doshomachi 4-chome Chuo-ku, Osaka-shi, Osaka 541-0045, JP  
 (72) MISAKI, Masafumi, c/o TAKEDA PHARMACEUTICAL COMPANY LIMITED 17-85 Jusohonmachi 2-chome Yodogawa-ku, Osaka-shi Osaka 532-8686, JP  
 TSUSHIMA, Yuki, c/o TAKEDA PHARMACEUTICAL COMPANY LIMITED 17-85 Jusohonmachi 2-chome Yodogawa-ku, Osaka-shi Osaka 532-8686, JP  
 NIWA, Masahiro, c/o TAKEDA PHARMACEUTICAL COMPANY LIMITED 17-85 Jusohonmachi 2-chome Yodogawa-ku, Osaka-shi Osaka 532-8686, JP

(51) MKP  
**C08B 37/10 (2006.01)** (97) **2558506 \***  
 (86) US2011032771 15.04.2011  
 (96) 11769718.5 20.02.2013  
 (87) WO2011130697, 15.04.2011  
 (97) 2558506, 20.02.2013 en  
 (54) TISSUE TARGETING  
 (71) Momenta Pharmaceuticals, Inc., 675 West Kendall Street, Cambridge, MA 02142, US  
 (72) ZHOU, He, Mei Shu Guan Hou Jie Building 25 ap. 701, Dong Cheng District Beijing, PR China 100010, CN  
 COCHRAN, Edward, 54 West Street, Marshfield MA 02050, US  
 KISHIMOTO, Takashi, Kei, 46 Coolidge Avenue, Lexington MA 02420, US

(51) MKP  
**B60R 25/04 (2006.01)** (97) **2484564**  
 (96) 11153725.4 08.08.2012  
 (97) 2484564, 08.08.2012 en  
 (54) Method and apparatus for vehicle security  
 (71) Delphi Technologies Holding S.à.r.l., Avenue de Luxembourg, 4940 Bascharage, LU  
 (72) Buriks, Adrian, 53 Woodside, Gillingham, Kent ME8 0PL, GB  
 Lamb, Rodney, 5 Amethyst Grove, Waterlooville, Hampshire PO7 8SR, GB

(51) MKP  
**A61K 31/485 (2006.01)** (97) **2590649 \***  
 (86) US2011034323 28.04.2011  
 (96) 11803957.7 15.05.2013  
 (87) WO2012005795, 28.04.2011  
 (97) 2590649, 15.05.2013 en  
 (54) PROCESS FOR THE SYNTHESIS OF SUBSTITUTED MORPHINANS  
 (71) Alkermes Pharma Ireland Limited, Connaught House 1 Burlington Road, Dublin 4, IE  
 (72) DUNCAN, Scott, 4 Wayte Road, Bedford, MA 01730, US

(51) MKP  
**A01N 25/08 (2006.01)** (97) **2592929 \***  
 (86) US2011043929 14.07.2011  
 (96) 11738547.6 22.05.2013  
 (87) WO2012009489, 14.07.2011  
 (97) 2592929, 22.05.2013 en  
 (54) SOLID HERBICIDE COMPOSITIONS WITH BUILT-IN ADJUVANT  
 (71) Dow AgroSciences LLC, 9330 Zionsville Road, Indianapolis, IN 46268, US  
 (72) DAVE, Hiteshkumar, 13220 Amundson Drive, Carmel IN 46074, US  
 LIU, Lei, 1501 Brookmill Court, Carmel IN 46032, US  
 BOUCHER, Raymond, 7920 East 400 North, Lebanon IN 46052, US  
 OUSE, David, 8315 Mockingbird Lane, Indianapolis IN 46256, US  
 MANN, Richard, 1828 South 550 East, Franklin IN 46131, US  
 GIFFORD, James, 800 North 200 East, Lebanon IN 46052, US  
 HUANG, Yi-hsiou, No. 100 Shui-yuan Road Fang-hua Tsun Chang-chih Hsiang Pingtung Hsieng, 90841, TW  
 MCVEIGH-NELSON, AEndrea, 1333 Alimingo Drive, Indianapolis IN 46260, US  
 BATRA, Ashish, 12666 Windham Pass, Carmel, IN 46032, US  
 LOGAN, Martin, C., 4204 North Meridian Street, Indianapolis, IN 46208, US

- (51) MKP  
**A61M 5/24 (2006.01)** (97) **2544737 \***  
**A61M 5/20 (2006.01)**  
 (86) EP2011053155 03.03.2011  
 (96) 11706581.3 16.01.2013  
 (87) WO2011110464, 03.03.2011  
 (97) 2544737, 16.01.2013 en  
 (54) RE-USABLE AUTOINJECTOR  
 (71) Sanofi-Aventis Deutschland GmbH, Brüningstraße 50, 65929 Frankfurt, DE  
 (72) KEMP, Thomas Mark, 3 Forresters Cottages High Steet, Ashwell SG7 5NW, GB  
 JENNINGS, Douglas, 73 Redwing Rise Royston, Herts SG8 7XU, GB  
 SCUDAMORE, Peter, 90 Macaulay Ave Great Shelford, Cambridge CB22 5AF, GB  
 EKMAN, Matthew, 59 Ecton Avenue Macclesfield, Cheshire SK10 1RD, GB

- (51) MKP  
**A47H 15/04 (2006.01)** (97) **2490577 \***  
**A47H 1/04 (2006.01)**  
**A47H 2/02 (2006.01)**  
**A47H 15/02 (2006.01)**  
**A47H 2/00 (2006.01)**  
**A47H 13/01 (2006.01)**  
 (86) EP2010006363 19.10.2010  
 (96) 10773248.9 29.08.2012  
 (87) WO2011047825, 19.10.2010  
 (97) 2490577, 29.08.2012 de  
 (54) PANEL CURTAIN DEVICE  
 (71) Hinno AG, Huobmattstrasse 7, 6045 Meggen, CH  
 (72) PEPLIES, Hartmut, Teisigweg 2, 42489 Wülfrath, DE

- (51) MKP  
**C07K 1/18 (2006.01)** (97) **2571892 \***  
**C07K 1/22 (2006.01)**  
**C07K 1/34 (2006.01)**  
**B01D 15/12 (2006.01)**  
**C07K 1/36 (2006.01)**  
**B01D 15/38 (2006.01)**  
 (86) US2011032279 13.04.2011  
 (96) 11717391.4 27.03.2013  
 (87) WO2011146179, 13.04.2011  
 (97) 2571892, 27.03.2013 en  
 (54) APPARATUS AND PROCESS OF PURIFICATION OF PROTEINS  
 (71) AbbVie Inc., 1 North Waukegan Road, North Chicago, IL 60064, US  
 (72) WANG, Chen, 11 Flamingo Circle, Shrewsbury MA 01545, US  
 HICKMAN, Robert, K., 6 Hibiscus Drive, Worcester MA 01605, US  
 LUNDELL, Edwin, O., 34 Knight Way, Malborough MA 01752, US  
 HEGEDUS, Roy, D., 11 Montvale Road, Worcester MA 01609, US

- (51) MKP  
**G06K 5/00 (2006.01)** (97) **2572314 \***  
 (86) US2011037041 18.05.2011  
 (96) 11784196.5 27.03.2013  
 (87) WO2011146651, 18.05.2011  
 (97) 2572314, 27.03.2013 en  
 (54) SYSTEMS AND METHODS FOR CARDS AND DEVICES OPERABLE TO COMMUNICATE VIA LIGHT PULSES AND TOUCH SENSITIVE DISPLAYS  
 (71) Dynamics Inc., 493 Nixon Road, Cheswick, PA 15024, US  
 (72) MULLEN, Jeffrey, D., 731 South Negley Avenue Apartment 2, Pittsburgh, PA 15232, US  
 HARTWICK, David, J., 1127 Fairlane Drive, Aliquippa, PA 15001, US  
 RIGATTI, Christopher, J., 321 Jacksonia Street, Pittsburgh, PA 15212, US  
 YEN, Philip, W., 21821 McClellan Road, Cupertino, CA 95014, US

- (51) MKP  
**A61P 7/02 (2006.01)** (97) **2585078 \***  
**A61K 31/727 (2006.01)**  
 (86) EP2011060597 24.06.2011  
 (96) 11727182.5 01.05.2013  
 (87) WO2011161228, 24.06.2011  
 (97) 2585078, 01.05.2013 en  
 (54) SEMULOPARIN FOR THE PREVENTION OF A MORTALITY AND/OR MORBIDITY EVENT IN A PATIENT UNDERGOING MAJOR ORTHOPAEDIC SURGERY  
 (71) Aventis Pharma S.A., 20, avenue Raymond Aron, 92160 Antony, FR  
 (72) DESTREE, Dominique, c/o Sanofi Patent Department 174 avenue de France, F-75013 Paris, FR  
 JEAN DE POTTER, Chantal, c/o Sanofi Patent Departent 174 avenue de France, F-75013 Paris, FR  
 LAWSON, Francesca, c/o Sanofi-Aventis US. Inc. Patent Department 1041 Route 202-206 Mail Code: D-303A, 08807 Bridgewater, NJ, FR  
 LORENZATO, Christelle, c/o Sanofi Patent Department 174 avenue de France, F-75013 Paris, FR

- (51) MKP  
**G01N 1/38 (2006.01)** (97) **2564206 \***  
**G01N 35/00 (2006.01)**  
**G01N 35/10 (2006.01)**  
 (86) US2011034527 29.04.2011  
 (96) 11778047.8 06.03.2013  
 (87) WO2011139888, 29.04.2011  
 (97) 2564206, 06.03.2013 en  
 (54) ANALYTICAL SYSTEM FOR PERFORMING LABORATORY PROTOCOLS AND ASSOCIATED METHODS  
 (71) StatSpin, Inc., 60 Glacier Drive, Westwood, MA 02090, US  
 (72) ADEY, Nils, B., 1730 Nevada Street, Salt Lake City UT 84108, US  
 PARRY, Rob, 5317 Sandhill Court, Park City UT 84098, US  
 KELLAND, James, 57 Pleasant Street, E. Walpole MA 02032, US  
 SULLIVAN, Kevin, 149 Rangeley Road, Chestnut Hill MA 02467, US

- (51) MKP  
**A61K 31/519 (2006.01)** (97) **2549998 \***  
**A61K 47/34 (2006.01)**  
**A61K 47/14 (2006.01)**  
**A61P 3/10 (2006.01)**  
**A61K 47/38 (2006.01)**  
**A61P 25/04 (2006.01)**  
**A61P 25/00 (2006.01)**  
**A61P 29/00 (2006.01)**  
 (86) IB2011000605 21.03.2011  
 (96) 11721640.8 30.01.2013  
 (87) WO2011117711, 21.03.2011  
 (97) 2549998, 30.01.2013 en  
 (54) PHARMACEUTICAL COMPOSITION COMPRISING A PYRIMIDINEONE DERIVATIVE  
 (71) Glenmark Pharmaceuticals S.A., Chemin de la Combeta, 5, 2300 La Chaux-de-Fonds, CH  
 (72) DHUPPAD, Ulhas, 3 Coral Park Shahu Nagar Motwani Factory Road Nashik Road, Nashik 422 101, IN  
 CHAUDHARI, Sunil, A-4 Pralhad Arcade Ashoka Marg Nashik Road, Nashik 422 101, IN

- (51) MKP  
**F03B 15/00 (2006.01)** (97) **2558711 \***  
**F03B 13/18 (2006.01)**  
**F03B 17/06 (2006.01)**  
**F03B 13/26 (2006.01)**  
 (86) GB2011000576 13.04.2011  
 (96) 11718136.2 20.02.2013  
 (87) WO2011128641, 13.04.2011  
 (97) 2558711, 20.02.2013 en  
 (54) FLUID ACTUATED ENERGY GENERATOR  
 (71) CORCOST LIMITED, 22 Great Close, Cawood, North Yorkshire YO8 3UG, GB  
 (72) CORCORAN, Steven, 22 Great Close Cawood, Selby North Yorkshire YO8 3UG, GB



(51) MKP  
**A61K 39/395 (2006.01)** (97) **2555797 \***  
 (86) US2011031381 06.04.2011  
 (96) 11766636.2 13.02.2013  
 (87) WO2011127141, 06.04.2011  
 (97) 2555797, 13.02.2013 en  
 (54) TNF- BINDING PROTEINS  
 (71) Abbvie Inc., 1 North Waukegan Road, North Chicago, IL 60064, US  
 (72) BENATUIL, Lorenzo, 33 Mohawk Drive, Northborough, MA 01532, US  
 GHAYUR, Tariq, 1014 Washington Street, Holliston, MA 01746, US  
 GOODREAU, Carrie, L., 201 Stevens Street, Ludlow, MA 01056, US  
 ISAKSON, Peter, C., 14 Hillside Avenue, Southborough, MA 01772, US  
 SALFELD, Jochen, 177 Old Westboro Road, North Grafton, MA 01536, US

(51) MKP  
**A01G 17/06 (2006.01)** (97) **2560471 \***  
 (86) EP2011055027 31.03.2011  
 (96) 11711362.1 27.02.2013  
 (87) WO2011131468, 31.03.2011  
 (97) 2560471, 27.02.2013 en  
 (54) FASTENING DEVICE FOR MOVABLE WIRES ON A ROW OF PLANTS  
 (71) Bortolussi, Claudio, Via Grigoletti 3, 33080 Fiume Veneto (Pordenone), IT  
 Bortolussi, Franco, Via Trieste 93, 33080 Fiume Veneto (Pordenone), IT  
 (72) Bortolussi, Claudio, Via Grigoletti 3, 33080 Fiume Veneto (Pordenone), IT  
 Bortolussi, Franco, Via Trieste 93, 33080 Fiume Veneto (Pordenone), IT

(51) MKP  
**F24J 2/05 (2006.01)** (97) **2561286 \***  
**C22C 38/08 (2006.01)**  
 (86) IB2011051541 11.04.2011  
 (96) 11722166.3 27.02.2013  
 (87) WO2011132107, 11.04.2011  
 (97) 2561286, 27.02.2013 en  
 (54) IMPROVEMENTS IN TUBULAR SOLAR COLLECTORS  
 (71) Archimede Solar Energy SRL, Loc. Cimacolle 464, 06056 Massa Martana (PG), IT  
 (72) RUFFINI, Federico, c/o Centro Sviluppo Materiali SpA Via Brin 218, I-05100 Terni, IT  
 RAGGI, Claudio, Via Gabelli 36, I-05100 Terni, IT  
 FORTUNATI, Stefano, Via Casventino 12, I-05029 Sangemini (TR), IT  
 CAGIOLA, Learco, Via Bastia 32, I-06089 Torgiano (PG), IT  
 DE LUCA, Antonio, Via dell'Impruneta 7, I-00146 Roma, IT

(51) MKP  
**A61P 9/00 (2006.01)** (97) **2582685 \***  
**A61K 31/343 (2006.01)**  
**C07D 307/80 (2006.01)**  
 (86) HU2011000054 10.06.2011  
 (96) 11730061.6 24.04.2013  
 (87) WO2011158050, 10.06.2011  
 (97) 2582685, 24.04.2013 en  
 (54) PROCESS FOR THE PREPARATION OF DRONEDARONE  
 (71) SANOFI, 174, Avenue de France, 75013 Paris, FR  
 (72) FRIESZ, Antal, c/o Chinoín Gyógyszer és Vegyészeti Termékek Gyára Zrt. Iparjog Tó u. 1 -5., H-1045 Budapest, HU

(51) MKP  
**A61F 13/02 (2006.01)** (97) **2491904**  
 (96) 12157247.3 29.08.2012  
 (97) 2491904, 29.08.2012 en  
 (54) Adhesive Bandage  
 (71) Johnson & Johnson Consumer Companies Inc., Grandview Road, Skillman, NJ 08558, US  
 (72) Chan, Jennifer Wing-Yee, 1123 Rhoads Drive, Belle Mead, NJ New Jersey 08502, US  
 Eknoian, Michael W., 10 Ellsworth Drive, Warren, NJ New Jersey 07059, US  
 Reddy, Megha, 1304 Wessex Place, Princeton, NJ New Jersey 08540, US  
 Rizzo, Carmine Michael, 234 Birchwood Drive, Cliffwood Beach, NJ New Jersey 07735, US  
 Petersack, Vincent John, 3 Carriage Drive, Eastampton, NJ New Jersey 08060, US

(51) MKP  
**B65F 1/14 (2006.01)** (97) **2544968 \***  
**B65F 1/16 (2006.01)**  
 (86) EP2011000816 21.02.2011  
 (96) 11713979.0 16.01.2013  
 (87) WO2011110283, 21.02.2011  
 (97) 2544968, 16.01.2013 en  
 (54) BIN FOR COLLECTING SOLID WASTE  
 (71) Leader Time S.r.l., Via IV Novembre 8, 36042 - Breganze (Vicenza), IT  
 (72) ROMAN, Guido, Via IV Novembre 10, I-36042 - Breganze (Vicenza), IT  
 DE TONI, Roberto, Via Muzzana 3, I-36034 - Malo (Vicenza), IT

(51) MKP  
**A61P 37/04 (2006.01)** (97) **2560981 \***  
**A61K 31/7028 (2006.01)**  
**C08B 37/00 (2006.01)**  
**C07H 15/04 (2006.01)**  
 (86) US2011000723 22.04.2011  
 (96) 11720906.4 27.02.2013  
 (87) WO2011133227, 22.04.2011  
 (97) 2560981, 27.02.2013 en  
 (54) SYNTHETIC OLIGOSACCHARIDES FOR STAPHYLOCOCCUS VACCINE  
 (71) Ancora Pharmaceuticals Inc., 200 Boston Avenue Suite 4975, Medford, MA 02155, US  
 (72) CAMPBELL, A., Stewart, 4 Sheehan Circle, Framingham MA 01701, US  
 PLANTE, Obadiah, J., 12 Roosevelt Avenue, Danvers MA 01923, US

(51) MKP  
**C07D 471/04 (2006.01)** (97) **2563789 \***  
**A61K 31/4462 (2006.01)**  
**A61P 19/02 (2006.01)**  
 (86) EP2011056600 27.04.2011  
 (96) 11719781.4 06.03.2013  
 (87) WO2011134971, 27.04.2011  
 (97) 2563789, 06.03.2013 en  
 (54) 7-(1H-PYRAZOL-4-YL)-1,6-NAPHTHYRIDINE COMPOUNDS AS SYK INHIBITORS  
 (71) Glaxo Group Limited, Glaxo Wellcome House Berkeley Avenue Greenford, Middlesex UB6 0NN, GB  
 ATKINSON, Francis Louis, GlaxoSmithKline Gunnels Wood Road, Stevenage Hertfordshire SG1 2NY, GB  
 BARKER, Michael David, GlaxoSmithKline Gunnels Wood Road, Stevenage Hertfordshire SG1 2NY, GB  
 DOUAULT, Clement, GlaxoSmithKline Gunnels Wood Road, Stevenage Hertfordshire SG1 2NY, GB  
 GARTON, Neil Stuart, GlaxoSmithKline Gunnels Wood Road, Stevenage Hertfordshire SG1 2NY, GB  
 LIDDLE, John, GlaxoSmithKline Gunnels Wood Road, Stevenage Hertfordshire SG1 2NY, GB  
 PATEL, Vipulkumar Kantibhai, GlaxoSmithKline Gunnels Wood Road, Stevenage Hertfordshire SG1 2NY, GB  
 PRESTON, Alexander George Steven, GlaxoSmithKline Gunnels Wood Road, Stevenage Hertfordshire SG1 2NY, GB  
 WILSON, David Matthew, GlaxoSmithKline Gunnels Wood Road, Stevenage Hertfordshire SG1 2NY, GB

- (51) MKP  
**A61K 47/48 (2006.01)** (97) **2579897 \***  
(86) US2011039386 07.06.2011  
(96) 11726020.8 17.04.2013  
(87) WO2011156328, 07.06.2011  
(97) 2579897, 17.04.2013 en  
(54) CYSTEINE ENGINEERED ANTIBODIES AND CONJUGATES  
(71) Genentech, Inc., 1 DNA Way, South San Francisco, CA 94080, US  
(72) BHAKTA, Sunil, c/o Genentech Inc. 1 DNA Way, South San Francisco, CA 94080, US  
JUNUTULA, Jagath, R., c/o Genentech Inc. 1 DNA Way, South San Francisco CA 94080, US
- 
- (51) MKP  
**B01D 5/00 (2006.01)** (97) **2590721 \***  
(86) US2011043359 08.07.2011  
(96) 11804400.7 15.05.2013  
(87) WO2012006523, 08.07.2011  
(97) 2590721, 15.05.2013 en  
(54) CONVERTING WHOLE TIRES AND OTHER SOLID CARBON MATERIALS INTO REUSABLE COMPONENTS  
(71) Taylor, Fredrick, P.O. Box 1853, Rome, GA 30162, US  
(72) Taylor, Fredrick, P.O. Box 1853, Rome, GA 30162, US
- 
- (51) MKP  
**C07C 2/00 (2006.01)** (97) **2545017 \***  
**C07C 1/00 (2006.01)**  
(86) US2011026277 25.02.2011  
(96) 11751112.1 16.01.2013  
(87) WO2011109244, 25.02.2011  
(97) 2545017, 16.01.2013 en  
(54) PROCESSES AND SYSTEMS FOR THE STAGED SYNTHESIS OF ALKYL BROMIDES  
(71) Marathon GTF Technology, Ltd., 5555 San Felipe, Houston, TX 77056-2799, US  
(72) WAYCUILIS, John, J., 14902 Quail Farms Road, Cypress Texas 77429, US  
TURNER, William, J., 1223 Goldendale Drive, Seabrook Texas 77586, US
- 
- (51) MKP  
**E01F 15/14 (2006.01)** (97) **2492398**  
(86) 12156242.5 29.08.2012  
(97) 2492398, 29.08.2012 en  
(54) System for protecting work sites subjected to road or highway traffic  
(71) Salvemini, Tiziano, Piazza Efrem, 4, 70056 Molfetta (BA), IT  
(72) Salvemini, Tiziano, Piazza Efrem, 4, 70056 Molfetta (BA), IT
- 
- (51) MKP  
**H03L 1/02 (2006.01)** (97) **2464012**  
**G01S 19/23 (2010.01)**  
(86) 11009742.5 13.06.2012  
(97) 2464012, 13.06.2012 en  
(54) Method and system for precise temperature and timebase PPM error estimation using multiple timebases  
(71) Maxlinear, Inc., 2051 Palomar Airport Road, Suite 100, Carlsbad, CA 92011, US  
(72) Ling, Curtis, 2051 Palomar Airport Road Suite 100, Carlsbad, CA 92011, US  
Tan, Xing, 841 Lantana Way Apt. 121, Vista, CA 92081, US  
Kim, Hyungjin, 7 Shelby, Irvine, CA 92620, US
- 
- (51) MKP  
**C07K 16/28 (2006.01)** (97) **2545077 \***  
**A61K 39/395 (2006.01)**  
(86) EP2011053646 10.03.2011  
(96) 11711490.0 16.01.2013  
(87) WO2011110642, 10.03.2011  
(97) 2545077, 16.01.2013 en  
(54) MONOCLONAL ANTIBODIES AGAINST C-MET  
(71) Genmab A/S, Bredgade 34 P.O. Box 9068, 1260 Copenhagen K, DK  
(72) NEIJSSSEN, Joost, J., Yalelaan 60, NL-3584 CM Utrecht, NL  
DE GOEIJ, Bart, Yalelaan 60, NL-3584 CM Utrecht, NL  
VAN DEN BRINK, Edward, Yalelaan 60, NL-3584 CM Utrecht, NL  
LABRIJN, Aran, Frank, Yalelaan 60, NL-3584 CM Utrecht, NL  
HOET, Rene, M., A., Egelinglaan 45, NL-3705 TB Zeist, NL  
SCHUURMAN, Janine, Yalelaan 60, NL-3584 CM Utrecht, NL  
PARREN, Paul, Yalelaan 60, NL-3584 CM Utrecht, NL  
VAN DE WINKEL, Jan, Yalelaan 60, NL-3584 CM Utrecht, NL
- 
- (51) MKP  
**A61P 31/16 (2006.01)** (97) **2585107 \***  
**C07K 16/00 (2006.01)**  
**C07K 19/00 (2006.01)**  
**A61P 35/00 (2006.01)**  
**C07K 16/44 (2006.01)**  
**C07K 14/52 (2006.01)**  
**A61K 39/385 (2006.01)**  
(86) EP2011060628 24.06.2011  
(96) 11727190.8 01.05.2013  
(87) WO2011161244, 24.06.2011  
(97) 2585107, 01.05.2013 en  
(54) HOMODIMERIC PROTEIN CONSTRUCTS  
(71) Vaccibody AS, Gaustadalleen 21, 0349 Oslo, NO  
(72) RUFFINI, Pier Adelchi, Via N. Palmieri 31, I-20141 Milano, IT  
BOGEN, Bjarne, Pelvikvn. 28, N-1367 Snarøya, NO  
FREDRIKSEN, Agnete Brunsvik, Strandvn. 5, N-2005 Rælingen, NO
- 
- (51) MKP  
**A47D 1/10 (2006.01)** (97) **2584940 \***  
(86) NO2011000180 23.06.2011  
(96) 11729782.0 01.05.2013  
(87) WO2011162618, 23.06.2011  
(97) 2584940, 01.05.2013 en  
(54) BABY CRADLE AND MOUNTING DEVICE  
(71) Stokke AS, Håhjem, 6260 Skodje, NO  
Peter Opsvik AS, Pilestredet 27h, 0164 Oslo, NO  
(72) OPSVIK, Peter, c/o Peter Opsvik AS Pilestredet 27H, N-0164 Oslo, NO  
EIDSVIK, Ingegjerd, c/o Stokke AS Håhjem, N-6260 Skodje, NO
- 
- (51) MKP  
**A61K 39/395 (2006.01)** (97) **2550017 \***  
**C07K 16/00 (2006.01)**  
**C07K 16/46 (2006.01)**  
(86) GB2011050608 25.03.2011  
(96) 11711386.0 30.01.2013  
(87) WO2011117648, 25.03.2011  
(97) 2550017, 30.01.2013 en  
(54) DISULFIDE STABILISED ANTIBODIES AND FRAGMENTS THEREOF  
(71) UCB Pharma S.A., Allée de la Recherche 60, 1070 Brussels, BE  
(72) HUMPHREYS, David Paul, c/o IPD UCB Celltech 208 Bath Road Slough, Berkshire SL1 3WE, GB

- (51) MKP  
**C02F 9/06 (2006.01)** (97) **2554521 \***  
**C02F 1/50 (2006.01)**
- (86) CN2011070739 28.01.2011  
(96) 11727100.7 06.02.2013  
(87) WO2011076152, 28.01.2011  
(97) 2554521, 06.02.2013 en
- (54) APPARATUS AND METHOD FOR PURIFYING AND STERILIZING WATER USING NANO CATALYTIC MICROELECTROLYSIS
- (71) Boying Xiamen Science And Technology Co. Ltd., Zhang, Shiwen 1st, No.42, Xinglinxi Road Jimei, Xiamen, Fujian 361000, CN
- (72) ZHANG, Shiwen, 1st No.42 Xinglinxi Road Jimei, Xiamen Fujian 361000, CN
- 
- (51) MKP  
**A61K 38/18 (2006.01)** (97) **2560644 \***  
**A61P 13/12 (2006.01)**  
**A61K 31/60 (2006.01)**  
**A61K 31/4365 (2006.01)**
- (86) IN2011000259 18.04.2011  
(96) 11736457.0 27.02.2013  
(87) WO2011132201, 18.04.2011  
(97) 2560644, 27.02.2013 en
- (54) A PHARMACEUTICAL COMPOSITION COMPRISING ANTIPLATELET AGENTS AND AN ERYTHROPOIESIS STIMULATING AGENT
- (71) Cadila Healthcare Limited, Zydus Tower Satellite Cross Roads, Ahmedabad 380 015 Gujarat, IN
- (72) SONI, Hitesh, Madanlal, Zydus Tower Satellite Cross Road, Ahmedabad 380 015 Gujarat, IN  
JAIN, Mukul, R., Zydus Tower Satellite Cross Road, Ahmedabad 380 015 Gujarat, IN
- 
- (51) MKP  
**A61P 19/02 (2006.01)** (97) **2575813 \***  
**A61K 9/00 (2006.01)**  
**A61P 29/00 (2006.01)**  
**A61K 31/444 (2006.01)**
- (86) US2011035788 09.05.2011  
(96) 11731545.7 10.04.2013  
(87) WO2011149645, 09.05.2011  
(97) 2575813, 10.04.2013 en
- (54) TOPICAL ETORICOXIB FORMULATION
- (71) Nuvo Research Inc., 7560 Airport Road, Unit 10, Mississauga, ON L4T 4H4, CA
- (72) BUYUKTIMKIN, Servet, 11772 Carmel Creek Road, 105, San Diego California 92130, US  
BUYUKTIMKIN, Nadir, 11772 Carmel Creek Road, 105, San Diego California 92130, US  
KISAK, Edward, T., 3525 Bayside Lane Apt. B, San Diego California 92109, US  
SINGH, Jagat, 64 Grover Drive, Scarborough Ontario M1C 4V7, CA  
NEWSAM, John, M., 525 Westbourne Street, La Jolla California 92037-5449, US  
KING-SMITH, Dominic, 5814 Lord Cecil Street, San Diego California 92122, US  
GALER, Bradley, S., 1740 Lenape Road Bldg. 2, West Chester Pennsylvania 19382, US
- 
- (51) MKP  
**C07D 241/02 (2006.01)** (97) **2576519 \***  
**A01N 43/56 (2006.01)**
- (86) US2011038517 31.05.2011  
(96) 11792904.2 10.04.2013  
(87) WO2011156174, 31.05.2011  
(97) 2576519, 10.04.2013 en
- (54) PYRAZINYL CARBOXAMIDES AS FUNGICIDES
- (71) Dow AgroSciences LLC, 9330 Zionsville Road, Indianapolis, IN 46268, US
- (72) BRYAN, Kristy, 1502 Cool Creek Drive, Carmel IN 46033, US  
DAVIS, George, 15114 Count Fleet Ct., Carmel IN 46032, US  
GRAUPNER, Paul, 12723 Wembly Road, Carmel IN 46033, US  
LORSBACH, Beth, 6034 Haverford Avenue, Indianapolis IN 46220, US  
OWEN, W., 12421 Pebblepointe Pass, Carmel IN 46033, US  
TISDELL, Francis, 67 Parkview Road, Carmel IN 46032, US
- 
- (51) MKP  
**A61K 47/42 (2006.01)** (97) **2571522 \***  
**A61P 35/00 (2006.01)**  
**A61K 39/00 (2006.01)**  
**A61K 39/385 (2006.01)**  
**A61K 47/48 (2006.01)**
- (86) US2011037327 20.05.2011  
(96) 11784317.7 27.03.2013  
(87) WO2011146828, 20.05.2011  
(97) 2571522, 27.03.2013 en
- (54) CANCER TREATMENT
- (71) University of Miami, 1507 Levante Avenue, Room 327, Coral Gables, FL 33146, US
- (72) PODACK, Eckhard, R., 1720 Espanola Drive, Coconut Grove, FL 33133, US
- 
- (51) MKP  
**C07D 401/10 (2006.01)** (97) **2588466 \***  
**A61P 25/16 (2006.01)**  
**C07D 403/10 (2006.01)**  
**C07D 401/12 (2006.01)**  
**A61K 31/496 (2006.01)**  
**A61P 25/28 (2006.01)**
- (86) EP2011059330 07.06.2011  
(96) 11723091.2 08.05.2013  
(87) WO2011154374, 07.06.2011  
(97) 2588466, 08.05.2013 en
- (54) 5-AMINO-3,6-DIHYDRO-1H-PYRAZIN-2-ONE DERIVATIVES USEFUL AS INHIBITORS OF BETA-SECRETASE (BACE)
- (71) Janssen Pharmaceutica, N.V., Turnhoutseweg 30, 2340 Beerse, BE
- (72) TRABANCO-SUÁREZ, Andrés, Avelino, c/o Janssen-Cilag S.A. Calle Jarama 75 Poligono Industrial, E-45007 Toledo, ES  
TRESADERN, Gary, John, c/o Janssen-Cilag S.A. Calle Jarama 75 Poligono Industrial, E-45007 Toledo, ES  
MACDONALD, Gregor, James, c/o Janssen Pharmaceutica NV Turnhoutseweg 30, B-2340 Beerse, BE  
VEGA RAMIRO, Juan, Antonio, c/o Janssen-Cilag S.A. Calle Jarama 75 Poligono Industrial, E-45007 Toledo, ES
- 
- (51) MKP  
**C12Q 1/68 (2006.01)** (97) **2585615 \***
- (86) EP2011060524 22.06.2011  
(96) 11736024.8 01.05.2013  
(87) WO2011161199, 22.06.2011  
(97) 2585615, 01.05.2013 en
- (54) HIGHLY SENSITIVE METHOD FOR DETECTION OF A TARGET NUCLEIC ACID IN A SAMPLE
- (71) Euroclone S.p.A., Via Spezia 1, 20142 Milano, IT  
(72) SPINELLI, Luigi, Via per Cabiato 61, I-20260 Mariano Comense, IT  
BOSIO, Paolo, Corso Piave 55, I-12051 Alba, IT  
CANFORA, Paola, Via IV Novembre 4, I-22069 Rovellasca, IT  
PIONA, Riccardo, Via L. della Pila 57, I-20162 Milano, IT  
PIZZIGONI, Alessandro, Piazza Mondadori 4, I-20122 Milan, IT
- 
- (51) MKP  
**A01N 39/02 (2006.01)** (97) **2566321 \***  
**A01N 57/16 (2006.01)**  
**A01N 43/40 (2006.01)**  
**A01N 25/00 (2006.01)**  
**A01N 25/02 (2006.01)**
- (86) US2011034881 03.05.2011  
(96) 11717924.2 13.03.2013  
(87) WO2011140005, 03.05.2011  
(97) 2566321, 13.03.2013 en
- (54) USE OF COLD-STABILIZED METHYLATED VEGETABLE OILS AS AN AGRICULTURAL CHEMICAL COFORMULANT
- (71) Dow AgroSciences LLC, 9330 Zionsville Road, Indianapolis, IN 46268, US
- (72) VOGLEWEDE, Christopher, 46 West Cedar Place SW, Calgary AB T3H 5T9, CA  
SWAYZE, Karen, 14280 Arcadian Circle, Carmel IN 46033, US  
TANK, Holger, 1172 Huntington Woods Point, Zionsville IN 46077, US

- (51) MKP  
**B65H 75/44 (2006.01)** (97) **2539265 \***  
**A47L 9/26 (2006.01)**
- (86) EP2011072920 15.12.2011  
(96) 11802894.3 02.01.2013  
(87) WO2012080401, 15.12.2011  
(97) 2539265, 02.01.2013 de  
(54) BRAKE SYSTEM FOR A CABLE REEL  
(71) Athos Holding GmbH, Westerfelder Weg 25, 58515 Lüdenscheid, DE  
Taicang Athos Electrical Components Co., Ltd., No. 1 The First Grade Road Outing of Taicang Hongliang Industrial Park Economic Developing Area, Taicang, Jiangsu, CN  
(72) STEINMÜLLER, Jörg, Schlund 7, 58540 Meinerzhagen, DE  
KLEINDOPPE, Günter, Jahnstr. 65, 58849 Herscheid, DE  
GLOMB, Martin, Lindenbergstr. 5, 58332 Schwelm, DE  
ZHANG, Lei, House 56 Lane89 Yehui RD Qingpu District, Shanghai, CN
- 
- (51) MKP  
**A61M 5/50 (2006.01)** (97) **2555814 \***  
**A61J 1/20 (2006.01)**  
**A61M 5/24 (2006.01)**
- (86) EP2011055394 07.04.2011  
(96) 11712568.2 13.02.2013  
(87) WO2011124631, 07.04.2011  
(97) 2555814, 13.02.2013 en  
(54) CODED DRUG RESERVOIR CONNECTION ELEMENT WITH BENDABLE LOCKING ELEMENTS  
(71) Sanofi-Aventis Deutschland GmbH, Brüningstraße 50, 65929 Frankfurt, DE  
(72) AVERY, Richard James Vincent, 28 Nursery Close Mickleton, Chipping Campden Gloucestershire GL55 6TX, GB  
JAMES, Aled Meredydd, 1 Ettington Chose, Dorridge B93 8RR, GB
- 
- (51) MKP  
**A01N 43/38 (2006.01)** (97) **2549868 \***  
**A61K 31/405 (2006.01)**
- (86) US2011029511 23.03.2011  
(96) 11760102.1 30.01.2013  
(87) WO2011119663, 23.03.2011  
(97) 2549868, 30.01.2013 en  
(54) CHEMICAL COMPOUNDS  
(71) GlaxoSmithKline LLC, One Franklin Plaza 200 North 16th Street, Philadelphia, PA 19102, US  
(72) AXTEN, Jeffrey, Michael, 1250 South Collegeville Road, Collegeville PA 19426, US  
GRANT, Seth, Wilson, 1250 South Collegeville Road, Collegeville PA 19426, US  
HEERDING, Dirk, A., 1250 South Collegeville Road, Collegeville PA 19426, US  
MEDINA, Jesus, Raul, 1250 South Collegeville Road, Collegeville PA 19426, US  
ROMERIL, Stuart, Paul, 1250 South Collegeville Road, Collegeville PA 19426, US  
TANG, Jun, Five Moore Drive, Research Triangle Park NC 27709, US
- 
- (51) MKP  
**A61K 9/22 (2006.01)** (97) **2544667 \***
- (86) US2011027736 09.03.2011  
(96) 11754004.7 16.01.2013  
(87) WO2011112709, 09.03.2011  
(97) 2544667, 16.01.2013 en  
(54) ALCOHOL RESISTANT ENTERIC PHARMACEUTICAL COMPOSITIONS  
(71) Alkermes Pharma Ireland Limited, Connaught House 1 Burlington Road, Dublin 4, IE  
(72) LIVERSIDGE, Gary, 258 Colwyn Terrace, West Chester PA 19380, US  
MANSER, David, 2 Mosstown Court Keenagh, Longford County, IE  
SHAH, Hardik, 21 Esker Pines Lucan, Dublin, IE  
RUDDY, Stephen B., 226 Stallion Lane, Schwenksville PA 19473, US  
REKHI, Gurvinder, Singh, 1492 Riverview Run Lane, Suwanee GA 30024, US

- (51) MKP  
**B66F 11/04 (2006.01)** (97) **2380846**
- (96) 11162932.5 26.10.2011  
(97) 2380846, 26.10.2011 en  
(54) Telescopic aerial work platform  
(71) CTE S.p.A., Via Caproni, 7, 38068 Rovereto (Trento), IT  
(72) Cipriani, Lorenzo, CTE S.p.A. Via Caproni, 7, 38068, ROVERETO (TN), IT
- 
- (51) MKP  
**C07D 277/46 (2006.01)** (97) **2547667 \***  
**C07D 277/40 (2006.01)**  
**C07D 277/50 (2006.01)**
- (86) US2011027121 04.03.2011  
(96) 11707764.4 23.01.2013  
(87) WO2011115758, 04.03.2011  
(97) 2547667, 23.01.2013 en  
(54) PROCESS FOR THE PRODUCTION OF 2-AMINO-5-FLUOROTHIAZOLE  
(71) Takeda California, Inc., 10410 Science Center Drive, San Diego, CA 92121, US  
(72) MATTSON, Matthew, Takeda San Diego Inc. 10410 Science Center Drive, San Diego, California 92121, US
- 
- (51) MKP  
**B65D 17/50 (2006.01)** (97) **2550206 \***  
**A61J 1/00 (2006.01)**  
**B65D 41/20 (2006.01)**  
**B65D 51/22 (2006.01)**
- (86) AU2010001296 01.10.2010  
(96) 10848138.3 30.01.2013  
(87) WO2011116408, 01.10.2010  
(97) 2550206, 30.01.2013 en  
(54) LIQUID CONTAINER  
(71) SDI Limited, 5-9 Brunson Street, Bayswater, VIC 3153, AU  
(72) CHEETHAM, Joshua, James, 23 Lewisham Road, Windsor, VIC 3181, AU
- 
- (51) MKP  
**A61K 31/506 (2006.01)** (97) **2588473 \***  
**C07D 401/14 (2006.01)**  
**A61P 19/00 (2006.01)**  
**A61P 37/00 (2006.01)**  
**A61P 35/00 (2006.01)**  
**C07D 473/16 (2006.01)**  
**A61K 31/497 (2006.01)**  
**A61P 29/00 (2006.01)**  
**A61K 31/4709 (2006.01)**
- (86) US2011042506 30.06.2011  
(96) 11738520.3 08.05.2013  
(87) WO2012003264, 30.06.2011  
(97) 2588473, 08.05.2013 en  
(54) NITROGEN CONTAINING HETEROCYCLIC COMPOUNDS AS PIK3 -DELTA INHIBITORS  
(71) Amgen Inc., One Amgen Center Drive, Thousand Oaks, California 91320-1799, US  
(72) DRANSFIELD, Paul John, 178 Allison Street, San Francisco, California 94112, US  
GONZALEZ LOPEZ DE TURISO, Felix, 10 De Sabla Road 509, San Mateo, California 94402, US  
PATTAROPONG, Vatee, 1408 El Camino Read Unit 1, Burlingame, California 94010, US  
SIMARD, Jillian L., 2584 Bush Street, San Francisco, California 94115, US

- (51) MKP  
**A61K 38/16 (2006.01)** (97) **2593126 \***  
**A61K 38/10 (2006.01)**  
**A61P 3/10 (2006.01)**  
**A61K 39/395 (2006.01)**  
**A61K 38/08 (2006.01)**  
**A61P 3/00 (2006.01)**  
**A61P 35/00 (2006.01)**
- (86) US2011043758 12.07.2011  
(96) 11816760.0 22.05.2013  
(87) WO2012021249, 12.07.2011  
(97) 2593126, 22.05.2013 en  
(54) INNOVATIVE DISCOVERY OF THERAPEUTIC, DIAGNOSTIC, AND ANTIBODY COMPOSITIONS RELATED TO PROTEIN FRAGMENTS OF HISTIDYL-TRNA SYNTHETASES
- (71) aTyr Pharma, Inc., 3545 John Hopkins Court, Suite 250, San Diego, CA 92121, US  
Pangu Biopharma Limited, Edinburgh Tower, 18/F The Landmark 15 Queen's Road Central, Hong Kong, CN
- (72) GREENE, Leslie, Ann, 13941 Davenport Avenue, San Diego California 92129, US  
CHIANG, Kyle, P., 1615 Debann Road, Cardiff, CA 92007, US  
HONG, Fei, 12646 Spindletop Road, San Diego California 92129, US  
VASSEROT, Alain, P., 6421 La Paloma Street, Carlsbad, California 92009, US  
LO, Wing-Sze, RM 815, Sui Ming House Siu Sai Wan Estate Chai Wan, Hong Kong, CN  
WATKINS, Jeffrey, D., 3442 Fortuna Ranch Road, Encinitas California 92014, US  
QUINN, Cheryl, L., 408 North 1st Street No. 706, Minneapolis, MN 55401, US  
MENDLEIN, John, D., 1550 Neptune Avenue, Encinitas California 92024, US
- 
- (51) MKP  
**B31F 1/28 (2006.01)** (97) **2552686 \***  
**B32B 29/08 (2006.01)**
- (86) NZ2011000044 31.03.2011  
(96) 11763109.3 06.02.2013  
(87) WO2011122968, 31.03.2011  
(97) 2552686, 06.02.2013 en  
(54) IMPROVED METHOD AND APPARATUS FOR FORMING CORRUGATED BOARD
- (71) Corcel IP Limited, Level 12, KPMG Centre 85 Alexandra Street, Hamilton 3204, NZ
- (72) VAN BERLO, Patrick Petrus Antonius Maria, C/- James & Wells Intellectual Property Level 12 KPMG Centre 85 Alexandra Street, Hamilton 3240, NZ
- 
- (51) MKP  
**A61K 31/505 (2006.01)** (97) **2575818 \***  
**A61P 35/02 (2006.01)**  
**A61P 35/00 (2006.01)**  
**A61K 31/519 (2006.01)**
- (86) US2011039190 03.06.2011  
(96) 11790524.0 10.04.2013  
(87) WO2011153514, 03.06.2011  
(97) 2575818, 10.04.2013 en  
(54) THE USE OF INHIBITORS OF BRUTON'S TYROSINE KINASE (BTK)
- (71) Pharmacyclics, Inc., 995 East Arques Avenue, Sunnyvale, CA 94085, US
- (72) BUGGY, Joseph, J., 1229 Marilyn Drive, Mountain View, CA 94040, US  
ELIAS, Laurence, 41 Alvarado Road, Berkeley, CA 94705, US  
FYFE, Gwen, 20 La Ferrera Terrace, San Francisco, CA 94133, US  
HEDRICK, Eric, 59 Hobart Avenue, Summit, NJ 07901, US  
LOURY, David, J., 7130 Galli Drive, San Jose, CA 95129, US  
MODY, Tarak, D., 955 La Mesa Terrace E, Sunnyvale, CA 94086, US
- 
- (51) MKP  
**C07D 489/08 (2006.01)** (97) **2580218 \***  
**C07D 489/12 (2006.01)**
- (86) IB2011001328 10.06.2011  
(96) 11736153.5 17.04.2013  
(87) WO2011154826, 10.06.2011  
(97) 2580218, 17.04.2013 en  
(54) PROCESS FOR N-DEALKYLATION OF TERTIARY AMINES
- (71) Rhodes Technologies, 498 Washington Street, Coventry, RI 02816, US
- (72) REISCH, Helge, A., 36 Wells Street, Westerly RI 02891, US  
SANDOVAL, Sergio, 34 Scenic Drive, West Warwick RI 02893, US  
STYMIEST, Jake, L., 41 Howard Hill Road, Foster RI 02825, US
- 
- (51) MKP  
**B60R 21/213 (2011.01)** (97) **2539185 \***
- (86) IB2011000338 21.02.2011  
(96) 11711641.8 02.01.2013  
(87) WO2011110909, 21.02.2011  
(97) 2539185, 02.01.2013 en  
(54) PROTECTION SYSTEM FOR PASSENGERS OF HEAVY OR MEDIUM HEAVY TRANSPORT MEANS
- (71) New Poli Group S.r.l., Via Brescia 186/B Statale BS-MN, 25018 Montichiari (BS), IT
- (72) POLI, Alessandro, c/o NEW POLI GROUP S.r.l. Via Brescia 186/B Statale BS-MN, I- 25018 Montichiari (BS), IT
- 
- (51) MKP  
**E05D 15/58 (2006.01)** (97) **2546441**
- (96) 11005746.0 16.01.2013  
(97) 2546441, 16.01.2013 de  
(54) Sliding and rotating leaf system
- (71) Sunflex Aluminiumsysteme GmbH, Im Ruttenberge 12, 57482 Wenden, DE
- (72) Schneider, Ernst-Josef, Pirschweg 2b, 57482 Wenden, DE  
Schneider, Malte, 1494 Pacaya Cove, Naples, FL 34119, US
- 
- (51) MKP  
**A61K 31/415 (2006.01)** (97) **2566331 \***  
**A01N 43/56 (2006.01)**
- (86) US2011035363 05.05.2011  
(96) 11778348.0 13.03.2013  
(87) WO2011140343, 05.05.2011  
(97) 2566331, 13.03.2013 en  
(54) PHARMACEUTICAL COMPOSITIONS AND METHODS OF MAKING SAME
- (71) Glaxo Wellcome Manufacturing Pte Ltd, 1 Pioneer Sector 1, Jurong 628413, SG
- (72) GUPTA, Manish K., GlaxoSmithKline Global Patents Department 1250 South Collegeville Road PO Box 5089, Collegeville Pennsylvania 19426, US
- 
- (51) MKP  
**G09F 27/00 (2006.01)** (97) **2306440**  
**E01F 9/011 (2006.01)**  
**E04H 1/12 (2006.01)**  
**G09F 19/22 (2006.01)**  
**G08G 1/123 (2006.01)**
- (96) 10177244.0 06.04.2011  
(97) 2306440, 06.04.2011 en  
(54) Display assembly having different types of display
- (71) Nexus Alpha Limited, 5a Old Town, Clapham London SW4 0JT, GB
- (72) McDougall, Patrick, c/o Nexus Alpha Limited 5a Old Town, Clapham, London, SW4 0JT, GB  
Coleman, Julian, c/o Nexus Alpha Limited 5a Old Town, Clapham, London, SW4 0JT, GB

- (51) MKP  
**A61K 9/20 (2006.01)** (97) **2549983 \***  
**A61K 31/517 (2006.01)**
- (86) EP2011054628 25.03.2011  
(96) 11710202.0 30.01.2013  
(87) WO2011117391, 25.03.2011  
(97) 2549983, 30.01.2013 en  
(54) NOVEL COMPOSITION FOR TREATMENT OF ESSENTIAL THROMBOCYTHEMIA  
(71) AOP Orphan Pharmaceuticals AG, Wilhelminenstrasse 91/II f/B 4, 1160 Wien, AT  
(72) WIDMANN, Rudolf, Winterg. 85/1b, A-3002 Purkersdorf, AT  
STRIEDER, Georg, Wilhelminenstr. 95b, A-1160 Vienna, AT
- 
- (51) MKP  
**A23K 1/175 (2006.01)** (97) **2584913 \***  
**A23K 1/16 (2006.01)**  
**A23L 1/03 (2006.01)**  
**A23K 1/00 (2006.01)**  
**A61K 33/06 (2006.01)**  
**A61K 9/14 (2006.01)**  
**A61K 31/593 (2006.01)**  
**A23L 1/304 (2006.01)**  
**A61K 9/16 (2006.01)**  
**A61P 19/10 (2006.01)**  
**A61K 36/185 (2006.01)**  
**A23L 1/303 (2006.01)**
- (86) EP2011060618 24.06.2011  
(96) 11727187.4 01.05.2013  
(87) WO2011161236, 24.06.2011  
(97) 2584913, 01.05.2013 en  
(54) STABILIZED ACTIVE COMPOUND  
(71) Prayon S.A., Rue Joseph Wauters 144, 4480 Engis, BE  
(72) TANTAOUI ELARAQI, Khadija, rue de Paris 12, B-4020 Liege, BE  
BROZE, Guy, rue des Enfants 2, B-4460 Grace-Hollogne, BE  
LERUITE, Audrey, rue Gustave Taillard 14B, B-4650 Herve, BE
- 
- (51) MKP  
**F24F 3/14 (2006.01)** (97) **2585196 \***  
**B01D 53/06 (2006.01)**  
**B01D 53/26 (2006.01)**
- (86) IN2011000412 20.06.2011  
(96) 11743645.1 01.05.2013  
(87) WO2011161693, 20.06.2011  
(97) 2585196, 01.05.2013 en  
(54) SYSTEM AND METHOD FOR IMPROVING THE PERFORMANCE OF DESICCANT DEHUMIDIFICATION EQUIPMENT FOR LOW-HUMIDITY APPLICATIONS  
(71) Bry-Air (Asia) Pvt. Ltd., 20, Rajpur Road, Delhi 110 054, IN  
(72) PAHWA, Deepak, 20 Rajpur Road, Delhi 110 054, IN  
SACHDEV, Rajan, C-1 1/222 Sector-3, Rohini Delhi 110 085, IN  
GRIFFITHS, William Charles, 6101 Myrtlewood Circle West, Palm Beach Gardens, FL 33418, US  
MALIK, Kuldeep Singh, A-16 A-Block Phase-1 Dindarpur Ext. Shyam Vihar, Najafgarh New Delhi 110 043, IN
- 
- (51) MKP  
**C07D 401/12 (2006.01)** (97) **2569280 \***  
**A61K 31/407 (2006.01)**  
**C07D 207/06 (2006.01)**  
**A61K 31/40 (2006.01)**  
**C07D 409/12 (2006.01)**  
**A61K 31/454 (2006.01)**  
**C07D 491/107 (2006.01)**  
**C07D 405/12 (2006.01)**  
**A61K 31/438 (2006.01)**  
**C07D 403/10 (2006.01)**  
**A61K 31/403 (2006.01)**  
**C07D 413/12 (2006.01)**  
**A61K 31/4535 (2006.01)**  
**C07D 471/10 (2006.01)**  
**A61K 31/453 (2006.01)**
- (86) US2011035826 10.05.2011  
(96) 11731173.8 20.03.2013  
(87) WO2011143150, 10.05.2011  
(97) 2569280, 20.03.2013 en  
(54) SUBSTITUTED PHENYL CYCLOALKYL PYRROLIDINE (PIPERIDINE) SPIROLACTAMS AND AMIDES, PREPARATION AND THERAPEUTIC USE THEREOF  
(71) SANOFI, 54, rue de la Boétie, 75008 Paris, FR  
(72) GAO, Zhongli, c/o sanofi-aventis U.S. 1041 Route 202-206 BWD-303A, Bridgewater, New Jersey 08807, US
- 
- (51) MKP  
**A61P 35/00 (2006.01)** (97) **2579877 \***  
**C07D 413/14 (2006.01)**  
**C07D 471/04 (2006.01)**  
**A61K 31/505 (2006.01)**
- (86) GB2011051074 09.06.2011  
(96) 11725494.6 17.04.2013  
(87) WO2011154737, 09.06.2011  
(97) 2579877, 17.04.2013 en  
(54) MORPHOLINO PYRIMIDINES AND THEIR USE IN THERAPY  
(71) AstraZeneca AB, null, 151 85 Södertälje, SE  
(72) FOOTE, Kevin, Michael, AstraZeneca R&D Alderley Alderley Park, Macclesfield, Cheshire SK10 4TG, GB  
NISSINK, Johannes, Wilhelmus, Maria, AstraZeneca R&D Alderley Alderley Park, Macclesfield, Cheshire SK10 4TG, GB  
TURNER, Paul, AstraZeneca R&D Alderley Alderley Park, Macclesfield, Cheshire SK10 4TG, GB
- 
- (51) MKP  
**A61K 31/47 (2006.01)** (97) **2593090 \***  
**A61K 9/20 (2006.01)**
- (86) US2011044378 18.07.2011  
(96) 11740764.3 22.05.2013  
(87) WO2012009722, 18.07.2011  
(97) 2593090, 22.05.2013 en  
(54) C-MET MODULATOR PHARMACEUTICAL COMPOSITIONS  
(71) Exelixis, Inc., 210 East Grand Avenue, South San Francisco, CA 94080, US  
(72) WILSON, Jo Ann, 74 Seward Street, San Francisco CA 94114, US
- 
- (51) MKP  
**A61M 5/315 (2006.01)** (97) **2455122**
- (96) 10191803.5 23.05.2012  
(97) 2455122, 23.05.2012 en  
(54) Drive mechanism for a drug delivery device  
(71) Sanofi-Aventis Deutschland GmbH, Brüningstraße 50, 65929 Frankfurt, DE  
(72) Mariami, Faiza, c/o Sanofi-Aventis Deutschland GmbH Geb. K 607, 65926 Frankfurt, DE

(51) MKP  
**A43B 5/00 (2006.01)** (97) **2555834 \***  
**A63B 31/11 (2006.01)**  
**B63C 11/02 (2006.01)**  
(86) CA2011000395 07.04.2011  
(96) 11764992.1 13.02.2013  
(87) WO2011123950, 07.04.2011  
(97) 2555834, 13.02.2013 en  
(54) FLIPPERS, BOOTS, SYSTEMS INCLUDING SAME, AND METHODS OF USING SAME  
(71) Cetatek Holdings Inc., 125-998 Harbourside Drive, North Vancouver, British Columbia V7P 3T2, CA  
(72) ORTWIG, Jan Peter, 900 Clipper Place RR 1 U-56, Bowen Island, British Columbia V0N 1G0, CA

(51) MKP  
**G10L 19/00 (2006.01)** (97) **2355554**  
**H04S 7/00 (2006.01)**  
**H04S 5/00 (2006.01)**  
(96) 10192878.6 10.08.2011  
(97) 2355554, 10.08.2011 en  
(54) Musical tone signal-processing apparatus  
(71) Roland Corporation, 2036-1, Nakagawa, Hosoe-cho Kita-ku Hamamatsu, Shizuoka 431-1304, JP  
(72) Sato, Kenji, 2036-1 Nakagawa, Hosoe-cho Kita-ku, Hamamatsu Shizuoka 431-1304, JP  
Hagino, Takaaki, 2036-1 Nakagawa, Hosoe-cho Kita-ku, Hamamatsu Shizuoka 431-1304, JP

(51) MKP  
**A61K 38/00 (2006.01)** (97) **2580242 \***  
**C07K 16/28 (2006.01)**  
**A61K 38/18 (2006.01)**  
(86) DK2011050214 14.06.2011  
(96) 11725865.7 17.04.2013  
(87) WO2011157275, 14.06.2011  
(97) 2580242, 17.04.2013 en  
(54) MODULATION OF THE INTERACTION BETWEEN SORLA AND GDNF-FAMILY LIGAND RECEPTORS  
(71) H. Lundbeck A/S, Otiliavej 9, 2500 Valby, DK  
(72) NYKJÆR, Anders, Skolevangs Allé 1B, DK-8240 Risskov, DK  
GLERUP, Simon, Agerbæksvej 5, DK-8240 Risskov, DK  
MADSEN, Peder Søndergaard, Krogagre 9, DK-8240 Risskov, DK  
PETERSEN, Claus Munck, Åboulevarden 100 3, DK-8000 Århus C, DK  
OLSEN, Ditte, Vilh. Bergsøes Vej 25 3, DK-8210 Århus V, DK

(51) MKP  
**A61K 31/53 (2006.01)** (97) **2579880 \***  
**A61K 9/20 (2006.01)**  
(86) EP2011059590 09.06.2011  
(96) 11726105.7 17.04.2013  
(87) WO2011154497, 09.06.2011  
(97) 2579880, 17.04.2013 en  
(54) TREATMENT OF TYPE 2 DIABETES  
(71) Poxel, 200 avenue Jean Jaurès, 69007 Lyon, FR  
(72) FOUQUERAY, Pascale, Sonnhalde 6, CH-5643 Sins, CH  
CRAVO, Daniel, 18 bis chemin des Murgers, F-78360 Montesson, FR  
HALLAKOU-BOZEC, Sophie, 166 avenue Henri Ginoux, F-92120 Montrouge, FR  
BOLZE, Sébastien, 382 chemin des Dorriers, F-01600 Massieux, FR

(51) MKP  
**A61H 1/02 (2006.01)** (97) **2575725 \***  
(86) US2011038565 31.05.2011  
(96) 11790282.5 10.04.2013  
(87) WO2011153143, 31.05.2011  
(97) 2575725, 10.04.2013 en  
(54) HUMERUS-STABILIZED SHOULDER STRETCH DEVICE  
(71) Bua, Dunne Enterprise LLC, 7 Knollwood Terrace, Randolph, NJ 07869, US  
(72) BUA, Alesandro, 7 Knollwood Terrace, Randolph NJ 07889, US  
DUNNE, Michael, 351 Kingsland Avenue, Lyndhurst NJ 07071, US

(51) MKP  
**A61M 5/24 (2006.01)** (97) **2579921 \***  
**A61M 5/315 (2006.01)**  
(86) EP2011059569 09.06.2011  
(96) 11724220.6 17.04.2013  
(87) WO2011154484, 09.06.2011  
(97) 2579921, 17.04.2013 en  
(54) DRIVE MECHANISM FOR A DRUG DELIVERY DEVICE  
(71) Sanofi-Aventis Deutschland GmbH, Brüningstraße 50, 65929 Frankfurt, DE  
(72) RAAB, Steffen, c/o Sanofi-Aventis Deutschland GmbH, 65926 Frankfurt am Main, DE  
SMITH, Christopher, James, 4 Elm Drive Cheshire, Holmes Chapel CW4 7QG, GB  
HORLOCK, Mark, Philip, 18 Mayfield Close, Timperley, Cheshire WA15 7TE, GB  
BUTLER, Stephen, David, 25 High Hill South Staffords, Essington, Staffordshire WV11 2DP, GB

(51) MKP  
**C07D 487/04 (2006.01)** (97) **2593451 \***  
**A61K 31/519 (2006.01)**  
**C07D 471/04 (2006.01)**  
**A61K 31/437 (2006.01)**  
(86) EP2011061508 07.07.2011  
(96) 11730003.8 22.05.2013  
(87) WO2012007345, 07.07.2011  
(97) 2593451, 22.05.2013 en  
(54) SUBSTITUTED IMIDAZO[1,2-A]PYRIMIDINES AND -PYRIDINES  
(71) Bayer Intellectual Property GmbH, Alfred-Nobel-Strasse 10, 40789 Monheim, DE  
(72) INCE, Stuart, Katteweg 27a, 14129 Berlin, DE  
HAEGEBARTH, Andrea, An den Eldenaer Höfen 13, 10247Berlin, DE  
POLITZ, Oliver, Steenerbuschstr. 73, 16341 Panketal OT Zepernick, DE  
NEUHAUS, Roland, Lauenburger Strasse 28, 12157 Berlin, DE  
BÖMER, Ulf, Leipziger Str. 49, 16548 Glienicke, DE  
SCOTT, William, 210 Saddle Hill Drive, 06437 Guilford, US

(51) MKP  
**A61K 31/519 (2006.01)** (97) **2574168 \***  
**A61K 9/107 (2006.01)**  
**A61K 47/06 (2006.01)**  
**A61K 47/10 (2006.01)**  
**A61K 9/00 (2006.01)**  
(86) US2011037291 20.05.2011  
(96) 11724104.2 03.04.2013  
(87) WO2011146808, 20.05.2011  
(97) 2574168, 03.04.2013 en  
(54) TOPICAL FORMULATION FOR A JAK INHIBITOR  
(71) Incyte Corporation, Experimental Station Route 141 & Henry Clay Road Building 336, Wilmington, DE 19880, US  
(72) PARIKH, Bhavnish, 120 Portmarmock Drive, Avondale, Pennsylvania 19311, US  
SHAH, Bhavesh, 24907 Flying Arrow, San Antonio, Texas 78258, US  
YELESWARAM, Krishnaswamy, 136 Harrogate Drive, Landenberg, Pennsylvania 19350, US

(51) MKP  
**C23C 30/00 (2006.01)** (97) **2497841**  
**C22C 13/00 (2006.01)**  
**C23C 26/00 (2006.01)**  
**C22C 7/00 (2006.01)**  
**C22C 5/06 (2006.01)**  
(96) 11157478.6 12.09.2012  
(97) 2497841, 12.09.2012 de  
(54) Sn-Ag-Cu-Alloys  
(71) Umicore AG & Co. KG, Rodenbacher Chaussee 4, 63457 Hanau-Wolfgang, DE  
(72) Hutin, Olivier, Konrad-Zuse-Ring 3, 63505, Langenselbold, DE  
Ringstein, Hans-Martin, Inheidenerstraße 22, 60385, Frankfurt (Main), DE

- (51) MKP  
**A61P 9/06 (2006.01)** (97) **2544681 \***  
**A61K 31/343 (2006.01)**  
 (86) IB2011051027 11.03.2011  
 (96) 11713080.7 16.01.2013  
 (87) WO2011111026, 11.03.2011  
 (97) 2544681, 16.01.2013 en  
 (54) USE OF DRONEDARONE OR A PHARMACEUTICALLY ACCEPTABLE SALT THEREOF, FOR THE PREPARATION OF A MEDICAMENT FOR ADMINISTRATION SHORTLY AFTER AMIODARONE DISCONTINUATION  
 (71) SANOFI, 54, rue de la Boétie, 75008 Paris, FR  
 (72) GAUDIN, Christophe, c/o sanofi-aventis Patent Department 174 avenue de France, F-75013 Paris, FR  
 MERIOUA, Ihsen, c/o sanofi-aventis Patent Department 174 avenue de France, F-75013 Paris, FR  
 RADZIK, Davide, c/o sanofi-aventis Patent Department 174 avenue de France, F-75013 Paris, FR

- (51) MKP  
**A61K 31/196 (2006.01)** (97) **2544662 \***  
**A61K 47/20 (2006.01)**  
**A61P 19/02 (2006.01)**  
**A61K 31/192 (2006.01)**  
**A61K 9/12 (2006.01)**  
 (86) US2011028004 10.03.2011  
 (96) 11713105.2 16.01.2013  
 (87) WO2011112875, 10.03.2011  
 (97) 2544662, 16.01.2013 en  
 (54) FOAMABLE FORMULATION  
 (71) Nuvo Research Inc., 7560 Airport Road, Unit 10, Mississauga, ON L4T 4H4, CA  
 (72) BUYUKTIMKIN, Servet, 11772 Carmel Creek Road, 105, San Diego California 92130, US  
 BUYUKTIMKIN, Nadir, 11772 Carmel Creek Road 105, San Diego California 92130, US  
 KISAK, Edward T., 3525 Bayside Lane Apt. B, San Diego California 92109, US  
 SINGH, Jagat, 64 Grover Drive, Scarborough Ontario M1C 4V7, CA  
 NEWSAM, John M., 525 Westbourne Street, La Jolla California 92037-5449, US  
 KING-SMITH, Dominic, 5814 Lord Cecil Street, San Diego California 92122, US  
 GALER, Bradley S., 1740 Lenape Road Bldg. 2, West Chester Pennsylvania 19382, US

- (51) MKP  
**C12N 15/37 (2006.01)** (97) **2558482 \***  
**C07K 14/08 (2006.01)**  
**C12N 9/50 (2006.01)**  
 (86) US2011032526 14.04.2011  
 (96) 11718186.7 20.02.2013  
 (87) WO2011130533, 14.04.2011  
 (97) 2558482, 20.02.2013 en  
 (54) ENGINEERED PLANT CYSTEINE PROTEASES AND THEIR USES  
 (71) Janssen Biotech, Inc., 800/850 Ridgeview Drive, Horsham, PA 19044, US  
 (72) CHI, Ellen, 3210 Merryfield Row, San Diego, CA 92121, US  
 HUNTER, Michael, 3210 Merryfield Row, San Diego, CA 92121, US  
 SWANSON, Ronald, 3210 Merryfield Row, San Diego, CA 92121, US

- (51) MKP  
**C07D 501/34 (2006.01)** (97) **2569321 \***  
 (86) EP2011057404 09.05.2011  
 (96) 11717676.8 20.03.2013  
 (87) WO2011141415, 09.05.2011  
 (97) 2569321, 20.03.2013 en  
 (54) OXIDATION PROCESS FOR PREPARING 3-FORMYL-CEPHEM DERIVATIVES  
 (71) Basilea Pharmaceutica International Ltd., Grenzacherstrasse 487, 4058 Basel, CH  
 (72) VERVEST, Ivan, Joseph, Maria, c/o Janssen Pharmaceutica NV Turnhoutseweg 30, B-2340 Beerse, BE

- (51) MKP  
**E02D 3/12 (2006.01)** (97) **2543769**  
**E02D 1/02 (2006.01)**  
 (96) 12172908.1 09.01.2013  
 (97) 2543769, 09.01.2013 en  
 (54) Method of consolidating a foundation soil  
 (71) GEOSEC s.r.l., via Giuseppe di Vittorio, 41/B, 43044 Lemignano di Collecchio (PR), IT  
 (72) Occhi, Marco, via Buozzi, 24, 43126 Parma, IT

- (51) MKP  
**C07C 227/42 (2006.01)** (97) **2580184 \***  
 (86) EP2011059243 06.06.2011  
 (96) 11724612.4 17.04.2013  
 (87) WO2011154333, 06.06.2011  
 (97) 2580184, 17.04.2013 de  
 (54) PROCESS FOR PREPARING CRYSTALLINE 3,6,9-TRIAZA-3,6,9-TRIS(CARBOXYMETHYL)-4-(4-ETHOXYBENZYL) UNDECANEDIOIC ACID AND USE FOR PRODUCTION OF PRIMOVISt®  
 (71) Bayer Intellectual Property GmbH, Alfred-Nobel-Strasse 10, 40789 Monheim, DE  
 (72) PLATZEK, Johannes, Grottkauer Str. 55, 12621 Berlin, DE  
 TRENTMANN, Wilhelm, Gasselstiege 419, 48159 Münster, DE

- (51) MKP  
**G01N 33/53 (2006.01)** (97) **2577315 \***  
**C07K 14/00 (2006.01)**  
**C07K 14/775 (2006.01)**  
**G01N 33/68 (2006.01)**  
 (86) US2011039122 03.06.2011  
 (96) 11725846.7 10.04.2013  
 (87) WO2011153469, 03.06.2011  
 (97) 2577315, 10.04.2013 en  
 (54) MARKERS FOR RENAL DISEASE  
 (71) IDEXX LABORATORIES, INC., One Idexx Drive, Westbrook, ME 04092, US  
 (72) YERRAMILLI, Mahalakshmi, 7 Old Oak Way, Falmouth, ME 04105, US  
 ATKINSON, Michael, Randolph, 50 Gray Road, Gorham, ME 04038, US  
 YERRAMILLI, Murthy, V.S.N., 7 Old Oak Way, Falmouth, ME 04105, US

- (51) MKP  
**C07F 7/08 (2006.01)** (97) **2545060 \***  
**A61K 31/695 (2006.01)**  
**A61P 31/14 (2006.01)**  
 (86) US2011027117 04.03.2011  
 (96) 11707763.6 16.01.2013  
 (87) WO2011112429, 04.03.2011  
 (97) 2545060, 16.01.2013 en  
 (54) FUSED TRICYCLIC SILYL COMPOUNDS AND METHODS OF USE THEREOF FOR THE TREATMENT OF VIRAL DISEASES  
 (71) Merck Sharp & Dohme Corp., 126 East Lincoln Avenue, Rahway, NJ 07065-0907, US  
 (72) Nair, Anilkumar Gopinadhan, 2000 Galloping Hill Road, Kenilworth, New Jersey 07033, US  
 Keertikar, Kerry M., 2000 Galloping Hill Road, Kenilworth, New Jersey 07033, US  
 Kim, Seong Heon, 2000 Galloping Hill Road, Kenilworth, New Jersey 07033, US  
 Kozlowski, Joseph A., 2000 Galloping Hill Road, Kenilworth, New Jersey 07033, US  
 Rosenblum, Stuart, 2000 Galloping Hill Road, Kenilworth, New Jersey 07033, US  
 Selyutin, Oleg B., 2000 Galloping Hill Road, Kenilworth, New Jersey 07033, US  
 Wong, Michael, 2000 Galloping Hill Road, Kenilworth, New Jersey 07033, US  
 Yu, Wensheng, 2000 Galloping Hill Road, Kenilworth, New Jersey 07033, US  
 Zeng, Qingbei, 2000 Galloping Hill Road, Kenilworth, New Jersey 07033, US



(51) MKP  
**A61M 5/50 (2006.01)** (97) **2555815 \***  
**A61J 1/20 (2006.01)**  
**A61M 5/24 (2006.01)**  
(86) EP2011055395 07.04.2011  
(96) 11712569.0 13.02.2013  
(87) WO2011124632, 07.04.2011  
(97) 2555815, 13.02.2013 en  
(54) CODED DRUG RESERVOIR CONNECTION ELEMENT WITH HINGED FLANGE  
(71) Sanofi-Aventis Deutschland GmbH, Brüningstraße 50, 65929 Frankfurt, DE  
(72) AVERY, Richard James Vincent, 28 Nursery Close Mickleton, Chipping Campden Gloucestershire GL55 6TX, GB  
**JAMES, Aled Meredydd, 5 Moorefield Avenue Knowle, West Midlands B93 9RE, GB**

(51) MKP  
**C05G 1/00 (2006.01)** (97) **2590909 \***  
(86) CN2011076707 30.06.2011  
(96) 11803136.8 15.05.2013  
(87) WO2012003782, 30.06.2011  
(97) 2590909, 15.05.2013 en  
(54) COMPOSITIONS AND METHODS OF MAKING AND USING THE COMPOSITIONS FOR IMPROVING SOIL AND/OR PLANT GROWTH AND IMPROVED SOIL, IMPROVED PLANTS, AND/OR IMPROVED SEEDS  
(71) Zhang, Jianmin, No. 1038 Baxian Villa Beiqijia Changping District, Beijing 102209, CN  
(72) Zhang, Jianmin, No. 1038 Baxian Villa Beiqijia Changping District, Beijing 102209, CN

(51) MKP  
**A61K 8/89 (2006.01)** (97) **2592935 \***  
**A61K 8/20 (2006.01)**  
**A01N 59/12 (2006.01)**  
**A61K 47/24 (2006.01)**  
**A61P 31/02 (2006.01)**  
**A01N 25/02 (2006.01)**  
**A61K 33/18 (2006.01)**  
**A01P 1/00 (2006.01)**  
(86) HU2011000065 12.07.2011  
(96) 11751629.4 22.05.2013  
(87) WO2012007776, 12.07.2011  
(97) 2592935, 22.05.2013 en  
(54) DISINFECTANT AND ANTISEPTIC FORMULATION HAVING REDUCED IODINE CONTENT  
(71) Egis Gyógyszergyár Nyilvánosan Működő Részvénytársaság, Keresztúri út 30-38, 1106 Budapest, HU  
(72) MIKULÁSIK, Endre, Bástya u. 23, 1a, 9900 Körmen, HU  
**SPAITS, Tamás, Bástya u. 19, 2/6, 9900 Körmen, HU**

(51) MKP  
**A47K 5/12 (2006.01)** (97) **2560529 \***  
(86) AT2011000198 21.04.2011  
(96) 11722274.5 27.02.2013  
(87) WO2011130764, 21.04.2011  
(97) 2560529, 27.02.2013 de  
(54) DISPENSER  
(71) Hagleitner, Hans Georg, Lindenallee 11, 5700 Zell am See, AT  
**Hagleitner, Hans Georg, Lindenallee 11, 5700 Zell am See, AT**

(51) MKP  
**B42D 13/00 (2006.01)** (97) **2316659**  
**B42D 15/10 (2006.01)**  
(96) 10405192.5 04.05.2011  
(97) 2316659, 04.05.2011 de  
(54) Data sheet for a means of identification  
(71) Trüb AG, Hintere Bahnhofstrasse 12, CH-5001 Aarau, CH  
(72) Egli, Stefan, Hochstrasse 69, 4053 Basel, CH  
**Fawer, Urs, Scharthenstrasse 10, 5400 Baden, CH**

(51) MKP  
**F23J 15/04 (2006.01)** (97) **2479495**  
**F23J 15/02 (2006.01)**  
**F23M 7/04 (2006.01)**  
**F23G 5/50 (2006.01)**  
**B01D 53/34 (2006.01)**  
**F23G 5/00 (2006.01)**  
**F23G 5/30 (2006.01)**  
**F23G 5/46 (2006.01)**  
(96) 11002375.1 25.07.2012  
(97) 2479495, 25.07.2012 en  
(54) A multipurpose biologic sludge, organic wastes and biomasses cogeneration incineration plant and process developed therein  
(71) Technelep S.R.L., Via Valsesia, 50, 20152 Milano (MI), IT  
(72) Bobbiesi, Giuseppe, Via Valsesia 50, 20152 Milano, IT  
**Scalari, Mauro, Via Marcello Chizzolini 16, 46010 Campitello (MN), IT**

(51) MKP  
**A61K 39/395 (2006.01)** (97) **2575863 \***  
**A61P 35/00 (2006.01)**  
**A61P 35/02 (2006.01)**  
**A61K 38/20 (2006.01)**  
(86) US2011039149 03.06.2011  
(96) 11790502.6 10.04.2013  
(87) WO2011153485, 03.06.2011  
(97) 2575863, 10.04.2013 en  
(54) USE OF THE SPARC MICROENVIRONMENT SIGNATURE IN THE TREATMENT OF CANCER  
(71) Abraxis BioScience, LLC, 11755 Wilshire Boulevard Suite 2000, Los Angeles, CA 90025, US  
(72) TRIEU, Vuong, 4003 Jim Bowie Boulevard, Agoura Hills, California 91301, US  
**LIU, Xiping, 6035 Camellia Ave., Temple City, California 91780, US**  
**DESAI, Neil, 11755 Wilshire Boulevard Suite 2000, Los Angeles, California 90025, US**

(51) MKP  
**A61K 31/375 (2006.01)** (97) **2473037 \***  
**A61K 31/315 (2006.01)**  
(86) IN2010000583 02.09.2010  
(96) 10813434.7 11.07.2012  
(87) WO2011027363, 02.09.2010  
(97) 2473037, 11.07.2012 en  
(54) METHOD OF TREATMENT OF NEURODEGENERATIVE OR NEURO-MUSCULAR DEGENERATIVE DISEASES AND THERAPEUTIC AGENT TO TREAT THE SAME  
(71) Medasani, Munisekhar, S-1, Plot 31B Vimal Road 5 Jubilee Hills, Hyderabad 500 033 Andhra Pradesh, IN  
(72) DIVI, Satyasayee Babu, 55-1-19 JR Nagar, Vishakapatnam 530 022 Andhra Pradesh, IN  
**PALEMPATI, Satya Laxmi Priyanka, S-1 Plot 31B Vimal Road 5 Jubilee Hills, Hyderabad 500 033 Andhra Pradesh, IN**

(51) MKP  
**C12Q 1/68 (2006.01)** (97) **2563934 \***  
(86) US2011034244 28.04.2011  
(96) 11719705.3 06.03.2013  
(87) WO2011137206, 28.04.2011  
(97) 2563934, 06.03.2013 en  
(54) PREDICTIVE MARKERS USEFUL IN THE TREATMENT OF FRAGILE X SYNDROME (FXS)  
(71) Novartis AG, Lichtstrasse 35, 4056 Basel, CH  
(72) GOMEZ-MANCILLA, Baltazar, Novartis Pharma AG Postfach, CH-4002 Basel, CH  
**HE, Yunsheng, Novartis Institutes for BioMedical Research Inc. 45 Sidney Street, Cambridge, Massachusetts 02139, US**  
**JOHNS, Donald, Novartis Institutes for BioMedical Research Inc. 220 Massachusetts Avenue, Cambridge, Massachusetts 02139, US**  
**MEYER, Joanne, Novartis Institutes for BioMedical Research Inc. 45 Sidney Street, Cambridge, Massachusetts 02139, US**  
**PAULDING, Charles, 58 Whispering Brook Road, Groton Massachusetts 01450, US**

(51) MKP  
**A61K 31/196 (2006.01)** (97) **2590931 \***  
**C07C 235/24 (2006.01)**  
**A61K 31/277 (2006.01)**  
**A61P 3/10 (2006.01)**  
**C07C 255/44 (2006.01)**  
(86) EP2011061335 05.07.2011  
(96) 11731315.5 15.05.2013  
(87) WO2012004269, 05.07.2011  
(97) 2590931, 15.05.2013 de  
(54) (2-ARYLOXY-ACETYLAMINO)-PHENYL-PROPIONIC ACID DERIVATIVES, METHOD FOR PRODUCING SAME AND USE THEREOF AS PHARMACEUTICALS  
(71) SANOFI, 54 rue La Boétie, 75008 Paris, FR  
(72) DEFOSSA, Elisabeth, c/o Sanofi-Aventis Deutschland GmbH, 65926 Frankfurt am Main, DE  
KEIL, Stefanie, c/o Sanofi-Aventis Deutschland GmbH, 65926 Frankfurt am Main, DE  
DIETRICH, Viktoria, c/o Sanofi-Aventis Deutschland GmbH, 65926 Frankfurt am Main, DE  
STENGELIN, Siegfried, c/o Sanofi-Aventis Deutschland GmbH, 65926 Frankfurt am Main, DE  
HERLING, Andreas, c/o Sanofi-Aventis Deutschland GmbH, 65926 Frankfurt am Main, DE  
HASCHKE, Guido, c/o Sanofi-Aventis Deutschland GmbH, 65926 Frankfurt am Main, DE  
KLABUNDE, Thomas, c/o Sanofi-Aventis Deutschland GmbH, 65926 Frankfurt am Main, DE

(51) MKP  
**F04B 1/04 (2006.01)** (97) **2492506**  
**F04B 53/12 (2006.01)**  
**F04B 53/16 (2006.01)**  
**F02M 37/04 (2006.01)**  
(96) 11156280.7 29.08.2012  
(97) 2492506, 29.08.2012 en  
(54) Pumping head  
(71) Delphi Technologies Holding S.à.r.l., Avenue de Luxembourg, 4940 Bascharage, LU  
(72) McHattie, James, 11 Bysing Wood Road, Faversham, Kent ME13 7QA, GB

(51) MKP  
**A61P 7/00 (2006.01)** (97) **2542255 \***  
**A61P 37/02 (2006.01)**  
**A61K 39/00 (2006.01)**  
**C07K 16/00 (2006.01)**  
(86) US2011026602 01.03.2011  
(96) 11751164.2 09.01.2013  
(87) WO2011109338, 01.03.2011  
(97) 2542255, 09.01.2013 en  
(54) METHODS AND COMPOSITIONS FOR TREATING DEGOS' DISEASE  
(71) Alexion Pharmaceuticals, Inc., 352 Knotter Drive, Cheshire, CT 06410, US  
(72) MAGRO, Cynthia, 44 East 65th Street, Apt. 2B, New York, NY 10065, US

(51) MKP  
**A61K 38/17 (2006.01)** (97) **2593128 \***  
**C07K 16/28 (2006.01)**  
**C07K 16/46 (2006.01)**  
(86) US2011044172 15.07.2011  
(96) 11741717.0 22.05.2013  
(87) WO2012009631, 15.07.2011  
(97) 2593128, 22.05.2013 en  
(54) HUMANIZED ANTIBODIES TARGETING THE EC1 DOMAIN OF CADHERIN-11 AND RELATED COMPOSITIONS AND METHODS  
(71) Synovex Corporation, 200 Boston Avenue Suite 1100, Medford, MA 02155, US  
(72) MCARTHUR, James, G., 95 Conant Street 311, Concord, MA 01742, US

(51) MKP  
**A61K 38/01 (2006.01)** (97) **2526939**  
**A61K 36/00 (2006.01)**  
**A61K 31/353 (2006.01)**  
**A61P 1/04 (2006.01)**  
**A61P 1/00 (2006.01)**  
(96) 11176814.9 28.11.2012  
(97) 2526939, 28.11.2012 en  
(54) Gelatine tannate and associations thereof for use in the treatment of inflammatory gastrointestinal diseases  
(71) Alonso Cohen, Miguel Angel, Calle Sagrat Cor, 1, 08034 Barcelona, ES  
(72) Alonso Cohen, Miguel Angel, Calle Sagrat Cor, 1, 08034 BARCELONA, ES  
Di Fulvio, Marco, c/o NOVINTETHICAL PHARMA, SAGL Via Pian Scairolo, 11, 6915 PAMBIO-NORANCO, CH

(51) MKP  
**G06F 3/033 (2013.01)** (97) **2569684 \***  
(86) US2011036674 16.05.2011  
(96) 11781414.5 20.03.2013  
(87) WO2011143661, 16.05.2011  
(97) 2569684, 20.03.2013 en  
(54) METHODS AND SYSTEMS FOR POINTING DEVICE USING ACOUSTIC IMPEDIOGRAPHY  
(71) Sonavation, Inc., 357 Hiatt Drive, Palm Beach Gardens, FL 33418, US  
(72) IRVING, Richard, 15819 80th Drive North, Palm Beach Gardens, FL 33418, US  
JAHROMI, Omid, 9103 Ducale Way Apt. 302, Palm Beach Gardens, FL 33418, US  
KROPP, Ronald, A., 3618 Alder Drive Apt. F1, West Palm Beach, FL 33417, US  
SCHMITT, Rainer, M., 86 Ironwood Way, Palm Beach Gardens, FL 33418, US

(51) MKP  
**A61F 5/00 (2006.01)** (97) **2538894 \***  
**A61F 13/00 (2006.01)**  
(86) US2011024213 09.02.2011  
(96) 11705108.6 02.01.2013  
(87) WO2011106157, 09.02.2011  
(97) 2538894, 02.01.2013 en  
(54) DEVICES FOR TREATING MORBID OBESITY USING HYDROGEL  
(71) Ethicon Endo-Surgery, Inc., 4545 Creek Road, Cincinnati, OH 45242, US  
(72) BURRELL, Janna, M., 1294 Herlin Apartment 2, Cincinnati OH 45208, US  
BYRUM, Randal, T., 370 Forest Edge Drive, South Lebanon OH 45065, US  
KOCH, Robert, L., Jr., 2515 Byrneside Drive, Cincinnati OH 45239, US  
POOL, Larry, D., 7758 Alexandra Drive, Mason OH 45040, US  
WIDENHOUSE, Christopher, W., 1005 Arabian Run Drive, Clarksville OH 45113, US

(51) MKP  
**C09D 5/16 (2006.01)** (97) **2587918 \***  
**A01N 59/20 (2006.01)**  
**A01N 43/40 (2006.01)**  
**D06M 13/355 (2006.01)**  
**A01P 9/00 (2006.01)**  
**A01N 37/10 (2006.01)**  
**D06M 13/203 (2006.01)**  
**A01P 13/00 (2006.01)**  
**A01N 59/16 (2006.01)**  
**A01N 43/36 (2006.01)**  
**D06M 13/352 (2006.01)**  
(86) EP2011060873 29.06.2011  
(96) 11735823.4 08.05.2013  
(87) WO2012001027, 29.06.2011  
(97) 2587918, 08.05.2013 en  
(54) ANTIFOULING BENZOATE COMBINATIONS  
(71) Janssen Pharmaceutica, N.V., Turnhoutseweg 30, 2340 Beerse, BE  
(72) KEMPEN, Tony Mathilde Jozef, Janssen Pharmaceutica NV Turnhoutseweg 30, B-2340 Beerse, BE

(51) MKP  
**A61L 2/07 (2006.01)** (97) **2563410 \***  
**A61L 2/025 (2006.01)**  
**A61L 2/10 (2006.01)**  
(86) EP2011056595 26.04.2011  
(96) 11716266.9 06.03.2013  
(87) WO2011134970, 26.04.2011  
(97) 2563410, 06.03.2013 de  
(54) METHOD FOR MACHINE-CLEANING AND MACHINE-DISINFECTING OBJECTS  
(71) Saiger, Lothar, Hauptstrasse 3, 88525 Dürmentingen, DE  
(72) Saiger, Lothar, Hauptstrasse 3, 88525 Dürmentingen, DE

---

(51) MKP  
**A61M 5/145 (2006.01)** (97) **2538993 \***  
(86) EP2011052303 16.02.2011  
(96) 11704066.7 02.01.2013  
(87) WO2011101381, 16.02.2011  
(97) 2538993, 02.01.2013 en  
(54) GEARBOX  
(71) Sanofi-Aventis Deutschland GmbH, Brüningstraße 50, 65929 Frankfurt, DE  
(72) EKMAN, Matthew, 59 Ecton Avenue, Macclesfield Cheshire SK10 1RD, GB  
KEMP, Thomas Mark, 3 Forresters Cottages, High Street, Ashwell, SG7 5NW, GB  
BARROW-WILLIAMS, Timothy Donald, 1 Grange Street, St. Albans, Herts. AL3 5NA, GB

---

(51) MKP  
**A61P 15/00 (2006.01)** (97) **2543729 \***  
**A61P 9/12 (2006.01)**  
**A61K 38/27 (2006.01)**  
**C12N 15/09 (2006.01)**  
**A61K 48/00 (2006.01)**  
**A01K 67/027 (2006.01)**  
**A61P 13/12 (2006.01)**  
(86) JP2011055087 04.03.2011  
(96) 11750820.0 09.01.2013  
(87) WO2011108711, 04.03.2011  
(97) 2543729, 09.01.2013 en  
(54) MODEL ANIMAL FOR PREGNANCY-INDUCED HYPERTENSION SYNDROME, AND TREATMENT METHOD THEREFOR  
(71) Okabe, Masaru, 6-39-10, Onoharahigashi, Minoo-shi, Osaka 562-0031, JP  
Ikawa, Masahito, 5-15-21 Senrioka-higashi, Settsu-shi, Osaka 566-0011, JP  
Fuso Pharmaceutical Industries, Ltd., 7-10 Dosho-machi 1-chome Chuo-ku, Osaka-shi, Osaka 541-0045, JP  
(72) KIMURA, Tadashi, 5-14-2-601 Nakano-cho Miyakojima-ku, Osaka-shi Osaka 534-0027, JP  
KUMASAWA, Keiichi, 1-19-1-1008 Kamishinden, Toyonaka-shi Osaka 560-0085, JP

---

(51) MKP  
**A61K 31/445 (2006.01)** (97) **2585064 \***  
**C07D 211/06 (2006.01)**  
(86) US2011041910 24.06.2011  
(96) 11799027.5 01.05.2013  
(87) WO2011163640, 24.06.2011  
(97) 2585064, 01.05.2013 en  
(54) C5AR ANTAGONISTS  
(71) ChemoCentryx, Inc., 850 Maude Avenue, Mountain View, California 94043, US  
(72) FAN, Pingchen, 40190 Santa Teresa Common, Fremont California 94539, US  
GREENMAN, Kevin Lloyd, 463 Bryan Avenue, Sunnyvale California 94086, US  
LELETI, Manmohan Reddy, 19608 Pruneridge Avenue, 8304, Cupertino California 95014, US  
LI, Yandong, 121 La Quebrada Way, San Jose California 95127, US  
POWERS, Jay, 745 Rockaway Beach Avenue, Pacifica California 94044, US  
TANAKA, Hiroko, 815 Catamaran Street, 1, Foster City California 94404, US  
YANG, Ju, 19608 Pruneridge Avenue, 7304, Cupertino California 95014, US  
ZENG, Yibin, 917 Aruba Lane, Foster City California 94404, US

(51) MKP  
**C07K 14/00 (2006.01)** (97) **2585476 \***  
(86) US2011041502 22.06.2011  
(96) 11798875.8 01.05.2013  
(87) WO2011163401, 22.06.2011  
(97) 2585476, 01.05.2013 en  
(54) COLON AND PANCREAS CANCER SPECIFIC ANTIGENS AND ANTIBODIES  
(71) Neogenix Oncology, Inc., 15010 Broschart Road, Suite 270, Rockville, MD 20850, US  
(72) DU, Xiulian, 25406 Damascus Park Terrace, Damascus Maryland 20872, US  
LUKA, Janos, 3700 Franklinville Road, New Windsor Maryland 21776, US  
STAFFORD, Lewis Joe, 9909 Gable Ridge Terrace Apt. C, Rockville, Maryland 20850, US  
SEMENUK, Mark, 107 Orchard Hills Drive, Gaithersburg Maryland 20878, US  
WANG, Xue-Ping, 18 Pequot Avenue, Port Washington New York 11050, US  
KANTOR, Judith, 1096 Larkspur Terrace, Rockville Maryland 20850, US  
BRISTOL, J., Andrew, 3201 Flushing Meadow Terrace, Chevy Chase Maryland 20815, US

---

(51) MKP  
**A61L 27/20 (2006.01)** (97) **2560694 \***  
**A61L 27/24 (2006.01)**  
**A61L 27/34 (2006.01)**  
**A61L 27/26 (2006.01)**  
**A61L 27/54 (2006.01)**  
(86) IB2011051253 24.03.2011  
(96) 11731084.7 27.02.2013  
(87) WO2011132096, 24.03.2011  
(97) 2560694, 27.02.2013 en  
(54) IMPLANTING DEVICE WITH ANTIBACTERIAL PROPERTIES AND MULTIFUNCTIONAL SURFACE  
(71) Nobil Bio Ricerche S.r.l., Via della Stella 64, 25062 Concesio (BS), IT  
(72) BOLLATI, Daniele, c/o Nobil Bio Ricerche S.r.l. Via della Stella 64, 25062 Concesio Brescia, IT  
MORRA, Marco, c/o Nobil Bio Ricerche S.r.l. Via della Stella 64, 25062 Concesio Brescia, IT  
CASSINELLI, Clara, c/o Nobil Bio Ricerche S.r.l. Via della Stella 64, 25062 Concesio Brescia, IT  
CASCARDO, Giovanna, c/o Nobil Bio Ricerche S.r.l. Via della Stella 64, 25062 Concesio Brescia, IT

---

(51) MKP  
**H04N 7/14 (2006.01)** (97) **2569938 \***  
**H04N 7/15 (2006.01)**  
**H04N 7/00 (2011.01)**  
(86) US2011036263 12.05.2011  
(96) 11721199.5 20.03.2013  
(87) WO2011143438, 12.05.2011  
(97) 2569938, 20.03.2013 en  
(54) SYSTEMS AND METHODS FOR SCALABLE DISTRIBUTED GLOBAL INFRASTRUCTURE FOR REAL-TIME MULTIMEDIA COMMUNICATION  
(71) Blue Jeans Network, Inc., 3000 Lakeside Drive, Santa Clara, CA 95054, US  
(72) PERIYANNAN, Alagu, 3152 Ross Road, Palo Alto CA 94303, US  
ANAND, Raghavan, 2650 Keystone Avenue 113, Santa Clara 95051, US  
GRUPENHOFF, Michael, 3314 Saint Michael Drive, Palo Alto CA 94306, US  
KALLURI, Ravi, Kiran, 3287 Cantamar Court, San Jose CA 95135, US  
WEBER, Emmanuel, 4512 Carnaby Court, San Jose CA 95136, US  
VILLAIT, Anil, C3-906 Lok Everest J.S.D. Marg, Mulund (west) Mumbai 400080, IN

(51) MKP  
**A01F 25/18 (2006.01)** (97) **2584883 \***  
 (86) DK2011000068 24.06.2011  
 (96) 11738150.9 01.05.2013  
 (87) WO2011160631, 24.06.2011  
 (97) 2584883, 01.05.2013 en  
 (54) AN AGRICULTURAL DEVICE AND METHOD  
 (71) Kjær, Erling, Røddingvej 5, 7480 Vildbjerg, DK  
 (72) Kjær, Erling, Røddingvej 5, 7480 Vildbjerg, DK

(51) MKP  
**A61M 5/20 (2006.01)** (97) **2585135 \***  
**A61M 5/00 (2006.01)**  
 (86) EP2011060726 27.06.2011  
 (96) 11727478.7 01.05.2013  
 (87) WO2012000939, 27.06.2011  
 (97) 2585135, 01.05.2013 en  
 (54) AUTO-INJECTOR  
 (71) Sanofi-Aventis Deutschland GmbH, Brüningstraße 50, 65929 Frankfurt, DE  
 (72) EKMAN, Matthew, 59 Ecton Avenue Cheshire, Macclesfield Cheshire SK10 1RD, GB  
 HOURMAND, Yannick, 14 The Elms, Haslingfield Cambridgeshire CB23 1ND, GB  
 BARROW-WILLIAMS, Timothy Donald, 1 Grange Street, St. Albans Hertfordshire AL3 5NA, GB

(51) MKP  
**C07D 487/04 (2006.01)** (97) **2547680 \***  
**A61K 31/4985 (2006.01)**  
**A61P 35/00 (2006.01)**  
 (86) EP2011053967 16.03.2011  
 (96) 11708301.4 23.01.2013  
 (87) WO2011113862, 16.03.2011  
 (97) 2547680, 23.01.2013 en  
 (54) IMIDAZOPYRAZINES  
 (71) Bayer Intellectual Property GmbH, Alfred-Nobel-Strasse 10, 40789 Monheim, DE  
 (72) KLAR, Ulrich, Isegrimsteig 8 a, 13503 Berlin, DE  
 KOPPITZ, Marcus, Scharnhorststr. 28, 10115 Berlin, DE  
 KOSEMUND, Dirk, Klutstr. 14, 12587 Berlin, DE  
 BOHLMANN, Rolf, Kuehler Weg 6a, 14055 Berlin, DE  
 BADER, Benjamin, Hillmannstr. 14, 13467 Berlin, DE  
 LIENAU, Philip, Jahnstr. 13, 10967 Berlin, DE  
 SIEMEISTER, Gerhard, Reimerswalder Steig 26, 13503 Berlin, DE  
 PRECHTL, Stefan, Kanzowstr. 5a, 10439 Berlin, DE  
 NGUYEN, Duy, Heinrich-Heine-Straße 27, 10179 Berlin, DE  
 SCOTT, William, Alsterweg 50, 14167 Berlin, DE

(51) MKP  
**A01H 1/04 (2006.01)** (97) **2582226 \***  
**A01H 5/00 (2006.01)**  
 (86) EP2011003052 15.06.2011  
 (96) 11726718.7 24.04.2013  
 (87) WO2011157453, 15.06.2011  
 (97) 2582226, 24.04.2013 en  
 (54) METHODS FOR DETERMINING FITNESS IN PLANTS  
 (71) Bayer CropScience NV, J.E. Mommaertslaan 14, 1831 Diegem, BE  
 (72) AKPO, Essè, Ifèbi, Hervé, Zinniastraat 24, 9000 Gent, BE  
 LAGA, Benjamin, Rakestraat 4, 8750 Wingene, BE  
 DE BLOCK, Marc, Abrikozenstraat 26, 9820 Merelbeke, BE

(51) MKP  
**C07D 403/12 (2006.01)** (97) **2552908 \***  
**C07D 473/34 (2006.01)**  
**A61P 29/00 (2006.01)**  
**C07D 471/04 (2006.01)**  
**A61K 31/506 (2006.01)**  
**C07D 487/04 (2006.01)**  
**C07D 401/14 (2006.01)**  
**C07D 409/12 (2006.01)**  
 (86) US2011030888 01.04.2011  
 (96) 11713167.2 06.02.2013  
 (87) WO2011123751, 01.04.2011  
 (97) 2552908, 06.02.2013 en  
 (54) HETEROCYCLIC COMPOUNDS AND THEIR USES  
 (71) Amgen Inc., One Amgen Center Drive, Thousand Oaks, California 91320-1799, US  
 (72) CUSHING, Timothy, D., 1064 Glacier Avenue, Pacificia, California 94044, US  
 DUQUETTE, Jason, A., 460 Bayview Avenue, Millbrae, California 94030, US  
 HE, Xiao, 725 Crane Avenue, Foster City, California 94404, US  
 LOHMAN, Julia, Winslow, 94A Sussex Street, San Francisco, California 94131, US  
 SHIN, Youngsook, 64 Loop 22, Emeryville, California 94608, US

(51) MKP  
**A61P 31/14 (2006.01)** (97) **2552933 \***  
**A61K 31/7076 (2006.01)**  
**C07H 19/20 (2006.01)**  
 (86) US2011030767 31.03.2011  
 (96) 11714467.5 06.02.2013  
 (87) WO2011123672, 31.03.2011  
 (97) 2552933, 06.02.2013 en  
 (54) PURINE NUCLEOSIDE PHOSPHORAMIDATE  
 (71) Gilead Pharmasset LLC, c/o Gilead Sciences, Inc. 333 Lakeside Drive, Foster City, CA 94404, US  
 (72) CHANG, Wonsuk, 311 Rodney Ct, Princeton NJ 08540, KP  
 NADUTHAMBI, Devan, 3806 Fox Run Drive, Plainsboro, NJ 08536, US  
 NAGARATHNAM, Dhanapalan, 52 Virginia Rail Drive, Bethany, CT 06524, US  
 PAMULAPATI, Ganapati, Reddy, 4608 Hunters Glen Drive, Plainsboro, NJ 08536, US  
 ROSS, Bruce, S., 8 Keppel Road, Plainboro, NJ 08536, US  
 SOFIA, Michael, Joseph, 3066 Antler Drive, Doylestown, PA 18901, US  
 ZHANG, Hai-Ren, 8680 Manahan Drive, Ellicott City, MD 21043, US

(51) MKP  
**C12N 15/10 (2006.01)** (97) **2571976 \***  
**G01N 33/569 (2006.01)**  
**C12Q 1/68 (2006.01)**  
**C12N 1/06 (2006.01)**  
 (86) EP2011002303 09.05.2011  
 (96) 11718666.8 27.03.2013  
 (87) WO2011144304, 09.05.2011  
 (97) 2571976, 27.03.2013 en  
 (54) UNIVERSALLY APPLICABLE LYSIS BUFFER AND PROCESSING METHODS FOR THE LYSIS OF BODILY SAMPLES  
 (71) Curetis AG, Max-Eyth-Strasse 42, 71088 Holzgerlingen, DE  
 (72) KLEIN, Matthias, Keltenburgstrasse 33, 71034 Böblingen, DE  
 LÜDKE, Gerd, Hülbenstr. 28, 71088 Holzgerlingen, DE  
 BOOS, Andreas, Schlehenstrasse 23/1, 71149 Bondorf, DE

(51) MKP  
**C07K 16/18 (2006.01)** (97) **2563812 \***  
 (86) US2011034598 29.04.2011  
 (96) 11775642.9 06.03.2013  
 (87) WO2011137362, 29.04.2011  
 (97) 2563812, 06.03.2013 en  
 (54) ANTIBODIES HAVING REDUCED IMMUNOGENICITY IN A HUMAN  
 (71) ALEXION PHARMACEUTICALS, INC., 352 Knottter Drive, Cheshire, CT 06410, US  
 (72) ROTHER, Russell, P., 10325 Forest Meadow Drive, Oklahoma City, OK 73151, US  
 TAMBURINI, Paul, P., 80 Devonshire Way, Kensington, CT 06037, US

(51) MKP  
**H05B 37/02 (2006.01)** (97) **2570004 \***  
 (86) EP2011057414 09.05.2011  
 (96) 11718107.3 20.03.2013  
 (87) WO2011141420, 09.05.2011  
 (97) 2570004, 20.03.2013 en  
 (54) LED LIGHTING DEVICES  
 (71) Foti, Ivan, 114 Sheen Road, Richmond Surrey TW9 1UR, GB  
 (72) Foti, Ivan, 114 Sheen Road, Richmond Surrey TW9 1UR, GB

(51) MKP  
**C04B 28/02 (2006.01)** (97) **2590905 \***  
**C04B 38/08 (2006.01)**  
 (86) EP2011061485 07.07.2011  
 (96) 11741143.9 15.05.2013  
 (87) WO2012004335, 07.07.2011  
 (97) 2590905, 15.05.2013 en  
 (54) DRY CEMENT MIX FOR FORMING LIGHT CONCRETES WITH LOW THERMAL CONDUCTIVITY, AND CONCRETES THUS OBTAINED  
 (71) ITALCEMENTI S.p.A., Via G. Camozzi, 124, 24121 Bergamo, IT  
 (72) CANGIANO, Stefano, Via A. Moro 73, I-24060 Torre De Roveri, IT  
 MORBI, Alessandro, Via Crodarolo 3, I-24067 Sarnico, IT

(51) MKP  
**A61K 47/36 (2006.01)** (97) **2582356 \***  
**A61K 47/38 (2006.01)**  
**A61K 9/00 (2006.01)**  
**A61P 17/00 (2006.01)**  
**A61K 31/13 (2006.01)**  
 (86) EP2011003023 17.06.2011  
 (96) 11729255.7 24.04.2013  
 (87) WO2011157449, 17.06.2011  
 (97) 2582356, 24.04.2013 en  
 (54) GEL FORMULATIONS FOR THE TOPICAL USE OF 1-AMINO-ALKYLCYCLOHEXANE DERIVATIVES  
 (71) Merz Pharma GmbH & Co. KGaA, Eckenheimer Landstrasse 100, 60318 Frankfurt am Main, DE  
 (72) SCHEPPLER, Petra, Peter-Weyer-Str. 90, 55129 Mainz, DE  
 HAUPTMEIER, Bernhard, Neue Weinbergstr. 10, 63571 Gelnhäusen, DE  
 ABTS, Harry Frank, Kurmainzer-Str. 14, 61440 Oberursel, DE  
 LINKO, Alexander, Schleswiger Str. 16, 60435 Frankfurt am Main, DE

(51) MKP  
**A61K 35/50 (2006.01)** (97) **2585084 \***  
 (86) US2012024798 13.02.2012  
 (96) 12746721.5 01.05.2013  
 (87) WO2012112410, 13.02.2012  
 (97) 2585084, 01.05.2013 en  
 (54) MICRONIZED PLACENTAL TISSUE COMPOSITIONS AND METHODS FOR MAKING AND USING THE SAME  
 (71) MIMEDX Group Inc., 60 Chastain Center Blvd. Suite 60, Kennesaw, GA 30144, US  
 (72) MORSE, Brenda, S., 1703 Harts Run, Chamblee, GA 30341, US  
 SITH, Somaly, 1535 Indian Forest Rd., Stone Mountain, GA 30083, US  
 SPENCER, Randall, 1108 Cool Springs Dr., Kennesaw, GA 30144, US  
 RAY, Steven, 210 Boulder Road, Kingston, GA 30145, US  
 DANIEL, John, 4891 Gresham Ridge Dr., Kennesaw, GA 30144, US

(51) MKP  
**C07D 405/12 (2006.01)** (97) **2576509 \***  
**C07D 409/06 (2006.01)**  
**A61K 31/4462 (2006.01)**  
**A61K 31/4465 (2006.01)**  
**C07D 211/22 (2006.01)**  
**A61P 25/28 (2006.01)**  
**A61K 31/4545 (2006.01)**  
**C07D 211/24 (2006.01)**  
**C07D 401/12 (2006.01)**  
 (86) EP2011058374 23.05.2011  
 (96) 11722384.2 10.04.2013  
 (87) WO2011147780, 23.05.2011  
 (97) 2576509, 10.04.2013 en  
 (54) FLUFENOXINE DERIVATIVES FOR THE TREATMENT AND PREVENTION OF AMILOYD PATHOLOGIES  
 (71) Faes Farma, S.A., Máximo Aguirre 14, 48940 Lamiako (Lejona) - Vizcaya, ES  
 (72) LEDO GÓMEZ, Francisco, Máximo Aguirre 14, E-48940 Lamiako (Lejona) - Vizcaya, ES  
 MUÑOZ MUÑOZ, Ana, Máximo Aguirre 14, E-48940 Lamiako (Lejona) - Vizcaya, ES  
 PUMAR DURÁN, Carmen, C/Máximo Aguirre 14, E-48940 Leioa - Vizcaya, ES

(51) MKP  
**B67B 1/06 (2006.01)** (97) **2576359 \***  
**B65D 39/16 (2006.01)**  
**B65D 1/02 (2006.01)**  
 (86) EP2011002664 30.05.2011  
 (96) 11727645.1 10.04.2013  
 (87) WO2011151050, 30.05.2011  
 (97) 2576359, 10.04.2013 en  
 (54) GLASS CONTAINER WITH INTERNALLY THREADED NECK  
 (71) Owens-Brockway Glass Container INC., One Michael Owens Way, Perrysburg, OH 43551, US  
 (72) VILLARET DE CHAUVIGNY, Benoît, 71 av. Valioud, F-69110 Sinte Foy les Lyon, FR  
 BRIGNOLO, Gino, Giovanni, Via Andrea Costa N 14 C, I-20090 Trezzano sul Naviglio, IT  
 MORETTIN, Ambrogio, Via Friuli 23, I-30020 Cinto Caomaggiore, IT  
 CAMPODONICO, Federico, Via Nizza 1/4, I-16145 Genova, IT  
 PERRONE, Dalmazio, Quarto Superiore 44, I-Asti, IT

(51) MKP  
**A61K 31/454 (2006.01)** (97) **2589595 \***  
**C07D 401/14 (2006.01)**  
**A61P 31/14 (2006.01)**  
**C07D 471/04 (2006.01)**  
**A61K 31/5383 (2006.01)**  
**A61K 31/7056 (2006.01)**  
**C07D 405/12 (2006.01)**  
**C07D 403/10 (2006.01)**  
**A61K 31/4164 (2006.01)**  
**C07D 233/66 (2006.01)**  
**C07D 498/04 (2006.01)**  
**A61K 38/21 (2006.01)**  
**C07D 409/14 (2006.01)**  
**A61K 31/4178 (2006.01)**  
**C07D 401/10 (2006.01)**  
**C07D 233/61 (2006.01)**  
**A61P 43/00 (2006.01)**  
**C07D 491/10 (2006.01)**  
 (86) JP2011063602 14.06.2011  
 (96) 11795738.1 08.05.2013  
 (87) WO2011158833, 14.06.2011  
 (97) 2589595, 08.05.2013 en  
 (54) AGENT FOR TREATING HCV INFECTION  
 (71) Eisai R&D Management Co., Ltd., 6-10, Koishikawa 4-chome Bunkyo-ku, Tokyo 112-8088, JP  
 (72) YANAGIMACHI Mamoru, c/o Tsukuba Research Laboratories Eisai Co. Ltd. 1-3, Tokodai 5-chome, Tsukuba-shi Ibaraki 300-2635, JP  
 INO Mitsuhiro, c/o Tsukuba Research Laboratories Eisai Co. Ltd. 1-3, Tokodai 5-chome, Tsukuba-shi Ibaraki 300-2635, JP

- (51) MKP  
**C07D 401/14 (2006.01)** (97) **2545045 \***  
**A61K 31/4468 (2006.01)**  
**A61K 31/4155 (2006.01)**  
**C07D 405/14 (2006.01)**  
**A61P 29/00 (2006.01)**  
**A61K 31/437 (2006.01)**
- (86) US2011027665 09.03.2011  
(96) 11711709.3 16.01.2013  
(87) WO2011112662, 09.03.2011  
(97) 2545045, 16.01.2013 en
- (54) PIPERIDIN-4-YL AZETIDINE DERIVATIVES AS JAK1 INHIBITORS
- (71) Incyte Corporation, Experimental Station Route 141 & Henry Clay Road Building 336, Wilmington, DE 19880, US
- (72) HUANG, Taisheng, 8 Rector Court Apt. B, Wilmington Delaware 19810, US  
XUE, Chu-Biao, 307 Wellspring Court, Hockessin Delaware 19707, US  
WANG, Anlai, 102 Bunting Drive, Wilmington Delaware 19808, US  
KONG, Ling, 5 Fritze Court, Hockessin Delaware 19707, US  
YE, Hai Fen, 45 West Park Place, Newark Delaware 19711, US  
YAO, Wenqing, 748 Meadowbank Road, Kennett Square Pennsylvania 19348, US  
RODGERS, James D., 2 Hillside Lane, Landenberg Pennsylvania 19350, US  
SHEPARD, Stacey, 2200 C Inglewood Road, Wilmington Delaware 19803, US  
WANG, Haisheng, 207 Hockessin Circle, Hockessin Delaware 19707, US  
SHAO, Lixin, 22 Golf View Drive Apt. A5, Newark Delaware 19702, US  
LI, Hui-Yin, 161 Thompson Drive, Hockessin Delaware 19707, US  
LI, Qun, 10 Crompton Court, Newark Delaware 19702, US

- (51) MKP  
**A61P 29/00 (2006.01)** (97) **2558468 \***  
**C07D 487/04 (2006.01)**  
**A61K 31/519 (2006.01)**  
**A61P 37/00 (2006.01)**
- (86) US2011031896 11.04.2011  
(96) 11715818.8 20.02.2013  
(87) WO2011130146, 11.04.2011  
(97) 2558468, 20.02.2013 en
- (54) 5, 7-SUBSTITUTED-IMIDAZO [1, 2-C]PYRIMIDINES AS INHIBITORS OF JAK KINASES
- (71) Array Biopharma, Inc., 3200 Walnut Street, Boulder, CO 80301, US
- (72) BOYS, Mark Laurence, c/o Array BioPharma Inc. 3200 Walnut Street, Boulder, Colorado 80301, US  
BURGESS, Laurence, E., c/o Array BioPharma Inc. 3200 Walnut Street, Boulder, Colorado 80301, US  
GRONEBERG, Robert, D., c/o Array BioPharma Inc. 3200 Walnut Street, Boulder, Colorado 80301, US  
HARVEY, Darren, M., c/o Array BioPharma Inc. 3200 Walnut Street, Boulder, Colorado 80301, US  
HUANG, Lily, c/o Array BioPharma Inc. 3200 Walnut Street, Boulder, Colorado 80301, US  
KERCHER, Timothy, c/o Array BioPharma Inc. 3200 Walnut Street, Boulder, Colorado 80301, US  
KRASER, Christopher, F., c/o Array BioPharma Inc. 3200 Walnut Street, Boulder, Colorado 80301, US  
LAIRD, Ellen, c/o Array BioPharma Inc. 3200 Walnut Street, Boulder, Colorado 80301, US  
TARLTON, Eugene, c/o Array BioPharma Inc. 3200 Walnut Street, Boulder, Colorado 80301, US  
ZHAO, Qian, c/o Array BioPharma Inc. 3200 Walnut Street, Boulder, Colorado 80301, US

- (51) MKP  
**A61K 38/46 (2006.01)** (97) **2563406 \***  
**A61K 47/48 (2006.01)**  
**C12N 9/16 (2006.01)**  
**A61K 31/7088 (2006.01)**  
**A61P 19/08 (2006.01)**  
**A61K 38/17 (2006.01)**  
**C12N 15/867 (2006.01)**  
**A61K 48/00 (2006.01)**  
**C12N 15/55 (2006.01)**
- (86) CA2011050258 29.04.2011  
(96) 11774253.6 06.03.2013  
(87) WO2011134084, 29.04.2011  
(97) 2563406, 06.03.2013 en
- (54) METHODS, COMPOSITIONS, AND KITS FOR THE TREATMENT OF MATRIX MINERALIZATION DISORDERS
- (71) Alexion Pharma International SARL, Avenue du Tribunal Fédéral 34, 1005 Lausanne, CH
- (72) CRINE, Philippe, 28 Avenue Claude-Champagne, Outremont Quebec H2V 2X1, CA  
LEONARD, Pierre, 12364 Notre-Dame des Anges street, Montreal Quebec H4J 2C4, CA

- (51) MKP  
**A61K 38/08 (2006.01)** (97) **2566492 \***
- (86) US2011035250 04.05.2011  
(96) 11778296.1 13.03.2013  
(87) WO2011140266, 04.05.2011  
(97) 2566492, 13.03.2013 en
- (54) INNOVATIVE DISCOVERY OF THERAPEUTIC, DIAGNOSTIC, AND ANTIBODY COMPOSITIONS RELATED TO PROTEIN FRAGMENTS OF GLUTAMYL-PROLYL-TRNA SYNTHETASES
- (71) aTyr Pharma, Inc., 3545 John Hopkins Court, Suite 250, San Diego, CA 92121, US  
Pangu Biopharma Limited, Edinburgh Tower, 18/F The Landmark 15 Queen's Road Central, Hong Kong, CN
- (72) GREENE, Leslie, Ann, 13941 Davenport Avenue, San Diego California 92129, US  
CHIANG, Kyle, P., 943 Torrance Street Apt. 6, San Diego California 92103, US  
HONG, Fei, 7979 Caminito Dia, 2, San Diego California 92122, US  
VASSEROT, Alain, P., 6421 La Paloma Street, Carlsbad California 92009, US  
LO, Wing-Sze, RM 815 Sui Ming House Siu Sai Wan Estate Chai Wan, Hong Kong, CN  
WATKINS, Jeffry, D., 3442 Fortuna Ranch Road, Encinitas California 92024, US  
MENDLEIN, John, D., 1550 Neptune Avenue, Encinitas California 92024, US  
QUINN, Cheryl, L., 11227 Cedar Pointe Drive South, Minnetonka Minnesota 55305, US

- (51) MKP  
**D21H 21/02 (2006.01)** (97) **2546410**  
**D21C 9/08 (2006.01)**
- (96) 11173471.1 16.01.2013  
(97) 2546410, 16.01.2013 en
- (54) Hydrophobised calcium carbonate particles
- (71) Ormya Development AG, Baslerstrasse 42, 4665 Oftringen, CH
- (72) Gantenbein, Daniel, Vogesenstrasse 27, 4056 Basel, CH  
Schoelkopf, Joachim, Buechbühlstrasse 3, 8956 Killwangen, CH  
Gane, Patrick A. C., Studenweg 8, 4852 Rothrist, CH

- (51) MKP  
**A01N 43/42 (2006.01)** (97) **2542079 \***
- (86) US2011026885 02.03.2011  
(96) 11751300.2 09.01.2013  
(87) WO2011109531, 02.03.2011  
(97) 2542079, 09.01.2013 en
- (54) TREATMENT OF RHEUMATOID ARTHRITIS WITH A COMBINATION OF LAQUINIMOD AND METHOTREXATE
- (71) Teva Pharmaceutical Industries Ltd., 5 Basel Street P.O. Box 3190, 49131 Petach-Tikva, IL
- (72) BLAUGRUND, Eran, 94 Remez Street, 76449 Rehovot, IL  
TARCIC, Nora, Migdal David 29/1, Modiin, IL  
KAYE, Joel, 14/5 Hazamir St. Netanya, IL

(51) MKP  
**C02F 1/68 (2006.01)** (97) **2548848**  
 (96) 11175012.1 23.01.2013  
 (97) 2548848, 23.01.2013 en  
 (54) Micronized CaCO<sub>3</sub> slurry injection system for the remineralization of desalinated and fresh water  
 (71) Omya Development AG, Baslerstrasse 42, 4665 Oftringen, CH  
 (72) Skovby, Michael, Wampflenstrasse 52, 8706 Meilen, CH  
 Poffet, Martine, Wohlenstrasse 29, 3043 Uetligen, CH

---

(51) MKP  
**A61M 5/142 (2006.01)** (97) **2555813 \***  
**A61M 5/178 (2006.01)**  
**A61M 5/28 (2006.01)**  
**A61B 17/03 (2006.01)**  
 (86) US2011031235 05.04.2011  
 (96) 11766590.1 13.02.2013  
 (87) WO2011127045, 05.04.2011  
 (97) 2555813, 13.02.2013 en  
 (54) METHOD AND APPARATUS FOR WOUND SEALANT APPLICATION  
 (71) Neomend, Inc., 60 Technology Drive, Irvine, California 92618, US  
 (72) CASSINGHAM, Charles Vaughn, 501 Ventaja, Newport Beach California 92660, US  
 MEZGER, William Jerome, 31741 Contijo Way, Trabuco Canyon California 92679-3614, US

---

(51) MKP  
**C07K 16/10 (2006.01)** (97) **2560993 \***  
**C07K 16/28 (2006.01)**  
**C07K 16/46 (2006.01)**  
**C07K 16/32 (2006.01)**  
 (86) EP2011056388 20.04.2011  
 (96) 11716882.3 27.02.2013  
 (87) WO2011131746, 20.04.2011  
 (97) 2560993, 27.02.2013 en  
 (54) HETERODIMERIC ANTIBODY FC-CONTAINING PROTEINS AND METHODS FOR PRODUCTION THEREOF  
 (71) Genmab A/S, Bredgade 34 P.O. Box 9068, 1260 Copenhagen K, DK  
 (72) LABRIJN, Aran, Frank, Yalelaan 60, NL-3584 CM Utrecht, NL  
 MEESTERS, Joyce, Yalelaan 60, NL-3584 CM Utrecht, NL  
 BREMER, Ewald van den, Yalelaan 60, NL-3584 CM Utrecht, NL  
 NEIJSSSEN, Joost, J., Yalelaan 60, NL-3584 CM Utrecht, NL  
 BERKEL, Patrick van, Derde Westerparklaan 321, NL-3544 NH Utrecht, NL  
 GOEIJ, Bart de, Yalelaan 60, NL-3584 CM Utrecht, NL  
 VINK, Tom, Yalelaan 60, NL-3584 CM Utrecht, NL  
 VAN DE WINKEL, Jan, Yalelaan 60, NL-3584 CM Utrecht, NL  
 SCHUURMAN, Janine, Yalelaan 60, NL-3584 CM Utrecht, NL  
 PARREN, Paul, Yalelaan 60, NL-3584 CM Utrecht, NL

---

(51) MKP  
**A61K 31/505 (2006.01)** (97) **2563129 \***  
**A01N 43/54 (2006.01)**  
 (86) US2011033203 20.04.2011  
 (96) 11775446.5 06.03.2013  
 (87) WO2011137002, 20.04.2011  
 (97) 2563129, 06.03.2013 en  
 (54) N3-SUBSTITUTED-N1-SULFONYL-5-FLUOROPYRIMIDINONE DERIVATIVES  
 (71) Dow AgroSciences, LLC, 9330 Zionsville Road, Indianapolis, IN 46268, US  
 (72) BOEBEL, Timothy, 5747 North Oxford Street, Indianapolis, IN 46220, US  
 LORSBACH, Beth, 6034 Haverford Avenue, Indianapolis, IN 46220, US  
 MARTIN, Timothy, 6095 Ramsey Drive, Noblesville, IN 46062, US  
 OWEN, W., John, 12421 Pebblepointe Pass, Carmel, IN 46033, US  
 SULLENBERGER, Michael, 910 Hadleigh Pass, Westfield, IN 46074, US  
 WEBSTER, Jeffery, 7581 W. Oakwood Court, New Palestine, IN 46163, US  
 YAO, Chenglin, 14178 Esprit Drive, Westfield, IN 46074, US

(51) MKP  
**B65G 1/04 (2006.01)** (97) **2542485 \***  
**B65G 1/02 (2006.01)**  
 (86) IB2011050845 28.02.2011  
 (96) 11711674.9 09.01.2013  
 (87) WO2011107926, 28.02.2011  
 (97) 2542485, 09.01.2013 en  
 (54) A PLANT FOR STORING PRODUCTS  
 (71) System Logistics S.p.a., Via Ghiarola Vecchia 73, 41042 Fiorano Modenese (Modena), IT  
 (72) STEFANI, Franco, Via P. Ferrari 1, I-41049 Sassuolo MODENA, IT  
 CASSANI, Stefano, Via Casola Canina 51, I-40056 Imola BOLOGNA, IT  
 CALZINI, Federico, Via Sasso 64, I-61029 Urbino PESARO-URBINO, IT

---

(51) MKP  
**B42D 15/00 (2006.01)** (97) **2567026 \***  
**D21F 1/44 (2006.01)**  
 (86) EP2010067998 23.11.2010  
 (96) 10787060.2 13.03.2013  
 (87) WO2011137941, 23.11.2010  
 (97) 2567026, 13.03.2013 en  
 (54) METHOD FOR PROVIDING A WATERMARKING WIRE MESH, WATERMARKING WIRE MESH, APPARATUS FOR OBTAINING IT AND ANTI-COUNTERFEITING DOCUMENT  
 (71) FEDRIGONI S.P.A., Viale Piave 3, 37135 Verona, IT  
 (72) PALLOTTA, Pasquale, c/o CARTIERE MILIANI FABRIANO Viale Pietro Miliani 31/33, I-60044 Fabriano, IT

---

(51) MKP  
**A01N 25/00 (2006.01)** (97) **2576523 \***  
**C07D 261/04 (2006.01)**  
 (86) US2011037083 19.05.2011  
 (96) 11727834.1 10.04.2013  
 (87) WO2011149749, 19.05.2011  
 (97) 2576523, 10.04.2013 en  
 (54) CRYSTALLINE FORM OF 4- [5 - [3 -CHLORO-5 - (TRIFLUOROMETHYL) PHENYL]-4, 5 - DIHYDRO - 5 - (TRIFLUOROMETHYL) -3 - ISOXAZOLYL]-N- [2-OXO-2- [ ( 2, 2, 2 - TRIFLUOROETHYL) AMINO]ETHYL]-1- NAPHTHALENECARBOXAMIDE  
 (71) E.I. DU PONT DE NEMOURS AND COMPANY, Barley Mill Plaza, Bldg 25/1114 4417 Lancaster Pike, Wilmington DE 19805, US  
 (72) CURRIE, Martin, James, 6 Para Lane, Newark DE 19702, US

---

(51) MKP  
**H01R 24/58 (2011.01)** (97) **2577812 \***  
 (86) US2011038451 27.05.2011  
 (96) 11787546.8 10.04.2013  
 (87) WO2011150402, 27.05.2011  
 (97) 2577812, 10.04.2013 en  
 (54) D-SHAPED CONNECTOR  
 (71) Apple Inc., 1 Infinite Loop, MS 169-3IPL, Cupertino, CA 95014, US  
 (72) GOLKO, Albert J, 1 Infinite Loop, M/S 305-1DR., Cupertino, CA 95014, US  
 SCHMIDT, Mathias, 1 Infinite Loop, M/S 305-1DR., Cupertino, CA 95014, US  
 JOL, Eric, 1 Infinite Loop, M/S 305-1DR., Cupertino, CA 95014, US

---

(51) MKP  
**A61M 5/32 (2006.01)** (97) **2588170 \***  
 (86) EP2011060324 21.06.2011  
 (96) 11728808.4 08.05.2013  
 (87) WO2012000839, 21.06.2011  
 (97) 2588170, 08.05.2013 en  
 (54) NEEDLE SHIELD FOR A SAFETY DEVICE, SAFETY DEVICE AND INJECTION DEVICE  
 (71) Sanofi-Aventis Deutschland GmbH, Brüningstraße 50, 65929 Frankfurt, DE  
 (72) ROBERTS, Gareth, Glendale Pen-y-cae Road Ruabon, Wrexham LL14 6EB, GB  
 OWEN, Sioned, Berllan Bach Denbigh, Prion Denbigh LL16 4SE, GB  
 EKMAN, Matthew, 59 Ecton Avenue, Macclesfield, Cheshire SK10 1RD, GB

- (51) MKP  
**G01N 27/02 (2006.01)** (97) **2492481**  
**F02D 41/22 (2006.01)**  
**G01N 15/06 (2006.01)**  
(96) 11155332.7 29.08.2012  
(97) 2492481, 29.08.2012 en  
(54) Soot sensor functional capability monitoring  
(71) Delphi Technologies Holding S.à.r.l., Avenue de Luxembourg, 4940 Bascharage, LU  
(72) Van Marion, Willem, Rue de Capellen 5, 8393, Olm, LU
- 
- (51) MKP  
**A61K 31/21 (2006.01)** (97) **2563350 \***  
**A61K 31/11 (2006.01)**  
**A61P 27/02 (2006.01)**  
**A61K 31/22 (2006.01)**  
(86) IB2011001294 19.04.2011  
(96) 11771664.7 06.03.2013  
(87) WO2011132084, 19.04.2011  
(97) 2563350, 06.03.2013 en  
(54) THERAPEUTIC REGIMEN AND METHOD FOR TREATING OR AMELIORATING VISUAL DISORDERS ASSOCIATED WITH AN ENDOGENOUS RETINOID DEFICIENCY  
(71) QLT, Inc., 887 Great Northern Way Suite 101, Vancouver, BC V5T 4T5, CA  
(72) STRONG, H., Andrew, 4459 Lions Avenue, North Vancouver, British Columbia V7R 3S7, CA  
CADDEN, Suzanne, 2235 Alden Lane, North Vancouver, British Columbia V7P 2J7, CA  
BOCH, Ronald Erwin, 5118 Redonda Drive, North Vancouver, British Columbia V7R 3K2, CA
- 
- (51) MKP  
**A61P 25/16 (2006.01)** (97) **2566861 \***  
**A61P 19/10 (2006.01)**  
**A61P 29/00 (2006.01)**  
**A61K 31/496 (2006.01)**  
**A61P 37/06 (2006.01)**  
**C07D 405/12 (2006.01)**  
**A61P 35/00 (2006.01)**  
**A61P 25/28 (2006.01)**  
**A61P 3/00 (2006.01)**  
**A61P 25/22 (2006.01)**  
**A61P 9/12 (2006.01)**  
**A61P 25/30 (2006.01)**  
**A61P 3/10 (2006.01)**  
**A61P 25/24 (2006.01)**  
**A61P 15/00 (2006.01)**  
(86) US2011034755 02.05.2011  
(96) 11719136.1 13.03.2013  
(87) WO2011139951, 02.05.2011  
(97) 2566861, 13.03.2013 en  
(54) MODULATORS OF FATTY ACID AMIDE HYDROLASE  
(71) Janssen Pharmaceutica, N.V., Turnhoutseweg 30, 2340 Beerse, BE  
(72) KEITH, John, M., 16724 Alondra Drive, San Diego CA 92128, US  
LIU, Jing, 9368 Adolphia Street, San Diego CA 92129, US
- 
- (51) MKP  
**B32B 7/02 (2006.01)** (97) **2492091**  
**B32B 3/08 (2006.01)**  
**B32B 7/12 (2006.01)**  
**B32B 21/14 (2006.01)**  
**B32B 21/13 (2006.01)**  
**B27M 3/00 (2006.01)**  
(96) 12155269.9 29.08.2012  
(97) 2492091, 29.08.2012 en  
(54) A process for working or realizing a wood manufacture with application of various wood types  
(71) De Luca, Denis, 61, Via per Cabiante, 22066 Mariano Comense (COMO), IT  
(72) De Luca, Denis, 61, Via per Cabiante, 22066 Mariano Comense (COMO), IT
- 
- (51) MKP  
**C12N 15/113 (2010.01)** (97) **2571988 \***  
**A61K 31/7088 (2006.01)**  
**C12Q 1/68 (2006.01)**  
**A61P 19/08 (2006.01)**  
**A61P 9/00 (2006.01)**  
(86) EP2011058379 23.05.2011  
(96) 11727134.6 27.03.2013  
(87) WO2011144761, 23.05.2011  
(97) 2571988, 27.03.2013 en  
(54) COMPOSITIONS FOR USE IN TREATING OR DIAGNOSING BONE DISORDERS AND/OR CARDIOVASCULAR DISORDERS  
(71) Universität für Bodenkultur Wien, Gregor Mendel-Strasse 33, 1180 Wien, AT  
(72) GRILLARI, Johannes, Setzgasse 7, A-2102 Bisamberg, AT  
SCHRAML, Elisabeth, Marc-Aurel-Strasse 9/10, A-1010 Wien, AT  
FORTSCHEGGER, Klaus, Margaretenstr. 45, A-1040 Wien, AT  
GRILLARI, Regina, Setzgasse 7, A-2102 Bisamberg, AT
- 
- (51) MKP  
**E06C 7/46 (2006.01)** (97) **2569502 \***  
(86) EP2011001540 28.03.2011  
(96) 11715874.1 20.03.2013  
(87) WO2011141092, 28.03.2011  
(97) 2569502, 20.03.2013 en  
(54) PORTABLE LADDER  
(71) Siviero, Monica, Quartiere Diaz 4, 36028 Rossano - Veneto (VI), IT  
Ferremi, Luca, Via G. Filippini 12/D, 25087 Salò (BS), IT  
Sordo, Pietro, Via Della Pace 2, 36027 - Rosà (Vicenza), IT  
(72) SORDO, Pietro, Via Della Pace 2, 36027 - Rosà (Vicenza), IT
- 
- (51) MKP  
**G01L 1/00 (2006.01)** (97) **2572174 \***  
**G01B 21/32 (2006.01)**  
(86) US2011037028 18.05.2011  
(96) 11784189.0 27.03.2013  
(87) WO2011146641, 18.05.2011  
(97) 2572174, 27.03.2013 en  
(54) METHOD AND APPARATUS FOR INTERNALLY DETERMINING A LOAD APPLIED BY A JACK  
(71) Loadtest, Inc., 2631 N.W. 41st Street, Gainesville, FL 32606, US  
(72) HAYES, John, A., 927 N.W. 40th Drive, Gainesville FL 32605, US
- 
- (51) MKP  
**A61N 5/06 (2006.01)** (97) **2578269 \***  
**A61N 5/067 (2006.01)**  
**A61B 18/20 (2006.01)**  
(86) KR2011003812 25.05.2011  
(96) 11789986.4 10.04.2013  
(87) WO2011152628, 25.05.2011  
(97) 2578269, 10.04.2013 en  
(54) IPL DEVICE OF WHICH THE ENERGY LEVEL CAN BE ADJUSTED USING A THYRISTOR  
(71) Ko, YoungSan, 137-704, Lotte Apt. 55 Sunae-dong Bundang-gu Seongnam-si, Gyeonggi-do 463-852, KR  
(72) Ko, YoungSan, 137-704, Lotte Apt. 55 Sunae-dong Bundang-gu Seongnam-si, Gyeonggi-do 463-852, KR
- 
- (51) MKP  
**E04B 1/80 (2006.01)** (97) **2588674 \***  
(86) IE2011000033 27.06.2011  
(96) 11733708.9 08.05.2013  
(87) WO2012001672, 27.06.2011  
(97) 2588674, 08.05.2013 en  
(54) A PREFABRICATED COMPOSITE INSULATION BOARD  
(71) Kingspan Holdings (IRL) Limited, Dublin Road, Kingscourt County Cavan, IE  
(72) PARGETER, Adrian, 25 Borrowdale Close Brierly Hill, West Midlands DY5 3RW, GB  
ROCHEFORT, Malcolm, The Old Rectory Leinthall Starkes, Ludlow SY8 2HP, GB



(51) MKP  
**C07K 16/28 (2006.01)** (97) **2539370 \***  
 (86) IB2011000344 22.02.2011  
 (96) 11714394.1 02.01.2013  
 (87) WO2011104604, 22.02.2011  
 (97) 2539370, 02.01.2013 en  
 (54) ANTI-ALPHA2 INTEGRIN ANTIBODIES AND THEIR USES  
 (71) SANOFI, 54, rue de la Boétie, 75008 Paris, FR  
 (72) BLEIN, Stanislas, Chemin de la Combeta 5, CH-2300 La  
 Chaux-de-Fonds, CH  
 HOU, Samuel, Chemin de la Combeta 5, CH-2300 La Chaux-  
 de-Fonds, CH  
 SKEGRO, Darko, Chemin de la Combeta 5, CH-2300 La  
 Chaux-de-Fonds, CH

(51) MKP  
**C12N 15/09 (2006.01)** (97) **2569429 \***  
 (86) US2011036647 16.05.2011  
 (96) 11781405.3 20.03.2013  
 (87) WO2011143651, 16.05.2011  
 (97) 2569429, 20.03.2013 en  
 (54) COMPOSITIONS AND METHODS FOR MODULATING  
 METABOLISM  
 (71) Dana-Farber Cancer Institute, Inc., 450 Brookline Avenue,  
 Boston, MA 02215, US  
 Brigham and Women's Hospital, Inc., 75 Francis Street,  
 Boston, MA 02115, US  
 (72) BRADNER, James, Elliott, 9 Rollins Court, Cambridge MA  
 02139, US  
 BROWN, Jonathan, 131 Sewall Ave 1, Brookline MA 02446,  
 US  
 PLUTZKY, Jorge, 110 Middlesex Road, Chestnut Hill, MA  
 02467, US

(51) MKP  
**A61P 11/08 (2006.01)** (97) **2580194 \***  
**C07D 207/12 (2006.01)**  
**A61P 11/00 (2006.01)**  
**A61P 11/06 (2006.01)**  
**A61K 31/40 (2006.01)**  
 (86) EP2011058787 30.05.2011  
 (96) 11724156.2 17.04.2013  
 (87) WO2011157536, 30.05.2011  
 (97) 2580194, 17.04.2013 en  
 (54) PROCESS FOR THE PREPARATION OF  
 GLYCOPYRRONIUM CHLORIDE  
 (71) Chiesi Farmaceutici S.p.A., Via Palermo, 26/A, 43100 Parma,  
 IT  
 (72) PIVETTI, Fausto, c/o Chiesi Farmaceutici S.p.A. Via Palermo  
 26/A, I-43100 Parma, IT  
 BOCCHI, Monica, c/o Chiesi Farmaceutici S.p.A. Via Palermo  
 26/A, I-43100 Parma, IT  
 FERRARI, Emanuele, c/o Chiesi Farmaceutici S.p.A. Via  
 Palermo 26/A, I-43100 Parma, IT

(51) MKP  
**A61K 31/198 (2006.01)** (97) **2583682 \***  
**A61P 17/16 (2006.01)**  
**A61K 31/12 (2006.01)**  
**A61K 31/736 (2006.01)**  
**A61P 17/06 (2006.01)**  
**A61K 35/12 (2006.01)**  
**A61K 9/00 (2006.01)**  
**A61P 17/00 (2006.01)**  
**A61P 17/02 (2006.01)**  
 (86) ES2011070427 14.06.2011  
 (96) 11758490.4 24.04.2013  
 (87) WO2011157880, 14.06.2011  
 (97) 2583682, 24.04.2013 en  
 (54) ANTIOXIDANT COMPOSITION  
 (71) HistoCell, S.L., Parque Tecnológico 800, 2º, 48160 Derio  
 (Bizkaia), ES  
 (72) CASTRO FEO, María Begoña, Aldekoane 128 2ºD, E-48490  
 Leioa - Vizcaya, ES  
 AZCOITIA RAMSDEN, Iker, Sancho de Azpeitia 2 4ºD,  
 E-48014 Bilbao - Vizcaya, ES  
 PALOMARES CASADO, Teodoro, Beato Tomás de Zumárraga  
 2 2ºB, E-01008 Vitoria - Alava, ES  
 HERRERO DE MIGUEL, Jone, Landaluze 18 Bajo, E-48600  
 Sopelana - Vizcaya, ES  
 ALONSO VARONA, Ana Isabel, Sarenebarri 1 1ºB, E-48992  
 Getxo - Vizcaya, ES  
 DEL OLMO BASTERRECHEA, Maite, Gatzarriñe 10 1ºB,  
 E-48600 Sopelana - Vizcaya, ES

(51) MKP  
**A61K 31/13 (2006.01)** (97) **2585049 \***  
**A61K 9/48 (2006.01)**  
**A61K 9/16 (2006.01)**  
**A61K 9/50 (2006.01)**  
**A61K 9/28 (2006.01)**  
**A61K 9/20 (2006.01)**  
 (86) EP2011003098 22.06.2011  
 (96) 11727403.5 01.05.2013  
 (87) WO2011160839, 22.06.2011  
 (97) 2585049, 01.05.2013 en  
 (54) NERAMEXANE MULTIPLE UNIT DOSAGE FORM  
 (71) Merz Pharma GmbH & Co. KGaA, Eckenheimer Landstrasse  
 100, 60318 Frankfurt am Main, DE  
 (72) HAUPTMEIER, Bernhard, Neue Weinbergstr. 10, 63571  
 Gelnhausen, DE  
 PURMANN, Brigitte, Nelkenweg 5, 63165 Mühlheim, DE

(51) MKP  
**A61K 33/26 (2006.01)** (97) **2594277 \***  
**A61K 47/32 (2006.01)**  
**A61P 3/00 (2006.01)**  
**A61P 13/12 (2006.01)**  
**A61K 9/20 (2006.01)**  
**A61K 47/38 (2006.01)**  
**A61P 7/00 (2006.01)**  
 (86) JP2011065629 07.07.2011  
 (96) 11803674.8 22.05.2013  
 (87) WO2012005340, 07.07.2011  
 (97) 2594277, 22.05.2013 en  
 (54) TABLET CONTAINING FERRIC CITRATE  
 (71) Japan Tobacco, Inc., 2-1, Toranomon 2-chome Minato-ku,  
 Tokyo 105-8422, JP  
 (72) FUKUSHIMA, Masayoshi, c/o Central Pharmaceutical  
 Research Institute of Japan Tobacco Inc. 1-1 Murasaki-cho,  
 Takatsuki-shi, Osaka 569-1125, JP  
 ORITA, Kazuhiro, c/o Central Pharmaceutical Research  
 Institute of Japan Tobacco Inc. 1-1 Murasaki-cho, Takatsuki-  
 shi, Osaka 569-1125, JP  
 YAMANE, Shogo, c/o Central Pharmaceutical Research  
 Institute of Japan Tobacco Inc. 1-1 Murasaki-cho, Takatsuki-  
 shi, Osaka 569-1125, JP

- (51) MKP  
**A61K 38/17 (2006.01)** (97) **2552947 \***  
**A61K 39/395 (2006.01)**  
**A61P 19/02 (2006.01)**  
**A61P 37/00 (2006.01)**  
**C07K 19/00 (2006.01)**  
**C07K 16/18 (2006.01)**  
**C07K 14/47 (2006.01)**  
(86) US2011030087 25.03.2011  
(96) 11760352.2 06.02.2013  
(87) WO2011120013, 25.03.2011  
(97) 2552947, 06.02.2013 en  
(54) VISTA REGULATORY T CELL MEDIATOR PROTEIN, VISTA BINDING AGENTS AND USE THEREOF  
(71) Trustees of Dartmouth College, 11 Rope Ferry Road, Room 6210, Hanover, NH 03755-1404, US  
(72) NOELLE, Randolph, J., 301 Freeman Hill Road, Plainfield New Hampshire 03781, US  
WANG, Lili, 948 New Boston Road, Norwich Vermont 05055, US
- 
- (51) MKP  
**F01C 1/344 (2006.01)** (97) **2558684 \***  
(86) HR2011000011 18.03.2011  
(96) 11724015.0 20.02.2013  
(87) WO2011128708, 18.03.2011  
(97) 2558684, 20.02.2013 en  
(54) FOUR-STROKE ROTATING VANE ENGINE WITH AN ELLIPTIC CASING AND GUIDED VANES  
(71) Marovic, Mato, Marici bb, 85320 Tivat, ME  
(72) Marovic, Mato, Marici bb, 85320 Tivat, ME
- 
- (51) MKP  
**C11B 9/00 (2006.01)** (97) **2566838 \***  
**C07C 33/14 (2006.01)**  
**C07C 403/08 (2006.01)**  
**C07C 31/135 (2006.01)**  
**A61K 8/34 (2006.01)**  
(86) IB2011051976 04.05.2011  
(96) 11724462.4 13.03.2013  
(87) WO2011138747, 04.05.2011  
(97) 2566838, 13.03.2013 fr  
(54) COMPOUNDS WITH A WOODY NOTE  
(71) V. Mane Fils, 620, route de Grasse, 06620 Bar sur Loup, FR  
(72) MURATORE, Agnès, 179 route de Nice, F-06560 Valbonne, FR  
CHANOT, Jean-Jacques, 21 bis, rue des Orangers, F-06530 Speracedes, FR
- 
- (51) MKP  
**A61F 6/14 (2006.01)** (97) **2585011 \***  
(86) US2011041447 22.06.2011  
(96) 11798841.0 01.05.2013  
(87) WO2011163358, 22.06.2011  
(97) 2585011, 01.05.2013 en  
(54) INTRAVAGINAL DEVICES COMPRISING ANTICHOLINERGIC AGENTS, AND METHODS OF MAKING THEREOF  
(71) Mahashabde, Anu, 13 Village Road, Kendall Park, New Jersey 08824, US  
Tsao, Jiaxiang, 4 Morgan Court, Nanuet, NY 10954, US  
(72) Mahashabde, Anu, 13 Village Road, Kendall Park, New Jersey 08824, US  
Tsao, Jiaxiang, 4 Morgan Court, Nanuet, NY 10954, US
- 
- (51) MKP  
**C07D 215/56 (2006.01)** (97) **2590949 \***  
(86) EP2011061490 07.07.2011  
(96) 11732421.0 15.05.2013  
(87) WO2012004338, 07.07.2011  
(97) 2590949, 15.05.2013 en  
(54) METHOD FOR MANUFACTURING OF QUINOLINE-3-CARBOXAMIDES  
(71) Active Biotech AB, Box 724, 220 07 Lund, SE  
(72) BOCK, Lillemor Maria, Högåsen 812, S-691 93 Karlskoga, SE  
HOLMBERG, Pär Henning, Haraldstorp, S-571 66 Bodatorp, SE  
JANSSON, Karl-Erik, Spannmålsvägen 11, S-247 55 Dalby, SE
- 
- (51) MKP  
**A61L 27/56 (2006.01)** (97) **2538985 \***  
**A61L 27/18 (2006.01)**  
(86) US2011025852 23.02.2011  
(96) 11707016.9 02.01.2013  
(87) WO2011106369, 23.02.2011  
(97) 2538985, 02.01.2013 en  
(54) MENISCUS REPAIR ASSEMBLY AND METHOD  
(71) Orteq B.V., WTC Schiphol Airport, Tower B 5th Floor Schiphol Boulevard 231, 1118 BH Amsterdam Schiphol, NL  
(72) KURZWEIL, Peter, R, 2760 Atlantic Avenue, Long Beach CA 90806, US
- 
- (51) MKP  
**F02B 39/10 (2006.01)** (97) **2553234 \***  
**H02K 7/18 (2006.01)**  
**F02B 37/04 (2006.01)**  
(86) DK2011000016 10.03.2011  
(96) 11762049.2 06.02.2013  
(87) WO2011120520, 10.03.2011  
(97) 2553234, 06.02.2013 en  
(54) AN ELECTRICALLY ASSISTED TURBOCHARGER  
(71) Rotrex A/S, Herlev Hovedgade 17, 2730 Herlev, DK  
(72) KOLSTRUP, Anders, Skelmoøvej 1, DK-2500 Valby, DK
- 
- (51) MKP  
**H01Q 19/00 (2006.01)** (97) **2584654 \***  
**H04B 7/02 (2006.01)**  
(86) RU2011000418 11.06.2011  
(96) 11796037.7 24.04.2013  
(87) WO2011159203, 11.06.2011  
(97) 2584654, 24.04.2013 en  
(54) DEVICE FOR WIRELESS COMMUNICATION  
(71) Voloshin, Arkady Iosifovich, Ul. Tekhnicheskaya 35/45-141, Saratov 410009, RU  
Soldatkin, Andrey Stepanovich, Navashina 32-69, Saratov 410010, RU  
(72) Voloshin, Arkady Iosifovich, Ul. Tekhnicheskaya 35/45-141, Saratov 410009, RU  
Soldatkin, Andrey Stepanovich, Navashina 32-69, Saratov 410010, RU
- 
- (51) MKP  
**A61K 31/485 (2006.01)** (97) **2568967 \***  
**A61K 9/20 (2006.01)**  
(86) EP2011057566 10.05.2011  
(96) 11718747.6 20.03.2013  
(87) WO2011141488, 10.05.2011  
(97) 2568967, 20.03.2013 en  
(54) PHARMACEUTICAL COMPOSITIONS COMPRISING HYDROMORPHONE AND NALOXONE  
(71) Euro-Celtique S.A., 2, avenue Charles de Gaulle, 1653 Luxembourg, LU  
(72) DANAGHER, Helen, Kathleen, Mundipharma Research Limited 191 Cambridge Science Park Milton Road, Cambridge Cambridgeshire CB4 0GW, GB  
MOHAMMAD, Hassan, Mundipharma Research Limited 191 Cambridge Science Park Milton Road, Cambridge Cambridgeshire CB4 0GW, GB  
WALDEN, Malcolm, Mundipharma Research Limited 191 Cambridge Science Park Milton Road, Cambridge Cambridgeshire CB4 0GW, GB  
HAYES, Geoffrey, Gerard, Mundipharma Research Limited 191 Cambridge Science Park Milton Road, Cambridge Cambridgeshire CB4 0GW, GB  
WHITEHOUSE, Jonathon Oliver, Mundipharma Research Limited 191 Cambridge Science Park Milton Road, Cambridge Cambridgeshire CB4 0GW, GB  
KRISHNAMURTHY, Thinnayam Naganathan, 168 Bonis Avenue Apartment 711 Scarborough, Ontario M1T 3V6, CA  
VARGAS RINCON, Ricardo Alberto, 6602 Harmony Hill, Mississauga Ontario L5W 1S4, CA

(51) MKP  
**B60H 1/00 (2006.01)** (97) **2489532**  
 (96) 12155247.5 22.08.2012  
 (97) 2489532, 22.08.2012 en  
 (54) Air conditioner for vehicle  
 (71) Halla Climate Control Corporation, 1689-1 Shinil-dong Daedeok-gu, Daejeon-si 306-230, KR  
 (72) Han, Seongseok, 1689-1, Sinil-dong Daedeok-gu, Daejeon-si 306-230, KR  
 Kim, Seonghyun, 1689-1, Sinil-dong Daedeok-gu, Daejeon-si 306-230, KR  
 Kim, Donggyun, 1689-1, Sinil-dong Daedeok-gu, Daejeon-si 306-230, KR  
 Kim, Hyunjoo, 1689-1, Sinil-dong Daedeok-gu, Daejeon-si 306-230, KR

(51) MKP  
**A61K 31/17 (2006.01)** (97) **2546231 \***  
**A61K 31/417 (2006.01)**  
**A61K 31/167 (2006.01)**  
**A61K 31/27 (2006.01)**  
**A61K 31/198 (2006.01)**  
**C07C 275/42 (2006.01)**  
**A61K 31/4245 (2006.01)**  
**A61K 31/4045 (2006.01)**  
**A23L 1/226 (2006.01)**  
 (86) JP2011055033 04.03.2011  
 (96) 11750799.6 16.01.2013  
 (87) WO2011108690, 04.03.2011  
 (97) 2546231, 16.01.2013 en  
 (54) ALKYLAMINE DERIVATIVE  
 (71) Ajinomoto Co., Inc., 15-1, Kyobashi 1-chome Chuo-ku, Tokyo 104-8315, JP  
 (72) SUGIKI Masayuki, c/o Ajinomoto Pharmaceuticals Co. Ltd. 1-1 Suzuki-cho Kawasaki-ku, Kawasaki-shi Kanagawa 210-0801, JP  
 OKAMATSU Toru, c/o Ajinomoto Pharmaceuticals Co. Ltd. 1-1 Suzuki-cho Kawasaki-ku, Kawasaki-shi Kanagawa 210-0801, JP  
 YANO Tetsuo, c/o Ajinomoto Pharmaceuticals Co. Ltd. 1-1 Suzuki-cho Kawasaki-ku, Kawasaki-shi Kanagawa 210-0801, JP  
 TANIGUCHI Shinya, c/o Ajinomoto Pharmaceuticals Co. Ltd. 1-1 Suzuki-cho Kawasaki-ku, Kawasaki-shi Kanagawa 210-0801, JP

(51) MKP  
**A61Q 19/00 (2006.01)** (97) **2555808 \***  
**A61K 8/00 (2006.01)**  
**A61K 31/732 (2006.01)**  
**A61L 27/20 (2006.01)**  
**A61K 9/00 (2006.01)**  
 (86) EP2011001737 07.04.2011  
 (96) 11713696.0 13.02.2013  
 (87) WO2011124381, 07.04.2011  
 (97) 2555808, 13.02.2013 en  
 (54) FILLERS COMPRISING GELLAN OR PECTIN BEADS  
 (71) Merz Pharma GmbH & Co. KGaA, Eckenheimer Landstrasse 100, 60318 Frankfurt am Main, DE  
 (72) KIEHM, Kevin, Landgraf-Philipp-Strasse 44, 60431 Frankfurt am Main, DE  
 HAUPTMEIER, Bernhard, Neue Weinbergstr. 10, 63571 Gelnhhausen, DE  
 BODERKE, Peter, Bockenheimer Str. 3, 65824 Schwalbach, DE

(51) MKP  
**A61K 9/20 (2006.01)** (97) **2555755 \***  
**C07D 405/14 (2006.01)**  
**A61K 9/16 (2006.01)**  
**C07D 213/75 (2006.01)**  
**C07D 405/12 (2006.01)**  
**A61K 9/28 (2006.01)**  
 (86) US2011031519 07.04.2011  
 (96) 11715637.2 13.02.2013  
 (87) WO2011127241, 07.04.2011  
 (97) 2555755, 13.02.2013 en  
 (54) PHARMACEUTICAL COMPOSITIONS OF 3-(6-(1-(2,2-DIFLUOROBENZO[D][1,3]DIOXOL-5-YL)CYCLOPROPANECARBOXAMIDO)-3-METHYLPYRIDIN-2-YL)BENZOIC ACID AND ADMINISTRATION THEREOF  
 (71) Vertex Pharmaceuticals Incorporated, 130 Waverly Street, Cambridge, MA 02139, US  
 (72) VERWIJS, Marinus, Jacobus, 4 Carter Drive, Framingham MA 01701, US  
 ALARGOVA, Rossitza, Gueorguieva, 148 Newton Street, Brighton MA 02135, US  
 KAUSHIK, Ritu, Rohit, 24 Church Street, Watertown MA 02472, US  
 KADIYALA, Irina, Nikolaevna, 40 Hagen Road, Newton MA 02457, US  
 YOUNG, Christopher, Ryan, 42 Francis Street Unit 1, Waltham, MA 02451, US

(51) MKP  
**A61K 9/20 (2006.01)** (97) **2549982 \***  
**A61K 9/16 (2006.01)**  
**A61K 31/405 (2006.01)**  
**A61K 31/397 (2006.01)**  
 (86) EP2011001491 24.03.2011  
 (96) 11710434.9 30.01.2013  
 (87) WO2011116973, 24.03.2011  
 (97) 2549982, 30.01.2013 en  
 (54) METHOD OF PREPARING A GRANULATED PHARMACEUTICAL COMPOSITION COMPRISING SIMVASTATIN AND/OR EZETIMIBE  
 (71) Krka, Torvarna Zdravil, D.D., Novo Mesto, Smarjeska cesta 6, 8501 Novo mesto, SI  
 (72) VRECER, Franc, Potok 5b, SL-8351 Straza pri Novem mestu, SI  
 BUKOVEC, Polona, Regrca vas 37 A, SL-8000 Novo mesto, SI  
 GERMAN, Tamara, Jarebova 8C, SL-8000 Novo mesto, SI

(51) MKP  
**A61K 31/69 (2006.01)** (97) **2555625 \***  
**A01N 55/08 (2006.01)**  
 (86) US2011031384 06.04.2011  
 (96) 11766638.8 13.02.2013  
 (87) WO2011127143, 06.04.2011  
 (97) 2555625, 13.02.2013 en  
 (54) PROCESS FOR PREPARING BENZOXABOROLES  
 (71) GlaxoSmithKline LLC, One Franklin Plaza 200 North 16th Street, Philadelphia, PA 19102, US  
 (72) CONDE, Jose, J., c/o GlaxoSmithKline Global Patents Dept. 709 Swedeland Road P.O. Box 1539, King of Prussia, PA 19406-1539, US  
 KOWALSKI, Anthony, John, c/o GlaxoSmithKline Global Patents Dept. 709 Swedeland Road P.O. Box 1539, King of Prussia, PA 19406-1539, US  
 ZAJAC, Matthew, Allen, c/o GlaxoSmithKline Global Patents Dept. 709 Swedeland Road P.O. Box 1539, King of Prussia, PA 19406-1539, US

(51) MKP  
**H01M 2/02 (2006.01)** (97) **2572395 \***  
 (86) US2011037254 19.05.2011  
 (96) 11784285.6 27.03.2013  
 (87) WO2011146782, 19.05.2011  
 (97) 2572395, 27.03.2013 en  
 (54) MODULAR MOBILE ACCESSORY FOR MOBILE DEVICE  
 (71) Mophie, Inc., 2850 Red Hill Avenue Suite 128, Santa Ana, CA 92705, US  
 (72) HUANG, Daniel, 20 Buellton, Irvin, CA 92602, US

- (51) MKP  
**A61M 5/20 (2006.01)** (97) **2585139 \***  
 (86) EP2011060728 27.06.2011  
 (96) 11728262.4 01.05.2013  
 (87) WO2012000940, 27.06.2011  
 (97) 2585139, 01.05.2013 en  
 (54) NEEDLE SAFETY ARRANGEMENT AND METHOD FOR OPERATING IT  
 (71) Sanofi-Aventis Deutschland GmbH, Brüningstraße 50, 65929 Frankfurt, DE  
 (72) BRERETON, Simon Francis, 75 De Freville Avenue, Cambridge Cambridgeshire CB4 1HP, GB  
 EKMAN, Matthew, 59 Ecton Avenue Cheshire, Macclesfield Cheshire SK10 1RD, GB
- 

- (51) MKP  
**B02C 13/04 (2006.01)** (97) **2560762 \***  
**B02C 13/28 (2006.01)**  
 (86) PL2011000020 23.02.2011  
 (96) 11713892.5 27.02.2013  
 (87) WO2011105918, 23.02.2011  
 (97) 2560762, 27.02.2013 en  
 (54) HAMMER MILL  
 (71) Torunskie Zakłady Urządzeń Młynskich Spomasz Spółka Akcyjna, Ul. Grudziadzka 124/126, 87-100 Torun, PL  
 (72) GLEBOV, Leonid, Trietyj Samotiecznyj pierieulok 16/48, Moscow 127473, RU  
 HALBEDEL, Pawe, ul. Rze biarska 33A, PL-04-633 Warszawa, PL
- 

- (51) MKP  
**A61F 13/15 (2006.01)** (97) **2581068**  
 (96) 12188581.8 17.04.2013  
 (97) 2581068, 17.04.2013 en  
 (54) Methods and apparatus for application of nested zero waste ear to traveling web and formation of articles using a dual cut slip unit  
 (71) Curt G. Joa, Inc., PO Box 903, Sheboygan Falls, WI 53085-0903, US  
 (72) Pagel, Tyler W, 2192 Willow Pond Way, Grafton, WI Wisconsin 53024, US  
 Jankuski, Brian, W7762 Glen Road, Glenbeulah, WI Wisconsin 53023, US  
 Herberg, Robert, 521 Madison Street, Sheboygan Falls, WI Wisconsin 53085, US  
 Jenquin, Peter J, W6085 Whispering Lane, Plymouth, WI Wisconsin 53072, US  
 Andrews, Robert E, N7488 Sunset Circle Drive, Sheboygan, WI Wisconsin 53085, US
- 

- (51) MKP  
**A61P 29/00 (2006.01)** (97) **2571513 \***  
**A61P 3/00 (2006.01)**  
**A61P 35/00 (2006.01)**  
**A61K 39/395 (2006.01)**  
**A61K 38/17 (2006.01)**  
**A61K 38/16 (2006.01)**  
 (86) US2011036684 16.05.2011  
 (96) 11784047.0 27.03.2013  
 (87) WO2011146410, 16.05.2011  
 (97) 2571513, 27.03.2013 en  
 (54) INNOVATIVE DISCOVERY OF THERAPEUTIC, DIAGNOSTIC, AND ANTIBODY COMPOSITIONS RELATED TO PROTEIN FRAGMENTS OF LEUCYL-TRNA SYNTHETASES  
 (71) aTyr Pharma, Inc., 3545 John Hopkins Court, Suite 250, San Diego, CA 92121, US  
 Pangu Biopharma Limited, Edinburgh Tower, 18/F The Landmark 15 Queen's Road Central, Hong Kong, CN  
 (72) GREENE, Leslie, Ann, 13941 Davenport Avenue, San Diego California 92129, US  
 CHIANG, Kyle, P., 943 Torrance Street Apt. 6, San Diego California 92103, US  
 HONG, Fei, 7979 Caminito Dia, 2, San Diego California 92122, US  
 VASSEROT, Alain, P., 6421 La Paloma Street, Carlsbad California 92009, US  
 LO, Wing-Sze, RM 815 Sui Ming House Siu Sai Wan Estate Chai Wan, Hong Kong, CN  
 WATKINS, Jeffry, D., 3442 Fortuna Ranch Road, Encinitas California 92024, US  
 QUINN, Cheryl, L., 11227 Cedar Pointe Drive South, Minnetonka Minnesota 55305, US  
 MENDLEIN, John, D., 1550 Neptune Avenue, Encinitas California 92024, US
- 

- (51) MKP  
**G06K 19/077 (2006.01)** (97) **2577556 \***  
**G06K 7/00 (2006.01)**  
 (86) IB2011052464 06.06.2011  
 (96) 11733704.8 10.04.2013  
 (87) WO2011154889, 06.06.2011  
 (97) 2577556, 10.04.2013 en  
 (54) A REMOVABLE MEMORY CARD WITH AN ANTENNA, ARRANGEMENT OF ITS LEVELS  
 (71) Logomotion, s.r.o., Winterova 15, 921 01 Piestany, SK  
 (72) FLOREK, Miroslav, Ing. Miroslav Florek Sedmokraskova 4, 821 01 Bratislava, SK  
 MASARYK, Michal, Ing. Michal Masaryk PhD. Medzilaborecká 7, 821 01 Bratislava, SK
- 

- (51) MKP  
**A61K 31/7036 (2006.01)** (97) **2542233 \***  
**A61P 27/02 (2006.01)**  
**A61K 31/205 (2006.01)**  
 (86) EP2011051941 10.02.2011  
 (96) 11702470.3 09.01.2013  
 (87) WO2011107334, 10.02.2011  
 (97) 2542233, 09.01.2013 en  
 (54) COMPOSITION COMPRISING AS ACTIVE INGREDIENT L-CARNITINE IN COMBINATION WITH HYDROXYKYNURENNINE-0-BETA-DL-GLUCOSIDE, FOR THE PREVENTION AND/OR TREATMENT OF PATHOLOGIES OF THE EYE DUE TO ULTRAVIOLET RADIATION  
 (71) SIGMA-TAU Industrie Farmaceutiche Riunite S.p.A., Viale Shakespeare 47, 00147 Roma, IT  
 (72) PESCOLIDIO, Nicola, Via Paolo Albera 33, I-00181 Rome, IT  
 KOVERECH, Aleardo, Via Aurelia Antica 200, I-00165 Rome, IT
-

(51) MKP  
**C03C 17/42 (2006.01)** (97) **2556036 \***  
**B65D 23/08 (2006.01)**  
(86) US2011031595 07.04.2011  
(96) 11715362.7 13.02.2013  
(87) WO2011127294, 07.04.2011  
(97) 2556036, 13.02.2013 en  
(54) IMPROVING ADHESION OF ORGANIC COATINGS ON GLASS  
(71) Owens-Brockway Glass Container INC., One Michael Owens Way, Perrysburg, OH 43551, US  
(72) REMINGTON, Michael, P., Jr., 1936 Dority Road, Toledo OH 43615, US  
MARSH, Dennis, R., 3434 Indian Road, Ottawa Hills OH 43606, US

---

(51) MKP  
**A61K 39/395 (2006.01)** (97) **2542261 \***  
**A61P 25/28 (2006.01)**  
**C07K 16/18 (2006.01)**  
(86) EP2011053038 01.03.2011  
(96) 11705617.6 09.01.2013  
(87) WO2011107480, 01.03.2011  
(97) 2542261, 09.01.2013 en  
(54) ANTIGEN BINDING PROTEINS SPECIFIC FOR SERUM AMYLOID P COMPONENT  
(71) Glaxo Group Limited, Glaxo Wellcome House Berkeley Avenue Greenford, Middlesex UB6 0NN, GB  
(72) BHINDER, Tejinder, Kaur, GlaxoSmithKline Gunnels Wood Road, Stevenage Hertfordshire SG1 2NY, GB  
FORD, Susannah, Karen, GlaxoSmithKline Gunnels Wood Road, Stevenage Hertfordshire SG1 2NY, GB  
GERMASCHIEWSKI, Volker, GlaxoSmithKline Gunnels Wood Road, Stevenage Hertfordshire SG1 2NY, GB  
LEWIS, Alan, Peter, GlaxoSmithKline Gunnels Wood Road, Stevenage Hertfordshire SG1 2NY, GB  
PEPYS, Mark, Brian, Pentraxin Therapeutics Ltd UCL Business PLC Network Building 97 Tottenham Court Road, London W1T 4TP, GB

---

(51) MKP  
**C12N 1/06 (2006.01)** (97) **2585581 \***  
(86) GB2011000898 15.06.2011  
(96) 11743561.0 01.05.2013  
(87) WO2011157989, 15.06.2011  
(97) 2585581, 01.05.2013 en  
(54) CELL DISRUPTION  
(71) BG Research Ltd, 6 The Business Centre Harvard Way Kimbolton, Cambridgeshire PE28 0NJ, GB  
(72) NAZARETH, Nelson, 1 Clockwinders High Street Upper Dean, Cambridgeshire PE28 0ND, GB  
EDGE, David, 41 Verdayne Gardens Warlingham, Surrey CR6 9RP, GB  
WARD, David, 30 Fernie Road, Guisborough TS14 7LZ, GB

---

(51) MKP  
**A61K 35/64 (2006.01)** (97) **2547347 \***  
(86) IB2011051086 15.03.2011  
(96) 11714664.7 23.01.2013  
(87) WO2011114291, 15.03.2011  
(97) 2547347, 23.01.2013 en  
(54) PROCESS FOR OBTAINING NON-ALLERGIC PROPOLIS  
(71) Ricchiuto, Giuseppe Maria, Via Ciro Menotti 22, 37126 Verona, IT  
(72) GARDANA, Claudio Sebastiano, Via Locatelli 12, I-24050 Civate al Piano - Bergamo, IT  
GUGLIELMETTI, Simone Domenico, Via Cima 23, I-20134 Milano, IT

---

(51) MKP  
**C07D 417/14 (2006.01)** (97) **2588465 \***  
**A61K 31/4155 (2006.01)**  
**C07D 405/14 (2006.01)**  
**C07D 413/14 (2006.01)**  
**C07D 401/04 (2006.01)**  
**C07D 401/14 (2006.01)**  
(86) US2011042716 30.06.2011  
(96) 11734221.2 08.05.2013  
(87) WO2012003405, 30.06.2011  
(97) 2588465, 08.05.2013 en  
(54) SGC STIMULATORS  
(71) Ironwood Pharmaceuticals, Inc., 301 Binney Street, 2nd Floor, Cambridge, MA 02142, US  
(72) KIM, Charles, 348 Franklin St. Apt. 4D, Cambridge, MA 021398, US  
NAKAI, Takashi, 7 Gardner Street, Newton, MA 02458, US  
WAI-HO LEE, Thomas, 665 Lowell Street Unit 60, Lexington, MA 02420, US  
MOORE, Joel, 4 Cherry Street, Lexington, MA 02421, US  
PERL, Nicholas, Robert, 1569 Beacon Street Apt. 44, Brookline, MA 02446, US  
ROHDE, Jason, 151 Temescal Circle, Emeryville, CA 94608, US  
IYENGAR, Rajesh, R., 23 Stratford Road, West Newton, MA 02465, US  
MERMERIAN, Ara, 18 Island Hill Avenue Unit 212, Melrose, MA 02176, US  
FRETZEN, Angelika, 7 Avon Street, Somerville, MA 02143, US

---

(51) MKP  
**H05K 7/20 (2006.01)** (97) **2561728 \***  
**H05K 1/14 (2006.01)**  
(86) EP2011056256 19.04.2011  
(96) 11715916.0 27.02.2013  
(87) WO2011131684, 19.04.2011  
(97) 2561728, 27.02.2013 en  
(54) A THERMALLY CONTROLLED ASSEMBLY  
(71) Napatech A/S, Tobakstangsvej 6, 2860 Søborg, DK  
(72) EK, Claus, Hestetangsvej 6, DK-3520 Farum, DK

---

(51) MKP  
**C07D 223/10 (2006.01)** (97) **2580197 \***  
**C07D 211/76 (2006.01)**  
**A61P 29/00 (2006.01)**  
**A61K 31/45 (2006.01)**  
(86) GB2011000862 08.06.2011  
(96) 11725489.6 17.04.2013  
(87) WO2011154695, 08.06.2011  
(97) 2580197, 17.04.2013 en  
(54) ANTI-INFLAMMATORY AGENTS  
(71) Cambridge Enterprise Ltd., The Old Schools Trinity Lane, Cambridge Cambridgeshire CB2 1TN, GB  
BOEHRINGER INGELHEIM INTERNATIONAL GMBH, Binger Str. 173, 55216 Ingelheim am Rhein, DE  
(72) GRAINGER, David, John, Department of Medicine Cambridge University Box 157 Addenbrookes Hospital Hills Road, Cambridge CB2 2QQ, GB  
FOX, David, John, Department of Chemistry University of Warwick Gibbet Hill Road, Coventry CV4 7AL, GB

---

- (51) MKP  
**A61K 31/00 (2006.01)** (97) **2579854 \***  
**A61K 9/16 (2006.01)**  
**A61K 9/20 (2006.01)**  
**A61K 9/14 (2006.01)**  
(86) US2011039769 09.06.2011  
(96) 11727080.1 17.04.2013  
(87) WO2011156578, 09.06.2011  
(97) 2579854, 17.04.2013 en  
(54) SOLID COMPOSITIONS  
(71) Abbott Laboratories, Dept. 377, Bldg AP6A-1 100 Abbott Park Road, Abbott Park, IL 60064-6008, US  
(72) LIEPOLD, Bernd, Birkenweg 44, 69221 Dossheim, DE  
JUNG, Tina, Eugenie\_Kaufmann-Str. 22, 68163 Mannheim, DE  
HOLIG, Peter, Hopfengarten 11, 63607 Waechtersbach, DE  
SCHROEDER, Rudolf, Brahmstr.3, 67551 Worms-pfeddersheim, DE  
SEVER, Nancy E., 2643 N. Drury Lane, Arlington Heights Illinois 60004, US  
LAFOUNTAINE, Justin, 659 W. Randolph 913, Chicago Illinois 60661, US  
SINCLAIR, Brent D., 18377 Meander Drive, Grayslake Illinois 60030, US  
GAO, Yi, 210 East Baltusrol, Vernon Hills Illinois 60061, US  
WU, Jianwei, 1520 Eric Lane, Libertyville Illinois 60048, US  
ERICKSON, Bryan K., 9299 8th Avenue, Pleasant Prarie Wisconsin 53158, US  
KULLMANN, Simon, Dr.-Sammelweis-Str. 27, 67433 Neustadt an der Weinstrasse, DE  
WESTEDT, Ulrich, Weinheimer Str. 2, 69198 Schriesheim, DE  
PAULI, Mirko, Wielandstr. 30, 67065 Ludwigshafen, DE  
HEITERMANN, Tanja, Zum Hahnenschrei 1, 69168 Wiesloch, DE  
KOENIG, Renato, Meckenheimer Str. 20 e, 67454 Hassloch, DE  
THIEL, Madlen, Görlitzer Str. 27, 67105 Schifferstadt, DE  
WOEHRLE, Gerd, Seestr. 58, 69214 Eppelheim, DE

- (51) MKP  
**A61P 29/00 (2006.01)** (97) **2580212 \***  
**C07D 471/04 (2006.01)**  
**A61K 31/437 (2006.01)**  
(86) GB2011051076 09.06.2011  
(96) 11729655.8 17.04.2013  
(87) WO2011154738, 09.06.2011  
(97) 2580212, 17.04.2013 en  
(54) UREA DERIVATIVES AND THEIR THERAPEUTIC USE IN THE TREATMENT OF, INTER ALIA, DISEASES OF THE RESPIRATORY TRACT  
(71) CHIESI FARMACEUTICI S.p.A., Via Palermo, 26/A, 43122 Parma, IT  
(72) WOO, Chi-kit, Pulmagen Therapeutics (Inflammation) Ltd Fulmer Hall Windmill Road Fulmer, Slough, Berkshire SL3 6HD, GB  
VAN NIEL, Monique, Bodil, Pulmagen Therapeutics (Inflammation)Limited The Coach House, Grenville Court Britwell Road, Burnham Slough SL1 8DF, GB

- (51) MKP  
**A61K 31/44 (2006.01)** (97) **2549870 \***  
**A01N 43/42 (2006.01)**  
(86) US2011029369 22.03.2011  
(96) 11760040.3 30.01.2013  
(87) WO2011119566, 22.03.2011  
(97) 2549870, 30.01.2013 en  
(54) PROCESS FOR PREPARING CARBAMOYLPIRIDONE DERIVATIVES AND INTERMEDIATES  
(71) VIIV Healthcare Company, Five Moore Drive, Research Triangle Park, NC 27709, US  
(72) WANG, Huan, GlaxoSmithKline c/o Global Patents 709 Swedeland Road, King of Prussia, Pennsylvania 19406, US  
GOODMAN, Steven N, GlaxoSmithKline c/o Global Patents 709 Swedeland Road, King of Prussia, Pennsylvania 19406, US  
MANS, Douglas, GlaxoSmithKline c/o Global Patents 709 Swedeland Road, King of Prussia, Pennsylvania 19406, US  
KOWALSKI, Matthew, GlaxoSmithKline c/o Global Patents 709 Swedeland Road, King of Prussia, Pennsylvania 19406, US

- (51) MKP  
**A61K 48/00 (2006.01)** (97) **2552490 \***  
(86) US2011030205 28.03.2011  
(96) 11760377.9 06.02.2013  
(87) WO2011120045, 28.03.2011  
(97) 2552490, 06.02.2013 en  
(54) ECTODOMAINS OF INFLUENZA MATRIX 2 PROTEIN, EXPRESSION SYSTEM, AND USES THEREOF  
(71) Emergent Product Development Gaithersburg Inc., 300 Professional Drive, Gaithersburg, MD 20879, US  
(72) GUINA, Tina, 10407 Barrie Ave., Silver Spring Maryland 20902, US  
LACY, Michael, 26946 Ridge Road, Damascus Maryland 20872, US  
SKIADOPOULOS, Mario, 8303 Aqueduct Road, Potomac Maryland 20854, US  
MYTLE, Nutan, 133035 Darnestown Road, Gaithersburg Maryland 20878, US

- (51) MKP  
**D02J 3/00 (2006.01)** (97) **2566399 \***  
**A61B 17/064 (2006.01)**  
**A61B 17/03 (2006.01)**  
(86) US2011035431 05.05.2011  
(96) 11778387.8 13.03.2013  
(87) WO2011140400, 05.05.2011  
(97) 2566399, 13.03.2013 en  
(54) SURFACE TEXTURE CONFIGURATION FOR SELF-RETAINING SUTURES AND METHODS FOR FORMING SAME  
(71) Ethicon, LLC, Road 183 KM 8.3 Hato Industrial Area, San Lorenzo, PR 00754, US  
(72) HUNTER, William, L., 1618 Station Street, Vancouver British Columbia V6A 1B6, CA  
GROSS, Jeffrey, M., 1100 Garden View Road 200, Encinitas, CA 92024, US  
AVELAR, Rui, 1989 King Edward Avenue West, Vancouver British Columbia V6J 2W7, CA

- (51) MKP  
**C12N 15/02 (2006.01)** (97) **2573175 \***  
**C12N 15/09 (2006.01)**  
**C12P 21/08 (2006.01)**  
**A61P 35/00 (2006.01)**  
**C12N 5/10 (2006.01)**  
**C07K 16/42 (2006.01)**  
**A61K 39/395 (2006.01)**  
**G01N 33/574 (2006.01)**  
**C07K 16/24 (2006.01)**  
**C07K 14/495 (2006.01)**  
(86) JP2011061347 17.05.2011  
(96) 11783563.7 27.03.2013  
(87) WO2011145629, 17.05.2011  
(97) 2573175, 27.03.2013 en  
(54) ANTIBODY CAPABLE OF BINDING TO TRANSFORMING GROWTH FACTOR ALPHA AND HAVING ANTIPROLIFERATIVE ACTIVITY ON CANCER HAVING Ras GENE MUTATION  
(71) Medical and Biological Laboratories Co., Ltd., 5-3, Sakae 4-chome Naka-ku Nagoya-shi, Aichi 460-0008, JP  
(72) KANEDA Makoto, c/o Medical&Biological Laboratories Co. Ltd. Ina Laboratory 1063-103 Terasawaoka, Ina-shi Nagano 396-0002, JP  
FUJII Yoshihiro, c/o Medical&Biological Laboratories Co. Ltd. Ina Laboratory 1063-103 Terasawaoka, Ina-shi Nagano 396-0002, JP  
HAYATA Yoshihiro, c/o Medical&Biological Laboratories Co. Ltd. Ina Laboratory 1063-103 Terasawaoka, Ina-shi Nagano 396-0002, JP  
KISHI Yoshiro, c/o Medical&Biological Laboratories Co. Ltd. Ina Laboratory 1063-103 Terasawaoka, Ina-shi Nagano 396-0002, JP  
YAHARA Ichiro, c/o Medical&Biological Laboratories Co. Ltd. Ina Laboratory 1063-103 Terasawaoka, Ina-shi Nagano 396-0002, JP

(51) MKP  
**A61K 31/55 (2006.01)** (97) **2574167 \***  
**A61K 31/485 (2006.01)**  
**A61K 9/00 (2006.01)**  
(86) EP2011058284 20.05.2011  
(96) 11726367.3 03.04.2013  
(87) WO2011144746, 20.05.2011  
(97) 2574167, 03.04.2013 en  
(54) LIQUID NASAL SPRAY CONTAINING LOW-DOSE NALTREXONE  
(71) L. MOLteni & C. DEI FRATELLI ALITTI SOCIETA' DI ESERCIZIO S.P.A, Strada Statale, 67 Tosco Romagnola Località Granatieri, 50018 Scandicci, IT  
(72) ANGELI, Roberto, Via dell'Acciaio 44, I-50018 Scandicci, IT  
RAFFAELI, William, Via Giarabub 30, I-47923 Rimini, IT  
RIGAMONTI, Maria Adele, Via Locchi 90, I-50145 Firenze, IT

(51) MKP  
**A61M 5/32 (2006.01)** (97) **2588166 \***  
(86) EP2011060317 21.06.2011  
(96) 11726437.4 08.05.2013  
(87) WO2012000833, 21.06.2011  
(97) 2588166, 08.05.2013 en  
(54) SAFETY DEVICE FOR A PRE-FILLED SYRINGE AND INJECTION DEVICE  
(71) Sanofi-Aventis Deutschland GmbH, Brüningstraße 50, 65929 Frankfurt, DE  
(72) ROBERTS, Gareth, Glendale Pen-y-cae Road Ruabon, Wrexham LL14 6EB, GB  
OWEN, Sioned, Berlan Bach, Prion Denbigh LL16 4SE, GB  
EKMAN, Matthew, 59 Ecton Avenue, Macclesfield, Cheshire SK10 1RD, GB

(51) MKP  
**C07C 255/54 (2006.01)** (97) **2590929 \***  
**C07D 213/65 (2006.01)**  
**A61K 31/192 (2006.01)**  
**C07C 59/64 (2006.01)**  
**A61K 31/44 (2006.01)**  
(86) EP2011061334 05.07.2011  
(96) 11733622.2 15.05.2013  
(87) WO2012010413, 05.07.2011  
(97) 2590929, 15.05.2013 de  
(54) ARYLOXY-ALKYLENE SUBSTITUTED HYDROXYPHENYL HEXYNOIC ACIDS, METHODS FOR THE PRODUCTION THEREOF AND USE OF THE SAME AS MEDICAMENT  
(71) SANOFI, 54 rue La Boétie, 75008 Paris, FR  
(72) KEIL, Stefanie, c/o Sanofi-Aventis Deutschland GmbH, 65926 Frankfurt am Main, DE  
DEFOSSA, Elisabeth, c/o Sanofi-Aventis Deutschland GmbH, 65926 Frankfurt am Main, DE  
DIETRICH, Viktoria, c/o Sanofi-Aventis Deutschland GmbH, 65926 Frankfurt am Main, DE  
STENGELIN, Siegfried, c/o Sanofi-Aventis Deutschland GmbH, 65926 Frankfurt am Main, DE  
HERLING, Andreas, c/o Sanofi-Aventis Deutschland GmbH, 65926 Frankfurt am Main, DE  
HASCHKE, Guido, c/o Sanofi-Aventis Deutschland GmbH, 65926 Frankfurt am Main, DE  
KLABUNDE, Thomas, c/o Sanofi-Aventis Deutschland GmbH, 65926 Frankfurt am Main, DE

(51) MKP  
**G01N 35/00 (2006.01)** (97) **2539717 \***  
**G02B 7/00 (2006.01)**  
**B01L 9/00 (2006.01)**  
**G01N 21/00 (2006.01)**  
(86) US2011000317 22.02.2011  
11707232.2 02.01.2013  
(96) WO2011102909, 22.02.2011  
(87) 2539717, 02.01.2013 en  
(54) MICROPLATE MOUNT SYSTEM AND SENSING METHODS  
(71) PerkinElmer Health Sciences, Inc., 940 Winter Street, Waltham, MA 02451, US  
Coming Incorporated, SP-TI-3, Corning, NY 14831, US  
(72) NOBLETT, David, 2707 Deering Bay Drive, Naperville, IL 60564, US  
NEUMANN, Ken, 2325 Flambeau Drive, Naperville, IL 60564, US  
KRUG, Robert E., 2258 Gleneagles Drive, Naperville, IL 60565, US  
LIEBOLD, Steven, 532 S. Benton Street, Palatine, IL 60067, US  
KROL, Mark, Francis, 11 Linden Lane, Painted Post, NY 14870, US  
PASTEL, David Andrew, 60 Lemae Drive, Horseheads, NY 14845, US  
MARALA, Ravi, 3522 Conhocton Road, Painted Post, NY 14870, US

(51) MKP  
**G06F 3/01 (2006.01)** (97) **2548099 \***  
(86) US2011028061 11.03.2011  
(96) 11710085.9 23.01.2013  
(87) WO2011115829, 11.03.2011  
(97) 2548099, 23.01.2013 en  
(54) SYSTEMS AND METHODS FOR HAPTIC INFORMATION PREVIEW  
(71) Immersion Corporation, 30 Rio Robles, San Jose, CA 95134, US  
(72) RAMSAY, Erin, 106 Beechwood Street, Dollard-Des-Ormeaux Québec H9A 1K5, CA  
CRUZ-HERNANDEZ, Juan, Manuel, 4840 Ste-Catherine West, Montreal Québec H3Z 1T1, CA  
MODARRES, Ali, 3777 Cote-des-Neiges Apt. 520, Montreal Québec H3H 1V8, CA

(51) MKP  
**B01J 37/00 (2006.01)** (97) **2484440**  
**B01J 27/057 (2006.01)**  
**C01B 19/00 (2006.01)**  
**B01J 23/18 (2006.01)**  
**F23G 5/027 (2006.01)**  
**B01J 37/02 (2006.01)**  
(96) 12153586.8 08.08.2012  
(97) 2484440, 08.08.2012 en  
(54) A catalyst for waste thermolysis  
(71) Eonsudenergia S.r.l., Via di Renazzo 86/1, 44042 Cento (Ferrara), IT  
(72) Galantini, Gilberto, Via Fratelli Rosselli 7, 44042 Cento (Ferrara), IT

(51) MKP  
**C07K 14/025 (2006.01)** (97) **2589604 \***  
**A61P 31/20 (2006.01)**  
**C12N 1/21 (2006.01)**  
**C12N 15/70 (2006.01)**  
**A61K 39/12 (2006.01)**  
(86) CN2011076763 01.07.2011  
(96) 11800199.9 08.05.2013  
(87) WO2012000454, 01.07.2011  
(97) 2589604, 08.05.2013 en  
(54) TRUNCATED L1 PROTEIN OF HUMAN PAPILLOMAVIRUS TYPE 52  
(71) Xiamen University, No. 422 Si Ming Nan Road Siming District, Xiamen, Fujian 361005, CN  
Xiamen Innovax Biotech Co., Ltd., 130 Xinyuan Road Haicang, Xiamen, Fujian 361022, CN  
(72) LI, Shaowei, No.422 Si Ming Nan Road Siming District, Xiamen Fujian 361005, CN  
MO, Xiaobing, No.422 Si Ming Nan Road Siming District, Xiamen Fujian 361005, CN  
WEI, Minxi, No.422 Si Ming Nan Road Siming District, Xiamen Fujian 361005, CN  
PAN, Huirong, No.422 Si Ming Nan Road Siming District, Xiamen Fujian 361005, CN  
ZHANG, Jun, No.422 Si Ming Nan Road Siming District, Xiamen Fujian 361005, CN  
XIA, Ningshao, No.422 Si Ming Nan Road Siming District, Xiamen Fujian 361005, CN

(51) MKP  
**C07K 16/26 (2006.01)** (97) **2550294 \***  
**C07K 16/46 (2006.01)**  
**G01N 33/53 (2006.01)**  
**A61K 39/395 (2006.01)**  
**C12N 5/12 (2006.01)**  
**A61P 35/00 (2006.01)**  
**C12N 15/13 (2006.01)**  
(86) EP2011001448 23.03.2011  
(96) 11710711.0 30.01.2013  
(87) WO2011116954, 23.03.2011  
(97) 2550294, 30.01.2013 en  
(54) PROPHYLAXIS OF COLORECTAL AND GASTROINTESTINAL CANCER  
(71) Bioréalités, 35, rue de Verdun, 92284 Suresnes Cedex, FR  
Institut National de la Santé et de la Recherche Médicale - Inserm, 101, rue de Tolbiac, 75854 Paris Cedex 13, FR  
Centre National de la Recherche Scientifique CNRS, 3 rue Michel Ange, 75794 Paris Cedex 16, FR  
(72) HOUHOU, Leila, 2 rue Renaud de Villeneuve, F-34090 Montpellier, FR  
JOUBERT, Dominique, 10 rue Gabriel Péri, F-34200 Sète, FR  
HOLLANDE, Frédéric, 26 Moresby Street, Mitcham, VIC 3132, AU  
PETREMANN, Mathieu, Résidence Les Jardins du Père Soulas, 76 rue Saint Priest, F-34000 Montpellier, FR

(51) MKP  
**A61M 5/32 (2006.01)** (97) **2550044 \***  
**A61M 5/28 (2006.01)**  
**A61M 5/24 (2006.01)**  
(86) EP2011054426 23.03.2011  
(96) 11711311.8 30.01.2013  
(87) WO2011117287, 23.03.2011  
(97) 2550044, 30.01.2013 en  
(54) MEDICATED MODULE WITH AUTOMATIC RESERVOIR ENGAGEMENT  
(71) Sanofi-Aventis Deutschland GmbH, Brüningstraße 50, 65929 Frankfurt, DE  
(72) MOORE, David, 28 Bridle Path Road Elmesthorpe, Leicester Leicestershire LE9 7SA, GB  
KOUYOUJIAN, Garen, 2A Plymouth Place, Leamington Spa Warwickshire CV31 1HN, GB  
JONES, Christopher John, The Old Thatch Grafton, Tewkesbury Gloucestershire GL20 7AT, GB  
WATSON, James Mark, 68 Craigcrook Road, Edinburgh EH4 3PJ, GB  
CROSS, John David, 34 Station Road Long Buckby, Northhampton Northamptonshire NN6 7QB, GB  
BOYD, Malcolm Stanley, 28 Whitehead Drive, Wellsbourne Warwickshire CV35 9PW, GB  
YOUNG, Alasdair George, Bakehouse Cottage 50 West Street Chipping Norton, Oxfordshire OX7 5ER, GB  
REKAYA, Naceur, 8 The Old Stone Yard 74 Rugby Road Leamington Spa, Warwickshire CV32 6DQ, GB

(51) MKP  
**C07D 515/22 (2006.01)** (97) **2576569 \***  
(86) EP2011058466 24.05.2011  
(96) 11721308.2 10.04.2013  
(87) WO2011147828, 24.05.2011  
(97) 2576569, 10.04.2013 en  
(54) SYNTHETIC PROCESS FOR THE MANUFACTURE OF ECTEINASCIDIN COMPOUNDS  
(71) Pharma Mar S.A., Avda. de los Reyes, 1 Polígono Industrial La Mina-Norte, 28770 Colmenar Viejo Madrid, ES  
(72) MARTÍN LÓPEZ, M<sup>a</sup> Jesús, Polígono Industrial La Mina-Norte Avda. de los Reyes 1, E-28770 Colmenar Viejo - Madrid, ES  
FRANCESCH SOLLOSO, Andrés, Polígono Industrial La Mina-Norte Avda. de los Reyes 1, E-28770 Colmenar Viejo - Madrid, ES  
CUEVAS MARCHANTE, María del Carmen, Polígono Industrial La Mina-Norte Avda. de los Reyes 1, E-28770 Colmenar Viejo - Madrid, ES

(51) MKP  
**A61K 9/20 (2006.01)** (97) **2582361 \***  
**A61K 31/4184 (2006.01)**  
(86) EP2011060381 21.06.2011  
(96) 11728238.4 24.04.2013  
(87) WO2011161123, 21.06.2011  
(97) 2582361, 24.04.2013 en  
(54) MULTILAYER PHARMACEUTICAL TABLET COMPRISING TELMISARTAN AND A DIURETIC  
(71) Krka Tovarna Zdravil, D.D., Novo Mesto, Smarjeska cesta 6, 8501 Novo Mesto, SI  
(72) SEDMAK, Gregor, Palmejeva 30, 1000 Ljubljana, SI  
VRECER, Franc, Potok 5b, 8351 Straza pri Novem mestu, SI

(51) MKP  
**C07K 14/605 (2006.01)** (97) **2585481 \***  
(86) DK2011000067 23.06.2011  
(96) 11741513.3 01.05.2013  
(87) WO2011160630, 23.06.2011  
(97) 2585481, 01.05.2013 en  
(54) GLUCAGON ANALOGUES  
(71) Zealand Pharma A/S, Smedeland 36, 2600 Glostrup, DK  
MEIER, Eddi, Bringebakken 88, DK-3500 Værløse, DK  
RIBER, Ditte, Degnemose Allé 64, DK-2700 Brønshøj, DK  
DAUGAARD, Jens, Rosengren, Bakkevej 6, DK-2830 Virum, DK  
SKOVGAARD, Marie, Strandvejen 75 A 3. th., DK-2100 Copenhagen Ø, DK



- (51) MKP  
**A61P 35/00 (2006.01)** (97) **2569312 \***  
**C07D 413/14 (2006.01)**  
**A61K 31/4245 (2006.01)**  
(86) EP2011057021 03.05.2011  
(96) 11716595.1 20.03.2013  
(87) WO2011141326, 03.05.2011  
(97) 2569312, 20.03.2013 de  
(54) SUBSTITUTED HETEROCYCLYL BENZYL PYRAZOLES,  
AND USE THEREOF  
(71) Bayer Pharma Aktiengesellschaft, Müllerstrasse 178, 13353  
Berlin, DE  
(72) HÄRTER, Michael, Ernst-Ludwig-Kirchner-Str. 56, 51375  
Leverkusen, DE  
BECK, Hartmut, Ursula-von-Reibnitz-Straße 69, 42287  
Wuppertal, DE  
GRESCHAT-SCHADE, Susanne, Im Collmoor 6a, 49419  
Wagenfeld, DE  
ELLINGHAUS, Peter, Auf der Obstwiese 3, 49324 Melle, DE  
UNTERSCHHEMMANN, Kerstin, Am Vogelherd 15, 45239  
Essen, DE  
SCHUHMACHER, Joachim, Lipkenskothen 31, 42113  
Wuppertal, DE

- (51) MKP  
**A61K 39/00 (2006.01)** (97) **2542256 \***  
**C07K 16/00 (2006.01)**  
(86) US2011026689 01.03.2011  
(96) 11751204.6 09.01.2013  
(87) WO2011109400, 01.03.2011  
(97) 2542256, 09.01.2013 en  
(54) ANTIBODIES REACTIVE WITH B7-H3, IMMUNOLOGICALLY  
ACTIVE FRAGMENTS THEREOF AND USES THEREOF  
(71) MacroGenics, Inc., 9640 Medical Center Drive, Rockville, MD  
20850, US  
(72) LOO, Deryk, T., 1509 Pine Knoll Drive, Belmont, CA 94402, US  
HUANG, Ling, 8210 Moorland Lane, Bethesda, MD 20817, US  
CHEN, Francine Zhifen, 2660-31 St Ave, San Francisco, CA  
94116, US  
MOORE, Paul A., 7013 Old Gate Road, North Bethesda, MD  
20852, US  
JOHNSON, Leslie S., 14411 Poplar Hill Road, Darnestown,  
MD 20874, US

- (51) MKP  
**A61Q 17/04 (2006.01)** (97) **2588068 \***  
**A61K 8/27 (2006.01)**  
**A61K 8/67 (2006.01)**  
**A61K 8/34 (2006.01)**  
**A61K 8/68 (2006.01)**  
**A61K 8/40 (2006.01)**  
**A61K 8/365 (2006.01)**  
**A61K 8/37 (2006.01)**  
**A61K 8/42 (2006.01)**  
**A61Q 19/00 (2006.01)**  
(86) EP2011060967 29.06.2011  
(96) 11729608.7 08.05.2013  
(87) WO2012001082, 29.06.2011  
(97) 2588068, 08.05.2013 en  
(54) MOISTURIZING COMPOSITION WITH SPF 30  
(71) Galderma S.A., Zugerstrasse 8, 6330 Cham, CH  
(72) NADAU FOURCADE, Karine, « Les Restanques de Vaugrenier  
» 1214 Avenue de Vaugrenier, F-06270 Villeneuve Loubet, FR  
MALLARD, Claire, Domaine La Jouvencelle 1122 Chemins du  
Château, F-06250 Mougins, FR  
FREDON, Laurent, Chemin du Camouyer - Lotissement Les  
Templiers Cidex 410 Bis, F-06330 Roquefort Les Pins, FR

- (51) MKP  
**A61K 31/519 (2006.01)** (97) **2593458 \***  
**C07D 487/04 (2006.01)**  
**A61P 35/00 (2006.01)**  
(86) EP2011061736 11.07.2011  
(96) 11736032.1 22.05.2013  
(87) WO2012007416, 11.07.2011  
(97) 2593458, 22.05.2013 en  
(54) BICYCLIC PYRIMIDINES  
(71) Bayer Intellectual Property GmbH, Alfred-Nobel-Strasse 10,  
40789 Monheim, DE  
(72) INCE, Stuart, Katteweg 27a, 14129 Berlin, DE  
REHWINKEL, Hartmut, Blücherstr. 13, 10961 Berlin, DE  
HAEGEBARTH, Andrea, An den Eldenaer Höfen 13, 10247  
Berlin, DE  
POLITZ, Oliver, Steenerbuschstr. 73, 16341 Panketal OT  
Zepernick, DE  
NEUHAUS, Roland, Lauenburger Strasse 28, 12157 Berlin,  
DE  
BÖMNER, Ulf, Leipziger Str. 49, 16548 Glienicke, DE

- (51) MKP  
**B01J 31/24 (2006.01)** (97) **2593226 \***  
(86) US2011044282 15.07.2011  
(96) 11739235.7 22.05.2013  
(87) WO2012009698, 15.07.2011  
(97) 2593226, 22.05.2013 en  
(54) PHOSPHINE LIGANDS FOR CATALYTIC REACTIONS  
(71) Abbvie Inc., 1 North Waukegan Road, North Chicago, IL  
60064, US  
(72) SHEKHAR, Shashank, 2101 St. Johns Avenue, Highland Park  
Illinois 60035, US  
FRANCZYK, Thaddeus S., 18630 W. Lazy Acre, Lake Villa  
Illinois 60046, US  
BARNES, David M., 15895 88th Street, Bristol Wisconsin  
53104, US  
DUNN, Travis B., 6647 Foxworth Lane, Gurnee Illinois 60031,  
US  
HAIGHT, Anthony R., 40381 Reed Ct., Wadsworth Illinois  
60083, US  
CHAN, Vincent S., 412 Lee Street Apt. 3, Evanston Illinois  
60202, US

- (51) MKP  
**F16C 37/00 (2006.01)** (97) **2463536**  
**F16C 17/02 (2006.01)**  
**F16C 33/20 (2006.01)**  
(96) 11192548.3 13.06.2012  
(97) 2463536, 13.06.2012 en  
(54) Bearing Assembly  
(71) Delphi Technologies Holding S.à.r.l., Avenue de Luxembourg,  
4940 Bascharage, LU  
(72) Evans, Gareth, 242 Malling Road, Snodland, Kent ME6 5JG,  
GB  
Rosu, Cristian, 59 Chaucer Road, Gillingham, Kent ME7 5LX,  
GB

- (51) MKP  
**F25D 3/08 (2006.01)** (97) **2572148 \***  
(86) US2011036933 18.05.2011  
(96) 11784143.7 27.03.2013  
(87) WO2011146572, 18.05.2011  
(97) 2572148, 27.03.2013 en  
(54) KEG APPARATUS FOR SELF COOLING AND SELF  
DISPENSING LIQUIDS  
(71) Joseph Company International, Inc., 27612 Fargo Road,  
Laguna Hills, CA 92653, US  
(72) CULL, David, 214/1 Moo 9 Prachauti Soi 16 Ratburana,  
Bankok 10140, TH  
SILLINCE, Mark, 14 Cowdray Drive, Rustington West Sussex  
BN16 3SJ, GB

- (51) MKP  
**C05F 1/00 (2006.01)** (97) **2550244 \***  
**C05F 11/00 (2006.01)**  
**C05F 9/00 (2006.01)**  
**C05F 5/00 (2006.01)**  
**C05F 7/00 (2006.01)**  
**B09B 3/00 (2006.01)**  
**C05F 3/00 (2006.01)**
- (86) SG2011000113 23.03.2011  
(96) 11759808.6 30.01.2013  
(87) WO2011119112, 23.03.2011  
(97) 2550244, 30.01.2013 en  
(54) TREATMENT OF ORGANIC WASTE
- (71) Biomax Holdings Pte Ltd, Blk 4 Kaki Bukit Avenue 1 No. 05-07-08, Singapore 417939, SG  
(72) PUAH, Chum Mok, Block 2 Taman Serasi 03-02, Singapore 257718, SG  
SIM, Eng Tong, Block 435 Yishun Ave 6 02-2096, Singapore 760435, SG  
CHUA, Siok Lui, Block 3 Delta Ave 05-28, Singapore 160003, SG

- (51) MKP  
**A61K 39/395 (2006.01)** (97) **2558496 \***  
**C07K 16/18 (2006.01)**
- (86) US2011032468 14.04.2011  
(96) 11769579.1 20.02.2013  
(87) WO2011130499, 14.04.2011  
(97) 2558496, 20.02.2013 en  
(54) ANTI-POLYUBIQUITIN ANTIBODIES AND METHODS OF USE
- (71) Genentech, Inc., 1 DNA Way, South San Francisco CA 94080-4990, US  
(72) DIXIT, Vishva, c/o Genentech Inc. 1 DNA Way, South San Francisco California 94080-4990, US  
KELLEY, Robert F., c/o Genentech Inc. 1 DNA Way, South San Francisco California 94080-4990, US  
MATSUMOTO, Marissa L., c/o Genentech Inc. 1 DNA Way, South San Francisco California 94080-4990, US

- (51) MKP  
**C07C 323/62 (2006.01)** (97) **2582664 \***  
**C07D 213/24 (2006.01)**  
**A61K 31/192 (2006.01)**  
**A61K 31/44 (2006.01)**  
**A61P 19/06 (2006.01)**
- (86) US2011040586 15.06.2011  
(96) 11796397.5 24.04.2013  
(87) WO2011159840, 15.06.2011  
(97) 2582664, 24.04.2013 en  
(54) PHENYLTHIOACETATE COMPOUNDS, COMPOSITIONS AND METHODS OF USE
- (71) Ardea Biosciences, Inc., 4939 Directors Place, San Diego, CA 92121, US  
(72) OUK, Samedy, 10790 Dabney Drive Apt 2., San Diego, CA 92121, US  
VERNIER, Jean-michel, 5150 Sea Mist, San Diego, CA 92121, US  
GUNIC, Esmir, 8952 Capcano Road, San Diego, CA 92129, US

- (51) MKP  
**B05B 17/08 (2006.01)** (97) **2588252 \***
- (86) EP2011003305 04.07.2011  
(96) 11787594.8 08.05.2013  
(87) WO2012003951, 04.07.2011  
(97) 2588252, 08.05.2013 en  
(54) PLAYGROUND COMPRISING FOUNTAINS
- (71) Ice-World Holding B.V., Wilhelminalaan 14, 3743 DC Baarn, NL  
(72) SCHOEREN, Hubertus, Johannes, Bernardes, Heiweg 11, NL-6581 EA Malden, NL  
HOEKS, Wilhelmus, Adolfus, Johannes, Marie, Wilhelminalaan 14, NL-3743 DC Baarn, NL  
VAN KEMPEN, Frits, Jan, Lanseloetstraat 37 III, NL-1055 BC Amsterdam, NL

- (51) MKP  
**C07D 205/08 (2006.01)** (97) **2590940 \***  
**C07D 263/38 (2006.01)**
- (86) EP2011061616 08.07.2011  
(96) 11738419.8 15.05.2013  
(87) WO2012004382, 08.07.2011  
(97) 2590940, 15.05.2013 en  
(54) NEW METHOD FOR PREPARING EZETIMIBE
- (71) Moehs Ibérica, S.L., César Martinell i Brunet 12A Polígon Rubí Sud, 08191 Rubí (Barcelona), ES  
(72) SÁNCHEZ CASALS, Carles, Moehs Iberica S.L. Polígono Rubí Sur C/ César Martinell i Brunet 12A, E-08191 Rubí-Barcelona, ES  
DOBARRO RODRÍGUEZ, Alicia, Moehs Iberica S.L. Polígono Rubí Sur C/ César Martinell i Brunet 12A, E-08191 Rubí-Barcelona, ES  
BOSCH CARTES, Juan, Calle Violante de Hungría 111-A. SAT-1ª, E-08028 Barcelona, ES  
GARCÍA DÍAZ, Davinia, Av/ Isabel la Católica 80, At, E-08905 Hospitalet de Llobregat-Barcelona, ES

- (51) MKP  
**D01D 1/06 (2006.01)** (97) **2558624 \***  
**D01D 5/12 (2006.01)**  
**D01F 2/00 (2006.01)**
- (86) EP2011055680 12.04.2011  
(96) 11715203.3 20.02.2013  
(87) WO2011128322, 12.04.2011  
(97) 2558624, 20.02.2013 en  
(54) PROCESS FOR THE MANUFACTURE OF CELLULOSE-BASED FIBRES AND THE FIBRES THUS OBTAINED
- (71) SAPPI Netherlands Services B.V., Biesenweg 16, 6211 AA Maastricht, NL  
(72) TURNER, Philip, c/o The Court of Edinburgh Napier University Merchiston Tower Colinton Road, Edinburgh Lothian EH10 5DT, GB  
HERNANDEZ, Zurine, c/o The Court of Edinburgh Napier University Merchiston Tower Colinton Road, Edinburgh loth EH10 5DT, GB  
HILL, Callum, c/o The Court of Edinburgh Napier University Merchiston Tower Colinton Road, Edinburgh Lothian EH10 5DT, GB

- (51) MKP  
**C07C 323/52 (2006.01)** (97) **2576505 \***  
**A61K 31/215 (2006.01)**  
**A61P 31/00 (2006.01)**  
**A61P 17/00 (2006.01)**
- (86) AT2011000237 23.05.2011  
(96) 11724938.3 10.04.2013  
(87) WO2011146954, 23.05.2011  
(97) 2576505, 10.04.2013 en  
(54) PROCESS FOR THE PREPARATION OF PLEUROMUTILINS
- (71) Nabriva Therapeutics AG, Leberstrasse 20, 1110 Wien, AT  
(72) RIEDL, Rosemarie, Reglergasse 3/204, 1220 Wien, AT  
HEILMAYER, Werner, Obere Weideaecker 19, 7034 Zillingtal, AT  
SPENCE, Lee, Pilgramgasse 5/5, 1050 Wien, AT

- (51) MKP  
**F28D 9/00 (2006.01)** (97) **2585784 \***  
**F24F 3/147 (2006.01)**  
**F28D 15/00 (2006.01)**  
**F24F 12/00 (2006.01)**  
**F28F 3/12 (2006.01)**
- (86) IB2011002145 22.06.2011  
(96) 11797695.1 01.05.2013  
(87) WO2011161547, 22.06.2011  
(97) 2585784, 01.05.2013 en  
(54) LIQUID-TO-AIR MEMBRANE ENERGY EXCHANGER
- (71) Venmar, Ces Inc., 1502 D Quebec Avenue, Saskatoon, SK, CA  
University of Saskatchewan, 501- 121 Research Drive, Saskatoon, SK S7N 1K2, CA  
(72) ERB, Blake, 302 Faldo Cres., Warman, SK S0K 0A1, CA  
BESANT, Robert, W., 404-102 Kingsmere Place, Saskatoon, SK S7J 2K3, CA  
SIMONSON, Carey, J., 2390 Baker Road E., Corman Park, SK S7T 1C1, CA  
HEMINGSON, Howard, 823 3rd Street E., Saskatoon, SK S7H 1M6, CA

(51) MKP  
**A61K 38/22 (2006.01)** (97) **2563808 \***  
**C07K 14/595 (2006.01)**  
**C07K 19/00 (2006.01)**  
**C07K 14/575 (2006.01)**  
(86) DK2011050133 27.04.2011  
(96) 11774431.8 06.03.2013  
(87) WO2011134471, 27.04.2011  
(97) 2563808, 06.03.2013 en  
(54) PEPTIDE CONJUGATES OF GLP-1 RECEPTOR AGONISTS AND GASTRIN AND THEIR USE  
(71) Zealand Pharma A/S, Smedeland 36, 2600 Glostrup, DK  
(72) NEERUP, Trine Skovlund Ryge, Bøgeallé 27, DK-3600 Frederikssund, DK  
ØSTERLUND, Torben, Orkestervägen 28, S-224 72 Lund, SE  
TOLBORG, Jakob Lind, Tubberupvænge 40 B, DK-2730 Herlev, DK  
FOSGERAU, Keld, Lyngholmvej 45, DK-2720 Vanløse, DK  
MÅRTENSSON, Ulrika, Trastvägen 17, S-227 31 Lund, SE  
BRORSON, Marianne, Hagavej 12 2. tv., DK-2860 Søborg, DK  
ROLSTED, Kamilla, Bag Klostret 4, DK-4200 Slagelse, DK

(51) MKP  
**B65D 81/20 (2006.01)** (97) **2573003 \***  
**B65D 75/32 (2006.01)**  
**B65D 30/20 (2006.01)**  
(86) JP2011061198 16.05.2011  
(96) 11783495.2 27.03.2013  
(87) WO2011145561, 16.05.2011  
(97) 2573003, 27.03.2013 en  
(54) CONTAINER  
(71) Uni-charm Corporation, 182 Shimobun Kinsei-cho Shikokuchuo-shi, Ehime 799-0111, JP  
(72) UEDA Takahiro, c/o UNI-CHARM CORPORATION Technical Center 1531-7 Wadahama Toyohama-cho, Kanonji-shi Kagawa 769-1602, JP  
KOYAMA Yasuhiro, c/o UNI-CHARM CORPORATION Technical Center 1531-7 Wadahama Toyohama-cho, Kanonji-shi Kagawa 769-1602, JP

(51) MKP  
**F02M 59/46 (2006.01)** (97) **2492492**  
**F02M 59/20 (2006.01)**  
**F02M 59/26 (2006.01)**  
**F02M 59/34 (2006.01)**  
(96) 11156276.5 29.08.2012  
(97) 2492492, 29.08.2012 en  
(54) Pumping head  
(71) Delphi Technologies Holding S.à.r.l., Avenue de Luxembourg, 4940 Bascharage, LU  
(72) McHattie, James, 11 Bysing Wood Road, Faversham, Kent ME13 7QA, GB  
Garland, Paul, 39 Holmside, Gillingham, Kent ME7 4BQ, GB

(51) MKP  
**A61P 3/00 (2006.01)** (97) **2576618 \***  
**C07K 16/22 (2006.01)**  
**A61P 21/00 (2006.01)**  
**A61K 39/395 (2006.01)**  
(86) US2011037837 25.05.2011  
(96) 11726005.9 10.04.2013  
(87) WO2011150008, 25.05.2011  
(97) 2576618, 10.04.2013 en  
(54) ANTIBODIES TO HUMAN GDF8  
(71) Regeneron Pharmaceuticals, Inc., 777 Old Saw Mill River Road, Tarrytown, NY 10591, US  
(72) STITT, Trevor, 251 Briarcliff Road, Ridgewood, NJ 07450, US  
LATRES, Esther, 123 Sullivan Street Apt. 3, New York, NY 10012, US

(51) MKP  
**A01N 65/06 (2009.01)** (97) **2579718 \***  
**A01N 43/54 (2006.01)**  
**A01P 3/00 (2006.01)**  
**A01N 65/10 (2009.01)**  
**A01N 65/22 (2009.01)**  
**B27K 3/34 (2006.01)**  
**B27K 3/50 (2006.01)**  
**A01N 35/06 (2006.01)**  
**A01N 31/08 (2006.01)**  
(86) EP2011059572 09.06.2011  
(96) 11724423.6 17.04.2013  
(87) WO2011154487, 09.06.2011  
(97) 2579718, 17.04.2013 en  
(54) COMBINATIONS OF PYRIMETHANIL AND MONOTERPENES  
(71) Janssen Pharmaceutica, N.V., Turnhoutseweg 30, 2340 Beerse, BE  
(72) BYLEMANS, Dany, Leopold, Jozefien, Janssen Pharmaceutica NV Turnhoutseweg 30, B-2340 Beerse, BE  
BOSSLAERS, Jan, Pieter, Hendrik, Janssen Pharmaceutica NV Turnhoutseweg 30, B-2340 Beerse, BE

(51) MKP  
**F16L 55/103 (2006.01)** (97) **2583014 \***  
**G05D 23/19 (2006.01)**  
(86) US2011001083 15.06.2011  
(96) 11740742.9 24.04.2013  
(87) WO2011159355, 15.06.2011  
(97) 2583014, 24.04.2013 en  
(54) METHODS, DEVICES AND SYSTEMS FOR EXTRACTION OF THERMAL ENERGY FROM A HEAT CONDUCTING METAL CONDUIT  
(71) Biofilm IP, LLC, 990 Ironwood Drive, Minden, NV 89423, US  
(72) WRAY, Daniel, X., P.O. Box 2649, Minden NV 89423, US  
WRAY, Robert, J., P.O. Box 2649, Minden NV 89423, US  
CUTBIRTH, Henry, P.O. Box 2649, Minden NV 89423, US

(51) MKP  
**A61K 38/22 (2006.01)** (97) **2568999 \***  
**A61P 21/00 (2006.01)**  
**A61K 38/16 (2006.01)**  
**A61P 21/02 (2006.01)**  
(86) US2011035831 10.05.2011  
(96) 11781106.7 20.03.2013  
(87) WO2011143152, 10.05.2011  
(97) 2568999, 20.03.2013 en  
(54) ACTH FOR TREATMENT OF AMYOTROPHIC LATERAL SCLEROSIS  
(71) Questcor Pharmaceuticals, Inc., 26118 Research Road, Hayward, CA 94545, US  
(72) SOMERA-MOLINA, Kathleen, C., 9460 Farley Drive, Huntley IL 60142, US

(51) MKP  
**C07D 471/00 (2006.01)** (97) **2571875 \***  
(86) US2011036667 16.05.2011  
(96) 11781410.3 27.03.2013  
(87) WO2011143657, 16.05.2011  
(97) 2571875, 27.03.2013 en  
(54) MALE CONTRACEPTIVE COMPOSITIONS AND METHODS OF USE  
(71) Dana-Farber Cancer Institute, Inc., 450 Brookline Avenue, Boston, MA 02115-5450, US  
Baylor College Of Medicine, One Baylor Plaza MSC BCM210 - 600D, Houston, TX 77030, US  
(72) BRADNER, James, Elliott, 9 Rollins Court, Cambridge, MA 02139, US  
MATZUK, Martin, One Baylor Plaza S217, Houston, TX 77030, US  
Ol, Jun, 54 Linden Avenue Apt.1, Malden, MA 02148, US

- (51) MKP  
**A47C 7/54 (2006.01)** (97) **2510838**  
**A47C 17/12 (2006.01)**
- (96) 12163371.3 17.10.2012  
(97) 2510838, 17.10.2012 en  
(54) Sofa with moveable armrests  
(71) Molteni & C. S.p.A., Via Rossini 50, 20033 Giussano, Milano, IT  
(72) Molteni, Carlo, c/o Molteni & C. S.p.A., I-20033 Giussano, Monza e Brianza, IT
- 
- (51) MKP  
**C08L 15/00 (2006.01)** (97) **2559709 \***  
**C08C 19/25 (2006.01)**  
**C08K 3/36 (2006.01)**
- (86) JP2011059352 15.04.2011  
(96) 11768946.3 20.02.2013  
(87) WO2011129425, 15.04.2011  
(97) 2559709, 20.02.2013 en  
(54) PROCESS FOR PRODUCING MODIFIED CONJUGATED DIENE POLYMER, MODIFIED CONJUGATED DIENE POLYMER, AND COMPOSITION OF MODIFIED CONJUGATED DIENE POLYMER  
(71) Asahi Kasei Chemicals Corporation, 1-105, Kanda Jinbocho Chiyoda-ku, Tokyo 101-8101, JP  
(72) SEKIKAWA, Shinichi, 1-105, Kanda Jinbocho Chiyoda-ku, Tokyo 101-8101, JP  
YOSHIDA, Junichi, 1-105, Kanda Jinbocho Chiyoda-ku, Tokyo 101-8101, JP  
MATSUDA, Takaaki, 1-105, Kanda Jinbocho Chiyoda-ku, Tokyo 101-8101, JP
- 
- (51) MKP  
**B65G 51/03 (2006.01)** (97) **2457833**  
**B65B 5/06 (2006.01)**  
**B65B 35/28 (2006.01)**  
**B65B 35/40 (2006.01)**  
**B65B 29/02 (2006.01)**
- (96) 10192764.8 30.05.2012  
(97) 2457833, 30.05.2012 en  
(54) Device for positioning of portion packets  
(71) Swedish Match North Europe AB, null, 118 85 Stockholm, SE  
(72) Löfman, Lars-Olof, Solskiftegatan 42, 442 53 Ytterby, SE  
Aspgren, Thom, Båtsman Dubbels Gata 10, 422 57 Hisings Backa, SE  
Eriksson, Dennis, Iglastjärnsvägen 32A, 424 70 Olofstorp, SE  
Larsson, Tomas, Posta-Johansväg 24, 434 97 Kungälv, SE
- 
- (51) MKP  
**C12N 15/82 (2006.01)** (97) **2580335 \***
- (86) EP2011002895 07.06.2011  
(96) 11727397.9 17.04.2013  
(87) WO2011154159, 07.06.2011  
(97) 2580335, 17.04.2013 en  
(54) METHODS AND MEANS TO MODIFY A PLANT GENOME AT A NUCLEOTIDE SEQUENCE COMMONLY USED IN PLANT GENOME ENGINEERING  
(71) Bayer CropScience NV, J.E. Mommaertslaan 14, 1831 Diegem, BE  
(72) D'HALLUIN, Kathleen, Hooiland 48, B-9030 Mariakerke, BE
- 
- (51) MKP  
**A61M 5/14 (2006.01)** (97) **2579916 \***  
**A61M 5/142 (2006.01)**
- (86) EP2011002897 13.06.2011  
(96) 11728584.1 17.04.2013  
(87) WO2011154160, 13.06.2011  
(97) 2579916, 17.04.2013 en  
(54) APPARATUS AND CASE FOR INFUSION EQUIPMENT  
(71) Britannia Pharmaceuticals Limited, Park View House 65 London Road, Newbury, Berkshire RG14 1JN, GB  
(72) NOWAK, Rachael, Britannia Pharmaceuticals Limited Park View House 65 London Road, Newbury Berkshire RG14 1JN, GB  
SHAW, Andrew, Tagdraw Limited School Street Wolston, Coventry Warwickshire CV8 3HG, GB  
MARTIN, Graham, John, Tagdraw Limited School Street Wolston, Coventry Warwickshire CV8 3HG, GB
- 
- (51) MKP  
**A61M 5/24 (2006.01)** (97) **2579920 \***  
**A61M 5/315 (2006.01)**
- (86) EP2011059566 09.06.2011  
(96) 11724218.0 17.04.2013  
(87) WO2011154482, 09.06.2011  
(97) 2579920, 17.04.2013 en  
(54) ASSEMBLY FOR A DRUG DELIVERY DEVICE AND DRUG DELIVERY DEVICE  
(71) Sanofi-Aventis Deutschland GmbH, Brüningstraße 50, 65929 Frankfurt, DE  
(72) RAAB, Steffen, c/o Sanofi-Aventis Deutschland GmbH, 65926 Frankfurt am Main, DE  
HORLOCK, Mark, Philip, 18 Mayfield Close Cheshire, Timperley WA15 7TE, GB  
BUTLER, Stephen, David, 25 High Hill South Staffords, Essington WV11 2DP, GB
- 
- (51) MKP  
**C07K 16/26 (2006.01)** (97) **2542585 \***
- (86) EP2011000046 07.01.2011  
(96) 11704178.0 09.01.2013  
(87) WO2011083088, 07.01.2011  
(97) 2542585, 09.01.2013 en  
(54) METHODS FOR TREATING COLORECTAL CANCER  
(71) Bioréalités, 35, rue de Verdun, 92284 Suresnes Cedex, FR  
INSERM - Institut National de la Santé et de la Recherche Médicale, 101, rue de Tolblac, 75654 Paris Cedex 13, FR  
Centre National de la Recherche Scientifique CNRS, 3 rue Michel Ange, 75794 Paris Cedex 16, FR  
(72) PANNEQUIN, Julie, 13 rue Henri Barbusse, F-34200 Sète, FR  
HOUHOU, Leïla, 2 rue Renaud de Villeneuve, F-34090 Montpellier, FR  
FRAMERY, Bérénice, 1469 rue de Las Sorbes, 34070 Montpellier, FR  
ERKILIC, Nejla, 11 rue de la Combe du Renard, 34990 Juvignac, FR  
Joubert, Dominique, 10 rue Gabriel Péri, F-34200 Sète, FR  
HOLLANDE, Frédéric, 9, rue des Capriers, F-34790 Grabels, FR
- 
- (51) MKP  
**C07D 471/04 (2006.01)** (97) **2558463 \***  
**A61P 17/00 (2006.01)**  
**A61P 3/00 (2006.01)**  
**A61K 31/407 (2006.01)**  
**A61P 29/00 (2006.01)**
- (86) US2011032213 13.04.2011  
(96) 11716725.4 20.02.2013  
(87) WO2011130342, 13.04.2011  
(97) 2558463, 20.02.2013 en  
(54) FUSED DERIVATIVES AS I3 INHIBITORS  
(71) Incyte Corporation, Experimental Station Route 141 & Henry Clay Road Building 336, Wilmington, DE 19880, US  
(72) COMBS, Andrew P., 329 East Doe Run Road, Kennett Square Pennsylvania 19348, US  
SPARKS, Richard B., 3316 Englewood Road, Wilmington Delaware 19810, US  
YUE, Eddy W., 9 Altemus Drive, Landenberg Pennsylvania 19350, US
-

- (51) MKP  
**A61K 9/16 (2006.01)** (97) **2564847 \***  
**A61K 31/4365 (2006.01)**  
**A61P 7/02 (2006.01)**  
**A61K 47/26 (2006.01)**  
**A61K 9/20 (2006.01)**  
**A61K 47/20 (2006.01)**  
**A61K 47/40 (2006.01)**  
**A61K 9/48 (2006.01)**  
**A61K 47/30 (2006.01)**  
(86) CN2011073162 22.04.2011  
(96) 11774360.9 06.03.2013  
(87) WO2011134369, 22.04.2011  
(97) 2564847, 06.03.2013 en  
(54) PHARMACEUTICAL COMPOSITION FOR IMPROVING SOLUBILITY OF PRASUGREL AND ITS PREPARATION METHOD  
(71) Sun, Yuan, Kaitai Road Dapu Industrial Zone Lianyungang, Jiangsu 222000, CN  
(72) CEN, Junda, Economic and Technological Development Zone, Lianyungang Jiangsu 222047, CN  
ZHANG, Chunhong, Kaitai Road Dapu Industrial Zone, Lianyungang Jiangsu 222000, CN  
ZHANG, Qi, Kaitai Road Dapu Industrial Zone, Lianyungang Jiangsu 222000, CN  
LU, Aifeng, Kaitai Road Dapu Industrial Zone, Lianyungang Jiangsu 222000, CN
- 
- (51) MKP  
**H04W 88/08 (2009.01)** (97) **2540136 \***  
(86) FR2011050380 24.02.2011  
(96) 11712630.0 02.01.2013  
(87) WO2011104481, 24.02.2011  
(97) 2540136, 02.01.2013 fr  
(54) METHOD AND DEVICE FOR SENDING/RECEIVING ELECTROMAGNETIC SIGNALS RECEIVED/SENT ON ONE OR MORE FIRST FREQUENCY BANDS  
(71) E-Blink, 3-5 Rue Marcel Pagnol, 91800 Boussy St. Antoine, FR  
(72) BELLOT, Laurent, 03 bis rue Rémont, F-78000 Versailles, FR  
BLANC, Stéphane, 15 rue de la Badaudière, F-91650 Breuillet, FR  
BOUKOUR, Tariq, 480 rue Albert Ricquier, F-59310 Beuvry La Forêt, FR  
PLUMECOQ, Jean-Christophe, 2 résidence du Parc d'Ardenay, F-91120 Palaiseau, FR  
EL SAYED, Jawad, 1 place Raphaël, F-92400 Courbevoise, FR
- 
- (51) MKP  
**A61P 5/00 (2006.01)** (97) **2547650 \***  
**A61P 25/24 (2006.01)**  
**A61K 31/165 (2006.01)**  
**A61P 25/00 (2006.01)**  
**A61P 25/22 (2006.01)**  
**C07C 231/12 (2006.01)**  
**C07C 233/18 (2006.01)**  
(86) CN2011071912 17.03.2011  
(96) 11755680.3 23.01.2013  
(87) WO2011113363, 17.03.2011  
(97) 2547650, 23.01.2013 en  
(54) AGOMELATINE HYDROBROMIDE HYDRATE AND PREPARATION THEREOF  
(71) Les Laboratoires Servier, 35, rue de Verdun, 92284 Suresnes Cedex, FR  
(72) SHAN, Hanbin, No. 24, Dongfangxincun, Gaoan, Jiangxi 330800, CN  
YUAN, Zhedong, Room 201, No. 14, Lane 58, Aomen Road, Shanghai 200060, CN  
ZHU, Xueyan, Room 602, No. 78, lane 283, Yangcheng Road, Zhabei District, Shanghai 200436, CN  
ZHANG, Peng, No. 826, Zhangheng Road Pudong New Area, Shanghai 201203, CN  
PAN, Hongjuan, Room 801, No. 21, lane 150, Qingshan Road, Minhang District, Shanghai 201103, CN  
YU, Xiong, Room 107, No. 32, Duolun Road, Hongkou District, Shanghai 200081, CN

- (51) MKP  
**B26D 1/10 (2006.01)** (97) **2560798 \***  
**B26B 5/00 (2006.01)**  
(86) IB2011051676 18.04.2011  
(96) 11721117.7 27.02.2013  
(87) WO2011132134, 18.04.2011  
(97) 2560798, 27.02.2013 fr  
(54) BLADE FOR CUTTING A PIECE OF PLASTERBOARD, METHOD FOR IMPLEMENTING SAID BLADE, AND USE THEREOF  
(71) Mallet, Benoît, 10 rue des Bas de Ferrières, 27190 Ferrieres Haut Clocher, FR  
(72) Mallet, Benoît, 10 rue des Bas de Ferrières, 27190 Ferrieres Haut Clocher, FR
- 
- (51) MKP  
**A61P 35/00 (2006.01)** (97) **2544704 \***  
**A61K 38/17 (2006.01)**  
(86) US2011028080 11.03.2011  
(96) 11754152.4 16.01.2013  
(87) WO2011112921, 11.03.2011  
(97) 2544704, 16.01.2013 en  
(54) SPARC ANGIOGENIC DOMAIN AND METHODS OF USE  
(71) Abraxis BioScience, LLC, 11755 Wilshire Boulevard Suite 2000, Los Angeles, CA 90025, US  
(72) TRIEU, Vuong, 4003 Jim Bowie Boulevard, Agoura Hills California 91301, US  
KNAUER, Daniel, 1109 El Camino Drive, Costa Mesa California 92626, US  
DESAI, Neil, 11755 Wilshire Boulevard Suite 2310, Los Angeles, California 90025, US
- 
- (51) MKP  
**C07K 16/26 (2006.01)** (97) **2542584 \***  
**A61P 35/00 (2006.01)**  
**A61K 39/395 (2006.01)**  
(86) EP2011000049 07.01.2011  
(96) 11700115.6 09.01.2013  
(87) WO2011083091, 07.01.2011  
(97) 2542584, 09.01.2013 en  
(54) METHODS FOR TREATING PANCREATIC CANCER  
(71) Bioréalités, 35, rue de Verdun, 92284 Suresnes Cedex, FR  
INSTITUT NATIONAL DE LA SANTE ET DE LA RECHERCHE MEDICALE (INSERM), 101, rue de Tolbiac, 75654 Paris Cédex 13, FR  
Centre National de la Recherche Scientifique (CNRS), 3, rue Michel-Ange, 75794 Paris Cedex 16, FR  
(72) HOUHOU, Leïla, 2 rue Renaud de Villeneuve, 34090 Montpellier, FR  
JOURBERT, Dominique, 10 rue Gabriel Péri, 34200 Sète, FR  
HOLLANDE, Frédéric, 9, rue des Capries, 34790 Grabels, FR
- 
- (51) MKP  
**A61M 5/20 (2006.01)** (97) **2544738 \***  
**A61M 5/24 (2006.01)**  
(86) EP2011053157 03.03.2011  
(96) 11706812.2 16.01.2013  
(87) WO2011110465, 03.03.2011  
(97) 2544738, 16.01.2013 en  
(54) INJECTION DEVICE  
(71) Sanofi-Aventis Deutschland GmbH, Brüningstraße 50, 65929 Frankfurt, DE  
(72) KEMP, Thomas Mark, 3 Forresters Cottages High Steet, Ashwell SG7 5NW, GB  
JENNINGS, Douglas, 73 Redwing Rise Royston, Herts SG8 7XU, GB  
SCUDAMORE, Peter, 90 Macaulay Ave Great Shelford, Cambridge CB22 5AF, GB  
EKMAN, Matthew, 59 Ecton Avenue Macclesfield, Cheshire SK10 1RD, GB

- (51) MKP  
**B01D 53/00 (2006.01)** (97) **2563495 \***  
 (86) US2011034684 29.04.2011  
 (96) 11775671.8 06.03.2013  
 (87) WO2011137398, 29.04.2011  
 (97) 2563495, 06.03.2013 en  
 (54) SYSTEM AND METHOD FOR CARBON DIOXIDE CAPTURE AND SEQUESTRATION  
 (71) Eisenberger, Peter, 170 Brooks Bend, Princeton, NJ 08540, US  
 (72) Eisenberger, Peter, 170 Brooks Bend, Princeton, NJ 08540, US

- (51) MKP  
**A61F 13/00 (2006.01)** (97) **2552371 \***  
 (86) IB2010051414 31.03.2010  
 (96) 10713525.3 06.02.2013  
 (87) WO2011121394, 31.03.2010  
 (97) 2552371, 06.02.2013 en  
 (54) A WOUND CARE DRESSING, A METHOD AND A PRODUCTION LINE FOR MANUFACTURING THE WOUND CARE DRESSING  
 (71) Pharmaplast SAE, Amria Free Zone, Alexandria 23512, EG  
 (72) ATTEIA, Mamdouh H., Pharmaplast Amria free zone, Alexandria 23512, EG

- (51) MKP  
**A61P 27/00 (2006.01)** (97) **2552965 \***  
**A61K 39/395 (2006.01)**  
**A61P 37/00 (2006.01)**  
**C07K 16/28 (2006.01)**  
**C12N 15/13 (2006.01)**  
 (86) US2011030427 30.03.2011  
 (96) 11712447.9 06.02.2013  
 (87) WO2011123489, 30.03.2011  
 (97) 2552965, 06.02.2013 en  
 (54) ANTI-CD40 ANTIBODIES  
 (71) Boehringer Ingelheim International GmbH, Binger Strasse 173, 55216 Ingelheim am Rhein, DE  
 (72) BARRETT, Rachel, Boehringer Ingelheim Pharmaceuticals Inc. 900 Ridgebury Road P.O. Box 368, Ridgefield, Connecticut 06877-0368, US  
 BRODEUR, Scott, Boehringer Ingelheim Pharmaceuticals Inc. 900 Ridgebury Road P.O. Box 368, Ridgefield, Connecticut 06877-0368, US  
 CANADA, Keith A., Boehringer Ingelheim Pharmaceuticals Inc. 900 Ridgebury Road P.O. Box 368, Ridgefield, Connecticut 06877-0368, US  
 LITZENBURGER, Tobias, Boehringer Ingelheim GmbH Corporate Patents Binger Strasse 173, 55216 Ingelheim Am Rhein, DE  
 SINGH, Sanjaya, Boehringer Ingelheim Pharmaceuticals Inc. 900 Ridgebury Road P.O. Box 368, Ridgefield, Connecticut 06877-0368, US

- (51) MKP  
**A61K 39/395 (2006.01)** (97) **2552966 \***  
**C07K 16/32 (2006.01)**  
**A61P 35/00 (2006.01)**  
**C07K 16/28 (2006.01)**  
**A61P 35/02 (2006.01)**  
 (86) US2011030148 28.03.2011  
 (96) 11713416.3 06.02.2013  
 (87) WO2011123381, 28.03.2011  
 (97) 2552966, 06.02.2013 en  
 (54) ANTIBODIES AGAINST CSF-1R  
 (71) ImClone LLC, 440 Route 22 East, Bridgewater, NJ 08807, US  
 (72) DOODY, Jacqueline, Françoise, c/o Eli Lilly and Company Lilly Corporate Center, Indianapolis Indiana 46285, US  
 LI, Yanxia, c/o Eli Lilly and Company Lilly Corporate Center, Indianapolis Indiana 46285, US

- (51) MKP  
**B61L 5/04 (2006.01)** (97) **2558345 \***  
**B61L 5/10 (2006.01)**  
 (86) CZ2011000035 14.04.2011  
 (96) 11728766.4 20.02.2013  
 (87) WO2011127874, 14.04.2011  
 (97) 2558345, 20.02.2013 en  
 (54) ACTIVE MEMBER OF THE HYDRAULIC LOCKING DEVICE EQUIPPED WITH MECHANIC LOCKING AND RETENTION  
 (71) DT- Vyhybkárna A Strojirna, A.S., Dolni 100, 797 11 Prostejov, CZ  
 (72) NAVRATIL, Dusan, Kotkova 23, CZ-796 01 Prostejov, CZ

- (51) MKP  
**A61K 39/00 (2006.01)** (97) **2560681 \***  
**C07K 16/00 (2006.01)**  
 (86) US2011033649 22.04.2011  
 (96) 11772806.3 27.02.2013  
 (87) WO2011133919, 22.04.2011  
 (97) 2560681, 27.02.2013 en  
 (54) USE OF TAU TO MONITOR IMMUNOTHERAPY  
 (71) Janssen Alzheimer Immunotherapy, Little Island Industrial Estate, Little Island, County Cork, IE  
 Wyeth LLC, Five Giralda Farms, Madison, NJ 07940, US  
 (72) BLACK, Ronald, 826 Mill Grove Drive, Audubon Pennsylvania 19403, US  
 JACOBSEN, Jack Steven, 229 Mulberry Road Apt. 6, Ramsey New Jersey 07446, US  
 TCHISTIAKOVA, Lioudmila, 19 Abbot Bridge Drive, Andover Massachusetts 01810, US  
 WIDOM, Angela, 19 Cherokee Road, Acton Massachusetts 01720, US  
 GILL, Davinder, 20 Charlotte Drive, Andover Massachusetts 01810, US  
 EKMAN, Lars, 213 Avenida Cortez, La Jolla California 92037, US  
 LIEBERBURG, Ivan, 85 Hillcrest Road, Berkeley California 94705, US  
 GRUNDMAN, Michael, 13236 Haxton Place, San Diego California 92130, US  
 CALLAWAY, James, 4893 Drakewood Terrace, San Diego California 92130, US  
 GREGG, Keith, M., 17719 W. Wind Song Avenue, Goodyear Arizona 85338, US  
 ZAGO, Wagner, 22 Creekside Lane, San Mateo California 94401, US  
 BUTTINI, Manuel, J., 8 Admiral Drive, No. A131, Emeryville California 94608, US  
 KINNEY, Gene, G., 1600 Forest View Ave., Burlingame California 94010, US

- (51) MKP  
**A61K 31/519 (2006.01)** (97) **2590979 \***  
**A61K 31/522 (2006.01)**  
**A61P 9/00 (2006.01)**  
**C07D 487/04 (2006.01)**  
 (86) EP2011061305 05.07.2011  
 (96) 11732409.5 15.05.2013  
 (87) WO2012004258, 05.07.2011  
 (97) 2590979, 15.05.2013 de  
 (54) RING-FUSED PYRIMIDINES AND TRIAZINES AND USE THEREOF FOR THE TREATMENT AND/OR PROPHYLAXIS OF CARDIOVASCULAR DISEASES  
 (71) Bayer Intellectual Property GmbH, Alfred-Nobel-Strasse 10, 40789 Monheim, DE  
 (72) FOLLMANN, Markus, Rosmarinweg 28, 50859 Köln, DE  
 STASCH, Johannes-Peter, Alfred-Nobel-Str. 109, 42651 Solingen, DE  
 REDLICH, Gorden, Schadowstr. 50, 44799 Bochum, DE  
 ACKERSTAFF, Jens, Schliemannstr.15, 410437 Berlin, DE  
 GRIEBENOW, Nils, Kurfürstenstr. 39, 41541 Dormagen, DE  
 KNORR, Andreas, Trillser Graben 10, 40699 Erkrath, DE  
 WUNDER, Frank, Schwarzer Weg 251, 42117 Wuppertal, DE  
 LI, Volkhart, Min-Jian, Im Wiesengrund 40, 42553 Velbert, DE  
 KROH, Walter, Breuerweg 18, 42115 Wuppertal, DE  
 BÄRFACKER, Lars, Walter-Flex-Str. 29, 46047 Oberhausen, DE

(51) MKP  
**A61K 38/48 (2006.01)** (97) **2544697 \***  
**A61K 35/14 (2006.01)**  
**A61K 35/16 (2006.01)**  
(86) IB2011000684 11.03.2011  
(96) 11719062.9 16.01.2013  
(87) WO2011110948, 11.03.2011  
(97) 2544697, 16.01.2013 en  
(54) PROCESS, TUBE AND DEVICE FOR THE PREPARATION OF WOUND HEALANT COMPOSITION  
(71) Turzi, Antoine, 5 B Rue de l'Eglise, 1146 Mollens, CH  
(72) Turzi, Antoine, 5 B Rue de l'Eglise, 1146 Mollens, CH

(51) MKP  
**G01N 33/15 (2006.01)** (97) **2576778 \***  
**C12N 15/09 (2006.01)**  
**C12Q 1/68 (2006.01)**  
(86) JP2011003059 31.05.2011  
(96) 11789456.8 10.04.2013  
(87) WO2011152043, 31.05.2011  
(97) 2576778, 10.04.2013 en  
(54) TRANSGENIC REPORTER SYSTEM THAT REVEALS EXPRESSION PROFILES AND REGULATION MECHANISMS OF ALTERNATIVE SPLICING IN MAMMALIAN ORGANISMS  
(71) Kyoto University, 36-1, Yoshida-honmachi, Sakyo-ku Kyoto-shi Kyoto 606-8501, JP  
(72) HAGIWARA, Masatoshi, c/o Graduate School of Medicine Kyoto University Yoshida-Konoe-cho Sakyo-ku, Kyoto-shi, Kyoto 606-8501, JP  
TAKEUCHI, Akihide, c/o Graduate School of Medicine Kyoto University Yoshida-Konoe-cho Sakyo-ku, Kyoto-shi, Kyoto 606-8501, JP

(51) MKP  
**A61K 31/727 (2006.01)** (97) **2585080 \***  
**A61P 7/02 (2006.01)**  
(86) EP2011060615 24.06.2011  
(96) 11730928.6 01.05.2013  
(87) WO2011161235, 24.06.2011  
(97) 2585080, 01.05.2013 en  
(54) SEMULOPARIN FOR USE AS AN ANTITHROMBOTIC TREATMENT IN HIP REPLACEMENT SURGERY WITH IMPROVED SAFETY IN TERMS OF CLINICALLY RELEVANT BLEEDINGS  
(71) Aventis Pharma S.A., 20, avenue Raymond Aron, 92160 Antony, FR  
(72) DESTREE, Dominique, Sanofi Patent Department 174 avenue de France, F-75013 Paris, FR  
JEAN DE POTTER, Chantal, Sanofi Patent Department 174 avenue de France, F-75013 Paris, FR

(51) MKP  
**A61N 1/36 (2006.01)** (97) **2588185 \***  
**A61N 1/04 (2006.01)**  
**A61N 1/05 (2006.01)**  
**A61H 39/00 (2006.01)**  
(86) AT2011000218 09.05.2011  
(96) 11722712.4 08.05.2013  
(87) WO2012000003, 09.05.2011  
(97) 2588185, 08.05.2013 de  
(54) ELECTRICAL STIMULATION DEVICE  
(71) Ducest Medical GmbH, Waldstrasse 61, 7222 Rohrbach bei Mattersburg, AT  
(72) SCHNETZ, Guntram, Kirschenweg 4/5, A-2362 Biedermannsdorf, AT  
NETAUSCHEK, Friedrich, Silberseestrasse 49, A-3421 Höflein an der Donau, AT

(51) MKP  
**A61P 25/24 (2006.01)** (97) **2590969 \***  
**C07D 413/06 (2006.01)**  
**A61K 31/4245 (2006.01)**  
**C07D 413/14 (2006.01)**  
**A61K 31/4523 (2006.01)**  
(86) GB2011051256 04.07.2011  
(96) 11729458.7 15.05.2013  
(87) WO2012004588, 04.07.2011  
(97) 2590969, 15.05.2013 en  
(54) THERAPEUTIC AGENTS 976  
(71) AstraZeneca AB, null, 151 85 Södertälje, SE  
(72) BÖKMAN-WINIWARTER, Susanne, Doris, Margit, AstraZeneca R&D Mölndal, S-431 83 Mölndal, SE  
FREDENWALL, Marlene, AstraZeneca R&D Mölndal, S-431 83 Mölndal, SE  
HOGNER, Anders, Carl, AstraZeneca R&D Mölndal, S-431 83 Mölndal, SE  
JOHANSSON, Lars Anders, Mikael, AstraZeneca R&D Mölndal, S-431 83 Mölndal, SE  
JUDKINS, Robert, Andrew, AstraZeneca R&D Mölndal, S-431 83 Mölndal, SE  
LI, Lanna, c/o AstraZeneca Intellectual Property AstraZeneca R%D Alderley Alderley Park, Macclesfield Cheshire, SK10 4TG, GB  
LÖFBERG, Björn, Christian, Ingvar, AstraZeneca R&D Mölndal, S-431 83 Mölndal, SE  
VON UNGE, Per Oskar, Sverker, AstraZeneca R&D Mölndal, S-431 83 Mölndal, SE

(51) MKP  
**C40B 30/06 (2006.01)** (97) **2553151 \***  
(86) US2011030198 28.03.2011  
(96) 11760374.6 06.02.2013  
(87) WO2011120042, 28.03.2011  
(97) 2553151, 06.02.2013 en  
(54) USE OF INDUCED PLURIPOTENT CELLS AND OTHER CELLS FOR SCREENING COMPOUND LIBRARIES  
(71) X-Body, Inc., 100 Beaver Street, Suite 101, Waltham, MA 02453, US  
(72) YUZHAKOV, Alexander, 5291 Washington Street, West Roxbury, MA 02132, US  
SANDBERG, Eric, 2010 Garry Oaks Avenue, C, Dupont, WA 98327, US  
SHAMAH, Steven, 11 Orchard Drive, Acton, MA 01720, US  
WAGNER, Rick, 24 Coolidge Avenue, Cambridge, MA 02138, US

(51) MKP  
**C07H 7/04 (2006.01)** (97) **2580225 \***  
**A61K 31/70 (2006.01)**  
**A61P 3/00 (2006.01)**  
(86) CN2011075554 10.06.2011  
(96) 11791943.1 17.04.2013  
(87) WO2011153953, 10.06.2011  
(97) 2580225, 17.04.2013 en  
(54) CRYSTALLINE FORM OF BENZYL BENZENE SGLT2 INHIBITOR  
(71) Theracos, Inc., 225 Cedar Hill Street, Suite 200, Marlborough, Massachusetts 01752, US  
(72) CAI, Mengzhuang, Room 1302 No. 3 Lane 31 Lan Cun Rd Pudong, Shanghai 200127, CN  
LIU, Qian, Room 701 No.7 Lane 999 Ding Xiang Rd Pudong, Shanghai 200135, CN  
XU, Ge, Room 301 Building 36 No. 1155 Guanglan Road Zhangjiang Town Pudong New District, Shanghai 201203, CN  
LV, Binhua, Room 1303 Building 42 No. 825 Chenhui Road Pudong New District, Shanghai 201203, CN  
SEED, Brian, 2 Hawthorne Place Apt. 2J Boston, Massachusetts 02114, US  
ROBERGE, Jacques Y., 57 Southern Way Princeton, New Jersey 08540, US

- (51) MKP  
**A61K 9/06 (2006.01)** (97) **2538919 \***  
**A61K 9/00 (2006.01)**  
**A61P 29/00 (2006.01)**  
**A61P 25/00 (2006.01)**  
**A61K 31/407 (2006.01)**  
**A61P 25/02 (2006.01)**  
**A61P 25/06 (2006.01)**  
(86) US2011026359 25.02.2011  
(96) 11707750.3 02.01.2013  
(87) WO2011106729, 25.02.2011  
(97) 2538919, 02.01.2013 en  
(54) PHARMACEUTICAL COMPOSITIONS OF SPIRO-OXINDOLE COMPOUND FOR TOPICAL ADMINISTRATION AND THEIR USE AS THERAPEUTIC AGENTS  
(71) Xenon Pharmaceuticals Inc., 3650 Gilmore Way, Burnaby, BC V5G 4W8, CA  
(72) WINTERS, Conrad, Stewart, 4454 West 4th Avenue, Vancouver, British Columbia V6R 1R1, CA  
YANG, Meidong, 1400 Pinnacle Court 204, Point Richmond, California 94801, US  
CHEN, Haigang, 1962 Lansdowne Way, Petaluma, California 94954, US

- (51) MKP  
**A01N 3/00 (2006.01)** (97) **2561754 \***  
**A01N 27/00 (2006.01)**  
**A01N 25/02 (2006.01)**  
**A01N 55/00 (2006.01)**  
(86) KR2011002692 15.04.2011  
(96) 11772176.1 27.02.2013  
(87) WO2011132888, 15.04.2011  
(97) 2561754, 27.02.2013 en  
(54) CYCLOPROPENE COMPOUND, AND METHOD FOR ADDING SAME TO CROPS  
(71) Erum Biotechnologies Inc., 1ra-404 Sihwa-gongdan 1250-3 Jeongwang-dong Siheung-si, Gyeonggi-do 429-450, KR  
(72) YOO, Sang-Ku, 601-203 Ju-gong Apt. Byeolyang-dong, Gwacheon-si Gyeonggi-do 427-040, KR  
CHUNG, Jin Wook, A-1704 Samsung-Towerfeliz Apt Dogok-2dong Kangnam-gu, Seoul 135-542, KR

- (51) MKP  
**A61K 8/41 (2006.01)** (97) **2566442 \***  
(86) US2011035203 04.05.2011  
(96) 11719433.2 13.03.2013  
(87) WO2011140226, 04.05.2011  
(97) 2566442, 13.03.2013 en  
(54) COMPOSITIONS COMPRISING EXTRACTS OF SOUTHERNWOOD AND AN AMINE COMPOUND  
(71) Johnson & Johnson Consumer Companies, Inc., Grandview Road, Skillman, NJ 08558, US  
(72) ANTHONAVAGE, Michael, 52 Water Street, Lebanon NJ 08833, US  
RUSSELL, Meghan, 15 Dix Ln., Lawrenceville NJ 08648, US  
TUCKER-SAMARAS, Samantha, D., 30 Schooleys Mountain Road, Long Valley NJ 07853, US

- (51) MKP  
**C09C 1/02 (2006.01)** (97) **2565237**  
**D21H 17/00 (2006.01)**  
(96) 11179604.1 06.03.2013  
(97) 2565237, 06.03.2013 en  
(54) Process for preparing self-binding pigment particle suspensions  
(71) Omya Development AG, Baslerstrasse 42, 4665 Oftringen, CH  
(72) Gantenbein, Daniel, Vogesenstrasse 27, 4056 Basel, CH  
Schoelkopf, Joachim, Buechbühlstrasse 3, 8956 Killwangen, CH  
Gane, Patrick A. C., Studenweg 8, 4852 Rothrist, CH

- (51) MKP  
**C07D 471/04 (2006.01)** (97) **2576546 \***  
**A61K 31/437 (2006.01)**  
**A61K 35/00 (2006.01)**  
(86) US2010057587 22.11.2010  
(96) 10784398.9 10.04.2013  
(87) WO2011149492, 22.11.2010  
(97) 2576546, 10.04.2013 en  
(54) APOPTOSIS-INDUCING AGENTS FOR THE TREATMENT OF CANCER AND IMMUNE AND AUTOIMMUNE DISEASES  
(71) Abbvie Inc., 1 North Waukegan Road, North Chicago, IL 60064, US  
(72) BRUNCKO, Milan, 31231 Prairie Ridge, Green Oaks Illinois 60048, US  
DING, Hong, 9 Mayfair Lane, Lincolnshire Illinois 60069, US  
DOHERTY, George, 1605 Bush Court, Libertyville Illinois 60048, US  
ELMORE, Steven, 2139 Ash Lane, Northbrook Illinois 60062, US  
HASVOLD, Lisa, 552 Shakespeare Drive, Grayslake Illinois 60030, US  
HEXAMER, Laura, 439 Gatewood Lane, Grayslake Illinois 60030, US  
KUNZER, Aaron R., 615 W. Burr Oak Drive, Arlington Illinois 60004, US  
SONG, Xiaohong, 34037 Sulkey Drive, Grayslake Illinois 60030, US  
SOUERS, Andrew, J., 901 Hinman, Apt. 3A, Evanston Illinois 60202, US  
SULLIVAN, Gerard, 1212 Tulip Tree Court, Lake Villa Illinois 60046, US  
TAO, Zhi-Fu, 1532 Vineyard Drive, Gurnee Illinois 60031, US  
WANG, Gary, T., 1904 Darnell Street, Libertyville Illinois 60048, US  
WANG, Le, 338 East Colonial Drive, Vernon Hills Illinois 60061, US  
WANG, Xilu, 1617 Eric Lane, Libertyville Illinois 60048, US  
WENDT, Michael, 1445 Maidstone Drive, Vernon Hills Illinois 60061, US  
MANTEI, Robert, 4203 Carolyn Court, Franklin Wisconsin 53132, US  
HANSEN, Todd, M., 191 Seymour Avenue, Grayslake Illinois 60030, US

- (51) MKP  
**C07K 16/30 (2006.01)** (97) **2556379 \***  
**A61K 39/395 (2006.01)**  
**A61P 35/00 (2006.01)**  
**G01N 33/68 (2006.01)**  
**G01N 33/574 (2006.01)**  
(86) SE2011051289 28.10.2011  
(96) 11836736.6 13.02.2013  
(87) WO2012057697, 28.10.2011  
(97) 2556379, 13.02.2013 en  
(54) NEW DIAGNOSTIC AND THERAPEUTIC TARGET  
(71) Avicenna Research Institute, Chamran Exp. Way Tehran, P.O. Box 1936773493, IR  
(72) RABBANI, Hodjattallah, Byälvsvägen 203, S-12847 Bagarmossen, SE

- (51) MKP  
**C08L 89/06 (2006.01)** (97) **2500371**  
**C08L 89/04 (2006.01)**  
**C08H 1/06 (2006.01)**  
(96) 12159237.2 19.09.2012  
(97) 2500371, 19.09.2012 en  
(54) Biocomposite fertiliser materials  
(71) SICIT 2000 S.p.A., Via Arzignano, 80, 36072 Chiampo, VI, IT  
(72) Sartore, Luciana, c/o SICIT 2000 S.p.A. Via Arzignano, 80, 36072 CHIAMPO (VI), IT  
Barbaglio, Marzia, c/o SICIT 2000 S.p.A. Via Arzignano, 80, 36072 CHIAMPO (VI), IT  
Neresini, Massimo Costantino, c/o SICIT 2000 S.p.A. Via Arzignano, 80, 36072 CHIAMPO (VI), IT  
Candido, Manuela Cinzia, c/o SICIT 2000 S.p.A. Via Arzignano, 80, 36072 CHIAMPO (VI), IT



(51) MKP  
**C12H 1/16 (2006.01)** (97) **2592135 \***  
**A23L 3/10 (2006.01)**  
(86) ES2011070500 08.07.2011  
(96) 11803187.1 15.05.2013  
(87) WO2012004446, 08.07.2011  
(97) 2592135, 15.05.2013 en  
(54) METHOD FOR CONSERVING BOTTLED WINE IN AN OPEN BOTTLE AND DEVICE FOR IMPLEMENTING SAME  
(71) Brucart Bonich, Marta, Bertrand Russell, 31, Castellarnau, 08206 Sabadell, ES  
(72) BRUCART PUIG, Ramón, Bertrand Russell 31 Castellarnau, E-08206 Sabadell, ES

(51) MKP  
**A61K 35/28 (2006.01)** (97) **2471543**  
**C07K 16/28 (2006.01)**  
**A61P 37/06 (2006.01)**  
**C12N 5/00 (2006.01)**  
(96) 10015236.2 04.07.2012  
(97) 2471543, 04.07.2012 en  
(54) Tolerance induction or immunosuppression to prevent in particular Graft-versus-Host-Disease (GvHD) by short-term pre-incubation of transplanted cell suspensions, tissues or organs coated with ligands to cell surface molecules  
(71) Fraunhofer-Gesellschaft zur Förderung der angewandten Forschung e.V., Hansastrasse 27c, 80686 München, DE  
Universität Leipzig, Ritterstrasse 26, 04109 Leipzig, DE  
(72) Fricke, Stephan, Stieglitzstr. 12, 04229 Leipzig, DE  
Emmrich, Frank, Naunhofer Str. 22, 04299 Leipzig, DE  
Hilger, Nadja, Kohlenstr. 32a, 04107 Leipzig, DE

(51) MKP  
**A61K 39/205 (2006.01)** (97) **2571521 \***  
**C07K 14/145 (2006.01)**  
**C12N 15/863 (2006.01)**  
(86) IB2011051847 27.04.2011  
(96) 11722560.7 27.03.2013  
(87) WO2011145013, 27.04.2011  
(97) 2571521, 27.03.2013 en  
(54) PARAPOXVIRUS VECTORS CONTAINING RABIES VIRUS ANTIGEN  
(71) AH USA 42 LLC, 235 East 42nd Street, New York, NY 10017, US  
(72) MARTINON, Olivier, Michel, Pfizer Global Research and Development 7000 Portage Road, Kalamazoo, Michigan 49001, US  
REDDY, Nanda, Kumar, Damavarapu, Pfizer Pharmaceutical India Pvt. Ltd Plot No. 16 TTC MIDC Indl Area Thane Belapur Road K.U. Bazar Post Turbhe, Navi Mumbai 400 705, IN

(51) MKP  
**B61L 29/30 (2006.01)** (97) **2576317 \***  
**B61L 23/04 (2006.01)**  
(86) IT2010000228 24.05.2010  
(96) 10737384.7 10.04.2013  
(87) WO2011148394, 24.05.2010  
(97) 2576317, 10.04.2013 en  
(54) A SAFETY DEVICE FOR THE SURVEILLANCE ALONG A RAILWAY ROUTE OF THE CROSSING AREAS FOR PEDESTRIANS AND VEHICLES IN CORRESPONDENCE OF LEVEL CROSSINGS OR RISK ZONES  
(71) 3 S Sistemi S.R.L., Corso Europa n. 278, 80016 Marano di Napoli (NA), IT  
(72) SGUEGLIA, Luciano, Corso Europa n. 278, I-80016 Marano di Napoli (NA), IT  
SGUEGLIA, Luca, Via dell'Abbondanza n. 52 is. 13, I-80145 Napoli (NA), IT  
SGUEGLIA, Aldo, Rue Fernand D'Huart n.9, L-1739 Luxembourg, LU

(51) MKP  
**A61K 31/155 (2006.01)** (97) **2548570**  
**A61K 38/18 (2006.01)**  
**A61P 3/10 (2006.01)**  
**A61K 38/26 (2006.01)**  
(96) 11305939.8 23.01.2013  
(97) 2548570, 23.01.2013 en  
(54) Pharmaceutical composition for treating a metabolic syndrome  
(71) SANOFI, 54 rue La Boétie, 75008 Paris, FR  
(72) The designation of the inventor has not yet been filed, null, null, null

(51) MKP  
**A61K 31/4709 (2006.01)** (97) **2588469 \***  
**A61P 29/00 (2006.01)**  
**C07D 487/04 (2006.01)**  
**A61P 35/00 (2006.01)**  
**C07D 401/12 (2006.01)**  
(86) US2011042519 30.06.2011  
(96) 11730846.0 08.05.2013  
(87) WO2012003271, 30.06.2011  
(97) 2588469, 08.05.2013 en  
(54) HETEROCYCLIC COMPOUNDS AND THEIR USE AS INHIBITORS OF PI3K ACTIVITY  
(71) Amgen Inc., One Amgen Center Drive, Thousand Oaks, California 91320-1799, US  
(72) DUQUETTE, Jason A., 460 Bayview Avenue, Millbrae, California 94030, US  
LUCAS, Brian, 133 10th Avenue, San Francisco, California 94118, US

(51) MKP  
**G01N 33/567 (2006.01)** (97) **2527842**  
(96) 12167014.5 28.11.2012  
(97) 2527842, 28.11.2012 en  
(54) Neuropeptide release assay for sodium channels  
(71) Regeneron Pharmaceuticals, Inc., 777 Old Saw Mill River Road, Tarrytown, NY 10591, US  
(72) Alessandri Haber, Nicole M., 4 Elizabeth Street, Rye, NY 10580, US  
MacDonald, Lynn, 16 Gedney Way, White Plains, NY 10605, US  
Lacroix-Fralish, Michael L., 197 North Washington Street, No. 3, Sleepy Hollow, NY 10591, US  
Murphy, Andrew J., 10 Newton Court, Croton-on-Hudson, NY 10520, US

(51) MKP  
**A61K 31/165 (2006.01)** (97) **2585435 \***  
**A61K 31/216 (2006.01)**  
**A61K 31/145 (2006.01)**  
**C07C 323/25 (2006.01)**  
**A61P 5/30 (2006.01)**  
**A61K 31/18 (2006.01)**  
**C07C 317/28 (2006.01)**  
**A61K 31/277 (2006.01)**  
(86) EP2011060335 21.06.2011  
(96) 11729943.8 01.05.2013  
(87) WO2011161101, 21.06.2011  
(97) 2585435, 01.05.2013 de  
(54) 6,7-DIHYDRO-5H-BENZO[7]ANNULENE DERIVATIVES, PROCESS FOR PREPARATION THEREOF, PHARMACEUTICAL PREPARATIONS COMPRISING THEM, AND THE USE THEREOF FOR PRODUCTION OF MEDICAMENTS  
(71) Bayer Intellectual Property GmbH, Alfred-Nobel-Strasse 10, 40789 Monheim, DE  
(72) WINTERMANTEL, Tim, Maybachstrasse 48 a, 50670 Köln, DE  
MÖLLER, Carsten, Pflugstrasse 9a, 10115 Berlin, DE  
BOTHE, Ulrich, Kavalerstrasse 15, 13187 Berlin, DE  
NUBBEMEYER, Reinhard, Wilhelmstrasse 9, 13467 Berlin, DE  
ZORN, Ludwig, Osianderweg 45a, 13509 Berlin, DE  
KOSEMUND, Dirk, Klutstrasse 14, 12587 Berlin, DE  
TER LAAK, Antonius, Hedwigstrasse 11, 12159 Berlin, DE  
BOHLMANN, Rolf, Kuehler Weg 6a, 14055 Berlin, DE  
WORTMANN, Lars, Kastanienallee 103, 10435 Berlin, DE  
BIERER, Donald, Horst 9, 42781 Haan, DE

- (51) MKP  
**A61K 31/513 (2006.01)** (97) **2593098 \***  
**A61P 35/00 (2006.01)**  
**A61K 31/56 (2006.01)**  
**A61K 31/505 (2006.01)**  
**A61P 29/00 (2006.01)**  
**A61K 31/7042 (2006.01)**  
**A61K 31/337 (2006.01)**
- (86) US2011044134 15.07.2011  
(96) 11807555.5 22.05.2013  
(87) WO2012009611, 15.07.2011  
(97) 2593098, 22.05.2013 en  
(54) METHODS AND COMPOSITIONS FOR CANCER IMMUNOTHERAPY  
(71) The Johns Hopkins University, 3400 North Charles Street, Baltimore, MD 21218, US  
Yale University, 55 Prospect Street, New Haven, Connecticut 06511, US  
(72) FUCHS, Ephraim Joseph, 3217 Hunting Tweed Drive, Owings Mills Maryland 21117, US  
FAHMY, Tarek M., 5 Colony Road, New Haven Connecticut 06511, US
- 
- (51) MKP  
**A61P 25/28 (2006.01)** (97) **2580200 \***  
**C07D 265/30 (2006.01)**  
**C07D 413/04 (2006.01)**  
**A61P 25/16 (2006.01)**  
**A61K 31/535 (2006.01)**  
**A61K 31/5355 (2006.01)**
- (86) EP2011059441 08.06.2011  
(96) 11723974.9 17.04.2013  
(87) WO2011154431, 08.06.2011  
(97) 2580200, 17.04.2013 en  
(54) 5,6-DIHYDRO-2H-[1,4]OXAZIN-3-YL-AMINE DERIVATIVES USEFUL AS INHIBITORS OF BETA-SECRETASE (BACE)  
(71) Janssen Pharmaceutica, N.V., Turnhoutseweg 30, 2340 Beerse, BE  
(72) TRABANCO-SUÁREZ, Andrés, Avelino, c/o Janssen-Cilag S.A. Calle Jarama 75 Poligono Industrial, E-45007 Toledo, ES  
ROMBOUTS, Frederik, Jan, Rita, c/o Janssen Pharmaceutica NV Turnhoutseweg 30, B-2340 Beerse, BE  
TRESADERN, Gary, John, c/o Janssen-Cilag S.A. Calle Jarama 75 Poligono Industrial, E-45007 Toledo, ES  
VAN GOOL, Michiel, Luc, Maria, c/o Janssen-Cilag S.A. Calle Jarama 75 Poligono Industrial, E-45007 Toledo, ES  
MACDONALD, Gregor, James, c/o Janssen Pharmaceutica NV Turnhoutseweg 30, B-2340 Beerse, BE  
MARTINEZ LAMENCA, Carolina, c/o Janssen Pharmaceutica NV Turnhoutseweg 30, B-2340 Beerse, BE  
GIJSEN, Henricus, Jacobus, Maria, c/o Janssen Pharmaceutica NV Turnhoutseweg 30, B-2340 Beerse, BE
- 
- (51) MKP  
**A61K 31/00 (2006.01)** (97) **2552404 \***  
**A61P 15/18 (2006.01)**  
**A61K 45/06 (2006.01)**  
**A61K 31/4196 (2006.01)**  
**A61K 9/00 (2006.01)**  
**A61K 31/569 (2006.01)**  
**A61P 15/00 (2006.01)**
- (86) EP2011054737 28.03.2011  
(96) 11714245.5 06.02.2013  
(87) WO2011120925, 28.03.2011  
(97) 2552404, 06.02.2013 de  
(54) PARENTERAL PHARMACEUTICAL FORM WHICH RELEASES AROMATSE INHIBITOR AND GESTAGENS, FOR THE TREATMENT OF ENDOMETRIOSIS  
(71) Bayer Pharma Aktiengesellschaft, Müllerstrasse 178, 13353 Berlin, DE  
(72) PAKKALIN, Arto, Rauhankatu 11 C 47, 00170 Helsinki, FI  
KNAUTHE, Rudolf, Pirschgang 14 A, 16548 Glienicke, DE  
SCHMITZ, Heinz, Weimarische Str. 27/I, 10715 Berlin, DE  
TALLING, Christine, Hännikönkatu 51, FI-20610 Turku, FI  
JUKARAINEN, Harri, Vadelmakatu 3, FI-21620 Kuusisto, FI  
KOROLAINEN, Henriikka, Loimijoenrantatie 10, FI-32210 Loimaa, FI
- 
- (51) MKP  
**A61K 36/88 (2006.01)** (97) **2462941**
- (96) 10472002.4 13.06.2012  
(97) 2462941, 13.06.2012 en  
(54) Method and instalation for extraction of plant raw material  
(71) R&D Ltd., 11, Slaveikov sq. Et.2, office 5., Sofia 1000, BG  
(72) Lubenova, Shopova Daniela, 94 A Kostenski vodopad Str., et. 8, apt. 22, Sofia, BG
- 
- (51) MKP  
**E06B 3/00 (2006.01)** (97) **2539527 \***
- (86) US2011025879 23.02.2011  
(96) 11747973.3 02.01.2013  
(87) WO2011106390, 23.02.2011  
(97) 2539527, 02.01.2013 en  
(54) BONDED-IN, ANTI-VANDALISM TRANSIT VEHICLE WINDOW SYSTEM  
(71) Ricon Corp., 7900 Nelson Road, Panorama City, CA 91402, US  
(72) SAUCIER, Stanton, D., 6175 Melvin Avenue, Tarzana California 91356, US  
GRIFFIS, David, C., 2280 West Bentley Lane, Round Lake Illinois 60073, US  
EVANS, Simon, 58 Washford Road, Hilton Derbyshire DE65 5HN, GB
- 
- (51) MKP  
**A61K 47/26 (2006.01)** (97) **2561892 \***  
**A61K 47/36 (2006.01)**  
**A61K 47/10 (2006.01)**  
**A61K 47/38 (2006.01)**  
**A61K 47/02 (2006.01)**  
**A61K 47/32 (2006.01)**  
**A61K 9/30 (2006.01)**
- (86) JP2011058133 30.03.2011  
(96) 11765698.3 27.02.2013  
(87) WO2011125798, 30.03.2011  
(97) 2561892, 27.02.2013 en  
(54) EASILY DOSABLE SOLID PREPARATION  
(71) Mochida Pharmaceutical Co., Ltd., 7 Yotsuya 1-chome Shinjuku-ku, Tokyo 160-8515, JP  
(72) KUDOU Yumio, c/o MOCHIDA PHARMACEUTICAL CO. LTD. 7 Yotsuya 1-chome Shinjuku-ku, Tokyo 160-8515, JP  
WARABINO Kuniomi, c/o MOCHIDA PHARMACEUTICAL CO. LTD. 7 Yotsuya 1-chome Shinjuku-ku, Tokyo 160-8515, JP
- 
- (51) MKP  
**C07D 487/04 (2006.01)** (97) **2542554 \***  
**A61P 37/00 (2006.01)**  
**A61P 31/12 (2006.01)**  
**A61K 31/407 (2006.01)**
- (86) US2011026806 02.03.2011  
(96) 11707330.4 09.01.2013  
(87) WO2011109471, 02.03.2011  
(97) 2542554, 09.01.2013 en  
(54) PROCESSES FOR THE PREPARATION OF S1P1 RECEPTOR MODULATORS AND CRYSTALLINE FORMS THEREOF  
(71) Arena Pharmaceuticals, Inc., 6166 Nancy Ridge Drive, San Diego, CA 92121, US  
(72) JONES, Robert M., 10937 Corte luz del Sol, San Diego California 92130, US  
BUZARD, Daniel J., 14494 Janal Way, San Diego California 92129, US  
GHARBAOUI, Tawfik, 2340 Lomica Place, Escondido California 92029, US  
JOHNSON, Benjamin R., 8574 Summerdale Road No. 146, San Diego California 92126, US  
KASEM, Michelle, 1112 Paseo Entrada, Chula Vista California 91910, US  
SCHRADER, Thomas O., 575 6th Avenue No. 508, San Diego California 92101, US  
STIRN, Scott, 14710 Carmel Ridge Road, San Diego California 92128, US

(51) MKP  
**F25D 3/00 (2006.01)** (97) **2561290 \***  
 (86) US2011032715 15.04.2011  
 (96) 11772481.5 27.02.2013  
 (87) WO2011133428, 15.04.2011  
 (97) 2561290, 27.02.2013 en  
 (54) HEAT EXCHANGE UNIT FOR SELF-COOLING CONTAINERS  
 (71) Joseph Company International, Inc., 1711 Langley Avenue, Irvine, CA 92614, US  
 (72) CULL, David, 214/1 Moo 9 Prachautit Soi 16 Ratburana, Bangkok 10140, TH  
 SILLINCE, Mark, 14 Cowdray Drive Rustington, West Sussex BN16 3SJ, GB

(51) MKP  
**B65B 35/40 (2006.01)** (97) **2457834**  
**B65B 5/06 (2006.01)**  
**B65B 35/28 (2006.01)**  
**B65B 29/02 (2006.01)**  
 (96) 10192765.5 30.05.2012  
 (97) 2457834, 30.05.2012 en  
 (54) Device for positioning of portion packets  
 (71) Swedish Match North Europe AB, null, 118 85 Stockholm, SE  
 (72) Löfman, Lars-Olof, Solskiftegatan 42, 442 53 Ytterby, SE  
 Aspgren, Thom, Båtsman Dubbels Gata 10, 422 57 Hisings Backa, SE  
 Eriksson, Dennis, Iglastjärnsvägen 32A, 424 70 Olofstorp, SE  
 Larsson, Tomas, Posta-Johansväg 24, 434 97 Kungälv, SE

(51) MKP  
**A61K 39/395 (2006.01)** (97) **2542257 \***  
**A61K 39/00 (2006.01)**  
 (86) US2011026766 01.03.2011  
 (96) 11751244.2 09.01.2013  
 (87) WO2011109452, 01.03.2011  
 (97) 2542257, 09.01.2013 en  
 (54) OPTIMIZED MONOCLONAL ANTIBODIES AGAINST TISSUE FACTOR PATHWAY INHIBITOR (TFPI)  
 (71) Bayer HealthCare LLC, 555 White Plains Road, Tarrytown, NY 10591, US  
 (72) SCHOLZ, Peter, Biesenkamp 10, 47533 Kleve, DE  
 WANG, Zhuozhi, 1388 Broadway Unit 383, Millbrae California 94030, US  
 PAN, Junliang, 7 Ketelsen Court, Moraga California 94556, US  
 GRUDZINSKA, Joanna, Liselotte-Herrmannstrasse 11, 10407 Berlin, DE  
 VOTSMEIER, Christian, Pellenzstrasse 25, 50823 Köln, DE  
 TEBBE, Jan, Am Alten Stellwerk 16, 50733 Köln, DE  
 BIRKENFELD, Jörg, Kurfürstenstrasse 3, 60486 Frankfurt am Main, DE  
 WOBST, Nina, Hummelsbergstrasse 7, 50939 Köln, DE  
 BRÜCKNER, Simone, Zedernweg 2, 50259 Pulheim, DE  
 STEINIG, Susanne, Untere Dorfstrasse 41a, 50829 Köln, DE

(51) MKP  
**C07D 307/32 (2006.01)** (97) **2539330 \***  
**A01N 43/08 (2006.01)**  
**C07D 405/10 (2006.01)**  
**C07D 307/20 (2006.01)**  
**C07D 409/12 (2006.01)**  
**C07D 307/30 (2006.01)**  
**C07D 413/12 (2006.01)**  
**C07D 405/04 (2006.01)**  
**C07D 407/12 (2006.01)**  
**C07D 307/28 (2006.01)**  
**C07D 409/14 (2006.01)**  
**C07D 307/58 (2006.01)**  
 (86) EP2011051284 31.01.2011  
 (96) 11702173.3 02.01.2013  
 (87) WO2011101229, 31.01.2011  
 (97) 2539330, 02.01.2013 en  
 (54) DIHYDROFURAN DERIVATIVES AS INSECTICIDAL COMPOUNDS  
 (71) Syngenta Participations AG, Schwarzwaldallee 215, 4058 Basel, CH  
 (72) EL QACEMI, Myriem, Syngenta Crop Protection Münchwilen AG Schaffhauserstrasse, CH-4332 Stein, CH  
 CASSAYRE, Jérôme Yves, Syngenta Crop Protection Münchwilen AG Schaffhauserstrasse, CH-4332 Stein, CH  
 TOUEG, Julie Clementine, Syngenta Crop Protection Münchwilen AG Schaffhauserstrasse, CH-4332 Stein, CH  
 RENOLD, Peter, Syngenta Crop Protection Münchwilen AG Schaffhauserstrasse, CH-4332 Stein, CH  
 PITTERNA, Thomas, Syngenta Crop Protection Münchwilen AG Schaffhauserstrasse, CH-4332 Stein, CH

(51) MKP  
**C07D 471/04 (2006.01)** (97) **2540720 \***  
**A61P 43/00 (2006.01)**  
**A61K 31/4985 (2006.01)**  
**A61P 31/18 (2006.01)**  
**A61K 31/5377 (2006.01)**  
 (86) JP2011054404 25.02.2011  
 (96) 11747546.7 02.01.2013  
 (87) WO2011105590, 25.02.2011  
 (97) 2540720, 02.01.2013 en  
 (54) 1,3,4,8-TETRAHYDRO-2H-PYRIDO[1,2-A]PYRAZINE DERIVATIVE AND USE OF SAME AS HIV INTEGRASE INHIBITOR  
 (71) Japan Tobacco, Inc., 2-1, Toranomon 2-chome Minato-ku, Tokyo 105-8422, JP  
 (72) MIYAZAKI, Susumu, c/o Central Pharmaceutical Research Institute of Japan Tobacco Inc. 1-1 Murasaki-cho, Takatsuki-shi Osaka 569-1125, JP  
 BESSHO, Yuki, c/o Central Pharmaceutical Research Institute of Japan Tobacco Inc. 1-1 Murasaki-cho, Takatsuki-shi Osaka 569-1125, JP  
 ADACHI, Kaoru, c/o Central Pharmaceutical Research Institute of Japan Tobacco Inc. 1-1 Murasaki-cho, Takatsuki-shi Osaka 569-1125, JP  
 KAWASHITA, Seiji, c/o Central Pharmaceutical Research Institute of Japan Tobacco Inc. 1-1 Murasaki-cho, Takatsuki-shi Osaka 569-1125, JP  
 ISOSHIMA, Hirotaka, c/o Central Pharmaceutical Research Institute of Japan Tobacco Inc. 1-1 Murasaki-cho, Takatsuki-shi Osaka 569-1125, JP  
 OSHITA, Kengo, c/o Central Pharmaceutical Research Institute of Japan Tobacco Inc. 1-1 Murasaki-cho, Takatsuki-shi Osaka 569-1125, JP  
 FUKUDA, Shunichi, c/o Central Pharmaceutical Research Institute of Japan Tobacco Inc. 1-1 Murasaki-cho, Takatsuki-shi Osaka 569-1125, JP

- (51) MKP  
**A61P 25/22 (2006.01)** (97) **2580189 \***  
**C07C 231/06 (2006.01)**  
**C07C 231/12 (2006.01)**  
**C07C 233/18 (2006.01)**  
**A61P 25/24 (2006.01)**  
**A61P 25/20 (2006.01)**  
**A61P 25/06 (2006.01)**  
**A61K 31/165 (2006.01)**  
(86) CN2011075438 08.06.2011  
(96) 11791930.8 17.04.2013  
(87) WO2011153939, 08.06.2011  
(97) 2580189, 17.04.2013 en  
(54) AGOMELATINE INTERMEDIATES AND PREPARATION METHOD THEREOF  
(71) Les Laboratoires Servier, 35, rue de Verdun, 92284 Suresnes Cedex, FR  
(72) ZHANG, Peng, No. 826, Zhangheng Road Pudong New Area, Shanghai 201203, CN  
HUANG, Yu, No.1320, West Beijing Road Jing'an District, Shanghai 200040, CN  
YUAN, Zhedong, Room 201, No.14, Lane 58 Aomen Road, Shanghai 200060, CN  
SHAN, Hanbin, No.24, Dongfangxincun Gaoan, Jiangxi 330800, CN  
YU, Xiong, Room 107, No. 32 Duolun Road Hongkou District, Shanghai 200081, CN
- 
- (51) MKP  
**A61K 9/00 (2006.01)** (97) **2552424 \***  
**A61K 9/50 (2006.01)**  
(86) EP2011053695 11.03.2011  
(96) 11712196.2 06.02.2013  
(87) WO2011120779, 11.03.2011  
(97) 2552424, 06.02.2013 en  
(54) PROCESS FOR PREPARING CARRIER PARTICLES FOR DRY POWDERS FOR INHALATION  
(71) Chiesi Farmaceutici S.p.A., Via Palermo, 26/A, 43100 Parma, IT  
(72) MUSA, Rossella, Chiesi Farmaceutici S.p.A. Via Palermo 26/A, I-43100 Parma, IT  
COCCONI, Daniela, Chiesi Farmaceutici S.p.A. Via Palermo 26/A, I-43100 Parma, IT  
CHAMAYOU, Alain, Chiesi Farmaceutici S.P.A. Via Palermo 26/A, I-43100 Parma, IT  
GALET, Laurence, Chiesi Farmaceutici S.p.a. Via Palermo 26/A, I-43100 Parma, IT
- 
- (51) MKP  
**G01F 1/58 (2006.01)** (97) **2564169 \***  
**G01F 1/60 (2006.01)**  
(86) EP2011056617 27.04.2011  
(96) 11716545.6 06.03.2013  
(87) WO2011134976, 27.04.2011  
(97) 2564169, 06.03.2013 de  
(54) MEASURING DEVICE AND METHOD FOR MEASURING THE FLOW RATE OF A MEDIUM FLOWING THROUGH A MEASURING TUBE  
(71) Zylum Beteiligungsgesellschaft mbH & Co. Patente II KG, Berliner Strasse 1, 12529 Schönfeld/OT Waltersdorf, DE  
(72) STANGE, Gerd, Kronkamp 39, 24589 Nortorf, DE  
BOLLMANN, Rainer, Grebener Weg 38, 24148 Kiel, DE  
STADE, Wolfgang, Röbsdorfer Weg 27, 24226 Heikendorf, DE  
ZELLENKA, Dr. Thomas, Kalkberg 4, 24248 Mönkeberg, DE
- 
- (51) MKP  
**F02B 25/04 (2006.01)** (97) **2557294**  
**F02B 47/02 (2006.01)**  
**F02B 75/04 (2006.01)**  
**F02B 33/22 (2006.01)**  
**F02B 41/04 (2006.01)**  
(96) 12179324.4 13.02.2013  
(97) 2557294, 13.02.2013 de  
(54) Combustion Engine  
(71) v. Görtz & Finger Techn. Entwicklungs GmbH, Vorderburg, 36110 Schlitz, DE  
(72) Graf von Schlitz, gen. von Görtz, Rüdiger Maria, Vorderburg, 36110 Schlitz, DE  
Finger, Ulrich, An der Hecke 5, 87647 Oberthingau, DE
- 
- (51) MKP  
**C09C 1/02 (2006.01)** (97) **2576704 \***  
**D21H 19/00 (2006.01)**  
**C09C 3/04 (2006.01)**  
**D21H 17/00 (2006.01)**  
**C09C 1/42 (2006.01)**  
(86) EP2011058649 26.05.2011  
(96) 11722057.4 10.04.2013  
(87) WO2011147922, 26.05.2011  
(97) 2576704, 10.04.2013 en  
(54) PROCESS FOR MANUFACTURING HIGH SOLIDS SUSPENSIONS OF MINERAL MATERIALS  
(71) Omya Development AG, Baslerstrasse 42, 4665 Oftringen, CH  
(72) BURI, Matthias, Mätteliweg 20, CH-4852 Rothrist, CH  
GANÉ, Patrick A.C., Studenweg 8, CH-4852 Rothrist, CH
- 
- (51) MKP  
**C07D 209/16 (2006.01)** (97) **2582666 \***  
**C07D 231/56 (2006.01)**  
**C07D 209/12 (2006.01)**  
**C07D 471/04 (2006.01)**  
**A61K 31/404 (2006.01)**  
**A61K 31/416 (2006.01)**  
**A61P 25/00 (2006.01)**  
(86) IB2011001382 16.06.2011  
(96) 11795252.3 24.04.2013  
(87) WO2011158108, 16.06.2011  
(97) 2582666, 24.04.2013 en  
(54) ARYL SUBSTITUTED INDOLES AND THEIR USE AS BLOCKERS OF SODIUM CHANNELS  
(71) Purdue Pharma L.P., One Stamford Forum 201 Tresser Boulevard, Stamford, CT 06901-3431, US  
(72) KYLE, Donald, J., 173 N. Main Street, Yardley, PA 19067, US  
NI, Chiyou, 5 Ford Court, Belle Mead, NJ 08502, US  
TAFESSE, Laykea, 11 Abbington Lane, Robbinsville, NJ 08691, US  
YAO, Jiangchao, 10 Bellflower CT, Princeton, NJ 08540, US
- 
- (51) MKP  
**B60R 7/00 (2006.01)** (97) **2527201**  
(96) 11004293.4 28.11.2012  
(97) 2527201, 28.11.2012 de  
(54) Method for making a strong fixture of a textile sheet  
(71) Perzi Kunststoff Ges.m.b.H., Rasisbündt 4, 6890 Lustenau, AT  
(72) Perzi, Reinhard, Zellgasse 12, 6890 Lustenau, AT
- 
- (51) MKP  
**F24J 2/54 (2006.01)** (97) **2577185 \***  
(86) EP2010006063 05.10.2010  
(96) 10774129.0 10.04.2013  
(87) WO2011147437, 05.10.2010  
(97) 2577185, 10.04.2013 de  
(54) MOUNTING RACK FOR A PHOTOVOLTAIC MODULE AND TRACKING DEVICE FOR A PHOTOVOLTAIC INSTALLATION  
(71) Fischer, Hans-Peter, Hubertusstrasse 5, 90530 Wendelstein, DE  
(72) Fischer, Hans-Peter, Hubertusstrasse 5, 90530 Wendelstein, DE
- 
- (51) MKP  
**G08B 25/01 (2006.01)** (97) **2552542 \***  
**G08B 25/08 (2006.01)**  
**A62C 37/50 (2006.01)**  
**A61F 17/00 (2006.01)**  
**G06F 19/00 (2011.01)**  
**A61B 19/02 (2006.01)**  
**G08B 21/02 (2006.01)**  
**A61N 1/39 (2006.01)**  
(86) FR2011050630 24.03.2011  
(96) 11718425.9 06.02.2013  
(87) WO2011124808, 24.03.2011  
(97) 2552542, 06.02.2013 fr  
(54) DEVICE FOR ACCESS TO AN ITEM OF ASSISTANCE AND EMERGENCY HARDWARE, AND A SYSTEM IMPLEMENTING SUCH DEVICES.  
(71) Atialis, 21 boulevard Haussmann, 75009 Paris, FR  
(72) BROSSON, Hubert, 5 rue du Sergent Hoff, F-75017 Paris, FR  
DUVERDIER, Hubert, 64 rue Léon Barbier, F-78400 Chatou, FR

- (51) MKP  
**C07C 237/14 (2006.01)** (97) **2582660 \***  
**A61K 31/16 (2006.01)**  
**A61P 11/00 (2006.01)**  
**A61P 37/00 (2006.01)**  
**C07D 233/58 (2006.01)**
- (86) IB2011052613 16.06.2011  
(96) 11795278.8 24.04.2013  
(87) WO2011158197, 16.06.2011  
(97) 2582660, 24.04.2013 en  
(54) NEW CATHEPSIN S PROTEASE INHIBITORS, USEFUL IN THE TREATMENT OF E.G. AUTOIMMUNE DISORDERS, ALLERGY AND CHRONIC PAIN CONDITIONS
- (71) Medivir UK Ltd, The Mansion Chesterford Research Park, Little Chesterford Essex CB10 1XL, GB  
(72) AYESA, Susana, Medivir AB PO Box 1086, S-141 22 Huddinge, SE  
GRABOWSKA, Urszula, Medivir AB PO Box 1086, S-141 22 Huddinge, SE  
HEWITT, Ellen, Medivir AB PO Box 1086, S-141 22 Huddinge, SE  
JÖNSSON, Daniel, Medivir AB PO Box 1086, S-141 22 Huddinge, SE  
KLASSON, Björn, Medivir AB PO Box 1086, S-141 22 Huddinge, SE  
KAHNBERG, Pia, Medivir AB PO Box 1086, S-141 22 Huddinge, SE  
LUNDGREN, Stina, Medivir AB PO Box 1086, S-141 22 Huddinge, SE  
TEJBRANT, Jan, Medivir AB PO Box 1086, S-141 22 Huddinge, SE  
WIKTELIUS, Daniel, Medivir AB PO Box 1086, S-141 22 Huddinge, SE
- 
- (51) MKP  
**A61K 9/50 (2006.01)** (97) **2491930**  
**A61K 9/14 (2006.01)**  
**A61K 31/4402 (2006.01)**  
**A61K 31/495 (2006.01)**  
**A61K 9/20 (2006.01)**  
**A61P 27/16 (2006.01)**  
**A61K 9/48 (2006.01)**  
**A61K 9/00 (2006.01)**
- (96) 11155916.7 29.08.2012  
(97) 2491930, 29.08.2012 en  
(54) Pharmaceutical combination of betahistine and trimetazidine
- (71) Deva Holding Anonim Sirketi, Halkali Merkez Mah. Basin Ekpres Caddesi, No. 1, Kat: 5 Kucukcekmece, 34303 Istanbul, TR  
(72) Haas, Philipp Daniel, DEVA HOLDING ANONIM SIRKETI Halkali Merkez Mah., Basin Ekpres Caddesi N1 Patent Law Department, Kat 5 Kucukcekmece, 34303, ISTANBUL, TR  
Koc, Fikret, R&D DEVA HOLDING ANONIM SIRKETI Halkali Merkez Mah., Basin Ekpres Caddesi N1 Patent Law Department, Kat 5 Kucukcekmece, 34303, ISTANBUL, TR  
Sivasligil, Ramazan, R&D DEVA HOLDING ANONIM SIRKETI Halkali Merkez Mah., Basin Ekpres Caddesi N1 Patent Law Department, Kat 5 Kucukcekmece, 34303, ISTANBUL, TR  
Kandemir, Levent, R&D DEVA HOLDING ANONIM SIRKETI Halkali Merkez Mah., Basin Ekpres Caddesi N1 Patent Law Department, Kat 5 Kucukcekmece, 34303, ISTANBUL, TR
- 
- (51) MKP  
**G01N 33/543 (2006.01)** (97) **2571617 \***  
**B01L 3/00 (2006.01)**  
**B01L 7/00 (2006.01)**  
**C12Q 1/68 (2006.01)**
- (86) EP2011002507 19.05.2011  
(96) 11720402.4 27.03.2013  
(87) WO2011144345, 19.05.2011  
(97) 2571617, 27.03.2013 en  
(54) REACTION VESSEL FOR PCR DEVICE AND METHOD OF PERFORMING PCR
- (71) Curetis AG, Max-Eyth-Strasse 42, 71088 Holzgerlingen, DE  
LÜDKE, Gerd, Hülbenstr. 28, 71088 Holzgerlingen, DE  
BOOS, Andreas, Schlehenstrasse 23/1, 71149 Bondorf, DE  
MOTJADDED, Hassan, Nelkenstr. 6, 71069 Sindelfingen, DE  
BACHER, Johannes, Höhenweg 3, 71229 Leinberg-Warmbronn, DE

- (51) MKP  
**B29C 51/44 (2006.01)** (97) **2586589**  
**B29C 51/22 (2006.01)**
- (96) 12189515.5 01.05.2013  
(97) 2586589, 01.05.2013 en  
(54) Thermoforming press and thermoforming process using said press
- (71) OMV Machinery S.r.l., Lungadige Attiraglio, 67, 37124 Verona, IT  
(72) Bissoli, Giancarlo, Via Fratelli Rosselli, 1, 37138 Verona, IT
- 
- (51) MKP  
**A61L 2/20 (2006.01)** (97) **2590687 \***
- (86) EP2011003331 05.07.2011  
(96) 11738161.6 15.05.2013  
(87) WO2012003962, 05.07.2011  
(97) 2590687, 15.05.2013 en  
(54) USE OF A STERILIZATION AGENT FOR ENHANCING HEMOCOMPATIBILITY
- (71) Fresenius Medical Care Deutschland GmbH, Elise-Kröner-Strasse 1, 61352 Bad Homburg, DE  
(72) FEHR, Thorsten, Provinzialstrasse 40, 66679 Losheim am See, DE  
HAUPERT, Claus, Zu den Erlen 13, 66809 Nalbach, DE  
KUGELMANN, Franz, Auf Backofen 27, 66606 St. Wendel, DE  
SIMON, Nicole, Enkeltrieschen 18, 66839 Schmelz, DE  
ERLENKÖTTER, Ansgar, Riottestrasse 40, 66606 St. Wendel, DE
- 
- (51) MKP  
**B63B 35/04 (2006.01)** (97) **2591992**  
**B65H 75/36 (2006.01)**
- (96) 12156206.0 15.05.2013  
(97) 2591992, 15.05.2013 en  
(54) A storage and deployment unit for a coilable element and a method of handling a coilable element
- (71) Skagerak Engineering AS, Åbyveien 17, 3400 Lier, NO  
(72) Nodberg, Trond Kjetil, Åbyveien 17, N-3400 Lier, NO
- 
- (51) MKP  
**C08G 64/06 (2006.01)** (97) **2592102 \***  
**B29C 49/00 (2006.01)**  
**B65D 1/00 (2006.01)**
- (86) JP2011065383 05.07.2011  
(96) 11803584.9 15.05.2013  
(87) WO2012005250, 05.07.2011  
(97) 2592102, 15.05.2013 en  
(54) BRANCHED POLYCARBONATE
- (71) Asahi Kasei Chemicals Corporation, 1-105, Kanda Jinbocho Chiyoda-ku, Tokyo 101-8101, JP  
(72) NAMBA Nobutsugu, 1-105, Kanda Jinbocho Chiyoda-ku, Tokyo 101-8101, JP  
HACHIYA Hiroshi, "-," "deceased", JP
- 
- (51) MKP  
**F25D 3/10 (2006.01)** (97) **2558013 \***  
**A61B 18/02 (2006.01)**  
**A61M 19/00 (2006.01)**
- (86) EP2011055486 08.04.2011  
(96) 11717517.4 20.02.2013  
(87) WO2011141243, 08.04.2011  
(97) 2558013, 20.02.2013 de  
(54) HAND-OPERATED COOLING DEVICE FOR CRYOTHERAPY
- (71) Müller, Stefan, Frittlinger Str. 40, 78549 Spaichingen, DE  
Ortlib, Steffen, Ulmenweg 10, 78549 Spaichingen, DE  
Dreher, Ingo, Spaichinger Str. 4, 78582 Balgheim, DE  
(72) Müller, Stefan, Frittlinger Str. 40, 78549 Spaichingen, DE  
Ortlib, Steffen, Ulmenweg 10, 78549 Spaichingen, DE  
Dreher, Ingo, Spaichinger Str. 4, 78582 Balgheim, DE

- (51) MKP  
**A61K 31/4706 (2006.01)** (97) **2588477 \***  
**A61P 31/18 (2006.01)**  
**C07D 417/14 (2006.01)**
- (86) US2011042531 30.06.2011  
(96) 11730847.8 08.05.2013  
(87) WO2012003278, 30.06.2011  
(97) 2588477, 08.05.2013 en  
(54) QUINOLINES AS PI3K INHIBITORS  
(71) Amgen Inc., One Amgen Center Drive, Thousand Oaks, California 91320-1799, US  
(72) DRANSFIELD, Paul, John, 178 Allison Street, San Francisco, California 94112, US
- 
- (51) MKP  
**B65D 75/58 (2006.01)** (97) **2563682 \***
- (86) EP2011056789 28.04.2011  
(96) 11718018.2 06.03.2013  
(87) WO2011135051, 28.04.2011  
(97) 2563682, 06.03.2013 de  
(54) WAFER POCKET  
(71) Bayer Intellectual Property GmbH, Alfred-Nobel-Strasse 10, 40789 Monheim, DE  
(72) REICHARDT, Kathrin, Speyerer Str. 4, 10779 Berlin, DE  
FILLER, Sven, Freiburger Str. 30, 16515 Oranienburg, DE  
GOLLIN, Kirsten, Ketziner Str. 10, 14476 Potsdam, DE
- 
- (51) MKP  
**A61K 51/00 (2006.01)** (97) **2538982 \***
- (86) US2011026365 25.02.2011  
(96) 11748201.8 02.01.2013  
(87) WO2011106732, 25.02.2011  
(97) 2538982, 02.01.2013 en  
(54) PET MONITORING OF AB-DIRECTED IMMUNOTHERAPY  
(71) Janssen Alzheimer Immunotherapy, Little Island Industrial Estate, Little Island, County Cork, IE  
Wyeth LLC, Five Giralda Farms, Madison, NJ 07940, US  
(72) BLACK, Ronald, 826 Mill Grove Drive, Audubon, PA 19403, US  
GRUNDMAN, Michael, 13236 Haxton Place, San Diego, CA 92130, US
- 
- (51) MKP  
**A61M 5/315 (2006.01)** (97) **2579922 \***  
**A61M 5/24 (2006.01)**
- (86) EP2011059571 09.06.2011  
(96) 11724221.4 17.04.2013  
(87) WO2011154486, 09.06.2011  
(97) 2579922, 17.04.2013 en  
(54) DRIVE MECHANISM FOR A DRUG DELIVERY DEVICE AND DRUG DELIVERY DEVICE  
(71) Sanofi-Aventis Deutschland GmbH, Brüningstraße 50, 65929 Frankfurt, DE  
(72) SMITH, Christopher, James, 4 Elm Drive, Holmes Chapel Cheshire CW4 7QG, GB  
BUTLER, Stephen, David, 25 High Hill South Staffords, Essington, Staffordshire WV11 2DP, GB  
HORLOCK, Mark, Philip, 18 Mayfield Close, Timperley, Cheshire WA15 7TE, GB
- 
- (51) MKP  
**H01L 31/058 (2006.01)** (97) **2463921**
- (96) 11192263.9 13.06.2012  
(97) 2463921, 13.06.2012 en  
(54) Photovoltaic and thermal panel  
(71) FEA S.r.l., Via Saluzzo 49, 12030 Scarnafigi (Cuneo), IT  
(72) Fea, Antonio, Via Saluzzo 55, I-12030 Scarnafigi (Cuneo), IT
- 
- (51) MKP  
**F24F 7/08 (2006.01)** (97) **2527753**  
**F24F 11/00 (2006.01)**
- (96) 12169131.5 28.11.2012  
(97) 2527753, 28.11.2012 de  
(54) Device and method for regulating a fresh air supply for a device for cooling, heating and/or ventilating a building  
(71) SES Spar European Shopping Centers GmbH, Europastrasse 3, 5015 Salzburg, AT  
(72) Gruber, Roland, Gartenstraße 56, 5071 Siesenheim, AT
- 
- (51) MKP  
**H04N 7/15 (2006.01)** (97) **2569940 \***  
**H04N 7/14 (2006.01)**  
**H04N 7/00 (2011.01)**
- (86) US2011036266 12.05.2011  
(96) 11722956.7 20.03.2013  
(87) WO2011143440, 12.05.2011  
(97) 2569940, 20.03.2013 en  
(54) SYSTEMS AND METHODS FOR NOVEL INTERACTIONS WITH PARTICIPANTS IN VIDEOCONFERENCE MEETINGS  
(71) Blue Jeans Network, Inc., 3000 Lakeside Drive, Santa Clara, CA 95054, US  
(72) PERIYANNAN, Alagu, 3152 Ross Road, Palo Alto CA 94303, US  
RAMAKRISHNAN, Krish, 21225 Comer Drive, Saratoga CA 95070, US  
ANAND, Raghavan, 2650 Keystone Avenue, 113, Santa Clara 95051, US  
GRUPENHOFF, Michael, 3314 Saint Michael Drive, Palo Alto CA 94306, US  
RAGHAVAN, Anand, 19 Scott Alley, San Francisco CA 94107, US  
KALLURI, Ravi, Kiran, 3287 Cantamar Court, San Jose CA 95135, US  
WEBER, Emmanuel, 4512 Carnaby Court, San Jose CA 95136, US
- 
- (51) MKP  
**A47L 9/24 (2006.01)** (97) **2484260**
- (96) 12152887.1 08.08.2012  
(97) 2484260, 08.08.2012 en  
(54) Sealing gasket for a telescopic extension, in particular for a household appliance  
(71) OMEC S.p.A., Via E. Mattei 20, 21055 Gorla Minore (Varese), IT  
(72) Canale, Stefano, OMEC S.p.A. Via E. Mattei, 20, 21055 Gorla Minore (VA), IT
- 
- (51) MKP  
**A61P 31/16 (2006.01)** (97) **2575969 \***  
**A61P 31/18 (2006.01)**  
**A61K 31/519 (2006.01)**  
**A61K 31/52 (2006.01)**  
**A61P 31/14 (2006.01)**  
**A61P 31/12 (2006.01)**  
**A61K 31/551 (2006.01)**
- (86) EP2011058276 20.05.2011  
(96) 11720777.9 10.04.2013  
(87) WO2011147753, 20.05.2011  
(97) 2575969, 10.04.2013 en  
(54) ANTIVIRAL ACTIVITY OF NOVEL BICYCLIC HETEROCYCLES  
(71) Katholieke Universiteit Leuven, K.U. Leuven R&D, Minderbroedersstraat 8a, bus 5105, 3000 Leuven, BE  
DE JONGHE, Steven, c/o IVAP Kapucijnenvoer 33 blok i - bus 7001, B-3000 Leuven, BE  
GAO, Ling-Jie, c/o IVAP Kapucijnenvoer 33 blok i - bus 7001, B-3000 Leuven, BE  
HERDEWIJN, Piet, c/o Lab voor Medicinale Chemie Minderbroedersstraat 10 blok x - bus 1030, B-3000 Leuven, BE  
HERMAN, Jean, c/o IVAP Kapucijnenvoer 33 blok i - bus 7001, B-3000 Leuven, BE  
JANG, Miyeon, c/o Lab voor Medicinale Chemie Minderbroedersstraat 10 blok x - bus 1030, B-3000 Leuven, BE  
LEYSSSEN, Pieter, c/o Afd. Virologie en Chemotherapie Kapucijnenvoer 33 blok i - bus 1030, B-3000 Leuven, BE  
LOUAT, Thierry, c/o IVAP Kapucijnenvoer 33 blok i - bus 7001, B-3000 Leuven, BE  
NEYTS, Johan, c/o Afd. Virologie en Chemotherapie Kapucijnenvoer 33 blok i - bus 1030, B-3000 Leuven, BE  
PANNECOUQUE, Christophe, c/o Afd. Virologie en Chemotherapie Kapucijnenvoer 33 blok i - bus 1030, B-3000 Leuven, BE  
VANDERHOYDONCK, Bart, c/o IVAP Kapucijnenvoer 33 blok i - bus 7001, B-3000 Leuven, BE
-

(51) MKP  
**A61P 35/00 (2006.01)** (97) **2563383 \***  
**A61P 29/00 (2006.01)**  
**A61P 3/10 (2006.01)**  
**A61K 38/16 (2006.01)**  
**A61K 39/395 (2006.01)**  
**A61K 48/00 (2006.01)**  
**A61K 38/17 (2006.01)**  
(86) US2011034626 29.04.2011  
(96) 11778063.5 06.03.2013  
(87) WO2011139907, 29.04.2011  
(97) 2563383, 06.03.2013 en  
(54) INNOVATIVE DISCOVERY OF THERAPEUTIC, DIAGNOSTIC, AND ANTIBODY COMPOSITIONS RELATED TO PROTEIN FRAGMENTS OF VALYL TRNA SYNTHETASES  
(71) aTyr Pharma, Inc., 3545 John Hopkins Court, Suite 250, San Diego, CA 92121, US  
Pangu Biopharma Limited, Edinburgh Tower, 18/F The Landmark 15 Queen's Road Central, Hong Kong, CN  
(72) GREENE, Leslie, Ann, 13941 Davenport Avenue, San Diego California 92129, US  
CHIANG, Kyle, P., 943 Torrance Street Apt. 6, San Diego California 92103, US  
HONG, Fei, 7979 Caminito Dia 2, San Diego California 92122, US  
VASSEROT, Alain, P., 6421 La Paloma Street, Carlsbad California 92009, US  
LO, Wing-Sze, RM 815 Sui Ming House Siu Sai Wan Estate Chai Wan, Hong Kong, CN  
WATKINS, Jeffrey, D., 3442 Fortuna Ranch Road, Encinitas California 92024, US  
MENDLEIN, John, D., 1550 Neptune Avenue, Encinitas California 92024, US  
QUINN, Cheryl, L., 5392 Renaissance Avenue, San Diego California 92122, US

(51) MKP  
**C05C 9/02 (2006.01)** (97) **2563745 \***  
**C05C 9/00 (2006.01)**  
(86) US2011034669 29.04.2011  
(96) 11775668.4 06.03.2013  
(87) WO2011137393, 29.04.2011  
(97) 2563745, 06.03.2013 en  
(54) REACTION PRODUCTS AND METHODS FOR MAKING AND USING THE SAME  
(71) Koch Agronomic Services, LLC, 4111 E. 37th Street North, Wichita, Kansas 67220, US  
(72) GABRIELSON, Kurt D., 1710 Lake Lucerne Road, Lilburn, Georgia 30047, US  
EPLING, Mary L., 3950 Cumberland Trail, Conyers, California 30094, US

(51) MKP  
**E01F 15/02 (2006.01)** (97) **2567030 \***  
**E01F 15/04 (2006.01)**  
(86) EP2011056988 03.05.2011  
(96) 11718039.8 13.03.2013  
(87) WO2011138291, 03.05.2011  
(97) 2567030, 13.03.2013 de  
(54) GUARD RAIL  
(71) SAH Verkehrstechnik GmbH, Werk 3 u. 4, 83404 Ainring, DE  
(72) AICHER, Maximilian, Ladenbergstrasse 3, 83395 Freilassing, DE

(51) MKP  
**H04L 29/06 (2006.01)** (97) **2583431 \***  
**H04M 3/51 (2006.01)**  
(86) IB2011001179 30.05.2011  
(96) 11738036.0 24.04.2013  
(87) WO2011158078, 30.05.2011  
(97) 2583431, 24.04.2013 en  
(54) SYSTEM AND PROCEDURE FOR COMMERCIAL COMMUNICATIONS  
(71) Whisbi Technologies, S.L., C/ Tarragona 110, 08015 Barcelona, ES  
(72) CANTERO ESCOLÀ, José Luis, C/ Santiago Rosinyol 3, 4, E-08750 Molins de Rei, ES  
BISBE TOSAT, Alex, C/ Clementine Arderiu 26, 3- 1, E-08173 Sant Cugat Del Valles, ES

(51) MKP  
**C07D 495/04 (2006.01)** (97) **2594570 \***  
**A61K 31/519 (2006.01)**  
**A61P 3/10 (2006.01)**  
**A61P 13/08 (2006.01)**  
**A61P 13/10 (2006.01)**  
**A61P 7/02 (2006.01)**  
**A61P 15/10 (2006.01)**  
**A61P 9/10 (2006.01)**  
**A61P 25/00 (2006.01)**  
**A61P 9/12 (2006.01)**  
**A61P 25/28 (2006.01)**  
**A61P 11/00 (2006.01)**  
**A61P 13/02 (2006.01)**  
**A61P 13/04 (2006.01)**  
(86) JP2011062513 31.05.2011  
(96) 11789814.8 22.05.2013  
(87) WO2011152411, 31.05.2011  
(97) 2594570, 22.05.2013 en  
(54) CRYSTAL OF THIENOPYRIMIDINE DERIVATIVE  
(71) ASKA Pharmaceutical Co., Ltd., 5-1, Shibaura 2-chome, Minato-ku, Tokyo 108-8532, JP  
(72) HAYASHI, Hiroyuki, c/o ASKA Pharmaceutical Co. Ltd. 5-36-1 Shimosakunobe Takatsu-ku, Kawasaki-shi Kanagawa 213-8522, JP  
NAKAGAWA, Takayoshi, c/o ASKA Pharmaceutical Co. Ltd. 5-36-1 Shimosakunobe Takatsu-ku, Kawasaki-shi Kanagawa 213-8522, JP  
MIYAZAKI, Koichi, c/o ASKA Pharmaceutical Co. Ltd. 5-36-1 Shimosakunobe Takatsu-ku, Kawasaki-shi Kanagawa 213-8522, JP

(51) MKP  
**A01N 43/78 (2006.01)** (97) **2575467 \***  
**A61K 31/425 (2006.01)**  
(86) US2011038246 26.05.2011  
(96) 11787462.8 10.04.2013  
(87) WO2011150283, 26.05.2011  
(97) 2575467, 10.04.2013 en  
(54) MACROCYCLIC COMPOUNDS USEFUL AS INHIBITORS OF HISTONE DEACETYLASES  
(71) The Regents of the University of Colorado, A Body Corporate, 800 Grant Street, 8th Floor, Denver, CO 80203, US  
(72) LIU, Xuedong, 7007 Johnson Circle, Niwot Colorado 80309, US  
PHILLIPS, Andrew, J., 1485 Long Hill Rd., Guilford Connecticut 06437, US  
UNGERMANNNOVA, Dana, 2 Longfellow lane, Houston Texas 77005, US  
NASVESCHUK, Christopher, G., 15 Philips Rd., Stoneham Massachusetts 02180, US  
ZHANG, Gan, 7007 Johnson Circle, Niwot Colorado 80309, US

- (51) MKP  
**C12N 15/52 (2006.01)** (97) **2563912 \***  
**A61K 38/43 (2006.01)**  
**C12N 9/00 (2006.01)**  
**C07K 19/00 (2006.01)**  
**C12N 15/113 (2010.01)**  
**C07K 16/40 (2006.01)**  
**G01N 33/68 (2006.01)**
- (86) US2011034388 28.04.2011  
(96) 11778026.2 06.03.2013  
(87) WO2011139854, 28.04.2011  
(97) 2563912, 06.03.2013 en  
(54) INNOVATIVE DISCOVERY OF THERAPEUTIC, DIAGNOSTIC, AND ANTIBODY COMPOSITIONS RELATED TO PROTEIN FRAGMENTS OF ASPARAGINYL TRNA SYNTHETASES
- (71) aTyr Pharma, Inc., 3545 John Hopkins Court, Suite 250, San Diego, CA 92121, US  
Pangu Biopharma Limited, Edinburgh Tower, 18/F The Landmark 15 Queen's Road Central, Hong Kong, CN
- (72) GREENE, Leslie, Ann, 13941 Davenport Avenue, San Diego California 92129, US  
CHIANG, Kyle, P., 943 Torrance Street Apt. 6, San Diego California 92103, US  
HONG, Fei, 7979 Caminito Dia 2, San Diego California 92122, US  
VASSEROT, Alain, P., 6421 La Paloma Street, Carlsbad California 92009, US  
LO, Wing-Sze, RM 815 Sui Ming House Siu Sai Wan Estate Chai Wan, Hong Kong, CN  
WATKINS, Jeffrey, D., 3442 Fortuna Ranch Road, Encinitas California 92024, US  
MENDLEIN, John, D., 1550 Neptune Avenue, Encinitas California 92024, US  
QUINN, Cheryl, L., 5392 Renaissance Avenue, San Diego California 92122, US

- (51) MKP  
**C12N 15/00 (2006.01)** (97) **2591101 \***  
**C12P 21/04 (2006.01)**
- (86) US2011043568 11.07.2011  
(96) 11804475.9 15.05.2013  
(87) WO2012006623, 11.07.2011  
(97) 2591101, 15.05.2013 en  
(54) SYSTEMS FOR FACTOR VIII PROCESSING AND METHODS THEREOF
- (71) BIOGEN IDEC HEMOPHILIA INC., 9 Fourth Avenue, Waltham, MA 02451, US
- (72) LOW, Susan, C., 86 Brookline Street, Pepperell Massachusetts 01463, US  
PETERS, Robert, T., 51 Newfield Street, West Roxbury Massachusetts 02132, US

- (51) MKP  
**H02G 3/08 (2006.01)** (97) **2593996 \***
- (86) EP2011003225 30.06.2011  
(96) 11729570.9 22.05.2013  
(87) WO2012007108, 30.06.2011  
(97) 2593996, 22.05.2013 en  
(54) CONNECTING DEVICE FOR ELECTRICAL JUNCTION BOXES.
- (71) Palazzoli S.p.A., Via Palazzoli Federico 31, 25128 Brescia, IT
- (72) LEVI, Bruno, Via Vittorio Emanuele II 1, I-25122 Brescia, IT

- (51) MKP  
**B29C 45/14 (2006.01)** (97) **2582536 \***  
**B60J 1/00 (2006.01)**  
**B60J 10/02 (2006.01)**
- (86) FR2011051351 15.06.2011  
(96) 11735495.1 24.04.2013  
(87) WO2011157945, 15.06.2011  
(97) 2582536, 24.04.2013 fr  
(54) GLASS PANEL INCLUDING AN INSERT HAVING A PRESSURE ELEMENT, METHOD FOR MANUFACTURING THE GLASS PANEL, AND INSERT FOR THE GLASS PANEL
- (71) Saint-Gobain Glass France, 18 avenue d'Alsace, 92400 Courbevoie, FR
- (72) GRANDGIRARD, Bastien, 198 rue du Moulin Becquerel, F-60490 Marquèglise, FR  
FROISSARD, Loïc, 18 Square Paul Fort, F-60750 Choisy-au-Bac, FR  
GONNET, Romain, 10 Impasse du Solitaire, F-60610 Lacroix Saint Ouen, FR

- (51) MKP  
**A61P 37/08 (2006.01)** (97) **2569294 \***  
**A61K 31/4427 (2006.01)**  
**C07D 403/14 (2006.01)**  
**C07D 401/04 (2006.01)**
- (86) US2011035844 10.05.2011  
(96) 11725830.1 20.03.2013  
(87) WO2011143162, 10.05.2011  
(97) 2569294, 20.03.2013 en  
(54) SUBSTITUTED N-HETEROARYL BIPYRROLIDINE CARBOXAMIDES, PREPARATION AND THERAPEUTIC USE THEREOF
- (71) SANOFI, 54 rue La Boétie, 75008 Paris, FR
- (72) GAO, Zhongli, c/o sanofi-aventis U.S. 1041 Route 202-206 BWD-303A, Bridgewater, New Jersey 08807, US  
HALL, Daniel, c/o sanofi-aventis U.S. 1041 Route 202-206 BWD-303A, Bridgewater, New Jersey 08807, US  
STEFANY, David, c/o sanofi-aventis U.S. 1041 Route 202-206 BWD-303A, Bridgewater, New Jersey 08807, US

- (51) MKP  
**B62K 21/26 (2006.01)** (97) **2560862 \***  
**B62K 3/16 (2006.01)**  
**B62K 11/14 (2006.01)**  
**B62K 23/04 (2006.01)**
- (86) IB2010051727 20.04.2010  
(96) 10721850.5 27.02.2013  
(87) WO2011132019, 20.04.2010  
(97) 2560862, 27.02.2013 en  
(54) STEERING MEANS FOR VEHICLES, PARTICULARLY SUITABLE FOR USE BY DISABLED PERSONS
- (71) Ghedin, Patrizia, Via Cadorna 14, 31040 Volpago Del Montello (TV), IT  
Innovation Factory S.r.l., Area Science Park Padriciano 99, 34149 Trieste, IT
- (72) MAROTTO, Fulvio, Via Tommaso Salsa, 40, I- 31100 TREVISO, IT

- (51) MKP  
**A61K 49/00 (2006.01)** (97) **2588078 \***  
**A61K 47/14 (2006.01)**  
**A61K 31/557 (2006.01)**  
**A61K 9/00 (2006.01)**
- (86) EP2011060848 28.06.2011  
(96) 11727707.9 08.05.2013  
(87) WO2012001009, 28.06.2011  
(97) 2588078, 08.05.2013 fr  
(54) POLYMERIC SYSTEM FOR DELIVERING A PRESERVATIVE-FREE PROSTAGLANDIN-BASED NONVISCIOUS SOLUTION
- (71) Laboratoires Thèa, 12, rue Louis Bléroit Zone Industrielle du Brezet, 63100 Clermont-Ferrand, FR
- (72) MERCIER, Fabrice, 34 Avenue Léon Blum, F-63000 Clermont-Ferrand, FR



(51) MKP  
**A61K 31/404 (2006.01)** (97) **2538942 \***  
**A61P 17/00 (2006.01)**  
(86) US2011025785 23.02.2011  
(96) 11708360.0 02.01.2013  
(87) WO2011106334, 23.02.2011  
(97) 2538942, 02.01.2013 en  
(54) TREATMENT OF DERMATOLOGICAL ALLERGIC CONDITIONS  
(71) SANOFI, 54, rue de la Boétie, 75008 Paris, FR  
(72) CHOI-SLEDESKI, Yong Mi, Sanofi-Aventis U.S. 1041 Route 202-206 Mail Code: BWD-303A, Bridgewater, New Jersey 08807, US  
FITCH, Neil, Sanofi-aventis U.S. 1041 Route 202-206 Mail Code: BWD-303A, Bridgewater, New Jersey 08807, US  
MINNICH, Anne, Sanofi-aventis U.S. 1041 Route 202-206 Mail Code: BWD-303A, Bridgewater, New Jersey 08807, US

(51) MKP  
**H04B 17/00 (2006.01)** (97) **2589166 \***  
(86) US2010045047 10.08.2010  
(96) 10747731.7 08.05.2013  
(87) WO2012002978, 10.08.2010  
(97) 2589166, 08.05.2013 en  
(54) MEASURING RECEIVED SIGNAL STRENGTH ON NEIGHBORING FREQUENCIES OF A CHANNEL WITH INTERFERENCE IN A WIRELESS DEVICE  
(71) Qualcomm Incorporated, International IP Administration 5775 Morehouse Drive, San Diego, CA 92121-1714, US  
(72) HUSTED, Paul J., 5480 Great America Parkway, Santa Clara California 95054, US  
DUA, Praveen, 5480 Great America Parkway, Santa Clara California 95054, US  
KOGAN, Douglas J., 5480 Great America Parkway, Santa Clara California 95054, US

(51) MKP  
**C12N 15/13 (2006.01)** (97) **2552959 \***  
**C12N 5/18 (2006.01)**  
**A61P 35/00 (2006.01)**  
**A61K 39/395 (2006.01)**  
**C07K 16/18 (2006.01)**  
(86) US2011030025 25.03.2011  
(96) 11760326.6 06.02.2013  
(87) WO2011119979, 25.03.2011  
(97) 2552959, 06.02.2013 en  
(54) ANTIBODIES TO MUC16 AND METHODS OF USE THEREOF  
(71) Memorial Sloan-Kettering Cancer Center, 1275 York Avenue, New York, NY 10065, US  
(72) SPRIGGS, David, 1233 York Avenue, 22 C, New York, NY 10065, US  
THAPI, Dharmarao, 56-34, Bell Boulevard, Bayside, NY 11364, US

(51) MKP  
**C08L 67/02 (2006.01)** (97) **2540769**  
**G02B 6/02 (2006.01)**  
**C08L 63/00 (2006.01)**  
**B24B 13/005 (2006.01)**  
**C08K 5/053 (2006.01)**  
**C09J 167/00 (2006.01)**  
(96) 12006548.7 02.01.2013  
(97) 2540769, 02.01.2013 de  
(54) Compound, in particular blocking agent compound, for fixing blanks for ophthalmic or optical lenses  
(71) Schneider GmbH & Co. KG, Biegenstrasse 8-12, 35112 Fronhausen, DE  
(72) Schneider, Gunter, Wilhelm-Roser-Strasse 21., D - 35037 Marburg, DE  
Huttenhuis, Stephan, In der Struth 2, D - 35041 Marburg, DE  
Achenbach, Ferdinand, Bornsbachweg 10, D - 35236 Breidenbach-Wolzhausen, DE

(51) MKP  
**A01J 9/04 (2006.01)** (97) **2538771 \***  
**A01J 5/00 (2006.01)**  
(86) DK2011000003 28.01.2011  
(96) 11705427.0 02.01.2013  
(87) WO2011095166, 28.01.2011  
(97) 2538771, 02.01.2013 en  
(54) AUTOMATIC MILKING SYSTEM AND COMPONENTS THEREFOR  
(71) Jensen, Johannes, Marienlyst 1, 6660 Lintrup, DK  
(72) Jensen, Johannes, Marienlyst 1, 6660 Lintrup, DK

(51) MKP  
**C07D 401/12 (2006.01)** (97) **2582692 \***  
**A61K 31/517 (2006.01)**  
**C07D 405/14 (2006.01)**  
**A61P 29/00 (2006.01)**  
**C07D 401/14 (2006.01)**  
**A61K 31/4709 (2006.01)**  
**C07D 403/12 (2006.01)**  
**A61K 31/502 (2006.01)**  
**C07D 403/14 (2006.01)**  
**A61K 31/4375 (2006.01)**  
**C07D 413/14 (2006.01)**  
**C07D 417/14 (2006.01)**  
**C07D 471/04 (2006.01)**  
(86) US2011040610 16.06.2011  
(96) 11729234.2 24.04.2013  
(87) WO2011159854, 16.06.2011  
(97) 2582692, 24.04.2013 en  
(54) CYCLOHEXYL-AZETIDINYL ANTAGONISTS OF CCR2  
(71) Janssen Pharmaceutica, N.V., Turnhoutseweg 30, 2340 Beerse, BE  
(72) LANTER, James, C., Welsh&McKean Roads, Spring House, PA 19477, US  
MARKOTAN, Thomas, P., 506 Estate Road, Morgantown, PA 19543, US  
SUBASINGHE, Nalin, 302 Long Ridge Lane, Exton, PA 19341, US  
SUI, Zhihua, Welsh & McKean Roads, Spring House, PA 19477, US

(51) MKP  
**G01N 21/90 (2006.01)** (97) **2567221 \***  
(86) EP2011056996 03.05.2011  
(96) 11716946.6 13.03.2013  
(87) WO2011138297, 03.05.2011  
(97) 2567221, 13.03.2013 en  
(54) DEVICE AND METHOD FOR DETECTION OF DEFECTS IN VITREOUS BODIES  
(71) Sanofi-Aventis Deutschland GmbH, Brüningstraße 50, 65929 Frankfurt, DE  
(72) KIBAT, Paul-Gerhard, c/o Sanofi-Aventis Deutschland GmbH, 65926 Frankfurt am Main, DE  
SCHARF, Matthias, c/o Sanofi-Aventis Deutschland GmbH, 65926 Frankfurt am Main, DE  
JUHNIKE, Hanno, c/o Sanofi-Aventis Deutschland GmbH, 65926 Frankfurt am Main, DE  
BERNHARDT, Rainer, c/o Sanofi-Aventis Deutschland GmbH, 65926 Frankfurt am Main, DE  
SPENGLER, Jan-Peter, c/o Sanofi-Aventis Deutschland GmbH, 65926 Frankfurt am Main, DE  
SCHRACK, Michael, Schwalbenstr.16, 72124 Pliezhausen, DE  
GROESCHKE, Jasmin, c/o Sanofi-Aventis Deutschland GmbH, 65926 Frankfurt am Main, DE

(86) US2011040610 16.06.2011  
(96) 11729234.2 24.04.2013  
(87) WO2011159854, 16.06.2011  
(97) 2582692, 24.04.2013 en  
(54) CYCLOHEXYL-AZETIDINYL ANTAGONISTS OF CCR2  
(71) Janssen Pharmaceutica, N.V., Turnhoutseweg 30, 2340 Beerse, BE  
(72) LANTER, James, C., Welsh&McKean Roads, Spring House, PA 19477, US  
MARKOTAN, Thomas, P., 506 Estate Road, Morgantown, PA 19543, US  
SUBASINGHE, Nalin, 302 Long Ridge Lane, Exton, PA 19341, US  
SUI, Zhihua, Welsh & McKean Roads, Spring House, PA 19477, US

(51) MKP  
**A61K 38/16 (2006.01)** (97) **2566494 \***  
(86) US2011026322 25.02.2011  
(96) 11748182.0 13.03.2013  
(87) WO2011106703, 25.02.2011  
(97) 2566494, 13.03.2013 en  
(54) CXCR4 RECEPTOR COMPOUNDS  
(71) Anchor Therapeutics, Inc., 67 Rogers Street, Cambridge, MA 02142, US  
(72) LOOBY, Richard, J., 32 William Road, Reading, MA 01867, US  
TCHERNYCHEV, Boris, 20 Payson Road, Chestnut Hill, MA 02467, US

(51) MKP  
**A61K 38/16 (2006.01)** (97) **2566494 \***  
(86) US2011026322 25.02.2011  
(96) 11748182.0 13.03.2013  
(87) WO2011106703, 25.02.2011  
(97) 2566494, 13.03.2013 en  
(54) CXCR4 RECEPTOR COMPOUNDS  
(71) Anchor Therapeutics, Inc., 67 Rogers Street, Cambridge, MA 02142, US  
(72) LOOBY, Richard, J., 32 William Road, Reading, MA 01867, US  
TCHERNYCHEV, Boris, 20 Payson Road, Chestnut Hill, MA 02467, US

- (51) MKP  
**C07D 211/58 (2006.01)** (97) **2542524 \***  
**C07D 487/08 (2006.01)**  
**C07D 243/08 (2006.01)**  
**A61K 31/4418 (2006.01)**  
**C07D 401/02 (2006.01)**  
**A61K 31/444 (2006.01)**  
**C07D 401/12 (2006.01)**  
**C07D 295/08 (2006.01)**  
**A61K 31/40 (2006.01)**  
**C07D 205/04 (2006.01)**  
**C07D 403/12 (2006.01)**  
**C07D 211/56 (2006.01)**  
**C07D 413/12 (2006.01)**  
**C07D 207/08 (2006.01)**  
**C07D 405/12 (2006.01)**
- (86) EP2011053024 01.03.2011  
(96) 11706236.4 09.01.2013  
(87) WO2011107474, 01.03.2011  
(97) 2542524, 09.01.2013 en  
(54) DERIVATIVES OF AMINOINDANES, THEIR PREPARATION AND THEIR APPLICATION IN THERAPEUTICS  
(71) SANOFI, 54, rue de la Boétie, 75008 Paris, FR  
(72) FOLLMANN, Markus, c/o Sanofi Aventis Département Brevets Brüningsstrasse 50, 65929 Frankfurt am Main, DE  
GOBERVILLE, Pascale, c/o Sanofi Aventis Département Brevets 174 avenue de France, F-75013 Paris, FR  
HACHTEL, Stéphanie, c/o Sanofi Aventis Département Brüningsstrasse 50, 65929 Frankfurt am Main, DE  
HESSLER, Gerhard, c/o Sanofi Aventis Patent Departement Brüningsstrasse 50, 65929 Frankfurt am Main, DE  
KLEEMANN, Heinz-Werner, c/o Sanofi Aventis Patent Departement Brüningsstrasse 50, 65929 Frankfurt am Main, DE  
MAIER, Thomas, c/o Sanofi Aventis Patent Departement Brüningsstrasse 50, 65929 Frankfurt am Main, DE  
MC COURT, Gary, c/o Sanofi Aventis Département Brevets 174 avenue de France, F-75013 Paris, FR  
STRÜBING, Carsten, c/o Sanofi Aventis Patent Departement Brüningsstrasse 50, 65929 Frankfurt am Main, DE  
THIERS, Bérangère, c/o Sanofi Aventis Département Brevets 174 avenue de France, F-75013 Paris, FR  
WANG, Li-Hsing, c/o Sanofi Aventis Patent Departement Brüningsstrasse 50, 65929 Frankfurt am Main, DE
- 
- (51) MKP  
**B01J 37/18 (2006.01)** (97) **2554267 \***  
**C10G 2/00 (2006.01)**
- (86) JP2011056068 15.03.2011  
(96) 11762571.5 06.02.2013  
(87) WO2011122331, 15.03.2011  
(97) 2554267, 06.02.2013 en  
(54) PREPARATION METHOD FOR ACTIVATED CATALYST FOR FISCHER-TROPSCH SYNTHESIS, PREPARATION METHOD FOR CATALYST SLURRY, AND METHOD FOR SUPPLYING CATALYST SLURRY TO FISCHER-TROPSCH SYNTHESIS REACTOR  
(71) Japan Oil, Gas and Metals National Corporation, 2-10-1, Toranomon Minato-ku, Tokyo 105-0001, JP  
INPEX Corporation, 5-3-1 Akasaka Minato-ku, Tokyo 107-6332, JP  
JX Nippon Oil & Energy Corporation, 6-3, Otemachi 2-chome, Chiyoda-ku Tokyo 100-8162, JP  
Japan Petroleum Exploration Co., Ltd., 7-12, Marunouchi 1-chome Chiyoda-ku, Tokyo 100-0005, JP  
Cosmo Oil Co., Ltd., 1-1, Shibaura 1-chome Minato-ku, Tokyo 105-8528, JP  
Nippon Steel Engineering Co., Ltd, 5-1, Osaki 1-chome Shinagawa-ku, Tokyo 141-8604, JP  
(72) TASAKA, Kazuhiko, c/o JX Nippon Oil&Energy Corporation 8 Chidori-cho Naka-ku, Yokohama-shi Kanagawa 231-0815, JP
- 
- (51) MKP  
**A47K 10/34 (2006.01)** (97) **2560534 \***  
**A47K 5/12 (2006.01)**  
**H05F 3/02 (2006.01)**
- (86) AT2011000199 21.04.2011  
(96) 11722275.2 27.02.2013  
(87) WO2011130765, 21.04.2011  
(97) 2560534, 27.02.2013 de  
(54) SANITARY DISPENSER  
(71) Hagleitner, Hans Georg, Lindenallee 11, 5700 Zell am See, AT  
(72) Hagleitner, Hans Georg, Lindenallee 11, 5700 Zell am See, AT
- 
- (51) MKP  
**B65D 1/02 (2006.01)** (97) **2588379 \***
- (86) US2011040142 13.06.2011  
(96) 11728117.0 08.05.2013  
(87) WO2012003086, 13.06.2011  
(97) 2588379, 08.05.2013 en  
(54) OVAL-NECK BOTTLE  
(71) Owens-Brockway Glass Container INC., One Michael Owens Way, Perrysburg, OH 43551, US  
(72) REISIG, Karl, A., 541 Southfield Drive, Maumee OH 43537, US
- 
- (51) MKP  
**B62D 9/02 (2006.01)** (97) **2593352 \***  
**B62K 5/08 (2006.01)**
- (86) IB2011001619 07.07.2011  
(96) 11751935.5 22.05.2013  
(87) WO2012007819, 07.07.2011  
(97) 2593352, 22.05.2013 en  
(54) TILTABLE MOTORCYCLES WITH TWO FRONT STEERING WHEELS  
(71) PIAGGIO & C. S.p.A., Viale Rinaldo Piaggio 25, 56025 Pontedera (Pisa), IT  
(72) BARTOLOZZI, Stefano, Via Isonzo 76, I-50126 Firenze, IT  
BERNARDI, Luca, Via Nilde Jotti 134, I-56012 Calcinia (PI), IT  
PROFETI, Marco, Via Zara 36, I-56025 La Rotta (PI), IT  
ROSELLINI, Walter, Via delle Magnolie 43, I-51016 Montecatini Terme (PT), IT
- 
- (51) MKP  
**A61K 31/4375 (2006.01)** (97) **2545053 \***  
**A61P 11/00 (2006.01)**  
**A61P 25/24 (2006.01)**  
**A61P 25/04 (2006.01)**  
**C07D 471/04 (2006.01)**  
**A61P 25/08 (2006.01)**  
**A61P 25/16 (2006.01)**  
**A61P 25/22 (2006.01)**  
**A61P 25/28 (2006.01)**  
**A61P 3/04 (2006.01)**  
**A61P 25/18 (2006.01)**  
**A61P 13/00 (2006.01)**
- (86) DK2011050080 11.03.2011  
(96) 11709626.3 16.01.2013  
(87) WO2011110183, 11.03.2011  
(97) 2545053, 16.01.2013 en  
(54) AZAISQUINOLINONE DERIVATIVES AS NK3 ANTAGONISTS  
(71) H. Lundbeck A/S, Ottiliavej 9, 2500 Valby, DK  
(72) KHANZHIN, Nikolay, Teglgårdsvej 545, 2.tv., DK-3050 Humlebæk, DK  
SIMONSEN, Klaus Bæk, Læssøegade 75, DK-5230 Odense M, DK  
NIELSEN, Søren Møller, Åmosevej 15, DK-3400 Hillerød, DK  
JUHL, Karsten, Brydeholm 56, DK-2670 Greve, DK
-

- (51) MKP  
**C07D 487/04 (2006.01)** (97) **2588480 \***  
**C07D 207/337 (2006.01)**  
**A61P 9/00 (2006.01)**  
**A61P 25/28 (2006.01)**  
**A61P 29/00 (2006.01)**  
**A61K 31/4985 (2006.01)**  
**C07D 241/06 (2006.01)**  
**A61P 25/00 (2006.01)**  
(86) IB2011001594 01.06.2011  
(96) 11781590.2 08.05.2013  
(87) WO2011161537, 01.06.2011  
(97) 2588480, 08.05.2013 en  
(54) 3,4-DIHYDROPIRROLO[1,2-A]PYRAZINE-2,8(1H)-  
DICARBOXAMIDE DERIVATIVES, PREPARATION THEREOF AND  
THERAPEUTIC USE THEREOF & xA;  
(71) SANOFI, 54, rue de la Boétie, 75008 Paris, FR  
(72) COTE-DES-COMBES, Sylvain, c/o Sanofi Patent Department 174  
avenue de France, F-75013 Paris, FR  
FROISSANT, Jacques, c/o Sanofi Patent Department 174 avenue  
de France, F-75013 Paris, FR  
GIBERT, Jean-François, c/o Sanofi Patent Department 174 avenue  
de France, F-75013 Paris, FR  
MARGUET, Frank, c/o Sanofi Patent Department 174 avenue de  
France, F-75013 Paris, FR  
PACAUD, Christophe, c/o Sanofi Patent Department 174 avenue de  
France, F-75013 Paris, FR  
PUECH, Frédéric, c/o Sanofi Patent Department 174 avenue de  
France, F-75013 Paris, FR  
RAVET, Antoine, c/o Sanofi Patent Department 174 avenue de  
France, F-75013 Paris, FR
- 
- (51) MKP  
**A61M 11/02 (2006.01)** (97) **2585150 \***  
**A61M 16/00 (2006.01)**  
(86) IT2010000284 25.06.2010  
(96) 10747499.1 01.05.2013  
(87) WO2011161706, 25.06.2010  
(97) 2585150, 01.05.2013 en  
(54) AEROSOL THERAPY DEVICE  
(71) MED 2000 S.r.l., Via dell'Artigianato, 23/25, 25080 Padenghe  
Sul Garda BS, IT  
(72) FRACCAROLI, Davide, Via Vincenzo Monti 15, I-25015  
Desenzano del Garda Brescia, IT
- 
- (51) MKP  
**A61P 35/00 (2006.01)** (97) **2566496 \***  
**A61P 3/10 (2006.01)**  
**A61K 39/395 (2006.01)**  
**A61K 38/16 (2006.01)**  
**C07K 14/525 (2006.01)**  
**A61P 29/00 (2006.01)**  
(86) US2011035056 03.05.2011  
(96) 11778207.8 13.03.2013  
(87) WO2011140135, 03.05.2011  
(97) 2566496, 13.03.2013 en  
(54) INNOVATIVE DISCOVERY OF THERAPEUTIC,  
DIAGNOSTIC, AND ANTIBODY COMPOSITIONS RELATED  
TO PROTEIN FRAGMENTS OF METHIONYL-TRNA  
SYNTHETASES  
(71) aTyr Pharma, Inc., 3545 John Hopkins Court, Suite 250, San  
Diego, CA 92121, US  
Pangu Biopharma Limited, Edinburgh Tower, 18/F The  
Landmark 15 Queen's Road Central, Hong Kong, CN  
(72) GREENE, Leslie, Ann, 13941 Davenport Avenue, San Diego  
California 92129, US  
CHIANG, Kyle, P., 943 Torrance Street Apt. 6, San Diego  
California 92103, US  
HONG, Fei, 7979 Caminito Dia 2, San Diego California 92122,  
US  
VASSEROT, Alain, P., 6421 La Paloma Street, Carlsbad  
California 92009, US  
LO, Wing-Sze, RM 815 Sui Ming House Siu Sai Wan Estate  
Chai Wan, Hong Kong, CN  
WATKINS, Jeffrey, D., 3442 Fortuna Ranch Road, Encinitas  
California 92024, US  
MENDLEIN, John, D., 1550 Neptune Avenue, Encinitas  
California 92024, US  
QUINN, Cheryl, L., 5392 Renaissance Avenue, San Diego  
California 92122, US
- 
- (51) MKP  
**C07D 401/14 (2006.01)** (97) **2571864 \***  
**A61P 3/10 (2006.01)**  
**A61K 31/4545 (2006.01)**  
(86) US2011036443 13.05.2011  
(96) 11754769.5 27.03.2013  
(87) WO2011146335, 13.05.2011  
(97) 2571864, 27.03.2013 en  
(54) PIPERIDINYL-SUBSTITUTED LACTAMS AS GPR119  
MODULATORS  
(71) Array Biopharma, Inc., 3200 Walnut Street, Boulder, CO  
80301, US  
(72) AICHER, Thomas Daniel, c/o Array BioPharma Inc. 3200  
Walnut Street, Boulder Colorado 80301, US  
BENCSEK, Josef Roland, c/o Array BioPharma Inc. 3200  
Walnut Street, Boulder Colorado 80301, US  
CONDROSKI, Kevin Ronald, c/o Array BioPharma Inc. 3200  
Walnut Street, Boulder Colorado 80301, US  
FELL, Jay Bradford, c/o Array BioPharma Inc. 3200 Walnut  
Street, Boulder Colorado 80301, US  
FISCHER, John P., c/o Array BioPharma Inc. 3200 Walnut  
Street, Boulder Colorado 80301, US  
HINKLIN, Ronald Jay, c/o Array BioPharma Inc. 3200 Walnut  
Street, Boulder Colorado 80301, US  
PRATT, Scott Alan, c/o Array BioPharma Inc. 3200 Walnut  
Street, Boulder Colorado 80301, US  
SINGH, Ajay, c/o Array BioPharma Inc. 3200 Walnut Street,  
Boulder Colorado 80301, US  
TURNER, Timothy M., c/o Array BioPharma Inc. 3200 Walnut  
Street, Boulder Colorado 80301, US  
BOYD, Steven Armen, c/o Array BioPharma Inc. 3200 Walnut  
Street, Boulder Colorado 80301, US
- 
- (51) MKP  
**A61P 21/00 (2006.01)** (97) **2575857 \***  
**A61K 39/395 (2006.01)**  
**A61K 38/16 (2006.01)**  
**A61P 37/00 (2006.01)**  
**A61K 38/17 (2006.01)**  
**A61K 38/08 (2006.01)**  
(86) US2011038813 01.06.2011  
(96) 11790361.7 10.04.2013  
(87) WO2011153277, 01.06.2011  
(97) 2575857, 10.04.2013 en  
(54) INNOVATIVE DISCOVERY OF THERAPEUTIC,  
DIAGNOSTIC, AND ANTIBODY COMPOSITIONS  
RELATED TO PROTEIN FRAGMENTS OF LYSYL-TRNA  
SYNTHETASES  
(71) aTyr Pharma, Inc., 3545 John Hopkins Court, Suite 250, San  
Diego, CA 92121, US  
Pangu Biopharma Limited, Edinburgh Tower, 18/F The  
Landmark 15 Queen's Road Central, Hong Kong, CN  
(72) GREENE, Leslie, Ann, 13941 Davenport Avenue, San Diego  
CA 92129, US  
CHIANG, Kyle, P., 1615 Debann Road, Cardiff, CA 92007, US  
HONG, Fei, 12646 Spindletop Road, San Diego CA 92129, US  
VASSEROT, Alain, P., 6421 La Paloma Street, Carlsbad CA  
92009, US  
LO, Wing-Sze, RM 815 Sui Ming House Siu Sai Wan Estate  
Chai Wan, Hong Kong, CN  
WATKINS, Jeffrey, D., 3442 Fortuna Ranch Road, Encinitas CA  
92024, US  
QUINN, Cheryl, L., 408 North 1st Street No. 706, Minneapolis,  
MN 55401, US  
MENDLEIN, John, D., 1550 Neptune Avenue, Encinitas CA  
92024, US
- 
- (51) MKP  
**G06F 21/24 (2006.01)** (97) **2477137**  
(96) 11150677.0 18.07.2012  
(97) 2477137, 18.07.2012 en  
(54) Method for verifying the integrity of a set of data  
(71) Safelayer Secure Communications, S.A., Edifici World Trade  
Center (Edif. Sud, 4ª planta) Moll de Barcelona, s/n, 08039  
Barcelona, ES  
(72) Iñigo Griera, Jordi, Passeig de les Masies, 53, esc.2, 2º 2ª,  
08780 Pallejà, ES  
Osorio Herrero, David, C. Jordi ferran, 19-21, 5ª 2ª, 08028  
Barcelona, ES

- (51) MKP  
**C12N 15/09 (2006.01)** (97) **2592141 \***  
**C12N 15/00 (2006.01)**  
**A01K 67/027 (2006.01)**  
**C12Q 1/02 (2006.01)**  
**C12N 5/09 (2010.01)**  
(86) JP2011066029 07.07.2011  
(96) 11803711.8 15.05.2013  
(87) WO2012005383, 07.07.2011  
(97) 2592141, 15.05.2013 en  
(54) METHOD FOR PRODUCTION OF TUMOR CELLS FROM NORMAL MAMMARY EPITHELIAL CELLS  
(71) Eisai R&D Management Co., Ltd., 6-10, Koishikawa 4-chome Bunkyo-ku, Tokyo 112-8088, JP  
(72) AKAGI, Tsuyoshi, KAN Research Institute Inc. Kobe MI R&D Center 6-7-3 Minatojima-minamimachi Chuo-ku, Kobe-shi, Hyogo 650-0047, JP
- 
- (51) MKP  
**A01N 43/02 (2006.01)** (97) **2552202 \***  
(86) US2011029988 25.03.2011  
(96) 11760306.8 06.02.2013  
(87) WO2011119953, 25.03.2011  
(97) 2552202, 06.02.2013 en  
(54) METHODS AND COMPOSITIONS FOR WEIGHT LOSS  
(71) SDG, Inc., 10000 Cedar Avenue Suite 6, Cleveland, OH 44106, US  
(72) LAU, John, R., 585 King Beach Drive, Howard OH 43028, US GEHO, Blair, W., 533 Beachwood Drive, Wooster OH 44691, US
- 
- (51) MKP  
**C10G 65/02 (2006.01)** (97) **2479242**  
**B01J 35/04 (2006.01)**  
**C10G 45/12 (2006.01)**  
**B01J 21/12 (2006.01)**  
**C10G 45/08 (2006.01)**  
**B01J 35/10 (2006.01)**  
(96) 11151377.6 25.07.2012  
(97) 2479242, 25.07.2012 de  
(54) Method for hydroprocessing of hydrocarbon compounds heavily contaminated with inorganic substances  
(71) Puralube Germany GmbH, Hauptstraße 30, 06729 Elsteraue, DE  
(72) Schüppel, Andreas, Städtelner Str. 164, 04416 Markkleeberg, DE  
John, Heino Dr., Nikolaus-Weins-Str. 10, 06120 Halle (S.), DE  
Bongardt, Tim Dr., Hauptstr. 76, 04416 Markkleeberg, DE
- 
- (51) MKP  
**A61B 17/70 (2006.01)** (97) **2502594**  
(96) 11159254.9 26.09.2012  
(97) 2502594, 26.09.2012 en  
(54) Polyaxial pedicle screw and fixation system kit comprising said screw  
(71) Medacta International S.A., Strada Regina, 6874 Castel San Pietro (TI), CH  
(72) Siccardi Francesco, Riva lago Preabella, CH-6921 Vico Morcote, CH  
Fiechter, Meinrad, Strada Regina 3a, CH-6900 Lugano, CH  
Auerbach, Joshua, 100 Sterling Place, 3F, Brooklyn, NY 11217, US  
Fekete, Zsolt, Im Holze 6b, 28355 Bremen, DE  
Heyde, Christoph E., Paul-Michael-Str. 14, 04179 Leipzig, DE
- 
- (51) MKP  
**C23C 16/50 (2006.01)** (97) **2585274 \***  
**B05D 7/24 (2006.01)**  
**B29C 59/14 (2006.01)**  
(86) EP2011059333 07.06.2011  
(96) 11725680.0 01.05.2013  
(87) WO2011160939, 07.06.2011  
(97) 2585274, 01.05.2013 en  
(54) SURFACE TREATMENT OF RUBBER USING LOW PRESSURE PLASMA  
(71) Carnehammar, Lars Bertil, Sonnenbergstrasse 126, 8032 Zürich, CH  
(72) RONLAN, Alvin, Östermalmsgatan 103, S-114 59 Stockholm, SE
- 
- (51) MKP  
**A61M 5/20 (2006.01)** (97) **2585138 \***  
(86) EP2011060507 22.06.2011  
(96) 11728244.2 01.05.2013  
(87) WO2012000875, 22.06.2011  
(97) 2585138, 01.05.2013 en  
(54) AUTO-INJECTOR  
(71) Sanofi-Aventis Deutschland GmbH, Brüningstraße 50, 65929 Frankfurt, DE  
(72) HOURMAND, Yannick, 14 The Elms, Haslingfield CB23 1ND, GB  
BARROW-WILLIAMS, Timothy Donald, 1 Grange Street, St. Albans Hertfordshire AL3 5NA, GB  
EKMAN, Matthew, 59 Ecton Avenue, Macclesfield Cheshire SK10 1RD, GB
- 
- (51) MKP  
**A61K 47/34 (2006.01)** (97) **2582395 \***  
(86) EP2011059001 31.05.2011  
(96) 11723441.9 24.04.2013  
(87) WO20111151356, 31.05.2011  
(97) 2582395, 24.04.2013 en  
(54) METHODS FOR THE PREPARATION OF INJECTABLE DEPOT COMPOSITIONS  
(71) Laboratorios Farmacéuticos Rovi, S.A., C/ Julián Camarillo 35, 28037 Madrid, ES  
(72) GUTIERRO ADURIZ, Ibon, c/ Julián Camarillo 35, E-28037 Madrid, ES  
GÓMEZ OCHOA, María, Teresa, c/ Julián Camarillo 35, E-28037 Madrid, ES
- 
- (51) MKP  
**A21B 1/48 (2006.01)** (97) **2508076**  
**F24C 15/16 (2006.01)**  
**A21B 3/15 (2006.01)**  
(96) 11187443.4 10.10.2012  
(97) 2508076, 10.10.2012 de  
(54) Stone slab for ovens  
(71) Daub Backtechnik GmbH, Heykenauweg 1, 21160 Hamburg, DE  
(72) Rucker, Andreas, Zur Dalbek 56, 21039 Borsen, DE
- 
- (51) MKP  
**C07D 491/10 (2006.01)** (97) **2547684 \***  
**A61P 35/00 (2006.01)**  
**C07D 487/10 (2006.01)**  
**C07D 519/00 (2006.01)**  
**A61K 31/5386 (2006.01)**  
(86) IB2011051047 11.03.2011  
(96) 11715742.0 23.01.2013  
(87) WO2011114275, 11.03.2011  
(97) 2547684, 23.01.2013 en  
(54) SPIROCYCLIC COMPOUNDS AND THEIR USE AS THERAPEUTIC AGENTS AND DIAGNOSTIC PROBES  
(71) University of Basel, Office of Technology Transfer Schützenmattstrasse 16, 4003 Basel, CH  
(72) CMILJANOVIC, Vladimir, Hohe Winde-Strasse 120, CH-4059 Basel, CH  
CMILJANOVIC, Natasa, Davidsrain 4, CH-4056 Basel, CH  
GIESE, Bernd, Boulevard de Pérolles 15, CH-1700 Fribourg, CH  
WYMANN, Matthias, Bühlstrasse 44, CH-3012 Bern, CH

(51) MKP  
**A61K 31/137 (2006.01)** (97) **2579857 \***  
**A61K 9/50 (2006.01)**  
**A61K 9/20 (2006.01)**  
(86) US2011035768 09.05.2011  
(96) 11719443.1 17.04.2013  
(87) WO2011143119, 09.05.2011  
(97) 2579857, 17.04.2013 en  
(54) ALCOHOL-RESISTANT EXTENDED RELEASE DOSAGE FORMS COMPRISING VENLAFAXINE  
(71) Cima Labs Inc., 7325 Aspen Lane, Brooklyn Park, Minnesota 55428, US  
(72) HAMED, Ehab, 9206 Holly Lane North, Maple Grove Minnesota 55311, US

(51) MKP  
**A61K 39/395 (2006.01)** (97) **2542583 \***  
**A61P 35/00 (2006.01)**  
**C07K 16/26 (2006.01)**  
(86) EP2011000048 07.01.2011  
(96) 11700068.7 09.01.2013  
(87) WO2011083090, 07.01.2011  
(97) 2542583, 09.01.2013 en  
(54) METHODS FOR TREATING BREAST CANCER  
(71) Bioréalités, 35, rue de Verdun, 92284 Suresnes Cedex, FR  
INSTITUT NATIONAL DE LA SANTE ET DE LA RECHERCHE MEDICALE (INSERM), 101, rue de Tolbiac, 75654 Paris Cédex 13, FR  
THE CENTRE NATIONAL DE LA RECHERCHE SCIENTIFIQUE (CNRS), 3, rue Michel-Ange, 75794 Paris Cedex 16, FR  
(72) FLOCH, Jean-François, 10 rue Gabriel Péri, 34200 Sète, FR  
HOUHOU, Leïla, 2 rue Renaud de Villeneuve, 34090 Montpellier, FR  
CAILLER, Françoise, 14 rue Rey, 34000 Montpellier, FR  
JOURBERT, Dominique, 10 rue Gabriel Péri, 34200 Sète, FR  
HOLLANDE, Frédéric, 9, rue des Capriers, 34790 Grabels, FR

(51) MKP  
**G06Q 20/00 (2012.01)** (97) **2584512**  
**A63F 3/06 (2006.01)**  
(96) 12189337.4 24.04.2013  
(97) 2584512, 24.04.2013 en  
(54) Voucher and method for determining validity thereof  
(71) Paybay Networks Srl, Piazza della Vittoria 6/6, 16121 Genova, IT  
(72) Ferretto, Luigi, c/o Paybay Networks Srl, Piazza della Vittoria 6/6, 16121 Genova, IT

(51) MKP  
**C12P 7/64 (2006.01)** (97) **2542685 \***  
(86) IL2011000121 02.02.2011  
(96) 11706030.1 09.01.2013  
(87) WO2011107977, 02.02.2011  
(97) 2542685, 09.01.2013 en  
(54) A PROCESS FOR THE ENZYMATIC SYNTHESIS OF FATTY ACID ALKYL ESTERS  
(71) Trans Bio-Diesel Ltd., Regional R&D Center P.O. Box 437, 20200 Shfaram, IL  
(72) BASHEER, Sobhi, P.O. Box 9327, 20173 Sakhnine, IL  
HAJ, Maisa, Jabor St., 20200 Shfaram, IL  
MOHSEN, Usama, Elgabal 1, Ibleen 30012, IL  
SHEHADEH, Doaa, P.O.Box 5046 St. 7000, 16000 Nazareth, IL  
HINDAWI, Ahmad, Alfwar, 20200 Shfar-Am, IL  
MASOUD, Emad, POB 52, 30026 Arara, IL

(51) MKP  
**A61B 1/04 (2006.01)** (97) **2592992 \***  
(86) US2011043759 12.07.2011  
(96) 11818516.4 22.05.2013  
(87) WO2012024034, 12.07.2011  
(97) 2592992, 22.05.2013 en  
(54) A DEVICE AND METHODS FOR IN VIVO MONITORING OF AN INDIVIDUAL  
(71) Therasyn Sensors, Inc., 100 Crosby Boulevard, Amherst, NY 14226, US  
(72) SCHENTAG, Jerome, J., 100 Crosy Blvd., Eggertsville NY 14226, US  
BRIGHT, Frank, V., 108 Fleetwood Terrace, Williamsville NY 14221, US  
D'ANDREA, David, T., 1795 North French Rd, Getzville NY 14068, US

(51) MKP  
**A61K 39/00 (2006.01)** (97) **2575884 \***  
**C07K 16/00 (2006.01)**  
**A61K 39/395 (2006.01)**  
(86) US2011039135 03.06.2011  
(96) 11790495.3 10.04.2013  
(87) WO2011153477, 03.06.2011  
(97) 2575884, 10.04.2013 en  
(54) USES AND COMPOSITIONS FOR TREATMENT OF HIDRADENITIS SUPPURATIVA (HS)  
(71) AbbVie Biotechnology Ltd, Clarendon House 2, Church Street, HM 11 Hamilton, BM  
(72) OKUN, Martin, M., 207 W. Park Avenue, Libertyville, IL 60048, US  
HARRIS, Thomas, C., 432 Saint Andrews Lane, Gurnee, IL 60031, US

(51) MKP  
**C07K 19/00 (2006.01)** (97) **2569332 \***  
**C07K 14/705 (2006.01)**  
(86) US2011036552 13.05.2011  
(96) 11781394.9 20.03.2013  
(87) WO2011143637, 13.05.2011  
(97) 2569332, 20.03.2013 en  
(54) IMPROVED COMPLEMENT RECEPTOR 2 (CR2) TARGETING GROUPS  
(71) The Regents of the University of Colorado, A Body Corporate, 1800 Grant Street, 8th Floor, Denver, CO 80203, US  
(72) KOVACS, James, 1739 Woodmoor, Monument, CO 80132, US  
HANNAN, Jonathan P., 46 Lough Road, Antrim Co. Antrim BT41 4DQ, GB  
HOLERS, V. Michael, 4825 E. 1st. Avenue, Denver, CO 80220, US

(51) MKP  
**C25D 5/12 (2006.01)** (97) **2481838**  
**C23C 28/02 (2006.01)**  
**C23C 18/30 (2006.01)**  
**C23C 14/20 (2006.01)**  
**C23C 14/16 (2006.01)**  
**C25D 5/56 (2006.01)**  
**C25D 5/48 (2006.01)**  
**C25D 5/14 (2006.01)**  
**C23C 30/00 (2006.01)**  
**C23C 14/00 (2006.01)**  
(96) 12151844.3 01.08.2012  
(97) 2481838, 01.08.2012 en  
(54) Method for applying semi-dry electroplating method on surface of plastic substrate  
(71) Xiamen Runner Industrial Corporation, No. 69, Tianfeng Road North Industrial Park Jimei, Xiamen 361021, CN  
(72) Wu, Zi-bao, No. 69, Tianfeng Road, North Industrial Park, Jimei, 361021 Xiamen, CN  
Qiao, Yong-liang, No. 69, Tianfeng Road, North Industrial Park, Jimei, 361021 Xiamen, CN  
Yang, Bo, No. 69, Tianfeng Road, North Industrial Park, Jimei, 361021 Xiamen, CN  
Lee, Min-Zen, No. 69, Tianfeng Road, North Industrial Park, Jimei, 361021 Xiamen, CN

- (51) MKP  
**C07D 409/14 (2006.01)** (97) **2588475 \***  
**A61P 9/00 (2006.01)**  
**A61P 29/00 (2006.01)**  
**A61K 31/427 (2006.01)**  
**A61P 37/00 (2006.01)**  
**A61K 31/4196 (2006.01)**  
**A61K 31/4427 (2006.01)**  
**C07D 417/14 (2006.01)**  
(86) US2011042694 30.06.2011  
(96) 11734220.4 08.05.2013  
(87) WO2012003387, 30.06.2011  
(97) 2588475, 08.05.2013 en  
(54) APOPTOSIS SIGNAL-REGULATING KINASE INHIBITORS  
(71) Gilead Sciences, Inc., 333 Lakeside Drive, Foster City, CA 94404, US  
(72) CORKEY, Britton, 243 Harrison Avenue, Redwood City, CA 94062, US  
NOTTE, Gregory, 21 Otay Avenue, San Mateo, CA 94403, US  
ZABLOCKI, Jeff, 490 Raquel Court, Los Altos, CA 94022, US

- (51) MKP  
**A61K 39/395 (2006.01)** (97) **2542579 \***  
**C07K 16/18 (2006.01)**  
**C07K 16/46 (2006.01)**  
(86) EP2011053090 02.03.2011  
(96) 11708226.3 09.01.2013  
(87) WO2011107507, 02.03.2011  
(97) 2542579, 09.01.2013 en  
(54) BIPARATOPIK ABETA BINDING POLYPEPTIDES  
(71) Boehringer Ingelheim International GmbH, Binger Strasse 173, 55216 Ingelheim am Rhein, DE  
(72) PARK, John, E., Boehringer Ingelheim GmbH Corporate Patents Binger Strasse 173, 55216 Ingelheim Am Rhein, DE  
HOERER, Stefan, Boehringer Ingelheim GmbH Corporate Patents Binger Strasse 173, 55216 Ingelheim Am Rhein, DE  
KUSSMAUL, Lothar, Boehringer Ingelheim GmbH Corporate Patents Binger Strasse 173, 55216 Ingelheim Am Rhein, DE  
LENTER, Martin, Boehringer Ingelheim GmbH Corporate Patents Binger Strasse 173, 55216 Ingelheim Am Rhein, DE  
ZIMMERMANN, Katharina, Boehringer Ingelheim GmbH Corporate Patents Binger Strasse 173, 55216 Ingelheim Am Rhein, DE  
BESTE, Gerald, Jozef Kluyskensstraat 25 bus 20, B-9000 Gent, BE  
LAEREMANS, Toon, Krauwenberg 35, B-1653 Dworp, BE  
MERCHIERS, Pascal, Loopstraat 23, B-2460 Kasterlee, BE  
VERCAMMEN, Jo, Pijnbroekstraat 64, B-1600 Sint-Pieters-Leeuw, BE

- (51) MKP  
**B65G 49/06 (2006.01)** (97) **2576368 \***  
**B65D 85/48 (2006.01)**  
**B65D 21/08 (2006.01)**  
**B65D 19/12 (2006.01)**  
**B65D 81/05 (2006.01)**  
**B65D 19/44 (2006.01)**  
(86) GB2011050993 26.05.2011  
(96) 11723195.1 10.04.2013  
(87) WO2011148180, 26.05.2011  
(97) 2576368, 10.04.2013 en  
(54) PALLET CONTAINER  
(71) Belron Hungary Kft - Zug Branch, Gotthardstrasse 20, 6304 Zug, CH  
(72) GLOVER, Richard, 1333 Michael Scott Drive, Rocky Mount North Carolina 27803, US  
LANNO, Dino, 2689 Skelton Lane, Blacklick Ohio 43004, US  
PRICE, Ronald, 404 Colon Drive, Rocky Mount North Carolina 27804, US  
TAYLOR, Evan, 12147 Hwy 158, Conway North Carolina 27820, US  
HOAG, Al, 3708 Gloucester Road, Rocky Mount North Carolina 27803, US  
HOWARD, William F, 111 Horseshoe Road, Halifax North Carolina 27839, US  
SCOTT, Andrew P, 106 Frog Level Drive, Roanoke Rapids North Carolina 27870, US  
RUDYK, Richard, 211-28 William Carson Crescent, Toronto Ontario, CA  
COOKE, Richard, 45 Oadby Road, Wigston Leicestershire LE18 3RP, GB  
SCHMIDT, Markus, 297 Kings Road, Kingston Upon Thames Surrey KT2 5JJ, GB

- (51) MKP  
**B60N 2/50 (2006.01)** (97) **2552745 \***  
**G09B 9/00 (2006.01)**  
(86) GB2010001542 12.08.2010  
(96) 10752365.6 06.02.2013  
(87) WO2011121262, 12.08.2010  
(97) 2552745, 06.02.2013 en  
(54) MULTI AXIS MANOEUVRABLE PLATFORM  
(71) CORCOST LIMITED, 22 Great Close, Cawood North Yorkshire YO8 3UG, GB  
(72) CORCORAN, Steven, 22 Great Close Cawood Selby YO8 3UG, North Yorkshire, GB

- (51) MKP  
**C07D 213/81 (2006.01)** (97) **2558448 \***  
(86) EP2011055508 08.04.2011  
(96) 11712881.9 20.02.2013  
(87) WO2011128261, 08.04.2011  
(97) 2558448, 20.02.2013 en  
(54) PROCESS FOR THE PREPARATION OF 4- {4-[[{4 -CHLORO-3 -(TRIFLUOROMETHYL)-PHENYL]AMINO} CARBONYL]AMINO]-3-FLUOROPHENOXY]-N-METHYLPYRIDINE-2-CARBOXAMIDE, ITS SALTS AND MONOHYDRATE  
(71) Bayer HealthCare LLC, 555 White Plains Road, Tarrytown, NY 10591, US  
(72) STIEHL, Juergen, Rosenstr. 28, 45549 Sprockhövel, DE  
HEILMANN, Werner, Am Ringofen 21, 42327 Wuppertal, DE  
LÖGERS, Michael, Niederradenberg 15, 42327 Wuppertal, DE  
REHSE, Joachim, Am Kloster 12, 42799 Leichlingen, DE  
GOTTFRIED, Michael, Herzogstr. 44, 42103 Wuppertal, DE  
WICHMANN, Saskia, Nestorstr. 56, 10709 Berlin, DE

- (51) MKP  
**A47K 10/36 (2006.01)** (97) **2560535 \***  
(86) AT2011000200 21.04.2011  
(96) 11722708.2 27.02.2013  
(87) WO2011130766, 21.04.2011  
(97) 2560535, 27.02.2013 de  
(54) METHOD FOR DISPENSING PAPER SHEET BY SHEET FROM A STOCK  
(71) Hagleitner, Hans Georg, Lindenallee 11, 5700 Zell am See, AT  
(72) Hagleitner, Hans Georg, Lindenallee 11, 5700 Zell am See, AT

(51) MKP  
**A61K 9/50 (2006.01)** (97) **2568969 \***  
**A61K 9/20 (2006.01)**  
(86) US2011035767 09.05.2011  
(96) 11720686.2 20.03.2013  
(87) WO2011143118, 09.05.2011  
(97) 2568969, 20.03.2013 en  
(54) ALCOHOL-RESISTANT FORMULATIONS  
(71) Cima Labs Inc., 7325 Aspen Lane, Brooklyn Park, Minnesota 55428, US  
(72) HAMED, Ehab, 9206 Holly Lane North, Maple Grove Minnesota 55311, US

(51) MKP  
**C07D 405/10 (2006.01)** (97) **2580210 \***  
**C07D 311/04 (2006.01)**  
**C07D 405/12 (2006.01)**  
**A61P 25/28 (2006.01)**  
**A61K 31/352 (2006.01)**  
**A61K 31/453 (2006.01)**  
**A61P 35/00 (2006.01)**  
(86) US2011039669 08.06.2011  
(96) 11793115.4 17.04.2013  
(87) WO2011156518, 08.06.2011  
(97) 2580210, 17.04.2013 en  
(54) ESTROGEN RECEPTOR MODULATORS AND USES THEREOF  
(71) Aragon Pharmaceuticals, Inc., 12780 El Camino Real Suite 301, San Diego, CA 92130, US  
(72) KAHRAMAN, Mehmet, 8617 Via Mallorca Unit E, La Jolla CA 92037, US  
GOVEK, Steven, P., 13216 Via Santillana, San Diego CA 92129, US  
NAGASAWA, Johnny, Y., 8525 Park Run Road, San Diego CA 92129, US  
SMITH, Nicholas, D., 1204 Beryl Street, San Diego CA 92109, US

(51) MKP  
**C07J 41/00 (2006.01)** (97) **2550288 \***  
**A61K 31/57 (2006.01)**  
**A61P 5/36 (2006.01)**  
(86) US2010062068 23.12.2010  
(96) 10807575.5 30.01.2013  
(87) WO2011119194, 23.12.2010  
(97) 2550288, 30.01.2013 en  
(54) COMPOSITIONS AND METHODS FOR NON-TOXIC DELIVERY OF ANTIPROGESTINS  
(71) Repros Therapeutics Inc., 2408 Timberloch Place, B-7, The Woodlands, TX 77380, US  
(72) PODOLSKI, Joseph, S., 3 Pebble Hollow Court, The Woodlands, TX 77381, US  
WIEHLE, Ronald, D., 13903 Viewfield Court, Houston, TX 77059, US

(51) MKP  
**B43K 24/02 (2006.01)** (97) **2563603 \***  
(86) US2011027560 08.03.2011  
(96) 11775412.7 06.03.2013  
(87) WO2011136873, 08.03.2011  
(97) 2563603, 06.03.2013 en  
(54) IMPROVED EXPANDABLE WRITING INSTRUMENT  
(71) A.T.X. International, Inc., One Albion Road Suite 200, Lincoln, Rhode Island 02865, US  
(72) GREGORY, Rebecca, 50 Benjamin Day Drive, Wrentham MA 02093, US  
REEKIE, George, 102 King Phillip Avenue, Bristol RI 02809, US  
ROBERTS, Michael, 217 East Road, Tiverton RI 02878, US  
SANTOS, Donald, 29 Simmons Street, Rehoboth MA 02769, US  
TORNGREN, Frank, 39 Slater Street, Attleboro MA 02703-5427, US

(51) MKP  
**C03B 9/34 (2006.01)** (97) **2588421 \***  
**C03B 9/325 (2006.01)**  
(86) US2011040698 16.06.2011  
(96) 11729811.7 08.05.2013  
(87) WO2012005920, 16.06.2011  
(97) 2588421, 08.05.2013 en  
(54) GLASS WINE BOTTLES AND METHOD OF MOLDING THEM  
(71) Owens-Brockway Glass Container Inc., One Michael Owens Way, Perrysburg, OH 43551, US  
(72) NEMIRE, Jerald, D., 5760 Waterville Monclova Road, Waterville, OH 43566, US

(51) MKP  
**C07K 16/18 (2006.01)** (97) **2542582 \***  
(86) US2011026489 28.02.2011  
(96) 11751147.7 09.01.2013  
(87) WO2011109298, 28.02.2011  
(97) 2542582, 09.01.2013 en  
(54) THERAPEUTIC DLL4 BINDING PROTEINS  
(71) Abbvie Inc., 1 North Waukegan Road, North Chicago, IL 60064, US  
(72) LI, Yingchun, 103 Newfield Drive, Buffalo Grove, IL 60089, US  
GU, Jijie, James, 19 Crimson Drive, Shrewsbury, MA 01545, US  
MORGAN-LAPPE, Susan, 5419 North Canfield Avenue, Chicago, IL 60656, US  
CHEN, Mingjiu, 232 Barberry Drive, Wilmington, DE 19808, US  
HSIEH, Chung-Ming, 22 Olde Field Road, Newton, MA 02459, US

(51) MKP  
**C01B 4/00 (2006.01)** (97) **2582618 \***  
**C01B 3/50 (2006.01)**  
(86) IT2011000205 16.06.2011  
(96) 11739190.4 24.04.2013  
(87) WO2011158275, 16.06.2011  
(97) 2582618, 24.04.2013 en  
(54) MEMBRANE REACTOR FOR TREATING GASES CONTAINING TRITIUM  
(71) ENEA - Agenzia Nazionale Per Le Nuove Tecnologie, L'Energia e Lo Sviluppo Economico Sostenibile, Lungotevere Thaon di Revel 76, 00196 Roma, IT  
Commissariat à l'Énergie Atomique et aux Énergies Alternatives, Bâtiment "Le Ponant D" 25, rue Leblanc, 75015 Paris, FR  
(72) TOSTI, Silvano, Via della Sorgente 6, I- 00044 Frascati (RM), IT  
GHIRELLI, Nicolas, 23 Rue C. Kaloustian Résidence Vallon Florette Bat G2, F-13013 Marseille, FR  
BORGOGNONI, Fabio, Via Montessori 13, I -60035 lesi (AN), IT  
TRABUC, Pierre, 75 Avenue des Faurys, F-13770 Venelles, FR  
SANTUCCI, Alessia, Via Casilina 13, I-00030 Colonna (RM), IT  
LIGER, Karine, 123 Rue des Cédres, F-84120 Pertuis, FR  
MARINI, Fabrizio, Via della Macchia dello Sterparo 15, I-00044 Frascati (RM), IT

(51) MKP  
**G01N 27/48 (2006.01)** (97) **2484630**  
**B82Y 30/00 (2011.01)**  
**G01N 27/12 (2006.01)**  
**G01N 33/18 (2006.01)**  
(96) 11305112.2 08.08.2012  
(97) 2484630, 08.08.2012 en  
(54) Nanosensor for capturing charged molecules by using in situ stripping voltammetry  
(71) Ecole Polytechnique, Route de Saclay, 91128 Palaiseau Cedex, FR  
Centre National de la Recherche Scientifique, 3, rue Michel Ange, 75016 Paris, FR  
COMMISSARIAT A L'ENERGIE ATOMIQUE ET AUX ENERGIES ALTERNATIVES, Bâtiment "Le Ponant D" 25, rue Leblanc, 75015 Paris, FR  
(72) Wade, Travis Lee, 4, rue Juge, 75015 Paris, FR  
Clochard, Marie-Claude Laurence, 40, avenue de la Concorde, 78500 Sartrouville, FR  
Mezailles, Nicolas, 9, 11 Chemin de Prédecelle, 91530 Saint Maurice Montcouronne, FR  
Bessbousse, Haad, 17 rue du Trésor, 91120 Palaiseau, FR

- (51) MKP  
**C07D 239/70 (2006.01)** (97) **2571857 \***  
(86) US2011036821 17.05.2011  
(96) 11784095.9 27.03.2013  
(87) WO2011146494, 17.05.2011  
(97) 2571857, 27.03.2013 en  
(54) NOVEL PROCESSES  
(71) Glaxo Group Limited, Glaxo Wellcome House Berkeley Avenue Greenford, Middlesex UB6 0NN, GB  
(72) CARDWELL, Kevin, Stuart, Gunnels Wood Road, Stevenage Hertfordshire SG1 2NY, GB  
CRAWFORD, Claire, Frances, Gunnels Wood Road, Stevenage Hertfordshire SG1 2NY, GB  
DAVIES, Suzanne, Helen, Gunnels Wood Road, Stevenage Hertfordshire SG1 2NY, GB  
WADE, Charles, Edward, Gunnels Wood Road, Stevenage Hertfordshire SG1 2NY, GB
- 
- (51) MKP  
**B01D 24/14 (2006.01)** (97) **2542318 \***  
**B01D 24/00 (2006.01)**  
(86) GB2011000305 04.03.2011  
(96) 11715010.2 09.01.2013  
(87) WO2011107748, 04.03.2011  
(97) 2542318, 09.01.2013 en  
(54) APPARATUS AND METHOD FOR DE-WATERING OF FLOCCULATED MATERIALS  
(71) Hodges, Michael Kent, 1131 Milky Way, Colorado Springs, CO 80905, US  
(72) CAMPBELL, Larry D., 2700 N. Peebly Road, Harrah, CO 73045, US  
FRY, David L., 19501 SE 59th, Newalla, OK 74857, US
- 
- (51) MKP  
**A61K 9/20 (2006.01)** (97) **2575779 \***  
**A61K 47/02 (2006.01)**  
(86) HU2011000049 27.05.2011  
(96) 11727754.1 10.04.2013  
(87) WO2011148209, 27.05.2011  
(97) 2575779, 10.04.2013 en  
(54) USE OF DIATOMACEOUS EARTH IN THE PHARMACEUTICAL INDUSTRY  
(71) Egis Gyógyszergyár Nyilvánosan Működő Részvénytársaság, Keresztúri út 30-38, 1106 Budapest, HU  
Onp Holding SE, 20B Stasicratous Str. Krambis Building, 2nd floor, 1065 Nicosia, CY  
(72) MIKULÁSIK, Endre, Kossuth Lajos u. 60., H-8924 Alsónemesapáti, HU  
ALBRECHT, Ottó, Kaffka M. u. 48., H-1148 Budapest, HU
- 
- (51) MKP  
**A61M 5/24 (2006.01)** (97) **2560706 \***  
(86) EP2011056475 21.04.2011  
(96) 11715564.8 27.02.2013  
(87) WO2011131778, 21.04.2011  
(97) 2560706, 27.02.2013 en  
(54) CARTRIDGE HOLDER AND ALIGNMENT INTERFACE  
(71) Sanofi-Aventis Deutschland GmbH, Brüningstraße 50, 65929 Frankfurt, DE  
(72) AVERY, Richard, James, Vincent, 28 Nursery Close Mickleton, Chipping Campden Gloucestershire GL55 6TX, GB  
JAMES, Aled, Meredydd, 5 Moorefield Avenue, Knowle West Midlands B93 9RE, GB
- 
- (51) MKP  
**C07K 16/22 (2006.01)** (97) **2576619 \***  
**A61K 39/395 (2006.01)**  
**A61P 21/06 (2006.01)**  
(86) EP2011059173 02.06.2011  
(96) 11726378.0 10.04.2013  
(87) WO2011151432, 02.06.2011  
(97) 2576619, 10.04.2013 en  
(54) HUMANISED ANTIGEN BINDING PROTEINS TO MYOSTATIN6  
(71) Glaxo Group Limited, Glaxo Wellcome House Berkeley Avenue Greenford, Middlesex UB6 0NN, GB  
(72) ASHMAN, Claire, GlaxoSmithKline Gunnels Wood Road, Stevenage Hertfordshire SG1 2NY, GB  
ASHMAN, Stephen, GlaxoSmithKline Gunnels Wood Road, Stevenage Hertfordshire SG1 2NY, GB  
HAMBLIN, Paul Andrew, GlaxoSmithKline Gunnels Wood Road, Stevenage Hertfordshire SG1 2NY, GB  
LEWIS, Alan Peter, GlaxoSmithKline Gunnels Wood Road, Stevenage Hertfordshire SG1 2NY, GB  
ORECCHIA, Martin, Anibal, GlaxoSmithKline Gunnels Wood Road, Stevenage Hertfordshire SG1 2NY, GB
- 
- (51) MKP  
**A61K 9/20 (2006.01)** (97) **2462925**  
**A61K 9/50 (2006.01)**  
(86) 10191101.4 13.06.2012  
(97) 2462925, 13.06.2012 en  
(54) Pramipexole Dihydrochloride Granulate  
(71) Neuraxpharm Arzneimittel GmbH, Elisabeth-Selbert-Strasse 23, 40764 Langenfeld, DE  
(72) Sewarte-Ross, Günter, Burgholzstrasse 26, 44145 Dortmund, DE
- 
- (51) MKP  
**A61K 38/47 (2006.01)** (97) **2585104 \***  
**A61P 25/28 (2006.01)**  
**A61P 25/00 (2006.01)**  
(86) US2011041926 25.06.2011  
(96) 11799037.4 01.05.2013  
(87) WO2011163650, 25.06.2011  
(97) 2585104, 01.05.2013 en  
(54) METHODS AND COMPOSITIONS FOR CNS DELIVERY OF ARYLSULFATASE A  
(71) Shire Human Genetic Therapies, Inc., 700 Main Street, Cambridge, MA 02139, US  
(72) SALAMAT-MILLER, Nazila, 80 College Avenue, Arlington MA 02474, US  
TAYLOR, Katherine, 472 Appleton Street, Arlington MA 02476, US  
CAMPOLIETO, Paul, 3595 Red Hill Road, Charlottesville VA 22903, US  
SHAHROKH, Zahra, 5 Terrace Road, Weston MA 02493, US  
PAN, Jing, 868 Depot Road, Boxborough MA 01719, US  
CHARNAS, Lawrence, 49 Mill Street, Natick MA 01760, US  
WRIGHT, Teresa Leah, 39 Earl Street, Lexington MA 02142, US  
CALIAS, Pericles, 39 Swains Pond Road, Melrose MA 02176, US
-



(51) MKP  
**A23L 1/00 (2006.01)** (97) **2594140 \***  
**A61K 8/64 (2006.01)**  
(86) ES2011070518 15.07.2011  
(96) 11767022.4 22.05.2013  
(87) WO2012007628, 15.07.2011  
(97) 2594140, 22.05.2013 en  
(54) NANOPARTICLES FOR ENCAPSULATION OF COMPOUNDS, THE PRODUCTION AND USES THEREOF  
(71) Universidad de Navarra, Avda. Pío XII, 53, 31008 Pamplona - Navarra, ES  
Centro Nacional De Tecnologia Y Seguridad Alimentaria.  
Laboratorio Dei Ebro, Carretera NA-134, km. 50, 31570 San Adrián, Navarra, ES  
(72) AGÜEROS BAZO, Maite, ICT (D.P.I.) Avda. Pío XII 53, E-31008 Pamplona - Navarra, ES  
ESPARZA CATALÁN, Irene, ICT (D.P.I.) Avda. Pío XII 53, E-31008 Pamplona - Navarra, ES  
GONZÁLEZ FERRERO, Carolina, CNTA Ctra. NA - 134 Km 50, E-31570 San Adrián - Navarra, ES  
GONZÁLEZ NAVARRO, Carlos Javier, CNTA Ctra. NA - 134 Km 50, E-31570 San Adrián - Navarra, ES  
IRACHE GARRETA, Juan Manuel, ICT (D.P.I.) Avda. Pío XII 53, E-31008 Pamplona - Navarra, ES  
ROMO HUALDE, Ana, CNTA Ctra. NA - 134 Km 50, E-31570 San Adrián - Navarra, ES

(51) MKP  
**E06B 3/263 (2006.01)** (97) **2572068 \***  
**E06B 3/30 (2006.01)**  
(86) HR2011000016 18.04.2011  
(96) 11726167.7 27.03.2013  
(87) WO2011144952, 18.04.2011  
(97) 2572068, 27.03.2013 en  
(54) EXTERNAL LAYER OF COMPOUND FRAMES FOR WINDOWS AND DOORS DESCRIPTION OF THE INVENTION  
(71) Troha-dil D.o.o., Gudovacka cesta 85, 43000 Bjelovar, HR  
(72) KLASAN, Dinko, Gudovacka cesta 85, 43000 Bjelovar, HR

(51) MKP  
**C12N 15/00 (2006.01)** (97) **2550359 \***  
(86) US2011029682 23.03.2011  
(96) 11760175.7 30.01.2013  
(87) WO2011119773, 23.03.2011  
(97) 2550359, 30.01.2013 en  
(54) VECTORS CONDITIONALLY EXPRESSING THERAPEUTIC PROTEINS, HOST CELLS COMPRISING THE VECTORS, AND USES THEREOF  
(71) Intrexon Corporation, 1750 Kraft Drive, Suite 1400, Blacksburg, VA 24060, US  
(72) ROETH, Jeremiah F., 3915 Englewood Ct., Blacksburg, Virginia 24060, US  
REED, Charles C., 134 Skippack Creek Road, Souderton, Pennsylvania 18964, US  
CUTHBERTSON, Brandon, 374 Parkway Trails Circle, Newland, Connecticut 28657, US  
CHADA, Sunil, 4007 Waterview Court, Missouri City, Texas 77459, US  
FOGLER, William E., 3 Halifax Court, Rockville, Maryland 20850, US

(51) MKP  
**H01R 24/58 (2011.01)** (97) **2580824 \***  
(86) US2011039870 09.06.2011  
(96) 11793200.4 17.04.2013  
(87) WO2011156653, 09.06.2011  
(97) 2580824, 17.04.2013 en  
(54) FLEXIBLE TRS CONNECTOR  
(71) Apple Inc., 1 Infinite Loop, MS 169-3IPL, Cupertino, CA 95014, US  
(72) GOLKO, Albert, 1 Infinite Loop, MS 305-1DR, Cupertino, CA 95014, US  
SCHMIDT, Mathias, 1 Infinite Loop, MS 305-1DR, Cupertino, CA 95014, US  
JOL, Eric, 1 Infinite Loop, MS 305-1DR, Cupertino, CA 95014, US  
SPRAGGS, Ian, 1 Infinite Loop, MS 305-1DR, Cupertino, CA 95014, US

(51) MKP  
**B65D 33/16 (2006.01)** (97) **2468651**  
(96) 11195147.1 27.06.2012  
(97) 2468651, 27.06.2012 de  
(54) Clip fastener  
(71) Schnyder, Viktor, Steinmattenstrasse 21, 3942 Raron, CH  
(72) Schnyder, Viktor, Steinmattenstrasse 21, 3942 Raron, CH

(51) MKP  
**B60H 1/00 (2006.01)** (97) **2450204**  
(96) 11187771.8 09.05.2012  
(97) 2450204, 09.05.2012 de  
(54) Air conditioning for a motor vehicle  
(71) Behr GmbH & Co. KG, Mauserstr. 3, 70469 Stuttgart, DE  
(72) Schall, Matthias, Scharnhäuser Str. 18/1, 73760 Ostfildern-Ruit, DE  
Raimann, Joachim, Schillerstraße 20, 70825 Korntal-Münchingen, DE  
Bopp, Alexander, Falkenstraße 41, 75428 Illingen, DE

(51) MKP  
**B22D 41/02 (2006.01)** (97) **2560776 \***  
(86) CA2011000393 13.04.2011  
(96) 11771430.3 27.02.2013  
(87) WO2011130825, 13.04.2011  
(97) 2560776, 27.02.2013 en  
(54) MOLTEN METAL LEAKAGE CONFINEMENT AND THERMAL OPTIMIZATION IN VESSELS USED FOR CONTAINING MOLTEN METALS  
(71) Novelis Inc., 191 Evans Avenue, Toronto, ON M8Z 1J5, CA  
(72) REEVES, Eric W., 1171 Felton Drive, Walkinsville, Georgia, 30677, US  
BOORMAN, James, 2207 N. Flora, Greenacres Washington 99016, US  
WAGSTAFF, Robert Bruce, P.O. Box 891, Greenacres Washington 99016-0891, US  
WOMACK, Randal Guy, P.O. Box 96, Spokane Valley Washington 99037, US

(51) MKP  
**A61K 47/48 (2006.01)** (97) **2552411 \***  
**A61K 39/395 (2006.01)**  
**A61K 9/08 (2006.01)**  
**A61K 47/22 (2006.01)**  
(86) IB2011051372 31.03.2011  
(96) 11715753.7 06.02.2013  
(87) WO2011121559, 31.03.2011  
(97) 2552411, 06.02.2013 en  
(54) STABILIZED ANTIBODY PREPARATIONS AND USES THEREOF  
(71) Université de Genève, 24 rue du Général-Dufour, 1211 Genève 4, CH  
(72) GURNY, Robert, 7 rue Calvin, CH-1204 Geneva, CH  
SCAPOZZA, Leonardo, Chemin Pré Marétan 4, CH-1274 Grens, CH  
WESTERMAIER, Yvonne, Via Vitgé 10, CH-7017 Flims, CH  
VEURINK, Marieke, Rue St-Léger 5, CH-1205 Geneva, CH

(51) MKP  
**A61L 9/12 (2006.01)** (97) **2564877**  
(96) 12176492.2 06.03.2013  
(97) 2564877, 06.03.2013 en  
(54) An improvement of a deodorant device that gradually releases fragrance  
(71) Artoni, Simone, Via Pratissoli n. 11, 42015 Correggio (RE), IT  
(72) Artoni, Simone, Via Pratissoli n. 11, 42015 Correggio (RE), IT

- (51) MKP  
**C12Q 1/68 (2006.01)** (97) **2591126 \***  
**C12N 15/11 (2006.01)**
- (86) US2011043228 07.07.2011  
(96) 11804357.9 15.05.2013  
(87) WO2012006447, 07.07.2011  
(97) 2591126, 15.05.2013 en  
(54) GENE SIGNATURES FOR CANCER PROGNOSIS  
(71) Myriad Genetics, Inc., 320 Wakara Way, Salt Lake City, UT 84108, US  
Stone, Steve, 320 Wakara Way, Salt Lake City, UT 84108, US  
Gutin, Alexander, 320 Wakara Way, Salt Lake City, Utah 84108, US  
Wagner, Susanne, 320 Wakara Way, Salt Lake City, UT 84108, US  
Reid, Julia E., 320 Wakara Way, Salt Lake City, UT 84108, US  
(72) STONE, Steve, 320 Wakara Way, Salt Lake City Utah 84108, US  
GUTIN, Alexander, 320 Wakara Way, Salt Lake City Utah 84108, US  
WAGNER, Susanne, 320 Wakara Way, Salt Lake City Utah 84108, US  
REID, Julia, 320 Wakara Way, Salt Lake City Utah 84108, US
- 
- (51) MKP  
**C09D 5/14 (2006.01)** (97) **2545126 \***  
**A61L 27/54 (2006.01)**  
**A61L 27/34 (2006.01)**
- (86) US2011027122 04.03.2011  
(96) 11712714.2 16.01.2013  
(87) WO2011112430, 04.03.2011  
(97) 2545126, 16.01.2013 en  
(54) COATING WITH ANTIMICROBIAL AGENTS  
(71) Mentor Worldwide LLC, 5425 Hollister Avenue, Santa Barbara, CA 93111, US  
(72) BERG, Eric, P., 940 Spring Creek Drive, Grapevine TX 76051, US  
STELLA, Rita, 70 Jeavons Lane Cambourne, Cambridgeshire CB236AG, GB
- 
- (51) MKP  
**B64C 3/14 (2006.01)** (97) **2567891 \***
- (86) RU2011000744 29.09.2011  
(96) 11838305.8 13.03.2013  
(87) WO2012060735, 29.09.2011  
(97) 2567891, 13.03.2013 en  
(54) METHOD FOR FORMING LIFTING FORCE FOR AN AIRCRAFT AND WING PROFILE FOR REALIZING SAID METHOD (ALTERNATIVES)  
(71) Totorkulov, Aliy Khasanovich, Ul. Odesskaya 22, korp.1, kv 142, 117303 Moscow, RU  
Baziev, Dzhabrail Kharunovich, Ul. Nakhusheva 91-43, Nalchik 360051, RU  
(72) BAZIEV, Dzhabrail Kharunovich, Ul. Nakhusheva 91-43, NALCHIK 360051, RU
- 
- (51) MKP  
**G01N 33/74 (2006.01)** (97) **2542898 \***
- (86) EP2011000047 07.01.2011  
(96) 11700114.9 09.01.2013  
(87) WO2011083089, 07.01.2011  
(97) 2542898, 09.01.2013 en  
(54) PROGASTRIN AND LIVER PATHOLOGIES  
(71) Bioréalités S.A.S., 2040 Avenue du Père Soulas, 34090 Montpellier, FR  
(72) FLOCH, Jean-François, 10 rue Gabriel Péri, F-34200 Sète, FR  
HOUHOU, Leïla, 2 rue Renaud de Villeneuve, F-34090 Montpellier, FR
- 
- (51) MKP  
**A61K 31/495 (2006.01)** (97) **2582372 \***  
**A61P 9/00 (2006.01)**
- (86) US2011040363 14.06.2011  
(96) 11726037.2 24.04.2013  
(87) WO2011159706, 14.06.2011  
(97) 2582372, 24.04.2013 en  
(54) RANOLAZINE FOR USE FOR THE TREATMENT OF PULMONARY HYPERTENSION  
(71) Gilead Sciences, Inc., 333 Lakeside Drive, Foster City, CA 94404, US  
(72) BELARDINELLI, Luiz, 205 Manzanita Ave., Palo Alto, California 94304, US
- 
- (51) MKP  
**B42F 13/26 (2006.01)** (97) **2539159 \***  
**B42F 13/24 (2006.01)**
- (86) EP2011052751 24.02.2011  
(96) 11706210.9 02.01.2013  
(87) WO2011104305, 24.02.2011  
(97) 2539159, 02.01.2013 de  
(54) FILE MECHANISM  
(71) Biella-Neher Holding AG, Erlenstrasse 44, 2555 Brügg, CH  
(72) HORN, Hans Johann, Junkergasse 53, CH-3011 Bern, CH  
MICHEL, Thomas, Ottokerstrasse 31, CH-8006 Zürich, CH
- 
- (51) MKP  
**A61K 38/17 (2006.01)** (97) **2547354 \***
- (86) EP2011053863 15.03.2011  
(96) 11711292.0 23.01.2013  
(87) WO2011113819, 15.03.2011  
(97) 2547354, 23.01.2013 en  
(54) NOVEL IMMUNOTHERAPY AGAINST SEVERAL TUMORS INCLUDING GASTROINTESTINAL AND GASTRIC CANCER  
(71) Immatix Biotechnologies GmbH, Paul-Ehrlich-Strasse 15, 72076 Tübingen, DE  
(72) WEINSCHENK, Toni, Im Morgenrain 15, 73773 Aichwald, DE  
FRITSCHKE, Jens, Im Schoenblick 48, 72076 Tuebingen, DE  
WALTER, Steffen, Steinenbergstrasse 2, 72764 Reutlingen, DE  
LEWANDROWSKI, Peter, Burgstrasse 14, 72070 Tuebingen-Hirschau, DE  
SINGH, Harpreet, Bei den Pferdestaellen 9, 72072 Tuebingen, DE
- 
- (51) MKP  
**A61B 5/103 (2006.01)** (97) **2590558 \***  
**A61B 5/117 (2006.01)**  
**A61B 5/05 (2006.01)**
- (86) US2011043237 07.07.2011  
(96) 11804361.1 15.05.2013  
(87) WO2012006454, 07.07.2011  
(97) 2590558, 15.05.2013 en  
(54) A DEVICE AND METHOD FOR CONTINUOUS CHEMICAL SENSING  
(71) Therasyn Sensors, Inc., 100 Crosby Boulevard, Amherst, NY 14226, US  
(72) SCHENTAG, Jerome, J., 100 Crosby Blvd., Eggertsville NY 14226, US  
BRIGHT, Dr., Frank, V., 108 Fleetwood Terrace, Williamsville NY 14221, US  
D'ANDREA, David, T., 1795 North French Rd, Getzville NY 14068, US
-

(51) MKP  
**A61P 31/14 (2006.01)** (97) **2576534 \***  
**C07D 309/10 (2006.01)**  
**A61K 31/40 (2006.01)**  
(86) US2011038253 26.05.2011  
(96) 11725838.4 10.04.2013  
(87) WO2011150288, 26.05.2011  
(97) 2576534, 10.04.2013 en  
(54) 1'-SUBSTITUTED-CARBA-NUCLEOSIDE PRODRUGS FOR ANTIVIRAL TREATMENT  
(71) Gilead Sciences, Inc., 333 Lakeside Drive, Foster City, CA 94404, US  
(72) CHO, Aesop, 1656 Notre Dame Drive, Mountain View CA 94040, US  
KIM, Choung, U., 1750 Elizabeth Street, San Carlos CA 94070, US  
RAY, Adrian, S., 19 Pilot Circle, Redwood City CA 94065, US  
ZHANG, Lijun, 12525 Minorca Court, Los Altos Hills CA 94022, US

(51) MKP  
**A61P 25/24 (2006.01)** (97) **2585074 \***  
**A61P 25/18 (2006.01)**  
**A61P 25/22 (2006.01)**  
**A61K 31/565 (2006.01)**  
(86) HU2011000060 28.06.2011  
(96) 11754912.1 01.05.2013  
(87) WO2011161484, 28.06.2011  
(97) 2585074, 01.05.2013 en  
(54) USE OF AN ESTROGEN DERIVATIVE FOR THE MANUFACTURE OF PHARMACEUTICAL COMPOSITIONS USEFUL FOR THE TREATMENT AND/OR PREVENTION OF PSYCHIATRIC DISEASES AND FOR THE TREATMENT AND PREVENTION OF SAID DISEASES  
(71) "Avidin" Kutató, Fejlesztő és Kereskedelmi Korlátolt Felelősségű Társaság, Alsókikötő sor 11, Szeged, HU  
Ubichem Kutató Korlátolt Felelősségű Társaság, Illatos út 33., 1097 Budapest, HU  
Hajszán, Tibor, Tarján széle u. 5/b. 3/9, 6723 Szeged, HU  
(72) HAJSZÁN, Tibor, Tarján széle u. 5/b. 3/9, H-6723 Szeged, HU  
PUSKÁS, László, Mágdolna u. 17., H-6726 Szeged, HU  
ÓZSVÁRI, Béla, Vedres utca 14/B, 9/26., H-6726 Szeged, HU  
NAGY, Lajos, István, Móra Ferenc tér 13.2/8., H-6100 Kiskunfélegyháza, HU

(51) MKP  
**A61P 25/28 (2006.01)** (97) **2585105 \***  
**A61P 25/00 (2006.01)**  
**A61K 38/47 (2006.01)**  
(86) US2011041928 25.06.2011  
(96) 11799039.0 01.05.2013  
(87) WO2011163652, 25.06.2011  
(97) 2585105, 01.05.2013 en  
(54) TREATMENT OF SANFILIPPO SYNDROME TYPE B  
(71) Shire Human Genetic Therapies, Inc., 700 Main Street, Cambridge, MA 02139, US  
(72) CONCINO, Michael, F., 297 Long Hill Road, Bolton MA 01740, US  
CALIAS, Pericles, 39 Swains Pond Avenue, Melrose MA 02176, US  
PAN, Jing, 868 Depot Road, Boxborough MA 01719, US  
HOLMES, Kevin, 16 Upland Road, Belmont MA 02478, US  
MARTINI, Paolo, 662 Massachusetts Avenue, 3, Boston MA 02118, US  
ROMASHKO, Alla, 81 Fottler Avenue, Lexington MA 02420, US  
MEIYAPPAN, Muthuraman, 804 Centre Street, 207, Jamaica Plain MA 02130, US  
ZHANG, Bohong, 155 Washington Avenue, Newton MA 02465, US  
ISKENDERIAN, Andrea, 49 Rockland Avenue, Arlington MA 02474, US  
LUNDBERG, Dianna, 110 Deerhill Road, Brentwood NH 03833, US  
NORTON, Angela, 203 Haverhill Street, Reading MA 01867, US  
STRACK-LOGUE, Bettina, 26 Endicott Avenue, Somerville MA 02144, US  
HUANG, Yan, 9 Arborwood Road, Billerica MA 01821, US  
ALESSANDRINI, Mary, 200 Main Street, Clinton MA 01510, US  
PFEIFER, Richard, 243 Silver Street, North Granby CT 06060, US

(51) MKP  
**A61P 7/04 (2006.01)** (97) **2563402 \***  
**A61K 38/37 (2006.01)**  
**A61K 47/48 (2006.01)**  
(86) GB2011000662 28.04.2011  
(96) 11719040.5 06.03.2013  
(87) WO2011135307, 28.04.2011  
(97) 2563402, 06.03.2013 en  
(54) CONJUGATED BLOOD COAGULATION FACTOR VIII  
(71) Cantab Biopharmaceuticals Patents Limited, Palazzo Pietro Stiges 103 Strait Street, Valletta VLT 1436, MT  
(72) HENRY, William, Cantab Biopharmaceuticals Limited 155 Cambridge Science Park Milton Road, Cambridge CB4 0GN, GB

- (51) MKP  
**A61P 25/24 (2006.01)** (97) **2565194 \***  
**A61P 25/18 (2006.01)**  
**C07D 471/04 (2006.01)**  
**C07D 495/14 (2006.01)**  
**A61K 31/4545 (2006.01)**  
**A61P 25/28 (2006.01)**  
**A61K 31/437 (2006.01)**  
**C07D 519/00 (2006.01)**  
**A61K 31/438 (2006.01)**  
**A61P 43/00 (2006.01)**
- (86) JP2011060098 26.04.2011  
(96) 11774973.9 06.03.2013  
(87) WO2011136192, 26.04.2011  
(97) 2565194, 06.03.2013 en  
(54) IMIDAZO[1,2-a]PYRIDINE DERIVATIVE  
(71) Astellas Pharma Inc., 3-11, Nihonbashi-Honcho 2-chome Chuo-ku, Tokyo 103-8411, JP  
(72) SAMIZU, Kiyohiro, c/o Astellas Pharma Inc. 3-11 Nihonbashi-Honcho 2-chome Chuo-ku, Tokyo 103-8411, JP  
MASUDA, Naoyuki, c/o Astellas Pharma Inc. 3-11 Nihonbashi-Honcho 2-chome Chuo-ku, Tokyo 103-8411, JP  
IKKUBO, Kazuhiko, c/o Astellas Pharma Inc. 3-11 Nihonbashi-Honcho 2-chome Chuo-ku, Tokyo 103-8411, JP  
KOGANEMARU, Yohei, c/o Astellas Pharma Inc. 3-11 Nihonbashi-Honcho 2-chome Chuo-ku, Tokyo 103-8411, JP  
KAWANO, Noriyuki, c/o Astellas Research Technology Co. Ltd. 21 Miyukigaoka, Tsukuba-shi Ibaraki 305-8585, JP  
OHMORI, Junya, c/o Astellas Pharma Inc. 3-11 Nihonbashi-Honcho 2-chome Chuo-ku, Tokyo 103-8411, JP  
MITANI, Yasuyuki, c/o Astellas Pharma Inc. 3-11 Nihonbashi-Honcho 2-chome Chuo-ku, Tokyo 103-8411, JP  
NI, Keni, c/o Astellas Pharma Inc. 3-11 Nihonbashi-Honcho 2-chome Chuo-ku, Tokyo 103-8411, JP
- 
- (51) MKP  
**C07H 19/06 (2006.01)** (97) **2552930 \***  
**C07F 9/6561 (2006.01)**  
**A61P 31/14 (2006.01)**  
**C07H 19/10 (2006.01)**  
**C07F 9/26 (2006.01)**  
**C07H 19/052 (2006.01)**  
**C07H 19/207 (2006.01)**  
**C07H 19/04 (2006.01)**  
**C07F 9/6558 (2006.01)**  
**A61K 31/7056 (2006.01)**  
**C07F 9/655 (2006.01)**  
**A61K 31/664 (2006.01)**  
**A61K 31/7072 (2006.01)**  
**C07H 19/044 (2006.01)**  
**C07F 9/24 (2006.01)**  
**C07H 19/24 (2006.01)**
- (86) US2011030725 31.03.2011  
(96) 11714465.9 06.02.2013  
(87) WO2011123645, 31.03.2011  
(97) 2552930, 06.02.2013 en  
(54) NUCLEOSIDE PHOSPHORAMIDATES  
(71) Gilead Pharmasset LLC, Gilead Sciences, Inc. 333 Lakeside Drive, Foster City, CA 94404, US  
(72) ROSS, Bruce, S., 155 Del Monte Road, El Granada, CA 94018, US  
SOFIA, Michael, Joseph, 3066 Antler Drive, Doylestown, PA 18902, US  
PAMULAPATI, Ganapati, Reddy, 1709 Blakesley Drive, San Ramon, CA 94582, US  
RACHAKONDA, Suguna, 1272 Sharonbrook Drive, Twinsburg, OH 44087, US  
ZHANG, Hai-Ren, 6767 Mason Way, San Jose, CA 95129, US  
CHUN, Byoung-Kwon, 135 Heritage Street, Robbinsville, NJ 08691, US  
WANG, Peiyuan, 42 Continental Circle, Totowa, NJ 07512, US
- 
- (51) MKP  
**B23Q 1/01 (2006.01)** (97) **2560786 \***  
**B23K 26/08 (2006.01)**  
**B23K 37/02 (2006.01)**  
**B23K 26/10 (2006.01)**
- (86) PL2010000029 20.04.2010  
(96) 10732482.4 27.02.2013  
(87) WO2011133050, 20.04.2010  
(97) 2560786, 27.02.2013 en  
(54) METHOD AND DEVICE FOR CUTTING OPENINGS IN FLAT, CONCAVE OR CONVEX SURFACES  
(71) Promotech Sp. Z.o.o., Ul. Elewatorska 23/1, 15-620 Bialystok, PL  
(72) GOLABIEWSKI, Zbigniew, ul. Norweska 22, PL-15-613 Bialystok, PL  
FEDYK, Krzysztof, ul. Bociania 5, PL-15-533 Bialystok, PL  
FEDYK, Marcin, ul. Bociania 5, PL-15-533 Bialystok, PL  
BORCHERT, Marcin, ul. 1 Maja 1, PL-19-335 Prostki, PL
- 
- (51) MKP  
**C07C 291/10 (2006.01)** (97) **2539334 \***  
**C07C 231/14 (2006.01)**  
**C07C 233/31 (2006.01)**  
**C07C 235/14 (2006.01)**  
**C07D 403/12 (2006.01)**  
**C07C 237/04 (2006.01)**
- (86) EP2010063657 16.09.2010  
(96) 10755148.3 02.01.2013  
(87) WO2011103933, 16.09.2010  
(97) 2539334, 02.01.2013 en  
(54) PROCESS FOR THE PREPARATION OF -ACYLOXY -FORMAMIDO AMIDES  
(71) Vereniging Voor Christelijk Hoger Onderwijs, Wetenschappelijk Onderzoek En Patiëntenzorg, De Boelelaan 1105, 1081 HV Amsterdam, NL  
(72) RUIJTER, Eelco, Klaproosweide 52, NL-3448JH Woerden, NL  
ORRU, Romano, Saturnusstraat 6, NL-2024 GJ Haarlem, NL  
ZNABET, Anass, Burgemeester van de Pollstraat 126-II, NL-1064 AZ Amsterdam, NL  
POLAK, Marloes, Kroeskarperlaan 45, NL-2215 XN Voorhout, NL  
TURNER, Nicholas, 35 Old Broadway, Manchester Greater Manchester M20 3DN, GB
- 
- (51) MKP  
**A61K 47/00 (2006.01)** (97) **2544721 \***  
**A61K 48/00 (2006.01)**
- (86) US2011027677 09.03.2011  
(96) 11753982.5 16.01.2013  
(87) WO2011112669, 09.03.2011  
(97) 2544721, 16.01.2013 en  
(54) NON-AQUEOUS HIGH CONCENTRATION REDUCED VISCOSITY SUSPENSION FORMULATIONS  
(71) Janssen Biotech, Inc., 800/850 Ridgeview Drive, Horsham, PA 19044, US  
(72) HILL, Beth, 6500 Paseo Padre Parkway, Fremont, CA 94555, US  
DAI, Weiguo, 145 King Of Prussia Road, Radnor, PA 19087, US
- 
- (51) MKP  
**C40B 40/06 (2006.01)** (97) **2569450 \***  
**C40B 30/04 (2006.01)**  
**C12Q 1/68 (2006.01)**
- (86) US2011036430 13.05.2011  
(96) 11781345.1 20.03.2013  
(87) WO2011143553, 13.05.2011  
(97) 2569450, 20.03.2013 en  
(54) COMPOSITIONS AND METHODS FOR TARGETING A3G:RNA COMPLEXES  
(71) University of Rochester, 601 Elmwood Avenue, Box OTT, Rochester, NY 14642, US  
(72) SMITH, Harold, C., 1056 Farnsworth Road, South, Rochester, NY 14623, US  
PROHASKA, Kimberly, 17 Cottage Grove Circle, Rochester, NY 14514, US  
MCDOUGALL, William, M., 52 Raleigh Street, Rochester, NY 14620, US

**INDEKS BROJEVA ZAHTJEVA ZA PROŠIRENJE EVROPSKIH PRIJAVA  
PATENTA  
INDEX ON NUMBER OF REQUESTS FOR EXTENSION ON EUROPEAN PATENT  
APPLICATIONS**

Broj objave evropske prijave patenta (97)	MKP (51)	Broj objave evropske prijave patenta (97)	MKP (51)	Broj objave evropske prijave patenta (97)	MKP (51)
2579900 *	<b>C12N 9/16</b> (2006.01) <b>C12N 15/67</b> (2006.01) <b>C12N 9/14</b> (2006.01) <b>A61K 48/00</b> (2006.01) <b>C12N 15/68</b> (2006.01) <b>C12N 15/864</b> (2006.01)	2561104 *	<b>C12Q 1/70</b> (2006.01)	2585079 *	<b>A61P 7/02</b> (2006.01) <b>A61K 31/727</b> (2006.01)
		2579923 *	<b>A61M 5/315</b> (2006.01) <b>A61M 5/24</b> (2006.01)	2592054	<b>C02F 1/52</b> (2006.01)
		2563757 *	<b>C07C 215/60</b> (2006.01)	2552480 *	<b>A61P 31/18</b> (2006.01) <b>A61K 39/21</b> (2006.01)
2591673 *	<b>A01N 47/36</b> (2006.01) <b>C07D 417/06</b> (2006.01) <b>C07D 277/20</b> (2006.01) <b>A01N 47/18</b> (2006.01) <b>A01P 7/02</b> (2006.01) <b>C07D 401/14</b> (2006.01) <b>C07D 277/32</b> (2006.01) <b>A01P 7/04</b> (2006.01) <b>A01N 43/78</b> (2006.01) <b>C07D 401/04</b> (2006.01) <b>A01P 5/00</b> (2006.01) <b>C07D 417/14</b> (2006.01)	2576767 *	<b>C12N 5/077</b> (2010.01) <b>C12N 5/073</b> (2010.01)	2580224 *	<b>C07F 17/02</b> (2006.01)
		2564849 *	<b>A61P 13/08</b> (2006.01) <b>A61P 13/10</b> (2006.01) <b>C07D 401/14</b> (2006.01) <b>A61K 31/496</b> (2006.01) <b>C07D 213/65</b> (2006.01) <b>A61K 31/4545</b> (2006.01) <b>A61P 43/00</b> (2006.01) <b>A61P 13/00</b> (2006.01) <b>C07D 213/80</b> (2006.01) <b>A61P 29/00</b> (2006.01) <b>A61P 25/04</b> (2006.01) <b>A61P 19/00</b> (2006.01) <b>C07D 413/14</b> (2006.01) <b>C07D 401/12</b> (2006.01)	2538996 *	<b>A61M 5/20</b> (2006.01)
				2539642 *	<b>F24F 12/00</b> (2006.01) <b>E06B 7/10</b> (2006.01) <b>F24F 13/18</b> (2006.01) <b>F24F 11/00</b> (2006.01)
2552201 *	<b>A01N 43/00</b> (2006.01) <b>A61P 33/00</b> (2006.01)			2563765 *	<b>C07D 413/04</b> (2006.01) <b>A61P 3/00</b> (2006.01) <b>C07D 231/54</b> (2006.01) <b>A61K 31/416</b> (2006.01) <b>C07D 487/08</b> (2006.01) <b>C07D 263/56</b> (2006.01) <b>A61K 31/496</b> (2006.01) <b>C07D 417/04</b> (2006.01) <b>A61P 9/00</b> (2006.01) <b>C07D 307/81</b> (2006.01) <b>A61K 31/4365</b> (2006.01) <b>C07D 263/58</b> (2006.01) <b>A61K 31/4355</b> (2006.01) <b>C07D 498/04</b> (2006.01)
2593144 *	<b>A61L 2/00</b> (2006.01)	2593124 *	<b>A61K 38/10</b> (2006.01) <b>A61K 38/08</b> (2006.01) <b>A61P 3/00</b> (2006.01) <b>A61P 35/00</b> (2006.01) <b>A61K 38/16</b> (2006.01) <b>A61K 39/395</b> (2006.01) <b>A61P 3/10</b> (2006.01)		
2593696 *	<b>F16H 48/30</b> (2012.01)				
2489491	<b>B29C 45/00</b> (2006.01) <b>B29L 31/04</b> (2006.01) <b>B29C 45/04</b> (2006.01) <b>B29C 45/56</b> (2006.01)				

Broj objave evropske prijave patenta (97)	MKP (51)	Broj objave evropske prijave patenta (97)	MKP (51)	Broj objave evropske prijave patenta (97)	MKP (51)
2576697 *	<b>C09J 189/00</b> (2006.01) <b>C08L 97/02</b> (2006.01) <b>C08L 79/02</b> (2006.01) <b>C08L 89/00</b> (2006.01)	2571900 *	<b>A61K 31/00</b> (2006.01) <b>C07K 14/56</b> (2006.01) <b>A61K 38/21</b> (2006.01) <b>A61K 38/26</b> (2006.01) <b>C07K 14/575</b> (2006.01) <b>C07K 16/18</b> (2006.01) <b>C07K 16/28</b> (2006.01) <b>A61K 47/48</b> (2006.01)	2559477	<b>B01D 63/04</b> (2006.01) <b>B01D 65/00</b> (2006.01)
2594555 *	<b>A61K 31/437</b> (2006.01) <b>A61K 31/498</b> (2006.01) <b>C07D 231/40</b> (2006.01) <b>C07D 277/20</b> (2006.01) <b>A61K 31/4178</b> (2006.01) <b>A61P 29/00</b> (2006.01) <b>C07D 405/14</b> (2006.01) <b>A61K 31/341</b> (2006.01) <b>A61K 31/55</b> (2006.01) <b>C07D 307/68</b> (2006.01) <b>A61K 31/427</b> (2006.01) <b>A61P 43/00</b> (2006.01) <b>C07D 207/34</b> (2006.01) <b>A61K 31/5383</b> (2006.01) <b>C07D 277/42</b> (2006.01) <b>A61K 31/426</b> (2006.01) <b>A61P 35/00</b> (2006.01) <b>A61K 31/415</b> (2006.01) <b>A61P 3/10</b> (2006.01) <b>C07D 403/12</b> (2006.01)	2550296 *	<b>C07K 16/30</b> (2006.01)	2563382 *	<b>A61K 38/17</b> (2006.01) <b>A61K 38/16</b> (2006.01) <b>A61K 39/395</b> (2006.01) <b>A61P 29/00</b> (2006.01) <b>A61P 3/00</b> (2006.01) <b>A61P 35/00</b> (2006.01)
		2560530 *	<b>A47K 5/12</b> (2006.01)	2550613 *	<b>G06F 19/00</b> (2011.01)
		2585440 *	<b>A61K 31/495</b> (2006.01) <b>C07D 403/10</b> (2006.01) <b>C07D 401/12</b> (2006.01) <b>C07D 241/08</b> (2006.01) <b>A61P 25/28</b> (2006.01) <b>C07D 401/10</b> (2006.01)	2455120	<b>A61M 5/178</b> (2006.01) <b>H02K 7/18</b> (2006.01) <b>H02K 35/00</b> (2006.01)
		2569276 *	<b>C07C 271/20</b> (2006.01) <b>C07C 237/06</b> (2006.01) <b>C12N 15/11</b> (2006.01) <b>C07D 249/04</b> (2006.01) <b>C07C 229/30</b> (2006.01) <b>C12N 15/88</b> (2006.01) <b>A61K 48/00</b> (2006.01) <b>C07D 233/60</b> (2006.01) <b>C07C 217/08</b> (2006.01) <b>C07C 327/06</b> (2006.01) <b>C07C 217/46</b> (2006.01) <b>A61K 49/04</b> (2006.01) <b>C07C 229/12</b> (2006.01) <b>A61K 47/48</b> (2006.01)	2426300	<b>E05F 3/10</b> (2006.01)
				2569336 *	<b>A61K 39/395</b> (2006.01) <b>A61K 45/06</b> (2006.01) <b>A61P 35/00</b> (2006.01) <b>C12Q 1/68</b> (2006.01) <b>C07K 16/28</b> (2006.01)
2566854 *	<b>A61P 3/10</b> (2006.01) <b>A61K 31/4164</b> (2006.01) <b>C07D 233/22</b> (2006.01) <b>A61K 31/421</b> (2006.01) <b>C07D 263/16</b> (2006.01) <b>C07D 263/14</b> (2006.01) <b>C07D 231/14</b> (2006.01) <b>A61P 31/12</b> (2006.01)			2542220 *	<b>A61K 9/28</b> (2006.01) <b>A61K 31/275</b> (2006.01) <b>A61K 45/06</b> (2006.01) <b>A61K 9/00</b> (2006.01) <b>A61K 31/198</b> (2006.01) <b>A61P 25/16</b> (2006.01) <b>A61K 9/20</b> (2006.01)
		2591835 *	<b>A63G 27/00</b> (2006.01)	2582813 *	<b>C40B 30/06</b> (2006.01) <b>C12N 15/62</b> (2006.01) <b>C12N 15/10</b> (2006.01)

Broj objave evropske prijave patenta (97)	MKP (51)	Broj objave evropske prijave patenta (97)	MKP (51)	Broj objave evropske prijave patenta (97)	MKP (51)
2552521 *	<b>A61M 5/34</b> (2006.01) <b>A61M 5/31</b> (2006.01) <b>A61M 5/00</b> (2006.01)	2567700 *	<b>A61K 31/197</b> (2006.01) <b>A61K 31/714</b> (2006.01) <b>A61K 31/198</b> (2006.01) <b>A61K 33/06</b> (2006.01) <b>A61K 9/08</b> (2006.01) <b>A61K 31/525</b> (2006.01) <b>A61K 31/4188</b> (2006.01) <b>A61K 33/30</b> (2006.01) <b>A61K 31/4415</b> (2006.01) <b>A61K 47/12</b> (2006.01) <b>A61K 31/51</b> (2006.01) <b>A61K 31/455</b> (2006.01) <b>A61P 7/00</b> (2006.01) <b>A61K 31/19</b> (2006.01) <b>A61K 31/7004</b> (2006.01) <b>A61K 31/375</b> (2006.01) <b>A61K 33/20</b> (2006.01)	2568695 *	<b>H04M 9/08</b> (2006.01)
2569013 *	<b>A61K 39/395</b> (2006.01) <b>C12P 21/08</b> (2006.01) <b>C12N 5/07</b> (2010.01) <b>C12N 5/16</b> (2006.01)	2555703 *	<b>G06F 3/01</b> (2006.01) <b>A61B 5/11</b> (2006.01) <b>A61B 3/113</b> (2006.01) <b>A61B 19/00</b> (2006.01)	2556325 *	<b>F41H 11/02</b> (2006.01) <b>F41H 13/00</b> (2006.01)
2560707 *	<b>A61M 5/24</b> (2006.01)	2585051 *	<b>A61K 31/4422</b> (2006.01) <b>A61K 9/20</b> (2006.01) <b>A61K 31/401</b> (2006.01)		
2576637 *	<b>D21H 21/14</b> (2006.01) <b>D21H 17/35</b> (2006.01) <b>C08F 10/10</b> (2006.01) <b>C08F 10/08</b> (2006.01)	2585379 *	<b>B65D 19/24</b> (2006.01) <b>B65D 19/28</b> (2006.01) <b>B21D 9/05</b> (2006.01)		
2579824 *	<b>A61B 5/08</b> (2006.01) <b>A61M 16/00</b> (2006.01) <b>A61F 5/56</b> (2006.01)	2582245 *	<b>A01P 13/00</b> (2006.01) <b>A01N 43/90</b> (2006.01) <b>A01N 43/40</b> (2006.01)		
2588124 *	<b>A61K 47/48</b> (2006.01) <b>A61K 38/18</b> (2006.01) <b>A61K 38/17</b> (2006.01) <b>A61K 9/48</b> (2006.01) <b>A61P 35/00</b> (2006.01) <b>A61K 31/7105</b> (2006.01)	2594262 *	<b>A61K 31/167</b> (2006.01) <b>A61K 45/00</b> (2006.01) <b>A61K 31/192</b> (2006.01) <b>A61K 9/70</b> (2006.01)	2547266 *	<b>A61F 2/00</b> (2006.01) <b>A61B 17/00</b> (2006.01) <b>A61B 17/06</b> (2006.01)
		2544711 *	<b>A61P 31/04</b> (2006.01) <b>A61K 39/09</b> (2006.01)	2568294	<b>G01N 33/68</b> (2006.01)
		2547681 *	<b>A61P 15/00</b> (2006.01) <b>A61K 31/5517</b> (2006.01) <b>C07D 487/04</b> (2006.01)	2566529 *	<b>A61L 27/38</b> (2006.01)
		2556232 *	<b>F02D 41/34</b> (2006.01) <b>F02P 7/077</b> (2006.01)	2547685 *	<b>C07D 513/10</b> (2006.01) <b>A61K 31/429</b> (2006.01) <b>A61P 25/28</b> (2006.01) <b>A61K 31/424</b> (2006.01) <b>C07D 498/10</b> (2006.01) <b>C07D 498/20</b> (2006.01)
		2556235 *	<b>F02F 3/28</b> (2006.01) <b>F02F 7/00</b> (2006.01)		

Broj objave evropske prijava patenta (97)	MKP (51)	Broj objave evropske prijava patenta (97)	MKP (51)	Broj objave evropske prijava patenta (97)	MKP (51)
2558821 *	<b>G01F 15/06</b> (2006.01) <b>G01D 4/00</b> (2006.01)	2558450 *	<b>A61K 31/55</b> (2006.01) <b>C07D 405/14</b> (2006.01) <b>C07D 403/12</b> (2006.01) <b>A61P 35/00</b> (2006.01) <b>C07D 405/12</b> (2006.01) <b>C07D 249/08</b> (2006.01)	2579930 *	<b>A61M 5/24</b> (2006.01) <b>A61M 5/315</b> (2006.01)
2571805 *	<b>B01D 53/62</b> (2006.01) <b>C01B 3/04</b> (2006.01) <b>C01B 3/06</b> (2006.01) <b>C04B 5/00</b> (2006.01)	2582667 *	<b>A61K 31/538</b> (2006.01) <b>A61K 31/404</b> (2006.01) <b>C07D 209/34</b> (2006.01) <b>A61K 31/428</b> (2006.01) <b>A61K 31/4704</b> (2006.01) <b>C07D 215/227</b> (2006.01) <b>C07D 277/68</b> (2006.01) <b>C07D 498/04</b> (2006.01) <b>C07D 265/36</b> (2006.01) <b>A61K 31/5383</b> (2006.01)	2566401 *	<b>D02J 3/10</b> (2006.01) <b>A61B 17/04</b> (2006.01) <b>D02J 3/02</b> (2006.01) <b>A61B 17/08</b> (2006.01)
2544719 *	<b>A61K 39/395</b> (2006.01)	2542245 *	<b>A61K 31/56</b> (2006.01)	2547683 *	<b>C07D 487/04</b> (2006.01)
2539592 *	<b>F15B 3/00</b> (2006.01)	2582709 *	<b>A61K 31/425</b> (2006.01) <b>C07D 513/04</b> (2006.01)	2550666 *	<b>H01F 1/047</b> (2006.01) <b>B22F 1/00</b> (2006.01)
2547673 *	<b>C07D 403/04</b> (2006.01) <b>A61K 31/505</b> (2006.01) <b>A61P 11/00</b> (2006.01)	2545055 *	<b>C07D 487/04</b> (2006.01) <b>A61P 3/00</b> (2006.01) <b>A61P 25/00</b> (2006.01) <b>A61K 31/4985</b> (2006.01)	2558499 *	<b>C07K 16/28</b> (2006.01)
2571385 *	<b>A24B 3/12</b> (2006.01)	2586772 *	<b>A61P 11/06</b> (2006.01) <b>A61P 11/02</b> (2006.01) <b>C07D 217/18</b> (2006.01) <b>A61P 37/08</b> (2006.01) <b>A61K 31/472</b> (2006.01) <b>C07D 217/20</b> (2006.01) <b>A61P 43/00</b> (2006.01) <b>A61P 17/04</b> (2006.01)	2538997 *	<b>A61M 5/20</b> (2006.01)
2559020 *	<b>G09B 23/28</b> (2006.01)	2565165	<b>C02F 1/68</b> (2006.01) <b>C02F 103/42</b> (2006.01)	2560799 *	<b>B26D 3/08</b> (2006.01) <b>B26B 5/00</b> (2006.01) <b>B28D 1/22</b> (2006.01)
2468622	<b>B63B 25/00</b> (2006.01)	2566890 *	<b>A61K 39/395</b> (2006.01) <b>A61K 39/00</b> (2006.01) <b>C12P 21/06</b> (2006.01) <b>C07K 16/00</b> (2006.01) <b>C07H 21/04</b> (2006.01)	2576717 *	<b>C09J 163/10</b> (2006.01) <b>C09J 11/04</b> (2006.01) <b>C09J 9/02</b> (2006.01)
2585466 *	<b>A61K 31/4985</b> (2006.01) <b>C07D 487/04</b> (2006.01) <b>A61P 35/00</b> (2006.01)	2585142 *	<b>A61M 5/20</b> (2006.01)	2585047 *	<b>A61P 11/06</b> (2006.01) <b>A61K 9/00</b> (2006.01) <b>A61K 9/14</b> (2006.01) <b>A61K 31/439</b> (2006.01) <b>A61P 11/08</b> (2006.01)
2544739 *	<b>A61M 5/20</b> (2006.01) <b>A61M 5/24</b> (2006.01)	2582237 *	<b>A01N 37/18</b> (2006.01)		



Broj objave evropske prijave patenta (97)	MKP (51)	Broj objave evropske prijave patenta (97)	MKP (51)	Broj objave evropske prijave patenta (97)	MKP (51)
2591099 *	<b>C12N 9/96</b> (2006.01) <b>A61K 38/48</b> (2006.01) <b>A61K 38/36</b> (2006.01)	2575793 *	<b>A61P 27/02</b> (2006.01) <b>A61K 31/198</b> (2006.01) <b>A61K 31/00</b> (2006.01)	2558577 *	<b>C12N 15/10</b> (2006.01)
2575978 *	<b>A63B 55/00</b> (2006.01) <b>A63B 55/04</b> (2006.01) <b>A63B 55/06</b> (2006.01)	2581908 *	<b>H04N 5/765</b> (2006.01) <b>H04N 5/85</b> (2006.01) <b>G11B 20/10</b> (2006.01) <b>H04N 5/91</b> (2006.01)	2566539 *	<b>A61M 5/315</b> (2006.01) <b>A61M 5/24</b> (2006.01)
2539875 *	<b>G08C 17/02</b> (2006.01) <b>G06F 3/038</b> (2013.01)	2590508 *	<b>A01N 51/00</b> (2006.01) <b>A01N 25/30</b> (2006.01) <b>A01N 43/40</b> (2006.01) <b>A01N 47/18</b> (2006.01)	2476670	<b>C07D 239/34</b> (2006.01) <b>A61K 31/513</b> (2006.01)
2590671 *	<b>C12N 5/07</b> (2010.01) <b>A61K 39/00</b> (2006.01) <b>C12P 21/08</b> (2006.01) <b>C12N 5/16</b> (2006.01)	2553206 *	<b>E21B 10/32</b> (2006.01)	2544966 *	<b>B65D 85/76</b> (2006.01)
2263638	<b>G07F 11/44</b> (2006.01) <b>G07F 17/00</b> (2006.01) <b>A61J 7/00</b> (2006.01)	2439366	<b>F25D 23/02</b> (2006.01) <b>E05F 11/54</b> (2006.01) <b>E05B 17/00</b> (2006.01)	2566516 *	<b>C12N 9/00</b> (2006.01) <b>A61K 39/39</b> (2006.01) <b>A61K 38/16</b> (2006.01) <b>A61K 38/43</b> (2006.01) <b>A61P 37/00</b> (2006.01) <b>A61K 39/395</b> (2006.01)
2552909 *	<b>C07D 409/14</b> (2006.01) <b>C07D 413/14</b> (2006.01) <b>C07D 417/14</b> (2006.01) <b>A61K 31/506</b> (2006.01) <b>C07D 417/04</b> (2006.01) <b>C07D 403/04</b> (2006.01) <b>A61P 25/00</b> (2006.01) <b>C07D 403/14</b> (2006.01) <b>A61P 3/10</b> (2006.01)	2560912 *	<b>B66B 11/04</b> (2006.01)	2576557 *	<b>A61K 31/5517</b> (2006.01) <b>C07D 487/04</b> (2006.01) <b>A61P 31/10</b> (2006.01)
2585457 *	<b>A61P 11/00</b> (2006.01) <b>A61K 31/439</b> (2006.01) <b>C07D 453/02</b> (2006.01)	2544541 *	<b>A61K 31/425</b> (2006.01) <b>A01N 43/54</b> (2006.01) <b>A61K 31/505</b> (2006.01)	2566869 *	<b>A61P 35/00</b> (2006.01) <b>C07D 495/04</b> (2006.01) <b>C07D 498/04</b> (2006.01) <b>C07D 487/04</b> (2006.01) <b>A61K 31/498</b> (2006.01)
2395643	<b>H02M 5/257</b> (2006.01)	2560649 *	<b>A61K 31/4704</b> (2006.01) <b>A61K 31/404</b> (2006.01) <b>A61K 31/443</b> (2006.01)	2576773 *	<b>C12N 15/09</b> (2006.01) <b>C07K 14/11</b> (2006.01) <b>C12N 15/86</b> (2006.01) <b>C12N 7/02</b> (2006.01)
2569556 *	<b>F16H 57/08</b> (2006.01)	2576140 *	<b>C09J 167/06</b> (2006.01) <b>C08G 69/44</b> (2006.01) <b>C08G 63/676</b> (2006.01) <b>C08G 63/52</b> (2006.01) <b>B24D 3/28</b> (2006.01) <b>B24D 3/20</b> (2006.01)		

Broj objave evropske prijave patenta (97)	MKP (51)	Broj objave evropske prijave patenta (97)	MKP (51)	Broj objave evropske prijave patenta (97)	MKP (51)
2593131 *	<b>A61K 38/47</b> (2006.01) <b>A61P 25/28</b> (2006.01) <b>A61P 25/00</b> (2006.01)	2542580 *	<b>C07K 16/18</b> (2006.01) <b>G01N 33/564</b> (2006.01) <b>G01N 33/68</b> (2006.01)	2560630 *	<b>A61K 31/4409</b> (2006.01) <b>A61K 9/28</b> (2006.01) <b>A61K 31/4425</b> (2006.01) <b>A61K 9/48</b> (2006.01) <b>A61K 31/438</b> (2006.01) <b>A61K 9/20</b> (2006.01) <b>A61K 31/447</b> (2006.01) <b>A61K 9/50</b> (2006.01) <b>A61K 31/395</b> (2006.01) <b>A61K 9/02</b> (2006.01) <b>A61K 31/7036</b> (2006.01) <b>A61K 31/4965</b> (2006.01) <b>A61K 9/00</b> (2006.01) <b>A61K 31/133</b> (2006.01) <b>A61K 45/06</b> (2006.01)
2588162 *	<b>A61M 5/32</b> (2006.01) <b>A61M 5/20</b> (2006.01)	2563762 *	<b>C07D 213/64</b> (2006.01)		
2546255 *	<b>A61P 15/10</b> (2006.01) <b>A61K 31/55</b> (2006.01) <b>A61P 13/02</b> (2006.01) <b>C07D 498/04</b> (2006.01) <b>A61P 43/00</b> (2006.01) <b>A61P 3/04</b> (2006.01) <b>C07D 487/04</b> (2006.01) <b>A61P 13/00</b> (2006.01)	2567445 *	<b>H02J 7/00</b> (2006.01)		
		2582355 *	<b>A61P 17/14</b> (2006.01) <b>A61K 31/727</b> (2006.01) <b>A61Q 7/00</b> (2006.01) <b>A61K 45/06</b> (2006.01) <b>A61K 8/73</b> (2006.01) <b>A61K 31/337</b> (2006.01) <b>A61K 31/506</b> (2006.01) <b>A61K 31/58</b> (2006.01)		
2563403 *	<b>A61P 7/04</b> (2006.01) <b>A61K 47/48</b> (2006.01) <b>A61K 38/36</b> (2006.01)	2538928 *	<b>A61K 9/26</b> (2006.01) <b>A61K 31/485</b> (2006.01)	2471983	<b>D01D 1/02</b> (2006.01) <b>D01F 6/60</b> (2006.01) <b>C08G 69/32</b> (2006.01)
2585069 *	<b>A61P 25/04</b> (2006.01) <b>A61P 25/02</b> (2006.01) <b>A61K 31/513</b> (2006.01) <b>A61K 31/53</b> (2006.01)	2547697 *	<b>A61K 39/21</b> (2006.01) <b>C07K 14/16</b> (2006.01)	2500677	<b>F25B 43/02</b> (2006.01)
2571488 *	<b>A61K 9/10</b> (2006.01) <b>A61K 31/19</b> (2006.01) <b>A61K 47/18</b> (2006.01)	2566867 *	<b>C07D 487/04</b> (2006.01) <b>A61P 29/00</b> (2006.01) <b>A61K 31/519</b> (2006.01) <b>A61P 35/00</b> (2006.01)	2580196 *	<b>A61P 37/00</b> (2006.01) <b>C07D 401/12</b> (2006.01) <b>C07D 223/12</b> (2006.01) <b>C07D 211/56</b> (2006.01) <b>A61P 17/06</b> (2006.01) <b>A61K 31/45</b> (2006.01) <b>A61P 29/00</b> (2006.01) <b>A61K 31/55</b> (2006.01) <b>A61K 31/4523</b> (2006.01)
2547658 *	<b>A61K 31/47</b> (2006.01) <b>C07D 215/56</b> (2006.01) <b>A61P 11/00</b> (2006.01)				
2580162 *	<b>C01G 7/00</b> (2006.01) <b>C22B 11/06</b> (2006.01) <b>C22B 3/26</b> (2006.01)			2576548 *	<b>A61K 31/437</b> (2006.01) <b>C07D 471/04</b> (2006.01) <b>A61P 9/00</b> (2006.01) <b>A61P 15/00</b> (2006.01)

Broj objave evropske prijave patenta (97)	MKP (51)	Broj objave evropske prijave patenta (97)	MKP (51)	Broj objave evropske prijave patenta (97)	MKP (51)
2590993 *	<b>C07K 14/195</b> (2006.01)	2542537 *	<b>C07D 413/12</b> (2006.01) <b>C07D 498/04</b> (2006.01) <b>A61K 31/395</b> (2006.01) <b>C07D 267/22</b> (2006.01) <b>C07D 403/12</b> (2006.01) <b>C07D 417/12</b> (2006.01) <b>A61P 29/00</b> (2006.01) <b>C07D 245/06</b> (2006.01) <b>C07D 281/18</b> (2006.01) <b>C07D 413/10</b> (2006.01) <b>C07D 487/04</b> (2006.01) <b>A61P 37/00</b> (2006.01)	2569303 *	<b>A61P 25/00</b> (2006.01) <b>A61K 31/4709</b> (2006.01) <b>C07D 401/14</b> (2006.01) <b>C07D 495/04</b> (2006.01) <b>C07D 403/04</b> (2006.01) <b>C07D 407/14</b> (2006.01)
2386209	<b>A23L 1/236</b> (2006.01) <b>A23L 1/09</b> (2006.01)			2548883 *	<b>C07K 7/62</b> (2006.01)
2455121	<b>A61M 5/315</b> (2006.01)			2557940 *	<b>A23K 1/12</b> (2006.01) <b>A61P 33/00</b> (2006.01) <b>A23K 1/16</b> (2006.01) <b>A61K 31/575</b> (2006.01) <b>A61P 1/00</b> (2006.01) <b>A61K 36/54</b> (2006.01) <b>A23K 1/14</b> (2006.01)
2594082 *	<b>H04L 12/28</b> (2006.01) <b>H04Q 3/00</b> (2006.01)	2593120 *	<b>A61P 31/18</b> (2006.01) <b>A61K 38/08</b> (2006.01)		
2542569 *	<b>C07K 14/435</b> (2006.01) <b>A61K 38/16</b> (2006.01) <b>C12N 15/62</b> (2006.01)	2588197 *	<b>C07D 471/04</b> (2006.01) <b>A61P 3/10</b> (2006.01) <b>A61K 31/437</b> (2006.01) <b>A61P 9/00</b> (2006.01)	2558126 *	<b>A61K 31/4406</b> (2006.01) <b>A61K 31/519</b> (2006.01) <b>A61K 45/06</b> (2006.01) <b>A61K 31/5377</b> (2006.01) <b>A61K 31/18</b> (2006.01)
2563113 *	<b>A01H 5/00</b> (2006.01) <b>C12N 15/29</b> (2006.01) <b>C12N 15/82</b> (2006.01)			2579925 *	<b>A61M 5/315</b> (2006.01) <b>A61M 5/24</b> (2006.01)
2555990 *	<b>B65D 19/28</b> (2006.01) <b>B65G 1/02</b> (2006.01)	2588446 *	<b>C07C 233/58</b> (2006.01) <b>C07D 333/58</b> (2006.01) <b>A61K 31/167</b> (2006.01) <b>C07D 307/30</b> (2006.01) <b>C07C 233/60</b> (2006.01) <b>C07D 333/38</b> (2006.01) <b>C07C 233/59</b> (2006.01)	2479754	<b>G11B 20/10</b> (2006.01)
2566351 *	<b>A23L 1/216</b> (2006.01) <b>A23L 1/18</b> (2006.01) <b>A23L 1/164</b> (2006.01)			2471528	<b>A61K 31/23</b> (2006.01) <b>A61K 9/00</b> (2006.01)
2575901 *	<b>C02F 1/32</b> (2006.01) <b>A61L 2/00</b> (2006.01)	2575846 *	<b>A61K 39/00</b> (2006.01) <b>A61K 38/00</b> (2006.01) <b>C12P 21/06</b> (2006.01) <b>C12P 21/04</b> (2006.01)	2548282 *	<b>H02M 3/06</b> (2006.01) <b>H02J 7/00</b> (2006.01)
2588564 *	<b>C09K 101/00</b> (2006.01) <b>C09K 17/40</b> (2006.01) <b>C09K 17/00</b> (2006.01) <b>B09C 1/00</b> (2006.01) <b>C09K 17/50</b> (2006.01) <b>A01C 1/00</b> (2006.01)				

Broj objave evropske prijave patenta (97)	MKP (51)	Broj objave evropske prijave patenta (97)	MKP (51)	Broj objave evropske prijave patenta (97)	MKP (51)
2563780 *	<b>A61P 9/00</b> (2006.01) <b>A61K 31/4535</b> (2006.01) <b>C07D 451/06</b> (2006.01) <b>C07D 451/04</b> (2006.01) <b>A61P 25/28</b> (2006.01) <b>C07D 409/14</b> (2006.01) <b>A61P 3/10</b> (2006.01) <b>A61K 31/46</b> (2006.01) <b>C07D 451/02</b> (2006.01) <b>A61P 25/00</b> (2006.01) <b>A61P 3/04</b> (2006.01)	2542232 *	<b>A61K 31/337</b> (2006.01) <b>A61K 31/70</b> (2006.01) <b>A61K 31/185</b> (2006.01) <b>A61K 31/336</b> (2006.01)	2475373 *	<b>A61P 11/00</b> (2006.01) <b>A61K 35/42</b> (2006.01) <b>A61K 38/44</b> (2006.01)
2550297 *	<b>C07K 16/46</b> (2006.01)	2576462 *	<b>C03B 9/16</b> (2006.01) <b>B65D 1/02</b> (2006.01) <b>C03B 9/325</b> (2006.01)	2577318 *	<b>G01N 33/68</b> (2006.01) <b>C12Q 1/68</b> (2006.01) <b>G01N 33/15</b> (2006.01) <b>C12N 5/0735</b> (2010.01)
2547695 *	<b>A61K 39/29</b> (2006.01) <b>C07K 14/47</b> (2006.01) <b>C07K 14/02</b> (2006.01)	2540169 *	<b>A23L 1/00</b> (2006.01) <b>A61K 8/64</b> (2006.01)	2571828 *	<b>C04B 28/18</b> (2006.01) <b>H01L 35/22</b> (2006.01) <b>H01L 35/32</b> (2006.01)
2556163 *	<b>C12P 21/06</b> (2006.01) <b>H01J 49/00</b> (2006.01) <b>C12Q 1/00</b> (2006.01)	2547909 *	<b>F04B 13/00</b> (2006.01)	2588168 *	<b>A61M 5/32</b> (2006.01) <b>A61M 5/28</b> (2006.01) <b>A61M 5/50</b> (2006.01)
2559071 *	<b>H01L 31/04</b> (2006.01)	2571517 *	<b>A61K 9/00</b> (2006.01) <b>A61K 38/00</b> (2006.01) <b>A61K 38/28</b> (2006.01) <b>A61K 31/00</b> (2006.01) <b>A61K 9/08</b> (2006.01)	2538787 *	<b>A61K 31/41</b> (2006.01) <b>A01N 43/64</b> (2006.01)
2560615 *	<b>A61K 9/06</b> (2006.01) <b>A61K 9/08</b> (2006.01) <b>A61K 31/425</b> (2006.01) <b>A61K 9/00</b> (2006.01) <b>A61K 9/48</b> (2006.01)	2578760 *	<b>E04B 1/348</b> (2006.01) <b>B28B 7/22</b> (2006.01) <b>B28B 19/00</b> (2006.01)	2576486 *	<b>C07C 29/09</b> (2006.01) <b>B01J 21/18</b> (2006.01) <b>C07B 41/00</b> (2006.01) <b>C07C 45/42</b> (2006.01) <b>C07C 51/093</b> (2006.01)
2582472 *	<b>B08B 7/04</b> (2006.01)	2538968 *	<b>A61K 38/46</b> (2006.01) <b>C07K 1/16</b> (2006.01)	2585458 *	<b>C07D 453/02</b> (2006.01) <b>A61P 11/00</b> (2006.01) <b>A61K 31/439</b> (2006.01) <b>C07D 413/06</b> (2006.01) <b>A61K 31/4025</b> (2006.01)
2544708 *	<b>A61K 39/02</b> (2006.01)	2552415 *	<b>A61P 35/00</b> (2006.01) <b>A61K 31/555</b> (2006.01) <b>A61K 31/337</b> (2006.01) <b>A61K 9/14</b> (2006.01)	2560650 *	<b>A61K 31/404</b> (2006.01) <b>A61K 31/443</b> (2006.01) <b>A61K 31/4704</b> (2006.01)

Broj objave evropske prijave patenta (97)	MKP (51)	Broj objave evropske prijave patenta (97)	MKP (51)	Broj objave evropske prijave patenta (97)	MKP (51)
2538924 *	<b>A61K 31/403</b> (2006.01) <b>A61P 9/12</b> (2006.01) <b>A61K 9/20</b> (2006.01) <b>A61K 45/06</b> (2006.01)	2569263 *	<b>C01B 25/14</b> (2006.01) <b>C07D 213/63</b> (2006.01) <b>C07B 45/00</b> (2006.01) <b>C07D 211/84</b> (2006.01) <b>C07C 327/44</b> (2006.01) <b>C07D 211/72</b> (2006.01) <b>C07C 325/02</b> (2006.01) <b>C07D 241/06</b> (2006.01) <b>C07D 213/06</b> (2006.01) <b>C07D 239/93</b> (2006.01) <b>C07D 207/24</b> (2006.01) <b>C07D 209/30</b> (2006.01)	2555804 *	<b>A61L 26/00</b> (2006.01) <b>A61L 15/42</b> (2006.01) <b>A61L 15/58</b> (2006.01) <b>A61L 24/04</b> (2006.01) <b>A61L 15/22</b> (2006.01) <b>A61L 24/00</b> (2006.01)
2552835 *	<b>C01F 11/18</b> (2006.01)	2582683 *	<b>C07D 249/14</b> (2006.01)	2571883 *	<b>C07D 519/00</b> (2006.01) <b>A61K 31/519</b> (2006.01) <b>C07D 487/04</b> (2006.01)
2563380 *	<b>A61P 3/00</b> (2006.01) <b>A61K 39/395</b> (2006.01) <b>A61P 29/00</b> (2006.01) <b>A61P 35/00</b> (2006.01) <b>A61K 38/16</b> (2006.01) <b>A61K 38/17</b> (2006.01)	2545334 *	<b>F25J 3/00</b> (2006.01)	2423402	<b>E04B 7/22</b> (2006.01) <b>E04C 2/288</b> (2006.01) <b>E04B 1/14</b> (2006.01) <b>E04B 1/80</b> (2006.01)
2568968 *	<b>A61K 9/20</b> (2006.01)	2591357 *	<b>G01N 33/18</b> (2006.01) <b>G01N 33/49</b> (2006.01) <b>G01N 33/50</b> (2006.01)	2576423 *	<b>B65D 83/44</b> (2006.01) <b>B65D 83/16</b> (2006.01) <b>B67D 1/12</b> (2006.01) <b>B67D 1/08</b> (2006.01) <b>B65D 83/18</b> (2006.01) <b>G01F 11/08</b> (2006.01) <b>B67D 1/04</b> (2006.01) <b>B65D 83/14</b> (2006.01) <b>B65D 83/60</b> (2006.01) <b>B67D 1/02</b> (2006.01)
2547365 *	<b>A61K 39/395</b> (2006.01) <b>C07K 16/22</b> (2006.01) <b>C07K 16/18</b> (2006.01) <b>C07K 16/28</b> (2006.01)	2576850 *	<b>C22B 1/00</b> (2006.01) <b>C22B 11/00</b> (2006.01)	2566514 *	<b>C07K 14/00</b> (2006.01) <b>A61K 39/395</b> (2006.01)
2566514 *	<b>C07K 14/00</b> (2006.01) <b>A61K 39/395</b> (2006.01)	2563368 *	<b>A61P 35/00</b> (2006.01) <b>A61K 31/53</b> (2006.01) <b>C07D 403/04</b> (2006.01)	2588167 *	<b>A61M 5/32</b> (2006.01)
2588167 *	<b>A61M 5/32</b> (2006.01)	2544549 *	<b>A23C 19/09</b> (2006.01) <b>A23C 19/06</b> (2006.01) <b>A23L 1/00</b> (2006.01) <b>A23J 3/26</b> (2006.01)	2582309 *	<b>A61B 17/3205</b> (2006.01)
		2552511 *	<b>A61M 5/00</b> (2006.01)	2460970	<b>E06B 3/58</b> (2006.01) <b>E06B 3/54</b> (2006.01) <b>E06B 3/56</b> (2006.01) <b>E06B 3/64</b> (2006.01) <b>E06B 3/48</b> (2006.01)
				2469478	<b>G07C 9/00</b> (2006.01)

Broj objave evropske prijava patenta (97)	MKP (51)	Broj objave evropske prijava patenta (97)	MKP (51)	Broj objave evropske prijava patenta (97)	MKP (51)
2569304 *	<b>C07D 401/14</b> (2006.01) <b>A61P 25/28</b> (2006.01) <b>A61P 25/24</b> (2006.01) <b>A61K 31/407</b> (2006.01) <b>A61P 25/18</b> (2006.01) <b>C07D 491/107</b> (2006.01) <b>C07D 471/10</b> (2006.01) <b>A61P 25/16</b> (2006.01) <b>A61K 31/438</b> (2006.01) <b>A61K 31/4439</b> (2006.01)	2566849 *	<b>C07D 401/06</b> (2006.01) <b>C07D 401/12</b> (2006.01) <b>A61P 9/10</b> (2006.01) <b>C07D 413/12</b> (2006.01) <b>A61K 31/4709</b> (2006.01) <b>A61K 31/47</b> (2006.01) <b>C07D 215/26</b> (2006.01) <b>A61P 25/28</b> (2006.01) <b>C07D 401/14</b> (2006.01)	2558477 *	<b>A61K 31/704</b> (2006.01) <b>C07H 17/04</b> (2006.01)
2571553 *	<b>A61M 5/24</b> (2006.01) <b>A61M 5/34</b> (2006.01)	2577686 *	<b>H01F 41/14</b> (2006.01) <b>H01F 10/00</b> (2006.01)	2578084 *	<b>A01N 43/90</b> (2006.01) <b>C07D 491/052</b> (2006.01) <b>C07D 493/04</b> (2006.01) <b>A01P 7/04</b> (2006.01) <b>A01N 47/18</b> (2006.01) <b>A01N 55/00</b> (2006.01) <b>C07F 7/18</b> (2006.01)
2539673 *	<b>G01F 23/00</b> (2006.01)	2552744 *	<b>B60N 2/50</b> (2006.01)	2590565 *	<b>A61B 5/151</b> (2006.01)
2566472 *	<b>A61K 31/616</b> (2006.01) <b>A61K 9/50</b> (2006.01) <b>A61K 9/16</b> (2006.01) <b>A61K 9/52</b> (2006.01) <b>A61K 9/20</b> (2006.01) <b>A61K 31/138</b> (2006.01)	2564126 *	<b>F24J 1/00</b> (2006.01)	2571995 *	<b>C12P 1/02</b> (2006.01) <b>C12P 7/00</b> (2006.01)
2498191	<b>G06F 17/30</b> (2006.01)	2588132 *	<b>A61K 38/47</b> (2006.01) <b>A61P 25/28</b> (2006.01) <b>A61P 25/00</b> (2006.01)	2553568 *	<b>G06F 7/70</b> (2006.01)
2579720 *	<b>A01N 47/36</b> (2006.01) <b>A01N 47/30</b> (2006.01)	2568960 *	<b>A61K 9/00</b> (2006.01)	2563393 *	<b>A61K 39/395</b> (2006.01)
2584999 *	<b>A61F 2/04</b> (2013.01)	2552964 *	<b>C07K 16/30</b> (2006.01) <b>C07K 16/40</b> (2006.01) <b>A61K 39/395</b> (2006.01) <b>C07K 16/28</b> (2006.01)	2575473 *	<b>A01N 43/90</b> (2006.01) <b>A61K 31/519</b> (2006.01)
		2569735 *	<b>A63F 3/06</b> (2006.01) <b>G07F 17/32</b> (2006.01) <b>G06K 19/07</b> (2006.01)	2582699 *	<b>A61K 31/437</b> (2006.01) <b>A61P 35/00</b> (2006.01) <b>C07D 519/00</b> (2006.01) <b>C07D 471/04</b> (2006.01)
		2585134 *	<b>A61M 5/48</b> (2006.01) <b>A61M 5/32</b> (2006.01) <b>A61M 5/20</b> (2006.01) <b>A61M 5/315</b> (2006.01)	2592986 *	<b>A47L 7/04</b> (2006.01) <b>A47L 5/14</b> (2006.01)
				2520505	<b>B65D 21/06</b> (2006.01) <b>B65D 43/02</b> (2006.01)
				2542086 *	<b>A01N 47/28</b> (2006.01)

Broj objave evropske prijava patenta (97)	MKP (51)	Broj objave evropske prijava patenta (97)	MKP (51)	Broj objave evropske prijava patenta (97)	MKP (51)
2355556	<b>G10L 19/00</b> (2006.01) <b>H04S 7/00</b> (2006.01) <b>H04S 5/02</b> (2006.01)	2563809 *	<b>C07K 14/78</b> (2006.01) <b>A61K 9/00</b> (2006.01) <b>A61K 38/18</b> (2006.01) <b>A61K 47/22</b> (2006.01) <b>C07K 14/47</b> (2006.01)	2552961 *	<b>A61K 39/395</b> (2006.01) <b>C07K 16/24</b> (2006.01)
2579799 *	<b>A61B 19/08</b> (2006.01)	2544726 *	<b>A61L 27/38</b> (2006.01)	2563355 *	<b>A61K 31/165</b> (2006.01) <b>C07C 231/24</b> (2006.01) <b>C07C 237/06</b> (2006.01) <b>C07C 309/04</b> (2006.01)
2585480 *	<b>C07K 14/705</b> (2006.01) <b>C07K 14/435</b> (2006.01)	2549915 *	<b>A61M 5/315</b> (2006.01) <b>A61B 5/00</b> (2006.01)	2569325 *	<b>C07H 19/16</b> (2006.01) <b>A61K 31/7076</b> (2006.01) <b>C07H 19/167</b> (2006.01) <b>A61P 27/02</b> (2006.01) <b>C07H 19/00</b> (2006.01)
2590654 *	<b>A61K 45/06</b> (2006.01) <b>A61K 39/395</b> (2006.01) <b>A61P 35/00</b> (2006.01) <b>A61K 31/63</b> (2006.01) <b>A61K 31/498</b> (2006.01) <b>A61K 31/517</b> (2006.01) <b>A61K 31/7088</b> (2006.01)	2594532	<b>C02F 1/50</b> (2006.01)	2476853	<b>E06B 3/273</b> (2006.01) <b>E06B 3/263</b> (2006.01)
2591579 *	<b>H04L 12/64</b> (2006.01) <b>H04L 12/28</b> (2006.01)	2563524 *	<b>B05C 11/115</b> (2006.01) <b>B05C 9/10</b> (2006.01) <b>B01F 5/04</b> (2006.01) <b>B01F 15/02</b> (2006.01)	2569305 *	<b>C07D 413/14</b> (2006.01) <b>C07D 403/14</b> (2006.01) <b>C07D 401/14</b> (2006.01) <b>A61K 31/4709</b> (2006.01) <b>A61P 25/00</b> (2006.01)
2547974 *	<b>F27D 99/00</b> (2010.01) <b>F27B 1/10</b> (2006.01) <b>F27B 1/00</b> (2006.01) <b>F27B 1/08</b> (2006.01) <b>C04B 2/12</b> (2006.01)	2566346 *	<b>A23J 1/14</b> (2006.01) <b>A23J 3/14</b> (2006.01) <b>A23L 1/305</b> (2006.01) <b>A23L 2/66</b> (2006.01) <b>A23J 3/16</b> (2006.01)	2576614 *	<b>C07K 16/20</b> (2006.01) <b>A61K 38/17</b> (2006.01) <b>C07K 14/74</b> (2006.01) <b>A61P 35/00</b> (2006.01) <b>A61K 39/395</b> (2006.01) <b>G01N 33/68</b> (2006.01) <b>C07K 7/00</b> (2006.01)
2552471 *	<b>C07K 14/62</b> (2006.01) <b>A61K 38/26</b> (2006.01) <b>A61K 38/16</b> (2006.01) <b>C07K 14/47</b> (2006.01) <b>C07K 14/605</b> (2006.01) <b>A61K 38/30</b> (2006.01)	2593935 *	<b>G10D 3/18</b> (2006.01)		
		2550043 *	<b>A61M 5/24</b> (2006.01) <b>A61M 5/28</b> (2006.01) <b>A61M 5/32</b> (2006.01)		
		2550607 *	<b>G06F 17/30</b> (2006.01)		
		2552482 *	<b>A61K 47/26</b> (2006.01) <b>A61K 39/395</b> (2006.01)		

Broj objave evropske prijave patenta (97)	MKP (51)	Broj objave evropske prijave patenta (97)	MKP (51)	Broj objave evropske prijave patenta (97)	MKP (51)
2589430	<b>B01J 20/32</b> (2006.01) <b>C02F 1/56</b> (2006.01) <b>C02F 103/28</b> (2006.01) <b>B01J 20/04</b> (2006.01) <b>C02F 1/28</b> (2006.01) <b>C02F 11/14</b> (2006.01) <b>C02F 1/66</b> (2006.01)	2547631 *	<b>C03C 23/00</b> (2006.01) <b>C03C 17/00</b> (2006.01)	2564838 *	<b>A61K 9/22</b> (2006.01) <b>A61P 25/24</b> (2006.01) <b>A61K 47/02</b> (2006.01) <b>A61K 47/32</b> (2006.01) <b>A61K 31/495</b> (2006.01) <b>A61K 47/34</b> (2006.01) <b>A61K 9/32</b> (2006.01)
		2354326	<b>E02D 31/02</b> (2006.01) <b>E02B 3/10</b> (2006.01)		
		2518763	<b>H01J 37/32</b> (2006.01) <b>H01L 21/677</b> (2006.01) <b>H01L 21/687</b> (2006.01) <b>H01L 21/67</b> (2006.01)	2566487 *	<b>A61K 31/74</b> (2006.01)
2588472 *	<b>C07D 401/14</b> (2006.01)			2555801 *	<b>C07K 1/00</b> (2006.01) <b>A61K 45/00</b> (2006.01)
2564153 *	<b>G01B 9/02</b> (2006.01) <b>G02B 21/00</b> (2006.01)		<b>C23C 16/509</b> (2006.01) <b>C23C 16/458</b> (2006.01)		
2568965 *	<b>A61K 9/20</b> (2006.01) <b>A61K 9/16</b> (2006.01)	2585091 *	<b>C08G 63/08</b> (2006.01) <b>A61K 9/52</b> (2006.01) <b>A61K 47/34</b> (2006.01) <b>A61P 35/00</b> (2006.01) <b>A61K 38/08</b> (2006.01)	2474292	<b>A61G 7/057</b> (2006.01)
2544542 *	<b>A61K 31/425</b> (2006.01) <b>A01N 43/78</b> (2006.01)			2576361 *	<b>B65D 1/04</b> (2006.01) <b>B65D 3/04</b> (2006.01) <b>F04D 13/00</b> (2006.01)
2471386	<b>A61K 9/16</b> (2006.01) <b>A23L 1/30</b> (2006.01) <b>A61K 9/20</b> (2006.01) <b>A61K 9/48</b> (2006.01) <b>A61K 31/23</b> (2006.01) <b>A61K 9/00</b> (2006.01)	2576071 *	<b>B03C 7/12</b> (2006.01) <b>B03C 7/00</b> (2006.01)	2553117 *	<b>C12Q 1/42</b> (2006.01) <b>G01N 33/569</b> (2006.01) <b>C12Q 1/28</b> (2006.01)
		2542498 *	<b>B67D 3/00</b> (2006.01)	2580201 *	<b>C07D 265/30</b> (2006.01)
		2576560 *	<b>C07D 487/04</b> (2006.01) <b>A61K 31/4985</b> (2006.01)	2590930 *	<b>A61K 31/426</b> (2006.01) <b>A61K 31/421</b> (2006.01) <b>C07D 213/65</b> (2006.01) <b>C07D 305/06</b> (2006.01) <b>C07D 213/64</b> (2006.01) <b>A61K 31/192</b> (2006.01) <b>C07C 255/54</b> (2006.01) <b>A61K 31/381</b> (2006.01) <b>C07C 59/72</b> (2006.01) <b>A61K 31/34</b> (2006.01) <b>A61K 31/4439</b> (2006.01)
2552448 *	<b>A61K 9/00</b> (2006.01) <b>A61K 31/498</b> (2006.01) <b>A61P 17/00</b> (2006.01) <b>A61K 9/06</b> (2006.01)	2558864 *	<b>G01N 33/574</b> (2006.01)		
		2590996 *	<b>C07K 14/415</b> (2006.01) <b>C12N 15/82</b> (2006.01)		
2576048 *	<b>B01J 37/02</b> (2006.01) <b>B01J 19/24</b> (2006.01) <b>B01J 8/18</b> (2006.01) <b>B01J 21/18</b> (2006.01)	2568988 *	<b>A61K 31/7042</b> (2006.01) <b>A61K 9/20</b> (2006.01) <b>A61P 3/10</b> (2006.01)		



Broj objave evropske prijave patenta (97)	MKP (51)	Broj objave evropske prijave patenta (97)	MKP (51)	Broj objave evropske prijave patenta (97)	MKP (51)
2542544 *	<b>C07C 225/16</b> (2006.01) <b>C07C 311/08</b> (2006.01) <b>C07F 5/02</b> (2006.01) <b>C07D 307/83</b> (2006.01) <b>C07C 311/07</b> (2006.01) <b>A61P 9/00</b> (2006.01) <b>C07C 217/22</b> (2006.01) <b>A61K 31/43</b> (2006.01)	2555776 *	<b>A61P 27/02</b> (2006.01) <b>A61P 27/06</b> (2006.01) <b>A61K 31/7076</b> (2006.01) <b>A61K 31/085</b> (2006.01) <b>A61K 31/5377</b> (2006.01)	2560797 *	<b>B26B 5/00</b> (2006.01) <b>B26B 29/06</b> (2006.01) <b>B28D 1/22</b> (2006.01)
2460551	<b>A61M 5/24</b> (2006.01) <b>A61M 5/315</b> (2006.01)	2550118 *	<b>B09B 3/00</b> (2006.01)	2564786	<b>A61B 6/06</b> (2006.01)
2550067 *	<b>A61K 8/27</b> (2006.01) <b>A61K 8/46</b> (2006.01) <b>A61Q 11/00</b> (2006.01) <b>A61K 8/34</b> (2006.01)	2550047 *	<b>A61M 5/32</b> (2006.01)	2569277 *	<b>A61K 31/195</b> (2006.01) <b>C07C 229/38</b> (2006.01)
2566877 *	<b>C07J 71/00</b> (2006.01)	2552881 *	<b>C07C 61/40</b> (2006.01)	2585136 *	<b>A61M 5/20</b> (2006.01)
2560490 *	<b>A01N 43/42</b> (2006.01) <b>A61K 31/44</b> (2006.01)	2508451	<b>B65G 67/08</b> (2006.01) <b>B65G 41/00</b> (2006.01)	2558517 *	<b>C08G 69/16</b> (2006.01) <b>C08L 77/00</b> (2006.01) <b>C08K 7/00</b> (2006.01) <b>C08K 3/00</b> (2006.01)
2552932 *	<b>A61P 27/06</b> (2006.01) <b>A61P 9/10</b> (2006.01) <b>C07H 19/16</b> (2006.01) <b>A61P 29/00</b> (2006.01) <b>C07H 19/167</b> (2006.01) <b>A61K 31/7076</b> (2006.01) <b>A61P 27/02</b> (2006.01)	2494884	<b>A61C 19/02</b> (2006.01) <b>A45C 13/26</b> (2006.01)	2560978 *	<b>C07F 5/02</b> (2006.01) <b>A61K 31/155</b> (2006.01) <b>A61K 31/69</b> (2006.01) <b>A61K 49/00</b> (2006.01)
2548928 *	<b>C09D 11/00</b> (2006.01) <b>C09B 63/00</b> (2006.01) <b>C09B 67/20</b> (2006.01)	2588130 *	<b>A61K 38/46</b> (2006.01)	2566591 *	<b>A63F 9/00</b> (2006.01) <b>A63F 9/08</b> (2006.01)
2577485 *	<b>G06F 15/16</b> (2006.01)	2550236 *	<b>C01B 17/04</b> (2006.01)	2558497 *	<b>A61K 39/395</b> (2006.01) <b>A61P 3/10</b> (2006.01) <b>C07K 16/28</b> (2006.01)
2552953 *	<b>C07K 14/705</b> (2006.01)	2557082 *	<b>A61P 31/04</b> (2006.01) <b>C07D 501/46</b> (2006.01) <b>A61K 31/546</b> (2006.01) <b>C07D 519/06</b> (2006.01)		
		2583360 *	<b>H01R 24/62</b> (2011.01) <b>H01R 13/6581</b> (2011.01)		
		2593321 *	<b>B29C 41/00</b> (2006.01) <b>B29C 41/04</b> (2006.01) <b>B60K 15/03</b> (2006.01)		

Broj objave evropske prijave patenta (97)	MKP (51)	Broj objave evropske prijave patenta (97)	MKP (51)	Broj objave evropske prijave patenta (97)	MKP (51)
2563381 *	<b>A61K 39/395</b> (2006.01) <b>A61K 38/17</b> (2006.01) <b>A61K 38/16</b> (2006.01) <b>A61P 35/00</b> (2006.01) <b>A61P 3/00</b> (2006.01) <b>A61P 29/00</b> (2006.01)	2361673	<b>C12M 1/107</b> (2006.01) <b>F16M 11/00</b> (2006.01) <b>B01F 15/00</b> (2006.01) <b>B01F 7/00</b> (2006.01) <b>A01C 3/02</b> (2006.01)	2577210 *	<b>F28D 15/00</b> (2006.01) <b>H01L 23/34</b> (2006.01)
2562155 *	<b>A61K 31/337</b> (2006.01) <b>A61K 31/40</b> (2006.01) <b>A61K 31/415</b> (2006.01) <b>A61K 31/341</b> (2006.01) <b>A61K 31/4015</b> (2006.01) <b>A61K 31/416</b> (2006.01) <b>A61K 31/357</b> (2006.01) <b>A61K 31/4035</b> (2006.01) <b>A61K 31/36</b> (2006.01) <b>A61K 31/404</b> (2006.01) <b>C07C 259/06</b> (2006.01) <b>A61K 31/381</b> (2006.01) <b>A61K 31/4045</b> (2006.01) <b>A61K 31/166</b> (2006.01) <b>A61K 31/397</b> (2006.01) <b>A61K 31/407</b> (2006.01) <b>A61K 31/351</b> (2006.01) <b>A61K 31/403</b> (2006.01) <b>A61K 31/343</b> (2006.01) <b>A61K 31/402</b> (2006.01)	2588467 *	<b>C07D 405/14</b> (2006.01) <b>C07D 401/12</b> (2006.01) <b>C07D 401/14</b> (2006.01) <b>C07D 413/14</b> (2006.01)	2588198 *	<b>A61P 25/28</b> (2006.01) <b>A61K 31/4415</b> (2006.01) <b>A61K 31/519</b> (2006.01) <b>A61K 31/714</b> (2006.01)
		2556059 *	<b>A61K 31/41</b> (2006.01) <b>C07D 257/04</b> (2006.01)	2415557	<b>B23Q 1/76</b> (2006.01) <b>B24B 41/06</b> (2012.01)
		2579996 *	<b>B05D 5/08</b> (2006.01) <b>B05D 7/02</b> (2006.01) <b>B05D 7/24</b> (2006.01)	2542078 *	<b>A61K 31/47</b> (2006.01) <b>A01N 43/42</b> (2006.01)
		2575908 *	<b>A61L 27/60</b> (2006.01) <b>A61L 27/44</b> (2006.01) <b>A61L 27/04</b> (2006.01) <b>A61K 47/48</b> (2006.01) <b>A61L 27/24</b> (2006.01)	2558474 *	<b>A61P 37/00</b> (2006.01) <b>A61P 29/00</b> (2006.01) <b>A61K 31/5383</b> (2006.01) <b>C07D 498/04</b> (2006.01)
		2544710 *	<b>A61K 39/09</b> (2006.01) <b>A61P 43/00</b> (2006.01) <b>A61K 39/385</b> (2006.01)	2579747 *	<b>A47F 5/13</b> (2006.01)
		2433742	<b>B23Q 1/76</b> (2006.01) <b>B23Q 1/38</b> (2006.01)	2547649 *	<b>A61P 25/24</b> (2006.01) <b>A61K 31/165</b> (2006.01) <b>C07C 231/12</b> (2006.01) <b>C07C 233/18</b> (2006.01)
2479880	<b>H02M 7/06</b> (2006.01) <b>H01F 29/00</b> (2006.01)	2455895	<b>G06Q 10/00</b> (2012.01)	2558344 *	<b>B61D 19/02</b> (2006.01) <b>E05F 15/18</b> (2006.01) <b>E05D 15/06</b> (2006.01)
2548540	<b>A61F 13/15</b> (2006.01) <b>B26D 7/18</b> (2006.01)	2563115 *	<b>A01N 25/04</b> (2006.01)	2579831 *	<b>A61M 35/00</b> (2006.01) <b>A61B 19/02</b> (2006.01) <b>A61J 1/05</b> (2006.01)
		2568847 *	<b>A41C 3/12</b> (2006.01) <b>A44C 25/00</b> (2006.01)		

Broj objave evropske prijave patenta (97)	MKP (51)	Broj objave evropske prijave patenta (97)	MKP (51)	Broj objave evropske prijave patenta (97)	MKP (51)
2563803 *	<b>C07J 19/00</b> (2006.01) <b>A61K 31/585</b> (2006.01) <b>C07J 71/00</b> (2006.01) <b>A61P 35/00</b> (2006.01)	2552931 *	<b>A61K 31/7076</b> (2006.01) <b>A61K 31/7072</b> (2006.01) <b>C07F 9/6558</b> (2006.01) <b>C07H 19/044</b> (2006.01) <b>C07F 9/655</b> (2006.01) <b>C07H 19/04</b> (2006.01) <b>A61P 31/14</b> (2006.01) <b>A61K 31/664</b> (2006.01) <b>C07H 19/10</b> (2006.01) <b>C07H 19/06</b> (2006.01) <b>C07F 9/24</b> (2006.01) <b>C07F 7/18</b> (2006.01) <b>C07H 19/24</b> (2006.01) <b>C07F 9/6561</b> (2006.01) <b>C07H 19/052</b> (2006.01)	2545384 *	<b>G01N 33/68</b> (2006.01)
2571503 *	<b>A61K 31/553</b> (2006.01) <b>A61K 31/555</b> (2006.01)	2544689 *	<b>A61K 47/30</b> (2006.01) <b>A61K 9/20</b> (2006.01) <b>A61K 31/498</b> (2006.01) <b>A61K 31/4965</b> (2006.01) <b>A61K 31/395</b> (2006.01) <b>A61P 31/14</b> (2006.01)	2465822	<b>C02F 1/00</b> (2006.01) <b>C02F 1/52</b> (2006.01)
2576558 *	<b>C07D 487/04</b> (2006.01)	2542048 *	<b>A01H 5/10</b> (2006.01)	2554273	<b>B05B 7/04</b> (2006.01)
2556231 *	<b>F02D 41/22</b> (2006.01)	2552519 *	<b>A61M 5/315</b> (2006.01)	2560491 *	<b>A01N 43/42</b> (2006.01) <b>A61K 31/44</b> (2006.01)
2560536 *	<b>A47K 10/36</b> (2006.01)	2568806 *	<b>A01N 33/02</b> (2006.01)	2552384 *	<b>A61K 8/26</b> (2006.01) <b>A61K 8/24</b> (2006.01) <b>A61Q 11/00</b> (2006.01)
2582369 *	<b>A61K 31/555</b> (2006.01) <b>A61K 31/282</b> (2006.01) <b>A61K 33/24</b> (2006.01) <b>A61K 31/337</b> (2006.01) <b>A61K 45/06</b> (2006.01) <b>A61K 31/167</b> (2006.01) <b>A61P 35/00</b> (2006.01)	2495235	<b>C07C 405/00</b> (2006.01) <b>C07D 307/935</b> (2006.01)	2559627	<b>B65D 5/24</b> (2006.01) <b>B65D 5/20</b> (2006.01)
		2591006 *	<b>C07K 19/00</b> (2006.01) <b>A61K 47/42</b> (2006.01) <b>C07K 16/46</b> (2006.01)	2583356 *	<b>H01R 4/58</b> (2006.01)
				2590974 *	<b>A61P 29/00</b> (2006.01) <b>C07D 471/04</b> (2006.01) <b>A61K 31/517</b> (2006.01)
				2579924 *	<b>A61M 5/24</b> (2006.01) <b>A61M 5/315</b> (2006.01)
				2579878 *	<b>A61K 31/517</b> (2006.01) <b>A61P 35/02</b> (2006.01) <b>A61K 31/52</b> (2006.01)

Broj objave evropske prijave patenta (97)	MKP (51)	Broj objave evropske prijave patenta (97)	MKP (51)	Broj objave evropske prijave patenta (97)	MKP (51)
2578678 *	<b>G01N 33/50</b> (2006.01) <b>C12Q 1/02</b> (2006.01) <b>C07K 14/435</b> (2006.01) <b>C12N 5/10</b> (2006.01) <b>C07K 14/82</b> (2006.01) <b>A01K 67/027</b> (2006.01) <b>A61P 35/00</b> (2006.01) <b>G01N 33/15</b> (2006.01) <b>C12N 15/09</b> (2006.01)	2558498 *	<b>A61K 39/395</b> (2006.01) <b>A01K 67/027</b> (2006.01) <b>A61P 37/02</b> (2006.01) <b>C07K 16/28</b> (2006.01) <b>A61P 35/00</b> (2006.01) <b>C07K 14/705</b> (2006.01)	2588094 *	<b>A61P 25/36</b> (2006.01) <b>A61P 25/04</b> (2006.01) <b>A61K 9/00</b> (2006.01) <b>A61K 31/135</b> (2006.01) <b>A61K 31/137</b> (2006.01) <b>A61K 9/12</b> (2006.01)
2505736	<b>E04F 11/032</b> (2006.01)	2555812 *	<b>A61M 5/178</b> (2006.01) <b>A61M 39/22</b> (2006.01) <b>A61M 5/145</b> (2006.01)	2552216 *	<b>A01N 55/08</b> (2006.01)
2566499 *	<b>A61P 3/10</b> (2006.01) <b>A61P 35/00</b> (2006.01) <b>A61K 38/17</b> (2006.01) <b>C07K 14/525</b> (2006.01) <b>A61K 39/395</b> (2006.01) <b>A61P 29/00</b> (2006.01)	2484350	<b>A61K 31/05</b> (2006.01) <b>A61K 47/48</b> (2006.01) <b>A61K 9/00</b> (2006.01)	2585607 *	<b>C12P 21/02</b> (2006.01) <b>A61K 39/395</b> (2006.01) <b>C07K 16/00</b> (2006.01)
2542784 *	<b>F04D 29/40</b> (2006.01) <b>F04D 7/04</b> (2006.01) <b>F15D 1/04</b> (2006.01)	2556622 *	<b>H04L 9/00</b> (2006.01) <b>H04K 1/00</b> (2006.01)	2553642 *	<b>G06Q 20/00</b> (2012.01)
2579867 *	<b>A61P 3/00</b> (2006.01) <b>A61K 31/23</b> (2006.01)	2569308 *	<b>A61K 31/4709</b> (2006.01) <b>C07D 409/14</b> (2006.01) <b>A61P 11/00</b> (2006.01)	2585437 *	<b>C07D 241/18</b> (2006.01) <b>C07D 401/04</b> (2006.01) <b>A61P 9/12</b> (2006.01) <b>A61K 31/444</b> (2006.01) <b>C07D 213/70</b> (2006.01) <b>A61P 9/00</b> (2006.01) <b>A61P 19/06</b> (2006.01) <b>A61K 31/4965</b> (2006.01) <b>A61K 31/44</b> (2006.01)
2556167 *	<b>C12Q 1/68</b> (2006.01)	2558717 *	<b>F03D 7/02</b> (2006.01)	2575459 *	<b>A01N 43/36</b> (2006.01) <b>A61K 31/40</b> (2006.01) <b>A61K 31/35</b> (2006.01)
2558082 *	<b>A61K 31/436</b> (2006.01) <b>A61P 35/00</b> (2006.01) <b>A61K 31/496</b> (2006.01) <b>A61K 31/00</b> (2006.01)	2550542 *	<b>G01S 11/14</b> (2006.01) <b>G01S 1/82</b> (2006.01) <b>G01S 1/76</b> (2006.01) <b>G01S 5/18</b> (2006.01)		
		2561218 *	<b>F03D 1/06</b> (2006.01)		
		2574217 *	<b>H01H 85/30</b> (2006.01)		
		2585720 *	<b>F04D 13/12</b> (2006.01) <b>F04F 10/02</b> (2006.01)		

Broj objave evropske prijave patenta (97)	MKP (51)	Broj objave evropske prijave patenta (97)	MKP (51)	Broj objave evropske prijave patenta (97)	MKP (51)
2544684 *	<b>C07D 409/14</b> (2006.01) <b>A61K 31/4375</b> (2006.01) <b>C07D 417/14</b> (2006.01) <b>C07D 401/06</b> (2006.01) <b>C07D 211/66</b> (2006.01) <b>A61K 31/4436</b> (2006.01) <b>C07D 407/14</b> (2006.01) <b>C07D 407/06</b> (2006.01) <b>C07D 417/06</b> (2006.01) <b>A61K 31/4439</b> (2006.01) <b>C07D 409/06</b> (2006.01) <b>A61K 31/444</b> (2006.01) <b>A61P 19/02</b> (2006.01)	2588455 *	<b>C07D 215/38</b> (2006.01) <b>C07D 519/00</b> (2006.01) <b>C07D 215/14</b> (2006.01) <b>C07D 417/04</b> (2006.01) <b>C07D 405/04</b> (2006.01) <b>C07D 401/12</b> (2006.01) <b>A61K 31/47</b> (2006.01) <b>C07D 215/18</b> (2006.01) <b>C07D 487/04</b> (2006.01) <b>C07D 215/48</b> (2006.01) <b>C07D 215/227</b> (2006.01) <b>C07D 215/06</b> (2006.01) <b>C07D 413/04</b> (2006.01) <b>C07D 401/04</b> (2006.01) <b>A61P 31/18</b> (2006.01)	2590668 *	<b>A61K 38/36</b> (2006.01)
2575822 *	<b>A61K 31/58</b> (2006.01) <b>A61K 47/06</b> (2006.01) <b>A61K 47/10</b> (2006.01) <b>A61K 47/36</b> (2006.01) <b>A61K 9/06</b> (2006.01)	2574663	<b>A61K 35/36</b> (2006.01) <b>C12M 3/08</b> (2006.01)	2583361 *	<b>H05K 1/11</b> (2006.01) <b>H01R 13/66</b> (2006.01) <b>H01R 27/00</b> (2006.01) <b>H01R 13/6582</b> (2011.01) <b>H01R 13/03</b> (2006.01) <b>H01R 29/00</b> (2006.01) <b>H01R 13/627</b> (2006.01) <b>H01R 13/24</b> (2006.01) <b>H01R 13/642</b> (2006.01)
2532556	<b>B60R 13/10</b> (2006.01)	2552429 *	<b>A61K 31/00</b> (2006.01) <b>A61K 31/4433</b> (2006.01) <b>A61K 45/06</b> (2006.01) <b>A61K 31/496</b> (2006.01) <b>A61K 31/46</b> (2006.01) <b>A61K 31/4725</b> (2006.01) <b>A61K 31/427</b> (2006.01) <b>A61K 31/4545</b> (2006.01) <b>A61K 31/4178</b> (2006.01) <b>A61K 31/351</b> (2006.01) <b>A61K 31/506</b> (2006.01) <b>A61K 31/4402</b> (2006.01) <b>A61K 31/472</b> (2006.01) <b>A61P 31/18</b> (2006.01) <b>A61K 31/499</b> (2006.01)	2452948 *	<b>C07K 14/47</b> (2006.01) <b>C07K 16/30</b> (2006.01) <b>C07K 14/435</b> (2006.01) <b>G01N 33/574</b> (2006.01) <b>C07K 16/18</b> (2006.01) <b>A61K 39/395</b> (2006.01) <b>A61P 35/04</b> (2006.01)
2563374 *	<b>A61K 31/765</b> (2006.01) <b>A61P 31/22</b> (2006.01)	2568977 *	<b>A61K 31/135</b> (2006.01) <b>A61K 9/20</b> (2006.01)	2593206 *	<b>B01D 39/08</b> (2006.01) <b>B01D 39/20</b> (2006.01) <b>B01D 39/16</b> (2006.01)
2569030 *	<b>B65D 71/70</b> (2006.01) <b>A61M 5/00</b> (2006.01) <b>B65B 3/00</b> (2006.01)	2589303 *	<b>F26B 5/04</b> (2006.01) <b>B65D 33/01</b> (2006.01) <b>B65D 81/00</b> (2006.01) <b>A23L 3/015</b> (2006.01) <b>A01F 25/14</b> (2006.01) <b>B65D 30/00</b> (2006.01) <b>B65D 33/00</b> (2006.01) <b>B65D 33/16</b> (2006.01) <b>B65D 81/20</b> (2006.01)		

Broj objave evropske prijave patenta (97)	MKP (51)	Broj objave evropske prijave patenta (97)	MKP (51)	Broj objave evropske prijave patenta (97)	MKP (51)
2580195 *	<b>A61P 11/00</b> (2006.01) <b>A61P 11/06</b> (2006.01) <b>A61K 31/40</b> (2006.01) <b>C07D 207/12</b> (2006.01) <b>A61P 11/08</b> (2006.01)	2249466	<b>H02K 21/18</b> (2006.01)	2577418 *	<b>G06F 1/16</b> (2006.01) <b>H04L 12/28</b> (2006.01)
2560956 *	<b>C07D 213/51</b> (2006.01) <b>C07D 277/34</b> (2006.01)	2555615 *	<b>A01P 13/00</b> (2006.01) <b>A01P 3/00</b> (2006.01) <b>A01N 43/40</b> (2006.01) <b>A01N 25/32</b> (2006.01)	2582881 *	<b>E02B 3/00</b> (2006.01) <b>B65D 88/36</b> (2006.01)
2563813 *	<b>C07K 16/18</b> (2006.01)	2547691 *	<b>A61P 35/00</b> (2006.01) <b>C07K 7/06</b> (2006.01) <b>A61K 39/00</b> (2006.01)	2585137 *	<b>A61M 5/20</b> (2006.01) <b>A61M 5/00</b> (2006.01) <b>A61M 5/32</b> (2006.01)
2582621 *	<b>C01B 13/11</b> (2006.01) <b>B01J 19/08</b> (2006.01) <b>B01J 19/00</b> (2006.01)	2484550	<b>B60P 1/02</b> (2006.01)	2566318 *	<b>C12N 15/82</b> (2006.01) <b>A01H 5/10</b> (2006.01) <b>C07K 14/415</b> (2006.01) <b>A01H 1/06</b> (2006.01)
2590631 *	<b>A61K 9/20</b> (2006.01) <b>A61K 31/7072</b> (2006.01) <b>A61K 9/28</b> (2006.01) <b>A61K 31/155</b> (2006.01)	2542571 *	<b>A61K 39/00</b> (2006.01) <b>A61P 25/28</b> (2006.01) <b>A61P 37/04</b> (2006.01) <b>A61K 39/395</b> (2006.01) <b>C07K 16/18</b> (2006.01) <b>C07K 14/47</b> (2006.01) <b>C12N 15/13</b> (2006.01) <b>G01N 33/53</b> (2006.01)	2579928 *	<b>A61M 5/315</b> (2006.01)
2545047 *	<b>C07D 403/04</b> (2006.01) <b>C07D 403/14</b> (2006.01) <b>A61K 31/4184</b> (2006.01) <b>A61P 25/28</b> (2006.01) <b>C07D 401/04</b> (2006.01) <b>A61K 31/454</b> (2006.01) <b>A61P 31/04</b> (2006.01) <b>A61K 31/4709</b> (2006.01) <b>A61P 35/00</b> (2006.01) <b>A61K 31/5377</b> (2006.01) <b>A61P 29/00</b> (2006.01) <b>C07D 405/10</b> (2006.01) <b>A61P 25/18</b> (2006.01) <b>C07D 403/10</b> (2006.01) <b>A61P 1/04</b> (2006.01)	2471385	<b>A61K 9/00</b> (2006.01) <b>A23L 1/30</b> (2006.01) <b>A61K 31/23</b> (2006.01) <b>A61K 9/16</b> (2006.01)	2571610 *	<b>B01F 5/04</b> (2006.01) <b>B03D 3/06</b> (2006.01) <b>B01D 21/01</b> (2006.01)
		2566327 *	<b>A01N 43/38</b> (2006.01) <b>A61K 31/405</b> (2006.01)	2587145 *	<b>B09B 3/00</b> (2006.01) <b>F23G 5/00</b> (2006.01) <b>F23G 5/04</b> (2006.01)
		2588090 *	<b>A61K 9/50</b> (2006.01)	2444068	<b>A61K 31/498</b> (2006.01) <b>A61K 9/06</b> (2006.01) <b>A61K 47/14</b> (2006.01) <b>A61K 47/32</b> (2006.01) <b>A61K 9/00</b> (2006.01)
		2544599 *	<b>A61B 17/06</b> (2006.01)		
		2547372 *	<b>A61L 27/20</b> (2006.01) <b>C12R 1/02</b> (2006.01) <b>A61L 26/00</b> (2006.01)		

Broj objave evropske prijave patenta (97)	MKP (51)	Broj objave evropske prijave patenta (97)	MKP (51)	Broj objave evropske prijave patenta (97)	MKP (51)
2545037 *	<b>C07D 401/14</b> (2006.01) <b>A61K 31/496</b> (2006.01) <b>A61K 31/4418</b> (2006.01) <b>A61P 9/00</b> (2006.01) <b>C07D 401/12</b> (2006.01) <b>A61K 31/4436</b> (2006.01) <b>C07D 417/12</b> (2006.01) <b>A61P 29/00</b> (2006.01) <b>C07D 213/75</b> (2006.01) <b>A61K 31/44</b> (2006.01) <b>A61K 31/4545</b> (2006.01) <b>A61P 25/00</b> (2006.01) <b>A61K 31/4439</b> (2006.01) <b>C07D 409/12</b> (2006.01) <b>A61P 25/28</b> (2006.01)	2572717 *	<b>A61K 31/4725</b> (2006.01) <b>A61P 13/10</b> (2006.01) <b>A61K 9/10</b> (2006.01) <b>A61P 43/00</b> (2006.01) <b>A61K 47/32</b> (2006.01) <b>A61P 13/00</b> (2006.01) <b>A61P 11/06</b> (2006.01) <b>A61K 47/30</b> (2006.01) <b>A61P 11/00</b> (2006.01) <b>A61P 1/00</b> (2006.01)	2547453 *	<b>B03D 101/02</b> (2006.01) <b>C22B 26/00</b> (2006.01) <b>B03D 1/01</b> (2006.01) <b>C22B 26/20</b> (2006.01)
		2546556 *	<b>F17C 13/06</b> (2006.01) <b>F16J 13/08</b> (2006.01)	2566583 *	<b>A61K 8/19</b> (2006.01) <b>A61K 8/67</b> (2006.01) <b>A61Q 19/00</b> (2006.01) <b>A61Q 19/08</b> (2006.01) <b>A61K 8/98</b> (2006.01)
		2505100	<b>A47B 87/02</b> (2006.01)	2553665 *	<b>G07F 9/02</b> (2006.01)
		2550530 *	<b>G01N 33/487</b> (2006.01)	2576616 *	<b>C07K 16/00</b> (2006.01)
2586114 *	<b>H02J 7/14</b> (2006.01)			2583076 *	<b>G01M 5/00</b> (2006.01) <b>G01M 11/08</b> (2006.01)
		2552591 *	<b>B03C 3/06</b> (2006.01) <b>B03C 3/16</b> (2006.01)	2590550 *	<b>G01N 33/487</b> (2006.01) <b>A61B 5/1486</b> (2006.01) <b>A61B 5/157</b> (2006.01) <b>A61B 5/151</b> (2006.01) <b>A61B 5/00</b> (2006.01)
2575461 *	<b>A61K 31/44</b> (2006.01) <b>A01N 43/40</b> (2006.01)	2556824	<b>A61K 9/20</b> (2006.01) <b>A61K 31/165</b> (2006.01) <b>A61K 9/00</b> (2006.01)		
2560531 *	<b>A47K 5/12</b> (2006.01)			2544576 *	<b>A47L 13/20</b> (2006.01) <b>A47L 13/256</b> (2006.01) <b>A47L 13/44</b> (2006.01)
2563122 *	<b>A01N 43/02</b> (2006.01) <b>A01N 43/22</b> (2006.01) <b>A61K 31/38</b> (2006.01)	2514601	<b>B41N 6/00</b> (2006.01)		
		2590987 *	<b>A61K 31/437</b> (2006.01) <b>A61P 9/00</b> (2006.01) <b>C07D 519/00</b> (2006.01)	2544313 *	<b>H01R 13/52</b> (2006.01)
2571571 *	<b>H04R 25/00</b> (2006.01) <b>A61N 1/36</b> (2006.01)			2540719 *	<b>A01N 43/90</b> (2006.01) <b>A61P 33/10</b> (2006.01) <b>A01P 7/02</b> (2006.01) <b>C07D 491/052</b> (2006.01) <b>C07D 451/06</b> (2006.01)
2586034 *	<b>G21F 9/30</b> (2006.01) <b>G21F 9/02</b> (2006.01)	2566515 *	<b>A61K 39/39</b> (2006.01) <b>A61K 38/43</b> (2006.01) <b>C12N 9/00</b> (2006.01) <b>A61P 37/00</b> (2006.01) <b>A61K 39/395</b> (2006.01) <b>A61K 38/16</b> (2006.01)	2560708 *	<b>A61M 5/24</b> (2006.01)

Broj objave evropske prijave patenta (97)	MKP (51)	Broj objave evropske prijave patenta (97)	MKP (51)	Broj objave evropske prijave patenta (97)	MKP (51)
2588141 *	<b>A61K 47/08</b> (2006.01) <b>A61K 39/395</b> (2006.01) <b>A61K 9/08</b> (2006.01)	2566777 *	<b>B65D 77/04</b> (2006.01) <b>B65D 8/04</b> (2006.01) <b>B65D 77/06</b> (2006.01)	2585489 *	<b>A61M 1/14</b> (2006.01) <b>C07K 14/705</b> (2006.01) <b>C07K 17/02</b> (2006.01)
2591000 *	<b>C07K 16/10</b> (2006.01) <b>A61P 31/12</b> (2006.01)	2555851 *	<b>B01D 53/64</b> (2006.01) <b>B01D 53/34</b> (2006.01) <b>B01D 53/02</b> (2006.01)	2552689 *	<b>B32B 27/08</b> (2006.01) <b>B32B 27/36</b> (2006.01) <b>C08G 63/08</b> (2006.01)
2558867 *	<b>G01N 33/68</b> (2006.01)	2544685 *	<b>A61K 31/445</b> (2006.01) <b>A61K 9/20</b> (2006.01)	2569611 *	<b>G01M 3/32</b> (2006.01) <b>G01N 15/08</b> (2006.01) <b>C23C 16/00</b> (2006.01) <b>G01N 33/00</b> (2006.01)
2542541 *	<b>C07D 277/82</b> (2006.01)	2563911 *	<b>C07K 16/40</b> (2006.01) <b>C07K 19/00</b> (2006.01) <b>C12N 15/113</b> (2010.01) <b>G01N 33/68</b> (2006.01) <b>A61K 38/43</b> (2006.01) <b>C12N 9/00</b> (2006.01) <b>C12N 15/52</b> (2006.01)	2575464 *	<b>A01N 43/42</b> (2006.01) <b>C07D 291/00</b> (2006.01) <b>A61K 31/44</b> (2006.01)
2575804 *	<b>A61K 47/42</b> (2006.01) <b>A61P 35/00</b> (2006.01) <b>A61K 9/14</b> (2006.01) <b>A61K 31/337</b> (2006.01)	2585140 *	<b>A61M 5/32</b> (2006.01) <b>A61M 5/20</b> (2006.01) <b>A61M 5/00</b> (2006.01)	2390811	<b>G06F 19/24</b> (2011.01)
2575814 *	<b>A61K 31/47</b> (2006.01)	2573130 *	<b>C08J 3/22</b> (2006.01) <b>C08L 77/00</b> (2006.01) <b>C08K 3/22</b> (2006.01) <b>B29B 9/12</b> (2006.01)	2548257 *	<b>H01M 4/96</b> (2006.01) <b>G21B 3/00</b> (2006.01) <b>H01M 14/00</b> (2006.01) <b>C01B 3/00</b> (2006.01) <b>H01M 8/22</b> (2006.01) <b>H01M 4/94</b> (2006.01) <b>H01M 4/86</b> (2006.01)
2582916 *	<b>F03G 7/00</b> (2006.01) <b>F01B 23/02</b> (2006.01) <b>F01B 9/02</b> (2006.01) <b>B60W 20/00</b> (2006.01)	2576141 *	<b>C09J 167/06</b> (2006.01) <b>C08G 63/676</b> (2006.01) <b>C08G 63/52</b> (2006.01) <b>B24D 3/28</b> (2006.01) <b>B24D 3/20</b> (2006.01)		
2547645 *	<b>C07C 235/40</b> (2006.01) <b>C07C 69/74</b> (2006.01) <b>C07C 51/487</b> (2006.01) <b>C07C 61/06</b> (2006.01)	2460552	<b>A61M 5/24</b> (2006.01) <b>A61M 5/315</b> (2006.01)		
2471514	<b>A61K 9/48</b> (2006.01) <b>A61K 9/16</b> (2006.01) <b>A61K 9/20</b> (2006.01) <b>A61K 31/23</b> (2006.01)	2558681 *	<b>E21B 47/00</b> (2012.01)		



Broj objave evropske prijave patenta (97)	MKP (51)	Broj objave evropske prijave patenta (97)	MKP (51)	Broj objave evropske prijave patenta (97)	MKP (51)
2556056 *	<b>C07D 211/46</b> (2006.01) <b>C07D 413/14</b> (2006.01) <b>C07D 413/04</b> (2006.01) <b>C07D 413/06</b> (2006.01) <b>C07D 405/12</b> (2006.01) <b>A61K 31/495</b> (2006.01) <b>C07D 401/12</b> (2006.01) <b>A61K 31/445</b> (2006.01) <b>C07D 405/14</b> (2006.01) <b>A61P 3/10</b> (2006.01) <b>C07D 401/14</b> (2006.01) <b>A61K 31/454</b> (2006.01) <b>C07D 401/04</b> (2006.01) <b>C07D 417/14</b> (2006.01)	2580346 *	<b>C12Q 1/60</b> (2006.01)	2593434 *	<b>C07D 213/81</b> (2006.01) <b>A61K 31/4412</b> (2006.01) <b>C07D 413/12</b> (2006.01) <b>A61K 31/4439</b> (2006.01) <b>C07D 401/12</b> (2006.01) <b>A61P 25/00</b> (2006.01) <b>A61K 31/443</b> (2006.01) <b>A61K 31/444</b> (2006.01)
		2590501 *	<b>A01K 1/00</b> (2006.01) <b>A01K 1/01</b> (2006.01)	2563400 *	<b>A61P 35/00</b> (2006.01) <b>A61K 47/48</b> (2006.01) <b>A61P 27/02</b> (2006.01)
		2566474 *	<b>A61P 29/00</b> (2006.01) <b>A61K 31/337</b> (2006.01) <b>A61K 9/107</b> (2006.01) <b>A61K 9/10</b> (2006.01)	2591042 *	<b>C08J 3/11</b> (2006.01) <b>B29C 65/48</b> (2006.01) <b>C08J 5/12</b> (2006.01) <b>C09J 127/06</b> (2006.01) <b>C09J 155/02</b> (2006.01)
		2588630 *	<b>C12Q 1/68</b> (2006.01)	2576547 *	<b>A61P 9/00</b> (2006.01) <b>A61P 15/00</b> (2006.01) <b>A61K 31/437</b> (2006.01) <b>C07D 471/04</b> (2006.01)
		2505634	<b>C12M 1/02</b> (2006.01) <b>C12M 1/00</b> (2006.01) <b>B01F 11/00</b> (2006.01)	2576209 *	<b>E04B 1/74</b> (2006.01) <b>B27N 7/00</b> (2006.01) <b>E04F 13/00</b> (2006.01) <b>B60R 13/02</b> (2006.01) <b>B32B 5/28</b> (2006.01) <b>D06M 13/402</b> (2006.01) <b>C08J 7/06</b> (2006.01) <b>B32B 21/10</b> (2006.01)
2443231 *	<b>A61K 35/12</b> (2006.01) <b>C12N 5/10</b> (2006.01) <b>C12N 5/0735</b> (2010.01) <b>C12N 15/12</b> (2006.01) <b>C12N 5/074</b> (2010.01)	2588173 *	<b>A61M 5/32</b> (2006.01) <b>A61M 5/50</b> (2006.01)	2571885 *	<b>A61K 31/506</b> (2006.01) <b>C07D 487/14</b> (2006.01)
		2576387 *	<b>B65D 83/44</b> (2006.01) <b>B67D 1/12</b> (2006.01) <b>G01F 11/08</b> (2006.01) <b>B65D 83/18</b> (2006.01) <b>B65D 83/16</b> (2006.01) <b>G01F 11/04</b> (2006.01) <b>B65D 83/60</b> (2006.01) <b>B65D 83/14</b> (2006.01) <b>B67D 1/02</b> (2006.01) <b>B67D 1/04</b> (2006.01)		
2542254 *	<b>A61K 38/00</b> (2006.01) <b>A61K 38/16</b> (2006.01)	2569568 *	<b>F16L 51/03</b> (2006.01)		
2547686 *	<b>C07D 498/20</b> (2006.01) <b>A61K 31/537</b> (2006.01) <b>C07D 498/10</b> (2006.01) <b>A61K 31/5386</b> (2006.01) <b>C07D 513/10</b> (2006.01) <b>C07D 513/20</b> (2006.01) <b>A61P 25/28</b> (2006.01) <b>A61K 31/547</b> (2006.01)	2575784 *	<b>A61K 47/10</b> (2006.01) <b>A61K 9/14</b> (2006.01) <b>A61K 31/4184</b> (2006.01) <b>A61K 9/48</b> (2006.01)		
2560003 *	<b>G01N 33/548</b> (2006.01) <b>G01N 33/53</b> (2006.01)				

Broj objave evropske prijava patenta (97)	MKP (51)	Broj objave evropske prijava patenta (97)	MKP (51)	Broj objave evropske prijava patenta (97)	MKP (51)
2563878 *	<b>C10C 3/14</b> (2006.01)	2570149	<b>G06M 1/16</b> (2006.01) <b>A61M 15/00</b> (2006.01) <b>G06M 1/24</b> (2006.01)	2539326 *	<b>C07D 409/06</b> (2006.01) <b>C07D 249/12</b> (2006.01) <b>A61K 31/4196</b> (2006.01) <b>C07D 403/06</b> (2006.01) <b>C07D 413/14</b> (2006.01) <b>C07D 417/06</b> (2006.01) <b>C07D 409/14</b> (2006.01) <b>C07D 413/06</b> (2006.01) <b>C07D 401/06</b> (2006.01) <b>A61P 9/00</b> (2006.01)
2566329 *	<b>A61K 31/47</b> (2006.01) <b>A01N 43/42</b> (2006.01)	2569939 *	<b>H04N 7/00</b> (2011.01) <b>H04N 7/15</b> (2006.01) <b>H04N 7/14</b> (2006.01)	2588468 *	<b>A61P 35/00</b> (2006.01) <b>C07D 519/00</b> (2006.01) <b>A61K 31/4743</b> (2006.01) <b>C07D 401/12</b> (2006.01) <b>A61P 29/00</b> (2006.01) <b>C07D 487/04</b> (2006.01)
2550363 *	<b>C12N 9/64</b> (2006.01) <b>A01K 67/027</b> (2006.01) <b>C12N 15/85</b> (2006.01) <b>C07K 16/46</b> (2006.01)	2585055 *	<b>A61K 31/519</b> (2006.01) <b>A61P 7/06</b> (2006.01) <b>A61K 31/5377</b> (2006.01) <b>A61K 31/4439</b> (2006.01) <b>A61K 31/198</b> (2006.01) <b>A61K 45/06</b> (2006.01) <b>A61K 31/506</b> (2006.01) <b>A61K 31/427</b> (2006.01) <b>A61K 31/426</b> (2006.01)	2569326 *	<b>C07K 1/107</b> (2006.01) <b>A61P 31/20</b> (2006.01) <b>A61P 35/00</b> (2006.01) <b>A61P 31/18</b> (2006.01) <b>A61P 31/16</b> (2006.01) <b>C07K 14/47</b> (2006.01) <b>C07K 7/06</b> (2006.01) <b>C07K 14/715</b> (2006.01) <b>A61P 37/00</b> (2006.01)
2593125 *	<b>A61K 38/08</b> (2006.01) <b>A61K 39/395</b> (2006.01) <b>A61P 3/10</b> (2006.01) <b>A61K 38/10</b> (2006.01) <b>A61P 35/00</b> (2006.01) <b>A61K 38/16</b> (2006.01) <b>A61P 3/00</b> (2006.01)	2588483 *	<b>C07D 495/04</b> (2006.01)	2571534 *	<b>A61L 2/00</b> (2006.01)
2569418 *	<b>C12N 5/071</b> (2010.01)	2539468 *	<b>G06F 17/15</b> (2006.01) <b>C12Q 1/68</b> (2006.01) <b>G06F 19/10</b> (2011.01)	2585066 *	<b>A61K 31/496</b> (2006.01) <b>C07D 401/12</b> (2006.01)
2485573	<b>H05K 9/00</b> (2006.01)	2550048 *	<b>A61B 17/00</b> (2006.01) <b>B01L 3/02</b> (2006.01) <b>A61M 5/46</b> (2006.01) <b>A61M 5/315</b> (2006.01) <b>A61M 5/20</b> (2006.01) <b>A61M 5/32</b> (2006.01) <b>A61M 5/19</b> (2006.01)	2569631 *	<b>C12N 5/02</b> (2006.01) <b>C12N 5/00</b> (2006.01) <b>G01N 33/53</b> (2006.01)
2547360 *	<b>A61K 39/00</b> (2006.01)				
2579894 *	<b>A61K 39/395</b> (2006.01)				
2568817 *	<b>A23C 19/068</b> (2006.01)				
2471387	<b>A23L 1/30</b> (2006.01) <b>A61K 31/23</b> (2006.01) <b>A61K 9/00</b> (2006.01) <b>A61K 9/16</b> (2006.01)				
2584900 *	<b>A61K 31/44</b> (2006.01) <b>A01N 43/42</b> (2006.01)				

Broj objave evropske prijave patenta (97)	MKP (51)	Broj objave evropske prijave patenta (97)	MKP (51)	Broj objave evropske prijave patenta (97)	MKP (51)
2558124 *	<b>A61K 39/395</b> (2006.01)	2560532 *	<b>B65D 47/20</b> (2006.01) <b>A47K 5/12</b> (2006.01) <b>B65D 47/32</b> (2006.01) <b>B05B 11/00</b> (2006.01) <b>B65D 51/16</b> (2006.01) <b>A47K 5/13</b> (2006.01) <b>G01F 11/08</b> (2006.01)	2572700 *	<b>A61K 8/55</b> (2006.01) <b>A61Q 7/00</b> (2006.01) <b>A61Q 5/00</b> (2006.01)
2552902 *	<b>A61P 31/18</b> (2006.01) <b>A61K 31/4439</b> (2006.01) <b>C07D 401/06</b> (2006.01)	2547672 *	<b>A61K 31/505</b> (2006.01) <b>A61P 11/00</b> (2006.01) <b>C07D 403/04</b> (2006.01)	2542687 *	<b>C12Q 1/00</b> (2006.01) <b>G01N 33/487</b> (2006.01) <b>A61K 38/00</b> (2006.01) <b>A61P 5/26</b> (2006.01) <b>G01N 33/483</b> (2006.01) <b>A61P 3/00</b> (2006.01)
2566782 *	<b>B65D 83/44</b> (2006.01)	2580046 *	<b>B29C 53/82</b> (2006.01) <b>B29C 69/00</b> (2006.01) <b>B29C 53/70</b> (2006.01)	2577303 *	<b>G01N 33/487</b> (2006.01)
2394551	<b>A47K 10/38</b> (2006.01)	2575785 *	<b>A61K 31/4184</b> (2006.01) <b>A61K 9/28</b> (2006.01) <b>A61K 9/16</b> (2006.01) <b>A61K 9/48</b> (2006.01) <b>A61K 9/20</b> (2006.01) <b>A61K 47/10</b> (2006.01) <b>A61K 9/14</b> (2006.01)	2575879 *	<b>A61K 39/395</b> (2006.01) <b>A61P 35/00</b> (2006.01) <b>C07K 16/28</b> (2006.01)
2564875 *	<b>A61K 47/38</b> (2006.01) <b>A61K 9/08</b> (2006.01) <b>A61K 47/42</b> (2006.01) <b>A61K 47/10</b> (2006.01) <b>A61K 47/36</b> (2006.01) <b>A61K 47/34</b> (2006.01) <b>A61K 49/04</b> (2006.01) <b>A61K 47/26</b> (2006.01)	2576543 *	<b>C07D 413/06</b> (2006.01) <b>A61K 31/5377</b> (2006.01) <b>A61K 31/4025</b> (2006.01) <b>C07D 403/12</b> (2006.01) <b>C07D 413/14</b> (2006.01) <b>C07D 413/12</b> (2006.01) <b>A61K 31/496</b> (2006.01) <b>A61K 31/454</b> (2006.01) <b>C07D 401/12</b> (2006.01) <b>A61P 25/00</b> (2006.01)	2565236	<b>C09C 1/02</b> (2006.01) <b>D21H 17/00</b> (2006.01)
2575850 *	<b>A61P 35/00</b> (2006.01) <b>C07K 14/47</b> (2006.01) <b>A61K 39/00</b> (2006.01) <b>A61K 45/06</b> (2006.01) <b>A61K 38/04</b> (2006.01)	2447213	<b>C07K 14/535</b> (2006.01)	2563343 *	<b>A61M 1/16</b> (2006.01) <b>A61M 1/36</b> (2006.01) <b>A61K 9/50</b> (2006.01)
2588217 *	<b>B01D 53/22</b> (2006.01) <b>C10L 3/10</b> (2006.01)	2455573	<b>E05D 15/06</b> (2006.01) <b>E06B 3/46</b> (2006.01)		
2579926 *	<b>A61M 5/24</b> (2006.01) <b>A61M 5/315</b> (2006.01)				
2560651 *	<b>A61K 31/404</b> (2006.01) <b>A61K 31/4704</b> (2006.01) <b>A61K 31/443</b> (2006.01)	2577359 *	<b>G01V 1/48</b> (2006.01)		
		2588165 *	<b>A61M 5/32</b> (2006.01)		

Broj objave evropske prijave patenta (97)	MKP (51)	Broj objave evropske prijave patenta (97)	MKP (51)	Broj objave evropske prijave patenta (97)	MKP (51)
2576507 *	<b>C07D 211/16</b> (2006.01) <b>C07D 403/04</b> (2006.01) <b>C07D 211/62</b> (2006.01) <b>C07D 205/04</b> (2006.01) <b>A61K 31/4468</b> (2006.01) <b>C07D 211/54</b> (2006.01) <b>C07D 409/12</b> (2006.01) <b>C07D 207/12</b> (2006.01) <b>A61P 25/00</b> (2006.01) <b>C07D 211/58</b> (2006.01) <b>C07D 413/12</b> (2006.01) <b>C07D 211/46</b> (2006.01) <b>C07D 405/12</b> (2006.01) <b>C07D 207/14</b> (2006.01) <b>C07D 401/12</b> (2006.01)	2555754 *	<b>A61K 9/28</b> (2006.01) <b>A61K 9/16</b> (2006.01) <b>A61K 9/20</b> (2006.01) <b>C07D 405/12</b> (2006.01) <b>C07D 405/14</b> (2006.01) <b>C07D 213/75</b> (2006.01)	2575431 *	<b>A01H 5/00</b> (2006.01) <b>C12N 15/82</b> (2006.01)
		2585459 *	<b>A61K 31/439</b> (2006.01) <b>A61P 11/00</b> (2006.01) <b>C07D 453/02</b> (2006.01)	2538962 *	<b>A61K 38/18</b> (2006.01) <b>A61P 27/02</b> (2006.01)
		2545052 *	<b>C07D 471/04</b> (2006.01) <b>A61K 31/437</b> (2006.01) <b>A61P 29/00</b> (2006.01) <b>A61P 11/00</b> (2006.01) <b>A61P 35/00</b> (2006.01) <b>C07D 519/00</b> (2006.01) <b>A61P 35/02</b> (2006.01) <b>A61P 19/00</b> (2006.01)	2563351 *	<b>A61K 47/10</b> (2006.01) <b>A61K 47/32</b> (2006.01) <b>A61K 31/12</b> (2006.01)
2569296 *	<b>A61K 31/403</b> (2006.01) <b>C07D 403/10</b> (2006.01) <b>C07D 401/10</b> (2006.01) <b>A61P 25/00</b> (2006.01)	2566452 *	<b>A61K 31/422</b> (2006.01) <b>A61K 9/00</b> (2006.01) <b>A61K 31/497</b> (2006.01) <b>A61K 31/404</b> (2006.01)	2383249	<b>C07C 51/02</b> (2006.01) <b>C07C 51/44</b> (2006.01) <b>C07C 51/46</b> (2006.01)
		2545211 *	<b>C40B 40/06</b> (2006.01) <b>C40B 50/06</b> (2006.01)	2557129	<b>C02F 3/34</b> (2006.01) <b>C09C 1/02</b> (2006.01) <b>C02F 1/68</b> (2006.01)
2540728 *	<b>A61P 35/04</b> (2006.01) <b>C07D 495/04</b> (2006.01) <b>C07D 519/00</b> (2006.01) <b>A61K 31/5377</b> (2006.01) <b>A61P 43/00</b> (2006.01) <b>A61P 35/02</b> (2006.01) <b>A61P 35/00</b> (2006.01) <b>A61K 31/541</b> (2006.01) <b>A61K 31/519</b> (2006.01)	2555189 *	<b>G10L 21/02</b> (2013.01)	2570148	<b>A61M 15/00</b> (2006.01) <b>G06M 1/24</b> (2006.01) <b>G06M 1/16</b> (2006.01)
		2555809 *	<b>A61L 31/04</b> (2006.01) <b>A61K 9/16</b> (2006.01) <b>A61L 27/20</b> (2006.01)	2542552 *	<b>C07D 473/00</b> (2006.01) <b>A61K 31/437</b> (2006.01) <b>A61P 29/00</b> (2006.01) <b>A61P 9/00</b> (2006.01) <b>C07D 487/04</b> (2006.01) <b>A61K 31/52</b> (2006.01) <b>C07D 471/04</b> (2006.01) <b>A61K 31/4985</b> (2006.01)
		2557450 *	<b>G02B 27/34</b> (2006.01) <b>F41G 1/34</b> (2006.01)	2569309 *	<b>C07D 413/14</b> (2006.01) <b>C07D 413/04</b> (2006.01) <b>A61K 31/4245</b> (2006.01)

Broj objave evropske prijave patenta (97)	MKP (51)	Broj objave evropske prijave patenta (97)	MKP (51)	Broj objave evropske prijave patenta (97)	MKP (51)
2582703 *	<b>A61K 31/522</b> (2006.01) <b>A61P 29/00</b> (2006.01) <b>C07D 519/00</b> (2006.01) <b>C07D 487/04</b> (2006.01)	2539322 *	<b>C07D 498/04</b> (2006.01) <b>A61K 31/40</b> (2006.01) <b>C07D 401/04</b> (2006.01) <b>A61P 27/06</b> (2006.01) <b>C07D 209/96</b> (2006.01) <b>A61P 25/28</b> (2006.01) <b>C07D 491/10</b> (2006.01) <b>C07D 513/04</b> (2006.01) <b>C07D 471/04</b> (2006.01) <b>C07D 487/04</b> (2006.01)	2544690 *	<b>A61P 1/00</b> (2006.01) <b>C07D 239/26</b> (2006.01) <b>A61K 31/505</b> (2006.01) <b>A61K 31/506</b> (2006.01) <b>C07D 403/02</b> (2006.01) <b>A61P 25/00</b> (2006.01)
2563360 *	<b>A61P 35/02</b> (2006.01) <b>A61P 35/00</b> (2006.01) <b>A61K 31/404</b> (2006.01) <b>A61K 31/407</b> (2006.01)	2576218 *	<b>B32B 33/00</b> (2006.01)	2569297 *	<b>C07D 405/12</b> (2006.01) <b>A61P 25/00</b> (2006.01) <b>C07D 401/12</b> (2006.01) <b>A61K 31/351</b> (2006.01) <b>A61K 31/4439</b> (2006.01)
2588131 *	<b>A61K 38/47</b> (2006.01) <b>A61P 25/28</b> (2006.01) <b>A61P 25/00</b> (2006.01)	2503122	<b>F01N 3/20</b> (2006.01)	2500100	<b>B02C 18/24</b> (2006.01)
2590653 *	<b>A61K 31/497</b> (2006.01)	2583967 *	<b>C07D 401/12</b> (2006.01) <b>A61P 9/12</b> (2006.01) <b>A61P 13/12</b> (2006.01) <b>A61P 43/00</b> (2006.01) <b>A61K 31/5377</b> (2006.01) <b>A61P 9/00</b> (2006.01)	2585068 *	<b>A61P 25/04</b> (2006.01) <b>A61K 31/513</b> (2006.01) <b>A61P 25/02</b> (2006.01) <b>A61K 31/53</b> (2006.01)
2544243 *	<b>H01L 31/04</b> (2006.01) <b>B32B 3/30</b> (2006.01) <b>B32B 27/30</b> (2006.01) <b>B32B 27/00</b> (2006.01)	2566771 *	<b>B65D 85/30</b> (2006.01) <b>B65D 81/107</b> (2006.01) <b>B65D 81/127</b> (2006.01) <b>B65D 25/06</b> (2006.01) <b>B65D 81/02</b> (2006.01) <b>B65D 85/20</b> (2006.01)	2548927 *	<b>C09B 63/00</b> (2006.01) <b>C09B 67/20</b> (2006.01)
2588138 *	<b>C07K 16/22</b> (2006.01) <b>A61K 39/395</b> (2006.01) <b>A61P 27/02</b> (2006.01)	2472228	<b>G01C 21/36</b> (2006.01)	2590978 *	<b>A61K 31/407</b> (2006.01) <b>C07D 477/14</b> (2006.01) <b>C07D 403/06</b> (2006.01) <b>A61P 31/04</b> (2006.01) <b>C07D 487/04</b> (2006.01)
2592971 *	<b>A47C 1/14</b> (2006.01) <b>A47C 1/022</b> (2006.01) <b>A47C 17/04</b> (2006.01) <b>A47C 3/025</b> (2006.01)	2465480	<b>A61G 7/057</b> (2006.01)	2549984 *	<b>A61K 9/20</b> (2006.01) <b>A61K 31/485</b> (2006.01)

Broj objave evropske prijave patenta (97)	MKP (51)	Broj objave evropske prijave patenta (97)	MKP (51)	Broj objave evropske prijave patenta (97)	MKP (51)
2567698	<b>C07D 209/10</b> (2006.01) <b>C07K 14/72</b> (2006.01) <b>G01N 33/53</b> (2006.01) <b>A61K 31/405</b> (2006.01)	2550218 *	<b>B65H 19/22</b> (2006.01) <b>B65H 19/26</b> (2006.01)	2566495 *	<b>A61K 38/16</b> (2006.01) <b>A61K 39/395</b> (2006.01) <b>A61P 3/10</b> (2006.01) <b>A61P 35/00</b> (2006.01) <b>A61P 29/00</b> (2006.01) <b>C07K 14/525</b> (2006.01)
2576510 *	<b>C07D 407/04</b> (2006.01) <b>C07D 498/08</b> (2006.01) <b>C07D 417/06</b> (2006.01) <b>C07D 409/04</b> (2006.01) <b>A61K 31/4412</b> (2006.01) <b>C07D 413/06</b> (2006.01) <b>A61P 35/00</b> (2006.01) <b>C07D 401/04</b> (2006.01) <b>C07D 279/02</b> (2006.01) <b>C07D 401/06</b> (2006.01) <b>C07D 401/12</b> (2006.01) <b>C07D 407/06</b> (2006.01) <b>C07D 498/20</b> (2006.01) <b>C07D 211/40</b> (2006.01) <b>C07D 471/20</b> (2006.01)	2591001 *	<b>C07K 16/24</b> (2006.01) <b>C07K 16/28</b> (2006.01)	2590985 *	<b>A61K 31/438</b> (2006.01) <b>C07D 491/10</b> (2006.01) <b>A61P 13/02</b> (2006.01) <b>C07D 498/10</b> (2006.01)
		2556071 *	<b>C07D 403/04</b> (2006.01) <b>A61K 31/5377</b> (2006.01) <b>A61P 35/00</b> (2006.01) <b>C07D 413/14</b> (2006.01)	2593562 *	<b>C12Q 1/68</b> (2006.01)
		2547789 *	<b>G01N 33/50</b> (2006.01) <b>G01N 33/68</b> (2006.01) <b>C12Q 1/68</b> (2006.01)	2560486 *	<b>A61K 31/16</b> (2006.01) <b>A01N 37/18</b> (2006.01)
		2577372 *	<b>G02B 6/42</b> (2006.01) <b>H01R 13/40</b> (2006.01) <b>G02B 6/38</b> (2006.01)	2576838 *	<b>G01N 33/53</b> (2006.01) <b>C12N 15/12</b> (2006.01) <b>C12Q 1/68</b> (2006.01)
		2588086 *	<b>A61K 31/496</b> (2006.01) <b>A61K 9/20</b> (2006.01)	2593558 *	<b>C12N 15/53</b> (2006.01) <b>C12N 9/02</b> (2006.01) <b>C12N 9/04</b> (2006.01) <b>C12P 17/12</b> (2006.01) <b>C12P 21/02</b> (2006.01)
2539519 *	<b>E04D 1/30</b> (2006.01) <b>E04D 15/00</b> (2006.01) <b>E04D 1/34</b> (2006.01)	2566505 *	<b>A61P 1/16</b> (2006.01) <b>A61K 38/45</b> (2006.01)		
2433608	<b>A61J 1/05</b> (2006.01) <b>A61J 1/14</b> (2006.01) <b>A61J 1/20</b> (2006.01) <b>A61J 1/12</b> (2006.01)	2571975 *	<b>A61K 35/36</b> (2006.01) <b>C12M 3/08</b> (2006.01)	2585151 *	<b>B05B 11/00</b> (2006.01) <b>A61M 15/00</b> (2006.01)
2563365 *	<b>A61K 31/50</b> (2006.01)	2578379	<b>F24J 2/51</b> (2006.01) <b>B29C 49/00</b> (2006.01) <b>B29C 49/04</b> (2006.01) <b>F24J 2/04</b> (2006.01) <b>F24J 2/20</b> (2006.01) <b>F24J 2/52</b> (2006.01) <b>F24J 2/34</b> (2006.01) <b>F24J 2/46</b> (2006.01)	2542893 *	<b>G01N 33/574</b> (2006.01)
2569937 *	<b>H04N 7/15</b> (2006.01) <b>H04N 7/14</b> (2006.01)			2580402 *	<b>E04F 13/08</b> (2006.01) <b>E04B 2/90</b> (2006.01)
				2518434	<b>F41H 5/04</b> (2006.01)

Broj objave evropske prijave patenta (97)	MKP (51)	Broj objave evropske prijave patenta (97)	MKP (51)	Broj objave evropske prijave patenta (97)	MKP (51)
2567072 *	<b>F16J 15/02</b> (2006.01) <b>F01D 11/00</b> (2006.01) <b>F01D 25/24</b> (2006.01) <b>F02C 7/28</b> (2006.01)	2561340 *	<b>G01N 23/04</b> (2006.01)	2588471 *	<b>C07D 401/12</b> (2006.01) <b>A61K 31/4375</b> (2006.01) <b>C07D 471/04</b> (2006.01) <b>C07D 491/107</b> (2006.01) <b>C07D 409/14</b> (2006.01) <b>A61K 31/4709</b> (2006.01) <b>C07D 405/14</b> (2006.01) <b>A61P 29/00</b> (2006.01) <b>C07D 413/14</b> (2006.01) <b>C07D 401/14</b> (2006.01) <b>A61P 35/00</b> (2006.01)
2577301 *	<b>G01N 33/487</b> (2006.01)	2580538 *	<b>F24J 2/32</b> (2006.01) <b>H01L 31/058</b> (2006.01) <b>H01L 31/052</b> (2006.01) <b>F24J 2/34</b> (2006.01) <b>F24J 2/50</b> (2006.01) <b>F24J 2/54</b> (2006.01) <b>F24J 2/05</b> (2006.01) <b>F24J 2/26</b> (2006.01) <b>F24J 2/14</b> (2006.01)	2560525 *	<b>A47F 11/06</b> (2006.01)
2593439 *	<b>A61P 31/14</b> (2006.01) <b>A61K 31/522</b> (2006.01) <b>C07D 239/54</b> (2006.01)	2554183	<b>A61P 3/10</b> (2006.01) <b>A61K 47/10</b> (2006.01) <b>A61K 38/28</b> (2006.01) <b>A61K 47/18</b> (2006.01) <b>A61K 38/26</b> (2006.01) <b>A61K 9/00</b> (2006.01)	2545057 *	<b>A61K 31/519</b> (2006.01) <b>C07D 487/04</b> (2006.01) <b>A61P 11/00</b> (2006.01) <b>A61P 1/00</b> (2006.01)
2585462 *	<b>A61K 31/4355</b> (2006.01) <b>A61K 31/437</b> (2006.01) <b>C07D 471/04</b> (2006.01) <b>A61K 31/5025</b> (2006.01) <b>C07D 473/28</b> (2006.01) <b>A61K 31/519</b> (2006.01) <b>A61K 31/4985</b> (2006.01) <b>A61K 31/4427</b> (2006.01) <b>C07D 487/04</b> (2006.01) <b>A61K 31/52</b> (2006.01) <b>C07D 498/04</b> (2006.01) <b>A61P 25/18</b> (2006.01)	2593479 *	<b>A61P 35/02</b> (2006.01) <b>C07K 16/28</b> (2006.01) <b>A61K 39/395</b> (2006.01)	2539320 *	<b>C07D 209/58</b> (2006.01) <b>C07D 209/94</b> (2006.01) <b>C07D 241/24</b> (2006.01) <b>C07D 209/52</b> (2006.01) <b>C07D 403/06</b> (2006.01)
2560612 *	<b>A61K 9/00</b> (2006.01) <b>A61K 9/16</b> (2006.01) <b>A61K 9/50</b> (2006.01)	2575840 *	<b>A61P 17/02</b> (2006.01) <b>A61K 36/47</b> (2006.01) <b>A61K 36/61</b> (2006.01)	2542530 *	<b>C07D 217/04</b> (2006.01) <b>C07D 401/12</b> (2006.01)
2577616 *	<b>G07C 9/00</b> (2006.01)			2593619 *	<b>E04H 12/08</b> (2006.01) <b>E04H 12/34</b> (2006.01) <b>F03D 11/04</b> (2006.01)
2555775 *	<b>A61K 31/433</b> (2006.01) <b>A61P 27/06</b> (2006.01) <b>A61K 31/7076</b> (2006.01) <b>A61K 31/382</b> (2006.01) <b>A61P 27/02</b> (2006.01) <b>A61K 31/542</b> (2006.01)			2481769	<b>C08J 7/12</b> (2006.01) <b>A47J 36/04</b> (2006.01)

Broj objave evropske prijave patenta (97)	MKP (51)	Broj objave evropske prijave patenta (97)	MKP (51)	Broj objave evropske prijave patenta (97)	MKP (51)
2576849 *	<b>C21D 9/52</b> (2006.01) <b>C22C 38/04</b> (2006.01) <b>C22C 38/02</b> (2006.01) <b>C21D 1/20</b> (2006.01) <b>C21D 9/58</b> (2006.01)	2578082 *	<b>A01N 1/02</b> (2006.01)	2471384	<b>A23L 1/30</b> (2006.01) <b>A61K 31/23</b> (2006.01) <b>A61K 9/00</b> (2006.01)
2563240 *	<b>D02J 3/00</b> (2006.01) <b>D01F 6/06</b> (2006.01) <b>A61L 17/00</b> (2006.01) <b>A61B 17/064</b> (2006.01)	2585141 *	<b>A61M 5/00</b> (2006.01) <b>A61M 5/32</b> (2006.01) <b>A61M 5/20</b> (2006.01)	2580416 *	<b>E05F 3/00</b> (2006.01) <b>E05F 3/04</b> (2006.01)
2576535 *	<b>C07D 311/78</b> (2006.01)	2579927 *	<b>A61M 5/315</b> (2006.01)	2555785 *	<b>A61P 11/00</b> (2006.01) <b>A61K 35/74</b> (2006.01)
2417216 *	<b>C09K 11/77</b> (2006.01) <b>C01B 33/00</b> (2006.01) <b>C09K 11/06</b> (2006.01)	2588450 *	<b>C07D 205/04</b> (2006.01) <b>C07D 493/04</b> (2006.01) <b>C07D 213/64</b> (2006.01) <b>A61P 31/18</b> (2006.01) <b>C07D 231/12</b> (2006.01) <b>C07D 213/73</b> (2006.01) <b>C07D 211/48</b> (2006.01) <b>C07D 295/073</b> (2006.01) <b>C07D 233/58</b> (2006.01) <b>C07D 215/04</b> (2006.01) <b>C07D 213/65</b> (2006.01) <b>C07D 311/20</b> (2006.01) <b>C07D 241/12</b> (2006.01) <b>C07D 309/10</b> (2006.01) <b>C07D 239/34</b> (2006.01)	2580336 *	<b>C12N 15/82</b> (2006.01)
2560824 *	<b>B42D 15/00</b> (2006.01)	2576166 *	<b>E04F 13/00</b> (2006.01) <b>B32B 21/10</b> (2006.01) <b>B27N 7/00</b> (2006.01) <b>B32B 5/28</b> (2006.01) <b>B60R 13/02</b> (2006.01) <b>E04B 1/74</b> (2006.01) <b>D06M 13/402</b> (2006.01) <b>C08J 7/06</b> (2006.01)	2593463 *	<b>C07D 498/00</b> (2006.01)
2570332	<b>B62D 11/10</b> (2006.01) <b>B62D 11/04</b> (2006.01) <b>B66F 9/075</b> (2006.01)	2560942 *	<b>A61P 43/00</b> (2006.01) <b>A61K 31/19</b> (2006.01) <b>C07C 57/58</b> (2006.01) <b>A61P 25/28</b> (2006.01)	2558169 *	<b>A63B 22/04</b> (2006.01)
2579249 *	<b>G10L 13/08</b> (2013.01)	2555907 *	<b>B25G 3/12</b> (2006.01) <b>F16M 13/04</b> (2006.01) <b>F16C 11/10</b> (2006.01) <b>G05G 1/10</b> (2006.01)	2576166 *	<b>E04F 13/00</b> (2006.01) <b>B32B 21/10</b> (2006.01) <b>B27N 7/00</b> (2006.01) <b>B32B 5/28</b> (2006.01) <b>B60R 13/02</b> (2006.01) <b>E04B 1/74</b> (2006.01) <b>D06M 13/402</b> (2006.01) <b>C08J 7/06</b> (2006.01)
2582791 *	<b>A61K 35/36</b> (2006.01) <b>A61F 2/10</b> (2006.01) <b>C12N 5/071</b> (2010.01) <b>C12Q 1/68</b> (2006.01) <b>C12N 5/077</b> (2010.01)	2550418 *	<b>E05B 13/00</b> (2006.01) <b>E05B 47/00</b> (2006.01)	2569434 *	<b>A61K 31/55</b> (2006.01) <b>C12N 15/13</b> (2006.01) <b>A61K 31/7088</b> (2006.01)
2572394 *	<b>H01M 2/02</b> (2006.01)			2481537	<b>F16H 25/20</b> (2006.01) <b>B26D 7/08</b> (2006.01) <b>B26D 1/143</b> (2006.01) <b>B26D 7/00</b> (2006.01)
2576782 *	<b>C12N 15/113</b> (2010.01) <b>A61K 31/713</b> (2006.01) <b>A61P 27/02</b> (2006.01)				



Broj objave evropske prijave patenta (97)	MKP (51)	Broj objave evropske prijave patenta (97)	MKP (51)	Broj objave evropske prijave patenta (97)	MKP (51)
2544672 *	<b>A61K 31/53</b> (2006.01) <b>A61P 35/00</b> (2006.01) <b>A61K 31/4985</b> (2006.01) <b>A61K 31/00</b> (2006.01)	2500619	<b>F17C 13/00</b> (2006.01) <b>F17C 13/06</b> (2006.01)	2588453 *	<b>C07D 237/08</b> (2006.01) <b>A61K 31/44</b> (2006.01) <b>A61P 35/00</b> (2006.01) <b>C07D 401/14</b> (2006.01) <b>C07D 213/56</b> (2006.01) <b>C07D 401/12</b> (2006.01) <b>C07D 403/12</b> (2006.01) <b>C07D 279/12</b> (2006.01)
2561741 *	<b>H05K 1/14</b> (2006.01) <b>H05K 7/20</b> (2006.01)	2588087 *	<b>A61K 31/737</b> (2006.01) <b>A61K 31/7008</b> (2006.01) <b>A61K 9/20</b> (2006.01)	2508184	<b>A61P 43/00</b> (2006.01) <b>A61P 35/00</b> (2006.01) <b>A61K 31/4985</b> (2006.01) <b>A61K 31/501</b> (2006.01) <b>A61K 31/5377</b> (2006.01) <b>C07D 471/04</b> (2006.01)
2588169 *	<b>A61M 5/32</b> (2006.01) <b>A61M 5/28</b> (2006.01)	2474794	<b>F24J 2/04</b> (2006.01) <b>F24J 2/52</b> (2006.01)	2545064 *	<b>A61K 31/28</b> (2006.01) <b>C07F 13/00</b> (2006.01)
2561424 *	<b>G06F 3/01</b> (2006.01) <b>G06Q 30/00</b> (2012.01)	2571723 *	<b>E04F 10/04</b> (2006.01) <b>E04H 15/06</b> (2006.01) <b>B60P 3/34</b> (2006.01)	2538976 *	<b>A61K 39/395</b> (2006.01) <b>C07K 16/00</b> (2006.01)
2549985 *	<b>A61K 31/222</b> (2006.01) <b>A61K 9/20</b> (2006.01) <b>A61K 9/50</b> (2006.01) <b>A61K 9/16</b> (2006.01)	2571511 *	<b>A61K 38/11</b> (2006.01) <b>A61P 3/10</b> (2006.01) <b>A61P 3/04</b> (2006.01)	2563397 *	<b>A61K 39/395</b> (2006.01)
2564732 *	<b>A47G 23/02</b> (2006.01) <b>A47F 5/02</b> (2006.01) <b>A47G 19/00</b> (2006.01)	2587920 *	<b>C10M 161/00</b> (2006.01) <b>C02F 1/50</b> (2006.01) <b>A61K 31/44</b> (2006.01) <b>A61L 2/18</b> (2006.01) <b>A61K 31/785</b> (2006.01) <b>A01P 1/00</b> (2006.01) <b>A01N 43/40</b> (2006.01) <b>B27K 3/50</b> (2006.01)	2591134 *	<b>C22C 38/44</b> (2006.01) <b>C22C 38/58</b> (2006.01) <b>C21D 8/02</b> (2006.01) <b>C22C 38/42</b> (2006.01) <b>C22C 38/00</b> (2006.01)
2580425 *	<b>B01D 35/02</b> (2006.01) <b>G01N 33/28</b> (2006.01) <b>E21B 43/10</b> (2006.01) <b>E21B 43/08</b> (2006.01) <b>E21B 47/00</b> (2012.01)	2568996 *	<b>A61K 39/395</b> (2006.01) <b>A61P 37/00</b> (2006.01) <b>A61K 38/17</b> (2006.01) <b>A61K 38/16</b> (2006.01) <b>A61P 35/00</b> (2006.01) <b>A61P 29/00</b> (2006.01)	2552329 *	<b>A61B 17/295</b> (2006.01)
2590815 *	<b>B32B 3/10</b> (2006.01)	2575769 *	<b>A61K 9/14</b> (2006.01)	2563164 *	<b>A23L 1/035</b> (2006.01) <b>A23L 1/302</b> (2006.01) <b>A61K 9/107</b> (2006.01) <b>A23L 1/30</b> (2006.01)
2569315 *	<b>A61K 31/5025</b> (2006.01) <b>A61P 35/00</b> (2006.01) <b>C07D 487/04</b> (2006.01) <b>C07D 471/04</b> (2006.01)				

Broj objave evropske prijave patenta (97)	MKP (51)	Broj objave evropske prijave patenta (97)	MKP (51)	Broj objave evropske prijave patenta (97)	MKP (51)
2290792	<b>H02K 21/18</b> (2006.01) <b>H02K 29/00</b> (2006.01) <b>H02K 21/14</b> (2006.01)	2539323 *	<b>C07D 261/18</b> (2006.01) <b>A61K 31/506</b> (2006.01) <b>C07D 213/81</b> (2006.01) <b>A61K 31/165</b> (2006.01) <b>C07D 239/28</b> (2006.01) <b>A61K 31/505</b> (2006.01) <b>C07D 271/10</b> (2006.01) <b>C07D 401/12</b> (2006.01) <b>C07D 239/557</b> (2006.01) <b>C07D 405/12</b> (2006.01) <b>C07D 211/62</b> (2006.01) <b>C07C 237/24</b> (2006.01) <b>C07D 207/277</b> (2006.01) <b>C07D 233/90</b> (2006.01) <b>A61K 31/44</b> (2006.01)	2575867 *	<b>A61K 39/00</b> (2006.01)
2542555 *	<b>C07D 493/04</b> (2006.01)			2545674 *	<b>H04L 9/06</b> (2006.01) <b>H04L 29/06</b> (2006.01)
2548243 *	<b>H01L 31/00</b> (2006.01) <b>H01M 8/02</b> (2006.01) <b>H01M 10/42</b> (2006.01) <b>H01M 2/20</b> (2006.01) <b>H01G 9/20</b> (2006.01)			2585482 *	<b>C07K 14/605</b> (2006.01) <b>A61P 5/48</b> (2006.01) <b>A61K 38/26</b> (2006.01)
2579929 *	<b>A61M 5/315</b> (2006.01)			2566507 *	<b>A61K 39/085</b> (2006.01)
2545038 *	<b>A61P 35/00</b> (2006.01) <b>C07D 215/22</b> (2006.01) <b>A61K 31/47</b> (2006.01)			2575463 *	<b>A01N 43/42</b> (2006.01) <b>A61K 31/44</b> (2006.01) <b>A01N 43/38</b> (2006.01) <b>A01N 43/40</b> (2006.01)
		2542058 *	<b>A01N 35/00</b> (2006.01)	2547267 *	<b>A61B 17/072</b> (2006.01)
2555733 *	<b>A47C 1/024</b> (2006.01) <b>A47C 1/029</b> (2006.01) <b>A61G 5/14</b> (2006.01)			2560501 *	<b>A23G 4/06</b> (2006.01)
		2575774 *	<b>A61K 31/337</b> (2006.01) <b>A61K 31/16</b> (2006.01) <b>A61K 31/7068</b> (2006.01) <b>A61K 9/14</b> (2006.01) <b>A61P 35/00</b> (2006.01) <b>A61K 47/42</b> (2006.01)	2582689 *	<b>A61P 35/00</b> (2006.01) <b>A61K 31/505</b> (2006.01) <b>C07D 401/04</b> (2006.01)
2581332	<b>B65G 57/18</b> (2006.01)			2582391 *	<b>A61P 19/02</b> (2006.01) <b>A61P 19/00</b> (2006.01) <b>A61K 39/395</b> (2006.01) <b>A61P 29/00</b> (2006.01)
		2560709 *	<b>A61M 5/24</b> (2006.01) <b>A61M 5/31</b> (2006.01) <b>A61M 5/315</b> (2006.01) <b>A61M 5/00</b> (2006.01)	2588137 *	<b>A61K 39/02</b> (2006.01) <b>A61K 39/385</b> (2006.01) <b>C07K 14/245</b> (2006.01)
		2497464	<b>A61K 9/16</b> (2006.01) <b>A61K 9/48</b> (2006.01) <b>A61K 31/506</b> (2006.01)		
		2560653 *	<b>A61K 31/4965</b> (2006.01)		

Broj objave evropske prijave patenta (97)	MKP (51)	Broj objave evropske prijave patenta (97)	MKP (51)	Broj objave evropske prijave patenta (97)	MKP (51)
2581442 *	<b>C12N 5/10</b> (2006.01) <b>C12N 5/078</b> (2010.01) <b>A61K 31/122</b> (2006.01) <b>C12N 5/071</b> (2010.01) <b>A61P 43/00</b> (2006.01)	2575856 *	<b>A61P 3/10</b> (2006.01) <b>A61K 38/16</b> (2006.01) <b>A61K 38/10</b> (2006.01) <b>A61K 38/08</b> (2006.01) <b>A61K 39/395</b> (2006.01) <b>A61P 35/00</b> (2006.01) <b>A61P 29/00</b> (2006.01)	2588454 *	<b>A61P 9/00</b> (2006.01) <b>A61K 31/44</b> (2006.01) <b>C07D 213/85</b> (2006.01)
2558580 *	<b>C12N 15/64</b> (2006.01)	2582847 *	<b>G06F 19/18</b> (2011.01) <b>C12N 15/11</b> (2006.01) <b>C12Q 1/68</b> (2006.01) <b>C12N 5/09</b> (2010.01)	2543502 *	<b>A61J 3/10</b> (2006.01) <b>B30B 11/02</b> (2006.01)
2560489 *	<b>A61K 31/44</b> (2006.01) <b>A01N 43/42</b> (2006.01)	2575892 *	<b>A61K 31/724</b> (2006.01) <b>A61K 9/00</b> (2006.01) <b>A61K 47/40</b> (2006.01) <b>A61K 47/48</b> (2006.01) <b>A61K 47/12</b> (2006.01)	2565190 *	<b>A61K 31/55</b> (2006.01) <b>C07D 333/68</b> (2006.01) <b>A61P 3/12</b> (2006.01) <b>A61K 31/496</b> (2006.01) <b>A61K 31/4535</b> (2006.01) <b>C07D 409/12</b> (2006.01) <b>A61K 31/5377</b> (2006.01) <b>A61K 31/4436</b> (2006.01) <b>A61P 43/00</b> (2006.01) <b>A61K 31/4025</b> (2006.01) <b>A61P 13/12</b> (2006.01) <b>A61K 31/381</b> (2006.01) <b>A61P 9/00</b> (2006.01)
2576524 *	<b>C07D 277/00</b> (2006.01)	2569406 *	<b>C11D 3/00</b> (2006.01)	2569314 *	<b>A61K 31/437</b> (2006.01) <b>C07D 471/04</b> (2006.01) <b>A61P 35/00</b> (2006.01)
2582385 *	<b>A61K 38/19</b> (2006.01) <b>C07K 7/64</b> (2006.01) <b>C07K 14/525</b> (2006.01)	2580406 *	<b>E04C 2/54</b> (2006.01) <b>B28B 23/00</b> (2006.01) <b>E04C 2/06</b> (2006.01)	2556078 *	<b>C07F 11/00</b> (2006.01) <b>C08F 4/72</b> (2006.01)
2547687 *	<b>C07F 3/02</b> (2006.01) <b>C07D 405/06</b> (2006.01) <b>C07F 3/00</b> (2006.01)	2544679 *	<b>A61K 31/33</b> (2006.01)	2575871 *	<b>A61K 9/00</b> (2006.01) <b>A61P 37/04</b> (2006.01) <b>A61K 39/145</b> (2006.01)
2567260 *	<b>G01V 1/16</b> (2006.01) <b>G01V 1/38</b> (2006.01)	2557941 *	<b>A23K 1/18</b> (2006.01) <b>A23K 1/16</b> (2006.01) <b>A61P 1/14</b> (2006.01) <b>A61P 1/04</b> (2006.01) <b>A61P 1/12</b> (2006.01) <b>A61P 33/00</b> (2006.01)	2575797 *	<b>A61K 31/192</b> (2006.01) <b>A61P 31/00</b> (2006.01)
2575880 *	<b>C07K 16/32</b> (2006.01) <b>A61P 35/00</b> (2006.01) <b>A61K 39/395</b> (2006.01)	2574199 *	<b>F22B 1/00</b> (2006.01) <b>F01K 25/00</b> (2006.01)	2585010 *	<b>A61F 6/14</b> (2006.01)
2563117 *	<b>A01N 33/26</b> (2006.01)				
2491905	<b>A61F 13/02</b> (2006.01)				
2416060	<b>F21S 8/02</b> (2006.01) <b>F21V 21/22</b> (2006.01)				

Broj objave evropske prijava patenta (97)	MKP (51)	Broj objave evropske prijava patenta (97)	MKP (51)	Broj objave evropske prijava patenta (97)	MKP (51)
2591003 *	<b>C07K 16/28</b> (2006.01) <b>A61K 39/395</b> (2006.01) <b>A61P 35/00</b> (2006.01)	2569193 *	<b>B60T 8/40</b> (2006.01) <b>B60T 8/48</b> (2006.01)	2412976	<b>F04B 1/04</b> (2006.01) <b>F02M 59/10</b> (2006.01)
2585439 *	<b>A61K 31/437</b> (2006.01) <b>C07D 471/04</b> (2006.01) <b>C07D 401/12</b> (2006.01) <b>A61K 31/517</b> (2006.01) <b>A61P 9/00</b> (2006.01) <b>C07D 239/84</b> (2006.01)	2575890 *	<b>A61K 47/34</b> (2006.01)	2578285	<b>B01D 11/02</b> (2006.01) <b>C10G 1/04</b> (2006.01)
2545179 *	<b>C12P 7/62</b> (2006.01) <b>C08L 67/04</b> (2006.01) <b>C08G 63/89</b> (2006.01)	2542560 *	<b>A61P 9/12</b> (2006.01) <b>C07F 9/26</b> (2006.01) <b>A61K 31/683</b> (2006.01) <b>C07F 9/20</b> (2006.01) <b>C07F 9/14</b> (2006.01)	2585110 *	<b>C07K 16/28</b> (2006.01) <b>A61K 39/395</b> (2006.01)
2478755	<b>A01C 1/04</b> (2006.01) <b>A01G 1/00</b> (2006.01)	2463114	<b>B44C 1/00</b> (2006.01) <b>B44C 5/04</b> (2006.01) <b>B44D 5/10</b> (2006.01) <b>B44C 1/22</b> (2006.01)	2561069 *	<b>C12N 15/55</b> (2006.01) <b>A61K 38/46</b> (2006.01) <b>C12N 9/20</b> (2006.01)
2590672 *	<b>A61K 39/00</b> (2006.01)	2558548 *	<b>C09K 17/52</b> (2006.01) <b>A01G 7/00</b> (2006.01)	2594263 *	<b>A61P 17/00</b> (2006.01) <b>A61K 9/70</b> (2006.01) <b>A61K 31/545</b> (2006.01)
2569737 *	<b>G06K 19/077</b> (2006.01) <b>G06K 19/073</b> (2006.01)	2582728 *	<b>C07K 16/36</b> (2006.01) <b>A61K 47/48</b> (2006.01)	2558305 *	<b>B44C 1/17</b> (2006.01)
2575803 *	<b>A61K 31/337</b> (2006.01) <b>A61K 47/42</b> (2006.01) <b>A61K 9/14</b> (2006.01) <b>A61P 35/04</b> (2006.01)	2580243 *	<b>C07K 16/28</b> (2006.01)	2585467 *	<b>A61K 31/551</b> (2006.01) <b>C07D 487/04</b> (2006.01) <b>A61K 31/519</b> (2006.01) <b>A61K 31/55</b> (2006.01) <b>A61P 11/00</b> (2006.01)
2545056 *	<b>A61P 11/00</b> (2006.01) <b>A61P 1/00</b> (2006.01) <b>A61K 31/519</b> (2006.01) <b>C07D 487/04</b> (2006.01)	2543879	<b>F24J 2/38</b> (2006.01) <b>F24J 2/54</b> (2006.01) <b>F03G 6/06</b> (2006.01)	2564837 *	<b>A61K 31/4465</b> (2006.01) <b>A61K 47/34</b> (2006.01) <b>C07D 211/20</b> (2006.01) <b>A61P 25/24</b> (2006.01) <b>A61K 47/02</b> (2006.01) <b>A61K 47/32</b> (2006.01) <b>A61K 9/32</b> (2006.01) <b>A61K 9/22</b> (2006.01)
2552449 *	<b>A61K 9/06</b> (2006.01) <b>A61K 31/498</b> (2006.01) <b>A61P 17/00</b> (2006.01) <b>A61K 9/00</b> (2006.01)	2558105 *	<b>A61P 3/04</b> (2006.01) <b>A61K 31/56</b> (2006.01)	2558506 *	<b>C08B 37/10</b> (2006.01)
		2542285 *	<b>A61M 15/06</b> (2006.01) <b>A24F 47/00</b> (2006.01)	2484564	<b>B60R 25/04</b> (2006.01)
		2460771	<b>C02F 3/28</b> (2006.01)		
		2560925 *	<b>C03B 9/38</b> (2006.01)		

Broj objave evropske prijave patenta (97)	MKP (51)	Broj objave evropske prijave patenta (97)	MKP (51)	Broj objave evropske prijave patenta (97)	MKP (51)
2590649 *	<b>A61K 31/485</b> (2006.01)	2549998 *	<b>A61K 31/519</b> (2006.01) <b>A61K 47/34</b> (2006.01) <b>A61K 47/14</b> (2006.01) <b>A61P 3/10</b> (2006.01) <b>A61K 47/38</b> (2006.01) <b>A61P 25/04</b> (2006.01) <b>A61P 25/00</b> (2006.01) <b>A61P 29/00</b> (2006.01)	2563789 *	<b>C07D 471/04</b> (2006.01) <b>A61K 31/4462</b> (2006.01) <b>A61P 19/02</b> (2006.01)
2592929 *	<b>A01N 25/08</b> (2006.01)			2579897 *	<b>A61K 47/48</b> (2006.01)
2544737 *	<b>A61M 5/24</b> (2006.01) <b>A61M 5/20</b> (2006.01)			2590721 *	<b>B01D 5/00</b> (2006.01)
2490577 *	<b>A47H 15/04</b> (2006.01) <b>A47H 1/04</b> (2006.01) <b>A47H 2/02</b> (2006.01) <b>A47H 15/02</b> (2006.01) <b>A47H 2/00</b> (2006.01) <b>A47H 13/01</b> (2006.01)	2558711 *	<b>F03B 15/00</b> (2006.01) <b>F03B 13/18</b> (2006.01) <b>F03B 17/06</b> (2006.01) <b>F03B 13/26</b> (2006.01)	2545017 *	<b>C07C 2/00</b> (2006.01) <b>C07C 1/00</b> (2006.01)
				2492398	<b>E01F 15/14</b> (2006.01)
2571892 *	<b>C07K 1/18</b> (2006.01) <b>C07K 1/22</b> (2006.01) <b>C07K 1/34</b> (2006.01) <b>B01D 15/12</b> (2006.01) <b>C07K 1/36</b> (2006.01) <b>B01D 15/38</b> (2006.01)	2555797 *	<b>A61K 39/395</b> (2006.01)	2464012	<b>H03L 1/02</b> (2006.01) <b>G01S 19/23</b> (2010.01)
		2560471 *	<b>A01G 17/06</b> (2006.01)	2545077 *	<b>C07K 16/28</b> (2006.01) <b>A61K 39/395</b> (2006.01)
2572314 *	<b>G06K 5/00</b> (2006.01)	2561286 *	<b>F24J 2/05</b> (2006.01) <b>C22C 38/08</b> (2006.01)	2585107 *	<b>A61P 31/16</b> (2006.01) <b>C07K 16/00</b> (2006.01) <b>C07K 19/00</b> (2006.01) <b>A61P 35/00</b> (2006.01) <b>C07K 16/44</b> (2006.01) <b>C07K 14/52</b> (2006.01) <b>A61K 39/385</b> (2006.01)
2585078 *	<b>A61P 7/02</b> (2006.01) <b>A61K 31/727</b> (2006.01)	2582685 *	<b>A61P 9/00</b> (2006.01) <b>A61K 31/343</b> (2006.01) <b>C07D 307/80</b> (2006.01)		
2564206 *	<b>G01N 1/38</b> (2006.01) <b>G01N 35/00</b> (2006.01) <b>G01N 35/10</b> (2006.01)	2491904	<b>A61F 13/02</b> (2006.01)	2584940 *	<b>A47D 1/10</b> (2006.01)
		2544968 *	<b>B65F 1/14</b> (2006.01) <b>B65F 1/16</b> (2006.01)	2550017 *	<b>A61K 39/395</b> (2006.01) <b>C07K 16/00</b> (2006.01) <b>C07K 16/46</b> (2006.01)
		2560981 *	<b>A61P 37/04</b> (2006.01) <b>A61K 31/7028</b> (2006.01) <b>C08B 37/00</b> (2006.01) <b>C07H 15/04</b> (2006.01)	2554521 *	<b>C02F 9/06</b> (2006.01) <b>C02F 1/50</b> (2006.01)

Broj objave evropske prijava patenta (97)	MKP (51)	Broj objave evropske prijava patenta (97)	MKP (51)	Broj objave evropske prijava patenta (97)	MKP (51)
2560644 *	<b>A61K 38/18</b> (2006.01) <b>A61P 13/12</b> (2006.01) <b>A61K 31/60</b> (2006.01) <b>A61K 31/4365</b> (2006.01)	2555814 *	<b>A61M 5/50</b> (2006.01) <b>A61J 1/20</b> (2006.01) <b>A61M 5/24</b> (2006.01)	2593126 *	<b>A61K 38/16</b> (2006.01) <b>A61K 38/10</b> (2006.01) <b>A61P 3/10</b> (2006.01) <b>A61K 39/395</b> (2006.01) <b>A61K 38/08</b> (2006.01) <b>A61P 3/00</b> (2006.01) <b>A61P 35/00</b> (2006.01)
2575813 *	<b>A61P 19/02</b> (2006.01) <b>A61K 9/00</b> (2006.01) <b>A61P 29/00</b> (2006.01) <b>A61K 31/444</b> (2006.01)	2544667 *	<b>A61K 9/22</b> (2006.01)	2552686 *	<b>B31F 1/28</b> (2006.01) <b>B32B 29/08</b> (2006.01)
2576519 *	<b>C07D 241/02</b> (2006.01) <b>A01N 43/56</b> (2006.01)	2380846	<b>B66F 11/04</b> (2006.01)	2575818 *	<b>A61K 31/505</b> (2006.01) <b>A61P 35/02</b> (2006.01) <b>A61P 35/00</b> (2006.01) <b>A61K 31/519</b> (2006.01)
2571522 *	<b>A61K 47/42</b> (2006.01) <b>A61P 35/00</b> (2006.01) <b>A61K 39/00</b> (2006.01) <b>A61K 39/385</b> (2006.01) <b>A61K 47/48</b> (2006.01)	2547667 *	<b>C07D 277/46</b> (2006.01) <b>C07D 277/40</b> (2006.01) <b>C07D 277/50</b> (2006.01)	2580218 *	<b>C07D 489/08</b> (2006.01) <b>C07D 489/12</b> (2006.01)
2588466 *	<b>C07D 401/10</b> (2006.01) <b>A61P 25/16</b> (2006.01) <b>C07D 403/10</b> (2006.01) <b>C07D 401/12</b> (2006.01) <b>A61K 31/496</b> (2006.01) <b>A61P 25/28</b> (2006.01)	2550206 *	<b>B65D 17/50</b> (2006.01) <b>A61J 1/00</b> (2006.01) <b>B65D 41/20</b> (2006.01) <b>B65D 51/22</b> (2006.01)	2539185 *	<b>B60R 21/213</b> (2011.01)
2585615 *	<b>C12Q 1/68</b> (2006.01)	2588473 *	<b>A61K 31/506</b> (2006.01) <b>C07D 401/14</b> (2006.01) <b>A61P 19/00</b> (2006.01) <b>A61P 37/00</b> (2006.01) <b>A61P 35/00</b> (2006.01) <b>C07D 473/16</b> (2006.01) <b>A61K 31/497</b> (2006.01) <b>A61P 29/00</b> (2006.01) <b>A61K 31/4709</b> (2006.01)	2546441	<b>E05D 15/58</b> (2006.01)
2566321 *	<b>A01N 39/02</b> (2006.01) <b>A01N 57/16</b> (2006.01) <b>A01N 43/40</b> (2006.01) <b>A01N 25/00</b> (2006.01) <b>A01N 25/02</b> (2006.01)	2566331 *	<b>A61P 37/00</b> (2006.01) <b>A61P 35/00</b> (2006.01) <b>C07D 473/16</b> (2006.01) <b>A61K 31/497</b> (2006.01) <b>A61P 29/00</b> (2006.01) <b>A61K 31/4709</b> (2006.01)	2566331 *	<b>A61K 31/415</b> (2006.01) <b>A01N 43/56</b> (2006.01)
2539265 *	<b>B65H 75/44</b> (2006.01) <b>A47L 9/26</b> (2006.01)	2306440	<b>A61K 31/497</b> (2006.01) <b>A61P 29/00</b> (2006.01) <b>A61K 31/4709</b> (2006.01)	2549983 *	<b>G09F 27/00</b> (2006.01) <b>E01F 9/011</b> (2006.01) <b>E04H 1/12</b> (2006.01) <b>G09F 19/22</b> (2006.01) <b>G08G 1/123</b> (2006.01)

Broj objave evropske prijava patenta (97)	MKP (51)	Broj objave evropske prijava patenta (97)	MKP (51)	Broj objave evropske prijava patenta (97)	MKP (51)
2584913 *	<b>A23K 1/175</b> (2006.01) <b>A23K 1/16</b> (2006.01) <b>A23L 1/03</b> (2006.01) <b>A23K 1/00</b> (2006.01) <b>A61K 33/06</b> (2006.01) <b>A61K 9/14</b> (2006.01) <b>A61K 31/593</b> (2006.01) <b>A23L 1/304</b> (2006.01) <b>A61K 9/16</b> (2006.01) <b>A61P 19/10</b> (2006.01) <b>A61K 36/185</b> (2006.01) <b>A23L 1/303</b> (2006.01)	2579877 *	<b>A61P 35/00</b> (2006.01) <b>C07D 413/14</b> (2006.01) <b>C07D 471/04</b> (2006.01) <b>A61K 31/505</b> (2006.01)	2574168 *	<b>A61K 31/519</b> (2006.01) <b>A61K 9/107</b> (2006.01) <b>A61K 47/06</b> (2006.01) <b>A61K 47/10</b> (2006.01) <b>A61K 9/00</b> (2006.01)
		2593090 *	<b>A61K 31/47</b> (2006.01) <b>A61K 9/20</b> (2006.01)	2497841	<b>C23C 30/00</b> (2006.01) <b>C22C 13/00</b> (2006.01) <b>C23C 26/00</b> (2006.01) <b>C22C 7/00</b> (2006.01) <b>C22C 5/06</b> (2006.01)
		2455122	<b>A61M 5/315</b> (2006.01)		
		2555834 *	<b>A43B 5/00</b> (2006.01) <b>A63B 31/11</b> (2006.01) <b>B63C 11/02</b> (2006.01)	2544681 *	<b>A61P 9/06</b> (2006.01) <b>A61K 31/343</b> (2006.01)
2585196 *	<b>F24F 3/14</b> (2006.01) <b>B01D 53/06</b> (2006.01) <b>B01D 53/26</b> (2006.01)	2355554	<b>G10L 19/00</b> (2006.01) <b>H04S 7/00</b> (2006.01) <b>H04S 5/00</b> (2006.01)	2544662 *	<b>A61K 31/196</b> (2006.01) <b>A61K 47/20</b> (2006.01) <b>A61P 19/02</b> (2006.01) <b>A61K 31/192</b> (2006.01) <b>A61K 9/12</b> (2006.01)
2569280 *	<b>C07D 401/12</b> (2006.01) <b>A61K 31/407</b> (2006.01) <b>C07D 207/06</b> (2006.01) <b>A61K 31/40</b> (2006.01) <b>C07D 409/12</b> (2006.01) <b>A61K 31/454</b> (2006.01) <b>C07D 491/107</b> (2006.01) <b>C07D 405/12</b> (2006.01) <b>A61K 31/438</b> (2006.01) <b>C07D 403/10</b> (2006.01) <b>A61K 31/403</b> (2006.01) <b>C07D 413/12</b> (2006.01) <b>A61K 31/4535</b> (2006.01) <b>C07D 471/10</b> (2006.01) <b>A61K 31/453</b> (2006.01)	2580242 *	<b>A61K 38/00</b> (2006.01) <b>C07K 16/28</b> (2006.01) <b>A61K 38/18</b> (2006.01)	2558482 *	<b>C12N 15/37</b> (2006.01) <b>C07K 14/08</b> (2006.01) <b>C12N 9/50</b> (2006.01)
		2579880 *	<b>A61K 31/53</b> (2006.01) <b>A61K 9/20</b> (2006.01)	2569321 *	<b>C07D 501/34</b> (2006.01)
		2575725 *	<b>A61H 1/02</b> (2006.01)	2543769	<b>E02D 3/12</b> (2006.01) <b>E02D 1/02</b> (2006.01)
		2579921 *	<b>A61M 5/24</b> (2006.01) <b>A61M 5/315</b> (2006.01)	2580184 *	<b>C07C 227/42</b> (2006.01)
		2593451 *	<b>C07D 487/04</b> (2006.01) <b>A61K 31/519</b> (2006.01) <b>C07D 471/04</b> (2006.01) <b>A61K 31/437</b> (2006.01)	2577315 *	<b>G01N 33/53</b> (2006.01) <b>C07K 14/00</b> (2006.01) <b>C07K 14/775</b> (2006.01) <b>G01N 33/68</b> (2006.01)

Broj objave evropske prijava patenta (97)	MKP (51)	Broj objave evropske prijava patenta (97)	MKP (51)	Broj objave evropske prijava patenta (97)	MKP (51)
2545060 *	<b>C07F 7/08</b> (2006.01) <b>A61K 31/695</b> (2006.01) <b>A61P 31/14</b> (2006.01)	2575863 *	<b>A61K 39/395</b> (2006.01) <b>A61P 35/00</b> (2006.01) <b>A61P 35/02</b> (2006.01) <b>A61K 38/20</b> (2006.01)	2538894 *	<b>A61F 5/00</b> (2006.01) <b>A61F 13/00</b> (2006.01)
2555815 *	<b>A61M 5/50</b> (2006.01) <b>A61J 1/20</b> (2006.01) <b>A61M 5/24</b> (2006.01)	2473037 *	<b>A61K 31/375</b> (2006.01) <b>A61K 31/315</b> (2006.01)	2587918 *	<b>C09D 5/16</b> (2006.01) <b>A01N 59/20</b> (2006.01) <b>A01N 43/40</b> (2006.01) <b>D06M 13/355</b> (2006.01) <b>A01P 9/00</b> (2006.01) <b>A01N 37/10</b> (2006.01) <b>D06M 13/203</b> (2006.01) <b>A01P 13/00</b> (2006.01) <b>A01N 59/16</b> (2006.01) <b>A01N 43/36</b> (2006.01) <b>D06M 13/352</b> (2006.01)
2590909 *	<b>C05G 1/00</b> (2006.01)	2563934 *	<b>C12Q 1/68</b> (2006.01)	2563410 *	<b>A61L 2/07</b> (2006.01) <b>A61L 2/025</b> (2006.01) <b>A61L 2/10</b> (2006.01)
2592935 *	<b>A61K 8/89</b> (2006.01) <b>A61K 8/20</b> (2006.01) <b>A01N 59/12</b> (2006.01) <b>A61K 47/24</b> (2006.01) <b>A61P 31/02</b> (2006.01) <b>A01N 25/02</b> (2006.01) <b>A61K 33/18</b> (2006.01) <b>A01P 1/00</b> (2006.01)	2590931 *	<b>A61K 31/196</b> (2006.01) <b>C07C 235/24</b> (2006.01) <b>A61K 31/277</b> (2006.01) <b>A61P 3/10</b> (2006.01) <b>C07C 255/44</b> (2006.01)	2538993 *	<b>A61M 5/145</b> (2006.01)
2560529 *	<b>A47K 5/12</b> (2006.01)	2492506	<b>F04B 1/04</b> (2006.01) <b>F04B 53/12</b> (2006.01) <b>F04B 53/16</b> (2006.01) <b>F02M 37/04</b> (2006.01)	2543729 *	<b>A61P 15/00</b> (2006.01) <b>A61P 9/12</b> (2006.01) <b>A61K 38/27</b> (2006.01) <b>C12N 15/09</b> (2006.01) <b>A61K 48/00</b> (2006.01) <b>A01K 67/027</b> (2006.01) <b>A61P 13/12</b> (2006.01)
2316659	<b>B42D 13/00</b> (2006.01) <b>B42D 15/10</b> (2006.01)	2542255 *	<b>A61P 7/00</b> (2006.01) <b>A61P 37/02</b> (2006.01) <b>A61K 39/00</b> (2006.01) <b>C07K 16/00</b> (2006.01)	2593128 *	<b>A61K 38/17</b> (2006.01) <b>C07K 16/28</b> (2006.01) <b>C07K 16/46</b> (2006.01)
2479495	<b>F23J 15/04</b> (2006.01) <b>F23J 15/02</b> (2006.01) <b>F23M 7/04</b> (2006.01) <b>F23G 5/50</b> (2006.01) <b>B01D 53/34</b> (2006.01) <b>F23G 5/00</b> (2006.01) <b>F23G 5/30</b> (2006.01) <b>F23G 5/46</b> (2006.01)	2526939	<b>A61K 38/01</b> (2006.01) <b>A61K 36/00</b> (2006.01) <b>A61K 31/353</b> (2006.01) <b>A61P 1/04</b> (2006.01) <b>A61P 1/00</b> (2006.01)	2585064 *	<b>A61K 31/445</b> (2006.01) <b>C07D 211/06</b> (2006.01)
		2569684 *	<b>G06F 3/033</b> (2013.01)	2585476 *	<b>C07K 14/00</b> (2006.01)



Broj objave evropske prijava patenta (97)	MKP (51)	Broj objave evropske prijava patenta (97)	MKP (51)	Broj objave evropske prijava patenta (97)	MKP (51)
2560694 *	<b>A61L 27/20</b> (2006.01) <b>A61L 27/24</b> (2006.01) <b>A61L 27/34</b> (2006.01) <b>A61L 27/26</b> (2006.01) <b>A61L 27/54</b> (2006.01)	2571976 *	<b>C12N 15/10</b> (2006.01) <b>G01N 33/569</b> (2006.01) <b>C12Q 1/68</b> (2006.01) <b>C12N 1/06</b> (2006.01)	2589595 *	<b>A61K 31/454</b> (2006.01) <b>C07D 401/14</b> (2006.01) <b>A61P 31/14</b> (2006.01) <b>C07D 471/04</b> (2006.01) <b>A61K 31/5383</b> (2006.01) <b>A61K 31/7056</b> (2006.01) <b>C07D 405/12</b> (2006.01) <b>C07D 403/10</b> (2006.01) <b>A61K 31/4164</b> (2006.01) <b>C07D 233/66</b> (2006.01) <b>C07D 498/04</b> (2006.01)
2569938 *	<b>H04N 7/14</b> (2006.01) <b>H04N 7/15</b> (2006.01) <b>H04N 7/00</b> (2011.01)	2563812 *	<b>C07K 16/18</b> (2006.01)		
2584883 *	<b>A01F 25/18</b> (2006.01)	2570004 *	<b>H05B 37/02</b> (2006.01)		
2585135 *	<b>A61M 5/20</b> (2006.01) <b>A61M 5/00</b> (2006.01)	2590905 *	<b>C04B 28/02</b> (2006.01) <b>C04B 38/08</b> (2006.01)		
2547680 *	<b>C07D 487/04</b> (2006.01) <b>A61K 31/4985</b> (2006.01) <b>A61P 35/00</b> (2006.01)	2582356 *	<b>A61K 47/36</b> (2006.01) <b>A61K 47/38</b> (2006.01) <b>A61K 9/00</b> (2006.01) <b>A61P 17/00</b> (2006.01) <b>A61K 31/13</b> (2006.01)		
2582226 *	<b>A01H 1/04</b> (2006.01) <b>A01H 5/00</b> (2006.01)	2585084 *	<b>A61K 35/50</b> (2006.01)		
2552908 *	<b>C07D 403/12</b> (2006.01) <b>C07D 473/34</b> (2006.01) <b>A61P 29/00</b> (2006.01) <b>C07D 471/04</b> (2006.01) <b>A61K 31/506</b> (2006.01) <b>C07D 487/04</b> (2006.01) <b>C07D 401/14</b> (2006.01) <b>C07D 409/12</b> (2006.01)	2576509 *	<b>C07D 405/12</b> (2006.01) <b>C07D 409/06</b> (2006.01) <b>A61K 31/4462</b> (2006.01) <b>A61K 31/4465</b> (2006.01) <b>C07D 211/22</b> (2006.01) <b>A61P 25/28</b> (2006.01) <b>A61K 31/4545</b> (2006.01) <b>C07D 211/24</b> (2006.01) <b>C07D 401/12</b> (2006.01)	2545045 *	<b>C07D 401/14</b> (2006.01) <b>A61K 31/4468</b> (2006.01) <b>A61K 31/4155</b> (2006.01) <b>C07D 405/14</b> (2006.01) <b>A61P 29/00</b> (2006.01) <b>A61K 31/437</b> (2006.01)
2552933 *	<b>A61P 31/14</b> (2006.01) <b>A61K 31/7076</b> (2006.01) <b>C07H 19/20</b> (2006.01)	2576359 *	<b>B67B 1/06</b> (2006.01) <b>B65D 39/16</b> (2006.01) <b>B65D 1/02</b> (2006.01)	2558468 *	<b>A61P 29/00</b> (2006.01) <b>C07D 487/04</b> (2006.01) <b>A61K 31/519</b> (2006.01) <b>A61P 37/00</b> (2006.01)

Broj objave evropske prijava patenta (97)	MKP (51)	Broj objave evropske prijava patenta (97)	MKP (51)	Broj objave evropske prijava patenta (97)	MKP (51)
2563406 *	<b>A61K 38/46</b> (2006.01) <b>A61K 47/48</b> (2006.01) <b>C12N 9/16</b> (2006.01) <b>A61K 31/7088</b> (2006.01) <b>A61P 19/08</b> (2006.01) <b>A61K 38/17</b> (2006.01) <b>C12N 15/867</b> (2006.01) <b>A61K 48/00</b> (2006.01) <b>C12N 15/55</b> (2006.01)	2576523 *	<b>A01N 25/00</b> (2006.01) <b>C07D 261/04</b> (2006.01)	2492091	<b>B32B 7/02</b> (2006.01) <b>B32B 3/08</b> (2006.01) <b>B32B 7/12</b> (2006.01) <b>B32B 21/14</b> (2006.01) <b>B32B 21/13</b> (2006.01) <b>B27M 3/00</b> (2006.01)
2566492 *	<b>A61K 38/08</b> (2006.01)	2577812 *	<b>H01R 24/58</b> (2011.01)	2571988 *	<b>C12N 15/113</b> (2010.01) <b>A61K 31/7088</b> (2006.01) <b>C12Q 1/68</b> (2006.01) <b>A61P 19/08</b> (2006.01) <b>A61P 9/00</b> (2006.01)
2546410	<b>D21H 21/02</b> (2006.01) <b>D21C 9/08</b> (2006.01)	2563350 *	<b>A61K 31/21</b> (2006.01) <b>A61K 31/11</b> (2006.01) <b>A61P 27/02</b> (2006.01) <b>A61K 31/222</b> (2006.01)	2569502 *	<b>E06C 7/46</b> (2006.01)
2542079 *	<b>A01N 43/42</b> (2006.01)	2566861 *	<b>A61P 25/16</b> (2006.01) <b>A61P 19/10</b> (2006.01) <b>A61P 29/00</b> (2006.01) <b>A61K 31/496</b> (2006.01) <b>A61P 37/06</b> (2006.01) <b>C07D 405/12</b> (2006.01) <b>A61P 35/00</b> (2006.01) <b>A61P 25/28</b> (2006.01) <b>A61P 3/00</b> (2006.01) <b>A61P 25/22</b> (2006.01) <b>A61P 9/12</b> (2006.01) <b>A61P 25/30</b> (2006.01) <b>A61P 3/10</b> (2006.01) <b>A61P 25/24</b> (2006.01) <b>A61P 15/00</b> (2006.01)	2572174 *	<b>G01L 1/00</b> (2006.01) <b>G01B 21/32</b> (2006.01)
2548848	<b>C02F 1/68</b> (2006.01)	2555813 *	<b>A61M 5/142</b> (2006.01) <b>A61M 5/178</b> (2006.01) <b>A61M 5/28</b> (2006.01) <b>A61B 17/03</b> (2006.01)	2578269 *	<b>A61N 5/06</b> (2006.01) <b>A61N 5/067</b> (2006.01) <b>A61B 18/20</b> (2006.01)
2560993 *	<b>C07K 16/10</b> (2006.01) <b>C07K 16/28</b> (2006.01) <b>C07K 16/46</b> (2006.01) <b>C07K 16/32</b> (2006.01)	2568674 *	<b>E04B 1/80</b> (2006.01)	2539370 *	<b>C07K 16/28</b> (2006.01)
2563129 *	<b>A61K 31/505</b> (2006.01) <b>A01N 43/54</b> (2006.01)	2569429 *	<b>C12N 15/09</b> (2006.01)	2580194 *	<b>A61P 11/08</b> (2006.01) <b>C07D 207/12</b> (2006.01) <b>A61P 11/00</b> (2006.01) <b>A61P 11/06</b> (2006.01) <b>A61K 31/40</b> (2006.01)
2542485 *	<b>B65G 1/04</b> (2006.01) <b>B65G 1/02</b> (2006.01)	2567026 *	<b>B42D 15/00</b> (2006.01) <b>D21F 1/44</b> (2006.01)		

Broj objave evropske prijave patenta (97)	MKP (51)	Broj objave evropske prijave patenta (97)	MKP (51)	Broj objave evropske prijave patenta (97)	MKP (51)
2583682 *	<b>A61K 31/198</b> (2006.01) <b>A61P 17/16</b> (2006.01) <b>A61K 31/12</b> (2006.01) <b>A61K 31/736</b> (2006.01) <b>A61P 17/06</b> (2006.01) <b>A61K 35/12</b> (2006.01) <b>A61K 9/00</b> (2006.01) <b>A61P 17/00</b> (2006.01) <b>A61P 17/02</b> (2006.01)	2566838 *	<b>C11B 9/00</b> (2006.01) <b>C07C 33/14</b> (2006.01) <b>C07C 403/08</b> (2006.01) <b>C07C 31/135</b> (2006.01) <b>A61K 8/34</b> (2006.01)	2555808 *	<b>A61Q 19/00</b> (2006.01) <b>A61K 8/00</b> (2006.01) <b>A61K 31/732</b> (2006.01) <b>A61L 27/20</b> (2006.01) <b>A61K 9/00</b> (2006.01)
2585049 *	<b>A61K 31/13</b> (2006.01) <b>A61K 9/48</b> (2006.01) <b>A61K 9/16</b> (2006.01) <b>A61K 9/50</b> (2006.01) <b>A61K 9/28</b> (2006.01) <b>A61K 9/20</b> (2006.01)	2585011 *	<b>A61F 6/14</b> (2006.01)	2555755 *	<b>A61K 9/20</b> (2006.01) <b>C07D 405/14</b> (2006.01) <b>A61K 9/16</b> (2006.01) <b>C07D 213/75</b> (2006.01) <b>C07D 405/12</b> (2006.01) <b>A61K 9/28</b> (2006.01)
2594277 *	<b>A61K 33/26</b> (2006.01) <b>A61K 47/32</b> (2006.01) <b>A61P 3/00</b> (2006.01) <b>A61P 13/12</b> (2006.01) <b>A61K 9/20</b> (2006.01) <b>A61K 47/38</b> (2006.01) <b>A61P 7/00</b> (2006.01)	2538985 *	<b>A61L 27/56</b> (2006.01) <b>A61L 27/18</b> (2006.01)	2549982 *	<b>A61K 9/20</b> (2006.01) <b>A61K 9/16</b> (2006.01) <b>A61K 31/405</b> (2006.01) <b>A61K 31/397</b> (2006.01)
2552947 *	<b>A61K 38/17</b> (2006.01) <b>A61K 39/395</b> (2006.01) <b>A61P 19/02</b> (2006.01) <b>A61P 37/00</b> (2006.01) <b>C07K 19/00</b> (2006.01) <b>C07K 16/18</b> (2006.01) <b>C07K 14/47</b> (2006.01)	2584654 *	<b>H01Q 19/00</b> (2006.01) <b>H04B 7/02</b> (2006.01)	2555625 *	<b>A61K 31/69</b> (2006.01) <b>A01N 55/08</b> (2006.01)
2558684 *	<b>F01C 1/344</b> (2006.01)	2568967 *	<b>A61K 31/485</b> (2006.01) <b>A61K 9/20</b> (2006.01)	2572395 *	<b>H01M 2/02</b> (2006.01)
		2489532	<b>B60H 1/00</b> (2006.01)	2585139 *	<b>A61M 5/20</b> (2006.01)
		2546231 *	<b>A61K 31/17</b> (2006.01) <b>A61K 31/417</b> (2006.01) <b>A61K 31/167</b> (2006.01) <b>A61K 31/27</b> (2006.01) <b>A61K 31/198</b> (2006.01) <b>C07C 275/42</b> (2006.01) <b>A61K 31/4245</b> (2006.01) <b>A61K 31/4045</b> (2006.01) <b>A23L 1/226</b> (2006.01)	2560762 *	<b>B02C 13/04</b> (2006.01) <b>B02C 13/28</b> (2006.01)
				2581068	<b>A61F 13/15</b> (2006.01)
				2571513 *	<b>A61P 29/00</b> (2006.01) <b>A61P 3/00</b> (2006.01) <b>A61P 35/00</b> (2006.01) <b>A61K 39/395</b> (2006.01) <b>A61K 38/17</b> (2006.01) <b>A61K 38/16</b> (2006.01)

Broj objave evropske prijava patenta (97)	MKP (51)	Broj objave evropske prijava patenta (97)	MKP (51)	Broj objave evropske prijava patenta (97)	MKP (51)
2577556 *	<b>G06K 19/077</b> (2006.01) <b>G06K 7/00</b> (2006.01)	2580212 *	<b>A61P 29/00</b> (2006.01) <b>C07D 471/04</b> (2006.01) <b>A61K 31/437</b> (2006.01)	2539717 *	<b>G01N 35/00</b> (2006.01) <b>G02B 7/00</b> (2006.01) <b>B01L 9/00</b> (2006.01) <b>G01N 21/00</b> (2006.01)
2542233 *	<b>A61K 31/7036</b> (2006.01) <b>A61P 27/02</b> (2006.01) <b>A61K 31/205</b> (2006.01)	2549870 *	<b>A61K 31/44</b> (2006.01) <b>A01N 43/42</b> (2006.01)	2548099 *	<b>G06F 3/01</b> (2006.01)
2556036 *	<b>C03C 17/42</b> (2006.01) <b>B65D 23/08</b> (2006.01)	2552490 *	<b>A61K 48/00</b> (2006.01)	2484440	<b>B01J 37/00</b> (2006.01) <b>B01J 27/057</b> (2006.01) <b>C01B 19/00</b> (2006.01) <b>B01J 23/18</b> (2006.01) <b>F23G 5/027</b> (2006.01) <b>B01J 37/02</b> (2006.01)
2542261 *	<b>A61K 39/395</b> (2006.01) <b>A61P 25/28</b> (2006.01) <b>C07K 16/18</b> (2006.01)	2566399 *	<b>D02J 3/00</b> (2006.01) <b>A61B 17/064</b> (2006.01) <b>A61B 17/03</b> (2006.01)	2589604 *	<b>C07K 14/025</b> (2006.01) <b>A61P 31/20</b> (2006.01) <b>C12N 1/21</b> (2006.01) <b>C12N 15/70</b> (2006.01) <b>A61K 39/12</b> (2006.01)
2585581 *	<b>C12N 1/06</b> (2006.01)	2573175 *	<b>C12N 15/02</b> (2006.01) <b>C12N 15/09</b> (2006.01) <b>C12P 21/08</b> (2006.01) <b>A61P 35/00</b> (2006.01) <b>C12N 5/10</b> (2006.01) <b>C07K 16/42</b> (2006.01) <b>A61K 39/395</b> (2006.01) <b>G01N 33/574</b> (2006.01) <b>C07K 16/24</b> (2006.01) <b>C07K 14/495</b> (2006.01)	2550294 *	<b>C07K 16/26</b> (2006.01) <b>C07K 16/46</b> (2006.01) <b>G01N 33/53</b> (2006.01) <b>A61K 39/395</b> (2006.01) <b>C12N 5/12</b> (2006.01) <b>A61P 35/00</b> (2006.01) <b>C12N 15/13</b> (2006.01)
2547347 *	<b>A61K 35/64</b> (2006.01)	2574167 *	<b>A61K 31/55</b> (2006.01) <b>A61K 31/485</b> (2006.01) <b>A61K 9/00</b> (2006.01)	2550044 *	<b>A61M 5/32</b> (2006.01) <b>A61M 5/28</b> (2006.01) <b>A61M 5/24</b> (2006.01)
2588465 *	<b>C07D 417/14</b> (2006.01) <b>A61K 31/4155</b> (2006.01) <b>C07D 405/14</b> (2006.01) <b>C07D 413/14</b> (2006.01) <b>C07D 401/04</b> (2006.01) <b>C07D 401/14</b> (2006.01)	2588166 *	<b>A61M 5/32</b> (2006.01)	2590929 *	<b>C07C 255/54</b> (2006.01) <b>C07D 213/65</b> (2006.01) <b>A61K 31/192</b> (2006.01) <b>C07C 59/64</b> (2006.01) <b>A61K 31/44</b> (2006.01)
2561728 *	<b>H05K 7/20</b> (2006.01) <b>H05K 1/14</b> (2006.01)	2579854 *	<b>A61K 31/00</b> (2006.01) <b>A61K 9/16</b> (2006.01) <b>A61K 9/20</b> (2006.01) <b>A61K 9/14</b> (2006.01)	2576569 *	<b>C07D 515/22</b> (2006.01)
2580197 *	<b>C07D 223/10</b> (2006.01) <b>C07D 211/76</b> (2006.01) <b>A61P 29/00</b> (2006.01) <b>A61K 31/45</b> (2006.01)	2582361 *	<b>A61M 5/32</b> (2006.01) <b>A61M 5/28</b> (2006.01) <b>A61M 5/24</b> (2006.01)	2582361 *	<b>A61K 9/20</b> (2006.01) <b>A61K 31/4184</b> (2006.01)

Broj objave evropske prijave patenta (97)	MKP (51)	Broj objave evropske prijave patenta (97)	MKP (51)	Broj objave evropske prijave patenta (97)	MKP (51)
2585481 *	<b>C07K 14/605</b> (2006.01)	2550244 *	<b>C05F 1/00</b> (2006.01) <b>C05F 11/00</b> (2006.01) <b>C05F 9/00</b> (2006.01) <b>C05F 5/00</b> (2006.01) <b>C05F 7/00</b> (2006.01) <b>B09B 3/00</b> (2006.01) <b>C05F 3/00</b> (2006.01)	2563808 *	<b>A61K 38/22</b> (2006.01) <b>C07K 14/595</b> (2006.01) <b>C07K 19/00</b> (2006.01) <b>C07K 14/575</b> (2006.01)
2569312 *	<b>A61P 35/00</b> (2006.01) <b>C07D 413/14</b> (2006.01) <b>A61K 31/4245</b> (2006.01)			2573003 *	<b>B65D 81/20</b> (2006.01) <b>B65D 75/32</b> (2006.01) <b>B65D 30/20</b> (2006.01)
2542256 *	<b>A61K 39/00</b> (2006.01) <b>C07K 16/00</b> (2006.01)	2558496 *	<b>A61K 39/395</b> (2006.01) <b>C07K 16/18</b> (2006.01)	2492492	<b>F02M 59/46</b> (2006.01) <b>F02M 59/20</b> (2006.01) <b>F02M 59/26</b> (2006.01) <b>F02M 59/34</b> (2006.01)
2588068 *	<b>A61Q 17/04</b> (2006.01) <b>A61K 8/27</b> (2006.01) <b>A61K 8/67</b> (2006.01) <b>A61K 8/34</b> (2006.01) <b>A61K 8/68</b> (2006.01) <b>A61K 8/40</b> (2006.01) <b>A61K 8/365</b> (2006.01) <b>A61K 8/37</b> (2006.01) <b>A61K 8/42</b> (2006.01) <b>A61Q 19/00</b> (2006.01)	2582664 *	<b>C07C 323/62</b> (2006.01) <b>C07D 213/24</b> (2006.01) <b>A61K 31/192</b> (2006.01) <b>A61K 31/44</b> (2006.01) <b>A61P 19/06</b> (2006.01)	2576618 *	<b>A61P 3/00</b> (2006.01) <b>C07K 16/22</b> (2006.01) <b>A61P 21/00</b> (2006.01) <b>A61K 39/395</b> (2006.01)
2593458 *	<b>A61K 31/519</b> (2006.01) <b>C07D 487/04</b> (2006.01) <b>A61P 35/00</b> (2006.01)	2588252 *	<b>B05B 17/08</b> (2006.01)	2579718 *	<b>A01N 65/06</b> (2009.01) <b>A01N 43/54</b> (2006.01) <b>A01P 3/00</b> (2006.01) <b>A01N 65/10</b> (2009.01) <b>A01N 65/22</b> (2009.01) <b>B27K 3/34</b> (2006.01) <b>B27K 3/50</b> (2006.01) <b>A01N 35/06</b> (2006.01) <b>A01N 31/08</b> (2006.01)
2593226 *	<b>B01J 31/24</b> (2006.01)	2590940 *	<b>C07D 205/08</b> (2006.01) <b>C07D 263/38</b> (2006.01)		
2463536	<b>F16C 37/00</b> (2006.01) <b>F16C 17/02</b> (2006.01) <b>F16C 33/20</b> (2006.01)	2558624 *	<b>D01D 1/06</b> (2006.01) <b>D01D 5/12</b> (2006.01) <b>D01F 2/00</b> (2006.01)		
2572148 *	<b>F25D 3/08</b> (2006.01)	2576505 *	<b>C07C 323/52</b> (2006.01) <b>A61K 31/215</b> (2006.01) <b>A61P 31/00</b> (2006.01) <b>A61P 17/00</b> (2006.01)	2583014 *	<b>F16L 55/103</b> (2006.01) <b>G05D 23/19</b> (2006.01)
		2585784 *	<b>F28D 9/00</b> (2006.01) <b>F24F 3/147</b> (2006.01) <b>F28D 15/00</b> (2006.01) <b>F24F 12/00</b> (2006.01) <b>F28F 3/12</b> (2006.01)	2568999 *	<b>A61K 38/22</b> (2006.01) <b>A61P 21/00</b> (2006.01) <b>A61K 38/16</b> (2006.01) <b>A61P 21/02</b> (2006.01)

Broj objave evropske prijave patenta (97)	MKP (51)	Broj objave evropske prijave patenta (97)	MKP (51)	Broj objave evropske prijave patenta (97)	MKP (51)
2571875 *	<b>C07D 471/00</b> (2006.01)	2564847 *	<b>A61K 9/16</b> (2006.01) <b>A61K 31/4365</b> (2006.01) <b>A61P 7/02</b> (2006.01) <b>A61K 47/26</b> (2006.01) <b>A61K 9/20</b> (2006.01) <b>A61K 47/20</b> (2006.01) <b>A61K 47/40</b> (2006.01) <b>A61K 9/48</b> (2006.01) <b>A61K 47/30</b> (2006.01)	2552965 *	<b>A61P 27/00</b> (2006.01) <b>A61K 39/395</b> (2006.01) <b>A61P 37/00</b> (2006.01) <b>C07K 16/28</b> (2006.01) <b>C12N 15/13</b> (2006.01)
2510838	<b>A47C 7/54</b> (2006.01) <b>A47C 17/12</b> (2006.01)	2540136 *	<b>H04W 88/08</b> (2009.01)	2552966 *	<b>A61K 39/395</b> (2006.01) <b>C07K 16/32</b> (2006.01) <b>A61P 35/00</b> (2006.01) <b>C07K 16/28</b> (2006.01) <b>A61P 35/02</b> (2006.01)
2559709 *	<b>C08L 15/00</b> (2006.01) <b>C08C 19/25</b> (2006.01) <b>C08K 3/36</b> (2006.01)	2547650 *	<b>A61P 5/00</b> (2006.01) <b>A61P 25/24</b> (2006.01) <b>A61K 31/165</b> (2006.01) <b>A61P 25/00</b> (2006.01) <b>A61P 25/22</b> (2006.01) <b>C07C 231/12</b> (2006.01) <b>C07C 233/18</b> (2006.01)	2558345 *	<b>B61L 5/04</b> (2006.01) <b>B61L 5/10</b> (2006.01)
2457833	<b>B65G 51/03</b> (2006.01) <b>B65B 5/06</b> (2006.01) <b>B65B 35/28</b> (2006.01) <b>B65B 35/40</b> (2006.01) <b>B65B 29/02</b> (2006.01)	2560798 *	<b>B26D 1/10</b> (2006.01) <b>B26B 5/00</b> (2006.01)	2560681 *	<b>A61K 39/00</b> (2006.01) <b>C07K 16/00</b> (2006.01)
2580335 *	<b>C12N 15/82</b> (2006.01)	2544704 *	<b>A61P 35/00</b> (2006.01) <b>A61K 38/17</b> (2006.01)	2590979 *	<b>A61K 31/519</b> (2006.01) <b>A61K 31/522</b> (2006.01) <b>A61P 9/00</b> (2006.01) <b>C07D 487/04</b> (2006.01)
2579916 *	<b>A61M 5/14</b> (2006.01) <b>A61M 5/142</b> (2006.01)	2542584 *	<b>C07K 16/26</b> (2006.01)	2544697 *	<b>A61K 38/48</b> (2006.01) <b>A61K 35/14</b> (2006.01) <b>A61K 35/16</b> (2006.01)
2579920 *	<b>A61M 5/24</b> (2006.01) <b>A61M 5/315</b> (2006.01)	2544738 *	<b>A61M 5/20</b> (2006.01) <b>A61M 5/24</b> (2006.01)	2576778 *	<b>G01N 33/15</b> (2006.01) <b>C12N 15/09</b> (2006.01) <b>C12Q 1/68</b> (2006.01)
2542585 *	<b>C07K 16/26</b> (2006.01)	2563495 *	<b>B01D 53/00</b> (2006.01)	2585080 *	<b>A61K 31/727</b> (2006.01) <b>A61P 7/02</b> (2006.01)
2558463 *	<b>C07D 471/04</b> (2006.01) <b>A61P 17/00</b> (2006.01) <b>A61P 3/00</b> (2006.01) <b>A61K 31/407</b> (2006.01) <b>A61P 29/00</b> (2006.01)	2552371 *	<b>A61F 13/00</b> (2006.01)		

Broj objave evropske prijave patenta (97)	MKP (51)	Broj objave evropske prijave patenta (97)	MKP (51)	Broj objave evropske prijave patenta (97)	MKP (51)
2588185 *	<b>A61N 1/36</b> (2006.01) <b>A61N 1/04</b> (2006.01) <b>A61N 1/05</b> (2006.01) <b>A61H 39/00</b> (2006.01)	2576546 *	<b>C07D 471/04</b> (2006.01) <b>A61K 31/437</b> (2006.01) <b>A61K 35/00</b> (2006.01)	2588469 *	<b>A61K 31/4709</b> (2006.01) <b>A61P 29/00</b> (2006.01) <b>C07D 487/04</b> (2006.01) <b>A61P 35/00</b> (2006.01) <b>C07D 401/12</b> (2006.01)
2590969 *	<b>A61P 25/24</b> (2006.01) <b>C07D 413/06</b> (2006.01) <b>A61K 31/4245</b> (2006.01) <b>C07D 413/14</b> (2006.01) <b>A61K 31/4523</b> (2006.01)	2556379 *	<b>C07K 16/30</b> (2006.01) <b>A61K 39/395</b> (2006.01) <b>A61P 35/00</b> (2006.01) <b>G01N 33/68</b> (2006.01) <b>G01N 33/574</b> (2006.01)	2527842	<b>G01N 33/567</b> (2006.01)
2553151 *	<b>C40B 30/06</b> (2006.01)	2500371	<b>C08L 89/06</b> (2006.01) <b>C08L 89/04</b> (2006.01) <b>C08H 1/06</b> (2006.01)	2585435 *	<b>A61K 31/165</b> (2006.01) <b>A61K 31/216</b> (2006.01) <b>A61K 31/145</b> (2006.01) <b>C07C 323/25</b> (2006.01) <b>A61P 5/30</b> (2006.01) <b>A61K 31/18</b> (2006.01) <b>C07C 317/28</b> (2006.01) <b>A61K 31/277</b> (2006.01)
2580225 *	<b>C07H 7/04</b> (2006.01) <b>A61K 31/70</b> (2006.01) <b>A61P 3/00</b> (2006.01)	2592135 *	<b>C12H 1/16</b> (2006.01) <b>A23L 3/10</b> (2006.01)	2538919 *	<b>A61K 9/06</b> (2006.01) <b>A61K 9/00</b> (2006.01) <b>A61P 29/00</b> (2006.01) <b>A61P 25/00</b> (2006.01) <b>A61K 31/407</b> (2006.01) <b>A61P 25/02</b> (2006.01) <b>A61P 25/06</b> (2006.01)
2538919 *	<b>A61K 9/06</b> (2006.01) <b>A61K 9/00</b> (2006.01) <b>A61P 29/00</b> (2006.01) <b>A61P 25/00</b> (2006.01) <b>A61K 31/407</b> (2006.01) <b>A61P 25/02</b> (2006.01) <b>A61P 25/06</b> (2006.01)	2471543	<b>A61K 35/28</b> (2006.01) <b>C07K 16/28</b> (2006.01) <b>A61P 37/06</b> (2006.01) <b>C12N 5/00</b> (2006.01)	2593098 *	<b>A61K 31/513</b> (2006.01) <b>A61P 35/00</b> (2006.01) <b>A61K 31/56</b> (2006.01) <b>A61K 31/505</b> (2006.01) <b>A61P 29/00</b> (2006.01) <b>A61K 31/7042</b> (2006.01) <b>A61K 31/337</b> (2006.01)
2561754 *	<b>A01N 3/00</b> (2006.01) <b>A01N 27/00</b> (2006.01) <b>A01N 25/02</b> (2006.01) <b>A01N 55/00</b> (2006.01)	2571521 *	<b>A61K 39/205</b> (2006.01) <b>C07K 14/145</b> (2006.01) <b>C12N 15/863</b> (2006.01)	2580200 *	<b>A61P 25/28</b> (2006.01) <b>C07D 265/30</b> (2006.01) <b>C07D 413/04</b> (2006.01) <b>A61P 25/16</b> (2006.01) <b>A61K 31/535</b> (2006.01) <b>A61K 31/5355</b> (2006.01)
2566442 *	<b>A61K 8/41</b> (2006.01)	2576317 *	<b>B61L 29/30</b> (2006.01) <b>B61L 23/04</b> (2006.01)	2548570	<b>A61K 31/155</b> (2006.01) <b>A61K 38/18</b> (2006.01) <b>A61P 3/10</b> (2006.01) <b>A61K 38/26</b> (2006.01)
2565237	<b>C09C 1/02</b> (2006.01) <b>D21H 17/00</b> (2006.01)				

Broj objave evropske prijava patenta (97)	MKP (51)	Broj objave evropske prijava patenta (97)	MKP (51)	Broj objave evropske prijava patenta (97)	MKP (51)
2552404 *	<b>A61K 31/00</b> (2006.01) <b>A61P 15/18</b> (2006.01) <b>A61K 45/06</b> (2006.01) <b>A61K 31/4196</b> (2006.01) <b>A61K 9/00</b> (2006.01) <b>A61K 31/569</b> (2006.01) <b>A61P 15/00</b> (2006.01)	2539330 *	<b>C07D 307/32</b> (2006.01) <b>A01N 43/08</b> (2006.01) <b>C07D 405/10</b> (2006.01) <b>C07D 307/20</b> (2006.01) <b>C07D 409/12</b> (2006.01) <b>C07D 307/30</b> (2006.01) <b>C07D 413/12</b> (2006.01) <b>C07D 405/04</b> (2006.01) <b>C07D 407/12</b> (2006.01) <b>C07D 307/28</b> (2006.01) <b>C07D 409/14</b> (2006.01) <b>C07D 307/58</b> (2006.01)	2557294	<b>F02B 25/04</b> (2006.01) <b>F02B 47/02</b> (2006.01) <b>F02B 75/04</b> (2006.01) <b>F02B 33/22</b> (2006.01) <b>F02B 41/04</b> (2006.01)
2462941	<b>A61K 36/88</b> (2006.01)			2576704 *	<b>C09C 1/02</b> (2006.01) <b>D21H 19/00</b> (2006.01) <b>C09C 3/04</b> (2006.01) <b>D21H 17/00</b> (2006.01) <b>C09C 1/42</b> (2006.01)
2539527 *	<b>E06B 3/00</b> (2006.01)			2582666 *	<b>C07D 209/16</b> (2006.01) <b>C07D 231/56</b> (2006.01) <b>C07D 209/12</b> (2006.01) <b>C07D 471/04</b> (2006.01) <b>A61K 31/404</b> (2006.01) <b>A61K 31/416</b> (2006.01) <b>A61P 25/00</b> (2006.01)
2561892 *	<b>A61K 47/26</b> (2006.01) <b>A61K 47/36</b> (2006.01) <b>A61K 47/10</b> (2006.01) <b>A61K 47/38</b> (2006.01) <b>A61K 47/02</b> (2006.01) <b>A61K 47/32</b> (2006.01) <b>A61K 9/30</b> (2006.01)	2540720 *	<b>C07D 471/04</b> (2006.01) <b>A61P 43/00</b> (2006.01) <b>A61K 31/4985</b> (2006.01) <b>A61P 31/18</b> (2006.01) <b>A61K 31/5377</b> (2006.01)		
2542554 *	<b>C07D 487/04</b> (2006.01) <b>A61P 37/00</b> (2006.01) <b>A61P 31/12</b> (2006.01) <b>A61K 31/407</b> (2006.01)	2580189 *	<b>A61P 25/22</b> (2006.01) <b>C07C 231/06</b> (2006.01) <b>C07C 231/12</b> (2006.01) <b>C07C 233/18</b> (2006.01) <b>A61P 25/24</b> (2006.01) <b>A61P 25/20</b> (2006.01) <b>A61P 25/06</b> (2006.01) <b>A61K 31/165</b> (2006.01)	2527201	<b>B60R 7/00</b> (2006.01)
2561290 *	<b>F25D 3/00</b> (2006.01)			2577185 *	<b>F24J 2/54</b> (2006.01)
2457834	<b>B65B 35/40</b> (2006.01) <b>B65B 5/06</b> (2006.01) <b>B65B 35/28</b> (2006.01) <b>B65B 29/02</b> (2006.01)	2552424 *	<b>A61K 9/00</b> (2006.01) <b>A61K 9/50</b> (2006.01)	2552542 *	<b>G08B 25/01</b> (2006.01) <b>G08B 25/08</b> (2006.01) <b>A62C 37/50</b> (2006.01) <b>A61F 17/00</b> (2006.01) <b>G06F 19/00</b> (2011.01) <b>A61B 19/02</b> (2006.01) <b>G08B 21/02</b> (2006.01) <b>A61N 1/39</b> (2006.01)
2542257 *	<b>A61K 39/395</b> (2006.01) <b>A61K 39/00</b> (2006.01)	2564169 *	<b>G01F 1/58</b> (2006.01) <b>G01F 1/60</b> (2006.01)		



Broj objave evropske prijave patenta (97)	MKP (51)	Broj objave evropske prijave patenta (97)	MKP (51)	Broj objave evropske prijave patenta (97)	MKP (51)
2582660 *	<b>C07C 237/14</b> (2006.01) <b>A61K 31/16</b> (2006.01) <b>A61P 11/00</b> (2006.01) <b>A61P 37/00</b> (2006.01) <b>C07D 233/58</b> (2006.01)	2588477 *	<b>A61K 31/4706</b> (2006.01) <b>A61P 31/18</b> (2006.01) <b>C07D 417/14</b> (2006.01)	2563745 *	<b>C05C 9/02</b> (2006.01) <b>C05C 9/00</b> (2006.01)
		2563682 *	<b>B65D 75/58</b> (2006.01)	2567030 *	<b>E01F 15/02</b> (2006.01) <b>E01F 15/04</b> (2006.01)
2491930	<b>A61K 9/50</b> (2006.01) <b>A61K 9/14</b> (2006.01) <b>A61K 31/4402</b> (2006.01) <b>A61K 31/495</b> (2006.01) <b>A61K 9/20</b> (2006.01) <b>A61P 27/16</b> (2006.01) <b>A61K 9/48</b> (2006.01) <b>A61K 9/00</b> (2006.01)	2538982 *	<b>A61K 51/00</b> (2006.01)	2583431 *	<b>H04L 29/06</b> (2006.01) <b>H04M 3/51</b> (2006.01)
		2579922 *	<b>A61M 5/315</b> (2006.01) <b>A61M 5/24</b> (2006.01)	2594570 *	<b>C07D 495/04</b> (2006.01) <b>A61K 31/519</b> (2006.01) <b>A61P 3/10</b> (2006.01) <b>A61P 13/08</b> (2006.01) <b>A61P 13/10</b> (2006.01) <b>A61P 7/02</b> (2006.01) <b>A61P 15/10</b> (2006.01) <b>A61P 9/10</b> (2006.01) <b>A61P 25/00</b> (2006.01) <b>A61P 9/12</b> (2006.01) <b>A61P 25/28</b> (2006.01) <b>A61P 11/00</b> (2006.01) <b>A61P 13/02</b> (2006.01) <b>A61P 13/04</b> (2006.01)
		2463921	<b>H01L 31/058</b> (2006.01)		
		2527753	<b>F24F 7/08</b> (2006.01) <b>F24F 11/00</b> (2006.01)		
2571617 *	<b>G01N 33/543</b> (2006.01) <b>B01L 3/00</b> (2006.01) <b>B01L 7/00</b> (2006.01) <b>C12Q 1/68</b> (2006.01)	2569940 *	<b>H04N 7/15</b> (2006.01) <b>H04N 7/14</b> (2006.01) <b>H04N 7/00</b> (2011.01)		
		2484260	<b>A47L 9/24</b> (2006.01)		
2586589	<b>B29C 51/44</b> (2006.01) <b>B29C 51/22</b> (2006.01)	2575969 *	<b>A61P 31/16</b> (2006.01) <b>A61P 31/18</b> (2006.01) <b>A61K 31/519</b> (2006.01) <b>A61K 31/52</b> (2006.01) <b>A61P 31/14</b> (2006.01) <b>A61P 31/12</b> (2006.01) <b>A61K 31/551</b> (2006.01)	2575467 *	<b>A01N 43/78</b> (2006.01) <b>A61K 31/425</b> (2006.01)
2590687 *	<b>A61L 2/20</b> (2006.01)				
2591992	<b>B63B 35/04</b> (2006.01) <b>B65H 75/36</b> (2006.01)			2563912 *	<b>C12N 15/52</b> (2006.01) <b>A61K 38/43</b> (2006.01) <b>C12N 9/00</b> (2006.01) <b>C07K 19/00</b> (2006.01) <b>C12N 15/113</b> (2010.01) <b>C07K 16/40</b> (2006.01) <b>G01N 33/68</b> (2006.01)
2592102 *	<b>C08G 64/06</b> (2006.01) <b>B29C 49/00</b> (2006.01) <b>B65D 1/00</b> (2006.01)	2563383 *	<b>A61P 35/00</b> (2006.01) <b>A61P 29/00</b> (2006.01) <b>A61P 3/10</b> (2006.01) <b>A61K 38/16</b> (2006.01) <b>A61K 39/395</b> (2006.01) <b>A61K 48/00</b> (2006.01) <b>A61K 38/17</b> (2006.01)		
2558013 *	<b>F25D 3/10</b> (2006.01) <b>A61B 18/02</b> (2006.01) <b>A61M 19/00</b> (2006.01)				

Broj objave evropske prijave patenta (97)	MKP (51)	Broj objave evropske prijave patenta (97)	MKP (51)	Broj objave evropske prijave patenta (97)	MKP (51)
2591101 *	<b>C12N 15/00</b> (2006.01) <b>C12P 21/04</b> (2006.01)	2589166 *	<b>H04B 17/00</b> (2006.01)	2542524 *	<b>C07D 211/58</b> (2006.01) <b>C07D 487/08</b> (2006.01) <b>C07D 243/08</b> (2006.01) <b>A61K 31/4418</b> (2006.01) <b>C07D 401/02</b> (2006.01) <b>A61K 31/444</b> (2006.01) <b>C07D 401/12</b> (2006.01) <b>C07D 295/08</b> (2006.01) <b>A61K 31/40</b> (2006.01) <b>C07D 205/04</b> (2006.01) <b>C07D 403/12</b> (2006.01) <b>C07D 211/56</b> (2006.01) <b>C07D 413/12</b> (2006.01) <b>C07D 207/08</b> (2006.01) <b>C07D 405/12</b> (2006.01)
2593996 *	<b>H02G 3/08</b> (2006.01)	2540769	<b>C08L 67/02</b> (2006.01) <b>G02B 6/02</b> (2006.01) <b>C08L 63/00</b> (2006.01) <b>B24B 13/005</b> (2006.01) <b>C08K 5/053</b> (2006.01) <b>C09J 167/00</b> (2006.01)	2554267 *	<b>B01J 37/18</b> (2006.01) <b>C10G 2/00</b> (2006.01)
2582536 *	<b>B29C 45/14</b> (2006.01) <b>B60J 1/00</b> (2006.01) <b>B60J 10/02</b> (2006.01)	2582692 *	<b>C07D 401/12</b> (2006.01) <b>A61K 31/517</b> (2006.01) <b>C07D 405/14</b> (2006.01) <b>A61P 29/00</b> (2006.01) <b>C07D 401/14</b> (2006.01) <b>A61K 31/4709</b> (2006.01) <b>C07D 403/12</b> (2006.01) <b>A61K 31/502</b> (2006.01) <b>C07D 403/14</b> (2006.01) <b>A61K 31/4375</b> (2006.01) <b>C07D 413/14</b> (2006.01) <b>C07D 417/14</b> (2006.01) <b>C07D 471/04</b> (2006.01)	2560534 *	<b>A47K 10/34</b> (2006.01) <b>A47K 5/12</b> (2006.01) <b>H05F 3/02</b> (2006.01)
2569294 *	<b>A61P 37/08</b> (2006.01) <b>A61K 31/4427</b> (2006.01) <b>C07D 403/14</b> (2006.01) <b>C07D 401/04</b> (2006.01)	2566494 *	<b>A61K 38/16</b> (2006.01)	2588379 *	<b>B65D 1/02</b> (2006.01)
2560862 *	<b>B62K 21/26</b> (2006.01) <b>B62K 3/16</b> (2006.01) <b>B62K 11/14</b> (2006.01) <b>B62K 23/04</b> (2006.01)	2552959 *		2593352 *	<b>B62D 9/02</b> (2006.01) <b>B62K 5/08</b> (2006.01)
2588078 *	<b>A61K 49/00</b> (2006.01) <b>A61K 47/14</b> (2006.01) <b>A61K 31/557</b> (2006.01) <b>A61K 9/00</b> (2006.01)	2538942 *	<b>A61K 31/404</b> (2006.01) <b>A61P 17/00</b> (2006.01)		
2538942 *	<b>A61K 31/404</b> (2006.01) <b>A61P 17/00</b> (2006.01)	2538771 *	<b>A01J 9/04</b> (2006.01) <b>A01J 5/00</b> (2006.01)		
2552959 *	<b>C12N 15/13</b> (2006.01) <b>C12N 5/18</b> (2006.01) <b>A61P 35/00</b> (2006.01) <b>A61K 39/395</b> (2006.01) <b>C07K 16/18</b> (2006.01)	2567221 *	<b>G01N 21/90</b> (2006.01)		

Broj objave evropske prijave patenta (97)	MKP (51)	Broj objave evropske prijave patenta (97)	MKP (51)	Broj objave evropske prijave patenta (97)	MKP (51)
2545053 *	<b>A61K 31/4375</b> (2006.01) <b>A61P 11/00</b> (2006.01) <b>A61P 25/24</b> (2006.01) <b>A61P 25/04</b> (2006.01) <b>C07D 471/04</b> (2006.01) <b>A61P 25/08</b> (2006.01) <b>A61P 25/16</b> (2006.01) <b>A61P 25/22</b> (2006.01) <b>A61P 25/28</b> (2006.01) <b>A61P 3/04</b> (2006.01) <b>A61P 25/18</b> (2006.01) <b>A61P 13/00</b> (2006.01)	2575857 *	<b>A61P 21/00</b> (2006.01) <b>A61K 39/395</b> (2006.01) <b>A61K 38/16</b> (2006.01) <b>A61P 37/00</b> (2006.01) <b>A61K 38/17</b> (2006.01) <b>A61K 38/08</b> (2006.01)	2547684 *	<b>C07D 491/10</b> (2006.01) <b>A61P 35/00</b> (2006.01) <b>C07D 487/10</b> (2006.01) <b>C07D 519/00</b> (2006.01) <b>A61K 31/5386</b> (2006.01)
		2477137	<b>G06F 21/24</b> (2006.01)	2579857 *	<b>A61K 31/137</b> (2006.01) <b>A61K 9/50</b> (2006.01) <b>A61K 9/20</b> (2006.01)
		2592141 *	<b>C12N 15/09</b> (2006.01) <b>C12N 15/00</b> (2006.01) <b>A01K 67/027</b> (2006.01) <b>C12Q 1/02</b> (2006.01) <b>C12N 5/09</b> (2010.01)	2542583 *	<b>A61K 39/395</b> (2006.01) <b>A61P 35/00</b> (2006.01) <b>C07K 16/26</b> (2006.01)
2588480 *	<b>C07D 487/04</b> (2006.01) <b>C07D 207/337</b> (2006.01) <b>A61P 9/00</b> (2006.01) <b>A61P 25/28</b> (2006.01) <b>A61P 29/00</b> (2006.01) <b>A61K 31/4985</b> (2006.01) <b>C07D 241/06</b> (2006.01) <b>A61P 25/00</b> (2006.01)	2552202 *	<b>A01N 43/02</b> (2006.01)	2584512	<b>G06Q 20/00</b> (2012.01) <b>A63F 3/06</b> (2006.01)
		2479242	<b>C10G 65/02</b> (2006.01) <b>B01J 35/04</b> (2006.01) <b>C10G 45/12</b> (2006.01) <b>B01J 21/12</b> (2006.01) <b>C10G 45/08</b> (2006.01) <b>B01J 35/10</b> (2006.01)	2542685 *	<b>C12P 7/64</b> (2006.01)
2585150 *	<b>A61M 11/02</b> (2006.01) <b>A61M 16/00</b> (2006.01)	2502594	<b>A61B 17/70</b> (2006.01)	2592992 *	<b>A61B 1/04</b> (2006.01)
		2502594	<b>A61B 17/70</b> (2006.01)	2575884 *	<b>A61K 39/00</b> (2006.01) <b>C07K 16/00</b> (2006.01) <b>A61K 39/395</b> (2006.01)
2566496 *	<b>A61P 35/00</b> (2006.01) <b>A61P 3/10</b> (2006.01) <b>A61K 39/395</b> (2006.01) <b>A61K 38/16</b> (2006.01) <b>C07K 14/525</b> (2006.01) <b>A61P 29/00</b> (2006.01)	2585274 *	<b>C23C 16/50</b> (2006.01) <b>B05D 7/24</b> (2006.01) <b>B29C 59/14</b> (2006.01)	2569332 *	<b>C07K 19/00</b> (2006.01) <b>C07K 14/705</b> (2006.01)
		2585138 *	<b>A61M 5/20</b> (2006.01)		
		2582395 *	<b>A61K 47/34</b> (2006.01)		
2571864 *	<b>C07D 401/14</b> (2006.01) <b>A61P 3/10</b> (2006.01) <b>A61K 31/4545</b> (2006.01)	2508076	<b>A21B 1/48</b> (2006.01) <b>F24C 15/16</b> (2006.01) <b>A21B 3/15</b> (2006.01)		

Broj objave evropske prijave patenta (97)	MKP (51)	Broj objave evropske prijave patenta (97)	MKP (51)	Broj objave evropske prijave patenta (97)	MKP (51)
2481838	<b>C25D 5/12</b> (2006.01) <b>C23C 28/02</b> (2006.01) <b>C23C 18/30</b> (2006.01) <b>C23C 14/20</b> (2006.01) <b>C23C 14/16</b> (2006.01) <b>C25D 5/56</b> (2006.01) <b>C25D 5/48</b> (2006.01) <b>C25D 5/14</b> (2006.01) <b>C23C 30/00</b> (2006.01) <b>C23C 14/00</b> (2006.01)	2560535 *	<b>A47K 10/36</b> (2006.01)	2575779 *	<b>A61K 9/20</b> (2006.01) <b>A61K 47/02</b> (2006.01)
		2568969 *	<b>A61K 9/50</b> (2006.01) <b>A61K 9/20</b> (2006.01)	2560706 *	<b>A61M 5/24</b> (2006.01)
		2580210 *	<b>C07D 405/10</b> (2006.01) <b>C07D 311/04</b> (2006.01) <b>C07D 405/12</b> (2006.01) <b>A61P 25/28</b> (2006.01) <b>A61K 31/352</b> (2006.01) <b>A61K 31/453</b> (2006.01) <b>A61P 35/00</b> (2006.01)	2576619 *	<b>C07K 16/22</b> (2006.01) <b>A61K 39/395</b> (2006.01) <b>A61P 21/06</b> (2006.01)
				2462925	<b>A61K 9/20</b> (2006.01) <b>A61K 9/50</b> (2006.01)
2588475 *	<b>C07D 409/14</b> (2006.01) <b>A61P 9/00</b> (2006.01) <b>A61P 29/00</b> (2006.01) <b>A61K 31/427</b> (2006.01) <b>A61P 37/00</b> (2006.01) <b>A61K 31/4196</b> (2006.01) <b>A61K 31/4427</b> (2006.01) <b>C07D 417/14</b> (2006.01)	2550288 *	<b>C07J 41/00</b> (2006.01) <b>A61K 31/57</b> (2006.01) <b>A61P 5/36</b> (2006.01)	2585104 *	<b>A61K 38/47</b> (2006.01) <b>A61P 25/28</b> (2006.01) <b>A61P 25/00</b> (2006.01)
		2563603 *	<b>B43K 24/02</b> (2006.01)	2594140 *	<b>A23L 1/00</b> (2006.01) <b>A61K 8/64</b> (2006.01)
		2588421 *	<b>C03B 9/34</b> (2006.01) <b>C03B 9/325</b> (2006.01)	2572068 *	<b>E06B 3/263</b> (2006.01) <b>E06B 3/30</b> (2006.01)
2542579 *	<b>A61K 39/395</b> (2006.01) <b>C07K 16/18</b> (2006.01) <b>C07K 16/46</b> (2006.01)	2542582 *	<b>C07K 16/18</b> (2006.01)	2550359 *	<b>C12N 15/00</b> (2006.01)
		2582618 *	<b>C01B 4/00</b> (2006.01) <b>C01B 3/50</b> (2006.01)	2580824 *	<b>H01R 24/58</b> (2011.01)
2576368 *	<b>B65G 49/06</b> (2006.01) <b>B65D 85/48</b> (2006.01) <b>B65D 21/08</b> (2006.01) <b>B65D 19/12</b> (2006.01) <b>B65D 81/05</b> (2006.01) <b>B65D 19/44</b> (2006.01)	2484630	<b>G01N 27/48</b> (2006.01) <b>B82Y 30/00</b> (2011.01) <b>G01N 27/12</b> (2006.01) <b>G01N 33/18</b> (2006.01)	2468651	<b>B65D 33/16</b> (2006.01)
				2450204	<b>B60H 1/00</b> (2006.01)
				2560776 *	<b>B22D 41/02</b> (2006.01)
		2571857 *	<b>C07D 239/70</b> (2006.01)	2552411 *	<b>A61K 47/48</b> (2006.01) <b>A61K 39/395</b> (2006.01) <b>A61K 9/08</b> (2006.01) <b>A61K 47/22</b> (2006.01)
2552745 *	<b>B60N 2/50</b> (2006.01) <b>G09B 9/00</b> (2006.01)	2542318 *	<b>B01D 24/14</b> (2006.01) <b>B01D 24/00</b> (2006.01)	2564877	<b>A61L 9/12</b> (2006.01)
2558448 *	<b>C07D 213/81</b> (2006.01)				

Broj objave evropske prijava patenta (97)	MKP (51)	Broj objave evropske prijava patenta (97)	MKP (51)	Broj objave evropske prijava patenta (97)	MKP (51)
2591126 *	<b>C12Q 1/68</b> (2006.01) <b>C12N 15/11</b> (2006.01)	2563402 *	<b>A61P 7/04</b> (2006.01) <b>A61K 38/37</b> (2006.01) <b>A61K 47/48</b> (2006.01)	2560786 *	<b>B23Q 1/01</b> (2006.01) <b>B23K 26/08</b> (2006.01) <b>B23K 37/02</b> (2006.01) <b>B23K 26/10</b> (2006.01)
2545126 *	<b>C09D 5/14</b> (2006.01) <b>A61L 27/54</b> (2006.01) <b>A61L 27/34</b> (2006.01)	2565194 *	<b>A61P 25/24</b> (2006.01) <b>A61P 25/18</b> (2006.01) <b>C07D 471/04</b> (2006.01) <b>C07D 495/14</b> (2006.01) <b>A61K 31/4545</b> (2006.01) <b>A61P 25/28</b> (2006.01) <b>A61K 31/437</b> (2006.01) <b>C07D 519/00</b> (2006.01) <b>A61K 31/438</b> (2006.01) <b>A61P 43/00</b> (2006.01)	2539334 *	<b>C07C 291/10</b> (2006.01) <b>C07C 231/14</b> (2006.01) <b>C07C 233/31</b> (2006.01) <b>C07C 235/14</b> (2006.01) <b>C07D 403/12</b> (2006.01) <b>C07C 237/04</b> (2006.01)
2567891 *	<b>B64C 3/14</b> (2006.01)			2544721 *	<b>A61K 47/00</b> (2006.01) <b>A61K 48/00</b> (2006.01)
2542898 *	<b>G01N 33/74</b> (2006.01)			2569450 *	<b>C40B 40/06</b> (2006.01) <b>C40B 30/04</b> (2006.01) <b>C12Q 1/68</b> (2006.01)
2582372 *	<b>A61K 31/495</b> (2006.01) <b>A61P 9/00</b> (2006.01)	2552930 *	<b>C07H 19/06</b> (2006.01) <b>C07F 9/6561</b> (2006.01) <b>A61P 31/14</b> (2006.01) <b>C07H 19/10</b> (2006.01) <b>C07F 9/26</b> (2006.01) <b>C07H 19/052</b> (2006.01) <b>C07H 19/207</b> (2006.01) <b>C07H 19/04</b> (2006.01) <b>C07F 9/6558</b> (2006.01) <b>A61K 31/7056</b> (2006.01) <b>C07F 9/655</b> (2006.01) <b>A61K 31/664</b> (2006.01) <b>A61K 31/7072</b> (2006.01) <b>C07H 19/044</b> (2006.01) <b>C07F 9/24</b> (2006.01) <b>C07H 19/24</b> (2006.01)		
2539159 *	<b>B42F 13/26</b> (2006.01) <b>B42F 13/24</b> (2006.01)				
2547354 *	<b>A61K 38/17</b> (2006.01)				
2590558 *	<b>A61B 5/103</b> (2006.01) <b>A61B 5/117</b> (2006.01) <b>A61B 5/05</b> (2006.01)				
2576534 *	<b>A61P 31/14</b> (2006.01) <b>C07D 309/10</b> (2006.01) <b>A61K 31/40</b> (2006.01)				
2585074 *	<b>A61P 25/24</b> (2006.01) <b>A61P 25/18</b> (2006.01) <b>A61P 25/22</b> (2006.01) <b>A61K 31/565</b> (2006.01)				
2585105 *	<b>A61P 25/28</b> (2006.01) <b>A61P 25/00</b> (2006.01) <b>A61K 38/47</b> (2006.01)				



**INDEKS KLASIFIKACIJSKIH OZNAKA BROJEVA ZAHTJEVA ZA PROŠIRENJE  
EVROPSKIH PRIJAVA PATENTA PREMA MKP  
INDEX ON CLASSIFICATION MARKS ON REQUESTS FOR EXTENSION  
OF EUROPEAN PATENT APPLICATION IN ACCORDANCE WITH THE  
INTERNATIONAL PATENT CLASSIFICATION**

MKP (51)	Broj objave evropske prijava patenta (97)	Naziv pronalaska (54)
<b>C12N 9/16</b> (2006.01)	2579900 *	VECTORS AND SEQUENCES FOR THE TREATMENT OF DISEASES
<b>C12N 15/67</b> (2006.01)	2579900 *	VECTORS AND SEQUENCES FOR THE TREATMENT OF DISEASES
<b>C12N 9/14</b> (2006.01)	2579900 *	VECTORS AND SEQUENCES FOR THE TREATMENT OF DISEASES
<b>A61K 48/00</b> (2006.01)	2579900 *	VECTORS AND SEQUENCES FOR THE TREATMENT OF DISEASES
<b>C12N 15/68</b> (2006.01)	2579900 *	VECTORS AND SEQUENCES FOR THE TREATMENT OF DISEASES
<b>C12N 15/864</b> (2006.01)	2579900 *	VECTORS AND SEQUENCES FOR THE TREATMENT OF DISEASES
<b>A01N 47/36</b> (2006.01)	2591673 *	PEST CONTROL AGENT
<b>C07D 417/06</b> (2006.01)	2591673 *	PEST CONTROL AGENT
<b>C07D 277/20</b> (2006.01)	2591673 *	PEST CONTROL AGENT
<b>A01N 47/18</b> (2006.01)	2591673 *	PEST CONTROL AGENT
<b>A01P 7/02</b> (2006.01)	2591673 *	PEST CONTROL AGENT
<b>C07D 401/14</b> (2006.01)	2591673 *	PEST CONTROL AGENT
<b>C07D 277/32</b> (2006.01)	2591673 *	PEST CONTROL AGENT
<b>A01P 7/04</b> (2006.01)	2591673 *	PEST CONTROL AGENT
<b>A01N 43/78</b> (2006.01)	2591673 *	PEST CONTROL AGENT
<b>C07D 401/04</b> (2006.01)	2591673 *	PEST CONTROL AGENT
<b>A01P 5/00</b> (2006.01)	2591673 *	PEST CONTROL AGENT
<b>C07D 417/14</b> (2006.01)	2591673 *	PEST CONTROL AGENT
<b>A01N 43/00</b> (2006.01)	2552201 *	PARASITICIDAL COMPOSITIONS COMPRISING MULTIPLE ACTIVE AGENTS, METHODS AND USES THEREOF
<b>A61P 33/00</b> (2006.01)	2552201 *	PARASITICIDAL COMPOSITIONS COMPRISING MULTIPLE ACTIVE AGENTS, METHODS AND USES THEREOF
<b>A61L 2/00</b> (2006.01)	2593144 *	IMPROVED METHODS FOR THE STERILIZATION OF BENDAMUSTINE
<b>F16H 48/30</b> (2012.01)	2593696 *	AXLE ASSEMBLY WITH TORQUE DISTRIBUTION DRIVE MECHANISM
<b>B29C 45/00</b> (2006.01)	2489491	Method and device for producing ball bearing rings
<b>B29L 31/04</b> (2006.01)	2489491	Method and device for producing ball bearing rings
<b>B29C 45/04</b> (2006.01)	2489491	Method and device for producing ball bearing rings
<b>B29C 45/56</b> (2006.01)	2489491	Method and device for producing ball bearing rings
<b>C12Q 1/70</b> (2006.01)	2561104 *	DIAGNOSIS OF VIRAL INFECTIONS BY DETECTION OF GENOMIC AND INFECTIOUS VIRAL DNA BY MOLECULAR COMBINING
<b>A61M 5/315</b> (2006.01)	2579923 *	DRIVE MECHANISM FOR A DRUG DELIVERY DEVICE AND DRUG DELIVERY DEVICE
<b>A61M 5/24</b> (2006.01)	2579923 *	DRIVE MECHANISM FOR A DRUG DELIVERY DEVICE AND DRUG DELIVERY DEVICE
<b>C07C 215/60</b> (2006.01)	2563757 *	METHOD FOR PREPARING RITODRINE HYDROCHLORIDE
<b>C12N 5/077</b> (2010.01)	2576767 *	PROCESS FOR DIFFERENTIATING STEM CELLS OF THE AMNIOTIC MEMBRANE
<b>C12N 5/073</b> (2010.01)	2576767 *	PROCESS FOR DIFFERENTIATING STEM CELLS OF THE AMNIOTIC MEMBRANE
<b>A61P 13/08</b> (2006.01)	2564849 *	PROPHYLACTIC OR THERAPEUTIC AGENT FOR DISEASES ASSOCIATED WITH PAINS IN URINARY ORGANS
<b>A61P 13/10</b> (2006.01)	2564849 *	PROPHYLACTIC OR THERAPEUTIC AGENT FOR DISEASES ASSOCIATED WITH PAINS IN URINARY ORGANS

MKP (51)	Broj objave evropske prijava patenta (97)	Naziv pronalaska (54)
<b>C07D 401/14</b> (2006.01)	2564849 *	PROPHYLACTIC OR THERAPEUTIC AGENT FOR DISEASES ASSOCIATED WITH PAINS IN URINARY ORGANS
<b>A61K 31/496</b> (2006.01)	2564849 *	PROPHYLACTIC OR THERAPEUTIC AGENT FOR DISEASES ASSOCIATED WITH PAINS IN URINARY ORGANS
<b>C07D 213/65</b> (2006.01)	2564849 *	PROPHYLACTIC OR THERAPEUTIC AGENT FOR DISEASES ASSOCIATED WITH PAINS IN URINARY ORGANS
<b>A61K 31/4545</b> (2006.01)	2564849 *	PROPHYLACTIC OR THERAPEUTIC AGENT FOR DISEASES ASSOCIATED WITH PAINS IN URINARY ORGANS
<b>A61P 43/00</b> (2006.01)	2564849 *	PROPHYLACTIC OR THERAPEUTIC AGENT FOR DISEASES ASSOCIATED WITH PAINS IN URINARY ORGANS
<b>A61P 13/00</b> (2006.01)	2564849 *	PROPHYLACTIC OR THERAPEUTIC AGENT FOR DISEASES ASSOCIATED WITH PAINS IN URINARY ORGANS
<b>C07D 213/80</b> (2006.01)	2564849 *	PROPHYLACTIC OR THERAPEUTIC AGENT FOR DISEASES ASSOCIATED WITH PAINS IN URINARY ORGANS
<b>A61P 29/00</b> (2006.01)	2564849 *	PROPHYLACTIC OR THERAPEUTIC AGENT FOR DISEASES ASSOCIATED WITH PAINS IN URINARY ORGANS
<b>A61P 25/04</b> (2006.01)	2564849 *	PROPHYLACTIC OR THERAPEUTIC AGENT FOR DISEASES ASSOCIATED WITH PAINS IN URINARY ORGANS
<b>A61P 19/00</b> (2006.01)	2564849 *	PROPHYLACTIC OR THERAPEUTIC AGENT FOR DISEASES ASSOCIATED WITH PAINS IN URINARY ORGANS
<b>C07D 413/14</b> (2006.01)	2564849 *	PROPHYLACTIC OR THERAPEUTIC AGENT FOR DISEASES ASSOCIATED WITH PAINS IN URINARY ORGANS
<b>C07D 401/12</b> (2006.01)	2564849 *	PROPHYLACTIC OR THERAPEUTIC AGENT FOR DISEASES ASSOCIATED WITH PAINS IN URINARY ORGANS
<b>A61K 38/10</b> (2006.01)	2593124 *	INNOVATIVE DISCOVERY OF THERAPEUTIC, DIAGNOSTIC, AND ANTIBODY COMPOSITIONS RELATED TO PROTEIN FRAGMENTS OF ASPARTYL-TRNA SYNTHETASES
<b>A61K 38/08</b> (2006.01)	2593124 *	INNOVATIVE DISCOVERY OF THERAPEUTIC, DIAGNOSTIC, AND ANTIBODY COMPOSITIONS RELATED TO PROTEIN FRAGMENTS OF ASPARTYL-TRNA SYNTHETASES
<b>A61P 3/00</b> (2006.01)	2593124 *	INNOVATIVE DISCOVERY OF THERAPEUTIC, DIAGNOSTIC, AND ANTIBODY COMPOSITIONS RELATED TO PROTEIN FRAGMENTS OF ASPARTYL-TRNA SYNTHETASES
<b>A61P 35/00</b> (2006.01)	2593124 *	INNOVATIVE DISCOVERY OF THERAPEUTIC, DIAGNOSTIC, AND ANTIBODY COMPOSITIONS RELATED TO PROTEIN FRAGMENTS OF ASPARTYL-TRNA SYNTHETASES
<b>A61K 38/16</b> (2006.01)	2593124 *	INNOVATIVE DISCOVERY OF THERAPEUTIC, DIAGNOSTIC, AND ANTIBODY COMPOSITIONS RELATED TO PROTEIN FRAGMENTS OF ASPARTYL-TRNA SYNTHETASES
<b>A61K 39/395</b> (2006.01)	2593124 *	INNOVATIVE DISCOVERY OF THERAPEUTIC, DIAGNOSTIC, AND ANTIBODY COMPOSITIONS RELATED TO PROTEIN FRAGMENTS OF ASPARTYL-TRNA SYNTHETASES
<b>A61P 3/10</b> (2006.01)	2593124 *	INNOVATIVE DISCOVERY OF THERAPEUTIC, DIAGNOSTIC, AND ANTIBODY COMPOSITIONS RELATED TO PROTEIN FRAGMENTS OF ASPARTYL-TRNA SYNTHETASES
<b>A61P 7/02</b> (2006.01)	2585079 *	SEMULOPARIN FOR THE EXTENDED PREVENTION OF A MORTALITY AND/OR MORBIDITY EVENT IN A PATIENT HAVING UNDERGONE HIP FRACTURE SURGERY
<b>A61K 31/727</b> (2006.01)	2585079 *	SEMULOPARIN FOR THE EXTENDED PREVENTION OF A MORTALITY AND/OR MORBIDITY EVENT IN A PATIENT HAVING UNDERGONE HIP FRACTURE SURGERY
<b>C02F 1/52</b> (2006.01)	2592054	Aqueous suspensions of calcium carbonate-comprising materials with low deposit built up
<b>A61P 31/18</b> (2006.01)	2552480 *	HIV VACCINE
<b>A61K 39/21</b> (2006.01)	2552480 *	HIV VACCINE
<b>C07F 17/02</b> (2006.01)	2580224 *	METHOD OF SYNTHESIS OF FERROQUINE BY CONVERGENT REDUCTIVE AMINATION
<b>A61M 5/20</b> (2006.01)	2538996 *	AUTO - INJECTOR WITH NEEDLE SHROUD AND NEEDLE PROTECTION CAP



MKP (51)	Broj objave evropske prijava patenta (97)	Naziv pronalaska (54)
<b>F24F 12/00</b> (2006.01)	2539642 *	VENTILATION DEVICE
<b>E06B 7/10</b> (2006.01)	2539642 *	VENTILATION DEVICE
<b>F24F 13/18</b> (2006.01)	2539642 *	VENTILATION DEVICE
<b>F24F 11/00</b> (2006.01)	2539642 *	VENTILATION DEVICE
<b>C07D 413/04</b> (2006.01)	2563765 *	BICYCLIC COMPOUND DERIVATIVES AND THEIR USE AS ACC INHIBITORS.
<b>A61P 3/00</b> (2006.01)	2563765 *	BICYCLIC COMPOUND DERIVATIVES AND THEIR USE AS ACC INHIBITORS.
<b>C07D 231/54</b> (2006.01)	2563765 *	BICYCLIC COMPOUND DERIVATIVES AND THEIR USE AS ACC INHIBITORS.
<b>A61K 31/416</b> (2006.01)	2563765 *	BICYCLIC COMPOUND DERIVATIVES AND THEIR USE AS ACC INHIBITORS.
<b>C07D 487/08</b> (2006.01)	2563765 *	BICYCLIC COMPOUND DERIVATIVES AND THEIR USE AS ACC INHIBITORS.
<b>C07D 263/56</b> (2006.01)	2563765 *	BICYCLIC COMPOUND DERIVATIVES AND THEIR USE AS ACC INHIBITORS.
<b>A61K 31/496</b> (2006.01)	2563765 *	BICYCLIC COMPOUND DERIVATIVES AND THEIR USE AS ACC INHIBITORS.
<b>C07D 417/04</b> (2006.01)	2563765 *	BICYCLIC COMPOUND DERIVATIVES AND THEIR USE AS ACC INHIBITORS.
<b>A61P 9/00</b> (2006.01)	2563765 *	BICYCLIC COMPOUND DERIVATIVES AND THEIR USE AS ACC INHIBITORS.
<b>C07D 307/81</b> (2006.01)	2563765 *	BICYCLIC COMPOUND DERIVATIVES AND THEIR USE AS ACC INHIBITORS.
<b>A61K 31/4365</b> (2006.01)	2563765 *	BICYCLIC COMPOUND DERIVATIVES AND THEIR USE AS ACC INHIBITORS.
<b>C07D 263/58</b> (2006.01)	2563765 *	BICYCLIC COMPOUND DERIVATIVES AND THEIR USE AS ACC INHIBITORS.
<b>A61K 31/4355</b> (2006.01)	2563765 *	BICYCLIC COMPOUND DERIVATIVES AND THEIR USE AS ACC INHIBITORS.
<b>C07D 498/04</b> (2006.01)	2563765 *	BICYCLIC COMPOUND DERIVATIVES AND THEIR USE AS ACC INHIBITORS.
<b>C09J 189/00</b> (2006.01)	2576697 *	PROTEIN ADHESIVE FORMULATIONS WITH AMINE-EPOCHLOROHYDRIN AND ISOCYANATE ADDITIVES
<b>C08L 97/02</b> (2006.01)	2576697 *	PROTEIN ADHESIVE FORMULATIONS WITH AMINE-EPOCHLOROHYDRIN AND ISOCYANATE ADDITIVES
<b>C08L 79/02</b> (2006.01)	2576697 *	PROTEIN ADHESIVE FORMULATIONS WITH AMINE-EPOCHLOROHYDRIN AND ISOCYANATE ADDITIVES
<b>C08L 89/00</b> (2006.01)	2576697 *	PROTEIN ADHESIVE FORMULATIONS WITH AMINE-EPOCHLOROHYDRIN AND ISOCYANATE ADDITIVES
<b>A61K 31/437</b> (2006.01)	2594555 *	HETEROCYCLIC COMPOUND, AND p27 KIP1 DEGRADATION INHIBITOR
<b>A61K 31/498</b> (2006.01)	2594555 *	HETEROCYCLIC COMPOUND, AND p27 KIP1 DEGRADATION INHIBITOR
<b>C07D 231/40</b> (2006.01)	2594555 *	HETEROCYCLIC COMPOUND, AND p27 KIP1 DEGRADATION INHIBITOR
<b>C07D 277/20</b> (2006.01)	2594555 *	HETEROCYCLIC COMPOUND, AND p27 KIP1 DEGRADATION INHIBITOR
<b>A61K 31/4178</b> (2006.01)	2594555 *	HETEROCYCLIC COMPOUND, AND p27 KIP1 DEGRADATION INHIBITOR
<b>A61P 29/00</b> (2006.01)	2594555 *	HETEROCYCLIC COMPOUND, AND p27 KIP1 DEGRADATION INHIBITOR
<b>C07D 405/14</b> (2006.01)	2594555 *	HETEROCYCLIC COMPOUND, AND p27 KIP1 DEGRADATION INHIBITOR
<b>A61K 31/341</b> (2006.01)	2594555 *	HETEROCYCLIC COMPOUND, AND p27 KIP1 DEGRADATION INHIBITOR
<b>A61K 31/55</b> (2006.01)	2594555 *	HETEROCYCLIC COMPOUND, AND p27 KIP1 DEGRADATION INHIBITOR
<b>C07D 307/68</b> (2006.01)	2594555 *	HETEROCYCLIC COMPOUND, AND p27 KIP1 DEGRADATION INHIBITOR
<b>A61K 31/427</b> (2006.01)	2594555 *	HETEROCYCLIC COMPOUND, AND p27 KIP1 DEGRADATION INHIBITOR
<b>A61P 43/00</b> (2006.01)	2594555 *	HETEROCYCLIC COMPOUND, AND p27 KIP1 DEGRADATION INHIBITOR
<b>C07D 207/34</b> (2006.01)	2594555 *	HETEROCYCLIC COMPOUND, AND p27 KIP1 DEGRADATION INHIBITOR
<b>A61K 31/5383</b> (2006.01)	2594555 *	HETEROCYCLIC COMPOUND, AND p27 KIP1 DEGRADATION INHIBITOR
<b>C07D 277/42</b> (2006.01)	2594555 *	HETEROCYCLIC COMPOUND, AND p27 KIP1 DEGRADATION INHIBITOR
<b>A61K 31/426</b> (2006.01)	2594555 *	HETEROCYCLIC COMPOUND, AND p27 KIP1 DEGRADATION INHIBITOR
<b>A61P 35/00</b> (2006.01)	2594555 *	HETEROCYCLIC COMPOUND, AND p27 KIP1 DEGRADATION INHIBITOR
<b>A61K 31/415</b> (2006.01)	2594555 *	HETEROCYCLIC COMPOUND, AND p27 KIP1 DEGRADATION INHIBITOR
<b>A61P 3/10</b> (2006.01)	2594555 *	HETEROCYCLIC COMPOUND, AND p27 KIP1 DEGRADATION INHIBITOR
<b>C07D 403/12</b> (2006.01)	2594555 *	HETEROCYCLIC COMPOUND, AND p27 KIP1 DEGRADATION INHIBITOR
<b>A61P 3/10</b> (2006.01)	2566854 *	DESAZADESFERROTHIOCIN AND DESAZADESFERROTHIOCIN POLYETHER ANALOGUES AS METAL CHELATION AGENTS
<b>A61K 31/4164</b> (2006.01)	2566854 *	DESAZADESFERROTHIOCIN AND DESAZADESFERROTHIOCIN POLYETHER ANALOGUES AS METAL CHELATION AGENTS

MKP (51)	Broj objave evropske prijava patenta (97)	Naziv pronalaska (54)
<b>C07D 233/22</b> (2006.01)	2566854 *	DESAZADESFERROTHIOCIN AND DESAZADESFERROTHIOCIN POLYETHER ANALOGUES AS METAL CHELATION AGENTS
<b>A61K 31/421</b> (2006.01)	2566854 *	DESAZADESFERROTHIOCIN AND DESAZADESFERROTHIOCIN POLYETHER ANALOGUES AS METAL CHELATION AGENTS
<b>C07D 263/16</b> (2006.01)	2566854 *	DESAZADESFERROTHIOCIN AND DESAZADESFERROTHIOCIN POLYETHER ANALOGUES AS METAL CHELATION AGENTS
<b>C07D 263/14</b> (2006.01)	2566854 *	DESAZADESFERROTHIOCIN AND DESAZADESFERROTHIOCIN POLYETHER ANALOGUES AS METAL CHELATION AGENTS
<b>C07D 231/14</b> (2006.01)	2566854 *	DESAZADESFERROTHIOCIN AND DESAZADESFERROTHIOCIN POLYETHER ANALOGUES AS METAL CHELATION AGENTS
<b>A61P 31/12</b> (2006.01)	2566854 *	DESAZADESFERROTHIOCIN AND DESAZADESFERROTHIOCIN POLYETHER ANALOGUES AS METAL CHELATION AGENTS
<b>A61K 31/00</b> (2006.01)	2571900 *	IMPROVED ANTI-SERUM ALBUMIN BINDING VARIANTS
<b>C07K 14/56</b> (2006.01)	2571900 *	IMPROVED ANTI-SERUM ALBUMIN BINDING VARIANTS
<b>A61K 38/21</b> (2006.01)	2571900 *	IMPROVED ANTI-SERUM ALBUMIN BINDING VARIANTS
<b>A61K 38/26</b> (2006.01)	2571900 *	IMPROVED ANTI-SERUM ALBUMIN BINDING VARIANTS
<b>C07K 14/575</b> (2006.01)	2571900 *	IMPROVED ANTI-SERUM ALBUMIN BINDING VARIANTS
<b>C07K 16/18</b> (2006.01)	2571900 *	IMPROVED ANTI-SERUM ALBUMIN BINDING VARIANTS
<b>C07K 16/28</b> (2006.01)	2571900 *	IMPROVED ANTI-SERUM ALBUMIN BINDING VARIANTS
<b>A61K 47/48</b> (2006.01)	2571900 *	IMPROVED ANTI-SERUM ALBUMIN BINDING VARIANTS
<b>C07K 16/30</b> (2006.01)	2550296 *	MONOCLONAL ANTIBODIES FOR TREATMENT OF CANCER
<b>A47K 5/12</b> (2006.01)	2560530 *	STAND FOR A LIQUID DISPENSER
<b>A61K 31/495</b> (2006.01)	2585440 *	3-AMINO-5,6-DIHYDRO-1H-PYRAZIN-2-ONE DERIVATIVES USEFUL FOR THE TREATMENT OF ALZHEIMER'S DISEASE AND OTHER FORMS OF DEMENTIA
<b>C07D 403/10</b> (2006.01)	2585440 *	3-AMINO-5,6-DIHYDRO-1H-PYRAZIN-2-ONE DERIVATIVES USEFUL FOR THE TREATMENT OF ALZHEIMER'S DISEASE AND OTHER FORMS OF DEMENTIA
<b>C07D 401/12</b> (2006.01)	2585440 *	3-AMINO-5,6-DIHYDRO-1H-PYRAZIN-2-ONE DERIVATIVES USEFUL FOR THE TREATMENT OF ALZHEIMER'S DISEASE AND OTHER FORMS OF DEMENTIA
<b>C07D 241/08</b> (2006.01)	2585440 *	3-AMINO-5,6-DIHYDRO-1H-PYRAZIN-2-ONE DERIVATIVES USEFUL FOR THE TREATMENT OF ALZHEIMER'S DISEASE AND OTHER FORMS OF DEMENTIA
<b>A61P 25/28</b> (2006.01)	2585440 *	3-AMINO-5,6-DIHYDRO-1H-PYRAZIN-2-ONE DERIVATIVES USEFUL FOR THE TREATMENT OF ALZHEIMER'S DISEASE AND OTHER FORMS OF DEMENTIA
<b>C07D 401/10</b> (2006.01)	2585440 *	3-AMINO-5,6-DIHYDRO-1H-PYRAZIN-2-ONE DERIVATIVES USEFUL FOR THE TREATMENT OF ALZHEIMER'S DISEASE AND OTHER FORMS OF DEMENTIA
<b>C07C 271/20</b> (2006.01)	2569276 *	NOVEL CATIONIC LIPIDS AND METHODS OF USE THEREOF
<b>C07C 237/06</b> (2006.01)	2569276 *	NOVEL CATIONIC LIPIDS AND METHODS OF USE THEREOF
<b>C12N 15/11</b> (2006.01)	2569276 *	NOVEL CATIONIC LIPIDS AND METHODS OF USE THEREOF
<b>C07D 249/04</b> (2006.01)	2569276 *	NOVEL CATIONIC LIPIDS AND METHODS OF USE THEREOF
<b>C07C 229/30</b> (2006.01)	2569276 *	NOVEL CATIONIC LIPIDS AND METHODS OF USE THEREOF
<b>C12N 15/88</b> (2006.01)	2569276 *	NOVEL CATIONIC LIPIDS AND METHODS OF USE THEREOF
<b>A61K 48/00</b> (2006.01)	2569276 *	NOVEL CATIONIC LIPIDS AND METHODS OF USE THEREOF
<b>C07D 233/60</b> (2006.01)	2569276 *	NOVEL CATIONIC LIPIDS AND METHODS OF USE THEREOF
<b>C07C 217/08</b> (2006.01)	2569276 *	NOVEL CATIONIC LIPIDS AND METHODS OF USE THEREOF
<b>C07C 327/06</b> (2006.01)	2569276 *	NOVEL CATIONIC LIPIDS AND METHODS OF USE THEREOF
<b>C07C 217/46</b> (2006.01)	2569276 *	NOVEL CATIONIC LIPIDS AND METHODS OF USE THEREOF
<b>A61K 49/04</b> (2006.01)	2569276 *	NOVEL CATIONIC LIPIDS AND METHODS OF USE THEREOF
<b>C07C 229/12</b> (2006.01)	2569276 *	NOVEL CATIONIC LIPIDS AND METHODS OF USE THEREOF
<b>A61K 47/48</b> (2006.01)	2569276 *	NOVEL CATIONIC LIPIDS AND METHODS OF USE THEREOF

MKP (51)	Broj objave evropske prijava patenta (97)	Naziv pronalaska (54)
<b>A63G 27/00</b> (2006.01)	2591835 *	OBSERVATION WHEEL
<b>B01D 63/04</b> (2006.01)	2559477	Device for filtering and separating flow media with hollow fibre membrane elements
<b>B01D 65/00</b> (2006.01)	2559477	Device for filtering and separating flow media with hollow fibre membrane elements
<b>A61K 38/17</b> (2006.01)	2563382 *	INNOVATIVE DISCOVERY OF THERAPEUTIC, DIAGNOSTIC, AND ANTIBODY COMPOSITIONS RELATED TO PROTEIN FRAGMENTS OF THREONYL TRNA SYNTHETASES
<b>A61K 38/16</b> (2006.01)	2563382 *	INNOVATIVE DISCOVERY OF THERAPEUTIC, DIAGNOSTIC, AND ANTIBODY COMPOSITIONS RELATED TO PROTEIN FRAGMENTS OF THREONYL TRNA SYNTHETASES
<b>A61K 39/395</b> (2006.01)	2563382 *	INNOVATIVE DISCOVERY OF THERAPEUTIC, DIAGNOSTIC, AND ANTIBODY COMPOSITIONS RELATED TO PROTEIN FRAGMENTS OF THREONYL TRNA SYNTHETASES
<b>A61P 29/00</b> (2006.01)	2563382 *	INNOVATIVE DISCOVERY OF THERAPEUTIC, DIAGNOSTIC, AND ANTIBODY COMPOSITIONS RELATED TO PROTEIN FRAGMENTS OF THREONYL TRNA SYNTHETASES
<b>A61P 3/00</b> (2006.01)	2563382 *	INNOVATIVE DISCOVERY OF THERAPEUTIC, DIAGNOSTIC, AND ANTIBODY COMPOSITIONS RELATED TO PROTEIN FRAGMENTS OF THREONYL TRNA SYNTHETASES
<b>A61P 35/00</b> (2006.01)	2563382 *	INNOVATIVE DISCOVERY OF THERAPEUTIC, DIAGNOSTIC, AND ANTIBODY COMPOSITIONS RELATED TO PROTEIN FRAGMENTS OF THREONYL TRNA SYNTHETASES
<b>G06F 19/00</b> (2011.01)	2550613 *	METHOD AND RECORDING MACHINE FOR RECORDING HEALTH-RELATED INFORMATION
<b>A61M 5/178</b> (2006.01)	2455120	Medical device comprising mechanical-electrical transducing means
<b>H02K 7/18</b> (2006.01)	2455120	Medical device comprising mechanical-electrical transducing means
<b>H02K 35/00</b> (2006.01)	2455120	Medical device comprising mechanical-electrical transducing means
<b>E05F 3/10</b> (2006.01)	2426300	Door closer, particularly for glass doors
<b>A61K 39/395</b> (2006.01)	2569336 *	ENHANCED DEATH RECEPTOR AGONISTS
<b>A61K 45/06</b> (2006.01)	2569336 *	ENHANCED DEATH RECEPTOR AGONISTS
<b>A61P 35/00</b> (2006.01)	2569336 *	ENHANCED DEATH RECEPTOR AGONISTS
<b>C12Q 1/68</b> (2006.01)	2569336 *	ENHANCED DEATH RECEPTOR AGONISTS
<b>C07K 16/28</b> (2006.01)	2569336 *	ENHANCED DEATH RECEPTOR AGONISTS
<b>A61K 9/28</b> (2006.01)	2542220 *	USE OF LEVODOPA, CARBIDOPA AND ENTACAPONE FOR TREATING PARKINSON'S DISEASE
<b>A61K 31/275</b> (2006.01)	2542220 *	USE OF LEVODOPA, CARBIDOPA AND ENTACAPONE FOR TREATING PARKINSON'S DISEASE
<b>A61K 45/06</b> (2006.01)	2542220 *	USE OF LEVODOPA, CARBIDOPA AND ENTACAPONE FOR TREATING PARKINSON'S DISEASE
<b>A61K 9/00</b> (2006.01)	2542220 *	USE OF LEVODOPA, CARBIDOPA AND ENTACAPONE FOR TREATING PARKINSON'S DISEASE
<b>A61K 31/198</b> (2006.01)	2542220 *	USE OF LEVODOPA, CARBIDOPA AND ENTACAPONE FOR TREATING PARKINSON'S DISEASE
<b>A61P 25/16</b> (2006.01)	2542220 *	USE OF LEVODOPA, CARBIDOPA AND ENTACAPONE FOR TREATING PARKINSON'S DISEASE
<b>A61K 9/20</b> (2006.01)	2542220 *	USE OF LEVODOPA, CARBIDOPA AND ENTACAPONE FOR TREATING PARKINSON'S DISEASE
<b>C40B 30/06</b> (2006.01)	2582813 *	METHODS OF GENERATING AND SCREENING FOR LYTIC CHIMERIC POLYPEPTIDES
<b>C12N 15/62</b> (2006.01)	2582813 *	METHODS OF GENERATING AND SCREENING FOR LYTIC CHIMERIC POLYPEPTIDES
<b>C12N 15/10</b> (2006.01)	2582813 *	METHODS OF GENERATING AND SCREENING FOR LYTIC CHIMERIC POLYPEPTIDES
<b>A61M 5/34</b> (2006.01)	2552521 *	DEDICATED NEEDLE ASSEMBLY
<b>A61M 5/31</b> (2006.01)	2552521 *	DEDICATED NEEDLE ASSEMBLY
<b>A61M 5/00</b> (2006.01)	2552521 *	DEDICATED NEEDLE ASSEMBLY

MKP (51)	Broj objave evropske prijava patenta (97)	Naziv pronalaska (54)
<b>A61K 39/395</b> (2006.01)	2569013 *	HUMANIZED AND CHIMERIC MONOCLONAL ANTIBODIES TO CD47
<b>C12P 21/08</b> (2006.01)	2569013 *	HUMANIZED AND CHIMERIC MONOCLONAL ANTIBODIES TO CD47
<b>C12N 5/07</b> (2010.01)	2569013 *	HUMANIZED AND CHIMERIC MONOCLONAL ANTIBODIES TO CD47
<b>C12N 5/16</b> (2006.01)	2569013 *	HUMANIZED AND CHIMERIC MONOCLONAL ANTIBODIES TO CD47
<b>A61M 5/24</b> (2006.01)	2560707 *	CODED FASTENER ASSEMBLY
<b>D21H 21/14</b> (2006.01)	2576637 *	CREPING RELEASE AGENTS
<b>D21H 17/35</b> (2006.01)	2576637 *	CREPING RELEASE AGENTS
<b>C08F 10/10</b> (2006.01)	2576637 *	CREPING RELEASE AGENTS
<b>C08F 10/08</b> (2006.01)	2576637 *	CREPING RELEASE AGENTS
<b>A61B 5/08</b> (2006.01)	2579824 *	A METHOD AND DEVICE(S) FOR DIAGNOSIS AND/OR TREATMENT OF SLEEP APNEA AND RELATED DISORDERS
<b>A61M 16/00</b> (2006.01)	2579824 *	A METHOD AND DEVICE(S) FOR DIAGNOSIS AND/OR TREATMENT OF SLEEP APNEA AND RELATED DISORDERS
<b>A61F 5/56</b> (2006.01)	2579824 *	A METHOD AND DEVICE(S) FOR DIAGNOSIS AND/OR TREATMENT OF SLEEP APNEA AND RELATED DISORDERS
<b>A61K 47/48</b> (2006.01)	2588124 *	SINGLE-WALLED CARBON NANOTUBE/SIRNA COMPLEXES AND METHODS RELATED THERETO
<b>A61K 38/18</b> (2006.01)	2588124 *	SINGLE-WALLED CARBON NANOTUBE/SIRNA COMPLEXES AND METHODS RELATED THERETO
<b>A61K 38/17</b> (2006.01)	2588124 *	SINGLE-WALLED CARBON NANOTUBE/SIRNA COMPLEXES AND METHODS RELATED THERETO
<b>A61K 9/48</b> (2006.01)	2588124 *	SINGLE-WALLED CARBON NANOTUBE/SIRNA COMPLEXES AND METHODS RELATED THERETO
<b>A61P 35/00</b> (2006.01)	2588124 *	SINGLE-WALLED CARBON NANOTUBE/SIRNA COMPLEXES AND METHODS RELATED THERETO
<b>A61K 31/7105</b> (2006.01)	2588124 *	SINGLE-WALLED CARBON NANOTUBE/SIRNA COMPLEXES AND METHODS RELATED THERETO
<b>A61K 31/197</b> (2006.01)	2567700 *	VITAMIN-CONTAINING NUTRITION INFUSION FOR ADMINISTRATION THROUGH PERIPHERAL VEIN
<b>A61K 31/714</b> (2006.01)	2567700 *	VITAMIN-CONTAINING NUTRITION INFUSION FOR ADMINISTRATION THROUGH PERIPHERAL VEIN
<b>A61K 31/198</b> (2006.01)	2567700 *	VITAMIN-CONTAINING NUTRITION INFUSION FOR ADMINISTRATION THROUGH PERIPHERAL VEIN
<b>A61K 33/06</b> (2006.01)	2567700 *	VITAMIN-CONTAINING NUTRITION INFUSION FOR ADMINISTRATION THROUGH PERIPHERAL VEIN
<b>A61K 9/08</b> (2006.01)	2567700 *	VITAMIN-CONTAINING NUTRITION INFUSION FOR ADMINISTRATION THROUGH PERIPHERAL VEIN
<b>A61K 31/525</b> (2006.01)	2567700 *	VITAMIN-CONTAINING NUTRITION INFUSION FOR ADMINISTRATION THROUGH PERIPHERAL VEIN
<b>A61K 31/4188</b> (2006.01)	2567700 *	VITAMIN-CONTAINING NUTRITION INFUSION FOR ADMINISTRATION THROUGH PERIPHERAL VEIN
<b>A61K 33/30</b> (2006.01)	2567700 *	VITAMIN-CONTAINING NUTRITION INFUSION FOR ADMINISTRATION THROUGH PERIPHERAL VEIN
<b>A61K 31/4415</b> (2006.01)	2567700 *	VITAMIN-CONTAINING NUTRITION INFUSION FOR ADMINISTRATION THROUGH PERIPHERAL VEIN
<b>A61K 47/12</b> (2006.01)	2567700 *	VITAMIN-CONTAINING NUTRITION INFUSION FOR ADMINISTRATION THROUGH PERIPHERAL VEIN
<b>A61K 31/51</b> (2006.01)	2567700 *	VITAMIN-CONTAINING NUTRITION INFUSION FOR ADMINISTRATION THROUGH PERIPHERAL VEIN
<b>A61K 31/455</b> (2006.01)	2567700 *	VITAMIN-CONTAINING NUTRITION INFUSION FOR ADMINISTRATION THROUGH PERIPHERAL VEIN
<b>A61P 7/00</b> (2006.01)	2567700 *	VITAMIN-CONTAINING NUTRITION INFUSION FOR ADMINISTRATION THROUGH PERIPHERAL VEIN
<b>A61K 31/19</b> (2006.01)	2567700 *	VITAMIN-CONTAINING NUTRITION INFUSION FOR ADMINISTRATION THROUGH PERIPHERAL VEIN

MKP (51)	Broj objave evropske prijava patenta (97)	Naziv pronalaska (54)
<b>A61K 31/7004</b> (2006.01)	2567700 *	VITAMIN-CONTAINING NUTRITION INFUSION FOR ADMINISTRATION THROUGH PERIPHERAL VEIN
<b>A61K 31/375</b> (2006.01)	2567700 *	VITAMIN-CONTAINING NUTRITION INFUSION FOR ADMINISTRATION THROUGH PERIPHERAL VEIN
<b>A61K 33/20</b> (2006.01)	2567700 *	VITAMIN-CONTAINING NUTRITION INFUSION FOR ADMINISTRATION THROUGH PERIPHERAL VEIN
<b>A61K 31/167</b> (2006.01)	2594262 *	SUBSTRATE OF THREE-LAYER STRUCTURE AND WATER-CONTAINING ADHESIVE PATCH INCLUDING SAME
<b>A61K 45/00</b> (2006.01)	2594262 *	SUBSTRATE OF THREE-LAYER STRUCTURE AND WATER-CONTAINING ADHESIVE PATCH INCLUDING SAME
<b>A61K 31/192</b> (2006.01)	2594262 *	SUBSTRATE OF THREE-LAYER STRUCTURE AND WATER-CONTAINING ADHESIVE PATCH INCLUDING SAME
<b>A61K 9/70</b> (2006.01)	2594262 *	SUBSTRATE OF THREE-LAYER STRUCTURE AND WATER-CONTAINING ADHESIVE PATCH INCLUDING SAME
<b>A61P 31/04</b> (2006.01)	2544711 *	TREATMENT OF STREPTOCOCCAL INFECTIONS
<b>A61K 39/09</b> (2006.01)	2544711 *	TREATMENT OF STREPTOCOCCAL INFECTIONS
<b>A61P 15/00</b> (2006.01)	2547681 *	TOSYLATE SALT OF CYCLOPROPANECARBOXYLIC ACID 4-(6-CHLORO-3-METHYL-4,10-DIHYDRO-3H-2,3,4,9-TETRABENZO[F]AZULENE-9-CARBONYL)-2-FLUOROBENZYLAMIDE
<b>A61K 31/5517</b> (2006.01)	2547681 *	TOSYLATE SALT OF CYCLOPROPANECARBOXYLIC ACID 4-(6-CHLORO-3-METHYL-4,10-DIHYDRO-3H-2,3,4,9-TETRABENZO[F]AZULENE-9-CARBONYL)-2-FLUOROBENZYLAMIDE
<b>C07D 487/04</b> (2006.01)	2547681 *	TOSYLATE SALT OF CYCLOPROPANECARBOXYLIC ACID 4-(6-CHLORO-3-METHYL-4,10-DIHYDRO-3H-2,3,4,9-TETRABENZO[F]AZULENE-9-CARBONYL)-2-FLUOROBENZYLAMIDE
<b>F02D 41/34</b> (2006.01)	2556232 *	INJECTION CONTROL METHOD
<b>F02P 7/077</b> (2006.01)	2556232 *	INJECTION CONTROL METHOD
<b>F02F 3/28</b> (2006.01)	2556235 *	HIGH SPEED ENGINE
<b>F02F 7/00</b> (2006.01)	2556235 *	HIGH SPEED ENGINE
<b>H04M 9/08</b> (2006.01)	2568695 *	METHOD AND DEVICE FOR SUPPRESSING RESIDUAL ECHO
<b>F41H 11/02</b> (2006.01)	2556325 *	HIGH-ENERGY LASER SYSTEM INTERCEPTING A TARGET AND METHOD THEREOF
<b>F41H 13/00</b> (2006.01)	2556325 *	HIGH-ENERGY LASER SYSTEM INTERCEPTING A TARGET AND METHOD THEREOF
<b>A61K 31/4422</b> (2006.01)	2585051 *	PHARMACEUTICAL ORAL DOSAGE FORMS COMPRISING LERCANIDIPINE AND ENALAPRIL AND THEIR PHARMACEUTICALLY ACCEPTABLE SALTS
<b>A61K 9/20</b> (2006.01)	2585051 *	PHARMACEUTICAL ORAL DOSAGE FORMS COMPRISING LERCANIDIPINE AND ENALAPRIL AND THEIR PHARMACEUTICALLY ACCEPTABLE SALTS
<b>A61K 31/401</b> (2006.01)	2585051 *	PHARMACEUTICAL ORAL DOSAGE FORMS COMPRISING LERCANIDIPINE AND ENALAPRIL AND THEIR PHARMACEUTICALLY ACCEPTABLE SALTS
<b>G06F 3/01</b> (2006.01)	2555703 *	ROBOTIZED SURGERY SYSTEM WITH IMPROVED CONTROL
<b>A61B 5/11</b> (2006.01)	2555703 *	ROBOTIZED SURGERY SYSTEM WITH IMPROVED CONTROL
<b>A61B 3/113</b> (2006.01)	2555703 *	ROBOTIZED SURGERY SYSTEM WITH IMPROVED CONTROL
<b>A61B 19/00</b> (2006.01)	2555703 *	ROBOTIZED SURGERY SYSTEM WITH IMPROVED CONTROL
<b>B65D 19/24</b> (2006.01)	2585379 *	SECTIONAL METAL PALLET FORMED FROM CORRIGATED METAL TUBES
<b>B65D 19/28</b> (2006.01)	2585379 *	SECTIONAL METAL PALLET FORMED FROM CORRIGATED METAL TUBES
<b>B21D 9/05</b> (2006.01)	2585379 *	SECTIONAL METAL PALLET FORMED FROM CORRIGATED METAL TUBES
<b>A01P 13/00</b> (2006.01)	2582245 *	SYNERGISTIC HERBICIDAL COMPOSITION CONTAINING CLOPYRALID AND FLORASULAM
<b>A01N 43/90</b> (2006.01)	2582245 *	SYNERGISTIC HERBICIDAL COMPOSITION CONTAINING CLOPYRALID AND FLORASULAM
<b>A01N 43/40</b> (2006.01)	2582245 *	SYNERGISTIC HERBICIDAL COMPOSITION CONTAINING CLOPYRALID AND FLORASULAM
<b>A61F 2/00</b> (2006.01)	2547266 *	SURGICAL INSTRUMENT AND METHOD FOR THE TREATMENT OF URINARY INCONTINENCE

MKP (51)	Broj objave evropske prijava patenta (97)	Naziv pronalaska (54)
<b>A61B 17/00</b> (2006.01)	2547266 *	SURGICAL INSTRUMENT AND METHOD FOR THE TREATMENT OF URINARY INCONTINENCE
<b>A61B 17/06</b> (2006.01)	2547266 *	SURGICAL INSTRUMENT AND METHOD FOR THE TREATMENT OF URINARY INCONTINENCE
<b>G01N 33/68</b> (2006.01)	2568294	Risk Factors and Prediction of Myocardial Infarction
<b>A61L 27/38</b> (2006.01)	2566529 *	SMOOTH MUSCLE CELL CONSTRUCTS
<b>C07D 513/10</b> (2006.01)	2547685 *	SPIRO-TETRACYCLIC RING COMPOUNDS AS BETA - SECRETASE MODULATORS
<b>A61K 31/429</b> (2006.01)	2547685 *	SPIRO-TETRACYCLIC RING COMPOUNDS AS BETA - SECRETASE MODULATORS
<b>A61P 25/28</b> (2006.01)	2547685 *	SPIRO-TETRACYCLIC RING COMPOUNDS AS BETA - SECRETASE MODULATORS
<b>A61K 31/424</b> (2006.01)	2547685 *	SPIRO-TETRACYCLIC RING COMPOUNDS AS BETA - SECRETASE MODULATORS
<b>C07D 498/10</b> (2006.01)	2547685 *	SPIRO-TETRACYCLIC RING COMPOUNDS AS BETA - SECRETASE MODULATORS
<b>C07D 498/20</b> (2006.01)	2547685 *	SPIRO-TETRACYCLIC RING COMPOUNDS AS BETA - SECRETASE MODULATORS
<b>G01F 15/06</b> (2006.01)	2558821 *	APPARATUS FOR MONITORING AND/OR CONTROLLING ENERGY AND WATER MANAGEMENT
<b>G01D 4/00</b> (2006.01)	2558821 *	APPARATUS FOR MONITORING AND/OR CONTROLLING ENERGY AND WATER MANAGEMENT
<b>B01D 53/62</b> (2006.01)	2571805 *	A PROCESS FOR THE PRODUCTION OF HYDROGEN, THE SEQUESTRATION OF CARBON DIOXIDE AND THE PRODUCTION OF BUILDING MATERIALS STARTING FROM SLAGS AND/OR INDUSTRIAL ASHES
<b>C01B 3/04</b> (2006.01)	2571805 *	A PROCESS FOR THE PRODUCTION OF HYDROGEN, THE SEQUESTRATION OF CARBON DIOXIDE AND THE PRODUCTION OF BUILDING MATERIALS STARTING FROM SLAGS AND/OR INDUSTRIAL ASHES
<b>C01B 3/06</b> (2006.01)	2571805 *	A PROCESS FOR THE PRODUCTION OF HYDROGEN, THE SEQUESTRATION OF CARBON DIOXIDE AND THE PRODUCTION OF BUILDING MATERIALS STARTING FROM SLAGS AND/OR INDUSTRIAL ASHES
<b>C04B 5/00</b> (2006.01)	2571805 *	A PROCESS FOR THE PRODUCTION OF HYDROGEN, THE SEQUESTRATION OF CARBON DIOXIDE AND THE PRODUCTION OF BUILDING MATERIALS STARTING FROM SLAGS AND/OR INDUSTRIAL ASHES
<b>A61K 39/395</b> (2006.01)	2544719 *	CD37-BINDING MOLECULES AND IMMUNOCONJUGATES THEREOF
<b>F15B 3/00</b> (2006.01)	2539592 *	INTENSIFIER OF HYDRAULIC POWER WITH RELY WITH MAINTENANCE OF THE REACHED POSITION AND FORCE
<b>H01F 1/047</b> (2006.01)	2550666 *	COMPOSITION FOR PRODUCING MAGNETIC OR MAGNETIZABLE MOLDINGS, AND PROCESS FOR PRODUCING THE SAME
<b>B22F 1/00</b> (2006.01)	2550666 *	COMPOSITION FOR PRODUCING MAGNETIC OR MAGNETIZABLE MOLDINGS, AND PROCESS FOR PRODUCING THE SAME
<b>C07D 403/04</b> (2006.01)	2547673 *	A SUBSTITUTED PYRIMIDINE AS A PROSTAGLANDIN D2 RECEPTOR ANTAGONIST
<b>A61K 31/505</b> (2006.01)	2547673 *	A SUBSTITUTED PYRIMIDINE AS A PROSTAGLANDIN D2 RECEPTOR ANTAGONIST
<b>A61P 11/00</b> (2006.01)	2547673 *	A SUBSTITUTED PYRIMIDINE AS A PROSTAGLANDIN D2 RECEPTOR ANTAGONIST
<b>C07K 16/28</b> (2006.01)	2558499 *	ANTI-VLA-4 ANTIBODIES
<b>A24B 3/12</b> (2006.01)	2571385 *	METHOD FOR PREPARING TOBACCO EXTRACT FOR ELECTRONIC SMOKING DEVICES
<b>G09B 23/28</b> (2006.01)	2559020 *	HEART COMPRESSION SIMULATION DEVICE
<b>B26D 3/08</b> (2006.01)	2560799 *	CARRIAGE FOR CUTTING A SHEET OF GYPSUM BOARD, CUTTING KIT AND METHOD FOR IMPLEMENTING SAME

MKP (51)	Broj objave evropske prijava patenta (97)	Naziv pronalaska (54)
<b>B26B 5/00</b> (2006.01)	2560799 *	CARRIAGE FOR CUTTING A SHEET OF GYPSUM BOARD, CUTTING KIT AND METHOD FOR IMPLEMENTING SAME
<b>B28D 1/22</b> (2006.01)	2560799 *	CARRIAGE FOR CUTTING A SHEET OF GYPSUM BOARD, CUTTING KIT AND METHOD FOR IMPLEMENTING SAME
<b>B63B 25/00</b> (2006.01)	2468622	Storage system
<b>A61K 31/4985</b> (2006.01)	2585466 *	POLYMORPHS OF OSI-906
<b>C07D 487/04</b> (2006.01)	2585466 *	POLYMORPHS OF OSI-906
<b>A61P 35/00</b> (2006.01)	2585466 *	POLYMORPHS OF OSI-906
<b>A61M 5/20</b> (2006.01)	2544739 *	AUTO-INJECTOR
<b>A61M 5/24</b> (2006.01)	2544739 *	AUTO-INJECTOR
<b>A61K 31/55</b> (2006.01)	2558450 *	TRIAZOLE COMPOUNDS AS KSP INHIBITORS
<b>C07D 405/14</b> (2006.01)	2558450 *	TRIAZOLE COMPOUNDS AS KSP INHIBITORS
<b>C07D 403/12</b> (2006.01)	2558450 *	TRIAZOLE COMPOUNDS AS KSP INHIBITORS
<b>A61P 35/00</b> (2006.01)	2558450 *	TRIAZOLE COMPOUNDS AS KSP INHIBITORS
<b>C07D 405/12</b> (2006.01)	2558450 *	TRIAZOLE COMPOUNDS AS KSP INHIBITORS
<b>C07D 249/08</b> (2006.01)	2558450 *	TRIAZOLE COMPOUNDS AS KSP INHIBITORS
<b>A61K 31/538</b> (2006.01)	2582667 *	HETEROCYCLIC SUBSTITUTED METHOXYPHENYL DERIVATIVES HAVING AN OXO GROUP, METHOD FOR PRODUCING SAME, AND USE THEREOF AS GPR40 RECEPTOR MODULATORS
<b>A61K 31/404</b> (2006.01)	2582667 *	HETEROCYCLIC SUBSTITUTED METHOXYPHENYL DERIVATIVES HAVING AN OXO GROUP, METHOD FOR PRODUCING SAME, AND USE THEREOF AS GPR40 RECEPTOR MODULATORS
<b>C07D 209/34</b> (2006.01)	2582667 *	HETEROCYCLIC SUBSTITUTED METHOXYPHENYL DERIVATIVES HAVING AN OXO GROUP, METHOD FOR PRODUCING SAME, AND USE THEREOF AS GPR40 RECEPTOR MODULATORS
<b>A61K 31/428</b> (2006.01)	2582667 *	HETEROCYCLIC SUBSTITUTED METHOXYPHENYL DERIVATIVES HAVING AN OXO GROUP, METHOD FOR PRODUCING SAME, AND USE THEREOF AS GPR40 RECEPTOR MODULATORS
<b>A61K 31/4704</b> (2006.01)	2582667 *	HETEROCYCLIC SUBSTITUTED METHOXYPHENYL DERIVATIVES HAVING AN OXO GROUP, METHOD FOR PRODUCING SAME, AND USE THEREOF AS GPR40 RECEPTOR MODULATORS
<b>C07D 215/227</b> (2006.01)	2582667 *	HETEROCYCLIC SUBSTITUTED METHOXYPHENYL DERIVATIVES HAVING AN OXO GROUP, METHOD FOR PRODUCING SAME, AND USE THEREOF AS GPR40 RECEPTOR MODULATORS
<b>C07D 277/68</b> (2006.01)	2582667 *	HETEROCYCLIC SUBSTITUTED METHOXYPHENYL DERIVATIVES HAVING AN OXO GROUP, METHOD FOR PRODUCING SAME, AND USE THEREOF AS GPR40 RECEPTOR MODULATORS
<b>C07D 498/04</b> (2006.01)	2582667 *	HETEROCYCLIC SUBSTITUTED METHOXYPHENYL DERIVATIVES HAVING AN OXO GROUP, METHOD FOR PRODUCING SAME, AND USE THEREOF AS GPR40 RECEPTOR MODULATORS
<b>C07D 265/36</b> (2006.01)	2582667 *	HETEROCYCLIC SUBSTITUTED METHOXYPHENYL DERIVATIVES HAVING AN OXO GROUP, METHOD FOR PRODUCING SAME, AND USE THEREOF AS GPR40 RECEPTOR MODULATORS
<b>A61K 31/5383</b> (2006.01)	2582667 *	HETEROCYCLIC SUBSTITUTED METHOXYPHENYL DERIVATIVES HAVING AN OXO GROUP, METHOD FOR PRODUCING SAME, AND USE THEREOF AS GPR40 RECEPTOR MODULATORS
<b>A61P 11/06</b> (2006.01)	2586772 *	ISOQUINOLINE DERIVATIVE
<b>A61P 11/02</b> (2006.01)	2586772 *	ISOQUINOLINE DERIVATIVE
<b>C07D 217/18</b> (2006.01)	2586772 *	ISOQUINOLINE DERIVATIVE
<b>A61P 37/08</b> (2006.01)	2586772 *	ISOQUINOLINE DERIVATIVE
<b>A61K 31/472</b> (2006.01)	2586772 *	ISOQUINOLINE DERIVATIVE
<b>C07D 217/20</b> (2006.01)	2586772 *	ISOQUINOLINE DERIVATIVE
<b>A61P 43/00</b> (2006.01)	2586772 *	ISOQUINOLINE DERIVATIVE
<b>A61P 17/04</b> (2006.01)	2586772 *	ISOQUINOLINE DERIVATIVE
<b>A61K 39/395</b> (2006.01)	2566890 *	ANTI-PAI-1 ANTIBODIES AND METHODS OF USE THEREOF
<b>A61K 39/00</b> (2006.01)	2566890 *	ANTI-PAI-1 ANTIBODIES AND METHODS OF USE THEREOF

MKP (51)	Broj objave evropske prijava patenta (97)	Naziv pronalaska (54)
<b>C12P 21/06</b> (2006.01)	2566890 *	ANTI-PAI-1 ANTIBODIES AND METHODS OF USE THEREOF
<b>C07K 16/00</b> (2006.01)	2566890 *	ANTI-PAI-1 ANTIBODIES AND METHODS OF USE THEREOF
<b>C07H 21/04</b> (2006.01)	2566890 *	ANTI-PAI-1 ANTIBODIES AND METHODS OF USE THEREOF
<b>A01N 37/18</b> (2006.01)	2582237 *	SYNERGISTIC HERBICIDAL COMPOSITIONS CONTAINING PROPYZAMIDE AND AMINOPYRALID
<b>A61M 5/24</b> (2006.01)	2579930 *	DRUG DELIVERY DEVICE WITH DRIVE MEMBER HAVING INDICATION ELEMENTS
<b>A61M 5/315</b> (2006.01)	2579930 *	DRUG DELIVERY DEVICE WITH DRIVE MEMBER HAVING INDICATION ELEMENTS
<b>D02J 3/10</b> (2006.01)	2566401 *	LASER CUTTING SYSTEM AND METHODS FOR CREATING SELF-RETAINING SUTURES
<b>A61B 17/04</b> (2006.01)	2566401 *	LASER CUTTING SYSTEM AND METHODS FOR CREATING SELF-RETAINING SUTURES
<b>D02J 3/02</b> (2006.01)	2566401 *	LASER CUTTING SYSTEM AND METHODS FOR CREATING SELF-RETAINING SUTURES
<b>A61B 17/08</b> (2006.01)	2566401 *	LASER CUTTING SYSTEM AND METHODS FOR CREATING SELF-RETAINING SUTURES
<b>A61K 31/56</b> (2006.01)	2542245 *	ANTIMICROBIAL CATIONIC STEREOIDS AND METHODS OF USE
<b>C07D 487/04</b> (2006.01)	2547683 *	METHOD OF PREPARING SITAGLIPTIN
<b>A61K 31/425</b> (2006.01)	2582709 *	AZOLOPYRIDIN-3-ONE DERIVATIVES AS INHIBITORS OF LIPASES AND PHOSPHOLIPASES
<b>C07D 513/04</b> (2006.01)	2582709 *	AZOLOPYRIDIN-3-ONE DERIVATIVES AS INHIBITORS OF LIPASES AND PHOSPHOLIPASES
<b>C07D 487/04</b> (2006.01)	2545055 *	IMIDAZO [1, 2 -A]PYRAZINE DERIVATIVES AND THEIR USE FOR THE PREVENTION OR TREATMENT OF NEUROLOGICAL, PSYCHIATRIC AND METABOLIC DISORDERS AND DISEASES
<b>A61P 3/00</b> (2006.01)	2545055 *	IMIDAZO [1, 2 -A]PYRAZINE DERIVATIVES AND THEIR USE FOR THE PREVENTION OR TREATMENT OF NEUROLOGICAL, PSYCHIATRIC AND METABOLIC DISORDERS AND DISEASES
<b>A61P 25/00</b> (2006.01)	2545055 *	IMIDAZO [1, 2 -A]PYRAZINE DERIVATIVES AND THEIR USE FOR THE PREVENTION OR TREATMENT OF NEUROLOGICAL, PSYCHIATRIC AND METABOLIC DISORDERS AND DISEASES
<b>A61K 31/4985</b> (2006.01)	2545055 *	IMIDAZO [1, 2 -A]PYRAZINE DERIVATIVES AND THEIR USE FOR THE PREVENTION OR TREATMENT OF NEUROLOGICAL, PSYCHIATRIC AND METABOLIC DISORDERS AND DISEASES
<b>A61M 5/20</b> (2006.01)	2538997 *	FORCE TRANSMISSION ARRANGEMENT FOR AUTO-INJECTOR
<b>C02F 1/68</b> (2006.01)	2565165	Remineralization of desalinated and of fresh water by dosing of a calcium carbonate solution in soft water
<b>C02F 103/42</b> (2006.01)	2565165	Remineralization of desalinated and of fresh water by dosing of a calcium carbonate solution in soft water
<b>C09J 163/10</b> (2006.01)	2576717 *	CONDUCTIVE ADHESIVE
<b>C09J 11/04</b> (2006.01)	2576717 *	CONDUCTIVE ADHESIVE
<b>C09J 9/02</b> (2006.01)	2576717 *	CONDUCTIVE ADHESIVE
<b>A61M 5/20</b> (2006.01)	2585142 *	AUTO-INJECTOR
<b>A61P 11/06</b> (2006.01)	2585047 *	DRY POWDER FORMULATION COMPRISING AN ANTIMUSCARINIC DRUG
<b>A61K 9/00</b> (2006.01)	2585047 *	DRY POWDER FORMULATION COMPRISING AN ANTIMUSCARINIC DRUG
<b>A61K 9/14</b> (2006.01)	2585047 *	DRY POWDER FORMULATION COMPRISING AN ANTIMUSCARINIC DRUG
<b>A61K 31/439</b> (2006.01)	2585047 *	DRY POWDER FORMULATION COMPRISING AN ANTIMUSCARINIC DRUG
<b>A61P 11/08</b> (2006.01)	2585047 *	DRY POWDER FORMULATION COMPRISING AN ANTIMUSCARINIC DRUG
<b>C12N 9/96</b> (2006.01)	2591099 *	CHIMERIC CLOTTING FACTORS
<b>A61K 38/48</b> (2006.01)	2591099 *	CHIMERIC CLOTTING FACTORS
<b>A61K 38/36</b> (2006.01)	2591099 *	CHIMERIC CLOTTING FACTORS
<b>A63B 55/00</b> (2006.01)	2575978 *	GOLF BAG BANNER
<b>A63B 55/04</b> (2006.01)	2575978 *	GOLF BAG BANNER
<b>A63B 55/06</b> (2006.01)	2575978 *	GOLF BAG BANNER



MKP (51)	Broj objave evropske prijava patenta (97)	Naziv pronalaska (54)
<b>G08C 17/02</b> (2006.01)	2539875 *	METHOD AND DEVICE FOR CONTROLLING AT LEAST ONE APPARATUS BY MEANS OF AT LEAST ONE OTHER APPARATUS, AND SYSTEM IMPLEMENTING SUCH A DEVICE
<b>G06F 3/038</b> (2013.01)	2539875 *	METHOD AND DEVICE FOR CONTROLLING AT LEAST ONE APPARATUS BY MEANS OF AT LEAST ONE OTHER APPARATUS, AND SYSTEM IMPLEMENTING SUCH A DEVICE
<b>C12N 5/07</b> (2010.01)	2590671 *	DUAL VARIABLE DOMAIN IMMUNOGLOBULINS AND USES THEREOF
<b>A61K 39/00</b> (2006.01)	2590671 *	DUAL VARIABLE DOMAIN IMMUNOGLOBULINS AND USES THEREOF
<b>C12P 21/08</b> (2006.01)	2590671 *	DUAL VARIABLE DOMAIN IMMUNOGLOBULINS AND USES THEREOF
<b>C12N 5/16</b> (2006.01)	2590671 *	DUAL VARIABLE DOMAIN IMMUNOGLOBULINS AND USES THEREOF
<b>G07F 11/44</b> (2006.01)	2263638	Dispensing canister for delivery of solid medications
<b>G07F 17/00</b> (2006.01)	2263638	Dispensing canister for delivery of solid medications
<b>A61J 7/00</b> (2006.01)	2263638	Dispensing canister for delivery of solid medications
<b>C07D 409/14</b> (2006.01)	2552909 *	4 - AMINOPYRIMIDINE DERIVATIVES AND THEIR AS AS ADENOSINE A2A RECEPTOR ANTAGONISTS
<b>C07D 413/14</b> (2006.01)	2552909 *	4 - AMINOPYRIMIDINE DERIVATIVES AND THEIR AS AS ADENOSINE A2A RECEPTOR ANTAGONISTS
<b>C07D 417/14</b> (2006.01)	2552909 *	4 - AMINOPYRIMIDINE DERIVATIVES AND THEIR AS AS ADENOSINE A2A RECEPTOR ANTAGONISTS
<b>A61K 31/506</b> (2006.01)	2552909 *	4 - AMINOPYRIMIDINE DERIVATIVES AND THEIR AS AS ADENOSINE A2A RECEPTOR ANTAGONISTS
<b>C07D 417/04</b> (2006.01)	2552909 *	4 - AMINOPYRIMIDINE DERIVATIVES AND THEIR AS AS ADENOSINE A2A RECEPTOR ANTAGONISTS
<b>C07D 403/04</b> (2006.01)	2552909 *	4 - AMINOPYRIMIDINE DERIVATIVES AND THEIR AS AS ADENOSINE A2A RECEPTOR ANTAGONISTS
<b>A61P 25/00</b> (2006.01)	2552909 *	4 - AMINOPYRIMIDINE DERIVATIVES AND THEIR AS AS ADENOSINE A2A RECEPTOR ANTAGONISTS
<b>C07D 403/14</b> (2006.01)	2552909 *	4 - AMINOPYRIMIDINE DERIVATIVES AND THEIR AS AS ADENOSINE A2A RECEPTOR ANTAGONISTS
<b>A61P 3/10</b> (2006.01)	2552909 *	4 - AMINOPYRIMIDINE DERIVATIVES AND THEIR AS AS ADENOSINE A2A RECEPTOR ANTAGONISTS
<b>A61P 11/00</b> (2006.01)	2585457 *	ALKALOID AMINOESTER DERIVATIVES AND MEDICINAL COMPOSITION THEREOF
<b>A61K 31/439</b> (2006.01)	2585457 *	ALKALOID AMINOESTER DERIVATIVES AND MEDICINAL COMPOSITION THEREOF
<b>C07D 453/02</b> (2006.01)	2585457 *	ALKALOID AMINOESTER DERIVATIVES AND MEDICINAL COMPOSITION THEREOF
<b>H02M 5/257</b> (2006.01)	2395643	Method for adjusting an AC power controller
<b>F16H 57/08</b> (2006.01)	2569556 *	EXERCISE CYCLE WITH PLANETARY GEAR SYSTEM AND ROLLING RECOILED LATERAL MOTION SYSTEM
<b>A61P 27/02</b> (2006.01)	2575793 *	N-ACETYL-DL-LEUCINE, NEUROPROTECTIVE AND RETINOPROTECTIVE MEDICAMENT
<b>A61K 31/198</b> (2006.01)	2575793 *	N-ACETYL-DL-LEUCINE, NEUROPROTECTIVE AND RETINOPROTECTIVE MEDICAMENT
<b>A61K 31/00</b> (2006.01)	2575793 *	N-ACETYL-DL-LEUCINE, NEUROPROTECTIVE AND RETINOPROTECTIVE MEDICAMENT
<b>H04N 5/765</b> (2006.01)	2581908 *	REPRODUCTION DEVICE, RECORDING MEDIUM, REPRODUCTION METHOD, PROGRAM
<b>H04N 5/85</b> (2006.01)	2581908 *	REPRODUCTION DEVICE, RECORDING MEDIUM, REPRODUCTION METHOD, PROGRAM
<b>G11B 20/10</b> (2006.01)	2581908 *	REPRODUCTION DEVICE, RECORDING MEDIUM, REPRODUCTION METHOD, PROGRAM
<b>H04N 5/91</b> (2006.01)	2581908 *	REPRODUCTION DEVICE, RECORDING MEDIUM, REPRODUCTION METHOD, PROGRAM
<b>A01N 51/00</b> (2006.01)	2590508 *	WATER-BASED PESTICIDAL SUSPENSION
<b>A01N 25/30</b> (2006.01)	2590508 *	WATER-BASED PESTICIDAL SUSPENSION

MKP (51)	Broj objave evropske prijava patenta (97)	Naziv pronalaska (54)
<b>A01N 43/40</b> (2006.01)	2590508 *	WATER-BASED PESTICIDAL SUSPENSION
<b>A01N 47/18</b> (2006.01)	2590508 *	WATER-BASED PESTICIDAL SUSPENSION
<b>E21B 10/32</b> (2006.01)	2553206 *	DOWNHOLE TOOL
<b>F25D 23/02</b> (2006.01)	2439366	Device for opening sliding doors for cold rooms
<b>E05F 11/54</b> (2006.01)	2439366	Device for opening sliding doors for cold rooms
<b>E05B 17/00</b> (2006.01)	2439366	Device for opening sliding doors for cold rooms
<b>B66B 11/04</b> (2006.01)	2560912 *	DEVICE FOR SAVING ENERGY DURING VERTICAL AND HORIZONTAL MOTIONS
<b>A61K 31/425</b> (2006.01)	2544541 *	COMBINATION THERAPY FOR TREATING BREAST CANCER
<b>A01N 43/54</b> (2006.01)	2544541 *	COMBINATION THERAPY FOR TREATING BREAST CANCER
<b>A61K 31/505</b> (2006.01)	2544541 *	COMBINATION THERAPY FOR TREATING BREAST CANCER
<b>A61K 31/4704</b> (2006.01)	2560649 *	PHARMACEUTICAL COMPOSITIONS AND ADMINISTRATIONS THEREOF
<b>A61K 31/404</b> (2006.01)	2560649 *	PHARMACEUTICAL COMPOSITIONS AND ADMINISTRATIONS THEREOF
<b>A61K 31/443</b> (2006.01)	2560649 *	PHARMACEUTICAL COMPOSITIONS AND ADMINISTRATIONS THEREOF
<b>C09J 167/06</b> (2006.01)	2576140 *	ADHESIVE COMPOSITION CONTAINING A WATER-SOLUBLE OR WATER-DISPERSIBLE UNSATURATED POLYESTER AND AN ETHYLENE-UNSATURATED MONOMER, AND USES THEREOF
<b>C08G 69/44</b> (2006.01)	2576140 *	ADHESIVE COMPOSITION CONTAINING A WATER-SOLUBLE OR WATER-DISPERSIBLE UNSATURATED POLYESTER AND AN ETHYLENE-UNSATURATED MONOMER, AND USES THEREOF
<b>C08G 63/676</b> (2006.01)	2576140 *	ADHESIVE COMPOSITION CONTAINING A WATER-SOLUBLE OR WATER-DISPERSIBLE UNSATURATED POLYESTER AND AN ETHYLENE-UNSATURATED MONOMER, AND USES THEREOF
<b>C08G 63/52</b> (2006.01)	2576140 *	ADHESIVE COMPOSITION CONTAINING A WATER-SOLUBLE OR WATER-DISPERSIBLE UNSATURATED POLYESTER AND AN ETHYLENE-UNSATURATED MONOMER, AND USES THEREOF
<b>B24D 3/28</b> (2006.01)	2576140 *	ADHESIVE COMPOSITION CONTAINING A WATER-SOLUBLE OR WATER-DISPERSIBLE UNSATURATED POLYESTER AND AN ETHYLENE-UNSATURATED MONOMER, AND USES THEREOF
<b>B24D 3/20</b> (2006.01)	2576140 *	ADHESIVE COMPOSITION CONTAINING A WATER-SOLUBLE OR WATER-DISPERSIBLE UNSATURATED POLYESTER AND AN ETHYLENE-UNSATURATED MONOMER, AND USES THEREOF
<b>C12N 15/10</b> (2006.01)	2558577 *	BI-FUNCTIONAL COMPLEXES AND METHODS FOR MAKING AND USING SUCH COMPLEXES
<b>A61M 5/315</b> (2006.01)	2566539 *	DRIVE MECHANISM WITH A LOW FRICTION COATING FOR A DRUG DELIVERY DEVICE
<b>A61M 5/24</b> (2006.01)	2566539 *	DRIVE MECHANISM WITH A LOW FRICTION COATING FOR A DRUG DELIVERY DEVICE
<b>B65D 39/00</b> (2006.01)	2590869 *	CONTAINER STOPPER WITH A DECORATIVE LAYER
<b>B65D 51/24</b> (2006.01)	2590869 *	CONTAINER STOPPER WITH A DECORATIVE LAYER
<b>C07D 239/34</b> (2006.01)	2476670	Stable solid salts of ambrisentan
<b>A61K 31/513</b> (2006.01)	2476670	Stable solid salts of ambrisentan
<b>B65D 85/76</b> (2006.01)	2544966 *	PORTIONABLE PACKAGING FOR A FOOD PRODUCT
<b>C12N 9/00</b> (2006.01)	2566516 *	INNOVATIVE DISCOVERY OF THERAPEUTIC, DIAGNOSTIC, AND ANTIBODY COMPOSITIONS RELATED TO PROTEIN FRAGMENTS OF SERYL-TRNA SYNTHETASES
<b>A61K 39/39</b> (2006.01)	2566516 *	INNOVATIVE DISCOVERY OF THERAPEUTIC, DIAGNOSTIC, AND ANTIBODY COMPOSITIONS RELATED TO PROTEIN FRAGMENTS OF SERYL-TRNA SYNTHETASES
<b>A61K 38/16</b> (2006.01)	2566516 *	INNOVATIVE DISCOVERY OF THERAPEUTIC, DIAGNOSTIC, AND ANTIBODY COMPOSITIONS RELATED TO PROTEIN FRAGMENTS OF SERYL-TRNA SYNTHETASES
<b>A61K 38/43</b> (2006.01)	2566516 *	INNOVATIVE DISCOVERY OF THERAPEUTIC, DIAGNOSTIC, AND ANTIBODY COMPOSITIONS RELATED TO PROTEIN FRAGMENTS OF SERYL-TRNA SYNTHETASES

MKP (51)	Broj objave evropske prijava patenta (97)	Naziv pronalaska (54)
<b>A61P 37/00</b> (2006.01)	2566516 *	INNOVATIVE DISCOVERY OF THERAPEUTIC, DIAGNOSTIC, AND ANTIBODY COMPOSITIONS RELATED TO PROTEIN FRAGMENTS OF SERYL-TRNA SYNTHETASES
<b>A61K 39/395</b> (2006.01)	2566516 *	INNOVATIVE DISCOVERY OF THERAPEUTIC, DIAGNOSTIC, AND ANTIBODY COMPOSITIONS RELATED TO PROTEIN FRAGMENTS OF SERYL-TRNA SYNTHETASES
<b>A61K 31/5517</b> (2006.01)	2576557 *	NOVEL ANTIFUNGAL 5,6-DIHYDRO-4-[(DIFLUOROETHYL)PHENYL]-4H-PYRROLO[1,2-a][1,4]BENZODIAZEPINE AND 4-(DIFLUOROETHYL)PHENYL-6H-PYRROLO[1,2-a][1,4]BENZODIAZEPINE DERIVATIVES
<b>C07D 487/04</b> (2006.01)	2576557 *	NOVEL ANTIFUNGAL 5,6-DIHYDRO-4-[(DIFLUOROETHYL)PHENYL]-4H-PYRROLO[1,2-a][1,4]BENZODIAZEPINE AND 4-(DIFLUOROETHYL)PHENYL-6H-PYRROLO[1,2-a][1,4]BENZODIAZEPINE DERIVATIVES
<b>A61P 31/10</b> (2006.01)	2576557 *	NOVEL ANTIFUNGAL 5,6-DIHYDRO-4-[(DIFLUOROETHYL)PHENYL]-4H-PYRROLO[1,2-a][1,4]BENZODIAZEPINE AND 4-(DIFLUOROETHYL)PHENYL-6H-PYRROLO[1,2-a][1,4]BENZODIAZEPINE DERIVATIVES
<b>A61P 35/00</b> (2006.01)	2566869 *	PYRIDONE AND AZA-PYRIDONE COMPOUNDS AND METHODS OF USE
<b>C07D 495/04</b> (2006.01)	2566869 *	PYRIDONE AND AZA-PYRIDONE COMPOUNDS AND METHODS OF USE
<b>C07D 498/04</b> (2006.01)	2566869 *	PYRIDONE AND AZA-PYRIDONE COMPOUNDS AND METHODS OF USE
<b>C07D 487/04</b> (2006.01)	2566869 *	PYRIDONE AND AZA-PYRIDONE COMPOUNDS AND METHODS OF USE
<b>A61K 31/498</b> (2006.01)	2566869 *	PYRIDONE AND AZA-PYRIDONE COMPOUNDS AND METHODS OF USE
<b>C12N 15/09</b> (2006.01)	2576773 *	METHODS AND HELPER VIRUSES FOR THE GENERATION OF RNA VIRUS
<b>C07K 14/11</b> (2006.01)	2576773 *	METHODS AND HELPER VIRUSES FOR THE GENERATION OF RNA VIRUS
<b>C12N 15/86</b> (2006.01)	2576773 *	METHODS AND HELPER VIRUSES FOR THE GENERATION OF RNA VIRUS
<b>C12N 7/02</b> (2006.01)	2576773 *	METHODS AND HELPER VIRUSES FOR THE GENERATION OF RNA VIRUS
<b>A61K 38/47</b> (2006.01)	2593131 *	METHODS AND COMPOSITIONS FOR CNS DELIVERY OF IDURONATE-2-SULFATASE
<b>A61P 25/28</b> (2006.01)	2593131 *	METHODS AND COMPOSITIONS FOR CNS DELIVERY OF IDURONATE-2-SULFATASE
<b>A61P 25/00</b> (2006.01)	2593131 *	METHODS AND COMPOSITIONS FOR CNS DELIVERY OF IDURONATE-2-SULFATASE
<b>A61M 5/32</b> (2006.01)	2588162 *	SAFETY DEVICE FOR A PRE-FILLED SYRINGE AND INJECTION DEVICE
<b>A61M 5/20</b> (2006.01)	2588162 *	SAFETY DEVICE FOR A PRE-FILLED SYRINGE AND INJECTION DEVICE
<b>A61P 15/10</b> (2006.01)	2546255 *	BENZAEPINE COMPOUND
<b>A61K 31/55</b> (2006.01)	2546255 *	BENZAEPINE COMPOUND
<b>A61P 13/02</b> (2006.01)	2546255 *	BENZAEPINE COMPOUND
<b>C07D 498/04</b> (2006.01)	2546255 *	BENZAEPINE COMPOUND
<b>A61P 43/00</b> (2006.01)	2546255 *	BENZAEPINE COMPOUND
<b>A61P 3/04</b> (2006.01)	2546255 *	BENZAEPINE COMPOUND
<b>C07D 487/04</b> (2006.01)	2546255 *	BENZAEPINE COMPOUND
<b>A61P 13/00</b> (2006.01)	2546255 *	BENZAEPINE COMPOUND
<b>A61P 7/04</b> (2006.01)	2563403 *	CONJUGATED BLOOD COAGULATION FACTOR VIIA
<b>A61K 47/48</b> (2006.01)	2563403 *	CONJUGATED BLOOD COAGULATION FACTOR VIIA
<b>A61K 38/36</b> (2006.01)	2563403 *	CONJUGATED BLOOD COAGULATION FACTOR VIIA
<b>A61P 25/04</b> (2006.01)	2585069 *	PROKINETICIN 1 RECEPTOR ANTAGONISTS FOR THE TREATMENT OF PAIN
<b>A61P 25/02</b> (2006.01)	2585069 *	PROKINETICIN 1 RECEPTOR ANTAGONISTS FOR THE TREATMENT OF PAIN
<b>A61K 31/513</b> (2006.01)	2585069 *	PROKINETICIN 1 RECEPTOR ANTAGONISTS FOR THE TREATMENT OF PAIN
<b>A61K 31/53</b> (2006.01)	2585069 *	PROKINETICIN 1 RECEPTOR ANTAGONISTS FOR THE TREATMENT OF PAIN
<b>A61K 9/10</b> (2006.01)	2571488 *	PHARMACEUTICAL COMPOSITION OF IBUPROFEN FOR INJECTION
<b>A61K 31/19</b> (2006.01)	2571488 *	PHARMACEUTICAL COMPOSITION OF IBUPROFEN FOR INJECTION
<b>A61K 47/18</b> (2006.01)	2571488 *	PHARMACEUTICAL COMPOSITION OF IBUPROFEN FOR INJECTION

MKP (51)	Broj objave evropske prijava patenta (97)	Naziv pronalaska (54)
<b>A61K 31/47</b> (2006.01)	2547658 *	SOLID FORMS OF N-[2,4-BIS(1,1-DIMETHYLETHYL)-5-HYDROXYPHENYL]-1,4-DIHYDRO-4-OXOQUINOLINE-3-CARBOXAMIDE
<b>C07D 215/56</b> (2006.01)	2547658 *	SOLID FORMS OF N-[2,4-BIS(1,1-DIMETHYLETHYL)-5-HYDROXYPHENYL]-1,4-DIHYDRO-4-OXOQUINOLINE-3-CARBOXAMIDE
<b>A61P 11/00</b> (2006.01)	2547658 *	SOLID FORMS OF N-[2,4-BIS(1,1-DIMETHYLETHYL)-5-HYDROXYPHENYL]-1,4-DIHYDRO-4-OXOQUINOLINE-3-CARBOXAMIDE
<b>C01G 7/00</b> (2006.01)	2580162 *	METHOD FOR RECOVERING GOLD BY SOLVENT EXTRACTION
<b>C22B 11/06</b> (2006.01)	2580162 *	METHOD FOR RECOVERING GOLD BY SOLVENT EXTRACTION
<b>C22B 3/26</b> (2006.01)	2580162 *	METHOD FOR RECOVERING GOLD BY SOLVENT EXTRACTION
<b>C07K 16/18</b> (2006.01)	2542580 *	ANTIBODIES AGAINST PHOSPHORYLCHOLINE IN COMBINATION THERAPY WITH BIOLOGIC AGENTS
<b>G01N 33/564</b> (2006.01)	2542580 *	ANTIBODIES AGAINST PHOSPHORYLCHOLINE IN COMBINATION THERAPY WITH BIOLOGIC AGENTS
<b>G01N 33/68</b> (2006.01)	2542580 *	ANTIBODIES AGAINST PHOSPHORYLCHOLINE IN COMBINATION THERAPY WITH BIOLOGIC AGENTS
<b>C07D 213/64</b> (2006.01)	2563762 *	METHOD FOR PRODUCING SUBSTITUTED PYRIDIN-2-ONE
<b>H02J 7/00</b> (2006.01)	2567445 *	BIPOLAR OVERVOLTAGE BATTERY PULSER AND METHOD
<b>A61P 17/14</b> (2006.01)	2582355 *	METHODS AND COMPOSITIONS FOR PROMOTING HAIR GROWTH
<b>A61K 31/727</b> (2006.01)	2582355 *	METHODS AND COMPOSITIONS FOR PROMOTING HAIR GROWTH
<b>A61Q 7/00</b> (2006.01)	2582355 *	METHODS AND COMPOSITIONS FOR PROMOTING HAIR GROWTH
<b>A61K 45/06</b> (2006.01)	2582355 *	METHODS AND COMPOSITIONS FOR PROMOTING HAIR GROWTH
<b>A61K 8/73</b> (2006.01)	2582355 *	METHODS AND COMPOSITIONS FOR PROMOTING HAIR GROWTH
<b>A61K 31/337</b> (2006.01)	2582355 *	METHODS AND COMPOSITIONS FOR PROMOTING HAIR GROWTH
<b>A61K 31/506</b> (2006.01)	2582355 *	METHODS AND COMPOSITIONS FOR PROMOTING HAIR GROWTH
<b>A61K 31/58</b> (2006.01)	2582355 *	METHODS AND COMPOSITIONS FOR PROMOTING HAIR GROWTH
<b>A61K 9/26</b> (2006.01)	2538928 *	ABUSE-RESISTANT FORMULATIONS
<b>A61K 31/485</b> (2006.01)	2538928 *	ABUSE-RESISTANT FORMULATIONS
<b>A61K 39/21</b> (2006.01)	2547697 *	IMMUNE THERAPY
<b>C07K 14/16</b> (2006.01)	2547697 *	IMMUNE THERAPY
<b>C07D 487/04</b> (2006.01)	2566867 *	PYRAZOLE COMPOUNDS AS JAK INHIBITORS
<b>A61P 29/00</b> (2006.01)	2566867 *	PYRAZOLE COMPOUNDS AS JAK INHIBITORS
<b>A61K 31/519</b> (2006.01)	2566867 *	PYRAZOLE COMPOUNDS AS JAK INHIBITORS
<b>A61P 35/00</b> (2006.01)	2566867 *	PYRAZOLE COMPOUNDS AS JAK INHIBITORS
<b>A61K 31/4409</b> (2006.01)	2560630 *	TUBERCULOSIS DRUG BASED ON 4-THIOUREIDO-IMINOMETHYLPYRIDINIUM PERCHLORATE: METHOD OF PREPARATION AND TREATMENT
<b>A61K 9/28</b> (2006.01)	2560630 *	TUBERCULOSIS DRUG BASED ON 4-THIOUREIDO-IMINOMETHYLPYRIDINIUM PERCHLORATE: METHOD OF PREPARATION AND TREATMENT
<b>A61K 31/4425</b> (2006.01)	2560630 *	TUBERCULOSIS DRUG BASED ON 4-THIOUREIDO-IMINOMETHYLPYRIDINIUM PERCHLORATE: METHOD OF PREPARATION AND TREATMENT
<b>A61K 9/48</b> (2006.01)	2560630 *	TUBERCULOSIS DRUG BASED ON 4-THIOUREIDO-IMINOMETHYLPYRIDINIUM PERCHLORATE: METHOD OF PREPARATION AND TREATMENT
<b>A61K 31/438</b> (2006.01)	2560630 *	TUBERCULOSIS DRUG BASED ON 4-THIOUREIDO-IMINOMETHYLPYRIDINIUM PERCHLORATE: METHOD OF PREPARATION AND TREATMENT
<b>A61K 9/20</b> (2006.01)	2560630 *	TUBERCULOSIS DRUG BASED ON 4-THIOUREIDO-IMINOMETHYLPYRIDINIUM PERCHLORATE: METHOD OF PREPARATION AND TREATMENT
<b>A61K 31/47</b> (2006.01)	2560630 *	TUBERCULOSIS DRUG BASED ON 4-THIOUREIDO-IMINOMETHYLPYRIDINIUM PERCHLORATE: METHOD OF PREPARATION AND TREATMENT

MKP (51)	Broj objave evropske prijava patenta (97)	Naziv pronalaska (54)
<b>A61K 9/50</b> (2006.01)	2560630 *	TUBERCULOSIS DRUG BASED ON 4-THIOUREIDO- IMINOMETHYLPYRIDINIUM PERCHLORATE: METHOD OF PREPARATION AND TREATMENT
<b>A61K 31/395</b> (2006.01)	2560630 *	TUBERCULOSIS DRUG BASED ON 4-THIOUREIDO- IMINOMETHYLPYRIDINIUM PERCHLORATE: METHOD OF PREPARATION AND TREATMENT
<b>A61K 9/02</b> (2006.01)	2560630 *	TUBERCULOSIS DRUG BASED ON 4-THIOUREIDO- IMINOMETHYLPYRIDINIUM PERCHLORATE: METHOD OF PREPARATION AND TREATMENT
<b>A61K 31/7036</b> (2006.01)	2560630 *	TUBERCULOSIS DRUG BASED ON 4-THIOUREIDO- IMINOMETHYLPYRIDINIUM PERCHLORATE: METHOD OF PREPARATION AND TREATMENT
<b>A61K 31/4965</b> (2006.01)	2560630 *	TUBERCULOSIS DRUG BASED ON 4-THIOUREIDO- IMINOMETHYLPYRIDINIUM PERCHLORATE: METHOD OF PREPARATION AND TREATMENT
<b>A61K 9/00</b> (2006.01)	2560630 *	TUBERCULOSIS DRUG BASED ON 4-THIOUREIDO- IMINOMETHYLPYRIDINIUM PERCHLORATE: METHOD OF PREPARATION AND TREATMENT
<b>A61K 31/133</b> (2006.01)	2560630 *	TUBERCULOSIS DRUG BASED ON 4-THIOUREIDO- IMINOMETHYLPYRIDINIUM PERCHLORATE: METHOD OF PREPARATION AND TREATMENT
<b>A61K 45/06</b> (2006.01)	2560630 *	TUBERCULOSIS DRUG BASED ON 4-THIOUREIDO- IMINOMETHYLPYRIDINIUM PERCHLORATE: METHOD OF PREPARATION AND TREATMENT
<b>D01D 1/02</b> (2006.01)	2471983	Method For Preparing Meta-Aramid Fibers
<b>D01F 6/60</b> (2006.01)	2471983	Method For Preparing Meta-Aramid Fibers
<b>C08G 69/32</b> (2006.01)	2471983	Method For Preparing Meta-Aramid Fibers
<b>F25B 43/02</b> (2006.01)	2500677	Oil separator and refrigerating cycle apparatus using the same
<b>A61P 37/00</b> (2006.01)	2580196 *	ANTI-INFLAMMATORY AGENTS
<b>C07D 401/12</b> (2006.01)	2580196 *	ANTI-INFLAMMATORY AGENTS
<b>C07D 223/12</b> (2006.01)	2580196 *	ANTI-INFLAMMATORY AGENTS
<b>C07D 211/56</b> (2006.01)	2580196 *	ANTI-INFLAMMATORY AGENTS
<b>A61P 17/06</b> (2006.01)	2580196 *	ANTI-INFLAMMATORY AGENTS
<b>A61K 31/45</b> (2006.01)	2580196 *	ANTI-INFLAMMATORY AGENTS
<b>A61P 29/00</b> (2006.01)	2580196 *	ANTI-INFLAMMATORY AGENTS
<b>A61K 31/55</b> (2006.01)	2580196 *	ANTI-INFLAMMATORY AGENTS
<b>A61K 31/4523</b> (2006.01)	2580196 *	ANTI-INFLAMMATORY AGENTS
<b>A61K 31/437</b> (2006.01)	2576548 *	THE USE OF sGC STIMULATORS, sGC ACTIVATORS, ALONE AND COMBINATIONS WITH PDE5 INHIBITORS FOR THE TREATMENT OF SYSTEMIC SCLEROSIS (SSc).
<b>C07D 471/04</b> (2006.01)	2576548 *	THE USE OF sGC STIMULATORS, sGC ACTIVATORS, ALONE AND COMBINATIONS WITH PDE5 INHIBITORS FOR THE TREATMENT OF SYSTEMIC SCLEROSIS (SSc).
<b>A61P 9/00</b> (2006.01)	2576548 *	THE USE OF sGC STIMULATORS, sGC ACTIVATORS, ALONE AND COMBINATIONS WITH PDE5 INHIBITORS FOR THE TREATMENT OF SYSTEMIC SCLEROSIS (SSc).
<b>A61P 15/00</b> (2006.01)	2576548 *	THE USE OF sGC STIMULATORS, sGC ACTIVATORS, ALONE AND COMBINATIONS WITH PDE5 INHIBITORS FOR THE TREATMENT OF SYSTEMIC SCLEROSIS (SSc).
<b>C07K 14/195</b> (2006.01)	2590993 *	POLYPEPTIDES
<b>A23L 1/236</b> (2006.01)	2386209	Natural sweetener
<b>A23L 1/09</b> (2006.01)	2386209	Natural sweetener
<b>A61M 5/315</b> (2006.01)	2455121	Cartridge holder and drug delivery device
<b>H04L 12/28</b> (2006.01)	2594082 *	CONTINUITY OF THE AVAILABILITY OF A COMMUNICATION SERVICE
<b>H04Q 3/00</b> (2006.01)	2594082 *	CONTINUITY OF THE AVAILABILITY OF A COMMUNICATION SERVICE
<b>C07K 14/435</b> (2006.01)	2542569 *	CHIMERIC INHIBITOR MOLECULES OF COMPLEMENT ACTIVATION

MKP (51)	Broj objave evropske prijava patenta (97)	Naziv pronalaska (54)
<b>A61K 38/16</b> (2006.01)	2542569 *	CHIMERIC INHIBITOR MOLECULES OF COMPLEMENT ACTIVATION
<b>C12N 15/62</b> (2006.01)	2542569 *	CHIMERIC INHIBITOR MOLECULES OF COMPLEMENT ACTIVATION
<b>A01H 5/00</b> (2006.01)	2563113 *	MODIFIED PYR/PYL RECEPTORS ACTIVATED BY ORTHOGONAL LIGANDS
<b>C12N 15/29</b> (2006.01)	2563113 *	MODIFIED PYR/PYL RECEPTORS ACTIVATED BY ORTHOGONAL LIGANDS
<b>C12N 15/82</b> (2006.01)	2563113 *	MODIFIED PYR/PYL RECEPTORS ACTIVATED BY ORTHOGONAL LIGANDS
<b>B65D 19/28</b> (2006.01)	2555990 *	SUPPORT FRAME FOR RACKS
<b>B65G 1/02</b> (2006.01)	2555990 *	SUPPORT FRAME FOR RACKS
<b>A23L 1/216</b> (2006.01)	2566351 *	FOOD PRODUCT COMPRISING A MIXTURE OF SLICES OF POTATOES COOKED IN OIL AND CORNS PUFFED UP WHEN HEATED
<b>A23L 1/18</b> (2006.01)	2566351 *	FOOD PRODUCT COMPRISING A MIXTURE OF SLICES OF POTATOES COOKED IN OIL AND CORNS PUFFED UP WHEN HEATED
<b>A23L 1/164</b> (2006.01)	2566351 *	FOOD PRODUCT COMPRISING A MIXTURE OF SLICES OF POTATOES COOKED IN OIL AND CORNS PUFFED UP WHEN HEATED
<b>C02F 1/32</b> (2006.01)	2575901 *	DEVICE FOR VIRAL INACTIVATION OF LIQUID MEDIA
<b>A61L 2/00</b> (2006.01)	2575901 *	DEVICE FOR VIRAL INACTIVATION OF LIQUID MEDIA
<b>C09K 101/00</b> (2006.01)	2588564 *	CELL FOR CONDITIONING AND IMPROVING OF SOIL, AS WELL AS PROCESS FOR PRODUCTION AND ALLOCATION TO THE SOIL OF IT
<b>C09K 17/40</b> (2006.01)	2588564 *	CELL FOR CONDITIONING AND IMPROVING OF SOIL, AS WELL AS PROCESS FOR PRODUCTION AND ALLOCATION TO THE SOIL OF IT
<b>C09K 17/00</b> (2006.01)	2588564 *	CELL FOR CONDITIONING AND IMPROVING OF SOIL, AS WELL AS PROCESS FOR PRODUCTION AND ALLOCATION TO THE SOIL OF IT
<b>B09C 1/00</b> (2006.01)	2588564 *	CELL FOR CONDITIONING AND IMPROVING OF SOIL, AS WELL AS PROCESS FOR PRODUCTION AND ALLOCATION TO THE SOIL OF IT
<b>C09K 17/50</b> (2006.01)	2588564 *	CELL FOR CONDITIONING AND IMPROVING OF SOIL, AS WELL AS PROCESS FOR PRODUCTION AND ALLOCATION TO THE SOIL OF IT
<b>A01C 1/00</b> (2006.01)	2588564 *	CELL FOR CONDITIONING AND IMPROVING OF SOIL, AS WELL AS PROCESS FOR PRODUCTION AND ALLOCATION TO THE SOIL OF IT
<b>C07D 413/12</b> (2006.01)	2542537 *	NOVEL COMPOUNDS FOR MODULATION OF ORPHAN NUCLEAR RECEPTOR RAR-RELATED ORPHAN RECEPTOR-GAMMA (ROR GAMMA, NR1F3) ACTIVITY AND FOR THE TREATMENT OF CHRONIC INFLAMMATORY AND AUTOIMMUNE DISEASE
<b>C07D 498/04</b> (2006.01)	2542537 *	NOVEL COMPOUNDS FOR MODULATION OF ORPHAN NUCLEAR RECEPTOR RAR-RELATED ORPHAN RECEPTOR-GAMMA (ROR GAMMA, NR1F3) ACTIVITY AND FOR THE TREATMENT OF CHRONIC INFLAMMATORY AND AUTOIMMUNE DISEASE
<b>A61K 31/395</b> (2006.01)	2542537 *	NOVEL COMPOUNDS FOR MODULATION OF ORPHAN NUCLEAR RECEPTOR RAR-RELATED ORPHAN RECEPTOR-GAMMA (ROR GAMMA, NR1F3) ACTIVITY AND FOR THE TREATMENT OF CHRONIC INFLAMMATORY AND AUTOIMMUNE DISEASE
<b>C07D 267/22</b> (2006.01)	2542537 *	NOVEL COMPOUNDS FOR MODULATION OF ORPHAN NUCLEAR RECEPTOR RAR-RELATED ORPHAN RECEPTOR-GAMMA (ROR GAMMA, NR1F3) ACTIVITY AND FOR THE TREATMENT OF CHRONIC INFLAMMATORY AND AUTOIMMUNE DISEASE
<b>C07D 403/12</b> (2006.01)	2542537 *	NOVEL COMPOUNDS FOR MODULATION OF ORPHAN NUCLEAR RECEPTOR RAR-RELATED ORPHAN RECEPTOR-GAMMA (ROR GAMMA, NR1F3) ACTIVITY AND FOR THE TREATMENT OF CHRONIC INFLAMMATORY AND AUTOIMMUNE DISEASE
<b>C07D 417/12</b> (2006.01)	2542537 *	NOVEL COMPOUNDS FOR MODULATION OF ORPHAN NUCLEAR RECEPTOR RAR-RELATED ORPHAN RECEPTOR-GAMMA (ROR GAMMA, NR1F3) ACTIVITY AND FOR THE TREATMENT OF CHRONIC INFLAMMATORY AND AUTOIMMUNE DISEASE
<b>A61P 29/00</b> (2006.01)	2542537 *	NOVEL COMPOUNDS FOR MODULATION OF ORPHAN NUCLEAR RECEPTOR RAR-RELATED ORPHAN RECEPTOR-GAMMA (ROR GAMMA, NR1F3) ACTIVITY AND FOR THE TREATMENT OF CHRONIC INFLAMMATORY AND AUTOIMMUNE DISEASE
<b>C07D 245/06</b> (2006.01)	2542537 *	NOVEL COMPOUNDS FOR MODULATION OF ORPHAN NUCLEAR RECEPTOR RAR-RELATED ORPHAN RECEPTOR-GAMMA (ROR GAMMA, NR1F3) ACTIVITY AND FOR THE TREATMENT OF CHRONIC INFLAMMATORY AND AUTOIMMUNE DISEASE

MKP (51)	Broj objave evropske prijava patenta (97)	Naziv pronalaska (54)
<b>C07D 281/18</b> (2006.01)	2542537 *	NOVEL COMPOUNDS FOR MODULATION OF ORPHAN NUCLEAR RECEPTOR RAR-RELATED ORPHAN RECEPTOR-GAMMA (ROR GAMMA, NR1F3) ACTIVITY AND FOR THE TREATMENT OF CHRONIC INFLAMMATORY AND AUTOIMMUNE DISEASE
<b>C07D 413/10</b> (2006.01)	2542537 *	NOVEL COMPOUNDS FOR MODULATION OF ORPHAN NUCLEAR RECEPTOR RAR-RELATED ORPHAN RECEPTOR-GAMMA (ROR GAMMA, NR1F3) ACTIVITY AND FOR THE TREATMENT OF CHRONIC INFLAMMATORY AND AUTOIMMUNE DISEASE
<b>C07D 487/04</b> (2006.01)	2542537 *	NOVEL COMPOUNDS FOR MODULATION OF ORPHAN NUCLEAR RECEPTOR RAR-RELATED ORPHAN RECEPTOR-GAMMA (ROR GAMMA, NR1F3) ACTIVITY AND FOR THE TREATMENT OF CHRONIC INFLAMMATORY AND AUTOIMMUNE DISEASE
<b>A61P 37/00</b> (2006.01)	2542537 *	NOVEL COMPOUNDS FOR MODULATION OF ORPHAN NUCLEAR RECEPTOR RAR-RELATED ORPHAN RECEPTOR-GAMMA (ROR GAMMA, NR1F3) ACTIVITY AND FOR THE TREATMENT OF CHRONIC INFLAMMATORY AND AUTOIMMUNE DISEASE
<b>A61P 31/18</b> (2006.01)	2593120 *	METHOD OF TREATMENT OF HIV OR AIDS
<b>A61K 38/08</b> (2006.01)	2593120 *	METHOD OF TREATMENT OF HIV OR AIDS
<b>C07D 471/04</b> (2006.01)	2588197 *	FUSED HETEROCYCLIC COMPOUNDS AS ION CHANNEL MODULATORS
<b>A61P 3/10</b> (2006.01)	2588197 *	FUSED HETEROCYCLIC COMPOUNDS AS ION CHANNEL MODULATORS
<b>A61K 31/437</b> (2006.01)	2588197 *	FUSED HETEROCYCLIC COMPOUNDS AS ION CHANNEL MODULATORS
<b>A61P 9/00</b> (2006.01)	2588197 *	FUSED HETEROCYCLIC COMPOUNDS AS ION CHANNEL MODULATORS
<b>C07C 233/58</b> (2006.01)	2588446 *	NOVEL CALCIUM SALTS OF COMPOUND AS ANTI-INFLAMMATORY, IMMUNOMODULATORY AND ANTI-PROLIFERATORY AGENTS
<b>C07D 333/58</b> (2006.01)	2588446 *	NOVEL CALCIUM SALTS OF COMPOUND AS ANTI-INFLAMMATORY, IMMUNOMODULATORY AND ANTI-PROLIFERATORY AGENTS
<b>A61K 31/167</b> (2006.01)	2588446 *	NOVEL CALCIUM SALTS OF COMPOUND AS ANTI-INFLAMMATORY, IMMUNOMODULATORY AND ANTI-PROLIFERATORY AGENTS
<b>C07D 307/30</b> (2006.01)	2588446 *	NOVEL CALCIUM SALTS OF COMPOUND AS ANTI-INFLAMMATORY, IMMUNOMODULATORY AND ANTI-PROLIFERATORY AGENTS
<b>C07C 233/60</b> (2006.01)	2588446 *	NOVEL CALCIUM SALTS OF COMPOUND AS ANTI-INFLAMMATORY, IMMUNOMODULATORY AND ANTI-PROLIFERATORY AGENTS
<b>C07D 333/38</b> (2006.01)	2588446 *	NOVEL CALCIUM SALTS OF COMPOUND AS ANTI-INFLAMMATORY, IMMUNOMODULATORY AND ANTI-PROLIFERATORY AGENTS
<b>C07C 233/59</b> (2006.01)	2588446 *	NOVEL CALCIUM SALTS OF COMPOUND AS ANTI-INFLAMMATORY, IMMUNOMODULATORY AND ANTI-PROLIFERATORY AGENTS
<b>A61K 39/00</b> (2006.01)	2575846 *	INSULIN-LIKE GROWTH FACTOR 1 RECEPTOR BINDING PEPTIDES
<b>A61K 38/00</b> (2006.01)	2575846 *	INSULIN-LIKE GROWTH FACTOR 1 RECEPTOR BINDING PEPTIDES
<b>C12P 21/06</b> (2006.01)	2575846 *	INSULIN-LIKE GROWTH FACTOR 1 RECEPTOR BINDING PEPTIDES
<b>C12P 21/04</b> (2006.01)	2575846 *	INSULIN-LIKE GROWTH FACTOR 1 RECEPTOR BINDING PEPTIDES
<b>A61P 25/00</b> (2006.01)	2569303 *	SUBSTITUTED N-ALKYL AND N-ACYL TETRAHYDRO-ISOQUINOLINE DERIVATIVES, PREPARATION AND THERAPEUTIC USE THEREOF
<b>A61K 31/4709</b> (2006.01)	2569303 *	SUBSTITUTED N-ALKYL AND N-ACYL TETRAHYDRO-ISOQUINOLINE DERIVATIVES, PREPARATION AND THERAPEUTIC USE THEREOF
<b>C07D 401/14</b> (2006.01)	2569303 *	SUBSTITUTED N-ALKYL AND N-ACYL TETRAHYDRO-ISOQUINOLINE DERIVATIVES, PREPARATION AND THERAPEUTIC USE THEREOF
<b>C07D 495/04</b> (2006.01)	2569303 *	SUBSTITUTED N-ALKYL AND N-ACYL TETRAHYDRO-ISOQUINOLINE DERIVATIVES, PREPARATION AND THERAPEUTIC USE THEREOF
<b>C07D 403/04</b> (2006.01)	2569303 *	SUBSTITUTED N-ALKYL AND N-ACYL TETRAHYDRO-ISOQUINOLINE DERIVATIVES, PREPARATION AND THERAPEUTIC USE THEREOF
<b>C07D 407/14</b> (2006.01)	2569303 *	SUBSTITUTED N-ALKYL AND N-ACYL TETRAHYDRO-ISOQUINOLINE DERIVATIVES, PREPARATION AND THERAPEUTIC USE THEREOF
<b>C07K 7/62</b> (2006.01)	2548883 *	PEPTIDE COMPOUNDS THAT CAN BE USED AS ANTIBACTERIAL AGENTS
<b>A23K 1/12</b> (2006.01)	2557940 *	ANIMAL FEED ADDITIVE HAVING AN ANTIMICROBIAL AND GROWTH-PROMOTING EFFECT
<b>A61P 33/00</b> (2006.01)	2557940 *	ANIMAL FEED ADDITIVE HAVING AN ANTIMICROBIAL AND GROWTH-PROMOTING EFFECT

MKP (51)	Broj objave evropske prijava patenta (97)	Naziv pronalaska (54)
<b>A23K 1/16</b> (2006.01)	2557940 *	ANIMAL FEED ADDITIVE HAVING AN ANTIMICROBIAL AND GROWTH-PROMOTING EFFECT
<b>A61K 31/575</b> (2006.01)	2557940 *	ANIMAL FEED ADDITIVE HAVING AN ANTIMICROBIAL AND GROWTH-PROMOTING EFFECT
<b>A61P 1/00</b> (2006.01)	2557940 *	ANIMAL FEED ADDITIVE HAVING AN ANTIMICROBIAL AND GROWTH-PROMOTING EFFECT
<b>A61K 36/54</b> (2006.01)	2557940 *	ANIMAL FEED ADDITIVE HAVING AN ANTIMICROBIAL AND GROWTH-PROMOTING EFFECT
<b>A23K 1/14</b> (2006.01)	2557940 *	ANIMAL FEED ADDITIVE HAVING AN ANTIMICROBIAL AND GROWTH-PROMOTING EFFECT
<b>A61K 31/4406</b> (2006.01)	2558126 *	SUBSTITUTED 2,3-DIHYDROIMIDAZO[1,2-C]QUINAZOLINE-CONTAINING COMBINATIONS
<b>A61K 31/519</b> (2006.01)	2558126 *	SUBSTITUTED 2,3-DIHYDROIMIDAZO[1,2-C]QUINAZOLINE-CONTAINING COMBINATIONS
<b>A61K 45/06</b> (2006.01)	2558126 *	SUBSTITUTED 2,3-DIHYDROIMIDAZO[1,2-C]QUINAZOLINE-CONTAINING COMBINATIONS
<b>A61K 31/5377</b> (2006.01)	2558126 *	SUBSTITUTED 2,3-DIHYDROIMIDAZO[1,2-C]QUINAZOLINE-CONTAINING COMBINATIONS
<b>A61K 31/18</b> (2006.01)	2558126 *	SUBSTITUTED 2,3-DIHYDROIMIDAZO[1,2-C]QUINAZOLINE-CONTAINING COMBINATIONS
<b>A61M 5/315</b> (2006.01)	2579925 *	MEDICATION DELIVERY DEVICE
<b>A61M 5/24</b> (2006.01)	2579925 *	MEDICATION DELIVERY DEVICE
<b>G11B 20/10</b> (2006.01)	2479754	Circuits and methods for data detection using multiple detectors, storage device
<b>A61K 31/23</b> (2006.01)	2471528	A preparation method for suspension of cetyl myristate and/or cetyl palmitate
<b>A61K 9/00</b> (2006.01)	2471528	A preparation method for suspension of cetyl myristate and/or cetyl palmitate
<b>H02M 3/06</b> (2006.01)	2548282 *	CELL BALANCING SYSTEM
<b>H02J 7/00</b> (2006.01)	2548282 *	CELL BALANCING SYSTEM
<b>A61P 9/00</b> (2006.01)	2563780 *	3, 3 -DISUBSTITUTED- ( 8 - AZA - BICYCLO [3.2.1]OCT- 8 - YL ) -[5- (1H - PYRAZOL - 4 -YL) -THIOPHEN-3 -YL]METHANONES AS INHIBITORS OF 11 (BETA) -HSD1
<b>A61K 31/4535</b> (2006.01)	2563780 *	3, 3 -DISUBSTITUTED- ( 8 - AZA - BICYCLO [3.2.1]OCT- 8 - YL ) -[5- (1H - PYRAZOL - 4 -YL) -THIOPHEN-3 -YL]METHANONES AS INHIBITORS OF 11 (BETA) -HSD1
<b>C07D 451/06</b> (2006.01)	2563780 *	3, 3 -DISUBSTITUTED- ( 8 - AZA - BICYCLO [3.2.1]OCT- 8 - YL ) -[5- (1H - PYRAZOL - 4 -YL) -THIOPHEN-3 -YL]METHANONES AS INHIBITORS OF 11 (BETA) -HSD1
<b>C07D 451/04</b> (2006.01)	2563780 *	3, 3 -DISUBSTITUTED- ( 8 - AZA - BICYCLO [3.2.1]OCT- 8 - YL ) -[5- (1H - PYRAZOL - 4 -YL) -THIOPHEN-3 -YL]METHANONES AS INHIBITORS OF 11 (BETA) -HSD1
<b>A61P 25/28</b> (2006.01)	2563780 *	3, 3 -DISUBSTITUTED- ( 8 - AZA - BICYCLO [3.2.1]OCT- 8 - YL ) -[5- (1H - PYRAZOL - 4 -YL) -THIOPHEN-3 -YL]METHANONES AS INHIBITORS OF 11 (BETA) -HSD1
<b>C07D 409/14</b> (2006.01)	2563780 *	3, 3 -DISUBSTITUTED- ( 8 - AZA - BICYCLO [3.2.1]OCT- 8 - YL ) -[5- (1H - PYRAZOL - 4 -YL) -THIOPHEN-3 -YL]METHANONES AS INHIBITORS OF 11 (BETA) -HSD1
<b>A61P 3/10</b> (2006.01)	2563780 *	3, 3 -DISUBSTITUTED- ( 8 - AZA - BICYCLO [3.2.1]OCT- 8 - YL ) -[5- (1H - PYRAZOL - 4 -YL) -THIOPHEN-3 -YL]METHANONES AS INHIBITORS OF 11 (BETA) -HSD1
<b>A61K 31/46</b> (2006.01)	2563780 *	3, 3 -DISUBSTITUTED- ( 8 - AZA - BICYCLO [3.2.1]OCT- 8 - YL ) -[5- (1H - PYRAZOL - 4 -YL) -THIOPHEN-3 -YL]METHANONES AS INHIBITORS OF 11 (BETA) -HSD1
<b>C07D 451/02</b> (2006.01)	2563780 *	3, 3 -DISUBSTITUTED- ( 8 - AZA - BICYCLO [3.2.1]OCT- 8 - YL ) -[5- (1H - PYRAZOL - 4 -YL) -THIOPHEN-3 -YL]METHANONES AS INHIBITORS OF 11 (BETA) -HSD1
<b>A61P 25/00</b> (2006.01)	2563780 *	3, 3 -DISUBSTITUTED- ( 8 - AZA - BICYCLO [3.2.1]OCT- 8 - YL ) -[5- (1H - PYRAZOL - 4 -YL) -THIOPHEN-3 -YL]METHANONES AS INHIBITORS OF 11 (BETA) -HSD1



MKP (51)	Broj objave evropske prijava patenta (97)	Naziv pronalaska (54)
<b>A61P 3/04</b> (2006.01)	2563780 *	3, 3 -DISUBSTITUTED- ( 8 - AZA - BICYCLO [3.2.1]OCT- 8 - YL) -[5- (1H - PYRAZOL - 4 -YL) -THIOPHEN-3 -YL]METHANONES AS INHIBITORS OF 11 (BETA) -HSD1
<b>C07K 16/46</b> (2006.01)	2550297 *	DISULFIDE STABILIZED DVD-LG MOLECULES
<b>A61K 39/29</b> (2006.01)	2547695 *	TUMOR VACCINATION INVOLVING A HUMORAL IMMUNE RESPONSE AGAINST SELF-PROTEINS
<b>C07K 14/47</b> (2006.01)	2547695 *	TUMOR VACCINATION INVOLVING A HUMORAL IMMUNE RESPONSE AGAINST SELF-PROTEINS
<b>C07K 14/02</b> (2006.01)	2547695 *	TUMOR VACCINATION INVOLVING A HUMORAL IMMUNE RESPONSE AGAINST SELF-PROTEINS
<b>C12P 21/06</b> (2006.01)	2556163 *	HIGH MANNOSE GLYCANS
<b>H01J 49/00</b> (2006.01)	2556163 *	HIGH MANNOSE GLYCANS
<b>C12Q 1/00</b> (2006.01)	2556163 *	HIGH MANNOSE GLYCANS
<b>H01L 31/04</b> (2006.01)	2559071 *	SOLAR INSTALLATION WITH ARTIFICIAL LIGHT SOURCE
<b>A61K 9/06</b> (2006.01)	2560615 *	THIAZOLIDINEDIONE ANALOGUES
<b>A61K 9/08</b> (2006.01)	2560615 *	THIAZOLIDINEDIONE ANALOGUES
<b>A61K 31/425</b> (2006.01)	2560615 *	THIAZOLIDINEDIONE ANALOGUES
<b>A61K 9/00</b> (2006.01)	2560615 *	THIAZOLIDINEDIONE ANALOGUES
<b>A61K 9/48</b> (2006.01)	2560615 *	THIAZOLIDINEDIONE ANALOGUES
<b>B08B 7/04</b> (2006.01)	2582472 *	SYSTEM FOR PRODUCING AND DISTRIBUTING AN OZONATED FLUID
<b>A61K 39/02</b> (2006.01)	2544708 *	CONJUGATION PROCESS OF BACTERIAL POLYSACCHARIDES TO CARRIER PROTEINS
<b>A61K 31/337</b> (2006.01)	2542232 *	FATTY ACID INHIBITORS
<b>A61K 31/70</b> (2006.01)	2542232 *	FATTY ACID INHIBITORS
<b>A61K 31/185</b> (2006.01)	2542232 *	FATTY ACID INHIBITORS
<b>A61K 31/336</b> (2006.01)	2542232 *	FATTY ACID INHIBITORS
<b>C03B 9/16</b> (2006.01)	2576462 *	PROCESS AND EQUIPMENT FOR THE FABRICATION OF GLASS CONTAINERS WITH INTERNALLY THREADED NECK
<b>B65D 1/02</b> (2006.01)	2576462 *	PROCESS AND EQUIPMENT FOR THE FABRICATION OF GLASS CONTAINERS WITH INTERNALLY THREADED NECK
<b>C03B 9/325</b> (2006.01)	2576462 *	PROCESS AND EQUIPMENT FOR THE FABRICATION OF GLASS CONTAINERS WITH INTERNALLY THREADED NECK
<b>A61P 13/00</b> (2006.01)	2552910 *	NEW POLYMORPH
<b>A61P 13/02</b> (2006.01)	2552910 *	NEW POLYMORPH
<b>A61K 31/53</b> (2006.01)	2552910 *	NEW POLYMORPH
<b>C07D 409/12</b> (2006.01)	2552910 *	NEW POLYMORPH
<b>A23L 1/00</b> (2006.01)	2540169 *	NANOPARTICLES FOR THE ENCAPSULATION OF COMPOUNDS, PREPARATION THEREOF AND USE OF SAME
<b>A61K 8/64</b> (2006.01)	2540169 *	NANOPARTICLES FOR THE ENCAPSULATION OF COMPOUNDS, PREPARATION THEREOF AND USE OF SAME
<b>F04B 13/00</b> (2006.01)	2547909 *	DOSING PUMP WITH CONTROL DEVICE OF THE PISTON STROKE
<b>A61K 9/00</b> (2006.01)	2571517 *	LONG - ACTING FORMULATIONS OF INSULINS
<b>A61K 38/00</b> (2006.01)	2571517 *	LONG - ACTING FORMULATIONS OF INSULINS
<b>A61K 38/28</b> (2006.01)	2571517 *	LONG - ACTING FORMULATIONS OF INSULINS
<b>A61K 31/00</b> (2006.01)	2571517 *	LONG - ACTING FORMULATIONS OF INSULINS
<b>A61K 9/08</b> (2006.01)	2571517 *	LONG - ACTING FORMULATIONS OF INSULINS
<b>E04B 1/348</b> (2006.01)	2578760 *	PROCEDURE FOR MANUFACTURING OF COMPACT MODULES FOR CONSTRUCTION
<b>B28B 7/22</b> (2006.01)	2578760 *	PROCEDURE FOR MANUFACTURING OF COMPACT MODULES FOR CONSTRUCTION
<b>B28B 19/00</b> (2006.01)	2578760 *	PROCEDURE FOR MANUFACTURING OF COMPACT MODULES FOR CONSTRUCTION
<b>A61K 38/46</b> (2006.01)	2538968 *	PROCESS FOR PRODUCTION AND PURIFICATION OF RECOMBINANT LYSOSOMAL ALPHA-MANNOSIDASE

MKP (51)	Broj objave evropske prijava patenta (97)	Naziv pronalaska (54)
<b>C07K 1/16</b> (2006.01)	2538968 *	PROCESS FOR PRODUCTION AND PURIFICATION OF RECOMBINANT LYSOSOMAL ALPHA-MANNOSIDASE
<b>A61P 35/00</b> (2006.01)	2552415 *	METHODS OF TREATING CANCER
<b>A61K 31/555</b> (2006.01)	2552415 *	METHODS OF TREATING CANCER
<b>A61K 31/337</b> (2006.01)	2552415 *	METHODS OF TREATING CANCER
<b>A61K 9/14</b> (2006.01)	2552415 *	METHODS OF TREATING CANCER
<b>A61P 11/00</b> (2006.01)	2475373 *	A THERAPEUTIC COMBINATION COMPRISING A PULMONARY SURFACTANT AND ANTIOXIDANT ENZYMES
<b>A61K 35/42</b> (2006.01)	2475373 *	A THERAPEUTIC COMBINATION COMPRISING A PULMONARY SURFACTANT AND ANTIOXIDANT ENZYMES
<b>A61K 38/44</b> (2006.01)	2475373 *	A THERAPEUTIC COMBINATION COMPRISING A PULMONARY SURFACTANT AND ANTIOXIDANT ENZYMES
<b>G01N 33/68</b> (2006.01)	2577318 *	METHOD OF NOCICEPTOR DIFFERENTIATION OF HUMAN EMBRYONIC STEM CELLS AND USES THEREOF
<b>C12Q 1/68</b> (2006.01)	2577318 *	METHOD OF NOCICEPTOR DIFFERENTIATION OF HUMAN EMBRYONIC STEM CELLS AND USES THEREOF
<b>G01N 33/15</b> (2006.01)	2577318 *	METHOD OF NOCICEPTOR DIFFERENTIATION OF HUMAN EMBRYONIC STEM CELLS AND USES THEREOF
<b>C12N 5/0735</b> (2010.01)	2577318 *	METHOD OF NOCICEPTOR DIFFERENTIATION OF HUMAN EMBRYONIC STEM CELLS AND USES THEREOF
<b>C04B 28/18</b> (2006.01)	2571828 *	STRUCTURAL ELEMENT FOR GENERATING THERMOELECTRIC POWER AND METHOD FOR THE PRODUCTION THEREOF
<b>H01L 35/22</b> (2006.01)	2571828 *	STRUCTURAL ELEMENT FOR GENERATING THERMOELECTRIC POWER AND METHOD FOR THE PRODUCTION THEREOF
<b>H01L 35/32</b> (2006.01)	2571828 *	STRUCTURAL ELEMENT FOR GENERATING THERMOELECTRIC POWER AND METHOD FOR THE PRODUCTION THEREOF
<b>A61M 5/32</b> (2006.01)	2588168 *	SAFETY DEVICE FOR A PRE-FILLED SYRINGE AND INJECTION DEVICE
<b>A61M 5/28</b> (2006.01)	2588168 *	SAFETY DEVICE FOR A PRE-FILLED SYRINGE AND INJECTION DEVICE
<b>A61M 5/50</b> (2006.01)	2588168 *	SAFETY DEVICE FOR A PRE-FILLED SYRINGE AND INJECTION DEVICE
<b>C12Q 1/68</b> (2006.01)	2593561 *	METHODS AND KITS FOR THE DIAGNOSIS OF PROSTATE CANCER
<b>A61K 31/41</b> (2006.01)	2538787 *	TRIAZOLONES AS FATTY ACID SYNTHASE INHIBITORS
<b>A01N 43/64</b> (2006.01)	2538787 *	TRIAZOLONES AS FATTY ACID SYNTHASE INHIBITORS
<b>C07C 29/09</b> (2006.01)	2576486 *	CARBOCATALYSTS FOR CHEMICAL TRANSFORMATIONS
<b>B01J 21/18</b> (2006.01)	2576486 *	CARBOCATALYSTS FOR CHEMICAL TRANSFORMATIONS
<b>C07B 41/00</b> (2006.01)	2576486 *	CARBOCATALYSTS FOR CHEMICAL TRANSFORMATIONS
<b>C07C 45/42</b> (2006.01)	2576486 *	CARBOCATALYSTS FOR CHEMICAL TRANSFORMATIONS
<b>C07C 51/093</b> (2006.01)	2576486 *	CARBOCATALYSTS FOR CHEMICAL TRANSFORMATIONS
<b>C07D 453/02</b> (2006.01)	2585458 *	ALKALOID AMINOESTER DERIVATIVES AND MEDICINAL COMPOSITION THEREOF
<b>A61P 11/00</b> (2006.01)	2585458 *	ALKALOID AMINOESTER DERIVATIVES AND MEDICINAL COMPOSITION THEREOF
<b>A61K 31/439</b> (2006.01)	2585458 *	ALKALOID AMINOESTER DERIVATIVES AND MEDICINAL COMPOSITION THEREOF
<b>C07D 413/06</b> (2006.01)	2585458 *	ALKALOID AMINOESTER DERIVATIVES AND MEDICINAL COMPOSITION THEREOF
<b>A61K 31/4025</b> (2006.01)	2585458 *	ALKALOID AMINOESTER DERIVATIVES AND MEDICINAL COMPOSITION THEREOF
<b>A61K 31/404</b> (2006.01)	2560650 *	PHARMACEUTICAL COMPOSITIONS AND ADMINISTRATIONS THEREOF
<b>A61K 31/443</b> (2006.01)	2560650 *	PHARMACEUTICAL COMPOSITIONS AND ADMINISTRATIONS THEREOF
<b>A61K 31/4704</b> (2006.01)	2560650 *	PHARMACEUTICAL COMPOSITIONS AND ADMINISTRATIONS THEREOF
<b>A61K 31/403</b> (2006.01)	2538924 *	SOLID PHARMACEUTICAL FORMULATIONS OF RAMIPRIL AND AMLODIPINE BESYLATE, AND THEIR PREPARATION
<b>A61P 9/12</b> (2006.01)	2538924 *	SOLID PHARMACEUTICAL FORMULATIONS OF RAMIPRIL AND AMLODIPINE BESYLATE, AND THEIR PREPARATION

MKP (51)	Broj objave evropske prijava patenta (97)	Naziv pronalaska (54)
<b>A61K 9/20</b> (2006.01)	2538924 *	SOLID PHARMACEUTICAL FORMULATIONS OF RAMIPRIL AND AMLODIPINE BESYLATE, AND THEIR PREPARATION
<b>A61K 45/06</b> (2006.01)	2538924 *	SOLID PHARMACEUTICAL FORMULATIONS OF RAMIPRIL AND AMLODIPINE BESYLATE, AND THEIR PREPARATION
<b>C01F 11/18</b> (2006.01)	2552835 *	PROCESS FOR OBTAINING PRECIPITATED CALCIUM CARBONATE
<b>C07D 249/14</b> (2006.01)	2582683 *	TREATMENT OF GOUT AND HYPERURICEMIA
<b>A61P 3/00</b> (2006.01)	2563380 *	INNOVATIVE DISCOVERY OF THERAPEUTIC, DIAGNOSTIC, AND ANTIBODY COMPOSITIONS RELATED TO PROTEIN FRAGMENTS OF CYSTEINYL-TRNA SYNTHETASE
<b>A61K 39/395</b> (2006.01)	2563380 *	INNOVATIVE DISCOVERY OF THERAPEUTIC, DIAGNOSTIC, AND ANTIBODY COMPOSITIONS RELATED TO PROTEIN FRAGMENTS OF CYSTEINYL-TRNA SYNTHETASE
<b>A61P 29/00</b> (2006.01)	2563380 *	INNOVATIVE DISCOVERY OF THERAPEUTIC, DIAGNOSTIC, AND ANTIBODY COMPOSITIONS RELATED TO PROTEIN FRAGMENTS OF CYSTEINYL-TRNA SYNTHETASE
<b>A61P 35/00</b> (2006.01)	2563380 *	INNOVATIVE DISCOVERY OF THERAPEUTIC, DIAGNOSTIC, AND ANTIBODY COMPOSITIONS RELATED TO PROTEIN FRAGMENTS OF CYSTEINYL-TRNA SYNTHETASE
<b>A61K 38/16</b> (2006.01)	2563380 *	INNOVATIVE DISCOVERY OF THERAPEUTIC, DIAGNOSTIC, AND ANTIBODY COMPOSITIONS RELATED TO PROTEIN FRAGMENTS OF CYSTEINYL-TRNA SYNTHETASE
<b>A61K 38/17</b> (2006.01)	2563380 *	INNOVATIVE DISCOVERY OF THERAPEUTIC, DIAGNOSTIC, AND ANTIBODY COMPOSITIONS RELATED TO PROTEIN FRAGMENTS OF CYSTEINYL-TRNA SYNTHETASE
<b>A61K 9/20</b> (2006.01)	2568968 *	MANUFACTURING OF ACTIVE-FREE GRANULES AND TABLETS COMPRISING THE SAME
<b>A61K 39/395</b> (2006.01)	2547365 *	ANTI-NERVE GROWTH FACTOR (NGF) ANTIBODY COMPOSITIONS
<b>C07K 16/22</b> (2006.01)	2547365 *	ANTI-NERVE GROWTH FACTOR (NGF) ANTIBODY COMPOSITIONS
<b>C07K 16/18</b> (2006.01)	2547365 *	ANTI-NERVE GROWTH FACTOR (NGF) ANTIBODY COMPOSITIONS
<b>C07K 16/28</b> (2006.01)	2547365 *	ANTI-NERVE GROWTH FACTOR (NGF) ANTIBODY COMPOSITIONS
<b>C07K 14/00</b> (2006.01)	2566514 *	METHODS OF INHIBITING FIBROSIS USING ANTI-PAI-1 ANTIBODIES
<b>A61K 39/395</b> (2006.01)	2566514 *	METHODS OF INHIBITING FIBROSIS USING ANTI-PAI-1 ANTIBODIES
<b>A61M 5/32</b> (2006.01)	2588167 *	SAFETY DEVICE FOR A PRE-FILLED SYRINGE AND INJECTION DEVICE
<b>C01B 25/14</b> (2006.01)	2569263 *	A THIONATION PROCESS AND A THIONATING AGENT
<b>C07D 213/63</b> (2006.01)	2569263 *	A THIONATION PROCESS AND A THIONATING AGENT
<b>C07B 45/00</b> (2006.01)	2569263 *	A THIONATION PROCESS AND A THIONATING AGENT
<b>C07D 211/84</b> (2006.01)	2569263 *	A THIONATION PROCESS AND A THIONATING AGENT
<b>C07C 327/44</b> (2006.01)	2569263 *	A THIONATION PROCESS AND A THIONATING AGENT
<b>C07D 211/72</b> (2006.01)	2569263 *	A THIONATION PROCESS AND A THIONATING AGENT
<b>C07C 325/02</b> (2006.01)	2569263 *	A THIONATION PROCESS AND A THIONATING AGENT
<b>C07D 241/06</b> (2006.01)	2569263 *	A THIONATION PROCESS AND A THIONATING AGENT
<b>C07D 213/06</b> (2006.01)	2569263 *	A THIONATION PROCESS AND A THIONATING AGENT
<b>C07D 239/93</b> (2006.01)	2569263 *	A THIONATION PROCESS AND A THIONATING AGENT
<b>C07D 207/24</b> (2006.01)	2569263 *	A THIONATION PROCESS AND A THIONATING AGENT
<b>C07D 209/30</b> (2006.01)	2569263 *	A THIONATION PROCESS AND A THIONATING AGENT
<b>F25J 3/00</b> (2006.01)	2545334 *	PROCESS FOR DILUTE PHASE INJECTION OR DRY ALKALINE MATERIALS
<b>G01N 33/18</b> (2006.01)	2591357 *	LUNG CANCER BIOMARKERS AND USES THEREOF
<b>G01N 33/49</b> (2006.01)	2591357 *	LUNG CANCER BIOMARKERS AND USES THEREOF
<b>G01N 33/50</b> (2006.01)	2591357 *	LUNG CANCER BIOMARKERS AND USES THEREOF
<b>C22B 1/00</b> (2006.01)	2576850 *	METHOD FOR RECOVERING NOBLE METALS AND OTHER BYPRODUCTS FROM ORE
<b>C22B 11/00</b> (2006.01)	2576850 *	METHOD FOR RECOVERING NOBLE METALS AND OTHER BYPRODUCTS FROM ORE

MKP (51)	Broj objave evropske prijava patenta (97)	Naziv pronalaska (54)
<b>A61P 35/00</b> (2006.01)	2563368 *	PIPERAZINOTRIAZINES AS PI3K INHIBITORS FOR USE IN THE TREATMENT ANTIPROLIFERATIVE DISORDERS
<b>A61K 31/53</b> (2006.01)	2563368 *	PIPERAZINOTRIAZINES AS PI3K INHIBITORS FOR USE IN THE TREATMENT ANTIPROLIFERATIVE DISORDERS
<b>C07D 403/04</b> (2006.01)	2563368 *	PIPERAZINOTRIAZINES AS PI3K INHIBITORS FOR USE IN THE TREATMENT ANTIPROLIFERATIVE DISORDERS
<b>A23C 19/09</b> (2006.01)	2544549 *	A RETICULATE DAIRY BASED PRODUCT
<b>A23C 19/06</b> (2006.01)	2544549 *	A RETICULATE DAIRY BASED PRODUCT
<b>A23L 1/00</b> (2006.01)	2544549 *	A RETICULATE DAIRY BASED PRODUCT
<b>A23J 3/26</b> (2006.01)	2544549 *	A RETICULATE DAIRY BASED PRODUCT
<b>A61M 5/00</b> (2006.01)	2552511 *	ELECTRO-MECHANICAL DRUG DELIVERY DEVICE
<b>A61L 26/00</b> (2006.01)	2555804 *	HEMOSTATIC SPONGE
<b>A61L 15/42</b> (2006.01)	2555804 *	HEMOSTATIC SPONGE
<b>A61L 15/58</b> (2006.01)	2555804 *	HEMOSTATIC SPONGE
<b>A61L 24/04</b> (2006.01)	2555804 *	HEMOSTATIC SPONGE
<b>A61L 15/22</b> (2006.01)	2555804 *	HEMOSTATIC SPONGE
<b>A61L 24/00</b> (2006.01)	2555804 *	HEMOSTATIC SPONGE
<b>C07D 519/00</b> (2006.01)	2571883 *	MACROCYCLIC COMPOUNDS AS TRK KINASE INHIBITORS
<b>A61K 31/519</b> (2006.01)	2571883 *	MACROCYCLIC COMPOUNDS AS TRK KINASE INHIBITORS
<b>C07D 487/04</b> (2006.01)	2571883 *	MACROCYCLIC COMPOUNDS AS TRK KINASE INHIBITORS
<b>E04B 7/22</b> (2006.01)	2423402	Highly insulated prefabricated element
<b>E04C 2/288</b> (2006.01)	2423402	Highly insulated prefabricated element
<b>E04B 1/14</b> (2006.01)	2423402	Highly insulated prefabricated element
<b>E04B 1/80</b> (2006.01)	2423402	Highly insulated prefabricated element
<b>B65D 83/44</b> (2006.01)	2576423 *	METHOD AND APPARATUS FOR DISPENSING BEVERAGES, ESPECIALLY CARBONATED BEVERAGES
<b>B65D 83/16</b> (2006.01)	2576423 *	METHOD AND APPARATUS FOR DISPENSING BEVERAGES, ESPECIALLY CARBONATED BEVERAGES
<b>B67D 1/12</b> (2006.01)	2576423 *	METHOD AND APPARATUS FOR DISPENSING BEVERAGES, ESPECIALLY CARBONATED BEVERAGES
<b>B67D 1/08</b> (2006.01)	2576423 *	METHOD AND APPARATUS FOR DISPENSING BEVERAGES, ESPECIALLY CARBONATED BEVERAGES
<b>B65D 83/18</b> (2006.01)	2576423 *	METHOD AND APPARATUS FOR DISPENSING BEVERAGES, ESPECIALLY CARBONATED BEVERAGES
<b>G01F 11/08</b> (2006.01)	2576423 *	METHOD AND APPARATUS FOR DISPENSING BEVERAGES, ESPECIALLY CARBONATED BEVERAGES
<b>B67D 1/04</b> (2006.01)	2576423 *	METHOD AND APPARATUS FOR DISPENSING BEVERAGES, ESPECIALLY CARBONATED BEVERAGES
<b>B65D 83/14</b> (2006.01)	2576423 *	METHOD AND APPARATUS FOR DISPENSING BEVERAGES, ESPECIALLY CARBONATED BEVERAGES
<b>B65D 83/60</b> (2006.01)	2576423 *	METHOD AND APPARATUS FOR DISPENSING BEVERAGES, ESPECIALLY CARBONATED BEVERAGES
<b>B67D 1/02</b> (2006.01)	2576423 *	METHOD AND APPARATUS FOR DISPENSING BEVERAGES, ESPECIALLY CARBONATED BEVERAGES
<b>A61B 17/3205</b> (2006.01)	2582309 *	SURGICAL INSTRUMENT
<b>E06B 3/58</b> (2006.01)	2460970	A sectional door panel comprising a window assembly and a method of assembling said panel
<b>E06B 3/54</b> (2006.01)	2460970	A sectional door panel comprising a window assembly and a method of assembling said panel
<b>E06B 3/56</b> (2006.01)	2460970	A sectional door panel comprising a window assembly and a method of assembling said panel
<b>E06B 3/64</b> (2006.01)	2460970	A sectional door panel comprising a window assembly and a method of assembling said panel

MKP (51)	Broj objave evropske prijava patenta (97)	Naziv pronalaska (54)
<b>E06B 3/48</b> (2006.01)	2460970	A sectional door panel comprising a window assembly and a method of assembling said panel
<b>G07C 9/00</b> (2006.01)	2469478	Access control in location tracking system
<b>C07D 401/14</b> (2006.01)	2569304 *	SUBSTITUTED N-HETEROARYL SPIROLACTAM BIPYRROLIDINES, PREPARATION AND THERAPEUTIC USE THEREOF
<b>A61P 25/28</b> (2006.01)	2569304 *	SUBSTITUTED N-HETEROARYL SPIROLACTAM BIPYRROLIDINES, PREPARATION AND THERAPEUTIC USE THEREOF
<b>A61P 25/24</b> (2006.01)	2569304 *	SUBSTITUTED N-HETEROARYL SPIROLACTAM BIPYRROLIDINES, PREPARATION AND THERAPEUTIC USE THEREOF
<b>A61K 31/407</b> (2006.01)	2569304 *	SUBSTITUTED N-HETEROARYL SPIROLACTAM BIPYRROLIDINES, PREPARATION AND THERAPEUTIC USE THEREOF
<b>A61P 25/18</b> (2006.01)	2569304 *	SUBSTITUTED N-HETEROARYL SPIROLACTAM BIPYRROLIDINES, PREPARATION AND THERAPEUTIC USE THEREOF
<b>C07D 491/107</b> (2006.01)	2569304 *	SUBSTITUTED N-HETEROARYL SPIROLACTAM BIPYRROLIDINES, PREPARATION AND THERAPEUTIC USE THEREOF
<b>C07D 471/10</b> (2006.01)	2569304 *	SUBSTITUTED N-HETEROARYL SPIROLACTAM BIPYRROLIDINES, PREPARATION AND THERAPEUTIC USE THEREOF
<b>A61P 25/16</b> (2006.01)	2569304 *	SUBSTITUTED N-HETEROARYL SPIROLACTAM BIPYRROLIDINES, PREPARATION AND THERAPEUTIC USE THEREOF
<b>A61K 31/438</b> (2006.01)	2569304 *	SUBSTITUTED N-HETEROARYL SPIROLACTAM BIPYRROLIDINES, PREPARATION AND THERAPEUTIC USE THEREOF
<b>A61K 31/4439</b> (2006.01)	2569304 *	SUBSTITUTED N-HETEROARYL SPIROLACTAM BIPYRROLIDINES, PREPARATION AND THERAPEUTIC USE THEREOF
<b>A61M 5/24</b> (2006.01)	2571553 *	NEEDLE ASSEMBLY FOR DRUG DELIVERY DEVICES
<b>A61M 5/34</b> (2006.01)	2571553 *	NEEDLE ASSEMBLY FOR DRUG DELIVERY DEVICES
<b>G01F 23/00</b> (2006.01)	2539673 *	DEVICE FOR MEASURING LIQUID FILLING LEVELS
<b>A61K 31/616</b> (2006.01)	2566472 *	A PHARMACEUTICAL COMPOSITION COMPRISING ASPIRIN AND BISOPROLOL
<b>A61K 9/50</b> (2006.01)	2566472 *	A PHARMACEUTICAL COMPOSITION COMPRISING ASPIRIN AND BISOPROLOL
<b>A61K 9/16</b> (2006.01)	2566472 *	A PHARMACEUTICAL COMPOSITION COMPRISING ASPIRIN AND BISOPROLOL
<b>A61K 9/52</b> (2006.01)	2566472 *	A PHARMACEUTICAL COMPOSITION COMPRISING ASPIRIN AND BISOPROLOL
<b>A61K 9/20</b> (2006.01)	2566472 *	A PHARMACEUTICAL COMPOSITION COMPRISING ASPIRIN AND BISOPROLOL
<b>A61K 31/138</b> (2006.01)	2566472 *	A PHARMACEUTICAL COMPOSITION COMPRISING ASPIRIN AND BISOPROLOL
<b>G06F 17/30</b> (2006.01)	2498191	Feature conversion device, similar information search apparatus provided therewith, coding parameter generation method, and computer program
<b>A01N 47/36</b> (2006.01)	2579720 *	HERBICIDAL COMPOSITION
<b>A01N 47/30</b> (2006.01)	2579720 *	HERBICIDAL COMPOSITION
<b>A61F 2/04</b> (2013.01)	2584999 *	ORTHOTOPIC ARTIFICIAL BLADDER PROSTHESIS
<b>C07D 401/06</b> (2006.01)	2566849 *	8-HYDROXY-QUINOLINE DERIVATIVES
<b>C07D 401/12</b> (2006.01)	2566849 *	8-HYDROXY-QUINOLINE DERIVATIVES
<b>A61P 9/10</b> (2006.01)	2566849 *	8-HYDROXY-QUINOLINE DERIVATIVES
<b>C07D 413/12</b> (2006.01)	2566849 *	8-HYDROXY-QUINOLINE DERIVATIVES
<b>A61K 31/4709</b> (2006.01)	2566849 *	8-HYDROXY-QUINOLINE DERIVATIVES
<b>A61K 31/47</b> (2006.01)	2566849 *	8-HYDROXY-QUINOLINE DERIVATIVES
<b>C07D 215/26</b> (2006.01)	2566849 *	8-HYDROXY-QUINOLINE DERIVATIVES
<b>A61P 25/28</b> (2006.01)	2566849 *	8-HYDROXY-QUINOLINE DERIVATIVES
<b>C07D 401/14</b> (2006.01)	2566849 *	8-HYDROXY-QUINOLINE DERIVATIVES
<b>H01F 41/14</b> (2006.01)	2577686 *	MAGNETIC NANOCCLUSERS
<b>H01F 10/00</b> (2006.01)	2577686 *	MAGNETIC NANOCCLUSERS

MKP (51)	Broj objave evropske prijava patenta (97)	Naziv pronalaska (54)
<b>B60N 2/50</b> (2006.01)	2552744 *	LOAD RESPONSIVE SEAT/ BED
<b>F24J 1/00</b> (2006.01)	2564126 *	THERMAL SIGNALING OR MARKING DEVICE
<b>A61K 38/47</b> (2006.01)	2588132 *	METHODS AND COMPOSITIONS FOR CNS DELIVERY OF -GALACTOCEREBROSIDASE
<b>A61P 25/28</b> (2006.01)	2588132 *	METHODS AND COMPOSITIONS FOR CNS DELIVERY OF -GALACTOCEREBROSIDASE
<b>A61P 25/00</b> (2006.01)	2588132 *	METHODS AND COMPOSITIONS FOR CNS DELIVERY OF -GALACTOCEREBROSIDASE
<b>A61K 9/00</b> (2006.01)	2568960 *	LIQUID FORMULATION OF POLYPEPTIDES CONTAINING AN FC DOMAIN OF AN IMMUNOGLOBULIN
<b>C07K 16/30</b> (2006.01)	2552964 *	CROSS-SPECIES-SPECIFIC PSMAxCD3 BISPECIFIC SINGLE CHAIN ANTIBODY
<b>C07K 16/40</b> (2006.01)	2552964 *	CROSS-SPECIES-SPECIFIC PSMAxCD3 BISPECIFIC SINGLE CHAIN ANTIBODY
<b>A61K 39/395</b> (2006.01)	2552964 *	CROSS-SPECIES-SPECIFIC PSMAxCD3 BISPECIFIC SINGLE CHAIN ANTIBODY
<b>C07K 16/28</b> (2006.01)	2552964 *	CROSS-SPECIES-SPECIFIC PSMAxCD3 BISPECIFIC SINGLE CHAIN ANTIBODY
<b>A63F 3/06</b> (2006.01)	2569735 *	PAYMENT CARD COMPRISING AN ELECTRONIC GAME CHIP
<b>G07F 17/32</b> (2006.01)	2569735 *	PAYMENT CARD COMPRISING AN ELECTRONIC GAME CHIP
<b>G06K 19/07</b> (2006.01)	2569735 *	PAYMENT CARD COMPRISING AN ELECTRONIC GAME CHIP
<b>A61M 5/48</b> (2006.01)	2585134 *	AUTO-INJECTOR WITH INJECTION DAMPER
<b>A61M 5/32</b> (2006.01)	2585134 *	AUTO-INJECTOR WITH INJECTION DAMPER
<b>A61M 5/20</b> (2006.01)	2585134 *	AUTO-INJECTOR WITH INJECTION DAMPER
<b>A61M 5/315</b> (2006.01)	2585134 *	AUTO-INJECTOR WITH INJECTION DAMPER
<b>A61K 31/704</b> (2006.01)	2558477 *	ANALOGUES OF ETOPOSIDE FOR THE TREATMENT OF TUMOURS
<b>C07H 17/04</b> (2006.01)	2558477 *	ANALOGUES OF ETOPOSIDE FOR THE TREATMENT OF TUMOURS
<b>A01N 43/90</b> (2006.01)	2578084 *	NOXIOUS ORGANISM CONTROL AGENT
<b>C07D 491/052</b> (2006.01)	2578084 *	NOXIOUS ORGANISM CONTROL AGENT
<b>C07D 493/04</b> (2006.01)	2578084 *	NOXIOUS ORGANISM CONTROL AGENT
<b>A01P 7/04</b> (2006.01)	2578084 *	NOXIOUS ORGANISM CONTROL AGENT
<b>A01N 47/18</b> (2006.01)	2578084 *	NOXIOUS ORGANISM CONTROL AGENT
<b>A01N 55/00</b> (2006.01)	2578084 *	NOXIOUS ORGANISM CONTROL AGENT
<b>C07F 7/18</b> (2006.01)	2578084 *	NOXIOUS ORGANISM CONTROL AGENT
<b>A61B 5/151</b> (2006.01)	2590565 *	BLOOD SAMPLE COLLECTION
<b>C12P 1/02</b> (2006.01)	2571995 *	SYSTEM AND METHOD OF PRODUCING VOLATILE ORGANIC COMPOUNDS FROM FUNGI
<b>C12P 7/00</b> (2006.01)	2571995 *	SYSTEM AND METHOD OF PRODUCING VOLATILE ORGANIC COMPOUNDS FROM FUNGI
<b>G06F 7/70</b> (2006.01)	2553568 *	SYSTEMS AND METHODS FOR AIRCRAFT FLIGHT TRACKING AND ANALYSIS
<b>A61K 39/395</b> (2006.01)	2563393 *	SPARC BINDING ANTIBODIES AND USES THEREOF
<b>A01N 43/90</b> (2006.01)	2575473 *	SOLUBLE GUANYLATE CYCLASE ACTIVATORS
<b>A61K 31/519</b> (2006.01)	2575473 *	SOLUBLE GUANYLATE CYCLASE ACTIVATORS
<b>A61K 31/437</b> (2006.01)	2582699 *	SUBSTITUTED TRIAZOLOPYRIDINES
<b>A61P 35/00</b> (2006.01)	2582699 *	SUBSTITUTED TRIAZOLOPYRIDINES
<b>C07D 519/00</b> (2006.01)	2582699 *	SUBSTITUTED TRIAZOLOPYRIDINES
<b>C07D 471/04</b> (2006.01)	2582699 *	SUBSTITUTED TRIAZOLOPYRIDINES
<b>A47L 7/04</b> (2006.01)	2592986 *	A DISCHARGE VALVE FOR VACUUM CLEANERS
<b>A47L 5/14</b> (2006.01)	2592986 *	A DISCHARGE VALVE FOR VACUUM CLEANERS
<b>B65D 21/06</b> (2006.01)	2520505	Material handling device lid
<b>B65D 43/02</b> (2006.01)	2520505	Material handling device lid

MKP (51)	Broj objave evropske prijava patenta (97)	Naziv pronalaska (54)
<b>A01N 47/28</b> (2006.01)	2542086 *	COMPOUNDS AND THERAPEUTIC USES THEREOF
<b>G10L 19/00</b> (2006.01)	2355556	User interface apparatus
<b>H04S 7/00</b> (2006.01)	2355556	User interface apparatus
<b>H04S 5/02</b> (2006.01)	2355556	User interface apparatus
<b>A61B 19/08</b> (2006.01)	2579799 *	INTERVENTIONAL DRAPE COMPRISING A PATIENT INTERVENTIONAL DRAPE AND A BARRIER DRAPE
<b>C07K 14/705</b> (2006.01)	2585480 *	ANTICANCER FUSION PROTEIN
<b>C07K 14/435</b> (2006.01)	2585480 *	ANTICANCER FUSION PROTEIN
<b>A61K 45/06</b> (2006.01)	2590654 *	COMBINATIONS OF KINASE INHIBITORS FOR THE TREATMENT OF CANCER
<b>A61K 39/395</b> (2006.01)	2590654 *	COMBINATIONS OF KINASE INHIBITORS FOR THE TREATMENT OF CANCER
<b>A61P 35/00</b> (2006.01)	2590654 *	COMBINATIONS OF KINASE INHIBITORS FOR THE TREATMENT OF CANCER
<b>A61K 31/63</b> (2006.01)	2590654 *	COMBINATIONS OF KINASE INHIBITORS FOR THE TREATMENT OF CANCER
<b>A61K 31/498</b> (2006.01)	2590654 *	COMBINATIONS OF KINASE INHIBITORS FOR THE TREATMENT OF CANCER
<b>A61K 31/517</b> (2006.01)	2590654 *	COMBINATIONS OF KINASE INHIBITORS FOR THE TREATMENT OF CANCER
<b>A61K 31/7088</b> (2006.01)	2590654 *	COMBINATIONS OF KINASE INHIBITORS FOR THE TREATMENT OF CANCER
<b>H04L 12/64</b> (2006.01)	2591579 *	METHOD OF SELF-CONFIGURATION OF A DOMESTIC GATEWAY IN THE PRESENCE OF VARIOUS EXTERNAL NETWORKS, AND GATEWAY IMPLEMENTING SUCH A METHOD
<b>H04L 12/28</b> (2006.01)	2591579 *	METHOD OF SELF-CONFIGURATION OF A DOMESTIC GATEWAY IN THE PRESENCE OF VARIOUS EXTERNAL NETWORKS, AND GATEWAY IMPLEMENTING SUCH A METHOD
<b>F27D 99/00</b> (2010.01)	2547974 *	KILN FOR THE PRODUCTION OF CALCIUM OXIDE
<b>F27B 1/10</b> (2006.01)	2547974 *	KILN FOR THE PRODUCTION OF CALCIUM OXIDE
<b>F27B 1/00</b> (2006.01)	2547974 *	KILN FOR THE PRODUCTION OF CALCIUM OXIDE
<b>F27B 1/08</b> (2006.01)	2547974 *	KILN FOR THE PRODUCTION OF CALCIUM OXIDE
<b>C04B 2/12</b> (2006.01)	2547974 *	KILN FOR THE PRODUCTION OF CALCIUM OXIDE
<b>C07K 14/62</b> (2006.01)	2552471 *	NOVEL PEPTIDES AND METHODS FOR THEIR PREPARATION AND USE
<b>A61K 38/26</b> (2006.01)	2552471 *	NOVEL PEPTIDES AND METHODS FOR THEIR PREPARATION AND USE
<b>A61K 38/16</b> (2006.01)	2552471 *	NOVEL PEPTIDES AND METHODS FOR THEIR PREPARATION AND USE
<b>C07K 14/47</b> (2006.01)	2552471 *	NOVEL PEPTIDES AND METHODS FOR THEIR PREPARATION AND USE
<b>C07K 14/605</b> (2006.01)	2552471 *	NOVEL PEPTIDES AND METHODS FOR THEIR PREPARATION AND USE
<b>A61K 38/30</b> (2006.01)	2552471 *	NOVEL PEPTIDES AND METHODS FOR THEIR PREPARATION AND USE
<b>C07K 14/78</b> (2006.01)	2563809 *	STABLE AQUEOUS MIA/CD-RAP FORMULATIONS
<b>A61K 9/00</b> (2006.01)	2563809 *	STABLE AQUEOUS MIA/CD-RAP FORMULATIONS
<b>A61K 38/18</b> (2006.01)	2563809 *	STABLE AQUEOUS MIA/CD-RAP FORMULATIONS
<b>A61K 47/22</b> (2006.01)	2563809 *	STABLE AQUEOUS MIA/CD-RAP FORMULATIONS
<b>C07K 14/47</b> (2006.01)	2563809 *	STABLE AQUEOUS MIA/CD-RAP FORMULATIONS
<b>A61L 27/38</b> (2006.01)	2544726 *	CELL-SCAFFOLD CONSTRUCTS
<b>A61M 5/315</b> (2006.01)	2549915 *	DEVICE AND METHOD FOR DETERMINING INFORMATION RELATED TO A MEDICAL DEVICE
<b>A61B 5/00</b> (2006.01)	2549915 *	DEVICE AND METHOD FOR DETERMINING INFORMATION RELATED TO A MEDICAL DEVICE
<b>C02F 1/50</b> (2006.01)	2594532	Method and arrangement for hygienisation of water in a swimming pool system or swimming or bathing area
<b>B05C 11/115</b> (2006.01)	2563524 *	APPARATUS FOR MIXING AND DISPENSING MULTIPLE FLOWABLE COMPONENTS

MKP (51)	Broj objave evropske prijava patenta (97)	Naziv pronalaska (54)
<b>B05C 9/10</b> (2006.01)	2563524 *	APPARATUS FOR MIXING AND DISPENSING MULTIPLE FLOWABLE COMPONENTS
<b>B01F 5/04</b> (2006.01)	2563524 *	APPARATUS FOR MIXING AND DISPENSING MULTIPLE FLOWABLE COMPONENTS
<b>B01F 15/02</b> (2006.01)	2563524 *	APPARATUS FOR MIXING AND DISPENSING MULTIPLE FLOWABLE COMPONENTS
<b>A23J 1/14</b> (2006.01)	2566346 *	PRODUCTION OF SOLUBLE PROTEIN SOLUTIONS FROM PULSES
<b>A23J 3/14</b> (2006.01)	2566346 *	PRODUCTION OF SOLUBLE PROTEIN SOLUTIONS FROM PULSES
<b>A23L 1/305</b> (2006.01)	2566346 *	PRODUCTION OF SOLUBLE PROTEIN SOLUTIONS FROM PULSES
<b>A23L 2/66</b> (2006.01)	2566346 *	PRODUCTION OF SOLUBLE PROTEIN SOLUTIONS FROM PULSES
<b>A23J 3/16</b> (2006.01)	2566346 *	PRODUCTION OF SOLUBLE PROTEIN SOLUTIONS FROM PULSES
<b>H04B 7/00</b> (2006.01)	2564514 *	SYSTEM AND METHOD FOR CONTROLLING WLAN AND BLUETOOTH COMMUNICATIONS
<b>G10D 3/18</b> (2006.01)	2593935 *	ERGONOMIC CHINREST FOR VIOLINS/VIOLAS USING A NEW METHOD OF ATTACHMENT ONTO THE BODY OF AN INSTRUMENT AS WELL AS THE METHOD OF PRODUCING THE ERGONOMIC SURFACE OF THE CHINREST
<b>A61M 5/24</b> (2006.01)	2550043 *	MEDICATED MODULE WITH USER SELECTION
<b>A61M 5/28</b> (2006.01)	2550043 *	MEDICATED MODULE WITH USER SELECTION
<b>A61M 5/32</b> (2006.01)	2550043 *	MEDICATED MODULE WITH USER SELECTION
<b>G06F 17/30</b> (2006.01)	2550607 *	CLOUD-BASED WEB CONTENT FILTERING
<b>A61K 47/26</b> (2006.01)	2552482 *	STABILIZED ANTIBODY PREPARATIONS AND USES THEREOF
<b>A61K 39/395</b> (2006.01)	2552482 *	STABILIZED ANTIBODY PREPARATIONS AND USES THEREOF
<b>A61K 39/395</b> (2006.01)	2552961 *	HUMANIZED IL-25 ANTIBODIES
<b>C07K 16/24</b> (2006.01)	2552961 *	HUMANIZED IL-25 ANTIBODIES
<b>A61K 31/165</b> (2006.01)	2563355 *	PROCESS FOR THE PRODUCTION OF RALFINAMIDE METHANESULFONATE SALTS OR THEIR R-ENANTIOMERS
<b>C07C 231/24</b> (2006.01)	2563355 *	PROCESS FOR THE PRODUCTION OF RALFINAMIDE METHANESULFONATE SALTS OR THEIR R-ENANTIOMERS
<b>C07C 237/06</b> (2006.01)	2563355 *	PROCESS FOR THE PRODUCTION OF RALFINAMIDE METHANESULFONATE SALTS OR THEIR R-ENANTIOMERS
<b>C07C 309/04</b> (2006.01)	2563355 *	PROCESS FOR THE PRODUCTION OF RALFINAMIDE METHANESULFONATE SALTS OR THEIR R-ENANTIOMERS
<b>C07H 19/16</b> (2006.01)	2569325 *	METHOD OF REDUCING INTRAOCULAR PRESSURE IN HUMANS USING N6 - CYCLOPENTYLADENOSINE (CPA), CPA DERIVATIVES OR PRODRUGS THEREOF
<b>A61K 31/7076</b> (2006.01)	2569325 *	METHOD OF REDUCING INTRAOCULAR PRESSURE IN HUMANS USING N6 - CYCLOPENTYLADENOSINE (CPA), CPA DERIVATIVES OR PRODRUGS THEREOF
<b>C07H 19/167</b> (2006.01)	2569325 *	METHOD OF REDUCING INTRAOCULAR PRESSURE IN HUMANS USING N6 - CYCLOPENTYLADENOSINE (CPA), CPA DERIVATIVES OR PRODRUGS THEREOF
<b>A61P 27/02</b> (2006.01)	2569325 *	METHOD OF REDUCING INTRAOCULAR PRESSURE IN HUMANS USING N6 - CYCLOPENTYLADENOSINE (CPA), CPA DERIVATIVES OR PRODRUGS THEREOF
<b>C07H 19/00</b> (2006.01)	2569325 *	METHOD OF REDUCING INTRAOCULAR PRESSURE IN HUMANS USING N6 - CYCLOPENTYLADENOSINE (CPA), CPA DERIVATIVES OR PRODRUGS THEREOF
<b>E06B 3/273</b> (2006.01)	2476853	Connecting section for windows, doors and façades as well as method for producing the same
<b>E06B 3/263</b> (2006.01)	2476853	Connecting section for windows, doors and façades as well as method for producing the same
<b>C07D 413/14</b> (2006.01)	2569305 *	SUBSTITUTED N-HETEROARYL TETRAHYDRO-ISOQUINOLINE DERIVATIVES, PREPARATION AND THERAPEUTIC USE THEREOF
<b>C07D 403/14</b> (2006.01)	2569305 *	SUBSTITUTED N-HETEROARYL TETRAHYDRO-ISOQUINOLINE DERIVATIVES, PREPARATION AND THERAPEUTIC USE THEREOF
<b>C07D 401/14</b> (2006.01)	2569305 *	SUBSTITUTED N-HETEROARYL TETRAHYDRO-ISOQUINOLINE DERIVATIVES, PREPARATION AND THERAPEUTIC USE THEREOF



MKP (51)	Broj objave evropske prijava patenta (97)	Naziv pronalaska (54)
<b>A61K 31/4709</b> (2006.01)	2569305 *	SUBSTITUTED N-HETEROARYL TETRAHYDRO-ISOQUINOLINE DERIVATIVES, PREPARATION AND THERAPEUTIC USE THEREOF
<b>A61P 25/00</b> (2006.01)	2569305 *	SUBSTITUTED N-HETEROARYL TETRAHYDRO-ISOQUINOLINE DERIVATIVES, PREPARATION AND THERAPEUTIC USE THEREOF
<b>C07K 16/20</b> (2006.01)	2576614 *	CLASS I MHC PHOSPHOPEPTIDES FOR CANCER IMMUNOTHERAPY AND DIAGNOSIS
<b>A61K 38/17</b> (2006.01)	2576614 *	CLASS I MHC PHOSPHOPEPTIDES FOR CANCER IMMUNOTHERAPY AND DIAGNOSIS
<b>C07K 14/74</b> (2006.01)	2576614 *	CLASS I MHC PHOSPHOPEPTIDES FOR CANCER IMMUNOTHERAPY AND DIAGNOSIS
<b>A61P 35/00</b> (2006.01)	2576614 *	CLASS I MHC PHOSPHOPEPTIDES FOR CANCER IMMUNOTHERAPY AND DIAGNOSIS
<b>A61K 39/395</b> (2006.01)	2576614 *	CLASS I MHC PHOSPHOPEPTIDES FOR CANCER IMMUNOTHERAPY AND DIAGNOSIS
<b>G01N 33/68</b> (2006.01)	2576614 *	CLASS I MHC PHOSPHOPEPTIDES FOR CANCER IMMUNOTHERAPY AND DIAGNOSIS
<b>C07K 7/00</b> (2006.01)	2576614 *	CLASS I MHC PHOSPHOPEPTIDES FOR CANCER IMMUNOTHERAPY AND DIAGNOSIS
<b>B01J 20/32</b> (2006.01)	2589430	Surface-treated calcium carbonate and its use in water purification and for the dewatering of sludges and sediments
<b>C02F 1/56</b> (2006.01)	2589430	Surface-treated calcium carbonate and its use in water purification and for the dewatering of sludges and sediments
<b>C02F 103/28</b> (2006.01)	2589430	Surface-treated calcium carbonate and its use in water purification and for the dewatering of sludges and sediments
<b>B01J 20/04</b> (2006.01)	2589430	Surface-treated calcium carbonate and its use in water purification and for the dewatering of sludges and sediments
<b>C02F 1/28</b> (2006.01)	2589430	Surface-treated calcium carbonate and its use in water purification and for the dewatering of sludges and sediments
<b>C02F 11/14</b> (2006.01)	2589430	Surface-treated calcium carbonate and its use in water purification and for the dewatering of sludges and sediments
<b>C02F 1/66</b> (2006.01)	2589430	Surface-treated calcium carbonate and its use in water purification and for the dewatering of sludges and sediments
<b>C07D 401/14</b> (2006.01)	2588472 *	RUPATADINE SALT AS AN ANTIHISTAMINIC AGENT
<b>G01B 9/02</b> (2006.01)	2564153 *	OPTICAL DEVICE AND METHOD FOR INSPECTING STRUCTURED OBJECTS
<b>G02B 21/00</b> (2006.01)	2564153 *	OPTICAL DEVICE AND METHOD FOR INSPECTING STRUCTURED OBJECTS
<b>A61K 9/20</b> (2006.01)	2568965 *	COMBINATION OF ACTIVE LOADED GRANULES WITH ADDITIONAL ACTIVES
<b>A61K 9/16</b> (2006.01)	2568965 *	COMBINATION OF ACTIVE LOADED GRANULES WITH ADDITIONAL ACTIVES
<b>A61K 31/425</b> (2006.01)	2544542 *	ANALGESIC COMPOUNDS, COMPOSITIONS, AND USES THEREOF
<b>A01N 43/78</b> (2006.01)	2544542 *	ANALGESIC COMPOUNDS, COMPOSITIONS, AND USES THEREOF
<b>A61K 9/16</b> (2006.01)	2471386	Cetyl myristate and/or cetyl palmitate suspension formulations
<b>A23L 1/30</b> (2006.01)	2471386	Cetyl myristate and/or cetyl palmitate suspension formulations
<b>A61K 9/20</b> (2006.01)	2471386	Cetyl myristate and/or cetyl palmitate suspension formulations
<b>A61K 9/48</b> (2006.01)	2471386	Cetyl myristate and/or cetyl palmitate suspension formulations
<b>A61K 31/23</b> (2006.01)	2471386	Cetyl myristate and/or cetyl palmitate suspension formulations
<b>A61K 9/00</b> (2006.01)	2471386	Cetyl myristate and/or cetyl palmitate suspension formulations
<b>A61K 9/00</b> (2006.01)	2552448 *	IMPROVED METHODS AND COMPOSITIONS FOR SAFE AND EFFECTIVE TREATMENT OF TELANGIECTASIA
<b>A61K 31/498</b> (2006.01)	2552448 *	IMPROVED METHODS AND COMPOSITIONS FOR SAFE AND EFFECTIVE TREATMENT OF TELANGIECTASIA
<b>A61P 17/00</b> (2006.01)	2552448 *	IMPROVED METHODS AND COMPOSITIONS FOR SAFE AND EFFECTIVE TREATMENT OF TELANGIECTASIA

MKP (51)	Broj objave evropske prijava patenta (97)	Naziv pronalaska (54)
<b>A61K 9/06</b> (2006.01)	2552448 *	IMPROVED METHODS AND COMPOSITIONS FOR SAFE AND EFFECTIVE TREATMENT OF TELANGIECTASIA
<b>B01J 37/02</b> (2006.01)	2576048 *	GRAPHENE OXIDE AND GRAPHITE OXIDE CATALYSTS AND SYSTEMS
<b>B01J 19/24</b> (2006.01)	2576048 *	GRAPHENE OXIDE AND GRAPHITE OXIDE CATALYSTS AND SYSTEMS
<b>B01J 8/18</b> (2006.01)	2576048 *	GRAPHENE OXIDE AND GRAPHITE OXIDE CATALYSTS AND SYSTEMS
<b>B01J 21/18</b> (2006.01)	2576048 *	GRAPHENE OXIDE AND GRAPHITE OXIDE CATALYSTS AND SYSTEMS
<b>C03C 23/00</b> (2006.01)	2547631 *	CURING COATINGS ON GLASS CONTAINERS
<b>C03C 17/00</b> (2006.01)	2547631 *	CURING COATINGS ON GLASS CONTAINERS
<b>E02D 31/02</b> (2006.01)	2354326	Anti-flooding device
<b>E02B 3/10</b> (2006.01)	2354326	Anti-flooding device
<b>H01J 37/32</b> (2006.01)	2518763	A grounding assembly for vacuum processing apparatus
<b>H01L 21/677</b> (2006.01)	2518763	A grounding assembly for vacuum processing apparatus
<b>H01L 21/687</b> (2006.01)	2518763	A grounding assembly for vacuum processing apparatus
<b>H01L 21/67</b> (2006.01)	2518763	A grounding assembly for vacuum processing apparatus
<b>C23C 16/509</b> (2006.01)	2518763	A grounding assembly for vacuum processing apparatus
<b>C23C 16/458</b> (2006.01)	2518763	A grounding assembly for vacuum processing apparatus
<b>C08G 63/08</b> (2006.01)	2585091 *	SUSTAINED-RELEASE FORMULATION
<b>A61K 9/52</b> (2006.01)	2585091 *	SUSTAINED-RELEASE FORMULATION
<b>A61K 47/34</b> (2006.01)	2585091 *	SUSTAINED-RELEASE FORMULATION
<b>A61P 35/00</b> (2006.01)	2585091 *	SUSTAINED-RELEASE FORMULATION
<b>A61K 38/08</b> (2006.01)	2585091 *	SUSTAINED-RELEASE FORMULATION
<b>B03C 7/12</b> (2006.01)	2576071 *	A METHOD AND A DEVICE FOR SEPARATING PARTICLES OF A DETERMINED SYNTHETIC MATERIAL FROM PARTICLES OF DIFFERENT SYNTHETIC MATERIALS
<b>B03C 7/00</b> (2006.01)	2576071 *	A METHOD AND A DEVICE FOR SEPARATING PARTICLES OF A DETERMINED SYNTHETIC MATERIAL FROM PARTICLES OF DIFFERENT SYNTHETIC MATERIALS
<b>B67D 3/00</b> (2006.01)	2542498 *	SAFETY CAN
<b>C07D 487/04</b> (2006.01)	2576560 *	SUBSTITUTED IMIDAZOPYRAZINES
<b>A61K 31/4985</b> (2006.01)	2576560 *	SUBSTITUTED IMIDAZOPYRAZINES
<b>G01N 33/574</b> (2006.01)	2558864 *	FOX03A AS PREDICTIVE BIOMARKER FOR PI3K/AKT KINASE PATHWAY INHIBITOR EFFICACY
<b>C07K 14/415</b> (2006.01)	2590996 *	GLUCOSINOLATE TRANSPORTER PROTEIN AND USES THEREOF
<b>C12N 15/82</b> (2006.01)	2590996 *	GLUCOSINOLATE TRANSPORTER PROTEIN AND USES THEREOF
<b>A61K 31/7042</b> (2006.01)	2568988 *	PHARMACEUTICAL FORMULATIONS COMPRISING 1 - (BETA-D-GLUCOPYRANOSYL) - 2 -THIENYLMETHYLBENZENE DERIVATIVES AS INHIBITORS OF SGLT
<b>A61K 9/20</b> (2006.01)	2568988 *	PHARMACEUTICAL FORMULATIONS COMPRISING 1 - (BETA-D-GLUCOPYRANOSYL) - 2 -THIENYLMETHYLBENZENE DERIVATIVES AS INHIBITORS OF SGLT
<b>A61P 3/10</b> (2006.01)	2568988 *	PHARMACEUTICAL FORMULATIONS COMPRISING 1 - (BETA-D-GLUCOPYRANOSYL) - 2 -THIENYLMETHYLBENZENE DERIVATIVES AS INHIBITORS OF SGLT
<b>A61K 9/22</b> (2006.01)	2564838 *	ENTERIC TABLET
<b>A61P 25/24</b> (2006.01)	2564838 *	ENTERIC TABLET
<b>A61K 47/02</b> (2006.01)	2564838 *	ENTERIC TABLET
<b>A61K 47/32</b> (2006.01)	2564838 *	ENTERIC TABLET
<b>A61K 31/495</b> (2006.01)	2564838 *	ENTERIC TABLET
<b>A61K 47/34</b> (2006.01)	2564838 *	ENTERIC TABLET
<b>A61K 9/32</b> (2006.01)	2564838 *	ENTERIC TABLET
<b>A61K 31/74</b> (2006.01)	2566487 *	OPHTHALMIC COMPOSITION
<b>C07K 1/00</b> (2006.01)	2555801 *	SELECTION AND USE OF HOST CELLS FOR PRODUCTION OF GLYCOPROTEINS

MKP (51)	Broj objave evropske prijava patenta (97)	Naziv pronalaska (54)
<b>A61K 45/00</b> (2006.01)	2555801 *	SELECTION AND USE OF HOST CELLS FOR PRODUCTION OF GLYCOPROTEINS
<b>A61G 7/057</b> (2006.01)	2474292	Apparatus with inflatable mattress
<b>B65D 1/04</b> (2006.01)	2576361 *	DISPENSING UNIT AND METHOD FOR DISPENSING A LIQUID UNDER PRESSURE
<b>B65D 3/04</b> (2006.01)	2576361 *	DISPENSING UNIT AND METHOD FOR DISPENSING A LIQUID UNDER PRESSURE
<b>F04D 13/00</b> (2006.01)	2576361 *	DISPENSING UNIT AND METHOD FOR DISPENSING A LIQUID UNDER PRESSURE
<b>C12Q 1/42</b> (2006.01)	2553117 *	METHODS FOR DETECTING RAMAN SCATTERING USING AROMATIC COMPOUNDS COMPRISING PHOSPHATE AND AT LEAST ONE NON-LASER LIGHT SOURCE
<b>G01N 33/569</b> (2006.01)	2553117 *	METHODS FOR DETECTING RAMAN SCATTERING USING AROMATIC COMPOUNDS COMPRISING PHOSPHATE AND AT LEAST ONE NON-LASER LIGHT SOURCE
<b>C12Q 1/28</b> (2006.01)	2553117 *	METHODS FOR DETECTING RAMAN SCATTERING USING AROMATIC COMPOUNDS COMPRISING PHOSPHATE AND AT LEAST ONE NON-LASER LIGHT SOURCE
<b>C07D 265/30</b> (2006.01)	2580201 *	TRANSITION METAL-CATALYZED PROCESSES FOR THE PREPARATION OF N-ALLYL COMPOUNDS AND USE THEREOF
<b>A61K 31/426</b> (2006.01)	2590930 *	SPIROCYCLICALLY SUBSTITUTED 1,3-PROPANE DIOXIDE DERIVATIVES, METHODS FOR THE PRODUCTION THEREOF AND USE OF THE SAME AS MEDICAMENT
<b>A61K 31/421</b> (2006.01)	2590930 *	SPIROCYCLICALLY SUBSTITUTED 1,3-PROPANE DIOXIDE DERIVATIVES, METHODS FOR THE PRODUCTION THEREOF AND USE OF THE SAME AS MEDICAMENT
<b>C07D 213/65</b> (2006.01)	2590930 *	SPIROCYCLICALLY SUBSTITUTED 1,3-PROPANE DIOXIDE DERIVATIVES, METHODS FOR THE PRODUCTION THEREOF AND USE OF THE SAME AS MEDICAMENT
<b>C07D 305/06</b> (2006.01)	2590930 *	SPIROCYCLICALLY SUBSTITUTED 1,3-PROPANE DIOXIDE DERIVATIVES, METHODS FOR THE PRODUCTION THEREOF AND USE OF THE SAME AS MEDICAMENT
<b>C07D 213/64</b> (2006.01)	2590930 *	SPIROCYCLICALLY SUBSTITUTED 1,3-PROPANE DIOXIDE DERIVATIVES, METHODS FOR THE PRODUCTION THEREOF AND USE OF THE SAME AS MEDICAMENT
<b>A61K 31/192</b> (2006.01)	2590930 *	SPIROCYCLICALLY SUBSTITUTED 1,3-PROPANE DIOXIDE DERIVATIVES, METHODS FOR THE PRODUCTION THEREOF AND USE OF THE SAME AS MEDICAMENT
<b>C07C 255/54</b> (2006.01)	2590930 *	SPIROCYCLICALLY SUBSTITUTED 1,3-PROPANE DIOXIDE DERIVATIVES, METHODS FOR THE PRODUCTION THEREOF AND USE OF THE SAME AS MEDICAMENT
<b>A61K 31/381</b> (2006.01)	2590930 *	SPIROCYCLICALLY SUBSTITUTED 1,3-PROPANE DIOXIDE DERIVATIVES, METHODS FOR THE PRODUCTION THEREOF AND USE OF THE SAME AS MEDICAMENT
<b>C07C 59/72</b> (2006.01)	2590930 *	SPIROCYCLICALLY SUBSTITUTED 1,3-PROPANE DIOXIDE DERIVATIVES, METHODS FOR THE PRODUCTION THEREOF AND USE OF THE SAME AS MEDICAMENT
<b>A61K 31/34</b> (2006.01)	2590930 *	SPIROCYCLICALLY SUBSTITUTED 1,3-PROPANE DIOXIDE DERIVATIVES, METHODS FOR THE PRODUCTION THEREOF AND USE OF THE SAME AS MEDICAMENT
<b>A61K 31/4439</b> (2006.01)	2590930 *	SPIROCYCLICALLY SUBSTITUTED 1,3-PROPANE DIOXIDE DERIVATIVES, METHODS FOR THE PRODUCTION THEREOF AND USE OF THE SAME AS MEDICAMENT
<b>C07C 225/16</b> (2006.01)	2542544 *	KETOBENZOFURAN DERIVATIVES, METHOD FOR SYNTHESISING SAME, AND INTERMEDIATES
<b>C07C 311/08</b> (2006.01)	2542544 *	KETOBENZOFURAN DERIVATIVES, METHOD FOR SYNTHESISING SAME, AND INTERMEDIATES
<b>C07F 5/02</b> (2006.01)	2542544 *	KETOBENZOFURAN DERIVATIVES, METHOD FOR SYNTHESISING SAME, AND INTERMEDIATES

MKP (51)	Broj objave evropske prijava patenta (97)	Naziv pronalaska (54)
<b>C07D 307/83</b> (2006.01)	2542544 *	KETOBENZOFURAN DERIVATIVES, METHOD FOR SYNTHESISING SAME, AND INTERMEDIATES
<b>C07C 311/07</b> (2006.01)	2542544 *	KETOBENZOFURAN DERIVATIVES, METHOD FOR SYNTHESISING SAME, AND INTERMEDIATES
<b>A61P 9/00</b> (2006.01)	2542544 *	KETOBENZOFURAN DERIVATIVES, METHOD FOR SYNTHESISING SAME, AND INTERMEDIATES
<b>C07C 217/22</b> (2006.01)	2542544 *	KETOBENZOFURAN DERIVATIVES, METHOD FOR SYNTHESISING SAME, AND INTERMEDIATES
<b>A61K 31/43</b> (2006.01)	2542544 *	KETOBENZOFURAN DERIVATIVES, METHOD FOR SYNTHESISING SAME, AND INTERMEDIATES
<b>A61M 5/24</b> (2006.01)	2460551	Drug delivery device with locking arrangement for dose button
<b>A61M 5/315</b> (2006.01)	2460551	Drug delivery device with locking arrangement for dose button
<b>A61K 8/27</b> (2006.01)	2550067 *	NOVEL USE
<b>A61K 8/46</b> (2006.01)	2550067 *	NOVEL USE
<b>A61Q 11/00</b> (2006.01)	2550067 *	NOVEL USE
<b>A61K 8/34</b> (2006.01)	2550067 *	NOVEL USE
<b>C07J 71/00</b> (2006.01)	2566877 *	METHODS OF REDUCING SYMPTOMS IN SUBJECTS USING SINGLE DOSAGE FORMS WITH TAPERING RELEASE RATES
<b>A01N 43/42</b> (2006.01)	2560490 *	COMPOSITIONS COMPRISING ENZYME-CLEAVABLE PRODRUGS OF ACTIVE AGENTS AND INHIBITORS THEREOF
<b>A61K 31/44</b> (2006.01)	2560490 *	COMPOSITIONS COMPRISING ENZYME-CLEAVABLE PRODRUGS OF ACTIVE AGENTS AND INHIBITORS THEREOF
<b>A61P 27/06</b> (2006.01)	2552932 *	ADENOSINE COMPOUNDS AND THEIR USE THEREOF
<b>A61P 9/10</b> (2006.01)	2552932 *	ADENOSINE COMPOUNDS AND THEIR USE THEREOF
<b>C07H 19/16</b> (2006.01)	2552932 *	ADENOSINE COMPOUNDS AND THEIR USE THEREOF
<b>A61P 29/00</b> (2006.01)	2552932 *	ADENOSINE COMPOUNDS AND THEIR USE THEREOF
<b>C07H 19/167</b> (2006.01)	2552932 *	ADENOSINE COMPOUNDS AND THEIR USE THEREOF
<b>A61K 31/7076</b> (2006.01)	2552932 *	ADENOSINE COMPOUNDS AND THEIR USE THEREOF
<b>A61P 27/02</b> (2006.01)	2552932 *	ADENOSINE COMPOUNDS AND THEIR USE THEREOF
<b>C09D 11/00</b> (2006.01)	2548928 *	PIGMENT COMPOSITION
<b>C09B 63/00</b> (2006.01)	2548928 *	PIGMENT COMPOSITION
<b>C09B 67/20</b> (2006.01)	2548928 *	PIGMENT COMPOSITION
<b>G06F 15/16</b> (2006.01)	2577485 *	STREAMING MEDIA DELIVERY COMPOSITE
<b>C07K 14/705</b> (2006.01)	2552953 *	FRIZZLED-BINDING AGENTS AND USES THEREOF
<b>A61P 27/02</b> (2006.01)	2555776 *	COMBINATION COMPOSITIONS OF ADENOSINE A1 AGONISTS AND NON-SELECTIVE BETA-ADRENERGIC RECEPTOR BLOCKERS FOR REDUCING INTRAOCULAR PRESSURE
<b>A61P 27/06</b> (2006.01)	2555776 *	COMBINATION COMPOSITIONS OF ADENOSINE A1 AGONISTS AND NON-SELECTIVE BETA-ADRENERGIC RECEPTOR BLOCKERS FOR REDUCING INTRAOCULAR PRESSURE
<b>A61K 31/7076</b> (2006.01)	2555776 *	COMBINATION COMPOSITIONS OF ADENOSINE A1 AGONISTS AND NON-SELECTIVE BETA-ADRENERGIC RECEPTOR BLOCKERS FOR REDUCING INTRAOCULAR PRESSURE
<b>A61K 31/085</b> (2006.01)	2555776 *	COMBINATION COMPOSITIONS OF ADENOSINE A1 AGONISTS AND NON-SELECTIVE BETA-ADRENERGIC RECEPTOR BLOCKERS FOR REDUCING INTRAOCULAR PRESSURE
<b>A61K 31/5377</b> (2006.01)	2555776 *	COMBINATION COMPOSITIONS OF ADENOSINE A1 AGONISTS AND NON-SELECTIVE BETA-ADRENERGIC RECEPTOR BLOCKERS FOR REDUCING INTRAOCULAR PRESSURE
<b>C07K 14/475</b> (2006.01)	2558489 *	ROBO1-FC FUSION PROTEIN AND USE THEREOF FOR TREATING TUMOURS
<b>A61K 38/00</b> (2006.01)	2558489 *	ROBO1-FC FUSION PROTEIN AND USE THEREOF FOR TREATING TUMOURS
<b>B09B 3/00</b> (2006.01)	2550118 *	COMPOSITIONS OF MATTER AND USES THEREOF IN THE TREATMENT OF WASTE MATERIALS

MKP (51)	Broj objave evropske prijava patenta (97)	Naziv pronalaska (54)
<b>A61M 5/32</b> (2006.01)	2550047 *	NEEDLE ASSEMBLY
<b>C07C 61/40</b> (2006.01)	2552881 *	NOVEL POLYMORPHS AND SALTS
<b>B65G 67/08</b> (2006.01)	2508451	Cargo handling system
<b>B65G 41/00</b> (2006.01)	2508451	Cargo handling system
<b>A61C 19/02</b> (2006.01)	2494884	Container for storing and transporting dental casts, models, etc.
<b>A45C 13/26</b> (2006.01)	2494884	Container for storing and transporting dental casts, models, etc.
<b>A61K 38/46</b> (2006.01)	2588130 *	CNS DELIVERY OF THERAPEUTIC AGENTS
<b>C01B 17/04</b> (2006.01)	2550236 *	DEVICE AND METHOD FOR CONDENSING, SEPARATING, AND STORING LIQUID SULFUR IN A CLAUS PLANT
<b>A61P 31/04</b> (2006.01)	2557082 *	CEPHEM COMPOUND HAVING CATECHOL GROUP
<b>C07D 501/46</b> (2006.01)	2557082 *	CEPHEM COMPOUND HAVING CATECHOL GROUP
<b>A61K 31/546</b> (2006.01)	2557082 *	CEPHEM COMPOUND HAVING CATECHOL GROUP
<b>C07D 519/06</b> (2006.01)	2557082 *	CEPHEM COMPOUND HAVING CATECHOL GROUP
<b>H01R 24/62</b> (2011.01)	2583360 *	EXTERNAL CONTACT PLUG CONNECTOR
<b>H01R 13/6581</b> (2011.01)	2583360 *	EXTERNAL CONTACT PLUG CONNECTOR
<b>B29C 41/00</b> (2006.01)	2593321 *	TANK TO CONTAIN FUEL AND RELATIVE PRODUCTION METHOD
<b>B29C 41/04</b> (2006.01)	2593321 *	TANK TO CONTAIN FUEL AND RELATIVE PRODUCTION METHOD
<b>B60K 15/03</b> (2006.01)	2593321 *	TANK TO CONTAIN FUEL AND RELATIVE PRODUCTION METHOD
<b>B26B 5/00</b> (2006.01)	2560797 *	GUIDE FOR GUIDING THE CUTTING OF A PIECE OF PLASTERBOARD, AND KIT AND METHOD FOR THE IMPLEMENTATION THEREOF
<b>B26B 29/06</b> (2006.01)	2560797 *	GUIDE FOR GUIDING THE CUTTING OF A PIECE OF PLASTERBOARD, AND KIT AND METHOD FOR THE IMPLEMENTATION THEREOF
<b>B28D 1/22</b> (2006.01)	2560797 *	GUIDE FOR GUIDING THE CUTTING OF A PIECE OF PLASTERBOARD, AND KIT AND METHOD FOR THE IMPLEMENTATION THEREOF
<b>B32B 27/08</b> (2006.01)	2585297 *	A SHEET, A METHOD OF MAKING AND USING A SHEET AS A LID FOR PACKAGES
<b>B32B 27/36</b> (2006.01)	2585297 *	A SHEET, A METHOD OF MAKING AND USING A SHEET AS A LID FOR PACKAGES
<b>B65D 77/20</b> (2006.01)	2585297 *	A SHEET, A METHOD OF MAKING AND USING A SHEET AS A LID FOR PACKAGES
<b>B32B 27/32</b> (2006.01)	2585297 *	A SHEET, A METHOD OF MAKING AND USING A SHEET AS A LID FOR PACKAGES
<b>A61B 6/06</b> (2006.01)	2564786	Method for automatic contour filter positioning for medical X-ray imaging
<b>A61K 31/195</b> (2006.01)	2569277 *	SUBSTITUTED 8-ALKOXY-2-AMINOTETRALIN DERIVATIVES, AND USE THEREOF
<b>C07C 229/38</b> (2006.01)	2569277 *	SUBSTITUTED 8-ALKOXY-2-AMINOTETRALIN DERIVATIVES, AND USE THEREOF
<b>A61M 5/20</b> (2006.01)	2585136 *	NEEDLE SAFETY ARRANGEMENT AND METHOD FOR OPERATING IT
<b>C08G 69/16</b> (2006.01)	2558517 *	METHOD FOR PRODUCING MODIFIED POLYAMIDE 6
<b>C08L 77/00</b> (2006.01)	2558517 *	METHOD FOR PRODUCING MODIFIED POLYAMIDE 6
<b>C08K 7/00</b> (2006.01)	2558517 *	METHOD FOR PRODUCING MODIFIED POLYAMIDE 6
<b>C08K 3/00</b> (2006.01)	2558517 *	METHOD FOR PRODUCING MODIFIED POLYAMIDE 6
<b>C07F 5/02</b> (2006.01)	2560978 *	INHIBITORS OF ARGINASE AND THEIR THERAPEUTIC APPLICATIONS
<b>A61K 31/155</b> (2006.01)	2560978 *	INHIBITORS OF ARGINASE AND THEIR THERAPEUTIC APPLICATIONS
<b>A61K 31/69</b> (2006.01)	2560978 *	INHIBITORS OF ARGINASE AND THEIR THERAPEUTIC APPLICATIONS
<b>A61K 49/00</b> (2006.01)	2560978 *	INHIBITORS OF ARGINASE AND THEIR THERAPEUTIC APPLICATIONS
<b>A63F 9/00</b> (2006.01)	2566591 *	SPATIAL LOGICAL AND SKILL IMPROVEMENT GAME, PARTICULARLY A LABYRINTH GAME
<b>A63F 9/08</b> (2006.01)	2566591 *	SPATIAL LOGICAL AND SKILL IMPROVEMENT GAME, PARTICULARLY A LABYRINTH GAME
<b>A61K 39/395</b> (2006.01)	2558497 *	HUMAN FGF RECEPTOR AND BETA-KLOTHO BINDING PROTEINS
<b>A61P 3/10</b> (2006.01)	2558497 *	HUMAN FGF RECEPTOR AND BETA-KLOTHO BINDING PROTEINS
<b>C07K 16/28</b> (2006.01)	2558497 *	HUMAN FGF RECEPTOR AND BETA-KLOTHO BINDING PROTEINS

MKP (51)	Broj objave evropske prijava patenta (97)	Naziv pronalaska (54)
<b>A61K 39/395</b> (2006.01)	2563381 *	INNOVATIVE DISCOVERY OF THERAPEUTIC, DIAGNOSTIC, AND ANTIBODY COMPOSITIONS RELATED TO PROTEIN FRAGMENTS OF ISOLEUCYL TRNA SYNTHETASES
<b>A61K 38/17</b> (2006.01)	2563381 *	INNOVATIVE DISCOVERY OF THERAPEUTIC, DIAGNOSTIC, AND ANTIBODY COMPOSITIONS RELATED TO PROTEIN FRAGMENTS OF ISOLEUCYL TRNA SYNTHETASES
<b>A61K 38/16</b> (2006.01)	2563381 *	INNOVATIVE DISCOVERY OF THERAPEUTIC, DIAGNOSTIC, AND ANTIBODY COMPOSITIONS RELATED TO PROTEIN FRAGMENTS OF ISOLEUCYL TRNA SYNTHETASES
<b>A61P 35/00</b> (2006.01)	2563381 *	INNOVATIVE DISCOVERY OF THERAPEUTIC, DIAGNOSTIC, AND ANTIBODY COMPOSITIONS RELATED TO PROTEIN FRAGMENTS OF ISOLEUCYL TRNA SYNTHETASES
<b>A61P 3/00</b> (2006.01)	2563381 *	INNOVATIVE DISCOVERY OF THERAPEUTIC, DIAGNOSTIC, AND ANTIBODY COMPOSITIONS RELATED TO PROTEIN FRAGMENTS OF ISOLEUCYL TRNA SYNTHETASES
<b>A61P 29/00</b> (2006.01)	2563381 *	INNOVATIVE DISCOVERY OF THERAPEUTIC, DIAGNOSTIC, AND ANTIBODY COMPOSITIONS RELATED TO PROTEIN FRAGMENTS OF ISOLEUCYL TRNA SYNTHETASES
<b>A61K 31/337</b> (2006.01)	2562155 *	NOVEL HYDROXAMIC ACID DERIVATIVE
<b>A61K 31/40</b> (2006.01)	2562155 *	NOVEL HYDROXAMIC ACID DERIVATIVE
<b>A61K 31/415</b> (2006.01)	2562155 *	NOVEL HYDROXAMIC ACID DERIVATIVE
<b>A61K 31/341</b> (2006.01)	2562155 *	NOVEL HYDROXAMIC ACID DERIVATIVE
<b>A61K 31/4015</b> (2006.01)	2562155 *	NOVEL HYDROXAMIC ACID DERIVATIVE
<b>A61K 31/416</b> (2006.01)	2562155 *	NOVEL HYDROXAMIC ACID DERIVATIVE
<b>A61K 31/357</b> (2006.01)	2562155 *	NOVEL HYDROXAMIC ACID DERIVATIVE
<b>A61K 31/4035</b> (2006.01)	2562155 *	NOVEL HYDROXAMIC ACID DERIVATIVE
<b>A61K 31/36</b> (2006.01)	2562155 *	NOVEL HYDROXAMIC ACID DERIVATIVE
<b>A61K 31/404</b> (2006.01)	2562155 *	NOVEL HYDROXAMIC ACID DERIVATIVE
<b>C07C 259/06</b> (2006.01)	2562155 *	NOVEL HYDROXAMIC ACID DERIVATIVE
<b>A61K 31/381</b> (2006.01)	2562155 *	NOVEL HYDROXAMIC ACID DERIVATIVE
<b>A61K 31/4045</b> (2006.01)	2562155 *	NOVEL HYDROXAMIC ACID DERIVATIVE
<b>A61K 31/166</b> (2006.01)	2562155 *	NOVEL HYDROXAMIC ACID DERIVATIVE
<b>A61K 31/397</b> (2006.01)	2562155 *	NOVEL HYDROXAMIC ACID DERIVATIVE
<b>A61K 31/407</b> (2006.01)	2562155 *	NOVEL HYDROXAMIC ACID DERIVATIVE
<b>A61K 31/351</b> (2006.01)	2562155 *	NOVEL HYDROXAMIC ACID DERIVATIVE
<b>A61K 31/403</b> (2006.01)	2562155 *	NOVEL HYDROXAMIC ACID DERIVATIVE
<b>A61K 31/343</b> (2006.01)	2562155 *	NOVEL HYDROXAMIC ACID DERIVATIVE
<b>A61K 31/402</b> (2006.01)	2562155 *	NOVEL HYDROXAMIC ACID DERIVATIVE
<b>H02M 7/06</b> (2006.01)	2479880	Power supply assembly for rectification
<b>H01F 29/00</b> (2006.01)	2479880	Power supply assembly for rectification
<b>A61F 13/15</b> (2006.01)	2548540	Differential speed shafted machines and uses therefor, including discontinuous and continuous side by side bonding
<b>B26D 7/18</b> (2006.01)	2548540	Differential speed shafted machines and uses therefor, including discontinuous and continuous side by side bonding
<b>C12M 1/107</b> (2006.01)	2361673	Apparatus
<b>F16M 11/00</b> (2006.01)	2361673	Apparatus
<b>B01F 15/00</b> (2006.01)	2361673	Apparatus
<b>B01F 7/00</b> (2006.01)	2361673	Apparatus
<b>A01C 3/02</b> (2006.01)	2361673	Apparatus
<b>C07D 405/14</b> (2006.01)	2588467 *	HETEROCYCLIC COMPOUNDS AND THEIR USE AS INHIBITORS OF PI3K ACTIVITY
<b>C07D 401/12</b> (2006.01)	2588467 *	HETEROCYCLIC COMPOUNDS AND THEIR USE AS INHIBITORS OF PI3K ACTIVITY

MKP (51)	Broj objave evropske prijava patenta (97)	Naziv pronalaska (54)
<b>C07D 401/14</b> (2006.01)	2588467 *	HETEROCYCLIC COMPOUNDS AND THEIR USE AS INHIBITORS OF PI3K ACTIVITY
<b>C07D 413/14</b> (2006.01)	2588467 *	HETEROCYCLIC COMPOUNDS AND THEIR USE AS INHIBITORS OF PI3K ACTIVITY
<b>A61K 31/41</b> (2006.01)	2556059 *	IMPROVED PROCESS FOR PREPARING VALSARTAN
<b>C07D 257/04</b> (2006.01)	2556059 *	IMPROVED PROCESS FOR PREPARING VALSARTAN
<b>B05D 5/08</b> (2006.01)	2579996 *	LUBRICITY VESSEL COATING, COATING PROCESS AND APPARATUS
<b>B05D 7/02</b> (2006.01)	2579996 *	LUBRICITY VESSEL COATING, COATING PROCESS AND APPARATUS
<b>B05D 7/24</b> (2006.01)	2579996 *	LUBRICITY VESSEL COATING, COATING PROCESS AND APPARATUS
<b>A61L 27/60</b> (2006.01)	2575908 *	CONJUGATED POLYMERIC MATERIAL AND USES THEREOF
<b>A61L 27/44</b> (2006.01)	2575908 *	CONJUGATED POLYMERIC MATERIAL AND USES THEREOF
<b>A61L 27/04</b> (2006.01)	2575908 *	CONJUGATED POLYMERIC MATERIAL AND USES THEREOF
<b>A61K 47/48</b> (2006.01)	2575908 *	CONJUGATED POLYMERIC MATERIAL AND USES THEREOF
<b>A61L 27/24</b> (2006.01)	2575908 *	CONJUGATED POLYMERIC MATERIAL AND USES THEREOF
<b>A61K 39/09</b> (2006.01)	2544710 *	IMMUNOGENIC COMPOSITION COMPRISING S. PNEUMONIAE POLYSACCHARIDES CONJUGATED TO CARRIER PROTEINS
<b>A61P 43/00</b> (2006.01)	2544710 *	IMMUNOGENIC COMPOSITION COMPRISING S. PNEUMONIAE POLYSACCHARIDES CONJUGATED TO CARRIER PROTEINS
<b>A61K 39/385</b> (2006.01)	2544710 *	IMMUNOGENIC COMPOSITION COMPRISING S. PNEUMONIAE POLYSACCHARIDES CONJUGATED TO CARRIER PROTEINS
<b>B23Q 1/76</b> (2006.01)	2433742	Rest for hydrostatically supporting a workpiece of a machine tool
<b>B23Q 1/38</b> (2006.01)	2433742	Rest for hydrostatically supporting a workpiece of a machine tool
<b>G06Q 10/00</b> (2012.01)	2455895	A device for supporting a user in selecting clothes
<b>A01N 25/04</b> (2006.01)	2563115 *	STABILIZED AGRICULTURAL OIL DISPERSIONS
<b>A41C 3/12</b> (2006.01)	2568847 *	GARMENT AND BRASSIERE ACCESSORY
<b>A44C 25/00</b> (2006.01)	2568847 *	GARMENT AND BRASSIERE ACCESSORY
<b>F28D 15/00</b> (2006.01)	2577210 *	HEAT AND ENERGY EXCHANGE
<b>H01L 23/34</b> (2006.01)	2577210 *	HEAT AND ENERGY EXCHANGE
<b>A61P 25/28</b> (2006.01)	2588198 *	TREATMENT OF COGNITIVE DISORDERS
<b>A61K 31/4415</b> (2006.01)	2588198 *	TREATMENT OF COGNITIVE DISORDERS
<b>A61K 31/519</b> (2006.01)	2588198 *	TREATMENT OF COGNITIVE DISORDERS
<b>A61K 31/714</b> (2006.01)	2588198 *	TREATMENT OF COGNITIVE DISORDERS
<b>B23Q 1/76</b> (2006.01)	2415557	Device and method for reducing deviations in shape and/or position, in particular the run out of a workpiece
<b>B24B 41/06</b> (2012.01)	2415557	Device and method for reducing deviations in shape and/or position, in particular the run out of a workpiece
<b>A61K 31/47</b> (2006.01)	2542078 *	TREATMENT OF LUPUS NEPHRITIS USING LAQUINIMOD
<b>A01N 43/42</b> (2006.01)	2542078 *	TREATMENT OF LUPUS NEPHRITIS USING LAQUINIMOD
<b>A61P 37/00</b> (2006.01)	2558474 *	2, 4-PYRIMIDINEDIAMINE COMPOUNDS AND PRODRUGS THEREOF AND THEIR USES
<b>A61P 29/00</b> (2006.01)	2558474 *	2, 4-PYRIMIDINEDIAMINE COMPOUNDS AND PRODRUGS THEREOF AND THEIR USES
<b>A61K 31/5383</b> (2006.01)	2558474 *	2, 4-PYRIMIDINEDIAMINE COMPOUNDS AND PRODRUGS THEREOF AND THEIR USES
<b>C07D 498/04</b> (2006.01)	2558474 *	2, 4-PYRIMIDINEDIAMINE COMPOUNDS AND PRODRUGS THEREOF AND THEIR USES
<b>A47F 5/13</b> (2006.01)	2579747 *	SALES TABLE
<b>A61P 25/24</b> (2006.01)	2547649 *	AGOMELATINE HYDROCHLORIDE HYDRATE AND PREPARATION THEREOF
<b>A61K 31/165</b> (2006.01)	2547649 *	AGOMELATINE HYDROCHLORIDE HYDRATE AND PREPARATION THEREOF
<b>C07C 231/12</b> (2006.01)	2547649 *	AGOMELATINE HYDROCHLORIDE HYDRATE AND PREPARATION THEREOF
<b>C07C 233/18</b> (2006.01)	2547649 *	AGOMELATINE HYDROCHLORIDE HYDRATE AND PREPARATION THEREOF
<b>B61D 19/02</b> (2006.01)	2558344 *	MAGNETIC-ASSISTED LINEAR BEARING

MKP (51)	Broj objave evropske prijava patenta (97)	Naziv pronalaska (54)
<b>E05F 15/18</b> (2006.01)	2558344 *	MAGNETIC-ASSISTED LINEAR BEARING
<b>E05D 15/06</b> (2006.01)	2558344 *	MAGNETIC-ASSISTED LINEAR BEARING
<b>A61M 35/00</b> (2006.01)	2579831 *	DISPENSER AND METHODS OF USE
<b>A61B 19/02</b> (2006.01)	2579831 *	DISPENSER AND METHODS OF USE
<b>A61J 1/05</b> (2006.01)	2579831 *	DISPENSER AND METHODS OF USE
<b>C07J 19/00</b> (2006.01)	2563803 *	ANTICANCER STEROIDAL LACTONES UNSATURATED IN POSITION 7 (8)
<b>A61K 31/585</b> (2006.01)	2563803 *	ANTICANCER STEROIDAL LACTONES UNSATURATED IN POSITION 7 (8)
<b>C07J 71/00</b> (2006.01)	2563803 *	ANTICANCER STEROIDAL LACTONES UNSATURATED IN POSITION 7 (8)
<b>A61P 35/00</b> (2006.01)	2563803 *	ANTICANCER STEROIDAL LACTONES UNSATURATED IN POSITION 7 (8)
<b>A61K 31/553</b> (2006.01)	2571503 *	COMPOSITIONS AND METHODS FOR TREATING NEOPLASIA, INFLAMMATORY DISEASE AND OTHER DISORDERS
<b>A61K 31/555</b> (2006.01)	2571503 *	COMPOSITIONS AND METHODS FOR TREATING NEOPLASIA, INFLAMMATORY DISEASE AND OTHER DISORDERS
<b>C07D 487/04</b> (2006.01)	2576558 *	PROCESS FOR THE PREPARATION OF 5-SUBSTITUTED-8-ALKOXY[1,2,4] TRIAZOLO[1,5-C]PYRIMIDIN-2-AMINES
<b>F02D 41/22</b> (2006.01)	2556231 *	DIAGNOSIS DEVISE AND METHOD USING AN IN- CYLINDER PRESSURE SENSOR IN AN INTERNAL COMBUSTION ENGINE
<b>A47K 10/36</b> (2006.01)	2560536 *	PAPER DISPENSER
<b>A61K 31/555</b> (2006.01)	2582369 *	AN ANTITUMORAL COMBINATION COMPRISING OMBRABULIN, A TAXANE DERIVATIVE AND A PLATINUM DERIVATIVE
<b>A61K 31/282</b> (2006.01)	2582369 *	AN ANTITUMORAL COMBINATION COMPRISING OMBRABULIN, A TAXANE DERIVATIVE AND A PLATINUM DERIVATIVE
<b>A61K 33/24</b> (2006.01)	2582369 *	AN ANTITUMORAL COMBINATION COMPRISING OMBRABULIN, A TAXANE DERIVATIVE AND A PLATINUM DERIVATIVE
<b>A61K 31/337</b> (2006.01)	2582369 *	AN ANTITUMORAL COMBINATION COMPRISING OMBRABULIN, A TAXANE DERIVATIVE AND A PLATINUM DERIVATIVE
<b>A61K 45/06</b> (2006.01)	2582369 *	AN ANTITUMORAL COMBINATION COMPRISING OMBRABULIN, A TAXANE DERIVATIVE AND A PLATINUM DERIVATIVE
<b>A61K 31/167</b> (2006.01)	2582369 *	AN ANTITUMORAL COMBINATION COMPRISING OMBRABULIN, A TAXANE DERIVATIVE AND A PLATINUM DERIVATIVE
<b>A61P 35/00</b> (2006.01)	2582369 *	AN ANTITUMORAL COMBINATION COMPRISING OMBRABULIN, A TAXANE DERIVATIVE AND A PLATINUM DERIVATIVE
<b>A61K 31/7076</b> (2006.01)	2552931 *	STEREOSELECTIVE SYNTHESIS OF PHOSPHORUS CONTAINING ACTIVES
<b>A61K 31/7072</b> (2006.01)	2552931 *	STEREOSELECTIVE SYNTHESIS OF PHOSPHORUS CONTAINING ACTIVES
<b>C07F 9/6558</b> (2006.01)	2552931 *	STEREOSELECTIVE SYNTHESIS OF PHOSPHORUS CONTAINING ACTIVES
<b>C07H 19/044</b> (2006.01)	2552931 *	STEREOSELECTIVE SYNTHESIS OF PHOSPHORUS CONTAINING ACTIVES
<b>C07F 9/655</b> (2006.01)	2552931 *	STEREOSELECTIVE SYNTHESIS OF PHOSPHORUS CONTAINING ACTIVES
<b>C07H 19/04</b> (2006.01)	2552931 *	STEREOSELECTIVE SYNTHESIS OF PHOSPHORUS CONTAINING ACTIVES
<b>A61P 31/14</b> (2006.01)	2552931 *	STEREOSELECTIVE SYNTHESIS OF PHOSPHORUS CONTAINING ACTIVES
<b>A61K 31/664</b> (2006.01)	2552931 *	STEREOSELECTIVE SYNTHESIS OF PHOSPHORUS CONTAINING ACTIVES
<b>C07H 19/10</b> (2006.01)	2552931 *	STEREOSELECTIVE SYNTHESIS OF PHOSPHORUS CONTAINING ACTIVES
<b>C07H 19/06</b> (2006.01)	2552931 *	STEREOSELECTIVE SYNTHESIS OF PHOSPHORUS CONTAINING ACTIVES
<b>C07F 9/24</b> (2006.01)	2552931 *	STEREOSELECTIVE SYNTHESIS OF PHOSPHORUS CONTAINING ACTIVES
<b>C07F 7/18</b> (2006.01)	2552931 *	STEREOSELECTIVE SYNTHESIS OF PHOSPHORUS CONTAINING ACTIVES
<b>C07H 19/24</b> (2006.01)	2552931 *	STEREOSELECTIVE SYNTHESIS OF PHOSPHORUS CONTAINING ACTIVES
<b>C07F 9/6561</b> (2006.01)	2552931 *	STEREOSELECTIVE SYNTHESIS OF PHOSPHORUS CONTAINING ACTIVES
<b>C07H 19/052</b> (2006.01)	2552931 *	STEREOSELECTIVE SYNTHESIS OF PHOSPHORUS CONTAINING ACTIVES
<b>A61K 47/30</b> (2006.01)	2544689 *	SOLID COMPOSITIONS
<b>A61K 9/20</b> (2006.01)	2544689 *	SOLID COMPOSITIONS
<b>A61K 31/498</b> (2006.01)	2544689 *	SOLID COMPOSITIONS
<b>A61K 31/4965</b> (2006.01)	2544689 *	SOLID COMPOSITIONS
<b>A61K 31/395</b> (2006.01)	2544689 *	SOLID COMPOSITIONS



MKP (51)	Broj objave evropske prijava patenta (97)	Naziv pronalaska (54)
<b>A61P 31/14</b> (2006.01)	2544689 *	SOLID COMPOSITIONS
<b>A01H 5/10</b> (2006.01)	2542048 *	ULTRA-LOW TRYPSIN INHIBITOR SOYBEAN
<b>A61M 5/315</b> (2006.01)	2552519 *	PISTON ROD ASSEMBLY FOR A DRUG DELIVERY DEVICE
<b>A01N 33/02</b> (2006.01)	2568806 *	THERAPEUTIC REGIMENS
<b>C07C 405/00</b> (2006.01)	2495235	Process for the synthesis of prostaglandins and intermediates thereof
<b>C07D 307/935</b> (2006.01)	2495235	Process for the synthesis of prostaglandins and intermediates thereof
<b>C07K 19/00</b> (2006.01)	2591006 *	PROCESSABLE SINGLE CHAIN MOLECULES AND POLYPEPTIDES MADE USING SAME
<b>A61K 47/42</b> (2006.01)	2591006 *	PROCESSABLE SINGLE CHAIN MOLECULES AND POLYPEPTIDES MADE USING SAME
<b>C07K 16/46</b> (2006.01)	2591006 *	PROCESSABLE SINGLE CHAIN MOLECULES AND POLYPEPTIDES MADE USING SAME
<b>G01N 33/68</b> (2006.01)	2545384 *	METHOD FOR DETERMINING THE CONCENTRATION OF A PEPTIDE
<b>C02F 1/00</b> (2006.01)	2465822	Separator to separate fat from water and method for separating fat from water
<b>C02F 1/52</b> (2006.01)	2465822	Separator to separate fat from water and method for separating fat from water
<b>B05B 7/04</b> (2006.01)	2554273	Atomizing nozzle device and use of the same
<b>A01N 43/42</b> (2006.01)	2560491 *	PERIPHERAL OPIOID AGONISTS AND PERIPHERAL OPIOID ANTAGONISTS
<b>A61K 31/44</b> (2006.01)	2560491 *	PERIPHERAL OPIOID AGONISTS AND PERIPHERAL OPIOID ANTAGONISTS
<b>A61K 8/26</b> (2006.01)	2552384 *	NOVEL COMPOSITION
<b>A61K 8/24</b> (2006.01)	2552384 *	NOVEL COMPOSITION
<b>A61Q 11/00</b> (2006.01)	2552384 *	NOVEL COMPOSITION
<b>B65D 5/24</b> (2006.01)	2559627	Folding carton or the like, blank for forming a folding carton and process for erecting the folding carton
<b>B65D 5/20</b> (2006.01)	2559627	Folding carton or the like, blank for forming a folding carton and process for erecting the folding carton
<b>H01R 4/58</b> (2006.01)	2583356 *	DUAL ORIENTATION CONNECTOR WITH SIDE CONTACTS
<b>A61P 29/00</b> (2006.01)	2590974 *	TETRAHYDRO-PYRIDO-PYRIMIDINE DERIVATIVES
<b>C07D 471/04</b> (2006.01)	2590974 *	TETRAHYDRO-PYRIDO-PYRIMIDINE DERIVATIVES
<b>A61K 31/517</b> (2006.01)	2590974 *	TETRAHYDRO-PYRIDO-PYRIMIDINE DERIVATIVES
<b>A61M 5/24</b> (2006.01)	2579924 *	A DRIVE ASSEMBLY FOR A MEDICATION DELIVERY DEVICE AND MEDICATION DELIVERY DEVICE
<b>A61M 5/315</b> (2006.01)	2579924 *	A DRIVE ASSEMBLY FOR A MEDICATION DELIVERY DEVICE AND MEDICATION DELIVERY DEVICE
<b>A61K 31/517</b> (2006.01)	2579878 *	METHODS OF TREATING HEMATOLOGICAL DISORDERS WITH QUINAZOLINONE COMPOUNDS IN SELECTED PATIENTS
<b>A61P 35/02</b> (2006.01)	2579878 *	METHODS OF TREATING HEMATOLOGICAL DISORDERS WITH QUINAZOLINONE COMPOUNDS IN SELECTED PATIENTS
<b>A61K 31/52</b> (2006.01)	2579878 *	METHODS OF TREATING HEMATOLOGICAL DISORDERS WITH QUINAZOLINONE COMPOUNDS IN SELECTED PATIENTS
<b>G01N 33/50</b> (2006.01)	2578678 *	METHOD FOR PRODUCING TUMOR CELL
<b>C12Q 1/02</b> (2006.01)	2578678 *	METHOD FOR PRODUCING TUMOR CELL
<b>C07K 14/435</b> (2006.01)	2578678 *	METHOD FOR PRODUCING TUMOR CELL
<b>C12N 5/10</b> (2006.01)	2578678 *	METHOD FOR PRODUCING TUMOR CELL
<b>C07K 14/82</b> (2006.01)	2578678 *	METHOD FOR PRODUCING TUMOR CELL
<b>A01K 67/027</b> (2006.01)	2578678 *	METHOD FOR PRODUCING TUMOR CELL
<b>A61P 35/00</b> (2006.01)	2578678 *	METHOD FOR PRODUCING TUMOR CELL
<b>G01N 33/15</b> (2006.01)	2578678 *	METHOD FOR PRODUCING TUMOR CELL
<b>C12N 15/09</b> (2006.01)	2578678 *	METHOD FOR PRODUCING TUMOR CELL
<b>E04F 11/032</b> (2006.01)	2505736	Winding staircase
<b>A61P 3/10</b> (2006.01)	2566499 *	INNOVATIVE DISCOVERY OF THERAPEUTIC, DIAGNOSTIC, AND ANTIBODY COMPOSITIONS RELATED TO PROTEIN FRAGMENTS OF P38 MULTI-TRNA SYNTHETASE COMPLEX

MKP (51)	Broj objave evropske prijava patenta (97)	Naziv pronalaska (54)
<b>A61P 35/00</b> (2006.01)	2566499 *	INNOVATIVE DISCOVERY OF THERAPEUTIC, DIAGNOSTIC, AND ANTIBODY COMPOSITIONS RELATED TO PROTEIN FRAGMENTS OF P38 MULTI-TRNA SYNTHETASE COMPLEX
<b>A61K 38/17</b> (2006.01)	2566499 *	INNOVATIVE DISCOVERY OF THERAPEUTIC, DIAGNOSTIC, AND ANTIBODY COMPOSITIONS RELATED TO PROTEIN FRAGMENTS OF P38 MULTI-TRNA SYNTHETASE COMPLEX
<b>C07K 14/525</b> (2006.01)	2566499 *	INNOVATIVE DISCOVERY OF THERAPEUTIC, DIAGNOSTIC, AND ANTIBODY COMPOSITIONS RELATED TO PROTEIN FRAGMENTS OF P38 MULTI-TRNA SYNTHETASE COMPLEX
<b>A61K 39/395</b> (2006.01)	2566499 *	INNOVATIVE DISCOVERY OF THERAPEUTIC, DIAGNOSTIC, AND ANTIBODY COMPOSITIONS RELATED TO PROTEIN FRAGMENTS OF P38 MULTI-TRNA SYNTHETASE COMPLEX
<b>A61P 29/00</b> (2006.01)	2566499 *	INNOVATIVE DISCOVERY OF THERAPEUTIC, DIAGNOSTIC, AND ANTIBODY COMPOSITIONS RELATED TO PROTEIN FRAGMENTS OF P38 MULTI-TRNA SYNTHETASE COMPLEX
<b>F04D 29/40</b> (2006.01)	2542784 *	PUMP INTAKE DEVICE
<b>F04D 7/04</b> (2006.01)	2542784 *	PUMP INTAKE DEVICE
<b>F15D 1/04</b> (2006.01)	2542784 *	PUMP INTAKE DEVICE
<b>A61P 3/00</b> (2006.01)	2579867 *	TRIEPTANOIN DIET FOR ADULT POLYGLUCOSAN BODY DISEASE (APBD) TREATMENT
<b>A61K 31/23</b> (2006.01)	2579867 *	TRIEPTANOIN DIET FOR ADULT POLYGLUCOSAN BODY DISEASE (APBD) TREATMENT
<b>C12Q 1/68</b> (2006.01)	2556167 *	RAD51C AS A HUMAN CANCER SUSCEPTIBILITY GENE
<b>A61K 31/436</b> (2006.01)	2558082 *	COMBINATION OF ORGANIC COMPOUNDS
<b>A61P 35/00</b> (2006.01)	2558082 *	COMBINATION OF ORGANIC COMPOUNDS
<b>A61K 31/496</b> (2006.01)	2558082 *	COMBINATION OF ORGANIC COMPOUNDS
<b>A61K 31/00</b> (2006.01)	2558082 *	COMBINATION OF ORGANIC COMPOUNDS
<b>A61K 39/395</b> (2006.01)	2558498 *	ANTIBODIES THAT BIND HUMAN CD27 AND USES THEREOF
<b>A01K 67/027</b> (2006.01)	2558498 *	ANTIBODIES THAT BIND HUMAN CD27 AND USES THEREOF
<b>A61P 37/02</b> (2006.01)	2558498 *	ANTIBODIES THAT BIND HUMAN CD27 AND USES THEREOF
<b>C07K 16/28</b> (2006.01)	2558498 *	ANTIBODIES THAT BIND HUMAN CD27 AND USES THEREOF
<b>A61P 35/00</b> (2006.01)	2558498 *	ANTIBODIES THAT BIND HUMAN CD27 AND USES THEREOF
<b>C07K 14/705</b> (2006.01)	2558498 *	ANTIBODIES THAT BIND HUMAN CD27 AND USES THEREOF
<b>A61M 5/178</b> (2006.01)	2555812 *	SYSTEMS, DEVICES, METHODS FOR DELIVERING HYDROGEL COMPOSITIONS WITH SELF-PURGING TO PREVENT CLOGGING
<b>A61M 39/22</b> (2006.01)	2555812 *	SYSTEMS, DEVICES, METHODS FOR DELIVERING HYDROGEL COMPOSITIONS WITH SELF-PURGING TO PREVENT CLOGGING
<b>A61M 5/145</b> (2006.01)	2555812 *	SYSTEMS, DEVICES, METHODS FOR DELIVERING HYDROGEL COMPOSITIONS WITH SELF-PURGING TO PREVENT CLOGGING
<b>A61K 31/05</b> (2006.01)	2484350	Pharmaceutical preparation containing a complex of a salt of propofol and a cyclodextrin
<b>A61K 47/48</b> (2006.01)	2484350	Pharmaceutical preparation containing a complex of a salt of propofol and a cyclodextrin
<b>A61K 9/00</b> (2006.01)	2484350	Pharmaceutical preparation containing a complex of a salt of propofol and a cyclodextrin
<b>H04L 9/00</b> (2006.01)	2556622 *	METHOD TO ENCRYPT INFORMATION THAT IS TRANSFERRED BETWEEN TWO COMMUNICATION UNITS
<b>H04K 1/00</b> (2006.01)	2556622 *	METHOD TO ENCRYPT INFORMATION THAT IS TRANSFERRED BETWEEN TWO COMMUNICATION UNITS
<b>A61K 31/4709</b> (2006.01)	2569308 *	NEW CYCLOHEXYLAMINE DERIVATIVES HAVING 2 ADRENERGIC AGONIST AND M3 MUSCARINIC ANTAGONIST ACTIVITIES
<b>C07D 409/14</b> (2006.01)	2569308 *	NEW CYCLOHEXYLAMINE DERIVATIVES HAVING 2 ADRENERGIC AGONIST AND M3 MUSCARINIC ANTAGONIST ACTIVITIES
<b>A61P 11/00</b> (2006.01)	2569308 *	NEW CYCLOHEXYLAMINE DERIVATIVES HAVING 2 ADRENERGIC AGONIST AND M3 MUSCARINIC ANTAGONIST ACTIVITIES
<b>F03D 7/02</b> (2006.01)	2558717 *	WIND ENERGY INSTALLATION AZIMUTH OR PITCH DRIVE

MKP (51)	Broj objave evropske prijava patenta (97)	Naziv pronalaska (54)
<b>G01S 11/14</b> (2006.01)	2550542 *	ROBUST ULTRASONIC INDOOR POSITIONING SYSTEM WITH HIGH ACCURACY
<b>G01S 1/82</b> (2006.01)	2550542 *	ROBUST ULTRASONIC INDOOR POSITIONING SYSTEM WITH HIGH ACCURACY
<b>G01S 1/76</b> (2006.01)	2550542 *	ROBUST ULTRASONIC INDOOR POSITIONING SYSTEM WITH HIGH ACCURACY
<b>G01S 5/18</b> (2006.01)	2550542 *	ROBUST ULTRASONIC INDOOR POSITIONING SYSTEM WITH HIGH ACCURACY
<b>F03D 1/06</b> (2006.01)	2561218 *	REMOVABLE ROTOR BLADE TIP
<b>H01H 85/30</b> (2006.01)	2574217 *	FUSE LINK STATUS INDICATOR FOR A LOW-VOLTAGE HIGH -POWER FUSE
<b>F04D 13/12</b> (2006.01)	2585720 *	HYDRAULIC PUMP WITH COMMUNICATING VESSELS
<b>F04F 10/02</b> (2006.01)	2585720 *	HYDRAULIC PUMP WITH COMMUNICATING VESSELS
<b>A61P 25/36</b> (2006.01)	2588094 *	PHARMACEUTICAL COMPOSITIONS FOR SUBLINGUAL DELIVERY OF OPIOIDS
<b>A61P 25/04</b> (2006.01)	2588094 *	PHARMACEUTICAL COMPOSITIONS FOR SUBLINGUAL DELIVERY OF OPIOIDS
<b>A61K 9/00</b> (2006.01)	2588094 *	PHARMACEUTICAL COMPOSITIONS FOR SUBLINGUAL DELIVERY OF OPIOIDS
<b>A61K 31/135</b> (2006.01)	2588094 *	PHARMACEUTICAL COMPOSITIONS FOR SUBLINGUAL DELIVERY OF OPIOIDS
<b>A61K 31/137</b> (2006.01)	2588094 *	PHARMACEUTICAL COMPOSITIONS FOR SUBLINGUAL DELIVERY OF OPIOIDS
<b>A61K 9/12</b> (2006.01)	2588094 *	PHARMACEUTICAL COMPOSITIONS FOR SUBLINGUAL DELIVERY OF OPIOIDS
<b>A01N 55/08</b> (2006.01)	2552216 *	DERIVATIVES OF 1-AMINO-2-CYCLOPROPYLETHYLBORONIC ACID
<b>C12P 21/02</b> (2006.01)	2585607 *	DUAL VARIABLE DOMAIN IMMUNOGLOBULINS AND USES THEREOF
<b>A61K 39/395</b> (2006.01)	2585607 *	DUAL VARIABLE DOMAIN IMMUNOGLOBULINS AND USES THEREOF
<b>C07K 16/00</b> (2006.01)	2585607 *	DUAL VARIABLE DOMAIN IMMUNOGLOBULINS AND USES THEREOF
<b>G06Q 20/00</b> (2012.01)	2553642 *	METHODS AND SYSTEMS FOR VERIFYING TRANSACTIONS
<b>C07D 241/18</b> (2006.01)	2585437 *	THIOACETATE COMPOUNDS, COMPOSITIONS AND METHODS OF USE
<b>C07D 401/04</b> (2006.01)	2585437 *	THIOACETATE COMPOUNDS, COMPOSITIONS AND METHODS OF USE
<b>A61P 9/12</b> (2006.01)	2585437 *	THIOACETATE COMPOUNDS, COMPOSITIONS AND METHODS OF USE
<b>A61K 31/444</b> (2006.01)	2585437 *	THIOACETATE COMPOUNDS, COMPOSITIONS AND METHODS OF USE
<b>C07D 213/70</b> (2006.01)	2585437 *	THIOACETATE COMPOUNDS, COMPOSITIONS AND METHODS OF USE
<b>A61P 9/00</b> (2006.01)	2585437 *	THIOACETATE COMPOUNDS, COMPOSITIONS AND METHODS OF USE
<b>A61P 19/06</b> (2006.01)	2585437 *	THIOACETATE COMPOUNDS, COMPOSITIONS AND METHODS OF USE
<b>A61K 31/4965</b> (2006.01)	2585437 *	THIOACETATE COMPOUNDS, COMPOSITIONS AND METHODS OF USE
<b>A61K 31/44</b> (2006.01)	2585437 *	THIOACETATE COMPOUNDS, COMPOSITIONS AND METHODS OF USE
<b>A01N 43/36</b> (2006.01)	2575459 *	CANCER TREATMENT WITH WORTMANNIN ANALOGS
<b>A61K 31/40</b> (2006.01)	2575459 *	CANCER TREATMENT WITH WORTMANNIN ANALOGS
<b>A61K 31/35</b> (2006.01)	2575459 *	CANCER TREATMENT WITH WORTMANNIN ANALOGS
<b>C07D 409/14</b> (2006.01)	2544684 *	4,4-DISUBSTITUTED PIPERIDINE DERIVATIVES USEFUL AS INHIBITORS OF DIPEPTIDYL PEPTIDASE-1 (DPP-1)
<b>A61K 31/4375</b> (2006.01)	2544684 *	4,4-DISUBSTITUTED PIPERIDINE DERIVATIVES USEFUL AS INHIBITORS OF DIPEPTIDYL PEPTIDASE-1 (DPP-1)
<b>C07D 417/14</b> (2006.01)	2544684 *	4,4-DISUBSTITUTED PIPERIDINE DERIVATIVES USEFUL AS INHIBITORS OF DIPEPTIDYL PEPTIDASE-1 (DPP-1)
<b>C07D 401/06</b> (2006.01)	2544684 *	4,4-DISUBSTITUTED PIPERIDINE DERIVATIVES USEFUL AS INHIBITORS OF DIPEPTIDYL PEPTIDASE-1 (DPP-1)
<b>C07D 211/66</b> (2006.01)	2544684 *	4,4-DISUBSTITUTED PIPERIDINE DERIVATIVES USEFUL AS INHIBITORS OF DIPEPTIDYL PEPTIDASE-1 (DPP-1)
<b>A61K 31/4436</b> (2006.01)	2544684 *	4,4-DISUBSTITUTED PIPERIDINE DERIVATIVES USEFUL AS INHIBITORS OF DIPEPTIDYL PEPTIDASE-1 (DPP-1)

MKP (51)	Broj objave evropske prijava patenta (97)	Naziv pronalaska (54)
<b>C07D 407/14</b> (2006.01)	2544684 *	4,4-DISUBSTITUTED PIPERIDINE DERIVATIVES USEFUL AS INHIBITORS OF DIPEPTIDYL PEPTIDASE-1 (DPP-1)
<b>C07D 407/06</b> (2006.01)	2544684 *	4,4-DISUBSTITUTED PIPERIDINE DERIVATIVES USEFUL AS INHIBITORS OF DIPEPTIDYL PEPTIDASE-1 (DPP-1)
<b>C07D 417/06</b> (2006.01)	2544684 *	4,4-DISUBSTITUTED PIPERIDINE DERIVATIVES USEFUL AS INHIBITORS OF DIPEPTIDYL PEPTIDASE-1 (DPP-1)
<b>A61K 31/4439</b> (2006.01)	2544684 *	4,4-DISUBSTITUTED PIPERIDINE DERIVATIVES USEFUL AS INHIBITORS OF DIPEPTIDYL PEPTIDASE-1 (DPP-1)
<b>C07D 409/06</b> (2006.01)	2544684 *	4,4-DISUBSTITUTED PIPERIDINE DERIVATIVES USEFUL AS INHIBITORS OF DIPEPTIDYL PEPTIDASE-1 (DPP-1)
<b>A61K 31/444</b> (2006.01)	2544684 *	4,4-DISUBSTITUTED PIPERIDINE DERIVATIVES USEFUL AS INHIBITORS OF DIPEPTIDYL PEPTIDASE-1 (DPP-1)
<b>A61P 19/02</b> (2006.01)	2544684 *	4,4-DISUBSTITUTED PIPERIDINE DERIVATIVES USEFUL AS INHIBITORS OF DIPEPTIDYL PEPTIDASE-1 (DPP-1)
<b>A61K 31/58</b> (2006.01)	2575822 *	TOPICAL PHARMACEUTICAL COMPOSITIONS COMPRISING MOMETASONE FUROATE
<b>A61K 47/06</b> (2006.01)	2575822 *	TOPICAL PHARMACEUTICAL COMPOSITIONS COMPRISING MOMETASONE FUROATE
<b>A61K 47/10</b> (2006.01)	2575822 *	TOPICAL PHARMACEUTICAL COMPOSITIONS COMPRISING MOMETASONE FUROATE
<b>A61K 47/36</b> (2006.01)	2575822 *	TOPICAL PHARMACEUTICAL COMPOSITIONS COMPRISING MOMETASONE FUROATE
<b>A61K 9/06</b> (2006.01)	2575822 *	TOPICAL PHARMACEUTICAL COMPOSITIONS COMPRISING MOMETASONE FUROATE
<b>B60R 13/10</b> (2006.01)	2532556	Registration Plate Holder
<b>A61K 31/765</b> (2006.01)	2563374 *	POLYETHYLENE GLYCOL COMPOSITIONS FOR CONTROLLING RELAPSE OF HERPES LABIALIS, HERPES GENITALIS, AND HERPES ZOSTER
<b>A61P 31/22</b> (2006.01)	2563374 *	POLYETHYLENE GLYCOL COMPOSITIONS FOR CONTROLLING RELAPSE OF HERPES LABIALIS, HERPES GENITALIS, AND HERPES ZOSTER
<b>B65D 71/70</b> (2006.01)	2569030 *	WORKPIECE CARRIER FOR TRANSPORTING AND/OR STORING COMPONENTS OF DRUG DELIVERY DEVICES
<b>A61M 5/00</b> (2006.01)	2569030 *	WORKPIECE CARRIER FOR TRANSPORTING AND/OR STORING COMPONENTS OF DRUG DELIVERY DEVICES
<b>B65B 3/00</b> (2006.01)	2569030 *	WORKPIECE CARRIER FOR TRANSPORTING AND/OR STORING COMPONENTS OF DRUG DELIVERY DEVICES
<b>C07D 215/38</b> (2006.01)	2588455 *	2 -QUINOLINYL- ACETIC ACID DERIVATIVES AS HIV ANTIVIRAL COMPOUNDS
<b>C07D 519/00</b> (2006.01)	2588455 *	2 -QUINOLINYL- ACETIC ACID DERIVATIVES AS HIV ANTIVIRAL COMPOUNDS
<b>C07D 215/14</b> (2006.01)	2588455 *	2 -QUINOLINYL- ACETIC ACID DERIVATIVES AS HIV ANTIVIRAL COMPOUNDS
<b>C07D 417/04</b> (2006.01)	2588455 *	2 -QUINOLINYL- ACETIC ACID DERIVATIVES AS HIV ANTIVIRAL COMPOUNDS
<b>C07D 405/04</b> (2006.01)	2588455 *	2 -QUINOLINYL- ACETIC ACID DERIVATIVES AS HIV ANTIVIRAL COMPOUNDS
<b>C07D 401/12</b> (2006.01)	2588455 *	2 -QUINOLINYL- ACETIC ACID DERIVATIVES AS HIV ANTIVIRAL COMPOUNDS
<b>A61K 31/47</b> (2006.01)	2588455 *	2 -QUINOLINYL- ACETIC ACID DERIVATIVES AS HIV ANTIVIRAL COMPOUNDS
<b>C07D 215/18</b> (2006.01)	2588455 *	2 -QUINOLINYL- ACETIC ACID DERIVATIVES AS HIV ANTIVIRAL COMPOUNDS
<b>C07D 487/04</b> (2006.01)	2588455 *	2 -QUINOLINYL- ACETIC ACID DERIVATIVES AS HIV ANTIVIRAL COMPOUNDS
<b>C07D 215/48</b> (2006.01)	2588455 *	2 -QUINOLINYL- ACETIC ACID DERIVATIVES AS HIV ANTIVIRAL COMPOUNDS
<b>C07D 215/227</b> (2006.01)	2588455 *	2 -QUINOLINYL- ACETIC ACID DERIVATIVES AS HIV ANTIVIRAL COMPOUNDS

MKP (51)	Broj objave evropske prijava patenta (97)	Naziv pronalaska (54)
<b>C07D 215/06</b> (2006.01)	2588455 *	2 -QUINOLINYL- ACETIC ACID DERIVATIVES AS HIV ANTIVIRAL COMPOUNDS
<b>C07D 413/04</b> (2006.01)	2588455 *	2 -QUINOLINYL- ACETIC ACID DERIVATIVES AS HIV ANTIVIRAL COMPOUNDS
<b>C07D 401/04</b> (2006.01)	2588455 *	2 -QUINOLINYL- ACETIC ACID DERIVATIVES AS HIV ANTIVIRAL COMPOUNDS
<b>A61P 31/18</b> (2006.01)	2588455 *	2 -QUINOLINYL- ACETIC ACID DERIVATIVES AS HIV ANTIVIRAL COMPOUNDS
<b>A61K 35/36</b> (2006.01)	2574663	Method for preparing tissue, particularly adipose tissue
<b>C12M 3/08</b> (2006.01)	2574663	Method for preparing tissue, particularly adipose tissue
<b>A61K 31/00</b> (2006.01)	2552429 *	COMBINATION THERAPY COMPRISING A CCR5 ANTAGONIST, A HIV-1 PROTEASE INHIBITOR AND A PHARMACOKINETIC ENHANCER
<b>A61K 31/4433</b> (2006.01)	2552429 *	COMBINATION THERAPY COMPRISING A CCR5 ANTAGONIST, A HIV-1 PROTEASE INHIBITOR AND A PHARMACOKINETIC ENHANCER
<b>A61K 45/06</b> (2006.01)	2552429 *	COMBINATION THERAPY COMPRISING A CCR5 ANTAGONIST, A HIV-1 PROTEASE INHIBITOR AND A PHARMACOKINETIC ENHANCER
<b>A61K 31/496</b> (2006.01)	2552429 *	COMBINATION THERAPY COMPRISING A CCR5 ANTAGONIST, A HIV-1 PROTEASE INHIBITOR AND A PHARMACOKINETIC ENHANCER
<b>A61K 31/46</b> (2006.01)	2552429 *	COMBINATION THERAPY COMPRISING A CCR5 ANTAGONIST, A HIV-1 PROTEASE INHIBITOR AND A PHARMACOKINETIC ENHANCER
<b>A61K 31/4725</b> (2006.01)	2552429 *	COMBINATION THERAPY COMPRISING A CCR5 ANTAGONIST, A HIV-1 PROTEASE INHIBITOR AND A PHARMACOKINETIC ENHANCER
<b>A61K 31/427</b> (2006.01)	2552429 *	COMBINATION THERAPY COMPRISING A CCR5 ANTAGONIST, A HIV-1 PROTEASE INHIBITOR AND A PHARMACOKINETIC ENHANCER
<b>A61K 31/4545</b> (2006.01)	2552429 *	COMBINATION THERAPY COMPRISING A CCR5 ANTAGONIST, A HIV-1 PROTEASE INHIBITOR AND A PHARMACOKINETIC ENHANCER
<b>A61K 31/4178</b> (2006.01)	2552429 *	COMBINATION THERAPY COMPRISING A CCR5 ANTAGONIST, A HIV-1 PROTEASE INHIBITOR AND A PHARMACOKINETIC ENHANCER
<b>A61K 31/351</b> (2006.01)	2552429 *	COMBINATION THERAPY COMPRISING A CCR5 ANTAGONIST, A HIV-1 PROTEASE INHIBITOR AND A PHARMACOKINETIC ENHANCER
<b>A61K 31/506</b> (2006.01)	2552429 *	COMBINATION THERAPY COMPRISING A CCR5 ANTAGONIST, A HIV-1 PROTEASE INHIBITOR AND A PHARMACOKINETIC ENHANCER
<b>A61K 31/4402</b> (2006.01)	2552429 *	COMBINATION THERAPY COMPRISING A CCR5 ANTAGONIST, A HIV-1 PROTEASE INHIBITOR AND A PHARMACOKINETIC ENHANCER
<b>A61K 31/472</b> (2006.01)	2552429 *	COMBINATION THERAPY COMPRISING A CCR5 ANTAGONIST, A HIV-1 PROTEASE INHIBITOR AND A PHARMACOKINETIC ENHANCER
<b>A61P 31/18</b> (2006.01)	2552429 *	COMBINATION THERAPY COMPRISING A CCR5 ANTAGONIST, A HIV-1 PROTEASE INHIBITOR AND A PHARMACOKINETIC ENHANCER
<b>A61K 31/499</b> (2006.01)	2552429 *	COMBINATION THERAPY COMPRISING A CCR5 ANTAGONIST, A HIV-1 PROTEASE INHIBITOR AND A PHARMACOKINETIC ENHANCER
<b>A61K 38/36</b> (2006.01)	2590668 *	FACTOR IX POLYPEPTIDES AND METHODS OF USE THEREOF
<b>H05K 1/11</b> (2006.01)	2583361 *	EXTERNAL CONTACT PLUG CONNECTOR
<b>H01R 13/66</b> (2006.01)	2583361 *	EXTERNAL CONTACT PLUG CONNECTOR
<b>H01R 27/00</b> (2006.01)	2583361 *	EXTERNAL CONTACT PLUG CONNECTOR
<b>H01R 13/6582</b> (2011.01)	2583361 *	EXTERNAL CONTACT PLUG CONNECTOR
<b>H01R 13/03</b> (2006.01)	2583361 *	EXTERNAL CONTACT PLUG CONNECTOR
<b>H01R 29/00</b> (2006.01)	2583361 *	EXTERNAL CONTACT PLUG CONNECTOR
<b>H01R 13/627</b> (2006.01)	2583361 *	EXTERNAL CONTACT PLUG CONNECTOR
<b>H01R 13/24</b> (2006.01)	2583361 *	EXTERNAL CONTACT PLUG CONNECTOR
<b>H01R 13/642</b> (2006.01)	2583361 *	EXTERNAL CONTACT PLUG CONNECTOR
<b>C07K 14/47</b> (2006.01)	2452948 *	NEW TUMOR MARKER
<b>C07K 16/30</b> (2006.01)	2452948 *	NEW TUMOR MARKER
<b>C07K 14/435</b> (2006.01)	2452948 *	NEW TUMOR MARKER
<b>G01N 33/574</b> (2006.01)	2452948 *	NEW TUMOR MARKER
<b>C07K 16/18</b> (2006.01)	2452948 *	NEW TUMOR MARKER

MKP (51)	Broj objave evropske prijava patenta (97)	Naziv pronalaska (54)
<b>A61K 39/395</b> (2006.01)	2452948 *	NEW TUMOR MARKER
<b>A61P 35/04</b> (2006.01)	2452948 *	NEW TUMOR MARKER
<b>A61K 31/135</b> (2006.01)	2568977 *	ALCOHOL-RESISTANT METOPROLOL-CONTAINING EXTENDED- RELEASE ORAL DOSAGE FORMS
<b>A61K 9/20</b> (2006.01)	2568977 *	ALCOHOL-RESISTANT METOPROLOL-CONTAINING EXTENDED- RELEASE ORAL DOSAGE FORMS
<b>B01D 39/08</b> (2006.01)	2593206 *	FILTRATION MEDIA AND APPLICATIONS THEREOF
<b>B01D 39/20</b> (2006.01)	2593206 *	FILTRATION MEDIA AND APPLICATIONS THEREOF
<b>B01D 39/16</b> (2006.01)	2593206 *	FILTRATION MEDIA AND APPLICATIONS THEREOF
<b>F26B 5/04</b> (2006.01)	2589303 *	WATER EQUILIBRIUM VARIABLE PRESSURE DRIED FOODS, PROCESSING METHOD, DEVICE AND PACKAGE THEREOF
<b>B65D 33/01</b> (2006.01)	2589303 *	WATER EQUILIBRIUM VARIABLE PRESSURE DRIED FOODS, PROCESSING METHOD, DEVICE AND PACKAGE THEREOF
<b>B65D 81/00</b> (2006.01)	2589303 *	WATER EQUILIBRIUM VARIABLE PRESSURE DRIED FOODS, PROCESSING METHOD, DEVICE AND PACKAGE THEREOF
<b>A23L 3/015</b> (2006.01)	2589303 *	WATER EQUILIBRIUM VARIABLE PRESSURE DRIED FOODS, PROCESSING METHOD, DEVICE AND PACKAGE THEREOF
<b>A01F 25/14</b> (2006.01)	2589303 *	WATER EQUILIBRIUM VARIABLE PRESSURE DRIED FOODS, PROCESSING METHOD, DEVICE AND PACKAGE THEREOF
<b>B65D 30/00</b> (2006.01)	2589303 *	WATER EQUILIBRIUM VARIABLE PRESSURE DRIED FOODS, PROCESSING METHOD, DEVICE AND PACKAGE THEREOF
<b>B65D 33/00</b> (2006.01)	2589303 *	WATER EQUILIBRIUM VARIABLE PRESSURE DRIED FOODS, PROCESSING METHOD, DEVICE AND PACKAGE THEREOF
<b>B65D 33/16</b> (2006.01)	2589303 *	WATER EQUILIBRIUM VARIABLE PRESSURE DRIED FOODS, PROCESSING METHOD, DEVICE AND PACKAGE THEREOF
<b>B65D 81/20</b> (2006.01)	2589303 *	WATER EQUILIBRIUM VARIABLE PRESSURE DRIED FOODS, PROCESSING METHOD, DEVICE AND PACKAGE THEREOF
<b>A61P 11/00</b> (2006.01)	2580195 *	CRYSTAL FORM OF GLYCOPYRRONIUM CHLORIDE
<b>A61P 11/06</b> (2006.01)	2580195 *	CRYSTAL FORM OF GLYCOPYRRONIUM CHLORIDE
<b>A61K 31/40</b> (2006.01)	2580195 *	CRYSTAL FORM OF GLYCOPYRRONIUM CHLORIDE
<b>C07D 207/12</b> (2006.01)	2580195 *	CRYSTAL FORM OF GLYCOPYRRONIUM CHLORIDE
<b>A61P 11/08</b> (2006.01)	2580195 *	CRYSTAL FORM OF GLYCOPYRRONIUM CHLORIDE
<b>C07D 213/51</b> (2006.01)	2560956 *	NOVEL SYNTHESIS FOR THIAZOLIDINEDIONE COMPOUNDS
<b>C07D 277/34</b> (2006.01)	2560956 *	NOVEL SYNTHESIS FOR THIAZOLIDINEDIONE COMPOUNDS
<b>C07K 16/18</b> (2006.01)	2563813 *	ANTI-C5A ANTIBODIES AND METHODS FOR USING THE ANTIBODIES
<b>C01B 13/11</b> (2006.01)	2582621 *	OZONATED LIQUID DISPENSING UNIT
<b>B01J 19/08</b> (2006.01)	2582621 *	OZONATED LIQUID DISPENSING UNIT
<b>B01J 19/00</b> (2006.01)	2582621 *	OZONATED LIQUID DISPENSING UNIT
<b>A61K 9/20</b> (2006.01)	2590631 *	FORMULATION FOR CO-THERAPY TREATMENT OF DIABETES
<b>A61K 31/7072</b> (2006.01)	2590631 *	FORMULATION FOR CO-THERAPY TREATMENT OF DIABETES
<b>A61K 9/28</b> (2006.01)	2590631 *	FORMULATION FOR CO-THERAPY TREATMENT OF DIABETES
<b>A61K 31/155</b> (2006.01)	2590631 *	FORMULATION FOR CO-THERAPY TREATMENT OF DIABETES
<b>C07D 403/04</b> (2006.01)	2545047 *	HETEROCYCLIC INHIBITORS OF GLUTAMINYL CYCLASE (QC, EC 2.3.2.5)
<b>C07D 403/14</b> (2006.01)	2545047 *	HETEROCYCLIC INHIBITORS OF GLUTAMINYL CYCLASE (QC, EC 2.3.2.5)
<b>A61K 31/4184</b> (2006.01)	2545047 *	HETEROCYCLIC INHIBITORS OF GLUTAMINYL CYCLASE (QC, EC 2.3.2.5)
<b>A61P 25/28</b> (2006.01)	2545047 *	HETEROCYCLIC INHIBITORS OF GLUTAMINYL CYCLASE (QC, EC 2.3.2.5)
<b>C07D 401/04</b> (2006.01)	2545047 *	HETEROCYCLIC INHIBITORS OF GLUTAMINYL CYCLASE (QC, EC 2.3.2.5)
<b>A61K 31/454</b> (2006.01)	2545047 *	HETEROCYCLIC INHIBITORS OF GLUTAMINYL CYCLASE (QC, EC 2.3.2.5)
<b>A61P 31/04</b> (2006.01)	2545047 *	HETEROCYCLIC INHIBITORS OF GLUTAMINYL CYCLASE (QC, EC 2.3.2.5)
<b>A61K 31/4709</b> (2006.01)	2545047 *	HETEROCYCLIC INHIBITORS OF GLUTAMINYL CYCLASE (QC, EC 2.3.2.5)
<b>A61P 35/00</b> (2006.01)	2545047 *	HETEROCYCLIC INHIBITORS OF GLUTAMINYL CYCLASE (QC, EC 2.3.2.5)
<b>A61K 31/5377</b> (2006.01)	2545047 *	HETEROCYCLIC INHIBITORS OF GLUTAMINYL CYCLASE (QC, EC 2.3.2.5)

MKP (51)	Broj objave evropske prijava patenta (97)	Naziv pronalaska (54)
<b>A61P 29/00</b> (2006.01)	2545047 *	HETEROCYCLIC INHIBITORS OF GLUTAMINYL CYCLASE (QC, EC 2.3.2.5)
<b>C07D 405/10</b> (2006.01)	2545047 *	HETEROCYCLIC INHIBITORS OF GLUTAMINYL CYCLASE (QC, EC 2.3.2.5)
<b>A61P 25/18</b> (2006.01)	2545047 *	HETEROCYCLIC INHIBITORS OF GLUTAMINYL CYCLASE (QC, EC 2.3.2.5)
<b>C07D 403/10</b> (2006.01)	2545047 *	HETEROCYCLIC INHIBITORS OF GLUTAMINYL CYCLASE (QC, EC 2.3.2.5)
<b>A61P 1/04</b> (2006.01)	2545047 *	HETEROCYCLIC INHIBITORS OF GLUTAMINYL CYCLASE (QC, EC 2.3.2.5)
<b>H02K 21/18</b> (2006.01)	2249466	Disc motor with electromagnetic drive
<b>A01P 13/00</b> (2006.01)	2555615 *	SYNERGISTIC HERBICIDE/FUNGICIDE COMPOSITION CONTAINING A PYRIDINE CARBOXYLIC ACID AND A FUNGICIDE
<b>A01P 3/00</b> (2006.01)	2555615 *	SYNERGISTIC HERBICIDE/FUNGICIDE COMPOSITION CONTAINING A PYRIDINE CARBOXYLIC ACID AND A FUNGICIDE
<b>A01N 43/40</b> (2006.01)	2555615 *	SYNERGISTIC HERBICIDE/FUNGICIDE COMPOSITION CONTAINING A PYRIDINE CARBOXYLIC ACID AND A FUNGICIDE
<b>A01N 25/32</b> (2006.01)	2555615 *	SYNERGISTIC HERBICIDE/FUNGICIDE COMPOSITION CONTAINING A PYRIDINE CARBOXYLIC ACID AND A FUNGICIDE
<b>A61P 35/00</b> (2006.01)	2547691 *	COMPOSITION OF TUMOR-ASSOCIATED PEPTIDES AND RELATED ANTI-CANCER VACCINE FOR THE TREATMENT OF GASTRIC CANCER AND OTHER CANCERS
<b>C07K 7/06</b> (2006.01)	2547691 *	COMPOSITION OF TUMOR-ASSOCIATED PEPTIDES AND RELATED ANTI-CANCER VACCINE FOR THE TREATMENT OF GASTRIC CANCER AND OTHER CANCERS
<b>A61K 39/00</b> (2006.01)	2547691 *	COMPOSITION OF TUMOR-ASSOCIATED PEPTIDES AND RELATED ANTI-CANCER VACCINE FOR THE TREATMENT OF GASTRIC CANCER AND OTHER CANCERS
<b>B60P 1/02</b> (2006.01)	2484550	Vehicle
<b>A61K 39/00</b> (2006.01)	2542571 *	OLIGOMER-SPECIFIC AMYLOID BETA EPITOPE AND ANTIBODIES
<b>A61P 25/28</b> (2006.01)	2542571 *	OLIGOMER-SPECIFIC AMYLOID BETA EPITOPE AND ANTIBODIES
<b>A61P 37/04</b> (2006.01)	2542571 *	OLIGOMER-SPECIFIC AMYLOID BETA EPITOPE AND ANTIBODIES
<b>A61K 39/395</b> (2006.01)	2542571 *	OLIGOMER-SPECIFIC AMYLOID BETA EPITOPE AND ANTIBODIES
<b>C07K 16/18</b> (2006.01)	2542571 *	OLIGOMER-SPECIFIC AMYLOID BETA EPITOPE AND ANTIBODIES
<b>C07K 14/47</b> (2006.01)	2542571 *	OLIGOMER-SPECIFIC AMYLOID BETA EPITOPE AND ANTIBODIES
<b>C12N 15/13</b> (2006.01)	2542571 *	OLIGOMER-SPECIFIC AMYLOID BETA EPITOPE AND ANTIBODIES
<b>G01N 33/53</b> (2006.01)	2542571 *	OLIGOMER-SPECIFIC AMYLOID BETA EPITOPE AND ANTIBODIES
<b>A61K 9/00</b> (2006.01)	2471385	Cetyl myristate and/or cetyl palmitate suspension formulations
<b>A23L 1/30</b> (2006.01)	2471385	Cetyl myristate and/or cetyl palmitate suspension formulations
<b>A61K 31/23</b> (2006.01)	2471385	Cetyl myristate and/or cetyl palmitate suspension formulations
<b>A61K 9/16</b> (2006.01)	2471385	Cetyl myristate and/or cetyl palmitate suspension formulations
<b>A01N 43/38</b> (2006.01)	2566327 *	INDOLES
<b>A61K 31/405</b> (2006.01)	2566327 *	INDOLES
<b>A61K 9/50</b> (2006.01)	2588090 *	PHARMACEUTICAL ORAL DOSAGE FORMS COMPRISING DABIGATRAN ETEXILATE AND ITS PHARMACEUTICALLY ACCEPTABLE SALTS
<b>A61B 17/06</b> (2006.01)	2544599 *	SUTURE PACKAGES PROVIDING UNCONSTRAINED DISPENSING OF SUTURES AND METHODS THEREFOR
<b>A61L 27/20</b> (2006.01)	2547372 *	MULTI-PHASE BACTERIALLY-SYNTHESIZED-NANOCELLULOSE BIOMATERIALS AND METHOD FOR PRODUCING SAME
<b>C12R 1/02</b> (2006.01)	2547372 *	MULTI-PHASE BACTERIALLY-SYNTHESIZED-NANOCELLULOSE BIOMATERIALS AND METHOD FOR PRODUCING SAME
<b>A61L 26/00</b> (2006.01)	2547372 *	MULTI-PHASE BACTERIALLY-SYNTHESIZED-NANOCELLULOSE BIOMATERIALS AND METHOD FOR PRODUCING SAME
<b>G06F 1/16</b> (2006.01)	2577418 *	DOCKING STATION WITH REDUNDANT COMMUNICATION PATH
<b>H04L 12/28</b> (2006.01)	2577418 *	DOCKING STATION WITH REDUNDANT COMMUNICATION PATH
<b>E02B 3/00</b> (2006.01)	2582881 *	FLOATING DEVICE AND METHOD OF USING THE SAME
<b>B65D 88/36</b> (2006.01)	2582881 *	FLOATING DEVICE AND METHOD OF USING THE SAME
<b>A61M 5/20</b> (2006.01)	2585137 *	AUTO-INJECTOR
<b>A61M 5/00</b> (2006.01)	2585137 *	AUTO-INJECTOR

MKP (51)	Broj objave evropske prijava patenta (97)	Naziv pronalaska (54)
<b>A61M 5/32</b> (2006.01)	2585137 *	AUTO-INJECTOR
<b>C12N 15/82</b> (2006.01)	2566318 *	BRASSICA PLANTS WITH ALTERED ARCHITECTURE
<b>A01H 5/10</b> (2006.01)	2566318 *	BRASSICA PLANTS WITH ALTERED ARCHITECTURE
<b>C07K 14/415</b> (2006.01)	2566318 *	BRASSICA PLANTS WITH ALTERED ARCHITECTURE
<b>A01H 1/06</b> (2006.01)	2566318 *	BRASSICA PLANTS WITH ALTERED ARCHITECTURE
<b>A61M 5/315</b> (2006.01)	2579928 *	DRIVE ASSEMBLY, DRIVE COMPONENT AND DRUG DELIVERY DEVICE
<b>B01F 5/04</b> (2006.01)	2571610 *	METHOD AND DEVICE FOR IN-LINE INJECTION OF FLOCCULENT AGENT INTO A FLUID FLOW OF MATURE FINE TAILINGS
<b>B03D 3/06</b> (2006.01)	2571610 *	METHOD AND DEVICE FOR IN-LINE INJECTION OF FLOCCULENT AGENT INTO A FLUID FLOW OF MATURE FINE TAILINGS
<b>B01D 21/01</b> (2006.01)	2571610 *	METHOD AND DEVICE FOR IN-LINE INJECTION OF FLOCCULENT AGENT INTO A FLUID FLOW OF MATURE FINE TAILINGS
<b>B09B 3/00</b> (2006.01)	2587145 *	METHOD FOR THE POLLUTION-FREE THERMAL PROCESSING OF SOLID MUNICIPAL WASTE AND PLANT FOR CARRYING OUT SAID METHOD
<b>F23G 5/00</b> (2006.01)	2587145 *	METHOD FOR THE POLLUTION-FREE THERMAL PROCESSING OF SOLID MUNICIPAL WASTE AND PLANT FOR CARRYING OUT SAID METHOD
<b>F23G 5/04</b> (2006.01)	2587145 *	METHOD FOR THE POLLUTION-FREE THERMAL PROCESSING OF SOLID MUNICIPAL WASTE AND PLANT FOR CARRYING OUT SAID METHOD
<b>A61K 31/498</b> (2006.01)	2444068	Brimonidine gel composition
<b>A61K 9/06</b> (2006.01)	2444068	Brimonidine gel composition
<b>A61K 47/14</b> (2006.01)	2444068	Brimonidine gel composition
<b>A61K 47/32</b> (2006.01)	2444068	Brimonidine gel composition
<b>A61K 9/00</b> (2006.01)	2444068	Brimonidine gel composition
<b>C07D 401/14</b> (2006.01)	2545037 *	INHIBITORS OF PROTEIN KINASES
<b>A61K 31/496</b> (2006.01)	2545037 *	INHIBITORS OF PROTEIN KINASES
<b>A61K 31/4418</b> (2006.01)	2545037 *	INHIBITORS OF PROTEIN KINASES
<b>A61P 9/00</b> (2006.01)	2545037 *	INHIBITORS OF PROTEIN KINASES
<b>C07D 401/12</b> (2006.01)	2545037 *	INHIBITORS OF PROTEIN KINASES
<b>A61K 31/4436</b> (2006.01)	2545037 *	INHIBITORS OF PROTEIN KINASES
<b>C07D 417/12</b> (2006.01)	2545037 *	INHIBITORS OF PROTEIN KINASES
<b>A61P 29/00</b> (2006.01)	2545037 *	INHIBITORS OF PROTEIN KINASES
<b>C07D 213/75</b> (2006.01)	2545037 *	INHIBITORS OF PROTEIN KINASES
<b>A61K 31/44</b> (2006.01)	2545037 *	INHIBITORS OF PROTEIN KINASES
<b>A61K 31/4545</b> (2006.01)	2545037 *	INHIBITORS OF PROTEIN KINASES
<b>A61P 25/00</b> (2006.01)	2545037 *	INHIBITORS OF PROTEIN KINASES
<b>A61K 31/4439</b> (2006.01)	2545037 *	INHIBITORS OF PROTEIN KINASES
<b>C07D 409/12</b> (2006.01)	2545037 *	INHIBITORS OF PROTEIN KINASES
<b>A61P 25/28</b> (2006.01)	2545037 *	INHIBITORS OF PROTEIN KINASES
<b>H02J 7/14</b> (2006.01)	2586114 *	HANDHELD ROTATIONALLY RECHARGEABLE ELECTRONIC APPARATUS
<b>A61K 31/44</b> (2006.01)	2575461 *	SUBSTITUTED-6-METHYLNICOTINAMIDES AS MGLUR5 POSITIVE ALLOSTERIC MODULATORS
<b>A01N 43/40</b> (2006.01)	2575461 *	SUBSTITUTED-6-METHYLNICOTINAMIDES AS MGLUR5 POSITIVE ALLOSTERIC MODULATORS
<b>A47K 5/12</b> (2006.01)	2560531 *	DISPENSER
<b>A01N 43/02</b> (2006.01)	2563122 *	CHEMICAL COMPOUNDS
<b>A01N 43/22</b> (2006.01)	2563122 *	CHEMICAL COMPOUNDS
<b>A61K 31/38</b> (2006.01)	2563122 *	CHEMICAL COMPOUNDS
<b>H04R 25/00</b> (2006.01)	2571571 *	MULTI-ELECTRODE CHANNEL CONFIGURATIONS
<b>A61N 1/36</b> (2006.01)	2571571 *	MULTI-ELECTRODE CHANNEL CONFIGURATIONS
<b>G21F 9/30</b> (2006.01)	2586034 *	PROCESS FOR THE DETRITIATION OF SOFT HOUSEKEEPING WASTE AND PLANT THEREOF



MKP (51)	Broj objave evropske prijava patenta (97)	Naziv pronalaska (54)
<b>G21F 9/02</b> (2006.01)	2586034 *	PROCESS FOR THE DETRITIATION OF SOFT HOUSEKEEPING WASTE AND PLANT THEREOF
<b>A61K 31/4725</b> (2006.01)	2572717 *	PHARMACEUTICAL COMPOSITION CONTAINING SOLIFENACIN
<b>A61P 13/10</b> (2006.01)	2572717 *	PHARMACEUTICAL COMPOSITION CONTAINING SOLIFENACIN
<b>A61K 9/10</b> (2006.01)	2572717 *	PHARMACEUTICAL COMPOSITION CONTAINING SOLIFENACIN
<b>A61P 43/00</b> (2006.01)	2572717 *	PHARMACEUTICAL COMPOSITION CONTAINING SOLIFENACIN
<b>A61K 47/32</b> (2006.01)	2572717 *	PHARMACEUTICAL COMPOSITION CONTAINING SOLIFENACIN
<b>A61P 13/00</b> (2006.01)	2572717 *	PHARMACEUTICAL COMPOSITION CONTAINING SOLIFENACIN
<b>A61P 11/06</b> (2006.01)	2572717 *	PHARMACEUTICAL COMPOSITION CONTAINING SOLIFENACIN
<b>A61K 47/30</b> (2006.01)	2572717 *	PHARMACEUTICAL COMPOSITION CONTAINING SOLIFENACIN
<b>A61P 11/00</b> (2006.01)	2572717 *	PHARMACEUTICAL COMPOSITION CONTAINING SOLIFENACIN
<b>A61P 1/00</b> (2006.01)	2572717 *	PHARMACEUTICAL COMPOSITION CONTAINING SOLIFENACIN
<b>F17C 13/06</b> (2006.01)	2546556 *	HERMETIC SEALING SYSTEM FOR CONTAINERS
<b>F16J 13/08</b> (2006.01)	2546556 *	HERMETIC SEALING SYSTEM FOR CONTAINERS
<b>A47B 87/02</b> (2006.01)	2505100	Modular furnishing element and assembly comprising a composition with such furnishing element
<b>G01N 33/487</b> (2006.01)	2550530 *	RESIDUAL COMPENSATION FOR A BIOSENSOR
<b>B03C 3/06</b> (2006.01)	2552591 *	ELECTROSTATIC PRECIPITATOR WITH DUAL ENERGY ZONE DISCHARGE ELECTRODES
<b>B03C 3/16</b> (2006.01)	2552591 *	ELECTROSTATIC PRECIPITATOR WITH DUAL ENERGY ZONE DISCHARGE ELECTRODES
<b>A61K 9/20</b> (2006.01)	2556824	Solid pharmaceutical composition for buccal administration of agomelatine
<b>A61K 31/165</b> (2006.01)	2556824	Solid pharmaceutical composition for buccal administration of agomelatine
<b>A61K 9/00</b> (2006.01)	2556824	Solid pharmaceutical composition for buccal administration of agomelatine
<b>B41N 6/00</b> (2006.01)	2514601	An apparatus for providing bubble-less sealing of flexo-printing photopolymers on sleeves coated by an adhesive strip
<b>A61K 31/437</b> (2006.01)	2590987 *	RING-FUSED 4 -AMINOPYRIMIDINES AND USE THEREOF AS STIMULATORS OF SOLUABLE GUANYLATE CYCLASES
<b>A61P 9/00</b> (2006.01)	2590987 *	RING-FUSED 4 -AMINOPYRIMIDINES AND USE THEREOF AS STIMULATORS OF SOLUABLE GUANYLATE CYCLASES
<b>C07D 519/00</b> (2006.01)	2590987 *	RING-FUSED 4 -AMINOPYRIMIDINES AND USE THEREOF AS STIMULATORS OF SOLUABLE GUANYLATE CYCLASES
<b>A61K 39/39</b> (2006.01)	2566515 *	INNOVATIVE DISCOVERY OF THERAPEUTIC, DIAGNOSTIC, AND ANTIBODY COMPOSITIONS RELATED TO PROTEIN FRAGMENTS OF ARGINYLYL-TRNA SYNTHETASES
<b>A61K 38/43</b> (2006.01)	2566515 *	INNOVATIVE DISCOVERY OF THERAPEUTIC, DIAGNOSTIC, AND ANTIBODY COMPOSITIONS RELATED TO PROTEIN FRAGMENTS OF ARGINYLYL-TRNA SYNTHETASES
<b>C12N 9/00</b> (2006.01)	2566515 *	INNOVATIVE DISCOVERY OF THERAPEUTIC, DIAGNOSTIC, AND ANTIBODY COMPOSITIONS RELATED TO PROTEIN FRAGMENTS OF ARGINYLYL-TRNA SYNTHETASES
<b>A61P 37/00</b> (2006.01)	2566515 *	INNOVATIVE DISCOVERY OF THERAPEUTIC, DIAGNOSTIC, AND ANTIBODY COMPOSITIONS RELATED TO PROTEIN FRAGMENTS OF ARGINYLYL-TRNA SYNTHETASES
<b>A61K 39/395</b> (2006.01)	2566515 *	INNOVATIVE DISCOVERY OF THERAPEUTIC, DIAGNOSTIC, AND ANTIBODY COMPOSITIONS RELATED TO PROTEIN FRAGMENTS OF ARGINYLYL-TRNA SYNTHETASES
<b>A61K 38/16</b> (2006.01)	2566515 *	INNOVATIVE DISCOVERY OF THERAPEUTIC, DIAGNOSTIC, AND ANTIBODY COMPOSITIONS RELATED TO PROTEIN FRAGMENTS OF ARGINYLYL-TRNA SYNTHETASES
<b>B03D 101/02</b> (2006.01)	2547453 *	FROTH FLOTATION PROCESS FOR THE SEPARATION OF SILICATES AND ALKALINE EARTH METAL CARBONATES USING A COLLECTOR COMPRISING AT LEAST ONE HYDROPHOBICALLY MODIFIED POLYALKYLENEIMINE

MKP (51)	Broj objave evropske prijava patenta (97)	Naziv pronalaska (54)
<b>C22B 26/00</b> (2006.01)	2547453 *	FROTH FLOTATION PROCESS FOR THE SEPARATION OF SILICATES AND ALKALINE EARTH METAL CARBONATES USING A COLLECTOR COMPRISING AT LEAST ONE HYDROPHOBICALLY MODIFIED POLYALKYLENEIMINE
<b>B03D 1/01</b> (2006.01)	2547453 *	FROTH FLOTATION PROCESS FOR THE SEPARATION OF SILICATES AND ALKALINE EARTH METAL CARBONATES USING A COLLECTOR COMPRISING AT LEAST ONE HYDROPHOBICALLY MODIFIED POLYALKYLENEIMINE
<b>C22B 26/20</b> (2006.01)	2547453 *	FROTH FLOTATION PROCESS FOR THE SEPARATION OF SILICATES AND ALKALINE EARTH METAL CARBONATES USING A COLLECTOR COMPRISING AT LEAST ONE HYDROPHOBICALLY MODIFIED POLYALKYLENEIMINE
<b>A61K 8/19</b> (2006.01)	2566583 *	USE OF CELLULAR EXTRACTS FOR SKIN REJUVENATION
<b>A61K 8/67</b> (2006.01)	2566583 *	USE OF CELLULAR EXTRACTS FOR SKIN REJUVENATION
<b>A61Q 19/00</b> (2006.01)	2566583 *	USE OF CELLULAR EXTRACTS FOR SKIN REJUVENATION
<b>A61Q 19/08</b> (2006.01)	2566583 *	USE OF CELLULAR EXTRACTS FOR SKIN REJUVENATION
<b>A61K 8/98</b> (2006.01)	2566583 *	USE OF CELLULAR EXTRACTS FOR SKIN REJUVENATION
<b>G07F 9/02</b> (2006.01)	2553665 *	VENDING APPARATUS AND METHOD FOR PROVIDING TRAINING FOR A MEDICINAL PRODUCT OR MEDICAL DEVICE OR COMBINATION PRODUCT
<b>C07K 16/00</b> (2006.01)	2576616 *	METHOD FOR PREPARING ANTIBODIES HAVING IMPROVED PROPERTIES
<b>G01M 5/00</b> (2006.01)	2583076 *	SYSTEM FOR MEASURING AND MONITORING THE STRAIN ON OBJECTS STRESSED BY EXTERNAL FORCES
<b>G01M 11/08</b> (2006.01)	2583076 *	SYSTEM FOR MEASURING AND MONITORING THE STRAIN ON OBJECTS STRESSED BY EXTERNAL FORCES
<b>G01N 33/487</b> (2006.01)	2590550 *	ALLOWING MEASUREMENTS TO BE MADE OF A BLOOD SAMPLE
<b>A61B 5/1486</b> (2006.01)	2590550 *	ALLOWING MEASUREMENTS TO BE MADE OF A BLOOD SAMPLE
<b>A61B 5/157</b> (2006.01)	2590550 *	ALLOWING MEASUREMENTS TO BE MADE OF A BLOOD SAMPLE
<b>A61B 5/151</b> (2006.01)	2590550 *	ALLOWING MEASUREMENTS TO BE MADE OF A BLOOD SAMPLE
<b>A61B 5/00</b> (2006.01)	2590550 *	ALLOWING MEASUREMENTS TO BE MADE OF A BLOOD SAMPLE
<b>A47L 13/20</b> (2006.01)	2544576 *	WIPING PLATE HAVING AN ASSOCIATED WIPING CLOTH FOR PICKING UP THE WIPING CLOTH IN A HANDS-FREE MANNER
<b>A47L 13/256</b> (2006.01)	2544576 *	WIPING PLATE HAVING AN ASSOCIATED WIPING CLOTH FOR PICKING UP THE WIPING CLOTH IN A HANDS-FREE MANNER
<b>A47L 13/44</b> (2006.01)	2544576 *	WIPING PLATE HAVING AN ASSOCIATED WIPING CLOTH FOR PICKING UP THE WIPING CLOTH IN A HANDS-FREE MANNER
<b>H01R 13/52</b> (2006.01)	2544313 *	CONNECTOR AND CONNECTION DEVICE FOR ELECTRONIC EQUIPMENT
<b>A01N 43/90</b> (2006.01)	2540719 *	CYCLIC AMINE COMPOUND AND MITICIDE
<b>A61P 33/10</b> (2006.01)	2540719 *	CYCLIC AMINE COMPOUND AND MITICIDE
<b>A01P 7/02</b> (2006.01)	2540719 *	CYCLIC AMINE COMPOUND AND MITICIDE
<b>C07D 491/052</b> (2006.01)	2540719 *	CYCLIC AMINE COMPOUND AND MITICIDE
<b>C07D 451/06</b> (2006.01)	2540719 *	CYCLIC AMINE COMPOUND AND MITICIDE
<b>A61M 5/24</b> (2006.01)	2560708 *	CODED CARTRIDGE ASSEMBLY
<b>A61K 47/08</b> (2006.01)	2588141 *	ANTIBODY FORMULATIONS
<b>A61K 39/395</b> (2006.01)	2588141 *	ANTIBODY FORMULATIONS
<b>A61K 9/08</b> (2006.01)	2588141 *	ANTIBODY FORMULATIONS
<b>C07K 16/10</b> (2006.01)	2591000 *	ANTI-HUMAN RESPIRATORY SYNCYTIAL VIRUS (RSV) ANTIBODIES AND METHODS OF USE
<b>A61P 31/12</b> (2006.01)	2591000 *	ANTI-HUMAN RESPIRATORY SYNCYTIAL VIRUS (RSV) ANTIBODIES AND METHODS OF USE
<b>G01N 33/68</b> (2006.01)	2558867 *	METHOD FOR DIFFERENTIALLY QUANTIFYING NATURALLY PROCESSED HLA-RESTRICTED PEPTIDES FOR CANCER, AUTOIMMUNE AND INFECTIOUS DISEASES IMMUNOTHERAPY DEVELOPMENT
<b>C07D 277/82</b> (2006.01)	2542541 *	SYNTHESIS OF CHIRALLY PURIFIED SUBSTITUTED BENZOTHAZOLE DIAMINES
<b>A61K 47/42</b> (2006.01)	2575804 *	METHODS OF TREATMENT OF PANCREATIC CANCER

MKP (51)	Broj objave evropske prijava patenta (97)	Naziv pronalaska (54)
<b>A61P 35/00</b> (2006.01)	2575804 *	METHODS OF TREATMENT OF PANCREATIC CANCER
<b>A61K 9/14</b> (2006.01)	2575804 *	METHODS OF TREATMENT OF PANCREATIC CANCER
<b>A61K 31/337</b> (2006.01)	2575804 *	METHODS OF TREATMENT OF PANCREATIC CANCER
<b>A61M 5/32</b> (2006.01)	2585140 *	AUTO-INJECTOR
<b>A61M 5/20</b> (2006.01)	2585140 *	AUTO-INJECTOR
<b>A61M 5/00</b> (2006.01)	2585140 *	AUTO-INJECTOR
<b>A61K 31/47</b> (2006.01)	2575814 *	PHARMACEUTICAL COMPOSITIONS AND ADMINISTRATIONS THEREOF
<b>F03G 7/00</b> (2006.01)	2582916 *	COMPRESSED AIR ENGINE
<b>F01B 23/02</b> (2006.01)	2582916 *	COMPRESSED AIR ENGINE
<b>F01B 9/02</b> (2006.01)	2582916 *	COMPRESSED AIR ENGINE
<b>B60W 20/00</b> (2006.01)	2582916 *	COMPRESSED AIR ENGINE
<b>C07C 235/40</b> (2006.01)	2547645 *	PROCESSES AND INTERMEDIATES FOR PREPARING A MACROCYCLIC PROTEASE INHIBITOR OF HCV
<b>C07C 69/74</b> (2006.01)	2547645 *	PROCESSES AND INTERMEDIATES FOR PREPARING A MACROCYCLIC PROTEASE INHIBITOR OF HCV
<b>C07C 51/487</b> (2006.01)	2547645 *	PROCESSES AND INTERMEDIATES FOR PREPARING A MACROCYCLIC PROTEASE INHIBITOR OF HCV
<b>C07C 61/06</b> (2006.01)	2547645 *	PROCESSES AND INTERMEDIATES FOR PREPARING A MACROCYCLIC PROTEASE INHIBITOR OF HCV
<b>A61K 9/48</b> (2006.01)	2471514	Controlled moisture content of cetyl myristate and/or cetyl palmitate granules or formulations
<b>A61K 9/16</b> (2006.01)	2471514	Controlled moisture content of cetyl myristate and/or cetyl palmitate granules or formulations
<b>A61K 9/20</b> (2006.01)	2471514	Controlled moisture content of cetyl myristate and/or cetyl palmitate granules or formulations
<b>A61K 31/23</b> (2006.01)	2471514	Controlled moisture content of cetyl myristate and/or cetyl palmitate granules or formulations
<b>B65D 77/04</b> (2006.01)	2566777 *	CONTAINER FOR LIQUIDS
<b>B65D 8/04</b> (2006.01)	2566777 *	CONTAINER FOR LIQUIDS
<b>B65D 77/06</b> (2006.01)	2566777 *	CONTAINER FOR LIQUIDS
<b>B01D 53/64</b> (2006.01)	2555851 *	METHODS FOR REMOVAL OF MERCURY FROM FLUE GAS
<b>B01D 53/34</b> (2006.01)	2555851 *	METHODS FOR REMOVAL OF MERCURY FROM FLUE GAS
<b>B01D 53/02</b> (2006.01)	2555851 *	METHODS FOR REMOVAL OF MERCURY FROM FLUE GAS
<b>A61K 31/445</b> (2006.01)	2544685 *	SOLID PHARMACEUTICAL COMPOSITION, COMPRISING DONEPEZIL HYDROCHLORIDE OF THE CRYSTALLINE POLYMORPHOUS FORM I
<b>A61K 9/20</b> (2006.01)	2544685 *	SOLID PHARMACEUTICAL COMPOSITION, COMPRISING DONEPEZIL HYDROCHLORIDE OF THE CRYSTALLINE POLYMORPHOUS FORM I
<b>C07K 16/40</b> (2006.01)	2563911 *	INNOVATIVE DISCOVERY OF THERAPEUTIC, DIAGNOSTIC, AND ANTIBODY COMPOSITIONS RELATED TO PROTEIN FRAGMENTS OF ALANYL TRNA SYNTHETASES
<b>C07K 19/00</b> (2006.01)	2563911 *	INNOVATIVE DISCOVERY OF THERAPEUTIC, DIAGNOSTIC, AND ANTIBODY COMPOSITIONS RELATED TO PROTEIN FRAGMENTS OF ALANYL TRNA SYNTHETASES
<b>C12N 15/113</b> (2010.01)	2563911 *	INNOVATIVE DISCOVERY OF THERAPEUTIC, DIAGNOSTIC, AND ANTIBODY COMPOSITIONS RELATED TO PROTEIN FRAGMENTS OF ALANYL TRNA SYNTHETASES
<b>G01N 33/68</b> (2006.01)	2563911 *	INNOVATIVE DISCOVERY OF THERAPEUTIC, DIAGNOSTIC, AND ANTIBODY COMPOSITIONS RELATED TO PROTEIN FRAGMENTS OF ALANYL TRNA SYNTHETASES
<b>A61K 38/43</b> (2006.01)	2563911 *	INNOVATIVE DISCOVERY OF THERAPEUTIC, DIAGNOSTIC, AND ANTIBODY COMPOSITIONS RELATED TO PROTEIN FRAGMENTS OF ALANYL TRNA SYNTHETASES
<b>C12N 9/00</b> (2006.01)	2563911 *	INNOVATIVE DISCOVERY OF THERAPEUTIC, DIAGNOSTIC, AND ANTIBODY COMPOSITIONS RELATED TO PROTEIN FRAGMENTS OF ALANYL TRNA SYNTHETASES

MKP (51)	Broj objave evropske prijava patenta (97)	Naziv pronalaska (54)
<b>C12N 15/52</b> (2006.01)	2563911 *	INNOVATIVE DISCOVERY OF THERAPEUTIC, DIAGNOSTIC, AND ANTIBODY COMPOSITIONS RELATED TO PROTEIN FRAGMENTS OF ALANYL TRNA SYNTHETASES
<b>C08J 3/22</b> (2006.01)	2573130 *	MASTERBATCH PELLETS, PROCESS FOR PRODUCING SAME, AND POLYAMIDE RESIN COMPOSITION CONTAINING THE MASTERBATCH PELLETS
<b>C08L 77/00</b> (2006.01)	2573130 *	MASTERBATCH PELLETS, PROCESS FOR PRODUCING SAME, AND POLYAMIDE RESIN COMPOSITION CONTAINING THE MASTERBATCH PELLETS
<b>C08K 3/22</b> (2006.01)	2573130 *	MASTERBATCH PELLETS, PROCESS FOR PRODUCING SAME, AND POLYAMIDE RESIN COMPOSITION CONTAINING THE MASTERBATCH PELLETS
<b>B29B 9/12</b> (2006.01)	2573130 *	MASTERBATCH PELLETS, PROCESS FOR PRODUCING SAME, AND POLYAMIDE RESIN COMPOSITION CONTAINING THE MASTERBATCH PELLETS
<b>C09J 167/06</b> (2006.01)	2576141 *	ADHESIVE COMPOSITION CONTAINING A CARBOXYLIC-ACID-TERMINATED UNSATURATED POLYESTER AND USES THEREOF
<b>C08G 63/676</b> (2006.01)	2576141 *	ADHESIVE COMPOSITION CONTAINING A CARBOXYLIC-ACID-TERMINATED UNSATURATED POLYESTER AND USES THEREOF
<b>C08G 63/52</b> (2006.01)	2576141 *	ADHESIVE COMPOSITION CONTAINING A CARBOXYLIC-ACID-TERMINATED UNSATURATED POLYESTER AND USES THEREOF
<b>B24D 3/28</b> (2006.01)	2576141 *	ADHESIVE COMPOSITION CONTAINING A CARBOXYLIC-ACID-TERMINATED UNSATURATED POLYESTER AND USES THEREOF
<b>B24D 3/20</b> (2006.01)	2576141 *	ADHESIVE COMPOSITION CONTAINING A CARBOXYLIC-ACID-TERMINATED UNSATURATED POLYESTER AND USES THEREOF
<b>A61M 5/24</b> (2006.01)	2460552	Drug delivery device with locking arrangement for dose button
<b>A61M 5/315</b> (2006.01)	2460552	Drug delivery device with locking arrangement for dose button
<b>E21B 47/00</b> (2012.01)	2558681 *	PRODUCTION LOGGING PROCESSES AND SYSTEMS
<b>A61M 1/14</b> (2006.01)	2585489 *	NEW MEDIUM, DEVICES AND METHODS
<b>C07K 14/705</b> (2006.01)	2585489 *	NEW MEDIUM, DEVICES AND METHODS
<b>C07K 17/02</b> (2006.01)	2585489 *	NEW MEDIUM, DEVICES AND METHODS
<b>B32B 27/08</b> (2006.01)	2552689 *	BIAXIALLY ORIENTED POLYLACTIC ACID FILM WITH REDUCED NOISE LEVEL
<b>B32B 27/36</b> (2006.01)	2552689 *	BIAXIALLY ORIENTED POLYLACTIC ACID FILM WITH REDUCED NOISE LEVEL
<b>C08G 63/08</b> (2006.01)	2552689 *	BIAXIALLY ORIENTED POLYLACTIC ACID FILM WITH REDUCED NOISE LEVEL
<b>G01M 3/32</b> (2006.01)	2569611 *	VESSEL OUTGASSING INSPECTION METHODS
<b>G01N 15/08</b> (2006.01)	2569611 *	VESSEL OUTGASSING INSPECTION METHODS
<b>C23C 16/00</b> (2006.01)	2569611 *	VESSEL OUTGASSING INSPECTION METHODS
<b>G01N 33/00</b> (2006.01)	2569611 *	VESSEL OUTGASSING INSPECTION METHODS
<b>A01N 43/42</b> (2006.01)	2575464 *	NEW FORMS OF RIFAXIMIN AND USES THEREOF
<b>C07D 291/00</b> (2006.01)	2575464 *	NEW FORMS OF RIFAXIMIN AND USES THEREOF
<b>A61K 31/44</b> (2006.01)	2575464 *	NEW FORMS OF RIFAXIMIN AND USES THEREOF
<b>G06F 19/24</b> (2011.01)	2390811	Identification of ribosomal DNA sequences
<b>H01M 4/96</b> (2006.01)	2548257 *	ELECTROCHEMICAL HYDROGEN-CATALYST POWER SYSTEM
<b>G21B 3/00</b> (2006.01)	2548257 *	ELECTROCHEMICAL HYDROGEN-CATALYST POWER SYSTEM
<b>H01M 14/00</b> (2006.01)	2548257 *	ELECTROCHEMICAL HYDROGEN-CATALYST POWER SYSTEM
<b>C01B 3/00</b> (2006.01)	2548257 *	ELECTROCHEMICAL HYDROGEN-CATALYST POWER SYSTEM
<b>H01M 8/22</b> (2006.01)	2548257 *	ELECTROCHEMICAL HYDROGEN-CATALYST POWER SYSTEM
<b>H01M 4/94</b> (2006.01)	2548257 *	ELECTROCHEMICAL HYDROGEN-CATALYST POWER SYSTEM
<b>H01M 4/86</b> (2006.01)	2548257 *	ELECTROCHEMICAL HYDROGEN-CATALYST POWER SYSTEM
<b>C07D 211/46</b> (2006.01)	2556056 *	MODULATORS OF THE GPR119 RECEPTOR AND THE TREATMENT OF DISORDERS RELATED THERETO

MKP (51)	Broj objave evropske prijava patenta (97)	Naziv pronalaska (54)
<b>C07D 413/14</b> (2006.01)	2556056 *	MODULATORS OF THE GPR119 RECEPTOR AND THE TREATMENT OF DISORDERS RELATED THERETO
<b>C07D 413/04</b> (2006.01)	2556056 *	MODULATORS OF THE GPR119 RECEPTOR AND THE TREATMENT OF DISORDERS RELATED THERETO
<b>C07D 413/06</b> (2006.01)	2556056 *	MODULATORS OF THE GPR119 RECEPTOR AND THE TREATMENT OF DISORDERS RELATED THERETO
<b>C07D 405/12</b> (2006.01)	2556056 *	MODULATORS OF THE GPR119 RECEPTOR AND THE TREATMENT OF DISORDERS RELATED THERETO
<b>A61K 31/495</b> (2006.01)	2556056 *	MODULATORS OF THE GPR119 RECEPTOR AND THE TREATMENT OF DISORDERS RELATED THERETO
<b>C07D 401/12</b> (2006.01)	2556056 *	MODULATORS OF THE GPR119 RECEPTOR AND THE TREATMENT OF DISORDERS RELATED THERETO
<b>A61K 31/445</b> (2006.01)	2556056 *	MODULATORS OF THE GPR119 RECEPTOR AND THE TREATMENT OF DISORDERS RELATED THERETO
<b>C07D 405/14</b> (2006.01)	2556056 *	MODULATORS OF THE GPR119 RECEPTOR AND THE TREATMENT OF DISORDERS RELATED THERETO
<b>A61P 3/10</b> (2006.01)	2556056 *	MODULATORS OF THE GPR119 RECEPTOR AND THE TREATMENT OF DISORDERS RELATED THERETO
<b>C07D 401/14</b> (2006.01)	2556056 *	MODULATORS OF THE GPR119 RECEPTOR AND THE TREATMENT OF DISORDERS RELATED THERETO
<b>A61K 31/454</b> (2006.01)	2556056 *	MODULATORS OF THE GPR119 RECEPTOR AND THE TREATMENT OF DISORDERS RELATED THERETO
<b>C07D 401/04</b> (2006.01)	2556056 *	MODULATORS OF THE GPR119 RECEPTOR AND THE TREATMENT OF DISORDERS RELATED THERETO
<b>C07D 417/14</b> (2006.01)	2556056 *	MODULATORS OF THE GPR119 RECEPTOR AND THE TREATMENT OF DISORDERS RELATED THERETO
<b>A61K 35/12</b> (2006.01)	2443231 *	GENERATION OF INDUCED PLURIPOTENT STEM CELLS FROM CORD BLOOD
<b>C12N 5/10</b> (2006.01)	2443231 *	GENERATION OF INDUCED PLURIPOTENT STEM CELLS FROM CORD BLOOD
<b>C12N 5/0735</b> (2010.01)	2443231 *	GENERATION OF INDUCED PLURIPOTENT STEM CELLS FROM CORD BLOOD
<b>C12N 15/12</b> (2006.01)	2443231 *	GENERATION OF INDUCED PLURIPOTENT STEM CELLS FROM CORD BLOOD
<b>C12N 5/074</b> (2010.01)	2443231 *	GENERATION OF INDUCED PLURIPOTENT STEM CELLS FROM CORD BLOOD
<b>A61K 38/00</b> (2006.01)	2542254 *	SECONDARY STRUCTURE STABILIZED NMDA RECEPTOR MODULATORS AND USES THEREOF
<b>A61K 38/16</b> (2006.01)	2542254 *	SECONDARY STRUCTURE STABILIZED NMDA RECEPTOR MODULATORS AND USES THEREOF
<b>C07D 498/20</b> (2006.01)	2547686 *	AMINO -DIHYDROOXAZINE AND AMINO - DIHYDROTHIAZINE SPIRO COMPOUNDS AS BETA - SECRETASE MODULATORS AND THEIR MEDICAL USE
<b>A61K 31/537</b> (2006.01)	2547686 *	AMINO -DIHYDROOXAZINE AND AMINO - DIHYDROTHIAZINE SPIRO COMPOUNDS AS BETA - SECRETASE MODULATORS AND THEIR MEDICAL USE
<b>C07D 498/10</b> (2006.01)	2547686 *	AMINO -DIHYDROOXAZINE AND AMINO - DIHYDROTHIAZINE SPIRO COMPOUNDS AS BETA - SECRETASE MODULATORS AND THEIR MEDICAL USE
<b>A61K 31/5386</b> (2006.01)	2547686 *	AMINO -DIHYDROOXAZINE AND AMINO - DIHYDROTHIAZINE SPIRO COMPOUNDS AS BETA - SECRETASE MODULATORS AND THEIR MEDICAL USE
<b>C07D 513/10</b> (2006.01)	2547686 *	AMINO -DIHYDROOXAZINE AND AMINO - DIHYDROTHIAZINE SPIRO COMPOUNDS AS BETA - SECRETASE MODULATORS AND THEIR MEDICAL USE
<b>C07D 513/20</b> (2006.01)	2547686 *	AMINO -DIHYDROOXAZINE AND AMINO - DIHYDROTHIAZINE SPIRO COMPOUNDS AS BETA - SECRETASE MODULATORS AND THEIR MEDICAL USE

MKP (51)	Broj objave evropske prijava patenta (97)	Naziv pronalaska (54)
<b>A61P 25/28</b> (2006.01)	2547686 *	AMINO -DIHYDROOXAZINE AND AMINO - DIHYDROTHIAZINE SPIRO COMPOUNDS AS BETA - SECRETASE MODULATORS AND THEIR MEDICAL USE
<b>A61K 31/547</b> (2006.01)	2547686 *	AMINO -DIHYDROOXAZINE AND AMINO - DIHYDROTHIAZINE SPIRO COMPOUNDS AS BETA - SECRETASE MODULATORS AND THEIR MEDICAL USE
<b>G01N 33/548</b> (2006.01)	2560003 *	COMPLEX OF LABELED PROBE AND WATER-SOLUBLE CARRIER
<b>G01N 33/53</b> (2006.01)	2560003 *	COMPLEX OF LABELED PROBE AND WATER-SOLUBLE CARRIER
<b>C12Q 1/60</b> (2006.01)	2580346 *	METHOD FOR DETECTING COMPOUNDS THAT MODULATE THE CHOLESTEROL METABOLISM
<b>A01K 1/00</b> (2006.01)	2590501 *	APPARATUS AND METHOD FOR HANDLING A SEAL IN A SLURRY DUCT
<b>A01K 1/01</b> (2006.01)	2590501 *	APPARATUS AND METHOD FOR HANDLING A SEAL IN A SLURRY DUCT
<b>A61P 29/00</b> (2006.01)	2566474 *	NON-AQUEOUS TAXANE PRO-EMULSION FORMULATIONS AND METHODS OF MAKING AND USING THE SAME
<b>A61K 31/337</b> (2006.01)	2566474 *	NON-AQUEOUS TAXANE PRO-EMULSION FORMULATIONS AND METHODS OF MAKING AND USING THE SAME
<b>A61K 9/107</b> (2006.01)	2566474 *	NON-AQUEOUS TAXANE PRO-EMULSION FORMULATIONS AND METHODS OF MAKING AND USING THE SAME
<b>A61K 9/10</b> (2006.01)	2566474 *	NON-AQUEOUS TAXANE PRO-EMULSION FORMULATIONS AND METHODS OF MAKING AND USING THE SAME
<b>C12Q 1/68</b> (2006.01)	2588630 *	MOLECULAR GENETIC APPROACH TO TREATMENT AND DIAGNOSIS OF ALCOHOL AND DRUG DEPENDENCE
<b>C12M 1/02</b> (2006.01)	2505634	A solid state fermentation plant
<b>C12M 1/00</b> (2006.01)	2505634	A solid state fermentation plant
<b>B01F 11/00</b> (2006.01)	2505634	A solid state fermentation plant
<b>A61M 5/32</b> (2006.01)	2588173 *	SAFETY DEVICE FOR A PRE-FILLED SYRINGE AND INJECTION DEVICE
<b>A61M 5/50</b> (2006.01)	2588173 *	SAFETY DEVICE FOR A PRE-FILLED SYRINGE AND INJECTION DEVICE
<b>B65D 83/44</b> (2006.01)	2576387 *	METHOD AND APPARATUS FOR DISPENSING BEVERAGES, ESPECIALLY CARBONATED BEVERAGES
<b>B67D 1/12</b> (2006.01)	2576387 *	METHOD AND APPARATUS FOR DISPENSING BEVERAGES, ESPECIALLY CARBONATED BEVERAGES
<b>G01F 11/08</b> (2006.01)	2576387 *	METHOD AND APPARATUS FOR DISPENSING BEVERAGES, ESPECIALLY CARBONATED BEVERAGES
<b>B65D 83/18</b> (2006.01)	2576387 *	METHOD AND APPARATUS FOR DISPENSING BEVERAGES, ESPECIALLY CARBONATED BEVERAGES
<b>B65D 83/16</b> (2006.01)	2576387 *	METHOD AND APPARATUS FOR DISPENSING BEVERAGES, ESPECIALLY CARBONATED BEVERAGES
<b>G01F 11/04</b> (2006.01)	2576387 *	METHOD AND APPARATUS FOR DISPENSING BEVERAGES, ESPECIALLY CARBONATED BEVERAGES
<b>B65D 83/60</b> (2006.01)	2576387 *	METHOD AND APPARATUS FOR DISPENSING BEVERAGES, ESPECIALLY CARBONATED BEVERAGES
<b>B65D 83/14</b> (2006.01)	2576387 *	METHOD AND APPARATUS FOR DISPENSING BEVERAGES, ESPECIALLY CARBONATED BEVERAGES
<b>B67D 1/02</b> (2006.01)	2576387 *	METHOD AND APPARATUS FOR DISPENSING BEVERAGES, ESPECIALLY CARBONATED BEVERAGES
<b>B67D 1/04</b> (2006.01)	2576387 *	METHOD AND APPARATUS FOR DISPENSING BEVERAGES, ESPECIALLY CARBONATED BEVERAGES
<b>F16L 51/03</b> (2006.01)	2569568 *	IN-LINE PRESSURE BALANCED EXPANSION JOINT FOR PIPING AND DUCTING SYSTEMS WITH CIRCULAR CROSS SECTION AND INTERNALLY LOCATED TIE RODS
<b>A61K 47/10</b> (2006.01)	2575784 *	ORAL DOSAGE FORMS OF BENDAMUSTINE
<b>A61K 9/14</b> (2006.01)	2575784 *	ORAL DOSAGE FORMS OF BENDAMUSTINE
<b>A61K 31/4184</b> (2006.01)	2575784 *	ORAL DOSAGE FORMS OF BENDAMUSTINE
<b>A61K 9/48</b> (2006.01)	2575784 *	ORAL DOSAGE FORMS OF BENDAMUSTINE
<b>C07D 213/81</b> (2006.01)	2593434 *	PYRIDINE COMPOUNDS AS SODIUM CHANNEL BLOCKERS
<b>A61K 31/4412</b> (2006.01)	2593434 *	PYRIDINE COMPOUNDS AS SODIUM CHANNEL BLOCKERS

MKP (51)	Broj objave evropske prijava patenta (97)	Naziv pronalaska (54)
<b>C07D 413/12</b> (2006.01)	2593434 *	PYRIDINE COMPOUNDS AS SODIUM CHANNEL BLOCKERS
<b>A61K 31/4439</b> (2006.01)	2593434 *	PYRIDINE COMPOUNDS AS SODIUM CHANNEL BLOCKERS
<b>C07D 401/12</b> (2006.01)	2593434 *	PYRIDINE COMPOUNDS AS SODIUM CHANNEL BLOCKERS
<b>A61P 25/00</b> (2006.01)	2593434 *	PYRIDINE COMPOUNDS AS SODIUM CHANNEL BLOCKERS
<b>A61K 31/443</b> (2006.01)	2593434 *	PYRIDINE COMPOUNDS AS SODIUM CHANNEL BLOCKERS
<b>A61K 31/444</b> (2006.01)	2593434 *	PYRIDINE COMPOUNDS AS SODIUM CHANNEL BLOCKERS
<b>A61P 35/00</b> (2006.01)	2563400 *	MODIFIED BINDING PROTEINS INHIBITING THE VEGF-A RECEPTOR INTERACTION
<b>A61K 47/48</b> (2006.01)	2563400 *	MODIFIED BINDING PROTEINS INHIBITING THE VEGF-A RECEPTOR INTERACTION
<b>A61P 27/02</b> (2006.01)	2563400 *	MODIFIED BINDING PROTEINS INHIBITING THE VEGF-A RECEPTOR INTERACTION
<b>C08J 3/11</b> (2006.01)	2591042 *	GLUE COMPOSITION COMPRISING THE SOLVENT N-ACETYLMORPHOLINE
<b>B29C 65/48</b> (2006.01)	2591042 *	GLUE COMPOSITION COMPRISING THE SOLVENT N-ACETYLMORPHOLINE
<b>C08J 5/12</b> (2006.01)	2591042 *	GLUE COMPOSITION COMPRISING THE SOLVENT N-ACETYLMORPHOLINE
<b>C09J 127/06</b> (2006.01)	2591042 *	GLUE COMPOSITION COMPRISING THE SOLVENT N-ACETYLMORPHOLINE
<b>C09J 155/02</b> (2006.01)	2591042 *	GLUE COMPOSITION COMPRISING THE SOLVENT N-ACETYLMORPHOLINE
<b>A61P 9/00</b> (2006.01)	2576547 *	SUBSTITUTED 5-FLUORO-1H-PYRAZOLOPYRIDINES AND USE THEREOF
<b>A61P 15/00</b> (2006.01)	2576547 *	SUBSTITUTED 5-FLUORO-1H-PYRAZOLOPYRIDINES AND USE THEREOF
<b>A61K 31/437</b> (2006.01)	2576547 *	SUBSTITUTED 5-FLUORO-1H-PYRAZOLOPYRIDINES AND USE THEREOF
<b>C07D 471/04</b> (2006.01)	2576547 *	SUBSTITUTED 5-FLUORO-1H-PYRAZOLOPYRIDINES AND USE THEREOF
<b>E04B 1/74</b> (2006.01)	2576209 *	MAT OF POLYMER FIBRES CONTAINING AN ACETOACETAMIDE, AND ITS USE.
<b>B27N 7/00</b> (2006.01)	2576209 *	MAT OF POLYMER FIBRES CONTAINING AN ACETOACETAMIDE, AND ITS USE.
<b>E04F 13/00</b> (2006.01)	2576209 *	MAT OF POLYMER FIBRES CONTAINING AN ACETOACETAMIDE, AND ITS USE.
<b>B60R 13/02</b> (2006.01)	2576209 *	MAT OF POLYMER FIBRES CONTAINING AN ACETOACETAMIDE, AND ITS USE.
<b>B32B 5/28</b> (2006.01)	2576209 *	MAT OF POLYMER FIBRES CONTAINING AN ACETOACETAMIDE, AND ITS USE.
<b>D06M 13/402</b> (2006.01)	2576209 *	MAT OF POLYMER FIBRES CONTAINING AN ACETOACETAMIDE, AND ITS USE.
<b>C08J 7/06</b> (2006.01)	2576209 *	MAT OF POLYMER FIBRES CONTAINING AN ACETOACETAMIDE, AND ITS USE.
<b>B32B 21/10</b> (2006.01)	2576209 *	MAT OF POLYMER FIBRES CONTAINING AN ACETOACETAMIDE, AND ITS USE.
<b>A61K 31/506</b> (2006.01)	2571885 *	METHOD FOR PURIFYING A FUSED PYRROLOCARBAZOLE DERIVATIVE
<b>C07D 487/14</b> (2006.01)	2571885 *	METHOD FOR PURIFYING A FUSED PYRROLOCARBAZOLE DERIVATIVE
<b>C10C 3/14</b> (2006.01)	2563878 *	PELLETIZING ASPHALT
<b>A61K 31/47</b> (2006.01)	2566329 *	PROCESS FOR SYNTHESIZING OXIDIZED LACTAM COMPOUNDS
<b>A01N 43/42</b> (2006.01)	2566329 *	PROCESS FOR SYNTHESIZING OXIDIZED LACTAM COMPOUNDS
<b>C12N 9/64</b> (2006.01)	2550363 *	ADAM6 MICE
<b>A01K 67/027</b> (2006.01)	2550363 *	ADAM6 MICE
<b>C12N 15/85</b> (2006.01)	2550363 *	ADAM6 MICE
<b>C07K 16/46</b> (2006.01)	2550363 *	ADAM6 MICE
<b>A61K 38/08</b> (2006.01)	2593125 *	INNOVATIVE DISCOVERY OF THERAPEUTIC, DIAGNOSTIC, AND ANTIBODY COMPOSITIONS RELATED TO PROTEIN FRAGMENTS OF GLYCYL-TRNA SYNTHETASES
<b>A61K 39/395</b> (2006.01)	2593125 *	INNOVATIVE DISCOVERY OF THERAPEUTIC, DIAGNOSTIC, AND ANTIBODY COMPOSITIONS RELATED TO PROTEIN FRAGMENTS OF GLYCYL-TRNA SYNTHETASES

MKP (51)	Broj objave evropske prijava patenta (97)	Naziv pronalaska (54)
<b>A61P 3/10</b> (2006.01)	2593125 *	INNOVATIVE DISCOVERY OF THERAPEUTIC, DIAGNOSTIC, AND ANTIBODY COMPOSITIONS RELATED TO PROTEIN FRAGMENTS OF GLYCYL-TRNA SYNTHETASES
<b>A61K 38/10</b> (2006.01)	2593125 *	INNOVATIVE DISCOVERY OF THERAPEUTIC, DIAGNOSTIC, AND ANTIBODY COMPOSITIONS RELATED TO PROTEIN FRAGMENTS OF GLYCYL-TRNA SYNTHETASES
<b>A61P 35/00</b> (2006.01)	2593125 *	INNOVATIVE DISCOVERY OF THERAPEUTIC, DIAGNOSTIC, AND ANTIBODY COMPOSITIONS RELATED TO PROTEIN FRAGMENTS OF GLYCYL-TRNA SYNTHETASES
<b>A61K 38/16</b> (2006.01)	2593125 *	INNOVATIVE DISCOVERY OF THERAPEUTIC, DIAGNOSTIC, AND ANTIBODY COMPOSITIONS RELATED TO PROTEIN FRAGMENTS OF GLYCYL-TRNA SYNTHETASES
<b>A61P 3/00</b> (2006.01)	2593125 *	INNOVATIVE DISCOVERY OF THERAPEUTIC, DIAGNOSTIC, AND ANTIBODY COMPOSITIONS RELATED TO PROTEIN FRAGMENTS OF GLYCYL-TRNA SYNTHETASES
<b>C12N 5/071</b> (2010.01)	2569418 *	BIOACTIVE RENAL CELLS
<b>H05K 9/00</b> (2006.01)	2485573	Container box made of carbon fiber for electronic equipment
<b>A61K 39/00</b> (2006.01)	2547360 *	SYSTEM AND METHOD OF PREPARING AND STORING ACTIVATED MATURE DENDRITIC CELLS
<b>A61K 39/395</b> (2006.01)	2579894 *	CGRP ANTIBODIES
<b>A23C 19/068</b> (2006.01)	2568817 *	METHOD OF OBTAINING FRESH SPUN CHEESE
<b>A23L 1/30</b> (2006.01)	2471387	Cetyl myristate and/or cetyl palmitate suspension formulations
<b>A61K 31/23</b> (2006.01)	2471387	Cetyl myristate and/or cetyl palmitate suspension formulations
<b>A61K 9/00</b> (2006.01)	2471387	Cetyl myristate and/or cetyl palmitate suspension formulations
<b>A61K 9/16</b> (2006.01)	2471387	Cetyl myristate and/or cetyl palmitate suspension formulations
<b>A61K 31/44</b> (2006.01)	2584900 *	COMBINATION THERAPY WITH CRYOSURGERY AND LOW DOSAGE STRENGTH IMIQUIMOD TO TREAT ACTINIC KERATOSIS
<b>A01N 43/42</b> (2006.01)	2584900 *	COMBINATION THERAPY WITH CRYOSURGERY AND LOW DOSAGE STRENGTH IMIQUIMOD TO TREAT ACTINIC KERATOSIS
<b>G06M 1/16</b> (2006.01)	2570149	Counter
<b>A61M 15/00</b> (2006.01)	2570149	Counter
<b>G06M 1/24</b> (2006.01)	2570149	Counter
<b>H04N 7/00</b> (2011.01)	2569939 *	SYSTEMS AND METHODS FOR SCALABLE COMPOSITION OF MEDIA STREAMS FOR REAL-TIME MULTIMEDIA COMMUNICATION
<b>H04N 7/15</b> (2006.01)	2569939 *	SYSTEMS AND METHODS FOR SCALABLE COMPOSITION OF MEDIA STREAMS FOR REAL-TIME MULTIMEDIA COMMUNICATION
<b>H04N 7/14</b> (2006.01)	2569939 *	SYSTEMS AND METHODS FOR SCALABLE COMPOSITION OF MEDIA STREAMS FOR REAL-TIME MULTIMEDIA COMMUNICATION
<b>A61K 31/519</b> (2006.01)	2585055 *	USE OF STIMULATORS AND ACTIVATORS OF SOLUBLE GUANYLATE CYCLASE FOR TREATING SICKLE-CELL ANEMIA AND CONSERVING BLOOD SUBSTITUTES
<b>A61P 7/06</b> (2006.01)	2585055 *	USE OF STIMULATORS AND ACTIVATORS OF SOLUBLE GUANYLATE CYCLASE FOR TREATING SICKLE-CELL ANEMIA AND CONSERVING BLOOD SUBSTITUTES
<b>A61K 31/5377</b> (2006.01)	2585055 *	USE OF STIMULATORS AND ACTIVATORS OF SOLUBLE GUANYLATE CYCLASE FOR TREATING SICKLE-CELL ANEMIA AND CONSERVING BLOOD SUBSTITUTES
<b>A61K 31/4439</b> (2006.01)	2585055 *	USE OF STIMULATORS AND ACTIVATORS OF SOLUBLE GUANYLATE CYCLASE FOR TREATING SICKLE-CELL ANEMIA AND CONSERVING BLOOD SUBSTITUTES
<b>A61K 31/198</b> (2006.01)	2585055 *	USE OF STIMULATORS AND ACTIVATORS OF SOLUBLE GUANYLATE CYCLASE FOR TREATING SICKLE-CELL ANEMIA AND CONSERVING BLOOD SUBSTITUTES
<b>A61K 45/06</b> (2006.01)	2585055 *	USE OF STIMULATORS AND ACTIVATORS OF SOLUBLE GUANYLATE CYCLASE FOR TREATING SICKLE-CELL ANEMIA AND CONSERVING BLOOD SUBSTITUTES



MKP (51)	Broj objave evropske prijava patenta (97)	Naziv pronalaska (54)
<b>A61K 31/506</b> (2006.01)	2585055 *	USE OF STIMULATORS AND ACTIVATORS OF SOLUBLE GUANYLATE CYCLASE FOR TREATING SICKLE-CELL ANEMIA AND CONSERVING BLOOD SUBSTITUTES
<b>A61K 31/427</b> (2006.01)	2585055 *	USE OF STIMULATORS AND ACTIVATORS OF SOLUBLE GUANYLATE CYCLASE FOR TREATING SICKLE-CELL ANEMIA AND CONSERVING BLOOD SUBSTITUTES
<b>A61K 31/426</b> (2006.01)	2585055 *	USE OF STIMULATORS AND ACTIVATORS OF SOLUBLE GUANYLATE CYCLASE FOR TREATING SICKLE-CELL ANEMIA AND CONSERVING BLOOD SUBSTITUTES
<b>C07D 495/04</b> (2006.01)	2588483 *	IMPROVED PROCESS FOR PREPARING A PHARMACEUTICAL COMPOUND
<b>G06F 17/15</b> (2006.01)	2539468 *	DIAGNOSTIC METHODS INVOLVING LOSS OF HETEROZYGOSITY
<b>C12Q 1/68</b> (2006.01)	2539468 *	DIAGNOSTIC METHODS INVOLVING LOSS OF HETEROZYGOSITY
<b>G06F 19/10</b> (2011.01)	2539468 *	DIAGNOSTIC METHODS INVOLVING LOSS OF HETEROZYGOSITY
<b>A61B 17/00</b> (2006.01)	2550048 *	DEVICES FOR INJECTING A SUBSTANCE AND METHODS THEREFOR
<b>B01L 3/02</b> (2006.01)	2550048 *	DEVICES FOR INJECTING A SUBSTANCE AND METHODS THEREFOR
<b>A61M 5/46</b> (2006.01)	2550048 *	DEVICES FOR INJECTING A SUBSTANCE AND METHODS THEREFOR
<b>A61M 5/315</b> (2006.01)	2550048 *	DEVICES FOR INJECTING A SUBSTANCE AND METHODS THEREFOR
<b>A61M 5/20</b> (2006.01)	2550048 *	DEVICES FOR INJECTING A SUBSTANCE AND METHODS THEREFOR
<b>A61M 5/32</b> (2006.01)	2550048 *	DEVICES FOR INJECTING A SUBSTANCE AND METHODS THEREFOR
<b>A61M 5/19</b> (2006.01)	2550048 *	DEVICES FOR INJECTING A SUBSTANCE AND METHODS THEREFOR
<b>C07D 409/06</b> (2006.01)	2539326 *	BISARYL-BONDED ARYLTRIAZOLONES AND USE THEREOF
<b>C07D 249/12</b> (2006.01)	2539326 *	BISARYL-BONDED ARYLTRIAZOLONES AND USE THEREOF
<b>A61K 31/4196</b> (2006.01)	2539326 *	BISARYL-BONDED ARYLTRIAZOLONES AND USE THEREOF
<b>C07D 403/06</b> (2006.01)	2539326 *	BISARYL-BONDED ARYLTRIAZOLONES AND USE THEREOF
<b>C07D 413/14</b> (2006.01)	2539326 *	BISARYL-BONDED ARYLTRIAZOLONES AND USE THEREOF
<b>C07D 417/06</b> (2006.01)	2539326 *	BISARYL-BONDED ARYLTRIAZOLONES AND USE THEREOF
<b>C07D 409/14</b> (2006.01)	2539326 *	BISARYL-BONDED ARYLTRIAZOLONES AND USE THEREOF
<b>C07D 413/06</b> (2006.01)	2539326 *	BISARYL-BONDED ARYLTRIAZOLONES AND USE THEREOF
<b>C07D 401/06</b> (2006.01)	2539326 *	BISARYL-BONDED ARYLTRIAZOLONES AND USE THEREOF
<b>A61P 9/00</b> (2006.01)	2539326 *	BISARYL-BONDED ARYLTRIAZOLONES AND USE THEREOF
<b>A61P 35/00</b> (2006.01)	2588468 *	HETEROCYCLIC COMPOUNDS AND THEIR USE AS INHIBITORS OF PI3K ACTIVITY
<b>C07D 519/00</b> (2006.01)	2588468 *	HETEROCYCLIC COMPOUNDS AND THEIR USE AS INHIBITORS OF PI3K ACTIVITY
<b>A61K 31/4743</b> (2006.01)	2588468 *	HETEROCYCLIC COMPOUNDS AND THEIR USE AS INHIBITORS OF PI3K ACTIVITY
<b>C07D 401/12</b> (2006.01)	2588468 *	HETEROCYCLIC COMPOUNDS AND THEIR USE AS INHIBITORS OF PI3K ACTIVITY
<b>A61P 29/00</b> (2006.01)	2588468 *	HETEROCYCLIC COMPOUNDS AND THEIR USE AS INHIBITORS OF PI3K ACTIVITY
<b>C07D 487/04</b> (2006.01)	2588468 *	HETEROCYCLIC COMPOUNDS AND THEIR USE AS INHIBITORS OF PI3K ACTIVITY
<b>C07K 1/107</b> (2006.01)	2569326 *	PEPTIDE-BASED INHIBITOR OF INTERLEUKIN-10 OR INTERFERON-GAMMA SIGNALING
<b>A61P 31/20</b> (2006.01)	2569326 *	PEPTIDE-BASED INHIBITOR OF INTERLEUKIN-10 OR INTERFERON-GAMMA SIGNALING
<b>A61P 35/00</b> (2006.01)	2569326 *	PEPTIDE-BASED INHIBITOR OF INTERLEUKIN-10 OR INTERFERON-GAMMA SIGNALING
<b>A61P 31/18</b> (2006.01)	2569326 *	PEPTIDE-BASED INHIBITOR OF INTERLEUKIN-10 OR INTERFERON-GAMMA SIGNALING
<b>A61P 31/16</b> (2006.01)	2569326 *	PEPTIDE-BASED INHIBITOR OF INTERLEUKIN-10 OR INTERFERON-GAMMA SIGNALING
<b>C07K 14/47</b> (2006.01)	2569326 *	PEPTIDE-BASED INHIBITOR OF INTERLEUKIN-10 OR INTERFERON-GAMMA SIGNALING

MKP (51)	Broj objave evropske prijava patenta (97)	Naziv pronalaska (54)
<b>C07K 7/06</b> (2006.01)	2569326 *	PEPTIDE-BASED INHIBITOR OF INTERLEUKIN-10 OR INTERFERON-GAMMA SIGNALING
<b>C07K 14/715</b> (2006.01)	2569326 *	PEPTIDE-BASED INHIBITOR OF INTERLEUKIN-10 OR INTERFERON-GAMMA SIGNALING
<b>A61P 37/00</b> (2006.01)	2569326 *	PEPTIDE-BASED INHIBITOR OF INTERLEUKIN-10 OR INTERFERON-GAMMA SIGNALING
<b>A61L 2/00</b> (2006.01)	2571534 *	ULTRAVIOLET DISINFECTING DEVICE FOR FOOD AND BEVERAGE DISPENSERS
<b>A61K 31/496</b> (2006.01)	2585066 *	PRODRUGS OF NH-ACIDIC COMPOUNDS: ESTER, CARBONATE, CARBAMATE AND PHOSPHONATE DERIVATIVES
<b>C07D 401/12</b> (2006.01)	2585066 *	PRODRUGS OF NH-ACIDIC COMPOUNDS: ESTER, CARBONATE, CARBAMATE AND PHOSPHONATE DERIVATIVES
<b>C12N 5/02</b> (2006.01)	2569631 *	MARKERS FOR ACUTE KIDNEY INJURY
<b>C12N 5/00</b> (2006.01)	2569631 *	MARKERS FOR ACUTE KIDNEY INJURY
<b>G01N 33/53</b> (2006.01)	2569631 *	MARKERS FOR ACUTE KIDNEY INJURY
<b>A61K 39/395</b> (2006.01)	2558124 *	POLYSACCHARIDE COMPOSITIONS AND METHODS OF USE FOR THE TREATMENT AND PREVENTION OF DISORDERS ASSOCIATED WITH PROGENITOR CELL MOBILIZATION
<b>A61P 31/18</b> (2006.01)	2552902 *	NON-NUCLEOSIDE REVERSE TRANSCRIPTASE INHIBITORS
<b>A61K 31/4439</b> (2006.01)	2552902 *	NON-NUCLEOSIDE REVERSE TRANSCRIPTASE INHIBITORS
<b>C07D 401/06</b> (2006.01)	2552902 *	NON-NUCLEOSIDE REVERSE TRANSCRIPTASE INHIBITORS
<b>B65D 83/44</b> (2006.01)	2566782 *	OVER PRESSURE RELEASE VALVE
<b>A47K 10/38</b> (2006.01)	2394551	Paper roll dispenser comprising a base and at least one first door and one second door mounted on the base of the dispenser
<b>A61K 47/38</b> (2006.01)	2564875 *	LIQUID PREPARATION FOR ORAL ADMINISTRATION WHICH CAN BE USED IN CT COLONOGRAPHY, AND COMPOSITION FOR IMAGING OF DIGESTIVE TRACT
<b>A61K 9/08</b> (2006.01)	2564875 *	LIQUID PREPARATION FOR ORAL ADMINISTRATION WHICH CAN BE USED IN CT COLONOGRAPHY, AND COMPOSITION FOR IMAGING OF DIGESTIVE TRACT
<b>A61K 47/42</b> (2006.01)	2564875 *	LIQUID PREPARATION FOR ORAL ADMINISTRATION WHICH CAN BE USED IN CT COLONOGRAPHY, AND COMPOSITION FOR IMAGING OF DIGESTIVE TRACT
<b>A61K 47/10</b> (2006.01)	2564875 *	LIQUID PREPARATION FOR ORAL ADMINISTRATION WHICH CAN BE USED IN CT COLONOGRAPHY, AND COMPOSITION FOR IMAGING OF DIGESTIVE TRACT
<b>A61K 47/36</b> (2006.01)	2564875 *	LIQUID PREPARATION FOR ORAL ADMINISTRATION WHICH CAN BE USED IN CT COLONOGRAPHY, AND COMPOSITION FOR IMAGING OF DIGESTIVE TRACT
<b>A61K 47/34</b> (2006.01)	2564875 *	LIQUID PREPARATION FOR ORAL ADMINISTRATION WHICH CAN BE USED IN CT COLONOGRAPHY, AND COMPOSITION FOR IMAGING OF DIGESTIVE TRACT
<b>A61K 49/04</b> (2006.01)	2564875 *	LIQUID PREPARATION FOR ORAL ADMINISTRATION WHICH CAN BE USED IN CT COLONOGRAPHY, AND COMPOSITION FOR IMAGING OF DIGESTIVE TRACT
<b>A61K 47/26</b> (2006.01)	2564875 *	LIQUID PREPARATION FOR ORAL ADMINISTRATION WHICH CAN BE USED IN CT COLONOGRAPHY, AND COMPOSITION FOR IMAGING OF DIGESTIVE TRACT
<b>A61P 35/00</b> (2006.01)	2575850 *	IMPROVED CANCER THERAPY BASED ON TUMOR ASSOCIATED ANTIGENS DERIVED FROM CYCLIN D1
<b>C07K 14/47</b> (2006.01)	2575850 *	IMPROVED CANCER THERAPY BASED ON TUMOR ASSOCIATED ANTIGENS DERIVED FROM CYCLIN D1
<b>A61K 39/00</b> (2006.01)	2575850 *	IMPROVED CANCER THERAPY BASED ON TUMOR ASSOCIATED ANTIGENS DERIVED FROM CYCLIN D1
<b>A61K 45/06</b> (2006.01)	2575850 *	IMPROVED CANCER THERAPY BASED ON TUMOR ASSOCIATED ANTIGENS DERIVED FROM CYCLIN D1
<b>A61K 38/04</b> (2006.01)	2575850 *	IMPROVED CANCER THERAPY BASED ON TUMOR ASSOCIATED ANTIGENS DERIVED FROM CYCLIN D1

MKP (51)	Broj objave evropske prijava patenta (97)	Naziv pronalaska (54)
<b>B01D 53/22</b> (2006.01)	2588217 *	PROCESS FOR SEPARATION OF GASES
<b>C10L 3/10</b> (2006.01)	2588217 *	PROCESS FOR SEPARATION OF GASES
<b>A61M 5/24</b> (2006.01)	2579926 *	DRIVE MECHANISM FOR A DRUG DELIVERY DEVICE
<b>A61M 5/315</b> (2006.01)	2579926 *	DRIVE MECHANISM FOR A DRUG DELIVERY DEVICE
<b>A61K 31/404</b> (2006.01)	2560651 *	PHARMACEUTICAL COMPOSITIONS AND ADMINISTRATIONS THEREOF
<b>A61K 31/4704</b> (2006.01)	2560651 *	PHARMACEUTICAL COMPOSITIONS AND ADMINISTRATIONS THEREOF
<b>A61K 31/443</b> (2006.01)	2560651 *	PHARMACEUTICAL COMPOSITIONS AND ADMINISTRATIONS THEREOF
<b>G01V 1/48</b> (2006.01)	2577359 *	METHOD AND SYSTEM FOR DETERMINING THE RIGIDITY OF A GEOLOGICAL LAYER
<b>B65D 47/20</b> (2006.01)	2560532 *	REFILLING UNIT COMPRISING A CONTAINER
<b>A47K 5/12</b> (2006.01)	2560532 *	REFILLING UNIT COMPRISING A CONTAINER
<b>B65D 47/32</b> (2006.01)	2560532 *	REFILLING UNIT COMPRISING A CONTAINER
<b>B05B 11/00</b> (2006.01)	2560532 *	REFILLING UNIT COMPRISING A CONTAINER
<b>B65D 51/16</b> (2006.01)	2560532 *	REFILLING UNIT COMPRISING A CONTAINER
<b>A47K 5/13</b> (2006.01)	2560532 *	REFILLING UNIT COMPRISING A CONTAINER
<b>G01F 11/08</b> (2006.01)	2560532 *	REFILLING UNIT COMPRISING A CONTAINER
<b>A61K 31/505</b> (2006.01)	2547672 *	SUBSTITUTED PYRIMIDINES AS PROSTAGLANDIN D2 RECEPTOR ANTAGONISTS
<b>A61P 11/00</b> (2006.01)	2547672 *	SUBSTITUTED PYRIMIDINES AS PROSTAGLANDIN D2 RECEPTOR ANTAGONISTS
<b>C07D 403/04</b> (2006.01)	2547672 *	SUBSTITUTED PYRIMIDINES AS PROSTAGLANDIN D2 RECEPTOR ANTAGONISTS
<b>B29C 53/82</b> (2006.01)	2580046 *	METHOD AND DEVICE FOR MANUFACTURING COMPOSITE PRODUCTS COMPRISING A PLANAR PORTION
<b>B29C 69/00</b> (2006.01)	2580046 *	METHOD AND DEVICE FOR MANUFACTURING COMPOSITE PRODUCTS COMPRISING A PLANAR PORTION
<b>B29C 53/70</b> (2006.01)	2580046 *	METHOD AND DEVICE FOR MANUFACTURING COMPOSITE PRODUCTS COMPRISING A PLANAR PORTION
<b>A61K 31/4184</b> (2006.01)	2575785 *	ORAL DOSAGE FORMS OF BENDAMUSTINE AND THERAPEUTIC USE THEREOF
<b>A61K 9/28</b> (2006.01)	2575785 *	ORAL DOSAGE FORMS OF BENDAMUSTINE AND THERAPEUTIC USE THEREOF
<b>A61K 9/16</b> (2006.01)	2575785 *	ORAL DOSAGE FORMS OF BENDAMUSTINE AND THERAPEUTIC USE THEREOF
<b>A61K 9/48</b> (2006.01)	2575785 *	ORAL DOSAGE FORMS OF BENDAMUSTINE AND THERAPEUTIC USE THEREOF
<b>A61K 9/20</b> (2006.01)	2575785 *	ORAL DOSAGE FORMS OF BENDAMUSTINE AND THERAPEUTIC USE THEREOF
<b>A61K 47/10</b> (2006.01)	2575785 *	ORAL DOSAGE FORMS OF BENDAMUSTINE AND THERAPEUTIC USE THEREOF
<b>A61K 9/14</b> (2006.01)	2575785 *	ORAL DOSAGE FORMS OF BENDAMUSTINE AND THERAPEUTIC USE THEREOF
<b>C07D 413/06</b> (2006.01)	2576543 *	PYRAZOLE COMPOUNDS AS SIGMA RECEPTOR INHIBITORS
<b>A61K 31/5377</b> (2006.01)	2576543 *	PYRAZOLE COMPOUNDS AS SIGMA RECEPTOR INHIBITORS
<b>A61K 31/4025</b> (2006.01)	2576543 *	PYRAZOLE COMPOUNDS AS SIGMA RECEPTOR INHIBITORS
<b>C07D 403/12</b> (2006.01)	2576543 *	PYRAZOLE COMPOUNDS AS SIGMA RECEPTOR INHIBITORS
<b>C07D 413/14</b> (2006.01)	2576543 *	PYRAZOLE COMPOUNDS AS SIGMA RECEPTOR INHIBITORS
<b>C07D 413/12</b> (2006.01)	2576543 *	PYRAZOLE COMPOUNDS AS SIGMA RECEPTOR INHIBITORS
<b>A61K 31/496</b> (2006.01)	2576543 *	PYRAZOLE COMPOUNDS AS SIGMA RECEPTOR INHIBITORS
<b>A61K 31/454</b> (2006.01)	2576543 *	PYRAZOLE COMPOUNDS AS SIGMA RECEPTOR INHIBITORS
<b>C07D 401/12</b> (2006.01)	2576543 *	PYRAZOLE COMPOUNDS AS SIGMA RECEPTOR INHIBITORS
<b>A61P 25/00</b> (2006.01)	2576543 *	PYRAZOLE COMPOUNDS AS SIGMA RECEPTOR INHIBITORS
<b>A61M 5/32</b> (2006.01)	2588165 *	SAFETY DEVICE FOR A PRE-FILLED SYRINGE, INJECTION DEVICE AND INJECTION KIT

MKP (51)	Broj objave evropske prijava patenta (97)	Naziv pronalaska (54)
<b>A61K 8/55</b> (2006.01)	2572700 *	COMPOSITION FOR PREVENTING HAIR-LOSS OR STIMULATING HAIR GROWTH
<b>A61Q 7/00</b> (2006.01)	2572700 *	COMPOSITION FOR PREVENTING HAIR-LOSS OR STIMULATING HAIR GROWTH
<b>A61Q 5/00</b> (2006.01)	2572700 *	COMPOSITION FOR PREVENTING HAIR-LOSS OR STIMULATING HAIR GROWTH
<b>C12Q 1/00</b> (2006.01)	2542687 *	INVOLVEMENT OF ANDROGEN/ANDROGEN RECEPTOR PATHWAY IN FABRY DISEASE
<b>G01N 33/487</b> (2006.01)	2542687 *	INVOLVEMENT OF ANDROGEN/ANDROGEN RECEPTOR PATHWAY IN FABRY DISEASE
<b>A61K 38/00</b> (2006.01)	2542687 *	INVOLVEMENT OF ANDROGEN/ANDROGEN RECEPTOR PATHWAY IN FABRY DISEASE
<b>A61P 5/26</b> (2006.01)	2542687 *	INVOLVEMENT OF ANDROGEN/ANDROGEN RECEPTOR PATHWAY IN FABRY DISEASE
<b>G01N 33/483</b> (2006.01)	2542687 *	INVOLVEMENT OF ANDROGEN/ANDROGEN RECEPTOR PATHWAY IN FABRY DISEASE
<b>A61P 3/00</b> (2006.01)	2542687 *	INVOLVEMENT OF ANDROGEN/ANDROGEN RECEPTOR PATHWAY IN FABRY DISEASE
<b>G01N 33/487</b> (2006.01)	2577303 *	UNDERFILL MANAGEMENT SYSTEM FOR A BIOSENSOR
<b>C09C 1/02</b> (2006.01)	2565236	Self-binding pigment hybrid
<b>D21H 17/00</b> (2006.01)	2565236	Self-binding pigment hybrid
<b>A61K 39/395</b> (2006.01)	2575879 *	NOVEL ANTI-CMET ANTIBODY
<b>A61P 35/00</b> (2006.01)	2575879 *	NOVEL ANTI-CMET ANTIBODY
<b>C07K 16/28</b> (2006.01)	2575879 *	NOVEL ANTI-CMET ANTIBODY
<b>C07K 14/535</b> (2006.01)	2547699 *	METHOD FOR OBTAINING BIOLOGICALLY ACTIVE RECOMBINANT HUMAN G-CSF
<b>A61M 1/16</b> (2006.01)	2563343 *	APPARATUS AND KIT FOR ENCAPSULATING AT LEAST ONE COMPOUND FOR THERAPEUTIC AND/OR DIAGNOSTIC USE IN ERYTHROCYTES
<b>A61M 1/36</b> (2006.01)	2563343 *	APPARATUS AND KIT FOR ENCAPSULATING AT LEAST ONE COMPOUND FOR THERAPEUTIC AND/OR DIAGNOSTIC USE IN ERYTHROCYTES
<b>A61K 9/50</b> (2006.01)	2563343 *	APPARATUS AND KIT FOR ENCAPSULATING AT LEAST ONE COMPOUND FOR THERAPEUTIC AND/OR DIAGNOSTIC USE IN ERYTHROCYTES
<b>C01F 11/18</b> (2006.01)	2447213	Production of high purity precipitated calcium carbonate
<b>C09C 1/02</b> (2006.01)	2447213	Production of high purity precipitated calcium carbonate
<b>E05D 15/06</b> (2006.01)	2455573	Device for suspension fastening of pocket doors positionable in openings smaller than the door
<b>E06B 3/46</b> (2006.01)	2455573	Device for suspension fastening of pocket doors positionable in openings smaller than the door
<b>C07D 211/16</b> (2006.01)	2576507 *	HEXAFLUOROISOPROPYL CARBAMATE DERIVATIVES, THEIR PREPARATION AND THEIR THERAPEUTIC APPLICATION
<b>C07D 403/04</b> (2006.01)	2576507 *	HEXAFLUOROISOPROPYL CARBAMATE DERIVATIVES, THEIR PREPARATION AND THEIR THERAPEUTIC APPLICATION
<b>C07D 211/62</b> (2006.01)	2576507 *	HEXAFLUOROISOPROPYL CARBAMATE DERIVATIVES, THEIR PREPARATION AND THEIR THERAPEUTIC APPLICATION
<b>C07D 205/04</b> (2006.01)	2576507 *	HEXAFLUOROISOPROPYL CARBAMATE DERIVATIVES, THEIR PREPARATION AND THEIR THERAPEUTIC APPLICATION
<b>A61K 31/4468</b> (2006.01)	2576507 *	HEXAFLUOROISOPROPYL CARBAMATE DERIVATIVES, THEIR PREPARATION AND THEIR THERAPEUTIC APPLICATION
<b>C07D 211/54</b> (2006.01)	2576507 *	HEXAFLUOROISOPROPYL CARBAMATE DERIVATIVES, THEIR PREPARATION AND THEIR THERAPEUTIC APPLICATION
<b>C07D 409/12</b> (2006.01)	2576507 *	HEXAFLUOROISOPROPYL CARBAMATE DERIVATIVES, THEIR PREPARATION AND THEIR THERAPEUTIC APPLICATION
<b>C07D 207/12</b> (2006.01)	2576507 *	HEXAFLUOROISOPROPYL CARBAMATE DERIVATIVES, THEIR PREPARATION AND THEIR THERAPEUTIC APPLICATION
<b>A61P 25/00</b> (2006.01)	2576507 *	HEXAFLUOROISOPROPYL CARBAMATE DERIVATIVES, THEIR PREPARATION AND THEIR THERAPEUTIC APPLICATION

MKP (51)	Broj objave evropske prijava patenta (97)	Naziv pronalaska (54)
<b>C07D 211/58</b> (2006.01)	2576507 *	HEXAFLUOROISOPROPYL CARBAMATE DERIVATIVES, THEIR PREPARATION AND THEIR THERAPEUTIC APPLICATION
<b>C07D 413/12</b> (2006.01)	2576507 *	HEXAFLUOROISOPROPYL CARBAMATE DERIVATIVES, THEIR PREPARATION AND THEIR THERAPEUTIC APPLICATION
<b>C07D 211/46</b> (2006.01)	2576507 *	HEXAFLUOROISOPROPYL CARBAMATE DERIVATIVES, THEIR PREPARATION AND THEIR THERAPEUTIC APPLICATION
<b>C07D 405/12</b> (2006.01)	2576507 *	HEXAFLUOROISOPROPYL CARBAMATE DERIVATIVES, THEIR PREPARATION AND THEIR THERAPEUTIC APPLICATION
<b>C07D 207/14</b> (2006.01)	2576507 *	HEXAFLUOROISOPROPYL CARBAMATE DERIVATIVES, THEIR PREPARATION AND THEIR THERAPEUTIC APPLICATION
<b>C07D 401/12</b> (2006.01)	2576507 *	HEXAFLUOROISOPROPYL CARBAMATE DERIVATIVES, THEIR PREPARATION AND THEIR THERAPEUTIC APPLICATION
<b>A61K 31/403</b> (2006.01)	2569296 *	SUBSTITUTED N-PHENYL SPIROLACTAM BIPYRROLIDINES, PREPARATION AND THERAPEUTIC USE THEREOF
<b>C07D 403/10</b> (2006.01)	2569296 *	SUBSTITUTED N-PHENYL SPIROLACTAM BIPYRROLIDINES, PREPARATION AND THERAPEUTIC USE THEREOF
<b>C07D 401/10</b> (2006.01)	2569296 *	SUBSTITUTED N-PHENYL SPIROLACTAM BIPYRROLIDINES, PREPARATION AND THERAPEUTIC USE THEREOF
<b>A61P 25/00</b> (2006.01)	2569296 *	SUBSTITUTED N-PHENYL SPIROLACTAM BIPYRROLIDINES, PREPARATION AND THERAPEUTIC USE THEREOF
<b>A61P 35/04</b> (2006.01)	2540728 *	HETEROCYCLIC COMPOUND
<b>C07D 495/04</b> (2006.01)	2540728 *	HETEROCYCLIC COMPOUND
<b>C07D 519/00</b> (2006.01)	2540728 *	HETEROCYCLIC COMPOUND
<b>A61K 31/5377</b> (2006.01)	2540728 *	HETEROCYCLIC COMPOUND
<b>A61P 43/00</b> (2006.01)	2540728 *	HETEROCYCLIC COMPOUND
<b>A61P 35/02</b> (2006.01)	2540728 *	HETEROCYCLIC COMPOUND
<b>A61P 35/00</b> (2006.01)	2540728 *	HETEROCYCLIC COMPOUND
<b>A61K 31/541</b> (2006.01)	2540728 *	HETEROCYCLIC COMPOUND
<b>A61K 31/519</b> (2006.01)	2540728 *	HETEROCYCLIC COMPOUND
<b>A61K 9/28</b> (2006.01)	2555754 *	SOLID FORMS OF 3-(6-(1-(2,2-DIFLUOROBENZO[D][1,3]DIOXOL-5-YL)CYCLOPROPANECARBOXAMIDO)-3-METHYLPYRIDIN-2-YL)BENZOIC ACID
<b>A61K 9/16</b> (2006.01)	2555754 *	SOLID FORMS OF 3-(6-(1-(2,2-DIFLUOROBENZO[D][1,3]DIOXOL-5-YL)CYCLOPROPANECARBOXAMIDO)-3-METHYLPYRIDIN-2-YL)BENZOIC ACID
<b>A61K 9/20</b> (2006.01)	2555754 *	SOLID FORMS OF 3-(6-(1-(2,2-DIFLUOROBENZO[D][1,3]DIOXOL-5-YL)CYCLOPROPANECARBOXAMIDO)-3-METHYLPYRIDIN-2-YL)BENZOIC ACID
<b>C07D 405/12</b> (2006.01)	2555754 *	SOLID FORMS OF 3-(6-(1-(2,2-DIFLUOROBENZO[D][1,3]DIOXOL-5-YL)CYCLOPROPANECARBOXAMIDO)-3-METHYLPYRIDIN-2-YL)BENZOIC ACID
<b>C07D 405/14</b> (2006.01)	2555754 *	SOLID FORMS OF 3-(6-(1-(2,2-DIFLUOROBENZO[D][1,3]DIOXOL-5-YL)CYCLOPROPANECARBOXAMIDO)-3-METHYLPYRIDIN-2-YL)BENZOIC ACID
<b>C07D 213/75</b> (2006.01)	2555754 *	SOLID FORMS OF 3-(6-(1-(2,2-DIFLUOROBENZO[D][1,3]DIOXOL-5-YL)CYCLOPROPANECARBOXAMIDO)-3-METHYLPYRIDIN-2-YL)BENZOIC ACID
<b>A61K 31/439</b> (2006.01)	2585459 *	ALKALOID AMINOESTER DERIVATIVES AND MEDICINAL COMPOSITIONS THEREOF
<b>A61P 11/00</b> (2006.01)	2585459 *	ALKALOID AMINOESTER DERIVATIVES AND MEDICINAL COMPOSITIONS THEREOF
<b>C07D 453/02</b> (2006.01)	2585459 *	ALKALOID AMINOESTER DERIVATIVES AND MEDICINAL COMPOSITIONS THEREOF
<b>C07D 471/04</b> (2006.01)	2545052 *	IMIDAZOPYRIDINES SYK INHIBITORS
<b>A61K 31/437</b> (2006.01)	2545052 *	IMIDAZOPYRIDINES SYK INHIBITORS
<b>A61P 29/00</b> (2006.01)	2545052 *	IMIDAZOPYRIDINES SYK INHIBITORS
<b>A61P 11/00</b> (2006.01)	2545052 *	IMIDAZOPYRIDINES SYK INHIBITORS
<b>A61P 35/00</b> (2006.01)	2545052 *	IMIDAZOPYRIDINES SYK INHIBITORS
<b>C07D 519/00</b> (2006.01)	2545052 *	IMIDAZOPYRIDINES SYK INHIBITORS
<b>A61P 35/02</b> (2006.01)	2545052 *	IMIDAZOPYRIDINES SYK INHIBITORS
<b>A61P 19/00</b> (2006.01)	2545052 *	IMIDAZOPYRIDINES SYK INHIBITORS

MKP (51)	Broj objave evropske prijava patenta (97)	Naziv pronalaska (54)
<b>A61K 31/422</b> (2006.01)	2566452 *	MELTING TABLET COMPRISING A TRIPTANE OR ATYPICAL NEUROLEPTIC
<b>A61K 9/00</b> (2006.01)	2566452 *	MELTING TABLET COMPRISING A TRIPTANE OR ATYPICAL NEUROLEPTIC
<b>A61K 31/497</b> (2006.01)	2566452 *	MELTING TABLET COMPRISING A TRIPTANE OR ATYPICAL NEUROLEPTIC
<b>A61K 31/404</b> (2006.01)	2566452 *	MELTING TABLET COMPRISING A TRIPTANE OR ATYPICAL NEUROLEPTIC
<b>C40B 40/06</b> (2006.01)	2545211 *	METHODS AND ALGORITHMS FOR SELECTING POLYNUCLEOTIDES FOR SYNTHETIC ASSEMBLY
<b>C40B 50/06</b> (2006.01)	2545211 *	METHODS AND ALGORITHMS FOR SELECTING POLYNUCLEOTIDES FOR SYNTHETIC ASSEMBLY
<b>G10L 21/02</b> (2013.01)	2555189 *	METHOD AND DEVICE FOR SPEECH ENHANCEMENT, AND COMMUNICATION HEADPHONES WITH NOISE REDUCTION
<b>A61L 31/04</b> (2006.01)	2555809 *	CHITOSAN BEADS AND FILLER COMPRISING SUCH BEADS
<b>A61K 9/16</b> (2006.01)	2555809 *	CHITOSAN BEADS AND FILLER COMPRISING SUCH BEADS
<b>A61L 27/20</b> (2006.01)	2555809 *	CHITOSAN BEADS AND FILLER COMPRISING SUCH BEADS
<b>G02B 27/34</b> (2006.01)	2557450 *	OPTICAL SIGHT (VARIANTS)
<b>F41G 1/34</b> (2006.01)	2557450 *	OPTICAL SIGHT (VARIANTS)
<b>A01H 5/00</b> (2006.01)	2575431 *	TRANSGENIC BRASSICA EVENT MON 88302 AND METHODS OF USE THEREOF
<b>C12N 15/82</b> (2006.01)	2575431 *	TRANSGENIC BRASSICA EVENT MON 88302 AND METHODS OF USE THEREOF
<b>A61K 38/18</b> (2006.01)	2538962 *	USE OF TRANSFORMING GROWTH FACTOR - BETA 1 (TGF- 1) INHIBITOR PEPTIDES FOR THE TREATMENT OF CORNEAL FIBROSIS AND/OR HAZE
<b>A61P 27/02</b> (2006.01)	2538962 *	USE OF TRANSFORMING GROWTH FACTOR - BETA 1 (TGF- 1) INHIBITOR PEPTIDES FOR THE TREATMENT OF CORNEAL FIBROSIS AND/OR HAZE
<b>A61K 47/10</b> (2006.01)	2563351 *	ADHESIVE SLOW-RELEASE FORMULATIONS FOR THE LOCAL ADMINISTRATION OF CURCUMIN
<b>A61K 47/32</b> (2006.01)	2563351 *	ADHESIVE SLOW-RELEASE FORMULATIONS FOR THE LOCAL ADMINISTRATION OF CURCUMIN
<b>A61K 31/12</b> (2006.01)	2563351 *	ADHESIVE SLOW-RELEASE FORMULATIONS FOR THE LOCAL ADMINISTRATION OF CURCUMIN
<b>C07C 51/02</b> (2006.01)	2383249	Processes for producing adipic acid from fermentation broths containing diammonium adipate
<b>C07C 51/44</b> (2006.01)	2383249	Processes for producing adipic acid from fermentation broths containing diammonium adipate
<b>C07C 51/46</b> (2006.01)	2383249	Processes for producing adipic acid from fermentation broths containing diammonium adipate
<b>C02F 3/34</b> (2006.01)	2557129	Surface-treated calcium carbonate for binding and bioremediating hydrocarbon-containing compositions
<b>C09C 1/02</b> (2006.01)	2557129	Surface-treated calcium carbonate for binding and bioremediating hydrocarbon-containing compositions
<b>C02F 1/68</b> (2006.01)	2557129	Surface-treated calcium carbonate for binding and bioremediating hydrocarbon-containing compositions
<b>A61M 15/00</b> (2006.01)	2570148	Counter
<b>G06M 1/24</b> (2006.01)	2570148	Counter
<b>G06M 1/16</b> (2006.01)	2570148	Counter
<b>C07D 473/00</b> (2006.01)	2542552 *	SUBSTITUTED AZA-BICYCLIC IMIDAZOLE DERIVATIVES USEFUL AS TRPM8 RECEPTOR MODULATORS
<b>A61K 31/437</b> (2006.01)	2542552 *	SUBSTITUTED AZA-BICYCLIC IMIDAZOLE DERIVATIVES USEFUL AS TRPM8 RECEPTOR MODULATORS
<b>A61P 29/00</b> (2006.01)	2542552 *	SUBSTITUTED AZA-BICYCLIC IMIDAZOLE DERIVATIVES USEFUL AS TRPM8 RECEPTOR MODULATORS
<b>A61P 9/00</b> (2006.01)	2542552 *	SUBSTITUTED AZA-BICYCLIC IMIDAZOLE DERIVATIVES USEFUL AS TRPM8 RECEPTOR MODULATORS
<b>C07D 487/04</b> (2006.01)	2542552 *	SUBSTITUTED AZA-BICYCLIC IMIDAZOLE DERIVATIVES USEFUL AS TRPM8 RECEPTOR MODULATORS
<b>A61K 31/52</b> (2006.01)	2542552 *	SUBSTITUTED AZA-BICYCLIC IMIDAZOLE DERIVATIVES USEFUL AS TRPM8 RECEPTOR MODULATORS

MKP (51)	Broj objave evropske prijava patenta (97)	Naziv pronalaska (54)
<b>C07D 471/04</b> (2006.01)	2542552 *	SUBSTITUTED AZA-BICYCLIC IMIDAZOLE DERIVATIVES USEFUL AS TRPM8 RECEPTOR MODULATORS
<b>A61K 31/4985</b> (2006.01)	2542552 *	SUBSTITUTED AZA-BICYCLIC IMIDAZOLE DERIVATIVES USEFUL AS TRPM8 RECEPTOR MODULATORS
<b>C07D 413/14</b> (2006.01)	2569309 *	HYDROXYALKYL BENZYL PYRAZOLES, AND USE THEREOF FOR THE TREATMENT OF HYPERPROLIFERATIVE AND ANGIOGENIC DISEASES
<b>C07D 413/04</b> (2006.01)	2569309 *	HYDROXYALKYL BENZYL PYRAZOLES, AND USE THEREOF FOR THE TREATMENT OF HYPERPROLIFERATIVE AND ANGIOGENIC DISEASES
<b>A61K 31/4245</b> (2006.01)	2569309 *	HYDROXYALKYL BENZYL PYRAZOLES, AND USE THEREOF FOR THE TREATMENT OF HYPERPROLIFERATIVE AND ANGIOGENIC DISEASES
<b>A61K 31/522</b> (2006.01)	2582703 *	HETEROARYL IMIDAZOLONE DERIVATIVES AS JAK INHIBITORS
<b>A61P 29/00</b> (2006.01)	2582703 *	HETEROARYL IMIDAZOLONE DERIVATIVES AS JAK INHIBITORS
<b>C07D 519/00</b> (2006.01)	2582703 *	HETEROARYL IMIDAZOLONE DERIVATIVES AS JAK INHIBITORS
<b>C07D 487/04</b> (2006.01)	2582703 *	HETEROARYL IMIDAZOLONE DERIVATIVES AS JAK INHIBITORS
<b>A61P 35/02</b> (2006.01)	2563360 *	BIOMARKERS FOR MDM2 INHIBITORS FOR USE IN TREATING DISEASE
<b>A61P 35/00</b> (2006.01)	2563360 *	BIOMARKERS FOR MDM2 INHIBITORS FOR USE IN TREATING DISEASE
<b>A61K 31/404</b> (2006.01)	2563360 *	BIOMARKERS FOR MDM2 INHIBITORS FOR USE IN TREATING DISEASE
<b>A61K 31/407</b> (2006.01)	2563360 *	BIOMARKERS FOR MDM2 INHIBITORS FOR USE IN TREATING DISEASE
<b>A61K 38/47</b> (2006.01)	2588131 *	METHODS AND COMPOSITIONS FOR CNS DELIVERY OF HEPARAN N-SULFATASE
<b>A61P 25/28</b> (2006.01)	2588131 *	METHODS AND COMPOSITIONS FOR CNS DELIVERY OF HEPARAN N-SULFATASE
<b>A61P 25/00</b> (2006.01)	2588131 *	METHODS AND COMPOSITIONS FOR CNS DELIVERY OF HEPARAN N-SULFATASE
<b>A61K 31/497</b> (2006.01)	2590653 *	5-CHLORO-4-HYDROXY-1-METHYL-2-OXO-N-PHENYL-1,2-DIHYDROQUINOLINE-3-CARBOXAMIDE, SALTS AND USES THEREOF
<b>H01L 31/04</b> (2006.01)	2544243 *	TRANSPARENT CONDUCTIVE SUBSTRATE FOR SOLAR CELL, METHOD FOR MANUFACTURING THE SUBSTRATE, AND SOLAR CELL USING THE SUBSTRATE
<b>B32B 3/30</b> (2006.01)	2544243 *	TRANSPARENT CONDUCTIVE SUBSTRATE FOR SOLAR CELL, METHOD FOR MANUFACTURING THE SUBSTRATE, AND SOLAR CELL USING THE SUBSTRATE
<b>B32B 27/30</b> (2006.01)	2544243 *	TRANSPARENT CONDUCTIVE SUBSTRATE FOR SOLAR CELL, METHOD FOR MANUFACTURING THE SUBSTRATE, AND SOLAR CELL USING THE SUBSTRATE
<b>B32B 27/00</b> (2006.01)	2544243 *	TRANSPARENT CONDUCTIVE SUBSTRATE FOR SOLAR CELL, METHOD FOR MANUFACTURING THE SUBSTRATE, AND SOLAR CELL USING THE SUBSTRATE
<b>C07K 16/22</b> (2006.01)	2588138 *	TREATMENT OF VASCULARIZED PIGMENT EPITHELIAL DETACHMENT WITH ANTI-VEGF THERAPY
<b>A61K 39/395</b> (2006.01)	2588138 *	TREATMENT OF VASCULARIZED PIGMENT EPITHELIAL DETACHMENT WITH ANTI-VEGF THERAPY
<b>A61P 27/02</b> (2006.01)	2588138 *	TREATMENT OF VASCULARIZED PIGMENT EPITHELIAL DETACHMENT WITH ANTI-VEGF THERAPY
<b>A47C 1/14</b> (2006.01)	2592971 *	A SITTING ARRANGEMENT
<b>A47C 1/022</b> (2006.01)	2592971 *	A SITTING ARRANGEMENT
<b>A47C 17/04</b> (2006.01)	2592971 *	A SITTING ARRANGEMENT
<b>A47C 3/025</b> (2006.01)	2592971 *	A SITTING ARRANGEMENT
<b>C07D 498/04</b> (2006.01)	2539322 *	INHIBITORS OF BETA-SECRETASE
<b>A61K 31/40</b> (2006.01)	2539322 *	INHIBITORS OF BETA-SECRETASE
<b>C07D 401/04</b> (2006.01)	2539322 *	INHIBITORS OF BETA-SECRETASE
<b>A61P 27/06</b> (2006.01)	2539322 *	INHIBITORS OF BETA-SECRETASE
<b>C07D 209/96</b> (2006.01)	2539322 *	INHIBITORS OF BETA-SECRETASE
<b>A61P 25/28</b> (2006.01)	2539322 *	INHIBITORS OF BETA-SECRETASE
<b>C07D 491/10</b> (2006.01)	2539322 *	INHIBITORS OF BETA-SECRETASE

MKP (51)	Broj objave evropske prijava patenta (97)	Naziv pronalaska (54)
<b>C07D 513/04</b> (2006.01)	2539322 *	INHIBITORS OF BETA-SECRETASE
<b>C07D 471/04</b> (2006.01)	2539322 *	INHIBITORS OF BETA-SECRETASE
<b>C07D 487/04</b> (2006.01)	2539322 *	INHIBITORS OF BETA-SECRETASE
<b>B32B 33/00</b> (2006.01)	2576218 *	DISCONTINUOUS SHORT FIBER PREFORM AND FIBER-REINFORCED ALUMINUM BILLET AND METHODS OF MANUFACTURING THE SAME
<b>F01N 3/20</b> (2006.01)	2503122	Reagent dosing pump assembly
<b>C07D 401/12</b> (2006.01)	2583967 *	CRYSTAL OF AMIDE COMPOUND
<b>A61P 9/12</b> (2006.01)	2583967 *	CRYSTAL OF AMIDE COMPOUND
<b>A61P 13/12</b> (2006.01)	2583967 *	CRYSTAL OF AMIDE COMPOUND
<b>A61P 43/00</b> (2006.01)	2583967 *	CRYSTAL OF AMIDE COMPOUND
<b>A61K 31/5377</b> (2006.01)	2583967 *	CRYSTAL OF AMIDE COMPOUND
<b>A61P 9/00</b> (2006.01)	2583967 *	CRYSTAL OF AMIDE COMPOUND
<b>B65D 85/30</b> (2006.01)	2566771 *	CONTAINER FOR HANDLING AND TRANSPORTING CYLINDERS
<b>B65D 81/107</b> (2006.01)	2566771 *	CONTAINER FOR HANDLING AND TRANSPORTING CYLINDERS
<b>B65D 81/127</b> (2006.01)	2566771 *	CONTAINER FOR HANDLING AND TRANSPORTING CYLINDERS
<b>B65D 25/06</b> (2006.01)	2566771 *	CONTAINER FOR HANDLING AND TRANSPORTING CYLINDERS
<b>B65D 81/02</b> (2006.01)	2566771 *	CONTAINER FOR HANDLING AND TRANSPORTING CYLINDERS
<b>B65D 85/20</b> (2006.01)	2566771 *	CONTAINER FOR HANDLING AND TRANSPORTING CYLINDERS
<b>A61G 7/057</b> (2006.01)	2465480	Inflatable mattress
<b>A61P 1/00</b> (2006.01)	2544690 *	ARYLVINYLAZACYCLOALKANE COMPOUNDS FOR CONSTIPATION
<b>C07D 239/26</b> (2006.01)	2544690 *	ARYLVINYLAZACYCLOALKANE COMPOUNDS FOR CONSTIPATION
<b>A61K 31/505</b> (2006.01)	2544690 *	ARYLVINYLAZACYCLOALKANE COMPOUNDS FOR CONSTIPATION
<b>A61K 31/506</b> (2006.01)	2544690 *	ARYLVINYLAZACYCLOALKANE COMPOUNDS FOR CONSTIPATION
<b>C07D 403/02</b> (2006.01)	2544690 *	ARYLVINYLAZACYCLOALKANE COMPOUNDS FOR CONSTIPATION
<b>A61P 25/00</b> (2006.01)	2544690 *	ARYLVINYLAZACYCLOALKANE COMPOUNDS FOR CONSTIPATION
<b>C07D 405/12</b> (2006.01)	2569297 *	SUBSTITUTED N-HETEROCYCLOALKYL BIPYRROLIDINYLPHENYL AMIDE DERIVATIVES, PREPARATION AND THERAPEUTIC USE THEREOF
<b>A61P 25/00</b> (2006.01)	2569297 *	SUBSTITUTED N-HETEROCYCLOALKYL BIPYRROLIDINYLPHENYL AMIDE DERIVATIVES, PREPARATION AND THERAPEUTIC USE THEREOF
<b>C07D 401/12</b> (2006.01)	2569297 *	SUBSTITUTED N-HETEROCYCLOALKYL BIPYRROLIDINYLPHENYL AMIDE DERIVATIVES, PREPARATION AND THERAPEUTIC USE THEREOF
<b>A61K 31/351</b> (2006.01)	2569297 *	SUBSTITUTED N-HETEROCYCLOALKYL BIPYRROLIDINYLPHENYL AMIDE DERIVATIVES, PREPARATION AND THERAPEUTIC USE THEREOF
<b>A61K 31/4439</b> (2006.01)	2569297 *	SUBSTITUTED N-HETEROCYCLOALKYL BIPYRROLIDINYLPHENYL AMIDE DERIVATIVES, PREPARATION AND THERAPEUTIC USE THEREOF
<b>B02C 18/24</b> (2006.01)	2500100	Drive device and work machine device
<b>A61P 25/04</b> (2006.01)	2585068 *	PROKINETICIN 1 RECEPTOR ANTAGONISTS FOR THE TREATMENT OF PAIN
<b>A61K 31/513</b> (2006.01)	2585068 *	PROKINETICIN 1 RECEPTOR ANTAGONISTS FOR THE TREATMENT OF PAIN
<b>A61P 25/02</b> (2006.01)	2585068 *	PROKINETICIN 1 RECEPTOR ANTAGONISTS FOR THE TREATMENT OF PAIN
<b>A61K 31/53</b> (2006.01)	2585068 *	PROKINETICIN 1 RECEPTOR ANTAGONISTS FOR THE TREATMENT OF PAIN
<b>C09B 63/00</b> (2006.01)	2548927 *	PIGMENT COMPOSITION
<b>C09B 67/20</b> (2006.01)	2548927 *	PIGMENT COMPOSITION
<b>G01C 21/36</b> (2006.01)	2472228	System for collecting the geolocations of addresses
<b>A61K 31/407</b> (2006.01)	2590978 *	CARBAPENEM ANTIBACTERIALS WITH GRAM-NEGATIVE ACTIVITY
<b>C07D 477/14</b> (2006.01)	2590978 *	CARBAPENEM ANTIBACTERIALS WITH GRAM-NEGATIVE ACTIVITY
<b>C07D 403/06</b> (2006.01)	2590978 *	CARBAPENEM ANTIBACTERIALS WITH GRAM-NEGATIVE ACTIVITY
<b>A61P 31/04</b> (2006.01)	2590978 *	CARBAPENEM ANTIBACTERIALS WITH GRAM-NEGATIVE ACTIVITY
<b>C07D 487/04</b> (2006.01)	2590978 *	CARBAPENEM ANTIBACTERIALS WITH GRAM-NEGATIVE ACTIVITY



MKP (51)	Broj objave evropske prijava patenta (97)	Naziv pronalaska (54)
<b>A61K 9/20</b> (2006.01)	2549984 *	DOUBLE-LAYER PHARMACEUTICAL FORMULATIONS CONTAINING OPIOID AGONISTS AND ANTAGONISTS
<b>A61K 31/485</b> (2006.01)	2549984 *	DOUBLE-LAYER PHARMACEUTICAL FORMULATIONS CONTAINING OPIOID AGONISTS AND ANTAGONISTS
<b>C07D 209/10</b> (2006.01)	2567698	GPR 17 agonists and screening assay
<b>C07K 14/72</b> (2006.01)	2567698	GPR 17 agonists and screening assay
<b>G01N 33/53</b> (2006.01)	2567698	GPR 17 agonists and screening assay
<b>A61K 31/405</b> (2006.01)	2567698	GPR 17 agonists and screening assay
<b>C07D 407/04</b> (2006.01)	2576510 *	PIPERIDINONE DERIVATIVES AS MDM2 INHIBITORS FOR THE TREATMENT OF CANCER
<b>C07D 498/08</b> (2006.01)	2576510 *	PIPERIDINONE DERIVATIVES AS MDM2 INHIBITORS FOR THE TREATMENT OF CANCER
<b>C07D 417/06</b> (2006.01)	2576510 *	PIPERIDINONE DERIVATIVES AS MDM2 INHIBITORS FOR THE TREATMENT OF CANCER
<b>C07D 409/04</b> (2006.01)	2576510 *	PIPERIDINONE DERIVATIVES AS MDM2 INHIBITORS FOR THE TREATMENT OF CANCER
<b>A61K 31/4412</b> (2006.01)	2576510 *	PIPERIDINONE DERIVATIVES AS MDM2 INHIBITORS FOR THE TREATMENT OF CANCER
<b>C07D 413/06</b> (2006.01)	2576510 *	PIPERIDINONE DERIVATIVES AS MDM2 INHIBITORS FOR THE TREATMENT OF CANCER
<b>A61P 35/00</b> (2006.01)	2576510 *	PIPERIDINONE DERIVATIVES AS MDM2 INHIBITORS FOR THE TREATMENT OF CANCER
<b>C07D 401/04</b> (2006.01)	2576510 *	PIPERIDINONE DERIVATIVES AS MDM2 INHIBITORS FOR THE TREATMENT OF CANCER
<b>C07D 279/02</b> (2006.01)	2576510 *	PIPERIDINONE DERIVATIVES AS MDM2 INHIBITORS FOR THE TREATMENT OF CANCER
<b>C07D 401/06</b> (2006.01)	2576510 *	PIPERIDINONE DERIVATIVES AS MDM2 INHIBITORS FOR THE TREATMENT OF CANCER
<b>C07D 401/12</b> (2006.01)	2576510 *	PIPERIDINONE DERIVATIVES AS MDM2 INHIBITORS FOR THE TREATMENT OF CANCER
<b>C07D 407/06</b> (2006.01)	2576510 *	PIPERIDINONE DERIVATIVES AS MDM2 INHIBITORS FOR THE TREATMENT OF CANCER
<b>C07D 498/20</b> (2006.01)	2576510 *	PIPERIDINONE DERIVATIVES AS MDM2 INHIBITORS FOR THE TREATMENT OF CANCER
<b>C07D 211/40</b> (2006.01)	2576510 *	PIPERIDINONE DERIVATIVES AS MDM2 INHIBITORS FOR THE TREATMENT OF CANCER
<b>C07D 471/20</b> (2006.01)	2576510 *	PIPERIDINONE DERIVATIVES AS MDM2 INHIBITORS FOR THE TREATMENT OF CANCER
<b>E04D 1/30</b> (2006.01)	2539519 *	CLOSURE STRIP
<b>E04D 15/00</b> (2006.01)	2539519 *	CLOSURE STRIP
<b>E04D 1/34</b> (2006.01)	2539519 *	CLOSURE STRIP
<b>A61J 1/05</b> (2006.01)	2433608	Blood plasma collection bottle
<b>A61J 1/14</b> (2006.01)	2433608	Blood plasma collection bottle
<b>A61J 1/20</b> (2006.01)	2433608	Blood plasma collection bottle
<b>A61J 1/12</b> (2006.01)	2433608	Blood plasma collection bottle
<b>A61K 31/50</b> (2006.01)	2563365 *	CERTAIN AMINO-PYRIDAZINES, COMPOSITIONS THEREOF, AND METHODS OF THEIR USE
<b>H04N 7/15</b> (2006.01)	2569937 *	SYSTEMS AND METHODS FOR REAL-TIME MULTIMEDIA COMMUNICATION ACROSS MULTIPLE STANDARDS AND PROPRIETARY DEVICES
<b>H04N 7/14</b> (2006.01)	2569937 *	SYSTEMS AND METHODS FOR REAL-TIME MULTIMEDIA COMMUNICATION ACROSS MULTIPLE STANDARDS AND PROPRIETARY DEVICES
<b>B65H 19/22</b> (2006.01)	2550218 *	A CORE FEEDING DEVICE IN A REWINDING MACHINE FOR THE PRODUCTION OF ROLLS
<b>B65H 19/26</b> (2006.01)	2550218 *	A CORE FEEDING DEVICE IN A REWINDING MACHINE FOR THE PRODUCTION OF ROLLS
<b>C07K 16/24</b> (2006.01)	2591001 *	AGONISTIC ANTIBODY TO CD27

MKP (51)	Broj objave evropske prijava patenta (97)	Naziv pronalaska (54)
<b>C07K 16/28</b> (2006.01)	2591001 *	AGONISTIC ANTIBODY TO CD27
<b>C07D 403/04</b> (2006.01)	2556071 *	KINASE INHIBITORS AND METHOD OF TREATING CANCER WITH SAME
<b>A61K 31/5377</b> (2006.01)	2556071 *	KINASE INHIBITORS AND METHOD OF TREATING CANCER WITH SAME
<b>A61P 35/00</b> (2006.01)	2556071 *	KINASE INHIBITORS AND METHOD OF TREATING CANCER WITH SAME
<b>C07D 413/14</b> (2006.01)	2556071 *	KINASE INHIBITORS AND METHOD OF TREATING CANCER WITH SAME
<b>G01N 33/50</b> (2006.01)	2547789 *	METHODS AND USES RELATING TO THE IDENTIFICATION OF COMPOUND INVOLVED IN PAIN AS WELL AS METHODS OF DIAGNOSING ALGESIA
<b>G01N 33/68</b> (2006.01)	2547789 *	METHODS AND USES RELATING TO THE IDENTIFICATION OF COMPOUND INVOLVED IN PAIN AS WELL AS METHODS OF DIAGNOSING ALGESIA
<b>C12Q 1/68</b> (2006.01)	2547789 *	METHODS AND USES RELATING TO THE IDENTIFICATION OF COMPOUND INVOLVED IN PAIN AS WELL AS METHODS OF DIAGNOSING ALGESIA
<b>G02B 6/42</b> (2006.01)	2577372 *	HYBRID OPTICAL CONNECTOR
<b>H01R 13/40</b> (2006.01)	2577372 *	HYBRID OPTICAL CONNECTOR
<b>G02B 6/38</b> (2006.01)	2577372 *	HYBRID OPTICAL CONNECTOR
<b>A61K 31/496</b> (2006.01)	2588086 *	PHARMACEUTICAL COMPOSITIONS COMPRISING 4-AMINO-5-FLUORO-3-[6-(4-METHYLPIPERAZIN-1-YL)-1H-BENZIMIDAZOL-2-YL]-1H-QUINOLIN-2-ONE LACTATE MONOHYDRATE.
<b>A61K 9/20</b> (2006.01)	2588086 *	PHARMACEUTICAL COMPOSITIONS COMPRISING 4-AMINO-5-FLUORO-3-[6-(4-METHYLPIPERAZIN-1-YL)-1H-BENZIMIDAZOL-2-YL]-1H-QUINOLIN-2-ONE LACTATE MONOHYDRATE.
<b>A61P 1/16</b> (2006.01)	2566505 *	DELIVERY OF CHOLESTERYL ESTER TO STEROIDOGENIC TISSUES
<b>A61K 38/45</b> (2006.01)	2566505 *	DELIVERY OF CHOLESTERYL ESTER TO STEROIDOGENIC TISSUES
<b>A61K 35/36</b> (2006.01)	2571975 *	DEVICE AND A METHOD FOR PREPARING TISSUE, PARTICULARLY ADIPOSE TISSUE.
<b>C12M 3/08</b> (2006.01)	2571975 *	DEVICE AND A METHOD FOR PREPARING TISSUE, PARTICULARLY ADIPOSE TISSUE.
<b>F24J 2/51</b> (2006.01)	2578379	Solar thermal solutions using blow moulding technologies
<b>B29C 49/00</b> (2006.01)	2578379	Solar thermal solutions using blow moulding technologies
<b>B29C 49/04</b> (2006.01)	2578379	Solar thermal solutions using blow moulding technologies
<b>F24J 2/04</b> (2006.01)	2578379	Solar thermal solutions using blow moulding technologies
<b>F24J 2/20</b> (2006.01)	2578379	Solar thermal solutions using blow moulding technologies
<b>F24J 2/52</b> (2006.01)	2578379	Solar thermal solutions using blow moulding technologies
<b>F24J 2/34</b> (2006.01)	2578379	Solar thermal solutions using blow moulding technologies
<b>F24J 2/46</b> (2006.01)	2578379	Solar thermal solutions using blow moulding technologies
<b>A61K 38/16</b> (2006.01)	2566495 *	INNOVATIVE DISCOVERY OF THERAPEUTIC, DIAGNOSTIC, AND ANTIBODY COMPOSITIONS RELATED TO PROTEIN FRAGMENTS OF PHENYLALANYL-ALPHA-TRNA SYNTHETASES
<b>A61K 39/395</b> (2006.01)	2566495 *	INNOVATIVE DISCOVERY OF THERAPEUTIC, DIAGNOSTIC, AND ANTIBODY COMPOSITIONS RELATED TO PROTEIN FRAGMENTS OF PHENYLALANYL-ALPHA-TRNA SYNTHETASES
<b>A61P 3/10</b> (2006.01)	2566495 *	INNOVATIVE DISCOVERY OF THERAPEUTIC, DIAGNOSTIC, AND ANTIBODY COMPOSITIONS RELATED TO PROTEIN FRAGMENTS OF PHENYLALANYL-ALPHA-TRNA SYNTHETASES
<b>A61P 35/00</b> (2006.01)	2566495 *	INNOVATIVE DISCOVERY OF THERAPEUTIC, DIAGNOSTIC, AND ANTIBODY COMPOSITIONS RELATED TO PROTEIN FRAGMENTS OF PHENYLALANYL-ALPHA-TRNA SYNTHETASES
<b>A61P 29/00</b> (2006.01)	2566495 *	INNOVATIVE DISCOVERY OF THERAPEUTIC, DIAGNOSTIC, AND ANTIBODY COMPOSITIONS RELATED TO PROTEIN FRAGMENTS OF PHENYLALANYL-ALPHA-TRNA SYNTHETASES
<b>C07K 14/525</b> (2006.01)	2566495 *	INNOVATIVE DISCOVERY OF THERAPEUTIC, DIAGNOSTIC, AND ANTIBODY COMPOSITIONS RELATED TO PROTEIN FRAGMENTS OF PHENYLALANYL-ALPHA-TRNA SYNTHETASES
<b>A61K 31/438</b> (2006.01)	2590985 *	NOVEL SPIROHETEROCYCLIC COMPOUNDS AS MGLU5 ANTAGONISTS
<b>C07D 491/10</b> (2006.01)	2590985 *	NOVEL SPIROHETEROCYCLIC COMPOUNDS AS MGLU5 ANTAGONISTS
<b>A61P 13/02</b> (2006.01)	2590985 *	NOVEL SPIROHETEROCYCLIC COMPOUNDS AS MGLU5 ANTAGONISTS

MKP (51)	Broj objave evropske prijava patenta (97)	Naziv pronalaska (54)
<b>C07D 498/10</b> (2006.01)	2590985 *	NOVEL SPIROHETEROCYCLIC COMPOUNDS AS MGLU5 ANTAGONISTS
<b>C12Q 1/68</b> (2006.01)	2593562 *	METHODS AND KITS FOR THE DIAGNOSIS OF PROSTATE CANCER
<b>A61K 31/16</b> (2006.01)	2560486 *	COMPOSITIONS COMPRISING ENZYME-CLEAVABLE AMPHETAMINE PRODRUGS AND INHIBITORS THEREOF
<b>A01N 37/18</b> (2006.01)	2560486 *	COMPOSITIONS COMPRISING ENZYME-CLEAVABLE AMPHETAMINE PRODRUGS AND INHIBITORS THEREOF
<b>G01N 33/53</b> (2006.01)	2576838 *	METHODS FOR IMPROVING INFLAMMATORY BOWEL DISEASE DIAGNOSIS
<b>C12N 15/12</b> (2006.01)	2576838 *	METHODS FOR IMPROVING INFLAMMATORY BOWEL DISEASE DIAGNOSIS
<b>C12Q 1/68</b> (2006.01)	2576838 *	METHODS FOR IMPROVING INFLAMMATORY BOWEL DISEASE DIAGNOSIS
<b>C12N 15/53</b> (2006.01)	2593558 *	ENZYME FOR THE PRODUCTION OF OPTICALLY PURE 3 - QUINUCLIDINOL
<b>C12N 9/02</b> (2006.01)	2593558 *	ENZYME FOR THE PRODUCTION OF OPTICALLY PURE 3 - QUINUCLIDINOL
<b>C12N 9/04</b> (2006.01)	2593558 *	ENZYME FOR THE PRODUCTION OF OPTICALLY PURE 3 - QUINUCLIDINOL
<b>C12P 17/12</b> (2006.01)	2593558 *	ENZYME FOR THE PRODUCTION OF OPTICALLY PURE 3 - QUINUCLIDINOL
<b>C12P 21/02</b> (2006.01)	2593558 *	ENZYME FOR THE PRODUCTION OF OPTICALLY PURE 3 - QUINUCLIDINOL
<b>B05B 11/00</b> (2006.01)	2585151 *	NEBULIZER
<b>A61M 15/00</b> (2006.01)	2585151 *	NEBULIZER
<b>G01N 33/574</b> (2006.01)	2542893 *	BIOLOGICAL MARKERS PREDICTIVE OF ANTI-CANCER RESPONSE TO INSULIN-LIKE GROWTH FACTOR-1 RECEPTOR KINASE INHIBITORS
<b>E04F 13/08</b> (2006.01)	2580402 *	A STRUCTURAL INFILL WALL PANEL MODULE
<b>E04B 2/90</b> (2006.01)	2580402 *	A STRUCTURAL INFILL WALL PANEL MODULE
<b>F41H 5/04</b> (2006.01)	2518434	Protective composite structure with low radar visibility having integrated attack signaling system
<b>F16J 15/02</b> (2006.01)	2567072 *	BRUSH RING SEAL
<b>F01D 11/00</b> (2006.01)	2567072 *	BRUSH RING SEAL
<b>F01D 25/24</b> (2006.01)	2567072 *	BRUSH RING SEAL
<b>F02C 7/28</b> (2006.01)	2567072 *	BRUSH RING SEAL
<b>G01N 33/487</b> (2006.01)	2577301 *	METHOD FOR PRODUCING A BILIPID LAYER, AND MICROSTRUCTURE AND MEASURING ASSEMBLY
<b>A61P 31/14</b> (2006.01)	2593439 *	PROCESS FOR PREPARING ANTIVIRAL COMPOUNDS
<b>A61K 31/522</b> (2006.01)	2593439 *	PROCESS FOR PREPARING ANTIVIRAL COMPOUNDS
<b>C07D 239/54</b> (2006.01)	2593439 *	PROCESS FOR PREPARING ANTIVIRAL COMPOUNDS
<b>A61K 31/4355</b> (2006.01)	2585462 *	FUSED HETEROCYCLIC COMPOUNDS AS PHOSPHODIESTERASES (PDES) INHIBITORS
<b>A61K 31/437</b> (2006.01)	2585462 *	FUSED HETEROCYCLIC COMPOUNDS AS PHOSPHODIESTERASES (PDES) INHIBITORS
<b>C07D 471/04</b> (2006.01)	2585462 *	FUSED HETEROCYCLIC COMPOUNDS AS PHOSPHODIESTERASES (PDES) INHIBITORS
<b>A61K 31/5025</b> (2006.01)	2585462 *	FUSED HETEROCYCLIC COMPOUNDS AS PHOSPHODIESTERASES (PDES) INHIBITORS
<b>C07D 473/28</b> (2006.01)	2585462 *	FUSED HETEROCYCLIC COMPOUNDS AS PHOSPHODIESTERASES (PDES) INHIBITORS
<b>A61K 31/519</b> (2006.01)	2585462 *	FUSED HETEROCYCLIC COMPOUNDS AS PHOSPHODIESTERASES (PDES) INHIBITORS
<b>A61K 31/4985</b> (2006.01)	2585462 *	FUSED HETEROCYCLIC COMPOUNDS AS PHOSPHODIESTERASES (PDES) INHIBITORS
<b>A61K 31/4427</b> (2006.01)	2585462 *	FUSED HETEROCYCLIC COMPOUNDS AS PHOSPHODIESTERASES (PDES) INHIBITORS
<b>C07D 487/04</b> (2006.01)	2585462 *	FUSED HETEROCYCLIC COMPOUNDS AS PHOSPHODIESTERASES (PDES) INHIBITORS
<b>A61K 31/52</b> (2006.01)	2585462 *	FUSED HETEROCYCLIC COMPOUNDS AS PHOSPHODIESTERASES (PDES) INHIBITORS
<b>C07D 498/04</b> (2006.01)	2585462 *	FUSED HETEROCYCLIC COMPOUNDS AS PHOSPHODIESTERASES (PDES) INHIBITORS

MKP (51)	Broj objave evropske prijava patenta (97)	Naziv pronalaska (54)
<b>A61P 25/18</b> (2006.01)	2585462 *	FUSED HETEROCYCLIC COMPOUNDS AS PHOSPHODIESTERASES (PDES) INHIBITORS
<b>A61K 9/00</b> (2006.01)	2560612 *	METHOD FOR PREPARING PHARMACEUTICAL COMPOSITIONS INTENDED FOR ORAL ADMINISTRATION COMPRISING ONE OR MORE ACTIVE INGREDIENTS AND THE COMPOSITIONS COMPRISING SAME
<b>A61K 9/16</b> (2006.01)	2560612 *	METHOD FOR PREPARING PHARMACEUTICAL COMPOSITIONS INTENDED FOR ORAL ADMINISTRATION COMPRISING ONE OR MORE ACTIVE INGREDIENTS AND THE COMPOSITIONS COMPRISING SAME
<b>A61K 9/50</b> (2006.01)	2560612 *	METHOD FOR PREPARING PHARMACEUTICAL COMPOSITIONS INTENDED FOR ORAL ADMINISTRATION COMPRISING ONE OR MORE ACTIVE INGREDIENTS AND THE COMPOSITIONS COMPRISING SAME
<b>G07C 9/00</b> (2006.01)	2577616 *	A METHOD OF AUTHORIZING A PERSON, AN AUTHORIZING ARCHITECTURE AND A COMPUTER PROGRAM PRODUCT
<b>A61K 31/433</b> (2006.01)	2555775 *	COMBINATION COMPOSITIONS OF ADENOSINE A1 AGONISTS AND CARBONIC ANHYDRASE INHIBITORS FOR REDUCING INTRAOCULAR PRESSURE
<b>A61P 27/06</b> (2006.01)	2555775 *	COMBINATION COMPOSITIONS OF ADENOSINE A1 AGONISTS AND CARBONIC ANHYDRASE INHIBITORS FOR REDUCING INTRAOCULAR PRESSURE
<b>A61K 31/7076</b> (2006.01)	2555775 *	COMBINATION COMPOSITIONS OF ADENOSINE A1 AGONISTS AND CARBONIC ANHYDRASE INHIBITORS FOR REDUCING INTRAOCULAR PRESSURE
<b>A61K 31/382</b> (2006.01)	2555775 *	COMBINATION COMPOSITIONS OF ADENOSINE A1 AGONISTS AND CARBONIC ANHYDRASE INHIBITORS FOR REDUCING INTRAOCULAR PRESSURE
<b>A61P 27/02</b> (2006.01)	2555775 *	COMBINATION COMPOSITIONS OF ADENOSINE A1 AGONISTS AND CARBONIC ANHYDRASE INHIBITORS FOR REDUCING INTRAOCULAR PRESSURE
<b>A61K 31/542</b> (2006.01)	2555775 *	COMBINATION COMPOSITIONS OF ADENOSINE A1 AGONISTS AND CARBONIC ANHYDRASE INHIBITORS FOR REDUCING INTRAOCULAR PRESSURE
<b>G01N 23/04</b> (2006.01)	2561340 *	METHOD AND SYSTEM FOR USE IN PERFORMING SECURITY SCREENING
<b>F24J 2/32</b> (2006.01)	2580538 *	COMBINED SOLAR COLLECTOR
<b>H01L 31/058</b> (2006.01)	2580538 *	COMBINED SOLAR COLLECTOR
<b>H01L 31/052</b> (2006.01)	2580538 *	COMBINED SOLAR COLLECTOR
<b>F24J 2/34</b> (2006.01)	2580538 *	COMBINED SOLAR COLLECTOR
<b>F24J 2/50</b> (2006.01)	2580538 *	COMBINED SOLAR COLLECTOR
<b>F24J 2/54</b> (2006.01)	2580538 *	COMBINED SOLAR COLLECTOR
<b>F24J 2/05</b> (2006.01)	2580538 *	COMBINED SOLAR COLLECTOR
<b>F24J 2/26</b> (2006.01)	2580538 *	COMBINED SOLAR COLLECTOR
<b>F24J 2/14</b> (2006.01)	2580538 *	COMBINED SOLAR COLLECTOR
<b>A61P 3/10</b> (2006.01)	2554183	Pharmaceutical composition comprising a GLP-1-agonist, an insulin, and methionine
<b>A61K 47/10</b> (2006.01)	2554183	Pharmaceutical composition comprising a GLP-1-agonist, an insulin, and methionine
<b>A61K 38/28</b> (2006.01)	2554183	Pharmaceutical composition comprising a GLP-1-agonist, an insulin, and methionine
<b>A61K 47/18</b> (2006.01)	2554183	Pharmaceutical composition comprising a GLP-1-agonist, an insulin, and methionine
<b>A61K 38/26</b> (2006.01)	2554183	Pharmaceutical composition comprising a GLP-1-agonist, an insulin, and methionine
<b>A61K 9/00</b> (2006.01)	2554183	Pharmaceutical composition comprising a GLP-1-agonist, an insulin, and methionine
<b>A61P 35/02</b> (2006.01)	2593479 *	SUPERIOR EFFICACY OF CD37 ANTIBODIES IN CLL BLOOD SAMPLES
<b>C07K 16/28</b> (2006.01)	2593479 *	SUPERIOR EFFICACY OF CD37 ANTIBODIES IN CLL BLOOD SAMPLES
<b>A61K 39/395</b> (2006.01)	2593479 *	SUPERIOR EFFICACY OF CD37 ANTIBODIES IN CLL BLOOD SAMPLES

MKP (51)	Broj objave evropske prijava patenta (97)	Naziv pronalaska (54)
A61P 17/02 (2006.01)	2575840 *	KIT OF PARTS FOR TREATING AND/OR PREVENTING CUTANEOUS ULCERS
A61K 36/47 (2006.01)	2575840 *	KIT OF PARTS FOR TREATING AND/OR PREVENTING CUTANEOUS ULCERS
A61K 36/61 (2006.01)	2575840 *	KIT OF PARTS FOR TREATING AND/OR PREVENTING CUTANEOUS ULCERS
C07D 401/12 (2006.01)	2588471 *	HETEROCYCLIC COMPOUNDS AND THEIR USE AS INHIBITORS OF PI3K ACTIVITY
A61K 31/4375 (2006.01)	2588471 *	HETEROCYCLIC COMPOUNDS AND THEIR USE AS INHIBITORS OF PI3K ACTIVITY
C07D 471/04 (2006.01)	2588471 *	HETEROCYCLIC COMPOUNDS AND THEIR USE AS INHIBITORS OF PI3K ACTIVITY
C07D 491/107 (2006.01)	2588471 *	HETEROCYCLIC COMPOUNDS AND THEIR USE AS INHIBITORS OF PI3K ACTIVITY
C07D 409/14 (2006.01)	2588471 *	HETEROCYCLIC COMPOUNDS AND THEIR USE AS INHIBITORS OF PI3K ACTIVITY
A61K 31/4709 (2006.01)	2588471 *	HETEROCYCLIC COMPOUNDS AND THEIR USE AS INHIBITORS OF PI3K ACTIVITY
C07D 405/14 (2006.01)	2588471 *	HETEROCYCLIC COMPOUNDS AND THEIR USE AS INHIBITORS OF PI3K ACTIVITY
A61P 29/00 (2006.01)	2588471 *	HETEROCYCLIC COMPOUNDS AND THEIR USE AS INHIBITORS OF PI3K ACTIVITY
C07D 413/14 (2006.01)	2588471 *	HETEROCYCLIC COMPOUNDS AND THEIR USE AS INHIBITORS OF PI3K ACTIVITY
C07D 401/14 (2006.01)	2588471 *	HETEROCYCLIC COMPOUNDS AND THEIR USE AS INHIBITORS OF PI3K ACTIVITY
A61P 35/00 (2006.01)	2588471 *	HETEROCYCLIC COMPOUNDS AND THEIR USE AS INHIBITORS OF PI3K ACTIVITY
A47F 11/06 (2006.01)	2560525 *	EQUIPMENT FOR DISPLAYING INFORMATION CARRIERS, ESPECIALLY FOR ADVERTISING PURPOSES
A61K 31/519 (2006.01)	2545057 *	PYRIMIDINE DERIVATIVES AND THEIR USE IN THE TREATMENT OF RESPIRATORY DISEASES SUCH AS COPD
C07D 487/04 (2006.01)	2545057 *	PYRIMIDINE DERIVATIVES AND THEIR USE IN THE TREATMENT OF RESPIRATORY DISEASES SUCH AS COPD
A61P 11/00 (2006.01)	2545057 *	PYRIMIDINE DERIVATIVES AND THEIR USE IN THE TREATMENT OF RESPIRATORY DISEASES SUCH AS COPD
A61P 1/00 (2006.01)	2545057 *	PYRIMIDINE DERIVATIVES AND THEIR USE IN THE TREATMENT OF RESPIRATORY DISEASES SUCH AS COPD
C07D 209/58 (2006.01)	2539320 *	A PROCESS FOR THE PREPARATION OF SUBSTITUTED PROLYL PEPTIDES AND SIMILAR PEPTIDOMIMETICS
C07D 209/94 (2006.01)	2539320 *	A PROCESS FOR THE PREPARATION OF SUBSTITUTED PROLYL PEPTIDES AND SIMILAR PEPTIDOMIMETICS
C07D 241/24 (2006.01)	2539320 *	A PROCESS FOR THE PREPARATION OF SUBSTITUTED PROLYL PEPTIDES AND SIMILAR PEPTIDOMIMETICS
C07D 209/52 (2006.01)	2539320 *	A PROCESS FOR THE PREPARATION OF SUBSTITUTED PROLYL PEPTIDES AND SIMILAR PEPTIDOMIMETICS
C07D 403/06 (2006.01)	2539320 *	A PROCESS FOR THE PREPARATION OF SUBSTITUTED PROLYL PEPTIDES AND SIMILAR PEPTIDOMIMETICS
C07D 217/04 (2006.01)	2542530 *	PROCESS FOR THE PREPARATION OF 2-(CYCLOHEXYLMETHYL)-N-{2-[(2S)-1-METHYLPYRROLIDIN-2-YL]ETHYL}-1, 2, 3, 4-TETRAHYDROISOQUINOLINE-7-SULFONAMIDE
C07D 401/12 (2006.01)	2542530 *	PROCESS FOR THE PREPARATION OF 2-(CYCLOHEXYLMETHYL)-N-{2-[(2S)-1-METHYLPYRROLIDIN-2-YL]ETHYL}-1, 2, 3, 4-TETRAHYDROISOQUINOLINE-7-SULFONAMIDE
E04H 12/08 (2006.01)	2593619 *	METHOD OF ASSEMBLING A TUBULAR BUILDING STRUCTURE BY USING SCREW SOCKETS
E04H 12/34 (2006.01)	2593619 *	METHOD OF ASSEMBLING A TUBULAR BUILDING STRUCTURE BY USING SCREW SOCKETS

MKP (51)	Broj objave evropske prijava patenta (97)	Naziv pronalaska (54)
<b>F03D 11/04</b> (2006.01)	2593619 *	METHOD OF ASSEMBLING A TUBULAR BUILDING STRUCTURE BY USING SCREW SOCKETS
<b>C08J 7/12</b> (2006.01)	2481769	Article suitable for contact with foodstuffs and process for realizing the same
<b>A47J 36/04</b> (2006.01)	2481769	Article suitable for contact with foodstuffs and process for realizing the same
<b>C21D 9/52</b> (2006.01)	2576849 *	PROFILED WIRE MADE OF HYDROGEN-EMBRITTLMENT-RESISTANT STEEL HAVING HIGH MECHANICAL PROPERTIES
<b>C22C 38/04</b> (2006.01)	2576849 *	PROFILED WIRE MADE OF HYDROGEN-EMBRITTLMENT-RESISTANT STEEL HAVING HIGH MECHANICAL PROPERTIES
<b>C22C 38/02</b> (2006.01)	2576849 *	PROFILED WIRE MADE OF HYDROGEN-EMBRITTLMENT-RESISTANT STEEL HAVING HIGH MECHANICAL PROPERTIES
<b>C21D 1/20</b> (2006.01)	2576849 *	PROFILED WIRE MADE OF HYDROGEN-EMBRITTLMENT-RESISTANT STEEL HAVING HIGH MECHANICAL PROPERTIES
<b>C21D 9/58</b> (2006.01)	2576849 *	PROFILED WIRE MADE OF HYDROGEN-EMBRITTLMENT-RESISTANT STEEL HAVING HIGH MECHANICAL PROPERTIES
<b>D02J 3/00</b> (2006.01)	2563240 *	HIGH-DENSITY SELF-RETAINING SUTURES, MANUFACTURING EQUIPMENT AND METHODS
<b>D01F 6/06</b> (2006.01)	2563240 *	HIGH-DENSITY SELF-RETAINING SUTURES, MANUFACTURING EQUIPMENT AND METHODS
<b>A61L 17/00</b> (2006.01)	2563240 *	HIGH-DENSITY SELF-RETAINING SUTURES, MANUFACTURING EQUIPMENT AND METHODS
<b>A61B 17/064</b> (2006.01)	2563240 *	HIGH-DENSITY SELF-RETAINING SUTURES, MANUFACTURING EQUIPMENT AND METHODS
<b>C07D 311/78</b> (2006.01)	2576535 *	COMBINATION CANCER THERAPIES WITH WORTMANNIN ANALOGS
<b>C09K 11/77</b> (2006.01)	2417216 *	MODIFICATION OF LAYERED SILICATES FOR LUMINESCENCE ACTIVATION
<b>C01B 33/00</b> (2006.01)	2417216 *	MODIFICATION OF LAYERED SILICATES FOR LUMINESCENCE ACTIVATION
<b>C09K 11/06</b> (2006.01)	2417216 *	MODIFICATION OF LAYERED SILICATES FOR LUMINESCENCE ACTIVATION
<b>B42D 15/00</b> (2006.01)	2560824 *	OPTICALLY WRITABLE HOLOGRAPHIC MEDIA
<b>B62D 11/10</b> (2006.01)	2570332	An improved traction axle for work machines
<b>B62D 11/04</b> (2006.01)	2570332	An improved traction axle for work machines
<b>B66F 9/075</b> (2006.01)	2570332	An improved traction axle for work machines
<b>G10L 13/08</b> (2013.01)	2579249 *	PARAMETER SPEECH SYNTHESIS METHOD AND SYSTEM
<b>A61K 35/36</b> (2006.01)	2582791 *	HAIR FOLLICLE NEOGENESIS
<b>A61F 2/10</b> (2006.01)	2582791 *	HAIR FOLLICLE NEOGENESIS
<b>C12N 5/071</b> (2010.01)	2582791 *	HAIR FOLLICLE NEOGENESIS
<b>C12Q 1/68</b> (2006.01)	2582791 *	HAIR FOLLICLE NEOGENESIS
<b>C12N 5/077</b> (2010.01)	2582791 *	HAIR FOLLICLE NEOGENESIS
<b>H01M 2/02</b> (2006.01)	2572394 *	EXTERNAL PROCESSING ACCESSORY FOR MOBILE DEVICE
<b>C12N 15/113</b> (2010.01)	2576782 *	SIRNA AND THEIR USE IN METHODS AND COMPOSITIONS FOR THE TREATMENT AND/OR PREVENTION OF EYE CONDITIONS
<b>A61K 31/713</b> (2006.01)	2576782 *	SIRNA AND THEIR USE IN METHODS AND COMPOSITIONS FOR THE TREATMENT AND/OR PREVENTION OF EYE CONDITIONS
<b>A61P 27/02</b> (2006.01)	2576782 *	SIRNA AND THEIR USE IN METHODS AND COMPOSITIONS FOR THE TREATMENT AND/OR PREVENTION OF EYE CONDITIONS
<b>A01N 1/02</b> (2006.01)	2578082 *	COMPOSITION FOR THE COLD STORAGE OF ORGANS
<b>A61M 5/00</b> (2006.01)	2585141 *	AUTO-INJECTOR
<b>A61M 5/32</b> (2006.01)	2585141 *	AUTO-INJECTOR
<b>A61M 5/20</b> (2006.01)	2585141 *	AUTO-INJECTOR
<b>A61M 5/315</b> (2006.01)	2579927 *	DRIVE MECHANISM FOR A DRUG DELIVERY DEVICE AND DRUG DELIVERY DEVICE
<b>C07D 205/04</b> (2006.01)	2588450 *	NAPHT- 2 -YLACETIC ACID DERIVATIVES TO TREAT AIDS
<b>C07D 493/04</b> (2006.01)	2588450 *	NAPHT- 2 -YLACETIC ACID DERIVATIVES TO TREAT AIDS
<b>C07D 213/64</b> (2006.01)	2588450 *	NAPHT- 2 -YLACETIC ACID DERIVATIVES TO TREAT AIDS
<b>A61P 31/18</b> (2006.01)	2588450 *	NAPHT- 2 -YLACETIC ACID DERIVATIVES TO TREAT AIDS

MKP (51)	Broj objave evropske prijava patenta (97)	Naziv pronalaska (54)
<b>C07D 231/12</b> (2006.01)	2588450 *	NAPHT- 2 -YLACETIC ACID DERIVATIVES TO TREAT AIDS
<b>C07D 213/73</b> (2006.01)	2588450 *	NAPHT- 2 -YLACETIC ACID DERIVATIVES TO TREAT AIDS
<b>C07D 211/48</b> (2006.01)	2588450 *	NAPHT- 2 -YLACETIC ACID DERIVATIVES TO TREAT AIDS
<b>C07D 295/073</b> (2006.01)	2588450 *	NAPHT- 2 -YLACETIC ACID DERIVATIVES TO TREAT AIDS
<b>C07D 233/58</b> (2006.01)	2588450 *	NAPHT- 2 -YLACETIC ACID DERIVATIVES TO TREAT AIDS
<b>C07D 215/04</b> (2006.01)	2588450 *	NAPHT- 2 -YLACETIC ACID DERIVATIVES TO TREAT AIDS
<b>C07D 213/65</b> (2006.01)	2588450 *	NAPHT- 2 -YLACETIC ACID DERIVATIVES TO TREAT AIDS
<b>C07D 311/20</b> (2006.01)	2588450 *	NAPHT- 2 -YLACETIC ACID DERIVATIVES TO TREAT AIDS
<b>C07D 241/12</b> (2006.01)	2588450 *	NAPHT- 2 -YLACETIC ACID DERIVATIVES TO TREAT AIDS
<b>C07D 309/10</b> (2006.01)	2588450 *	NAPHT- 2 -YLACETIC ACID DERIVATIVES TO TREAT AIDS
<b>C07D 239/34</b> (2006.01)	2588450 *	NAPHT- 2 -YLACETIC ACID DERIVATIVES TO TREAT AIDS
<b>A61P 43/00</b> (2006.01)	2560942 *	1-(2-FLUOROBIPHENYL-4-YL)-ALKYL CARBOXYLIC ACID DERIVATIVES FOR THE THERAPY OF TRANSTHYRETIN AMYLOIDOSIS
<b>A61K 31/19</b> (2006.01)	2560942 *	1-(2-FLUOROBIPHENYL-4-YL)-ALKYL CARBOXYLIC ACID DERIVATIVES FOR THE THERAPY OF TRANSTHYRETIN AMYLOIDOSIS
<b>C07C 57/58</b> (2006.01)	2560942 *	1-(2-FLUOROBIPHENYL-4-YL)-ALKYL CARBOXYLIC ACID DERIVATIVES FOR THE THERAPY OF TRANSTHYRETIN AMYLOIDOSIS
<b>A61P 25/28</b> (2006.01)	2560942 *	1-(2-FLUOROBIPHENYL-4-YL)-ALKYL CARBOXYLIC ACID DERIVATIVES FOR THE THERAPY OF TRANSTHYRETIN AMYLOIDOSIS
<b>B25G 3/12</b> (2006.01)	2555907 *	ADJUSTABLE HANDLE ASSEMBLY WITH LOCKING MECHANISM
<b>F16M 13/04</b> (2006.01)	2555907 *	ADJUSTABLE HANDLE ASSEMBLY WITH LOCKING MECHANISM
<b>F16C 11/10</b> (2006.01)	2555907 *	ADJUSTABLE HANDLE ASSEMBLY WITH LOCKING MECHANISM
<b>G05G 1/10</b> (2006.01)	2555907 *	ADJUSTABLE HANDLE ASSEMBLY WITH LOCKING MECHANISM
<b>E05B 13/00</b> (2006.01)	2550418 *	SELECTIVELY DISENGAGEABLE AND COUPLABLE HANDLE WITH MOTOR
<b>E05B 47/00</b> (2006.01)	2550418 *	SELECTIVELY DISENGAGEABLE AND COUPLABLE HANDLE WITH MOTOR
<b>A23L 1/30</b> (2006.01)	2471384	Suspension formulations of cetyl myristate and/or cetyl palmitate
<b>A61K 31/23</b> (2006.01)	2471384	Suspension formulations of cetyl myristate and/or cetyl palmitate
<b>A61K 9/00</b> (2006.01)	2471384	Suspension formulations of cetyl myristate and/or cetyl palmitate
<b>E05F 3/00</b> (2006.01)	2580416 *	MOUNTING ARRANGEMENT FOR A DOOR ACTUATOR
<b>E05F 3/04</b> (2006.01)	2580416 *	MOUNTING ARRANGEMENT FOR A DOOR ACTUATOR
<b>A61P 11/00</b> (2006.01)	2555785 *	USE OF STREPTOCOCCUS SALIVARIUS IN THE TREATMENT OF CHRONIC INFECTIONS OF THE RESPIRATORY TRACT
<b>A61K 35/74</b> (2006.01)	2555785 *	USE OF STREPTOCOCCUS SALIVARIUS IN THE TREATMENT OF CHRONIC INFECTIONS OF THE RESPIRATORY TRACT
<b>C12N 15/82</b> (2006.01)	2580336 *	METHODS AND MEANS TO MODIFY A PLANT GENOME AT A NUCLEOTIDE SEQUENCE COMMONLY USED IN PLANT GENOME ENGINEERING
<b>C07D 498/00</b> (2006.01)	2593463 *	FORMULATIONS OF RIFAXIMIN AND USES THEREOF
<b>A63B 22/04</b> (2006.01)	2558169 *	IMPACT ABSORBING EXERCISE DEVICE
<b>E04F 13/00</b> (2006.01)	2576166 *	MAT OF POLYMER FIBRES CONTAINING A DIHYDRAZIDE, AND USE THEREOF
<b>B32B 21/10</b> (2006.01)	2576166 *	MAT OF POLYMER FIBRES CONTAINING A DIHYDRAZIDE, AND USE THEREOF
<b>B27N 7/00</b> (2006.01)	2576166 *	MAT OF POLYMER FIBRES CONTAINING A DIHYDRAZIDE, AND USE THEREOF
<b>B32B 5/28</b> (2006.01)	2576166 *	MAT OF POLYMER FIBRES CONTAINING A DIHYDRAZIDE, AND USE THEREOF
<b>B60R 13/02</b> (2006.01)	2576166 *	MAT OF POLYMER FIBRES CONTAINING A DIHYDRAZIDE, AND USE THEREOF
<b>E04B 1/74</b> (2006.01)	2576166 *	MAT OF POLYMER FIBRES CONTAINING A DIHYDRAZIDE, AND USE THEREOF
<b>D06M 13/402</b> (2006.01)	2576166 *	MAT OF POLYMER FIBRES CONTAINING A DIHYDRAZIDE, AND USE THEREOF
<b>C08J 7/06</b> (2006.01)	2576166 *	MAT OF POLYMER FIBRES CONTAINING A DIHYDRAZIDE, AND USE THEREOF

MKP (51)	Broj objave evropske prijava patenta (97)	Naziv pronalaska (54)
<b>A61K 31/55</b> (2006.01)	2569434 *	COMPOSITIONS AND METHODS FOR TREATING LEUKEMIA
<b>C12N 15/13</b> (2006.01)	2569434 *	COMPOSITIONS AND METHODS FOR TREATING LEUKEMIA
<b>A61K 31/7088</b> (2006.01)	2569434 *	COMPOSITIONS AND METHODS FOR TREATING LEUKEMIA
<b>F16H 25/20</b> (2006.01)	2481537	Cutting machine for food
<b>B26D 7/08</b> (2006.01)	2481537	Cutting machine for food
<b>B26D 1/143</b> (2006.01)	2481537	Cutting machine for food
<b>B26D 7/00</b> (2006.01)	2481537	Cutting machine for food
<b>A61K 31/53</b> (2006.01)	2544672 *	COMBINATION ANTI-CANCER THERAPY
<b>A61P 35/00</b> (2006.01)	2544672 *	COMBINATION ANTI-CANCER THERAPY
<b>A61K 31/4985</b> (2006.01)	2544672 *	COMBINATION ANTI-CANCER THERAPY
<b>A61K 31/00</b> (2006.01)	2544672 *	COMBINATION ANTI-CANCER THERAPY
<b>H05K 1/14</b> (2006.01)	2561741 *	A THERMALLY CONTROLLED ASSEMBLY
<b>H05K 7/20</b> (2006.01)	2561741 *	A THERMALLY CONTROLLED ASSEMBLY
<b>A61M 5/32</b> (2006.01)	2588169 *	INJECTION DEVICE WITH NEEDLE SHIELD
<b>A61M 5/28</b> (2006.01)	2588169 *	INJECTION DEVICE WITH NEEDLE SHIELD
<b>G06F 3/01</b> (2006.01)	2561424 *	SYSTEMS AND METHODS FOR PROVIDING HAPTIC EFFECTS
<b>G06Q 30/00</b> (2012.01)	2561424 *	SYSTEMS AND METHODS FOR PROVIDING HAPTIC EFFECTS
<b>A61K 31/222</b> (2006.01)	2549985 *	STABLE PHARMACEUTICAL COMPOSITIONS COMPRISING FESOTERODINE
<b>A61K 9/20</b> (2006.01)	2549985 *	STABLE PHARMACEUTICAL COMPOSITIONS COMPRISING FESOTERODINE
<b>A61K 9/50</b> (2006.01)	2549985 *	STABLE PHARMACEUTICAL COMPOSITIONS COMPRISING FESOTERODINE
<b>A61K 9/16</b> (2006.01)	2549985 *	STABLE PHARMACEUTICAL COMPOSITIONS COMPRISING FESOTERODINE
<b>A47G 23/02</b> (2006.01)	2564732 *	DEVICE FOR THE ROTATION OF OBJECTS (EMBODIMENTS). SET FOR THE ROTATION OF OBJECTS
<b>A47F 5/02</b> (2006.01)	2564732 *	DEVICE FOR THE ROTATION OF OBJECTS (EMBODIMENTS). SET FOR THE ROTATION OF OBJECTS
<b>A47G 19/00</b> (2006.01)	2564732 *	DEVICE FOR THE ROTATION OF OBJECTS (EMBODIMENTS). SET FOR THE ROTATION OF OBJECTS
<b>B01D 35/02</b> (2006.01)	2580425 *	WELLBORE SCREEN WITH TRACER FOR FLUID DETECTION
<b>G01N 33/28</b> (2006.01)	2580425 *	WELLBORE SCREEN WITH TRACER FOR FLUID DETECTION
<b>E21B 43/10</b> (2006.01)	2580425 *	WELLBORE SCREEN WITH TRACER FOR FLUID DETECTION
<b>E21B 43/08</b> (2006.01)	2580425 *	WELLBORE SCREEN WITH TRACER FOR FLUID DETECTION
<b>E21B 47/00</b> (2012.01)	2580425 *	WELLBORE SCREEN WITH TRACER FOR FLUID DETECTION
<b>B32B 3/10</b> (2006.01)	2590815 *	SIDE NOTCH PAPER
<b>A61K 31/5025</b> (2006.01)	2569315 *	FUSED BICYCLIC KINASE INHIBITORS
<b>A61P 35/00</b> (2006.01)	2569315 *	FUSED BICYCLIC KINASE INHIBITORS
<b>C07D 487/04</b> (2006.01)	2569315 *	FUSED BICYCLIC KINASE INHIBITORS
<b>C07D 471/04</b> (2006.01)	2569315 *	FUSED BICYCLIC KINASE INHIBITORS
<b>A61K 9/14</b> (2006.01)	2575769 *	STABILIZED TACROLIMUS COMPOSITION
<b>F17C 13/00</b> (2006.01)	2500619	Originality guarantee for compressed gas bottles
<b>F17C 13/06</b> (2006.01)	2500619	Originality guarantee for compressed gas bottles
<b>A61K 31/737</b> (2006.01)	2588087 *	COMPOSITIONS WITH A HIGH ACTIVE INGREDIENT FRACTION OF PHARMACEUTICALLY ACTIVE SUBSTANCES
<b>A61K 31/7008</b> (2006.01)	2588087 *	COMPOSITIONS WITH A HIGH ACTIVE INGREDIENT FRACTION OF PHARMACEUTICALLY ACTIVE SUBSTANCES
<b>A61K 9/20</b> (2006.01)	2588087 *	COMPOSITIONS WITH A HIGH ACTIVE INGREDIENT FRACTION OF PHARMACEUTICALLY ACTIVE SUBSTANCES
<b>F24J 2/04</b> (2006.01)	2474794	Seal board
<b>F24J 2/52</b> (2006.01)	2474794	Seal board



MKP (51)	Broj objave evropske prijava patenta (97)	Naziv pronalaska (54)
<b>E04F 10/04</b> (2006.01)	2571723 *	DEPLOYABLE SHELTER STRUCTURE
<b>E04H 15/06</b> (2006.01)	2571723 *	DEPLOYABLE SHELTER STRUCTURE
<b>B60P 3/34</b> (2006.01)	2571723 *	DEPLOYABLE SHELTER STRUCTURE
<b>A61K 38/11</b> (2006.01)	2571511 *	NEW USES OF OXYTOCIN-LIKE MOLECULES AND RELATED METHODS
<b>A61P 3/10</b> (2006.01)	2571511 *	NEW USES OF OXYTOCIN-LIKE MOLECULES AND RELATED METHODS
<b>A61P 3/04</b> (2006.01)	2571511 *	NEW USES OF OXYTOCIN-LIKE MOLECULES AND RELATED METHODS
<b>C10M 161/00</b> (2006.01)	2587920 *	ANTIMICROBIAL COMBINATIONS OF PYRION COMPOUNDS WITH POLYETHYLENEIMINES
<b>C02F 1/50</b> (2006.01)	2587920 *	ANTIMICROBIAL COMBINATIONS OF PYRION COMPOUNDS WITH POLYETHYLENEIMINES
<b>A61K 31/44</b> (2006.01)	2587920 *	ANTIMICROBIAL COMBINATIONS OF PYRION COMPOUNDS WITH POLYETHYLENEIMINES
<b>A61L 2/18</b> (2006.01)	2587920 *	ANTIMICROBIAL COMBINATIONS OF PYRION COMPOUNDS WITH POLYETHYLENEIMINES
<b>A61K 31/785</b> (2006.01)	2587920 *	ANTIMICROBIAL COMBINATIONS OF PYRION COMPOUNDS WITH POLYETHYLENEIMINES
<b>A01P 1/00</b> (2006.01)	2587920 *	ANTIMICROBIAL COMBINATIONS OF PYRION COMPOUNDS WITH POLYETHYLENEIMINES
<b>A01N 43/40</b> (2006.01)	2587920 *	ANTIMICROBIAL COMBINATIONS OF PYRION COMPOUNDS WITH POLYETHYLENEIMINES
<b>B27K 3/50</b> (2006.01)	2587920 *	ANTIMICROBIAL COMBINATIONS OF PYRION COMPOUNDS WITH POLYETHYLENEIMINES
<b>A61K 39/395</b> (2006.01)	2568996 *	INNOVATIVE DISCOVERY OF THERAPEUTIC, DIAGNOSTIC, AND ANTIBODY COMPOSITIONS RELATED TO PROTEIN FRAGMENTS OF PHENYLALANYL-BETA-TRNA SYNTHETASES
<b>A61P 37/00</b> (2006.01)	2568996 *	INNOVATIVE DISCOVERY OF THERAPEUTIC, DIAGNOSTIC, AND ANTIBODY COMPOSITIONS RELATED TO PROTEIN FRAGMENTS OF PHENYLALANYL-BETA-TRNA SYNTHETASES
<b>A61K 38/17</b> (2006.01)	2568996 *	INNOVATIVE DISCOVERY OF THERAPEUTIC, DIAGNOSTIC, AND ANTIBODY COMPOSITIONS RELATED TO PROTEIN FRAGMENTS OF PHENYLALANYL-BETA-TRNA SYNTHETASES
<b>A61K 38/16</b> (2006.01)	2568996 *	INNOVATIVE DISCOVERY OF THERAPEUTIC, DIAGNOSTIC, AND ANTIBODY COMPOSITIONS RELATED TO PROTEIN FRAGMENTS OF PHENYLALANYL-BETA-TRNA SYNTHETASES
<b>A61P 35/00</b> (2006.01)	2568996 *	INNOVATIVE DISCOVERY OF THERAPEUTIC, DIAGNOSTIC, AND ANTIBODY COMPOSITIONS RELATED TO PROTEIN FRAGMENTS OF PHENYLALANYL-BETA-TRNA SYNTHETASES
<b>A61P 29/00</b> (2006.01)	2568996 *	INNOVATIVE DISCOVERY OF THERAPEUTIC, DIAGNOSTIC, AND ANTIBODY COMPOSITIONS RELATED TO PROTEIN FRAGMENTS OF PHENYLALANYL-BETA-TRNA SYNTHETASES
<b>C07D 237/08</b> (2006.01)	2588453 *	COMPOSITIONS AND METHODS FOR MODULATING THE WNT SIGNALING PATHWAY
<b>A61K 31/44</b> (2006.01)	2588453 *	COMPOSITIONS AND METHODS FOR MODULATING THE WNT SIGNALING PATHWAY
<b>A61P 35/00</b> (2006.01)	2588453 *	COMPOSITIONS AND METHODS FOR MODULATING THE WNT SIGNALING PATHWAY
<b>C07D 401/14</b> (2006.01)	2588453 *	COMPOSITIONS AND METHODS FOR MODULATING THE WNT SIGNALING PATHWAY
<b>C07D 213/56</b> (2006.01)	2588453 *	COMPOSITIONS AND METHODS FOR MODULATING THE WNT SIGNALING PATHWAY
<b>C07D 401/12</b> (2006.01)	2588453 *	COMPOSITIONS AND METHODS FOR MODULATING THE WNT SIGNALING PATHWAY
<b>C07D 403/12</b> (2006.01)	2588453 *	COMPOSITIONS AND METHODS FOR MODULATING THE WNT SIGNALING PATHWAY
<b>C07D 279/12</b> (2006.01)	2588453 *	COMPOSITIONS AND METHODS FOR MODULATING THE WNT SIGNALING PATHWAY
<b>A61P 43/00</b> (2006.01)	2508184	Pyridopyrazine derivatives and their use
<b>A61P 35/00</b> (2006.01)	2508184	Pyridopyrazine derivatives and their use

MKP (51)	Broj objave evropske prijava patenta (97)	Naziv pronalaska (54)
<b>A61K 31/4985</b> (2006.01)	2508184	Pyridopyrazine derivatives and their use
<b>A61K 31/501</b> (2006.01)	2508184	Pyridopyrazine derivatives and their use
<b>A61K 31/5377</b> (2006.01)	2508184	Pyridopyrazine derivatives and their use
<b>C07D 471/04</b> (2006.01)	2508184	Pyridopyrazine derivatives and their use
<b>A61K 31/28</b> (2006.01)	2545064 *	CARBON MONOXIDE RELEASING RHENIUM COMPOUNDS FOR MEDICAL USE
<b>C07F 13/00</b> (2006.01)	2545064 *	CARBON MONOXIDE RELEASING RHENIUM COMPOUNDS FOR MEDICAL USE
<b>A61K 39/395</b> (2006.01)	2538976 *	FOLATE RECEPTOR 1 ANTIBODIES AND IMMUNOCONJUGATES AND USES THEREOF
<b>C07K 16/00</b> (2006.01)	2538976 *	FOLATE RECEPTOR 1 ANTIBODIES AND IMMUNOCONJUGATES AND USES THEREOF
<b>A61K 39/395</b> (2006.01)	2563397 *	SPARC BINDING APTAMERS AND USES THEREOF
<b>C22C 38/44</b> (2006.01)	2591134 *	AUSTENITIC-FERRITIC STAINLESS STEEL HAVING IMPROVED MACHINABILITY
<b>C22C 38/58</b> (2006.01)	2591134 *	AUSTENITIC-FERRITIC STAINLESS STEEL HAVING IMPROVED MACHINABILITY
<b>C21D 8/02</b> (2006.01)	2591134 *	AUSTENITIC-FERRITIC STAINLESS STEEL HAVING IMPROVED MACHINABILITY
<b>C22C 38/42</b> (2006.01)	2591134 *	AUSTENITIC-FERRITIC STAINLESS STEEL HAVING IMPROVED MACHINABILITY
<b>C22C 38/00</b> (2006.01)	2591134 *	AUSTENITIC-FERRITIC STAINLESS STEEL HAVING IMPROVED MACHINABILITY
<b>A61B 17/295</b> (2006.01)	2552329 *	SURGICAL CUTTING AND SEALING INSTRUMENT WITH REDUCED FIRING FORCE
<b>A23L 1/035</b> (2006.01)	2563164 *	NANOEMULSION INCLUDING SUCROSE FATTY ACID ESTER
<b>A23L 1/302</b> (2006.01)	2563164 *	NANOEMULSION INCLUDING SUCROSE FATTY ACID ESTER
<b>A61K 9/107</b> (2006.01)	2563164 *	NANOEMULSION INCLUDING SUCROSE FATTY ACID ESTER
<b>A23L 1/30</b> (2006.01)	2563164 *	NANOEMULSION INCLUDING SUCROSE FATTY ACID ESTER
<b>H02K 21/18</b> (2006.01)	2290792	Magnetic turbine
<b>H02K 29/00</b> (2006.01)	2290792	Magnetic turbine
<b>H02K 21/14</b> (2006.01)	2290792	Magnetic turbine
<b>C07D 493/04</b> (2006.01)	2542555 *	PROCESS FOR PRODUCING PYRIPYROPENE DERIVATIVES
<b>H01L 31/00</b> (2006.01)	2548243 *	MODULAR INTERCONNECTION SYSTEM
<b>H01M 8/02</b> (2006.01)	2548243 *	MODULAR INTERCONNECTION SYSTEM
<b>H01M 10/42</b> (2006.01)	2548243 *	MODULAR INTERCONNECTION SYSTEM
<b>H01M 2/20</b> (2006.01)	2548243 *	MODULAR INTERCONNECTION SYSTEM
<b>H01G 9/20</b> (2006.01)	2548243 *	MODULAR INTERCONNECTION SYSTEM
<b>A61M 5/315</b> (2006.01)	2579929 *	DRIVE MECHANISM FOR A DRUG DELIVERY DEVICE AND DRUG DELIVERY DEVICE
<b>A61P 35/00</b> (2006.01)	2545038 *	HYDRATED CRYSTALLINE FORMS OF N-[3-FLUORO-4-((6-(METHYLOXY)-7-[(3-MORPHOLIN-4-YLPROPYL)OXY]-QUINOLIN-4-YL)OXY)PHENYL]-N'-(4-FLUOROPHENYL)CYCLOPROPANE-1,1-DICARBOXAMIDE
<b>C07D 215/22</b> (2006.01)	2545038 *	HYDRATED CRYSTALLINE FORMS OF N-[3-FLUORO-4-((6-(METHYLOXY)-7-[(3-MORPHOLIN-4-YLPROPYL)OXY]-QUINOLIN-4-YL)OXY)PHENYL]-N'-(4-FLUOROPHENYL)CYCLOPROPANE-1,1-DICARBOXAMIDE
<b>A61K 31/47</b> (2006.01)	2545038 *	HYDRATED CRYSTALLINE FORMS OF N-[3-FLUORO-4-((6-(METHYLOXY)-7-[(3-MORPHOLIN-4-YLPROPYL)OXY]-QUINOLIN-4-YL)OXY)PHENYL]-N'-(4-FLUOROPHENYL)CYCLOPROPANE-1,1-DICARBOXAMIDE
<b>A47C 1/024</b> (2006.01)	2555733 *	SELF LOCKING MODULAR ARTICULATED FRAME
<b>A47C 1/029</b> (2006.01)	2555733 *	SELF LOCKING MODULAR ARTICULATED FRAME
<b>A61G 5/14</b> (2006.01)	2555733 *	SELF LOCKING MODULAR ARTICULATED FRAME
<b>B65G 57/18</b> (2006.01)	2581332	Procedure and mobile device for stacking wooden logs onto a pallet with raised sides

MKP (51)	Broj objave evropske prijava patenta (97)	Naziv pronalaska (54)
<b>C07D 261/18</b> (2006.01)	2539323 *	COMPOUNDS AS BRADYKININ B1 ANTAGONISTS
<b>A61K 31/506</b> (2006.01)	2539323 *	COMPOUNDS AS BRADYKININ B1 ANTAGONISTS
<b>C07D 213/81</b> (2006.01)	2539323 *	COMPOUNDS AS BRADYKININ B1 ANTAGONISTS
<b>A61K 31/165</b> (2006.01)	2539323 *	COMPOUNDS AS BRADYKININ B1 ANTAGONISTS
<b>C07D 239/28</b> (2006.01)	2539323 *	COMPOUNDS AS BRADYKININ B1 ANTAGONISTS
<b>A61K 31/505</b> (2006.01)	2539323 *	COMPOUNDS AS BRADYKININ B1 ANTAGONISTS
<b>C07D 271/10</b> (2006.01)	2539323 *	COMPOUNDS AS BRADYKININ B1 ANTAGONISTS
<b>C07D 401/12</b> (2006.01)	2539323 *	COMPOUNDS AS BRADYKININ B1 ANTAGONISTS
<b>C07D 239/557</b> (2006.01)	2539323 *	COMPOUNDS AS BRADYKININ B1 ANTAGONISTS
<b>C07D 405/12</b> (2006.01)	2539323 *	COMPOUNDS AS BRADYKININ B1 ANTAGONISTS
<b>C07D 211/62</b> (2006.01)	2539323 *	COMPOUNDS AS BRADYKININ B1 ANTAGONISTS
<b>C07C 237/24</b> (2006.01)	2539323 *	COMPOUNDS AS BRADYKININ B1 ANTAGONISTS
<b>C07D 207/277</b> (2006.01)	2539323 *	COMPOUNDS AS BRADYKININ B1 ANTAGONISTS
<b>C07D 233/90</b> (2006.01)	2539323 *	COMPOUNDS AS BRADYKININ B1 ANTAGONISTS
<b>A61K 31/44</b> (2006.01)	2539323 *	COMPOUNDS AS BRADYKININ B1 ANTAGONISTS
<b>A01N 35/00</b> (2006.01)	2542058 *	EFFECTIVE SENSITIZING DOSE OF A GELLED IMMUNOMODULATING TOPICAL COMPOSITION
<b>A61K 31/337</b> (2006.01)	2575774 *	COMBINATION THERAPY METHODS FOR TREATING PROLIFERATIVE DISEASES
<b>A61K 31/16</b> (2006.01)	2575774 *	COMBINATION THERAPY METHODS FOR TREATING PROLIFERATIVE DISEASES
<b>A61K 31/7068</b> (2006.01)	2575774 *	COMBINATION THERAPY METHODS FOR TREATING PROLIFERATIVE DISEASES
<b>A61K 9/14</b> (2006.01)	2575774 *	COMBINATION THERAPY METHODS FOR TREATING PROLIFERATIVE DISEASES
<b>A61P 35/00</b> (2006.01)	2575774 *	COMBINATION THERAPY METHODS FOR TREATING PROLIFERATIVE DISEASES
<b>A61K 47/42</b> (2006.01)	2575774 *	COMBINATION THERAPY METHODS FOR TREATING PROLIFERATIVE DISEASES
<b>A61M 5/24</b> (2006.01)	2560709 *	CARTRIDGE ASSEMBLY HAVING SHARED FASTENING MEANS AND DRUG DELIVERY DEVICE
<b>A61M 5/31</b> (2006.01)	2560709 *	CARTRIDGE ASSEMBLY HAVING SHARED FASTENING MEANS AND DRUG DELIVERY DEVICE
<b>A61M 5/315</b> (2006.01)	2560709 *	CARTRIDGE ASSEMBLY HAVING SHARED FASTENING MEANS AND DRUG DELIVERY DEVICE
<b>A61M 5/00</b> (2006.01)	2560709 *	CARTRIDGE ASSEMBLY HAVING SHARED FASTENING MEANS AND DRUG DELIVERY DEVICE
<b>A61K 9/16</b> (2006.01)	2497464	Pharmaceutical composition of imatinibe methanesulphonate and a process for its manufacture
<b>A61K 9/48</b> (2006.01)	2497464	Pharmaceutical composition of imatinibe methanesulphonate and a process for its manufacture
<b>A61K 31/506</b> (2006.01)	2497464	Pharmaceutical composition of imatinibe methanesulphonate and a process for its manufacture
<b>A61K 31/4965</b> (2006.01)	2560653 *	CERTAIN AMINO-PYRIMIDINES, COMPOSITIONS THEREOF, AND METHODS FOR THEIR USE
<b>A61K 39/00</b> (2006.01)	2575867 *	NOVEL INTERFERON-ALPHA-PRODUCING BONE MARROW DENDRITIC CELLS
<b>H04L 9/06</b> (2006.01)	2545674 *	ONE VAULT VOICE ENCRYPTION
<b>H04L 29/06</b> (2006.01)	2545674 *	ONE VAULT VOICE ENCRYPTION
<b>C07K 14/605</b> (2006.01)	2585482 *	GLUCAGON ANALOGUES
<b>A61P 5/48</b> (2006.01)	2585482 *	GLUCAGON ANALOGUES
<b>A61K 38/26</b> (2006.01)	2585482 *	GLUCAGON ANALOGUES
<b>A61K 39/085</b> (2006.01)	2566507 *	CAPSULAR GRAM-POSITIVE BACTERIA BIOCONJUGATE VACCINES

MKP (51)	Broj objave evropske prijava patenta (97)	Naziv pronalaska (54)
<b>A01N 43/42</b> (2006.01)	2575463 *	APOPTOSIS-INDUCING AGENTS FOR THE TREATMENT OF CANCER AND IMMUNE AND AUTOIMMUNE DISEASES
<b>A61K 31/44</b> (2006.01)	2575463 *	APOPTOSIS-INDUCING AGENTS FOR THE TREATMENT OF CANCER AND IMMUNE AND AUTOIMMUNE DISEASES
<b>A01N 43/38</b> (2006.01)	2575463 *	APOPTOSIS-INDUCING AGENTS FOR THE TREATMENT OF CANCER AND IMMUNE AND AUTOIMMUNE DISEASES
<b>A01N 43/40</b> (2006.01)	2575463 *	APOPTOSIS-INDUCING AGENTS FOR THE TREATMENT OF CANCER AND IMMUNE AND AUTOIMMUNE DISEASES
<b>A61B 17/072</b> (2006.01)	2547267 *	STAPLE CARTIDGE
<b>A23G 4/06</b> (2006.01)	2560501 *	SLOW-RELEASE DIETARY FORMULATIONS
<b>A61P 35/00</b> (2006.01)	2582689 *	NEW POLYMORPHIC FORM OF IMATINIB BASE AND PREPARATION OF SALTS THEREOF
<b>A61K 31/505</b> (2006.01)	2582689 *	NEW POLYMORPHIC FORM OF IMATINIB BASE AND PREPARATION OF SALTS THEREOF
<b>C07D 401/04</b> (2006.01)	2582689 *	NEW POLYMORPHIC FORM OF IMATINIB BASE AND PREPARATION OF SALTS THEREOF
<b>A61P 19/02</b> (2006.01)	2582391 *	ARTHRITIS TREATMENT
<b>A61P 19/00</b> (2006.01)	2582391 *	ARTHRITIS TREATMENT
<b>A61K 39/395</b> (2006.01)	2582391 *	ARTHRITIS TREATMENT
<b>A61P 29/00</b> (2006.01)	2582391 *	ARTHRITIS TREATMENT
<b>A61K 39/02</b> (2006.01)	2588137 *	FIMH VACCINE AGAINST URINARY TRACT INFECTIONS (UTI)
<b>A61K 39/385</b> (2006.01)	2588137 *	FIMH VACCINE AGAINST URINARY TRACT INFECTIONS (UTI)
<b>C07K 14/245</b> (2006.01)	2588137 *	FIMH VACCINE AGAINST URINARY TRACT INFECTIONS (UTI)
<b>C12N 5/10</b> (2006.01)	2581442 *	PROCESS FOR PRODUCTION OF HEMATOPOIETIC STEM CELL
<b>C12N 5/078</b> (2010.01)	2581442 *	PROCESS FOR PRODUCTION OF HEMATOPOIETIC STEM CELL
<b>A61K 31/122</b> (2006.01)	2581442 *	PROCESS FOR PRODUCTION OF HEMATOPOIETIC STEM CELL
<b>C12N 5/071</b> (2010.01)	2581442 *	PROCESS FOR PRODUCTION OF HEMATOPOIETIC STEM CELL
<b>A61P 43/00</b> (2006.01)	2581442 *	PROCESS FOR PRODUCTION OF HEMATOPOIETIC STEM CELL
<b>C12N 15/64</b> (2006.01)	2558580 *	METHOD FOR THE MANUFACTURE OF RECOMBINANT DSPA ALPHA1
<b>A61K 31/44</b> (2006.01)	2560489 *	COMPOSITIONS COMPRISING ENZYME-CLEAVABLE OPIOID PRODRUGS AND INHIBITORS THEREOF
<b>A01N 43/42</b> (2006.01)	2560489 *	COMPOSITIONS COMPRISING ENZYME-CLEAVABLE OPIOID PRODRUGS AND INHIBITORS THEREOF
<b>C07D 277/00</b> (2006.01)	2576524 *	USE OF METFORMIN IN COMBINATION WITH A GLUCOKINASE ACTIVATOR AND COMPOSITIONS COMPRISING METFORMIN AND A GLUCOKINASE ACTIVATOR
<b>A61K 38/19</b> (2006.01)	2582385 *	TREATMENT OF VASCULAR COMPLICATIONS OF DIABETES
<b>C07K 7/64</b> (2006.01)	2582385 *	TREATMENT OF VASCULAR COMPLICATIONS OF DIABETES
<b>C07K 14/525</b> (2006.01)	2582385 *	TREATMENT OF VASCULAR COMPLICATIONS OF DIABETES
<b>C07F 3/02</b> (2006.01)	2547687 *	A PROCESS USING GRIGNARD REAGENTS
<b>C07D 405/06</b> (2006.01)	2547687 *	A PROCESS USING GRIGNARD REAGENTS
<b>C07F 3/00</b> (2006.01)	2547687 *	A PROCESS USING GRIGNARD REAGENTS
<b>G01V 1/16</b> (2006.01)	2567260 *	OCEAN BOTTOM SEISMIC CABLE RECORDING APPARATUS
<b>G01V 1/38</b> (2006.01)	2567260 *	OCEAN BOTTOM SEISMIC CABLE RECORDING APPARATUS
<b>C07K 16/32</b> (2006.01)	2575880 *	MONOCLONAL ANTIBODIES AGAINST HER2 EPITOPE
<b>A61P 35/00</b> (2006.01)	2575880 *	MONOCLONAL ANTIBODIES AGAINST HER2 EPITOPE
<b>A61K 39/395</b> (2006.01)	2575880 *	MONOCLONAL ANTIBODIES AGAINST HER2 EPITOPE
<b>A01N 33/26</b> (2006.01)	2563117 *	FORMULATIONS AND USES OF 2-HYDROXY-5-PHENYLAZOBENZOIC ACID DERIVATIVES FOR THE TREATMENT OF MALES
<b>A61F 13/02</b> (2006.01)	2491905	Adhesive Bandage
<b>F21S 8/02</b> (2006.01)	2416060	Modular lighting apparatus
<b>F21V 21/22</b> (2006.01)	2416060	Modular lighting apparatus

MKP (51)	Broj objave evropske prijava patenta (97)	Naziv pronalaska (54)
<b>A61P 31/10</b> (2006.01)	2575856 *	INNOVATIVE DISCOVERY OF THERAPEUTIC, DIAGNOSTIC, AND ANTIBODY COMPOSITIONS RELATED TO PROTEIN FRAGMENTS OF GLUTAMINYL-TRNA SYNTHETASES
<b>A61K 38/16</b> (2006.01)	2575856 *	INNOVATIVE DISCOVERY OF THERAPEUTIC, DIAGNOSTIC, AND ANTIBODY COMPOSITIONS RELATED TO PROTEIN FRAGMENTS OF GLUTAMINYL-TRNA SYNTHETASES
<b>A61K 38/10</b> (2006.01)	2575856 *	INNOVATIVE DISCOVERY OF THERAPEUTIC, DIAGNOSTIC, AND ANTIBODY COMPOSITIONS RELATED TO PROTEIN FRAGMENTS OF GLUTAMINYL-TRNA SYNTHETASES
<b>A61K 38/08</b> (2006.01)	2575856 *	INNOVATIVE DISCOVERY OF THERAPEUTIC, DIAGNOSTIC, AND ANTIBODY COMPOSITIONS RELATED TO PROTEIN FRAGMENTS OF GLUTAMINYL-TRNA SYNTHETASES
<b>A61K 39/395</b> (2006.01)	2575856 *	INNOVATIVE DISCOVERY OF THERAPEUTIC, DIAGNOSTIC, AND ANTIBODY COMPOSITIONS RELATED TO PROTEIN FRAGMENTS OF GLUTAMINYL-TRNA SYNTHETASES
<b>A61P 35/00</b> (2006.01)	2575856 *	INNOVATIVE DISCOVERY OF THERAPEUTIC, DIAGNOSTIC, AND ANTIBODY COMPOSITIONS RELATED TO PROTEIN FRAGMENTS OF GLUTAMINYL-TRNA SYNTHETASES
<b>A61P 29/00</b> (2006.01)	2575856 *	INNOVATIVE DISCOVERY OF THERAPEUTIC, DIAGNOSTIC, AND ANTIBODY COMPOSITIONS RELATED TO PROTEIN FRAGMENTS OF GLUTAMINYL-TRNA SYNTHETASES
<b>G06F 19/18</b> (2011.01)	2582847 *	METHODS AND MATERIALS FOR ASSESSING LOSS OF HETEROZYGOSITY
<b>C12N 15/11</b> (2006.01)	2582847 *	METHODS AND MATERIALS FOR ASSESSING LOSS OF HETEROZYGOSITY
<b>C12Q 1/68</b> (2006.01)	2582847 *	METHODS AND MATERIALS FOR ASSESSING LOSS OF HETEROZYGOSITY
<b>C12N 5/09</b> (2010.01)	2582847 *	METHODS AND MATERIALS FOR ASSESSING LOSS OF HETEROZYGOSITY
<b>A61K 31/724</b> (2006.01)	2575892 *	2-IMINOBIOTIN FORMULATIONS AND USES THEREOF
<b>A61K 9/00</b> (2006.01)	2575892 *	2-IMINOBIOTIN FORMULATIONS AND USES THEREOF
<b>A61K 47/40</b> (2006.01)	2575892 *	2-IMINOBIOTIN FORMULATIONS AND USES THEREOF
<b>A61K 47/48</b> (2006.01)	2575892 *	2-IMINOBIOTIN FORMULATIONS AND USES THEREOF
<b>A61K 47/12</b> (2006.01)	2575892 *	2-IMINOBIOTIN FORMULATIONS AND USES THEREOF
<b>C11D 3/00</b> (2006.01)	2569406 *	POLYMER-CONTAINING CLEANING COMPOSITIONS AND METHODS OF PRODUCTION AND USE THEREOF
<b>E04C 2/54</b> (2006.01)	2580406 *	COMPOSITE PANEL BASED ON CEMENTITIOUS MORTAR WITH PROPERTIES OF TRANSPARENCY
<b>B28B 23/00</b> (2006.01)	2580406 *	COMPOSITE PANEL BASED ON CEMENTITIOUS MORTAR WITH PROPERTIES OF TRANSPARENCY
<b>E04C 2/06</b> (2006.01)	2580406 *	COMPOSITE PANEL BASED ON CEMENTITIOUS MORTAR WITH PROPERTIES OF TRANSPARENCY
<b>A61K 31/33</b> (2006.01)	2544679 *	PDE10 INHIBITORS AND RELATED COMPOSITIONS AND METHODS
<b>A23K 1/18</b> (2006.01)	2557941 *	ANIMAL FEED ADDITIVE HAVING AN ANTIMICROBIAL AND GROWTH-PROMOTING EFFECT
<b>A23K 1/16</b> (2006.01)	2557941 *	ANIMAL FEED ADDITIVE HAVING AN ANTIMICROBIAL AND GROWTH-PROMOTING EFFECT
<b>A61P 1/14</b> (2006.01)	2557941 *	ANIMAL FEED ADDITIVE HAVING AN ANTIMICROBIAL AND GROWTH-PROMOTING EFFECT
<b>A61P 1/04</b> (2006.01)	2557941 *	ANIMAL FEED ADDITIVE HAVING AN ANTIMICROBIAL AND GROWTH-PROMOTING EFFECT
<b>A61P 1/12</b> (2006.01)	2557941 *	ANIMAL FEED ADDITIVE HAVING AN ANTIMICROBIAL AND GROWTH-PROMOTING EFFECT
<b>A61P 33/00</b> (2006.01)	2557941 *	ANIMAL FEED ADDITIVE HAVING AN ANTIMICROBIAL AND GROWTH-PROMOTING EFFECT
<b>F22B 1/00</b> (2006.01)	2574199 *	METHOD FOR REUTILIZING CO <sub>2</sub> FROM COMBUSTED CARBONACEOUS MATERIAL
<b>F01K 25/00</b> (2006.01)	2574199 *	METHOD FOR REUTILIZING CO <sub>2</sub> FROM COMBUSTED CARBONACEOUS MATERIAL
<b>A61P 9/00</b> (2006.01)	2588454 *	SUBSTITUTED DICYANOPYRIDINES AND USE THEREOF
<b>A61K 31/44</b> (2006.01)	2588454 *	SUBSTITUTED DICYANOPYRIDINES AND USE THEREOF

MKP (51)	Broj objave evropske prijava patenta (97)	Naziv pronalaska (54)
<b>C07D 213/85</b> (2006.01)	2588454 *	SUBSTITUTED DICYANOPYRIDINES AND USE THEREOF
<b>A61J 3/10</b> (2006.01)	2543502 *	TABLET MANUFACTURING METHOD
<b>B30B 11/02</b> (2006.01)	2543502 *	TABLET MANUFACTURING METHOD
<b>A61K 31/55</b> (2006.01)	2565190 *	TETRAHYDROBENZOTHIOPHENE COMPOUND
<b>C07D 333/68</b> (2006.01)	2565190 *	TETRAHYDROBENZOTHIOPHENE COMPOUND
<b>A61P 3/12</b> (2006.01)	2565190 *	TETRAHYDROBENZOTHIOPHENE COMPOUND
<b>A61K 31/496</b> (2006.01)	2565190 *	TETRAHYDROBENZOTHIOPHENE COMPOUND
<b>A61K 31/4535</b> (2006.01)	2565190 *	TETRAHYDROBENZOTHIOPHENE COMPOUND
<b>C07D 409/12</b> (2006.01)	2565190 *	TETRAHYDROBENZOTHIOPHENE COMPOUND
<b>A61K 31/5377</b> (2006.01)	2565190 *	TETRAHYDROBENZOTHIOPHENE COMPOUND
<b>A61K 31/4436</b> (2006.01)	2565190 *	TETRAHYDROBENZOTHIOPHENE COMPOUND
<b>A61P 43/00</b> (2006.01)	2565190 *	TETRAHYDROBENZOTHIOPHENE COMPOUND
<b>A61K 31/4025</b> (2006.01)	2565190 *	TETRAHYDROBENZOTHIOPHENE COMPOUND
<b>A61P 13/12</b> (2006.01)	2565190 *	TETRAHYDROBENZOTHIOPHENE COMPOUND
<b>A61K 31/381</b> (2006.01)	2565190 *	TETRAHYDROBENZOTHIOPHENE COMPOUND
<b>A61P 9/00</b> (2006.01)	2565190 *	TETRAHYDROBENZOTHIOPHENE COMPOUND
<b>A61K 31/437</b> (2006.01)	2569314 *	FUSED BICYCLIC KINASE INHIBITORS
<b>C07D 471/04</b> (2006.01)	2569314 *	FUSED BICYCLIC KINASE INHIBITORS
<b>A61P 35/00</b> (2006.01)	2569314 *	FUSED BICYCLIC KINASE INHIBITORS
<b>C07F 11/00</b> (2006.01)	2556078 *	CATALYSTS FOR ALKYNE METATHESIS
<b>C08F 4/72</b> (2006.01)	2556078 *	CATALYSTS FOR ALKYNE METATHESIS
<b>A61K 9/00</b> (2006.01)	2575871 *	ORAL VACCINE COMPRISING AN ANTIGEN AND A TOLL-LIKE RECEPTOR AGONIST
<b>A61P 37/04</b> (2006.01)	2575871 *	ORAL VACCINE COMPRISING AN ANTIGEN AND A TOLL-LIKE RECEPTOR AGONIST
<b>A61K 39/145</b> (2006.01)	2575871 *	ORAL VACCINE COMPRISING AN ANTIGEN AND A TOLL-LIKE RECEPTOR AGONIST
<b>A61K 31/192</b> (2006.01)	2575797 *	1-(2-FLUOROBIPHENYL-4-YL)-CYCLOPROPANECARBOXYLIC ACID DERIVATIVES FOR THE THERAPY OF PRION DISEASES
<b>A61P 31/00</b> (2006.01)	2575797 *	1-(2-FLUOROBIPHENYL-4-YL)-CYCLOPROPANECARBOXYLIC ACID DERIVATIVES FOR THE THERAPY OF PRION DISEASES
<b>A61F 6/14</b> (2006.01)	2585010 *	METHODS OF TREATING CONDITIONS ASSOCIATED WITH OVERACTIVE BLADDER
<b>C07K 16/28</b> (2006.01)	2591003 *	CANCER THERAPY USING CLDN6 TARGET-DIRECTED ANTIBODIES IN VIVO
<b>A61K 39/395</b> (2006.01)	2591003 *	CANCER THERAPY USING CLDN6 TARGET-DIRECTED ANTIBODIES IN VIVO
<b>A61P 35/00</b> (2006.01)	2591003 *	CANCER THERAPY USING CLDN6 TARGET-DIRECTED ANTIBODIES IN VIVO
<b>A61K 31/437</b> (2006.01)	2585439 *	HETEROCYCLIC COMPOUNDS, THEIR PREPARATION AND THEIR THERAPEUTIC APPLICATION
<b>C07D 471/04</b> (2006.01)	2585439 *	HETEROCYCLIC COMPOUNDS, THEIR PREPARATION AND THEIR THERAPEUTIC APPLICATION
<b>C07D 401/12</b> (2006.01)	2585439 *	HETEROCYCLIC COMPOUNDS, THEIR PREPARATION AND THEIR THERAPEUTIC APPLICATION
<b>A61K 31/517</b> (2006.01)	2585439 *	HETEROCYCLIC COMPOUNDS, THEIR PREPARATION AND THEIR THERAPEUTIC APPLICATION
<b>A61P 9/00</b> (2006.01)	2585439 *	HETEROCYCLIC COMPOUNDS, THEIR PREPARATION AND THEIR THERAPEUTIC APPLICATION
<b>C07D 239/84</b> (2006.01)	2585439 *	HETEROCYCLIC COMPOUNDS, THEIR PREPARATION AND THEIR THERAPEUTIC APPLICATION
<b>C12P 7/62</b> (2006.01)	2545179 *	PRODUCTION OF POLYHYDROXYALKANOATES
<b>C08L 67/04</b> (2006.01)	2545179 *	PRODUCTION OF POLYHYDROXYALKANOATES
<b>C08G 63/89</b> (2006.01)	2545179 *	PRODUCTION OF POLYHYDROXYALKANOATES

MKP (51)	Broj objave evropske prijava patenta (97)	Naziv pronalaska (54)
<b>A01C 1/04</b> (2006.01)	2478755	Dry organic additivated clod and process for its preparation
<b>A01G 1/00</b> (2006.01)	2478755	Dry organic additivated clod and process for its preparation
<b>A61K 39/00</b> (2006.01)	2590672 *	COMBINATIONS OF ANTI-S1P ANTIBODIES AND SPHINGOLIPID PATHWAY INHIBITORS
<b>G06K 19/077</b> (2006.01)	2569737 *	MEMORY CARD CARRIER, THE METHOD OF FIRST DATA STORAGE INTO THE MEMORY CARD
<b>G06K 19/073</b> (2006.01)	2569737 *	MEMORY CARD CARRIER, THE METHOD OF FIRST DATA STORAGE INTO THE MEMORY CARD
<b>A61K 31/337</b> (2006.01)	2575803 *	METHODS OF TREATING BLADDER CANCER
<b>A61K 47/42</b> (2006.01)	2575803 *	METHODS OF TREATING BLADDER CANCER
<b>A61K 9/14</b> (2006.01)	2575803 *	METHODS OF TREATING BLADDER CANCER
<b>A61P 35/04</b> (2006.01)	2575803 *	METHODS OF TREATING BLADDER CANCER
<b>A61P 11/00</b> (2006.01)	2545056 *	PYRIMIDINE DERIVATIVES AND THEIR USE IN THE TREATMENT OF RESPIRATORY DISEASES SUCH AS COPD
<b>A61P 1/00</b> (2006.01)	2545056 *	PYRIMIDINE DERIVATIVES AND THEIR USE IN THE TREATMENT OF RESPIRATORY DISEASES SUCH AS COPD
<b>A61K 31/519</b> (2006.01)	2545056 *	PYRIMIDINE DERIVATIVES AND THEIR USE IN THE TREATMENT OF RESPIRATORY DISEASES SUCH AS COPD
<b>C07D 487/04</b> (2006.01)	2545056 *	PYRIMIDINE DERIVATIVES AND THEIR USE IN THE TREATMENT OF RESPIRATORY DISEASES SUCH AS COPD
<b>A61K 9/06</b> (2006.01)	2552449 *	COMPOSITIONS COMPRISING BRIMONIDINE FOR THE TREATMENT OF ERYTHEMA
<b>A61K 31/498</b> (2006.01)	2552449 *	COMPOSITIONS COMPRISING BRIMONIDINE FOR THE TREATMENT OF ERYTHEMA
<b>A61P 17/00</b> (2006.01)	2552449 *	COMPOSITIONS COMPRISING BRIMONIDINE FOR THE TREATMENT OF ERYTHEMA
<b>A61K 9/00</b> (2006.01)	2552449 *	COMPOSITIONS COMPRISING BRIMONIDINE FOR THE TREATMENT OF ERYTHEMA
<b>B60T 8/40</b> (2006.01)	2569193 *	METHOD FOR ADJUSTING THE PLAY IN A HYDRAULIC BRAKE SYSTEM, IN PARTICULAR FOR A MOTOR VEHICLE
<b>B60T 8/48</b> (2006.01)	2569193 *	METHOD FOR ADJUSTING THE PLAY IN A HYDRAULIC BRAKE SYSTEM, IN PARTICULAR FOR A MOTOR VEHICLE
<b>A61K 47/34</b> (2006.01)	2575890 *	ANTIPSYCHOTIC INJECTABLE DEPOT COMPOSITION
<b>A61P 9/12</b> (2006.01)	2542560 *	ARYLFLUOROPHOSPHATE INHIBITORS OF INTESTINAL APICAL MEMBRANE SODIUM/PHOSPHATE CO-TRANSPORT
<b>C07F 9/26</b> (2006.01)	2542560 *	ARYLFLUOROPHOSPHATE INHIBITORS OF INTESTINAL APICAL MEMBRANE SODIUM/PHOSPHATE CO-TRANSPORT
<b>A61K 31/683</b> (2006.01)	2542560 *	ARYLFLUOROPHOSPHATE INHIBITORS OF INTESTINAL APICAL MEMBRANE SODIUM/PHOSPHATE CO-TRANSPORT
<b>C07F 9/20</b> (2006.01)	2542560 *	ARYLFLUOROPHOSPHATE INHIBITORS OF INTESTINAL APICAL MEMBRANE SODIUM/PHOSPHATE CO-TRANSPORT
<b>C07F 9/14</b> (2006.01)	2542560 *	ARYLFLUOROPHOSPHATE INHIBITORS OF INTESTINAL APICAL MEMBRANE SODIUM/PHOSPHATE CO-TRANSPORT
<b>B44C 1/00</b> (2006.01)	2463114	Method for processing a brushed, glazed or mirror plate and plant for the obtainment thereof.
<b>B44C 5/04</b> (2006.01)	2463114	Method for processing a brushed, glazed or mirror plate and plant for the obtainment thereof.
<b>B44D 5/10</b> (2006.01)	2463114	Method for processing a brushed, glazed or mirror plate and plant for the obtainment thereof.
<b>B44C 1/22</b> (2006.01)	2463114	Method for processing a brushed, glazed or mirror plate and plant for the obtainment thereof.
<b>C09K 17/52</b> (2006.01)	2558548 *	BIODEGRADABLE MATERIALS FOR SOIL MULCHING BASED ON AQUEOUS MIXTURES OF POLYSACCHARIDES AND PLANT WASTE FIBERS AND METHODS FOR THEIR APPLICATION
<b>A01G 7/00</b> (2006.01)	2558548 *	BIODEGRADABLE MATERIALS FOR SOIL MULCHING BASED ON AQUEOUS MIXTURES OF POLYSACCHARIDES AND PLANT WASTE FIBERS AND METHODS FOR THEIR APPLICATION

MKP (51)	Broj objave evropske prijava patenta (97)	Naziv pronalaska (54)
<b>C07K 16/36</b> (2006.01)	2582728 *	HUMAN ANTIBODY DRUG CONJUGATES AGAINST TISSUE FACTOR
<b>A61K 47/48</b> (2006.01)	2582728 *	HUMAN ANTIBODY DRUG CONJUGATES AGAINST TISSUE FACTOR
<b>C07K 16/28</b> (2006.01)	2580243 *	ANTIBODIES AGAINST HUMAN CD38
<b>F24J 2/38</b> (2006.01)	2543879	Solar generator apparatus with cable-controlled tracking
<b>F24J 2/54</b> (2006.01)	2543879	Solar generator apparatus with cable-controlled tracking
<b>F03G 6/06</b> (2006.01)	2543879	Solar generator apparatus with cable-controlled tracking
<b>A61P 3/04</b> (2006.01)	2558105 *	METHOD OF TREATING OBESITY USING ANTIOXIDANT INFLAMMATION MODULATORS
<b>A61K 31/56</b> (2006.01)	2558105 *	METHOD OF TREATING OBESITY USING ANTIOXIDANT INFLAMMATION MODULATORS
<b>A61M 15/06</b> (2006.01)	2542285 *	AN INHALATOR
<b>A24F 47/00</b> (2006.01)	2542285 *	AN INHALATOR
<b>C02F 3/28</b> (2006.01)	2460771	An anaerobic reactor for psychrophilic and/or mesophilic wastewater treatment
<b>C03B 9/38</b> (2006.01)	2560925 *	GLASSWARE MOLD COOLING AIR SUPPLY
<b>F04B 1/04</b> (2006.01)	2412976	Intermediate drive assembly
<b>F02M 59/10</b> (2006.01)	2412976	Intermediate drive assembly
<b>B01D 11/02</b> (2006.01)	2578285	Analogue ionic liquids for the separation and recovery of hydrocarbons from particulate matter
<b>C10G 1/04</b> (2006.01)	2578285	Analogue ionic liquids for the separation and recovery of hydrocarbons from particulate matter
<b>C07K 16/28</b> (2006.01)	2585110 *	ANTIBODIES TO THE C3D FRAGMENT OF COMPLEMENT COMPONENT 3
<b>A61K 39/395</b> (2006.01)	2585110 *	ANTIBODIES TO THE C3D FRAGMENT OF COMPLEMENT COMPONENT 3
<b>C12N 15/55</b> (2006.01)	2561069 *	LYSOSOMAL STORAGE DISEASE ENZYME
<b>A61K 38/46</b> (2006.01)	2561069 *	LYSOSOMAL STORAGE DISEASE ENZYME
<b>C12N 9/20</b> (2006.01)	2561069 *	LYSOSOMAL STORAGE DISEASE ENZYME
<b>A61P 17/00</b> (2006.01)	2594263 *	PATCH FOR TREATING AND ALLEVIATING SYMPTOMS OF SKIN DISEASES ACCOMPANIED BY EFFUSION OF BLOOD PROTEINS
<b>A61K 9/70</b> (2006.01)	2594263 *	PATCH FOR TREATING AND ALLEVIATING SYMPTOMS OF SKIN DISEASES ACCOMPANIED BY EFFUSION OF BLOOD PROTEINS
<b>A61K 31/545</b> (2006.01)	2594263 *	PATCH FOR TREATING AND ALLEVIATING SYMPTOMS OF SKIN DISEASES ACCOMPANIED BY EFFUSION OF BLOOD PROTEINS
<b>B44C 1/17</b> (2006.01)	2558305 *	METHOD AND DEVICE FOR THE MANUFACTURE OF GLAZING COMPRISING A DECORATIVE FILM AND GLAZING COMPRISING A DECORATIVE FILM
<b>A61K 31/551</b> (2006.01)	2585467 *	PYRAZOLO [1, 5 -A]PYRIMIDINES AS ANTIVIRAL AGENTS
<b>C07D 487/04</b> (2006.01)	2585467 *	PYRAZOLO [1, 5 -A]PYRIMIDINES AS ANTIVIRAL AGENTS
<b>A61K 31/519</b> (2006.01)	2585467 *	PYRAZOLO [1, 5 -A]PYRIMIDINES AS ANTIVIRAL AGENTS
<b>A61K 31/55</b> (2006.01)	2585467 *	PYRAZOLO [1, 5 -A]PYRIMIDINES AS ANTIVIRAL AGENTS
<b>A61P 11/00</b> (2006.01)	2585467 *	PYRAZOLO [1, 5 -A]PYRIMIDINES AS ANTIVIRAL AGENTS
<b>A61K 31/4465</b> (2006.01)	2564837 *	ENTERIC TABLET
<b>A61K 47/34</b> (2006.01)	2564837 *	ENTERIC TABLET
<b>C07D 211/20</b> (2006.01)	2564837 *	ENTERIC TABLET
<b>A61P 25/24</b> (2006.01)	2564837 *	ENTERIC TABLET
<b>A61K 47/02</b> (2006.01)	2564837 *	ENTERIC TABLET
<b>A61K 47/32</b> (2006.01)	2564837 *	ENTERIC TABLET
<b>A61K 9/32</b> (2006.01)	2564837 *	ENTERIC TABLET
<b>A61K 9/22</b> (2006.01)	2564837 *	ENTERIC TABLET
<b>C08B 37/10</b> (2006.01)	2558506 *	TISSUE TARGETING
<b>B60R 25/04</b> (2006.01)	2484564	Method and apparatus for vehicle security
<b>A61K 31/485</b> (2006.01)	2590649 *	PROCESS FOR THE SYNTHESIS OF SUBSTITUTED MORPHINANS
<b>A01N 25/08</b> (2006.01)	2592929 *	SOLID HERBICIDE COMPOSITIONS WITH BUILT-IN ADJUVANT
<b>A61M 5/24</b> (2006.01)	2544737 *	RE-USABLE AUTOINJECTOR



MKP (51)	Broj objave evropske prijava patenta (97)	Naziv pronalaska (54)
<b>A61M 5/20</b> (2006.01)	2544737 *	RE-USABLE AUTOINJECTOR
<b>A47H 15/04</b> (2006.01)	2490577 *	PANEL CURTAIN DEVICE
<b>A47H 1/04</b> (2006.01)	2490577 *	PANEL CURTAIN DEVICE
<b>A47H 2/02</b> (2006.01)	2490577 *	PANEL CURTAIN DEVICE
<b>A47H 15/02</b> (2006.01)	2490577 *	PANEL CURTAIN DEVICE
<b>A47H 2/00</b> (2006.01)	2490577 *	PANEL CURTAIN DEVICE
<b>A47H 13/01</b> (2006.01)	2490577 *	PANEL CURTAIN DEVICE
<b>C07K 1/18</b> (2006.01)	2571892 *	APPARATUS AND PROCESS OF PURIFICATION OF PROTEINS
<b>C07K 1/22</b> (2006.01)	2571892 *	APPARATUS AND PROCESS OF PURIFICATION OF PROTEINS
<b>C07K 1/34</b> (2006.01)	2571892 *	APPARATUS AND PROCESS OF PURIFICATION OF PROTEINS
<b>B01D 15/12</b> (2006.01)	2571892 *	APPARATUS AND PROCESS OF PURIFICATION OF PROTEINS
<b>C07K 1/36</b> (2006.01)	2571892 *	APPARATUS AND PROCESS OF PURIFICATION OF PROTEINS
<b>B01D 15/38</b> (2006.01)	2571892 *	APPARATUS AND PROCESS OF PURIFICATION OF PROTEINS
<b>G06K 5/00</b> (2006.01)	2572314 *	SYSTEMS AND METHODS FOR CARDS AND DEVICES OPERABLE TO COMMUNICATE VIA LIGHT PULSES AND TOUCH SENSITIVE DISPLAYS
<b>A61P 7/02</b> (2006.01)	2585078 *	SEMULOPARIN FOR THE PREVENTION OF A MORTALITY AND/OR MORBIDITY EVENT IN A PATIENT UNDERGOING MAJOR ORTHOPAEDIC SURGERY
<b>A61K 31/727</b> (2006.01)	2585078 *	SEMULOPARIN FOR THE PREVENTION OF A MORTALITY AND/OR MORBIDITY EVENT IN A PATIENT UNDERGOING MAJOR ORTHOPAEDIC SURGERY
<b>G01N 1/38</b> (2006.01)	2564206 *	ANALYTICAL SYSTEM FOR PERFORMING LABORATORY PROTOCOLS AND ASSOCIATED METHODS
<b>G01N 35/00</b> (2006.01)	2564206 *	ANALYTICAL SYSTEM FOR PERFORMING LABORATORY PROTOCOLS AND ASSOCIATED METHODS
<b>G01N 35/10</b> (2006.01)	2564206 *	ANALYTICAL SYSTEM FOR PERFORMING LABORATORY PROTOCOLS AND ASSOCIATED METHODS
<b>A61K 31/519</b> (2006.01)	2549998 *	PHARMACEUTICAL COMPOSITION COMPRISING A PYRIMIDINEONE DERIVATIVE
<b>A61K 47/34</b> (2006.01)	2549998 *	PHARMACEUTICAL COMPOSITION COMPRISING A PYRIMIDINEONE DERIVATIVE
<b>A61K 47/14</b> (2006.01)	2549998 *	PHARMACEUTICAL COMPOSITION COMPRISING A PYRIMIDINEONE DERIVATIVE
<b>A61P 3/10</b> (2006.01)	2549998 *	PHARMACEUTICAL COMPOSITION COMPRISING A PYRIMIDINEONE DERIVATIVE
<b>A61K 47/38</b> (2006.01)	2549998 *	PHARMACEUTICAL COMPOSITION COMPRISING A PYRIMIDINEONE DERIVATIVE
<b>A61P 25/04</b> (2006.01)	2549998 *	PHARMACEUTICAL COMPOSITION COMPRISING A PYRIMIDINEONE DERIVATIVE
<b>A61P 25/00</b> (2006.01)	2549998 *	PHARMACEUTICAL COMPOSITION COMPRISING A PYRIMIDINEONE DERIVATIVE
<b>A61P 29/00</b> (2006.01)	2549998 *	PHARMACEUTICAL COMPOSITION COMPRISING A PYRIMIDINEONE DERIVATIVE
<b>F03B 15/00</b> (2006.01)	2558711 *	FLUID ACTUATED ENERGY GENERATOR
<b>F03B 13/18</b> (2006.01)	2558711 *	FLUID ACTUATED ENERGY GENERATOR
<b>F03B 17/06</b> (2006.01)	2558711 *	FLUID ACTUATED ENERGY GENERATOR
<b>F03B 13/26</b> (2006.01)	2558711 *	FLUID ACTUATED ENERGY GENERATOR
<b>A61K 39/395</b> (2006.01)	2555797 *	TNF- BINDING PROTEINS
<b>A01G 17/06</b> (2006.01)	2560471 *	FASTENING DEVICE FOR MOVABLE WIRES ON A ROW OF PLANTS
<b>F24J 2/05</b> (2006.01)	2561286 *	IMPROVEMENTS IN TUBULAR SOLAR COLLECTORS
<b>C22C 38/08</b> (2006.01)	2561286 *	IMPROVEMENTS IN TUBULAR SOLAR COLLECTORS
<b>A61P 9/00</b> (2006.01)	2582685 *	PROCESS FOR THE PREPARATION OF DRONEDARONE
<b>A61K 31/343</b> (2006.01)	2582685 *	PROCESS FOR THE PREPARATION OF DRONEDARONE
<b>C07D 307/80</b> (2006.01)	2582685 *	PROCESS FOR THE PREPARATION OF DRONEDARONE

MKP (51)	Broj objave evropske prijava patenta (97)	Naziv pronalaska (54)
<b>A61F 13/02</b> (2006.01)	2491904	Adhesive Bandage
<b>B65F 1/14</b> (2006.01)	2544968 *	BIN FOR COLLECTING SOLID WASTE
<b>B65F 1/16</b> (2006.01)	2544968 *	BIN FOR COLLECTING SOLID WASTE
<b>A61P 37/04</b> (2006.01)	2560981 *	SYNTHETIC OLIGOSACCHARIDES FOR STAPHYLOCOCCUS VACCINE
<b>A61K 31/7028</b> (2006.01)	2560981 *	SYNTHETIC OLIGOSACCHARIDES FOR STAPHYLOCOCCUS VACCINE
<b>C08B 37/00</b> (2006.01)	2560981 *	SYNTHETIC OLIGOSACCHARIDES FOR STAPHYLOCOCCUS VACCINE
<b>C07H 15/04</b> (2006.01)	2560981 *	SYNTHETIC OLIGOSACCHARIDES FOR STAPHYLOCOCCUS VACCINE
<b>C07D 471/04</b> (2006.01)	2563789 *	7-(1H-PYRAZOL-4-YL)-1,6-NAPHTHYRIDINE COMPOUNDS AS SYK INHIBITORS
<b>A61K 31/4462</b> (2006.01)	2563789 *	7-(1H-PYRAZOL-4-YL)-1,6-NAPHTHYRIDINE COMPOUNDS AS SYK INHIBITORS
<b>A61P 19/02</b> (2006.01)	2563789 *	7-(1H-PYRAZOL-4-YL)-1,6-NAPHTHYRIDINE COMPOUNDS AS SYK INHIBITORS
<b>A61K 47/48</b> (2006.01)	2579897 *	CYSTEINE ENGINEERED ANTIBODIES AND CONJUGATES
<b>B01D 5/00</b> (2006.01)	2590721 *	CONVERTING WHOLE TIRES AND OTHER SOLID CARBON MATERIALS INTO REUSABLE COMPONENTS
<b>C07C 2/00</b> (2006.01)	2545017 *	PROCESSES AND SYSTEMS FOR THE STAGED SYNTHESIS OF ALKYL BROMIDES
<b>C07C 1/00</b> (2006.01)	2545017 *	PROCESSES AND SYSTEMS FOR THE STAGED SYNTHESIS OF ALKYL BROMIDES
<b>E01F 15/14</b> (2006.01)	2492398	System for protecting work sites subjected to road or highway traffic
<b>H03L 1/02</b> (2006.01)	2464012	Method and system for precise temperature and timebase PPM error estimation using multiple timebases
<b>G01S 19/23</b> (2010.01)	2464012	Method and system for precise temperature and timebase PPM error estimation using multiple timebases
<b>C07K 16/28</b> (2006.01)	2545077 *	MONOCLONAL ANTIBODIES AGAINST C-MET
<b>A61K 39/395</b> (2006.01)	2545077 *	MONOCLONAL ANTIBODIES AGAINST C-MET
<b>A61P 31/16</b> (2006.01)	2585107 *	HOMODIMERIC PROTEIN CONSTRUCTS
<b>C07K 16/00</b> (2006.01)	2585107 *	HOMODIMERIC PROTEIN CONSTRUCTS
<b>C07K 19/00</b> (2006.01)	2585107 *	HOMODIMERIC PROTEIN CONSTRUCTS
<b>A61P 35/00</b> (2006.01)	2585107 *	HOMODIMERIC PROTEIN CONSTRUCTS
<b>C07K 16/44</b> (2006.01)	2585107 *	HOMODIMERIC PROTEIN CONSTRUCTS
<b>C07K 14/52</b> (2006.01)	2585107 *	HOMODIMERIC PROTEIN CONSTRUCTS
<b>A61K 39/385</b> (2006.01)	2585107 *	HOMODIMERIC PROTEIN CONSTRUCTS
<b>A47D 1/10</b> (2006.01)	2584940 *	BABY CRADLE AND MOUNTING DEVICE
<b>A61K 39/395</b> (2006.01)	2550017 *	DISULFIDE STABILISED ANTIBODIES AND FRAGMENTS THEREOF
<b>C07K 16/00</b> (2006.01)	2550017 *	DISULFIDE STABILISED ANTIBODIES AND FRAGMENTS THEREOF
<b>C07K 16/46</b> (2006.01)	2550017 *	DISULFIDE STABILISED ANTIBODIES AND FRAGMENTS THEREOF
<b>C02F 9/06</b> (2006.01)	2554521 *	APPARATUS AND METHOD FOR PURIFYING AND STERILIZING WATER USING NANO CATALYTIC MICROELECTROLYSIS
<b>C02F 1/50</b> (2006.01)	2554521 *	APPARATUS AND METHOD FOR PURIFYING AND STERILIZING WATER USING NANO CATALYTIC MICROELECTROLYSIS
<b>A61K 38/18</b> (2006.01)	2560644 *	A PHARMACEUTICAL COMPOSITION COMPRISING ANTIPLATELET AGENTS AND AN ERYTHROPOIESIS STIMULATING AGENT
<b>A61P 13/12</b> (2006.01)	2560644 *	A PHARMACEUTICAL COMPOSITION COMPRISING ANTIPLATELET AGENTS AND AN ERYTHROPOIESIS STIMULATING AGENT
<b>A61K 31/60</b> (2006.01)	2560644 *	A PHARMACEUTICAL COMPOSITION COMPRISING ANTIPLATELET AGENTS AND AN ERYTHROPOIESIS STIMULATING AGENT
<b>A61K 31/4365</b> (2006.01)	2560644 *	A PHARMACEUTICAL COMPOSITION COMPRISING ANTIPLATELET AGENTS AND AN ERYTHROPOIESIS STIMULATING AGENT
<b>A61P 19/02</b> (2006.01)	2575813 *	TOPICAL ETORICOXIB FORMULATION
<b>A61K 9/00</b> (2006.01)	2575813 *	TOPICAL ETORICOXIB FORMULATION
<b>A61P 29/00</b> (2006.01)	2575813 *	TOPICAL ETORICOXIB FORMULATION

MKP (51)	Broj objave evropske prijava patenta (97)	Naziv pronalaska (54)
<b>A61K 31/444</b> (2006.01)	2575813 *	TOPICAL ETORICOXIB FORMULATION
<b>C07D 241/02</b> (2006.01)	2576519 *	PYRAZINYL CARBOXAMIDES AS FUNGICIDES
<b>A01N 43/56</b> (2006.01)	2576519 *	PYRAZINYL CARBOXAMIDES AS FUNGICIDES
<b>A61K 47/42</b> (2006.01)	2571522 *	CANCER TREATMENT
<b>A61P 35/00</b> (2006.01)	2571522 *	CANCER TREATMENT
<b>A61K 39/00</b> (2006.01)	2571522 *	CANCER TREATMENT
<b>A61K 39/385</b> (2006.01)	2571522 *	CANCER TREATMENT
<b>A61K 47/48</b> (2006.01)	2571522 *	CANCER TREATMENT
<b>C07D 401/10</b> (2006.01)	2588466 *	5-AMINO-3,6-DIHYDRO-1H-PYRAZIN-2-ONE DERIVATIVES USEFUL AS INHIBITORS OF BETA-SECRETASE (BACE)
<b>A61P 25/16</b> (2006.01)	2588466 *	5-AMINO-3,6-DIHYDRO-1H-PYRAZIN-2-ONE DERIVATIVES USEFUL AS INHIBITORS OF BETA-SECRETASE (BACE)
<b>C07D 403/10</b> (2006.01)	2588466 *	5-AMINO-3,6-DIHYDRO-1H-PYRAZIN-2-ONE DERIVATIVES USEFUL AS INHIBITORS OF BETA-SECRETASE (BACE)
<b>C07D 401/12</b> (2006.01)	2588466 *	5-AMINO-3,6-DIHYDRO-1H-PYRAZIN-2-ONE DERIVATIVES USEFUL AS INHIBITORS OF BETA-SECRETASE (BACE)
<b>A61K 31/496</b> (2006.01)	2588466 *	5-AMINO-3,6-DIHYDRO-1H-PYRAZIN-2-ONE DERIVATIVES USEFUL AS INHIBITORS OF BETA-SECRETASE (BACE)
<b>A61P 25/28</b> (2006.01)	2588466 *	5-AMINO-3,6-DIHYDRO-1H-PYRAZIN-2-ONE DERIVATIVES USEFUL AS INHIBITORS OF BETA-SECRETASE (BACE)
<b>C12Q 1/68</b> (2006.01)	2585615 *	HIGHLY SENSITIVE METHOD FOR DETECTION OF A TARGET NUCLEIC ACID IN A SAMPLE
<b>A01N 39/02</b> (2006.01)	2566321 *	USE OF COLD-STABILIZED METHYLATED VEGETABLE OILS AS AN AGRICULTURAL CHEMICAL COFORMULANT
<b>A01N 57/16</b> (2006.01)	2566321 *	USE OF COLD-STABILIZED METHYLATED VEGETABLE OILS AS AN AGRICULTURAL CHEMICAL COFORMULANT
<b>A01N 43/40</b> (2006.01)	2566321 *	USE OF COLD-STABILIZED METHYLATED VEGETABLE OILS AS AN AGRICULTURAL CHEMICAL COFORMULANT
<b>A01N 25/00</b> (2006.01)	2566321 *	USE OF COLD-STABILIZED METHYLATED VEGETABLE OILS AS AN AGRICULTURAL CHEMICAL COFORMULANT
<b>A01N 25/02</b> (2006.01)	2566321 *	USE OF COLD-STABILIZED METHYLATED VEGETABLE OILS AS AN AGRICULTURAL CHEMICAL COFORMULANT
<b>B65H 75/44</b> (2006.01)	2539265 *	BRAKE SYSTEM FOR A CABLE REEL
<b>A47L 9/26</b> (2006.01)	2539265 *	BRAKE SYSTEM FOR A CABLE REEL
<b>A61M 5/50</b> (2006.01)	2555814 *	CODED DRUG RESERVOIR CONNECTION ELEMENT WITH BENDABLE LOCKING ELEMENTS
<b>A61J 1/20</b> (2006.01)	2555814 *	CODED DRUG RESERVOIR CONNECTION ELEMENT WITH BENDABLE LOCKING ELEMENTS
<b>A61M 5/24</b> (2006.01)	2555814 *	CODED DRUG RESERVOIR CONNECTION ELEMENT WITH BENDABLE LOCKING ELEMENTS
<b>A01N 43/38</b> (2006.01)	2549868 *	CHEMICAL COMPOUNDS
<b>A61K 31/405</b> (2006.01)	2549868 *	CHEMICAL COMPOUNDS
<b>A61K 9/22</b> (2006.01)	2544667 *	ALCOHOL RESISTANT ENTERIC PHARMACEUTICAL COMPOSITIONS
<b>B66F 11/04</b> (2006.01)	2380846	Telescopic aerial work platform
<b>C07D 277/46</b> (2006.01)	2547667 *	PROCESS FOR THE PRODUCTION OF 2-AMINO-5-FLUOROTHIAZOLE
<b>C07D 277/40</b> (2006.01)	2547667 *	PROCESS FOR THE PRODUCTION OF 2-AMINO-5-FLUOROTHIAZOLE
<b>C07D 277/50</b> (2006.01)	2547667 *	PROCESS FOR THE PRODUCTION OF 2-AMINO-5-FLUOROTHIAZOLE
<b>B65D 17/50</b> (2006.01)	2550206 *	LIQUID CONTAINER
<b>A61J 1/00</b> (2006.01)	2550206 *	LIQUID CONTAINER
<b>B65D 41/20</b> (2006.01)	2550206 *	LIQUID CONTAINER
<b>B65D 51/22</b> (2006.01)	2550206 *	LIQUID CONTAINER
<b>A61K 31/506</b> (2006.01)	2588473 *	NITROGEN CONTAINING HETEROCYCLIC COMPOUNDS AS PIK3 -DELTA INHIBITORS

MKP (51)	Broj objave evropske prijava patenta (97)	Naziv pronalaska (54)
<b>C07D 401/14</b> (2006.01)	2588473 *	NITROGEN CONTAINING HETEROCYCLIC COMPOUNDS AS PIK3 -DELTA INHIBITORS
<b>A61P 19/00</b> (2006.01)	2588473 *	NITROGEN CONTAINING HETEROCYCLIC COMPOUNDS AS PIK3 -DELTA INHIBITORS
<b>A61P 37/00</b> (2006.01)	2588473 *	NITROGEN CONTAINING HETEROCYCLIC COMPOUNDS AS PIK3 -DELTA INHIBITORS
<b>A61P 35/00</b> (2006.01)	2588473 *	NITROGEN CONTAINING HETEROCYCLIC COMPOUNDS AS PIK3 -DELTA INHIBITORS
<b>C07D 473/16</b> (2006.01)	2588473 *	NITROGEN CONTAINING HETEROCYCLIC COMPOUNDS AS PIK3 -DELTA INHIBITORS
<b>A61K 31/497</b> (2006.01)	2588473 *	NITROGEN CONTAINING HETEROCYCLIC COMPOUNDS AS PIK3 -DELTA INHIBITORS
<b>A61P 29/00</b> (2006.01)	2588473 *	NITROGEN CONTAINING HETEROCYCLIC COMPOUNDS AS PIK3 -DELTA INHIBITORS
<b>A61K 31/4709</b> (2006.01)	2588473 *	NITROGEN CONTAINING HETEROCYCLIC COMPOUNDS AS PIK3 -DELTA INHIBITORS
<b>A61K 38/16</b> (2006.01)	2593126 *	INNOVATIVE DISCOVERY OF THERAPEUTIC, DIAGNOSTIC, AND ANTIBODY COMPOSITIONS RELATED TO PROTEIN FRAGMENTS OF HISTIDYL-TRNA SYNTHETASES
<b>A61K 38/10</b> (2006.01)	2593126 *	INNOVATIVE DISCOVERY OF THERAPEUTIC, DIAGNOSTIC, AND ANTIBODY COMPOSITIONS RELATED TO PROTEIN FRAGMENTS OF HISTIDYL-TRNA SYNTHETASES
<b>A61P 3/10</b> (2006.01)	2593126 *	INNOVATIVE DISCOVERY OF THERAPEUTIC, DIAGNOSTIC, AND ANTIBODY COMPOSITIONS RELATED TO PROTEIN FRAGMENTS OF HISTIDYL-TRNA SYNTHETASES
<b>A61K 39/395</b> (2006.01)	2593126 *	INNOVATIVE DISCOVERY OF THERAPEUTIC, DIAGNOSTIC, AND ANTIBODY COMPOSITIONS RELATED TO PROTEIN FRAGMENTS OF HISTIDYL-TRNA SYNTHETASES
<b>A61K 38/08</b> (2006.01)	2593126 *	INNOVATIVE DISCOVERY OF THERAPEUTIC, DIAGNOSTIC, AND ANTIBODY COMPOSITIONS RELATED TO PROTEIN FRAGMENTS OF HISTIDYL-TRNA SYNTHETASES
<b>A61P 3/00</b> (2006.01)	2593126 *	INNOVATIVE DISCOVERY OF THERAPEUTIC, DIAGNOSTIC, AND ANTIBODY COMPOSITIONS RELATED TO PROTEIN FRAGMENTS OF HISTIDYL-TRNA SYNTHETASES
<b>A61P 35/00</b> (2006.01)	2593126 *	INNOVATIVE DISCOVERY OF THERAPEUTIC, DIAGNOSTIC, AND ANTIBODY COMPOSITIONS RELATED TO PROTEIN FRAGMENTS OF HISTIDYL-TRNA SYNTHETASES
<b>B31F 1/28</b> (2006.01)	2552686 *	IMPROVED METHOD AND APPARATUS FOR FORMING CORRUGATED BOARD
<b>B32B 29/08</b> (2006.01)	2552686 *	IMPROVED METHOD AND APPARATUS FOR FORMING CORRUGATED BOARD
<b>A61K 31/505</b> (2006.01)	2575818 *	THE USE OF INHIBITORS OF BRUTON'S TYROSINE KINASE (BTK)
<b>A61P 35/02</b> (2006.01)	2575818 *	THE USE OF INHIBITORS OF BRUTON'S TYROSINE KINASE (BTK)
<b>A61P 35/00</b> (2006.01)	2575818 *	THE USE OF INHIBITORS OF BRUTON'S TYROSINE KINASE (BTK)
<b>A61K 31/519</b> (2006.01)	2575818 *	THE USE OF INHIBITORS OF BRUTON'S TYROSINE KINASE (BTK)
<b>C07D 489/08</b> (2006.01)	2580218 *	PROCESS FOR N-DEALKYLATION OF TERTIARY AMINES
<b>C07D 489/12</b> (2006.01)	2580218 *	PROCESS FOR N-DEALKYLATION OF TERTIARY AMINES
<b>B60R 21/213</b> (2011.01)	2539185 *	PROTECTION SYSTEM FOR PASSENGERS OF HEAVY OR MEDIUM HEAVY TRANSPORT MEANS
<b>E05D 15/58</b> (2006.01)	2546441	Sliding and rotating leaf system
<b>A61K 31/415</b> (2006.01)	2566331 *	PHARMACEUTICAL COMPOSITIONS AND METHODS OF MAKING SAME
<b>A01N 43/56</b> (2006.01)	2566331 *	PHARMACEUTICAL COMPOSITIONS AND METHODS OF MAKING SAME
<b>G09F 27/00</b> (2006.01)	2306440	Display assembly having different types of display
<b>E01F 9/011</b> (2006.01)	2306440	Display assembly having different types of display
<b>E04H 1/12</b> (2006.01)	2306440	Display assembly having different types of display
<b>G09F 19/22</b> (2006.01)	2306440	Display assembly having different types of display
<b>G08G 1/123</b> (2006.01)	2306440	Display assembly having different types of display

MKP (51)	Broj objave evropske prijava patenta (97)	Naziv pronalaska (54)
<b>A61K 9/20</b> (2006.01)	2549983 *	NOVEL COMPOSITION FOR TREATMENT OF ESSENTIAL THROMBOCYTHEMIA
<b>A61K 31/517</b> (2006.01)	2549983 *	NOVEL COMPOSITION FOR TREATMENT OF ESSENTIAL THROMBOCYTHEMIA
<b>A23K 1/175</b> (2006.01)	2584913 *	STABILIZED ACTIVE COMPOUND
<b>A23K 1/16</b> (2006.01)	2584913 *	STABILIZED ACTIVE COMPOUND
<b>A23L 1/03</b> (2006.01)	2584913 *	STABILIZED ACTIVE COMPOUND
<b>A23K 1/00</b> (2006.01)	2584913 *	STABILIZED ACTIVE COMPOUND
<b>A61K 33/06</b> (2006.01)	2584913 *	STABILIZED ACTIVE COMPOUND
<b>A61K 9/14</b> (2006.01)	2584913 *	STABILIZED ACTIVE COMPOUND
<b>A61K 31/593</b> (2006.01)	2584913 *	STABILIZED ACTIVE COMPOUND
<b>A23L 1/304</b> (2006.01)	2584913 *	STABILIZED ACTIVE COMPOUND
<b>A61K 9/16</b> (2006.01)	2584913 *	STABILIZED ACTIVE COMPOUND
<b>A61P 19/10</b> (2006.01)	2584913 *	STABILIZED ACTIVE COMPOUND
<b>A61K 36/185</b> (2006.01)	2584913 *	STABILIZED ACTIVE COMPOUND
<b>A23L 1/303</b> (2006.01)	2584913 *	STABILIZED ACTIVE COMPOUND
<b>F24F 3/14</b> (2006.01)	2585196 *	SYSTEM AND METHOD FOR IMPROVING THE PERFORMANCE OF DESICCANT DEHUMIDIFICATION EQUIPMENT FOR LOW-HUMIDITY APPLICATIONS
<b>B01D 53/06</b> (2006.01)	2585196 *	SYSTEM AND METHOD FOR IMPROVING THE PERFORMANCE OF DESICCANT DEHUMIDIFICATION EQUIPMENT FOR LOW-HUMIDITY APPLICATIONS
<b>B01D 53/26</b> (2006.01)	2585196 *	SYSTEM AND METHOD FOR IMPROVING THE PERFORMANCE OF DESICCANT DEHUMIDIFICATION EQUIPMENT FOR LOW-HUMIDITY APPLICATIONS
<b>C07D 401/12</b> (2006.01)	2569280 *	SUBSTITUTED PHENYL CYCLOALKYL PYRROLIDINE (PIPERIDINE) SPIROLACTAMS AND AMIDES, PREPARATION AND THERAPEUTIC USE THEREOF
<b>A61K 31/407</b> (2006.01)	2569280 *	SUBSTITUTED PHENYL CYCLOALKYL PYRROLIDINE (PIPERIDINE) SPIROLACTAMS AND AMIDES, PREPARATION AND THERAPEUTIC USE THEREOF
<b>C07D 207/06</b> (2006.01)	2569280 *	SUBSTITUTED PHENYL CYCLOALKYL PYRROLIDINE (PIPERIDINE) SPIROLACTAMS AND AMIDES, PREPARATION AND THERAPEUTIC USE THEREOF
<b>A61K 31/40</b> (2006.01)	2569280 *	SUBSTITUTED PHENYL CYCLOALKYL PYRROLIDINE (PIPERIDINE) SPIROLACTAMS AND AMIDES, PREPARATION AND THERAPEUTIC USE THEREOF
<b>C07D 409/12</b> (2006.01)	2569280 *	SUBSTITUTED PHENYL CYCLOALKYL PYRROLIDINE (PIPERIDINE) SPIROLACTAMS AND AMIDES, PREPARATION AND THERAPEUTIC USE THEREOF
<b>A61K 31/454</b> (2006.01)	2569280 *	SUBSTITUTED PHENYL CYCLOALKYL PYRROLIDINE (PIPERIDINE) SPIROLACTAMS AND AMIDES, PREPARATION AND THERAPEUTIC USE THEREOF
<b>C07D 491/107</b> (2006.01)	2569280 *	SUBSTITUTED PHENYL CYCLOALKYL PYRROLIDINE (PIPERIDINE) SPIROLACTAMS AND AMIDES, PREPARATION AND THERAPEUTIC USE THEREOF
<b>C07D 405/12</b> (2006.01)	2569280 *	SUBSTITUTED PHENYL CYCLOALKYL PYRROLIDINE (PIPERIDINE) SPIROLACTAMS AND AMIDES, PREPARATION AND THERAPEUTIC USE THEREOF
<b>A61K 31/438</b> (2006.01)	2569280 *	SUBSTITUTED PHENYL CYCLOALKYL PYRROLIDINE (PIPERIDINE) SPIROLACTAMS AND AMIDES, PREPARATION AND THERAPEUTIC USE THEREOF
<b>C07D 403/10</b> (2006.01)	2569280 *	SUBSTITUTED PHENYL CYCLOALKYL PYRROLIDINE (PIPERIDINE) SPIROLACTAMS AND AMIDES, PREPARATION AND THERAPEUTIC USE THEREOF
<b>A61K 31/403</b> (2006.01)	2569280 *	SUBSTITUTED PHENYL CYCLOALKYL PYRROLIDINE (PIPERIDINE) SPIROLACTAMS AND AMIDES, PREPARATION AND THERAPEUTIC USE THEREOF

MKP (51)	Broj objave evropske prijava patenta (97)	Naziv pronalaska (54)
<b>C07D 413/12</b> (2006.01)	2569280 *	SUBSTITUTED PHENYL CYCLOALKYL PYRROLIDINE (PIPERIDINE) SPIROLACTAMS AND AMIDES, PREPARATION AND THERAPEUTIC USE THEREOF
<b>A61K 31/4535</b> (2006.01)	2569280 *	SUBSTITUTED PHENYL CYCLOALKYL PYRROLIDINE (PIPERIDINE) SPIROLACTAMS AND AMIDES, PREPARATION AND THERAPEUTIC USE THEREOF
<b>C07D 471/10</b> (2006.01)	2569280 *	SUBSTITUTED PHENYL CYCLOALKYL PYRROLIDINE (PIPERIDINE) SPIROLACTAMS AND AMIDES, PREPARATION AND THERAPEUTIC USE THEREOF
<b>A61K 31/453</b> (2006.01)	2569280 *	SUBSTITUTED PHENYL CYCLOALKYL PYRROLIDINE (PIPERIDINE) SPIROLACTAMS AND AMIDES, PREPARATION AND THERAPEUTIC USE THEREOF
<b>A61P 35/00</b> (2006.01)	2579877 *	MORPHOLINO PYRIMIDINES AND THEIR USE IN THERAPY
<b>C07D 413/14</b> (2006.01)	2579877 *	MORPHOLINO PYRIMIDINES AND THEIR USE IN THERAPY
<b>C07D 471/04</b> (2006.01)	2579877 *	MORPHOLINO PYRIMIDINES AND THEIR USE IN THERAPY
<b>A61K 31/505</b> (2006.01)	2579877 *	MORPHOLINO PYRIMIDINES AND THEIR USE IN THERAPY
<b>A61K 31/47</b> (2006.01)	2593090 *	C-MET MODULATOR PHARMACEUTICAL COMPOSITIONS
<b>A61K 9/20</b> (2006.01)	2593090 *	C-MET MODULATOR PHARMACEUTICAL COMPOSITIONS
<b>A61M 5/315</b> (2006.01)	2455122	Drive mechanism for a drug delivery device
<b>A43B 5/00</b> (2006.01)	2555834 *	FLIPPERS, BOOTS, SYSTEMS INCLUDING SAME, AND METHODS OF USING SAME
<b>A63B 31/11</b> (2006.01)	2555834 *	FLIPPERS, BOOTS, SYSTEMS INCLUDING SAME, AND METHODS OF USING SAME
<b>B63C 11/02</b> (2006.01)	2555834 *	FLIPPERS, BOOTS, SYSTEMS INCLUDING SAME, AND METHODS OF USING SAME
<b>G10L 19/00</b> (2006.01)	2355554	Musical tone signal-processing apparatus
<b>H04S 7/00</b> (2006.01)	2355554	Musical tone signal-processing apparatus
<b>H04S 5/00</b> (2006.01)	2355554	Musical tone signal-processing apparatus
<b>A61K 38/00</b> (2006.01)	2580242 *	MODULATION OF THE INTERACTION BETWEEN SORLA AND GDNF-FAMILY LIGAND RECEPTORS
<b>C07K 16/28</b> (2006.01)	2580242 *	MODULATION OF THE INTERACTION BETWEEN SORLA AND GDNF-FAMILY LIGAND RECEPTORS
<b>A61K 38/18</b> (2006.01)	2580242 *	MODULATION OF THE INTERACTION BETWEEN SORLA AND GDNF-FAMILY LIGAND RECEPTORS
<b>A61K 31/53</b> (2006.01)	2579880 *	TREATMENT OF TYPE 2 DIABETES
<b>A61K 9/20</b> (2006.01)	2579880 *	TREATMENT OF TYPE 2 DIABETES
<b>A61H 1/02</b> (2006.01)	2575725 *	HUMERUS-STABILIZED SHOULDER STRETCH DEVICE
<b>A61M 5/24</b> (2006.01)	2579921 *	DRIVE MECHANISM FOR A DRUG DELIVERY DEVICE
<b>A61M 5/315</b> (2006.01)	2579921 *	DRIVE MECHANISM FOR A DRUG DELIVERY DEVICE
<b>C07D 487/04</b> (2006.01)	2593451 *	SUBSTITUTED IMIDAZO[1,2-A]PYRIMIDINES AND -PYRIDINES
<b>A61K 31/519</b> (2006.01)	2593451 *	SUBSTITUTED IMIDAZO[1,2-A]PYRIMIDINES AND -PYRIDINES
<b>C07D 471/04</b> (2006.01)	2593451 *	SUBSTITUTED IMIDAZO[1,2-A]PYRIMIDINES AND -PYRIDINES
<b>A61K 31/437</b> (2006.01)	2593451 *	SUBSTITUTED IMIDAZO[1,2-A]PYRIMIDINES AND -PYRIDINES
<b>A61K 31/519</b> (2006.01)	2574168 *	TOPICAL FORMULATION FOR A JAK INHIBITOR
<b>A61K 9/107</b> (2006.01)	2574168 *	TOPICAL FORMULATION FOR A JAK INHIBITOR
<b>A61K 47/06</b> (2006.01)	2574168 *	TOPICAL FORMULATION FOR A JAK INHIBITOR
<b>A61K 47/10</b> (2006.01)	2574168 *	TOPICAL FORMULATION FOR A JAK INHIBITOR
<b>A61K 9/00</b> (2006.01)	2574168 *	TOPICAL FORMULATION FOR A JAK INHIBITOR
<b>C23C 30/00</b> (2006.01)	2497841	Sn-Ag-Cu-Alloys
<b>C22C 13/00</b> (2006.01)	2497841	Sn-Ag-Cu-Alloys
<b>C23C 26/00</b> (2006.01)	2497841	Sn-Ag-Cu-Alloys
<b>C22C 7/00</b> (2006.01)	2497841	Sn-Ag-Cu-Alloys
<b>C22C 5/06</b> (2006.01)	2497841	Sn-Ag-Cu-Alloys

MKP (51)	Broj objave evropske prijava patenta (97)	Naziv pronalaska (54)
<b>A61P 9/06</b> (2006.01)	2544681 *	USE OF DRONEDARONE OR A PHARMACEUTICALLY ACCEPTABLE SALT THEREOF, FOR THE PREPARATION OF A MEDICAMENT FOR ADMINISTRATION SHORTLY AFTER AMIODARONE DISCONTINUATION
<b>A61K 31/343</b> (2006.01)	2544681 *	USE OF DRONEDARONE OR A PHARMACEUTICALLY ACCEPTABLE SALT THEREOF, FOR THE PREPARATION OF A MEDICAMENT FOR ADMINISTRATION SHORTLY AFTER AMIODARONE DISCONTINUATION
<b>A61K 31/196</b> (2006.01)	2544662 *	FOAMABLE FORMULATION
<b>A61K 47/20</b> (2006.01)	2544662 *	FOAMABLE FORMULATION
<b>A61P 19/02</b> (2006.01)	2544662 *	FOAMABLE FORMULATION
<b>A61K 31/192</b> (2006.01)	2544662 *	FOAMABLE FORMULATION
<b>A61K 9/12</b> (2006.01)	2544662 *	FOAMABLE FORMULATION
<b>C12N 15/37</b> (2006.01)	2558482 *	ENGINEERED PLANT CYSTEINE PROTEASES AND THEIR USES
<b>C07K 14/08</b> (2006.01)	2558482 *	ENGINEERED PLANT CYSTEINE PROTEASES AND THEIR USES
<b>C12N 9/50</b> (2006.01)	2558482 *	ENGINEERED PLANT CYSTEINE PROTEASES AND THEIR USES
<b>C07D 501/34</b> (2006.01)	2569321 *	OXIDATION PROCESS FOR PREPARING 3-FORMYL-CEPHEM DERIVATIVES
<b>E02D 3/12</b> (2006.01)	2543769	Method of consolidating a foundation soil
<b>E02D 1/02</b> (2006.01)	2543769	Method of consolidating a foundation soil
<b>C07C 227/42</b> (2006.01)	2580184 *	PROCESS FOR PREPARING CRYSTALLINE 3,6,9-TRIAZA-3,6,9-TRIS(CARBOXYMETHYL)-4-(4-ETHOXYBENZYL)UNDECANEDIOIC ACID AND USE FOR PRODUCTION OF PRIMOVIST®
<b>G01N 33/53</b> (2006.01)	2577315 *	MARKERS FOR RENAL DISEASE
<b>C07K 14/00</b> (2006.01)	2577315 *	MARKERS FOR RENAL DISEASE
<b>C07K 14/775</b> (2006.01)	2577315 *	MARKERS FOR RENAL DISEASE
<b>G01N 33/68</b> (2006.01)	2577315 *	MARKERS FOR RENAL DISEASE
<b>C07F 7/08</b> (2006.01)	2545060 *	FUSED TRICYCLIC SILYL COMPOUNDS AND METHODS OF USE THEREOF FOR THE TREATMENT OF VIRAL DISEASES
<b>A61K 31/695</b> (2006.01)	2545060 *	FUSED TRICYCLIC SILYL COMPOUNDS AND METHODS OF USE THEREOF FOR THE TREATMENT OF VIRAL DISEASES
<b>A61P 31/14</b> (2006.01)	2545060 *	FUSED TRICYCLIC SILYL COMPOUNDS AND METHODS OF USE THEREOF FOR THE TREATMENT OF VIRAL DISEASES
<b>A61M 5/50</b> (2006.01)	2555815 *	CODED DRUG RESERVOIR CONNECTION ELEMENT WITH HINGED FLANGE
<b>A61J 1/20</b> (2006.01)	2555815 *	CODED DRUG RESERVOIR CONNECTION ELEMENT WITH HINGED FLANGE
<b>A61M 5/24</b> (2006.01)	2555815 *	CODED DRUG RESERVOIR CONNECTION ELEMENT WITH HINGED FLANGE
<b>C05G 1/00</b> (2006.01)	2590909 *	COMPOSITIONS AND METHODS OF MAKING AND USING THE COMPOSITIONS FOR IMPROVING SOIL AND/OR PLANT GROWTH AND IMPROVED SOIL, IMPROVED PLANTS, AND/OR IMPROVED SEEDS
<b>A61K 8/89</b> (2006.01)	2592935 *	DISINFECTANT AND ANTISEPTIC FORMULATION HAVING REDUCED IODINE CONTENT
<b>A61K 8/20</b> (2006.01)	2592935 *	DISINFECTANT AND ANTISEPTIC FORMULATION HAVING REDUCED IODINE CONTENT
<b>A01N 59/12</b> (2006.01)	2592935 *	DISINFECTANT AND ANTISEPTIC FORMULATION HAVING REDUCED IODINE CONTENT
<b>A61K 47/24</b> (2006.01)	2592935 *	DISINFECTANT AND ANTISEPTIC FORMULATION HAVING REDUCED IODINE CONTENT
<b>A61P 31/02</b> (2006.01)	2592935 *	DISINFECTANT AND ANTISEPTIC FORMULATION HAVING REDUCED IODINE CONTENT
<b>A01N 25/02</b> (2006.01)	2592935 *	DISINFECTANT AND ANTISEPTIC FORMULATION HAVING REDUCED IODINE CONTENT
<b>A61K 33/18</b> (2006.01)	2592935 *	DISINFECTANT AND ANTISEPTIC FORMULATION HAVING REDUCED IODINE CONTENT
<b>A01P 1/00</b> (2006.01)	2592935 *	DISINFECTANT AND ANTISEPTIC FORMULATION HAVING REDUCED IODINE CONTENT
<b>A47K 5/12</b> (2006.01)	2560529 *	DISPENSER

MKP (51)	Broj objave evropske prijava patenta (97)	Naziv pronalaska (54)
<b>B42D 13/00</b> (2006.01)	2316659	Data sheet for a means of identification
<b>B42D 15/10</b> (2006.01)	2316659	Data sheet for a means of identification
<b>F23J 15/04</b> (2006.01)	2479495	A multipurpose biologic sludge, organic wastes and biomasses cogeneration incineration plant and process developed therein
<b>F23J 15/02</b> (2006.01)	2479495	A multipurpose biologic sludge, organic wastes and biomasses cogeneration incineration plant and process developed therein
<b>F23M 7/04</b> (2006.01)	2479495	A multipurpose biologic sludge, organic wastes and biomasses cogeneration incineration plant and process developed therein
<b>F23G 5/50</b> (2006.01)	2479495	A multipurpose biologic sludge, organic wastes and biomasses cogeneration incineration plant and process developed therein
<b>B01D 53/34</b> (2006.01)	2479495	A multipurpose biologic sludge, organic wastes and biomasses cogeneration incineration plant and process developed therein
<b>F23G 5/00</b> (2006.01)	2479495	A multipurpose biologic sludge, organic wastes and biomasses cogeneration incineration plant and process developed therein
<b>F23G 5/30</b> (2006.01)	2479495	A multipurpose biologic sludge, organic wastes and biomasses cogeneration incineration plant and process developed therein
<b>F23G 5/46</b> (2006.01)	2479495	A multipurpose biologic sludge, organic wastes and biomasses cogeneration incineration plant and process developed therein
<b>A61K 39/395</b> (2006.01)	2575863 *	USE OF THE SPARC MICROENVIRONMENT SIGNATURE IN THE TREATMENT OF CANCER
<b>A61P 35/00</b> (2006.01)	2575863 *	USE OF THE SPARC MICROENVIRONMENT SIGNATURE IN THE TREATMENT OF CANCER
<b>A61P 35/02</b> (2006.01)	2575863 *	USE OF THE SPARC MICROENVIRONMENT SIGNATURE IN THE TREATMENT OF CANCER
<b>A61K 38/20</b> (2006.01)	2575863 *	USE OF THE SPARC MICROENVIRONMENT SIGNATURE IN THE TREATMENT OF CANCER
<b>A61K 31/375</b> (2006.01)	2473037 *	METHOD OF TREATMENT OF NEURODEGENERATIVE OR NEUROMUSCULAR DEGENERATIVE DISEASES AND THERAPEUTIC AGENT TO TREAT THE SAME
<b>A61K 31/315</b> (2006.01)	2473037 *	METHOD OF TREATMENT OF NEURODEGENERATIVE OR NEUROMUSCULAR DEGENERATIVE DISEASES AND THERAPEUTIC AGENT TO TREAT THE SAME
<b>C12Q 1/68</b> (2006.01)	2563934 *	PREDICTIVE MARKERS USEFUL IN THE TREATMENT OF FRAGILE X SYNDROME (FXS)
<b>A61K 31/196</b> (2006.01)	2590931 *	(2-ARYLOXY-ACETYLAMINO)-PHENYL-PROPIONIC ACID DERIVATIVES, METHOD FOR PRODUCING SAME AND USE THEREOF AS PHARMACEUTICALS
<b>C07C 235/24</b> (2006.01)	2590931 *	(2-ARYLOXY-ACETYLAMINO)-PHENYL-PROPIONIC ACID DERIVATIVES, METHOD FOR PRODUCING SAME AND USE THEREOF AS PHARMACEUTICALS
<b>A61K 31/277</b> (2006.01)	2590931 *	(2-ARYLOXY-ACETYLAMINO)-PHENYL-PROPIONIC ACID DERIVATIVES, METHOD FOR PRODUCING SAME AND USE THEREOF AS PHARMACEUTICALS
<b>A61P 3/10</b> (2006.01)	2590931 *	(2-ARYLOXY-ACETYLAMINO)-PHENYL-PROPIONIC ACID DERIVATIVES, METHOD FOR PRODUCING SAME AND USE THEREOF AS PHARMACEUTICALS
<b>C07C 255/44</b> (2006.01)	2590931 *	(2-ARYLOXY-ACETYLAMINO)-PHENYL-PROPIONIC ACID DERIVATIVES, METHOD FOR PRODUCING SAME AND USE THEREOF AS PHARMACEUTICALS
<b>F04B 1/04</b> (2006.01)	2492506	Pumping head
<b>F04B 53/12</b> (2006.01)	2492506	Pumping head
<b>F04B 53/16</b> (2006.01)	2492506	Pumping head
<b>F02M 37/04</b> (2006.01)	2492506	Pumping head
<b>A61P 7/00</b> (2006.01)	2542255 *	METHODS AND COMPOSITIONS FOR TREATING DEGOS' DISEASE
<b>A61P 37/02</b> (2006.01)	2542255 *	METHODS AND COMPOSITIONS FOR TREATING DEGOS' DISEASE
<b>A61K 39/00</b> (2006.01)	2542255 *	METHODS AND COMPOSITIONS FOR TREATING DEGOS' DISEASE
<b>C07K 16/00</b> (2006.01)	2542255 *	METHODS AND COMPOSITIONS FOR TREATING DEGOS' DISEASE



MKP (51)	Broj objave evropske prijava patenta (97)	Naziv pronalaska (54)
<b>A61K 38/17</b> (2006.01)	2593128 *	HUMANIZED ANTIBODIES TARGETING THE EC1 DOMAIN OF CADHERIN-11 AND RELATED COMPOSITIONS AND METHODS
<b>C07K 16/28</b> (2006.01)	2593128 *	HUMANIZED ANTIBODIES TARGETING THE EC1 DOMAIN OF CADHERIN-11 AND RELATED COMPOSITIONS AND METHODS
<b>C07K 16/46</b> (2006.01)	2593128 *	HUMANIZED ANTIBODIES TARGETING THE EC1 DOMAIN OF CADHERIN-11 AND RELATED COMPOSITIONS AND METHODS
<b>A61K 38/01</b> (2006.01)	2526939	Gelatine tannate and associations thereof for use in the treatment of inflammatory gastrointestinal diseases
<b>A61K 36/00</b> (2006.01)	2526939	Gelatine tannate and associations thereof for use in the treatment of inflammatory gastrointestinal diseases
<b>A61K 31/353</b> (2006.01)	2526939	Gelatine tannate and associations thereof for use in the treatment of inflammatory gastrointestinal diseases
<b>A61P 1/04</b> (2006.01)	2526939	Gelatine tannate and associations thereof for use in the treatment of inflammatory gastrointestinal diseases
<b>A61P 1/00</b> (2006.01)	2526939	Gelatine tannate and associations thereof for use in the treatment of inflammatory gastrointestinal diseases
<b>G06F 3/033</b> (2013.01)	2569684 *	METHODS AND SYSTEMS FOR POINTING DEVICE USING ACOUSTIC IMPEDIOGRAPHY
<b>A61F 5/00</b> (2006.01)	2538894 *	DEVICES FOR TREATING MORBID OBESITY USING HYDROGEL
<b>A61F 13/00</b> (2006.01)	2538894 *	DEVICES FOR TREATING MORBID OBESITY USING HYDROGEL
<b>C09D 5/16</b> (2006.01)	2587918 *	ANTIFOULING BENZOATE COMBINATIONS
<b>A01N 59/20</b> (2006.01)	2587918 *	ANTIFOULING BENZOATE COMBINATIONS
<b>A01N 43/40</b> (2006.01)	2587918 *	ANTIFOULING BENZOATE COMBINATIONS
<b>D06M 13/355</b> (2006.01)	2587918 *	ANTIFOULING BENZOATE COMBINATIONS
<b>A01P 9/00</b> (2006.01)	2587918 *	ANTIFOULING BENZOATE COMBINATIONS
<b>A01N 37/10</b> (2006.01)	2587918 *	ANTIFOULING BENZOATE COMBINATIONS
<b>D06M 13/203</b> (2006.01)	2587918 *	ANTIFOULING BENZOATE COMBINATIONS
<b>A01P 13/00</b> (2006.01)	2587918 *	ANTIFOULING BENZOATE COMBINATIONS
<b>A01N 59/16</b> (2006.01)	2587918 *	ANTIFOULING BENZOATE COMBINATIONS
<b>A01N 43/36</b> (2006.01)	2587918 *	ANTIFOULING BENZOATE COMBINATIONS
<b>D06M 13/352</b> (2006.01)	2587918 *	ANTIFOULING BENZOATE COMBINATIONS
<b>A61L 2/07</b> (2006.01)	2563410 *	METHOD FOR MACHINE-CLEANING AND MACHINE-DISINFECTING OBJECTS
<b>A61L 2/025</b> (2006.01)	2563410 *	METHOD FOR MACHINE-CLEANING AND MACHINE-DISINFECTING OBJECTS
<b>A61L 2/10</b> (2006.01)	2563410 *	METHOD FOR MACHINE-CLEANING AND MACHINE-DISINFECTING OBJECTS
<b>A61M 5/145</b> (2006.01)	2538993 *	GEARBOX
<b>A61P 15/00</b> (2006.01)	2543729 *	MODEL ANIMAL FOR PREGNANCY-INDUCED HYPERTENSION SYNDROME, AND TREATMENT METHOD THEREFOR
<b>A61P 9/12</b> (2006.01)	2543729 *	MODEL ANIMAL FOR PREGNANCY-INDUCED HYPERTENSION SYNDROME, AND TREATMENT METHOD THEREFOR
<b>A61K 38/27</b> (2006.01)	2543729 *	MODEL ANIMAL FOR PREGNANCY-INDUCED HYPERTENSION SYNDROME, AND TREATMENT METHOD THEREFOR
<b>C12N 15/09</b> (2006.01)	2543729 *	MODEL ANIMAL FOR PREGNANCY-INDUCED HYPERTENSION SYNDROME, AND TREATMENT METHOD THEREFOR
<b>A61K 48/00</b> (2006.01)	2543729 *	MODEL ANIMAL FOR PREGNANCY-INDUCED HYPERTENSION SYNDROME, AND TREATMENT METHOD THEREFOR
<b>A01K 67/027</b> (2006.01)	2543729 *	MODEL ANIMAL FOR PREGNANCY-INDUCED HYPERTENSION SYNDROME, AND TREATMENT METHOD THEREFOR
<b>A61P 13/12</b> (2006.01)	2543729 *	MODEL ANIMAL FOR PREGNANCY-INDUCED HYPERTENSION SYNDROME, AND TREATMENT METHOD THEREFOR
<b>A61K 31/445</b> (2006.01)	2585064 *	C5AR ANTAGONISTS
<b>C07D 211/06</b> (2006.01)	2585064 *	C5AR ANTAGONISTS
<b>C07K 14/00</b> (2006.01)	2585476 *	COLON AND PANCREAS CANCER SPECIFIC ANTIGENS AND ANTIBODIES

MKP (51)	Broj objave evropske prijava patenta (97)	Naziv pronalaska (54)
<b>A61L 27/20</b> (2006.01)	2560694 *	IMPLANTING DEVICE WITH ANTIBACTERIAL PROPERTIES AND MULTIFUNCTIONAL SURFACE
<b>A61L 27/24</b> (2006.01)	2560694 *	IMPLANTING DEVICE WITH ANTIBACTERIAL PROPERTIES AND MULTIFUNCTIONAL SURFACE
<b>A61L 27/34</b> (2006.01)	2560694 *	IMPLANTING DEVICE WITH ANTIBACTERIAL PROPERTIES AND MULTIFUNCTIONAL SURFACE
<b>A61L 27/26</b> (2006.01)	2560694 *	IMPLANTING DEVICE WITH ANTIBACTERIAL PROPERTIES AND MULTIFUNCTIONAL SURFACE
<b>A61L 27/54</b> (2006.01)	2560694 *	IMPLANTING DEVICE WITH ANTIBACTERIAL PROPERTIES AND MULTIFUNCTIONAL SURFACE
<b>H04N 7/14</b> (2006.01)	2569938 *	SYSTEMS AND METHODS FOR SCALABLE DISTRIBUTED GLOBAL INFRASTRUCTURE FOR REAL-TIME MULTIMEDIA COMMUNICATION
<b>H04N 7/15</b> (2006.01)	2569938 *	SYSTEMS AND METHODS FOR SCALABLE DISTRIBUTED GLOBAL INFRASTRUCTURE FOR REAL-TIME MULTIMEDIA COMMUNICATION
<b>H04N 7/00</b> (2011.01)	2569938 *	SYSTEMS AND METHODS FOR SCALABLE DISTRIBUTED GLOBAL INFRASTRUCTURE FOR REAL-TIME MULTIMEDIA COMMUNICATION
<b>A01F 25/18</b> (2006.01)	2584883 *	AN AGRICULTURAL DEVICE AND METHOD
<b>A61M 5/20</b> (2006.01)	2585135 *	AUTO-INJECTOR
<b>A61M 5/00</b> (2006.01)	2585135 *	AUTO-INJECTOR
<b>C07D 487/04</b> (2006.01)	2547680 *	IMIDAZOPYRAZINES
<b>A61K 31/4985</b> (2006.01)	2547680 *	IMIDAZOPYRAZINES
<b>A61P 35/00</b> (2006.01)	2547680 *	IMIDAZOPYRAZINES
<b>A01H 1/04</b> (2006.01)	2582226 *	METHODS FOR DETERMINING FITNESS IN PLANTS
<b>A01H 5/00</b> (2006.01)	2582226 *	METHODS FOR DETERMINING FITNESS IN PLANTS
<b>C07D 403/12</b> (2006.01)	2552908 *	HETEROCYCLIC COMPOUNDS AND THEIR USES
<b>C07D 473/34</b> (2006.01)	2552908 *	HETEROCYCLIC COMPOUNDS AND THEIR USES
<b>A61P 29/00</b> (2006.01)	2552908 *	HETEROCYCLIC COMPOUNDS AND THEIR USES
<b>C07D 471/04</b> (2006.01)	2552908 *	HETEROCYCLIC COMPOUNDS AND THEIR USES
<b>A61K 31/506</b> (2006.01)	2552908 *	HETEROCYCLIC COMPOUNDS AND THEIR USES
<b>C07D 487/04</b> (2006.01)	2552908 *	HETEROCYCLIC COMPOUNDS AND THEIR USES
<b>C07D 401/14</b> (2006.01)	2552908 *	HETEROCYCLIC COMPOUNDS AND THEIR USES
<b>C07D 409/12</b> (2006.01)	2552908 *	HETEROCYCLIC COMPOUNDS AND THEIR USES
<b>A61P 31/14</b> (2006.01)	2552933 *	PURINE NUCLEOSIDE PHOSPHORAMIDATE
<b>A61K 31/7076</b> (2006.01)	2552933 *	PURINE NUCLEOSIDE PHOSPHORAMIDATE
<b>C07H 19/20</b> (2006.01)	2552933 *	PURINE NUCLEOSIDE PHOSPHORAMIDATE
<b>C12N 15/10</b> (2006.01)	2571976 *	UNIVERSALLY APPLICABLE LYSIS BUFFER AND PROCESSING METHODS FOR THE LYSIS OF BODILY SAMPLES
<b>G01N 33/569</b> (2006.01)	2571976 *	UNIVERSALLY APPLICABLE LYSIS BUFFER AND PROCESSING METHODS FOR THE LYSIS OF BODILY SAMPLES
<b>C12Q 1/68</b> (2006.01)	2571976 *	UNIVERSALLY APPLICABLE LYSIS BUFFER AND PROCESSING METHODS FOR THE LYSIS OF BODILY SAMPLES
<b>C12N 1/06</b> (2006.01)	2571976 *	UNIVERSALLY APPLICABLE LYSIS BUFFER AND PROCESSING METHODS FOR THE LYSIS OF BODILY SAMPLES
<b>C07K 16/18</b> (2006.01)	2563812 *	ANTIBODIES HAVING REDUCED IMMUNOGENICITY IN A HUMAN
<b>H05B 37/02</b> (2006.01)	2570004 *	LED LIGHTING DEVICES
<b>C04B 28/02</b> (2006.01)	2590905 *	DRY CEMENT MIX FOR FORMING LIGHT CONCRETES WITH LOW THERMAL CONDUCTIVITY, AND CONCRETES THUS OBTAINED
<b>C04B 38/08</b> (2006.01)	2590905 *	DRY CEMENT MIX FOR FORMING LIGHT CONCRETES WITH LOW THERMAL CONDUCTIVITY, AND CONCRETES THUS OBTAINED
<b>A61K 47/36</b> (2006.01)	2582356 *	GEL FORMULATIONS FOR THE TOPICAL USE OF 1-AMINO-ALKYLCYCLOHEXANE DERIVATIVES
<b>A61K 47/38</b> (2006.01)	2582356 *	GEL FORMULATIONS FOR THE TOPICAL USE OF 1-AMINO-ALKYLCYCLOHEXANE DERIVATIVES

MKP (51)	Broj objave evropske prijava patenta (97)	Naziv pronalaska (54)
<b>A61K 9/00</b> (2006.01)	2582356 *	GEL FORMULATIONS FOR THE TOPICAL USE OF 1-AMINO-ALKYLCYCLOHEXANE DERIVATIVES
<b>A61P 17/00</b> (2006.01)	2582356 *	GEL FORMULATIONS FOR THE TOPICAL USE OF 1-AMINO-ALKYLCYCLOHEXANE DERIVATIVES
<b>A61K 31/13</b> (2006.01)	2582356 *	GEL FORMULATIONS FOR THE TOPICAL USE OF 1-AMINO-ALKYLCYCLOHEXANE DERIVATIVES
<b>A61K 35/50</b> (2006.01)	2585084 *	MICRONIZED PLACENTAL TISSUE COMPOSITIONS AND METHODS FOR MAKING AND USING THE SAME
<b>C07D 405/12</b> (2006.01)	2576509 *	FLUFENOXINE DERIVATIVES FOR THE TREATMENT AND PREVENTION OF AMILOYD PATHOLOGIES
<b>C07D 409/06</b> (2006.01)	2576509 *	FLUFENOXINE DERIVATIVES FOR THE TREATMENT AND PREVENTION OF AMILOYD PATHOLOGIES
<b>A61K 31/4462</b> (2006.01)	2576509 *	FLUFENOXINE DERIVATIVES FOR THE TREATMENT AND PREVENTION OF AMILOYD PATHOLOGIES
<b>A61K 31/4465</b> (2006.01)	2576509 *	FLUFENOXINE DERIVATIVES FOR THE TREATMENT AND PREVENTION OF AMILOYD PATHOLOGIES
<b>C07D 211/22</b> (2006.01)	2576509 *	FLUFENOXINE DERIVATIVES FOR THE TREATMENT AND PREVENTION OF AMILOYD PATHOLOGIES
<b>A61P 25/28</b> (2006.01)	2576509 *	FLUFENOXINE DERIVATIVES FOR THE TREATMENT AND PREVENTION OF AMILOYD PATHOLOGIES
<b>A61K 31/4545</b> (2006.01)	2576509 *	FLUFENOXINE DERIVATIVES FOR THE TREATMENT AND PREVENTION OF AMILOYD PATHOLOGIES
<b>C07D 211/24</b> (2006.01)	2576509 *	FLUFENOXINE DERIVATIVES FOR THE TREATMENT AND PREVENTION OF AMILOYD PATHOLOGIES
<b>C07D 401/12</b> (2006.01)	2576509 *	FLUFENOXINE DERIVATIVES FOR THE TREATMENT AND PREVENTION OF AMILOYD PATHOLOGIES
<b>B67B 1/06</b> (2006.01)	2576359 *	GLASS CONTAINER WITH INTERNALLY THREADED NECK
<b>B65D 39/16</b> (2006.01)	2576359 *	GLASS CONTAINER WITH INTERNALLY THREADED NECK
<b>B65D 1/02</b> (2006.01)	2576359 *	GLASS CONTAINER WITH INTERNALLY THREADED NECK
<b>A61K 31/454</b> (2006.01)	2589595 *	AGENT FOR TREATING HCV INFECTION
<b>C07D 401/14</b> (2006.01)	2589595 *	AGENT FOR TREATING HCV INFECTION
<b>A61P 31/14</b> (2006.01)	2589595 *	AGENT FOR TREATING HCV INFECTION
<b>C07D 471/04</b> (2006.01)	2589595 *	AGENT FOR TREATING HCV INFECTION
<b>A61K 31/5383</b> (2006.01)	2589595 *	AGENT FOR TREATING HCV INFECTION
<b>A61K 31/7056</b> (2006.01)	2589595 *	AGENT FOR TREATING HCV INFECTION
<b>C07D 405/12</b> (2006.01)	2589595 *	AGENT FOR TREATING HCV INFECTION
<b>C07D 403/10</b> (2006.01)	2589595 *	AGENT FOR TREATING HCV INFECTION
<b>A61K 31/4164</b> (2006.01)	2589595 *	AGENT FOR TREATING HCV INFECTION
<b>C07D 233/66</b> (2006.01)	2589595 *	AGENT FOR TREATING HCV INFECTION
<b>C07D 498/04</b> (2006.01)	2589595 *	AGENT FOR TREATING HCV INFECTION
<b>A61K 38/21</b> (2006.01)	2589595 *	AGENT FOR TREATING HCV INFECTION
<b>C07D 409/14</b> (2006.01)	2589595 *	AGENT FOR TREATING HCV INFECTION
<b>A61K 31/4178</b> (2006.01)	2589595 *	AGENT FOR TREATING HCV INFECTION
<b>C07D 401/10</b> (2006.01)	2589595 *	AGENT FOR TREATING HCV INFECTION
<b>C07D 233/61</b> (2006.01)	2589595 *	AGENT FOR TREATING HCV INFECTION
<b>A61P 43/00</b> (2006.01)	2589595 *	AGENT FOR TREATING HCV INFECTION
<b>C07D 491/10</b> (2006.01)	2589595 *	AGENT FOR TREATING HCV INFECTION
<b>C07D 401/14</b> (2006.01)	2545045 *	PIPERIDIN-4-YL AZETIDINE DERIVATIVES AS JAK1 INHIBITORS
<b>A61K 31/4468</b> (2006.01)	2545045 *	PIPERIDIN-4-YL AZETIDINE DERIVATIVES AS JAK1 INHIBITORS
<b>A61K 31/4155</b> (2006.01)	2545045 *	PIPERIDIN-4-YL AZETIDINE DERIVATIVES AS JAK1 INHIBITORS
<b>C07D 405/14</b> (2006.01)	2545045 *	PIPERIDIN-4-YL AZETIDINE DERIVATIVES AS JAK1 INHIBITORS
<b>A61P 29/00</b> (2006.01)	2545045 *	PIPERIDIN-4-YL AZETIDINE DERIVATIVES AS JAK1 INHIBITORS
<b>A61K 31/437</b> (2006.01)	2545045 *	PIPERIDIN-4-YL AZETIDINE DERIVATIVES AS JAK1 INHIBITORS

MKP (51)	Broj objave evropske prijava patenta (97)	Naziv pronalaska (54)
<b>A61P 29/00</b> (2006.01)	2558468 *	5, 7-SUBSTITUTED-IMIDAZO [1, 2-C]PYRIMIDINES AS INHIBITORS OF JAK KINASES
<b>C07D 487/04</b> (2006.01)	2558468 *	5, 7-SUBSTITUTED-IMIDAZO [1, 2-C]PYRIMIDINES AS INHIBITORS OF JAK KINASES
<b>A61K 31/519</b> (2006.01)	2558468 *	5, 7-SUBSTITUTED-IMIDAZO [1, 2-C]PYRIMIDINES AS INHIBITORS OF JAK KINASES
<b>A61P 37/00</b> (2006.01)	2558468 *	5, 7-SUBSTITUTED-IMIDAZO [1, 2-C]PYRIMIDINES AS INHIBITORS OF JAK KINASES
<b>A61K 38/46</b> (2006.01)	2563406 *	METHODS, COMPOSITIONS, AND KITS FOR THE TREATMENT OF MATRIX MINERALIZATION DISORDERS
<b>A61K 47/48</b> (2006.01)	2563406 *	METHODS, COMPOSITIONS, AND KITS FOR THE TREATMENT OF MATRIX MINERALIZATION DISORDERS
<b>C12N 9/16</b> (2006.01)	2563406 *	METHODS, COMPOSITIONS, AND KITS FOR THE TREATMENT OF MATRIX MINERALIZATION DISORDERS
<b>A61K 31/7088</b> (2006.01)	2563406 *	METHODS, COMPOSITIONS, AND KITS FOR THE TREATMENT OF MATRIX MINERALIZATION DISORDERS
<b>A61P 19/08</b> (2006.01)	2563406 *	METHODS, COMPOSITIONS, AND KITS FOR THE TREATMENT OF MATRIX MINERALIZATION DISORDERS
<b>A61K 38/17</b> (2006.01)	2563406 *	METHODS, COMPOSITIONS, AND KITS FOR THE TREATMENT OF MATRIX MINERALIZATION DISORDERS
<b>C12N 15/867</b> (2006.01)	2563406 *	METHODS, COMPOSITIONS, AND KITS FOR THE TREATMENT OF MATRIX MINERALIZATION DISORDERS
<b>A61K 48/00</b> (2006.01)	2563406 *	METHODS, COMPOSITIONS, AND KITS FOR THE TREATMENT OF MATRIX MINERALIZATION DISORDERS
<b>C12N 15/55</b> (2006.01)	2563406 *	METHODS, COMPOSITIONS, AND KITS FOR THE TREATMENT OF MATRIX MINERALIZATION DISORDERS
<b>A61K 38/08</b> (2006.01)	2566492 *	INNOVATIVE DISCOVERY OF THERAPEUTIC, DIAGNOSTIC, AND ANTIBODY COMPOSITIONS RELATED TO PROTEIN FRAGMENTS OF GLUTAMYL-PROLYL-TRNA SYNTHETASES
<b>D21H 21/02</b> (2006.01)	2546410	Hydrophobised calcium carbonate particles
<b>D21C 9/08</b> (2006.01)	2546410	Hydrophobised calcium carbonate particles
<b>A01N 43/42</b> (2006.01)	2542079 *	TREATMENT OF RHEUMATOID ARTHRITIS WITH A COMBINATION OF LAQUINIMOD AND METHOTREXATE
<b>C02F 1/68</b> (2006.01)	2548848	Micronized CaCO <sub>3</sub> slurry injection system for the remineralization of desalinated and fresh water
<b>A61M 5/142</b> (2006.01)	2555813 *	METHOD AND APPARATUS FOR WOUND SEALANT APPLICATION
<b>A61M 5/178</b> (2006.01)	2555813 *	METHOD AND APPARATUS FOR WOUND SEALANT APPLICATION
<b>A61M 5/28</b> (2006.01)	2555813 *	METHOD AND APPARATUS FOR WOUND SEALANT APPLICATION
<b>A61B 17/03</b> (2006.01)	2555813 *	METHOD AND APPARATUS FOR WOUND SEALANT APPLICATION
<b>C07K 16/10</b> (2006.01)	2560993 *	HETERODIMERIC ANTIBODY FC-CONTAINING PROTEINS AND METHODS FOR PRODUCTION THEREOF
<b>C07K 16/28</b> (2006.01)	2560993 *	HETERODIMERIC ANTIBODY FC-CONTAINING PROTEINS AND METHODS FOR PRODUCTION THEREOF
<b>C07K 16/46</b> (2006.01)	2560993 *	HETERODIMERIC ANTIBODY FC-CONTAINING PROTEINS AND METHODS FOR PRODUCTION THEREOF
<b>C07K 16/32</b> (2006.01)	2560993 *	HETERODIMERIC ANTIBODY FC-CONTAINING PROTEINS AND METHODS FOR PRODUCTION THEREOF
<b>A61K 31/505</b> (2006.01)	2563129 *	N3-SUBSTITUTED-N1-SULFONYL-5-FLUOROPYRIMIDINONE DERIVATIVES
<b>A01N 43/54</b> (2006.01)	2563129 *	N3-SUBSTITUTED-N1-SULFONYL-5-FLUOROPYRIMIDINONE DERIVATIVES
<b>B65G 1/04</b> (2006.01)	2542485 *	A PLANT FOR STORING PRODUCTS
<b>B65G 1/02</b> (2006.01)	2542485 *	A PLANT FOR STORING PRODUCTS
<b>B42D 15/00</b> (2006.01)	2567026 *	METHOD FOR PROVIDING A WATERMARKING WIRE MESH, WATERMARKING WIRE MESH, APPARATUS FOR OBTAINING IT AND ANTI-COUNTERFEITING DOCUMENT
<b>D21F 1/44</b> (2006.01)	2567026 *	METHOD FOR PROVIDING A WATERMARKING WIRE MESH, WATERMARKING WIRE MESH, APPARATUS FOR OBTAINING IT AND ANTI-COUNTERFEITING DOCUMENT

MKP (51)	Broj objave evropske prijava patenta (97)	Naziv pronalaska (54)
<b>A01N 25/00</b> (2006.01)	2576523 *	CRYSTALLINE FORM OF 4- [5 - [3 -CHLORO-5 - (TRIFLUOROMETHYL) PHENYL]-4, 5 - DIHYDRO - 5 - (TRIFLUOROMETHYL) -3 - ISOXAZOLYL]-N-[2-OXO-2- [ ( 2, 2, 2 - TRIFLUOROETHYL) AMINO]ETHYL]-1-NAPHTHALENECARBOXAMIDE
<b>C07D 261/04</b> (2006.01)	2576523 *	CRYSTALLINE FORM OF 4- [5 - [3 -CHLORO-5 - (TRIFLUOROMETHYL) PHENYL]-4, 5 - DIHYDRO - 5 - (TRIFLUOROMETHYL) -3 - ISOXAZOLYL]-N-[2-OXO-2- [ ( 2, 2, 2 - TRIFLUOROETHYL) AMINO]ETHYL]-1-NAPHTHALENECARBOXAMIDE
<b>H01R 24/58</b> (2011.01)	2577812 *	D-SHAPED CONNECTOR
<b>A61M 5/32</b> (2006.01)	2588170 *	NEEDLE SHIELD FOR A SAFETY DEVICE, SAFETY DEVICE AND INJECTION DEVICE
<b>G01N 27/02</b> (2006.01)	2492481	Soot sensor functional capability monitoring
<b>F02D 41/22</b> (2006.01)	2492481	Soot sensor functional capability monitoring
<b>G01N 15/06</b> (2006.01)	2492481	Soot sensor functional capability monitoring
<b>A61K 31/21</b> (2006.01)	2563350 *	THERAPEUTIC REGIMEN AND METHOD FOR TREATING OR AMELIORATING VISUAL DISORDERS ASSOCIATED WITH AN ENDOGENOUS RETINOID DEFICIENCY
<b>A61K 31/11</b> (2006.01)	2563350 *	THERAPEUTIC REGIMEN AND METHOD FOR TREATING OR AMELIORATING VISUAL DISORDERS ASSOCIATED WITH AN ENDOGENOUS RETINOID DEFICIENCY
<b>A61P 27/02</b> (2006.01)	2563350 *	THERAPEUTIC REGIMEN AND METHOD FOR TREATING OR AMELIORATING VISUAL DISORDERS ASSOCIATED WITH AN ENDOGENOUS RETINOID DEFICIENCY
<b>A61K 31/222</b> (2006.01)	2563350 *	THERAPEUTIC REGIMEN AND METHOD FOR TREATING OR AMELIORATING VISUAL DISORDERS ASSOCIATED WITH AN ENDOGENOUS RETINOID DEFICIENCY
<b>A61P 25/16</b> (2006.01)	2566861 *	MODULATORS OF FATTY ACID AMIDE HYDROLASE
<b>A61P 19/10</b> (2006.01)	2566861 *	MODULATORS OF FATTY ACID AMIDE HYDROLASE
<b>A61P 29/00</b> (2006.01)	2566861 *	MODULATORS OF FATTY ACID AMIDE HYDROLASE
<b>A61K 31/496</b> (2006.01)	2566861 *	MODULATORS OF FATTY ACID AMIDE HYDROLASE
<b>A61P 37/06</b> (2006.01)	2566861 *	MODULATORS OF FATTY ACID AMIDE HYDROLASE
<b>C07D 405/12</b> (2006.01)	2566861 *	MODULATORS OF FATTY ACID AMIDE HYDROLASE
<b>A61P 35/00</b> (2006.01)	2566861 *	MODULATORS OF FATTY ACID AMIDE HYDROLASE
<b>A61P 25/28</b> (2006.01)	2566861 *	MODULATORS OF FATTY ACID AMIDE HYDROLASE
<b>A61P 3/00</b> (2006.01)	2566861 *	MODULATORS OF FATTY ACID AMIDE HYDROLASE
<b>A61P 25/22</b> (2006.01)	2566861 *	MODULATORS OF FATTY ACID AMIDE HYDROLASE
<b>A61P 9/12</b> (2006.01)	2566861 *	MODULATORS OF FATTY ACID AMIDE HYDROLASE
<b>A61P 25/30</b> (2006.01)	2566861 *	MODULATORS OF FATTY ACID AMIDE HYDROLASE
<b>A61P 3/10</b> (2006.01)	2566861 *	MODULATORS OF FATTY ACID AMIDE HYDROLASE
<b>A61P 25/24</b> (2006.01)	2566861 *	MODULATORS OF FATTY ACID AMIDE HYDROLASE
<b>A61P 15/00</b> (2006.01)	2566861 *	MODULATORS OF FATTY ACID AMIDE HYDROLASE
<b>B32B 7/02</b> (2006.01)	2492091	A process for working or realizing a wood manufacture with application of various wood types
<b>B32B 3/08</b> (2006.01)	2492091	A process for working or realizing a wood manufacture with application of various wood types
<b>B32B 7/12</b> (2006.01)	2492091	A process for working or realizing a wood manufacture with application of various wood types
<b>B32B 21/14</b> (2006.01)	2492091	A process for working or realizing a wood manufacture with application of various wood types
<b>B32B 21/13</b> (2006.01)	2492091	A process for working or realizing a wood manufacture with application of various wood types
<b>B27M 3/00</b> (2006.01)	2492091	A process for working or realizing a wood manufacture with application of various wood types
<b>C12N 15/113</b> (2010.01)	2571988 *	COMPOSITIONS FOR USE IN TREATING OR DIAGNOSING BONE DISORDERS AND/OR CARDIOVASCULAR DISORDERS

MKP (51)	Broj objave evropske prijava patenta (97)	Naziv pronalaska (54)
<b>A61K 31/7088</b> (2006.01)	2571988 *	COMPOSITIONS FOR USE IN TREATING OR DIAGNOSING BONE DISORDERS AND/OR CARDIOVASCULAR DISORDERS
<b>C12Q 1/68</b> (2006.01)	2571988 *	COMPOSITIONS FOR USE IN TREATING OR DIAGNOSING BONE DISORDERS AND/OR CARDIOVASCULAR DISORDERS
<b>A61P 19/08</b> (2006.01)	2571988 *	COMPOSITIONS FOR USE IN TREATING OR DIAGNOSING BONE DISORDERS AND/OR CARDIOVASCULAR DISORDERS
<b>A61P 9/00</b> (2006.01)	2571988 *	COMPOSITIONS FOR USE IN TREATING OR DIAGNOSING BONE DISORDERS AND/OR CARDIOVASCULAR DISORDERS
<b>E06C 7/46</b> (2006.01)	2569502 *	PORTABLE LADDER
<b>G01L 1/00</b> (2006.01)	2572174 *	METHOD AND APPARATUS FOR INTERNALLY DETERMINING A LOAD APPLIED BY A JACK
<b>G01B 21/32</b> (2006.01)	2572174 *	METHOD AND APPARATUS FOR INTERNALLY DETERMINING A LOAD APPLIED BY A JACK
<b>A61N 5/06</b> (2006.01)	2578269 *	IPL DEVICE OF WHICH THE ENERGY LEVEL CAN BE ADJUSTED USING A THYRISTOR
<b>A61N 5/067</b> (2006.01)	2578269 *	IPL DEVICE OF WHICH THE ENERGY LEVEL CAN BE ADJUSTED USING A THYRISTOR
<b>A61B 18/20</b> (2006.01)	2578269 *	IPL DEVICE OF WHICH THE ENERGY LEVEL CAN BE ADJUSTED USING A THYRISTOR
<b>E04B 1/80</b> (2006.01)	2588674 *	A PREFABRICATED COMPOSITE INSULATION BOARD
<b>C07K 16/28</b> (2006.01)	2539370 *	ANTI-ALPHA2 INTEGRIN ANTIBODIES AND THEIR USES
<b>C12N 15/09</b> (2006.01)	2569429 *	COMPOSITIONS AND METHODS FOR MODULATING METABOLISM
<b>A61P 11/08</b> (2006.01)	2580194 *	PROCESS FOR THE PREPARATION OF GLYCOPYRRONIUM CHLORIDE
<b>C07D 207/12</b> (2006.01)	2580194 *	PROCESS FOR THE PREPARATION OF GLYCOPYRRONIUM CHLORIDE
<b>A61P 11/00</b> (2006.01)	2580194 *	PROCESS FOR THE PREPARATION OF GLYCOPYRRONIUM CHLORIDE
<b>A61P 11/06</b> (2006.01)	2580194 *	PROCESS FOR THE PREPARATION OF GLYCOPYRRONIUM CHLORIDE
<b>A61K 31/40</b> (2006.01)	2580194 *	PROCESS FOR THE PREPARATION OF GLYCOPYRRONIUM CHLORIDE
<b>A61K 31/198</b> (2006.01)	2583682 *	ANTIOXIDANT COMPOSITION
<b>A61P 17/16</b> (2006.01)	2583682 *	ANTIOXIDANT COMPOSITION
<b>A61K 31/12</b> (2006.01)	2583682 *	ANTIOXIDANT COMPOSITION
<b>A61K 31/736</b> (2006.01)	2583682 *	ANTIOXIDANT COMPOSITION
<b>A61P 17/06</b> (2006.01)	2583682 *	ANTIOXIDANT COMPOSITION
<b>A61K 35/12</b> (2006.01)	2583682 *	ANTIOXIDANT COMPOSITION
<b>A61K 9/00</b> (2006.01)	2583682 *	ANTIOXIDANT COMPOSITION
<b>A61P 17/00</b> (2006.01)	2583682 *	ANTIOXIDANT COMPOSITION
<b>A61P 17/02</b> (2006.01)	2583682 *	ANTIOXIDANT COMPOSITION
<b>A61K 31/13</b> (2006.01)	2585049 *	NERAMEXANE MULTIPLE UNIT DOSAGE FORM
<b>A61K 9/48</b> (2006.01)	2585049 *	NERAMEXANE MULTIPLE UNIT DOSAGE FORM
<b>A61K 9/16</b> (2006.01)	2585049 *	NERAMEXANE MULTIPLE UNIT DOSAGE FORM
<b>A61K 9/50</b> (2006.01)	2585049 *	NERAMEXANE MULTIPLE UNIT DOSAGE FORM
<b>A61K 9/28</b> (2006.01)	2585049 *	NERAMEXANE MULTIPLE UNIT DOSAGE FORM
<b>A61K 9/20</b> (2006.01)	2585049 *	NERAMEXANE MULTIPLE UNIT DOSAGE FORM
<b>A61K 33/26</b> (2006.01)	2594277 *	TABLET CONTAINING FERRIC CITRATE
<b>A61K 47/32</b> (2006.01)	2594277 *	TABLET CONTAINING FERRIC CITRATE
<b>A61P 3/00</b> (2006.01)	2594277 *	TABLET CONTAINING FERRIC CITRATE
<b>A61P 13/12</b> (2006.01)	2594277 *	TABLET CONTAINING FERRIC CITRATE
<b>A61K 9/20</b> (2006.01)	2594277 *	TABLET CONTAINING FERRIC CITRATE
<b>A61K 47/38</b> (2006.01)	2594277 *	TABLET CONTAINING FERRIC CITRATE
<b>A61P 7/00</b> (2006.01)	2594277 *	TABLET CONTAINING FERRIC CITRATE
<b>A61K 38/17</b> (2006.01)	2552947 *	VISTA REGULATORY T CELL MEDIATOR PROTEIN, VISTA BINDING AGENTS AND USE THEREOF

MKP (51)	Broj objave evropske prijava patenta (97)	Naziv pronalaska (54)
<b>A61K 39/395</b> (2006.01)	2552947 *	VISTA REGULATORY T CELL MEDIATOR PROTEIN, VISTA BINDING AGENTS AND USE THEREOF
<b>A61P 19/02</b> (2006.01)	2552947 *	VISTA REGULATORY T CELL MEDIATOR PROTEIN, VISTA BINDING AGENTS AND USE THEREOF
<b>A61P 37/00</b> (2006.01)	2552947 *	VISTA REGULATORY T CELL MEDIATOR PROTEIN, VISTA BINDING AGENTS AND USE THEREOF
<b>C07K 19/00</b> (2006.01)	2552947 *	VISTA REGULATORY T CELL MEDIATOR PROTEIN, VISTA BINDING AGENTS AND USE THEREOF
<b>C07K 16/18</b> (2006.01)	2552947 *	VISTA REGULATORY T CELL MEDIATOR PROTEIN, VISTA BINDING AGENTS AND USE THEREOF
<b>C07K 14/47</b> (2006.01)	2552947 *	VISTA REGULATORY T CELL MEDIATOR PROTEIN, VISTA BINDING AGENTS AND USE THEREOF
<b>F01C 1/344</b> (2006.01)	2558684 *	FOUR-STROKE ROTATING VANE ENGINE WITH AN ELLIPTIC CASING AND GUIDED VANES
<b>C11B 9/00</b> (2006.01)	2566838 *	COMPOUNDS WITH A WOODY NOTE
<b>C07C 33/14</b> (2006.01)	2566838 *	COMPOUNDS WITH A WOODY NOTE
<b>C07C 403/08</b> (2006.01)	2566838 *	COMPOUNDS WITH A WOODY NOTE
<b>C07C 31/135</b> (2006.01)	2566838 *	COMPOUNDS WITH A WOODY NOTE
<b>A61K 8/34</b> (2006.01)	2566838 *	COMPOUNDS WITH A WOODY NOTE
<b>A61F 6/14</b> (2006.01)	2585011 *	INTRAVAGINAL DEVICES COMPRISING ANTICHOLINERGIC AGENTS, AND METHODS OF MAKING THEREOF
<b>C07D 215/56</b> (2006.01)	2590949 *	METHOD FOR MANUFACTURING OF QUINOLINE-3-CARBOXAMIDES
<b>A61L 27/56</b> (2006.01)	2538985 *	MENISCUS REPAIR ASSEMBLY AND METHOD
<b>A61L 27/18</b> (2006.01)	2538985 *	MENISCUS REPAIR ASSEMBLY AND METHOD
<b>F02B 39/10</b> (2006.01)	2553234 *	AN ELECTRICALLY ASSISTED TURBOCHARGER
<b>H02K 7/18</b> (2006.01)	2553234 *	AN ELECTRICALLY ASSISTED TURBOCHARGER
<b>F02B 37/04</b> (2006.01)	2553234 *	AN ELECTRICALLY ASSISTED TURBOCHARGER
<b>H01Q 19/00</b> (2006.01)	2584654 *	DEVICE FOR WIRELESS COMMUNICATION
<b>H04B 7/02</b> (2006.01)	2584654 *	DEVICE FOR WIRELESS COMMUNICATION
<b>A61K 31/485</b> (2006.01)	2568967 *	PHARMACEUTICAL COMPOSITIONS COMPRISING HYDROMORPHONE AND NALOXONE
<b>A61K 9/20</b> (2006.01)	2568967 *	PHARMACEUTICAL COMPOSITIONS COMPRISING HYDROMORPHONE AND NALOXONE
<b>B60H 1/00</b> (2006.01)	2489532	Air conditioner for vehicle
<b>A61K 31/17</b> (2006.01)	2546231 *	ALKYLAMINE DERIVATIVE
<b>A61K 31/417</b> (2006.01)	2546231 *	ALKYLAMINE DERIVATIVE
<b>A61K 31/167</b> (2006.01)	2546231 *	ALKYLAMINE DERIVATIVE
<b>A61K 31/27</b> (2006.01)	2546231 *	ALKYLAMINE DERIVATIVE
<b>A61K 31/198</b> (2006.01)	2546231 *	ALKYLAMINE DERIVATIVE
<b>C07C 275/42</b> (2006.01)	2546231 *	ALKYLAMINE DERIVATIVE
<b>A61K 31/4245</b> (2006.01)	2546231 *	ALKYLAMINE DERIVATIVE
<b>A61K 31/4045</b> (2006.01)	2546231 *	ALKYLAMINE DERIVATIVE
<b>A23L 1/226</b> (2006.01)	2546231 *	ALKYLAMINE DERIVATIVE
<b>A61Q 19/00</b> (2006.01)	2555808 *	FILLERS COMPRISING GELLAN OR PECTIN BEADS
<b>A61K 8/00</b> (2006.01)	2555808 *	FILLERS COMPRISING GELLAN OR PECTIN BEADS
<b>A61K 31/732</b> (2006.01)	2555808 *	FILLERS COMPRISING GELLAN OR PECTIN BEADS
<b>A61L 27/20</b> (2006.01)	2555808 *	FILLERS COMPRISING GELLAN OR PECTIN BEADS
<b>A61K 9/00</b> (2006.01)	2555808 *	FILLERS COMPRISING GELLAN OR PECTIN BEADS
<b>A61K 9/20</b> (2006.01)	2555755 *	PHARMACEUTICAL COMPOSITIONS OF 3-(6-(1-(2,2-DIFLUOROBENZO[D][1,3]DIOXOL-5-YL) CYCLOPROPANECARBOXAMIDO)-3-METHYLPYRIDIN-2-YL)BENZOIC ACID AND ADMINISTRATION THEREOF

MKP (51)	Broj objave evropske prijava patenta (97)	Naziv pronalaska (54)
<b>C07D 405/14</b> (2006.01)	2555755 *	PHARMACEUTICAL COMPOSITIONS OF 3-(6-(1-(2,2-DIFLUOROBENZO[D][1,3]DIOXOL-5-YL) CYCLOPROPANECARBOXAMIDO)-3-METHYLPYRIDIN-2-YL)BENZOIC ACID AND ADMINISTRATION THEREOF
<b>A61K 9/16</b> (2006.01)	2555755 *	PHARMACEUTICAL COMPOSITIONS OF 3-(6-(1-(2,2-DIFLUOROBENZO[D][1,3]DIOXOL-5-YL) CYCLOPROPANECARBOXAMIDO)-3-METHYLPYRIDIN-2-YL)BENZOIC ACID AND ADMINISTRATION THEREOF
<b>C07D 213/75</b> (2006.01)	2555755 *	PHARMACEUTICAL COMPOSITIONS OF 3-(6-(1-(2,2-DIFLUOROBENZO[D][1,3]DIOXOL-5-YL) CYCLOPROPANECARBOXAMIDO)-3-METHYLPYRIDIN-2-YL)BENZOIC ACID AND ADMINISTRATION THEREOF
<b>C07D 405/12</b> (2006.01)	2555755 *	PHARMACEUTICAL COMPOSITIONS OF 3-(6-(1-(2,2-DIFLUOROBENZO[D][1,3]DIOXOL-5-YL) CYCLOPROPANECARBOXAMIDO)-3-METHYLPYRIDIN-2-YL)BENZOIC ACID AND ADMINISTRATION THEREOF
<b>A61K 9/28</b> (2006.01)	2555755 *	PHARMACEUTICAL COMPOSITIONS OF 3-(6-(1-(2,2-DIFLUOROBENZO[D][1,3]DIOXOL-5-YL) CYCLOPROPANECARBOXAMIDO)-3-METHYLPYRIDIN-2-YL)BENZOIC ACID AND ADMINISTRATION THEREOF
<b>A61K 9/20</b> (2006.01)	2549982 *	METHOD OF PREPARING A GRANULATED PHARMACEUTICAL COMPOSITION COMPRISING SIMVASTATIN AND/OR EZETIMIBE
<b>A61K 9/16</b> (2006.01)	2549982 *	METHOD OF PREPARING A GRANULATED PHARMACEUTICAL COMPOSITION COMPRISING SIMVASTATIN AND/OR EZETIMIBE
<b>A61K 31/405</b> (2006.01)	2549982 *	METHOD OF PREPARING A GRANULATED PHARMACEUTICAL COMPOSITION COMPRISING SIMVASTATIN AND/OR EZETIMIBE
<b>A61K 31/397</b> (2006.01)	2549982 *	METHOD OF PREPARING A GRANULATED PHARMACEUTICAL COMPOSITION COMPRISING SIMVASTATIN AND/OR EZETIMIBE
<b>A61K 31/69</b> (2006.01)	2555625 *	PROCESS FOR PREPARING BENZOXABOROLES
<b>A01N 55/08</b> (2006.01)	2555625 *	PROCESS FOR PREPARING BENZOXABOROLES
<b>H01M 2/02</b> (2006.01)	2572395 *	MODULAR MOBILE ACCESSORY FOR MOBILE DEVICE
<b>A61M 5/20</b> (2006.01)	2585139 *	NEEDLE SAFETY ARRANGEMENT AND METHOD FOR OPERATING IT
<b>B02C 13/04</b> (2006.01)	2560762 *	HAMMER MILL
<b>B02C 13/28</b> (2006.01)	2560762 *	HAMMER MILL
<b>A61F 13/15</b> (2006.01)	2581068	Methods and apparatus for application of nested zero waste ear to traveling web and formation of articles using a dual cut slip unit
<b>A61P 29/00</b> (2006.01)	2571513 *	INNOVATIVE DISCOVERY OF THERAPEUTIC, DIAGNOSTIC, AND ANTIBODY COMPOSITIONS RELATED TO PROTEIN FRAGMENTS OF LEUCYL-TRNA SYNTHETASES
<b>A61P 3/00</b> (2006.01)	2571513 *	INNOVATIVE DISCOVERY OF THERAPEUTIC, DIAGNOSTIC, AND ANTIBODY COMPOSITIONS RELATED TO PROTEIN FRAGMENTS OF LEUCYL-TRNA SYNTHETASES
<b>A61P 35/00</b> (2006.01)	2571513 *	INNOVATIVE DISCOVERY OF THERAPEUTIC, DIAGNOSTIC, AND ANTIBODY COMPOSITIONS RELATED TO PROTEIN FRAGMENTS OF LEUCYL-TRNA SYNTHETASES
<b>A61K 39/395</b> (2006.01)	2571513 *	INNOVATIVE DISCOVERY OF THERAPEUTIC, DIAGNOSTIC, AND ANTIBODY COMPOSITIONS RELATED TO PROTEIN FRAGMENTS OF LEUCYL-TRNA SYNTHETASES
<b>A61K 38/17</b> (2006.01)	2571513 *	INNOVATIVE DISCOVERY OF THERAPEUTIC, DIAGNOSTIC, AND ANTIBODY COMPOSITIONS RELATED TO PROTEIN FRAGMENTS OF LEUCYL-TRNA SYNTHETASES
<b>A61K 38/16</b> (2006.01)	2571513 *	INNOVATIVE DISCOVERY OF THERAPEUTIC, DIAGNOSTIC, AND ANTIBODY COMPOSITIONS RELATED TO PROTEIN FRAGMENTS OF LEUCYL-TRNA SYNTHETASES
<b>G06K 19/077</b> (2006.01)	2577556 *	A REMOVABLE MEMORY CARD WITH AN ANTENNA, ARRANGEMENT OF ITS LEVELS
<b>G06K 7/00</b> (2006.01)	2577556 *	A REMOVABLE MEMORY CARD WITH AN ANTENNA, ARRANGEMENT OF ITS LEVELS
<b>A61K 31/7036</b> (2006.01)	2542233 *	COMPOSITION COMPRISING AS ACTIVE INGREDIENT L-CARNITINE IN COMBINATION WITH HYDROXYKYNURENNINE-0-BETA-DL-GLUCOSIDE, FOR THE PREVENTION AND/OR TREATMENT OF PATHOLOGIES OF THE EYE DUE TO ULTRAVIOLET RADIATION



MKP (51)	Broj objave evropske prijava patenta (97)	Naziv pronalaska (54)
<b>A61P 27/02</b> (2006.01)	2542233 *	COMPOSITION COMPRISING AS ACTIVE INGREDIENT L-CARNITINE IN COMBINATION WITH HYDROXYKYNURENNINE-0-BETA-DL-GLUCOSIDE, FOR THE PREVENTION AND/OR TREATMENT OF PATHOLOGIES OF THE EYE DUE TO ULTRAVIOLET RADIATION
<b>A61K 31/205</b> (2006.01)	2542233 *	COMPOSITION COMPRISING AS ACTIVE INGREDIENT L-CARNITINE IN COMBINATION WITH HYDROXYKYNURENNINE-0-BETA-DL-GLUCOSIDE, FOR THE PREVENTION AND/OR TREATMENT OF PATHOLOGIES OF THE EYE DUE TO ULTRAVIOLET RADIATION
<b>C03C 17/42</b> (2006.01)	2556036 *	IMPROVING ADHESION OF ORGANIC COATINGS ON GLASS
<b>B65D 23/08</b> (2006.01)	2556036 *	IMPROVING ADHESION OF ORGANIC COATINGS ON GLASS
<b>A61K 39/395</b> (2006.01)	2542261 *	ANTIGEN BINDING PROTEINS SPECIFIC FOR SERUM AMYLOID P COMPONENT
<b>A61P 25/28</b> (2006.01)	2542261 *	ANTIGEN BINDING PROTEINS SPECIFIC FOR SERUM AMYLOID P COMPONENT
<b>C07K 16/18</b> (2006.01)	2542261 *	ANTIGEN BINDING PROTEINS SPECIFIC FOR SERUM AMYLOID P COMPONENT
<b>C12N 1/06</b> (2006.01)	2585581 *	CELL DISRUPTION
<b>A61K 35/64</b> (2006.01)	2547347 *	PROCESS FOR OBTAINING NON-ALLERGIC PROPOLIS
<b>C07D 417/14</b> (2006.01)	2588465 *	SGC STIMULATORS
<b>A61K 31/4155</b> (2006.01)	2588465 *	SGC STIMULATORS
<b>C07D 405/14</b> (2006.01)	2588465 *	SGC STIMULATORS
<b>C07D 413/14</b> (2006.01)	2588465 *	SGC STIMULATORS
<b>C07D 401/04</b> (2006.01)	2588465 *	SGC STIMULATORS
<b>C07D 401/14</b> (2006.01)	2588465 *	SGC STIMULATORS
<b>H05K 7/20</b> (2006.01)	2561728 *	A THERMALLY CONTROLLED ASSEMBLY
<b>H05K 1/14</b> (2006.01)	2561728 *	A THERMALLY CONTROLLED ASSEMBLY
<b>C07D 223/10</b> (2006.01)	2580197 *	ANTI-INFLAMMATORY AGENTS
<b>C07D 211/76</b> (2006.01)	2580197 *	ANTI-INFLAMMATORY AGENTS
<b>A61P 29/00</b> (2006.01)	2580197 *	ANTI-INFLAMMATORY AGENTS
<b>A61K 31/45</b> (2006.01)	2580197 *	ANTI-INFLAMMATORY AGENTS
<b>A61K 31/00</b> (2006.01)	2579854 *	SOLID COMPOSITIONS
<b>A61K 9/16</b> (2006.01)	2579854 *	SOLID COMPOSITIONS
<b>A61K 9/20</b> (2006.01)	2579854 *	SOLID COMPOSITIONS
<b>A61K 9/14</b> (2006.01)	2579854 *	SOLID COMPOSITIONS
<b>A61P 29/00</b> (2006.01)	2580212 *	UREA DERIVATIVES AND THEIR THERAPEUTIC USE IN THE TREATMENT OF, INTER ALIA, DISEASES OF THE RESPIRATORY TRACT
<b>C07D 471/04</b> (2006.01)	2580212 *	UREA DERIVATIVES AND THEIR THERAPEUTIC USE IN THE TREATMENT OF, INTER ALIA, DISEASES OF THE RESPIRATORY TRACT
<b>A61K 31/437</b> (2006.01)	2580212 *	UREA DERIVATIVES AND THEIR THERAPEUTIC USE IN THE TREATMENT OF, INTER ALIA, DISEASES OF THE RESPIRATORY TRACT
<b>A61K 31/44</b> (2006.01)	2549870 *	PROCESS FOR PREPARING CARBAMOYLPYRIDONE DERIVATIVES AND INTERMEDIATES
<b>A01N 43/42</b> (2006.01)	2549870 *	PROCESS FOR PREPARING CARBAMOYLPYRIDONE DERIVATIVES AND INTERMEDIATES
<b>A61K 48/00</b> (2006.01)	2552490 *	ECTODOMAINS OF INFLUENZA MATRIX 2 PROTEIN, EXPRESSION SYSTEM, AND USES THEREOF
<b>D02J 3/00</b> (2006.01)	2566399 *	SURFACE TEXTURE CONFIGURATION FOR SELF-RETAINING SUTURES AND METHODS FOR FORMING SAME
<b>A61B 17/064</b> (2006.01)	2566399 *	SURFACE TEXTURE CONFIGURATION FOR SELF-RETAINING SUTURES AND METHODS FOR FORMING SAME
<b>A61B 17/03</b> (2006.01)	2566399 *	SURFACE TEXTURE CONFIGURATION FOR SELF-RETAINING SUTURES AND METHODS FOR FORMING SAME
<b>C12N 15/02</b> (2006.01)	2573175 *	ANTIBODY CAPABLE OF BINDING TO TRANSFORMING GROWTH FACTOR ALPHA AND HAVING ANTIPROLIFERATIVE ACTIVITY ON CANCER HAVING Ras GENE MUTATION

MKP (51)	Broj objave evropske prijava patenta (97)	Naziv pronalaska (54)
<b>C12N 15/09</b> (2006.01)	2573175 *	ANTIBODY CAPABLE OF BINDING TO TRANSFORMING GROWTH FACTOR ALPHA AND HAVING ANTIPROLIFERATIVE ACTIVITY ON CANCER HAVING Ras GENE MUTATION
<b>C12P 21/08</b> (2006.01)	2573175 *	ANTIBODY CAPABLE OF BINDING TO TRANSFORMING GROWTH FACTOR ALPHA AND HAVING ANTIPROLIFERATIVE ACTIVITY ON CANCER HAVING Ras GENE MUTATION
<b>A61P 35/00</b> (2006.01)	2573175 *	ANTIBODY CAPABLE OF BINDING TO TRANSFORMING GROWTH FACTOR ALPHA AND HAVING ANTIPROLIFERATIVE ACTIVITY ON CANCER HAVING Ras GENE MUTATION
<b>C12N 5/10</b> (2006.01)	2573175 *	ANTIBODY CAPABLE OF BINDING TO TRANSFORMING GROWTH FACTOR ALPHA AND HAVING ANTIPROLIFERATIVE ACTIVITY ON CANCER HAVING Ras GENE MUTATION
<b>C07K 16/42</b> (2006.01)	2573175 *	ANTIBODY CAPABLE OF BINDING TO TRANSFORMING GROWTH FACTOR ALPHA AND HAVING ANTIPROLIFERATIVE ACTIVITY ON CANCER HAVING Ras GENE MUTATION
<b>A61K 39/395</b> (2006.01)	2573175 *	ANTIBODY CAPABLE OF BINDING TO TRANSFORMING GROWTH FACTOR ALPHA AND HAVING ANTIPROLIFERATIVE ACTIVITY ON CANCER HAVING Ras GENE MUTATION
<b>G01N 33/574</b> (2006.01)	2573175 *	ANTIBODY CAPABLE OF BINDING TO TRANSFORMING GROWTH FACTOR ALPHA AND HAVING ANTIPROLIFERATIVE ACTIVITY ON CANCER HAVING Ras GENE MUTATION
<b>C07K 16/24</b> (2006.01)	2573175 *	ANTIBODY CAPABLE OF BINDING TO TRANSFORMING GROWTH FACTOR ALPHA AND HAVING ANTIPROLIFERATIVE ACTIVITY ON CANCER HAVING Ras GENE MUTATION
<b>C07K 14/495</b> (2006.01)	2573175 *	ANTIBODY CAPABLE OF BINDING TO TRANSFORMING GROWTH FACTOR ALPHA AND HAVING ANTIPROLIFERATIVE ACTIVITY ON CANCER HAVING Ras GENE MUTATION
<b>A61K 31/55</b> (2006.01)	2574167 *	LIQUID NASAL SPRAY CONTAINING LOW-DOSE NALTREXONE
<b>A61K 31/485</b> (2006.01)	2574167 *	LIQUID NASAL SPRAY CONTAINING LOW-DOSE NALTREXONE
<b>A61K 9/00</b> (2006.01)	2574167 *	LIQUID NASAL SPRAY CONTAINING LOW-DOSE NALTREXONE
<b>A61M 5/32</b> (2006.01)	2588166 *	SAFETY DEVICE FOR A PRE-FILLED SYRINGE AND INJECTION DEVICE
<b>C07C 255/54</b> (2006.01)	2590929 *	ARYLOXY-ALKYLENE SUBSTITUTED HYDROXYPHENYL HEXYNOIC ACIDS, METHODS FOR THE PRODUCTION THEREOF AND USE OF THE SAME AS MEDICAMENT
<b>C07D 213/65</b> (2006.01)	2590929 *	ARYLOXY-ALKYLENE SUBSTITUTED HYDROXYPHENYL HEXYNOIC ACIDS, METHODS FOR THE PRODUCTION THEREOF AND USE OF THE SAME AS MEDICAMENT
<b>A61K 31/192</b> (2006.01)	2590929 *	ARYLOXY-ALKYLENE SUBSTITUTED HYDROXYPHENYL HEXYNOIC ACIDS, METHODS FOR THE PRODUCTION THEREOF AND USE OF THE SAME AS MEDICAMENT
<b>C07C 59/64</b> (2006.01)	2590929 *	ARYLOXY-ALKYLENE SUBSTITUTED HYDROXYPHENYL HEXYNOIC ACIDS, METHODS FOR THE PRODUCTION THEREOF AND USE OF THE SAME AS MEDICAMENT
<b>A61K 31/44</b> (2006.01)	2590929 *	ARYLOXY-ALKYLENE SUBSTITUTED HYDROXYPHENYL HEXYNOIC ACIDS, METHODS FOR THE PRODUCTION THEREOF AND USE OF THE SAME AS MEDICAMENT
<b>G01N 35/00</b> (2006.01)	2539717 *	MICROPLATE MOUNT SYSTEM AND SENSING METHODS
<b>G02B 7/00</b> (2006.01)	2539717 *	MICROPLATE MOUNT SYSTEM AND SENSING METHODS
<b>B01L 9/00</b> (2006.01)	2539717 *	MICROPLATE MOUNT SYSTEM AND SENSING METHODS
<b>G01N 21/00</b> (2006.01)	2539717 *	MICROPLATE MOUNT SYSTEM AND SENSING METHODS
<b>G06F 3/01</b> (2006.01)	2548099 *	SYSTEMS AND METHODS FOR HAPTIC INFORMATION PREVIEW
<b>B01J 37/00</b> (2006.01)	2484440	A catalyst for waste thermolysis
<b>B01J 27/057</b> (2006.01)	2484440	A catalyst for waste thermolysis
<b>C01B 19/00</b> (2006.01)	2484440	A catalyst for waste thermolysis
<b>B01J 23/18</b> (2006.01)	2484440	A catalyst for waste thermolysis
<b>F23G 5/027</b> (2006.01)	2484440	A catalyst for waste thermolysis
<b>B01J 37/02</b> (2006.01)	2484440	A catalyst for waste thermolysis
<b>C07K 14/025</b> (2006.01)	2589604 *	TRUNCATED L1 PROTEIN OF HUMAN PAPILLOMAVIRUS TYPE 52

MKP (51)	Broj objave evropske prijava patenta (97)	Naziv pronalaska (54)
<b>A61P 31/20</b> (2006.01)	2589604 *	TRUNCATED L1 PROTEIN OF HUMAN PAPILLOMAVIRUS TYPE 52
<b>C12N 1/21</b> (2006.01)	2589604 *	TRUNCATED L1 PROTEIN OF HUMAN PAPILLOMAVIRUS TYPE 52
<b>C12N 15/70</b> (2006.01)	2589604 *	TRUNCATED L1 PROTEIN OF HUMAN PAPILLOMAVIRUS TYPE 52
<b>A61K 39/12</b> (2006.01)	2589604 *	TRUNCATED L1 PROTEIN OF HUMAN PAPILLOMAVIRUS TYPE 52
<b>C07K 16/26</b> (2006.01)	2550294 *	PROPHYLAXIS OF COLORECTAL AND GASTROINTESTINAL CANCER
<b>C07K 16/46</b> (2006.01)	2550294 *	PROPHYLAXIS OF COLORECTAL AND GASTROINTESTINAL CANCER
<b>G01N 33/53</b> (2006.01)	2550294 *	PROPHYLAXIS OF COLORECTAL AND GASTROINTESTINAL CANCER
<b>A61K 39/395</b> (2006.01)	2550294 *	PROPHYLAXIS OF COLORECTAL AND GASTROINTESTINAL CANCER
<b>C12N 5/12</b> (2006.01)	2550294 *	PROPHYLAXIS OF COLORECTAL AND GASTROINTESTINAL CANCER
<b>A61P 35/00</b> (2006.01)	2550294 *	PROPHYLAXIS OF COLORECTAL AND GASTROINTESTINAL CANCER
<b>C12N 15/13</b> (2006.01)	2550294 *	PROPHYLAXIS OF COLORECTAL AND GASTROINTESTINAL CANCER
<b>A61M 5/32</b> (2006.01)	2550044 *	MEDICATED MODULE WITH AUTOMATIC RESERVOIR ENGAGEMENT
<b>A61M 5/28</b> (2006.01)	2550044 *	MEDICATED MODULE WITH AUTOMATIC RESERVOIR ENGAGEMENT
<b>A61M 5/24</b> (2006.01)	2550044 *	MEDICATED MODULE WITH AUTOMATIC RESERVOIR ENGAGEMENT
<b>C07D 515/22</b> (2006.01)	2576569 *	SYNTHETIC PROCESS FOR THE MANUFACTURE OF ECTEINASCIDIN COMPOUNDS
<b>A61K 9/20</b> (2006.01)	2582361 *	MULTILAYER PHARMACEUTICAL TABLET COMPRISING TELMISARTAN AND A DIURETIC
<b>A61K 31/4184</b> (2006.01)	2582361 *	MULTILAYER PHARMACEUTICAL TABLET COMPRISING TELMISARTAN AND A DIURETIC
<b>C07K 14/605</b> (2006.01)	2585481 *	GLUCAGON ANALOGUES
<b>A61P 35/00</b> (2006.01)	2569312 *	SUBSTITUTED HETEROCYCLYL BENZYL PYRAZOLES, AND USE THEREOF
<b>C07D 413/14</b> (2006.01)	2569312 *	SUBSTITUTED HETEROCYCLYL BENZYL PYRAZOLES, AND USE THEREOF
<b>A61K 31/4245</b> (2006.01)	2569312 *	SUBSTITUTED HETEROCYCLYL BENZYL PYRAZOLES, AND USE THEREOF
<b>A61K 39/00</b> (2006.01)	2542256 *	ANTIBODIES REACTIVE WITH B7-H3, IMMUNOLOGICALLY ACTIVE FRAGMENTS THEREOF AND USES THEREOF
<b>C07K 16/00</b> (2006.01)	2542256 *	ANTIBODIES REACTIVE WITH B7-H3, IMMUNOLOGICALLY ACTIVE FRAGMENTS THEREOF AND USES THEREOF
<b>A61Q 17/04</b> (2006.01)	2588068 *	MOISTURIZING COMPOSITION WITH SPF 30
<b>A61K 8/27</b> (2006.01)	2588068 *	MOISTURIZING COMPOSITION WITH SPF 30
<b>A61K 8/67</b> (2006.01)	2588068 *	MOISTURIZING COMPOSITION WITH SPF 30
<b>A61K 8/34</b> (2006.01)	2588068 *	MOISTURIZING COMPOSITION WITH SPF 30
<b>A61K 8/68</b> (2006.01)	2588068 *	MOISTURIZING COMPOSITION WITH SPF 30
<b>A61K 8/40</b> (2006.01)	2588068 *	MOISTURIZING COMPOSITION WITH SPF 30
<b>A61K 8/365</b> (2006.01)	2588068 *	MOISTURIZING COMPOSITION WITH SPF 30
<b>A61K 8/37</b> (2006.01)	2588068 *	MOISTURIZING COMPOSITION WITH SPF 30
<b>A61K 8/42</b> (2006.01)	2588068 *	MOISTURIZING COMPOSITION WITH SPF 30
<b>A61Q 19/00</b> (2006.01)	2588068 *	MOISTURIZING COMPOSITION WITH SPF 30
<b>A61K 31/519</b> (2006.01)	2593458 *	BICYCLIC PYRIMIDINES
<b>C07D 487/04</b> (2006.01)	2593458 *	BICYCLIC PYRIMIDINES
<b>A61P 35/00</b> (2006.01)	2593458 *	BICYCLIC PYRIMIDINES
<b>B01J 31/24</b> (2006.01)	2593226 *	PHOSPHINE LIGANDS FOR CATALYTIC REACTIONS
<b>F16C 37/00</b> (2006.01)	2463536	Bearing Assembly
<b>F16C 17/02</b> (2006.01)	2463536	Bearing Assembly
<b>F16C 33/20</b> (2006.01)	2463536	Bearing Assembly
<b>F25D 3/08</b> (2006.01)	2572148 *	KEG APPARATUS FOR SELF COOLING AND SELF DISPENSING LIQUIDS
<b>C05F 1/00</b> (2006.01)	2550244 *	TREATMENT OF ORGANIC WASTE
<b>C05F 11/00</b> (2006.01)	2550244 *	TREATMENT OF ORGANIC WASTE
<b>C05F 9/00</b> (2006.01)	2550244 *	TREATMENT OF ORGANIC WASTE
<b>C05F 5/00</b> (2006.01)	2550244 *	TREATMENT OF ORGANIC WASTE
<b>C05F 7/00</b> (2006.01)	2550244 *	TREATMENT OF ORGANIC WASTE

MKP (51)	Broj objave evropske prijava patenta (97)	Naziv pronalaska (54)
<b>B09B 3/00</b> (2006.01)	2550244 *	TREATMENT OF ORGANIC WASTE
<b>C05F 3/00</b> (2006.01)	2550244 *	TREATMENT OF ORGANIC WASTE
<b>A61K 39/395</b> (2006.01)	2558496 *	ANTI-POLYUBIQUITIN ANTIBODIES AND METHODS OF USE
<b>C07K 16/18</b> (2006.01)	2558496 *	ANTI-POLYUBIQUITIN ANTIBODIES AND METHODS OF USE
<b>C07C 323/62</b> (2006.01)	2582664 *	PHENYLTHIOACETATE COMPOUNDS, COMPOSITIONS AND METHODS OF USE
<b>C07D 213/24</b> (2006.01)	2582664 *	PHENYLTHIOACETATE COMPOUNDS, COMPOSITIONS AND METHODS OF USE
<b>A61K 31/192</b> (2006.01)	2582664 *	PHENYLTHIOACETATE COMPOUNDS, COMPOSITIONS AND METHODS OF USE
<b>A61K 31/44</b> (2006.01)	2582664 *	PHENYLTHIOACETATE COMPOUNDS, COMPOSITIONS AND METHODS OF USE
<b>A61P 19/06</b> (2006.01)	2582664 *	PHENYLTHIOACETATE COMPOUNDS, COMPOSITIONS AND METHODS OF USE
<b>B05B 17/08</b> (2006.01)	2588252 *	PLAYGROUND COMPRISING FOUNTAINS
<b>C07D 205/08</b> (2006.01)	2590940 *	NEW METHOD FOR PREPARING EZETIMIBE
<b>C07D 263/38</b> (2006.01)	2590940 *	NEW METHOD FOR PREPARING EZETIMIBE
<b>D01D 1/06</b> (2006.01)	2558624 *	PROCESS FOR THE MANUFACTURE OF CELLULOSE-BASED FIBRES AND THE FIBRES THUS OBTAINED
<b>D01D 5/12</b> (2006.01)	2558624 *	PROCESS FOR THE MANUFACTURE OF CELLULOSE-BASED FIBRES AND THE FIBRES THUS OBTAINED
<b>D01F 2/00</b> (2006.01)	2558624 *	PROCESS FOR THE MANUFACTURE OF CELLULOSE-BASED FIBRES AND THE FIBRES THUS OBTAINED
<b>C07C 323/52</b> (2006.01)	2576505 *	PROCESS FOR THE PREPARATION OF PLEUROMUTILINS
<b>A61K 31/215</b> (2006.01)	2576505 *	PROCESS FOR THE PREPARATION OF PLEUROMUTILINS
<b>A61P 31/00</b> (2006.01)	2576505 *	PROCESS FOR THE PREPARATION OF PLEUROMUTILINS
<b>A61P 17/00</b> (2006.01)	2576505 *	PROCESS FOR THE PREPARATION OF PLEUROMUTILINS
<b>F28D 9/00</b> (2006.01)	2585784 *	LIQUID-TO-AIR MEMBRANE ENERGY EXCHANGER
<b>F24F 3/147</b> (2006.01)	2585784 *	LIQUID-TO-AIR MEMBRANE ENERGY EXCHANGER
<b>F28D 15/00</b> (2006.01)	2585784 *	LIQUID-TO-AIR MEMBRANE ENERGY EXCHANGER
<b>F24F 12/00</b> (2006.01)	2585784 *	LIQUID-TO-AIR MEMBRANE ENERGY EXCHANGER
<b>F28F 3/12</b> (2006.01)	2585784 *	LIQUID-TO-AIR MEMBRANE ENERGY EXCHANGER
<b>A61K 38/22</b> (2006.01)	2563808 *	PEPTIDE CONJUGATES OF GLP-1 RECEPTOR AGONISTS AND GASTRIN AND THEIR USE
<b>C07K 14/595</b> (2006.01)	2563808 *	PEPTIDE CONJUGATES OF GLP-1 RECEPTOR AGONISTS AND GASTRIN AND THEIR USE
<b>C07K 19/00</b> (2006.01)	2563808 *	PEPTIDE CONJUGATES OF GLP-1 RECEPTOR AGONISTS AND GASTRIN AND THEIR USE
<b>C07K 14/575</b> (2006.01)	2563808 *	PEPTIDE CONJUGATES OF GLP-1 RECEPTOR AGONISTS AND GASTRIN AND THEIR USE
<b>B65D 81/20</b> (2006.01)	2573003 *	CONTAINER
<b>B65D 75/32</b> (2006.01)	2573003 *	CONTAINER
<b>B65D 30/20</b> (2006.01)	2573003 *	CONTAINER
<b>F02M 59/46</b> (2006.01)	2492492	Pumping head
<b>F02M 59/20</b> (2006.01)	2492492	Pumping head
<b>F02M 59/26</b> (2006.01)	2492492	Pumping head
<b>F02M 59/34</b> (2006.01)	2492492	Pumping head
<b>A61P 3/00</b> (2006.01)	2576618 *	ANTIBODIES TO HUMAN GDF8
<b>C07K 16/22</b> (2006.01)	2576618 *	ANTIBODIES TO HUMAN GDF8
<b>A61P 21/00</b> (2006.01)	2576618 *	ANTIBODIES TO HUMAN GDF8
<b>A61K 39/395</b> (2006.01)	2576618 *	ANTIBODIES TO HUMAN GDF8
<b>A01N 65/06</b> (2009.01)	2579718 *	COMBINATIONS OF PYRIMETHANIL AND MONOTERPENES
<b>A01N 43/54</b> (2006.01)	2579718 *	COMBINATIONS OF PYRIMETHANIL AND MONOTERPENES

MKP (51)	Broj objave evropske prijava patenta (97)	Naziv pronalaska (54)
<b>A01P 3/00</b> (2006.01)	2579718 *	COMBINATIONS OF PYRIMETHANIL AND MONOTERPENES
<b>A01N 65/10</b> (2009.01)	2579718 *	COMBINATIONS OF PYRIMETHANIL AND MONOTERPENES
<b>A01N 65/22</b> (2009.01)	2579718 *	COMBINATIONS OF PYRIMETHANIL AND MONOTERPENES
<b>B27K 3/34</b> (2006.01)	2579718 *	COMBINATIONS OF PYRIMETHANIL AND MONOTERPENES
<b>B27K 3/50</b> (2006.01)	2579718 *	COMBINATIONS OF PYRIMETHANIL AND MONOTERPENES
<b>A01N 35/06</b> (2006.01)	2579718 *	COMBINATIONS OF PYRIMETHANIL AND MONOTERPENES
<b>A01N 31/08</b> (2006.01)	2579718 *	COMBINATIONS OF PYRIMETHANIL AND MONOTERPENES
<b>F16L 55/103</b> (2006.01)	2583014 *	METHODS, DEVICES AND SYSTEMS FOR EXTRACTION OF THERMAL ENERGY FROM A HEAT CONDUCTING METAL CONDUIT
<b>G05D 23/19</b> (2006.01)	2583014 *	METHODS, DEVICES AND SYSTEMS FOR EXTRACTION OF THERMAL ENERGY FROM A HEAT CONDUCTING METAL CONDUIT
<b>A61K 38/22</b> (2006.01)	2568999 *	ACTH FOR TREATMENT OF AMYOTROPHIC LATERAL SCLEROSIS
<b>A61P 21/00</b> (2006.01)	2568999 *	ACTH FOR TREATMENT OF AMYOTROPHIC LATERAL SCLEROSIS
<b>A61K 38/16</b> (2006.01)	2568999 *	ACTH FOR TREATMENT OF AMYOTROPHIC LATERAL SCLEROSIS
<b>A61P 21/02</b> (2006.01)	2568999 *	ACTH FOR TREATMENT OF AMYOTROPHIC LATERAL SCLEROSIS
<b>C07D 471/00</b> (2006.01)	2571875 *	MALE CONTRACEPTIVE COMPOSITIONS AND METHODS OF USE
<b>A47C 7/54</b> (2006.01)	2510838	Sofa with moveable armrests
<b>A47C 17/12</b> (2006.01)	2510838	Sofa with moveable armrests
<b>C08L 15/00</b> (2006.01)	2559709 *	PROCESS FOR PRODUCING MODIFIED CONJUGATED DIENE POLYMER, MODIFIED CONJUGATED DIENE POLYMER, AND COMPOSITION OF MODIFIED CONJUGATED DIENE POLYMER
<b>C08C 19/25</b> (2006.01)	2559709 *	PROCESS FOR PRODUCING MODIFIED CONJUGATED DIENE POLYMER, MODIFIED CONJUGATED DIENE POLYMER, AND COMPOSITION OF MODIFIED CONJUGATED DIENE POLYMER
<b>C08K 3/36</b> (2006.01)	2559709 *	PROCESS FOR PRODUCING MODIFIED CONJUGATED DIENE POLYMER, MODIFIED CONJUGATED DIENE POLYMER, AND COMPOSITION OF MODIFIED CONJUGATED DIENE POLYMER
<b>B65G 51/03</b> (2006.01)	2457833	Device for positioning of portion packets
<b>B65B 5/06</b> (2006.01)	2457833	Device for positioning of portion packets
<b>B65B 35/28</b> (2006.01)	2457833	Device for positioning of portion packets
<b>B65B 35/40</b> (2006.01)	2457833	Device for positioning of portion packets
<b>B65B 29/02</b> (2006.01)	2457833	Device for positioning of portion packets
<b>C12N 15/82</b> (2006.01)	2580335 *	METHODS AND MEANS TO MODIFY A PLANT GENOME AT A NUCLEOTIDE SEQUENCE COMMONLY USED IN PLANT GENOME ENGINEERING
<b>A61M 5/14</b> (2006.01)	2579916 *	APPARATUS AND CASE FOR INFUSION EQUIPMENT
<b>A61M 5/142</b> (2006.01)	2579916 *	APPARATUS AND CASE FOR INFUSION EQUIPMENT
<b>A61M 5/24</b> (2006.01)	2579920 *	ASSEMBLY FOR A DRUG DELIVERY DEVICE AND DRUG DELIVERY DEVICE
<b>A61M 5/315</b> (2006.01)	2579920 *	ASSEMBLY FOR A DRUG DELIVERY DEVICE AND DRUG DELIVERY DEVICE
<b>C07K 16/26</b> (2006.01)	2542585 *	METHODS FOR TREATING COLORECTAL CANCER
<b>C07D 471/04</b> (2006.01)	2558463 *	FUSED DERIVATIVES AS I3 INHIBITORS
<b>A61P 17/00</b> (2006.01)	2558463 *	FUSED DERIVATIVES AS I3 INHIBITORS
<b>A61P 3/00</b> (2006.01)	2558463 *	FUSED DERIVATIVES AS I3 INHIBITORS
<b>A61K 31/407</b> (2006.01)	2558463 *	FUSED DERIVATIVES AS I3 INHIBITORS
<b>A61P 29/00</b> (2006.01)	2558463 *	FUSED DERIVATIVES AS I3 INHIBITORS
<b>A61K 9/16</b> (2006.01)	2564847 *	PHARMACEUTICAL COMPOSITION FOR IMPROVING SOLUBILITY OF PRASUGREL AND ITS PREPARATION METHOD
<b>A61K 31/4365</b> (2006.01)	2564847 *	PHARMACEUTICAL COMPOSITION FOR IMPROVING SOLUBILITY OF PRASUGREL AND ITS PREPARATION METHOD
<b>A61P 7/02</b> (2006.01)	2564847 *	PHARMACEUTICAL COMPOSITION FOR IMPROVING SOLUBILITY OF PRASUGREL AND ITS PREPARATION METHOD
<b>A61K 47/26</b> (2006.01)	2564847 *	PHARMACEUTICAL COMPOSITION FOR IMPROVING SOLUBILITY OF PRASUGREL AND ITS PREPARATION METHOD

MKP (51)	Broj objave evropske prijava patenta (97)	Naziv pronalaska (54)
<b>A61K 9/20</b> (2006.01)	2564847 *	PHARMACEUTICAL COMPOSITION FOR IMPROVING SOLUBILITY OF PRASUGREL AND ITS PREPARATION METHOD
<b>A61K 47/20</b> (2006.01)	2564847 *	PHARMACEUTICAL COMPOSITION FOR IMPROVING SOLUBILITY OF PRASUGREL AND ITS PREPARATION METHOD
<b>A61K 47/40</b> (2006.01)	2564847 *	PHARMACEUTICAL COMPOSITION FOR IMPROVING SOLUBILITY OF PRASUGREL AND ITS PREPARATION METHOD
<b>A61K 9/48</b> (2006.01)	2564847 *	PHARMACEUTICAL COMPOSITION FOR IMPROVING SOLUBILITY OF PRASUGREL AND ITS PREPARATION METHOD
<b>A61K 47/30</b> (2006.01)	2564847 *	PHARMACEUTICAL COMPOSITION FOR IMPROVING SOLUBILITY OF PRASUGREL AND ITS PREPARATION METHOD
<b>H04W 88/08</b> (2009.01)	2540136 *	METHOD AND DEVICE FOR SENDING/RECEIVING ELECTROMAGNETIC SIGNALS RECEIVED/SENT ON ONE OR MORE FIRST FREQUENCY BANDS
<b>A61P 5/00</b> (2006.01)	2547650 *	AGOMELATINE HYDROBROMIDE HYDRATE AND PREPARATION THEREOF
<b>A61P 25/24</b> (2006.01)	2547650 *	AGOMELATINE HYDROBROMIDE HYDRATE AND PREPARATION THEREOF
<b>A61K 31/165</b> (2006.01)	2547650 *	AGOMELATINE HYDROBROMIDE HYDRATE AND PREPARATION THEREOF
<b>A61P 25/00</b> (2006.01)	2547650 *	AGOMELATINE HYDROBROMIDE HYDRATE AND PREPARATION THEREOF
<b>A61P 25/22</b> (2006.01)	2547650 *	AGOMELATINE HYDROBROMIDE HYDRATE AND PREPARATION THEREOF
<b>C07C 231/12</b> (2006.01)	2547650 *	AGOMELATINE HYDROBROMIDE HYDRATE AND PREPARATION THEREOF
<b>C07C 233/18</b> (2006.01)	2547650 *	AGOMELATINE HYDROBROMIDE HYDRATE AND PREPARATION THEREOF
<b>B26D 1/10</b> (2006.01)	2560798 *	BLADE FOR CUTTING A PIECE OF PLASTERBOARD, METHOD FOR IMPLEMENTING SAID BLADE, AND USE THEREOF
<b>B26B 5/00</b> (2006.01)	2560798 *	BLADE FOR CUTTING A PIECE OF PLASTERBOARD, METHOD FOR IMPLEMENTING SAID BLADE, AND USE THEREOF
<b>A61P 35/00</b> (2006.01)	2544704 *	SPARC ANGIOGENIC DOMAIN AND METHODS OF USE
<b>A61K 38/17</b> (2006.01)	2544704 *	SPARC ANGIOGENIC DOMAIN AND METHODS OF USE
<b>C07K 16/26</b> (2006.01)	2542584 *	METHODS FOR TREATING PANCREATIC CANCER
<b>A61P 35/00</b> (2006.01)	2542584 *	METHODS FOR TREATING PANCREATIC CANCER
<b>A61K 39/395</b> (2006.01)	2542584 *	METHODS FOR TREATING PANCREATIC CANCER
<b>A61M 5/20</b> (2006.01)	2544738 *	INJECTION DEVICE
<b>A61M 5/24</b> (2006.01)	2544738 *	INJECTION DEVICE
<b>B01D 53/00</b> (2006.01)	2563495 *	SYSTEM AND METHOD FOR CARBON DIOXIDE CAPTURE AND SEQUESTRATION
<b>A61F 13/00</b> (2006.01)	2552371 *	A WOUND CARE DRESSING, A METHOD AND A PRODUCTION LINE FOR MANUFACTURING THE WOUND CARE DRESSING
<b>A61P 27/00</b> (2006.01)	2552965 *	ANTI-CD40 ANTIBODIES
<b>A61K 39/395</b> (2006.01)	2552965 *	ANTI-CD40 ANTIBODIES
<b>A61P 37/00</b> (2006.01)	2552965 *	ANTI-CD40 ANTIBODIES
<b>C07K 16/28</b> (2006.01)	2552965 *	ANTI-CD40 ANTIBODIES
<b>C12N 15/13</b> (2006.01)	2552965 *	ANTI-CD40 ANTIBODIES
<b>A61K 39/395</b> (2006.01)	2552966 *	ANTIBODIES AGAINST CSF-1R
<b>C07K 16/32</b> (2006.01)	2552966 *	ANTIBODIES AGAINST CSF-1R
<b>A61P 35/00</b> (2006.01)	2552966 *	ANTIBODIES AGAINST CSF-1R
<b>C07K 16/28</b> (2006.01)	2552966 *	ANTIBODIES AGAINST CSF-1R
<b>A61P 35/02</b> (2006.01)	2552966 *	ANTIBODIES AGAINST CSF-1R
<b>B61L 5/04</b> (2006.01)	2558345 *	ACTIVE MEMBER OF THE HYDRAULIC LOCKING DEVICE EQUIPPED WITH MECHANIC LOCKING AND RETENTION
<b>B61L 5/10</b> (2006.01)	2558345 *	ACTIVE MEMBER OF THE HYDRAULIC LOCKING DEVICE EQUIPPED WITH MECHANIC LOCKING AND RETENTION
<b>A61K 39/00</b> (2006.01)	2560681 *	USE OF TAU TO MONITOR IMMUNOTHERAPY
<b>C07K 16/00</b> (2006.01)	2560681 *	USE OF TAU TO MONITOR IMMUNOTHERAPY
<b>A61K 31/519</b> (2006.01)	2590979 *	RING-FUSED PYRIMIDINES AND TRIAZINES AND USE THEREOF FOR THE TREATMENT AND/OR PROPHYLAXIS OF CARDIOVASCULAR DISEASES

MKP (51)	Broj objave evropske prijava patenta (97)	Naziv pronalaska (54)
<b>A61K 31/522</b> (2006.01)	2590979 *	RING-FUSED PYRIMIDINES AND TRIAZINES AND USE THEREOF FOR THE TREATMENT AND/OR PROPHYLAXIS OF CARDIOVASCULAR DISEASES
<b>A61P 9/00</b> (2006.01)	2590979 *	RING-FUSED PYRIMIDINES AND TRIAZINES AND USE THEREOF FOR THE TREATMENT AND/OR PROPHYLAXIS OF CARDIOVASCULAR DISEASES
<b>C07D 487/04</b> (2006.01)	2590979 *	RING-FUSED PYRIMIDINES AND TRIAZINES AND USE THEREOF FOR THE TREATMENT AND/OR PROPHYLAXIS OF CARDIOVASCULAR DISEASES
<b>A61K 38/48</b> (2006.01)	2544697 *	PROCESS, TUBE AND DEVICE FOR THE PREPARATION OF WOUND HEALANT COMPOSITION
<b>A61K 35/14</b> (2006.01)	2544697 *	PROCESS, TUBE AND DEVICE FOR THE PREPARATION OF WOUND HEALANT COMPOSITION
<b>A61K 35/16</b> (2006.01)	2544697 *	PROCESS, TUBE AND DEVICE FOR THE PREPARATION OF WOUND HEALANT COMPOSITION
<b>G01N 33/15</b> (2006.01)	2576778 *	TRANSGENIC REPORTER SYSTEM THAT REVEALS EXPRESSION PROFILES AND REGULATION MECHANISMS OF ALTERNATIVE SPLICING IN MAMMALIAN ORGANISMS
<b>C12N 15/09</b> (2006.01)	2576778 *	TRANSGENIC REPORTER SYSTEM THAT REVEALS EXPRESSION PROFILES AND REGULATION MECHANISMS OF ALTERNATIVE SPLICING IN MAMMALIAN ORGANISMS
<b>C12Q 1/68</b> (2006.01)	2576778 *	TRANSGENIC REPORTER SYSTEM THAT REVEALS EXPRESSION PROFILES AND REGULATION MECHANISMS OF ALTERNATIVE SPLICING IN MAMMALIAN ORGANISMS
<b>A61K 31/727</b> (2006.01)	2585080 *	SEMULOPARIN FOR USE AS AN ANTITHROMBOTIC TREATMENT IN HIP REPLACEMENT SURGERY WITH IMPROVED SAFETY IN TERMS OF CLINICALLY RELEVANT BLEEDINGS
<b>A61P 7/02</b> (2006.01)	2585080 *	SEMULOPARIN FOR USE AS AN ANTITHROMBOTIC TREATMENT IN HIP REPLACEMENT SURGERY WITH IMPROVED SAFETY IN TERMS OF CLINICALLY RELEVANT BLEEDINGS
<b>A61N 1/36</b> (2006.01)	2588185 *	ELECTRICAL STIMULATION DEVICE
<b>A61N 1/04</b> (2006.01)	2588185 *	ELECTRICAL STIMULATION DEVICE
<b>A61N 1/05</b> (2006.01)	2588185 *	ELECTRICAL STIMULATION DEVICE
<b>A61H 39/00</b> (2006.01)	2588185 *	ELECTRICAL STIMULATION DEVICE
<b>A61P 25/24</b> (2006.01)	2590969 *	THERAPEUTIC AGENTS 976
<b>C07D 413/06</b> (2006.01)	2590969 *	THERAPEUTIC AGENTS 976
<b>A61K 31/4245</b> (2006.01)	2590969 *	THERAPEUTIC AGENTS 976
<b>C07D 413/14</b> (2006.01)	2590969 *	THERAPEUTIC AGENTS 976
<b>A61K 31/4523</b> (2006.01)	2590969 *	THERAPEUTIC AGENTS 976
<b>C40B 30/06</b> (2006.01)	2553151 *	USE OF INDUCED PLURIPOTENT CELLS AND OTHER CELLS FOR SCREENING COMPOUND LIBRARIES
<b>C07H 7/04</b> (2006.01)	2580225 *	CRYSTALLINE FORM OF BENZYL BENZENE SGLT2 INHIBITOR
<b>A61K 31/70</b> (2006.01)	2580225 *	CRYSTALLINE FORM OF BENZYL BENZENE SGLT2 INHIBITOR
<b>A61P 3/00</b> (2006.01)	2580225 *	CRYSTALLINE FORM OF BENZYL BENZENE SGLT2 INHIBITOR
<b>A61K 9/06</b> (2006.01)	2538919 *	PHARMACEUTICAL COMPOSITIONS OF SPIRO-OXINDOLE COMPOUND FOR TOPICAL ADMINISTRATION AND THEIR USE AS THERAPEUTIC AGENTS
<b>A61K 9/00</b> (2006.01)	2538919 *	PHARMACEUTICAL COMPOSITIONS OF SPIRO-OXINDOLE COMPOUND FOR TOPICAL ADMINISTRATION AND THEIR USE AS THERAPEUTIC AGENTS
<b>A61P 29/00</b> (2006.01)	2538919 *	PHARMACEUTICAL COMPOSITIONS OF SPIRO-OXINDOLE COMPOUND FOR TOPICAL ADMINISTRATION AND THEIR USE AS THERAPEUTIC AGENTS
<b>A61P 25/00</b> (2006.01)	2538919 *	PHARMACEUTICAL COMPOSITIONS OF SPIRO-OXINDOLE COMPOUND FOR TOPICAL ADMINISTRATION AND THEIR USE AS THERAPEUTIC AGENTS
<b>A61K 31/407</b> (2006.01)	2538919 *	PHARMACEUTICAL COMPOSITIONS OF SPIRO-OXINDOLE COMPOUND FOR TOPICAL ADMINISTRATION AND THEIR USE AS THERAPEUTIC AGENTS

MKP (51)	Broj objave evropske prijava patenta (97)	Naziv pronalaska (54)
<b>A61P 25/02</b> (2006.01)	2538919 *	PHARMACEUTICAL COMPOSITIONS OF SPIRO-OXINDOLE COMPOUND FOR TOPICAL ADMINISTRATION AND THEIR USE AS THERAPEUTIC AGENTS
<b>A61P 25/06</b> (2006.01)	2538919 *	PHARMACEUTICAL COMPOSITIONS OF SPIRO-OXINDOLE COMPOUND FOR TOPICAL ADMINISTRATION AND THEIR USE AS THERAPEUTIC AGENTS
<b>A01N 3/00</b> (2006.01)	2561754 *	CYCLOPROPENE COMPOUND, AND METHOD FOR ADDING SAME TO CROPS
<b>A01N 27/00</b> (2006.01)	2561754 *	CYCLOPROPENE COMPOUND, AND METHOD FOR ADDING SAME TO CROPS
<b>A01N 25/02</b> (2006.01)	2561754 *	CYCLOPROPENE COMPOUND, AND METHOD FOR ADDING SAME TO CROPS
<b>A01N 55/00</b> (2006.01)	2561754 *	CYCLOPROPENE COMPOUND, AND METHOD FOR ADDING SAME TO CROPS
<b>A61K 8/41</b> (2006.01)	2566442 *	COMPOSITIONS COMPRISING EXTRACTS OF SOUTHERNWOOD AND AN AMINE COMPOUND
<b>C09C 1/02</b> (2006.01)	2565237	Process for preparing self-binding pigment particle suspensions
<b>D21H 17/00</b> (2006.01)	2565237	Process for preparing self-binding pigment particle suspensions
<b>C07D 471/04</b> (2006.01)	2576546 *	APOPTOSIS-INDUCING AGENTS FOR THE TREATMENT OF CANCER AND IMMUNE AND AUTOIMMUNE DISEASES
<b>A61K 31/437</b> (2006.01)	2576546 *	APOPTOSIS-INDUCING AGENTS FOR THE TREATMENT OF CANCER AND IMMUNE AND AUTOIMMUNE DISEASES
<b>A61K 35/00</b> (2006.01)	2576546 *	APOPTOSIS-INDUCING AGENTS FOR THE TREATMENT OF CANCER AND IMMUNE AND AUTOIMMUNE DISEASES
<b>C07K 16/30</b> (2006.01)	2556379 *	NEW DIAGNOSTIC AND THERAPEUTIC TARGET
<b>A61K 39/395</b> (2006.01)	2556379 *	NEW DIAGNOSTIC AND THERAPEUTIC TARGET
<b>A61P 35/00</b> (2006.01)	2556379 *	NEW DIAGNOSTIC AND THERAPEUTIC TARGET
<b>G01N 33/68</b> (2006.01)	2556379 *	NEW DIAGNOSTIC AND THERAPEUTIC TARGET
<b>G01N 33/574</b> (2006.01)	2556379 *	NEW DIAGNOSTIC AND THERAPEUTIC TARGET
<b>C08L 89/06</b> (2006.01)	2500371	Biocomposite fertiliser materials
<b>C08L 89/04</b> (2006.01)	2500371	Biocomposite fertiliser materials
<b>C08H 1/06</b> (2006.01)	2500371	Biocomposite fertiliser materials
<b>C12H 1/16</b> (2006.01)	2592135 *	METHOD FOR CONSERVING BOTTLED WINE IN AN OPEN BOTTLE AND DEVICE FOR IMPLEMENTING SAME
<b>A23L 3/10</b> (2006.01)	2592135 *	METHOD FOR CONSERVING BOTTLED WINE IN AN OPEN BOTTLE AND DEVICE FOR IMPLEMENTING SAME
<b>A61K 35/28</b> (2006.01)	2471543	Tolerance induction or immunosuppression to prevent in particular Graft-versus-Host-Disease (GvHD) by short-term pre-incubation of transplanted cell suspensions, tissues or organs coated with ligands to cell surface molecules
<b>C07K 16/28</b> (2006.01)	2471543	Tolerance induction or immunosuppression to prevent in particular Graft-versus-Host-Disease (GvHD) by short-term pre-incubation of transplanted cell suspensions, tissues or organs coated with ligands to cell surface molecules
<b>A61P 37/06</b> (2006.01)	2471543	Tolerance induction or immunosuppression to prevent in particular Graft-versus-Host-Disease (GvHD) by short-term pre-incubation of transplanted cell suspensions, tissues or organs coated with ligands to cell surface molecules
<b>C12N 5/00</b> (2006.01)	2471543	Tolerance induction or immunosuppression to prevent in particular Graft-versus-Host-Disease (GvHD) by short-term pre-incubation of transplanted cell suspensions, tissues or organs coated with ligands to cell surface molecules
<b>A61K 39/205</b> (2006.01)	2571521 *	PARAPOXVIRUS VECTORS CONTAINING RABIES VIRUS ANTIGEN
<b>C07K 14/145</b> (2006.01)	2571521 *	PARAPOXVIRUS VECTORS CONTAINING RABIES VIRUS ANTIGEN
<b>C12N 15/863</b> (2006.01)	2571521 *	PARAPOXVIRUS VECTORS CONTAINING RABIES VIRUS ANTIGEN
<b>B61L 29/30</b> (2006.01)	2576317 *	A SAFETY DEVICE FOR THE SURVEILLANCE ALONG A RAILWAY ROUTE OF THE CROSSING AREAS FOR PEDESTRIANS AND VEHICLES IN CORRESPONDENCE OF LEVEL CROSSINGS OR RISK ZONES
<b>B61L 23/04</b> (2006.01)	2576317 *	A SAFETY DEVICE FOR THE SURVEILLANCE ALONG A RAILWAY ROUTE OF THE CROSSING AREAS FOR PEDESTRIANS AND VEHICLES IN CORRESPONDENCE OF LEVEL CROSSINGS OR RISK ZONES



MKP (51)	Broj objave evropske prijava patenta (97)	Naziv pronalaska (54)
<b>A61K 31/155</b> (2006.01)	2548570	Pharmaceutical composition for treating a metabolic syndrome
<b>A61K 38/18</b> (2006.01)	2548570	Pharmaceutical composition for treating a metabolic syndrome
<b>A61P 3/10</b> (2006.01)	2548570	Pharmaceutical composition for treating a metabolic syndrome
<b>A61K 38/26</b> (2006.01)	2548570	Pharmaceutical composition for treating a metabolic syndrome
<b>A61K 31/4709</b> (2006.01)	2588469 *	HETEROCYCLIC COMPOUNDS AND THEIR USE AS INHIBITORS OF PI3K ACTIVITY
<b>A61P 29/00</b> (2006.01)	2588469 *	HETEROCYCLIC COMPOUNDS AND THEIR USE AS INHIBITORS OF PI3K ACTIVITY
<b>C07D 487/04</b> (2006.01)	2588469 *	HETEROCYCLIC COMPOUNDS AND THEIR USE AS INHIBITORS OF PI3K ACTIVITY
<b>A61P 35/00</b> (2006.01)	2588469 *	HETEROCYCLIC COMPOUNDS AND THEIR USE AS INHIBITORS OF PI3K ACTIVITY
<b>C07D 401/12</b> (2006.01)	2588469 *	HETEROCYCLIC COMPOUNDS AND THEIR USE AS INHIBITORS OF PI3K ACTIVITY
<b>G01N 33/567</b> (2006.01)	2527842	Neuropeptide release assay for sodium channels
<b>A61K 31/165</b> (2006.01)	2585435 *	6,7-DIHYDRO-5H-BENZO[7]ANNULENE DERIVATIVES, PROCESS FOR PREPARATION THEREOF, PHARMACEUTICAL PREPARATIONS COMPRISING THEM, AND THE USE THEREOF FOR PRODUCTION OF MEDICAMENTS
<b>A61K 31/216</b> (2006.01)	2585435 *	6,7-DIHYDRO-5H-BENZO[7]ANNULENE DERIVATIVES, PROCESS FOR PREPARATION THEREOF, PHARMACEUTICAL PREPARATIONS COMPRISING THEM, AND THE USE THEREOF FOR PRODUCTION OF MEDICAMENTS
<b>A61K 31/145</b> (2006.01)	2585435 *	6,7-DIHYDRO-5H-BENZO[7]ANNULENE DERIVATIVES, PROCESS FOR PREPARATION THEREOF, PHARMACEUTICAL PREPARATIONS COMPRISING THEM, AND THE USE THEREOF FOR PRODUCTION OF MEDICAMENTS
<b>C07C 323/25</b> (2006.01)	2585435 *	6,7-DIHYDRO-5H-BENZO[7]ANNULENE DERIVATIVES, PROCESS FOR PREPARATION THEREOF, PHARMACEUTICAL PREPARATIONS COMPRISING THEM, AND THE USE THEREOF FOR PRODUCTION OF MEDICAMENTS
<b>A61P 5/30</b> (2006.01)	2585435 *	6,7-DIHYDRO-5H-BENZO[7]ANNULENE DERIVATIVES, PROCESS FOR PREPARATION THEREOF, PHARMACEUTICAL PREPARATIONS COMPRISING THEM, AND THE USE THEREOF FOR PRODUCTION OF MEDICAMENTS
<b>A61K 31/18</b> (2006.01)	2585435 *	6,7-DIHYDRO-5H-BENZO[7]ANNULENE DERIVATIVES, PROCESS FOR PREPARATION THEREOF, PHARMACEUTICAL PREPARATIONS COMPRISING THEM, AND THE USE THEREOF FOR PRODUCTION OF MEDICAMENTS
<b>C07C 317/28</b> (2006.01)	2585435 *	6,7-DIHYDRO-5H-BENZO[7]ANNULENE DERIVATIVES, PROCESS FOR PREPARATION THEREOF, PHARMACEUTICAL PREPARATIONS COMPRISING THEM, AND THE USE THEREOF FOR PRODUCTION OF MEDICAMENTS
<b>A61K 31/277</b> (2006.01)	2585435 *	6,7-DIHYDRO-5H-BENZO[7]ANNULENE DERIVATIVES, PROCESS FOR PREPARATION THEREOF, PHARMACEUTICAL PREPARATIONS COMPRISING THEM, AND THE USE THEREOF FOR PRODUCTION OF MEDICAMENTS
<b>A61K 31/513</b> (2006.01)	2593098 *	METHODS AND COMPOSITIONS FOR CANCER IMMUNOTHERAPY
<b>A61P 35/00</b> (2006.01)	2593098 *	METHODS AND COMPOSITIONS FOR CANCER IMMUNOTHERAPY
<b>A61K 31/56</b> (2006.01)	2593098 *	METHODS AND COMPOSITIONS FOR CANCER IMMUNOTHERAPY
<b>A61K 31/505</b> (2006.01)	2593098 *	METHODS AND COMPOSITIONS FOR CANCER IMMUNOTHERAPY
<b>A61P 29/00</b> (2006.01)	2593098 *	METHODS AND COMPOSITIONS FOR CANCER IMMUNOTHERAPY
<b>A61K 31/7042</b> (2006.01)	2593098 *	METHODS AND COMPOSITIONS FOR CANCER IMMUNOTHERAPY
<b>A61K 31/337</b> (2006.01)	2593098 *	METHODS AND COMPOSITIONS FOR CANCER IMMUNOTHERAPY
<b>A61P 25/28</b> (2006.01)	2580200 *	5,6-DIHYDRO-2H-[1,4]OXAZIN-3-YL-AMINE DERIVATIVES USEFUL AS INHIBITORS OF BETA-SECRETASE (BACE)
<b>C07D 265/30</b> (2006.01)	2580200 *	5,6-DIHYDRO-2H-[1,4]OXAZIN-3-YL-AMINE DERIVATIVES USEFUL AS INHIBITORS OF BETA-SECRETASE (BACE)

MKP (51)	Broj objave evropske prijava patenta (97)	Naziv pronalaska (54)
<b>C07D 413/04</b> (2006.01)	2580200 *	5,6-DIHYDRO-2H-[1,4]OXAZIN-3-YL-AMINE DERIVATIVES USEFUL AS INHIBITORS OF BETA-SECRETASE (BACE)
<b>A61P 25/16</b> (2006.01)	2580200 *	5,6-DIHYDRO-2H-[1,4]OXAZIN-3-YL-AMINE DERIVATIVES USEFUL AS INHIBITORS OF BETA-SECRETASE (BACE)
<b>A61K 31/535</b> (2006.01)	2580200 *	5,6-DIHYDRO-2H-[1,4]OXAZIN-3-YL-AMINE DERIVATIVES USEFUL AS INHIBITORS OF BETA-SECRETASE (BACE)
<b>A61K 31/5355</b> (2006.01)	2580200 *	5,6-DIHYDRO-2H-[1,4]OXAZIN-3-YL-AMINE DERIVATIVES USEFUL AS INHIBITORS OF BETA-SECRETASE (BACE)
<b>A61K 31/00</b> (2006.01)	2552404 *	PARENTERAL PHARMACEUTICAL FORM WHICH RELEASES AROMATSE INHIBITOR AND GESTAGENS, FOR THE TREATMENT OF ENDOMETRIOSIS
<b>A61P 15/18</b> (2006.01)	2552404 *	PARENTERAL PHARMACEUTICAL FORM WHICH RELEASES AROMATSE INHIBITOR AND GESTAGENS, FOR THE TREATMENT OF ENDOMETRIOSIS
<b>A61K 45/06</b> (2006.01)	2552404 *	PARENTERAL PHARMACEUTICAL FORM WHICH RELEASES AROMATSE INHIBITOR AND GESTAGENS, FOR THE TREATMENT OF ENDOMETRIOSIS
<b>A61K 31/4196</b> (2006.01)	2552404 *	PARENTERAL PHARMACEUTICAL FORM WHICH RELEASES AROMATSE INHIBITOR AND GESTAGENS, FOR THE TREATMENT OF ENDOMETRIOSIS
<b>A61K 9/00</b> (2006.01)	2552404 *	PARENTERAL PHARMACEUTICAL FORM WHICH RELEASES AROMATSE INHIBITOR AND GESTAGENS, FOR THE TREATMENT OF ENDOMETRIOSIS
<b>A61K 31/569</b> (2006.01)	2552404 *	PARENTERAL PHARMACEUTICAL FORM WHICH RELEASES AROMATSE INHIBITOR AND GESTAGENS, FOR THE TREATMENT OF ENDOMETRIOSIS
<b>A61P 15/00</b> (2006.01)	2552404 *	PARENTERAL PHARMACEUTICAL FORM WHICH RELEASES AROMATSE INHIBITOR AND GESTAGENS, FOR THE TREATMENT OF ENDOMETRIOSIS
<b>A61K 36/88</b> (2006.01)	2462941	Method and instalation for extraction of plant raw material
<b>E06B 3/00</b> (2006.01)	2539527 *	BONDED-IN, ANTI-VANDALISM TRANSIT VEHICLE WINDOW SYSTEM
<b>A61K 47/26</b> (2006.01)	2561892 *	EASILY DOSABLE SOLID PREPARATION
<b>A61K 47/36</b> (2006.01)	2561892 *	EASILY DOSABLE SOLID PREPARATION
<b>A61K 47/10</b> (2006.01)	2561892 *	EASILY DOSABLE SOLID PREPARATION
<b>A61K 47/38</b> (2006.01)	2561892 *	EASILY DOSABLE SOLID PREPARATION
<b>A61K 47/02</b> (2006.01)	2561892 *	EASILY DOSABLE SOLID PREPARATION
<b>A61K 47/32</b> (2006.01)	2561892 *	EASILY DOSABLE SOLID PREPARATION
<b>A61K 9/30</b> (2006.01)	2561892 *	EASILY DOSABLE SOLID PREPARATION
<b>C07D 487/04</b> (2006.01)	2542554 *	PROCESSES FOR THE PREPARATION OF S1P1 RECEPTOR MODULATORS AND CRYSTALLINE FORMS THEREOF
<b>A61P 37/00</b> (2006.01)	2542554 *	PROCESSES FOR THE PREPARATION OF S1P1 RECEPTOR MODULATORS AND CRYSTALLINE FORMS THEREOF
<b>A61P 31/12</b> (2006.01)	2542554 *	PROCESSES FOR THE PREPARATION OF S1P1 RECEPTOR MODULATORS AND CRYSTALLINE FORMS THEREOF
<b>A61K 31/407</b> (2006.01)	2542554 *	PROCESSES FOR THE PREPARATION OF S1P1 RECEPTOR MODULATORS AND CRYSTALLINE FORMS THEREOF
<b>F25D 3/00</b> (2006.01)	2561290 *	HEAT EXCHANGE UNIT FOR SELF-COOLING CONTAINERS
<b>B65B 35/40</b> (2006.01)	2457834	Device for positioning of portion packets
<b>B65B 5/06</b> (2006.01)	2457834	Device for positioning of portion packets
<b>B65B 35/28</b> (2006.01)	2457834	Device for positioning of portion packets
<b>B65B 29/02</b> (2006.01)	2457834	Device for positioning of portion packets
<b>A61K 39/395</b> (2006.01)	2542257 *	OPTIMIZED MONOCLONAL ANTIBODIES AGAINST TISSUE FACTOR PATHWAY INHIBITOR (TFPI)
<b>A61K 39/00</b> (2006.01)	2542257 *	OPTIMIZED MONOCLONAL ANTIBODIES AGAINST TISSUE FACTOR PATHWAY INHIBITOR (TFPI)
<b>C07D 307/32</b> (2006.01)	2539330 *	DIHYDROFURAN DERIVATIVES AS INSECTICIDAL COMPOUNDS
<b>A01N 43/08</b> (2006.01)	2539330 *	DIHYDROFURAN DERIVATIVES AS INSECTICIDAL COMPOUNDS
<b>C07D 405/10</b> (2006.01)	2539330 *	DIHYDROFURAN DERIVATIVES AS INSECTICIDAL COMPOUNDS
<b>C07D 307/20</b> (2006.01)	2539330 *	DIHYDROFURAN DERIVATIVES AS INSECTICIDAL COMPOUNDS
<b>C07D 409/12</b> (2006.01)	2539330 *	DIHYDROFURAN DERIVATIVES AS INSECTICIDAL COMPOUNDS
<b>C07D 307/30</b> (2006.01)	2539330 *	DIHYDROFURAN DERIVATIVES AS INSECTICIDAL COMPOUNDS

MKP (51)	Broj objave evropske prijava patenta (97)	Naziv pronalaska (54)
<b>C07D 413/12</b> (2006.01)	2539330 *	DIHYDROFURAN DERIVATIVES AS INSECTICIDAL COMPOUNDS
<b>C07D 405/04</b> (2006.01)	2539330 *	DIHYDROFURAN DERIVATIVES AS INSECTICIDAL COMPOUNDS
<b>C07D 407/12</b> (2006.01)	2539330 *	DIHYDROFURAN DERIVATIVES AS INSECTICIDAL COMPOUNDS
<b>C07D 307/28</b> (2006.01)	2539330 *	DIHYDROFURAN DERIVATIVES AS INSECTICIDAL COMPOUNDS
<b>C07D 409/14</b> (2006.01)	2539330 *	DIHYDROFURAN DERIVATIVES AS INSECTICIDAL COMPOUNDS
<b>C07D 307/58</b> (2006.01)	2539330 *	DIHYDROFURAN DERIVATIVES AS INSECTICIDAL COMPOUNDS
<b>C07D 471/04</b> (2006.01)	2540720 *	1,3,4,8-TETRAHYDRO-2H-PYRIDO[1,2-A]PYRAZINE DERIVATIVE AND USE OF SAME AS HIV INTEGRASE INHIBITOR
<b>A61P 43/00</b> (2006.01)	2540720 *	1,3,4,8-TETRAHYDRO-2H-PYRIDO[1,2-A]PYRAZINE DERIVATIVE AND USE OF SAME AS HIV INTEGRASE INHIBITOR
<b>A61K 31/4985</b> (2006.01)	2540720 *	1,3,4,8-TETRAHYDRO-2H-PYRIDO[1,2-A]PYRAZINE DERIVATIVE AND USE OF SAME AS HIV INTEGRASE INHIBITOR
<b>A61P 31/18</b> (2006.01)	2540720 *	1,3,4,8-TETRAHYDRO-2H-PYRIDO[1,2-A]PYRAZINE DERIVATIVE AND USE OF SAME AS HIV INTEGRASE INHIBITOR
<b>A61K 31/5377</b> (2006.01)	2540720 *	1,3,4,8-TETRAHYDRO-2H-PYRIDO[1,2-A]PYRAZINE DERIVATIVE AND USE OF SAME AS HIV INTEGRASE INHIBITOR
<b>A61P 25/22</b> (2006.01)	2580189 *	AGOMELATINE INTERMEDIATES AND PREPARATION METHOD THEREOF
<b>C07C 231/06</b> (2006.01)	2580189 *	AGOMELATINE INTERMEDIATES AND PREPARATION METHOD THEREOF
<b>C07C 231/12</b> (2006.01)	2580189 *	AGOMELATINE INTERMEDIATES AND PREPARATION METHOD THEREOF
<b>C07C 233/18</b> (2006.01)	2580189 *	AGOMELATINE INTERMEDIATES AND PREPARATION METHOD THEREOF
<b>A61P 25/24</b> (2006.01)	2580189 *	AGOMELATINE INTERMEDIATES AND PREPARATION METHOD THEREOF
<b>A61P 25/20</b> (2006.01)	2580189 *	AGOMELATINE INTERMEDIATES AND PREPARATION METHOD THEREOF
<b>A61P 25/06</b> (2006.01)	2580189 *	AGOMELATINE INTERMEDIATES AND PREPARATION METHOD THEREOF
<b>A61K 31/165</b> (2006.01)	2580189 *	AGOMELATINE INTERMEDIATES AND PREPARATION METHOD THEREOF
<b>A61K 9/00</b> (2006.01)	2552424 *	PROCESS FOR PREPARING CARRIER PARTICLES FOR DRY POWDERS FOR INHALATION
<b>A61K 9/50</b> (2006.01)	2552424 *	PROCESS FOR PREPARING CARRIER PARTICLES FOR DRY POWDERS FOR INHALATION
<b>G01F 1/58</b> (2006.01)	2564169 *	MEASURING DEVICE AND METHOD FOR MEASURING THE FLOW RATE OF A MEDIUM FLOWING THROUGH A MEASURING TUBE
<b>G01F 1/60</b> (2006.01)	2564169 *	MEASURING DEVICE AND METHOD FOR MEASURING THE FLOW RATE OF A MEDIUM FLOWING THROUGH A MEASURING TUBE
<b>F02B 25/04</b> (2006.01)	2557294	Combustion Engine
<b>F02B 47/02</b> (2006.01)	2557294	Combustion Engine
<b>F02B 75/04</b> (2006.01)	2557294	Combustion Engine
<b>F02B 33/22</b> (2006.01)	2557294	Combustion Engine
<b>F02B 41/04</b> (2006.01)	2557294	Combustion Engine
<b>C09C 1/02</b> (2006.01)	2576704 *	PROCESS FOR MANUFACTURING HIGH SOLIDS SUSPENSIONS OF MINERAL MATERIALS
<b>D21H 19/00</b> (2006.01)	2576704 *	PROCESS FOR MANUFACTURING HIGH SOLIDS SUSPENSIONS OF MINERAL MATERIALS
<b>C09C 3/04</b> (2006.01)	2576704 *	PROCESS FOR MANUFACTURING HIGH SOLIDS SUSPENSIONS OF MINERAL MATERIALS
<b>D21H 17/00</b> (2006.01)	2576704 *	PROCESS FOR MANUFACTURING HIGH SOLIDS SUSPENSIONS OF MINERAL MATERIALS
<b>C09C 1/42</b> (2006.01)	2576704 *	PROCESS FOR MANUFACTURING HIGH SOLIDS SUSPENSIONS OF MINERAL MATERIALS
<b>C07D 209/16</b> (2006.01)	2582666 *	ARYL SUBSTITUTED INDOLES AND THEIR USE AS BLOCKERS OF SODIUM CHANNELS
<b>C07D 231/56</b> (2006.01)	2582666 *	ARYL SUBSTITUTED INDOLES AND THEIR USE AS BLOCKERS OF SODIUM CHANNELS
<b>C07D 209/12</b> (2006.01)	2582666 *	ARYL SUBSTITUTED INDOLES AND THEIR USE AS BLOCKERS OF SODIUM CHANNELS

MKP (51)	Broj objave evropske prijava patenta (97)	Naziv pronalaska (54)
<b>C07D 471/04</b> (2006.01)	2582666 *	ARYL SUBSTITUTED INDOLES AND THEIR USE AS BLOCKERS OF SODIUM CHANNELS
<b>A61K 31/404</b> (2006.01)	2582666 *	ARYL SUBSTITUTED INDOLES AND THEIR USE AS BLOCKERS OF SODIUM CHANNELS
<b>A61K 31/416</b> (2006.01)	2582666 *	ARYL SUBSTITUTED INDOLES AND THEIR USE AS BLOCKERS OF SODIUM CHANNELS
<b>A61P 25/00</b> (2006.01)	2582666 *	ARYL SUBSTITUTED INDOLES AND THEIR USE AS BLOCKERS OF SODIUM CHANNELS
<b>B60R 7/00</b> (2006.01)	2527201	Method for making a strong fixture of a textile sheet
<b>F24J 2/54</b> (2006.01)	2577185 *	MOUNTING RACK FOR A PHOTOVOLTAIC MODULE AND TRACKING DEVICE FOR A PHOTOVOLTAIC INSTALLATION
<b>G08B 25/01</b> (2006.01)	2552542 *	DEVICE FOR ACCESS TO AN ITEM OF ASSISTANCE AND EMERGENCY HARDWARE, AND A SYSTEM IMPLEMENTING SUCH DEVICES.
<b>G08B 25/08</b> (2006.01)	2552542 *	DEVICE FOR ACCESS TO AN ITEM OF ASSISTANCE AND EMERGENCY HARDWARE, AND A SYSTEM IMPLEMENTING SUCH DEVICES.
<b>A62C 37/50</b> (2006.01)	2552542 *	DEVICE FOR ACCESS TO AN ITEM OF ASSISTANCE AND EMERGENCY HARDWARE, AND A SYSTEM IMPLEMENTING SUCH DEVICES.
<b>A61F 17/00</b> (2006.01)	2552542 *	DEVICE FOR ACCESS TO AN ITEM OF ASSISTANCE AND EMERGENCY HARDWARE, AND A SYSTEM IMPLEMENTING SUCH DEVICES.
<b>G06F 19/00</b> (2011.01)	2552542 *	DEVICE FOR ACCESS TO AN ITEM OF ASSISTANCE AND EMERGENCY HARDWARE, AND A SYSTEM IMPLEMENTING SUCH DEVICES.
<b>A61B 19/02</b> (2006.01)	2552542 *	DEVICE FOR ACCESS TO AN ITEM OF ASSISTANCE AND EMERGENCY HARDWARE, AND A SYSTEM IMPLEMENTING SUCH DEVICES.
<b>G08B 21/02</b> (2006.01)	2552542 *	DEVICE FOR ACCESS TO AN ITEM OF ASSISTANCE AND EMERGENCY HARDWARE, AND A SYSTEM IMPLEMENTING SUCH DEVICES.
<b>A61N 1/39</b> (2006.01)	2552542 *	DEVICE FOR ACCESS TO AN ITEM OF ASSISTANCE AND EMERGENCY HARDWARE, AND A SYSTEM IMPLEMENTING SUCH DEVICES.
<b>C07C 237/14</b> (2006.01)	2582660 *	NEW CATHEPSIN S PROTEASE INHIBITORS, USEFUL IN THE TREATMENT OF E.G. AUTOIMMUNE DISORDERS, ALLERGY AND CHRONIC PAIN CONDITIONS
<b>A61K 31/16</b> (2006.01)	2582660 *	NEW CATHEPSIN S PROTEASE INHIBITORS, USEFUL IN THE TREATMENT OF E.G. AUTOIMMUNE DISORDERS, ALLERGY AND CHRONIC PAIN CONDITIONS
<b>A61P 11/00</b> (2006.01)	2582660 *	NEW CATHEPSIN S PROTEASE INHIBITORS, USEFUL IN THE TREATMENT OF E.G. AUTOIMMUNE DISORDERS, ALLERGY AND CHRONIC PAIN CONDITIONS
<b>A61P 37/00</b> (2006.01)	2582660 *	NEW CATHEPSIN S PROTEASE INHIBITORS, USEFUL IN THE TREATMENT OF E.G. AUTOIMMUNE DISORDERS, ALLERGY AND CHRONIC PAIN CONDITIONS
<b>C07D 233/58</b> (2006.01)	2582660 *	NEW CATHEPSIN S PROTEASE INHIBITORS, USEFUL IN THE TREATMENT OF E.G. AUTOIMMUNE DISORDERS, ALLERGY AND CHRONIC PAIN CONDITIONS
<b>A61K 9/50</b> (2006.01)	2491930	Pharmaceutical combination of betahistine and trimetazidine
<b>A61K 9/14</b> (2006.01)	2491930	Pharmaceutical combination of betahistine and trimetazidine
<b>A61K 31/4402</b> (2006.01)	2491930	Pharmaceutical combination of betahistine and trimetazidine
<b>A61K 31/495</b> (2006.01)	2491930	Pharmaceutical combination of betahistine and trimetazidine
<b>A61K 9/20</b> (2006.01)	2491930	Pharmaceutical combination of betahistine and trimetazidine
<b>A61P 27/16</b> (2006.01)	2491930	Pharmaceutical combination of betahistine and trimetazidine
<b>A61K 9/48</b> (2006.01)	2491930	Pharmaceutical combination of betahistine and trimetazidine
<b>A61K 9/00</b> (2006.01)	2491930	Pharmaceutical combination of betahistine and trimetazidine
<b>G01N 33/543</b> (2006.01)	2571617 *	REACTION VESSEL FOR PCR DEVICE AND METHOD OF PERFORMING PCR
<b>B01L 3/00</b> (2006.01)	2571617 *	REACTION VESSEL FOR PCR DEVICE AND METHOD OF PERFORMING PCR
<b>B01L 7/00</b> (2006.01)	2571617 *	REACTION VESSEL FOR PCR DEVICE AND METHOD OF PERFORMING PCR

MKP (51)	Broj objave evropske prijava patenta (97)	Naziv pronalaska (54)
<b>C12Q 1/68</b> (2006.01)	2571617 *	REACTION VESSEL FOR PCR DEVICE AND METHOD OF PERFORMING PCR
<b>B29C 51/44</b> (2006.01)	2586589	Thermoforming press and thermoforming process using said press
<b>B29C 51/22</b> (2006.01)	2586589	Thermoforming press and thermoforming process using said press
<b>A61L 2/20</b> (2006.01)	2590687 *	USE OF A STERILIZATION AGENT FOR ENHANCING HEMOCOMPATIBILITY
<b>B63B 35/04</b> (2006.01)	2591992	A storage and deployment unit for a coilable element and a method of handling a coilable element
<b>B65H 75/36</b> (2006.01)	2591992	A storage and deployment unit for a coilable element and a method of handling a coilable element
<b>C08G 64/06</b> (2006.01)	2592102 *	BRANCHED POLYCARBONATE
<b>B29C 49/00</b> (2006.01)	2592102 *	BRANCHED POLYCARBONATE
<b>B65D 1/00</b> (2006.01)	2592102 *	BRANCHED POLYCARBONATE
<b>F25D 3/10</b> (2006.01)	2558013 *	HAND-OPERATED COOLING DEVICE FOR CRYOTHERAPY
<b>A61B 18/02</b> (2006.01)	2558013 *	HAND-OPERATED COOLING DEVICE FOR CRYOTHERAPY
<b>A61M 19/00</b> (2006.01)	2558013 *	HAND-OPERATED COOLING DEVICE FOR CRYOTHERAPY
<b>A61K 31/4706</b> (2006.01)	2588477 *	QUINOLINES AS PI3K INHIBITORS
<b>A61P 31/18</b> (2006.01)	2588477 *	QUINOLINES AS PI3K INHIBITORS
<b>C07D 417/14</b> (2006.01)	2588477 *	QUINOLINES AS PI3K INHIBITORS
<b>B65D 75/58</b> (2006.01)	2563682 *	WAFER POCKET
<b>A61K 51/00</b> (2006.01)	2538982 *	PET MONITORING OF AB-DIRECTED IMMUNOTHERAPY
<b>A61M 5/315</b> (2006.01)	2579922 *	DRIVE MECHANISM FOR A DRUG DELIVERY DEVICE AND DRUG DELIVERY DEVICE
<b>A61M 5/24</b> (2006.01)	2579922 *	DRIVE MECHANISM FOR A DRUG DELIVERY DEVICE AND DRUG DELIVERY DEVICE
<b>H01L 31/058</b> (2006.01)	2463921	Photovoltaic and thermal panel
<b>F24F 7/08</b> (2006.01)	2527753	Device and method for regulating a fresh air supply for a device for cooling, heating and/or ventilating a building
<b>F24F 11/00</b> (2006.01)	2527753	Device and method for regulating a fresh air supply for a device for cooling, heating and/or ventilating a building
<b>H04N 7/15</b> (2006.01)	2569940 *	SYSTEMS AND METHODS FOR NOVEL INTERACTIONS WITH PARTICIPANTS IN VIDEOCONFERENCE MEETINGS
<b>H04N 7/14</b> (2006.01)	2569940 *	SYSTEMS AND METHODS FOR NOVEL INTERACTIONS WITH PARTICIPANTS IN VIDEOCONFERENCE MEETINGS
<b>H04N 7/00</b> (2011.01)	2569940 *	SYSTEMS AND METHODS FOR NOVEL INTERACTIONS WITH PARTICIPANTS IN VIDEOCONFERENCE MEETINGS
<b>A47L 9/24</b> (2006.01)	2484260	Sealing gasket for a telescopic extension, in particular for a household appliance
<b>A61P 31/16</b> (2006.01)	2575969 *	ANTIVIRAL ACTIVITY OF NOVEL BICYCLIC HETEROCYCLES
<b>A61P 31/18</b> (2006.01)	2575969 *	ANTIVIRAL ACTIVITY OF NOVEL BICYCLIC HETEROCYCLES
<b>A61K 31/519</b> (2006.01)	2575969 *	ANTIVIRAL ACTIVITY OF NOVEL BICYCLIC HETEROCYCLES
<b>A61K 31/52</b> (2006.01)	2575969 *	ANTIVIRAL ACTIVITY OF NOVEL BICYCLIC HETEROCYCLES
<b>A61P 31/14</b> (2006.01)	2575969 *	ANTIVIRAL ACTIVITY OF NOVEL BICYCLIC HETEROCYCLES
<b>A61P 31/12</b> (2006.01)	2575969 *	ANTIVIRAL ACTIVITY OF NOVEL BICYCLIC HETEROCYCLES
<b>A61K 31/551</b> (2006.01)	2575969 *	ANTIVIRAL ACTIVITY OF NOVEL BICYCLIC HETEROCYCLES
<b>A61P 35/00</b> (2006.01)	2563383 *	INNOVATIVE DISCOVERY OF THERAPEUTIC, DIAGNOSTIC, AND ANTIBODY COMPOSITIONS RELATED TO PROTEIN FRAGMENTS OF VALYL TRNA SYNTHETASES
<b>A61P 29/00</b> (2006.01)	2563383 *	INNOVATIVE DISCOVERY OF THERAPEUTIC, DIAGNOSTIC, AND ANTIBODY COMPOSITIONS RELATED TO PROTEIN FRAGMENTS OF VALYL TRNA SYNTHETASES
<b>A61P 3/10</b> (2006.01)	2563383 *	INNOVATIVE DISCOVERY OF THERAPEUTIC, DIAGNOSTIC, AND ANTIBODY COMPOSITIONS RELATED TO PROTEIN FRAGMENTS OF VALYL TRNA SYNTHETASES

MKP (51)	Broj objave evropske prijava patenta (97)	Naziv pronalaska (54)
<b>A61K 38/16</b> (2006.01)	2563383 *	INNOVATIVE DISCOVERY OF THERAPEUTIC, DIAGNOSTIC, AND ANTIBODY COMPOSITIONS RELATED TO PROTEIN FRAGMENTS OF VALYL TRNA SYNTHETASES
<b>A61K 39/395</b> (2006.01)	2563383 *	INNOVATIVE DISCOVERY OF THERAPEUTIC, DIAGNOSTIC, AND ANTIBODY COMPOSITIONS RELATED TO PROTEIN FRAGMENTS OF VALYL TRNA SYNTHETASES
<b>A61K 48/00</b> (2006.01)	2563383 *	INNOVATIVE DISCOVERY OF THERAPEUTIC, DIAGNOSTIC, AND ANTIBODY COMPOSITIONS RELATED TO PROTEIN FRAGMENTS OF VALYL TRNA SYNTHETASES
<b>A61K 38/17</b> (2006.01)	2563383 *	INNOVATIVE DISCOVERY OF THERAPEUTIC, DIAGNOSTIC, AND ANTIBODY COMPOSITIONS RELATED TO PROTEIN FRAGMENTS OF VALYL TRNA SYNTHETASES
<b>C05C 9/02</b> (2006.01)	2563745 *	REACTION PRODUCTS AND METHODS FOR MAKING AND USING THE SAME
<b>C05C 9/00</b> (2006.01)	2563745 *	REACTION PRODUCTS AND METHODS FOR MAKING AND USING THE SAME
<b>E01F 15/02</b> (2006.01)	2567030 *	GUARD RAIL
<b>E01F 15/04</b> (2006.01)	2567030 *	GUARD RAIL
<b>H04L 29/06</b> (2006.01)	2583431 *	SYSTEM AND PROCEDURE FOR COMMERCIAL COMMUNICATIONS
<b>H04M 3/51</b> (2006.01)	2583431 *	SYSTEM AND PROCEDURE FOR COMMERCIAL COMMUNICATIONS
<b>C07D 495/04</b> (2006.01)	2594570 *	CRYSTAL OF THIENOPYRIMIDINE DERIVATIVE
<b>A61K 31/519</b> (2006.01)	2594570 *	CRYSTAL OF THIENOPYRIMIDINE DERIVATIVE
<b>A61P 3/10</b> (2006.01)	2594570 *	CRYSTAL OF THIENOPYRIMIDINE DERIVATIVE
<b>A61P 13/08</b> (2006.01)	2594570 *	CRYSTAL OF THIENOPYRIMIDINE DERIVATIVE
<b>A61P 13/10</b> (2006.01)	2594570 *	CRYSTAL OF THIENOPYRIMIDINE DERIVATIVE
<b>A61P 7/02</b> (2006.01)	2594570 *	CRYSTAL OF THIENOPYRIMIDINE DERIVATIVE
<b>A61P 15/10</b> (2006.01)	2594570 *	CRYSTAL OF THIENOPYRIMIDINE DERIVATIVE
<b>A61P 9/10</b> (2006.01)	2594570 *	CRYSTAL OF THIENOPYRIMIDINE DERIVATIVE
<b>A61P 25/00</b> (2006.01)	2594570 *	CRYSTAL OF THIENOPYRIMIDINE DERIVATIVE
<b>A61P 9/12</b> (2006.01)	2594570 *	CRYSTAL OF THIENOPYRIMIDINE DERIVATIVE
<b>A61P 25/28</b> (2006.01)	2594570 *	CRYSTAL OF THIENOPYRIMIDINE DERIVATIVE
<b>A61P 11/00</b> (2006.01)	2594570 *	CRYSTAL OF THIENOPYRIMIDINE DERIVATIVE
<b>A61P 13/02</b> (2006.01)	2594570 *	CRYSTAL OF THIENOPYRIMIDINE DERIVATIVE
<b>A61P 13/04</b> (2006.01)	2594570 *	CRYSTAL OF THIENOPYRIMIDINE DERIVATIVE
<b>A01N 43/78</b> (2006.01)	2575467 *	MACROCYCLIC COMPOUNDS USEFUL AS INHIBITORS OF HISTONE DEACETYLASES
<b>A61K 31/425</b> (2006.01)	2575467 *	MACROCYCLIC COMPOUNDS USEFUL AS INHIBITORS OF HISTONE DEACETYLASES
<b>C12N 15/52</b> (2006.01)	2563912 *	INNOVATIVE DISCOVERY OF THERAPEUTIC, DIAGNOSTIC, AND ANTIBODY COMPOSITIONS RELATED TO PROTEIN FRAGMENTS OF ASPARAGINYL TRNA SYNTHETASES
<b>A61K 38/43</b> (2006.01)	2563912 *	INNOVATIVE DISCOVERY OF THERAPEUTIC, DIAGNOSTIC, AND ANTIBODY COMPOSITIONS RELATED TO PROTEIN FRAGMENTS OF ASPARAGINYL TRNA SYNTHETASES
<b>C12N 9/00</b> (2006.01)	2563912 *	INNOVATIVE DISCOVERY OF THERAPEUTIC, DIAGNOSTIC, AND ANTIBODY COMPOSITIONS RELATED TO PROTEIN FRAGMENTS OF ASPARAGINYL TRNA SYNTHETASES
<b>C07K 19/00</b> (2006.01)	2563912 *	INNOVATIVE DISCOVERY OF THERAPEUTIC, DIAGNOSTIC, AND ANTIBODY COMPOSITIONS RELATED TO PROTEIN FRAGMENTS OF ASPARAGINYL TRNA SYNTHETASES
<b>C12N 15/113</b> (2010.01)	2563912 *	INNOVATIVE DISCOVERY OF THERAPEUTIC, DIAGNOSTIC, AND ANTIBODY COMPOSITIONS RELATED TO PROTEIN FRAGMENTS OF ASPARAGINYL TRNA SYNTHETASES
<b>C07K 16/40</b> (2006.01)	2563912 *	INNOVATIVE DISCOVERY OF THERAPEUTIC, DIAGNOSTIC, AND ANTIBODY COMPOSITIONS RELATED TO PROTEIN FRAGMENTS OF ASPARAGINYL TRNA SYNTHETASES

MKP (51)	Broj objave evropske prijava patenta (97)	Naziv pronalaska (54)
<b>G01N 33/68</b> (2006.01)	2563912 *	INNOVATIVE DISCOVERY OF THERAPEUTIC, DIAGNOSTIC, AND ANTIBODY COMPOSITIONS RELATED TO PROTEIN FRAGMENTS OF ASPARAGINYL TRNA SYNTHETASES
<b>C12N 15/00</b> (2006.01)	2591101 *	SYSTEMS FOR FACTOR VIII PROCESSING AND METHODS THEREOF
<b>C12P 21/04</b> (2006.01)	2591101 *	SYSTEMS FOR FACTOR VIII PROCESSING AND METHODS THEREOF
<b>H02G 3/08</b> (2006.01)	2593996 *	CONNECTING DEVICE FOR ELECTRICAL JUNCTION BOXES.
<b>B29C 45/14</b> (2006.01)	2582536 *	GLASS PANEL INCLUDING AN INSERT HAVING A PRESSURE ELEMENT, METHOD FOR MANUFACTURING THE GLASS PANEL, AND INSERT FOR THE GLASS PANEL
<b>B60J 1/00</b> (2006.01)	2582536 *	GLASS PANEL INCLUDING AN INSERT HAVING A PRESSURE ELEMENT, METHOD FOR MANUFACTURING THE GLASS PANEL, AND INSERT FOR THE GLASS PANEL
<b>B60J 10/02</b> (2006.01)	2582536 *	GLASS PANEL INCLUDING AN INSERT HAVING A PRESSURE ELEMENT, METHOD FOR MANUFACTURING THE GLASS PANEL, AND INSERT FOR THE GLASS PANEL
<b>A61P 37/08</b> (2006.01)	2569294 *	SUBSTITUTED N-HETEROARYL BIPYRROLIDINE CARBOXAMIDES, PREPARATION AND THERAPEUTIC USE THEREOF
<b>A61K 31/4427</b> (2006.01)	2569294 *	SUBSTITUTED N-HETEROARYL BIPYRROLIDINE CARBOXAMIDES, PREPARATION AND THERAPEUTIC USE THEREOF
<b>C07D 403/14</b> (2006.01)	2569294 *	SUBSTITUTED N-HETEROARYL BIPYRROLIDINE CARBOXAMIDES, PREPARATION AND THERAPEUTIC USE THEREOF
<b>C07D 401/04</b> (2006.01)	2569294 *	SUBSTITUTED N-HETEROARYL BIPYRROLIDINE CARBOXAMIDES, PREPARATION AND THERAPEUTIC USE THEREOF
<b>B62K 21/26</b> (2006.01)	2560862 *	STEERING MEANS FOR VEHICLES, PARTICULARLY SUITABLE FOR USE BY DISABLED PERSONS
<b>B62K 3/16</b> (2006.01)	2560862 *	STEERING MEANS FOR VEHICLES, PARTICULARLY SUITABLE FOR USE BY DISABLED PERSONS
<b>B62K 11/14</b> (2006.01)	2560862 *	STEERING MEANS FOR VEHICLES, PARTICULARLY SUITABLE FOR USE BY DISABLED PERSONS
<b>B62K 23/04</b> (2006.01)	2560862 *	STEERING MEANS FOR VEHICLES, PARTICULARLY SUITABLE FOR USE BY DISABLED PERSONS
<b>A61K 49/00</b> (2006.01)	2588078 *	POLYMERIC SYSTEM FOR DELIVERING A PRESERVATIVE-FREE PROSTAGLANDIN-BASED NONVISCIOUS SOLUTION
<b>A61K 47/14</b> (2006.01)	2588078 *	POLYMERIC SYSTEM FOR DELIVERING A PRESERVATIVE-FREE PROSTAGLANDIN-BASED NONVISCIOUS SOLUTION
<b>A61K 31/557</b> (2006.01)	2588078 *	POLYMERIC SYSTEM FOR DELIVERING A PRESERVATIVE-FREE PROSTAGLANDIN-BASED NONVISCIOUS SOLUTION
<b>A61K 9/00</b> (2006.01)	2588078 *	POLYMERIC SYSTEM FOR DELIVERING A PRESERVATIVE-FREE PROSTAGLANDIN-BASED NONVISCIOUS SOLUTION
<b>A61K 31/404</b> (2006.01)	2538942 *	TREATMENT OF DERMATOLOGICAL ALLERGIC CONDITIONS
<b>A61P 17/00</b> (2006.01)	2538942 *	TREATMENT OF DERMATOLOGICAL ALLERGIC CONDITIONS
<b>C12N 15/13</b> (2006.01)	2552959 *	ANTIBODIES TO MUC16 AND METHODS OF USE THEREOF
<b>C12N 5/18</b> (2006.01)	2552959 *	ANTIBODIES TO MUC16 AND METHODS OF USE THEREOF
<b>A61P 35/00</b> (2006.01)	2552959 *	ANTIBODIES TO MUC16 AND METHODS OF USE THEREOF
<b>A61K 39/395</b> (2006.01)	2552959 *	ANTIBODIES TO MUC16 AND METHODS OF USE THEREOF
<b>C07K 16/18</b> (2006.01)	2552959 *	ANTIBODIES TO MUC16 AND METHODS OF USE THEREOF
<b>A01J 9/04</b> (2006.01)	2538771 *	AUTOMATIC MILKING SYSTEM AND COMPONENTS THEREFOR
<b>A01J 5/00</b> (2006.01)	2538771 *	AUTOMATIC MILKING SYSTEM AND COMPONENTS THEREFOR
<b>G01N 21/90</b> (2006.01)	2567221 *	DEVICE AND METHOD FOR DETECTION OF DEFECTS IN VITREOUS BODIES
<b>H04B 17/00</b> (2006.01)	2589166 *	MEASURING RECEIVED SIGNAL STRENGTH ON NEIGHBORING FREQUENCIES OF A CHANNEL WITH INTERFERENCE IN A WIRELESS DEVICE
<b>C08L 67/02</b> (2006.01)	2540769	Compound, in particular blocking agent compound, for fixing blanks for ophthalmic or optical lenses
<b>G02B 6/02</b> (2006.01)	2540769	Compound, in particular blocking agent compound, for fixing blanks for ophthalmic or optical lenses

MKP (51)	Broj objave evropske prijava patenta (97)	Naziv pronalaska (54)
<b>C08L 63/00</b> (2006.01)	2540769	Compound, in particular blocking agent compound, for fixing blanks for ophthalmic or optical lenses
<b>B24B 13/005</b> (2006.01)	2540769	Compound, in particular blocking agent compound, for fixing blanks for ophthalmic or optical lenses
<b>C08K 5/053</b> (2006.01)	2540769	Compound, in particular blocking agent compound, for fixing blanks for ophthalmic or optical lenses
<b>C09J 167/00</b> (2006.01)	2540769	Compound, in particular blocking agent compound, for fixing blanks for ophthalmic or optical lenses
<b>C07D 401/12</b> (2006.01)	2582692 *	CYCLOHEXYL-AZETIDINYL ANTAGONISTS OF CCR2
<b>A61K 31/517</b> (2006.01)	2582692 *	CYCLOHEXYL-AZETIDINYL ANTAGONISTS OF CCR2
<b>C07D 405/14</b> (2006.01)	2582692 *	CYCLOHEXYL-AZETIDINYL ANTAGONISTS OF CCR2
<b>A61P 29/00</b> (2006.01)	2582692 *	CYCLOHEXYL-AZETIDINYL ANTAGONISTS OF CCR2
<b>C07D 401/14</b> (2006.01)	2582692 *	CYCLOHEXYL-AZETIDINYL ANTAGONISTS OF CCR2
<b>A61K 31/4709</b> (2006.01)	2582692 *	CYCLOHEXYL-AZETIDINYL ANTAGONISTS OF CCR2
<b>C07D 403/12</b> (2006.01)	2582692 *	CYCLOHEXYL-AZETIDINYL ANTAGONISTS OF CCR2
<b>A61K 31/502</b> (2006.01)	2582692 *	CYCLOHEXYL-AZETIDINYL ANTAGONISTS OF CCR2
<b>C07D 403/14</b> (2006.01)	2582692 *	CYCLOHEXYL-AZETIDINYL ANTAGONISTS OF CCR2
<b>A61K 31/4375</b> (2006.01)	2582692 *	CYCLOHEXYL-AZETIDINYL ANTAGONISTS OF CCR2
<b>C07D 413/14</b> (2006.01)	2582692 *	CYCLOHEXYL-AZETIDINYL ANTAGONISTS OF CCR2
<b>C07D 417/14</b> (2006.01)	2582692 *	CYCLOHEXYL-AZETIDINYL ANTAGONISTS OF CCR2
<b>C07D 471/04</b> (2006.01)	2582692 *	CYCLOHEXYL-AZETIDINYL ANTAGONISTS OF CCR2
<b>A61K 38/16</b> (2006.01)	2566494 *	CXCR4 RECEPTOR COMPOUNDS
<b>C07D 211/58</b> (2006.01)	2542524 *	DERIVATIVES OF AMINOINDANES, THEIR PREPARATION AND THEIR APPLICATION IN THERAPEUTICS
<b>C07D 487/08</b> (2006.01)	2542524 *	DERIVATIVES OF AMINOINDANES, THEIR PREPARATION AND THEIR APPLICATION IN THERAPEUTICS
<b>C07D 243/08</b> (2006.01)	2542524 *	DERIVATIVES OF AMINOINDANES, THEIR PREPARATION AND THEIR APPLICATION IN THERAPEUTICS
<b>A61K 31/4418</b> (2006.01)	2542524 *	DERIVATIVES OF AMINOINDANES, THEIR PREPARATION AND THEIR APPLICATION IN THERAPEUTICS
<b>C07D 401/02</b> (2006.01)	2542524 *	DERIVATIVES OF AMINOINDANES, THEIR PREPARATION AND THEIR APPLICATION IN THERAPEUTICS
<b>A61K 31/444</b> (2006.01)	2542524 *	DERIVATIVES OF AMINOINDANES, THEIR PREPARATION AND THEIR APPLICATION IN THERAPEUTICS
<b>C07D 401/12</b> (2006.01)	2542524 *	DERIVATIVES OF AMINOINDANES, THEIR PREPARATION AND THEIR APPLICATION IN THERAPEUTICS
<b>C07D 295/08</b> (2006.01)	2542524 *	DERIVATIVES OF AMINOINDANES, THEIR PREPARATION AND THEIR APPLICATION IN THERAPEUTICS
<b>A61K 31/40</b> (2006.01)	2542524 *	DERIVATIVES OF AMINOINDANES, THEIR PREPARATION AND THEIR APPLICATION IN THERAPEUTICS
<b>C07D 205/04</b> (2006.01)	2542524 *	DERIVATIVES OF AMINOINDANES, THEIR PREPARATION AND THEIR APPLICATION IN THERAPEUTICS
<b>C07D 403/12</b> (2006.01)	2542524 *	DERIVATIVES OF AMINOINDANES, THEIR PREPARATION AND THEIR APPLICATION IN THERAPEUTICS
<b>C07D 211/56</b> (2006.01)	2542524 *	DERIVATIVES OF AMINOINDANES, THEIR PREPARATION AND THEIR APPLICATION IN THERAPEUTICS
<b>C07D 413/12</b> (2006.01)	2542524 *	DERIVATIVES OF AMINOINDANES, THEIR PREPARATION AND THEIR APPLICATION IN THERAPEUTICS
<b>C07D 207/08</b> (2006.01)	2542524 *	DERIVATIVES OF AMINOINDANES, THEIR PREPARATION AND THEIR APPLICATION IN THERAPEUTICS
<b>C07D 405/12</b> (2006.01)	2542524 *	DERIVATIVES OF AMINOINDANES, THEIR PREPARATION AND THEIR APPLICATION IN THERAPEUTICS
<b>B01J 37/18</b> (2006.01)	2554267 *	PREPARATION METHOD FOR ACTIVATED CATALYST FOR FISCHER-TROPSCH SYNTHESIS, PREPARATION METHOD FOR CATALYST SLURRY, AND METHOD FOR SUPPLYING CATALYST SLURRY TO FISCHER-TROPSCH SYNTHESIS REACTOR



MKP (51)	Broj objave evropske prijava patenta (97)	Naziv pronalaska (54)
<b>C10G 2/00</b> (2006.01)	2554267 *	PREPARATION METHOD FOR ACTIVATED CATALYST FOR FISCHER-TROPSCH SYNTHESIS, PREPARATION METHOD FOR CATALYST SLURRY, AND METHOD FOR SUPPLYING CATALYST SLURRY TO FISCHER-TROPSCH SYNTHESIS REACTOR
<b>A47K 10/34</b> (2006.01)	2560534 *	SANITARY DISPENSER
<b>A47K 5/12</b> (2006.01)	2560534 *	SANITARY DISPENSER
<b>H05F 3/02</b> (2006.01)	2560534 *	SANITARY DISPENSER
<b>B65D 1/02</b> (2006.01)	2588379 *	OVAL-NECK BOTTLE
<b>B62D 9/02</b> (2006.01)	2593352 *	TILTABLE MOTORCYCLES WITH TWO FRONT STEERING WHEELS
<b>B62K 5/08</b> (2006.01)	2593352 *	TILTABLE MOTORCYCLES WITH TWO FRONT STEERING WHEELS
<b>A61K 31/4375</b> (2006.01)	2545053 *	AZAIISOQUINOLINONE DERIVATIVES AS NK3 ANTAGONISTS
<b>A61P 11/00</b> (2006.01)	2545053 *	AZAIISOQUINOLINONE DERIVATIVES AS NK3 ANTAGONISTS
<b>A61P 25/24</b> (2006.01)	2545053 *	AZAIISOQUINOLINONE DERIVATIVES AS NK3 ANTAGONISTS
<b>A61P 25/04</b> (2006.01)	2545053 *	AZAIISOQUINOLINONE DERIVATIVES AS NK3 ANTAGONISTS
<b>C07D 471/04</b> (2006.01)	2545053 *	AZAIISOQUINOLINONE DERIVATIVES AS NK3 ANTAGONISTS
<b>A61P 25/08</b> (2006.01)	2545053 *	AZAIISOQUINOLINONE DERIVATIVES AS NK3 ANTAGONISTS
<b>A61P 25/16</b> (2006.01)	2545053 *	AZAIISOQUINOLINONE DERIVATIVES AS NK3 ANTAGONISTS
<b>A61P 25/22</b> (2006.01)	2545053 *	AZAIISOQUINOLINONE DERIVATIVES AS NK3 ANTAGONISTS
<b>A61P 25/28</b> (2006.01)	2545053 *	AZAIISOQUINOLINONE DERIVATIVES AS NK3 ANTAGONISTS
<b>A61P 3/04</b> (2006.01)	2545053 *	AZAIISOQUINOLINONE DERIVATIVES AS NK3 ANTAGONISTS
<b>A61P 25/18</b> (2006.01)	2545053 *	AZAIISOQUINOLINONE DERIVATIVES AS NK3 ANTAGONISTS
<b>A61P 13/00</b> (2006.01)	2545053 *	AZAIISOQUINOLINONE DERIVATIVES AS NK3 ANTAGONISTS
<b>C07D 487/04</b> (2006.01)	2588480 *	3,4-DIHYDROPYRROLO[1,2-A]PYRAZINE-2,8(1H)-DICARBOXAMIDE DERIVATIVES, PREPARATION THEREOF AND THERAPEUTIC USE THEREOF& xA;
<b>C07D 207/337</b> (2006.01)	2588480 *	3,4-DIHYDROPYRROLO[1,2-A]PYRAZINE-2,8(1H)-DICARBOXAMIDE DERIVATIVES, PREPARATION THEREOF AND THERAPEUTIC USE THEREOF& xA;
<b>A61P 9/00</b> (2006.01)	2588480 *	3,4-DIHYDROPYRROLO[1,2-A]PYRAZINE-2,8(1H)-DICARBOXAMIDE DERIVATIVES, PREPARATION THEREOF AND THERAPEUTIC USE THEREOF& xA;
<b>A61P 25/28</b> (2006.01)	2588480 *	3,4-DIHYDROPYRROLO[1,2-A]PYRAZINE-2,8(1H)-DICARBOXAMIDE DERIVATIVES, PREPARATION THEREOF AND THERAPEUTIC USE THEREOF& xA;
<b>A61P 29/00</b> (2006.01)	2588480 *	3,4-DIHYDROPYRROLO[1,2-A]PYRAZINE-2,8(1H)-DICARBOXAMIDE DERIVATIVES, PREPARATION THEREOF AND THERAPEUTIC USE THEREOF& xA;
<b>A61K 31/4985</b> (2006.01)	2588480 *	3,4-DIHYDROPYRROLO[1,2-A]PYRAZINE-2,8(1H)-DICARBOXAMIDE DERIVATIVES, PREPARATION THEREOF AND THERAPEUTIC USE THEREOF& xA;
<b>C07D 241/06</b> (2006.01)	2588480 *	3,4-DIHYDROPYRROLO[1,2-A]PYRAZINE-2,8(1H)-DICARBOXAMIDE DERIVATIVES, PREPARATION THEREOF AND THERAPEUTIC USE THEREOF& xA;
<b>A61P 25/00</b> (2006.01)	2588480 *	3,4-DIHYDROPYRROLO[1,2-A]PYRAZINE-2,8(1H)-DICARBOXAMIDE DERIVATIVES, PREPARATION THEREOF AND THERAPEUTIC USE THEREOF& xA;
<b>A61M 11/02</b> (2006.01)	2585150 *	AEROSOL THERAPY DEVICE
<b>A61M 16/00</b> (2006.01)	2585150 *	AEROSOL THERAPY DEVICE
<b>A61P 35/00</b> (2006.01)	2566496 *	INNOVATIVE DISCOVERY OF THERAPEUTIC, DIAGNOSTIC, AND ANTIBODY COMPOSITIONS RELATED TO PROTEIN FRAGMENTS OF METHIONYL-TRNA SYNTHETASES
<b>A61P 3/10</b> (2006.01)	2566496 *	INNOVATIVE DISCOVERY OF THERAPEUTIC, DIAGNOSTIC, AND ANTIBODY COMPOSITIONS RELATED TO PROTEIN FRAGMENTS OF METHIONYL-TRNA SYNTHETASES
<b>A61K 39/395</b> (2006.01)	2566496 *	INNOVATIVE DISCOVERY OF THERAPEUTIC, DIAGNOSTIC, AND ANTIBODY COMPOSITIONS RELATED TO PROTEIN FRAGMENTS OF METHIONYL-TRNA SYNTHETASES

MKP (51)	Broj objave evropske prijava patenta (97)	Naziv pronalaska (54)
<b>A61K 38/16</b> (2006.01)	2566496 *	INNOVATIVE DISCOVERY OF THERAPEUTIC, DIAGNOSTIC, AND ANTIBODY COMPOSITIONS RELATED TO PROTEIN FRAGMENTS OF METHIONYL-TRNA SYNTHETASES
<b>C07K 14/525</b> (2006.01)	2566496 *	INNOVATIVE DISCOVERY OF THERAPEUTIC, DIAGNOSTIC, AND ANTIBODY COMPOSITIONS RELATED TO PROTEIN FRAGMENTS OF METHIONYL-TRNA SYNTHETASES
<b>A61P 29/00</b> (2006.01)	2566496 *	INNOVATIVE DISCOVERY OF THERAPEUTIC, DIAGNOSTIC, AND ANTIBODY COMPOSITIONS RELATED TO PROTEIN FRAGMENTS OF METHIONYL-TRNA SYNTHETASES
<b>C07D 401/14</b> (2006.01)	2571864 *	PIPERIDINYL-SUBSTITUTED LACTAMS AS GPR119 MODULATORS
<b>A61P 3/10</b> (2006.01)	2571864 *	PIPERIDINYL-SUBSTITUTED LACTAMS AS GPR119 MODULATORS
<b>A61K 31/4545</b> (2006.01)	2571864 *	PIPERIDINYL-SUBSTITUTED LACTAMS AS GPR119 MODULATORS
<b>A61P 21/00</b> (2006.01)	2575857 *	INNOVATIVE DISCOVERY OF THERAPEUTIC, DIAGNOSTIC, AND ANTIBODY COMPOSITIONS RELATED TO PROTEIN FRAGMENTS OF LYSYL-TRNA SYNTHETASES
<b>A61K 39/395</b> (2006.01)	2575857 *	INNOVATIVE DISCOVERY OF THERAPEUTIC, DIAGNOSTIC, AND ANTIBODY COMPOSITIONS RELATED TO PROTEIN FRAGMENTS OF LYSYL-TRNA SYNTHETASES
<b>A61K 38/16</b> (2006.01)	2575857 *	INNOVATIVE DISCOVERY OF THERAPEUTIC, DIAGNOSTIC, AND ANTIBODY COMPOSITIONS RELATED TO PROTEIN FRAGMENTS OF LYSYL-TRNA SYNTHETASES
<b>A61P 37/00</b> (2006.01)	2575857 *	INNOVATIVE DISCOVERY OF THERAPEUTIC, DIAGNOSTIC, AND ANTIBODY COMPOSITIONS RELATED TO PROTEIN FRAGMENTS OF LYSYL-TRNA SYNTHETASES
<b>A61K 38/17</b> (2006.01)	2575857 *	INNOVATIVE DISCOVERY OF THERAPEUTIC, DIAGNOSTIC, AND ANTIBODY COMPOSITIONS RELATED TO PROTEIN FRAGMENTS OF LYSYL-TRNA SYNTHETASES
<b>A61K 38/08</b> (2006.01)	2575857 *	INNOVATIVE DISCOVERY OF THERAPEUTIC, DIAGNOSTIC, AND ANTIBODY COMPOSITIONS RELATED TO PROTEIN FRAGMENTS OF LYSYL-TRNA SYNTHETASES
<b>G06F 21/24</b> (2006.01)	2477137	Method for verifying the integrity of a set of data
<b>C12N 15/09</b> (2006.01)	2592141 *	METHOD FOR PRODUCTION OF TUMOR CELLS FROM NORMAL MAMMARY EPITHELIAL CELLS
<b>C12N 15/00</b> (2006.01)	2592141 *	METHOD FOR PRODUCTION OF TUMOR CELLS FROM NORMAL MAMMARY EPITHELIAL CELLS
<b>A01K 67/027</b> (2006.01)	2592141 *	METHOD FOR PRODUCTION OF TUMOR CELLS FROM NORMAL MAMMARY EPITHELIAL CELLS
<b>C12Q 1/02</b> (2006.01)	2592141 *	METHOD FOR PRODUCTION OF TUMOR CELLS FROM NORMAL MAMMARY EPITHELIAL CELLS
<b>C12N 5/09</b> (2010.01)	2592141 *	METHOD FOR PRODUCTION OF TUMOR CELLS FROM NORMAL MAMMARY EPITHELIAL CELLS
<b>A01N 43/02</b> (2006.01)	2552202 *	METHODS AND COMPOSITIONS FOR WEIGHT LOSS
<b>C10G 65/02</b> (2006.01)	2479242	Method for hydroprocessing of hydrocarbon compounds heavily contaminated with inorganic substances
<b>B01J 35/04</b> (2006.01)	2479242	Method for hydroprocessing of hydrocarbon compounds heavily contaminated with inorganic substances
<b>C10G 45/12</b> (2006.01)	2479242	Method for hydroprocessing of hydrocarbon compounds heavily contaminated with inorganic substances
<b>B01J 21/12</b> (2006.01)	2479242	Method for hydroprocessing of hydrocarbon compounds heavily contaminated with inorganic substances
<b>C10G 45/08</b> (2006.01)	2479242	Method for hydroprocessing of hydrocarbon compounds heavily contaminated with inorganic substances
<b>B01J 35/10</b> (2006.01)	2479242	Method for hydroprocessing of hydrocarbon compounds heavily contaminated with inorganic substances
<b>A61B 17/70</b> (2006.01)	2502594	Polyaxial pedicle screw and fixation system kit comprising said screw
<b>C23C 16/50</b> (2006.01)	2585274 *	SURFACE TREATMENT OF RUBBER USING LOW PRESSURE PLASMA
<b>B05D 7/24</b> (2006.01)	2585274 *	SURFACE TREATMENT OF RUBBER USING LOW PRESSURE PLASMA
<b>B29C 59/14</b> (2006.01)	2585274 *	SURFACE TREATMENT OF RUBBER USING LOW PRESSURE PLASMA

MKP (51)	Broj objave evropske prijava patenta (97)	Naziv pronalaska (54)
<b>A61M 5/20</b> (2006.01)	2585138 *	AUTO-INJECTOR
<b>A61K 47/34</b> (2006.01)	2582395 *	METHODS FOR THE PREPARATION OF INJECTABLE DEPOT COMPOSITIONS
<b>A21B 1/48</b> (2006.01)	2508076	Stone slab for ovens
<b>F24C 15/16</b> (2006.01)	2508076	Stone slab for ovens
<b>A21B 3/15</b> (2006.01)	2508076	Stone slab for ovens
<b>C07D 491/10</b> (2006.01)	2547684 *	SPIROCYCLIC COMPOUNDS AND THEIR USE AS THERAPEUTIC AGENTS AND DIAGNOSTIC PROBES
<b>A61P 35/00</b> (2006.01)	2547684 *	SPIROCYCLIC COMPOUNDS AND THEIR USE AS THERAPEUTIC AGENTS AND DIAGNOSTIC PROBES
<b>C07D 487/10</b> (2006.01)	2547684 *	SPIROCYCLIC COMPOUNDS AND THEIR USE AS THERAPEUTIC AGENTS AND DIAGNOSTIC PROBES
<b>C07D 519/00</b> (2006.01)	2547684 *	SPIROCYCLIC COMPOUNDS AND THEIR USE AS THERAPEUTIC AGENTS AND DIAGNOSTIC PROBES
<b>A61K 31/5386</b> (2006.01)	2547684 *	SPIROCYCLIC COMPOUNDS AND THEIR USE AS THERAPEUTIC AGENTS AND DIAGNOSTIC PROBES
<b>A61K 31/137</b> (2006.01)	2579857 *	ALCOHOL-RESISTANT EXTENDED RELEASE DOSAGE FORMS COMPRISING VENLAFAXINE
<b>A61K 9/50</b> (2006.01)	2579857 *	ALCOHOL-RESISTANT EXTENDED RELEASE DOSAGE FORMS COMPRISING VENLAFAXINE
<b>A61K 9/20</b> (2006.01)	2579857 *	ALCOHOL-RESISTANT EXTENDED RELEASE DOSAGE FORMS COMPRISING VENLAFAXINE
<b>A61K 39/395</b> (2006.01)	2542583 *	METHODS FOR TREATING BREAST CANCER
<b>A61P 35/00</b> (2006.01)	2542583 *	METHODS FOR TREATING BREAST CANCER
<b>C07K 16/26</b> (2006.01)	2542583 *	METHODS FOR TREATING BREAST CANCER
<b>G06Q 20/00</b> (2012.01)	2584512	Voucher and method for determining validity thereof
<b>A63F 3/06</b> (2006.01)	2584512	Voucher and method for determining validity thereof
<b>C12P 7/64</b> (2006.01)	2542685 *	A PROCESS FOR THE ENZYMATIC SYNTHESIS OF FATTY ACID ALKYL ESTERS
<b>A61B 1/04</b> (2006.01)	2592992 *	A DEVICE AND METHODS FOR IN VIVO MONITORING OF AN INDIVIDUAL
<b>A61K 39/00</b> (2006.01)	2575884 *	USES AND COMPOSITIONS FOR TREATMENT OF HIDRADENITIS SUPPURATIVA (HS)
<b>C07K 16/00</b> (2006.01)	2575884 *	USES AND COMPOSITIONS FOR TREATMENT OF HIDRADENITIS SUPPURATIVA (HS)
<b>A61K 39/395</b> (2006.01)	2575884 *	USES AND COMPOSITIONS FOR TREATMENT OF HIDRADENITIS SUPPURATIVA (HS)
<b>C07K 19/00</b> (2006.01)	2569332 *	IMPROVED COMPLEMENT RECEPTOR 2 (CR2) TARGETING GROUPS
<b>C07K 14/705</b> (2006.01)	2569332 *	IMPROVED COMPLEMENT RECEPTOR 2 (CR2) TARGETING GROUPS
<b>C25D 5/12</b> (2006.01)	2481838	Method for applying semi-dry electroplating method on surface of plastic substrate
<b>C23C 28/02</b> (2006.01)	2481838	Method for applying semi-dry electroplating method on surface of plastic substrate
<b>C23C 18/30</b> (2006.01)	2481838	Method for applying semi-dry electroplating method on surface of plastic substrate
<b>C23C 14/20</b> (2006.01)	2481838	Method for applying semi-dry electroplating method on surface of plastic substrate
<b>C23C 14/16</b> (2006.01)	2481838	Method for applying semi-dry electroplating method on surface of plastic substrate
<b>C25D 5/56</b> (2006.01)	2481838	Method for applying semi-dry electroplating method on surface of plastic substrate
<b>C25D 5/48</b> (2006.01)	2481838	Method for applying semi-dry electroplating method on surface of plastic substrate
<b>C25D 5/14</b> (2006.01)	2481838	Method for applying semi-dry electroplating method on surface of plastic substrate
<b>C23C 30/00</b> (2006.01)	2481838	Method for applying semi-dry electroplating method on surface of plastic substrate

MKP (51)	Broj objave evropske prijava patenta (97)	Naziv pronalaska (54)
<b>C23C 14/00</b> (2006.01)	2481838	Method for applying semi-dry electroplating method on surface of plastic substrate
<b>C07D 409/14</b> (2006.01)	2588475 *	APOPTOSIS SIGNAL-REGULATING KINASE INHIBITORS
<b>A61P 9/00</b> (2006.01)	2588475 *	APOPTOSIS SIGNAL-REGULATING KINASE INHIBITORS
<b>A61P 29/00</b> (2006.01)	2588475 *	APOPTOSIS SIGNAL-REGULATING KINASE INHIBITORS
<b>A61K 31/427</b> (2006.01)	2588475 *	APOPTOSIS SIGNAL-REGULATING KINASE INHIBITORS
<b>A61P 37/00</b> (2006.01)	2588475 *	APOPTOSIS SIGNAL-REGULATING KINASE INHIBITORS
<b>A61K 31/4196</b> (2006.01)	2588475 *	APOPTOSIS SIGNAL-REGULATING KINASE INHIBITORS
<b>A61K 31/4427</b> (2006.01)	2588475 *	APOPTOSIS SIGNAL-REGULATING KINASE INHIBITORS
<b>C07D 417/14</b> (2006.01)	2588475 *	APOPTOSIS SIGNAL-REGULATING KINASE INHIBITORS
<b>A61K 39/395</b> (2006.01)	2542579 *	BIPARATOPIC ABETA BINDING POLYPEPTIDES
<b>C07K 16/18</b> (2006.01)	2542579 *	BIPARATOPIC ABETA BINDING POLYPEPTIDES
<b>C07K 16/46</b> (2006.01)	2542579 *	BIPARATOPIC ABETA BINDING POLYPEPTIDES
<b>B65G 49/06</b> (2006.01)	2576368 *	PALLET CONTAINER
<b>B65D 85/48</b> (2006.01)	2576368 *	PALLET CONTAINER
<b>B65D 21/08</b> (2006.01)	2576368 *	PALLET CONTAINER
<b>B65D 19/12</b> (2006.01)	2576368 *	PALLET CONTAINER
<b>B65D 81/05</b> (2006.01)	2576368 *	PALLET CONTAINER
<b>B65D 19/44</b> (2006.01)	2576368 *	PALLET CONTAINER
<b>B60N 2/50</b> (2006.01)	2552745 *	MULTI AXIS MANOEUVRABLE PLATFORM
<b>G09B 9/00</b> (2006.01)	2552745 *	MULTI AXIS MANOEUVRABLE PLATFORM
<b>C07D 213/81</b> (2006.01)	2558448 *	PROCESS FOR THE PREPARATION OF 4- {4-[[[4 -CHLORO-3-(TRIFLUOROMETHYL)-PHENYL]AMINO]CARBONYL]AMINO]-3-FLUOROPHENOXY}-N-METHYLPYRIDINE-2-CARBOXAMIDE, ITS SALTS AND MONOHYDRATE
<b>A47K 10/36</b> (2006.01)	2560535 *	METHOD FOR DISPENSING PAPER SHEET BY SHEET FROM A STOCK
<b>A61K 9/50</b> (2006.01)	2568969 *	ALCOHOL-RESISTANT FORMULATIONS
<b>A61K 9/20</b> (2006.01)	2568969 *	ALCOHOL-RESISTANT FORMULATIONS
<b>C07D 405/10</b> (2006.01)	2580210 *	ESTROGEN RECEPTOR MODULATORS AND USES THEREOF
<b>C07D 311/04</b> (2006.01)	2580210 *	ESTROGEN RECEPTOR MODULATORS AND USES THEREOF
<b>C07D 405/12</b> (2006.01)	2580210 *	ESTROGEN RECEPTOR MODULATORS AND USES THEREOF
<b>A61P 25/28</b> (2006.01)	2580210 *	ESTROGEN RECEPTOR MODULATORS AND USES THEREOF
<b>A61K 31/352</b> (2006.01)	2580210 *	ESTROGEN RECEPTOR MODULATORS AND USES THEREOF
<b>A61K 31/453</b> (2006.01)	2580210 *	ESTROGEN RECEPTOR MODULATORS AND USES THEREOF
<b>A61P 35/00</b> (2006.01)	2580210 *	ESTROGEN RECEPTOR MODULATORS AND USES THEREOF
<b>C07J 41/00</b> (2006.01)	2550288 *	COMPOSITIONS AND METHODS FOR NON-TOXIC DELIVERY OF ANTIPIROGESTINS
<b>A61K 31/57</b> (2006.01)	2550288 *	COMPOSITIONS AND METHODS FOR NON-TOXIC DELIVERY OF ANTIPIROGESTINS
<b>A61P 5/36</b> (2006.01)	2550288 *	COMPOSITIONS AND METHODS FOR NON-TOXIC DELIVERY OF ANTIPIROGESTINS
<b>B43K 24/02</b> (2006.01)	2563603 *	IMPROVED EXPANDABLE WRITING INSTRUMENT
<b>C03B 9/34</b> (2006.01)	2588421 *	GLASS WINE BOTTLES AND METHOD OF MOLDING THEM
<b>C03B 9/325</b> (2006.01)	2588421 *	GLASS WINE BOTTLES AND METHOD OF MOLDING THEM
<b>C07K 16/18</b> (2006.01)	2542582 *	THERAPEUTIC DLL4 BINDING PROTEINS
<b>C01B 4/00</b> (2006.01)	2582618 *	MEMBRANE REACTOR FOR TREATING GASES CONTAINING TRITIUM
<b>C01B 3/50</b> (2006.01)	2582618 *	MEMBRANE REACTOR FOR TREATING GASES CONTAINING TRITIUM
<b>G01N 27/48</b> (2006.01)	2484630	Nanosensor for capturing charged molecules by using in situ stripping voltammetry
<b>B82Y 30/00</b> (2011.01)	2484630	Nanosensor for capturing charged molecules by using in situ stripping voltammetry

MKP (51)	Broj objave evropske prijava patenta (97)	Naziv pronalaska (54)
<b>G01N 27/12</b> (2006.01)	2484630	Nanosensor for capturing charged molecules by using in situ stripping voltammetry
<b>G01N 33/18</b> (2006.01)	2484630	Nanosensor for capturing charged molecules by using in situ stripping voltammetry
<b>C07D 239/70</b> (2006.01)	2571857 *	NOVEL PROCESSES
<b>B01D 24/14</b> (2006.01)	2542318 *	APPARATUS AND METHOD FOR DE-WATERING OF FLOCCULATED MATERIALS
<b>B01D 24/00</b> (2006.01)	2542318 *	APPARATUS AND METHOD FOR DE-WATERING OF FLOCCULATED MATERIALS
<b>A61K 9/20</b> (2006.01)	2575779 *	USE OF DIATOMACEOUS EARTH IN THE PHARMACEUTICAL INDUSTRY
<b>A61K 47/02</b> (2006.01)	2575779 *	USE OF DIATOMACEOUS EARTH IN THE PHARMACEUTICAL INDUSTRY
<b>A61M 5/24</b> (2006.01)	2560706 *	CARTRIDGE HOLDER AND ALIGNMENT INTERFACE
<b>C07K 16/22</b> (2006.01)	2576619 *	HUMANISED ANTIGEN BINDING PROTEINS TO MYOSTATIN6
<b>A61K 39/395</b> (2006.01)	2576619 *	HUMANISED ANTIGEN BINDING PROTEINS TO MYOSTATIN6
<b>A61P 21/06</b> (2006.01)	2576619 *	HUMANISED ANTIGEN BINDING PROTEINS TO MYOSTATIN6
<b>A61K 9/20</b> (2006.01)	2462925	Pramipexole Dihydrochloride Granulate
<b>A61K 9/50</b> (2006.01)	2462925	Pramipexole Dihydrochloride Granulate
<b>A61K 38/47</b> (2006.01)	2585104 *	METHODS AND COMPOSITIONS FOR CNS DELIVERY OF ARYLSULFATASE A
<b>A61P 25/28</b> (2006.01)	2585104 *	METHODS AND COMPOSITIONS FOR CNS DELIVERY OF ARYLSULFATASE A
<b>A61P 25/00</b> (2006.01)	2585104 *	METHODS AND COMPOSITIONS FOR CNS DELIVERY OF ARYLSULFATASE A
<b>A23L 1/00</b> (2006.01)	2594140 *	NANOPARTICLES FOR ENCAPSULATION OF COMPOUNDS, THE PRODUCTION AND USES THEREOF
<b>A61K 8/64</b> (2006.01)	2594140 *	NANOPARTICLES FOR ENCAPSULATION OF COMPOUNDS, THE PRODUCTION AND USES THEREOF
<b>E06B 3/263</b> (2006.01)	2572068 *	EXTERNAL LAYER OF COMPOUND FRAMES FOR WINDOWS AND DOORS DESCRIPTION OF THE INVENTION
<b>E06B 3/30</b> (2006.01)	2572068 *	EXTERNAL LAYER OF COMPOUND FRAMES FOR WINDOWS AND DOORS DESCRIPTION OF THE INVENTION
<b>C12N 15/00</b> (2006.01)	2550359 *	VECTORS CONDITIONALLY EXPRESSING THERAPEUTIC PROTEINS, HOST CELLS COMPRISING THE VECTORS, AND USES THEREOF
<b>H01R 24/58</b> (2011.01)	2580824 *	FLEXIBLE TRS CONNECTOR
<b>B65D 33/16</b> (2006.01)	2468651	Clip fastener
<b>B60H 1/00</b> (2006.01)	2450204	Air conditioning for a motor vehicle
<b>B22D 41/02</b> (2006.01)	2560776 *	MOLTEN METAL LEAKAGE CONFINEMENT AND THERMAL OPTIMIZATION IN VESSELS USED FOR CONTAINING MOLTEN METALS
<b>A61K 47/48</b> (2006.01)	2552411 *	STABILIZED ANTIBODY PREPARATIONS AND USES THEREOF
<b>A61K 39/395</b> (2006.01)	2552411 *	STABILIZED ANTIBODY PREPARATIONS AND USES THEREOF
<b>A61K 9/08</b> (2006.01)	2552411 *	STABILIZED ANTIBODY PREPARATIONS AND USES THEREOF
<b>A61K 47/22</b> (2006.01)	2552411 *	STABILIZED ANTIBODY PREPARATIONS AND USES THEREOF
<b>A61L 9/12</b> (2006.01)	2564877	An improvement of a deodorant device that gradually releases fragrance
<b>C12Q 1/68</b> (2006.01)	2591126 *	GENE SIGNATURES FOR CANCER PROGNOSIS
<b>C12N 15/11</b> (2006.01)	2591126 *	GENE SIGNATURES FOR CANCER PROGNOSIS
<b>C09D 5/14</b> (2006.01)	2545126 *	COATING WITH ANTIMICROBIAL AGENTS
<b>A61L 27/54</b> (2006.01)	2545126 *	COATING WITH ANTIMICROBIAL AGENTS
<b>A61L 27/34</b> (2006.01)	2545126 *	COATING WITH ANTIMICROBIAL AGENTS
<b>B64C 3/14</b> (2006.01)	2567891 *	METHOD FOR FORMING LIFTING FORCE FOR AN AIRCRAFT AND WING PROFILE FOR REALIZING SAID METHOD (ALTERNATIVES)
<b>G01N 33/74</b> (2006.01)	2542898 *	PROGASTRIN AND LIVER PATHOLOGIES
<b>A61K 31/495</b> (2006.01)	2582372 *	RANOLAZINE FOR USE FOR THE TREATMENT OF PULMONARY HYPERTENSION

MKP (51)	Broj objave evropske prijava patenta (97)	Naziv pronalaska (54)
<b>A61P 9/00</b> (2006.01)	2582372 *	RANOLAZINE FOR USE FOR THE TREATMENT OF PULMONARY HYPERTENSION
<b>B42F 13/26</b> (2006.01)	2539159 *	FILE MECHANISM
<b>B42F 13/24</b> (2006.01)	2539159 *	FILE MECHANISM
<b>A61K 38/17</b> (2006.01)	2547354 *	NOVEL IMMUNOTHERAPY AGAINST SEVERAL TUMORS INCLUDING GASTROINTESTINAL AND GASTRIC CANCER
<b>A61B 5/103</b> (2006.01)	2590558 *	A DEVICE AND METHOD FOR CONTINUOUS CHEMICAL SENSING
<b>A61B 5/117</b> (2006.01)	2590558 *	A DEVICE AND METHOD FOR CONTINUOUS CHEMICAL SENSING
<b>A61B 5/05</b> (2006.01)	2590558 *	A DEVICE AND METHOD FOR CONTINUOUS CHEMICAL SENSING
<b>A61P 31/14</b> (2006.01)	2576534 *	1'-SUBSTITUTED-CARBA-NUCLEOSIDE PRODRUGS FOR ANTIVIRAL TREATMENT
<b>C07D 309/10</b> (2006.01)	2576534 *	1'-SUBSTITUTED-CARBA-NUCLEOSIDE PRODRUGS FOR ANTIVIRAL TREATMENT
<b>A61K 31/40</b> (2006.01)	2576534 *	1'-SUBSTITUTED-CARBA-NUCLEOSIDE PRODRUGS FOR ANTIVIRAL TREATMENT
<b>A61P 25/24</b> (2006.01)	2585074 *	USE OF AN ESTROGEN DERIVATIVE FOR THE MANUFACTURE OF PHARMACEUTICAL COMPOSITIONS USEFUL FOR THE TREATMENT AND/OR PREVENTION OF PSYCHIATRIC DISEASES AND FOR THE TREATMENT AND PREVENTION OF SAID DISEASES
<b>A61P 25/18</b> (2006.01)	2585074 *	USE OF AN ESTROGEN DERIVATIVE FOR THE MANUFACTURE OF PHARMACEUTICAL COMPOSITIONS USEFUL FOR THE TREATMENT AND/OR PREVENTION OF PSYCHIATRIC DISEASES AND FOR THE TREATMENT AND PREVENTION OF SAID DISEASES
<b>A61P 25/22</b> (2006.01)	2585074 *	USE OF AN ESTROGEN DERIVATIVE FOR THE MANUFACTURE OF PHARMACEUTICAL COMPOSITIONS USEFUL FOR THE TREATMENT AND/OR PREVENTION OF PSYCHIATRIC DISEASES AND FOR THE TREATMENT AND PREVENTION OF SAID DISEASES
<b>A61K 31/565</b> (2006.01)	2585074 *	USE OF AN ESTROGEN DERIVATIVE FOR THE MANUFACTURE OF PHARMACEUTICAL COMPOSITIONS USEFUL FOR THE TREATMENT AND/OR PREVENTION OF PSYCHIATRIC DISEASES AND FOR THE TREATMENT AND PREVENTION OF SAID DISEASES
<b>A61P 25/28</b> (2006.01)	2585105 *	TREATMENT OF SANFILIPPO SYNDROME TYPE B
<b>A61P 25/00</b> (2006.01)	2585105 *	TREATMENT OF SANFILIPPO SYNDROME TYPE B
<b>A61K 38/47</b> (2006.01)	2585105 *	TREATMENT OF SANFILIPPO SYNDROME TYPE B
<b>A61P 7/04</b> (2006.01)	2563402 *	CONJUGATED BLOOD COAGULATION FACTOR VIII
<b>A61K 38/37</b> (2006.01)	2563402 *	CONJUGATED BLOOD COAGULATION FACTOR VIII
<b>A61K 47/48</b> (2006.01)	2563402 *	CONJUGATED BLOOD COAGULATION FACTOR VIII
<b>A61P 25/24</b> (2006.01)	2565194 *	IMIDAZO[1,2-a]PYRIDINE DERIVATIVE
<b>A61P 25/18</b> (2006.01)	2565194 *	IMIDAZO[1,2-a]PYRIDINE DERIVATIVE
<b>C07D 471/04</b> (2006.01)	2565194 *	IMIDAZO[1,2-a]PYRIDINE DERIVATIVE
<b>C07D 495/14</b> (2006.01)	2565194 *	IMIDAZO[1,2-a]PYRIDINE DERIVATIVE
<b>A61K 31/4545</b> (2006.01)	2565194 *	IMIDAZO[1,2-a]PYRIDINE DERIVATIVE
<b>A61P 25/28</b> (2006.01)	2565194 *	IMIDAZO[1,2-a]PYRIDINE DERIVATIVE
<b>A61K 31/437</b> (2006.01)	2565194 *	IMIDAZO[1,2-a]PYRIDINE DERIVATIVE
<b>C07D 519/00</b> (2006.01)	2565194 *	IMIDAZO[1,2-a]PYRIDINE DERIVATIVE
<b>A61K 31/438</b> (2006.01)	2565194 *	IMIDAZO[1,2-a]PYRIDINE DERIVATIVE
<b>A61P 43/00</b> (2006.01)	2565194 *	IMIDAZO[1,2-a]PYRIDINE DERIVATIVE
<b>C07H 19/06</b> (2006.01)	2552930 *	NUCLEOSIDE PHOSPHORAMIDATES
<b>C07F 9/6561</b> (2006.01)	2552930 *	NUCLEOSIDE PHOSPHORAMIDATES
<b>A61P 31/14</b> (2006.01)	2552930 *	NUCLEOSIDE PHOSPHORAMIDATES
<b>C07H 19/10</b> (2006.01)	2552930 *	NUCLEOSIDE PHOSPHORAMIDATES
<b>C07F 9/26</b> (2006.01)	2552930 *	NUCLEOSIDE PHOSPHORAMIDATES
<b>C07H 19/052</b> (2006.01)	2552930 *	NUCLEOSIDE PHOSPHORAMIDATES
<b>C07H 19/207</b> (2006.01)	2552930 *	NUCLEOSIDE PHOSPHORAMIDATES

MKP (51)	Broj objave evropske prijava patenta (97)	Naziv pronalaska (54)
<b>C07H 19/04</b> (2006.01)	2552930 *	NUCLEOSIDE PHOSPHORAMIDATES
<b>C07F 9/6558</b> (2006.01)	2552930 *	NUCLEOSIDE PHOSPHORAMIDATES
<b>A61K 31/7056</b> (2006.01)	2552930 *	NUCLEOSIDE PHOSPHORAMIDATES
<b>C07F 9/655</b> (2006.01)	2552930 *	NUCLEOSIDE PHOSPHORAMIDATES
<b>A61K 31/664</b> (2006.01)	2552930 *	NUCLEOSIDE PHOSPHORAMIDATES
<b>A61K 31/7072</b> (2006.01)	2552930 *	NUCLEOSIDE PHOSPHORAMIDATES
<b>C07H 19/044</b> (2006.01)	2552930 *	NUCLEOSIDE PHOSPHORAMIDATES
<b>C07F 9/24</b> (2006.01)	2552930 *	NUCLEOSIDE PHOSPHORAMIDATES
<b>C07H 19/24</b> (2006.01)	2552930 *	NUCLEOSIDE PHOSPHORAMIDATES
<b>B23Q 1/01</b> (2006.01)	2560786 *	METHOD AND DEVICE FOR CUTTING OPENINGS IN FLAT, CONCAVE OR CONVEX SURFACES
<b>B23K 26/08</b> (2006.01)	2560786 *	METHOD AND DEVICE FOR CUTTING OPENINGS IN FLAT, CONCAVE OR CONVEX SURFACES
<b>B23K 37/02</b> (2006.01)	2560786 *	METHOD AND DEVICE FOR CUTTING OPENINGS IN FLAT, CONCAVE OR CONVEX SURFACES
<b>B23K 26/10</b> (2006.01)	2560786 *	METHOD AND DEVICE FOR CUTTING OPENINGS IN FLAT, CONCAVE OR CONVEX SURFACES
<b>C07C 291/10</b> (2006.01)	2539334 *	PROCESS FOR THE PREPARATION OF -ACYLOXY -FORMAMIDO AMIDES
<b>C07C 231/14</b> (2006.01)	2539334 *	PROCESS FOR THE PREPARATION OF -ACYLOXY -FORMAMIDO AMIDES
<b>C07C 233/31</b> (2006.01)	2539334 *	PROCESS FOR THE PREPARATION OF -ACYLOXY -FORMAMIDO AMIDES
<b>C07C 235/14</b> (2006.01)	2539334 *	PROCESS FOR THE PREPARATION OF -ACYLOXY -FORMAMIDO AMIDES
<b>C07D 403/12</b> (2006.01)	2539334 *	PROCESS FOR THE PREPARATION OF -ACYLOXY -FORMAMIDO AMIDES
<b>C07C 237/04</b> (2006.01)	2539334 *	PROCESS FOR THE PREPARATION OF -ACYLOXY -FORMAMIDO AMIDES
<b>A61K 47/00</b> (2006.01)	2544721 *	NON-AQUEOUS HIGH CONCENTRATION REDUCED VISCOSITY SUSPENSION FORMULATIONS
<b>A61K 48/00</b> (2006.01)	2544721 *	NON-AQUEOUS HIGH CONCENTRATION REDUCED VISCOSITY SUSPENSION FORMULATIONS
<b>C40B 40/06</b> (2006.01)	2569450 *	COMPOSITIONS AND METHODS FOR TARGETING A3G:RNA COMPLEXES
<b>C40B 30/04</b> (2006.01)	2569450 *	COMPOSITIONS AND METHODS FOR TARGETING A3G:RNA COMPLEXES
<b>C12Q 1/68</b> (2006.01)	2569450 *	COMPOSITIONS AND METHODS FOR TARGETING A3G:RNA COMPLEXES





**INDEKS PODNOSITELJA ZAHTEVA ZA PROŠIRENJE EVROPSKIH PRIJAVA  
PATENTA**

**INDEX ON NUMBER OF APPLICATIONS FOR EXTENSION OF EUROPEAN  
PATENT APPLICATION**

Podnosilac evropske prijave patenta (71)	MKP (51)	Broj objave evropske prijave patenta (97)	Naziv pronalaska (54)
Laboratorios del. Dr. Esteve, S.A.	<b>C12N 9/16</b> (2006.01) <b>C12N 15/67</b> (2006.01) <b>C12N 9/14</b> (2006.01) <b>A61K 48/00</b> (2006.01) <b>C12N 15/68</b> (2006.01) <b>C12N 15/864</b> (2006.01)	2579900 *	VECTORS AND SEQUENCES FOR THE TREATMENT OF DISEASES
Universitat Autònoma De Barcelona	<b>C12N 9/16</b> (2006.01) <b>C12N 15/67</b> (2006.01) <b>C12N 9/14</b> (2006.01) <b>A61K 48/00</b> (2006.01) <b>C12N 15/68</b> (2006.01) <b>C12N 15/864</b> (2006.01)	2579900 *	VECTORS AND SEQUENCES FOR THE TREATMENT OF DISEASES
Meiji Seika Pharma Co., Ltd.	<b>A01N 47/36</b> (2006.01) <b>C07D 417/06</b> (2006.01) <b>C07D 277/20</b> (2006.01) <b>A01N 47/18</b> (2006.01) <b>A01P 7/02</b> (2006.01) <b>C07D 401/14</b> (2006.01) <b>C07D 277/32</b> (2006.01) <b>A01P 7/04</b> (2006.01) <b>A01N 43/78</b> (2006.01) <b>C07D 401/04</b> (2006.01) <b>A01P 5/00</b> (2006.01) <b>C07D 417/14</b> (2006.01)	2591673 *	PEST CONTROL AGENT
Gifu University	<b>A01N 47/36</b> (2006.01) <b>C07D 417/06</b> (2006.01) <b>C07D 277/20</b> (2006.01) <b>A01N 47/18</b> (2006.01) <b>A01P 7/02</b> (2006.01) <b>C07D 401/14</b> (2006.01) <b>C07D 277/32</b> (2006.01) <b>A01P 7/04</b> (2006.01) <b>A01N 43/78</b> (2006.01) <b>C07D 401/04</b> (2006.01) <b>A01P 5/00</b> (2006.01) <b>C07D 417/14</b> (2006.01)	2591673 *	PEST CONTROL AGENT
Meriel Limited	<b>A01N 43/00</b> (2006.01) <b>A61P 33/00</b> (2006.01)	2552201 *	PARASITICIDAL COMPOSITIONS COMPRISING MULTIPLE ACTIVE AGENTS, METHODS AND USES THEREOF
Cephalon, Inc.	<b>A61L 2/00</b> (2006.01)	2593144 *	IMPROVED METHODS FOR THE STERILIZATION OF BENDAMUSTINE
E-AAM Driveline Systems AB	<b>F16H 48/30</b> (2012.01)	2593696 *	AXLE ASSEMBLY WITH TORQUE DISTRIBUTION DRIVE MECHANISM
NP Poschmann GmbH	<b>B29C 45/00</b> (2006.01) <b>B29L 31/04</b> (2006.01) <b>B29C 45/04</b> (2006.01) <b>B29C 45/56</b> (2006.01)	2489491	Method and device for producing ball bearing rings
Genomic Vision	<b>C12Q 1/70</b> (2006.01)	2561104 *	DIAGNOSIS OF VIRAL INFECTIONS BY DETECTION OF GENOMIC AND INFECTIOUS VIRAL DNA BY MOLECULAR COMBING
Sanofi-Aventis Deutschland GmbH	<b>A61M 5/315</b> (2006.01) <b>A61M 5/24</b> (2006.01)	2579923 *	DRIVE MECHANISM FOR A DRUG DELIVERY DEVICE AND DRUG DELIVERY DEVICE
Lundbeck Pharmaceuticals Italy S.p.A.	<b>C07C 215/60</b> (2006.01)	2563757 *	METHOD FOR PREPARING RITODRINE HYDROCHLORIDE

Podnosilac evropske prijave patenta (71)	MKP (51)	Broj objave evropske prijave patenta (97)	Naziv pronalaska (54)
Trauma Care Consult (TCC) Traumatologische Forschung Gemeinnuetzige Gesellschaft MBH	<b>C12N 5/077</b> (2010.01) <b>C12N 5/073</b> (2010.01)	2576767 *	PROCESS FOR DIFFERENTIATING STEM CELLS OF THE AMNIOTIC MEMBRANE
Bio-Products&Bio-Engineering AG	<b>C12N 5/077</b> (2010.01) <b>C12N 5/073</b> (2010.01)	2576767 *	PROCESS FOR DIFFERENTIATING STEM CELLS OF THE AMNIOTIC MEMBRANE
Astellas Pharma Inc.	<b>A61P 13/08</b> (2006.01) <b>A61P 13/10</b> (2006.01) <b>C07D 401/14</b> (2006.01) <b>A61K 31/496</b> (2006.01) <b>C07D 213/65</b> (2006.01) <b>A61K 31/4545</b> (2006.01) <b>A61P 43/00</b> (2006.01) <b>A61P 13/00</b> (2006.01) <b>C07D 213/80</b> (2006.01) <b>A61P 29/00</b> (2006.01) <b>A61P 25/04</b> (2006.01) <b>A61P 19/00</b> (2006.01) <b>C07D 413/14</b> (2006.01) <b>C07D 401/12</b> (2006.01)	2564849 *	PROPHYLACTIC OR THERAPEUTIC AGENT FOR DISEASES ASSOCIATED WITH PAINS IN URINARY ORGANS
aTyr Pharma, Inc.	<b>A61K 38/10</b> (2006.01) <b>A61K 38/08</b> (2006.01) <b>A61P 3/00</b> (2006.01) <b>A61P 35/00</b> (2006.01) <b>A61K 38/16</b> (2006.01) <b>A61K 39/395</b> (2006.01) <b>A61P 3/10</b> (2006.01)	2593124 *	INNOVATIVE DISCOVERY OF THERAPEUTIC, DIAGNOSTIC, AND ANTIBODY COMPOSITIONS RELATED TO PROTEIN FRAGMENTS OF ASPARTYL-TRNA SYNTHETASES
Pangu Biopharma Limited	<b>A61K 38/10</b> (2006.01) <b>A61K 38/08</b> (2006.01) <b>A61P 3/00</b> (2006.01) <b>A61P 35/00</b> (2006.01) <b>A61K 38/16</b> (2006.01) <b>A61K 39/395</b> (2006.01) <b>A61P 3/10</b> (2006.01)	2593124 *	INNOVATIVE DISCOVERY OF THERAPEUTIC, DIAGNOSTIC, AND ANTIBODY COMPOSITIONS RELATED TO PROTEIN FRAGMENTS OF ASPARTYL-TRNA SYNTHETASES
Aventis Pharma S.A.	<b>A61P 7/02</b> (2006.01) <b>A61K 31/727</b> (2006.01)	2585079 *	SEMULOPARIN FOR THE EXTENDED PREVENTION OF A MORTALITY AND/OR MORBIDITY EVENT IN A PATIENT HAVING UNDERGONE HIP FRACTURE SURGERY
Omya Development AG	<b>C02F 1/52</b> (2006.01)	2592054	Aqueous suspensions of calcium carbonate-comprising materials with low deposit built up
GlaxoSmithKline Biologicals S.A.	<b>A61P 31/18</b> (2006.01) <b>A61K 39/21</b> (2006.01)	2552480 *	HIV VACCINE
SANOFI	<b>C07F 17/02</b> (2006.01)	2580224 *	METHOD OF SYNTHESIS OF FERROQUINE BY CONVERGENT REDUCTIVE AMINATION
Sanofi-Aventis Deutschland GmbH	<b>A61M 5/20</b> (2006.01)	2538996 *	AUTO - INJECTOR WITH NEEDLE SHROUD AND NEEDLE PROTECTION CAP
Mik, D.o.o.	<b>F24F 12/00</b> (2006.01) <b>E06B 7/10</b> (2006.01) <b>F24F 13/18</b> (2006.01) <b>F24F 11/00</b> (2006.01)	2539642 *	VENTILATION DEVICE
Takeda Pharmaceutical Company Limited	<b>C07D 413/04</b> (2006.01) <b>A61P 3/00</b> (2006.01) <b>C07D 231/54</b> (2006.01) <b>A61K 31/416</b> (2006.01) <b>C07D 487/08</b> (2006.01) <b>C07D 263/56</b> (2006.01) <b>A61K 31/496</b> (2006.01) <b>C07D 417/04</b> (2006.01) <b>A61P 9/00</b> (2006.01) <b>C07D 307/81</b> (2006.01) <b>A61K 31/4365</b> (2006.01) <b>C07D 263/58</b> (2006.01) <b>A61K 31/4355</b> (2006.01) <b>C07D 498/04</b> (2006.01)	2563765 *	BICYCLIC COMPOUND DERIVATIVES AND THEIR USE AS ACC INHIBITORS.

Podnosilac evropske prijave patenta (71)	MKP (51)	Broj objave evropske prijave patenta (97)	Naziv pronalaska (54)
HERCULES INCORPORATED	<b>C09J 189/00</b> (2006.01) <b>C08L 97/02</b> (2006.01) <b>C08L 79/02</b> (2006.01) <b>C08L 89/00</b> (2006.01)	2576697 *	PROTEIN ADHESIVE FORMULATIONS WITH AMINE-EPICHLOROHYDRIN AND ISOCYANATE ADDITIVES
ASKA Pharmaceutical Co., Ltd.	<b>A61K 31/437</b> (2006.01) <b>A61K 31/498</b> (2006.01) <b>C07D 231/40</b> (2006.01) <b>C07D 277/20</b> (2006.01) <b>A61K 31/4178</b> (2006.01) <b>A61P 29/00</b> (2006.01) <b>C07D 405/14</b> (2006.01) <b>A61K 31/341</b> (2006.01) <b>A61K 31/55</b> (2006.01) <b>C07D 307/68</b> (2006.01) <b>A61K 31/427</b> (2006.01) <b>A61P 43/00</b> (2006.01) <b>C07D 207/34</b> (2006.01) <b>A61K 31/5383</b> (2006.01) <b>C07D 277/42</b> (2006.01) <b>A61K 31/426</b> (2006.01) <b>A61P 35/00</b> (2006.01) <b>A61K 31/415</b> (2006.01) <b>A61P 3/10</b> (2006.01) <b>C07D 403/12</b> (2006.01)	2594555 *	HETEROCYCLIC COMPOUND, AND p27 KIP1 DEGRADATION INHIBITOR
Shire LLC	<b>A61P 3/10</b> (2006.01) <b>A61K 31/4164</b> (2006.01) <b>C07D 233/22</b> (2006.01) <b>A61K 31/421</b> (2006.01) <b>C07D 263/16</b> (2006.01) <b>C07D 263/14</b> (2006.01) <b>C07D 231/14</b> (2006.01) <b>A61P 31/12</b> (2006.01)	2566854 *	DESAZADESFERROTHIOCIN AND DESAZADESFERROTHIOCIN POLYETHER ANALOGUES AS METAL CHELATION AGENTS
Glaxo Group Limited	<b>A61K 31/00</b> (2006.01) <b>C07K 14/56</b> (2006.01) <b>A61K 38/21</b> (2006.01) <b>A61K 38/26</b> (2006.01) <b>C07K 14/575</b> (2006.01) <b>C07K 16/18</b> (2006.01) <b>C07K 16/28</b> (2006.01) <b>A61K 47/48</b> (2006.01)	2571900 *	IMPROVED ANTI-SERUM ALBUMIN BINDING VARIANTS
GANYMED Pharmaceuticals AG	<b>C07K 16/30</b> (2006.01)	2550296 *	MONOCLONAL ANTIBODIES FOR TREATMENT OF CANCER
Johannes- Gutenberg- Universität Mainz	<b>C07K 16/30</b> (2006.01)	2550296 *	MONOCLONAL ANTIBODIES FOR TREATMENT OF CANCER
Hagleitner, Hans Georg	<b>A47K 5/12</b> (2006.01)	2560530 *	STAND FOR A LIQUID DISPENSER
Janssen Pharmaceutica, N.V.	<b>A61K 31/495</b> (2006.01) <b>C07D 403/10</b> (2006.01) <b>C07D 401/12</b> (2006.01) <b>C07D 241/08</b> (2006.01) <b>A61P 25/28</b> (2006.01) <b>C07D 401/10</b> (2006.01)	2585440 *	3-AMINO-5,6-DIHYDRO-1H-PYRAZIN-2-ONE DERIVATIVES USEFUL FOR THE TREATMENT OF ALZHEIMER'S DISEASE AND OTHER FORMS OF DEMENTIA
Protiva Biotherapeutics Inc.	<b>C07C 271/20</b> (2006.01) <b>C07C 237/06</b> (2006.01) <b>C12N 15/11</b> (2006.01) <b>C07D 249/04</b> (2006.01) <b>C07C 229/30</b> (2006.01) <b>C12N 15/88</b> (2006.01) <b>A61K 48/00</b> (2006.01) <b>C07D 233/60</b> (2006.01) <b>C07C 217/08</b> (2006.01) <b>C07C 327/06</b> (2006.01) <b>C07C 217/46</b> (2006.01) <b>A61K 49/04</b> (2006.01) <b>C07C 229/12</b> (2006.01) <b>A61K 47/48</b> (2006.01)	2569276 *	NOVEL CATIONIC LIPIDS AND METHODS OF USE THEREOF

Podnosilac evropske prijave patenta (71)	MKP (51)	Broj objave evropske prijave patenta (97)	Naziv pronalaska (54)
Gnezdilov, Vladimir Alexeevich	<b>A63G 27/00</b> (2006.01)	2591835 *	OBSERVATION WHEEL
TIG Automation GmbH	<b>B01D 63/04</b> (2006.01) <b>B01D 65/00</b> (2006.01)	2559477	Device for filtering and separating flow media with hollow fibre membrane elements
aTyr Pharma, Inc.	<b>A61K 38/17</b> (2006.01) <b>A61K 38/16</b> (2006.01) <b>A61K 39/395</b> (2006.01) <b>A61P 29/00</b> (2006.01) <b>A61P 3/00</b> (2006.01) <b>A61P 35/00</b> (2006.01)	2563382 *	INNOVATIVE DISCOVERY OF THERAPEUTIC, DIAGNOSTIC, AND ANTIBODY COMPOSITIONS RELATED TO PROTEIN FRAGMENTS OF THREONYL TRNA SYNTHETASES
Pangu Biopharma Limited	<b>A61K 38/17</b> (2006.01) <b>A61K 38/16</b> (2006.01) <b>A61K 39/395</b> (2006.01) <b>A61P 29/00</b> (2006.01) <b>A61P 3/00</b> (2006.01) <b>A61P 35/00</b> (2006.01)	2563382 *	INNOVATIVE DISCOVERY OF THERAPEUTIC, DIAGNOSTIC, AND ANTIBODY COMPOSITIONS RELATED TO PROTEIN FRAGMENTS OF THREONYL TRNA SYNTHETASES
Normamed S.A.	<b>G06F 19/00</b> (2011.01)	2550613 *	METHOD AND RECORDING MACHINE FOR RECORDING HEALTH-RELATED INFORMATION
Sanofi-Aventis Deutschland GmbH	<b>A61M 5/178</b> (2006.01) <b>H02K 7/18</b> (2006.01) <b>H02K 35/00</b> (2006.01)	2455120	Medical device comprising mechanical-electrical transducing means
Gosio Dianora	<b>E05F 3/10</b> (2006.01)	2426300	Door closer, particularly for glass doors
Amgen Inc.	<b>A61K 39/395</b> (2006.01) <b>A61K 45/06</b> (2006.01) <b>A61P 35/00</b> (2006.01) <b>C12Q 1/68</b> (2006.01) <b>C07K 16/28</b> (2006.01)	2569336 *	ENHANCED DEATH RECEPTOR AGONISTS
Orion Corporation	<b>A61K 9/28</b> (2006.01) <b>A61K 31/275</b> (2006.01) <b>A61K 45/06</b> (2006.01) <b>A61K 9/00</b> (2006.01) <b>A61K 31/198</b> (2006.01) <b>A61P 25/16</b> (2006.01) <b>A61K 9/20</b> (2006.01)	2542220 *	USE OF LEVODOPA, CARBIDOPA AND ENTACAPONE FOR TREATING PARKINSON'S DISEASE
Hyglos Invest GmbH	<b>C40B 30/06</b> (2006.01) <b>C12N 15/62</b> (2006.01) <b>C12N 15/10</b> (2006.01)	2582813 *	METHODS OF GENERATING AND SCREENING FOR LYTIC CHIMERIC POLYPEPTIDES
Sanofi-Aventis Deutschland GmbH	<b>A61M 5/34</b> (2006.01) <b>A61M 5/31</b> (2006.01) <b>A61M 5/00</b> (2006.01)	2552521 *	DEDICATED NEEDLE ASSEMBLY
The Board of Trustees of the Leland Stanford Junior University	<b>A61K 39/395</b> (2006.01) <b>C12P 21/08</b> (2006.01) <b>C12N 5/07</b> (2010.01) <b>C12N 5/16</b> (2006.01)	2569013 *	HUMANIZED AND CHIMERIC MONOCLONAL ANTIBODIES TO CD47
Sanofi-Aventis Deutschland GmbH	<b>A61M 5/24</b> (2006.01)	2560707 *	CODED FASTENER ASSEMBLY
Hercules Incorporated	<b>D21H 21/14</b> (2006.01) <b>D21H 17/35</b> (2006.01) <b>C08F 10/10</b> (2006.01) <b>C08F 10/08</b> (2006.01)	2576637 *	CREPING RELEASE AGENTS
YRT Limited	<b>A61B 5/08</b> (2006.01) <b>A61M 16/00</b> (2006.01) <b>A61F 5/56</b> (2006.01)	2579824 *	A METHOD AND DEVICE(S) FOR DIAGNOSIS AND/OR TREATMENT OF SLEEP APNEA AND RELATED DISORDERS
Ensysce Biosciences, Inc.	<b>A61K 47/48</b> (2006.01) <b>A61K 38/18</b> (2006.01) <b>A61K 38/17</b> (2006.01) <b>A61K 9/48</b> (2006.01) <b>A61P 35/00</b> (2006.01) <b>A61K 31/7105</b> (2006.01)	2588124 *	SINGLE-WALLED CARBON NANOTUBE/SIRNA COMPLEXES AND METHODS RELATED THERETO

Podnosilac evropske prijave patenta (71)	MKP (51)	Broj objave evropske prijave patenta (97)	Naziv pronalaska (54)
Ajinomoto Co., Inc.	<b>A61K 31/197</b> (2006.01) <b>A61K 31/714</b> (2006.01) <b>A61K 31/198</b> (2006.01) <b>A61K 33/06</b> (2006.01) <b>A61K 9/08</b> (2006.01) <b>A61K 31/525</b> (2006.01) <b>A61K 31/4188</b> (2006.01) <b>A61K 33/30</b> (2006.01) <b>A61K 31/4415</b> (2006.01) <b>A61K 47/12</b> (2006.01) <b>A61K 31/51</b> (2006.01) <b>A61K 31/455</b> (2006.01) <b>A61P 7/00</b> (2006.01) <b>A61K 31/19</b> (2006.01) <b>A61K 31/7004</b> (2006.01) <b>A61K 31/375</b> (2006.01) <b>A61K 33/20</b> (2006.01)	2567700 *	VITAMIN-CONTAINING NUTRITION INFUSION FOR ADMINISTRATION THROUGH PERIPHERAL VEIN
Teikoku Seiyaku Co., Ltd.	<b>A61K 31/167</b> (2006.01) <b>A61K 45/00</b> (2006.01) <b>A61K 31/192</b> (2006.01) <b>A61K 9/70</b> (2006.01)	2594262 *	SUBSTRATE OF THREE-LAYER STRUCTURE AND WATER-CONTAINING ADHESIVE PATCH INCLUDING SAME
Toyobo Co., Ltd.	<b>A61K 31/167</b> (2006.01) <b>A61K 45/00</b> (2006.01) <b>A61K 31/192</b> (2006.01) <b>A61K 9/70</b> (2006.01)	2594262 *	SUBSTRATE OF THREE-LAYER STRUCTURE AND WATER-CONTAINING ADHESIVE PATCH INCLUDING SAME
GlaxoSmithKline Biologicals S.A.	<b>A61P 31/04</b> (2006.01) <b>A61K 39/09</b> (2006.01)	2544711 *	TREATMENT OF STREPTOCOCCAL INFECTIONS
Vantia Limited	<b>A61P 15/00</b> (2006.01) <b>A61K 31/5517</b> (2006.01) <b>C07D 487/04</b> (2006.01)	2547681 *	TOSYLATE SALT OF CYCLOPROPANECARBOXYLIC ACID 4-(6-CHLORO-3-METHYL-4,10-DIHYDRO-3H-2,3,4,9-TETRABENZO[F]AZULENE-9-CARBONYL)-2-FLUOROBENZYLAMIDE
Delphi Technologies Holding S.à.r.l.	<b>F02D 41/34</b> (2006.01) <b>F02P 7/077</b> (2006.01)	2556232 *	INJECTION CONTROL METHOD
Ozdamar, Hasan Basri	<b>F02F 3/28</b> (2006.01) <b>F02F 7/00</b> (2006.01)	2556235 *	HIGH SPEED ENGINE
Goertek Inc.	<b>H04M 9/08</b> (2006.01)	2568695 *	METHOD AND DEVICE FOR SUPPRESSING RESIDUAL ECHO
Korea Advanced Institute Of Science And Technology	<b>F41H 11/02</b> (2006.01) <b>F41H 13/00</b> (2006.01)	2556325 *	HIGH-ENERGY LASER SYSTEM INTERCEPTING A TARGET AND METHOD THEREOF
Krka Tovarna Zdravil, D.D., Novo Mesto	<b>A61K 31/4422</b> (2006.01) <b>A61K 9/20</b> (2006.01) <b>A61K 31/401</b> (2006.01)	2585051 *	PHARMACEUTICAL ORAL DOSAGE FORMS COMPRISING LERCANIDIPINE AND ENALAPRIL AND THEIR PHARMACEUTICALLY ACCEPTABLE SALTS
Sofar SPA	<b>G06F 3/01</b> (2006.01) <b>A61B 5/11</b> (2006.01) <b>A61B 3/113</b> (2006.01) <b>A61B 19/00</b> (2006.01)	2555703 *	ROBOTIZED SURGERY SYSTEM WITH IMPROVED CONTROL
Novelis, Inc.	<b>B65D 19/24</b> (2006.01) <b>B65D 19/28</b> (2006.01) <b>B21D 9/05</b> (2006.01)	2585379 *	SECTIONAL METAL PALLET FORMED FROM CORRIGATED METAL TUBES
Dow AgroSciences LLC	<b>A01P 13/00</b> (2006.01) <b>A01N 43/90</b> (2006.01) <b>A01N 43/40</b> (2006.01)	2582245 *	SYNERGISTIC HERBICIDAL COMPOSITION CONTAINING CLOPYRALID AND FLORASULAM
Ethicon. Inc.	<b>A61F 2/00</b> (2006.01) <b>A61B 17/00</b> (2006.01) <b>A61B 17/06</b> (2006.01)	2547266 *	SURGICAL INSTRUMENT AND METHOD FOR THE TREATMENT OF URINARY INCONTINENCE
BG Medicine, Inc.	<b>G01N 33/68</b> (2006.01)	2568294	Risk Factors and Prediction of Myocardial Infarction
Tengion, Inc.	<b>A61L 27/38</b> (2006.01)	2566529 *	SMOOTH MUSCLE CELL CONSTRUCTS

Podnosilac evropske prijave patenta (71)	MKP (51)	Broj objave evropske prijave patenta (97)	Naziv pronalaska (54)
Amgen Inc.	<b>C07D 513/10</b> (2006.01) <b>A61K 31/429</b> (2006.01) <b>A61P 25/28</b> (2006.01) <b>A61K 31/424</b> (2006.01) <b>C07D 498/10</b> (2006.01) <b>C07D 498/20</b> (2006.01)	2547685 *	SPIRO-TETRACYCLIC RING COMPOUNDS AS BETA - SECRETASE MODULATORS
Ploder, Edwin	<b>G01F 15/06</b> (2006.01) <b>G01D 4/00</b> (2006.01)	2558821 *	APPARATUS FOR MONITORING AND/OR CONTROLLING ENERGY AND WATER MANAGEMENT
A.S.I.U. S.p.A.	<b>B01D 53/62</b> (2006.01) <b>C01B 3/04</b> (2006.01) <b>C01B 3/06</b> (2006.01) <b>C04B 5/00</b> (2006.01)	2571805 *	A PROCESS FOR THE PRODUCTION OF HYDROGEN, THE SEQUESTRATION OF CARBON DIOXIDE AND THE PRODUCTION OF BUILDING MATERIALS STARTING FROM SLAGS AND/OR INDUSTRIAL ASHES
Immunogen, Inc.	<b>A61K 39/395</b> (2006.01)	2544719 *	CD37-BINDING MOLECULES AND IMMUNOCONJUGATES THEREOF
Rozzi De Hieronymis, Carlo Maria	<b>F15B 3/00</b> (2006.01)	2539592 *	INTENSIFIER OF HYDRAULIC POWER WITH RELY WITH MAINTENANCE OF THE REACHED POSITION AND FORCE
BASF SE	<b>H01F 1/047</b> (2006.01) <b>B22F 1/00</b> (2006.01)	2550666 *	COMPOSITION FOR PRODUCING MAGNETIC OR MAGNETIZABLE MOLDINGS, AND PROCESS FOR PRODUCING THE SAME
Aventis Pharmaceuticals Inc.	<b>C07D 403/04</b> (2006.01) <b>A61K 31/505</b> (2006.01) <b>A61P 11/00</b> (2006.01)	2547673 *	A SUBSTITUTED PYRIMIDINE AS A PROSTAGLANDIN D2 RECEPTOR ANTAGONIST
Biogen Idec MA Inc.	<b>C07K 16/28</b> (2006.01)	2558499 *	ANTI-VLA-4 ANTIBODIES
Global Vapor Trademarks Incorporated	<b>A24B 3/12</b> (2006.01)	2571385 *	METHOD FOR PREPARING TOBACCO EXTRACT FOR ELECTRONIC SMOKING DEVICES
May, Daniel C.	<b>G09B 23/28</b> (2006.01)	2559020 *	HEART COMPRESSION SIMULATION DEVICE
Mallet, Benoît	<b>B26D 3/08</b> (2006.01) <b>B26B 5/00</b> (2006.01) <b>B28D 1/22</b> (2006.01)	2560799 *	CARRIAGE FOR CUTTING A SHEET OF GYPSUM BOARD, CUTTING KIT AND METHOD FOR IMPLEMENTING SAME
Åsa Westin desingner	<b>B63B 25/00</b> (2006.01)	2468622	Storage system
OSI Pharmaceuticals, LLC	<b>A61K 31/4985</b> (2006.01) <b>C07D 487/04</b> (2006.01) <b>A61P 35/00</b> (2006.01)	2585466 *	POLYMORPHS OF OSI-906
Sanofi-Aventis Deutschland GmbH	<b>A61M 5/20</b> (2006.01) <b>A61M 5/24</b> (2006.01)	2544739 *	AUTO-INJECTOR
Novartis AG	<b>A61K 31/55</b> (2006.01) <b>C07D 405/14</b> (2006.01) <b>C07D 403/12</b> (2006.01) <b>A61P 35/00</b> (2006.01) <b>C07D 405/12</b> (2006.01) <b>C07D 249/08</b> (2006.01)	2558450 *	TRIAZOLE COMPOUNDS AS KSP INHIBITORS
SANOFI	<b>A61K 31/538</b> (2006.01) <b>A61K 31/404</b> (2006.01) <b>C07D 209/34</b> (2006.01) <b>A61K 31/428</b> (2006.01) <b>A61K 31/4704</b> (2006.01) <b>C07D 215/227</b> (2006.01) <b>C07D 277/68</b> (2006.01) <b>C07D 498/04</b> (2006.01) <b>C07D 265/36</b> (2006.01) <b>A61K 31/5383</b> (2006.01)	2582667 *	HETEROCYCLIC SUBSTITUTED METHOXYPHENYL DERIVATIVES HAVING AN OXO GROUP, METHOD FOR PRODUCING SAME, AND USE THEREOF AS GPR40 RECEPTOR MODULATORS
Taisho Pharmaceutical Co., Ltd.	<b>A61P 11/06</b> (2006.01) <b>A61P 11/02</b> (2006.01) <b>C07D 217/18</b> (2006.01) <b>A61P 37/08</b> (2006.01) <b>A61K 31/472</b> (2006.01) <b>C07D 217/20</b> (2006.01) <b>A61P 43/00</b> (2006.01) <b>A61P 17/04</b> (2006.01)	2586772 *	ISOQUINOLINE DERIVATIVE

Podnosilac evropske prijave patenta (71)	MKP (51)	Broj objave evropske prijave patenta (97)	Naziv pronalaska (54)
AbbVie Inc.	<b>A61K 39/395</b> (2006.01) <b>A61K 39/00</b> (2006.01) <b>C12P 21/06</b> (2006.01) <b>C07K 16/00</b> (2006.01) <b>C07H 21/04</b> (2006.01)	2566890 *	ANTI-PAI-1 ANTIBODIES AND METHODS OF USE THEREOF
Dow AgroSciences LLC	<b>A01N 37/18</b> (2006.01)	2582237 *	SYNERGISTIC HERBICIDAL COMPOSITIONS CONTAINING PROPYZAMIDE AND AMINOPYRALID
Sanofi-Aventis Deutschland GmbH	<b>A61M 5/24</b> (2006.01) <b>A61M 5/315</b> (2006.01)	2579930 *	DRUG DELIVERY DEVICE WITH DRIVE MEMBER HAVING INDICATION ELEMENTS
Ethicon, LLC	<b>D02J 3/10</b> (2006.01) <b>A61B 17/04</b> (2006.01) <b>D02J 3/02</b> (2006.01) <b>A61B 17/08</b> (2006.01)	2566401 *	LASER CUTTING SYSTEM AND METHODS FOR CREATING SELF-RETAINING SUTURES
The Trustees Of The University Of Pennsylvania	<b>A61K 31/56</b> (2006.01)	2542245 *	ANTIMICROBIAL CATIONIC STEREOIDS AND METHODS OF USE
Zentiva, K.S.	<b>C07D 487/04</b> (2006.01)	2547683 *	METHOD OF PREPARING SITAGLIPTIN
SANOFI	<b>A61K 31/425</b> (2006.01) <b>C07D 513/04</b> (2006.01)	2582709 *	AZOLOPYRIDIN-3-ONE DERIVATIVES AS INHIBITORS OF LIPASES AND PHOSPHOLIPASES
Janssen Pharmaceutica, N.V.	<b>C07D 487/04</b> (2006.01) <b>A61P 3/00</b> (2006.01) <b>A61P 25/00</b> (2006.01) <b>A61K 31/4985</b> (2006.01)	2545055 *	IMIDAZO [1, 2 -A]PYRAZINE DERIVATIVES AND THEIR USE FOR THE PREVENTION OR TREATMENT OF NEUROLOGICAL, PSYCHIATRIC AND METABOLIC DISORDERS AND DISEASES
Sanofi-Aventis Deutschland GmbH	<b>A61M 5/20</b> (2006.01)	2538997 *	FORCE TRANSMISSION ARRANGEMENT FOR AUTO-INJECTOR
Omya Development AG	<b>C02F 1/68</b> (2006.01) <b>C02F 103/42</b> (2006.01)	2565165	Remineralization of desalinated and of fresh water by dosing of a calcium carbonate solution in soft water
Turbosonic Inc.	<b>C09J 163/10</b> (2006.01) <b>C09J 11/04</b> (2006.01) <b>C09J 9/02</b> (2006.01)	2576717 *	CONDUCTIVE ADHESIVE
Sanofi-Aventis Deutschland GmbH	<b>A61M 5/20</b> (2006.01)	2585142 *	AUTO-INJECTOR
Chiesi Farmaceutici S.p.A.	<b>A61P 11/06</b> (2006.01) <b>A61K 9/00</b> (2006.01) <b>A61K 9/14</b> (2006.01) <b>A61K 31/439</b> (2006.01) <b>A61P 11/08</b> (2006.01)	2585047 *	DRY POWDER FORMULATION COMPRISING AN ANTIMUSCARINIC DRUG
BIOGEN IDEC HEMOPHILIA INC.	<b>C12N 9/96</b> (2006.01) <b>A61K 38/48</b> (2006.01) <b>A61K 38/36</b> (2006.01)	2591099 *	CHIMERIC CLOTTING FACTORS
Drenaline Products, LLC	<b>A63B 55/00</b> (2006.01) <b>A63B 55/04</b> (2006.01) <b>A63B 55/06</b> (2006.01)	2575978 *	GOLF BAG BANNER
Archos	<b>G08C 17/02</b> (2006.01) <b>G06F 3/038</b> (2013.01)	2539875 *	METHOD AND DEVICE FOR CONTROLLING AT LEAST ONE APPARATUS BY MEANS OF AT LEAST ONE OTHER APPARATUS, AND SYSTEM IMPLEMENTING SUCH A DEVICE
Abbott Laboratories	<b>C12N 5/07</b> (2010.01) <b>A61K 39/00</b> (2006.01) <b>C12P 21/08</b> (2006.01) <b>C12N 5/16</b> (2006.01)	2590671 *	DUAL VARIABLE DOMAIN IMMUNOGLOBULINS AND USES THEREOF
Talyst Inc.	<b>G07F 11/44</b> (2006.01) <b>G07F 17/00</b> (2006.01) <b>A61J 7/00</b> (2006.01)	2263638	Dispensing canister for delivery of solid medications

Podnosilac evropske prijave patenta (71)	MKP (51)	Broj objave evropske prijave patenta (97)	Naziv pronalaska (54)
Palobiofarma, S.L.	<b>C07D 409/14</b> (2006.01) <b>C07D 413/14</b> (2006.01) <b>C07D 417/14</b> (2006.01) <b>A61K 31/506</b> (2006.01) <b>C07D 417/04</b> (2006.01) <b>C07D 403/04</b> (2006.01) <b>A61P 25/00</b> (2006.01) <b>C07D 403/14</b> (2006.01) <b>A61P 3/10</b> (2006.01)	2552909 *	4 - AMINOPYRIMIDINE DERIVATIVES AND THEIR AS AS ADENOSINE A2A RECEPTOR ANTAGONISTS
Chiesi Farmaceutici S.p.A.	<b>A61P 11/00</b> (2006.01) <b>A61K 31/439</b> (2006.01) <b>C07D 453/02</b> (2006.01)	2585457 *	ALKALOID AMINOESTER DERIVATIVES AND MEDICINAL COMPOSITION THEREOF
AEG Power Solutions B.V.	<b>H02M 5/257</b> (2006.01)	2395643	Method for adjusting an AC power controller
Relay Fitness Group	<b>F16H 57/08</b> (2006.01)	2569556 *	EXERCISE CYCLE WITH PLANETARY GEAR SYSTEM AND ROLLING RECOILED LATERAL MOTION SYSTEM
Rekik, Raouf	<b>A61P 27/02</b> (2006.01) <b>A61K 31/198</b> (2006.01) <b>A61K 31/00</b> (2006.01)	2575793 *	N-ACETYL-DL-LEUCINE, NEUROPROTECTIVE AND RETINOPROTECTIVE MEDICAMENT
Panasonic Corporation	<b>H04N 5/765</b> (2006.01) <b>H04N 5/85</b> (2006.01) <b>G11B 20/10</b> (2006.01) <b>H04N 5/91</b> (2006.01)	2581908 *	REPRODUCTION DEVICE, RECORDING MEDIUM, REPRODUCTION METHOD, PROGRAM
Ishihara Sangyo Kaisha, Ltd.	<b>A01N 51/00</b> (2006.01) <b>A01N 25/30</b> (2006.01) <b>A01N 43/40</b> (2006.01) <b>A01N 47/18</b> (2006.01)	2590508 *	WATER-BASED PESTICIDAL SUSPENSION
Pedem Limited	<b>E21B 10/32</b> (2006.01)	2553206 *	DOWNHOLE TOOL
Dervet S.r.l.	<b>F25D 23/02</b> (2006.01) <b>E05F 11/54</b> (2006.01) <b>E05B 17/00</b> (2006.01)	2439366	Device for opening sliding doors for cold rooms
Jezeq, Giorgio	<b>B66B 11/04</b> (2006.01)	2560912 *	DEVICE FOR SAVING ENERGY DURING VERTICAL AND HORIZONTAL MOTIONS
Genzyme Corporation	<b>A61K 31/425</b> (2006.01) <b>A01N 43/54</b> (2006.01) <b>A61K 31/505</b> (2006.01)	2544541 *	COMBINATION THERAPY FOR TREATING BREAST CANCER
Vertex Pharmaceuticals Incorporated	<b>A61K 31/4704</b> (2006.01) <b>A61K 31/404</b> (2006.01) <b>A61K 31/443</b> (2006.01)	2560649 *	PHARMACEUTICAL COMPOSITIONS AND ADMINISTRATIONS THEREOF
SAINT-GOBAIN RECHERCHE	<b>C09J 167/06</b> (2006.01) <b>C08G 69/44</b> (2006.01) <b>C08G 63/676</b> (2006.01) <b>C08G 63/52</b> (2006.01) <b>B24D 3/28</b> (2006.01) <b>B24D 3/20</b> (2006.01)	2576140 *	ADHESIVE COMPOSITION CONTAINING A WATER-SOLUBLE OR WATER-DISPERSIBLE UNSATURATED POLYESTER AND AN ETHYLENE-UNSATURATED MONOMER, AND USES THEREOF
Nuevolution A/S	<b>C12N 15/10</b> (2006.01)	2558577 *	BI-FUNCTIONAL COMPLEXES AND METHODS FOR MAKING AND USING SUCH COMPLEXES
Sanofi-Aventis Deutschland GmbH	<b>A61M 5/315</b> (2006.01) <b>A61M 5/24</b> (2006.01)	2566539 *	DRIVE MECHANISM WITH A LOW FRICTION COATING FOR A DRUG DELIVERY DEVICE
Nomacor LLC	<b>B65D 39/00</b> (2006.01) <b>B65D 51/24</b> (2006.01)	2590869 *	CONTAINER STOPPER WITH A DECORATIVE LAYER
Zentiva, K.S.	<b>C07D 239/34</b> (2006.01) <b>A61K 31/513</b> (2006.01)	2476670	Stable solid salts of ambrisentan
Sanofi-Aventis Deutschland GmbH	<b>C07D 239/34</b> (2006.01) <b>A61K 31/513</b> (2006.01)	2476670	Stable solid salts of ambrisentan
BONGRAIN S.A.	<b>B65D 85/76</b> (2006.01)	2544966 *	PORTIONABLE PACKAGING FOR A FOOD PRODUCT



Podnosilac evropske prijave patenta (71)	MKP (51)	Broj objave evropske prijave patenta (97)	Naziv pronalaska (54)
aTyr Pharma, Inc.	<b>C12N 9/00</b> (2006.01) <b>A61K 39/39</b> (2006.01) <b>A61K 38/16</b> (2006.01) <b>A61K 38/43</b> (2006.01) <b>A61P 37/00</b> (2006.01) <b>A61K 39/395</b> (2006.01)	2566516 *	INNOVATIVE DISCOVERY OF THERAPEUTIC, DIAGNOSTIC, AND ANTIBODY COMPOSITIONS RELATED TO PROTEIN FRAGMENTS OF SERYL-TRNA SYNTHETASES
Pangu Biopharma Limited	<b>C12N 9/00</b> (2006.01) <b>A61K 39/39</b> (2006.01) <b>A61K 38/16</b> (2006.01) <b>A61K 38/43</b> (2006.01) <b>A61P 37/00</b> (2006.01) <b>A61K 39/395</b> (2006.01)	2566516 *	INNOVATIVE DISCOVERY OF THERAPEUTIC, DIAGNOSTIC, AND ANTIBODY COMPOSITIONS RELATED TO PROTEIN FRAGMENTS OF SERYL-TRNA SYNTHETASES
Janssen Pharmaceutica, N.V.	<b>A61K 31/5517</b> (2006.01) <b>C07D 487/04</b> (2006.01) <b>A61P 31/10</b> (2006.01)	2576557 *	NOVEL ANTIFUNGAL 5,6-DIHYDRO-4-[(DIFLUOROETHYL)PHENYL]-4H-PYRROLO[1,2-a][1,4]BENZODIAZEPINE AND 4-(DIFLUOROETHYL)PHENYL-6H-PYRROLO[1,2-a][1,4]BENZODIAZEPINE DERIVATIVES
Gilead Connecticut, Inc.	<b>A61P 35/00</b> (2006.01) <b>C07D 495/04</b> (2006.01) <b>C07D 498/04</b> (2006.01) <b>C07D 487/04</b> (2006.01) <b>A61K 31/498</b> (2006.01)	2566869 *	PYRIDONE AND AZA-PYRIDONE COMPOUNDS AND METHODS OF USE
Genentech, Inc.	<b>A61P 35/00</b> (2006.01) <b>C07D 495/04</b> (2006.01) <b>C07D 498/04</b> (2006.01) <b>C07D 487/04</b> (2006.01) <b>A61K 31/498</b> (2006.01)	2566869 *	PYRIDONE AND AZA-PYRIDONE COMPOUNDS AND METHODS OF USE
Avir Green Hills Biotechnology Research Development Trade AG	<b>C12N 15/09</b> (2006.01) <b>C07K 14/11</b> (2006.01) <b>C12N 15/86</b> (2006.01) <b>C12N 7/02</b> (2006.01)	2576773 *	METHODS AND HELPER VIRUSES FOR THE GENERATION OF RNA VIRUS
Shire Human Genetic Therapies, Inc.	<b>A61K 38/47</b> (2006.01) <b>A61P 25/28</b> (2006.01) <b>A61P 25/00</b> (2006.01)	2593131 *	METHODS AND COMPOSITIONS FOR CNS DELIVERY OF IDURONATE-2-SULFATASE
Sanofi-Aventis Deutschland GmbH	<b>A61M 5/32</b> (2006.01) <b>A61M 5/20</b> (2006.01)	2588162 *	SAFETY DEVICE FOR A PRE-FILLED SYRINGE AND INJECTION DEVICE
Astellas Pharma Inc.	<b>A61P 15/10</b> (2006.01) <b>A61K 31/55</b> (2006.01) <b>A61P 13/02</b> (2006.01) <b>C07D 498/04</b> (2006.01) <b>A61P 43/00</b> (2006.01) <b>A61P 3/04</b> (2006.01) <b>C07D 487/04</b> (2006.01) <b>A61P 13/00</b> (2006.01)	2546255 *	BENZAZEPINE COMPOUND
Cantab Biopharmaceuticals Patents Limited	<b>A61P 7/04</b> (2006.01) <b>A61K 47/48</b> (2006.01) <b>A61K 38/36</b> (2006.01)	2563403 *	CONJUGATED BLOOD COAGULATION FACTOR VIIA
Polytherics Limited	<b>A61P 7/04</b> (2006.01) <b>A61K 47/48</b> (2006.01) <b>A61K 38/36</b> (2006.01)	2563403 *	CONJUGATED BLOOD COAGULATION FACTOR VIIA
Janssen Pharmaceutica, N.V.	<b>A61P 25/04</b> (2006.01) <b>A61P 25/02</b> (2006.01) <b>A61K 31/513</b> (2006.01) <b>A61K 31/53</b> (2006.01)	2585069 *	PROKINETICIN 1 RECEPTOR ANTAGONISTS FOR THE TREATMENT OF PAIN
Spain Pharma, S.A.	<b>A61K 9/10</b> (2006.01) <b>A61K 31/19</b> (2006.01) <b>A61K 47/18</b> (2006.01)	2571488 *	PHARMACEUTICAL COMPOSITION OF IBUPROFEN FOR INJECTION
Vertex Pharmaceuticals Incorporated	<b>A61K 31/47</b> (2006.01) <b>C07D 215/56</b> (2006.01) <b>A61P 11/00</b> (2006.01)	2547658 *	SOLID FORMS OF N-[2,4-BIS(1,1-DIMETHYLETHYL)-5-HYDROXYPHENYL]-1,4-DIHYDRO-4-OXOQUINOLINE-3-CARBOXAMIDE
Outotec OYJ	<b>C01G 7/00</b> (2006.01) <b>C22B 11/06</b> (2006.01) <b>C22B 3/26</b> (2006.01)	2580162 *	METHOD FOR RECOVERING GOLD BY SOLVENT EXTRACTION

Podnosilac evropske prijave patenta (71)	MKP (51)	Broj objave evropske prijave patenta (97)	Naziv pronalaska (54)
Medirista Biotechnologies AB	<b>C07K 16/18</b> (2006.01) <b>G01N 33/564</b> (2006.01) <b>G01N 33/68</b> (2006.01)	2542580 *	ANTIBODIES AGAINST PHOSPHORYLCHOLINE IN COMBINATION THERAPY WITH BIOLOGIC AGENTS
Bayer Intellectual Property GmbH	<b>C07D 213/64</b> (2006.01)	2563762 *	METHOD FOR PRODUCING SUBSTITUTED PYRIDIN-2-ONE
Aanensen, Ove T.	<b>H02J 7/00</b> (2006.01)	2567445 *	BIPOLAR OVERVOLTAGE BATTERY PULSER AND METHOD
Valand, Dag Arild	<b>H02J 7/00</b> (2006.01)	2567445 *	BIPOLAR OVERVOLTAGE BATTERY PULSER AND METHOD
Momenta Pharmaceuticals, Inc.	<b>A61P 17/14</b> (2006.01) <b>A61K 31/727</b> (2006.01) <b>A61Q 7/00</b> (2006.01) <b>A61K 45/06</b> (2006.01) <b>A61K 8/73</b> (2006.01) <b>A61K 31/337</b> (2006.01) <b>A61K 31/506</b> (2006.01) <b>A61K 31/58</b> (2006.01)	2582355 *	METHODS AND COMPOSITIONS FOR PROMOTING HAIR GROWTH
Cima Labs Inc.	<b>A61K 9/26</b> (2006.01) <b>A61K 31/485</b> (2006.01)	2538928 *	ABUSE-RESISTANT FORMULATIONS
Vaxxit Srl	<b>A61K 39/21</b> (2006.01) <b>C07K 14/16</b> (2006.01)	2547697 *	IMMUNE THERAPY
Cellzome Limited	<b>C07D 487/04</b> (2006.01) <b>A61P 29/00</b> (2006.01) <b>A61K 31/519</b> (2006.01) <b>A61P 35/00</b> (2006.01)	2566867 *	PYRAZOLE COMPOUNDS AS JAK INHIBITORS
Joint Stock Company "Pharmasyntez"	<b>A61K 31/4409</b> (2006.01) <b>A61K 9/28</b> (2006.01) <b>A61K 31/4425</b> (2006.01) <b>A61K 9/48</b> (2006.01) <b>A61K 31/438</b> (2006.01) <b>A61K 9/20</b> (2006.01) <b>A61K 31/47</b> (2006.01) <b>A61K 9/50</b> (2006.01) <b>A61K 31/395</b> (2006.01) <b>A61K 9/02</b> (2006.01) <b>A61K 31/7036</b> (2006.01) <b>A61K 31/4965</b> (2006.01) <b>A61K 9/00</b> (2006.01) <b>A61K 31/133</b> (2006.01) <b>A61K 45/06</b> (2006.01)	2560630 *	TUBERCULOSIS DRUG BASED ON 4-THIOUREIDO-IMINOMETHYLPYRIDINIUM PERCHLORATE: METHOD OF PREPARATION AND TREATMENT
Zhong, Zhou	<b>D01D 1/02</b> (2006.01) <b>D01F 6/60</b> (2006.01) <b>C08G 69/32</b> (2006.01)	2471983	Method For Preparing Meta-Aramid Fibers
Panasonic Healthcare Co., Ltd.	<b>F25B 43/02</b> (2006.01)	2500677	Oil separator and refrigerating cycle apparatus using the same
Cambridge Enterprise Ltd.	<b>A61P 37/00</b> (2006.01) <b>C07D 401/12</b> (2006.01) <b>C07D 223/12</b> (2006.01) <b>C07D 211/56</b> (2006.01) <b>A61P 17/06</b> (2006.01) <b>A61K 31/45</b> (2006.01) <b>A61P 29/00</b> (2006.01) <b>A61K 31/55</b> (2006.01) <b>A61K 31/4523</b> (2006.01)	2580196 *	ANTI-INFLAMMATORY AGENTS
BOEHRINGER INGELHEIM INTERNATIONAL GMBH	<b>A61P 37/00</b> (2006.01) <b>C07D 401/12</b> (2006.01) <b>C07D 223/12</b> (2006.01) <b>C07D 211/56</b> (2006.01) <b>A61P 17/06</b> (2006.01) <b>A61K 31/45</b> (2006.01) <b>A61P 29/00</b> (2006.01) <b>A61K 31/55</b> (2006.01) <b>A61K 31/4523</b> (2006.01)	2580196 *	ANTI-INFLAMMATORY AGENTS

Podnosilac evropske prijave patenta (71)	MKP (51)	Broj objave evropske prijave patenta (97)	Naziv pronalaska (54)
Bayer Intellectual Property GmbH	<b>A61K 31/437</b> (2006.01) <b>C07D 471/04</b> (2006.01) <b>A61P 9/00</b> (2006.01) <b>A61P 15/00</b> (2006.01)	2576548 *	THE USE OF sGC STIMULATORS, sGC ACTIVATORS, ALONE AND COMBINATIONS WITH PDE5 INHIBITORS FOR THE TREATMENT OF SYSTEMIC SCLEROSIS (SSc).
Affibody AB	<b>C07K 14/195</b> (2006.01)	2590993 *	POLYPEPTIDES
Jungbunzlauer Austria AG	<b>A23L 1/236</b> (2006.01) <b>A23L 1/09</b> (2006.01)	2386209	Natural sweetener
Sanofi-Aventis Deutschland GmbH	<b>A61M 5/315</b> (2006.01)	2455121	Cartridge holder and drug delivery device
Softathome	<b>H04L 12/28</b> (2006.01) <b>H04Q 3/00</b> (2006.01)	2594082 *	CONTINUITY OF THE AVAILABILITY OF A COMMUNICATION SERVICE
Rigshospitalet	<b>C07K 14/435</b> (2006.01) <b>A61K 38/16</b> (2006.01) <b>C12N 15/62</b> (2006.01)	2542569 *	CHIMERIC INHIBITOR MOLECULES OF COMPLEMENT ACTIVATION
Københavns Universitet	<b>C07K 14/435</b> (2006.01) <b>A61K 38/16</b> (2006.01) <b>C12N 15/62</b> (2006.01)	2542569 *	CHIMERIC INHIBITOR MOLECULES OF COMPLEMENT ACTIVATION
Syddansk Universitet	<b>C07K 14/435</b> (2006.01) <b>A61K 38/16</b> (2006.01) <b>C12N 15/62</b> (2006.01)	2542569 *	CHIMERIC INHIBITOR MOLECULES OF COMPLEMENT ACTIVATION
The Regents of the University of California	<b>A01H 5/00</b> (2006.01) <b>C12N 15/29</b> (2006.01) <b>C12N 15/82</b> (2006.01)	2563113 *	MODIFIED PYR/PYL RECEPTORS ACTIVATED BY ORTHOGONAL LIGANDS
Tegometall International AG	<b>B65D 19/28</b> (2006.01) <b>B65G 1/02</b> (2006.01)	2555990 *	SUPPORT FRAME FOR RACKS
Perini, Oscar	<b>A23L 1/216</b> (2006.01) <b>A23L 1/18</b> (2006.01) <b>A23L 1/164</b> (2006.01)	2566351 *	FOOD PRODUCT COMPRISING A MIXTURE OF SLICES OF POTATOES COOKED IN OIL AND CORNS PUFFED UP WHEN HEATED
Genzyme Corporation	<b>C02F 1/32</b> (2006.01) <b>A61L 2/00</b> (2006.01)	2575901 *	DEVICE FOR VIRAL INACTIVATION OF LIQUID MEDIA
Endrödi, László	<b>C09K 101/00</b> (2006.01) <b>C09K 17/40</b> (2006.01) <b>C09K 17/00</b> (2006.01) <b>B09C 1/00</b> (2006.01) <b>C09K 17/50</b> (2006.01) <b>A01C 1/00</b> (2006.01)	2588564 *	CELL FOR CONDITIONING AND IMPROVING OF SOIL, AS WELL AS PROCESS FOR PRODUCTION AND ALLOCATION TO THE SOIL OF IT
Phenex Pharmaceuticals AG	<b>C07D 413/12</b> (2006.01) <b>C07D 498/04</b> (2006.01) <b>A61K 31/395</b> (2006.01) <b>C07D 267/22</b> (2006.01) <b>C07D 403/12</b> (2006.01) <b>C07D 417/12</b> (2006.01) <b>A61P 29/00</b> (2006.01) <b>C07D 245/06</b> (2006.01) <b>C07D 281/18</b> (2006.01) <b>C07D 413/10</b> (2006.01) <b>C07D 487/04</b> (2006.01) <b>A61P 37/00</b> (2006.01)	2542537 *	NOVEL COMPOUNDS FOR MODULATION OF ORPHAN NUCLEAR RECEPTOR RAR-RELATED ORPHAN RECEPTOR-GAMMA (ROR GAMMA, NR1F3) ACTIVITY AND FOR THE TREATMENT OF CHRONIC INFLAMMATORY AND AUTOIMMUNE DISEASE
Adistem Ltd	<b>A61P 31/18</b> (2006.01) <b>A61K 38/08</b> (2006.01)	2593120 *	METHOD OF TREATMENT OF HIV OR AIDS
Gilead Sciences, Inc.	<b>C07D 471/04</b> (2006.01) <b>A61P 3/10</b> (2006.01) <b>A61K 31/437</b> (2006.01) <b>A61P 9/00</b> (2006.01)	2588197 *	FUSED HETEROCYCLIC COMPOUNDS AS ION CHANNEL MODULATORS
4SC AG	<b>C07C 233/58</b> (2006.01) <b>C07D 333/58</b> (2006.01) <b>A61K 31/167</b> (2006.01) <b>C07D 307/30</b> (2006.01) <b>C07C 233/60</b> (2006.01) <b>C07D 333/38</b> (2006.01) <b>C07C 233/59</b> (2006.01)	2588446 *	NOVEL CALCIUM SALTS OF COMPOUND AS ANTI-INFLAMMATORY, IMMUNOMODULATORY AND ANTI-PROLIFERATORY AGENTS

Podnosilac evropske prijave patenta (71)	MKP (51)	Broj objave evropske prijave patenta (97)	Naziv pronalaska (54)
Janssen Biotech, Inc.	<b>A61K 39/00</b> (2006.01) <b>A61K 38/00</b> (2006.01) <b>C12P 21/06</b> (2006.01) <b>C12P 21/04</b> (2006.01)	2575846 *	INSULIN-LIKE GROWTH FACTOR 1 RECEPTOR BINDING PEPTIDES
SANOFI	<b>A61P 25/00</b> (2006.01) <b>A61K 31/4709</b> (2006.01) <b>C07D 401/14</b> (2006.01) <b>C07D 495/04</b> (2006.01) <b>C07D 403/04</b> (2006.01) <b>C07D 407/14</b> (2006.01)	2569303 *	SUBSTITUTED N-ALKYL AND N-ACYL TETRAHYDRO-ISOQUINOLINE DERIVATIVES, PREPARATION AND THERAPEUTIC USE THEREOF
Universidad de Barcelona	<b>C07K 7/62</b> (2006.01)	2548883 *	PEPTIDE COMPOUNDS THAT CAN BE USED AS ANTIBACTERIAL AGENTS
Neufeld, Klaus	<b>A23K 1/12</b> (2006.01) <b>A61P 33/00</b> (2006.01) <b>A23K 1/16</b> (2006.01) <b>A61K 31/575</b> (2006.01) <b>A61P 1/00</b> (2006.01) <b>A61K 36/54</b> (2006.01) <b>A23K 1/14</b> (2006.01)	2557940 *	ANIMAL FEED ADDITIVE HAVING AN ANTIMICROBIAL AND GROWTH-PROMOTING EFFECT
Bayer Intellectual Property GmbH	<b>A61K 31/4406</b> (2006.01) <b>A61K 31/519</b> (2006.01) <b>A61K 45/06</b> (2006.01) <b>A61K 31/5377</b> (2006.01) <b>A61K 31/18</b> (2006.01)	2558126 *	SUBSTITUTED 2,3-DIHYDROIMIDAZO[1,2-C]QUINAZOLINE-CONTAINING COMBINATIONS
Sanofi-Aventis Deutschland GmbH	<b>A61M 5/315</b> (2006.01) <b>A61M 5/24</b> (2006.01)	2579925 *	MEDICATION DELIVERY DEVICE
LSI Corporation	<b>G11B 20/10</b> (2006.01)	2479754	Circuits and methods for data detection using multiple detectors, storage device
Deva Holding Anonim Sirketi	<b>A61K 31/23</b> (2006.01) <b>A61K 9/00</b> (2006.01)	2471528	A preparation method for suspension of cetyl myristate and/or cetyl palmitate
Electronvault Inc.	<b>H02M 3/06</b> (2006.01) <b>H02J 7/00</b> (2006.01)	2548282 *	CELL BALANCING SYSTEM
THE UNIVERSITY OF EDINBURGH	<b>A61P 9/00</b> (2006.01) <b>A61K 31/4535</b> (2006.01) <b>C07D 451/06</b> (2006.01) <b>C07D 451/04</b> (2006.01) <b>A61P 25/28</b> (2006.01) <b>C07D 409/14</b> (2006.01) <b>A61P 3/10</b> (2006.01) <b>A61K 31/46</b> (2006.01) <b>C07D 451/02</b> (2006.01) <b>A61P 25/00</b> (2006.01) <b>A61P 3/04</b> (2006.01)	2563780 *	3, 3 -DISUBSTITUTED- ( 8 - AZA - BICYCLO [3.2.1]OCT- 8 - YL) -[5- (1H - PYRAZOL - 4 -YL) -THIOPHEN-3 -YL]METHANONES AS INHIBITORS OF 11 (BETA) -HSD1
UCB Pharma, S.A.	<b>C07K 16/46</b> (2006.01)	2550297 *	DISULFIDE STABILIZED DVD-LG MOLECULES
Biontech AG	<b>A61K 39/29</b> (2006.01) <b>C07K 14/47</b> (2006.01) <b>C07K 14/02</b> (2006.01)	2547695 *	TUMOR VACCINATION INVOLVING A HUMORAL IMMUNE RESPONSE AGAINST SELF-PROTEINS
Universitätsmedizin der Johannes Gutenberg-Universität Mainz	<b>A61K 39/29</b> (2006.01) <b>C07K 14/47</b> (2006.01) <b>C07K 14/02</b> (2006.01)	2547695 *	TUMOR VACCINATION INVOLVING A HUMORAL IMMUNE RESPONSE AGAINST SELF-PROTEINS
Momenta Pharmaceuticals, Inc.	<b>C12P 21/06</b> (2006.01) <b>H01J 49/00</b> (2006.01) <b>C12Q 1/00</b> (2006.01)	2556163 *	HIGH MANNOSE GLYCANS
Rabold, Ludwig	<b>H01L 31/04</b> (2006.01)	2559071 *	SOLAR INSTALLATION WITH ARTIFICIAL LIGHT SOURCE
Metabolic Solutions Development Company LLC	<b>A61K 9/06</b> (2006.01) <b>A61K 9/08</b> (2006.01) <b>A61K 31/425</b> (2006.01) <b>A61K 9/00</b> (2006.01) <b>A61K 9/48</b> (2006.01)	2560615 *	THIAZOLIDINEDIONE ANALOGUES
Food Safety Technology LLC	<b>B08B 7/04</b> (2006.01)	2582472 *	SYSTEM FOR PRODUCING AND DISTRIBUTING AN OZONATED FLUID

Podnosilac evropske prijave patenta (71)	MKP (51)	Broj objave evropske prijave patenta (97)	Naziv pronalaska (54)
GlaxoSmithKline Biologicals S.A.	<b>A61K 39/02</b> (2006.01)	2544708 *	CONJUGATION PROCESS OF BACTERIAL POLYSACCHARIDES TO CARRIER PROTEINS
Complexa, Inc.	<b>A61K 31/337</b> (2006.01) <b>A61K 31/70</b> (2006.01) <b>A61K 31/185</b> (2006.01) <b>A61K 31/336</b> (2006.01)	2542232 *	FATTY ACID INHIBITORS
Owens-Brockway Glass Container INC.	<b>C03B 9/16</b> (2006.01) <b>B65D 1/02</b> (2006.01) <b>C03B 9/325</b> (2006.01)	2576462 *	PROCESS AND EQUIPMENT FOR THE FABRICATION OF GLASS CONTAINERS WITH INTERNALLY THREADED NECK
Vantia Limited	<b>A61P 13/00</b> (2006.01) <b>A61P 13/02</b> (2006.01) <b>A61K 31/53</b> (2006.01) <b>C07D 409/12</b> (2006.01)	2552910 *	NEW POLYMORPH
Universidad de Navarra	<b>A23L 1/00</b> (2006.01) <b>A61K 8/64</b> (2006.01)	2540169 *	NANOPARTICLES FOR THE ENCAPSULATION OF COMPOUNDS, PREPARATION THEREOF AND USE OF SAME
Centro Nacional De Tecnologia Y Seguridad Alimentaria. Laboratorio Dei Ebro	<b>A23L 1/00</b> (2006.01) <b>A61K 8/64</b> (2006.01)	2540169 *	NANOPARTICLES FOR THE ENCAPSULATION OF COMPOUNDS, PREPARATION THEREOF AND USE OF SAME
Etatron D.S. SpA.	<b>F04B 13/00</b> (2006.01)	2547909 *	DOSING PUMP WITH CONTROL DEVICE OF THE PISTON STROKE
SANOFI	<b>A61K 9/00</b> (2006.01) <b>A61K 38/00</b> (2006.01) <b>A61K 38/28</b> (2006.01) <b>A61K 31/00</b> (2006.01) <b>A61K 9/08</b> (2006.01)	2571517 *	LONG - ACTING FORMULATIONS OF INSULINS
Medrán López, Francisco	<b>E04B 1/348</b> (2006.01) <b>B28B 7/22</b> (2006.01) <b>B28B 19/00</b> (2006.01)	2578760 *	PROCEDURE FOR MANUFACTURING OF COMPACT MODULES FOR CONSTRUCTION
Zymenex A/S	<b>A61K 38/46</b> (2006.01) <b>C07K 1/16</b> (2006.01)	2538968 *	PROCESS FOR PRODUCTION AND PURIFICATION OF RECOMBINANT LYSOSOMAL ALPHA-MANNOSIDASE
Abraxis BioScience, LLC	<b>A61P 35/00</b> (2006.01) <b>A61K 31/555</b> (2006.01) <b>A61K 31/337</b> (2006.01) <b>A61K 9/14</b> (2006.01)	2552415 *	METHODS OF TREATING CANCER
Chiesi Farmaceutici S.p.A.	<b>A61P 11/00</b> (2006.01) <b>A61K 35/42</b> (2006.01) <b>A61K 38/44</b> (2006.01)	2475373 *	A THERAPEUTIC COMBINATION COMPRISING A PULMONARY SURFACTANT AND ANTIOXIDANT ENZYMES
Memorial Sloan-Kettering Cancer Center	<b>G01N 33/68</b> (2006.01) <b>C12Q 1/68</b> (2006.01) <b>G01N 33/15</b> (2006.01) <b>C12N 5/0735</b> (2010.01)	2577318 *	METHOD OF NOCICEPTOR DIFFERENTIATION OF HUMAN EMBRYONIC STEM CELLS AND USES THEREOF
Aiysh, Jehad	<b>C04B 28/18</b> (2006.01) <b>H01L 35/22</b> (2006.01) <b>H01L 35/32</b> (2006.01)	2571828 *	STRUCTURAL ELEMENT FOR GENERATING THERMOELECTRIC POWER AND METHOD FOR THE PRODUCTION THEREOF
Sanofi-Aventis Deutschland GmbH	<b>A61M 5/32</b> (2006.01) <b>A61M 5/28</b> (2006.01) <b>A61M 5/50</b> (2006.01)	2588168 *	SAFETY DEVICE FOR A PRE-FILLED SYRINGE AND INJECTION DEVICE
Fundació Institut de Recerca Hospital Universitari Vall d'Hebron, Fundació Privada	<b>C12Q 1/68</b> (2006.01)	2593561 *	METHODS AND KITS FOR THE DIAGNOSIS OF PROSTATE CANCER
GlaxoSmithKline LLC	<b>A61K 31/41</b> (2006.01) <b>A01N 43/64</b> (2006.01)	2538787 *	TRIAZOLONES AS FATTY ACID SYNTHASE INHIBITORS
Graphea, Inc.	<b>C07C 29/09</b> (2006.01) <b>B01J 21/18</b> (2006.01) <b>C07B 41/00</b> (2006.01) <b>C07C 45/42</b> (2006.01) <b>C07C 51/093</b> (2006.01)	2576486 *	CARBOCATALYSTS FOR CHEMICAL TRANSFORMATIONS

Podnosilac evropske prijave patenta (71)	MKP (51)	Broj objave evropske prijave patenta (97)	Naziv pronalaska (54)
Chiesi Farmaceutici S.p.A.	<b>C07D 453/02</b> (2006.01) <b>A61P 11/00</b> (2006.01) <b>A61K 31/439</b> (2006.01) <b>C07D 413/06</b> (2006.01) <b>A61K 31/4025</b> (2006.01)	2585458 *	ALKALOID AMINOESTER DERIVATIVES AND MEDICINAL COMPOSITION THEREOF
Vertex Pharmaceuticals Incorporated	<b>A61K 31/404</b> (2006.01) <b>A61K 31/443</b> (2006.01) <b>A61K 31/4704</b> (2006.01)	2560650 *	PHARMACEUTICAL COMPOSITIONS AND ADMINISTRATIONS THEREOF
Sanofi-Aventis Deutschland GmbH	<b>A61K 31/403</b> (2006.01) <b>A61P 9/12</b> (2006.01) <b>A61K 9/20</b> (2006.01) <b>A61K 45/06</b> (2006.01)	2538924 *	SOLID PHARMACEUTICAL FORMULATIONS OF RAMIPRIL AND AMLODIPINE BESYLATE, AND THEIR PREPARATION
Omya Development AG	<b>C01F 11/18</b> (2006.01)	2552835 *	PROCESS FOR OBTAINING PRECIPITATED CALCIUM CARBONATE
Ardea Biosciences, Inc.	<b>C07D 249/14</b> (2006.01)	2582683 *	TREATMENT OF GOUT AND HYPERURICEMIA
aTyr Pharma, Inc.	<b>A61P 3/00</b> (2006.01) <b>A61K 39/395</b> (2006.01) <b>A61P 29/00</b> (2006.01) <b>A61P 35/00</b> (2006.01) <b>A61K 38/16</b> (2006.01) <b>A61K 38/17</b> (2006.01)	2563380 *	INNOVATIVE DISCOVERY OF THERAPEUTIC, DIAGNOSTIC, AND ANTIBODY COMPOSITIONS RELATED TO PROTEIN FRAGMENTS OF CYSTEINYL-TRNA SYNTHETASE
Pangu Biopharma Limited	<b>A61P 3/00</b> (2006.01) <b>A61K 39/395</b> (2006.01) <b>A61P 29/00</b> (2006.01) <b>A61P 35/00</b> (2006.01) <b>A61K 38/16</b> (2006.01) <b>A61K 38/17</b> (2006.01)	2563380 *	INNOVATIVE DISCOVERY OF THERAPEUTIC, DIAGNOSTIC, AND ANTIBODY COMPOSITIONS RELATED TO PROTEIN FRAGMENTS OF CYSTEINYL-TRNA SYNTHETASE
Euro-Celtique S.A.	<b>A61K 9/20</b> (2006.01)	2568968 *	MANUFACTURING OF ACTIVE-FREE GRANULES AND TABLETS COMPRISING THE SAME
Abbott Research B.V.	<b>A61K 39/395</b> (2006.01) <b>C07K 16/22</b> (2006.01) <b>C07K 16/18</b> (2006.01) <b>C07K 16/28</b> (2006.01)	2547365 *	ANTI-NERVE GROWTH FACTOR (NGF) ANTIBODY COMPOSITIONS
AbbVie Inc.	<b>C07K 14/00</b> (2006.01) <b>A61K 39/395</b> (2006.01)	2566514 *	METHODS OF INHIBITING FIBROSIS USING ANTI-PAI-1 ANTIBODIES
Sanofi-Aventis Deutschland GmbH	<b>A61M 5/32</b> (2006.01)	2588167 *	SAFETY DEVICE FOR A PRE-FILLED SYRINGE AND INJECTION DEVICE
Vironova AB	<b>C01B 25/14</b> (2006.01) <b>C07D 213/63</b> (2006.01) <b>C07B 45/00</b> (2006.01) <b>C07D 211/84</b> (2006.01) <b>C07C 327/44</b> (2006.01) <b>C07D 211/72</b> (2006.01) <b>C07C 325/02</b> (2006.01) <b>C07D 241/06</b> (2006.01) <b>C07D 213/06</b> (2006.01) <b>C07D 239/93</b> (2006.01) <b>C07D 207/24</b> (2006.01) <b>C07D 209/30</b> (2006.01)	2569263 *	A THIONATION PROCESS AND A THIONATING AGENT
ADA-ES, Inc.	<b>F25J 3/00</b> (2006.01)	2545334 *	PROCESS FOR DILUTE PHASE INJECTION OR DRY ALKALINE MATERIALS
Somalogic, Inc.	<b>G01N 33/18</b> (2006.01) <b>G01N 33/49</b> (2006.01) <b>G01N 33/50</b> (2006.01)	2591357 *	LUNG CANCER BIOMARKERS AND USES THEREOF
Belakovs, Voldemars	<b>C22B 1/00</b> (2006.01) <b>C22B 11/00</b> (2006.01)	2576850 *	METHOD FOR RECOVERING NOBLE METALS AND OTHER BYPRODUCTS FROM ORE
Costache, Nicolae	<b>C22B 1/00</b> (2006.01) <b>C22B 11/00</b> (2006.01)	2576850 *	METHOD FOR RECOVERING NOBLE METALS AND OTHER BYPRODUCTS FROM ORE
Crestin, Dumitru	<b>C22B 1/00</b> (2006.01) <b>C22B 11/00</b> (2006.01)	2576850 *	METHOD FOR RECOVERING NOBLE METALS AND OTHER BYPRODUCTS FROM ORE
Banu, Geanina Silvana	<b>C22B 1/00</b> (2006.01) <b>C22B 11/00</b> (2006.01)	2576850 *	METHOD FOR RECOVERING NOBLE METALS AND OTHER BYPRODUCTS FROM ORE

Podnosilac evropske prijave patenta (71)	MKP (51)	Broj objave evropske prijave patenta (97)	Naziv pronalaska (54)
University of Basel	<b>A61P 35/00</b> (2006.01) <b>A61K 31/53</b> (2006.01) <b>C07D 403/04</b> (2006.01)	2563368 *	PIPERAZINOTRIAZINES AS PI3K INHIBITORS FOR USE IN THE TREATMENT ANTIPROLIFERATIVE DISORDERS
Arla Foods Amba	<b>A23C 19/09</b> (2006.01) <b>A23C 19/06</b> (2006.01) <b>A23L 1/00</b> (2006.01) <b>A23J 3/26</b> (2006.01)	2544549 *	A RETICULATE DAIRY BASED PRODUCT
Sanofi-Aventis Deutschland GmbH	<b>A61M 5/00</b> (2006.01)	2552511 *	ELECTRO-MECHANICAL DRUG DELIVERY DEVICE
Baxter International Inc.	<b>A61L 26/00</b> (2006.01) <b>A61L 15/42</b> (2006.01) <b>A61L 15/58</b> (2006.01) <b>A61L 24/04</b> (2006.01) <b>A61L 15/22</b> (2006.01) <b>A61L 24/00</b> (2006.01)	2555804 *	HEMOSTATIC SPONGE
Baxter Healthcare S.A.	<b>A61L 26/00</b> (2006.01) <b>A61L 15/42</b> (2006.01) <b>A61L 15/58</b> (2006.01) <b>A61L 24/04</b> (2006.01) <b>A61L 15/22</b> (2006.01) <b>A61L 24/00</b> (2006.01)	2555804 *	HEMOSTATIC SPONGE
Array Biopharma, Inc.	<b>C07D 519/00</b> (2006.01) <b>A61K 31/519</b> (2006.01) <b>C07D 487/04</b> (2006.01)	2571883 *	MACROCYCLIC COMPOUNDS AS TRK KINASE INHIBITORS
Alpha beton SPRL	<b>E04B 7/22</b> (2006.01) <b>E04C 2/288</b> (2006.01) <b>E04B 1/14</b> (2006.01) <b>E04B 1/80</b> (2006.01)	2423402	Highly insulated prefabricated element
Heineken Supply Chain B.V.	<b>B65D 83/44</b> (2006.01) <b>B65D 83/16</b> (2006.01) <b>B67D 1/12</b> (2006.01) <b>B67D 1/08</b> (2006.01) <b>B65D 83/18</b> (2006.01) <b>G01F 11/08</b> (2006.01) <b>B67D 1/04</b> (2006.01) <b>B65D 83/14</b> (2006.01) <b>B65D 83/60</b> (2006.01) <b>B67D 1/02</b> (2006.01)	2576423 *	METHOD AND APPARATUS FOR DISPENSING BEVERAGES, ESPECIALLY CARBONATED BEVERAGES
MTW-Endoskopie W. Haag KG	<b>A61B 17/3205</b> (2006.01)	2582309 *	SURGICAL INSTRUMENT
Nassau Door A/S	<b>E06B 3/58</b> (2006.01) <b>E06B 3/54</b> (2006.01) <b>E06B 3/56</b> (2006.01) <b>E06B 3/64</b> (2006.01) <b>E06B 3/48</b> (2006.01)	2460970	A sectional door panel comprising a window assembly and a method of assembling said panel
9Solutions Oy	<b>G07C 9/00</b> (2006.01)	2469478	Access control in location tracking system
SANOFI	<b>C07D 401/14</b> (2006.01) <b>A61P 25/28</b> (2006.01) <b>A61P 25/24</b> (2006.01) <b>A61K 31/407</b> (2006.01) <b>A61P 25/18</b> (2006.01) <b>C07D 491/107</b> (2006.01) <b>C07D 471/10</b> (2006.01) <b>A61P 25/16</b> (2006.01) <b>A61K 31/438</b> (2006.01) <b>A61K 31/4439</b> (2006.01)	2569304 *	SUBSTITUTED N-HETEROARYL SPIROLACTAM BIPYRROLIDINES, PREPARATION AND THERAPEUTIC USE THEREOF
Sanofi-Aventis Deutschland GmbH	<b>A61M 5/24</b> (2006.01) <b>A61M 5/34</b> (2006.01)	2571553 *	NEEDLE ASSEMBLY FOR DRUG DELIVERY DEVICES
Gaslock GmbH	<b>G01F 23/00</b> (2006.01)	2539673 *	DEVICE FOR MEASURING LIQUID FILLING LEVELS

Podnosilac evropske prijave patenta (71)	MKP (51)	Broj objave evropske prijave patenta (97)	Naziv pronalaska (54)
CAL INTERNATIONAL LIMITED	<b>A61K 31/616</b> (2006.01) <b>A61K 9/50</b> (2006.01) <b>A61K 9/16</b> (2006.01) <b>A61K 9/52</b> (2006.01) <b>A61K 9/20</b> (2006.01) <b>A61K 31/138</b> (2006.01)	2566472 *	A PHARMACEUTICAL COMPOSITION COMPRISING ASPIRIN AND BISOPROLOL
Denso IT Laboratory, Inc.	<b>G06F 17/30</b> (2006.01)	2498191	Feature conversion device, similar information search apparatus provided therewith, coding parameter generation method, and computer program
Ishihara Sangyo Kaisha, Ltd.	<b>A01N 47/36</b> (2006.01) <b>A01N 47/30</b> (2006.01)	2579720 *	HERBICIDAL COMPOSITION
Sambusseti, Antonio	<b>A61F 2/04</b> (2013.01)	2584999 *	ORTHOTOPIC ARTIFICIAL BLADDER PROSTHESIS
"Avidin" Kutató, Fejlesztés és Kereskedelmi Korlátolt Felelőségu Tarsasag	<b>C07D 401/06</b> (2006.01) <b>C07D 401/12</b> (2006.01) <b>A61P 9/10</b> (2006.01) <b>C07D 413/12</b> (2006.01) <b>A61K 31/4709</b> (2006.01) <b>A61K 31/47</b> (2006.01) <b>C07D 215/26</b> (2006.01) <b>A61P 25/28</b> (2006.01) <b>C07D 401/14</b> (2006.01)	2566849 *	8-HYDROXY-QUINOLINE DERIVATIVES
Ubichem Kutató Korlátolt Felelőségu Társaság	<b>C07D 401/06</b> (2006.01) <b>C07D 401/12</b> (2006.01) <b>A61P 9/10</b> (2006.01) <b>C07D 413/12</b> (2006.01) <b>A61K 31/4709</b> (2006.01) <b>A61K 31/47</b> (2006.01) <b>C07D 215/26</b> (2006.01) <b>A61P 25/28</b> (2006.01) <b>C07D 401/14</b> (2006.01)	2566849 *	8-HYDROXY-QUINOLINE DERIVATIVES
Institute Of Geological And Nuclear Sciences Limited	<b>H01F 41/14</b> (2006.01) <b>H01F 10/00</b> (2006.01)	2577686 *	MAGNETIC NANOCLUSTERS
CORCOST LIMITED	<b>B60N 2/50</b> (2006.01)	2552744 *	LOAD RESPONSIVE SEAT/ BED
Cyalume Technologies, Inc	<b>F24J 1/00</b> (2006.01)	2564126 *	THERMAL SIGNALING OR MARKING DEVICE
Shire Human Genetic Therapies, Inc.	<b>A61K 38/47</b> (2006.01) <b>A61P 25/28</b> (2006.01) <b>A61P 25/00</b> (2006.01)	2588132 *	METHODS AND COMPOSITIONS FOR CNS DELIVERY OF -GALACTOCEREBROSIDASE
Intas Biopharmaceuticals Limited	<b>A61K 9/00</b> (2006.01)	2568960 *	LIQUID FORMULATION OF POLYPEPTIDES CONTAINING AN FC DOMAIN OF AN IMMUNOGLOBULIN
Amgen Research (Munich) GmbH	<b>C07K 16/30</b> (2006.01) <b>C07K 16/40</b> (2006.01) <b>A61K 39/395</b> (2006.01) <b>C07K 16/28</b> (2006.01)	2552964 *	CROSS-SPECIES-SPECIFIC PSMAxCD3 BISPECIFIC SINGLE CHAIN ANTIBODY
UINT	<b>A63F 3/06</b> (2006.01) <b>G07F 17/32</b> (2006.01) <b>G06K 19/07</b> (2006.01)	2569735 *	PAYMENT CARD COMPRISING AN ELECTRONIC GAME CHIP
Sanofi-Aventis Deutschland GmbH	<b>A61M 5/48</b> (2006.01) <b>A61M 5/32</b> (2006.01) <b>A61M 5/20</b> (2006.01) <b>A61M 5/315</b> (2006.01)	2585134 *	AUTO-INJECTOR WITH INJECTION DAMPER
CellAct Pharma GmbH	<b>A61K 31/704</b> (2006.01) <b>C07H 17/04</b> (2006.01)	2558477 *	ANALOGUES OF ETOPOSIDE FOR THE TREATMENT OF TUMOURS
Meiji Seika Pharma Co., Ltd.	<b>A01N 43/90</b> (2006.01) <b>C07D 491/052</b> (2006.01) <b>C07D 493/04</b> (2006.01) <b>A01P 7/04</b> (2006.01) <b>A01N 47/18</b> (2006.01) <b>A01N 55/00</b> (2006.01) <b>C07F 7/18</b> (2006.01)	2578084 *	NOXIOUS ORGANISM CONTROL AGENT



Podnosilac evropske prijave patenta (71)	MKP (51)	Broj objave evropske prijave patenta (97)	Naziv pronalaska (54)
Sanofi-Aventis Deutschland GmbH	<b>A61B 5/151</b> (2006.01)	2590565 *	BLOOD SAMPLE COLLECTION
Strobel, Gary A.	<b>C12P 1/02</b> (2006.01) <b>C12P 7/00</b> (2006.01)	2571995 *	SYSTEM AND METHOD OF PRODUCING VOLATILE ORGANIC COMPOUNDS FROM FUNGI
Tomsheck, Angela R.	<b>C12P 1/02</b> (2006.01) <b>C12P 7/00</b> (2006.01)	2571995 *	SYSTEM AND METHOD OF PRODUCING VOLATILE ORGANIC COMPOUNDS FROM FUNGI
Cloudahoy, Inc.	<b>G06F 7/70</b> (2006.01)	2553568 *	SYSTEMS AND METHODS FOR AIRCRAFT FLIGHT TRACKING AND ANALYSIS
Abraxis BioScience, LLC	<b>A61K 39/395</b> (2006.01)	2563393 *	SPARC BINDING ANTIBODIES AND USES THEREOF
Merck Sharp & Dohme Corp.	<b>A01N 43/90</b> (2006.01) <b>A61K 31/519</b> (2006.01)	2575473 *	SOLUBLE GUANYLATE CYCLASE ACTIVATORS
Bayer Intellectual Property GmbH	<b>A61K 31/437</b> (2006.01) <b>A61P 35/00</b> (2006.01) <b>C07D 519/00</b> (2006.01) <b>C07D 471/04</b> (2006.01)	2582699 *	SUBSTITUTED TRIAZOLOPYRIDINES
Nilfisk-Advance A/S	<b>A47L 7/04</b> (2006.01) <b>A47L 5/14</b> (2006.01)	2592986 *	A DISCHARGE VALVE FOR VACUUM CLEANERS
CANADA POST CORPORATION	<b>B65D 21/06</b> (2006.01) <b>B65D 43/02</b> (2006.01)	2520505	Material handling device lid
Myrexix, Inc.	<b>A01N 47/28</b> (2006.01)	2542086 *	COMPOUNDS AND THERAPEUTIC USES THEREOF
Roland Corporation	<b>G10L 19/00</b> (2006.01) <b>H04S 7/00</b> (2006.01) <b>H04S 5/02</b> (2006.01)	2355556	User interface apparatus
USABCD A/S	<b>A61B 19/08</b> (2006.01)	2579799 *	INTERVENTIONAL DRAPE COMPRISING A PATIENT INTERVENTIONAL DRAPE AND A BARRIER DRAPE
Adamed sp. z o.o.	<b>C07K 14/705</b> (2006.01) <b>C07K 14/435</b> (2006.01)	2585480 *	ANTICANCER FUSION PROTEIN
Exelixis, Inc.	<b>A61K 45/06</b> (2006.01) <b>A61K 39/395</b> (2006.01) <b>A61P 35/00</b> (2006.01) <b>A61K 31/63</b> (2006.01) <b>A61K 31/498</b> (2006.01) <b>A61K 31/517</b> (2006.01) <b>A61K 31/7088</b> (2006.01)	2590654 *	COMBINATIONS OF KINASE INHIBITORS FOR THE TREATMENT OF CANCER
SANOFI	<b>A61K 45/06</b> (2006.01) <b>A61K 39/395</b> (2006.01) <b>A61P 35/00</b> (2006.01) <b>A61K 31/63</b> (2006.01) <b>A61K 31/498</b> (2006.01) <b>A61K 31/517</b> (2006.01) <b>A61K 31/7088</b> (2006.01)	2590654 *	COMBINATIONS OF KINASE INHIBITORS FOR THE TREATMENT OF CANCER
Vanderbilt University	<b>A61K 45/06</b> (2006.01) <b>A61K 39/395</b> (2006.01) <b>A61P 35/00</b> (2006.01) <b>A61K 31/63</b> (2006.01) <b>A61K 31/498</b> (2006.01) <b>A61K 31/517</b> (2006.01) <b>A61K 31/7088</b> (2006.01)	2590654 *	COMBINATIONS OF KINASE INHIBITORS FOR THE TREATMENT OF CANCER
Softathome	<b>H04L 12/64</b> (2006.01) <b>H04L 12/28</b> (2006.01)	2591579 *	METHOD OF SELF-CONFIGURATION OF A DOMESTIC GATEWAY IN THE PRESENCE OF VARIOUS EXTERNAL NETWORKS, AND GATEWAY IMPLEMENTING SUCH A METHOD
Cimprogetti S.p.A.	<b>F27D 99/00</b> (2010.01) <b>F27B 1/10</b> (2006.01) <b>F27B 1/00</b> (2006.01) <b>F27B 1/08</b> (2006.01) <b>C04B 2/12</b> (2006.01)	2547974 *	KILN FOR THE PRODUCTION OF CALCIUM OXIDE

Podnosilac evropske prijave patenta (71)	MKP (51)	Broj objave evropske prijave patenta (97)	Naziv pronalaska (54)
ELI LILLY AND COMPANY	<b>C07K 14/62</b> (2006.01) <b>A61K 38/26</b> (2006.01) <b>A61K 38/16</b> (2006.01) <b>C07K 14/47</b> (2006.01) <b>C07K 14/605</b> (2006.01) <b>A61K 38/30</b> (2006.01)	2552471 *	NOVEL PEPTIDES AND METHODS FOR THEIR PREPARATION AND USE
Scil Technology GmbH	<b>C07K 14/78</b> (2006.01) <b>A61K 9/00</b> (2006.01) <b>A61K 38/18</b> (2006.01) <b>A61K 47/22</b> (2006.01) <b>C07K 14/47</b> (2006.01)	2563809 *	STABLE AQUEOUS MIA/CD-RAP FORMULATIONS
Tengion, Inc.	<b>A61L 27/38</b> (2006.01)	2544726 *	CELL-SCAFFOLD CONSTRUCTS
Sanofi-Aventis Deutschland GmbH	<b>A61M 5/315</b> (2006.01) <b>A61B 5/00</b> (2006.01)	2549915 *	DEVICE AND METHOD FOR DETERMINING INFORMATION RELATED TO A MEDICAL DEVICE
Martin Bergmann Umwelttechnik	<b>C02F 1/50</b> (2006.01)	2594532	Method and arrangement for hygienisation of water in a swimming pool system or swimming or bathing area
Integra Adhesives Inc.	<b>B05C 11/115</b> (2006.01) <b>B05C 9/10</b> (2006.01) <b>B01F 5/04</b> (2006.01) <b>B01F 15/02</b> (2006.01)	2563524 *	APPARATUS FOR MIXING AND DISPENSING MULTIPLE FLOWABLE COMPONENTS
Burcon Nutrascience (MB) Corp.	<b>A23J 1/14</b> (2006.01) <b>A23J 3/14</b> (2006.01) <b>A23L 1/305</b> (2006.01) <b>A23L 2/66</b> (2006.01) <b>A23J 3/16</b> (2006.01)	2566346 *	PRODUCTION OF SOLUBLE PROTEIN SOLUTIONS FROM PULSES
Qualcomm Atheros, Inc.	<b>H04B 7/00</b> (2006.01)	2564514 *	SYSTEM AND METHOD FOR CONTROLLING WLAN AND BLUETOOTH COMMUNICATIONS
GEO3D d.o.o.	<b>G10D 3/18</b> (2006.01)	2593935 *	ERGONOMIC CHINREST FOR VIOLINS/VIOLAS USING A NEW METHOD OF ATTACHMENT ONTO THE BODY OF AN INSTRUMENT AS WELL AS THE METHOD OF PRODUCING THE ERGONOMIC SURFACE OF THE CHINREST
Sanofi-Aventis Deutschland GmbH	<b>A61M 5/24</b> (2006.01) <b>A61M 5/28</b> (2006.01) <b>A61M 5/32</b> (2006.01)	2550043 *	MEDICATED MODULE WITH USER SELECTION
Reversinglabs Corporation	<b>G06F 17/30</b> (2006.01)	2550607 *	CLOUD-BASED WEB CONTENT FILTERING
Université de Genève	<b>A61K 47/26</b> (2006.01) <b>A61K 39/395</b> (2006.01)	2552482 *	STABILIZED ANTIBODY PREPARATIONS AND USES THEREOF
Janssen Biotech, Inc.	<b>A61K 39/395</b> (2006.01) <b>C07K 16/24</b> (2006.01)	2552961 *	HUMANIZED IL-25 ANTIBODIES
Newron Pharmaceuticals S.p.A.	<b>A61K 31/165</b> (2006.01) <b>C07C 231/24</b> (2006.01) <b>C07C 237/06</b> (2006.01) <b>C07C 309/04</b> (2006.01)	2563355 *	PROCESS FOR THE PRODUCTION OF RALFINAMIDE METHANESULFONATE SALTS OR THEIR R-ENANTIOMERS
Inotek Pharmaceuticals Corporation	<b>C07H 19/16</b> (2006.01) <b>A61K 31/7076</b> (2006.01) <b>C07H 19/167</b> (2006.01) <b>A61P 27/02</b> (2006.01) <b>C07H 19/00</b> (2006.01)	2569325 *	METHOD OF REDUCING INTRAOCULAR PRESSURE IN HUMANS USING N6 - CYCLOPENTYLADENOSINE (CPA), CPA DERIVATIVES OR PRODRUGS THEREOF
Jansen AG	<b>E06B 3/273</b> (2006.01) <b>E06B 3/263</b> (2006.01)	2476853	Connecting section for windows, doors and façades as well as method for producing the same
SANOFI	<b>C07D 413/14</b> (2006.01) <b>C07D 403/14</b> (2006.01) <b>C07D 401/14</b> (2006.01) <b>A61K 31/4709</b> (2006.01) <b>A61P 25/00</b> (2006.01)	2569305 *	SUBSTITUTED N-HETEROARYL TETRAHYDRO-ISOQUINOLINE DERIVATIVES, PREPARATION AND THERAPEUTIC USE THEREOF

Podnosilac evropske prijave patenta (71)	MKP (51)	Broj objave evropske prijave patenta (97)	Naziv pronalaska (54)
Phosimmune Inc.	<b>C07K 16/20</b> (2006.01) <b>A61K 38/17</b> (2006.01) <b>C07K 14/74</b> (2006.01) <b>A61P 35/00</b> (2006.01) <b>A61K 39/395</b> (2006.01) <b>G01N 33/68</b> (2006.01) <b>C07K 7/00</b> (2006.01)	2576614 *	CLASS I MHC PHOSPHOPEPTIDES FOR CANCER IMMUNOTHERAPY AND DIAGNOSIS
Omya Development AG	<b>B01J 20/32</b> (2006.01) <b>C02F 1/56</b> (2006.01) <b>C02F 103/28</b> (2006.01) <b>B01J 20/04</b> (2006.01) <b>C02F 1/28</b> (2006.01) <b>C02F 11/14</b> (2006.01) <b>C02F 1/66</b> (2006.01)	2589430	Surface-treated calcium carbonate and its use in water purification and for the dewatering of sludges and sediments
J. Uriach y Compania S.A.	<b>C07D 401/14</b> (2006.01)	2588472 *	RUPATADINE SALT AS AN ANTIHISTAMINIC AGENT
Nanotec Solution	<b>G01B 9/02</b> (2006.01) <b>G02B 21/00</b> (2006.01)	2564153 *	OPTICAL DEVICE AND METHOD FOR INSPECTING STRUCTURED OBJECTS
Euro-Celtique S.A.	<b>A61K 9/20</b> (2006.01) <b>A61K 9/16</b> (2006.01)	2568965 *	COMBINATION OF ACTIVE LOADED GRANULES WITH ADDITIONAL ACTIVES
Galleon Pharmaceuticals, Inc.	<b>A61K 31/425</b> (2006.01) <b>A01N 43/78</b> (2006.01)	2544542 *	ANALGESIC COMPOUNDS, COMPOSITIONS, AND USES THEREOF
Deva Holding Anonim Sirketi	<b>A61K 9/16</b> (2006.01) <b>A23L 1/30</b> (2006.01) <b>A61K 9/20</b> (2006.01) <b>A61K 9/48</b> (2006.01) <b>A61K 31/23</b> (2006.01) <b>A61K 9/00</b> (2006.01)	2471386	Cetyl myristate and/or cetyl palmitate suspension formulations
Galderma Research & Development	<b>A61K 9/00</b> (2006.01) <b>A61K 31/498</b> (2006.01) <b>A61P 17/00</b> (2006.01) <b>A61K 9/06</b> (2006.01)	2552448 *	IMPROVED METHODS AND COMPOSITIONS FOR SAFE AND EFFECTIVE TREATMENT OF TELANGIECTASIA
Graphea, Inc.	<b>B01J 37/02</b> (2006.01) <b>B01J 19/24</b> (2006.01) <b>B01J 8/18</b> (2006.01) <b>B01J 21/18</b> (2006.01)	2576048 *	GRAPHENE OXIDE AND GRAPHITE OXIDE CATALYSTS AND SYSTEMS
Owens-Brockway Glass Container Inc.	<b>C03C 23/00</b> (2006.01) <b>C03C 17/00</b> (2006.01)	2547631 *	CURING COATINGS ON GLASS CONTAINERS
Techne Grado Studio Associato di Ingegneria Geologia	<b>E02D 31/02</b> (2006.01) <b>E02B 3/10</b> (2006.01)	2354326	Anti-flooding device
Orbotech LT Solar, LLC	<b>H01J 37/32</b> (2006.01) <b>H01L 21/677</b> (2006.01) <b>H01L 21/687</b> (2006.01) <b>H01L 21/67</b> (2006.01) <b>C23C 16/509</b> (2006.01) <b>C23C 16/458</b> (2006.01)	2518763	A grounding assembly for vacuum processing apparatus
Takeda Pharmaceutical Company Limited	<b>C08G 63/08</b> (2006.01) <b>A61K 9/52</b> (2006.01) <b>A61K 47/34</b> (2006.01) <b>A61P 35/00</b> (2006.01) <b>A61K 38/08</b> (2006.01)	2585091 *	SUSTAINED-RELEASE FORMULATION
Cassani, Stefano	<b>B03C 7/12</b> (2006.01) <b>B03C 7/00</b> (2006.01)	2576071 *	A METHOD AND A DEVICE FOR SEPARATING PARTICLES OF A DETERMINED SYNTHETIC MATERIAL FROM PARTICLES OF DIFFERENT SYNTHETIC MATERIALS
Justrite Manufacturing Company, L.L.C.	<b>B67D 3/00</b> (2006.01)	2542498 *	SAFETY CAN
Carter, Glen	<b>B67D 3/00</b> (2006.01)	2542498 *	SAFETY CAN
Goddard, Mark	<b>B67D 3/00</b> (2006.01)	2542498 *	SAFETY CAN
Bayer Intellectual Property GmbH	<b>C07D 487/04</b> (2006.01) <b>A61K 31/4985</b> (2006.01)	2576560 *	SUBSTITUTED IMIDAZOPYRAZINES

Podnosilac evropske prijave patenta (71)	MKP (51)	Broj objave evropske prijave patenta (97)	Naziv pronalaska (54)
Genentech, Inc.	<b>G01N 33/574</b> (2006.01)	2558864 *	FOX03A AS PREDICTIVE BIOMARKER FOR PI3K/ AKT KINASE PATHWAY INHIBITOR EFFICACY
Bayer CropScience NV	<b>C07K 14/415</b> (2006.01) <b>C12N 15/82</b> (2006.01)	2590996 *	GLUCOSINOLATE TRANSPORTER PROTEIN AND USES THEREOF
University of Copenhagen	<b>C07K 14/415</b> (2006.01) <b>C12N 15/82</b> (2006.01)	2590996 *	GLUCOSINOLATE TRANSPORTER PROTEIN AND USES THEREOF
Janssen Pharmaceutica, N.V.	<b>A61K 31/7042</b> (2006.01) <b>A61K 9/20</b> (2006.01) <b>A61P 3/10</b> (2006.01)	2568988 *	PHARMACEUTICAL FORMULATIONS COMPRISING 1 - (BETA-D-GLUCOPYRANOSYL) - 2 -THIENYLMETHYLBENZENE DERIVATIVES AS INHIBITORS OF SGLT
Takeda Pharmaceutical Company Limited	<b>A61K 9/22</b> (2006.01) <b>A61P 25/24</b> (2006.01) <b>A61K 47/02</b> (2006.01) <b>A61K 47/32</b> (2006.01) <b>A61K 31/495</b> (2006.01) <b>A61K 47/34</b> (2006.01) <b>A61K 9/32</b> (2006.01)	2564838 *	ENTERIC TABLET
SENJU USA, INC.	<b>A61K 31/74</b> (2006.01)	2566487 *	OPHTHALMIC COMPOSITION
Momenta Pharmaceuticals, Inc.	<b>C07K 1/00</b> (2006.01) <b>A61K 45/00</b> (2006.01)	2555801 *	SELECTION AND USE OF HOST CELLS FOR PRODUCTION OF GLYCOPROTEINS
MKS Innovatech S.r.l.	<b>A61G 7/057</b> (2006.01)	2474292	Apparatus with inflatable mattress
Heineken Supply Chain B.V.	<b>B65D 1/04</b> (2006.01) <b>B65D 3/04</b> (2006.01) <b>F04D 13/00</b> (2006.01)	2576361 *	DISPENSING UNIT AND METHOD FOR DISPENSING A LIQUID UNDER PRESSURE
Sword Diagnostics, Inc.	<b>C12Q 1/42</b> (2006.01) <b>G01N 33/569</b> (2006.01) <b>C12Q 1/28</b> (2006.01)	2553117 *	METHODS FOR DETECTING RAMAN SCATTERING USING AROMATIC COMPOUNDS COMPRISING PHOSPHATE AND AT LEAST ONE NON-LASER LIGHT SOURCE
Rhodes Technologies	<b>C07D 265/30</b> (2006.01)	2580201 *	TRANSITION METAL-CATALYZED PROCESSES FOR THE PREPARATION OF N-ALLYL COMPOUNDS AND USE THEREOF
SANOFI	<b>A61K 31/426</b> (2006.01) <b>A61K 31/421</b> (2006.01) <b>C07D 213/65</b> (2006.01) <b>C07D 305/06</b> (2006.01) <b>C07D 213/64</b> (2006.01) <b>A61K 31/192</b> (2006.01) <b>C07C 255/54</b> (2006.01) <b>A61K 31/381</b> (2006.01) <b>C07C 59/72</b> (2006.01) <b>A61K 31/34</b> (2006.01) <b>A61K 31/4439</b> (2006.01)	2590930 *	SPIROCYCLICALLY SUBSTITUTED 1,3-PROPANE DIOXIDE DERIVATIVES, METHODS FOR THE PRODUCTION THEREOF AND USE OF THE SAME AS MEDICAMENT
SANOFI	<b>C07C 225/16</b> (2006.01) <b>C07C 311/08</b> (2006.01) <b>C07F 5/02</b> (2006.01) <b>C07D 307/83</b> (2006.01) <b>C07C 311/07</b> (2006.01) <b>A61P 9/00</b> (2006.01) <b>C07C 217/22</b> (2006.01) <b>A61K 31/43</b> (2006.01)	2542544 *	KETOBENZOFURAN DERIVATIVES, METHOD FOR SYNTHESISING SAME, AND INTERMEDIATES
Sanofi-Aventis Deutschland GmbH	<b>A61M 5/24</b> (2006.01) <b>A61M 5/315</b> (2006.01)	2460551	Drug delivery device with locking arrangement for dose button
Glaxo Group Limited	<b>A61K 8/27</b> (2006.01) <b>A61K 8/46</b> (2006.01) <b>A61Q 11/00</b> (2006.01) <b>A61K 8/34</b> (2006.01)	2550067 *	NOVEL USE
Teva Women's Health, Inc.	<b>C07J 71/00</b> (2006.01)	2566877 *	METHODS OF REDUCING SYMPTOMS IN SUBJECTS USING SINGLE DOSAGE FORMS WITH TAPERING RELEASE RATES
Signature Therapeutics, Inc.	<b>A01N 43/42</b> (2006.01) <b>A61K 31/44</b> (2006.01)	2560490 *	COMPOSITIONS COMPRISING ENZYME-CLEAVABLE PRODRUGS OF ACTIVE AGENTS AND INHIBITORS THEREOF

Podnosilac evropske prijave patenta (71)	MKP (51)	Broj objave evropske prijave patenta (97)	Naziv pronalaska (54)
Inotek Pharmaceuticals Corporation	<b>A61P 27/06</b> (2006.01) <b>A61P 9/10</b> (2006.01) <b>C07H 19/16</b> (2006.01) <b>A61P 29/00</b> (2006.01) <b>C07H 19/167</b> (2006.01) <b>A61K 31/7076</b> (2006.01) <b>A61P 27/02</b> (2006.01)	2552932 *	ADENOSINE COMPOUNDS AND THEIR USE THEREOF
Taisho Pharmaceutical Co., Ltd.	<b>C09D 11/00</b> (2006.01) <b>C09B 63/00</b> (2006.01) <b>C09B 67/20</b> (2006.01)	2548928 *	PIGMENT COMPOSITION
Ineoquest Technologies, Inc.	<b>G06F 15/16</b> (2006.01)	2577485 *	STREAMING MEDIA DELIVERY COMPOSITE
OncoMed Pharmaceuticals, Inc.	<b>C07K 14/705</b> (2006.01)	2552953 *	FRIZZLED-BINDING AGENTS AND USES THEREOF
Inotek Pharmaceuticals Corporation	<b>A61P 27/02</b> (2006.01) <b>A61P 27/06</b> (2006.01) <b>A61K 31/7076</b> (2006.01) <b>A61K 31/085</b> (2006.01) <b>A61K 31/5377</b> (2006.01)	2555776 *	COMBINATION COMPOSITIONS OF ADENOSINE A1 AGONISTS AND NON-SELECTIVE BETA-ADRENERGIC RECEPTOR BLOCKERS FOR REDUCING INTRAOCULAR PRESSURE
SANOFI	<b>C07K 14/475</b> (2006.01) <b>A61K 38/00</b> (2006.01)	2558489 *	ROBO1-FC FUSION PROTEIN AND USE THEREOF FOR TREATING TUMOURS
Agrobics Ltd	<b>B09B 3/00</b> (2006.01)	2550118 *	COMPOSITIONS OF MATTER AND USES THEREOF IN THE TREATMENT OF WASTE MATERIALS
Sanofi-Aventis Deutschland GmbH	<b>A61M 5/32</b> (2006.01)	2550047 *	NEEDLE ASSEMBLY
Chiesi Farmaceutici S.p.A.	<b>C07C 61/40</b> (2006.01)	2552881 *	NOVEL POLYMORPHS AND SALTS
Precision Automation and Robotics India Ltd.	<b>B65G 67/08</b> (2006.01) <b>B65G 41/00</b> (2006.01)	2508451	Cargo handling system
Speiko - Dr. Speier GmbH	<b>A61C 19/02</b> (2006.01) <b>A45C 13/26</b> (2006.01)	2494884	Container for storing and transporting dental casts, models, etc.
Shire Human Genetic Therapies, Inc.	<b>A61K 38/46</b> (2006.01)	2588130 *	CNS DELIVERY OF THERAPEUTIC AGENTS
ThyssenKrupp Uhde GmbH	<b>C01B 17/04</b> (2006.01)	2550236 *	DEVICE AND METHOD FOR CONDENSING, SEPARATING, AND STORING LIQUID SULFUR IN A CLAUS PLANT
Shionogi & Co., Ltd.	<b>A61P 31/04</b> (2006.01) <b>C07D 501/46</b> (2006.01) <b>A61K 31/546</b> (2006.01) <b>C07D 519/06</b> (2006.01)	2557082 *	CEPHEM COMPOUND HAVING CATECHOL GROUP
Apple Inc.	<b>H01R 24/62</b> (2011.01) <b>H01R 13/6581</b> (2011.01)	2583360 *	EXTERNAL CONTACT PLUG CONNECTOR
Polymtec Engineering AG, Mauren (FL), Succursale Di Lugano	<b>B29C 41/00</b> (2006.01) <b>B29C 41/04</b> (2006.01) <b>B60K 15/03</b> (2006.01)	2593321 *	TANK TO CONTAIN FUEL AND RELATIVE PRODUCTION METHOD
Mallet, Benoît	<b>B26B 5/00</b> (2006.01) <b>B26B 29/06</b> (2006.01) <b>B28D 1/22</b> (2006.01)	2560797 *	GUIDE FOR GUIDING THE CUTTING OF A PIECE OF PLASTERBOARD, AND KIT AND METHOD FOR THE IMPLEMENTATION THEREOF
Danapak Flexibles A/S	<b>B32B 27/08</b> (2006.01) <b>B32B 27/36</b> (2006.01) <b>B65D 77/20</b> (2006.01) <b>B32B 27/32</b> (2006.01)	2585297 *	A SHEET, A METHOD OF MAKING AND USING A SHEET AS A LID FOR PACKAGES
General Electric Company	<b>A61B 6/06</b> (2006.01)	2564786	Method for automatic contour filter positioning for medical X-ray imaging
Bayer Intellectual Property GmbH	<b>A61K 31/195</b> (2006.01) <b>C07C 229/38</b> (2006.01)	2569277 *	SUBSTITUTED 8-ALKOXY-2-AMINOTETRALIN DERIVATIVES, AND USE THEREOF
Sanofi-Aventis Deutschland GmbH	<b>A61M 5/20</b> (2006.01)	2585136 *	NEEDLE SAFETY ARRANGEMENT AND METHOD FOR OPERATING IT

Podnosilac evropske prijave patenta (71)	MKP (51)	Broj objave evropske prijave patenta (97)	Naziv pronalaska (54)
Wingspeed AG	<b>C08G 69/16</b> (2006.01) <b>C08L 77/00</b> (2006.01) <b>C08K 7/00</b> (2006.01) <b>C08K 3/00</b> (2006.01)	2558517 *	METHOD FOR PRODUCING MODIFIED POLYAMIDE 6
Mars, Incorporated	<b>C07F 5/02</b> (2006.01) <b>A61K 31/155</b> (2006.01) <b>A61K 31/69</b> (2006.01) <b>A61K 49/00</b> (2006.01)	2560978 *	INHIBITORS OF ARGINASE AND THEIR THERAPEUTIC APPLICATIONS
ART & SMART EGG KFT.	<b>A63F 9/00</b> (2006.01) <b>A63F 9/08</b> (2006.01)	2566591 *	SPATIAL LOGICAL AND SKILL IMPROVEMENT GAME, PARTICULARLY A LABYRINTH GAME
Amgen Inc.	<b>A61K 39/395</b> (2006.01) <b>A61P 3/10</b> (2006.01) <b>C07K 16/28</b> (2006.01)	2558497 *	HUMAN FGF RECEPTOR AND BETA-KLOTHO BINDING PROTEINS
aTyr Pharma, Inc.	<b>A61K 39/395</b> (2006.01) <b>A61K 38/17</b> (2006.01) <b>A61K 38/16</b> (2006.01) <b>A61P 35/00</b> (2006.01) <b>A61P 3/00</b> (2006.01) <b>A61P 29/00</b> (2006.01)	2563381 *	INNOVATIVE DISCOVERY OF THERAPEUTIC, DIAGNOSTIC, AND ANTIBODY COMPOSITIONS RELATED TO PROTEIN FRAGMENTS OF ISOLEUCYL TRNA SYNTHETASES
Pangu Biopharma Limited	<b>A61K 39/395</b> (2006.01) <b>A61K 38/17</b> (2006.01) <b>A61K 38/16</b> (2006.01) <b>A61P 35/00</b> (2006.01) <b>A61P 3/00</b> (2006.01) <b>A61P 29/00</b> (2006.01)	2563381 *	INNOVATIVE DISCOVERY OF THERAPEUTIC, DIAGNOSTIC, AND ANTIBODY COMPOSITIONS RELATED TO PROTEIN FRAGMENTS OF ISOLEUCYL TRNA SYNTHETASES
Taisho Pharmaceutical Co., Ltd.	<b>A61K 31/337</b> (2006.01) <b>A61K 31/40</b> (2006.01) <b>A61K 31/415</b> (2006.01) <b>A61K 31/341</b> (2006.01) <b>A61K 31/4015</b> (2006.01) <b>A61K 31/416</b> (2006.01) <b>A61K 31/357</b> (2006.01) <b>A61K 31/4035</b> (2006.01) <b>A61K 31/36</b> (2006.01) <b>A61K 31/404</b> (2006.01) <b>C07C 259/06</b> (2006.01) <b>A61K 31/381</b> (2006.01) <b>A61K 31/4045</b> (2006.01) <b>A61K 31/166</b> (2006.01) <b>A61K 31/397</b> (2006.01) <b>A61K 31/407</b> (2006.01) <b>A61K 31/351</b> (2006.01) <b>A61K 31/403</b> (2006.01) <b>A61K 31/343</b> (2006.01) <b>A61K 31/402</b> (2006.01)	2562155 *	NOVEL HYDROXAMIC ACID DERIVATIVE
Toyama Chemical Co., Ltd.	<b>A61K 31/337</b> (2006.01) <b>A61K 31/40</b> (2006.01) <b>A61K 31/415</b> (2006.01) <b>A61K 31/341</b> (2006.01) <b>A61K 31/4015</b> (2006.01) <b>A61K 31/416</b> (2006.01) <b>A61K 31/357</b> (2006.01) <b>A61K 31/4035</b> (2006.01) <b>A61K 31/36</b> (2006.01) <b>A61K 31/404</b> (2006.01) <b>C07C 259/06</b> (2006.01) <b>A61K 31/381</b> (2006.01) <b>A61K 31/4045</b> (2006.01) <b>A61K 31/166</b> (2006.01) <b>A61K 31/397</b> (2006.01) <b>A61K 31/407</b> (2006.01) <b>A61K 31/351</b> (2006.01) <b>A61K 31/403</b> (2006.01) <b>A61K 31/343</b> (2006.01) <b>A61K 31/402</b> (2006.01)	2562155 *	NOVEL HYDROXAMIC ACID DERIVATIVE
AEG Power Solutions B.V.	<b>H02M 7/06</b> (2006.01) <b>H01F 29/00</b> (2006.01)	2479880	Power supply assembly for rectification

Podnosilac evropske prijave patenta (71)	MKP (51)	Broj objave evropske prijave patenta (97)	Naziv pronalaska (54)
Curt G. Joa, Inc.	<b>A61F 13/15</b> (2006.01) <b>B26D 7/18</b> (2006.01)	2548540	Differential speed shafted machines and uses therefor, including discontinuous and continuous side by side bonding
Thürwächter GmbH & Co.KG	<b>C12M 1/107</b> (2006.01) <b>F16M 11/00</b> (2006.01) <b>B01F 15/00</b> (2006.01) <b>B01F 7/00</b> (2006.01) <b>A01C 3/02</b> (2006.01)	2361673	Apparatus
Amgen Inc.	<b>C07D 405/14</b> (2006.01) <b>C07D 401/12</b> (2006.01) <b>C07D 401/14</b> (2006.01) <b>C07D 413/14</b> (2006.01)	2588467 *	HETEROCYCLIC COMPOUNDS AND THEIR USE AS INHIBITORS OF PI3K ACTIVITY
KRKA, d.d., Novo mesto	<b>A61K 31/41</b> (2006.01) <b>C07D 257/04</b> (2006.01)	2556059 *	IMPROVED PROCESS FOR PREPARING VALSARTAN
SiO2 Medical Products, Inc.	<b>B05D 5/08</b> (2006.01) <b>B05D 7/02</b> (2006.01) <b>B05D 7/24</b> (2006.01)	2579996 *	LUBRICITY VESSEL COATING, COATING PROCESS AND APPARATUS
The Curators Of The University Of Missouri	<b>A61L 27/60</b> (2006.01) <b>A61L 27/44</b> (2006.01) <b>A61L 27/04</b> (2006.01) <b>A61K 47/48</b> (2006.01) <b>A61L 27/24</b> (2006.01)	2575908 *	CONJUGATED POLYMERIC MATERIAL AND USES THEREOF
GlaxoSmithKline Biologicals S.A.	<b>A61K 39/09</b> (2006.01) <b>A61P 43/00</b> (2006.01) <b>A61K 39/385</b> (2006.01)	2544710 *	IMMUNOGENIC COMPOSITION COMPRISING S. PNEUMONIAE POLYSACCHARIDES CONJUGATED TO CARRIER PROTEINS
WFL Millturn Technologies GmbH & Co. KG	<b>B23Q 1/76</b> (2006.01) <b>B23Q 1/38</b> (2006.01)	2433742	Rest for hydrostatically supporting a workpiece of a machine tool
DNA Interactif Fashion	<b>G06Q 10/00</b> (2012.01)	2455895	A device for supporting a user in selecting clothes
Dow AgroSciences, LLC	<b>A01N 25/04</b> (2006.01)	2563115 *	STABILIZED AGRICULTURAL OIL DISPERSIONS
De Sousa, Michelle E.	<b>A41C 3/12</b> (2006.01) <b>A44C 25/00</b> (2006.01)	2568847 *	GARMENT AND BRASSIERE ACCESSORY
De Sousa, Jose De Jesus	<b>A41C 3/12</b> (2006.01) <b>A44C 25/00</b> (2006.01)	2568847 *	GARMENT AND BRASSIERE ACCESSORY
Forced Physics Llc	<b>F28D 15/00</b> (2006.01) <b>H01L 23/34</b> (2006.01)	2577210 *	HEAT AND ENERGY EXCHANGE
Isis Innovation Limited	<b>A61P 25/28</b> (2006.01) <b>A61K 31/4415</b> (2006.01) <b>A61K 31/519</b> (2006.01) <b>A61K 31/714</b> (2006.01)	2588198 *	TREATMENT OF COGNITIVE DISORDERS
WFL Millturn Technologies GmbH & Co. KG	<b>B23Q 1/76</b> (2006.01) <b>B24B 41/06</b> (2012.01)	2415557	Device and method for reducing deviations in shape and/or position, in particular the run out of a workpiece
Teva Pharmaceutical Industries Ltd.	<b>A61K 31/47</b> (2006.01) <b>A01N 43/42</b> (2006.01)	2542078 *	TREATMENT OF LUPUS NEPHRITIS USING LAQUINIMOD
Rigel Pharmaceuticals, Inc.	<b>A61P 37/00</b> (2006.01) <b>A61P 29/00</b> (2006.01) <b>A61K 31/5383</b> (2006.01) <b>C07D 498/04</b> (2006.01)	2558474 *	2, 4-PYRIMIDINEDIAMINE COMPOUNDS AND PRODRUGS THEREOF AND THEIR USES
Tegometall International AG	<b>A47F 5/13</b> (2006.01)	2579747 *	SALES TABLE
Les Laboratoires Servier	<b>A61P 25/24</b> (2006.01) <b>A61K 31/165</b> (2006.01) <b>C07C 231/12</b> (2006.01) <b>C07C 233/18</b> (2006.01)	2547649 *	AGOMELATINE HYDROCHLORIDE HYDRATE AND PREPARATION THEREOF
Ricon Corp.	<b>B61D 19/02</b> (2006.01) <b>E05F 15/18</b> (2006.01) <b>E05D 15/06</b> (2006.01)	2558344 *	MAGNETIC-ASSISTED LINEAR BEARING
Fern Innovations IP, LLC	<b>A61M 35/00</b> (2006.01) <b>A61B 19/02</b> (2006.01) <b>A61J 1/05</b> (2006.01)	2579831 *	DISPENSER AND METHODS OF USE

Podnosilac evropske prijave patenta (71)	MKP (51)	Broj objave evropske prijave patenta (97)	Naziv pronalaska (54)
Pharma Mar S.A.	<b>C07J 19/00</b> (2006.01) <b>A61K 31/585</b> (2006.01) <b>C07J 71/00</b> (2006.01) <b>A61P 35/00</b> (2006.01)	2563803 *	ANTICANCER STEROIDAL LACTONES UNSATURATED IN POSITION 7 (8)
Dana-Farber Cancer Institute, Inc.	<b>A61K 31/553</b> (2006.01) <b>A61K 31/555</b> (2006.01)	2571503 *	COMPOSITIONS AND METHODS FOR TREATING NEOPLASIA, INFLAMMATORY DISEASE AND OTHER DISORDERS
Dow AgroSciences LLC	<b>C07D 487/04</b> (2006.01)	2576558 *	PROCESS FOR THE PREPARATION OF 5-SUBSTITUTED-8-ALKOXY[1,2,4]TRIAZOLO[1,5-C]PYRIMIDIN-2-AMINES
Delphi Technologies Holding S.à.r.l.	<b>F02D 41/22</b> (2006.01)	2556231 *	DIAGNOSIS DEVICE AND METHOD USING AN IN-CYLINDER PRESSURE SENSOR IN AN INTERNAL COMBUSTION ENGINE
Hagleitner, Hans Georg	<b>A47K 10/36</b> (2006.01)	2560536 *	PAPER DISPENSER
SANOFI	<b>A61K 31/555</b> (2006.01) <b>A61K 31/282</b> (2006.01) <b>A61K 33/24</b> (2006.01) <b>A61K 31/337</b> (2006.01) <b>A61K 45/06</b> (2006.01) <b>A61K 31/167</b> (2006.01) <b>A61P 35/00</b> (2006.01)	2582369 *	AN ANTITUMORAL COMBINATION COMPRISING OMBRABULIN, A TAXANE DERIVATIVE AND A PLATINUM DERIVATIVE
Gilead Pharmasset LLC	<b>A61K 31/7076</b> (2006.01) <b>A61K 31/7072</b> (2006.01) <b>C07F 9/6558</b> (2006.01) <b>C07H 19/044</b> (2006.01) <b>C07F 9/655</b> (2006.01) <b>C07H 19/04</b> (2006.01) <b>A61P 31/14</b> (2006.01) <b>A61K 31/664</b> (2006.01) <b>C07H 19/10</b> (2006.01) <b>C07H 19/06</b> (2006.01) <b>C07F 9/24</b> (2006.01) <b>C07F 7/18</b> (2006.01) <b>C07H 19/24</b> (2006.01) <b>C07F 9/6561</b> (2006.01) <b>C07H 19/052</b> (2006.01)	2552931 *	STEREOSELECTIVE SYNTHESIS OF PHOSPHORUS CONTAINING ACTIVES
Abbott Laboratories	<b>A61K 47/30</b> (2006.01) <b>A61K 9/20</b> (2006.01) <b>A61K 31/498</b> (2006.01) <b>A61K 31/4965</b> (2006.01) <b>A61K 31/395</b> (2006.01) <b>A61P 31/14</b> (2006.01)	2544689 *	SOLID COMPOSITIONS
Schillinger Genetics, Inc.	<b>A01H 5/10</b> (2006.01)	2542048 *	ULTRA-LOW TRYPSIN INHIBITOR SOYBEAN
Sanofi-Aventis Deutschland GmbH	<b>A61M 5/315</b> (2006.01)	2552519 *	PISTON ROD ASSEMBLY FOR A DRUG DELIVERY DEVICE
Radius Health, Inc.	<b>A01N 33/02</b> (2006.01)	2568806 *	THERAPEUTIC REGIMENS
Newchem S.p.A.	<b>C07C 405/00</b> (2006.01) <b>C07D 307/935</b> (2006.01)	2495235	Process for the synthesis of prostaglandins and intermediates thereof
BIOGEN IDEC HEMOPHILIA INC.	<b>C07K 19/00</b> (2006.01) <b>A61K 47/42</b> (2006.01) <b>C07K 16/46</b> (2006.01)	2591006 *	PROCESSABLE SINGLE CHAIN MOLECULES AND POLYPEPTIDES MADE USING SAME
JPT Peptide Technologies GmbH	<b>G01N 33/68</b> (2006.01)	2545384 *	METHOD FOR DETERMINING THE CONCENTRATION OF A PEPTIDE
ACO Severin Ahlmann GmbH & Co. KG	<b>C02F 1/00</b> (2006.01) <b>C02F 1/52</b> (2006.01)	2465822	Separator to separate fat from water and method for separating fat from water
Omya Development AG	<b>B05B 7/04</b> (2006.01)	2554273	Atomizing nozzle device and use of the same
Signature Therapeutics, Inc.	<b>A01N 43/42</b> (2006.01) <b>A61K 31/44</b> (2006.01)	2560491 *	PERIPHERAL OPIOID AGONISTS AND PERIPHERAL OPIOID ANTAGONISTS
Glaxo Group Limited	<b>A61K 8/26</b> (2006.01) <b>A61K 8/24</b> (2006.01) <b>A61Q 11/00</b> (2006.01)	2552384 *	NOVEL COMPOSITION



Podnosilac evropske prijave patenta (71)	MKP (51)	Broj objave evropske prijave patenta (97)	Naziv pronalaska (54)
Van Genechten Packaging N.V.	<b>B65D 5/24</b> (2006.01) <b>B65D 5/20</b> (2006.01)	2559627	Folding carton or the like, blank for forming a folding carton and process for erecting the folding carton
Apple Inc.	<b>H01R 4/58</b> (2006.01)	2583356 *	DUAL ORIENTATION CONNECTOR WITH SIDE CONTACTS
Novartis AG	<b>A61P 29/00</b> (2006.01) <b>C07D 471/04</b> (2006.01) <b>A61K 31/517</b> (2006.01)	2590974 *	TETRAHYDRO-PYRIDO-PYRIMIDINE DERIVATIVES
Sanofi-Aventis Deutschland GmbH	<b>A61M 5/24</b> (2006.01) <b>A61M 5/315</b> (2006.01)	2579924 *	A DRIVE ASSEMBLY FOR A MEDICATION DELIVERY DEVICE AND MEDICATION DELIVERY DEVICE
Gilead Calistoga LLC	<b>A61K 31/517</b> (2006.01) <b>A61P 35/02</b> (2006.01) <b>A61K 31/52</b> (2006.01)	2579878 *	METHODS OF TREATING HEMATOLOGICAL DISORDERS WITH QUINAZOLINONE COMPOUNDS IN SELECTED PATIENTS
Eisai R&D Management Co., Ltd.	<b>G01N 33/50</b> (2006.01) <b>C12Q 1/02</b> (2006.01) <b>C07K 14/435</b> (2006.01) <b>C12N 5/10</b> (2006.01) <b>C07K 14/82</b> (2006.01) <b>A01K 67/027</b> (2006.01) <b>A61P 35/00</b> (2006.01) <b>G01N 33/15</b> (2006.01) <b>C12N 15/09</b> (2006.01)	2578678 *	METHOD FOR PRODUCING TUMOR CELL
Cerioni, Sandro	<b>E04F 11/032</b> (2006.01)	2505736	Winding staircase
aTyr Pharma, Inc.	<b>A61P 3/10</b> (2006.01) <b>A61P 35/00</b> (2006.01) <b>A61K 38/17</b> (2006.01) <b>C07K 14/525</b> (2006.01) <b>A61K 39/395</b> (2006.01) <b>A61P 29/00</b> (2006.01)	2566499 *	INNOVATIVE DISCOVERY OF THERAPEUTIC, DIAGNOSTIC, AND ANTIBODY COMPOSITIONS RELATED TO PROTEIN FRAGMENTS OF P38 MULTI-TRNA SYNTHETASE COMPLEX
Weir Minerals Australia Ltd	<b>F04D 29/40</b> (2006.01) <b>F04D 7/04</b> (2006.01) <b>F15D 1/04</b> (2006.01)	2542784 *	PUMP INTAKE DEVICE
Baylor Research Institute	<b>A61P 3/00</b> (2006.01) <b>A61K 31/23</b> (2006.01)	2579867 *	TRihePTANOIN DIET FOR ADULT POLYGLUCOSAN BODY DISEASE (APBD) TREATMENT
Hanenberg, Helmut	<b>C12Q 1/68</b> (2006.01)	2556167 *	RAD51C AS A HUMAN CANCER SUSCEPTIBILITY GENE
Heinrich-Heine-Universität Düsseldorf	<b>C12Q 1/68</b> (2006.01)	2556167 *	RAD51C AS A HUMAN CANCER SUSCEPTIBILITY GENE
Universität zu Köln	<b>C12Q 1/68</b> (2006.01)	2556167 *	RAD51C AS A HUMAN CANCER SUSCEPTIBILITY GENE
Novartis AG	<b>A61K 31/436</b> (2006.01) <b>A61P 35/00</b> (2006.01) <b>A61K 31/496</b> (2006.01) <b>A61K 31/00</b> (2006.01)	2558082 *	COMBINATION OF ORGANIC COMPOUNDS
Celldex Therapeutics, Inc.	<b>A61K 39/395</b> (2006.01) <b>A01K 67/027</b> (2006.01) <b>A61P 37/02</b> (2006.01) <b>C07K 16/28</b> (2006.01) <b>A61P 35/00</b> (2006.01) <b>C07K 14/705</b> (2006.01)	2558498 *	ANTIBODIES THAT BIND HUMAN CD27 AND USES THEREOF
Neomend, Inc.	<b>A61M 5/178</b> (2006.01) <b>A61M 39/22</b> (2006.01) <b>A61M 5/145</b> (2006.01)	2555812 *	SYSTEMS, DEVICES, METHODS FOR DELIVERING HYDROGEL COMPOSITIONS WITH SELF-PURGING TO PREVENT CLOGGING
Roewer, Norbert, Univ.-Prof. Dr. med.	<b>A61K 31/05</b> (2006.01) <b>A61K 47/48</b> (2006.01) <b>A61K 9/00</b> (2006.01)	2484350	Pharmaceutical preparation containing a complex of a salt of propofol and a cyclodextrin
Broscheit, Jens, Dr. med.	<b>A61K 31/05</b> (2006.01) <b>A61K 47/48</b> (2006.01) <b>A61K 9/00</b> (2006.01)	2484350	Pharmaceutical preparation containing a complex of a salt of propofol and a cyclodextrin

Podnosilac evropske prijave patenta (71)	MKP (51)	Broj objave evropske prijave patenta (97)	Naziv pronalaska (54)
Exformation Communication AB	<b>H04L 9/00</b> (2006.01) <b>H04K 1/00</b> (2006.01)	2556622 *	METHOD TO ENCRYPT INFORMATION THAT IS TRANSFERRED BETWEEN TWO COMMUNICATION UNITS
Almirall S.A.	<b>A61K 31/4709</b> (2006.01) <b>C07D 409/14</b> (2006.01) <b>A61P 11/00</b> (2006.01)	2569308 *	NEW CYCLOHEXYLAMINE DERIVATIVES HAVING 2 ADRENERGIC AGONIST AND M3 MUSCARINIC ANTAGONIST ACTIVITIES
Wobben Properties GmbH	<b>F03D 7/02</b> (2006.01)	2558717 *	WIND ENERGY INSTALLATION AZIMUTH OR PITCH DRIVE
University Of Oslo	<b>G01S 11/14</b> (2006.01) <b>G01S 1/82</b> (2006.01) <b>G01S 1/76</b> (2006.01) <b>G01S 5/18</b> (2006.01)	2550542 *	ROBUST ULTRASONIC INDOOR POSITIONING SYSTEM WITH HIGH ACCURACY
Wobben Properties GmbH	<b>F03D 1/06</b> (2006.01)	2561218 *	REMOVABLE ROTOR BLADE TIP
Kopcic, Nikola	<b>H01H 85/30</b> (2006.01)	2574217 *	FUSE LINK STATUS INDICATOR FOR A LOW-VOLTAGE HIGH -POWER FUSE
Kopcic, Davor	<b>H01H 85/30</b> (2006.01)	2574217 *	FUSE LINK STATUS INDICATOR FOR A LOW-VOLTAGE HIGH -POWER FUSE
Masciarelli, Giuseppe	<b>F04D 13/12</b> (2006.01) <b>F04F 10/02</b> (2006.01)	2585720 *	HYDRAULIC PUMP WITH COMMUNICATING VESSELS
Londonpharma Ltd.	<b>A61P 25/36</b> (2006.01) <b>A61P 25/04</b> (2006.01) <b>A61K 9/00</b> (2006.01) <b>A61K 31/135</b> (2006.01) <b>A61K 31/137</b> (2006.01) <b>A61K 9/12</b> (2006.01)	2588094 *	PHARMACEUTICAL COMPOSITIONS FOR SUBLINGUAL DELIVERY OF OPIOIDS
Millennium Pharmaceuticals, Inc.	<b>A01N 55/08</b> (2006.01)	2552216 *	DERIVATIVES OF 1-AMINO-2-CYCLOPROPYLETHYLBORONIC ACID
Abbott Laboratories	<b>C12P 21/02</b> (2006.01) <b>A61K 39/395</b> (2006.01) <b>C07K 16/00</b> (2006.01)	2585607 *	DUAL VARIABLE DOMAIN IMMUNOGLOBULINS AND USES THEREOF
Isignthis Ltd	<b>G06Q 20/00</b> (2012.01)	2553642 *	METHODS AND SYSTEMS FOR VERIFYING TRANSACTIONS
Ardea Biosciences, Inc.	<b>C07D 241/18</b> (2006.01) <b>C07D 401/04</b> (2006.01) <b>A61P 9/12</b> (2006.01) <b>A61K 31/444</b> (2006.01) <b>C07D 213/70</b> (2006.01) <b>A61P 9/00</b> (2006.01) <b>A61P 19/06</b> (2006.01) <b>A61K 31/4965</b> (2006.01) <b>A61K 31/44</b> (2006.01)	2585437 *	THIOACETATE COMPOUNDS, COMPOSITIONS AND METHODS OF USE
Oncothyreon Inc.	<b>A01N 43/36</b> (2006.01) <b>A61K 31/40</b> (2006.01) <b>A61K 31/35</b> (2006.01)	2575459 *	CANCER TREATMENT WITH WORTMANNIN ANALOGS
Janssen Pharmaceutica, N.V.	<b>C07D 409/14</b> (2006.01) <b>A61K 31/4375</b> (2006.01) <b>C07D 417/14</b> (2006.01) <b>C07D 401/06</b> (2006.01) <b>C07D 211/66</b> (2006.01) <b>A61K 31/4436</b> (2006.01) <b>C07D 407/14</b> (2006.01) <b>C07D 407/06</b> (2006.01) <b>C07D 417/06</b> (2006.01) <b>A61K 31/4439</b> (2006.01) <b>C07D 409/06</b> (2006.01) <b>A61K 31/444</b> (2006.01) <b>A61P 19/02</b> (2006.01)	2544684 *	4,4-DISUBSTITUTED PIPERIDINE DERIVATIVES USEFUL AS INHIBITORS OF DIPEPTIDYL PEPTIDASE-1 (DPP-1)
Almirall S.A.	<b>A61K 31/58</b> (2006.01) <b>A61K 47/06</b> (2006.01) <b>A61K 47/10</b> (2006.01) <b>A61K 47/36</b> (2006.01) <b>A61K 9/06</b> (2006.01)	2575822 *	TOPICAL PHARMACEUTICAL COMPOSITIONS COMPRISING MOMETASONE FUROATE

Podnosilac evropske prijave patenta (71)	MKP (51)	Broj objave evropske prijave patenta (97)	Naziv pronalaska (54)
Modeltek SNC di Salvarani - Vacondio - Masi	<b>B60R 13/10</b> (2006.01)	2532556	Registration Plate Holder
Devirex AG	<b>A61K 31/765</b> (2006.01) <b>A61P 31/22</b> (2006.01)	2563374 *	POLYETHYLENE GLYCOL COMPOSITIONS FOR CONTROLLING RELAPSE OF HERPES LABIALIS, HERPES GENITALIS, AND HERPES ZOSTER
Sanofi-Aventis Deutschland GmbH	<b>B65D 71/70</b> (2006.01) <b>A61M 5/00</b> (2006.01) <b>B65B 3/00</b> (2006.01)	2569030 *	WORKPIECE CARRIER FOR TRANSPORTING AND/OR STORING COMPONENTS OF DRUG DELIVERY DEVICES
Gilead Sciences, Inc.	<b>C07D 215/38</b> (2006.01) <b>C07D 519/00</b> (2006.01) <b>C07D 215/14</b> (2006.01) <b>C07D 417/04</b> (2006.01) <b>C07D 405/04</b> (2006.01) <b>C07D 401/12</b> (2006.01) <b>A61K 31/47</b> (2006.01) <b>C07D 215/18</b> (2006.01) <b>C07D 487/04</b> (2006.01) <b>C07D 215/48</b> (2006.01) <b>C07D 215/227</b> (2006.01) <b>C07D 215/06</b> (2006.01) <b>C07D 413/04</b> (2006.01) <b>C07D 401/04</b> (2006.01) <b>A61P 31/18</b> (2006.01)	2588455 *	2 -QUINOLINYL- ACETIC ACID DERIVATIVES AS HIV ANTIVIRAL COMPOUNDS
Lipogems International SRL	<b>A61K 35/36</b> (2006.01) <b>C12M 3/08</b> (2006.01)	2574663	Method for preparing tissue, particularly adipose tissue
Phivco-1 LLC	<b>A61K 31/00</b> (2006.01) <b>A61K 31/4433</b> (2006.01) <b>A61K 45/06</b> (2006.01) <b>A61K 31/496</b> (2006.01) <b>A61K 31/46</b> (2006.01) <b>A61K 31/4725</b> (2006.01) <b>A61K 31/427</b> (2006.01) <b>A61K 31/4545</b> (2006.01) <b>A61K 31/4178</b> (2006.01) <b>A61K 31/351</b> (2006.01) <b>A61K 31/506</b> (2006.01) <b>A61K 31/4402</b> (2006.01) <b>A61K 31/472</b> (2006.01) <b>A61P 31/18</b> (2006.01) <b>A61K 31/499</b> (2006.01)	2552429 *	COMBINATION THERAPY COMPRISING A CCR5 ANTAGONIST, A HIV-1 PROTEASE INHIBITOR AND A PHARMACOKINETIC ENHANCER
BIOGEN IDEC HEMOPHILIA INC.	<b>A61K 38/36</b> (2006.01)	2590668 *	FACTOR IX POLYPEPTIDES AND METHODS OF USE THEREOF
Apple Inc.	<b>H05K 1/11</b> (2006.01) <b>H01R 13/66</b> (2006.01) <b>H01R 27/00</b> (2006.01) <b>H01R 13/6582</b> (2011.01) <b>H01R 13/03</b> (2006.01) <b>H01R 29/00</b> (2006.01) <b>H01R 13/627</b> (2006.01) <b>H01R 13/24</b> (2006.01) <b>H01R 13/642</b> (2006.01)	2583361 *	EXTERNAL CONTACT PLUG CONNECTOR
Tsinghua University	<b>C07K 14/47</b> (2006.01) <b>C07K 16/30</b> (2006.01) <b>C07K 14/435</b> (2006.01) <b>G01N 33/574</b> (2006.01) <b>C07K 16/18</b> (2006.01) <b>A61K 39/395</b> (2006.01) <b>A61P 35/04</b> (2006.01)	2452948 *	NEW TUMOR MARKER
Protgen Ltd.	<b>C07K 14/47</b> (2006.01) <b>C07K 16/30</b> (2006.01) <b>C07K 14/435</b> (2006.01) <b>G01N 33/574</b> (2006.01) <b>C07K 16/18</b> (2006.01) <b>A61K 39/395</b> (2006.01) <b>A61P 35/04</b> (2006.01)	2452948 *	NEW TUMOR MARKER

Podnosilac evropske prijave patenta (71)	MKP (51)	Broj objave evropske prijave patenta (97)	Naziv pronalaska (54)
Cima Labs Inc.	<b>A61K 31/135</b> (2006.01) <b>A61K 9/20</b> (2006.01)	2568977 *	ALCOHOL-RESISTANT METOPROLOL-CONTAINING EXTENDED- RELEASE ORAL DOSAGE FORMS
PPG Industries Ohio, Inc.	<b>B01D 39/08</b> (2006.01) <b>B01D 39/20</b> (2006.01) <b>B01D 39/16</b> (2006.01)	2593206 *	FILTRATION MEDIA AND APPLICATIONS THEREOF
Wu, Dinan	<b>F26B 5/04</b> (2006.01) <b>B65D 33/01</b> (2006.01) <b>B65D 81/00</b> (2006.01) <b>A23L 3/015</b> (2006.01) <b>A01F 25/14</b> (2006.01) <b>B65D 30/00</b> (2006.01) <b>B65D 33/00</b> (2006.01) <b>B65D 33/16</b> (2006.01) <b>B65D 81/20</b> (2006.01)	2589303 *	WATER EQUILIBRIUM VARIABLE PRESSURE DRIED FOODS, PROCESSING METHOD, DEVICE AND PACKAGE THEREOF
Chiesi Farmaceutici S.p.A.	<b>A61P 11/00</b> (2006.01) <b>A61P 11/06</b> (2006.01) <b>A61K 31/40</b> (2006.01) <b>C07D 207/12</b> (2006.01) <b>A61P 11/08</b> (2006.01)	2580195 *	CRYSTAL FORM OF GLYCOPYRRONIUM CHLORIDE
Metabolic Solutions Development Company LLC	<b>C07D 213/51</b> (2006.01) <b>C07D 277/34</b> (2006.01)	2560956 *	NOVEL SYNTHESIS FOR THIAZOLIDINEDIONE COMPOUNDS
Alexion Pharmaceuticals, Inc.	<b>C07K 16/18</b> (2006.01)	2563813 *	ANTI-C5A ANTIBODIES AND METHODS FOR USING THE ANTIBODIES
Food Safety Technology LLC	<b>C01B 13/11</b> (2006.01) <b>B01J 19/08</b> (2006.01) <b>B01J 19/00</b> (2006.01)	2582621 *	OZONATED LIQUID DISPENSING UNIT
Janssen Pharmaceutica, N.V.	<b>A61K 9/20</b> (2006.01) <b>A61K 31/7072</b> (2006.01) <b>A61K 9/28</b> (2006.01) <b>A61K 31/155</b> (2006.01)	2590631 *	FORMULATION FOR CO-THERAPY TREATMENT OF DIABETES
Probiodrug AG	<b>C07D 403/04</b> (2006.01) <b>C07D 403/14</b> (2006.01) <b>A61K 31/4184</b> (2006.01) <b>A61P 25/28</b> (2006.01) <b>C07D 401/04</b> (2006.01) <b>A61K 31/454</b> (2006.01) <b>A61P 31/04</b> (2006.01) <b>A61K 31/4709</b> (2006.01) <b>A61P 35/00</b> (2006.01) <b>A61K 31/5377</b> (2006.01) <b>A61P 29/00</b> (2006.01) <b>C07D 405/10</b> (2006.01) <b>A61P 25/18</b> (2006.01) <b>C07D 403/10</b> (2006.01) <b>A61P 1/04</b> (2006.01)	2545047 *	HETEROCYCLIC INHIBITORS OF GLUTAMINYL CYCLASE (QC, EC 2.3.2.5)
Kutzke, Arthur	<b>H02K 21/18</b> (2006.01)	2249466	Disc motor with electromagnetic drive
Dow AgroSciences LLC	<b>A01P 13/00</b> (2006.01) <b>A01P 3/00</b> (2006.01) <b>A01N 43/40</b> (2006.01) <b>A01N 25/32</b> (2006.01)	2555615 *	SYNERGISTIC HERBICIDE/FUNGICIDE COMPOSITION CONTAINING A PYRIDINE CARBOXYLIC ACID AND A FUNGICIDE
Immatics Biotechnologies GmbH	<b>A61P 35/00</b> (2006.01) <b>C07K 7/06</b> (2006.01) <b>A61K 39/00</b> (2006.01)	2547691 *	COMPOSITION OF TUMOR-ASSOCIATED PEPTIDES AND RELATED ANTI-CANCER VACCINE FOR THE TREATMENT OF GASTRIC CANCER AND OTHER CANCERS
ES Smede & Maskinservice ApS	<b>B60P 1/02</b> (2006.01)	2484550	Vehicle

Podnosilac evropske prijave patenta (71)	MKP (51)	Broj objave evropske prijave patenta (97)	Naziv pronalaska (54)
The University of British Columbia	<b>A61K 39/00</b> (2006.01) <b>A61P 25/28</b> (2006.01) <b>A61P 37/04</b> (2006.01) <b>A61K 39/395</b> (2006.01) <b>C07K 16/18</b> (2006.01) <b>C07K 14/47</b> (2006.01) <b>C12N 15/13</b> (2006.01) <b>G01N 33/53</b> (2006.01)	2542571 *	OLIGOMER-SPECIFIC AMYLOID BETA EPITOPE AND ANTIBODIES
Deva Holding Anonim Sirketi	<b>A61K 9/00</b> (2006.01) <b>A23L 1/30</b> (2006.01) <b>A61K 31/23</b> (2006.01) <b>A61K 9/16</b> (2006.01)	2471385	Cetyl myristate and/or cetyl palmitate suspension formulations
GlaxoSmithKline LLC	<b>A01N 43/38</b> (2006.01) <b>A61K 31/405</b> (2006.01)	2566327 *	INDOLES
Krka Tovarna Zdravil, D.D., Novo Mesto	<b>A61K 9/50</b> (2006.01)	2588090 *	PHARMACEUTICAL ORAL DOSAGE FORMS COMPRISING DABIGATRAN ETEXILATE AND ITS PHARMACEUTICALLY ACCEPTABLE SALTS
Ethicon, Inc	<b>A61B 17/06</b> (2006.01)	2544599 *	SUTURE PACKAGES PROVIDING UNCONSTRAINED DISPENSING OF SUTURES AND METHODS THEREFOR
Friedrich-Schiller-Universität Jena	<b>A61L 27/20</b> (2006.01) <b>C12R 1/02</b> (2006.01) <b>A61L 26/00</b> (2006.01)	2547372 *	MULTI-PHASE BACTERIALLY-SYNTHESIZED-NANOCELLULOSE BIOMATERIALS AND METHOD FOR PRODUCING SAME
Savant Systems LLC.	<b>G06F 1/16</b> (2006.01) <b>H04L 12/28</b> (2006.01)	2577418 *	DOCKING STATION WITH REDUNDANT COMMUNICATION PATH
Top-It-Up Ltd.	<b>E02B 3/00</b> (2006.01) <b>B65D 88/36</b> (2006.01)	2582881 *	FLOATING DEVICE AND METHOD OF USING THE SAME
Sanofi-Aventis Deutschland GmbH	<b>A61M 5/20</b> (2006.01) <b>A61M 5/00</b> (2006.01) <b>A61M 5/32</b> (2006.01)	2585137 *	AUTO-INJECTOR
Bayer CropScience NV	<b>C12N 15/82</b> (2006.01) <b>A01H 5/10</b> (2006.01) <b>C07K 14/415</b> (2006.01) <b>A01H 1/06</b> (2006.01)	2566318 *	BRASSICA PLANTS WITH ALTERED ARCHITECTURE
Sanofi-Aventis Deutschland GmbH	<b>A61M 5/315</b> (2006.01)	2579928 *	DRIVE ASSEMBLY, DRIVE COMPONENT AND DRUG DELIVERY DEVICE
Suncor Energy Inc.	<b>B01F 5/04</b> (2006.01) <b>B03D 3/06</b> (2006.01) <b>B01D 21/01</b> (2006.01)	2571610 *	METHOD AND DEVICE FOR IN-LINE INJECTION OF FLOCCULENT AGENT INTO A FLUID FLOW OF MATURE FINE TAILINGS
Obchestvo S Ogranichennoj Otvetstvennostju Promishlennaja Kompanija "Tehnologija Metallov"	<b>B09B 3/00</b> (2006.01) <b>F23G 5/00</b> (2006.01) <b>F23G 5/04</b> (2006.01)	2587145 *	METHOD FOR THE POLLUTION-FREE THERMAL PROCESSING OF SOLID MUNICIPAL WASTE AND PLANT FOR CARRYING OUT SAID METHOD
Galderma S.A.	<b>A61K 31/498</b> (2006.01) <b>A61K 9/06</b> (2006.01) <b>A61K 47/14</b> (2006.01) <b>A61K 47/32</b> (2006.01) <b>A61K 9/00</b> (2006.01)	2444068	Brimonidine gel composition

Podnosilac evropske prijave patenta (71)	MKP (51)	Broj objave evropske prijave patenta (97)	Naziv pronalaska (54)
Ingenium Pharmaceuticals GmbH	<b>C07D 401/14</b> (2006.01) <b>A61K 31/496</b> (2006.01) <b>A61K 31/4418</b> (2006.01) <b>A61P 9/00</b> (2006.01) <b>C07D 401/12</b> (2006.01) <b>A61K 31/4436</b> (2006.01) <b>C07D 417/12</b> (2006.01) <b>A61P 29/00</b> (2006.01) <b>C07D 213/75</b> (2006.01) <b>A61K 31/44</b> (2006.01) <b>A61K 31/4545</b> (2006.01) <b>A61P 25/00</b> (2006.01) <b>A61K 31/4439</b> (2006.01) <b>C07D 409/12</b> (2006.01) <b>A61P 25/28</b> (2006.01)	2545037 *	INHIBITORS OF PROTEIN KINASES
Budziszek, Bobby Lee	<b>H02J 7/14</b> (2006.01)	2586114 *	HANDHELD ROTATIONALLY RECHARGEABLE ELECTRONIC APPARATUS
McMaster, Collin James	<b>H02J 7/14</b> (2006.01)	2586114 *	HANDHELD ROTATIONALLY RECHARGEABLE ELECTRONIC APPARATUS
Vanderbilt University	<b>A61K 31/44</b> (2006.01) <b>A01N 43/40</b> (2006.01)	2575461 *	SUBSTITUTED-6-METHYLNICOTINAMIDES AS MGLUR5 POSITIVE ALLOSTERIC MODULATORS
Hagleitner, Hans Georg	<b>A47K 5/12</b> (2006.01)	2560531 *	DISPENSER
Glaxosmithkline LLC	<b>A01N 43/02</b> (2006.01) <b>A01N 43/22</b> (2006.01) <b>A61K 31/38</b> (2006.01)	2563122 *	CHEMICAL COMPOUNDS
Cochlear Limited	<b>H04R 25/00</b> (2006.01) <b>A61N 1/36</b> (2006.01)	2571571 *	MULTI-ELECTRODE CHANNEL CONFIGURATIONS
ENEA - Agenzia Nazionale Per Le Nuove Tecnologie, L'Energia e Lo Sviluppo Economico Sostenibile	<b>G21F 9/30</b> (2006.01) <b>G21F 9/02</b> (2006.01)	2586034 *	PROCESS FOR THE DETRITIATION OF SOFT HOUSEKEEPING WASTE AND PLANT THEREOF
Commissariat à l'Énergie Atomique et aux Énergies Alternatives	<b>G21F 9/30</b> (2006.01) <b>G21F 9/02</b> (2006.01)	2586034 *	PROCESS FOR THE DETRITIATION OF SOFT HOUSEKEEPING WASTE AND PLANT THEREOF
Astellas Pharma Inc.	<b>A61K 31/4725</b> (2006.01) <b>A61P 13/10</b> (2006.01) <b>A61K 9/10</b> (2006.01) <b>A61P 43/00</b> (2006.01) <b>A61K 47/32</b> (2006.01) <b>A61P 13/00</b> (2006.01) <b>A61P 11/06</b> (2006.01) <b>A61K 47/30</b> (2006.01) <b>A61P 11/00</b> (2006.01) <b>A61P 1/00</b> (2006.01)	2572717 *	PHARMACEUTICAL COMPOSITION CONTAINING SOLIFENACIN
Forpogui, S.L.	<b>F17C 13/06</b> (2006.01) <b>F16J 13/08</b> (2006.01)	2546556 *	HERMETIC SEALING SYSTEM FOR CONTAINERS
Molteni & C. S.p.A.	<b>A47B 87/02</b> (2006.01)	2505100	Modular furnishing element and assembly comprising a composition with such furnishing element
Bayer HealthCare LLC	<b>G01N 33/487</b> (2006.01)	2550530 *	RESIDUAL COMPENSATION FOR A BIOSENSOR
Turbosonic Inc.	<b>B03C 3/06</b> (2006.01) <b>B03C 3/16</b> (2006.01)	2552591 *	ELECTROSTATIC PRECIPITATOR WITH DUAL ENERGY ZONE DISCHARGE ELECTRODES
Les Laboratoires Servier	<b>A61K 9/20</b> (2006.01) <b>A61K 31/165</b> (2006.01) <b>A61K 9/00</b> (2006.01)	2556824	Solid pharmaceutical composition for buccal administration of agomelatine
Biesse Equipment Solutions S.r.l.	<b>B41N 6/00</b> (2006.01)	2514601	An apparatus for providing bubble-less sealing of flexo-printing photopolymers on sleeves coated by an adhesive strip
Bayer Intellectual Property GmbH	<b>A61K 31/437</b> (2006.01) <b>A61P 9/00</b> (2006.01) <b>C07D 519/00</b> (2006.01)	2590987 *	RING-FUSED 4 -AMINOPYRIMIDINES AND USE THEREOF AS STIMULATORS OF SOLUBLE GUANYLATE CYCLASES

Podnosilac evropske prijave patenta (71)	MKP (51)	Broj objave evropske prijave patenta (97)	Naziv pronalaska (54)
aTyr Pharma, Inc.	<b>A61K 39/39</b> (2006.01) <b>A61K 38/43</b> (2006.01) <b>C12N 9/00</b> (2006.01) <b>A61P 37/00</b> (2006.01) <b>A61K 39/395</b> (2006.01) <b>A61K 38/16</b> (2006.01)	2566515 *	INNOVATIVE DISCOVERY OF THERAPEUTIC, DIAGNOSTIC, AND ANTIBODY COMPOSITIONS RELATED TO PROTEIN FRAGMENTS OF ARGINYL-TRNA SYNTHETASES
Pangu Biopharma Limited	<b>A61K 39/39</b> (2006.01) <b>A61K 38/43</b> (2006.01) <b>C12N 9/00</b> (2006.01) <b>A61P 37/00</b> (2006.01) <b>A61K 39/395</b> (2006.01) <b>A61K 38/16</b> (2006.01)	2566515 *	INNOVATIVE DISCOVERY OF THERAPEUTIC, DIAGNOSTIC, AND ANTIBODY COMPOSITIONS RELATED TO PROTEIN FRAGMENTS OF ARGINYL-TRNA SYNTHETASES
Omya Development AG	<b>B03D 101/02</b> (2006.01) <b>C22B 26/00</b> (2006.01) <b>B03D 1/01</b> (2006.01) <b>C22B 26/20</b> (2006.01)	2547453 *	FROTH FLOTATION PROCESS FOR THE SEPARATION OF SILICATES AND ALKALINE EARTH METAL CARBONATES USING A COLLECTOR COMPRISING AT LEAST ONE HYDROPHOBICALLY MODIFIED POLYALKYLENEIMINE
Regenics AS	<b>A61K 8/19</b> (2006.01) <b>A61K 8/67</b> (2006.01) <b>A61Q 19/00</b> (2006.01) <b>A61Q 19/08</b> (2006.01) <b>A61K 8/98</b> (2006.01)	2566583 *	USE OF CELLULAR EXTRACTS FOR SKIN REJUVENATION
Sanofi-Aventis Deutschland GmbH	<b>G07F 9/02</b> (2006.01)	2553665 *	VENDING APPARATUS AND METHOD FOR PROVIDING TRAINING FOR A MEDICINAL PRODUCT OR MEDICAL DEVICE OR COMBINATION PRODUCT
Merck Sharp & Dohme Corp.	<b>C07K 16/00</b> (2006.01)	2576616 *	METHOD FOR PREPARING ANTIBODIES HAVING IMPROVED PROPERTIES
Persi Del Marmo, Paolo	<b>G01M 5/00</b> (2006.01) <b>G01M 11/08</b> (2006.01)	2583076 *	SYSTEM FOR MEASURING AND MONITORING THE STRAIN ON OBJECTS STRESSED BY EXTERNAL FORCES
Sanofi-Aventis Deutschland GmbH	<b>G01N 33/487</b> (2006.01) <b>A61B 5/1486</b> (2006.01) <b>A61B 5/157</b> (2006.01) <b>A61B 5/151</b> (2006.01) <b>A61B 5/00</b> (2006.01)	2590550 *	ALLOWING MEASUREMENTS TO BE MADE OF A BLOOD SAMPLE
Edi Baur AG Bürstenfabrik	<b>A47L 13/20</b> (2006.01) <b>A47L 13/256</b> (2006.01) <b>A47L 13/44</b> (2006.01)	2544576 *	WIPING PLATE HAVING AN ASSOCIATED WIPING CLOTH FOR PICKING UP THE WIPING CLOTH IN A HANDS-FREE MANNER
EX Company Limited	<b>H01R 13/52</b> (2006.01)	2544313 *	CONNECTOR AND CONNECTION DEVICE FOR ELECTRONIC EQUIPMENT
Nippon Soda Co., Ltd.	<b>A01N 43/90</b> (2006.01) <b>A61P 33/10</b> (2006.01) <b>A01P 7/02</b> (2006.01) <b>C07D 491/052</b> (2006.01) <b>C07D 451/06</b> (2006.01)	2540719 *	CYCLIC AMINE COMPOUND AND MITICIDE
Sanofi-Aventis Deutschland GmbH	<b>A61M 5/24</b> (2006.01)	2560708 *	CODED CARTRIDGE ASSEMBLY
MedImmune, LLC	<b>A61K 47/08</b> (2006.01) <b>A61K 39/395</b> (2006.01) <b>A61K 9/08</b> (2006.01)	2588141 *	ANTIBODY FORMULATIONS
Crucell Holland B.V.	<b>C07K 16/10</b> (2006.01) <b>A61P 31/12</b> (2006.01)	2591000 *	ANTI-HUMAN RESPIRATORY SYNCYTIAL VIRUS (RSV) ANTIBODIES AND METHODS OF USE
Immatics Biotechnologies GmbH	<b>G01N 33/68</b> (2006.01)	2558867 *	METHOD FOR DIFFERENTIALLY QUANTIFYING NATURALLY PROCESSED HLA-RESTRICTED PEPTIDES FOR CANCER, AUTOIMMUNE AND INFECTIOUS DISEASES IMMUNOTHERAPY DEVELOPMENT
KNOPP NEUROSCIENCES	<b>C07D 277/82</b> (2006.01)	2542541 *	SYNTHESIS OF CHIRALLY PURIFIED SUBSTITUTED BENZOTHAZOLE DIAMINES

Podnosilac evropske prijave patenta (71)	MKP (51)	Broj objave evropske prijave patenta (97)	Naziv pronalaska (54)
Abraxis BioScience, LLC	<b>A61K 47/42</b> (2006.01) <b>A61P 35/00</b> (2006.01) <b>A61K 9/14</b> (2006.01) <b>A61K 31/337</b> (2006.01)	2575804 *	METHODS OF TREATMENT OF PANCREATIC CANCER
Sanofi-Aventis Deutschland GmbH	<b>A61M 5/32</b> (2006.01) <b>A61M 5/20</b> (2006.01) <b>A61M 5/00</b> (2006.01)	2585140 *	AUTO-INJECTOR
Vertex Pharmaceuticals Incorporated	<b>A61K 31/47</b> (2006.01)	2575814 *	PHARMACEUTICAL COMPOSITIONS AND ADMINISTRATIONS THEREOF
HB Spider, LLC	<b>F03G 7/00</b> (2006.01) <b>F01B 23/02</b> (2006.01) <b>F01B 9/02</b> (2006.01) <b>B60W 20/00</b> (2006.01)	2582916 *	COMPRESSED AIR ENGINE
Janssen Pharmaceuticals, Inc.	<b>C07C 235/40</b> (2006.01) <b>C07C 69/74</b> (2006.01) <b>C07C 51/487</b> (2006.01) <b>C07C 61/06</b> (2006.01)	2547645 *	PROCESSES AND INTERMEDIATES FOR PREPARING A MACROCYCLIC PROTEASE INHIBITOR OF HCV
Deva Holding Anonim Sirketi	<b>A61K 9/48</b> (2006.01) <b>A61K 9/16</b> (2006.01) <b>A61K 9/20</b> (2006.01) <b>A61K 31/23</b> (2006.01)	2471514	Controlled moisture content of cetyl myristate and/or cetyl palmitate granules or formulations
Eurokeg B.V.	<b>B65D 77/04</b> (2006.01) <b>B65D 8/04</b> (2006.01) <b>B65D 77/06</b> (2006.01)	2566777 *	CONTAINER FOR LIQUIDS
Calgon Carbon Corporation	<b>B01D 53/64</b> (2006.01) <b>B01D 53/34</b> (2006.01) <b>B01D 53/02</b> (2006.01)	2555851 *	METHODS FOR REMOVAL OF MERCURY FROM FLUE GAS
Pollack, Nicholas R.	<b>B01D 53/64</b> (2006.01) <b>B01D 53/34</b> (2006.01) <b>B01D 53/02</b> (2006.01)	2555851 *	METHODS FOR REMOVAL OF MERCURY FROM FLUE GAS
STADA ARZNEIMITTEL AG	<b>A61K 31/445</b> (2006.01) <b>A61K 9/20</b> (2006.01)	2544685 *	SOLID PHARMACEUTICAL COMPOSITION, COMPRISING DONEPEZIL HYDROCHLORIDE OF THE CRYSTALLINE POLYMORPHOUS FORM I
aTyr Pharma, Inc.	<b>C07K 16/40</b> (2006.01) <b>C07K 19/00</b> (2006.01) <b>C12N 15/113</b> (2010.01) <b>G01N 33/68</b> (2006.01) <b>A61K 38/43</b> (2006.01) <b>C12N 9/00</b> (2006.01) <b>C12N 15/52</b> (2006.01)	2563911 *	INNOVATIVE DISCOVERY OF THERAPEUTIC, DIAGNOSTIC, AND ANTIBODY COMPOSITIONS RELATED TO PROTEIN FRAGMENTS OF ALANYL TRNA SYNTHETASES
Pangu Biopharma Limited	<b>C07K 16/40</b> (2006.01) <b>C07K 19/00</b> (2006.01) <b>C12N 15/113</b> (2010.01) <b>G01N 33/68</b> (2006.01) <b>A61K 38/43</b> (2006.01) <b>C12N 9/00</b> (2006.01) <b>C12N 15/52</b> (2006.01)	2563911 *	INNOVATIVE DISCOVERY OF THERAPEUTIC, DIAGNOSTIC, AND ANTIBODY COMPOSITIONS RELATED TO PROTEIN FRAGMENTS OF ALANYL TRNA SYNTHETASES
Asahi Kasei Chemicals Corporation	<b>C08J 3/22</b> (2006.01) <b>C08L 77/00</b> (2006.01) <b>C08K 3/22</b> (2006.01) <b>B29B 9/12</b> (2006.01)	2573130 *	MASTERBATCH PELLETS, PROCESS FOR PRODUCING SAME, AND POLYAMIDE RESIN COMPOSITION CONTAINING THE MASTERBATCH PELLETS
SAINT-GOBAIN RECHERCHE	<b>C09J 167/06</b> (2006.01) <b>C08G 63/676</b> (2006.01) <b>C08G 63/52</b> (2006.01) <b>B24D 3/28</b> (2006.01) <b>B24D 3/20</b> (2006.01)	2576141 *	ADHESIVE COMPOSITION CONTAINING A CARBOXYLIC-ACID-TERMINATED UNSATURATED POLYESTER AND USES THEREOF
Sanofi-Aventis Deutschland GmbH	<b>A61M 5/24</b> (2006.01) <b>A61M 5/315</b> (2006.01)	2460552	Drug delivery device with locking arrangement for dose button
Marathon Oil Company	<b>E21B 47/00</b> (2012.01)	2558681 *	PRODUCTION LOGGING PROCESSES AND SYSTEMS
JJK Medical Ltd.	<b>A61M 1/14</b> (2006.01) <b>C07K 14/705</b> (2006.01) <b>C07K 17/02</b> (2006.01)	2585489 *	NEW MEDIUM, DEVICES AND METHODS



Podnosilac evropske prijave patenta (71)	MKP (51)	Broj objave evropske prijave patenta (97)	Naziv pronalaska (54)
Toray, Plastics (America), Inc.	<b>B32B 27/08</b> (2006.01) <b>B32B 27/36</b> (2006.01) <b>C08G 63/08</b> (2006.01)	2552689 *	BIAXIALLY ORIENTED POLYLACTIC ACID FILM WITH REDUCED NOISE LEVEL
SiO2 Medical Products, Inc.	<b>G01M 3/32</b> (2006.01) <b>G01N 15/08</b> (2006.01) <b>C23C 16/00</b> (2006.01) <b>G01N 33/00</b> (2006.01)	2569611 *	VESSEL OUTGASSING INSPECTION METHODS
Salix Pharmaceuticals, Ltd.	<b>A01N 43/42</b> (2006.01) <b>C07D 291/00</b> (2006.01) <b>A61K 31/44</b> (2006.01)	2575464 *	NEW FORMS OF RIFAXIMIN AND USES THEREOF
Tata Consultancy Services Limited	<b>G06F 19/24</b> (2011.01)	2390811	Identification of ribosomal DNA sequences
Blacklight Power, Inc.	<b>H01M 4/96</b> (2006.01) <b>G21B 3/00</b> (2006.01) <b>H01M 14/00</b> (2006.01) <b>C01B 3/00</b> (2006.01) <b>H01M 8/22</b> (2006.01) <b>H01M 4/94</b> (2006.01) <b>H01M 4/86</b> (2006.01)	2548257 *	ELECTROCHEMICAL HYDROGEN-CATALYST POWER SYSTEM
Arena Pharmaceuticals, Inc.	<b>C07D 211/46</b> (2006.01) <b>C07D 413/14</b> (2006.01) <b>C07D 413/04</b> (2006.01) <b>C07D 413/06</b> (2006.01) <b>C07D 405/12</b> (2006.01) <b>A61K 31/495</b> (2006.01) <b>C07D 401/12</b> (2006.01) <b>A61K 31/445</b> (2006.01) <b>C07D 405/14</b> (2006.01) <b>A61P 3/10</b> (2006.01) <b>C07D 401/14</b> (2006.01) <b>A61K 31/454</b> (2006.01) <b>C07D 401/04</b> (2006.01) <b>C07D 417/14</b> (2006.01)	2556056 *	MODULATORS OF THE GPR119 RECEPTOR AND THE TREATMENT OF DISORDERS RELATED THERETO
The Salk Institute for Biological Studies	<b>A61K 35/12</b> (2006.01) <b>C12N 5/10</b> (2006.01) <b>C12N 5/0735</b> (2010.01) <b>C12N 15/12</b> (2006.01) <b>C12N 5/074</b> (2010.01)	2443231 *	GENERATION OF INDUCED PLURIPOTENT STEM CELLS FROM CORD BLOOD
Center Of Regenerative Medicine Of Barcelona, Spain	<b>A61K 35/12</b> (2006.01) <b>C12N 5/10</b> (2006.01) <b>C12N 5/0735</b> (2010.01) <b>C12N 15/12</b> (2006.01) <b>C12N 5/074</b> (2010.01)	2443231 *	GENERATION OF INDUCED PLURIPOTENT STEM CELLS FROM CORD BLOOD
Northwestern University	<b>A61K 38/00</b> (2006.01) <b>A61K 38/16</b> (2006.01)	2542254 *	SECONDARY STRUCTURE STABILIZED NMDA RECEPTOR MODULATORS AND USES THEREOF
Amgen Inc.	<b>C07D 498/20</b> (2006.01) <b>A61K 31/537</b> (2006.01) <b>C07D 498/10</b> (2006.01) <b>A61K 31/5386</b> (2006.01) <b>C07D 513/10</b> (2006.01) <b>C07D 513/20</b> (2006.01) <b>A61P 25/28</b> (2006.01) <b>A61K 31/547</b> (2006.01)	2547686 *	AMINO -DIHYDROOXAZINE AND AMINO - DIHYDROTHIAZINE SPIRO COMPOUNDS AS BETA - SECRETASE MODULATORS AND THEIR MEDICAL USE
EIKEN KAGAKU KABUSHIKI KAISHA	<b>G01N 33/548</b> (2006.01) <b>G01N 33/53</b> (2006.01)	2560003 *	COMPLEX OF LABELED PROBE AND WATER-SOLUBLE CARRIER
Advanced Life Science Institute, Inc.	<b>G01N 33/548</b> (2006.01) <b>G01N 33/53</b> (2006.01)	2560003 *	COMPLEX OF LABELED PROBE AND WATER-SOLUBLE CARRIER
SANOFI	<b>C12Q 1/60</b> (2006.01)	2580346 *	METHOD FOR DETECTING COMPOUNDS THAT MODULATE THE CHOLESTEROL METABOLISM
MT Højgaard A/S	<b>A01K 1/00</b> (2006.01) <b>A01K 1/01</b> (2006.01)	2590501 *	APPARATUS AND METHOD FOR HANDLING A SEAL IN A SLURRY DUCT

Podnosilac evropske prijave patenta (71)	MKP (51)	Broj objave evropske prijave patenta (97)	Naziv pronalaska (54)
Teikoku Pharma USA, Inc.	<b>A61P 29/00</b> (2006.01) <b>A61K 31/337</b> (2006.01) <b>A61K 9/107</b> (2006.01) <b>A61K 9/10</b> (2006.01)	2566474 *	NON-AQUEOUS TAXANE PRO-EMULSION FORMULATIONS AND METHODS OF MAKING AND USING THE SAME
University of Virginia Patent Foundation	<b>C12Q 1/68</b> (2006.01)	2588630 *	MOLECULAR GENETIC APPROACH TO TREATMENT AND DIAGNOSIS OF ALCOHOL AND DRUG DEPENDENCE
Technelep srl	<b>C12M 1/02</b> (2006.01) <b>C12M 1/00</b> (2006.01) <b>B01F 11/00</b> (2006.01)	2505634	A solid state fermentation plant
Sanofi-Aventis Deutschland GmbH	<b>A61M 5/32</b> (2006.01) <b>A61M 5/50</b> (2006.01)	2588173 *	SAFETY DEVICE FOR A PRE-FILLED SYRINGE AND INJECTION DEVICE
Heineken Supply Chain B.V.	<b>B65D 83/44</b> (2006.01) <b>B67D 1/12</b> (2006.01) <b>G01F 11/08</b> (2006.01) <b>B65D 83/18</b> (2006.01) <b>B65D 83/16</b> (2006.01) <b>G01F 11/04</b> (2006.01) <b>B65D 83/60</b> (2006.01) <b>B65D 83/14</b> (2006.01) <b>B67D 1/02</b> (2006.01) <b>B67D 1/04</b> (2006.01)	2576387 *	METHOD AND APPARATUS FOR DISPENSING BEVERAGES, ESPECIALLY CARBONATED BEVERAGES
Numikon D.O.O	<b>F16L 51/03</b> (2006.01)	2569568 *	IN-LINE PRESSURE BALANCED EXPANSION JOINT FOR PIPING AND DUCTING SYSTEMS WITH CIRCULAR CROSS SECTION AND INTERNALLY LOCATED TIE RODS
Pipetech, Jovic	<b>F16L 51/03</b> (2006.01)	2569568 *	IN-LINE PRESSURE BALANCED EXPANSION JOINT FOR PIPING AND DUCTING SYSTEMS WITH CIRCULAR CROSS SECTION AND INTERNALLY LOCATED TIE RODS
Innospin AG	<b>F16L 51/03</b> (2006.01)	2569568 *	IN-LINE PRESSURE BALANCED EXPANSION JOINT FOR PIPING AND DUCTING SYSTEMS WITH CIRCULAR CROSS SECTION AND INTERNALLY LOCATED TIE RODS
Astellas Deutschland GmbH	<b>A61K 47/10</b> (2006.01) <b>A61K 9/14</b> (2006.01) <b>A61K 31/4184</b> (2006.01) <b>A61K 9/48</b> (2006.01)	2575784 *	ORAL DOSAGE FORMS OF BENDAMUSTINE
Purdue Pharma LP	<b>C07D 213/81</b> (2006.01) <b>A61K 31/4412</b> (2006.01) <b>C07D 413/12</b> (2006.01) <b>A61K 31/4439</b> (2006.01) <b>C07D 401/12</b> (2006.01) <b>A61P 25/00</b> (2006.01) <b>A61K 31/443</b> (2006.01) <b>A61K 31/444</b> (2006.01)	2593434 *	PYRIDINE COMPOUNDS AS SODIUM CHANNEL BLOCKERS
Molecular Partners AG	<b>A61P 35/00</b> (2006.01) <b>A61K 47/48</b> (2006.01) <b>A61P 27/02</b> (2006.01)	2563400 *	MODIFIED BINDING PROTEINS INHIBITING THE VEGF-A RECEPTOR INTERACTION
Nordcoll A/S	<b>C08J 3/11</b> (2006.01) <b>B29C 65/48</b> (2006.01) <b>C08J 5/12</b> (2006.01) <b>C09J 127/06</b> (2006.01) <b>C09J 155/02</b> (2006.01)	2591042 *	GLUE COMPOSITION COMPRISING THE SOLVENT N-ACETYLMORPHOLINE
Bayer Intellectual Property GmbH	<b>A61P 9/00</b> (2006.01) <b>A61P 15/00</b> (2006.01) <b>A61K 31/437</b> (2006.01) <b>C07D 471/04</b> (2006.01)	2576547 *	SUBSTITUTED 5-FLUORO-1H-PYRAZOLOPYRIDINES AND USE THEREOF

Podnosilac evropske prijave patenta (71)	MKP (51)	Broj objave evropske prijave patenta (97)	Naziv pronalaska (54)
Saint-Gobain Adfors	<b>E04B 1/74</b> (2006.01) <b>B27N 7/00</b> (2006.01) <b>E04F 13/00</b> (2006.01) <b>B60R 13/02</b> (2006.01) <b>B32B 5/28</b> (2006.01) <b>D06M 13/402</b> (2006.01) <b>C08J 7/06</b> (2006.01) <b>B32B 21/10</b> (2006.01)	2576209 *	MAT OF POLYMER FIBRES CONTAINING AN ACETOACETAMIDE, AND ITS USE.
Cephalon, Inc.	<b>A61K 31/506</b> (2006.01) <b>C07D 487/14</b> (2006.01)	2571885 *	METHOD FOR PURIFYING A FUSED PYRROLOCARBAZOLE DERIVATIVE
Cephalon France	<b>A61K 31/506</b> (2006.01) <b>C07D 487/14</b> (2006.01)	2571885 *	METHOD FOR PURIFYING A FUSED PYRROLOCARBAZOLE DERIVATIVE
Gala Industries, Inc.	<b>C10C 3/14</b> (2006.01)	2563878 *	PELLETIZING ASPHALT
Alkermes Pharma Ireland Limited	<b>A61K 31/47</b> (2006.01) <b>A01N 43/42</b> (2006.01)	2566329 *	PROCESS FOR SYNTHESIZING OXIDIZED LACTAM COMPOUNDS
REGENERON PHARMACEUTICALS, INC.	<b>C12N 9/64</b> (2006.01) <b>A01K 67/027</b> (2006.01) <b>C12N 15/85</b> (2006.01) <b>C07K 16/46</b> (2006.01)	2550363 *	ADAM6 MICE
aTyr Pharma, Inc.	<b>A61K 38/08</b> (2006.01) <b>A61K 39/395</b> (2006.01) <b>A61P 3/10</b> (2006.01) <b>A61K 38/10</b> (2006.01) <b>A61P 35/00</b> (2006.01) <b>A61K 38/16</b> (2006.01) <b>A61P 3/00</b> (2006.01)	2593125 *	INNOVATIVE DISCOVERY OF THERAPEUTIC, DIAGNOSTIC, AND ANTIBODY COMPOSITIONS RELATED TO PROTEIN FRAGMENTS OF GLYCYL-TRNA SYNTHETASES
Pangu Biopharma Limited	<b>A61K 38/08</b> (2006.01) <b>A61K 39/395</b> (2006.01) <b>A61P 3/10</b> (2006.01) <b>A61K 38/10</b> (2006.01) <b>A61P 35/00</b> (2006.01) <b>A61K 38/16</b> (2006.01) <b>A61P 3/00</b> (2006.01)	2593125 *	INNOVATIVE DISCOVERY OF THERAPEUTIC, DIAGNOSTIC, AND ANTIBODY COMPOSITIONS RELATED TO PROTEIN FRAGMENTS OF GLYCYL-TRNA SYNTHETASES
Tengion, Inc.	<b>C12N 5/071</b> (2010.01)	2569418 *	BIOACTIVE RENAL CELLS
Aeronautical Service S.r.l.	<b>H05K 9/00</b> (2006.01)	2485573	Container box made of carbon fiber for electronic equipment
The Trustees of The University of Pennsylvania	<b>A61K 39/00</b> (2006.01)	2547360 *	SYSTEM AND METHOD OF PREPARING AND STORING ACTIVATED MATURE DENDRITIC CELLS
Eli Lilly and Company	<b>A61K 39/395</b> (2006.01)	2579894 *	CGRP ANTIBODIES
Ece, Abdulvahit	<b>A23C 19/068</b> (2006.01)	2568817 *	METHOD OF OBTAINING FRESH SPUN CHEESE
Deva Holding Anonim Sirketi	<b>A23L 1/30</b> (2006.01) <b>A61K 31/23</b> (2006.01) <b>A61K 9/00</b> (2006.01) <b>A61K 9/16</b> (2006.01)	2471387	Cetyl myristate and/or cetyl palmitate suspension formulations
Medicis Pharmaceutical Corporation	<b>A61K 31/44</b> (2006.01) <b>A01N 43/42</b> (2006.01)	2584900 *	COMBINATION THERAPY WITH CRYOSURGERY AND LOW DOSAGE STRENGTH IMIQUIMOD TO TREAT ACTINIC KERATOSIS
EURO-CELTIQUE S.A.	<b>G06M 1/16</b> (2006.01) <b>A61M 15/00</b> (2006.01) <b>G06M 1/24</b> (2006.01)	2570149	Counter
Blue Jeans Network, Inc.	<b>H04N 7/00</b> (2011.01) <b>H04N 7/15</b> (2006.01) <b>H04N 7/14</b> (2006.01)	2569939 *	SYSTEMS AND METHODS FOR SCALABLE COMPOSITION OF MEDIA STREAMS FOR REAL-TIME MULTIMEDIA COMMUNICATION
Bayer Intellectual Property GmbH	<b>A61K 31/519</b> (2006.01) <b>A61P 7/06</b> (2006.01) <b>A61K 31/5377</b> (2006.01) <b>A61K 31/4439</b> (2006.01) <b>A61K 31/198</b> (2006.01) <b>A61K 45/06</b> (2006.01) <b>A61K 31/506</b> (2006.01) <b>A61K 31/427</b> (2006.01) <b>A61K 31/426</b> (2006.01)	2585055 *	USE OF STIMULATORS AND ACTIVATORS OF SOLUBLE GUANYLATE CYCLASE FOR TREATING SICKLE-CELL ANEMIA AND CONSERVING BLOOD SUBSTITUTES

Podnosilac evropske prijave patenta (71)	MKP (51)	Broj objave evropske prijave patenta (97)	Naziv pronalaska (54)
EGIS GYÓGYSZERGYÁR Nyilvánosan Működő Részvénytársaság	<b>C07D 495/04</b> (2006.01)	2588483 *	IMPROVED PROCESS FOR PREPARING A PHARMACEUTICAL COMPOUND
Myriad Genetics, Inc.	<b>G06F 17/15</b> (2006.01) <b>C12Q 1/68</b> (2006.01) <b>G06F 19/10</b> (2011.01)	2539468 *	DIAGNOSTIC METHODS INVOLVING LOSS OF HETEROZYGOSITY
Abkevich, Victor	<b>G06F 17/15</b> (2006.01) <b>C12Q 1/68</b> (2006.01) <b>G06F 19/10</b> (2011.01)	2539468 *	DIAGNOSTIC METHODS INVOLVING LOSS OF HETEROZYGOSITY
Timms, Kirsten	<b>G06F 17/15</b> (2006.01) <b>C12Q 1/68</b> (2006.01) <b>G06F 19/10</b> (2011.01)	2539468 *	DIAGNOSTIC METHODS INVOLVING LOSS OF HETEROZYGOSITY
Gutin, Alexander	<b>G06F 17/15</b> (2006.01) <b>C12Q 1/68</b> (2006.01) <b>G06F 19/10</b> (2011.01)	2539468 *	DIAGNOSTIC METHODS INVOLVING LOSS OF HETEROZYGOSITY
Omrix Biopharmaceuticals Ltd.	<b>A61B 17/00</b> (2006.01) <b>B01L 3/02</b> (2006.01) <b>A61M 5/46</b> (2006.01) <b>A61M 5/315</b> (2006.01) <b>A61M 5/20</b> (2006.01) <b>A61M 5/32</b> (2006.01) <b>A61M 5/19</b> (2006.01)	2550048 *	DEVICES FOR INJECTING A SUBSTANCE AND METHODS THEREFOR
Bayer Intellectual Property GmbH	<b>C07D 409/06</b> (2006.01) <b>C07D 249/12</b> (2006.01) <b>A61K 31/4196</b> (2006.01) <b>C07D 403/06</b> (2006.01) <b>C07D 413/14</b> (2006.01) <b>C07D 417/06</b> (2006.01) <b>C07D 409/14</b> (2006.01) <b>C07D 413/06</b> (2006.01) <b>C07D 401/06</b> (2006.01) <b>A61P 9/00</b> (2006.01)	2539326 *	BISARYL-BONDED ARYLTRIAZOLONES AND USE THEREOF
Amgen Inc.	<b>A61P 35/00</b> (2006.01) <b>C07D 519/00</b> (2006.01) <b>A61K 31/4743</b> (2006.01) <b>C07D 401/12</b> (2006.01) <b>A61P 29/00</b> (2006.01) <b>C07D 487/04</b> (2006.01)	2588468 *	HETEROCYCLIC COMPOUNDS AND THEIR USE AS INHIBITORS OF PI3K ACTIVITY
The U.S.A. as represented by the Secretary, Department of Health and Human Services	<b>C07K 1/107</b> (2006.01) <b>A61P 31/20</b> (2006.01) <b>A61P 35/00</b> (2006.01) <b>A61P 31/18</b> (2006.01) <b>A61P 31/16</b> (2006.01) <b>C07K 14/47</b> (2006.01) <b>C07K 7/06</b> (2006.01) <b>C07K 14/715</b> (2006.01) <b>A61P 37/00</b> (2006.01)	2569326 *	PEPTIDE-BASED INHIBITOR OF INTERLEUKIN-10 OR INTERFERON-GAMMA SIGNALING
Automatic Bar Controls, Inc.	<b>A61L 2/00</b> (2006.01)	2571534 *	ULTRAVIOLET DISINFECTING DEVICE FOR FOOD AND BEVERAGE DISPENSERS
Alkermes Pharma Ireland Limited	<b>A61K 31/496</b> (2006.01) <b>C07D 401/12</b> (2006.01)	2585066 *	PRODRUGS OF NH-ACIDIC COMPOUNDS: ESTER, CARBONATE, CARBAMATE AND PHOSPHONATE DERIVATIVES
Austin Health	<b>C12N 5/02</b> (2006.01) <b>C12N 5/00</b> (2006.01) <b>G01N 33/53</b> (2006.01)	2569631 *	MARKERS FOR ACUTE KIDNEY INJURY
Brownstein, Michael	<b>C12N 5/02</b> (2006.01) <b>C12N 5/00</b> (2006.01) <b>G01N 33/53</b> (2006.01)	2569631 *	MARKERS FOR ACUTE KIDNEY INJURY
Intrinsic Lifesciences LLC	<b>C12N 5/02</b> (2006.01) <b>C12N 5/00</b> (2006.01) <b>G01N 33/53</b> (2006.01)	2569631 *	MARKERS FOR ACUTE KIDNEY INJURY

Podnosilac evropske prijave patenta (71)	MKP (51)	Broj objave evropske prijave patenta (97)	Naziv pronalaska (54)
Momenta Pharmaceuticals, Inc.	<b>A61K 39/395</b> (2006.01)	2558124 *	POLYSACCHARIDE COMPOSITIONS AND METHODS OF USE FOR THE TREATMENT AND PREVENTION OF DISORDERS ASSOCIATED WITH PROGENITOR CELL MOBILIZATION
Merck Canada Inc.	<b>A61P 31/18</b> (2006.01) <b>A61K 31/4439</b> (2006.01) <b>C07D 401/06</b> (2006.01)	2552902 *	NON-NUCLEOSIDE REVERSE TRANSCRIPTASE INHIBITORS
Joseph Company International, Inc.	<b>B65D 83/44</b> (2006.01)	2566782 *	OVER PRESSURE RELEASE VALVE
SCA TISSUE FRANCE	<b>A47K 10/38</b> (2006.01)	2394551	Paper roll dispenser comprising a base and at least one first door and one second door mounted on the base of the dispenser
Ajinomoto Co., Inc.	<b>A61K 47/38</b> (2006.01) <b>A61K 9/08</b> (2006.01) <b>A61K 47/42</b> (2006.01) <b>A61K 47/10</b> (2006.01) <b>A61K 47/36</b> (2006.01) <b>A61K 47/34</b> (2006.01) <b>A61K 49/04</b> (2006.01) <b>A61K 47/26</b> (2006.01)	2564875 *	LIQUID PREPARATION FOR ORAL ADMINISTRATION WHICH CAN BE USED IN CT COLONOGRAPHY, AND COMPOSITION FOR IMAGING OF DIGESTIVE TRACT
Immatics Biotechnologies GmbH	<b>A61P 35/00</b> (2006.01) <b>C07K 14/47</b> (2006.01) <b>A61K 39/00</b> (2006.01) <b>A61K 45/06</b> (2006.01) <b>A61K 38/04</b> (2006.01)	2575850 *	IMPROVED CANCER THERAPY BASED ON TUMOR ASSOCIATED ANTIGENS DERIVED FROM CYCLIN D1
Evonik Fibres GmbH	<b>B01D 53/22</b> (2006.01) <b>C10L 3/10</b> (2006.01)	2588217 *	PROCESS FOR SEPARATION OF GASES
Sanofi-Aventis Deutschland GmbH	<b>A61M 5/24</b> (2006.01) <b>A61M 5/315</b> (2006.01)	2579926 *	DRIVE MECHANISM FOR A DRUG DELIVERY DEVICE
Vertex Pharmaceuticals Incorporated	<b>A61K 31/404</b> (2006.01) <b>A61K 31/4704</b> (2006.01) <b>A61K 31/443</b> (2006.01)	2560651 *	PHARMACEUTICAL COMPOSITIONS AND ADMINISTRATIONS THEREOF
Uretek S.r.l.	<b>G01V 1/48</b> (2006.01)	2577359 *	METHOD AND SYSTEM FOR DETERMINING THE RIGIDITY OF A GEOLOGICAL LAYER
Hagleitner, Hans Georg	<b>B65D 47/20</b> (2006.01) <b>A47K 5/12</b> (2006.01) <b>B65D 47/32</b> (2006.01) <b>B05B 11/00</b> (2006.01) <b>B65D 51/16</b> (2006.01) <b>A47K 5/13</b> (2006.01) <b>G01F 11/08</b> (2006.01)	2560532 *	REFILLING UNIT COMPRISING A CONTAINER
Aventis Pharmaceuticals Inc.	<b>A61K 31/505</b> (2006.01) <b>A61P 11/00</b> (2006.01) <b>C07D 403/04</b> (2006.01)	2547672 *	SUBSTITUTED PYRIMIDINES AS PROSTAGLANDIN D2 RECEPTOR ANTAGONISTS
Airborne International B.V.	<b>B29C 53/82</b> (2006.01) <b>B29C 69/00</b> (2006.01) <b>B29C 53/70</b> (2006.01)	2580046 *	METHOD AND DEVICE FOR MANUFACTURING COMPOSITE PRODUCTS COMPRISING A PLANAR PORTION
Astellas Deutschland GmbH	<b>A61K 31/4184</b> (2006.01) <b>A61K 9/28</b> (2006.01) <b>A61K 9/16</b> (2006.01) <b>A61K 9/48</b> (2006.01) <b>A61K 9/20</b> (2006.01) <b>A61K 47/10</b> (2006.01) <b>A61K 9/14</b> (2006.01)	2575785 *	ORAL DOSAGE FORMS OF BENDAMUSTINE AND THERAPEUTIC USE THEREOF
Laboratorios del Dr. Esteve S.A.	<b>C07D 413/06</b> (2006.01) <b>A61K 31/5377</b> (2006.01) <b>A61K 31/4025</b> (2006.01) <b>C07D 403/12</b> (2006.01) <b>C07D 413/14</b> (2006.01) <b>C07D 413/12</b> (2006.01) <b>A61K 31/496</b> (2006.01) <b>A61K 31/454</b> (2006.01) <b>C07D 401/12</b> (2006.01) <b>A61P 25/00</b> (2006.01)	2576543 *	PYRAZOLE COMPOUNDS AS SIGMA RECEPTOR INHIBITORS

Podnosilac evropske prijave patenta (71)	MKP (51)	Broj objave evropske prijave patenta (97)	Naziv pronalaska (54)
Sanofi-Aventis Deutschland GmbH	<b>A61M 5/32</b> (2006.01)	2588165 *	SAFETY DEVICE FOR A PRE-FILLED SYRINGE, INJECTION DEVICE AND INJECTION KIT
Biopid Corporation	<b>A61K 8/55</b> (2006.01) <b>A61Q 7/00</b> (2006.01) <b>A61Q 5/00</b> (2006.01)	2572700 *	COMPOSITION FOR PREVENTING HAIR-LOSS OR STIMULATING HAIR GROWTH
Baylor Research Institute	<b>C12Q 1/00</b> (2006.01) <b>G01N 33/487</b> (2006.01) <b>A61K 38/00</b> (2006.01) <b>A61P 5/26</b> (2006.01) <b>G01N 33/483</b> (2006.01) <b>A61P 3/00</b> (2006.01)	2542687 *	INVOLVEMENT OF ANDROGEN/ANDROGEN RECEPTOR PATHWAY IN FABRY DISEASE
Bayer HealthCare LLC	<b>G01N 33/487</b> (2006.01)	2577303 *	UNDERFILL MANAGEMENT SYSTEM FOR A BIOSENSOR
Omya Development AG	<b>C09C 1/02</b> (2006.01) <b>D21H 17/00</b> (2006.01)	2565236	Self-binding pigment hybrid
Pierre Fabre Medicament	<b>A61K 39/395</b> (2006.01) <b>A61P 35/00</b> (2006.01) <b>C07K 16/28</b> (2006.01)	2575879 *	NOVEL ANTI-CMET ANTIBODY
Biogenerix GmbH	<b>C07K 14/535</b> (2006.01)	2547699 *	METHOD FOR OBTAINING BIOLOGICALLY ACTIVE RECOMBINANT HUMAN G-CSF
EryDel S.p.A.	<b>A61M 1/16</b> (2006.01) <b>A61M 1/36</b> (2006.01) <b>A61K 9/50</b> (2006.01)	2563343 *	APPARATUS AND KIT FOR ENCAPSULATING AT LEAST ONE COMPOUND FOR THERAPEUTIC AND/OR DIAGNOSTIC USE IN ERYTHROCYTES
Omya Development AG	<b>C01F 11/18</b> (2006.01) <b>C09C 1/02</b> (2006.01)	2447213	Production of high purity precipitated calcium carbonate
ECLISSE SRL	<b>E05D 15/06</b> (2006.01) <b>E06B 3/46</b> (2006.01)	2455573	Device for suspension fastening of pocket doors positionable in openings smaller than the door
SANOFI	<b>C07D 211/16</b> (2006.01) <b>C07D 403/04</b> (2006.01) <b>C07D 211/62</b> (2006.01) <b>C07D 205/04</b> (2006.01) <b>A61K 31/4468</b> (2006.01) <b>C07D 211/54</b> (2006.01) <b>C07D 409/12</b> (2006.01) <b>C07D 207/12</b> (2006.01) <b>A61P 25/00</b> (2006.01) <b>C07D 211/58</b> (2006.01) <b>C07D 413/12</b> (2006.01) <b>C07D 211/46</b> (2006.01) <b>C07D 405/12</b> (2006.01) <b>C07D 207/14</b> (2006.01) <b>C07D 401/12</b> (2006.01)	2576507 *	HEXAFLUOROISOPROPYL CARBAMATE DERIVATIVES, THEIR PREPARATION AND THEIR THERAPEUTIC APPLICATION
SANOFI	<b>A61K 31/403</b> (2006.01) <b>C07D 403/10</b> (2006.01) <b>C07D 401/10</b> (2006.01) <b>A61P 25/00</b> (2006.01)	2569296 *	SUBSTITUTED N-PHENYL SPIROLACTAM BIPYRROLIDINES, PREPARATION AND THERAPEUTIC USE THEREOF
Takeda Pharmaceutical Company Limited	<b>A61P 35/04</b> (2006.01) <b>C07D 495/04</b> (2006.01) <b>C07D 519/00</b> (2006.01) <b>A61K 31/5377</b> (2006.01) <b>A61P 43/00</b> (2006.01) <b>A61P 35/02</b> (2006.01) <b>A61P 35/00</b> (2006.01) <b>A61K 31/541</b> (2006.01) <b>A61K 31/519</b> (2006.01)	2540728 *	HETEROCYCLIC COMPOUND
Vertex Pharmaceuticals Incorporated	<b>A61K 9/28</b> (2006.01) <b>A61K 9/16</b> (2006.01) <b>A61K 9/20</b> (2006.01) <b>C07D 405/12</b> (2006.01) <b>C07D 405/14</b> (2006.01) <b>C07D 213/75</b> (2006.01)	2555754 *	SOLID FORMS OF 3-(6-(1-(2,2-DIFLUOROBENZO[D][1,3]DIOXOL-5-YL) CYCLOPROPANECARBOXAMIDO)-3-METHYLPYRIDIN-2-YL)BENZOIC ACID
Chiesi Farmaceutici S.p.A.	<b>A61K 31/439</b> (2006.01) <b>A61P 11/00</b> (2006.01) <b>C07D 453/02</b> (2006.01)	2585459 *	ALKALOID AMINOESTER DERIVATIVES AND MEDICINAL COMPOSITIONS THEREOF

Podnosilac evropske prijave patenta (71)	MKP (51)	Broj objave evropske prijave patenta (97)	Naziv pronalaska (54)
Gilead Connecticut, Inc.	<b>C07D 471/04</b> (2006.01) <b>A61K 31/437</b> (2006.01) <b>A61P 29/00</b> (2006.01) <b>A61P 11/00</b> (2006.01) <b>A61P 35/00</b> (2006.01) <b>C07D 519/00</b> (2006.01) <b>A61P 35/02</b> (2006.01) <b>A61P 19/00</b> (2006.01)	2545052 *	IMIDAZOPYRIDINES SYK INHIBITORS
STADA ARZNEIMITTEL AG	<b>A61K 31/422</b> (2006.01) <b>A61K 9/00</b> (2006.01) <b>A61K 31/497</b> (2006.01) <b>A61K 31/404</b> (2006.01)	2566452 *	MELTING TABLET COMPRISING A TRIPTANE OR ATYPICAL NEUROLEPTIC
Centocor Ortho Biotech Inc.	<b>C40B 40/06</b> (2006.01) <b>C40B 50/06</b> (2006.01)	2545211 *	METHODS AND ALGORITHMS FOR SELECTING POLYNUCLEOTIDES FOR SYNTHETIC ASSEMBLY
Goertek Inc.	<b>G10L 21/02</b> (2013.01)	2555189 *	METHOD AND DEVICE FOR SPEECH ENHANCEMENT, AND COMMUNICATION HEADPHONES WITH NOISE REDUCTION
Merz Pharma GmbH & Co. KGaA	<b>A61L 31/04</b> (2006.01) <b>A61K 9/16</b> (2006.01) <b>A61L 27/20</b> (2006.01)	2555809 *	CHITOSAN BEADS AND FILLER COMPRISING SUCH BEADS
RusOpticalSystem Ltd.	<b>G02B 27/34</b> (2006.01) <b>F41G 1/34</b> (2006.01)	2557450 *	OPTICAL SIGHT (VARIANTS)
Monsanto Technology LLC	<b>A01H 5/00</b> (2006.01) <b>C12N 15/82</b> (2006.01)	2575431 *	TRANSGENIC BRASSICA EVENT MON 88302 AND METHODS OF USE THEREOF
Proyecto de Biomedicina Cima, S.L.	<b>A61K 38/18</b> (2006.01) <b>A61P 27/02</b> (2006.01)	2538962 *	USE OF TRANSFORMING GROWTH FACTOR - BETA 1 (TGF- 1) INHIBITOR PEPTIDES FOR THE TREATMENT OF CORNEAL FIBROSIS AND/OR HAZE
Digna Biotech, S.L.	<b>A61K 38/18</b> (2006.01) <b>A61P 27/02</b> (2006.01)	2538962 *	USE OF TRANSFORMING GROWTH FACTOR - BETA 1 (TGF- 1) INHIBITOR PEPTIDES FOR THE TREATMENT OF CORNEAL FIBROSIS AND/OR HAZE
Orphanidis Pharma Research GmbH	<b>A61K 47/10</b> (2006.01) <b>A61K 47/32</b> (2006.01) <b>A61K 31/12</b> (2006.01)	2563351 *	ADHESIVE SLOW-RELEASE FORMULATIONS FOR THE LOCAL ADMINISTRATION OF CURCUMIN
BioAmber S.A.S.	<b>C07C 51/02</b> (2006.01) <b>C07C 51/44</b> (2006.01) <b>C07C 51/46</b> (2006.01)	2383249	Processes for producing adipic acid from fermentation broths containing diammonium adipate
Omya Development AG	<b>C02F 3/34</b> (2006.01) <b>C09C 1/02</b> (2006.01) <b>C02F 1/68</b> (2006.01)	2557129	Surface-treated calcium carbonate for binding and bioremediating hydrocarbon-containing compositions
EURO-CELTIQUE S.A.	<b>A61M 15/00</b> (2006.01) <b>G06M 1/24</b> (2006.01) <b>G06M 1/16</b> (2006.01)	2570148	Counter
Janssen Pharmaceutica, N.V.	<b>C07D 473/00</b> (2006.01) <b>A61K 31/437</b> (2006.01) <b>A61P 29/00</b> (2006.01) <b>A61P 9/00</b> (2006.01) <b>C07D 487/04</b> (2006.01) <b>A61K 31/52</b> (2006.01) <b>C07D 471/04</b> (2006.01) <b>A61K 31/4985</b> (2006.01)	2542552 *	SUBSTITUTED AZA-BICYCLIC IMIDAZOLE DERIVATIVES USEFUL AS TRPM8 RECEPTOR MODULATORS
Bayer Intellectual Property GmbH	<b>C07D 413/14</b> (2006.01) <b>C07D 413/04</b> (2006.01) <b>A61K 31/4245</b> (2006.01)	2569309 *	HYDROXYALKYL BENZYL PYRAZOLES, AND USE THEREOF FOR THE TREATMENT OF HYPERPROLIFERATIVE AND ANGIOGENIC DISEASES
Almirall S.A.	<b>A61K 31/522</b> (2006.01) <b>A61P 29/00</b> (2006.01) <b>C07D 519/00</b> (2006.01) <b>C07D 487/04</b> (2006.01)	2582703 *	HETEROARYL IMIDAZOLONE DERIVATIVES AS JAK INHIBITORS

Podnosilac evropske prijave patenta (71)	MKP (51)	Broj objave evropske prijave patenta (97)	Naziv pronalaska (54)
The Regents of The University of Michigan	<b>A61P 35/02</b> (2006.01) <b>A61P 35/00</b> (2006.01) <b>A61K 31/404</b> (2006.01) <b>A61K 31/407</b> (2006.01)	2563360 *	BIOMARKERS FOR MDM2 INHIBITORS FOR USE IN TREATING DISEASE
Shire Human Genetic Therapies, Inc.	<b>A61K 38/47</b> (2006.01) <b>A61P 25/28</b> (2006.01) <b>A61P 25/00</b> (2006.01)	2588131 *	METHODS AND COMPOSITIONS FOR CNS DELIVERY OF HEPARAN N-SULFATASE
Teva Pharmaceutical Industries Ltd.	<b>A61K 31/497</b> (2006.01)	2590653 *	5-CHLORO-4-HYDROXY-1-METHYL-2-OXO-N-PHENYL-1,2-DIHYDROQUINOLINE-3-CARBOXAMIDE, SALTS AND USES THEREOF
JX Nippon Oil & Energy Corporation	<b>H01L 31/04</b> (2006.01) <b>B32B 3/30</b> (2006.01) <b>B32B 27/30</b> (2006.01) <b>B32B 27/00</b> (2006.01)	2544243 *	TRANSPARENT CONDUCTIVE SUBSTRATE FOR SOLAR CELL, METHOD FOR MANUFACTURING THE SUBSTRATE, AND SOLAR CELL USING THE SUBSTRATE
Tokyo Institute of Technology	<b>H01L 31/04</b> (2006.01) <b>B32B 3/30</b> (2006.01) <b>B32B 27/30</b> (2006.01) <b>B32B 27/00</b> (2006.01)	2544243 *	TRANSPARENT CONDUCTIVE SUBSTRATE FOR SOLAR CELL, METHOD FOR MANUFACTURING THE SUBSTRATE, AND SOLAR CELL USING THE SUBSTRATE
Genentech, Inc.	<b>C07K 16/22</b> (2006.01) <b>A61K 39/395</b> (2006.01) <b>A61P 27/02</b> (2006.01)	2588138 *	TREATMENT OF VASCULARIZED PIGMENT EPITHELIAL DETACHMENT WITH ANTI-VEGF THERAPY
Ekornes ASA	<b>A47C 1/14</b> (2006.01) <b>A47C 1/022</b> (2006.01) <b>A47C 17/04</b> (2006.01) <b>A47C 3/025</b> (2006.01)	2592971 *	A SITTING ARRANGEMENT
Vitae Pharmaceuticals, Inc.	<b>C07D 498/04</b> (2006.01) <b>A61K 31/40</b> (2006.01) <b>C07D 401/04</b> (2006.01) <b>A61P 27/06</b> (2006.01) <b>C07D 209/96</b> (2006.01) <b>A61P 25/28</b> (2006.01) <b>C07D 491/10</b> (2006.01) <b>C07D 513/04</b> (2006.01) <b>C07D 471/04</b> (2006.01) <b>C07D 487/04</b> (2006.01)	2539322 *	INHIBITORS OF BETA-SECRETASE
Triton Systems, Inc.	<b>B32B 33/00</b> (2006.01)	2576218 *	DISCONTINUOUS SHORT FIBER PREFORM AND FIBER-REINFORCED ALUMINUM BILLET AND METHODS OF MANUFACTURING THE SAME
Delphi Technologies Holding S.à.r.l.	<b>F01N 3/20</b> (2006.01)	2503122	Reagent dosing pump assembly
Takeda Pharmaceutical Company Limited	<b>C07D 401/12</b> (2006.01) <b>A61P 9/12</b> (2006.01) <b>A61P 13/12</b> (2006.01) <b>A61P 43/00</b> (2006.01) <b>A61K 31/5377</b> (2006.01) <b>A61P 9/00</b> (2006.01)	2583967 *	CRYSTAL OF AMIDE COMPOUND
Sanofi-Aventis Deutschland GmbH	<b>B65D 85/30</b> (2006.01) <b>B65D 81/107</b> (2006.01) <b>B65D 81/127</b> (2006.01) <b>B65D 25/06</b> (2006.01) <b>B65D 81/02</b> (2006.01) <b>B65D 85/20</b> (2006.01)	2566771 *	CONTAINER FOR HANDLING AND TRANSPORTING CYLINDERS
MKS Innovatech S.r.l.	<b>A61G 7/057</b> (2006.01)	2465480	Inflatable mattress
Targacept Inc.	<b>A61P 1/00</b> (2006.01) <b>C07D 239/26</b> (2006.01) <b>A61K 31/505</b> (2006.01) <b>A61K 31/506</b> (2006.01) <b>C07D 403/02</b> (2006.01) <b>A61P 25/00</b> (2006.01)	2544690 *	ARYLVINYLAZACYCLOALKANE COMPOUNDS FOR CONSTIPATION
SANOFI	<b>C07D 405/12</b> (2006.01) <b>A61P 25/00</b> (2006.01) <b>C07D 401/12</b> (2006.01) <b>A61K 31/351</b> (2006.01) <b>A61K 31/4439</b> (2006.01)	2569297 *	SUBSTITUTED N-HETEROCYCLOALKYL BIPYRROLIDINYLPHENYL AMIDE DERIVATIVES, PREPARATION AND THERAPEUTIC USE THEREOF



Podnosilac evropske prijave patenta (71)	MKP (51)	Broj objave evropske prijave patenta (97)	Naziv pronalaska (54)
Desch Antriebstechnik GmbH & Co. KG	<b>B02C 18/24</b> (2006.01)	2500100	Drive device and work machine device
Janssen Pharmaceutica, N.V.	<b>A61P 25/04</b> (2006.01) <b>A61K 31/513</b> (2006.01) <b>A61P 25/02</b> (2006.01) <b>A61K 31/53</b> (2006.01)	2585068 *	PROKINETICIN 1 RECEPTOR ANTAGONISTS FOR THE TREATMENT OF PAIN
Taisho Pharmaceutical Co., Ltd.	<b>C09B 63/00</b> (2006.01) <b>C09B 67/20</b> (2006.01)	2548927 *	PIGMENT COMPOSITION
Deutsche Post AG	<b>G01C 21/36</b> (2006.01)	2472228	System for collecting the geolocations of addresses
FOB Synthesis, Inc.	<b>A61K 31/407</b> (2006.01) <b>C07D 477/14</b> (2006.01) <b>C07D 403/06</b> (2006.01) <b>A61P 31/04</b> (2006.01) <b>C07D 487/04</b> (2006.01)	2590978 *	CARBAPENEM ANTIBACTERIALS WITH GRAM-NEGATIVE ACTIVITY
Molteni L. E. C. Dei Fratelli Alitti Societa' Di Esercizio S.P.A.	<b>A61K 9/20</b> (2006.01) <b>A61K 31/485</b> (2006.01)	2549984 *	DOUBLE-LAYER PHARMACEUTICAL FORMULATIONS CONTAINING OPIOID AGONISTS AND ANTAGONISTS
Rheinische Friedrich-Wilhelms-Universität Bonn	<b>C07D 209/10</b> (2006.01) <b>C07K 14/72</b> (2006.01) <b>G01N 33/53</b> (2006.01) <b>A61K 31/405</b> (2006.01)	2567698	GPR 17 agonists and screening assay
Amgen Inc.	<b>C07D 407/04</b> (2006.01) <b>C07D 498/08</b> (2006.01) <b>C07D 417/06</b> (2006.01) <b>C07D 409/04</b> (2006.01) <b>A61K 31/4412</b> (2006.01) <b>C07D 413/06</b> (2006.01) <b>A61P 35/00</b> (2006.01) <b>C07D 401/04</b> (2006.01) <b>C07D 279/02</b> (2006.01) <b>C07D 401/06</b> (2006.01) <b>C07D 401/12</b> (2006.01) <b>C07D 407/06</b> (2006.01) <b>C07D 498/20</b> (2006.01) <b>C07D 211/40</b> (2006.01) <b>C07D 471/20</b> (2006.01)	2576510 *	PIPERIDINONE DERIVATIVES AS MDM2 INHIBITORS FOR THE TREATMENT OF CANCER
Marco Industries, Inc.	<b>E04D 1/30</b> (2006.01) <b>E04D 15/00</b> (2006.01) <b>E04D 1/34</b> (2006.01)	2539519 *	CLOSURE STRIP
Deutsche Gesellschaft für Humanplasma mbH	<b>A61J 1/05</b> (2006.01) <b>A61J 1/14</b> (2006.01) <b>A61J 1/20</b> (2006.01) <b>A61J 1/12</b> (2006.01)	2433608	Blood plasma collection bottle
Cytokinetics, Inc.	<b>A61K 31/50</b> (2006.01)	2563365 *	CERTAIN AMINO-PYRIDAZINES, COMPOSITIONS THEREOF, AND METHODS OF THEIR USE
Blue Jeans Network, Inc.	<b>H04N 7/15</b> (2006.01) <b>H04N 7/14</b> (2006.01)	2569937 *	SYSTEMS AND METHODS FOR REAL-TIME MULTIMEDIA COMMUNICATION ACROSS MULTIPLE STANDARDS AND PROPRIETARY DEVICES
Studio Duebi S.A.S.	<b>B65H 19/22</b> (2006.01) <b>B65H 19/26</b> (2006.01)	2550218 *	A CORE FEEDING DEVICE IN A REWINDING MACHINE FOR THE PRODUCTION OF ROLLS
BioNovion Holding B.V.	<b>C07K 16/24</b> (2006.01) <b>C07K 16/28</b> (2006.01)	2591001 *	AGONISTIC ANTIBODY TO CD27
University Health Network	<b>C07D 403/04</b> (2006.01) <b>A61K 31/5377</b> (2006.01) <b>A61P 35/00</b> (2006.01) <b>C07D 413/14</b> (2006.01)	2556071 *	KINASE INHIBITORS AND METHOD OF TREATING CANCER WITH SAME
SANOFI	<b>G01N 33/50</b> (2006.01) <b>G01N 33/68</b> (2006.01) <b>C12Q 1/68</b> (2006.01)	2547789 *	METHODS AND USES RELATING TO THE IDENTIFICATION OF COMPOUND INVOLVED IN PAIN AS WELL AS METHODS OF DIAGNOSING ALGESIA

Podnosilac evropske prijave patenta (71)	MKP (51)	Broj objave evropske prijave patenta (97)	Naziv pronalaska (54)
Apple Inc.	<b>G02B 6/42</b> (2006.01) <b>H01R 13/40</b> (2006.01) <b>G02B 6/38</b> (2006.01)	2577372 *	HYBRID OPTICAL CONNECTOR
Novartis AG	<b>A61K 31/496</b> (2006.01) <b>A61K 9/20</b> (2006.01)	2588086 *	PHARMACEUTICAL COMPOSITIONS COMPRISING 4-AMINO-5-FLUORO-3-[6-(4-METHYLPIPERAZIN-1-YL)-1H-BENZIMIDAZOL-2-YL]-1H-QUINOLIN-2-ONE LACTATE MONOHYDRATE.
Alphacore Pharma LLC	<b>A61P 1/16</b> (2006.01) <b>A61K 38/45</b> (2006.01)	2566505 *	DELIVERY OF CHOLESTERYL ESTER TO STEROIDOGENIC TISSUES
Lipogems International SRL	<b>A61K 35/36</b> (2006.01) <b>C12M 3/08</b> (2006.01)	2571975 *	DEVICE AND A METHOD FOR PREPARING TISSUE, PARTICULARLY ADIPOSE TISSUE.
Sumika Polymer Compounds (France) SA	<b>F24J 2/51</b> (2006.01) <b>B29C 49/00</b> (2006.01) <b>B29C 49/04</b> (2006.01) <b>F24J 2/04</b> (2006.01) <b>F24J 2/20</b> (2006.01) <b>F24J 2/52</b> (2006.01) <b>F24J 2/34</b> (2006.01) <b>F24J 2/46</b> (2006.01)	2578379	Solar thermal solutions using blow moulding technologies
EXCELL CORPORATION	<b>F24J 2/51</b> (2006.01) <b>B29C 49/00</b> (2006.01) <b>B29C 49/04</b> (2006.01) <b>F24J 2/04</b> (2006.01) <b>F24J 2/20</b> (2006.01) <b>F24J 2/52</b> (2006.01) <b>F24J 2/34</b> (2006.01) <b>F24J 2/46</b> (2006.01)	2578379	Solar thermal solutions using blow moulding technologies
aTyr Pharma, Inc.	<b>A61K 38/16</b> (2006.01) <b>A61K 39/395</b> (2006.01) <b>A61P 3/10</b> (2006.01) <b>A61P 35/00</b> (2006.01) <b>A61P 29/00</b> (2006.01) <b>C07K 14/525</b> (2006.01)	2566495 *	INNOVATIVE DISCOVERY OF THERAPEUTIC, DIAGNOSTIC, AND ANTIBODY COMPOSITIONS RELATED TO PROTEIN FRAGMENTS OF PHENYLALANYL-ALPHA-TRNA SYNTHETASES
Pangu Biopharma Limited	<b>A61K 38/16</b> (2006.01) <b>A61K 39/395</b> (2006.01) <b>A61P 3/10</b> (2006.01) <b>A61P 35/00</b> (2006.01) <b>A61P 29/00</b> (2006.01) <b>C07K 14/525</b> (2006.01)	2566495 *	INNOVATIVE DISCOVERY OF THERAPEUTIC, DIAGNOSTIC, AND ANTIBODY COMPOSITIONS RELATED TO PROTEIN FRAGMENTS OF PHENYLALANYL-ALPHA-TRNA SYNTHETASES
Recordati Ireland Limited	<b>A61K 31/438</b> (2006.01) <b>C07D 491/10</b> (2006.01) <b>A61P 13/02</b> (2006.01) <b>C07D 498/10</b> (2006.01)	2590985 *	NOVEL SPIROHETEROCYCLIC COMPOUNDS AS MGLU5 ANTAGONISTS
Fundació Institut de Recerca Hospital Universitari Vall d'Hebron, Fundació Privada	<b>C12Q 1/68</b> (2006.01)	2593562 *	METHODS AND KITS FOR THE DIAGNOSIS OF PROSTATE CANCER
Signature Therapeutics, Inc.	<b>A61K 31/16</b> (2006.01) <b>A01N 37/18</b> (2006.01)	2560486 *	COMPOSITIONS COMPRISING ENZYME-CLEAVABLE AMPHETAMINE PRODRUGS AND INHIBITORS THEREOF
Nestec S.A.	<b>G01N 33/53</b> (2006.01) <b>C12N 15/12</b> (2006.01) <b>C12Q 1/68</b> (2006.01)	2576838 *	METHODS FOR IMPROVING INFLAMMATORY BOWEL DISEASE DIAGNOSIS
Cadila Healthcare Limited	<b>C12N 15/53</b> (2006.01) <b>C12N 9/02</b> (2006.01) <b>C12N 9/04</b> (2006.01) <b>C12P 17/12</b> (2006.01) <b>C12P 21/02</b> (2006.01)	2593558 *	ENZYME FOR THE PRODUCTION OF OPTICALLY PURE 3 - QUINUCLIDINOL
Boehringer Ingelheim International GmbH	<b>B05B 11/00</b> (2006.01) <b>A61M 15/00</b> (2006.01)	2585151 *	NEBULIZER
OSI Pharmaceuticals, LLC	<b>G01N 33/574</b> (2006.01)	2542893 *	BIOLOGICAL MARKERS PREDICTIVE OF ANTI-CANCER RESPONSE TO INSULIN-LIKE GROWTH FACTOR-1 RECEPTOR KINASE INHIBITORS

Podnosilac evropske prijave patenta (71)	MKP (51)	Broj objave evropske prijave patenta (97)	Naziv pronalaska (54)
Kingspan Holdings (IRL) Limited	<b>E04F 13/08</b> (2006.01) <b>E04B 2/90</b> (2006.01)	2580402 *	A STRUCTURAL INFILL WALL PANEL MODULE
Aeronautical Service S.r.l.	<b>F41H 5/04</b> (2006.01)	2518434	Protective composite structure with low radar visibility having integrated attack signaling system
Elliott Company	<b>F16J 15/02</b> (2006.01) <b>F01D 11/00</b> (2006.01) <b>F01D 25/24</b> (2006.01) <b>F02C 7/28</b> (2006.01)	2567072 *	BRUSH RING SEAL
Albert-Ludwigs-Universität Freiburg	<b>G01N 33/487</b> (2006.01)	2577301 *	METHOD FOR PRODUCING A BILIPID LAYER, AND MICROSTRUCTURE AND MEASURING ASSEMBLY
Abbvie Inc.	<b>A61P 31/14</b> (2006.01) <b>A61K 31/522</b> (2006.01) <b>C07D 239/54</b> (2006.01)	2593439 *	PROCESS FOR PREPARING ANTIVIRAL COMPOUNDS
Takeda Pharmaceutical Company Limited	<b>A61K 31/4355</b> (2006.01) <b>A61K 31/437</b> (2006.01) <b>C07D 471/04</b> (2006.01) <b>A61K 31/5025</b> (2006.01) <b>C07D 473/28</b> (2006.01) <b>A61K 31/519</b> (2006.01) <b>A61K 31/4985</b> (2006.01) <b>A61K 31/4427</b> (2006.01) <b>C07D 487/04</b> (2006.01) <b>A61K 31/52</b> (2006.01) <b>C07D 498/04</b> (2006.01) <b>A61P 25/18</b> (2006.01)	2585462 *	FUSED HETEROCYCLIC COMPOUNDS AS PHOSPHODIESTERASES (PDES) INHIBITORS
SANOFI	<b>A61K 9/00</b> (2006.01) <b>A61K 9/16</b> (2006.01) <b>A61K 9/50</b> (2006.01)	2560612 *	METHOD FOR PREPARING PHARMACEUTICAL COMPOSITIONS INTENDED FOR ORAL ADMINISTRATION COMPRISING ONE OR MORE ACTIVE INGREDIENTS AND THE COMPOSITIONS COMPRISING SAME
Ubiqu B.V.	<b>G07C 9/00</b> (2006.01)	2577616 *	A METHOD OF AUTHORIZING A PERSON, AN AUTHORIZING ARCHITECTURE AND A COMPUTER PROGRAM PRODUCT
Inotek Pharmaceuticals Corporation	<b>A61K 31/433</b> (2006.01) <b>A61P 27/06</b> (2006.01) <b>A61K 31/7076</b> (2006.01) <b>A61K 31/382</b> (2006.01) <b>A61P 27/02</b> (2006.01) <b>A61K 31/542</b> (2006.01)	2555775 *	COMBINATION COMPOSITIONS OF ADENOSINE A1 AGONISTS AND CARBONIC ANHYDRASE INHIBITORS FOR REDUCING INTRAOCULAR PRESSURE
Optosecurity Inc.	<b>G01N 23/04</b> (2006.01)	2561340 *	METHOD AND SYSTEM FOR USE IN PERFORMING SECURITY SCREENING
Ferschitz, Reinold	<b>F24J 2/32</b> (2006.01) <b>H01L 31/058</b> (2006.01) <b>H01L 31/052</b> (2006.01) <b>F24J 2/34</b> (2006.01) <b>F24J 2/50</b> (2006.01) <b>F24J 2/54</b> (2006.01) <b>F24J 2/05</b> (2006.01) <b>F24J 2/26</b> (2006.01) <b>F24J 2/14</b> (2006.01)	2580538 *	COMBINED SOLAR COLLECTOR
Sanofi-Aventis Deutschland GmbH	<b>A61P 3/10</b> (2006.01) <b>A61K 47/10</b> (2006.01) <b>A61K 38/28</b> (2006.01) <b>A61K 47/18</b> (2006.01) <b>A61K 38/26</b> (2006.01) <b>A61K 9/00</b> (2006.01)	2554183	Pharmaceutical composition comprising a GLP-1-agonist, an insulin, and methionine
Boehringer Ingelheim International GmbH	<b>A61P 35/02</b> (2006.01) <b>C07K 16/28</b> (2006.01) <b>A61K 39/395</b> (2006.01)	2593479 *	SUPERIOR EFFICACY OF CD37 ANTIBODIES IN CLL BLOOD SAMPLES
Logi, Roberto	<b>A61P 17/02</b> (2006.01) <b>A61K 36/47</b> (2006.01) <b>A61K 36/61</b> (2006.01)	2575840 *	KIT OF PARTS FOR TREATING AND/OR PREVENTING CUTANEOUS ULCERS

Podnosilac evropske prijave patenta (71)	MKP (51)	Broj objave evropske prijave patenta (97)	Naziv pronalaska (54)
Amgen Inc.	<b>C07D 401/12</b> (2006.01) <b>A61K 31/4375</b> (2006.01) <b>C07D 471/04</b> (2006.01) <b>C07D 491/107</b> (2006.01) <b>C07D 409/14</b> (2006.01) <b>A61K 31/4709</b> (2006.01) <b>C07D 405/14</b> (2006.01) <b>A61P 29/00</b> (2006.01) <b>C07D 413/14</b> (2006.01) <b>C07D 401/14</b> (2006.01) <b>A61P 35/00</b> (2006.01)	2588471 *	HETEROCYCLIC COMPOUNDS AND THEIR USE AS INHIBITORS OF PI3K ACTIVITY
Flyvision Kft.	<b>A47F 11/06</b> (2006.01)	2560525 *	EQUIPMENT FOR DISPLAYING INFORMATION CARRIERS, ESPECIALLY FOR ADVERTISING PURPOSES
Chiesi Farmaceutici S.p.A.	<b>A61K 31/519</b> (2006.01) <b>C07D 487/04</b> (2006.01) <b>A61P 11/00</b> (2006.01) <b>A61P 1/00</b> (2006.01)	2545057 *	PYRIMIDINE DERIVATIVES AND THEIR USE IN THE TREATMENT OF RESPIRATORY DISEASES SUCH AS COPD
Vereniging Voor Christelijk Hoger Onderwijs, Wetenschappelijk Onderzoek En Patiëntenzorg	<b>C07D 209/58</b> (2006.01) <b>C07D 209/94</b> (2006.01) <b>C07D 241/24</b> (2006.01) <b>C07D 209/52</b> (2006.01) <b>C07D 403/06</b> (2006.01)	2539320 *	A PROCESS FOR THE PREPARATION OF SUBSTITUTED PROLYL PEPTIDES AND SIMILAR PEPTIDOMIMETICS
SANOFI	<b>C07D 217/04</b> (2006.01) <b>C07D 401/12</b> (2006.01)	2542530 *	PROCESS FOR THE PREPARATION OF 2-(CYCLOHEXYLMETHYL)-N-{2- [(2S)-1-METHYLPYRROLIDIN-2-YL]ETHYL}-1, 2, 3, 4-TETRAHYDROISOQUINOLINE-7-SULFONAMIDE
Andresen Towers A/S	<b>E04H 12/08</b> (2006.01) <b>E04H 12/34</b> (2006.01) <b>F03D 11/04</b> (2006.01)	2593619 *	METHOD OF ASSEMBLING A TUBULAR BUILDING STRUCTURE BY USING SCREW SOCKETS
Tescoma S.P.A.	<b>C08J 7/12</b> (2006.01) <b>A47J 36/04</b> (2006.01)	2481769	Article suitable for contact with foodstuffs and process for realizing the same
Arcelormittal Wire France	<b>C21D 9/52</b> (2006.01) <b>C22C 38/04</b> (2006.01) <b>C22C 38/02</b> (2006.01) <b>C21D 1/20</b> (2006.01) <b>C21D 9/58</b> (2006.01)	2576849 *	PROFILED WIRE MADE OF HYDROGEN-EMBRITTELEMENT-RESISTANT STEEL HAVING HIGH MECHANICAL PROPERTIES
Ethicon, LLC	<b>D02J 3/00</b> (2006.01) <b>D01F 6/06</b> (2006.01) <b>A61L 17/00</b> (2006.01) <b>A61B 17/064</b> (2006.01)	2563240 *	HIGH-DENSITY SELF-RETAINING SUTURES, MANUFACTURING EQUIPMENT AND METHODS
Oncothyreon Inc.	<b>C07D 311/78</b> (2006.01)	2576535 *	COMBINATION CANCER THERAPIES WITH WORTMANNIN ANALOGS
Inbio Prof. Jürgen Büddefeld Dr. Peter Klauth Prof. Manfred Rietz Gbr	<b>C09K 11/77</b> (2006.01) <b>C01B 33/00</b> (2006.01) <b>C09K 11/06</b> (2006.01)	2417216 *	MODIFICATION OF LAYERED SILICATES FOR LUMINESCENCE ACTIVATION
LaserCard Corporation	<b>B42D 15/00</b> (2006.01)	2560824 *	OPTICALLY WRITABLE HOLOGRAPHIC MEDIA
OTO S.p.A.	<b>B62D 11/10</b> (2006.01) <b>B62D 11/04</b> (2006.01) <b>B66F 9/075</b> (2006.01)	2570332	An improved traction axle for work machines
Goertek Inc.	<b>G10L 13/08</b> (2013.01)	2579249 *	PARAMETER SPEECH SYNTHESIS METHOD AND SYSTEM
The Henry M. Jackson Foundation for the Advancement of Military Medicine, Inc.	<b>A61K 35/36</b> (2006.01) <b>A61F 2/10</b> (2006.01) <b>C12N 5/071</b> (2010.01) <b>C12Q 1/68</b> (2006.01) <b>C12N 5/077</b> (2010.01)	2582791 *	HAIR FOLLICLE NEOGENESIS
Mophie, Inc.	<b>H01M 2/02</b> (2006.01)	2572394 *	EXTERNAL PROCESSING ACCESSORY FOR MOBILE DEVICE

Podnosilac evropske prijave patenta (71)	MKP (51)	Broj objave evropske prijave patenta (97)	Naziv pronalaska (54)
Sylentis S.A.U.	<b>C12N 15/113</b> (2010.01) <b>A61K 31/713</b> (2006.01) <b>A61P 27/02</b> (2006.01)	2576782 *	SIRNA AND THEIR USE IN METHODS AND COMPOSITIONS FOR THE TREATMENT AND/OR PREVENTION OF EYE CONDITIONS
Digna Biotech, S.L.	<b>A01N 1/02</b> (2006.01)	2578082 *	COMPOSITION FOR THE COLD STORAGE OF ORGANS
Proyecto de Biomedicina Cima, S.L.	<b>A01N 1/02</b> (2006.01)	2578082 *	COMPOSITION FOR THE COLD STORAGE OF ORGANS
Sanofi-Aventis Deutschland GmbH	<b>A61M 5/00</b> (2006.01) <b>A61M 5/32</b> (2006.01) <b>A61M 5/20</b> (2006.01)	2585141 *	AUTO-INJECTOR
Sanofi-Aventis Deutschland GmbH	<b>A61M 5/315</b> (2006.01)	2579927 *	DRIVE MECHANISM FOR A DRUG DELIVERY DEVICE AND DRUG DELIVERY DEVICE
Gilead Sciences, Inc.	<b>C07D 205/04</b> (2006.01) <b>C07D 493/04</b> (2006.01) <b>C07D 213/64</b> (2006.01) <b>A61P 31/18</b> (2006.01) <b>C07D 231/12</b> (2006.01) <b>C07D 213/73</b> (2006.01) <b>C07D 211/48</b> (2006.01) <b>C07D 295/073</b> (2006.01) <b>C07D 233/58</b> (2006.01) <b>C07D 215/04</b> (2006.01) <b>C07D 213/65</b> (2006.01) <b>C07D 311/20</b> (2006.01) <b>C07D 241/12</b> (2006.01) <b>C07D 309/10</b> (2006.01) <b>C07D 239/34</b> (2006.01)	2588450 *	NAPHT- 2 -YLACETIC ACID DERIVATIVES TO TREAT AIDS
Chiesi Farmaceutici S.p.A.	<b>A61P 43/00</b> (2006.01) <b>A61K 31/19</b> (2006.01) <b>C07C 57/58</b> (2006.01) <b>A61P 25/28</b> (2006.01)	2560942 *	1-(2-FLUOROBIPHENYL-4-YL)-ALKYL CARBOXYLIC ACID DERIVATIVES FOR THE THERAPY OF TRANSTHYRETIN AMYLOIDOSIS
Shape WLB Inc.	<b>B25G 3/12</b> (2006.01) <b>F16M 13/04</b> (2006.01) <b>F16C 11/10</b> (2006.01) <b>G05G 1/10</b> (2006.01)	2555907 *	ADJUSTABLE HANDLE ASSEMBLY WITH LOCKING MECHANISM
Assa Oem AB	<b>E05B 13/00</b> (2006.01) <b>E05B 47/00</b> (2006.01)	2550418 *	SELECTIVELY DISENGAGEABLE AND COUPLABLE HANDLE WITH MOTOR
Deva Holding Anonim Sirketi	<b>A23L 1/30</b> (2006.01) <b>A61K 31/23</b> (2006.01) <b>A61K 9/00</b> (2006.01)	2471384	Suspension formulations of cetyl myristate and/or cetyl palmitate
Dorma GmbH&Co. KG	<b>E05F 3/00</b> (2006.01) <b>E05F 3/04</b> (2006.01)	2580416 *	MOUNTING ARRANGEMENT FOR A DOOR ACTUATOR
D.M.G. Italia Srl	<b>A61P 11/00</b> (2006.01) <b>A61K 35/74</b> (2006.01)	2555785 *	USE OF STREPTOCOCCUS SALIVARIUS IN THE TREATMENT OF CHRONIC INFECTIONS OF THE RESPIRATORY TRACT
Bayer CropScience NV	<b>C12N 15/82</b> (2006.01)	2580336 *	METHODS AND MEANS TO MODIFY A PLANT GENOME AT A NUCLEOTIDE SEQUENCE COMMONLY USED IN PLANT GENOME ENGINEERING
Salix Pharmaceuticals, Ltd.	<b>C07D 498/00</b> (2006.01)	2593463 *	FORMULATIONS OF RIFAXIMIN AND USES THEREOF
Lepore, Marianne	<b>A63B 22/04</b> (2006.01)	2558169 *	IMPACT ABSORBING EXERCISE DEVICE
Saint-Gobain Adfors	<b>E04F 13/00</b> (2006.01) <b>B32B 21/10</b> (2006.01) <b>B27N 7/00</b> (2006.01) <b>B32B 5/28</b> (2006.01) <b>B60R 13/02</b> (2006.01) <b>E04B 1/74</b> (2006.01) <b>D06M 13/402</b> (2006.01) <b>C08J 7/06</b> (2006.01)	2576166 *	MAT OF POLYMER FIBRES CONTAINING A DIHYDRAZIDE, AND USE THEREOF
Dana-Farber Cancer Institute, Inc.	<b>A61K 31/55</b> (2006.01) <b>C12N 15/13</b> (2006.01) <b>A61K 31/7088</b> (2006.01)	2569434 *	COMPOSITIONS AND METHODS FOR TREATING LEUKEMIA

Podnosilac evropske prijave patenta (71)	MKP (51)	Broj objave evropske prijave patenta (97)	Naziv pronalaska (54)
COLD SPRING HARBOR LABORATORY	<b>A61K 31/55</b> (2006.01) <b>C12N 15/13</b> (2006.01) <b>A61K 31/7088</b> (2006.01)	2569434 *	COMPOSITIONS AND METHODS FOR TREATING LEUKEMIA
Gebr. Graef GmbH & Co. KG	<b>F16H 25/20</b> (2006.01) <b>B26D 7/08</b> (2006.01) <b>B26D 1/143</b> (2006.01) <b>B26D 7/00</b> (2006.01)	2481537	Cutting machine for food
OSI Pharmaceuticals, LLC	<b>A61K 31/53</b> (2006.01) <b>A61P 35/00</b> (2006.01) <b>A61K 31/4985</b> (2006.01) <b>A61K 31/00</b> (2006.01)	2544672 *	COMBINATION ANTI-CANCER THERAPY
Napatech A/S	<b>H05K 1/14</b> (2006.01) <b>H05K 7/20</b> (2006.01)	2561741 *	A THERMALLY CONTROLLED ASSEMBLY
Sanofi-Aventis Deutschland GmbH	<b>A61M 5/32</b> (2006.01) <b>A61M 5/28</b> (2006.01)	2588169 *	INJECTION DEVICE WITH NEEDLE SHIELD
Immersion Corporation	<b>G06F 3/01</b> (2006.01) <b>G06Q 30/00</b> (2012.01)	2561424 *	SYSTEMS AND METHODS FOR PROVIDING HAPTIC EFFECTS
Birnbaum, David M.	<b>G06F 3/01</b> (2006.01) <b>G06Q 30/00</b> (2012.01)	2561424 *	SYSTEMS AND METHODS FOR PROVIDING HAPTIC EFFECTS
Grant, Danny A.	<b>G06F 3/01</b> (2006.01) <b>G06Q 30/00</b> (2012.01)	2561424 *	SYSTEMS AND METHODS FOR PROVIDING HAPTIC EFFECTS
Ramstein, Christophe	<b>G06F 3/01</b> (2006.01) <b>G06Q 30/00</b> (2012.01)	2561424 *	SYSTEMS AND METHODS FOR PROVIDING HAPTIC EFFECTS
Ullrich, Christopher J.	<b>G06F 3/01</b> (2006.01) <b>G06Q 30/00</b> (2012.01)	2561424 *	SYSTEMS AND METHODS FOR PROVIDING HAPTIC EFFECTS
Cadila Healthcare Limited	<b>A61K 31/222</b> (2006.01) <b>A61K 9/20</b> (2006.01) <b>A61K 9/50</b> (2006.01) <b>A61K 9/16</b> (2006.01)	2549985 *	STABLE PHARMACEUTICAL COMPOSITIONS COMPRISING FESOTERODINE
Bushkovskiy, Evgeniy Vladimirovich	<b>A47G 23/02</b> (2006.01) <b>A47F 5/02</b> (2006.01) <b>A47G 19/00</b> (2006.01)	2564732 *	DEVICE FOR THE ROTATION OF OBJECTS (EMBODIMENTS). SET FOR THE ROTATION OF OBJECTS
Absolute Completion Technologies Ltd.	<b>B01D 35/02</b> (2006.01) <b>G01N 33/28</b> (2006.01) <b>E21B 43/10</b> (2006.01) <b>E21B 43/08</b> (2006.01) <b>E21B 47/00</b> (2012.01)	2580425 *	WELLBORE SCREEN WITH TRACER FOR FLUID DETECTION
Resman AS	<b>B01D 35/02</b> (2006.01) <b>G01N 33/28</b> (2006.01) <b>E21B 43/10</b> (2006.01) <b>E21B 43/08</b> (2006.01) <b>E21B 47/00</b> (2012.01)	2580425 *	WELLBORE SCREEN WITH TRACER FOR FLUID DETECTION
Azzar, James, Douglas	<b>B32B 3/10</b> (2006.01)	2590815 *	SIDE NOTCH PAPER
OSI Pharmaceuticals, LLC	<b>A61K 31/5025</b> (2006.01) <b>A61P 35/00</b> (2006.01) <b>C07D 487/04</b> (2006.01) <b>C07D 471/04</b> (2006.01)	2569315 *	FUSED BICYCLIC KINASE INHIBITORS
Veloxis Pharmaceuticals A/S	<b>A61K 9/14</b> (2006.01)	2575769 *	STABILIZED TACROLIMUS COMPOSITION
Messer GasPack GmbH	<b>F17C 13/00</b> (2006.01) <b>F17C 13/06</b> (2006.01)	2500619	Originality guarantee for compressed gas bottles
Mepha Schweiz AG	<b>A61K 31/737</b> (2006.01) <b>A61K 31/7008</b> (2006.01) <b>A61K 9/20</b> (2006.01)	2588087 *	COMPOSITIONS WITH A HIGH ACTIVE INGREDIENT FRACTION OF PHARMACEUTICALLY ACTIVE SUBSTANCES
FibreCem Holding AG	<b>F24J 2/04</b> (2006.01) <b>F24J 2/52</b> (2006.01)	2474794	Seal board
Belron Hungary Kft - Zug Branch	<b>E04F 10/04</b> (2006.01) <b>E04H 15/06</b> (2006.01) <b>B60P 3/34</b> (2006.01)	2571723 *	DEPLOYABLE SHELTER STRUCTURE

Podnosilac evropske prijave patenta (71)	MKP (51)	Broj objave evropske prijave patenta (97)	Naziv pronalaska (54)
Université de Genève	<b>A61K 38/11</b> (2006.01) <b>A61P 3/10</b> (2006.01) <b>A61P 3/04</b> (2006.01)	2571511 *	NEW USES OF OXYTOCIN-LIKE MOLECULES AND RELATED METHODS
Janssen Pharmaceutica, N.V.	<b>C10M 161/00</b> (2006.01) <b>C02F 1/50</b> (2006.01) <b>A61K 31/44</b> (2006.01) <b>A61L 2/18</b> (2006.01) <b>A61K 31/785</b> (2006.01) <b>A01P 1/00</b> (2006.01) <b>A01N 43/40</b> (2006.01) <b>B27K 3/50</b> (2006.01)	2587920 *	ANTIMICROBIAL COMBINATIONS OF PYRION COMPOUNDS WITH POLYETHYLENEIMINES
aTyr Pharma, Inc.	<b>A61K 39/395</b> (2006.01) <b>A61P 37/00</b> (2006.01) <b>A61K 38/17</b> (2006.01) <b>A61K 38/16</b> (2006.01) <b>A61P 35/00</b> (2006.01) <b>A61P 29/00</b> (2006.01)	2568996 *	INNOVATIVE DISCOVERY OF THERAPEUTIC, DIAGNOSTIC, AND ANTIBODY COMPOSITIONS RELATED TO PROTEIN FRAGMENTS OF PHENYLALANYL-BETA-TRNA SYNTHETASES
Pangu Biopharma Limited	<b>A61K 39/395</b> (2006.01) <b>A61P 37/00</b> (2006.01) <b>A61K 38/17</b> (2006.01) <b>A61K 38/16</b> (2006.01) <b>A61P 35/00</b> (2006.01) <b>A61P 29/00</b> (2006.01)	2568996 *	INNOVATIVE DISCOVERY OF THERAPEUTIC, DIAGNOSTIC, AND ANTIBODY COMPOSITIONS RELATED TO PROTEIN FRAGMENTS OF PHENYLALANYL-BETA-TRNA SYNTHETASES
IRM LLC	<b>C07D 237/08</b> (2006.01) <b>A61K 31/44</b> (2006.01) <b>A61P 35/00</b> (2006.01) <b>C07D 401/14</b> (2006.01) <b>C07D 213/56</b> (2006.01) <b>C07D 401/12</b> (2006.01) <b>C07D 403/12</b> (2006.01) <b>C07D 279/12</b> (2006.01)	2588453 *	COMPOSITIONS AND METHODS FOR MODULATING THE WNT SIGNALING PATHWAY
Novartis AG	<b>C07D 237/08</b> (2006.01) <b>A61K 31/44</b> (2006.01) <b>A61P 35/00</b> (2006.01) <b>C07D 401/14</b> (2006.01) <b>C07D 213/56</b> (2006.01) <b>C07D 401/12</b> (2006.01) <b>C07D 403/12</b> (2006.01) <b>C07D 279/12</b> (2006.01)	2588453 *	COMPOSITIONS AND METHODS FOR MODULATING THE WNT SIGNALING PATHWAY
Æterna Zentaris GmbH	<b>A61P 43/00</b> (2006.01) <b>A61P 35/00</b> (2006.01) <b>A61K 31/4985</b> (2006.01) <b>A61K 31/501</b> (2006.01) <b>A61K 31/5377</b> (2006.01) <b>C07D 471/04</b> (2006.01)	2508184	Pyridopyrazine derivatives and their use
University of Zürich	<b>A61K 31/28</b> (2006.01) <b>C07F 13/00</b> (2006.01)	2545064 *	CARBON MONOXIDE RELEASING RHENIUM COMPOUNDS FOR MEDICAL USE
Immunogen, Inc.	<b>A61K 39/395</b> (2006.01) <b>C07K 16/00</b> (2006.01)	2538976 *	FOLATE RECEPTOR 1 ANTIBODIES AND IMMUNOCONJUGATES AND USES THEREOF
Abraxis BioScience, LLC	<b>A61K 39/395</b> (2006.01)	2563397 *	SPARC BINDING APTAMERS AND USES THEREOF
Motamed, Kouros	<b>A61K 39/395</b> (2006.01)	2563397 *	SPARC BINDING APTAMERS AND USES THEREOF
Dai, Yanshan	<b>A61K 39/395</b> (2006.01)	2563397 *	SPARC BINDING APTAMERS AND USES THEREOF
Trieu, Vuong	<b>A61K 39/395</b> (2006.01)	2563397 *	SPARC BINDING APTAMERS AND USES THEREOF
Desai, Neil	<b>A61K 39/395</b> (2006.01)	2563397 *	SPARC BINDING APTAMERS AND USES THEREOF
Arcelormittal Investigación y Desarrollo SL	<b>C22C 38/44</b> (2006.01) <b>C22C 38/58</b> (2006.01) <b>C21D 8/02</b> (2006.01) <b>C22C 38/42</b> (2006.01) <b>C22C 38/00</b> (2006.01)	2591134 *	AUSTENITIC-FERRITIC STAINLESS STEEL HAVING IMPROVED MACHINABILITY
Ugitech	<b>C22C 38/44</b> (2006.01) <b>C22C 38/58</b> (2006.01) <b>C21D 8/02</b> (2006.01) <b>C22C 38/42</b> (2006.01) <b>C22C 38/00</b> (2006.01)	2591134 *	AUSTENITIC-FERRITIC STAINLESS STEEL HAVING IMPROVED MACHINABILITY

Podnosilac evropske prijave patenta (71)	MKP (51)	Broj objave evropske prijave patenta (97)	Naziv pronalaska (54)
Ethicon Endo-Surgery, Inc.	<b>A61B 17/295</b> (2006.01)	2552329 *	SURGICAL CUTTING AND SEALING INSTRUMENT WITH REDUCED FIRING FORCE
VIRUN, INC.	<b>A23L 1/035</b> (2006.01) <b>A23L 1/302</b> (2006.01) <b>A61K 9/107</b> (2006.01) <b>A23L 1/30</b> (2006.01)	2563164 *	NANOEMULSION INCLUDING SUCROSE FATTY ACID ESTER
Kutzke, Arthur	<b>H02K 21/18</b> (2006.01) <b>H02K 29/00</b> (2006.01) <b>H02K 21/14</b> (2006.01)	2290792	Magnetic turbine
Meiji Seika Pharma Co., Ltd.	<b>C07D 493/04</b> (2006.01)	2542555 *	PROCESS FOR PRODUCING PYRIPYROPENE DERIVATIVES
Electronvault Inc.	<b>H01L 31/00</b> (2006.01) <b>H01M 8/02</b> (2006.01) <b>H01M 10/42</b> (2006.01) <b>H01M 2/20</b> (2006.01) <b>H01G 9/20</b> (2006.01)	2548243 *	MODULAR INTERCONNECTION SYSTEM
Sanofi-Aventis Deutschland GmbH	<b>A61M 5/315</b> (2006.01)	2579929 *	DRIVE MECHANISM FOR A DRUG DELIVERY DEVICE AND DRUG DELIVERY DEVICE
Exelixis, Inc.	<b>A61P 35/00</b> (2006.01) <b>C07D 215/22</b> (2006.01) <b>A61K 31/47</b> (2006.01)	2545038 *	HYDRATED CRYSTALLINE FORMS OF N-[3-FLUORO-4-((6-(METHYLOXY)-7-[(3-MORPHOLIN-4-YLPROPYL)OXY]-QUINOLIN-4-YL)OXY)PHENYL]-N'-(4-FLUOROPHENYL)CYCLOPROPANE-1,1-DICARBOXAMIDE
CORCOST LIMITED	<b>A47C 1/024</b> (2006.01) <b>A47C 1/029</b> (2006.01) <b>A61G 5/14</b> (2006.01)	2555733 *	SELF LOCKING MODULAR ARTICULATED FRAME
Winkl, Peter	<b>B65G 57/18</b> (2006.01)	2581332	Procedure and mobile device for stacking wooden logs onto a pallet with raised sides
Siegel, Rudolf	<b>B65G 57/18</b> (2006.01)	2581332	Procedure and mobile device for stacking wooden logs onto a pallet with raised sides
Boehringer Ingelheim International GmbH	<b>C07D 261/18</b> (2006.01) <b>A61K 31/506</b> (2006.01) <b>C07D 213/81</b> (2006.01) <b>A61K 31/165</b> (2006.01) <b>C07D 239/28</b> (2006.01) <b>A61K 31/505</b> (2006.01) <b>C07D 271/10</b> (2006.01) <b>C07D 401/12</b> (2006.01) <b>C07D 239/557</b> (2006.01) <b>C07D 405/12</b> (2006.01) <b>C07D 211/62</b> (2006.01) <b>C07C 237/24</b> (2006.01) <b>C07D 207/277</b> (2006.01) <b>C07D 233/90</b> (2006.01) <b>A61K 31/44</b> (2006.01)	2539323 *	COMPOUNDS AS BRADYKININ B1 ANTAGONISTS
Hapten Pharmaceuticals, LLC	<b>A01N 35/00</b> (2006.01)	2542058 *	EFFECTIVE SENSITIZING DOSE OF A GELLED IMMUNOMODULATING TOPICAL COMPOSITION
Abraxis BioScience, LLC	<b>A61K 31/337</b> (2006.01) <b>A61K 31/16</b> (2006.01) <b>A61K 31/7068</b> (2006.01) <b>A61K 9/14</b> (2006.01) <b>A61P 35/00</b> (2006.01) <b>A61K 47/42</b> (2006.01)	2575774 *	COMBINATION THERAPY METHODS FOR TREATING PROLIFERATIVE DISEASES
Sanofi-Aventis Deutschland GmbH	<b>A61M 5/24</b> (2006.01) <b>A61M 5/31</b> (2006.01) <b>A61M 5/315</b> (2006.01) <b>A61M 5/00</b> (2006.01)	2560709 *	CARTRIDGE ASSEMBLY HAVING SHARED FASTENING MEANS AND DRUG DELIVERY DEVICE
Adamed SP. Z O.O.	<b>A61K 9/16</b> (2006.01) <b>A61K 9/48</b> (2006.01) <b>A61K 31/506</b> (2006.01)	2497464	Pharmaceutical composition of imatinibe methanesulphonate and a process for its manufacture
Cytokinetics, Inc.	<b>A61K 31/4965</b> (2006.01)	2560653 *	CERTAIN AMINO-PYRIMIDINES, COMPOSITIONS THEREOF, AND METHODS FOR THEIR USE



Podnosilac evropske prijave patenta (71)	MKP (51)	Broj objave evropske prijave patenta (97)	Naziv pronalaska (54)
Bavarian Nordic A/S	<b>A61K 39/00</b> (2006.01)	2575867 *	NOVEL INTERFERON-ALPHA-PRODUCING BONE MARROW DENDRITIC CELLS
SRA International, Inc.	<b>H04L 9/06</b> (2006.01) <b>H04L 29/06</b> (2006.01)	2545674 *	ONE VAULT VOICE ENCRYPTION
Zealand Pharma A/S	<b>C07K 14/605</b> (2006.01) <b>A61P 5/48</b> (2006.01) <b>A61K 38/26</b> (2006.01)	2585482 *	GLUCAGON ANALOGUES
Glycovaxyn AG	<b>A61K 39/085</b> (2006.01)	2566507 *	CAPSULAR GRAM-POSITIVE BACTERIA BIOCONJUGATE VACCINES
Abbvie Inc.	<b>A01N 43/42</b> (2006.01) <b>A61K 31/44</b> (2006.01) <b>A01N 43/38</b> (2006.01) <b>A01N 43/40</b> (2006.01)	2575463 *	APOPTOSIS-INDUCING AGENTS FOR THE TREATMENT OF CANCER AND IMMUNE AND AUTOIMMUNE DISEASES
Ethicon Endo-Surgery, Inc.	<b>A61B 17/072</b> (2006.01)	2547267 *	STAPLE CARTIDGE
Perfetti Van Melle S.p.A.	<b>A23G 4/06</b> (2006.01)	2560501 *	SLOW-RELEASE DIETARY FORMULATIONS
KRKA, D.D., Novo Mesto	<b>A61P 35/00</b> (2006.01) <b>A61K 31/505</b> (2006.01) <b>C07D 401/04</b> (2006.01)	2582689 *	NEW POLYMORPHIC FORM OF IMATINIB BASE AND PREPARATION OF SALTS THEREOF
XBioTech, Inc	<b>A61P 19/02</b> (2006.01) <b>A61P 19/00</b> (2006.01) <b>A61K 39/395</b> (2006.01) <b>A61P 29/00</b> (2006.01)	2582391 *	ARTHRITIS TREATMENT
Sigma-Tau Industrie Farmaceutiche Riunite S.P.A.	<b>A61K 39/02</b> (2006.01) <b>A61K 39/385</b> (2006.01) <b>C07K 14/245</b> (2006.01)	2588137 *	FIMH VACCINE AGAINST URINARY TRACT INFECTIONS (UTI)
Nissan Chemical Industries, Ltd.	<b>C12N 5/10</b> (2006.01) <b>C12N 5/078</b> (2010.01) <b>A61K 31/122</b> (2006.01) <b>C12N 5/071</b> (2010.01) <b>A61P 43/00</b> (2006.01)	2581442 *	PROCESS FOR PRODUCTION OF HEMATOPOIETIC STEM CELL
National University Corporation Chiba University	<b>C12N 5/10</b> (2006.01) <b>C12N 5/078</b> (2010.01) <b>A61K 31/122</b> (2006.01) <b>C12N 5/071</b> (2010.01) <b>A61P 43/00</b> (2006.01)	2581442 *	PROCESS FOR PRODUCTION OF HEMATOPOIETIC STEM CELL
H. Lundbeck A/S	<b>C12N 15/64</b> (2006.01)	2558580 *	METHOD FOR THE MANUFACTURE OF RECOMBINANT DSPA ALPHA1
Signature Therapeutics, Inc.	<b>A61K 31/44</b> (2006.01) <b>A01N 43/42</b> (2006.01)	2560489 *	COMPOSITIONS COMPRISING ENZYME-CLEAVABLE OPIOID PRODRUGS AND INHIBITORS THEREOF
TransTech Pharma, Inc	<b>C07D 277/00</b> (2006.01)	2576524 *	USE OF METFORMIN IN COMBINATION WITH A GLUCOKINASE ACTIVATOR AND COMPOSITIONS COMPRISING METFORMIN AND A GLUCOKINASE ACTIVATOR
Apeptico Forschung und Entwicklung GmbH	<b>A61K 38/19</b> (2006.01) <b>C07K 7/64</b> (2006.01) <b>C07K 14/525</b> (2006.01)	2582385 *	TREATMENT OF VASCULAR COMPLICATIONS OF DIABETES
BASF SE	<b>C07F 3/02</b> (2006.01) <b>C07D 405/06</b> (2006.01) <b>C07F 3/00</b> (2006.01)	2547687 *	A PROCESS USING GRIGNARD REAGENTS
Magseis AS	<b>G01V 1/16</b> (2006.01) <b>G01V 1/38</b> (2006.01)	2567260 *	OCEAN BOTTOM SEISMIC CABLE RECORDING APPARATUS
Genmab A/S	<b>C07K 16/32</b> (2006.01) <b>A61P 35/00</b> (2006.01) <b>A61K 39/395</b> (2006.01)	2575880 *	MONOCLONAL ANTIBODIES AGAINST HER2 EPI TOPE
Salix Pharmaceuticals, Ltd.	<b>A01N 33/26</b> (2006.01)	2563117 *	FORMULATIONS AND USES OF 2-HYDROXY-5-PHENYLZOBENZOIC ACID DERIVATIVES FOR THE TREATMENT OF MALES

Podnosilac evropske prijave patenta (71)	MKP (51)	Broj objave evropske prijave patenta (97)	Naziv pronalaska (54)
Johnson & Johnson Consumer Companies Inc.	<b>A61F 13/02</b> (2006.01)	2491905	Adhesive Bandage
Palazzoli S.p.A.	<b>F21S 8/02</b> (2006.01) <b>F21V 21/22</b> (2006.01)	2416060	Modular lighting apparatus
aTyr Pharma, Inc.	<b>A61P 3/10</b> (2006.01) <b>A61K 38/16</b> (2006.01) <b>A61K 38/10</b> (2006.01) <b>A61K 38/08</b> (2006.01) <b>A61K 39/395</b> (2006.01) <b>A61P 35/00</b> (2006.01) <b>A61P 29/00</b> (2006.01)	2575856 *	INNOVATIVE DISCOVERY OF THERAPEUTIC, DIAGNOSTIC, AND ANTIBODY COMPOSITIONS RELATED TO PROTEIN FRAGMENTS OF GLUTAMINYL-TRNA SYNTHETASES
Pangu Biopharma Limited	<b>A61P 3/10</b> (2006.01) <b>A61K 38/16</b> (2006.01) <b>A61K 38/10</b> (2006.01) <b>A61K 38/08</b> (2006.01) <b>A61K 39/395</b> (2006.01) <b>A61P 35/00</b> (2006.01) <b>A61P 29/00</b> (2006.01)	2575856 *	INNOVATIVE DISCOVERY OF THERAPEUTIC, DIAGNOSTIC, AND ANTIBODY COMPOSITIONS RELATED TO PROTEIN FRAGMENTS OF GLUTAMINYL-TRNA SYNTHETASES
Myriad Genetics, Inc.	<b>G06F 19/18</b> (2011.01) <b>C12N 15/11</b> (2006.01) <b>C12Q 1/68</b> (2006.01) <b>C12N 5/09</b> (2010.01)	2582847 *	METHODS AND MATERIALS FOR ASSESSING LOSS OF HETEROZYGOSITY
Abkevich, Victor	<b>G06F 19/18</b> (2011.01) <b>C12N 15/11</b> (2006.01) <b>C12Q 1/68</b> (2006.01) <b>C12N 5/09</b> (2010.01)	2582847 *	METHODS AND MATERIALS FOR ASSESSING LOSS OF HETEROZYGOSITY
Gutin, Alexander	<b>G06F 19/18</b> (2011.01) <b>C12N 15/11</b> (2006.01) <b>C12Q 1/68</b> (2006.01) <b>C12N 5/09</b> (2010.01)	2582847 *	METHODS AND MATERIALS FOR ASSESSING LOSS OF HETEROZYGOSITY
Timms, Kirsten	<b>G06F 19/18</b> (2011.01) <b>C12N 15/11</b> (2006.01) <b>C12Q 1/68</b> (2006.01) <b>C12N 5/09</b> (2010.01)	2582847 *	METHODS AND MATERIALS FOR ASSESSING LOSS OF HETEROZYGOSITY
Lanchbury, Jerry	<b>G06F 19/18</b> (2011.01) <b>C12N 15/11</b> (2006.01) <b>C12Q 1/68</b> (2006.01) <b>C12N 5/09</b> (2010.01)	2582847 *	METHODS AND MATERIALS FOR ASSESSING LOSS OF HETEROZYGOSITY
Neurophyxia B.V., .	<b>A61K 31/724</b> (2006.01) <b>A61K 9/00</b> (2006.01) <b>A61K 47/40</b> (2006.01) <b>A61K 47/48</b> (2006.01) <b>A61K 47/12</b> (2006.01)	2575892 *	2-IMINOBIOTIN FORMULATIONS AND USES THEREOF
The Sun Products Corporation	<b>C11D 3/00</b> (2006.01)	2569406 *	POLYMER-CONTAINING CLEANING COMPOSITIONS AND METHODS OF PRODUCTION AND USE THEREOF
ITALCEMENTI S.p.A.	<b>E04C 2/54</b> (2006.01) <b>B28B 23/00</b> (2006.01) <b>E04C 2/06</b> (2006.01)	2580406 *	COMPOSITE PANEL BASED ON CEMENTITIOUS MORTAR WITH PROPERTIES OF TRANSPARENCY
Omeros Corporation	<b>A61K 31/33</b> (2006.01)	2544679 *	PDE10 INHIBITORS AND RELATED COMPOSITIONS AND METHODS
Neufeld, Klaus	<b>A23K 1/18</b> (2006.01) <b>A23K 1/16</b> (2006.01) <b>A61P 1/14</b> (2006.01) <b>A61P 1/04</b> (2006.01) <b>A61P 1/12</b> (2006.01) <b>A61P 33/00</b> (2006.01)	2557941 *	ANIMAL FEED ADDITIVE HAVING AN ANTIMICROBIAL AND GROWTH-PROMOTING EFFECT
Powerdyne, Inc.	<b>F22B 1/00</b> (2006.01) <b>F01K 25/00</b> (2006.01)	2574199 *	METHOD FOR REUTILIZING CO2 FROM COMBUSTED CARBONACEOUS MATERIAL
Bayer Intellectual Property GmbH	<b>A61P 9/00</b> (2006.01) <b>A61K 31/44</b> (2006.01) <b>C07D 213/85</b> (2006.01)	2588454 *	SUBSTITUTED DICYANOPYRIDINES AND USE THEREOF

Podnosilac evropske prijave patenta (71)	MKP (51)	Broj objave evropske prijave patenta (97)	Naziv pronalaska (54)
Taisho Pharmaceutical Co., Ltd.	<b>A61J 3/10</b> (2006.01) <b>B30B 11/02</b> (2006.01)	2543502 *	TABLET MANUFACTURING METHOD
Astellas Pharma Inc.	<b>A61K 31/55</b> (2006.01) <b>C07D 333/68</b> (2006.01) <b>A61P 3/12</b> (2006.01) <b>A61K 31/496</b> (2006.01) <b>A61K 31/4535</b> (2006.01) <b>C07D 409/12</b> (2006.01) <b>A61K 31/5377</b> (2006.01) <b>A61K 31/4436</b> (2006.01) <b>A61P 43/00</b> (2006.01) <b>A61K 31/4025</b> (2006.01) <b>A61P 13/12</b> (2006.01) <b>A61K 31/381</b> (2006.01) <b>A61P 9/00</b> (2006.01)	2565190 *	TETRAHYDROBENZOTHIOPHENE COMPOUND
OSI Pharmaceuticals, LLC	<b>A61K 31/437</b> (2006.01) <b>C07D 471/04</b> (2006.01) <b>A61P 35/00</b> (2006.01)	2569314 *	FUSED BICYCLIC KINASE INHIBITORS
Studiengesellschaft Kohle MbH	<b>C07F 11/00</b> (2006.01) <b>C08F 4/72</b> (2006.01)	2556078 *	CATALYSTS FOR ALKYNE METATHESIS
GlaxoSmithKline Biologicals S.A.	<b>A61K 9/00</b> (2006.01) <b>A61P 37/04</b> (2006.01) <b>A61K 39/145</b> (2006.01)	2575871 *	ORAL VACCINE COMPRISING AN ANTIGEN AND A TOLL-LIKE RECEPTOR AGONIST
Chiesi Farmaceutici S.p.A.	<b>A61K 31/192</b> (2006.01) <b>A61P 31/00</b> (2006.01)	2575797 *	1-(2-FLUOROBIPHENYL-4-YL)-CYCLOPROPANECARBOXYLIC ACID DERIVATIVES FOR THE THERAPY OF PRION DISEASES
Mahashabde, Anu	<b>A61F 6/14</b> (2006.01)	2585010 *	METHODS OF TREATING CONDITIONS ASSOCIATED WITH OVERACTIVE BLADDER
Tsao, Jiaxiang	<b>A61F 6/14</b> (2006.01)	2585010 *	METHODS OF TREATING CONDITIONS ASSOCIATED WITH OVERACTIVE BLADDER
GANYMED Pharmaceuticals AG	<b>C07K 16/28</b> (2006.01) <b>A61K 39/395</b> (2006.01) <b>A61P 35/00</b> (2006.01)	2591003 *	CANCER THERAPY USING CLDN6 TARGET-DIRECTED ANTIBODIES IN VIVO
Johannes- Gutenberg-Universität Mainz	<b>C07K 16/28</b> (2006.01) <b>A61K 39/395</b> (2006.01) <b>A61P 35/00</b> (2006.01)	2591003 *	CANCER THERAPY USING CLDN6 TARGET-DIRECTED ANTIBODIES IN VIVO
Fovea Pharmaceuticals	<b>A61K 31/437</b> (2006.01) <b>C07D 471/04</b> (2006.01) <b>C07D 401/12</b> (2006.01) <b>A61K 31/517</b> (2006.01) <b>A61P 9/00</b> (2006.01) <b>C07D 239/84</b> (2006.01)	2585439 *	HETEROCYCLIC COMPOUNDS, THEIR PREPARATION AND THEIR THERAPEUTIC APPLICATION
G5 International Holdings Pte Ltd	<b>C12P 7/62</b> (2006.01) <b>C08L 67/04</b> (2006.01) <b>C08G 63/89</b> (2006.01)	2545179 *	PRODUCTION OF POLYHYDROXYALKANOATES
Biocart S.r.l.	<b>A01C 1/04</b> (2006.01) <b>A01G 1/00</b> (2006.01)	2478755	Dry organic additivated clod and process for its preparation
Lpath, Inc.	<b>A61K 39/00</b> (2006.01)	2590672 *	COMBINATIONS OF ANTI-S1P ANTIBODIES AND SPHINGOLIPID PATHWAY INHIBITORS
Logomotion, s.r.o.	<b>G06K 19/077</b> (2006.01) <b>G06K 19/073</b> (2006.01)	2569737 *	MEMORY CARD CARRIER, THE METHOD OF FIRST DATA STORAGE INTO THE MEMORY CARD
Abraxis BioScience, LLC	<b>A61K 31/337</b> (2006.01) <b>A61K 47/42</b> (2006.01) <b>A61K 9/14</b> (2006.01) <b>A61P 35/04</b> (2006.01)	2575803 *	METHODS OF TREATING BLADDER CANCER
CHIESI FARMACEUTICI S.p.A.	<b>A61P 11/00</b> (2006.01) <b>A61P 1/00</b> (2006.01) <b>A61K 31/519</b> (2006.01) <b>C07D 487/04</b> (2006.01)	2545056 *	PYRIMIDINE DERIVATIVES AND THEIR USE IN THE TREATMENT OF RESPIRATORY DISEASES SUCH AS COPD

Podnosilac evropske prijave patenta (71)	MKP (51)	Broj objave evropske prijave patenta (97)	Naziv pronalaska (54)
Galderma Research & Development	<b>A61K 9/06</b> (2006.01) <b>A61K 31/498</b> (2006.01) <b>A61P 17/00</b> (2006.01) <b>A61K 9/00</b> (2006.01)	2552449 *	COMPOSITIONS COMPRISING BRIMONIDINE FOR THE TREATMENT OF ERYTHEMA
Continental Teves AG & Co. oHG	<b>B60T 8/40</b> (2006.01) <b>B60T 8/48</b> (2006.01)	2569193 *	METHOD FOR ADJUSTING THE PLAY IN A HYDRAULIC BRAKE SYSTEM, IN PARTICULAR FOR A MOTOR VEHICLE
Laboratorios Farmacéuticos Rovi, S.A.	<b>A61K 47/34</b> (2006.01)	2575890 *	ANTIPSYCHOTIC INJECTABLE DEPOT COMPOSITION
Duophos	<b>A61P 9/12</b> (2006.01) <b>C07F 9/26</b> (2006.01) <b>A61K 31/683</b> (2006.01) <b>C07F 9/20</b> (2006.01) <b>C07F 9/14</b> (2006.01)	2542560 *	ARYLFLUOROPHOSPHATE INHIBITORS OF INTESTINAL APICAL MEMBRANE SODIUM/ PHOSPHATE CO-TRANSPORT
Metal Riv S.r.l.	<b>B44C 1/00</b> (2006.01) <b>B44C 5/04</b> (2006.01) <b>B44D 5/10</b> (2006.01) <b>B44C 1/22</b> (2006.01)	2463114	Method for processing a brushed, glazed or mirror plate and plant for the obtainment thereof.
Malinconico, Mario	<b>C09K 17/52</b> (2006.01) <b>A01G 7/00</b> (2006.01)	2558548 *	BIODEGRADABLE MATERIALS FOR SOIL MULCHING BASED ON AQUEOUS MIXTURES OF POLYSACCHARIDES AND PLANT WASTE FIBERS AND METHODS FOR THEIR APPLICATION
Genmab A/S	<b>C07K 16/36</b> (2006.01) <b>A61K 47/48</b> (2006.01)	2582728 *	HUMAN ANTIBODY DRUG CONJUGATES AGAINST TISSUE FACTOR
Genmab A/S	<b>C07K 16/28</b> (2006.01)	2580243 *	ANTIBODIES AGAINST HUMAN CD38
TOPPER SUN ENERGY TECHNOLOGY CO., LTD.	<b>F24J 2/38</b> (2006.01) <b>F24J 2/54</b> (2006.01) <b>F03G 6/06</b> (2006.01)	2543879	Solar generator apparatus with cable-controlled tracking
Luo, Chia Ching	<b>F24J 2/38</b> (2006.01) <b>F24J 2/54</b> (2006.01) <b>F03G 6/06</b> (2006.01)	2543879	Solar generator apparatus with cable-controlled tracking
Reata Pharmaceuticals, Inc.	<b>A61P 3/04</b> (2006.01) <b>A61K 31/56</b> (2006.01)	2558105 *	METHOD OF TREATING OBESITY USING ANTIOXIDANT INFLAMMATION MODULATORS
LK Investment APS	<b>A61M 15/06</b> (2006.01) <b>A24F 47/00</b> (2006.01)	2542285 *	AN INHALATOR
National University of Ireland, Galway	<b>C02F 3/28</b> (2006.01)	2460771	An anaerobic reactor for psychrophilic and/or mesophilic wastewater treatment
Owens-Brockway Glass Container Inc.	<b>C03B 9/38</b> (2006.01)	2560925 *	GLASSWARE MOLD COOLING AIR SUPPLY
Delphi Technologies Holding S.à.r.l.	<b>F04B 1/04</b> (2006.01) <b>F02M 59/10</b> (2006.01)	2412976	Intermediate drive assembly
The Penn State Research Foundation	<b>B01D 11/02</b> (2006.01) <b>C10G 1/04</b> (2006.01)	2578285	Analogue ionic liquids for the separation and recovery of hydrocarbons from particulate matter
The Regents of the University of Colorado, A Body Corporate	<b>C07K 16/28</b> (2006.01) <b>A61K 39/395</b> (2006.01)	2585110 *	ANTIBODIES TO THE C3D FRAGMENT OF COMPLEMENT COMPONENT 3
Synageva BioPharma Corp.	<b>C12N 15/55</b> (2006.01) <b>A61K 38/46</b> (2006.01) <b>C12N 9/20</b> (2006.01)	2561069 *	LYSOSOMAL STORAGE DISEASE ENZYME
Biopid Corporation	<b>A61P 17/00</b> (2006.01) <b>A61K 9/70</b> (2006.01) <b>A61K 31/545</b> (2006.01)	2594263 *	PATCH FOR TREATING AND ALLEVIATING SYMPTOMS OF SKIN DISEASES ACCOMPANIED BY EFFUSION OF BLOOD PROTEINS
Saint-Gobain Glass France	<b>B44C 1/17</b> (2006.01)	2558305 *	METHOD AND DEVICE FOR THE MANUFACTURE OF GLAZING COMPRISING A DECORATIVE FILM AND GLAZING COMPRISING A DECORATIVE FILM
Gilead Sciences, Inc.	<b>A61K 31/551</b> (2006.01) <b>C07D 487/04</b> (2006.01) <b>A61K 31/519</b> (2006.01) <b>A61K 31/55</b> (2006.01) <b>A61P 11/00</b> (2006.01)	2585467 *	PYRAZOLO [1, 5 -A]PYRIMIDINES AS ANTIVIRAL AGENTS

Podnosilac evropske prijave patenta (71)	MKP (51)	Broj objave evropske prijave patenta (97)	Naziv pronalaska (54)
Takeda Pharmaceutical Company Limited	<b>A61K 31/4465</b> (2006.01) <b>A61K 47/34</b> (2006.01) <b>C07D 211/20</b> (2006.01) <b>A61P 25/24</b> (2006.01) <b>A61K 47/02</b> (2006.01) <b>A61K 47/32</b> (2006.01) <b>A61K 9/32</b> (2006.01) <b>A61K 9/22</b> (2006.01)	2564837 *	ENTERIC TABLET
Momenta Pharmaceuticals, Inc.	<b>C08B 37/10</b> (2006.01)	2558506 *	TISSUE TARGETING
Delphi Technologies Holding S.à.r.l.	<b>B60R 25/04</b> (2006.01)	2484564	Method and apparatus for vehicle security
Alkermes Pharma Ireland Limited	<b>A61K 31/485</b> (2006.01)	2590649 *	PROCESS FOR THE SYNTHESIS OF SUBSTITUTED MORPHINANS
Dow AgroSciences LLC	<b>A01N 25/08</b> (2006.01)	2592929 *	SOLID HERBICIDE COMPOSITIONS WITH BUILT-IN ADJUVANT
Sanofi-Aventis Deutschland GmbH	<b>A61M 5/24</b> (2006.01) <b>A61M 5/20</b> (2006.01)	2544737 *	RE-USABLE AUTOINJECTOR
Hinno AG	<b>A47H 15/04</b> (2006.01) <b>A47H 1/04</b> (2006.01) <b>A47H 2/02</b> (2006.01) <b>A47H 15/02</b> (2006.01) <b>A47H 2/00</b> (2006.01) <b>A47H 13/01</b> (2006.01)	2490577 *	PANEL CURTAIN DEVICE
AbbVie Inc.	<b>C07K 1/18</b> (2006.01) <b>C07K 1/22</b> (2006.01) <b>C07K 1/34</b> (2006.01) <b>B01D 15/12</b> (2006.01) <b>C07K 1/36</b> (2006.01) <b>B01D 15/38</b> (2006.01)	2571892 *	APPARATUS AND PROCESS OF PURIFICATION OF PROTEINS
Dynamics Inc.	<b>G06K 5/00</b> (2006.01)	2572314 *	SYSTEMS AND METHODS FOR CARDS AND DEVICES OPERABLE TO COMMUNICATE VIA LIGHT PULSES AND TOUCH SENSITIVE DISPLAYS
Aventis Pharma S.A.	<b>A61P 7/02</b> (2006.01) <b>A61K 31/727</b> (2006.01)	2585078 *	SEMULOPARIN FOR THE PREVENTION OF A MORTALITY AND/OR MORBIDITY EVENT IN A PATIENT UNDERGOING MAJOR ORTHOPAEDIC SURGERY
StatSpin, Inc.	<b>G01N 1/38</b> (2006.01) <b>G01N 35/00</b> (2006.01) <b>G01N 35/10</b> (2006.01)	2564206 *	ANALYTICAL SYSTEM FOR PERFORMING LABORATORY PROTOCOLS AND ASSOCIATED METHODS
Glenmark Pharmaceuticals S.A.	<b>A61K 31/519</b> (2006.01) <b>A61K 47/34</b> (2006.01) <b>A61K 47/14</b> (2006.01) <b>A61P 3/10</b> (2006.01) <b>A61K 47/38</b> (2006.01) <b>A61P 25/04</b> (2006.01) <b>A61P 25/00</b> (2006.01) <b>A61P 29/00</b> (2006.01)	2549998 *	PHARMACEUTICAL COMPOSITION COMPRISING A PYRIMIDINEONE DERIVATIVE
CORCOST LIMITED	<b>F03B 15/00</b> (2006.01) <b>F03B 13/18</b> (2006.01) <b>F03B 17/06</b> (2006.01) <b>F03B 13/26</b> (2006.01)	2558711 *	FLUID ACTUATED ENERGY GENERATOR
AbbVie Inc.	<b>A61K 39/395</b> (2006.01)	2555797 *	TNF- BINDING PROTEINS
Bortolussi, Claudio	<b>A01G 17/06</b> (2006.01)	2560471 *	FASTENING DEVICE FOR MOVABLE WIRES ON A ROW OF PLANTS
Bortolussi, Franco	<b>A01G 17/06</b> (2006.01)	2560471 *	FASTENING DEVICE FOR MOVABLE WIRES ON A ROW OF PLANTS
Archimede Solar Energy SRL	<b>F24J 2/05</b> (2006.01) <b>C22C 38/08</b> (2006.01)	2561286 *	IMPROVEMENTS IN TUBULAR SOLAR COLLECTORS
SANOFI	<b>A61P 9/00</b> (2006.01) <b>A61K 31/343</b> (2006.01) <b>C07D 307/80</b> (2006.01)	2582685 *	PROCESS FOR THE PREPARATION OF DRONEDARONE

Podnosilac evropske prijave patenta (71)	MKP (51)	Broj objave evropske prijave patenta (97)	Naziv pronalaska (54)
Johnson & Johnson Consumer Companies Inc.	<b>A61F 13/02</b> (2006.01)	2491904	Adhesive Bandage
Leader Time S.r.l.	<b>B65F 1/14</b> (2006.01) <b>B65F 1/16</b> (2006.01)	2544968 *	BIN FOR COLLECTING SOLID WASTE
Ancora Pharmaceuticals Inc.	<b>A61P 37/04</b> (2006.01) <b>A61K 31/7028</b> (2006.01) <b>C08B 37/00</b> (2006.01) <b>C07H 15/04</b> (2006.01)	2560981 *	SYNTHETIC OLIGOSACCHARIDES FOR STAPHYLOCOCCUS VACCINE
Glaxo Group Limited	<b>C07D 471/04</b> (2006.01) <b>A61K 31/4462</b> (2006.01) <b>A61P 19/02</b> (2006.01)	2563789 *	7-(1H-PYRAZOL-4-YL)-1,6-NAPHTHYRIDINE COMPOUNDS AS SYK INHIBITORS
Genentech, Inc.	<b>A61K 47/48</b> (2006.01)	2579897 *	CYSTEINE ENGINEERED ANTIBODIES AND CONJUGATES
Taylor, Fredrick	<b>B01D 5/00</b> (2006.01)	2590721 *	CONVERTING WHOLE TIRES AND OTHER SOLID CARBON MATERIALS INTO REUSABLE COMPONENTS
Marathon GTF Technology, Ltd.	<b>C07C 2/00</b> (2006.01) <b>C07C 1/00</b> (2006.01)	2545017 *	PROCESSES AND SYSTEMS FOR THE STAGED SYNTHESIS OF ALKYL BROMIDES
Salvemini, Tiziano	<b>E01F 15/14</b> (2006.01)	2492398	System for protecting work sites subjected to road or highway traffic
Maxlinear, Inc.	<b>H03L 1/02</b> (2006.01) <b>G01S 19/23</b> (2010.01)	2464012	Method and system for precise temperature and timebase PPM error estimation using multiple timebases
Genmab A/S	<b>C07K 16/28</b> (2006.01) <b>A61K 39/395</b> (2006.01)	2545077 *	MONOCLONAL ANTIBODIES AGAINST C-MET
Vaccibody AS	<b>A61P 31/16</b> (2006.01) <b>C07K 16/00</b> (2006.01) <b>C07K 19/00</b> (2006.01) <b>A61P 35/00</b> (2006.01) <b>C07K 16/44</b> (2006.01) <b>C07K 14/52</b> (2006.01) <b>A61K 39/385</b> (2006.01)	2585107 *	HOMODIMERIC PROTEIN CONSTRUCTS
Stokke AS	<b>A47D 1/10</b> (2006.01)	2584940 *	BABY CRADLE AND MOUNTING DEVICE
Peter Opsvik AS	<b>A47D 1/10</b> (2006.01)	2584940 *	BABY CRADLE AND MOUNTING DEVICE
UCB Pharma S.A.	<b>A61K 39/395</b> (2006.01) <b>C07K 16/00</b> (2006.01) <b>C07K 16/46</b> (2006.01)	2550017 *	DISULFIDE STABILISED ANTIBODIES AND FRAGMENTS THEREOF
Boying Xiamen Science And Technology Co. Ltd.	<b>C02F 9/06</b> (2006.01) <b>C02F 1/50</b> (2006.01)	2554521 *	APPARATUS AND METHOD FOR PURIFYING AND STERILIZING WATER USING NANO CATALYTIC MICROELECTROLYSIS
Cadila Healthcare Limited	<b>A61K 38/18</b> (2006.01) <b>A61P 13/12</b> (2006.01) <b>A61K 31/60</b> (2006.01) <b>A61K 31/4365</b> (2006.01)	2560644 *	A PHARMACEUTICAL COMPOSITION COMPRISING ANTIPLATELET AGENTS AND AN ERYTHROPOIESIS STIMULATING AGENT
Nuvo Research Inc.	<b>A61P 19/02</b> (2006.01) <b>A61K 9/00</b> (2006.01) <b>A61P 29/00</b> (2006.01) <b>A61K 31/444</b> (2006.01)	2575813 *	TOPICAL ETORICOXIB FORMULATION
Dow AgroSciences LLC	<b>C07D 241/02</b> (2006.01) <b>A01N 43/56</b> (2006.01)	2576519 *	PYRAZINYL CARBOXAMIDES AS FUNGICIDES
University of Miami	<b>A61K 47/42</b> (2006.01) <b>A61P 35/00</b> (2006.01) <b>A61K 39/00</b> (2006.01) <b>A61K 39/385</b> (2006.01) <b>A61K 47/48</b> (2006.01)	2571522 *	CANCER TREATMENT
Janssen Pharmaceutica, N.V.	<b>C07D 401/10</b> (2006.01) <b>A61P 25/16</b> (2006.01) <b>C07D 403/10</b> (2006.01) <b>C07D 401/12</b> (2006.01) <b>A61K 31/496</b> (2006.01) <b>A61P 25/28</b> (2006.01)	2588466 *	5-AMINO-3,6-DIHYDRO-1H-PYRAZIN-2-ONE DERIVATIVES USEFUL AS INHIBITORS OF BETA-SECRETASE (BACE)

Podnosilac evropske prijave patenta (71)	MKP (51)	Broj objave evropske prijave patenta (97)	Naziv pronalaska (54)
Euroclone S.p.A.	<b>C12Q 1/68</b> (2006.01)	2585615 *	HIGHLY SENSITIVE METHOD FOR DETECTION OF A TARGET NUCLEIC ACID IN A SAMPLE
Dow AgroSciences LLC	<b>A01N 39/02</b> (2006.01) <b>A01N 57/16</b> (2006.01) <b>A01N 43/40</b> (2006.01) <b>A01N 25/00</b> (2006.01) <b>A01N 25/02</b> (2006.01)	2566321 *	USE OF COLD-STABILIZED METHYLATED VEGETABLE OILS AS AN AGRICULTURAL CHEMICAL COFORMULANT
Athos Holding GmbH	<b>B65H 75/44</b> (2006.01) <b>A47L 9/26</b> (2006.01)	2539265 *	BRAKE SYSTEM FOR A CABLE REEL
Taicang Athos Electrical Components Co., Ltd.	<b>B65H 75/44</b> (2006.01) <b>A47L 9/26</b> (2006.01)	2539265 *	BRAKE SYSTEM FOR A CABLE REEL
Sanofi-Aventis Deutschland GmbH	<b>A61M 5/50</b> (2006.01) <b>A61J 1/20</b> (2006.01) <b>A61M 5/24</b> (2006.01)	2555814 *	CODED DRUG RESERVOIR CONNECTION ELEMENT WITH BENDABLE LOCKING ELEMENTS
GlaxoSmithKline LLC	<b>A01N 43/38</b> (2006.01) <b>A61K 31/405</b> (2006.01)	2549868 *	CHEMICAL COMPOUNDS
Alkermes Pharma Ireland Limited	<b>A61K 9/22</b> (2006.01)	2544667 *	ALCOHOL RESISTANT ENTERIC PHARMACEUTICAL COMPOSITIONS
CTE S.p.A.	<b>B66F 11/04</b> (2006.01)	2380846	Telescopic aerial work platform
Takeda California, Inc.	<b>C07D 277/46</b> (2006.01) <b>C07D 277/40</b> (2006.01) <b>C07D 277/50</b> (2006.01)	2547667 *	PROCESS FOR THE PRODUCTION OF 2-AMINO-5-FLUOROTHIAZOLE
SDI Limited	<b>B65D 17/50</b> (2006.01) <b>A61J 1/00</b> (2006.01) <b>B65D 41/20</b> (2006.01) <b>B65D 51/22</b> (2006.01)	2550206 *	LIQUID CONTAINER
Amgen Inc.	<b>A61K 31/506</b> (2006.01) <b>C07D 401/14</b> (2006.01) <b>A61P 19/00</b> (2006.01) <b>A61P 37/00</b> (2006.01) <b>A61P 35/00</b> (2006.01) <b>C07D 473/16</b> (2006.01) <b>A61K 31/497</b> (2006.01) <b>A61P 29/00</b> (2006.01) <b>A61K 31/4709</b> (2006.01)	2588473 *	NITROGEN CONTAINING HETEROCYCLIC COMPOUNDS AS PIK3-DELTA INHIBITORS
aTyr Pharma, Inc.	<b>A61K 38/16</b> (2006.01) <b>A61K 38/10</b> (2006.01) <b>A61P 3/10</b> (2006.01) <b>A61K 39/395</b> (2006.01) <b>A61K 38/08</b> (2006.01) <b>A61P 3/00</b> (2006.01) <b>A61P 35/00</b> (2006.01)	2593126 *	INNOVATIVE DISCOVERY OF THERAPEUTIC, DIAGNOSTIC, AND ANTIBODY COMPOSITIONS RELATED TO PROTEIN FRAGMENTS OF HISTIDYL-TRNA SYNTHETASES
Pangu Biopharma Limited	<b>A61K 38/16</b> (2006.01) <b>A61K 38/10</b> (2006.01) <b>A61P 3/10</b> (2006.01) <b>A61K 39/395</b> (2006.01) <b>A61K 38/08</b> (2006.01) <b>A61P 3/00</b> (2006.01) <b>A61P 35/00</b> (2006.01)	2593126 *	INNOVATIVE DISCOVERY OF THERAPEUTIC, DIAGNOSTIC, AND ANTIBODY COMPOSITIONS RELATED TO PROTEIN FRAGMENTS OF HISTIDYL-TRNA SYNTHETASES
Corcel IP Limited	<b>B31F 1/28</b> (2006.01) <b>B32B 29/08</b> (2006.01)	2552686 *	IMPROVED METHOD AND APPARATUS FOR FORMING CORRUGATED BOARD
Pharmacyclics, Inc.	<b>A61K 31/505</b> (2006.01) <b>A61P 35/02</b> (2006.01) <b>A61P 35/00</b> (2006.01) <b>A61K 31/519</b> (2006.01)	2575818 *	THE USE OF INHIBITORS OF BRUTON'S TYROSINE KINASE (BTK)
Rhodes Technologies	<b>C07D 489/08</b> (2006.01) <b>C07D 489/12</b> (2006.01)	2580218 *	PROCESS FOR N-DEALKYLATION OF TERTIARY AMINES
New Poli Group S.r.l.	<b>B60R 21/213</b> (2011.01)	2539185 *	PROTECTION SYSTEM FOR PASSENGERS OF HEAVY OR MEDIUM HEAVY TRANSPORT MEANS
Sunflex Aluminiumsysteme GmbH	<b>E05D 15/58</b> (2006.01)	2546441	Sliding and rotating leaf system

Podnosilac evropske prijave patenta (71)	MKP (51)	Broj objave evropske prijave patenta (97)	Naziv pronalaska (54)
Glaxo Wellcome Manufacturing Pte Ltd	<b>A61K 31/415</b> (2006.01) <b>A01N 43/56</b> (2006.01)	2566331 *	PHARMACEUTICAL COMPOSITIONS AND METHODS OF MAKING SAME
Nexus Alpha Limited	<b>G09F 27/00</b> (2006.01) <b>E01F 9/011</b> (2006.01) <b>E04H 1/12</b> (2006.01) <b>G09F 19/22</b> (2006.01) <b>G08G 1/123</b> (2006.01)	2306440	Display assembly having different types of display
AOP Orphan Pharmaceuticals AG	<b>A61K 9/20</b> (2006.01) <b>A61K 31/517</b> (2006.01)	2549983 *	NOVEL COMPOSITION FOR TREATMENT OF ESSENTIAL THROMBOCYTHEMIA
Prayon S.A.	<b>A23K 1/175</b> (2006.01) <b>A23K 1/16</b> (2006.01) <b>A23L 1/03</b> (2006.01) <b>A23K 1/00</b> (2006.01) <b>A61K 33/06</b> (2006.01) <b>A61K 9/14</b> (2006.01) <b>A61K 31/593</b> (2006.01) <b>A23L 1/304</b> (2006.01) <b>A61K 9/16</b> (2006.01) <b>A61P 19/10</b> (2006.01) <b>A61K 36/185</b> (2006.01) <b>A23L 1/303</b> (2006.01)	2584913 *	STABILIZED ACTIVE COMPOUND
Bry-Air (Asia) Pvt. Ltd.	<b>F24F 3/14</b> (2006.01) <b>B01D 53/06</b> (2006.01) <b>B01D 53/26</b> (2006.01)	2585196 *	SYSTEM AND METHOD FOR IMPROVING THE PERFORMANCE OF DESICCANT DEHUMIDIFICATION EQUIPMENT FOR LOW-HUMIDITY APPLICATIONS
SANOFI	<b>C07D 401/12</b> (2006.01) <b>A61K 31/407</b> (2006.01) <b>C07D 207/06</b> (2006.01) <b>A61K 31/40</b> (2006.01) <b>C07D 409/12</b> (2006.01) <b>A61K 31/454</b> (2006.01) <b>C07D 491/107</b> (2006.01) <b>C07D 405/12</b> (2006.01) <b>A61K 31/438</b> (2006.01) <b>C07D 403/10</b> (2006.01) <b>A61K 31/403</b> (2006.01) <b>C07D 413/12</b> (2006.01) <b>A61K 31/4535</b> (2006.01) <b>C07D 471/10</b> (2006.01) <b>A61K 31/453</b> (2006.01)	2569280 *	SUBSTITUTED PHENYL CYCLOALKYL PYRROLIDINE (PIPERIDINE) SPIROLACTAMS AND AMIDES, PREPARATION AND THERAPEUTIC USE THEREOF
AstraZeneca AB	<b>A61P 35/00</b> (2006.01) <b>C07D 413/14</b> (2006.01) <b>C07D 471/04</b> (2006.01) <b>A61K 31/505</b> (2006.01)	2579877 *	MORPHOLINO PYRIMIDINES AND THEIR USE IN THERAPY
Exelixis, Inc.	<b>A61K 31/47</b> (2006.01) <b>A61K 9/20</b> (2006.01)	2593090 *	C-MET MODULATOR PHARMACEUTICAL COMPOSITIONS
Sanofi-Aventis Deutschland GmbH	<b>A61M 5/315</b> (2006.01)	2455122	Drive mechanism for a drug delivery device
Cetatek Holdings Inc.	<b>A43B 5/00</b> (2006.01) <b>A63B 31/11</b> (2006.01) <b>B63C 11/02</b> (2006.01)	2555834 *	FLIPPERS, BOOTS, SYSTEMS INCLUDING SAME, AND METHODS OF USING SAME
Roland Corporation	<b>G10L 19/00</b> (2006.01) <b>H04S 7/00</b> (2006.01) <b>H04S 5/00</b> (2006.01)	2355554	Musical tone signal-processing apparatus
H. Lundbeck A/S	<b>A61K 38/00</b> (2006.01) <b>C07K 16/28</b> (2006.01) <b>A61K 38/18</b> (2006.01)	2580242 *	MODULATION OF THE INTERACTION BETWEEN SORLA AND GDNF-FAMILY LIGAND RECEPTORS
Poxel	<b>A61K 31/53</b> (2006.01) <b>A61K 9/20</b> (2006.01)	2579880 *	TREATMENT OF TYPE 2 DIABETES
Bua, Dunne Enterprise LLC	<b>A61H 1/02</b> (2006.01)	2575725 *	HUMERUS-STABILIZED SHOULDER STRETCH DEVICE
Sanofi-Aventis Deutschland GmbH	<b>A61M 5/24</b> (2006.01) <b>A61M 5/315</b> (2006.01)	2579921 *	DRIVE MECHANISM FOR A DRUG DELIVERY DEVICE



Podnosilac evropske prijave patenta (71)	MKP (51)	Broj objave evropske prijave patenta (97)	Naziv pronalaska (54)
Bayer Intellectual Property GmbH	<b>C07D 487/04</b> (2006.01) <b>A61K 31/519</b> (2006.01) <b>C07D 471/04</b> (2006.01) <b>A61K 31/437</b> (2006.01)	2593451 *	SUBSTITUTED IMIDAZO[1,2-A]PYRIMIDINES AND -PYRIDINES
Incyte Corporation	<b>A61K 31/519</b> (2006.01) <b>A61K 9/107</b> (2006.01) <b>A61K 47/06</b> (2006.01) <b>A61K 47/10</b> (2006.01) <b>A61K 9/00</b> (2006.01)	2574168 *	TOPICAL FORMULATION FOR A JAK INHIBITOR
Umicore AG & Co. KG	<b>C23C 30/00</b> (2006.01) <b>C22C 13/00</b> (2006.01) <b>C23C 26/00</b> (2006.01) <b>C22C 7/00</b> (2006.01) <b>C22C 5/06</b> (2006.01)	2497841	Sn-Ag-Cu-Alloys
SANOFI	<b>A61P 9/06</b> (2006.01) <b>A61K 31/343</b> (2006.01)	2544681 *	USE OF DRONEDARONE OR A PHARMACEUTICALLY ACCEPTABLE SALT THEREOF, FOR THE PREPARATION OF A MEDICAMENT FOR ADMINISTRATION SHORTLY AFTER AMIODARONE DISCONTINUATION
Nuvo Research Inc.	<b>A61K 31/196</b> (2006.01) <b>A61K 47/20</b> (2006.01) <b>A61P 19/02</b> (2006.01) <b>A61K 31/192</b> (2006.01) <b>A61K 9/12</b> (2006.01)	2544662 *	FOAMABLE FORMULATION
Janssen Biotech, Inc.	<b>C12N 15/37</b> (2006.01) <b>C07K 14/08</b> (2006.01) <b>C12N 9/50</b> (2006.01)	2558482 *	ENGINEERED PLANT CYSTEINE PROTEASES AND THEIR USES
Basilea Pharmaceutica International Ltd.	<b>C07D 501/34</b> (2006.01)	2569321 *	OXIDATION PROCESS FOR PREPARING 3-FORMYL-CEPHEM DERIVATIVES
GEOSEC s.r.l.	<b>E02D 3/12</b> (2006.01) <b>E02D 1/02</b> (2006.01)	2543769	Method of consolidating a foundation soil
Bayer Intellectual Property GmbH	<b>C07C 227/42</b> (2006.01)	2580184 *	PROCESS FOR PREPARING CRYSTALLINE 3,6,9-TRIAZA-3,6,9-TRIS(CARBOXYMETHYL)-4-(4-ETHOXYBENZYL)UNDECANEDIOIC ACID AND USE FOR PRODUCTION OF PRIMOVIST®
IDEXX LABORATORIES, INC.	<b>G01N 33/53</b> (2006.01) <b>C07K 14/00</b> (2006.01) <b>C07K 14/775</b> (2006.01) <b>G01N 33/68</b> (2006.01)	2577315 *	MARKERS FOR RENAL DISEASE
Merck Sharp & Dohme Corp.	<b>C07F 7/08</b> (2006.01) <b>A61K 31/695</b> (2006.01) <b>A61P 31/14</b> (2006.01)	2545060 *	FUSED TRICYCLIC SILYL COMPOUNDS AND METHODS OF USE THEREOF FOR THE TREATMENT OF VIRAL DISEASES
Sanofi-Aventis Deutschland GmbH	<b>A61M 5/50</b> (2006.01) <b>A61J 1/20</b> (2006.01) <b>A61M 5/24</b> (2006.01)	2555815 *	CODED DRUG RESERVOIR CONNECTION ELEMENT WITH HINGED FLANGE
Zhang, Jianmin	<b>C05G 1/00</b> (2006.01)	2590909 *	COMPOSITIONS AND METHODS OF MAKING AND USING THE COMPOSITIONS FOR IMPROVING SOIL AND/OR PLANT GROWTH AND IMPROVED SOIL, IMPROVED PLANTS, AND/OR IMPROVED SEEDS
Egis Gyógyszergyár Nyilvánosan Működő Részvénytársaság	<b>A61K 8/89</b> (2006.01) <b>A61K 8/20</b> (2006.01) <b>A01N 59/12</b> (2006.01) <b>A61K 47/24</b> (2006.01) <b>A61P 31/02</b> (2006.01) <b>A01N 25/02</b> (2006.01) <b>A61K 33/18</b> (2006.01) <b>A01P 1/00</b> (2006.01)	2592935 *	DISINFECTANT AND ANTISEPTIC FORMULATION HAVING REDUCED IODINE CONTENT
Hagleitner, Hans Georg Trüb AG	<b>A47K 5/12</b> (2006.01) <b>B42D 13/00</b> (2006.01) <b>B42D 15/10</b> (2006.01)	2560529 * 2316659	DISPENSER Data sheet for a means of identification

Podnosilac evropske prijave patenta (71)	MKP (51)	Broj objave evropske prijave patenta (97)	Naziv pronalaska (54)
Technelep S.R.L.	<b>F23J 15/04</b> (2006.01) <b>F23J 15/02</b> (2006.01) <b>F23M 7/04</b> (2006.01) <b>F23G 5/50</b> (2006.01) <b>B01D 53/34</b> (2006.01) <b>F23G 5/00</b> (2006.01) <b>F23G 5/30</b> (2006.01) <b>F23G 5/46</b> (2006.01)	2479495	A multipurpose biologic sludge, organic wastes and biomasses cogeneration incineration plant and process developed therein
Abraxis BioScience, LLC	<b>A61K 39/395</b> (2006.01) <b>A61P 35/00</b> (2006.01) <b>A61P 35/02</b> (2006.01) <b>A61K 38/20</b> (2006.01)	2575863 *	USE OF THE SPARC MICROENVIRONMENT SIGNATURE IN THE TREATMENT OF CANCER
Medasani, Munisekhar	<b>A61K 31/375</b> (2006.01) <b>A61K 31/315</b> (2006.01)	2473037 *	METHOD OF TREATMENT OF NEURODEGENERATIVE OR NEURO-MUSCULAR DEGENERATIVE DISEASES AND THERAPEUTIC AGENT TO TREAT THE SAME
Novartis AG	<b>C12Q 1/68</b> (2006.01)	2563934 *	PREDICTIVE MARKERS USEFUL IN THE TREATMENT OF FRAGILE X SYNDROME (FXS)
SANOFI	<b>A61K 31/196</b> (2006.01) <b>C07C 235/24</b> (2006.01) <b>A61K 31/277</b> (2006.01) <b>A61P 3/10</b> (2006.01) <b>C07C 255/44</b> (2006.01)	2590931 *	(2-ARYLOXY-ACETYLAMINO)-PHENYL-PROPIONIC ACID DERIVATIVES, METHOD FOR PRODUCING SAME AND USE THEREOF AS PHARMACEUTICALS
Delphi Technologies Holding S.à.r.l.	<b>F04B 1/04</b> (2006.01) <b>F04B 53/12</b> (2006.01) <b>F04B 53/16</b> (2006.01) <b>F02M 37/04</b> (2006.01)	2492506	Pumping head
Alexion Pharmaceuticals, Inc.	<b>A61P 7/00</b> (2006.01) <b>A61P 37/02</b> (2006.01) <b>A61K 39/00</b> (2006.01) <b>C07K 16/00</b> (2006.01)	2542255 *	METHODS AND COMPOSITIONS FOR TREATING DEGOS' DISEASE
Synovex Corporation	<b>A61K 38/17</b> (2006.01) <b>C07K 16/28</b> (2006.01) <b>C07K 16/46</b> (2006.01)	2593128 *	HUMANIZED ANTIBODIES TARGETING THE EC1 DOMAIN OF CADHERIN-11 AND RELATED COMPOSITIONS AND METHODS
Alonso Cohen, Miguel Angel	<b>A61K 38/01</b> (2006.01) <b>A61K 36/00</b> (2006.01) <b>A61K 31/353</b> (2006.01) <b>A61P 1/04</b> (2006.01) <b>A61P 1/00</b> (2006.01)	2526939	Gelatine tannate and associations thereof for use in the treatment of inflammatory gastrointestinal diseases
Sonavation, Inc.	<b>G06F 3/033</b> (2013.01)	2569684 *	METHODS AND SYSTEMS FOR POINTING DEVICE USING ACOUSTIC IMPEDIOMETRY
Ethicon Endo-Surgery, Inc.	<b>A61F 5/00</b> (2006.01) <b>A61F 13/00</b> (2006.01)	2538894 *	DEVICES FOR TREATING MORBID OBESITY USING HYDROGEL
Janssen Pharmaceutica, N.V.	<b>C09D 5/16</b> (2006.01) <b>A01N 59/20</b> (2006.01) <b>A01N 43/40</b> (2006.01) <b>D06M 13/355</b> (2006.01) <b>A01P 9/00</b> (2006.01) <b>A01N 37/10</b> (2006.01) <b>D06M 13/203</b> (2006.01) <b>A01P 13/00</b> (2006.01) <b>A01N 59/16</b> (2006.01) <b>A01N 43/36</b> (2006.01) <b>D06M 13/352</b> (2006.01)	2587918 *	ANTIFOULING BENZOATE COMBINATIONS
Saiger, Lothar	<b>A61L 2/07</b> (2006.01) <b>A61L 2/025</b> (2006.01) <b>A61L 2/10</b> (2006.01)	2563410 *	METHOD FOR MACHINE-CLEANING AND MACHINE-DISINFECTING OBJECTS
Sanofi-Aventis Deutschland GmbH	<b>A61M 5/145</b> (2006.01)	2538993 *	GEARBOX

Podnosilac evropske prijave patenta (71)	MKP (51)	Broj objave evropske prijave patenta (97)	Naziv pronalaska (54)
Okabe, Masaru	<b>A61P 15/00</b> (2006.01) <b>A61P 9/12</b> (2006.01) <b>A61K 38/27</b> (2006.01) <b>C12N 15/09</b> (2006.01) <b>A61K 48/00</b> (2006.01) <b>A01K 67/027</b> (2006.01) <b>A61P 13/12</b> (2006.01)	2543729 *	MODEL ANIMAL FOR PREGNANCY-INDUCED HYPERTENSION SYNDROME, AND TREATMENT METHOD THEREFOR
Ikawa, Masahito	<b>A61P 15/00</b> (2006.01) <b>A61P 9/12</b> (2006.01) <b>A61K 38/27</b> (2006.01) <b>C12N 15/09</b> (2006.01) <b>A61K 48/00</b> (2006.01) <b>A01K 67/027</b> (2006.01) <b>A61P 13/12</b> (2006.01)	2543729 *	MODEL ANIMAL FOR PREGNANCY-INDUCED HYPERTENSION SYNDROME, AND TREATMENT METHOD THEREFOR
Fuso Pharmaceutical Industries, Ltd.	<b>A61P 15/00</b> (2006.01) <b>A61P 9/12</b> (2006.01) <b>A61K 38/27</b> (2006.01) <b>C12N 15/09</b> (2006.01) <b>A61K 48/00</b> (2006.01) <b>A01K 67/027</b> (2006.01) <b>A61P 13/12</b> (2006.01)	2543729 *	MODEL ANIMAL FOR PREGNANCY-INDUCED HYPERTENSION SYNDROME, AND TREATMENT METHOD THEREFOR
ChemoCentryx, Inc.	<b>A61K 31/445</b> (2006.01) <b>C07D 211/06</b> (2006.01)	2585064 *	C5AR ANTAGONISTS
Neogenix Oncology, Inc.	<b>C07K 14/00</b> (2006.01)	2585476 *	COLON AND PANCREAS CANCER SPECIFIC ANTIGENS AND ANTIBODIES
Nobil Bio Ricerche S.r.l.	<b>A61L 27/20</b> (2006.01) <b>A61L 27/24</b> (2006.01) <b>A61L 27/34</b> (2006.01) <b>A61L 27/26</b> (2006.01) <b>A61L 27/54</b> (2006.01)	2560694 *	IMPLANTING DEVICE WITH ANTIBACTERIAL PROPERTIES AND MULTIFUNCTIONAL SURFACE
Blue Jeans Network, Inc.	<b>H04N 7/14</b> (2006.01) <b>H04N 7/15</b> (2006.01) <b>H04N 7/00</b> (2011.01)	2569938 *	SYSTEMS AND METHODS FOR SCALABLE DISTRIBUTED GLOBAL INFRASTRUCTURE FOR REAL-TIME MULTIMEDIA COMMUNICATION
Kjær, Erling	<b>A01F 25/18</b> (2006.01)	2584883 *	AN AGRICULTURAL DEVICE AND METHOD
Sanofi-Aventis Deutschland GmbH	<b>A61M 5/20</b> (2006.01) <b>A61M 5/00</b> (2006.01)	2585135 *	AUTO-INJECTOR
Bayer Intellectual Property GmbH	<b>C07D 487/04</b> (2006.01) <b>A61K 31/4985</b> (2006.01) <b>A61P 35/00</b> (2006.01)	2547680 *	IMIDAZOPYRAZINES
Bayer CropScience NV	<b>A01H 1/04</b> (2006.01) <b>A01H 5/00</b> (2006.01)	2582226 *	METHODS FOR DETERMINING FITNESS IN PLANTS
Amgen Inc.	<b>C07D 403/12</b> (2006.01) <b>C07D 473/34</b> (2006.01) <b>A61P 29/00</b> (2006.01) <b>C07D 471/04</b> (2006.01) <b>A61K 31/506</b> (2006.01) <b>C07D 487/04</b> (2006.01) <b>C07D 401/14</b> (2006.01) <b>C07D 409/12</b> (2006.01)	2552908 *	HETEROCYCLIC COMPOUNDS AND THEIR USES
Gilead Pharmasset LLC	<b>A61P 31/14</b> (2006.01) <b>A61K 31/7076</b> (2006.01) <b>C07H 19/20</b> (2006.01)	2552933 *	PURINE NUCLEOSIDE PHOSPHORAMIDATE
Curetis AG	<b>C12N 15/10</b> (2006.01) <b>G01N 33/569</b> (2006.01) <b>C12Q 1/68</b> (2006.01) <b>C12N 1/06</b> (2006.01)	2571976 *	UNIVERSALLY APPLICABLE LYSIS BUFFER AND PROCESSING METHODS FOR THE LYSIS OF BODILY SAMPLES
ALEXION PHARMACEUTICALS, INC.	<b>C07K 16/18</b> (2006.01)	2563812 *	ANTIBODIES HAVING REDUCED IMMUNOGENICITY IN A HUMAN
Foti, Ivan	<b>H05B 37/02</b> (2006.01)	2570004 *	LED LIGHTING DEVICES

Podnosilac evropske prijave patenta (71)	MKP (51)	Broj objave evropske prijave patenta (97)	Naziv pronalaska (54)
ITALCEMENTI S.p.A.	<b>C04B 28/02</b> (2006.01) <b>C04B 38/08</b> (2006.01)	2590905 *	DRY CEMENT MIX FOR FORMING LIGHT CONCRETES WITH LOW THERMAL CONDUCTIVITY, AND CONCRETES THUS OBTAINED
Merz Pharma GmbH & Co. KGaA	<b>A61K 47/36</b> (2006.01) <b>A61K 47/38</b> (2006.01) <b>A61K 9/00</b> (2006.01) <b>A61P 17/00</b> (2006.01) <b>A61K 31/13</b> (2006.01)	2582356 *	GEL FORMULATIONS FOR THE TOPICAL USE OF 1-AMINO-ALKYL CYCLOHEXANE DERIVATIVES
MIMEDX Group Inc.	<b>A61K 35/50</b> (2006.01)	2585084 *	MICRONIZED PLACENTAL TISSUE COMPOSITIONS AND METHODS FOR MAKING AND USING THE SAME
Faes Farma, S.A.	<b>C07D 405/12</b> (2006.01) <b>C07D 409/06</b> (2006.01) <b>A61K 31/4462</b> (2006.01) <b>A61K 31/4465</b> (2006.01) <b>C07D 211/22</b> (2006.01) <b>A61P 25/28</b> (2006.01) <b>A61K 31/4545</b> (2006.01) <b>C07D 211/24</b> (2006.01) <b>C07D 401/12</b> (2006.01)	2576509 *	FLUFENOXINE DERIVATIVES FOR THE TREATMENT AND PREVENTION OF AMILOYD PATHOLOGIES
Owens-Brockway Glass Container INC.	<b>B67B 1/06</b> (2006.01) <b>B65D 39/16</b> (2006.01) <b>B65D 1/02</b> (2006.01)	2576359 *	GLASS CONTAINER WITH INTERNALLY THREADED NECK
Eisai R&D Management Co., Ltd.	<b>A61K 31/454</b> (2006.01) <b>C07D 401/14</b> (2006.01) <b>A61P 31/14</b> (2006.01) <b>C07D 471/04</b> (2006.01) <b>A61K 31/5383</b> (2006.01) <b>A61K 31/7056</b> (2006.01) <b>C07D 405/12</b> (2006.01) <b>C07D 403/10</b> (2006.01) <b>A61K 31/4164</b> (2006.01) <b>C07D 233/66</b> (2006.01) <b>C07D 498/04</b> (2006.01) <b>A61K 38/21</b> (2006.01) <b>C07D 409/14</b> (2006.01) <b>A61K 31/4178</b> (2006.01) <b>C07D 401/10</b> (2006.01) <b>C07D 233/61</b> (2006.01) <b>A61P 43/00</b> (2006.01) <b>C07D 491/10</b> (2006.01)	2589595 *	AGENT FOR TREATING HCV INFECTION
Incyte Corporation	<b>C07D 401/14</b> (2006.01) <b>A61K 31/4468</b> (2006.01) <b>A61K 31/4155</b> (2006.01) <b>C07D 405/14</b> (2006.01) <b>A61P 29/00</b> (2006.01) <b>A61K 31/437</b> (2006.01)	2545045 *	PIPERIDIN-4-YL AZETIDINE DERIVATIVES AS JAK1 INHIBITORS
Array Biopharma, Inc.	<b>A61P 29/00</b> (2006.01) <b>C07D 487/04</b> (2006.01) <b>A61K 31/519</b> (2006.01) <b>A61P 37/00</b> (2006.01)	2558468 *	5, 7-SUBSTITUTED-IMIDAZO [1, 2-C]PYRIMIDINES AS INHIBITORS OF JAK KINASES
Alexion Pharma International SARL	<b>A61K 38/46</b> (2006.01) <b>A61K 47/48</b> (2006.01) <b>C12N 9/16</b> (2006.01) <b>A61K 31/7088</b> (2006.01) <b>A61P 19/08</b> (2006.01) <b>A61K 38/17</b> (2006.01) <b>C12N 15/867</b> (2006.01) <b>A61K 48/00</b> (2006.01) <b>C12N 15/55</b> (2006.01)	2563406 *	METHODS, COMPOSITIONS, AND KITS FOR THE TREATMENT OF MATRIX MINERALIZATION DISORDERS
aTyr Pharma, Inc.	<b>A61K 38/08</b> (2006.01)	2566492 *	INNOVATIVE DISCOVERY OF THERAPEUTIC, DIAGNOSTIC, AND ANTIBODY COMPOSITIONS RELATED TO PROTEIN FRAGMENTS OF GLUTAMYL-PROLYL-TRNA SYNTHETASES

Podnosilac evropske prijave patenta (71)	MKP (51)	Broj objave evropske prijave patenta (97)	Naziv pronalaska (54)
Pangu Biopharma Limited	<b>A61K 38/08</b> (2006.01)	2566492 *	INNOVATIVE DISCOVERY OF THERAPEUTIC, DIAGNOSTIC, AND ANTIBODY COMPOSITIONS RELATED TO PROTEIN FRAGMENTS OF GLUTAMYL-PROLYL-TRNA SYNTHETASES
Omya Development AG	<b>D21H 21/02</b> (2006.01) <b>D21C 9/08</b> (2006.01)	2546410	Hydrophobised calcium carbonate particles
Teva Pharmaceutical Industries Ltd.	<b>A01N 43/42</b> (2006.01)	2542079 *	TREATMENT OF RHEUMATOID ARTHRITIS WITH A COMBINATION OF LAQUINIMOD AND METHOTREXATE
Omya Development AG	<b>C02F 1/68</b> (2006.01)	2548848	Micronized CaCO <sub>3</sub> slurry injection system for the remineralization of desalinated and fresh water
Neomend, Inc.	<b>A61M 5/142</b> (2006.01) <b>A61M 5/178</b> (2006.01) <b>A61M 5/28</b> (2006.01) <b>A61B 17/03</b> (2006.01)	2555813 *	METHOD AND APPARATUS FOR WOUND SEALANT APPLICATION
Genmab A/S	<b>C07K 16/10</b> (2006.01) <b>C07K 16/28</b> (2006.01) <b>C07K 16/46</b> (2006.01) <b>C07K 16/32</b> (2006.01)	2560993 *	HETERODIMERIC ANTIBODY FC-CONTAINING PROTEINS AND METHODS FOR PRODUCTION THEREOF
Dow AgroSciences, LLC	<b>A61K 31/505</b> (2006.01) <b>A01N 43/54</b> (2006.01)	2563129 *	N <sub>3</sub> -SUBSTITUTED-N <sub>1</sub> -SULFONYL-5-FLUOROPYRIMIDINONE DERIVATIVES
System Logistics S.p.a.	<b>B65G 1/04</b> (2006.01) <b>B65G 1/02</b> (2006.01)	2542485 *	A PLANT FOR STORING PRODUCTS
FEDRIGONI S.P.A.	<b>B42D 15/00</b> (2006.01) <b>D21F 1/44</b> (2006.01)	2567026 *	METHOD FOR PROVIDING A WATERMARKING WIRE MESH, WATERMARKING WIRE MESH, APPARATUS FOR OBTAINING IT AND ANTI-COUNTERFEITING DOCUMENT
E.I. DU PONT DE NEMOURS AND COMPANY	<b>A01N 25/00</b> (2006.01) <b>C07D 261/04</b> (2006.01)	2576523 *	CRYSTALLINE FORM OF 4- [5 - [3 -CHLORO-5 - (TRIFLUOROMETHYL) PHENYL]-4, 5 - DIHYDRO - 5 - (TRIFLUOROMETHYL) -3 - ISOXAZOLYL]-N-[2-OXO-2- [ ( 2, 2, 2 - TRIFLUOROETHYL) AMINO] ETHYL]-1- NAPHTHALENECARBOXAMIDE
Apple Inc.	<b>H01R 24/58</b> (2011.01)	2577812 *	D-SHAPED CONNECTOR
Sanofi-Aventis Deutschland GmbH	<b>A61M 5/32</b> (2006.01)	2588170 *	NEEDLE SHIELD FOR A SAFETY DEVICE, SAFETY DEVICE AND INJECTION DEVICE
Delphi Technologies Holding S.à.r.l.	<b>G01N 27/02</b> (2006.01) <b>F02D 41/22</b> (2006.01) <b>G01N 15/06</b> (2006.01)	2492481	Soot sensor functional capability monitoring
QLT, Inc.	<b>A61K 31/21</b> (2006.01) <b>A61K 31/11</b> (2006.01) <b>A61P 27/02</b> (2006.01) <b>A61K 31/222</b> (2006.01)	2563350 *	THERAPEUTIC REGIMEN AND METHOD FOR TREATING OR AMELIORATING VISUAL DISORDERS ASSOCIATED WITH AN ENDOGENOUS RETINOID DEFICIENCY
Janssen Pharmaceutica, N.V.	<b>A61P 25/16</b> (2006.01) <b>A61P 19/10</b> (2006.01) <b>A61P 29/00</b> (2006.01) <b>A61K 31/496</b> (2006.01) <b>A61P 37/06</b> (2006.01) <b>C07D 405/12</b> (2006.01) <b>A61P 35/00</b> (2006.01) <b>A61P 25/28</b> (2006.01) <b>A61P 3/00</b> (2006.01) <b>A61P 25/22</b> (2006.01) <b>A61P 9/12</b> (2006.01) <b>A61P 25/30</b> (2006.01) <b>A61P 3/10</b> (2006.01) <b>A61P 25/24</b> (2006.01) <b>A61P 15/00</b> (2006.01)	2566861 *	MODULATORS OF FATTY ACID AMIDE HYDROLASE
De Luca, Denis	<b>B32B 7/02</b> (2006.01) <b>B32B 3/08</b> (2006.01) <b>B32B 7/12</b> (2006.01) <b>B32B 21/14</b> (2006.01) <b>B32B 21/13</b> (2006.01) <b>B27M 3/00</b> (2006.01)	2492091	A process for working or realizing a wood manufacture with application of various wood types

Podnosilac evropske prijave patenta (71)	MKP (51)	Broj objave evropske prijave patenta (97)	Naziv pronalaska (54)
Universität für Bodenkultur Wien	<b>C12N 15/113</b> (2010.01) <b>A61K 31/7088</b> (2006.01) <b>C12Q 1/68</b> (2006.01) <b>A61P 19/08</b> (2006.01) <b>A61P 9/00</b> (2006.01)	2571988 *	COMPOSITIONS FOR USE IN TREATING OR DIAGNOSING BONE DISORDERS AND/OR CARDIOVASCULAR DISORDERS
Siviero, Monica	<b>E06C 7/46</b> (2006.01)	2569502 *	PORTABLE LADDER
Ferremi, Luca	<b>E06C 7/46</b> (2006.01)	2569502 *	PORTABLE LADDER
Sordo, Pietro	<b>E06C 7/46</b> (2006.01)	2569502 *	PORTABLE LADDER
Loadtest, Inc.	<b>G01L 1/00</b> (2006.01) <b>G01B 21/32</b> (2006.01)	2572174 *	METHOD AND APPARATUS FOR INTERNALLY DETERMINING A LOAD APPLIED BY A JACK
Ko, YoungSan	<b>A61N 5/06</b> (2006.01) <b>A61N 5/067</b> (2006.01) <b>A61B 18/20</b> (2006.01)	2578269 *	IPL DEVICE OF WHICH THE ENERGY LEVEL CAN BE ADJUSTED USING A THYRISTOR
Kingspan Holdings (IRL) Limited	<b>E04B 1/80</b> (2006.01)	2588674 *	A PREFABRICATED COMPOSITE INSULATION BOARD
SANOFI	<b>C07K 16/28</b> (2006.01)	2539370 *	ANTI-ALPHA2 INTEGRIN ANTIBODIES AND THEIR USES
Dana-Farber Cancer Institute, Inc.	<b>C12N 15/09</b> (2006.01)	2569429 *	COMPOSITIONS AND METHODS FOR MODULATING METABOLISM
Brigham and Women's Hospital, Inc.	<b>C12N 15/09</b> (2006.01)	2569429 *	COMPOSITIONS AND METHODS FOR MODULATING METABOLISM
Chiesi Farmaceutici S.p.A.	<b>A61P 11/08</b> (2006.01) <b>C07D 207/12</b> (2006.01) <b>A61P 11/00</b> (2006.01) <b>A61P 11/06</b> (2006.01) <b>A61K 31/40</b> (2006.01)	2580194 *	PROCESS FOR THE PREPARATION OF GLYCOPYRRONIUM CHLORIDE
Histocell, S.L.	<b>A61K 31/198</b> (2006.01) <b>A61P 17/16</b> (2006.01) <b>A61K 31/12</b> (2006.01) <b>A61K 31/736</b> (2006.01) <b>A61P 17/06</b> (2006.01) <b>A61K 35/12</b> (2006.01) <b>A61K 9/00</b> (2006.01) <b>A61P 17/00</b> (2006.01) <b>A61P 17/02</b> (2006.01)	2583682 *	ANTIOXIDANT COMPOSITION
Merz Pharma GmbH & Co. KGaA	<b>A61K 31/13</b> (2006.01) <b>A61K 9/48</b> (2006.01) <b>A61K 9/16</b> (2006.01) <b>A61K 9/50</b> (2006.01) <b>A61K 9/28</b> (2006.01) <b>A61K 9/20</b> (2006.01)	2585049 *	NERAMEXANE MULTIPLE UNIT DOSAGE FORM
Japan Tobacco, Inc.	<b>A61K 33/26</b> (2006.01) <b>A61K 47/32</b> (2006.01) <b>A61P 3/00</b> (2006.01) <b>A61P 13/12</b> (2006.01) <b>A61K 9/20</b> (2006.01) <b>A61K 47/38</b> (2006.01) <b>A61P 7/00</b> (2006.01)	2594277 *	TABLET CONTAINING FERRIC CITRATE
Trustees of Dartmouth College	<b>A61K 38/17</b> (2006.01) <b>A61K 39/395</b> (2006.01) <b>A61P 19/02</b> (2006.01) <b>A61P 37/00</b> (2006.01) <b>C07K 19/00</b> (2006.01) <b>C07K 16/18</b> (2006.01) <b>C07K 14/47</b> (2006.01)	2552947 *	VISTA REGULATORY T CELL MEDIATOR PROTEIN, VISTA BINDING AGENTS AND USE THEREOF
Marovic, Mato	<b>F01C 1/344</b> (2006.01)	2558684 *	FOUR-STROKE ROTATING VANE ENGINE WITH AN ELLIPTIC CASING AND GUIDED VANES
V. Mane Fils	<b>C11B 9/00</b> (2006.01) <b>C07C 33/14</b> (2006.01) <b>C07C 403/08</b> (2006.01) <b>C07C 31/135</b> (2006.01) <b>A61K 8/34</b> (2006.01)	2566838 *	COMPOUNDS WITH A WOODY NOTE

Podnosilac evropske prijave patenta (71)	MKP (51)	Broj objave evropske prijave patenta (97)	Naziv pronalaska (54)
Mahashabde, Anu	<b>A61F 6/14</b> (2006.01)	2585011 *	INTRAVAGINAL DEVICES COMPRISING ANTICHOLINERGIC AGENTS, AND METHODS OF MAKING THEREOF
Tsao, Jiaxiang	<b>A61F 6/14</b> (2006.01)	2585011 *	INTRAVAGINAL DEVICES COMPRISING ANTICHOLINERGIC AGENTS, AND METHODS OF MAKING THEREOF
Active Biotech AB	<b>C07D 215/56</b> (2006.01)	2590949 *	METHOD FOR MANUFACTURING OF QUINOLINE-3-CARBOXAMIDES
Orteq B.V.	<b>A61L 27/56</b> (2006.01) <b>A61L 27/18</b> (2006.01)	2538985 *	MENISCUS REPAIR ASSEMBLY AND METHOD
Rotrex A/S	<b>F02B 39/10</b> (2006.01) <b>H02K 7/18</b> (2006.01) <b>F02B 37/04</b> (2006.01)	2553234 *	AN ELECTRICALLY ASSISTED TURBOCHARGER
Voloshin, Arkady Iosifovich	<b>H01Q 19/00</b> (2006.01) <b>H04B 7/02</b> (2006.01)	2584654 *	DEVICE FOR WIRELESS COMMUNICATION
Soldatkin, Andrey Stepanovich	<b>H01Q 19/00</b> (2006.01) <b>H04B 7/02</b> (2006.01)	2584654 *	DEVICE FOR WIRELESS COMMUNICATION
Euro-Celtique S.A.	<b>A61K 31/485</b> (2006.01) <b>A61K 9/20</b> (2006.01)	2568967 *	PHARMACEUTICAL COMPOSITIONS COMPRISING HYDROMORPHONE AND NALOXONE
Halla Climate Control Corporation	<b>B60H 1/00</b> (2006.01)	2489532	Air conditioner for vehicle
Ajinomoto Co., Inc.	<b>A61K 31/17</b> (2006.01) <b>A61K 31/417</b> (2006.01) <b>A61K 31/167</b> (2006.01) <b>A61K 31/27</b> (2006.01) <b>A61K 31/198</b> (2006.01) <b>C07C 275/42</b> (2006.01) <b>A61K 31/4245</b> (2006.01) <b>A61K 31/4045</b> (2006.01) <b>A23L 1/226</b> (2006.01)	2546231 *	ALKYLAMINE DERIVATIVE
Merz Pharma GmbH & Co. KGaA	<b>A61Q 19/00</b> (2006.01) <b>A61K 8/00</b> (2006.01) <b>A61K 31/732</b> (2006.01) <b>A61L 27/20</b> (2006.01) <b>A61K 9/00</b> (2006.01)	2555808 *	FILLERS COMPRISING GELLAN OR PECTIN BEADS
Vertex Pharmaceuticals Incorporated	<b>A61K 9/20</b> (2006.01) <b>C07D 405/14</b> (2006.01) <b>A61K 9/16</b> (2006.01) <b>C07D 213/75</b> (2006.01) <b>C07D 405/12</b> (2006.01) <b>A61K 9/28</b> (2006.01)	2555755 *	PHARMACEUTICAL COMPOSITIONS OF 3-(6-(1-(2,2-DIFLUOROBENZO[D][1,3]DIOXOL-5-YL) CYCLOPROPANECARBOXAMIDO)-3-METHYLPYRIDIN-2-YL)BENZOIC ACID AND ADMINISTRATION THEREOF
Krka, Torvarna Zdravil, D.D., Novo Mesto	<b>A61K 9/20</b> (2006.01) <b>A61K 9/16</b> (2006.01) <b>A61K 31/405</b> (2006.01) <b>A61K 31/397</b> (2006.01)	2549982 *	METHOD OF PREPARING A GRANULATED PHARMACEUTICAL COMPOSITION COMPRISING SIMVASTATIN AND/OR EZETIMIBE
GlaxoSmithKline LLC	<b>A61K 31/69</b> (2006.01) <b>A01N 55/08</b> (2006.01)	2555625 *	PROCESS FOR PREPARING BENZOXABORoles
Mophie, Inc.	<b>H01M 2/02</b> (2006.01)	2572395 *	MODULAR MOBILE ACCESSORY FOR MOBILE DEVICE
Sanofi-Aventis Deutschland GmbH	<b>A61M 5/20</b> (2006.01)	2585139 *	NEEDLE SAFETY ARRANGEMENT AND METHOD FOR OPERATING IT
Torunskie Zaklady Urzadzen Mlynskich Spomasz Spólka Akcyjna	<b>B02C 13/04</b> (2006.01) <b>B02C 13/28</b> (2006.01)	2560762 *	HAMMER MILL
Curt G. Joa, Inc.	<b>A61F 13/15</b> (2006.01)	2581068	Methods and apparatus for application of nested zero waste ear to traveling web and formation of articles using a dual cut slip unit

Podnosilac evropske prijave patenta (71)	MKP (51)	Broj objave evropske prijave patenta (97)	Naziv pronalaska (54)
aTyr Pharma, Inc.	<b>A61P 29/00</b> (2006.01) <b>A61P 3/00</b> (2006.01) <b>A61P 35/00</b> (2006.01) <b>A61K 39/395</b> (2006.01) <b>A61K 38/17</b> (2006.01) <b>A61K 38/16</b> (2006.01)	2571513 *	INNOVATIVE DISCOVERY OF THERAPEUTIC, DIAGNOSTIC, AND ANTIBODY COMPOSITIONS RELATED TO PROTEIN FRAGMENTS OF LEUCYL-TRNA SYNTHETASES
Pangu Biopharma Limited	<b>A61P 29/00</b> (2006.01) <b>A61P 3/00</b> (2006.01) <b>A61P 35/00</b> (2006.01) <b>A61K 39/395</b> (2006.01) <b>A61K 38/17</b> (2006.01) <b>A61K 38/16</b> (2006.01)	2571513 *	INNOVATIVE DISCOVERY OF THERAPEUTIC, DIAGNOSTIC, AND ANTIBODY COMPOSITIONS RELATED TO PROTEIN FRAGMENTS OF LEUCYL-TRNA SYNTHETASES
Logomotion, s.r.o.	<b>G06K 19/077</b> (2006.01) <b>G06K 7/00</b> (2006.01)	2577556 *	A REMOVABLE MEMORY CARD WITH AN ANTENNA, ARRANGEMENT OF ITS LEVELS
SIGMA-TAU Industrie Farmaceutiche Riunite S.p.A.	<b>A61K 31/7036</b> (2006.01) <b>A61P 27/02</b> (2006.01) <b>A61K 31/205</b> (2006.01)	2542233 *	COMPOSITION COMPRISING AS ACTIVE INGREDIENT L-CARNITINE IN COMBINATION WITH HYDROXYKYNURENNINE-0-BETA-DL-GLUCOSIDE, FOR THE PREVENTION AND/OR TREATMENT OF PATHOLOGIES OF THE EYE DUE TO ULTRAVIOLET RADIATION
Owens-Brockway Glass Container INC.	<b>C03C 17/42</b> (2006.01) <b>B65D 23/08</b> (2006.01)	2556036 *	IMPROVING ADHESION OF ORGANIC COATINGS ON GLASS
Glaxo Group Limited	<b>A61K 39/395</b> (2006.01) <b>A61P 25/28</b> (2006.01) <b>C07K 16/18</b> (2006.01)	2542261 *	ANTIGEN BINDING PROTEINS SPECIFIC FOR SERUM AMYLOID P COMPONENT
BG Research Ltd	<b>C12N 1/06</b> (2006.01)	2585581 *	CELL DISRUPTION
Ricchiuto, Giuseppe Maria	<b>A61K 35/64</b> (2006.01)	2547347 *	PROCESS FOR OBTAINING NON-ALLERGIC PROPOLIS
Ironwood Pharmaceuticals, Inc.	<b>C07D 417/14</b> (2006.01) <b>A61K 31/4155</b> (2006.01) <b>C07D 405/14</b> (2006.01) <b>C07D 413/14</b> (2006.01) <b>C07D 401/04</b> (2006.01) <b>C07D 401/14</b> (2006.01)	2588465 *	SGC STIMULATORS
Napatech A/S	<b>H05K 7/20</b> (2006.01) <b>H05K 1/14</b> (2006.01)	2561728 *	A THERMALLY CONTROLLED ASSEMBLY
Cambridge Enterprise Ltd.	<b>C07D 223/10</b> (2006.01) <b>C07D 211/76</b> (2006.01) <b>A61P 29/00</b> (2006.01) <b>A61K 31/45</b> (2006.01)	2580197 *	ANTI-INFLAMMATORY AGENTS
BOEHRINGER INGELHEIM INTERNATIONAL GMBH	<b>C07D 223/10</b> (2006.01) <b>C07D 211/76</b> (2006.01) <b>A61P 29/00</b> (2006.01) <b>A61K 31/45</b> (2006.01)	2580197 *	ANTI-INFLAMMATORY AGENTS
Abbott Laboratories	<b>A61K 31/00</b> (2006.01) <b>A61K 9/16</b> (2006.01) <b>A61K 9/20</b> (2006.01) <b>A61K 9/14</b> (2006.01)	2579854 *	SOLID COMPOSITIONS
CHIESI FARMACEUTICI S.p.A.	<b>A61P 29/00</b> (2006.01) <b>C07D 471/04</b> (2006.01) <b>A61K 31/437</b> (2006.01)	2580212 *	UREA DERIVATIVES AND THEIR THERAPEUTIC USE IN THE TREATMENT OF, INTER ALIA, DISEASES OF THE RESPIRATORY TRACT
VIIV Healthcare Company	<b>A61K 31/44</b> (2006.01) <b>A01N 43/42</b> (2006.01)	2549870 *	PROCESS FOR PREPARING CARBAMOYLPIRIDONE DERIVATIVES AND INTERMEDIATES
Emergent Product Development Gaithersburg Inc.	<b>A61K 48/00</b> (2006.01)	2552490 *	ECTODOMAINS OF INFLUENZA MATRIX 2 PROTEIN, EXPRESSION SYSTEM, AND USES THEREOF
Ethicon, LLC	<b>D02J 3/00</b> (2006.01) <b>A61B 17/064</b> (2006.01) <b>A61B 17/03</b> (2006.01)	2566399 *	SURFACE TEXTURE CONFIGURATION FOR SELF-RETAINING SUTURES AND METHODS FOR FORMING SAME



Podnosilac evropske prijave patenta (71)	MKP (51)	Broj objave evropske prijave patenta (97)	Naziv pronalaska (54)
Medical and Biological Laboratories Co., Ltd.	<b>C12N 15/02</b> (2006.01) <b>C12N 15/09</b> (2006.01) <b>C12P 21/08</b> (2006.01) <b>A61P 35/00</b> (2006.01) <b>C12N 5/10</b> (2006.01) <b>C07K 16/42</b> (2006.01) <b>A61K 39/395</b> (2006.01) <b>G01N 33/574</b> (2006.01) <b>C07K 16/24</b> (2006.01) <b>C07K 14/495</b> (2006.01)	2573175 *	ANTIBODY CAPABLE OF BINDING TO TRANSFORMING GROWTH FACTOR ALPHA AND HAVING ANTIPROLIFERATIVE ACTIVITY ON CANCER HAVING Ras GENE MUTATION
L. MOLteni & C. DEI FRATELLI ALITTI SOCIETA' DI ESERCIZIO S.P.A	<b>A61K 31/55</b> (2006.01) <b>A61K 31/485</b> (2006.01) <b>A61K 9/00</b> (2006.01)	2574167 *	LIQUID NASAL SPRAY CONTAINING LOW-DOSE NALTREXONE
Sanofi-Aventis Deutschland GmbH	<b>A61M 5/32</b> (2006.01)	2588166 *	SAFETY DEVICE FOR A PRE-FILLED SYRINGE AND INJECTION DEVICE
SANOFI	<b>C07C 255/54</b> (2006.01) <b>C07D 213/65</b> (2006.01) <b>A61K 31/192</b> (2006.01) <b>C07C 59/64</b> (2006.01) <b>A61K 31/44</b> (2006.01)	2590929 *	ARYLOXY-ALKYLENE SUBSTITUTED HYDROXYPHENYL HEXANOIC ACIDS, METHODS FOR THE PRODUCTION THEREOF AND USE OF THE SAME AS MEDICAMENT
PerkinElmer Health Sciences, Inc.	<b>G01N 35/00</b> (2006.01) <b>G02B 7/00</b> (2006.01) <b>B01L 9/00</b> (2006.01) <b>G01N 21/00</b> (2006.01)	2539717 *	MICROPLATE MOUNT SYSTEM AND SENSING METHODS
Corning Incorporated	<b>G01N 35/00</b> (2006.01) <b>G02B 7/00</b> (2006.01) <b>B01L 9/00</b> (2006.01) <b>G01N 21/00</b> (2006.01)	2539717 *	MICROPLATE MOUNT SYSTEM AND SENSING METHODS
Immersion Corporation	<b>G06F 3/01</b> (2006.01)	2548099 *	SYSTEMS AND METHODS FOR HAPTIC INFORMATION PREVIEW
Eonsudenergia S.r.l.	<b>B01J 37/00</b> (2006.01) <b>B01J 27/057</b> (2006.01) <b>C01B 19/00</b> (2006.01) <b>B01J 23/18</b> (2006.01) <b>F23G 5/027</b> (2006.01) <b>B01J 37/02</b> (2006.01)	2484440	A catalyst for waste thermolysis
Xiamen University	<b>C07K 14/025</b> (2006.01) <b>A61P 31/20</b> (2006.01) <b>C12N 1/21</b> (2006.01) <b>C12N 15/70</b> (2006.01) <b>A61K 39/12</b> (2006.01)	2589604 *	TRUNCATED L1 PROTEIN OF HUMAN PAPILLOMAVIRUS TYPE 52
Xiamen Innovax Biotech Co., Ltd.	<b>C07K 14/025</b> (2006.01) <b>A61P 31/20</b> (2006.01) <b>C12N 1/21</b> (2006.01) <b>C12N 15/70</b> (2006.01) <b>A61K 39/12</b> (2006.01)	2589604 *	TRUNCATED L1 PROTEIN OF HUMAN PAPILLOMAVIRUS TYPE 52
Bioréalités	<b>C07K 16/26</b> (2006.01) <b>C07K 16/46</b> (2006.01) <b>G01N 33/53</b> (2006.01) <b>A61K 39/395</b> (2006.01) <b>C12N 5/12</b> (2006.01) <b>A61P 35/00</b> (2006.01) <b>C12N 15/13</b> (2006.01)	2550294 *	PROPHYLAXIS OF COLORECTAL AND GASTROINTESTINAL CANCER
Institut National de la Santé et de la Recherche Médicale - Inserm	<b>C07K 16/26</b> (2006.01) <b>C07K 16/46</b> (2006.01) <b>G01N 33/53</b> (2006.01) <b>A61K 39/395</b> (2006.01) <b>C12N 5/12</b> (2006.01) <b>A61P 35/00</b> (2006.01) <b>C12N 15/13</b> (2006.01)	2550294 *	PROPHYLAXIS OF COLORECTAL AND GASTROINTESTINAL CANCER

Podnosilac evropske prijave patenta (71)	MKP (51)	Broj objave evropske prijave patenta (97)	Naziv pronalaska (54)
Centre National de la Recherche Scientifique CNRS	<b>C07K 16/26</b> (2006.01) <b>C07K 16/46</b> (2006.01) <b>G01N 33/53</b> (2006.01) <b>A61K 39/395</b> (2006.01) <b>C12N 5/12</b> (2006.01) <b>A61P 35/00</b> (2006.01) <b>C12N 15/13</b> (2006.01)	2550294 *	PROPHYLAXIS OF COLORECTAL AND GASTROINTESTINAL CANCER
Sanofi-Aventis Deutschland GmbH	<b>A61M 5/32</b> (2006.01) <b>A61M 5/28</b> (2006.01) <b>A61M 5/24</b> (2006.01)	2550044 *	MEDICATED MODULE WITH AUTOMATIC RESERVOIR ENGAGEMENT
Pharma Mar S.A.	<b>C07D 515/22</b> (2006.01)	2576569 *	SYNTHETIC PROCESS FOR THE MANUFACTURE OF ECTEINASCIDIN COMPOUNDS
Krka Tovarna Zdravil, D.D., Novo Mesto	<b>A61K 9/20</b> (2006.01) <b>A61K 31/4184</b> (2006.01)	2582361 *	MULTILAYER PHARMACEUTICAL TABLET COMPRISING TELMISARTAN AND A DIURETIC
Zealand Pharma A/S	<b>C07K 14/605</b> (2006.01)	2585481 *	GLUCAGON ANALOGUES
Bayer Pharma Aktiengesellschaft	<b>A61P 35/00</b> (2006.01) <b>C07D 413/14</b> (2006.01) <b>A61K 31/4245</b> (2006.01)	2569312 *	SUBSTITUTED HETEROCYCLYL BENZYL PYRAZOLES, AND USE THEREOF
MacroGenics, Inc.	<b>A61K 39/00</b> (2006.01) <b>C07K 16/00</b> (2006.01)	2542256 *	ANTIBODIES REACTIVE WITH B7-H3, IMMUNOLOGICALLY ACTIVE FRAGMENTS THEREOF AND USES THEREOF
Galderma S.A.	<b>A61Q 17/04</b> (2006.01) <b>A61K 8/27</b> (2006.01) <b>A61K 8/67</b> (2006.01) <b>A61K 8/34</b> (2006.01) <b>A61K 8/68</b> (2006.01) <b>A61K 8/40</b> (2006.01) <b>A61K 8/365</b> (2006.01) <b>A61K 8/37</b> (2006.01) <b>A61K 8/42</b> (2006.01) <b>A61Q 19/00</b> (2006.01)	2588068 *	MOISTURIZING COMPOSITION WITH SPF 30
Bayer Intellectual Property GmbH	<b>A61K 31/519</b> (2006.01) <b>C07D 487/04</b> (2006.01) <b>A61P 35/00</b> (2006.01)	2593458 *	BICYCLIC PYRIMIDINES
Abbvie Inc.	<b>B01J 31/24</b> (2006.01)	2593226 *	PHOSPHINE LIGANDS FOR CATALYTIC REACTIONS
Delphi Technologies Holding S.à.r.l.	<b>F16C 37/00</b> (2006.01) <b>F16C 17/02</b> (2006.01) <b>F16C 33/20</b> (2006.01)	2463536	Bearing Assembly
Joseph Company International, Inc.	<b>F25D 3/08</b> (2006.01)	2572148 *	KEG APPARATUS FOR SELF COOLING AND SELF DISPENSING LIQUIDS
Biomax Holdings Pte Ltd	<b>C05F 1/00</b> (2006.01) <b>C05F 11/00</b> (2006.01) <b>C05F 9/00</b> (2006.01) <b>C05F 5/00</b> (2006.01) <b>C05F 7/00</b> (2006.01) <b>B09B 3/00</b> (2006.01) <b>C05F 3/00</b> (2006.01)	2550244 *	TREATMENT OF ORGANIC WASTE
Genentech, Inc.	<b>A61K 39/395</b> (2006.01) <b>C07K 16/18</b> (2006.01)	2558496 *	ANTI-POLYUBIQUITIN ANTIBODIES AND METHODS OF USE
Ardea Biosciences, Inc.	<b>C07C 323/62</b> (2006.01) <b>C07D 213/24</b> (2006.01) <b>A61K 31/192</b> (2006.01) <b>A61K 31/44</b> (2006.01) <b>A61P 19/06</b> (2006.01)	2582664 *	PHENYLTHIOACETATE COMPOUNDS, COMPOSITIONS AND METHODS OF USE
Ice-World Holding B.V.	<b>B05B 17/08</b> (2006.01)	2588252 *	PLAYGROUND COMPRISING FOUNTAINS
Moehs Ibérica, S.L.	<b>C07D 205/08</b> (2006.01) <b>C07D 263/38</b> (2006.01)	2590940 *	NEW METHOD FOR PREPARING EZETIMIBE
SAPPI Netherlands Services B.V.	<b>D01D 1/06</b> (2006.01) <b>D01D 5/12</b> (2006.01) <b>D01F 2/00</b> (2006.01)	2558624 *	PROCESS FOR THE MANUFACTURE OF CELLULOSE-BASED FIBRES AND THE FIBRES THUS OBTAINED

Podnosilac evropske prijave patenta (71)	MKP (51)	Broj objave evropske prijave patenta (97)	Naziv pronalaska (54)
Nabriva Therapeutics AG	<b>C07C 323/52</b> (2006.01) <b>A61K 31/215</b> (2006.01) <b>A61P 31/00</b> (2006.01) <b>A61P 17/00</b> (2006.01)	2576505 *	PROCESS FOR THE PREPARATION OF PLEUROMUTILINS
Venmar, Ces Inc.	<b>F28D 9/00</b> (2006.01) <b>F24F 3/147</b> (2006.01) <b>F28D 15/00</b> (2006.01) <b>F24F 12/00</b> (2006.01) <b>F28F 3/12</b> (2006.01)	2585784 *	LIQUID-TO-AIR MEMBRANE ENERGY EXCHANGER
University of Saskatchewan	<b>F28D 9/00</b> (2006.01) <b>F24F 3/147</b> (2006.01) <b>F28D 15/00</b> (2006.01) <b>F24F 12/00</b> (2006.01) <b>F28F 3/12</b> (2006.01)	2585784 *	LIQUID-TO-AIR MEMBRANE ENERGY EXCHANGER
Zealand Pharma A/S	<b>A61K 38/22</b> (2006.01) <b>C07K 14/595</b> (2006.01) <b>C07K 19/00</b> (2006.01) <b>C07K 14/575</b> (2006.01)	2563808 *	PEPTIDE CONJUGATES OF GLP-1 RECEPTOR AGONISTS AND GASTRIN AND THEIR USE
Uni-charm Corporation	<b>B65D 81/20</b> (2006.01) <b>B65D 75/32</b> (2006.01) <b>B65D 30/20</b> (2006.01)	2573003 *	CONTAINER
Delphi Technologies Holding S.à.r.l.	<b>F02M 59/46</b> (2006.01) <b>F02M 59/20</b> (2006.01) <b>F02M 59/26</b> (2006.01) <b>F02M 59/34</b> (2006.01)	2492492	Pumping head
Regeneron Pharmaceuticals, Inc.	<b>A61P 3/00</b> (2006.01) <b>C07K 16/22</b> (2006.01) <b>A61P 21/00</b> (2006.01) <b>A61K 39/395</b> (2006.01)	2576618 *	ANTIBODIES TO HUMAN GDF8
Janssen Pharmaceutica, N.V.	<b>A01N 65/06</b> (2009.01) <b>A01N 43/54</b> (2006.01) <b>A01P 3/00</b> (2006.01) <b>A01N 65/10</b> (2009.01) <b>A01N 65/22</b> (2009.01) <b>B27K 3/34</b> (2006.01) <b>B27K 3/50</b> (2006.01) <b>A01N 35/06</b> (2006.01) <b>A01N 31/08</b> (2006.01)	2579718 *	COMBINATIONS OF PYRIMETHANIL AND MONOTERPENES
Biofilm IP, LLC	<b>F16L 55/103</b> (2006.01) <b>G05D 23/19</b> (2006.01)	2583014 *	METHODS, DEVICES AND SYSTEMS FOR EXTRACTION OF THERMAL ENERGY FROM A HEAT CONDUCTING METAL CONDUIT
Questcor Pharmaceuticals, Inc.	<b>A61K 38/22</b> (2006.01) <b>A61P 21/00</b> (2006.01) <b>A61K 38/16</b> (2006.01) <b>A61P 21/02</b> (2006.01)	2568999 *	ACTH FOR TREATMENT OF AMYOTROPHIC LATERAL SCLEROSIS
Dana-Farber Cancer Institute, Inc.	<b>C07D 471/00</b> (2006.01)	2571875 *	MALE CONTRACEPTIVE COMPOSITIONS AND METHODS OF USE
Baylor College Of Medicine	<b>C07D 471/00</b> (2006.01)	2571875 *	MALE CONTRACEPTIVE COMPOSITIONS AND METHODS OF USE
Molteni & C. S.p.A.	<b>A47C 7/54</b> (2006.01) <b>A47C 17/12</b> (2006.01)	2510838	Sofa with moveable armrests
Asahi Kasei Chemicals Corporation	<b>C08L 15/00</b> (2006.01) <b>C08C 19/25</b> (2006.01) <b>C08K 3/36</b> (2006.01)	2559709 *	PROCESS FOR PRODUCING MODIFIED CONJUGATED DIENE POLYMER, MODIFIED CONJUGATED DIENE POLYMER, AND COMPOSITION OF MODIFIED CONJUGATED DIENE POLYMER
Swedish Match North Europe AB	<b>B65G 51/03</b> (2006.01) <b>B65B 5/06</b> (2006.01) <b>B65B 35/28</b> (2006.01) <b>B65B 35/40</b> (2006.01) <b>B65B 29/02</b> (2006.01)	2457833	Device for positioning of portion packets

Podnosilac evropske prijave patenta (71)	MKP (51)	Broj objave evropske prijave patenta (97)	Naziv pronalaska (54)
Bayer CropScience NV	<b>C12N 15/82</b> (2006.01)	2580335 *	METHODS AND MEANS TO MODIFY A PLANT GENOME AT A NUCLEOTIDE SEQUENCE COMMONLY USED IN PLANT GENOME ENGINEERING
Britannia Pharmaceuticals Limited	<b>A61M 5/14</b> (2006.01) <b>A61M 5/142</b> (2006.01)	2579916 *	APPARATUS AND CASE FOR INFUSION EQUIPMENT
Sanofi-Aventis Deutschland GmbH	<b>A61M 5/24</b> (2006.01) <b>A61M 5/315</b> (2006.01)	2579920 *	ASSEMBLY FOR A DRUG DELIVERY DEVICE AND DRUG DELIVERY DEVICE
Bioréalités	<b>C07K 16/26</b> (2006.01)	2542585 *	METHODS FOR TREATING COLORECTAL CANCER
INSERM - Institut National de la Santé et de la Recherche Médicale	<b>C07K 16/26</b> (2006.01)	2542585 *	METHODS FOR TREATING COLORECTAL CANCER
Centre National de la Recherche Scientifique CNRS	<b>C07K 16/26</b> (2006.01)	2542585 *	METHODS FOR TREATING COLORECTAL CANCER
Incyte Corporation	<b>C07D 471/04</b> (2006.01) <b>A61P 17/00</b> (2006.01) <b>A61P 3/00</b> (2006.01) <b>A61K 31/407</b> (2006.01) <b>A61P 29/00</b> (2006.01)	2558463 *	FUSED DERIVATIVES AS I3 INHIBITORS
Sun, Yuan	<b>A61K 9/16</b> (2006.01) <b>A61K 31/4365</b> (2006.01) <b>A61P 7/02</b> (2006.01) <b>A61K 47/26</b> (2006.01) <b>A61K 9/20</b> (2006.01) <b>A61K 47/20</b> (2006.01) <b>A61K 47/40</b> (2006.01) <b>A61K 9/48</b> (2006.01) <b>A61K 47/30</b> (2006.01)	2564847 *	PHARMACEUTICAL COMPOSITION FOR IMPROVING SOLUBILITY OF PRASUGREL AND ITS PREPARATION METHOD
E-Blink	<b>H04W 88/08</b> (2009.01)	2540136 *	METHOD AND DEVICE FOR SENDING/RECEIVING ELECTROMAGNETIC SIGNALS RECEIVED/SENT ON ONE OR MORE FIRST FREQUENCY BANDS
Les Laboratoires Servier	<b>A61P 5/00</b> (2006.01) <b>A61P 25/24</b> (2006.01) <b>A61K 31/165</b> (2006.01) <b>A61P 25/00</b> (2006.01) <b>A61P 25/22</b> (2006.01) <b>C07C 231/12</b> (2006.01) <b>C07C 233/18</b> (2006.01)	2547650 *	AGOMELATINE HYDROBROMIDE HYDRATE AND PREPARATION THEREOF
Mallet, Benoît	<b>B26D 1/10</b> (2006.01) <b>B26B 5/00</b> (2006.01)	2560798 *	BLADE FOR CUTTING A PIECE OF PLASTERBOARD, METHOD FOR IMPLEMENTING SAID BLADE, AND USE THEREOF
Abraxis BioScience, LLC	<b>A61P 35/00</b> (2006.01) <b>A61K 38/17</b> (2006.01)	2544704 *	SPARC ANGIOGENIC DOMAIN AND METHODS OF USE
Bioréalités	<b>C07K 16/26</b> (2006.01) <b>A61P 35/00</b> (2006.01) <b>A61K 39/395</b> (2006.01)	2542584 *	METHODS FOR TREATING PANCREATIC CANCER
INSTITUT NATIONAL DE LA SANTE ET DE LA RECHERCHE MEDICALE (INSERM)	<b>C07K 16/26</b> (2006.01) <b>A61P 35/00</b> (2006.01) <b>A61K 39/395</b> (2006.01)	2542584 *	METHODS FOR TREATING PANCREATIC CANCER
Centre National de la Recherche Scientifique (CNRS)	<b>C07K 16/26</b> (2006.01) <b>A61P 35/00</b> (2006.01) <b>A61K 39/395</b> (2006.01)	2542584 *	METHODS FOR TREATING PANCREATIC CANCER
Sanofi-Aventis Deutschland GmbH	<b>A61M 5/20</b> (2006.01) <b>A61M 5/24</b> (2006.01)	2544738 *	INJECTION DEVICE
Eisenberger, Peter	<b>B01D 53/00</b> (2006.01)	2563495 *	SYSTEM AND METHOD FOR CARBON DIOXIDE CAPTURE AND SEQUESTRATION
Pharmaplast SAE	<b>A61F 13/00</b> (2006.01)	2552371 *	A WOUND CARE DRESSING, A METHOD AND A PRODUCTION LINE FOR MANUFACTURING THE WOUND CARE DRESSING

Podnosilac evropske prijave patenta (71)	MKP (51)	Broj objave evropske prijave patenta (97)	Naziv pronalaska (54)
Boehringer Ingelheim International GmbH	<b>A61P 27/00</b> (2006.01) <b>A61K 39/395</b> (2006.01) <b>A61P 37/00</b> (2006.01) <b>C07K 16/28</b> (2006.01) <b>C12N 15/13</b> (2006.01)	2552965 *	ANTI-CD40 ANTIBODIES
ImClone LLC	<b>A61K 39/395</b> (2006.01) <b>C07K 16/32</b> (2006.01) <b>A61P 35/00</b> (2006.01) <b>C07K 16/28</b> (2006.01) <b>A61P 35/02</b> (2006.01)	2552966 *	ANTIBODIES AGAINST CSF-1R
DT- Vyhybkárna A Strojirna, A.S.	<b>B61L 5/04</b> (2006.01) <b>B61L 5/10</b> (2006.01)	2558345 *	ACTIVE MEMBER OF THE HYDRAULIC LOCKING DEVICE EQUIPPED WITH MECHANIC LOCKING AND RETENTION
Janssen Alzheimer Immunotherapy	<b>A61K 39/00</b> (2006.01) <b>C07K 16/00</b> (2006.01)	2560681 *	USE OF TAU TO MONITOR IMMUNOTHERAPY
Wyeth LLC	<b>A61K 39/00</b> (2006.01) <b>C07K 16/00</b> (2006.01)	2560681 *	USE OF TAU TO MONITOR IMMUNOTHERAPY
Bayer Intellectual Property GmbH	<b>A61K 31/519</b> (2006.01) <b>A61K 31/522</b> (2006.01) <b>A61P 9/00</b> (2006.01) <b>C07D 487/04</b> (2006.01)	2590979 *	RING-FUSED PYRIMIDINES AND TRIAZINES AND USE THEREOF FOR THE TREATMENT AND/OR PROPHYLAXIS OF CARDIOVASCULAR DISEASES
Turzi, Antoine	<b>A61K 38/48</b> (2006.01) <b>A61K 35/14</b> (2006.01) <b>A61K 35/16</b> (2006.01)	2544697 *	PROCESS, TUBE AND DEVICE FOR THE PREPARATION OF WOUND HEALANT COMPOSITION
Kyoto University	<b>G01N 33/15</b> (2006.01) <b>C12N 15/09</b> (2006.01) <b>C12Q 1/68</b> (2006.01)	2576778 *	TRANSGENIC REPORTER SYSTEM THAT REVEALS EXPRESSION PROFILES AND REGULATION MECHANISMS OF ALTERNATIVE SPLICING IN MAMMALIAN ORGANISMS
Aventis Pharma S.A.	<b>A61K 31/727</b> (2006.01) <b>A61P 7/02</b> (2006.01)	2585080 *	SEMULOPARIN FOR USE AS AN ANTITHROMBOTIC TREATMENT IN HIP REPLACEMENT SURGERY WITH IMPROVED SAFETY IN TERMS OF CLINICALLY RELEVANT BLEEDINGS
Ducept Medical GmbH	<b>A61N 1/36</b> (2006.01) <b>A61N 1/04</b> (2006.01) <b>A61N 1/05</b> (2006.01) <b>A61H 39/00</b> (2006.01)	2588185 *	ELECTRICAL STIMULATION DEVICE
AstraZeneca AB	<b>A61P 25/24</b> (2006.01) <b>C07D 413/06</b> (2006.01) <b>A61K 31/4245</b> (2006.01) <b>C07D 413/14</b> (2006.01) <b>A61K 31/4523</b> (2006.01)	2590969 *	THERAPEUTIC AGENTS 976
X-Body, Inc.	<b>C40B 30/06</b> (2006.01)	2553151 *	USE OF INDUCED PLURIPOTENT CELLS AND OTHER CELLS FOR SCREENING COMPOUND LIBRARIES
Theracos, Inc.	<b>C07H 7/04</b> (2006.01) <b>A61K 31/70</b> (2006.01) <b>A61P 3/00</b> (2006.01)	2580225 *	CRYSTALLINE FORM OF BENZYL BENZENE SGLT2 INHIBITOR
Xenon Pharmaceuticals Inc.	<b>A61K 9/06</b> (2006.01) <b>A61K 9/00</b> (2006.01) <b>A61P 29/00</b> (2006.01) <b>A61P 25/00</b> (2006.01) <b>A61K 31/407</b> (2006.01) <b>A61P 25/02</b> (2006.01) <b>A61P 25/06</b> (2006.01)	2538919 *	PHARMACEUTICAL COMPOSITIONS OF SPIRO-OXINDOLE COMPOUND FOR TOPICAL ADMINISTRATION AND THEIR USE AS THERAPEUTIC AGENTS
Erum Biotechnologies Inc.	<b>A01N 3/00</b> (2006.01) <b>A01N 27/00</b> (2006.01) <b>A01N 25/02</b> (2006.01) <b>A01N 55/00</b> (2006.01)	2561754 *	CYCLOPROPENE COMPOUND, AND METHOD FOR ADDING SAME TO CROPS
Johnson & Johnson Consumer Companies, Inc.	<b>A61K 8/41</b> (2006.01)	2566442 *	COMPOSITIONS COMPRISING EXTRACTS OF SOUTHERNWOOD AND AN AMINE COMPOUND

Podnosilac evropske prijave patenta (71)	MKP (51)	Broj objave evropske prijave patenta (97)	Naziv pronalaska (54)
Omya Development AG	<b>C09C 1/02</b> (2006.01) <b>D21H 17/00</b> (2006.01)	2565237	Process for preparing self-binding pigment particle suspensions
Abbvie Inc.	<b>C07D 471/04</b> (2006.01) <b>A61K 31/437</b> (2006.01) <b>A61K 35/00</b> (2006.01)	2576546 *	APOPTOSIS-INDUCING AGENTS FOR THE TREATMENT OF CANCER AND IMMUNE AND AUTOIMMUNE DISEASES
Avicenna Research Institute	<b>C07K 16/30</b> (2006.01) <b>A61K 39/395</b> (2006.01) <b>A61P 35/00</b> (2006.01) <b>G01N 33/68</b> (2006.01) <b>G01N 33/574</b> (2006.01)	2556379 *	NEW DIAGNOSTIC AND THERAPEUTIC TARGET
SICIT 2000 S.P.A.	<b>C08L 89/06</b> (2006.01) <b>C08L 89/04</b> (2006.01) <b>C08H 1/06</b> (2006.01)	2500371	Biocomposite fertiliser materials
Brucart Bonich, Marta	<b>C12H 1/16</b> (2006.01) <b>A23L 3/10</b> (2006.01)	2592135 *	METHOD FOR CONSERVING BOTTLED WINE IN AN OPEN BOTTLE AND DEVICE FOR IMPLEMENTING SAME
Fraunhofer-Gesellschaft zur Förderung der angewandten Forschung e.V.	<b>A61K 35/28</b> (2006.01) <b>C07K 16/28</b> (2006.01) <b>A61P 37/06</b> (2006.01) <b>C12N 5/00</b> (2006.01)	2471543	Tolerance induction or immunosuppression to prevent in particular Graft-versus-Host-Disease (GvHD) by short-term pre-incubation of transplanted cell suspensions, tissues or organs coated with ligands to cell surface molecules
Universität Leipzig	<b>A61K 35/28</b> (2006.01) <b>C07K 16/28</b> (2006.01) <b>A61P 37/06</b> (2006.01) <b>C12N 5/00</b> (2006.01)	2471543	Tolerance induction or immunosuppression to prevent in particular Graft-versus-Host-Disease (GvHD) by short-term pre-incubation of transplanted cell suspensions, tissues or organs coated with ligands to cell surface molecules
AH USA 42 LLC	<b>A61K 39/205</b> (2006.01) <b>C07K 14/145</b> (2006.01) <b>C12N 15/863</b> (2006.01)	2571521 *	PARAPOXVIRUS VECTORS CONTAINING RABIES VIRUS ANTIGEN
3 S Sistemi S.R.L.	<b>B61L 29/30</b> (2006.01) <b>B61L 23/04</b> (2006.01)	2576317 *	A SAFETY DEVICE FOR THE SURVEILLANCE ALONG A RAILWAY ROUTE OF THE CROSSING AREAS FOR PEDESTRIANS AND VEHICLES IN CORRESPONDENCE OF LEVEL CROSSINGS OR RISK ZONES
SANOFI	<b>A61K 31/155</b> (2006.01) <b>A61K 38/18</b> (2006.01) <b>A61P 3/10</b> (2006.01) <b>A61K 38/26</b> (2006.01)	2548570	Pharmaceutical composition for treating a metabolic syndrome
Amgen Inc.	<b>A61K 31/4709</b> (2006.01) <b>A61P 29/00</b> (2006.01) <b>C07D 487/04</b> (2006.01) <b>A61P 35/00</b> (2006.01) <b>C07D 401/12</b> (2006.01)	2588469 *	HETEROCYCLIC COMPOUNDS AND THEIR USE AS INHIBITORS OF PI3K ACTIVITY
Regeneron Pharmaceuticals, Inc.	<b>G01N 33/567</b> (2006.01)	2527842	Neuropeptide release assay for sodium channels
Bayer Intellectual Property GmbH	<b>A61K 31/165</b> (2006.01) <b>A61K 31/216</b> (2006.01) <b>A61K 31/145</b> (2006.01) <b>C07C 323/25</b> (2006.01) <b>A61P 5/30</b> (2006.01) <b>A61K 31/18</b> (2006.01) <b>C07C 317/28</b> (2006.01) <b>A61K 31/277</b> (2006.01)	2585435 *	6,7-DIHYDRO-5H-BENZO[7]ANNULENE DERIVATIVES, PROCESS FOR PREPARATION THEREOF, PHARMACEUTICAL PREPARATIONS COMPRISING THEM, AND THE USE THEREOF FOR PRODUCTION OF MEDICAMENTS
The Johns Hopkins University	<b>A61K 31/513</b> (2006.01) <b>A61P 35/00</b> (2006.01) <b>A61K 31/56</b> (2006.01) <b>A61K 31/505</b> (2006.01) <b>A61P 29/00</b> (2006.01) <b>A61K 31/7042</b> (2006.01) <b>A61K 31/337</b> (2006.01)	2593098 *	METHODS AND COMPOSITIONS FOR CANCER IMMUNOTHERAPY

Podnosilac evropske prijave patenta (71)	MKP (51)	Broj objave evropske prijave patenta (97)	Naziv pronalaska (54)
Yale University	<b>A61K 31/513</b> (2006.01) <b>A61P 35/00</b> (2006.01) <b>A61K 31/56</b> (2006.01) <b>A61K 31/505</b> (2006.01) <b>A61P 29/00</b> (2006.01) <b>A61K 31/7042</b> (2006.01) <b>A61K 31/337</b> (2006.01)	2593098 *	METHODS AND COMPOSITIONS FOR CANCER IMMUNOTHERAPY
Janssen Pharmaceutica, N.V.	<b>A61P 25/28</b> (2006.01) <b>C07D 265/30</b> (2006.01) <b>C07D 413/04</b> (2006.01) <b>A61P 25/16</b> (2006.01) <b>A61K 31/535</b> (2006.01) <b>A61K 31/5355</b> (2006.01)	2580200 *	5,6-DIHYDRO-2H-[1,4]OXAZIN-3-YL-AMINE DERIVATIVES USEFUL AS INHIBITORS OF BETA-SECRETASE (BACE)
Bayer Pharma Aktiengesellschaft	<b>A61K 31/00</b> (2006.01) <b>A61P 15/18</b> (2006.01) <b>A61K 45/06</b> (2006.01) <b>A61K 31/4196</b> (2006.01) <b>A61K 9/00</b> (2006.01) <b>A61K 31/569</b> (2006.01) <b>A61P 15/00</b> (2006.01)	2552404 *	PARENTERAL PHARMACEUTICAL FORM WHICH RELEASES AROMATSE INHIBITOR AND GESTAGENS, FOR THE TREATMENT OF ENDOMETRIOSIS
R&D Ltd.	<b>A61K 36/88</b> (2006.01)	2462941	Method and instalation for extraction of plant raw material
Ricon Corp.	<b>E06B 3/00</b> (2006.01)	2539527 *	BONDED-IN, ANTI-VANDALISM TRANSIT VEHICLE WINDOW SYSTEM
Mochida Pharmaceutical Co., Ltd.	<b>A61K 47/26</b> (2006.01) <b>A61K 47/36</b> (2006.01) <b>A61K 47/10</b> (2006.01) <b>A61K 47/38</b> (2006.01) <b>A61K 47/02</b> (2006.01) <b>A61K 47/32</b> (2006.01) <b>A61K 9/30</b> (2006.01)	2561892 *	EASILY DOSABLE SOLID PREPARATION
Arena Pharmaceuticals, Inc.	<b>C07D 487/04</b> (2006.01) <b>A61P 37/00</b> (2006.01) <b>A61P 31/12</b> (2006.01) <b>A61K 31/407</b> (2006.01)	2542554 *	PROCESSES FOR THE PREPARATION OF S1P1 RECEPTOR MODULATORS AND CRYSTALLINE FORMS THEREOF
Joseph Company International, Inc.	<b>F25D 3/00</b> (2006.01)	2561290 *	HEAT EXCHANGE UNIT FOR SELF-COOLING CONTAINERS
Swedish Match North Europe AB	<b>B65B 35/40</b> (2006.01) <b>B65B 5/06</b> (2006.01) <b>B65B 35/28</b> (2006.01) <b>B65B 29/02</b> (2006.01)	2457834	Device for positioning of portion packets
Bayer HealthCare LLC	<b>A61K 39/395</b> (2006.01) <b>A61K 39/00</b> (2006.01)	2542257 *	OPTIMIZED MONOCLONAL ANTIBODIES AGAINST TISSUE FACTOR PATHWAY INHIBITOR (TFPI)
Syngenta Participations AG	<b>C07D 307/32</b> (2006.01) <b>A01N 43/08</b> (2006.01) <b>C07D 405/10</b> (2006.01) <b>C07D 307/20</b> (2006.01) <b>C07D 409/12</b> (2006.01) <b>C07D 307/30</b> (2006.01) <b>C07D 413/12</b> (2006.01) <b>C07D 405/04</b> (2006.01) <b>C07D 407/12</b> (2006.01) <b>C07D 307/28</b> (2006.01) <b>C07D 409/14</b> (2006.01) <b>C07D 307/58</b> (2006.01)	2539330 *	DIHYDROFURAN DERIVATIVES AS INSECTICIDAL COMPOUNDS
Japan Tobacco, Inc.	<b>C07D 471/04</b> (2006.01) <b>A61P 43/00</b> (2006.01) <b>A61K 31/4985</b> (2006.01) <b>A61P 31/18</b> (2006.01) <b>A61K 31/5377</b> (2006.01)	2540720 *	1,3,4,8-TETRAHYDRO-2H-PYRIDO[1,2-A]PYRAZINE DERIVATIVE AND USE OF SAME AS HIV INTEGRASE INHIBITOR

Podnosilac evropske prijave patenta (71)	MKP (51)	Broj objave evropske prijave patenta (97)	Naziv pronalaska (54)
Les Laboratoires Servier	<b>A61P 25/22</b> (2006.01) <b>C07C 231/06</b> (2006.01) <b>C07C 231/12</b> (2006.01) <b>C07C 233/18</b> (2006.01) <b>A61P 25/24</b> (2006.01) <b>A61P 25/20</b> (2006.01) <b>A61P 25/06</b> (2006.01) <b>A61K 31/165</b> (2006.01)	2580189 *	AGOMELATINE INTERMEDIATES AND PREPARATION METHOD THEREOF
Chiesi Farmaceutici S.p.A.	<b>A61K 9/00</b> (2006.01) <b>A61K 9/50</b> (2006.01)	2552424 *	PROCESS FOR PREPARING CARRIER PARTICLES FOR DRY POWDERS FOR INHALATION
Zylum Beteiligungsgesellschaft mbH & Co. Patente II KG	<b>G01F 1/58</b> (2006.01) <b>G01F 1/60</b> (2006.01)	2564169 *	MEASURING DEVICE AND METHOD FOR MEASURING THE FLOW RATE OF A MEDIUM FLOWING THROUGH A MEASURING TUBE
v. Görtz & Finger Techn. Entwicklungs GmbH	<b>F02B 25/04</b> (2006.01) <b>F02B 47/02</b> (2006.01) <b>F02B 75/04</b> (2006.01) <b>F02B 33/22</b> (2006.01) <b>F02B 41/04</b> (2006.01)	2557294	Combustion Engine
Omya Development AG	<b>C09C 1/02</b> (2006.01) <b>D21H 19/00</b> (2006.01) <b>C09C 3/04</b> (2006.01) <b>D21H 17/00</b> (2006.01) <b>C09C 1/42</b> (2006.01)	2576704 *	PROCESS FOR MANUFACTURING HIGH SOLIDS SUSPENSIONS OF MINERAL MATERIALS
Purdue Pharma L.P.	<b>C07D 209/16</b> (2006.01) <b>C07D 231/56</b> (2006.01) <b>C07D 209/12</b> (2006.01) <b>C07D 471/04</b> (2006.01) <b>A61K 31/404</b> (2006.01) <b>A61K 31/416</b> (2006.01) <b>A61P 25/00</b> (2006.01)	2582666 *	ARYL SUBSTITUTED INDOLES AND THEIR USE AS BLOCKERS OF SODIUM CHANNELS
Perzi Kunststoff Ges.m.b.H.	<b>B60R 7/00</b> (2006.01)	2527201	Method for making a strong fixture of a textile sheet
Fischer, Hans-Peter	<b>F24J 2/54</b> (2006.01)	2577185 *	MOUNTING RACK FOR A PHOTOVOLTAIC MODULE AND TRACKING DEVICE FOR A PHOTOVOLTAIC INSTALLATION
Atialis	<b>G08B 25/01</b> (2006.01) <b>G08B 25/08</b> (2006.01) <b>A62C 37/50</b> (2006.01) <b>A61F 17/00</b> (2006.01) <b>G06F 19/00</b> (2011.01) <b>A61B 19/02</b> (2006.01) <b>G08B 21/02</b> (2006.01) <b>A61N 1/39</b> (2006.01)	2552542 *	DEVICE FOR ACCESS TO AN ITEM OF ASSISTANCE AND EMERGENCY HARDWARE, AND A SYSTEM IMPLEMENTING SUCH DEVICES.
Medivir UK Ltd	<b>C07C 237/14</b> (2006.01) <b>A61K 31/16</b> (2006.01) <b>A61P 11/00</b> (2006.01) <b>A61P 37/00</b> (2006.01) <b>C07D 233/58</b> (2006.01)	2582660 *	NEW CATHEPSIN S PROTEASE INHIBITORS, USEFUL IN THE TREATMENT OF E.G. AUTOIMMUNE DISORDERS, ALLERGY AND CHRONIC PAIN CONDITIONS
Deva Holding Anonim Sirketi	<b>A61K 9/50</b> (2006.01) <b>A61K 9/14</b> (2006.01) <b>A61K 31/4402</b> (2006.01) <b>A61K 31/495</b> (2006.01) <b>A61K 9/20</b> (2006.01) <b>A61P 27/16</b> (2006.01) <b>A61K 9/48</b> (2006.01) <b>A61K 9/00</b> (2006.01)	2491930	Pharmaceutical combination of betahistine and trimetazidine
Curetis AG	<b>G01N 33/543</b> (2006.01) <b>B01L 3/00</b> (2006.01) <b>B01L 7/00</b> (2006.01) <b>C12Q 1/68</b> (2006.01)	2571617 *	REACTION VESSEL FOR PCR DEVICE AND METHOD OF PERFORMING PCR
OMV Machinery S.r.l.	<b>B29C 51/44</b> (2006.01) <b>B29C 51/22</b> (2006.01)	2586589	Thermoforming press and thermoforming process using said press
Fresenius Medical Care Deutschland GmbH	<b>A61L 2/20</b> (2006.01)	2590687 *	USE OF A STERILIZATION AGENT FOR ENHANCING HEMOCOMPATIBILITY



Podnosilac evropske prijave patenta (71)	MKP (51)	Broj objave evropske prijave patenta (97)	Naziv pronalaska (54)
Skagerak Engineering AS	<b>B63B 35/04</b> (2006.01) <b>B65H 75/36</b> (2006.01)	2591992	A storage and deployment unit for a coilable element and a method of handling a coilable element
Asahi Kasei Chemicals Corporation	<b>C08G 64/06</b> (2006.01) <b>B29C 49/00</b> (2006.01) <b>B65D 1/00</b> (2006.01)	2592102 *	BRANCHED POLYCARBONATE
Müller, Stefan	<b>F25D 3/10</b> (2006.01) <b>A61B 18/02</b> (2006.01) <b>A61M 19/00</b> (2006.01)	2558013 *	HAND-OPERATED COOLING DEVICE FOR CRYOTHERAPY
Ortlib, Steffen	<b>F25D 3/10</b> (2006.01) <b>A61B 18/02</b> (2006.01) <b>A61M 19/00</b> (2006.01)	2558013 *	HAND-OPERATED COOLING DEVICE FOR CRYOTHERAPY
Dreher, Ingo	<b>F25D 3/10</b> (2006.01) <b>A61B 18/02</b> (2006.01) <b>A61M 19/00</b> (2006.01)	2558013 *	HAND-OPERATED COOLING DEVICE FOR CRYOTHERAPY
Amgen Inc.	<b>A61K 31/4706</b> (2006.01) <b>A61P 31/18</b> (2006.01) <b>C07D 417/14</b> (2006.01)	2588477 *	QUINOLINES AS PI3K INHIBITORS
Bayer Intellectual Property GmbH	<b>B65D 75/58</b> (2006.01)	2563682 *	WAFER POCKET
Janssen Alzheimer Immunotherapy	<b>A61K 51/00</b> (2006.01)	2538982 *	PET MONITORING OF AB-DIRECTED IMMUNOTHERAPY
Wyeth LLC	<b>A61K 51/00</b> (2006.01)	2538982 *	PET MONITORING OF AB-DIRECTED IMMUNOTHERAPY
Sanofi-Aventis Deutschland GmbH	<b>A61M 5/315</b> (2006.01) <b>A61M 5/24</b> (2006.01)	2579922 *	DRIVE MECHANISM FOR A DRUG DELIVERY DEVICE AND DRUG DELIVERY DEVICE
FEA S.r.l.	<b>H01L 31/058</b> (2006.01)	2463921	Photovoltaic and thermal panel
SES Spar European Shopping Centers GmbH	<b>F24F 7/08</b> (2006.01) <b>F24F 11/00</b> (2006.01)	2527753	Device and method for regulating a fresh air supply for a device for cooling, heating and/or ventilating a building
Blue Jeans Network, Inc.	<b>H04N 7/15</b> (2006.01) <b>H04N 7/14</b> (2006.01) <b>H04N 7/00</b> (2011.01)	2569940 *	SYSTEMS AND METHODS FOR NOVEL INTERACTIONS WITH PARTICIPANTS IN VIDEOCONFERENCE MEETINGS
OMEC S.p.A.	<b>A47L 9/24</b> (2006.01)	2484260	Sealing gasket for a telescopic extension, in particular for a household appliance
Katholieke Universiteit Leuven, K.U. Leuven R&D	<b>A61P 31/16</b> (2006.01) <b>A61P 31/18</b> (2006.01) <b>A61K 31/519</b> (2006.01) <b>A61K 31/52</b> (2006.01) <b>A61P 31/14</b> (2006.01) <b>A61P 31/12</b> (2006.01) <b>A61K 31/551</b> (2006.01)	2575969 *	ANTIVIRAL ACTIVITY OF NOVEL BICYCLIC HETEROCYCLES
aTyr Pharma, Inc.	<b>A61P 35/00</b> (2006.01) <b>A61P 29/00</b> (2006.01) <b>A61P 3/10</b> (2006.01) <b>A61K 38/16</b> (2006.01) <b>A61K 39/395</b> (2006.01) <b>A61K 48/00</b> (2006.01) <b>A61K 38/17</b> (2006.01)	2563383 *	INNOVATIVE DISCOVERY OF THERAPEUTIC, DIAGNOSTIC, AND ANTIBODY COMPOSITIONS RELATED TO PROTEIN FRAGMENTS OF VALYL TRNA SYNTHETASES
Pangu Biopharma Limited	<b>A61P 35/00</b> (2006.01) <b>A61P 29/00</b> (2006.01) <b>A61P 3/10</b> (2006.01) <b>A61K 38/16</b> (2006.01) <b>A61K 39/395</b> (2006.01) <b>A61K 48/00</b> (2006.01) <b>A61K 38/17</b> (2006.01)	2563383 *	INNOVATIVE DISCOVERY OF THERAPEUTIC, DIAGNOSTIC, AND ANTIBODY COMPOSITIONS RELATED TO PROTEIN FRAGMENTS OF VALYL TRNA SYNTHETASES
Koch Agronomic Services, LLC	<b>C05C 9/02</b> (2006.01) <b>C05C 9/00</b> (2006.01)	2563745 *	REACTION PRODUCTS AND METHODS FOR MAKING AND USING THE SAME
SAH Verkehrstechnik GmbH	<b>E01F 15/02</b> (2006.01) <b>E01F 15/04</b> (2006.01)	2567030 *	GUARD RAIL
Whisbi Technologies, S.L.	<b>H04L 29/06</b> (2006.01) <b>H04M 3/51</b> (2006.01)	2583431 *	SYSTEM AND PROCEDURE FOR COMMERCIAL COMMUNICATIONS

Podnosilac evropske prijave patenta (71)	MKP (51)	Broj objave evropske prijave patenta (97)	Naziv pronalaska (54)
ASKA Pharmaceutical Co., Ltd.	<b>C07D 495/04</b> (2006.01) <b>A61K 31/519</b> (2006.01) <b>A61P 3/10</b> (2006.01) <b>A61P 13/08</b> (2006.01) <b>A61P 13/10</b> (2006.01) <b>A61P 7/02</b> (2006.01) <b>A61P 15/10</b> (2006.01) <b>A61P 9/10</b> (2006.01) <b>A61P 25/00</b> (2006.01) <b>A61P 9/12</b> (2006.01) <b>A61P 25/28</b> (2006.01) <b>A61P 11/00</b> (2006.01) <b>A61P 13/02</b> (2006.01) <b>A61P 13/04</b> (2006.01)	2594570 *	CRYSTAL OF THIENOPYRIMIDINE DERIVATIVE
The Regents of the University of Colorado, A Body Corporate	<b>A01N 43/78</b> (2006.01) <b>A61K 31/425</b> (2006.01)	2575467 *	MACROCYCLIC COMPOUNDS USEFUL AS INHIBITORS OF HISTONE DEACETYLASES
aTyr Pharma, Inc.	<b>C12N 15/52</b> (2006.01) <b>A61K 38/43</b> (2006.01) <b>C12N 9/00</b> (2006.01) <b>C07K 19/00</b> (2006.01) <b>C12N 15/113</b> (2010.01) <b>C07K 16/40</b> (2006.01) <b>G01N 33/68</b> (2006.01)	2563912 *	INNOVATIVE DISCOVERY OF THERAPEUTIC, DIAGNOSTIC, AND ANTIBODY COMPOSITIONS RELATED TO PROTEIN FRAGMENTS OF ASPARAGINYL TRNA SYNTHETASES
Pangu Biopharma Limited	<b>C12N 15/52</b> (2006.01) <b>A61K 38/43</b> (2006.01) <b>C12N 9/00</b> (2006.01) <b>C07K 19/00</b> (2006.01) <b>C12N 15/113</b> (2010.01) <b>C07K 16/40</b> (2006.01) <b>G01N 33/68</b> (2006.01)	2563912 *	INNOVATIVE DISCOVERY OF THERAPEUTIC, DIAGNOSTIC, AND ANTIBODY COMPOSITIONS RELATED TO PROTEIN FRAGMENTS OF ASPARAGINYL TRNA SYNTHETASES
BIOGEN IDEC HEMOPHILIA INC.	<b>C12N 15/00</b> (2006.01) <b>C12P 21/04</b> (2006.01)	2591101 *	SYSTEMS FOR FACTOR VIII PROCESSING AND METHODS THEREOF
Palazzoli S.p.A.	<b>H02G 3/08</b> (2006.01)	2593996 *	CONNECTING DEVICE FOR ELECTRICAL JUNCTION BOXES.
Saint-Gobain Glass France	<b>B29C 45/14</b> (2006.01) <b>B60J 1/00</b> (2006.01) <b>B60J 10/02</b> (2006.01)	2582536 *	GLASS PANEL INCLUDING AN INSERT HAVING A PRESSURE ELEMENT, METHOD FOR MANUFACTURING THE GLASS PANEL, AND INSERT FOR THE GLASS PANEL
SANOFI	<b>A61P 37/08</b> (2006.01) <b>A61K 31/4427</b> (2006.01) <b>C07D 403/14</b> (2006.01) <b>C07D 401/04</b> (2006.01)	2569294 *	SUBSTITUTED N-HETEROARYL BIPYRROLIDINE CARBOXAMIDES, PREPARATION AND THERAPEUTIC USE THEREOF
Ghedini, Patrizia	<b>B62K 21/26</b> (2006.01) <b>B62K 3/16</b> (2006.01) <b>B62K 11/14</b> (2006.01) <b>B62K 23/04</b> (2006.01)	2560862 *	STEERING MEANS FOR VEHICLES, PARTICULARLY SUITABLE FOR USE BY DISABLED PERSONS
Innovation Factory S.r.l.	<b>B62K 21/26</b> (2006.01) <b>B62K 3/16</b> (2006.01) <b>B62K 11/14</b> (2006.01) <b>B62K 23/04</b> (2006.01)	2560862 *	STEERING MEANS FOR VEHICLES, PARTICULARLY SUITABLE FOR USE BY DISABLED PERSONS
Laboratoires Thèa	<b>A61K 49/00</b> (2006.01) <b>A61K 47/14</b> (2006.01) <b>A61K 31/557</b> (2006.01) <b>A61K 9/00</b> (2006.01)	2588078 *	POLYMERIC SYSTEM FOR DELIVERING A PRESERVATIVE-FREE PROSTAGLANDIN-BASED NONVISCIOUS SOLUTION
SANOFI	<b>A61K 31/404</b> (2006.01) <b>A61P 17/00</b> (2006.01)	2538942 *	TREATMENT OF DERMATOLOGICAL ALLERGIC CONDITIONS
Memorial Sloan-Kettering Cancer Center	<b>C12N 15/13</b> (2006.01) <b>C12N 5/18</b> (2006.01) <b>A61P 35/00</b> (2006.01) <b>A61K 39/395</b> (2006.01) <b>C07K 16/18</b> (2006.01)	2552959 *	ANTIBODIES TO MUC16 AND METHODS OF USE THEREOF
Jensen, Johannes	<b>A01J 9/04</b> (2006.01) <b>A01J 5/00</b> (2006.01)	2538771 *	AUTOMATIC MILKING SYSTEM AND COMPONENTS THEREFOR

Podnosilac evropske prijave patenta (71)	MKP (51)	Broj objave evropske prijave patenta (97)	Naziv pronalaska (54)
Sanofi-Aventis Deutschland GmbH	<b>G01N 21/90</b> (2006.01)	2567221 *	DEVICE AND METHOD FOR DETECTION OF DEFECTS IN VITREOUS BODIES
Qualcomm Incorporated	<b>H04B 17/00</b> (2006.01)	2589166 *	MEASURING RECEIVED SIGNAL STRENGTH ON NEIGHBORING FREQUENCIES OF A CHANNEL WITH INTERFERENCE IN A WIRELESS DEVICE
Schneider GmbH & Co. KG	<b>C08L 67/02</b> (2006.01) <b>G02B 6/02</b> (2006.01) <b>C08L 63/00</b> (2006.01) <b>B24B 13/005</b> (2006.01) <b>C08K 5/053</b> (2006.01) <b>C09J 167/00</b> (2006.01)	2540769	Compound, in particular blocking agent compound, for fixing blanks for ophthalmic or optical lenses
Janssen Pharmaceutica, N.V.	<b>C07D 401/12</b> (2006.01) <b>A61K 31/517</b> (2006.01) <b>C07D 405/14</b> (2006.01) <b>A61P 29/00</b> (2006.01) <b>C07D 401/14</b> (2006.01) <b>A61K 31/4709</b> (2006.01) <b>C07D 403/12</b> (2006.01) <b>A61K 31/502</b> (2006.01) <b>C07D 403/14</b> (2006.01) <b>A61K 31/4375</b> (2006.01) <b>C07D 413/14</b> (2006.01) <b>C07D 417/14</b> (2006.01) <b>C07D 471/04</b> (2006.01)	2582692 *	CYCLOHEXYL-AZETIDINYL ANTAGONISTS OF CCR2
Anchor Therapeutics, Inc.	<b>A61K 38/16</b> (2006.01)	2566494 *	CXCR4 RECEPTOR COMPOUNDS
SANOFI	<b>C07D 211/58</b> (2006.01) <b>C07D 487/08</b> (2006.01) <b>C07D 243/08</b> (2006.01) <b>A61K 31/4418</b> (2006.01) <b>C07D 401/02</b> (2006.01) <b>A61K 31/444</b> (2006.01) <b>C07D 401/12</b> (2006.01) <b>C07D 295/08</b> (2006.01) <b>A61K 31/40</b> (2006.01) <b>C07D 205/04</b> (2006.01) <b>C07D 403/12</b> (2006.01) <b>C07D 211/56</b> (2006.01) <b>C07D 413/12</b> (2006.01) <b>C07D 207/08</b> (2006.01) <b>C07D 405/12</b> (2006.01)	2542524 *	DERIVATIVES OF AMINOINDANES, THEIR PREPARATION AND THEIR APPLICATION IN THERAPEUTICS
Japan Oil, Gas and Metals National Corporation	<b>B01J 37/18</b> (2006.01) <b>C10G 2/00</b> (2006.01)	2554267 *	PREPARATION METHOD FOR ACTIVATED CATALYST FOR FISCHER-TROPSCH SYNTHESIS, PREPARATION METHOD FOR CATALYST SLURRY, AND METHOD FOR SUPPLYING CATALYST SLURRY TO FISCHER-TROPSCH SYNTHESIS REACTOR
INPEX Corporation	<b>B01J 37/18</b> (2006.01) <b>C10G 2/00</b> (2006.01)	2554267 *	PREPARATION METHOD FOR ACTIVATED CATALYST FOR FISCHER-TROPSCH SYNTHESIS, PREPARATION METHOD FOR CATALYST SLURRY, AND METHOD FOR SUPPLYING CATALYST SLURRY TO FISCHER-TROPSCH SYNTHESIS REACTOR
JX Nippon Oil & Energy Corporation	<b>B01J 37/18</b> (2006.01) <b>C10G 2/00</b> (2006.01)	2554267 *	PREPARATION METHOD FOR ACTIVATED CATALYST FOR FISCHER-TROPSCH SYNTHESIS, PREPARATION METHOD FOR CATALYST SLURRY, AND METHOD FOR SUPPLYING CATALYST SLURRY TO FISCHER-TROPSCH SYNTHESIS REACTOR
Japan Petroleum Exploration Co., Ltd.	<b>B01J 37/18</b> (2006.01) <b>C10G 2/00</b> (2006.01)	2554267 *	PREPARATION METHOD FOR ACTIVATED CATALYST FOR FISCHER-TROPSCH SYNTHESIS, PREPARATION METHOD FOR CATALYST SLURRY, AND METHOD FOR SUPPLYING CATALYST SLURRY TO FISCHER-TROPSCH SYNTHESIS REACTOR

Podnosilac evropske prijave patenta (71)	MKP (51)	Broj objave evropske prijave patenta (97)	Naziv pronalaska (54)
Cosmo Oil Co., Ltd.	<b>B01J 37/18</b> (2006.01) <b>C10G 2/00</b> (2006.01)	2554267 *	PREPARATION METHOD FOR ACTIVATED CATALYST FOR FISCHER-TROPSCH SYNTHESIS, PREPARATION METHOD FOR CATALYST SLURRY, AND METHOD FOR SUPPLYING CATALYST SLURRY TO FISCHER-TROPSCH SYNTHESIS REACTOR
Nippon Steel Engineering Co., Ltd	<b>B01J 37/18</b> (2006.01) <b>C10G 2/00</b> (2006.01)	2554267 *	PREPARATION METHOD FOR ACTIVATED CATALYST FOR FISCHER-TROPSCH SYNTHESIS, PREPARATION METHOD FOR CATALYST SLURRY, AND METHOD FOR SUPPLYING CATALYST SLURRY TO FISCHER-TROPSCH SYNTHESIS REACTOR
Hagleitner, Hans Georg	<b>A47K 10/34</b> (2006.01) <b>A47K 5/12</b> (2006.01) <b>H05F 3/02</b> (2006.01)	2560534 *	SANITARY DISPENSER
Owens-Brockway Glass Container INC.	<b>B65D 1/02</b> (2006.01)	2588379 *	OVAL-NECK BOTTLE
PIAGGIO & C. S.p.A.	<b>B62D 9/02</b> (2006.01) <b>B62K 5/08</b> (2006.01)	2593352 *	TILTABLE MOTORCYCLES WITH TWO FRONT STEERING WHEELS
H. Lundbeck A/S	<b>A61K 31/4375</b> (2006.01) <b>A61P 11/00</b> (2006.01) <b>A61P 25/24</b> (2006.01) <b>A61P 25/04</b> (2006.01) <b>C07D 471/04</b> (2006.01) <b>A61P 25/08</b> (2006.01) <b>A61P 25/16</b> (2006.01) <b>A61P 25/22</b> (2006.01) <b>A61P 25/28</b> (2006.01) <b>A61P 3/04</b> (2006.01) <b>A61P 25/18</b> (2006.01) <b>A61P 13/00</b> (2006.01)	2545053 *	AZAIISOQUINOLINONE DERIVATIVES AS NK3 ANTAGONISTS
SANOFI	<b>C07D 487/04</b> (2006.01) <b>C07D 207/337</b> (2006.01) <b>A61P 9/00</b> (2006.01) <b>A61P 25/28</b> (2006.01) <b>A61P 29/00</b> (2006.01) <b>A61K 31/4985</b> (2006.01) <b>C07D 241/06</b> (2006.01) <b>A61P 25/00</b> (2006.01)	2588480 *	3,4-DIHYDROPIRROLO[1,2-A]PYRAZINE-2,8(1H)-DICARBOXAMIDE DERIVATIVES, PREPARATION THEREOF AND THERAPEUTIC USE THEREOF& xA;
MED 2000 S.r.l.	<b>A61M 11/02</b> (2006.01) <b>A61M 16/00</b> (2006.01)	2585150 *	AEROSOL THERAPY DEVICE
aTyr Pharma, Inc.	<b>A61P 35/00</b> (2006.01) <b>A61P 3/10</b> (2006.01) <b>A61K 39/395</b> (2006.01) <b>A61K 38/16</b> (2006.01) <b>C07K 14/525</b> (2006.01) <b>A61P 29/00</b> (2006.01)	2566496 *	INNOVATIVE DISCOVERY OF THERAPEUTIC, DIAGNOSTIC, AND ANTIBODY COMPOSITIONS RELATED TO PROTEIN FRAGMENTS OF METHIONYL-TRNA SYNTHETASES
Pangu Biopharma Limited	<b>A61P 35/00</b> (2006.01) <b>A61P 3/10</b> (2006.01) <b>A61K 39/395</b> (2006.01) <b>A61K 38/16</b> (2006.01) <b>C07K 14/525</b> (2006.01) <b>A61P 29/00</b> (2006.01)	2566496 *	INNOVATIVE DISCOVERY OF THERAPEUTIC, DIAGNOSTIC, AND ANTIBODY COMPOSITIONS RELATED TO PROTEIN FRAGMENTS OF METHIONYL-TRNA SYNTHETASES
Array Biopharma, Inc.	<b>C07D 401/14</b> (2006.01) <b>A61P 3/10</b> (2006.01) <b>A61K 31/4545</b> (2006.01)	2571864 *	PIPERIDINYL-SUBSTITUTED LACTAMS AS GPR119 MODULATORS
aTyr Pharma, Inc.	<b>A61P 21/00</b> (2006.01) <b>A61K 39/395</b> (2006.01) <b>A61K 38/16</b> (2006.01) <b>A61P 37/00</b> (2006.01) <b>A61K 38/17</b> (2006.01) <b>A61K 38/08</b> (2006.01)	2575857 *	INNOVATIVE DISCOVERY OF THERAPEUTIC, DIAGNOSTIC, AND ANTIBODY COMPOSITIONS RELATED TO PROTEIN FRAGMENTS OF LYSYL-TRNA SYNTHETASES

Podnosilac evropske prijave patenta (71)	MKP (51)	Broj objave evropske prijave patenta (97)	Naziv pronalaska (54)
Pangu Biopharma Limited	<b>A61P 21/00</b> (2006.01) <b>A61K 39/395</b> (2006.01) <b>A61K 38/16</b> (2006.01) <b>A61P 37/00</b> (2006.01) <b>A61K 38/17</b> (2006.01) <b>A61K 38/08</b> (2006.01)	2575857 *	INNOVATIVE DISCOVERY OF THERAPEUTIC, DIAGNOSTIC, AND ANTIBODY COMPOSITIONS RELATED TO PROTEIN FRAGMENTS OF LYSYL-TRNA SYNTHETASES
Safelayer Secure Communications, S.A.	<b>G06F 21/24</b> (2006.01)	2477137	Method for verifying the integrity of a set of data
Eisai R&D Management Co., Ltd.	<b>C12N 15/09</b> (2006.01) <b>C12N 15/00</b> (2006.01) <b>A01K 67/027</b> (2006.01) <b>C12Q 1/02</b> (2006.01) <b>C12N 5/09</b> (2010.01)	2592141 *	METHOD FOR PRODUCTION OF TUMOR CELLS FROM NORMAL MAMMARY EPITHELIAL CELLS
SDG, Inc.	<b>A01N 43/02</b> (2006.01)	2552202 *	METHODS AND COMPOSITIONS FOR WEIGHT LOSS
Puralube Germany GmbH	<b>C10G 65/02</b> (2006.01) <b>B01J 35/04</b> (2006.01) <b>C10G 45/12</b> (2006.01) <b>B01J 21/12</b> (2006.01) <b>C10G 45/08</b> (2006.01) <b>B01J 35/10</b> (2006.01)	2479242	Method for hydroprocessing of hydrocarbon compounds heavily contaminated with inorganic substances
Medacta International S.A.	<b>A61B 17/70</b> (2006.01)	2502594	Polyaxial pedicle screw and fixation system kit comprising said screw
Carnehammar, Lars Bertil	<b>C23C 16/50</b> (2006.01) <b>B05D 7/24</b> (2006.01) <b>B29C 59/14</b> (2006.01)	2585274 *	SURFACE TREATMENT OF RUBBER USING LOW PRESSURE PLASMA
Sanofi-Aventis Deutschland GmbH	<b>A61M 5/20</b> (2006.01)	2585138 *	AUTO-INJECTOR
Laboratorios Farmacéuticos Rovi, S.A.	<b>A61K 47/34</b> (2006.01)	2582395 *	METHODS FOR THE PREPARATION OF INJECTABLE DEPOT COMPOSITIONS
Daub Backtechnik GmbH	<b>A21B 1/48</b> (2006.01) <b>F24C 15/16</b> (2006.01) <b>A21B 3/15</b> (2006.01)	2508076	Stone slab for ovens
University of Basel	<b>C07D 491/10</b> (2006.01) <b>A61P 35/00</b> (2006.01) <b>C07D 487/10</b> (2006.01) <b>C07D 519/00</b> (2006.01) <b>A61K 31/5386</b> (2006.01)	2547684 *	SPIROCYCLIC COMPOUNDS AND THEIR USE AS THERAPEUTIC AGENTS AND DIAGNOSTIC PROBES
Cima Labs Inc.	<b>A61K 31/137</b> (2006.01) <b>A61K 9/50</b> (2006.01) <b>A61K 9/20</b> (2006.01)	2579857 *	ALCOHOL-RESISTANT EXTENDED RELEASE DOSAGE FORMS COMPRISING VENLAFAXINE
Bioréalités	<b>A61K 39/395</b> (2006.01) <b>A61P 35/00</b> (2006.01) <b>C07K 16/26</b> (2006.01)	2542583 *	METHODS FOR TREATING BREAST CANCER
INSTITUT NATIONAL DE LA SANTE ET DE LA RECHERCHE MEDICALE (INSERM)	<b>A61K 39/395</b> (2006.01) <b>A61P 35/00</b> (2006.01) <b>C07K 16/26</b> (2006.01)	2542583 *	METHODS FOR TREATING BREAST CANCER
THE CENTRE NATIONAL DE LA RECHERCHE SCIENTIFIQUE (CNRS)	<b>A61K 39/395</b> (2006.01) <b>A61P 35/00</b> (2006.01) <b>C07K 16/26</b> (2006.01)	2542583 *	METHODS FOR TREATING BREAST CANCER
Paybay Networks Srl	<b>G06Q 20/00</b> (2012.01) <b>A63F 3/06</b> (2006.01)	2584512	Voucher and method for determining validity thereof
Trans Bio-Diesel Ltd.	<b>C12P 7/64</b> (2006.01)	2542685 *	A PROCESS FOR THE ENZYMATIC SYNTHESIS OF FATTY ACID ALKYL ESTERS
Therasyn Sensors, Inc.	<b>A61B 1/04</b> (2006.01)	2592992 *	A DEVICE AND METHODS FOR IN VIVO MONITORING OF AN INDIVIDUAL
AbbVie Biotechnology Ltd	<b>A61K 39/00</b> (2006.01) <b>C07K 16/00</b> (2006.01) <b>A61K 39/395</b> (2006.01)	2575884 *	USES AND COMPOSITIONS FOR TREATMENT OF HIDRADENITIS SUPPURATIVA (HS)

Podnosilac evropske prijave patenta (71)	MKP (51)	Broj objave evropske prijave patenta (97)	Naziv pronalaska (54)
The Regents of the University of Colorado, A Body Corporate	<b>C07K 19/00</b> (2006.01) <b>C07K 14/705</b> (2006.01)	2569332 *	IMPROVED COMPLEMENT RECEPTOR 2 (CR2) TARGETING GROUPS
Xiamen Runner Industrial Corporation	<b>C25D 5/12</b> (2006.01) <b>C23C 28/02</b> (2006.01) <b>C23C 18/30</b> (2006.01) <b>C23C 14/20</b> (2006.01) <b>C23C 14/16</b> (2006.01) <b>C25D 5/56</b> (2006.01) <b>C25D 5/48</b> (2006.01) <b>C25D 5/14</b> (2006.01) <b>C23C 30/00</b> (2006.01) <b>C23C 14/00</b> (2006.01)	2481838	Method for applying semi-dry electroplating method on surface of plastic substrate
Gilead Sciences, Inc.	<b>C07D 409/14</b> (2006.01) <b>A61P 9/00</b> (2006.01) <b>A61P 29/00</b> (2006.01) <b>A61K 31/427</b> (2006.01) <b>A61P 37/00</b> (2006.01) <b>A61K 31/4196</b> (2006.01) <b>A61K 31/4427</b> (2006.01) <b>C07D 417/14</b> (2006.01)	2588475 *	APOPTOSIS SIGNAL-REGULATING KINASE INHIBITORS
Boehringer Ingelheim International GmbH	<b>A61K 39/395</b> (2006.01) <b>C07K 16/18</b> (2006.01) <b>C07K 16/46</b> (2006.01)	2542579 *	BIPARATOPIC ABETA BINDING POLYPEPTIDES
Belron Hungary Kft - Zug Branch	<b>B65G 49/06</b> (2006.01) <b>B65D 85/48</b> (2006.01) <b>B65D 21/08</b> (2006.01) <b>B65D 19/12</b> (2006.01) <b>B65D 81/05</b> (2006.01) <b>B65D 19/44</b> (2006.01)	2576368 *	PALLET CONTAINER
CORCOST LIMITED	<b>B60N 2/50</b> (2006.01) <b>G09B 9/00</b> (2006.01)	2552745 *	MULTI AXIS MANOEUVRABLE PLATFORM
Bayer HealthCare LLC	<b>C07D 213/81</b> (2006.01)	2558448 *	PROCESS FOR THE PREPARATION OF 4- {4-[[[4-CHLORO-3-(TRIFLUOROMETHYL)-PHENYL] AMINO] CARBONYL] AMINO]-3-FLUOROPHENOXY}-N-METHYLPYRIDINE-2-CARBOXAMIDE, ITS SALTS AND MONOHYDRATE
Hagleitner, Hans Georg	<b>A47K 10/36</b> (2006.01)	2560535 *	METHOD FOR DISPENSING PAPER SHEET BY SHEET FROM A STOCK
Cima Labs Inc.	<b>A61K 9/50</b> (2006.01) <b>A61K 9/20</b> (2006.01)	2568969 *	ALCOHOL-RESISTANT FORMULATIONS
Aragon Pharmaceuticals, Inc.	<b>C07D 405/10</b> (2006.01) <b>C07D 311/04</b> (2006.01) <b>C07D 405/12</b> (2006.01) <b>A61P 25/28</b> (2006.01) <b>A61K 31/352</b> (2006.01) <b>A61K 31/453</b> (2006.01) <b>A61P 35/00</b> (2006.01)	2580210 *	ESTROGEN RECEPTOR MODULATORS AND USES THEREOF
Repros Therapeutics Inc.	<b>C07J 41/00</b> (2006.01) <b>A61K 31/57</b> (2006.01) <b>A61P 5/36</b> (2006.01)	2550288 *	COMPOSITIONS AND METHODS FOR NON-TOXIC DELIVERY OF ANTIPROGESTINS
A.T.X. International, Inc.	<b>B43K 24/02</b> (2006.01)	2563603 *	IMPROVED EXPANDABLE WRITING INSTRUMENT
Owens-Brockway Glass Container Inc.	<b>C03B 9/34</b> (2006.01) <b>C03B 9/325</b> (2006.01)	2588421 *	GLASS WINE BOTTLES AND METHOD OF MOLDING THEM
Abbvie Inc.	<b>C07K 16/18</b> (2006.01)	2542582 *	THERAPEUTIC DLL4 BINDING PROTEINS
ENEA - Agenzia Nazionale Per Le Nuove Tecnologie, L'Energia e Lo Sviluppo Economico Sostenibile	<b>C01B 4/00</b> (2006.01) <b>C01B 3/50</b> (2006.01)	2582618 *	MEMBRANE REACTOR FOR TREATING GASES CONTAINING TRITIUM
Commissariat à l'Énergie Atomique et aux Énergies Alternatives	<b>C01B 4/00</b> (2006.01) <b>C01B 3/50</b> (2006.01)	2582618 *	MEMBRANE REACTOR FOR TREATING GASES CONTAINING TRITIUM

Podnosilac evropske prijave patenta (71)	MKP (51)	Broj objave evropske prijave patenta (97)	Naziv pronalaska (54)
Ecole Polytechnique	<b>G01N 27/48</b> (2006.01) <b>B82Y 30/00</b> (2011.01) <b>G01N 27/12</b> (2006.01) <b>G01N 33/18</b> (2006.01)	2484630	Nanosensor for capturing charged molecules by using in situ stripping voltammetry
Centre National de la Recherche Scientifique	<b>G01N 27/48</b> (2006.01) <b>B82Y 30/00</b> (2011.01) <b>G01N 27/12</b> (2006.01) <b>G01N 33/18</b> (2006.01)	2484630	Nanosensor for capturing charged molecules by using in situ stripping voltammetry
COMMISSARIAT A L'ENERGIE ATOMIQUE ET AUX ENERGIES ALTERNATIVES	<b>G01N 27/48</b> (2006.01) <b>B82Y 30/00</b> (2011.01) <b>G01N 27/12</b> (2006.01) <b>G01N 33/18</b> (2006.01)	2484630	Nanosensor for capturing charged molecules by using in situ stripping voltammetry
Glaxo Group Limited	<b>C07D 239/70</b> (2006.01)	2571857 *	NOVEL PROCESSES
Hodges, Michael Kent	<b>B01D 24/14</b> (2006.01) <b>B01D 24/00</b> (2006.01)	2542318 *	APPARATUS AND METHOD FOR DE-WATERING OF FLOCCULATED MATERIALS
Egis Gyógyszergyár Nyilvánosan Működő Részvénytársaság	<b>A61K 9/20</b> (2006.01) <b>A61K 47/02</b> (2006.01)	2575779 *	USE OF DIATOMACEOUS EARTH IN THE PHARMACEUTICAL INDUSTRY
Onp Holding SE	<b>A61K 9/20</b> (2006.01) <b>A61K 47/02</b> (2006.01)	2575779 *	USE OF DIATOMACEOUS EARTH IN THE PHARMACEUTICAL INDUSTRY
Sanofi-Aventis Deutschland GmbH	<b>A61M 5/24</b> (2006.01)	2560706 *	CARTRIDGE HOLDER AND ALIGNMENT INTERFACE
Glaxo Group Limited	<b>C07K 16/22</b> (2006.01) <b>A61K 39/395</b> (2006.01) <b>A61P 21/06</b> (2006.01)	2576619 *	HUMANISED ANTIGEN BINDING PROTEINS TO MYOSTATIN6
Neuraxpharm Arzneimittel GmbH	<b>A61K 9/20</b> (2006.01) <b>A61K 9/50</b> (2006.01)	2462925	Pramipexole Dihydrochloride Granulate
Shire Human Genetic Therapies, Inc.	<b>A61K 38/47</b> (2006.01) <b>A61P 25/28</b> (2006.01) <b>A61P 25/00</b> (2006.01)	2585104 *	METHODS AND COMPOSITIONS FOR CNS DELIVERY OF ARYLSULFATASE A
Universidad de Navarra	<b>A23L 1/00</b> (2006.01) <b>A61K 8/64</b> (2006.01)	2594140 *	NANOPARTICLES FOR ENCAPSULATION OF COMPOUNDS, THE PRODUCTION AND USES THEREOF
Centro Nacional De Tecnologia Y Seguridad Alimentaria. Laboratorio Dei Ebro	<b>A23L 1/00</b> (2006.01) <b>A61K 8/64</b> (2006.01)	2594140 *	NANOPARTICLES FOR ENCAPSULATION OF COMPOUNDS, THE PRODUCTION AND USES THEREOF
Troha-dil D.o.o	<b>E06B 3/263</b> (2006.01) <b>E06B 3/30</b> (2006.01)	2572068 *	EXTERNAL LAYER OF COMPOUND FRAMES FOR WINDOWS AND DOORS DESCRIPTION OF THE INVENTION
Intrexon Corporation	<b>C12N 15/00</b> (2006.01)	2550359 *	VECTORS CONDITIONALLY EXPRESSING THERAPEUTIC PROTEINS, HOST CELLS COMPRISING THE VECTORS, AND USES THEREOF
Apple Inc.	<b>H01R 24/58</b> (2011.01)	2580824 *	FLEXIBLE TRS CONNECTOR
Schnyder, Viktor	<b>B65D 33/16</b> (2006.01)	2468651	Clip fastener
Behr GmbH & Co. KG	<b>B60H 1/00</b> (2006.01)	2450204	Air conditioning for a motor vehicle
Novelis Inc.	<b>B22D 41/02</b> (2006.01)	2560776 *	MOLTEN METAL LEAKAGE CONFINEMENT AND THERMAL OPTIMIZATION IN VESSELS USED FOR CONTAINING MOLTEN METALS
Université de Genève	<b>A61K 47/48</b> (2006.01) <b>A61K 39/395</b> (2006.01) <b>A61K 9/08</b> (2006.01) <b>A61K 47/22</b> (2006.01)	2552411 *	STABILIZED ANTIBODY PREPARATIONS AND USES THEREOF
Artoni, Simone	<b>A61L 9/12</b> (2006.01)	2564877	An improvement of a deodorant device that gradually releases fragrance
Myriad Genetics, Inc.	<b>C12Q 1/68</b> (2006.01) <b>C12N 15/11</b> (2006.01)	2591126 *	GENE SIGNATURES FOR CANCER PROGNOSIS
Stone, Steve	<b>C12Q 1/68</b> (2006.01) <b>C12N 15/11</b> (2006.01)	2591126 *	GENE SIGNATURES FOR CANCER PROGNOSIS

Podnosilac evropske prijave patenta (71)	MKP (51)	Broj objave evropske prijave patenta (97)	Naziv pronalaska (54)
Gutin, Alexander	<b>C12Q 1/68</b> (2006.01) <b>C12N 15/11</b> (2006.01)	2591126 *	GENE SIGNATURES FOR CANCER PROGNOSIS
Wagner, Susanne	<b>C12Q 1/68</b> (2006.01) <b>C12N 15/11</b> (2006.01)	2591126 *	GENE SIGNATURES FOR CANCER PROGNOSIS
Reid, Julia E.	<b>C12Q 1/68</b> (2006.01) <b>C12N 15/11</b> (2006.01)	2591126 *	GENE SIGNATURES FOR CANCER PROGNOSIS
Mentor Worldwide LLC	<b>C09D 5/14</b> (2006.01) <b>A61L 27/54</b> (2006.01) <b>A61L 27/34</b> (2006.01)	2545126 *	COATING WITH ANTIMICROBIAL AGENTS
Totorkulov, Aliy Khasanovich	<b>B64C 3/14</b> (2006.01)	2567891 *	METHOD FOR FORMING LIFTING FORCE FOR AN AIRCRAFT AND WING PROFILE FOR REALIZING SAID METHOD (ALTERNATIVES)
Baziev, Dzhabrail Kharunovich	<b>B64C 3/14</b> (2006.01)	2567891 *	METHOD FOR FORMING LIFTING FORCE FOR AN AIRCRAFT AND WING PROFILE FOR REALIZING SAID METHOD (ALTERNATIVES)
Bioréalités S.A.S.	<b>G01N 33/74</b> (2006.01)	2542898 *	PROGASTRIN AND LIVER PATHOLOGIES
Gilead Sciences, Inc.	<b>A61K 31/495</b> (2006.01) <b>A61P 9/00</b> (2006.01)	2582372 *	RANOLAZINE FOR USE FOR THE TREATMENT OF PULMONARY HYPERTENSION
Biella-Neher Holding AG	<b>B42F 13/26</b> (2006.01) <b>B42F 13/24</b> (2006.01)	2539159 *	FILE MECHANISM
Immatics Biotechnologies GmbH	<b>A61K 38/17</b> (2006.01)	2547354 *	NOVEL IMMUNOTHERAPY AGAINST SEVERAL TUMORS INCLUDING GASTROINTESTINAL AND GASTRIC CANCER
Therasyn Sensors, Inc.	<b>A61B 5/103</b> (2006.01) <b>A61B 5/117</b> (2006.01) <b>A61B 5/05</b> (2006.01)	2590558 *	A DEVICE AND METHOD FOR CONTINUOUS CHEMICAL SENSING
Gilead Sciences, Inc.	<b>A61P 31/14</b> (2006.01) <b>C07D 309/10</b> (2006.01) <b>A61K 31/40</b> (2006.01)	2576534 *	1'-SUBSTITUTED-CARBA-NUCLEOSIDE PRODRUGS FOR ANTIVIRAL TREATMENT
"Avidin" Kutató, Fejlesztő és Kereskedelmi Korlátolt Felelősségű Társaság	<b>A61P 25/24</b> (2006.01) <b>A61P 25/18</b> (2006.01) <b>A61P 25/22</b> (2006.01) <b>A61K 31/565</b> (2006.01)	2585074 *	USE OF AN ESTROGEN DERIVATIVE FOR THE MANUFACTURE OF PHARMACEUTICAL COMPOSITIONS USEFUL FOR THE TREATMENT AND/OR PREVENTION OF PSYCHIATRIC DISEASES AND FOR THE TREATMENT AND PREVENTION OF SAID DISEASES
Ubichem Kutató Korlátolt Felelősségű Társaság	<b>A61P 25/24</b> (2006.01) <b>A61P 25/18</b> (2006.01) <b>A61P 25/22</b> (2006.01) <b>A61K 31/565</b> (2006.01)	2585074 *	USE OF AN ESTROGEN DERIVATIVE FOR THE MANUFACTURE OF PHARMACEUTICAL COMPOSITIONS USEFUL FOR THE TREATMENT AND/OR PREVENTION OF PSYCHIATRIC DISEASES AND FOR THE TREATMENT AND PREVENTION OF SAID DISEASES
Hajszán, Tibor	<b>A61P 25/24</b> (2006.01) <b>A61P 25/18</b> (2006.01) <b>A61P 25/22</b> (2006.01) <b>A61K 31/565</b> (2006.01)	2585074 *	USE OF AN ESTROGEN DERIVATIVE FOR THE MANUFACTURE OF PHARMACEUTICAL COMPOSITIONS USEFUL FOR THE TREATMENT AND/OR PREVENTION OF PSYCHIATRIC DISEASES AND FOR THE TREATMENT AND PREVENTION OF SAID DISEASES
Shire Human Genetic Therapies, Inc.	<b>A61P 25/28</b> (2006.01) <b>A61P 25/00</b> (2006.01) <b>A61K 38/47</b> (2006.01)	2585105 *	TREATMENT OF SANFILIPPO SYNDROME TYPE B
Cantab Biopharmaceuticals Patents Limited	<b>A61P 7/04</b> (2006.01) <b>A61K 38/37</b> (2006.01) <b>A61K 47/48</b> (2006.01)	2563402 *	CONJUGATED BLOOD COAGULATION FACTOR VIII
Astellas Pharma Inc.	<b>A61P 25/24</b> (2006.01) <b>A61P 25/18</b> (2006.01) <b>C07D 471/04</b> (2006.01) <b>C07D 495/14</b> (2006.01) <b>A61K 31/4545</b> (2006.01) <b>A61P 25/28</b> (2006.01) <b>A61K 31/437</b> (2006.01) <b>C07D 519/00</b> (2006.01) <b>A61K 31/438</b> (2006.01) <b>A61P 43/00</b> (2006.01)	2565194 *	IMIDAZO[1,2-a]PYRIDINE DERIVATIVE



Podnosilac evropske prijave patenta (71)	MKP (51)	Broj objave evropske prijave patenta (97)	Naziv pronalaska (54)
Gilead Pharmasset LLC	<b>C07H 19/06</b> (2006.01) <b>C07F 9/6561</b> (2006.01) <b>A61P 31/14</b> (2006.01) <b>C07H 19/10</b> (2006.01) <b>C07F 9/26</b> (2006.01) <b>C07H 19/052</b> (2006.01) <b>C07H 19/207</b> (2006.01) <b>C07H 19/04</b> (2006.01) <b>C07F 9/6558</b> (2006.01) <b>A61K 31/7056</b> (2006.01) <b>C07F 9/655</b> (2006.01) <b>A61K 31/664</b> (2006.01) <b>A61K 31/7072</b> (2006.01) <b>C07H 19/044</b> (2006.01) <b>C07F 9/24</b> (2006.01) <b>C07H 19/24</b> (2006.01)	2552930 *	NUCLEOSIDE PHOSPHORAMIDATES
Promotech Sp. Z.o.o.	<b>B23Q 1/01</b> (2006.01) <b>B23K 26/08</b> (2006.01) <b>B23K 37/02</b> (2006.01) <b>B23K 26/10</b> (2006.01)	2560786 *	METHOD AND DEVICE FOR CUTTING OPENINGS IN FLAT, CONCAVE OR CONVEX SURFACES
Vereniging Voor Christelijk Hoger Onderwijs, Wetenschappelijk Onderzoek En Patiëntenzorg	<b>C07C 291/10</b> (2006.01) <b>C07C 231/14</b> (2006.01) <b>C07C 233/31</b> (2006.01) <b>C07C 235/14</b> (2006.01) <b>C07D 403/12</b> (2006.01) <b>C07C 237/04</b> (2006.01)	2539334 *	PROCESS FOR THE PREPARATION OF -ACYLOXY -FORMAMIDO AMIDES
Janssen Biotech, Inc.	<b>A61K 47/00</b> (2006.01) <b>A61K 48/00</b> (2006.01)	2544721 *	NON-AQUEOUS HIGH CONCENTRATION REDUCED VISCOSITY SUSPENSION FORMULATIONS
University of Rochester	<b>C40B 40/06</b> (2006.01) <b>C40B 30/04</b> (2006.01) <b>C12Q 1/68</b> (2006.01)	2569450 *	COMPOSITIONS AND METHODS FOR TARGETING A3G:RNA COMPLEXES



**OBJAVA POVUČENIH ZAHTJEVA ZA PROŠIRENJE EVROPSKIH PRIJAVA  
PATENTA**  
**PUBLICATION OF WITHDRAWN REQUESTS FOR EXTENSION OF EUROPEAN  
PATENT APPLICATION**

Broj objave evropske prijave patenta (97)	MKP (51)	Datum kada je zahtev za proširenje evropske prijave patenta povučen	Zahtev objavljen u CGIS-u broj	Naziv pronalaska (54)	Podnosilac evropske prijave patenta (71)
2249466	H02K 21/18	24.07.2012	2/2013	Disc motor with electro- magnetic drive	Kutzke, Arthur



- (51) **A61K38/00** (11) **01228**  
 (21) **P-2010-164**
- (30) 20040602825P 19.08.2004. US  
 20050694067P 24.06.2005. US
- (86) PCT/US2005/029637 18.08.2005.  
 (87) WO 2006/023781 02.03.2006.  
 (96) 05789285.3 18.08.2005.  
 (97) EP 1786454 21.07.2010. 2010/29 EN
- (54) (ME) **NEUBLASTIN**  
 (EN) NEUBLASTIN VARIANTS
- (73) Biogen Idec MA Inc.; 14 Cambridge Center, Cambridge, Massachusetts 02142 (US)  
 (72) 01/ ROSSOMANDO, Anthony; 7 Pratt Street South Grafton, MA 01560 (US)  
 02/ SILVIAN, Laura; 1325 Beacon Street, Waban, MA 02468 (US)  
 03/ PEPINSKY, R., Blake; 30 Falmouth Road, Arlington, MA 02474 (US)
- (74) Čupić Branislav, Dalmatinska 10, Podgorica (ME), Dalmatinska 10, Podgorica (ME)
- (57) Polipeptid koji uključuje amino kisjelinsku sekvencu koja je najmanje 80% identična amino kisjelinama 15-113 u SEQ ID NO:1, naznačen time što amino kisjelinske sekvence sadrže amino kisjeline koje nisu arginin supstituisane na poziciji koja odgovara poziciji 48 i 49 u SEQ ID NO:1, pri čemu se polipeptid, kada je dimerizovan, vezuje za kompleks koji sadrži GFRalfa3 i RET, i gdje polipeptid pokazuje smanjeno vezivanje za heparin u poređenju sa prirodnim tipom Neublastin proteina SEQ ID NO:1.  
 Patent sadrži još 31 patentni zahtjev

- (51) **A61K31/165**  
**A61K31/381**  
**A61K31/40**  
**A61P25/30**  
**A61P25/32**  
**A61P25/34**  
**A61P25/36**  
**A61K45/06**  
**A61K31/198**
- (30) 20040009532 22.04.2004. EP  
(96) 07022078.5 19.04.2005.  
(97) EP 1900362 12.01.2011. 2011/02 EP
- (54) (ME) **ALFA-AMINOAMID DERIVATI KORISNI U LIJEČENJU BOLESTI ZAVISNOSTI**  
(EN) ALFA-AMINOAMIDE DERIVATIVES USEFUL IN THE TREATMENT OF ADDICTIVE DISORDERS
- (73) Newron Pharmaceuticals S.p.A.; Via Ariosto, 21, 20091 Bresso (MI)/ IT  
(72) 01/ Besana, Claudia; c/o NEWRON PHARMACEUTICALS S.p.A., Via L. Ariosto, 21, 20091 Bresso (MI) / IT  
02/ Barbanti, Elena; Via dei Platani, 6, 20093 Cologno Monzese (MI)/IT  
03/ Izzo, Emanuela; Via L. Ariosto, 21, 20091 Bresso (MI) / IT  
04/ Thaler, Florian c/o NEWRON PHARMACEUTICALS S.p.A., Via L. Ariosto, 21, 20091 Bresso (MI) / IT  
05/ Fariello, Ruggero; Via L. Ariosto, 21, 20091 Bresso (MI) / IT  
06/ Salvati, Patricia; Via L. Ariosto, 21, 20091 Bresso (MI) / IT  
07/ Benatti, Luca; Via L. Ariosto, 21, 20091 Bresso (MI) / IT
- (74) Radulović Božidar, Jovana Tomaševića 9/III, Podgorica (ME)
- (57) 1. Upotreba jedinjenja izabranog od:  
2-(4-Benziloksibenzilamino)propanamid;  
2-[4-(2-Metoksibenziloksi)-benzilamino]propanamid;  
2-[4-(2-Fluorobenziloksi)-benzilamino]propanamid;  
(S)-(+)-2-[4-(2-Fluorobenziloksi)-benzilamino]propanamid;  
(S)-(+)-2-[4-(3-Fluorobenziloksi)-benzilamino]propanamid;  
2-[4-(2-Fluorobenziloksi)-benzilamino]-2-metil-propanamid;  
2-[4-(2-Fluorobenziloksi)-benzilamino]-N-metil-propanamid;  
N-{2-[4-(2-Fluorobenziloksi)-benzilamino]}propionil-pirolidin;  
2-[4-(3-Metoksibenziloksi)-benzilamino]propanamid;  
2-[4-(3-Cijanobenziloksi)-benzilamino]propanamid;  
2-[4-(3-Fluorobenziloksi)-benzilamino]propanamid;  
2-[4-(3-Fluorobenziloksi)-benzilamino]-2-metil-propanamid;  
2-[4-(3-Fluorobenziloksi)-benzilamino]-N-metil-propanamid;  
N-{2-[4-(3-Fluorobenziloksi)-benzilamino]}propionil-pirolidin;  
2-[4-(4-Fluorobenziloksi)-benzilamino]propanamid;  
2-[4-(3-Fluorobenziloksi)-benzilamino]-2-metil-propanamid;  
2-[4-(2-Hlorobenziloksi)-benzilamino]propanamid;  
2-[4-(3-Hlorobenziloksi)-benzilamino]propanamid,  
2-(4-Benziloksibenzilamino)-3-hidroksi-propanamid;  
2-[4-(2-Fluorobenziloksi)-benzilamino]-3-hidroksi-propanamid;  
2-[4-(3-Fluorobenziloksi)-benzilamino]-3-hidroksi-propanamid;

2-(4-Benziloksibenzilamino)-3-hidroksi-N-metil-propanamid;  
2-[4-(2-Fluorobenziloksi)-benzilamino]-3-hidroksi-N-metil-propanamid;  
2-[4-(3-Fluorobenziloksi)-benzilamino]-3-hidroksi-N-metil-propanamid;  
2-[4-(2-Hlorobenziloksi)-benzilamino]-3-hidroksi-N-metil-propanamid;  
2-[4-(3-Cijanobenziloksi)-benzilamino]-3-hidroksi-N-metil-propanamid;  
2-[4-(3-Cijanobenziloksi)-benzilamino]-2-metil-3-hidroksi-N-metil-propanamid;  
2-[4-(3-Hlorobenziloksi)-feniletilamino]propanamid;  
2-{4-[2-(3-Fluorofenil)-etiloksi]benzilamino}propanamid;  
2-{4-[2-(3-Fluorofenil)-etil]benzilamino}propanamid;  
2-[N-(4-Benziloksibenzil)-N-metilamino]propanamid;  
2-{4-[(3-Hlorobenziloksi)-feniletil]-amino}propanamid;  
2-[4-Benziltiobenzilamino]propanamid;  
2-[4-(2-Fluorobenziltio)-benzilamino]propanamid;  
2-[4-(3-Fluorobenziltio)-benzilamino]propanamid;  
2-[4-(3-Fenilpropiloksi)-benzilamino]propanamid;  
2-[4-(4-Fenilbutiloksi)-benzilamino]propanamid;  
2-[4-(5-Fenilpentiloksi)-benzilamino]propanamid;  
2-(4-Benziloksibenzilamino)-3-fenil-N-metil-propanamid;  
2-(4-Benziloksibenzilamino)-3-metil-N-metil-butanamid;  
2-(4-Benziloksibenzilamino)-2-fenil-acetamid;  
2-[4-(2-Fluorobenziloksi)-benzilamino]-2-fenil-acetamid;  
2-[4-(3-Fluorobenziloksi)-benzilamino]-2-fenil-acetamid;  
2-[4-(2-Fluorobenziloksi)-benzil-N-metilamino]-2-fenil-acetamid;  
2-[4-(3-Fluorobenziloksi)-benzil-N-metilamino]-2-fenil-acetamid;  
2-[4-(3-Hlorobenziloksi)-benzilamino]-2-fenil-acetamid;  
2-[4-(2-Fluorobenziloksi)-benzilamino]-2-(2fluorofenil)-acetamid;  
2-[4-(2-Fluorobenziloksi)-benzilamino]-2-(3-fluorofenil)-acetamid;  
2-[4-(3-Fluorobenziloksi)-benzilamino]-2-(2fluorofenil)-acetamid;  
2-[4-(3-Fluorobenziloksi)-benzilamino]-2-(3fluorofenil)-acetamid;  
25 2-[4-(3-Hlorobenziloksi)-benzilamino]-2-(3-fluorofenil)-acetamid;  
2-(4-(2-Tieniloksi)-benzilamino)propanamid;  
Ili opticki izomeri, smješe, i njihove farmaceutske prihvatljive soli, za pripremanje lijeka za liječenje .  
Patent sadrži još 4 patentna zahtjeva.

- (51) **A61K39/395**  
**A61K38/34**  
**C07K14/68**  
**C07K14/725**  
**C07K16/46**  
**C12N5/10**  
**C12N15/11**  
**C12N15/16**  
**C12N15/62**  
**C12N15/86**
- (11) **01234**  
(21) **P-2011-85**
- (30) 20040621960P 25.10.2004 US  
(86) PCT/US2005/038431 25.10.2005.  
(87) WO 2006/047535 04.05.2006  
(96) 05819741.9 25.10.2005.  
(97) EP 1812046 16.03.2011. 2011/11 EN
- (54) (ME) **MIMETIČKA TIJELA KOJA VEZUJU RECEPTORE MELANOKORTINA, SMJESE, POSTUPCI I UPOTREBE**  
(EN) MELANOCORTIN RECEPTOR BINDING MIMETIBODIES, COMPOSITIONS, METHODS AND USES
- (73) Centocor Ortho Biotech Inc.; 800/850 Ridgeview Drive, Horsham, PA 19044 (US)  
(72) 01/ CUNNINGHAM, Mark; 716 Garden Drive, Kennett Square, Pennsylvania 19348 (US)  
02/ STOJANOVIC-SUSULIC, Vedrana, 26 Norchester Drive, Princeton Junction, Pennsylvania 08550 (US)  
03/ O'NEIL, Karyn; 222 Kirkbrae Road, Kennett Square, Pennsylvania 19348 (US)  
04/ HUANG, Chichi; 69 Highpoint Drive, Berwyn, Pennsylvania 19312 (US)  
05/ LUO, Jeffrey; 46 Knickerbocker Lane, Malvern, Pennsylvania 19355 (US)
- (74) Radulović Božidar, Jovana Tomaševića 9/III, Podgorica (ME)
- (57) Polipeptid prema formuli (I):  
(Mp-Lk-v2-Hg- C<sub>H</sub>2- C<sub>H</sub>3) (t) (I)  
gdje Mp je molekula koja veže receptor melanokortina, Lk je polipeptid ili hemijska veza, V2 je dio na C-terminalnom dijelu imunoglobulinskog promjenjivog područja, Hg je barem dio imunoglobulinskog promjenjivog spojnog područja, C<sub>H</sub>2 je konstantno područje imunoglobulinskog teškog lanca C<sub>H</sub>2 i C<sub>H</sub>3 konstantno područje imunoglobulinskog teškog lanca C<sub>H</sub>3 i t je nezavisno cijeli broj od 1 do 10.  
Patent sadrži još 17 patentnih zahtjeva.



- (51) **C07D487/04**  
**C07D487/14**  
**A61K31/407**  
**A61P35/00**

- (11) **01266**  
(21) **P-2011-90**

- (30) 20030532182P 23.12.2003. US  
20040017947 22.12.2004. US  
(86) PCT/US2004/043160 23.12.2004  
(87) WO 2005/063763 14.07.2005.  
(96) 04815262.3 23.12.2004.  
(97) EP 1704148 02.03.2011. 2011/09 EN

(54) (ME) **NOVI FUZIONIRANI PIROLOKARBAZOLI**

(EN) NOVEL FUSED PYRROLOCARBAZOLES

- (73) CEPHALON, INC.; 41 Moores Road, P.O.Box 4011, Frazer, PA 19355 (US)  
(72) 01/ BECKNELL, Nadine, C. 1537 Birdell Road, Coatesville, PA 19320 (US)  
02/ DIEBOLD, James, L. 3220 Hayes Road, Norristown, PA 19403 (US)  
03/ GINGRICH, Diane, E. 23 Southwind Avenue, Downingtown, PA 19335 (US)  
04/ HUDKINS, Robert, L. 430 S. Saddlebrook Circle, Chester Springs, PA 19425 (US)  
05/ REDDY, Dandu, R. 1321 Stonegate Drive, Downingtown, PA 19335 (US)  
06/ TAO, Ming 1704 Brittany Drive, Maple Glen, PA 19002 (US)  
07/ UNDERINER, Theodore, L. 20 Dobs Lane, Malver, PA 19355 (US)  
08/ ZULLI, Allison, L. 1020 Washington Place, Wayne, PA 19087 (US)  
(74) Radulović Božidar, Jovana Tomaševića 9/III, Podgorica (ME)  
(57) Jedinjenje, naznačeno time to ima strukturu formule II

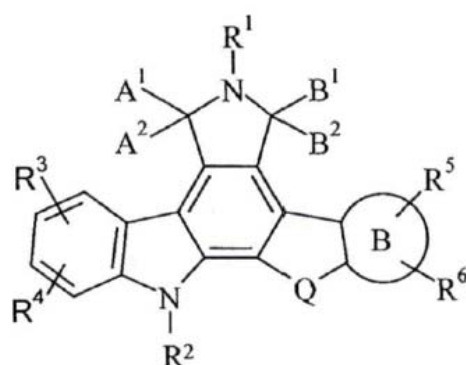

II

ili njegova farmaceutska prihvatljiva so, gde je prsten B zajedno s atomima ugljenika na koje je vezan, izabran između:

(a) fenilenski prsten u kojemu se od 1 do 3 atoma ugljenika mogu zameniti atomima azota; i

(b) 5-člani aromatski prsten u kojemu se od 1 do 2 atoma ugljenika mogu zameniti atomima azota; i

Q je CH<sub>2</sub>CH<sub>2</sub>;

A<sup>1</sup>, A<sup>2</sup> je H, H; i B<sup>1</sup>, B<sup>2</sup> zajedno formiraju =O;

R<sup>1</sup> je nezavisno izabran između: H, C(=O)R<sup>1a</sup>, OR<sup>1b</sup>, C(=O)NHR<sup>1c</sup>, NR<sup>1d</sup>R<sup>1e</sup>, te proizvoljno supstituisan C<sub>1</sub>-C<sub>8</sub> alkil, gde su navedeni nezavisni supstituenti jedna do tri R<sup>10</sup> grupe;

R<sup>2a</sup> je nezavisno izabran između: proizvoljno supstituisan C<sub>1</sub>-C<sub>8</sub> alkil, proizvoljno supstituisani C<sub>6</sub>-C<sub>12</sub> aril i proizvoljno supstituisan hetero C<sub>5</sub>-C<sub>10</sub> aril, gde su navedeni nezavisni supstituenti jedna do tri R<sup>10</sup> grupe;

R<sup>1b</sup> je nezavisno izabran između: H i proizvoljno supstituisan C<sub>1</sub>-C<sub>8</sub> alkil, gde su navedeni nezavisni supstituenti jedna do tri R<sup>10</sup> grupe;

R<sup>1c</sup> i R<sup>1d</sup> su svaki nezavisno izabrani između: H i proizvoljno supstituisan C<sub>1</sub>-C<sub>8</sub> alkil, ili zajedno s atomom azota za kojega je vezan formira proizvoljno supstituisan

hetero C<sub>7</sub>-C<sub>10</sub> cikloalkil, gde su navedeni nezavisni supstituenti jedna do tri R<sup>10</sup> grupe;

R<sup>2</sup> je izabran između: H, C(=O)R<sup>2a</sup>, C(=O)NR<sup>2b</sup>R<sup>2c</sup>, SO<sub>2</sub>R<sup>2d</sup>, CO<sub>2</sub>R<sup>2e</sup>, (C<sub>1</sub>-C<sub>8</sub> alkilen)-OC(=O)-(C<sub>1</sub>-C<sub>8</sub> alkilen)CO<sub>2</sub>R<sup>2f</sup>, proizvoljno supstituisan C<sub>1</sub>-C<sub>8</sub> alkil, proizvoljno supstituisan C<sub>2</sub>-C<sub>8</sub> alkenil, proizvoljno supstituisan C<sub>2</sub>-C<sub>8</sub> alkinil, proizvoljno supstituisan C<sub>7</sub>-C<sub>10</sub> cikloalkil, te proizvoljno supstituisani hetero C<sub>7</sub>-C<sub>10</sub> cikloalkil, gde su navedeni nezavisni supstituenti jedna do tri R<sup>10</sup> grupe;

R<sup>2a</sup> je nezavisno izabran između: proizvoljno supstituisan C<sub>1</sub>-C<sub>8</sub> alkil, proizvoljno supstituisani C<sub>6</sub>-C<sub>12</sub> aril, OR<sup>2b</sup>, te NR<sup>2c</sup>R<sup>2d</sup>, gde su navedeni nezavisni supstituenti jedna do tri R<sup>10</sup> grupe;

R<sup>2b</sup> je izabran između: H i proizvoljno supstituisan C<sub>1</sub>-C<sub>8</sub> alkil, gde su navedeni nezavisni supstituenti jedna do tri R<sup>10</sup> grupe;

R<sup>2c</sup> i R<sup>2d</sup> su svaki nezavisno izabrani između: H i proizvoljno supstituisan C<sub>1</sub>-C<sub>8</sub> alkil, ili zajedno s atomom azota za kojega je vezan formira proizvoljno supstituisan hetero C<sub>7</sub>-C<sub>10</sub> cikloalkil, gde su navedeni nezavisni supstituenti jedna do tri R<sup>10</sup> grupe;

bar jedan od R<sup>3</sup>, R<sup>4</sup>, R<sup>5</sup> i R<sup>6</sup> su izabrani između: (C<sub>1</sub>-C<sub>8</sub> alkilen),OR<sup>13</sup>, C(=O)R<sup>13</sup>, (CH<sub>2</sub>)<sub>n</sub>OR<sup>22</sup>, O-(C<sub>1</sub>-C<sub>8</sub> alkilen)-R<sup>27</sup>, OCH(CO<sub>2</sub>R<sup>18</sup>)<sub>2</sub>, OCH[(CH<sub>2</sub>)<sub>n</sub>OR<sup>20</sup>]<sub>2</sub>, C(=O)-(C<sub>1</sub>-C<sub>8</sub> alkilen)-R<sup>25</sup>, NR<sup>11</sup>R<sup>12</sup>, NR<sup>11</sup>R<sup>13</sup>, (C<sub>1</sub>-C<sub>8</sub> alkilen)-NR<sup>18</sup>R<sup>19</sup>, C(R<sup>12</sup>)-N-R<sup>18</sup>, CH-N-OR<sup>13</sup>, C(R<sup>12</sup>)-N-OR<sup>20</sup>, C(R<sup>11</sup>)-N-NR<sup>11</sup>C(=O)NR<sup>14a</sup>R<sup>14b</sup>, C(R<sup>11</sup>)N-NR<sup>11</sup>SO<sub>2</sub>R<sup>18</sup>, OC(=O)NR<sup>11</sup>(C<sub>1</sub>-C<sub>8</sub> alkilen)-R<sup>26</sup>, OC(=O)[N(CH<sub>2</sub>CH<sub>2</sub>)<sub>2</sub>N]-R<sup>21</sup>, NR<sup>11</sup>C(=O)OR<sup>23</sup>, NR<sup>11</sup>C(=O)S-R<sup>18</sup>, NR<sup>11</sup>C(=O)NR<sup>11</sup>R<sup>23</sup>, NR<sup>11</sup>C(=S)NR<sup>11</sup>R<sup>23</sup>, NR<sup>11</sup>S(=O)<sub>2</sub>N(R<sup>15</sup>)<sub>2</sub>, NR<sup>11</sup>C(=O)NR<sup>11</sup>(C<sub>1</sub>-C<sub>8</sub> alkilen)-R<sup>24</sup>, NR<sup>11</sup>C(=O)N(R<sup>11</sup>)NR<sup>16a</sup>R<sup>16b</sup>, supstituisani C<sub>1</sub>-C<sub>8</sub> alkil, gde je jedan od supstituenata spirocikloalkilna grupa, proizvoljno supstituisani (C<sub>1</sub>-C<sub>8</sub> alkilen),-C<sub>7</sub>-C<sub>10</sub> cikloalkil, te proizvoljno supstituisani -(C<sub>1</sub>-C<sub>8</sub> alkilen),-hetero C<sub>7</sub>-C<sub>10</sub> cikloalkil, gde hetero C<sub>7</sub>-C<sub>10</sub> cikloalkil ne uključuje nesupstituisani N-morfolinil, N-piperidil ili N-thiomorfolinil;

gde bilo koja navedena C<sub>1</sub>-C<sub>8</sub> alkilen grupa može biti proizvoljno supstituisana s jednom do tri R<sup>10</sup> grupe;

pod uslovom da kada je bilo koji od R<sup>3</sup>, R<sup>4</sup>, R<sup>5</sup> ili R<sup>6</sup> jednak C(=O)R<sup>13</sup>, onda R<sup>13</sup> ne uključuje hetero C<sub>7</sub>-C<sub>10</sub> cikloalkilnu grupu koja sadrži azot vezan za karbonilnu vrstu; a druge R<sup>3</sup>, R<sup>4</sup>, R<sup>5</sup> ili R<sup>6</sup> vrste mogu da se odaberu nezavisno između: H, halogen, R<sup>10</sup>, OR<sup>20</sup>, proizvoljno supstituisan C<sub>1</sub>-C<sub>8</sub> alkil, proizvoljno supstituisani C<sub>2</sub>-C<sub>8</sub> alkenil, te proizvoljno supstituisan

- $C_2-C_4$  alkinil, gde su navedeni nezavisni supstituenti jedna do tri  $R^{10}$  grupe;
- $R^7$  je izabran između: H, proizvoljno supstituisan  $C_1-C_8$  alkil, te  $OR^{11}$ , gde navedeni su nezavisni supstituenti jedna do tri  $R^{10}$  grupe;
- $R^{10}$  je izabran između:  $C_1-C_8$  alkil,  $C_6-C_{12}$  aril, hetero  $C_5-C_{10}$  aril,  $C_3-C_{10}$  cikloalkil, spirocikloalkil, hetero  $C_3-C_{10}$  cikloalkil, arilalkoksi, F, Cl, Br, I, CN,  $CF_3$ ,  $NR^{11A}R^{11B}$ ,  $NO_2$ ,  $OR^{20}$ ,  $OCF_3$ ,  $-O$ ,  $-NR^{22}$ ,  $-N-OR^{21}$ ,  $-N-NR^{21A}R^{21B}$ ,  $OC(=O)R^{23}$ ,  $OC(=O)NHR^{20}$ ,  $O-Si(R^{20})_4$ , O-tetrahidropiraniil, etilen oksid,  $NR^{25}C(=O)R^{26}$ ,  $NR^{25}CO_2R^{26}$ ,  $NR^{25}C(=O)NR^{11A}R^{11B}$ ,  $NHC(=NH)NH_2$ ,  $NR^{25}S(O)_2R^{26}$ ,  $S(O)_2R^{18}$ ,  $CO_2R^{19}$ ,  $C(=O)NR^{11A}R^{11B}$ ,  $C(=O)R^{20}$ ,  $(CH_2)_6OR^{20}$ ,  $CH=N-NR^{21A}R^{21B}$ ,  $CH=NOR^{20}$ ,  $CH=NR^{20}$ ,  $CH=NNHCH(N-NH)NH_2$ ,  $S(=O)_2NR^{11A}R^{11B}$ ,  $P(=O)(OR^{20})_2$ ,  $OR^{20}$ , te monosaharid gde je svaka hidroksilna grupa monosaharida nezavisno bilo nesupstituisana ili je zamenjena s H,  $C_1-C_8$  alkil, alkilkarboniloksi, ili alkoksi;
- $R^{11}$  je izabran između: H i proizvoljno supstituisan  $C_1-C_8$  alkil, gde su navedeni nezavisni supstituenti jedna do tri  $R^{10}$  grupe;
- $R^{12}$  je izabran između: proizvoljno supstituisan  $C_1-C_8$  alkil, proizvoljno supstituisan  $C_6-C_{12}$  aril, te proizvoljno supstituisan hetero  $C_3-C_{10}$  aril, gde su navedeni proizvoljni supstituenti jedna do tri  $R^{10}$  grupe;
- $R^{13}$  je nezavisno izabran između: proizvoljno supstituisan  $C_3-C_{10}$  cikloalkil, te proizvoljno supstituisan hetero  $C_3-C_{10}$  cikloalkil, gde su navedeni proizvoljni supstituenti jedna do tri  $R^{10}$  grupe;
- $R^{14A}$  i  $R^{14B}$  su svaki nezavisno izabrani između: H, proizvoljno supstituisan  $C_1-C_8$  alkil, proizvoljno supstituisan  $C_6-C_{12}$  aril, te proizvoljno supstituisan hetero  $C_3-C_{10}$  aril, gde su navedeni nezavisni supstituenti jedna do tri  $R^{10}$  grupe;
- $R^{15}$  je nezavisno izabran između: proizvoljno supstituisan  $C_1-C_8$  alkil, proizvoljno supstituisan  $C_6-C_{12}$  aril, proizvoljno supstituisan hetero  $C_3-C_{10}$  aril, proizvoljno supstituisan  $C_3-C_{10}$  cikloalkil, te proizvoljno supstituisan hetero  $C_3-C_{10}$  cikloalkil, gde su navedeni nezavisni supstituenti jedna do tri  $R^{10}$  grupe;
- $R^{16A}$  i  $R^{16B}$  su svaki nezavisno izabrani između: H i proizvoljno supstituisani  $C_1-C_8$  alkil, ili zajedno s atomom azota za kojega je vezan formira proizvoljno supstituisan hetero  $C_3-C_{10}$  cikloalkil, gde su navedeni nezavisni supstituenti jedna do tri  $R^{10}$  grupe;
- $R^{17}$  je izabran između: proizvoljno supstituisan  $C_3-C_{10}$  cikloalkil, proizvoljno supstituisani hetero  $C_3-C_{10}$  cikloalkil, te proizvoljno supstituisan hetero  $C_5-C_{10}$  aril, gde su navedeni nezavisni supstituenti jedna do tri  $R^{10}$  grupe;
- $R^{18}$  izabran između: H, proizvoljno supstituisan  $C_1-C_8$  alkil, proizvoljno supstituisan  $C_6-C_{12}$  aril, proizvoljno supstituisan hetero  $C_3-C_{10}$  aril, proizvoljno supstituisani  $C_3-C_{10}$  cikloalkil, te proizvoljno supstituisan hetero  $C_3-C_{10}$  cikloalkil, gde su navedeni nezavisni supstituenti jedna do tri  $R^{10}$  grupe;
- $R^{19}$  je izabran između CN i triazola;
- $R^{20}$  je izabran između: H, proizvoljno supstituisan  $C_1-C_8$  alkil, proizvoljno supstituisan  $C_2-C_8$  alkenil, proizvoljno supstituisan  $C_2-C_8$  alkinil, proizvoljno supstituisani  $C_6-C_{12}$  aril, proizvoljno supstituisan  $C_3-C_{10}$  aril,  $C_1-C_8$  alkil, proizvoljno supstituisan hetero  $C_3-C_{10}$  aril, proizvoljno supstituisan  $C_3-C_{10}$  cikloalkil, te proizvoljno supstituisan hetero  $C_3-C_{10}$  cikloalkil, gde su navedeni nezavisni supstituenti jedna do tri  $R^{10}$  grupe;
- $R^{21}$  je izabran između: proizvoljno supstituisan  $C_6-C_{12}$  aril, te proizvoljno supstituisani hetero  $C_3-C_{10}$  aril, gde su navedeni nezavisni supstituenti jedna do tri  $R^{10}$  grupe;
- $R^{22}$  je proizvoljno supstituisan  $C_3-C_{10}$  alkil, gde su navedeni nezavisni supstituenti jedna do tri  $R^{10}$  grupe;
- $R^{23}$  je izabran između: proizvoljno supstituisan  $C_6-C_{12}$  aril, proizvoljno supstituisan hetero  $C_3-C_{10}$  aril, proizvoljno supstituisan  $C_3-C_{10}$  cikloalkil, te proizvoljno supstituisan hetero  $C_3-C_{10}$  cikloalkil, gde su navedeni nezavisni supstituenti jedna do tri  $R^{10}$  grupe;
- $R^{24}$  je izabran između: proizvoljno supstituisan  $C_2-C_8$  alkenil, proizvoljno supstituisan  $C_2-C_8$  alkinil, proizvoljno supstituisan  $C_4-C_{12}$  aril, proizvoljno supstituisan hetero  $C_3-C_{10}$  aril, proizvoljno supstituisan  $C_3-C_{10}$  cikloalkil, proizvoljno supstituisani hetero  $C_3-C_{10}$  cikloalkil,  $OR^{20}$ ,  $O(CH_2)_6OR^{20}$ ,  $(CH_2)_6OR^{20}$ ,  $SR^{17}$ ,  $SOR^{15}$ ,  $SO_2R^{18}$ , CN,  $N(R^{18})_2$ ,  $C(=O)N(R^{18})_2$ ,  $NR^{18}C(=O)R^{18}$ ,  $NR^{18}C(=O)N(R^{18})_2$ ,  $C(=NR^{18})OR^{18}$ ,  $C(R^{12})=NOR^{18}$ ,  $NHOR^{20}$ ,  $NR^{18}C(=NR^{18})N(R^{18})_2$ ,  $NHCN$ ,  $CONR^{18}OR^{18}$ ,  $CO_2R^{18}$ ,  $OCOR^{15}$ ,  $OC(=O)N(R^{18})_2$ ,  $NR^{18}C(=O)OR^{15}$ , te  $C(=O)R^{18}$ , gde su navedeni nezavisni supstituenti jedna do tri  $R^{10}$  grupe;
- $R^{25}$  je izabran između: proizvoljno supstituisan  $C_3-C_{10}$  cikloalkil, proizvoljno supstituisani hetero  $C_3-C_{10}$  cikloalkil,  $OR^{20}$ ,  $O(CH_2)_6OR^{20}$ ,  $(CH_2)_6OR^{20}$ ,  $SR^{17}$ ,  $SOR^{15}$ ,  $SO_2R^{18}$ , CN,  $N(R^{17})_2$ ,  $C(=O)N(R^{18})_2$ ,  $NR^{18}C(=O)R^{18}$ ,  $NR^{18}C(=O)N(R^{18})_2$ ,  $C(=NR^{18})OR^{18}$ ,  $C(R^{12})=NOR^{18}$ ,  $NHOR^{20}$ ,

$\text{NR}^{18}\text{C}(\text{--NR}^{18})\text{N}(\text{R}^{18})_2\text{NHCN}$ ,  $\text{CONR}^{18}\text{OR}^{18}$ ,  $\text{CO}_2\text{R}^{18}$ ,  $\text{OCOR}^{18}$ ,  
 $\text{OC}(\text{--O})\text{N}(\text{R}^{18})_2$ ,  $\text{NR}^{18}\text{C}(\text{--O})\text{OR}^{18}$ , te  $\text{C}(\text{--O})\text{R}^{18}$ , gde su navedeni nezavisni  
 supstituenti jedna do tri  $\text{R}^{10}$  grupe;

- $\text{R}^{26}$  je izabran između: proizvoljno supstituisan  $\text{C}_3\text{--C}_{10}$  cikloalkil, proizvoljno  
 supstituisani hetero  $\text{C}_3\text{--C}_{10}$  cikloalkil, proizvoljno supstituisan  $\text{C}_6\text{--C}_{12}$  aril,  
 proizvoljno supstituisan hetero  $\text{C}_5\text{--C}_{10}$  aril,  $\text{OR}^{11}$ ,  $\text{O}(\text{CH}_2)_x\text{OR}^{20}$ ,  $(\text{CH}_2)_x\text{OR}^{20}$ ,  
 $\text{SR}^{17}$ ,  $\text{SOR}^{15}$ ,  $\text{SO}_2\text{R}^{18}$ ,  $\text{CN}$ ,  $\text{N}(\text{R}^{18})_2$ ,  $\text{C}(\text{--O})\text{N}(\text{R}^{18})_2$ ,  $\text{NR}^{18}\text{C}(\text{--O})\text{R}^{18}$ ,  
 $\text{NR}^{18}\text{C}(\text{--O})\text{N}(\text{R}^{18})_2$ ,  $\text{C}(\text{--NR}^{18})\text{OR}^{18}$ ,  $\text{C}(\text{R}^{17})\text{--NOR}^{18}$ ,  $\text{NHOR}^{20}$ ,  
 $\text{NR}^{18}\text{C}(\text{--NR}^{18})\text{N}(\text{R}^{18})_2$ ,  $\text{NHCN}$ ,  $\text{CONR}^{18}\text{OR}^{18}$ ,  $\text{CO}_2\text{R}^{18}$ ,  $\text{OCOR}^{18}$ ,  
 $\text{OC}(\text{--O})\text{N}(\text{R}^{18})_2$ ,  $\text{NR}^{18}\text{C}(\text{--O})\text{OR}^{18}$ , te  $\text{C}(\text{--O})\text{R}^{18}$ , gde su navedeni nezavisni  
 supstituenti jedna do tri  $\text{R}^{10}$  grupe;
- $\text{R}^{27}$  je izabran između: proizvoljno supstituisan  $\text{C}_3\text{--C}_{10}$  cikloalkil,  $\text{CN}$ ,  $\text{C}(\text{R}^{12})\text{--NOR}^{18}$ , te  
 $\text{C}(\text{--O})\text{N}(\text{R}^{18})_2$ , gde su navedeni nezavisni supstituenti jedna do tri  $\text{R}^{10}$  grupe;
- $\text{R}^{28}$  je rezidua aminokiseline nakon uklanjanja hidroksilne vrste s njene karboksilne  
 grupe;
- $\text{R}^{29}$  je H ili  $\text{C}_1\text{--C}_4$  alkil;
- $\text{R}^{30}$  je H,  $\text{C}_1\text{--C}_3$  alkil,  $\text{C}_6\text{--C}_{12}$  aril,  $\text{C}_6\text{--C}_{16}$  aril  $\text{C}_1\text{--C}_4$  alkil, hetero  $\text{C}_3\text{--C}_{10}$  aril,  $\text{C}_3\text{--C}_{10}$   
 cikloalkil, ili hetero  $\text{C}_7\text{--C}_{10}$  cikloalkil;
- $\text{R}^{31\text{A}}$  i  $\text{R}^{31\text{B}}$  su svaki nezavisno izabrani između: H,  $\text{C}_1\text{--C}_8$  alkil, te  $\text{C}_6\text{--C}_{16}$  aril  $\text{C}_1\text{--C}_8$   
 alkil, ili zajedno s atomom azota za kojega je vezan formira hetero  $\text{C}_3\text{--C}_{10}$   
 cikloalkil;
- $\text{R}^{32}$  je proizvoljno supstituisan  $\text{C}_6\text{--C}_{12}$  aril, gde su navedeni nezavisni supstituenti jedna  
 do tri  $\text{R}^{10}$  grupe;
- $\text{R}^{33}$  je izabran između: proizvoljno supstituisan  $\text{C}_3\text{--C}_{10}$  cikloalkil, proizvoljno  
 supstituisani hetero  $\text{C}_3\text{--C}_{10}$  aril, te proizvoljno supstituisan hetero  $\text{C}_3\text{--C}_{10}$   
 cikloalkil, gde su navedeni nezavisni supstituenti jedna do tri  $\text{R}^{10}$  grupe;
- p je nezavisno izabran između 1, 2, 3 i 4;
- x je 0 ili 1; te
- y je nezavisno izabran između 0, 1 i 2,
- ili stereoisomer ili njegova farmaceutski prihvatljiva so.

Patent sadrži još 17 patentnih zahtjeva.

- (51) **C07D215/14**
- C07D401/04**
- C07D413/04**
- C07D417/04**
- A61K31/496**
- A61P31/04**

- (30) 20060125529 06.12.2006. EP
- (86) PCT/EP2007/063316 04.12.2007.
- (87) WO 2008/068270 12.06.2008.
- (96) 07847814.6 04.12.2007.
- (97) EP 2099759 18.05.2011. 2011/20] EN

(54) (ME) **ANTIBAKTERIJSKI HINOLINSKI DERIVATI**  
(EN) ANTIBACTERIAL QUINOLINE DERIVATIVES

- (73) Janssen Pharmaceutica NV; Turnhoutseweg 30, 2340 Beerse (BE)
- (72) 01/ GUILLEMONT, Jérôme Emile Georges, Johnson & Johnson Pharmaceutical Research and Development A division of Janssen-Cilag Campus de Maigremont BP615, 27106 Val de Reuil Cedex (FR)
- 02/ ANDRIES, Koenraad Jozef Lodewijk Marcel Janssen Pharmaceutica N.V. Turnhoutseweg 30, 2340 Beerse (BE)
- 03/ KOUL, Anil Janssen Pharmaceutica N.V. Turnhoutseweg 30, 2340 Beerse (BE)
- (74) Radulović Božidar, Jovana Tomaševića 9/III, Podgorica (ME)

1. Jedinjenje, naznačeno time, da je predstavljeno formulom (la) ili (lb)

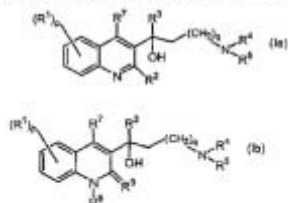

uključujući i sve njegove stereohemijske izomerne forme, gde

p je neki celi broj koji je jednak 1, 2, 3 ili 4;

q je neki celi broj koji je jednak nuli, 1, 2, 3 ili 4;

R<sup>1</sup> je vodonik, cijano, formil, karboksil, halo, alkil, C<sub>2-6</sub>alkenil, C<sub>2-6</sub>alkinil, haloalkil, hidroksi, alkiloksi, alkiltio, alkiltioalkil -C(=O)-N-OR<sup>1</sup>, amino, mono ili di(alkil)amino, aminoalkil, mono ili di(alkil)aminoalkil, alkilkarbonilaminoalkil, aminokarbonil, mono ili di(alkil)aminokarbonil, arilalkil, arilkarbonil, R<sup>2a</sup>R<sup>2b</sup>Nalkil, di(aril)alkil, aril, R<sup>2a</sup>R<sup>2b</sup>N-, R<sup>2a</sup>R<sup>2b</sup>N-C(=O)- ili Het;

R<sup>2</sup> je vodonik, alkiloksi, aril, ariloksi, hidroksi, merkaptio, alkiloksilalkiloksi, alkiltio,

mono ili di(alkil)amino, piperidino ili neki radikal sa formulom  gde Y je CH<sub>2</sub>, O, S, NH ili N-alkil;

R<sup>3</sup> je alkil, arilalkil, aril-O-alkil, aril-alkil-O-alkil, aril, aril-aril, Het, Het-alkil, Het-

O-alkil, Het-alkil-O-alkil ili 

R<sup>4</sup> i R<sup>5</sup> svaki nezavisno je vodonik; alkil; alkiloksilalkil; arilalkil; Het-alkil; mono- ili dialkilaminoalkil; biciklo[2.2.1]heptil; Het; aril; ili -C(=NH)-NH<sub>2</sub>; ili

(57)

- $R^1$  i  $R^2$  zajedno sa atomom azota, na kojeg su vezani, formiraju neki radikal koji je izabran iz grupe koja obuhvata pirolidino, piperidin, piperazino, morfolino, 4-tiomorfolino, 1,1-dioksid-tiomorfolinil, azetidini, 2,3-dihidroizoindol-1-il, tiazolidin-3-il, 1,2,3,6-tetrahidropiridil, heksahidro-1*H*-azepinil, heksahidro-1*H*-1,4-diazepinil, heksahidro-1,4-oksazepinil, 1,2,3,4-tetrahidroizoholin-2-il, 2,5-diazabicyklo[2,2,1]heptil, pirolinil, pirolil, imidazolidinil, pirazolidinil, 2-imidazolil, 2-pirazolinil, imidazolil, pirazolil, triazolil, piridinil, piridazinil, pirimidinil, pirazinil i triazinil, a svaki radikal je ponekad supstituisan sa 1, 2, 3 ili 4 supstituenata, a svaki supstituenat je nezavisno izabran iz alkila, haloalkila, alkilkarbonila, halo, arilalkila, hidroksi, alkiloksi, amino, mono- ili dialkilamino, aminoalkila, mono- ili dialkilaminoalkila, alkilio, alkilioalkila, arila, piridila, pirimidinila, piperidinila koji je ponekad supstituisan sa alkilom ili pirolidinilom koji je ponekad supstituisan sa arilalkilom;
- $R^{1a}$  i  $R^{1b}$  zajedno sa atomom azota, na kojeg su spojeni, formiraju neki radikal koji je izabran iz grupe koja obuhvata pirolidino, piperidino, piperazino, morfolino, 4-tiomorfolino, 2,3-dihidroizoindol-1-il, tiazolidin-3-il, 1,2,3,6-tetrahidropiridil, heksahidro-1*H*-azepinil, heksahidro-1*H*-1,4-diazepinil, heksahidro-1,4-oksazepinil, 1,2,3,4-tetrahidroizoholin-2-il, pirolinil, pirolil, imidazolidinil, pirazolidinil, 2-imidazolil, 2-pirazolinil, imidazolil, pirazolil, triazolil, piridinil, piridazinil, pirimidinil, pirazinil i triazinil, a svaki radikal je ponekad supstituisan sa 1, 2, 3 ili 4 supstituenata, a svaki supstituenat je nezavisno izabran iz alkila, haloalkila, halo, arilalkila, hidroksi, alkiloksi, amino, mono- ili dialkilamino, alkilio, alkilioalkila, arila, piridila ili pirimidinila;
- $R^7$  je vodonik, halo, alkil, aril ili Het;
- $R^8$  je vodonik ili alkil;
- $R^9$  je okso; ili
- $R^8$  i  $R^9$  zajedno formiraju radikal  $-CH=CH-N-$ ;
- $R^{11}$  je vodonik ili alkil;
- aril je neki homocikal koji je izabran iz fenila, naftila, acenafila ili tetrahidronaftila, a svaki od njih je ponekad supstituisan sa 1, 2 ili 3 supstituenata, a svaki

supstituenat je nezavisno izabran iz hidroksi, halo, cijano, nitro, amino, mono- ili dialkilamino, alkila,  $C_{2-6}$ alkenila koji je ponekad supstituisan sa fenilom, haloalkilom, alkiloksi, haloalkiloksi, karboksilom, alkiloksisarbonilom, aminokarbonilom, morfolinilom ili mono- ili dialkilaminokarbonilom;

- Het je neki monociklički heterocikal koji je izabran iz *N*-fenoksipiperidinila, piperidinila, pirolila, pirazolila, imidazolila, furanila, tienila, oksazolila, izoksazolila, tiazolila, izotiazolila, piridinila, pirimidinila, pirazinila ili piridazinila; ili neki biciklički heterocikal koji je izabran iz hinolinila, kinoksalinila, indolila, benzimidazolila, benzoksazolila, benzizoksazolila, benzotiazolila, benzizotiazolila, benzofuranila, benzotienila, 2,3-dihidrobenzo[1,4]dioxinila ili benzo[1,3]dioxolila; a svaki monociklički ili biciklički heterocikal je ponekad supstituisan sa 1, 2 ili 3 supstituenata, a svaki supstituenat je nezavisno izabran iz halo, hidroksi, alkila ili alkiloksi;
- neki njegov *N*-oksid, njegova farmaceutski prihvatljiva so ili njegov solvat.

Patent sadrži još 17 patentnih zahtjeva.

- (51) **H02G3/04** (11) **01220**  
**H01R13/46** (21) **P-2011-110**
- (30) 102004054237 10.11.2004. DE  
(96) 05024242.9 08.11.2005.  
(97) EP1657794 16.03.2011.
- (54) (ME) **ZAVRŠETAK ZA CIJEVI ILI KABLOVE**  
(EN) END CLOSING FOR CABLE OR TUBING
- (73) Gabo Systemtechnik GmbH; Am Schaidweg 7, 94559 Niederwinkling (DE)  
(72) 01 / Bauer, Peter; Kleinmenhaupten 5, 94357 Konzell (DE)  
02 / Lederer, Roland; Tassilostrasse 5, 94374 Schwarzach (DE)  
03 / Karl, Markus; Degernbach 62, 94327 Bogen (DE)  
(74) Radulović Božidar, Jovana Tomaševića 9/III, Podgorica (ME)
- (57) Završetak za cijevi ili kablove sa poljem za obelježavanje, naznačen time, što sadrži identifikacionu pločicu (1) tangencijalnu na cilindrični kraj završetka (3) sa otvorom (5) na prednjoj strani i osnovom (4), koja nosi polje (2) za obelježavanje, i što sadrži oslabljeni dio (7) zida završetka (3) između osnove (4) završetka (3) i ivice (6) polja (2) za obelježavanje, i što se obujmica (10) završetka (3) pruža preko ivice (6) polja (2) za obelježavanje približno na dužini koja je pet puta veća od njenog prečnika.  
Patent sadrži još 3 patentna zahtjeva.

(51) **C07D487/04**  
**C07D405/06**  
**C07D309/32**  
**C07D513/04**  
**C07D405/14**  
**A61K31/351**  
**A61K31/366**  
**A61P31/14**

(11) **01235**  
(21) **P-2011-112**

(30) 20040602618P 18.08.2004. US  
(86) PCT/IB2005/002697 05.08.2005.  
(87) WO 2006/018725 23.02.2006.  
(96) 05775853.4 05.08.2005.  
(97) EP 1781662 20.04.2011. 2011/16 EN

(54) (ME) **INHIBITORI RNA-OVISNE RNA-POLIMERAZE IZ VIRUSA HEPATITISA C, TE PRIPRAVCI I LIJEČENJE U KOJEM SE KORISTE**

(EN) INHIBITORS OF HEPATITIS C VIRUS RNA-DEPENDENT RNA POLYMERASE, AND COMPOSITIONS AND TREATMENTS USING THE SAME

(73) Pfizer Inc., 235 East 42nd Street, New York, NY 10017 (US)

(72) 01/ GONZALEZ, Javier; Agouron/Pfizer La Jolla 10777 Science Center Drive, San Diego, CA 92121 (US)

02/ JEWELL, Tanya, Michelle; Agouron Pfizer La Jolla 10777 Science Center Drive, San Diego, CA 92121 (US)

03/ LI, Hui; Agouron/Pfizer La Jolla 10777 Science Center Drive, San Diego, CA 92121 (US)

04/ LINTON, Angelica; Agouron/Pfizer La Jolla 10777 Science Center Drive, San Diego, CA 92121 (US)

05/ TATLOCK, John, Howard; Agouron/Pfizer La Jolla 10777 Science Center Drive, San Diego, CA 92121 (US)

(74) Ćupić Branislav, Dalmatinska 10, Podgorica (ME)

(57) Spoj formule (4).

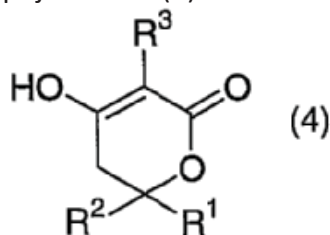

naznačen time što:

R<sup>1</sup> je ciklopentil;

R<sup>2</sup> je -(CR<sup>6</sup>R<sup>7</sup>)<sub>n</sub> (5-6-eročlani heterocikl), gdje je navedena 5-6-eročlana heterociklična grupa izborno supstituisana s najmanje jednom grupom R<sup>4</sup>; R<sup>3</sup> je -(CR<sup>6</sup>R<sup>7</sup>)<sub>n</sub> (4-10-eročlani heterocikl), izborno supstituisan s najmanje jednom grupom R<sup>5</sup>; svakog R<sup>4</sup> se nezavisno bira između halogena, -OR<sup>6</sup>, okso, -NR<sup>6</sup>R<sup>7</sup>, -CF<sub>3</sub>, -CN, -C(O)R<sup>6</sup>, -C(O)OR<sup>6</sup>, -OC(O)R<sup>6</sup>, -NR<sup>6</sup>C(O)R<sup>7</sup>, -NR<sup>6</sup>C(O)OR<sup>7</sup>, -NR<sup>6</sup>C(O)NR<sup>6</sup>R<sup>7</sup>, -C(O)NR<sup>6</sup>R<sup>7</sup>, -SO<sub>2</sub>NR<sup>6</sup>R<sup>7</sup>, -NR<sup>6</sup>SO<sub>2</sub>R<sup>7</sup>, C<sub>1</sub>-C<sub>6</sub> alkila, C<sub>2</sub>-C<sub>6</sub> alkenila i C<sub>2</sub>-C<sub>6</sub> alkinila, gdje su navedene C<sub>1</sub>-C<sub>6</sub> alkilna, C<sub>2</sub>-C<sub>6</sub> alkenilna i C<sub>2</sub>-C<sub>6</sub> alkinilna grupa izborno supstituisane s najmanje jedan R<sup>5</sup>; svakog R<sup>5</sup> se nezavisno bira između C<sub>1</sub>-C<sub>6</sub> alkila, halogena, -OR<sup>6</sup>, -CF<sub>3</sub> i -CN; svakog R<sup>6</sup> i R<sup>7</sup> se nezavisno bira između vodonika i C<sub>1</sub>-C<sub>6</sub> alkila; n je 2; i t je 1 ili 2; ili njegova farmaceutski prillvatljiva so ili solvat, uz uslov da jedinjenje formule (4) nije 6-ciklopentil-3-[(5,7-dimetil[1,2,4]triazolo[1,5-a]pirimidin-2-il)metil]-6-[2-(2-etilpiridin-



4-il)etil]-4-hidroksi-5,6-dihidro-2H-piran-2-on, 3-[(6-hlor[ 1,2,4]triazolo[ 1,5- $\alpha$ ]pirimidin-2-il)metil]-6-ciklopentil-6-[2-(2-etilpiridin-4-il)etil]-4-hidroksi-5,6-dihidro-2 H -piran-2-on ili 6-ciklopentil-3-[(5,7-dimetil[1,2,4]triazolo[ 1,5-  $\alpha$ ]pirimidin-2-il)metil]-6-[2-(5-etilpiridin-3-il)etil]-4-hidroksi-5,6-dihidro-2 H -piran-2-on.

Patent sadrži još 22 patentna zahtjeva.

- (51) **C07D405/14**  
**C07D417/06**  
**C07C229/26**  
**A61K31/4196**  
**A61K31/427**  
**A61P31/04**

- (11) **01226**  
(21) **P-2011-119**

- (30) 20050676932P 03.05.2005. US  
(86) PCT/JP2006/309435 01.05.2006.  
(87) WO 2006/118351 09.11.2006.  
(96) 06746245.7 01.05.2006.  
(97) EP1877403 30.03.2011. 2011/13 EN

- (54) (ME) **MONOLIZINSKE SOLI AZOLNIH JEDINJENJA**  
(EN) MONO-LYSINE SALTS OF AZOLE COMPOUNDS

- (73) Eisai R&D Management Co., Ltd., 6-10, Koishikawa 4-chome Bunkyo-ku, Tokyo 112-8088 (JP)

- (72) 01/ GAO, Qi; 17 Quarry Run Court, Wallingford, Connecticut 06492(US)  
02/ CHEN, Chung-Pin, H.; 92 Joshua Trail, Madison, Connecticut 06443 (US)  
03/ FAKES, Michael, G.; 15 Derby Chase Court, Belle Mead, New Jersey 08502 (US)  
04/ PENDRI, Yadagiri, R.; 54 Aspen Drive, South Glastonbury, Connecticut 06073 (US)  
05/ KIAU, Susanne; 10-2K Petunia Drive, North Brunswick, New Jersey 08902 (US)  
06/ VAKKALAGADDA, Blisse; 4 Riverbend Drive, North Brunswick, New Jersey 08902 (US)

- (74) Mugoša Stanković Ana, Trg Republike 13, Podgorica (ME)

- (57) Monolizinska so jedinjenja formule I, ili njen solvat:

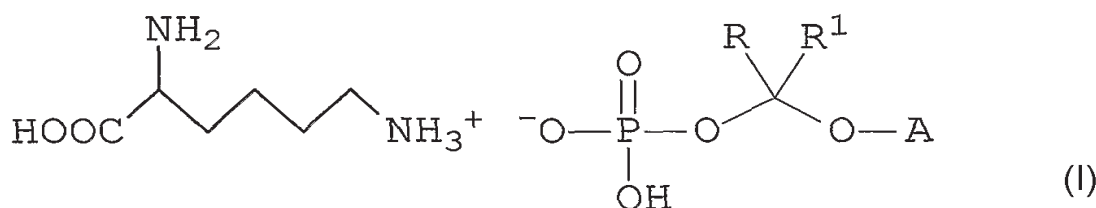

u kojoj svaki od R i R<sup>1</sup> označava vodonik ili (C<sub>1</sub>-C<sub>6</sub>)-alkil; i A je odabran iz grupe koja se sastoji od:

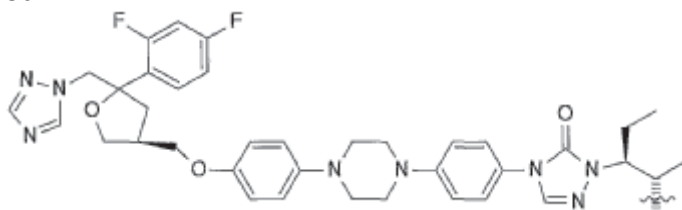

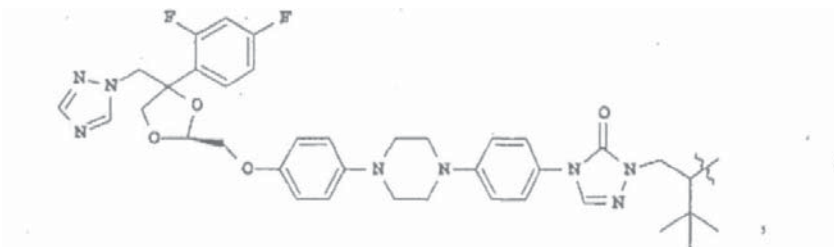
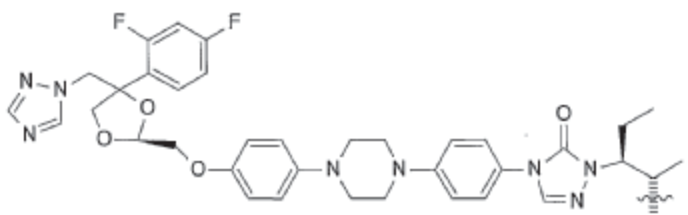
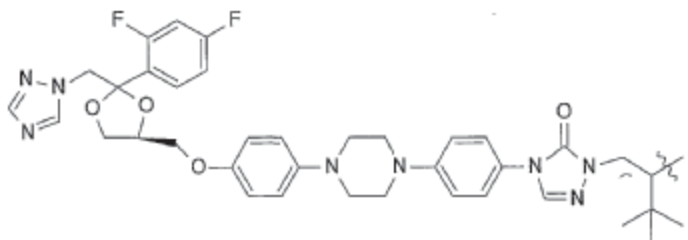
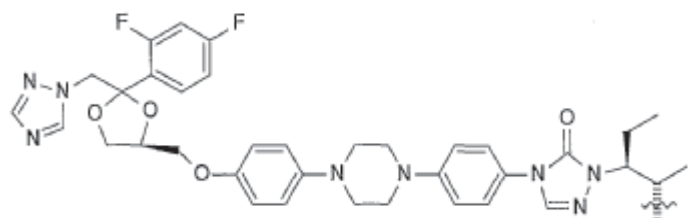
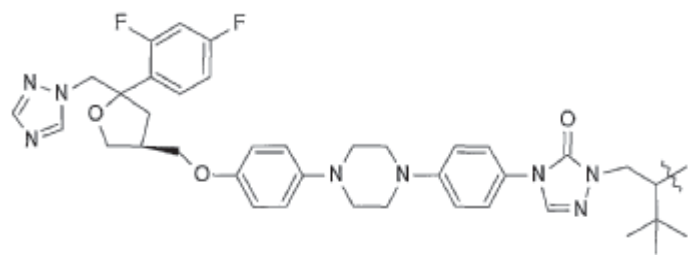

i formule (i):

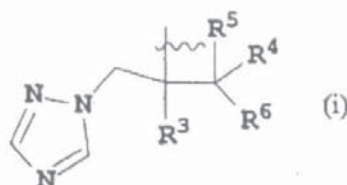

pri čemu u formuli (i)

R<sup>3</sup> označava fenil-grupu koja je supstutuisana sa jednim ili više atoma halogena;  
 R<sup>4</sup> označava vodonik ili CH<sub>3</sub>; R<sup>5</sup> označava vodonik, ili uzet zajedno sa R<sup>4</sup> označava =CH<sub>2</sub>; i  
 R<sup>6</sup> označava tiazolil, pirimidinil ili triazolil pri čemu je svaki prsten opciono supstutuisan sa  
 jednom ili više grupa odabranih iz grupe koja se sastoji od halogena, =O, CH=CH-(C<sub>6</sub>H<sub>4</sub>)-  
 OCH<sub>2</sub>CF<sub>2</sub>CHF<sub>2</sub>, i fenila koji je supstutuisan sa jednom ili više grupa odabranih iz grupe koja se  
 sastoji od CN i OCH<sub>2</sub>CF<sub>2</sub>CHF<sub>2</sub>, ili fenila koji je supstutuisan sa jednom ili više grupa odabranih  
 iz grupe koja se sastoji od halogena ili metilpirazolila.

Patent sadrži još 42 patentna zahtjeva.

- (51) **E04H12/08** (11) **01221**  
**E01F9/018** (21) **P-2011-125**
- (30) 20070000300 15.06.2007. BE  
(86) PCT/EP2008/053853 31.03.2008.  
(87) WO 2008/151862 18.12.2008  
(96) 08749508.1 31.03.2008.  
(97) EP 2167761 13.04.2011. 2011/15 EN
- (54) (ME) **ULIČNI STUB I POSTUPAK ZA POSTAVLJANJE ULIČNOG STUBA**  
(EN) **STREET POLE AND METHOD FOR PLACING THE STREET POLE**
- (73) Safety Product, Beverlosesteenweg 100, 3580 Beringen (BE)
- (72) 01/ GOOSSENS, Urbanus, Paul, Marguerite; Kapellestraat 64B, B-9220 Hamme (BE)  
02/ MAES, Albert, Moerstraat 12, B-2240 Zandhoven (BE)  
03/ LIEVENS, Anja, Rademakersstraat 18, B-2250 Olen (BE)  
04/ WILLEMS, Carolien, Bovenpad 11, B-2280 Grobbendonk (BE)
- (74) Radulović Božidar, Jovana Tomaševića 9/III, Podgorica (ME)
- (57) Ulični stub (1) koji se u osnovi prostire duž podužnog pravca (8) i koji obuhvata šuplje cilindrično tijelo (6) koje se proteže oko podužnog pravca (8) i duž obimnog pravca (9), gdje šuplje cilindrično tijelo (6) obuhvata najmanje jedan preklop (2) prve i druge ivice (3, 4) obimnog zida (7) koji obrazuje šuplje cilindrično tijelo (6), pri čemu šuplje cilindrično tijelo (6) obuhvata sredstva (5) za pričvršćivanje za spajanje prve i druge ivice (3, 4), gdje preklop (2) ima dužinu (10) koja se prostire u osnovi paralelno podužnom pravcu (8) i širinu (11) koja se u osnovi prostire duž obimnog pravca (9), naznačen time, što su bočni zid (7) i sredstva (5) za pričvršćivanje izvedeni tako da se razdvajaju duž preklopa (2) lomljenjem sredstava (5) za pričvršćivanje udarom u mjesto (15) udara na uličnom stubu (1), pri čemu je na mjestu (15) udara izvedeno šuplje cilindrično tijelo (6).

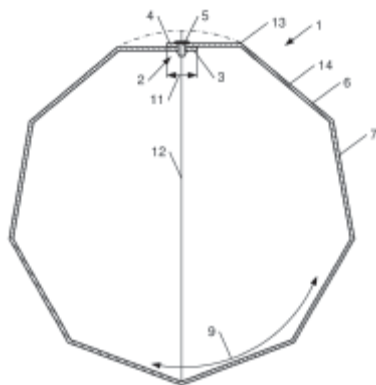

Fig. 1

Patent sadrži još 16 patentnih zahtjeva.

- (51) **A01N43/56** (11) **01244**  
 (21) **P-2011-127**  
 (30) 20070008370 25.04.2007. EP  
 (96) 10157582.7 23.04.2008.  
 (97) EP 2193717 25.05.2011. 2011/21 EN

(54) (ME) **Fungicidne kompozicije**

(EN) Fungicidal Compositions

- (73) Syngenta Participations AG, Schwarzwaldallee 215, 4058 Basel (CH)  
 (72) 01/ Tobler, Hans; Birsigstrasse 129, 4054, Basel (CH)  
 02/ Walter, Harald; Syngenta Crop Protection Münchwilen AG, Schaffhau 4332, Stein (CH)  
 03/ Haas, Ulrich Johannes; Syngenta Crop Protection Münchwilen AG, Schaffhau 4332, Steine (CH)  
 (74) Radulović Božidar, Jovana Tomaševića 9/III, Podgorica (ME)  
 (57) Kompozicija prikladna za kontrolu bolesti koje su uzrokovane preko fitopatogena, naznačena time, da obuhvata (A) jedinjenje sa formulom I

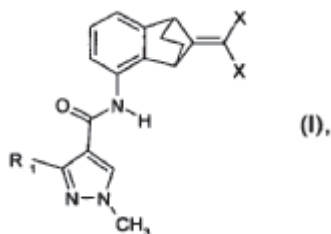

gde  $R_1$  je difluorometil ili trifluorometil, a X je hlora, fluoro ili bromo; i (B) jedinjenje mandipropamid.

Patent sadrži još 11 patentnih zahtjeva.

- (51) **A61K31/18**  
**A61K31/343**  
**A61K31/381**  
**A61K31/404**  
**A61K31/498**  
**A61K31/517**  
**A61K31/64**  
**A61K39/395**  
**A61K45/00**  
**A61P35/00**  
**A61P43/00**
- (11) **01222**  
(21) **P-2011-128**
- (30) 20050054111 28.02.2005. JP  
(86) PCT/JP2006/304218 28.02.2006.  
(87) WO 2006/090930 31.08.2006.  
(96) 06715261.1 28.02.2006.  
(97) EP 1859793 20.04.2011. 2011/16 EN
- (54) (ME) **NOVA KOMBINOVANA UPOTREBA JEDINJENJA SULFONAMIDA U LIJEČENJU KANCERA**  
(EN) NOVEL COMBINATIONAL USE OF A SULFONAMIDE COMPOUND IN THE TREATMENT OF CANCER
- (73) Eisai R&D Management Co., Ltd., 6-10, Koishikawa 4-chome, Bunkyo-ku, Tokyo 112-8088 (JP)
- (72) 01 / OWA, Takashi,; Tsukuba Res. Lab., Eisai Co., Ltd., 1-3, Tokodai 5-chome, Tsukuba-shi, Ibaraki 3002635 (JP)  
02 / OZAWA, Yoichi,; Tsukuba Res. Lab., Eisai Co., Ltd., 1-3, Tokodai 5-chome, Tsukuba-shi, Ibaraki 3002635 (JP)  
03 / SEMBA, Taro,; Tsukuba Res. Lab., Eisai Co., Ltd., 1-3, Tokodai 5-chome, Tsukuba-shi, Ibaraki 3002635 (JP)  
04 / WAKABAYASHI, T.; Tsukuba Res. Lab., Eisai Co., Ltd, 1-3, Tokodai 5-chome, Tsukuba-shi, Ibaraki 3002635 (JP)
- (74) Ćupić Branislav, Dalmatinska 10, Podgorica (ME)
- (57) Farmaceutsko jedinjenje koje uključuje jedinjenje sulfonamida u kombinaciji sa supstancom koja ima EGF inhibitorsku aktivnost, gdje je jedinjenje sulfonamida: N-(3-hloro-1H-indole-7-yl)-4-sulfamoylbenzensulfonamid, N-(3-cijano-4-metil-1H-indole-7-yl)-3-cijano-benzensulfonamid, ili farmaceutsko prihvatljivu so istog ili njegov rastvor, i gdje je supstanca koja ima EGF inhibitorsku aktivnost gefitinib, erlotinib ili cetuksimab.  
Patent sadrži još 9 patentnih zahtjeva.

- (51) **A61K31/445** (11) **01224**  
**A61K31/4412** (21) **P-2011-133**  
**A61P25/28**
- (30) 20050667665P 04.04.2005. US  
 20050689519P 13.06.2005. US
- (86) PCT/US2006/012284 04.04.2006.  
 (87) WO 2006/107859 12.10.2006.  
 (96) 06740387.3 04.04.2006.  
 (97) EP1871368 08.06.2011. 2011/23 En
- (54) (ME) **JEDINJENJA DIHIDROPIRIDINA ZA LIJEČENJE NEURODEGENERATIVNIH BOLESTI I DEMENCIJE**  
 (EN) DIHYDROPYRIDINE COMPOUNDS FOR NEURODEGENERATIVE DISEASES AND DEMENTIA
- (73) Eisai R&D Management Co., Ltd., 6-10, Koishikawa 4-chome Bunkyo-ku, Tokyo 112-8088 (JP)
- (72) 01/ GRAY, Julian, A.; Blumenacker 33, D-79594 Inzlingen (DE)  
 02/ YOSHIHARU, Yamanishi; EISAI CO., LTD. 5-1-3 Tokodai, Tsukuba-shi, Ibaraki, 300-2635 (JP)  
 03/ NOBUYUKI, Mori; EISAI CO., LTD. 5-1-3 Tokodai, Tsukuba-shi, Ibaraki 300-2635 (JP)  
 04/ FIELDS, Scott; EISAI MEDICAL RESEARCH INC. 55 Challenger Road, Ridgefield Park, New Jersey 07660 (US)
- (74) Ćupić Branislav, Dalmatinska 10, Podgorica (ME)
- (57) Jedinjenje za upotrebu u kombinaciji sa donepezilom ili farmaceutski prihvatljivom solju istog u tretiranju (i) Alchajmerove bolesti kod pacijenta ili (ii) demencije ili jednog ili više kognitivnih oštećenja kod pacijenta; gdje je jedinjenje 3-(2-cijanofenil)-5-(2-piridil)-1-fenil-1,2-dihidropiridin-2-jedan, farmaceutski prihvatljiva so istog, hidrat istog ili hidrat farmaceutski prihvatljive soli istog.  
 Patent sadrži još 7 patentnih zahtjeva.

- (51) **C07D471/04** (11) **01240**  
 (21) **P-2011-134**
- (30) 20060793971P 21.04.2006. US  
 (86) PCT/IB2007/001001 10.04.2007.  
 (87) WO 2007/122466 01.11.2007.  
 (96) 07734320.0 10.04.2007.  
 (97) EP 2013208 22.06.2011. 2011/25 EN
- (54) **(ME) PIRIDINO[3,4-B]PIRAZINONI**  
 (EN) PYRIDIN[3,4-B]PYRAZINONES
- (73) Pfizer Products Inc., Eastern Point Road, Groton, CT 06340 (US)  
 (72) 01/ HUGHES, Robert, O.; Chesterfield, MO 63017 (US)  
 02/ BELL, Andrew, Simon; Kent CT13 9NJ (GB)  
 03/ BROWN, David, Graham; Kent CT13 9NJ (GB)  
 04/ OWEN, Dafydd, Rhys; Kent CT13 9NJ (GB)  
 05/ PALMER, Michael, John; Kent CT13 9NJ (GB)  
 06/ PHILLIPS, Christopher; Kent CT13 9NJ (GB)  
 07/ BROWN, David, Louis; Chesterfield, MO 63017 (US)  
 08/ FOBIAN, Yvette, Marlene; Chesterfield, MO 63017 (US)  
 09/ FRESKOS, John, Nicholas; Chesterfield, MO 63017 (US)  
 10/ HEASLEY, Steven, Edward; Chesterfield, MO 63017 (US)  
 11/ JACOBSEN, Eric, Jon; Chesterfield, MO 63017 (US)  
 12/ MADDUX, Todd, Michael; Chesterfield, MO 63017 (US)  
 13 / MISCHKE, Brent, Virgil; Chesterfield, MO 63017 (US)  
 14 / MOLYNEAUX, John, Major; Chesterfield, MO 63017 (US)  
 15/ MOON, Joseph, Blair; Chesterfield, MO 63017(US)  
 16/ ROGIER, Donald, Joseph, Jr.; Chesterfield, MO 63017 (US)  
 17/ TOLLEFSON, Michael, Brent; Chesterfield, MO 63017 (US)  
 18/ WALKER, John, Keith; Chesterfield, MO 63017 (US)
- (74) Ćupić Branislav, Dalmatinska 10, Podgorica (ME)  
 (57) Spoj, ili farmaceutski prihvatljiva sol spoja, naznačen time što spoj ima strukturu Formule I:

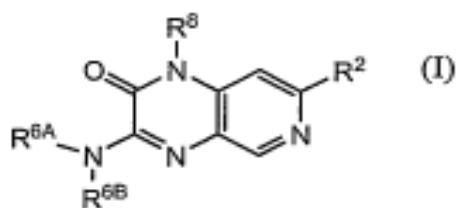

te time što:  $R^2$  se bira iz grupe koju čine aril i 3- do 10-eročlani heterociklični prsten, gdje navedeni  $R^2$  arilni i heterociklični supstituenti mogu izborno biti supstituirani s jednim ili više supstituenata, koje se nezavisno bira iz grupe koju čine halogen, cijano, nitro, okso, alkil, alkenil, alkinil, cikloalkil,  $OR^{201}$ ,  $-C(O)R^{201}$ ,  $-OC(O)R^{201}$ ,  $-C(O)OR^{201}$ ,  $-NR^{201}R^{202}$ ,  $-N(R^{202})C(O)R^{202}$ ,  $-C(O)NR^{201}R^{202}$ ,  $-C(O)NR^{201}C(O)R^{202}$ ,  $-SR^{201}$ ,  $-S(O)R^{201}$  i  $-S(O)_2R^{201}$ ; gdje navedeni alkinilni, alkenilni, alkinilni i cikloalkilni supstituenti mogu izborno biti supstituirani s jednim ili više supstituenata, koje se nezavisno bira iz grupe koju čine halogen, okso,  $-OR^{203}$  i  $-C(O)OR^{203}$ ;  $R^{201}$ ,  $R^{202}$  i  $R^{203}$  se nezavisno bira iz grupe koju čine vodonik i alkil, gdje navedeni alkil može izborno biti supstituiran s jednim ili više supstituenata, koje se nezavisno bira iz skupine koju čine halogen, hidroksi, alkoksi, karboksi i  $-C(O)NH_2$ ;  $R^{6A}$  i  $R^{6B}$ , zajedno s azotom na koji



su vezani, obrazuju djelimično ili posve zasićeni 3- do 14-eročlani heterociklični prsten, gdje heterociklil može izborno biti supstituiran s jednim ili više supstituenata, koje se nezavisno bira iz grupe koju čine vodonik, halogen, okso, alkil, alkenil, alkinil, cijano, cikloalkil, aril, heterociklil,  $-OR^{601}$ ,  $-C(O)R^{601}$ ,  $OC(O)R^{601}$ ,  $-C(O)OR^{601}$ ,  $-NR^{601}R^{602}$ ,  $-N(R^{601})C(O)R^{602}$ ,  $-C(O)NR^{601}R^{602}$  i  $-C(O)NR^{601}C(O)R^{602}$ , gdje (a) navedeni alkilni, alkenilni, alkinilni i cikloalkilni supstituenti mogu izborno biti supstituirani s jednim ili više supstituenata, koje se nezavisno bira iz grupe koju čine halogen, cijano, okso,  $-OR^{603}$ ,  $-C(O)R^{603}$ ,  $-C(O)OR^{603}$ ,  $-OC(O)R^{603}$ ,  $-NR^{603}R^{604}$ ,  $-N(R^{603})C(O)R^{604}$ ,  $-C(O)NR^{603}R^{604}$ ,  $-C(O)NR^{603}C(O)R^{604}$ ,  $-SR^{603}$ ,  $-S(O)R^{603}$ ,  $-S(O)_2R^{603}$ ,  $-N(R^{603})S(O)_2R^{604}$ ,  $-S(O)_2R^{604}$ ,  $-S(O)_2NR^{603}R^{604}$ ,  $C(O)NR^{603}C(O)R^{604}$ ,  $-SR^{603}$ ,  $-S(O)R^{603}$ ,  $-S(O)_2R^{603}$ ,  $-N(R^{603})S(O)_2R^{604}$  i  $-S(O)_2NR^{603}R^{604}$ , i (b) navedeni arilni i heterociklični supstituenti mogu izborno biti supstituisani s jednim ili više supstituenata, koje se nezavisno bira iz grupe koju čine halogen, alkil, alkenil, alkinil, cijano, okso,  $-OR^{601}$ ,  $-C(O)R^{601}$ ,  $-C(O)OR^{601}$ ,  $-OC(O)R^{601}$ ,  $-NR^{601}R^{601}$ ,  $-N(R^{601})C(O)R^{602}$ ,  $-C(O)NR^{601}R^{602}$ ,  $-C(O)NR^{601}C(O)R^{602}$ ,  $-SR^{601}$ ,  $-S(O)R^{602}$ ,  $-S(O)_2R^{601}$ ,  $-N(R^{601})S(O)_2R^{602}$  i  $-S(O)_2NR^{601}R^{602}$ ;  $R^{601}$ ,  $R^{602}$ ,  $R^{603}$  i  $R^{604}$  se nezavisno bira iz grupe koju čine vodonik, alkil, alkenil, i alkinil, gdje (a) navedeni  $R^{601}$  i  $R^{602}$  alkil mogu izborno biti supstituisani s jednim ili više supstituenata, koje se nezavisno bira iz skupine koju čine halogen, cijano, hidroksi, karboksi, okso, alkenil, alkinil, halogenalkenil, hidroksialkenil, karboksialkenil, halogenalkinil, hidroksialkinil, karboksialkinil, alkoksi, halogenalkoksi, hidroksialkoksi i karboksialkoksi, i (b) navedeni  $R^{601}$  i  $R^{602}$  alkenilni i alkinilni supstituenti mogu izborno biti supstituirani s jednim ili više supstituenata, koje se nezavisno bira iz grupe koju čine halogen, cijano, hidroksi, karboksi, okso i alkoksi, i halogenalkoksi, hidroksialkoksi i karboksialkoksi;  $R^8$  je alkil, gdje navedeni  $R^8$  supstituent može izborno biti supstituisan s jednim ili više supstituenata, koje se nezavisno bira iz grupe koju čine halogen, cijano, hidroksi, karboksi, alkenil, alkinil,  $-OR^{801}$ ,  $-C(O)R^{801}$ ,  $-C(O)OR^{801}$ ,  $-OC(O)R^{801}$ ,  $-NR^{801}R^{802}$ ,  $-N(R^{801})C(O)R^{802}$ ,  $-C(O)NR^{801}R^{802}$  i  $-C(O)NR^{801}C(O)R^{802}$ , gdje navedeni alkenilni i alkinilni supstituenti mogu izborno biti supstituisani s jednim ili više supstituenata, koje se nezavisno bira iz grupe koju čine halogen, cijano, hidroksi, karboksi, okso i alkoksi;  $R^{801}$  i  $R^{802}$  se nezavisno bira iz grupe koju čine vodonik, alkil, alkenil i alkinil, gdje (a) kada navedeni alkil je metil, navedeni metil može izborno biti supstituisano s 1, 2 ili 3 fluora kao supstituentima, (b) kada navedeni alkil sadrži najmanje dva atoma ugljenika, navedeni alkil može izborno biti supstituisan s jednim ili više supstituenata, koje se nezavisno bira iz grupe koju čine halogen, cijano, hidroksi, karboksi, okso, alkinil, halogenalkinil, hidroksialkinil, karboksialkinil, alkoksi, halogenalkoksi, hidroksialkoksi i karboksialkoksi i (c) navedeni  $R^{801}$  i  $R^{802}$  alkenilni i alkinilni supstituenti mogu izborno biti supstituisani s jednim ili više supstituenata, koje se nezavisno bira iz grupe koju čine halogen, cijano, hidroksi, karboksi, okso, alkoksi, halogenalkoksi, hidroksialkoksi i karboksialkoksi.

Patent sadrži još 23 patentna zahtjeva.

(51) **C07D487/08**  
**C07D519/00**  
**A61K31/416**  
**A61K31/551**  
**A61P25/00**  
**A61P9/00**

(11) **01223**  
(21) **P-2011-135**

(30) 20040000390 16.01.2004. FR  
(86) PCT/FR2005/000027 07.01.2005.  
(87) WO 2005/077955 25.08.2005.  
(96) 05717375.9 07.01.2005.  
(97) EP 1709052 27.04.2011 2011/17 FR

(54) (ME) **DERIVATI 1,4-DIAZIBICIKLO 3.2.1.OKTANKARBOKSAMIDA, NJIHOVO DOBIJANJE I NJIHOVA TERAPEUTSKA PRIMJENA**

(EN) DERIVATIVES OF 1,4-DIAZABICYCLO 3.2.1OCTANECARBOXAMIDE, PREPARATION METHOD THEREOF AND USE OF SAME IN THERAPEUTICS

(73) SANOFI, 174, Avenue de France, 75013 Paris (FR)

(72) 01/GALLI, Frédéric; 6, avenue de Rueil, F-92420 Vaucresson (FR)  
02/LECLERC, Odile; 11, rue Winston Churchill, F-91300 Massy (FR)  
03/LOCHEAD, Alistair; 95,rue de Paris, F-94220 Charenton le Pont (FR)

(74) Čupić Branislav, Dalmatinska 10, Podgorica (ME)

(57) Jedinjenje, u obliku čistog enantiomera ili smješe enantiomera, koje odgovara opštoj formuli (I)

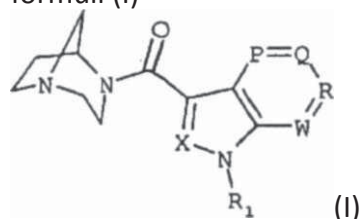

Gdje X odgovara jednom atomu azota ili jednoj grupi opšte formule C-R<sub>2</sub>, P, Q, R i W odgovaraju svaki, nezavisno jedan od drugog, jednom atomu azota ili jednoj grupi opšte formule C-R<sub>3</sub>, R<sub>1</sub> odgovara jednom atomu vodonika ili jednoj grupi (C<sub>1</sub> - C<sub>6</sub>) alkil, R<sub>2</sub> odgovara jednoj grupi (C<sub>1</sub> - C<sub>6</sub>) alkil, R<sub>3</sub> odgovara jednom atomu vodonika ili halogena ili jednoj grupi (C<sub>1</sub> - C<sub>6</sub>) alkil, (C<sub>1</sub> - C<sub>6</sub>)alkoksi, nitro, amino, trifluorometil, cijano, ili opštoj formuli -NR<sub>4</sub>R<sub>5</sub>, -NR<sub>4</sub>C(=O)R<sub>5</sub>, -NR<sub>4</sub>C(=O)NR<sub>5</sub>R<sub>6</sub>, -NR<sub>4</sub>C(=O)OR<sub>5</sub>, NR<sub>4</sub>S(=O)<sub>2</sub>NR<sub>5</sub>R<sub>6</sub>, -OR<sub>5</sub>, -OC(=O)R<sub>5</sub>, -OC(=P)OR<sub>5</sub>, -OC(=O)ONR<sub>4</sub>R<sub>5</sub>, -OC(=O)SR<sub>5</sub>, -C(=O)OR<sub>5</sub>, C(=O)R<sub>5</sub>, -C(=O)NR<sub>4</sub>R<sub>5</sub>, SR<sub>5</sub>, -S(=O)<sub>2</sub>R<sub>5</sub>, -S(=O)<sub>2</sub>NR<sub>4</sub>R<sub>6</sub>, ili jednoj grupi fenil eventualno supstituisanoj sa jednom ili više grupa izabranih između atoma halogena i grupa (C<sub>1</sub> - C<sub>6</sub>)alkil, (C<sub>1</sub> - C<sub>6</sub>)alkoksi, nitro, amino, trifluorometil, cijano, ili opštoj formuli -NR<sub>4</sub>R<sub>5</sub>, -NR<sub>4</sub>C(=O)R<sub>5</sub>, -NR<sub>9</sub>C(=O)NR<sub>5</sub>R<sub>6</sub>, -NR<sub>4</sub>C(=O)OR<sub>5</sub>, -NR<sub>4</sub>S(=O)<sub>2</sub>NR<sub>5</sub>R<sub>6</sub>, -OR<sub>5</sub>, -OC(=O)R<sub>5</sub>, -OC(=O)OR<sub>5</sub>, -OC(=O)ONR<sub>4</sub>R<sub>5</sub>, -OC(=O)SR<sub>5</sub>, -C(=O)OR<sub>5</sub>, -C(=O)NR<sub>4</sub>R<sub>5</sub>, SR<sub>5</sub>, -S(=O)<sub>2</sub>R<sub>5</sub>, -S(=O)<sub>2</sub>NR<sub>4</sub>R<sub>6</sub>, ili R<sub>3</sub> odgovara jednoj grupi izabranoj između prstenova imidazol, piridin, piridazin, pirimidin, pirazol, pirazin, triazol, hinolein, izohinolein, tetrazol, furan, tiofen, tiazol, izotiazol, oksazol, izoksazol, pirol, tetrahidrohinolein, tetrahidroizohinolein, indol, benzimidazol, benzofuran, dihidrobenzofuran, cinolin, indazol, ftalazin, triazin, izoindol, oksadiazol, tiadiazol, furazan, benzofurazan, benzotiofen, dihidrobenzotiofen, benzotriazol, benzotiazol, benzisotiazol, benzoksazol, benzisoksazol, hinazolin, hinoksalin, naftiridin, dihidrohinolein, dihidroizohinolein, furopiridin, dihidrofuropiridin, piropiridin, tienopiridin, dihidrotienopiridin, imidazopiridin, pirazolopiridin, oksazolopiridin, izoksazolopiridin, izoksazolopiridin, tiazolopiridin, izotiazolopiridin, piropirimidin, fluopirimidin,

dihidrofupirimidin, tienopirimidin, dihidrotienopirimidin, imidazopirimidin, pirazolopirimidin, oksazolopirimidin, izoksazolopirimidin, tiazolopirimidin, izotiazolopirimidin, furopirazin, dihidrofupirazin, pirolpirazin, tienopirazin, dihidrotienopirazin, imidazopirazin, pirazolpirazin, oksazolpirazin, izoksazolpirazin, tiazolpirazin, izotiazolpirazin, furopiridazin, dihidrofupiridazin, pirolpiridazin, tienopiridazin, dihidrotienopiridazin, imidazopiridazin, pirazolpiridazin, oksazolpiridazin, izoksazolpiridazin, tiazolpiridazin ili izotiazolpiridazin,  $R_4$ ,  $R_5$  i  $R_6$  odgovaraju svaki, nezavisno jedan od drugog, jednom atomu halogena ili jednoj grupi ( $C_1 - C_6$ )alkil linearnoj ili razgranatoj, ( $C_2 - C_6$ )alkenil linearnoj ili razgranatoj ili ( $C_2 - C_6$ )alkinil linearnoj ili razgranatoj, ili jednoj grupi ( $C_3 - C_8$ )cikloalkil, ( $C_3 - C_8$ )cikloalkil( $C_1 - C_3$ )alkil, ( $C_4 - C_8$ )cikloalkenil, ili fenil, grupe opšte formule  $NR_4R_5$  i  $NR_5R_6$  mogu formirati, sa atomom azota koji ih nosi, jednu grupu izabranu između grupe aziridinil, azetidinil, pirolidinil, piperidinil, azepinil, piperazinil, morfolinil, tiomorfolinil, pirolinil, indolinil, pirazolinil, pirazolidinil, imidazolinil, 3H-indolil, hinuklidinil i hinolizinil, u obliku baze, solvate ili adicione soli jedne kisjeline.

Patent sadrži još 3 patentna zahtjeva.

- (51) **A61K31/505** (11) **01246**  
**A61P31/18** (21) **P-2011-144**
- (30) 0403578 02.09.2004. MY  
PCT/EP2004/052028 03.09.2004. WO  
05101467 25.02.2005. EP
- (96) 05108086.9 02.09.2005.
- (97) EP 1632232 11.05.2011. 2011/19 EN
- (54) (ME) **SO 4[[4-[[4-(2-CIJANOETENIL)-2,6-DIMETILFENIL]AMINO]-2-PIRIMIDINIL]AMINO] BENZONITRILA**  
(EN) SALT OF 4[[4-[[4-(2-CYANOETHENYL)-2,6-DIMETHYLPHENYL]AMINO]-2-PYRIMIDINYL]AMINO]BENZONITRILE
- (73) Janssen Pharmaceutica NV, Turnhoutseweg 30, 2340 Beerse (BE)
- (72) 01/ Stevens, Paul, Theodoor, Agnes; c/o Janssen Pharmaceutica N.V. Turnhoutseweg 30, 2340, Beerse (BE)  
02/ Peeters, Jozef; c/o Janssen Pharmaceutica N.V. Turnhoutseweg 30, 2340, Beerse (BE)  
03/ Vandecruys, Roger, Petrus, Gerebern; c/o Janssen Pharmaceutica N.V. Turnhoutseweg 30, 2340, Beerse (BE)  
04/ Stappers, Alfred, Elisabeth; c/o Janssen Pharmaceutica N.V. Turnhoutseweg 30, 2340, Beerse (BE)  
05/ Copmans, Alex, Herman; c/o Janssen Pharmaceutica N.V. Turnhoutseweg 30, 2340, Beerse (BE)
- (74) Radulović Božidar, Jovana Tomaševića 9/III, Podgorica (ME)
- (57) Kruta farmaceutska kompozicija, naznačena time, da obuhvata farmaceutske prihvatljivi kerijer i kao aktivni sastojak neku terapeutske efektivnu količinu jedinjenja sa formulom (I)

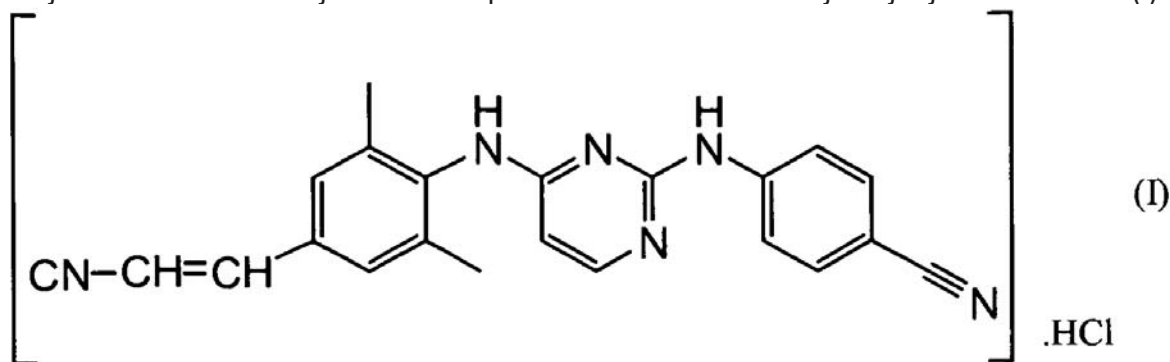

Nekog njegovog N-oksida ili neke njegove stereohemijske izomerne forme.  
Patent sadrži još 43 patentna zahtjeva.

- (51) **C07D471/08**  
**A61P25/00**  
**A61K31/407**  
**C07D487/04**
- (30) 20060856079P 02.11.2006. US  
(86) PCT/US2007/083330 01.11.2007.  
(87) WO 2008/057938 15.05.2008.  
(96) 07863786.5 01.11.2007.  
(97) EP 2094703 11.05.2011. 2011/19 En
- (54) (ME) **AMIDI DIAZABICIKLOALKANA SELEKTIVNI NA PODVRSTU NIKOTINSKIH ACETILHOLINSKIH RECEPTORA**  
(EN) NICOTINIC ACETYLCHOLINE RECEPTORSUB-TYPE SELECTIVE AMIDES OF DIAZABICYCLO-ALKANES
- (73) Targacept, Inc., 200 East First Street, Suite 300, Winston-Salem, NC 27101-4165 (US)  
(72) 01/ MAZUROV, Anatoly; 3704 Timberoak Drive, Greensboro, North Carolina 27410 (US)  
02/ MIAO, Lan; 226 March Ferry Road, Advance, North Carolina 27006 (US)  
03/ XIAO, Yun-de; 2079 Waterford Village Drive, Clemmons, North Carolina 27012 (US)  
(74) Lutovac Branislav, Bulevar Crnojevića 93, Podgorica (ME)  
(57) Jedinjenje N-(5-hlorofuran-2-ilkarbonil)-3,7-diazabiciklo[3.3.0]oktan, ili neka njegova farmaceutski prihvatljiva so.  
Patent sadrži još 7 patentnih zahtjeva.

- (51) **A61K31/4015**  
**A61P9/10**  
**A61P25/00**  
**A61P25/28**
- (11) **01227**  
(21) **P-2011-148**
- (30) 20060109678 28.03.2006. RU  
(86) PCT/RU2007/000094 27.02.2007.  
(87) WO 2007/111528 04.10.2007.  
(96) 07747831.1 27.02.2007.  
(97) EP 2011497 04.05.2011. 2011/18 EN
- (54) (ME) **FENOTROPIL ZA PROFILAKSU I LIJEČENJE HEMORAGIČNOG MOŽDANOG UDARA I AKUTNE FAZE ISHEMIČNOG MOŽDANOG UDARA**  
(EN) PHENOTROPIL FOR THE PROPHYLAXIS AND TREATMENT OF HEMORRHAGIC STROKE AND ACUTE PHASE OF ISCHEMIC STROKE
- (73) Akhapkina, Valentina Ivanovna, ul. 5-aya Parkovaya, 33-24, 105264 Moscow (RU)  
(72) 01/ VORONINA, Tatiana Aleksandrovna; ul. Usacheva, 29/3-165 Moscow, 119048 (RU)  
02/ AKHAPKIN, Roman Vitalevich; ul. 5-aya Parkovaya, 33-24 Moscow, 105264 (RU)  
(74) Lutovac Branislav, Bulevar Crnojevića 93, Podgorica (ME)  
(57) Jedinjenja N-(5-hlorofuran-2-ilkarbonil)-3,7-diazabiciklo[3.3.0]oktan, ili neka njegova farmaceutski prihvatljiva so.  
Patent sadrži još 8 patentnih zahtjeva.

- (51) **A61K9/62** (11) **01268**  
**A61K9/26** (21) **P-2012-4**
- (30) 20040101982 07.05.2004. EP  
(86) PCT/EP2005/052066 04.05.2005.  
(87) WO 2005/107721 17.11.2005.  
(96) 05743110.8 04.05.2005.  
(97) EP 1746980 02.11.2011. 2011/44 EN
- (54) (ME) **FARMACEUTSKI DOZIRNI OBLIK KOJI OBUHVATA GRANULE KAO I NJEGOV POSTUPAK PROIZVODNJE**  
(EN) PHARMACEUTICAL DOSAGE FORM COMPRISING PELLETS AS WELL AS ITS MANUFACTURING PROCESS
- (73) Nycomed GmbH, Byk-Gulden-Strasse 2; 78467 Konstanz (DE)  
(72) 01/ ANSTETT-KLEIN, Isabel Neuffenstrasse 13, 70771 Leinfelden - Echterdingen (DE)  
02/ SCHILLER, Marc Finkenweg 1, 78315 Radolfzell (DE)  
(74) Radulović Božidar, Jovana Tomaševića 9/III, Podgorica (ME)  
(57) Granula koja sadrži starter granulu obloženu sa slojem koji sadrži aktivni sastojak, dezintegrant i opciono druge farmaceutske prihvatljive ekscipijente, pri čemu je sloj formiran prskanjem suspenzije dezintegranta koji sadrži aktivni sastojak i opciono farmaceutski aktivne ekscipijente na starter granulu, gde je dezintegrant preželatizovani kukuruzni (eng. corn or maize) škrob, a aktivni sastojak je magenzijumova so pantoprazola.  
Patent sadrži još 30 patentnih zahtjeva.

- (51) **C07K14/29**  
**A61K39/02**
- (30) 552350P 11.03.2004. US  
(86) PCT/US2005/007875 10.03.2005.  
(87) WO 2005/087803 22.09.2005.  
(96) 05735365.8 10.03.2005.  
(97) EP 1723170 22.11.2006. 2011/43 EN
- (54) (ME) **PSEĆA VAKCINA ZA ZAŠTITU OD ERLIHIOZE**  
(EN) A CANINE VACCINE FOR PROTECTION AGAINST EHRlichIOSIS
- (73) Wyeth LLC, Five Giralda Farms, Madison, NJ 07940 (US)
- (72) 01/ HU, Liangbiao (George) 17806 Wellington Crest Court, Wildwood, MO 63005 (US)  
02/ HESS, Thomas, Jay 1887 Hidden Valley Lane, Fort Dodge, IA 50501 (US)  
03/ CHIANG, Yu-Wei 1223 North 23rd Street, Fort Dodge, IA 50501 (US)  
04/ CHU, Hsien-Jue (Steve) 1955 Louise Ridge, Fort Dodge, IA 50501 (US)
- (74) Ćupić Branislav, Dalmatinska 10, Podgorica (ME)
- (57) Kompozicija vakcine koja sadrži: efikasnu imunizujuću količinu dva soja inaktiviranog Ehrlichia canis bakterina, pri čemu navedeni inaktivirani sojevi bakterina sadrže Ehrlichia canis Ebony i Ehrlichia canis Broadfoot, farmakološki prihvatljiv nosač i imunogeno stimulišuću količinu sistema adjuvanta koji se sastoji uglavnom od sredstva koje indukuje odgovor antitela i sredstva koje indukuje ćelijski-posredovani imuni odgovor.  
Patent sadrži još 10 patentnih zahtjeva.



- (51) **A61K31/505**  
**C07D239/94**  
**A61P43/00**  
**A61P35/00**

- (11) **01267**  
(21) **P-2012-2**

- (30) 568872 P 06.05.2004. US  
(86) PCT/IB2005/001139 25.04.2005.  
(87) WO 2005/107758 17.11.2005.  
(96) 05732761.1 25.04.2005.  
(97) EP 1746999 16.11.2011 2011/46 EN

- (54) (ME) **4-FENILAMINO-HINAZOLIN-6-IL-AMIDI**  
(EN) 4-PHENYLAMINO-QUINAZOLIN-6-YL-AMIDES

- (73) Warner-Lambert Company LLC, 235 East 42nd Street, New York, NY 10017 (US)  
(72) 01/ FAKHOURY, Stephen, Alan Pfizer Global Research and Development, Ann Arbor Laboratories, 2800 Plymouth Road, Ann Arbor, MI 48105 (US)  
02/ LEE, Helen, Tsenwei Pfizer Global Research and Development, Ann Arbor Laboratories, 2800 Plymouth Road, Ann Arbor, MI 48105 (US)  
03/ REED, Jessica, Elizabeth Pfizer Global Research and Development, Ann Arbor Laboratories, 2800 Plymouth Road, Ann Arbor, MI 48105(US)  
04/ SCHLOSSER, Kevin, Matthew Pfizer Global Research and Development, Ann Arbor Laboratories, 2800 Plymouth Road, Ann Arbor, MI 48105 (US)  
05/ SEXTON, Karen, Elaine Pfizer Global Research and Development, Ann Arbor Laboratories, 2800 Plymouth Road, Ann Arbor, MI 48105 (US)  
06/ TECLÉ, Haile Pfizer Global Research and Development, Ann Arbor Laboratories, 2800 Plymouth Road, Ann Arbor, MI 48105 (US)  
07/ WINTERS, Roy, Thomas Pfizer Global Research and Development, Ann Arbor Laboratories, 2800 Plymouth Road, Anne Arbor, MI 48105 (US)  
(74) Ćupić Branislav, Dalmatinska 10, Podgorica (ME)  
(57) Spoj formule:

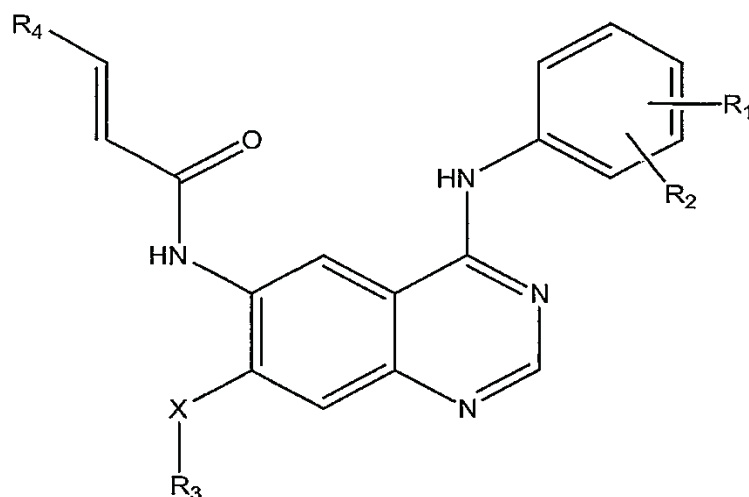

naznačen time što:

$R_3$  je  $C_1$ - $C_3$  nerazgranati ili razgranati alkil, izborno supstituiran s jednim ili više halogena;  $R_5$  i  $R_6$  se nezavisno bira između H,  $C_1$ - $C_3$  alkila, F, Br, I ili Cl; X je O, S ili NH; i isprekidane linije, označene s a odnosno b, označuju izbornu dvostruku vezu, uz uvjet da u određenom spoju postoji samo jedna dvostruka veza, a ili b; ili njegova farmaceutski prihvatljiva sol.

Patent sadrži još 11 patentnih zahtjeva.

- (51) **A61K31/444** (11) **01273**  
**A61P25/00** (21) **P-2012-15**
- (30) 0702852 19.04.2007. FR  
(86) PCT/FR2008/000531 16.04.2008.  
(87) WO 2008/145838 04.12.2008.  
(96) 08787960.7 16.04.2008.  
(97) EP 2146713 09.11.2011. 2011/45 FR
- (54) (ME) **UPOTREBA 4-CIKLOPROPILMETOKSI-N-(3,5-DIHLORO-1-OKSIDOPIRIDIN-4-IL)-5-(METOKSI)PIRIDIN-2-KARBOKSAMIDA ZA LIJEČENJE POVREDA LOBANJE**  
(EN) USE OF 4-CYCLOPROPYLMETHOXY-N-(3,5-DICHLORO-1-OXIDOPYRIDIN-4-YL)-5-(METHOXY)PYRIDINE-2-CARBOXAMIDE FOR THE TREATMENT OF CRANIAL TRAUMAS
- (73) SANOFI, 174, Avenue de France, 75013 Paris (FR)  
(72) 01/ DELAY-GOYET, Philippe c/o Sanofi-Aventis, Département Brevets, 174 avenue de France F-75013 Paris (FR)  
02/ PERRON, Corinne c/o Sanofi-aventis, Département Brevets, 174 avenue de France F-75013 Paris (FR)
- (74) Ćupić Branislav, Dalmatinska 10, Podgorica (ME)  
(57) Upotreba 4-ciklopropilmetoksi-N-(3,5-dihloro-1-oksido-piridin-4-il)-5-(metoksi)piridin-2-karboksamida, u vidu hidrata, solvata, baze ili adicione soli neke kisjeline za dobijanje nekog lijeka namijenjenog tretmanu cerebralnih povreda.  
Patent sadrži još 1 patentni zahtjev.

- (51) **C12N5/00** (11) **01218**  
 (21) **P-2008-642**
- (30) 20040100800 01.03.2004 EP  
 20040551171P 08.03.2004 US
- (86) PCT/EP2005/050855 28.02.2005  
 (87) WO2005083058 09.09.2005  
 (96) 05729822.6 28.02.2005  
 (97) EP 1720979 28.02.2005. 2006/46 EN
- (54) (ME) **UPOTREBA PODLOGE ZA ĆELIJSKU STRUKTURU BEZ SADRŽAJA SERUMA ZA PRODUKCIJU IL-18BP U ĆELIJAMA SISARA**  
 (EN) USE OF A SERUM-FREE CELL CULTURE MEDIUM FOR THE PRODUCTION OF IL-18BP IN MAMMALIAN CELLS
- (73) ARES TRADING S.A., Zone Industrielle de l'Ourietta, 1170 Aubonne / CH  
 (72) 01 / ALONI, Yehoshua, Nof Harim 130 Kochav Yair 44862 Zur Yigal / IL  
 02 / AHARONOVITZ, Orit Haeshel 21/2 Mazkeret Batya, 76804 / IL  
 03 / ZIEGLER, Thierry 18, chemin de Jacquin F-33850 Leognan / FR
- (74) Prelevic Dragan, ul.Slobode 74; Podgorica (ME)
- (57) Proces za kultivaciju/gajenje ćelija koje proizvode IL-18BP, koji obuhvata korak gajenja ćelija u podlozi za kulturu ćelija koja je bez sadržaja komponenti dobijenih iz seruma životinja, naznačeno time da takva podloga za kulturu ćelija obuhvata: Asparagin u koncentraciji u rasponu od oko 800 do oko 900 mg/L; Natrijum hlorid u koncentraciji u rasponu od oko 3000 do oko 4500 mg/L; Selenit u koncentraciji u rasponu od oko 0.005 do oko 0.015 mg/L; Hidrolizat žita u koncentraciji u rasponu od oko 5000 do oko 15000 mg/L; i Insulin u koncentraciji u rasponu od oko 2.5 do oko 6 mg/L  
 Patent sadrži još 20 patentnih zahtjeva.

(51) **C07D239/48**  
**A61K31/505**  
**A61P31/18**  
**C07D405/12**

(11) **01229**  
(21) **P-2010-147**

(30) 20050101707 04.03.2005 EP  
(86) PCT/EP2006/060407 02.03.2006  
(87) WO2006094930 14.09.2006  
(96) 06708609.0 02.03.2006  
(97) EP1858861 07.07.2010. 2010/27 EN

(54) (ME) **2-(4-CIJANOFENIL)-6-HIDROKSILAMINOPIRIMIDINI KOJI INHIBIRAJU HIV**

(EN) HIV INHIBITING 2-(4-CYANOPHENYL)-6-YDROXYLAMINOPYRIMIDINES

(73) Tibotec Pharmaceuticals, Eastgate Village Eastgate Little Island Co Cork / IE

(72) DE KOCK, Herman, Augustinus, Wolfseind 10, B-2370 Arendonk / BE

(74) Radulović Božidar, Jovana Tomaševića 9/III, Podgorica (ME)

(57) Jedinjenje sa formulom

CN

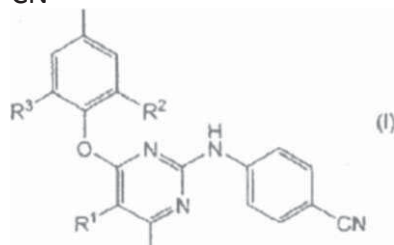

NH-OH

njegova Farmaceutski prihvatljiva adicijska so; ili njegova stereohemijski izomerna forma, naznačeno time, da R<sup>1</sup> je halo, R'' i R svaki nezavisno su C1-6alkil.

Patent sadrži još 8 patentnih zahtjeva.

- (51) **C07D215/22**  
**C07D401/12**  
**C07D487/08**  
**A61K31/47**  
**C07D401/06**  
**C07D401/14**  
**C07D417/06**  
**C07D215/227**  
**A61K31/551**  
**A61K31/4995**  
**A61P31/04**
- (30) 20060125545 06.12.2006 EP  
(86) PCT/EP2007/063319 04.12.2007  
(87) WO2008068272 12.06.2008  
(96) 07847817.9 04.12.2007  
(97) EP 2 099 761 27.10.2010. 2010/43 EN
- (54) (MN) **ANTIBAKTERIJSKI KINOLINSKI DERIVATI**  
(EN) ANTIBACTERIAL QUINOLINE DERIVATIVES
- (73) Janssen Pharmaceutica NV, Turnhoutseweg 302340 Beerse / BE
- (72) 01 / GUILLEMONT, Jérôme Emile Georges Johnson & Johnson Pharmaceutical Research and Development A division of Janssen-Cilag Campus de Maigremont BP615 27106 Val de Reuil Cedex / FR  
02 / DORANGE, Ismet Sickla Alle 21 13165 Nacka / SE  
03 / LANÇOIS, David Francis Alain Johnson & Johnson Pharmaceutical Research and Development A division of Janssen-Cilag Campus de Maigremont BP615 27106 Val de Reuil Cedex / FR  
04 / VILLALGORDO-SOTO, José Manuel Villapharma Research S.L. Parque tecnologico de Fuente Alamo Carretera El Estrecho-Lobosillo, Km.2.5 30320 Fuente Alamo, Murcia / ES  
05 / SIMONNET, Yvan René Ferdinand Johnson & Johnson Pharmaceutical Research and Development A division of Janssen-Cilag Campus de Maigremont BP 615 27106 Val de Reuil Cedex / FR  
06 / MOTTE, Magali Madeleine Simone, Johnson & Johnson Pharmaceutical Research and Development A division of Janssen-Cilag Campus de Maigremont BP615 27106 Val de Reuil Cedex / FR  
07 / ANDRIES, Koenraad Jozef Lodewijk Marcel Janssen Pharmaceutica N.V. Turnhoutseweg 30 2340 Beerse / BE  
08 / KOUL, Anil, Janssen Pharmaceutica N.V. Turnhoutseweg 30 2340 Beerse / BE
- (74) Radulović Božidar, Jovana Tomaševića 9/III, Podgorica (ME)
- (57) Jedinjenje sa formulom (Ia) ili (Ib)

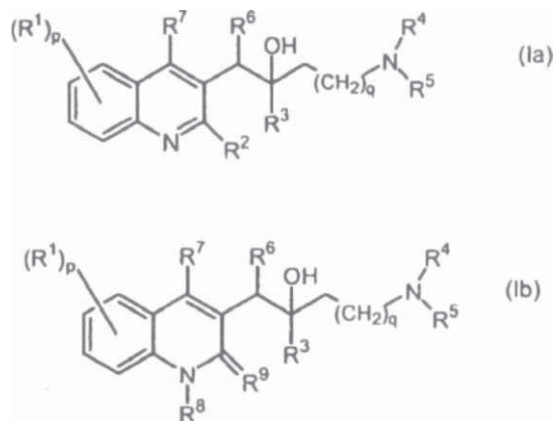

uključujući bilo koju njegovu stereohemijsku izomernu formu, naznačeno time, da p je celi broj jednak 1, 2, 3 ili 4; q je celi broj jednak nuli, 1, 2, 3 ili 4; R<sup>1</sup> je vodonik, cijano, formil, karboksil, halo, alkil, C2-6alkenil, C2-6alkinil, haloalkil, hidroksi, alkiloksi, alkiltio, alkiltioalkil, -C=N-OR<sup>n</sup>, amino, mono ili di(alkil)amint), aminoalkil, mono ili di(alkil)aminoalkil, alkilkarbonilaminoalkil, aminokarbonil, mono ili di(alkil)aminokarbonil, arilalkil, arilkarbonil, R<sup>a</sup>R<sup>4a</sup>Nalkil, di(aril)alkil, aril, R<sup>a</sup>R<sup>4a</sup>N-, R<sup>a</sup>R<sup>4a</sup>N-C(=O)- ili Het; R je vodonik, alkiloksi, aril, ariloksi, hidroksi, merkpto, alkiloksialkiloksi, alkiltio, mono ili di(alkil)amino, pirolidino ili radikal sa formulom

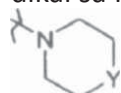

gde Y je CH<sub>2</sub>, O, S, NH ili W-alkil;

R<sup>3</sup> je alkil, arilalkil, aril-O-alkil, aril-alkil-O-alkil, aril, aril-aril, Het, Het-alkil, Het-O-alkil, Het-alkil-O-alkil ili R<sup>4</sup> je vodonik ili alkil; R je -C(=NH)-NH<sub>2</sub>; arilalkil; Het-alkil; mono- ili dialkilaminoalkil; biciklo[2.2.1]heptil; Het ili aril; ili R<sup>4</sup> i R<sup>5</sup> zajedno sa atomom azota na kojeg su spojeni formiraju radikal koji je izabran iz grupe koja obuhvata azetidil; 2,3-dihidroizoin-dol-1-il; tiazolidin-3-il; 1,2,3,6-tertahidropiridil; heksahidro-1<sup>^</sup>azepinil; heksahidro-1/-/1,4-diazepinil; heksahidro-1,4-oksazepinil; 1,2,3,4-tetrahidroizokinolin-2-il; 2,5-diazabiciklo[2.2.1]heptil; 1.1-dioksid-tiomorfolinil; a svaki radikal je ponekad supstituisan sa 1, 2, 3 ili 4 <sup>^</sup>psti-tuenata, a svaki supstituenat je nezavisno izabran iz alkila, haloalkila, alkilkarbonila, halo, arilalkila, hidroksi, alkiloksi, amino, mono- ili dialkilamino, mono- ili dialkilaminoalkila, alkiltio, alkiloksialkila, alkiltioalkila, arila, piperidinila koji je ponekad supstituisan sa alkilom, pirolidinilom koji je ponekad supstituisan sa arilalkilom, piridilom ili pirimidinilom; ili R i R zajedno sa atomom azota na kojeg su spojeni formiraju radikal koji je izabran iz grupe koja obuhvata piperidinil ili piperazinil, a svaki od njih je supstituisan sa arilom, alkilkarbonilom, piperidinilom ili pirolidinilom koji je ponekad supstituisan sa arilalkilom; R<sup>4a</sup> i R<sup>5d</sup> zajedno sa atomom azota na kojeg su spojeni formiraju radikal koji je izabran iz grupe koja obuhvata pirolidino, piperidino, piperazino, morfolino, 4-tiomorfolino, 2,3-dihidroizoindol-1-il, tiazolidin-3-il, 1,2,3,6-tertahidropiridil, heksahidro- $\Psi$ -azepinil, heksahidro- $\#$ -1,4-diazepinil, heksahidro-1,4-oksazepinil, 1,2,3,4-tetrahidroizokinolin-2-il, pirolinil, pirolil, imidazolidinil, pirazolidinil, 2-imidazolinil, 2-pirazolinil, imidazolil, pirazolil, triazolil, piridinil, piridazinil, pirimidinil, pirazinil i triazinil, a svaki radikal je ponekad supstituisan sa 1, 2, 3 ili 4 supstitu-enata, a svaki supstituenat je nezavisno izabran iz alkila, haloalkila, halo, arilalkila, hidroksi, alkiloksi, amino, mono- ili dialkilamino, alkiltio, alkiltioalkila, arila, piridila ili pirimidinila; R<sup>6</sup> je aril<sup>1</sup> ili Het; R<sup>7</sup> je vodonik, halo, alkil, aril ili Het; R<sup>8</sup> je vodonik ili alkil; R<sup>1b</sup> je okso; ili 8 9 R i R zajedno formiraju radikal -CH=CH-N=; R<sup>11</sup> je vodonik ili alkil; aril je homocikal izabran iz fe-nila, naftila, acenaftila ili tetrahidronaftila, a svaki od njih je ponekad supstituisan sa 1, 2 ili 3 supstituenta, a svaki supstituenat je nezavisno izabran iz hidroksi, halo, cijano, nitro, amino, mono- ili dialkilamino, alkila, C2- ftalkenila koji je ponekad supstituisan sa fenilom, haloal-

kilom, alkiloksi, haloalkiloksi. karboksilom, alkiloksikarbonilom. aminokarbonilom, morfolinilom ili mono- ili dialkilaminokarbonilom; aril'je homocikal izabran iz fenila, naftila. ace-naftila ili tetrahidronaftila. a svaki je ponekad supstituisan sa 1, 2 ili 3 supstituenta, a svaki supstituenat je nezavisno abran iz hidroksi, halo, cijano, nitro, amino, mono- ili dialkilamino, alkila, haloalkila, alkiloksi, alkiltio, haloalkiloksi, karboksila, alkiloksikarbonila. aminokarbonila, morfolinila, Het ili mono- ili dialkilaminokarbonila; I let je monoeiklički heterocikal koji je izabran iz A4enoksipiperidinila, piperidinila. piperazina, pirolila, pirazolila, imidazolila, furanila, tienila, oksazolila, izoksazolila, tiazolila, izotiazolila, piridinila, pirimidinila, pirazinila ili piridazinila; ili bieiklički heterocikal izabran iz kinolinila, kinoksalinila, indolila, benzimidazolila, benzoksazolila, benzizoksazolila, benzotiazolila, benzizotiazolila, benzofuranila, benzotienila, 2,3-dihidrobenzo[1,4]dioksinila ili benzo[1.3]dioksolila; a svaki monociklički i biciklički heterocikal je ponekad supstituisan sa 1, 2 ili 3 supstituenata. a svaki supstituenat je nezavisno izabran iz halo, hidroksi, alkila ili alkiloksi; pod uslovom da R<sup>5</sup> je različit od benzila; i njegov γV-oksidi, njegova farmaceutski prihvatljiva so i njegova rastvoriva materija. Patent sadrži još 8 patentnih zahtjeva

(51) **C07D487/04**  
**C07D245/04**  
**C07K5/078**  
**A61K38/05**  
**A61K31/33**  
**A61P31/14**  
**C07K5/06**

(11) **01231**  
(21) **P-2011-58**

(30) 20050107074 29.07.2005 EP  
20050107417 11.08.2005 EP  
20060101280 03.02.2006 EP

(86) PCT/EP2006/064820 28.07.2006

(87) WO2007014926 08.02.2007

(96) 06778071.8 28.07.2006

(97) EP1912999 05.01.2011. 2011/01 EN

(54) (ME) **MAKROCIKLIČKI INHIBITORI VIRUSA HEPATITISA C**  
(EN) **MACROCYCLIC INHIBITORS OF HEPATITIS C VIRUS**

(73) 1.Tibotec Pharmaceuticals, Eastgate Village Eastgate Little Island Co Cork / IE, MEDIVIR AB Lunastigen 7 141 44 Huddinge / SE, 1.Eastgate Village Eastgate Little Island Co Cork / IE  
2.MEDIVIR AB, 2.Lunastigen 7 S-141 44 Huddinge / SE

(72) 01 / RABOISSON, Pierre Jean-Marie Bernard Sint Pancratiuslaan 26 B-1933 Sterrebeek / BE  
02 / DE KOCK, Herman Augustinus Wolfseind 10 Arendonk, 2370 / BE  
03 / HU, Lili Vrouw van Mechelenstraat 28 2800 Mechelen / BE  
04 / VENDEVILLE, Sandrine Marie Helene Rue du Bémel 142 B-1150 Woluwe-Saint-Pierre / BE

05 / TAHRI, Abdellah Rue Maurice Albert Raskin 30 B-1070 Anderlecht / BE

06 / SURLERAUX, Dominique Louis Nestor Ghislain Rue de la Scailée, 13 B-1440 Braine-le-Château / BE

07 / SIMMEN, Kenneth Alan Boterbloemenlaan 35 Tervuren, 3080 / BE

08 / NILSSON, Karl Magnus, c/o Medivir AB Lunastigen 7 S-141 44, Huddinge / SE

09 / SAMUELSSON, Bengt Bertil, c/o Medivir AB Lunastigen 7 S-141 44, Huddinge / SE

10 / ROSENQUIST, Asa Annica Kristina, c/o Medivir AB Lunastigen 7 S-141 44, Huddinge / SE

11 / IVANOV, Vladimir, c/o Medivir AB Lunastigen 7 S-141 44, Huddinge / SE

12 / PELCMAN, Michael, c/o Medivir AB Lunastigen 7 S-141 44, Huddinge / SE

13/BELFRAGE, Anna Karin Gertrud L., c/o Medivir AB Lunastigen 7 S-141 44, Huddinge / SE

14/JOHANSSON, Per-Ola Mikael, c/o Medivir AB Lunastigen 7 S-141 44, Huddinge / SE

(74) Radulović Božidar, Jovana Tomaševića 9/III, Podgorica (ME)

(57) Jedinjenje koje ima formulu

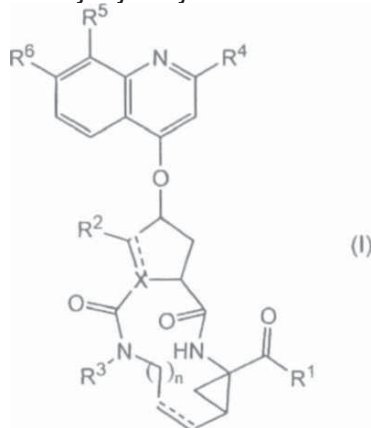



neki njegov N-oksidi, so ili stereoizomer, naznačeno time, dasvaka isprekidana linija (predstavljena sa - - -) ponekad predstavlja dvostruku vezu; X je N, CH, a kada X nosi dvostruku vezu, pomenuti je C; R<sup>1</sup> je-OR<sup>7</sup>-NH-SO<sub>2</sub>R<sup>x</sup>; R<sup>2</sup> je vodonik, a kada X je C ili CH, R<sup>2</sup> može takode da bude C1-6alkil; R<sup>3</sup> je vodonik, C1-6alkil, C1-6alkoksiC1-6alkil, C3-7cikloalkil; R<sup>4</sup> je aril ili Het; n je 3, 4, 5 ili 6; R<sup>5</sup> predstavlja halo, C1-6alkil, hidroksi, C1-6alkoksi, polihaloC1-6alkil, fenil ili Het; R<sup>6</sup> predstavlja C1-6alkoksi ili dimetilamino; R<sup>7</sup> je vodonik; aril; Het; C3-7cikloalkil koji je ponekad supstituisan sa C1-6alkilom; ili C1-6alkil koji je ponekad supstituisan sa C3-7cikloalkilom, arilom ili sa Het; R<sup>8</sup> je aril; Het; C3-7cikloalkil koji je ponekad supstituisan sa C1-6alkilom; ili C1-6alkil koji je ponekad supstituisan sa C3-7cikloalkilom. arilom ili sa Het; aril kao grupa ili kao deo grupe je fenil koji je ponekad supstituisan sa jednim, dva ili tri supstituenata koji su izabrani iz halo, hidroksi, nitro, cijano, karboksila, C1-6alkila, C1-6alkoksi, C1-6alkoksiC1-6alkila, C1-6alkilkarbonila, amino, mono- ili di-C1-6alkilamino, azido, merkpto, polihaloC1-6alkila, polihaloC1-6alkoksi, C3-7cikloalkila, pirolidinila, piperidinila, piperazinila, 4-C1-6alkilpiperazinila, 4-C1-6alkilkarbonilpiperazinila i morfolinila; gde pomenuta morfolinilna i piperidinilna grupa može da ponekad bude supstituisan sa jednim ili sa dva C1-6alkil radikala: Het kao grupa ili kao deo grupe je 5- ili 6-člani zasićeni, delomično nezasićeni ili kompletno nezasićeni heterociklički prsten koji sadrži 1 do 4 heteroatoma od kojih je svaki nezavisno izabran iz azota, kiseonika i sumpora, pri čemu je pomenuti heterociklički prsten ponekad kondenzovan sa nekim benzenskim prstenom; i gde pomenuti het kao celina je ponekad supstituisan sa jednim, dva ili tri supstituenata od kojih je svaki nezavisno izabran iz grupe koja se sastoji od halo, hidroksi, nitro, cijano, karboksila, C1-6alkila, C1-6alkoksi, C1-6alkoksiC1-6alkila, C1-6alkilkarbonila, amino, mono-ili di-C1-6alkilamino, azido, merkpto, polihaloC1-6alkila, polihaloC1-6alkoksi, C<sub>3</sub>-7cikloalkila, pirolidinila, piperidinila, piperazinila, 4-C1-6alkilpiperazinila, 4-C1-6alkilkarbonilpiperazinila i morfolinila; a gde morfolinilna i piperidinilna grupa mogu da ponekad budu supstituisane sa jednim ili dva C1-6alkil radikala.

Patent sadrži još 28 patentnih zahtjeva.

- (51) **C07D307/20** (11) **01232**  
**C07D493/04** (21) **P-2011-65**
- (30) 20060123752 09.11.2006 EP  
 (86) PCT/EP2007/62119 09.11.2007  
 (87) WO2008055970 15.05.2008  
 (96) 07822416.9 09.11.2007  
 (97) EP2089371 02.02.2011. 2011/05 EN
- (54) **(ME) METODE ZA DOBIJANJE HEKSAHIDROFURO (2,3-B)FURAN-3-OLA**  
**(EN) METHODS FOR THE PREPARATION OF HEXAHYDROFURO[2,3-B]FURAN-3-OL**
- (73) Tibotec Pharmaceuticals, Eastgate Village Eastgate Little Island Co Cork / IE  
 (72) LEMAIRE, Sébastien François Emmanuel avenue des pagodes, 20 1020 Bruxelles / BE  
 HORVATH, Andras Smalvoortstraat 46 bus 2 2300 Turnhout / BE  
 AELTERMAN, Wim Albert Alex Oude Lillebaan 7 2275 Gierle / BE  
 RAMMELOO, Thomas Joachim Landewald Secretaris van de Venlaan 14 Vosselaar, 2350 / BE
- (74) Radulović Božidar, Jovana Tomaševića 9/III, Podgorica (ME)
- (57) Proces za preparaciju jedinjenja sa formulom (V), naznačen time, da obuhvata reagovanje 2,3-dihidrofurana sa formulom (II) sa nekim derivatom gliksilata sa formulom (III) u prisutnosti titanijumove soli sa formulom  $Ti(Hal)_n(OR)_{4-n}$  gde Hal je neki halogenski radikal, n je 0, 1, 2 ili 3. a R je alkil ili arilalkil, a nakon toga reagovanje nastalog reakeionog produkta sa nekim alkoholom sa formulom (IV) sa ciljem da se dobije jedinjenje sa formulom (V):

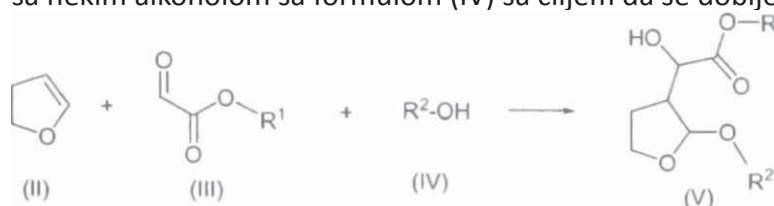

gde R<sup>1</sup> je alkil ili arilalkil. a R<sup>2</sup> je alkil ili arilalkil.

Patent sadrži još 15 patentnih zahtjeva

- (51) **C07K5/078**  
**A61K31/4709**  
**A61P31/14**  
**C07K5/06**

- (11) **01233**  
(21) **P-2011-73**

- (30) 20050107066 29.07.2005 EP  
20060101278 03.02.2006. EP
- (86) PCT/EP2006/64812 28.07.2006
- (87) WO2007014918 08.02.2007
- (96) 06764263.7 28.07.2006
- (97) EP1913014 26.01.2011. 2011/04 EN
- (54) (ME) **MAKROCIKLIČKI INHIBITORI VIRUSA HEPATITISA C**  
(EN) **MACROCYCLIC INHIBITORS OF HEPATITIS C VIRUS**
- (73) 1. TIBOTEC PHARMACEUTICALS, Eastgate Village Eastgate Little Island Co Cork / IE  
2. MEDIVIR AB, . Lunastigen 7 141 44 Huddinge / SE
- (72) DE KOCK, Herman, Augustinus Wolfseind 10 B-2370 Arendonk / BE  
RABOISSON, Pierre, Jean-Marie, Bernard Sint Pancratiuslaan 26 B-1933 Sterrebeek / BE  
SIMMEN, Kenneth, Alan Boterbloemenlaan 35 B-3080 Tervuren / BE  
LINDSTRÖM, Mats Stefan Medivir AB Lunastigen 7 S-141 44 Huddinge / SE  
KAHNBERG, Pia Cecilia Medivir AB Lunastigen 7 S-141 44 Huddinge / SE  
ANTONOV, Dmitry Medivir AB Lunastigen 7 S-141 44 Huddinge / SE  
NILSSON, Karl Magnus Medivir AB Lunastigen 7 S-141 44 Huddinge / SE  
SAMUELSSON, Bengt Bertil Medivir AB Lunastigen 7 S-141 44 Huddinge / SE  
ROSENQUIST, Asa Annica, Kristina Medivir AB Lunastigen 7 S-141 44 Huddinge / SE
- (74) Radulović Božidar, Jovana Tomaševića 9/III, Podgorica (ME)
- (57) Jedinjenje koje ima formulu  
OMe

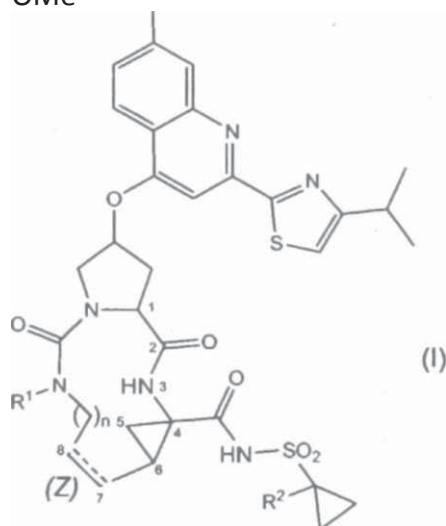

i njegovi N-oksidi, soli i stereoizomeri, naznačeno time, da isprekidana linija ponekad predstavlja dvostruku vezu među atomima C7 i C8; R<sup>1</sup> je vodonik ili C1-6alkil; R<sup>2</sup> je vodonik ili C1-6alkil; a n je 3, 4, 5 ili 6.

Patent sadrži još 14 patentnih zahtjeva.

- (51) **A61K31/485** (11) **01238**  
**A61P25/14** (21) **P-2011-18**
- (30) 20040013469 08.06.2004 EP  
 (86) PCT/EP2005/005888 01.06.2005  
 (87) WO2005120506 22.12.2005  
 (96) 05754710.1 01.06.2005  
 (97) EP1781291 03.11.2010. 2010/44 EN
- (54) (ME) **OPIOIDI ZA LIJEČENJE NEMIRNIH DONJIH UDOVA**  
 (EN) OPIOIDS FOR THE TREATMENT OF THE RESTLESSNESS OF THE LOWER LIMBS
- (73) EURO-CELIQUE S.A., 2, avenue Charles de Gaulle 1653 Luxembourg / LU  
 (72) LEISCHER, Wolfgang Posener Strasse 6 55218 Ingelheim / DE  
 REIMER, Karen Im Rehwinkel 12 65582 Hambach / DE  
 GAWORA, Karin Ostendstrasse 2 35080 Bad Endbach / DE
- (74) Lutovac Branislav, Bulevar Crnojevića 93, Podgorica (ME)
- (57) Upotreba opioidnog oralnog doznog oblika sa usporenim oslobađanjem koji sadrži smešu opioidnog agonista izabranog iz grupe koju cine oksikodon. hidrokodon. hidromorfon. morfin, metadon. oksimorfon. fentanil i sufentanil u obliku slobodne baze ili farmaceutski prihvatljive soli i opioidnog antagonista izabranog iz grupe koju čine naltrekson. nalmelen i nalokson u obliku slobodne baze ill farmaceutski pihvatljie soli, za proizvodnju leka za lečenje pacijenata sa sindiomom nemirnih nogu (RLS).  
 Patent sadrži još 10 patentnih zahtjeva.

- (51) **A61K9/24** (11) **01239**  
 (21) **P-2011-167**
- (30) JP20070023594 01.02.2007 JP  
 (86) PCT/JP2008/051900 30.01.2008  
 (87) WO2008093882 07.08.2008  
 (96) 08704473.1 30.01.2008  
 (97) EP2107905 17.11.2010. 2011/46 EN
- (54) (ME) **ČVRSTI PREPARAT KOJI SADRŽI ALOGLIPTIN I PIOGLITAZON**  
 (EN) SOLID PREPARATION COMPRISING ALOGLIPTIN AND PIOGLITAZONE
- (73) Takeda Pharmaceutical Company Limited, 1-1, Doshomachi 4-chome Chuo-ku Osaka-shi, Osaka 541-0045 / JP
- (72) NAKAMURA, Kenji c/o TAKEDA PHARMACEUTICAL COMPANY LIMITED 17-85, Jusohonmachi 2-chome Yodogawa-ku Osaka-shi Osaka 532-8686 / JP  
 KIYOSHIMA, Kenichiro c/o TAKEDA PHARMACEUTICAL COMPANY LIMITED 17-85, Jusohonmachi 2-chome Yodogawa-ku Osaka-shi Osaka 532-8686 / JP  
 NOMURA, Junya c/o TAKEDA PHARMACEUTICAL COMPANY LIMITED 17-85, Jusohonmachi 2-chome Yodogawa-ku Osaka-shi Osaka 532-8686 / JP
- (74) Čupić Branislav, Dalmatinska 10, Podgorica (ME)
- (57) Čvrsti preparat koji sadrži kao sledeće delove: prvi i drugi deo : prvi deo sadrži 2-[[6-[(3R)-3-amino-1-piperidinil]-3,4-dihidro-3-metil-2,4-diokso-1(2H)-pirimidinil]metil]-benzoni-tril ili njegovu so i, kao prvi ekspanz, šećer ii šećerni alkohol; I drugi deo sadrži pioglitazon ili njegovu so i, kao drugi ekspanz, šećer ili šećerni alkohol.  
 Patent sadrži još 6 patentnih zahtjeva.

(51) **C07D211/76**  
**C07D401/04**  
**C07D413/04**  
**C07D403/04**  
**C07D417/04**  
**A61K31/506**  
**A61K31/5377**  
**A61K31/45**  
**A61P7/02**

(11) **01241**  
(21) **P-2011-161**

(30) 20040152000 21.05.2004 JP  
(86) PCT/JP2005/009711 20.05.2005  
(87) WO2005113504 01.12.2005  
(96) 05743594.3 20.05.2005  
(97) EP 1748985 22.06.2011. 2011/25 EN

(54) (ME) **DERIVATI CIKLIČNIH AMIDA, NJIHOVO DOBIJANJE I UPOTREBA KAO ANTITROMBOTSКИH AGENASA**  
(EN) CYCLIC AMIDE DERIVATIVES, AND THEIR PRODUCTION AND USE AS ANTITHROMBOTIC AGENTS

(73) Takeda Pharmaceutical Company Limited, 1-1, Doshomachi 4-chome Chuo-ku Osaka-shi, Osaka 541-0045 / JP  
(72) KUBO, K.; c/o TAKEDA PHARMACEUTICAL COMPANY LTD 17-85, Jusohonmachi 2-chome, Yodogawa-ku Osaka-shi, Osaka 5328686 / JP  
IMAEDA, Y.; c/o TAKEDA PHARMACEUTICAL COMPANY LTD 17-85, Jusohonmachi 2-chome, Yodogawa-ku Osaka-shi, Osaka 5328686 / JP  
(74) Ćupić Branislav, Dalmatinska 10, Podgorica (ME)  
(57) Jedinjenje odobreno od: 4-(14(2S)-3-(6-hloroftalen-2-il)sulfonil]-2-hidroksipropanoil} pipendin-4-il)morfolin-3-on, ili njegova so; 1-(4-{{(2S)-3-[(6-hloroftalen-2-il)sulfonil]-2-hidroksipropanoil}piperazin-1-il)piperidin-2-on, ili njegova so; 1-(1-{{(2S)-3-[(6-hloroftalen-2-il)sulfonil]-2-hidroksipropanoil}piperidin-4-il)tetrahidropirimidin-2(1H)-on, ili njegova so; 1-(4-{{(2S)-3-[(6-hloroftalen-2-il)sulfonil]-2-hidroksipropanoil}piperazin-l-il) tetrahidropirimidin-2(1H)-on, ili njegova so; 1-(1-{{3-[(6-hloroftalen-2-il)sulfonil]propanoil} piperazin-4-il)tetrahidropirimidin-2(1 H)-on, ili njegova so; (2S)-3-[(6-hloroftalen-2-il) sulfonil]-1-(2-imino-1,4'-bipiperidin-1'-il)-1-oksopropan-2-ol, ili njegova so; 1'-{{(2S)-3-[(6-hloroftalen-2-il)sulfonil]-2-hidroksipropanoil}-1,4'-bipiperidin-2-on, ili a salt thereof; i 2-(1-{{(2S)-3-[(6-hloroftalen-2-il)sulfonil]-2-hidroksipropanoil}piperidin-4-il)izoindolin-1-on, ili njegova so.  
Patent sadrži još 8 patentnih zahtjeva.

- (51) **C07D217/24**  
**A61K31/472**  
**A61P9/12**
- (30) EP05016153 26.07.2005  
(86) PCT/EP2006/007140 20.07.2006  
(87) WO2007012422 01.02.2007  
(96) 06776307.8 20.07.2006  
(97) EP1912949 24.08.2011 2011/34 EN
- (54) (ME) **DERIVATI CIKLOHEKSILAMIN IZOHINOLONA KAO INHIBITORI RHOKINAZE**  
(EN) CYCLOHEXYLAMIN ISOQUINOLONE DERIVATIVES AS RHO-KINASE INHIBITORS
- (73) SANOFI, 174, Avenue de France, 75013 Paris / FR
- (72) PLETTENBURG, Oliver, Sanofi-Aventis Deutschland GmbH, 65926 Frankfurt am Main / DE  
HOFMEISTER, Armin, Sanofi-Aventis Deutschland GmbH, 65926 Frankfurt am Main / DE  
KADEREIT, Dieter, Sanofi-Aventis Deutschland GmbH, 65926 Frankfurt am Main / DE  
BRENDDEL, Joachim, Sanofi-Aventis Deutschland GmbH, 65926 Frankfurt am Main / DE  
LOEHN, Matthias, Sanofi-Aventis Deutschland GmbH, 65926 Frankfurt am Main / DE
- (74) Ćupić Branislav, Dalmatinska 10, Podgorica (ME)

Patentni zahtevi

I. Jedinjenje formule (I)

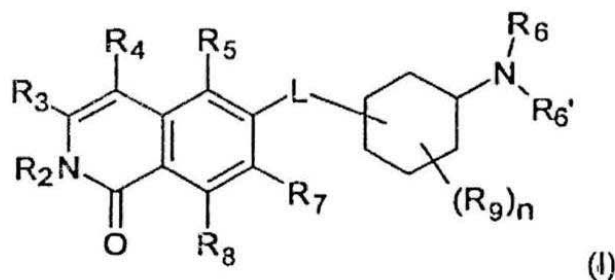

ili formule (I')

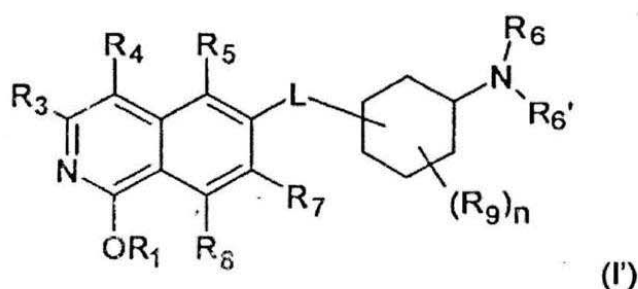

u kome

R<sub>1</sub> je H, (C<sub>1</sub>-C<sub>6</sub>)alkil, (C<sub>2</sub>-C<sub>6</sub>)alkenil, (C<sub>2</sub>-C<sub>6</sub>)alkinil, [(C<sub>1</sub>-C<sub>6</sub>)alkilen]<sub>0-1</sub>-(C<sub>3</sub>-C<sub>8</sub>)cikloalkil, [(C<sub>1</sub>-C<sub>6</sub>)alkilen]<sub>0-1</sub>-(C<sub>5</sub>-C<sub>10</sub>)heterociklil, [(C<sub>1</sub>-C<sub>6</sub>)alkilen]<sub>0-1</sub>-(C<sub>6</sub>-C<sub>10</sub>)aril, C(O)-(C<sub>1</sub>-C<sub>6</sub>)alkil, C(O)(C<sub>2</sub>-C<sub>6</sub>)alkenil, C(O)-(C<sub>2</sub>-C<sub>6</sub>)alkinil, C(O)-[(C<sub>1</sub>-C<sub>6</sub>)alkilen]<sub>0-1</sub>-(C<sub>3</sub>-C<sub>8</sub>)cikloalkil, C(O)-[(C<sub>1</sub>-C<sub>6</sub>)alkilen]<sub>0-1</sub>-(C<sub>5</sub>-C<sub>10</sub>)heterociklil ili C(O)-[(C<sub>1</sub>-C<sub>6</sub>)alkilen]<sub>0-1</sub>-(C<sub>6</sub>-C<sub>10</sub>)aril,

R<sub>2</sub> je H, (C<sub>1</sub>-C<sub>6</sub>)alkil, [(C<sub>1</sub>-C<sub>6</sub>)alkilen]<sub>0-1</sub>-R', [(C<sub>1</sub>-C<sub>6</sub>)alkilen]<sub>0-1</sub>-O-(C<sub>1</sub>-C<sub>6</sub>)alkil, [(C<sub>1</sub>-C<sub>6</sub>)alkilen]<sub>0-1</sub>-O-R', [(C<sub>1</sub>-C<sub>6</sub>)alkilen]<sub>0-1</sub>-NH<sub>2</sub>, [(C<sub>1</sub>-C<sub>6</sub>)alkilen]<sub>0-1</sub>-NH(C<sub>1</sub>-C<sub>6</sub>)alkil, [(C<sub>1</sub>-C<sub>6</sub>)alkilen]<sub>0-1</sub>-N[(C<sub>1</sub>-C<sub>6</sub>)alkil]<sub>2</sub>, [(C<sub>1</sub>-C<sub>6</sub>)alkilen]<sub>0-1</sub>-CH[R']<sub>2</sub>, [(C<sub>1</sub>-C<sub>6</sub>)alkilen]<sub>0-1</sub>-C(O)-R', [(C<sub>1</sub>-C<sub>6</sub>)alkilen]<sub>0-1</sub>-C(O)NH<sub>2</sub>, [(C<sub>1</sub>-C<sub>6</sub>)alkilen]<sub>0-1</sub>-C(O)NH-R' ili [(C<sub>1</sub>-C<sub>6</sub>)alkilen]<sub>0-1</sub>-C(O)N[R']<sub>2</sub>;

R<sub>3</sub> je H, halogen, CN, (C<sub>1</sub>-C<sub>6</sub>)alkil, (C<sub>1</sub>-C<sub>6</sub>)alkilen-R', OH, O-R'', NH<sub>2</sub>, NHR'', NR''R'' ili N H-C(O)-R'',

(57) R<sub>4</sub> je H, halogen, hidroksi, CN, (C<sub>1</sub>-C<sub>6</sub>)alkil, (C<sub>3</sub>-C<sub>8</sub>)cikloalkil, (C<sub>1</sub>-C<sub>6</sub>)alkilen-R';

R<sub>5</sub> je H, halogen, CN, NO<sub>2</sub>, (C<sub>1</sub>-C<sub>6</sub>)alkil, (C<sub>2</sub>-C<sub>6</sub>)alkenil, (C<sub>2</sub>-C<sub>6</sub>)alkinil, (C<sub>1</sub>-C<sub>6</sub>)alkilen-(C<sub>6</sub>-C<sub>10</sub>)aril, (C<sub>2</sub>-C<sub>6</sub>)alkenilen-(C<sub>6</sub>-C<sub>10</sub>)aril, (C<sub>1</sub>-C<sub>6</sub>)alkilen-(C<sub>5</sub>-C<sub>10</sub>)heterociklil, NH<sub>2</sub>, NH-R', NH-SO<sub>2</sub>H, NH-SO<sub>2</sub>-(C<sub>1</sub>-C<sub>6</sub>)alkil, NHSO<sub>2</sub>-R', NH-C(O)-(C<sub>1</sub>-C<sub>6</sub>)alkil, NH-C(O)-R', C(O)N[(C<sub>1</sub>-C<sub>6</sub>)alkil]<sub>2</sub>, C(O)OH ili C(O)O-(C<sub>1</sub>-C<sub>6</sub>)alkil; R<sub>6</sub> i R<sub>6</sub>' međusobno nezavisno su H, R', (C<sub>1</sub>-C<sub>s</sub>)alkil, (C<sub>1</sub>-C<sub>6</sub>)alkilen-R', (C<sub>1</sub>-C<sub>6</sub>)alkilen-O-(C<sub>1</sub>-C<sub>6</sub>)alkil, (C<sub>1</sub>-C<sub>6</sub>)alkilen-O-R', (C<sub>1</sub>-C<sub>6</sub>)alkilen-CH[R']<sub>2</sub>, (C<sub>1</sub>-C<sub>6</sub>)alkilen-C(O)-R', (C<sub>1</sub>-C<sub>6</sub>)alkilen-C(O)NH<sub>2</sub>, (C<sub>1</sub>-C<sub>6</sub>)alkilen-C(O)NH-R' ili (C<sub>1</sub>-C<sub>6</sub>)alkilen-C(O)N[R']<sub>2</sub>; R<sub>7</sub> i R<sub>8</sub> međusobno nezavisno su H, halogen, CN, NO<sub>2</sub>, (C<sub>1</sub>-C<sub>6</sub>)alkil, O-(C<sub>1</sub>-C<sub>6</sub>)alkil, O-[(C<sub>1</sub>-C<sub>6</sub>)alkilen]<sub>0-1</sub>-R', (C<sub>2</sub>-C<sub>6</sub>)alkenil, R', (C<sub>2</sub>-C<sub>6</sub>)alkenilen-(C<sub>6</sub>-C<sub>10</sub>)aril, (C<sub>1</sub>-C<sub>6</sub>)alkilen-R', NH<sub>2</sub>, NH-R', NH-SO<sub>2</sub>H, NH-SO<sub>2</sub>-(C<sub>1</sub>-C<sub>6</sub>)alkil, NH-SO<sub>2</sub>-R', SO<sub>2</sub>-NH<sub>2</sub>, SO<sub>2</sub>-NHR', NH-C(O)-(C<sub>1</sub>-C<sub>6</sub>)alkil, NH-C(O)-R', C(O)N[(C<sub>1</sub>-C<sub>6</sub>)alkil]<sub>2</sub>, C(O)OH ili C(O)O-(C<sub>1</sub>-C<sub>6</sub>)alkil; R<sub>9</sub> je halogen ili (C<sub>1</sub>-C<sub>6</sub>)alkil; n je 0, 1, 2, 3 ili 4; iL je 0 ili O-(C<sub>1</sub>-C<sub>6</sub>)alkil; pri čemu, R' je (C<sub>3</sub>-C<sub>s</sub>)cikloalkil, (C<sub>s</sub>-C<sub>10</sub>)heterociklil ili (C<sub>6</sub>-C<sub>10</sub>)aril; i R'' je (C<sub>3</sub>-C<sub>s</sub>)cikloalkil, (C<sub>s</sub>-C<sub>10</sub>)heterociklil, (C<sub>6</sub>-C<sub>10</sub>)aril, (C<sub>1</sub>-C<sub>6</sub>)alkil, (C<sub>1</sub>-C<sub>6</sub>)alkilen-R', (C<sub>1</sub>-C<sub>6</sub>)alkilen-O-(C<sub>1</sub>-C<sub>6</sub>)



aikil, (C t-C6)alkii en-O-R' ili (C,-C6)aikiien-NR<sub>x</sub>R); i pri čemu, R<sub>x</sub> i R<sub>y</sub> međusobno nezavisno su (C 1-C6)alkii, (C5-C10)heterociklil, (C6-C10)aril, (C1 -C4)ai kilen-(Cs-C10)heterociklii, (C,-C4)alkilen-(C6-C10)aril, (C,-C4)alkilen-NH(C, C6)ai kil, (C1 -C4)al kiien-N[(C1 -C6)alkii]<sub>2</sub>, (C1 -C4)al ki ien-N[(C6-C10)arii]<sub>2</sub> ili (C,-C4)aikilen N[(Cs-C10)heterociklil]; i pri čemu u ostacima R<sub>4</sub>, R<sub>5</sub>, R<sub>7</sub> i R<sub>8</sub> jedan atom vodonika aikila ili aikiiena može izborno biti supstituisan sa OH, OCH<sub>3</sub>, COOH, COOCH<sub>3</sub>, NH<sub>2</sub>, NHCH<sub>3</sub>, N(CH<sub>3</sub>)<sub>2</sub>, CONH<sub>2</sub>, CONH CH<sub>3</sub> i ili CON(CH<sub>3</sub>)<sub>2</sub>, ili alkii ili alkiiien može biti halogeni sa jednom ili više puta; pri čemu, (C3-C8)cik loalkli grupa može da sadrži 1 ili 2 dvogube veze i (C6-C 10)aiil i (C5- C1 0)heterocikl il grupe su nesupstituisane ili susptituisane jednom ili vise puta sa pogodnim grupama koje su nezavisno izabrane iz grupe koju ine halogen, CF<sub>3</sub>, N<sub>2</sub>, N<sub>3</sub> CN, C(O)-(C1 - C6)alkii, C(O)-(C6-C10)aril, COOH, COO(C1 -C6)alkil, CONH<sub>2</sub>, CONH(C1 -C6)alkii, CON[(C, C6)alkilh, (C3-C8)cikloalki i, (C1 -C6)alkil, (C1 -C6)aikilen-OH, (C1 -C6)alkilen-N H<sub>2</sub>, (C1 - C6)alkilen-NH(C1-C6)alkil, (C1 -C6)alkilen-N[(C1 -C6)alkil]<sub>2</sub>, (C2-C6)alkenil, (C2-C6)alkinil, O (C,-C6)alkil, O-C(O)-(C1 -C6) aikil, O-C(O)-(C6-C10)aril, O-C(O)-(Cs-C10)heterociklil, P<sub>3</sub>O<sub>2</sub>H<sub>2</sub>, S<sub>3</sub>O<sub>2</sub>H, S<sub>2</sub>O-NH<sub>2</sub>, S<sub>2</sub>O<sub>2</sub>NH(C1 -C6)alkil, S<sub>2</sub>O<sub>2</sub>N[(C1 -C6)alkii]<sub>2</sub>, S-(C1 -C6)alkil ; S-(C1 -C6)aikiien (C6-C10)aril, S-(C1 -C6)alkiiien-(Cs-C10)heterociklil, SO-(C1 -C6)alkii, SO-(C1 -C6)alkilen-(C6- C10)aril, SO-(C,-C6)aikiilen-(C5-C 10)heterocikil il, S<sub>2</sub>-(C, -C6)alkii, S<sub>2</sub>-(C,-C6)alkiiien-(C6-C10)aril, SOz-(C1-C6)alkilen-(C5-C 10)heterocik il il, SOz-NH(C1 -C6)alkilen-(C1 -C 10)aril, SOz NH(C,-C6)alkilen-(C5-C 10)heterociklil, SOz-N[(C,-C6)alkii][(C1 -C6)alkilen-(C6-C 10)aril], SOz-N[(Ct-C6)alkil][(C1-C6) alkilen-(C5-C1 0)heterociklil], SOz-N[(C1 -C6)alkilen-(C6- C 10)aril]z, SOz-N[(C1 -C6)alkilen-(C5-C10)heterociklil h, C(NH)(NH<sub>z</sub>), NH<sub>2</sub>, NH-(C1 -C6)alkil, N[(C,-C6)alkilh, NH-C(O)-(C,-C6) alkil, NHC(O)O-(C,-C6)alkil, NH-C(O)-(C6-C1 0)aril, NH C(O)-(Cs-C,o)heterociklil, NH-C(O)O-(C6-C10)ari l, NH-C(O)O-(Cs-C 10)heterociklil, NH C(O)-NH-(C1 -C6)alkil, NH-C(O)-NH-(C6-C10)aril, NH-C(O)-NH-(Cs-C 10)heterociklil, NH SOz-(C,-C6)alkil, NH-S<sub>2</sub>-(C6-C 10)aril, NH-SOz-(Cs-C10)heterociklil, N(C1 -C6)alkil -C(O) (C,-C6)alkil, N(C1 -C6)alki i-C(O)O-(C1 -C6)alkil, N(C,-C6)alkil-C(O)-(C6-C10)aril, N(C,C6)alkil-C(O)-heterociklil, N(C1 -C6)a lkil-C(O)O-(C6-C1 0)aril, N(C1 -C6)alkil-C(O)O-(C5- C10)heterociklil, N(C1 -C6)alkii -C(O)-NH-(C1-C6)alkil ], N(C1 -C6)a l kii-C(O)-NH-(C6-C1 0)aril, N(C1 -C6)alki i-C(O)-NH-(C5-C10)heterociklil, N[(C1 -C6)alkil]-C(O)-N[(C1 -C6)alkil]<sub>2</sub>, N[(C1 - C6)alki l]-C(O)-N[(C,-C6)alkil]-C(O)aril, N[(C,-C6) alkii]-C(O)-N[(C,-C6)alkil]-C(O)heterociklil, N[(C1 -C6)al kil]-C(O)-N[(C6-C10)aril]<sub>2</sub>, N[(C1 -C6)alkil]-C(O)-N[(Cs- C10)heterociklil]z, N[(C6-C10)ari l]-C(O)-(C1 -C6)alkil, N[(C5-C10) heterociklil]-C(O)-(C1- C6)alkil, N[(C6-C10)aril]-C(O)O-(C1 -C6)alkil, N[(C5-C1 0)heterociklil]-C(O)O-(C1 -C6)alkil, N(aril)-C(O)-(C6-C10)aril, N[(C5-C10)heterocikli1]-C(O)-(C6-C10)aril, N[(C6-C10)aril]-C(O)O (C6-Ct o) aril, N[(Cs-C10)heterociklii]-C(O)O-(C6-C 10)aril, N[(C6-C to)arii]-C(O)-NH-(C,C6)alkil, N[(Cs-C10)heterociklii ]-C(O)-NH-(C1 -C6)alkil, N(arii)-C(O)-NH-(C6-C10)aril, N[(Cs- C10)heterociklil]-C(O)-NH-(C6-Ct o)aril, N((C6-Ct o)arii)-C(O)-N[(C,-C6) alkil ]z, N[(Cs- C 10)heterociklii]-C(O)-N[(C1-C6)al kil]z, N[(C6-C10)arii]-C(O)-N[(C1 -C6)alki i]-C(O)-C 10)aril, N[(Cs-C, o)heterociklii]-C(O)-N[(C1 -C6)alkil]- (C6-C10)aril, N[(C6-C1 0)aril]-C(O)-N[(C6- C10)aril]<sub>2</sub>, N[(Cs-C10)heterociklii]-C(O)-N[(C6-C t o)aril]z, (C6-C io)aril, (C, -C6) alkilen-(C6- C10)aril, O-(C1 -C6)alkilen-(C6-C10)aril, (Cs-C10)heterociklil, (C1 -C6)alkilen-(Cs C10)heterociklil, O-(C1 -C6)alkilen-(C5-C10)heteroci kli l, pri emu (C6-C10)atil ili (C5- C10) heterociklil može biti supstituisan jednom do 3 puta sa halogenom, OH, N<sub>2</sub>, C, O-(C1 - C6) al ki l, (C, -C6)alkil, NH<sub>z</sub>, NH(C1 -C6)alkil, N[(C1 -C6)alkil]z, SOzCH<sub>3</sub>, COOH, C(O)O-(C, C6)al k il, CONH<sub>z</sub>, (C1 -C6)a lkilen-O-(C1-C6)alkil, (C1 -C6)alkilen-O-(C6-C10)aril, O-(C1 - C6)alkilen-(C6-C1 0)ari l; ili pri čemu (C6-C1 0)aril je supstituisan sa susjednim atomima ugljenika u molekulu O-(C1 -C4)alkilen-O grupe ime se formira 5-8- !ani prsten zajedno sa atomima ugljenika za koje su vezani atomi kiseonika i pri čemu aril ili heterociklil supstituenti (C6-C10)aril i (Cs-C 10)heterociklil grupa ne moraju biti dalje supstituisani gru pom koja sadrži arilili heterociklil ili njihove farmaceutski prihvatljive soli i/ili stereozomerni oblici.

Patent sadrži još 51 patentnih zahtjeva.

- (51) **A61K31/352**  
**A61K31/353**  
**A61K31/357**  
**A61P3/06**  
**A61P3/10**

(11) **01254**  
(21) **P-2010-205**

- (30) US20050751677P 19.12.2005  
US20060611961 18.12.2006  
(86) PCT/US2006/048477 19.12.2006  
(87) WO2007092086 16.08.2007  
(96) 06849983.9 19.12.2006  
(97) EP1973541 03.11.2010. 2010/44 EN

(54) (ME) **UPOTREBA DERIVATA BENZO-FUZIONISANOG HETEROCIKLIČNOG SULFAMIDA ZA SNIŽAVANJE LIPIDA I SADRŽAJA GLUKOZE U KRVI**

(EN) VERWENDUNG VON BENZOKONDENSIERTEN HETEROCYCLISCHEN SULFAMID-DERIVATEN ZUR SENKUNG DER LIPID- UND BLUTZUCKERSPIEGEL

- (73) Janssen Pharmaceutica N.V., Turnhoutseweg 30, 2340 Beerse / BE  
(72) SMITH-SWINTOSKY, Virginia, L. 3163 Line Lexington Road Hatfield, Pennsylvania 19440 / US  
REITZ, Allen, B. 109 Greenbriar Road Lansdale, Pennsylvania 19446 / US

(74) Lutovac Branislav, Bulevar Crnojevića 93, Podgorica (ME)

(57) Jedinjenje formule (I)

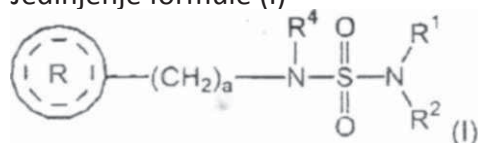

ili njegova farmaceutski prihvatljiva so, za upotrebu u tretmanu nekog poremećaja koga karakterišu povećani sadržaji glukoze, gde se: R<sup>1</sup> i R<sup>2</sup> svaki nezavisno, biraju iz grupe koju čine vodonik i niži alkil; R<sup>4</sup> se bira iz grupe koju čine vodonik i niži alkil; se bira iz grupe koju čine a je ceo broj od 1 do 2;

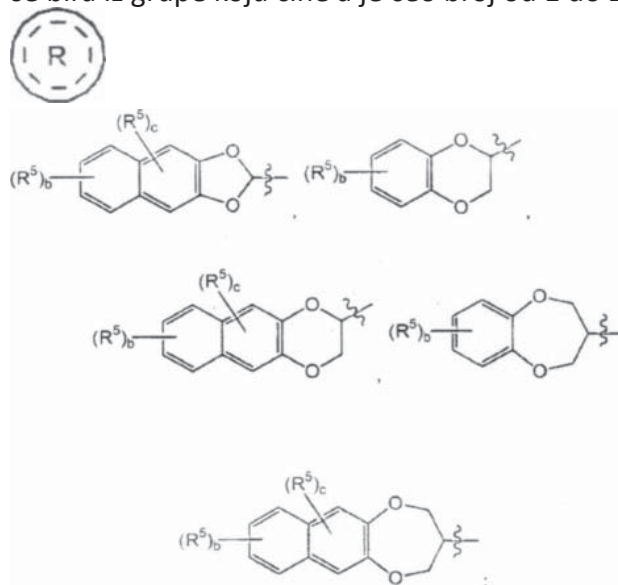

gde b predstavlja ceo broj od 0 do 4; i gde c predstavlja ceo broj od 0 do 2; a svaki R<sup>5</sup> se nezavisno bira iz grupe koju čine halogen, niži alkil i nitro; pod uslovom, da kada



predstavlja  
da je tada  $a$  jednako 1.  
pri čemu se niži alkil odnosi na niz ugljeničnog lanca sa 1-4 atoma ugljenika.  
Patent sadrži još 12 patentnih zahtjeva.

- (51) **A61K31/485** (11) **01255**  
**A61K9/22** (21) **P-2011-26**  
**A61K9/32**
- (30) 20060840244P 25.08.2006 US  
 (96) 09156832.9 24.08.2007  
 (97) EP2070538 01.12.2010. 2010/48 EN
- (54) (ME) **FARMACEUTSKI DOZNI OBLICI REZISTENTNI NA ZLOUPOTREBU KOJI SADRŽE OPIOIDNI ANALGETIK**  
 (EN) TAMPER RESISTANT ORAL PHARMACEUTICAL DOSAGE FORMS COMPRISING AN OPIOID ANALGESIC
- (73) Purdue Pharma LP, One Stamford Forum 201 Tresser Boulevard, Stamford, CT 06901 / US  
 (72) McKenna, William Henry, 10 Longmeadow Road, Yonkers, NY 10704 / US  
 Mannion, Richard Owen, 3860 Green Ridge Road, Furlong, PA 18925 / US  
 O'Donnell, Edward Patrick, 38 Chestnut Court, Basking Ridge, NJ 07920 / US  
 Huang, Haiyong Hugh, 33 Ketley Place, Princeton, NJ 08540 / US
- (74) Lutovac Branislav, Bulevar Crnojevića 93, Podgorica (ME)
- (57) Čvrst oralni farmaceutski dozni oblik sa produženim oslobađanjem, koji sadrži formulaciju matrice sa produženim oslobađanjem, a formulacija matrice sa produženim oslobađanjem sadrži kompoziciju koja sadrži bar jedan aktivan agens i bar jedan polietilen oksid koji na osnovu reoloških merenja ima približnu molekulsku težinu od najmanje 1,000,000; gde je formulacija matrice sa produženim oslobađanjem očvršćavana na oko 60°C u toku vremenskog perioda od oko 1 minut u obliku tablete ili zrnaca, pri čemu ova tableta ili pojedinačno znce može da se zgnječi bez kidanja, naznačen time, što debljina tablete ili pojedinačnog zrnca posle-ovog gnječenja. nije veća od oko 60% debljine te tablete ili pojedinačnog zrnca pre nego što su zgnječeni, pri čemu ova zgnječena ili nezgnječena tableta ili zgnječena ili nezgnječena zrnca imaju brzinu rastvaranja in vitro, merenu u aparatu USP Apparatus 1 (sa korpom), pri 100 o/min, u 900 ml\_ simuliranog želudačnog fluida bez enzima (SŽF), koji sadrži 40% etanola, na 37° C, naznačen time, što procenat oslobođene aktivne supstance tokom 0,5 sati rastvaranja, ne odstupa više od oko 20% od odgovarajuće brzine oslobađanja in vitro, merene u aparatu USP Apparatus 1 (sa korpom), pri 100 o/min, u 900 mL simuliranog želudačnog fluida bez enzima (SŽF), na 37° C, bez etanola, ako se koriste zgnječena ili nezgnječena referentna tableta ili zgnječna ili nezgnječena referentna zrnca, respektivno.  
 Patent sadrži još 31 patentnih zahtjeva.

- (51) **A61K9/46** (11) **01256**  
**A61K31/58** (21) **P-2011-46**
- (96) 08013091.7 21.07.2008
- (97) EP2151235 16.02.2011. 2011/07 EN
- (54) (ME) **FARMACEUTSKA FORMULACIJA ZA LIJEČENJE GORNJEG DIGESTIVNOG TRAKTA**  
(EN) PHARMACEUTICAL FORMULATION FOR TREATING THE UPPER DIGESTIVE TRACT
- (73) DR. FALK PHARMA GMBH, Leinenweberstrasse, 5 D-79108 Freiburg / DE
- (72) Pröls Markus.Dr. Johann-von-Weerth-Str. 11 791000 Freiburg/Breisgau / DE  
Wilhelm Rudolf, Dr. Feuerkirschenweg 2a 76476 Bischweier / DE
- (74) Lutovac Branislav, Bulevar Crnojevića 93, Podgorica (ME)
- (57) Šumeća tableta, koja sadrži budesonid, za pripremanje rastvora za ispiranje usta koji se može davati oralno, naznačena time, što sadrži dokuzat-natrijum u koncentraciji od 0,1% do 5% težine, u odnosu na šumeću tabletu.  
Patent sadrži još 9 patentnih zahtjeva.

- (51) **A01N1/02**  
**A61K31/192**  
**A61K31/216**  
**A61K31/7028**  
**A61K35/00**  
**A61P37/02**  
**A61P1/00**
- (11) **01257**  
(21) **P-2011-165**
- (30) 20070006838 02.04.2007 EP  
(86) PCT/EP2008/002542 31.03.2008  
(87) WO2008119534 09.10.2008  
(96) 08734901.5 31.03.2008  
(97) EP2129216 09.12.2009 2011/33 EN
- (54) (ME) **PROIZVODNJA VIJABILNE SUSPENZIJE SA JAJIMA CRVA KOJA MOŽE DA SE SKLADIŠTI**  
(EN) PRODUCTION OF A VIABLE, STORABLE WORM EGG SUSPENSION
- (73) Dr. Falk Pharma GmbH, Leinenweberstrasse 5, 79108 Freiburg / DE  
(72) WILHELM, Rudolf, Feuerkirschenweg 2a, 76476 Bischweier / DE  
ROEPSTORFF, Allan, Knud, Damhus Boulevard 88, DK-2610 Rodovre / DK  
KAPEL, Christian, Moliin, Outzen Vallerod Banevej 12 DK-2960 Rungsted Kyst / DK  
(74) Lutovac Branislav, Bulevar Crnojevića 93, Podgorica (ME)  
(57) Postupak za proizvodnju farmaceutskog preparata za oralno davanje koji sadrži suspenziju, koja se može skladištiti, vijabilnih jaja parazitnih helminta, koji nisu patogeni za ljude, naime Trichuris suis, gde se posle uzimanja suspenzije razvija dovoljan broj helminta koji dovodi do stimulacije regulatornih humanih T ćelija, naznačen time, što se suspenzija od jaja helminta u jednom koraku tretira kisjelinom pri pH vrednosti od  $\leq 2$  i što se u sledećem koraku pH vrednost podešava na  $\geq 4$  i dodaje farmakološki prihvatljiv konzervans.  
Patent sadrži još 10 patentnih zahtjeva.

(51) **A61L15/22**  
**A61L15/60**  
**C08L83/04**

(11) **01258**  
 (21) **P-2011-196**

(30) 997166P 30.09.2007 US  
 (86) PCT/US2008/078340 30.09.2008  
 (87) WO2009046033 09.04.2009.  
 (96) 08836714.9 30.09.2008  
 (97) EP2211919 04.08.2010. 2011/36 EN

(54) (ME) **KOMPOZICIJE NA BAZI SILIKONSKOG GELA ZA ZARASTANJE RANA I SMANJIVANJE OŽILJAKA**

(EN) SILICONE GEL-BASED COMPOSITIONS FOR WOUND HEALING AND SCAR REDUCTION

(73) Meda AB, Pipers väg 2 A/Box 906, 17009 Solna / SE

(72) PALEFSKY, Irwin, 83 Sagamore Drive Plainview New York 11803 / US  
 WILSON, Ni'kita, 408 Wallingford Terrace Union NJ 07083 / US

(74) Lutovac Branislav, Bulevar Crnojevića 93, Podgorica (ME)

(57) Kompozicija za stvaranje barijere zaštitnog filma za smanjenje obrazovanja velikih ožiljaka posle hiruških rezova ili slučajnih povreda, koja sadrži:

ciklični siloksan; silikonski okluzivni fluid u obliku polialkilsiloksana izabranog od poli(dimetildiloksana), poli(metiletilsiloksana), poli(metilfenilsiloksana) i njihovih smeša koje imaju viskoznost između 50 i 500 mm<sup>2</sup>.s<sup>-1</sup>(CSt); silikonski okluzivni gel u obliku disperzije silikonskog elastomera u silikonskom ulju, naznačen time, što je silikonski elastomer izabran od umreženog dimetikona, stearil metil-dimetil siloksan kopolimera, polisilikon-11, cetearil dimetikon/vinil dimetikon umreženog polimera, dimetikon/fenil vinil dimetikona umreženog polimera i dimetikon/vinil dimetikon umreženog polimera, a silikonsko ulje je izabrano od fenil trimetikona, fenil dimetikona, dimetikton kopoliola i alkil dimetikon kopoliola, prah silikonske smole u obliku polimetil silseskvioksana.

Patent sadrži još 13 patentnih zahtjeva.



- (51) **A61K31/517**  
**A61P13/06**  
**A61P13/10**
- (11) **01259**  
(21) **P-2011-204**
- (30) 20070291148 26.09.2007 EP  
20070975324P 26.09.2007 US
- (86) PCT/IB2008/003126 24.09.2008  
(87) WO2009040671 02.04.2009  
(96) 08833688.8 24.09.2008  
(97) EP2203170 14.09.2011. 2011/37 EN
- (54) (ME) **NOVA TERAPEUTSKA UPOTREBA ADRENERGIČKOG ALFUZOSINA**  
(EN) **NOVEL THERAPEUTIC USES OF ADRENERGIC ALFUZOSINE**
- (73) SANOFI, 174, Avenue de France, 75013 Paris / FR  
(72) GEPPETTI, Pierangelo, Vie Per Capponi 41, I-50132 Firenze / IT  
(74) Ćupić Branislav, Dalmatinska 10, Podgorica (ME)
- (57) Alfuzosin ili njegove farmaceutski prihvatljive soli za upotrebu u liječenju i/iliprevjenciju upale mokraćne bešike  
Patent sadrži još 9 patentnih zahtjeva.

- (51) **C07K14/75** (11) **01260**  
**C07K7/06** (21) **P-2011-175**  
**C07C271/22**  
**C07K5/06**

- (30) 20040560453P 08.04.2004 US  
 (96) 09075233.8 08.04.2005  
 (97) EP2204383 10.08.2011. 2011/32 EN

(54) (ME) **POSTUPAK ZA DOBIJANJE EPTIFIBATIDA I ODGOVARAJUĆIH INTERMEDIJERNIH JEDINJENJA**

(EN) Processes for preparing eptifibatide and pertinent intermediate compounds

- (73) Millennium Pharmaceuticals, Inc., 40 Landsdowne Street Cambridge, MA 02139 / US  
 (72) Ho, Guojie, 33 Grindstone Lane Sudury Massachusetts 01776 / US Paone, Antoinette D. 9 Apollo Circle Lexington Massachusetts 02421 / US  
 Forni, Luciano, c/o UCB S.A. (Bioproducts) Chemin du Foriest 1420 Braine-l'Alleud / BE  
 Detollenaere, Catherine c/o UCB S.A. (Bioproducts) Chemin du Foriest 1420 Braine-l'Alleud / BE  
 (74) Lutovac Branislav, Bulevar Crnojevića 93, Podgorica (ME)  
 (57) Proizvod dobijen postupkom koji obuhvata:  
 • dobijanje jedinjenja formule II  
 Mpa-OH H-Har..Qly-Asp(O-PTrp-Pro-CY.s-NH2  
 I · I  
 s-----s

(II)

u kojoj

Har je hornoargini I; Gly je glicil;  
 Asp je asparagil; Trp je triptofanil; Pro je prolil;  
 Cys-NH2 je cisteinam i d;  
 Mpaje rnerkaptopropionska kisjelina; i  
 P2 je karboksilna zastitna grupa i

- kuplovanje Har i Mpa ostataka da bi se dobilo jedinjenje formule III:

Mra-Har-Gly-Asp(O-P:O-T:rp-Pro-Cys-NH2

I · I  
 s-----s

(ID)

Patent sadrži još 11 patentnih zahtjeva.

- (51) **B42D15/10** (11) **01261**  
(21) **P-2011-14**
- (30) 20061031396 17.03.2006 NL  
(86) PCT/NL2007/050114 19.03.2007  
(87) WO2007108685 27.09.2007.  
(96) 07715922.6 19.03.2007  
(97) EP2001687 20.10.2010. 2010/42 EN
- (54) (ME) **IDENTIFIKACIONI DOKUMENT SA TKANIM SLOJEM OJAČANJA**  
(EN) **IDENTITY DOCUMENT WITH TISSUE REINFORCEMENT**
- (73) Sdu Identification B.V., Oudeweg 32, 2031 CC Haarlem, NL  
(72) VAN DEN BERG, Jan, Bloklandpolderstraat 15 NL-2807 LH Gouda /NL  
(74) Čupić Branislav, Dalmatinska 10, Podgorica (ME)
- (57) Identifikacioni dokument/bankovna kartica (1) koji sadrži veći broj međupovezanih slojeva i veći broj zaštitnih karakteristika protiv krivotvorenja uključujući i perforaciju izvedenu u pomenutim slojevima i koji sadrži sloj (8) ojačanja sa nitima koje se pružaju u blizini perforacija (3), naznačen time, što se opisane perforacije pružaju kroz opisani sloj ojačanja  
Patent sadrži još 16 patentnih zahtjeva.

- (51) **A61K9/28** (11) **01262**  
**A61K31/485** (21) **P-2011-173**  
**A61P25/04**
- (30) 20050004377 28.02.2005 EP  
(86) PCT/EP2006/060341 28.02.2006  
(87) WO2006089973 31.08.2006  
(96) 06708567.0 28.02.2006  
(97) EP1855657 27.07.2011. 2011/30 EN
- (54) (ME) **OBLIK ZA DOZIRANJE KOJI SADRŽI OKSIKODON I NALOKSON**  
(EN) DOSAGE FORM CONTAINING OXYCODONE AND NALOXONE
- (73) EURO-CELTIQUE S.A., 2, avenue Charles de Gaulle, 1653 Luxembourg / LU  
(72) LEYENDECKER, Petra, Geiersberg 13, 35578 Wetzlar / DE  
HOPP, Michael, Dillenburg Strasse 17, 65520 Bad Camberg / DE  
SMITH, Kevin, 18 Poplar Road Histon, Cambridge Cambridgeshire CB4 9LN / GB
- (74) Lutovac Branislav, Bulevar Crnojevića 93, Podgorica (ME)
- (57) Farmaceutski oblik za doziranje sa usporenim oslobađanjem, koji sadrži 40 mg oksikodona, ili neku njegovu farmaceutski prihvatljivu so, i 20 mg naloksona, ili neku njegovu farmaceutski prihvatljivu so, gde su oksikodon, ili neka njegova farmaceutski prihvatljiva so, i nalokson, ili neka njegova farmaceutski prihvatljiva so, prisutni u masenom odnosu 2:1, za upotrebu u tretmanu umerenog do jakog bola, i sindroma opijatne disfunkcije utrobe koji se dešavaju tokom terapije bola, gde pomenuti sindrom opijatne disfunkcije utrobe predstavljaju konstipacija i neželjena dejstva, gde su pomenuta neželjena dejstva tipična neželjena dejstva izazvana sa naloksonom, a biraju se iz grupe koju čine abdominalni bol, grčevi i dijareja.  
Patent sadrži još 2 patentna zahtjeva.

(51) **C12N9/68**

(11) **01263**

(21) **P-2010-187**

(30) 20040564472P 22.04.2004 US

(86) PCT/US2005/013562 21.04.2005

(87) WO2005105990 10.11.2005

(96) 05737862.2 21.04.2005

(97) EP1740698 2010/31 04.082010 EN

(54) (ME) **REKOMBINANTNO MODIFIKOVAN PLAZMIN**

(EN) RECOMBINANTLY MODIFIED PLASMIN

(73) Talecris Biotherapeutics, Inc., 4101 Research Commons, Suite 300 79 T.W. Alexander Drive  
Research Triangle Park NC 27709 / US

(72) HUNT, Jennifer, Audrey, 8709 O'Neal Road Raleigh, NC 27613 / US NOVOKHATNY, Valery,  
4617 Wee Burn Trail Raleigh, NC 27612 / US

(74) Mugoša Stanković Ana, Trg Republike 13, Podgorica (ME)

(57) Polinukleotid koji sadrži (obuhvata) sekvencu nukleotida koja kodira polipeptid koji ima pojedinačni N-terminalni kringl domen koji je najmanje 90% identičan kringl 1 domenu nativnog humanog plazminogena; i C-terminalni domen koji je najmanje 90% identičan mestu (položaju) aktiviranja i domenu serinske proteaze humanog plazminogena, pri čemu se ovaj polipeptid vezuje za imobilizovan lizin i može se aktivirati pomoću plazminogenog akti vatora.

Patent sadrži još 17 patentnih zahtjeva.

- (51) **A61K31/519**  
**A61K31/4985**  
**A61P29/00**  
**A61P35/00**
- (30) 20040019363 14.08.2004 EP  
(86) PCT/EP2005/08735 11.08.2005  
(87) WO2006018221 23.02.2006  
(96) 05778137.9 11.08.2005  
(97) EP1778238 12.10.2011. 2011/41 EN
- (54) (ME) **INFUZIONI RASTVOR DIHIDROPTERIDINONA KOJI JE STABILAN PRI ČUVANJU**  
(EN) DIHYDROPTERIDINONE INFUSION SOLUTION HAVING A LONG SHELF LIFE
- (73) Boehringer Ingelheim International GmbH, Binger Strasse 173, 55216 Ingelheim am Rhein/ DE
- (72) MOHR, Detlef, Braendlinweg 13, 88400 Biberach / DE  
VEIT, Claus, Fabrikstr. 10, 88400 Biberach / DE  
TRAULSEN, Fridtjof, Steigstr. 19, 88400 Biberach / DE
- (74) Radulović Božidar, Jovana Tomaševića 9/III, Podgorica (ME)
- (57) Vodeni infuzioni ili injekcioni rastvor koji je stabilan pri čuvanju i sadrži aktivnu materiju opšte formule (I)

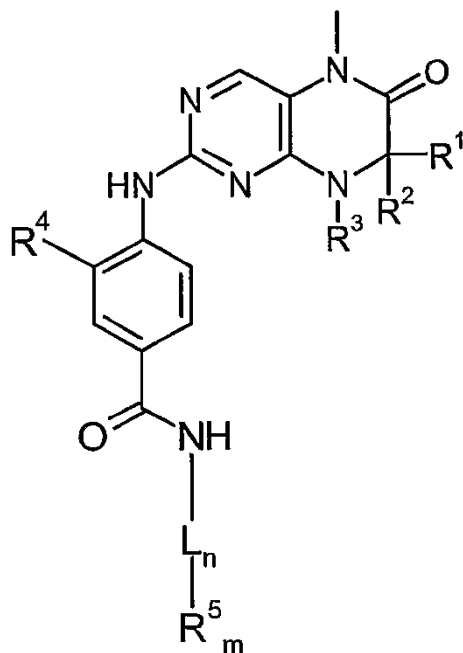

(I)

Bsp.	R <sup>1</sup>	R <sup>2</sup>	Konfig. R <sup>1</sup> od. R <sup>2</sup>	R <sup>3</sup>	R <sup>4</sup>	L <sub>n</sub> -R <sup>m</sup>

pri čemu skraćenice X1, X2, X3, X4 i Xs koje se upotrebljavaju u Tabeli uvek označavaju vezu sa pozicijom u opštoj formuli navedenoj u Tabeli umesto odgovarajućih grupa R1 R2, R3, R4 i Ln-R5m, ili njihove tautomere racemate, enantiomere, diastereomere ili eventualno njihove farmakoloski prihvatljive kisele adicione soli i količinu fiziološki prihvatljive kiseline ili smeše kisjelina koja je dovoljna za rastvaranje aktivne materije i djeluje kao stabilizator, eventualno zajedno sa pomocnim materijama za formulaciju podesnim za parenteralno davanje.

Patent sadrži još 13 patentnih zahtjeva.

- (51) **A61K39/145** (11) **01265**  
**C12Q1/70** (21) **P-2011-36**
- (30) 20040255471 09.09.2004 EP  
(86) PCT/IB2005/003266 09.09.2005  
(87) WO 2006/027698 16.03.2006.  
(96) 09075377.3 09.09.2005  
(97) EP2179744 01.12.2010. 2010/48 EN
- (54) (ME) **SMANJENJE POTENCIJALNIH JATROGENIH RIZIKA POVEZANIH SA VAKCINAMA PROTIV GRIPA**  
(EN) **DECREASING POTENTIAL LATROGENIC RISKS ASSOCIATED WITH INFLUENZA VACCINES**
- (73) Novartis Vaccines and Diagnostics GmbH, Emil-von-Behring-Strasse 76,35041 Marburg / DE
- (72) Gregersen, Jens Peter, Emil-von-Behring-Strasse 76, 35041 Marburg / DE
- (74) Radulović Božidar, Jovana Tomaševića 9/III, Podgorica (ME)
- (57) Postupak za pripremanje vakcine protiv gripa od virusa gripa koji je uzgajan na kulturi MDCK ćelijske linije, obuhvata fazu u kojoj se inokulum vakcionalnog soja virusa za umnožavanje virusa i/ili vakcina i/ili kultura testira na prisustvo infektivnog agensa koji može da se razvija na navedenoj ćelijskoj liniji, ali se ne razvija u embrioniranim kokošijim jajima, pri čemu je pomenuti infektivni agens jedan ili više od sledećih patogena: Reoviridae sisara; Pneumoviridae; Pneumovirusi familije Pneumoviridae; Morbilivirusi familije Paramyxoviridae; Ekovirusi Enterovirusa familije Picornaviridae; ili Rotavirus.  
Patent sadrži još 11 patentnih zahtjeva.



- (51) **C07D235/08**  
**C07D401/06**  
**C07D403/06**  
**A61K31/4184**  
**A61K31/4706**  
**A61P29/00**

- (30) 20060797504P 03.05.2006 US  
 (86) PCT/US2007/066748 17.04.2007.  
 (87) WO2007130780 15.11.2007  
 (96) 07760746.3 17.04.2007  
 (97) EP2021330 22.09.2010.

- (54) (ME) **BENZIMIDAZOLSKI MODULATORI VR1**  
 (EN) BENZIMIDAZOLE MODULATORS OF VR1

- (73) Janssen Pharmaceutica N.V., Turnhoutseweg 30, 2340 Beerse / BE  
 (72) CALVO, Raul, L. 72 Orchard Court Royersford, Pennsylvania 09468 / US  
 PLAYER, Mark, R. 80 Page Lane Phoenixville, Pennsylvania 19460 / US  
 DAX, Scott, L. 3 Quail Drive Landenberg, Pennsylvania 09350 / US  
 PARSONS, William, H. 29 Grayson Drive Belle Mead, New Jersey 08502 / US  
 BRANDT, Michael 16 Lenape Road Flemington, New Jersey 08822 / US  
 PATEL, Sharmila 2267 Sunrise Way Jamison, Pennsylvania 18929 / US  
 LIU, Jian 54 Heron Court Manalapan, New Jersey 07726 / US  
 CHEUNG, Wing, S. 7-14 Wuail Ridge Drive Plainsboro, New Jersey 08536 / US  
 JETTER, Michele, C. 3036 Brambling Lane Norristown, Pennsylvania 19403 / US  
 LEE, Yu-kai PO Box 918 Exton, Pennsylvania 19341 / US  
 YOUNGMAN, Mark, A. 110 Franklin Court North Wales, PA 19454 / US  
 PAN, Wenxi 140 Messner Lane Glenmoore, Pennsylvania 19343 / US  
 WELLS, Kenneth, M. 12 Norz Drive Hillsborough, New Jersey 08844 / US  
 BEAUCHAMP, Derek, A. 600 Patricia Circle Stewartsville, New Jersey 08886 / US  
 (74) Lutovac Branislav, Bulevar Crnojevića 93, Podgorica (ME)  
 (57) Jedinjenje Formule (1): i neki njegov oblik, u kame: isprekidane linije između položaja 1, 2 i 3 u Formuli (I) ukazuju na položaje tautomerne dvogube veze, pri čemu, ako se dvoguba veza formira između položaja 1 i 2, tada je prisutan R<sub>3b</sub>, a ukoliko se dvoguba veza formira između položaja 2 i 3, tada je prisutan p je 1 ili 2; q je 0 ili 1; r je 0, 1, 2 ili 3; L je C<sub>1-3</sub> alkil, C<sub>2-3</sub> alkenil, C<sub>2-3</sub> alkinil ili ciklopropil; A<sub>1</sub> se bira iz grupe koju čine fenil, bifenil, naftil, piridinil, hinolinil i indo!; R<sub>1</sub> svaki se bira iz grupe koju čine hidroksi, cijano, halogen, formil, karboksi, C<sub>1-6</sub> alkil, haloC<sub>1</sub>-salkil, C<sub>1</sub>-salkoksi, haloC<sub>1</sub>-salkoksi, C<sub>1</sub>-salkilkarbonil, C<sub>1</sub>-salkoksikarbonil, C<sub>1-6</sub>

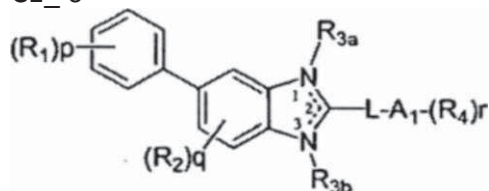

(I)

alkiltio, C<sub>1-6</sub> alkilsulfonil, C<sub>3-8</sub> cikloalkil, C<sub>3-8</sub> cikloalkii-C<sub>1-4</sub>alkil, C<sub>3-8</sub> cikloalkii-C<sub>1-4</sub>alkoksi, C<sub>3-8</sub> cikloalkil-oksi, amino, (C<sub>1</sub>-salkilh-2-amino, (C<sub>3</sub>-ecikloalkilh-2-amino, (C<sub>3-8</sub> cikloalkii-C<sub>1-4</sub>alkil)<sub>1-2</sub> amino, aminokarbonil, (C<sub>1-6</sub>alkil)<sub>1-2</sub>aminokarbonil, C<sub>1-6</sub>alkilkarbonilamino, C<sub>1-6</sub>alkoksikarbonilamino, aminokarbonilamino, (C<sub>1-6</sub>alkil)<sub>1-2</sub>aminokarbonilamino, C<sub>1-6</sub>alkilsulfonilamino, C<sub>1-6</sub>alkilsulfonilamino, aminosulfonil, (C<sub>1-4</sub>alkil)<sub>1-2</sub>aminosulfonil,

aminosulfonilamino i (C1\_6alkil)1\_2aminosulfonilamino, gde je alkil opciono supstituisan sa C1-ealkoksi, amino, (C1-4alkil)1\_2amino, C1\_6 alkilkarbonilamino, C1-6alkoksikarbonilamino, aminokarbonilamino, (C1\_6alkil)1\_2 aminokarbonilamino, C1-6alkilsulfonilamino, aminosulfonilamino, (C1-6alkil)1\_2 aminosulfonilamino hidroksi i fenil, gde je fenil opciono supstituisan sa jednim, dva ili tri supstituenta koji se nezavisno biraju iz grupe koju cine halogen, cijano, nitro, C1-salkil, C1\_6alkoksi, C1\_ salkiltio i c1-6 alkilsulfonil, i gde je svaki alkil i alkoksi opciono perfluorovan; R2 se bira iz grupe koju cine halogen, C1-4alkil, C1-4alkoksi, C1-4alkilsulfonil, nitro, amino, (C1-4alkil)1-2amino i cijano, gde je svaki alkil i alkoksi opciono perfluorovan ; R3a i R3b svaki se bira iz grupe koju cine vodonik i opciono perfluorovani C1-4alkil; i R4 svaki se bira iz grupe koju cine halogen, nitro, cijano, karboksi, C1\_6alkil, C1-5 alkoksi, haloC1-5alkil, haloC1-5alkoksi, C1-salkoksi-C1-salkil, C1-salkilkarbonil, C1-5alkiltio, haloC1-salkiltio, C1-salkilsulfonil, haloC1-salkilsulfonil, C3\_8cikloalkil, C3\_8cikloalkii-C1-4alkil, C3-ecikloalkii-C1-4alkoksi, C3-ecikloalkil-oksi, amino, (C1-salkil)1-2amino, (C3-ecikloalkil)1-2 amino, (C3-ecikloalkii-C1-4alkil)1-2amino, aminokarbonil, (C1\_6alkil)1\_2aminokarbonil, C1\_6 alkilkarbonilamino, C1\_6alkoksikarbonilamino, aminokarbonilamino, (C1\_6alkil)1\_2 aminokarbonilamino, C1-salkilsulfonilamino, haloC1\_6alkilsulfonilamino, C1\_6 alkilsulfonilamino, aminosulfonil i (C1-4alkil)1-2aminosulfonil, gde je svaki alkil opciono supstituisan sa jednim, dva ili tri supstituenta koji se nezavisno biraju iz grupe koju cine C1\_8alkoksi, amino, (C1-4alkil)1\_2amino, C1-6 alkilkarbonilamino, C1-5alkoksikarbonilamino, aminokarbonilamino, (C1-6alkil)1\_2 aminokarbonilamino, c1-6alkilsulfonilamino, okso i hidroksi.

Patent sadrži još 17 patentnih zahtjeva.



# ŽIGOVI

## TRADEMARKS

Službeni glasnik Zavoda za intelektualnu svojinu Crne Gore  
Official Gazette of the Montenegrin Intellectual Property Office

# 12/2013



Zavod za intelektualnu svojinu Crne Gore  
ul. Rimski trg br. 46,  
81000 Podgorica,  
Crna Gora



**MEĐUNARODNI KODOVI ZA IDENTIFIKACIJU BIBLIOGRAFSKIH  
PODATAKA O ŽIGOVIMA PREMA WIPO ST 60**  
RECOMMENDATION CONCERNING BIBLIOGRAFIC DATA RELATING TO  
TRADEMARKS- WIPO-ST. 60

<b>CRNOGORSKI</b>	<b>MDK</b>	<b>ENGLESKI</b>
REGISTRARSKI BROJ	<b>111</b>	NUMBER OF THE REGISTRATION
DATUM REGISTRACIJE	<b>151</b>	DATE OF THE REGISTRATION
OČEKIVANI DATUM PRESTANKA VAŽENJA ŽIGA	<b>181</b>	EXPECTED EXPIRATION DATE OF THE REGISTRATION
BROJ PRIJAVE	<b>210</b>	NUMBER OF THE APPLICATION
DATUM PODNOŠENJA PRIJAVE	<b>220</b>	DATE OF FILING OF THE APPLICATION
PODACI O IZLOŽBENOM PRAVU PRVENSTVA	<b>230</b>	DATA CONCERNING EXHIBITIONS
PODACI O PRAVU PRVENSTVA NA OSNOVU PARISKE KONVENCIJE	<b>300</b>	DATA RELATING TO PRIORITU UNDER THE PARIS CONVENTION
DATUM OBJAVLJIVANJA PRIJAVE	<b>442</b>	DATA OF PUBLICATION OF APPLICATION
SPISAK ROBA I USLUGA PREMA NIČANSKOJ KLASIFIKACIJI ROBA I USLUGA	<b>511</b>	LIST OF GOODS AND SERVICES ACCORDING THE NICE CLASSIFICATION OF GOODS AND SERVICE
IZJAVA PODNOSIOCA PRIJAVE DA NE TRAŽE EKSKLUZIVNO PRAVO ZA POJEDINE NEDINSTIKTIVNE ELEMENTE ZNAKA	<b>526</b>	DISCLAIMER
IZGLED ZNAKA	<b>540</b>	REPRODUCTION OF THE MARK
NAZNAKA O PRIRODI ILI VRSTI ZNAKA	<b>550</b>	INDICATION RELATING TO THE NATURE OR KIND OF MARK
INFORMACIJA O ZATRAŽENIM BOJAMA NA ZNAKU	<b>591</b>	INFORMATION CONCERNING THE COLORS CLAIMED
PODACI O PODNOSIOCU PRIJAVE	<b>731</b>	NAME AND ADRESS OF THE APPLICANT
IME I ADRESA NOSIOCA ŽIGA	<b>732</b>	NAME AND ADDRESS OF THE HOLDER OF THE REGISTRATION
INFORMACIJA O ZATRAŽENIM BOJAMA NA ZNAKU	<b>591</b>	INFORMATION CONCERNING THE COLORS CLAIMED
PODACI O PODNOSIOCU PRIJAVE	<b>731</b>	NAME AND ADRESS OF THE APPLICANT
IME I ADRESA NOSIOCA ŽIGA	<b>732</b>	NAME AND ADDRESS OF THE HOLDER OF THE REGISTRATION
IME I ADRESA PUNOMOĆNIKA	<b>740</b>	NAME AND ADDRESS OF THE REPRESENTATIVE



## OBAVJEŠTENJE NOTICE

Obavještavamo korisnike da se od 7-og broja Crnogorskog glasnika za intelektualnu svojinu koji se objavljuje na web stranici Zavoda za intelektualnu svojinu Crne Gore, u elektronskoj formi, odnosno od 20.12.2011 godine (Glasnik broj 7/2011) uvodi objava prijave za registraciju žiga. Stupanjem na snagu Pravilnika o postupku za priznanje, promjenama, obnovi i međunarodnoj registraciji žiga ("Sl. list CG" broj 55/11) stekli su se uslovi da Zavod postupa u skladu sa odredbom člana 29 stav 1 Zakona o žigu i uredne prijave, za koje nije utvrđen razlog za odbijanje registracije iz člana 28 ovog zakona, objavi u Službenom glasilu.

Od dana objavljivanja prijave u Službenom glasilu, shodno odredbi člana 30 stav 1 Zakona o žigu, pravna i fizička lica ili udruženja proizvođača roba ili usluga, pružaoci usluga, trgovci i potrošači mogu, u roku od 90 dana od datuma objavljivanja prijave, dostaviti Zavodu obrazloženo mišljenje u pisanoj formi o apsolutnim razlozima za odbijanje registracije iz člana 6 Zakona o žigu.

U roku od 90 dana od dana objavljivanja prijave u Službenom glasilu, nosilac ranijeg žiga ili sticalac licence, na osnovu ovlašćenja nosioca žiga, mogu zbog razloga iz čl. 7 i 8 Zakona o žigu, u roku od 90 dana od dana objavljivanja prijave, shodno odredbi člana 31 stav 1 i 2 Zakona o žigu podnijeti Zavodu Prigovor za odbijanje registracije žiga.





(210) 2009-486

(442) 20.06.2013

(220) 4.8.2009

(731) **DELTA PRONATURA DR KRASUSS DR.BECKMANN KG**, KURT-SCHUMACHER-RING 15 17, 63329 EGLSBACH DE

(540)

(550) I

(740) Dedić Tomislav, Bulevar Ivana Crnojevića 139 Podgorica (ME)

(511) **Klasa 01:** Hemijski proizvodi za zanatske svrhe, uključujući dodatne materije sredstvima za pranje i čišćenje, sredstva za čišćenje u oblasti zanatstva i industrije.**Klasa 03:** Sredstva za pranje i beljenje, sredstva za čišćenje, poliranje, ribanje, odmaščivanje i brušenje; sapuni; sredstva za čišćenje (ukoliko su obuhvaćena klasom 03), posebno sredstva za uklanjanje mrlja, jaka sredstva za uklanjanje nečistoće i masnoće, višenamenska sredstva za čišćenje, sredstva za uklanjanje naslaga kamenca, sapuna, rđe, prljavštine, boje i ostalih naslaga odnosno ostataka, deterdženti.**Klasa 05:** Sredstva za dezinfekciju; sredstva za čišćenje (ukoliko su obuhvaćena klasom 05)

(210) 2009-487

(442) 20.06.2013

(220) 4.8.2009

(731) **IMPERIAL TOBACCO LIMITED**, P.O. BOX 244 SOUTHVILLE, BRISTOL BS99 7 UJ, GB;

(540)

(550) I

(740) Dedić Tomislav, Bulevar Ivana Crnojevića 139 Podgorica (ME)

(511) **Klasa 34:** duvan prerađen ili sirov; proizvodi od duvana; cigarete, cigare, zamjene za duvan koje nisu medicinske kurativne svrhe; artikli za pušače i šibice;

(210) **2010-381**

(442) **20.06.2013**

(220) 22.10.2010

(731) **GLAHO SMITHKLINE LLC**, 2711 CENTERVILLE ROAD, SUITE 400, WILMINGTON, DELAWARE 19808 US

## BREATHE RIGHT

(540)

(550) I

(740) Popović Miladin, Đoka Miraševića 21/III, Podgorica (ME)

(511) **Klasa 05:** Farmaceutski i veterinarski preparati; sanitarni preparati za medicinsku upotrebu; dijetetske supstance prilagođene za upotrebu u medicini, hrana za bebe; flasteri, materijali za zavijanje; materijali za plombiranje zuba, zubarska smola; dezinfekciona sredstva; preparati za uništavanje štetočina; fungicidi, herbicidi.

**Klasa 10:** Hirurški, medicinski, zubarski i veterinarski aparati i instrumenti, veštački udovi, oči i zubi; ortopedski artikli; hirurški materijali za zašivanje.

---

(210) **2010-94**

(442) **20.06.2013**

(220) 6.4.2010

(731) **HARI-UNO DOO**, TRZNI CENTAR-BULEVAR MARŠALA TITA 85360 ULCINJ ME

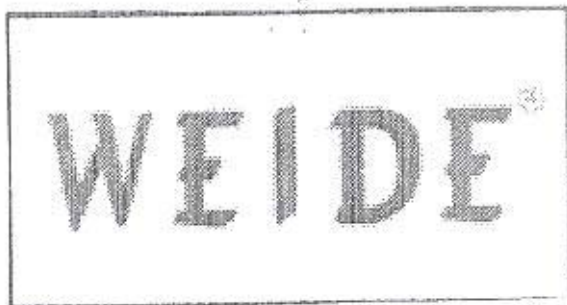

(540)

(550) I

(511) **Klasa 25:** Odjeća, obuća i pokrivala za glavu.

---

(210) **2011-100**

(442) **20.06.2013**

(220) 28.2.2011

(731) **PHILIP MORRIS OPERATIONS** AD NIŠ BULEVAR 12. FEBRUAR 74, 18000 NIŠ RS



(540)

(550) I

(511) **Klasa 34:** Cigarete.

---

(210) **2011-110**

(442) **20.06.2013**

(220) 7.3.2011

(731) **ASTRA ZENECA AB**, SE-151 85 SODERTALJE, SE

MARCAIN

(540)

(550) I

(740) Božović Vesko, Rimski trg 50/11, Podgorica (ME)

(511) **Klasa 05:** Farmaceutski preparati i supstance.

---

(210) **2011-111**

(442) **20.06.2013**

(220) 7.3.2011

(731) **MAGNUM INDUSTRIA DA AMAZONIA S.A.**, AVENIDA CUPIUBA, 1.500, DISTRITO INDUSTRIAL, CEP 69075-060, MANAUS, AM BR



- (540)  
 (550) I  
 (740) Čejović Vladimir, 13. jula 21, Podgorica (ME)  
 (511) **Klasa 14:** satovi i njihovi djelovi, nakit i bižuterija.

(210) **2011-112** (442) **20.06.2013**  
 (220) 8.3.2011

(300) PRIJAVA ŽIGA U SAD BR 77-756951 OD 11 06 2009

(731) **GENERAL MOTORS LLC**, 300 RENAISSANCE CENTER, CITY OF DETROIT, STATE OF MICHIGAN 48265-3000 US

**CHEVROLET TRAX**

- (540)  
 (550) I  
 (740) Popović Miladin, Đoka Miraševića 21/III, Podgorica (ME)  
 (511) **Klasa 12:** Motorna vozila i njihovi djelovi (osim uređaja protiv krađa za vozila).

(210) **2011-118** (442) **20.06.2013**  
 (220) 10.3.2011

(731) **SUMITOMO CHEMICAL CO.LTD**, 27-1, SHINKAWA 2-CHOME, CHUO-KU TOKYO 104-8260 JP

**APACHE**

- (540)  
 (550) I  
 (740) Mugoša Stanković Ana, Trg Republike 13, Podgorica (ME)  
 (511) **Klasa 01:** Hemijski proizvodi koji se koriste u proizvodnji insekticida, fungicida i herbici-

da;

**Klasa 05:** Insekticidi, fungicidi, herbicidi, i preparati za uništavanje gamadi i korova.

(210) **2011-119**

(442) **20.06.2013**

(220) 10.3.2011

(731) **SUMITOMO CHEMICAL CO., LTD**, 27-1, SHINKAWA 2-CHOME, CHUO-KU TOKYO 104-8260 JP

**DANTOP**

(540)

(550) I

(740) Mugoša Stanković Ana, Trg Republike 13, Podgorica (ME)

(511) **Klasa 01:** Hemijski proizvodi koji se koriste u proizvodnji insekticida, fungicida i herbicida;

**Klasa 05:** Insekticidi, fungicidi, herbicidi, i preparati za uništavanje gamadi i korova.

(210) **2011-120**

(442) **20.06.2013**

(220) 11.3.2011

(731) **BELUPO LJEKOVI I KOZMETIKA D.D.**, DANICA 5 48000 KOPRIVNICA HR

**GLIKA**

(540)

(550) I

(740) Popović Miladin, Đoka Miraševića 21/III, Podgorica (ME)

(511) **Klasa 05:** Farmaceutski proizvodi.

(210) **2011-125**

(442) **20.06.2013**

(220) 11.3.2011

(731) **RUBYCON CORPORATION**, 1938-1 NISHI MINOWA INA-SHI, NAGANO-KEN, JP

**Rubycon**

(540)

(550) I

(740) Čupić Branislav, Dalmatinska 10, Podgorica (ME)

(511) **Klasa 09:** Kondenzatori, otpornici i drugi električni djelovi.

(210) 2011-126

(442) 20.06.2013

(220) 11.3.2011

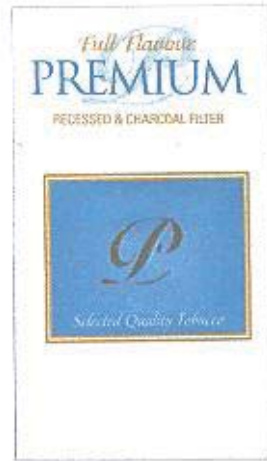
(731) SEBA DIS TICARET VE NAKLIYAT A.S., SAMANDIRA CADDESİ, NO.18  
BUYUKBAKKALKOY-MALTEPE-INSTANBUL, TR

(540)

(550) I

(740) Ćupić Branislav, Dalmatinska 10, Podgorica (ME)

(511) **Klasa 34:** Cigarete, duvan, artikli za pušače, šibice.

(210) 2011-127

(442) 20.06.2013

(220) 11.3.2011

(731) SEBA DIS TICARET VE NAKLIYAT A.S., SAMANDIRA CADDESİ, NO. 18  
BUYUKBAKKALKOY-MALTEPE-INSTANBUL, TR

(540)

(550) I

(740) Ćupić Branislav, Dalmatinska 10, Podgorica (ME)

(511) **Klasa 34:** Cigarete, duvan, artikli za pušače, šibice.

(210) 2011-128

(442) 20.06.2013

(220) 11.3.2011

(731) SEBA DIS TICARET VE NAKLIYAT A.S., SAMANDIRA CADDESİ, NO. 18

BUYUKBAKKALKOY-MALTEPE-INSTANBUL, TR



(540)

(550) I

(740) Ćupić Branislav, Dalmatinska 10, Podgorica (ME)

(511) **Klasa 34:** Cigarete, duvan, artikli za pušače, šibice.

(210) **2011-129**

(442) **20.06.2013**

(220) 14.3.2011

(731) **AKZO NOBEL COATINGS INTERNATIONAL B.V.**, VELPERWEG 76, 6824 BM ARNHEM, THE NL

INTERNATIONAL

(540)

(550) I

(740) Ćupić Branislav, Dalmatinska 10, Podgorica (ME)

(511) **Klasa 02:** Boje, firnajzi, emajl; lakovi; materije za bojenje; tempere; crni lakovi; preparati i substance za sušenje boja i lakova; sredstva za zaštitu od truljenja drva; sredstva za bojenje drva; sredstva protiv rđe; farbe za sprečavanje razvoja organizama; razređivači za gore navedenu robu; osnovni premaz boja.

(210) **2011-130**

(442) **20.06.2013**

(220) 14.3.2011

(731) **CONVATEC INC.**, 200 HEADQUARTERS PARK DRIVE, SKILLMAN, NJ08558,US

# REALIZE THE POSSIBILITIES

(540)

(550) I

(740) Ćupić Branislav, Dalmatinska 10, Podgorica (ME)

(511) **Klasa 16:** Štampani materijal, a naročito bilteni, brošure, pamfleti, informativni listići, prikazi i poster i iz oblasti tretmana ostomije, njege kože i obrade rana.

**Klasa 44:** Usluge davanja medicinskih informacija, a naročito davanje informacija ljekarima, zdravstvenim radnicima i pacijentima na temu tretmana ostomije, njege kože i obrade rana.

---

(210) **2011-131**

(442) **20.06.2013**

(220) 14.3.2011

(731) **SANOFI**, 54 Rue La Boetie, 75008 PARIS. FR

(540)

(550) I

(740) Popović Miladin, Đoka Miraševića 21/III, Podgorica (ME)

(511) **Klasa 05:** Farmaceutski proizvodi, dietetski dodaci, funkcionalna hrana (polna hrana, polna lijek), prehrambeni dodaci, za medicinsku i ljudsku upotrebu.

---

(210) **2011-133**

(442) **20.06.2013**

(220) 15.3.2011

(731) **KWIZDA HOLDING GMBH**, DR.KARL LUEGER-RING 6,A-1010 WIEN, AT

## VERAGOL

(540)

(550) I

(740) Čejović Vladimir, 13. jula 21, Podgorica (ME)

(511) **Klasa 05:** Farmaceutski i veterinarski preparati; sanitarni preparati za medicinske svrhe; dijetetske supstance prilagođene za upotrebu u medicini, hrana za bebe; flasteri, materijali za zavijanje; materijali za plombiranje zuba; zubarska smola; dezinfekciona sredstva; preparati za uništavanje štetočina; fungicidi, herbicidi.

---

(210) **2011-134**

(442) **20.06.2013**

(220) 15.3.2011

(731) **NOVARTIS AG**, 4002 BASEL, CH



# LADIOMIL

(540)

(550) I

(740) Radulović Božidar, Jovana Tomaševića 9/III, Podgorica (ME)

(511) **Klasa 05:** Farmaceutski preparati.

---

(210) **2011-135**

(442) **20.06.2013**

(220) 16.3.2011

(731) **DEUTCHE TELEKOM AG**, FRIEDRICH-EBERT-ALLEE 140 53113 BONN DE



(540)

(550) I

(740) Popović Miladin, Đoka Miraševića 21/III, Podgorica (ME)

(511) **Klasa 35:** Oglašavanje; vođenje poslova; poslovno upravljanje; kancelarijski poslovi

**Klasa 38:** Telekomunikacije

**Klasa 41:** Obrazovne usluge; pripremanje obuke; razonoda; sportske i kulturne aktivnosti.

**Klasa 45:** Pravne usluge; usluge obezbjeđenja radi zaštite imovine i lica; individualne i društvene usluge koje pružaju drugi, radi zadovoljavanja potreba pojedinaca

---

(210) **2011-136**

(442) **20.06.2013**

(220) 18.3.2011

(731) **VULCABRAS-AZALEIA-RS**, CALCADOS E ARTIGOS ESPORTIVOS S.A, RUA DR. LEGEN-  
DRE, 34, PAROBE, RIO GRANDE DO SUL BRAZIL, 95630-000, BR

# OLK

(540)

(550) I

(740) Popović Miladin, Đoka Miraševića 21/III, Podgorica (ME)

(511) **Klasa 25:** Odjeća, obuća i pokrivala za glavu.

---

(210) **2011-137** (442) **20.06.2013**  
(220) 22.3.2011

(731) **IT TECHNOLOGIES SERVICES S.A.**, WICKHAMS CAY, TRIDENT CHAMBERS, ROAD TOWN, TORTOLA, VG

# ELECTIS

(540)  
(550) I  
(740) Radulović Božidar, Jovana Tomaševića 9/III, Podgorica (ME)  
(511) **Klasa 05:** Poljoprivredni pesticidi.

---

(210) **2011-138** (442) **20.06.2013**  
(220) 22.3.2011

(731) **IT TECHNOLOGIES SERVICES S.A.**, WICKHAMS CAY, TRIDENT CHAMBERS, ROAD TOWN, TORTOLA, VG

# DEMITAN

(540)  
(550) I  
(740) Radulović Božidar, Jovana Tomaševića 9/III, Podgorica (ME)  
(511) **Klasa 05:** Poljoprivredni pesticidi.

---

(210) **2011-139** (442) **20.06.2013**  
(220) 22.3.2011

(731) **GOWAN COMPANY, LLC**, 370 S MAIN STREET, YUMA, ARIZONA 85364, US

# IMIDAN

(540)  
(550) I  
(740) Radulović Božidar, Jovana Tomaševića 9/III, Podgorica (ME)  
(511) **Klasa 05:** Poljoprivredni pesticidi.

---

(210) **2011-140** (442) **20.06.2013**  
(220) 22.3.2011

(300) 1,496,854 22.09.2010. CA

(731) **RESEARCH IN MOTION LIMITED**, 295 PHILLIP STREET, WATERLOO, ONTARI N2L 3W8, CA

## BLACKBERRY PLAYBOOK

(540)

(550) I

(740) Čejović Vladimir, 13. jula 21, Podgorica (ME)

(511) **Klasa 06:** Privjesci za ključeve; neelektrični kablovi i žice od običnog metala; mali predmeti od metala; proizvodi od običnog metala koji nisu uključeni u druge klase;

**Klasa 09:** Aparati i instrumenti naučni, pomorski, geodetski, fotografski, kinemato-grafski, optički, za vaganje, mjerenje, signalizaciju, kontrolu (inspekciju), spašavanje i nastavu; aparati za snimanje, prenos i reprodukovanje podataka, zvuka ili slike; magnetni nosioci podataka, diskovi za snimanje; računске mašine, oprema za obradu podataka, kompjuteri; kompjuterski softver; elektornske prenosne jedinice i uređaji, naime, personalni digitalni asistenti, bežični telefoni, mobilni telefoni, celularni telefoni, pametni telefoni, videofoni, priručni, mobilni, slejt i tablet kompjuteri za sinhronizaciju, prenos, snimanje, skladištenje i upravljanje podacima i/ili glasom; oprema za bežične priručne jedinice i uređaje za sinhronizaciju, prenos, snimanje, skladištenje i upravljanje podacima i/ili glasom, naime baterije, vrata za baterije, oprema za auto, punjači za baterije i postolja punjača, slušalice, mikrofoni, adaptori, postolja, postolja za opremu, tastature, kablovi za kompjutere, kućišta, tašne, registratori, futrole; kompjuterski komunikacijski softver za sinhronizaciju, prenos, snimanje, skladištenje i upravljanje podacima i/ili glasom; kompjuterski softver koji omogućava sinhronizaciju i prenos mapa, navigacije, informacija o saobraćaju, vremena i podataka od interesa ka bežičnim prenosnim jedinicama i uređajima, naime, personalnim digitalnim asistentima, bežičnim telefonima, mobilnim telefonima, celularnim telefonima, pametnim telefonima, videofonima, prenosnim, mobilnim, slejt i tablet kompjuterima; kompjuterski softver sa omogućavanje pristupa bazama podataka;

**Klasa 11:** Aparati za osvjetljavanje;

**Klasa 14:** Igle sa ornamentom, značke, igle za kravatu, igle svih vrsta;

**Klasa 16:** Štampane stvari, kancelarijski materijal, nemagnetički kodirane pretplatne kartice za kupovinu i poklon kartice; ljepila;

**Klasa 18:** Koža i imitacija kože, i proizvodi izrađeni od ovih materijala koji nisu uključeni u druge klase; kišobrani. suncobrani;

**Klasa 20:** Ramovi za slike; proizvodi (koji nisu obuhvaćeni drugim klasama) od drveta, plute, trske, rogoza, vrbovog pruća, roga, kosti, kitove kosti, školjki, ćilibara, sedefa, morske pjene i zamjene svih ovih materijala, ili od plastike;

**Klasa 21:** Vrčevi;

**Klasa 25:** Odjeća, obuća i pokrivala za glavu;

**Klasa 28:** Igre i igračke; gimnastički i sportski artikli koji nisu obuhvaćeni drugim klasama; ukrasi za jelke;

**Klasa 35:** Usluge oglašavanja; on lajn maloprodajne usluge; pružanje poslovnih informacija; marketinške usluge;

**Klasa 36:** Omogućavanje usluga on lajn plaćanja;

**Klasa 37:** Usluge popravke i instaliranja;

**Klasa 38:** Telekomunikacije; omogućavanje pristupa internetu; omogućavanje pristupa elektronskim bazama podataka, omogućavanje pristupa uslugama GPS (globalni sistem pozicioniranja) navigacije; pružanje usluga povezivanja i pristupa elektronskim komunikacionim mrežama, za prenos ili prijem audio, video ili multimedijalnog sadržaja; pružanje usluga povezivanja i pristupa elektronskim komunikacionim mrežama za prenos ili prijem kompjuterskog softvera ili aplikacija; usluge veb prenosa; usluge elektronske pošte; dostava poruka elektronskim prenosom; usluge bežičnog slanja poruka, naročito usluge koje omogućavaju korisniku da pošalje i/ili primi poruke preko bežične mreže podataka; jednosmjerne ili dvosmjerne pejdžing usluge; komunikacione usluge prenosa ili prijema glasa; elektronski prenos kompjuterskog softvera i aplikacija preko interneta i drugih kompjuterskih i elektronskih komunikacionih mreža i bežičnih uređaja; emitovanje; emitovanje ili prenos radio programa; emitovanje ili prenos protočnog digitalnog audio i video sadržaja kao i sadržaja koji se može preuzeti preko kompjuterske i drugih komunikacionih mreža; konsultacije u vezi telekomunikacija, naime, davanje informacija trećim licima kao pomoć kod razvoja i integrisanja jednosmjerne i dvosmjerne bežične veze sa podacima, uključujući korporativne i kućne/lične podatke, i/ili glasovnu komunikaciju.

**Klasa 39:** Pružanje usluga GPS navigacije; pružanje podataka o mapama, navigaciji, saobraćaju, vremenu i drugim podacima od interesa preko telekomunikacionih mreža, mobilnih telefona, telefona, smartfona, elektronskih prenosnih uređaja i navigacionih uređaja;

**Klasa 41:** Obrazovanje; pripremanje obuke; razonoda; sportske i kulturne aktivnosti i pružanje informacija u vezi sa ovim uslugama; objavljivanje; organizacija igara; usluge obrazovanja i obuke, naime časovi, seminari i konferencije u cilju pružanja informacija trećim licima kako bi im se pomoglo u korišćenju, razvoju i podršci uređajima za bežično povezivanje i sličnih bežičnih povezivanja i kompjuterskog komunikacionog softvera;

**Klasa 42:** Naučne i tehnološke usluge i usluge istraživanja i projektovanja u vezi sa njima; usluge industrijske analize i istraživanja; projektovanje i razvoj kompjuterskog hardvera i softvera; usluge softvera kao usluge (SAAS); obezbjeđivanje alata za pretragu za dobijanje podataka preko komunikacionih mreža; internet usluge; pretraga, pregled i preuzimanje informacija, sajtova i drugih resursa raspoloživih na globalnim kompjuterskim mrežama i drugim komunikacionim mrežama za druge; konsultantske usluge i usluge tehničke podrške u vezi sa kompjuterskim hardverom i softverom, telekomunikacijama i GPS (Globalni Pozicioni Sistem) uslugama; obezbjeđivanje on-lajn opreme preko globalne kompjuterske mreže i drugih kompjuterskih i elektronskih komunikacionih mreža, u cilju omogućavanja korisnicima da programiraju audio, video, filmove, tekst i druge multimedijalne sadržaje; usluge tehničke podrške, naime, ažuriranje i održavanje kompjuterskog softvera i programi za traženje grešaka za dijagnosticiranje i rješavanje problema kod uređaja za bežično povezivanje i kod odgovarajućeg kompjuterskog softvera i hardvera; pružanje informacija o vremenu preko telekomunikacijske mreže, mobilnih telefona, telefona, pametnih telefona, elektronskih priručnih uređaja i uređaja za navigaciju.

**Klasa 45:** Licenciranje kompjuterskog softvera.

(210) **2011-141**

(442) **20.06.2013**

(220) 22.3.2011

(300) 1,496,855 22.09.2010 CA

(731) **RESEARCH IN MOTION LIMITED**, 295 PHILLIP STREET, WATERLOO, ONTARI N2L 3W8, CA

## PLAYBOOK

(540)

(550) I

(740) Čejović Vladimir, 13. jula 21, Podgorica (ME)

(511) **Klasa 06:** Privjesci za ključeve; neelektrični kablovi i žice od običnog metala; mali predmeti od metala; proizvodi od običnog metala koji nisu uključeni u druge klase;

**Klasa 09:** Aparati i instrumenti naučni, pomorski, geodetski, fotografski, kinemato-grafski, optički, za vaganje, mjerenje, signalizaciju, kontrolu (inspekciju), spašavanje i nastavu; aparati za snimanje, prenos i reprodukovanje podataka, zvuka ili slike; magnetni nosioci podataka, diskovi za snimanje; računске mašine, oprema za obradu podataka, kompjuteri; kompjuterski softver; elektornske prenosne jedinice i uređaji, naime, personalni digitalni asistenti, bežični telefoni, mobilni telefoni, celularni telefoni, pametni telefoni, videofoni, priručni, mobilni, slejt i tablet kompjuteri za sinhronizaciju, prenos, snimanje, skladištenje i upravljanje podacima i/ili glasom; oprema za bežične priručne jedinice i uređaje za sinhronizaciju, prenos, snimanje, skladištenje i upravljanje podacima i/ili glasom, naime baterije, vrata za baterije, oprema za auto, punjači za baterije i postolja punjača, slušalice, mikrofoni, adapteri, postolja, postolja za opremu, tastature, kablovi za kompjutere, kućišta, tašne, registratori, futrole; kompjuterski komunikacijski softver za sinhronizaciju, prenos, snimanje, skladištenje i upravljanje podacima i/ili glasom; kompjuterski softver koji omogućava sinhronizaciju i prenos mapa, navigacije, informacija o saobraćaju, vremena i podataka od interesa ka bežičnim prenosnim jedinicama i uređajima, naime, personalnim digitalnim asistentima, bežičnim telefonima, mobilnim telefonima, celularnim telefonima, pametnim telefonima, videofonima, prenosnim, mobilnim, slejt i tablet kompjuterima; kompjuterski softver sa omogućavanje pristupa bazama podataka;

**Klasa 11:** Aparati za osvjetljavanje;

**Klasa 14:** Igle sa ornamentom, značke, igle za kravatu, igle svih vrsta;

**Klasa 16:** Štampane stvari, kancelarijski materijal, nemagnetički kodirane pretplatne kartice za kupovinu i poklon kartice; ljepila;

**Klasa 18:** Koža i imitacija kože, i proizvodi izrađeni od ovih materijala koji nisu uključeni u druge klase; kišobrani. suncobrani;

**Klasa 20:** Ramovi za slike; proizvodi (koji nisu obuhvaćeni drugim klasama) od drveta, plute, trske, rogoza, vrbovog pruća, roga, kosti, kitove kosti, školjki, ćilibara, sedefa, morske pjene i zamjene svih ovih materijala, ili od plastike;

**Klasa 21:** Vrčevi;

**Klasa 25:** Odjeća, obuća i pokrivala za glavu;

**Klasa 28:** Igre i igračke; gimnastički i sportski artikli koji nisu obuhvaćeni drugim klasama; ukrasi za jelke;

**Klasa 35:** Usluge oglašavanja; on lajn maloprodajne usluge; pružanje poslovnih informacija; marketinške usluge;

**Klasa 36:** Omogućavanje usluga on lajn plaćanja;

**Klasa 37:** Usluge popravke i instaliranja;

**Klasa 38:** Telekomunikacije; omogućavanje pristupa internetu; omogućavanje pristupa elektronskim bazama podataka, omogućavanje pristupa uslugama GPS (globalni sistem pozicioniranja) navigacije; pružanje usluga povezivanja i pristupa elektronskim komunikacionim mrežama, za prenos ili prijem audio, video ili multimedijalnog sadržaja; pružanje usluga povezivanja i pristupa elektronskim komunikacionim mrežama za prenos ili prijem kompjuterskog softvera ili aplikacija; usluge veb prenosa; usluge elektronske pošte; dostava poruka elektronskim prenosom; usluge bežičnog slanja poruka, naročito usluge koje omogućavaju korisniku da pošalje i/ili primi poruke preko bežične mreže podataka; jednosmjerne ili dvosmjerne pejdžing usluge; komunikacione usluge prenosa ili prijema glasa; elektronski prenos kompjuterskog softvera i aplikacija preko interneta i drugih kompjuterskih i elektronskih komunikacionih mreža i bežičnih uređaja; emitovanje; emitovanje ili prenos radio programa; emitovanje ili prenos protočnog digitalnog audio i video sadržaja kao i sadržaja koji se može preuzeti preko kompjuterske i drugih komunikacionih mreža; konsultacije u vezi telekomunikacija, naime, davanje informacija trećim licima kao pomoć kod razvoja i integrisanja jednosmjerne i dvosmjerne bežične veze sa podacima, uključujući korporativne i kućne/lične podatke, i/ili glasovnu komunikaciju.

**Klasa 39:** Pružanje usluga GPS navigacije; pružanje podataka o mapama, navigaciji, saobraćaju, vremenu i drugim podacima od interesa preko telekomunikacionih mreža, mobilnih telefona, telefona, smartfona, elektronskih prenosnih uređaja i navigacionih uređaja;

**Klasa 41:** Obrazovanje; pripremanje obuke; razonoda; sportske i kulturne aktivnosti i pružanje informacija u vezi sa ovim uslugama; objavljivanje; organizacija igara; usluge obrazovanja i obuke, naime časovi, seminari i konferencije u cilju pružanja informacija trećim licima kako bi im se pomoglo u korišćenju, razvoju i podršci uređajima za bežično povezivanje i sličnih bežičnih povezivanja i kompjuterskog komunikacionog softvera;

**Klasa 42:** Naučne i tehnološke usluge i usluge istraživanja i projektovanja u vezi sa njima; usluge industrijske analize i istraživanja; projektovanje i razvoj kompjuterskog hardvera i softvera; usluge softvera kao usluge (SAAS); obezbjeđivanje alata za pretragu za dobijanje podataka preko komunikacionih mreža; internet usluge; pretraga, pregled i preuzimanje informacija, sajtova i drugih resursa raspoloživih na globalnim kompjuterskim mrežama i drugim komunikacionim mrežama za druge; konsultantske usluge i usluge tehničke podrške u vezi sa kompjuterskim hardverom i softverom, telekomunikacijama i GPS (Globalni Pozicioni Sistem) uslugama; obezbjeđivanje on-lajn opreme preko globalne kompjuterske mreže i drugih kompjuterskih i elektronskih komunikacionih mreža, u cilju omogućavanja korisnicima da programiraju audio, video, filmove, tekst i druge multimedijalne sadržaje; usluge tehničke podrške, naime, ažuriranje i održavanje kompjuterskog softvera i programi za traženje grešaka za dijagnosticiranje i rješavanje problema kod uređaja za bežično povezivanje i kod odgovarajućeg kompjuterskog softvera i hardvera; pružanje informacija o vremenu preko telekomunikacijske mreže, mobilnih telefona, telefona, pametnih telefona, elektronskih priručnih uređaja i uređaja za navigaciju.

**Klasa 45:** Licenciranje kompjuterskog softvera.

(210) **2011-142**

(442) **20.06.2013**

(220) 23.3.2011

(731) **E.I.DU PONT DE NEMOURS AND COMPANY**, 1007 MARKET STREET, WILMINGTON, DE 19898, US

# ARIGO

(540)

(550) I

(740) Čejović Vladimir, 13. jula 21, Podgorica (ME)

(511) **Klasa 05:** Herbicidi.

---

(210) **2011-144**

(442) **20.06.2013**

(220) 24.3.2011

(731) **GOTHICA DOO** BAR, RISTA LEKIĆA D 12, BAR ME



(540)

(550) I

(511) **Klasa 43:** Pripremanje i usluživanja svih vrsta kafa.

---

(210) **2011-145**

(442) **20.06.2013**

(220) 24.3.2011

(731) **AMGEN INC.**, ONE AMGEN CENTER DRIVE THOUSAND OAKS, CALIFORNIA 91320-1799, US

# STROSTEO

(540)

(550) I

(740) Radulović Božidar, Jovana Tomaševića 9/III, Podgorica (ME)

(511) **Klasa 05:** Farmaceutski preparati.

---

(210) **2011-146**

(442) **20.06.2013**

(220) 25.3.2011

(731) **ABBOTT LABORATORIES**, ABBOTT PARK, ILLINOIS 60064 US

# CELL-DYN

(540)

(550) I

(740) Popović Miladin, Đoka Miraševića 21/III, Podgorica (ME)

(511) **Klasa 05:** Farmaceutski preparati, medicinski dijagnostički reagensi, dijagnostički preparati za kliničku i medicinsko laboratorysku upotrebu.

**Klasa 10:** Hirurški i medicinski aparati i instrumenti, medicinski dijagnostički aparati i instrumenti.

(210) **2011-147** (442) **20.06.2013**

(220) 25.3.2011

(731) **Schering Corpration**, 2000 Galloping Hill Road, New Jersey 07033,US

M-M-RVAXPRO

(540)

(550) I

(740) Čupić Branislav, Dalmatinska 10, Podgorica (ME)

(511) **Klasa 05:** Farmaceutski preparati, naročito za ljudsku upotrebu.

(210) **2011-148** (442) **20.06.2013**

(220) 28.3.2011

(731) **DIAGEO BRANDS B.V.**, MOLENWERF 10 -12,1014 BG AMSTERDAM, NL

GOLD LABEL RESERVE

(540)

(550) I

(740) Čejović Vladimir, 13. jula 21, Podgorica (ME)

(511) **Klasa 33:** Alkoholna pića (izuzev piva).

(210) **2011-149** (442) **20.06.2013**

(220) 28.3.2011

(731) **KSIN LUXEBOURG ILS.AR.L.**, 1, RUE DES GLACIS, L-1628, LUXEMBOURG, LU



(540)

(550) I



(740) Čejović Vladimir, 13. jula 21, Podgorica (ME)

(511) **Klasa 04:** Lubrikanti.

**Klasa 09:** Šivaće mašine; mašine za vez; nosači mašina za pletenje; kontrolni kablovi za mašine, stojeve ili motore; kontrolni mehanizmi za mašine, strojeve ili motore; mašine za siječenje; mašine za krpljenje; motori, koji nijesu za kopnena vozila; remenici ventilatora za motore i strojeve; ventilatori za motore i strojeve; alati koji nijesu za kopnena vozila; štitnici (djelovi mašina); vođice mašina; alati koji se drže u ruci ali se ne pokreću ručno; mašine za porublivanje; poklopci (djelovi mašina); kućišta (djelovi mašina); mašine za peglanje; mašine za pletenje; mašine za pravljenje čipke; mašine za obradu kože; razboji; pumpe za podmazivanje; podmazivači (djelovi mašina); mašine za tekstilu industriju; motori koji nijesu za kopnena vozila; pogonske pedale za šivaće mašine; rotacione parne prese (pegle), prenosive za tkanine; makaze električne; prigušivači za motore i strojeve; klizne vođice za mašine za pletenje; klizači za mašine za pletenje; prese za glačanje; opruge (djelovi mašina); postolja za mašine; starteri za izradu spoljnih navoja; mašine za šavove; stolovi za mašine; strojevi za izradu spoljnih navoja; mašine za štepanje; mašine za skraćivanje; razboji za tkanje; kalemi za šivaće mašine; papučiće za šivaće mašine; papučiće za mašine za vez.

**Klasa 09:** Elektronski kontrolni aparati za šivaće mašine; mjere (etaloni); trake za mjerenje; električni kablovi; kompakt diskovi; kompjuterski softver; nasnimljeni kompjuterski programi; krojačke mjere; elektronske publikacije koje se mogu daunloudovati; električne ravne pegle; električne parne prese električne prese za peglanje.

**Klasa 26:** Igle za ručno šivenje i igle za mašinsko šivenje; čipka i vez; trake (pantiljke); gajtani; dugmad; naprstci za šivenje; kopče; petlje; igle (osim nakita); i kompleti šivaćeg pribora.

(210) **2011-150**

(442) **20.06.2013**

(220) 28.3.2011

(731) **JT INTERNATIONAL S.A.**, 1, RUE DE LA GABELE, 1211 GENEVA 26, CH



(540)

(550) I

(740) Čejović Vladimir, 13. jula 21, Podgorica (ME)

(511) **Klasa 34:** Duvan, koji je prerađen ili neprerađen; duvan za pušenje, duvan za lule, duvan za savijanje, duvan za žvakanje, duvan za sisanje; cigarete, cigare, cigarilosi; supstance za pušenje koje se prodaju odvojeno ili izmiješane sa duvanom, i koje nijesu za medicinsku ili svrhu liječenja; burmut; artikli za pušaće uključeni u klasu 34; papir za cigarete, fišeci za cigarete i šibice.

---

(210) **2011-160** (442) **20.06.2013**

(220) 31.3.2011

(731) **PHARMANOVA D.O.O.**, INDUSTRIJSKA 8, OBRENOVAC RS

# ALEFOSS

(540)

(550) I

(740) Lutovac Branislav, Bulevar Crnojevića 93, Podgorica (ME)

(511) **Klasa 05:** Farmaceutski preparati.

---

(210) **2011-161** (442) **20.06.2013**

(220) 31.3.2011

(731) **PHARMANOVA D.O.O.**, INDUSTRIJSKA 8 OBRENOVAC RS

# Meloxan

(540)

(550) I

(740) Lutovac Branislav, Bulevar Crnojevića 93, Podgorica (ME)

(511) **Klasa 05:** Farmaceutski preparati.

---

(210) **2011-162** (442) **20.06.2013**

(220) 31.3.2011

(731) **PREMIJER MONTENEGRO D.O.O.**, V. BOŽOVIĆA BR.9, PODGORICA ME



(540)

(550) I

(511) **Klasa 36:** Novčani (monetrani poslovi).

**Klasa 41:** Priređivanje igara na sreću, razonoda.

---

(210) **2011-163** (442) **20.06.2013**

(220) 1.4.2011

(731) **CHIGUITA BRANDS L.C.C.**, 250 EAST FIFTH STREET, CINCINNATI, OHIO 45202 US



(540)

(550) I

(740) Popović Miladin, Đoka Miraševića 21/III, Podgorica (ME)

(511) **Klasa 29:** Konzervisano, sušeno, kuvano voće i povrće.**Klasa 31:** Svježe voće i povrće(210) **2011-164**(442) **20.06.2013**

(220) 1.4.2011

(731) **CHIQUITA BRANDS L.L.C.**, 250 EAST FIFTH STREET, CINCINNATI, OHIO 45202 US

(540)

(550) I

(740) Popović Miladin, Đoka Miraševića 21/III, Podgorica (ME)

(511) **Klasa 29:** Konzervisano, sušeno, kuvano voće i povrće.**Klasa 31:** Svježe voće i povrće(210) **2011-165**(442) **20.06.2013**

(220) 4.4.2011

(731) **MELGONIA-PRIMORKA DOO**, BARTULA B.B. STARI BAR, BAR, ME

**PRIMORKA**



(540)

(550) I

(511) **Klasa 29:** Konzervisano, zamrznuto, sušeno i kuvano voće i povrće; želei, džemovi, kompoti, jestiva ulja i mast.**Klasa 31:** Svježe voće i povrće, sjeme, prirodne biljke i cvijeće.(210) **2011-166**(442) **20.06.2013**

(220) 4.4.2011

(731) **MELGONIA-PRIMORKA DOO**, BARTULA B.B. STARI BAR, BAR, ME

**VOLĪ VAS  
VOLĪ**

(540)

(550) I

(511) **Klasa 29:** konzervisano, zamrznuto, sušeno i kuvano voće i povrće, želei, džemovi, kompoti, jestiva ulja i masti**Klasa 30:** kafa, čaj, kako, šećer, pirinač, brašno i proizvodi od žitarica, hleb, kolači i poslastice, sladoledi, med**Klasa 32:** mineralne i sodne vode i druga bezalkoholna pića, pića od voća i voćni sokovi, sirupi i drugi preparati za proizvodnju pića,(210) **2011-167**(442) **20.06.2013**

(220) 4.4.2011

(731) **MELGONIA-PRIMORKA D.O.O.**, BARTULA B.B. STARI BAR, BAR, ME

**VOLĪ**

(540)

(550) I

(511) **Klasa 29:** konzervisano, zamrznuto, sušeno i kuvano voće i povrće, želei, džemovi, kompoti, j estiva ulja i masti

**Klasa 30:** kafa, čaj, kako, šećer, pirinač, brašno i proizvodi od žitarica, hleb, kolači i poslastice, sladoledi, med

**Klasa 32:** mineralne i sodne vode i druga bezalkoholna pića, pića od voća i voćni sokovi, sirupi i drugi preparati za proizvodnju pića,

(210) **2011-168**

(442) **20.06.2013**

(220) 4.4.2011

(731) **MELGONIA-PRIMORKA DOO**, BARTULA B.B. STARI BAR, BAR, ME



(540)

(550) I

(511) **Klasa 29:** konzervisano, zamrznuto, sušeno i kuvano voće i povrće, želei, džemovi, kompoti, j estiva ulja i masti

**Klasa 30:** kafa, čaj, kako, šećer, pirinač, brašno i proizvodi od žitarica, hleb, kolači i poslastice, sladoledi, med

**Klasa 31:** svježe voće i povrće, sjeme, prirodne biljke i cvijeće.

**Klasa 32:** mineralne i sodne vode i druga bezalkoholna pića, pića od voća i voćni sokovi, sirupi i drugi preparati za proizvodnju pića,

(210) **2011-169**

(442) **20.06.2013**

(220) 4.4.2011

(731) **AUSTRIA TABAK GMBH**, KOPPSTRASSE 166, A-1160 WIEN, AT



(540) \_\_\_\_\_

(550) I

(740) Čejović Vladimir, 13. jula 21, Podgorica (ME)

(511) **Klasa 34:** Duvan, koji je prerađen ili neprerađen; duvan za pušenje, duvan za lule, duvan za savijanje, duvan za žvakanje; duvan za sisanje; cigarete, cigare, cigarilosi; supstance za pušenje koje se prodaju odvojeno ili izmiješane sa duvanom, i koje nijesu za medicinsku ili svrhu liječenja; burmut;

(210) **2011-170**

(442) **20.06.2013**

(220) 6.4.2011

(731) **CHURCH & DWIGHT CO. INC**, 469 NORTH CO HARRISON STREET, PRINCETON, NEW JERSEY 08543, US



(540)

(550) I

(740) Čejović Vladimir, 13. jula 21, Podgorica (ME)

(511) **Klasa 10:** Kondomi, aparati za masažu; rukavice za masažu; seksualna pomagala za odrasle, naime, lični vibratori, vibrirajuće prstenje, stimulacioni uređaji za pomoć u seksualnom uzbuđenju i seksualnim performansima, lični masažeri na baterije.

(210) **2011-171**

(442) **20.06.2013**

(220) 6.4.2011

(731) **KICKERS INTERNATIONAL BV**, CLAUDE DEBUSSYLAAN 24, 1082 MD AMSTREDAM, THE NL

## KICKERS

- (540)  
(550) I  
(740) Čejović Vladimir, 13. jula 21, Podgorica (ME)  
(511) **Klasa 25:** Odjeća, obuća, pokrivala za glavu.

- 
- (210) **2011-174** (442) **20.06.2013**  
(220) 8.4.2011  
(731) **GENERAL MOTORS LLC**, KOMPANIJA ORGANIZOVANA PO PRPISIMA DRŽAVE DE-LAWARE, 300 RENAISSANCE CENTER, DETROIT, MICHIGAN 48265-3000, US

## CHEVROLET TRACKER

- (540)  
(550) I  
(740) Radulović Božidar, Jovana Tomaševića 9/III, Podgorica (ME)  
(511) **Klasa 12:** Motorna vozila i djelovi za njih (izuzev uređaja protiv krađe vozila).

- 
- (210) **2011-178** (442) **20.06.2013**  
(220) 11.4.2011  
(731) **THE PROCTER & GAMBLE COMPANY**, ONE PROCTER & GAMBLE PLAZA, CIN-CINNATI, OHIO 45202, US

## PROSPETIMEA NATURII

- (540)  
(550) I  
(740) Lutovac Branislav, Bulevar Crnojevića 93, Podgorica (ME)  
(511) **Klasa 03:** Sredstva za pranje i beljenje i druga sredstva za upotrebu u pranju veša; preparati za čišćenje, poliranje, nagrizajuća sredstva, abrazivna sredstva; sapuni; deterdženti, sredstva za uklanjanje krečnih naslaga i kamenca; sva naprijed navedena roba sa ili bez dezinfikujuće komponente.

**Klasa 05:** Sredstva za dezinfekciju, sterilizaciju i antibakterijska sredstva, sve za upotrebu u

domaćinstvu.

(210) **2011-183** (442) **20.06.2013**  
(220) 12.4.2011

(731) **SCERING CORPRATION**, 2000 GALLOPING HILL ROAD, KENILWORTH, NEW JERSEY 07033, US



(540) |  
(550) |  
(740) Ćupić Branislav, Dalmatinska 10, Podgorica (ME)  
(511) **Klasa 05:** vakcine za ljudsku upotrebu.

(210) **2011-184** (442) **20.06.2013**  
(220) 12.4.2011

(731) **SCERING CORPRATION**, 2000 GALLOPING HILL ROAD, KENILWORTH, NEW JERSEY 07033, US

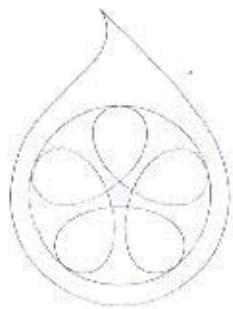

(540) |  
(550) |  
(740) Ćupić Branislav, Dalmatinska 10, Podgorica (ME)  
(511) **Klasa 05:** Vakcina za ljudsku upotrebu.

(210) **2011-185** (442) **20.06.2013**



(220) 13.4.2011

(731) **GOODYEAR DUNLOP TYRES UK LIMITED**, TYRE FORT 88-98, WINGFOOT WAY, BIRMINGHAM B24 9 HY, UK, GB

## SPORT MAXX

(540)

(550) I

(740) Čejović Vladimir, 13. jula 21, Podgorica (ME)

(511) **Klasa 12:** Gume.

---

(210) **2011-186**

(442) **20.06.2013**

(220) 13.4.2011

(731) **GOODYEAR DUNLOP TYRES UK LIMITED**, TYRE FORT 88-98, WINGFOOT WAY, BIRMINGHAM B24 9 HY, UK, GB

## SPORT MAXX RACE

(540)

(550) I

(740) Čejović Vladimir, 13. jula 21, Podgorica (ME)

(511) **Klasa 12:** Gume.

---

(210) **2011-187**

(442) **20.06.2013**

(220) 14.4.2011

(731) **SCHERING CORPRATION**, 2000 GALLOPING HILL ROAD, KENILWORTH, NEW JERSEY 07033, US

## ZOLINZA

(540)

(550) I

(740) Čupić Branislav, Dalmatinska 10, Podgorica (ME)

(511) **Klasa 05:** Farmaceutski preparati za liječenje raka.

---

(210) **2011-188**

(442) **20.06.2013**

(220) 18.4.2011

(731) **THE PROCTER & GAMBLE COMPANY**, ONE PROCTER & GAMBLE PLAZA, CINCINNATI, OHIO 45202, US



(540)

(550) I

(740) Lutovac Branislav, Bulevar Crnojevića 93, Podgorica (ME)

(511) **Klasa 03:** Preparati za njegu kože.

(210) **2011-189**

(442) **20.06.2013**

(220) 18.4.2011

(731) **THE PROCTER & GAMBLE COMPANY**, ONE PROCTER & GAMBLE PLAZA, CINCINNATI, OHIO 45202, US

# OLAY

(540)

(550) I

(740) Lutovac Branislav, Bulevar Crnojevića 93, Podgorica (ME)

(511) **Klasa 03:** Preparati za njegu kože.

(210) **2011-190**

(442) **20.06.2013**

(220) 18.4.2011

(731) **CHLORIDE GROUP LIMITED**, EBURY GATE, 23 LOWER BELGRAVE STREET, LONDON SW1W 0NR, GB

# CHLORIDE

(540)

(550) I

(740) Radulović Božidar, Jovana Tomaševića 9/III, Podgorica (ME)

(511) **Klasa 09:** Električne baterije; punjači električnih baterija; aparati za napajanje električnom energijom, aparati za neprekidno napajanje električnom energijom (UPS aparati) i kompjuterski programi koji se uz njih koriste; aparati za ispitivanje u elektrici, moduli za zaštitu od prevelikog napona, indikatori nestanka struje, aparati za regulaciju električne energije, aparati za praćenje strujnih vodova i napajanje električnom energijom, aparati za regulaciju električne energije, konvertori, invertori, regulatori ripla, aparati za prekidanje električne energije, transformatori, linijski filteri za električnu energiju, ublaživači strujnih udara, svijetleći znaci, alarmi, alarmi protiv krađe, protivpožarni alarmi, aparati za protivpožarnu kontrolu, aparati za detekciju požara, aparati za protivprovalne alarme, generatori buke i detektori koji se uz njih koriste, aparati za kontrolu pristupa; dijelovi svih gore pomenutih proizvoda.

(210) **2011-191**

(442) **20.06.2013**

(220) 18.4.2011

(731) **VLASINKA D.O.O.**, BATAJNICKI DRUM 14-16, BEOGRAD-ZEMUN RS



(540)

(550) I

(740) Popović Miladin, Đoka Miraševića 21/III, Podgorica (ME)

(511) **Klasa 25:** Kućne ili kuhinjske sprave i posude; češljevi i sušeri; četke (izuzev kičica); materijali za pravljenje četki; artikli koji se koriste pri čišćenju; čelična vuna; neprerađeno ili poluprerađeno staklo (osim stakla koje se koristi u građevinarstvu); staklarija, porcelan i grnčarija koja nije uključena u druge klase.

**Klasa 32:** Piva; mineralne i sodne vode i druga bezalkoholna pica; voćna pica i voćni sokovi; sirupi i drugi preparati za pravljenje pica

(210) **2011-193**

(442) **20.06.2013**

(220) 19.4.2011

(731) **GIGA-BITE TECHNOLOGY CO.LTD.**, NO.6, BAU CHIANG RD. HSIN-TIEN, TAIPEI 231, TW

# Booktop

(540)

(550) I

(740) Radulović Božidar, Jovana Tomaševića 9/III, Podgorica (ME)

(511) **Klasa 09:** Kompjuteri, laptop kompjuteri, kompjuterski periferni uređaji.

---

(210) **2011-194**

(442) **20.06.2013**

(220) 21.4.2011

(731) **BERLIN-CHEMIE AG**, GLIENICKER WEG 125, D-12489 BERLIN, DE

# MIG

(540)

(550) I

(740) Radulović Božidar, Jovana Tomaševića 9/III, Podgorica (ME)

(511) **Klasa 05:** Farmaceutski proizvodi, dijetetske supstance prilagođene za upotrebu u medicini.

---

(210) **2011-195**

(442) **20.06.2013**

(220) 21.4.2011

(731) **WYETH LLC**, A COMPANY ORGANIZED UNDER THE LAWS OF DELAWARE, FIVE GIRALDA FARMS, MADISON, NEW JERSEY 07940, US

# CONBRIZA

(540)

(550) I

(740) Čejović Vladimir, 13. jula 21, Podgorica (ME)

(511) **Klasa 05:** Farmaceutski preparati uključujući preparate za liječenje stanja menopauze i postmenopauze i prevenciju i liječenje osteoporoze.

---

(210) **2011-197**

(442) **20.06.2013**

(220) 26.4.2011

(731) **MEDOCHEMIE LTD.**, CONSTANTINOPOLEOS STREET 3011 LIMASSOL. KIPAR, MT

# MEDOCLAV

(540)

(550) I

(740) Popović Miladin, Đoka Miraševića 21/III, Podgorica (ME)

(511) **Klasa 05:** Farmaceutski proizvodi.

---

(210) **2011-202**

(442) **20.06.2013**

(220) 26.4.2011

(731) **GENERAL MOTORS LLC**, 300 RENAISSANCE CENTER, DETROIT, MICHIGAN 48265-3000, US

# CHEVROLET ORLANDO

(540)

(550) I

(740) Radulović Božidar, Jovana Tomaševića 9/III, Podgorica (ME)

(511) **Klasa 12:** motorna vozila za kretanje po zemlji, odnosno automobili, terenska vozila, teretna i monovolumenska vozila.

---

(210) **2011-208**

(442) **20.06.2013**

(220) 28.4.2011

(731) **SAMSONITE IP HOLDING S.a.r.l.**, 13-15 AVENUE DE LA LIBERTE.L-1931 LUXEMBURG, LU

# Sams<sup>o</sup>nite

(540)

(550) I

(740) Popović Miladin, Đoka Miraševića 21/III, Podgorica (ME)

(511) **Klasa 09:** Torbe za nošenje za prenosive računare; torbe sa točkovima specijalno prilagođene za držanje prenosivih računara; zaštitne navlake za prenosive računare; zaštitne torbe za prenosive računare; električne pegle za putovanja; konvertor električne struje; kompleti konvertora električne struje i adaptera; pegle na paru; pegla na paru za odeću; dvogledi i futrole za dvoglede; naočari i naočari za sunce; futrole za naočari; torbe za nošenje foto, video, audio, elektronske i kompjuterske opreme; futrole za telefone, kaiševi za fotografsku i video opremu koji se kače oko vrata i ramena; torbe za kamere; tronošci za fotografsku i video opremu; alarmi na baterije koji se aktiviraju pokretom protiv krađe prtljaga, vage

**Klasa 18:** Putni koferi, vreće za nošenje stvari za sve namene, putne torbe, kolica, rančevi, vreće za nošenje stvari, vreće za nošenje stvari na točkove, sportske torbe, meke torbe sa držačima, ruksaci, uprtnjače, mali koferi, torbe za nošenje knjiga, rančevi, aktovke, akten-tašne, torbe za kupovinu, torbe za nošenje preko ramena, Boston torbe (torbe sa dve ruč-ke), kaiševi za prtljag, etikete za prtljag, identifikacione oznake, držači za novae, novčanici, bezbednosne kese, novčanici za račune, damske tašnice, tašnice za držanje sitnine, večernje torbice, torbe za rame, ručne torbe, futrole za kreditne kartice, futrole za ključeve, torbe koje se nose oko struka, torbice za toaletni pribor koje se prodaju prazne, organizatori za toaletni pribor koji se prodaju prazni, kutije za toaletni pribor koje se prodaju prazne, torbi-ce za pribor za brijanje koje se prodaju prazne, male torbe za putovanja, kozmetičke torbe koje se prodaju prazne, torbe za donji veš koje se prodaju prazne, navlake za odeću, torbe za odeću, kišobrani, torbe za cipele naročito za putovanja; torbe za pelene; remenice za kai-ševe za prtljag, koje se prodaju kao sastavni deo putnog kofera, umeci za putni kofer, naime, torbice za pakovanje.

**Klasa 35:** Usluge maloprodaje u vezi sa predmetima koji se tiču putnih kofera i srodnih pred-meta za putovanja i pribora; onlajn usluge maloprodaje putnih kofera koji se tiču naime putnih kofera i pribora za putovanja.

(210) **2011-209**

(442) **20.06.2013**

(220) 28.4.2011

(300) 0892092 17.11.2010 BENELUKS

(731) **EDISON NATION, LLC**, 520 ELLIOT STREET, SUITE 200, CHARLOTTE, NC 28202 US

## GYRO BOWL

(540)

(550) I

(740) Popović Miladin, Đoka Miraševića 21/III, Podgorica (ME)

(511) **Klasa 21:** Kućne ili kuhinjske sprave i posude; sudovi i činije za hranu za bebe i djecu.

(210) **2011-210**

(442) **20.06.2013**

(220) 28.4.2011

(300) 0892090 17.11.2010 BENELUKS

(731) **EDISON NATION, LLC**, 20 AVENUE MONTEREY, L-2163 LUXEMBOURG, LU



(540)

(550) I

(740) Popović Miladin, Đoka Miraševića 21/III, Podgorica (ME)

(511) **Klasa 21:** Kućne ili kuhinjske sprave i posude; sudovi i činije za hranu za bebe i djecu.

(210) **2011-211**

(442) **20.06.2013**

(220) 29.4.2011

(731) **STARBUCKS CORPORATION d/b/a STARBUCKS COFFEE COMPANY,**  
2401 UTAH AVENUE SOUTH, SEATTLE, WASHINGTON 98134 US



(540)

(550) I

(740) Čejović Vladimir, 13. jula 21, Podgorica (ME)

(511) **Klasa 30:** Mljevena kafa i kafa u zrnu, kakao, čaj (biljni i onaj koji nije biljni), napici od kafe, čaja, kakaoa, espressa, i napici napravljeni na bazi kafe i/ili espressa, napici na bazi čaja, čokolade u prahu i vanile; sosovi koji se dodaju napicima; čokoladni sirup, sirupi raznih ukusa koji se dodaju napicima, pekarski proizvodi uključujući mafine, kornete, kekse, kolačiće, peciva i hlebove, sendviče, musli, kafa za ponijeti, čaj za ponijeti, sladoled i smrznute poslastice; čokolada, slatkiši i poslastice.

**Klasa 35:** Poslovno upravljanje; poslovni menadžment; franšizing, naime usluge tehničke pomoći u uspostavljanju i/ili upravljanju restoranima, kafićima, kućama kafe i snek-barovima; usluge maloprodaje u vezi: kafe, čaja, kakaoa, zapakovane i pripremljene hrane, električnih aparata, aparata koji nijesu na struju, kućnih potrepština, kuhinjskog posuđa, satova, ručnih satova, kuhinjskih tajmera, štoperica, nakita, knjiga, muzičkih zapisa, podloga za miševе, novčanika, lisnica, velikih torbi, torbica, aktovki, torbi za knjige, putnih torbi i kišobrana, svi napravljeni od platna, plastike ili kože, priveszaka za ključeve od kože, odjeće, kapa i šešira, igračaka, uključujući medvediće, punjene igračke, plišane igračke, lutke i dodatke za njih, Božićne ukrase; veleprodajna distribucija, veleprodajne radnje i usluge naručivanja na veliko sve u vezi: kafe, čaja, kakaoa, zapakovane i pripremljene hrane, električnih aparata, aparata koji nisu na struju, kućnih potrepština, kuhinjskog posuđa, satova, ručnih satova, kuhinjskih tajmera, štoperica, nakita, knjiga, muzičkih zapisa, podloga za miševе, novčanika, lisnica, velikih torbi, torbica, aktovki, torbi za knjige, putnih torbi i kišobrana, svi napravljeni od platna, plasike ili kože, priveszaka za ključeve od kože, odjeće, kapa i šešira, igračaka, uključujući medvediće, punjene igračke, plišane igračke, lutke i dodatke za njih, Božićnih ukrasa; kompjuterizovane on-line usluge naručivanja putem pošte i usluge naručivanja putem pošte preko kataloga, kompjuterizovane on-line usluge naručivanja, kompjuterizovane on-line usluge maloprodaje, on-line usluge naručivanja i on-line usluge maloprodajnih radnji, sve u vezi sa: kafom, čajem, kakaom, zapakovanom i pripremljenom hranom, električnim aparatima, aparatima koji nisu na struju, kućnim potrepštinama, kuhinjskim posuđem, satovima, ručnim satovima, kuhinjskim tajmerima, štopericama, nakitom, knjigama, muzičkim zapisima, podlogama za miševе, novčanicima, lisnicama, velikim torbama, torbicama, aktovkama, torbama za knjige, putnim torbama i kišobranima, svi napravljeni od platna,

plastike ili kože, privescima za ključeve od kože, odjećom, kapama i šeširima, igračkama, uključujući medvediče, punjene igračke, plišane igračke, lutke i dodatke za njih, Božićnim ukrasima; kompjuterizovane on-line usluge zapisivanja i naručivanja poklona.

**Klasa 43:** Usluge restorana, kafea, kafeterije, snek bara, kafe bara i kuće kafe, usluge restorana koji služe hranu za poneti; usluge kateringa; usluge dostave kafe kancelarijama; usluge pripremanja hrane po ugovoru; pripremanje hrane; pripremanje i prodaja hrane i napitaka za ponijeti.

(210) **2011-212**

(442) **20.06.2013**

(220) 4.5.2011

(731) **APPLE INC.**, 1 INFINITE LOOP, CUPERTINO, 95014 CALIFORNIA, US

## APP STORE

(540)

(550) I

(740) Čupić Branislav, Dalmatinska 10, Podgorica (ME)

(511) **Klasa 09:** Računari, računarski hardver, računarski periferni uređaji; mikroprocesori, memorijske ploče, monitori, displeji, tastature, kablovi, modemi, štampači, disk drajvovi, adapted, adapterske karte, konektori i drajveri; hard drajvovi; uređaji za čuvanje podataka; računarske mašine za igranje; prazni računarski memorijski medijumi; magnetni nosači podataka; audio diskovi, video diskovi, kompakt diskovi, CD-ROM-ovi, DVD-ovi; čipovi, diskovi i trake sa nasnimljenim ili za snimanje računarskih programa i softvera; memorije sa direktnim pristupom (RAM); čitačke memorije (ROM); memorijski uređaji bez pokretnih djelova; podloge za miša; baterije; punjači; punjači za električne baterije; kamere; video kamere; ručni računari, tablet računari, personalni digitalni asistenti (PDA); elektronski organizatori, elektronske sveske; mobilni digitalni elektronski uređaji, GPS uređaji; ručni digitalni elektronski uređaji i softver za navedeno; elektronske ručne jedinice za bežični prijem, čuvanje i/ili prenos podataka i poruka, i elektronski uređaji koji omogućavaju korisniku da prati ili upravlja ličnim informacijama; elektronska komunikaciona oprema i instrumenti; telekomunikacioni aparati i instrumenti; telefoni; videofoni; ručni i mobilni digitalni elektronski uređaji za slanje i prijem telefonskih poziva, faksova, elektronske pošte i drugih digitalnih podataka; MP3 i drugi audio plejeri digitalnog formata; digitalni audio i video rekorderi i plejeri; rekorderi i plejeri za audio i video kasete, kompakt diskove, DVD-ove i digitalne audio trake; aparati za snimanje i reprodukciju zvuka; slušalice, stereo slušalice; zvučnici, stereo zvučnici, audio zvučnici; stereo uređaji; radio uređaji, radio odašiljači i prijemnici; pojačala; električni fonografi, gramofoni; aparati za snimanje i reprodukciju traka; aparati za snimanje; mikrofoni; audio, video, i digitalni mikseri; audio aparati za automobile; računarski softver; računarski softver za autorizaciju, preuzimanje, prenos, prijem, montažu, ekstrakciju, kodiranje, dekodiranje, prikazivanje, čuvanje i uređivanje teksta, grafika, slika, audio fajlova, video fajlova, elektronskih igara i elektronskih publikacija; računarski izvršni softver za mobilne telefone, prenosive media plejere i ručne računare; računarski softver za pretraživanje, pregled, kupovinu i preuzimanje elektronskih igara i softverskih aplikacija; softver za računarske operativne sisteme; softver za sinhronizaciju podataka; softver za razvoj aplikacija; računarski programi za upravljanje ličnim podacima; softver za upravljanje bazom podataka; softver za prepoznavanje znakova (karaktera); softver za elektronsku po-



štu i poruke; softver za mobilne telefone; računarski programi za pristup, pregled i pretraživanje onlajn baza podataka; kompjuterske i elektronske igrice; elektronske publikacije koje se mogu preuzeti; uputstva za upotrebu u elektronski, mašinski ili kompjuterski čitljivoj formi koja se koriste za i koja su prodana zajedno sa gore navedenom robom; navlake, torbe i futrole za svu gore navedenu robu; pribor, djelovi i oprema za svu gore navedenu robu.

**Klasa 35:** Oglašavanje; poslovno upravljanje; vodenje poslova; kancelarijsko poslovanje; usluge trgovine na malo; promovisanje roba i usluga drugih; organizovanje i vođenje komercijalnih, trgovinskih i poslovnih konferencija, sajmova i izložbi; izrada za druge indeksa onlajn informacija, sajtova i drugih resursa dostupnih na globalnim računarskim mrežama; pružanje poslovnih i komercijalnih informacija preko računarskih i globalnih komunikacionih mreža; kompilacije direktorijuma za publikovanje na Internetu i drugim elektronskim, računarskim i komunikacionim mrežama; upravljanje kompjuterizovanim bazama podataka i fajlovima; usluge obrade podataka; usluge pretplate, naročito obezbjeđivanje pretplate za tekstove, podatke, slike, audio i video sadržaje, igre i multimedijalne sadržaje, dobijene preko Interneta i drugih elektronskih i komunikacionih mreža; uređivanje sadržaja informacija dobijenih preko globalne računarske mreže i drugih elektronskih i komunikacionih mreža, u skladu sa željama korisnika; usluge obavještanja, savjetovanja i konsultovanja u vezi sa svim gore navedenim.

**Klasa 42:** Naučne i tehnološke usluge i istraživanje i projektovanje u vezi navedenih usluga; usluge industrijske analize i istraživanja; projektovanje i razvoj računarskog hardvera i softvera; instalacija, ažuriranje, održavanje i popravka softvera; usluge tehničke podrške, naročito otkrivanje smetnji kod računarskog hardvera, računarskih perifernih uređaja, računarskog softvera i korisničkih elektronskih uređaja; savjetodavne usluge u vezi sa izborom, ugradnjom i korišćenjem računarskog hardvera, softvera i korisničkih elektronskih sistema; obnavljanje računarskih podataka; računarsko programiranje; usluge podrške i savjetovanja u vezi sa razvojem računarskih sistema, baza podataka i aplikacija; obezbeđivanje pretraživača za dobijanje podataka preko komunikacionih mreža; obezbeđivanje privremenog korišćenja računarskog softvera i onlajn instalacija da bi se omogućilo korisnicima da pristupe i preuzmu računarski softver; savjetodavne usluge u vezi računarskog hardvera i softvera; iznajmljivanje hardverskih i softverskih aparata i opreme; informacije koje se odnose na računarski hardver ili softver dobijene onlajn sa globalne računarske mreže ili Interneta; kreiranje i održavanje web-sajtova; dizajn i razvoj web-sajtova; hostovanje web-sajtova drugih subjekata; usluge davanja aplikacionih usluga (ASP) praćene kompjuterskim softverom; kreiranje i razvoj baze podataka; usluge obavještanja, savjetovanja i konsultovanja u vezi sa svim gore navedenim.

(210) **2011-213** (442) **20.06.2013**  
(220) 4.5.2011

(300) 30 11 2010 BR.830802207

(731) **COMPANHIA NITRO QUIMICA BRASILERIA**, A BRAZILIAN COMPANY, AV. DR. JOSE ARTUR NOVA, 951, SAO MIGUEL PAULISTA, SAO PAULO, SP, BR

greencell

(540)

(550) I

(740) Radulović Božidar, Jovana Tomaševića 9/III, Podgorica (ME)

(511) **Klasa 13:** Nitroceluloza.

(210) **2011-214** (442) **20.06.2013**  
(220) 4.5.2011

(300) 30 11 2010 BR. 830802215 BR

(731) **COMPANHIA NITRO QUIMICA BRASILEIRA**, A BRAZILIAN COMPANY, AV. DR. JOSE ARTUR NOVA, 951, SAO MIGUEL PAULISTA, SAO PAULO, SP, BR.



(540)

(550) I

(740) Radulović Božidar, Jovana Tomaševića 9/III, Podgorica (ME)

(511) **Klasa 13:** Nitroceluloza.

(210) **2011-216** (442) **20.06.2013**  
(220) 5.5.2011

(731) **GLAXOSMITH KLINE BIOLOGICALS SA**, RUE DE L, INSTITUT 89, B-1330 RIXEN-SART BE

**POLIORIX**

(540)

(550) I

(740) Popović Miladin, Đoka Miraševića 21/III, Podgorica (ME)

(511) **Klasa 05:** Farmaceuski preparati i supstance za ljudsku upotrebu, vakcine

(210) **2011-217** (442) **20.06.2013**  
(220) 5.5.2011

(731) **APPLE INC.**, 1 INFINITE LOOP, CUPERTINO, CA 95014, US

**THUNDERBOLT**

(540)

(550) I

(740) Čejović Vladimir, 13. jula 21, Podgorica (ME)

(511) **Klasa 09:** Računari, računarski periferni uređaji, računarski terminali; računarski hardver; mašine za kompjuterske igre, mikroprocesori, memorijske ploče, monitori, displeji, tastature, kablovi, modemi, štampači, disk drajvovi, adapteri, kartice za adaptere, konektori i drajveri; nepopunjeni mediji za skladištenje kompjuterskog sadržaja; magnetni nosači podataka; kompjuterski softver; kompjuterski softver za kreiranje, preuzimanje, prenos, prijem, uređivanje, izvlačenje, kodiranje, dekodiranje, prikazivanje, čuvanje i organizovanje teksta, grafike, slike, i elektronskih publikacija; kompjuterski softver i firmver, naime, operativni sistemi, programi za sinhronizaciju podataka i programi aplikacija za razvijanje pomoćnih

alatki za lične i ručne računare; kompjuterski hardver i softver za pružanje integrisane telefonske komunikacije sa kompjuterskim globalnim informacionim mrežama; prethodno snimljeni kompjuterski programi za lično upravljanje informacijama, softver za upravljanje bazama podataka, softver za prepoznavanje znakova, softver za upravljanje telefonijom, softver za elektronsku poštu i slanje poruka, pejdžing softver, softver za mobilni telefon; softver za sinhronizaciju baza podataka, kompjuterski programi za pristup, pregled i pretraživanje on-line baza podataka, kompjuterski softver za preusmeravanje poruka, elektronske pošte preko interneta, i / ili drugih podataka na jedan ili više elektronskih ručnih uređaja iz prodavnice podataka na ili u vezi sa ličnim računarima ili serverima; kompjuterski softver za sinhronizaciju podataka između daljinskih stanica ili uređaja i fiksnih stanica ili daljinskih stanica ili uređaja; elektronske publikacije koje se mogu preuzeti kao što su knjige, drame, pamfleti, brošure, bilteni, dnevne novine, magazini, i časopisi o širokom spektru tema od opšteg interesa; ručni digitalni elektronski uređaji i odgovarajući softver; MP3 i drugi audio plejeri u digitalnom formatu; ručni računari, tablet računari, lični digitalni asistenti, elektronski organizatori, elektronske sveske; mobilni digitalni elektronski uređaji, uređaji za globalni sistem pozicioniranja (GPS), telefoni; ručni i mobilni digitalni elektronski uređaji za slanje i primanje telefonskih poziva, faksova, elektronske pošte i drugih digitalnih podataka; bežični telefoni; mobilni telefoni; djelovi i pribor za mobilne telefone; faks mašine, telefonske sekretarice, kamere, uređaji za prenos videa preko telefona, softver i hardver za pronalaženje informacija preko telefona; elektronske ručne jedinice za bežični prijem, skladištenje i / ili prenos podataka i poruka, i elektronski uređaji koji omogućavaju korisniku da prate i upravljaju ličnim podacima; elektronska komunikaciona oprema i instrumenti; telekomunikacioni aparati i instrumenti; fontovi, slogovi, štamparski dizajni i simboli u obliku snimljenih podataka; čipovi, diskovi i trake koje sadrže ili su za snimanje kompjuterskih programa i softvera; ram memorija, rom memorija; solid state memorijski aparat; kompjuterske i elektronske igre; uputstva za rukovanje u obliku koji se može čitati elektronskim putem, putem mašina ili putem računara za upotrebu sa, i koji se prodaju zajedno sa svom gore navedenom robom; aparati za skladištenje podataka; hard drajvovi; minijaturni hard disk drajvovi za skladištenje podataka; audio-video diskovi, čitači kompakt diskova, i digitalni višenamjenski diskovi; podloge za miša; baterije; punjive baterije; punjači; punjači za električne baterije; slušalice; stereo slušalice; slušalice koje se stavljaju direktno u ušni kanal; stereo zvučnici; audio zvučnici; audio zvučnici za kućnu upotrebu; zvučnici za monitore; zvučnici za računare; zvučni sistemi za lični stereo; radio prijemnici, pojačala, aparati za snimanje i reprodukciju zvuka, električni fonografi, gramofoni, stereo uređaji za visoko kvalitetnu reprodukciju zvuka, magnetofoni i aparati za reprodukciju, zvučnici, jedinice sa više zvučnika, mikrofoni; digitalni audio i video uređaji; uređaji za snimanje i reprodukciju zvuka, uređaji za snimanje i reprodukciju pokretnih slika, uređaji za reprodukciju kompakt diskova, uređaji za snimanje i reprodukciju digitalnih višenamjenskih diskova, uređaji za snimanje i reprodukciju digitalnih audio kaseti; digitalni uređaji za reprodukciju muzike i/ili pokretnih slika; radio aparati; video kamere; audio, video, i digitalni mikseri; radio predajnici; zvučni uređaji za automobile; računarska oprema za upotrebu sa svom gore navedenom robom; elektronski aparati sa multimedijalnim funkcijama za upotrebu sa svom gore navedenom robom; elektronski aparati sa interaktivnim funkcijama za upotrebu sa svom gore navedenom robom; pribor, djelovi, oprema i aparati za testiranje za svu gore navedenu robu; djelovi i oprema za svu gore navedenu robu; pokrivači, torbe i futrole prilagodene ili oblikovane da sadrže svu gore navedenu robu, od kože, imitacije kože, tkanine, ili tekstilnih materijala.

(210) **2011-218**

(442) **20.06.2013**

(220) 5.5.2011

(731) **MONSTER ENERGY COMPANY (A DELAWARE )**, 550 MONICA CIRCLE, SUITE 201 CORONA, CALIFORNIA 92880 US

**UNLEASH THE BEAST!**

(540)

(550) I

(740) Radulović Božidar, Jovana Tomaševića 9/III, Podgorica (ME)

(511) **Klasa 05:** Nutricioni dodaci.

**Klasa 32:** Bezalkoholna pića.

(210) **2011-219**

(442) **20.06.2013**

(220) 6.5.2011

(731) **TDR DOO**, OBALA VLADIMIRA NAZORA BR.1 52210 ROVINJ, HR

uz pomoć računara



(540)

(550) I

(740) Vukotić Petar, Novaka Miloševa, Podgorica (ME)

(511) **Klasa 34:** duvan sirov i prerađen. proizvodi od duvana, cigare, cigarete, filter, cigarete, cigarilosi, artikli za pušače, upaljači, šibice.

**Klasa 35:** usluge u vezi sa prometom robe, Dosebno usluge u prometu duvana i duvan skin proizvoda; oglašavanje: vodenje poslova; poslovno upravljanje; kancelarijski poslovi; komercijalno zastupanje; propagandne i reklamne usluge; marketing; usluge istraživanja tržišta; usluge promocije, posebno promovisanje ili reklamiranje kulturnih i zabavnih događaja, sportskih tajcmicjenja i niodnih revija; organizovanje i vođenje sajrnova i izložbi u reklamne i komercijaine svrhe; naprijed navedene usluge koje pripadaju ovoj klasi ko)č se obavljaju putem intemeta; davanje i širenje informacija u vezi sa gore navedenim uslugama.

(210) **2011-220**

(442) **20.06.2013**

(220) 6.5.2011

(731) **TDR DOO**, OBALA VLADIMIRA NAZORA BR.1 52210 ROVINJ, HR

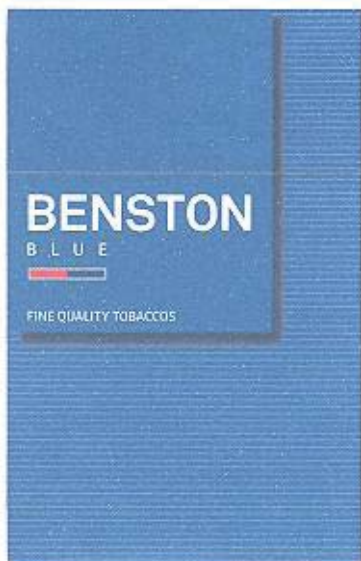

(540) \_\_\_\_\_

(550) I

(740) Vukotić Petar, Novaka Miloševa, Podgorica (ME)

(511) **Klasa 34:** duvan sirov i prerađen. proizvodi od duvana, cigare, cigarete, filter, cigarete, cigarilosi, artikli za pušaće, upaljači, šibice.

**Klasa 35:** usluge u vezi sa prometom robe, Dosebno usluge u prometu duvana i duvan skin proizvoda; oglašavanje: vodenje poslova; poslovno upravljanje; kancelarijski poslovi; komercijalno zastupanje; propagandne i reklamne usluge; marketing; usluge istraživanja tržišta; usluge promocije, posebno promovisnje ili reklamiranje kulturnih i zabavnih događaja, sportskih tajcmicjenja i niodnih revija; organizovanje i vođenje sajrnova i izložbi u reklamne i komercijaine svrhe; naprijed navedene usluge koje pripadaju ovoj klasi ko)č se obavljaju putem intemeta; davanje i širenje informacija u vezi sa gore navedenim uslugama.

(210) **2011-221**

(442) **20.06.2013**

(220) 10.5.2011

(731) **INTERVET INTERNATIONAL B.V.**, WIM DE KORVERSTRAAT 35, 5831 AN BOXMEER, NL

RABDOMUN

(540)

(550) I

(740) Čejović Vladimir, 13. jula 21, Podgorica (ME)

(511) **Klasa 05:** Ljekovi i farmaceutski preparati za veterinarsku upotrebu

(210) **2011-222**

(442) **20.06.2013**

(220) 10.5.2011

(731) **PROCTER & GAMBLE BUSINESS SERVICER CANADA COMPANY**, SUITE 800,1959 UPPER WATER STREET,P,O BOX 997, HALIFAX,NOVA SCOTIA B3J2X2, CA

## CROSSACTION

(540)

(550) I

(740) Lutovac Branislav, Bulevar Crnojevića 93, Podgorica (ME)

(511) **Klasa 21:** Četkice za zube, četkice za desni i djelovi i oprema za iste, električne četkice za zube; četke i materijal za pravljenje četki, čačkalice za zube, materijal i instrumenti za čišćenje i poliranje prirodnih ili vještačkih zuba, patrone, držači i tacne za upotrebu u domaćinstvu i kupatilu, koji nisu od plemenitih metala.

(210) **2011-223**

(442) **20.06.2013**

(220) 10.5.2011

(731) **THE PROCTER & GAMBLE COMPANY**, ONE PROCTER & GAMBLE PLAZA. CINCINNATI, OHIO 45202 US

## MICRO CAPSULES

(540)

(550) I

(740) Lutovac Branislav, Bulevar Crnojevića 93, Podgorica (ME)

(511) **Klasa 03:** Sredstva za pranje i beljenje, i druge supstance za upotrebu kod pranja veša; preparati za čišćenje, poliranje, nagrizajuća sredstva, abrazivna sredstva; sredstva za omekšavanje i oplemenjivanje tkanina; sapuni; parfimerija, eterična ulja, kozmetika, losioni za kosu; proizvodi za negu zuba, ništa od napred navedene robe u obliku kapsula.

(210) **2011-224**

(442) **20.06.2013**

(220) 10.5.2011

(731) **LASHUA HK LIMITED**, A HONG KONG PRIVATE LIMITED COMPANY, SUITE A,7 FLOOR, HONG KONG DIAMOND EXCHANGE BUILDING, 8-10 DUDDLELL STREET, CENTRAL HONG KONG, CN

## LASHOU

(540)

(550) I

(740) Popović Miladin, Đoka Miraševića 21/III, Podgorica (ME)

(511) **Klasa 09:** Kompjuterska softver aplikacija za mobilne digitalne uređaje, naime, softver koji dopušta korisnicima da pristupe kuponima, popustima, informacijama o poređenju

cena, pregledu proizvoda, linkovima za maloprodajne objekte i informacijama o popustima.

**Klasa 35:** Usluge promocije robe i usluga za druge obezbjeđivanjem kupona putem web stranica, popusta, informacija o poređenju cena, linkova za web stranice maloprodaje i informacije o popustima; usluge oglašavanja i marketinga, naime, promocija brendova, roba i usluga za druge; organizovanje onlajn kampanja za rasprodaju za potrebe poslovanja i oglašavanja za druge; usluge planiranja i menadžmenta za potrebe marketinga, promocija i oglašavanja robe i usluga za druge; administriranje programa za grupe koje imaju popuste pri kupovini, naime, pružanje platforme za grupno kupovanje i za popuste, u kojoj su sniženi proizvodi ili usluge razmjenjivane za količinu potrošačke kupovine

(210) **2011-225**

(442) **20.06.2013**

(220) 10.5.2011

(731) **LASHOU HK LIMITED**, A HONG KONG PRIVATE LIMITED COMPANY, SUITE A,7 FLOOR, HONG KONG DIAMOND EXCHANGE BUILDING, 8-10 DUDELL STREET, CENTRAL HONG KONG, CN

**LASHO**

(540)

(550) I

(740) Popović Miladin, Đoka Miraševića 21/III, Podgorica (ME)

(511) **Klasa 09:** Kompjuterska softver aplikacija za mobilne digitalne uređaje, naime, softver koji dopušta korisnicima da pristupe kuponima, popustima, informacijama o poređenju cena, pregledu proizvoda, linkovima za maloprodajne objekte i informacijama o popustima.

**Klasa 35:** Usluge promocije robe i usluga za druge obezbjeđivanjem kupona putem web stranica, popusta, informacija o poređenju cena, linkova za web stranice maloprodaje i informacije o popustima; usluge oglašavanja i marketinga, naime, promocija brendova, roba i usluga za druge; organizovanje onlajn kampanja za rasprodaju za potrebe poslovanja i oglašavanja za druge; usluge planiranja i menadžmenta za potrebe marketinga, promocija i oglašavanja robe i usluga za druge; administriranje programa za grupe koje imaju popuste pri kupovini, naime, pružanje platforme za grupno kupovanje i za popuste, u kojoj su sniženi proizvodi ili usluge razmjenjivane za količinu potrošačke kupovine

(210) **2011-226**

(442) **20.06.2013**

(220) 10.5.2011

(731) **LASHOU HK LIMITED**, A HONG KONG PRIVATE LIMITED COMPANY, SUITE A,7 FLOOR, HONG KONG DIAMOND EXCHANGE BUILDING, 8-10 DUDELL STREET, CENTRAL HONG KONG, CN

**LASO**

(540)

(550) I

(740) Popović Miladin, Đoka Miraševića 21/III, Podgorica (ME)

(511) **Klasa 09:** Kompjuterska softver aplikacija za mobilne digitalne uređaje, naime, softver koji dopušta korisnicima da pristupe kuponima, popustima, informacijama o poređenju cena, pregledu proizvoda, linkovima za maloprodajne objekte i informacijama o popustima.

**Klasa 35:** Usluge promocije robe i usluga za druge obezbjeđivanjem kupona putem web stranica, popusta, informacija o poređenju cena, linkova za web stranice maloprodaje i informacije o popustima; usluge oglašavanja i marketinga, naime, promocija brendova, roba i usluga za druge; organizovanje onlajn kampanja za rasprodaju za potrebe poslovanja i oglašavanja za druge; usluge planiranja i menadžmenta za potrebe marketinga, promocija i oglašavanja robe i usluga za druge; administriranje programa za grupe koje imaju popuste pri kupovini, naime, pružanje platforme za grupno kupovanje i za popuste, u kojoj su sniženi proizvodi ili usluge razmjenjivane za količinu potrošačke kupovine

(210) **2011-227**

(442) **20.06.2013**

(220) 11.5.2011

(300) EU 009706326 02022011

(731) **DIAGEO BRANDS B.V.**, MOLENWERF 10-12,1014 BG AMSTERDAM, NL

JOHNNIE WALKER  
PLATINUM LABEL

(540)

(550) I

(740) Čejović Vladimir, 13. jula 21, Podgorica (ME)

(511) **Klasa 33:** Alkoholna pića (osim piva).

(210) **2011-228**

(442) **20.06.2013**

(220) 13.5.2011

(731) **STERISOL AB**, BOX 149 592 23 VADSTENA SE

STERISOL

(540)

(550) I

(740) Ćupić Branislav, Dalmatinska 10, Podgorica (ME)

(511) **Klasa 03:** Sapuni, uključujući tečne sapune i šampone za kosu; paste za čišćenje; parfimerija, eterična ulja, kozmetika uključujući kozmetičke kreme, losioni za kosu; preparati za njegu zuba.

**Klasa 05:** Farmaceutski i sanitarni preparati za ličnu higijenu; flasteri za medicinsku svrhu, materijali za zavijanje; dezinfekciona sredstva u svrhu održavanja higijene; medicinski melemi; proizvodi za tretiranje rana, zaštitu kože i njegu kose.



(210) **2011-229**(442) **20.06.2013**

(220) 13.5.2011

(731) **THE PROCTER & GAMBLE COMPANY**, ONE PROCTER & GAMBLE PLAZA, CINCINNATI, OHIO 45202 US**MYSTERIEUSE**

(540)

(550) I

(740) Lutovac Branislav, Bulevar Crnojevića 93, Podgorica (ME)

(511) **Klasa 03:** Sredstva za pranje i beljenje i druge supstance za upotrebu u domaćinstvu; sredstva za čišćenje, poliranje, odmaščivanje i abrazivna sredstva; sredstva za čišćenje, negu i ulepšavanje pribora za jelo i posuda; sapuni za upotrebu u domaćinstvu.(210) **2011-230**(442) **20.06.2013**

(220) 13.5.2011

(731) **THE PROCTER & GAMBLE COMPANY**, ONE PROCTER & GAMBLE PLAZA, CINCINNATI, OHIO 45202 US

(540)

(550) I

(740) Lutovac Branislav, Bulevar Crnojevića 93, Podgorica (ME)

(511) **Klasa 03:** Sredstva za pranje i beljenje i druge supstance za upotrebu u domaćinstvu; sredstva za čišćenje, poliranje, odmaščivanje i abrazivna sredstva; sredstva za čišćenje, negu i ulepšavanje pribora za jelo i posuda; sapuni za upotrebu u domaćinstvu.(210) **2011-231**(442) **20.06.2013**

(220) 16.5.2011

(731) **PHARMACEUTICAL CHEMICAL COSMETICS INDUSTRY ALKALOID AD SKOPLJE**, BIL. ALEKSANDAR MAKEDONSKI 12 1000 SKOPLJE MK



(540)

(550) I

(740) Popović Miladin, Đoka Miraševića 21/III, Podgorica (ME)

(511) **Klasa 03:** Sapuni; parfimerija, eterična ulja, kozmetika, losioni za kosu, paste za zube.**Klasa 05:** Farmaceutski preparati; dietetske supstance prilagođene za medicinsku upotrebu, hrana za bebe; flasteri, materijali za zavijanje;**Klasa 16:** Pelene za bebe, kartoni i robe napravljene od ovih materijala, koji nisu uključeni u druge klase;(210) **2011-232**(442) **20.06.2013**

(220) 16.5.2011

(731) **SHIMANO INC**, 3-77 OIMATSUCHO, SAKAI-KU SAKAI CITY, OSAKA JP

(540)

(550) I

(740) Popović Miladin, Đoka Miraševića 21/III, Podgorica (ME)

(511) **Klasa 09:** Električne žice za bicikla.(210) **2011-234**(442) **20.06.2013**

(220) 17.5.2011

(731) **KRAFT FOODS GLOBAL BRANDS LLC**, A STATE OF DELAWARE LIMITED LIABILITY COMPANY, THREE LAKES DRIVE, NORTFIELD ILLINOIS 60093, US

# BELVITA

(540)

(550) I

(740) Ćupić Branislav, Dalmatinska 10, Podgorica (ME)

(511) **Klasa 30:** Keksi, keks štanglice, krekeri, čokoladne štanglice, grickalice u obliku štanglica, uključujući štanglice od žitarica, štanglice za doručak, slatkiše u obliku štanglica, štanglice sa koštunjavim voćem, energetske štanglice, proteinske štanglice, štanglice sa niskim sadržajem ugljenih hidrata, štanglice od žitarica i mlijeka, štanglice sa voćem, jogurt štanglice i dijetalne štanglice, slatkiši; koji svi proizvodi nisu namjenjeni za novorođenčad, bebe i dojenčad.

(210) **2011-238**

(442) **20.06.2013**

(220) 17.5.2011

(731) **ALKALOID AD SKOPLJE**, BUL.ALEKSANDAR MAKEDONSKI 12, 1000 SKOPLJE REPULIKA MAKEDONIJA, MK



(540) \_\_\_\_\_

(550) I

(740) Popović Miladin, Đoka Miraševića 21/III, Podgorica (ME)

(511) **Klasa 03:** Dečja vitaminska mast.

(210) **2011-239**

(442) **20.06.2013**

(220) 17.5.2011

(731) **CP KELCO U.S INC**, 1000 PARKWOOD CIRCLE.ATLANTA, GEORGIA US

# CP KELCO

(540)

(550) I

(740) Popović Miladin, Đoka Miraševića 21/III, Podgorica (ME)

(511) **Klasa 01:** Hemijski aditivi koji se koriste u proizvodnji u oblasti agrohemije, proizvodnje ulja, farmacije, proizvoda za ličnu higijenu, papira i proizvodnje hrane.

(210) **2011-240**

(442) **20.06.2013**

(220) 17.5.2011

(731) **GENERAL MOTORS LLC**, 300 RENAISSANCE CENTER DETROIT, MICHIGAN 48265-3000, US



(540)

(550) I

(740) Radulović Božidar, Jovana Tomaševića 9/III, Podgorica (ME)

(511) **Klasa 12:** Dijelovi i komponente za automobile koje se ugrađuju u motorna vozila za kretanje po zemlji namjenjeni smanjivanju emisije CO2 i povećanju ekonomije goriva, naime, motori, transmisije, vješanje, pogonsko vratilo, kočnice, gume, točkovi, prednji i bočni nastavci poda karoserije, modul kontrole goriva, spojler, aero paneli, prekrivači za maske, vazdušne blende na maskama, usmjerivači za vazduh, prednji spojler.

(210) **2011-241**

(442) **20.06.2013**

(220) 17.5.2011

(731) **GENERAL MOTORS LLC**, 300 RENAISSANCE CENTER DETROIT, MICHIGAN 48265-3000, US

(540)

(550) I

(740) Radulović Božidar, Jovana Tomaševića 9/III, Podgorica (ME)

(511) **Klasa 12:** Dijelovi i komponente za automobile koje se ugrađuju u motorna vozila za kretanje po zemlji namjenjeni smanjivanju emisije CO2 i povećanju ekonomije goriva, naime, motori, transmisije, vješanje, pogonsko vratilo, kočnice, gume, točkovi, prednji i bočni nastavci poda karoserije, modul kontrole goriva, spojler, aero paneli, prekrivači za maske, vazdušne blende na maskama, usmjerivači za vazduh, prednji spojler.

(210) **2011-242** (442) **20.06.2013**  
(220) 19.5.2011

(731) **HONGTA TOBACCO (GROUP) CO.LTD**, NO.118, HONGTA AVENUE, HONGTA DISTRICT, YUXI, YUNNAN, CN;

(540)

(550) I

(740) Ćupić Branislav, Dalmatinska 10, Podgorica (ME)

(511) **Klasa 34:** Cigarete; duvan; cigare; filteri za cigarete; kutije za cigarete; pepeljare za pušaće; šibice; upaljači za pušaće; papir za cigarete; lule za duvan.

(210) **2011-243** (442) **20.06.2013**  
(220) 19.5.2011

(731) **HONGTA TOBACCO (GROUP) CO.LTD.**, NO.118, HONGTA AVENUE, HONGTA DISTRICT, YUXI, YUNNAN, CN

(540)

(550) I

(740) Ćupić Branislav, Dalmatinska 10, Podgorica (ME)

(511) **Klasa 34:** Cigarete; duvan; cigare; filteri za cigarete; kutije za cigarete; pepeljare za pušaće; šibice; upaljači za pušaće; papir za cigarete; lule za duvan.

(210) **2011-244** (442) **20.06.2013**  
(220) 19.5.2011

(731) **DUNHILL TOBACCO OF LONDON LIMITED**, GLOBE HOUSE 4 TEMPLE LONDON WC2R 2 PG UK, GB

**DUNHILL MASTER BLEND**

(540)

(550) I

(740) Popović Miladin, Đoka Miraševića 21/III, Podgorica (ME)

(511) **Klasa 34:** Cigarete; cigare; cigarilosi; duvan za lule; duvan za uvijanje; duvan za pušenje; duvan za žvakanje i duvan.

---

(210) **2011-246**

(442) **20.06.2013**

(220) 20.5.2011

(731) **RATIOPHARM GMBH**, GRAF-ARCO-STR.3 89079 ULM DE

### EPORATIO

(540)

(550) I

(740) Lutovac Branislav, Bulevar Crnojevića 93, Podgorica (ME)

(511) **Klasa 05:** Farmaceutski i veterinarski preparati; sanitarni preparati za medicinske svrhe; dijetetske supstance prilagodjene za upotrebu u medicini, hrana za bebe; flasteri, materijali za zavijanje; materijali za plombiranje zuba, zubarska smola; dezinfekciona sredstva; preparati za uništavanje štetočina; fungicidi, herbicidi.

---

(210) **2011-247**

(442) **20.06.2013**

(220) 20.5.2011

(731) **GLAXO GROUOP LIMITED**, GLAXO WELLCOME HOUSE, BERKELEY AVENUE, GREENFORD, MIDDLESEX UB6 0NN, ENGLAND, GB;

### NILACEF

(540)

(550) I

(740) Lutovac Branislav, Bulevar Crnojevića 93, Podgorica (ME)

(511) **Klasa 05:** Farmaceutski i medicinski preparati i supstance.

---

(210) **2011-248**

(442) **20.06.2013**

(220) 20.5.2011

(731) **CRNAGORACOOP AD-U STEČAJU**, LANDŽA BB DANILOVGRAD, ME



(540)

(550) I

(511) **Klasa 30:** Keksi.(210) **2011-249**(442) **20.06.2013**

(220) 20.5.2011

(731) **CRNAGORACOOP AD-U STEČAJU**, LANDŽA BB DANILOVGRAD, ME

(540)

(550) I

(511) **Klasa 30:** Keksi.(210) **2011-25**(442) **20.06.2013**

(220) 20.1.2011

(731) **NOVARTIS AG**, 4002 BASEL CH

# BRINERDIN

(540)

(550) I

(740) Radulović Božidar, Jovana Tomaševića 9/III, Podgorica (ME)

(511) **Klasa 05:** Farmaceutski preparati.

(210) **2011-250**

(442) **20.06.2013**

(220) 20.5.2011

(731) **WESTINGHOUSE ELECTRIC CORPORATION**, 51 WEST 52ND STREET NEW YORK, NEW YORK 10019, US



(540)

(550) I

(740) Radulović Božidar, Jovana Tomaševića 9/III, Podgorica (ME)

(511) **Klasa 07:** Mašine i mašinski alati; motori i pogonske mašine (osim za suvozemna vozila); mašinske spojnice i transmisioni elementi (osim za suvozemna vozila); poljoprivredne sprave; inkubatori za jaja.

(210) **2011-251**

(442) **20.06.2013**

(220) 20.5.2011

(731) **WESTINGHOUSE ELECTRIC CORPORATION (DELAWARE CORPORATION)**, 51 WEST 52ND STREET NEW YORK, NEW YORK 10019, US



(540)

(550) I

(740) Radulović Božidar, Jovana Tomaševića 9/III, Podgorica (ME)



(511) **Klasa 09:** Aparati i instrumenti naučni, pomorski, geodetski, električni, fotografski, kinematografski, optički, za vaganje, mjerenje, signalizaciju, kontrolu (inspekciju), spasavanje i nastavu; aparati i instrumenti za sprovođenje, uključivanje, pretvaranje, akumuliranje, regulisanje i kontrolu struje; aparati za snimanje, prenos i reprodukovanje zvuka ili slike; magnetni nosioci podataka, diskovi za snimanje; automatske mašine i mehanizmi za aparate koji se pokreću novcem ili žetonom; registar kase, računске mašine, oprema za obradu podataka i kompjuteri; aparati za gašenje požara.

(210) **2011-252** (442) **20.06.2013**  
(220) 20.5.2011

(731) **WESTINGHOUSE ELECTRIC CORPORATION (DELAWARE CORPORATION)**, 51 WEST 52ND STREET NEW YORK, NEW YORK 10019, US



(540)

(550) I

(740) Radulović Božidar, Jovana Tomaševića 9/III, Podgorica (ME)

(511) **Klasa 11:** Aparati za osvjetljavanje, grijanje, proizvodnju pare, kuvanje, hlađenje, sušenje, ventilaciju, snabdijevanje vodom i za sanitarne svrhe.

(210) **2011-253** (442) **20.06.2013**  
(220) 24.5.2011

(731) **GLAXO GROUP LIMITED**, GLAXO WELLCOME HOUSE, BERKELEY AVENUE, GREENFORD, MIDDLESEX UB6 ONN, ENGLAND, GB

**MODUTAB**

(540)

(550) I

(740) Lutovac Branislav, Bulevar Crnojevića 93, Podgorica (ME)

(511) **Klasa 05:** Farmaceutski preparati i supstance.

(210) **2011-254** (442) **20.06.2013**  
(220) 24.5.2011

(731) **PHARMA SWISS SA**, BUNDESPLATZ 1, 6300 ZUG, CH

# MOFETAN

(540)

(550) I

(740) Radulović Božidar, Jovana Tomaševića 9/III, Podgorica (ME)

(511) **Klasa 05:** Farmaceutski preparati-lijekovi.

(210) **2011-270**

(442) **20.06.2013**

(220) 31.5.2011

(731) **SHOKO HOLDING LIMITED OF CRAIGMUIR CHAMBERS**, ROAD TOWN, TORTOLA, BRITISH VIRGIN ISLANDS, NL



(540)

(550) I

(740) Čejović Vladimir, 13. jula 21, Podgorica (ME)

(511) **Klasa 43:** Usluge obezbjeđivanja hrane i pića; privremeni smještaj.

(210) **2011-303**

(442) **20.06.2013**

(220) 23.6.2011

(731) **THE PROCTER & GAMBLE COMPANY**, ONE PROCTER & GAMBLE PLAZA, CINCINNATI, OHIO 45202 US

# ARIEL PRO-ZIM

(540)

(550) I

(740) Lutovac Branislav, Bulevar Crnojevića 93, Podgorica (ME)

(511) **Klasa 03:** Sredstva za bijeljenje i druge supstance za upotrebu kod pranja veša; preparati za čišćenje, poliranje, ribanje i nagrizanj

(210) **2011-304** (442) **20.06.2013**

(220) 23.6.2011

(731) **THE PROCTER & GAMBLE COMPANY**, ONE PROCTER & GAMBLE PLAZA, CINCINNATI, OHIO 45202 US

**AMBI PUR FRESHELLE**

(540) |

(550) |

(740) Lutovac Branislav, Bulevar Crnojevića 93, Podgorica (ME)

(511) **Klasa 03:** Sredstva za pranje i bijeljenje i druge supstance za upotrebu pri pranju; preparati za negu, tretiranje i ulepšavanje tkanina; preparati za čišćenje, poliranje, ribanje i nagrižanje; potpuri; tamjan; ulja za parfeme i mirise; mirišljava voda za upotrebu u domaćinstvu i na tkaninama; mirišljivo drvo; aromatični preparati; eterična ulja; preparati za nadimljavanje koji se ispuštaju u vazduh, atmosferu ili na tkanine u obliku dima, pare ili gasa; mirisni ili parfimisani preparati za vazduh.

**Klasa 04:** Jedinjenja za skupljanje prašine vlaženjem i vezivanjem; svijeće, mirišljave ili parfimisane svijeće, svijeće koje ispuštaju u atmosferu mirise ili parfeme; materije za osvetljavanje; vosak za osvetljavanje; tanke svijeće; svijeće u posudama i fitilji.

**Klasa 05:** Osveživači vazduha; preparati za prečišćavanje vazduha; osveživači vazduha za sobnu upotrebu; dezodoransi za tkanine i vazduh; preparati za neutralisanje mirisa.

**Klasa 11:** Aparati i instrumenti za ispuštanje mirisa, prečišćavanje ili osvežavanje atmosfere; djelovi i oprema za svu naprijed navedenu robu; jedinice za aromaterapiju i prečišćavanje vazduha koje rade na baterije ili na struju, kao i punjenja za takve jedinice; samostalni uređaji i filteri za dezodorisanje vazduha koji ne ispuštaju mirise ni druge supstance.

**Klasa 21:** Kuhinjske sprave i posude (koje nisu od dragocjenih metala ili presvučene istim); gorionici za ulja i mirise; aparati za grijanje ulja za parfeme i za ispuštanje mirisa u okolnu atmosferu; dozeri i aparati za raspršivanje parfimerijskih proizvoda, eteričnih ulja i proizvoda za osvežavanje vazduha u okolnu atmosferu; aparati za dezodorisanje; aparati i posude za ispuštanje mirisa u atmosferu ili za raspršivanje parfema, preparata za osvježavanje vazduha ili preparata za prečišćavanje vazduha u okolnu atmosferu; proizvodi od stakla; porcelan i grnčarija.

(210) **2011-305** (442) **20.06.2013**

(220) 23.6.2011

(731) **THE PROCTER & GAMBLE COMPANY**, ONE PROCTER & GAMBLE PLAZA, CINCINNATI, OHIO 45202 US



(540)

(550) I

(740) Lutovac Branislav, Bulevar Crnojevića 93, Podgorica (ME)

(511) **Klasa 03:** Preparati za negu i ulepšavanje tkanina; mirišljava sredstva za kađenje; ulja za parfeme i mirise; mirišljava voda za upotrebu u domaćinstvu i na tkaninama; osveživači tkanina; mirišljivo drvo; aromatični preparati, eterična ulja; preparati za nadimljavanje koji se ispuštaju u vazduh, atmosferu ili na tkanine u obliku dima, pare ili gasa; mirisni ili parfimisani preparati za vazduh i tkanine.

**Klasa 05:** Osveživači vazduha; preparati za prečišćavanje vazduha; osveživači vazduha za sobnu upotrebu; dezodoransi za tkanine i vazduh, preparati za neutralisanje mirisa.

**Klasa 11:** Aparati i instrumenti za ispuštanje mirisa, prečišćavanje ili osvežavanje atmosfere; delovi i oprema za svu napred navedenu robu; jedinice za aromaterapiju i prečišćavanje vazduha koje rade na baterije ili na struju, kao i punjenja za takve jedinice; samostalni uređaji i filteri koji ne ispuštaju mirise ni druge supstance, za otklanjanje neprijatnih mirisa iz frižidera i drugih malih prostora.

(210) **2011-306**

(442) **20.06.2013**

(220) 23.6.2011

(731) **THE PROCTER & GAMBLE COMPANY**, ONE PROCTER & GAMBLE PLAZA, CINCINNATI, OHIO 45202 US



(540)

(550) I

(740) Lutovac Branislav, Bulevar Crnojevića 93, Podgorica (ME)

(511) **Klasa 03:** Sredstva za pranje i bijeljenje za upotrebu u domaćinstvu; preparati za njegu, tretiranje i ulepšavanje tkanina; preparati za čišćenje, poliranje, ribanje i nagrivanje; tamjan; ulja za parfeme i mirise; mirišljava voda za upotrebu u domaćinstvu i na tkaninama; eterična ulja; mirisni preparati za osvežavanje vazduha i tkanina.

(210) **2011-307** (442) **20.06.2013**

(220) 27.6.2011

(731) **ALKALOID AD SKOPLJE**, BUL.ALEKSANDAR MAKEDONSKI 12,1000 SKOPLJE MK

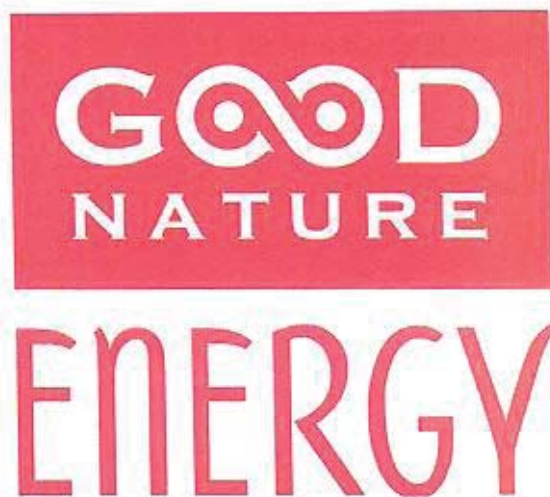

(540)

(550) I

(740) Popović Miladin, Đoka Miraševića 21/III, Podgorica (ME)

(511) **Klasa 29:** Sušeno voće.

**Klasa 31:** Sušeno sjeme-sjeme suncokreta, sjeme bundeve, sjeme badema, sjeme lješnika.

(210) **2011-308** (442) **20.06.2013**

(220) 28.6.2011

(731) **THE PROCTER & GAMBLE COMPANY**, ONE PROCTER & GAMBLE PLAZA, CINCINNATI, OHIO 45202 US

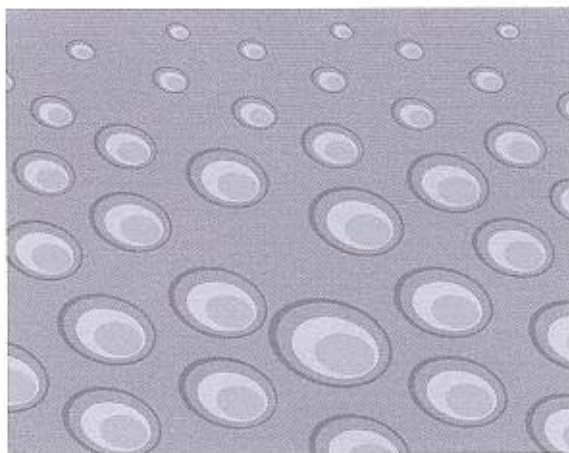

(540)

(550) I

(740) Lutovac Branislav, Bulevar Crnojevića 93, Podgorica (ME)

(511) **Klasa 03:** Sredstva za pranje i bijeljenje za upotrebu u domaćinstvu; preparati za njegu, tretiranje i uljepšavanje tkanina; preparati za čišćenje, poliranje, ribanje i nagrizanje; tamjan; ulja za parfeme i mirise; mirišljava voda za upotrebu u domaćinstvu i na tkaninama; eterična ulja; mirišljava sredstva za osvježavanje vazduha i tkanina.

(210) **2011-309**

(442) **20.06.2013**

(220) 28.6.2011

(731) **THE PROCTER & GAMBLE COMPANY**, ONE PROCTER & GAMBLE PLAZA, CINCINNATI, OHIO 45202 US



(540)

(550) I

(740) Lutovac Branislav, Bulevar Crnojevića 93, Podgorica (ME)

(511) **Klasa 16:** Pelene za jednokratnu upotrebu.

(210) **2011-310**

(442) **20.06.2013**

(220) 28.6.2011

(731) **THE PROCTER & GAMBLE COMPANY**, ONE PROCTER & GAMBLE PLAZA, CINCINNATI, OHIO 45202 US

računara

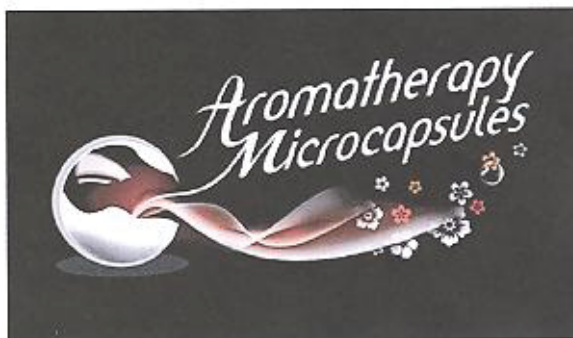

(540)

(550) I

(740) Lutovac Branislav, Bulevar Crnojevića 93, Podgorica (ME)

(511) **Klasa 03:** Sredstva za pranje, bijeljenje i druga sredstva za upotrebu kod pranja veša; preparati za čišćenje, poliranje, ribanje i nagrizanje; omekšivači tkanina; sapuni za upotrebu u domaćinstvu.

(210) **2011-311** (442) **20.06.2013**

(220) 28.6.2011

(731) **PROCTER & GAMBLE HOLDING GMBH**, 40-50 SULZBACHER STRASSE, 65824 SCHWALBACH, DE

**blend-a-med**   
PRO·EXPERT

(540)

(550) I

(740) Lutovac Branislav, Bulevar Crnojevića 93, Podgorica (ME)

(511) **Klasa 03:** Preparati za njegu i higijenu usta, zuba, grla, desni i usne duplje, preparati za ispiranje zaprevenciju kamenca i karijesa, preparati za čišćenje zuba, preparati za njegu zuba, paste za zube, sredstva za ispiranje usta, sprejevi za usta, gelovi za zube, gelovi sa fluorom, sredstva za ispiranje usta sa fluorom, praškovi za čišćenje, tablete za bojenje kamenca.

**Klasa 21:** Četkice za zube; električne četkice za zube; materijali pripremljeni za pravljenje četkica, neelektrični instrumenti i materijali za čišćenje usta, zuba i usne duplje; djelovi i oprema za naprijed navedenu robu; zubni konac, držači za zubnikonac, čačkalice, držači za čačkalice, četke; držači i kutije za automatsko izdavanje (dispenseri) za naprijed navedenu robu; četkice za desni, interdentalne četkice.

(210) **2011-312** (442) **20.06.2013**

(220) 28.6.2011

(731) **THE PROCTER & GAMBLE COMPANY**, ONE PROCTER & GAMBLE PLAZA, CINCINNATI, OHIO 45202 US

**COLOUR THERAPY**

(540)

(550) I

(740) Lutovac Branislav, Bulevar Crnojevića 93, Podgorica (ME)

(511) **Klasa 03:** Kozmetički preparati za kosu, losioni za kosu, preparati za čišćenje, njegu i uljepšavanje kože glave i kose, proizvodi za oblikovanje frizure, preparati za nijansiranje, blajhanje, farbanje i kolorisanje kose.

(210) **2011-313** (442) **20.06.2013**

(220) 28.6.2011

(731) **THE PROCTER & GAMBLE COMPANY**, ONE PROCTER & GAMBLE PLAZA, CINCINNATI, OHIO 45202 US

## DAZZLING SHINE

(540)

(550) I

(740) Lutovac Branislav, Bulevar Crnojevića 93, Podgorica (ME)

(511) **Klasa 03:** Sapuni, parfimerija, eterična ulja, kozmetički preparati, losioni za kosu, preparati za čišćenje, njegu i uljepšavanje kože, kože glave i kose, proizvodi za oblikovanje frizure, preparati za nijansiranje, blajhanje, farbanje i kolorisanje kose.

---

(210) **2011-314**

(442) **20.06.2013**

(220) 28.6.2011

(731) **THE PROCTER & GAMBLE COMPANY**, ONE PROCTER & GAMBLE PLAZA, CINCINNATI, OHIO 45202 US

## FIRED DANDRUFF

(540)

(550) I

(740) Lutovac Branislav, Bulevar Crnojevića 93, Podgorica (ME)

(511) **Klasa 03:** Sapuni, parfimerija, eterična ulja, kozmetički preparati, losioni za kosu, preparati za čišćenje, njegu i uljepšavanje kože, kože glave i kose, proizvodi za oblikovanje frizure, preparati za nijansiranje, blajhanje, farbanje i kolorisanje kose.

---

(210) **2011-315**

(442) **20.06.2013**

(220) 28.6.2011

(731) **THE PROCTER & GAMBLE COMPANY**, ONE PROCTER & GAMBLE PLAZA, CINCINNATI, OHIO 45202 US

## CLAIROL HERBAL ESSENCES DAZZLING SHINE

(540)

(550) I

(740) Lutovac Branislav, Bulevar Crnojevića 93, Podgorica (ME)

(511) **Klasa 03:** Sapuni, parfimerija, eterična ulja, kozmetički preparati, losioni za kosu, preparati za čišćenje, njegu i uljepšavanje kože, kože glave i kose, proizvodi za oblikovanje frizure, preparati za nijansiranje, blajhanje, farbanje i kolorisanje kose.

---

(210) **2011-316**

(442) **20.06.2013**

(220) 28.6.2011

(731) **THE PROCTER & GAMBLE COMPANY**, ONE PROCTER & GAMBLE PLAZA, CINCINNATI, OHIO 45202 US



## FRESH BALANCE

(540)

(550) |

(740) Lutovac Branislav, Bulevar Crnojevića 93, Podgorica (ME)

(511) **Klasa 03:** Sapuni, parfimerija, eterična ulja, kozmetički preparati, losioni za kosu, preparati za čišćenje, njegu i uljepšavanje kože, kože glave i kose, proizvodi za oblikovanje frizure, preparati za nijansiranje, blajhanje, farbanje i kolorisanje kose.

(210) **2011-317**

(442) **20.06.2013**

(220) 28.6.2011

(731) **THE PROCTER & GAMBLE COMPANY**, ONE PROCTER & GAMBLE PLAZA, CINCINNATI, OHIO 45202 US

## HAPPY COLOUR

(540)

(550) |

(740) Lutovac Branislav, Bulevar Crnojevića 93, Podgorica (ME)

(511) **Klasa 03:** Sapuni, parfimerija, eterična ulja, kozmetički preparati, losioni za kosu, preparati za čišćenje, njegu i uljepšavanje kože, kože glave i kose, proizvodi za oblikovanje frizure, preparati za nijansiranje, blajhanje, farbanje i kolorisanje kose.

(210) **2011-318**

(442) **20.06.2013**

(220) 28.6.2011

(731) **THE PROCTER & GAMBLE COMPANY**, ONE PROCTER & GAMBLE PLAZA, CINCINNATI, OHIO 45202 US

## HELLO HYDRATION

(540)

(550) |

(740) Lutovac Branislav, Bulevar Crnojevića 93, Podgorica (ME)

(511) **Klasa 03:** Sapuni, parfimerija, eterična ulja, kozmetički preparati, losioni za kosu, preparati za čišćenje, njegu i uljepšavanje kože, kože glave i kose, proizvodi za oblikovanje frizure, preparati za nijansiranje, blajhanje, farbanje i kolorisanje kose.

(210) **2011-319**

(442) **20.06.2013**

(220) 28.6.2011

(731) **THE PROCTER & GAMBLE COMPANY**, ONE PROCTER & GAMBLE PLAZA, CINCINNATI, OHIO 45202 US

## HERBAL ESSENCES

(540)

(550) I

(740) Lutovac Branislav, Bulevar Crnojevića 93, Podgorica (ME)

(511) **Klasa 03:** Sapuni, parfimerija, eterična ulja, kozmetički preparati, losioni za kosu, preparati za čišćenje, njegu i uljepšavanje kože, kože glave i kose, proizvodi za oblikovanje frizure, preparati za nijansiranje, blajhanje, farbanje i kolorisanje kose.

(210) **2011-320**

(442) **20.06.2013**

(220) 28.6.2011

(731) **THE PROCTER & GAMBLE COMPANY**, ONE PROCTER & GAMBLE PLAZA, CINCINNATI, OHIO 45202 US

## IGNITE MY COLOUR

(540)

(550) I

(740) Lutovac Branislav, Bulevar Crnojevića 93, Podgorica (ME)

(511) **Klasa 03:** Sapuni, parfimerija, eterična ulja, kozmetički preparati, losioni za kosu, preparati za čišćenje, njegu i uljepšavanje kože, kože glave i kose, proizvodi za oblikovanje frizure, preparati za nijansiranje, blajhanje, farbanje i kolorisanje kose.

(210) **2011-321**

(442) **20.06.2013**

(220) 28.6.2011

(731) **THE PROCTER & GAMBLE COMPANY**, ONE PROCTER & GAMBLE PLAZA, CINCINNATI, OHIO 45202 US

## INFRIZZABLE WOMAN

(540)

(550) I

(740) Lutovac Branislav, Bulevar Crnojevića 93, Podgorica (ME)

(511) **Klasa 03:** Sapuni, parfimerija, eterična ulja, kozmetički preparati, losioni za kosu, preparati za čišćenje, njegu i uljepšavanje kože, kože glave i kose, proizvodi za oblikovanje frizure, preparati za nijansiranje, blajhanje, farbanje i kolorisanje kose.

(210) **2011-322**

(442) **20.06.2013**

(220) 28.6.2011

(731) **THE PROCTER & GAMBLE COMPANY**, ONE PROCTER & GAMBLE PLAZA, CINCINNATI, OHIO 45202 US

## IT'S A CURL THING

(540)

(550) I

(740) Lutovac Branislav, Bulevar Crnojevića 93, Podgorica (ME)

(511) **Klasa 03:** Sapuni, parfimerija, eterična ulja, kozmetički preparati, losioni za kosu, preparati za čišćenje, njegu i uljepšavanje kože, kože glave i kose, proizvodi za oblikovanje frizure, preparati za nijansiranje, blajhanje, farbanje i kolorisanje kose.

(210) **2011-323**

(442) **20.06.2013**

(220) 28.6.2011

(731) **THE PROCTER & GAMBLE COMPANY**, ONE PROCTER & GAMBLE PLAZA, CINCINNATI, OHIO 45202 US

## BODY ENVY

(540)

(550) I

(740) Lutovac Branislav, Bulevar Crnojevića 93, Podgorica (ME)

(511) **Klasa 03:** Sapuni, parfimerija, eterična ulja, kozmetički preparati, losioni za kosu, preparati za čišćenje, njegu i uljepšavanje kože, kože glave i kose, proizvodi za oblikovanje frizure, preparati za nijansiranje, blajhanje, farbanje i kolorisanje kose.

(210) **2011-324**

(442) **20.06.2013**

(220) 28.6.2011

(731) **THE PROCTER & GAMBLE COMPANY**, ONE PROCTER & GAMBLE PLAZA, CINCINNATI, OHIO 45202 US

## CLAIROL HERBAL ESSENCE

(540)

(550) I

(740) Lutovac Branislav, Bulevar Crnojevića 93, Podgorica (ME)

(511) **Klasa 03:** Sapuni, parfimerija, eterična ulja, kozmetički preparati, losioni za kosu, preparati za čišćenje, njegu i uljepšavanje kože, kože glave i kose, proizvodi za oblikovanje frizure, preparati za nijansiranje, blajhanje, farbanje i kolorisanje kose.

(210) **2011-325**

(442) **20.06.2013**

(220) 28.6.2011

(731) **THE PROCTER & GAMBLE COMPANY**, ONE PROCTER & GAMBLE PLAZA, CINCINNATI, OHIO 45202 US

## BREAK'S OVER

(540)

(550) |

(740) Lutovac Branislav, Bulevar Crnojevića 93, Podgorica (ME)

(511) **Klasa 03:** Sapuni, parfimerija, eterična ulja, kozmetički preparati, losioni za kosu, preparati za čišćenje, njegu i uljepšavanje kože, kože glave i kose, proizvodi za oblikovanje frizure, preparati za nijansiranje, blajhanje, farbanje i kolorisanje kose.

(210) **2011-326**

(442) **20.06.2013**

(220) 28.6.2011

(731) **THE PROCTER & GAMBLE COMPANY**, ONE PROCTER & GAMBLE PLAZA, CINCINNATI, OHIO 45202 US

LENOR MAGNEFIQUE

(540)

(550) |

(740) Lutovac Branislav, Bulevar Crnojevića 93, Podgorica (ME)

(511) **Klasa 03:** Sredstva za bijeljenje i druge supstance za upotrebu kod pranja veša; preparati za njegu, tretiranje i uljepšavanje tkanina; preparati za čišćenje, poliranje, ribanje i nagrižanje; preparati za nadimljavanje za emitovanje u vazduh, atmosferu ili na tkanine u obliku dima, isparenja ili gasa

(210) **2011-327**

(442) **20.06.2013**

(220) 29.6.2011

(731) **THE PROCTER & GAMBLE COMPANY**, ONE PROCTER & GAMBLE PLAZA, CINCINNATI, OHIO 45202 US

NO FLAKIN' WAY

(540)

(550) |

(740) Lutovac Branislav, Bulevar Crnojevića 93, Podgorica (ME)

(511) **Klasa 03:** Sapuni, parfimerija, eterična ulja, kozmetički preparati, losioni za kosu, preparati za čišćenje, njegu i uljepšavanje kože, kože glave i kose, proizvodi za oblikovanje frizure, preparati za nijansiranje, blajhanje, farbanje i kolorisanje kose.

(210) **2011-328**

(442) **20.06.2013**

(220) 29.6.2011

(731) **THE PROCTER & GAMBLE COMPANY**, ONE PROCTER & GAMBLE PLAZA, CINCINNATI, OHIO 45202 US



(540)

(550) I

(740) Lutovac Branislav, Bulevar Crnojevića 93, Podgorica (ME)

(511) **Klasa 03:** Sredstva za bijeljenje i druge supstance za upotrebu kod pranja veša; preparati za čišćenje, poliranje, nagrizajuća sredstva, abrazivna sredstva; omekšivači tkanina; sapuni; parfimerija, eterična ulja, kozmetika, losioni za kosu; proizvodi za njegu zuba.(210) **2011-329**(442) **20.06.2013**

(220) 29.6.2011

(731) **THE PROCTER & GAMBLE COMPANY**, ONE PROCTER & GAMBLE PLAZA, CINCINNATI, OHIO 45202 US

## LENOR SUBTILE

(540)

(550) I

(740) Lutovac Branislav, Bulevar Crnojevića 93, Podgorica (ME)

(511) **Klasa 03:** Sredstva za pranje i bijeljenje i druge supstance za upotrebu kod pranja veša; preparati za njegu, tretiranje i uljepšavanje tkanina; preparati za čišćenje, poliranje, ribanje i nagrizanje; parfemski ili mirišljavi preparati za osvežavanje vazduha.(210) **2011-330**(442) **20.06.2013**

(220) 29.6.2011

(731) **THE PROCTER & GAMBLE COMPANY**, ONE PROCTER & GAMBLE PLAZA, CINCINNATI, OHIO 45202 US

*premium  
care*

(540)

(550) I

(740) Lutovac Branislav, Bulevar Crnojevića 93, Podgorica (ME)

(511) **Klasa 03:** Maramice impregnirane sredstvima za ličnu higijenu ili kozmetičkim preparatima.

**Klasa 16:** Pelene za jednokratnu upotrebu od papira i/ili celuloze; papirnati proizvodi za ličnu upotrebu i upotrebu u domaćinstvu kao što su papirni ubrusi, papirne salvete, toalet papir, maramice za lice i drugi mekani papirnati proizvodi.

(210) **2011-331**

(442) **20.06.2013**

(220) 29.6.2011

(731) **THE PROCTER & GAMBLE COMPANY**, ONE PROCTER & GAMBLE PLAZA, CINCINNATI, OHIO 45202 US



(540) .....

(550) I

(740) Lutovac Branislav, Bulevar Crnojevića 93, Podgorica (ME)

(511) **Klasa 03:** Sapuni, parfimerija, eterična ulja, kozmetički preparati, losioni za kosu, preparati za čišćenje, njegu i uljepšavanje kože, kože glave i kose, proizvodi za oblikovanje frizure, preparati za nijansiranje, blajhanje, farbanje i kolorisanje kose.

(210) **2011-332**

(442) **20.06.2013**

(220) 30.6.2011

(731) **THE PROCTER & GAMBLE COMPANY**, ONE PROCTER & GAMBLE PLAZA, CINCINNATI, OHIO 45202 US



(540) -----

(550) I

(740) Lutovac Branislav, Bulevar Crnojevića 93, Podgorica (ME)

(511) **Klasa 03:** Sapuni, parfimerija, eterična ulja, kozmetički preparati, losioni za kosu, preparati za čišćenje, njegu i uljepšavanje kože, kože glave i kose, proizvodi za oblikovanje frizure, preparati za nijansiranje, blajhanje, farbanje i kolorisanje kose.

(210) **2011-333**

(442) **20.06.2013**

(220) 30.6.2011

(731) **THE PROCTER & GAMBLE COMPANY**, ONE PROCTER & GAMBLE PLAZA, CINCINNATI, OHIO 45202 US



(540)

(550) I

(740) Lutovac Branislav, Bulevar Crnojevića 93, Podgorica (ME)

(511) **Klasa 03:** Sapuni, parfimerija, eterična ulja, kozmetički preparati, losioni za kosu, preparati za čišćenje, njegu i uljepšavanje kože, kože glave i kose, proizvodi za oblikovanje frizure, preparati za nijansiranje, blajhanje, farbanje i kolorisanje kose.

(210) **2011-334**

(442) **20.06.2013**

(220) 30.6.2011

(731) **THE PROCTER & GAMBLE COMPANY**, ONE PROCTER & GAMBLE PLAZA, CIN-

CINNATI, OHOI 45202 US



(540) \_\_\_\_\_

(550) I

(740) Lutovac Branislav, Bulevar Crnojevića 93, Podgorica (ME)

(511) **Klasa 03:** Sapuni, parfimerija, eterična ulja, kozmetički preparati, losioni za kosu, preparati za čišćenje, njegu i uljepšavanje kože, kože glave i kose, proizvodi za oblikovanje frizure, preparati za nijansiranje, blajhanje, farbanje i kolorisanje kose.

(210) **2011-335**

(442) **20.06.2013**

(220) 30.6.2011

(731) **THE PROCTER & GAMBLE COMPANY**, ONE PROCTER & GAMBLE PLAZA, CINCINNATI, OHOI 45202 US



(540) \_\_\_\_\_

(550) I

(740) Lutovac Branislav, Bulevar Crnojevića 93, Podgorica (ME)

(511) **Klasa 03:** Sapuni, parfimerija, eterična ulja, kozmetički preparati, losioni za kosu, preparati za čišćenje, njegu i uljepšavanje kože, kože glave i kose.

(210) **2011-336**

(442) **20.06.2013**

(220) 30.6.2011

(731) **SLAĐANA RAIČKOVIĆ**, BEOGRADSKA 7 PODGORICA, ME



financeplus

(540)

(550) I

(511) **Klasa 35:** Oglašavanje Vođenje poslova Poslovno upravljanje Kancelarijski poslovi.

**Klasa 36:** Osiguranje Finansijski poslovi Novčani (monetarni poslovi) Poslovi vezani za nepokretnosti.

**Klasa 41:** Obrazovne usluge Pripremanje obuke Razonoda Sportske i kulturne aktivnosti.

**Klasa 42:** Naučne i tehnološke usluge i istraživanje i projektovanje u vezi navedenih usluga Usluge industrijske analize i istraživanja Projektovanje i razvoj kompjuterskog hardvera i softvera.

**Klasa 45:** Pravne usluge Usluge obezbjeđenja radi zaštite imovine i lica Individualne i društvene usluge koje pružaju drugi, radi zadovoljenja potreba pojedinaca.

(210) **2011-337**

(442) **20.06.2013**

(220) 1.7.2011

(731) **THE PROCTER & GAMBLE COMPANY**, ONE PROCTER & GAMBLE PLAZA, CINCINNATI, OHIO 45202, US

SASSOON

(540)

(550) I

(740) Lutovac Branislav, Bulevar Crnojevića 93, Podgorica (ME)

(511) **Klasa 03:** Sapuni, parfimerija, esencijalna ulja, kozmetika, losioni za kosu, preparati za čišćenje, njegu, tretiranje i uljepšavanje kože, kože glave i kose, uključujući šampone, regeneratore, pjene, gelove i lakove za kosu; sredstva za bijeljenje, farbanje i kolorisanje kose.

**Klasa 11:** Fenovi za kosu i djelovi i oprema za njih.

**Klasa 21:** Četke (osim kičica) i češljevi (uključujući električne i one koje se pokreću baterijama) kao i djelovi i pribor za iste.

**Klasa 41:** Frizerske škole.

**Klasa 42:** Usluge frizerskih salona.

(210) **2011-338**

(442) **20.06.2013**

(220) 1.7.2011

(731) **THE PROCTER & GAMBLE COMPANY**, ONE PROCTER & GAMBLE PLAZA, CINCINNATI, OHIO 45202, US

# SASSOON

(540)

(550) |

(740) Lutovac Branislav, Bulevar Crnojevića 93, Podgorica (ME)

(511) **Klasa 03:** Sapuni, parfimerija, esencijalna ulja, kozmetika, losioni za kosu, preparati za čišćenje, njegu, tretiranje i uljepšavanje kože, kože glave i kose, uključujući šampone, regeneratore, pjene, gelove i lakove za kosu; sredstva za bijeljenje, farbanje i kolorisanje kose.

**Klasa 11:** Fenovi za kosu i djelovi i oprema za njih.

**Klasa 21:** Četke (osim kičica) i češljevi (uključujući električne i one koje se pokreću baterijama) kao i djelovi i pribor za iste.

**Klasa 41:** Frizerske škole.

**Klasa 42:** Usluge frizerskih salona.

---

(210) **2011-339**

(442) **20.06.2013**

(220) 1.7.2011

(731) **THE PROCTER & GAMBLE COMPANY**, ONE PROCTER & GAMBLE PLAZA, CINCINNATI, OHIO 45202, US

# SCENT TOUCH

(540)

(550) |

(740) Lutovac Branislav, Bulevar Crnojevića 93, Podgorica (ME)

(511) **Klasa 03:** Sredstva za pranje i bijeljenje i druge supstance z upotrebu kod pranja veša; preparati za čišćenje, poliranje nagrizajuća sredstva, abrazivna sredstva; sapuni parfimerija, eterična ulja, kozmetika, losioni za kosu proizvodi za njegu zuba.

---

(210) **2011-340**

(442) **20.06.2013**

(220) 1.7.2011

(731) **THE PROCTER & GAMBLE COMPANY**, ONE PROCTER & GAMBLE PLAZA, CINCINNATI, OHIO 45202, US

# TOTALLY TWISTED

(540)

(550) |

(740) Lutovac Branislav, Bulevar Crnojevića 93, Podgorica (ME)

(511) **Klasa 03:** Sapuni, parfimerija, eterična ulja, kozmetički preparati, losioni za kosu, preparati za čišćenje, njegu i uljepšavanje kože, kože glave i kose, proizvodi za oblikovanje frizure, preparati za nijansiranje, blajhanje, farbanje i kolorisanje kose.

(210) **2011-341** (442) **20.06.2013**  
(220) 1.7.2011

(731) **THE PROCTER & GAMBLE COMPANY**, ONE PROCTER & GAMBLE PLAZA, CINCINNATI, OHIO 45202, US;

## UPLIFTING VOLUME

(540)

(550) I

(740) Lutovac Branislav, Bulevar Crnojevića 93, Podgorica (ME)

(511) **Klasa 03:** Sapuni, parfimerija, eterična ulja, kozmetički preparati, losioni za kosu, preparati za čišćenje, njegu i uljepšavanje kože, kože glave i kose, proizvodi za oblikovanje frizure, preparati za nijansiranje, blajhanje, farbanje i kolorisanje kose.

(210) **2011-342** (442) **20.06.2013**  
(220) 1.7.2011

(731) **THE PROCTER & GAMBLE COMPANY**, ONE PROCTER & GAMBLE PLAZA, CINCINNATI, OHIO 45202, US

## VAPORUB

(540)

(550) I

(740) Lutovac Branislav, Bulevar Crnojevića 93, Podgorica (ME)

(511) **Klasa 03:** Kozmetički proizvodi, sredstva za ispiranje usta i njegu zuba.

**Klasa 05:** Farmaceutski proizvodi, veterinarski proizvodi, sredstva za dezinfekciju i sterilizaciju i održavanje u sterilizovanom stanju, tablete i sirupi protiv kašlja

**Klasa 10:** Pipete za lijekove

**Klasa 30:** Hranljivi proizvodi, biskviti, kolači, poslastice

(210) **2011-343** (442) **20.06.2013**  
(220) 1.7.2011

(731) **THE PROCTER & GAMBLE COMPANY**, ONE PROCTER & GAMBLE PLAZA, CINCINNATI, OHIO 45202, US

# VICKS

(540)

(550) I

(740) Lutovac Branislav, Bulevar Crnojevića 93, Podgorica (ME)

(511) **Klasa 03:** Kozmetički proizvodi, sredstva za ispiranje usta i njegu zuba.

**Klasa 05:** Farmaceutski proizvodi, veterinarski proizvodi, sredstva za dezinfekciju i sterilizaciju i održavanje u sterilizovanom stanju, tablete i sirupi protiv kašlja

**Klasa 10:** Pipete za lijekove

**Klasa 30:** Hranljivi proizvodi, biskviti, kolači, poslastice

---

(210) **2011-344**

(442) **20.06.2013**

(220) 1.7.2011

(731) **THE GILLETTE COMPANY**, ONE GILLETTE PARK, BOSTON, MASSACHUSETTS 02127, US

# VENUS OCEANA

(540)

(550) I

(740) Lutovac Branislav, Bulevar Crnojevića 93, Podgorica (ME)

(511) **Klasa 08:** Brijači za jednokratnu upotrebu.

---

(210) **2011-345**

(442) **20.06.2013**

(220) 1.7.2011

(731) **COORS BREWING COMPANY**, 1225 17 STREET, SUITE 3200 DENVER, COLORADO, 80202 US



(540)

(550) I

(740) Ćupić Branislav, Dalmatinska 10, Podgorica (ME)

(511) **Klasa 25:** Odjeća, obuća, pokrivala za glavu.

**Klasa 32:** Piva, tamna piva, svijetla piva, crna i laka piva; mineralne i sodne vode i druga bezalkoholna pica; voćna pica i voćni sokovi; sirupi i drugi preparati za proizvodnju pica.

**Klasa 33:** Alkoholna pica (izuzev piva).

(210) **2011-347**

(442) **20.06.2013**

(220) 5.7.2011

(300) GR 212272/2011 9.3. 2011

(731) **CHIPITA INDUSTRIAL AND COMMERCIAL COMPANY S.A.**, 12 KM NATIONAL ROAD ATHENS-LAMIA, METAMOFOSI, 14452, GR



(540)

(550) I

(740) Đakonović Vido, Bajova 8, Cetinje, (ME)

(511) **Klasa 29:** Proizvodi od krompira bilo koje vrste; Grickalice na bazi krompira; Čips od krompira.

**Klasa 30:** Slane grickalice; Ekstrudirane grickalice; Grickalice sa ukusom sira; Grickalice na bazi pirinča, izuzev žitarica za doručak i štapića na bazi žitarica; grickalice na bazi pšenice, izuzev žitarica za doručak i cerealnih štapića; grickalice na bazi kukuruza, izuzev žitarica za doručak i cerealnih štapića.

(210) **2011-348**

(442) **20.06.2013**

(220) 6.7.2011

(731) **MITSUBISHI JIDOSHA KOGYO KABUSHIKI KAISHA**, 33-8, SHIBA 5-CHOME, MINATO-KU, TOKYO (JP), JP

MIEV

(540)

(550) I

(740) Radulović Božidar, Jovana Tomaševića 9/III, Podgorica (ME)

(511) **Klasa 12:** Automobili i njihovi dijelovi i oprema; motocikli i njihovi dijelovi i oprema; bicikli i njihovi dijelovi i oprema; motori (ne-električni) za kopnena vozila; plovila i njihovi dijelovi i oprema; letilice i njihovi dijelovi i oprema; transmisioni elementi i zupčasti prenosnici za kopnena vozila; amortizeri za kopnena vozila; opruge za kopnena vozila.

(210) **2011-349** (442) **20.06.2013**  
(220) 8.7.2011

(731) **EXPO COMMERCE DOO KOTOR**, RADANOVIĆI INDUSTRIJSKA ZONA, KOTOR ME



(540) \_\_\_\_\_

(550) I

(511) **Klasa 35:** Oglašavanje; vođenje poslova; poslovno upravljanje; kancelarijski poslovi.

(210) **2011-350** (442) **20.06.2013**  
(220) 8.7.2011

(731) **FOOD INDUSTRY DOO PODGORICA**, PUT RADOMIRA IVANOVIĆA BR.2, PODGORICA ME



(540) \_\_\_\_\_

(550) I

(511) **Klasa 30:** Kafa, čaj, kakao, šećer, pirinač, apioka, sago, zamjena kafe; brašno i proizvodi ožitarica, hleb, kolači i poslastice, sladoledi med, melasa, kvasac, prašak za pecivo, so, senf, sirće, sosovi (kao dodaci); začini, led.

(210) **2011-351** (442) **20.06.2013**  
(220) 11.7.2011

(731) **THE GILLETTE COMPANY**, ONE GILLETTE PARK, BOSTON, MA 02127, US

# GILLETTE PRO

(540) \_\_\_\_\_

(550) I

(740) Lutovac Branislav, Bulevar Crnojevića 93, Podgorica (ME)

(511) **Klasa 03:** Sredstva za pranje tijela; anti-perspiranti i dezodoransi za ličnu upotrebu; sredstva za brijanje, naročito kreme za brijanje, gelovi za brijanje, losioni za brijanje i pjene za brijanje; sredstva za posle brijanja („after-šejv“), losioni, melemi i gelovi za posle brijanja; sredstva za pranje lica i piling lica prije brijanja; preparati za njegu kože, naročito hidratantne kreme; i toaletne vodice.

(210) **2011-352** (442) **20.06.2013**

(220) 12.7.2011

(731) **DUVANSKI KOMBINAT, AD, U STEČAJU**, PODGORICA, NASELJE KRUŠEVAC BB  
PODGORICA, ME

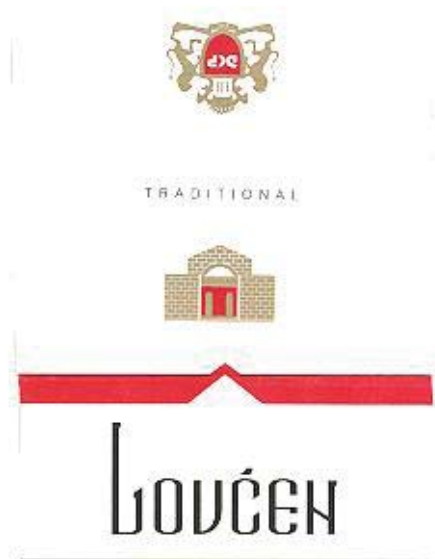

(540) \_\_\_\_\_

(550) I

(511) **Klasa 34:** duvan; artikli za pušenje; šibice.

(210) **2011-353** (442) **20.06.2013**

(220) 12.7.2011

(731) **DUVANSKI KOMBINAT, AD, U STEČAJU**, PODGORICA, NASELJE KRUŠEVAC BB  
PODGORICA, ME



(540) \_\_\_\_\_

(550) I

(511) **Klasa 34:** duvan; artikli za pušenje; šibice.

(210) **2011-354**(442) **20.06.2013**

(220) 12.7.2011

(731) **TDR ROVINJ**, OBALA VLADIMIRA NAZORA 1, 52210 ROVINJ, HR(540) **čanskoj klasifikaciji:**

(550) I

(740) Vukotić Petar, Novaka Miloševa, Podgorica (ME)

(511) **Klasa 34:** duvan sirov i preraden, proizvodi od duvana. cigare, cigarete, filter, cigarete, cigarilosi. artikli za pušaće, upaljači, šibice.

**Klasa 35:** usluge u vezi sa prometom robe, posebno usluge u prometu duvana i duvanskih proizvoda; oglašavanje; vođenje poslova; poslovno upravljanje; kancelarijski poslovi; komercijalno zastupanje; propagandne i reklamne usluge; marketing; usluge istraživanja tržišta; usluge promocije, posebno promovisanje ili reklamiranje kulturnih i zabavnih događaja, sportskih takmičenja i modnih revija; organizovanje i vođenje sajмова i izložbi u reklamne i komercijalne svrhe; naprijed navedene usluge koje pripadaju ovoj klasi koje se obavljaju putem interneta; davanje i širenje informacija u vezi sa gore navedenim uslugama.

(210) **2011-355**(442) **20.06.2013**

(220) 12.7.2011

(731) **JOHNSON CONTROLS HYBRID AND RECYCLING GMBH**, AM LEINNEUFER, 30419 DE

(540)

(550) I



(740) Popović Miladin, Đoka Miraševića 21/III, Podgorica (ME)

(511) **Klasa 07:** Mašine za proizvodnju baterija, naročito baterija za motorna vozila.

**Klasa 09:** Aparati za provodjenje, distribuciju, transformaciju, akumulaciju, regulisanje i kontrolu električne energije; akumulatori, baterije i punjači za baterije, uključujući automobilske akumulatorne i punjače; uređaji za kontrolu baterija.

(210) **2011-356**

(442) **20.06.2013**

(220) 15.7.2011

(731) **STADION DOO**, PODGORICA, ME



(540)

(550) I

(511) **Klasa 30:** kava, čaj, kakao, šećer, riža, tapioka, sago, nadomjesci kave; brašno i proizvodi od žitarica, kruh, kolači, slastice, bomboni; sladoled; med, sirup od melase; kvasac, prašak za dizanje; sol, slačica (senf); ocat, umaci (začini); mirođije; led za hlađenje.

(210) **2011-357**

(442) **20.06.2013**

(220) 15.7.2011

(300) CTM BR.9984436 OD 20 05 2011

(731) **BRITISH AMERICAN TOBACCO (BRANDS) INC.**, 2711 CENTERVILLE ROAD, SUITE 300, WILMINGTON, DELAWARE 19808 US



(540)

(550) I

(740) Popović Miladin, Đoka Miraševića 21/III, Podgorica (ME)

(511) **Klasa 34:** Cigarete; duvan; proizvodi od duvana; upaljači; šibice; artikli za pušače.

(210) **2011-358**(442) **20.06.2013**

(220) 15.7.2011

(731) **FARMONT MP DOO**, UL. 8 MARTA BR. 55 PODGORICA, ME

(540)

(550) I

(511) **Klasa 03:** Sredstva za bjeljenje i druge supstance za upotrebu u perionicama; preparati za čišćenje, poliranje, ribanje i nagrizanje; sapuni; parfimerija, eterična ulja, kozmetika, losioni za kosu; paste za zube.

**Klasa 05:** Farmaceutski i veterinarski preparati; sanitarni preparati za medicinsku upotrebu; dijetetske supstance prilagodene za upotrebu u medicini, hrana za bebe; flasteri, materijali za zavijanje; materijali za plombiranje zuba, zubarska smola; dezinfekciona sredstva; preparati za uništavanje štetočina; fungicidi, herbicidi.

**Klasa 10:** Hirurški, medicinski, zubarski i veterinarski aparati i instrumenti, vještački udovi, oči i zubi; ortopedski artikli; hirurški materijali za zašivanje.

**Klasa 31:** Poljoprivredni, vrtlarski i šumarski proizvodi i zrnevlje koji nisu uključeni u druge klase; žive životinje; svježe voće i povrće; sjeme, prirodne biljke i cvijeće; hrana za životinje; slad; ljekovito bilje i šumski plodovi.

**Klasa 35:** Oglašavanje; vođenje poslova; poslovno upravljanje; promet lijekova, medicinskog i sa otkup ljekovitog bilja i šumskih plodova.

**Klasa 37:** Građevinsko konstruisanje; popravljavanje; usluge instaliranja (instalacione usluge).

**Klasa 39:** Transportne usluge; pakovanje i skladištenje robe; organizovanje putovanja.

**Klasa 44:** Medicinske usluge; veterinarske usluge; higijenska zaštita i njega ljepote za ljude ili životinje; agrikulturne, hortikulturne i šumarske usluge; farmaceutske usluge; plantažno gajenje ljekovitog bilja i šumskih plodova.

(210) **2011-359**(442) **20.06.2013**

(220) 15.7.2011

(731) **ABBOTT PRODUCTS OPERATIONS AG**, HEGENHEIMERMATTWEG 127, 4123 ALLSCHWIL, CH

TEVEZIDE

(540)

(550) I

(740) Čejović Vladimir, 13. jula 21, Podgorica (ME)

(511) **Klasa 05:** Kardiovaskularni preparati sa eprosartanom kao aktivnim sastojkom.

(210) **2011-36**

(442) **20.06.2013**

(220) 28.1.2011

(731) **CONTRACTWORLD DOO**, UL.SLOBODE BR.16/11, ME



(540)

(550) I

(511) **Klasa 02:** Boje, sredstva za zaštitu od truljenja drveta.

**Klasa 20:** Namještaj.

**Klasa 24:** Tekstil, tekstilni proizvodi.

**Klasa 27:** Tepisi, asure, prostirke i otirači, linoleum i drugi materijali za pokrivanje podova, prekrivači za zidove (netekstilni).

(210) **2011-360**

(442) **20.06.2013**

(220) 15.7.2011

(731) **UNIPHARM.INC**, 350 FIFTH AVE., STE.6701 NEW YORK, NY 10118. US

# VITRUM

(540)

(550) I

(740) Ćupić Branislav, Dalmatinska 10, Podgorica (ME)

(511) **Klasa 05:** Aminokiseline za medicinske potrebe; bujoni (hranjive podloge za bakterije) za bakteriološke kulture; balzami za medicinske potrebe; medicinske narukvice; pamuk za medicinske potrebe; dijetne tvari za medicinske potrebe; mineralne vode za medicinske potrebe; nehranjiva jestiva biljna vlakna; dezodorirajuća sredstva osim onih za biljnu upotrebu; ulje iz bakalareve jetre; jod za farmaceutsku upotrebu; alkalni jod za farmaceutsku upotrebu; kapsule za lijekove; kapsule za farmaceutske potrebe; šećer za medicinske potrebe; slatkiši za farmaceutske potrebe; kore za farmaceutske potrebe; ljekovito korijenje; flasteri (court plaster); losioni za farmaceutsku upotrebu; masti za farmaceutske potrebe; ulje za medicinske potrebe; materijal za zavijanje rana; hrana u prahu za dojenčad; brašno za farmaceutske potrebe; dijetni napici za medicinske potrebe; medicinske infuzije; uvarci za farmaceutske potrebe (dekokti); flasteri za medicinske potrebe; bakteriološki preparati za medicinske ili veterinarske potrebe; biološki preparati za medicinske potrebe; veterinarski proizvodi; vitaminski pripravci; sredstva za osvježavanje zraka; proizvodi za pročišćavanje

zraka; ogrlica protiv nametnika za životinje; herbicidi; paraziticidi; farmaceutuski proizvodi za njegu kože; medicinske kupke; medicinski pripravci za rast kose; preparati mikroelemenata za ljudsku i životinjsku prehranu; farmaceutuski proizvodi; hemijsko-farmaceutuski proizvodi; hemijski preparati za medicinske potrebe; namirnice na osnovi bjelančevina za medicinske potrebe; hrana za dojenčad; dijetna hrana za medicinske potrebe; žvakaća guma za medicinske potrebe; higijenski ubrusići za mjesečnicu; higijenski ulošci; natopljeni medicinski ubrusići; sirupi za farmaceutuske potrebe; cigarete bez duvana za medicinske potrebe; soli za medicinske kupke; soli za medicinske potrebe; dezinfekcijska sredstva za higijenske potrebe; sredstva za smanjenje apetita za medicinske svrhe; dijetne tvari za medicinske potrebe; medicinski proizvodi za njegu usta; deterdženti za medicinske potrebe; digestivna sredstva za farmaceutuske potrebe; tonici za medicinske potrebe; trave za pušenje za medicinske svrhe; čaj od trava za medicinske potrebe; biljni čajevi za medicinske potrebe; farmaceutuski proizvodi.

(210) **2011-361**

(442) **20.06.2013**

(220) 18.7.2011

(731) **CUMMINS FILTRATION INC.**, 500 JACKSON STREET, COLUMBUS, INDIANA, US



(540)

(550) I

(740) Popović Miladin, Đoka Miraševića 21/III, Podgorica (ME)

(511) **Klasa 07:** Mašine i mašinski alati; motori i pogonske mašine (osim za suvozemna vozila); djelovi i dodaci za motore i pogonske mašine; mašinske spojnice i transmisioni elementi (osim za suvozemna vozila); poljoprivredne sprave osim onih kojima se ručno upravlja; inkubatori za jaja; pogonske mašine za sagorijevanje na dizel i benzin i njihovi djelovi; pogonske mašine za sagorijevanje; Generatori struje i njihovi djelovi; filteri za ulje; filteri za ulje, benzin, dizel gorivo i vazduh za motore i pogonske mašine; Uređaji protiv zagađenja za motore, pogonske mašine i industrijske instalacije; turbokompresori i djelovi toga; filteri za gorivo i strukturalni djelovi toga; filteri za vazduh i ulje i strukturalni djelovi toga; filteri za vazduh i ulje za mehaničke svrhe; filteri za hidraulične tečnosti za mehaničke svrhe; filteri za ulje, benzin, vazduh i gorivo za motore i mašinske pogone za suvozemna i nautička vozila; kaništeri i kućišta za sve navedene filtere; aparati, uređaji i filteri za smanjenje emisije izduvnih gasova i smanjene buke kod korišćenja pogonskih mašina.

(210) **2011-362**

(442) **20.06.2013**

(220) 18.7.2011

(731) **ALDO GROUP INTERNATIONAL**, LINDENSTRASSE 8 6340 BAAR, ZG CH

# CALL IT SPRING

(540)

(550) I

(740) Popović Miladin, Đoka Miraševića 21/III, Podgorica (ME)

(511) **Klasa 03:** Kozmetika; parfimerija; eterična ulja i sapuni; preparati za održavanje obuće i odeće, naime, preparati za poliranje cipela, preparati za čišćenje na bazi aerosoli i bez aerosoli i preparati za zaštitu kože, jelenske kože i tkanine.

**Klasa 09:** Naočare za sunce.

**Klasa 14:** Modna oprema, naime, nakit, satovi i privesci za ključeve.

**Klasa 18:** Torbe za nošenje svih namena, naime, ručne torbe, torbe preko ramena, velike ručne torbe, sportske putne torbe, rančevi, torbe za kompjuter i torbe za nošenje cipela; novčanici; kišobrani.

**Klasa 25:** Obuća, naime, cipele, čizme, mokasine, cipele za šetnju, patike, atletske cipele, sandale i papuče; oprema za obuću, naime, unutrašnji đonovi za cipele, umeci za cipele, dodaci protiv klizanja za cipele; odeća, naime, kaputi, jakne, prsluci, kupaći kostimi, šalovi, rukavice, rukavice bez prstiju sa palcem, šeširi, kaiševi, kravate, pletene čarape; koža i jelenske kože, naime, kaputi, jakne, kaiševi, rukavice.

**Klasa 26:** Ukrasi za kosu, trake za kosu, šnale za kosu, držači za pletenice.

**Klasa 35:** Maloprodajne usluge, online maloprodajne i veleprodajne usluge u oblasti kozmetike, parfimerije; eteričnih ulja, sapuna preparata za održavanje obuće i odeće, naočara za sunce, modne opreme, torbi, obuće, opreme za obuću, odeće, kože i jelenskih koža, ukrasa za kosu.

(210) **2011-363**

(442) **20.06.2013**

(220) 18.7.2011

(300) Z201170116 31012011 SI

(731) **TOBACNA LJUBLJANA DOO**, CESTA 24, JUNIJA 90 LJUBLJANA-ČRNUČE 1231, SI



(540)

(550) I

(740) Čupić Branislav, Dalmatinska 10, Podgorica (ME)

(511) **Klasa 34:** Duvan, prerađen ili neprerađen; proizvodi od duvana; zamjene za duvan koja nisu za upotrebu u medicinske svrhe ili svrhe liječenja; cigarete, cigarilos; cigare; ručne mašine za pravljenje cigareta; tube za cigarete; filteri za cigarete; papir za cigarete; šibice i

artikli za pušače.

---

(210) **2011-364** (442) **20.06.2013**  
(220) 18.7.2011

(731) **BERLIN-CHEMIE AG**, GLIENICKER WEG 125, D-12489, BERLIN, DE

## PROMARON

(540)

(550) I

(740) Radulović Božidar, Jovana Tomaševića 9/III, Podgorica (ME)

(511) **Klasa 05:** Farmaceutski proizvodi, dijetetske supstance prilagodjene za upotrebu u medicini.

---

(210) **2011-365** (442) **20.06.2013**  
(220) 18.7.2011

(731) **BERLIN-CHEMIE AG**, GLIENICKER WEG 125, D-12489, BERLIN, DE

## SILTION

(540)

(550) I

(740) Radulović Božidar, Jovana Tomaševića 9/III, Podgorica (ME)

(511) **Klasa 05:** Farmaceutski proizvodi, dijetetske supstance prilagodjene za upotrebu u medicini.

---

(210) **2011-366** (442) **20.06.2013**  
(220) 18.7.2011

(731) **BERLIN-CHEMIE AG**, GLIENICKER WEG 125, D-12489, BERLIN, DE

## ZITON

(540)

(550) I

(740) Radulović Božidar, Jovana Tomaševića 9/III, Podgorica (ME)

(511) **Klasa 05:** Farmaceutski proizvodi, dijetetske supstance prilagođene za upotrebu u medicini.

---

(210) **2011-367** (442) **20.06.2013**  
(220) 19.7.2011

(300) Z201170115 31012011 SI

(731) **TOBACANA LJUBLJANA DOO**, CESTA 24, JUNIJA 90 LJUBLJANA-ČRNUČE 1231, SI

BOSS



(540) asifikaciji:

(550) I

(740) Ćupić Branislav, Dalmatinska 10, Podgorica (ME)

(511) **Klasa 34:** Duvan, prerađen ili neprerađen; proizvodi od duvana; zamjene za duvan koja nisu za upotrebu u medicinske svrhe ili svrhe liječenja; cigarete, cigarilosi; cigare; ručne mašine za pravljenje cigareta; tube za cigarete; filteri za cigarete; papir za cigarete; šibice i artikli za pušače.

(210) **2011-368**(442) **20.06.2013**

(220) 19.7.2011

(731) **DOO SILBI**, VOJVOĐANSKA 32 BUDVA, ME

SILBI

(540)

(550) I

(511) **Klasa 35:** Veleprodaja i maloprodaja suvenira.(210) **2011-37**(442) **20.06.2013**

(220) 28.1.2011

(731) **COTRACTWORLD DOO**, UL. SLOBODE BR.16/11, PODGORICA ME

(540)

(550) I

(511) **Klasa 02:** Boje, sredstva za zaštitu od truljenja drveta.

**Klasa 20:** Namještaj.

**Klasa 24:** Tekstil, tekstilni proizvodi.

**Klasa 27:** Tepisi, asure, prostirke i otirači, linoleum i drugi materijali za pokrivanje podova, prekrivači za zidove (netekstilni).

(210) **2011-371**

(442) **20.06.2013**

(220) 20.7.2011

(731) **NO FEAR INTERNATIONAL LIMITED**, UNIT A, BROOK PARK EAST SHIREBROOK NG20 8 RY UK, GB



(540)

(550) I

(740) Popović Miladin, Đoka Miraševića 21/III, Podgorica (ME)

(511) **Klasa 18:** Koža i imitacija kože, proizvodi izrađeni od ovih materijala koji nisu uključeni u druge klase; životinjska koža, krzno; koferi i putne torbe; kišobrani, suncobrani i štapovi za hodanje; bičevi, saračka i sedlarska oprema.

**Klasa 25:** Odeća, obuća, pokrivala za glavu.

**Klasa 32:** Pivo; mineralne i sodne vode i druga bezalkoholna pica; pica od voća i voćni sokovi; sirupi i drugi preparati za proizvodnju pica.

(210) **2011-372**

(442) **20.06.2013**

(220) 20.7.2011

(731) **NO FEAR INTERNATIONAL LIMITED**, UNIT A, BROOK PARK EAST SHIREBROOK NG20 8 RY UK, GB

**NO FEAR**

(540)

(550) I

(740) Popović Miladin, Đoka Miraševića 21/III, Podgorica (ME)

(511) **Klasa 16:** Hartija, karton i proizvodi od njih, koji nisu uključeni u druge klase; štampane stvari; knjigovezački materijal; fotografije; kancelarijski materijal; lepila za kancelarijske i kućne potrebe; umetnički materijali; kičice; pišaće mašine i kancelarijski rekviziti (izuzev nameštaja); materijali za obuku i nastavu (izuzev aparata); plastični materijal za pakovanje



(koji nije uključen u druge klase); štamparska slova; klišeji.

**Klasa 18:** Koža i imitacija kože, proizvodi izrađeni od ovih materijala koji nisu uključeni u druge klase; životinjska koža, krzno; koferi i putne torbe; kišobrani, suncobrani i štapovi za hodanje; bičevi, saračka i sedlarska oprema

**Klasa 25:** Odeća, obuća, pokrivala za glavu.

**Klasa 32:** Pivo; mineralne isodne vode idroga bezalkoholna pića; pića od voća i voćni sokovi; sirupi i drugi pre parati za prizvodnju pića.

(210) **2011-373**

(442) **20.06.2013**

(220) 20.7.2011

(731) **COUNTRY FARMS SDN BHD**, LOT 13-01A.LEVEL 13 (EASTT WING) BERJAYA TIMES SQUARE, NO.1 JALAN IMBI 55100 KUALA LUMPUR, MALAYSIA, MY



(540)

(550) I

(740) Radulović Božidar, Jovana Tomaševića 9/III, Podgorica (ME)

(511) **Klasa 29:** Meso, riba, morski plodovi, živina i divljač; mesne preradevine, riblje preradevine, povrćne preradevine i voćne preradevine; konzervisano, sušeno i kuvano voće i povrće; ekstrakti od voća i/ili povrća; mesni proizvodi; kobasice; gotova jela; grickalice; želei, džemovi, slatko od voća, konzervisano povrće; sosovi; dezerti; jaja; mleko; mlečni proizvodi; jogurt; smrznuti jogurt; jestivi protein od soje; jestiva ulja i masti; orašasti plodovi i puteri od orašastih plodova; turšija; bilje; tofu; ekstrakti korova za ishranu; namazi koji se u potpunosti ili u znatnoj meri sastoje od povrća, mleka, mesa, živine, ribe, morskih plodova ili jestivih masti; supe; proizvodi od soje.

**Klasa 30:** Kafa, esencije kafe, ekstrakti kafe; čaj, ekstrakti čaja; kakao; proizvodi pripremljeni uglavnom od kaka; čokolada; proizvodi od čokolade; šećer, maltoza, pirinač, tapioka, sago, kus-kus; brašno i proizvodi od žitarica i/ili pirinča i/ili brašna; pasta od orašastih plodova, poslastice i slatkiši, žitarice; peciva; pica, pasta i proizvodi od paste; hleb; biskviti; kolači; torte; led, sladoled, sladoledi pravljeni na bazi vode, smrznute poslastice; proizvodi za pripremu sladoleda i/ili sladoleda na bazi vode i/ili smrznutih poslastica; sladoled od soje i napitci od blendiranog voća (smoothie); med; proizvodi koji se u potpunosti ili u znatnoj meri sastoje od šećera, koji se koriste kao zamena za med; sirup, šećerni sirup, melasa; kečap; sosovi i proizvodi za pripremu sosova; krem od jaja u prahu; gotova jela; musevi; dezerti; pudinzi; kvasac, prašak za pecivo; so, biber, sent; sirće; indijski ljuti začim (chutney); začini i začinske

trave; proizvodi od bilja koji se koriste kao piće; infuzije (osim za medicinske svrhe); pite od mesa; majonez; sredstva za omekšavanje mesa, za kućne potrebe; mleč za ljudsku ishranu (osim za medicinske svrhe); prirodni zaslađivači; sirup; prelive za salate.

**Klasa 35:** Oglašavanje; vođenje poslova; poslovno upravljanje; usluge u vezi sa poslovnim informacijama koje se pružaju onlajn putem kompjuterskih baza podataka ili globalne kompjuterske mreže (Interneta); kupovina putem globalne kompjuterske mreže; usluge istraživanja tržišta, tržišne studije; reklamiranje putem radija; reklamiranje putem televizije; televizijske reklame; usluge promocije prodaje za druge; distribucija uzoraka; usluge maloprodaje za raznovrsne organske proizvode; usluge maloprodajnih objekata (outlets); usluge veleprodaje za raznovrsne organske proizvode; usluge poslovnog upravljanja za obradu prodaje putem interneta; usluge upravljanja poslovnim delatnostima franšiza; savetodavne usluge koje se odnose na reklamiranje franšiza; usluge poslovne pomoći koja se odnosi na osnivanje franšiza; obezbeđivanje poslovne pomoći za vođenje franšiza; usluge poslovnog reklamiranja koje se odnose na franšize; usluge poslovnih saveta koje se odnose na franšize.

(210) **2011-374**

(442) **20.06.2013**

(220) 21.7.2011

(300) NACIONALAN PRIJAVA USA 21 01 2011 US 85/223,620

(731) **FAROUK SYSTEMS, INC (TEXAS CORPORATION)**, 250 PENNBRIGHT, SUITE 150 HOUSTON, TX 77090, US

## CHI ENVIRO

(540)

(550) I

(740) Radulović Božidar, Jovana Tomaševića 9/III, Podgorica (ME)

(511) **Klasa 03:** Proizvodi za negu kose, naročito, šamponi, regeneratori, sprejevi za kosu, sprejevi za sjaj kose, nemedicinski serumi za ispravljanje kose, nemedicinski tretmani za ispravljanje kose, i maske za kosu.

(210) **2011-375**

(442) **20.06.2013**

(220) 22.7.2011

(731) **SOCIETE DES PRODUCTS NESTLES.A.**, 1800 VEVEY, CH

računara



(540)

(550) I

(740) Lutovac Branislav, Bulevar Crnojevića 93, Podgorica (ME)

(511) **Klasa 30:** Sladoled.

(210) **2011-376**

(442) **20.06.2013**

(220) 22.7.2011

(731) **TAIHO PHARMACEUTICAL CO.LTD**, 1-27 KANDANISHIKI-CHO,CHIYODA-KU, TOKYO 101-8444, JP

TEYSUNO

(540)

(550) I

(740) Čejović Vladimir, 13. jula 21, Podgorica (ME)

(511) **Klasa 01:** Hemijski proizvodi koji se upotrebljavaju u industriji, nauci, fotografiji, poljoprivredi, hortikulturi i šumarstvu; neprerađene vještačke smole, neprerađene plastične materije; đubriva; smješe za gašenje vatre; preparati za kaljenje i zavarivanje; hemijske supstance za očuvanje namirnica; materije za štavljenje; ljepljive supstance koje se upotrebljavaju u industriji. Hemijski proizvodi; preparati i supstance za upotrebu u proizvodnji lijekova protiv raka, reagensi koji se koriste za naučno ili medicinsko istraživanje na području onkologije.

**Klasa 05:** Preparati protiv raka; agensi protiv raka, hemijski reagensi za medicinske svrhe na području onkologije.

(210) **2011-377**

(442) **20.06.2013**

(220) 25.7.2011

(731) **IL CAMMINO SH.P.K.**, RRUGA E QELQIT TEK ISH TERRITORII FABRIKES SE QELGIT,GODINE 1 KATESHE, KOMBINAT, TIRANA, AL



(540)

(550) I

(740) Đakonović Vido, Bajova 8, Cetinje, (ME)

(511) **Klasa 25:** Obuća za plažu; čizme; odjeća; obuća; polučizme; sportska obuća; sandale; cipele; pokrivala za glavu

(210) **2011-378**

(442) **20.06.2013**

(220) 25.7.2011

(300) 302011004752.9 26 01 2011 DE

(731) **DAIMLER AG**, MERCEDESSTRASSE 137 70327 STUTTGART, DE

## BIGSPACE

(540)

(550) I

(511) **Klasa 12:** Motorna vozila i njihovi djelovi.

---

(210) **2011-379**

(442) **20.06.2013**

(220) 25.7.2011

(731) **DAIMLER AG**, MERCEDESSTRASSE 137 70327 STUTTGART, DE

## COMPACTSPACE

(540)

(550) I

(511) **Klasa 12:** Motorna vozila i njihovi djelovi.

---

(210) **2011-38**

(442) **20.06.2013**

(220) 31.1.2011

(731) **SOCIETE DES PRODUITS NESTLE S.A.**, 1800 VEVEY, CH

## MOJITO

(540)

(550) I

(740) Lutovac Branislav, Bulevar Crnojevića 93, Podgorica (ME)

(511) **Klasa 30:** Sladoled

---

(210) **2011-380**

(442) **20.06.2013**

(220) 25.7.2011

(300) 08 06 2011-ENGLSKA PRIJAVA GB 2583956

(731) **FIL LIMITED A BERMUDA COMPANY**, PEMBROKE HALL, 42 CROW LANE, PEMBROKE HM 19, P.O.BOX HM 670, HAMILTON HMCX, BERMUDA, BM



(540) ~~Međunarodna klasifikacija~~

(550) I

(740) Ćupić Branislav, Dalmatinska 10, Podgorica (ME)

(511) **Klasa 36:** Finansijske usluge; usluge osiguranja; usluge u oblasti investicija; usluge u vezi sa međunarodnim i domaćim investicijama; usluge diskrecionog upravljanja investicijama; savjetodavne usluge u vezi sa investicijama; zajednički fondovi i usluge u vezi sa njima; penzioni fondovi i usluge u vezi sa njima; brokerske usluge u oblasti hartija od vrijednosti i usluge u vezi sa njima; bankarski poslovi i usluge u vezi sa njima; trustovi i usluge u vezi sa njima; usluge vođenja portfolia, zajedničkih fondova, penzionih fondova i trustova; finansijsko upravljanje i planiranje; finansijsko savjetovanje; kreditne usluge; bankarske usluge u vezi sa investicijama; usluge u oblasti poslovnih finansija i kapitala za poslovne projekte; usluge u vezi sa privatnim investicijama (private equity); usluge u vezi sa nekretninama; usluge u vezi sa investiranjem u nekretnine; usluge davanja garancija za hartije od vrijednosti; usluge vezane za tržište strane valute i finansijskih derivata; pružanje informacija, davanje savjeta i konsalting u vezi sa hartijama od vrijednosti, finansijama i investicijama; usluge pružanja informacija iz interaktivne baze podataka u vezi sa hartijama od vrijednosti, finansijama i investicijama; usluge u vezi sa kreditnim i debitnim karticama; usluge novčanih plaćanja; davanje kredita uz garancije ili bez garancija; mjenjački poslovi; procjena antikviteta; brokerske usluge; davanje garancija; prikupljanje sredstava za dobrotvorne fondove; davanje zajmova na osnovu hartija od vrijednosti; davanje zajmova na rate; usluge hipotekarnog bankarstva; usluge poslovne likvidacije; usluge berzanskih kotacija; naplata zakupa; pružanje informacija, davanje savjeta i konsalting u vezi sa svim navedenim uslugama.

(210) **2011-381**

(442) **20.06.2013**

(220) 25.7.2011

(300) 08.06.2011-ENGLESKA PRIJAVA GB 2583955

(731) **FIL LIMITED ABERMUDA COMPANY**, PEMBROKE HALL, 42 CROW LANE, PEMBROKE HM 19, P.O.BOX HM 670, HAMILTON HMCX, BERMUDA, BM



(540)

(550) I

(740) Ćupić Branislav, Dalmatinska 10, Podgorica (ME)

(511) **Klasa 36:** Finansijske usluge; usluge osiguranja; usluge u oblasti investicija; usluge u vezi sa međunarodnim i domaćim investicijama; usluge diskrecionog upravljanja investicijama; savjetodavne usluge u vezi sa investicijama; zajednički fondovi i usluge u vezi sa njima; penzionirani fondovi i usluge u vezi sa njima; brokerske usluge u oblasti hartija od vrijednosti i usluge u vezi sa njima; bankarski poslovi i usluge u vezi sa njima; trustovi i usluge u vezi sa njima; usluge vodenja portfolia, zajedničkih fondova, penzioniranih fondova i trustova; finansijsko upravljanje i planiranje; finansijsko savjetovanje; kreditne usluge; bankarske usluge u vezi sa investicijama; usluge u oblasti poslovnih finansija i kapitala za poslovne projekte; usluge u vezi sa privatnim investicijama (private equity); usluge u vezi sa nekretninama; usluge u vezi sa investiranjem u nekretnine; usluge davanja garancija za hartije od vrijednosti; usluge vezane za tržište strane valute i finansijskih derivata; pružanje informacija, davanje savjeta i konsalting u vezi sa hartijama od vrijednosti, finansijama i investicijama; usluge pružanja informacija iz interaktivne baze podataka u vezi sa hartijama od vrijednosti, finansijama i investicijama; usluge u vezi sa kreditnim i debitnim karticama; usluge novčanih plaćanja; davanje kredita uz garancije ili bez garancija; mjenjački poslovi; procjena antikviteta; brokerske usluge; davanje garancija; prikupljanje sredstava za dobrotvorne fondove; davanje zajmova na osnovu hartija od vrijednosti; davanje zajmova na rate; usluge hipotekarnog bankarstva; usluge poslovne likvidacije; usluge berzanskih kotacija; naplata zakupa; pružanje informacija, davanje savjeta i konsalting u vezi sa svim navedenim uslugama.

(210) **2011-387**(442) **20.06.2013**

(220) 29.7.2011

(731) **S.C. COMCEH S.A.**, STRADA BUURESTI, N.358 910048 CALARASI RO

## VOLARE

(540)

(550) I

(740) Popović Miladin, Đoka Miraševića 21/III, Podgorica (ME)

(511) **Klasa 16:** Krep papir i gladak papir; proizvodi od papira i/ili celuloze za kućnu upotrebu, za čišćenje za ličnu upotrebu, higijenu i njegu uključujući maramice, maramice za lice, stolnjake, salvete za stolove, kuhinjske ubruse i toaletni papir, u pakovanjima za domaćinstvo i za upotrebu u industriji i šire.

(210) **2011-388** (442) **20.06.2013**

(220) 29.7.2011

(731) **KENTUCKY FRIED CHIKEN INTERNATIONAL HOLDINGS, INC**, 1441 GARDINER LANE, LOUSSVILLE, KENTUCKY 40213, US



sogood

(540)

(550) I

(740) Čejović Vladimir, 13. jula 21, Podgorica (ME)

(511) **Klasa 29:** Meso, riba, živina i divljač; mesne prerađevine; konzervisano, zamrznuto, sušeno i kuvano voće i povrće; želei, džemovi, kompoti; jaja, mlijeko i mliječni proizvodi; jestiva ulja i masti.

**Klasa 30:** Kafa, čaj, kakao, šećer, pirinač, tapioka, sago, zamjena kafe; brašno i proizvodi od žitarica, hljeb, kolači i poslastice, sladoledi; med, melasa; kvasac, prašak za pecivo; so, senf; sirće, sosevi (kao začini); začini; led.

**Klasa 32:** Pivo, mineralne i sodne vode i druga bezalkoholna pica; pica od voća i voćnih sokova; sirupi i drugi preparati za proizvodnju pica.

**Klasa 43:** Usluge obezbjeđivanja hrane i pica, privremeni smještaj.

(210) **2011-389** (442) **20.06.2013**

(220) 1.8.2011

(731) **PLIVA HRVATSKA D.O.O.**, PRILAZ BARUNA FILIPOVIĆA 25 10 000 ZAGREB, HR

ULOM

(540)

(550) I

(740) Radulović Božidar, Jovana Tomaševića 9/III, Podgorica (ME)

(511) **Klasa 05:** Farmaceutski proizvodi.

(210) **2011-390** (442) **20.06.2013**

(220) 2.8.2011

(731) **PHILIP MORRIS BRANDS SARL**, QUAI JEANRENAUD 3, NEUCHATEL, 2000, CH



(540)

(550) I

- (511) **Klasa 34:** Duvan, sirov ili prerađen; duvanski proizvodi, naročito cigare, cigarete, cigarilosi/male cigarete, duvan za uvijanje cigareta, duvan za lule, duvan za žvakanje, duvan za šmrkanje, kretek, snus (duvan u prahu), zamena za duvan (za nemedicinsku upotrebu); artikli za pušače, naročito papir za cigarete i lule, filtri za cigarete, kutije za duvan (od neplemenitih metala), tabakere (kutije za cigarete) i pepeljare (od neplemenitih metala), lule, ručni aparati/spravice za uvijanje cigareta, upaljači; šibice. /

(210) **2011-391**(442) **20.06.2013**

(220) 2.8.2011

(731) **SHIMANO INC.**, 3-77 OIMATSU-CHO, SAKAI CITY, OSAKA JP

# ZEE

(540)

(550) I

(740) Popović Miladin, Đoka Miraševića 21/III, Podgorica (ME)

- (511) **Klasa 12:** Električne bicikle, bicikle, delovi i oprema za bicikle, naime: glavčine, unutrašnje glavčine menjača, glavčine dinamama za bicikle, glavčine za brzo otpuštanje poluge menjača, otpusne poluge menjača, poluge za menjanje brzina, prednji prenosni mehanizmi, zadnji prenosni mehanizmi, vođice lanca, pomoćni zupčanici za menjanje brzina (skretači lanca), zupčanici, dizalice za bicikle, lanci za bicikle, sajle, obrtaljke, komplet obrtaljka, prednji lančanici za točak, pedale za bicikle, klipseri (korpice za stopala), poluge kočnica, prednje kočnice, zadnje kočnice, sajle za kočnice, kočne papuče, obruči, točkovi, lanci za kočenje, klipovi za kočenje, donje sponje, nosači za sedišta, mehanizmi za brzo otpuštanje nosača sedišta, glavni delovi za sklapanje rama viljuški, amortizeri, upravljači, drške upravljača, ručice upravljača, krajevi drške upravljača, uporišta sedišta, sedišta, prenosni mehanizmi kojima upravlja kompjuter, vreće za točkove bicikla, pokazivači pozicije brzine bicikla.

(210) **2011-392**(442) **20.06.2013**

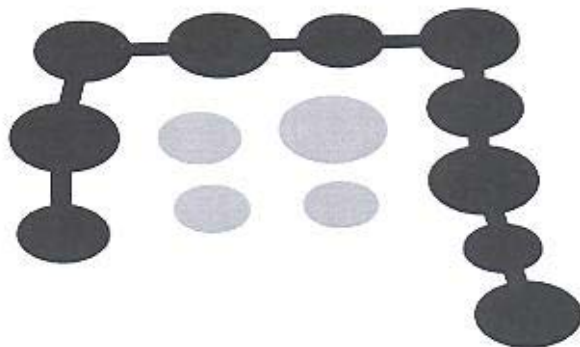

(220) 2.8.2011

(731) **IRONWOOD PHARMACEUTICALS, INC.**, 301 BINNEY STREET CAMBRIDGE, MASSACHUSETTS 02142 US

(540)

(550) I

(740) Popović Miladin, Đoka Miraševića 21/III, Podgorica (ME)

(511) **Klasa 05:** Farmaceutski preparati za upotrebu kod lečenja hronične konstipacije, sindroma razdražljivog creva, poremećaja gastrointestinalnog motiliteta i drugih gastrointestinalnih poremećaja.(210) **2011-393**(442) **20.06.2013**

(220) 3.8.2011

(731) **EDEL WEISS GMBH & CO.KG**, OBERSTDORFER STRASSE 7,87435 KEMPTEN, DE

## EDELWEISS

(540)

(550) I

(740) Lutovac Branislav, Bulevar Crnojevića 93, Podgorica (ME)

(511) **Klasa 29:** Mlijeko, sir; puter i mliječni proizvodi; jaja; jestiva ulja i masti.(210) **2011-394**(442) **20.06.2013**

(220) 5.8.2011

(300) CTM REG.ZIGA BR.009734641 OD 14 02 2011

(731) **LRC PRODUCTS LIMITED**, 103-105 BATH ROAD SLOUGH,SL1 3UH, GB

## POCKET BALLERINA

(540)

(550) I

(740) Popović Miladin, Đoka Miraševića 21/III, Podgorica (ME)

(511) **Klasa 03:** Nemedicinski preparati za negu stopala, tela i kože i za ulepšavanje; kreme, gelovi, losioni, ulja, balsami, puderi, puderi u talku i sprejevi za upotrebu na stopalima, telu

i koži; nemedicinski preparati za tretman, negu, čišćenje, umirivanje, revitalizaciju i relaksaciju stopala, tela i kože; nemedicinski preparati za kupanje u obliku soli, ulja i kupki; kupke u obliku tableta; nemedicinski toaletni preparati; dezodoransi; mirisne kreme, gelovi, losioni, puderi, puderi u talku i sprejevi; dezodoransi impregnirani u uloške; dezodoransi za stopala.

**Klasa 25:** Odeća, obuća, pokrivala za glavu; oprema za obuću, higijenska obuća, uključujući cipele, papuče, čizme, sandale, klompe; duge i kratke čarape; đonovi; papuče, ulošci za obuću; ulošci sa jastučićima za obuću; pletene čarape.

(210) **2011-395**

(442) **20.06.2013**

(220) 5.8.2011

(300) PRIJAVA ZIGA U NJEMACKOJ BR.30 2011 007 395.3/38 OD 09.02.2011

(731) **DEUTCHE TELEKOM AG**, FRIEDRICH-EBERT-ALLEE 140 53113 BONN DE

## Travel & Surf

(540)

(550) I

(740) Popović Miladin, Đoka Miraševića 21/III, Podgorica (ME)

(511) **Klasa 09:** Aparati i instrumenti naučni, pomorski, geodetski, fotografski, kinematografski, optički, za vaganje, merenje, signalizaciju, kontrolu (inspekciju), spasavanje i nastavu; aparati i instrumenti za provođenje, prekid, transformaciju, akumulaciju, regulisanje ili kontrolu elektriciteta; aparati za snimanje, prenos, obradu i reprodukovanje zvuka, slika ili podataka; magnetni nosioci podataka; automatske mašine i mehanizmi za aparate koji se pokreću novcem ili žetonom; računске mašine, oprema za obradu podataka i kompjuteri; snimljeni i prazni nosioci podataka svih vrsta (uključeni u klasu 9); kompjuterski programi (snimljeni); elektronskim putem snimljeni podaci (koji se mogu preuzimati); elektronska izdanja (koja se mogu preuzimati).

**Klasa 38:** Telekomunikacije; usluge novinskih agencija; iznajmljivanje telekomunikacione opreme; informacije o telekomunikacijama.

**Klasa 42:** Naučne i tehnološke usluge i usluge istraživanja i dizajna s tim u vezi; usluge industrijske analize i istraživanja; dizajn i razvoj kompjuterskog hardvera, softvera i baza podataka; održavanje kompjuterskog softvera; tehničke konsultacije; kompjuterske usluge u vezi sa elektronskim čuvanjem podataka; iznajmljivanje kompjutera; usluge dizajniranja web strana za druge.

(210) **2011-396**

(442) **20.06.2013**

(220) 5.8.2011

(731) **GREAT WALL MOTOR COMPANY LIMITED**, 2266 CHAOYANG SOUTH STREET, BAODING, HEBEI 071000, CN

**STEED**

(540)

(550) I

(740) Đakonović Vido, Bajova 8, Cetinje, (ME)

(511) **Klasa 37:** Održavanje i popravka motornih vozila; stanice za servisiranje vozila (pumpe za gorivo i za održavanje); popravka Sara na gumama; čišćenje vozila; podmazivanje vozila; zaštita vozila od rde; poliranje vozila; popravka vozila; pranje vozila.

(210) **2011-397**

(442) **20.06.2013**

(220) 5.8.2011

(731) **GENERAL MOTORS LLC**, 300 RENAISSANCE CENTER DETROIT, MICHIGAN 48265-3000 US

# CADILLAC CUE

(540)

(550) I

(740) Radulović Božidar, Jovana Tomaševića 9/III, Podgorica (ME)

(511) **Klasa 09:** Elektronski modul interfejsa koji se prodaje kao sastavni dio motornog vozila za kretanje po zemlji za žični i bežični interfejs ručnih elektronskih uređaja; softver za mobilne telefone koji korisnicima omogućava sposobnost daljinske kontrole funkcija motornog vozila, uključujući, zaključavanje i otključavanje vrata vozila, paljenje ili gašenje motora vozila; daljinsku kontrolu statusa operativnog sistema motornog vozila, uključujući, vijek motornog ulja, nivo goriva, pritisak u gumama, stanje akumulatora i da se konektuju sa kol centrom radi pomoći.

(210) **2011-398**

(442) **20.06.2013**

(220) 5.8.2011

(731) **GENERAL MOTORS LLC**, 300 RENAISSANCE CENTER DETROIT, MICHIGAN 48265-3000 US

# DURAMAX

(540)

(550) I

(740) Radulović Božidar, Jovana Tomaševića 9/III, Podgorica (ME)

(511) **Klasa 12:** Dizel motori za motorna vozila za kretanje po zemlji.

(210) **2011-399**

(442) **20.06.2013**

(220) 8.8.2011

(731) **SOCIETE DES PRODUITS NESTLE S.A.**, 1800 VEVEY, CH



(540)

(550) I

(740) Lutovac Branislav, Bulevar Crnojevića 93, Podgorica (ME)

(511) **Klasa 30:** Sladoled.(210) **2011-400**(442) **20.06.2013**

(220) 8.8.2011

(731) **COMBE INTERNATIONAL LTD.**, 1101 WESTCHESTER AVENUE, WHITE PLAINS, NEW YORK 10604, US

## RESTORIA

(540)

(550) I

(740) Čejović Vladimir, 13. jula 21, Podgorica (ME)

(511) **Klasa 03:** Sredstva za bijeljenje i druge supstance za upotrebu u perionicama; preparati za čišćenje, poliranje, ribanje i nagrizanje; sapuni; parfimerija, eterična ulja, kozmetika, losioni za kosu; paste za zube; preparati za bojenje kose.(210) **2011-401**(442) **20.06.2013**

(220) 9.8.2011

(731) **MEC AUTO D.O.O.**, LAMELA II-STARI AERODROM, PODGORICA ME

(540)

(550) I

(511) **Klasa 35:** Sakupljanje u korist drugih, citavog niza roba (uključujući i njihov uvoz i transport) prodaju originalnih rezervnih dijelova omogućavajući klijentima da zgodno razgledaju i ku-

puju ovu robu (MBORGINAL, MAHLE, MONROE, RUVILLE, SACHS, KWP, VALEO.TRW, SKF, SN R, PAYEN, HUTCHINSON, FAG-INA, FRAM, DELPHI, CLEAN, AIRTEX, HANSE PREASE....);takve usluge mogu se pružiti prodavnicama na veliko I malo,rasprodajama,porudzbina postom preko kataloga ili putem elektronskih medija,na primer preko web cite-a ili televiziskih programa za kupovinu; Usluge koje se sastoje od registracije,transkripcije,kompezacijeili sistematizacije pisanih saopštenja I registracija I takodje kompilacije matematičkih ili statističkih podataka;

(210) **2011-403** (442) **20.06.2013**

(220) 9.8.2011

(731) **DOO THE BEST WAY**, ZELENKA B.B. HERCEG NOVI, ME



(540)

(550) I

(511) **Klasa 36:** Poslovi vezani za nepokretnosti (promet i upravljanje nepokretnostima, posredovanje u prometu nepokretnosti); finansijske, investicione i kreditne usluge;

**Klasa 37:** Gradjevinsko konstruisanje, popravljanje i usluge instalisanja (izgradnja, adaptacija i rekonstrukcija gradjevinskih objekata);

**Klasa 39:** Transportne usluge (prevoz putnika i robe ) bilo kojim sredstvom prevoza; Organizovanje putovanja;Organizovanje turističkih aranžmana i pratnja turista;

**Klasa 41:** Razonoda i rekreativne aktivnosti; Organizovanje i vodjenje seminara, konferencija, kongres...; Sportske i kulturne aktivnosti;

**Klasa 42:** Rezervisanje soba u hotelima, pansionima, privataom smjestaju, od strane turističkih agencija;

**Klasa 43:** Usluge obezbjedjenja hrane i pica (restorani i dr. ugostiteljski objekti); Privremeni smjestaj (hoteli, pansioni, iznajmljivanje soba - privatni smjestaj);

**Klasa 44:** Higijenska zastita i njega ljudi i zivotinja; Agrikulturne, hortikulturne i sumarske usluge

(210) **2011-404** (442) **20.06.2013**

(220) 9.8.2011

(731) **MEC AUTO DOO**, LAMELA II STARI AERODROM, PODGORICA ME

uz pomoć računara



(540)

(550) I

- (511) **Klasa 35:** Sakupljanje u korist drugih, citavog niza roba (uključujući I njihov uvoz I transport) prodaju originalnih rezervnih dijelova omogućavajući klijentima da zgodno razgledaju I kupuju ovu robu (MBORGINAL, MAHLE, MONROE, RUVILLE, SACHS, KWP, VALEO, TRW, SKF, SN R, PAYEN, HUTCHINSON, FAG-INA, FRAM, DELPHI, CLEAN, AIRTEX, HANSE PREASE...); takve usluge mogu se pružiti prodavnicama na veliko I malo, rasprodajama, porudžbinama postom preko kataloga ili putem elektronskih medija, na primer preko web cije-a ili televizijskih programa za kupovinu; Usluge koje se sastoje od registracije, transkripcije, kompezacije ili sistematizacije pisanih saopštenja I registracija I takodje kompilacije matematičkih ili statističkih podataka;

(210) **2011-405**(442) **20.06.2013**

(220) 9.8.2011

(731) **SANDVIK INTELLECTUAL PROPERTY AB, SE-811 81 SANDVIKEN, SE**

# COROMANT

(540)

(550) I

(740) Radulović Božidar, Jovana Tomaševića 9/III, Podgorica (ME)

- (511) **Klasa 07:** proizvodi od karbonskih legura, kao što su valjci, vretena za izvlačenje, kalupi za izvlačenje, naprave vodilje, dizne za vazdušne duvaljke, glave mašina; metalne opruge (dijelovi mašina); makaze (mašinski alat); mašinski alati, poljoprivredni alati i mašine, električne mašine, uključujući njihove dijelove i pribor; (mašinski) alati za obradu metala, kamena, lima, kosti i vještačkih materijala.

(210) **2011-406**(442) **20.06.2013**

(220) 9.8.2011

(731) **SANDVIK INTELLECTUAL PROPERTY AB,, SE-811 81 SANDVIKEN, SE**

# SANDVIK

(540)

(550) I

(740) Radulović Božidar, Jovana Tomaševića 9/III, Podgorica (ME)

(511) **Klasa 06:** čelik i gvožđe u blokovima, cijevima, trakama i žicama, opruge i gibnjevi (gvoždarska roba), drugi proizvodi od gvožđa i čelika, kaljenog ili nekaljenog, hladno valjanog ili usijano valjanog

(210) **2011-407** (442) **20.06.2013**

(220) 9.8.2011

(731) **SANDVIK INTELLECTUAL PROPERTY AB**, SE-811 81 SANDVIKEN, SE

# KANTHAL

(540)

(550) I

(740) Radulović Božidar, Jovana Tomaševića 9/III, Podgorica (ME)

(511) **Klasa 09:** materijal za električne otpornike: u obliku žica, traka i cijevi, termoelementi, bimetali, elementi od folija, električni i elektronski mjerni aparati i instrumenti, električni uređaji za paljenje, električni uređaji za paljenje i kontrolu za gasne i uljne gorionike

(210) **2011-408** (442) **20.06.2013**

(220) 9.8.2011

(731) **SECO TOOLS AB**, SE-7637 82 FAGERSTA, SE

# SECO

(540)

(550) I

(740) Radulović Božidar, Jovana Tomaševića 9/III, Podgorica (ME)

(511) **Klasa 07:** mašinski alati na motorni pogon, uključujući alate za struganje, alati za rezanje i alati za bušenje, te alati ulošci za takve alate.

(210) **2011-409** (442) **20.06.2013**

(220) 9.8.2011

(731) **SECO TOOLS AB**, SE-7637 82 FAGERSTA, SE

# SNAP-TAP

(540)

(550) I

(740) Radulović Božidar, Jovana Tomaševića 9/III, Podgorica (ME)

(511) **Klasa 07:** navojni nastavci za strugove i prated pribor, naročito automatske reverzibilne jedinice i rotirajući centralni elementi, karbidni ulošci, držači alata i alati za brušenje.

(210) **2011-410** (442) **20.06.2013**

(220) 9.8.2011

(731) **SECO TOOLS AB**, SE-7637 82 FAGERSTA,SE

(540)

(550) I

(740) Radulović Božidar, Jovana Tomaševića 9/III, Podgorica (ME)

(511) **Klasa 07:** mašinski alati na mašinski pogon; alati i ulošci za alate koji sadrže cementirane karbide za upotrebu u mašinskim alatima na mašinski pogon(210) **2011-411**(442) **20.06.2013**

(220) 9.8.2011

(731) **SECO TOOLS AB**, SE-7637 82 FAGERSTA, SE**SECOLOR**

(540)

(550) I

(740) Radulović Božidar, Jovana Tomaševića 9/III, Podgorica (ME)

(511) **Klasa 07:** masinski alati pokretani mašinski; alati i alatni dodaci koji u sebi sadrže cementirane karbide za upotrebu u mašinskim alatima pokretanim mašinski(210) **2011-412**(442) **20.06.2013**

(220) 9.8.2011

(731) **DIAMOND INNOVATIONS INC**, 6325 HANTLEY ROAD, WORTHINGTON, OHIO 46085 US**BORAZON**

(540)

(550) I

(740) Radulović Božidar, Jovana Tomaševića 9/III, Podgorica (ME)

(511) **Klasa 03:** Industrijska mehanička sredstva za brušenje.**Klasa 08:** Tocila.(210) **2011-413**(442) **20.06.2013**

(220) 10.8.2011



(731) **TOYOTA JIDOSHA KABUSHIKI KAISHA**, 1, TOYOTA-SHO, TOYOTA-SHI, AICHI-KEN, JP

## GT86

(540)

(550) I

(740) Čejović Vladimir, 13. jula 21, Podgorica (ME)

(511) **Klasa 12:** Automobili i njihovi strukturni djelovi.

(210) **2011-415**

(442) **20.06.2013**

(220) 15.8.2011

(731) **NIMCRO DOO ZAGREB**, METALČEVA 5, ZAGREB HR

## MORETTO

(540)

(550) I

(740) Božović Vesko, Rimski trg 50/11, Podgorica (ME)

(511) **Klasa 33:** Alkoholna pića (izuzev piva).

(210) **2011-416**

(442) **20.06.2013**

(220) 16.8.2011

(731) **PET INCORPORATED(DELAWARE CORPORATION)**, NUMBER ONE GENERAL MILLS BOULEVARD, MENNEAPOLIS MINNESOTA 55426 US

## OLD EL PASO

(540)

(550) I

(740) Radulović Božidar, Jovana Tomaševića 9/III, Podgorica (ME)

(511) **Klasa 29:** Meso, riba, živina i divljač; mesne prerađevine; smrznuto, konzervisano, sušeno i kuvano voće i povrće; želei, džemovi, kompoti; jaja, mleko i mlečni proizvodi; jestiva ulja i masti

**Klasa 30:** Kafa, čaj, kakao, šećer, pirinač, tapioka, sago, zamena kafe; brašno i proizvodi od žitarica, hleb, kolači, poslastice, sladoledi; med, melasa; kvasac, prašak za pecivo; so, senf; sirće, sosovi (kao začini); začini; led.

(210) **2011-417**

(442) **20.06.2013**

(220) 17.8.2011

(731) **ALKALOID AD SKOPLJE**, BUL. ALEKSANDAR MAKEDONSKI 12 SKOPLJE MK



(540) \_\_\_\_\_

(550) I

(740) Popović Miladin, Đoka Miraševića 21/III, Podgorica (ME)

(511) **Klasa 03:** Sapuni; parfimerija, eterična ulja, kozmetika, losioni za kosu; paste za zube.

**Klasa 05:** Farmaceutski preparati; dijetetske supstance prilagodene za medicinsku upotrebu, hrana za bebe; flasteri, materijali za zavijanje;

**Klasa 16:** Pelene za bebe, kartoni i robe napravljene od ovih materijala, koji nisu uključeni u druge klase;

(210) **2011-418**

(442) **20.06.2013**

(220) 18.8.2011

(731) **LYXOR LTD**, ZOLLSTRASSE 16, FL-9494 SCHAAN, LI



(540)

(550) I

(511) **Klasa 36:** finansijske usluge, pružanje finansijskih informacija, finansijski derivati, usluge u vezi sa valutama, robom (kao što je zlato, srebro i nafta), berzanski indeksi, trgovanje akcijama preko interneta i fiksna i bežična komunikaciona sredstva i mreže, usluge posredovanja u vezi sa finansijskim proizvodima, agencije za brokerske usluge u trgovanju hartijama od vrednosti na domaćem i inostranom tržištu hartija od vrednosti i u transakcijama na proviziju na domaćem i inostranom tržištu hartija od vrednosti i fjučersa, razmena strane valute preko interneta, pružanje informacija i finansijskih podataka u vezi sa razmenom valute i upravljenjem investicionim portfolijima, obezbeđenje gotovog novca i transakcija za razmenu valute preko globalne komunikacione mreže, pružanje informacije o razmeni valute preko globalne komunikacione mreže.

(210) **2011-419**

(442) **20.06.2013**

(220) 19.8.2011

(731) **THE GILLETTE COMPANY**, ONE GILLETTE PARK, BOSTON, MA 02127 US

# ORANGE BURST

(540)

(550) I

(740) Lutovac Branislav, Bulevar Crnojevića 93, Podgorica (ME)

(511) **Klasa 03:** Kolonjske i toaletne vode.

(210) **2011-420**

(442) **20.06.2013**

(220) 22.8.2011

(731) **ALKALOID AD SKOPLJE**, BUL. ALEKSANDAR MAKEDONSKI 12, SKOPLJE MK



(540)

(550) I

(740) Popović Miladin, Đoka Miraševića 21/III, Podgorica (ME)

(511) **Klasa 03:** Noćna regenerativna krema.

(210) **2011-421**

(442) **20.06.2013**

(220) 22.8.2011

(731) **ALKALOID AD SKOPLJE**, BUL. ALEKSANDAR MAKEDONSKI 12, SKOPLJE, MK



(540)

(550) I

(740) Popović Miladin, Đoka Miraševića 21/III, Podgorica (ME)

(511) **Klasa 03:** Krema protiv bora.(210) **2011-422**(442) **20.06.2013**

(220) 22.8.2011

(731) **ALKALOID AD SKOPLJE**, BUL. ALEKSANDAR MAKEDONSKI 12, SKOPLJE, MK

(540) a Ničanskoj klasifikaciji:

(550) I

(740) Popović Miladin, Đoka Miraševića 21/III, Podgorica (ME)

(511) **Klasa 03:** Krema sa voćnim kiselinama.(210) **2011-423**(442) **20.06.2013**

(220) 22.8.2011

(731) **ALKALOID AD SKOPLJE**, BUL ALEKSANDAR MAKEDONSKI 12, SKOPLJE, MK



(540)

(550) I

(740) Popović Miladin, Đoka Miraševića 21/III, Podgorica (ME)

(511) **Klasa 03:** Kreema sa vitaminom C.

(210) **2011-424**

(442) **20.06.2013**

(220) 22.8.2011

(731) **ALKALOID AD SKOPLJE**, BUL. ALEKSANDAR MAKEDONSKI 12, SKOPLJE, MK;



(540)

(550) I

(740) Popović Miladin, Đoka Miraševića 21/III, Podgorica (ME)

(511) **Klasa 03:** Dnevna krema.

(210) **2011-425**

(442) **20.06.2013**

(220) 22.8.2011

(731) **ALKALOID AD SKOPLJE**, BUL. ALEKSANDAR MAKEDONSKI 12, SKOPLJE MK



(540)

(550) I

(740) Popović Miladin, Đoka Miraševića 21/III, Podgorica (ME)

(511) **Klasa 03**: Polivitaminska dnevna krema.

(210) **2011-426**

(442) **20.06.2013**

(220) 22.8.2011

(731) **ALKALOID AD SKOPLJE**, BUL. ALEKSANDAR MAKEDONSKI 12, SKOPLJE MK



(540)

(550) I

(740) Popović Miladin, Đoka Miraševića 21/III, Podgorica (ME)

(511) **Klasa 03**: Regenerativna dnevna krema.

(210) **2011-427**

(442) **20.06.2013**

(220) 22.8.2011

(731) **ALKALOID AD SKOPLJE**, BUL. ALEKSANDAR MAKEDONSKI 12, SKOPLJE MK



(540)

(550) I

(740) Popović Miladin, Đoka Miraševića 21/III, Podgorica (ME)

(511) **Klasa 03**: Noćna krema.

(210) **2011-428**

(442) **20.06.2013**

(220) 22.8.2011

(731) **ALKALOID AD SKOPLJE**, BUL.ALEKSANDAR MAKEDONSKI 12, SKOPLJE MK



(540) ličninski klasifikacija

(550) I

(740) Popović Miladin, Đoka Miraševića 21/III, Podgorica (ME)

(511) **Klasa 03**: Noćna polivitaminska krema.

(210) **2011-429**

(442) **20.06.2013**

(220) 23.8.2011

(731) **INDUSTRIJA PIVA I SOKOVA TREBJESA AD NIKŠIĆ**, NJEGOŠEVA BR. 18 NIKŠIĆ, ME

inajeprii izgica znaka a verbaini znak otucati masinom ili  
uz pomoć računara



(540) ta Ničanskoj klasifikaciji:

(550) I

(740) Božović Vesko, Rimski trg 50/11, Podgorica (ME)

(511) **Klasa 32:** Pivo, mineralne i sodne vode i druga bezalkoholna pica; pica od voća i voćni sokovi; sirupi i drugi preparati za proizvodnju pica.

**Klasa 35:** Oglašavanje; vođenje poslova; poslovno upravljanje; kancelarijski poslovi. Obuhvata: usluge koje pružaju lica ili organizacije u pomoći u radu ili upravljanju preduzećima i u vođenju poslova preduzeća; usluge koje pružaju preuzeća koja se bave oglašavanjem (reklamiranjem), tako što, za račun drugih lica, komuniciraju sa javnošću (reklama) putem prenosa bilo kakvih informacija o proizvodima i uslugama omogućavajući potrošačima prigodan pogled na te proizvode i usluge; usluge koje se sastoje od upisivanja, uređivanja, obrade, prerade ili sistematizacije pisanih informacija i zapisa; usluge reklamnih agencija; distribuciju prospekata i uzoraka direktno ili poštom; izradu i korišćenje matematičkih i statističkih podataka; organizovanje sajmova i izložbi u komercijalne ili reklamne svrhe.

(210) **2011-43**

(442) **20.06.2013**

(220) 31.1.2011

(731) **BONGRAIN S.A.**, 42 RUE RIEUSSEC, 78220 VIROFLAY, FR



(540)



(550) I

(740) Lutovac Branislav, Bulevar Crnojevića 93, Podgorica (ME)

(511) **Klasa 29:** Mlijeko, sir i mliječni proizvodi; jestiva ulja i masti.

(210) **2011-430**

(442) **20.06.2013**

(220) 23.8.2011

(731) **CELGENE CORPORATION**, 86 MORRIS AVENUE, SUMMIT, NEW JERSEY 07901, US

ИМНОВИД

(540)

(550) I

(740) Čejović Vladimir, 13. jula 21, Podgorica (ME)

(511) **KLASA 05:** Farmaceutski preparati, naime, lijekovi inhibitori citokina; farmaceutski preparati koji modulišu imuni sistem; farmaceutski preparati za liječenje pojedinih vrsta raka i oboljenja krvi.

(210) **2011-431**

(442) **20.06.2013**

(220) 23.8.2011

(731) **JT INTERNTIONAL S.A.**, 1, RUE DE LA GABELLE, 1211 GENEVA 26, CH

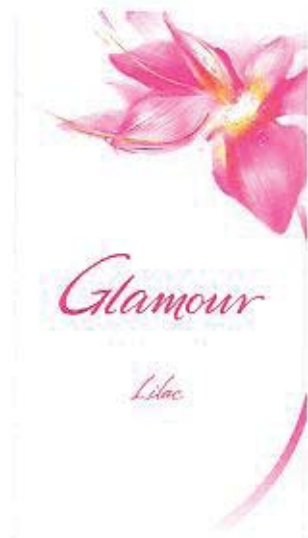

(540)

(550) I

(740) Čejović Vladimir, 13. jula 21, Podgorica (ME)

(511) **Klasa 34:** Duvan, koji je prerađen ili neprerađen; duvan za pušenje, duvan za lule, duvan za savijanje, duvan za žvakanje, duvan za sisanje; cigarete, cigare, cigarilosi; supstance za pušenje koje se prodaju odvojeno ili izmiješane sa duvanom, i koje nijesu za medicinsku ili svrhu liječenja; burmut; artikli za pušače uključeni u klasu 34; papir za cigarete, fišeci za cigarete i šibice.

(210) **2011-432**

(442) **20.06.2013**

(220) 23.8.2011

(731) **JT INTERNATIONAL S.A.**, 1, RUE DE LA GABELLE, 1211 GENEVA 26, CH

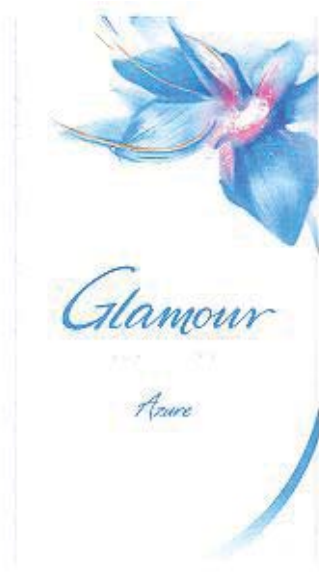

(540) ni klasifikaciji:

(550) I

(740) Čolović Branko, Mediteranska br 2 Budva (ME)

(511) **Klasa 34:** Duvan, koji je prerađen ili neprerađen; duvan za pušenje, duvan za lule, duvan za savijanje, duvan za žvakanje, duvan za sisanje; cigarete, cigare, cigarilosi; supstance za pušenje koje se prodaju odvojeno ili izmiješane sa duvanom, i koje nijesu za medicinsku ili svrhu liječenja; burmut; artikli za pušaće uključeni u klasu 34; papir za cigarete, fišeci za cigarete i šibice.

(210) **2011-433**

(442) **20.06.2013**

(220) 24.8.2011

(731) **LOGATE D.O.O**, DŽORDŽA VAŠINGTONA BB PODGORICA ME



(540)

(550) I

(511) **Klasa 35:** Oglašavanje; vođenje poslova; poslovno upravljanje.

**Klasa 42:** Naučne i tehnološke usluge i istraživanje i projektovanje u vezi navedenih usluga; usluge industry ske analize i istraživanja; projektovanje i razvoj kompjuterskog hardvera i softvera.

(210) **2011-434**

(442) **20.06.2013**

(220) 26.8.2011

(731) **THE GILLETTE COMPANY**, ONE GILLETTE PARK, BOSTON, MA 02127, US

**PROGLIDE STYLER**

(540)

(550) I

(740) Lutovac Branislav, Bulevar Crnojevića 93, Podgorica (ME)

(511) **Klasa 08:** Brijači i noževi za brijanje; dozne, kasete, držači i patrone koje sadrže nozeve za brijanje; i strukturni delovi za napred navedeno.

---

(210) **2011-435**

(442) **20.06.2013**

(220) 26.8.2011

(731) **AMERICAN-CIGARETTE COMPANY (OVERSEAS) LIMITED**, ZAEHLERWEG 4, ZUG 6300 CH

## FOLIES

(540)

(550) I

(740) Popović Miladin, Đoka Miraševića 21/III, Podgorica (ME)

(511) **Klasa 34:** Cigarete, duvan; proizvodi od duvana; upaljači; šibice; artikli za pušače.

---

(210) **2011-436**

(442) **20.06.2013**

(220) 26.8.2011

(731) **AMERICAN-CIGARETTEE COMPANY (OVERSEAS) LIMITED**, ZAEHLERWEG 4,ZUG 6300 CH

## FRISSON

(540)

(550) I

(740) Popović Miladin, Đoka Miraševića 21/III, Podgorica (ME)

(511) **Klasa 34:** Cigarete, duvan; proizvodi od duvana; upaljači; šibice; artikli za pušače.

---

(210) **2011-437**

(442) **20.06.2013**

(220) 29.8.2011

(300) CN 9164747 02.03.2011 klasa 12, CN 9164746 02.03. 2011 klasa 37

(731) **CHONGPING YUAN INNOVATION TECHNOLOGY CO,LTD.**, FENGHUANG, SHAPINGBA DISTRICT, CHONGPING, CN

# SOKON

(540)

(550) I

(740) Čejović Vladimir, 13. jula 21, Podgorica (ME)

(511) **Klasa 12:** Lokomotive; cyclecar vozila; automobili; motorna vozila; mmortizeri za vozila; točkovi za vozila; motori za kopnena vozila; amortzeri za automobile; motocikli; bicikli.**Klasa 37:** Usluge građevinskog informisanja; izgradnja fabrika; građevinske usluge; usluge rudarskih iskopa; tapaciranje; održavanje i popravka motornih vozila; pranje vozila; usluge servisnih stanica za vozila (dosipanje goriva i održavanje); reparacija guma; usluge instaliranja, održavanja i popravke mašinerije.(210) **2011-439**(442) **20.06.2013**

(220) 1.9.2011

(300) PRIJAVA U EU.BROJ 9773573 OD 01 03 2011

(731) **DEUTCHE TELECOM AG**, FRIEDRICH-EBERT-ALLEE 140 53113 BONN DE;

## MusicWorld

(540)

(550) I

(740) Popović Miladin, Đoka Miraševića 21/III, Podgorica (ME)

(511) **Klasa 09:** Aparati i instrumenti naučni, pomorski, geodetski, fotografski, kinematografski, optički, za vaganje, merenje, signalizaciju, kontrolu (inspekciju), spasavanje i nastavu; Aparati i instrumenti za provodenje, prekid, transformaciju, akumulaciju, regulisanje ili kontrolu električne energije; Aparati za snimanje, prenos, obradu i reprodukovanje zvuka, slika ili podataka; Magnetni nosioci podataka; Automatske mašine i mehanizmi za aparate koji se pokreću novcem ili žetonom; Računske mašine, oprema za obradu podataka i kompjuteri; Sve vrste snimljenih i nesnimljenih nosioca podataka (koji su uključeni u klasu 09); Kompjuterski programi (snimljeni); Elektronski snimljeni podaci (koji se mogu preuzeti); Elektronske publikacije (koje se mogu preuzeti).**Klasa 38:** Telekomunikacije; Novinske agencije; Iznajmljivanje telekomunikacionih aparata; Informacije o telekomunikacijama.**Klasa 42:** Naučne i tehnološke usluge i istraživanje i projektovanje u vezi sa tim; Usluge industrijske analize i istraživanja; Projektovanje i razvoj kompjuterskog hardvera, softvera i baza podataka: Održavanje kompjuterskog softvera; Tehničke konsultacije; Kompjuterske usluge koje se tiču elektronskog čuvanja podataka; Iznajmljivanje kompjutera; Usluge dizajniranja vebajtova za druge.(210) **2011-440**(442) **20.06.2013**

(220) 1.9.2011

(731) **GOODYEAR DUNLOP TIRES GERMANY GMBH**, DUNLOPSTRASSE 2,63450 HANAU, DE

## KRISTALL

(540)

(550) I

(740) Čejović Vladimir, 13. jula 21, Podgorica (ME)

(511) **Klasa 12:** Gume.

---

(210) **2011-441**

(442) **20.06.2013**

(220) 1.9.2011

(731) **GEOGRAFIA-PACIFIC CONSUMER PRODUCTS LP**, 133 PEACHTREE STREET NE, ATLANTA, GEORGIA 30303, US

## SERIE 3000

(540)

(550) I

(740) Čejović Vladimir, 13. jula 21, Podgorica (ME)

(511) **Klasa 21:** Dispenzeri za osvježivače vazduha, za sredstva za čišćenje dasaka za WC šolje, za kante za otpatke.

---

(210) **2011-442**

(442) **20.06.2013**

(220) 2.9.2011

(731) **REEBOK INTERNATIONAL LIMITED**, MOOR LANE MILL, LANCASTER, LA1 1GF, GB

## REEBOK

(540)

(550) I

(740) Radulović Božidar, Jovana Tomaševića 9/III, Podgorica (ME)

(511) **Klasa 28:** Igračke, igre, proizvodi za sport.

---

(210) **2011-443**

(442) **20.06.2013**

(220) 5.9.2011

(731) **THE PROCTER & GAMBLE COMPANY**, ONE PROCTER & GAMBLE PLAZA, CINCINNATI, OHIO 45202 US



Naturella

(540)

(550) I

(740) Lutovac Branislav, Bulevar Crnojevića 93, Podgorica (ME)

(511) **Klasa 05:** Proizvodi za žensku higijenu, naročito maxi ulošci, mini ulošci, dnevni ulošci i tamponi; ulošci za inkontinenciju; dnevni ulošci za inkontinenciju.(210) **2011-444**(442) **20.06.2013**

(220) 6.9.2011

(731) **SAVIČEVIĆ BILJANA**, UL.27 MARTA G/7 ULAZ 10 PODGORICA, ME  
uz pomoć računara

(540)

(550) I

(511) **Klasa 38:** Telekomunikacije.**Klasa 41:** Obrazovne usluge; pripremanje obuke; razonoda; sportske i kulturne aktivnosti.(210) **2011-445**(442) **20.06.2013**

(220) 7.9.2011

(300) RO M 2011 02288(MARCH 22,2011)

(731) **JT INTERNATIONAL S.A.**, 1, RUE DE LA GABELE,1211 GENEVA 26, CH

## SOBRANIE CREATIONS BEYOND COMPARE

(540)

(550) I

(740) Čejović Vladimir, 13. jula 21, Podgorica (ME)

(511) **Klasa 34:** Duvan, koji je prerađen ili neprerađen; duvan za pušenje, duvan za lule, duvan za savijanje, duvan za žvakanje, duvan za sisanje; cigarete, cigare, cigarilosi; supstance za pušenje koje se prodaju odvojeno ili izmiješane sa duvanom, i koje nijesu za medicinsku ili svrhu liječenja; burmut; artikli za pušače uključeni u klasu 34; papir za cigarete; fišeci za cigarete i šibice.

(210) **2011-447**

(442) **20.06.2013**

(220) 8.9.2011

(300) CTM 10200699 (AVGUST 17,2011)

(731) **MARS, INCORPORATED**, 6885 ELM STREET,MCLEAN,VA 22101-3883,US



(540)

(550) I

(740) Čejović Vladimir, 13. jula 21, Podgorica (ME)

(511) **Klasa 29:** Meso, riba, živina i divljač; mesne prerađevine; konzervisano, sušeno i kuvano voće i povrće; jaja; mlječni proizvodi; želei, džemovi, kompoti; mlijeko i mlječni napitci; proizvodi pripremljeni za konzumiranje i koji se sastoje uglavnom od gore navedenih proizvoda.

**Klasa 30:** Kafa i zamjena kafe; čaj, kakao, čokolada za piće; šećer, pirinač, tapioka, sago; brašno i proizvodi od žitarica; hljeb, biskviti, kolači, pecivo, čokolada i slatkiši; sladoled; led, led sa dodatkom voćnog soka i šećera u vidu dezerta; med, melasa; so, sent; sirće, sosevi; pesto; dodaci jelima; bilje; začini; proizvodi pripremljeni za konzumiranje i koji se sastoje uglavnom od gore navedenih proizvoda.

(210) **2011-448**

(442) **20.06.2013**

(220) 9.9.2011

(731) **SHELL BRANDS INTERNATIONAL AG**, BAARERMATTE,6340 BAAR, CH

## TACTIC

- (540)  
 (550) I  
 (740) Čejović Vladimir, 13. jula 21, Podgorica (ME)  
 (511) **Klasa 04:** Ulja; masti; maziva; goriva.

- 
- (210) **2011-449** (442) **20.06.2013**  
 (220) 12.9.2011  
 (731) **ROTHMANS OF PALL MALL LIMITED**, ZAEHLERWEG 4, ZUG, CH 6300 CH

## CONSULATE

- (540)  
 (550) I  
 (740) Popović Miladin, Đoka Miraševića 21/III, Podgorica (ME)  
 (511) **Klasa 34:** Cigarete, duvan; proizvodi od duvana; upaljači; šibice; artikli za pušače.

- 
- (210) **2011-450** (442) **20.06.2013**  
 (220) 13.9.2011  
 (731) **TOTO LTD.**, 1-1, NAKASHIMA 2-CHOME, KOKURAKITA-KU, KITAKYSHU-SHI, JP

## NEOREST

- (540)  
 (550) I  
 (740) Lutovac Branislav, Bulevar Crnojevića 93, Podgorica (ME)  
 (511) **Klasa 06:** Gradjevinski materijali od metala, metalne ploče, metalne pločice za oblaganje i pokrivanje; metalne podne pločice; metalni okviri za zgrade; metalne opiate; podovi od metala; tavanice od metala; metalna vrata; metalni okviri za prozore i prozori za zgrade; stepenište od metala; krovovi od metala; krovne obloge od metala jkapije od metala; ograde od metala; škure od metala; zaštitne ograde od metala; znakovi, ne-svjetleći i ne-mehanički, od metala; rešetke i paravani od metala; spoljašnje roletne od metala; metalne grobnice ; prenosive zgrade od metala; paneli od metala; metalni znakovi i natpisi; metalni kontejneri (za skladištenje, transport); metalni zidovi nepropusni na zvuk (odn. zvučno izolovani); metalne šipke za peškire; metalne kuke; metalni rukohvati (gelenderi); razdjelnici za peškire, fiksirani, ne-metalni; mašina za pranje od metala; odvodne cijevi od metala; metalne cijevi za vodu; metalne cijevi; metalni mufovi za cijevi; metalne spona za cijevi; držači cijevi od metala; metalni odvodni trapovi; elementi za cjevovode od metala; razvodni sklopovi za



cjevovode od metala; sva ostala roba uključena u ovu klasu.

**Klasa 20:** Postolja za pranje; stolovi za oblačenje; ogledala (toaletna ogledala); namještaj (1 to, stalci za peškire, prečke, kuhinjski ormarići, pobočni ormarići (ormari za posuđe), toaletni ormarići) ; namještaj za kupatilo (i to: pultovi, ormarći, police); merdevine, ne-metalne; pultovi (stolovi); postolje za lavabo; toaletni pultovi; kuhinjske površine; pobočne kuhinjske površine /kuhinjski pultovi/ ormarići uključujući sudopere ali ne gasne gorionike; klupe; sjedišta za djecu (namještaj); dječija stolica (namještaj); šipke za peškire, ne-metalne; kuke, ne-metalne; navrtke, ne-metalne; odvodni zaklopci od plastike; dispenser/ razdjelnici za peškire, fiksirani, ne-metalni; plastični ventili za cijevi za vodu; jastučići; jastuci; kreveti; krevetske prostirke i pokrivači, izuzev posteljine; sva ostala roba uključena u ovu klasu.

**Klasa 21:** Držači za toaletni papir ; dispenser/razdjelnici za toaletni papir ; držači za papirne presvlake za toaletnu dasku; metalne kutije, za držanje papirnatih ubrusa; dispenser/razdjelnici za toaletne ubruse; držači i kutije za sapun; dispenser/razdjelnici za sapun; toaletne kutije; držači i kutije za četkice za zube; čaše za vodu i držači za case za vodu; kupatilske četke i držači; nosači za peškire u obliku prečki i prstenova; rukohvati, nemetalni; kante za smeće; noćne posude; uređaji na vodu za čišćenje zuba i desni; pribor za čišćenje (ručno pokretane); kade za djecu (prenosne); krpe (tkanine) za čišćenje ; sva ostala roba uključena u ovu klasu.

(210) **2011-451**

(442) **20.06.2013**

(220) 14.9.2011

(731) **RECKITT BENCKISER N.V.**, SIRIUSDREEF 14,2132 WT HOOFDORP, NL



(540)

(550) I

(740) Popović Miladin, Đoka Miraševića 21/III, Podgorica (ME)

(511) **Klasa 03:** preparati i šamponi za čišćenje tepiha; deterdženti za veš, dodaci za pranje veša, preparati za uklanjanje mrlja sa tkanina i tepiha.

(210) **2011-452**

(442) **20.06.2013**

(220) 15.9.2011

(731) **E.MISHAN & SONS, INC(NEW YORK CORPORATON)**, 230 FIFTH AVENUE, SUITE 800, NEW YORK, NY 10001 US

**DRx** *Levinés*

(540)

(550) I

(740) Čejović Vladimir, 13. jula 21, Podgorica (ME)

(511) **Klasa 10:** ortopedske trake za koljena, ortopedski zavoj za članke, ortopedski zavoj za vrat, ortopedski zavoj za ručne zglobove, ortopedski zavoj za ramena, ortopedski pojasi za leđa, ortopedski ulošci za cipele, ortopedski podvezi, podupirači za leđa, članke, vrat i ramena koji se koriste u medicinske potrebe, ortopedski steznici za koljena, ortopedski rastezljivi podupirači za koljena, steznici za leđa koji se koriste za medicinske svrhe, medicinski uređaji i instrumenti, terapijski galvanski uređaji, medicinski uređaji za magnetnu terapiju koji spadaju u klasu 10.

(210) **2011-453**

(442) **20.06.2013**

(220) 19.9.2011

(731) **J&J COMPANY DOO**, BOTUN BB, PODGORICA, ME



(540)

(550) I

(511) **Klasa 29:** Konzervisano, zamrznuto, sušeno i kuvano voće i povrće,; mlijeko u prahu.

**Klasa 30:** šećer, kakao, pirinac; so; mljevena paprika, susam, kokos brašno.

**Klasa 31:** Kikiriki u ljusci, kikiriki oljušteni, badem, lješnik, kukuruz kokičar, pistači, pšenica, pasulj, orah, bundevina sjemenka, suncokretova sjemenka.

(210) **2011-456**

(442) **20.06.2013**

(220) 19.9.2011

(731) **FRES & CO. DOO**, IVANA GORANA KOVAČIĆA 3, SUBOTICA 24000 RS



(540)

(550) I

(740) Popović Miladin, Đoka Miraševića 21/III, Podgorica (ME)

(511) **Klasa 32:** Piva; mineralne i sodne vode i druga bezalkoholna pica; pica od voća i voćni sokovi; sirupi i drugi preparati za proizvodnju pica.

(210) **2011-497**

(442) **20.06.2013**

(220) 12.10.2011

(731) **NIMCRO DOO.** ZAGREB, METALČEVA 5, HR-10000 ZAGREB HR

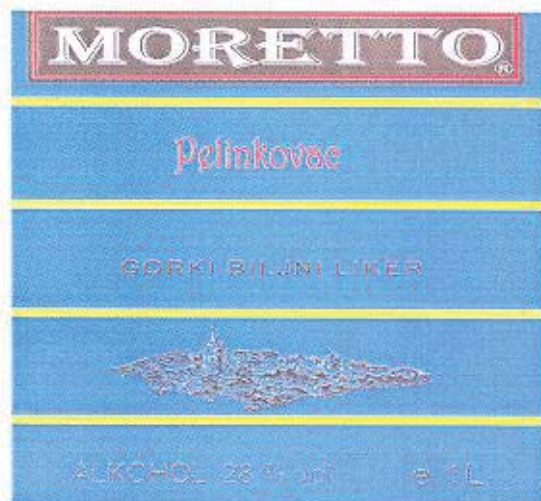

(540)

(550) I

(740) Božović Vesko, Rimski trg 50/11, Podgorica (ME)

(511) **Klasa 33:** Alkoholna pića (izuzev piva).

(210) **2011-552**

(442) **20.06.2013**

(220) 10.11.2011

(731) **J. & P. COATS, LIMITED,** 1 GEORGE SQUARE, GLASGOW G2 1AL SCOTLAND UK



(540)

(550) I

(740) Popović Miladin, Đoka Miraševića 21/III, Podgorica (ME)

(511) **Klasa 23:** prediva i konci za tekstilnu upotrebu;

---

(210) **2011-63**

(442) **20.06.2013**

(220) 7.2.2011

(731) **GROUPON, INC**, 600 WEST CHICAGO AVENUE, CHICAGO, ILLINOIS 60654 US

# GROUPON

(540)

(550) I

(740) Čupić Branislav, Dalmatinska 10, Podgorica (ME)

(511) **Klasa 35:** Promovisanje roba i usluga za druge obezbjeđivanjem veb-sajtova koje karakterišu kuponi, rabati, obavještenja o uporednim cjenama proizvoda, procjene proizvoda, linkovi ka veb-sajtovima drugih maloprodajnih subjekata i informacije o popustima.

---

(210) **2011-81**

(442) **20.06.2013**

(220) 18.2.2011

(731) **CALCADOS AZALEIA S/A**, RUA DR.LEGENDRE,34,PAROBE, RIO GRANDE DO SUL BRAZIL, 95630-000, BR



(540)

(550) I

(740) Popović Miladin, Đoka Miraševića 21/III, Podgorica (ME)

(511) **Klasa 25:** Odjeća, obuća i pokrivala za glavu.

(210) **2011-92**

(442) **20.06.2013**

(220) 25.2.2011

(731) **PANASONIC CORPORATION**, 1006, OAZA KADOMA, KADOMA-SHI, OSAKA 571-8501, JP

# Panasonic

(540)

(550) I

(740) Radulović Božidar, Jovana Tomaševića 9/III, Podgorica (ME)

(511) **Klasa 01:** Hemijski proizvodi za industriju, nauku, ratarstvo, povrtlarstvo i šumarstvo; sirova vještačka smola, sirova plastika; đubrivo za zemlju; mješavine za gašenje požara; preparati za kaljenje, zavarivanje i lemljenje metala; hemijski proizvodi za konzervisanje hrane; sredstva za štavljenje kože; ljepila (ljepljive tvari) namijenjene za industriju.

**Klasa 02:** Boje, lakovi i glazure; zaštite od rđe te od propadanja i truljenja drveta; tvari za bojenje; nagrizajuće tvari; prirodne sirove smole; metali u listovima i u prahu za slikare, dekoratere, štampare i umjetnike.

**Klasa 03:** Preparati za bijeljenje i ostale tvari za pranje rublja; preparati za čišćenje, poliranje, odmašćivanje i struganje; sapuni; parfimerijski proizvodi, eterična ulja, kozmetički proizvodi, losioni za kosu; proizvodi za njegu zuba.

**Klasa 04:** Industrijska ulja i masti; sredstva za podmazivanje; proizvodi za upijanje, vlaženje i vezanje prašine; goriva (uključujući benzin za motore) i rasvjetne tvari; svijeće, fitilji za rasvjetu..

**Klasa 05:** Farmaceutski i veterinarski proizvodi; higijenski proizvodi za upotrebu u medicini; dijetne tvari za medicinske potrebe, hrana za dojenčad; flasteri, materijal za previjanje; materijali za plombiranje zuba i za zubne otiske; dezinfekciona sredstva; proizvodi za uništavanje

životinjskih štetočina; fungicidi, herbicidi.

**Klasa 06:** Obični metali i njihove legure; metalni građevinski materijali; metalne prenosive konstrukcije; metalni materijali za sine; metalna užad i neelektrične metalne žice; metalni bravarski proizvodi i sitni metalni predmeti; metalne cijevi; metalne blagajne; metalni proizvodi koji nisu obuhvaćeni drugim klasama; rude.

**Klasa 07:** Mašine i alatne mašine; motori (osim motora za kopnena vozila); spojke, prenosni uređaji (osim onih za kopnena vozila); poljoprivredne naprave osim onih koji se pokreću ručno; inkubatori za jaja

**Klasa 08:** Ručni alati i sprave s ručnim pokretanjem; noževi, viljuške i kašike; hladno oružje; mehaničke i električne sprave za brijanje.

**Klasa 09:** Naučnici, nautički, geodetski instrumenti kao i aparati i instrumenti za vaganje, mjerenje signalizaciju, kontrolu (inspekciju), za pomoć (spašavanje) i za obuku; aparati i instrumenti za vodenje, distribuiranje, transformisanje, akumuliranje, podešavanje ili upravljanje električne struje; aparati za snimanje, prenos, reprodukciju zvuka ili slike; magnetne podloge za snimanje, akustične ploče; automati i mehanizmi za automatske uređaje koji se pokreću uz prethodno ubacivanje kovanica; registarske blagajne, računari, oprema za obradu podataka i računala; uređaji za gašenje požara.

**Klasa 10:** Hirurški, medicinski, zubarski i veterinarski aparati i instrumenti, vještački udovi, oči i zubi; ortopedski proizvodi; pribor za šivanje rana.

**Klasa 11:** Uređaji za rasvjetu, grijanje, proizvodnju pare, kuvanje, hlađenje, sušenje, ventilaciju, vodosnabdijevanje i sanitarna oprema.

**Klasa 12:** Vozila; uređaji za kretanje po zemlji, po vodi ili po vazduhu.

**Klasa 14:** Plemeniti metali i njihove legure i proizvodi od tih materijala ili obloženi tim metalima, koji nisu obuhvaćeni drugim klasama; pravi i lažni nakit, drago kamenje; časovničarski proizvodi i hronometrički instrumenti.

**Klasa 16:** Papir, karton i proizvodi od tih materijala koji nisu obuhvaćeni drugim klasama; štamparski proizvodi; proizvodi za uvezivanje knjiga; pribor za pisanje; ljepila (ljepljive tvari za papirnate proizvode ili za domaćinstvo); slikarski pribor; kistovi; pisaće mašine i kancelarijski pribor (osim namještaja); oprema za nastavu i obuku (osim aparata); plastični materijali za ambalažu (koji nisu obuhvaćeni drugim klasama); štamparska slova; i klišeji.

**Klasa 17:** Guma, gutaperka, biljna smola, azbest, liskun i proizvodi od tih materijala koji nisu obuhvaćeni drugim klasama; proizvodi od poluobrađene plastike; materijali za hermetičko zatvaranje, za brtvljenje i za izolaciju; nemetalne savitljive cijevi..

**Klasa 19:** Nemetalni građevinski materijali; krute nemetalne cijevi za gradnju; asfalt, katran i bitumen (smola); nemetalne prenosive konstrukcije; i nemetalni spomenici.

**Klasa 20:** Namještaj, ogledala, okviri; proizvodi koji nisu obuhvaćeni drugim klasama, od drveta, plute, trske, vrbovog pruća, roga, kosti, slonovače, kitove kosti, kornjačevine, školjki, ćilibara, sedefa, morske pjene i zamjena svih tih materijala ili plastični proizvodi.

**Klasa 21:** Pribor i posude za domaćinstvo ili za kuhinju (koji nisu od plemenitih metala niti su presvućeni metalom); češljevi i sunđer; četke (osim kistova); materijali za četke; pribor za čišćenje; žica za struganje parketa; sirovo ili poluobrađeno staklo (osim građevinskog stakla); stakleni proizvodi, porculanski i keramički proizvodi koji nisu obuhvaćeni drugim klasama.

**Klasa 24:** Tkanine i tekstilni proizvodi koji nisu obuhvaćeni drugim klasama; pokrivači za krevete i stolove.

**Klasa 27:** Sagovi, prostirači, strunjače, linoleumi i ostali pokrivači za podove; netekstilne zidne tapete.

**Klasa 28:** Igre i igračke; gimnastički i sportski predmeti koji nisu obuhvaćeni drugim klasama;

ukrasi za novogodišnje jelke.

**Klasa 35:** Oglašavanje i reklamiranje; vođenje komercijalnih poslova; komercijalna administracija i kancelarijski poslovi.

**Klasa 36:** Osiguranje; finansijski poslovi; monetarni poslovi i upravljanje nekretninama.

**Klasa 37:** Izgradnja; popravke; usluge postavljanja.

**Klasa 40:** Obrada materijala.

**Klasa 41:** Obuka; stručno osposobljavanje; razonoda; sportske i kulturne djelatnosti.

**Klasa 42:** Naučne i tehnološke usluge kao i pripadajuće usluge istraživanja i koncepcije; usluge industrijskih analiza i istraživanja, koncepcija i razvoj računara i računarskih programa.

**Klasa 43:** Usluge obezbjeđivanja hrane i pica; privremeni smještaj.

**Klasa 44:** Medicinske usluge; veterinarske usluge; higijenska njega i njega ljepote za ljude za životinje; poljoprivredne, povrtlarske i šumarske usluge.

**Klasa 45:** Pravne usluge; Lične i društvene usluge namijenjene za zadovoljenje ljudskih potreba; usluge sigurnosti za zaštitu imovine i ljudi.

(210) **2011-99**

(442) **20.06.2013**

(220) 28.2.2011

(731) **PHILIP MORRIS OPERATIONS** AD NIŠ BULEVAR 12.FEBRUAR 74,18000 NIŠ, RS



(540)

(550) I

(511) **Klasa 34:** Cigarete.

(210) **2012-117**

(442) **20.06.2013**

(220) 24.2.2012

(731) **ADRIATIC MARINAS doo**, Obala bb 85320 Tivat ME

**CASINO ROYALE**

(540)

(550) V

(740) Đjurovc Savo, Dom Vojske, Seljanovo b.b. Tivat (ME)

(511) **Klasa 36:** Osiguranje ; finansijski poslovi; novčani (monetarni) poslovi; poslovi vezani za nepokretnosti.

**Klasa 39:** Transportne usluge; pakovanje i skladištenje roba; organizovanje putovanja.

**Klasa 41:** Obrazovne usluge; pripremanje obuke; razonoda; sportske i kulturne aktivnosti.

**Klasa 43:** Usluge obezbjeđivanje hrane i pića; privremeni smještaj.

**Klasa 43:** Medicinske usluge; veterinarske usluge; higijenska zaštita i njega ljepote za ljude i životinje; agrikulture, hortikulture i šumarske usluge.

---



(111) 07584

(151) 22.04.2013

(210) **2010-91**(442) **20.06.2012**

(220) 06.04.2010

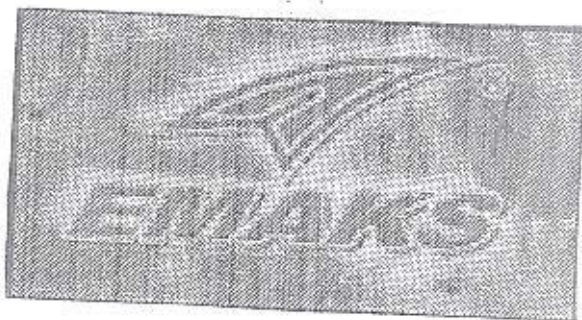
(732) **HARI-UNO DOO**, TRŽNI CENTAR-BULEVAR MARŠALA TITA ULCINJ ME

(540)

(550) I

(511) **Klasa 25:** Odjeća, obuća, i pokrivala za glavu.

(111) 07812

(151) 29.04.2013.

(210) **2009-620**(442) **20.03.2012**

(220) 21.10.2009

(732) **INCOGNITO DOO**; HERCEGOVACKA 31 81000 PODGORICA ME

(540)

(550) I

(511) **Klasa 35:** Oglašavanje i reklamiranje.

(111) 07793

(151) 17.04.2013

(210) **2010-270**(442) **20.06.2012**

(220) 30.07.2010

(732) **ARTERIUM CORPORATION**, 139 SAKSAGANSKOGO STR, KIEV 01032 UA

UROLESAN

(540)

(550) I

(740) Čejović Vladimir, 13. jula 21, Podgorica (ME)

(511) **Klasa 05:** Farmaceutski i veterinarski proizvodi, sanitarni preparati za medicinsku upotrebu, dijetetske supstance prilagođene za upotrebu u medicini, hrana za bebe, flasteri, materijali za previjanje, materijali za plombiranje zuba, zubarska smola, sredstva za dezinfekciju, proizvodi za uništavanje životinjskih štetočina, fungicidi, herbicidi,

(111) 07994

(151) 31.05.2013

(210) **2010-291**

(442) **20.10.2012**

(220) 11.08.2010

(732) **NOVARTIS AG**, 4002 BASEL CH

## HEXAL

(540)

(550) I

(740) Popović Miladin, Đoka Miraševića 21/III, Podgorica (ME)

(511) **Klasa 05:** Farmaceutski i veterinarski preparati, sanitarni preparati za medicinsku upotrebu, dijetetske supstance prilagođene za upotrebu u medicini, hrana za bebe, flasteri, materijali za zavijanje, materijali za plombiranje zuba, zubarska smola, dezinfekciona sredstva, preparati za uništavanje štetočina, fungicidi, herbicidi

(111) 07995

(151) 31.05.2013.

(210) **2010-312**

(442) **20.10.2012**

(220) 03.09.2010

(732) **PWC BUSINESS TRUST STATE OF DELAWARE USA**, 300 MADISON AVENUE, NEW YORK, NY 10017 US

## PWC

(540)

(550) I

(740) Čupić Branislav, Dalmatinska 10, Podgorica (ME)

(511) **Klasa 09:** Kompjuterski softver, elektronske publikacije, ne-štampane publikacije, publikacije koje se mogu preuzeti elektronskim putem (downloadable), aparati, instrumenti i mediji za snimanje, skladištenje, prenošenje, manipulaciju, emitovanje, reprodukciju i očitavanje podataka, signala, informacija, koda, slika, teksta, video, zvučnih i audio zapisa, CD-ROM-ovi, DVD-i, audio, vizuelni i audiovizuelni materijali koji se mogu preuzeti elektronskim putem (downloadable), interaktivni kompjuterski softver, aparati i instrumenti za nastavu, kodirane kartice i identifikacione kartice, kompjuterski softver za prikupljanje i upravljanje podacima, vršenje analiza, sprovođenje studija i pravljenje i generisanje izvještaja u oblasti računovodstva, revizije, menadžmenta, biznisa i poreza, djelovi i oprema za svu navedenu robu.

**Klasa 35:** Poslovni menadžment, poslovna administracija, kancelarijski poslovi, računovod-

stvene usluge, usluge poslovne revizije, usluge konsaltinga i savjetodavne usluge u vezi sa porezom, usluge konsaltinga i savjetodavne usluge u vezi sa spajanjem, akvizicijom i devastacijom privrednih subjekata, usluge konsaltinga i savjetodavne usluge u vezi sa poslovnim menadžmentom i biznisom, savjetodavne usluge u vezi sa korporativnim upravljanjem, usluge istraživanja tržišta, savjetodavne uloge u vezi sa upravljanjem ljudskim resursima, savjetodavne usluge u vezi sa poslovnim informacijama i istraživanjem, knjigovodstvo, revizija, usluge pripreme poreskih prijava i konsaltinga u vezi sa porezom, konsalting usluge u vezi sa poslovnim menadžmentom u oblasti informacionih tehnologija, usluge davanja savjeta i istraživanja u vezi sa porezom, informacione, savjetodavne i konsultantske usluge u vezi sa svim uslugama navedenim u ovoj klasi, usluge selekcije i regrutovanja osoblja, usluge poslovnog informisanja i istraživanja, pružanje informacija kao i savjetodavnih i konsultantskih usluga u vezi sa svim uslugama navedenim u ovoj klasi onlajn putem, u štampanoj i elektronskoj formi.

**Klasa 36:** Finansijski poslovi, monetarni poslovi, finansijski menadžment, usluge pružanja pomoći, savjetodavne, konsultantske, informacijske i istraživačke usluge u oblasti finansija, konsultantske usluge u vezi poreza i dažbina, usluge vezane za stečaj, usluge u vezi investicija, usluge procjene, konsultantske i savjetodavne usluge u vezi sa investicionim bankarstvom, konsultantske i savjetodavne usluge u vezi sa finansijama, konsultantske usluge u vezi sa procjenom rizika, konsultantske usluge u vezi sa beneficijama za zaposlene, usluge finansijske procjene u oblastima privrednih preduzeća, zaliha, imovine, opreme, licenciranja, nekretnina i intelektualne svojine, usluge procjene nekretnina, usluge upravljanja rizicima, konsultantske usluge u oblasti programa za beneficije za zaposlene, usluge agencija za imovinu i menadžmenta imovine, usluge u vezi sa nekretninama, pružanje finansijskih informacija, pružanje informacija onlajn putem, u štampanoj i elektronskoj formi, savjetodavne i konsultantske usluge u vezi sa svim uslugama navedenim u ovoj klasi.

(111) 03.06.2013

(151) 08011

(210) **2010-310**

(442) **20.10.2012**

(220) 01.09.2010

(732) **MISS SELFRIDGE RETAIL LIMITED**, COLEGRAVE HOUSE, 70 BERNERS STREET, LONDON W1P 3AE GB

MISS SELFRIDGE

(540)

(550) I

(740) Kojić Ivana, Serdara Jola Piletića bb, Podgorica (ME)

(511) **Klasa 25:** Odjeća, obuća i pokrivala za glavu.

(111) 07801

(151) 29.04.2013.

(210) **2010-7**

(442) **20.06.2012**

(220) 20.01.2010

(732) **INSTITUT ZA STANDRADIZACIJU CG**, VII OMLADINSKE BR 28, PODGORICA ME



(540)

(550) I

(511) **Klasa 35:** Oglašavanje vođenje poslova poslovno upravljanje kancelarijski poslovi. usluge koje pružaju lica ili organizacije uglavnom radi, pomoći u radu ili upravljanju preduzećima pomoći u upravljanju poslovnom ili komercijalnom djelatnošću u industrijskim ili komercijalnim privrednim društvima.

**Klasa 41:** Obrazovne usluge pripremanje obuke izdavanje tekstova i knjiga.

**Klasa 42:** Naučne i tehnološke usluge i istraživanje i projektovanje u vezi navedenih usluga usluge industrijske analize i istraživanja usluge koje pružaju lica, individualno ili kolektivno, u vezi teorijskih i praktičnih aspekata složenog polja aktivnosti takve usluge obezbjeđuju profesionalci kao što su hemičari, fizičari, inženjeri, kompjuterski stručnjaci i drugi, usluge inženjera koje se preduzimaju radi planiranja, ocjene, istraživanja i izvještavanja u naučnim i tehnološkim oblasima usluge naučnog istraživanja u medicinske svrhe.

(111) 07802

(151) 29.04.2013.

(210) **2010-8**(442) **20.06.2012**

(220) 20.01.2010

(732) **INSTITUT ZA STANDRADIZACIJU CG**, VII OMLADINSKE BR 28, PODGORICA ME

# MEST

(540)

(550) I

(511) **Klasa 35:** Oglašavanje vođenje poslova poslovno upravljanje, kancelarijski poslovi, usluge koje pružaju lica ili organizacije uglavnom radi, pomoći u radu ili upravljanju preduzećima pomoći u upravljanju poslovnom ili komercijalnom djelatnošću u industrijskim ili komercijalnim privrednim društvima.

**Klasa 41:** Obrazovne usluge pripremanje obuke izdavanje tekstova i knjiga.

**Klasa 42:** Naučne i tehnološke usluge i istraživanje i projektovanje u vezi navedenih usluga usluge industry ske analize i istraživanja usluge koje pružaju lica, individualno ili kolektivno, u vezi teorijskih i praktičnih aspekata složenog polja aktivnosti takve usluge obezbjeđuju profesionalci kao što su hemičari, fizičari, inženjeri, kompjuterski stručnjaci i drugi, usluge inženjera koje se preduzimaju radi planiranja, ocjene, istraživanja i izvještavanja u naučnim i tehnološkim oblastima usluge naučnog istraživanja u medicinske svrhe.

(111) 07803

(151) 29.04.2013.

(210) **2010-9**

(442) **20.06.2012**

(220) 20.01.2010

(732) **INSTITUT ZA STANDRADIZACIJU CG, VII OMLADINSKE BR 28, PODGORICA ME**



(540)

(550) I

(511) **Klasa 35:** Oglašavanje vođenje poslova poslovno upravljanje kancelarijski poslovi. usluge koje pružaju lica ili organizacije uglavnom radi, pomoći u radu ili upravljanju preduzećima pomoći u upravljanju poslovnom ili komercijalnom djelatnošću u industrijskim ili komercijalnim privrednim društvima.

**Klasa 41:** Obrazovne usluge pripremanje obuke izdavanje tekstova i knjiga.

**Klasa 42:** Naučne i tehnološke usluge i istraživanje i projektovanje u vezi navedenih usluga usluge industriske analize i istraživanja usluge koje pružaju lica, individualno ili kolektivno, u vezi teorijskih i praktičnih aspekata složenog polja aktivnosti takve usluge obezbjeđuju profesionalci kao što su hemičari, fizičari, inženjeri, kompjuterski stručnjaci i drugi, usluge inženjera koje se preduzimaju radi planiranja, ocjene, istraživanja i izvještavanja u naučnim i tehnološkim oblasima usluge naučnog istraživanja u medicinske svrhe.

(111) 07968

(151) 30.05.2013.

(210) **2009-515**

(442) **20.10.2012**

(220) 17.08.2009

(732) **THE PROCTER GAMBLE COMPANY, ONE PROCTER GAMBLE PLAZA, CINCINNATI, OHIO 45202 US**

## COLOUR BLEND TECHNOLOGY

(540)

(550) I

(740) Lutovac Branislav, Bulevar Crnojevića 93, Podgorica (ME)

(511) **Klasa 03:** sapuni, parfimerija, esencijalna ulja, kozmetički preparati, losioni za kosu, preparati za čišćenje, njegu i uljepšavanje kože, vlasišta i kose, proizvodi za oblikovanje frizure, preparati za nijansiranje, blajhanje, farbanje i bojenje kose.

(111) 07969

(151) 30.05.2013.

(210) **2009-590**(442) **20.06.2012**

(220) 10.05.2009

(732) **DROGA KOLINSKA**, ZIVILSKA INDUSTRIJA DD, KOLUNSKA ULICA1 SL-1544 LJUBLJANA SI

## СОКТА

(540)

(550) I

(740) Ćosović Dejan, 13. jula 1/5, Budva (ME)

(511) **Klasa 32:** Bezalkoholna pića svih vrsta, koncentрати, sirupi i arome za pripremanje bezalkoholnih pića.**Klasa 33:** Alkoholna pića.

(111) 07970

(151) 30.05.2013.

(210) **2010-24**(442) **20.06.2012**

(220) 10.02.2010

(300) RS Z-1247-09 59443-25.09.2009

(732) **GALENKA AD**, BATAJNIČKI DRUM BB, 11080 BEOGRAD RS

## АТОЛИП

## АТОЛИП

(540)

(550) I

(740) Kovačević Aleksandar, Kružni put bb, Cetinje (ME)

(511) **Klasa 05:** Farmaceutski preparati.

(111) (151)  
(210) **2010-26** (442) **20.06.2012**  
(220) 10.02.2010  
(300) RS Z-1763-09 60 035- 03.12.2009  
(732) **GALENIKA AD**, BATAJNIČKI DRUM BB, 11080 BEOGRAD RS

**AGLIMEX**

**АГЛИМЕКС**

(540)  
(550) I  
(740) Kovačević Aleksandar, Kružni put bb, Cetinje (ME)  
(511) **Klasa 05:** Farmaceutski preparati.

---

(111) 07972 (151) 30.05.2013.  
(210) **2010-27** (442) **20.06.2012**  
(220) 10.02.2010  
(300) RS Z-1986-09 17.12.2009 60449  
(732) **GALENIKA AD**, BATAJNIČKI DRUM BB, 11080 BEOGRAD RS

**LIPOGAL**

**ЛИПОГАЛ**

(540)  
(550) I  
(740) Kovačević Aleksandar, Kružni put bb, Cetinje (ME)  
(511) **Klasa 05:** Farmaceutski preparati.

---

(111) 07973 (151) 30.05.2013.  
(210) **2010-283** (442) **20.06.2012**  
(220) 10.08.2010  
(300) RS Z-409/10 1803.2010  
(732) **GALENIKA AD**, BATAJNIČKI DRUM BB, 11080 BEOGRAD RS

## PROBIOGAL

## ПРОБИОГАЛ

(540)

(550) I

(740) Kovačević Aleksandar, Kružni put bb, Cetinje (ME)

(511) **Klasa 05:** Farmaceutski preparati.

---

(111) 07974

(151) 30.05.2013.

(210) **2010-284**

(442) **20.06.2012**

(220) 10.08.2010

(300) RS Z-898/10 25.05.2010

(732) **GALENIKA AD**, BATAJNIČKI DRUM BB, 11080 BEOGRAD RS

## BISPROL

## БИСПРОЛ

(540)

(550) I

(740) Kovačević Aleksandar, Kružni put bb, Cetinje (ME)

(511) **Klasa 05:** Farmaceutski preparati.

---

(111) 07975

(151) 30.05.2013.

(210) **2010-483**

(442) **20.06.2012**

(220) 27.12.2010

(300) RS Z-1832/10 01.11.2010

(732) **GALENIKA AD**, BATAJNIČKI DRUM BB, 11080 BEOGRAD RS



MELOGAL

МЕЛОГАЛ

(540)

(550) I

(740) Kovačević Aleksandar, Kružni put bb, Cetinje (ME)

(511) **Klasa 05:** Farmaceutski preparati.

(111) 07976

(151) 30.05.2013

(210) **2010-484**(442) **20.06.2012**

(220) 27.12.2010

(300) RS Z-1831/10 10.11.2010

(732) **GALENIKA AD**, BATAJNIČKI DRUM BB, 11080 BEOGRAD RS

AEROGAL

АЕРОГАЛ

(540)

(550) I

(740) Kovačević Aleksandar, Kružni put bb, Cetinje (ME)

(511) **Klasa 05:** Farmaceutski preparati.

(111) 07529

(151) 07.03.2013.

(210) **2010-415**(442) **20.06.2012**

(220) 10.11.2010

(300) 17.10.2005

(732) **KOPAS KOZMETIK PAZARLAMA VE SANAYI ANONIM SIRKETI**, AYAZAGA KOYU YOLU G-42 SOKAK NO.6 MASLAK SISLI INSTANBUL TR

# VIACTIV

(540)

(550) I

(740) Radulović Božidar, Jovana Tomaševića 9/III, Podgorica (ME)

(511) **Klasa 3:** Kreme, emulzije, losioni, gelovi i ulja za ruke, lice i noge, maske za lice, podloge za lice, make-up puderi, puderi za upotrebu poslije kupanja, parfemi, toaletna voda, kolonjska voda, mirisna voda za osobnu upotrebu, kozmetički preparati za kupanje naime nemedicinske soli za kupanje, pjene, ulja, gelovi, depilacijska sredstva, antiperspiranti za osobnu upotrebu, preparati za njegu kose naime boje za kosu, izbjeljivači kose, preparati za uvijanje, učvršćivanje i ravnanje kose naime losioni za kosu, puderi za kosu, šamponi, balzami, preparati za oblikovanje kose naime lak za kosu, losion za kosu, briljantin, preparati za brijanje naime kreme za brijanje, pjene, losioni, preparati za make-up lica i očiju naime sjena za oči, maskara, tuš za oči, olovke za oči, preparati za usne naime ruževi za usne, sjajila za usne, olovke za usne, preparati za njegu usta i zuba naime paste za zube, praškovi za zube, nemedicinska voda za usta, nemedicinski sprejevi za usta, preparati za njegu i ukrašavanje noktiju naime lak za nokte, učvršćivač za nokte, nutritiv za nokte, sredstvo za odstranjivanje laka za nokte, gel za manikuru, kozmetički preparati za sunčanje, preparati za samotamnjenje, preparati za bijeljenje kože, preparati protiv bora, toaletni sapuni, mirisni sapuni, preparati za njegu beba u nemedicinske svrhe naime šamponi za bebe, ulja za bebe, losioni i kreme za bebe, vlažne kozmetičke maramice, kolonjska voda za bebe, puder za bebe, gel za čišćenje ruku za bebe, losion za ruke za bebe, krema za ruke za bebe.

(111) 07530

(151) 13.03.2013.

(210) **2009-23**(442) **20.03.2012**

(220) 23.01.2009

(732) **DAYCO PRODUCTS LLC;** 1 PRESTICE PLACE MIAMISBURG, OHIO 45342 US

# DAYCO

(540)

(550) I

(740) Dedić Tomislav, Bulevar Ivana Crnojevića 139 Podgorica (ME)

(511) **Klasa 7:** kaiševi za motore i mašine; kaiševi za prenos snage; remenici; vučni kaiševi (za mašine); njihovi djelovi i prateća oprema obuhvaćeni ovom klasom;

**Klasa 12:** kaiševi za prenos snage za kopnena vozila; vučni kaiševi za kopnena vozila; mlaznice za punjenje rezervoara za gorivo za kopnena vozila; uređaji za kontrolu emisije ugljovodoni-ka za kopnena vozila; njihovi djelovi i prateća oprema obuhvaćeni ovom klasom;

**Klasa 17:** fleksibilni cjevovodi i cijevi od nemetala; crijeva za prenos fluida; njihovi djelovi i

prateća oprema obuhvaćeni ovom klasom.

- 
- (111) 07316 (151) 22.03.2013.  
 (210) **2009-181** (442) **20.06.2012**  
 (220) 30.03.2009  
 (300) 882686 18.01.2006  
 (732) **SHIMANO INC**, 3-77, OIMATSU-CHO, SAKAI-SHI OSAKA 590-8577 JP

**ALFINE**

- (540) |  
 (550) |  
 (740) Ćosović Dejan, 13. jula 1/5, Budva (ME)  
 (511) **Klasa 09:** Kompjuteri za bicikle, pokazivači brzine, aparati za mjerenje razdaljine, aparati za snimanje razdaljine, uređaji za vozila za snimanje kilometraže, uređaji za vozila za snimanje milja, aparati za snimanje razdaljine, automatski pokazivači pritiska u gumama bicikla, zaštitni šlemovi za sportove, naočari, sigurnosne naočare i kutije, signalni uređaji, okviri za naočare.

- 
- (111) 07645 (151) 18.04.2013.  
 (210) **2010-92** (442) **20.06.2012**  
 (220) 06.04.2010  
 (732) **HARI -UNO DOO**, TRŽNI CENTAR-BULEVAR MARŠALA TITA 85360 ULCINJ ME

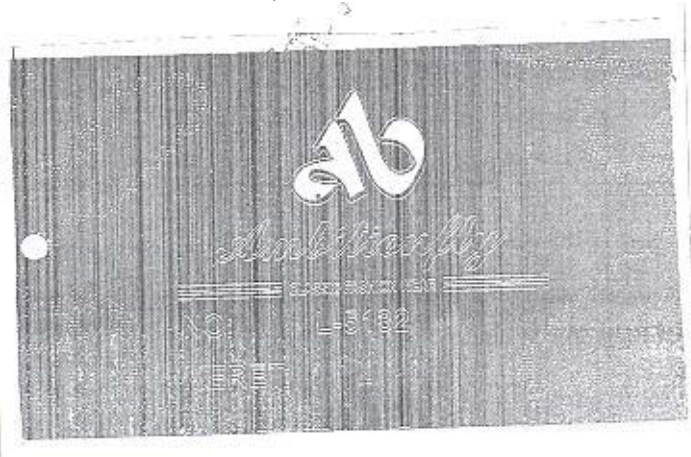

- (540) |  
 (550) |  
 (511) **Klasa 25:** Odjeća, obuća i pokrivala za glavu.

- 
- (111) 07646 (151) 18.04.2013.  
 (210) **2010-93** (442) **20.06.2012**  
 (220) 06.04.2010  
 (732) **HARI -UNO DOO**, TRŽNI CENTAR-BULEVAR MARŠALA TITA 85360 ULCINJ ME



(540) Nižnjoj klasifikaciji:

(550) I

(511) **Klasa 25:** Odjeća, obuća, i pokrivala za glavu.

(111) 07647

(151) 18.04.2013.

(210) **2010-97**

(442) **20.06.2012**

(220) 09.04.2010

(732) **DRUŠTVO ZA TELEKOMUNIKACIJE FIBERNET D.O.O**, KRALJA NIKOLE 27A  
PODGORICA ME

**FiberNet**

(540)

(550) I

(511) **Klasa 38:** Telekomunikacije.

(111) 07795

(151) 29.04.2013.

(210) **2010-442**

(442) **20.06.2012**

(220) 08.12.2010

(732) **UNIVERZITET DONJA GORICA**, DONJA GORICA BB, PODGORICA ME



(540)

(550) I

(511) **Klasa 41:** Obrazovne usluge, pripremanje obuke, sportske i kulturne aktivnosti, usluge koje pružaju sve vrste edukacije lica (obrazovanje) organizovanje (priređivanje) i vođenje seminara, konferencija, kongresa organizovanje izložbi ili prezentacije knjiga (književne večeri) u kulturne i obrazovne svrhe, sportskih takmičenja izdavanje tekstova i knjiga

**Klasa 42:** Naučne i tehnološke usluge i istraživanje i projektovanje u vezi navedenih usluga

(111) 07796

(151) 29.04.2013.

(210) **2010-443**

(442) **20.06.2012**

(220) 08.12.2010

(732) **SAVEZ EKONOMISTA CRNE GORE**, CRNOGORSKIH SERDARA, LAMELA CI I II, ME



(540)

(550) I

(511) **Klasa 25:** Odjeća, obuća, pokrivala za glavu.

**Klasa 41:** Obrazovne usluge, pripremanje obuke, sportske i kulturne aktivnosti, usluge koje pružaju sve vrste edukacije lica (obrazovanje) organizovanje (priređivanje) i vođenje seminara, konferencija, kongresa, organizovanje izložbi ili prezentacije knjiga (književne večeri) u kulturne i obrazovne svrhe, sportskih takmičenja, Izdavanje tekstova i knjiga.

**Klasa 42:** Naučne i tehnološke usluge i istraživanje i projektovanje u vezi navedenih usluga

(111) 07967

(151) 30.05.2013.

(210) **2009-377**

(442) **20.06.2012**

(220) 28.05.2009

(300) SR 17.12.2007

(732) **BERLIN-CHEMIE AG**, GLIENICER WEG 125 D-12489 BERLIN DE

**RENERGIN**

(540)

(550) I

(740) Ćosović Dejan, 13. jula 1/5, Budva (ME)

(511) **Klasa 05:** Farmaceutski proizvodi dijetetske supstance prilagođene za medicinsku upotrebu, osim vitaminskih preparata.



**INDEKS NOSILACA ŽIGOVA**  
**INDEX OF THE HOLDER OF THE REGISTRATION**

(732)	(111)	(210)
ARTERIUM CORPORATION	07793	2010-270
BERLIN-CHEMIE AG	07967	2009-377
DAYCO PRODUCTS LLC	07530	2009-23
DROGA KOLINSKA	07969	2009-590
DRUŠTVO ZA TELEKOMUNIKACIJE FIBERNET D.O.O	07647	2010-97
GALENKA AD	07970	2010-24
GALENKA AD	07972	2010-27
GALENKA AD	07973	2010-283
GALENKA AD	07974	2010-284
GALENKA AD	07975	2010-483
GALENKA AD	07976	2010-484
HARI -UNO DOO	07584	2010-91
HARI -UNO DOO	07645	2010-92
HARI -UNO DOO	07646	2010-93
INCOGNITO DOO	07812	2009-620
INSTITUT ZA STANDRADIZACIJU CG	07801	2010-7
INSTITUT ZA STANDRADIZACIJU CG	07802	2010-8
INSTITUT ZA STANDRADIZACIJU CG	07803	2010-9
KOPAS KOZMETIK PAZARLAMA VE SANAYI ANONIM SIRKETI	07529	2010-415
MISS SELFRIDGE RETAIL LIMITED	03.06.2013	2010-310
NOVARTIS AG	07994	2010-291
PWC BUSINESS TRUST STATE OF DELAWARE USA	07995	2010-312
SAVEZ EKONOMISTA CRNE GORE	07796	2010-443
SHIMANO INC	07316	2009-181
THE PROCTER GAMBLE COMPANY	07968	2009-515
UNIVERZITET DONJA GORICA	07795	2010-442





INDEKS BROJEVA ŽIGOVA  
INDEX OF THE TRADEMARK NUMBERS

(210)	(111)
2008-1160	07310
2009-23	07530
2009-181	07316
2009-377	07967
2009-515	07968
2009-590	07969
2009-620	07812
2010-7	07801
2010-8	07802
2010-9	07803
2010-24	07970
2010-27	07972
2010-91	07584
2010-92	07645
2010-93	07646
2010-97	07647
2010-270	07793
2010-283	07973
2010-284	07974
2010-291	07994
2010-310	03.06.2013
2010-312	07995
2010-415	07529
2010-442	07795
2010-443	07796
2010-483	07975
2010-484	07976



**INDEKS PO KLASAMA NIČANSKE KLASIFIKACIJE ROBA I USLUGA**  
**INDEX ACCORDING TO THE NICE CLASSIFICATION OF GOODS AND SERVICES**

**Klasa 03**07529  
07968**Klasa 05**07793  
07967  
07970  
07972  
07973  
07974  
07975  
07976  
07994**Klasa 07**

07530

**Klasa 09**07316  
07995**Klasa 12**

07530

**Klasa 17**

07530

**Klasa 25**07584  
07645  
07646  
07796

03.06.2013

**Klasa 32**

07969

**Klasa 33**

07969

**Klasa 35**07801  
07802  
07803

07812

07995

**Klasa 36**

07995

**Klasa 38**

07647

**Klasa 41**07795  
07796  
07801  
07802  
07803**Klasa 42**07795  
07796  
07801  
07802  
07803



**OBJAVA ISPRAVKI  
CORRECTIONS**

U „Crnogorskom glasniku intelektualne svojine“ broj 11. od 20.03.2013. godine objavljeni su pogrešni podaci za žig **2009-427**

***Pogrešni podaci***

(511) **Klasa 39:** Iznajmljivanje novih i korišćenih letilica, brokerstvo i usluge posredovanja u oblasti korišćenih letilica, usluge distributerstva u oblasti novih i korišćenih letilica.

***Ispravni podaci***

(511) **Klasa 39:** Iznajmljivanje novih i korišćenih letilica, brokerstvo i usluge posredovanja u oblasti korišćenih letilica, usluge distributerstva (**distribucija aviona, kao robe**) u oblasti novih i korišćenih letilica.

U „Crnogorskom glasniku intelektualne svojine“ broj 11. od 20.03.2013. godine objavljeni su pogrešni podaci za žig **2009-481**

***Pogrešni podaci***

(732) CONVATEC INC,A DELAWARE CORPORATION, 200 HEADQUARTERS PARK DRIVE, SKILLMAN, NJ08558 US

***Ispravni podaci***

(732) ConvaTec Inc., a Delaware corporation  
200 Headquarters Park Drive, Skillman, New Jersey 08558, US

U „Crnogorskom glasniku intelektualne svojine“ broj 11. od 20.03.2013. godine objavljeni su pogrešni podaci za žig **2009-485**

***Pogrešni podaci***

(732) UNITED PARCEL SERVICE OF AMERICA, INC, 55 GLENLAKE PARKWAY, NE ATLANTA, GEORGIA 30328 US

***Ispravni podaci***

(732) United Parcel Service of America, Inc.  
**a corporation organized and existing under the laws of the State of Delaware, U.S.A.**  
55 Glenlake Parkway, NE, Atlanta, Georgia 30328, US

U „Crnogorskom glasniku intelektualne svojine“ broj 11. od 20.03.2013. godine objavljeni su pogrešni podaci za žig **2010-462**

***Pogrešni podaci***

(732) C.I. UNION DE BANANEROS DE URABA S,A, UNIBAN, CALLE 52 NO.47-42 PISO 15, MEDELLIN, ANTIGUIA CO

***Ispravni podaci***

(732) C.I.UNION DE BANANEROS DE URABA S.A. UNIBAN  
Calle 52 no. 47-42 piso 15, Medellin, Antioquia, CO

U „Crnogorskom glasniku intelektualne svojine“ broj 11. od 20.03.2013. godine objavljeni su pogrešni podaci za žig **2010-460**

***Pogrešni podaci***

(732) BRISTOL-MYERS SGUIBB SARL A FRENCH LIMITED LIABILITY COMPANY, 3 RUE JOSEPH MONIER, 92500 RUEIL-MALMASION FR

***Ispravni podaci***

(732) Bristol-Myers Squibb Sarl, a French limited liability company  
3, rue Joseph Monier, 92500 Rueil-Malmaison, FR

U „Crnogorskom glasniku intelektualne svojine“ broj 11. od 20.03.2013. godine objavljeni su pogrešni podaci za žig **2010-459**

***Pogrešni podaci***

(732) BRISTOL-MYERS SGUIBB SARL A FRENCH LIMITED LIABILITY COMPANY, 3 RUE JOSEPH MONIER, 92500 RUEIL-MALMASION FR

***Ispravni podaci***

(732) Bristol-Myers Squibb Sarl, a French limited liability company  
3, rue Joseph Monier, 92500 Rueil-Malmaison, FR

U „Crnogorskom glasniku intelektualne svojine“ broj 11. od 20.03.2013. godine objavljeni su pogrešni podaci za žig **2010-448**

***Pogrešni podaci***

(732) DAIICHI SANKYO COMPANY, LIMITED, 3-5-1, NIHONBASHI HONCHO, CHUO-KU, TOKYO 103-8426 JP

***Ispravni podaci***

(732) DAIICHI SANKYO COMPANY, LIMITED  
**Established under Japanese Law**  
3-5-1, Nihonbashi Honcho, Chuo-ku, Tokyo 103-8426, JP

U „Crnogorskom glasniku intelektualne svojine“ broj 11. od 20.03.2013. godine objavljeni su pogrešni podaci za žig **2010-401**

***Pogrešni podaci***

(732) BRISTOL-MYERS SQUIBB COMPANY, 345 PARK AVENUE, NEW YORK, NY 10154 US

***Ispravni podaci***

(732) Bristol-Myers Squibb Company  
a Delaware Corporation  
345 Park Avenue, New York, NY 10154, US

U „Crnogorskom glasniku intelektualne svojine“ broj 11. od 20.03.2013. godine objavljeni su pogrešni podaci za žig **2010-139**

***Pogrešni podaci***

(732) JACK DANIELS PROPERTIES, INC, A DELAWARE USA CORPORATION 4040 CIVIC CENTER DRIVE, SUITE 528 SAN RAFAEL, CALIFORNIA 94903 US

***Ispravni podaci***

(732) Jack Daniel's Properties, Inc., a Delaware U.S.A. corporation  
4040 Civic Center Drive, Suite 528, San Rafael, California 94903, US

U „Crnogorskom glasniku intelektualne svojine“ broj 11. od 20.03.2013. godine objavljeni su pogrešni podaci za žig **2010-132**

***Pogrešni podaci***

(732) JACK DANIELS PROPERTIES INC, A DELAWARE USA CORPORATION 4040 CIVIC CENTER DRIVE, SUITE 528 SAN RAFAEL, CALIFORNIA 94903 US

***Ispravni podaci***

(732) Jack Daniel's Properties, Inc., a Delaware U.S.A. corporation  
4040 Civic Center Drive, Suite 528, San Rafael, California 94903, US

U „Crnogorskom glasniku intelektualne svojine“ broj 11. od 20.03.2013. godine objavljeni su pogrešni podaci za žig **2010-123**

***Pogrešni podaci***

(732) JACK DANIELS PROPERTIS INC, A DELAWARE USA CORPORATION 4040 CIVIC CENTER DRIVE, SUITE 528 SAN RAFAEL, CALIFORNIA 94903 US

***Ispravni podaci***

(732) Jack Daniel's Properties, Inc., a Delaware U.S.A. corporation  
4040 Civic Center Drive, Suite 528, San Rafael, California 94903, US

U „Crnogorskom glasniku intelektualne svojine“ broj 11. od 20.03.2013. godine objavljeni su pogrešni podaci za žig **2010-122**

***Pogrešni podaci***

(732) FINLANDIA VODKA WORLDWIDE LTD A FINLAND CORPORATION, PORKKALANKATU 24, 00180 HESINKI FI

***Ispravni podaci***

(732) FINLANDIA VODKA WORLDWIDE Ltd., a Finland corporation  
Porkkalankatu 24, 00180 Helsinki, FI

U „Crnogorskom glasniku intelektualne svojine“ broj 11. od 20.03.2013. godine objavljeni su pogrešni podaci za žig **2010-399**

***Pogrešni podaci***

(732) FINLANDIA VODKA WORLDWIDE LTD, PORKKALANKATU 24,00180 HELSINKI FI

***Ispravni podaci***

(732) Finlandia Vodka Worldwide Ltd.

**a Finland corporation**

Porkkalankatu 24, 00180 Helsinki, FI

U „Crnogorskom glasniku intelektualne svojine“ broj 11. od 20.03.2013. godine objavljeni su pogrešni podaci za žig **2010-311**

**Pogrešni podaci**

(732) MERCK SHARP & DOHME CORP, ONE MERCK DRIVE, WHITEHOUSE STATION, NEW JERESY 08889-0100 US

**Ispravni podaci**

(732) Merck Sharp & Dohme Corp.,

One Merck Drive, Whitehouse Station, New Jersey 08889, US

U „Crnogorskom glasniku intelektualne svojine“ broj 11. od 20.03.2013. godine objavljeni su pogrešni podaci za žig **2010-296**

**Pogrešni podaci**

(220) 20.08.2010.

**Ispravni podaci**

(220) 19.08.2010.

U „Crnogorskom glasniku intelektualne svojine“ broj 11. od 20.03.2013. godine objavljeni su pogrešni podaci za žig **2010-47**

**Pogrešni podaci**

(740) Božović Radisav, 5 Crnogorske brigade 21, Igalo, Herceg Novi (ME)

**Ispravni podaci**

(740) Čupić Branislav, Dalmatinska 10, Podgorica (ME)

U „Crnogorskom glasniku intelektualne svojine“ broj 11. od 20.03.2013. godine objavljeni su pogrešni podaci za žig **2010-45**

**Pogrešni podaci**

(732) DISCOVER FINANCIAL SERVICER STATE OF INCORPORATION, DELAWARE, USA, 2500 LAKE COOK ROAD, RIVERWOODS, IL60013 US

**Ispravni podaci**

(732) Discover Financial Services

State of Incorporation: Delaware, USA

2500 Lake Cook Road, Riverwoods, IL 60015, US

U „Crnogorskom glasniku intelektualne svojine“ broj 11. od 20.03.2013. godine objavljeni su pogrešni podaci za žig **2010-33**



***Pogrešni podaci***

(732) GOOGLE INC, 1600 AMPHITHEATRE PARKWAY, MOUNTIAN VIEW, CA 94043 US

***Ispravni podaci***

(732) Google Inc.

1600 Amphitheatre Parkway, Mountain View, CA 94043, US

U „Crnogorskom glasniku intelektualne svojine“ broj 11. od 20.03.2013. godine objavljeni su pogrešni podaci za žig **2010-29**

***Pogrešni podaci***

(732) BROWN-FORMAN CORPORATION, 850 DIXIE HIGHWAY, LOUISVILLE KENTUCKY 40210 US

***Ispravni podaci***

(732) BROWN-FORMAN CORPORATION, A DELAWARE, U.S.A., CORPORATION

850 DIXIE HIGHWAY, LOUISVILLE, KENTUCKY 40210, US

U „Crnogorskom glasniku intelektualne svojine“ broj 11. od 20.03.2013. godine objavljeni su pogrešni podaci za žig **2010-18**

***Pogrešni podaci***

(732) BRISTOL-MYERS SQUIBB COMPANY 345 PARK AVENUE, NEW YORK, NY10154 US

***Ispravni podaci***

(732) Bristol-Myers Squibb Company

a Delaware corporation

345 Park Avenue, New York, New York 10154, US

U „Crnogorskom glasniku intelektualne svojine“ broj 11. od 20.03.2013. godine objavljeni su pogrešni podaci za žig **2010-14**

***Pogrešni podaci***

(732) McDONALD INTERNATIONAL PROPERTY COMPANY,LTD, A CORPORATION ORGANIZED AND EXISTING UNDER THE LAWS OF THE STATE OF DELAWARE 2711 CENTRVILLE ROAD, SUITE 400, WILMINGTON, DELAWARE 19808 US

***Ispravni podaci***

(732) **McDonald's** International Property Company, Ltd.

a corporation organized and **existing** under the laws of the State of Delaware

2711 **Centerville** Road, Suite 400, Wilmington, Delaware 19808, US

U „Crnogorskom glasniku intelektualne svojine“ broj 11. od 20.03.2013. godine objavljeni su pogrešni podaci za žig **2010-250**

***Pogrešni podaci***

(732) McDonald s INTERNATIONAL PRPERTY COMPANY LTD, 2711 CENTERVILLE ROAD, SUITE 400, WILMINGTON, DELAWARE 19808 US

**Ispravni podaci**

(732) **McDonald's International Property Company, Ltd.**  
**a corporation organized and existing under the laws of the State of Delaware**  
2711 Centerville Road, Suite 400, Wilmington, Delaware 19808, US

U „Crnogorskom glasniku intelektualne svojine“ broj 11. od 20.03.2013. godine objavljeni su pogrešni podaci za žig **2010-251**

**Pogrešni podaci**

(732) McDonald s INTERNATIONAL PROPERTY COMPANY LTD, 2711 CENTERVILLE ROAD, SUITE 400, WILMINGTON, DELAWARE 19808 US

**Ispravni podaci**

(732) **McDonald's International Property Company, Ltd.**  
**a corporation organized and existing under the laws of the State of Delaware**  
2711 Centerville Road, Suite 400, Wilmington, Delaware 19808, US

U „Crnogorskom glasniku intelektualne svojine“ broj 11. od 20.03.2013. godine objavljeni su pogrešni podaci za žig **2010-252**

**Pogrešni podaci**

(732) McDonald s INTERNATIONAL PROPERTY COMPANY LTD, 2711 CENTERVILLE ROAD, SUITE 400, WILMINGTON, DELAWARE 19808 US

**Ispravni podaci**

(732) **McDonald's International Property Company, Ltd.**  
**a corporation organized and existing under the laws of the State of Delaware**  
2711 Centerville Road, Suite 400, Wilmington, Delaware 19808, US

U „Crnogorskom glasniku intelektualne svojine“ broj 11. od 20.03.2013. godine objavljeni su pogrešni podaci za žig **2010-254**

**Pogrešni podaci**

(732) McDonald INTERNATIONAL PROPERTY COMPANY LTD, 2711 CENTERVILLE ROAD, SUITE 400, WILMINGTON, DELAWARE 19808 US

**Ispravni podaci**

(732) **McDonald's International Property Company, Ltd.**  
**a corporation organized and existing under the laws of the State of Delaware**  
2711 Centerville Road, Suite 400, Wilmington, Delaware 19808, US

U „Crnogorskom glasniku intelektualne svojine“ broj 11. od 20.03.2013. godine objavljeni su pogrešni podaci za žig **2010-249**

**Pogrešni podaci**

(732) McDonald s INTERNATIONAL PROPERTY COMPANY, LTD, 2711 CENTERVILLE ROAD, SUITE 400, WILMINGTON, DELAWARE 19808 US

**Ispravni podaci**

(732) **McDonald's International Property Company, Ltd.**  
**a corporation organized and existing under the laws of the State of Delaware**  
2711 Centerville Road, Suite 400, Wilmington, Delaware 19808, US

U „Crnogorskom glasniku intelektualne svojine“ broj 11. od 20.03.2013. godine objavljeni su pogrešni podaci za žig **2010-253**

**Pogrešni podaci**

(732) McDonald s INTERNATIONAL PROPERTY COMPANY LTD, 2711 CENTERVILLE ROAD, SUITE 400, WILMINGTON, DELAWARE 19808 US

**Ispravni podaci**

(732) **McDonald's International Property Company, Ltd.**  
**a corporation organized and existing under the laws of the State of Delaware**  
2711 Centerville Road, Suite 400, Wilmington, Delaware 19808, US

U „Crnogorskom glasniku intelektualne svojine“ broj 11. od 20.03.2013. godine objavljeni su pogrešni podaci za žig **2010-247**

**Pogrešni podaci**

(732) McDonald s INTERNATIONAL PROPERTY COMPANY LTD, 2711 CENTERVILLE ROAD, SUITE 400, WILMINGTON, DELAWARE 19808 US

**Ispravni podaci**

(732) **McDonald's International Property Company, Ltd.**  
**a corporation organized and existing under the laws of the State of Delaware**  
2711 Centerville Road, Suite 400, Wilmington, Delaware 19808, US

U „Crnogorskom glasniku intelektualne svojine“ broj 11. od 20.03.2013. godine objavljeni su pogrešni podaci za žig **2010-248**

**Pogrešni podaci**

(732) McDonald s INTERNATIONAL PROPERTY COMPANY LTD, 2711 CENTERVILLE ROAD, SUITE 400, WILMINGTON, DELAWARE 19808 US

**Ispravni podaci**

(732) **McDonald's International Property Company, Ltd.**  
**a corporation organized and existing under the laws of the State of Delaware**  
2711 Centerville Road, Suite 400, Wilmington, Delaware 19808, US

U „Crnogorskom glasniku intelektualne svojine“ broj 11. od 20.03.2013. godine objavljeni su pogrešni podaci za žig **2010-180**

**Pogrešni podaci**

(732) BAYER AKTINGESELLSCHAFT, D-51368, LEVERKUSEN DE

**Ispravni podaci**

(732) BAYER AKTIENGESELLSCHAFT

D-51368, Leverkusen, DE

U „Crnogorskom glasniku intelektualne svojine“ broj 11. od 20.03.2013. godine objavljeni su pogrešni podaci za žig **2010-232**

***Pogrešni podaci***

(732) PLAYBOY ENTERPRISES INTERNATIONAL INC, 680 NORTH LAKE SHORE DRIVE, CHICAGO, ILLINOIS 60611 US

***Ispravni podaci***

(732) Playboy Enterprises International Inc.,  
680 North Lake Shore Drive, Chicago, Illinois 60611, US

U „Crnogorskom glasniku intelektualne svojine“ broj 11. od 20.03.2013. godine objavljeni su pogrešni podaci za žig **2010-231**

***Pogrešni podaci***

(732) PLAYBOY ENTERPRISES INTERNATIONAL INC, 680 NORTH LAKE SHORE DRIVE, CHICAGO, ILLINOIS 60611 US

***Ispravni podaci***

(732) Playboy Enterprises International Inc.,  
680 North Lake Shore Drive, Chicago, Illinois 60611, US

U „Crnogorskom glasniku intelektualne svojine“ broj 11. od 20.03.2013. godine objavljeni su pogrešni podaci za žig **2010-234**

***Pogrešni podaci***

(732) PLAYBOY ENTERPRISES INTERNATIONAL INC, 680 NORTH LAKE SHORE DRIVE, CHICAGO, ILLINOIS 60611, US

***Ispravni podaci***

(732) Playboy Enterprises International Inc.,  
680 North Lake Shore Drive, Chicago, Illinois 60611, US

U „Crnogorskom glasniku intelektualne svojine“ broj 11. od 20.03.2013. godine objavljeni su pogrešni podaci za žig **2010-233**

***Pogrešni podaci***

(732) PLAYBOY ENTERPRISES INTERNATIONAL INC, 680 NORTH LAKE SHORE DRIVE, CHICAGO, ILLINOIS 60611 US

***Ispravni podaci***

(732) Playboy Enterprises International Inc.,  
680 North Lake Shore Drive, Chicago, Illinois 60611, US

U „Crnogorskom glasniku intelektualne svojine“ broj 11. od 20.03.2013. godine objavljeni su pogrešni podaci za žig **2010-28**

**Pogrešni podaci**

(732) BROWN-FORMAN CORPORATION, 850 DIXIE HIGHWAY, LOUISVILLE KENTUCKY 40210 US

**Ispravni podaci**

(732) BROWN-FORMAN CORPORATION, **A DELAWARE, U.S.A., CORPORATION**  
850 DIXIE HIGHWAY, LOUISVILLE, KENTUCKY 40210, US

U „Crnogorskom glasniku intelektualne svojine“ broj 11. od 20.03.2013. godine objavljeni su pogrešni podaci za žig **2010-501**

**Pogrešni podaci**

(731)

**Ispravni podaci**

(731) **International truck Intellectual Prperty Company,LLC, 4201 Winfield road,warrenville,IL 60555, US**

U „Crnogorskom glasniku intelektualne svojine“ broj 11. od 20.03.2013. godine objavljeni su pogrešni podaci za žig **2011-258**

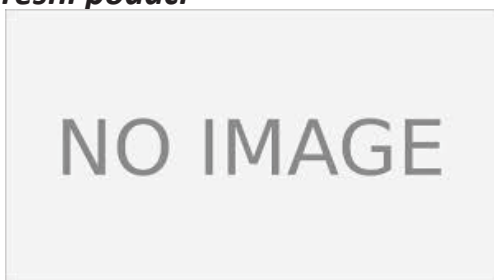
**Pogrešni podaci**

(540)

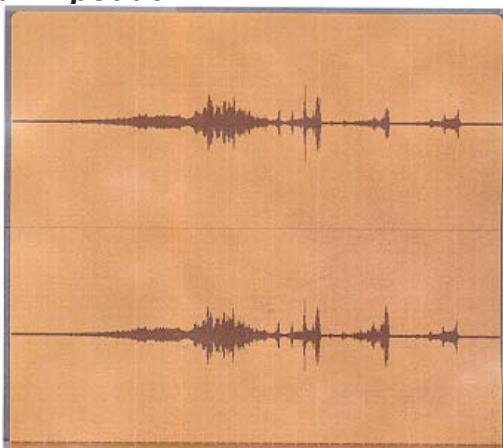
**Ispravni podaci**

(540)

U „Crnogorskom glasniku intelektualne svojine“ broj 11. od 20.03.2013. godine objavljeni su pogrešni podaci za žig **2012-117**

**Pogrešni podaci**



NO IMAGE

(540)

***Ispravni podaci***

CASINO ROYALE

(540)

U „Crnogorskom glasniku intelektualne svojine“ broj 11. od 20.03.2013. godine objavljeni su pogrešni podaci za žig **2009-493**

***Pogrešni podaci***



NO IMAGE

(540)

***Ispravni podaci***

**BACKFLIP**

(540)

U „Crnogorskom glasniku intelektualne svojine“ broj 11. od 20.03.2013. godine objavljeni su pogrešni podaci za žig **2009-480**

***Pogrešni podaci***



NO IMAGE

(540)

***Ispravni podaci*****ZDRAVI POČETAK ZA ZDRAVI ŽIVOT**

(540)

U „Crnogorskom glasniku intelektualne svojine“ broj 11. od 20.03.2013. godine objavljeni su pogrešni podaci za žig **2009-379**

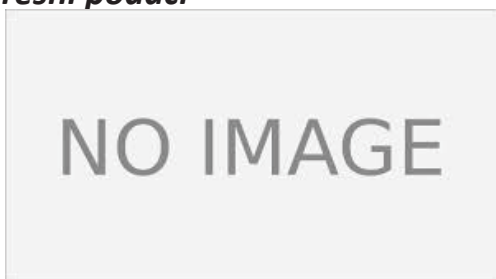
***Pogrešni podaci***

(540)

***Ispravni podaci*****ELAVIA**

(540)

U „Crnogorskom glasniku intelektualne svojine“ broj 11. od 20.03.2013. godine objavljeni su pogrešni podaci za žig **2009-432**

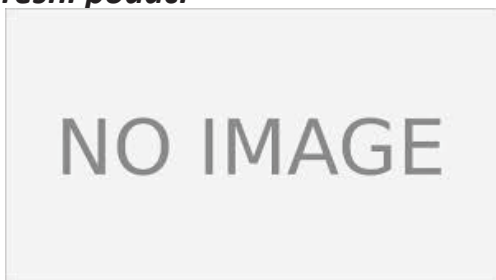
***Pogrešni podaci***

(540)

***Ispravni podaci*****YONEX**

(540)

U „Crnogorskom glasniku intelektualne svojine“ broj 11. od 20.03.2013. godine objavljeni su pogrešni podaci za žig **2010-381**

***Pogrešni podaci***

(210) **2011-381**

(220) 25.7.2011

(731) **FIL LIMITED ABERMUDA COMPANY**, PEMBROKE HALL, 42 CROW LANE, PEMBROKE HM 19, P.O.BOX HM 670, HAMILTON HMCX BM



(540)

(550) I

(740) Čupić Branislav, Dalmatinska 10, Podgorica (ME)

***Ispravni podaci***

(210) **2010-381**

(220) 22.10.2010

(731) GlaxoSmithKline LLC., 2711 Centerville Road, Suite 400, Wilmington, Delaware 19808 US

**BREATHE RIGHT**

(540)

(740) Popovic Miladin, Đoka Miraševića 21/III Podgorica (ME)



## OBAVJEŠTENJE NOTICE

### Objava upisa u Registar žigova CG priznatih žigova, registrovanih u Zavodu SCG, odnosno Zavodu Srbije, prije otvaranja Zavoda CG

Članom 65 stav 1 Zakona o žigu ("Sl.list CG", br. 72/10) priznata su prava na žigovima koji su registrovani i upisani u Registar žigova u Zavodu za intelektualnu svojinu Srbije i Crne Gore, odnosno Zavodu za intelektualnu svojinu Srbije do 28. maja 2008. godine (do dana otvaranja Zavoda za intelektualnu svojinu Crne Gore) do isteka njihovog trajanja.

Zavod je implementirao odredbu člana 65 stav 2 Zakona o žigu i izvršio upis u Registar, po službenoj dužnosti žigove za koje je izdao uvjerenja o važenju žiga u formi zabilješke u 2008. godini.

Zavod je implementirao odredbu stava 4 istog člana i donio rješenja o upisu u Registar žigova za koje su podnijeti zahtjevi u 2008. godini za obnovu važnosti žiga, prenos prava i promjenu imena i adrese shodno koja propisuje da se ti zahtjevi smatraju kao zahtjevi za upis u registar.

### MEĐUNARODNI KODOVI ZA IDENTIFIKACIJU BIBLIOGRAFSKIH PODATAKA O ŽIGOVIMA PREMA WIPO ST 60 RECOMMENDATION CONCERNING BIBLIOGRAFIC DATA RELATING TO TRADEMARKS- WIPO-ST. 60

CRNOGORSKI	MDK	ENGLESKI
REGISTARSKI BROJ CG	<b>111</b>	NUMBER OF THE REGISTRATION CG
REGISTARSKI BROJ SCG	<b>111</b>	NUMBER OF THE REGISTRATION SCG
BROJ PRIJAVE	<b>210</b>	NUMBER OF THE APPLICATION
IME I ADRESA NOSIOCA ŽIGA	<b>732</b>	NAME AND ADDRESS OF THE HOLDER OF THE REGISTRATION



(111) CG	(210) Ž	(732)	(111) SCG
07419	1974-781	<b>FRANKLIN ELECTRIC CO., INC.;</b> 400 EAST SPRING STREET, BLUFFTON, INDIANA, US	25248
07452	1961-82	<b>UNILEVER N.V.;</b> WEENA 455, 3013 AL ROTTERDAM, NL	15257
07461	2004-1285	<b>TRACTORS AND FARM EQUIPMENT LIMITED;</b> 861, Anna Salai, Chennai - 600 002, State of Tamil Nadu, India, IN	50239
07453	2005-969	<b>Motorola Trademark Holdings,LLC;</b> 600 North US Highway 45,Libertyville,IL 60048,USA	51592
07455	2002-95	<b>Motorola Trademark Holdings,LLC.,;</b> 600 North US Highway 45,Libertyville,IL 60048 USA	47689
07467	2001-1318	<b>Rigs Services Ltd. and YUM! Restaurants International S.a.r.l.;</b> 2-4 Auch/ Makarios III Avenue, Capital Centre, 9th Floor, 1505 Nicosia, CYPRUS, CY and 46a, Avenue JF Kenedy, L-1855, Luxembourg, LU	47783
07473	2006-560	<b>3m company A Delaware corporation;</b> 3M Center, 2501 Hudson Road, St. Paul, Minnesota, 55144 S.A.D., US	52340
07463	2005-1225	<b>SHENZHEN SKYWORTH-RGB ELECTRONICS CO., LTD.;</b> 13-16/F block A, Skyworth building, Shennan Road, Nanshan District, Shenzhen, People s Republic of China, CN	53528
07458	2006-1434	<b>Motorola Trademark Holdings,LLC;</b> 600 North US Highway 45,Libertyville,IL 60048,USA	53732
07460	2006-2784	<b>Motorola Trademark Holdings,LLC;</b> 600 North US Highway 45,Libertyville,IL 60048,USA	54593
07468	2001-1782	<b>S.C. Johnsnon &amp; Son, Inc. ( Winsconsin Corporation);</b> 1525 Howe Street, Racine, Wisconsin 53403-2236, US	47657
07456	2002-1259	<b>Motorola Trademark Holding,LLC;</b> 600 North US Highway 45,Libertyville,IL60048 USA	48522
07466	1997-18	<b>COLUMBIA SPORTSWEAR COMPANY;</b> 14375 NW Science Park Drive, Portland, Oregon 97229, US	42379
07446	1994-598	<b>Official Pillowtex LLC;</b> 1800 Moler Road, Columbus, Ohio 43207, US	41260
07449	1984-217	<b>EBARA CORPORATION;</b> 11-1, HANEDA ASAHI-CHO, OTA-KU, TOKYO, JP	30386
07450	1977-475	<b>EBARA CORPORATION;</b> 11-1, Haneda Asahi-Cho, Ota-Ku, Tokyo, JP	26107
07447	1994-599	<b>Official Pillowtex LLC;</b> 1800 Moler Road, Columbus, Ohio 43207, US	41258
07472	2001-1450	<b>SHARP KABUSHIKI KAISHA (SHARP CORPORATION);</b> 22-22, Nagaike-cho, Abenoku, Osaka 545-8522, Japan, JP	47245
07459	2006-2785	<b>Motorola Trademark Holdings,LLC;</b> 600 North US Highway 45,Libertyville,IL 60048,USA	54594
07454	2006-1477	<b>Motorola Trademark Holdings,LLC;</b> 600 North US Highway 45,Libertyville,IL 60048,USA	53824
07448	1963-282	<b>OFFICIAL PILLOWTEX LLC.;</b> 1800 MOLER ROAD, COLUMBOS, OHIO 43207, US	16099
07469	2003-863	<b>Apple and Pear Australia Limited, an australian company;</b> 39 O'Connell Street, North Melbourne, Victoria, 3051, AU	49029
07482	2001-746	<b>Coloplast A/S;</b> Holtedam 1, 3050 Humlebaek, DK	46840
07484	1974-411	<b>KONSBERG MARITIME AS;</b> Strandpromenaden 50,3190 HORTEN,HORTEN,Norveska	22741
07555	2005-1014	<b>"BONITO" a.d. za proizvodnju, promet i usluge;</b> Beograd-Novi Beograd, Milentija Popovića 9, RS	53580
07548	2005-105	<b>AKCIONARSKO DRUŠTVO ZA PROIZVODNJU KONDITORSKIH PROIZVODA "SOKO-NADA ŠTARK";</b> 11000 Beograd, Kumodraška 249, YU	50716
07554	2006-1455	<b>Akcionarsko društvo za proizvodnju konditorskih proizvoda SOKO-NADA ŠTARK"";</b> Kumodraška 249, Beograd, RS	52673
07558	2005-1061	<b>"Grand prom" a.d. za proizvodnju, promet i usluge;</b> Beograd-Novi Beograd, Surčinska 6a , RS	54056
07553	2005-1380	<b>AKCIONARSKO DRUŠTVO ZA PROIZVODNJU KONDITORSKIH PROIZVODA "SOKO NADA ŠTARK";</b> 11000 Beograd, Kumodraška br. 249, YU	49878

07550	2007-635	Akcionarsko društvo za proizvodnju konditorskih proizvoda "SOKO NADA ŠTARK"; 11000 Beograd, Kumodraška br. 249, RS	52635
07556	1996-1626	AKCIONARSKO DRUŠTVO ZA PROIZVODNJU KONDITORSKIH PROIZVODA "SOKO-NADA ŠTARK"; BEOGRAD, KUMODRAŠKA 249, YU	43051
07551	2006-1454	Akcionarsko društvo za proizvodnju konditorskih proizvoda SOKO-NADA ŠTARK"; Kumodraška 249, Beograd, RS	52670
07547	2004-1614	Akcionarsko društvo za proizvodnju konditorskih proizvoda "SOKO-NADA ŠTARK"; 11000 Beograd, Kumodraška 249, YU	51055
07557	1997-371	AKCIONARSKO DRUŠTVO ZA PROIZVODNJU KONDITORSKIH PROIZVODA "SOKO-NADA ŠTARK"; BEOGRAD, KUMODRAŠKA 249, YU	43585
07552	2007-2919	Akcionarsko društvo za proizvodnju konditorskih proizvoda "SOKO NADA ŠTARK"; 11000 Beograd, Kumodraška br. 249, RS	54663
07549	2005-1208	Akcionarsko društvo za proizvodnju konditorskih proizvoda "Soko Nada Štark"; Beograd, Kumodraška 249, RS	51880
07562	2002-794	"Soko-Nada Štark", a.d. za proizvodnju konditorskih proizvoda; Kumodraška 249, Beograd, YU	48075
07559	2006-1456	Akcionarsko društvo za proizvodnju konditorskih proizvoda SOKO-NADA ŠTARK"; Kumodraška 249, Beograd, RS	52671
07563	2002-294	"SOKO-NADA ŠTARK" A.D. za proizvodnju konditorskih proizvoda,; Kumodraška 249, Beograd, YU	47833
07561	2005-1060	"Grand prom" a.d. za proizvodnju, promet i usluge; Beograd-Novi Beograd, Surčinska 6a , RS	54055
07560	2006-1641	Privredno društvo "Grand Prom" a.d. za proizvodnju, promet i usluge; Beograd-Novi Beograd, Surčinska 6a, RS	51373
07524	1978-410	Yamaha Hatsudoki Kabushiki Kaisha; 2500 Shingai, Iwata-shi, Shizuoka-ken, Japan	25974
07825	1977-879	EXXON MOBIL CORPORATION; 5959 Las Colinas Boulevard, Irving, Texas, 75039-2298, US	26070
07809	2005-650	Intervet International B.V.; Wim de Korverstraat 35, NL-5831, AN Boxmeer, Netherlands	51174
07810	1985-734	MSD International Holding GmbH; Weyrstrasse 20, CH 6000 Lucerne 6, Switzerland	30895
07811	1996-838	Merck Sharp & Dohme Corp.; One Merck Drive, Whitehouse Station, New Jersey 08889, U.S.A.	42121
07834	1973-400	SCHERING CORPORATION; 60 ORANGE STREET, BLOOMFIELD, NEW JERSEY 07003, US	22611
07948	1955-104	ROLLS-ROYCE PLC.; 65 BUCKINGHAM GATE, LONDON, SW1E 6AT, ENGLSKA, GB	13402
07950	1997-913	BAYERISCHE MOTOREN WERKE AG; Petuelring 130, BMW Haus, D-800 Munchen 40, DE	44346
07949	2003-1731	Rolls-Royce Plc.; 65 Buckingham Gate, London SW1E 6AT, Velika Britanija, GB	49788

**OBJAVA UPISA PROMJENA U REGISTAR ŽIGOVA**

## PUBLICATION OF RECORD OF CHANGES TO THE TRADEMARK REGISTER

Registarski broj (111)

**07316**

datum upisa promjene (580)

22.03.2013

**Raniji zapis**

**Klasa 9:** Kompjuteri za bicikle, pokazivači brzine, aparati za mjerenje razdaljine, aparati za snimanje razdaljine, uređaji za vozila za snimanje kilometraže, uređaji za vozila za snimanje milja, aparati za snimanje razdaljine, automatski pokazivači pritiska u gumama bicikla, zaštitni šlemovi za sportove, naočari, sigurnosne naočare i kutije, signalni uređaji, okviri za naočare.

**Novi zapis**

**Klasa 9:** kompjuteri za bicikle, pokazivači brzine, aparati za mjerenje razdaljine, aparati za snimanje razdaljine, uređaji za vozila za snimanje kilometraže, uređaji za vozila za snimanje milja, aparati za snimanje razdaljine, automatski pokazivači pritiska u gumama bicikla, sigurnosne naočari i kutije, signalni uređaji, okviri za naočari.

Registarski broj (111)

**07967**

datum upisa promjene (580)

30.05.2013

**Raniji zapis**

**Klasa 05:** Farmaceutski proizvodi dijetetske supstance prilagođene za medicinsku upotrebu, osim vitaminskih preparata.

**Novi zapis**

**Klasa 5:** Dijetetske supstance prilagođene za upotrebu u medicini, osim vitaminskih preparata.

Registarski broj (111)

**04181**

datum upisa promjene (580)

09.05.2013

**Zalogodavac**

PINUS TOVARNA KEMIČNIH IZDELKOV D.D. RAČE, GRAJSKI TRG 21, SI

**Zalogoprimac**

NOVE KREDITNE BANKE MARIBOR d.d., Ulica Vita Kraigherja 4, 2505 Maribor SI

**Obavještenje:**

Oglašava se ništavim rješenje broj 02-290 od 24.01.2013. godine o registraciji i upisu žiga u Registar žigova kojim je žig nosioca Island Global Yaachting Ltd. (Cayman Islands Exempt Company) 717 Fifth Avenue, New York, New York 10022, U.S.A., po osnovu prijave Ž-2010-294 registrovan i upisan u Registar žigova pod brojem 07026.





**DIZAJN**

**DESIGNS**

Službeni glasnik Zavoda za intelektualnu svojinu Crne Gore  
Official Gazette of the Montenegrin Intellectual Property Office

**12/2013**



Zavod za intelektualnu svojinu Crne Gore  
ul. Rimski trg br. 46,  
81000 Podgorica,  
Crna Gora





**MEĐUNARODNI KODOVI ZA IDENTIFIKACIJU BIBLIOGRAFSKIH  
PODATAKA O DIZAJNU PREMA WIPO CT.80**  
RECOMMENDATION CONCERNING BIBLIOGRAPHIC DATA RELATING TO  
INDUSTRIAL DESIGNS WIPO CT.80

<b>CRNOGORSKI</b>	<b>MDK</b>	<b>ENGLESKI</b>
Registarski broj	<b>11</b>	Number of registration
Datum registracije	<b>15</b>	Date of the registration
Očekivani datum isteka registracije	<b>18</b>	Expected expiration date of the registration
Broj prijave	<b>21</b>	Number of the application
Datum podnošenja prijave	<b>22</b>	Date of filing of the application
Podaci o izložbenom pravu prvenstva	<b>23</b>	Exhibition priority data
Broj prijavljenih dizajna	<b>28</b>	Number of industrial designs included in the application
Podaci o pravu prvenstva na osnovu Pariske konvencije	<b>30</b>	Data relating to priority under the Paris Convention
Klasa i podklasa Lokarnske klasifikacije	<b>51</b>	Class and subclass of the Locarno Classification
Naziv dizajna	<b>54</b>	Title of the industrial design
Prikaz	<b>55</b>	Reproduction of the industrial design (e.g., drawing, photograph) and explanations relating to the reproduction
Ime autora dizajna	<b>72</b>	Name of the creator
Ime i adresa nosioca prava	<b>73</b>	Name and address of the owner
Ime i adresa punomoćnika	<b>74</b>	Name and address of the representative



OBJAVE DIZAJNA  
PUBLICATION OF DESIGNS

- (11) **00070**  
(21) D-2010/02  
(22) 19.02. 2010.  
(28) 2  
(30) 001160519-0001 EM  
001160519-0002 EM

- (51) **09-03**  
(15) 31.05.2013.  
(18) 19.02.2015.

- (54) **AMBALAŽA ZA PREHRAMBENE PROIZVODE (PAKOVANJE)**  
(72) 1) John Cowan-Hughes, 42 Cowleigh Road, Malvern, Worcs, England, WR14 1QD, UK;  
2) Hayley Woolford, 22 Prospect Road, Farnborough, Hampshire, GU14 0DX, UK  
3) Bruce Hannant, Flat 9, 171 Queenstown Road, Battersea, London, SW8 3RL, UK.  
(73) Mars, Incorporated 6885 Elm Street, McLean, VA 22101-3883, US  
(74) Jusić Jasni, Ul Crnogorskih serdara bb, Podgorica ME  
(55)



1.1



1.2

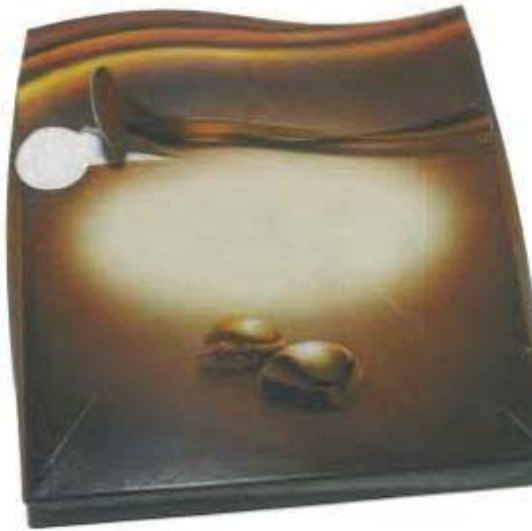

1.3



1.4



1.5



1.6



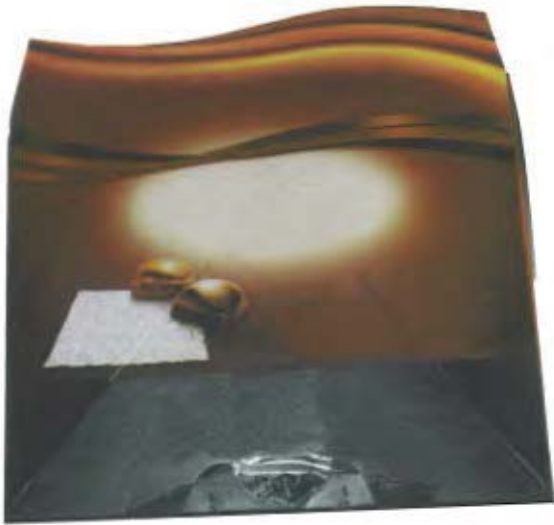

1.7



1.8



1.9



1.10



1.11



2.1

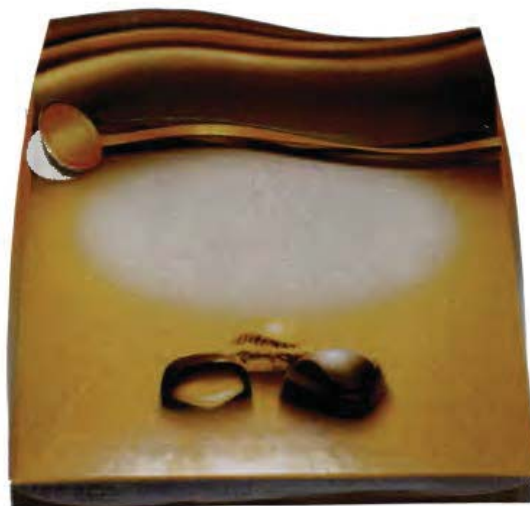

2.2



2.3



2.4



2.5



2.6

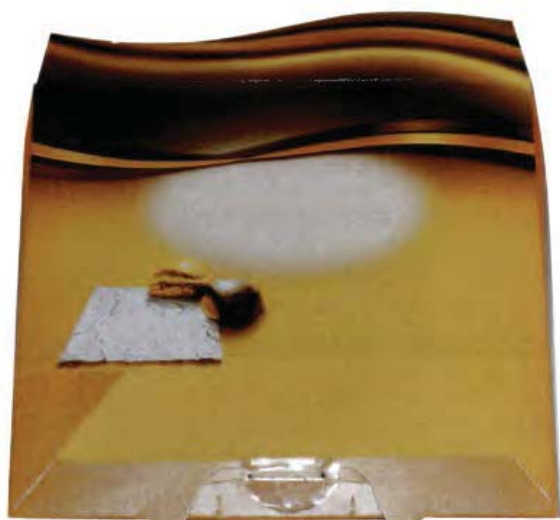

2.7



2.8



2.9

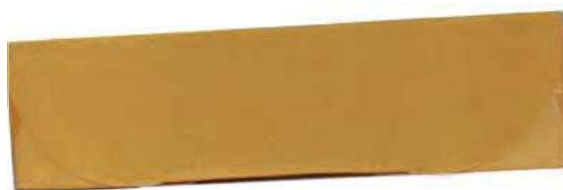

2.10



2.11



- (11) **00067** (51) **09-02**  
(21) D-2010/4 (15) 27.05.2013  
(22) 26.03. 2010. (18) 26.03.2015.  
(28) 1  
(30) 001666298-0001 EM  
(54) **KANISTER ZA MAZIVA**  
(72) 1.Martin BUNCE, c/o TIN HORSE DESIGN LIMITED, Pelham House, Pelhams Court, London Road, Marlborough, Wiltshire SN8 2AG, GB;  
2.Will MASKELL c/o TIN HORSE DESIGN LIMITED, Pelham House, Pelhams Court, London Road, Marlborough, Wiltshire SN8 2AG, GB  
3.Corinne ELSTOW c/o TIN HORSE DESIGN LIMITED, Pelham House, Pelhams Court, London Road, Marlborough, Wiltshire SN8 2AG, GB.  
(73) CASTROL LIMITED Wakefield House, Pipers Way, Swindon, Wiltshire SN3 1RE, United Kingdom, GB  
(74) Lutovac Branislav, Bulevar Ivana Crnojevića 93, Podgorica ME  
(55)



1.1



1.2



1.3



1.4



1.5

(11) **00071**

(21) D-2010/5

(22) 29.03.2010

(28) 1

(54) **BOCA**

(73) DUKAT mliječna industrija d.d. Marijana Čavića 9, 10000 Zagreb, Hrvatska, HR

(74) Kojić Ivana, Serdara Jola Piletića bb, Podgorica, ME

(55)

(51) **09-01**

(15) 31.05.2013

(18) 29.03.2015



1.1



1.2



1.3

- (11) **00077** (51) **14-03**  
 (21) D-2010/6 (15) 07.06.2013  
 (22) 29.03. 2010. (18) 29.03.2015.  
 (28) 3  
 (30) 001167993 EM  
 (54) **STB DALJINSKI UPRAVLJAČ**  
 (72) 1) Dominic Flik, Friedrich-Ebert-Allee 140, 53113 Bonn, DE  
 2) Caroline Seifert, Friedrich-Ebert-Allee 140, 53113 Bonn, DE  
 (73) Deutsche Telekom AG Friedrich-Ebert-Allee 140 53113 Bonn DE  
 (74) Popović Miladin, Đoka Miraševića 21/III, Podgorica (ME)  
 (55)

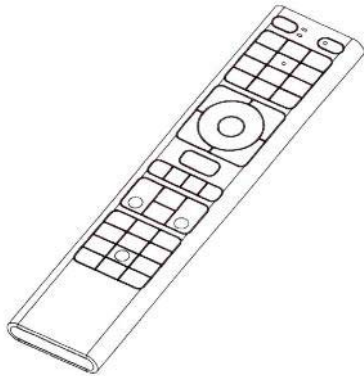

1.1



1.2

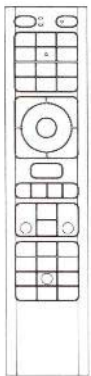

1.3

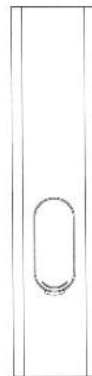

1.4

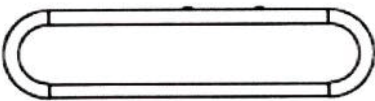

1.7

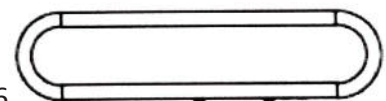

1.6



1.7

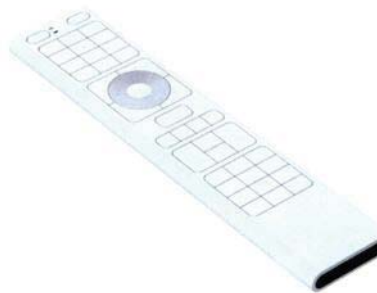

2.1

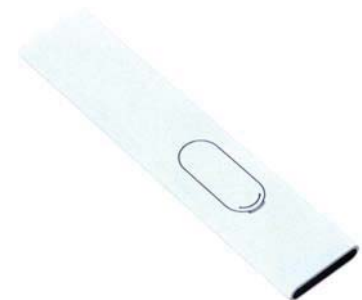

2.2

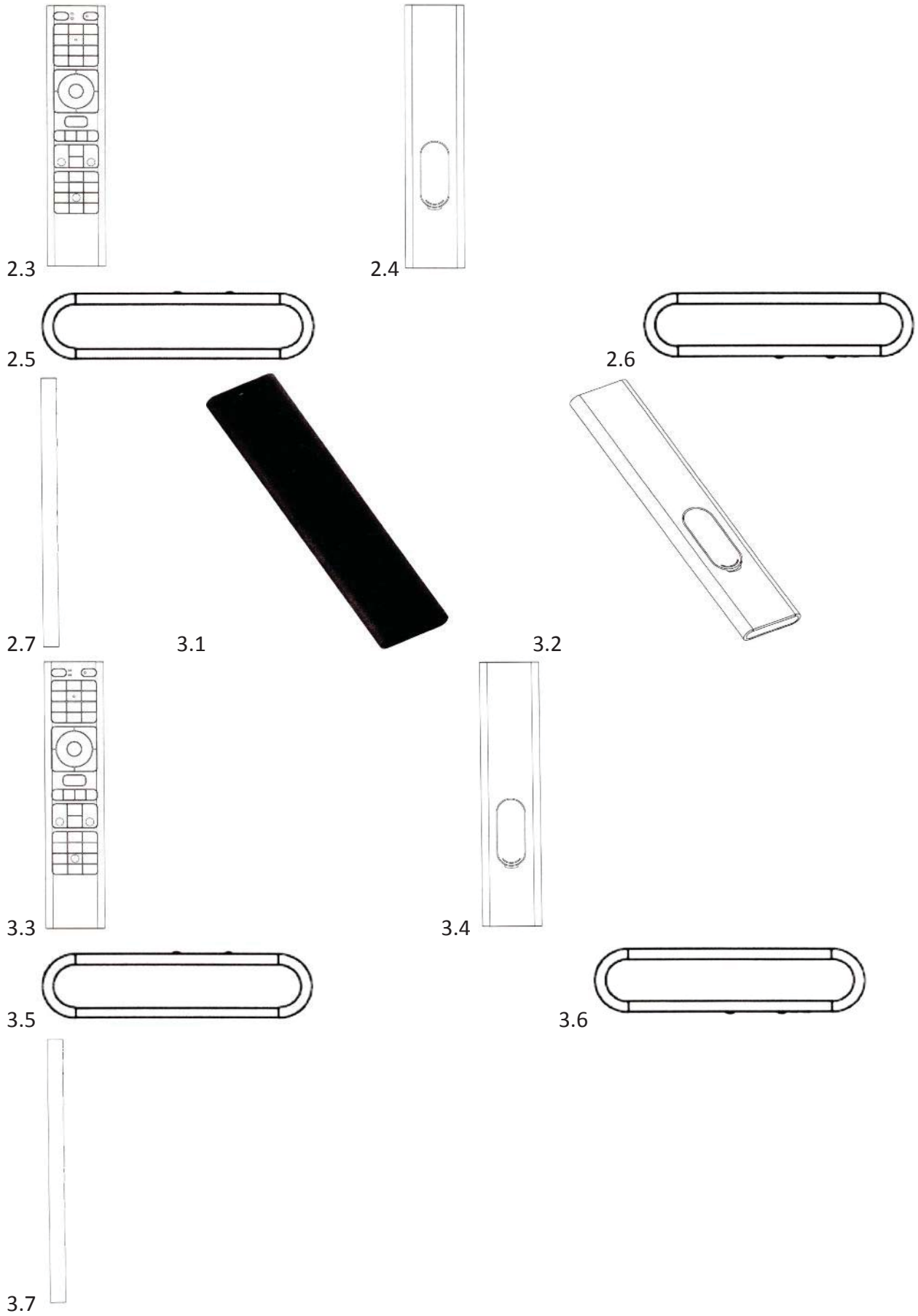

- (11) **00078** (51) **14-03**  
 (21) D-2010/7 (15) 07.06.2013  
 (22) 01.04. 2010. (18) 01.04.2015  
 (28) 5  
 (30) 001174882 EM  
 (54) **PRIJEMNIK**  
 (72) 1) Dominic Flik, Friedrich-Ebert-Allee 140, 53113 Bonn, DE  
 2) Caroline Seifert, Friedrich-Ebert-Allee 140, 53113 Bonn, DE  
 (73) Deutsche Telekom AG Friedrich-Ebert-Allee 140 53113 Bonn DE  
 (74) Popović Miladin, Đoka Miraševića 21/III, Podgorica (ME)  
 (55)

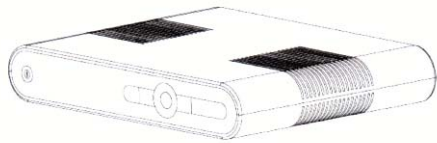

1.1

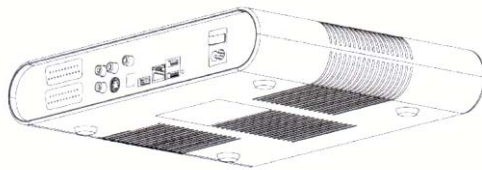

1.2

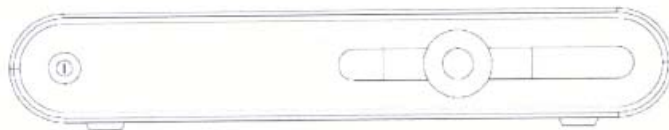

1.3

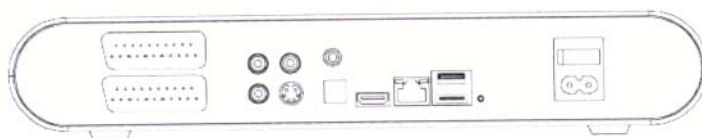

1.4

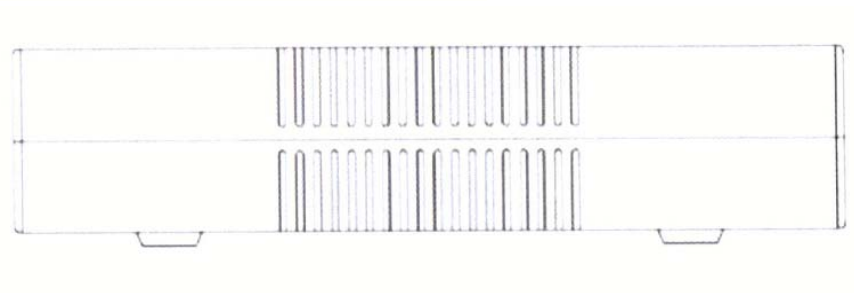
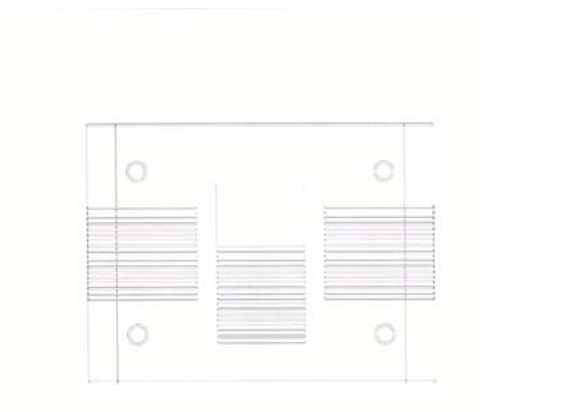
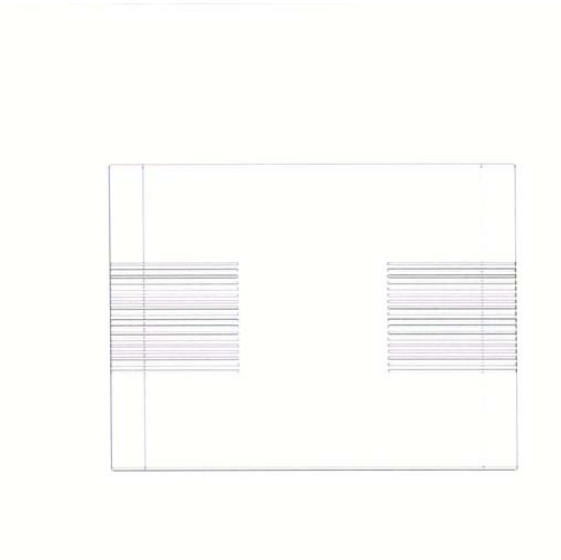



2.2

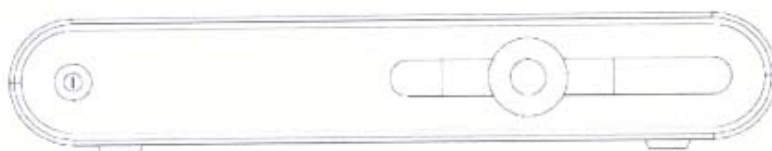

2.3

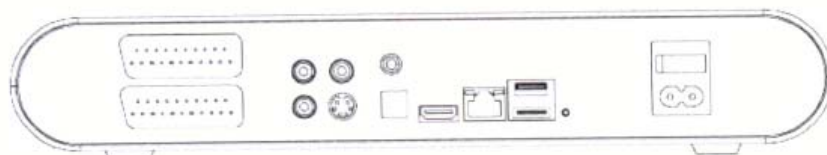

2.4

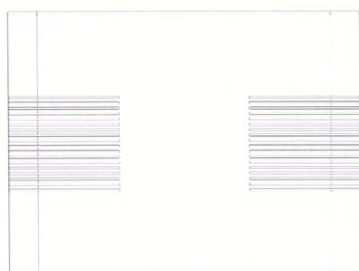

2.5



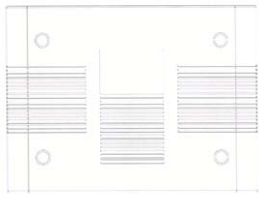

2.6

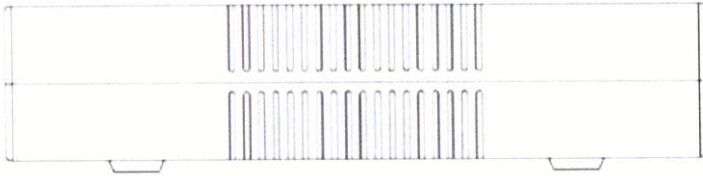

2.7



3.1

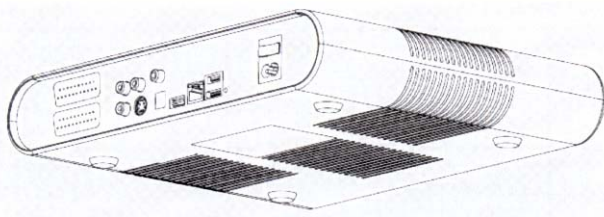

3.2

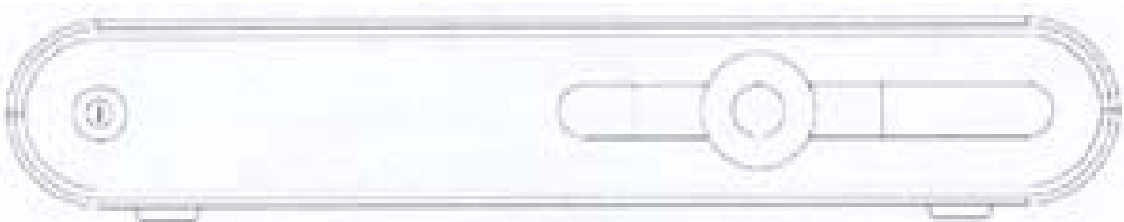

3.3



3.4

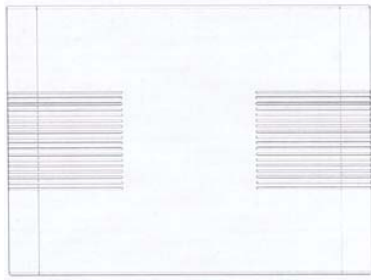

3.5

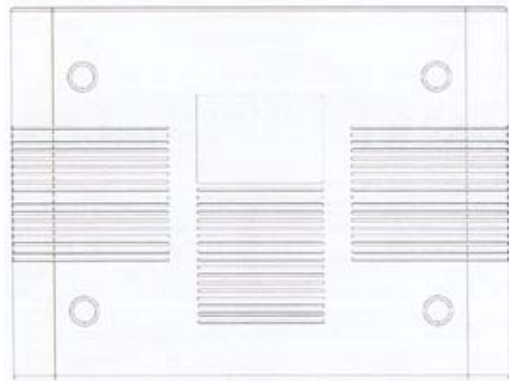

3.6

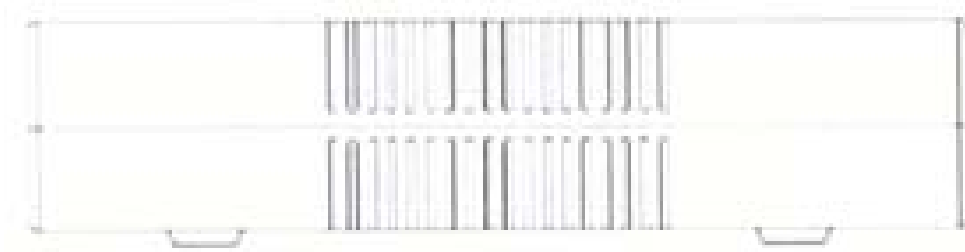

3.7

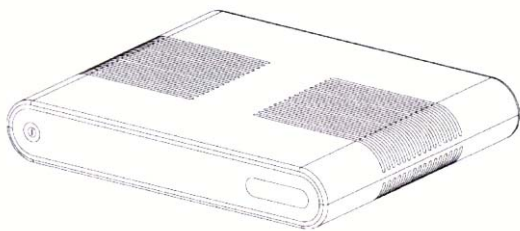

4.1

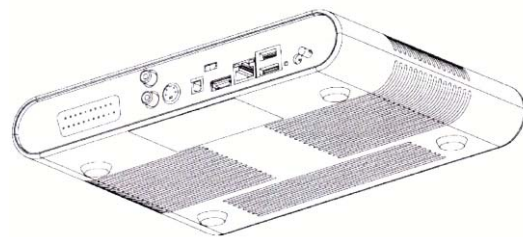

4.2

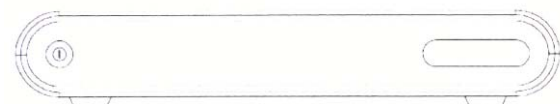

4.3

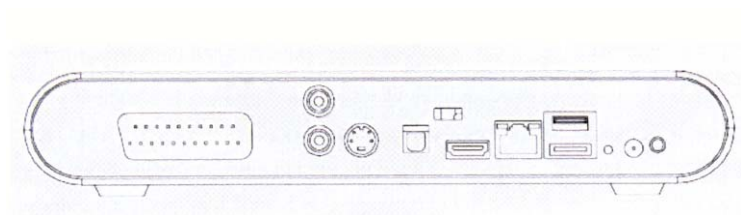

4.4

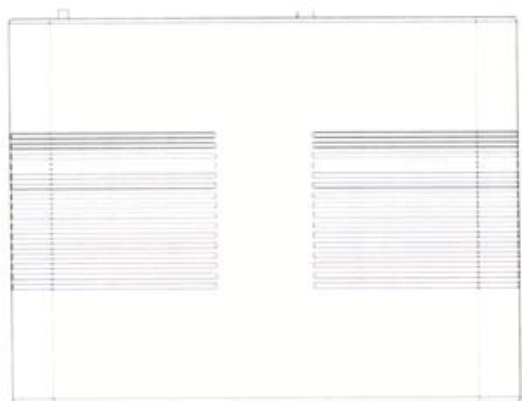

4.5

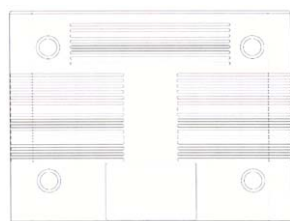

4.6

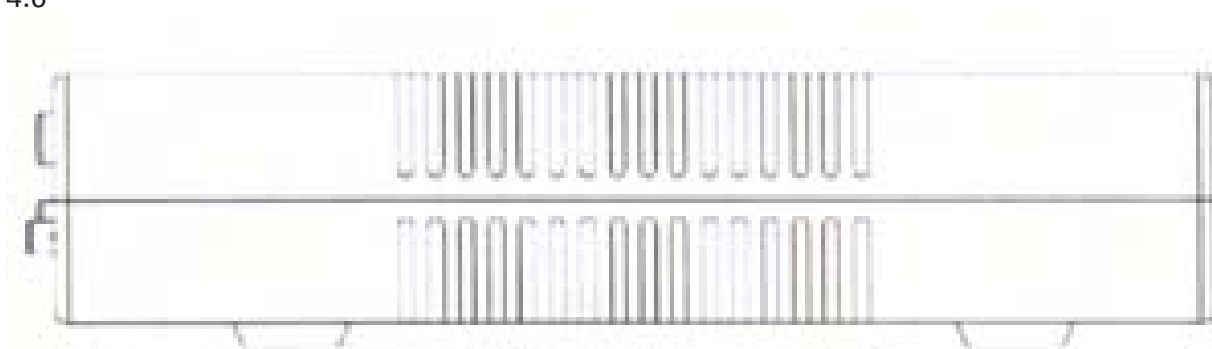

4.7



5.1



5.2

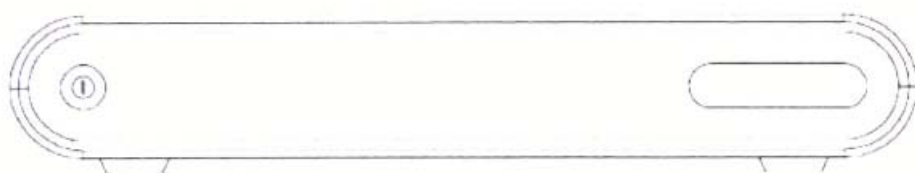

5.3

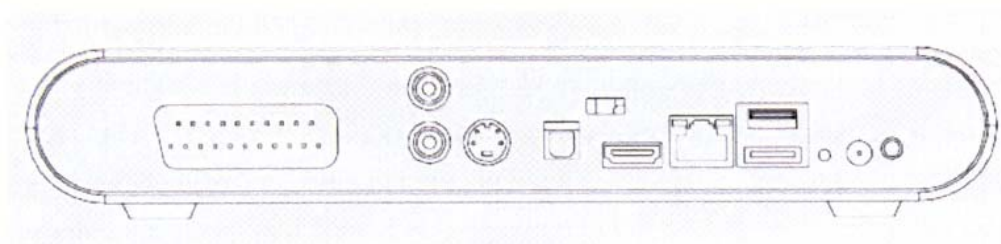

5.4

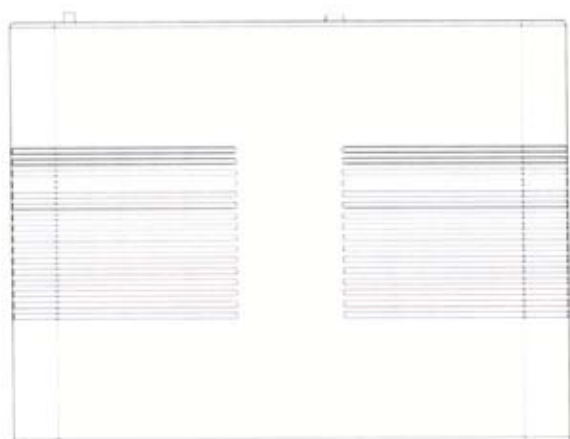

5.5

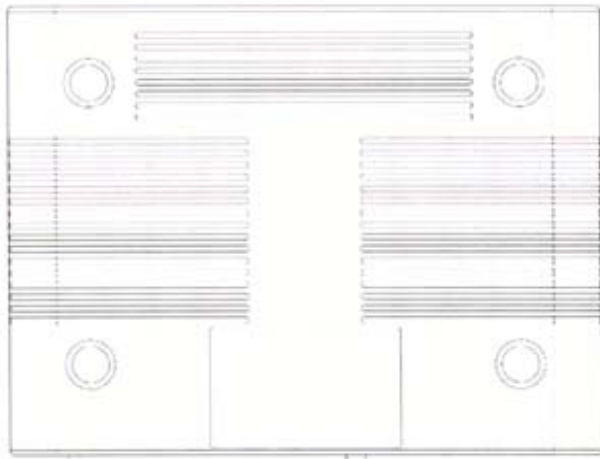

5.6

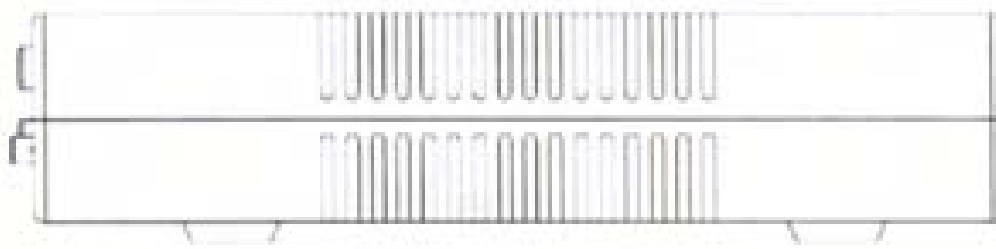

5.7

- (11) **00068**  
 (21) D-2010/8  
 (22) 29.04. 2010  
 (28) 1  
 (30) 2009-025562 JP

- (51) **15-01**  
 (15) 31.05.2013  
 (18) 29.04.2015

(54) **MOTOR SA UNUTRAŠNJIJIM SAGORIJEVANJEM**

- (72) MASAYUKI OSUMI, c/o Kabushiki Kaisha Honda Gijutsu Kenkyusho, 4-1, Chuo 1-chome, Wako-shi, Saitama, (JP).  
 (73) HONDA MOTOR CO., LTD. 1-1, Minami-Aoyama 2-chome, Minato-ku, Tokyo, JP  
 (74) Lutovac Branislav, Bulevar Crnojevića 93, Podgorica (ME)  
 (55)

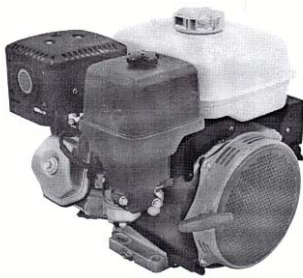

1.1

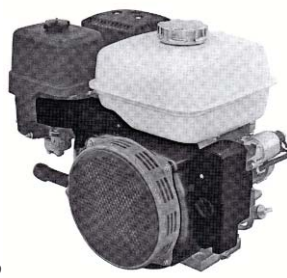

1.2



1.3

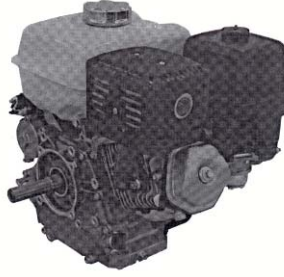

1.4

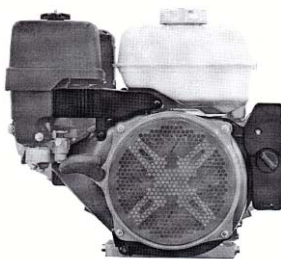

1.5

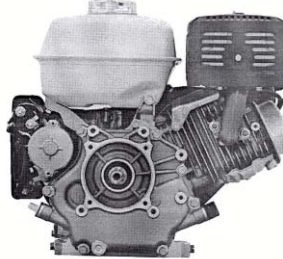

1.6



1.7

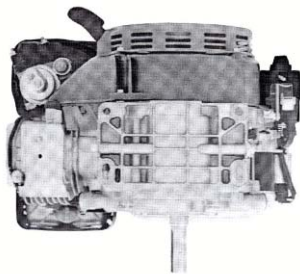

1.8



1.9

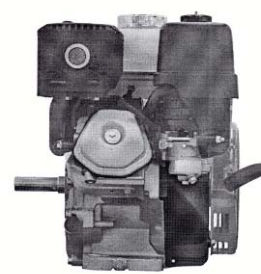

1.10

- (11) **00072**  
(21) D-2010/10  
(22) 12.05. 2010  
(28) 1  
(30) 29/354,802 US

- (51) **09-03**  
(15) 31.05.2013  
(18) 12.05.2015

(54) **AMBALAŽA (PAKOVANJE)**

- (72) 1) TOM ORAVEZ, c/o Mars Snackfood US, 800 High Street, 07840 Hackettstown, NJ, US  
2) ROBERT FRIEDMAN, c/o Mars Snackfood US, 800 High Street, 07840 Hackettstown, NJ, USi  
3) JOANNE RISKO, c/o Mars Snackfood US, 800 High Street 07840 Hackettstown, NJ, US.  
(73) Mars, Incorporated 6885 Elm Street, McLean, VA 22101-3883, U.S.A.  
(74) Jusić Jasni, Ul Crnogorskih serdara bb, Podgorica ME  
(55)

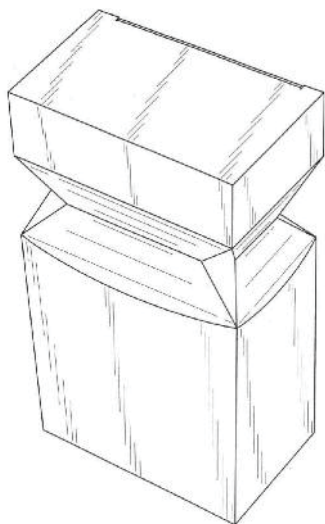

1.1

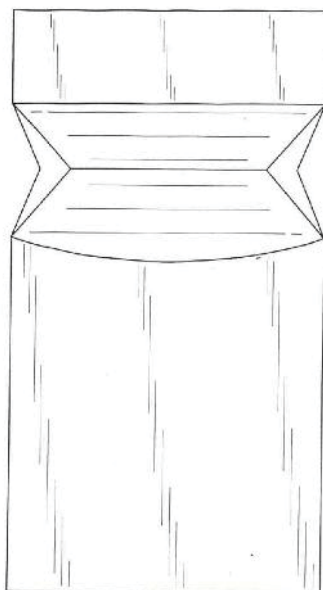

1.2

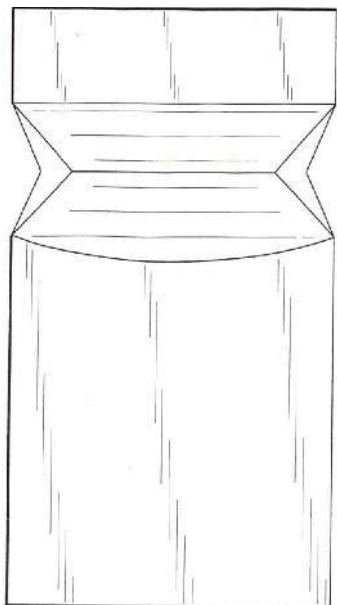

1.3

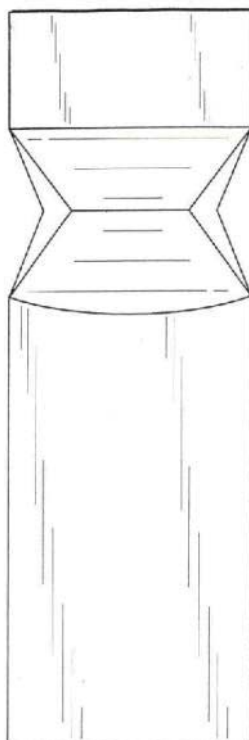

1.4

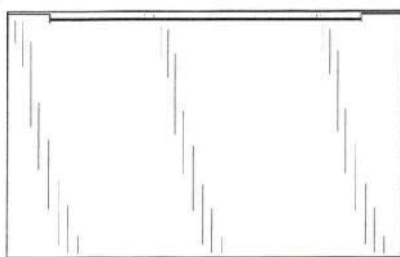

1.5

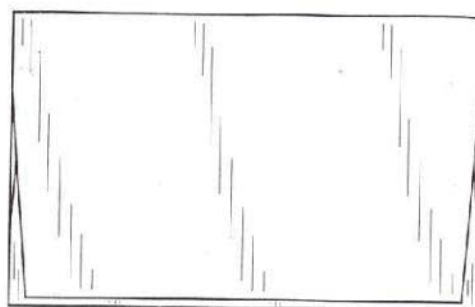

1.6

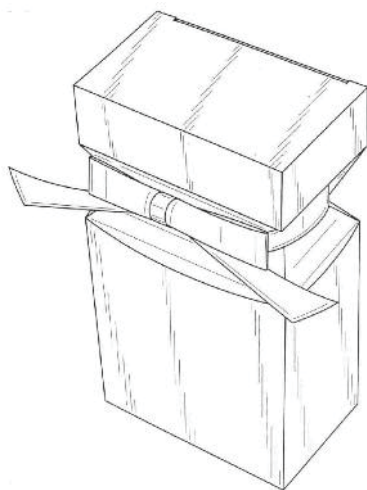

1.7



- (11) **00079** (51) **14-02, 14-03**  
 (21) D-2010/18 (15) 07.06.2013  
 (22) 20.07.2010 (18) 20.07.2015  
 (28) 4

(30) 001198980 EM

(54) **BEŽIČNA OPREMA ZA OBRADU PODATAKA**

(72) Mr Thomas Mamero, Friedrich-Ebert-Allee 140, 53113 Bonn, DE

(73) Deutsche Telekom AG, Friedrich-Ebert-Allee 140 53113 Bonn, DE

(74) Popović Miladin, Đoka Miraševića 21/III, Podgorica (ME)

(55)

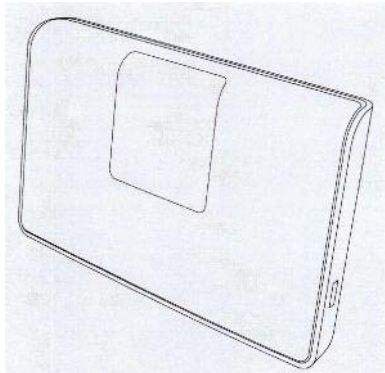

1.1

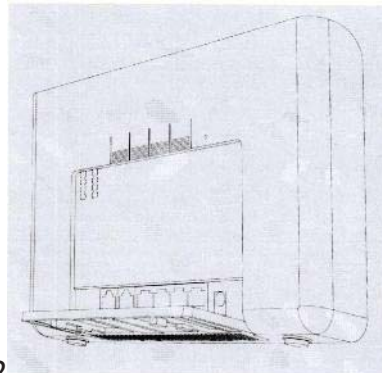

1.2

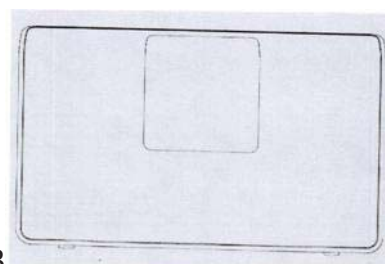

1.3

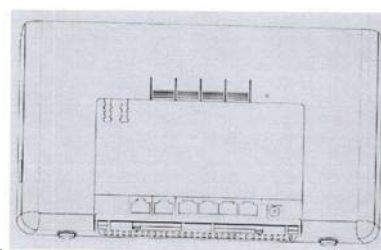

1.4

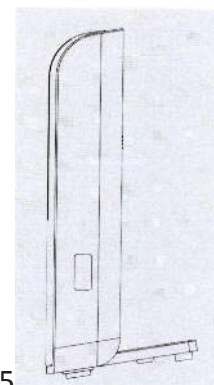

1.5

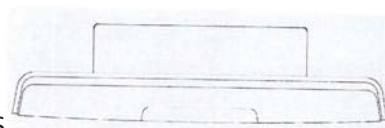

1.6

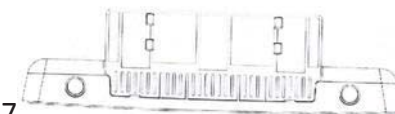

1.7

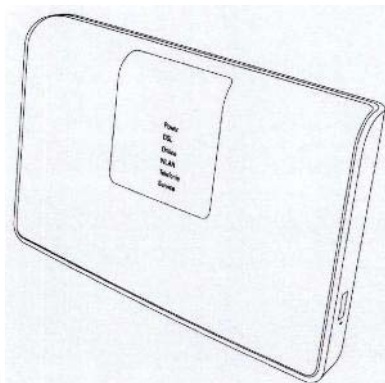

2.1

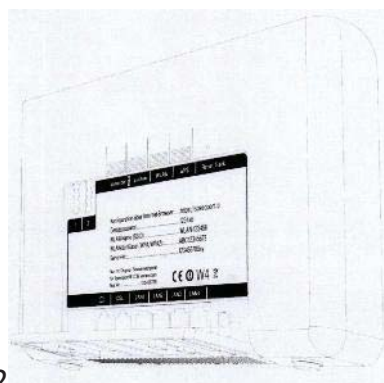

2.2

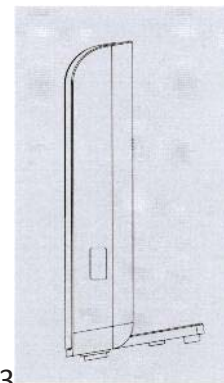

2.3

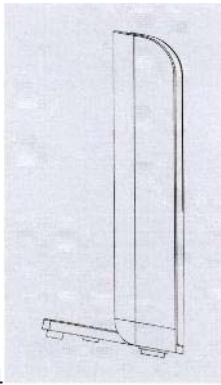

2.4

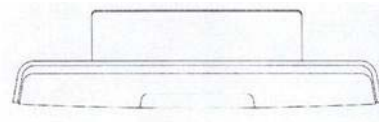

2.5

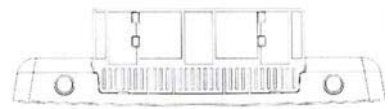

2.6

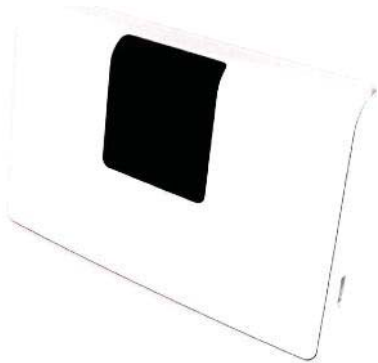

3.1

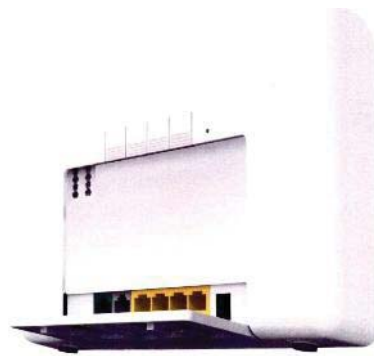

3.2

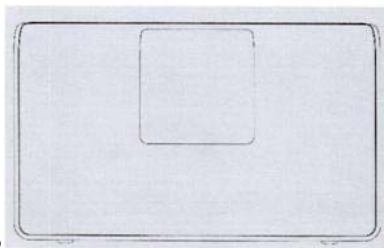

3.3

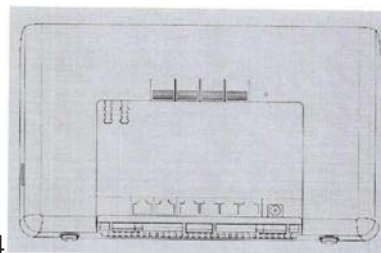

3.4

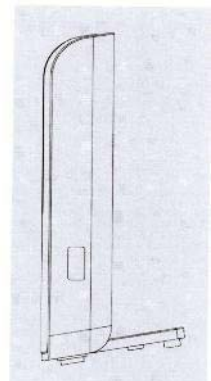

3.5

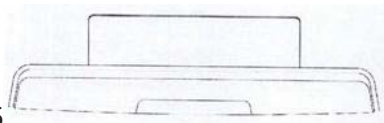

3.6

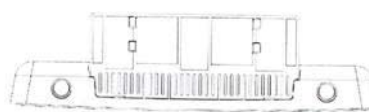

3.7



4.1



4.2

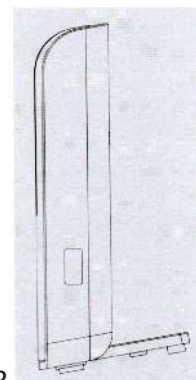

4.3

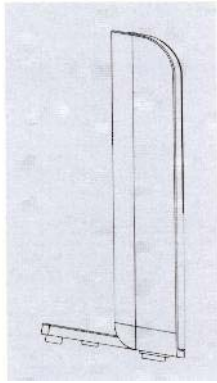

4.4

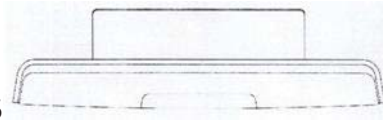

4.5

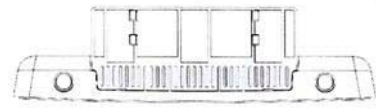

4.6

- (11) **00080** (51) **14-02, 14-03.**  
 (21) D-2010/19 (15) 07.06.2013  
 (22) 20.07. 2010. (18) 20.07.2015.  
 (28) 5

(30) 001195101 EM

(54) **BEŽIČNA OPREMA ZA OBRADU PODATAKA**

(72) Mr Sven Bastiaen Schulz, Friedrich-Ebert-Allee 140, 53113 Bonn, DE

(73) Deutsche Telekom AG, Friedrich-Ebert-Allee 140, 53113 Bonn DE

(74) Popović Miladin, Đoka Miraševića 21/III, Podgorica (ME)

(55)

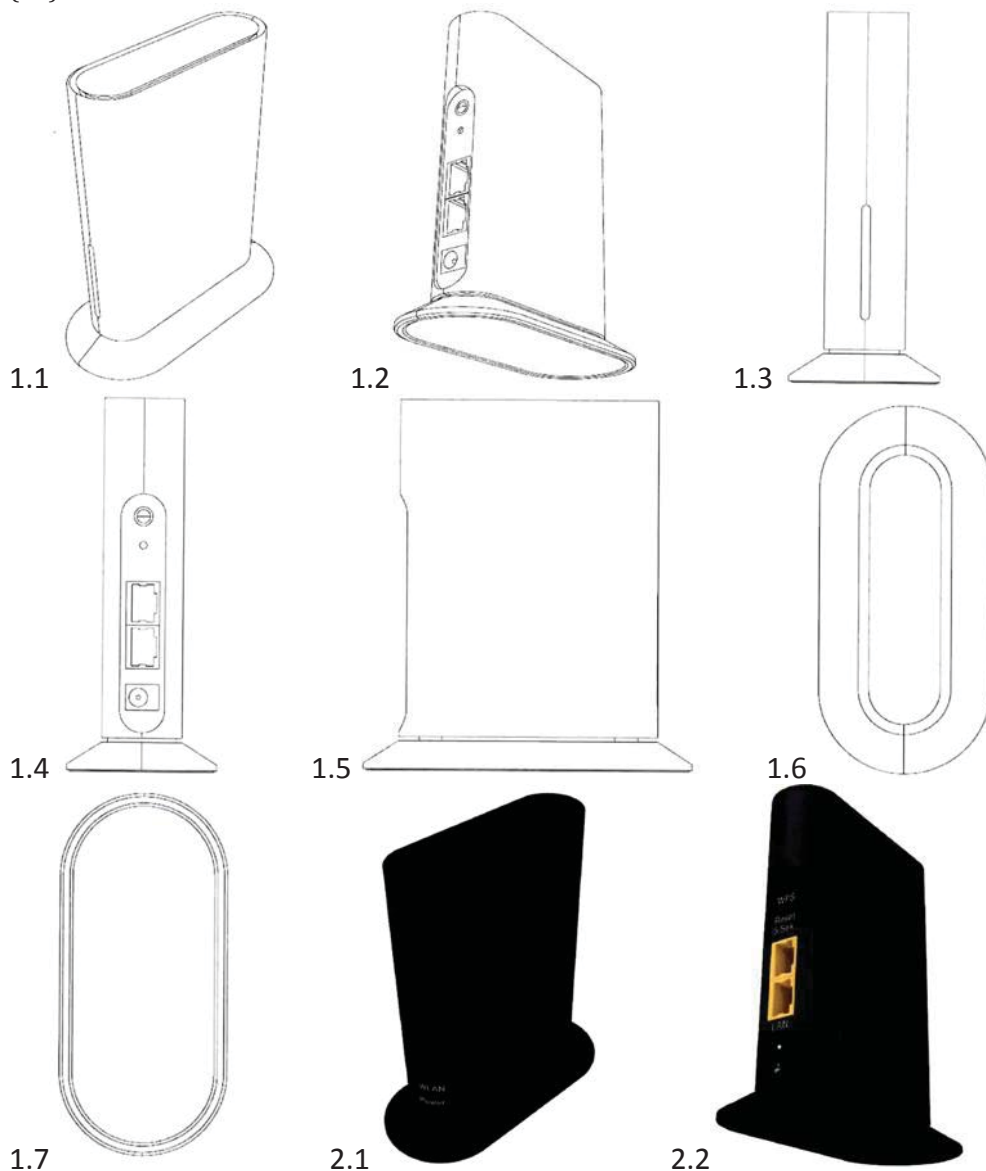

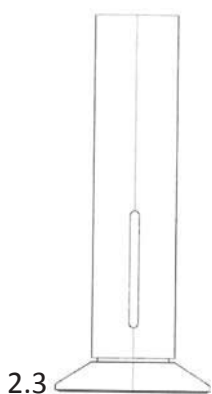

2.3

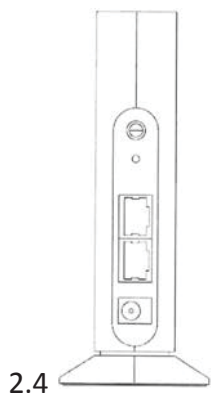

2.4

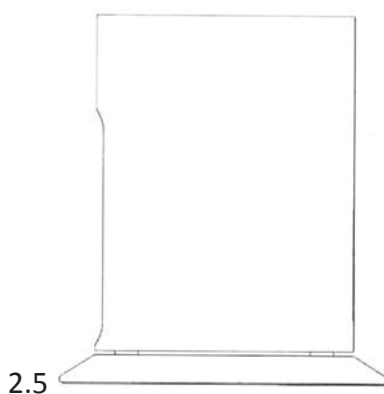

2.5

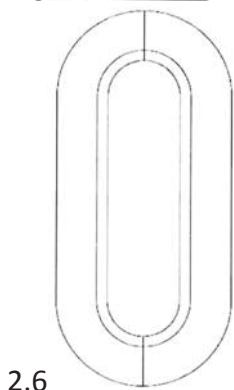

2.6

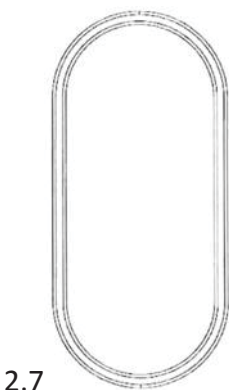

2.7



3.1



3.2

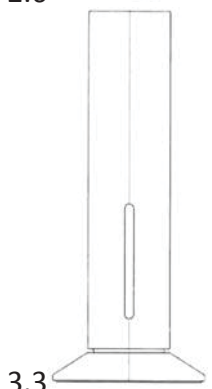

3.3

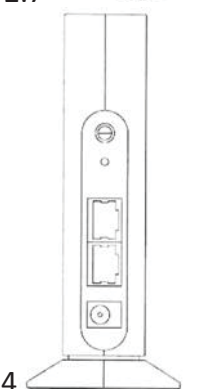

3.4

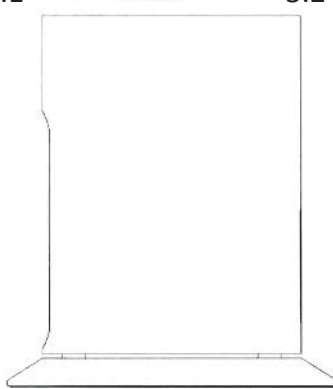

3.5

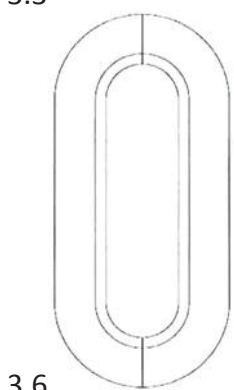

3.6

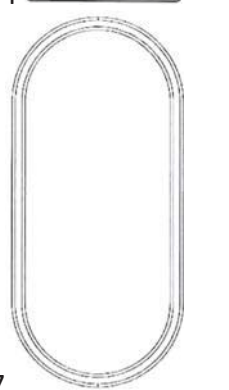

3.7



4.1



4.2

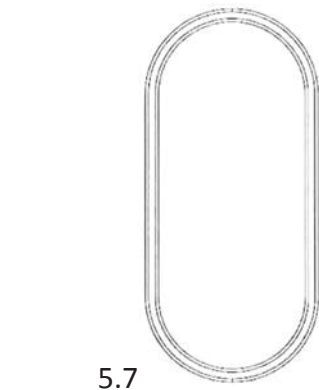
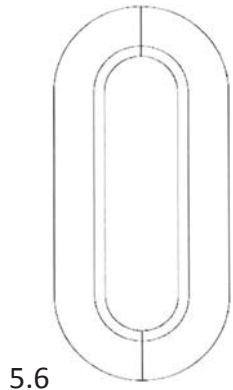
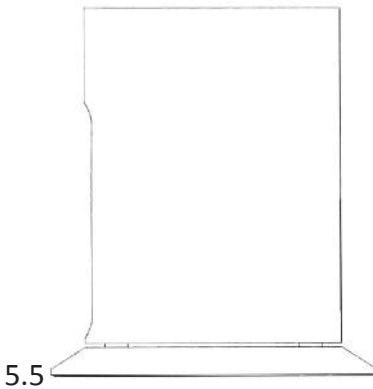
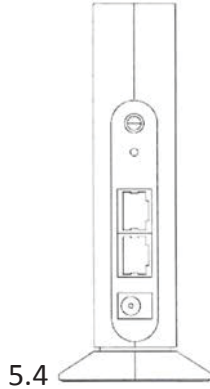
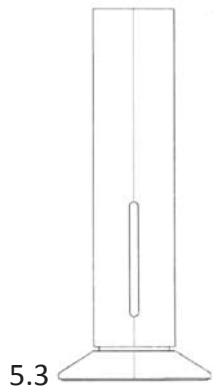
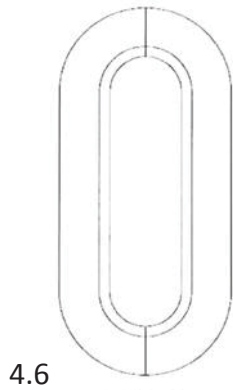
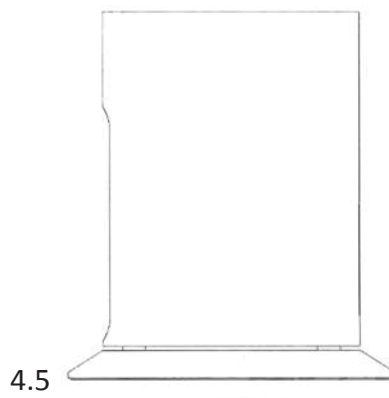
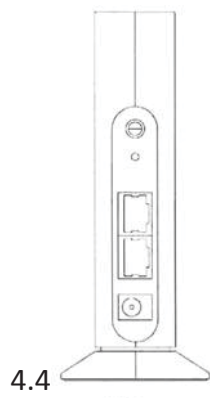
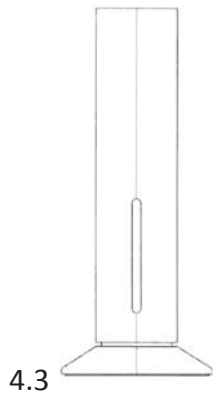

- (11) **00069**  
 (21) D-2010/22  
 (22) 24.08. 2010  
 (28) 1  
 (30) 2010-005145 JP

- (51) **13-01**  
 (15) 31.05.2013  
 (18) 24.08.2015

(54) **MOTORNI GENERATOR**

- (72) Yuya KATO c/o Kabushiki Kaisha Honda Gijutsu Kenkyusho 4-1, Chuo 1-chome, Wako-shi, Saitama-ken, (JP).  
 (73) HONDA MOTOR CO., LTD. 1-1, Minamiaoyama 2-chome, Minato-ku, Tokyo, JP,  
 (74) Lutovac Branislav, Bulevar Crnojevića 93, Podgorica (ME)  
 (55)



1.1



1.2



1.3



1.4



1.5

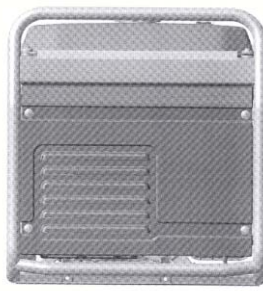

1.6

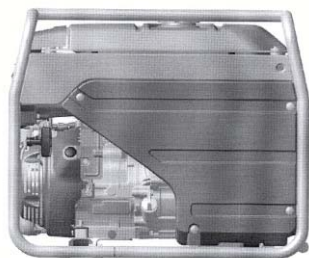

1.7

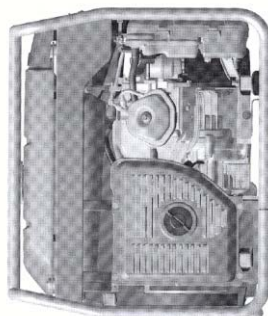

1.8



1.9

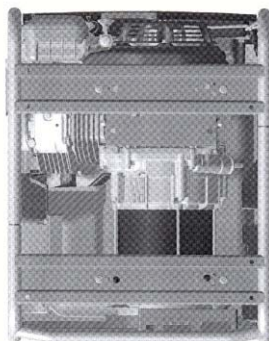

1.10



- (11) **00073** (51) **09-05**  
 (21) D-2010/24 (15) 31.05.2013  
 (22) 24.09. 2010 (18) 24.09.2015  
 (28) 1

(30) 29/358,453 US

(54) **DRŽAČ ZA ČAŠU**

- (72) 1) Thomas Fu 2607 Saltmeadow Rd., Naperville, Illinois 60564, US  
 2) Matthew R. Cook 508 Warren Court, Hinsdale, Illinois 60521, US  
 3) Kurt M. Wolf 6908 North Ashland, Chicago, Illinois US  
 (73) LBP MANUFACTURING INC. 1325 South Cicero, Illinois 60804, US  
 (74) Čejović Vladimir, 13. jula 21, Podgorica (ME)  
 (55)

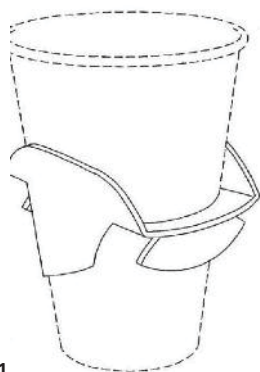

1.1

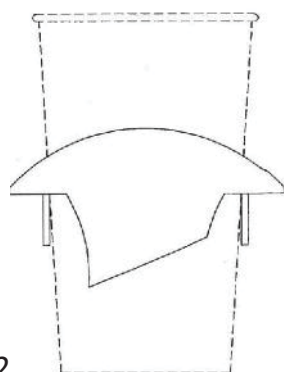

1.2

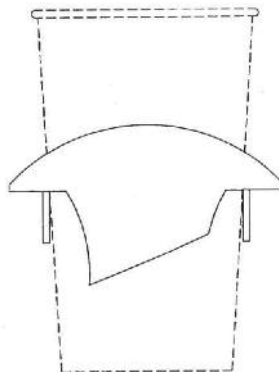

1.3

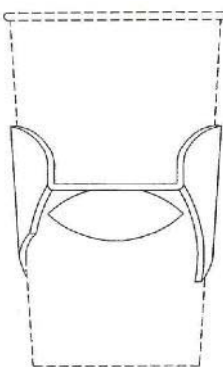

1.4

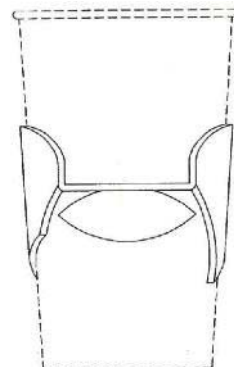

1.5

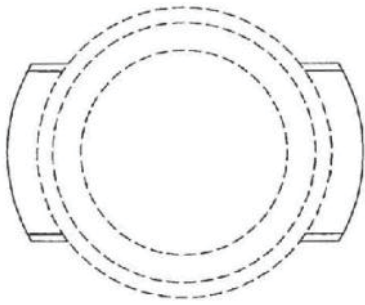

1.6

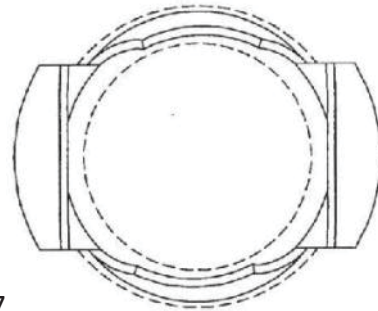

1.7

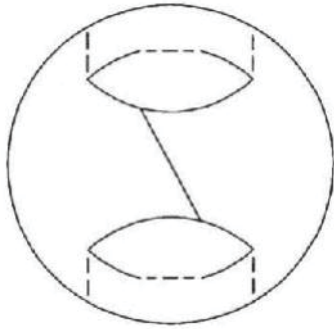

1.8

- (11) **00074**  
 (21) D-2010/25  
 (22) 24.09. 2010  
 (28) 1  
 (30) 29/358,446, US

- (51) **09-05**  
 (15) 31.05.2013  
 (18) 24.09.2015

(54) **DRŽAČ ZA KONTEJNER (SPREMNIK)**

- (72) 1) Thomas Fu 2607 Saltmeadow Rd., Naperville, Illinois 60564, US  
 2) Matthew R. Cook 508 Warren Court, Hinsdale, Illinois 60521, US  
 3) Kurt M. Wolf 6908 North Ashland, Chicago, Illinois 60626, US  
 (73) LBP MANUFACTURING INC. 1325 South Cicero, Illinois 60804, US  
 (74) Čejović Vladimir, 13. jula 21, Podgorica (ME)  
 (55)



1.1



1.2

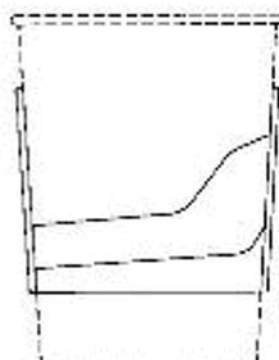

1.3

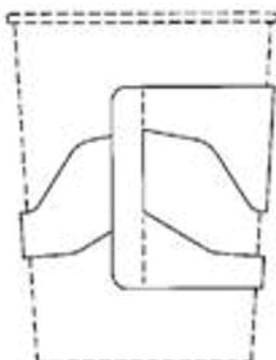

1.4

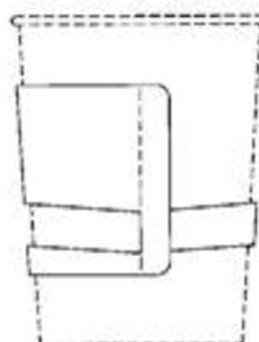

1.5

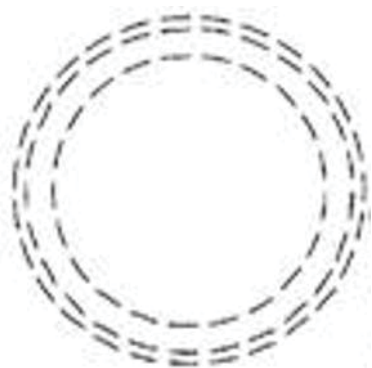

1.6



1.7

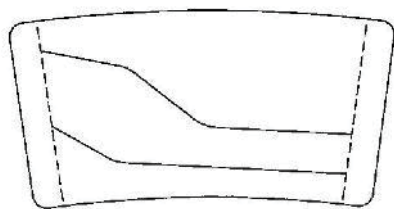

1.8

- (11) **00081** (51) **13-02**  
 (21) D-2011/1 (15) 07.06.2013  
 (22) 09.02. 2011 (18) 09.02.2016  
 (28) 3  
 (30) 0011229272 EN  
 (54) **PUNJAČ ZA MOBILNI TELEFON**  
 (72) 1) Jan Christian Delfs, Friedrich-Ebert-Allee 140, 53113 Bonn, DE  
 2) Dominic Flik, Friedrich-Ebert-Allee 140, 53113 Bonn, DE  
 3) Philipp Haselwander, Friedrich-Ebert-Allee 140, 53113 Bonn, DE  
 (73) Deutsche Telekom AG Friedrich-Ebert-Allee 140 53113 Bonn DE  
 (74) Popović Miladin, Ul.Đoka Miraševića 21/III, Podgorica ME  
 (55)

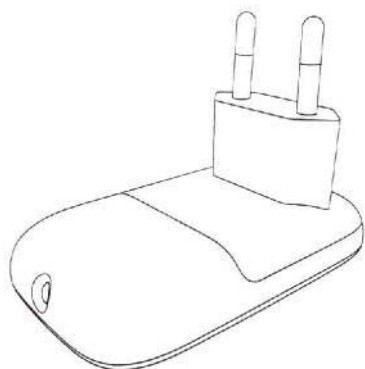

1.1



1.2

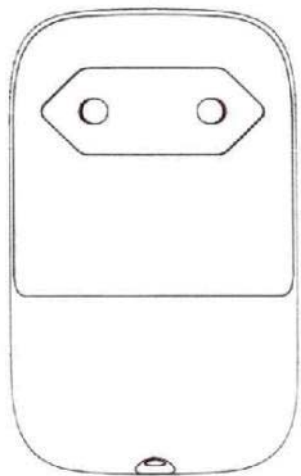

1.3

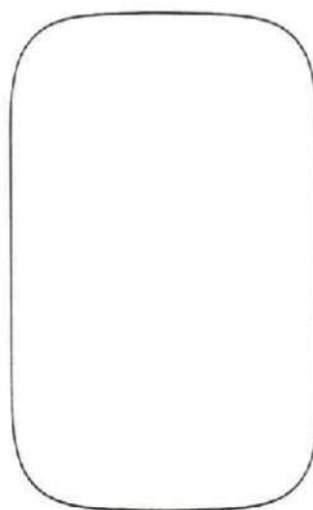

1.4

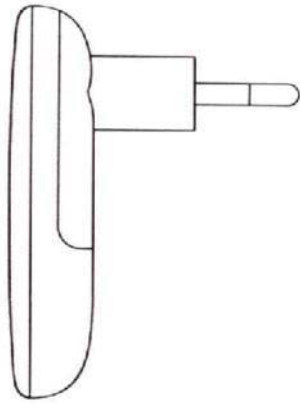

1.5

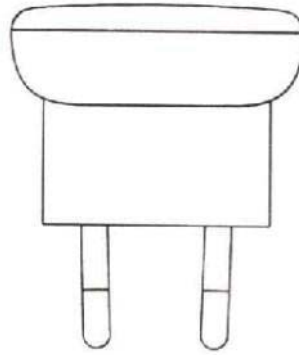

1.6

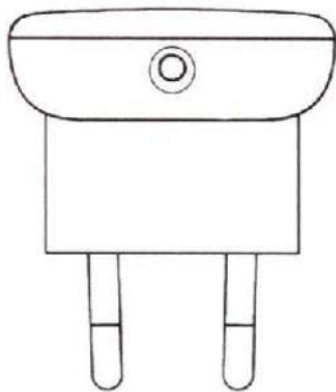

1.7

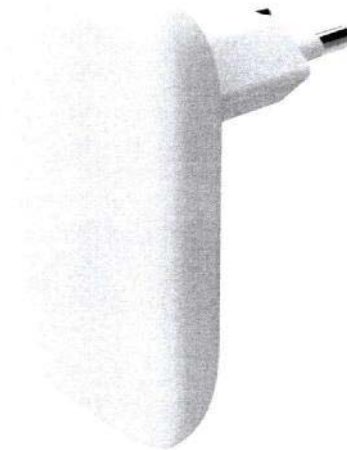

2.1



2.2

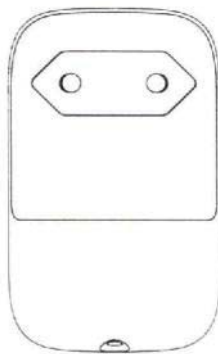

2.3



2.4

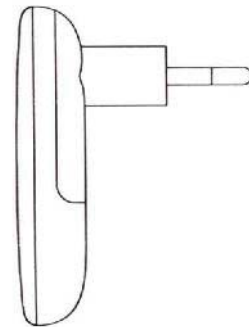

2.5

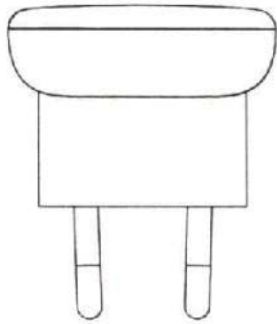

2.6

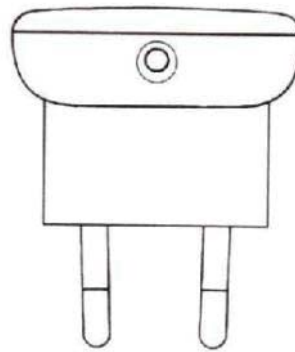

2.7



3.1



3.2

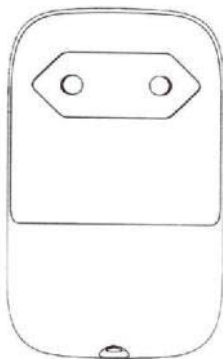

3.3



3.4

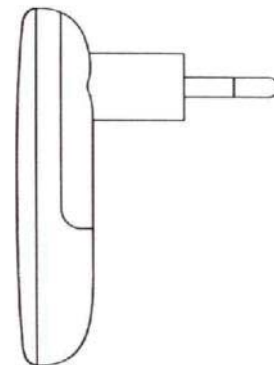

3.5

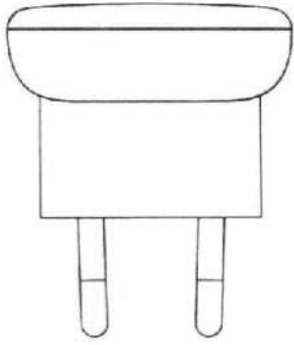

3.6

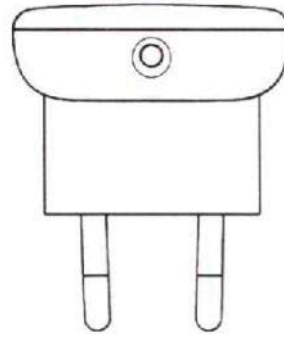

3.7



(11) **00082**

(21) D-2011/6

(22) 08.04. 2011

(28) 1

(54) **AMBALAŽA ZA DEZODORANS**

(73) HUNCA KOZMETİK SANAYİ ANONİM ŞİRKETİ Hunca Cad. No:12 Bahçeköy Sarıyer, İstanbul, TR

(74) Kojić Ivana, Serdara Jola Piletića bb, Podgorica, ME

(55)

(51) **09-03.**

(15) 07.06.2013

(18) 08.04.2016.



1.1



1.2



1.3



1.4



1.5



1.6

- (11) **00083** (51) **14-03**  
 (21) D-2011/7 (15) 07.06.2013  
 (22) 28.04.2011 (18) 28.04.2016  
 (28) 3  
 (30) 001243315 EM  
 (54) **TELEVIZIJSKI PRIJEMNIK**  
 (72) 1) Jan Christian Delfs, Lerchenstr. 13, 22767 Hamburg, DE  
 2) Dominic Flik, Frühlingstrasse 1, 85521 Ottobrunn, DE  
 3) Michael Schiffer, Belderberg 20, 53111 Bonn, DE  
 (73) Deutsche Telekom AG Friedrich-Ebert-Allee 140 53113 Bonn DE  
 (74) Popović Miladin, Đoka Miraševića 21/III, Podgorica (ME)  
 (55)

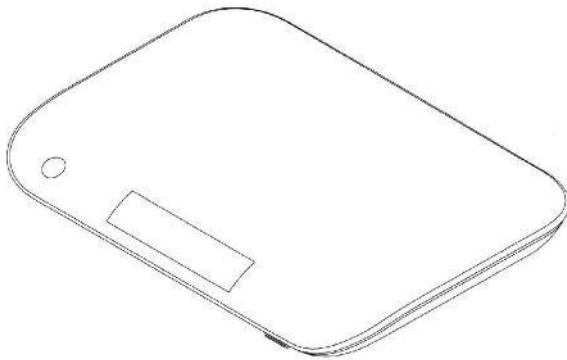

1.1



1.2

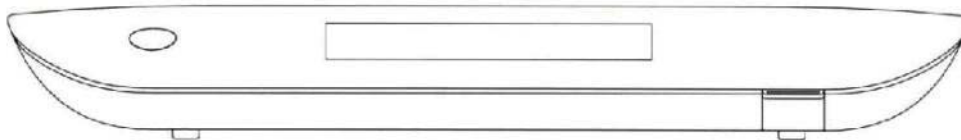

1.3

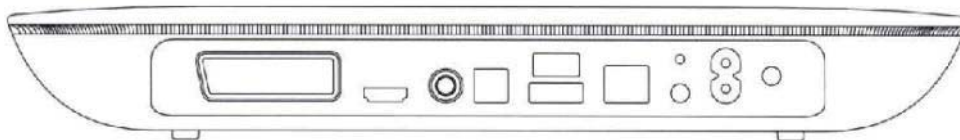

1.4

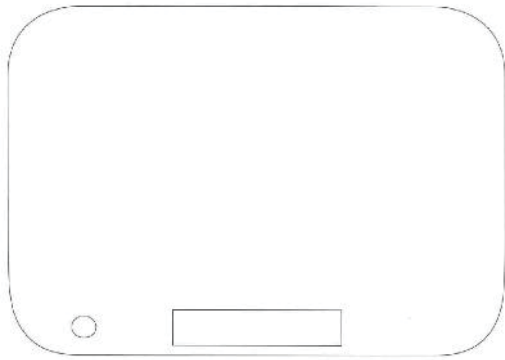

1.5

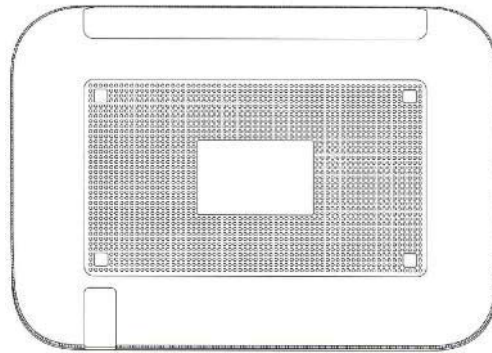

1.6

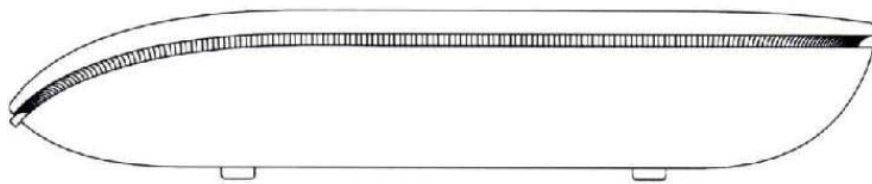

1.7

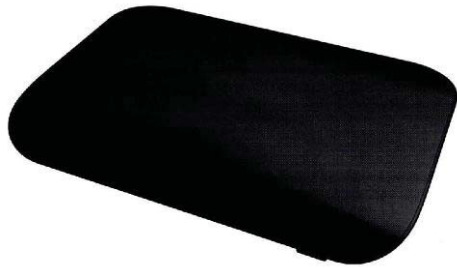

2.1



2.2

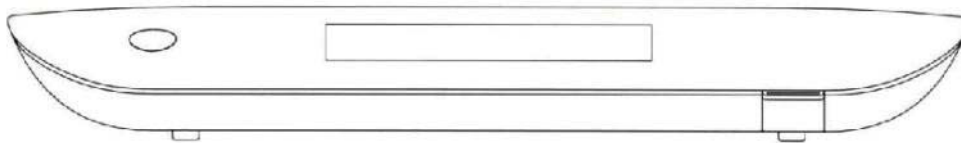

2.3

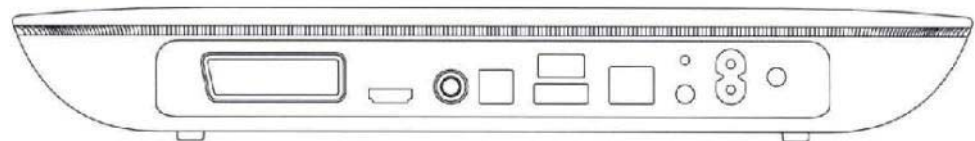

2 . 4

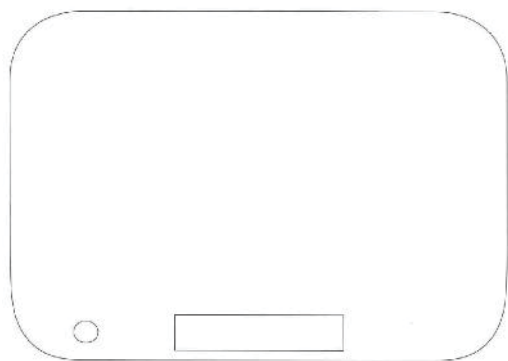

2.5

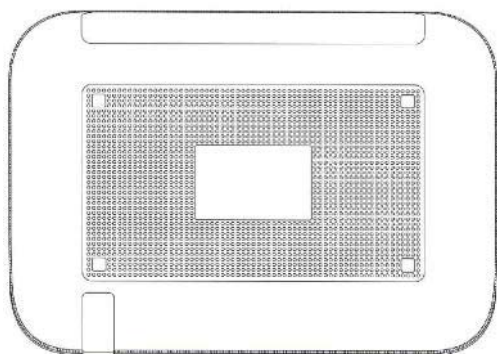

2.6

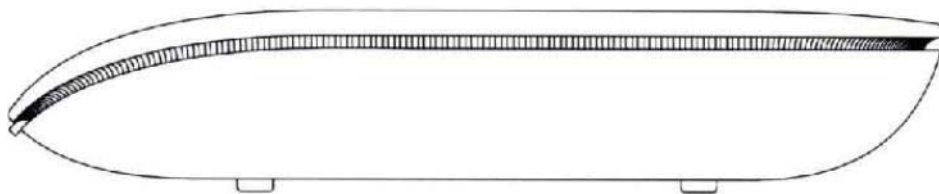

2.7



3.1



3.2

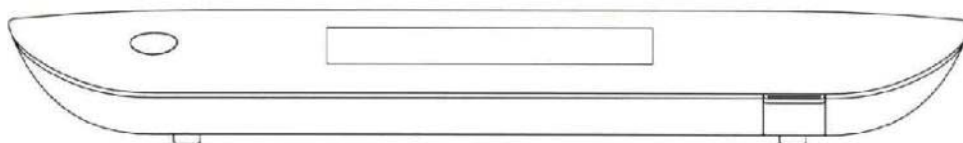

3.3

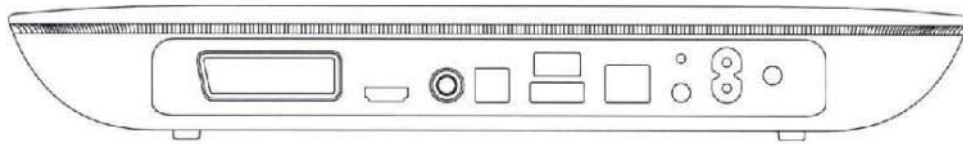

3.4

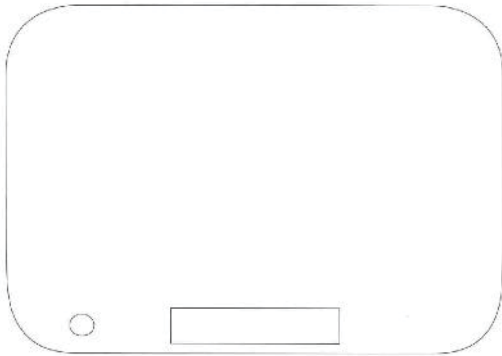

3.5

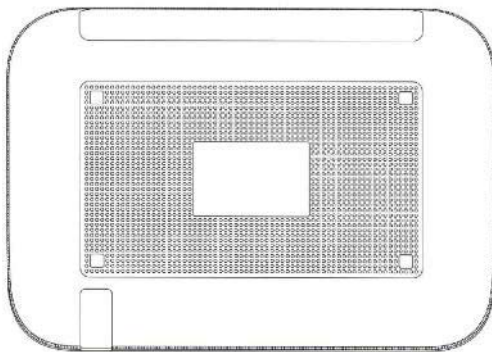

3.6

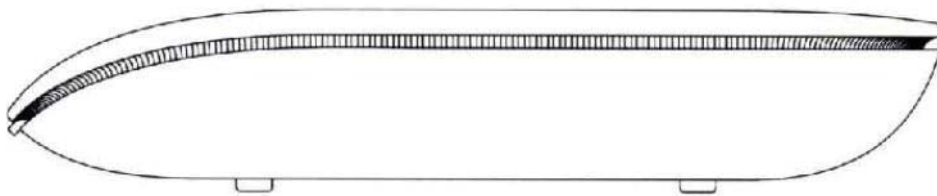

3.7

- (11) **00084** (51) **09-03**  
(21) D-2011/8 (15) 07.06.2013  
(22) 25.05. 2011 (18) 25.05.2016  
(28) 1

(54) **TEGLA ZA KREMU**

- (72) Bojan Ilievski, Bul.Jane Sandanski 46/3-4, Skoplje, Republika Makedonija  
(73) Farmaceutska Hemijska Kozmetička industrija ALKALOID AD- Skoplje, Bul. Aleksandar Makedonski br.12, 1000 Skoplje, MK  
(74) Popović Miladin, Đoka Miraševića 21/III, Podgorica (ME)  
(55)

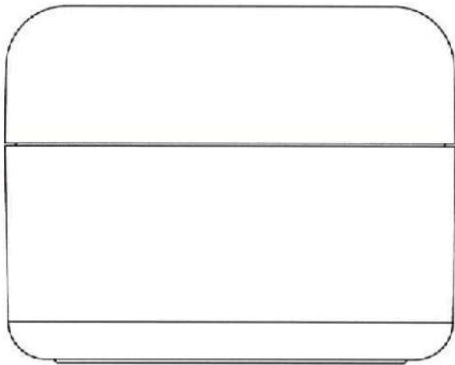

1.1

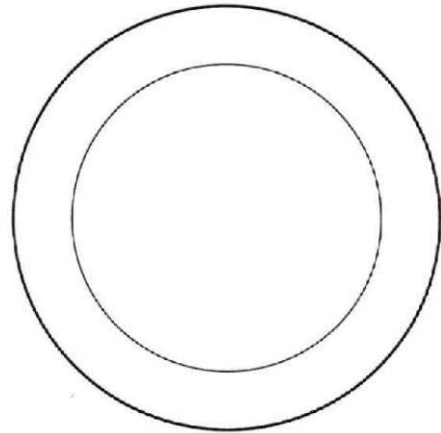

1.2

(11) **00085** (51) **14-03**  
 (21) D-2011/9 (15) 07.06.2013  
 (22) 25.05. 2011 (18) 25.05.2016  
 (28) 1

(30) 001246904 EM

(54) **TELEKOMUNIKACIJSKI UREĐAJ**

(72) Mr Stefan Wössner, Hirschhorner Weg 18, 14163 Berlin, DE

(73) Deutsche Telekom AG Friedrich-Ebert-Allee 140 53113 Bonn, DE

(74) Popović Miladin, Đoka Miraševića 21/III, Podgorica (ME)

(55)

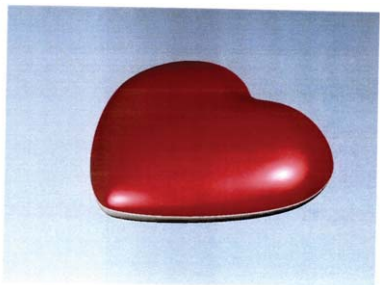

1.1

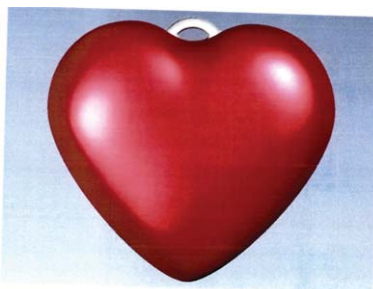

1.2

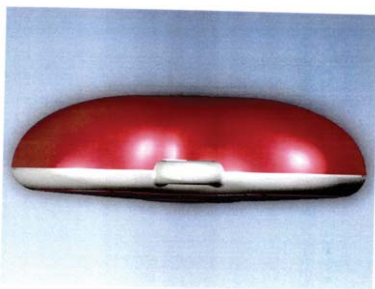

1.3

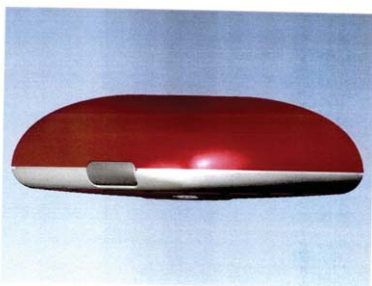

1.4

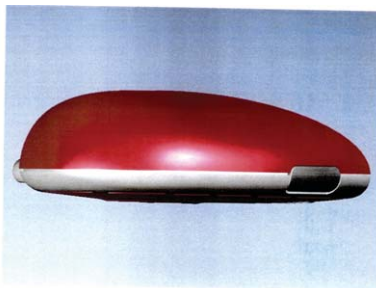

1.5

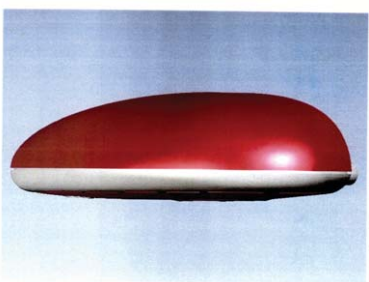

1.6



1.7

- (11) **00086**  
 (21) D-2011/11  
 (22) 07.06.2011.  
 (28) 2  
 (30) 001248439-0001 EM  
 001248439-0003 EM

- (51) **14-03**  
 (15) 07.06.2013.  
 (18) 07.06.2016

(54) **DALJINSKI UPRAVLJAČ**

- (72) 1) Jan Christian Delfs, Lerchenstr. 13, 22767 Hamburg, DE  
 2) Dominic Flik, Frühlingstrasse 1, 85521 Ottobrunn, DE  
 3) Michael Schiffer, Belderberg 20, 53111 Bonn, DE  
 4) Andre Hanisch, Am Lambertushof 33, 53347 Witterschlick, DE  
 (73) Deutsche Telekom AG Friedrich-Ebert-Allee 140 53113 Bonn, DE  
 (74) Popović Miladin, Đoka Miraševića 21/III, Podgorica (ME)  
 (55)

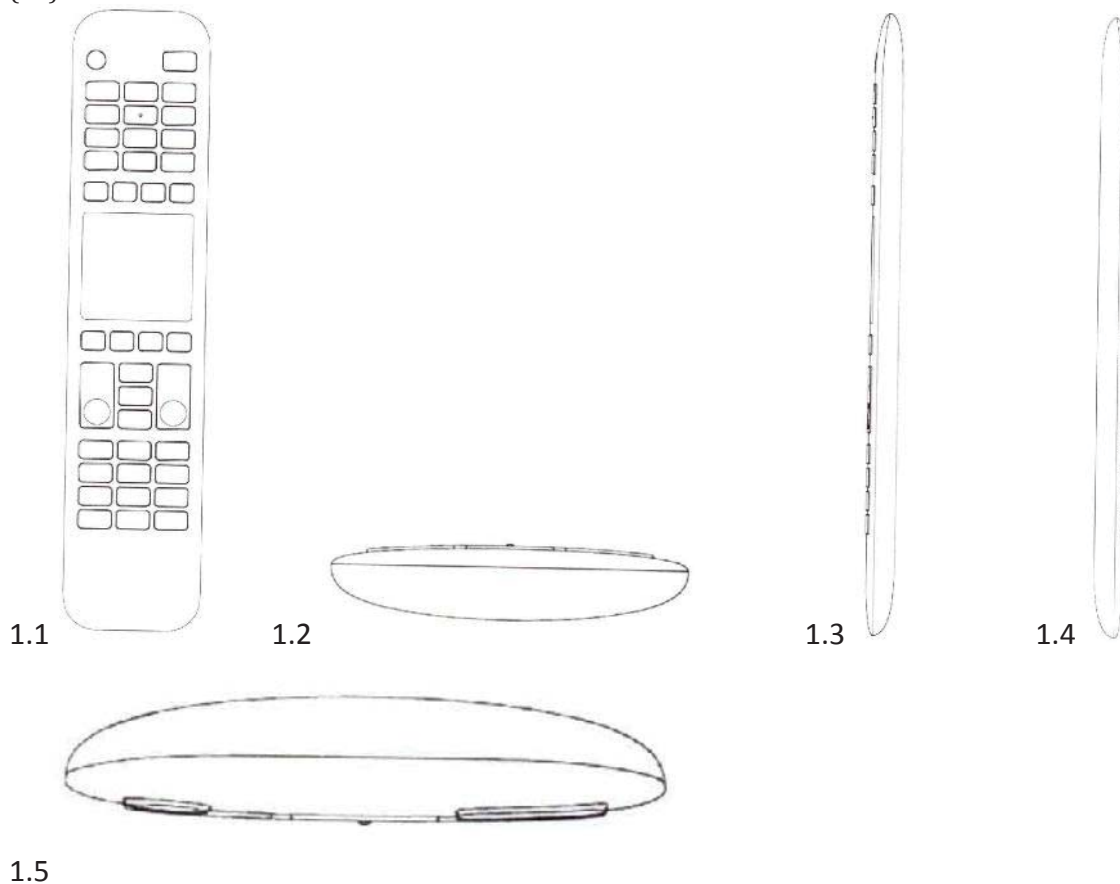



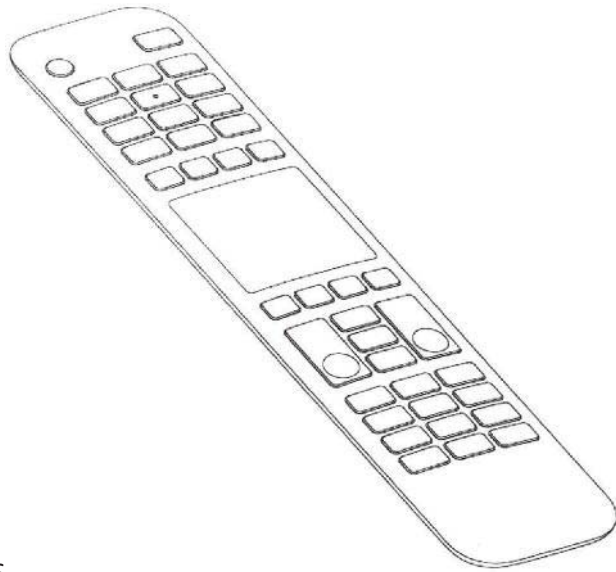

1.6



1.7

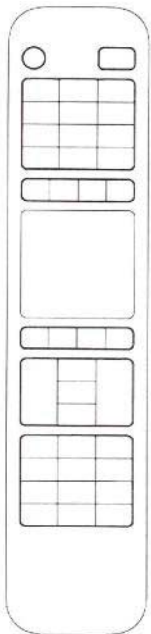

2.1



2.2

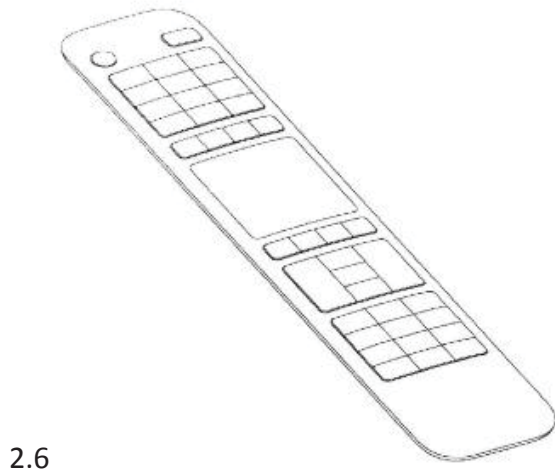

- (11) **00087** (51) **14-04**  
 (21) D-2011/14 (15) 07.06.2013  
 (22) 15.06.2011. (18) 15.06.2016  
 (28) 10  
 (30) 001250039 EM  
 (54) **GRAFIČKO KORISNIČKI INTERFEJS/DISPLEJ**  
 (72) 1) Losang Ngodup, Im Bergfeld 10 in 76744 Wörth am Rhein, DE  
 2) Jeannette Bergen, Am Kaiserkai 28 in 20457 Hamburg, DE  
 3) Oliver Böckle, Neumann-Reichardt-Str. 27-33 in 22041 Hamburg, DE  
 (73) Deutsche Telekom AG Friedrich-Ebert-Allee 140 53113 Bonn DE  
 (74) Popović Miladin, Đoka Miraševića 21/III, Podgorica (ME)  
 (55)

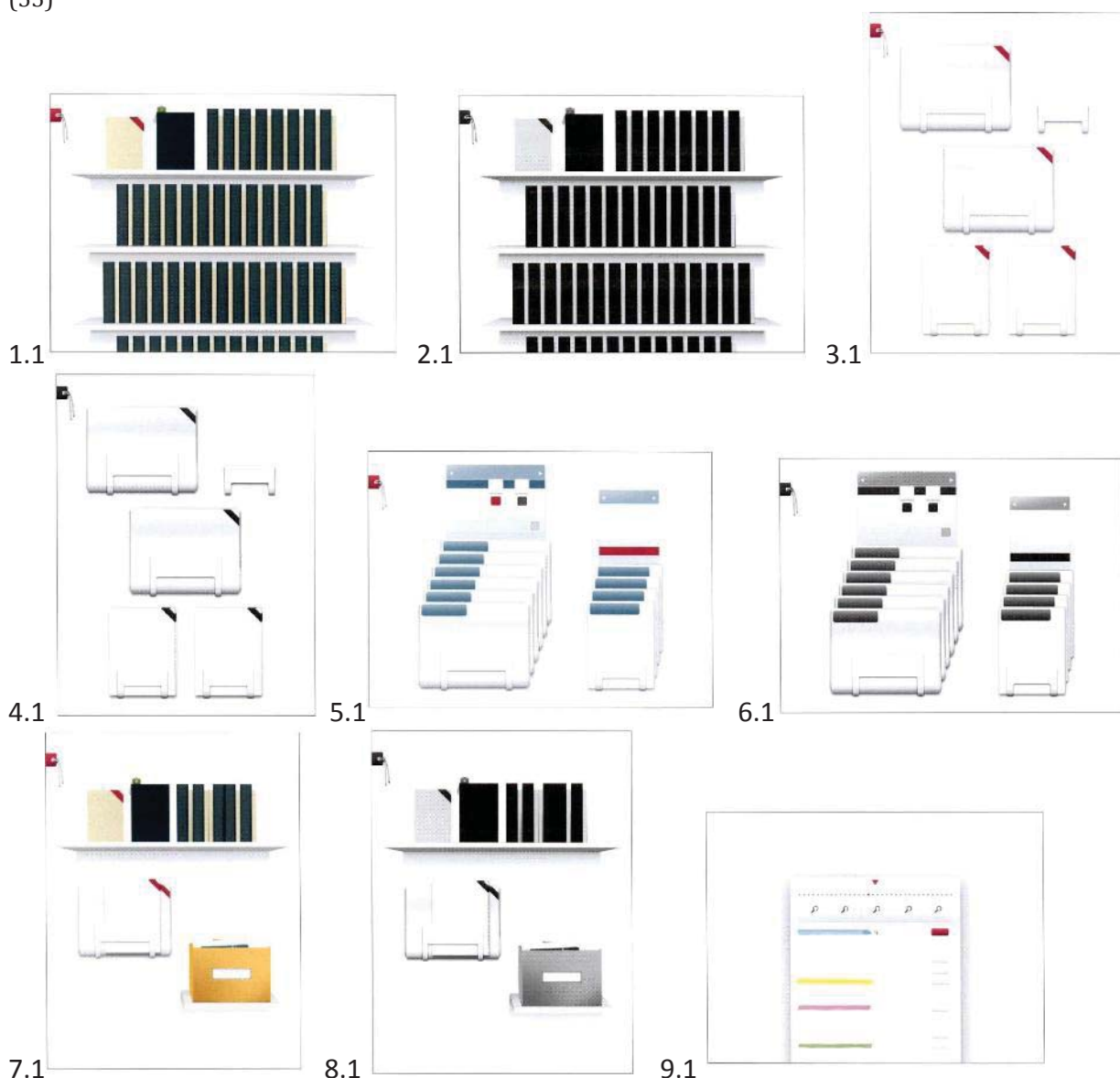



10.1

- (11) **00075** (51) **09-03**  
 (21) D-2011/19 (15) 31.05.2013  
 (22) 12.12. 2011 (18) 12.12.2016.  
 (28) 1  
 (30) 29/399,860 US

(54) **AMBALAŽA ZA PREHRAMBENE PROIZVODE (PAKOVANJE)**

- (72) 1) Nicholas White, c/o Mars Chocolate North America, 800 High Street, 07840 Hacketts-town, NJ, US  
 2) Brent Lindberg, c/o Fuseneo, Dekalb, IL 60115-2328, US  
 (73) Mars, Incorporated 6885 Elm Street, McLean, VA 22101-3883, US  
 (74) Jusić Jasni, Ul Crnogorskih serdara bb, Podgorica ME  
 (55)

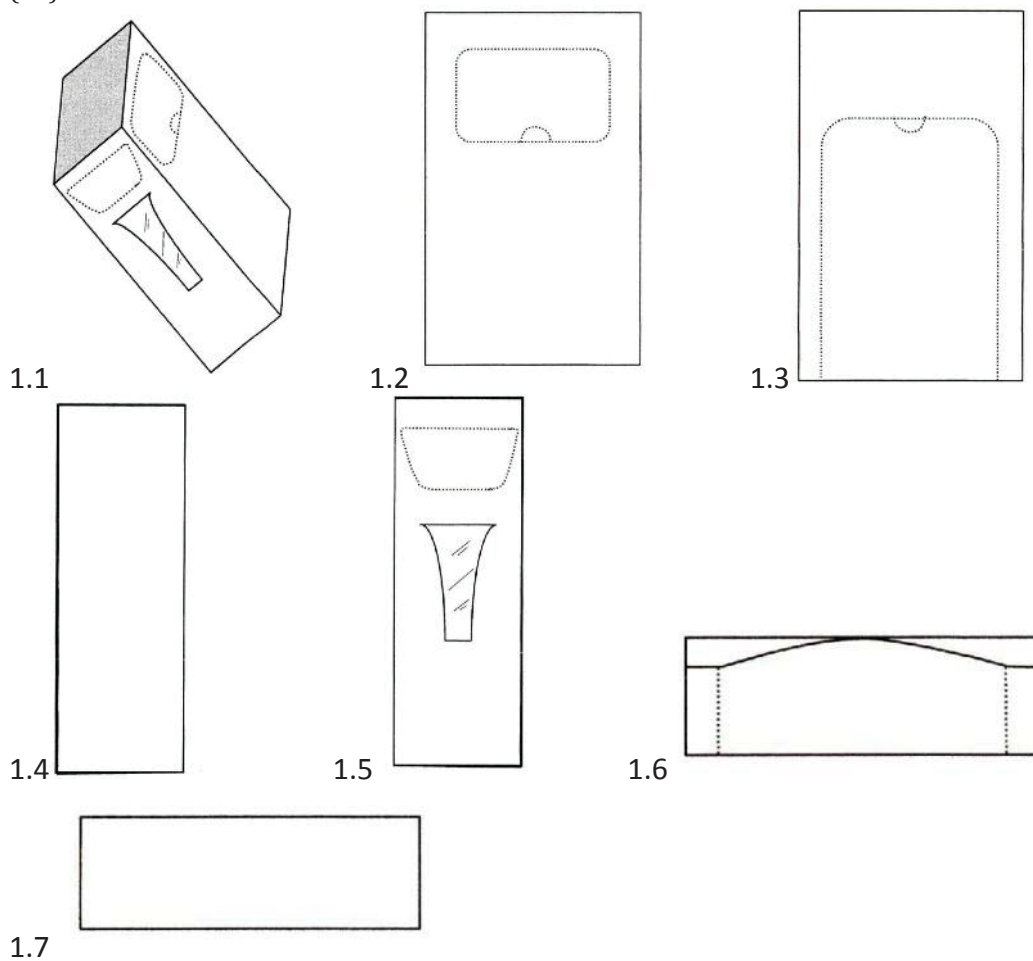

- (11) **00088**  
 (21) D-2011/21  
 (22) 21.12.2011  
 (28) 2  
 (30) 001881160-0001 EM  
 001881160-0002 EM

- (51) **14-02**  
 (15) 07.06.2013  
 (18) 21.12.2016

- (54) **BEŽIČNA OPREMA ZA OBRADU PODATAKA**  
 (72) 1) Thomas Mamer, Düvelsbeker Weg 12, 24105 Kiel, DE  
 2) Anita Patrovicova, Kessenicher Str. 115, 53129 Bonn, DE  
 3) Dominik Flik, Frühlingstrasse 1, 85521 Ottobrunn, DE  
 (73) Deutsche Telekom AG Friedrich-Ebert-Allee 140 53113 Bonn DE  
 (74) Popović Miladin, Đoka Miraševića 21/III, Podgorica (ME)  
 (55)

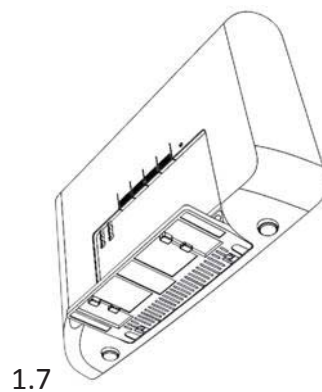
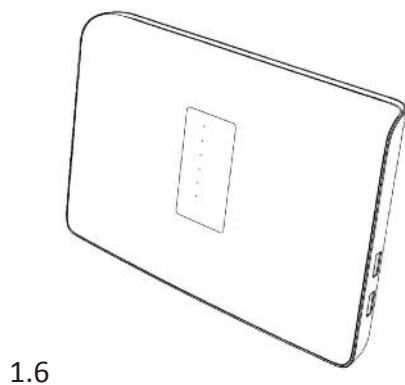
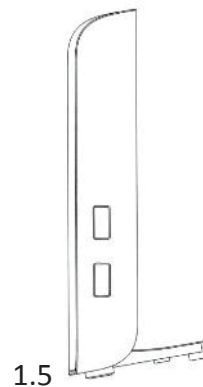
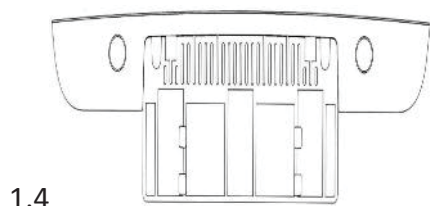
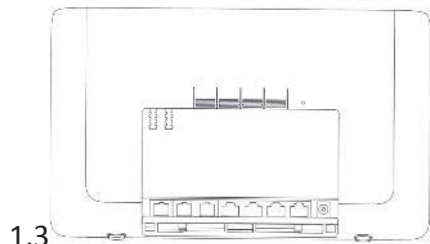
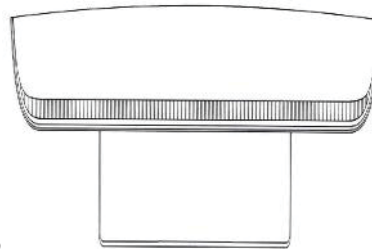
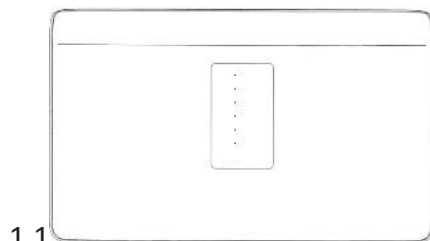



2.1

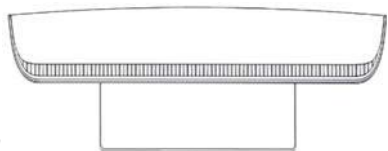

2.2

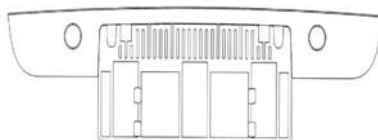

2.3



2.4

(11) **00076**

(21) D-2011/22

(22) 22.12. 2011

(28) 1

(30) 001297261-0001 EM

(54) **AMBALAŽA ZA PREHRAMBENE PROIZVODE (PAKOVANJE)**

(72) Steven Robert Binding, Equals Design Ltd, Barn B, New Barnes Mill, Cottonmill Lane, St Albans, Hertfordshire, AL1 2HA, UK.

(73) Mars, Incorporated 6885 Elm Street, McLean, VA 22101-3883, US

(74) Jusić Jasni, Ul Crnogorskih serdara bb, Podgorica ME

(55)

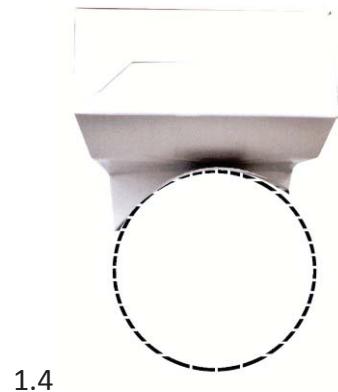
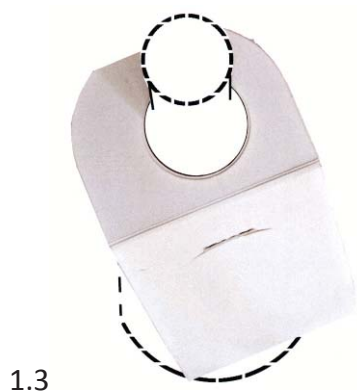



(11) **00089**

(21) D-2011/23

(22) 23.12.2011

(28) 1

(51) **09-03**

(15) 07.06.2013

(18) 23.12.2016

(54) **KUTIJA ZA PAKOVANJE**

(72) Roger Nuetzi Vordere Gasse 68, CH-4628 Wolfwil, CH

(73) Holmen Aktiebolag Strandvägen 1, Box 5407, SE-114 84 Stockholm, SE

(74) Radulović Božidar, Jovana Tomaševića 9/III, Podgorica (ME)

(55)

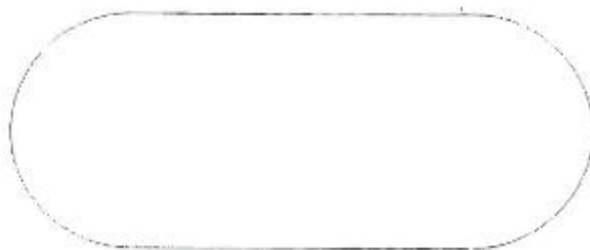
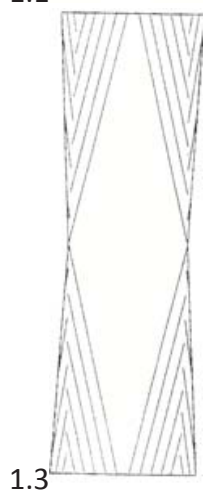
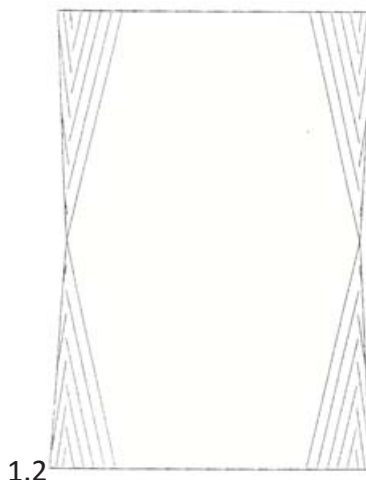
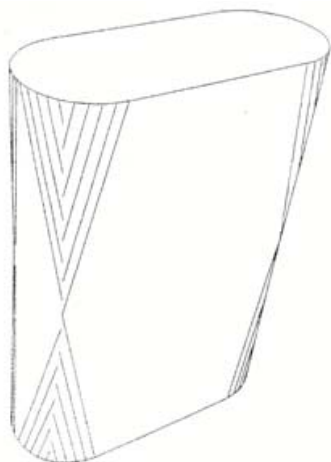

(11) **00090**

(21) D-2012-18

(22) 15.08.2012

(28) 6

(30) 001992256 EP

(54) **TERMINAL OPTIČKE MREŽE DO KUĆE ( MODEM)**

(73) Deutsche Telekom AG Friedrich-Ebert-Allee 140 53113 Bonn DE

(74) Popović Miladin, Đoka Miraševića 21/III, Podgorica (ME)

(55)

(51) **14-03**

(15) 07.06.2013

(18) 15.08.2017

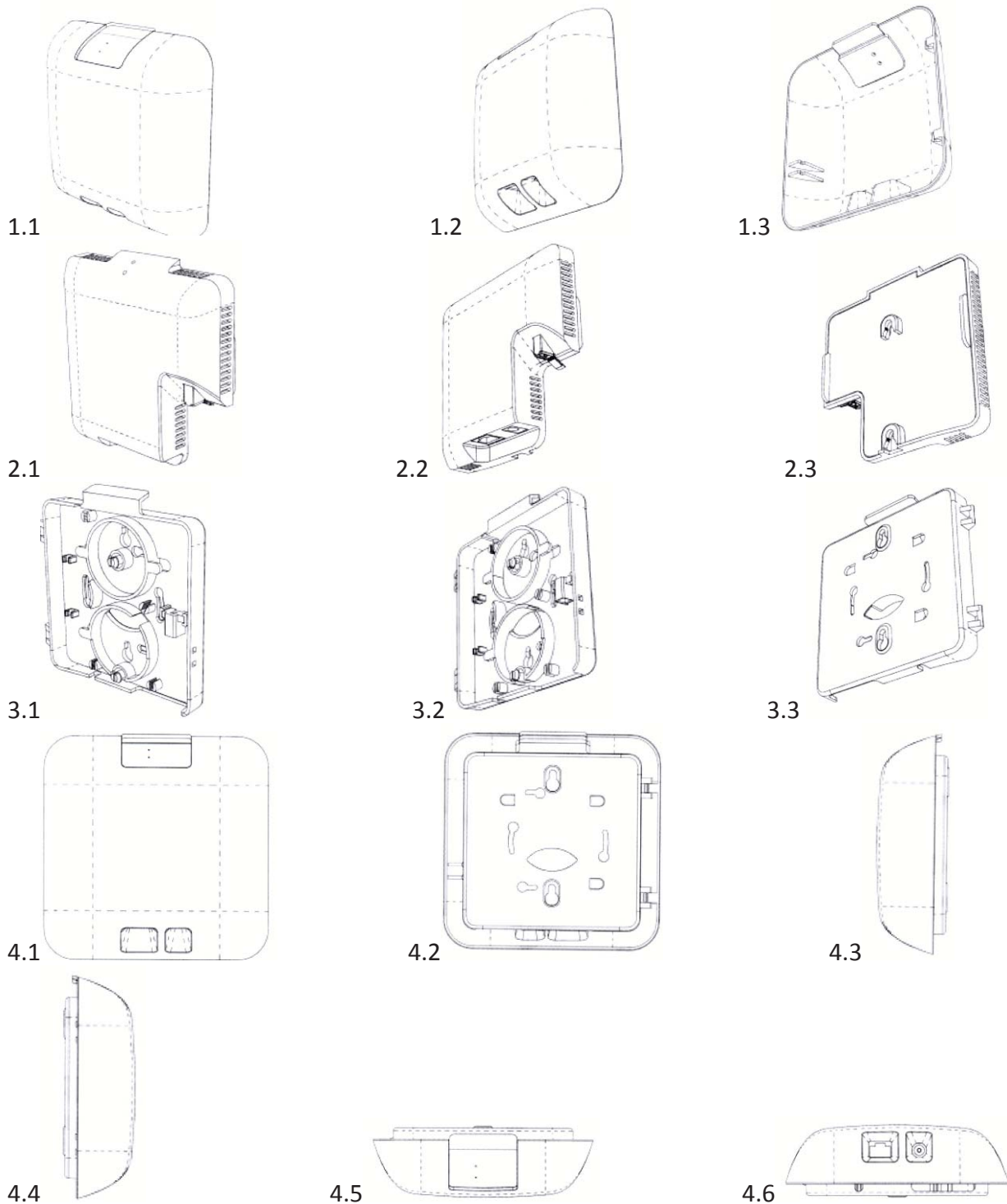

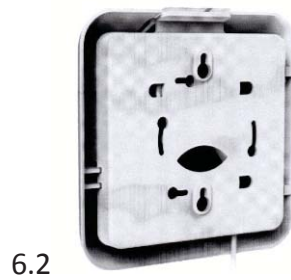
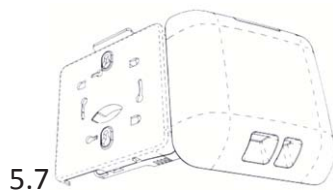
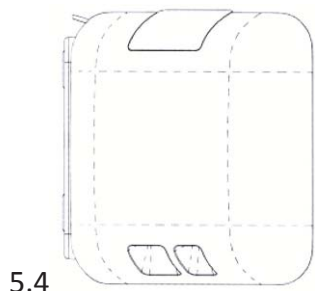
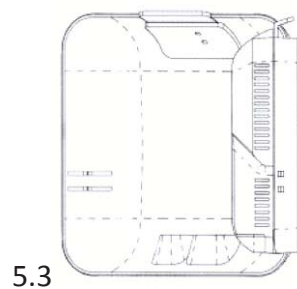
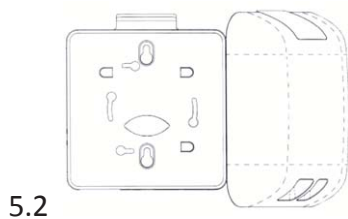
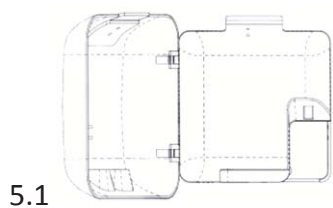



**INDEKS NOSILACA DIZAJNA**  
**INDEX OF INDUSTRIAL DESIGNS OWNERS**

(73)	(51)	(21)	(22)	(11)
ALKALOID AD	09-03	D-2011/8	25.05. 2011	00084
CASTROL LIMITED	09-02	D-2010/4	26.03. 2010.	00067
Deutsche Telekom	13-02	D-2011/1	09.02. 2011	00081
Deutsche Telekom	14-02	D-2010/18	20.07.2010	00079
Deutsche Telekom	14-02	D-2011/21	21.12.2011	00088
Deutsche Telekom	14-03	D-2010/6	29.03. 2010.	00077
Deutsche Telekom	14-03	D-2010/7	01.04. 2010.	00078
Deutsche Telekom	14-03	D-2010/19	20.07. 2010.	00080
Deutsche Telekom	14-03	D-2011/7	28.04.2011	00083
Deutsche Telekom	14-03	D-2011/9	25.05. 2011	00085
Deutsche Telekom	14-03	D-2011/11	07.06.2011.	00086
Deutsche Telekom	14-03	D-2012-18	15.08.2012	00090
Deutsche Telekom	14-04	D-2011/14	15.06.2011.	00087
DUKAT	09-01	D-2010/5	29.03.2010	00071
Holmen Aktiebolag	09-03	D-2011/23	23.12.2011	00089
HONDA MOTOR CO.	13-01	D-2010/22	24.08. 2010	00069
HONDA MOTOR CO.	15-01	D-2010/8	29.04. 2010	00068
HUNCA KOZMETİK SANAYİ ANONİM ŞİRKETİ	09-03	D-2011/6	08.04. 2011	00082
LBP MANUFACTURING INC.	09-05	D-2010/24	24.09. 2010	00073
LBP MANUFACTURING INC.	09-05	D-2010/25	24.09. 2010	00074
Mars	09-03	D-2010/02	19.02. 2010.	00070
Mars	09-03	D-2010/10	12.05. 2010	00072
Mars	09-03	D-2011/19	12.12. 2011	00075
Mars	09-03	D-2011/22	22.12. 2011	00076



**INDEX BROJEVA DIZAJNA**  
**INDEX OF INDUSTRIAL DESIGNS NUMBERS**

(11)	(21)
00067	D-2010/4
00068	D-2010/8
00069	D-2010/22
00070	D-2010/02
00071	D-2010/5
00072	D-2010/10
00073	D-2010/24
00074	D-2010/25
00075	D-2011/19
00076	D-2011/22
00077	D-2010/6
00078	D-2010/7
00079	D-2010/18
00080	D-2010/19
00081	D-2011/1
00082	D-2011/6
00083	D-2011/7
00084	D-2011/8
00085	D-2011/9
00086	D-2011/11
00087	D-2011/14
00088	D-2011/21
00089	D-2011/23
00090	D-2012-18





INDEKS PO KLASAMA I PODKLASAMA LOKARNSKE KLASIFIKACIJE  
INDEX ACCORDING TO CLASSES SUBCLASSEN THE LOCARNO  
CLASSIFICATION

(21)	(11)
D-2010/4	00067
D-2010/5	00071
D-2010/6	00077
D-2010/7	00078
D-2010/8	00068
D-2010/02	00070
D-2010/10	00072
D-2010/18	00079
D-2010/19	00080
D-2010/22	00069
D-2010/24	00073
D-2010/25	00074
D-2011/1	00081
D-2011/6	00082
D-2011/7	00083
D-2011/8	00084
D-2011/9	00085
D-2011/11	00086
D-2011/14	00087
D-2011/19	00075
D-2011/21	00088
D-2011/22	00076
D-2011/23	00089
D-2012-18	00090



**OBJAVE OBNOVE VAŽENJA INDUSTRIJSKOG DIZAJNA**  
**PUBLICATION OF INDUSTRIAL DESIGN RENEWAL**

Registarski broj dizajna CG (11)	Ime i adresa nosioca industrijskog dizajna (73)	Datum do kojeg važi obnova industrijskog dizajna (18)	Registarski broj dizajna SCG (11)
00029 PP	SONY COMPUTER ENTERTAINMENT INC. 2-6-21, Minami-Aoyama, Minato-ku, Tokyo, 107-0062, JP	<b>14.03.2014.</b>	10323
00030 PP	SONY COMPUTER ENTERTAINMENT INC. 2-6-21, Minami-Aoyama, Minato-ku, Tokyo, 107-0062, JP	<b>14.03.2014.</b>	10322
00031 PP	SONY COMPUTER ENTERTAINMENT INC. 2-6-21, Minami-Aoyama, Minato-ku, Tokyo, 107-0062, JP	<b>14.03.2014.</b>	10321





# INFORMATOR

## INFORMATION

Službeni glasnik Zavoda za intelektualnu svojinu Crne Gore  
Official Gazette of the Montenegrin Intellectual Property Office

# 12/2013



Zavod za intelektualnu svojinu Crne Gore  
ul. Rimski trg br. 46,  
81000 Podgorica,  
Crna Gora



**MEĐUNARODNA SARADNJA  
Zavoda za intelektualnu svojinu Crne Gore  
u periodu januar – jun 2013.god.**



*Snežana Džuverović,  
samostalni savjetnik I  
za međunarodnu saradnju*

Zavod za intelektualnu svojinu Crne Gore nastavlja redovnu i intenzivnu saradnju sa Svjetskom organizacijom za intelektualnu svojinu (WIPO), sa sjedištem u Ženevi, kao i sa Evropskim patentnim zavodom (EPO), sa sjedištem u Minhenu. Zavod takođe ostvaruje i bilateralnu saradnju. Predstavnici Zavoda učestvuju na međunarodnim događajima iz oblasti zaštite prava intelektualne svojine.

### **I Saradnja sa Svjetskom organizacijom za intelektualnu svojinu**

Saradnja sa Svjetskom organizacijom za intelektualnu svojinu (WIPO) odvija se na osnovu Plana saradnje između WIPO-a i Crne Gore, gdje je Zavod za intelektualnu svojinu Crne Gore glavna kontakt tačka. Saradnja se ostvaruje kroz konkretne dogovore sa gospodinom Michalom Svantnerom, direktorom Sektora za određene zemlje Evrope i Azije (DCEA), kao i sa gospođom Biserkom Strel, šeficom Odsjeka za centralno evropske i baltičke zemlje (CEBS) i dr. U okviru Plana saradnje između WIPO-a i Crne Gore za 2013. godinu, realizovane su sljedeće aktivnosti:

a) Direktor Zavoda za intelektualnu svojinu Crne Gore, gospodin Novak Adžić, sa saradnicima: gospođom Dušankom Perović, pomoćnicom direktora; i gospođom Snežanom Džuverović, samostalnim savjetnikom I za međunarodnu saradnju, posjetio je Zavod za patente i žigove Sjedinjenih Američkih Država (USPTO), u Aleksandriji, Virginija, SAD, 14. i 15. januara 2013. godine.

Ovu posjetu organizovala je Svjetska organizacija za intelektualnu svojinu (WIPO), i to Sektor za inovacije i tehnologije, na čelu sa gospodinom James Pooley-em, pomoćnikom generalnog direktora WIPO-a za oblast patenata.

Ključni segment posjete bio je sastanak direktora Zavoda za patente i žigove SAD, gospodina David Kappos-a, koji je ujedno i pomoćnik Ministra trgovine u Vladi SAD, čija je obaveza da informiše i savjetuje Predsjednika SAD o pitanjima intelektualne svojine, i direktora Zavoda za intelektualnu svojinu Crne Gore, gospodina Novaka Adžića. Gospodin Kappos izrazio je zadovoljstvo zbog prve posjete direktora crnogorskog Zavoda i pozdravio goste, izrazivši uvjerenost da su ovlašteni predstavnici USPTO-a pripremili dobre prezentacije i da će u potpunosti i na pravi način predstaviti rad američkog Zavoda. Gospodin Kappos izdvojio je osnovne podatke o USPTO, ističući da u Zavodu ima 11.000 zaposlenih, od kojih 7.000 ispitivača patenata, koji svojim izuzetnim znanjima i kvalifikacijama obezbjeđuju efikasno obavljanje funkcija Zavoda i ostvaruju profit od 2,9 milijardi US dolara godišnje. Gospodin Kappos takođe je naglasio da USPTO pruža podršku Zavodima u čitavom svijetu i u tom kontekstu izrazio zainteresovanost za oblasti u kojima bi mogli sličnu podršku pružiti crnogorskom Zavodu. Gospodin Novak Adžić, direktor crnogorskog Zavoda, zahvalio se na srdačnoj dobrodošlici i izvanredno pripremljenoj posjeti i iskoristio priliku da izrazi zahvalnost zbog značajne podrške koju je Vlada SAD pružila Crnoj Gori tokom pregovora za pristupanje Svjetskoj trgovinskoj organizaciji (WTO). Nakon što je direktora Kappos-a ukratko upoznao

sa radom crnogorskog Zavoda i dao uvid u status zaštite prava intelektualne svojine u Crnoj Gori, direktor Adžić je istakao da crnogorski Zavod posebnu pažnju poklanja međunarodnoj saradnji i da ovu studijsku posjetu uglednom američkom Zavodu, lideru u globalnoj politici zaštite prava intelektualne svojine, vidi kao događaj od krucijalnog značaja. Gospodin Adžić je informisao da je Zavodu Crne Gore u ovom momentu potrebna pomoć u daljem unaprijeđenju informacione infra-strukture u oblasti žigova, kao i podrška u oblasti sprovođenja prava IS. Gospodin Kappos obećao je pomoć u poboljšanju IT infrastrukture za žigove u Zavodu Crne Gore i obuku za sudije crnogorskih sudova koji rade na predmetima intelektualne svojine.

Tokom dvodnevne posjete, predstavnici dva Zavoda prezentirali su podatke o funkciji, radu Zavoda, iskustvu, praksi i aktuelnim potrebama.

Gospođa Rachel Wallace, direktorka Globalne akademije intelektualne svojine, iznijela je osnovne podatke o radu Akademije, i to: Akademija je osnovana 2006. godine kao izraz potrebe za obezbjeđivanjem sveobuhvatnih obuka i treninga namijenjenim učesnicima u sistemu zaštite prava intelektualne svojine u oblasti patenata, žigova, sprovođenja prava intelektualne svojine. U toku svog rada, Akademija je sprovela 140 različitih programa obuke za 9.000 polaznika iz 130 država iz čitavog svijeta. Obuke koje Akademija obezbjeđuje su tipa face-to-face (licem u lice – direktno za polaznike) i tipa učenja na daljinu (tkzv. Distance learning programmes) koji su dostupni besplatno svim ljudima koji nemaju mogućnost direktnog pohađanja predavanja. Trenutno, preko web site-a Akademije, dostupno je 7 besplatnih programa obuke na 5 različitih jezika. Predavači su eksperti koji posjeduju znanja visokog nivoa iz oblasti patenata, žigova, sprovođenja prava IS, autorskog prava, geografskih oznaka, trgovine.

Nakon toga, za Delegaciju Zavoda Crne Gore prikazana je DVD prezentacija o USPTO-u tokom koje su, u video formatu, na izuzetno interesantna način, date najznačajnije informacije o istorijatu, misiji i viziji USPTO-a: prvi Patentni zavod osnovan je 23.01.1862. godine, od strane država Konfederacije, sa sjedištem u Ričmondu, Virdžinija, i poznato je da je izdao 266 patenata; s obzirom na značaj ove institucije u okviru Vlade SAD, Zavod je mijenjao lokacije, nalazivši se tako tokom svog postojanja u mnogim poznatim zgradama (zgradi Smnithsonian muzeja, i dr.), dok mu je danas sjedište u Aleksandriji, Virginija, u bloku od pet zgrada; misija USPTO-a je podsticanje inovativnosti, konkurentnosti i ekonomskog rasta, na domaćem i međunarodnom nivou, putem obezbjeđenja visokokvalitetnog i blagovremenog ispitivanja prijave patenata i žigova, vođenje domaće i međunarodne politike intelektualne svojine i pružanje informacija o IS i edukacije u čitavom svijetu, sa svojom visoko kvalifikovanom, raznovrsnom radnom snagom; a vizija da ostvaruje vodeću ulogu u svijetu u globalnoj politici u oblasti zaštite prava intelektualne svojine.

Predstavnici USPTO-a, gospođa Binta Robinson, gospođa Lynn Bristol i gospođa Soma Saha, koje su stručnjaci za oblast patenata, konkretno licencirani pravni zastupnici za patente, prezentirale su legislativni okvir za zaštitu patenata, istakavši sljedeće informacije kao najznačajnije: USPTO je federalna agencija za priznavanje US patenata i registrovanje žigova. Obavljanjem poslova iz svoje nadležnosti, USPTO ispunjava mandat iz člana I, Poglavlje 8, klauzula 8 iz Ustava SAD, po kome je kao izvršni organ „dužan da promoviše progres u nauci i korisnim tehnologijama putem obezbjeđenja ekskluzivnog prava pronalazačima na određeni vremenski period za njihove pronalazke“; Zakon o patentima (Leahy-Smith America Invents Act), potpisao je predsjednik Barack Obama, 16. septembra 2011. godine; ovim zakonom utvrđene su najveće promjene u sistemu patenata u periodu od skoro 200 godina; usaglašen je sa globalnim standardima IS; omogućava USPTO da ima održiviji sistem finansiranja, obezbjeđuje unaprijeđene postupke; podržava napore USPTO za poboljšanje kvaliteta patenata, smanjenje zaostatka u prijavama patenata (tkzv. backlog), smanjuje domaće i globalne troškove vezane za patente za SAD kompanije; USPTO godišnje primi oko 500.000 prijave patenata.

Predstavnik USPTO-a, gospodin George Elliott, v.d. upravnika Sektora za politiku i vanjske poslove, predstavio je međunarodnu saradnju USPTO-a, istakavši da, u skladu sa TRIPS-om, Član



67 – Međunarodna saradnja, USPTO kao zavod „razvijene zemlje, na zahtjev, pruža tehničku pomoć u cilju razvoja zemalja u razvoju i nerazvijenih zemalja“. Pored toga, rekao je da USPTO ima Strateški plan za period 2010-2015 čiji je cilj da obezbijedi smjernice, na domaćem i globalnom nivou, za unaprijeđenje politike i poboljšanje zaštite prava IS, kao i segmenta enforcementa. USPTO ima saradnju sa mnogobrojnim zavodima iz čitavog svijeta kroz raznovrsne projekte, i to: Trilateralani projekat (sa EPO-om i Zavodom Japana - JPO); Projekat IP5 (sa EPO-om, JPO, KIPO, SIPO); Projekat PPH (postupak u slučaju ulaganja tužbe za patente).

Prezentaciju o žigovima, pod nazivom „Pregled operacija i postupaka u oblasti žigova“, pripremio je i izložio gospodin Scott Baldwin, licencirani pravni zastupnik za žigove. U ovoj izuzetno iscrpnoj i interesantnoj prezentaciji, gospodin Baldwin istakao je sljedeće detalje: USPTO registruje žigove na osnovu Klauzule o trgovini iz Ustava SAD (član I, Poglavlje 8, klauzula 3); u USPTO-u zaposleno je 378 ispitivača žigova, što predstavlja znatno manji broj u odnosu na broj ispitivača patenata; ovo je rezultat projekta koji je USPTO razvio i kojim se omogućava zaposlenima da rade kod kuće, čime postižu znatne uštede za sebe i američki Zavod, a pri tom su im otvorene mogućnosti jednake onima koji rade u prostorijama Zavoda, kao i prilike da za povećan obim poslova dobiju bonuse i do 5.000 US dolara godišnje.

Gospodin Ben Hardman, pravni zastupnik, u prezentaciji pod nazivom „Osnovne karakteristike američkog Zakona o autorskom pravu“ iznio je niz značajnih podataka o odredbama Bernske konvencije, kojoj su SAD pristupile 1989. god., i TRIPS-u, a zatim istakao da se u SAD ne štite naslovi, imena, kratke fraze i slogani; poznati simboli ili dizajni; radovi koji se sastoje u potpunosti od informacije koja predstavlja zajedničku svojinu i nema originalno autorstvo, i dr. S obzirom da se ova prezentacija pokazala izuzetno interesantnom za goste iz Crne Gore, uslijedio je razgovor u toku koga je direktor Adžić upoznao g. Hardman-a da je Crna Gora pristupila Bernskoj konvenciji davne 1893. godine.

Uslijedile su prezentacije članova Delegacije Zavoda za intelektualnu svojinu Crne Gore. Gospođa Dušanka Perović, pomoćnica direktora, u prezentaciji pod nazivom „Pregled prava intelektualne svojine u Crnoj Gori“ dala je iscrpne podatke o sporazumima i konvencijama koje je Crna Gora potvrdila, crnogorskoj legislativi za oblast intelektualne svojine, kao i informacije o organizacionoj strukturi i radu Zavoda Crne Gore. Gospođa Snežana Džuverović, u prezentaciji „Međunarodna saradnja Zavoda za intelektualnu svojinu Crne Gore“, iznijela je podatke o međunarodnoj saradnji koju Zavod obavlja intenzivno, kroz tri osnovna kolosjeka, i to: sa WIPO-om, EPO-om i bilateralna saradnja sa zavodima iz država regiona i Mađarskim zavodom za intelektualnu svojinu.

Tokom čitave posjete, očigledna je bila uzajamna zainteresovanost za rad i aktivnosti dva Zavoda, tako da je bilo puno pitanja i odgovora sa obje strane. Posjeta je ocijenjena kao odlična i korisna, u smislu detaljne informisanosti o svim elementima rada dva Zavoda, kao i razmjene iskustava i prakse. Posjeta ima poseban značaj za Zavod Crne Gore jer će pomoć koja će uslijediti biti od velike koristi za Zavod i druge učesnike u sistemu zaštite prava intelektualne svojine u Crnoj Gori (konkretno za sudije koje rade na predmetima intelektualne svojine).

b) Jedan predstavnik Zavoda za intelektualnu svojinu Crne Gore, gospođa Dušanka Perović, pomoćnica direktora, učestvovala je na Dvanaestom zasjedanju Stalnog komiteta za patentno pravo, koje je održano u sjedištu WIPO-a, u Ženevi, 25 – 28. februara 2013. godine.

Sastanak je otvorio generalni direktor WIPO-a, gospodin Francis Gurry, koji je poželio dobrodošlicu svim učesnicima i održao kratak uvodni govor. Gospodin Gurry naročito je istakao da je Stalni komitet za patentno pravo normativni komitet i da je potrebno da svi zajedno uložimo napore kako bi se harmonizovalo patentno zakonodavstvo država članica WIPO-a. Sjednicom je predsjedavao gospodin Vittorio Ragonesi iz Italije, a potpredsjednice su bile Sara Norkor Anku iz Gane i Simon Sej iz Singapura.

Glavne tačke dnevnog reda su bile: izuzeća od patentibilnosti i ograničenja prava; kvalitet patenata, uključujući sistem opozicije; patenti i zdravlje; povjerljivost komunikacije klijent-patentni zastupnik; transfer tehnologije; doprinos za sprovođenje preporuka usvojenih na zasjedanju SCP; budući rad Stalnog komiteta za patentno pravo.

Na predlog država članica WIPO-a i prisutnih delegacija, Sekretarijati WIPO-a, WHO-a i WTO-a su 26. februara, u okviru zasjedanja Komiteta, održali prezentaciju pod nazivom: "Promovisanje pristupa medicinskim tehnologijama i inovacijama: Preplitanje javnog zdravlja, intelektualne svojine i trgovine". U ovoj prezentaciji, sve tri međunarodne organizacije su predstavile svoj rad po navedenoj temi i međusobnu saradnju. Prisutnim delegacijama dostavljena je studija u kojoj je detaljno opisana saradnja tri međunarodne organizacije. Prisutne delegacije su pozvane da iznesu usmene komentare i postavbe pitanja, kao i da podnesu pisane primjedbe na izrađenu studiju.

Delegacija Južne Afrike je ispred Afričke grupe i grupe Zemalja u razvoju izložila Predlog prisutnim delegacijama. Predlog delegacije Južne Afrike odnosio se na to da patentni sistem treba da bude u skladu sa osnovnim prioritetima državne politike, a posebno za promovisanje i zaštitu javnog zdravlja. Predlog delegacije Južne Afrike bio je predmet usaglašavanja svih grupa i završen je bez postignutog dogovora.

c) Jedan predstavnik Zavoda za intelektualnu svojinu Crne Gore, gospođa Dušanka Perović, pomoćnica direktora, učestvovala je na Seminaru o Ugovoru o saradnji u oblasti patenata (PCT), u Zagrebu, 12. marta 2013. god., koji je WIPO organizovao u saradnji sa Državnim zavodom za intelektualno vlasništvo Hrvatske (DZIV).

Učesnici Seminara, pored predstavnika DZIV-a, bili su predstavnici zavoda iz Crne Gore, Slovenije, Bosne i Hercegovine, Srbije, Makedonije, Albanije i Bugarske. Osim njih, Seminaru su prisustvovali predstavnici univerziteta, naučnih ustanova i zastupnici iz Hrvatske.

Predavači iz WIPO-a, g-đa Silvija Trpkovska (Odsjek za saradnju sa zavodima. Sektor za međunarodnu saradnju prema PCT-u), kao i g. Peter Waring (rukovodilac Odsjeka za tehničku saradnju prema PCT-u), predstavili su najnovija kretanja u sastavu PCT-a, izmjene i dopune Pravilnika prema PCT-u, sastav pretraživanja PATENTSCOPE, kao i mogućnosti izbora informatičkih alata i informatičkih usluga u PCT koje stoje na raspolaganju zavodima zemalja članica, kao i svim ostalim korisnicima PCT sistema. Jednodnevni seminar koji je održan u Zagrebu bila je prilika za ažuriranje znanja u području međunarodne zaštite patenata putem PCT sastava, sticanje informacija o novim mogućnostima u području informatičkih usluga koje taj sistem pruža, ali i za razmjenu iskustava u rješavanju pojedinih problema i pitanja iz ove oblasti.

d) Jedan predstavnik ZIS-a, Gordana Tripković, samostalni savjetnik I, učestvovala je na Međusesijskom sastanku WIPO Komiteta za zaštitu radiodifuznih organizacija, koji je održan u WIPO-u, u Ženevi, 10-12. aprila 2013. godine, na kojem je diskutovano o radnom dokumentu koji služi kao priprema za izradu sporazuma o zaštiti radiodifuznih organizacija.

## II Saradnja sa Evropskim patentnim zavodom

Saradnja Zavoda za intelektualnu svojinu Crne Gore (ZIS) sa Evropskim patentnim zavodom (EPO) odvija se u okviru realizacije **Plana bilateralne saradnje**, koji je stupio na snagu 24. septembra 2012. godine, a koji je potpisan od strane g. Novaka Adžića, direktora ZIS-a CG, i g. Francois-Regis Hannart-a, direktora Sektora za evropsku i međunarodnu saradnju, EPO Direktorat 5.1.. Plan bilateralne saradnje pokriva period 2012 – 2013. godine, sa mogućnošću produženja. Glavni koordinatori projekta su: g. David Jelerčić, EPO; i g-đa Snežana Džuverović, ZIS CG, samostalni savjetnik I za međunarodnu saradnju.

Na osnovu Plana bilateralne saradnje, EPO pruža pomoć Zavodu kroz:

- organizovanje osnovne i specijalističke obuke za osoblje ZIS-a;
- izradu odgovarajuće dokumentacije koja se odnosi na informacije o patentima;

- izradu oficijelnih publikacija Zavoda iz oblasti patenata;
- modernizaciju informacionog sistema za patente;
- instaliranje sistema obrade podataka za patentnu proceduru.

U periodu januar – jun 2013. godine, sprovedene su sljedeće aktivnosti:

a) Jedan predstavnik ZIS-a, Milica Petrović Njegoš, samostalni savjetnik I, boravila je u studijskoj posjeti Državnom zavodu za intelektualno vlasništvo Hrvatske, u Zagrebu, 22. i 23. januara 2013. godine, gdje se upoznala sa načinom rada hrvatskog Zavoda, i to u dijelu toka i kretanja dokumenata, kroz konkretno pojašnjenje od strane domaćina, gospođe Ljiljane Bošnjak i gospodina Davora Prahina, o načinu prijema dokumenata, razvrstavanju, evidentiranju, načinu dodjele klasa / rednih brojeva koje dokument dobija na ulazu, odlaganju dokumenta u omot spisa i otpremanju na obradu savjetnicima, kao i o otpremi obrađenih akata putem pošte.

b) Dva predstavnika ZIS-a, Snežana Džuverović, samostalni savjetnik I za međunarodnu saradnju, i Nataša Vukašinić, samostalni savjetnik II za patente, iz Sektora za industrijsku svojinu, učestvovala su na „Informativnom danu o saradnji sa državama članicama EPO-a“, koji je održan u Minhenu, 6. marta 2013. godine.

Sastanak je otvorio srdačnom dobrodošlicom gospodin Francois-Regis Hannart, direktor Sektora za evropsku i međunarodnu saradnju, EPO, koji je iskoristio priliku da predstavi svoje saradnike iz Sektora, koji su organizovali ovaj značajni događaj. Gospodin Hannart izrazio je zadovoljstvo zbog učešća velikog broja predstavnika država članica (24), a potom dao riječ gospodinu Georgu Artelsmairu, direktoru Odsjeka za evropsku saradnju, koji je govorio o prioritetima saradnje sa državama članicama u 2013. godine. Gospodin Artelsmair objasnio je da EPO sa gotovo svakom državom članicom, kao i sa 2 države posmatrača (Crnom Gorom i B&H), ima neku vrstu projekta koji je u toku. Novom politikom EPO-a, svaka vrsta projekta ima svoju specifičnu numeraciju, a svaka aktivnost poziv na tu numeraciju. Nekadašnji nacionalni projekti sada se rade u formi Planova bilateralne saradnje. Svi projekti imaju svoje koordinate koji su direktno odgovorni za njihovo sprovođenje. Potom su uslijedile prezentacije o svim projektima EPO-a, koje su sadržale cilj projekta, način implementacije, izazove i rezultate.

Na ovom sastanku istaknuto je da je EPO iz okvira svoje ogromne ekspertize i spektra raznovrsnih projekata koje sprovodi sa državama članicama, posebno ponosan na projekte Unitarnog evropskog patenta, Mašinskog prevođenja i Jedinstvenog evropskog patentnog registra (Federated European Patent Register).

Gospodin David A. Smith, iz Sektora za evropsku saradnju, imao je prezentaciju o EPN web site-u, u kojoj je objasnio da korisnici i svi zainteresovani mogu posjećivati EPN web site i EPO web site, s tim da moraju znati razliku među njima, kao i jasnu poruku da EPO web site ima prednost kao pravi EPO-ov reprezent.

Gospodin Wolfgang Tager, administrator iz Odjeljenja za finansije i podršku korisnika, izložio je kratku prezentaciju na temu “Administrativna i finansijska pitanja”.

Na kraju sastanka, kroz tačku Agende “Tour de table”, predstavnicima država članica i nečlanica EPO-a data je mogućnost da iznesu svoje mišljenje na temu “Saradnja sa EPO-om iz perspektive nacionalnog zavoda”. G-đa Snežana Džuverović, u ime Zavoda za intelektualnu svojinu Crne Gore, izrazila je zadovoljstvo i zahvalnost što Crna Gora po prvi put ima predstavnike na ovom sastanku, a potom iskoristila priliku da istakne da crnogorski Zavod ima izvanrednu saradnju sa EPO-om gotovo od samog osnivanja: Zavod je osnovan 28.05.2008., a Regionalni projekat u kojem je CG učestvovala sa još 7 država, počeo je 16.11.2008. god. Saradnja je nastavljena kroz Nacionalni projekat, a trenutno se odvija na osnovu Plana bilateralne saradnje, gdje je koordinator g. D. Jelerčić, kome se zahvalila na izvanrednoj saradnji.

Učešće na ovom događaju bila je prilika za sastanak sa koordinatorom Plana bilateralne saradnje, gospodinom Davidom Jelarčićem, koji je održan 7. marta 2013. godine. Na sastanku su detaljno prodiskutovane sve predstojeće aktivnosti i napravljen precizan spisak i plan aktivnosti čija realizacija je predviđena za period mart – septembar, kao i okvirni plan - dinamika njihovog sprovođenja.

c) Dva predstavnika ZIS-a CG, direktor Novak Adžić i Snežana Džuverović, samostalni savjetnik I za međunarodnu saradnju, učestvovali su na 135. sastanku Administrativnog odbora EPO-a, koji je održan 20. i 21. marta 2013. godine, u svojstvu predstavnika Crne Gore iz statusa posmatrača u AO EPO-a, koji je Crnoj Gori odobren na 133. sastanku AO EPO-a, održanom 25. oktobra 2012. godine.

Status posmatrača u Administrativnom odboru EPO-a obezbjeđuje predstavnicima Crne Gore, odnosno Zavoda za intelektualnu svojinu, priliku da se upoznaju sa načinom rada ove eminentne organizacije, a takođe pruža mogućnost za proširenje saradnje kako sa EPO-om tako i sa zavodima iz država članica EPO-a. Ovaj status predstavlja pripremu i korak naprijed prema pristupanju Evropskoj patentnoj konvenciji (EPC) i sticanju članstva u EPO-u, što je cilj i obaveza Vlade Crne Gore iz Sporazuma o stabilizaciji i pridruživanju.

d) EPO je uradio poster „Sedam smrtnih grijehova pronalazača“ koji predstavlja popularan prikaz načina na koji jedan pronalazač treba da postupa sa svojim pronalaskom. Poster je urađen u 20 primjeraka, koji su postavljeni u Pisarnici Zavoda i u kancelariji savjetnika za patente.

e) Zavod je pripremio tekst brošure o patentima, koji je prihvaćen od strane EPO-a. Izrada ove brošure je u toku. Brošura sadrži značajne podatke iz oblasti patenata i moći će se koristiti u svrhe podizanja svijesti o značaju patentne zaštite, kao i o ulozi ZIS-a u postupku priznanja patenata.

f) Delagacija Zavoda za intelektualnu svojinu Crne Gore (u daljem tekstu: Zavod) boravila je u dvodnevnoj radnoj posjeti Mađarskom zavodu za intelektualnu svojinu (u daljem tekstu: HIPO), 22. i 23. maja 2013. godine. Delegacija Zavoda bila je u sastavu: g-din Novak Adžić, direktor Zavoda, g-đa Dušanka Perović, pomoćnica direktora i i g-đa Nataša Vukašinić, samostalna savjetnica za patente.

Zavod je sa HIPO-om, 18. jula 2012. godine, zaključio Memorandum o saradnji, u skladu sa kojim je i realizovana ova posjeta.

Dr. Mikloš Bendzsel, Predsjednik HIPO, sa svojim timom, poželio je toplu dobrodošlicu delegaciji Zavoda. Dr Bendzsel je istakao zadovoljstvo što je sa svojim saradnicima domaćin crnogorskoj delegaciji na čelu sa direktorom g-dinom Novakom Adžićem, u sjedištu HIPO-a, u Budimpešti. Dr. Bendzsel je zatim predstavio sadržaj programa posjete, stavljajući akcenat na najaktuelnije pitanja patentnog i žigovnog prava u Evropi, Dunavski patentni institut kao i saradnju sa IP zavodima tkz. IP diplomatiju. Prilikom svoje posjete Zavodu, jula 2012 godine informisao je o radu HIPAVILONA, što je kratko učinio i ovom prilikom. HIPAVILON je neprofitna mađarska agencija intelektualne svojine, kojom upravlja HIPO, koja pruža spektar kompleksnih usluga, sa ciljem podrške inovacijama, izradi portfolia intelektualne svojine kao i izradi oruđa za uspješnost firmi na konkurentnom tržištu, u inovativnom biznis okruženju.

Gospodin Novak Adžić, direktor Zavoda izrazio je iskrenu zahvalnost na iskazanoj vrlo srdačnoj dobrodošlici Dr. Bendzsela kao i članovima njegovog tima, posebno se osvrćući na organizaciju crnogorske posjete i pripremu vrlo interesantnog programa. Direktor Zavoda je iskazao svoje zadovoljstvo kao i svojih saradnika sa sadržajem programa posjete i predstavljanjem najaktuelnijih tema u polju intelektualne svojine.

Radni dio posjete otpočeo je prezentacijom g-dina Andrasa Jokuti, zamjenika šefa Sektora za pravna pitanja HIPO-a o unitarnom patentu i unitarnom sudu. G-din Jokuti, se osvrnuo na značaj unitarnog patenta koji će biti još jedna mogućnost zaštite za korisnike, pored već postojećih nacionalnih patenata i klasičnih evropskih patenata. Unitarni patent će biti priznat od Evropskog patentnog zavoda, na osnovu Konvencije o evropskom patentu, koji će imati unitarni efekat na 25 država članica (osim Italije i Španije) a unitarni sud će biti nadležan za sudske sporove koji se odnose na evropske patente i unitarne patente.

G-đa Judit Hajdu, zamjenik Predsjednika HIPO za tehnička pitanja, predstavila je rad Dunavskog patentnog instituta. Dunavski patentni institut (DPI) je međunarodni institut za pretragu i preliminarno ispitivanje za centralnu Evropu., na osnovu PCT-a. Uspostavljen je kao nova međunarodna organizacija. Zasnovan je na konceptu umrežavanja (nekolika instituta u Evropi, ali ne i u Centralnoj Evropi). Slične je strukture kao Nordijski patentni institut. Zaključen je specijalni Sporazum između Evropske patentne organizacije i DPI-a o saradnji u skladu sa Protokolom o centralizaciji evropskog patenta. Urađena je studija izvodljivosti, nacrt zajedničkog poslovnog plana, nacrt ugovora i uredba za implementaciju. HIPO je dobio mandat od Vlade Mađarske za vođenje pregovora i potpisivanje ugovora, kojim se uspostavlja DPI.

G-din Imre Gonda, zamjenik šefa žigovnog Sektora HIPO u svojoj prezentaciji izložio je vrlo detaljno tkz. evropsku reformu žiga kroz predloženu TM direktivu i novu Uredbu., koja je u skladu sa EU IP strategijom. evaluacijom. MAX Planck Instituta iz Minhena koji je izradio Studiju jedinstvenog funkcionisanja evropskog žigovnog sistema. Predstavio je „package approach“ tj da pravni instrumenti trebaju da se razmatraju zajedno u „paketu“. Osnovna reforma počiva na sadašnjem pravnom okviru kao solidnoj osnovi, potrebi modernizacije i poboljšanja postojećih odredbi kao i EU standardizaciji kojom bi upravljao OHIM. Npr. interesantno je da definicija žiga kojom je obavezno grafickio predstavljnje je zastarela, nova definicija uvodi proširenu upotrebu elektronskim sredstavima. G-din Gonda je izložio sve vrlo važne predloge. Reforma žigovnog prava kritikovana je od država članica. Glavni razlozi su da nije u skladu sa MAX PLANCK studijom, da će narušiti balans između Žiga zajednice- CTM i nacionalnih žigovnih sistema kao i da harmonizacija proceduralnih zakona nije prihvatljiva za pojedine države članice a posebno nedostaje distribucija više od 50% taksi za obnovu žiga. Prema mišljenju mađarskog kolege teško je predviđeti budući tok pregovora oko reforme žigovnog prava u EU.

Drugog dana boravka, crnogorskoj delegaciji je predstavljena tema „Sertifikat o dodatnoj zaštiti“ koju je izložila g-đa Ildikò Prohászka-Németh, patentna ispitivačica HIPO-a. Imenovana je istakla značaj Sertifikata, koji omogućava nosiocu patenta da zadrži isključivo ovalašćenje za proizvodnju i promet lijeka i sredstva za zaštitu bilja i posle isteka roka patentne zaštite. Kako je postupak priznanja patenta veoma dug i skup, ovo je način da nosilac patenta nadoknadi ekonomske efekte koje je propustio čekajući dobijanje dozvole za stavljanje na tržište,. Takođe, crnogorski predstavnici posjetili su Sektor za patente i imali priliku da se informišu o iskustvu HIPO-a. HIPO je Zavod sa dugom tradicijom, osnovan 1896. godine.

Vrlo važan segment posjete jeste dogovor dvije delegacije da HIPO bude nadležna institucija koja će obavljati pretraživanje i ispitivanje patenata. S obzirom da se u Crnoj Gori vrši samo formalno ispitivanje patenata, obaveza Zavoda je da zainteresovanim subjektima u slučaju sudskog spora pruži mogućnost suštinskog ispitivanja patenta. U HIPO-u je već pokrenuta interna procedura pripreme Sporazuma i zaključivanje istog očekuje se u vrlo kratkom roku.

Posjeta crnogorske delegacije bila je vrlo uspješna i značajno je produbila već dobre uspostavljene bilateralne odnose. To su konstatovala dva direktora Zavoda. Predsjednik HIPO, sa svojim timom iskazao je otvorenu podršku Zavodu, kao i pružanje svake stručne pomoći, sve u duhu zaključenog Memoranduma o saradnji kao i tradicionalno dobrih odnosa dvije zemlje.

### III Bilateralna saradnja

a) Zavod za intelektualnu svojinu ostvaruje dobru saradnju sa zavodima iz regiona i visokofunkcionalnim zavodima Evrope i svijeta. U periodu januar - jun 2013.godine, ostvarena je posjeta Delegacije ZIS-a Zavodu za patente i žigove SAD-a (finansirana od strane WIPO-a), studijska posjeta jednog predstavnika ZIS-a Državnom zavodu za intelektualno vlasništvo Hrvatske (finansirana od strane EPO-a, na osnovu Plana bilateralne saradnje) i posjeta Mađarskom zavodu za intelektualnu svojinu (finansirana od strane EPO-a, na osnovu Plana bilateralne saradnje), u svemu kao u gornjem tekstu.

b) Direktor Zavoda za intelektualnu svojinu Crne Gore, gospodin Novak Adžić, sa saradnicima: gospodinom Igorom Gojnićem, rukovodiocem Sektora za informacione tehnologije i registre, i gospođom Snežanom Džuverovi, samostalnim savjetnikom I za međunarodnu saradnju, boravio je u službenoj posjeti Zavodu za intelektualnu svojinu Ukrajine, u Kijevu, od 11. do 14. marta 2013.godine.

Cilj posjete bio je potpisivanje Sporazuma o saradnji između Zavoda za intelektualnu svojinu Crne Gore i Zavoda za intelektualnu svojinu Ukrajine i postizanje dogovora o konkretnim aktivnostima iz opsega buduće saradnje.

Prvi radni dan počeo je sastankom direktora Adžića i njegovih saradnika sa gospodinom Mykola Kovinya-om, predsjednikom Zavoda za intelektualnu svojinu Ukrajine, i njegovim najbližim saradnicima. Gospodin Kovinya srdačno je pozdravio direktora Adžića i izrazio izuzetno zadovoljstvo zbog prilike za sastanak i potpisivanje Sporazuma koji će biti osnova buduće saradnje između dva Zavoda. Direktor Adžić se zahvalio na dobrodošlici i potvrdio spremnost crnogorskog Zavoda za razmjenu iskustava i prakse, kroz oblike saradnje predviđene Sporazumom. Nakon toga uslijedila je prezentacija rada Zavoda Ukrajine, koju je izložila gospođa Oksana Shpytal, glavni ekspert i v.d. direktora Sektora za evropsku i međunarodnu saradnju, i u kojoj je dala najznačajnije podatke o radu i organizacionoj strukturi Zavoda Ukrajine, i to: Zavod za intelektualnu svojinu Ukrajine je organ državne uprave Ukrajine, koji je organizaciono koncipiran tako da se u Zavodu nalazi kabinet predsjednika, Sektor za evropsku i međunarodnu saradnju, Sektor za pravnu podršku, Sektor za finansijsku podršku i inspektori; ukupan broj zaposlenih 57 (od čega 27 inspektora, koji su raspoređeni po regionima); nadzor nad njihovim radom vrši Ministarstvo prosvjete i nauke; prijem prijava i registraciju prava industrijske svojine vrši Institut za industrijsku svojinu, koji broji 600 zaposlenih i predstavlja posebnu organizacionu jedinicu. Direktor Adžić govorio je o sistemu zaštite prava intelektualne svojine u Crnoj Gori. Snežana Džuverović izložila je prezentaciju o radu i međunarodnoj saradnji Zavoda Crne Gore.

Prema preciznoj Agendi, direktor Adžić i predsjednik Kovinya potpisali su Sporazum o saradnji između Zavoda za intelektualnu svojinu Crne Gore i Zavoda za intelektualnu svojinu Ukrajine u 11.30 časova.

U razgovoru nakon potpisivanja Sporazuma, predsjednik Kovinya predložio je da stručnjaci dva Zavoda u komunikaciji dogovore susrete radi razmjene iskustava i prakse, i pozvao da predstavnik Zavoda Crne Gore učestvuje na konferenciji na Jalti koja će se održati u 4. Kvartalu ove godine, uz napomenu da Sporazum daje mogućnost organizovanja zajedničkih aktivnosti. Direktor Adžić je prihvatio predloge predsjednika Kovinya-e i predložio da predstavnik Zavoda Ukrajine učestvuje na Konferenciji koja će se održati u julu ove godine u Podgorici. Direktor Adžić uputio je poziv predsjedniku Kovinya-i da posjeti Zavod Crne Gore u terminu koji bi dogovorili u međusobnoj komunikaciji, što je on sa zadovoljstvom prihvatio.

Delegacija Zavoda za intelektualnu svojinu posjetila je Ukrajinski institut za industrijsku svojinu, gdje im je pripremljen izvanredan prijem. Direktor Adžiću prva je poželjela dobrodošlicu gospođa Eleonora Melnyk, direktorka Instituta, a potom i njeni najbliži saradnici: gospodin Igor

Kovalenko, prvi pomoćnik direktora; gospođa Iryna Vasylenko, pomoćnica direktora za pravne poslove; gospodin Sergii Mosov, pomoćnik direktora za informacionu i tehničku podršku. Na sastanku je izložena sveobuhvatna prezentacija o radu ovog renomiranog Instituta, tokom koje je dat niz značajnih informacija, i to: Institut je nadležan za ispitivanje prijave žigova, patenata, korisnih modela, dizajna, topografija integrisanih kola; najveći je broj prijave žigova, koji je u stalnom porastu; broj prijave patenata je u opadanju zbog krize; Institut ima izvanrednu informatičku opremljenost i Informaciono odjeljenje sa 24 zaposlenih; Institut zapošljava visokoobrazovane i stručne kadrove; ukupan broj zaposlenih: 600. Nakon prezentacije, gosti iz crnogorskog Zavoda imali su priliku da se, tokom obilaska Instituta, na licu mjesta upoznaju sa postupkom rada i zaposlenima, gdje su u neposrednom razgovoru dobili odgovore na sva stručna pitanja. Kruna posjete, kao izuzetna atrakcija, bila je posjeta Muzeju intelektualne svojine, gdje se direktor Adžić upisao u Knjigu utisaka.

Posjeta je obostrano ocijenjena kao izvanredno uspješna. Zajednički je konstatovano da je ova posjeta prva u nizu budućih zajedničkih aktivnosti čija se osnova nalazi u upravo potpisanom Sporazumu.

#### IV Učešće na značajnim međunarodnim događajima

a) Delegacija Zavoda za intelektualnu svojinu Crne Gore, na čelu sa direktorom Novakom Adžićem, u čijem sastavu su bile: Emina Mujević, samostalni savjetnik za autorsko i srodna prava, i Milica Petrović Njegoš, samostalni savjetnik I, učestvovala je na Sedmom globalnom kongresu o borbi protiv piraterije i krivotvorenja, koji je održan u Istanbulu 24-26. aprila 2013.godine.

Kongres je organizovan od strane nekoliko međunarodnih institucija, i to: Svjetske organizacije za intelektualnu svojinu (WIPO), Zavoda za industrijsku svojinu Turske, INTERPOL, Svjetske carinske organizacije, Svjetske poslovne zajednice, koju predstavlja Međunarodna privredna komora (ICC) preko svog Odjeljenja specijalizovanog za borbu protiv krivotvorenja i piraterije (BASCAP) i Međunarodnog udruženja za zaštitu žigova (INTA). Pokrovitelj Kongresa bio je gospodin Recep Tayyip Erdogan, premijer Turske, koji je otvorio kongres. U svom govoru, gospodin Erdogan naglasio je značaj borbe protiv krivotvorenja i piraterije, kako na globalnom, tako i na nivou pojedinih država koje su članice međunarodnih organizacija čiji je osnovni cilj zaštita prava intelektualne svojine.

Prvog dana Kongresa, govorili su: gospodin Kunio Mikurya, generalni direktor WCO, koji je naglasio da se u mnogim državama organi zaduženi za sprovođenje prava IS suočavaju sa pojavom krivotvorenih lijekova, što predstavlja jedan od najvećih problema savremenog društva; gospodin Hayati Yazici, ministar carina i trgovine Turske, koji je nakon iznošenja podatka da se Turska nalazi među 10 zemalja sa najbrže rastućim ekonomijama u svijetu, informisao da Ministarstvo carina i trgovine Turske razvija mnogobrojne projekte kojim je planirano podizanje opsega međunarodne trgovine sa prioritonom na efikasnoj zaštiti prava IS; gospodin Francis Gurry, generalni direktor WIPO-a, koji je istakao da krivotvorenje i piraterija ostaju jedan od glavnih problema u svijetu koji, praćeni socio-ekonomskim promjenama, kao što su siromaštvo, sve lakšim pristupom nelegalnim dobrima, učešćem mreža organizovanog kriminala, uprkos poboljšanim pravnim i institucionalnim okvirima, i dalje egzistiraju kao problem koji zahtijeva poboljšanje sistema zaštite prava IS na međunarodnom nivou; gospodin Ronald K. Noble, generalni sekretar INTERPOL-a, koji je konstatovao da je od Prvog globalnog kongresa, koji je održan 2004.godine, do danas primijetno ojačala saradnja između privatnog i javnog sektora u borbi protiv krivotvorenja i piraterije i da je tu saradnju neophodno nastaviti; zatim gospodin Rifat Hisarcikioglu, predsjednik Privredne komore Turske; g. Omar Celik, generalni sekretar ICC, i dr.

Generalni direktor WIPO-a, gospodin Francis Gurry, iskoristio je priliku da pozove sve prisutne direktore zavoda za intelektualnu svojinu na sastanak na kojem je naglasio potrebu za čvršćom

saradnjom WIPO-a i nacionalnih zavoda. Sastanku su prisustvovali: g. Novak Adžić, direktor Zavoda za intelektualnu svojinu Crne Gore; gospođa Branka Totić, direktorka Zavoda za intelektualnu svojinu Srbije; g. Ives Lapiere, direktor Nacionalnog instituta za industrijsku svojinu Francuske; g. Ahmet Kocer, direktor Zavoda za patente Turske; g. Irakli Ghvaladze, direktor Nacionalnog centra za intelektualnu svojinu Gruzije, kao i predstavnici WIPO-a.

Drugog dana kongresa predstavljena su raznovrsna istraživanja, uključujući primjere iz prakse, o podizanju svijesti potrošača u odnosu na krivotvorenje i pirateriju.

Trećeg dana Kongresa, učesnici su upoznati sa regionalnim i nacionalnim izazovima sa kojima se suočavaju zemlje u razvoju po pitanju borbe protiv krivotvorenja i piraterije. Takođe je predstavljena šema privatno – javnog partnerstva i alternativnih samoregulatornih mehanizama borbe. Istaknuta je potreba za izradom različitih tehnoloških alata koje bi koristila lica uključena u sprovođenje prava IS, kao i sistema razmjene informacija iz baza podataka o nelegalnim dobrima.

**b)** Direktor Zavoda za intelektualnu svojinu Crne Gore, gospodin Novak Adžić, i samostalni savjetnik I za međunarodnu saradnju, gospođa Snežana Džuverović, prisustvovali su Ceremoniji dodjele nagrada evropskim pronalazačima, koja je održana u Amsterdamu, u čuvenom zdanju Beurs van Berlage, 28. maja 2013.godine.

Organizator ovog značajnog događaja, Evropski patentni zavod (EPO), Dodjelu nagrada evropskim pronalazačima ustanovio je prije osam godina sa ciljem odavanja priznanja izuzetnim pronalazačima čija djela nalaze primjenu u industriji i nauci i doprinose razvoju i napretku društva u cjelini. Ovogodišnju, Osmu ceremoniju dodjele nagrada evropskim pronalazačima, svojim prisustvom uveličala je **NJ.K.V. Princeza Beatrix od Holandije**, čime je potvrđen izuzetan značaj ovog prestižnog događaja. U ime organizatora, ceremoniju je otvorio gospodin Benoit Battistelli, predsjednik EPO-a, koji je u svom govoru naglasio da se ovaj događaj održava u godini kada slavimo 40 godina od potpisivanja Evropske patentne konvencije iz koje je rođen EPO, kao i okončanje procesa ustanovljavanja Unitarnog evropskog patenta od koga se očekuje da će učiniti Evropu atraktivnom destinacijom za podnošenje prijave za zaštitu pronalazaka. Gospodin Battistelli je iskazao zadovoljstvo što prisutni gosti imaju priliku da se upoznaju sa radom i dostignućima ovogodišnjih finalista čiji pronalasci doprinose poboljšanju svakodnevnog života ljudi, otvaranju novih radnih mjesta i stvaranju bogatstva i prosperiteta. Događaju su prisustvovali gospodin Michel Barnier, Visoki predstavnik Evropske komisije za Interno tržište i usluge, gospodin Sander Dekker, državni sekretar za prosvjetu, kulturu i nauku u Vladi Holandije, kao i direktori zavoda za intelektualnu svojinu iz čitavog svijeta, naučnici, profesori, pronalazači i dr.

Nagrade su dodijeljene u pet (5) kategorija: 1) u kategoriji istraživanja, nagradu je dobio gospodin Patrick Couvreur, Belgijanac zaposlen na Paris Sud Univerzitetu, koji je sa svojim saradnicima izumio nano-kapsule koje se mogu koristiti u medicini u liječenju raka, a koje djeluju direktno na tumorom zahvaćene djelove tijela, bez oštećenja okolnih zdravih tkiva; 2) u kategoriji malih i srednjih preduzeća, nagradu je dobio gospodin Paul Nyren, švedski istraživač, koji je otkrio redosljed DNK nizova, metod kojim se brže, jednostavnije i uz manje troškove postižu bolji rezultati u liječenju teških oboljenja, prvenstveno raka; 3) u kategoriji pronalazaka koji dolaze iz ne-evropskih zemalja, nagradu je dobio g. Ajay V. Bhatt, iz SAD, koji je sa svojim timom usavršio USB tehnologiju kojom se omogućava korisnicima olakšana konekcija na kompjutere; 4) u kategoriji industrije, nagradu su dobili g. Klaus Hammerle i g. Klaus Brustle, Austrijanci, čiji je pronalazak „šarka za lagano zatvaranje“ našla ogromnu primjenu u industriji namještaja; 5) u kategoriji „Nagrada za životno djelo“, nagradu je dobio g. Martin Schadt, koji je izumio čuvenu LCD tehnologiju, čijom primjenom u proizvodnji tablet kompjutera, mobilnih telefona i LCD TV prijemnika je ostvarena nevjerojatna prodaja ovih uređaja u čitavom svijetu. Po prvi put ove godine, dodijeljena je nagrada „Najpopularniji pronalazač“, čiji dobitnik je izabran direktnim glasanjem na sajtu EPO-a. Ova nagrada pripala je g. Jose Luis Lopez Gomez-u, inženjeru iz Španije, koji je izumio novi metod



kojim se omogućava sigurno zadržavanje voza u tračnicama, u optimalnom položaju, bez isklizavanja, i uz to omogućava 30% brži prolazak voza kroz krivine.

Nagrađeni pronalazači zahvalili su se biranim riječima na prestižnim nagradama i svima je uručen trofej „Jedro“, statueta u obliku jedra koju je dizajnirala gospođa Miriam Irle. Simbolika ovog trofeja leži u činjenici da je jedro i danas simbol dinamizma – jednostavna tehnološka ideja koja predstavlja prirodne sile koje čovjeku omogućavaju kretanje morima i okeanima hiljadama godina unazad.

Osma ceremonija dodjele nagrada evropskim pronalazačima privukla je veliku pažnju javnosti, pa su događaj pratili mnogobrojni štampani i elektronski mediji iz Holandije i svijeta.

Nakon završetka ceremonije, direktor Adžić imao je susrete sa gospodinom Yves Lapierre-om, generalnim direktorom Nacionalnog instituta za intelektualnu svojinu Francuske (INPI), gospodinom Friedrich Rodler-om, predsjednikom Austrijskog zavoda za patente, tokom kojih je izražena obostrana želja za unaprijeđenjem saradnje između Zavoda u cilju razmjene iskustava i prakse.



# INTELEKTUALNA SVOJINA

## AUTORSKO PRAVO I SRODNA PRAVA

## INDUSTRIJSKA SVOJINA

- \* Patenti
- \* Žigovi
- \* Industrijski dizajn
- \* Oznake geografskog porijekla roba i usluga
- \* Topografija integriranih kola

### AUTORSKO PRAVO

*(Koje se odnosi na duhovne tvorevine)*

- Kao što su naročito:
- \* Književna djela  
*(pisana, govorna, kompjuterski programi)*
  - \* Muzička djela
  - \* Dramska i dramsko-muzička djela
  - \* Koreografska i pantomimska djela
  - \* Djela likovnih umjetnosti iz područja slikarstva, vajarstva i arhitekture
  - \* Djela primjenjenih umjetnosti
  - \* Fotografiska djela
  - \* Kinematografska djela
  - \* Prevodi, obrade i druge prerade djela
  - \* Zbirke autorskih djela, podataka ili druge građe

### SRODNA PRAVA

- Koja se odnose:
- \* Izvođenja umjetnika izvođača
  - \* Fonograme
  - \* Emitovanja radija I televizije

CIP - Каталогizacija u publikaciji  
Централна народна библиотека Црне Горе, Цетиње

347.77/78(497.16)

CRNOGORSKI glasnik intelektualne svojine : Službeni glasnik  
Zavoda za Intelektualnu svojinu Crne Gore = Journal of intel-  
lectual properti in Montenegro = Official Gazete of the Intellec-  
tual Property Office of Montenegro / glavni i odgovorni urednik  
Novak Adžić - 2011, br.7 - 322. - Podgorica (Bulevar Revolucije  
9) : Zavod za intelektualnu svojinu Crne Gore, 2010. - 30 cm

Tromjesečno.

ISSN 1800-8003 = Crnogorski glasnik intelektualne svojine  
(Podgorica)

COBISS.CG-ID 15168784

