



CRNOGORSKI GLASNIK INTELEKTUALNE SVOJINE

INTELLECTUAL PROPERTY GAZETTE OF MONTENEGRO

Službeni glasnik Zavoda za intelektualnu svojinu Crne Gore
Official Gazette of the Montenegrin Intellectual Property Office

14/2014



Zavod za intelektualnu svojinu Crne Gore
ul. Rimski trg br. 46,
81000 Podgorica,
Crna Gora

CRNOGORSKI GLASNIK INTELEKTUALNE SVOJINE

Godina V

Datum objavljivanja: 20. 04. 2014. god.

Izdavač:

ZAVOD ZA INTELEKTUALNU
SVOJINU CRNE GORE
Rimski trg br. 46,
81000 Podgorica, Crna Gora

Za izdavača:

Novak Adžić, direktor

Glavni i odgovorni urednik:

Novak Adžić

Urednički odbor:

Novak Adžić, Predrag Malbaša,
Dušanka Perović, Milica Savić,
Gordana Tripković

Tehnički urednik:

Predrag Malbaša

Prevod:

Gordana Tripković

Dizajn:

Aleksandar-Saša Samardžić

OVAJ BROJ SLUŽBENOG GLASNIKA OBJAVLJEN JE U ELEKTRONSKOJ FORMI

Crnogorski glasnik intelektualne svojine službeno je glasilo Zavoda za intelektualnu svojinu Crne Gore. U Glasniku se objavljuju sve relevantnim zakonima i pravilnicima propisane informacije iz postupka dodjele prava industrijskog vlasništva, informacije o dodijeljenim pravima te o kasnijim promjenama u vezi s tim pravima, kao i ostale službene informacije.

The Montenegrinan intellectual property gazette is the official gazette of the State Intellectual Property Office of the Montenegro. The Gazette publishes all the information, prescribed by the relevant laws and regulations, relating to the industrial property granting procedure concerning granted rights and subsequent changes made in connection with such right, as well as other official information.

SADRŽAJ

DVOSLOVNE OZNAKE ZEMALJA, TERITORIJA I MEĐUNARODNIH ORGANIZACIJA
TWO LETTER CODE COUNTRIES, TERRITORIES AND INTERNATIONAL ORGANIZATIONS 5

PATENTI

PATENTS 7

MEĐUNARODNI KODOVI ZA IDENTIFIKACIJU BIBLIOGRAFSKIH PODATAKA O PATENTIMA

PREMA WIPO STANDARDU ST. 9

RECOMMENDATION CONCERNING BIBLIOGRAFIC DATA ON AND RELATING TO

PATENTS- WIPO-ST. 9..... 9

OBAVJEŠTENJE

NOTICE 11

OBJAVE PRIJAVA PATENATA

PUBLICATION OF PATENT APPLICATIONS..... 13

INDEKS NOSILACA PATENTA

PATENT OWNER INDEX 23

INDEKS BROJEVA PRIJAVA PATENATA

APPLICANTS NUMBER INDEX 25

INDEKS OBJAVLJENIH PRIJAVA PATENATA PREMA MKP

INDEX OF PATENT APPLICANTS ACCORDINT TO IPC 27

OBJAVE ZAHTJEVA ZA PROŠIRENJE EVROPSKIH PRIJAVA PATENATA

PUBLICATION OF REQUEST FOR THE EXTENSION OF THE EFFECTS OF EUROPEAN PATENT

APPLICATIONS 29

INDEKS BROJEVA ZAHTJEVA ZA PROŠIRENJE EVROPSKIH PRIJAVA PATENTA

INDEX ON NUMBER OF REQUESTS FOR EXTENSION ON EUROPEAN PATENT APPLICATIONS ... 161

INDEKS KLASIFIKACIJSKIH OZNAKA BROJEVA ZAHTJEVA ZA PROŠIRENJE EVROPSKIH

PRIJAVA PATENTA PREMA MKP

INDEX ON CLASSIFICATION MARKS ON REQUESTS FOR EXTENSION OF EUROPEAN PATENT

APPLICATION IN ACCORDANCE WITH THE INTERNATIONAL PATENT CLASSIFICATION 205

INDEKS PODNOSITELJA ZAHTJEVA ZA PROŠIRENJE EVROPSKIH PRIJAVA PATENTA

INDEX ON NUMBER OF APPLICATIONS FOR EXTENSION OF EUROPEAN PATENT

APPLICATION 307

OBJAVA POVUČENIH ZAHTJEVA ZA PROŠIRENJE EVROPSKIH PRIJAVA PATENTA

PUBLICATION OF WITHDRAWN REQUESTS FOR EXTENSION OF EUROPEAN PATENT

APPLICATION 377

OBJAVA PROŠIRENIH EVROPSKIH PATENATA

PUBLICATION OF EXTENDED EUROPEAN PATENTS..... 379

OBJAVA UPISA PROMJENA

PUBLICATION OF RECORD OF CHANGES 517

ŽIGOVI

TRADEMARKS..... 519

MEĐUNARODNI KODOVI ZA IDENTIFIKACIJU BIBLIOGRAFSKIH PODATAKA O ŽIGOVIMA

PREMA WIPO ST 60

RECOMMENDATION CONCERNING BIBLIOGRAPHIC DATA RELATING TO TRADEMARKS- WIPO-ST. 60	521
OBAVJEŠTENJE NOTICE	523
OBJAVA PRIJAVA ŽIGOVA PUBLICATION OF TRADEMARK APPLICATIONS	525
OBJAVA ŽIGOVA PUBLICATION OF TRADEMARKS	721
INDEKS NOSILACA ŽIGOVA INDEX OF THE HOLDER OF THE REGISTRATION	779
INDEKS BROJEVA ŽIGOVA INDEX OF THE TRADEMARK NUMBERS	783
INDEKS PO KLASAMA NIČANSKE KLASIFIKACIJE ROBA I USLUGA INDEX ACCORDING TO THE NICE CLASSIFICATION OF GOODS AND SERVICES	785
OBJAVA ISPRAVKI CORRECTIONS.....	787
OBJAVA UPISA U REGISTAR ŽIGOVA CRNE GORE PUBLICATION OF THE ENTRY TRADEMARK REGISTER MONTENEGRO	789
DIZAJN	
DESIGNS	795
MEĐUNARODNI KODOVI ZA IDENTIFIKACIJU BIBLIOGRAFSKIH PODATAKA O DIZAJNU PREMA WIPO CT.80	
RECOMMENDATION CONCERNING BIBLIOGRAPHIC DATA RELATING TO INDUSTRIJAL DESIGNS WIPO CT.80	797
OBJAVE DIZAJNA PUBLICATION OF DESIGNS.....	799
INDEKS NOSILACA DIZAJNA INDEX OF INDUSTRIAL DESIGN OWNERS	805
INDEKS BROJEVA DIZAJNA INDEX OF INDUSTRIAL DESIGN NUMBERS.....	807
INDEKS PO KLASAMA I PODKLASAMA LOKARNSKE KLASIFIKACIJE INDEX ACCORDING TO CLASSES SUBCLASSES THE LOCARNO CLASSIFICATION	809
OBJAVE OBNOVE VAŽENJA INDUSTRIJSKOG DIZAJNA PUBLICATION OF INDUSTRIAL DESIGN RENEWAL	811
OBJAVE UPISA PROMJENA DIZAJNA PUBLICATION OF RECORD OF CHANGES	813
INFORMATOR	
INFORMATION.....	815

**DVOSLOVNE OZNAKE ZEMALJA, TERITORIJA I MEĐUNARODNIH
ORGANIZACIJA
(prema WIPO standardu ST. 3)**

AD	Andora	CF	Centralna Afrička Republika	GB	Velika Britanija
AE	Ujedinjeni Arapski Emirati	CG	Kongo	GC	Patentna kancelarija Savjeta za saradnju država Arapskog Zaliva (GCC)
AF	Afganistan	CH	Švajcarska	GD	Grenada
AG	Antigva i Barbuda	CI	Obala Bjelokosti	GE	Gruzija
AI	Angvila	CK	Kukova ostrva	GG	Guernsey
AL	Albanija	CL	Čile	GH	Gana
AM	Armenija	CM	Kamerun	GI	Gibraltar
AN	Holandski Antili	CN	Kina	GL	Grenland
AO	Angola	CO	Kolumbija	GM	Gambija
AP	Afrička regionalna organizacija za industrijsko vlasništvo (ARIPO)	CR	Kostarika	GN	Gvineja
AR	Argentina	CU	Kuba	GQ	Ekvatorska Gvineja
AT	Austrija	CV	Kabo Verde	GR	Grčka
AU	Australija	CY	Kipar	GS	Južna Džordžija i Ostrva Južni Sendvič
AW	Aruba	CZ	Češka Republika	GT	Gvatemala
AZ	Azerbejdžan	DE	Njemačka	GW	Gvineja-Bisao
BA	Bosna i Hercegovina	DJ	Džibuti	GY	Gvajana
BB	Barbados	DK	Danska	HK	Hongkong – Posebna administrativna regija
BD	Bangladeš	DM	Dominika		NR Kine
BE	Belgija	DO	Dominikanska Republika	HN	Honduras
BF	Burkina Faso	DZ	Alžir	HR	Hrvatska
BG	Bugarska	EA	Evroazijska patentna organizacija (EAPO)	HT	Haiti
BH	Bahrein	EC	Ekvador	HU	Mađarska
BI	Burundi	EE	Estonija	IB	Međunarodna kancelarija Svjetske organizacije za intelektualno vlasništvo (WIPO)
BJ	Benin	EG	Egipat	ID	Indonezija
BM	Bermudi	EH	Zapadna Sahara	IE	Irska
BN	Brunej Darussalam	EM	Kancelarija za harmonizaciju Unutrašnjeg tržišta (žigovi i dizajn) (OHIM)	IL	Izrael
BO	Bolivija	EP	Evropska patentna kancelarija (EPO)	IM	Ostrvo Man
BR	Brazil	ER	Eritreja	IN	Indija
BS	Bahami	ES	Španija	IQ	Irak
BT	Butan	ET	Etiopija	IR	Iran (Islamska Republika)
BV	Ostrvo Buve	FI	Finska	IS	Island
BW	Bocvana	FJ	Fidži	IT	Italija
BX	Kancelarija za intelektualno vlasništvo Beneluksa (BOIP)	FK	Foklandska ostrva (Malvini)	JE	Džersi
BY	Bjelorusija	FO	Farska Ostrva	JM	Jamajka
BZ	Belize	FR	Francuska	JO	Jordan
CA	Kanada	GA	Gabon		
CD	Demokratska Republika Kongo				

JP	Japan	NA	Namibija	SY	Sirijska Arapska Republika
KE	Kenija	NE	Niger	SZ	Svazi
KG	Kirgistan	NG	Nigerija	TC	Turska i Kajkoska Ostrva
KH	Kambodža	NI	Nikaragva	TD	Čad
KI	Kiribati	NL	Holandija	TG	Togo
KM	Komori	NO	Norveška	TH	Tajland
KN	Sveti Kristofor i Nevis	NP	Nepal	TJ	Tadžikistan
KP	Demokratska Narodna Republika Koreja	NR	Nauru	TL	Istočni Timor
KR	Republika Koreja	NZ	Novi Zeland	TM	Turkmenistan
KW	Kuvajt	OA	Afrička organizacija za intelektualno vlasništvo (OAPI)	TN	Tunis
KY	Kajmanska Ostrva	OM	Oman	TO	Tonga
KZ	Kazahstan	PA	Panama	TR	Turska
LA	Narodna Demokratska Republika Laos	PE	Peru	TT	Trinidad i Tobago
LB	Libanon	PG	Papuanska Nova Gvineja	TV	Tuvalu
LC	Sveta Lucija	PH	Filipini	TW	Tajvan, Kineska Pokrajina
LI	Lihtenštajn	PK	Pakistan	TZ	Ujedinjena Republika Tanzanija
LK	Šri Lanka	PL	Poljska	UA	Ukrajina
LR	Liberija	PT	Portugal	UG	Uganda
LS	Lesoto	PW	Palau	US	Sjedinjene Američke Države
LT	Litva	PY	Paragvaj	UY	Urugvaj
LU	Luksemburg	QA	Katar	UZ	Uzbekistan
LV	Latvija	QZ	Kancelarija Zajednice za biljne sorte (Evropska Unija) (CPVO)	VA	Sveta Stolica (Vatikan)
LY	Libijska Arapska Džamahirija	RO	Rumunija	VC	Sveti Vincent i Grenadini
MA	Maroko	RS	Srbija	VE	Venecuela
MC	Monako	RU	Ruska Federacija	VG	Britanska Djevičanska Ostrva
MD	Republika Moldavija	RW	Ruanda	VN	Vijetnam
ME	Crna Gora	SA	Saudijska Arabija	VU	Vanuatu
MG	Madagaskar	SB	Solomonska Ostrva	WO	Svjetska organizacije za intelektualno vlasništvo (WIPO) (Međunarodna kancelarija)
MK	Bivša Jugoslovenska Republika Makedonija	SC	Sejšeli	WS	Samoa
ML	Mali	SD	Sudan	XN	Nordijski institut za patente (NPI)
MM	Mianmar	SE	Švedska	YE	Jemen
MN	Mongolija	SG	Singapur	ZA	Južnoafrička Republika
MO	Makao	SH	Sveta Jelena	ZM	Zambija
MP	Sjeverna Marijanska Ostrva	SI	Slovenija	ZW	Zimbabve
MR	Mauritanija	SK	Slovačka		
MS	Montserrat	SL	Sijera Leone		
MT	Malta	SM	San Marino		
MU	Mauricijus	SN	Senegal		
MV	Maldivi	SO	Somalija		
MW	Malavi	SR	Surinam		
MX	Meksiko	ST	Sveti Toma i Princip		
MY	Malezija	SV	Salvador		
MZ	Mozambik				



PATENTI

PATENTS

Službeni glasnik Zavoda za intelektualnu svojinu Crne Gore
Official Gazette of the Montenegrin Intellectual Property Office

14/2014



Zavod za intelektualnu svojinu Crne Gore
ul. Rimski trg br. 46,
81000 Podgorica,
Crna Gora

MEĐUNARODNI KODOVI ZA IDENTIFIKACIJU BIBLIOGRAFSKIH PODATAKA O PATENTIMA PREMA WIPO STANDARDU ST. 9
RECOMMENDATION CONCERNING BIBLIOGRAFIC DATA ON AND RELATING TO PATENTS- WIPO-ST. 9

CRNOGORSKI	MDK	ENGLSKI
IDENTIFIKATOR DOKUMENTA	10	IDENTIFICATION OF THE PATENT
BROJ DOKUMENTA	11	NUMBER OF THE PATENT
VRST DOKUMENTA	13	KIND-OF-DOCUMENT CODE ACCORDING TO WIPO STANDARD
BROJ PRIJAVE	21	NUMBER(S) ASSIGNED TO THE APPLICATION(S)
DATUM PODNOŠENJA PRIJAVE	22	DATE(S) OF FILING THE APPLICATION(S)
DATUM IZLAGANJA NA MEĐUNARODNOJ IZLOŽBI	23	DATE OF EXHIBITING AT THE INTERNATIONAL EXHIBITION
PODACI O PRAVU PRVJENSTVA	30	PRIORITY DATA
DATUM OBJAVLJIVANJA PRIJAVE	43	PUBLICATION DATE OF THE UNEXAMINED APPLICATION
DATUM OBJAVLJIVANJA PATENTA	45	PUBLICATION DATE OF REGISTERED PATENT
MEĐUNARODNA KLASIFIKACIJA PATENATA	51	INTERNATIONAL PATENT CLASSIFICATION CODE
NAZIV PRONALASKA	54	TITLE OF THE INVENTION
APSTRAKT ILI PATENTNI ZAHTJEV	57	ABSTRACT OR CLAIM
BROJ OSNOVNE PRIJAVE (ILI PATENTA) ZA KOJI SE PODNOSI DOPUNSKA PRIJAVA	61	NUMBER OF THE EARLIER APPLICATION (OR PATENT) TO WHICH THE PRESENT DOCUMENT IS AN ADDITION
BROJ PRVOBITNE PRIJAVE IZ KOJE JE PRIJAVA IZDOJENA	62	NUMBER OF THE EARLIER APPLICATION FROM WHICH THE PRESENT DOCUMENT HAS BEEN DIVIDED UP
IME PODNOSIOCA PRIJAVE	71	NAME OF THE APPLICANT
IME PRONALAZAČA	72	NAME OF THE INVENTOR
IME NOSIOCA PATENTA	73	NAME OF THE OWNER OF PATENT
IME PUNOMOĆNIKA	74	NAME OF THE REPRESENTATIVE
BROJ I DATUM PODNOŠENJA MEĐUNARODNE PRIJAVE	86	NUMBER AND FILING DATE OF THE INTERNATIONAL APPLICATION
BROJ I DATUM MEĐUNARODNE OBJAVE	87	NUMBER AND DATE OF THE PUBLICATION OF THE INTERNATIONAL APPLICATION

VRSTA DOKUMENTA		TYPES OF DOCUMENTS
OBJAVA PRIJAVA PATENATA	A	PUBLICATION OF PATENT APPLICATIONS
REGISTROVANI PATENTI	B	REGISTERED PATENTS

OBAVJEŠTENJE
NOTICE

Obavještavamo korisnike da se od 6-og broja Crnogorskog glasnika za intelektualnu svojinu koji se objavljuje na web stranici Zavoda za intelektualnu svojinu Crne Gore, u elektronskoj formi, odnosno od 10.10.2011 godine (Glasnik broj 6/2011) uvode promjene u objavi patentnih dokumenata.

Tako, objavljena prijava patenta (dokument A) sadrži i broj pod kojim je patent upisan u Registar patenata, (međunarodni kod 11 – broj dokumenta), koji je do sada bio objavljivan u svakom narednom broju Crnogorskog glasnika za intelektualnu svojinu. Kako Zavoda za intelektualnu svojinu Crne Gore, ispituje samo formalne uslove za priznavanje patenta, izmjenu uvodimo da bi svi podaci o priznatom patentu bili u istom broju Crnogorskog glasnika za intelektualnu svojinu, a ujedno i pojednostavili put do dodjele isprave, sve u skladu sa članom 40 Zakona o patenima ("Sl. list CG" broj 66/2008 i 40/2010).

- (51) **A61K31/445**^{2006,01} (11) **01530**
C07D401 /04²⁰⁰⁶⁰¹
- (21) P-2008-776
(22) 03. 09. 2004
(30) 60/499,723 04. 09. 2003 US
(96) EP/04783095.5/03. 09. 2004
(86) WO/PCT/US2004/028736
(87) WO 2005/023192/17. 03. 2005/en/2005/11
(97) EP 1667682/14. 06. 2006/en/2006/24
EP 1667682/02. 11. 2011/en/2011/44
- (54) me **POLIMORFNI OBLICI 3- (4-AMINO-1- OKSO-1, 3-DIHIDRO- IZOINDOL -2-IL)- PIPERIDIN-2,6- DIONA**
en POLYMORPHIC FORMS OF 3-(4-AMINO-1-OXO-1,3 DIHYDRO-ISOINDOL-2-YL)-PIPERIDINE-2,6- DIONE
- (73) CELGENE CORPORATION,86 Morris Avenue,Summit, NJ 07901, US ,
(72) CHEN, Roger, Shen-Chu,110 Christie St.,Edison, NJ 08820, US ,
MULLER, George, W.,250 Windmill Court, Bridgewater, NJ 08807, US ,
JAWORSKY, Markian, S.,57 Featherbed Lane, Hopewell, NJ 08525-1001, US ,
SAINDANE, Manohar, T., 20 Arbutus Way, Monmouth Junction, NJ 08852, US ,
CAMERON, Louise, M., 25 Keswick Rd., East Windsor, NJ 08520, US ,
(74) Stanković Mugoša Ana, Trg Republike 13, Podgorica ME
(57) Obelodanjeni (otkriveni) su polimorfni oblici 3-(4- amino-1-okso-1, 3-dihidro-izoindol-2-il)-piperidin-2, 6-diona. Takođe su obelodanjeni kompozicije (smeše) koje sadrže ove polimorfne oblike, postupci za proizvodnju ovih polimorfnih oblika i postupci za njihovu primenu.

(51) **H 01 F 4100/**^{2006 01} (11) **01451**

(21) P-2013-73

(22) 24. 06. 2013

(30) P-2013-73/01451 24. 06. 2013 ME

(54) me **TRANSFORMATOR**
en TRANSFORMER

(73) BOJOVIĆ, Milan, Njegoševa 4, Žabljak, 84220, ME

(72) BOJOVIĆ, Milan, Njegoševa 4, Žabljak, 84220, ME
SAVOVIĆ, Zoran, Đura Petrovića 25, Lovćenac, RS

(57) Novo konstruktivno rješenje Transformatora kao uređaja koji transformiše energiju iz jednog kola u drugo, posredstvom magnetne indukcije bez ikakvih pokretnih djelova. Konstrukcija se sastoji u tome: sto se tačka 1 napuni trafo uljem koje je prirodno razgradljivo, u njega se potopi tačka 3 i tačka 4, gdje su na tačku 4 nanizane i povezane tačke 3. Zatvori se tačka 1 sa tačkom 2. Na tačku 2 se pričvrste tačka 5, tačka 6, tačka 7 i to se poveže sa inicijalnim izvorom energije i čine jedan kompletan transformator.

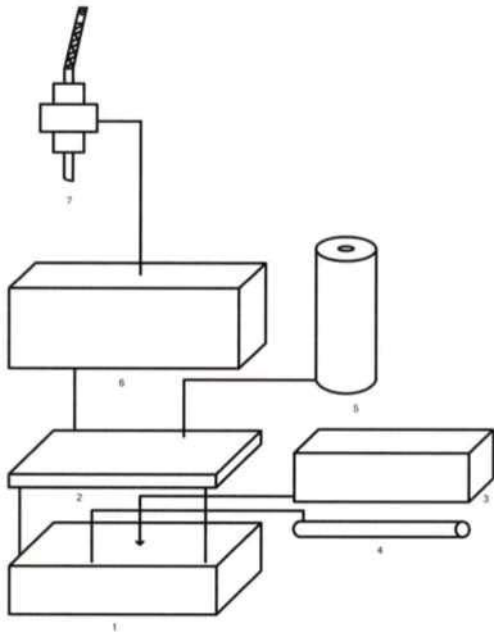

(51) **C07K 1900/**²⁰⁰⁶⁰¹
C07K 14 245/⁰⁰⁶⁰¹
C12N 15 62 /²⁰⁰⁶⁰¹
C12N 15 63 /²⁰⁰⁶⁰¹
C12N 15 31 /²⁰⁰⁶⁰¹
A61K 38 16 /²⁰⁰⁶⁰¹
A61K 39 395/²⁰⁰⁶⁰¹
A61K 35 00/²⁰⁰⁶⁰¹

(11) **01463**

(21) P-2012-78

(22) 26. 02. 2010

(30) 20091242838 17. 12. 2009 CN

(96) EP/10836940/26. 02. 2010

(86) WO/W02010CN70762

(87) WO 2011072501 /23. 06. 2011/zh/2011/25

(97) EP 2514768/24. 10. 2012/en/2012/43

(54) me **FUZIONI POLIPEPTID PROTIV TUMORA INDUKOVANOG EB VIRUSOM I MUTANT KOLICINA IA**

en FUSION POLYPEPTIDE AGAINST EB VIRUS-INDUCED TUMOR AND COLICIN IA MUTANT

(73) Protein Design Lab, Ltd., Qianshajian Sujiatuo Haidian District, Beijing 100095, CN ,

(72) QIU, Xiaoqing, HUAXI HOSPITAL OF SICHUAN UNIVERSITY, No.37 Guoxuexiang, Chengdu, Sichuan 610041, CN ,

(74) Sekulić Vuk, Bulevar Despota Stefana 1a, Beograd SR

(57) Predstavljeni pronalazak daje fuzioni polipeptid protiv tumora indukovanog EB virusom, koji sadrži antitelo ili mimetičko antitelo protiv EB virusa i količina koji formira jonske kanale koji je izabran od E1, Ia, Ib, A, B, N i njihovih mutanata. Predstavljeni pronalazak takođe daje mutant količina Ia, koji sadrži mutacije G11A, H22G, A26G, V31L i H40D. Predstavljeni pronalazak takođe daje gen, vektor, postupak za pripremu i upotrebu fuzionog polipeptida, i daje gen i upotrebu mutanta.



(51) F03D3 00/

(11) 01450

(21) P-2013-59

(22) 06. 06. 2013

(54) me **VERTIKALNA VJETRENJAČA SA POKRETNIM KRILIMA**

en VERTICAL WINDMILL WITH MOVING WINGS

(73) JOVOVIĆ, Darko, Kosić, Danilovgrad, 81410, ME

(72) JOVOVIĆ, Darko, Kosić, Danilovgrad, 81410, ME

(74) JOVOVIĆ, Darko, Kosić, Danilovgrad, 81410, ME

(57) Vertikalni vjetrogenerator sa pokretnim krilima (1) pripada mehanizmima čiji rad se bazira na kretanju vazduha - vjetru. Problem preuzimanja energije vjetra u što višem iznosu riješenje funkcionisanjem zakrivljenih pokretnih krila (3) koja, zahvaljujući obliku i oprugama otvaranja (29) i zatvaranja (30) preusmjeravaju pravac kretanja vjetra, oduzimaju mu energiju, i rotor pokreću u željenom pravcu- kontinuirano. Pri kretanju niz vjetar (12, 13, 14, 15 ,16 i 17) i onda kad se rotor kreće u vjetar (18, 19, 20 i 21).

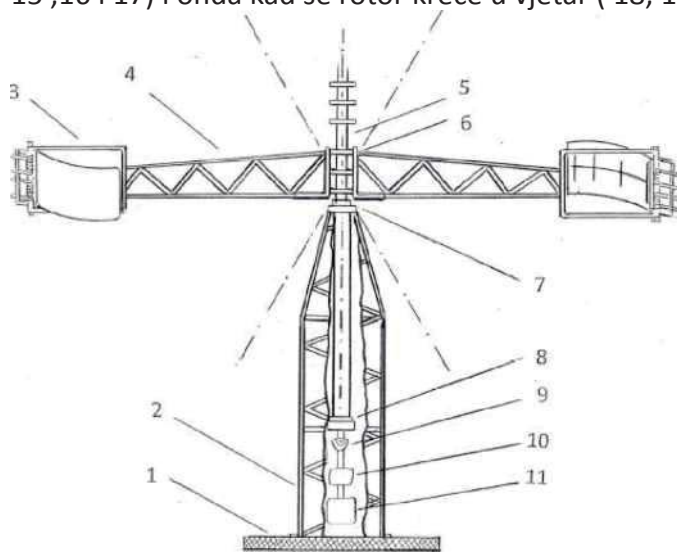

(51) **H3F1 /30** ^{2006 01}

(11) **01452**

(21) P-2013-89

(22) 31. 07. 2013

(54) me **INDUKTIVNI KOMPENZATOR ELEKTRIČNE ENERGIJE**
en INDUCTIVE COMPENSATOR

(73) BOJOVIĆ, Milan, Njegoševa 4, Žabljak, ME

(72) BOJOVIĆ, Milan, Njegoševa 4, Žabljak, ME

SAVOVIĆ, Zoran, Đura Petrovića 25, Lovćenac, Srbija, RS

(57) Konstruktivno rešenje induktivnog kompezatora ZMP-2013-73 kao uređaja, koji smanjuje potrošnju električne energije , je da posredstvom jakih magnetnih struja uz pomoć transformatora. Konstrukcija se sastoji u tome: sto se u tačka 1 napuni rashladnom tečnošću (prirodno razgradljivo ulje) u nju se potopi tačka 3. Postavi se tačka 2 i fiksira za tačku 1. Na tačku 2 montira se tačka 6, tačka 4, tačka 5 i na kraju se montira tačka 7. Sve to čini jedan komplet uređaja koji se postavlja posle mjernog mjesta na instalaciju.

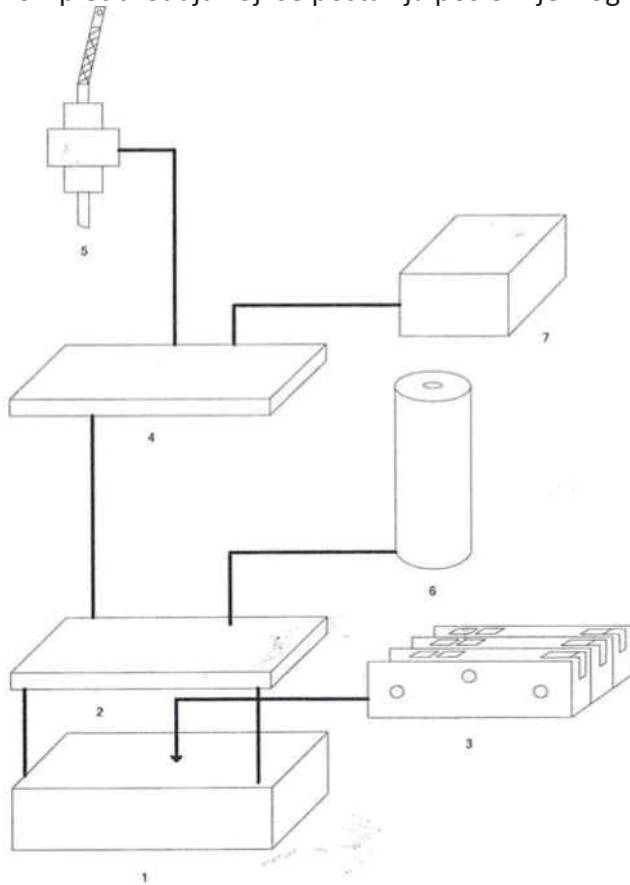

(51) **B63H 19/00**(11) **01500**

(21) P-2013-102

(22) 11. 09. 2013

(54) me **BRODOVI, JAHTE I OSTALI PLOVNI OBJEKTI NA ELEKTRO POGON**
en SHIPS , YACHTS AND ELECTRIC VESSELS

(73) BOJOVIĆ, Milan, Njegoševa 4, Žabljak, 84220, ME

(72) BOJOVIĆ, Milan, Njegoševa 4 , Žabljak, 84220, ME

SAVOVIĆ, Zoran, Đura Petrovića 25, Lovćenac, RS

ČABARKAPA, Obrad,Vojvode Stepe 403H/16, Beograd, 11000, RS

(74) BOJOVIĆ, Milan, Njegoševa 4, Žabljak, 84220, ME

(57) Novo konstruktivno rešenje iz oblasti brodogradnje pogon brodova, jahti i ostalih plovila pomoću elektromotora koji pokreće poseban autonoman sistem bez korišćenja drugih izvora energije osim inicijalne energije iz 12V baterije. Pouzdan u radu, jevtine izrade, ekološki čist bez sagorevanja goriva. Konstrukcija se sastoji u tome: što se baterija 12V tačka 7 poveže sa amperimetrom i voltimetrom jednosmjerne energije tačka 8 zatim sa tačkom 9 inverterom tačkom 10 visikonaponskim transformatorom tačkom II amperimetrom i voltimetrom naizmenične energije tačkom 12 regulatorom napona i tačkom 4 elektromotorom i postojećom instalacijom na brodu.

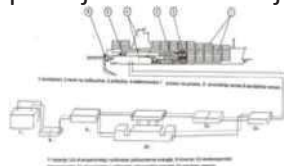

(51) **B64C 39/00/**

(11) **01501**

(21) P-2013-103

(22) 11. 09. 2013

(54) me **HELIKOPTER, BEZPILOTNE LETILICE I OSTALI VAZDUHOPLOVI NA ELEKTRIČNI POGON**

en HELICOPTERS. UNMANNED AERIAL VEHICLES AND OTHER ELECTRIC POWERED AIRCRAFTS

(73) BOJOVIĆ, Milan, Njegoševa 4, Žabljak, ME

(72) BOJOVIĆ, Milan, Njegoševa 4, Žabljak, ME

SAVOVIĆ, Zoran, Đura Petrovića 25, Lovćenc, RS

ČABARKAPA, Obrad, Vojvode Stepe 403H/16, Beograd, 11000, RS

(57) Konstrukcija sistema pokretanja helikoptera na električni pogon je novo i posebno rešenje gdje se uz pomoć i posredstvom jakih magnetnih struja dobijenih pomoću transformatora pokreće elektromotor helikoptera. Konstrukcija se sastoji tome što se Tačka 1 pogonska grupa poveže tačkom 2 glavom rotora, tačka 3 lopatice rotora tačkom 4 glavni rotor tačkom 5 elektromotorom, tačkom 6 prvi reduktor, tačkom 7 ploča sa instrumentima, tačkom 8 zglobovi lopatica, tačkom 9 repna transmisija, tačkom 10 repni reduktor, tačkom 11 repni rotor, tačkom 12 T-ZMP-2013-73, inverter i baterija 12V. Sve ovo naprijed navedeno čini jedan kompletan sistem koji ugrađen i međusobno povezan pokreće helikopter.

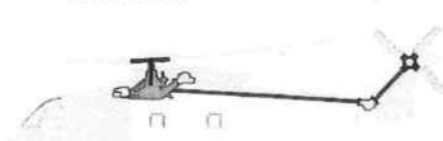
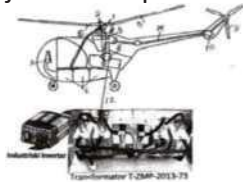

- (51) **B61L 3/00/** ²⁰¹³⁰¹ (11) **01502**
 (21) P-2013-109
 (22) 25. 09. 2013

(54) me **VOZ I DRUGA ŠINSKA VOZILA NA ELEKTRO POGON**
 en TRAIN AND OTHER ELECTRIC RAIL VEHICLES

(73) BOJOVIĆ, Milan, Njegoševa 4 , Žabljak, ME

(72) BOJOVIĆ, Milan, Njegoševa 4 , Žabljak, ME

SAVOVIĆ, Zoran, Đura Petrovića 25, Lovćenac, RS

ČABARKAPA, Obrad, Vojvode Stepe 403H/16, Beograd, 11000, RS

- (57) Konstruktivno rešenje uređaja-sistema za pokretanje elektromotora u lokomotivi za vuču voza i drugih vozila koja se kreću po šinama je rešenje gdje se posredstvom jakih magnetnih struja uz pomoć industrijskog mrežnog invertera i transformatora T-2013-73 pokrene elektromotor i obezbijedi dovoljno električne energije za potrebe lokomotive i voza. Konstrukcija se sastoji: U tome što se tačka 1 poveže tačkom 2, tačka 2 sa tačkom 3, i sve to kao cjelina sistema sa mjestom na elektromotoru koje je predviđeno za priključak izvora energije i ostalom instalacijom za jednosmjernu i naizmjeničnu električnu energiju.

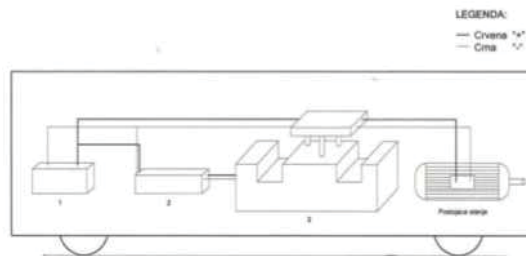

Slika 1/1

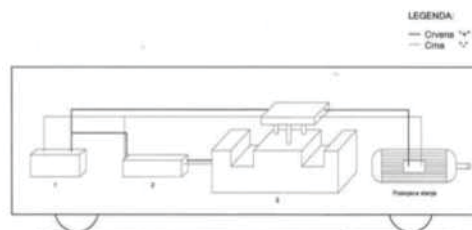

- (51) **C07D 401 /04** ^{2006.01} (11) **01571**
A61K 31 /445 ^{2006.01}
- (21) P-2012-97
(22) 03. 09. 2004
(61) 11185757.9
(62) P-2008-776
(30) 20030499723P 04. 09. 2003 US
(96) EP /11185757.9/03. 09. 2004
(86) EP/11185757.9/03. 09. 2004
(87) EP 2425836 /07. 03. 2012
(97) EP 2425836 /23. 01. 2013/en/2013/04
- (54) me **POLIMORFNI OBLICI 3-(4-AMINO-1-OKSO-1, 3-DIHIDRO-IZOINDOL-2-IL)-PIPERIDIN-2, 6-DIONA**
en POLYMORPHIC FORMS OF 3-(4-AMINO-1-OXO-1,3 DIHYDRO-ISOINDOL-2-YL)-PIPERIDINE-2,6-DIONE
- (73) Celgene Corporation, 86 Morris Avenue, Summit, NJ 07901, US
(72) Chen, Roger, Shen-Chu, 110 Christie St., Edison, NJ 08820, US
Muller, George, W., 250 Windmill Court Bridgewater NJ 08807 US ,
Jaworsky, Markian, S., 57 Featherbed Lane, Hopewell, NJ 08525-1001, US ,
Saindane, Manohar, T., 20 Arbutus Way, Monmouth Junction, NJ 08852, US
Cameron, Louise, M., 25 Keswick Rd, East Windsor, NJ 08520 US
- (74) Stanković Mugoša Ana, Trg Republike 13, Podgorica ME
- (57) Otkriveni su polimorfni oblici 3-(4-amino-1-okso-1,3- dihidroizoindol-2-il)-piperidin-2, 6-diona. Takođe su otkrivene kompozicije koje sadrže ove polimorfne oblike , postupci za proizvodnju ovih polimorfnih oblika i postupci za njihovu upotrebu.

- (51) **C07D 401 /04** ^{2006.01} (11) **01572**
(21) P-2012-98
(22) 04. 09. 2003
(61) 11185767.8
(62) P-2008-776
(30) 20030499723P 04. 09. 2003 US
(96) EP /11185767.8/03.09.2004
(86) EP/11185767.8/03. 09. 2004
(87) EP/2426118/07.03.12/
(97) EP 2426118 /07. 03. 2012/en/2012/10
(54) me **POLIMORFNI OBLICI 3-(4 -AMINO-1-OKSO- 1, 3-DIHIDRO-IZOINDOL-2- IL)- PIPERIDIN-2, 6-DIONA**
en POLYMORPHIC FORMS OF 3-(4-AMINO-1-OXO-1,3 DIHYDRO-ISOINDOL-2-YL)-PIPERIDINE-2,6-DIONE
(73) Celgene Corporation,86 Morris Avenue,Summit, NJ 07901, US
(72) Chen, Roger, Shen-Chu,110 Christie St.,Edison, NJ 08820, US
Muller, George, W.,250 Windmill Court Bridgewater NJ 08807 US ,
Jaworsky, Markian, S.,57 Featherbed Lane,Hopewell, NJ 08525-1001, US ,
Saindane, Manohar, T.,20 Arbutus Way, Monmouth Junction, NJ 08852, US
Cameron, Louise, M,25 Keswick Rd,East Windsor, NJ 08520 US
(74) Stanković Mugoša Ana, Trg Republike 13, Podgorica ME
(57) Otvoreni su polimorfni oblici 3-(4--amino-1-okso-1,3-dihidro-izoindol-2-il)-piperidin-2,6-diona. Također su otkrivene kompozicije koje sadrže ove polimorfne oblike, postupci za proizvodnju ovih polimorfnih oblika i postupci za njihovu upotrebu.

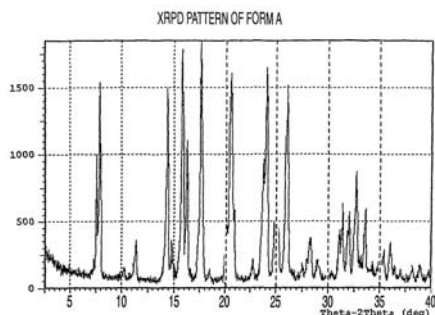

INDEKS NOSILACA PATENTA
PATENT OWNER INDEX

(73)	(51)	(21)
BOJOVIĆ, Milan	H01F 4100/ ^{2006 01}	P-2013-73
BOJOVIĆ, Milan	H3F1 /30 ^{2006 01}	P-2013-89
BOJOVIĆ, Milan	B63H 19/00	P-2013-102
BOJOVIĆ, Milan	B64C 39/00/	P-2013-103
BOJOVIĆ, Milan	B61L 3/00/ ²⁰¹³⁰¹	P-2013-109
Celgene Corporation	A61K 31/445 ^{2006,01} C07D 401 /04 ²⁰⁰⁶⁰¹	P-2008-776
Celgene Corporation	C07D 401 /04 ^{2006.01} A61K 31 /445 ^{2006.01}	P-2012-97
Celgene Corporation	C07D 401 /04 ^{2006.01}	P-2012-98
JOVOVIĆ, Darko	F03D 3 00/	P-2013-59
Protein Design Lab, Ltd.	C07K 19 00/ ²⁰⁰⁶⁰¹ C07K 14 245/ ²⁰⁰⁶⁰¹ C12N 15 62 / ²⁰⁰⁶⁰¹ C12N 15 63 / ²⁰⁰⁶⁰¹ C12N 15 31 / ²⁰⁰⁶⁰¹ A61K 38 16 / ²⁰⁰⁶⁰¹ A61K 39 395/ ²⁰⁰⁶⁰¹ A61K 35 00/ ²⁰⁰⁶⁰¹	P-2012-78

INDEKS BROJEVA PRIJAVA PATENATA
APPLICANTS NUMBER INDEX

(21)	(51)
------	------

P-2008-776 A61K31/445^{2006.01}
C07D401 /04²⁰⁰⁶⁰¹

P-2012-78 C07K 1900/²⁰⁰⁶⁰¹
C07K 14 245/²⁰⁰⁶⁰¹
C12N 15 62 /²⁰⁰⁶⁰¹
C12N 15 63 /²⁰⁰⁶⁰¹
C12N 15 31 /²⁰⁰⁶⁰¹
A61K 38 16 /²⁰⁰⁶⁰¹
A61K 39 395/²⁰⁰⁶⁰¹
A61K 35 00/²⁰⁰⁶⁰¹

P-2012-97 C07D 401 /04^{2006.01}
A61K 31 /445^{2006.01}

P-2012-98 C07D 401 /04^{2006.01}

P-2013-59 F03D 3 00/

P-2013-73 H01F 4100/^{2006 01}

P-2013-89 H3F1 /30^{2006 01}

P-2013-102 B63H 19/00

P-2013-103 B64C 39/00/

P-2013-109 B61L 3/00/²⁰¹³⁰¹

INDEKS OBJAVLJENIH PRIJAVA PATENATA PREMA MKP
INDEX OF PATENT APPLICANTS ACCORDINT TO IPC

(51)	(21)
A61K 31 /445 ^{2006.01}	P-2008-776
A61K 31 /445 ^{2006.01}	P-2012-97
A61K 35 00/ ²⁰⁰⁶⁰¹	P-2012-78
A61K 38 16 / ²⁰⁰⁶⁰¹	P-2012-78
A61K 39 395/ ²⁰⁰⁶⁰¹	P-2012-78
B61L 3/00/ ²⁰¹³⁰¹	P-2013-109
B63H 19/00	P-2013-102
B64C 39/00/	P-2013-103
C07D 401 /04 ^{2006.01}	P-2008-776
C07D 401 /04 ^{2006.01}	P-2012-97
C07D 401 /04 ^{2006.01}	P-2012-98
C07K 14 245/ ²⁰⁰⁶⁰¹	P-2012-78
C07K 19 00/ ²⁰⁰⁶⁰¹	P-2012-78
C12N 15 31 / ²⁰⁰⁶⁰¹	P-2012-78
C12N 15 62 / ²⁰⁰⁶⁰¹	P-2012-78
C12N 15 63 / ²⁰⁰⁶⁰¹	P-2012-78
F03D 3 00/	P-2013-59
H01F 4100/ ^{2006 01}	P-2013-73
H3F1 /30 ^{2006 01}	P-2013-89

OBJAVE ZAHTJEVA ZA PROŠIRENJE EVROPSKIH PRIJAVA PATENATA
PUBLICATION OF REQUEST FOR THE EXTENSION OF THE EFFECTS OF
EUROPEAN PATENT APPLICATIONS

- (51) MKP
A01N 3/02 (2006.01) (97) **2690951 ***
A01N 25/34 (2006.01)
A01N 27/00 (2006.01)
A23B 7/152 (2006.01)
A23L 3/3445 (2006.01)
C08F 2/46 (2006.01)
C08J 7/04 (2006.01)
C08K 5/01 (2006.01)
C08K 5/101 (2006.01)
C08K 5/16 (2006.01)
(86) US2011057017 20.10.2011
(96) 11785170.9 05.02.2014
(87) WO2012134539, 20.10.2011
(97) 2690951, 05.02.2014 en
(54) CYCLODEXTRIN COMPOSITIONS, ARTICLES, AND METHODS
(71) Cellresin Technologies, LLC, 4567 American Boulevard West, Minneapolis, MN 55437, US
(72) WOOD, Willard E., 3470 Siems Court, Arden Hills MN 55112, US
KUDUK, William J., 2716 Hennepin Avenue South, Apt. B1, Minneapolis MN 55408, US
KEUTE, Joseph, S., 11103 Woodhill Lane, Blaine MN 55449, US
-
- (51) MKP
A61K 38/10 (2006.01) (97) **2700648 ***
A61P 31/00 (2006.01)
C07K 1/04 (2006.01)
C07K 1/06 (2006.01)
C07K 7/08 (2006.01)
(86) CN2012000079 17.01.2012
(96) 12774269.0 26.02.2014
(87) WO2012142855, 17.01.2012
(97) 2700648, 26.02.2014 en
(54) ANTIBIOTIC PEPTIDE AND PREPARATION METHOD THEREFOR AND APPLICATION THEREOF
(71) Jiangsu Protelight Pharmaceutical & Biotechnology Co., Ltd, CHEN, Mingxia D2, 6 Dongsheng West Road, Jiangyin, Jiangsu 214437, CN
Chen, Yuxin, D2, 6 Dongsheng West Road, Jiangyin, Jiangsu 214437, CN
(72) CHEN, Yuxin, D2, 6 Dongsheng West Road, Jiangyin Jiangsu 214437, CN
CHEN, Mingxia, D2, 6 Dongsheng West Road, Jiangyin Jiangsu 214437, CN
HUANG, Yibing, D2, 6 Dongsheng West Road, Jiangyin Jiangsu 214437, CN
LI, Yang, D2, 6 Dongsheng West Road, Jiangyin Jiangsu 214437, CN
WANG, Yong, D2, 6 Dongsheng West Road, Jiangyin Jiangsu 214437, CN
QU, Lili, D2, 6 Dongsheng West Road, Jiangyin Jiangsu 214437, CN
WANG, Wenren, D2, 6 Dongsheng West Road, Jiangyin Jiangsu 214437, CN
-
- (51) MKP
C12N 7/00 (2006.01) (97) **2697368 ***
(86) US2012033684 13.04.2012
(96) 12716971.2 19.02.2014
(87) WO2012142529, 13.04.2012
(97) 2697368, 19.02.2014 en
(54) CLONAL STRAINS OF ATTENUATED VACCINIA VIRUSES AND METHODS OF USE THEREOF
(71) Genelux Corporation, 3030 Bunker Hill Road, Suite 301, San Diego, CA 92109, US
(72) SZALAY, Aladar, A., 7704 North Fork Road, Highland, CA 92364, US
CHEN, Nanhai, George, 9167 Buckwheat Street, San Diego, CA 92129, US
YU, Yong, A., 3830 Elijah Court, Unit 422, San Diego, CA 92130, US
ZHANG, Qian, 5573 Willowmere Ln., San Diego, CA 92130, US
-
- (51) MKP
G06F 1/32 (2006.01) (97) **2673712 ***
G06F 11/30 (2006.01)
H04L 12/24 (2006.01)
H05K 7/14 (2006.01)
(86) US2012024405 09.02.2012
(96) 12705553.1 18.12.2013
(87) WO2012109401, 09.02.2012
(97) 2673712, 18.12.2013 en
(54) INFRASTRUCTURE CONTROL FABRIC SYSTEM AND METHOD
(71) Avocent Huntsville Corporation, 4991 Corporate Drive, Huntsville, Alabama 35805-5906, US
(72) ZIMMERMANN, Arnaldo, 1024 Avila Terraza, Fremont, California 94538, US
WAKIZAKA, Fanny, 3553 Madison Cmn, Fremont, California 94538, US
PECCIN, Marcelo E., 488 Corinthia Drive, Milpitas, California 95035, US
KALLEY, Vibhor, 1326 The Alameda Apt. 367, San Jose, California 95126, US
GEFFIN, Steven, 19430 NE 21st Court, Miami, Florida 33179, US
KHUTI, Bharat A., 601 Madison Park Drive, Madison, Alabama 35758, US
NICHOLSON, Sean, 6 Metcalf Road, Mendon, Massachusetts 01756, US
-
- (51) MKP
A01N 43/56 (2006.01) (97) **2663189 ***
(86) US2012020863 11.01.2012
(96) 12733916.6 20.11.2013
(87) WO2012097021, 11.01.2012
(97) 2663189, 20.11.2013 en
(54) COMBINATION
(71) GlaxoSmithKline LLC, One Franklin Plaza 200 North 16th Street, Philadelphia, PA 19102, US
(72) KUMAR, Rakesh, 1250 South Collegeville Road, Collegeville PA 19426, US
-

- (51) MKP
C07K 1/18 (2006.01) (97) **2681231 ***
C07K 14/47 (2006.01)
C07K 14/52 (2006.01)
- (86) EP2012053749 05.03.2012
(96) 12707103.3 08.01.2014
(87) WO2012117120, 05.03.2012
(97) 2681231, 08.01.2014 en
(54) METHOD FOR ISOLATING OSTEOPOINTIN USING CONCENTRATED FEEDS
- (71) Arla Foods Amba, Sønderhøj 14, 8260 Viby J, DK
(72) BERTELSEN, Hans, Chr. Aagaardsvej 8, DK-6920 Videbæk, DK
WEJSE, Peter Langborg, Fridtjof Nansens Vej 25, DK-8200 Aarhus N, DK
TRÚGVASON, Trine, Kirkegade 49, DK-6940 Lem St., DK
-
- (51) MKP
A61K 9/00 (2006.01) (97) **2696848 ***
A61K 9/14 (2006.01)
A61K 9/19 (2006.01)
- (86) EP2012056818 13.04.2012
(96) 12713187.8 19.02.2014
(87) WO2012140220, 13.04.2012
(97) 2696848, 19.02.2014 en
(54) FREEZE DRIED DRUG NANOSUSPENSIONS
- (71) Janssen Pharmaceutica N.V., Turnhoutseweg 30, 2340 Beerse, BE
(72) INGHELBRECHT, Sabine Karine Katrien, c/o Janssen Pharmaceutica NV Turnhoutseweg 30, B-2340 Beerse, BE
GIESELER, Henning, c/o Friedrich-Alexander-Universitaet Erlangen-Nuernberg Schlossplatz 4, 91054 Erlangen, DE
BEIROWSKI, Jakob Andreas, Wilhelmstrasse 13, 91054 Erlangen, DE
-
- (51) MKP
E01F 7/04 (2006.01) (97) **2652202 ***
- (86) AT2011000494 13.12.2011
(96) 11813520.1 23.10.2013
(87) WO2012079102, 13.12.2011
(97) 2652202, 23.10.2013 de
(54) DEVICE FOR BREAKING UP SNOW CORNICES AND/OR TRIGGERING AVALANCHES
- (71) STRACKE, Markus, Himmelpfortgasse 11, 1010 Wien, AT
Maculan, Alexander, Annagasse 6, 1010 Wien, AT
Stracke, Matthias, Hauptstrasse 36, 3411 Klosterneuburg-Weidling, AT
(72) STRACKE, Markus, Himmelpfortgasse 11, 1010 Wien, AT
Maculan, Alexander, Annagasse 6, 1010 Wien, AT
Stracke, Matthias, Hauptstrasse 36, 3411 Klosterneuburg-Weidling, AT
-
- (51) MKP
A61K 36/06 (2006.01) (97) **2672991 ***
A61K 39/29 (2006.01)
C07K 14/02 (2006.01)
- (86) US2012024409 09.02.2012
(96) 12744328.1 18.12.2013
(87) WO2012109404, 09.02.2012
(97) 2672991, 18.12.2013 en
(54) YEAST-BASED THERAPEUTIC FOR CHRONIC HEPATITIS B INFECTION
- (71) Globeimmune, Inc., 1450 Infinite Drive, Louisville, CO 80027, US
(72) APELIAN, David, 3 Old Beach Glen Road, Boonton Township, NJ 07005, US
KING, Thomas, H., 4105 Perry Street, Denver, CO 80212, US
GUO, Zhimin, 3130 Huron Peak Avenue, Superior, CO 80027, US
COESHOTT, Claire, 875 South Josephine Street, Denver, CO 80209, US
-
- (51) MKP
B65D 5/42 (2006.01) (97) **2675715 ***
B65D 5/46 (2006.01)
- (86) US2012025147 15.02.2012
(96) 12706386.5 25.12.2013
(87) WO2012112631, 15.02.2012
(97) 2675715, 25.12.2013 en
(54) MEDICAL PRODUCT PACKAGE
- (71) Sanofi-Aventis U.S. LLC, 55 Corporate Drive, Bridgewater, NJ 08835, US
(72) LIMBACK, Nancy Gail, 1608 Centenary Court, Valley Park, Missouri 63088, US
-
- (51) MKP
C07K 16/22 (2006.01) (97) **2662388 ***
- (86) CU2011000009 26.12.2011
(96) 11820879.2 13.11.2013
(87) WO2012089176, 26.12.2011
(97) 2662388, 13.11.2013 en
(54) RECOMBINANT ANTIBODIES TO THE VASCULAR ENDOTHELIAL GROWTH FACTOR (VEGF) WHICH ARE OBTAINED BY MEANS OF MUTAGENESIS OF VARIABLE REGIONS
- (71) Centro De Ingenieria Genetica Y Biotecnologia, Avenida 31 entre 158 y 190 Playa, La Habana 11600, CU
Biorec S.A., Cerrito 532 - Oficina 802, Montevideo 11.000, UY
LAMBDAN ORDAS, Humberto, Calle 148, No. 24707, entre 247 y 249 Bauta, Artemisa 32400, CU
GAVILONDO COWLEY, Jorge, Víctor, Calle G, No. 460, entre 19 y 21, Apto. 11 Vedado Plaza, La Habana 10 400, CU
AYALA AVILA, Marta, Calle 186, No. 3117, Apto 3D, entre 31 y 33 Playa, La Habana 11 600, CU
MUÑOZ POZO, Yasmiana, Ave. 57 No. 5004, entre 50 y 52 Playa, La Habana 11 400, CU
PUPO MERIÑO, Amaury, Calle 1ra, S/N, entre 156A y 158 Playa, La Habana 11 300, CU
ROJAS DORANTES, Gertrudis, Santa Irene, No. 164 (altos) entre Flores y San Benigno Santos Suárez, La Habana 10500, CU
PÉREZ SÁNCHEZ, Lincidio, Cárcel No. 165 bajos entre Prado y San Lázaro Centro Habana, La Habana 10200, CU
-
- (51) MKP
A61K 31/255 (2006.01) (97) **2686298 ***
A61K 31/37 (2006.01)
A61K 31/655 (2006.01)
A61P 35/00 (2006.01)
C07C 305/24 (2006.01)
C07C 307/02 (2006.01)
C07D 311/12 (2006.01)
- (86) DE2012000258 12.03.2012
(96) 12724856.5 22.01.2014
(87) WO2012122969, 12.03.2012
(97) 2686298, 22.01.2014 de
(54) SUBSTITUTED DIPHENYL DERIVATIVES
- (71) Creative Therapeutics GmbH, Am Rohm 86, 42113 Wuppertal, DE
(72) FÖRSTER, Heinz, Römerstrasse 38, 56337 Kadenbach, DE
-
- (51) MKP
F16L 53/00 (2006.01) (97) **2694859 ***
- (86) EP2012056326 05.04.2012
(96) 12715898.8 12.02.2014
(87) WO2012136789, 05.04.2012
(97) 2694859, 12.02.2014 en
(54) CONNECTOR ELEMENT
- (71) Delphi Technologies Holding S.a.r.l., Avenue de Luxembourg, 4940 Bascharage, LU
(72) WRIGHT, Keith, 6 Kinross Close Walderslade, Chatham Kent ME5 7RS, GB
GRUMBRECHT, Frank, 4 Teal Drive, Chatham Kent ME4 3FA, GB

(51) MKP
A61K 38/20 (2006.01) (97) **2672986 ***
A61K 47/48 (2006.01)
(86) US2012024452 09.02.2012
(96) 12744782.9 18.12.2013
(87) WO2012109429, 09.02.2012
(97) 2672986, 18.12.2013 en
(54) LYOPHILIZED FORMULATIONS
(71) GlaxoSmithKline LLC, One Franklin Plaza 200 North 16th Street, Philadelphia, PA 19102, US
(72) KRANZ, James, 709 Swedeland Road, King Of Prussia, PA 19406, US
RINELLA, Joseph, 709 Swedeland Road, King Of Prussia, PA 19406, US

(51) MKP
A61K 31/4412 (2006.01) (97) **2697199 ***
A61K 31/444 (2006.01)
A61P 35/00 (2006.01)
C07D 213/64 (2006.01)
C07D 401/12 (2006.01)
C07D 405/12 (2006.01)
C07D 409/12 (2006.01)
C07D 413/12 (2006.01)
C07D 417/12 (2006.01)
C07D 491/08 (2006.01)
C07D 491/107 (2006.01)
(86) US2012033648 13.04.2012
(96) 12719529.5 19.02.2014
(87) WO2012142504, 13.04.2012
(97) 2697199, 19.02.2014 en
(54) ARYL-OR HETEROARYL-SUBSTITUTED BENZENE COMPOUNDS
(71) Epizyme, Inc., 400 Technology Square, 4th Floor, Cambridge, MA 02139, US
(72) KUNTZ, Kevin, Wayne, 8 New Village Road, Woburn MA 01801, US
CHESWORTH, Richard, 584 Strawberry Hill Road, Concord MA 01742, US
DUNCAN, Kenneth, William, 132 Roosevelt Avenue, Norwood MA 02062, US
KEILHACK, Heike, 3 Falmouth Street, Belmont MA 02478, US
WARHOLIC, Natalie, 81 Strathmore Road Apartment 32, Brighton MA 02135, US
KLAUS, Christine, 29 Weyham Road, Weymouth MA 02191, US
SEKI, Masashi, Tsukuba Research Laboratories Eisai Co. Ltd. 5-1-3 Tokodai, Tsukubashi Ibaraki 300-2635, JP
SHIROTORI, Syuji, Tsukuba Research Laboratories Eisai Co. Ltd. 5-1-3 Tokodai, Tsukubashi Ibaraki 300-2635, JP
KAWANO, Satoshi, Tsukuba Research Laboratories Eisai Co. Ltd. 5-1-3 Tokodai, Tsukubashi Ibaraki 300-2635, JP
WIGLE, Timothy James Nelson, 111 Marivista Avenue, Waltham, MA 02451, US

(51) MKP
A24B 13/00 (2006.01) (97) **2649888**
A24B 15/30 (2006.01)
(96) 12163576.7 16.10.2013
(97) 2649888, 16.10.2013 en
(54) A smokeless tobacco composition comprising non-tobacco fibers and a method for its manufacture.
(71) Swedish Match North Europe AB, null, 118 85 Stockholm, SE
(72) Sjögren, Martin, Melongatan 167, 426 56 Västra Frölunda, SE
Hassler, Thord, Nedre Långvinkelsgatan 8A, 252 20 Helsingborg, SE
Lundin, Jörgen, Dragonvägen 26, 194 33 Upplands-Väsby, SE
Börjesson, Bengt, Krokängsvägen 150, 449 40 Nol, SE

(51) MKP
A61K 31/4184 (2006.01) (97) **2683377 ***
A61K 31/4439 (2006.01)
A61K 31/52 (2006.01)
A61K 39/00 (2006.01)
A61K 45/06 (2006.01)
A61P 35/00 (2006.01)
A61P 35/02 (2006.01)
(86) US2012028654 09.03.2012
(96) 12710838.9 15.01.2014
(87) WO2012125510, 09.03.2012
(97) 2683377, 15.01.2014 en
(54) COMBINATION THERAPIES FOR HEMATOLOGIC MALIGNANCIES
(71) Gilead Calistoga LLC, Gilead Sciences, Inc. 333 Lakeside Drive, Foster City, CA 94404, US
(72) GALLATIN, Michael, c/o Gilead Sciences, Inc. 333 Lakeside Drive, Foster City, CA 94404, US
ULRICH, Roger, G., c/o Gilead Sciences, Inc. 333 Lakeside Drive, Foster City, CA 94404, US
GIESE, Neill, A., c/o Gilead Sciences, Inc. 333 Lakeside Drive, Foster City, CA 94404, US
LANNUTTI, Brian, c/o Gilead Sciences, Inc. 333 Lakeside Drive, Foster City, CA 94404, US
YU, Albert, c/o Gilead Sciences, Inc. 333 Lakeside Drive, Foster City, CA 94404, US
MILLER, Langdon, c/o Gilead Sciences, Inc. 333 Lakeside Drive, Foster City, CA 94404, US
JAHN, Thomas, M., c/o Gilead Sciences, Inc. 333 Lakeside Drive, Foster City, CA 94404, US

(51) MKP
C09C 1/02 (2006.01) (97) **2684916**
D21H 17/00 (2006.01)
(96) 12176320.5 15.01.2014
(97) 2684916, 15.01.2014 en
(54) Surface modified calcium carbonate containing minerals and its use
(71) Omya International AG, Baslerstrasse 42, 4665 Oftringen, CH
Gerard, Daniel Edward, Rheinfelderstrasse 12, 4058 Basel, CH
Schölkopf, Joachim, Buechbühlstrasse 3, 8956 Killwangen, CH
Gane, Patrick Arthur Charles, Studenweg 8, 4852 Rothrist, CH
Lehner, Fritz, Kilchbergstrasse 5, 4800 Zofingen, CH
Werner, Dennis, Mühletalweg 18, 4600 Olten, CH

(51) MKP
G01N 33/574 (2006.01) (97) **2656077 ***
(86) US2011066624 21.12.2011
(96) 11805738.9 30.10.2013
(87) WO2012088337, 21.12.2011
(97) 2656077, 30.10.2013 en
(54) DRUG SELECTION FOR MALIGNANT CANCER THERAPY USING ANTIBODY-BASED ARRAYS
(71) Nestec S.A., Avenue Nestlé 55, 1800 Vevey, CH
(72) SINGH, Sharat, 8171 Top of the Morning Way, Rancho Santa Fe, California 92127, US
HOE, Nicholas, 9072 Renato Street, San Diego, California 92129, US
PRINCEN, Fred, 610 Kirkwood Place, La Jolla, California 92037, US
LIU, Xinjun, 12890 Caminito Diego, San Diego, California 92130, US

- (51) MKP
A61K 31/295 (2006.01) (97) **2666764 ***
A61P 3/12 (2006.01)
C07C 51/41 (2006.01)
C07C 59/265 (2006.01)
- (86) JP2012050885 18.01.2012
(96) 12736578.1 27.11.2013
(87) WO2012099139, 18.01.2012
(97) 2666764, 27.11.2013 en
(54) FERRIC CITRATE CONTAINING SUBSTANTIALLY NO -OXIDIZED IRON HYDROXIDE
- (71) Japan Tobacco, Inc., 2-1, Toranomom 2-chome Minato-ku, Tokyo 105-8422, JP
(72) ANDO Koji, c/o Central Pharmaceutical Research Institute Japan Tobacco Inc. 1-1 Murasaki-cho, Takatsuki-shi Osaka 569-1125, JP
MANTA Naoki, c/o Central Pharmaceutical Research Institute Japan Tobacco Inc. 1-1 Murasaki-cho, Takatsuki-shi Osaka 569-1125, JP
-
- (51) MKP
A23L 1/30 (2006.01) (97) **2674162**
A61K 35/74 (2006.01)
A61L 29/08 (2006.01)
A61L 29/16 (2006.01)
A61P 1/00 (2006.01)
A61P 19/06 (2006.01)
A61P 31/04 (2006.01)
C12R 1/225 (2006.01)
- (96) 13460042.8 18.12.2013
(97) 2674162, 18.12.2013 en
(54) NANOPRODUCT COMPRISING LACTOBACILLUS REUTERI DAN080 USEFUL IN PROPHYLAXIS AND MEDICINE, BOTH HUMAN AND VETERINARY AND MEDICAL USE OF THE SAME
- (71) Kruszewska, Danuta, Al. Wilanowska 43 m 5, 02-765 Warszawa, PL
(72) Kruszewska, Danuta, Al. Wilanowska 43 m 5, 02-765 Warszawa, PL
-
- (51) MKP
A61K 31/437 (2006.01) (97) **2651933 ***
A61P 31/12 (2006.01)
C07D 471/04 (2006.01)
- (86) EP2011073014 16.12.2011
(96) 11794794.5 23.10.2013
(87) WO2012080449, 16.12.2011
(97) 2651933, 23.10.2013 en
(54) AZABENZIMIDAZOLES AS RESPIRATORY SYNCYTIAL VIRUS ANTIVIRAL AGENTS
- (71) Janssen R&D Ireland, Eastgate Village, Eastgate, Little Island, County Cork, IE
(72) COOYMANS, Ludwig Paul, Grote Beekstraat 24, B-2340 Beerse, BE
DEMIN, Samuël Dominique, Professor Claraplein 14, Bus 308, B-2018 Antwerpen, BE
HU, Lili, Vrouw van Mechelenstraat 28, B-2800 Mechelen, BE
JONCKERS, Tim Hugo Maria, Pastoor Wouterstraat 19, bus 5, B-2650 Edegem, BE
RABOISSON, Pierre Jean-Marie Bernard, Rue Jolie 3, B-1331 Rosieres, BE
TAHRI, Abdellah, Rue Maurice Albert Raskin 30, B-1070 Anderlecht, BE
VENDEVILLE, Sandrine Marie Helene, Rue du Bémel 142, B-1150 Woluwe-Saint-Pierre, BE
-
- (51) MKP
A61K 9/20 (2006.01) (97) **2694038 ***
A61K 9/50 (2006.01)
A61K 31/198 (2006.01)
A61K 47/48 (2006.01)
- (86) EP2012056366 05.04.2012
(96) 12713721.4 12.02.2014
(87) WO2012136816, 05.04.2012
(97) 2694038, 12.02.2014 en
(54) PHARMACEUTICAL COMPOSITION
- (71) Sovic Brkicic, Ljiljana, Kralja Zvonimira 82, 10000 Zagreb, HR
Brkicic, Cvjetko, Kralja Zvonimira 82, 10000 Zagreb, HR
(72) DOKUZOVIC, Zdravko, Zelengaj 27a, 10000 Zagreb, HR
-
- (51) MKP
A61K 39/02 (2006.01) (97) **2697385 ***
C07K 14/195 (2006.01)
C07K 14/34 (2006.01)
C12P 21/00 (2006.01)
- (86) EP2012056728 12.04.2012
(96) 12713175.3 19.02.2014
(87) WO2012140171, 12.04.2012
(97) 2697385, 19.02.2014 en
(54) FERMENTATION PROCESS
- (71) GlaxoSmithKline Biologicals S.A., rue de l'Institut, 89, 1330 Rixensart, BE
(72) DEHOTTAY, Philippe, Marc, Helene, GlaxoSmithKline Biologicals S.A. Rue de l'Institut 89, B-1330 Rixensart, BE
GOFFIN, Philippe, GlaxoSmithKline Biologicals S.A. Rue de l'Institut 89, B-1330 Rixensart, BE
-
- (51) MKP
A61K 31/44 (2006.01) (97) **2648729 ***
A61K 31/498 (2006.01)
A61K 31/519 (2006.01)
A61P 35/00 (2006.01)
- (86) US2011063871 08.12.2011
(96) 11806025.0 16.10.2013
(87) WO2012078832, 08.12.2011
(97) 2648729, 16.10.2013 en
(54) COMPOSITIONS COMPRISING A PI3K INHIBITOR AND A MEK INHIBITOR AND THEIR USE FOR TREATING CANCER
- (71) SANOFI, 54, rue de la Boétie, 75008 Paris, FR
Merck Patent GmbH, Frankfurter Strasse 250, 64293 Darmstadt, DE
(72) DEBUSSCHE, Laurent, c/o Sanofi 174 avenue de France, F-75013 Paris, FR
GARCIA-ESCHEVERRIA, Carlos, c/o Sanofi 174 avenue de France, F-75013 Paris, FR
MA, Jianguo, c/o Merck Patent GmbH Frankfurterstrasse 250, 64293 Darmstadt, DE
MCMILLAN, Stuart, c/o Merck Patent GmbH Frankfurterstrasse 250, 64293 Darmstadt, DE
OGDEN, Janet Anne Meurer, c/o Merck Patent GmbH Frankfurterstrasse 250, 64293 Darmstadt, DE
VINCENT, Loic, c/o Sanofi 174 avenue de France, F-75013 Paris, FR
-
- (51) MKP
B63B 35/32 (2006.01) (97) **2675697 ***
E02B 15/04 (2006.01)
- (86) IB2012050687 15.02.2012
(96) 12711240.7 25.12.2013
(87) WO2012110962, 15.02.2012
(97) 2675697, 25.12.2013 en
(54) DEVICE AND METHOD FOR RECOVERING SOLID AND/OR LIQUID SUBSTANCES FLOATING IN A LIQUID MASS
- (71) Perrella, Luigi, Sistiana 12/R -2, 34011 Duino Aurisina, IT
(72) Perrella, Luigi, Sistiana 12/R -2, 34011 Duino Aurisina, IT
-
- (51) MKP
C02F 1/32 (2006.01) (97) **2692694 ***
C02F 1/36 (2006.01)
- (86) RU2012000221 27.03.2012
(96) 12765347.5 05.02.2014
(87) WO2012134350, 27.03.2012
(97) 2692694, 05.02.2014 en
(54) DEVICE FOR REMOVING ORGANIC AND CHEMICAL MICROBIC POLLUTANTS FROM WATER
- (71) Obshchestvo S Ogranichennoy Otvetstvennostyu «Plazma-Pro», Ul. B. Sadovaya 239-616, Saratov 410005, RU
(72) BARKHUDAROV, Eduard Mikhaylovich, Universitetskij pr. 5-24, Moscow 117296, RU
TAKTAKISHVILI, Merab Ivanovich, ul. Donskaya 21-2-20, Moscow 119049, RU
ANPILOV, Andrey Mitrofanovich, ul. Ivana Babushkina 20-5, Moscow 117292, RU
KOSSYJ, Igor Antonovich, Leninskiy pr. 52-361, Moscow 119333, RU

(51) MKP
A61K 31/4196 (2006.01) (97) **2678013 ***
A61P 35/00 (2006.01)
(86) US2012026101 22.02.2012
(96) 12707012.6 01.01.2014
(87) WO2012116061, 22.02.2012
(97) 2678013, 01.01.2014 en
(54) COMBINATION THERAPY OF HSP90 INHIBITORY
COMPOUNDS WITH RADIOTHERAPY
(71) Synta Pharmaceuticals Corp., 45 Hartwell Avenue, Lexington,
MA 02421, US
(72) FOLEY, Kevin, P., 4402 Merchant Square Place, Landsdale,
PA 19446, US
PROIA, David, 30 Silver Lake Avenue, Newton, MA 02458, US

(51) MKP
A61K 31/4706 (2006.01) (97) **2699550 ***
A61K 31/4709 (2006.01)
A61P 29/00 (2006.01)
A61P 35/00 (2006.01)
C07D 215/42 (2006.01)
C07D 215/44 (2006.01)
C07D 401/12 (2006.01)
(86) EP2012057111 19.04.2012
(96) 12716378.0 26.02.2014
(87) WO2012143413, 19.04.2012
(97) 2699550, 26.02.2014 en
(54) TETRAHYDROQUINOLINE DERIVATIVES USEFUL AS
BROMODOMAIN INHIBITORS
(71) Glaxosmithkline LLC, One Franklin Plaza 200 North 16th
Street, Philadelphia, PA 19102, US
(72) AMANS, Dominique, GlaxoSmithKline Gunnels Wood Road,
Stevenage Hertfordshire SG1 2NY, GB
DEMONT, Emmanuel Hubert, GlaxoSmithKline Gunnels Wood
Road, Stevenage Hertfordshire SG1 2NY, GB
MITCHELL, Darren Jason, GlaxoSmithKline Gunnels Wood
Road, Stevenage Hertfordshire SG1 2NY, GB
WATSON, Robert J, GlaxoSmithKline Gunnels Wood Road,
Stevenage Hertfordshire SG1 2NY, GB

(51) MKP
A61K 31/4155 (2006.01) (97) **2680831 ***
A61P 9/14 (2006.01)
A61K 31/41 (2006.01)
A61K 31/616 (2006.01)
A61K 31/405 (2006.01)
A61K 31/505 (2006.01)
A61K 31/366 (2006.01)
A61K 31/44 (2006.01)
A61K 31/4015 (2006.01)
A61K 31/47 (2006.01)
A61K 31/416 (2006.01)
A61K 31/122 (2006.01)
A61K 31/422 (2006.01)
A61K 31/415 (2006.01)
A61P 9/10 (2006.01)
(86) EP2012053378 28.02.2012
(96) 12706831.0 08.01.2014
(87) WO2012116996, 28.02.2012
(97) 2680831, 08.01.2014 en
(54) TREATMENT OF ARTERIAL AGEING BY RAAS INHIBITOR
(71) Farmicom Pharmaceutical Company D.O.O., Obrtna Cona
Logatec 30, 1370 Logatec, SI
(72) SABOVIC, Miso, Ulica Bratov Ucakar 46, 1000 Ljubljana, SI

(51) MKP
A61B 17/072 (2006.01) (97) **2517648**
(96) 12166191.2 31.10.2012
(97) 2517648, 31.10.2012 en
(54) Staple cartridge comprising a releasable portion
(71) Ethicon Endo-Surgery, Inc., 4545 Creek Road, Cincinnati, OH
45242, US
(72) Shelton, IV, Frederick E., 245 East Main Street, Hillsboro, OH
Ohio 45133, US
Baxter, III, Chester O., 6375 Pawnee Ridge, Loveland, OH
Ohio 45140, US
Aronhalt, Taylor W., 306 Beech Road, Loveland, OH Ohio
45140, US
Morgan, Jerome R., 3275 S. Whitetree Circle, Cincinnati, OH
Ohio 45236, US
Young, Joseph E., 9523 Carroll Court, Loveland, OH Ohio
45140, US

(51) MKP
A61K 31/519 (2006.01) (97) **2681215 ***
A61P 35/00 (2006.01)
C07D 471/04 (2006.01)
(86) US2012027009 28.02.2012
(96) 12709429.0 08.01.2014
(87) WO2012118850, 28.02.2012
(97) 2681215, 08.01.2014 en
(54) SERINE/THREONINE KINASE INHIBITORS
(71) Array Biopharma, Inc., 3200 Walnut Street, Boulder, CO
80301, US
Genentech, Inc., 1 DNA Way, South San Francisco CA 94080-
4990, US
(72) BLAKE, James F., 3200 Walnut Street, Boulder, Colorado
80301, US
CHEN, Huifen, 1 DNA Way, South San Francisco, Colorado
94080-4990, US
CHICARELLI, Mark Joseph, 3200 Walnut Street, Boulder,
Colorado 80301, US
DEMEESE, Jason, 3200 Walnut Street, Boulder, Colorado
80301, US
GARREY, Rustam, 3200 Walnut Street, Boulder, Colorado
80301, US
GAUDINO, John J., 3200 Walnut Street, Boulder, Colorado
80301, US
KAUS, Robert J., 3200 Walnut Street, Boulder, Colorado
80301, US
KOLAKOWSKI, Gabrielle R., 3200 Walnut Street, Boulder,
Colorado 80301, US
MARLOW, Allison L., 3200 Walnut Street, Boulder, Colorado
80301, US
MOHR, Peter J., 3200 Walnut Street, Boulder, Colorado
80301, US
REN, Li, 3200 Walnut Street, Boulder, Colorado 80301, US
SCHWARZ, Jacob, 1 DNA Way, South San Francisco,
California 94080-4990, US
SIEDEM, Christopher S., 3200 Walnut Street, Boulder,
Colorado 80301, US
THOMAS, Allen A., 3200 Walnut Street, Boulder, Colorado
80301, US
WALLACE, Eli, 3200 Walnut Street, Boulder, Colorado 80301,
US
WENGLOWSKY, Steven Mark, 3055 O'Neal Parkway, Boulder,
Colorado 80301, US

(51) MKP
C07D 487/18 (2006.01) (97) **2695883 ***
(86) RU2012000239 02.04.2012
(96) 12768097.3 12.02.2014
(87) WO2012138255, 02.04.2012
(97) 2695883, 12.02.2014 en
(54) TRICYCLIC DERIVATIVES OF N,N'-SUBSTITUTED
3,7-DIAZABICYCLO [3.3.1]NONANES AND DRUGS BASED
THEREON
(71) Zapolsky, Maxim Eduardovich, ul. Serafimovicha 6 Tomilino,
Moskovskaya obl. 140073, RU
(72) ZEFIROV, Nikolai Serafimovich, Leninsky Pr-t 99-553, Moscow
117421, RU
PALYULIN, Vladimir Alexandrovich, Pr. Vernadskogo 9/10-17,
Moscow 119311, RU
LAVROV, Mstislav Igorevich, Ul. Serpuhovskaya 36-8, Moscow
115093, RU

- (51) MKP
A61K 31/4166 (2006.01) (97) **2685989 ***
A61K 31/7088 (2006.01)
A61P 5/28 (2006.01)
A61P 35/00 (2006.01)
- (86) IB2012000609 14.03.2012
(96) 12757052.1 22.01.2014
(87) WO2012123820, 14.03.2012
(97) 2685989, 22.01.2014 en
- (54) COMBINATION OF ANTI-CLUSTERIN OLIGONUCLEOTIDE WITH ANDROGEN RECEPTOR ANTAGONIST FOR THE TREATMENT OF PROSTATE CANCER
- (71) The University of British Columbia, University - Industry Liaison Office 103 - 6190 Agronomy Road, Vancouver, BC V6T 1Z3, CA
- (72) GLEAVE, Martin, E., 4693 Drummond Drive, Vancouver, BC V6R 1E8, CA
ZOUBEIDI, Amina, 6331 Imperial Avenue, West Vancouver, British Columbia V7W 2J5, CA

- (51) MKP
A61K 31/435 (2006.01) (97) **2694160 ***
A61P 31/18 (2006.01)
C07D 491/06 (2006.01)
- (86) US2012032026 03.04.2012
(96) 12715787.3 12.02.2014
(87) WO2012138669, 03.04.2012
(97) 2694160, 12.02.2014 en
- (54) SOLID STATE FORMS OF HIV INHIBITOR
- (71) Gilead Sciences, Inc., 333 Lakeside Drive, Foster City, CA 94404, US
- (72) LI, Zheng, Jane, 900 Ridgebury Road, Ridgefield CT 06877-0368, US
LI, Zhibin, 900 Ridgebury Road, Ridgefield CT 06877-0368, US
LUO, Laibin, 900 Ridgebury Road, Ridgefield CT 06877-0368, US
OFFERDAHL, Thomas, 900 Ridgebury Road, Ridgefield CT 06877-0368, US
KIM, Soojin, 900 Ridgebury Road, Ridgefield CT 06877-0368, US
YANG, Bing-shiou, 900 Ridgebury Road, Ridgefield CT 06877-0368, US

- (51) MKP
A61K 31/4985 (2006.01) (97) **2694067 ***
A61K 31/5377 (2006.01)
A61P 35/00 (2006.01)
A61P 43/00 (2006.01)
C07D 471/04 (2006.01)
- (86) EP2012056138 04.04.2012
(96) 12713705.7 12.02.2014
(87) WO2012136691, 04.04.2012
(97) 2694067, 12.02.2014 en
- (54) PYRIDOPYRAZINE DERIVATIVES AND THEIR USE
- (71) Æterna Zentaris GmbH, Weismüllerstraße 50, 60314 Frankfurt am Main, DE
- (72) GERLACH, Matthias, Pfarrgasse 1, 63636 Brachtal, DE
SEIPELT, Irene, Hermannstrasse 5, 63069 Offenbach, DE
BLUMENSTEIN, Lars, Erich-Kästner-Strasse 11, 60388 Frankfurt am Main, DE
MUELLER, Gilbert, Bischofsweg 1A, 60598 Frankfurt am Main, DE
GÜNTHER, Eckhard, Wingertstraße 176, 63477 Maintal, DE
SCHUSTER, Tilmann, Valentin-Hock-Str. 32, 63762 Großostheim, DE
TEIFEL, Michael, Franz-Seliger-Straße 15, 64331 Weiterstadt, DE

- (51) MKP
A61K 31/519 (2006.01) (97) **2513105 ***
A61P 25/00 (2006.01)
C07D 471/04 (2006.01)
C07D 487/04 (2006.01)
- (86) DK2010050343 15.12.2010
(96) 10797990.8 24.10.2012
(87) WO2011072696, 15.12.2010
(97) 2513105, 24.10.2012 en
- (54) 2-ARYLIMIDAZOLE DERIVATIVES AS PDE10A ENZYME INHIBITORS
- (71) H. Lundbeck A/S, Ottiliavej 9, 2500 Valby, DK
PÜSCHL, Ask, Harsdorffsvej 7A 4.tv., DK-1874 Frederiksberg C, DK
NIELSEN, Jacob, Dannebrogsgade 17 1.th., DK-1660 København V, DK
KEHLER, Jan, Nymøllevej 28, DK-2800 Lyngby, DK
KILBURN, John, Paul, Kærsgårdvej 7, DK-4690 Haslev, DK
MARIGO, Mauro, Jyttevej 23, DK-2740 Skovlunde, DK
LANGGÅRD, Morten, Rågevej 20, DK-2600 Glostrup, DK

- (51) MKP
A61M 5/20 (2006.01) (97) **2675503 ***
A61M 5/32 (2006.01)
- (86) EP2012052649 16.02.2012
(96) 12703837.0 25.12.2013
(87) WO2012110580, 16.02.2012
(97) 2675503, 25.12.2013 en
- (54) AUTO-INJECTOR
- (71) Sanofi-Aventis Deutschland GmbH, Brüningstraße 50, 65929 Frankfurt am Main, DE
- (72) BRERETON, Simon Francis, 75 De Freville Avenue, Cambridge Cambridgeshire CB4 1HP, GB
KEMP, Thomas, 3 Forresters Cottages High Steet, Ashwell Hertfordshire SG7 5NW, GB
BURNELL, Rosie, 56 Cavendish Avenue, Cambridge Cambridgeshire CB1 7UT, GB
EKMAN, Matthew, 59 Ecton Avenue, Macclesfield Cheshire SK10 1RD, GB

- (51) MKP
C07H 21/00 (2006.01) (97) **2694526 ***
C12Q 1/68 (2006.01)
- (86) US2012031454 30.03.2012
(96) 12763939.1 12.02.2014
(87) WO2012135620, 30.03.2012
(97) 2694526, 12.02.2014 en
- (54) MOLECULAR GRAM STAIN
- (71) AdvanDx, Inc., 400 TradeCenter, Suite 6990, Woburn, MA 01801, US
- (72) SHEPARD, Janeen, R., 8 Flagstaff Road, Wilmington, MA 01887, US
FIANDACA, Mark, 80 Main Street, Princeton, MA 01541, US
STENDER, Henrik, Fasanhaven 5, 2820 Gentofte, DK

- (51) MKP
C05D 3/02 (2006.01) (97) **2649027 ***
C05G 3/00 (2006.01)
- (86) IB2011002976 07.12.2011
(96) 11810637.6 16.10.2013
(87) WO2012076971, 07.12.2011
(97) 2649027, 16.10.2013 fr
- (54) SOIL CONDITIONERS AND FERTILISERS HAVING DYNAMIC DISINTEGRATION, METHOD FOR MANUFACTURING SAME, AND USES THEREOF IN AGRICULTURE
- (71) Omya International AG, Baslerstrasse 42, 4665 Oftringen, CH
(72) GAUMONT, François-Xavier, 8 rue Bleriot, F-28000 Chartres, FR

- (51) MKP
C03C 17/36 (2006.01) (97) **2661417 ***
(86) FR2012050041 06.01.2012
(96) 12702304.2 13.11.2013
(87) WO2012093238, 06.01.2012
(97) 2661417, 13.11.2013 fr
(54) SUBSTRATE PROVIDED WITH A STACK HAVING THERMAL PROPERTIES, IN PARTICULAR FOR MANUFACTURING HEATED GLASS
(71) Saint-Gobain Glass France, 18 avenue d'Alsace, 92400 Courbevoie, FR
(72) LAURENT, Stéphane, 134 Boulevard Jean Jaurès, 92110 CLICHY, FR
DRESE, Robert, ... Décédé, DE
-
- (51) MKP
A01N 43/00 (2006.01) (97) **2683242 ***
(86) US2012026984 28.02.2012
(96) 12782326.8 15.01.2014
(87) WO2012154285, 28.02.2012
(97) 2683242, 15.01.2014 en
(54) EFFECTIVE AMOUNTS OF (3AR)-1,3A,8-TRIMETHYL-1,2,3,3A,8,8A-HEXAHYDROPIRROLO[2,3-B]INDOL-5-YL PHENYL CARBAMATE AND METHODS THEREOF
(71) QR Pharma Inc., 1055 Westlakes Drive, Suite 300, Berwyn, PA 19312, US
(72) MACCECCHINI, Maria, 1223 Fox Glove Lane, West Chester, PA 19380, US
-
- (51) MKP
A47K 3/06 (2006.01) (97) **2690998 ***
(86) IB2012051328 20.03.2012
(96) 12715172.8 05.02.2014
(87) WO2012131535, 20.03.2012
(97) 2690998, 05.02.2014 en
(54) REVERSIBLY EXTENDIBLE BATHTUB
(71) Lastella, Michele, Via delle Castagnole 98, 00047 Marino (RM), IT
(72) Lastella, Michele, Via delle Castagnole 98, 00047 Marino (RM), IT
-
- (51) MKP
G06Q 10/08 (2012.01) (97) **2624185**
(86) 12153622.1 07.08.2013
(97) 2624185, 07.08.2013 en
(54) Handheld device and method for determining the location of physical objects stored in storage containers
(71) Rotho Kunststoff AG, Industriestrasse Althau 11, 5303 Würenlingen, CH
(72) Cohen Wollin, Moshe, Yavetz 2A, 65603 Tel Aviv, IL
-
- (51) MKP
A43B 7/12 (2006.01) (97) **2645896 ***
(86) EP2011069550 07.11.2011
(96) 11782407.8 09.10.2013
(87) WO2012072379, 07.11.2011
(97) 2645896, 09.10.2013 en
(54) WATERPROOF AND VAPOR-PERMEABLE SHOE, PROVIDED PREDOMINANTLY BY MEANS OF THE WORKING METHOD KNOWN AS "AGO LASTING"
(71) Geox S.p.A., Via Feltrina Centro, 16, 31044 Montebelluna Località Biadene (Treviso), IT
(72) POLEGATO MORETTI, Mario, Via Fantin 96, I-31035 Crocetta Del Montello, IT
-
- (51) MKP
B65D 19/38 (2006.01) (97) **2665658 ***
(86) IB2012050254 19.01.2012
(96) 12736059.2 27.11.2013
(87) WO2012098514, 19.01.2012
(97) 2665658, 27.11.2013 en
(54) PALLET LEADER BOARD SYSTEM
(71) Whiteford, Bede, 40 Moonbi Lookout Road, Moonbi, New South Wales 2353, AU
(72) Whiteford, Bede, 40 Moonbi Lookout Road, Moonbi, New South Wales 2353, AU
-
- (51) MKP
A61K 35/74 (2006.01) (97) **2655595 ***
A61P 17/00 (2006.01)
C12N 1/20 (2006.01)
C12R 1/36 (2006.01)
(86) EP2011073747 22.12.2011
(96) 11802426.4 30.10.2013
(87) WO2012085182, 22.12.2011
(97) 2655595, 30.10.2013 en
(54) NOVEL BACTERIUM AND EXTRACTS OF SAID BACTERIUM AND THE USE OF SAME IN DERMATOLOGY
(71) Pierre Fabre Dermo-Cosmétique, 45, place Abel-Gance, 92100 Boulogne-Billancourt, FR
Université Pierre et Marie Curie (Paris 6), 4, Place Jussieu, 75005 Paris, FR
Centre National de la Recherche Scientifique CNRS, 3, rue Michel Ange, 75016 Paris, FR
(72) LEBARON, Philippe, 39 rue des Orangers, F-66650 Banyuls-sur-Mer, FR
BOURRAIN, Muriel, 2 rue de Cerdagne, F-66690 Sorede, FR
CASTEX-RIZZI, Nathalie, 47 allée de Carpentras, F-31770 Colomiers, FR
NGUYEN, Thien, 5 Chemin du Cros, F-31180 Rouffiac-Tolosan, FR
-
- (51) MKP
A61K 38/00 (2006.01) (97) **2679234**
A61K 38/18 (2006.01)
C07K 14/00 (2006.01)
C07K 14/05 (2006.01)
C07K 14/475 (2006.01)
C07K 14/50 (2006.01)
C07K 14/705 (2006.01)
(86) 13183844.3 01.01.2014
(97) 2679234, 01.01.2014 en
(54) Binding proteins that bind to human FGFR1C, human beta-klotho and both human FGFR1C and human beta-klotho
(71) Amgen Inc., Law Department One Amgen Center Drive, Thousand Oaks, CA 91320-1799, US
(72) Smith, Richard, 1374 Sunnyside Avenue, Belmont, CA 94002-3728, US
Bakker, Alice, 1234 Bubb Road, Cupertino, CA 95014, US
Duguay, Amy N., 18242 Baylor Avenue, Saratoga, CA 95070, US
Li, Peng, 1220 14th Avenue, San Francisco, CA 94122, US
Li, Yang, 1142 Cuesta Drive, Mountain View, CA 94040, US
-
- (51) MKP
A61B 5/024 (2006.01) (97) **2691779 ***
G01C 22/00 (2006.01)
G01P 13/00 (2006.01)
G06F 3/01 (2006.01)
G06F 3/033 (2013.01)
(86) US2012031620 30.03.2012
(96) 12719121.1 05.02.2014
(87) WO2012135726, 30.03.2012
(97) 2691779, 05.02.2014 en
(54) DEVICES, METHODS, AND APPARATUSES FOR INFERRING A POSITION OF A MOBILE DEVICE
(71) Qualcomm Incorporated, International IP Administration 5775 Morehouse Drive, San Diego, CA 92121-1714, US
(72) GROKOP, Leonard Henry, 5775 Morehouse Drive, San Diego, California 92121-1714, US
-
- (51) MKP
A61K 39/395 (2006.01) (97) **2699261 ***
(86) US2012034107 18.04.2012
(96) 12717002.5 26.02.2014
(87) WO2012145417, 18.04.2012
(97) 2699261, 26.02.2014 en
(54) METHOD FOR TREATING OSTEOPOROSIS
(71) Amgen Inc., Patent Operations M/S 28-2-C One Amgen Center Drive, Thousand Oaks, California 91320-1799, US
(72) SAN MARTIN, Javier, One Amgen Center Drive, Thousand Oaks CA 91320-1799, US
WASSERMAN, Scott, 5238 Via Pisa, Newbury Park, CA 91320, US

- (51) MKP
B01D 11/04 (2006.01) (97) **2695653 ***
C22B 3/02 (2006.01)
- (86) CN2012073660 09.04.2012
(96) 12768064.3 12.02.2014
(87) WO2012136154, 09.04.2012
(97) 2695653, 12.02.2014 en
(54) HEATER AND HEATING METHOD FOR WET EXTRACTION TANK
- (71) Jiangxi Rare Earth & Rare Metals Tungsten Group Holding Co., Ltd., No. 118 Beijing West Road, Nanchang, Jiangxi 330046, CN
(72) LI, Changqing, NO. 118 Beijing West Road, Nanchang Jiangxi 330046, CN
XU, Jun, NO. 118 Beijing West Road, Nanchang Jiangxi 330046, CN
ZHANG, Wuguo, NO. 118 Beijing West Road, Nanchang Jiangxi 330046, CN
ZHAN, Haibo, NO. 118 Beijing West Road, Nanchang Jiangxi 330046, CN

- (51) MKP
H01R 43/052 (2006.01) (97) **2590275**
H01R 43/28 (2006.01)
- (96) 11187480.6 08.05.2013
(97) 2590275, 08.05.2013 de
(54) Circuit positioning device
(71) Schleuniger Holding AG, Bierigutstrasse 9, 3608 Thun, CH
(72) Schütz, Peter, Ziegelstrasse 10, 42719 Solingen, DE

- (51) MKP
A61K 9/00 (2006.01) (97) **2675432 ***
A61K 33/04 (2006.01)
A61P 15/02 (2006.01)
- (86) AT2012000032 16.02.2012
(96) 12707218.9 25.12.2013
(87) WO2012109685, 16.02.2012
(97) 2675432, 25.12.2013 de
(54) PHARMACEUTICAL PREPARATION CONTAINING SELENITE OR SELENITE-CONTAINING COMPOUNDS FOR TREATING CERVICAL DYSPLASIA OR CARCINOMAS
(71) Selo Medical GmbH, Moosham 29, 5585 Unternberg, AT
(72) FUCHS, Norbert, Bruckdorf 135, A-5571 Mariapfarr, AT

- (51) MKP
C07D 471/04 (2006.01) (97) **2678338 ***
- (86) US2012026377 23.02.2012
(96) 12708450.7 01.01.2014
(87) WO2012116217, 23.02.2012
(97) 2678338, 01.01.2014 en
(54) COMPOUNDS AND COMPOSITIONS AS TRK INHIBITORS
(71) IRM LLC, 131 Front Street P.O. Box HM 2899, Hamilton HM LX, BM
(72) MOLteni, Valentina, Genomics Institute of the Novartis Research Foundation 10675 John Jay Hopkins Drive, San Diego, California 92121, US
FAN, Yi, Genomics Institute of the Novartis Research Foundation 10675 John Jay Hopkins Drive, San Diego, California 92121, US
LOREN, Jon, Genomics Institute of the Novartis Research Foundation 10675 John Jay Hopkins Drive, San Diego, California 92121, US
SMITH, Jeffrey M., Genomics Institute of the Novartis Research Foundation 10675 John Jay Hopkins Drive, San Diego, California 92121, US
FLATT, Brenton T., Genomics Institute of the Novartis Research Foundation 10675 John Jay Hopkins Drive, San Diego, California 92121, US

- (51) MKP
G06F 17/30 (2006.01) (97) **2587770**
G09B 5/00 (2006.01)
H04L 29/08 (2006.01)
H04M 1/725 (2006.01)
- (96) 12190300.9 01.05.2013
(97) 2587770, 01.05.2013 en
(54) A system for the display, by a user, of multimedia content items
(71) Rotas Italia S.r.l., San Francesco di Sales 11, 31100 Treviso, IT
(72) Celante, Francesco, Via Genova, 6, 31100 Treviso, IT
Mason, Enrico, Via Trento, 45, 31021 Mogliano Veneto (TV), IT

- (51) MKP
A61K 39/395 (2006.01) (97) **2670438 ***
- (86) US2012023590 02.02.2012
(96) 12742734.2 11.12.2013
(87) WO2012106497, 02.02.2012
(97) 2670438, 11.12.2013 en
(54) SELECTION AND TREATMENT OF SUBJECTS
(71) Santarus, Inc., 3721 Valley Centre Drive, Suite 400, San Diego, CA 92130, US
(72) TOTORITIS, Mark, 18318 Calle La Serra, Rancho Santa Fe, CA 92091, US

- (51) MKP
H02G 1/12 (2006.01) (97) **2676345 ***
- (86) EP2012052453 14.02.2012
(96) 12704408.9 25.12.2013
(87) WO2012110475, 14.02.2012
(97) 2676345, 25.12.2013 de
(54) DEVICE FOR INDUCTIVELY REMOVING THE INSULATION FROM WIRES AND/OR PROFILES
(71) Wobben Properties GmbH, Dreekamp 5, 26605 Aurich, DE
(72) MARYNIAK, Bernd, Ahornweg 51, 19069 Seehof, DE
SAATHOFF, Timo, Meentemoorweg 5, 26632 Ihlow, DE
FLEISCHER, Mirko, Würdestraße 10, 26847 Detern, DE
CLAAßEN, Thorsten, Hauptstraße 15, 26409 Wittmund, DE
WAGENAAR, Carsten, Dorfstraße 12, 26529 Wirdum, DE

- (51) MKP
A61K 31/44 (2006.01) (97) **2691371 ***
A61P 9/00 (2006.01)
C07D 213/16 (2006.01)
- (86) EP2012055364 27.03.2012
(96) 12711858.6 05.02.2014
(87) WO2012130821, 27.03.2012
(97) 2691371, 05.02.2014 en
(54) BENZOIC ACID SALT OF OTAMIXABAN
(71) SANOFI, 54 rue La Boétie, 75008 Paris, FR
(72) NAGEL, Norbert, c/o Sanofi-Aventis Deutschland GmbH, 65926 Frankfurt am Main, DE
BAUMGARTNER, Bruno, c/o Sanofi-Aventis Deutschland GmbH, 65926 Frankfurt am Main, DE
BERCHTOLD, Harald, c/o Sanofi-Aventis Deutschland GmbH, 65926 Frankfurt am Main, DE
AYERS, Timothy, c/o sanofi-aventis 1041 Route 202-206 Mail Code: BWD-303A, Bridgewater, New Jersey 8807, US

- (51) MKP
A44C 5/04 (2006.01) (97) **2688439 ***
A44C 5/06 (2006.01)
A44C 13/00 (2006.01)
- (86) IT2011000085 22.03.2011
(96) 11722926.0 29.01.2014
(87) WO2012127511, 22.03.2011
(97) 2688439, 29.01.2014 en
(54) JEWELLERY ITEM
(71) Barbazza Fratelli Sas - Di Barbazza Roberto E C., Via Bergamo 19, 15048 Valenza, IT
(72) BARBAZZA, Piero, c/o BARBAZZA FRATELLI SAS di Barbazza Roberto e C. Via Bergamo 19, I-15048 Valenza, Alessandria, IT

- (51) MKP
F01N 3/20 (2006.01) (97) **2689119 ***
- (86) EP2012055141 22.03.2012
(96) 12709893.7 29.01.2014
(87) WO2012127010, 22.03.2012
(97) 2689119, 29.01.2014 en
(54) REAGENT DOSING PUMP ASSEMBLY
(71) Delphi Technologies Holding S.a.r.l., Avenue de Luxembourg, 4940 Bascharage, LU
(72) WRIGHT, Keith E., 6 Kinross Close, Walderslade Kent ME5 7RS, GB
COOKE, Michael, P., 52 Burnt Oak Terrace, Gillingham Kent ME7 1DR, GB
NEEDHAM, David, W., 77 High Street, Lenham Kent ME17 2LA, GB
HARDY, Martin, P., 71 Cedar Grove, Hempstead Kent ME7 3QZ, GB

- (51) MKP (97) **2675792 ***
- C07D 257/04 (2006.01)*
A61K 31/4192 (2006.01)
C07D 249/18 (2006.01)
A61K 31/4164 (2006.01)
C07D 249/04 (2006.01)
C07C 233/47 (2006.01)
A61P 13/00 (2006.01)
C07D 231/14 (2006.01)
C07D 403/04 (2006.01)
A61K 31/42 (2006.01)
C07D 261/12 (2006.01)
A61K 31/4196 (2006.01)
C07D 249/10 (2006.01)
A61K 31/415 (2006.01)
C07D 239/36 (2006.01)
C07C 233/46 (2006.01)
A61P 9/00 (2006.01)
C07D 231/20 (2006.01)
C07D 471/04 (2006.01)
A61K 31/405 (2006.01)
- (86) US2012025369 16.02.2012
(96) 12708195.8 25.12.2013
(87) WO2012154249, 16.02.2012
(97) 2675792, 25.12.2013 en
(54) SUBSTITUTED AMINO BUTYRIC DERIVATIVES AS NEPRILYSIN INHIBITORS
(71) Theravance, Inc., 901 Gateway Boulevard, South San Francisco, CA 94080, US
(72) FLEURY, Melissa, 1023 Divisadero Street, San Francisco, California 94115, US
GENDRON, Roland, 345 Franconia Street, San Francisco, California 94110, US
HUGHES, Adam D., 1221 Judson Street, Belmont, California 94002, US
SMITH, Cameron, 1401 Floribunda Avenue Apt 101, Burlingame, California 94010, US
-
- (51) MKP (97) **2430014 ***
- A61K 31/4178 (2006.01)*
A61K 31/4188 (2006.01)
A61P 31/12 (2006.01)
C07D 401/14 (2006.01)
C07D 403/04 (2006.01)
C07D 403/14 (2006.01)
C07D 405/14 (2006.01)
C07D 409/14 (2006.01)
C07D 413/04 (2006.01)
C07D 417/04 (2006.01)
C07D 417/14 (2006.01)
C07D 495/04 (2006.01)
- (86) US2010034600 12.05.2010
(96) 10720970.2 21.03.2012
(87) WO2010132601, 12.05.2010
(97) 2430014, 21.03.2012 en
(54) ANTIVIRAL COMPOUNDS
(71) Gilead Sciences, Inc., 333 Lakeside Drive, Foster City, CA 94404, US
(72) GUO, Hongyan, 333 Lakeside Drive, Foster City California 94404, US
KATO, Darryl, 333 Lakeside Drive, Foster City California 94404, US
KIRSCHBERG, Thorstens A., 333 Lakeside Drive, Foster City California 94404, US
LIU, Hongtae, 333 Lakeside Drive, Foster City California 94404, US
LINK, John O., 333 Lakeside Drive, Foster City California 94404, US
MITCHELL, Michael L., 333 Lakeside Drive, Foster City California 94404, US
PARRISH, Jay P., 333 Lakeside Drive, Foster City California 94404, US
SQUIRES, Neil, 333 Lakeside Drive, Foster City California 94404, US
SUN, Jianyu, 333 Lakeside Drive, Foster City California 94404, US
TAYLOR, James, 333 Lakeside Drive, Foster City California 94404, US
BACON, Elizabeth M., 333 Lakeside Drive, Foster City California 94404, US
CANALES, Eda, 333 Lakeside Drive, Foster City California 94404, US
CHO, Aesop, 333 Lakeside Drive, Foster City California 94404, US
COTTELL, Jeromy J., 333 Lakeside Drive, Foster City California 94404, US
DESAI, Manoj C., 333 Lakeside Drive, Foster City California 94404, US
HALCOMB, Randall L., 333 Lakeside Drive, Foster City California 94404, US
KRYGOWSKI, Evan S., 333 Lakeside Drive, Foster City California 94404, US
LAZERWITH, Scott E., 333 Lakeside Drive, Foster City California 94404, US
LIU, Qi, 333 Lakeside Drive, Foster City California 94404, US
MACKMAN, Richard, 333 Lakeside Drive, Foster City California 94404, US
PYUN, Hyung-Jung, 333 Lakeside Drive, Foster City California 94404, US
SAUGIER, Joseph H., 333 Lakeside Drive, Foster City California 94404, US
TRENKLE, James D., 333 Lakeside Drive, Foster City California 94404, US
TSE, Winston C., 333 Lakeside Drive, Foster City California 94404, US
VIVIAN, Randall W., 333 Lakeside Drive, Foster City California 94404, US
SCHROEDER, Scott D., 333 Lakeside Drive, Foster City California 94404, US
WATKINS, William J., 333 Lakeside Drive, Foster City California 94404, US
XU, Lianhong, 333 Lakeside Drive, Foster City California 94404, US
YANG, Zheng-Yu, 333 Lakeside Drive, Foster City California 94404, US
KELLAR, Terry, 333 Lakeside Drive, Foster City California 94404, US
SHENG, Xiaoning, 333 Lakeside Drive, Foster City California 94404, US
CLARKE, Michael O'Neil Hanrahan, 333 Lakeside Drive, Foster City California 94404, US
CHOU, Chien-hung, 333 Lakeside Drive, Foster City California 94404, US
GRAUPE, Michael, 333 Lakeside Drive, Foster City California 94404, US
JIN, Haolun, 333 Lakeside Drive, Foster City California 94404, US
MCFADDEN, Ryan, 333 Lakeside Drive, Foster City California 94404, US
MISH, Michael R., 333 Lakeside Drive, Foster City California 94404, US
METOBO, Samuel E., 333 Lakeside Drive, Foster City California 94404, US
PHILLIPS, Barton W., 333 Lakeside Drive, Foster City California 94404, US
VENKATARAMANI, Chandrasekar, 333 Lakeside Drive, Foster City California 94404, US
KIM, Chuong U., 333 Lakeside Drive, Foster City, California 94404, US
-
- (51) MKP (97) **2683821 ***
- C12N 15/10 (2006.01)*
- (86) IL2012000109 05.03.2012
(96) 12713786.7 15.01.2014
(87) WO2012120500, 05.03.2012
(97) 2683821, 15.01.2014 en
(54) LOW FUCOSE CELL LINES AND USES THEREOF
(71) Merck Serono SA, Centre Industriel, 1267 Coinsins, Vaud, CH
(72) HELMAN, Daniel, 37 Hatzivoni St., 55525 Kiryat Ono, IL
TOISTER-ACHITUV, Mira, 6 Taran St., 76248 Rehovot, IL
BAR-SHIMON, Meirav, 3 Zvi Harkin St., 70700 Gedera, IL

(51) MKP
A61K 31/66 (2006.01) (97) **2649099 ***
A61K 31/7076 (2006.01)
A61K 31/708 (2006.01)
A61P 31/00 (2006.01)
C07K 17/02 (2006.01)
(86) US2011063401 06.12.2011
(96) 11846166.4 16.10.2013
(87) WO2012078559, 06.12.2011
(97) 2649099, 16.10.2013 en
(54) SMALL-MOLECULE HYDROPHOBIC TAGGING OF FUSION PROTEINS AND INDUCED DEGRADATION OF SAME
(71) Yale University, Two Whitney Avenue, New Haven, CT 06511, US
(72) CREWS, Craig, M., 286 Livingston St., New Haven, CT 06511, US
TAE, Hyun, Seop, 589A Prospect Street, New Haven, CT 06511-2150, US
SCHNEEKLOTH, Ashley, R., 6120 Samuel Rd., New Market, MD 21774, US
NEKLESA, Taavi, 614 East Slope Dr., Orange, CT 06577, US
SUNDBERG, Thomas, 108 Edwards St. Apt 1, New Haven, CT 06511, US

(51) MKP
A45D 34/04 (2006.01) (97) **2609830**
A61K 8/02 (2006.01)
A61K 9/20 (2006.01)
A61Q 19/02 (2006.01)
B65D 81/32 (2006.01)
(96) 12166531.9 03.07.2013
(97) 2609830, 03.07.2013 en
(54) Apparatus and method for using effervescent tablets for cosmetic care
(71) Pollogen Ltd, 6 Kaufman Street P.O.B. 50320 Gibor House, 68012 Tel-Aviv, IL
(72) Shalev, Pinchas, 14 Kaplan Street, 46728 Herzeliya, IL

(51) MKP
B01J 3/04 (2006.01) (97) **2654940 ***
B01J 4/02 (2006.01)
C01B 11/02 (2006.01)
(86) EP2011006510 22.12.2011
(96) 11805787.6 30.10.2013
(87) WO2012084247, 22.12.2011
(97) 2654940, 30.10.2013 de
(54) METHOD FOR PRODUCING AN AQUEOUS STABLE CHLORINE DIOXIDE SOLUTION
(71) A.P.F. Aqua System AG, Friedrich-Ebert-Str. 143 d-e, 42117 Wuppertal, DE
(72) UHLMANN, Helmut, Friedrich-Ebert-Str. 143 d-e, 42117 Wuppertal, DE

(51) MKP
G02C 7/04 (2006.01) (97) **2652544 ***
(86) US2011064579 13.12.2011
(96) 11808999.4 23.10.2013
(87) WO2012082710, 13.12.2011
(97) 2652544, 23.10.2013 en
(54) COLORED CONTACT LENS
(71) Novartis AG, Lichtstrasse 35, 4056 Basel, CH
(72) CORTI, Sandra, 3420 Ashton Drive, Suwanee, Georgia 30024, US
CREECH, Laura, Ashley, 2479 Peachtree Road NE Apartment 1702, Atlanta, Georgia 30305, US

(51) MKP
A61K 9/08 (2006.01) (97) **2646051 ***
A61K 31/70 (2006.01)
A61K 39/15 (2006.01)
A61K 48/00 (2006.01)
A61P 31/12 (2006.01)
(86) US2011063040 02.12.2011
(96) 11844824.0 09.10.2013
(87) WO2012075379, 02.12.2011
(97) 2646051, 09.10.2013 en
(54) LIQUID VIRAL FORMULATIONS
(71) Oncolytics Biotech Inc., Suite 210 1167 Kensington Crescent N. W., Calgary, AB T2N 1X7, CA
(72) COFFEY, Matthew C., 2231 Bowness Road, N.W., Calgary, AB T2N 3L4, CA
SERL, Sarah, 5-310 Brookmere Rd., S.W., Calgary, AB T2W 2T7, CA
PAVLIV, Leo, 707 Walcott Way, Cary, NC 27519, US

(51) MKP
A61K 31/428 (2006.01) (97) **2699558 ***
A61K 31/436 (2006.01)
A61P 31/18 (2006.01)
C07D 277/62 (2006.01)
C07D 277/64 (2006.01)
C07D 277/82 (2006.01)
C07D 417/04 (2006.01)
C07D 491/06 (2006.01)
(86) US2012034593 20.04.2012
(96) 12719182.3 26.02.2014
(87) WO2012145728, 20.04.2012
(97) 2699558, 26.02.2014 en
(54) BENZOTHAZOLE COMPOUNDS AND THEIR PHARMACEUTICAL USE
(71) Gilead Sciences, Inc., 333 Lakeside Drive, Foster City, CA 94404, US
(72) MITCHELL, Michael L., 108 Crossing Court, Hayward, CA 94544, US
ROETHLE, Paul A., 675 Guerrero Street, San Francisco, CA 94110, US
XU, Lianhong, 970 Blair Court, Palo Alto, CA 94303, US
YANG, Hong, 4769 Canvasback Common, Fremont, CA 94555, US
MCFADDEN, Ryan, 1171 Compass Lane 213, Foster City, CA 94404, US
BABAOLU, Kerim, 2209 Wentz Church Road, Lansdale, Pennsylvania 19446, US

(51) MKP
A61K 31/495 (2006.01) (97) **2694064 ***
(86) US2012032566 06.04.2012
(96) 12767744.1 12.02.2014
(87) WO2012139027, 06.04.2012
(97) 2694064, 12.02.2014 en
(54) METHODS AND COMPOSITIONS FOR TREATING NEURODEGENERATIVE DISEASES
(71) Ariad Pharmaceuticals, Incorporated, 26 Landsdowne Street, Cambridge, MA 02139, US
(72) SHAKESPEARE, William, C., 2 Hubley Lane, Southborough, MA 01772, US
HALUSKA, Frank, G., 102 Sears Road, Wayland, MA 01778, US

- (51) MKP
A61K 31/445 (2006.01) (97) **2688568 ***
 (86) US2012030552 26.03.2012
 (96) 12765641.1 29.01.2014
 (87) WO2012135113, 26.03.2012
 (97) 2688568, 29.01.2014 en
 (54) CYCLOPROPYLAMINES AS LSD1 INHIBITORS
 (71) GlaxoSmithKline Intellectual Property Development Limited,
 980 Great West Road, Brentford Middlesex TW8 9GS, GB
 (72) JOHNSON, Neil, W., 1250 South Collegeville Road,
 Collegeville, PA 19426, US
 KASPAREC, Jiri, 1250 South Collegeville Road, Collegeville,
 PA 19426, US
 MILLER, William, Henry, 1250 South Collegeville Road,
 Collegeville, PA 19426, US
 ROUSE, Meagan, B., 1250 South Collegeville Road,
 Collegeville, PA 19426, US
 SUAREZ, Dominic, 1250 South Collegeville Road, Collegeville,
 PA 19426, US
 TIAN, Xinrong, 1250 South Collegeville Road, Collegeville, PA
 19426, US
-
- (51) MKP
A61K 31/4436 (2006.01) (97) **2665479 ***
C12Q 1/68 (2006.01)
 (86) US2012020606 09.01.2012
 (96) 12734726.8 27.11.2013
 (87) WO2012096873, 09.01.2012
 (97) 2665479, 27.11.2013 en
 (54) METHODS AND DRUG PRODUCTS FOR TREATING
 ALZHEIMER'S DISEASE
 (71) Zinfandel Pharmaceuticals, Inc., One Science Drive, Durham,
 NC 27708, US
 Takeda Pharmaceutical Company Limited, 1-1 Doshomachi
 4-chome Chuo-ku, Osaka-shi, Osaka 541-0045, JP
 (72) ROSES, Allen D., 53525 Bickett, Chapel Hill North Carolina
 27517, US
 TANEJA, Rajneesh, 821 Pembroke Road, Libertyville Illinois
 60048, US
-
- (51) MKP
A61K 31/4439 (2006.01) (97) **2651920 ***
A61P 31/00 (2006.01)
C07D 401/12 (2006.01)
C07D 401/14 (2006.01)
 (86) US2011065215 15.12.2011
 (96) 11849188.5 23.10.2013
 (87) WO2012083048, 15.12.2011
 (97) 2651920, 23.10.2013 en
 (54) ANTI-VIRAL COMPOUNDS
 (71) Abbvie Inc., 1 North Waukegan Road, North Chicago, IL
 60064, US
 (72) KRUEGER, Allan C., 7260 Presidential Drive, Gurnee Illinois
 60031, US
 KATI, Warren M., 152 Knob Hill Lane, Gurnee Illinois 60031,
 US
 MARING, Clarence J., 1228 W. Borders Drive, Palatine Illinois
 60067, US
 WAGNER, Rolf, 42530 Sheridan Oaks Drive, Antioch Illinois
 60002, US
 HUTCHINS, Charles W., 31005 Prairie Ridge Rd, Green Oaks
 Illinois 600048, US
-
- (51) MKP
A61K 31/53 (2006.01) (97) **2646423 ***
C07D 251/54 (2006.01)
 (86) US2011062386 29.11.2011
 (96) 11845815.7 09.10.2013
 (87) WO2012074999, 29.11.2011
 (97) 2646423, 09.10.2013 en
 (54) NOVEL COMPOUNDS AS RESPIRATORY STIMULANTS
 FOR TREATMENT OF BREATHING CONTROL DISORDERS
 OR DISEASES
 (71) Galleon Pharmaceuticals, Inc., 213 Witmer Road, Horsham,
 PA 19044, US
 (72) DAX, Scott, L., 3 Quail Drive, Landenberg PA 19350, US
 WOODWARD, Richard, 2032 Welsh Valley Road, Phoenixville
 PA 19460, US
 PENG, Sean, 821 Warren Road, Ambler PA 19002, US

- (51) MKP
F21S 8/08 (2006.01) (97) **2681486 ***
F21S 9/03 (2006.01)
F21V 21/10 (2006.01)
F21W 131/103 (2006.01)
 (86) DK2011000013 03.03.2011
 (96) 11708388.1 08.01.2014
 (87) WO2012116696, 03.03.2011
 (97) 2681486, 08.01.2014 en
 (54) POLE WITH SOLAR CELL PANELS
 (71) Scotialight APS, Martinsen Statsaut. Revisionspartner Øster
 Allé 42 4, 2100 Copenhagen Ø, DK
 (72) SCOTT, Steven, Frydenlundsvej 55, DK-2950 Vedbaek, DK
 OLSEN, Heine, Allegårdsvej 14, DK-8230 Åbyhøj, DK
 CHRISTENSEN, Torben, Paaske, Fuglesangs Alle 41, DK-
 8210 Århus V, DK
-
- (51) MKP
G06K 9/00 (2006.01) (97) **2671189 ***
 (86) US2012024034 06.02.2012
 (96) 12741824.2 11.12.2013
 (87) WO2012106728, 06.02.2012
 (97) 2671189, 11.12.2013 en
 (54) SYSTEMS AND METHODS FOR BIOMETRIC
 IDENTIFICATION
 (71) Gannon Technologies Group LLC, 1340 Braddock Road Suite
 410, Alexandria VA 22314, US
 (72) WALCH, Mark, Anthony, 11002 Hampton Road, Fairfax Station
 VA 22032, US
 GANTZ, Donald, T., 10824 Mt. Vineyard Ct., Fairfax VA 22032,
 US
 GANTZ, Daniel, Thomas, 2027 N. Utah St., Arlington VA
 22207, US
-
- (51) MKP
C07D 231/14 (2006.01) (97) **2668167 ***
C07D 275/03 (2006.01)
 (86) EP2012051191 26.01.2012
 (96) 12700866.2 04.12.2013
 (87) WO2012101199, 26.01.2012
 (97) 2668167, 04.12.2013 en
 (54) AMINO-SUBSTITUTED 3-HETEROAROYLAMINO-
 PROPIONIC ACID DERIVATIVES AND THEIR USE AS
 PHARMACEUTICALS
 (71) SANOFI, 54 rue La Boétie, 75008 Paris, FR
 (72) RUF, Sven, c/o Sanofi-Aventis Deutschland GmbH, 65926
 Frankfurt am Main, DE
 SADOWSKI, Thorsten, c/o Sanofi-Aventis Deutschland GmbH,
 65926 Frankfurt am Main, DE
 HORSTICK, Georg, c/o Sanofi-Aventis Deutschland GmbH,
 65926 Frankfurt am Main, DE
 SCHREUDER, Herman, c/o Sanofi-Aventis Deutschland
 GmbH, 65926 Frankfurt am Main, DE
 BUNING, Christian, c/o Sanofi-Aventis Deutschland GmbH,
 65926 Frankfurt am Main, DE
 OLPP, Thomas, c/o Sanofi-Aventis Deutschland GmbH, 65926
 Frankfurt am Main, DE
 WIRTH, Klaus, c/o Sanofi-Aventis Deutschland GmbH, 65926
 Frankfurt am Main, DE
-
- (51) MKP
G07D 7/00 (2006.01) (97) **2573739**
G07D 7/12 (2006.01)
 (86) 11182728.3 27.03.2013
 (97) 2573739, 27.03.2013 en
 (54) Optically variable entity authenticating device and method
 (71) SICPA HOLDING SA, Avenue de Florissant 41, 1008 Prilly, CH
 Müller, Dr. Edgar, Rue P.-A. de Faucigny 7, 1700 Fribourg, CH
 Despland, Claude-Alain, Chemin de la Cure 8, 1008 Prilly, CH
 Degott, Pierre, Chemin des Falaises 15, 1023 Crissier, CH

- (51) MKP
D01D 1/02 (2006.01) (97) **2683859 ***
D01D 5/06 (2006.01)
D01D 5/40 (2006.01)
D01F 2/00 (2006.01)
D01F 2/24 (2006.01)
D21H 13/00 (2006.01)
D21H 15/00 (2006.01)
- (86) EP2012053989 08.03.2012
(96) 12707354.2 15.01.2014
(87) WO2012120074, 08.03.2012
(97) 2683859, 15.01.2014 en
(54) METHOD FOR SPINNING ANIONICALLY MODIFIED CELLULOSE AND FIBRES MADE USING THE METHOD
(71) Sappi Services Netherlands b.v., Biesenweg 16, 6211 AA Maastricht, NL
(72) GRAVESON, Ian, 75 Bettina Close, Nuneaton Warwickshire CV10 9EX, GB
-
- (51) MKP
A01N 43/42 (2006.01) (97) **2675276 ***
A61K 31/44 (2006.01)
- (86) US2012025019 14.02.2012
(96) 12747008.6 25.12.2013
(87) WO2012112525, 14.02.2012
(97) 2675276, 25.12.2013 en
(54) PERIPHERIALLY ACTING μ OPIOID ANTAGONISTS
(71) Alkermes, Inc., 852 Winter Street, Waltham, MA 02451, US
(72) SILVERMAN, Bernard, 311 Charles River Street, Needham, MA 02492, US
TODTENKOPF, Mark, 4 Stephen Way, Franklin, MA 02038, US
DEAVER, Daniel, 4 Maple Brook Lane, Franklin, MA 02038, US
DIPETRILLO, Lauren, 474 Broadway Apt. 23, Somerville, MA 02145, US
-
- (51) MKP
A61K 31/422 (2006.01) (97) **2668182 ***
A61P 29/00 (2006.01)
C07D 413/04 (2006.01)
- (86) EP2012051357 27.01.2012
(96) 12703013.8 04.12.2013
(87) WO2012101261, 27.01.2012
(97) 2668182, 04.12.2013 en
(54) IL17 AND IFN-GAMMA INHIBITION FOR THE TREATMENT OF AUTOIMMUNE INFLAMMATION
(71) 4SC Discovery GmbH, Am Klopferspitz 19a, 82152 Planegg-Martinsried, DE
Tasler, Stefan, Friedinger Str. 18a, 82229 Seefeld, DE
(72) LEBAN, Johann, Pyrkergerasse 31 Apartment 10, A-1190 Wien, AT
BAUMGARTNER, Roland, Keplerweg 6, 82152 Martinsried, DE
SAEB, Wael, Kopernikusweg 10, Martinsried 82152, DE
CHEVRIER, Carine, Malerwinkel 1, 81479 München, DE
TASLER, Stefan, Friedinger Str. 18a, 82229 Seefeld, DE
-
- (51) MKP
A01N 43/36 (2006.01) (97) **2661424 ***
C07D 207/36 (2006.01)
C07D 307/12 (2006.01)
C07D 317/34 (2006.01)
C07D 401/12 (2006.01)
C07D 405/12 (2006.01)
C07D 409/12 (2006.01)
- (86) CN2011085024 30.12.2011
(96) 11854829.6 13.11.2013
(87) WO2012092827, 30.12.2011
(97) 2661424, 13.11.2013 en
(54) CHEMICAL COMPOUNDS
(71) Syngenta Participations AG, Schwarzwaldallee 215, 4058 Basel, CH
(72) JEANMART, Stephane André Marie, Syngenta Crop Protection Münchwilen AG Schaffhauserstrasse, CH-4332 Stein, CH
LU, Long, Shanghai Institute of Organic Chemistry Chinese Academy of Sciences No.354 Fenglin Road, Shanghai 200032, CN
WU, Yaming, Shanghai Institute of Organic Chemistry Chinese Academy of Sciences No.354 Fenglin Road, Shanghai 200032, CN
MAO, Lisheng, Shanghai Institute of Organic Chemistry Chinese Academy of Sciences No.354 Fenglin Road, Shanghai 200032, CN
MUEHLEBACH, Michel, Syngenta Crop Protection Münchwilen AG Schaffhauserstrasse, CH-4332 Stein, CH
-
- (51) MKP
A61K 51/00 (2006.01) (97) **2658580 ***
A61M 36/14 (2006.01)
- (86) US2011045373 26.07.2011
(96) 11852428.9 06.11.2013
(87) WO2012091757, 26.07.2011
(97) 2658580, 06.11.2013 en
(54) ARGINASE INHIBITORS AND METHODS OF USE THEREOF
(71) Corridor Pharmaceuticals, Inc., 1122 Kenilworth Dr., Baltimore, MD 21204, US
(72) TOMCZUK, Bruce, Edward, 333 Sonnet Lane, Colleegeville, PA 19426, US
OLSON, Gary, Lee, 1505 Coles Avenue, Mountainside, NJ 07092, US
POTTORF, Richard, Scott, 74 Monroe Avenue, Belle Mead, NJ 08502, US
WANG, Jane, 919 Crown Point Est. Dr., Wildwood, MO 63021, US
NALLAGANCHU, Bhaskara, Rao, 99 Norstrand Road, Hillsborough, NJ 08844, US
-
- (51) MKP
F17D 5/02 (2006.01) (97) **2694938 ***
G01M 3/24 (2006.01)
G01M 3/32 (2006.01)
- (86) DK2012000029 28.03.2012
(96) 12718892.8 12.02.2014
(87) WO2012136209, 28.03.2012
(97) 2694938, 12.02.2014 en
(54) A METHOD AND MEANS FOR DETECTING LEAKAGES IN PIPE INSTALLATIONS
(71) Dantaet A/S, Højmevej 36-38, 5250 Odense SV, DK
(72) GARNÆS, Svend, c/o Dantaet A/S Højmevej 36-38, DK-5250 Odense 3V, DK
-
- (51) MKP
C02F 1/52 (2006.01) (97) **2662338 ***
- (86) ES2012070430 08.06.2012
(96) 12738147.3 13.11.2013
(87) WO2012168531, 08.06.2012
(97) 2662338, 13.11.2013 en
(54) SYSTEM FOR PURIFYING POLLUTED WATER AND PURIFICATION METHOD
(71) Bioener Bierzo, S.L., Avenida Gómez Núñez 2 Planta 3, 24400 Ponferrada (León), ES
(72) GARCÍA MERAYO, Pedro, Avenida Gómez Núñez 2 Planta 3, E-24400 Ponferrada (León), ES
LAMELAS POMBRIEGO, Fernando Óscar, Avenida Gómez Núñez 2 Planta 3, E-24400 Ponferrada (León), ES
GUTIÉRREZ DE LA ROZA PÉREZ, Gonzalo, Avenida Gómez Núñez 2 Planta 3, E-24400 Ponferrada (León), ES
-

(51) MKP
B01D 53/14 (2006.01)
B01D 53/62 (2006.01)
B01J 20/12 (2006.01)
C01F 5/24 (2006.01)
C01F 11/18 (2006.01)
C02F 1/66 (2006.01)
C02F 5/06 (2006.01)
C02F 5/08 (2006.01)
(86) 12179675.9 12.02.2014
(97) 2695661, 12.02.2014 en
(54) Regeneratable ion exchange material for reducing the amount of CO₂
(71) Omya International AG, Baslerstrasse 42, 4665 Oftringen, CH
(72) Schenker, Michel, Baslerstrasse 9, 4665 Oftringen, CH
Gane, Patrick A.C., Studenweg 8, 4852 Rothrist, CH
Schoelkopf, Joachim, Buechbühlstrasse 3, 8956 Killwangen, CH
Gantenbein, Daniel, Vogesenstrasse 27, 4056 Basel, CH

(51) MKP
A61K 31/416 (2006.01)
A61P 29/00 (2006.01)
C07D 403/04 (2006.01)
(86) US2012026506 24.02.2012
(96) 12709201.3 01.01.2014
(87) WO2012116276, 24.02.2012
(97) 2678330, 01.01.2014 en
(54) CRYSTALLINE FORMS AND PROCESSES FOR THE PREPARATION OF CONDENSED AZACYCLES (CANNABINOID RECEPTOR MODULATORS)
(71) Arena Pharmaceuticals, Inc., 6154 Nancy Ridge Drive, San Diego, CA 92121, US
(72) BLACKBURN, Anthony C., 12633 Caminito Rosita, San Diego California 92128, US
HAN, Sangdon, 9953 Fieldthorn Street, San Diego California 92127, US
JONES, Robert M., 10937 Corte luz del Sol, San Diego California 92130, US
MONTALBAN, Antonio Garrido, 10339 Azuaga Street, No. 213, San Diego California 92129, US
PAL, Biman B., 8560 Foxcroft Place, San Diego California 92129, US
RUETER, Jaimie Karyn, 9022 Westvale Road, San Diego California 92129, US

(51) MKP
G06F 17/30 (2006.01)
(86) US2012000060 06.02.2012
(96) 12757117.2 22.01.2014
(87) WO2012125204, 06.02.2012
(97) 2686788, 22.01.2014 en
(54) SYSTEM AND METHOD FOR MEDIA FILE SYNCHRONIZATION
(71) Remote Media, LLC, 102 E. Farnham Lane, Wheaton, IL 60189, US
(72) SAVENOK, Alexander, 12212 Bennington Avenue, Grandview, MO 64030, US
SAVENOK, Pavel, 102 E. Farnham Lane, Wheaton, IL 60189, US

(51) MKP
A61K 31/404 (2006.01)
A61P 25/04 (2006.01)
C07D 401/12 (2006.01)
C07D 401/14 (2006.01)
C07D 403/12 (2006.01)
C07D 403/14 (2006.01)
C07D 471/04 (2006.01)
(86) US2011066972 22.12.2011
(96) 11811264.8 30.10.2013
(87) WO2012088469, 22.12.2011
(97) 2655356, 30.10.2013 en
(54) FAAH INHIBITORS
(71) Ironwood Pharmaceuticals, Inc., 301 Binney Street, Cambridge, MA 02142, US
(72) HUDSON, Colleen, 146 Clifton Street Apt. 7, Malden, MA 02148, US
BARDEN, Timothy, C., 19 Intervale Road, Salem, MA 01970, US
JIA, James, 209 Highland Avenue Apt. 3, Somerville, MA 02143, US
MERMERIAN, Ara, 18 Island Hill Avenue Unit 212, Melrose, MA 02176, US
PENG, Bo, 282 Gray Street, Arlington, MA 02476, US
YANG, Jane, 104 Burroughs Road, Boxborough, MA 01719, US
YU, Xiang, Y., 2 Whispering Way, Acton, MA 01720, US
SPROTT, Kevin, 40 Rolling Lane, Needham, MA 02492, US
FRETZEN, Angelika, 7 Avon Street, Somerville, MA 02143, US

(51) MKP
A61B 1/00 (2006.01)
A61B 1/06 (2006.01)
G01B 11/25 (2006.01)
G03B 17/54 (2006.01)
G03B 35/08 (2006.01)
G03B 37/00 (2006.01)
(86) AT2012000061 12.03.2012
(96) 12714526.6 22.01.2014
(87) WO2012126022, 12.03.2012
(97) 2686734, 22.01.2014 de
(54) DEVICE FOR RECORDING IMAGES OF THREE-DIMENSIONAL OBJECTS
(71) a.tron3d GmbH, Palais Sterneck Sterneckstrasse 19, 9020 Klagenfurt am Wörthersee, AT
(72) KOINIG, Horst, St. Primusweg 62, A-9020 Klagenfurt, AT
JESENKO, Jürgen, Untertöllern 49, A-9161 Maria Rain, AT

(51) MKP
A61P 35/00 (2006.01)
C07K 14/705 (2006.01)
C07K 16/28 (2006.01)
C07K 16/30 (2006.01)
C12N 5/0783 (2010.01)
(86) US2012030388 23.03.2012
(96) 12725893.7 29.01.2014
(87) WO2012129514, 23.03.2012
(97) 2689010, 29.01.2014 en
(54) METHOD AND COMPOSITIONS FOR CELLULAR IMMUNOTHERAPY
(71) Fred Hutchinson Cancer Research Center, 1100 Fairview Avenue N. M/S J6-200, Seattle, WA 98109-1024, US
(72) RIDDELL, Stanley, R., 1763 268th SE, Sammamish, WA 98075, US
HUDECEK, Michael, Mozartstrasse 13/810, 04107 Leipzig, DE

(51) MKP
H04L 29/08 (2006.01) (97) **2684342 ***
H04L 29/12 (2006.01)
(86) US2012028518 09.03.2012
(96) 12711296.9 15.01.2014
(87) WO2012125467, 09.03.2012
(97) 2684342, 15.01.2014 en
(54) REMOTE ACCESS AND ADMINISTRATION OF DEVICE CONTENT AND CONFIGURATION USING HTTP PROTOCOL
(71) Qualcomm Incorporated, 5775 Morehouse Drive, San Diego, CA 92121-1714, US
(72) HERSHKO, Yuval Corey, 5775 Morehouse Drive, San Diego, CA 92121, US
STRAUSS, Nir, 5775 Morehouse Drive, San Diego, CA 92121, US

(51) MKP
G03D 15/00 (2006.01) (97) **2656345 ***
G11B 23/50 (2006.01)
(86) AT2011000516 23.12.2011
(96) 11818970.3 30.10.2013
(87) WO2012088553, 23.12.2011
(97) 2656345, 30.10.2013 de
(54) METHOD FOR RECONDITIONING DATA CARRIERS
(71) Österreichische Akademie der Wissenschaften, Liebiggasse 5, 1010 Wien, AT
(72) WALLASZKOVITS, Nadja, Hauptstrasse 28a, A-2491 Neufeld, AT
LIEPERT, Peter, Seckendorfstrasse 4/3/30, A-1140 Wien, AT
SPOJJARIC-LUKACIC, Lidija, Am Kabelwerk 5/3.11, A-1120 Wien, AT

(51) MKP
A61M 5/20 (2006.01) (97) **2675507 ***
A61M 5/315 (2006.01)
A61M 5/32 (2006.01)
A61M 5/50 (2006.01)
(86) EP2012052648 16.02.2012
(96) 12705275.1 25.12.2013
(87) WO2012110579, 16.02.2012
(97) 2675507, 25.12.2013 en
(54) AUTO-INJECTOR
(71) Sanofi-Aventis Deutschland GmbH, Brüningstraße 50, 65929 Frankfurt am Main, DE
(72) BRERETON, Simon Francis, 75 De Freville Avenue, Cambridge Cambridgeshire CB4 1HP, GB
KEMP, Thomas, 3 Forresters Cottages High Steet, Ashwell Hertfordshire SG7 5NW, GB
BURNELL, Rosie, 56 Cavendish Avenue, Cambridge Cambridgeshire CB1 7UT, GB
EKMANN, Matthew, 59 Ecton Avenue, Macclesfield Cheshire SK10 1RD, GB

(51) MKP
A61K 31/336 (2006.01) (97) **2683706 ***
A61P 3/04 (2006.01)
C07D 303/22 (2006.01)
C07D 303/32 (2006.01)
C07D 303/34 (2006.01)
C07D 303/36 (2006.01)
C07D 491/10 (2006.01)
(86) US2012028068 07.03.2012
(96) 12709761.6 15.01.2014
(87) WO2012122264, 07.03.2012
(97) 2683706, 15.01.2014 en
(54) OXASPIRO [2.5]OCTANE DERIVATIVES AND ANALOGS
(71) Zafgen, Inc., One Broadway, 8th Floor, Cambridge, MA 02142, US
(72) VATH, James, E., 3 Green Meadow Drive, Lynnfield, MA 01940, US
CHAFFEE, Stuart, 15 Pleasant Street, Wellesley, Massachusetts 02482, US

(51) MKP
F16L 55/10 (2006.01) (97) **2649359 ***
(86) EP2011068633 25.10.2011
(96) 11782574.5 16.10.2013
(87) WO2012076240, 25.10.2011
(97) 2649359, 16.10.2013 en
(54) DEVICE FOR AUTOMATIC CLOSURE OF CONTROL VALVES IN SEPARABLE CONNECTION UNITS FOR FLEXIBLE PIPES.
(71) MIB ITALIANA S.p.A., Via Garibaldi 6, 35020 Casalsarugo (PD), IT
BORMIOLI, Lorenzo, Via Carlo Cerato 14, I-35100 Padova, IT

(51) MKP
A61K 38/17 (2006.01) (97) **2665485 ***
A61P 3/10 (2006.01)
C07K 14/775 (2006.01)
(86) US2012021802 19.01.2012
(96) 12705517.6 27.11.2013
(87) WO2012100010, 19.01.2012
(97) 2665485, 27.11.2013 en
(54) APOLIPOPROTEIN AIV AS AN ANTIDIABETIC PEPTIDE
(71) University Of Cincinnati, 51 Goodman Drive Suite 240, Cincinnati, OH 45221-0829, US
(72) TSO, Patrick, 51 Goodman Drive Suite 240, Cincinnati OH 45221, US
DAVIDSON, Sean, 51 Goodman Drive Suite 240, Cincinnati OH 45221, US
WOODS, Stephen, 51 Goodman Drive Suite 240, Cincinnati OH 45221, US
WANG, Fei, 10811 Fallsington Court, Cincinnati OH 45242, US

(51) MKP
A61K 31/416 (2006.01) (97) **2678318 ***
A61K 31/4439 (2006.01)
A61K 31/497 (2006.01)
A61K 31/661 (2006.01)
A61P 29/00 (2006.01)
C07D 231/54 (2006.01)
C07D 401/04 (2006.01)
C07D 401/14 (2006.01)
C07D 403/04 (2006.01)
C07D 405/14 (2006.01)
C07F 9/09 (2006.01)
(86) US2012026517 24.02.2012
(96) 12716763.3 01.01.2014
(87) WO2012116279, 24.02.2012
(97) 2678318, 01.01.2014 en
(54) CANNABINOID RECEPTOR MODULATORS
(71) Arena Pharmaceuticals, Inc., 6154 Nancy Ridge Drive, San Diego, CA 92121, US
(72) THATTE, Jayant, 16881 Abundante Street, San Diego California 92127, US
BLACKBURN, Anthony C., 12633 Caminito Rosita, San Diego California 92128, US
HAN, Sangdon, 9953 Fieldthorn Street, San Diego California 92127, US
JONES, Robert M., 10937 Corte luz del Sol, San Diego California 92130, US
JUNG, Jae-Kyu, 16478 Camelias Walk, San Diego California 92127, US
MONTALBAN, Anthonio Garrido, 10339 Azuaga Street, No. 213, San Diego California 92129, US
PAL, Biman B., 8560 Foxcroft Place, San Diego California 92129, US
RUETER, Jaimie Karyn, 9022 Westvale Road, San Diego California 92129, US
STRAH-PLEYNET, Sonja, 27 Melrose Avenue, Newton Massachusetts 02466, US
THORESEN, Lars, 7130 Shoreline Drive, No. 1110, San Diego California 92122, US
XIONG, Yifeng, 5036 Pearlman Way, San Diego California 92130, US
YUE, Dawei, 11353 Nahama Lane, San Diego California 92130, US
ZHU, Xiuwen, 11367 Black Colt Lane, San Diego California 92130, US

(51) MKP
C12Q 1/68 (2006.01) (97) **2686441 ***
 (86) US2012029479 16.03.2012
 (96) 12710643.3 22.01.2014
 (87) WO2012129100, 16.03.2012
 (97) 2686441, 22.01.2014 en
 (54) METHODS AND COMPOSITIONS FOR PREDICTING RESPONSE TO ERIBULIN
 (71) Eisai R&D Management Co., Ltd., 6-10, Koishikawa 4-chome Bunkyo-ku, Tokyo 112-8088, JP
 (72) AGOULNIK, Sergei, I., 62 Wildwood Road, Andover, MA 01810, US
 BYRNE, Michael, Chapman, 70 Park Street, Apt 54, Brookline, MA 02446-6335, US
 LITTLEFIELD, Bruce, A., 4 Twin Brook Circle, Andover, MA 01810, US

(51) MKP
A61K 39/395 (2006.01) (97) **2668960 ***
 (86) ES2011070832 01.12.2011
 (96) 11845312.5 04.12.2013
 (87) WO2012072850, 01.12.2011
 (97) 2668960, 04.12.2013 en
 (54) COMPOUNDS FOR TREATING CARDIAC DAMAGE AFTER ISCHAEMIA/REPERFUSION
 (71) Fundacion Centro Nacional De Investigaciones Cardiovasculares Carlos III (CINC), C/ Melchor Fernandez Almagro 3, 28029 Madrid, ES
 (72) ZARAGOZA SÁNCHEZ, Carlos, Fundación Centro Nacional De Investigaciones Cardiovasculares Carlos III (cnic) Melchor Fernández Almagro 3, E-28029 Madrid, ES
 GÓMEZ PARRIZAS, Mónica, Fundación Centro Nacional De Investigaciones Cardiovasculares Carlos III (cnic) Melchor Fernández Almagro, 3, E-28029 Madrid, ES
 LAVÍN PLAZA, Begoña, Fundación Centro Nacional De Investigaciones Cardiovasculares Carlos III (cnic) Melchor Fernández Almagro, 3, E-28029 Madrid, ES
 TARÍN CERESO, Carlos, Fundación Centro Nacional De Investigaciones Cardiovasculares Carlos III (cnic) Melchor Fernández Almagro, 3, E-28029 Madrid, ES

(51) MKP
F16B 25/00 (2006.01) (97) **2657547**
 (96) 12165334.9 30.10.2013
 (97) 2657547, 30.10.2013 de
 (54) Screw
 (71) Nedschroef Fraulautern GmbH, Klosterstrasse 13, 66740 Saarlouis, DE
 (72) Wendels, Jörg Michael, Herchenbacherstr. 84, 66292 Riegelsberg, DE
 Egele, Jean Joseph, Dr. Wolfgang-Krämer-Straße 47, 66386 St. Ingbert, DE

(51) MKP
H01F 29/14 (2006.01) (97) **2383756**
H02M 1/16 (2006.01)
 (96) 11154545.5 02.11.2011
 (97) 2383756, 02.11.2011 de
 (54) Device for current amplification for electromagnetic pulse shaping and use
 (71) Helmholtz-Zentrum Dresden - Rossendorf e.V., Bautzner Landstrasse 400, 01328 Dresden, DE
 (72) Herrmannsdörfer, Thomas, Dr., Zachengrundring 7, 01328 Dresden, DE
 Dittrich, Steffen, Marsdorfer Hauptstr. 32, 01108 Dresden, DE

(51) MKP
F26B 5/14 (2006.01) (97) **2652422 ***
 (86) US2011065290 15.12.2011
 (96) 11848867.5 23.10.2013
 (87) WO2012083084, 15.12.2011
 (97) 2652422, 23.10.2013 en
 (54) METHODS OF DRYING BIOMASS AND CARBONACEOUS MATERIALS
 (71) GTL Energy Holdings Pty Limited, 140 Greenhill Road, Unley, SA 5061, AU
 (72) FRENCH, Robert, 6215 Cottonwood Shores Drive, Wellington CO 80549, US
 REEVES, Robert, A., 6424 Deframe Court, Arvada CO 80004, US

(51) MKP
H04L 29/08 (2006.01) (97) **2684341 ***
H04L 29/12 (2006.01)
 (86) US2012028514 09.03.2012
 (96) 12711295.1 15.01.2014
 (87) WO2012125464, 09.03.2012
 (97) 2684341, 15.01.2014 en
 (54) SYSTEM AND METHOD USING A WEB PROXY-SERVER TO ACCESS A DEVICE HAVING AN ASSIGNED NETWORK ADDRESS
 (71) Qualcomm Incorporated, 5775 Morehouse Drive, San Diego, CA 92121-1714, US
 (72) HERSHKO, Yuval Corey, 5775 Morehouse Drive, San Diego, California 92121, US
 STRAUSS, Nir, 5775 Morehouse Drive, San Diego, California 92121, US

(51) MKP
A61K 39/00 (2006.01) (97) **2655415 ***
C07K 16/00 (2006.01)
 (86) US2011066530 21.12.2011
 (96) 11850224.4 30.10.2013
 (87) WO2012088290, 21.12.2011
 (97) 2655415, 30.10.2013 en
 (54) TRI-VARIABLE DOMAIN BINDING PROTEINS AND USES THEREOF
 (71) AbbVie Inc., 1 North Waukegan Road, North Chicago, IL 60064, US
 (72) WU, Chengbin, 300 Jin Xiu Road 14. Apt. 602 Pudong, Shanghai, CN
 YING, Hua, Line 99 Zhongshanbeier Road 44 Room 201, Shanghai 200093, CN
 GHAYUR, Tariq, 1014 Washington Street, Holliston, MA 01746, US
 GOODREAU, Carrie, 201 Stevens Street, Ludlow, MA 01056, US
 BARDWELL, Philip, 258 Shawmut Avenue, Apt. 4, Boston, MA 02118, US

(51) MKP
E21B 17/01 (2006.01) (97) **2614211 ***
 (86) US2011050975 09.09.2011
 (96) 11758637.0 17.07.2013
 (87) WO2012034004, 09.09.2011
 (97) 2614211, 17.07.2013 en
 (54) RIGID HULL GAS-CAN BUOYS WITH VARIABLE BUOYANCY
 (71) Yemington, Charles R., 3206 Caliente Ct., No. 3103, Arlington, TX 76017, US
 (72) Yemington, Charles R., 3206 Caliente Ct., No. 3103, Arlington, TX 76017, US

(51) MKP
C07K 16/22 (2006.01) (97) **2681242 ***
G21C 17/017 (2006.01)
G21C 19/14 (2006.01)
 (86) US2012027154 29.02.2012
 (96) 12708472.1 08.01.2014
 (87) WO2012118903, 29.02.2012
 (97) 2681242, 08.01.2014 en
 (54) SCLEROSTIN AND DKK-1 BISPECIFIC BINDING AGENTS
 (71) Amgen Inc., One Amgen Center Drive, Thousand Oaks, California 91320-1799, US
 (72) FLORIO, Monica, 3264 Casino Drive, Thousand Oaks, CA 91362, US
 ARORA, Taruna, 5380 Via Pisa, Thousand Oaks, CA 91320, US
 PASZTY, Christopher, J., R., 1027 Westridge Drive, Ventura, CA 93003, US
 RICHARDS, William, G., 3079 Espana Lane, Thousand Oaks, CA 91362-4921, US

- (51) MKP
C12Q 1/68 (2006.01) (97) **2652154 ***
 (86) US2011065617 16.12.2011
 (96) 11848622.4 23.10.2013
 (87) WO2012083235, 16.12.2011
 (97) 2652154, 23.10.2013 en
 (54) UNIVERSAL REFERENCE DYE FOR QUANTITATIVE AMPLIFICATION
 (71) Bio-Rad Laboratories, Inc., 1000 Alfred Nobel Drive, Hercules, CA 94547, US
 (72) WANG, Yan, 211 Juanita Way, San Francisco California 94127, US

- (51) MKP
A61K 31/538 (2006.01) (97) **2686306 ***
A61P 5/18 (2006.01)
C07D 265/36 (2006.01)
C07D 413/04 (2006.01)
 (86) IB2012051268 16.03.2012
 (96) 12713351.0 22.01.2014
 (87) WO2012127388, 16.03.2012
 (97) 2686306, 22.01.2014 en
 (54) BENZO [B][1, 4]OXAZIN DERIVATIVES AS CALCIUM SENSING RECEPTOR MODULATORS
 (71) Lupin Limited, 159 CST Road Kalina Santacruz (East), State of Maharashtra, Mumbai 400 098, IN
 (72) SHUKLA, Manojkumar, Ramprasad, Lupin Limited (Research Park) 46A/47A Village Nande Taluka Mulshi, Maharashtra, Pune 411 042, IN
 ANKUSH, Sarde, Gangaram, Lupin Limited (Research Park) 46A/47A Village Nande Taluka Mulshi, Maharashtra, Pune 411 042, IN
 VIPUL, Pachpute, Dilip, Lupin Limited (Research Park) 46A/47A Village Nande Taluka Mulshi, Maharashtra, Pune 411 042, IN
 SAYYED, Majid, Bashir, Lupin Limited (Research Park) 46A/47A Village Nande Taluka Mulshi, Maharashtra, Pune 411 042, IN
 TRYAMBAKE, Mahadeo, Bhaskar, Lupin Limited (Research Park) 46A/47A Village Nande Taluka Mulshi, Maharashtra, Pune 411 042, IN
 PAWAR, Chetan, Sanjay, Lupin Limited (Research Park) 46A/47A Village Nande Taluka Mulshi, Maharashtra, Pune 411 042, IN
 GOTE, Ganesh, Navinchandra, Lupin Limited (Research Park) 46A/47A Village Nande Taluka Mulshi, Maharashtra, Pune 411 042, IN
 KULKARNI, Sanjeev, Anant, Lupin Limited (Research Park) 46A/47A Village Nande Taluka Mulshi, Maharashtra, Pune 411 042, IN
 PALLE, Venkata, P., Lupin Limited (Research Park) 46A/47A Village Nande Taluka Mulshi, Maharashtra, Pune 411 042, IN
 KAMBOJ, Rajender, Kumar, Lupin Limited (Research Park) 46A/47A Village Nande Taluka Mulshi, Maharashtra, Pune 411 042, IN

- (51) MKP
B29B 13/02 (2006.01) (97) **2623284**
 (96) 12153486.1 07.08.2013
 (97) 2623284, 07.08.2013 de
 (54) Method and device for heating an end section of a plastic tube
 (71) Lüers Maschinen- und Stahlbau GmbH, Vechtaer Str. 101/103, 49424 Lutten-Goldenstedt, DE
 (72) Lüers, Gregor, Vechtaer Str. 94, 49424 Lutten, DE

- (51) MKP
A61C 11/08 (2006.01) (97) **2685930 ***
 (86) EP2012000970 05.03.2012
 (96) 12714559.7 22.01.2014
 (87) WO2012126571, 05.03.2012
 (97) 2685930, 22.01.2014 de
 (54) MODEL PLATE ARRAY FOR PRODUCING DENTURES
 (71) Heraeus Kulzer GmbH, Grüner Weg 1, 63450 Hanau, DE
 (72) FUNK, Matthias, Odenwaldstr. 41, 63456 Hanau, DE

- (51) MKP
C07K 16/28 (2006.01) (97) **2513147 ***
 (86) IB2010055917 17.12.2010
 (96) 10813028.7 24.10.2012
 (87) WO2011073954, 17.12.2010
 (97) 2513147, 24.10.2012 en
 (54) NOVEL ANTAGONIST ANTIBODIES AND THEIR FAB FRAGMENTS AGAINST GPVI AND USES THEREOF
 (71) SANOFI, 54, rue de la Boétie, 75008 Paris, FR
 (72) BAURIN, Nicolas, c/o sanofi-aventis Département Brevets 174 avenue de France, F-75013 Paris, FR
 BLANCHE, Francis, c/o sanofi-aventis Département Brevets 174 avenue de France, F-75013 Paris, FR
 CAMERON, Béatrice, c/o sanofi-aventis Département Brevets 174 avenue de France, F-75013 Paris, FR
 CORVEY, Carsten, c/o sanofi-aventis Deutschland GmbH Patent Department, 65926 Frankfurt, DE
 DABDOUBI, Tarik, c/o sanofi-aventis Département Brevets 174 avenue de France, F-75013 Paris, FR
 ENGEL, Christian, c/o sanofi-aventis Deutschland GmbH Patent Department, 65926 Frankfurt, DE
 FLORIAN, Peter, c/o sanofi-aventis Deutschland GmbH Patent Department, 65926 Frankfurt, DE
 FOCKEN, Ingo, c/o sanofi-aventis Deutschland GmbH Patent Department, 65926 Frankfurt, DE
 KROLL, Katja, c/o sanofi-aventis Deutschland GmbH Patent Department, 65926 Frankfurt, DE
 KRUIP, Jochen, c/o sanofi-aventis Deutschland GmbH Patent Department, 65926 Frankfurt, DE
 LANGE, Christian, c/o sanofi-aventis Deutschland GmbH Patent Department, 65926 Frankfurt, DE
 LANGER, Thomas, c/o sanofi-aventis Deutschland GmbH Patent Department, 65926 Frankfurt, DE
 LORENZ, Martin, c/o sanofi-aventis Deutschland GmbH Patent Department, 65926 Frankfurt, DE
 MIKOL, Vincent, c/o sanofi-aventis Département Brevets 174 avenue de France, F-75013 Paris, FR
 RAO, Ercole, c/o sanofi-aventis Deutschland GmbH Patent Department, 65926 Frankfurt, DE
 WONEROW, Peter, c/o sanofi-aventis Deutschland GmbH Patent Department, 65926 Frankfurt, DE

- (51) MKP
E05C 17/44 (2006.01) (97) **2678502 ***
E05C 17/54 (2006.01)
E05C 19/00 (2006.01)
E05C 19/18 (2006.01)
 (86) GB2012053099 12.12.2012
 (96) 12806637.0 01.01.2014
 (87) WO2013093426, 12.12.2012
 (97) 2678502, 01.01.2014 en
 (54) DOOR BRACE
 (71) ST. James, Steve, 155 W Jason 13, Encinitas CA 92024, US
 (72) HATTON, James, Penn Elcom Ltd., Drury Lane, Ponswood Industrial Estate, St Leonards-on-Sea, Sussex TN38 9BA, GB
 ST. JAMES, Steve, 155 W Jason 13, Encinitas, California 92024, US

- (51) MKP
A61M 5/32 (2006.01) (97) **2651474 ***
 (86) EP2011072237 08.12.2011
 (96) 11793796.1 23.10.2013
 (87) WO2012080087, 08.12.2011
 (97) 2651474, 23.10.2013 en
 (54) INJECTION SUPPORTING DEVICE FOR A SYRINGE AND INJECTION DEVICE
 (71) Sanofi-Aventis Deutschland GmbH, Brüningstraße 50, 65929 Frankfurt, DE
 (72) HEMMANN, Kerstine, c/o Sanofi-Aventis Deutschland GmbH, 65926 Frankfurt am Main, DE
 MINSHULL, Stephen, c/o Sanofi-Aventis UK London Road Holmes Chapel, Crewe, Cheshire CW48BE, GB
 HEALD, Michael, 22 Wells Avenue, Crewe, Cheshire CW1 5RZ, GB
 JAY, Graham, c/o Sanofi-Aventis Deutschland GmbH, 65926 Frankfurt am Main, DE

(51) MKP
A61K 39/395 (2006.01) (97) **2668211 ***
A61P 3/06 (2006.01)
C07K 16/40 (2006.01)
(86) EP2012051321 27.01.2012
(96) 12701015.5 04.12.2013
(87) WO2012101253, 27.01.2012
(97) 2668211, 04.12.2013 en
(54) PHARMACEUTICAL COMPOSITIONS COMPRISING HUMAN ANTIBODIES TO PCSK9
(71) SANOFI, 54 rue La Boétie, 75008 Paris, FR
(72) HANOTIN, Corinne, c/o SANOFI Diabetes R&D/Development 54 rue La Boétie, F-75008 Paris, FR
BESSAC, Laurence, c/o SANOFI Diabetes R&D/Development 54 rue La Boétie, F-75008 Paris, FR
CHAUDHARI, Umesh, c/o SANOFI US R&D Bridgewater Phase III - Clinical Development Mail Stop: 55B-415B 55 Corporate Drive, Bridgewater New Jersey 08807, US

(51) MKP
A01H 1/04 (2006.01) (97) **2645846 ***
G06F 19/14 (2011.01)
G06F 19/18 (2011.01)
(86) US2011062616 30.11.2011
(96) 11845711.8 09.10.2013
(87) WO2012075125, 30.11.2011
(97) 2645846, 09.10.2013 en
(54) METHODS FOR INCREASING GENETIC GAIN IN A BREEDING POPULATION
(71) Syngenta Participations AG, Schwarzwaldallee 215, 4058 Basel, CH
(72) KISHORE, Venkata, Krishna, C/o Syngenta Biotechnology Inc. P.O. Box 12257 3054 Cornwallis Road, Research Triangle Park, NC 27709-2257, US
GUO, Zhigang, C/o Syngenta Biotechnology Inc. P.O. Box 12257 3054 Cornwallis Road, Research Triangle Park, NC 27709-2257, US

(51) MKP
A61K 31/155 (2006.01) (97) **2663299 ***
A61K 31/194 (2006.01)
A61K 31/327 (2006.01)
A61K 31/4045 (2006.01)
A61K 31/4745 (2006.01)
A61K 31/65 (2006.01)
A61K 31/7048 (2006.01)
A61K 31/7056 (2006.01)
A61K 33/30 (2006.01)
A61K 45/06 (2006.01)
A61P 17/10 (2006.01)
(86) IB2012000013 05.01.2012
(96) 12701934.7 20.11.2013
(87) WO2012095719, 05.01.2012
(97) 2663299, 20.11.2013 en
(54) MELATONIN AND AN ANTIMICROBIAL OR ANTIBACTERIAL AGENT FOR THE TREATMENT OF ACNE
(71) NOVAERA S.r.l., Via Giambattista Unterverger, 78, 38122 Trento (TN), IT
(72) NOVAERA S.r.l., Via Giambattista Unterverger, 78, 38122 Trento (TN), IT

(51) MKP
C12P 21/08 (2006.01) (97) **2668283 ***
(86) US2012022742 26.01.2012
(96) 12738765.2 04.12.2013
(87) WO2012103345, 26.01.2012
(97) 2668283, 04.12.2013 en
(54) COMPOSITIONS CONTAINING GLYCOSYLATED ANTIBODIES AND USES THEREOF
(71) Abbvie Inc., 1 North Waukegan Road, North Chicago, IL 60064, US
(72) CORREIA, Ivan, R.S., 55 Pond Street, Winchester, MA 01890, US
FUJIMORI, Taro, 10 Lantern Lane, Shrewsbury, MA 01545, US
HRUSKA, Matthew, W., 457 Mockingbird Lane, Lindenhurst, IL 60046, US
PAULSON, Susan, Kaye, 1490 Wood Avenue, Downers Grove, IL 60515, US

(51) MKP
F21K 2/06 (2006.01) (97) **2649363 ***
(86) US2011064293 10.12.2011
(96) 11804847.9 16.10.2013
(87) WO2012079062, 10.12.2011
(97) 2649363, 16.10.2013 en
(54) CHEMILUMINESCENT DEVICE WITH TIME DELAY ACTIVATION
(71) Cyalume Technologies, Inc, 96 Windsor Street, West Springfield, MA 01089, US
(72) Cyalume Technologies, Inc, 96 Windsor Street, West Springfield, MA 01089, US

(51) MKP
B65H 75/14 (2006.01) (97) **2565140**
B65H 75/22 (2006.01)
(96) 12182284.5 06.03.2013
(97) 2565140, 06.03.2013 en
(54) Cable holder
(71) Imballaggi San Felice SRL, Via A. Vespucci, 38, 24056 Fontanella (BG), IT
(72) Pedrotti, Gianluca, Via Nazionale, 1/1, 25070 Caino (BS), IT

(51) MKP
C07D 307/81 (2006.01) (97) **2691382 ***
(86) HU2012000019 27.03.2012
(96) 12719899.2 05.02.2014
(87) WO2012131408, 27.03.2012
(97) 2691382, 05.02.2014 en
(54) PROCESS FOR PREPARATION OF DRONEDARONE BY MESYLATION
(71) SANOFI, 54 rue La Boétie, 75008 Paris, FR
(72) FRIESZ, Antal, c/o Chinoin Gyógyszer és Vegyészeti Termékek Gyára Zrt. Iparjog Tó u. 1-5, 1045 Budapest, HU
HUSZÁR, Csaba, c/o Chinoin Gyógyszer és Vegyészeti Termékek Gyára Zrt. Iparjog Tó u. 1-5, 1045 Budapest, HU

(51) MKP
E04F 11/18 (2006.01) (97) **2694752 ***
E04G 21/32 (2006.01)
(86) DK2012050119 10.04.2012
(96) 12721748.7 12.02.2014
(87) WO2012136227, 10.04.2012
(97) 2694752, 12.02.2014 en
(54) A GUARDRAIL AND METHOD FOR ASSEMBLING IT
(71) Lasse Ramskov Holding Aps, Nordholmen 10, 2650 Hvidovre, DK
(72) RAMSKOV, Lasse Fomsgaard, Birkholmvej 27, DK-Vanløse 2720, DK

- (51) MKP
A61K 31/357 (2006.01) (97) **2686310 ***
A61P 19/00 (2006.01)
A61P 29/00 (2006.01)
C07D 319/20 (2006.01)
C07D 405/10 (2006.01)
C07D 405/12 (2006.01)
C07D 405/14 (2006.01)
C07D 487/10 (2006.01)
(86) US2012028843 13.03.2012
(96) 12711504.6 22.01.2014
(87) WO2012125598, 13.03.2012
(97) 2686310, 22.01.2014 en
(54) BENZODIOXANE INHIBITORS OF LEUKOTRIENE PRODUCTION
(71) Boehringer Ingelheim International GmbH, Binger Strasse 173, 55216 Ingelheim am Rhein, DE
(72) ABEYWARDANE, Asitha, Boehringer Ingelheim Pharm., Inc. 900 Ridgebury Road P.O. Box 368, Ridgefield Connecticut 06877-0368, US
BURKE, Michael J., Boehringer Ingelheim Pharm., Inc. 900 Ridgebury Road P.O. Box 368, Ridgefield Connecticut 06877-0368, US
KIRRANE, Thomas Martin, Jr., Boehringer Ingelheim Pharm., Inc. 900 Ridgebury Road P.O. Box 368, Ridgefield Connecticut 06877-0368, US
NETHERTON, Matthew Russell, Boehringer Ingelheim Pharm., Inc. 900 Ridgebury Road P.O. Box 368, Ridgefield Connecticut 06877-0368, US
PADYANA, Anil Kumar, Boehringer Ingelheim Pharm., Inc. 900 Ridgebury Road P.O. Box 368, Ridgefield Connecticut 06877-0368, US
SMITH KEENAN, Lana Louise, Boehringer Ingelheim Pharm., Inc. 900 Ridgebury Road P.O. Box 368, Ridgefield Connecticut 06877-0368, US
TAKAHASHI, Hidenori, Boehringer Ingelheim Pharm., Inc. 900 Ridgebury Road P.O. Box 368, Ridgefield Connecticut 06877-0368, US
TURNER, Michael Robert, Boehringer Ingelheim Pharm., Inc. 900 Ridgebury Road P.O. Box 368, Ridgefield Connecticut 06877-0368, US
ZHANG, Qiang, Boehringer Ingelheim Pharm., Inc. 900 Ridgebury Road P.O. Box 368, Ridgefield Connecticut 06877-0368, US
ZHANG, Qing, Bai Di Road Xindayuan 7-2-702 Nankai, Tianjin 300192, CN

- (51) MKP
C09K 8/582 (2006.01) (97) **2678422 ***
C12N 1/26 (2006.01)
C12N 9/00 (2006.01)
(86) US2012026395 23.02.2012
(96) 12707217.1 01.01.2014
(87) WO2012116230, 23.02.2012
(97) 2678422, 01.01.2014 en
(54) ALKALINE MICROBIAL ENHANCED OIL RECOVERY
(71) Geo Fossil Fuels, LLC, 14818 West 6th Avenue Unit A1, Golden, CO 80401, US
(72) KOHR, William, J., 1308 Redwood Lane, Davis, CA 95616, US
ZHANG, Zhaoduo, 1599 Calle Santiago Street, Pleasanton, CA 94566, US
GALGOCZY, David, J., 1219 Rhode Island Street, San Francisco, CA 94107, US

- (51) MKP
F03D 11/00 (2006.01) (97) **2549845**
H02B 1/04 (2006.01)
H02B 1/40 (2006.01)
H05K 7/18 (2006.01)
(96) 12178648.7 23.01.2013
(97) 2549845, 23.01.2013 de
(54) Switch cabinet for a pitch system
(71) Moog Unna GmbH, Max-Born-Strasse 1, 59423 Unna, DE
(72) Springauf, Michael, Eichenwinkel 5, 33165 Lichtenau, DE
Franzak, Bernd, Brahmsstraße 14, 44534 Lünen, DE

- (51) MKP
A61K 31/519 (2006.01) (97) **2697229 ***
A61P 31/00 (2006.01)
C07D 487/04 (2006.01)
(86) US2012032994 11.04.2012
(96) 12799934.0 19.02.2014
(87) WO2012173689, 11.04.2012
(97) 2697229, 19.02.2014 en
(54) ANTIMICROBIAL COMPOUNDS AND METHODS OF MAKING AND USING THE SAME
(71) Melinta Therapeutics, Inc., 300 George Street, Commerce Suite 301, New Haven, CT 06511, US
(72) DUFFY, Erin, M., 349 River Road, Deep River, CT 06417, US
BHATTACHARJEE, Ashoke, 461 Cardinal Lane, Cheshire, CT 06410, US
CHEN, Shili, 290 Sorghum Ridge, Cheshire, CT 06410, US
SCHEIDEMAN, Matthew, 702 Quinniplac Ave., New Haven, CT 06513, US
KANYO, Zoltan, F., 1270 Ridge Road, North Haven, CT 06473, US
TANG, Yuanqing, 1005 Moss Farms Road, Cheshire, CT 06410, US

- (51) MKP
H05B 7/09 (2006.01) (97) **2651184**
(96) 13176197.5 16.10.2013
(97) 2651184, 16.10.2013 en
(54) Electrode paste for electrodes in binder-free graphite with hydrocarbon base
(71) Italgisa S.p.A., Via Gramsci 184, 25021 Bagnolo Mella (Brescia), IT
(72) Ferrari, Sandro, Via Carlo Serassi, 11, 24125 Bergamo, IT
Cavallotti, Irma, Via Fara, 3/A, 24129 Bergamo, IT
Conti, Giuseppe, Via Antonio Mambretti, 22, 20157 Milano, IT
Dusi, Maurizio, Vicolo Molino, 1, 25021 Bagnolo Mella (Brescia), IT

- (51) MKP
G01C 21/34 (2006.01) (97) **2602777**
G08G 1/01 (2006.01)
G08G 1/0968 (2006.01)
G08G 1/14 (2006.01)
(96) 11191926.2 12.06.2013
(97) 2602777, 12.06.2013 de
(54) Method for guiding a vehicle driver searching for a parking space
(71) Skobbler GmbH, Luisenstraße 41, 10117 Berlin, DE
(72) Kandal, Philipp, Birkensteige 27, 88069 Tettnang, DE

- (51) MKP
G01N 33/50 (2006.01) (97) **2681552 ***
G01N 33/574 (2006.01)
(86) US2012027574 02.03.2012
(96) 12708484.6 08.01.2014
(87) WO2012119113, 02.03.2012
(97) 2681552, 08.01.2014 en
(54) PREDICTION OF DRUG SENSITIVITY OF LUNG TUMORS BASED ON MOLECULAR AND GENETIC SIGNATURES
(71) Nestec S.A., Avenue Nestlé 55, 1800 Vevey, CH
(72) GONG, Hua, 12457 Carmel Park Drive, San Diego, California 92130-2274, US
SINGH, Sharat, 8171 Top of the Morning Way, Rancho Santa Fe, California 92127, US

- (51) MKP
A61K 31/55 (2006.01) (97) **2685986 ***
 (86) US2012029417 16.03.2012
 (96) 12760259.7 22.01.2014
 (87) WO2012129084, 16.03.2012
 (97) 2685986, 22.01.2014 en
 (54) GLUCOSYLCERAMIDE SYNTHASE INHIBITORS
 (71) Genzyme Corporation, 500 Kendall Street, Cambridge, MA 02142, US
 (72) BOURQUE, Elyse, 153 Second Avenue, Waltham, MA 02451, US
 CELATKA, Cassandra, 153 Second Avenue, Waltham, MA 02451, US
 HIRTH, Bradford, 153 Second Avenue, Waltham, MA 02451, US
 METZ, Markus, 153 Second Avenue, Waltham, MA 02451, US
 ZHAO, Zhong, 153 Second Avenue, Waltham, MA 02451, US
 SKERLJ, Renato, 153 Second Avenue, Waltham, MA 02451, US
 XIANG, Yibin, 153 Second Avenue, Waltham, MA 02451, US
 JANCISICS, Katherine, 153 Second Avenue, Waltham, MA 02451, US
 MARSHALL, John, 49 New York Avenue, Framingham, MA 01701, US
 CHENG, Seng, 49 New York Avenue, Framingham, MA 01701, US
 SCHEULE, Ronald, 49 New York Avenue, Framingham, MA 01701, US
 CABRERA-SALAZAR, Mario, 49 New York Avenue, Framingham, MA 01701, US
 GOOD, Andrew, 153 Second Avenue, Waltham, MA 02451, US

- (51) MKP
A47K 10/38 (2006.01) (97) **2606795**
 (96) 11010001.3 26.06.2013
 (97) 2606795, 26.06.2013 en
 (54) Sheet product dispenser
 (71) SCA TISSUE FRANCE, 60, avenue de l'Europe, 92270 Bois-Colombes, FR
 (72) Marietta-Tondin, Julien, 15B, rue du Maréchal Joffre, 67390 Marckolsheim, FR
 Cattacin, Gilles, 30, rue de Thann, 68000 Colmar, FR
 Stoeffler, Yves, 279, rue de la Montagne, 57200 Sarreguemines, FR

- (51) MKP
A61K 31/4985 (2006.01) (97) **2681219 ***
A61P 25/28 (2006.01)
C07D 487/04 (2006.01)
 (86) EP2012053455 29.02.2012
 (96) 12707276.7 08.01.2014
 (87) WO2012117027, 29.02.2012
 (97) 2681219, 08.01.2014 en
 (54) 6,7-DIHYDRO-PYRAZOLO[1,5-A]PYRAZIN-4-YLAMINE DERIVATIVES USEFUL AS INHIBITORS OF BETA-SECRETASE (BACE)
 (71) Janssen Pharmaceutica, N.V., Turnhoutseweg 30, 2340 Beerse, BE
 (72) TRABANCO-SUÁREZ, Andrés, Avelino, c/o Janssen-Cilag S.A. Calle Jarama 75 Poligono Industrial, E-45007 Toledo, ES
 GIJSEN, Henricus, Jacobus, Maria, c/o Janssen Pharmaceutica NV Turnhoutseweg 30, B-2340 Beerse, BE
 VAN GOOL, Michiel, Luc, Maria, c/o Janssen-Cilag S.A. Calle Jarama 75 Poligono Industrial, E-45007 Toledo, ES
 VEGA RAMIRO, Juan, Antonio, c/o Janssen-Cilag S.A. Calle Jarama 75 Poligono Industrial, E-45007 Toledo, ES
 DELGADO-JIMÉNEZ, Francisca, c/o Janssen-Cilag S.A. Calle Jarama 75 Poligono Industrial, E-45007 Toledo, ES

- (51) MKP
A23G 1/32 (2006.01) (97) **2672835 ***
A23K 1/16 (2006.01)
A23L 1/03 (2006.01)
A23L 2/52 (2006.01)
A23L 2/60 (2006.01)
A61Q 1/00 (2006.01)
A61Q 11/00 (2006.01)
C07C 259/06 (2006.01)
 (86) EP2012000537 07.02.2012
 (96) 12703250.6 18.12.2013
 (87) WO2012107201, 07.02.2012
 (97) 2672835, 18.12.2013 en
 (54) SWEETNESS ENHANCERS, SWEETENER COMPOSITIONS, METHODS OF MAKING THE SAME AND CONSUMABLES CONTAINING THE SAME
 (71) Nutrinova Nutrition Specialties & Food Ingredients GmbH, Industriepark Höchst, 65926 Frankfurt am Main, DE
 (72) KROHN, Michael, Alexanderstrasse 8, 64653 Lorsch, DE
 SEIBERT, Simon, Mollerstrasse 9, 64289 Darmstadt, DE
 KLEBER, Alice, Arminstrasse 4, 64625 Bensheim, DE
 WONSCHIK, Johann, Riepenbrik 16, 37647 Brevörde, DE
 SIEMS, Karsten, Feuerbachstrasse 7, 14552 Michendorf, DE
 MÜLLER, Jens-Peter, Varziner Strasse 10, 12161 Berlin, DE
 HAUSTEDT, Lars, Ole, Clara-Zetkin-Strasse 27, 14471 Potsdam, DE
 SCHWARZ, Oliver, Schenkenlandstrasse 7, 15711 Königs Wusterhausen, DE

- (51) MKP
C07K 16/22 (2006.01) (97) **2694547 ***
 (86) US2012030802 28.03.2012
 (96) 12712049.1 12.02.2014
 (87) WO2012138510, 28.03.2012
 (97) 2694547, 12.02.2014 en
 (54) ANTIBODIES THAT BIND TGF-ALPHA AND EPIREGULIN
 (71) Eli Lilly and Company, Lilly Corporate Center, Indianapolis, IN 46285, US
 (72) BEIDLER, Catherine, Brautigam, c/o Eli Lilly and Company P.O. Box 6288, Indianapolis Indiana 46206-6288, US
 HEUER, Josef, George, c/o Eli Lilly and Company P.O. Box 6288, Indianapolis Indiana 46206-6288, US
 PETROVAN, Ramona, Judita, c/o Eli Lilly and Company P.O. Box 6288, Indianapolis Indiana 46206-6288, US

- (51) MKP
C01B 25/14 (2006.01) (97) **2650274**
C07B 45/00 (2006.01)
C07C 325/02 (2006.01)
C07C 327/44 (2006.01)
C07D 207/24 (2006.01)
C07D 209/30 (2006.01)
C07D 211/72 (2006.01)
C07D 211/84 (2006.01)
C07D 213/06 (2006.01)
C07D 213/63 (2006.01)
C07D 239/93 (2006.01)
C07D 241/06 (2006.01)
 (96) 13175186.9 16.10.2013
 (97) 2650274, 16.10.2013 en
 (54) A thionation process and a thionating agent
 (71) Vironova AB, Gävlegatan 22, 113 30 Stockholm, SE
 (72) Pettersson, Birgitta, Mellanbergsvägen 11, 126 42 HÄGERSTEN, SE
 Hasimbegovic, Vedran, Räsundavägen 75, 169 57 SOLNA, SE
 Svensson, Per H., Fatburs Brunnsgata 18, 118 28 STOCKHOLM, SE
 Bergman, Jan, Lekgränd 5, 163 46 SPÅNGA, SE

- (51) MKP
A61J 1/05 (2006.01) (97) **2671562 ***
B65D 81/32 (2006.01)
 (86) JP2012052053 31.01.2012
 (96) 12742501.5 11.12.2013
 (87) WO2012105524, 31.01.2012
 (97) 2671562, 11.12.2013 en
 (54) MULTI-CHAMBERED CONTAINER
 (71) Ajinomoto Co., Inc., 15-1, Kyobashi 1-chome Chuo-ku, Tokyo 104-8315, JP
 (72) KOUNO, Katsumi, c/o Ajinomoto Pharmaceuticals Co. Ltd. 649-1 Miyakami Shimizu-ku, Shizuoka-shi Shizuoka 424-0911, JP
 SAKAI, Hidetoshi, c/o Ajinomoto Pharmaceuticals Co. Ltd. 649-1 Miyakami Shimizu-ku, Shizuoka-shi Shizuoka 424-0911, JP
 SHIMIZU, Kaoru, c/o Ajinomoto Pharmaceuticals Co. Ltd. 649-1 Miyakami Shimizu-ku, Shizuoka-shi Shizuoka 424-0911, JP
 KAWAI, Takahide, c/o Ajinomoto Pharmaceuticals Co. Ltd. 103-1 Ushishimizu Shirasaka, Shirakawa-shi Fukushima 961-0835, JP

- (51) MKP
A61K 31/5355 (2006.01) (97) **2694492 ***
A61P 25/00 (2006.01)
C07D 401/12 (2006.01)
C07D 405/12 (2006.01)
C07D 413/12 (2006.01)
 (86) IN2011000380 07.06.2011
 (96) 11749555.6 12.02.2014
 (87) WO2012114348, 07.06.2011
 (97) 2694492, 12.02.2014 en
 (54) NOVEL COMPOUNDS AS HISTAMINE H3 RECEPTOR LIGANDS
 (71) Suven Life Sciences Limited, Serene Chambers Road No. 5 Avenue 7 Banjara Hills, Hyderabad 500034, IN
 (72) NIROGI, Ramakrishna, Serene Chambers Road 5 Avenue 7 Banjara Hills, Hyderabad 500 034, IN
 SHINDE, Anil Karbhari, Serene Chambers Road 5 Avenue 7 Banjara Hills, Hyderabad 500 034, IN
 KAMBHAMPATI, Ramasastri, Serene Chambers Road 5 Avenue 7 Banjara Hills, Hyderabad 500 034, IN
 DESHPANDE, Amol Dinakar, Serene Chambers Road 5 Avenue 7 Banjara Hills, Hyderabad 500 034, IN
 DWARAMPUDI, Adi Reddy, Serene Chambers Road 5 Avenue 7 Banjara Hills, Hyderabad 500 034, IN
 GANGADASARI, Narasimhareddy, Serene Chambers Road 5 Avenue 7 Banjara Hills, Hyderabad 500 034, IN
 SARAF, Sangram Keshari, Serene Chambers Road 5 Avenue 7 Banjara Hills, Hyderabad 500 034, IN
 KANDIKERE, Vishwottam Nagaraj, Serene Chambers Road 5 Avenue 7 Banjara Hills, Hyderabad 500 034, IN
 JAYARAJAN, Pradeep, Serene Chambers Road 5 Avenue 7 Banjara Hills, Hyderabad 500 034, IN
 AHMAD, Ishtiyaque, Serene Chambers Road 5 Avenue 7 Banjara Hills, Hyderabad 500 034, IN
 MULLA, Mohmadsadiq Abdulhamid, Serene Chambers Road 5 Avenue 7 Banjara Hills, Hyderabad 500 034, IN
 JASTI, Venkateswarlu, Serene Chambers Road 5 Avenue 7 Banjara Hills, Hyderabad 500 034, IN

- (51) MKP
A01H 5/12 (2006.01) (97) **2681321 ***
A24B 15/10 (2006.01)
C12N 15/82 (2006.01)
 (86) US2012026795 27.02.2012
 (96) 12708462.2 08.01.2014
 (87) WO2012118754, 27.02.2012
 (97) 2681321, 08.01.2014 en
 (54) TOBACCO INBRED PLANTS ALBEX1F AND ALBEX1MS
 (71) Altria Client Services Inc., 6601 West Broad Street, Richmond, VA 23230, US
 (72) XU, Dongmei, 12192 Turning Branch Circle, Glen Allen, VA 23059, US
 NIELSEN, Mark, 116 Paddock Drive, Nicholasville, KY 40356, US
 SHEN, Yanxin, 11913 Amberwood Lane, Glen Allen, VA 23059, US

- (51) MKP
H01L 35/24 (2006.01) (97) **2676303 ***
H01L 51/00 (2006.01)
 (86) US2012025654 17.02.2012
 (96) 12747815.4 25.12.2013
 (87) WO2012112893, 17.02.2012
 (97) 2676303, 25.12.2013 en
 (54) SEMICONDUCTING POLYMER
 (71) United Arab Emirates University, P.O. Box 15551, Al Ain, AE
 (72) HAIK, Yousef, P.O. Box 17555, Al Ain, AE
 AYESH, Ahmad, Ibrahim, P.O. Box 17551, Al Ain, AE
 MOHSIN, Mahmood, Allawy, P.O. Box 17551, Al Ain, AE

- (51) MKP
A61K 9/00 (2006.01) (97) **2651410 ***
A61K 9/70 (2006.01)
A61K 31/27 (2006.01)
 (86) EP2011072812 14.12.2011
 (96) 11799413.7 23.10.2013
 (87) WO2012080365, 14.12.2011
 (97) 2651410, 23.10.2013 de
 (54) TRANSDERMAL THERAPEUTIC SYSTEM FOR ADMINISTERING AN ACTIVE SUBSTANCE
 (71) Acino AG, Am Windfeld 35, 83714 Miesbach, DE
 (72) LANGER, Britta, Alte Brauerei 12, 10965 Berlin, DE
 SCHURAD, Bjoern, Michael-Huber-Weg 26, 81667 München, DE
 PRINZ, Heike, Malvenweg 16, 82008 Unterhaching, DE

- (51) MKP
G06F 3/048 (2013.01) (97) **2695332 ***
H04L 12/28 (2006.01)
 (86) US2012000191 05.04.2012
 (96) 12720305.7 12.02.2014
 (87) WO2012138401, 05.04.2012
 (97) 2695332, 12.02.2014 en
 (54) METHOD AND APPARATUS FOR CREATING AND MODIFYING GRAPHICAL SCHEDULES
 (71) Savant Systems LLC, 45 Perseverance Way, Hyannis, MA 02601, US
 (72) CIPOLLO, Nicholas, J., 17 Irving Street Apt. 9, Boston, MA 02114, US
 SILVA, Michael, C., 6 Fairfield Drive, East Sandwich, MA 02537, US
 LOCASCIO, Timothy, R., 424 Old Mill Road, Osterville, MA 02655, US
 MADONNA, Robert, P., 32 Wianno Avenue, Osterville, MA 02655, US

- (51) MKP
A61K 9/00 (2006.01) (97) **2672955 ***
A61K 31/167 (2006.01)
 (86) EP2011051971 10.02.2011
 (96) 11706498.0 18.12.2013
 (87) WO2012107093, 10.02.2011
 (97) 2672955, 18.12.2013 en
 (54) STORAGE-STABLE FORMULATION OF PARACETAMOL IN AQUEOUS SOLUTION
 (71) Neogen N.V., Square Marie Curie 50, 1070 Anderlecht, BE
 (72) AL DANDACHI ATASSI, Khaled, Avenue du Derby 7, B-1050 Brussels, BE

(51) MKP
A61K 31/5517 (2006.01) (97) **2668187 ***
A61P 31/10 (2006.01)
C07D 487/04 (2006.01)
(86) EP2011073215 19.12.2011
(96) 11802072.6 04.12.2013
(87) WO2012084804, 19.12.2011
(97) 2668187, 04.12.2013 en
(54) NOVEL ANTIFUNGAL 5,6-DIHYDRO-4H-PYRROLO[1,2-a][1,4]-BENZODIAZEPINES AND 6H-PYRROLO[1,2-a][1,4]-BENZODIAZEPINES SUBSTITUTED WITH BICYCLIC BENZENE DERIVATIVES
(71) Janssen Pharmaceutica, N.V., Turnhoutseweg 30, 2340 Beerse, BE
(72) MEERPOEL, Lieven, Janssen Pharmaceutica NV Turnhoutseweg 30, B-2340 Beerse, BE
MAES, Louis, Jules, Roger, Marie, University of Antwerp Prinsstraat 13, B-2000 Antwerp, BE
DE WIT, Kelly, Hendrik van Boutersemstraat 15, B-2170 Merksem, BE

(51) MKP
C07B 57/00 (2006.01) (97) **2646422 ***
C07D 251/10 (2006.01)
(86) EP2011071347 30.11.2011
(96) 11788512.9 09.10.2013
(87) WO2012072663, 30.11.2011
(97) 2646422, 09.10.2013 en
(54) SEPARATION OF TRIAZINE DERIVATIVES ENANTIOMERS USING TARTARIC ACID
(71) Poxel, 200 avenue Jean Jaurès, 69007 Lyon, FR
(72) CRAVO, Daniel, 18 bis chemin des Murgers, F-78360 Montesson, FR
HELMREICH, Matthias, Erwin-Rohde-Strasse 10, 64120 Heidelberg, DE

(51) MKP
A61K 9/00 (2006.01) (97) **2675457 ***
A61K 31/4985 (2006.01)
A61P 31/22 (2006.01)
(86) EP2012052763 17.02.2012
(96) 12704419.6 25.12.2013
(87) WO2012110631, 17.02.2012
(97) 2675457, 25.12.2013 en
(54) PHARMACEUTICAL FORMULATION FOR TOPICAL ADMINISTRATION COMPRISING B220
(71) Vironova AB, Gävlegatan 22, 113 30 Stockholm, SE
(72) HOMMAN, Mohammed, Serenadvägen 1 A 8tr., S-131 53 Nacka, SE
BERGMAN, Jan, Lekgränd 5, S-163 46 Spånga, SE

(51) MKP
A61K 31/19 (2006.01) (97) **2658536 ***
A61P 1/18 (2006.01)
(86) US2011066736 22.12.2011
(96) 11810759.8 06.11.2013
(87) WO2012092103, 22.12.2011
(97) 2658536, 06.11.2013 en
(54) GEMCABENE AND DERIVATIVES FOR TREATING PANCREATITIS
(71) Michigan Life Therapeutics LLC, 2020 Shadford Road, Ann Arbor, Michigan 48104, US
(72) BISGAIER, Charles L., 3605 Tanglewood Dr., Ann Arbor Michigan 48105, US

(51) MKP
A61K 9/00 (2006.01) (97) **2658530 ***
A61K 9/20 (2006.01)
A61K 9/50 (2006.01)
A61K 31/4439 (2006.01)
(86) JP2011080568 26.12.2011
(96) 11811174.9 06.11.2013
(87) WO2012091153, 26.12.2011
(97) 2658530, 06.11.2013 en
(54) ORALLY DISINTEGRATING TABLET
(71) Takeda Pharmaceutical Company Limited, 1-1 Doshomachi 4-chome Chuo-ku, Osaka-shi, Osaka 541-0045, JP
(72) ISHII, Shiro, c/o TAKEDA PHARMACEUTICAL COMPANY LIMITED 17-85 Jusohonmachi 2-chome Yodogawa-ku, Osaka-shi Osaka 532-0024, JP
EBISAWA, Yutaka, c/o TAKEDA PHARMACEUTICAL COMPANY LIMITED 17-85 Jusohonmachi 2-chome Yodogawa-ku, Osaka-shi Osaka 532-0024, JP
OKABE, Takayuki, c/o TAKEDA PHARMACEUTICAL COMPANY LIMITED 17-85 Jusohonmachi 2-chome Yodogawa-ku, Osaka-shi Osaka 532-0024, JP

(51) MKP
A01F 12/18 (2006.01) (97) **2684444 ***
(86) KZ2011000020 21.12.2011
(96) 11859143.7 15.01.2014
(87) WO2012115494, 21.12.2011
(97) 2684444, 15.01.2014 en
(54) CROP THRESHING METHOD
(71) Republican Public Enterprise "Kazakh National Agrarian University" of Ministry of Education and Science of the Republic of Kazakhstan, Pr. Abaya 8, Almaty 050010, KZ
(72) SADYKOV, Zharylkasyn, ul. Manasa 51-30, Almaty 050008, KZ
ESPOLOV, Tiektes, 16-13 Al-Farabi Av., Almaty 050010, KZ
ZHALNIN, Eduard, 1- Institutskiy proezd, 5, Moscow 109428, RU
AL'PEYSOV, Shohan, 145-98 Kurmangazy Str., Almaty 050008, KZ
SADYKOVA, Saule, 51-30 Manasa Str., Almaty 050008, KZ

(51) MKP
A61J 1/03 (2006.01) (97) **2685956 ***
B65D 75/32 (2006.01)
(86) FR2012050561 16.03.2012
(96) 12714803.9 22.01.2014
(87) WO2012123689, 16.03.2012
(97) 2685956, 22.01.2014 fr
(54) PACKAGING FOR UNIT PHARMACEUTICAL PRODUCTS
(71) SANOFI, 54 rue La Boétie, 75008 Paris, FR
(72) CHABANOL, Stéphane, c/o SANOFI Département Brevets 54 rue La Boétie, F-75008 Paris, FR
DESPINS, Guillaume, c/o SANOFI Département Brevets 54 rue La Boétie, F-75008 Paris, FR
DREXLER, Sophie, c/o SANOFI Département Brevets 54 rue La Boétie, F-75008 Paris, FR
GASTE, Stéphanie, c/o SANOFI Département Brevets 54 rue La Boétie, F-75008 Paris, FR
MARIN, François, c/o SANOFI Département Brevets 54 rue La Boétie, F-75008 Paris, FR

(51) MKP
C12Q 1/68 (2006.01) (97) **2678441 ***
(86) EP2012053026 22.02.2012
(96) 12704842.9 01.01.2014
(87) WO2012123227, 22.02.2012
(97) 2678441, 01.01.2014 en
(54) SINGLE NUCLEOTIDE POLYMORPHISMS IN THE PROMOTER OF VEGFA GENE AND THEIR USE AS PREDICTIVE MARKERS FOR ANTI-VEGF TREATMENTS
(71) SANOFI, 54 rue La Boétie, 75008 Paris, FR
(72) CHIRON BLONDEL, Marielle, c/o Sanofi Patent Department 54 rue La Boétie, F-75008 Paris, FR
COUSIN, Emmanuelle, c/o Sanofi Patent Department 54 rue La Boétie, F-75008 Paris, FR
DELEUZE, Jean-François, c/o Sanofi Patent Department 54 rue La Boétie, F-75008 Paris, FR
DREYMANN, Jennifer, c/o Sanofi Patent Department 54 rue La Boétie, F-75008 Paris, FR
MACE, Sandrine, c/o Sanofi Patent Department 54 rue La Boétie, F-75008 Paris, FR

- (51) MKP
A61K 31/519 (2006.01) (97) **2694508 ***
A61P 35/00 (2006.01)
C07D 487/04 (2006.01)
(86) EP2012055600 29.03.2012
(96) 12712104.4 12.02.2014
(87) WO2012136553, 29.03.2012
(97) 2694508, 12.02.2014 en
(54) SUBSTITUTED 2,3-DIHYDROIMIDAZO[1,2-C]QUINAZOLINE SALTS
(71) Bayer Intellectual Property GmbH, Alfred-Nobel-Strasse 10, 40789 Monheim, DE
(72) PETERS, Jan, Georg, Belliniweg 6, 42719 Solingen, DE
MILTZER, Hans-Christian, Waldweg 2, 51519 Odenthal, DE
MÜLLER, Hartwig, Wiesenweg 10, 42553 Velbert, DE

- (51) MKP
A61K 35/20 (2006.01) (97) **2648739 ***
A61P 15/02 (2006.01)
(86) EP2011071612 02.12.2011
(96) 11799655.3 16.10.2013
(87) WO2012076409, 02.12.2011
(97) 2648739, 16.10.2013 en
(54) MULTIPURPOSE GEL FOR VAGINAL DRYNESS WITH DIRECT AND DELAYED EFFECT
(71) Zambon S.p.A., Via Lillo del Duca, 10, 20091 Bresso MI, IT
BARTORELLI, Alberto, Chalet Cristina - Bois Doré Chemin des Biolirs, CH-3963 Crans sur Sierre, CH
(72) GOBBI, Maria Rosa, Comprensorio del Golf Club Monticello Via Volta 4, I-22073 FINO MORNASCO (CO), IT

- (51) MKP
C07C 269/04 (2006.01) (97) **2687506**
C07D 223/16 (2006.01)
C12P 41/00 (2006.01)
(96) 13176588.5 22.01.2014
(97) 2687506, 22.01.2014 fr
(54) Method for enzymatic synthesis of (7S)-1-(3,4-dimethoxybicyclo[4.2.0]octa-1,3,5-triene-7-yl) N-methylmethanamine, and use for the synthesis of Ivabradine and the salts thereof
(71) Les Laboratoires Servier, 35, rue de Verdun, 92284 Suresnes Cedex, FR
(72) Pedragosa Moreau, Sandrine, 79 bis A, rue Vieille Levée, 45100 ORLEANS, FR
Lefoulon, François, 33, rue Jules Lemaître, 45000 ORLEANS, FR
Moris Varas, Francisco, Periodista Carantona 17, 3A, 33209 GIJON, ES
Gonzalez Sabin, Javier, Belarmino Cabal, 18, 3A, 33012 OVIEDO, ES

- (51) MKP
C08G 69/26 (2006.01) (97) **2687555 ***
C08K 3/00 (2006.01)
C08L 77/06 (2006.01)
(86) JP2012056588 14.03.2012
(96) 12758039.7 22.01.2014
(87) WO2012124740, 14.03.2012
(97) 2687555, 22.01.2014 en
(54) POLYAMIDE AND POLYAMIDE COMPOSITION
(71) Asahi Kasei Chemicals Corporation, 1-105, Kanda Jinbocho Chiyoda-ku, Tokyo 101-8101, JP
(72) IEDA, Shinji, 1-105 Kanda Jinbocho Chiyoda-ku, Tokyo 101-8101, JP
TERADA, Kazunori, 1-105 Kanda Jinbocho Chiyoda-ku, Tokyo 101-8101, JP
NITTO, Yu, 1-105 Kanda Jinbocho Chiyoda-ku, Tokyo 101-8101, JP

- (51) MKP
A61K 31/41 (2006.01) (97) **2668169 ***
A61P 3/04 (2006.01)
C07D 257/06 (2006.01)
(86) US2012022721 26.01.2012
(96) 12704958.3 04.12.2013
(87) WO2012103333, 26.01.2012
(97) 2668169, 04.12.2013 en
(54) TETRAZOLE COMPOUNDS AND METHODS OF MAKING AND USING SAME
(71) Zafgen, Inc., One Broadway, 8th Floor, Cambridge, MA 02142, US
(72) DYKE, Hazel, Joan, 8/9 Spire Green Centre Flex Meadow, Harlow Essex CM19 5TR, GB
PALLIN, Thomas, David, 8/9 Spire Green Centre Flex Meadow, Harlow Essex CM19 5TR, GB
CRAMP, Susan, Mary, 8/9 Spire Green Centre Flex Meadow, Harlow Essex CM19 5TR, GB

- (51) MKP
H02K 3/32 (2006.01) (97) **2695285 ***
(86) EP2012055530 28.03.2012
(96) 12713064.9 12.02.2014
(87) WO2012130892, 28.03.2012
(97) 2695285, 12.02.2014 de
(54) LAMINATED CORE ASSEMBLY
(71) Wobben Properties GmbH, Dreekamp 5, 26605 Aurich, DE
(72) LENSCHOW, Gerhard, Baltrumstrasse 4, 26603 Aurich, DE

- (51) MKP
C03B 5/235 (2006.01) (97) **2688846 ***
F23M 5/02 (2006.01)
F27B 3/20 (2006.01)
(86) EP2012055108 22.03.2012
(96) 12710266.3 29.01.2014
(87) WO2012130725, 22.03.2012
(97) 2688846, 29.01.2014 de
(54) MELTING DEVICE
(71) Messer Hungarogaz Kft., Váci út 117, 1044 Budapest, HU
Messer Austria GmbH, Industriestrasse 5, 2352 Gumpoldskirchen, AT
(72) DEMUTH, Martin, Badener Str. 37/5, A-2352 Gumpoldskirchen, AT
HOLLEIS, Burkhardt, Lichtäckerstr. 20b, A-2522 Oberwaltersdorf, DE
PALMAI, Gyula, Meredek ut 6, H-3100 Salgotarjan, HU
POTESSE, Michael, Wohlmutstr. 15-17/1/31, A-1020 Wien, AT
SPOLJARIC, Davor, Schulstrasse 87, A-2103 Langenzersdorf, AT

- (51) MKP
G01N 33/48 (2006.01) (97) **2673729 ***
G06F 19/22 (2011.01)
(86) US2011061506 18.11.2011
(96) 11858061.2 18.12.2013
(87) WO2012108920, 18.11.2011
(97) 2673729, 18.12.2013 en
(54) METHODS FOR NON-INVASIVE PRENATAL PLOIDY CALLING
(71) Natera, Inc., 201 Industrial Road Suite 410, San Carlos, CA 94070, US
(72) RABINOWITZ, Matthew, 1133 Dolores Street, San Francisco, California 94110, US
GEMELOS, George, 1546 Cameo Drive, San Jose, California 95129, US
BANJEVIC, Milena, 26799 Elena Road, Los Altos Hills, California 94022, US
RYAN, Allison, 77 Columbia Avenue, Redwood City, California 94063, US
DEMKO, Zachary, 26799 Elena Drive, Los Altos Hills, California 94022, US
HILL, Matthew, 56 Loyola Avenue, Menlo Park, California 94025, US
ZIMMERMANN, Bernhard, 1662 Lodi Avenue, San Mateo, California 94401, US
BANER, Johan, 2000 Broadway Street Apt. 309, San Francisco, California 94115, US

(51) MKP
A24D 1/00 (2006.01) (97) **2662418**
C09C 1/02 (2006.01)
D21H 17/00 (2006.01)
D21H 17/26 (2006.01)
D21H 17/69 (2006.01)
(96) 12167664.7 13.11.2013
(97) 2662418, 13.11.2013 en
(54) Sustainable adsorbable polymers
(71) Omya International AG, Baslerstrasse 42, 4665 Oftringen, CH
(72) Buri, Matthias, Mätteliweg 20, 4852 Rothrist, CH
Gane, Patrick A.C., Studenweg 8, 4852 Rothrist, CH
Rentsch, Samuel, Höheweg 1, 4663 Aarburg, CH

(51) MKP
C01F 11/18 (2006.01) (97) **2684999**
C08K 3/20 (2006.01)
C09C 1/02 (2006.01)
C09C 3/10 (2006.01)
D21H 17/69 (2006.01)
D21H 19/38 (2006.01)
D21H 19/42 (2006.01)
D21H 19/44 (2006.01)
D21H 21/14 (2006.01)
(96) 12176392.4 15.01.2014
(97) 2684999, 15.01.2014 en
(54) High solids and low viscous aqueous slurries of calcium carbonate-comprising materials with improved rheological stability under increased temperature
(71) Omya International AG, Baslerstrasse 42, 4665 Oftringen, CH
(72) Rentsch, Samuel, Burgpark 2, 4663 Aarburg, CH
Buri, Matthias, Mätteliweg 20, 4852 Rothrist, CH
Gane, Patrick A. C., Studenweg 8, 4852 Rothrist, CH

(51) MKP
A01N 41/04 (2006.01) (97) **2667719 ***
A01N 43/50 (2006.01)
A01N 43/56 (2006.01)
A01N 43/60 (2006.01)
A01N 43/72 (2006.01)
A01N 47/06 (2006.01)
A01N 47/10 (2006.01)
A01N 47/18 (2006.01)
A01N 47/30 (2006.01)
A01N 47/34 (2006.01)
A01N 47/40 (2006.01)
A01N 47/44 (2006.01)
A01N 59/02 (2006.01)
(86) IN2012000066 30.01.2012
(96) 12739075.5 04.12.2013
(87) WO2012101659, 30.01.2012
(97) 2667719, 04.12.2013 en
(54) PESTICIDE COMPOSITION COMPRISING SULPHUR, AN INSECTICIDE AND AN AGROCHEMICAL EXCIPIENT.
(71) Shah, Deepak Pranjivandas, 501/502 Vandana Apartments Janki Kutir Juhu Church Road Juhu, Mumbai, Maharashtra 400 009, IN
(72) Shah, Deepak Pranjivandas, 501/502 Vandana Apartments Janki Kutir Juhu Church Road Juhu, Mumbai, Maharashtra 400 009, IN

(51) MKP
A61F 13/15 (2006.01) (97) **2656827**
A61F 13/49 (2006.01)
(96) 13165203.4 30.10.2013
(97) 2656827, 30.10.2013 en
(54) Disposable Products Containing Parallel Flared Elastics
(71) Curt G. Joa, Inc., PO Box 903, Sheboygan Falls, WI 53085-0903, US
(72) Fritz, Jeff W., N4989 Country Aire Road Plymouth, Wisconsin 53073, US
Nelson, Chris, W6244 Hill and Dale Road Plymouth, Wisconsin 53073, US
McCabe, John A., 1141 Partridge Run Sheboygan Falls, Wisconsin 53085, US
Peterson, Daniel A., 1817 South 8th Street Sheboygan, Wisconsin 53083, US

(51) MKP
A01N 43/16 (2006.01) (97) **2688403 ***
A61K 31/35 (2006.01)
(86) US2012030327 23.03.2012
(96) 12760456.9 29.01.2014
(87) WO2012129495, 23.03.2012
(97) 2688403, 29.01.2014 en
(54) OPIOID RECEPTOR LIGANDS AND METHODS OF USING AND MAKING SAME
(71) Trevena, Inc., 1018 West 8th Avenue Suite A, King Of Prussia, PA 19406, US
(72) YAMASHITA, Dennis, 531 Walker Road, Wayne Pennsylvania 19087, US
GOTCHEV, Dimitar, 224 Diane Avenue, Hatboro Pennsylvania 19040, US
PITIS, Philip, 108 Sunrise Drive, North Wales Pennsylvania 19454, US
CHEN, Xiao-Tao, 3708 Powder Horn Drive, Furlong Pennsylvania 18925, US
LIU, Guodong, 2206 Sunrise Way, Jamison Pennsylvania 18929, US
YUAN, Catherine C.K., 119 Pinecrest Drive, King of Prussia Pennsylvania 19406, US

(51) MKP
A61K 31/4164 (2006.01) (97) **2699561 ***
A61P 35/00 (2006.01)
C07D 401/04 (2006.01)
C07D 403/04 (2006.01)
C07D 403/12 (2006.01)
C07D 413/12 (2006.01)
C07D 413/14 (2006.01)
C07D 471/04 (2006.01)
C07D 487/04 (2006.01)
C07D 513/04 (2006.01)
(86) FI2012000022 20.04.2012
(96) 12722174.5 26.02.2014
(87) WO2012143599, 20.04.2012
(97) 2699561, 26.02.2014 en
(54) ANDROGEN RECEPTOR MODULATING CARBOXAMIDES
(71) Orion Corporation, Orionintie 1, 02200 Espoo, FI
(72) TÖRMÄKANGAS, Olli, Rossinpolku 2 D 4, FI-20380 Turku, FI
WOHLFAHRT, Gerd, Vattuniemenkatu 14 C 35, FI-00210 Helsinki, FI
SALO, Harri, Puolikontie 6 C, FI-20300 Turku, FI
RAMASUBRAMANIAN, Rathna, Durga, Leirikmatu 12E 19 20360 12 E 19, FI-20360 Turku, FI
PATRA, Pranab, Kumar, 92/Harmony Apartment Sector 62, IN-201301 Noida, IN
MARTIN, Arputharaj, Ebenezer, A/30 Sector 53, IN-201301, IN
HEIKKINEN, Terhi, Jalaskuja 7B, FI-21420 Lieto, FI
VESALAINEN, Anniina, Valkovuokko 10, FI-21530 Paimio, FI
MOILANEN, Anu, Kuutamokatu 3, FI-20900 Turku, FI
KARJALAINEN, Arja, Iltatie 4 B 6, FI-02210 Espoo, FI

(51) MKP
A61K 31/4427 (2006.01) (97) **2651925 ***
A61P 31/12 (2006.01)
C07D 401/12 (2006.01)
C07D 403/04 (2006.01)
C07D 403/14 (2006.01)
(86) US2011065239 15.12.2011
(96) 11849149.7 23.10.2013
(87) WO2012083058, 15.12.2011
(97) 2651925, 23.10.2013 en
(54) ANTI-VIRAL COMPOUNDS
(71) Abbvie Inc., 1 North Waukegan Road, North Chicago, IL 60064, US
(72) KRUEGER, Allan C., 7260 Presidential Drive, Gurnee Illinois 60031, US
KATI, Warren M., 152 Knob Hill Lane, Gurnee Illinois 60031, US
MARING, Clarence J., 1228 W. Borders Drive, Palatine Illinois 60067, US
WAGNER, Rolf, 42530 Sheridan Oaks Drive, Antioch Illinois 60002, US
HUTCHINS, Charles W., 31005 Prairie Ridge Rd, Green Oaks Illinois 600048, US

(51) MKP
H04L 29/08 (2006.01) (97) **2684337 ***
H04L 29/12 (2006.01)
 (86) US2012028494 09.03.2012
 (96) 12710409.9 15.01.2014
 (87) WO2012125458, 09.03.2012
 (97) 2684337, 15.01.2014 en
 (54) SYSTEM AND METHOD FOR ACCESSING A DEVICE HAVING AN ASSIGNED NETWORK ADDRESS
 (71) Qualcomm Incorporated, 5775 Morehouse Drive, San Diego, CA 92121-1714, US
 (72) HERSHKO, Yuval Corey, c/o QUALCOMM Incorporated 5775 Morehouse Drive, San Diego, California 92121-1714, US
 STRAUSS, Nir, c/o QUALCOMM Incorporated 5775 Morehouse Drive, San Diego, California 92121-1714, US

(51) MKP
H01M 2/02 (2006.01) (97) **2549563**
H01M 2/10 (2006.01)
 (96) 12190153.2 23.01.2013
 (97) 2549563, 23.01.2013 de
 (54) System comprising a battery tray and a tray receiver for mounting the battery tray in a battery cabinet of a wind turbine
 (71) Moog Unna GmbH, Max-Born-Strasse 1, 59423 Unna, DE
 (72) Springauf, Michael, Eichenwinkel 5, 33165 Lichtenau, DE
 Franzak, Bernd, Brahmstraße 14, 44534 Lünen, DE

(51) MKP
G06F 19/00 (2011.01) (97) **2597584**
 (96) 12191267.9 29.05.2013
 (97) 2597584, 29.05.2013 en
 (54) Apparatus, process and infrastructure of monitoring a plurality of patients affected by kidney failure
 (71) Gambro Lundia AB, P.O. Box 10101, 220 10 Lund, SE
 (72) Bene, Bernard, GAMBRO INDUSTRIES No. 35, rue de la Visina, 69540 Irigny, FR
 Fouilleul, Achille, GAMBRO INDUSTRIES Château de Thézieu Avenue des Cantinières, 38300 RUY, FR
 Buttin, Lionel, GAMBRO HOSPAL SAS No. 47, rue Coste, 69300 Caluire et Cuire, FR

(51) MKP
A61K 33/26 (2006.01) (97) **2668175 ***
A61P 7/06 (2006.01)
C07D 309/40 (2006.01)
 (86) GB2012050160 26.01.2012
 (96) 12708368.1 04.12.2013
 (87) WO2012101442, 26.01.2012
 (97) 2668175, 04.12.2013 en
 (54) PROCESS
 (71) Iron Therapeutics Holdings AG, Sihleggstrasse 23, 8832 Wollerau, CH
 (72) STOCKHAM, Michael Arthur, "Baltroy" Stickling Green Clavering, Saffron Walden Essex CB11 4QX, GB

(51) MKP
A61K 31/498 (2006.01) (97) **2654751 ***
A61P 3/02 (2006.01)
A61P 23/00 (2006.01)
A61P 25/00 (2006.01)
A61P 25/16 (2006.01)
A61P 25/24 (2006.01)
C07D 401/04 (2006.01)
C07D 401/14 (2006.01)
 (86) IB2011003132 21.12.2011
 (96) 11811125.1 30.10.2013
 (87) WO2012085648, 21.12.2011
 (97) 2654751, 30.10.2013 en
 (54) PHOSPHORUS-SUBSTITUTED QUINOXALINE-TYPE PIPERIDINE COMPOUNDS AND USES THEREOF
 (71) Purdue Pharma L.P., One Stamford Forum 201 Tresser Boulevard, Stamford, CT 06901-3431, US
 (72) TADESSE, Dawit, 1 Koenig Dr., Parlin New Jersey 08859, US
 TAFESSE, Laykea, 8 Windward Way, Robbinsville NJ 08690, US
 ZHOU, Xiaoming, 22 Dogwood Drive, Plainsboro NJ 08536, US

(51) MKP
F03D 11/00 (2006.01) (97) **2665930 ***
 (86) EP2012067348 05.09.2012
 (96) 12756455.7 27.11.2013
 (87) WO2013034607, 05.09.2012
 (97) 2665930, 27.11.2013 de
 (54) METHOD FOR DETERMINING THE INCLINATION OF A TOWER
 (71) GL Garrad Hassan Deutschland GmbH, Sommerdeich 14 b, 25709 Kaiser-Wilhelm-Koog, DE
 (72) Heining, Nils, Herderstrasse 6, 25421 Pinneberg, DE

(51) MKP
A61K 9/00 (2006.01) (97) **2675452 ***
A61K 31/439 (2006.01)
 (86) EP2012052425 13.02.2012
 (96) 12706504.3 25.12.2013
 (87) WO2012110462, 13.02.2012
 (97) 2675452, 25.12.2013 en
 (54) LIQUID PROPELLANT-FREE FORMULATION COMPRISING AN ANTIMUSCARINIC DRUG
 (71) Chiesi Farmaceutici S.p.A., Via Palermo, 26/A, 43100 Parma, IT
 (72) SOLIANI RASCHINI, Annamaria, Chiesi Farmaceutici S.p.A. Via Palermo 26/A, I-43100 Parma, IT
 LUTERO, Emilio, Chiesi Farmaceutici S.p.A. Via Palermo 26/A, I-43100 Parma, IT

(51) MKP
G21G 1/10 (2006.01) (97) **2659491 ***
 (86) US2011067340 27.12.2011
 (96) 11852655.7 06.11.2013
 (87) WO2012092243, 27.12.2011
 (97) 2659491, 06.11.2013 en
 (54) PROTON ENGINE
 (71) Ross, Owen Venmore, 32 Ozone Avenue, Venice, CA 90291, US
 (72) Ross, Owen Venmore, 32 Ozone Avenue, Venice, CA 90291, US

(51) MKP
A61K 9/00 (2006.01) (97) **2672958 ***
A61K 9/127 (2006.01)
A61K 38/00 (2006.01)
A61K 38/47 (2006.01)
A61K 47/24 (2006.01)
 (86) US2012024376 08.02.2012
 (96) 12704217.4 18.12.2013
 (87) WO2012109387, 08.02.2012
 (97) 2672958, 18.12.2013 en
 (54) COMPOSITION AND LIPID FORMULATION OF A HYALURONAN-DEGRADING ENZYME AND THE USE THEREOF FOR TREATMENT OF BENIGN PROSTATIC HYPERPLASIA
 (71) Halozyme, Inc., 11388 Sorrento Valley Road, San Diego, CA 92121, US
 (72) LI, Xiaoming, 8886 Adobe Bluffs Dr., San Diego, CA 92129, US
 RAMPRASAD, Mysore, 7593 Mona Lane, San Diego, CA 92130, US
 THOMPSON, Curtis, 29 East Street, Encinitas, CA 92024, US
 SHEPARD, Harold, Michael, 4637 Pavlov Ave., San Diego, CA 92122, US
 BOOKBINDER, Louis, Howard, 14823 Gable Ridge Rd., San Diego, CA 92128, US
 FROST, Gregory, Ian, 13662 Mercado Drive, Del Mar, CA 92014, US

(51) MKP
G01F 1/28 (2006.01) (97) **2659234 ***
 (86) IB2012000003 02.01.2012
 (96) 12722826.0 06.11.2013
 (87) WO2012101490, 02.01.2012
 (97) 2659234, 06.11.2013 en
 (54) DEVICE FOR MEASURING THE FLOW RATE OF A FLUID
 (71) Ingegnerie Toscane S.r.l., Via di Villamagna 90/C, 50126 Firenze (FI), IT
 BRE ELETTRONICA S.r.l., Via di Cardeta 2B Arena Metato, 56010 San Giuliano Terme (PI), IT
 (72) RINDI, Piero, Via Jacopo Arrosti 38, I-56122 PISA, IT

(51) MKP
A61K 31/517 (2006.01) (97) **2694072 ***
A61P 35/00 (2006.01)
C07D 239/70 (2006.01)
(86) US2012031679 30.03.2012
(96) 12764765.9 12.02.2014
(87) WO2012135759, 30.03.2012
(97) 2694072, 12.02.2014 en
(54) COMBINATIONS OF AKT INHIBITOR COMPOUNDS AND ABIRATERONE, AND METHODS OF USE
(71) Genentech, Inc., One DNA Way, South San Francisco, CA 94080-4990, US
Nannini, Michelle, 1 DNA Way, South San Francisco, California 94080, US
Sampath, Deepak, 1 DNA Way, South San Francisco, California 94080-4990, US
(72) NANNINI, Michelle, 1 DNA Way, South San Francisco California 94080-4990, US
SAMPATH, Deepak, 1 DNA Way, South San Francisco California 94080-4990, US

(51) MKP
A61K 31/405 (2006.01) (97) **2680838 ***
A61K 31/47 (2006.01)
A61K 31/22 (2006.01)
A61K 31/416 (2006.01)
A61K 31/4015 (2006.01)
A61K 31/44 (2006.01)
A61K 31/41 (2006.01)
A61K 31/616 (2006.01)
A61K 31/415 (2006.01)
A61P 9/10 (2006.01)
A61K 31/4155 (2006.01)
A61K 31/366 (2006.01)
A61K 31/422 (2006.01)
A61K 31/122 (2006.01)
A61K 31/505 (2006.01)
(86) EP2012053360 28.02.2012
(96) 12707729.5 08.01.2014
(87) WO2012116985, 28.02.2012
(97) 2680838, 08.01.2014 en
(54) TREATMENT OF ARTERIAL AGEING BY COMBINATION OF RAAS INHIBITOR AND HMG-CoA REDUCTASE INHIBITOR
(71) Farmicom Pharmaceutical Company D.O.O., Obrtna Cona Logatec 30, 1370 Logatec, SI
(72) SABOVIC, Miso, Ulica Bratov Ucakar 46, 1000 Ljubljana, SI

(51) MKP
A01N 43/68 (2006.01) (97) **2672825 ***
(86) US2011024457 11.02.2011
(96) 11858415.0 18.12.2013
(87) WO2012108873, 11.02.2011
(97) 2672825, 18.12.2013 en
(54) STABLE AGROCHEMICAL OIL DISPERSIONS
(71) Dow AgroSciences LLC, 9330 Zionsville Road, Indianapolis, IN 46268, US
(72) HOPKINS, Derek, 503 Mangorei Road, New Plymouth 4312, NZ
KEENEY, Franklin, 12304 Windsor Drive, Carmel, IN 46033, US
LIU, Lei, 1501 Brookmill Court, Carmel, IN 46032, US
QIN, Kuide, 13179 Lamana Place, Westfield, IN 46074, US

(51) MKP
A61K 31/5377 (2006.01) (97) **2667874 ***
(86) US2012023035 27.01.2012
(96) 12739403.9 04.12.2013
(87) WO2012103524, 27.01.2012
(97) 2667874, 04.12.2013 en
(54) INHIBITORS OF MTOR KINASA AS ANTI- VIRAL AGENTS
(71) THE TRUSTEES OF PRINCETON UNIVERSITY, P.O. Box 36 4 New South Building, Princeton, New Jersey 08544, US
Kadmon Corporation, LLC, 450 East 29th St., New York, NY 10016, US
(72) SHENK, Thomas, E., 12 Boudinot Street, Princeton, NJ 08540, US
KIM, Ji-In, 672 Prospect Avenue, Princeton, NJ 08540, US

(51) MKP
A61K 39/12 (2006.01) (97) **2655604 ***
A61K 39/235 (2006.01)
C12N 7/01 (2006.01)
(86) US2011064944 14.12.2011
(96) 11849865.8 30.10.2013
(87) WO2012082918, 14.12.2011
(97) 2655604, 30.10.2013 en
(54) ADENOVIRUS SEROTYPE 26 AND SEROTYPE 35 FILOVIRUS VACCINES
(71) The Government of The United States of America as represented by The Secretary of The Department of Health and Human Services, Office of Technology Transfer 6011 Executive Boulevard, Suite 325, Rockville, Maryland 20852, US
Crucell Holland B.V., Archimedesweg 4, 2333 CN Leiden, NL
SULLIVAN, Nancy J., 4408 Ambler Drive, Kensington Maryland 20895, US
NABEL, Gary J., 2520 30th Street NW, Washington District of Columbia 20008, US
ASIEDU, Clement, 18141 Marksman Circle, Apt 101, Olney Maryland 20832, US
CHENG, Cheng, 12004 Montrose Village Terrace, Rockville Maryland 20852, US
PAU, Maria Grazia, Bargelaan 80, NL-2333 CW Leiden, NL
GOUDSMIT, Jaap, Koninginneweg 4, NL-1075 CX Amsterdam, NL

(51) MKP
G06F 21/00 (2013.01) (97) **2678794 ***
(86) US2012023789 03.02.2012
(96) 12707410.2 01.01.2014
(87) WO2012115764, 03.02.2012
(97) 2678794, 01.01.2014 en
(54) SYSTEMS AND METHODS FOR RULE-DRIVEN MANAGEMENT OF SENSOR DATA ACROSS GEOGRAPHIC AREAS AND DERIVED ACTIONS
(71) Fedex Corporate Services, Inc., 30 FedEx Pkwy 1st Fl. Vertical, Collierville, TN 38017, US
SKAAKSURUD, Ole-Petter, 4114 East Fir Hill Drive, Lakeland, TN 38002, US
AINSWORTH, Miley, 1814 Tara Drive, Hernando, MS 38632, US

(51) MKP
A61K 31/454 (2006.01) (97) **2665719 ***
A61K 31/4545 (2006.01)
A61K 31/497 (2006.01)
A61K 31/506 (2006.01)
A61P 3/10 (2006.01)
A61P 5/50 (2006.01)
C07D 407/14 (2006.01)
C07D 413/14 (2006.01)
C07D 491/048 (2006.01)
(86) EP2012050841 20.01.2012
(96) 12700413.3 27.11.2013
(87) WO2012098217, 20.01.2012
(97) 2665719, 27.11.2013 en
(54) FUSED DIHYDROFURANS AS GPR119 MODULATORS FOR THE TREATMENT OF DIABETES, OBESITY AND RELATED DISORDERS
(71) Boehringer Ingelheim International GmbH, Binger Strasse 173, 55216 Ingelheim am Rhein, DE
(72) HIMMELSBACH, Frank, Boehringer Ingelheim GmbH Corporate Patents Binger Strasse 173, 55216 Ingelheim Am Rhein, DE
LANGKOPF, Elke, Boehringer Ingelheim GmbH Corporate Patents Binger Strasse 173, 55216 Ingelheim Am Rhein, DE
NOSSE, Bernd, Boehringer Ingelheim GmbH Corporate Patents Binger Strasse 173, 55216 Ingelheim Am Rhein, DE

(51) MKP
A61K 31/7056 (2006.01) (97) **2655388 ***
C07D 513/04 (2006.01)
C07H 9/06 (2006.01)
C12Q 1/34 (2006.01)
(86) CA2011001397 21.12.2011
(96) 11850773.0 30.10.2013
(87) WO2012083435, 21.12.2011
(97) 2655388, 30.10.2013 en
(54) SELECTIVE GLYCOSIDASE INHIBITORS AND USES THEREOF
(71) Alectos Therapeutics Inc., 8999 Nelson Way, Burnaby, British Columbia V5A 4B5, CA
Merck Sharp & Dohme Corp., 126 East Lincoln Avenue, Rahway, NJ 07065, US
(72) KAUL, Ramesh, 8999 Nelson Way, Burnaby British Columbia V5A 4B5, CA
McEACHERN, Ernest J., 8999 Nelson Way, Burnaby British Columbia V5A 4B5, CA
MU, Changwei, No. 18 South Xihuan Road BDA, Beijing 100176, CN
SELNICK, Harold G., 770 Sumneytown Pike, West Point Pennsylvania 19486, US
VOCADLO, David J., 8999 Nelson Way, Burnaby British Columbia V5A 4B5, CA
WANG, Yaode, No. 18 South Xihuan Road BDA, Beijing 100176, CN
WEI, Zhongyong, No. 18 South Xihuan Road BDA, Beijing 100176, CN
ZHOU, Yuanxi, 8999 Nelson Way, Burnaby British Columbia V5A 4B5, CA
ZHU, Yongbao, 8999 Nelson Way, Burnaby British Columbia V5A 4B5, CA

(51) MKP
B01J 49/00 (2006.01) (97) **2651559 ***
(86) US2011064862 14.12.2011
(96) 11848467.4 23.10.2013
(87) WO2012082869, 14.12.2011
(97) 2651559, 23.10.2013 en
(54) METHODS AND DEVICES FOR MEASURING THE CONCENTRATION OF AN ADDITIVE
(71) Ferrate Treatment Technologies, LLC, 300 Sunport Lane, Suite 101-a, Orlando, FL 32809, US
(72) DALY, Luke, J., 1322 Waltham Avenue, Belle Isle FL 32806, US
ALIG, Craig, S., 509 Delaney Park Drive, Orlando FL 32806, US

(51) MKP
A61K 39/395 (2006.01) (97) **2699262 ***
A61K 47/48 (2006.01)
A61P 35/00 (2006.01)
C07K 16/10 (2006.01)
C07K 16/28 (2006.01)
C07K 16/32 (2006.01)
C07K 16/46 (2006.01)
(86) EP2012057307 20.04.2012
(96) 12718626.0 26.02.2014
(87) WO2012143524, 20.04.2012
(97) 2699262, 26.02.2014 en
(54) BISPECIFIC ANTIBODIES AGAINST HER2 AND CD3
(71) Genmab A/S, Bredgade 34 E, 1260 Copenhagen K, DK
(72) NEIJSEEN, Joost, J., c/o Genmab B.V. Yalelaan 60, NL-3584 CM Utrecht, NL
MEESTERS, Joyce, I., c/o Genmab B.V. Yalelaan 60, NL-3584 Utrecht, NL
DE GOEIJ, Bart, c/o Genmab B.V. Yalelaan 60, NL-3584 CM Utrecht, NL
LABRIJN, Aran, Frank, c/o Genmab B.V. Yalelaan 60, NL-3584 CM Utrecht, NL
PARREN, Paul, c/o Genmab B.V. Yalelaan 60, NL-3584 CM Utrecht, NL
SCHUURMAN, Janine, c/o Genmab B.V. Yalelaan 60, NL-3584 CM Utrecht, NL

(51) MKP
C07K 16/28 (2006.01) (97) **2661449 ***
(86) EP2012050061 04.01.2012
(96) 12700019.8 13.11.2013
(87) WO2012093125, 04.01.2012
(97) 2661449, 13.11.2013 en
(54) LIGANDS THAT BIND TGF-BETA RECEPTOR II
(71) Glaxo Group Limited, 980 Great West Road, Brentford, Middlesex TW8 9GS, GB
(72) BEATON, Andrew, GlaxoSmithKline Gunnels Wood Road, Stevenage Hertfordshire SG1 2NY, GB
DIMECH, Caroline, GlaxoSmithKline Gunnels Wood Road, Stevenage Hertfordshire SG1 2NY, GB
ERTL, Peter, Franz, GlaxoSmithKline Gunnels Wood Road, Stevenage Hertfordshire SG1 2NY, GB
FORD, Susannah, Karen, GlaxoSmithKline Gunnels Wood Road, Stevenage Hertfordshire SG1 2NY, GB
MCADAM, Ruth, GlaxoSmithKline Gunnels Wood Road, Stevenage Hertfordshire SG1 2NY, GB

(51) MKP
A61K 31/00 (2006.01) (97) **2670401 ***
A61K 31/506 (2006.01)
A61P 35/00 (2006.01)
(86) US2012023669 02.02.2012
(96) 12703670.5 11.12.2013
(87) WO2012106540, 02.02.2012
(97) 2670401, 11.12.2013 en
(54) METHODS OF USING ALK INHIBITORS
(71) IRM LLC, 131 Front Street P.O. Box HM 2899, Hamilton HM LX, BM
(72) LI, Nanxin, Genomics Institute of the Novartis Research Foundation 10675 John Jay Hopkins Drive San Diego, California 92121, US
HARRIS, Jennifer L., Genomics Institute of the Novartis Research Foundation 10675 John Jay Hopkins Drive San Diego, California 92121, US
McNAMARA, Peter, Genomics Institute of the Novartis Research Foundation 10675 John Jay Hopkins Drive San Diego, California 92121, US
SUN, Fangxian, 4 Cedarwood Lane, Melrose Massachusetts 02176, US

(51) MKP
B66C 1/34 (2006.01) (97) **2657175**
F16B 21/12 (2006.01)
(96) 13164786.9 30.10.2013
(97) 2657175, 30.10.2013 en
(54) Retaining Pin Assembly for a Lifting System.
(71) The Crosby Group LLC, 2857 Dawson Road, Tulsa, OK 74110, US
(72) Ohman III, Rodger, 6637 South 223rd East Avenue., Broken Arrow, OK Oklahoma 74014, US
Postelwait, Larry, 3613 North Old Highway 66., Catoosa, OK Oklahoma 74015, US

(51) MKP
G06K 19/00 (2006.01) (97) **2649585 ***
G06Q 50/24 (2012.01)
(86) US2011064363 12.12.2011
(96) 11846295.1 16.10.2013
(87) WO2012079069, 12.12.2011
(97) 2649585, 16.10.2013 en
(54) ELECTRONIC HEALTH RECORD WEB-BASED PLATFORM
(71) Lese, Gail Bronwyn, 75 Willow Road, Nahant, MA 01908, US
(72) Lese, Gail Bronwyn, 75 Willow Road, Nahant, MA 01908, US

- (51) MKP
A61K 9/20 (2006.01) (97) **2654732 ***
A61K 9/50 (2006.01)
- (86) EP2011073772 22.12.2011
(96) 11810593.1 30.10.2013
(87) WO2012085194, 22.12.2011
(97) 2654732, 30.10.2013 en
(54) COMPRESSED SOLID DOSAGE FORMS
(71) Laboratorios del. Dr. Esteve, S.A., Avda Mare de Deu de Montserrat 221, 08041 Barcelona, ES
(72) SOLER RANZANI, Luis, Avda. Diagonal 255-257 2-1, E-08013 Barcelona, ES
FALIVENE ALDEA, Albert, Calle Ronda Sant Pere 50 2º 2ª, E-08010 Barcelona, ES
SANTANACH DELISAU, Àngel, C/ Portal de la Rambla 5 3º-2ª, E-08500 Vic - Barcelona, ES
CASADEVALL PUJALS, Gemma, Psg. Garcia i Faria 57-59 4º-2, E-08019 Barcelona, ES
-
- (51) MKP
F02D 19/06 (2006.01) (97) **2573368**
F02D 19/08 (2006.01)
F02D 41/00 (2006.01)
F02D 41/14 (2006.01)
F02D 41/30 (2006.01)
- (96) 12290279.4 27.03.2013
(97) 2573368, 27.03.2013 fr
(54) METHOD FOR CONTROLLING IN PARTICULAR THE IGNITION OF THE COMBUSTION OF A GASOLINE DIRECT INJECTION INTERNAL COMBUSTION ENGINE
(71) IFP Energies Nouvelles, 1 et 4 avenue de Bois Préau, 92852 Rueil Malmaison Cedex, FR
(72) Obiols, Jérôme, 2 Rue Lamartine, 69320 Feyzin, FR
-
- (51) MKP
A61K 9/00 (2006.01) (97) **2694074 ***
A61K 31/40 (2006.01)
A61K 31/403 (2006.01)
A61K 31/522 (2006.01)
A61K 45/06 (2006.01)
A61P 9/00 (2006.01)
A61P 9/04 (2006.01)
A61P 9/10 (2006.01)
- (86) US2012032378 05.04.2012
(96) 12715516.6 12.02.2014
(87) WO2012154340, 05.04.2012
(97) 2694074, 12.02.2014 en
(54) USE OF A2B ADENOSINE RECEPTOR ANTAGONISTS FOR TREATING HEART FAILURE AND ARRHYTHMIA IN POST-MYOCARDIAL INFARCTION PATIENTS
(71) Gilead Sciences, Inc., 333 Lakeside Drive, Foster City, CA 94404, US
(72) BELARDINELLI, Luiz, 205 Manzanita Ave., Palo Alto, California 94306, US
ZHONG, Hongyan, 156 Montelena Ct., Mountain View, California 94040, US
ZENG, Dewan, 871 Sycamore Dr., Palo Alto, California 94303, US
-

- (51) MKP
C07H 21/04 (2006.01) (97) **2656263 ***
G06F 19/00 (2011.01)
- (86) US2011066938 22.12.2011
(96) 11851621.0 30.10.2013
(87) WO2012088456, 22.12.2011
(97) 2656263, 30.10.2013 en
(54) METHODS FOR NON-INVASIVE PRENATAL PATERNITY TESTING
(71) Natera, Inc., 2686 Middlefield Road Suite C, Redwood City, California 94063, US
(72) RYAN, Allison, 77 Columbia Avenue, Redwood City, California 94063, US
SIGURJONSSON, Styrmir, 1945 Serge Avenue, San Jose, California 95130, US
BANJEVIC, Milena, 26799 Elena Road, Los Altos Hills, California 94022, US
GEMELOS, George, 1546 Cameo Drive, San Jose, California 95129, US
HILL, Matthew, 56 Loyola Avenue, Menlo Park, California 94025, US
BANER, Johan, 2000 Broadway St. Apt. 309, San Francisco, California 94115, US
RABINOWITZ, Matthew, 1133 Dolores Street, San Francisco, California 94110, US
DEMKO, Zachary, 26799 Elena Road, Los Altos Hills, California 94022, US
-
- (51) MKP
A61K 47/48 (2006.01) (97) **2691155 ***
A61P 35/00 (2006.01)
- (86) US2012031243 29.03.2012
(96) 12714160.4 05.02.2014
(87) WO2012135517, 29.03.2012
(97) 2691155, 05.02.2014 en
(54) PREPARATION OF MAYTANSINOID ANTIBODY CONJUGATES BY A ONE-STEP PROCESS
(71) Immunogen, Inc., 830 Winter Street, Waltham, MA 02451-1477, US
(72) LI, Xinfang, 34 Hammond Pond Parkway, Chestnut Hill, Massachusetts 02467, US
WORFUL, Jared M., 127 Elm Street 1, Somerville Massachusetts 02144, US
-
- (51) MKP
C12M 1/107 (2006.01) (97) **2691506 ***
- (86) IL2012050110 28.03.2012
(96) 12720971.6 05.02.2014
(87) WO2012131679, 28.03.2012
(97) 2691506, 05.02.2014 en
(54) AN APPARATUS FOR WASTE SEPARATION
(71) Rainbowtec Environmental Solutions 2010 Ltd., Pob 92, 22825 Kfar Rosh Hanikra, IL
(72) ZAID, Lior, Pob.92, 22825 Kfar Rosh Hanikra, IL
-
- (51) MKP
A61B 17/02 (2006.01) (97) **2612606**
A61B 19/00 (2006.01)
- (96) 12000021.1 10.07.2013
(97) 2612606, 10.07.2013 en
(54) System and method for inhibiting injury to a patient during laparoscopic surgery
(71) Langlois, David Allen, 145 Country Club Drive, Hamilton ON L8K 5W4, CA
Schembri, Lawrence, 29 Stroud Crescent, London ON N6E 1Z5, CA
(72) Langlois, David Allen, 145 Country Club Drive, Hamilton ON L8K 5W4, CA
Schembri, Lawrence, 29 Stroud Crescent, London ON N6E 1Z5, CA
-

(51) MKP
A61K 31/7068 (2006.01) (97) **2697241 ***
A61K 31/7072 (2006.01)
A61K 38/21 (2006.01)
A61P 31/14 (2006.01)
C07H 19/06 (2006.01)
C07H 19/067 (2006.01)
C07H 19/073 (2006.01)
C07H 19/10 (2006.01)
(86) US2012033675 13.04.2012
(96) 12716969.6 19.02.2014
(87) WO2012142523, 13.04.2012
(97) 2697241, 19.02.2014 en
(54) 1'-SUBSTITUTED PYRIMIDINE N-NUCLEOSIDE ANALOGS FOR ANTIVIRAL TREATMENT
(71) Gilead Sciences, Inc., 333 Lakeside Drive, Foster City, CA 94404, US
(72) CHO, Aesop, 1656 Notre Dame Drive, Mountain View CA 94040, US
KIM, Choung, U., 1750 Elizabeth Street, San Carlos CA 94070, US
KIRSCHBERG, Thorsten, A., 340 Hillview Avenue, Redwood City CA 94062, US
MISH, Michael, R., 442 Chesapeake Avenue, Foster City CA 94404, US
SQUIRES, Neil, 627 Taylor Street, Apt. 43, San Francisco CA 94102, US

(51) MKP
F24J 2/04 (2006.01) (97) **2592364**
F24J 2/46 (2006.01)
F24J 2/52 (2006.01)
H01L 31/042 (2006.01)
H01L 31/048 (2006.01)
(96) 11425274.5 15.05.2013
(97) 2592364, 15.05.2013 en
(54) An integrated structural system for mounting of photovoltaic panels
(71) D.Motica S.R.L., Via Ancona, 15/bis, 60035 Jesi (AN), IT
(72) Ceccarelli, Lorenzo, Via Buratta, 5/B, 60018 Montemarcano (AN), IT

(51) MKP
A61K 31/502 (2006.01) (97) **2646432 ***
A61P 35/00 (2006.01)
C07D 403/04 (2006.01)
(86) GB2011052356 29.11.2011
(96) 11805567.2 09.10.2013
(87) WO2012073017, 29.11.2011
(97) 2646432, 09.10.2013 en
(54) SUBSTITUTED BENZOPYRAZIN DERIVATIVES AS FGFR KINASE INHIBITORS FOR THE TREATMENT OF CANCER DISEASES
(71) Astex Therapeutics Limited, 436 Cambridge Science Park Milton Park Cambridge, Cambridgeshire CB4 0QA, GB
(72) BERDINI, Valerio, c/o Astex Therapeutics Limited 436 Cambridge Science Park Milton Road Cambridge, Cambridgeshire CB4 0QA, GB
SAXTY, Gordon, c/o Astex Therapeutics Limited 436 Cambridge Science Park Milton Road Cambridge, Cambridgeshire CB4 0QA, GB
MURRAY, Christopher William, c/o Astex Therapeutics Limited 436 Cambridge Science Park Milton Road Cambridge, Cambridgeshire CB4 0QA, GB
BESONG, Gilbert Ebai, Kaiserslauterer Str. 32, D-67098 Bad Duerkheim, DE
HAMLETT, Christopher Charles Frederick, c/o Astex Therapeutics Limited 436 Cambridge Science Park Milton Road Cambridge, Cambridgeshire CB4 0QA, GB
WOODHEAD, Steven John, 10300 Campus Point Drive Suite 200 San Diego, California 92121, US
LIGNY, Yannick Aimé Eddy, c/o JANSSEN - CILAG Campus de Maigremont B.P. 615, F-27106 Val de Reuil Cedex, FR
ANGIBAUD, Patrick René, c/o JANSSEN - CILAG Campus de Maigremont B.P. 615, F-27106 Val de Reuil Cedex, FR

(51) MKP
C12P 7/44 (2006.01) (97) **2694664 ***
(86) US2012031510 30.03.2012
(96) 12768472.8 12.02.2014
(87) WO2012138567, 30.03.2012
(97) 2694664, 12.02.2014 en
(54) VINYL ACID MONOMER RECOVERY
(71) University of New Hampshire, Office for Research Partnerships and Commercialization University of New Hampshire 35 Colovos Road 136 Gregg Hall, Durham, New Hampshire 03824, US
Itaconix, Llc, P.O. Box 777 86 Exeter Road, Hampton Falls, New Hampshire 03844, US
(72) DURANT, Jennifer, 10 Pinkham Road, Lee New Hampshire 03861, US
DURANT, Yvon, 10 Pinkham Road, Lee New Hampshire 03861, US
SHAW, John, 86 Exeter Road, Hampton Falls New Hampshire 03844, US

(51) MKP
C07D 211/34 (2006.01) (97) **2651892 ***
(86) IB2011003140 16.12.2011
(96) 11811127.7 23.10.2013
(87) WO2012080834, 16.12.2011
(97) 2651892, 23.10.2013 en
(54) LOW-TEMPERATURE SYNTHESIS OF METHYLPHENIDATE HYDROCHLORIDE
(71) Rhodes Technologies, 498 Washington Street, Coventry, RI 02816, US
(72) HUNTLEY, C., Frederick, M., 250 Howland Rd., East Greenwich, Rhode Island 02818, US
KATAISTO, Erik, Wayne, 125 Providence St. No.S408, West Warwick, Rhode Island 02893, US
LA LUMIERE, Knicholaus, Dudley, 187 Douglas Avenue Apartment No.3, Providence, RI 02908, US
REISCH, Helge, Alfred, 36 Wells Street, Westerly, Rhode Island 02891, US

(51) MKP
A61K 31/57 (2006.01) (97) **2658545 ***
A61P 15/00 (2006.01)
A61P 29/00 (2006.01)
(86) IB2011055941 23.12.2011
(96) 11813568.0 06.11.2013
(87) WO2012090143, 23.12.2011
(97) 2658545, 06.11.2013 en
(54) TREATMENT OF PAIN ASSOCIATED WITH DISLOCATION OF BASAL ENDOMETRIUM
(71) PregLem S.A., Chemin du Pré-Fleuri 3, 1228 Plan-les-Ouates Geneva, CH
(72) LOUMAYE, Ernest, 29 Chemin de Planta, CH-1223 Cologny, CH
BESTEL, Elke, 2 Chemin de Crêt Millet, F-74160 Saint-Julien-en-Genevois, FR
OSTERLOH, Ian, Beechen House Beech Hill, Bridge Kent CT4 5AU, GB

(51) MKP
B63B 1/10 (2006.01) (97) **2691289 ***
B63B 35/44 (2006.01)
(86) IT2011000323 16.09.2011
(96) 11784796.2 05.02.2014
(87) WO2013038433, 16.09.2011
(97) 2691289, 05.02.2014 en
(54) MODULAR SEMI-SUBMERSIBLE STRUCTURE AND METHOD FOR MAKING SUCH STRUCTURE
(71) Fincantieri Cantieri Navali Italiani S.p.A., Via Genova 1, 34121 Trieste, IT
(72) GONAN, Roberto, FINCANTIERI CANTIERI NAVALI ITALIANI S.p.A. Via Genova 1, I-34121 Trieste, IT

(51) MKP
A61K 9/00 (2006.01) (97) **2594258**
A61K 31/495 (2006.01)
A61K 47/10 (2006.01)
A61K 47/38 (2006.01)
(86) 11189706.2 22.05.2013
(97) 2594258, 22.05.2013 en
(54) Oral gel comprising praziquantel
(71) Veterinärmedizinische Universität Wien, Veterinärplatz 1, 1210 Vienna, AT
(72) Dadak, Agnes, Mühlfeldg. 3/43, 1020 Vienna, AT
Franz, Sonja, Mühlg. 12, 2403 Wildungsmauer, AT
Liebhart, Andreas, Kaiserebersdorferstr. 35-37/3/14, 1110 Vienna, AT

(51) MKP
A61K 31/44 (2006.01) (97) **2655330 ***
A61K 31/4439 (2006.01)
A61P 25/00 (2006.01)
C07D 213/75 (2006.01)
C07D 401/02 (2006.01)
C07D 401/12 (2006.01)
C07D 401/14 (2006.01)
(86) IB2011003137 21.12.2011
(96) 11813366.9 30.10.2013
(87) WO2012085650, 21.12.2011
(97) 2655330, 30.10.2013 en
(54) SUBSTITUTED PYRIDINES AS SODIUM CHANNEL BLOCKERS
(71) Purdue Pharma LP, One Stamford Forum 201 Tresser Boulevard, Stamford, CT 06901-3431, US
(72) NI, Chiyou, 5 Ford Court, Belle Mead NJ 08502, US
PARK, Minnie, 22 Warwick Road, West Windsor NJ 08550, US
SHAO, Bin, 23 Shelbourne Road, Richboro PA 18954, US
TAFESSE, Laykea, 8 Windward Way, Robbinsville, NJ 08690, US
YAO, Jiangchao, 10 Bellflower Court, Princeton NJ 08540, US
YOUNGMAN, Mark, 110 Franklin Court, North Wales PA 19454, US
ZHOU, Xiaoming, 22 Dogwood Drive, Plainsboro NJ 08536, US

(51) MKP
A61K 31/337 (2006.01) (97) **2678011 ***
A61K 33/24 (2006.01)
A61P 35/00 (2006.01)
(86) EP2012053125 24.02.2012
(96) 12706546.4 01.01.2014
(87) WO2012113897, 24.02.2012
(97) 2678011, 01.01.2014 en
(54) ANTITUMORAL COMBINATION COMPRISING CABAZITAXEL AND CISPLATIN
(71) Aventis Pharma S.A., 20, avenue Raymond Aron, 92160 Antony, FR
(72) BISSERY, Marie-Christine, c/o Sanofi Patent Department 54 rue La Boétie, F-75008 Paris, FR
DEDIEU, Jean-Francois, c/o Sanofi Patent Department 54 rue La Boétie, F-75008 Paris, FR
KHAN, Akbar, c/o Sanofi Patent Department 54 rue La Boétie, F-75008 Paris, FR
VRIGNAUD, Patricia, c/o Sanofi Patent Department 54 rue La Boétie, F-75008 Paris, FR

(51) MKP
G06F 17/30 (2006.01) (97) **2697725 ***
G06K 9/62 (2006.01)
(86) US2012033620 13.04.2012
(96) 12718803.5 19.02.2014
(87) WO2012142483, 13.04.2012
(97) 2697725, 19.02.2014 en
(54) ROBUST FEATURE MATCHING FOR VISUAL SEARCH
(71) Qualcomm Incorporated, 5775 Morehouse Drive, San Diego, CA 92121-1714, US
(72) VADDADI, Sundeep, 5775 Morehouse Drive, San Diego California 92121-1714, US
HAMSICI, Onur C., 5775 Morehouse Drive, San Diego California 92121-1714, US
REZNIK, Yuriy, 5775 Morehouse Drive, San Diego California 92121-1714, US
HONG, John H., 5775 Morehouse Drive, San Diego California 92121-1714, US
LEE, Chong U., 5775 Morehouse Drive, San Diego California 92121-1714, US

(51) MKP
A61L 2/07 (2006.01) (97) **2596808**
B01J 3/04 (2006.01)
(86) 12191549.0 29.05.2013
(97) 2596808, 29.05.2013 en
(54) Apparatus and process for recycling absorbent sanitary products
(71) Fater S.p.A., Via Alessandro Volta, 10, 65129 Pescara, IT
Somma, Marcello, Viale Regina Elena, 74, I-65122 Pescara, IT
Vaccaro, Giorgio, Via Primo Levi, 7, I-65010 Spoltore (Pescara), IT
(72) Michalek, Jan K., 3762 Alward Road, Pataskala, OH Ohio 43062, US
Thomas, Theodore, 864 Lookout Point Drive, Columbus, OH Ohio 43235, US

(51) MKP
A61K 31/00 (2006.01) (97) **2678679 ***
A61K 38/00 (2006.01)
G01N 33/50 (2006.01)
(86) EP2012052954 21.02.2012
(96) 12704826.2 01.01.2014
(87) WO2012113802, 21.02.2012
(97) 2678679, 01.01.2014 en
(54) USE OF ACETYLATED TUBULIN AS A BIOMARKER OF DRUG RESPONSE TO FURAZANOBENZIMIDAZOLES
(71) Basilea Pharmaceutica AG, Grenzacherstrasse 487, 4005 Basel, CH
(72) LANE, Heidi Alexandra, Kaltbrunnenweg 8, CH-4106 Therwil, CH
BACHMANN, Felix, Sierenzerstrasse 16, CH-4055 Basel, CH

(51) MKP
A61K 31/422 (2006.01) (97) **2678015 ***
A61P 31/04 (2006.01)
(86) EP2012050759 19.01.2012
(96) 12700487.7 01.01.2014
(87) WO2012113594, 19.01.2012
(97) 2678015, 01.01.2014 en
(54) USE OF NIFURATEL TO TREAT INFECTIONS CAUSED BY CLOSTRIDIUM SPECIES
(71) Polichem SA, 50, Val Fleuri, 1526 Luxembourg, LU
(72) BULGHERONI, Anna, Via Robarello 31, I-21100 Varese, IT
MAILLAND, Federico, Strada Regina 10, CH-6900 Lugano, CH
IOB, Giuliana, Via Cantonale, CH-6953 Lugaggia, CH

- (51) MKP
A61K 31/5025 (2006.01) (97) **2655376 ***
A61P 25/00 (2006.01)
C07D 487/04 (2006.01)
(86) EP2011073522 21.12.2011
(96) 11804561.6 30.10.2013
(87) WO2012085038, 21.12.2011
(97) 2655376, 30.10.2013 en
(54) 5,6-DIHYDRO-IMIDAZO[1,2-a]PYRAZIN-8-YLAMINE DERIVATIVES USEFUL AS INHIBITORS OF BETA-SECRETASE (BACE)
(71) Janssen Pharmaceutica NV, Turnhoutseweg 30, 2340 Beerse, BE
(72) TRABANCO-SUÁREZ, Andrés, Avelino, c/o Janssen-Cilag S.A. Calle Jarama 75 Poligono Industrial, E-45007 Toledo, ES
DELGADO-JIMÉNEZ, Francisca, c/o Janssen-Cilag S.A. Calle Jarama 75 Poligono Industrial, E-45007 Toledo, ES
VEGA RAMIRO, Juan, Antonio, c/o Janssen-Cilag S.A. Calle Jarama 75 Poligono Industrial, E-45007 Toledo, ES
TRESADERN, Gary, John, c/o Janssen-Cilag S.A. Calle Jarama 75 Poligono Industrial, E-45007 Toledo, ES
GIJSEN, Henricus, Jacobus, Maria, c/o Janssen Pharmaceutica NV Turnhoutseweg 30, B-2340 Beerse, BE
OEHLRICH, Daniel, c/o Janssen Pharmaceutica NV Turnhoutseweg 30, B-2340 Beerse, BE

- (51) MKP
A61K 31/4162 (2006.01) (97) **2685990 ***
A61K 31/7088 (2006.01)
A61P 35/00 (2006.01)
(86) IB2012000696 12.03.2012
(96) 12757133.9 22.01.2014
(87) WO2012123823, 12.03.2012
(97) 2685990, 22.01.2014 en
(54) COMBINATION OF ANTI-CLUSTERIN OLIGONUCLEOTIDE WITH HSP90 INHIBITOR FOR THE TREATMENT OF PROSTATE CANCER
(71) The University of British Columbia, University - Industry Liaison Office 103 - 6190 Agronomy Road, Vancouver, BC V6T 1Z3, CA
(72) GLEAVE, Martin, E., 4693 Drummond Drive, Vancouver British Columbia V6R 1E8, CA
ZOUBEIDI, Amina, 6331 Imperial Avenue, West Vancouver British Columbia V7W 2J5, CA
LAMOUREUX, François, 19 rue des Tilleuls, F-49260 Breze, FR

- (51) MKP
A61K 9/02 (2006.01) (97) **2679242 ***
A61K 9/06 (2006.01)
A61K 9/14 (2006.01)
A61K 9/70 (2006.01)
A61K 39/00 (2006.01)
A61K 39/39 (2006.01)
(86) JP2012054544 24.02.2012
(96) 12750249.0 01.01.2014
(87) WO2012115222, 24.02.2012
(97) 2679242, 01.01.2014 en
(54) ADJUVANT FOR TRANSDERMAL OR TRANSMUCOSAL ADMINISTRATION AND PHARMACEUTICAL PREPARATION CONTAINING SAME
(71) Hisamitsu Pharmaceutical Co., Inc., 408, Tashirodaikanmachi, Tosu-shi Saga 841-0017, JP
(72) MORIMOTO, Kumi, c/o HISAMITSU PHARMACEUTICAL CO., INC. 25-11 Kannondai 1-chome, Tsukuba-shi Ibaraki 305-0856, JP
TOKUMOTO, Seiji, c/o HISAMITSU PHARMACEUTICAL CO., INC. 25-11 Kannondai 1-chome, Tsukuba-shi Ibaraki 305-0856, JP

- (51) MKP
A61K 39/09 (2006.01) (97) **2694101 ***
A61K 39/21 (2006.01)
A61K 39/295 (2006.01)
A61P 31/18 (2006.01)
(86) IB2012000857 06.04.2012
(96) 12721921.0 12.02.2014
(87) WO2012137071, 06.04.2012
(97) 2694101, 12.02.2014 en
(54) PHARMACEUTICAL COMPOSITIONS FOR PREVENTING AND/OR TREATING AN HIV DISEASE IN HUMANS
(71) Biovaxim Limited, Finsgate 5-7 Cranwood Street, London EC1V 9EE, GB
Université Paris Descartes, 12, rue de l'Ecole de Médecine, 75006 Paris, FR
Institut De Recherche Pour Le Développement (IRD), Le Sextant 44 Bd Dunkerque CS90009, 13000 Marseille, FR
(72) ANDRIEU, Jean-Marie, 95 Boulevard Saint Michel, F-75005 PARIS, FR
LU, Louis, Room 3201 Building 13 Dong Hu Wan 8 Li Ze Xi Jie Wang Jing Area Chaoyang District, Beijing 100102 PRC, CN

- (51) MKP
F16K 1/18 (2006.01) (97) **2649358 ***
F16L 23/036 (2006.01)
F16L 55/10 (2006.01)
(86) EP2011068683 25.10.2011
(96) 11773737.9 16.10.2013
(87) WO2012076242, 25.10.2011
(97) 2649358, 16.10.2013 en
(54) CONTROL VALVE FOR SEPARABLE CONNECTION UNIT FOR FLEXIBLE PIPES.
(71) MIB ITALIANA S.p.A., Via Garibaldi 6, 35020 Casalsarugo (PD), IT
(72) BORMIOLI, Lorenzo, Via Carlo Cerato 14, I-35100 Padova, IT

- (51) MKP
F41H 1/02 (2006.01) (97) **2671041 ***
(86) US2012020509 06.01.2012
(96) 12741708.7 11.12.2013
(87) WO2012106065, 06.01.2012
(97) 2671041, 11.12.2013 en
(54) BALLISTIC MATERIAL SYSTEM FOR TACTICAL BODY ARMOR
(71) Barrday Corporation, 1450 West Pointe Drive Unit C, Charlotte, NC 28214, US
(72) KRUMMEL, Joe, 65 Northland Drive, Rising Sun, MD 21911, US

- (51) MKP
A61B 5/11 (2006.01) (97) **2691918 ***
G06K 9/00 (2006.01)
(86) US2012031697 30.03.2012
(96) 12714173.7 05.02.2014
(87) WO2012135767, 30.03.2012
(97) 2691918, 05.02.2014 en
(54) SYSTEMS, METHODS, AND APPARATUSES FOR CLASSIFYING USER ACTIVITY USING COMBINING OF LIKELIHOOD FUNCTION VALUES IN A MOBILE DEVICE
(71) Qualcomm Incorporated, International IP Administration 5775 Morehouse Drive, San Diego, CA 92121-1714, US
(72) GROKOP, Leonard Henry, 5775 Morehouse Drive, San Diego, CA 92121, US
SARAH, Anthony, 5775 Morehouse Drive, San Diego, CA 92121, US
NANDA, Sanjiv, 5775 Morehouse Drive, San Diego, CA 92121, US

- (51) MKP
A61M 25/06 (2006.01) (97) **2696929 ***
A61M 25/09 (2006.01)
(86) US2011064301 12.12.2011
(96) 11813841.1 19.02.2014
(87) WO2012141748, 12.12.2011
(97) 2696929, 19.02.2014 en
(54) NEEDLE AND GUIDEWIRE HOLDER
(71) The Spectranetics Corporation, 9965 Federal Drive, Colorado Springs, CO 80921-3617, US
(72) ROTTENBERG, Dan, 117 Einstein Street, 34601 Haifa, IL
SACHER, Ronen, 31 Achi Dakar Street, 46702 Herzelia, IL

(51) MKP
A01N 43/08 (2006.01) (97) **2667721 ***
A01N 43/56 (2006.01)
A01N 43/58 (2006.01)
A01N 47/24 (2006.01)
A01N 47/32 (2006.01)
A01N 53/06 (2006.01)
A01N 59/02 (2006.01)
(86) IN2012000068 30.01.2012
(96) 12739150.6 04.12.2013
(87) WO2012101661, 30.01.2012
(97) 2667721, 04.12.2013 en
(54) PESTICIDE COMPOSITION COMPRISING SULPHUR, AN ACARICIDE AND AN AGROCHEMICAL EXCIPIENT
(71) Shah, Deepak Pranjivandas, 501/502 Vandana Apartments Janki Kutir Juhu Church Road Juhu, Mumbai, Maharashtra 400 009, IN
(72) Shah, Deepak Pranjivandas, 501/502 Vandana Apartments Janki Kutir Juhu Church Road Juhu, Mumbai, Maharashtra 400 009, IN

(51) MKP
A61K 35/37 (2006.01) (97) **2651421 ***
A61L 2/00 (2006.01)
(86) US2011064960 14.12.2011
(96) 11808044.9 23.10.2013
(87) WO2012082931, 14.12.2011
(97) 2651421, 23.10.2013 en
(54) VIRAL INACTIVATION USING IMPROVED SOLVENT-DETERGENT METHOD
(71) Baxter International Inc, One Baxter Parkway, Deerfield, IL 60015, US
Baxter Healthcare SA, Thurgauerstrasse 130, 8152 Glattpark (Opfikon), CH
(72) FELGENHAUER, Martin, Colloredogasse 27, A-1180 Vienna, AT
MISON, Dominique, Au Ruz Baron 34, CH-2046 Fontaines, CH
MONTANDON, Frederic, 2 Grande Rue, F-25500 Morteau, FR
FARCET, Maria, Herzgasse 78/8-10, A-1100 Vienna, AT

(51) MKP
G06Q 10/08 (2012.01) (97) **2689383 ***
H04L 9/32 (2006.01)
H04L 29/06 (2006.01)
H04W 12/06 (2009.01)
(86) US2012030435 23.03.2012
(96) 12718763.1 29.01.2014
(87) WO2012129529, 23.03.2012
(97) 2689383, 29.01.2014 en
(54) SYSTEMS AND METHODS FOR ELECTRONICALLY SIGNING FOR A DELIVERED PACKAGE
(71) Fedex Corporate Services, Inc., 30 FedEx Pkwy 1st Fl. Vertical, Collierville, TN 38017, US
(72) SKAAKSURUD, Ole-Petter, 4114 East Fir Hill Drive, Lakeland TN 38002, US
AINSWORTH, Miley, 1814 Tara Drive, Hernando MS 38632, US

(51) MKP
A61M 1/02 (2006.01) (97) **2675494 ***
A61M 1/34 (2006.01)
B01L 3/14 (2006.01)
G01N 33/49 (2006.01)
(86) US2012025491 16.02.2012
(96) 12707194.2 25.12.2013
(87) WO2012154257, 16.02.2012
(97) 2675494, 25.12.2013 en
(54) APPARATUS AND METHOD FOR ISOLATING LEUKOCYTES AND TUMOR CELLS BY FILTRATION
(71) Nestec S.A., Avenue Nestlé 55, 1800 Vevey, CH
(72) SINGH, Sharat, 8171 Top of the Morning Way, Rancho Santa Fe, California 92127, US
LIU, Xinjun, 12890 Caminito Diego, San Diego, California 92130, US
HESTER, Kelly D., 5225 Setting Sun Way, San Diego, California 92121, US

(51) MKP
A61K 31/4985 (2006.01) (97) **2616443 ***
A61P 35/00 (2006.01)
C07D 217/22 (2006.01)
C07D 237/34 (2006.01)
C07D 403/10 (2006.01)
C07D 405/04 (2006.01)
C07D 409/04 (2006.01)
C07D 417/10 (2006.01)
C07D 471/04 (2006.01)
(86) US2011051408 13.09.2011
(96) 11764895.6 24.07.2013
(87) WO2012037132, 13.09.2011
(97) 2616443, 24.07.2013 en
(54) PHTALAZINE DERIVATIVES AS JAK1 INHIBITORS
(71) Exelixis, Inc., 210 East Grand Avenue P.O. Box 511, South San Francisco, CA 94080-0511, US
(72) ANAND, Neel, Kumar, 977 El Camino Real, Unit 303, Burlingame CA 94010, US
BROWN, S., David, 12 Sorrel Lane, San Carlos CA 94070, US
TESFAI, Zerom, 23219 Canyon Terrace Drive, Castro Valley CA 94552, US
ZAHARIA, Cristiana, A., 644 Topaz Street, Redwood City CA 94061, US

(51) MKP
A61K 39/395 (2006.01) (97) **2648749 ***
A61K 49/00 (2006.01)
C07K 16/22 (2006.01)
C07K 16/30 (2006.01)
C07K 16/40 (2006.01)
G01N 33/574 (2006.01)
(86) US2011063834 07.12.2011
(96) 11802250.8 16.10.2013
(87) WO2012078813, 07.12.2011
(97) 2648749, 16.10.2013 en
(54) NOVEL MODULATORS AND METHODS OF USE
(71) Stem Centrx, Inc., 450 East Jamie Court, South San Francisco, CA 94080, US
(72) BANKOVICH, Alex, 635 Tennessee Street No. 204, San Francisco, CA 94107, US
FOORD, Orit, 712 Cayman Lane, Foster City, CA 94404, US
HAMPL, Johannes, 1540 Franklin Street, Santa Clara, CA 95050, US
DYLLA, Scott J., 743 Wake Forest Drive, Mountain View, CA 94043, US

(51) MKP
A61K 31/506 (2006.01) (97) **2663558 ***
C07D 407/04 (2006.01)
(86) US2012021275 13.01.2012
(96) 12704453.5 20.11.2013
(87) WO2012097270, 13.01.2012
(97) 2663558, 20.11.2013 en
(54) SOLID FORMS OF GYRASE INHIBITOR (R)-1-ETHYL-3-[5-[2-(1-HYDROXY-1-METHYL-ETHYL)PYRIMIDIN-5-YL]-7-(TETRAHYDROFURAN-2-YL)-1H-BENZIMIDAZOL-2-YL] UREA
(71) Vertex Pharmaceuticals Incorporated, 130 Waverly Street, Cambridge, MA 02139, US
(72) SHANNON, Dean, 19 Stonnybrook Lane, Milford MA 01757, US
LUISE, Brian, 15 Gibbens Treet, Somerville MA 02143, US
LIAO, Yusheng, 54 Spring Street, Lexington MA 02421, US
KRAWIEC, Mariusz, 46 Littlefield Lane, Marlborough MA 01752, US

(51) MKP
A61K 39/395 (2006.01) (97) **2670487 ***
A61P 37/06 (2006.01)
(86) US2012023831 03.02.2012
(96) 12741568.5 11.12.2013
(87) WO2012106634, 03.02.2012
(97) 2670487, 11.12.2013 en
(54) USE OF AN ANTI-CD200 ANTIBODY FOR PROLONGING THE SURVIVAL OF ALLOGRAFTS
(71) Alexion Pharmaceuticals, Inc., 352 Knottter Drive, Cheshire, CT 06410, US
(72) WANG, Yi, 19 Aldo Drive, Woodbridge CT 06525, US
FAAS MCKNIGHT, Susan, 14 Stonewood Drive, Old Lyme CT 06371, US
YU, Zhao, Xue, 25 Evelen Court, Cheshire CT 06410, US
WANG, Hao, 480 Sandybrook Drive, London Ontario N5X 4X2, CA

(51) MKP
A61K 38/55 (2006.01) (97) **2670774 ***
A61P 25/28 (2006.01)
C07K 14/B1 (2006.01)
C12N 9/64 (2006.01)
(86) EP2012051367 27.01.2012
(96) 12704726.4 11.12.2013
(87) WO2012104224, 27.01.2012
(97) 2670774, 11.12.2013 en
(54) CASPASE-2 INHIBITORS
(71) Chiesi Farmaceutici S.p.A., Via Palermo, 26/A, 43100 Parma, IT
(72) CHAUVIER, David, c/o Chiesi Farmaceutici S.p.A. Via Palermo 26/A, I-43122 Parma, IT
JACOTOT, Etienne, c/o Chiesi Farmaceutici S.p.A. Via Palermo 26/A, I-43122 Parma, IT

(51) MKP
A61K 47/48 (2006.01) (97) **2675480 ***
A61P 35/00 (2006.01)
C07D 487/04 (2006.01)
C07D 519/00 (2006.01)
(86) US2012025257 15.02.2012
(96) 12705761.0 25.12.2013
(87) WO2012112687, 15.02.2012
(97) 2675480, 25.12.2013 en
(54) METHODS OF PREPARATION OF CONJUGATES
(71) ImmunoGen, Inc., 830 Winter Street, Waltham, MA 02451, US
(72) FISHKIN, Nathan, 179 E. Tall Oaks Drive, Weymouth, MA 02170, US
MILLER, Michael, 4 Maymount Drive, Framingham, MA 01701, US
LI, Wei, 6 Knowlton Drive, Acton, MA 01720, US
SINGH, Rajeeva, 40 Lanewood Avenue, Framingham, MA 01701, US

(51) MKP
A61K 47/48 (2006.01) (97) **2697288 ***
C08G 83/00 (2006.01)
C08G 85/00 (2006.01)
(86) GB2012050792 11.04.2012
(96) 12718319.2 19.02.2014
(87) WO2012140418, 11.04.2012
(97) 2697288, 19.02.2014 en
(54) DECORATED MACROMOLECULAR SCAFFOLDS
(71) UNIVERSITE DE GENEVE, Rue Général-Dufour 24, 1211 Geneve 4, CH
(72) GAERTNER, Hubert, 1369 Route de Blecheins, F-74160 Archamps, FR
HARTLEY, Oliver, 1 Chemin de la Grande-Piece, CH-1227 Carouge, CH

(51) MKP
A61K 31/727 (2006.01) (97) **2697265 ***
C08B 37/00 (2006.01)
(86) IB2012051768 11.04.2012
(96) 12718395.2 19.02.2014
(87) WO2012140580, 11.04.2012
(97) 2697265, 19.02.2014 en
(54) POLYSACCHARIDES COMPRISING TWO ANTITHROMBIN III-BINDING SITES, PREPARATION THEREOF AND USE THEREOF AS ANTITHROMBOTIC MEDICAMENTS
(71) SANOFI, 54 rue La Boétie, 75008 Paris, FR
(72) MOURIER, Pierre, c/o Sanofi Patent Department 54 rue La Boétie, 75008 Paris, FR
VSKOV, Christian, c/o Sanofi Patent Department 54 rue La Boétie, 75008 Paris, FR

(51) MKP
C07C 201/08 (2006.01) (97) **2699537 ***
C07C 201/16 (2006.01)
C07C 205/02 (2006.01)
(86) US2012032277 05.04.2012
(96) 12717519.8 26.02.2014
(87) WO2012148643, 05.04.2012
(97) 2699537, 26.02.2014 en
(54) APPARATUS AND PROCESS FOR NITRATION SELECTIVITY FLEXIBILITY ENABLED BY AZEOTROPIC DISTILLATION
(71) Dow Global Technologies LLC, 2040 Dow Center, Midland, MI 48674, US
ANGUS Chemical Company, 1500 E. Lake Cook Road, Buffalo Grove, IL 60089, US
(72) SAWANT, Mahesh, A6/202 Mirchandani Palm Rahatni Chowk Pimple Saudagar, Pune 411007, IN
TRAUTH, Daniel, M., 5817 Meadowbrook Lane, Crystal Lake, IL 60014, US
PENDERGAST, John, G., Jr., 60 Parsley Court, Lake Jackson, TX 77566, US

(51) MKP
A61K 31/535 (2006.01) (97) **2694075 ***
(86) US2012031361 30.03.2012
(96) 12764605.7 12.02.2014
(87) WO2012135571, 30.03.2012
(97) 2694075, 12.02.2014 en
(54) PHOSPHOINOSITIDE 3-KINASE INHIBITOR WITH A ZINC BINDING MOIETY
(71) Curis, Inc., 4 Maguire Road, Lexington, MA 02421, US
(72) CAI, Xiong, 37 Liberty Road, Bedford, MA 01730, US
ZHAI, Haixiao, 283 South Road, Bedford, MA 01730, US
LAI, Chengjung, 3 Oxford Circle, Belmont, MA 02478, US
QIAN, Changgeng, 163 Old Connecticut Path, Wayland, MA 01778, US
BAO, Rudi, 1 Ivy Road, Wellesley, MA 02482, US

(51) MKP
B62D 21/00 (2006.01) (97) **2681103 ***
B62D 21/02 (2006.01)
B62D 21/10 (2006.01)
B62D 31/00 (2006.01)
B62D 63/02 (2006.01)
(86) FR2012050426 29.02.2012
(96) 12712303.2 08.01.2014
(87) WO2012117204, 29.02.2012
(97) 2681103, 08.01.2014 fr
(54) FLAT MODULAR CHASSIS, AND VEHICLE PROVIDED WITH SUCH A CHASSIS
(71) Courb, 9 rue de la République, 69001 Lyon, FR
(72) JULIÉ, Laurent, Daniel, Lionel, 10 Port de Salomon, F-81220 Damiatte, FR
HOSPITAL, Matthieu, Alexandre, 1 rue du Pré Long, F-12850 Onet le Château, FR

(51) MKP
A61G 7/057 (2006.01) (97) **2465482**
 (96) 11193560.7 20.06.2012
 (97) 2465482, 20.06.2012 en
 (54) INFLATABLE MATTRESS WITH DEFLATABLE DEVICE
 (71) MKS Innovatech S.r.l., Via Simone D'Orsenigo, 5, 20135 Milano, IT
 (72) Gelmetti, Nicola, Via Paiari, 52, 37017 Lazise (VR), IT
 Martinelli, Fabio, Via Mozart, 1, 37029 San Pietro in Cariano (VR), IT

(51) MKP
A61K 8/25 (2006.01) (97) **2484337**
A61K 8/58 (2006.01)
A61K 8/891 (2006.01)
A61K 8/895 (2006.01)
A61Q 15/00 (2006.01)
 (96) 12153794.8 08.08.2012
 (97) 2484337, 08.08.2012 en
 (54) Treatment of sweating
 (71) Janssen Pharmaceuticals, Inc., 1125 Trenton-Harbourton Road, Titusville, NJ 08560, US
 (72) Frentzko, Michael J., 32 Sleepy Hollow Road, Sussex, NJ New Jersey 07461, US
 Kendall, Clare S. L., 5 Yardley Road, Mendham, NJ New Jersey 07945, US
 Newburger, Joan, 72 Jacobs Creek Road, West Trenton, NJ New Jersey 08628, US
 Revankar, Ratna, 29 Scarlet Oak Drive, Princeton, NJ New Jersey 08540, US
 Shana'a, May, 15 Loller Drive, Martinsville, NJ New Jersey 08836, US

(51) MKP
A61K 31/4709 (2006.01) (97) **2678329 ***
A61P 29/00 (2006.01)
C07D 401/06 (2006.01)
C07D 471/04 (2006.01)
C07D 519/00 (2006.01)
 (96) US2012026572 24.02.2012
 (96) 12716770.8 01.01.2014
 (87) WO2012154274, 24.02.2012
 (97) 2678329, 01.01.2014 en
 (54) TRIAZOLOPYRIDINE COMPOUNDS AS PIM KINASE INHIBITORS
 (71) Array Biopharma, Inc., 3200 Walnut Street, Boulder, CO 80301, US
 (72) BLAKE, James, F, c/o Array Biopharma Inc. 3200 Walnut Street, Boulder, CO 80301, US
 DELISLE, Robert, Kirk, c/o Array Biopharma Inc. 3200 Walnut Street, Boulder, CO 80301, US
 DE MEESE, Lisa, A., 2925 E. Riggs Road 8-176, Phoenix, AZ 85249, US
 GRAHAM, James, M., 1518 Chukar Drive, Longmont, CO 80501, US
 LE HUEROU, Yvan, 2775 Lee Hill Road, Boulder, CO 80302, US
 LYON, Michael, c/o Array Biopharma Inc. 3200 Walnut Street, Boulder, CO 80301, US
 ROBINSON, John, E., c/o Array Biopharma Inc. 3200 Walnut Street, Boulder, CO 80301, US
 WALLACE, Eli, M., 404 Arborcrest Drive, Richardson, TX 75080, US
 WANG, Bin, 3434 Lovers Lane, Dallas, TX 75225, US
 XU, Rui, c/o Array Biopharma Inc. 3200 Walnut Street, Boulder, CO 80301, US

(51) MKP
A61K 31/46 (2006.01) (97) **2655370 ***
A61P 3/00 (2006.01)
C07D 451/06 (2006.01)
C07D 471/04 (2006.01)
C07D 487/04 (2006.01)
 (86) US2011062724 30.11.2011
 (96) 11796872.7 30.10.2013
 (87) WO2012087519, 30.11.2011
 (97) 2655370, 30.10.2013 en
 (54) COMPOSITIONS AND METHODS FOR MODULATING FXR IRM LLC, 131 Front Street P.O. Box HM 2899, Hamilton HM LX, BM
 (72) TULLY, David C., Genomics Institute of the Novartis Research Foundation 10675 John Jay Hopkins Drive, San Diego, CA 92121, US
 RUCKER, Paul Vincent, Genomics Institute of the Novartis Research Foundation 10675 John Jay Hopkins Drive, San Diego, CA 92121, US
 ALPER, Phillip B., Genomics Institute of the Novartis Research Foundation 10675 John Jay Hopkins Drive, San Diego, CA 92121, US
 MUTNICK, Daniel, Genomics Institute of the Novartis Research Foundation 10675 John Jay Hopkins Drive, San Diego, CA 92121, US
 CHIANELLI, Donatella, Genomics Institute of the Novartis Research Foundation 10675 John Jay Hopkins Drive, San Diego, CA 92121, US

(51) MKP
 (86) US2012000049 31.01.2012
 (96) 12704142.4 11.12.2013
 (87) WO2012106049, 31.01.2012
 (97) 2671184, 11.12.2013 en
 (54) SECURITY ARRANGEMENTS FOR EXTENDED USB PROTOCOL STACK OF A USB HOST SYSTEM
 (71) MCCI Corporation, 3520 Krums Corners Road, Ithaca, NY 14880, US
 (72) MOORE, Terrill, M., 3170 Perry City Road, Trumansburg, NY 14886, US
 GARNEY, John, I., 8711 NW Benson Street, Portland, OR 97229, US
 SCAFFIDI, Salvatore, Gregory, Jr., 24207 Bingham Creek Road, Leander, TX 78641, US
 YOKUM, Christopher, Jay, 425 West Beech Street 501, San Diego, CA 92101, US

(51) MKP
A61K 31/4709 (2006.01) (97) **2694493 ***
C07D 401/12 (2006.01)
 (86) EP2012055331 26.03.2012
 (96) 12710293.7 12.02.2014
 (87) WO2012136504, 26.03.2012
 (97) 2694493, 12.02.2014 en
 (54) METHOD FOR THE PREPARATION OF PROCESS INTERMEDIATES FOR THE SYNTHESIS OF ARGATROBAN MONOHYDRATE
 (71) Lundbeck Pharmaceuticals Italy S.P.A., Via Quarta Strada 2, 35129 Padova, IT
 (72) STIVANELLO, Mariano, Via Marostica 20, I-36015 Schio, Vicenza, IT
 HUBER, Florian Anton Martin, Via Velluti 34, I-30031 Dolo, Venezia, IT
 RICCI, Antonio, Via Parini 10, I-65010 Spoltore, Pesaro, IT

(51) MKP
A61B 10/00 (2006.01) (97) **2662028**
 (96) 13159567.0 13.11.2013
 (97) 2662028, 13.11.2013 de
 (54) Swab and container for taking biological samples and storing them in a sterile environment
 (71) Riess, Nathanael, Spökerdamm 2, 25436 Heidgraben, DE
 (72) Riess, Nathanael, Spökerdamm 2, 25436 Heidgraben, DE

(51) MKP
A61K 31/58 (2006.01) (97) **2686332 ***
A61P 5/44 (2006.01)
A61P 11/06 (2006.01)
A61P 37/08 (2006.01)
C07J 71/00 (2006.01)
(86) EP2012054439 14.03.2012
(96) 12711601.0 22.01.2014
(87) WO2012123482, 14.03.2012
(97) 2686332, 22.01.2014 en
(54) ISOXAZOLIDINE DERIVATIVES
(71) Chiesi Farmaceutici S.p.A., Via Palermo, 26/A, 43100 Parma, IT
(72) GHIDINI, Eleonora, c/o CHIESI FARMACEUTICI S.p.A. Via Palermo 26/A, I-43100 Parma, IT
RIZZI, Andrea, Via Palermo 26/A, I-43100 Parma, IT

(51) MKP
A23K 1/16 (2006.01) (97) **2680710 ***
A23K 1/175 (2006.01)
A23K 1/18 (2006.01)
C07C 19/07 (2006.01)
C07C 211/65 (2006.01)
(86) US2012026246 23.02.2012
(96) 12709418.3 08.01.2014
(87) WO2012118688, 23.02.2012
(97) 2680710, 08.01.2014 en
(54) ENHANCED BIOAVAILABLE IODINE MOLECULES
(71) Zinpro Corporation, 10400 Viking Drive, Suite 240, Eden Prairie, MN 55344, US
(72) STARK, Peter A., 10400 Viking Drive, Suite 240, Eden Prairie, Minnesota 55344, US

(51) MKP
B62D 1/22 (2006.01) (97) **2675692 ***
(86) US2012025659 17.02.2012
(96) 12747864.2 25.12.2013
(87) WO2012112897, 17.02.2012
(97) 2675692, 25.12.2013 en
(54) LOWER EXTREMITY VEHICLE NAVIGATION CONTROL SYSTEM
(71) United Arab Emirates University, P.O. Box 15551, Al Ain, AE
(72) ELSHORBAGY, Hazem, P.O. Box 17555, Al Ain, AE
HABOUSH, Husam, P.O. Box 17555, Al Ain, AE
ALMARZOUQI, Reem, P.O. Box 17555, Al Ain, AE
HAIK, Yousef, P.O. Box 17555, Al Ain, AE

(51) MKP
A45C 11/00 (2006.01) (97) **2651259 ***
(86) US2011065430 16.12.2011
(96) 11808480.5 23.10.2013
(87) WO2012083140, 16.12.2011
(97) 2651259, 23.10.2013 en
(54) PRESSURE-VENTING CONTAINER FOR DISINFECTION AND STORAGE OF CONTACT LENSES
(71) Novartis AG, Lichtstrasse 35, 4056 Basel, CH
(72) WINTERTON, Lynn, Cook, 6201 South Freeway AB2-2, Fort Worth Texas 76134, US
WHITE, Jack, C., 9830 Kennebec Way, Alpharetta Georgia 30022, US

(51) MKP
A61K 39/395 (2006.01) (97) **2569010 ***
A61K 47/12 (2006.01)
C07K 16/22 (2006.01)
(86) US2011036062 11.05.2011
(96) 11720278.8 20.03.2013
(87) WO2011143307, 11.05.2011
(97) 2569010, 20.03.2013 en
(54) HIGH CONCENTRATION ANTIBODY FORMULATIONS
(71) Amgen, Inc, One Amgen Center Drive, Thousand Oaks, CA 91320-1799, US
(72) OSSSLUND, Timothy, D., 475 Vista Montana, Camarillo, CA 93010, US

(51) MKP
A01N 25/34 (2006.01) (97) **2685820 ***
(86) US2012029300 15.03.2012
(96) 12756974.7 22.01.2014
(87) WO2012125870, 15.03.2012
(97) 2685820, 22.01.2014 en
(54) COMPOSITIONS AND METHODS FOR TREATMENT OF INFECTIONS
(71) Thompson Cooper Laboratories, LLC, 612 Mann Road, Horsham, Pennsylvania 19044, US
(72) COOPER, Eugene, R, 2621 Crum Creek Drive, Berwyn Pennsylvania 19312, US
THOMPSON, Evan, R, 612 Mann Road, Horsham Pennsylvania 19044, US
THOMPSON, Elliot, R, 612 Mann Road, Horsham Pennsylvania 19044, US

(51) MKP
A61K 39/12 (2006.01) (97) **2667890 ***
C07K 14/025 (2006.01)
C07K 14/235 (2006.01)
(86) EP2012051027 24.01.2012
(96) 12701110.4 04.12.2013
(87) WO2012101112, 24.01.2012
(97) 2667890, 04.12.2013 en
(54) CYAA-CARRIED POLYPEPTIDE(S) AND USE TO INDUCE BOTH THERAPEUTIC AND PROPHYLACTIC IMMUNE RESPONSES
(71) Genticel, Rue Pierre et Marie Curie Prologue Biotech BP 28262, 31670 Labège, FR
(72) ESQUERRÉ, Michael, 4 rue Antoine de Gargas Résidence Sud Horizon Appt B21, 31500 Toulouse, FR
MOMOT, Marie, 3 cheminement du Dr Didier Dasque App C24, 31400 Toulouse, FR
GOUBIER, Anne, Le Périssé, 64390 Sauveterre de Béarn, FR
LISSERI, Yolande, 2 place des Cordeliers, 31280 Dremil-Lafage, FR

(51) MKP
B65C 9/06 (2006.01) (97) **2658783 ***
B67B 3/26 (2006.01)
B67C 3/00 (2006.01)
(86) IB2011055377 30.11.2011
(96) 11805203.4 06.11.2013
(87) WO2012090093, 30.11.2011
(97) 2658783, 06.11.2013 en
(54) A DEVICE FOR DETECTING MOVING CONTAINERS
(71) Makro Labelling S.r.l., Via Don Doride Bertoldi 91 Marmirolo, 46045 Mantova, IT
(72) BELLINI, Marco, Via F.lli Rosselli 51, I-46047 Porto Mantovano (Mantova), IT
MARCANTONI, Simone, Via Zigagnolo 3b, I-46040 Ponti sul Mincio (Mantova), IT

(51) MKP
G01N 33/567 (2006.01) (97) **2631654**
(86) 13169122.2 28.08.2013
(97) 2631654, 28.08.2013 en
(54) Neuropeptide release assay for sodium channels
(71) Regeneron Pharmaceuticals, Inc., 777 Old Saw Mill River Road, Tarrytown, NY 10591, US
(72) Alessandri Haber, Nicole M., 15 Bonwit Road, Rye Brook, NY 10573, US
MacDonald, Lynn, 16 Gedney Way, White Plains, NY 10605, US
Lacroix-Fralish, Michael L., 776 Swed Circle, Yorktown Heights, NY 10598, US
Murphy, Andrew J., 10 Newton Court, Croton-on-Hudson, NY 10520, US

(51) MKP
A61K 38/11 (2006.01) (97) **2696882 ***
A61P 15/12 (2006.01)
(86) EP2012056813 13.04.2012
(96) 12715932.5 19.02.2014
(87) WO2012140216, 13.04.2012
(97) 2696882, 19.02.2014 en
(54) PHARMACEUTICAL COMPOSITION
(71) Peptonic Medical AB, Honnörsgatan 16, 352 36 Växjö, SE
(72) UVNÄS-MOBERG, Kerstin, Ynglingavägen 11, S-182 62 Djursholm, SE
CARLSSON, Anders, Hornsbergs Strand 49, S-112 16 Stockholm, SE

(51) MKP
C09C 1/02 (2006.01) (97) **2661470 ***
C09C 1/36 (2006.01)
C09C 1/40 (2006.01)
C09C 1/42 (2006.01)
C09C 3/10 (2006.01)
D21H 17/00 (2006.01)
G01N 21/25 (2006.01)
(86) EP2011073801 22.12.2011
(96) 11799108.3 13.11.2013
(87) WO2012093039, 22.12.2011
(97) 2661470, 13.11.2013 en
(54) PROCESS FOR WATER BASED MINERAL MATERIAL SLURRY SURFACE WHITENING
(71) Omya International AG, Baslerstrasse 42, 4665 Oftringen, CH
(72) BURI, Matthias, Mätteliweg 20, CH-4852 Rothrist, CH
RENTSCH, Samuel, Burgpark 2, CH-4663 Aarburg, CH
PUDACK, Claudia, Hadlaubstrasse 68, CH-8006 Zürich, CH

(51) MKP
A61K 9/00 (2006.01) (97) **2691075 ***
A61K 31/4418 (2006.01)
A61K 47/12 (2006.01)
A61P 7/02 (2006.01)
(86) EP2012055361 27.03.2012
(96) 12710516.1 05.02.2014
(87) WO2012130819, 27.03.2012
(97) 2691075, 05.02.2014 en
(54) OTAMIXABAN FORMULATIONS WITH IMPROVED STABILITY
(71) SANOFI, 54 rue La Boétie, 75008 Paris, FR
(72) KAMM, Walter, c/o Sanofi-Aventis Deutschland GmbH, 65926 Frankfurt am Main, DE
BUSSEMER, Till, c/o Sanofi-Aventis Deutschland GmbH, 65926 Frankfurt am Main, DE
ANDERT, Doris, c/o Sanofi-Aventis Deutschland GmbH, 65926 Frankfurt am Main, DE
KÜHN, Bernd, c/o Sanofi-Aventis Deutschland GmbH, 65926 Frankfurt am Main, DE
TODT, Ernst-Josef, c/o Sanofi-Aventis Deutschland GmbH, 65926 Frankfurt am Main, DE

(51) MKP
A61K 31/424 (2006.01) (97) **2646446 ***
A61K 31/55 (2006.01)
A61P 35/00 (2006.01)
C07D 498/04 (2006.01)
C07D 498/14 (2006.01)
(86) US2011063046 02.12.2011
(96) 11844513.9 09.10.2013
(87) WO2012075383, 02.12.2011
(97) 2646446, 09.10.2013 en
(54) BROMODOMAIN INHIBITORS AND USES THEREOF
(71) Constellation Pharmaceuticals, Inc., 215 First Street, Suite 200, Cambridge, MA 02142, US
(72) ALBRECHT, Brian K., 179 Chestnut Street 2, Cambridge MA 02139, US
AUDIA, James Edmund, 1 Stone Wall Lane, Zionsville IN 46077, US
CÔTÉ, Alexandre, 12 Florence Street, Cambridge MA 02139, US
GEHLING, Victor S., 35 Jay Street 3, Somerville MA 02144, US
HARMANGE, Jean-christophe, 57 William Street, Andover MA 01810, US
HEWITT, Michael C., 186 Holland Street Unit 2, Somerville MA 02144, US
LEBLANC, Yves, 8 Lafford, Kirkland Quebec H9J 3Y3, CA
NASVESHUK, Christopher G., 15 Phillips Road, Stoneham MA 02180-4425, US
TAYLOR, Alexander M., 33 Parker Street 2, Cambridge MA 02138, US
VASWANI, Rishi G., 45 Butts Street, Newton MA 02464, US

(51) MKP
B29C 44/12 (2006.01) (97) **2335900**
(96) 10192426.4 22.06.2011
(97) 2335900, 22.06.2011 de
(54) Interior panel substrate for vehicle, foaming tool and method for producing a moulded interior panel
(71) Bayerische Motorenwerke AG, Petuelring 130, 80788 München, DE
FRIMO Group GmbH, Hansaring 6, 49504 Lotte, DE
(72) Lesser, Roman, Unterglaim 73, 84030, Ergolding, DE
Huynh, Dienhung, Von-Hohenhausen-Str. 19, 84036, Landshut, DE
Franz, Gunter, Adolf-Damaschke-Weg 56, 49082, Osnabrück, DE
Lause, Jürgen, Gudenusweg 16, 49205, Hasbergen, DE

(51) MKP
A61K 31/519 (2006.01) (97) **2694504 ***
A61P 25/00 (2006.01)
C07D 413/14 (2006.01)
C07D 471/04 (2006.01)
(86) US2012032803 09.04.2012
(96) 12834216.9 12.02.2014
(87) WO2013043232, 09.04.2012
(97) 2694504, 12.02.2014 en
(54) 8-ETHYL-6-(ARYL)PYRIDO [2,3-D]PYRIMIDIN-7(8H)-ONES FOR THE TREATMENT OF NERVOUS SYSTEM DISORDERS AND CANCER
(71) Afraxis Holdings, Inc., 11099 North Torrey Pines Road Suite 290, La Jolla CA 92037, US
(72) CAMPBELL, David, 13318 Seagrove Street, San Diego, CA 92130, US
DURÓN, Sergio, G., 1605 Neale Street, San Diego, CA 92103, US

- (51) MKP
B01D 21/00 (2006.01) (97) **2664380 ***
B01D 21/02 (2006.01)
B01D 21/24 (2006.01)
B01D 21/30 (2006.01)
B01J 38/00 (2006.01)
C10G 2/00 (2006.01)
- (86) JP2012050560 13.01.2012
(96) 12734649.2 20.11.2013
(87) WO2012096366, 13.01.2012
(97) 2664380, 20.11.2013 en
- (54) CATALYST RECOVERY SYSTEM, HYDROCARBON SYNTHESIS REACTION APPARATUS, HYDROCARBON SYNTHESIS REACTION SYSTEM, AND CATALYST RECOVERY METHOD
- (71) Japan Oil, Gas and Metals National Corporation, 2-10-1, Toranomon, Minato-ku, Tokyo 105-0001, JP
INPEX Corporation, 5-3-1 Akasaka Minato-ku, Tokyo 107-6332, JP
JX Nippon Oil & Energy Corporation, 6-3, Otemachi 2-chome, Chiyoda-ku Tokyo 100-8162, JP
Japan Petroleum Exploration Co., Ltd., 7-12, Marunouchi 1-chome Chiyoda-ku, Tokyo 100-0005, JP
Cosmo Oil Co., Ltd., 1-1-1, Shibaura 1-chome, Minato-ku Tokyo 105-8528, JP
Nippon Steel & Sumikin Engineering Co., Ltd., Osaki Center Building 5-1, Osaki 1-chome Shinagawa-ku, Tokyo 141-8604, JP
- (72) SHIBATA, Toshiyuki, c/o Nippon Steel & Sumikin Engineering Co., Ltd. Osaki Center Building 5-1, Osaki 1-chome Shinagawa-ku, Tokyo 141-8604, JP
HONDA, Hidekatsu, c/o JX Nippon Oil&Energy Corporation 6-3, Otemachi 2-chome Chiyoda-ku, Tokyo 100-8162, JP
KAWAMURA, Akira, c/o JX Nippon Oil&Energy Corporation 6-3, Otemachi 2-chome Chiyoda-ku, Tokyo 100-8162, JP

- (51) MKP
A61K 36/23 (2006.01) (97) **2688577 ***
A61K 36/235 (2006.01)
A61K 36/534 (2006.01)
A61K 36/57 (2006.01)
A61P 1/02 (2006.01)
- (86) EP2012000301 24.01.2012
(96) 12701225.0 29.01.2014
(87) WO2012130351, 24.01.2012
(97) 2688577, 29.01.2014 de
- (54) COMPOSITION FOR USE FOR DIGESTIVE PROBLEMS
- (71) Maria Clementine Martin Klosterfrau Vertriebsgesellschaft mbH, Gereonsmühlengasse 1-11, 50670 Köln, DE
- (72) VESTWEBER, Anna-Maria, Maxhan 34, 51399 Burscheid, DE

- (51) MKP
A61M 5/28 (2006.01) (97) **2661297 ***
A61M 5/32 (2006.01)
- (86) EP2011074274 30.12.2011
(96) 11807702.3 13.11.2013
(87) WO2012093069, 30.12.2011
(97) 2661297, 13.11.2013 en
- (54) ADAPTOR MEANS FOR USE IN COMBINATION WITH A PRE-FILLED SYRINGE AND A SAFETY DEVICE, SAFETY DEVICE AND INJECTION DEVICE
- (71) Sanofi-Aventis Deutschland GmbH, Brüningstraße 50, 65929 Frankfurt, DE
- (72) ROBERTS, Gareth, Glendale Pen-y-cae Road Ruabon, Wrexham LL14 6EB, GB
OWEN, Sioned, Berlan Bach Denbigh, Prion Denbigh LL16 4SE, GB
EKMAN, Matthew, 59 Ecton Avenue Cheshire, Macclesfield Cheshire SK10 1RD, GB

- (51) MKP
C12Q 1/68 (2006.01) (97) **2597160**
- (96) 11425283.6 29.05.2013
(97) 2597160, 29.05.2013 en
- (54) Screening tool for anti-inflammatory drug discovery comprising the FPR2/ALX gene promoter
- (71) Università' Degli Studi "G. d'Annunzio" Chieti-Pescara, Via dei Vestini 31, 66013 Chieti, IT
- (72) Romano, Mario, c/o Dipartimento Scienze Biomediche Università degli Studi "G. d'Annunzio" Chieti-Pescara Via dei Vestini n. 31, 66013 Chieti Scalo (CH), IT
Favaloro, Bartolo, c/o Dipartimento Scienze Biomediche Università degli Studi "G. d'Annunzio" Chieti-Pescara Via dei Vestini n. 31, 66013 Chieti Scalo (CH), IT

- (51) MKP
G01P 5/26 (2006.01) (97) **2661636 ***
- (86) FR2011053200 28.12.2011
(96) 11815547.2 13.11.2013
(87) WO2012093221, 28.12.2011
(97) 2661636, 13.11.2013 fr
- (54) METHOD AND DEVICE FOR DETERMINING THE MOVEMENTS OF A FLUID FROM REMOTE MEASUREMENTS OF RADIAL VELOCITIES
- (71) Leosphere, 43 rue de Liège, 75008 Paris, FR
Aria Technologies, 8-10 rue de la Ferme, 92100 Boulogne Billancourt, FR
- (72) BOQUET, Matthieu, 33 rue de l'Abbé Carton, F-75014 Paris, FR
NIBART, Maxime, 2 rue Jacques Le Paire, F-77400 Lagny Sur Marne, FR
ALBERGEL, Armand, 4 rue Mozart, F-92500 Rueil Malmaison, FR

- (51) MKP
A01N 43/64 (2006.01) (97) **2696684 ***
A61K 9/14 (2006.01)
A61K 9/48 (2006.01)
A61K 31/53 (2006.01)
- (86) US2012033312 12.04.2012
(96) 12771771.8 19.02.2014
(87) WO2012142281, 12.04.2012
(97) 2696684, 19.02.2014 en
- (54) SOLID PHARMACEUTICAL COMPOSITION
- (71) Endocyte, Inc., 3000 Kent Avenue, West Lafayette, IN 47906, US
- (72) RITTER, Allen, 3906 East 800 South, West Lafayette Indiana 47909, US
WILLIAMS, Amy C., 498 Old Dunstable Road, Groton Massachusetts 01450, US
WALDMANN, Lars, 5 Lockwood Street, Hyde Park Massachusetts 02136, US
ZHANG, Huamin, 2411 Trace 24, West Lafayette Indiana 47906, US

- (51) MKP
A61K 31/7056 (2006.01) (97) **2646038 ***
A61K 38/13 (2006.01)
A61K 38/21 (2006.01)
A61P 31/14 (2006.01)
- (86) EP2011071330 29.11.2011
(96) 11788502.0 09.10.2013
(87) WO2012072655, 29.11.2011
(97) 2646038, 09.10.2013 en
- (54) NEW TREATMENTS OF HEPATITIS C VIRUS INFECTION
- (71) Novartis AG, Lichtstrasse 35, 4056 Basel, CH
- (72) AVILA, Claudio, Novartis Pharma AG Postfach, CH-4002 Basel, CH

(51) MKP
A61K 47/48 (2006.01) (97) **2691117 ***
A61P 35/00 (2006.01)
(86) US2012031253 29.03.2012
(96) 12714161.2 05.02.2014
(87) WO2012135522, 29.03.2012
(97) 2691117, 05.02.2014 en
(54) PROCESS FOR MANUFACTURING CONJUGATES OF IMPROVED HOMOGENEITY
(71) Immunogen, Inc., 830 Winter Street, Waltham, MA 02451-1477, US
(72) JIN, Shengjin, 415 Arlington Street, Acton, MA 01720, US

(51) MKP
A61L 9/16 (2006.01) (97) **2691181 ***
B01D 49/00 (2006.01)
B03C 3/16 (2006.01)
B03C 3/45 (2006.01)
B03C 3/47 (2006.01)
C08J 5/04 (2006.01)
C08K 7/06 (2006.01)
(86) CA2012000277 28.03.2012
(96) 12763929.2 05.02.2014
(87) WO2012129656, 28.03.2012
(97) 2691181, 05.02.2014 en
(54) EROSION-RESISTANT CONDUCTIVE COMPOSITE MATERIAL COLLECTING ELECTRODE FOR WESP
(71) MEGTEC TurboSonic Inc., 550 Parkside Drive, Suite A-14, Waterloo, ON N2L 5V4, CA
(72) MCGRATH, Paul, 42-7284 Bellshire Gate, Mississauga, Ontario L5N 8E4, CA

(51) MKP
B60L 5/28 (2006.01) (97) **2646272 ***
B60L 5/32 (2006.01)
(86) IT2011000378 17.11.2011
(96) 11805975.7 09.10.2013
(87) WO2012073266, 17.11.2011
(97) 2646272, 09.10.2013 en
(54) COMMAND SYSTEM FOR THE ACTIVE AND DIAGNOSTIC CONTROL OF A RAILWAY PANTOGRAPH
(71) Contact S.r.l., Via G. Porzio IS E/3, 80143 Napoli, IT
(72) BORRIELLO, Gianfranco, Via Alcide de Gasperi n° 88, 81020 San Nicola La Strada (CE), IT
DIANA, Giorgio, Via dell'Ontano 4 A, 20090 Mille Pini di Rodano (MI), IT
COLLINA, Andrea, Via Moltoni n. 3, 20010 Milano, IT

(51) MKP
A61K 9/08 (2006.01) (97) **2646052 ***
A61K 31/70 (2006.01)
A61K 39/15 (2006.01)
A61K 48/00 (2006.01)
A61P 31/00 (2006.01)
A61P 31/12 (2006.01)
(86) US2011063037 02.12.2011
(96) 11845053.5 09.10.2013
(87) WO2012075376, 02.12.2011
(97) 2646052, 09.10.2013 en
(54) LYOPHILIZED VIRAL FORMULATIONS
(71) Oncolytics Biotech Inc., Suite 210 1167 Kensington Crescent N. W., Calgary, AB T2N 1X7, CA
(72) COFFEY, Matthew C., 2231 Bowness Road N.W., Calgary Alberta T2N 3L4, CA
SERL, Sarah, 5-310 Brookmere Rd. S.W., Calgary Alberta T2W 2T7, CA
PAVLIV, Leo, 707 Walcott Way, Cary North Carolina 27519, US

(51) MKP
A61M 5/20 (2006.01) (97) **2675505 ***
A61M 5/32 (2006.01)
(86) EP2012052647 16.02.2012
(96) 12704087.1 25.12.2013
(87) WO2012110578, 16.02.2012
(97) 2675505, 25.12.2013 en
(54) AUTO-INJECTOR
(71) Sanofi-Aventis Deutschland GmbH, Brüningstraße 50, 65929 Frankfurt am Main, DE
(72) BRERETON, Simon Francis, 75 De Freville Avenue, Cambridge Cambridgeshire CB4 1HP, GB
KEMP, Thomas, 3 Forresters Cottages High Steet, Ashwell Hertfordshire SG7 5NW, GB
BURNELL, Rosie, 56 Cavendish Avenue, Cambridge Cambridgeshire CB1 7UT, GB
EKMAN, Matthew, 59 Ecton Avenue, Macclesfield Cheshire SK10 1RD, GB

(51) MKP
A61N 2/12 (2006.01) (97) **2686065 ***
(86) AU2012000276 16.03.2012
(96) 12761407.1 22.01.2014
(87) WO2012126044, 16.03.2012
(97) 2686065, 22.01.2014 en
(54) DEVICE INCLUDING MOVING MAGNET CONFIGURATIONS
(71) University Of Technology, Sydney, 15 Broadway, Ultimo, New South Wales 2007, AU
(72) WATTERSON, Peter Andrew, C/- 15 Broadway, Ultimo, NSW 2007, AU

(51) MKP
A61K 31/519 (2006.01) (97) **2670753 ***
A61P 35/00 (2006.01)
C07D 487/04 (2006.01)
(86) IB2012050428 30.01.2012
(96) 12704135.8 11.12.2013
(87) WO2012104776, 30.01.2012
(97) 2670753, 11.12.2013 en
(54) NOVEL HETEROCYCLIC DERIVATIVES
(71) Novartis AG, Lichtstrasse 35, 4056 Basel, CH
RADETICH, Branko, Novartis Institutes for BioMedical Research Inc. 250 Massachusetts Avenue, Cambridge, Massachusetts 02139, US
YU, Bing, Novartis Institutes for BioMedical Research Inc. 250 Massachusetts Avenue, Cambridge, Massachusetts 02139, US
ZHU, Yanyi, Novartis Institutes for BioMedical Research Inc. 250 Massachusetts Avenue, Cambridge, Massachusetts 02139, US

(51) MKP
D01D 1/02 (2006.01) (97) **2683858 ***
D01D 5/04 (2006.01)
D01D 5/40 (2006.01)
D01F 2/00 (2006.01)
D01F 2/24 (2006.01)
D21H 13/00 (2006.01)
D21H 15/00 (2006.01)
(86) EP2012053987 08.03.2012
(96) 12707352.6 15.01.2014
(87) WO2012120073, 08.03.2012
(97) 2683858, 15.01.2014 en
(54) METHOD FOR DRY SPINNING NEUTRAL AND ANIONICALLY MODIFIED CELLULOSE AND FIBRES MADE USING THE METHOD
(71) SAPPI Netherlands Services B.V., Biesenweg 16, 6211 AA Maastricht, NL
(72) GRAVESON, Ian, 75 Bettina Clos, Nuneaton Warwickshire CV10 9EX, GB
TURNER, Philip, c/o The Court of Edinburgh Napier University Merchiston Tower Colinton Road, Edinburgh Lothian EH10 5DT, GB

(51) MKP
A61K 31/7034 (2006.01) (97) **2697240 ***
A61P 3/00 (2006.01)
C07D 407/10 (2006.01)
C07D 413/10 (2006.01)
C07D 417/10 (2006.01)
C07H 13/04 (2006.01)
C07H 15/04 (2006.01)
C07H 15/12 (2006.01)
C07H 15/14 (2006.01)
C07H 15/203 (2006.01)
C07H 19/044 (2006.01)
C07H 19/24 (2006.01)
(86) IB2012051798 12.04.2012
(96) 12719082.5 19.02.2014
(87) WO2012140596, 12.04.2012
(97) 2697240, 19.02.2014 en
(54) GLYCOSIDE DERIVATIVES AND USES THEREOF
(71) Novartis AG, Lichtstrasse 35, 4056 Basel, CH
(72) BEBERNITZ, Gregory Raymond, Novartis Institutes for BioMedical Research Inc. 100 Technology Square, Cambridge Massachusetts 02139, US
BOCK, Mark Gary, Novartis Institutes for BioMedical Research Inc. 100 Technology Square, Cambridge Massachusetts 02139, US

(51) MKP
A61K 39/395 (2006.01) (97) **2694108 ***
C12N 15/11 (2006.01)
(86) US2012032650 06.04.2012
(96) 12767899.3 12.02.2014
(87) WO2012139081, 06.04.2012
(97) 2694108, 12.02.2014 en
(54) METHODS FOR TREATING CONDITIONS ASSOCIATED WITH MASP-2 DEPENDENT COMPLEMENT ACTIVATION
(71) University Of Leicester, 9 University Road, Leicester LE1 7RH, GB
Omeros Corporation, 201 Elliott Avenue West, Seattle, WA 98119, US
(72) DEMOPULOS, Gregory A., 4845 Forest Avenue SE, Mercer Island Washington 98040, US
DUDLER, Tom, 13410 NE 36th Street, Bellevue Washington 98005, US
SCHWAEBLE, Hans-Wilhelm, 36 The Green, Mountsorrel Leicestershire LE12 7AF, GB

(51) MKP
A61F 13/15 (2006.01) (97) **2656825**
A61F 13/49 (2006.01)
(96) 13165195.2 30.10.2013
(97) 2656825, 30.10.2013 en
(54) Elastic Break Brake Apparatus and Method For Minimizing Broken Elastic Retreading
(71) Curt G. Joa, Inc., PO Box 903, Sheboygan Falls, WI 53085-0903, US
(72) Fritz, Jeff W., N4989 Country Aire Road Plymouth, Wisconsin 53073, US
Nelson, Chris, W6244 Hill and Dale Road Plymouth, Wisconsin 53073, US
McCabe, John A., 1141 Partridge Run Sheboygan Falls, Wisconsin 53085, US
Peterson, Daniel A., 1817 South 8th Street Sheboygan, Wisconsin 53083, US

(51) MKP
G21F 9/06 (2006.01) (97) **2657943**
G21F 9/30 (2006.01)
(96) 12425082.0 30.10.2013
(97) 2657943, 30.10.2013 en
(54) A method for removing the 137 Cs from polluted EAF dusts
(71) Cianchi, Aldo, Viale San Marco 10, 30173 Mestre (VE), IT
Degetto, Sandro, Via Bartolino da Padova 7, 35132 Padova, IT
(72) Cianchi, Aldo, Viale San Marco 10, 30173 Mestre (VE), IT
Degetto, Sandro, Via Bartolino da Padova 7, 35132 Padova, IT

(51) MKP
H01B 7/18 (2006.01) (97) **2477195**
H01B 7/40 (2006.01)
H01B 13/22 (2006.01)
H02G 11/02 (2006.01)
(96) 12450003.4 18.07.2012
(97) 2477195, 18.07.2012 de
(54) Cable drum cable
(71) Feller GmbH, Wärndorfer Strasse 3, 2525 Günselsdorf, AT
(72) Hammer, Walter, Harzbergstraße 12, 2601 Sollenau, AT
Renner, Andreas, Johann Wegscheiderstraße 33, 2630 Ternitz, AT
Brandstätter, Dietmar, Hersteinerstrasse 46, 2753 Markt Piesting, AT

(51) MKP
A61K 35/28 (2006.01) (97) **2689008 ***
A61K 35/50 (2006.01)
C12N 5/073 (2010.01)
C12N 5/0775 (2010.01)
(86) IB2012000664 22.03.2012
(96) 12715149.6 29.01.2014
(87) WO2012127320, 22.03.2012
(97) 2689008, 29.01.2014 en
(54) METHODS FOR TREATING RADIATION OR CHEMICAL INJURY
(71) Pluristem Ltd., Matam Building 20, 31905 Haifa, IL
(72) ABERMAN, Zami, 46 HaTapuz Street, 40600 Tel-Mond, IL
GORODESTKY, Raphael, 32 Hakfir Street, 96952 Jerusalem, IL

(51) MKP
A61K 9/51 (2006.01) (97) **2691116 ***
A61K 47/48 (2006.01)
A61K 49/18 (2006.01)
(86) EP2012055756 30.03.2012
(96) 12713673.7 05.02.2014
(87) WO2012131018, 30.03.2012
(97) 2691116, 05.02.2014 en
(54) NANOPARTICLES LOADED WITH CHEMOTHERAPEUTIC ANTITUMORAL DRUG
(71) BioAlliance Pharma, 49, boulevard du Général Martial Valin, 75015 Paris, FR
(72) PISANI, Emilia, 78 rue Pasteur, F-94120 Fontenay Sous Bois, FR
LEBEL-BINAY, Sophie, 23 rue du Bel Air, F-94800 Villejuif, FR
POLARD, Valérie, 7 rue Hélène Boucher, F-29860 Plabennec, FR

(51) MKP
B65G 15/32 (2006.01) (97) **2636617**
B65G 15/48 (2006.01)
B65G 23/06 (2006.01)
F16G 3/02 (2006.01)
(96) 12405026.1 11.09.2013
(97) 2636617, 11.09.2013 de
(54) Transport system with endless element composed of flexible belt sections
(71) Rychiger AG, Alte Bernstrasse 135, 3613 Steffisburg, CH
(72) Aeschlimann, Daniel, Kirchfeldstrasse 41 b, 3613 Steffisburg, CH

(51) MKP
C01B 3/04 (2006.01) (97) **2649009 ***
C01B 31/20 (2006.01)
C04B 2/10 (2006.01)
F27B 7/10 (2006.01)
F27B 15/00 (2006.01)
(86) GB2011052383 02.12.2011
(96) 11808278.3 16.10.2013
(87) WO2012076863, 02.12.2011
(97) 2649009, 16.10.2013 en
(54) CARBON DIOXIDE PRODUCTION
(71) Rockfuel Innovations Limited, 39 Shakespeare Road, Lexden Colchester, Essex CO3 4HL, GB
(72) STAMP, Clive R., 2 School Close Capel St. Mary, Ipswich Suffolk IP9 2UP, GB

(51) MKP
A61K 9/14 (2006.01) (97) **2416650 ***
A61K 9/51 (2006.01)
A61K 31/337 (2006.01)
(86) US2010030596 09.04.2010
(96) 10762524.6 15.02.2012
(87) WO2010118365, 09.04.2010
(97) 2416650, 15.02.2012 en
(54) NANOPARTICLE FORMULATIONS AND USES THEROF
(71) Abraxis BioScience, LLC, 11755 Wilshire Boulevard Suite 2100, Los Angeles, CA 90025, US
(72) DESAI, Neil, P., 20th Floor 11755 Wilshire Boulevard, Los Angeles, CA 90025, US
TAO, Chunlin, Suite 301 1800 Camden Avenue, Los Angeles, CA 90025, US
DE, Tapas, Apt. 2 10927 Palms Boulevard, Los Angeles, CA 90034, US
CI, Sherry, Xiaopei, 1987 San Salvatore Place, San Marino CA 91108, US
TRIEU, Vuong, 4003 Jim Bowie, Agoura Hills CA 91301, US

(51) MKP
A61K 9/00 (2006.01) (97) **2654719 ***
A61K 9/08 (2006.01)
A61K 31/136 (2006.01)
(86) EP2011073754 22.12.2011
(96) 11799722.1 30.10.2013
(87) WO2012085185, 22.12.2011
(97) 2654719, 30.10.2013 en
(54) AQUEOUS SOLUTION OF AMBROXOL
(71) LECTIO Pharmaentwicklungs- und Verwertungs GmbH, Sachsengasse 20, 3400 Klosterneuburg, AT
(72) PASSETTI, Gianluigi, Via Luca Ghini 4, I-20141 Milano, IT

(51) MKP
B21D 5/08 (2006.01) (97) **2604354**
(96) 12196563.6 19.06.2013
(97) 2604354, 19.06.2013 de
(54) Roller forming station, profiling system and method for forming a metal sheet or sheet metal strip
(71) Kronenberg Profil GmbH, Hochstrasse 2, 42799 Leichlingen, DE
(72) Lindemann, Dirk, Landrat-Trimborn-Strasse 29, 42799 Leichlingen, DE

(51) MKP
C03B 3/02 (2006.01) (97) **2678279 ***
C03B 5/225 (2006.01)
C03C 1/02 (2006.01)
(86) US2012026569 24.02.2012
(96) 12718441.4 01.01.2014
(87) WO2012116303, 24.02.2012
(97) 2678279, 01.01.2014 en
(54) PROCESS FOR MELTING AND REFINING SODA-LIME GLASS
(71) Owens-Brockway Glass Container INC., One Michael Owens Way, Perrysburg, OH 43551, US
(72) DEWET-SMITH, Dawid, 206 Three Meadows Court, Perrysburg OH 43551, US
FAYERWEATHER, Carl, L., 6408 Char Court, Maumee OH 43551, US
HIXSON, Brett, E., 4240 Radcliffe Court, Adrian MI 49221, US

(51) MKP
A61K 9/08 (2006.01) (97) **2658525 ***
A61K 47/34 (2006.01)
(86) IB2011003323 29.12.2011
(96) 11822867.5 06.11.2013
(87) WO2012090070, 29.12.2011
(97) 2658525, 06.11.2013 en
(54) BIODEGRADABLE DRUG DELIVERY COMPOSITIONS
(71) MedinCell, 1 Avenue Charles Cros, 34830 Jacou, FR
(72) GAUDRIault, Georges, 334 rue Louis-Martin Berthoud, 34080 Montpellier, FR

(51) MKP
A61K 31/21 (2006.01) (97) **2594557**
A61K 31/435 (2006.01)
C07C 233/47 (2006.01)
C07D 213/82 (2006.01)
C07D 239/36 (2006.01)
C07D 261/18 (2006.01)
C07D 271/06 (2006.01)
(96) 13151795.5 22.05.2013
(97) 2594557, 22.05.2013 en
(54) Substituted aminopropionic derivatives as neprilysin inhibitors
(71) Novartis AG, Lichtstrasse 35, 4056 Basel, CH
(72) Coppola, Gary Mark, 18 Aldersgate Circle, Budd Lake, NJ 07828, US
Iwaki, Yuki, Novartis Institutes for BioMedical Research Inc., 400 Technology Square, Cambridge, MA 02139, US
Karki, Rajeshri Ganesh, Novartis Institutes for BioMedical Research Inc., 100 Technology Square, Cambridge, MA 02139, US
Kawanami, Toshio, Novartis Institutes for BioMedical Research Inc., 100 Technology Square, Cambridge, MA 02139, US
Ksander, Gary Michael, Novartis Institutes for BioMedical Research Inc., 100 Technology Square, Cambridge, MA 02139, US
Mogi, Muneto, Novartis Institutes for BioMedical Research Inc., 100 Technology Square, Cambridge, MA 02139, US
Sun, Robert, Novartis Institutes for BioMedical Research Inc., 100 Technology Square, Cambridge, MA 02139, US

(51) MKP
F21S 4/00 (2006.01) (97) **2691800 ***
F21V 13/04 (2006.01)
F21Y 101/02 (2006.01)
F21Y 105/00 (2006.01)
G02B 6/00 (2006.01)
G02F 1/13357 (2006.01)
(86) FR2012050639 27.03.2012
(96) 12720227.3 05.02.2014
(87) WO2012131249, 27.03.2012
(97) 2691800, 05.02.2014 fr
(54) LIGHTING MODULE HAVING IMPROVED LIGHTING UNIFORMITY
(71) GB Developpement, 59 rue Voltaire, 92800 Puteaux, FR
(72) BOULAIS, Guillaume, 44 rue Voltaire, F-92300 Levallois Perret, FR

(51) MKP
G01N 30/36 (2006.01) (97) **2684039 ***
(86) US2012028424 09.03.2012
(96) 12754317.1 15.01.2014
(87) WO2012122450, 09.03.2012
(97) 2684039, 15.01.2014 en
(54) PEPTIDE DEFORMYLASE INHIBITORS
(71) Glaxosmithkline Intellectual Property (No. 2) Limited, 980 Great West Road, Brentford, Middlesex TW8 9SG, GB
(72) AUBART, Kelly, M., 1250 South Collegeville Road, Collegeville, PA 19426, US
BENOWITZ, Andrew, B., 1250 South Collegeville Road, Collegeville, PA 19426, US
FANG, Yuhong, 930 Heritage Drive, Eagleville, PA 19403, US
HOFFMAN, James, 2425 Chestnut Avenue, Ardmore, PA 19003, US
KARPINSKI, Joseph, M., 507 W. Vine Street, Stowe, PA 19464, US
KNOX, Andrew, Nicholson, 506 South 22nd Street, Philadelphia, PA 19146, US
LIAO, Xiangmin, 1250 South Collegeville Road, Collegeville, PA 19426, US
QIN, Donghui, 1250 South Collegeville Road, Collegeville, PA 19426, US
SHI, Dongchuan, 1042 Greenes Way Circle, Collegeville, PA 19426, US
SPLETSTOSER, Jared, T., 1250 South Collegeville Road, Collegeville, PA 19426, US

(51) MKP
A61K 9/00 (2006.01) (97) **2675438 ***
A61K 9/50 (2006.01)
A61K 31/4458 (2006.01)
(86) US2011024873 15.02.2011
(96) 11705137.5 25.12.2013
(87) WO2012112140, 15.02.2011
(97) 2675438, 25.12.2013 en
(54) EXTENDED RELEASE POWDER AND AQUEOUS
SUSPENSION COMPRISING METHYLPHENIDATE
(71) Tris Pharma, Inc., 2033 Route 130, Suite D, Monmouth
Junction, NJ 08852, US
(72) MEHTA, Ketan, 20 Nostrand Road, Cranbury NJ 08572, US
TU, Yu-Hsing, 19 E. Kincaid Drive, West Windsor NJ 08550, US
PERUMAL, Ashok, 208 Forest Drive, Edison NJ 08817, US

(51) MKP
C07D 231/20 (2006.01) (97) **2651900 ***
C07D 249/12 (2006.01)
C07D 249/04 (2006.01)
C07D 237/24 (2006.01)
C07D 261/18 (2006.01)
C07D 231/40 (2006.01)
C07D 257/04 (2006.01)
C07D 231/14 (2006.01)
C07D 249/10 (2006.01)
C07D 239/54 (2006.01)
C07D 263/38 (2006.01)
C07D 231/22 (2006.01)
C07D 249/18 (2006.01)
C07D 239/36 (2006.01)
C07D 263/34 (2006.01)
(86) US2011064837 14.12.2011
(96) 11805709.0 23.10.2013
(87) WO2012082857, 14.12.2011
(97) 2651900, 23.10.2013 en
(54) NEPRILYSIN INHIBITORS
(71) Theravance, Inc., 901 Gateway Boulevard, South San
Francisco, CA 94080, US
(72) SMITH, Cameron, 1401 Floribunda Avenue, Apt 101,
Burlingame California 94010, US
FLEURY, Melissa, 1023 Divisadero Street, San Francisco
California 94115, US
GENDRON, Roland, 345 Franconia Street, San Francisco
California 94110, US
HUDSON, Ryan, 1454 Walbrook Drive, San Jose California
95129, US
HUGHES, Adam D., 1221 Judson Street, Belmont California
94002, US

(51) MKP
A01N 43/38 (2006.01) (97) **2688404 ***
A01N 43/90 (2006.01)
A01N 45/00 (2006.01)
A01P 21/00 (2006.01)
C05F 11/10 (2006.01)
(86) CA2012000258 21.03.2012
(96) 12760385.0 29.01.2014
(87) WO2012126094, 21.03.2012
(97) 2688404, 29.01.2014 en
(54) AUXIN PLANT GROWTH REGULATORS
(71) The Governors Of The University Of Alberta, 10230 - Jasper
Avenue Suite 4000, Edmonton, Alberta T5J 4P6, CA
(72) OZGA, Jocelyn, c/o 4000 10230 Jasper Avenue, Edmonton,
Alberta T5J 4P5, CA
REINECKE, Dennis, c/o 4000 10230 Jasper Avenue,
Edmonton, Alberta T5J0P6, CA

(51) MKP
C07D 401/14 (2006.01) (97) **2649065 ***
C07D 403/04 (2006.01)
C07D 403/14 (2006.01)
C07D 405/14 (2006.01)
C07D 413/14 (2006.01)
C07D 417/14 (2006.01)
C07D 471/04 (2006.01)
C07D 487/04 (2006.01)
C07D 498/04 (2006.01)
C07D 491/107 (2006.01)
A61K 31/497 (2006.01)
A61K 31/437 (2006.01)
A61K 31/506 (2006.01)
A61K 31/444 (2006.01)
A61K 31/4709 (2006.01)
(86) US2011063776 07.12.2011
(96) 11802248.2 16.10.2013
(87) WO2012078777, 07.12.2011
(97) 2649065, 16.10.2013 en
(54) BICYCLIC COMPOUNDS AS PIM INHIBITORS
(71) Amgen Inc., One Amgen Center Dr., Thousand Oaks, California
93012, US
(72) WANG, Hui-Ling, 822 Lynnmere Drive, Thousand Oaks,
California 91360, US
BISWAS, Kaustav, 26003 Alizia Canyon Drive Unit B,
Calabasas, California 91302, US
CEE, Victor J., 2881 Capella Way, Thousand Oaks, California
91362, US
CHAVEZ JR., Frank, 1111 San Clemente Way, Camarillo,
California 93010, US
HERBERICH, Bradley, 1197 Ramona Dr., Newbury Park,
California 91320, US
JACKSON, Claire L.M., 1922 Deerfield Street, Thousand Oaks,
California 91362, US
LEE, Matthew, 4416 Park Mallorca, Calabasas California 91302,
US
NIXEY, Thomas, 4554 Via Laguna, Newbury Park, California
91320, US
PETTUS, Liping H., 3309 Big Cloud Circle, Thousand Oaks,
California 91360, US
REED, Anthony B., 3101 Peninsula Road 304, Oxnard,
California 93035, US
RZASA, Robert M., 160 Kennedy Avenue, Ventura California
93003, US
RUMFELT, Shannon, 2766 Wendell Street, Camarillo, California
93010, US
TASKER, Andrew, 645 Country Club Drive 821, Simi Valley,
California 93065, US
WU, Bin, 3090 Hollycrest Avenue, Thousand Oaks, California
91362, US
WURZ, Ryan, 53 Ocatillo Avenue, Newbury Park, California
91320, US
LANMAN, Brian, A., 762 Deer Run Lane No 246, Oak Park, CA
91377, US

(51) MKP
G06K 9/00 (2006.01) (97) **2666121 ***
(86) US2012021743 18.01.2012
(96) 12704340.4 27.11.2013
(87) WO2012154230, 18.01.2012
(97) 2666121, 27.11.2013 en
(54) LEARNING SITUATIONS VIA PATTERN MATCHING
(71) Qualcomm Incorporated, International IP Administration 5775
Morehouse Drive, San Diego, CA 92121-1714, US
NARAYANAN, Vidya, 5775 Morehouse Drive, San Diego,
California 92121, US
NANDA, Sanjiv, 5775 Morehouse Drive, San Diego, California
92121, US
SHIH, Fuming, 280 Vassar Street J-2, Cambridge,
Massachusetts 02139, US

(51) MKP
A61L 27/20 (2006.01) (97) **2678049 ***
A61L 31/04 (2006.01)
 (86) EP2012000718 17.02.2012
 (96) 12704709.0 01.01.2014
 (87) WO2012113529, 17.02.2012
 (97) 2678049, 01.01.2014 en
 (54) IN SITU FORMATION OF A FILLER
 (71) Merz Pharma GmbH & Co. KGaA, Eckenheimer Landstrasse 100, 60318 Frankfurt, DE
 (72) KIEHM, Kevin, Landgraf-Philipp-Strasse 44, 60431 Frankfurt am Main, DE
 HAUPTMEIER, Bernhard, Neue Weinbergstr. 10, 63571 Gelnhausen, DE
BODERKE, Peter, Bockenheimer Str. 3, 65824 Schwalbach, DE

(51) MKP
H02J 5/00 (2006.01) (97) **2649697 ***
 (86) US2011064248 09.12.2011
 (96) 11847650.6 16.10.2013
 (87) WO2012079027, 09.12.2011
 (97) 2649697, 16.10.2013 en
 (54) POWER SUPPLIES FOR POOL AND SPA EQUIPMENT
 (71) Hayward Industries, Inc., 620 Division Street, Elizabeth NJ 07201, US
 (72) POTUCEK, Kevin L., 18 Spring Lake Drive, Far Hills, NJ 07931, US
 WILLIS, Dennis, 6410 Peppermill Drive, Oak Ridge, NC 27310, US
 SUMONTHEE, Jeffrey, 3218 Turtle Cove, West Palm Beach, FL 33411, US
 RENAUD, Benoit J., 30 Red Bud Trail, Newnan, GA 30263, US
 PHILHOWER, Douglas H., 205 North Forke Drive, Advance, NC 27006, US
 FORSYTHE, Patrick J., 149 Arbor Hill Avenue, Mocksville, NC 27028, US
 NORMYLE, William M., 2002 Tory Drive, Yadkinville, NC 27055-8647, US

(51) MKP
F02D 41/00 (2006.01) (97) **2581588**
 (96) 11184524.4 17.04.2013
 (97) 2581588, 17.04.2013 en
 (54) Method of fuel quality determination
 (71) Delphi Technologies Holding S.à.r.l., Avenue de Luxembourg, 4940 Bascharage, LU
 (72) Malaczynski, Gerard, 1183 Ashover Drive, Bloomfield Hills, MI Michigan 48304, US
Van der Poel, Robert, 14 Katergaass, L-8562 Schweich, LU

(51) MKP
A61K 31/195 (2006.01) (97) **2697191 ***
A61P 9/00 (2006.01)
C07C 233/55 (2006.01)
 (86) EP2012055474 28.03.2012
 (96) 12711861.0 19.02.2014
 (87) WO2012139888, 28.03.2012
 (97) 2697191, 19.02.2014 de
 (54) BRANCHED 3-PHENYLPROPIONIC ACID DERIVATIVES AND THE USE THEREOF
 (71) Bayer Intellectual Property GmbH, Alfred-Nobel-Strasse 10, 40789 Monheim, DE
 (72) HAHN, Michael, Rietherbach 42D, 40764 Langenfeld, DE
 LAMPE, Thomas, Kaiser-Wilhelm-Ring 25, 40545 Düsseldorf, DE
 STASCH, Johannes-Peter, Alfred-Nobel-Str. 109, 42651 Solingen, DE
 SCHLEMMER, Karl-Heinz, Wildsteig 22a, 42113 Wuppertal, DE
 WUNDER, Frank, Schwarzer Weg 251, 42117 Wuppertal, DE
 LI, Volkhart, Min-Jian, Im Wiesengrund 40, 42553 Velbert, DE
 BECKER-PELSTER, Eva-Maria, Düsseldorf Höhe 22, 42327 Wuppertal, DE
 STOLL, Friedericke, Remscheid Str. 22, 40215 Düsseldorf, DE
 KNORR, Andreas, Trillser Graben 10, 40699 Erkrath, DE
WOLTERING, Elisabeth, Narzissenweg 1B, 40723 Hilden, DE

(51) MKP
B05B 17/06 (2006.01) (97) **2700085 ***
G01N 30/32 (2006.01)
G01N 30/72 (2006.01)
H01J 49/04 (2006.01)
 (86) US2012000209 19.04.2012
 (96) 12720707.4 26.02.2014
 (87) WO2012145039, 19.04.2012
 (97) 2700085, 26.02.2014 en
 (54) SAMPLE INTRODUCTION METHOD AND SYSTEM FOR ATOMIC SPECTROMETRY
 (71) PerkinElmer Health Sciences, Inc., 940 Winter Street, Waltham, MA 02451, US
 (72) IVALDI, Juan, C., 2 Great Pond Lane, Redding, CT 06896, US
 ANDERAU, Cindy, 22 Farm Field Ridge Road, Sandy Hook, Connecticut 06482, US
 MORRISROE, Peter, J., 27 Cornwall Drive, New Milford, CT 0667-5305, US
 KAHEN, Kaveh, 109 Parktree Drive, Maple, ON L6A 2R3, CA
 BADIEI, Hamid, 65 Bordeaux Drive, Woodbridge, ON L4L 3C3, CA

(51) MKP
A61K 31/5377 (2006.01) (97) **2683697 ***
A61P 3/14 (2006.01)
A61P 5/20 (2006.01)
C07D 265/30 (2006.01)
C07D 265/32 (2006.01)
 (86) IB2012051109 09.03.2012
 (96) 12711455.1 15.01.2014
 (87) WO2012120476, 09.03.2012
 (97) 2683697, 15.01.2014 en
 (54) SUBSTITUTED MORPHOLINES AS MODULATORS FOR THE CALCIUM SENSING RECEPTOR
 (71) Lupin Limited, 159 CST Road Kalina Santacruz (East), State of Maharashtra, Mumbai 400 098, IN
 (72) SHUKLA, Manojkumar, Ramprasad, Lupin Limited (Research Park) 46A/47A Village Nande Taluka Mulshi Maharashtra, Pune 411 042, IN
 CHAUDHARI, Vinod, Dinkar, Lupin Limited (Research Park) 46A/47A Village Nande Taluka Mulshi Maharashtra, Pune 411 042, IN
 SAYYED, Majid, Bashir, Lupin Limited (Research Park) 46A/47A Village Nande Taluka Mulshi Maharashtra, Pune 411 042, IN
 PHADTARE, Ramesh, Dattatraya, Lupin Limited (Research Park) 46A/47A Village Nande Taluka Mulshi Maharashtra, Pune 411 042, IN
 WALKER, Navnath, Bajirao, Lupin Limited (Research Park) 46A/47A Village Nande Taluka Mulshi Maharashtra, Pune 411 042, IN
 KULKARNI, Sanjeev, Anant, Lupin Limited (Research Park) 46A/47A Village Nande Taluka Mulshi Maharashtra, Pune 411 042, IN
 PALLE, Venkata, P., Lupin Limited (Research Park) 46A/47A Village Nande Taluka Mulshi Maharashtra, Pune 411 042, IN
 KAMBOJ, Rajender, Kumar, Lupin Limited (Research Park) 46A/47A Village Nande Taluka Mulshi Maharashtra, Pune 411 042, IN

(51) MKP
B32B 27/32 (2006.01) (97) **2672546**
H01M 2/16 (2006.01)
 (96) 13182599.4 11.12.2013
 (97) 2672546, 11.12.2013 en
 (54) Polyolefin microporous membrane
 (71) Asahi Kasei E-materials Corporation, 1-105, Kanda Jinbocho Chiyoda-ku, Tokyo 101-8101, JP
 (72) Ohashi, Masahiro, 1-105, Kanda Jinbocho, Chiyoda-ku, Tokyo, 101-8101, JP
 Ameyama, Keitaro, 1-105, Kanda Jinbocho, Chiyoda-ku, Tokyo, 101-8101, JP
 Sakakibara, Yuzuru, 1-105, Kanda Jinbocho, Chiyoda-ku, Tokyo, 101-8101, JP

- (51) MKP
A61K 31/4745 (2006.01) (97) **2663564 ***
A61P 35/00 (2006.01)
C07D 471/04 (2006.01)
- (86) US2012020897 11.01.2012
(96) 12701207.8 20.11.2013
(87) WO2012097039, 11.01.2012
(97) 2663564, 20.11.2013 en
(54) IMIDAZO [4, 5 -C]QUINOLIN- 2 -ONE COMPOUND AND ITS USE AS PI3 KINASE / MTOR DUAL INHIBITOR
- (71) Eli Lilly and Company, Lilly Corporate Center, Indianapolis, IN 46285, US
(72) BARDA, David Anthony, c/o Eli Lilly and Company P.O. Box 6288 Indianapolis, Indiana 46206-6288, US
MADER, Mary Margaret, c/o Eli Lilly and Company P.O.Box 6288 Indianapolis, Indiana 46206-6288, US

- (51) MKP
A01N 43/56 (2006.01) (97) **2655333 ***
C07D 231/14 (2006.01)
- (86) EP2011073225 19.12.2011
(96) 11802073.4 30.10.2013
(87) WO2012084812, 19.12.2011
(97) 2655333, 30.10.2013 en
(54) AMINOINDANES AMIDES HAVING A HIGH FUNGICIDAL ACTIVITY AND THEIR PHYTOSANITARY COMPOSITIONS
- (71) Stichting I-F Product Collaboration, Prins Bernhardplein 200, 1097 JB Amsterdam, NL
(72) VENTURINI, Isabella, Via Camillo Cavour 29, I-28062 Cameri (NO), IT
VAZZOLA, Matteo Santino, Via P. Mascagni 11, I-20815 Cogliate (MB), IT
SINANI, Entela, Via Monte San Michele 4, I-28100 Novara, IT
PELLACINI, Franco, Via Giacomo Balla 14, I-20151 Milano, IT
FILIPPINI, Lucio, Via Belvedere 17, I-28100 Novara, IT

- (51) MKP
(86) US2012023027 27.01.2012
(96) 12739468.2 04.12.2013
(87) WO2012103517, 27.01.2012
(97) 2668608, 04.12.2013 en
(54) INTERNET ISOLATION FOR AVOIDING INTERNET SECURITY THREATS
- (71) L-3 Communications Corporation, 600 Third Avenue, New York, NY 10016, US
(72) HOY, Robert, B., 241 Barnsboro Road, Sewell, NJ 08080, US
FENKNER, Mark, 115 Cottonwood Drive, Marlton, NJ 08053, US
FARREN, Sean, W., 62 Boardner Street, Newburyport, MA 01950, US

- (51) MKP
C12Q 1/68 (2006.01) (97) **2652145 ***
- (86) GB2011052509 16.12.2011
(96) 11804757.0 23.10.2013
(87) WO2012080754, 16.12.2011
(97) 2652145, 23.10.2013 en
(54) OLIGONUCLEOTIDE PROBE SET AND METHODS OF MICROBIOTA PROFILING
- (71) Genetic Analysis AS, Pb 4239 Nydalen, 0401 Oslo, NO
(72) VEBØ, Heidi, Dr. Sørdrings vei 23, N-1430 Ås, NO
RUDI, Knut, Joans Wessels vei 29, N-1540 Vestby, NO
SEKELJA, Monika, Nordahl Brunsgate 18A, N-0165 Oslo, NO

- (51) MKP
G01N 27/327 (2006.01) (97) **2333542**
- (96) 10252088.9 15.06.2011
(97) 2333542, 15.06.2011 en
(54) Fill sufficiency method and system
- (71) Lifescan Scotland Ltd, Beechwood Park North, Inverness Inverness-shire IV2 3ED, GB
(72) Rodgers, James Iain, 30 Stratherrick Road,, Lochardil, Inverness-shire IV2 4LL, GB
Mills, Leanne, 33 Ardgowan, Rosebank, Cory, Inverness IV2 5PA, GB
Cardosi, Marco, 21 Healthfield,, Croy, Inverness-shire IV2 5FP, GB
Leach, Chris, 131 Miller Street,, Inverness, Inverness-shire IV2 3DP, GB
Moffat, James, 2 Blarmore Avenue,, Inverness, Inverness-shire IV3 8QU, GB

- (51) MKP
C07D 233/26 (2006.01) (97) **2651896 ***
C07D 257/04 (2006.01)
C07D 233/90 (2006.01)
C07D 261/18 (2006.01)
C07D 241/24 (2006.01)
C07D 271/06 (2006.01)
C07D 239/34 (2006.01)
C07D 263/34 (2006.01)
C07D 249/04 (2006.01)
C07D 213/81 (2006.01)
C07D 249/10 (2006.01)
C07D 231/14 (2006.01)
C07D 249/18 (2006.01)
C07D 237/24 (2006.01)
C07D 261/20 (2006.01)
- (86) US2011064829 14.12.2011
(96) 11808444.1 23.10.2013
(87) WO2012082853, 14.12.2011
(97) 2651896, 23.10.2013 en
(54) NEPRILYSIN INHIBITORS
- (71) Theravance, Inc., 901 Gateway Boulevard, South San Francisco, CA 94080, US
(72) GENDRON, Roland, 345 Franconia Street, San Francisco California 94110, US
FLEURY, Melissa, 1023 Divisadero Street, San Francisco California 94115, US
HUGHES, Adam D., 1221 Judson Street, Belmont California 94002, US

- (51) MKP
A61K 9/20 (2006.01) (97) **2654736 ***
A61K 9/28 (2006.01)
A61K 31/519 (2006.01)
A61P 35/00 (2006.01)
- (86) US2011066021 20.12.2011
(96) 11849974.8 30.10.2013
(87) WO2012088033, 20.12.2011
(97) 2654736, 30.10.2013 en
(54) NOVEL PHARMACEUTICAL COMPOSITION
- (71) Glaxosmithkline Intellectual Property (No. 2) Limited, 980 Great West Road, Brentford, Middlesex TW8 9GS, GB
(72) DeMARINI, Douglas, J., 1250 South Collegeville Road, Collegeville PA 19426, US
LE, Ngocdiep, T., 1250 South Collegeville Road, Collegeville PA 19426, US
HENRIQUEZ, Francisco, 1250 South Collegeville Road, Collegeville PA 19426, US
WANG, Lihong, 1250 South Collegeville Road, Collegeville PA 19426, US

- (51) MKP
A01K 67/027 (2006.01) (97) **2688396 ***
- (86) FR2012050579 19.03.2012
(96) 12714814.6 29.01.2014
(87) WO2012131223, 19.03.2012
(97) 2688396, 29.01.2014 fr
(54) METHOD FOR OBTAINING A TRIPLOID INTERSPECIFIC HYBRID OF MEAGRE AND RED DRUM
- (71) Scea Les Poissons Du Soleil, 1 Rue des Trimarans, 34540 Balaruc Les Bains, FR
(72) BALMA, Georges, 227 Chemin du Mas Rousson, F-34200 Sete, FR

(51) MKP
A23L 1/30 (2006.01) (97) **2677886 ***
A23L 1/308 (2006.01)
(86) SE2012050202 23.02.2012
(96) 12749453.2 01.01.2014
(87) WO2012115588, 23.02.2012
(97) 2677886, 01.01.2014 en
(54) INDIRECT SUBSTRATES FOR MICROORGANISMS METABOLIZING 1,2-PROPANEDIOL
(71) BIOGAIA AB, Box 3242, 103 64 Stockholm, SE
(72) Roos, Stefan, Västgötagatan 57, S-757 54 Uppsala, SE

(51) MKP
B64F 1/32 (2006.01) (97) **2433870**
(96) 11182468.6 28.03.2012
(97) 2433870, 28.03.2012 de
(54) Airport vehicle and method for its operation
(71) Losch Airport Equipment GmbH, Flughafenstrasse, 70629 Stuttgart, DE
(72) Werner, Losch, Blumenstr. 24, 70794 Filderstadt, DE

(51) MKP
G01N 23/04 (2006.01) (97) **2676128 ***
(86) IB2012000570 16.02.2012
(96) 12722827.8 25.12.2013
(87) WO2012110898, 16.02.2012
(97) 2676128, 25.12.2013 en
(54) SYSTEM AND METHOD FOR MULTI-SCANNER X-RAY INSPECTION
(71) Smiths Heimann GmbH, Im Herzen 4, 65205 Wiesbaden, DE
(72) DREISEITEL, Pia, Gehspitz 9, 65760 Eschborn, DE
MUENSTER, Matthias, Hohenstaufenstrasse 10a, 65189 Wiesbaden, DE
KOENIG, Sebastian, Muellerstrasse 1, 65183 Wiesbaden, DE

(51) MKP
C07K 16/00 (2006.01) (97) **2691416 ***
C07K 16/24 (2006.01)
C07K 16/28 (2006.01)
C07K 16/32 (2006.01)
C07K 16/46 (2006.01)
(86) US2012030948 28.03.2012
(96) 12716818.5 05.02.2014
(87) WO2012135345, 28.03.2012
(97) 2691416, 05.02.2014 en
(54) DUAL VARIABLE REGION ANTIBODY-LIKE BINDING PROTEINS HAVING CROSS-OVER BINDING REGION ORIENTATION
(71) SANOFI, 54 rue La Boétie, 75008 Paris, FR
(72) BAURIN, Nicolas, c/o Sanofi 54 Rue La Boétie, 75008 Paris, FR
BEIL, Christian, c/o Sanofi-Aventis Deutschland GmbH Industriepark Hoechst Building K801, 65926 Frankfurt am Main, DE
CORVEY, Carsten, c/o Sanofi-Aventis Deutschland GmbH Industriepark Hoechst Building K801, 65926 Frankfurt am Main, DE
LANGE, Christian, c/o Sanofi-Aventis Deutschland GmbH Industriepark Hoechst Building K801, 65926 Frankfurt am Main, DE
LI, Danxi, c/o Sanofi U.S. 1041 Route 202-206 Mail Code BWD-303A, Bridgewater, NJ 08807, US
MIKOL, Vincent, c/o Sanofi 54 Rue La Boétie, 75008 Paris, FR
STEINMETZ, Anke, c/o Sanofi 54 Rue La Boétie, 75008 Paris, FR
RAO, Ercole, c/o Sanofi-Aventis Deutschland GmbH Industriepark Hoechst Building K801, 65926 Frankfurt am Main, DE

(51) MKP
B23Q 17/20 (2006.01) (97) **2492048**
G01B 5/20 (2006.01)
G05B 19/401 (2006.01)
(96) 11157897.7 29.08.2012
(97) 2492048, 29.08.2012 en
(54) Tolerance detection method and tolerance detection device for shape measuring apparatus
(71) Mitutoyo Corporation, 20-1, Sakado 1-chome, Takatsuku, Kawasaki-shi, Kanagawa 213-8533, JP
(72) Sakurada, Junji, c/o Mitutoyo Corporation 20-1 Sakado 1-chome Takatsu-ku Kawasaki-shi, Kanagawa Kanagawa 213-8533, JP

(51) MKP
A61K 31/407 (2006.01) (97) **2672967 ***
(86) US2012023543 01.02.2012
(96) 12745360.3 18.12.2013
(87) WO2012109075, 01.02.2012
(97) 2672967, 18.12.2013 en
(54) COMPOUNDS AND METHODS FOR KINASE MODULATION, AND INDICATIONS THEREFOR
(71) Plexikon, Inc., 91 Bolivar Drive, Suite A, Berkeley, CA 94710, US
(72) IBRAHIM, Prabha N., 3380 Lubich Drive, Mountain View, CA 94040, US
ZHANG, Chao, 397 Springfield Plaza, Moraga, CA 94556, US
SPEVAK, Wayne, 1585 Campus Drive, Berkeley, California 94708, US
ZHANG, Jiazhong, 888 Foster City Blvd. Apt. Q4, Foster City, CA 94404, US
WU, Guoxian, 240 Ventura Avenue, Palo Alto, CA 94306, US
LIN, Jack, 166 Ferragut Street, Hercules, California 94547, US
CHO, Hanna, 4363 Terrabella Place, Oakland, California 94619, US
NESPI, Marika, 564 San Luis Road, Berkeley, CA 94707, US
SHI, Songyuan, 3979 Via Cangrejo, San Diego, California 92130, US
EWING, Todd, 20 Edmund Court, Walnut Creek, California 94596, US
ZHANG, Ying, 39201 Red Hawk Terrace A204, Fremont, California 94538, US

(51) MKP
A61M 5/24 (2006.01) (97) **2688614 ***
A61M 5/315 (2006.01)
(86) EP2012055054 22.03.2012
(96) 12711382.7 29.01.2014
(87) WO2012130703, 22.03.2012
(97) 2688614, 29.01.2014 en
(54) DOSE SETTING MECHANISM AND INJECTION DEVICE
(71) Sanofi-Aventis Deutschland GmbH, Brüningstraße 50, 65929 Frankfurt, DE
(72) PLUMPTRE, David, Aubrey, 36 Shire Way, Droitwich Spa, Worcestershire WR9 7RQ, GB

(51) MKP
B21D 51/30 (2006.01) (97) **2688696 ***
(86) US2012024933 14.02.2012
(96) 12760735.6 29.01.2014
(87) WO2012128863, 14.02.2012
(97) 2688696, 29.01.2014 en
(54) STRESS CORROSION RESISTANT ALUMINUM BEVERAGE END CLOSURE
(71) Ball Corporation, 10 Longs Peak Drive, Broomfield, CO 80021, US
(72) BURT, Ronald, Paul, 4305 Easley Road, Golden, CO 80403, US

(51) MKP
A61B 6/03 (2006.01) (97) **2677936 ***
G01N 23/04 (2006.01)
G01V 5/00 (2006.01)
G06T 11/00 (2006.01)
(86) IB2012000416 23.02.2012
(96) 12742937.1 01.01.2014
(87) WO2012114199, 23.02.2012
(97) 2677936, 01.01.2014 en
(54) IMAGE RECONSTRUCTION BASED ON PARAMETRIC MODELS
(71) Smiths Heimann GmbH, Im Herzen 4, 65205 Wiesbaden, DE
(72) MUENSTER, Matthias, Hohenstaufenstrasse 10a, 65189 Wiesbaden, DE
DREISEITEL, Pia, Gehspitz 9, 65760 Eschborn, DE

(51) MKP
B65D 85/812 (2006.01) (97) **2694404 ***
(86) SI2012000020 28.03.2012
(96) 12762417.9 12.02.2014
(87) WO2012134403, 28.03.2012
(97) 2694404, 12.02.2014 en
(54) FASTENING ELEMENT FOR HANDLING AN INGREDIENT CONTAINER
(71) Hrvatin, Ales, Fijeroga 12, 6274 Smarje, SI
Nadizar, Branko, Kozinova 7 Lucija, 6320 Portoroz, SI
(72) Hrvatin, Ales, Fijeroga 12, 6274 Smarje, SI
Nadizar, Branko, Kozinova 7 Lucija, 6320 Portoroz, SI

(51) MKP
H04M 1/725 (2006.01) (97) **2664126 ***
H04M 3/42 (2006.01)
H04W 4/04 (2009.01)
(86) US2012021063 12.01.2012
(96) 12701591.5 20.11.2013
(87) WO2012097139, 12.01.2012
(97) 2664126, 20.11.2013 en
(54) DETERMINING A DYNAMIC USER PROFILE INDICATIVE OF A USER BEHAVIOR CONTEXT WITH A MOBILE DEVICE
(71) Qualcomm Incorporated, 5775 Morehouse Drive, San Diego, CA 92121-1714, US
(72) KUHN, Lukas Daniel, 5775 Morehouse Drive, San Diego California 92121, US
NANDA, Sanjiv, 5775 Morehouse Drive, San Diego California 92121, US
NARAYANAN, Vidya, 5775 Morehouse Drive, San Diego California 92121, US

(51) MKP
A23F 3/16 (2006.01) (97) **2665366 ***
A23F 3/32 (2006.01)
A23L 1/236 (2006.01)
A23L 2/395 (2006.01)
A23L 2/60 (2006.01)
(86) EP2011006261 13.12.2011
(96) 11808827.7 27.11.2013
(87) WO2012097842, 13.12.2011
(97) 2665366, 27.11.2013 de
(54) REDUCED-CALORIE PREPARATIONS FOR PRODUCING INSTANT BEVERAGES AND THE PRODUCTION THEREOF
(71) Krüger GmbH & Co. KG, Senefelderstrasse 44, 51469 Bergisch-Gladbach, DE
(72) KRÜGER, Willibert, Zaunkönigweg 5, 51467 Bergisch Gladbach, DE

(51) MKP
A61K 47/48 (2006.01) (97) **2694112 ***
C12N 15/62 (2006.01)
G01N 33/574 (2006.01)
(86) US2012032527 06.04.2012
(96) 12723769.1 12.02.2014
(87) WO2012139002, 06.04.2012
(97) 2694112, 12.02.2014 en
(54) ANTI-TUMOR ANTIBODY-TUMOR SUPPRESSOR FUSION PROTEIN COMPOSITIONS AND METHODS OF USE FOR THE TREATMENT OF CANCER
(71) Memorial Sloan-Kettering Cancer Center, 1275 York Avenue, New York, NY 10065, US
(72) WENDEL, Hans-Guido, 124 West 60th Street, Apt. 51a, New York NY 10023, US
ORCCHIO, Elisa, 504 East 81st Street, Apt. 5L, New York NY 10028, US

(51) MKP
A01N 27/00 (2006.01) (97) **2685821 ***
A61K 31/015 (2006.01)
(86) US2012029184 15.03.2012
(96) 12758037.1 22.01.2014
(87) WO2012125797, 15.03.2012
(97) 2685821, 22.01.2014 en
(54) NUCLEAR HORMONE RECEPTOR MODULATORS
(71) AbbVie Inc., 1 North Waukegan Road, North Chicago, IL 60064, US
(72) CUSACK, Kevin, P., 115 Jennifer Drive, Holden MA 01520, US
GORDON, Thomas, D., 6 Rainbow Drive, Medway MA 01473, US
IHLE, David, C., 505 Plantation Street, No.403, Worcester MA 01605, US
HAYES, Martin, E., 200 Market Street - Unit 3114, Lowell MA 01852, US
BREINLINGER, Eric, C., 54 Hanson Road, Charlton MA 01507, US
ERICSSON, Anna, M., 16 Venus Drive, Shrewsbury MA 01545, US
LI, Bin, 11 Hunters Lane, Ashland MA 01721, US
WANG, Lei, 3 Joseph Reed Lane, Acton US 01720, US
MARTINEZ, Gloria, Y., 195 Grafton Street, Shrewsbury MA 01545, US
BURCHAT, Andrew, 31 Foxhill Road, Shrewsbury MA 01545, US
HOBSON, Adrian, D., 25 Holman Street, Shrewsbury MA 01545, US
MULLEN, Kelly, D., 64 Cranberry Meadow Road, Charlton MA 01507, US
FRIEDMAN, Michael, 34 Garrison Road, Apt. 2, Brookline MA 02445, US
MORYTKO, Michael, J., 1269 Worcester Road, No.2510, Framingham MA 01702, US

(51) MKP
A01N 43/80 (2006.01) (97) **2683723 ***
C07D 491/10 (2006.01)
(86) IB2012050842 23.02.2012
(96) 12709376.3 15.01.2014
(87) WO2012120399, 23.02.2012
(97) 2683723, 15.01.2014 en
(54) SPIROCYCLIC ISOXAZOLINE DERIVATIVES AS ANTIPARASITIC AGENTS
(71) Zoetis LLC, 100 Campus Drive, Florham Park, New Jersey 07940, US
(72) BILLEN, Denis, Pfizer Global Research & Development 7000 Portage Road, Kalamazoo, MI 49001, US
CHUBB, Nathan Anthony Logan, Pfizer Global Research & Development 7000 Portage Road, Kalamazoo, MI 49001, US
CURTIS, Michael, Pfizer Global Research & Development 7000 Portage Road, Kalamazoo, MI 49001, US
GREENWOOD, Sean DW, Pfizer Global Research & Development 7000 Portage Road, Kalamazoo, MI 49001, US
MENON, Sanjay, Pfizer Global Research & Development 7000 Portage Road, Kalamazoo, MI 49001, US
STUK, Timothy, Pfizer Global Research & Development 7000 Portage Road, Kalamazoo, MI 49001, US
VAILLANCOURT, Valerie A., Pfizer Global Research & Development 7000 Portage Road, Kalamazoo, MI 49001, US

- (51) MKP
A01N 43/42 (2006.01) (97) **2663187 ***
 (86) US2012020649 09.01.2012
 (96) 12734573.4 20.11.2013
 (87) WO2012096887, 09.01.2012
 (97) 2663187, 20.11.2013 en
 (54) COMPOSITIONS COMPRISING ENZYME-CLEAVABLE OXYCODONE PRODRUG
 (71) Signature Therapeutics, Inc., 75 Shoreway Road, Suite D, San Carlos, CA 94070, US
 (72) JENKINS, Thomas E., 75 Shoreway Road Suite D San Carlos, California 94070, US
 HUSFELD, Craig O., 75 Shoreway Road Suite D San Carlos, California 94070, US

- (51) MKP
A61K 9/00 (2006.01) (97) **2683375 ***
A61K 31/375 (2006.01)
A61K 47/10 (2006.01)
A61P 1/10 (2006.01)
 (86) GB2012050526 09.03.2012
 (96) 12710777.9 15.01.2014
 (87) WO2012123720, 09.03.2012
 (97) 2683375, 15.01.2014 en
 (54) COLONOSCOPY - PREPARATION
 (71) Norgine B.V., Hogehilweg 7, 1101 CA Amsterdam ZO, NL
 HALPHEN, Marc, c/o Norgine Limited New Road Tir-y-Berth, Hengoed Mid-Glamorgan CF82 8SJ, GB
 GRUSS, Hans-Jürgen, c/o Norgine Limited New Road Tir-y-Berth, Hengoed Mid-Glamorgan CF82 8SJ, GB
 COX, Ian, c/o Norgine Limited New Road Tir-y-Berth, Hengoed Mid-Glamorgan CF82 8SJ, GB
 COCKETT, Alasdair, c/o Norgine Limited New Road Tir-y-Berth, Hengoed Mid-Glamorgan CF82 8SJ, GB
 STEIN, Peter, c/o Norgine Limited New Road Tir-y-Berth, Hengoed Mid-Glamorgan CF82 8SJ, GB
 UNGAR, Alex, Moorthwaite Cottage, Wigton Cumberland CA7 0LZ, GB

- (51) MKP
C07F 9/38 (2006.01) (97) **2673282 ***
C07F 9/58 (2006.01)
C07F 9/6506 (2006.01)
 (86) HU2012000009 08.02.2012
 (96) 12716591.8 18.12.2013
 (87) WO2012107787, 08.02.2012
 (97) 2673282, 18.12.2013 en
 (54) NOVEL PROCESS FOR THE PREPARATION OF DRONIC ACIDS
 (71) Richter Gedeon Nyrt., Gyömrői út 19-21., 1103 Budapest, HU
 (72) KEGLEVICH, György, Bartók Béla út 53., H-1114 Budapest, HU
 GRÜN, Alajos, Ónodi köz 1., H-1105 Budapest, HU
 GARADNAY, Sándor, Bánomi lakótelep 12., H-2500 Esztergom, HU
 NEU, József, Hegedüs Gyula u. 44/B., H-1133 Budapest, HU

- (51) MKP
B01D 19/00 (2006.01) (97) **2675543 ***
E21B 43/34 (2006.01)
 (86) US2012024788 12.02.2012
 (96) 12747465.8 25.12.2013
 (87) WO2012112403, 12.02.2012
 (97) 2675543, 25.12.2013 en
 (54) GAS TRAP
 (71) Gas Trap, LLC, 1629 Avenue K, Tahoka, TX 79373-1308, US
 (72) HANEY, Perry, Cr 22, No 2731, Tahoka, TX 79373, US

- (51) MKP
A01G 7/04 (2006.01) (97) **2656728**
A01G 9/20 (2006.01)
 (96) 12165894.2 30.10.2013
 (97) 2656728, 30.10.2013 en
 (54) A tilting horticultural light and method of plant cultivation
 (71) Valoya Oy, Lauttasaarentie 54 A 3. krs, 00200 Helsinki, FI
 (72) Ringbom, Rabbe, Kylmäläntie 352, 02540 Kylmäla, FI
 Kivimäki, Ilkka, Merikatu 41 A 11, 00150 Helsinki, FI

- (51) MKP
C01B 17/02 (2006.01) (97) **2699514 ***
 (86) EP2012057069 18.04.2012
 (96) 12719305.0 26.02.2014
 (87) WO2012143387, 18.04.2012
 (97) 2699514, 26.02.2014 en
 (54) PROCEDURE FOR THE STORAGE AND HANDLING OF SULPHUR BLOCKS
 (71) Ausy S.r.L., Via Mezzano 9/11/13, 27039 Sannazzaro De' Burgondi (PV), IT
 Falconieri, Antonio, Salvatore, Via L. Pasteur 4, 20871 Vimercate (MI), IT
 (72) FALCONIERI, Antonio, Salvatore, Via L. Pasteur 4, 20871 Vimercate (MI), IT
 FINOCCHIARO, Franco, Viale Bligny 36, 20136 Milano, IT
 CECCHINI, Claudio Paolo, Via Sannio 20, 20135 Milano, IT

- (51) MKP
C10L 1/02 (2006.01) (97) **2694627 ***
F02B 1/02 (2006.01)
 (86) EP2012001222 20.03.2012
 (96) 12712936.9 12.02.2014
 (87) WO2012130407, 20.03.2012
 (97) 2694627, 12.02.2014 en
 (54) A PROCESS FOR PREPARING A FUEL FOR AUTOMOTIVE APPLICATIONS, STATIONARY ENGINES AND MARINE APPLICATIONS BY CATALYTIC LIQUID PHASE ALCOHOL CONVERSION AND A COMPACT DEVICE FOR CARRYING OUT THE PROCESS
 (71) Haldor Topsøe A/S, Nymøllevej 55, 2800 Kgs. Lyngby, DK
 (72) DUWIG, Christophe, Axel Danierlssonsväg 442, S-215 82 Malmö, SE
 GABRIELSSON, Pär, L.T., Karl X Gustavsgatan 7, S-254 38 Helsingborg, SE
 JANSSENS, Ton., V., Gunnarsvej 3, DK-2880 Bagsværd, DK

- (51) MKP
D06B 3/04 (2006.01) (97) **2697421 ***
D06M 15/643 (2006.01)
G01N 19/02 (2006.01)
 (86) IB2012051727 06.04.2012
 (96) 12722852.6 19.02.2014
 (87) WO2012140558, 06.04.2012
 (97) 2697421, 19.02.2014 fr
 (54) YARN, METHOD FOR MANUFACTURING SAME, FACILITY FOR IMPLEMENTING THE METHOD, AND USE OF THE YARN
 (71) Massebeuf Textiles, Lieu dit Pourtalou, 07380 Pont de Labeaume, FR
 (72) MASSEBEUF, Patrick, 1175 chemin de Ternis, F-07000 Privas, FR
 NOWAK, Pascal, Quartier Soulier, F-07200 Mercuer, FR

- (51) MKP
F24J 2/52 (2006.01) (97) **2664006 ***
H01L 31/042 (2006.01)
 (86) US2012020829 10.01.2012
 (96) 12733845.7 20.11.2013
 (87) WO2012096998, 10.01.2012
 (97) 2664006, 20.11.2013 en
 (54) PHOTOVOLTAIC MODULES AND MOUNTING SYSTEMS
 (71) Nuvosun, Inc., 1565 Barber Lane, Milpitas, CA 95035, US
 (72) PEARCE, David, B., 20932 Hidden View Lane, Saratoga CA 95070-6344, US
 HOLLARS, Dennis, R., 1908 Cresmont Drive, San Jose CA 95124-1103, US
 CLEEREMAN, Robert, J., 5908 Wimbledon Court, Midland MI 48642, US

- (51) MKP
A61K 31/437 (2006.01) (97) **2567959**
A61P 3/10 (2006.01)
A61P 9/00 (2006.01)
A61P 25/00 (2006.01)
A61P 35/00 (2006.01)
C07D 471/04 (2006.01)
(96) 11306130.3 13.03.2013
(97) 2567959, 13.03.2013 en
(54) 6-(4-Hydroxy-phenyl)-3-styryl-1H-pyrazolo[3,4-b]pyridine-4-carboxylic acid amide derivatives as kinase inhibitors
(71) SANOFI, 54 rue La Boétie, 75008 Paris, FR
(72) Loehn, Matthias, Dr., c/o Sanofi-Aventis Deutschland GmbH, 65926 Frankfurt am Main, DE
Mendez-Perez, Maria, Dr., c/o Sanofi-Aventis Deutschland GmbH, 65926 Frankfurt am Main, DE
Pfeiffer-Marek, Stefania, Dr., c/o Sanofi-Aventis Deutschland GmbH, 65926 Frankfurt am Main, DE
Kannt, Aimo, Dr., c/o Sanofi-Aventis Deutschland GmbH, 65926 Frankfurt am Main, DE
Begis, Guillaume, Dr., Sanofi, Patentabteilung, 54, rue de la Boétie, 75008 Paris, FR
Jeannot, Frédéric, Dr., Sanofi, Patentabteilung, 54, rue de la Boétie, 75008 Paris, FR
Duclos, Olivier, Sanofi, Patentabteilung, 54, rue de la Boétie, 75008 Paris, FR

- (51) MKP
A61K 9/48 (2006.01) (97) **2502622**
(96) 12160674.3 26.09.2012
(97) 2502622, 26.09.2012 en
(54) Pharmaceutical formulation comprising inositol
(71) L.O. I. Pharma S.r.l., Via Orgosolo 27, 00132 Roma, IT
(72) Unfer, Vittorio, Via Cesare Massini 43, 00155 Roma, IT

- (51) MKP
A61K 39/04 (2006.01) (97) **2651436 ***
(86) EP2011072817 14.12.2011
(96) 11794778.8 23.10.2013
(87) WO2012080370, 14.12.2011
(97) 2651436, 23.10.2013 en
(54) MYCOBACTERIUM ANTIGENIC COMPOSITION
(71) GlaxoSmithKline Biologicals S.A., rue de l'Institut, 89, 1330 Rixensart, BE
(72) GODART, Stephane Andre Georges, GlaxoSmithKline Biologicals s.a. rue de l'Institut 89, B-1330 Rixensart, BE
LAANAN, Amina, GlaxoSmithKline Biologicals s.a. rue de l'Institut 89, B-1330 Rixensart, BE
LEMOINE, Dominique Ingrid, GlaxoSmithKline Biologicals s.a. rue de l'Institut 89, B-1330 Rixensart, BE

- (51) MKP
A61K 9/28 (2006.01) (97) **2672970 ***
A61K 31/4375 (2006.01)
A61P 1/00 (2006.01)
C07D 498/22 (2006.01)
(86) US2012024746 10.02.2012
(96) 12745372.8 18.12.2013
(87) WO2012109605, 10.02.2012
(97) 2672970, 18.12.2013 en
(54) FORMS OF RIFAXIMIN AND USES THEREOF
(71) Salix Pharmaceuticals, Ltd., 8510 Colonnade Center Drive, Raleigh, NC 27615, US
(72) PARENT, Stephan, 2120 Cumulus Ct, West Lafayette, IN 47906, US
McQUEEN, Lisa, 3472 Tunbridge Way, West Lafayette, IN 47906, US
ANDRES, Patricia, 2307 Sycamore Lane, West Lafayette, IN 47906, US
SCHIELDS, Paul, 4203 Peterborough, West Lafayette, IN 47906, US
WU, Yiduo, 947B Village Drive East, North Brunswick, NJ 08902, US
DING, Fei, 7575 West 106th Street Apartment 370, Overland Park, KS 66212, US
SMIT, Jared P., 4509 McCarty Lane, Lafayette, Indiana 47905, US

- (51) MKP
A61K 9/00 (2006.01) (97) **2675453 ***
A61K 31/4468 (2006.01)
(86) US2012024218 08.02.2012
(96) 12704486.5 25.12.2013
(87) WO2012112348, 08.02.2012
(97) 2675453, 25.12.2013 en
(54) METHODS FOR CONTROLLING PAIN IN CANINES USING A TRANSDERMAL SOLUTION OF FENTANYL
(71) ELI LILLY AND CO., Lilly Corporate Center, Indianapolis, IN 46285, US
(72) NEWBOUND, Garret, Conrad, Eli Lilly and Company P.O. Box 6288, Indianapolis, Indiana 46206-6288, US
CLARK, Terrence, Patrick, Eli Lilly and Company P.O. Box 6288, Indianapolis, Indiana 46206-6288, US

- (51) MKP
A61K 31/4245 (2006.01) (97) **2686308 ***
A61P 31/00 (2006.01)
C07D 213/72 (2006.01)
C07D 271/06 (2006.01)
C07D 401/04 (2006.01)
(86) US2012029234 15.03.2012
(96) 12756938.2 22.01.2014
(87) WO2012125832, 15.03.2012
(97) 2686308, 22.01.2014 en
(54) ANTIMICROBIAL AGENTS
(71) Rib-X Pharmaceuticals, Inc., 300 George Street Suite 301, New Haven, CT 06511, US
(72) DUFFY, Erin, M., 349 River Road, Deep River CT 06417, US
CHEN, Shili, 290 Sorghum Ridge, Cheshire, CT 06410, US
KANYO, Zoltan, F., 1270 Ridge Road, North Haven, CT 06473, US
GOLDBERG, Joel, A., 2116 Short Street, New Orleans, LA 70118, US
WANG, Deping, 52 Cannon Ball Road, Sharon, MA 02067, US
TANG, Yuanqing, 1005 Moss Farms Road, Cheshire, CT 06410, US

- (51) MKP
E04B 2/24 (2006.01) (97) **2683884 ***
(86) AT2012000054 08.03.2012
(96) 12723360.9 15.01.2014
(87) WO2012119167, 08.03.2012
(97) 2683884, 15.01.2014 de
(54) STRUCTURAL ELEMENT FOR PRODUCING MASONRY
(71) Pall, Hans, Kärtnerstraße 39 Stiege 1 Postfach 62, 9601 Arnoldstein, AT
(72) Pall, Hans, Kärtnerstraße 39 Stiege 1 Postfach 62, 9601 Arnoldstein, AT

- (51) MKP
B63B 27/14 (2006.01) (97) **2673187 ***
E01D 15/24 (2006.01)
(86) SE2012050109 06.02.2012
(96) 12744958.5 18.12.2013
(87) WO2012108823, 06.02.2012
(97) 2673187, 18.12.2013 en
(54) RAMP FOR A MOVABLE PASSENGER BRIDGE FOR A SHIP
(71) FMT INTERNATIONAL TRADE AB, Dalaslingan 8, S-231 32 Trelleborg, SE
(72) ANDERBERG, Nils-Erik, Asbjer Gärd, S-231 96 Trelleborg, SE

- (51) MKP
A61K 31/675 (2006.01) (97) **2678021 ***
A61P 35/00 (2006.01)
C07F 9/58 (2006.01)
C07F 9/6509 (2006.01)
C07F 9/6558 (2006.01)
(86) US2012026083 22.02.2012
(96) 12748976.3 01.01.2014
(87) WO2012116050, 22.02.2012
(97) 2678021, 01.01.2014 en
(54) PHOSPHORUS CONTAINING COMPOUNDS AS PROTEIN KINASE INHIBITORS
(71) Jiangsu Hansoh Pharmaceutical Co., Ltd., The 10th Industrial Sub-Zone of Development Zone Lianyungang, Jiangsu Province 222047, CN
(72) HU, Baihua, 2502 Condor Drive, Audubon, PA 19403, US
HE, Kan, 10 Borrowby Circle, Montgomery, NJ 08540, US
ZHANG, Minsheng, 31 Scheurman Terrace, Greenbrook, NJ 07059, US

- (51) MKP
A61K 31/437 (2006.01) (97) **2699575 ***
A61P 35/00 (2006.01)
C07D 471/04 (2006.01)
(86) EP2012056914 16.04.2012
(96) 12721779.2 26.02.2014
(87) WO2012143329, 16.04.2012
(97) 2699575, 26.02.2014 en
(54) TRIAZOLOPYRIDINES
(71) Bayer Intellectual Property GmbH, Alfred-Nobel-Strasse 10, 40789 Monheim, DE
(72) SCHULZE, Volker, Emil-Czekowski-Str. 5, 16562 Hohen Neuendorf, Bergfelde, DE
KOSEMUND, Dirk, Klutstr. 14, 12587 Berlin, DE
WENIGNER, Antje, Margret, Borkumstr. 12 e, 13189 Berlin, DE
SIEMEISTER, Gerhard, Reimerswalder Steig 26, 13503 Berlin, DE
STÖCKIGT, Detlef, Clara-Zetkin-Str. 27, 14471 Potsdam, DE
LIENAU, Philip, Jahnstr. 13, 10967 Berlin, DE
SCHIROK, Hartmut, Pestalozzistr. 39a, 40764 Langenfeld, DE
BRIEM, Hans, Emser Str. 3, 10719 Berlin, DE

- (51) MKP
A63B 49/02 (2006.01) (97) **2699322 ***
A63B 49/04 (2006.01)
(86) FR2012050855 19.04.2012
(96) 12722440.0 26.02.2014
(87) WO2012172217, 19.04.2012
(97) 2699322, 26.02.2014 fr
(54) NEXT-GENERATION WOODEN RACKET
(71) Lacoste, 8 rue Castiglione, 75001 Paris, FR
(72) GALLAIS, Alain, 9 rue Van Loo, F-75016 Paris, FR
ZANCO, Alain, 191 rue des Seigneurs de Cor, F-73260 Grand Cœur, FR

- (51) MKP
A61K 9/00 (2006.01) (97) **2680825 ***
A61K 9/48 (2006.01)
A61K 31/4525 (2006.01)
A61K 47/14 (2006.01)
A61K 47/26 (2006.01)
(86) EP2012053341 28.02.2012
(96) 12710458.6 08.01.2014
(87) WO2012116976, 28.02.2012
(97) 2680825, 08.01.2014 en
(54) PRUCALOPRIDE ORAL SOLUTION
(71) Shire-Movetis N.V., Veedijk 58, 2300 Turnhout, BE
(72) EMBRECHTS, Roger Carolus Augusta, Sperwersweg 5, B-2360 Oud Turnhout, BE

- (51) MKP
A61K 31/52 (2006.01) (97) **2655374 ***
A61P 35/00 (2006.01)
C07D 473/32 (2006.01)
(86) US2011065743 19.12.2011
(96) 11811232.5 30.10.2013
(87) WO2012087881, 19.12.2011
(97) 2655374, 30.10.2013 en
(54) N-(1-(SUBSTITUTED-PHENYL)ETHYL)-9H-PURIN-6-AMINES AS PI3K INHIBITORS
(71) Incyte Corporation, Experimental Station Route 141 & Henry Clay Road Building 336, Wilmington, DE 19880, US
(72) LI, Yun-Long, 1 Pin Oak Drive, Chadds Ford Pennsylvania 19317, US
COMBS, Andrew P., 329 East Doe Run Road, Kennett Square Pennsylvania 19348, US
YUE, Eddy W., 9 Altemus Drive, Landenberg Pennsylvania 19350, US
MADUSKUIE JR., Thomas P., 613 Foulkstone Road, Wilmington Delaware 19803, US
SPARKS, Richard B., 3316 Englewood Road, Wilmington Delaware 19810, US

- (51) MKP
A01H 5/00 (2006.01) (97) **2668278 ***
C12N 15/82 (2006.01)
(86) EP2012051036 24.01.2012
(96) 12701113.8 04.12.2013
(87) WO2012101118, 24.01.2012
(97) 2668278, 04.12.2013 en
(54) USE OF THE RD29 PROMOTER OR FRAGMENTS THEREOF FOR STRESS-INDUCIBLE EXPRESSION OF TRANSGENES IN COTTON
(71) Bayer CropScience NV, J.E. Mommaertslaan 14, 1831 Diegem, BE
(72) PIEN, Stéphane, Boulevard Saint-Michel 75, B-1040 Etterbeek, BE
DEN BOER, Bart, Wilgenstraat 21, B-9820 Merelbeke, BE

- (51) MKP
G06F 17/30 (2006.01) (97) **2678862 ***
G06Q 30/02 (2012.01)
G06Q 30/06 (2012.01)
G11B 27/034 (2006.01)
G11B 27/036 (2006.01)
G11B 27/11 (2006.01)
G11B 27/34 (2006.01)
G11B 27/36 (2006.01)
H04N 21/258 (2011.01)
H04N 21/442 (2011.01)
H04N 21/658 (2011.01)
(86) IL2012000081 16.02.2012
(96) 12712369.3 01.01.2014
(87) WO2012114330, 16.02.2012
(97) 2678862, 01.01.2014 en
(54) SYSTEM AND METHOD FOR DATA MINING WITHIN INTERACTIVE
(71) JBF Interlude (2009) Ltd., Pomerock 17, 69357 Tel Aviv, IL
(72) BLOCH, Jonathan, 150 N. 5th Street, Apt 3h, Brooklyn, NY 11211, US
FELDMAN, Barak, 101 Windsor Road, Tenafly, NJ 07670, US
ZUBALSKY, Tal, 32 Viesburg St., Tel Aviv 69358, IL
ROTBARD, Kfir, Y., 7/5 Menachem Begin St., Ramat Hasharon 47100, IL

- (51) MKP
A01K 67/027 (2006.01) (97) **2568049**
C07K 16/00 (2006.01)
C07K 16/46 (2006.01)
C12N 15/85 (2006.01)
(96) 12195716.1 13.03.2013
(97) 2568049, 13.03.2013 en
(54) Mice expressing an immunoglobulin hybrid light chain with a human variable region
(71) Regeneron Pharmaceuticals, Inc., 777 Old Saw Mill Road, Tarrytown, NY 10591, US
(72) Macdonald, Lynn, 16 Gedney Way, White Plains, NY New York 10605, US
Stevens, Sean, 355 Berry Street No. 413, San Francisco, CA California 94158, US
Gurer, Cagan, 8 Pamela Lane, Valhalla, NY New York 10595, US
Murphy, Andrew, J., 10 Newton Court, Croton-on-Hudson, NY New York 10520, US
Hosiawa, Karolina A., 14 Church Street, 2nd Floor, Tarrytown, NY New York 10591, US
-
- (51) MKP
A41D 1/06 (2006.01) (97) **2658407 ***
A41D 13/00 (2006.01)
A41D 17/00 (2006.01)
A41F 17/04 (2006.01)
(86) EP2012000482 03.02.2012
(96) 12703699.4 06.11.2013
(87) WO2012126551, 03.02.2012
(97) 2658407, 06.11.2013 de
(54) ITEM OF CLOTHING HAVING A DEVICE FOR PROTECTION AGAINST PESTS, IN PARTICULAR TICKS
(71) Blücher GmbH, Mettmanner Strasse 25, 40699 Erkrath, DE
(72) KÜHL, Kai-Uwe, Liesemorgen 4, 44229 Dortmund, DE
-
- (51) MKP
G08C 23/04 (2006.01) (97) **2608178**
(96) 12197787.0 26.06.2013
(97) 2608178, 26.06.2013 en
(54) Device for control and connection via cable by remote control of two or more apparatuses
(71) Teleco S.P.A., Via Majorana Ettore, 49, 48022 Lugo (RA), IT
(72) Baravelli, Thomas, Via Argine Senio a sinistra, 4, 48022 Lugo Ra, IT
-
- (51) MKP
C07C 323/12 (2006.01) (97) **2459524 ***
C07D 213/24 (2006.01)
C07D 305/06 (2006.01)
C07D 213/65 (2006.01)
C07D 407/12 (2006.01)
C07D 263/14 (2006.01)
C07D 307/02 (2006.01)
C07C 311/08 (2006.01)
C07D 277/24 (2006.01)
C07D 333/16 (2006.01)
A61K 31/18 (2006.01)
C07D 231/12 (2006.01)
C07D 309/12 (2006.01)
C07D 261/08 (2006.01)
A61P 29/00 (2006.01)
(86) IN2010000502 30.07.2010
(96) 10782722.2 06.06.2012
(87) WO2011016050, 30.07.2010
(97) 2459524, 06.06.2012 en
(54) NOVEL COMPOUNDS AS MODULATORS OF GLUCOCORTICOID RECEPTORS
(71) Cadila Healthcare Limited, Zydus Tower Satellite Cross Roads, Ahmedabad 380 015, Gujarat, IN
KARO BIO AB, Novum, 141 57 Huddinge, SE
(72) THOMBARE, Pravin S., Cadila Healthcare Limited Zydus Tower Satellite Cross Roads Ahmedabad 380 015, Gujarat, IN
GOSWAMI, Amitgiri, Cadila Healthcare Limited Zydus Tower Satellite Cross Roads Ahmedabad 380 015, Gujarat, IN
ZAMARATSKI, Edouard, KARO BIO AB Novum, S-141 57 Huddinge, SE
HANSSON, Tomas, Karo Bio AB Novum, S-141 57 Huddinge, SE
THOMAS, Norin, Karo Bio AB Novum, S-141 57 Huddinge, SE
-
- (51) MKP
A61K 9/16 (2006.01) (97) **2645999 ***
A61P 35/00 (2006.01)
(86) US2011062837 01.12.2011
(96) 11794907.3 09.10.2013
(87) WO2012075253, 01.12.2011
(97) 2645999, 09.10.2013 en
(54) PHARMACEUTICAL COMPOSITIONS
(71) Novartis AG, Lichtstrasse 35, 4056 Basel, CH
(72) CAO, Yu, Novartis Pharmaceuticals Corporation One Health Plaza, East Hanover, New Jersey 07936-1080, US
HACKL, Wolfgang, Novartis Pharma AG Postfach, CH-4002 Basel, CH
LI, Ping, Novartis Pharmaceuticals Corporation One Health Plaza, East Hanover, New Jersey 07936-1080, US
LI, Shoufeng, Novartis Pharmaceuticals Corporation One Health Plaza, East Hanover, New Jersey 07936-1080, US
MIRZA, Tahseen, 14232 Arbor Forest Drive Apt. 202, Rockville, Maryland 20850, US
ZEHENDER, Hartmut, 16A Rue du Winkel, F-68210 Fulleren, FR
ZHU, Jiahao, Novartis Pharmaceuticals Corporation One Health Plaza, East Hanover, New Jersey 07936-1080, US
-
- (51) MKP
A61K 38/26 (2006.01) (97) **2665487 ***
A61K 38/28 (2006.01)
A61P 3/04 (2006.01)
A61P 3/10 (2006.01)
(86) IB2012000134 20.01.2012
(96) 12704117.6 27.11.2013
(87) WO2012098462, 20.01.2012
(97) 2665487, 27.11.2013 en
(54) COMBINATION OF ACYLATED GLUCAGON ANALOGUES WITH INSULIN ANALOGUES
(71) Zealand Pharma A/S, Smedeland 36, 2600 Glostrup, DK
(72) FOSGERAU, Keld, Lyngholmvej 45, DK-2720 Vanløse, DK
RIBER, Ditte, Degnemose Allé 64, DK-2700 Broenshoej, DK
-
- (51) MKP
A61K 31/47 (2006.01) (97) **2673262 ***
A61P 35/00 (2006.01)
C07D 215/227 (2006.01)
(86) US2012024591 10.02.2012
(96) 12704492.3 18.12.2013
(87) WO2012109510, 10.02.2012
(97) 2673262, 18.12.2013 en
(54) PROCESSES FOR PREPARING QUINOLINE COMPOUNDS AND PHARMACEUTICAL COMPOSITIONS CONTAINING SUCH COMPOUNDS
(71) Exelixis, Inc., 210 East Grand Avenue, South San Francisco, CA 94080, US
(72) WILSON, Jo Ann, 74 Seward Street, San Francisco, CA 94114, US
-
- (51) MKP
G01N 33/558 (2006.01) (97) **2646825 ***
G01N 33/569 (2006.01)
(86) DE2011075292 30.11.2011
(96) 11817311.1 09.10.2013
(87) WO2012097788, 30.11.2011
(97) 2646825, 09.10.2013 de
(54) RAPID TEST FOR THE QUALITATIVE AND/OR QUANTITATIVE ANALYSIS OF ANTIBODIES AGAINST HUMAN PAPILLOMA VIRUSES (HPV) PRESENT IN BODY FLUID, AND DEVICE FOR CARRYING OUT THE RAPID TEST
(71) Hilfrich, Ralf, Zum Römberg 24, 65597 Hünfelden, DE
(72) Hilfrich, Ralf, Zum Römberg 24, 65597 Hünfelden, DE

- (51) MKP
A61K 31/381 (2006.01) (97) **2678327 ***
A61P 25/28 (2006.01)
C07D 333/22 (2006.01)
C07D 409/04 (2006.01)
- (86) IB2012050806 22.02.2012
(96) 12709965.3 01.01.2014
(87) WO2012114285, 22.02.2012
(97) 2678327, 01.01.2014 en
(54) HETEROARYL DERIVATIVES AS ALPHA7 NACHR MODULATORS
- (71) Lupin Limited, 159 CST Road Kalina Santacruz (East), State of Maharashtra, Mumbai 400 098, IN
(72) SINHA, Neelima, Lupin Limited (Research Park) 46A/47A Village Nande Taluka Mulshi Maharashtra, Pune 411 042, IN
JANA, Gourhari, Lupin Limited (Research Park) 46A/47A Village Nande Taluka Mulshi Maharashtra, Pune 411 042, IN
SACHCHIDANAND, Sachchidanand, Lupin Limited (Research Park) 46A/47A Village Nande Taluka Mulshi Maharashtra, Pune 411 042, IN
KURHADE, Sanjay, Pralhad, Lupin Limited (Research Park) 46A/47A Village Nande Taluka Mulshi Maharashtra, Pune 411 042, IN
KARCHE, Navnath, Papat, Lupin Limited (Research Park) 46A/47A Village Nande Taluka Mulshi Maharashtra, Pune 411 042, IN
HAJARE, Anil, Kashiram, Lupin Limited (Research Park) 46A/47A Village Nande Taluka Mulshi Maharashtra, Pune 411 042, IN
TILEKAR, Ajay, Ramchandra, Lupin Limited (Research Park) 46A/47A Village Nande Taluka Mulshi Maharashtra, Pune 411 042, IN
PALLE, Venkata, P., Lupin Limited (Research Park) 46A/47A Village Nande Taluka Mulshi Maharashtra, Pune 411 042, IN
KAMBOJ, Rajender, Kumar, Lupin Limited (Research Park) 46A/47A Village Nande Taluka Mulshi Maharashtra, Pune 411 042, IN
-
- (51) MKP
A61K 31/542 (2006.01) (97) **2665732 ***
A61P 3/00 (2006.01)
A61P 25/00 (2006.01)
C07D 513/04 (2006.01)
- (86) EP2012050833 20.01.2012
(96) 12708716.1 27.11.2013
(87) WO2012098213, 20.01.2012
(97) 2665732, 27.11.2013 en
(54) FUSED AMINODIHYDROTHIAZINE DERIVATIVES USEFUL AS BACE INHIBITORS
- (71) Eisai R&D Management Co., Ltd., 6-10, Koishikawa 4-chome Bunkyo-ku, Tokyo 112-8088, JP
(72) HALL, Adrian, c/o Eisai Limited European Knowledge Centre Mosquito Way, Hatfield Hertfordshire AL10 9SN, GB
FARTHING, Christopher Neil, c/o Eisai Limited European Knowledge Centre Mosquito Way, Hatfield Hertfordshire AL10 9SN, GB
CASTRO PINEIRO, Jose, Luis, c/o Eisai Limited European Knowledge Centre Mosquito Way, Hatfield Hertfordshire AL10 9SN, GB
-
- (51) MKP
H02M 1/42 (2007.01) (97) **2697898 ***
- (86) DK2012000038 13.04.2012
(96) 12719250.8 19.02.2014
(87) WO2012139576, 13.04.2012
(97) 2697898, 19.02.2014 en
(54) CIRCUIT ADAPTED TO SUPPLY A VOLTAGE TO AN ELECTRONIC DEVICE AND USES THEREOF
- (71) Mancic, Milan, PRVI Ustanak, 24000 Subotica, RS
(72) MÖLLER, Nicholas, Oblah Palic Omladinaca 4, 22000 Sibenik, HR

- (51) MKP
A61K 31/4439 (2006.01) (97) **2667871 ***
- (86) US2012022638 26.01.2012
(96) 12739192.8 04.12.2013
(87) WO2012103276, 26.01.2012
(97) 2667871, 04.12.2013 en
(54) COMBINATIONS
- (71) GlaxoSmithKline Intellectual Property Limited, 980 Great West Road, Brentford, Middlesex TW8 9GS, GB
Board of Regents, The University of Texas System, 201 West 7th Street, Austin, TX 78701, US
(72) AUGER, Kurt R., 1250 South Collegeville Road, Collegeville, PA 19426, US
BOTTSFORD-MILLER, Justin, 5927 Alameda Road Apt. 22205, Houston, TX 77004, US
SOOD, Anil K., 2719 Lakercrest Drive, Pearland, TX 77584, US
-
- (51) MKP
C07K 1/18 (2006.01) (97) **2681230 ***
C07K 14/47 (2006.01)
C07K 14/52 (2006.01)
- (86) EP2012053748 05.03.2012
(96) 12706623.1 08.01.2014
(87) WO2012117119, 05.03.2012
(97) 2681230, 08.01.2014 en
(54) METHOD FOR ISOLATING OSTEOPONTIN USING FEEDS CONTAINING CMP OR CASEIN SPECIES
- (71) Arla Foods Amba, Sønderhøj 14, 8260 Viby J, DK
(72) BERTELSEN, Hans, Chr. Aagaardsvej 8, DK-6920 Videbæk, DK
WEJSE, Peter Langborg, Fridtjof Nansens Vej 25, DK-8200 Aarhus N, DK
TRÜGVASON, Trine, Kirkegade 49, DK-6940 Lem St., DK
-
- (51) MKP
H01J 49/00 (2006.01) (97) **2691972 ***
- (86) IB2012051522 29.03.2012
(96) 12722513.4 05.02.2014
(87) WO2012131620, 29.03.2012
(97) 2691972, 05.02.2014 en
(54) SYSTEM FOR QUANTITATIVE CHEMICAL ANALYSIS OF SAMPLES, IN PARTICULAR IN THE MEDICAL FIELD, WITH CALIBRATION OF THE INSTRUMENTAL RESPONSE, AND THE CORRESPONDING METHOD
- (71) Florida, Matteo, Via Giulio Cesare 21, 20010 Bareggio (MI), IT
Cristoni, Simone, Via Madre Teresa di Calcutta 3, 20010 Vanzago (MI), IT
(72) Florida, Matteo, Via Giulio Cesare 21, 20010 Bareggio (MI), IT
Cristoni, Simone, Via Madre Teresa di Calcutta 3, 20010 Vanzago (MI), IT
-
- (51) MKP
A61L 27/00 (2006.01) (97) **2683419 ***
A61L 31/08 (2006.01)
A61L 31/16 (2006.01)
C07K 14/00 (2006.01)
C07K 14/40 (2006.01)
- (86) EP2012054285 12.03.2012
(96) 12707813.7 15.01.2014
(87) WO2012123419, 12.03.2012
(97) 2683419, 15.01.2014 en
(54) MOLECULES AND METHODS FOR INHIBITION AND DETECTION OF PROTEINS
- (71) VIB VZW, Rijvischestraat 120, 9052 Gent, BE
Vrije Universiteit Brussel, Pleinlaan 2, 1050 Brussel, BE
Katholieke Universiteit Leuven K.U. Leuven R&D, Waaistraat 6 Bus 5105, 3000 Leuven, BE
Universiteit Gent, Sint-Pietersnieuwstraat 25, 9000 Gent, BE
(72) SCHYMKOWITZ, Joost, Attenrodestraat 15, B-3391 Meensel-Kiezegem, BE
ROUSSEAU, Frederic, Stichelberg 18, B-1702 Groot-Bijgaarden, BE

(51) MKP
B21C 9/00 (2006.01) (97) **2581466**
B21D 5/01 (2006.01)
B21J 1/06 (2006.01)
C22F 1/04 (2006.01)
(86) 11185347.9 17.04.2013
(97) 2581466, 17.04.2013 de
(54) Method for producing a moulded part
(71) voestalpine Automotive GmbH, voestalpine-Strasse 1, 4020 Linz, AT
(72) DI Kelsch, Reiner, Ulmen 22, 73557 Mutlangen, DE
B.Eng. Hägele, Tobias, Marienstraße 9, 73529 Schwäbisch Gmünd, DE

(51) MKP
A61K 38/00 (2006.01) (97) **2665521 ***
A61P 35/00 (2006.01)
(86) US2012021738 18.01.2012
(96) 12736801.7 27.11.2013
(87) WO2012099973, 18.01.2012
(97) 2665521, 27.11.2013 en
(54) COMPOSITIONS AND METHODS FOR TREATING CANCER
(71) The Trustees Of The University Of Pennsylvania, Center for Technology Transfer 3160 Chestnut Street, Suite 200, Philadelphia, PA 19104-6283, US
(72) POWELL, Daniel, J., 36 Aberdale Road, Bala Cynwyd PA 19004, US
COUKOS, George, 465 Clothier Road, Wynnewood PA 19096, US

(51) MKP
A61B 5/103 (2006.01) (97) **2648615 ***
(86) US2011063678 07.12.2011
(96) 11847867.6 16.10.2013
(87) WO2012078718, 07.12.2011
(97) 2648615, 16.10.2013 en
(54) PHYSICAL ACTIVITY MONITORING SYSTEM
(71) Ez As A Drink Productions, Inc., 393 Rutland Avenue, San Jose, CA 95128, US
(72) YANEV, Kostadin, Dimitrov, 239 Michelle Lane, Alamo, CA 94507, US
MARINOV, Asen, Angelov, 62 Duane Street Apt. 108, Redwood City, CA 94062, US
ANGELOV, Angel, Marinov, 62 Duane Street Apt. 103, Redwood City, CA 94062, US

(51) MKP
A61M 5/20 (2006.01) (97) **2675508 ***
A61M 5/32 (2006.01)
(86) EP2012052645 16.02.2012
(96) 12705646.3 25.12.2013
(87) WO2012110576, 16.02.2012
(97) 2675508, 25.12.2013 en
(54) AUTO-INJECTOR
(71) Sanofi-Aventis Deutschland GmbH, Brüningstraße 50, 65929 Frankfurt am Main, DE
(72) BRERETON, Simon Francis, 75 De Freville Avenue, Cambridge Cambridgeshire CB4 1HP, GB
KEMP, Thomas, 3 Forresters Cottages High Steet, Ashwell Hertfordshire SG7 5NW, GB
BURNELL, Rosie, 56 Cavendish Avenue, Cambridge Cambridgeshire CB1 7UT, GB
EKMAN, Matthew, 59 Ecton Avenue Cheshire, Macclesfield Cheshire SK10 1RD, GB

(51) MKP
C12N 5/00 (2006.01) (97) **2694640 ***
(86) US2012032322 05.04.2012
(96) 12767723.5 12.02.2014
(87) WO2012138858, 05.04.2012
(97) 2694640, 12.02.2014 en
(54) REVERSING THE EFFECTS OF THE TUMOR MICROENVIRONMENT USING CHIMERIC CYTOKINE RECEPTORS
(71) Baylor College Of Medicine, One Baylor Plaza, Houston, TX 77030, US
(72) LEEN, Ann, Marie, 5227 Maple Street, Bellaire, TX 77401, US
VERA, Juan, F., 5227 Maple Street, Bellaire, TX 77401, US

(51) MKP
B82B 3/00 (2006.01) (97) **2686271 ***
B82Y 40/00 (2011.01)
B82Y 99/00 (2011.01)
C01B 31/02 (2006.01)
C10M 125/02 (2006.01)
F01M 9/00 (2006.01)
F16D 13/74 (2006.01)
F16N 15/02 (2006.01)
(86) US2012029276 15.03.2012
(96) 12757257.6 22.01.2014
(87) WO2012125854, 15.03.2012
(97) 2686271, 22.01.2014 en
(54) FACILE SYNTHESIS OF GRAPHENE, GRAPHENE DERIVATIVES AND ABRASIVE NANOPARTICLES AND THEIR VARIOUS USES, INCLUDING AS TRIBOLOGICALLY-BENEFICIAL LUBRICANT ADDITIVES
(71) Peerless Worldwide, LLC, 2536 Nw 53rd Street, Boca Raton, FL 33496-2204, US
(72) SHANKMAN, Richard S., 2536 NW 53rd Street, Boca Raton, FL 33496-2204, US

(51) MKP
G01N 33/48 (2006.01) (97) **2686677 ***
(86) NL2012050025 16.01.2012
(96) 12702324.0 22.01.2014
(87) WO2012128616, 16.01.2012
(97) 2686677, 22.01.2014 en
(54) A METHOD OF ANALYSING A BLOOD SAMPLE OF A SUBJECT FOR THE PRESENCE OF A DISEASE MARKER
(71) Vereniging voor Christelijk Hoger Onderwijs, Wetenschappelijk Onderzoek en Patiëntenzorg, De Boelelaan 1105, 1081 HV Amsterdam, NL
Stichting VU-VUmc, De Boelelaan 1105, 1081 HV Amsterdam, NL
(72) WÜRDINGER, Thomas, c/o VU&VUMC De Boelelaan 1085 Kamer F-545, NL-1081 HV Amsterdam, NL
NILSSON, Rolf Jonas, c/o VU&VUMC De Boelelaan 1085 Kamer F-545, NL-1081 HV Amsterdam, NL

(51) MKP
A61K 9/24 (2006.01) (97) **2647381 ***
A61K 9/26 (2006.01)
A61K 31/4439 (2006.01)
A61K 31/616 (2006.01)
A61K 47/04 (2006.01)
A61K 47/32 (2006.01)
A61K 47/36 (2006.01)
A61K 47/44 (2006.01)
A61P 1/04 (2006.01)
A61P 9/10 (2006.01)
A61P 29/00 (2006.01)
A61P 43/00 (2006.01)
(86) JP2011077978 02.12.2011
(96) 11844056.9 09.10.2013
(87) WO2012074110, 02.12.2011
(97) 2647381, 09.10.2013 en
(54) ORALLY DISINTEGRATING TABLET
(71) Takeda Pharmaceutical Company Limited, 1-1 Doshomachi 4-chome Chuo-ku, Osaka-shi, Osaka 541-0045, JP
(72) MIMA, Yasushi, c/o TAKEDA PHARMACEUTICAL COMPANY LIMITED 17-85 Jusohonmachi 2-chome Yodogawa-ku, Osaka-shi Osaka 532-0024, JP
KAWANO, Tetsuya, c/o TAKEDA PHARMACEUTICAL COMPANY LIMITED 17-85 Jusohonmachi 2-chome Yodogawa-ku, Osaka-shi Osaka 532-0024, JP
MIZUNO, Yumiko, c/o TAKEDA PHARMACEUTICAL COMPANY LIMITED 17-85 Jusohonmachi 2-chome Yodogawa-ku, Osaka-shi Osaka 532-0024, JP

(51) MKP
C07K 16/24 (2006.01) (97) **2663577 ***
 (86) GB2012050050 11.01.2012
 (96) 12700433.1 20.11.2013
 (87) WO2012095662, 11.01.2012
 (97) 2663577, 20.11.2013 en
 (54) ANTIBODY MOLECULES WHICH BIND IL-17A AND IL-17F
 (71) UCB Pharma, S.A., 60, allée de la Recherche, 1070 Brussels, BE
 (72) ADAMS, Ralph, c/o IPD UCB Celltech 208 Bath Road, Slough Berkshire SL1 3WE, GB
 BAKER, Terence Seward, c/o IPD UCB Celltech 208 Bath Road, Slough Berkshire SL1 3WE, GB
 LAWSON, Alastair David Griffiths, c/o IPD UCB Celltech 208 Bath Road, Slough Berkshire SL1 3WE, GB

(51) MKP
A61K 9/00 (2006.01) (97) **2591768**
A61K 9/16 (2006.01)
A61K 9/20 (2006.01)
A61K 31/593 (2006.01)
A61K 31/785 (2006.01)
A61K 47/02 (2006.01)
A61K 47/20 (2006.01)
A61K 47/38 (2006.01)
A61K 47/44 (2006.01)
 (96) 11188919.2 15.05.2013
 (97) 2591768, 15.05.2013 en
 (54) Single unit dosage formulations of sevelamer and fat soluble vitamins and surface active agents
 (71) Deva Holding Anonim Sirketi, Halkali Merkez Mah. Basın Ekspres Caddesi, No. 1, Kat: 5 Kucukcekmece, 34303 Istanbul, TR
 (72) Haas, Philipp Daniel, DEVA HOLDING ANONIM SIRKETI Halkali Merkez Mah. Basın Ekspres Cad. No:1, Kat:5, Patent Law Department, Kucukcekmece, 34303 Istanbul, TR
 Koc, Fikret, DEVA HOLDING ANONIM SIRKETI Halkali Merkez Mah. Basın Ekspres Cad. No:1, Kat:5, Patent Law Department, Kucukcekmece, 34303 Istanbul, TR
 Sivasligil, Ramazan, DEVA HOLDING ANONIM SIRKETI Halkali Merkez Mah. Basın Ekspres Cad. No:1, Kat:5, Patent Law Department, Kucukcekmece, 34303 Istanbul, TR
 Kandemir, Levent, DEVA HOLDING ANONIM SIRKETI Halkali Merkez Mah. Basın Ekspres Cad. No:1, Kat:5, Patent Law Department, Kucukcekmece, 34303 Istanbul, TR

(51) MKP
A61B 5/042 (2006.01) (97) **2699151 ***
 (86) US2012027182 01.03.2012
 (96) 12709740.0 26.02.2014
 (87) WO2012145073, 01.03.2012
 (97) 2699151, 26.02.2014 en
 (54) BASKET STYLE CARDIAC MAPPING CATHETER HAVING SPLINE BENDS FOR DETECTION OF CARDIAC RHYTHM DISORDERS
 (71) Topera, Inc., 11445 E. Via Linda Suite 2, Scottsdale, AZ 85259, US
 (72) KORDIS, Thomas, F., C/o Topera Inc. 11445 E. Via Linda Suite 2 P.o. Box 224, Scottsdale, AZ 85259, US
 SEHRA, Ruchir, C/o Topera Inc. 11445 E. Via Linda Suite 2 P.o. Box 224, Scottsdale, AZ 85259, US
 JOHNSON, Eric, T., C/o Topera Inc. 11445 E. Via Linda Suite 2 P.o. Box 224, Scottsdale, AZ 85259, US
 RAGLAND, Robert, Ryan, C/o Topera Inc. 11445 E. Via Linda Suite 2 P.o. Box 224, Scottsdale, AZ 85259, US
 KENT, Darrin, J., C/o Topera Inc. 11445 E. Via Linda Suite 2 P.o. Box 224, Scottsdale, AZ 85259, US

(51) MKP
C07D 241/02 (2006.01) (97) **2655342 ***
C07D 471/04 (2006.01)
 (86) US2011065354 16.12.2011
 (96) 11808471.4 30.10.2013
 (87) WO2012087784, 16.12.2011
 (97) 2655342, 30.10.2013 en
 (54) HETEROCYCLIC COMPOUNDS AND THEIR USES
 (71) Amgen Inc., One Amgen Center Drive, Thousand Oaks, California 91320-1799, US
 (72) CHEN, Yi, 103 Muller Place, San Jose CA 95126, US
 CUSHING, Timothy, D., 1064 Glacier Avenue, Pacifica CA 94044, US
 FISHER, Benjamin, 411-23rd Avenue, San Mateo CA 94403, US
 GONZALEZ LOPEZ DE TURISO, Felix, 10 De Sabla Road 509, San Mateo CA 94402, US
 HAO, Xiaolin, 637 Sandy Hook Court, Foster City CA 94404, US
 SHIN, Youngsook, 64 Loop 22, Emeryville CA 94608, US

(51) MKP
G01F 23/26 (2006.01) (97) **2663843 ***
 (86) IL2011050085 29.12.2011
 (96) 11817489.5 20.11.2013
 (87) WO2012095838, 29.12.2011
 (97) 2663843, 20.11.2013 en
 (54) DEVICE FOR MEASURING FLUID LEVEL IN A CONTAINER
 (71) Strauss Water Ltd, 49 Hasivim Street, Petach Tikva 49517, IL
 (72) WILDER, Haim, 7 Yehuda Halevi Street, 43555 Raanana, IL
 MATZA, Yaniv, 8 Mishol Bika Tzin St., 4463608 Kfar saba, IL

(51) MKP
A61B 17/04 (2006.01) (97) **2677941 ***
A61B 17/08 (2006.01)
A61B 17/11 (2006.01)
A61F 2/08 (2006.01)
 (86) US2012026605 24.02.2012
 (96) 12749047.2 01.01.2014
 (87) WO2012116319, 24.02.2012
 (97) 2677941, 01.01.2014 en
 (54) SUTURE MESH AND METHOD OF USE
 (71) Kumar, Avinash, 7912 Treeddale Glen, Lakewood Ranch, FL 34202, US
 (72) Kumar, Avinash, 7912 Treeddale Glen, Lakewood Ranch, FL 34202, US

(51) MKP
F16L 19/02 (2006.01) (97) **2600050**
 (96) 12195186.7 05.06.2013
 (97) 2600050, 05.06.2013 de
 (54) Swivel coupling for barrel bung
 (71) Jehle, Georg, Schöneggweg 22a, 87727 Babenhausen, DE
 (72) Jehle, Georg, Schöneggweg 22a, 87727 Babenhausen, DE

(51) MKP
H04L 9/14 (2006.01) (97) **2677452 ***
 (86) KR2011001376 28.02.2011
 (96) 11858891.2 25.12.2013
 (87) WO2012111872, 28.02.2011
 (97) 2677452, 25.12.2013 en
 (54) ENCRYPTION DEVICE AND METHOD FOR DEFENDING A PHYSICAL ATTACK
 (71) IUCF-HYU (Industry-University Cooperation Foundation Hanyang University), 17 Haengdang-dong, Seongdong-gu, Seoul 133-791, KR
 (72) KIM, Dong Kyue, No. 105-2103 Ramian Jangan 1-cha Apt. Jangan 3-dong Dongdaemun-gu, Seoul 130-100, KR
 CHOI, Byoung Deok, 77-5 Seongnae 2-dong Gangdong-gu, Seoul 134-840, KR

- (51) MKP
C07K 16/18 (2006.01) (97) **2678357 ***
 (86) EP2012053065 23.02.2012
 (96) 12706541.5 01.01.2014
 (87) WO2012113863, 23.02.2012
 (97) 2678357, 01.01.2014 en
 (54) METHOD OF PRODUCTION OF SIALYLATED ANTIBODIES
 (71) SANOFI, 54 rue La Boétie, 75008 Paris, FR
 (72) BLANCHE, Francis, c/o Sanofi Patent Department 54 rue La Boétie, 75008 Paris, FR
 CAMERON, Béatrice, c/o Sanofi Patent Department 54 rue La Boétie, 75008 Paris, FR
 GENET, Bruno, c/o Sanofi Patent Department 54 rue La Boétie, 75008 Paris, FR
 SOUBRIER, Fabienne, c/o Sanofi Patent Department 54 rue La Boétie, 75008 Paris, FR

- (51) MKP
A61K 47/48 (2006.01) (97) **2670440 ***
A61P 35/00 (2006.01)
C07K 16/28 (2006.01)
 (86) EP2012051679 01.02.2012
 (96) 12702033.7 11.12.2013
 (87) WO2012104344, 01.02.2012
 (97) 2670440, 11.12.2013 en
 (54) HUMAN ANTIBODIES AND ANTIBODY-DRUG CONJUGATES AGAINST CD74
 (71) Genmab A/S, Bredgade 34 E, 1260 Copenhagen K, DK
 (72) VERPLOEGEN, Sandra, c/o Genmab B.V. Yalelaan 60, 3584 CM Utrecht, NL
 OVERDIJK, Marije, c/o Genmab B.V. Yalelaan 60, 3584 CM Utrecht, NL
 DIJKHUIZEN, Riemke Van, c/o Genmab B.V. Yalelaan 60, 3584 CM Utrecht, NL
 BLEEKER, Willem Karel, c/o Genmab B.V. Yalelaan 60, 3584 CM Utrecht, NL
 BERKEL, Patrick Van, Derde Westerparklaan 321, 3544 NH Utrecht, NL
 PARREN, Paul, c/o Genmab B.V. Yalelaan 60, 3584 CM Utrecht, NL
 LISBY, Steen, Stockflethsvej 5, 2000 Frederiksberg, DK

- (51) MKP
A61K 38/18 (2006.01) (97) **2694092 ***
A61P 3/00 (2006.01)
 (86) US2012032415 05.04.2012
 (96) 12761825.4 12.02.2014
 (87) WO2012138919, 05.04.2012
 (97) 2694092, 12.02.2014 en
 (54) METHOD OF TREATING OR AMELIORATING METABOLIC DISORDERS USING GROWTH DIFFERENTIATION FACTOR 15 (GDF-15)
 (71) Amgen Inc., One Amgen Center Drive, Thousand Oaks, California 91320-1799, US
 (72) XIONG, YuMei, 140 Daley Court, San Bruno California 94066, US
 LI, Yang, 1142 Cuesta Drive, Mountain View California 94040, US
 YEH, Wen-Chen, 2920 Belmont Woods Way, Belmont California 94002, US
 SHAN, Bei, 349 Quay Lane, Redwood City California 94065, US
 SHENG, Jackie Zeqi, 559 Lone Oak Drive, Thousand Oaks California 91320, US

- (51) MKP
A61F 13/15 (2006.01) (97) **2659868**
B26D 1/00 (2006.01)
 (96) 13166314.8 06.11.2013
 (97) 2659868, 06.11.2013 en
 (54) Single transfer insert placement method and apparatus
 (71) Curt G. Joa, Inc., 100 Crocker Avenue, Sheboygan Falls, Wisconsin 53085, US
 (72) McCabe, John A, 1141 Partridge Run, Sheboygan Falls, WI Wisconsin 53085, US

- (51) MKP
A23K 1/10 (2006.01) (97) **2683253 ***
A23K 1/16 (2006.01)
A23K 1/175 (2006.01)
A23K 1/18 (2006.01)
 (86) IB2012000586 07.03.2012
 (96) 12719796.0 15.01.2014
 (87) WO2012120378, 07.03.2012
 (97) 2683253, 15.01.2014 en
 (54) COMPOSITIONS AND METHODS FOR NUTRITIONAL SUPPLEMENTATION
 (71) Olympic Seafood AS, P.O. Box 234, 6099 Fosnavaag, NO
 (72) BRUHEIM, Inge, Storhagen 24, N-6100 Volda, NO
 GRIINARI, Mikko, Kultarinnantie 1b, FI-02660 Espoo, FI
 REMOY, Stig Rune, Ovre Myklebust 20, N-6092 Fosnavag, NO

- (51) MKP
A61K 31/443 (2006.01) (97) **2665478 ***
A61P 25/18 (2006.01)
A61P 25/28 (2006.01)
 (86) US2012021472 17.01.2012
 (96) 12702358.8 27.11.2013
 (87) WO2012099836, 17.01.2012
 (97) 2665478, 27.11.2013 en
 (54) TREATMENT OF COGNITIVE DYSFUNCTION IN SCHIZOPHRENIA
 (71) Targacept, Inc., null, 100 North Main Street Suite 1510 Winston-Salem, NC 27101, US
 (72) BENCHERIF, Merouane, 104 Brampton Court, Winston-Salem North Carolina 27106, US
 DUNBAR, Geoffrey Charles, 300 Chadbourne Drive, Winston-Salem North Carolina 27104, US
 HOSFORD, David A., 3412 Cottonwood Drive, Durham North Carolina 27707, US
 GATTO, Gregory J., 1148 S. Hawthorne Road, Winston-Salem North Carolina 27103-4302, US
 HAUSER, Terry, 4525 Woodsman Way, Winston-Salem North Carolina 27103, US
 JORDAN, Kristen G., 1869 Curraghmore Road, Clemmons North Carolina 27012, US
 SEGRETI, Anthony Carl, 1104 Askham Drive, Cary North Carolina 27511, US

- (51) MKP
C02F 3/28 (2006.01) (97) **2366673**
C02F 3/30 (2006.01)
C02F 11/04 (2006.01)
C02F 11/12 (2006.01)
C02F 101/16 (2006.01)
 (96) 10002478.5 21.09.2011
 (97) 2366673, 21.09.2011 de
 (54) Method for biological purification of wastewater containing ammonium
 (71) Cyklar-stulz Abwassertechnik GmbH, Rietwiesstrasse 39, 8737 Gommiswald, CH
 (72) Nyhuis, Geert, Dr.-Ing., Rietwiesstraße 39, 8737 Gommiswald, CH

- (51) MKP
A61K 31/4184 (2006.01) (97) **2696870 ***
A61P 25/02 (2006.01)
 (86) US2012032724 09.04.2012
 (96) 12715262.7 19.02.2014
 (87) WO2012141990, 09.04.2012
 (97) 2696870, 19.02.2014 en
 (54) PARP INHIBITORS FOR THE TREATMENT OF CIPN
 (71) Abbvie Inc., 1 North Waukegan Road, North Chicago, IL 60064, US
 (72) GIRANDA, Vincent Louis, 272 South Fork Drive, Gurnee, Illinois 60031, US
 SHOEMAKER, Alexander R., 14877 Old Rockland Road, Green Oaks, Illinois 60048, US
 BROWMAN, Kaitlin E., 1101 Fair Oaks, Deerfield, Illinois 60015, US
 JOSHI, Shailen K., 9975 Highgate Lane, Grayslake, Illinois 60030, US
 BREDERSON, Jill-Desiree, P.O. Box 1970, Evanston, Illinois 60204, US
 PENNING, Thomas D., 321 Highview, Elmhurst, Illinois 60126, US

(51) MKP
A61K 9/107 (2006.01) (97) **2670392 ***
 (86) GB2012000075 25.01.2012
 (96) 12705699.2 11.12.2013
 (87) WO2012104576, 25.01.2012
 (97) 2670392, 11.12.2013 en
 (54) CAROTENOID PARTICLES AND USES THEREOF
 (71) IP Science Limited, Browning House 3 Tunwells Lane, Great Shelford, Cambridge CB22 5LJ, GB
 (72) PETYAEV, Ivan, IP Science Limited Browning House 3 Tunwells Lane, Great Shelford Cambridge CB22 5LJ, GB

(51) MKP
G01N 33/48 (2006.01) (97) **2694959 ***
 (86) US2012031662 30.03.2012
 (96) 12765178.4 12.02.2014
 (87) WO2012135749, 30.03.2012
 (97) 2694959, 12.02.2014 en
 (54) BIOMARKERS FOR PREDICTING SENSITIVITY TO CANCER TREATMENTS
 (71) Genentech, Inc., One DNA Way, South San Francisco, CA 94080-4990, US
 Lin, Kui, 1 DNA Way, South San Francisco, CA 94080-4990, US
 Punnoose, Elizabeth, 1 DNA Way, South San Francisco, California 94080-4990, US
 Seshagiri, Somasekar, 1 DNA Way, South San Francisco, California 94080-4990, US
 (72) LIN, Kui, 1 DNA Way, South San Francisco California 94080-4990, US
 PUNNOOSE, Elizabeth, 1 DNA Way, South San Francisco California 94080-4990, US
 SESHAGIRI, Somasekar, 1 DNA Way, South San Francisco California 94080-4990, US

(51) MKP
B60P 7/08 (2006.01) (97) **2698283**
B60R 9/048 (2006.01)
 (96) 12180948.7 19.02.2014
 (97) 2698283, 19.02.2014 fr
 (54) Roof rack
 (71) ROLIX S.p.r.l., 34 Grande Rue, 5310 Waret la Chaussée (Eghezee), BE
 (72) Burnick, Frank, 34 Grande Rue, B 5310 Waret la Chaussée (Eghezée), BE

(51) MKP
C01F 15/00 (2006.01) (97) **2578538**
C01G 43/00 (2006.01)
C01G 99/00 (2010.01)
 (96) 12152025.8 10.04.2013
 (97) 2578538, 10.04.2013 en
 (54) A selective extraction of uranium and Protactinium from material containing thorium
 (71) Instytut Chemii i Techniki Jadrowej, ul. Dorodna 16, 03-195 Warszawa, PL
 (72) Kalbarczyk, Pawel, Stare Raszczycze 4A., 05-870 Blonie, PL
 Polkowska-Motrenko, Halina, Laki 16C, 05-250 Laki, PL
 Chajduk, Ewelina, Mostowa 9/11 m. 15., 96-300 Zyrardów, PL

(51) MKP
A61L 2/07 (2006.01) (97) **2596809**
A61L 11/00 (2006.01)
B01J 3/04 (2006.01)
B02C 17/00 (2006.01)
B02C 19/00 (2006.01)
B29B 17/00 (2006.01)
 (96) 12191569.8 29.05.2013
 (97) 2596809, 29.05.2013 en
 (54) Process for sterilising absorbent sanitary products
 (71) Fater S.p.A., Via Alessandro Volta, 10, 65129 Pescara, IT
 (72) SOMMA, Marcello, Viale Regina Elena, 74, I-65122 Pescara, IT
 VACCARO, Giorgio, Via Primo Levi, 7, I-65010 Spoltore (Pescara), IT
 MICHALEK, Jan K., 3762 Alward Road, Pataskala, OH Ohio 43062, US
 THOMAS, Theodore, 864 Lookout Point Drive, Columbus, OH Ohio 43235, US

(51) MKP
C07D 231/54 (2006.01) (97) **2651902 ***
 (86) US2011065897 19.12.2011
 (96) 11807826.0 23.10.2013
 (87) WO2012083306, 19.12.2011
 (97) 2651902, 23.10.2013 en
 (54) PYRAZOLYL AND PYRIMIDINYL TRICYCLIC ENONES AS ANTIOXIDANT INFLAMMATION MODULATORS
 (71) Reata Pharmaceuticals, Inc., 2801 Gateway Drive, Suite 150, Irving, TX 75063-2648, US
 (72) ANDERSON, Eric, 602 Nicholas Ct., Southlake TX 76092, US
 BOLTON, Gary, L., 4800 Hillway Court, Ann Arbor MI 48105, US
 CAPRATHE, Bradley, 31480 Myrna, Livonia MI 48154, US
 JIANG, Xin, 920 Mill Trail, Coppell TX 75019, US
 LEE, Chitase, 695 Skynob Court, Ann Arbor MI 48105, US
 ROARK, William, H., 2810 Gladstone Ave., Ann Arbor MI 48104, US
 VISNICK, Melean, 330 E. Las Colinas Blvd., Unit 428, Irving TX 75039, US

(51) MKP
A61K 31/57 (2006.01) (97) **2655394 ***
A61P 5/36 (2006.01)
C07J 9/00 (2006.01)
 (86) US2011050859 08.09.2011
 (96) 11761438.8 30.10.2013
 (87) WO2012087389, 08.09.2011
 (97) 2655394, 30.10.2013 en
 (54) NOVEL 19-NOR-STERIODS AND THEIR USE FOR TREATING PROGESTERONE-DEPENDENT CONDITIONS
 (71) Repros Therapeutics Inc., 2408 Timberloch Place, B-7, The Woodlands, TX 77380, US
 (72) PODOLSKI, Joseph, S., 3 Pebble Hollow Court, The Woodlands TX 77381, US
 WIEHLE, Ronald, D., 13903 Viewfield Court, Houston TX 77059, US

(51) MKP
A61K 39/21 (2006.01) (97) **2678351 ***
C07K 14/16 (2006.01)
C12N 15/10 (2006.01)
G01N 33/569 (2006.01)
G01N 33/68 (2006.01)
 (86) EP2012053185 24.02.2012
 (96) 12705689.3 01.01.2014
 (87) WO2012113921, 24.02.2012
 (97) 2678351, 01.01.2014 en
 (54) RAPID SELECTION METHOD FOR HIV GP-120 VARIANTS
 (71) Laboratorios del. Dr. Esteve, S.A., Avda Mare de Deu de Montserrat 221, 08041 Barcelona, ES
 Fundació Privada Institut de Recerca de la SIDA-Caixa, Hospital Universitari Germans Trias i Pujol Carretera de Canyet, s/n, 08916 Badalona, ES
 (72) YUSTE HERRANZ, Maria Eloisa, Hospital Clínic Casanovas 143, E-08036 Barcelona, ES
 SÁNCHEZ MERINO, Víctor, Hospital Clínic Casanovas 143, E-08036 Barcelona, ES
 FERREIRA, Carolina, Paris 13 Principal 2, E-08903 Hospitalet de Llobregat, ES

(51) MKP
A61K 31/7088 (2006.01) (97) **2673363 ***
C07H 21/00 (2006.01)
C12N 15/113 (2010.01)
 (86) US2012024697 10.02.2012
 (96) 12745124.3 18.12.2013
 (87) WO2012109567, 10.02.2012
 (97) 2673363, 18.12.2013 en
 (54) TREATMENT OF ANGIOGENESIS DISORDERS
 (71) The Rockefeller University, 1230 York Avenue, New York, NY 10021, US
 (72) TAVAZOIE, Sohail, 325 E. 84th Street, New York, NY 10028, US
 HALBERG, Nils, 20 Columbia Place, Brooklyn, NY 11201, US
 PNG, Kim, 747 10th Avenue, New York, NY 10019, US

- (51) MKP
A61K 31/138 (2006.01) (97) **2699543 ***
A61K 31/145 (2006.01)
A61K 31/397 (2006.01)
A61K 31/4453 (2006.01)
A61P 25/14 (2006.01)
A61P 25/16 (2006.01)
A61P 25/18 (2006.01)
C07C 317/22 (2006.01)
C07D 205/04 (2006.01)
C07D 295/088 (2006.01)
(86) EP2012056959 17.04.2012
(96) 12714704.9 26.02.2014
(87) WO2012143337, 17.04.2012
(97) 2699543, 26.02.2014 en
(54) NOVEL MODULATORS OF CORTICAL DOPAMINERGIC- AND NMDA-RECEPTOR-MEDIATED GLUTAMATERGIC NEUROTRANSMISSION
(71) Integrative Research Laboratories Sweden AB, Solbångsgatan 22, 411 19 Göteborg, SE
(72) SONESSON, Clas, Bilddals Hagenväg 18, S-427 37 Billdal, SE
KARLSSON, Jonas, Skepparegängen 12, S-413 18 Göteborg, SE
SVENSSON, Peder, Nordenskiöldsgatan 12, S-413 09 Göteborg, SE

- (51) MKP
C07D 235/26 (2006.01) (97) **2681201 ***
(86) CZ2012000023 05.03.2012
(96) 12712549.0 08.01.2014
(87) WO2012119573, 05.03.2012
(97) 2681201, 08.01.2014 en
(54) A METHOD OF MANUFACTURING 2-ETHOXY-1-((2'-(HYDROXYAMINO) IMINOMETHYL)BIPHENYL-4- YL) METHYL)-1H-BENZO [D]IMIDAZOLE-7-CARBOXYLIC ACID AND ITS ESTERS
(71) Zentiva, K.S., U Kabelovny 130, 102 37 Praha, CZ
(72) RADL, Stanislav, Ohnicova 127, 250 84 Kvetnice, CZ

- (51) MKP
A61K 31/7068 (2006.01) (97) **2646453 ***
A61K 31/7072 (2006.01)
A61K 31/7076 (2006.01)
A61P 31/14 (2006.01)
C07H 19/06 (2006.01)
C07H 19/10 (2006.01)
C07H 19/16 (2006.01)
C07H 19/20 (2006.01)
C07H 23/00 (2006.01)
(86) US2011062643 30.11.2011
(96) 11794350.6 09.10.2013
(87) WO2012075140, 30.11.2011
(97) 2646453, 09.10.2013 en
(54) COMPOUNDS
(71) Gilead Pharmasset LLC, Gilead Sciences, Inc. 333 Lakeside Drive, Foster City, CA 94404, US
(72) DU, Jinfa, 1206 Reins Circle, Hew Hope PA 18938, US
SOFIA, Michael Joseph, 3066 Antler Drive, Doylestown PA 18901, US

- (51) MKP
A61K 31/737 (2006.01) (97) **2668198 ***
A61P 17/02 (2006.01)
C07H 15/04 (2006.01)
C08B 37/00 (2006.01)
(86) IB2012050390 27.01.2012
(96) 12703584.8 04.12.2013
(87) WO2012101605, 27.01.2012
(97) 2668198, 04.12.2013 en
(54) FGF RECEPTOR-ACTIVATING 3-O-ALKYL OLIGOSACCHARIDES, PREPARATION THEREOF AND THERAPEUTIC USE THEREOF
(71) SANOFI, 54 rue La Boétie, 75008 Paris, FR
(72) DRIGUEZ, Pierre Alexandre, c/o Sanofi Patent Department 54 rue La Boétie, F-75008 Paris, FR
DUCHAUSOY, Philippe, c/o Sanofi Patent Department 54 rue La Boétie, F-75008 Paris, FR
FONS, Pierre, c/o Sanofi Patent Department 54 rue La Boétie, F-75008 Paris, FR

- (51) MKP
A01N 43/40 (2006.01) (97) **2672823 ***
A61K 31/445 (2006.01)
(86) US2012023799 03.02.2012
(96) 12745253.0 18.12.2013
(87) WO2012109108, 03.02.2012
(97) 2672823, 18.12.2013 en
(54) S1P MODULATING AGENTS
(71) Biogen Idec MA Inc., 14 Cambridge Center, Cambridge, MA 02142, US
(72) THOMAS, Jermaine, 130 Library Street, Chelsea, MA 02150, US
MI, Sha, 4 Vernon Road, Belmont, MA 02478, US
LIN, Edward, Yin-shiang, 73 Thornton Rd, Chestnut Hill, MA 02467, US
ZHENG, Guo, Zhu, 14 Meriam Street, Lexington, MA 02420, US
MA, Bin, 211 Wachusett Ave., Arlington, MA 02476, US
CALDWELL, Richard, D., 56 Prospect Street, Woburn, MA 01801, US
GUCKIAN, Kevin, 44 Little Pond Road, Northborough, MA 01532, US
KUMARAVEL, Gnanasambandam, 21 Appletree Lane, Lexington, MA 02420, US

- (51) MKP
A61K 31/7056 (2006.01) (97) **2672976 ***
A61K 31/715 (2006.01)
A61P 7/02 (2006.01)
(86) EP2012051964 06.02.2012
(96) 12702546.8 18.12.2013
(87) WO2012107402, 06.02.2012
(97) 2672976, 18.12.2013 en
(54) IDRABIOTAPARINUX FOR THE TREATMENT OF PULMONARY EMBOLISM AND FOR THE SECONDARY PREVENTION OF VENOUS THROMBOEMBOLIC EVENTS
(71) SANOFI, 54 rue La Boétie, 75008 Paris, FR
(72) HOSPITEL, Marie, c/o Sanofi Patent Department 54 rue La Boétie, F-75008 Paris, FR
MININI, Pascal, c/o Sanofi Patent Department 54 rue La Boétie, F-75008 Paris, FR
PATY, Isabelle, c/o Sanofi Patent Department 54 rue La Boétie, F-75008 Paris, FR
PILLION, Gérard, c/o Sanofi Patent Department 54 rue La Boétie, F-75008 Paris, FR

- (51) MKP
A61K 31/433 (2006.01) (97) **2688886 ***
A61K 31/4439 (2006.01)
A61K 31/4745 (2006.01)
A61K 31/496 (2006.01)
A61P 35/00 (2006.01)
C07D 413/14 (2006.01)
C07D 417/04 (2006.01)
C07D 417/14 (2006.01)
C07D 487/04 (2006.01)
- (86) US2012029997 21.03.2012
(96) 12719496.7 29.01.2014
(87) WO2012129338, 21.03.2012
(97) 2688886, 29.01.2014 en
(54) AZOLE COMPOUNDS AS PIM INHIBITORS
(71) Amgen Inc., One Amgen Center Drive, Thousand Oaks, CA 91320, US
(72) WANG, Hui-Ling, 822 Lynnmere Drive, Thousand Oaks California 91360, US
CEE, Victor, J., 2881 Capella Way, Thousand Oaks California 91362, US
HERBERICH, Bradley, J., 1197 Ramona Dr., Newbury Park California 91320, US
JACKSON, Claire, L., M., 1922 Deerfield Street, Thousand Oaks California 91362, US
LANMAN, Brian, Alan, 6000 De Sotto Avenue 306, Woodland Hille, California 91367, US
NIXEY, Thomas, 4554 Via Laguna, Newbury Park California 91320, US
PETTUS, Liping, H., 3309 Big Cloud Circle, Thousand Oaks California 91360, US
REED, Anthony, B., 3269 Felton Street, Newbury Park, CA 91320, US
WU, Bin, 3090 Hollycrest Avenue, Thousand Oaks California 91362, US
WURZ, Ryan, 53 Ocatillo Avenue, Newbury Park California 91320, US
TASKER, Andrew, 390 Arbour Court, Simi Valley, California 93065, US
-
- (51) MKP
A61K 31/444 (2006.01) (97) **2646029 ***
A61K 31/505 (2006.01)
A61K 31/506 (2006.01)
A61K 31/5377 (2006.01)
A61K 31/541 (2006.01)
A61P 7/06 (2006.01)
- (86) AU2011001551 29.11.2011
(96) 11845391.9 09.10.2013
(87) WO2012071612, 29.11.2011
(97) 2646029, 09.10.2013 en
(54) TREATMENT OF JAK2-MEDIATED CONDITIONS
(71) YM BioSciences Australia Pty Ltd, 2nd Floor 499 St Kilda Road, Melbourne, VIC 3004, AU
(72) SMITH, Gregg David, 14 Gourlay Street, Balaclava, Victoria 3183, AU
FIDA, Rose, 8a Acacia Street, Glenroy, Victoria 3046, AU
KOWALSKI, Mark Marion, 10 Priscilla Lane, Winchester, Massachusetts 01890, US
-
- (51) MKP
E01B 7/12 (2006.01) (97) **2697432 ***
- (86) CZ2012000032 12.04.2012
(96) 12721706.5 19.02.2014
(87) WO2012139537, 12.04.2012
(97) 2697432, 19.02.2014 en
(54) FROG
(71) DT- Vyhybkárna A Strojima, A.S., Dolni 100, 797 11 Prostějov, CZ
(72) CERNÝ, Petr, Otaslavice 160, 796 08 Otaslavice, CZ
SMOLKA, Marek, Ivan 204, 798 23 Klenovice na Hané, CZ

- (51) MKP
A23L 1/30 (2006.01) (97) **2699109 ***
A23L 1/308 (2006.01)
A61K 31/702 (2006.01)
- (86) EP2012052474 14.02.2012
(96) 12710451.1 26.02.2014
(87) WO2012113677, 14.02.2012
(97) 2699109, 26.02.2014 de
(54) PREBIOTIC CARBOHYDRATE COMPOSITIONS
(71) Deutsches Milchkontor eG, Industriestrasse 27, 27404 Zeven, DE
(72) SAWATZKI, Günther, Ricarda-Huch-Str. 13, 35516 Münzenberg, DE
ZELENKA, Richard, Lübberstraße 30, 32052 Herford, DE
-
- (51) MKP
A01K 67/027 (2006.01) (97) **2649184 ***
C07K 16/00 (2006.01)
C12N 9/64 (2006.01)
C12N 15/85 (2006.01)
- (86) GB2012052956 30.11.2012
(96) 12795606.8 16.10.2013
(87) WO2013079953, 30.11.2012
(97) 2649184, 16.10.2013 en
(54) FERTILE TRANSGENIC ANIMALS USEFUL FOR PRODUCING ANTIBODIES BEARING HUMAN VARIABLE REGIONS
(71) Kymab Limited, Meditrina (B260) Babraham Research Campus, Cambridge, Cambridgeshire CB22 3AT, GB
(72) FRIEDRICH, Glenn A, c/o Kymab Limited Meditrina (B260) Babraham Research Campus, Cambridge Cambridgeshire CB22 3AT, GB
LEE, E-Chiang, c/o Kymab Limited Meditrina (B260) Babraham Research Campus, Cambridge Cambridgeshire CB22 3AT, GB
-
- (51) MKP
A47K 3/12 (2006.01) (97) **2651274 ***
- (86) IB2011055714 15.12.2011
(96) 11813405.5 23.10.2013
(87) WO2012080980, 15.12.2011
(97) 2651274, 23.10.2013 en
(54) AID DEVICE FOR WASHING INFANTS, CHILDREN OR THE LIKE
(71) Mattei, Alessandro, Via Rossini 29, 10042 Nichelino (TO), IT
(72) Mattei, Alessandro, Via Rossini 29, 10042 Nichelino (TO), IT
-
- (51) MKP
C05F 9/04 (2006.01) (97) **2647614**
C05F 17/00 (2006.01)
- (96) 12002508.5 09.10.2013
(97) 2647614, 09.10.2013 fr
(54) Method for preparing activated plant complexes and plant/ organic matter complexes that are doped or overdoped, carbonated, and the uses thereof in particular in anaerobic digestion or biogas production
(71) Mezy, Marcel Léon, 17 route du Maquis Jean Pierre, 12340 Bozouls, FR
(72) Mezy, Marcel Léon, 17 route du Maquis Jean Pierre, 12340 Bozouls, FR
-
- (51) MKP
C04B 20/00 (2006.01) (97) **2573058**
C04B 35/66 (2006.01)
F27D 1/00 (2006.01)
- (96) 11182167.4 27.03.2013
(97) 2573058, 27.03.2013 de
(54) Granulate containing agglomerated bulk material
(71) Rheinkalk GmbH, Am Kalkstein 1, 42489 Wülfrath, DE
(72) Rückert, Wolfgang, Rheinkalk GmbH, Vertrieb Stahl Roßstraße 78, 40476 Düsseldorf, DE

- (51) MKP
C07H 21/04 (2006.01) (97) **2655619 ***
C12N 15/11 (2006.01)
 (86) US2010062096 23.12.2010
 (96) 10861010.6 30.10.2013
 (87) WO2012087336, 23.12.2010
 (97) 2655619, 30.10.2013 en
 (54) AUTOPHAGY INDUCER AND INHIBITOR COMBINATION THERAPY FOR THE TREATMENT OF NEOPLASMS
 (71) Genentech, Inc., 1 DNA Way, South San Francisco CA 94080-4990, US
 (72) LIN, Kui, 1 DNA Way, South San Francisco, CA 94080-4990, US
 DEGTYAREV, Michael, 1 DNA Way, South San Francisco, CA 94080-4990, US

- (51) MKP
A61K 31/12 (2006.01) (97) **2691088 ***
A61K 31/216 (2006.01)
A61P 31/12 (2006.01)
 (86) EP2011066746 27.09.2011
 (96) 11761085.7 05.02.2014
 (87) WO2012038553, 27.09.2011
 (97) 2691088, 05.02.2014 en
 (54) VIRAL INHIBITOR COMPOSITION FOR IN VIVO THERAPEUTIC USE
 (71) Cesa Alliance S.A., 80, Rue des Romains, 8041 Strassen, LU
 (72) COPPENS, Christine, 65, Rue des Romains, L-8041 Strassen, LU

- (51) MKP
G01N 27/02 (2006.01) (97) **2584357**
G01N 27/07 (2006.01)
G01N 33/49 (2006.01)
G01N 33/86 (2006.01)
 (96) 11009743.3 24.04.2013
 (97) 2584357, 24.04.2013 en
 (54) Platelet aggregation measuring device
 (71) CHRONO-LOG CORPORATION, 2 West Park Road, Havertown, PA 19083, US
 (72) Roth, Andrew, 2F East Monoa Road, 1st Floor, Havertown PA 19083, US
 Veriabo, Nicholas J., 232 Sedgewood Road, Springfield PA 19064, US

- (51) MKP
B01D 15/36 (2006.01) (97) **2652491 ***
C07K 1/18 (2006.01)
C07K 14/755 (2006.01)
G01N 30/34 (2006.01)
G01N 30/80 (2006.01)
G01N 30/96 (2006.01)
 (86) US2011064962 14.12.2011
 (96) 11813477.4 23.10.2013
 (87) WO2012082933, 14.12.2011
 (97) 2652491, 23.10.2013 en
 (54) ELUATE COLLECTION USING CONDUCTIVITY GRADIENT
 (71) Baxter International Inc, One Baxter Parkway, Deerfield, IL 60015, US
 Baxter Healthcare SA, Thurgauerstrasse 130, 8152 Glattpark (Opfikon), CH
 (72) FELGENHAUER, Martin, Colloredogasse 27, A-1180 Vienna, AT
 MAIERHOFER, Helmut, Untere Hauptstrasse 108, A-7122 Gols, AT
 MISON, Dominique, Au Ruz Baron 34, CH-2046 Fontaines, CH
 DESPONDS, Arnaud, 20 Rue Du Milieu, CH-1400 Yverdon-les-bains, CH

- (51) MKP
H04N 21/478 (2011.01) (97) **2700243 ***
 (86) US2012032835 10.04.2012
 (96) 12718785.4 26.02.2014
 (87) WO2012145189, 10.04.2012
 (97) 2700243, 26.02.2014 en
 (54) AUGMENTED REALITY FOR LIVE EVENTS
 (71) Qualcomm Incorporated, 5775 Morehouse Drive, San Diego, CA 92121-1714, US
 (72) SATYANARAYANA, Madhukara B., 5775 Morehouse Drive, San Diego, California 92121, US
 BARCLAY, Strachan P., 5775 Morehouse Drive, San Diego, California 92121, US

- (51) MKP
A61K 31/519 (2006.01) (97) **2513107 ***
A61P 25/00 (2006.01)
C07D 471/04 (2006.01)
C07D 487/04 (2006.01)
 (86) DK2010050341 15.12.2010
 (96) 10798255.5 24.10.2012
 (87) WO2011072694, 15.12.2010
 (97) 2513107, 24.10.2012 en
 (54) HETEROAROMATIC PHENYLIMIDAZOLE DERIVATIVES AS PDE10A ENZYME INHIBITORS
 (71) H. Lundbeck A/S, Ottiliavej 9, 2500 Valby, DK
 (72) PÜSCHL, Ask, Harsdorffsvej 7A 4.tv., DK-1874 Frederiksberg C, DK
 NIELSEN, Jacob, Dannebrogsgade 17 1.th., DK-1660 København V, DK
 KEHLER, Jan, Nymøllevej 28, DK-2800 Lyngby, DK
 KILBURN, John, Paul, Kærsgårdvej 7, DK-4690 haslev, DK
 MARIGO, Mauro, Jyttevej 23, DK-2740 Skovlunde, DK
 LANGGÅRD, Morten, Rågevej 20, DK-2600 Glostrup, DK

- (51) MKP
A61M 5/20 (2006.01) (97) **2675502 ***
A61M 5/32 (2006.01)
 (86) EP2012052646 16.02.2012
 (96) 12703836.2 25.12.2013
 (87) WO2012110577, 16.02.2012
 (97) 2675502, 25.12.2013 en
 (54) AUTO-INJECTOR
 (71) Sanofi-Aventis Deutschland GmbH, Brüningstraße 50, 65929 Frankfurt am Main, DE
 (72) BRERETON, Simon Francis, 75 De Freville Avenue, Cambridge Cambridgeshire CB4 1HP, GB
 KEMP, Thomas, 3 Forresters Cottages High Steet, Ashwell Hertfordshire SG7 5NW, GB
 BURNELL, Rosie, 56 Cavendish Avenue, Cambridge Cambridgeshire CB1 7UT, GB
 EKMAN, Matthew, 59 Ecton Avenue, Macclesfield Cheshire SK10 1RD, GB

- (51) MKP
G01N 33/50 (2006.01) (97) **2694964 ***
 (86) US2012032587 06.04.2012
 (96) 12768275.5 12.02.2014
 (87) WO2012139040, 06.04.2012
 (97) 2694964, 12.02.2014 en
 (54) HIGH-THROUGHPUT SCREENING FOR COMPOUNDS MODULATING EXPRESSION OF CELLULAR MACROMOLECULES
 (71) The Scripps Research Institute, 10550 North Torrey Pines Road, La Jolla, CA 92037, US
 (72) LASMEZAS, Corinne, 1828 Flower Drive, Palm Beach Gardens FL 33410, US
 WEISSMANN, Charles, 100 Sunrise Avenue, Palm Beach FL 33480, US

(51) MKP
C07K 14/55 (2006.01) (97) **2681308 ***
C07K 14/765 (2006.01)
C07K 14/79 (2006.01)
C12N 1/19 (2006.01)
C12N 9/00 (2006.01)
C12N 9/04 (2006.01)
C12N 9/90 (2006.01)
C12N 15/81 (2006.01)
C12P 21/02 (2006.01)
(86) EP2012066949 31.08.2012
(96) 12751541.9 08.01.2014
(87) WO2013030329, 31.08.2012
(97) 2681308, 08.01.2014 en
(54) PROTEIN EXPRESSION
(71) VTU Holding GmbH, Parkring 18, 8074 Grambach, AT
(72) WEIS, Roland, Parkring 18, A-8074 Grambach, AT
PURKARTHOFFER, Thomas, Parkring 18, A-8074 Grambach, AT

(51) MKP
A61K 31/4192 (2006.01) (97) **2655345 ***
A61P 35/00 (2006.01)
C07D 249/06 (2006.01)
C07D 413/12 (2006.01)
(86) EP2011072558 13.12.2011
(96) 11805449.3 30.10.2013
(87) WO2012084602, 13.12.2011
(97) 2655345, 30.10.2013 en
(54) ARYL TRIAZOLE COMPOUNDS WITH ANTITUMOURAL ACTIVITY
(71) SIGMA-TAU Research Switzerland S.A., Via Motta, 2, 6850 Mendriso, CH
(72) GIANNINI, Giuseppe, Via Boezio 46/B, I-00040 Pomezia (RM), IT
CABRI, Walter, Via Pisacane 5, I-20089 Rozzano (MI), IT
VESCOI, Loredana, Via Elio Petri 3, I-00128 Rome, IT
CERVONI, Maria Luisa, Via Ugo La Malfa 35/C, I-00040 Pomezia (RM), IT
PISANO, Claudio, Via Cherubini 60/B, I-04011 Aprila (LT), IT
TADDEI, Maurizio, Via di Uopini 58, I-53034 Monteriggioni (SI), IT
FERRINI, Serena, Località Ponelle n° 46/1, I-53034 Gracciano di Colle Val d'Elsa (SI), IT

(51) MKP
A61K 38/08 (2006.01) (97) **2680872 ***
C07K 7/00 (2006.01)
(86) US2012027480 02.03.2012
(96) 12751964.3 08.01.2014
(87) WO2012119072, 02.03.2012
(97) 2680872, 08.01.2014 en
(54) COMPOSITIONS AND METHODS FOR TREATMENT OF INTRACELLULAR DAMAGE
(71) Bioincept LLC, 1697 Lark Lane, Cherry Hill, NJ 08003, US
(72) BARNEA, Eytan R., 1697 Lark Lane, Cherry Hill, New Jersey 08003, US

(51) MKP
G06F 3/048 (2013.01) (97) **2665043**
G06T 19/20 (2011.01)
(96) 12171882.9 20.11.2013
(97) 2665043, 20.11.2013 en
(54) Method and system for providing information from a patient-specific model of blood flow
(71) Heartflow, Inc., 1700 Seaport Boulevard Suite 400, Redwood City, CA 94063, US
(72) Hart, Gregory Richard, 345 Iris Way, Palo Alto, CA California 94303, US
Stevens, John Henry, 1107 Cowper Street, Palo Alto, CA California 94303, US

(51) MKP
G01N 21/35 (2006.01) (97) **2605004**
G01N 21/84 (2006.01)
G01N 21/88 (2006.01)
G01N 21/90 (2006.01)
G01N 25/72 (2006.01)
(96) 12168391.6 19.06.2013
(97) 2605004, 19.06.2013 de
(54) Method and system for testing objects with a gas barrier coating
(71) Finatec Holding AG, Moosweg 1, 2555 Brügg bei Biel, CH
Schärer, Matthias, Bernstrasse 22, 3270 Aarberg, CH
Kubalek, Bernhard, Staffelweg 1, 3302 Moosseedorf, CH
Maibach, Fridolin, Ulmenweg 1, 2560 Nidau, CH
Hermle, Matthias, Gottstattstrasse 8, 2555 Brügg, CH

(51) MKP
A61P 1/00 (2006.01) (97) **2653469 ***
A61P 25/18 (2006.01)
A61K 31/444 (2006.01)
A61P 25/14 (2006.01)
A61P 29/00 (2006.01)
C07D 401/14 (2006.01)
A61P 9/12 (2006.01)
A61P 25/24 (2006.01)
A61P 5/00 (2006.01)
A61P 25/22 (2006.01)
A61K 31/506 (2006.01)
A61P 25/16 (2006.01)
A61K 31/4439 (2006.01)
A61P 25/08 (2006.01)
A61P 25/30 (2006.01)
A61P 1/14 (2006.01)
A61P 25/20 (2006.01)
A61K 31/4192 (2006.01)
A61P 25/04 (2006.01)
A61P 25/28 (2006.01)
(86) JP2011079158 16.12.2011
(96) 11848589.5 23.10.2013
(87) WO2012081692, 16.12.2011
(97) 2653469, 23.10.2013 en
(54) PYRAZOLE DERIVATIVE
(71) Taisho Pharmaceutical Co., Ltd., 24-1, Takada 3-chome Toshima-ku, Tokyo 170-8633, JP
(72) NOZAWA Dai, c/o TAISHO PHARMACEUTICAL CO. LTD. 24-1 Takada 3-chome Toshima-ku, Tokyo 170-8633, JP
TAKADA 3-chome Toshima-ku, Tokyo 170-8633, JP
SUZUKI Ryo, c/o TAISHO PHARMACEUTICAL CO. LTD. 24-1 Takada 3-chome Toshima-ku, Tokyo 170-8633, JP
FUTAMURA Aya, c/o TAISHO PHARMACEUTICAL CO. LTD. 24-1 Takada 3-chome Toshima-ku, Tokyo 170-8633, JP
SHIMONO Rie, c/o TAISHO PHARMACEUTICAL CO. LTD. 24-1 Takada 3-chome Toshima-ku, Tokyo 170-8633, JP
ABE Masahito, c/o TAISHO PHARMACEUTICAL CO. LTD. 24-1 Takada 3-chome Toshima-ku, Tokyo 170-8633, JP
OHTA Hiroshi, c/o TAISHO PHARMACEUTICAL CO. LTD. 24-1 Takada 3-chome Toshima-ku, Tokyo 170-8633, JP
ARAKI Yuko, c/o TAISHO PHARMACEUTICAL CO. LTD. 24-1 Takada 3-chome Toshima-ku, Tokyo 170-8633, JP

(51) MKP
B32B 7/06 (2006.01) (97) **2675619 ***
B32B 27/08 (2006.01)
B32B 27/20 (2006.01)
B32B 27/28 (2006.01)
G09F 3/00 (2006.01)
(86) EP2012000522 06.02.2012
(96) 12708240.2 25.12.2013
(87) WO2012110206, 06.02.2012
(97) 2675619, 25.12.2013 de
(54) RELEASE FILM HAVING A ROUGH SURFACE STRUCTURE
(71) Huhtamaki Films Germany GmbH & Co. KG, Zweibrückenstrasse 15-25, 91301 Forchheim, DE
(72) ENGELHARD, Heinz, Steinacher Str. 3, 90427 Nürnberg, DE

(51) MKP
A61K 9/20 (2006.01) (97) **2651399 ***
 (86) IB2011003139 12.12.2011
 (96) 11811126.9 23.10.2013
 (87) WO2012080833, 12.12.2011
 (97) 2651399, 23.10.2013 en
 (54) CONTROLLED RELEASE DOSAGE FORMS
 (71) Purdue Pharma LP, One Stamford Forum 201 Tresser
 Boulevard, Stamford, CT 06901-3431, US
 (72) O'DONNELL, Edward, 38 Chestnut Court, Basking Ridge, NJ
 07920, US

(51) MKP
A61K 31/69 (2006.01) (97) **2680858 ***
A61K 45/06 (2006.01)
A61P 17/00 (2006.01)
A61P 37/00 (2006.01)
 (86) US2012027440 02.03.2012
 (96) 12712440.2 08.01.2014
 (87) WO2012119056, 02.03.2012
 (97) 2680858, 08.01.2014 en
 (54) PROTEASOME INHIBITOR DELANZOMIB FOR USE IN THE
 TREATMENT OF LUPUS
 (71) Cephalon, Inc., 41 Moores Road P.O. Box 4011, Frazer, PA
 19355, US
 (72) RUGGERI, Bruce, A., 1202 Killington Circle, West Chester, PA
 19380, US
 SEAVEY, Matthew, M., 887 Quincy Lane, Secane, PA 19018,
 US

(51) MKP
B32B 27/10 (2006.01) (97) **2683549 ***
 (86) EP2012001038 08.03.2012
 (96) 12707988.7 15.01.2014
 (87) WO2012123085, 08.03.2012
 (97) 2683549, 15.01.2014 de
 (54) IMPROVED COMPOSITE SYSTEM FOR PACKAGING
 (71) Deutsche SiSi-Werke Betriebs GmbH, Rudolf-Wild-Strasse 107-
 115, 69214 Eppelheim/Heidelberg, DE
 (72) KAISIG, Carsten, Goethestraße 18, 68165 Mannheim, DE
 BYL, Torsten, Maria-Montessori-Straße 16, 69221 Dossenheim,
 DE
 SCHWARTZ, Erhard, Im Mühlhölzle 8, 69168 Wiesloch, DE
 STUMPF, Thomas, Bergstraße 9, 69226 Nussloch, DE

(51) MKP
C12Q 1/48 (2006.01) (97) **2691533 ***
G01N 33/574 (2006.01)
G01N 33/68 (2006.01)
 (86) EP2012055522 28.03.2012
 (96) 12710755.5 05.02.2014
 (87) WO2012130887, 28.03.2012
 (97) 2691533, 05.02.2014 en
 (54) USE OF PHOSPHO-AKT AS A BIOMARKER OF DRUG
 RESPONSE
 (71) Basilea Pharmaceutica AG, Grenzacherstrasse 487, 4005
 Basel, CH
 (72) BACHMANN, Felix, Sierenzerstrasse 16, CH-4055 Basel, CH
 LANE, Heidi, Alexandra, Kaltbrunnenweg 8, CH-4106 Therwil,
 CH

(51) MKP
H01L 31/042 (2006.01) (97) **2695199 ***
 (86) US2012031702 30.03.2012
 (96) 12764623.0 12.02.2014
 (87) WO2012135769, 30.03.2012
 (97) 2695199, 12.02.2014 en
 (54) SHINGLE-LIKE PHOTOVOLTAIC MODULES
 (71) Nuvosun, Inc., 1565 Barber Lane, Milpitas, CA 95035, US
 (72) PEARCE, David, B., 20932 Hidden View Lane, Saratoga, CA
 95070-6344, US
 HOLLARS, Dennis, R., 1908 Crestmont Drive, San Jose, CA
 95124-1103, US
 CLEEREMAN, Robert, J., 5908 Wimbledon Court, Midland, MI
 48642, US

(51) MKP
A61K 39/12 (2006.01) (97) **2658570 ***
A61P 31/14 (2006.01)
 (86) US2011066384 21.12.2011
 (96) 11813490.7 06.11.2013
 (87) WO2012092053, 21.12.2011
 (97) 2658570, 06.11.2013 en
 (54) BOVINE VIRAL DIARRHEA VIRUS TYPE 1B VACCINE
 COMPOSITIONS AND METHODS
 (71) Eli Lilly and Company, Lilly Corporate Center, Indianapolis, IN
 46285, US
 (72) WEISE, Dale, Wade, c/o Eli Lilly and Company P. O. Box 6288,
 Indianapolis, Indiana 46206-6288, US
 HARRIS, James, Robert, c/o Eli Lilly and Company P.O. Box
 6288, Indianapolis, Indiana 46206-6288, US

(51) MKP
H03H 17/06 (2006.01) (97) **2608409**
 (96) 11194460.9 26.06.2013
 (97) 2608409, 26.06.2013 en
 (54) Multichannel sample rate converter
 (71) Televic Conference NV, Leo Bekaertlaan 1, 8870 Izegem, BE
 Melange, Cedric, Kapelhoekstraat 30, 8800 Beveren
 (Roeselare), BE

(51) MKP
H04B 7/26 (2006.01) (97) **2678960 ***
H04J 11/00 (2006.01)
 (86) US2012026327 23.02.2012
 (96) 12749743.6 01.01.2014
 (87) WO2012116184, 23.02.2012
 (97) 2678960, 01.01.2014 en
 (54) MULTIPLE APERIODIC CHANNEL STATE INFORMATION
 TRANSMISSION ON PUSCH
 (71) ZTE Corporation, ZTE Plaza Keji Road South Hi-Tech
 Industrial Park Nanshan District, Shenzhen, Guangdong
 518057, CN
 ZTE (USA) Inc., 2425 N. Central Expressway, Suite 323,
 Richardson, TX 75080, US
 (72) LI, Shupeng, 78 Shaffer Road, Bridgewater, NJ 08807, US
 HUO, David, 87 Skytop Road, Newton, NJ 07860, US

(51) MKP
A61K 9/00 (2006.01) (97) **2651391 ***
A61K 9/20 (2006.01)
A61K 31/437 (2006.01)
A61K 33/10 (2006.01)
A61P 25/20 (2006.01)
 (86) EP2011072933 15.12.2011
 (96) 11799420.2 23.10.2013
 (87) WO2012080408, 15.12.2011
 (97) 2651391, 23.10.2013 en
 (54) PHARMACEUTICAL COMPOSITION FOR ORAL
 ADMINISTRATION INTENDED TO PREVENT MISUSE
 (71) Sanofi, 54 rue La Boétie, 75008 Paris, FR
 (72) MARTINEZ, Annick, c/o Sanofi Patent Department 174 avenue
 de France, F-75013 Paris, FR
 ROUGEOT, Olivier, c/o Sanofi Patent Department 174 avenue
 de France, F-75013 Paris, FR
 YAGUCHI, Yoshikatsu, c/o Sanofi Patent Department 174
 avenue de France, F-75013 Paris, FR

(51) MKP
A61K 39/00 (2006.01) (97) **2654780 ***
 (86) US2011065174 15.12.2011
 (96) 11851794.5 30.10.2013
 (87) WO2012087746, 15.12.2011
 (97) 2654780, 30.10.2013 en
 (54) ACTIVE PROTEASE-RESISTANT ANTIBODY FC MUTANTS
 (71) Janssen Biotech, Inc., 800/850 Ridgeview Drive, Horsham, PA
 19044, US
 (72) STROHL, William, 1400 McKean Road, Spring House, PA
 19477, US
 JORDAN, Robert, 15 Memel Drive, Thorton, PA 19373, US
 BREZSKI, Randall, 1400 McKean Road, Spring House, PA
 19477, US

(51) MKP
A61K 9/16 (2006.01) (97) **2658528 ***
A61K 31/55 (2006.01)
(86) PT2011000048 30.12.2011
(96) 11811186.3 06.11.2013
(87) WO2012091593, 30.12.2011
(97) 2658528, 06.11.2013 en
(54) GRANULATES COMPRISING ESLICARBAZEPINE ACETATE
(71) Bial-Portela & CA, S.A., À Avenida da Siderurgia Nacional Apartado 19, 4745-457 S. Mamede do Coronado, PT
(72) DA COSTA BARROCAS, Pedro Miguel, À Av. Da Siderurgica Nacional, P-4745-457 S. Mamede do Coronado, PT
DOS SANTOS LIMA, Ricardo Jorge, À Av. Da Siderurgica Nacional, P-4745-457 S. Mamede do Coronado, PT
CARDOSO DE VASCONCELOS, Teófilo, À Av. Da Siderurgica Nacional, P-4745-457 S. Mamede do Coronado, PT
DE CASTRO PERREIRA, Lígia Sofia, À Av. Da Siderurgica Nacional, P-4745-457 S. Mamede do Coronado, PT
DE ALMEIDA JERÓNIMO, Paula Cristina, À Av. Da Siderurgica Nacional, P-4745-457 S. Mamede do Coronado, PT
DE CAMPOS COSTA, Rui Cerdeira, À Av. Da Siderurgica Nacional, P-4745-457 S. Mamede do Coronado, PT

(51) MKP
A61K 31/58 (2006.01) (97) **2686333 ***
A61P 5/44 (2006.01)
A61P 11/06 (2006.01)
A61P 37/08 (2006.01)
C07J 71/00 (2006.01)
(86) EP2012054455 14.03.2012
(96) 12712601.9 22.01.2014
(87) WO2012123493, 14.03.2012
(97) 2686333, 22.01.2014 en
(54) ISOXAZOLIDINE DERIVATIVES
(71) Chiesi Farmaceutici S.p.A., Via Palermo, 26/A, 43100 Parma, IT
(72) GHIDINI, Eleonora, c/o Chiesi Farmaceutici S.P.A. Via Palermo 26/A, I-43100 Parma, IT
CAPELLI, Anna Maria, c/o Chiesi Farmaceutici S.P.A. Via Palermo 26/A, I-43100 Parma, IT

(51) MKP
B01D 1/14 (2006.01) (97) **2661478 ***
B01D 1/16 (2006.01)
C08H 8/00 (2010.01)
C10G 3/00 (2006.01)
C13K 1/00 (2006.01)
(86) DE2011001423 12.07.2011
(96) 11770676.2 13.11.2013
(87) WO2012013177, 12.07.2011
(97) 2661478, 13.11.2013 de
(54) METHOD AND APPARATUS FOR EVAPORATING HYDROGEN HALIDE AND WATER FROM BIOMASS HYDROLYZATES CONTAINING HALOGEN ACID
(71) Green Sugar GmbH, Produktinnovationen Aus Biomasse, Hermann-Grafe-Strasse 40, 01662 Meissen, DE
(72) KOSE, Frank, Westerlandstrasse 17A, 13189 Berlin, DE
SCHMIDT, Matthias, Rudolfstrasse 21, 01097 Dresden, DE

(51) MKP
A61K 31/498 (2006.01) (97) **2687507 ***
A61P 9/10 (2006.01)
A61K 31/454 (2006.01)
A61P 1/16 (2006.01)
C07D 217/06 (2006.01)
A61K 31/497 (2006.01)
A61P 3/10 (2006.01)
A61K 31/472 (2006.01)
A61P 3/04 (2006.01)
C07D 217/22 (2006.01)
A61K 31/506 (2006.01)
A61P 9/12 (2006.01)
A61K 31/4725 (2006.01)
A61P 3/06 (2006.01)
C07D 223/16 (2006.01)
A61K 31/4035 (2006.01)
A61K 31/55 (2006.01)
C07D 217/04 (2006.01)
C07D 209/44 (2006.01)
A61K 31/538 (2006.01)
A61P 43/00 (2006.01)
(86) JP2012056600 14.03.2012
(96) 12757861.5 22.01.2014
(87) WO2012124744, 14.03.2012
(97) 2687507, 22.01.2014 en
(54) NITROGEN-CONTAINING CONDENSED HETEROCYCLIC COMPOUND
(71) Taisho Pharmaceutical Co., Ltd., 24-1, Takada 3-chome Toshima-ku, Tokyo 170-8633, JP
(72) BUSUJIMA, Tsuyoshi, c/o Taisho Pharmaceutical Co. Ltd. 24-1 Takada 3-chome Toshima-ku, Tokyo 170-8633, JP
Ol, Takahiro, c/o Taisho Pharmaceutical Co. Ltd. 24-1 Takada 3-chome Toshima-ku, Tokyo 170-8633, JP
TANAKA, Hiroaki, c/o Taisho Pharmaceutical Co. Ltd. 24-1 Takada 3-chome Toshima-ku, Tokyo 170-8633, JP
SHIRASAKI, Yoshihisa, c/o Taisho Pharmaceutical Co. Ltd. 24-1 Takada 3-chome Toshima-ku, Tokyo 170-8633, JP
IWAKIRI, Kanako, c/o Taisho Pharmaceutical Co. Ltd. 24-1 Takada 3-chome Toshima-ku, Tokyo 170-8633, JP
SATO, Nagaaki, c/o Taisho Pharmaceutical Co. Ltd. 24-1 Takada 3-chome Toshima-ku, Tokyo 170-8633, JP
TOKITA, Shigeru, c/o Taisho Pharmaceutical Co. Ltd. 24-1 Takada 3-chome Toshima-ku, Tokyo 170-8633, JP

(51) MKP
C07K 7/06 (2006.01) (97) **2690107 ***
(86) CU2012000002 21.03.2012
(96) 12716190.9 29.01.2014
(87) WO2012126441, 21.03.2012
(97) 2690107, 29.01.2014 en
(54) CYCLIC PEPTIDES WITH AN ANTI-NEOPLASIC AND ANTI-ANGIOGENIC ACTIVITY
(71) Centro De Ingenieria Genetica Y Biotecnologia, Avenida 31 entre 158 y 190 Cubanacán, Playa, La Habana 11600, CU
(72) ABRAHANTES PÉREZ, María, del Carmen, Calle 186, No 3112 Apto 68, e/ 31 y 33 Cubanacán, Playa., La Habana 11600, CU
CHINEA SANTIAGO, Glay, Ave 31, No. 18207 Entre 182 y 184 Playa, La Habana 11600, CU
MARTÍNEZ DÍAZ, Eduardo, Calle 186, No 3117 Apto 14E, e/ 31 y 33 Cubanacán, Playa, La Habana 11600, CU
GARAY PÉREZ, Hilda, Elisa, Ave 31, No 18207 Entre 182 y 184 Playa, La Habana 11600, CU
REYES ACOSTA, Osvaldo, Ave 31, No 18207 Entre 182 y 184 Playa, La Habana 11600, CU
LÓPEZ MOLA, Ernesto, Calle 186 No 3112 Apto. 35, entre 31 y 33 Cubanacán Playa, La Habana 11600, CU
LÓPEZ ABAD, Cruz, Matilde, Calle 186 No. 3115 Entre 31 y 33 Apto.9-I Playa, La Habana 11600, CU
GONZALEZ BLANCO, Sonia, Calle 184 No. 3112 Apto 42, e/ 31 y 33-A Playa, La Habana 11600, CU

- (51) MKP
A61K 39/104 (2006.01) (97) **2655402 ***
A61K 39/40 (2006.01)
C07K 14/21 (2006.01)
C07K 16/12 (2006.01)
C07K 19/00 (2006.01)
(86) EP2011054127 18.03.2011
(96) 11714502.9 30.10.2013
(87) WO2012084272, 18.03.2011
(97) 2655402, 30.10.2013 en
(54) OPRF/I AGENTS AND THEIR USE IN HOSPITALIZED AND OTHER PATIENTS
(71) Intercell Austria AG, Campus Vienna Biocenter 3, 1030 Vienna, AT
(72) KLADE, Christoph, Gröhrmühlgasse 1B/17, 2700 Wiener Neustadt, AT
SCHLEGL, Robert, Rosental 63, 2500 Siegenfeld, AT
WESTRITSCHNIG, Kerstin, Vegagasse 16, 1190 Vienna, AT
-
- (51) MKP
A61K 8/04 (2006.01) (97) **2482800 ***
A61K 8/97 (2006.01)
A61K 9/00 (2006.01)
A61K 9/12 (2006.01)
A61K 9/46 (2006.01)
A61K 31/01 (2006.01)
A61K 31/19 (2006.01)
A61K 31/191 (2006.01)
A61K 36/886 (2006.01)
A61K 45/06 (2006.01)
A61K 47/10 (2006.01)
A61K 47/40 (2006.01)
A61K 47/46 (2006.01)
A61Q 19/00 (2006.01)
(86) AU2010001269 28.09.2010
(96) 10819731.0 08.08.2012
(87) WO2011038446, 28.09.2010
(97) 2482800, 08.08.2012 en
(54) COSMETIC FOAM
(71) Stiefel Research Australia Pty Ltd, 8 Macro Court, Rowville VIC 3178, AU
(72) ABRAM, Albert Zorko, 8 Marco Court, Rowville VIC 3178, AU
GOLDSTEIN, Julian, 8 Marco Court, Rowville VIC 3178, AU
-
- (51) MKP
A61B 17/54 (2006.01) (97) **2678055 ***
A61C 17/02 (2006.01)
A61M 5/30 (2006.01)
(86) IL2012050053 20.02.2012
(96) 12714381.6 01.01.2014
(87) WO2012114337, 20.02.2012
(97) 2678055, 01.01.2014 en
(54) A DEVICE FOR ADMINISTERING THERAPEUTIC SUBSTANCES USING A HIGH VELOCITY LIQUID-GAS STREAM
(71) Tavtech Ltd., Top Rasco Building 40 Haatzmaut Street P.O. Box 1167, 56000 Yehud, IL
(72) POLYAKOV, Alexander, 135 Kidmat Tzvi, 12421 Ramat Hagolan, IL
YANIV, Yitzhak, 12 Hacarmel Street, 55900 Ganei Tikva, IL
-
- (51) MKP
F02M 47/02 (2006.01) (97) **2568157**
F02M 61/12 (2006.01)
F02M 63/00 (2006.01)
(96) 11180619.6 13.03.2013
(97) 2568157, 13.03.2013 en
(54) Injection Nozzle
(71) Delphi Technologies Holding S.à.r.l., Avenue de Luxembourg, 4940 Bascharage, LU
(72) Cooke, Michael, 52 Burnt Oak Terrace, Gillingham, Kent ME7 1DR, GB
-
- (51) MKP
A61K 31/575 (2006.01) (97) **2646457 ***
A61P 1/16 (2006.01)
C07J 9/00 (2006.01)
(86) EP2011071406 30.11.2011
(96) 11788533.5 09.10.2013
(87) WO2012072689, 30.11.2011
(97) 2646457, 09.10.2013 en
(54) OPTIMIZED SYNTHESIS OF PURE, NON-POLYMORPHIC, CRYSTALLINE BILE ACIDS WITH DEFINED PARTICLE SIZE
(71) Dr. Falk Pharma GmbH, Leinenweberstrasse 5, 79108 Freiburg, DE
(72) WILHELM, Rudolf, Feuerkirchweg 2a, 76476 Bischweier, DE
PRÖLS, Markus, Johann-von-Weerth-Str. 11, 79100 Freiburg, DE
FISCHER, Erik, Rosen Allé 1A, DK-3500 Vaerlose, DK
WAENERLUND POULSEN, Heidi, Bagsværdvej 155, DK-2880 Bagsværd, DK
-
- (51) MKP
A61K 31/439 (2006.01) (97) **2681199 ***
A61P 25/00 (2006.01)
C07D 221/20 (2006.01)
(86) US2012025628 17.02.2012
(96) 12755750.2 08.01.2014
(87) WO2012121863, 17.02.2012
(97) 2681199, 08.01.2014 en
(54) (--)- HUPERZINE A PROCESSES AND RELATED COMPOSITIONS AND METHODS OF TREATMENT
(71) Yale University, Two Whitney Avenue, New Haven, CT 06511, US
(72) HERZON, Seth, 1017 State Street 3rd Floor, New Haven, CT 06511, US
TUN, Maung Kway, Moe, 136 Edwards Street, New Haven, CT 06511, US
-
- (51) MKP
A61K 38/18 (2006.01) (97) **2696889 ***
C07K 14/475 (2006.01)
(86) US2012031927 03.04.2012
(96) 12712874.2 19.02.2014
(87) WO2012141936, 03.04.2012
(97) 2696889, 19.02.2014 en
(54) VARIANTS OF HUMAN GDNF
(71) Eli Lilly and Company, Lilly Corporate Center, Indianapolis, IN 46285, US
(72) LEUNG, Donmienne, Doen, Mun, c/o Eli Lilly and Company P.O. Box 6288, Indianapolis, Indiana 46206-6288, US
LU, Jirong, c/o Eli Lilly and Company P.O. Box 6288, Indianapolis, Indiana 46206-6288, US
MERCHANT, Kalpana, Mahesh, c/o Eli Lilly and Company P.O. Box 6288, Indianapolis, Indiana 46206-6288, US
GHANEM, Mahmoud, c/o Eli Lilly and Company P.O. Box 6288, Indianapolis, Indiana 46206-6288, US
O'BRYAN, Linda, Maureen, c/o Eli Lilly and Company P.O. Box 6288, Indianapolis, Indiana 46206-6288, US
SMITH, Rosamund, Carol, c/o Eli Lilly and Company P.O. Box 6288, Indianapolis, Indiana 46206-6288, US
-

- (51) MKP
A61K 31/4178 (2006.01) (97) **2649066 ***
A61K 31/4439 (2006.01)
A61K 31/506 (2006.01)
A61P 25/08 (2006.01)
A61P 25/18 (2006.01)
A61P 27/16 (2006.01)
A61P 43/00 (2006.01)
C07D 405/12 (2006.01)
C07D 413/12 (2006.01)
C07D 413/14 (2006.01)
(86) GB2011052414 06.12.2011
(96) 11805571.4 16.10.2013
(87) WO2012076877, 06.12.2011
(87) 2649066, 16.10.2013 en
(54) HYDANTOIN DERIVATIVES USEFUL AS KV3 INHIBITORS
(71) Autifony Therapeutics Limited, B205 Imperial College Incubator Level 1 Bessemer Building Imperial College, London SW7 2AZ, GB
(72) ALVARO, Giuseppe, C/o Autifony Srl Medicines Research Centre Via Fleming 4, I-37135 Verona, IT
DAMBRUOSO, Paolo, C/o Autifony Srl Medicines Research Centre Via Fleming 4, I-37135 Verona, IT
MARASCO, Agostino, C/o Autifony Srl Medicines Research Centre Via Fleming 4, I-37135 Verona, IT
TOMMASI, Simona, C/o Autifony Srl Medicines Research Centre Via Fleming 4, I-37135 Verona, IT
DECOR, Anne, C/o Autifony Srl Medicines Research Centre Via Fleming 4, I-37135 Verona, IT
LARGE, Charles, C/o Autifony Srl Medicines Research Centre Via Fleming 4, I-37135 Verona, IT

- (51) MKP
C12N 15/82 (2006.01) (97) **2655629 ***
(86) EP2011073135 16.12.2011
(96) 11802063.5 30.10.2013
(87) WO2012084742, 16.12.2011
(97) 2655629, 30.10.2013 en
(54) BRASSICA PLANT COMPRISING A MUTANT ALCATRAZ ALLELE
(71) Bayer CropScience NV, J.E. Mommaertslaan 14, 1831 Diegem, BE
(72) LAGA, Benjamin, Rakestraat 4, 8750 Wingene, BE

- (51) MKP
A61K 31/427 (2006.01) (97) **2567958**
A61P 9/06 (2006.01)
A61P 9/10 (2006.01)
C07D 417/12 (2006.01)
C07D 417/14 (2006.01)
C07D 471/04 (2006.01)
C07D 487/04 (2006.01)
(96) 11306128.7 13.03.2013
(97) 2567958, 13.03.2013 en
(54) Substituted 2-(chroman-6-yloxy)-thiazoles and their use as pharmaceuticals
(71) SANOFI, 54 rue La Boétie, 75008 Paris, FR
(72) Czechtizky, Werngard, c/o Sanofi-Aventis Deutschland GmbH, 65926 Frankfurt am Main, DE
Weston, John, c/o Sanofi-Aventis Deutschland GmbH, 65926 Frankfurt am Main, DE
Rackelmann, Nils, c/o Sanofi-Aventis Deutschland GmbH, 65926 Frankfurt am Main, DE
Podeschwa, Michael, c/o Sanofi-Aventis Deutschland GmbH, 65926 Frankfurt am Main, DE
Arndt, Petra, c/o Sanofi-Aventis Deutschland GmbH, 65926 Frankfurt am Main, DE
Wirth, Klaus, c/o Sanofi-Aventis Deutschland GmbH, 65926 Frankfurt am Main, DE
Goegelien, Heinz, c/o Sanofi-Aventis Deutschland GmbH, 65926 Frankfurt am Main, DE
Ritzeler, Olaf, c/o Sanofi-Aventis Deutschland GmbH, 65926 Frankfurt am Main, DE
Kraft, Volker, c/o Sanofi-Aventis Deutschland GmbH, 65926 Frankfurt am Main, DE
Bellevue, Patrice, c/o Sanofi-Aventis Deutschland GmbH, 65926 Frankfurt am Main, DE
McCort, Gary, c/o Sanofi-Aventis Deutschland GmbH, 65926 Frankfurt am Main, DE

- (51) MKP
A61K 39/00 (2006.01) (97) **2529748**
C07K 7/14 (2006.01)
(96) 12182229.0 05.12.2012
(97) 2529748, 05.12.2012 en
(54) Vaccine
(71) Affiris AG, Karl-Farkas-Gasse 22, 1030 Wien, AT
Staffler, Günther, Juchgasse 8/10, 1030 Vienna, AT
(72) Lühns, Petra, Römersthalgasse 1/27, 1110 Vienna, AT
Dolischka, Andrea, Richterergasse 8/9, 1070 Vienna, AT
Mairhofer, Andreas, Baumgasse 36/5, 1030 Vienna, AT
Mattner, Frank, Cobenzlgasse 134, 1190 Vienna, AT
Schmidt, Walter, Böcklinstrasse 19, 1020 Vienna, AT

- (51) MKP
A61K 39/02 (2006.01) (97) **2655668 ***
C12R 1/00 (2006.01)
(86) EP2011073749 22.12.2011
(96) 11813784.3 30.10.2013
(87) WO2012085183, 22.12.2011
(97) 2655668, 30.10.2013 en
(54) NOVEL BACTERIUM AND EXTRACTS OF SAID BACTERIUM AND THE USE OF SAME IN THERAPY
(71) Pierre Fabre Dermo-Cosmétique, 45, place Abel-Gance, 92100 Boulogne-Billancourt, FR
Pierre Fabre Medicament, 45, Place Abel Gance, 92100 Boulogne-Billancourt, FR
(72) CASTEX-RIZZI, Nathalie, 47 allée de Carpentras, 31770 Colomiers, FR
NGUYEN, Thien, 5 Chemin du Cros, 31180 Rouffiac-Tolosan, FR
LIBON, Christine, 3 avenue Se Canto, 31320 Castanet-Tolosan, FR

- (51) MKP
E04B 1/76 (2006.01) (97) **2652218 ***
E04F 13/08 (2006.01)
F16B 7/02 (2006.01)
F16B 13/06 (2006.01)
F16B 13/08 (2006.01)
F16B 19/00 (2006.01)
(86) HU2011000125 15.12.2011
(96) 11805167.1 23.10.2013
(87) WO2012080761, 15.12.2011
(97) 2652218, 23.10.2013 en
(54) RETAINING UNIT FOR FIXING HEAT INSULATION ELEMENTS TO A SUPPORTING STRUCTURE
(71) Fazakas, Gábor, Bartók Béla út 61, H-1114 Budapest, HU
Fazakas, Zsolt, József u. 47. Katona, 2045 Törökbálint, HU
Györfi, László, Becő u.42, 1165 Budapest, HU
Pirityi, László, Szatmár u. 65., 1142 Budapest, HU
(72) FAZAKAS, Gábor, Bartók Béla út 61., 1114 Budapest, HU
FAZAKAS, Zsolt, József u. 47. Katona, 2045 Törökbálint, HU
GYÖRFI, László, Becő u.42, 1165 Budapest, HU

- (51) MKP
A61K 31/404 (2006.01) (97) **2691370 ***
A61K 38/03 (2006.01)
C07D 209/20 (2006.01)
C07K 5/037 (2006.01)
- (86) CA2012000327 30.03.2012
(96) 12765128.9 05.02.2014
(87) WO2012129680, 30.03.2012
(97) 2691370, 05.02.2014 en
(54) PRODRUGS OF D-GAMMA-GLUTAMYL-D-TRYPTOPHAN AND D-GAMMA-GLUTAMYL-L-TRYPTOPHAN
(71) Apotex Technologies Inc., 150 Signet Drive, Toronto, ON M9L 1T9, CA
(72) TAM, Tim, Fat, 155 Veneto Drive, Vaughan Ontario L4L 8X6, CA
LEUNG-TOUNG, Regis, 5530 McFarren Blvd, Mississauga Ontario L5M 5X9, CA
WANG, Yingsheng, 63 Woodlot Crescent, Toronto Ontario M9W 6T3, CA
ZHAO, Yanqing, 9 Limelight Street, Richmond Hill Ontario L4E 0P9, CA
XIN, Tao, 158 Rossi Drive, Vaughan Ontario L4H 0M8, CA
LI, Wanren, 26 Kiskadee Dr., Toronto Ontario M9V 4P4, CA
WODZINSKA, Jolanta, Maria, 3494 Enniskillen Circle, Mississauga Ontario L5C 2N1, CA
RABADIA, Vrajlal, S., 28-7155 Mgistrate Terrace, Mississauga Ontario L5W 1Y7, CA
SHAH, Birenkumar, 63 Palleschi Drive, Brampton ON L6P 2S1, CA
FEENEY, Christopher, John, 104 Sixteenth Street, Unit 12, Toronto Ontario M8V 3K1, CA
-
- (51) MKP
C07D 239/36 (2006.01) (97) **2649053 ***
C07D 239/47 (2006.01)
C07D 239/52 (2006.01)
C07D 239/56 (2006.01)
C07D 401/06 (2006.01)
C07D 401/12 (2006.01)
C07D 401/14 (2006.01)
C07D 403/06 (2006.01)
C07D 403/12 (2006.01)
C07D 403/14 (2006.01)
C07D 413/06 (2006.01)
C07D 417/06 (2006.01)
- (86) EP2011071690 05.12.2011
(96) 11802872.9 16.10.2013
(87) WO2012076435, 05.12.2011
(97) 2649053, 16.10.2013 en
(54) PYRIMIDINONE COMPOUNDS FOR USE IN THE TREATMENT OF DISEASES OR CONDITIONS MEDIATED BY LP - PLA2
(71) Glaxo Group Limited, 980 Great West Road, Brentford, Middlesex TW8 9GS, GB
(72) JIN, Yun, GlaxoSmithKline (China) R&D Co Ltd Building 3 898 Halei Road Zhangjiang Hi-Tech Park, Shanghai 201203, CN
WAN, Zehong, GlaxoSmithKline (China) R&D Co Ltd Building 3 898 Halei Road Zhangjiang Hi-Tech Park, Shanghai 201203, CN
ZHANG, Qing, GlaxoSmithKline (China) R&D Co Ltd Building 3 898 Halei Road Zhangjiang Hi-Tech Park, Shanghai 201203, CN
-
- (51) MKP
A61K 9/00 (2006.01) (97) **2672962 ***
A61K 31/00 (2006.01)
A61K 47/10 (2006.01)
A61K 47/12 (2006.01)
- (86) EP2012052327 10.02.2012
(96) 12703537.6 18.12.2013
(87) WO2012107565, 10.02.2012
(97) 2672962, 18.12.2013 en
(54) NOVEL ANTIFUNGAL COMPOSITION
(71) Moberg Pharma AB, Gustavslundsvägen 42, 5 tr, 167 51 Bromma, SE
(72) LINDAHL, Åke, Köpenhamnsvägen 105 D, S-217 75 Malmö, SE
-
- (51) MKP
A61F 2/00 (2006.01) (97) **2683326 ***
A61F 2/02 (2006.01)
A61F 2/04 (2013.01)
A61L 27/18 (2006.01)
A61L 27/54 (2006.01)
- (86) EP2012053676 02.03.2012
(96) 12706853.4 15.01.2014
(87) WO2012123272, 02.03.2012
(97) 2683326, 15.01.2014 en
(54) HEMISPHERE FOR BLADDER EXPANSION IN PATIENTS WITH LOW COMPLIANCE
(71) Sambusseti, Antonio, Via San Predengo, 13, 26100 Cremona, IT
(72) Sambusseti, Antonio, Via San Predengo, 13, 26100 Cremona, IT
-
- (51) MKP
B65D 43/02 (2006.01) (97) **2597050**
B65D 85/78 (2006.01)
- (96) 11191007.1 29.05.2013
(97) 2597050, 29.05.2013 en
(54) Closure lid
(71) Nestec S.A., Avenue Nestlé 55, 1800 Vevey, CH
(72) Lebrand Pierre-Henri, 1, Rue de Velennes, 60510 Bonlier, FR
Labrousse Molla, Sophie, 18, Rue Boutmy, 80000 Amiens, FR
-
- (51) MKP
A61K 9/16 (2006.01) (97) **2654726 ***
A61K 9/48 (2006.01)
A61K 31/495 (2006.01)
- (86) US2012028088 07.03.2012
(96) 12754568.9 30.10.2013
(87) WO2012122279, 07.03.2012
(97) 2654726, 30.10.2013 en
(54) SOLID DISPERSION FORMULATIONS AND METHODS OF USE THEREOF
(71) Zalicus Pharmaceuticals Ltd., 2389 Health Sciences Mall Suite 301, Vancouver, British Columbia V6T 1Z3, CA
(72) PADVAL, Mahesh, V., 814 Central Avenue, Needham, MA 02492, US
GAUTSCHI, Jeff, T., 2428 N.W. 2nd Street, Bend, OR 97701, US
SMITHEY, Daniel, T., 19009 Innes Market Road, Bend, OR 97701, US
CREW, Marshall, D., 63536 Old Deschutes Road, Bend, OR 97701, US
HARIANAWALA, Abizer, 10 Wilson Lane, Acton, MA 01720, US
-
- (51) MKP
A61K 31/4985 (2006.01) (97) **2694068 ***
A61K 31/501 (2006.01)
A61K 31/5377 (2006.01)
A61P 35/00 (2006.01)
A61P 43/00 (2006.01)
C07D 471/04 (2006.01)
- (86) EP2012056142 04.04.2012
(96) 12713706.5 12.02.2014
(87) WO2012136694, 04.04.2012
(97) 2694068, 12.02.2014 en
(54) PYRIDOPYRAZINE DERIVATIVES AND THEIR USE
(71) Æterna Zentaris GmbH, Weismüllerstraße 50, 60314 Frankfurt am Main, DE
(72) GERLACH, Matthias, Pfarrgasse 1, 63636 Brachtal Brachtal, DE
SEIPELT, Irene, Hermannstrasse 5, 63069 Offenbach, DE
BLUMENSTEIN, Lars, Erich-Kästner-Strasse 11, 60388 Frankfurt am Main, DE
MUELLER, Gilbert, Bischofsweg 1A, 60598 Frankfurt am Main, DE
GÜNTHER, Eckhard, Wingertstraße 176, 63477 Maintal, DE
SCHUSTER, Tilmann, Valentin-Hock-Str. 32, 63762 Großostheim, DE
TEIFEL, Michael, Franz-Seliger-Straße 15, 64331 Weiterstadt, DE

- (51) MKP
A61K 31/522 (2006.01) (97) **2672975 ***
A61P 9/08 (2006.01)
A61P 9/12 (2006.01)
- (86) US2012024411 09.02.2012
(96) 12704620.9 18.12.2013
(87) WO2012109406, 09.02.2012
(97) 2672975, 18.12.2013 en
- (54) METHODS FOR TREATING PULMONARY HYPERTENSION
(71) The Medicines Company, 8 Sylvan Way, Parsippany, NJ 07054, US
(72) KYLHAMMAR, David, Hjärtmottagningen Kliniken för Hjärtsvikt och Klaffsjukdom Skånes Universitetssjukhus, S-221-85 Lund, SE
RÅDEGRAN, Göran, Hjärtmottagningen Kliniken för Hjärtsvikt och Klaffsjukdom Skånes Universitetssjukhus, S-221 85 Lund, SE
-
- (51) MKP
A61K 31/404 (2006.01) (97) **2688884 ***
A61P 25/24 (2006.01)
C07D 405/14 (2006.01)
- (86) IN2012000182 16.03.2012
(96) 12738632.4 29.01.2014
(87) WO2012131706, 16.03.2012
(97) 2688884, 29.01.2014 en
- (54) AMORPHOUS FORM OF VILAZODONE HYDROCHLORIDE AND PROCESS FOR ITS PREPARATION
(71) Cadila Healthcare Limited, Zydus Tower Satellite Cross Roads, Ahmedabad 380015, IN
(72) DWIVED, Shriprakash Dhar, Cadila Healthcare Limited Zydus Tower Satellite Cross Roads, Ahmedabad 380015 Gujarat, IN
SINGH, Ramesh, Chandra, Cadila Healthcare Limited Zydus Tower Satellite Cross Roads, Ahmedabad 380015 Gujarat, IN
RAVAL, Jigar, Mukundbhai, Cadila Healthcare Limited Zydus Tower Satellite Cross Roads, Ahmedabad 380015 Gujarat, IN
-
- (51) MKP
A61K 31/00 (2006.01) (97) **2646010 ***
A61K 31/198 (2006.01)
A61K 31/20 (2006.01)
A61K 31/375 (2006.01)
A61K 31/403 (2006.01)
A61K 31/505 (2006.01)
A61K 31/519 (2006.01)
A61K 31/70 (2006.01)
A61K 31/714 (2006.01)
A61K 33/06 (2006.01)
A61K 33/14 (2006.01)
- (86) IB2011000960 06.05.2011
(96) 11724029.1 09.10.2013
(87) WO2012073077, 06.05.2011
(97) 2646010, 09.10.2013 en
- (54) FOLIC ACID - RAMIPRIL COMBINATION: CELLPROTECTIVE, NEUROPROTECTIVE AND RETINOPROTECTIVE OPHTHALMOLOGIC COMPOSITIONS
(71) Rekik, Raouf, Tanit Medical Avenue du Japon-Mont Plaisir, 1073 Tunis, TN
(72) Rekik, Raouf, Tanit Medical Avenue du Japon-Mont Plaisir, 1073 Tunis, TN
-
- (51) MKP
B60H 1/00 (2006.01) (97) **2607118**
F24F 13/20 (2006.01)
H05K 5/00 (2006.01)
- (96) 12197715.1 26.06.2013
(97) 2607118, 26.06.2013 de
- (54) Housing, in particular for a motor vehicle air conditioning device
(71) Behr GmbH & Co. KG, Mausersstr. 3, 70469 Stuttgart, DE
(72) Grieb, Dipl.-Ing Andreas, Ungsteiner Str. 14, 70499 Stuttgart, DE
Bürkle, Dipl.-Ing. Rainer, Fellbacher Straße 174, 70736 Fellbach, DE
Feith, Dipl.-Ing. Thomas, Astenstr. 9/2, 70825 Korntal-Münchingen, DE

- (51) MKP
A61K 9/00 (2006.01) (97) **2658523 ***
A61K 9/14 (2006.01)
A61K 9/16 (2006.01)
A61K 9/20 (2006.01)
A61K 9/28 (2006.01)
A61K 31/485 (2006.01)
A61K 45/06 (2006.01)
A61P 1/10 (2006.01)
A61P 25/00 (2006.01)
A61P 25/02 (2006.01)
A61P 25/14 (2006.01)
A61P 25/16 (2006.01)
- (86) EP2011074103 27.12.2011
(96) 11802440.5 06.11.2013
(87) WO2012089738, 27.12.2011
(97) 2658523, 06.11.2013 en
- (54) A COMBINATION OF AN OPIOID AGONIST AND AN OPIOID ANTAGONIST IN THE TREATMENT OF PARKINSON'S DISEASE
(71) Euro-Celtique S.A., 2, avenue Charles de Gaulle, 1653 Luxembourg, LU
(72) HOPP, Michael, Dillenburger Strasse 17, 65520 Bad Camberg, DE
TRENKWALDER, Claudia, In der Roten Erde 13, 37075 Göttingen, DE
-
- (51) MKP
C12Q 1/68 (2006.01) (97) **2686442 ***
- (86) US2012029205 15.03.2012
(96) 12710849.6 22.01.2014
(87) WO2012125812, 15.03.2012
(97) 2686442, 22.01.2014 en
- (54) FGFR AND LIGANDS THEREOF AS BIOMARKERS FOR BREAST CANCER IN HR POSITIVE SUBJECTS
(71) Novartis AG, Lichtstrasse 35, 4056 Basel, CH
(72) GARDNER, Humphrey Athelstan Roy, 170 Federal Street, Salem Massachusetts 01970, US
SHI, Michael, Novartis Pharmaceuticals Corporation One Health Plaza, East Hanover New Jersey 07936, US
YOVINE, Alejandro, Novartis Pharma AG Postfach, CH-4002 Basel, CH
-
- (51) MKP
A61K 9/70 (2006.01) (97) **2700401 ***
A61K 31/435 (2006.01)
A61K 31/551 (2006.01)
A61K 47/12 (2006.01)
A61K 47/32 (2006.01)
A61K 47/34 (2006.01)
A61P 11/02 (2006.01)
A61P 17/04 (2006.01)
A61P 37/08 (2006.01)
A61P 43/00 (2006.01)
- (86) JP2012059982 12.04.2012
(96) 12774629.5 26.02.2014
(87) WO2012144405, 12.04.2012
(97) 2700401, 26.02.2014 en
- (54) METHOD FOR PRODUCING ADHESIVE PATCH, AND ADHESIVE PATCH
(71) Hisamitsu Pharmaceutical Co., Inc., 408, Tashirodaikan-machi, Tosu-shi, Saga 841-0017, JP
(72) HASHIMOTO Eiji, c/o Hisamitsu Pharmaceutical Co. Inc. 1-25-11 Kannondai, Tsukuba-shi Ibaraki 305-0856, JP
HAGIWARA Isao, c/o Hisamitsu Pharmaceutical Co. Inc. 1-25-11 Kannondai, Tsukuba-shi Ibaraki 305-0856, JP
NAKA Yukihiisa, c/o Hisamitsu Pharmaceutical Co. Inc. 1-25-11 Kannondai, Tsukuba-shi Ibaraki 305-0856, JP
CHONO Hideharu, c/o Hisamitsu Pharmaceutical Co. Inc. 1-25-11 Kannondai, Tsukuba-shi Ibaraki 305-0856, JP

(51) MKP
H02K 1/14 (2006.01) (97) **2649704 ***
H02K 11/00 (2006.01)
H02K 21/14 (2006.01)
H02K 47/20 (2006.01)
(86) IB2011055363 29.11.2011
(96) 11799855.9 16.10.2013
(87) WO2012077016, 29.11.2011
(97) 2649704, 16.10.2013 en
(54) ELECTROMECHANICAL MACHINE FOR REGULATING SUPPLIABLE ELECTRIC POWER
(71) Electrogen Research & Development S.r.L., Viale Aventino 36, 00153 Roma, IT
(72) CHIAPPINI, Goffredo, ELECTROGEN RESEARCH& DEVELOPMENT S.r.l. Viale Aventino 36, I-00153 Roma, IT

(51) MKP
A61K 9/14 (2006.01) (97) **2656846 ***
A61K 31/665 (2006.01)
A61K 47/18 (2006.01)
A61P 13/02 (2006.01)
A61P 31/04 (2006.01)
(86) ES2011000366 19.12.2011
(96) 11851679.8 30.10.2013
(87) WO2012085304, 19.12.2011
(97) 2656846, 30.10.2013 en
(54) PHOSPHOMYCIN PHARMACEUTICAL COMPOSITION
(71) Arafarma Group, S.A., 6-10 Pol. Ind. del Henares, Marchamalo 19180, Guadalajara, ES
(72) PICORNELL DARDER, Carlos, C/ Machaquito 48, E-28043 Madrid, ES

(51) MKP
F02M 63/00 (2006.01) (97) **2589790**
(96) 12188925.7 08.05.2013
(97) 2589790, 08.05.2013 en
(54) Plug assembly for high-pressure valve
(71) Delphi Technologies Holding S.à.r.l., Avenue de Luxembourg, 4940 Bascharage, LU
(72) Simon, Jerome, 18 avenue des tailles, 41350 Vineuil, FR
Breant, Christophe, 3 bis rue des Tilleuls, 41000 Saint Sulpice de Pommerary, FR
Priet, Guillaume, 22 rue de la mare, 41000 Blois, FR

(51) MKP
C07D 235/16 (2006.01) (97) **2670735 ***
(86) US2012021686 18.01.2012
(96) 12701642.6 11.12.2013
(87) WO2012106117, 18.01.2012
(97) 2670735, 11.12.2013 en
(54) METHODS FOR THE PREPARATION OF BENDAMUSTINE
(71) Cephalon, Inc., 41 Moores Road P.O. Box 4011, Frazer, PA 19355, US
(72) GAYRING, Anton H., Ahornweg 5, CH-4434 Holstein, CH
MILLER, Scott A., 472 Shadeland Avenue, Drexel Hill, Pennsylvania 19026, US

(51) MKP
C07D 487/08 (2006.01) (97) **2686323 ***
(86) US2012028856 13.03.2012
(96) 12711303.3 22.01.2014
(87) WO2012125603, 13.03.2012
(97) 2686323, 22.01.2014 en
(54) MACROCYCLIC COMPOUNDS AS ALK, FAK AND JAK2 INHIBITORS
(71) Cephalon, Inc., 41 Moores Road P.O. Box 4011, Frazer, PA 19355, US
(72) BRESLIN, Henry J., 1974 Muhlenburg Drive, Lansdale, Pennsylvania 19446, US
DORSEY, Bruce, 1213 Meetinghouse Road, Ambler, Pennsylvania 19002, US
OTT, Gregory R., 117 Wilton Woods Lane, Media, Pennsylvania 19063, US

(51) MKP
A61K 31/137 (2006.01) (97) **2670402 ***
(86) US2012023483 01.02.2012
(96) 12741808.5 11.12.2013
(87) WO2012106426, 01.02.2012
(97) 2670402, 11.12.2013 en
(54) ISOLATED COMPOUNDS FROM TURMERIC OIL AND METHODS OF USE
(71) Cognition Therapeutics, Inc., 2043 Sidney Street, Suite 261, Pittsburgh, PA 15203, US
(72) RISHTON, Gilbert M., 12160 Montana Ave. Apt. 9, Los Angeles, California 90049, US
CATALANO, Susan, 2536 A Sidney Street, Pittsburgh, Pennsylvania 15203, US

(51) MKP
C08H 7/00 (2011.01) (97) **2688939 ***
C08H 8/00 (2010.01)
D21C 5/00 (2006.01)
(86) EP2012053592 02.03.2012
(96) 12706604.1 29.01.2014
(87) WO2012126709, 02.03.2012
(97) 2688939, 29.01.2014 de
(54) METHOD FOR PRODUCING LIGNIN DERIVATIVES
(71) Annikki GmbH, Rankengasse 28a, 8020 Graz, AT
(72) SREBOTNIK, Ewald, Rudolf-Nurejew-Promenade 1/6/12, A-1220 Wien, AT
TERS, Thomas, Rudolf Waisenhorngasse 41/35, A-1230 Wien, AT
FACKLER, Karin, Märzstrasse 163/6, A-1140 Wien, AT
MESSNER, Kurt, Neuwaldeggerstrasse 16/3/7, A-1170 Wien, AT
ERTL, Ortwin, Goethestrasse 19, A-8010 Graz, AT

(51) MKP
F01D 21/00 (2006.01) (97) **2689110 ***
(86) FR2012050463 06.03.2012
(96) 12714750.2 29.01.2014
(87) WO2012127146, 06.03.2012
(97) 2689110, 29.01.2014 fr
(54) SHUT-OFF DEVICE WITH AUTOMATICALLY ACTIVATABLE LOCKING
(71) JPB Systeme, Allée des Pleus ZAC du Tuboeuf, 77170 Briec-Comte-Robert, FR
(72) MARC, Damien, Jacky, 27 rue de Bel Air, F-77370 Nangis, FR

(51) MKP
A61M 5/20 (2006.01) (97) **2661292 ***
A61M 5/32 (2006.01)
(86) EP2011074275 30.12.2011
(96) 11807703.1 13.11.2013
(87) WO2012093070, 30.12.2011
(97) 2661292, 13.11.2013 en
(54) A SAFETY DEVICE FOR A PRE-FILLED SYRINGE AND AN INJECTION DEVICE
(71) Sanofi-Aventis Deutschland GmbH, Brüningstraße 50, 65929 Frankfurt, DE
(72) ROBERTS, Gareth, Glendale Pen-y-cae Road Ruabon, Wrexham LL14 6EB, GB
EKMAN, Matthew, 59 Ecton Avenue Cheshire, Macclesfield Cheshire SK10 1RD, GB

- (51) MKP
A61P 35/02 (2006.01) (97) **2658871 ***
C07K 16/28 (2006.01)
- (86) US2011068235 30.12.2011
(96) 11811633.4 06.11.2013
(87) WO2012092612, 30.12.2011
(97) 2658871, 06.11.2013 en
(54) ANTI-CD38 ANTIBODIES
(71) Takeda Pharmaceutical Company Limited, 1-1 Doshomachi 4-chome Chuo-ku, Osaka-shi, Osaka 541-0045, JP
(72) ELIAS, Kathleen Ann, C/o Takeda San Francisco Inc. 285 East Grand Avenue, South San Francisco, CA 94080, US
LANDES, Gregory, C/o Takeda San Francisco Inc. 285 East Grand Avenue, South San Francisco, CA 94080, US
SINGH, Shweta, C/o Takeda San Francisco Inc. 285 East Grand Avenue, South San Francisco, CA 94080, US
KORVER, Wouter, C/o Takeda San Francisco Inc. 285 East Grand Avenue, South San Francisco, CA 94080, US
DRAKE, Andrew Walling, C/o Takeda San Francisco Inc. 285 East Grand Avenue, South San Francisco, CA 94080, US
HAAK-FRENDSCHO, Mary, C/o Takeda San Francisco Inc. 285 East Grand Avenue, South San Francisco, CA 94080, US
SNELL, Gyorgy Pal, C/o Takeda San Francisco Inc. 285 East Grand Avenue, South San Francisco, CA 94080, US
BHASKAR, Vinay, C/o Takeda San Francisco Inc. 285 East Grand Avenue, South San Francisco, CA 94080, US
-
- (51) MKP
H02K 1/27 (2006.01) (97) **2615723**
H02K 15/03 (2006.01)
H02K 21/12 (2006.01)
H02K 29/03 (2006.01)
- (96) 12179620.5 17.07.2013
(97) 2615723, 17.07.2013 en
(54) A permanent magnet rotor for a rotary electric machine
(71) Montanari Giulio&C. S.r.l., Via Bulgaria 39, 41122 Modena, IT
(72) Mantovani, Alberto, Via Don Giorgio Govoni 4/3, 41035 Massa Finalese, Modena, IT
-
- (51) MKP
A61K 31/519 (2006.01) (97) **2675807 ***
A61P 25/28 (2006.01)
C07D 487/04 (2006.01)
- (86) EP2012052378 13.02.2012
(96) 12705246.2 25.12.2013
(87) WO2012110440, 13.02.2012
(97) 2675807, 25.12.2013 en
(54) 6 - CYCLOBUTYL - 1, 5 - DIHYDRO - PYRAZOLO [3, 4-D] PYRIMIDIN- 4 - ONE DERIVATIVES THEIR USE AS PDE9A INHIBITORS
(71) Boehringer Ingelheim International GmbH, Binger Strasse 173, 55217 Ingelheim am Rhein, DE
(72) HEINE, Niklas, Boehringer Ingelheim GmbH Corporate Patents Binger Strasse 173, 55216 Ingelheim am Rhein, DE
GIOVANNINI, Riccardo, Boehringer Ingelheim GmbH Corporate Patents Binger Strasse 173, 55216 Ingelheim am Rhein, DE
FERRARA, Marco, Boehringer Ingelheim GmbH Corporate Patents Binger Strasse 173, 55216 Ingelheim am Rhein, DE
-
- (51) MKP
C07B 57/00 (2006.01) (97) **2661427 ***
C07D 241/04 (2006.01)
- (86) EP2012050174 06.01.2012
(96) 12700382.0 13.11.2013
(87) WO2012093165, 06.01.2012
(97) 2661427, 13.11.2013 en
(54) METHOD FOR RESOLUTION OF 4-((1R,3S)-6-CHLORO-3-PHENYL-INDAN-1-YL)-1,2,2-TRIMETHYL-PIPERAZINE AND 1-((1R,3S)-6-CHLORO-3-PHENYL-INDAN, 1-YL)-3,3-DIMETHYL-PIPERAZINE
(71) H. Lundbeck A/S, Ottiliavej 9, 2500 Valby, DK
(72) DANCER, Robert, Sønderkær 53, DK-2650 Hvidovre, DK
-
- (51) MKP
A61K 31/155 (2006.01) (97) **2670427 ***
A61K 38/22 (2006.01)
A61P 3/10 (2006.01)
A61P 5/50 (2006.01)
- (86) EP2012051670 01.02.2012
(96) 12703494.0 11.12.2013
(87) WO2012104342, 01.02.2012
(97) 2670427, 11.12.2013 en
(54) PREVENTION OF HYPOGLYCAEMIA IN DIABETES MELLITUS TYPE 2 PATIENTS
(71) Sanofi-Aventis Deutschland GmbH, Brüningstraße 50, 65929 Frankfurt, DE
(72) SILVESTRE, Louise, SANOFI, Département Brevets 174 Avenue de France, F-75013 Paris, FR
BOKA, Gabor, SANOFI, Département Brevets 174 Avenue de France, F-75013 Paris, FR
MIOSSSEC, Patrick, SANOFI, Département Brevets 174 Avenue de France, F-75013 Paris, FR
-
- (51) MKP
G01N 21/78 (2006.01) (97) **2678673 ***
G01N 31/22 (2006.01)
- (86) SI2011000068 25.11.2011
(96) 11813715.7 01.01.2014
(87) WO2012071019, 25.11.2011
(97) 2678673, 01.01.2014 en
(54) SOL-GEL BASED OPTICAL CHEMICAL SENSOR FOR DETECTION OF ORGANOPHOSPHATES AND METHOD FOR PREPARATION THEREOF
(71) Ios, In Titul Za Okoljevarstvo In Senzorje, D.O.O., Beloruska ulica 7, 2000 Maribor, SI
(72) LOBNIK, Aleksandra, Strma ulica 16, 2311 Hoce, SI
KORENT, Urek Spela, Solska ulica 2, 2310 Slovenska Bistrica, SI
-
- (51) MKP
G01R 31/40 (2006.01) (97) **2653880**
- (96) 12165049.3 23.10.2013
(97) 2653880, 23.10.2013 de
(54) Method and system for determining the performance of photovoltaic assemblies
(71) Vodermayr, Christian, Schabing 3, 83119 Obing, DE
(72) Vodermayr, Christian, Schabing 3, 83119 Obing, DE
-
- (51) MKP
F03D 3/06 (2006.01) (97) **2610483**
F03D 7/02 (2006.01)
- (96) 12194989.5 03.07.2013
(97) 2610483, 03.07.2013 fr
(54) Windkraftanlage mit vertikaler Achse
(71) Société Financière Gérard Allot, 9 Rue de l'église, 27370 La Harengère, FR
(72) Allot, Gérard, 9 rue de l'Eglise, 27370 LA HARENGERE, FR
-
- (51) MKP
B21D 22/02 (2006.01) (97) **2576096 ***
B21D 53/78 (2006.01)
F03D 1/06 (2006.01)
- (86) EP2012062927 03.07.2012
(96) 12734882.9 10.04.2013
(87) WO2013020757, 03.07.2012
(97) 2576096, 10.04.2013 de
(54) FORMING PROCESS FOR HOT FORMING A STEEL SHEET OF A ROTOR BLADE TO BE PRODUCED FOR A WIND ENERGY PLANT
(71) Wobben Properties GmbH, Dreekamp 5, 26605 Aurich, DE
(72) VOIGT, Burkhard, Arndstrasse 22, 39108 Magdeburg, DE
LABS, Oliver, Westring 31, 39108 Magdeburg, DE
KERSTEN, Roy, Hauptstrasse 28, 39291 Hohenwarthe, DE

- (51) MKP
A61K 48/00 (2006.01) (97) **2623604**
C12N 15/86 (2006.01)
 (96) 12000703.4 07.08.2013
 (97) 2623604, 07.08.2013 en
 (54) Adenoviral-based biological delivery and expression system for use in the treatment of osteoarthritis
 (71) Baylor College Of Medicine, One Baylor Plaza, Houston, TX 77030, US
 (72) Lee, Brendan, 2219 Sheridan Street, Houston, Texas 77030, US
 Guse, Kilian, Merimiehenkatu 28C 42, 00150 Helsinki, FI
 Ruan, Zhechao, 1922 Augusta Dr., Houston, TX 77057, US

- (51) MKP
G01N 33/564 (2006.01) (97) **2646826 ***
G01N 33/68 (2006.01)
 (86) NL2011050819 30.11.2011
 (96) 11794866.1 09.10.2013
 (87) WO2012074396, 30.11.2011
 (97) 2646826, 09.10.2013 en
 (54) METHOD FOR PROGNOSTICATING THE CLINICAL RESPONSE OF A PATIENT TO B-LYMPHOCYTE INHIBITING OR DEPLETING THERAPY IN INTERFERON DRIVEN DISEASES SUCH AS SLE
 (71) Vereniging Voor Christelijk Hoger Onderwijs, Wetenschappelijk Onderzoek en Patientenzorg, De Boelelaan 1105, 1081 HV Amsterdam, NL
 (72) VERWEIJ, Cornelis Lammert, Willem van Abcoudeaan 24, NL-1391 CD Abcoude, NL

- (51) MKP
E04B 1/00 (2006.01) (97) **2649248 ***
E04F 17/08 (2006.01)
 (86) GB2011051715 13.09.2011
 (96) 11761690.4 16.10.2013
 (87) WO2012076858, 13.09.2011
 (97) 2649248, 16.10.2013 en
 (54) A VERTICAL DUCT FOR BUILDING SERVICES LIKE GAS, WATER, ELECTRICITY, SAID DUCT BEING ACCESSIBLE FROM THE OUTSIDE OF THE BUILDING
 (71) Honeywell Technologies Sarl, Z.A. La Piece 16, 1180 Rolle, CH
 (72) SWINBOURNE, Harry Thomas, Honeywell House Arlington Business Park, Bracknell Berkshire RG12 1EB, GB
 GORDON, Matthew, Honeywell House Arlington Business Park, Bracknell Berkshire RG12 1EB, GB

- (51) MKP
A61K 31/165 (2006.01) (97) **2690088 ***
A61P 1/00 (2006.01)
A61P 9/00 (2006.01)
A61P 25/00 (2006.01)
A61P 25/20 (2006.01)
A61P 25/22 (2006.01)
A61P 25/24 (2006.01)
C07C 231/24 (2006.01)
C07C 233/18 (2006.01)
 (86) CN2012072818 22.03.2012
 (96) 12761142.4 29.01.2014
 (87) WO2012126386, 22.03.2012
 (97) 2690088, 29.01.2014 en
 (54) MIXED CRYSTAL AGOMELATINE (FORM-VIII), PREPARATION METHOD AND USE THEREOF AND PHARMACEUTICAL COMPOSITION CONTAINING SAME
 (71) Les Laboratoires Servier, 35, rue de Verdun, 92284 Suresnes Cedex, FR
 Shanghai Institute Of Pharmaceutical Industry, No.1320 West Beijing Road Jing'an District, Shanghai 200040, CN
 (72) HUANG, Yu, Room 601, No.6, Lane 560 Xinshinan Road, Shanghai 200122, CN
 LONG, Qing, No.143, LeiGuang Road Haojiang District, Shantou, Guangdong 515000, CN
 ZHU, Xueyan, Room 602, No.78, Lane 283 Yangcheng Road Zhabei District, Shanghai 200436, CN
 SHAN, Hanbin, No. 24, Dongfangxincun, Gaoan, Jiangxi 330800, CN
 YUAN, Zhedong, Room 201, No.14, Lane 58 Aomen Road, Shanghai 200060, CN
 YU, Xiong, Room 107, No. 32, Duolun Road Hongkou District, Shanghai 200081, CN

- (51) MKP
A61K 31/357 (2006.01) (97) **2680839 ***
A61K 39/395 (2006.01)
A61P 35/00 (2006.01)
 (86) US2012027488 02.03.2012
 (96) 12708479.6 08.01.2014
 (87) WO2012119077, 02.03.2012
 (97) 2680839, 08.01.2014 en
 (54) CO-ADMINISTRATION OF ERIBULIN AND FARLETUZUMAB FOR THE TREATMENT OF BREAST CANCER
 (71) Morphotek, Inc., 210 Welsh Pool Road, Exton, PA 19341, US
 (72) MALTZMAN, Julia, D., 924 Primrose Lane, Wynnewood, PA 19096, US

- (51) MKP
A61K 31/4188 (2006.01) (97) **2697227 ***
A61P 37/02 (2006.01)
C07D 487/04 (2006.01)
 (86) US2012033245 12.04.2012
 (96) 12715295.7 19.02.2014
 (87) WO2012142237, 12.04.2012
 (97) 2697227, 19.02.2014 en
 (54) FUSED IMIDAZOLE DERIVATIVES USEFUL AS IDO INHIBITORS
 (71) Newlink Genetics Corporation, 2901 South Loop Drive, Suite 3900, Ames, IA 50010-8646, US
 (72) MAUTINO, Mario, 4203 NE Trilein Drive, Ankeny IA 50021, US
 KUMAR, Sanjeev, 2810 Stange Road, 1, Ames IA 50010, US
 WALDO, Jesse, 306 Sycamore Boulevard, Huxley IA 50124, US
 JAIPURI, Firoz, 2719 Laurel Street, Ames IA 50010, US
 KESHARWANI, Tanay, 2927 Woodland Street, 4, Ames IA 50014, US
 ZHANG, Xiaoxia, 1318 B Street B113, Hayward, CA 94541, US

- (51) MKP
C12N 5/00 (2006.01) (97) **2697362 ***
C12N 5/077 (2010.01)
 (86) IB2012000933 15.04.2012
 (96) 12727416.5 19.02.2014
 (87) WO2012140519, 15.04.2012
 (97) 2697362, 19.02.2014 en
 (54) METHODS AND SYSTEMS FOR HARVESTING CELLS
 (71) Pluristem Ltd., Matam Building 20, 31905 Haifa, IL
 (72) KASUTO, Harel, null, 30069 Kibbutz Yifat, IL
 DRORI-CARMI, Nirit, null, 30815 Kibbutz Nahsholim, IL
 ZOHAR, Barak, Mivtza Ovda 16/2, 21996 Karmiel, IL

- (51) MKP
A61F 2/18 (2006.01) (97) **2675394 ***
 (86) US2012025614 17.02.2012
 (96) 12707959.8 25.12.2013
 (87) WO2012112874, 17.02.2012
 (97) 2675394, 25.12.2013 en
 (54) BIOABSORBABLE MULTILAYER NASAL VALVE SPREADER GRAFT
 (71) Ethicon, Inc., U.S. Route 22, Somerville, NJ 08876, US
 (72) CHEN, G., Gavin, 218 Fairfield Lane, Hillsborough, NJ 08844, US
 HRISTOV, Krasimira, 903 Primrose Court, Belle Mead, NJ 08502, US
 GUO, Jianxin, 17 Belmont Drive, Livingston, NJ 07039, US
 MATRUNICH, James, A., 248 Old Tote Road, Mountainside, NJ 07092, US
 ZHOU, Jianguo, Jack, 4308 Rexford Drive, Bethlehem, PA 18020, US

- (51) MKP
A61M 16/00 (2006.01) (97) **2688627 ***
 (86) US2012029817 20.03.2012
 (96) 12764893.9 29.01.2014
 (87) WO2012134887, 20.03.2012
 (97) 2688627, 29.01.2014 en
 (54) BREATHING APPARATUS
 (71) Insleep Technologies, LLC, 3265 Meridian Parkway Suite 114, Weston, FL 33331, US
 (72) GUSKY, Michael, H., 2696 Boot Lane, Weston, FL 33331, US
 LAUK, Michael, Im Wannele 11, 79112 Freiburg, DE
 OSSEO-ASARE, Kwame, L., c/o Insleep Technologies, LLC 3265 Meridian Parkway Suite 114, Weston, FL 33331, US

(51) MKP
F01B 3/00 (2006.01) (97) **2681415 ***
F04B 1/22 (2006.01)
(86) EP2012053531 01.03.2012
(96) 12707284.1 08.01.2014
(87) WO2012117063, 01.03.2012
(97) 2681415, 08.01.2014 de
(54) FLUID ENERGY MACHINE HAVING TWO OPPOSITE CYLINDER ROTORS
(71) Völkerer, Klaus, Diepolz 4, 2620 Wartmannstetten, AT
Eidler, Willibald, Aussichtsgasse 37, 2630 Ternitz, AT
Past, Arno, Ober-Danegg 49, 2632 Grafenbach, AT
Koglbauer, Josef, Feldgasse 3, 2632 Grafenbach, AT
(72) Völkerer, Klaus, Diepolz 4, 2620 Wartmannstetten, AT
Eidler, Willibald, Aussichtsgasse 37, 2630 Ternitz, AT
Past, Arno, Ober-Danegg 49, 2632 Grafenbach, AT
Koglbauer, Josef, Feldgasse 3, 2632 Grafenbach, AT

(51) MKP
C07K 16/00 (2006.01) (97) **2604625**
C07K 16/10 (2006.01)
C07K 16/28 (2006.01)
C07K 16/30 (2006.01)
C07K 16/46 (2006.01)
(96) 12186010.0 19.06.2013
(97) 2604625, 19.06.2013 en
(54) Generation of binding molecules
(71) Merus B.V., Padualaan 8 (postvak 133), 3584 CH Utrecht, NL
(72) Throsby, Mark, c/o Merus B.V. Padualaan 8 (postvak 133), 3584 CH Utrecht, NL
Logtenberg, Ton, c/o Merus B.V. Padualaan 8 (postvak 133), 3584 CH Utrecht, NL
de Kruijff, Cornelis Adriaan, c/o Merus B.V. Padualaan 8 (postvak 133), 3584 CH Utrecht, NL

(51) MKP
B60K 15/04 (2006.01) (97) **2665901 ***
F01N 3/20 (2006.01)
(86) EP2011055706 12.04.2011
(96) 11718958.9 27.11.2013
(87) WO2012139631, 12.04.2011
(97) 2665901, 27.11.2013 de
(54) FILLER NECK FOR A LIQUID TANK, IN PARTICULAR A UREA TANK, ON MOTOR VEHICLES
(71) Reutter GmbH, Hans-Paul-Kaysser-Straße 10, 71397 Leutenbach, DE
(72) KÖRBER, René, Zum Holderbusch 35, 71397 Leutenbach, DE
AL, Igor, Bismarktstraße 30, 71409 Schwaikheim, DE
HÖRNER, Frank, Schippertsacker 8, 71332 Waiblingen, DE

(51) MKP
C07K 16/28 (2006.01) (97) **2694552 ***
(86) US2012032519 06.04.2012
(96) 12723768.3 12.02.2014
(87) WO2012138997, 06.04.2012
(97) 2694552, 12.02.2014 en
(54) NOVEL EGFR BINDING PROTEINS
(71) Amgen Inc., One Amgen Center Drive, Thousand Oaks, California 91320-1799, US
(72) GUO, Amy, 8441 SE 68th Street, No. 238, Mercer Island Washington 98040, US

(51) MKP
A61K 31/00 (2006.01) (97) **2686015 ***
A61K 33/00 (2006.01)
A61K 39/395 (2006.01)
C07K 16/32 (2006.01)
(86) US2012029292 15.03.2012
(96) 12714108.3 22.01.2014
(87) WO2012125864, 15.03.2012
(97) 2686015, 22.01.2014 en
(54) OVERCOMING RESISTANCE TO ERBB PATHWAY INHIBITORS
(71) Merrimack Pharmaceuticals, Inc., One Kendall Square Suite B7201, Cambridge, MA 02139, US
(72) GARCIA, Gabriela, 14 Knoll Street, Roslindale, MA 02131, US
KUBASEK, William, 165 Fairview Avenue, Belmont, MA 02478, US
LAHDENRANTA, Maria, Johanna, 29 Wendell St., 2, Cambridge, MA 02138, US
MACBEATH, Gavin, 9 Sophia's Way, Wakefield, MA 01880, US
MCDONAGH, Charlotte, 11 Sargent Road, Winchester, MA 01890, US
MOYO, Victor, 2 Neshanic Dr., Ringoes, MA 08551, US
ONSUM, Matthew, David, 90 Bynner Street, Jamaica Plain, MA 02130, US
SEVECKA, Mark, 333 Pearl Street, Cambridge, MA 02139, US
WAINSELBAUM, Marisa, 1 Emerson Pl, Apt. 12h, Boston, MA 02114, US
ZHANG, Bo, 14 Village Row, Lynnfield, MA 01940, US
SCHOEBERL, Birgit, 183 Clark Street, Cambridge, MA 02139, US

(51) MKP
A47K 10/38 (2006.01) (97) **2583603**
(96) 11008479.5 24.04.2013
(97) 2583603, 24.04.2013 en
(54) Portable sheet product dispenser
(71) SCA TISSUE FRANCE, 60, avenue de l'Europe, 92270 Bois-Colombes, FR
(72) Marietta-Tondin, Julien, 15 b, rue du Maréchal Joffre, 67390 Marckolsheim, FR
Cattacin, Gilles, 30, rue du Thann, 68000 Colmar, FR
Taylor, James, 5, avenue de Corses Boite 11, Ixelle 1050, BE

(51) MKP
C09D 7/04 (2006.01) (97) **2661473 ***
C09D 167/08 (2006.01)
(86) GB2012000006 06.01.2012
(96) 12700515.5 13.11.2013
(87) WO2012093250, 06.01.2012
(97) 2661473, 13.11.2013 en
(54) ANTISKINNING COMPOSITIONS
(71) OMG UK Technology Limited, Floor 5, 100 Wood Street, London EC2V 7EX, GB
(72) HAGE, Ronald, Rahu Catalytics B.V. BioPartner Center Leiden Wassenaarseweg 72, NL-2333 AL Leiden, NL
GOL, Franjo, Im Steinfeld 17, 51371 Leverkusen, DE
GIBBS, Hugh, Wynn, 13 Birchwood Drive Lower Peover Knutsford, Cheshire WA16 9QJ, GB
MAAIJEN, Karin, Rahu Catalytics B.V. BioPartner Center Leiden Wassenaarseweg 72, NL-2333 AL Leiden, NL

(51) MKP
A61K 31/496 (2006.01) (97) **2658543 ***
A61P 35/00 (2006.01)
(86) US2011067752 29.12.2011
(96) 11811286.1 06.11.2013
(87) WO2012092442, 29.12.2011
(97) 2658543, 06.11.2013 en
(54) THERAPEUTIC COMPOUNDS AND COMPOSITIONS
(71) Agios Pharmaceuticals, Inc., 38 Sidney Street, Cambridge, MA 02139, US
(72) SALITURO, Francesco G., 28 Baker Drive, Marlborough Massachusetts 01752, US
SAUNDERS, Jeffrey O., 188 Tower Road, Lincoln Massachusetts 01773, US
YAN, Shunqi, 55 Stepping Stone, Irvine California 92603, US

(51) MKP
B29C 35/00 (2006.01) (97) **2681041 ***
B29C 53/56 (2006.01)
B29C 53/64 (2006.01)
B29C 70/32 (2006.01)
B29D 23/00 (2006.01)
F16L 9/16 (2006.01)
(86) NL2012050134 05.03.2012
(96) 12709974.5 08.01.2014
(87) WO2012118379, 05.03.2012
(97) 2681041, 08.01.2014 en
(54) METHOD FOR MANUFACTURING CONTINUOUS COMPOSITE TUBE, APPARATUS FOR MANUFACTURING CONTINUOUS COMPOSITE TUBE
(71) Airborne International B.V., Laan van Ypenburg 70-78, 2497 GB 's-Gravenhage, NL
(72) KREMERS, Marcus Antonius Ivonne, Stoombootweg 41, NL-1035 TT Amsterdam, NL

(51) MKP
A61K 31/4709 (2006.01) (97) **2680844 ***
(86) US2012027439 02.03.2012
(96) 12755475.6 08.01.2014
(87) WO2012122011, 02.03.2012
(97) 2680844, 08.01.2014 en
(54) AMINO-QUINOLINES AS KINASE INHIBITORS
(71) GlaxoSmithKline Intellectual Property Development Limited, 980 Great West Road, Brentford Middlesex TW8 9GS, GB
(72) BURY, Michael, Jonathan, 1250 South Collegeville Road, Collegeville, PA 19426, US
CASILLAS, Linda, N., 1250 South Collegeville Road, Collegeville, PA 19426, US
CHARNLEY, Adam, Kenneth, 1250 South Collegeville Road, Collegeville, PA 19426, US
HAILE, Pamela, A., 1250 South Collegeville Road, Collegeville, PA 19426, US
MARQUIS, Robert, W., Jr., 1250 South Collegeville Road, Collegeville, PA 19426, US
MEHLMANN, John, F., 1250 South Collegeville Road, Collegeville, PA 19426, US
ROMANO, Joseph, J., 1250 South Collegeville Road, Collegeville, PA 19426, US
SINGHAUS, Robert, R., 1250 South Collegeville Road, Collegeville, PA 19426, US
WANG, Gren, Z., 1250 South Collegeville Road, Collegeville, PA 19426, US

(51) MKP
B02C 18/30 (2006.01) (97) **2667971 ***
B02C 18/36 (2006.01)
(86) IB2012050140 11.01.2012
(96) 12701943.8 04.12.2013
(87) WO2012101536, 11.01.2012
(97) 2667971, 04.12.2013 en
(54) IMPROVEMENTS FOR A MINCING UNIT CUTTING GROUP
(71) Evolution S.r.l., Via Rigosa 46, 40069 Zola Predosa (Bo), IT
(72) QUADRANA, Marcello, Via Rigosa 46, I-40069 Zola Predosa (bo), IT

(51) MKP
E21B 43/26 (2006.01) (97) **2665937 ***
F04D 1/06 (2006.01)
F04D 29/16 (2006.01)
F04D 29/44 (2006.01)
(86) CA2012000047 19.01.2012
(96) 12736275.4 27.11.2013
(87) WO2012097440, 19.01.2012
(97) 2665937, 27.11.2013 en
(54) HIGH PRESSURE MULTISTAGE CENTRIFUGAL PUMP FOR FRACTURING HYDROCARBON RESERVES
(71) Nexen Energy ULC, 2900, 801 - 7th Avenue S.W., Calgary, Alberta T2P 3P7, CA
(72) PETTIGREW, Dana, 238 Canals Circle S.W., Airdrie Alberta T4B 2Z6, CA
LIMANOWKA, Wojciech A., 81052059 Range Road 220, Sherwood Park Alberta T8E 1B9, CA
VUKADIN, Zoran, 4907 115A St. NW, Edmonton Alberta T6H 3P7, CA

(51) MKP
C09K 11/07 (2006.01) (97) **2652085 ***
F21K 2/06 (2006.01)
(86) US2011065690 17.12.2011
(96) 11811230.9 23.10.2013
(87) WO2012083283, 17.12.2011
(97) 2652085, 23.10.2013 en
(54) VISCOUS CHEMILUMINESCENT COMPONENTS AND DISPENSING MEANS
(71) Cyalume Technologies, Inc, 96 Windsor Street, West Springfield MA 01089, US
(72) PALMER, William, R., 3026 Whitetail Drive, Rescue, CA 95672, US
PALMER, Stephen, L., 4391 Cameron Road, Cameron Park, CA 95682, US

(51) MKP
G02B 6/122 (2006.01) (97) **2652535 ***
G02F 1/19 (2006.01)
(86) CA2011001363 14.12.2011
(96) 11849384.0 23.10.2013
(87) WO2012079152, 14.12.2011
(97) 2652535, 23.10.2013 en
(54) PHOTONIC CRYSTAL DEVICE WITH OFFSET ACTIVATION
(71) Opalux Incorporated, Lash Miller Laboratories Room 308 80 St. George Street, Toronto, Ontario M5S 3H6, CA
(72) ARSENAULT, Andre, 25 Holland Avenue, Toronto, Ontario M4B 2C4, CA

(51) MKP
H02B 1/32 (2006.01) (97) **2684264 ***
(86) US2012028175 08.03.2012
(96) 12755622.3 15.01.2014
(87) WO2012122324, 08.03.2012
(97) 2684264, 15.01.2014 en
(54) ELECTRICAL ENCLOSURE
(71) Ericson Manufacturing Company, 4215 Hamann Parkway, Willoughby, OH 44094, US
(72) HUGHES, Ron, 6040 Sidley Road, Thompson, OH 44086, US

(51) MKP
C07K 1/18 (2006.01) (97) **2649087 ***
(86) US2011062094 23.11.2011
(96) 11793955.3 16.10.2013
(87) WO2012078376, 23.11.2011
(97) 2649087, 16.10.2013 en
(54) ION EXCHANGE CHROMATOGRAPHY IN THE PRESENCE OF AN AMINO ACID
(71) Amgen Inc., One Amgen Center Drive, Thousand Oaks, California 91320-1799, US
(72) GILLESPIE, Ronald, 7344 Earl Avenue NW, Seattle WA 98117, US
VUNNUM, Suresh, 13805 SE 52nd Place, Bellevue WA 98006, US
NGUYEN, Thao, 2021 NE 32nd Street, Renton WA 98056, US
MACNEIL, Sean, 4814 51st Avenue S, Seattle WA 98118, US

- (51) MKP
A61K 9/00 (2006.01) (97) **2651396 ***
A61K 9/107 (2006.01)
A61K 9/48 (2006.01)
A61K 38/13 (2006.01)
A61K 47/10 (2006.01)
A61K 47/14 (2006.01)
A61K 47/22 (2006.01)
A61K 47/26 (2006.01)
(86) EP2011072463 12.12.2011
(96) 11794739.0 23.10.2013
(87) WO2012080176, 12.12.2011
(97) 2651396, 23.10.2013 en
(54) PHARMACEUTICAL COMPOSITIONS
(71) Novartis AG, Lichtstrasse 35, 4056 Basel, CH
Debiopharm S.A., Forum "Après-Demain" Chemin Messidor
5-7 CP 5911, 1002 Lausanne, CH
(72) GONCALVES, Elisabete, c/o Novartis Pharma AG Postfach,
CH-4002 Basel, CH
RAPP, Karin, c/o Novartis Pharma AG Postfach, CH-4002
Basel, CH
SUTTER, Bertrand, c/o Novartis Pharma AG Postfach, CH-4002
Basel, CH
STOWASSER, Frank, c/o Novartis Pharma AG Postfach, CH-
4002 Basel, CH
TRUPP, Bjoern, c/o Novartis Pharma AG Postfach, CH-4002
Basel, CH
CHABAUT, Sebastian, c/o Debiopharm S.A. Forum "apres-
demain" Chemin Messidor 5-7, CH-5911-1002 Lausanne, CH
THORENS, Julien, c/o Debiopharm S.A. Forum "apres-demain"
Chemin Messidor 5-7, CH-5911-1002 Lausanne, CH

- (51) MKP
A01N 43/54 (2006.01) (97) **2667720 ***
A01N 59/02 (2006.01)
A01N 43/50 (2006.01)
A01N 47/36 (2006.01)
A01N 43/28 (2006.01)
A01N 47/34 (2006.01)
A01N 43/16 (2006.01)
A01N 47/30 (2006.01)
A01N 37/24 (2006.01)
A01N 47/24 (2006.01)
A01N 37/16 (2006.01)
A01N 43/653 (2006.01)
A01N 35/04 (2006.01)
A01N 47/32 (2006.01)
A01N 37/34 (2006.01)
(86) IN2012000067 30.01.2012
(96) 12739082.1 04.12.2013
(87) WO2012101660, 30.01.2012
(97) 2667720, 04.12.2013 en
(54) PESTICIDAL COMPOSITION COMPRISING SULPHUR, A
FUNGICIDE AND AN AGROCHEMICAL EXCIPIENT
(71) Shah, Deepak Pranjivandas, 501/502 Vandana Apartments
Janki Kutir Juhu Church Road Juhu, Mumbai, Maharashtra
400 009, IN
(72) Shah, Deepak Pranjivandas, 501/502 Vandana Apartments
Janki Kutir Juhu Church Road Juhu, Mumbai, Maharashtra
400 009, IN

- (51) MKP
G01S 7/28 (2006.01) (97) **2678711 ***
G01S 13/58 (2006.01)
G01S 13/93 (2006.01)
G01S 15/58 (2006.01)
G01S 15/93 (2006.01)
G01S 17/93 (2006.01)
(86) IB2012050864 24.02.2012
(96) 12711247.2 01.01.2014
(87) WO2012114313, 24.02.2012
(97) 2678711, 01.01.2014 en
(54) PROXIMITY SENSOR
(71) CY.PAG. S.r.l., Via del Commercio 13, 23017 Morbegno
(sondrio), IT
(72) POZZI, Silvio, c/o CY.PAG. S.R.L. Via del Commercio 13,
I-23017 Morbegno (Sondrio), IT
PRANDINI, Ivano, c/o CY.PAG. S.R.L. Via del Commercio 13,
I-23017 Morbegno (Sondrio), IT
BOTTA', Nicola, c/o CY.PAG. S.R.L. Via del Commercio 13,
I-23017 Morbegno (Sondrio), IT
PAGNI, Luca, c/o CY.PAG. S.R.L. Via del Commercio 13,
I-23017 Morbegno (Sondrio), IT

- (51) MKP
B63B 1/24 (2006.01) (97) **2665638 ***
(86) CA2012000054 16.01.2012
(96) 12736898.3 27.11.2013
(87) WO2012097444, 16.01.2012
(97) 2665638, 27.11.2013 en
(54) FOIL STRUCTURE FOR PROVIDING BUOYANCY AND LIFT
(71) Aeromarine Innovations Inc., 50 Confederation Villas, N.W.
Calgary, Alberta T2L 2K9, CA
(72) JESS, Peter E., 50 Confederation Villas, N.W. Calgary Alberta
T2L 2K9, CA
DALEY, Carl, 1 Camden Causeway, Apt 11, Elizabeth City,
North Carolina 27909, US

- (51) MKP
A61K 31/4412 (2006.01) (97) **2683689 ***
A61K 31/4427 (2006.01)
A61K 31/4433 (2006.01)
A61K 31/4439 (2006.01)
A61P 31/00 (2006.01)
C07D 213/64 (2006.01)
C07D 213/69 (2006.01)
C07D 401/04 (2006.01)
C07D 401/10 (2006.01)
C07D 405/04 (2006.01)
C07D 405/12 (2006.01)
C07D 413/10 (2006.01)
C07D 417/12 (2006.01)
(86) IB2012050812 22.02.2012
(96) 12709179.1 15.01.2014
(87) WO2012120397, 22.02.2012
(97) 2683689, 15.01.2014 en
(54) FLUORO-PYRIDINONE DERIVATIVES USEFUL AS
ANTIBACTERIAL AGENTS
(71) Pfizer Inc, 235 East 42nd Street, New York, NY 10017, US
BROWN, Matthew Frank, Pfizer Global Research &
Development Eastern Point Road, Groton, CT 06340, US
CHE, Ye, Pfizer Global Research & Development Eastern Point
Road, Groton, Connecticut 06340, US
MELNICK, Michael Joseph, 7159 Hickory Point Drive, Portage,
Michigan 49024, US
MONTGOMERY, Justin Ian, Pfizer Global Research &
Development Eastern Point Road, Groton, CT 06340, US
PLUMMER, Mark Stephen, 6 Halls Road, Westbrook,
Connecticut 06498, US
PRICE, Loren Michael, Pfizer Global Research & Development
Eastern Point Road, Groton, Connecticut 06340, US
REILLY, Usa, Pfizer Global Research & Development Eastern
Point Road, Groton, Connecticut 06340, US

- (51) MKP
A61K 31/444 (2006.01) (97) **2679585 ***
A61P 25/24 (2006.01)
A61P 25/04 (2006.01)
A61P 43/00 (2006.01)
A61K 31/4439 (2006.01)
A61P 25/22 (2006.01)
C07D 401/04 (2006.01)
A61P 25/20 (2006.01)
C07D 417/14 (2006.01)
A61P 25/16 (2006.01)
C07D 401/14 (2006.01)
A61K 31/506 (2006.01)
A61P 25/28 (2006.01)
A61P 25/00 (2006.01)
A61P 25/30 (2006.01)
A61P 25/18 (2006.01)
C07D 413/14 (2006.01)
(86) JP2012054110 21.02.2012
(96) 12749664.4 01.01.2014
(87) WO2012115097, 21.02.2012
(97) 2679585, 01.01.2014 en
(54) GLYCINE TRANSPORT INHIBITOR
(71) Taisho Pharmaceutical Co., Ltd., 24-1, Takada 3-chome
Toshima-ku, Tokyo 170-8633, JP
(72) MORIYA, Minoru, c/o Taisho Pharmaceutical Co. Ltd. 24-1
Takada 3-chome Toshima-ku, Tokyo 170-8633, JP
OHTA, Hiroshi, c/o Taisho Pharmaceutical Co. Ltd. 24-1 Takada
3-chome Toshima-ku, Tokyo 170-8633, JP
YAMAMOTO, Shuji, c/o Taisho Pharmaceutical Co. Ltd. 24-1
Takada 3-chome Toshima-ku, Tokyo 170-8633, JP
ABE, Kumi, c/o Taisho Pharmaceutical Co. Ltd. 24-1 Takada
3-chome Toshima-ku, Tokyo 170-8633, JP
ARAKI, Yuko, c/o Taisho Pharmaceutical Co. Ltd. 24-1 Takada
3-chome Toshima-ku, Tokyo 170-8633, JP
SUN, Xiang-Min, c/o Taisho Pharmaceutical Co. Ltd. 24-1
Takada 3-chome Toshima-ku, Tokyo 170-8633, JP
WAKASUGI, Daisuke, c/o Taisho Pharmaceutical Co. Ltd. 24-1
Takada 3-chome Toshima-ku, Tokyo 170-8633, JP

- (51) MKP
F24J 2/04 (2006.01) (97) **2646757 ***
F24J 2/52 (2006.01)
(86) FR2011052806 29.11.2011
(96) 11808671.9 09.10.2013
(87) WO2012072941, 29.11.2011
(97) 2646757, 09.10.2013 fr
(54) BUOYANT SOLAR PANEL, AND SOLAR POWER PLANT
CONSISTING OF AN ASSEMBLY OF SAID PANELS
(71) Active Innovation Management, 42 rue des sources, 92160
Antony, FR
(72) BERSANO, Giacomo, 42 rue des Sources, F-92160 Antony, FR
BOBBIO, Massimo, Strada dei Biononi 3, I-10156 Torino, IT

- (51) MKP
B60R 19/03 (2006.01) (97) **2567932**
B60R 19/22 (2006.01)
B60R 21/11 (2006.01)
B60R 21/13 (2006.01)
B62D 33/06 (2006.01)
B66F 9/075 (2006.01)
E02F 9/16 (2006.01)
(96) 11180784.8 13.03.2013
(97) 2567932, 13.03.2013 en
(54) Impact deceleration device for material handling equipments.
(71) Ingenieursbureau Wuylens BVBA, Vossenberglaan 10, 9070
Destelbergen, BE
(72) Wuylens Philippe, Philippe, Vossenberglaan 10, 9070
DESTELBERGEN, BE

- (51) MKP
B65B 31/02 (2006.01) (97) **2651767 ***
(86) IB2011055606 12.12.2011
(96) 11813399.0 23.10.2013
(87) WO2012080932, 12.12.2011
(97) 2651767, 23.10.2013 en
(54) DEVICE FOR VACUUM PACKAGING, PARTICULARLY OF
FOOD PRODUCTS
(71) Blu Pack Di Scolaro Mauro, Via Pio X 1, 20063 Cernusco Sul
Naviglio, IT
Extru SA, Poligono Industrial, S/N, 31840 Huarte Araquil
Navarra, ES
(72) SCOLARO, Mauro, Via Pio X 1, I-20063 Cernusco Sul Naviglio,
IT

- (51) MKP
A61K 31/437 (2006.01) (97) **2651934 ***
A61P 31/12 (2006.01)
C07D 471/04 (2006.01)
C07D 487/04 (2006.01)
(86) EP2011073017 16.12.2011
(96) 11796711.7 23.10.2013
(87) WO2012080451, 16.12.2011
(97) 2651934, 23.10.2013 en
(54) IMIDAZOPYRIDINES AS RESPIRATORY SYNCYTIAL VIRUS
ANTIVIRAL AGENTS
(71) Janssen R&D Ireland, Eastgate Village, Eastgate, Little Island,
County Cork, IE
(72) COOYMANS, Ludwig Paul, Grote Beekstraat 24, B-2340
Beerse, BE
HU, Lili, Vrouw van Mechelenstraat 28, B-2800 Mechelen, BE
JONCKERS, Tim Hugo Maria, Pastoor Wouterstraat 19, bus 5,
B-2650 Edegem, BE
RABOISSON, Pierre Jean-Marie Bernard, Rue Jolie 3, B-1331
Rosieres, BE
TAHRI, Abdellah, Rue Maurice Albert Raskin 30, B-1070
Anderlecht, BE
VAN HOOFF, Steven Maurice Paula, Hundelgemsesteenweg
804, B-9820 Merelbeke, BE
VENDEVILLE, Sandrine Marie Helene, Rue du Bémel 142,
B-1150 Woluwe-Saint-Pierre, BE

- (51) MKP
B60G 9/02 (2006.01) (97) **2444304**
B60G 17/016 (2006.01)
B60R 21/013 (2006.01)
B62D 49/08 (2006.01)
B66F 9/06 (2006.01)
E02F 9/22 (2006.01)
G08B 19/00 (2006.01)
(96) 11186576.2 25.04.2012
(97) 2444304, 25.04.2012 en
(54) System and method for preventing overturning of land vehicles
(71) CNH Italia S.p.A., Via Plava 80, 10135 Torino, IT
(72) Bordini, Giorgio, Via Pascoli 111, 41043 Formigine, IT

- (51) MKP
A61K 31/35 (2006.01) (97) **2670407 ***
A61K 31/70 (2006.01)
A61P 29/00 (2006.01)
A61P 31/12 (2006.01)
(86) US2012024005 06.02.2012
(96) 12741734.3 11.12.2013
(87) WO2012106722, 06.02.2012
(97) 2670407, 11.12.2013 en
(54) TREATMENT OF BACTERIAL INFECTIONS
(71) Optimer Pharmaceuticals, Inc., 10110 Sorrento Valley Road
Suite C, San Diego, CA 92121, US
(72) ICHIKAWA, Yoshi, 10110 Sorrento Valley Road Suite C, San
Diego CA 92121, US
GORBACH, Sherwood, 10110 Sorrento Valley Road Suite C,
San Diego CA 92121, US

- (51) MKP
A61K 31/4985 (2006.01) (97) **2570415**
A61P 19/02 (2006.01)
C07D 487/04 (2006.01)
(96) 11306179.0 20.03.2013
(97) 2570415, 20.03.2013 en
(54) N-[4-(1H-Pyrazolo[3,4-b]pyrazin-6-yl)-phenyl]-sulfonamides and their use as pharmaceuticals
(71) SANOFI, 54 rue La Boétie, 75008 Paris, FR
(72) Nazaré, Marc, c/o Sanofi-Aventis Deutschland GmbH, 65926 Frankfurt am Main, DE
Halland, Nis, c/o Sanofi-Aventis Deutschland GmbH, 65926 Frankfurt am Main, DE
Schmidt, Friedemann, c/o Sanofi-Aventis Deutschland GmbH, 65926 Frankfurt am Main, DE
Weiss, Tilo, c/o Sanofi-Aventis Deutschland GmbH, 65926 Frankfurt am Main, DE
Dietz, Uwe, c/o Sanofi-Aventis Deutschland GmbH, 65926 Frankfurt am Main, DE
Hofmeister, Armin, c/o Sanofi-Aventis Deutschland GmbH, 65926 Frankfurt am Main, DE

- (51) MKP
G01N 33/564 (2006.01) (97) **2676137 ***
G01N 33/94 (2006.01)
(86) US2012025437 16.02.2012
(96) 12707193.4 25.12.2013
(87) WO2012154253, 16.02.2012
(97) 2676137, 25.12.2013 en
(54) ASSAYS FOR DETECTING AUTOANTIBODIES TO ANTI-TNF DRUGS
(71) Nestec S.A., Avenue Nestlé 55, 1800 Vevey, CH
(72) SINGH, Sharat, 8171 Top of the Morning Way, Rancho Santa Fe California 92127, US
WANG, Shui Long, 4555 Saddle Mountain Court, San Diego California 92130, US
OHRMUND, Linda, 3519 Tennyson Street, San Diego California 92106, US
HAUENSTEIN, Scott, 3565 Caminito El Rincon 211, San Diego California 92130, US

- (51) MKP
C12N 15/09 (2006.01) (97) **2684963 ***
C12Q 1/02 (2006.01)
(86) JP2012055719 06.03.2012
(96) 12755075.4 15.01.2014
(87) WO2012121261, 06.03.2012
(97) 2684963, 15.01.2014 en
(54) METHOD FOR SCREENING FOR COMPOUND CAPABLE OF ENHANCING OR INHIBITING OATP1B1 TRANSPORT ACTIVITY, AND METHOD FOR DETERMINING EXPRESSION LEVEL OF OATP1B1
(71) Eisai R&D Management Co., Ltd., 6-10, Koishikawa 4-chome Bunkyo-ku, Tokyo 112-8088, JP
(72) IZUMI Saki, c/o EISAI CO. LTD. Tsukuba Research Laboratories 1-3 Tokodai 5-chome, Tsukuba-shi Ibaraki 300-2635, JP
KOMORI Takafumi, c/o EISAI CO. LTD. Tsukuba Research Laboratories 1-3 Tokodai 5-chome, Tsukuba-shi Ibaraki 300-2635, JP
NOZAKI Yoshitane, c/o EISAI CO. LTD. Tsukuba Research Laboratories 1-3 Tokodai 5-chome, Tsukuba-shi Ibaraki 300-2635, JP

- (51) MKP
A61K 8/23 (2006.01) (97) **2614812**
A61K 8/43 (2006.01)
A61K 8/67 (2006.01)
A61K 8/73 (2006.01)
A61Q 11/00 (2006.01)
(96) 13150734.5 17.07.2013
(97) 2614812, 17.07.2013 en
(54) Mouthwash
(71) Castellaccio, Restituta, Via Trento 34, 21047 Saronno (VA), IT
(72) Castellaccio, Restituta, Via Trento 34, 21047 Saronno (VA), IT

- (51) MKP
B32B 17/10 (2006.01) (97) **2665601 ***
B32B 17/12 (2006.01)
B60Q 3/02 (2006.01)
G02B 6/00 (2006.01)
(86) FR2012050101 17.01.2012
(96) 12705335.3 27.11.2013
(87) WO2012098330, 17.01.2012
(97) 2665601, 27.11.2013 fr
(54) LUMINOUS GLASS PANEL
(71) Saint-Gobain Glass France, 18 avenue d'Alsace, 92400 Courbevoie, FR
(72) VERGER, Arnaud, 20 rue de la Glacière, F-75013 Paris, FR
VERMERSCH, François-Julien, 26 avenue Reille, F-75014 Paris, FR
LECAMP, Guillaume, 52 rue de Clignancourt, F-75018 Paris, FR
SOLARSKI, Samuel, 269bis Avenue de la République, F-59110 la Madeleine, FR
VERRAT-DEBAILLEUL, Adèle, 14 Allée de la Montagne, F-60150 Villers-sur-Coudun, FR
MOTTELET, Béatrice, 14 boulevard Gambetta, F-60200 Compiègne, FR
KLEO, Christophe, 17 rue Coqueret, F-60350 Attichy, FR
BAUERLE, Pascal, 2A rue Pasteur, F-80700 Roye, FR
PIROUX, Fabienne, 11 bis rue Notre Dame de Bon Secours, 60200 Compiègne, FR
RICHARD, Alexandre, 31 rue Tandou - Apt C29, F-75019 Paris, FR

- (51) MKP
B32B 23/06 (2006.01) (97) **2651642 ***
B32B 29/04 (2006.01)
B65D 65/46 (2006.01)
(86) IT2010000498 13.12.2010
(96) 10807490.7 23.10.2013
(87) WO2012081041, 13.12.2010
(97) 2651642, 23.10.2013 en
(54) MULTILAYER BASED ON CELLULOSE AND DERIVATES THEREOF
(71) B.B.S. S.p.A., Via Viazza 3043, 41018 San Cesario Sul Panaro (Modena), IT
(72) LELLI, Marco, Via San Michele 46, I-40063 Monghidoro (Bologna), IT
BALDUCCI, Giulia, Via Vincini 7, I-47921 Rimini, IT
FORESTI, Elizabetta, Via Capriglia 148, I-55045, IT
LECSI, Isidoro Georgio, Viale Firenze 235, I-48014 Castel Bolognese (Ravenna), IT
MARCHETTI, Marco, Via San Giovanni 19, I-63010 Montefiore Dell'Aso (Ascoli Piceno), IT
PIERINI, Filippo, Via Saragat 35, I-61037 Mondolfo (Pesaro-Urbino), IT
ROVERI, Norberto, Via Q. di Marzio 20, I-40133 Bologna, IT
SANGIORGI, Sabrina, Via Emilia Est 150/A, 41013 Castelfranco Emilia (Modena), IT
SANGIORGI, Linda, Via Emilia Est 150/B, I-41013 Castelfranco Emilia (Modena), IT

- (51) MKP
A61K 9/20 (2006.01) (97) **2654733 ***
A61K 31/485 (2006.01)
(86) IB2011003162 22.12.2011
(96) 11813813.0 30.10.2013
(87) WO2012085657, 22.12.2011
(97) 2654733, 30.10.2013 en
(54) TAMPER RESISTANT SOLID ORAL DOSAGE FORMS
(71) Purdue Pharma LP, One Stamford Forum 201 Tresser Boulevard, Stamford, CT 06901-3431, US
(72) SACKLER, Richard, S., 25 Windrose Way, Greenwich CT 06830, US

- (51) MKP
B65G 1/137 (2006.01) (97) **2390204**
(96) 11158966.9 30.11.2011
(97) 2390204, 30.11.2011 de
(54) System for completing a warehouse for small articles
(71) Ferrometal OY, Karhutie 9, 01900 Nurmijärvi, FI
Würth Industrie Service GmbH & Co. KG, Drillberg, 97980 Bad Mergentheim, DE
(72) Rantanen, Mika, Ferrometal Oy Karhutie 9, 01900, Nurmijärvi, FI
Brandt, Mika, Ferrometal Oy Karhutie 9, 01900, Nurmijärvi, FI

- (51) MKP
G09F 7/18 (2006.01) (97) **2671212 ***
- (86) EP2012051598 31.01.2012
(96) 12703045.0 11.12.2013
(87) WO2012104317, 31.01.2012
(97) 2671212, 11.12.2013 en
(54) HANGERS FOR DISPLAY MATERIAL
(71) AUGUSTUS MARTIN LIMITED, St. Andrews Way, Bromley-by-Bow, London E3 3PB, GB
(72) PATTISON, Daniel, Augustus Martin Limited St Andrews Way Bromley-by-Bow, London E3 3PB, GB
ASLET, Peter, Augustus Martin Limited St Andrews Way Bromley-by-Bow, London E3 3PB, GB
STOKES, Glyn, Augustus Martin Limited St Andrews Way Bromley-by-Bow, London E3 3PB, GB
BARROW, Lascelle, Augustus Martin Limited St Andrews Way Bromley-by-Bow, London E3 3PB, GB
-
- (51) MKP
A61K 31/40 (2006.01) (97) **2670486 ***
A61P 3/00 (2006.01)
- (86) IN201200069 30.01.2012
(96) 12710562.5 11.12.2013
(87) WO2012104869, 30.01.2012
(97) 2670486, 11.12.2013 en
(54) TREATMENT FOR LIPODYSTROPHY
(71) Cadila Healthcare Limited, Zydus Tower Satellite Cross Roads, Ahmedabad 380 015, Gujarat, IN
(72) GAMBHIRE, Dhiraj, Cadila Healthcare Limited Zydus Tower Satellite Cross Roads Ahmedabad 380015, Gujarat, IN
JANI, Rajendrakumar Hariprasad, Cadila Healthcare Limited Zydus Tower Satellite Cross Roads Ahmedabad 380015, Gujarat, IN
PANDEY, Bipin, Cadila Healthcare Limited Zydus Tower Satellite Cross Roads Ahmedabad 380015, Gujarat, IN
SATA, Kaushik, Cadila Healthcare Limited Zydus Tower Satellite Cross Roads Ahmedabad 380015, Gujarat, IN
KOTHARI, Himanshu, Cadila Healthcare Limited Zydus Tower Satellite Cross Roads Ahmedabad 380015, Gujarat, IN
PATEL, Pankaj Ramanbhai, Cadila Healthcare Limited Zydus Tower Satellite Cross Roads Ahmedabad 380015, Gujarat, IN
-
- (51) MKP
B05B 7/16 (2006.01) (97) **2574424**
B23Q 11/10 (2006.01)
- (96) 12186301.3 03.04.2013
(97) 2574424, 03.04.2013 de
(54) Method for cooling aerosols
(71) Rother Technologie GmbH & Co. KG, Rübteile 20, 72574 Bad Urach, DE
(72) Rother, Reiner, Wasenweg 29, 72574 Bad Urach, DE
-
- (51) MKP
A61K 39/395 (2006.01) (97) **2654792 ***
C12P 21/08 (2006.01)
- (86) US2011066557 21.12.2011
(96) 11851807.5 30.10.2013
(87) WO2012088302, 21.12.2011
(97) 2654792, 30.10.2013 en
(54) HALF IMMUNOGLOBULIN BINDING PROTEINS AND USES THEREOF
(71) AbbVie Inc., 1 North Waukegan Road, North Chicago, IL 60064, US
(72) GHAYUR, Tariq, 1014 Washington Street, Holliston, MA 01746, US
GU, Jijie, 19 Crimson Drive, Shrewsbury, MA 01545, US
LIU, Junjian, 14 Crimson Drive, Shrewsbury, MA 01545, US
HUTCHINS, Charles, W., 31005 Prairie Ridge Road, Green Oaks, IL 60048, US
-
- (51) MKP
F02D 41/22 (2006.01) (97) **2594775**
F02M 25/07 (2006.01)
- (96) 11189279.0 22.05.2013
(97) 2594775, 22.05.2013 en
(54) A method of assessing the functioning of an EGR cooler in an internal combustion engine
(71) Delphi Technologies Holding S.à.r.l., Avenue de Luxembourg, 4940 Bascharage, LU
(72) Michel, Eric, Rue de Guerlange 42, 6780 Messancy, BE
-
- (51) MKP
A61K 31/402 (2006.01) (97) **2697196 ***
A61K 31/415 (2006.01)
A61P 9/10 (2006.01)
C07D 207/34 (2006.01)
C07D 231/14 (2006.01)
- (86) US2012033353 12.04.2012
(96) 12723771.7 19.02.2014
(87) WO2012142308, 12.04.2012
(97) 2697196, 19.02.2014 en
(54) PRODRUGS OF INHIBITORS OF PLASMA KALLIKREIN
(71) Activesite Pharmaceuticals, Inc., 187 Magellan Avenue, San Francisco, CA 94116, US
(72) SINHA, Sukanto, 187 Magellan Avenue, San Francisco California 94116, US
CHILCOTE, Tamie Jo, 187 Magellan Avenue, San Francisco California 94116, US
SURESH, Joghee Raju, null, Bangalore Karnataka, IN
NARASIMHAN, Sriram, null, Bangalore Karnataka, IN
-
- (51) MKP
B65D 75/58 (2006.01) (97) **2589547**
B65D 75/62 (2006.01)
- (96) 11187803.9 08.05.2013
(97) 2589547, 08.05.2013 en
(54) Flow wrap packaging
(71) Nestec S.A., Avenue Nestlé 55, 1800 Vevey, CH
(72) Labrousse Molla, Sophie, 18, Rue Boutmy, 80000 Amiens, FR
Rota, Mikael, 13, Rue Jean Mazille, 60000 Beauvais, FR
Lebrand, Pierre-Henri, 1, Rue de Velennes, 60510 Bonlier, FR
-
- (51) MKP
G06Q 20/40 (2012.01) (97) **2695121 ***
- (86) IB2011003344 30.12.2011
(96) 11854421.2 12.02.2014
(87) WO2012090074, 30.12.2011
(97) 2695121, 12.02.2014 en
(54) TERMINAL AUTHENTICITY VERIFICATION
(71) Kanngard, Lars Olof, 333-34 Mooban Ladawan Soi Chalermpraiat (Sukhumvit 103), Nongbon Pravate, Bangkok 10250, TH
(72) Kanngard, Lars Olof, 333-34 Mooban Ladawan Soi Chalermpraiat (Sukhumvit 103), Nongbon Pravate, Bangkok 10250, TH
-
- (51) MKP
A61M 5/20 (2006.01) (97) **2675506 ***
A61M 5/32 (2006.01)
- (86) EP2012052640 16.02.2012
(96) 12705108.4 25.12.2013
(87) WO2012110573, 16.02.2012
(97) 2675506, 25.12.2013 en
(54) AUTO-INJECTOR
(71) Sanofi-Aventis Deutschland GmbH, Brüningstraße 50, 65929 Frankfurt am Main, DE
(72) BRERETON, Simon Francis, 75 De Freville Avenue, Cambridge Cambridgeshire CB4 1HP, GB
KEMP, Thomas, 3 Forresters Cottages High Steet, Ashwell Hertfordshire SG7 5NW, GB
BURNELL, Rosie, 56 Cavendish Avenue, Cambridge Cambridgeshire CB1 7UT, GB
EKMAN, Matthew, 59 Ecton Avenue, Macclesfield Cheshire SK10 1RD, GB

(51) MKP
C12Q 1/68 (2006.01) (97) **2675916 ***
 (86) IB2012000995 15.02.2012
 (96) 12728767.0 25.12.2013
 (87) WO2012110899, 15.02.2012
 (97) 2675916, 25.12.2013 en
 (54) METHOD FOR LOCALIZED IN SITU DETECTION OF mRNA
 (71) Leica Biosystems Newcastle Limited, Balliol Business Park
 West Benton Lane, Newcastle Upon Tyne NE12 8EW, GB
 (72) BERNITZ, Mats, Nilsson, Appelviksvagen 1, 16753 Bromma,
 SE
 LARSSON, Chatarina, Cellövägen 124A, 75654 Uppsala, SE
 GRUNDBERG, Ida, Marielundsgatan 3A, 75325 Uppsala, SE

(51) MKP
C02F 1/68 (2006.01) (97) **2675759 ***
 (86) US2011051244 12.09.2011
 (96) 11862244.8 25.12.2013
 (87) WO2012134527, 12.09.2011
 (97) 2675759, 25.12.2013 en
 (54) SUSTAINABLE METHOD AND SYSTEM FOR TREATING
 WATER BODIES AFFECTED BY BACTERIA AND
 MICROALGAE AT LOW COST
 (71) Crystal Lagoons (Curaçao) B.V., Kaya W.F.G. (Jombi), Mensing
 14, CW
 (72) FISCHMANN, T., Fernando, Avenida Kennedy, 8830 Vitacura,
 Santiago, CL

(51) MKP
H04W 74/08 (2009.01) (97) **2692194 ***
 (86) US2012029655 19.03.2012
 (96) 12711316.5 05.02.2014
 (87) WO2012134863, 19.03.2012
 (97) 2692194, 05.02.2014 en
 (54) SYSTEM AND METHOD FOR CLEAR CHANNEL
 ASSESSMENT THAT SUPPORTS SIMULTANEOUS
 TRANSMISSION BY MULTIPLE WIRELESS PROTOCOLS
 (71) QUALCOMM Incorporated, International IP Administration 5775
 Morehouse Drive, San Diego, California 92121-1714, US
 (72) HUSTED, Paul J., 1700 Technology Drive, San Jose, California
 95110, US
 HIRSCH, Olaf J., 1700 Technology Drive, San Jose, California
 95110, US

(51) MKP
A61K 31/437 (2006.01) (97) **2651922 ***
A61P 31/12 (2006.01)
C07D 403/06 (2006.01)
C07D 471/04 (2006.01)
 (86) EP2011073011 16.12.2011
 (96) 11794793.7 23.10.2013
 (87) WO2012080447, 16.12.2011
 (97) 2651922, 23.10.2013 en
 (54) INDOLES AS RESPIRATORY SYNCYTIAL VIRUS ANTIVIRAL
 AGENTS
 (71) Janssen R&D Ireland, Eastgate Village, Eastgate, Little Island,
 County Cork, IE
 (72) COOYMANS, Ludwig Paul, Grote Beekstraat 24, B-2340
 Beerse, BE
 DEMIN, Samuël Dominique, Professor Claraplein 14, Bus 308,
 B-2018 Antwerpen, BE
 HU, Lili, Vrouw van Mechelenstraat 28, B-2800 Mechelen, BE
 JONCKERS, Tim Hugo Maria, Pastoor Wouterstraat 19, bus 5,
 B-2650 Edegem, BE
 RABOISSON, Pierre Jean-Marie Bernard, Rue Jolie 3, B-1331
 Rosières, BE
 TAHRI, Abdellah, Rue Maurice Albert Raskin 30, B-1070
 Anderlecht, BE
 VENDEVILLE, Sandrine Marie Helene, Rue du Bémel 142,
 B-1150 Woluwe-Saint-Pierre, BE

(51) MKP
A61B 17/00 (2006.01) (97) **2683302 ***
A61B 17/28 (2006.01)
A61B 17/29 (2006.01)
A61B 17/30 (2006.01)
F16C 11/12 (2006.01)
 (86) EP2012053788 06.03.2012
 (96) 12706865.8 15.01.2014
 (87) WO2012123281, 06.03.2012
 (97) 2683302, 15.01.2014 de
 (54) RESILIENT TOOLS
 (71) EMPA Eidgenössische Materialprüfungs- und
 Forschungsanstalt, Überlandstrasse 129, 8600 Dübendorf, CH
 HASSE, Alexander, Altindenu 2a, 01445 Radebeul, DE
 (72) CAMPANILE, Lucio, Flavio, Vieristrasse 6, CH-8603
 Schwerzenbach, CH

(51) MKP
C07D 473/34 (2006.01) (97) **2694505 ***
C07D 473/40 (2006.01)
 (86) US2012032371 05.04.2012
 (96) 12717520.6 12.02.2014
 (87) WO2012138894, 05.04.2012
 (97) 2694505, 12.02.2014 en
 (54) HSP90 INHIBITORS
 (71) Sloan-kettering Institute For Cancer Research, 1275 York
 Avenue, New York, NY 10065, US
 (72) SUN, Weilin, 475 Main Street Apartment 2B, New York New
 York 10044, US
 TALDONE, Tony, 425 Main Street Apartment 12F, New York
 New York 10044, US
 PATEL, Pallav, 4040 Presidential Blvd. Apartment 2915,
 Philadelphia Pennsylvania 19131, US
 CHIOSIS, Gabriela, c/o Memorial Sloan Kettering Cancer
 Center 1275 York Avenue, New York New York 10065, US

(51) MKP
A23G 3/00 (2006.01) (97) **2670254 ***
A23G 3/52 (2006.01)
A23L 1/00 (2006.01)
 (86) EP2012051588 31.01.2012
 (96) 12702803.3 11.12.2013
 (87) WO2012126655, 31.01.2012
 (97) 2670254, 11.12.2013 en
 (54) METHOD FOR PRODUCING AERATED FOOD PRODUCTS
 (71) DuPont Nutrition Biosciences ApS, Langebrogade 1 Postboks
 17, 1001 Copenhagen K., DK
 (72) LUND, Casper, Engdalgårdsvej 9, DK-8330 Beder, DK
 O'SULLIVAN, Geoffrey, Flat 12 York House Brighton Road
 Lower Kingswood, Tadworth Surrey KT20 6SU, GB
 JENSEN, Henrik, Aabye, Tonraa 14, DK-8751 Gedved, DK
 KRAGH, Henrik, Danisco A/S Edwin Rahrs Vej 38, DK-8220
 Brabrand, DK
 LUND, Susanne, Budde, Hulen 15 Lindbjerg, DK-8930 Randers
 NØ, DK
 MADSEN, Finn, Ludvig Holbergs Vej 11, DK-8230 Åbyhøj, DK

(51) MKP
A61B 17/00 (2006.01) (97) **2688484 ***
A61B 17/06 (2006.01)
A61L 27/36 (2006.01)
A61L 27/50 (2006.01)
A61M 27/00 (2006.01)
 (86) GB2011051810 26.09.2011
 (96) 11768071.0 29.01.2014
 (87) WO2011151659, 26.09.2011
 (97) 2688484, 29.01.2014 en
 (54) A DEVICE
 (71) Keighleycolo Ltd, Whalebone Cottage Vicarage Hill Tanworth-
 in-Arden, Solihull, West Midlands B94 5AN, GB
 (72) KEIGHLEY, Michael Robert Burch, Whalebone Cottage
 Vicarage Hill, Tanworth-in-Arden Solihull B94 5AN, GB

- (51) MKP
B63B 19/02 (2006.01) (97) **2562076**
(96) 12181757.1 27.02.2013
(97) 2562076, 27.02.2013 de
(54) Glass pane assembly in an aquatic vehicle
(71) TILSE Industrie- und Schiffstechnik GmbH, Sottorfallee 12, 22592 Hamburg, DE
(72) Tilse, Hans-Joachim, Sottorfallee 12, 22529 Hamburg, DE
- (51) MKP
G06F 17/30 (2006.01) (97) **2666108 ***
(86) US2012022047 20.01.2012
(96) 12704463.4 27.11.2013
(87) WO2012100173, 20.01.2012
(97) 2666108, 27.11.2013 en
(54) SYSTEMS AND METHODS FOR PROVIDING A DISCOVER PROMPT TO AUGMENTED CONTENT OF A WEB PAGE
(71) Vibrant Media, Inc., 565 5th Avenue 15th Floor, New York, NY 10017, US
Doig, Toby, 565 5th Ave., 15th Fl, New York, New York 10017, US
Gooding, Craig, 565 5th Ave., 15th Fl, New York, New York 10017, US
(72) DOIG, Toby, c/o Vibrant Media Inc. 565 5th Ave., 15th Fl, New York, New York 10017, US
GOODING, Craig, c/o Vibrant Media Inc. 565 5th Ave., 15th Fl, New York, New York 10017, US
- (51) MKP
A45D 40/06 (2006.01) (97) **2543276**
(96) 11174352.2 09.01.2013
(97) 2543276, 09.01.2013 en
(54) Lipstick tube
(71) Il Makiage Ltd, 8 Hacharash St, 67613 Tel Aviv, IL
(72) Hefetz, Safi, 12 Shvil Hatzabar, 67948 Tel Aviv, IL
Moheban, Raz, 26A Gordon St, 63438 Tel Aviv, IL
- (51) MKP
C07H 21/00 (2006.01) (97) **2663642 ***
C12N 15/63 (2006.01)
G01N 33/53 (2006.01)
(86) US2012021323 13.01.2012
(96) 12733941.4 20.11.2013
(87) WO2012097304, 13.01.2012
(97) 2663642, 20.11.2013 en
(54) TREPONEMA PALLIDUM TRIPLET ANTIGEN
(71) ORTHO-CLINICAL DIAGNOSTICS, INC., 1001 U.S. Route 202, Raritan, NJ 08869, US
(72) ZHENG, Jian, 7 Renzi Road, Raritan NJ 08869, US
YURA, Renee, 4641 Steeplechase Dr., Easton, PA 18040-6752, US
YANG, Jianping, 2111 Holly Hill Drive, Tyler, TX 75703, US
- (51) MKP
A61K 39/395 (2006.01) (97) **2661448 ***
C07K 16/24 (2006.01)
(86) US2012020529 06.01.2012
(96) 12732270.9 13.11.2013
(87) WO2012094623, 06.01.2012
(97) 2661448, 13.11.2013 en
(54) ANTI-IL-12/IL-23 ANTIBODIES AND USES THEREOF
(71) AbbVie Inc., 1 North Waukegan Road, North Chicago, IL 60064, US
(72) BORHANI, David, W., 109 Ridge Road, Hartsdale, NY 10530, US
SADHUKHAN, Ramkrishna, 31 Drummer Road, Acton, MA 01720, US
LACY, Susan, E., 38 Glen Street, Westborough, MA 01581, US
SOUTTER, Holly, H., 36 Old Brook Road, Shrewsbury, MA 01545, US
- (51) MKP
B82Y 20/00 (2011.01) (97) **2668529 ***
G02B 5/26 (2006.01)
(86) CA2012000077 25.01.2012
(96) 12739837.8 04.12.2013
(87) WO2012100338, 25.01.2012
(97) 2668529, 04.12.2013 en
(54) PHOTONIC CRYSTAL DEVICE WITH INFILTRATING COMPONENT
(71) Opalux Incorporated, Lash Miller Laboratories Room 308 80 St. George Street, Toronto, Ontario M5S 3H6, CA
(72) ARSENAULT, Andre, 25 Holland Avenue, Toronto, Ontario M4B 2C4, CA
ARSENAULT, Eric, 74 Constance Street, Toronto, Ontario M6R 1S6, CA
CHENG, Alison Yee-Shun, 12 Whistle Point Street, Toronto, Ontario M4E 3W8, CA
- (51) MKP
A61K 31/4178 (2006.01) (97) **2651928 ***
A61P 31/14 (2006.01)
C07D 403/10 (2006.01)
C07D 403/12 (2006.01)
C07D 403/14 (2006.01)
(86) US2011065247 15.12.2011
(96) 11849892.2 23.10.2013
(87) WO2012083061, 15.12.2011
(97) 2651928, 23.10.2013 en
(54) ANTI-VIRAL COMPOUNDS
(71) Abbvie Inc., 1 North Waukegan Road, North Chicago, IL 60064, US
(72) KRUEGER, Allan C., 7260 Presidential Drive, Gurnee Illinois 60031, US
KATI, Warren M., 152 Knob Hill Lane, Gurnee Illinois 60031, US
MARING, Clarence J., 1228 W. Borders Drive, Palatine Illinois 60067, US
WAGNER, Rolf, 42530 Sheridan Oaks Drive, Antioch Illinois 60002, US
HUTCHINS, Charles W., 31005 Prairie Ridge Rd, Green Oaks Illinois 60048, US
- (51) MKP
A47J 31/36 (2006.01) (97) **2653440**
A47J 31/40 (2006.01)
A47J 31/41 (2006.01)
B67D 1/00 (2006.01)
B67D 7/02 (2010.01)
B67D 7/62 (2010.01)
(96) 13177242.8 23.10.2013
(97) 2653440, 23.10.2013 en
(54) Beverage cartridge
(71) Koninklijke Douwe Egberts B.V., Vleutensevaart 35, 3532 AD Utrecht, NL
(72) Biewenga, Tjasse Willem, Hobbemalaan 50, 3723 ET Bilthoven, NL
- (51) MKP
C07D 473/34 (2006.01) (97) **2694506 ***
(86) US2012032373 05.04.2012
(96) 12717521.4 12.02.2014
(87) WO2012138896, 05.04.2012
(97) 2694506, 12.02.2014 en
(54) HSP90 INHIBITORS
(71) Sloan-kettering Institute For Cancer Research, 1275 York Avenue, New York, NY 10065, US
(72) TALDONE, Tony, 425 Main Street Apartment 12F, New York, New York 10044, US
CHIOSIS, Gabriela, c/o Memorial Sloan Kettering Cancer Center 1275 York Avenue, New York, New York 10065, US

(51) MKP
A61K 31/4196 (2006.01) (97) **2648725 ***
A61K 45/06 (2006.01)
A61P 19/02 (2006.01)
A61P 37/00 (2006.01)
(86) US2011063272 05.12.2011
(96) 11794915.6 16.10.2013
(87) WO2012078504, 05.12.2011
(97) 2648725, 16.10.2013 en
(54) TREATMENT OF CHRONIC INFLAMMATION WITH A
1,2,4-TRIAZOLO [1,5a]PYRIDINE DERIVATIVE
(71) Cephalon, Inc., 41 Moores Road P.O. Box 4011, Frazer, PA
19355, US
(72) DOBRZANSKI, Pawel T., 306 Pintail Circle, Downingtown
Pennsylvania 19335, US
SEAVEY, Matthew M., 887 Quincy Lane, Secane Pennsylvania
19018, US

(51) MKP
E04H 12/00 (2006.01) (97) **2681824 ***
F03D 9/00 (2006.01)
F03D 11/04 (2006.01)
H01L 31/042 (2006.01)
H02J 3/38 (2006.01)
H02J 4/00 (2006.01)
H02J 13/00 (2006.01)
(86) CA2012000095 03.02.2012
(96) 12752328.0 08.01.2014
(87) WO2012116428, 03.02.2012
(97) 2681824, 08.01.2014 en
(54) METHODS, SYSTEMS, AND APPARATUS FOR NATURAL
POWER COLLECTION AND DISTRIBUTION
(71) Peck, Gordon, Old Mill Trail Penthouse 7, Toronto, Ontario M8X
2Y9, CA
(72) Peck, Gordon, Old Mill Trail Penthouse 7, Toronto, Ontario M8X
2Y9, CA

(51) MKP
A61K 38/08 (2006.01) (97) **2683394 ***
(86) US2012028367 08.03.2012
(96) 12754373.4 15.01.2014
(87) WO2012122422, 08.03.2012
(97) 2683394, 15.01.2014 en
(54) ACTIVE AGENT PRODRUGS WITH HETEROCYCLIC
LINKERS
(71) Signature Therapeutics, Inc., 75 Shoreway Road, Suite D, San
Carlos, CA 94070, US
(72) JENKINS, Thomas E., 75 Shoreway Road Suite D, San Carlos,
California 94070, US
HUSFELD, Craig O., 75 Shoreway Road Suite D, San Carlos,
California 94070, US

(51) MKP
A01N 43/02 (2006.01) (97) **2693879 ***
A61K 31/335 (2006.01)
(86) US2012032642 06.04.2012
(96) 12768014.8 12.02.2014
(87) WO2012139074, 06.04.2012
(97) 2693879, 12.02.2014 en
(54) MIGRASTATINS AND USES THEREOF
(71) Sloan Kettering Institute For Cancer Research, 1275 York
Avenue, New York, NY 10021, US
(72) DANISHEFSKY, Samuel J., 22 Brayton Street, Englewood, NJ
07631, US
MASSAGUE, Joan, 1233 York Avenue, Apt 23A, New York, NY
10065, US
CORTES, Manuel, Valiente, 1376 York Avenue, Apt. 1B, New
York, NY 10021, US
OSKARSSON, Thordur, 900 Vestmannaeyjar, Vestmannaeyjar,
IS
MOORE, Malcolm, 504 East 63rd Street, Apt. 31P, New York,
NY 10065, US
LECOMTE, Nicolas, 504 East 81st Street, Apt. 4B, New York,
NY 10028, US
OUERFELLI, Ouathek, 1275 York Avenue PO Box 237, New
York, NY 10065, US
YANG, Guangli, 7 5th Place, Syosset, NY 11791, US

(51) MKP
C09C 1/02 (2006.01) (97) **2700680**
(96) 12181089.9 26.02.2014
(97) 2700680, 26.02.2014 en
(54) Process for manufacturing white pigment containing products
(71) Omya International AG, Baslerstrasse 42, 4665 Oftringen, CH
(72) Sötemann, Jörg, Italienerstrasse 35, 9500 Villach, AT

(51) MKP
A61K 31/337 (2006.01) (97) **2694056 ***
A61K 31/519 (2006.01)
A61P 35/00 (2006.01)
(86) GB2012050736 02.04.2012
(96) 12715421.9 12.02.2014
(87) WO2012131399, 02.04.2012
(97) 2694056, 12.02.2014 en
(54) THERAPEUTIC TREATMENT
(71) AstraZeneca AB, null, 151 85 Södertälje, SE
(72) DAVIES, Barry, Robert, AstraZeneca R&D Alderley Alderley
Park, Macclesfield, Cheshire SK10 4TG, GB

(51) MKP
A63B 69/00 (2006.01) (97) **2654909 ***
B60L 13/04 (2006.01)
B63B 35/79 (2006.01)
(86) AU2011001665 21.12.2011
(96) 11852190.5 30.10.2013
(87) WO2012083373, 21.12.2011
(97) 2654909, 30.10.2013 en
(54) SURFING DEVICE AND METHOD
(71) Kriticos, Stephen Con, 143 Behrens Road, Caboolture,
Queensland 4510, AU
(72) Kriticos, Stephen Con, 143 Behrens Road, Caboolture,
Queensland 4510, AU

(51) MKP
A61K 31/4155 (2006.01) (97) **2687524 ***
A61K 31/4196 (2006.01)
A61K 31/422 (2006.01)
A61K 31/4245 (2006.01)
A61K 31/433 (2006.01)
A61K 31/4439 (2006.01)
A61K 31/506 (2006.01)
A61K 31/5377 (2006.01)
A61P 17/14 (2006.01)
C07D 403/04 (2006.01)
C07D 413/04 (2006.01)
C07D 413/14 (2006.01)
C07D 417/04 (2006.01)
(86) JP2012056624 15.03.2012
(96) 12757646.0 22.01.2014
(87) WO2012124750, 15.03.2012
(97) 2687524, 22.01.2014 en
(54) AZOLE DERIVATIVE
(71) Taisho Pharmaceutical Co., Ltd., 24-1, Takada 3-chome
Toshima-ku, Tokyo 170-8633, JP
(72) ONO, Naoya, c/o Taisho Pharmaceutical Co. Ltd. 24-1 Takada
3-chome Toshima-ku, Tokyo 170-8633, JP
KURODA, Shoichi, c/o Taisho Pharmaceutical Co. Ltd. 24-1
Takada 3-chome Toshima-ku, Tokyo 170-8633, JP
SHIRASAKI, Yoshihisa, c/o Taisho Pharmaceutical Co. Ltd. 24-1
Takada 3-chome Toshima-ku, Tokyo 170-8633, JP
TAKAYAMA, Tetsuo, c/o Taisho Pharmaceutical Co. Ltd. 24-1
Takada 3-chome Toshima-ku, Tokyo 170-8633, JP
SEKIGUCHI, Yoshinori, c/o Taisho Pharmaceutical Co. Ltd. 24-1
Takada 3-chome Toshima-ku, Tokyo 170-8633, JP
USHIYAMA, Fumihito, c/o Taisho Pharmaceutical Co. Ltd. 24-1
Takada 3-chome Toshima-ku, Tokyo 170-8633, JP
OKA, Yusuke, c/o Taisho Pharmaceutical Co. Ltd. 24-1 Takada
3-chome Toshima-ku, Tokyo 170-8633, JP

- (51) MKP
A61K 31/554 (2006.01) (97) **2653466**
A61P 9/00 (2006.01)
A61P 19/08 (2006.01)
A61P 25/00 (2006.01)
C07D 281/10 (2006.01)
(96) 13164051.8 23.10.2013
(97) 2653466, 23.10.2013 en
(54) Agents for treating disorders involving modulation of ryanodine receptors
(71) Les Laboratoires Servier, 35, rue de Verdun, 92284 Suresnes Cedex, FR
Armgo Pharma, Inc., 777 Old Saw Mill River Rd, Tarrytown, NY 10591, US
(72) Yan, Jiaming, 100 La Salle Street, Apt. 9C, NEW YORK, NY 10027, US
Belvedere, Sandro, 393 W49th Street, NEW YORK, NY 10019, US
Webb, Yael, 217 High Ridge Ct. Yorktown Heights, New York, New York 10598, US
Bertrand, Marc, 79 Route de Sandillon, 45650 Saint Jean Le Blanc, FR
Villeneuve, Nicole, 60, rue de la Chapelle, 92500 RUEIL MALMAISON, FR
-
- (51) MKP
G01R 1/067 (2006.01) (97) **2647088 ***
H01R 12/71 (2011.01)
H01R 13/24 (2006.01)
H01R 13/6599 (2011.01)
H01R 43/20 (2006.01)
(86) US2011062815 01.12.2011
(96) 11793640.1 09.10.2013
(87) WO2012075240, 01.12.2011
(97) 2647088, 09.10.2013 en
(54) ELECTRICAL CONNECTOR WITH EMBEDDED SHELL LAYER
(71) INTERCONNECT DEVICES INC, 5101 Richland Avenue, Kansas City, Kansas 66106, US
HENRY, David, P.O. Box 2582, Platte City MO 64079, US
(72) ZHOU, Jiachun, P.O. Box 3306, Gilbert AZ 85299, US
PRABAKARAN, Kanapathipillai, 18434 E. Superstition Dr., Queen Creek AZ 85142, US
JI, Yingdong, No. 255 SuHong Middle Road, Suzhou City JiangSu Province, CN
-
- (51) MKP
H01R 13/523 (2006.01) (97) **2697870 ***
H01R 13/627 (2006.01)
(86) GB2012050825 13.04.2012
(96) 12720002.0 19.02.2014
(87) WO2012140443, 13.04.2012
(97) 2697870, 19.02.2014 en
(54) SUBSEA ELECTRICAL CONNECTOR
(71) Subsea Technologies Limited, Donside Facility Davidson Mill Mugiemoss Road, Aberdeen Aberdeenshire AB21 9PA, GB
(72) MCKAY, David Earnest, 28 Arduthie Gardens, Stonehaven Kincardineshire AB39 2NG, GB
-
- (51) MKP
C07D 307/80 (2006.01) (97) **2688879 ***
C07D 307/84 (2006.01)
(86) FR2012050607 23.03.2012
(96) 12717365.6 29.01.2014
(87) WO2012127174, 23.03.2012
(97) 2688879, 29.01.2014 fr
(54) METHOD FOR SYNTHESIZING KETOBENZOFURAN DERIVATIVES
(71) SANOFI, 54 rue La Boétie, 75008 Paris, FR
(72) GRIMAUD, Bernard, c/o Sanofi Patent Department 54 rue La Boétie, F-75008 Paris, FR
GROSSI, Pierre-Jean, c/o Sanofi Patent Department 54 rue La Boétie, F-75008 Paris, FR
-
- (51) MKP
A62D 1/00 (2006.01) (97) **2674198 ***
C08J 9/34 (2006.01)
(86) IB2012000221 09.02.2012
(96) 12744457.8 18.12.2013
(87) WO2012107825, 09.02.2012
(97) 2674198, 18.12.2013 en
(54) AUTONOMOUS FIRE-FIGHTING AGENT
(71) Obschestvo s Ogranichennoy Otvetstvennostyu "Pirochimica-Center", ul. Bolshaya Ochakovskaya, 44, str. 1, Moscow 119361, RU
(72) BLIZNETS, Igor, ul. Khabarovskaia 14/2-133, Moscow 107589, RU
SEREGIN, Victor, ul. Oktiabrskaya 4-10 Sergiev-Posad, Moskovskaya obl. 141300, RU
-
- (51) MKP
A01M 29/34 (2011.01) (97) **2691346 ***
C03C 25/10 (2006.01)
C03C 25/24 (2006.01)
C03C 25/26 (2006.01)
C03C 25/30 (2006.01)
C03C 25/40 (2006.01)
C03C 25/54 (2006.01)
D06M 13/00 (2006.01)
D06M 15/00 (2006.01)
(86) FR2012050654 28.03.2012
(96) 12717401.9 05.02.2014
(87) WO2012131255, 28.03.2012
(97) 2691346, 05.02.2014 fr
(54) GLASS YARN PROVIDED WITH A POLYMER COATING, AND SCREEN CONTAINING SAID YARN
(71) Saint-Gobain Adfors, 517, Avenue de la Boisse, 73000 Chambéry, FR
(72) BLANCHARD, Benjamin, 7 rue René Echavidre, F-95150 Taverny, FR
CHUDA, Katarzyna, 3 rue Marguerite Chapon, 94800 Villejuif, FR
-
- (51) MKP
A61K 31/504 (2006.01) (97) **2649076 ***
A61P 31/14 (2006.01)
C07D 487/08 (2006.01)
C07D 498/08 (2006.01)
C07D 498/18 (2006.01)
(86) US2011064009 08.12.2011
(96) 11805697.7 16.10.2013
(87) WO2012078915, 08.12.2011
(97) 2649076, 16.10.2013 en
(54) MACROCYCLIC INHIBITORS OF FLAVIVIRIDAE VIRUSES
(71) Gilead Sciences, Inc., 333 Lakeside Drive, Foster City, CA 94404, US
Selcia Ltd, Fyfield Business & Research Park Fyfield Road, Ongar, Essex CM5 0GS, GB
(72) APPLEBY, Todd, 535 Oak Park Drive, San Francisco, CA 94131, US
FLIRI, Hans, G., 35 Bridge Street, Saffron Walden Essex CB10 1BT, GB
KEATS, Andrew, J., 97 Upper Bridge Road, Chelmsford Essex CM2 0BA, GB
LAZARIDES, Linos, 24 Gladeside, London N21 1QD, GB
MACKMAN, Richard, L., 360 Ashton Avenue, Millbrae, CA 94030, US
PETTIT, Simon, N., 4 Camulus Close, Colchester Essex C02 9SB, GB
POULLENNEC, Karine, G., 39 Evelyn Plac, Chelmsford Essex CM1 3GZ, GB
SANVOISIN, Jonathan, Flat 1 Hodge Court Broomfield Road, Chelmsford Essex CM1 1SD, GB
STEADMAN, Victoria, A., 33 Blythwood Garden, Stansted Mountfitchet Essex CM24 8HQ, GB
WATT, Gregory, M., 64 Hill View, Bristol Bristol BS9 4PU, GB
-

(51) MKP
C07K 14/435 (2006.01) (97) **2686340 ***
 (86) US2012029537 16.03.2012
 (96) 12711312.4 22.01.2014
 (87) WO2012125973, 16.03.2012
 (97) 2686340, 22.01.2014 en
 (54) POTENT AND SELECTIVE INHIBITORS OF NAV1.3 AND NAV1.7
 (71) Amgen Inc., One Amgen Center Drive M/S 28-2-C, Thousand Oaks, CA 91320-1799, US
 (72) MURRAY, Justin K., 6879 Pecan Avenue, Moorpark, California 93021, US
 MIRANDA, Leslie P., 3586 Mapleknoll Place, Thousand Oaks, California 91362, US
 MCDONOUGH, Stefan I., 199 Tiffany Ave, Apt 408, San Francisco, CA 94110-4984, US

(51) MKP
A61K 8/00 (2006.01) (97) **2699625 ***
A61K 8/91 (2006.01)
A61K 35/00 (2006.01)
B82Y 5/00 (2011.01)
B82Y 30/00 (2011.01)
C08F 292/00 (2006.01)
C08J 3/07 (2006.01)
 (86) EP2012056900 16.04.2012
 (96) 12715953.1 26.02.2014
 (87) WO2012140252, 16.04.2012
 (97) 2699625, 26.02.2014 en
 (54) NANOPARTICLES COMPRISING ESTERS OF POLY (METHYL VINYL ETHER-CO-MALEIC ANHYDRIDE) AND USES THEREOF
 (71) Bionanoplus, S.L., Polígono Mocholí Plaza Cein, 5 - nave B14, 31110 Noáin- Navarra, ES
 (72) SALMAN, Hesham H.A., BIONANOPLUS S.L. Polígono Mocholí Plaza Cein 5 - nave B14, E-31110 Noáin - Navarra, ES
 GOÑI AZCARATE, Izaskun, Arbizu 13 - 4º Izda, E-31008 Pamplona, ES

(51) MKP
A61K 9/16 (2006.01) (97) **2591772**
A61K 9/20 (2006.01)
A61K 9/50 (2006.01)
 (96) 11188597.6 15.05.2013
 (97) 2591772, 15.05.2013 en
 (54) New coated controlled release active agent carriers
 (71) Omya International AG, Baslerstrasse 42, 4665 Oftringen, CH
 (72) Schwarzertruber, Ptryk, Untere Lättenstrasse 193, 5245 Habsburg, CH
 Schoelkopf, Joachim, Buechbühlstrasse 3, 8956 Killwangen, CH
 Ridgway, Catherine Jean, Wannenweg 12, 4812 Mühlethal, CH
 Gane, Patrick Arthur Charles, Stundenweg 8, 4852 Rothrist, CH
 Di Maiuta, Nicola, Amselweg 8, 4528 Zuchwil, CH

(51) MKP
E21B 19/084 (2006.01) (97) **2673456 ***
E21B 19/086 (2006.01)
 (86) AU2011000639 26.05.2011
 (96) 11858119.8 18.12.2013
 (87) WO2012106750, 26.05.2011
 (97) 2673456, 18.12.2013 en
 (54) DRILL RIG AND ASSOCIATED DRILL RIG TRAVERSE SYSTEM
 (71) Strange Investments (WA) Pty Ltd, 26A Blackwall Reach Parade, Bicton, WA 6157, AU
 (72) STRANGE, Warren, 26A Blackwall Reach Parade, Bicton, Western Australia 6157, AU

(51) MKP
B05D 5/06 (2006.01) (97) **2463031**
B05D 7/02 (2006.01)
 (96) 11192830.5 13.06.2012
 (97) 2463031, 13.06.2012 en
 (54) Method of preparing sandwich composite coating on engineering plastic surface
 (71) Xiamen Runner Industrial Corporation, No. 69, Tianfeng Road North Industrial Park Jimei, Xiamen 361021, CN
 (72) Wu, Zi-Bao, Xiamen Runner Industrial Corporation No. 69, Tianfeng Road North Industrial Park Jimei, 361021 Xiamen, CN
 Lee, Min-Zen, Xiamen Runner Industrial Corporation No. 69, Tianfeng Road North Industrial Park Jimei, 361021 Xiamen, CN

(51) MKP
A61K 31/437 (2006.01) (97) **2651939 ***
A61P 35/00 (2006.01)
C07D 471/04 (2006.01)
 (86) US2011064549 13.12.2011
 (96) 11808427.6 23.10.2013
 (87) WO2012082689, 13.12.2011
 (97) 2651939, 23.10.2013 en
 (54) SUBSTITUTED N-(1H-INDAZOL-4-YL)IMIDAZO[1,2-a]PYRIDINE-3-CARBOXAMIDE COMPOUNDS AS TYPE III RECEPTOR TYROSINE KINASE INHIBITORS
 (71) Array Biopharma, Inc., 3200 Walnut Street, Boulder, CO 80301, US
 (72) BOYS, Mark Laurence, c/o Array BioPharma Inc. 3200 Walnut Street, Boulder, Colorado 80301, US
 DELISLE, Robert Kirk, c/o Array BioPharma Inc. 3200 Walnut Street, Boulder, Colorado 80301, US
 HICKEN, Erik James, c/o Array BioPharma Inc. 3200 Walnut Street, Boulder, Colorado 80301, US
 KENNEDY, April L., 2435 California Street, Denver, Colorado 80205, US
 MARESKA, David A., 145 Hemloch Avenue, McMurray, PA 15317, US
 MARMASATER, Fredrik P., 88 Misty Vale Court, Boulder, Colorado 80502, US
 MUNSON, Mark C., 45 Central Street, Acton, MA 01720, US
 NEWHOUSE, Brad, c/o Array BioPharma Inc. 3200 Walnut Street, Boulder, Colorado 80301, US
 RAST, Bryson, 9802 Quay Way, Westminster, Colorado 80021, US
 RIZZI, James P., 3724 Woodshadow Lane, Addison, Texas 75001, US
 RODRIGUEZ, Martha E., 1315 Lambert Circle, Lafayette, CO 80026, US
 TOPALOV, George T., 1697 Reliance Circle, Superior, Colorado 80027, US
 ZHAO, Qian, 681 St. Andrews Lane, Louisville, CO 80027, US

(51) MKP
A01N 43/58 (2006.01) (97) **2677869 ***
 (86) US2012026261 23.02.2012
 (96) 12749051.4 01.01.2014
 (87) WO2012116145, 23.02.2012
 (97) 2677869, 01.01.2014 en
 (54) NOVEL CYCLIC AZABENZIMIDAZOLE DERIVATIVES USEFUL AS ANTI-DIABETIC AGENTS
 (71) Merck Sharp & Dohme Corp., 126 East Lincoln Avenue, Rahway NJ 07065-0907, US
 (72) ANAND, Rajan, 126 East Lincoln Avenue, Rahway, NJ 07065-0907, US
 APGAR, James, M., 126 East Lincoln Avenue, Rahway, NJ 07065-0907, US
 BIFTU, Tesfaye, 126 East Lincoln Avenue, Rahway, NJ 07065-0907, US
 CHEN, Ping, 126 East Lincoln Avenue, Rahway, NJ 07065-0907, US
 CHU, Lin, 126 East Lincoln Avenue, Rahway, NJ 07065-0907, US
 COLANDREA, Vincent, J., 126 East Lincoln Avenue, Rahway, NJ 07065-0907, US
 DONG, Guizhen, 126 East Lincoln Avenue, Rahway, NJ 07065-0907, US
 DROPINSKI, James, F., 126 East Lincoln Avenue, Rahway, NJ 07065-0907, US
 FENG, Danqing, 126 East Lincoln Avenue, Rahway, NJ 07065-0907, US
 HICKS, Jacqueline, D., 126 East Lincoln Avenue, Rahway, NJ 07065-0907, US
 JIANG, Jinlong, 126 East Lincoln Avenue, Rahway, NJ 07065-0907, US
 KIM, Alexander, J., 126 East Lincoln Avenue, Rahway, NJ 07065-0907, US
 LEAVITT, Kenneth, J., 126 East Lincoln Avenue, Rahway, NJ 07065-0907, US
 LI, Bing, 126 East Lincoln Avenue, Rahway, NJ 07065-0907, US
 QIAN, Xiaoxia, 126 East Lincoln Avenue, Rahway, NJ 07065-0907, US
 SEBHAT, Iyassu, 126 East Lincoln Avenue, Rahway, NJ 07065-0907, US
 WEI, Lan, 126 East Lincoln Avenue, Rahway, NJ 07065-0907, US
 WILKENING, Robert, R., 126 East Lincoln Avenue, Rahway, NJ 07095-0907, US
 WU, Zhicai, 126 East Lincoln Avenue, Rahway, NJ 07065-0907, US

(51) MKP
E04F 15/02 (2006.01) (97) **2573296**
E04F 21/00 (2006.01)
 (96) 12184701.6 27.03.2013
 (97) 2573296, 27.03.2013 en
 (54) Leveling spacer for laying wall tiles, paving tiles and the like with the interposition of gaps
 (71) Progress Profiles SPA, Via dell'Artigianato, 35, 31011 Asolo, Frazione Casella TV, IT
 (72) Bordin, Lino, Via Carlo Goldoni, 1, 31010 Maser TV, IT

(51) MKP
A61K 39/00 (2006.01) (97) **2686009 ***
A61K 47/48 (2006.01)
C07K 9/00 (2006.01)
 (86) IB2012051285 16.03.2012
 (96) 12712748.8 22.01.2014
 (87) WO2012123926, 16.03.2012
 (97) 2686009, 22.01.2014 en
 (54) METHOD FOR PREPARING MULTIPLE ANTIGEN GLYCOPEPTIDE CARBOHYDRATE CONJUGATES
 (71) Institut Pasteur, 28 rue du Docteur Roux, 75015 Paris, FR
 Centre National de la Recherche Scientifique, 3, rue Michel-Ange, 75764 Paris Cedex 16, FR
 (72) BAY, Sylvie, 12 rue Beccaria, F-75012 Paris, FR
 LECLERC, Claude, 13 rue de l'Amiral Roussin, F-75015 Paris, FR
 LO-MAN, Richard, 2 passage des Entrepreneurs, F-75015 Paris, FR

(51) MKP
A61K 9/16 (2006.01) (97) **2646001 ***
A61K 9/20 (2006.01)
A61K 31/165 (2006.01)
A61P 25/08 (2006.01)
A61P 25/14 (2006.01)
A61P 25/18 (2006.01)
 (86) EP2011006026 01.12.2011
 (96) 11817472.1 09.10.2013
 (87) WO2012084126, 01.12.2011
 (97) 2646001, 09.10.2013 en
 (54) FORMULATION OF LACOSAMIDE
 (71) UCB Pharma GmbH, Alfred-Nobel-Strasse 10, 40789 Monheim, DE
 (72) CAWELLO, Willi, Fasanenweg 7, 40789 Monheim, DE
 SCHUBERT, Martin, Alexander, Memeler Str. 25a, 38126 Braunschweig, DE

(51) MKP
G07F 17/32 (2006.01) (97) **2584545**
 (96) 12185388.1 24.04.2013
 (97) 2584545, 24.04.2013 de
 (54) Device for displaying a device code of a coin-activated entertainment device
 (71) adp Gauselmann GmbH, Merkur-Allee 1-15, 32339 Espelkamp, DE

(51) MKP
A61K 39/395 (2006.01) (97) **2683741 ***
A61P 35/00 (2006.01)
C07K 16/32 (2006.01)
 (86) US2012028792 12.03.2012
 (96) 12711080.7 15.01.2014
 (87) WO2012125573, 12.03.2012
 (97) 2683741, 15.01.2014 en
 (54) USE OF INHIBITORS OF EGFR-FAMILY RECEPTORS IN THE TREATMENT OF HORMONE REFRACTORY BREAST CANCERS
 (71) Merrimack Pharmaceuticals, Inc., One Kendall Square Suite B7201, Cambridge, MA 02139, US
 (72) GARCIA, Gabriela, 14 Knoll St., Roslindale, MA 02131, US
 KUBASEK, William, 165 Fairview Ave, Belmont, MA 02478, US
 MOYO, Victor, 2 Neshanic Dr., Ringoes, NJ 08551, US
 MACBEATH, Gavin, 9 Sophia's Way, Wakefield, MA 01880, US

(51) MKP
C12Q 1/48 (2006.01) (97) **2646819 ***
G01N 33/50 (2006.01)
 (86) US2011062468 29.11.2011
 (96) 11793632.8 09.10.2013
 (87) WO2012075046, 29.11.2011
 (97) 2646819, 09.10.2013 en
 (54) ASSAYS AND BIOMARKERS FOR LRRK2
 (71) Genentech, Inc., 1 DNA Way, South San Francisco, CA 94080, US
 (72) BUSTOS, Daisy, c/o Genentech Inc. 1 DNA Way South San Francisco, California 94080, US
 KIRKPATRICK, Donald, c/o Genentech Inc. 1 DNA Way South San Francisco, California 94080, US
 KLEINHEINZ, Tracy, c/o Genentech Inc. 1 DNA Way South San Francisco, California 94080, US
 MOFFAT, John, c/o Genentech Inc. 1 DNA Way South San Francisco, California 94080, US
 SHENG, Zejuan, c/o Genentech Inc. 1 DNA Way South San Francisco, California 94080, US
 ZHANG, Shuo, c/o Genentech Inc. 1 DNA Way South San Francisco, California 94080, US
 ZHU, Haitao, c/o Genentech Inc. 1 DNA Way South San Francisco, California 94080, US

(51) MKP
B42D 15/10 (2006.01) (97) **2665607 ***
 (86) CH2012000008 13.01.2012
 (96) 12700772.2 27.11.2013
 (87) WO2012097463, 13.01.2012
 (97) 2665607, 27.11.2013 de
 (54) METHOD FOR PRODUCING A MULTILAYER DATA CARRIER AND DATA CARRIER PRODUCED BY SAID METHOD
 (71) Trüb AG, Hintere Bahnhofstrasse 12, 5001 Aarau, CH
 (72) EGLI, Stefan, Hochstrasse 69, CH-4053 Basel, CH
 WIDMER GOMRES, Heidi, Juraweg 12, CH-3046 Wahlendorf, CH

(51) MKP
B01J 19/00 (2006.01) (97) **2671635 ***
C10G 2/00 (2006.01)
 (86) JP2012050853 17.01.2012
 (96) 12742759.9 11.12.2013
 (87) WO2012105311, 17.01.2012
 (97) 2671635, 11.12.2013 en
 (54) TEMPERATURE CONTROL SYSTEM
 (71) Japan Oil, Gas and Metals National Corporation, 2-10-1, Toranomon, Minato-ku, Tokyo 105-0001, JP
 INPEX Corporation, 5-3-1 Akasaka Minato-ku, Tokyo 107-6332, JP
 JX Nippon Oil & Energy Corporation, 6-3, Otemachi 2-chome, Chiyoda-ku Tokyo 100-8162, JP
 Japan Petroleum Exploration Co., Ltd., 7-12, Marunouchi 1-chome Chiyoda-ku, Tokyo 100-0005, JP
 Cosmo Oil Co., Ltd., 1-1-1, Shibaura 1-chome, Minato-ku Tokyo 105-8528, JP
 Nippon Steel & Sumikin Engineering Co., Ltd., Osaki Center Building 5-1, Osaki 1-chome Shinagawa-ku, Tokyo 141-8604, JP
 (72) MORITA, Kentarou, c/o Nippon Steel & Sumikin Engineering Co., Ltd. Osaki Center Building 5-1, Osaki 1-chome Shinagawa-ku, Tokyo 141-8604, JP
 KATO, Yuzuru, c/o Nippon Steel & Sumikin Engineering Co., Ltd. Osaki Center Building 5-1, Osaki 1-chome Shinagawa-ku, Tokyo 141-8604, JP

(51) MKP
A61K 31/7048 (2006.01) (97) **2678349 ***
A61P 31/04 (2006.01)
C07H 17/08 (2006.01)
 (86) JP2012054677 20.02.2012
 (96) 12749570.3 01.01.2014
 (87) WO2012115256, 20.02.2012
 (97) 2678349, 01.01.2014 en
 (54) C-4" POSITION SUBSTITUTED MACROLIDE DERIVATIVE
 (71) Taisho Pharmaceutical Co., Ltd., 24-1, Takada 3-chome Toshima-ku, Tokyo 170-8633, JP
 Meiji Seika Pharma Co., Ltd., 4-16, Kyobashi 2-chome Chuo-ku, Tokyo 104-8002, JP
 (72) SUGIMOTO, Tomohiro, c/o TAISHO PHARMACEUTICAL CO. LTD. 24-1 Takada 3-chome Toshima-ku, Tokyo 170-8633, JP
 SASAMOTO, Naoki, c/o TAISHO PHARMACEUTICAL CO. LTD. 24-1 Takada 3-chome Toshima-ku, Tokyo 170-8633, JP
 KUROSAKA, Jun, c/o TAISHO PHARMACEUTICAL CO. LTD. 24-1 Takada 3-chome Toshima-ku, Tokyo 170-8633, JP
 HAYASHI, Masato, c/o TAISHO PHARMACEUTICAL CO. LTD. 24-1 Takada 3-chome Toshima-ku, Tokyo 170-8633, JP
 YAMAMOTO, Kanako, c/o TAISHO PHARMACEUTICAL CO. LTD. 24-1 Takada 3-chome Toshima-ku, Tokyo 170-8633, JP
 KASHIMURA, Masato, c/o TAISHO PHARMACEUTICAL CO. LTD. 24-1 Takada 3-chome Toshima-ku, Tokyo 170-8633, JP
 USHIKI, Yasunobu, c/o TAISHO PHARMACEUTICAL CO. LTD. 24-1 Takada 3-chome Toshima-ku, Tokyo 170-8633, JP
 OGITA, Haruhisa, c/o TAISHO PHARMACEUTICAL CO. LTD. 24-1 Takada 3-chome Toshima-ku, Tokyo 170-8633, JP
 MIURA, Tomoaki, c/o MEIJI SEIKA PHARMA CO. LTD. 760 Morooka-cho Kouhoku-ku, Yokohama-shi, Kanagawa 222-8567, JP
 KANEMOTO, Kenichi, c/o MEIJI SEIKA PHARMA CO. LTD. 760 Morooka-cho Kouhoku-ku, Yokohama-shi, Kanagawa 222-8567, JP
 KUMURA, Kou, c/o MEIJI SEIKA PHARMA CO. LTD. 760 Morooka-cho Kouhoku-ku, Yokohama-shi, Kanagawa 222-8567, JP
 YOSHIDA, Satoshi, c/o MEIJI SEIKA PHARMA CO. LTD. 760 Morooka-cho Kouhoku-ku, Yokohama-shi, Kanagawa 222-8567, JP
 TAMURA, Keiji, c/o MEIJI SEIKA PHARMA CO. LTD. 760 Morooka-cho Kouhoku-ku, Yokohama-shi, Kanagawa 222-8567, JP
 SHITARA, Eiki, c/o MEIJI SEIKA PHARMA CO. LTD. 760 Morooka-cho Kouhoku-ku, Yokohama-shi, Kanagawa 222-8567, JP

(51) MKP
B65B 31/04 (2006.01) (97) **2699491 ***
B65D 81/24 (2006.01)
B65D 85/00 (2006.01)
 (86) US2012034097 18.04.2012
 (96) 12774755.8 26.02.2014
 (87) WO2012145408, 18.04.2012
 (97) 2699491, 26.02.2014 en
 (54) IMPROVED FLAT PACKAGING OF PETRI DISHES FOR PROLONGED PRESERVATION AND METHOD OF PRODUCING THE SAME
 (71) Barnhizer, Bret T., 6935, Youngstown-Pittsburgh Road, Poland, OH 44514, US
 (72) Barnhizer, Bret T., 6935, Youngstown-Pittsburgh Road, Poland, OH 44514, US

(51) MKP
B63B 27/14 (2006.01) (97) **2673417 ***
E01D 15/24 (2006.01)
 (86) SE2012050110 06.02.2012
 (96) 12745107.8 18.12.2013
 (87) WO2012108824, 06.02.2012
 (97) 2673417, 18.12.2013 en
 (54) A MOVABLE PASSENGER BRIDGE FOR A SHIP
 (71) FMT INTERNATIONAL TRADE AB, Dalaslingan 8, 231 32 Trelleborg, SE
 (72) ANDERBERG, Nils-Erik, Asbjer Gärd, S-231 96 Trelleborg, SE

- (51) MKP
A61K 8/04 (2006.01) (97) **2654665 ***
A61K 8/34 (2006.01)
A61K 8/55 (2006.01)
A61K 8/86 (2006.01)
A61Q 19/00 (2006.01)
G01F 22/00 (2006.01)
G01N 13/02 (2006.01)
- (86) DE2011001416 07.07.2011
(96) 11801553.6 30.10.2013
(87) WO2012083906, 07.07.2011
(97) 2654665, 30.10.2013 de
(54) METHOD FOR DEVELOPING A LIQUID COMPOSITION TO BE APPLIED TO THE SKIN AS A FOAM AND A COMPOSITION THAT CAN BE APPLIED TOPICALLY
(71) MIKA Pharma Gesellschaft für die Entwicklung und Vermarktung pharmazeutischer Produkte mbH, An der Rheinschanze 1, 67059 Ludwigshafen, DE
(72) SEIGFRIED, Bernd. G., Domholz 20, 67117 Limburgerhof, DE
-
- (51) MKP
C07D 401/06 (2006.01) (97) **2699562 ***
C07D 471/04 (2006.01)
C07D 471/10 (2006.01)
- (86) GB2012050867 20.04.2012
(96) 12717460.5 26.02.2014
(87) WO2012143726, 20.04.2012
(97) 2699562, 26.02.2014 en
(54) BICYCLIC HETEROCYCLE COMPOUNDS AND THEIR USES IN THERAPY
(71) Astex Therapeutics Limited, 436 Cambridge Science Park Milton Park Cambridge, Cambridgeshire CB4 0QA, GB
(72) WOOLFORD, Alison Jo-Anne, c/o Astex Therapeutics Limited 436 Cambridge Science Park Milton Road, Cambridge Cambridgeshire CB4 0QA, GB
HOWARD, Steven, c/o Astex Therapeutics Limited 436 Cambridge Science Park Milton Road, Cambridge Cambridgeshire CB4 0QA, GB
BUCK, Ildiko Maria, c/o Astex Therapeutics Limited 436 Cambridge Science Park Milton Road, Cambridge Cambridgeshire CB4 0QA, GB
CHESSARI, Gianni, c/o Astex Therapeutics Limited 436 Cambridge Science Park Milton Road, Cambridge Cambridgeshire CB4 0QA, GB
JOHNSON, Christopher Norbert, c/o Astex Therapeutics Limited 436 Cambridge Science Park Milton Road, Cambridge Cambridgeshire CB4 0QA, GB
TAMANINI, Emiliano, c/o Astex Therapeutics Limited 436 Cambridge Science Park Milton Road, Cambridge Cambridgeshire CB4 0QA, GB
DAY, James Edward Harvey, c/o Astex Therapeutics Limited 436 Cambridge Science Park Milton Road, Cambridge Cambridgeshire CB4 0QA, GB
CHIARPARIN, Elisabetta, c/o Astex Therapeutics Limited 436 Cambridge Science Park Milton Road, Cambridge Cambridgeshire CB4 0QA, GB
HEIGHTMAN, Thomas Daniel, c/o Astex Therapeutics Limited 436 Cambridge Science Park Milton Road, Cambridge Cambridgeshire CB4 0QA, GB
FREDERICKSON, Martyn, c/o Astex Therapeutics Limited 436 Cambridge Science Park Milton Road, Cambridge Cambridgeshire CB4 0QA, GB
GRIFFITHS-JONES, Charlotte Mary, c/o Astex Therapeutics Limited 436 Cambridge Science Park Milton Road, Cambridge Cambridgeshire CB4 0QA, GB
-
- (51) MKP
F02M 27/04 (2006.01) (97) **2699786 ***
- (86) IB2012051484 28.03.2012
(96) 12717866.3 26.02.2014
(87) WO2012143804, 28.03.2012
(97) 2699786, 26.02.2014 en
(54) METHOD FOR OPTIMIZING COMBUSTION ENGINES
(71) Titano S.R.L., Via Antonio Gramsci, 17/b, 80122 Napoli (NA), IT
(72) BOVE, Fabrizio, Via Aniello Falcone 290/a Sc. B, 80127 Napoli (NA), IT
BOVE, Alessandro, Via Aniello Falcone 290/a Sc. B, 80127 Napoli (NA), IT
-
- (51) MKP
A61K 31/422 (2006.01) (97) **2573073**
A61P 35/00 (2006.01)
C07C 229/40 (2006.01)
C07D 231/14 (2006.01)
C07D 471/04 (2006.01)
- (96) 11306217.8 27.03.2013
(97) 2573073, 27.03.2013 en
(54) Pyrazoloquinolinone derivatives, preparation thereof and therapeutic use thereof
(71) SANOFI, 54 rue La Boétie, 75008 Paris, FR
(72) Benazet, Alexandre, c/o Sanofi, Patent Department. 54 rue La Boétie, 75013 Paris, FR
Duclos, Olivier, c/o Sanofi, Patent Department. 54 rue La Boétie, 75013 Paris, FR
Guillo, Nathalie, c/o Sanofi, Patent Department. 54 rue La Boétie, 75013 Paris, FR
Lassalle, Gilbert, c/o Sanofi, Patent Department. 54 rue La Boétie, 75013 Paris, FR
Macary, Karim, c/o Sanofi, Patent Department. 54 rue La Boétie, 75013 Paris, FR
Viv, Valérie, c/o Sanofi, Patent Department. 54 rue La Boétie, 75013 Paris, FR
-
- (51) MKP
B01L 3/00 (2006.01) (97) **2683483 ***
- (86) IL2012000120 08.03.2012
(96) 12716649.4 15.01.2014
(87) WO2012120506, 08.03.2012
(97) 2683483, 15.01.2014 en
(54) DISPOSABLE CARTRIDGE FOR PREPARING A SAMPLE FLUID CONTAINING CELLS FOR ANALYSIS
(71) Pixcell Medical Technologies Ltd., Hayezira st. 6 P.O. Box 113, 20692 Yokneam Ilit, IL
(72) BRANSKY, Avishay, Narkisim 41, 36073 Kyriat Tivon, IL
SHLOMO, Liron, ... 25218 Kibbutz Shomrat, IL
-
- (51) MKP
H04L 9/14 (2006.01) (97) **2650813 ***
- (86) KR2011000605 28.01.2011
(96) 11847167.1 16.10.2013
(87) WO2012077856, 28.01.2011
(97) 2650813, 16.10.2013 en
(54) DEVICE AND METHOD FOR GENERATING AN IDENTIFICATION KEY
(71) ICTK Co., Ltd., 2, 3rd Floor, Jawon Building 912-31 Daechi-dong Gangnam-gu, Seoul 135-997, KR
(72) KIM, Dong Kyue, 105-2103 Raemian Jangan 1-cha Apt. Jangan 3-dong Dongdaemun-gu, Seoul 130-718, KR
CHOI, Byong Deok, 77-5, Seongnae 2-dong Gangdong-gu, Seoul 134-840, KR
KIM, Tae Wook, 1217, ITBT Hanyang University Haengdang-dong Seongdong-gu, Seoul 133-791, KR
-
- (51) MKP
A61K 39/00 (2006.01) (97) **2651434 ***
C07K 14/47 (2006.01)
C07K 14/705 (2006.01)
- (86) EP2011070024 14.11.2011
(96) 11782613.1 23.10.2013
(87) WO2012079878, 14.11.2011
(97) 2651434, 23.10.2013 en
(54) HLA-BINDING PEPTIDES DERIVED FROM PROSTATE-ASSOCIATED ANTIGENIC MOLECULES AND METHODS OF USE THEREOF
(71) Immatics Biotechnologies GmbH, Paul-Ehrlich-Strasse 15, 72076 Tübingen, DE
(72) WEINSCHENK, Toni, Im Morgenrain 15, 73773 Aichwald, DE
LEWANDROWSKI, Peter, Burgstrasse 14, 72070 Tuebingen-Hirschau, DE
RAMMENSEE, Hans-Georg, Sommerhalde 3, 72070 Tübingen, DE
STEVANOVIC, Stefan, Auf der Burg 3, 72074 Tübingen, DE
GOUTTEFANGEAS, Cécile, Mauerstrasse 19b, 72070 Tübingen, DE
-

(51) MKP
A61K 31/64 (2006.01) (97) **2691109 ***
A61K 38/26 (2006.01)
A61P 3/08 (2006.01)
(86) EP2012055660 29.03.2012
(96) 12712106.9 05.02.2014
(87) WO2012130955, 29.03.2012
(97) 2691109, 05.02.2014 en
(54) PREVENTION OF HYPOGLYCAEMIA IN DIABETES MELLITUS TYPE 2 PATIENTS
(71) Sanofi-Aventis Deutschland GmbH, Brüningstraße 50, 65929 Frankfurt, DE
(72) BOKA, Gabor, Sanofi Département Brevets 54 rue La Boétie, F-75008 Paris, FR
SILVESTRE, Louise, Sanofi Département Brevets 54 rue La Boétie, F-75008 Paris, FR
MIOSSEC, Patrick, Sanofi Département Brevets 54 rue La Boétie, F-75008 Paris, FR

(51) MKP
A61M 5/145 (2006.01) (97) **2658589 ***
A61M 5/24 (2006.01)
A61M 5/315 (2006.01)
(86) EP2011073818 22.12.2011
(96) 11808206.4 06.11.2013
(87) WO2012089620, 22.12.2011
(97) 2658589, 06.11.2013 en
(54) DEDICATED CARTRIDGE AND HOLDER
(71) Sanofi-Aventis Deutschland GmbH, Brüningstraße 50, 65929 Frankfurt, DE
(72) RIESS, Ralf, c/o Sanofi-Aventis Deutschland GmbH, 65926 Frankfurt am Main, DE
TRINKLE, Stefan, c/o Sanofi-Aventis Deutschland GmbH, 65926 Frankfurt am Main, DE
SENIOR, James, 8 Turberville place, Warwick Warwickshire CV34 4JZ, GB
DAVIES, James Alexander, 7 Old School Mews Cubbington Road Leamington Spa, Warwickshire CV32 7XB, GB
WALLACE, Andrew Gordon, The Old Gardens Highleadon, Gloucestershire GL18 1HJ, GB

(51) MKP
A61K 47/48 (2006.01) (97) **2675479 ***
A61P 35/00 (2006.01)
C07D 487/04 (2006.01)
C07D 519/00 (2006.01)
(86) US2012025252 15.02.2012
(96) 12705600.0 25.12.2013
(87) WO2012128868, 15.02.2012
(97) 2675479, 25.12.2013 en
(54) CYTOTOXIC BENZODIAZEPINE DERIVATIVES
(71) Immunogen, Inc., 830 Winter Street, Waltham, MA 02451, US
(72) LI, Wei, 6 Knowlton Drive, Acton, MA 01720, US
MILLER, Michael, 4 Maymount Drive, Framingham, MA 01701, US
FISHKIN, Nathan, 179 E. Tall Oaks Drive, Weymouth, MA 02170, US
CHARI, Ravi, V. J., 174 Winchester Street, Newton, MA 02461, US

(51) MKP
A61K 9/08 (2006.01) (97) **2691086 ***
A61K 31/015 (2006.01)
A61K 31/201 (2006.01)
A61K 31/202 (2006.01)
A61K 31/203 (2006.01)
A61K 31/355 (2006.01)
A61P 25/16 (2006.01)
A61P 25/28 (2006.01)
A61P 43/00 (2006.01)
(86) IB2012000824 28.03.2012
(96) 12727411.6 05.02.2014
(87) WO2012131493, 28.03.2012
(97) 2691086, 05.02.2014 en
(54) COMPOSITIONS FOR THE TREATMENT OF NEUROLOGIC DISORDERS
(71) Palupa Medical Ltd., 66 Metochiou Avenue 2407 Engomi, Nicosia, CY
(72) PANTZARIS, Marios, 15 Akamantos Street Efl Court 18. Apt. 302, 2045 Strovolos Nicosia, CY
PATRIKIOS, Ioannis, 7 Atalantis Plati Aglantzia, Nicosia 2115, CY
LUOKAIDIS, Georgios, 19 Smyrnis Street 1035 Pal/ssa, Nicosia, CY

(51) MKP
A61K 31/497 (2006.01) (97) **2646448 ***
C07F 9/40 (2006.01)
(86) US2011062290 29.11.2011
(96) 11794899.2 09.10.2013
(87) WO2012074951, 29.11.2011
(97) 2646448, 09.10.2013 en
(54) MACROCYCLIC KINASE INHIBITORS
(71) OSI Pharmaceuticals, LLC, 1 Bioscience Park Drive, Farmingdale, NY 11735, US
(72) CREW, Andrew, P., Osi Pharmaceuticals Llc 1 Bioscience Park Drive, Farmingdale, NY 11735, US
DONG, Hanqing, Osi Pharmaceuticals Llc 1 Bioscience Park Drive, Farmingdale, NY 11735, US
FERRARO, Caterina, Osi Pharmaceuticals Llc 1 Bioscience Park Drive, Farmingdale, NY 11735, US
SHERMAN, Dan, Osi Pharmaceuticals Llc 1 Bioscience Park Drive, Farmingdale, NY 11735, US
SIU, Kam, W., Osi Pharmaceuticals Llc 1 Bioscience Park Drive, Farmingdale, NY 11735, US

(51) MKP
A61K 31/70 (2006.01) (97) **2697217 ***
A61P 3/10 (2006.01)
C07D 405/10 (2006.01)
(86) IB2012051799 12.04.2012
(96) 12719083.3 19.02.2014
(87) WO2012140597, 12.04.2012
(97) 2697217, 19.02.2014 en
(54) GLYCOSIDE DERIVATIVES AND THEIR USES FOR THE TREATMENT OF DIABETES
(71) Novartis AG, Lichtstrasse 35, 4056 Basel, CH
(72) BEBERNITZ, Gregory Raymond, Novartis Institutes for BioMedical Research Inc. 100 Technology Square, Cambridge Massachusetts 02139, US

(51) MKP
A61K 9/16 (2006.01) (97) **2662075**
A61K 47/44 (2006.01)
(96) 13002434.2 13.11.2013
(97) 2662075, 13.11.2013 en
(54) Taste masking compositions of praziquantel
(71) Lavet Gyogyszergyarto es Szolgaltato Kft., Otto u. 14., 1161 Budapest, HU
(72) The designation of the inventor has not yet been filed , null, null, null

- (51) MKP
A61K 39/10 (2006.01) (97) **2670432 ***
A61K 39/295 (2006.01)
C07K 14/235 (2006.01)
- (86) IB2012050512 03.02.2012
(96) 12705438.5 11.12.2013
(87) WO2012104821, 03.02.2012
(97) 2670432, 11.12.2013 en
(54) IMMUNOGENIC BORDETELLA BRONCHISEPTICA COMPOSITIONS
(71) Zoetis LLC, 100 Campus Drive, Florham Park NJ 07932, US
(72) ABDELMAGID, Omar, Yousif, Pfizer Global Research&Development 7000 Portage Road, Kalamazoo, MI 49001, US
BRICKER, Joseph, Michael, Pfizer Global Research&Development 7000 Portage Road, Kalamazoo, MI 49001, US
SHIELDS, Shelly, Lynn, Pfizer Global Research&Development 7000 Portage Road, Kalamazoo, MI 49001, US
GALVIN, Jeffrey, E., Pfizer Global Research&Development 7000 Portage Road, Kalamazoo, MI 49001, US
-
- (51) MKP
A61K 31/519 (2006.01) (97) **2670754 ***
A61P 25/00 (2006.01)
C07D 487/04 (2006.01)
- (86) EP2012051546 31.01.2012
(96) 12708774.0 11.12.2013
(87) WO2012104293, 31.01.2012
(97) 2670754, 11.12.2013 en
(54) (1,2,4)TRIAZOLO[4,3-A]QUINOXALINE DERIVATIVES AS INHIBITORS OF PHOSPHODIESTERASES
(71) Boehringer Ingelheim International GmbH, Binger Strasse 173, 55216 Ingelheim am Rhein, DE
(72) LANKAU, Hans-Joachim, Coswiger Str. 19, 01689 Weinböhla, DE
LANGEN, Barbara, Herderstr. 1, 01445 Radebeul, DE
GRUNWALD, Christian, Johann-Meyer-Str. 22, 01097 Dresden, DE
HÖFGEN, Norbert, Hufenweg 1, 01458 Ottendorf-Okrilla, DE
STANGE, Hans, Dresdner Str. 3, 01587 Riesa, DE
DOST, Rita, Leon-Pohle-Str. 2, 01219 Dresden, DE
EGERLAND, Ute, Magdalenenstr. 1, 01445 Radebeul, DE
-
- (51) MKP
A61K 9/00 (2006.01) (97) **2691087 ***
A61K 31/04 (2006.01)
A61K 33/04 (2006.01)
A61K 47/06 (2006.01)
A61P 9/10 (2006.01)
A61P 9/12 (2006.01)
A61P 17/06 (2006.01)
A61P 17/10 (2006.01)
A61P 25/24 (2006.01)
A61P 29/00 (2006.01)
A61P 31/00 (2006.01)
- (86) HU2012000023 30.03.2012
(96) 12725876.2 05.02.2014
(87) WO2012131412, 30.03.2012
(97) 2691087, 05.02.2014 en
(54) PHARMACEUTICAL COMPOSITION CONTAINING NO, PROCESS FOR THE PREPARATION AND USE THEREOF
(71) Szabó László Gábor, Mátyás király út 35. 1/3, 3300 Eger, HU
Piller, István, Egri út 4, 3348 Szilvásvárad, HU
(72) Szabó László Gábor, Mátyás király út 35. 1/3, 3300 Eger, HU
Piller, István, Egri út 4, 3348 Szilvásvárad, HU
-
- (51) MKP
C09C 1/02 (2006.01) (97) **2662419**
D21H 17/00 (2006.01)
- (96) 12167683.7 13.11.2013
(97) 2662419, 13.11.2013 en
(54) Charge controlled PHCH
(71) Omya International AG, Baslerstrasse 42, 4665 Oftringen, CH
(72) Gantenbein, Daniel, Vogesenstrasse 27, 4056 Basel, CH
Gane, Patrick A.C., Studenweg 8, 4852 Rothrist, CH
Schoelkopf, Joachim, Buechbühlstrasse 3, 8956 Killwangen, CH
Laufmann, Maximilian, Zelglistrasse 6A, 4800 Zofingen, CH
Andersson, Lars, Stockengasse 3, 8802 Kilchberg, CH
-
- (51) MKP
A61K 31/497 (2006.01) (97) **2604604**
A61K 31/506 (2006.01)
A61P 3/04 (2006.01)
A61P 3/10 (2006.01)
C07D 405/14 (2006.01)
- (96) 13158856.8 19.06.2013
(97) 2604604, 19.06.2013 en
(54) Benzofuranil derivatives used as glucokinase inhibitors
(71) Pfizer Inc, 235 East 42nd Street, New York, NY 10017, US
Ling, Anthony Lai, 11314 Breckenridge Way, San Diego, CA California 92131, US
Pfefferkorn, Jeffrey Allen, Pfizer Global Research and Development Eastern Point Road, Groton, CT Connecticut 06340, US
-
- (51) MKP
E03C 1/122 (2006.01) (97) **2685013**
E03F 5/08 (2006.01)
F16K 17/19 (2006.01)
- (96) 12176031.8 15.01.2014
(97) 2685013, 15.01.2014 en
(54) Pressure regulating device and use thereof
(71) Planet Patent S.A., 1, rue Joseph Hackin, 1746 Luxembourg, LU
(72) Kovács, József, Markó u. 1/a, H-1055 Budapest, HU
-
- (51) MKP
A23G 1/56 (2006.01) (97) **2670253 ***
A23L 1/236 (2006.01)
- (86) EP2011006262 13.12.2011
(96) 11808828.5 11.12.2013
(87) WO2012103911, 13.12.2011
(97) 2670253, 11.12.2013 de
(54) REDUCED-CALORIE COMPOSITIONS FOR PRODUCING INSTANT DRINKS CONTAINING COCOA
(71) Krüger GmbH & Co. KG, Senefelderstrasse 44, 51469 Bergisch-Gladbach, DE
(72) KRÜGER, Willibert, Zaunkönigweg 5, 51467 Bergisch Gladbach, DE
-
- (51) MKP
A23J 1/14 (2006.01) (97) **2651238 ***
A23J 3/16 (2006.01)
C07K 1/14 (2006.01)
- (86) CA2011001380 16.12.2011
(96) 11848836.0 23.10.2013
(87) WO2012079161, 16.12.2011
(97) 2651238, 23.10.2013 en
(54) SOY PROTEIN PRODUCTS OF IMPROVED WATER-BINDING CAPACITY
(71) Burcon Nutrascience (MB) Corp., 1388 Waller Avenue, Winnipeg, Manitoba R3T 1P9, CA
(72) SEGALL, Kevin I., 31 Dunbar Crescent, Winnipeg, Manitoba R3P 0W6, CA
GREEN, Brent E., 24 Poplarwood Drive Box 603, Warren, Manitoba R0C 3E0, CA
-
- (51) MKP
A61K 31/201 (2006.01) (97) **2680837 ***
A61K 31/231 (2006.01)
A61P 3/06 (2006.01)
A61P 9/00 (2006.01)
A61P 9/10 (2006.01)
- (86) US2012027489 02.03.2012
(96) 12752848.7 08.01.2014
(87) WO2012119078, 02.03.2012
(97) 2680837, 08.01.2014 en
(54) COMPOSITIONS AND METHODS COMPRISING C16:1n7-PALMITOLEATE
(71) Tersus Pharmaceuticals, LLC, 5966 Heisley Road, Mentor, Ohio 44060, US
(72) GREEN, Jeffrey, 2568 Eaton Road, University Heights, Ohio 44118, US
-

(51) MKP
A61K 38/18 (2006.01) (97) **2655408 ***
C07K 14/475 (2006.01)
 (86) EP2011073739 22.12.2011
 (96) 11802949.5 30.10.2013
 (87) WO2012085178, 22.12.2011
 (97) 2655408, 30.10.2013 en
 (54) ROBO1-FC FUSION PROTEIN FOR USE IN THE TREATMENT OF HEPATOCARCINOMA
 (71) Sanofi, 174 avenue de France, 75013 Paris, FR
 (72) DOL-GLEIZES, Frédérique, c/o Sanofi Département Brevets 174 avenue de France, F-75013 Paris, FR
 GUEGUEN-DORBES, Geneviève, c/o Sanofi Département Brevets 174 avenue de France, F-75013 Paris, FR

(51) MKP
A01N 57/00 (2006.01) (97) **2675278 ***
A61K 31/665 (2006.01)
 (86) US2012025689 17.02.2012
 (96) 12747519.2 25.12.2013
 (87) WO2012112922, 17.02.2012
 (97) 2675278, 25.12.2013 en
 (54) METHODS FOR SYNTHESIZING MOLYBDOPTERIN PRECURSOR Z DERIVATIVES
 (71) Alexion Pharma International SARL, Avenue du Tribunal Fédéral 34, 1005 Lausanne, CH
 (72) LONG, Xiangtian, Room 2-2-302 Gezhi Garden Sun Yat-sen University Guangzhou Higher Education Mega Center PanYu District, Guangzhou 510006, CN
 DAL, Danmei, Room A1905, Building 19, Dongfang 3 Lu Tianhe District, Guangzhou 510630, CN
 BRUNNER, Andreas, Metzgergasse 2, 3900 Brig, CH
 WATT, Derek, Kevin, 150 Hill Road, Belmont, Lower Hutt 5010, NZ
 CLINCH, Keith, 144B Seddon Street, Naenae, Lower Hutt 5011, NZ
 BAARS, Sylvia, Myrna, 28 Coolidge Street, Brooklyn, Wellington 6021, NZ
 DIXON, Rachel, Anne, 24 Izard Road, Khandallah, Wellington 6035, NZ
 LITTLE, Gillian, Mary, 4 Warder Close, Dunmow Essex CM6 3TT, GB
 LANDREAU, Cyrille, Abel, Sébastien, 9 Woodland Way, Ongar Essex CM5 9EP, GB
 PROISY, Nicolas, Georges, Rene, 5 Keats Close, Royston Hertfordshire SG8 5AU, GB

(51) MKP
C12Q 1/68 (2006.01) (97) **2670867 ***
 (86) US2012023974 06.02.2012
 (96) 12742591.6 11.12.2013
 (87) WO2012106711, 06.02.2012
 (97) 2670867, 11.12.2013 en
 (54) A METHOD FOR DETECTING CHROMOSOME STRUCTURE AND GENE EXPRESSION SIMULTANEOUSLY IN SINGLE CELLS
 (71) The Trustees of The University of Pennsylvania, Center for Technology Transfer 3160 Chestnut Street, Suite 200, Philadelphia, PA 19104-6283, US
 (72) RAJ, Arjun, 2323 Race Street, Apt. 622, Philadelphia, PA 19103, US
 LEVESQUE, Marshall, J., 3505 Caminito El Rincon Unit 273, San Diego, CA 92130, US

(51) MKP
F02B 75/32 (2006.01) (97) **2652288 ***
 (86) US2011064448 12.12.2011
 (96) 11848931.9 23.10.2013
 (87) WO2012082637, 12.12.2011
 (97) 2652288, 23.10.2013 en
 (54) CRANKPIN INCLUDING CAM, CONNECTING ROD INCLUDING FOLLOWER, AND INTERNAL COMBUSTION ENGINE INCLUDING CRANKPIN AND CONNECTING ROD
 (71) Wilkins, Larry C., 401 East Las Olas Boulevard No. 130-260, Fort Lauderdale, Florida 33301, US
 (72) Wilkins, Larry C., 401 East Las Olas Boulevard No. 130-260, Fort Lauderdale, Florida 33301, US

(51) MKP
G06F 21/00 (2006.01) (97) **2447877**
 (96) 11181345.7 02.05.2012
 (97) 2447877, 02.05.2012 en
 (54) System and method for detection of malware and management of malware-related information
 (71) Kaspersky Lab, ZAO, 39A/3 Leningradskoe Shosse, Moscow 125212, RU
 (72) Zaitsev, Oleg V., c/o KASPERSKY LAB ZAO 10/1, 1st Volokolamsky Proezd, 123060 Moscow, RU

(51) MKP
C07D 409/10 (2006.01) (97) **2697218 ***
C07D 409/14 (2006.01)
 (86) EP2012056649 12.04.2012
 (96) 12715362.5 19.02.2014
 (87) WO2012140120, 12.04.2012
 (97) 2697218, 19.02.2014 en
 (54) PROCESS FOR THE PREPARATION OF COMPOUNDS USEFUL AS INHIBITORS OF SGLT2
 (71) Janssen Pharmaceutica, N.V., Turnhoutseweg 30, 2340 Beerse, BE
 (72) HOUPIS, Ioannis, Nicolaos, c/o Janssen Pharmaceutica NV Turnhoutseweg 30, B-2340 Beerse, BE
 LEMAIRE, Sebastien, François, Emmanuel, c/o Janssen Pharmaceutica NV Turnhoutseweg 30, B-2340 Beerse, BE

(51) MKP
A61C 8/00 (2006.01) (97) **2654603 ***
 (86) EP2011073336 20.12.2011
 (96) 11805482.4 30.10.2013
 (87) WO2012084896, 20.12.2011
 (97) 2654603, 30.10.2013 de
 (54) CRESTAL IMPLANT AND METHOD FOR PROCESSING SAME
 (71) Spahn, Frank-Peter, Genkersteenweg 470, 3500 Hasselt, BE
 (72) Spahn, Frank-Peter, Genkersteenweg 470, 3500 Hasselt, BE

(51) MKP
B41F 33/00 (2006.01) (97) **2675623 ***
 (86) EP2012050333 11.01.2012
 (96) 12700640.1 25.12.2013
 (87) WO2012110265, 11.01.2012
 (97) 2675623, 25.12.2013 en
 (54) METHOD AND DEVICE FOR THE CONTROL AND MANAGEMENT OF THE PRINTING PARAMETERS OF A PRINTING MACHINE, PARTICULARLY WITH A PLURALITY OF CONSECUTIVE PRINTING PROCESSES
 (71) Nuova Gidue S.R.L., Via Cassia 67, 50023 Tavarnuzze, Impruneta, IT
 (72) D'ANNUNZIO, Federico, Via Minniti 182, I-21040 Cislago, IT
 CARDINOTTI, Matteo, Via Arcivescovado 13, I-55100 Lucca, IT

(51) MKP
E03F 5/04 (2006.01) (97) **2551415**
 (96) 11195624.9 30.01.2013
 (97) 2551415, 30.01.2013 de
 (54) Process component
 (71) Dallmer GmbH & Co. KG, Wiebelsheidestrasse 25, 59757 Arnsberg, DE
 (72) Dallmer, Johannes, Binnerfeld 27, 59757 Arnsberg, DE

- (51) MKP
A61K 31/13 (2006.01) (97) **2661421 ***
A61P 9/12 (2006.01)
C07C 211/35 (2006.01)
- (86) US2012020246 05.01.2012
(96) 12731898.8 13.11.2013
(87) WO2012094437, 05.01.2012
(97) 2661421, 13.11.2013 en
- (54) NICOTINIC RECEPTOR NON-COMPETITIVE ANTAGONISTS
(71) Targacept, Inc., null, 100 North Main Street Suite 1510 Winston-Salem, NC 27101, US
(72) AKIREDDY, Srinivasa Rao, 5829 Fox Point Circle, Winston-Salem, North Carolina 27104, US
BREINING, Scott R., 2363 Rosewood Avenue, Winston-Salem, North Carolina 27103, US
MELVIN, Matt S., 2208 Elizabeth Avenue, Winston-Salem, North Carolina 27103, US
MURTHY, Srinivasa V., 5337 Hidden Stream Drive, Lewisville, North Carolina 27023, US
MAZUROV, Anatoly A., 3704 Timberoak Drive, Greensboro, North Carolina 27410, US
BHATTI, Balwinder Singh, 2536 Polo Road, Winston-Salem, North Carolina 27106, US
STRACHAN, Jon-Paul, 1871 Dunbar Place, Burlington, North Carolina 27215, US
HEEMSTRA, Ronald Joseph, 1145 Norwood Lane, Lewisville, North Carolina 27023, US
SHOWALTER, Todd, 100 Claron Court, Clemmons, North Carolina 27012, US
XIAO, Yunde, 2079 Waterford Village Drive, Clemmons, North Carolina 27012, US
HAMMOND, Philip S., 1162 Bradley Road, Pinnacle, North Carolina 27043, US
MIAO, Lan, 226 March Ferry Road, Advance, North Carolina 27006, US
KOMBO, David, 5324 Villas Court, Winston-Salem, North Carolina 27103, US
YOHANNES, Daniel, 1211 W. 4th Street, Winston-Salem, North Carolina 27101, US
SPEAKE, Jason, 1714 Woodston Drive, Winston-Salem, North Carolina 27127, US
-
- (51) MKP
A61K 31/4188 (2006.01) (97) **2651903 ***
A61P 11/00 (2006.01)
C07D 235/26 (2006.01)
C07D 471/04 (2006.01)
- (86) EP2011073008 16.12.2011
(96) 11802054.4 23.10.2013
(87) WO2012080446, 16.12.2011
(97) 2651903, 23.10.2013 en
- (54) BENZIMIDAZOLE RESPIRATORY SYNCYTIAL VIRUS INHIBITORS
(71) Janssen R&D Ireland, Eastgate Village, Eastgate, Little Island, County Cork, IE
(72) COOYMANS, Ludwig Paul, Grote Beekstraat 24, B-2340 Beerse, BE
DEMIN, Samuël Dominique, Professor Claraplein 14, Bus 308, B-2018 Antwerpen, BE
HU, Lili, Vrouw van Mechelenstraat 28, B-2800 Mechelen, BE
JONCKERS, Tim Hugo Maria, Pastoor Wouterstraat 19, bus 5, B-2650 Edegem, BE
RABOISSON, Pierre Jean-Marie Bernard, Rue Jolie 3, B-1331 Rosieres, BE
TAHRI, Abdellah, Rue Maurice Albert Raskin 30, B-1070 Anderlecht, BE
VENDEVILLE, Sandrine Marie Helene, Rue du Bémel 142, B-1150 Woluwe-Saint-Pierre, BE
-
- (51) MKP
E05D 15/06 (2006.01) (97) **2586945**
- (96) 12165698.7 01.05.2013
(97) 2586945, 01.05.2013 en
- (54) Carriage
(71) ECLISSE SRL, Via Sernaglia, 76, 31053 Pieve di Soligo TV, IT
(72) De Faveri, Luigi, Via Vittoria, 114, 31020 Refrontolo TV, IT
-
- (51) MKP
A61K 9/00 (2006.01) (97) **2654721 ***
A61K 9/127 (2006.01)
A61K 31/4425 (2006.01)
A61K 31/4706 (2006.01)
A61K 47/48 (2006.01)
A61P 31/10 (2006.01)
A61P 31/12 (2006.01)
A61P 33/00 (2006.01)
A61P 35/00 (2006.01)
- (86) EP2011073722 22.12.2011
(96) 11805029.3 30.10.2013
(87) WO2012085171, 22.12.2011
(97) 2654721, 30.10.2013 en
- (54) PHARMACEUTICAL COMPOSITIONS OF PYRIDINIUM AND QUINOLINIUM DERIVATIVES
(71) Traslational Cancer Drugs Pharma, S.L., José Antonio Primo de Rivera 4, 2º izda., 47001 Valladolid, ES
(72) PALACIOS IZQUIERDO, Beatriz, Virgen de los reyes 22 2º 3, E-28027 Madrid, ES
VAN HOOGEVEST, Peter, Phares Drug Delivery AG
Kluenenfeldstrasse 30, 4132 Muttenz Baselland, CH
L.S. LEIGH, Mathew, Phares Drug Delivery AG
Kluenenfeldstrasse 30, 4132 Muttenz Baselland, CH
-
- (51) MKP
F24D 3/12 (2006.01) (97) **2689192 ***
F24J 2/04 (2006.01)
- (86) IB2012051394 23.03.2012
(96) 12716083.6 29.01.2014
(87) WO2012127451, 23.03.2012
(97) 2689192, 29.01.2014 en
- (54) A HEAT ENERGY SYSTEM FOR HEATING OR MAINTAINING THERMAL BALANCE IN THE INTERIORS OF BUILDINGS OR BUILDING PARTS
(71) Gutai, Mátyás, Janus Pannonius u. 11., 6000 Kecskemét, HU
(72) Gutai, Mátyás, Janus Pannonius u. 11., 6000 Kecskemét, HU
-
- (51) MKP
A47G 1/20 (2006.01) (97) **2592286**
A47G 25/06 (2006.01)
B25C 1/02 (2006.01)
B25C 5/16 (2006.01)
F16B 43/02 (2006.01)
- (96) 12163879.5 15.05.2013
(97) 2592286, 15.05.2013 en
- (54) Anchors and anchor systems for hanging objects, and a tool for installing such anchors
(71) Hip Innovations, LLC, 291 Hurricane Lane, Williston, VT 05495, US
(72) Pettingill, James, 20 Aspen Drive, Essex Junction VT Vermont 05452, US
-
- (51) MKP
G06F 9/44 (2006.01) (97) **2663931 ***
G06F 9/445 (2006.01)
G06F 9/46 (2006.01)
G06F 11/30 (2006.01)
G06F 17/00 (2006.01)
G06F 17/30 (2006.01)
- (86) IB2011002411 02.09.2011
(96) 11821185.3 20.11.2013
(87) WO2012028957, 02.09.2011
(97) 2663931, 20.11.2013 en
- (54) A SYSTEM AND METHOD FOR RUNNING APPLICATIONS ON A PLATFORM
(71) Tse, Ronald Henry, Suite 1 8/F New Henry House 10 Ice House Street, Central, Hong Kong, CN
(72) Tse, Ronald Henry, Suite 1 8/F New Henry House 10 Ice House Street, Central, Hong Kong, CN
-

(51) MKP
F16D 27/112 (2006.01) (97) **2518359**
F16D 27/14 (2006.01)
F16D 28/00 (2006.01)
F16D 43/25 (2006.01)
(86) 12165732.4 31.10.2012
(97) 2518359, 31.10.2012 de
(54) Coupling device for a vehicle assembly and control method
(71) Behr Thermot-tronik GmbH,ENZstrasse 25-35, 70806 Kornwestheim, DE
Bayerische Motoren Werke Aktiengesellschaft, Petuelring 130, 80788 München, DE
(72) Willers, Eike, Kräherstr. 2, 70469 Stuttgart, DE
Lemberger, Heinz, Hofäckerallee 1, 85774 Unterföhring, DE

(51) MKP
C07K 14/005 (2006.01) (97) **2699586 ***
C12N 7/00 (2006.01)
G01N 33/68 (2006.01)
(86) US2012034054 18.04.2012
(96) 12718003.2 26.02.2014
(87) WO2012145386, 18.04.2012
(97) 2699586, 26.02.2014 en
(54) METHODS FOR ISOLATING AND QUANTIFYING ANTIGEN FROM VACCINES
(71) Baxter International Inc., One Baxter Parkway, Deerfield, IL 60015, US
Baxter Healthcare SA, Thurgauerstrasse 130, 8152 Glattpark (Opfikon), CH
(72) GRANINGER, Michael, Gemotgasse 3/11, 1150 Vienna, AT
KALIWODA, Martin, Schrekergergasse 8/3, 1160 Vienna, AT

(51) MKP
A61K 31/4178 (2006.01) (97) **2651926 ***
A61P 31/00 (2006.01)
C07D 403/10 (2006.01)
C07D 403/14 (2006.01)
C07D 409/14 (2006.01)
(86) US2011065224 15.12.2011
(96) 11849553.0 23.10.2013
(87) WO2012083053, 15.12.2011
(97) 2651926, 23.10.2013 en
(54) ANTI-VIRAL COMPOUNDS
(71) Abbvie Inc., 1 North Waukegan Road, North Chicago, IL 60064, US
(72) KRUEGER, Allan C., 7260 Presidential Drive, Gurnee Illinois 60031, US
KATI, Warren M., 152 Knob Hill Lane, Gurnee Illinois 60031, US
MARING, Clarence J., 1228 W. Borders Drive, Palatine Illinois 60067, US
WAGNER, Rolf, 42530 Sheridan Oaks Drive, Antioch Illinois 60002, US
HUTCHINS, Charles W., 31005 Prairie Ridge Rd, Green Oaks Illinois 600048, US

(51) MKP
A61K 31/517 (2006.01) (97) **2694073 ***
C07D 239/70 (2006.01)
(86) US2012031716 30.03.2012
(96) 12764894.7 12.02.2014
(87) WO2012135779, 30.03.2012
(97) 2694073, 12.02.2014 en
(54) COMBINATIONS OF AKT AND MEK INHIBITOR COMPOUNDS, AND METHODS OF USE
(71) Genentech, Inc., One DNA Way, South San Francisco, CA 94080-4990, US
(72) LEE, Brian, 1 DNA Way, South San Francisco California 94080-4990, US
LIN, Kui, 1 DNA Way, South San Francisco California 94080-4990, US
NANNINI, Michelle, 1 DNA Way, South San Francisco California 94080-4990, US
PUNNOOSE, Elizabeth, 1 DNA Way, South San Francisco California 94080-4990, US
SAMPATH, Deepak, 1 DNA Way, South San Francisco California 94080-4990, US

(51) MKP
A61K 31/343 (2006.01) (97) **2649453 ***
G01N 33/68 (2006.01)
(86) EP2011072294 09.12.2011
(96) 11796979.0 16.10.2013
(87) WO2012076679, 09.12.2011
(97) 2649453, 16.10.2013 en
(54) USE OF DRONEDARONE FOR THE PREPARATION OF A DRUG FOR USE IN THE MANAGEMENT OF THE RISK OF LIVER INJURY
(71) Sanofi, 174 avenue de France, 75013 Paris, FR
(72) AUCLERT, Laurent, sanofi 174 avenue de France, F-75013 Paris, FR

(51) MKP
A61K 31/505 (2006.01) (97) **2694484 ***
A61K 31/506 (2006.01)
C07D 239/48 (2006.01)
C07D 401/12 (2006.01)
C07D 403/12 (2006.01)
C07D 405/12 (2006.01)
C07D 413/12 (2006.01)
C07D 471/04 (2006.01)
(86) EP2012056388 10.04.2012
(96) 12712666.2 12.02.2014
(87) WO2012136834, 10.04.2012
(97) 2694484, 12.02.2014 en
(54) PYRIMIDINE DERIVATIVES FOR THE TREATMENT OF VIRAL INFECTIONS
(71) Janssen R&D Ireland, Eastgate Village, Eastgate, Little Island, County Cork, IE
(72) MC GOWAN, David, De Biollelyaan 80, B-1150 Brussel, BE
RABOISSON, Pierre Jean-Marie Bernard, Rue Jolie 3, B-1331 Rosieres, BE
EMBRECHTS, Werner, Bremstraat 7, B-2340 Beerse, BE
JONCKERS, Tim, Hugo, Maria, Bollostraat 2a, B-2220 Heist-op-den-Berg, BE
LAST, Stefaan, Julien, Crauwelshoeve 59, B-2547 Lint, BE
PIETERS, Serge, Maria, Aloysius, Pizarrostraat 2, NL-4562 AR Hulst, NL
VLACH, Jaromir, 144 Impasse de l'Orchidée, F-74800 La Roche sur Foron, FR

(51) MKP
C12Q 1/68 (2006.01) (97) **2670863 ***
(86) US2012023411 31.01.2012
(96) 12741485.2 11.12.2013
(87) WO2012106385, 31.01.2012
(97) 2670863, 11.12.2013 en
(54) METHODS OF IDENTIFYING MULTIPLE EPITOPES IN CELLS
(71) Apprise Bio, Inc., 248 Upper Terrace, San Francisco, CA 94117, US
(72) NOLAN, Garry, P., 248 Upper Terrace, San Francisco, CA 94117, US

(51) MKP
G01N 1/22 (2006.01) (97) **2570810**
G01N 33/543 (2006.01)
(86) 12185079.6 20.03.2013
(97) 2570810, 20.03.2013 de
(54) Method for examination of air for the presence of biological substances by means of removable multi-well strips on which an immunological assay is performed directly
(71) BMA Labor Gbr, Technologiezentrum Ruhr Universitätsstrasse 142, 44799 Bochum, DE
(72) Stephan, Ute, Dr., Meisenweg 4, 44807 Bochum, DE
Putz, Stephanie, Am Teimenort 15, 44894 Bochum, DE

- (51) MKP
C07K 16/40 (2006.01) (97) **2668212 ***
 (86) EP2012051320 27.01.2012
 (96) 12701742.4 04.12.2013
 (87) WO2012101252, 27.01.2012
 (97) 2668212, 04.12.2013 en
 (54) HUMAN ANTIBODIES TO PCSK9 FOR USE IN METHODS OF TREATING PARTICULAR GROUPS OF SUBJECTS
 (71) SANOFI, 54 rue La Boétie, 75008 Paris, FR
 (72) HANOTIN, Corinne, c/o SANOFI Diabetes - R&D/Development 54 rue La Boétie, F-75008 Paris, FR
 BESSAC, Laurence, c/o SANOFI Diabetes - R&D/Development 54 rue La Boétie, F-75008 Paris, FR
 CHAUDHARI, Umesh, c/o SANOFI US R&D Bridgewater Phase III - Clinical Development Mail Stop: 55B-415B 55 Corporate Drive, Bridgewater, NJ 08807, US

- (51) MKP
C07K 16/00 (2006.01) (97) **2699596 ***
 (86) US2012034575 20.04.2012
 (96) 12773598.3 26.02.2014
 (87) WO2012145714, 20.04.2012
 (97) 2699596, 26.02.2014 en
 (54) PROSTATE-SPECIFIC MEMBRANE ANTIGEN BINDING PROTEINS AND RELATED COMPOSITIONS AND METHODS
 (71) Emergent Product Development Seattle, LLC, 2401 Fourth Avenue, Suite 1050, Seattle, Washington 98121, US
 (72) BLANKENSHIP, John W., Emergent Product Development Seattle LLC 2401 Fourth Avenue Suite 1050, Seattle Washington 98121, US
 SEWELL, Elaine Todd, Emergent Product Development Seattle LLC 2401 Fourth Avenue Suite 1050, Seattle Washington 98121, US
 TAN, Philip, Emergent Product Development Seattle LLC 2401 Fourth Avenue Suite 1050, Seattle Washington 98121, US

- (51) MKP
A61K 31/437 (2006.01) (97) **2657233 ***
A61K 31/519 (2006.01)
A61K 31/5377 (2006.01)
A61P 35/00 (2006.01)
A61P 35/02 (2006.01)
A61P 43/00 (2006.01)
C07D 471/04 (2006.01)
C07D 487/04 (2006.01)
 (86) JP2013050740 17.01.2013
 (96) 13728918.7 30.10.2013
 (87) WO2013108809, 17.01.2013
 (97) 2657233, 30.10.2013 en
 (54) 3,5-DISUBSTITUTED ALKYNILBENZENE COMPOUND AND SALT THEREOF
 (71) Taiho Pharmaceutical Co., Ltd., 1-27, Kandanishiki-cho, Chiyoda-ku, Tokyo 101-8444, JP
 (72) SAGARA, Takeshi, c/o TAIHO PHARMACEUTICAL CO. LTD. 3 Okubo, Tsukuba-shi Ibaraki 300-2611, JP
 ITO, Satoru, c/o TAIHO PHARMACEUTICAL CO. LTD. 3 Okubo, Tsukuba-shi Ibaraki 300-2611, JP
 OTSUKI, Sachie, c/o TAIHO PHARMACEUTICAL CO. LTD. 3 Okubo, Tsukuba-shi Ibaraki 300-2611, JP
 SOOTOME, Hiroshi, c/o TAIHO PHARMACEUTICAL CO. LTD. 3 Okubo, Tsukuba-shi Ibaraki 300-2611, JP

- (51) MKP
A01N 25/22 (2006.01) (97) **2683236 ***
A01N 43/40 (2006.01)
A01N 47/40 (2006.01)
A01N 51/00 (2006.01)
A01P 7/00 (2006.01)
 (86) GB2012050500 07.03.2012
 (96) 12710991.6 15.01.2014
 (87) WO2012123714, 07.03.2012
 (97) 2683236, 15.01.2014 en
 (54) COMPOSITIONS AND METHODS FOR CONTROLLING PESTICIDE RESISTANT PESTS
 (71) Rothamsted Research Limited, Harpenden, Hertfordshire AL5 2JQ, GB
 Endura S.p.A., Viale Pietramellara 5, 40121 Bologna, IT
 (72) MOORES, Graham David, 61 Brook Drive, Stevenage Hertfordshire SG2 8TP, GB
 PHILIPPOU, Despina, Eleftherias 37, Orounda Nicosia 2779, CY
 BORZATTA, Valerio, Via Bellettini 20, I-40127 Bologna, IT
 CAPPARELLA, Elisa, Via Dradi 31, I-48123 Ravenna, IT

- (51) MKP
A61K 31/495 (2006.01) (97) **2694518 ***
A61P 9/00 (2006.01)
C07D 495/04 (2006.01)
 (86) GB2012050710 29.03.2012
 (96) 12718725.0 12.02.2014
 (87) WO2012131379, 29.03.2012
 (97) 2694518, 12.02.2014 en
 (54) THIENO [2, 3 -D]PYRIMIDINE DERIVATIVES AND THEIR USE TO TREAT ARRHYTHMIA
 (71) Xention Limited, Iconix Park London Road, Pampisford Cambridge Cambridgeshire CB22 3EG, GB
 (72) JOHN, Derek Edward, Xention Limited Iconix Park London Road Pampisford, Cambridge CB22 3EG, GB
 FORD, John, Xention Limited Iconix Park London Road Pampisford, Cambridge CB22 3EG, GB

- (51) MKP
A61K 9/20 (2006.01) (97) **2648701 ***
A61K 31/675 (2006.01)
A61K 47/32 (2006.01)
A61P 31/12 (2006.01)
 (86) US2011064263 09.12.2011
 (96) 11804846.1 16.10.2013
 (87) WO2012079035, 09.12.2011
 (97) 2648701, 16.10.2013 en
 (54) HIGHLY STABLE COMPOSITIONS OF ORALLY ACTIVE NUCLEOTIDE ANALOGUES OR ORALLY ACTIVE NUCLEOTIDE ANALOGUE PRODRUGS
 (71) Sigmapharm Laboratories, LLC, 3375 Progress Drive, Bensalem, Pennsylvania 19020, US
 (72) SPIREAS, Spiridon, 1536 Pebletown Drive, New Hope, Pennsylvania 18938, US
 PIYA, Ishari, 110 Dawn Drive, Landsdale, Pennsylvania 19446, US
 GROVER, Rakesh, 32 Renfield Drive, Princeton, New Jersey 08540, US
 SAGI, Sunil, 537 Shoemaker Drive, Fountainville, Pennsylvania 18923, US
 KALLUR, Ram, K., 539 Shoemaker Drive, Fountainville, Pennsylvania 18923, US

- (51) MKP
C08G 18/52 (2006.01) (97) **2660262 ***
C08G 18/70 (2006.01)
C08L 75/04 (2006.01)
G02B 1/04 (2006.01)
G02B 3/00 (2006.01)
(86) KR2011010315 29.12.2011
(96) 11852482.6 06.11.2013
(87) WO2012091493, 29.12.2011
(97) 2660262, 06.11.2013 en
(54) METHOD FOR MANUFACTURING RESIN FOR URETHANE-BASED OPTICAL MATERIAL, RESIN COMPOSITION FOR SAME, AND OPTICAL MATERIAL MANUFACTURED THEREBY
(71) Koc Solution Co.,LTD., 104-15 Munji-dong, Yuseong-gu, Daejeon 305-380, KR
(72) JANG, Dong Gyu, 222-804 Saemmeori Apt 908 Dunsan 2-dong Seo-gu, Daejeon 302-777, KR
ROH, Soo Gyun, 706-405 Daedeok Technovalley Apt. 892 Gwanpyeong-dong Yuseong-gu, Daejeon 305-790, KR
KIM, Jong Hyo, 207-103 Daejeon Deurium Apt. 317-1 Daejeong-dong Yuseong-gu, Daejeon 305-251, KR

- (51) MKP
A61K 31/165 (2006.01) (97) **2690087 ***
A61P 1/00 (2006.01)
A61P 9/00 (2006.01)
A61P 25/00 (2006.01)
A61P 25/20 (2006.01)
A61P 25/22 (2006.01)
A61P 25/24 (2006.01)
C07C 231/24 (2006.01)
C07C 233/18 (2006.01)
(86) CN2012072816 22.03.2012
(96) 12760538.4 29.01.2014
(87) WO2012126385, 22.03.2012
(97) 2690087, 29.01.2014 en
(54) NEW CRYSTAL FORM VII OF AGOMELATINE, PREPARATION METHOD AND USE THEREOF AND PHARMACEUTICAL COMPOSITION CONTAINING SAME
(71) Les Laboratoires Servier, 35, rue de Verdun, 92284 Suresnes Cedex, FR
Shanghai Institute Of Pharmaceutical Industry, No.1320 West Beijing Road Jing'an District, Shanghai 200040, CN
(72) HUANG, Yu, Room 601, No.6, Lane 560 Xin Shi Nan Road,, Shanghai 200122, CN
TONG, Ling, Dong Yang Guang High-Tech Park Shangsha, Chang'an Town, Dongguan, Guangdong 523871, CN
ZHU, Xueyan, Room 602, No.78, Lane283 Yangcheng Road, Zhabei District, Shanghai 200436, CN
SHAN, Hanbin, No.24, Dongfangxincun, Gaoan, Jiangxi 330800, CN
YUAN, Zhedong, Room 201, No.14, Lane58 Aomen Road,, Shanghai 200060, CN
YU, Xiong, Room 107, No. 32, DuolunRoad Hongkou District,, Shanghai 200081, CN

- (51) MKP
E03F 5/042 (2006.01) (97) **2685016**
(96) 12176030.0 15.01.2014
(97) 2685016, 15.01.2014 en
(54) Shut-off device and drain with such a device
(71) Planet Patent S.A., 1, rue Joseph Hackin, 1746 Luxembourg, LU
(72) Kovács, József, Markó u. 1/a, H-1055 Budapest, HU

- (51) MKP
A01N 43/42 (2006.01) (97) **2685825 ***
(86) US2012029085 14.03.2012
(96) 12757940.7 22.01.2014
(87) WO2012125732, 14.03.2012
(97) 2685825, 22.01.2014 en
(54) SUBSTITUTED IMADAZOPYRIMIDIN-5(6H)-ONES AS ALLOSTERIC MODULATORS OF MGLUR5 RECEPTORS
(71) Vanderbilt University, Center for Technology Transfer and Commercialization 305 Kirkland Hall 2201 West End Avenue, Nashville, TN 37240, US
(72) CONN, P., Jeffrey, 9012 Grey Point Ct., Brentwood TN 37027, US
LINSLEY, Craig, W., 401 Brierly Court, Brentwood TN 37027, US
STAUFFER, Shaun, R., 9500 Wexcorft Drive, Brentwood TN 37027, US
BARTOLOME-NEBREDÁ, Jose, Manuel, Janssen Research And Development Calle Jarama 75 Poligono Industrial, E-45007 Toledo, ES
MACDONALD, Gregor, James, Janssen Pharmaceutica NV Turnhoutseweg 30, 2340 Beerse, BE
CONDE-CEIDE, Susana, Janssen Research And Development Calle Jarama 75 Poligono Industrial, E-45007 Toledo, ES
JONES, Carrie, K., 7221 Highway 70 South, Apt. 636, Nashville TN 37221, US
MARTIN-MARTIN, Maria, Luz, Janssen Research And Development Calle Jarama 75 Poligono Industrial, E-45007 Toledo, ES
TONG, Han, Min, Janssen Research And Development Calle Jarama 75 Poligono Industrial, E-45007 Toledo, ES

- (51) MKP
C07H 19/06 (2006.01) (97) **2691524 ***
C12N 15/11 (2006.01)
C12Q 1/68 (2006.01)
(86) DK2012000030 28.03.2012
(96) 12716208.9 05.02.2014
(87) WO2012130238, 28.03.2012
(97) 2691524, 05.02.2014 en
(54) STACKING NUCLEIC ACID AND METHODS FOR USE THEREOF
(71) Quantibact A/S, Kettegård Allé 30, 2650 Hvidovre, DK
(72) SCHNEIDER, Uffe, Vest, Nystedvej 28, 1. th, DK-2500 Valby, DK
LISBY, Gorm, Brøndsted 319, DK-3670 Veksø, DK
MIKKELSEN, Nikolaj, Dam, Stenmagervej 13, DK-2700 Brønshøj, DK

- (51) MKP
E04G 5/04 (2006.01) (97) **2525107**
F16B 13/00 (2006.01)
(96) 12168531.7 21.11.2012
(97) 2525107, 21.11.2012 de
(54) Scaffolding anchoring device
(71) Henning GmbH & Co. KG, An der Helle 1, 59505 Bad Sassendorf - Lohne, DE
(72) Henning, Wolfgang, Eickelbornerstr. 34, 59505 Bad Sassendorf, DE

- (51) MKP
A61K 38/47 (2006.01) (97) **2699676 ***
C12N 9/24 (2006.01)
(86) US2012034479 20.04.2012
(96) 12717025.6 26.02.2014
(87) WO2012145644, 20.04.2012
(97) 2699676, 26.02.2014 en
(54) MODIFIED ACID ALPHA GLUCOSIDASE WITH ACCELERATED PROCESSING
(71) Genzyme Corporation, 500 Kendall Street, Cambridge, MA 02142, US
(72) CANFIELD, William, M., 7108 Brentwood Road, Oklahoma City, OK 73116, US
MORELAND, Rodney, J., 2 David Henry Gardner Lane, Southborough, MA 01772, US
KUDO, Mariko, 2220 Nw 56th Terrace, Oklahoma City, OK 73112, US

- (51) MKP
A61K 39/00 (2006.01) (97) **2694109 ***
A61K 39/395 (2006.01)
A61K 51/10 (2006.01)
A61P 11/00 (2006.01)
A61P 19/02 (2006.01)
A61P 25/28 (2006.01)
A61P 27/02 (2006.01)
C07K 16/18 (2006.01)
C07K 16/46 (2006.01)
C12P 21/02 (2006.01)
(86) US2012032635 06.04.2012
(96) 12768510.5 12.02.2014
(87) WO2012139069, 06.04.2012
(97) 2694109, 12.02.2014 en
(54) COMPOSITIONS AND METHODS FOR TREATING DISEASES OF PROTEIN AGGREGATION INVOLVING IC3B DEPOSITION
(71) Neotope Biosciences Limited, 25-28 North Wall Quay, Dublin 1, IE
(72) BASI, Guriqbal S., 514 Rhodes Drive, Palo Alto California 94303, US
BARBOUR, Robin, 250 Normandy Lane, Walnut Creek California 94598, US
-
- (51) MKP
C08B 37/10 (2006.01) (97) **2655421 ***
C12N 9/00 (2006.01)
C12P 19/04 (2006.01)
C12P 19/18 (2006.01)
(86) US2011066843 22.12.2011
(96) 11849994.6 30.10.2013
(87) WO2012088416, 22.12.2011
(97) 2655421, 30.10.2013 en
(54) CHEMOENZYMATIC SYNTHESIS OF STRUCTURALLY HOMOGENEOUS ULTRA-LOW MOLECULAR WEIGHT HEPARINS
(71) The University Of North Carolina At Chapel Hill, 308 Bynum Hall Campus Box 4105, Chapel Hill, NC 27599-4105, US
(72) XU, Yongmei, 7 Audley Lane, Chapel Hill, NC 27517, US
LIU, Jian, 106 Ivy Brook Lane, Chapel Hill, NC 27514, US
-
- (51) MKP
A61K 31/433 (2006.01) (97) **2699581 ***
A61P 25/08 (2006.01)
C07D 513/04 (2006.01)
(86) EP2012001658 17.04.2012
(96) 12714587.8 26.02.2014
(87) WO2012143117, 17.04.2012
(97) 2699581, 26.02.2014 en
(54) 2-OXO-1-IMIDAZOLIDINYL IMIDAZOTHIADIAZOLE DERIVATIVES
(71) UCB Pharma, S.A., 60, allée de la Recherche, 1070 Brussels, BE
(72) PROVINS, Laurent, c/o UCB Pharma S.A. 60 Allée de la Recherche, B-1070 Brussels, BE
QUESNEL, Yannick, c/o UCB Pharma S.A. 60 Allée de la Recherche, B-1070 Brussels, BE
-
- (51) MKP
A61K 9/00 (2006.01) (97) **2683360 ***
A61K 38/00 (2006.01)
(86) US2012028298 08.03.2012
(96) 12757055.4 15.01.2014
(87) WO2012125408, 08.03.2012
(97) 2683360, 15.01.2014 en
(54) PEGYLATED APELIN AND USES THEREOF
(71) Genzyme Corporation, 500 Kendall Street, Cambridge, MA 02142, US
(72) JIA, Zhiqiang, 500 Kendall St., Cambridge, Massachusetts 02142, US
HOU, Lihui, 500 Kendall St., Cambridge, Massachusetts 02142, US
PAN, Clark Q., 500 Kendall St., Cambridge, Massachusetts 02142, US
AKITA, Geoffrey Y., 500 Kendall St., Cambridge, Massachusetts 02142, US
-
- (51) MKP
C09C 1/02 (2006.01) (97) **2662417**
D21H 17/00 (2006.01)
(96) 12167656.3 13.11.2013
(97) 2662417, 13.11.2013 en
(54) Starch-based PHCH
(71) Omya International AG, Baslerstrasse 42, 4665 Oftringen, CH
Senti-Wenk, Armelle, Schartenstraße 80, 5430 Wettingen, CH
Gane, Patrick A. C., Studenweg 8, 4852 Rothrist, CH
Schoelkopf, Joachim, Buechbühlstraße 3, 8956 Killwangen, CH
-
- (51) MKP
A61K 31/517 (2006.01) (97) **2694069 ***
A61P 35/00 (2006.01)
G01N 33/48 (2006.01)
(86) EP2012055595 29.03.2012
(96) 12710955.1 12.02.2014
(87) WO2012136549, 29.03.2012
(97) 2694069, 12.02.2014 en
(54) USE OF SUBSTITUTED 2,3-DIHYDROIMIDAZO[1,2-C] QUINAZOLINES
(71) Bayer Pharma Aktiengesellschaft, Müllerstrasse 178, 13353 Berlin, DE
(72) LIU, Ningshu, Ringstr. 89a, 12203 Berlin, DE
SCHNEIDER, Claudia, Sprenglerstr. 38, 13353 Berlin, DE
-
- (51) MKP
B60H 1/00 (2006.01) (97) **2679420**
B60H 1/32 (2006.01)
F04B 39/12 (2006.01)
(96) 13174294.2 01.01.2014
(97) 2679420, 01.01.2014 en
(54) Motor-driven compressor
(71) Kabushiki Kaisha Toyota Jidoshokki, 2-1, Toyoda-cho, Kariya-shi, Aichi-ken, JP
(72) Arai, Tomoharu, c/o KABUSHIKI KAISHA TOYOTA JIDOSHOKKI 2-1, Toyoda-cho Kariya-shi, Aichi-ken, JP
Ito, Tatsuya, c/o KABUSHIKI KAISHA TOYOTA JIDOSHOKKI 2-1, Toyoda-cho Kariya-shi, Aichi-ken, JP
Suitou, Ken, c/o KABUSHIKI KAISHA TOYOTA JIDOSHOKKI 2-1, Toyoda-cho Kariya-shi, Aichi-ken, JP
-
- (51) MKP
C04B 41/61 (2006.01) (97) **2660224 ***
C04B 111/27 (2006.01)
(86) UA2011000126 22.12.2011
(96) 11852774.6 06.11.2013
(87) WO2012091688, 22.12.2011
(97) 2660224, 06.11.2013 de
(54) WATERPROOFING COMPOSITION
(71) Mischenko, Valentyn Nikolayevich, Ul. Klovsykyi uzviz 14/24-76, Kiev 01021, UA
Lykhoded, Yuriy Anatolevich, Ul. Ybileynaya 26-12, Alushta, Avtonomnaja Respublika Krym 98500, UA
Melnik, Stefaniya Stefanovna, Ul. Pushkina 8-23 Kalush, Ivano-Frankovskaja obl. 77300, UA
Shimanskiy, Arkadiy Petrovich, Ul. Marshala Gryechko 8-G-35, Kiev 04136, UA
(72) Mischenko, Valentyn Nikolayevich, Ul. Klovsykyi uzviz 14/24-76, Kiev 01021, UA
Lykhoded, Yuriy Anatolevich, Ul. Ybileynaya 26-12, Alushta, Avtonomnaja Respublika Krym 98500, UA
Melnik, Stefaniya Stefanovna, Ul. Pushkina 8-23 Kalush, Ivano-Frankovskaja obl. 77300, UA
Shimanskiy, Arkadiy Petrovich, Ul. Marshala Gryechko 8-G-35, Kiev 04136, UA
-

(51) MKP
A61K 39/12 (2006.01) (97) **2646459 ***
C07K 14/005 (2006.01)
C07K 14/025 (2006.01)
C07K 14/045 (2006.01)
C07K 14/075 (2006.01)
C07K 14/085 (2006.01)
C07K 14/11 (2006.01)
C07K 14/16 (2006.01)
C07K 14/18 (2006.01)
(86) DK2011050460 02.12.2011
(96) 11844256.5 09.10.2013
(87) WO2012072088, 02.12.2011
(97) 2646459, 09.10.2013 en
(54) PEPTIDE SCAFFOLD DESIGN
(71) Bionor Immuno AS, Klostergata 33 P.O. Box 2870, 3702 Skien, NO
(72) LANGE, Einar Tønnes, Strømdalbakken 6, N-3744 Skien, NO
GRØNVOLD, Maja Sommerfelt, Akland, N-4950 Risør, NO
HOLMBERG, Jens Olof, Hjalmslultsgatan 15, S-254 41 Helsingborg, SE
SØRENSEN, Birger, Meierlia 3, N-3744 Skien, NO

(51) MKP
C07D 205/04 (2006.01) (97) **2695881 ***
A61K 31/5377 (2006.01)
A61P 9/10 (2006.01)
A61K 31/495 (2006.01)
A61P 1/16 (2006.01)
A61K 31/506 (2006.01)
A61P 9/00 (2006.01)
A61K 31/426 (2006.01)
A61K 31/551 (2006.01)
A61P 9/12 (2006.01)
A61K 31/4545 (2006.01)
A61P 1/04 (2006.01)
A61K 31/505 (2006.01)
A61P 3/10 (2006.01)
A61K 31/4402 (2006.01)
A61P 1/02 (2006.01)
A61P 11/00 (2006.01)
A61K 31/496 (2006.01)
A61P 3/04 (2006.01)
(86) JP2012056429 13.03.2012
(96) 12758359.9 12.02.2014
(87) WO2012124696, 13.03.2012
(97) 2695881, 12.02.2014 en
(54) GUANIDINE COMPOUND
(71) Astellas Pharma Inc., 3-11, Nihonbashi-Honcho 2-chome Chuo-ku, Tokyo 103-8411, JP
(72) YOSHIHARA, Kousei, c/o Astellas Pharma Inc. 3-11 Nihonbashi-Honcho 2-chome Chuo-ku, Tokyo 103-8411, JP
SUZUKI, Daisuke, c/o Astellas Pharma Inc. 3-11 Nihonbashi-Honcho 2-chome Chuo-ku, Tokyo 103-8411, JP
YAMAKI, Susumu, c/o Astellas Pharma Inc. 3-11 Nihonbashi-Honcho 2-chome Chuo-ku, Tokyo 103-8411, JP
YAMADA, Hiroyoshi, c/o Astellas Pharma Inc. 3-11 Nihonbashi-Honcho 2-chome Chuo-ku, Tokyo 103-8411, JP
MIHARA, Hisashi, c/o Astellas Pharma Inc. 3-11 Nihonbashi-Honcho 2-chome Chuo-ku, Tokyo 103-8411, JP
SEKI, Norio, c/o Astellas Pharma Inc. 3-11 Nihonbashi-Honcho 2-chome Chuo-ku, Tokyo 103-8411, JP

(51) MKP
C12N 5/075 (2010.01) (97) **2697365 ***
(86) US2012033643 13.04.2012
(96) 12770662.0 19.02.2014
(87) WO2012142500, 13.04.2012
(97) 2697365, 19.02.2014 en
(54) COMPOSITIONS AND METHODS FOR AUTOLOGOUS GERMLINE MITOCHONDRIAL ENERGY TRANSFER
(71) The General Hospital Corporation, 55 Fruit Street, Boston, MA 02114, US
(72) TILLY, Jonathan, Lee, 39 Mockingbird Hill Road, Windham NH 03087, US
WOODS, Dori C., 34 Shasta Dr., Londonderry, NH 03053-3007, US

(51) MKP
A61K 38/48 (2006.01) (97) **2661493 ***
C12N 9/68 (2006.01)
(86) EP2012050074 04.01.2012
(96) 12700154.3 13.11.2013
(87) WO2012093132, 04.01.2012
(97) 2661493, 13.11.2013 en
(54) PLASMINOGEN AND PLASMIN VARIANTS
(71) ThromboGenics N.V., Gaston Geenslaan 1, 3001 Heverlee, BE
(72) ZWAAL, Richard Reinier, Geldenaaksebaan 199/2, 3001 Heverlee, BE

(51) MKP
A61G 5/04 (2013.01) (97) **2606867**
(96) 12008409.0 26.06.2013
(97) 2606867, 26.06.2013 en
(54) Powered wheelchair
(71) Brandale SAGL, Via Carlo Frasca, 3, 6901 Lugano, CH
(72) Badano, Paolo, Via Marmorassi, 62B, I - 17100 Savona, IT

(51) MKP
A61K 31/4196 (2006.01) (97) **2678014 ***
A61K 31/661 (2006.01)
A61K 45/06 (2006.01)
A61P 35/00 (2006.01)
(86) US2012026268 23.02.2012
(96) 12743551.9 01.01.2014
(87) WO2012141796, 23.02.2012
(97) 2678014, 01.01.2014 en
(54) PROSTATE CANCER THERAPY WITH HSP90 INHIBITORY COMPOUNDS
(71) Synta Pharmaceuticals Corp., 45 Hartwell Avenue, Lexington, MA 02421, US
(72) PROIA, David, 30 Silver Lake Avenue, Newton, MA 02458, US
HE, Sujin, 12 Loyola Circle, West Roxbury, MA 02132, US

(51) MKP
C03C 25/24 (2006.01) (97) **2691345 ***
C03C 25/26 (2006.01)
C03C 25/40 (2006.01)
C08J 5/08 (2006.01)
(86) US2012030024 22.03.2012
(96) 12714112.5 05.02.2014
(87) WO2012134924, 22.03.2012
(97) 2691345, 05.02.2014 en
(54) FIBER GLASS STRANDS AND REINFORCED PRODUCTS COMPRISING THE SAME
(71) PPG Industries Ohio, Inc., 3800 West 143rd Street, Cleveland, OH 44111, US
(72) VAN DER WOUDE, Jacobus, Hendricus, Antonius, Burgemeester van Waninglaan 43, NL-9351 JL Leek, NL
DIJT, Jacob, Cornelis, Verdeweg 7, NL-9761 JL Eelde, NL
PENNING, John, Theo, Dorpsstraat 15, NL-9482 PA Tynaarlo, NL
BOELMAN, Ronald, Weegbrog 5, NL-9501 KJ Stadskanaal, NL
TABAK, Johannes, Leonardus, Sloep 195, NL-9732 CL Groningen, NL
BOWLAND, Creig, Dean, 3155 West Zion Church Road, Shelby, North Carolina 28150, US

(51) MKP
A61F 13/02 (2006.01) (97) **2700387 ***
A61K 9/70 (2006.01)
(86) JP2012057205 21.03.2012
(96) 12773765.8 26.02.2014
(87) WO2012144287, 21.03.2012
(97) 2700387, 26.02.2014 en
(54) ADHESIVE TAPE PACKAGING BAG
(71) Hisamitsu Pharmaceutical Co., Inc., 408, Tashirodaikan-machi, Tosu-shi, Saga 841-0017, JP
(72) MIYACHIKA Takafumi, c/o HISAMITSU PHARMACEUTICAL CO. INC. 408 Tashirodaikan-machi, Tosu-shi Saga 841-0017, JP
TAKETOMI Hiroyuki, c/o HISAMITSU PHARMACEUTICAL CO. INC. 408 Tashirodaikan-machi, Tosu-shi Saga 841-0017, JP

- (51) MKP
A61K 31/4427 (2006.01) (97) **2697198 ***
A61P 35/00 (2006.01)
C07D 213/64 (2006.01)
C07D 401/12 (2006.01)
C07D 401/14 (2006.01)
C07D 407/12 (2006.01)
C07D 409/12 (2006.01)
C07D 413/12 (2006.01)
C07D 413/14 (2006.01)
C07D 491/10 (2006.01)
C07D 491/113 (2006.01)
(86) US2012033662 13.04.2012
(96) 12716968.8 19.02.2014
(87) WO2012142513, 13.04.2012
(97) 2697198, 19.02.2014 en
(54) SUBSTITUTED BENZENE COMPOUNDS
(71) Epizyme, Inc., 400 Technology Square, 4th Floor, Cambridge, MA 02139, US
(72) KUNTZ, Kevin, Wayne, 8 New Village Road, Woburn MA 01801, US
CHESWORTH, Richard, 584 Strawberry Hill Road, Concord MA 01742, US
DUNCAN, Kenneth, William, 132 Roosevelt Avenue, Norwood MA 02062, US
KEILHACK, Heike, 3 Falmouth Street, Belmont MA 02478, US
WARHOLIC, Natalie, 81 Strathmore Road Apartment 32, Brighton MA 02135, US
KLAUS, Christine, 29 Weyham Road, Weymouth MA 02191, US
SEKI, Masashi, c/o Tsukuba Research Laboratories Eisai Co. Ltd. 5-1-3 Tokodai Tsukubashi, Ibaraki 300-2635, JP
KNUTSON, Sarah, K., 24 Bay State Road Unit 22, Cambridge, MA 02138, US
WIGLE, Timothy, James, Nelson, 111 Marivista Avenue, Waltham, MA 02451, US

- (51) MKP
A61B 17/86 (2006.01) (97) **2699187 ***
A61B 19/02 (2006.01)
A61C 8/00 (2006.01)
A61F 2/00 (2006.01)
A61L 2/26 (2006.01)
(86) FR2012050852 19.04.2012
(96) 12722437.6 26.02.2014
(87) WO2012172215, 19.04.2012
(97) 2699187, 26.02.2014 fr
(54) MEDICAL ASSEMBLY COMPRISING A MEDICAL ARTICLE AND A PACKAGE CONTAINING SAID ARTICLE
(71) Selenium Medical, 40 rue Chef de Baie ZI Chef de Baie, 17000 La Rochelle, FR
(72) RICHART, Olivier, 7 rue Joséphine Baker, F-17140 Lagord, FR
LARCHE, Grégoire, 19 rue de l'Ancien Hôpital, F-49300 Cholet, FR
PODGORSKI, Jean-Pierre, 15 rue du Fief D'ares, F-49230 Saint Crespin Sur Moine, FR

- (51) MKP
A61K 31/4164 (2006.01) (97) **2655336 ***
C07D 233/88 (2006.01)
C07D 233/91 (2006.01)
(86) NL2011000083 21.12.2011
(96) 11810907.3 30.10.2013
(87) WO2012087115, 21.12.2011
(97) 2655336, 30.10.2013 en
(54) CANCER TARGETING USING CARBONIC ANHYDRASE ISOFORM IX INHIBITORS
(71) STICHTING MAASTRICHT RADIATION ONCOLOGY "MAASTRO CLINIC", Dr. Tanslaan 12, 6229 ET Maastricht, NL
CNRS Centre National de la Recherche Scientifique, 3, rue Michel Ange, 75794 Paris Cedex 16, FR
Supuran, Claudiu, Via de Magalotti 7, 50122 Florence, IT
(72) SUPURAN, Claudiu, Via de Magalotti 7, I-50122 Florence, IT
LAMBIN, Philippe, Rue de Wanroux 17, B-1400 Genappe Bousvalle, BE
WINUM, Jean-Yves, Rue Pierre Mendès France 20, F-34725 Saint Andre de Sangonis, FR

- (51) MKP
A61K 31/5377 (2006.01) (97) **2663561 ***
A61P 25/00 (2006.01)
C07D 413/14 (2006.01)
C07D 487/04 (2006.01)
(86) EP2012050395 11.01.2012
(96) 12700390.3 20.11.2013
(87) WO2012095469, 11.01.2012
(97) 2663561, 20.11.2013 en
(54) NOVEL HETEROCYCLIC DERIVATIVES AND THEIR USE IN THE TREATMENT OF NEUROLOGICAL DISORDERS
(71) Novartis AG, Lichtstrasse 35, 4056 Basel, CH
(72) BADIGER, Sangamesh, Aurigene Discovery Technologies Limited 39-40 KIADB Industrial Area Electronic City Phase II Hosur Road Bangalore, Karnataka 560 100, IN
CHEBROLU, Murali, Aurigene Discovery Technologies Limited 39-40 KIADB Industrial Area Electronic City Phase II Hosur Road Bangalore, Karnataka 560 100, IN
HURTH, Konstanze, Novartis Pharma AG Werk Klybeck Postfach, CH-4002 Basel, CH
JACQUIER, Sébastien, Novartis Pharma AG Werk Klybeck Postfach, CH-4002 Basel, CH
LUEOEND, Rainer Martin, Novartis Pharma AG Werk Klybeck Postfach, CH-4002 Basel, CH
MACHAUER, Rainer, Novartis Pharma AG Werk Klybeck Postfach, CH-4002 Basel, CH
RUEEGER, Heinrich, Novartis Pharma AG Werk Klybeck Postfach, CH-4002 Basel, CH
TINTELOT-BLOMLEY, Marina, Novartis Pharma AG Werk Klybeck Postfach, CH-4002 Basel, CH
VEENSTRA, Siem Jacob, Novartis Pharma AG Werk Klybeck Postfach, CH-4002 Basel, CH
VOEGTLE, Markus, Novartis Pharma AG Werk Klybeck Postfach, CH-4002 Basel, CH

- (51) MKP
A61K 9/20 (2006.01) (97) **2694039 ***
A61K 31/4188 (2006.01)
(86) JP2012059276 29.03.2012
(96) 12717499.3 12.02.2014
(87) WO2012133918, 29.03.2012
(97) 2694039, 12.02.2014 en
(54) SOLID PREPARATION
(71) Takeda Pharmaceutical Company Limited, 1-1 Doshomachi 4-chome Chuo-ku, Osaka-shi, Osaka 541-0045, JP
(72) HOSHINA, Wataru, c/o TAKEDA PHARMACEUTICAL COMPANY LIMITED 17-85 Jusohonmachi 2-chome Yodogawa-ku, Osaka-shi Osaka 532-0024, JP
MISAKI, Masafumi, c/o TAKEDA PHARMACEUTICAL COMPANY LIMITED 17-85 Jusohonmachi 2-chome Yodogawa-ku, Osaka-shi Osaka 532-0024, JP

- (51) MKP
A61K 36/00 (2006.01) (97) **2670415 ***
A61K 36/28 (2006.01)
A61K 36/45 (2006.01)
A61K 36/53 (2006.01)
A61K 36/539 (2006.01)
A61K 36/73 (2006.01)
A61K 36/734 (2006.01)
A61K 36/77 (2006.01)
A61P 3/02 (2006.01)
A61P 29/00 (2006.01)
A61P 39/06 (2006.01)
C12Q 1/02 (2006.01)
G01N 33/48 (2006.01)
(86) CA2012000090 01.02.2012
(96) 12742455.4 11.12.2013
(87) WO2012103637, 01.02.2012
(97) 2670415, 11.12.2013 en
(54) FUNCTIONAL FOODS AND BEVERAGES WITH SYNERGISTIC PROPERTIES TO PROMOTE HOMEOSTASIS
(71) Justbio Inc., 1642 rue de la Ferme, La Pocatière, Québec G0R 1Z0, CA
(72) CHABOT, Sophie, 347 rue des Artisans, St-Jean-Port-Joli, Québec G0R 3G0, CA

- (51) MKP
F02C 7/08 (2006.01) (97) **2673490 ***
 (86) US2012025006 14.02.2012
 (96) 12747787.5 18.12.2013
 (87) WO2012112514, 14.02.2012
 (97) 2673490, 18.12.2013 en
 (54) RADIATION SHIELD FOR A GAS TURBINE COMBUSTOR
 (71) ICR Turbine Engine Corporation, 75 Lafayette Road Unit 1, Hamton, NH 03842, US
 (72) NASH, James, S., 181 Mill Road, North Hampton, NH 03862, US
 MOERLEIN, Alex, 23 Turner Street, Salem, MA 01970, US
-
- (51) MKP
F17C 13/08 (2006.01) (97) **2686602 ***
 (86) EP2012053792 06.03.2012
 (96) 12707306.2 22.01.2014
 (87) WO2012123283, 06.03.2012
 (97) 2686602, 22.01.2014 de
 (54) ARRANGEMENT FOR STORING AND EXTRACTING COMPRESSED GAS
 (71) Messer GasPack GmbH, Gahlingspfad 31, 47803 Krefeld, DE
 Wystrach GmbH, Holtumsweg 10, 47652 Weeze, DE
 (72) KRIESE, Alexander, Melkergasse 31, A-2500 Baden bei Wien, AT
 WOLTER, Wolfgang, Triftstr. 195, 47574 Goch-Asperden, DE
-
- (51) MKP
G08G 1/08 (2006.01) (97) **2682927 ***
 (86) RU2011000318 11.05.2011
 (96) 11859778.0 08.01.2014
 (87) WO2012118399, 11.05.2011
 (97) 2682927, 08.01.2014 en
 (54) VEHICLE TRAFFIC CONTROL METHOD AND DEVICE FOR IMPLEMENTING SAME
 (71) Matur, Igor Yurievich, ul. Sofyi Perovskoy, 37-49-50, Tula 300034, RU
 (72) Matur, Igor Yurievich, ul. Sofyi Perovskoy, 37-49-50, Tula 300034, RU
-
- (51) MKP
B07C 5/12 (2006.01) (97) **2691762 ***
G01N 21/90 (2006.01)
 (86) US2012031217 29.03.2012
 (96) 12714459.0 05.02.2014
 (87) WO2012135503, 29.03.2012
 (97) 2691762, 05.02.2014 en
 (54) OPTICAL INSPECTION OF CONTAINERS
 (71) Owens-Brockway Glass Container Inc., One Michael Owens Way, Perrysburg, OH 43551, US
 (72) RINGLIEN, James, A., 2210 Glenview Drive, Maumee, OH 43537, US
-
- (51) MKP
H04N 7/18 (2006.01) (97) **2681910 ***
 (86) IB2012000588 28.02.2012
 (96) 12781819.3 08.01.2014
 (87) WO2012153171, 28.02.2012
 (97) 2681910, 08.01.2014 en
 (54) METHOD AND APPARATUS FOR REAL TIME VIDEO IMAGING OF THE SNOUT INTERIOR ON A HOT DIP COATING LINE
 (71) Arcelormittal Investigación y Desarrollo SL, CL/Chavarrí, 6, 48910 Sestao, Bizkaia, ES
 Connors Industrial, Inc, 2733 Condit Street, Highland, IN 46322, US
 (72) ROTOLE, John, 231 Vulpine Dr., Valparaiso, IN 46385, US
 KRCMARIC, Charles, 9 Beach Lane Court, Ogden Dunes, IN 46368, US

- (51) MKP
C07D 307/22 (2006.01) (97) **2665716 ***
C07D 498/04 (2006.01)
C07D 513/04 (2006.01)
 (86) US2012022053 20.01.2012
 (96) 12702690.4 27.11.2013
 (87) WO2012100179, 20.01.2012
 (97) 2665716, 27.11.2013 en
 (54) METHODS AND COMPOUNDS USEFUL IN THE SYNTHESIS OF FUSED AMINODIHYDROTHIAZINE DERIVATIVES
 (71) Eisai R&D Management Co., Ltd., 6-10, Koishikawa 4-chome Bunkyo-ku, Tokyo 112-8088, JP
 (72) MITASEV, Branko, 3 Vine Street, North Reading Massachusetts 01864, US
 KIM, Dae-Shik, 311 Lowell Street, Apt 3113, Andover Massachusetts 01810, US
 ZHANG, Huiming, 2 Dorset Circle, Andover Massachusetts 01810, US
 SCHNADERBECK, Matthew J., 26 Morgan Drive, Methuen Massachusetts 01844, US
 FARTHING, Christopher N., 29 Portland Rise, London Greater London N4 2PT, GB
 YOSHIZAWA, Kazuhiro, 2-11-4-101 Miyashita, Kashima Ibaraki 314-0032, JP
-
- (51) MKP
H02J 7/00 (2006.01) (97) **2575235**
 (96) 11388004.1 03.04.2013
 (97) 2575235, 03.04.2013 en
 (54) Battery control system
 (71) Nilfisk-Advance A/S, Sognevej 25, 2605 Brøndby, DK
 (72) Thorsøe, Jan, Ørnevej 23, 9230 Svenstrup J, DK
-
- (51) MKP
C12N 5/02 (2006.01) (97) **2658966 ***
C12N 5/0735 (2010.01)
C12N 5/079 (2010.01)
 (86) US2011065810 19.12.2011
 (96) 11854189.5 06.11.2013
 (87) WO2012091978, 19.12.2011
 (97) 2658966, 06.11.2013 en
 (54) DIFFERENTIATION OF HUMAN PLURIPOTENT STEM CELLS TO MULTIPOTENT NEURAL CREST CELLS
 (71) University of Georgia Research Foundation, Inc., 809 Boyd Graduate Studies Research Center 200 D.W. Brooks Drive, Athens, GA 30602-7411, US
 (72) DALTON, Stephen, 1030 Coday Bluff, Athens, GA 30606, US
 MENENDEZ, Laura, M., River Chase Drive, Athens, GA 30605, US
-
- (51) MKP
E03F 5/042 (2006.01) (97) **2685017**
 (96) 12176032.6 15.01.2014
 (97) 2685017, 15.01.2014 en
 (54) Bi-directional shut-off valve system, manhole assembly comprising such valve system and use of such valve system in a sewer network
 (71) Planet Patent S.A., 1, rue Joseph Hackin, 1746 Luxembourg, LU
 (72) Kovács, József, Markó u. 1/a, H-1055 Budapest, HU
-
- (51) MKP
G01N 33/574 (2006.01) (97) **2694972 ***
 (86) US2012032206 04.04.2012
 (96) 12716858.1 12.02.2014
 (87) WO2012138785, 04.04.2012
 (97) 2694972, 12.02.2014 en
 (54) METHODS FOR PREDICTING AND IMPROVING THE SURVIVAL OF GASTRIC CANCER PATIENTS
 (71) Nestec S.A., Avenue Nestlé 55, 1800 Vevey, CH
 (72) KIM, Phillip, 28 Exeter, Irvine, CA 92612, US
 SINGH, Sharat, 8171 Top of the Morning Way, Rancho Santa Fe, CA 92127, US

(51) MKP
A01N 43/40 (2006.01) (97) **2683243 ***
A61K 31/435 (2006.01)
C07D 213/56 (2006.01)
C07D 273/00 (2006.01)
(86) US2012028293 08.03.2012
(96) 12755552.2 15.01.2014
(87) WO2012122383, 08.03.2012
(97) 2683243, 15.01.2014 en
(54) P13 KINASE INHIBITORS AND USES THEREOF
(71) Celgene Avilomics Research, Inc., 45 Wiggins Avenue, Bedford, MA 01730, US
(72) QIAO, Lixin, 49 Blanchard Street, Andover, MA 01810, US
NIU, Deqiang, 30 Grapevine Avenue, Lexington, MA 02421, US
PETTER, Russell, C., 22 Robinwood Lane, Stow, MA 01775, US
ZHU, Zhendong, 8 Nipmuck Drive, Westborough, MA 01581, US

(51) MKP
A01K 67/027 (2006.01) (97) **2663575 ***
C07K 14/54 (2006.01)
C07K 14/715 (2006.01)
(86) US2012062379 29.10.2012
(96) 12795905.4 20.11.2013
(87) WO2013063556, 29.10.2012
(97) 2663575, 20.11.2013 en
(54) HUMANIZED IL-6 AND IL-6 RECEPTOR
(71) Regeneron Pharmaceuticals, Inc., 777 Old Saw Mill River Road, Tarrytown, NY 10591, US
(72) WANG, Li-hsien, 184 Brianwood Drive, Somers, NY 10589, US
DORE, Anthony, T., 485 Gramatan Avenue, Mount Vernon, NY 10552, US
STEVENS, Sean, 355 Berry Street No. 413, San Francisco, CA 94158, US
MURPHY, Andrew, J., 10 Newton Court, Croton-on-Hudson, NY 10520, US

(51) MKP
A61K 31/4184 (2006.01) (97) **2651923 ***
A61P 31/14 (2006.01)
C07D 403/04 (2006.01)
C07D 403/10 (2006.01)
C07D 403/12 (2006.01)
C07D 403/14 (2006.01)
(86) US2011065206 15.12.2011
(96) 11849362.6 23.10.2013
(87) WO2012083043, 15.12.2011
(97) 2651923, 23.10.2013 en
(54) ANTI-VIRAL COMPOUNDS
(71) Abbvie Inc., 1 North Waukegan Road, North Chicago, IL 60064, US
(72) KRUEGER, Allan C., 7260 Presidential Drive, Gurnee Illinois 60031, US
KATI, Warren M., 152 Knob Hill Lane, Gurnee Illinois 60031, US
MARING, Clarence J., 1228 W. Borders Drive, Palatine Illinois 60067, US
WAGNER, Rolf, 42530 Sheridan Oaks Drive, Antioch Illinois 60002, US
HUTCHINS, Charles W., 31005 Prairie Ridge Rd, Green Oaks Illinois 600048, US

(51) MKP
C07D 407/14 (2006.01) (97) **2694491 ***
C07D 513/04 (2006.01)
C07D 409/12 (2006.01)
A61K 31/381 (2006.01)
C07D 407/12 (2006.01)
C07D 495/04 (2006.01)
C07D 413/12 (2006.01)
C07D 409/14 (2006.01)
A61K 31/422 (2006.01)
C07D 333/58 (2006.01)
C07D 417/14 (2006.01)
C07D 321/10 (2006.01)
C07D 417/12 (2006.01)
C07D 409/04 (2006.01)
A61K 31/357 (2006.01)
(86) US2012032192 04.04.2012
(96) 12713839.4 12.02.2014
(87) WO2012138776, 04.04.2012
(97) 2694491, 12.02.2014 en
(54) BENZODIOXEPINE AND BENZODIOXINE COMPOUNDS THAT INTERACT WITH GLUCOKINASE REGULATORY PROTEIN FOR THE TREATMENT OF DIABETES
(71) Amgen Inc., One Amgen Center Drive M/S 28-2-C, Thousand Oaks, CA 91320, US
(72) BARTBERGER, Michael, D., 4471 Ventura Canyon Avenue D-105, Sherman Oaks, California 91423, US
CROGHAN, Michael, D., 10266 Wateridge Circle Unit No 226, San Diego, California 92121, US
FOTSCH, Christopher, H., 533 Timberwood Avenue, Thousand Oaks, California 91360, US
NORMAN, Mark, H., 130 Venus Street, Thousand Oaks, California 91360, US
PENNINGTON, Lewis, D., 5477 Ralston Street 114, Ventura, California 93003, US
REICHEL, Andreas, 6625 Pinnacle Way, Moorpark, California 93021, US
ST. JEAN, David, J., Jr., 4690 Marrisay Way, Camarillo, California 93012, US
TEGLEY, Christopher, M., 478 Thunderhead Street, Thouand Oaks, California 91360, US

(51) MKP
A61G 5/10 (2006.01) (97) **2648671 ***
A61G 7/10 (2006.01)
(86) IT2010000497 10.12.2010
(96) 10805656.5 16.10.2013
(87) WO2012077148, 10.12.2010
(97) 2648671, 16.10.2013 en
(54) A CHAIR FOR DISABLED OR NON SELF-SUFFICIENT PEOPLE PROVIDED WITH AUTOMATIZED LIFTING OF THE SEAT.
(71) Ciotti, Giancarlo, Via delle Begonie 134/0, 63100 Ascoli Piceno (AP), IT
(72) Ciotti, Giancarlo, Via delle Begonie 134/0, 63100 Ascoli Piceno (AP), IT

(51) MKP
G06K 19/073 (2006.01) (97) **2693370 ***
(86) KR2012002417 30.03.2012
(96) 12765862.3 05.02.2014
(87) WO2012134239, 30.03.2012
(97) 2693370, 05.02.2014 en
(54) APPARATUS AND METHOD FOR GENERATING A DIGITAL VALUE
(71) ICTK Co., Ltd., 2, 3th Floor, Jawon Building 912-31 Daechi-dong Gangnam-gu, Seoul 135-280, KR
(72) KIM, Tae Wook, No. 1217 ITBT Hanyang University Haengdang-dong Seongdong-gu, Seoul 133-791, KR
KIM, Dong Kyue, No. 105-2103 Raemian Jangan 1-cha Apt. Jangan 3-dong Dongdaemun-gu, Seoul 130-718, KR
CHOI, Byong Deok, 77-5 Seongnae 2-dong Gangdong-gu, Seoul 134-840, KR

(51) MKP
B65G 47/31 (2006.01) (97) **2670690 ***
 (86) NZ2012000008 01.02.2012
 (96) 12742030.5 11.12.2013
 (87) WO2012105855, 01.02.2012
 (97) 2670690, 11.12.2013 en
 (54) IMPROVEMENTS IN AND RELATING TO LAMINATED BOARD
 (71) Corcel IP Limited, Level 12, KPMG Centre 85 Alexandra Street, Hamilton 3204, NZ
 (72) VAN BERLO, Patrick Petrus Antonius Maria, c/o Level 12 KPMG Centre 85 Alexandra Street, Hamilton 3204, NZ
 ROGERS, Jason Paul, c/o Level 12 KPMG Centre 85 Alexandra Street, Hamilton 3204, NZ

(51) MKP
A61C 19/06 (2006.01) (97) **2688513 ***
A61K 8/22 (2006.01)
A61K 8/24 (2006.01)
A61Q 11/00 (2006.01)
 (86) CA2012050177 22.03.2012
 (96) 12760818.0 29.01.2014
 (87) WO2012126120, 22.03.2012
 (97) 2688513, 29.01.2014 en
 (54) DEVICE AND METHOD FOR TEETH BRIGHTENING
 (71) Klox Technologies Inc., 759 Victoria Square Suite 224, Montreal, QC H2Y 2J7, CA
 (72) PIERGALLINI, Remigio, Via Bologna 11, I-63038 Grottammare Ascoli Piceno, IT
 LOUPIS, Nikolaos, Dionisou 1 Papadamanti Kifissia, GR-14562 Athens, GR
 RASTOGI, Shipra, 3095 Edouard Montpetit, 114, Laval Québec H7T 1V3, CA

(51) MKP
G08B 29/20 (2006.01) (97) **2686839 ***
 (86) US2012029371 16.03.2012
 (96) 12757113.1 22.01.2014
 (87) WO2012125897, 16.03.2012
 (97) 2686839, 22.01.2014 en
 (54) METHOD FOR UPGRADING RFID READERS IN SITU
 (71) Assa Abloy Ab, Klarabergsviadukten 90, 111 64 Stockholm, SE
 (72) DAVIS, Michael, L., 12 Hummingbird Lane, Amherst NY 14228, US
 HULUSI, Tam, 1221 Foothills Boulevard, Santa Ana CA 92705, US
 SPITLER, Debra, 9 Lakeview, Irvine CA 92604, US

(51) MKP
A61K 39/00 (2006.01) (97) **2649086 ***
C07H 21/04 (2006.01)
 (86) US2011064191 09.12.2011
 (96) 11846757.0 16.10.2013
 (87) WO2012079000, 09.12.2011
 (97) 2649086, 16.10.2013 en
 (54) USE OF CHIMERIC ANTIGEN RECEPTOR-MODIFIED T CELLS TO TREAT CANCER
 (71) The Trustees Of The University Of Pennsylvania, Center for Technology Transfer 3160 Chestnut Street Suite 200, Philadelphia, PA 19104-6283, US
 (72) JUNE, Carl, H., 409 Baird Road, Merion Station, PA 19066, US
 LEVINE, Bruce, L., 1258 Liberty Bell Drive, Cherry Hill, NJ 08003, US
 PORTER, David, L., 821 Crum Creek Road, Springfield, PA 19064, US
 KALOS, Michael, D., 716 Carpenter Lane, Philadelphia, PA 19119, US
 MILONE, Michael C., 314 Surrey Road, Cherry Hill, NJ 08002, US

(51) MKP
A01N 43/54 (2006.01) (97) **2696694 ***
A01N 43/56 (2006.01)
A01N 43/58 (2006.01)
A01N 43/653 (2006.01)
A01N 43/76 (2006.01)
A01N 43/82 (2006.01)
A01N 43/84 (2006.01)
A01N 43/90 (2006.01)
A01N 47/36 (2006.01)
A01P 13/00 (2006.01)
 (86) JP2012060090 06.04.2012
 (96) 12719089.0 19.02.2014
 (87) WO2012141276, 06.04.2012
 (97) 2696694, 19.02.2014 en
 (54) HERBICIDAL COMPOSITION COMPRISING FLAZASULFURON AND AN INHIBITOR OF PROTOPORPHYRINOGEN OXIDASE
 (71) Ishihara Sangyo Kaisha, Ltd., 3-15 Edobori 1-chome Nishi-ku, Osaka-shi, Osaka 550-0002, JP
 (72) YAMADA, Ryu, c/o Ishihara Sangyo Kaisha Ltd. Chuo Kenkyusho 3-1 Nishi-shibukawa 2-chome, Kusatsu-shi Shiga 525-0025, JP
 OKAMOTO, Hiroyuki, c/o Ishihara Sangyo Kaisha Ltd. Chuo Kenkyusho 3-1 Nishi-shibukawa 2-chome, Kusatsu-shi Shiga 525-0025, JP
 TERADA, Takashi, c/o Ishihara Sangyo Kaisha Ltd. Chuo Kenkyusho 3-1 Nishi-shibukawa 2-chome, Kusatsu-shi Shiga 525-0025, JP

(51) MKP
A01N 43/16 (2006.01) (97) **2672821 ***
A61K 31/35 (2006.01)
 (86) US2012024428 09.02.2012
 (96) 12744272.1 18.12.2013
 (87) WO2012109415, 09.02.2012
 (97) 2672821, 18.12.2013 en
 (54) CATHEPSIN C INHIBITORS
 (71) GlaxoSmithKline Intellectual Property Development Limited, 980 Great West Road, Brentford Middlesex TW8 9GS, GB
 (72) NEIPP, Christopher, E., 709 Swedeland Road, King Of Prussia, PA 19406, US
 PALOVICH, Michael, R., 709 Swedeland Road, King Of Prussia, PA 19406, US

(51) MKP
A01C 15/02 (2006.01) (97) **2658360 ***
A01C 23/02 (2006.01)
A01G 7/06 (2006.01)
A01G 29/00 (2006.01)
 (86) RS2011000017 29.12.2011
 (96) 11831778.3 06.11.2013
 (87) WO2012091595, 29.12.2011
 (97) 2658360, 06.11.2013 en
 (54) A TUBE SHAPED DEVICE FILLED WITH A LIQUID MEANS FOR THE PLANTS NUTRITION AND / OR PROTECTION, A PROCESS OF THIS DEVICE CONSTRUCTION AND ITS USAGE
 (71) Kostic, Marko, Ljubinke Bobic 1/4, 11000 Beograd, RS
 (72) Kostic, Marko, Ljubinke Bobic 1/4, 11000 Beograd, RS

(51) MKP
A61K 35/12 (2006.01) (97) **2650361 ***
A61K 49/00 (2006.01)
A61P 29/00 (2006.01)
A61P 31/00 (2006.01)
A61P 35/00 (2006.01)
A61P 37/06 (2006.01)
A61P 37/08 (2006.01)
A61P 43/00 (2006.01)
C12N 5/0783 (2010.01)
C12Q 1/02 (2006.01)
(86) JP2011078623 09.12.2011
(96) 11847227.3 16.10.2013
(87) WO2012077811, 09.12.2011
(97) 2650361, 16.10.2013 en
(54) GALECTIN 9-SECRETING CELL, PRODUCTION METHOD FOR SAME, AND APPLICATION FOR SAME
(71) Galpharma Co., Ltd., 884-3-302 Fuseishi-cho, Takamatsu-shi, Kagawa 761-8071, JP
(72) HIRASHIMA, Mitsuomi, c/o Galpharma Co., Ltd. 884-3-302, Fuseishi-cho, Takamatsu-shi Kagawa 761-8071, JP
NIKI, Toshiro, c/o Galpharma Co., Ltd. 884-3-302, Fuseishi-cho, Takamatsu-shi Kagawa 761-8071, JP
ARIKAWA, Tomohiro, C106, Square Kuratsuki 54, Kuratsuki 4-chome, Kanazawa-shi Ishikawa 920-8203, JP
OOMIZU, Souichi, C-205, 1239-2, Ikenobe Miki-cho, Kida-gun Kagawa 761-0701, JP
KADOWAKI, Takeshi, D-103, 505-2, Maeda Higashi-machi, Takamatsu-shi Kagawa 761-0322, JP

(51) MKP
E01H 1/08 (2006.01) (97) **2691576 ***
(86) US2011051229 12.09.2011
(96) 11862058.2 05.02.2014
(87) WO2012134525, 12.09.2011
(97) 2691576, 05.02.2014 en
(54) METHOD AND SYSTEM FOR THE SUSTAINABLE COOLING OF INDUSTRIAL PROCESSES
(71) Crystal Lagoons (Curaçao) B.V., Kaya W.F.G. (Jombi), Mensing 14, CW
(72) FISCHMANN, T., Fernando, Avenida Kennedy, 8830 Vitacura, Santiago, CL

(51) MKP
A61M 5/19 (2006.01) (97) **2675500 ***
(86) EP2012052451 14.02.2012
(96) 12703547.5 25.12.2013
(87) WO2012110474, 14.02.2012
(97) 2675500, 25.12.2013 en
(54) DISPENSE INTERFACE FOR USE WITH A DRUG DELIVERY DEVICE FOR DELIVERY OF TWO OR MORE DRUG AGENTS
(71) Sanofi-Aventis Deutschland GmbH, Brünningstraße 50, 65929 Frankfurt am Main, DE
(72) HOLTWICK, Marc, c/o Sanofi-Aventis Deutschland GmbH, 65926 Frankfurt am Main, DE
EGGERT, Ilona, c/o Sanofi-Aventis Deutschland GmbH, 65926 Frankfurt am Main, DE
DAVIES, James Alexander, 7 Old School Mews Cubbington Road, Leamington Spa Warwickshire CV32 7XB, GB
BILTON, Simon Lewis, 15 Clarendon Square, Leamington Spa Warwickshire CV32 5QT, GB
MOORE, David, 28 Bridle Path Road Elmesthorpe, Leicester Leicestershire LE9 7SA, GB
WIMPENNY, Steven, 12 Greatheed Road, Leamington Spa Warwickshire CV32 6ES, GB
LANGLEY, Christopher Nigel, 120 Leicester Lane, Leamington Spa Warwickshire CV32 7HH, GB
ZAJAC, Jeffrey, 5 Bubbling Brook Drive, Franklin, Massachusetts 02038, US

(51) MKP
C03C 1/00 (2006.01) (97) **2678282 ***
C03C 17/00 (2006.01)
(86) US2012026562 24.02.2012
(96) 12718440.6 01.01.2014
(87) WO2012166221, 24.02.2012
(97) 2678282, 01.01.2014 en
(54) HYBRID SOL-GEL COATED GLASS CONTAINERS
(71) Owens-Brockway Glass Container INC., One Michael Owens Way, Perrysburg, OH 43551, US
(72) CLICK, Carol, A., P.O. Box 1055, Corning, New York 14830, US
SHARMA, Pramod, K., 2287 Hickory Point Dr., Ann Arbor, MI 48105, US

(51) MKP
G06F 3/023 (2006.01) (97) **2624115**
G06F 3/048 (2013.01)
(96) 12153910.0 07.08.2013
(97) 2624115, 07.08.2013 de
(54) Method and electronic system for user interface independent execution of functions
(71) basycs GmbH Technische Unternehmens- und Managementberatung, Hochstraße 8, 76703 Kraichtal-Oberöwisheim, DE
(72) Kiehl, Gerhard, Dekan-Schuster-Straße 47, 63110 Rodgau, DE

(51) MKP
F16B 19/05 (2006.01) (97) **2697520 ***
(86) US2012033091 11.04.2012
(96) 12771947.4 19.02.2014
(87) WO2012142137, 11.04.2012
(97) 2697520, 19.02.2014 en
(54) CAPSULES COMPRISING AN EMULSIFIED SYRUP AND METHODS OF MAKING THE SAME
(71) R.P. Scherer Technologies, LLC, CSC Services of Nevada, Inc. 502 East John Street, Carson City, NV 89706, US
(72) LIN, Jing, 20 Prospect Tce, Keysborough, Vic.3173, AU

(51) MKP
G06K 9/00 (2006.01) (97) **2681718 ***
G06K 9/32 (2006.01)
G06K 9/46 (2006.01)
G06K 9/62 (2006.01)
G06Q 30/00 (2012.01)
G06T 7/20 (2006.01)
G06T 19/00 (2011.01)
(86) US2012027426 02.03.2012
(96) 12707969.7 08.01.2014
(87) WO2012122008, 02.03.2012
(97) 2681718, 08.01.2014 en
(54) DYNAMIC TEMPLATE TRACKING
(71) Qualcomm Incorporated, 5775 Morehouse Drive, San Diego, CA 92121-1714, US
(72) SWEET III, Charles Wheeler, 5775 Morehouse Drive, San Diego, California 92121, US

(51) MKP
C07D 471/04 (2006.01) (97) **2675795 ***
A61K 31/405 (2006.01)
C07D 261/12 (2006.01)
A61K 31/42 (2006.01)
C07D 249/10 (2006.01)
A61K 31/4192 (2006.01)
C07C 233/47 (2006.01)
A61P 13/00 (2006.01)
C07C 233/46 (2006.01)
A61P 9/00 (2006.01)
C07D 249/18 (2006.01)
A61K 31/4196 (2006.01)
C07D 249/04 (2006.01)
A61K 31/4164 (2006.01)
A61K 31/415 (2006.01)
(86) US2012025365 16.02.2012
(96) 12708194.1 25.12.2013
(87) WO2012112742, 16.02.2012
(97) 2675795, 25.12.2013 en
(54) SUBSTITUTED AMINOBUTYRIC DERIVATIVES AS NEPRILYSIN INHIBITORS
(71) Theravance, Inc., 901 Gateway Boulevard, South San Francisco, CA 94080, US
(72) FLEURY, Melissa, 1023 Divisadero Street, San Francisco, California 94115, US
GENDRON, Roland, 345 Franconia Street, San Francisco, California 94110, US
HUGHES, Adam D., 1221 Judson Street, Belmont, California 94002, US

(51) MKP
B24B 19/20 (2006.01) (97) **2578358**
B24B 27/00 (2006.01)
B24B 27/04 (2006.01)
(96) 12182794.3 10.04.2013
(97) 2578358, 10.04.2013 de
(54) Grinding machine and method for processing the interiors of moulds
(71) Schweissttechnik Düsseldorf GmbH & Co. KG, Auf der Bleiche 20, 58300 Wetter, DE
(72) Johann, Karl-Peter, Wilhelmstr. 69, D-35614 Asslar, DE

(51) MKP
A61M 5/24 (2006.01) (97) **2688611 ***
A61M 5/315 (2006.01)
(86) EP2012055058 22.03.2012
(96) 12709648.5 29.01.2014
(87) WO2012130705, 22.03.2012
(97) 2688611, 29.01.2014 en
(54) DOSE SETTING MECHANISM AND INJECTION DEVICE
(71) Sanofi-Aventis Deutschland GmbH, Brüningsstraße 50, 65929 Frankfurt, DE
(72) PLUMPTRE, David Aubrey, 36 Shire Way, Droitwich Spa, Worcestershire WR9 7RQ, GB

(51) MKP
B65D 85/804 (2006.01) (97) **2573008**
(96) 12185726.2 27.03.2013
(97) 2573008, 27.03.2013 en
(54) Capsule for making an infused drink
(71) Capitani S.r.l., Piazza IV Novembre, 1, 22070 Solbiate (CO), IT
(72) Capitani, Gionata, c/o CAPITANI S.r.l. Piazza IV Novembre, 1, I-22070 Solbiate, Como, IT

(51) MKP
A61K 31/4196 (2006.01) (97) **2648728 ***
A61K 31/437 (2006.01)
A61K 31/495 (2006.01)
A61K 31/496 (2006.01)
A61P 17/00 (2006.01)
(86) US2011063427 06.12.2011
(96) 11846725.7 16.10.2013
(87) WO2012078574, 06.12.2011
(97) 2648728, 16.10.2013 en
(54) JANUS KINASE 2 (JAK2) INHIBITOR FOR THE TREATMENT OF LUPUS
(71) Cephalon, Inc., 41 Moores Road P.O. Box 4011, Frazer, PA 19355, US
(72) DOBRZANSKI, Pawel T., 306 Pintail Circle, Downingtown Pennsylvania 19335, US
SEAVEY, Matthew M., 887 Quincy Lane, Secane Pennsylvania 19018, US

(51) MKP
C10M 125/10 (2006.01) (97) **2657325 ***
C10M 125/26 (2006.01)
C10M 177/00 (2006.01)
(86) UA2011000116 16.11.2011
(96) 11851847.1 30.10.2013
(87) WO2012087260, 16.11.2011
(97) 2657325, 30.10.2013 en
(54) LUBRICATING COMPOSITION AND METHOD FOR THE PREPARATION THEREOF
(71) Zozulya, Vladimir Leonidovich, Per. 23 Avgusta, 4, Kharkov 61018, UA
Zozulya, Sergey Leonidovich, ul. Sumgaitkaya, 4-3, Kharkov, 61018, UA
Alexandrov, Sergey Nikolaevich, ul. 2-y Pyatiletly 18-54, Kharkov, 61007, UA
(72) Zozulya, Vladimir Leonidovich, Per. 23 Avgusta, 4, Kharkov 61018, UA
Zozulya, Sergey Leonidovich, ul. Sumgaitkaya, 4-3, Kharkov, 61018, UA
Alexandrov, Sergey Nikolaevich, ul. 2-y Pyatiletly 18-54, Kharkov, 61007, UA

(51) MKP
C07C 25/02 (2006.01) (97) **2675774 ***
C07C 43/205 (2006.01)
C07D 307/80 (2006.01)
C07F 15/00 (2006.01)
(86) JP2012054337 16.02.2012
(96) 12709184.1 25.12.2013
(87) WO2012111849, 16.02.2012
(97) 2675774, 25.12.2013 en
(54) PRODUCTION METHOD OF OPTICALLY ACTIVE DIHYDROBENZOFURAN DERIVATIVE
(71) Takeda Pharmaceutical Company Limited, 1-1 Doshomachi 4-chome Chuo-ku, Osaka-shi, Osaka 541-0045, JP
(72) YAMANO, Mitsuhsa, c/o TAKEDA PHARMACEUTICAL COMPANY LIMITED 17-85 Jusohonmachi 2-chome Yodogawa-ku, Osaka-shi Osaka 532-0024, JP
GOTO, Mitsutaka, c/o TAKEDA PHARMACEUTICAL COMPANY LIMITED 4720 Aza-Takeda Oaza-Mitsui, Hikari-shi Yamaguchi 743-0011, JP
KAJIWARA, Takeshi, c/o TAKEDA PHARMACEUTICAL COMPANY LIMITED 17-85 Jusohonmachi 2-chome Yodogawa-ku, Osaka-shi Osaka 532-0024, JP
MAEDA, Hiroyuki, c/o TAKEDA PHARMACEUTICAL COMPANY LIMITED 17-85 Jusohonmachi 2-chome Yodogawa-ku, Osaka-shi Osaka 532-0024, JP
KONISHI, Takahiro, c/o TAKEDA PHARMACEUTICAL COMPANY LIMITED 17-85 Jusohonmachi 2-chome Yodogawa-ku, Osaka-shi Osaka 532-0024, JP
SERA, Misayo, c/o TAKEDA PHARMACEUTICAL COMPANY LIMITED 17-85 Jusohonmachi 2-chome Yodogawa-ku, Osaka-shi Osaka 532-0024, JP
KONDO, Yuichiro, 15-10-1105, Kugenuma-Tachibana 1-chome, Fujisawa, Kanagawa, 251-0024, JP
YAMASAKI, Seiji, c/o TAKEDA PHARMACEUTICAL COMPANY LIMITED 26-1 Muraoka-Higashi 2-chome, Fujisawa-shi Kanagawa 251-0012, JP

- (51) MKP
B62B 3/00 (2006.01) (97) **2340978**
B62B 5/00 (2006.01)
(96) 10196168.8 06.07.2011
(97) 2340978, 06.07.2011 en
(54) A system for the mounting of shelves and the reduction of noise
(71) Container Centralen A/S, Egegårdsvej 20 Hjallesø, 5260 Odense S, DK
(72) Mogensen, Erling, Færgøgårdvej 78, Strib, 5500, Middelfart, DK
Holmgaard, Berno, Årøvænget 16, 5610, Assens, DK
-
- (51) MKP
A61K 31/00 (2006.01) (97) **2666015 ***
G01N 33/50 (2006.01)
(86) EP2012050819 19.01.2012
(96) 12700827.4 27.11.2013
(87) WO2012098208, 19.01.2012
(97) 2666015, 27.11.2013 en
(54) USE OF STATHMIN AS A BIOMARKER OF DRUG RESPONSE TO FURAZANOBENZIMIDAZOLES
(71) Basilea Pharmaceutica AG, Grenzacherstrasse 487, 4005 Basel, CH
(72) LANE, Heidi Alexandra, Kaltbrunnenweg 8, CH-4106 Therwil, CH
BACHMANN, Felix, Sierenzerstrasse 16, CH-4055 Basel, CH
-
- (51) MKP
A61K 31/13 (2006.01) (97) **2665474 ***
A61P 27/16 (2006.01)
(86) EP2012000245 19.01.2012
(96) 12700619.5 27.11.2013
(87) WO2012098000, 19.01.2012
(97) 2665474, 27.11.2013 en
(54) NERAMEXANE FOR THE TREATMENT OR PREVENTION OF TINNITUS RELATED WITH STRESS OR ACUTE HEARING LOSS
(71) Merz Pharma GmbH & Co. KGaA, Eckenheimer Landstrasse 100, 60318 Frankfurt am Main, DE
(72) ALTHAUS, Michael, Dresdener Strasse 82, 61137 Schoeneck, DE
ELLERS-LENZ, Barbara, Friedensstrasse 18, 64546 Moerfelden-Walldorf, DE
-
- (51) MKP
B23B 27/04 (2006.01) (97) **2682208 ***
B23B 27/14 (2006.01)
B23B 27/22 (2006.01)
(86) JP2012052004 30.01.2012
(96) 12751877.7 08.01.2014
(87) WO2012117791, 30.01.2012
(97) 2682208, 08.01.2014 en
(54) CUTTING INSERT, CUTTING TOOL, AND METHOD FOR MANUFACTURING CUT PRODUCT USING CUTTING INSERT AND CUTTING TOOL
(71) Kyocera Corporation, 6 Takeda Tobadono-cho Fushimi-ku, Kyoto-shi Kyoto 612-8501, JP
(72) FUJII, Kanenori, c/o KYOCERA CORPORATION Head Office 6, Takeda Tobadono-cho., Fushimi-ku, Kyoto-shi 612-8501, JP
INOUE, Yoshihiro, c/o KYOCERA CORPORATION Head Office 6, Takeda Tobadono-cho., Fushimi-ku, Kyoto-shi 612-8501, JP
-
- (51) MKP
A61K 38/38 (2006.01) (97) **2655410 ***
A61P 29/00 (2006.01)
C07K 14/76 (2006.01)
G01N 33/533 (2006.01)
G01N 33/68 (2006.01)
(86) NZ2011000271 22.12.2011
(96) 11851351.4 30.10.2013
(87) WO2012087160, 22.12.2011
(97) 2655410, 30.10.2013 en
(54) ANTI-INFLAMMATORY PROTEINS AND METHODS OF PREPARATION AND USE THEREOF
(71) ManukaMed Limited, 13 Edwin Feist Place, Masterton 5810, NZ
(72) BEAN, Amanda, c/- The University of Waikato B Block, Hillcrest Road, Hamilton 3216, NZ
MOLAN, Peter, c/- The University of Waikato B Block, Hillcrest Road, Hamilton 3216, NZ
CURSONS, Ray, c/- The University of Waikato B Block, Hillcrest Road, Hamilton 3216, NZ
-
- (51) MKP
C12M 1/34 (2006.01) (97) **2661485 ***
C12M 1/38 (2006.01)
C12Q 1/68 (2006.01)
(86) US2012020278 05.01.2012
(96) 12732188.3 13.11.2013
(87) WO2012094459, 05.01.2012
(97) 2661485, 13.11.2013 en
(54) ASSAY CARTRIDGES AND METHODS OF USING THE SAME
(71) Meso Scale Technologies, LLC, 9238 Gaither Road, Gaithersburg, MD 20877, US
Higgins, Stephen, 19132 Kinglet Place, Gaithersburg, Maryland 20879, US
Kovacs, Sandor, 42 Augustine Blvd., Middletown, Delaware 19709, US
Kumar, Sudeep, 20427 Ivybridge Court, Gaithersburg, Maryland 20886, US
Page, Kenneth, 20408 Apple Harvest Circle Apt. H, Germantown, Maryland 20876, US
Roth, Kristian, 19993 Wild Cherry Lane, Germantown, Maryland 20876, US
Sigal, George, 5333 Trailway Drive, Rockville, Maryland 20853, US
(72) HIGGINS, Stephen, 32 Kinglet Place., Gaithersburg, Maryland 20879, US
KOVACS, Sandor, 42 Augustine Blvd., Middletown, Delaware 19709, US
KUMAR, Sundeep, 20427 Ivybridge Court., Gaithersburg, Maryland 20886, US
PAGE, Kenneth, 20408 Apple Harvest Circle, Apt H., Germantown, Maryland 20876, US
ROTH, Kristian, 19993 Wild Cherry Lane., Germantown, Maryland 20876, US
SIGAL, George, 5333 Trailway Drive., Rockville, Maryland 20853, US
-
- (51) MKP
A61K 31/404 (2006.01) (97) **2646429 ***
A61K 31/437 (2006.01)
A61P 3/00 (2006.01)
A61P 11/00 (2006.01)
C07D 401/12 (2006.01)
C07D 471/04 (2006.01)
(86) US2011062593 30.11.2011
(96) 11794348.0 09.10.2013
(87) WO2012075115, 30.11.2011
(97) 2646429, 09.10.2013 en
(54) 4-SUBSTITUTED-CYCLOHEXYLAMINO-4-PIPERIDINYL-ACETAMIDE ANTAGONISTS OF CCR2
(71) Janssen Pharmaceutica, N.V., Turnhoutseweg 30, 2340 Beerse, BE
(72) LANTER, James, C., 1729 Osprey Drive, Audubon, PA 19403, US
MARKOTAN, Thomas, P., 506 Estate Road, Morgantown, PA 19543, US
SUBASINGHE, Nalin, 302 Long Ridge Lane, Exton, PA 19341, US
SUI, Zhihua, 2704 Baldeagle Circle, Norristown, NJ 19403, US
ZHANG, Xuqing, Welsh&McKean Roads, Spring House PA 19477, US
-

(51) MKP
C05D 9/00 (2006.01) (97) **2668259 ***
C12M 1/04 (2006.01)
C12N 1/12 (2006.01)
C12N 1/36 (2006.01)
C12N 13/00 (2006.01)
C12P 7/64 (2006.01)
C12P 19/04 (2006.01)
C12R 1/89 (2006.01)
(86) GB2012050194 30.01.2012
(96) 12704896.5 04.12.2013
(87) WO2012101459, 30.01.2012
(97) 2668259, 04.12.2013 en
(54) PROCESS FOR PRODUCTION OF MICROALGAE, CYANOBACTERIA AND METABOLITES THEREOF
(71) Algaecytes Limited, Camburgh House 27 New Dover Road Canterbury, Kent CT1 3DN, GB
(72) DODD, John, 44 Lodge Field Road Whitstable, Kent CT5 3RF, GB
MARSALEK, Blahsolov, Kunesova 3, 64300 Brno, CZ
VOSATKA, Miroslav, U Geofyzikalniho ustavu 64, 252 43 Pruhonice, CZ
BASHIR, Nazir, 11 The Forelands Canterbury, Kent CT1 3NT, GB

(51) MKP
A62C 31/24 (2006.01) (97) **2612694**
A62C 37/36 (2006.01)
A62C 99/00 (2010.01)
(96) 12150087.0 10.07.2013
(97) 2612694, 10.07.2013 en
(54) An automatic fire extinguishing apparatus and a method for operating the same
(71) GearTeam ApS, Æblehaven 26, 3400 Hillerød, DK
(72) Løvbo, Jesper Bille, Æblehaven 26, 3400 Hillerød, DK

(51) MKP
A01D 45/16 (2006.01) (97) **2687082**
(96) 12002566.3 22.01.2014
(97) 2687082, 22.01.2014 en
(54) Machine for cutting off tobacco leaves with stem holding for eastern type plants for harvesting, layering and collecting the leaves in collection containers
(71) V.I.T S.A Processing Equipment, Sindos Industrial Area P.O. Box 210, 570 22 Thessaloniki, GR
(72) Tsikis, Stephanos, A. Papandreou 9C, 55132 Kalamaria Thessaloniki, GR

(51) MKP
A61K 31/5585 (2006.01) (97) **2663313 ***
A61K 35/28 (2006.01)
C12N 5/078 (2010.01)
(86) EP2012050484 13.01.2012
(96) 12700137.8 20.11.2013
(87) WO2012095511, 13.01.2012
(97) 2663313, 20.11.2013 en
(54) METHOD FOR ENHANCING ENGRAFTMENT OF HAEMATOPOETIC STEM CELLS
(71) SciPharm SàRL, 33, rue Hiehl Junglinster, 6131 Luxembourg, LU
(72) FREISSMUTH, Michael, Billrothstr. 68, A-1190 Wien, AT
ZEBEDIN-BRANDL, Eva-Maria, Institut fuer Pharmakologie Medizinische Universitaet Wien Waehringer Str. 13a, Wien 1090, AT
BERGMAYR, Christian, Institut fuer Pharmakologie Medizinische Universitaet Wien Waehringer Str. 13a, Wien 1090, AT
HUSSAIN, Filza, Institut fuer Pharmakologie Medizinische Universitaet Wien Waehringer Str. 13a, Wien 1090, AT

(51) MKP
H04L 29/08 (2006.01) (97) **2684338 ***
H04L 29/12 (2006.01)
(86) US2012028536 09.03.2012
(96) 12710410.7 15.01.2014
(87) WO2012125474, 09.03.2012
(97) 2684338, 15.01.2014 en
(54) SYSTEM AND METHOD USING A CLIENT-LOCAL PROXY-SERVER TO ACCESS A DEVICE HAVING AN ASSIGNED NETWORK ADDRESS
(71) Qualcomm Incorporated, 5775 Morehouse Drive, San Diego, CA 92121-1714, US
(72) HERSHKO, Yuval Corey, 5775 Morehouse Drive, San Diego, California 92121, US
STRAUSS, Nir, 5775 Morehouse Drive, San Diego, California 92121, US

(51) MKP
A61K 31/4375 (2006.01) (97) **2670410 ***
A61K 31/444 (2006.01)
A61K 31/4545 (2006.01)
A61K 31/4709 (2006.01)
A61K 31/496 (2006.01)
A61K 31/506 (2006.01)
A61K 38/12 (2006.01)
A61P 31/04 (2006.01)
C07D 455/02 (2006.01)
(86) EP2012051563 31.01.2012
(96) 12702023.8 11.12.2013
(87) WO2012104305, 31.01.2012
(97) 2670410, 11.12.2013 en
(54) ANTIMICROBIAL 4-OXOQUINOLIZINES
(71) Evolva SA, Duggingerstrasse 23, 4153 Reinach, CH
HEIM, Jutta, Zelgling 17, CH-4433 Ramllinsburg, CH
SCHNEIDER, Peter, Bäumlackerstrasse 8, CH-4103 Bottmingen/BL, CH
ROUSSEL, Patrick, 3 Sentier au Bois, F-68100 Mulhouse, FR
MILLIGAN, Daniel, 3650 18th Street Apt. 4, San Francisco, CA 94110, US
BARTELS, Christian, Baslerstrasse 128, CH-4123 Allschwil/BL, CH
DALE, Glenn, C.F. Meyerstrasse 10, CH-4059 Basel, CH

(51) MKP
C03C 17/34 (2006.01) (97) **2646385 ***
(86) FR2011052722 22.11.2011
(96) 11799765.0 09.10.2013
(87) WO2012072915, 22.11.2011
(97) 2646385, 09.10.2013 fr
(54) ANTICORROSIVE AND ANTIFOULING GLASS SUBSTRATE FOR USE IN A WET ATMOSPHERE
(71) Saint-Gobain Glass France, 18 avenue d'Alsace, 92400 Courbevoie, FR
(72) CLABAU, Frédéric, 67 rue Pascal (Bât. C), F-75013 Paris, FR
GUILLEMOT, François, 9 rue d'Alésia, F-75014 Paris, FR

(51) MKP
C09D 5/08 (2006.01) (97) **2697346 ***
C09D 191/00 (2006.01)
C11B 3/06 (2006.01)
C11D 1/04 (2006.01)
C11D 13/00 (2006.01)
C11D 17/08 (2006.01)
C23F 11/12 (2006.01)
(86) IB2012000714 06.04.2012
(96) 12724704.7 19.02.2014
(87) WO2012140488, 06.04.2012
(97) 2697346, 19.02.2014 fr
(54) PROCESS FOR THE PROTECTIVE TREATMENT OF METALS BASED ON A WATER-SOLUBLE COMPOSITION OF SAPONIFIED PLANT OIL(S), AND PRODUCTS AND COMPOSITIONS OBTAINED
(71) Laboratoires Labema, Rue Denis Papin ZA Adèle Bourdon, 42420 Lorette, FR
Université de Lorraine, 34 Cours Léopold CS 25233, 54052 Nancy Cedex, FR
(72) LARONZE, Jean, Pierre, Philippe, 4 rue du Lozange, F-42800 Tartaras, FR
ROCCA, Emmanuel, 4 rue de la Mairie, F-54670 Malleloy, FR
RENAUX, Delphine, 70 rue Jules Ferry - Pavillon 5, F-54130 Saint Max, FR

- (51) MKP
B29C 35/00 (2006.01) (97) **2681040 ***
B29C 53/56 (2006.01)
B29C 53/64 (2006.01)
B29C 70/32 (2006.01)
B29D 23/00 (2006.01)
F16L 9/16 (2006.01)
- (86) NL2012050133 05.03.2012
(96) 12709973.7 08.01.2014
(87) WO2012118378, 05.03.2012
(97) 2681040, 08.01.2014 en
(54) METHOD FOR MANUFACTURING CONTINUOUS COMPOSITE TUBE, APPARATUS FOR MANUFACTURING CONTINUOUS COMPOSITE TUBE
(71) Airborne International B.V., Laan van Ypenburg 70-78, 2497 GB 's-Gravenhage, NL
(72) KREMERS, Marcus Antonius Ivonne, Stoombootweg 41, NL-1035 TT Amsterdam, NL
-
- (51) MKP
C07D 215/14 (2006.01) (97) **2694479 ***
C07D 401/04 (2006.01)
C07D 405/04 (2006.01)
C07D 409/04 (2006.01)
C07D 417/04 (2006.01)
C07D 491/06 (2006.01)
- (86) US2012032027 03.04.2012
(96) 12713571.3 12.02.2014
(87) WO2012138670, 03.04.2012
(97) 2694479, 12.02.2014 en
(54) PROCESS FOR THE PREPARATION OF AN HIV INTEGRASE INHIBITOR
(71) Gilead Sciences, Inc., 333 Lakeside Drive, Foster City, CA 94404, US
(72) LI, Wenjie, 900 Ridgebury Road, Ridgefield CT 06877-368, US
DE CROOS, Philomen, 900 Ridgebury Road, Ridgefield CT 06877-0368, US
FANDRICK, Keith, R., 900 Ridgebury Road, Ridgefield CT 06877-0368, US
GAO, Joe, Ju, 900 Ridgebury Road, Ridgefield CT 06877-0368, US
HADDAD, Nizar, 900 Ridgebury Road, Ridgefield CT 06877-0368, US
LU, Zhi-Hui, 900 Ridgebury Road, Ridgefield CT 06877-368, US
QU, Bo, 900 Ridgebury Road, Ridgefield CT 06877-0368, US
RODRIGUEZ, Sonia, 900 Ridgebury Road, Ridgefield CT 06877-0368, US
SEANAYAKE, Chris, H., 900 Ridgebury Road, Ridgefield CT 06877-0368, US
ZHANG, Yongda, 900 Ridgebury Road, Ridgefield CT 06877-0368, US
TANG, Wenjun, 900 Ridgebury Road, Ridgefield CT 06877-0368, US
-
- (51) MKP
A61K 9/00 (2006.01) (97) **2593109 ***
A61K 9/20 (2006.01)
A61K 9/22 (2006.01)
A61K 31/7012 (2006.01)
A61K 47/38 (2006.01)
A61P 21/00 (2006.01)
- (86) US2011043910 13.07.2011
(96) 11807478.0 22.05.2013
(87) WO2012009474, 13.07.2011
(97) 2593109, 22.05.2013 en
(54) METHOD AND FORMULATIONS FOR TREATING SIALIC ACID DEFICIENCIES
(71) Ultragenyx Pharmaceutical Inc., 77 Digital Drive, Suite 210, Novato, CA 94949, US
(72) KAKKIS, Emil, 2512 Laguna Vista Drive, Novato CA 94945, US
-
- (51) MKP
C12N 5/16 (2006.01) (97) **2646557 ***
C12N 15/67 (2006.01)
- (86) EP2011006061 02.12.2011
(96) 11791447.3 09.10.2013
(87) WO2012072269, 02.12.2011
(97) 2646557, 09.10.2013 en
(54) METHOD FOR CELLULAR RNA EXPRESSION
(71) Biontech AG, Hölderlinstrasse 8, 55131 Mainz, DE
Translationale Onkologie an der Universitätsmedizin der JGU Mainz gGmbH (TRON), Langenbeckstrasse 1, 55131 Mainz, DE
Universitätsmedizin der Johannes Gutenberg-Universität Mainz, Langenbeckstraße 1, 55131 Mainz, DE
(72) SAHIN, Ugur, Philipp-von-Zabern-Platz 1, 55116 Mainz, DE
BEISSERT, Tim, Edith-Stein-Weg 4, 64521 Gross-Gerau, DE
POLEGANOV, Marco, Bruchfeldstrasse 32, 60528 Frankfurt, DE
HERZ, Stephanie, Weinbergstrasse 7, 54317 Kasel, DE
-
- (51) MKP
H01S 3/04 (2006.01) (97) **2700131 ***
H01S 3/042 (2006.01)
H01S 3/06 (2006.01)
H01S 3/08 (2006.01)
H01S 5/024 (2006.01)
- (86) FR2012050850 18.04.2012
(96) 12722435.0 26.02.2014
(87) WO2012172213, 18.04.2012
(97) 2700131, 26.02.2014 fr
(54) DEVICE FOR MANAGING HEAT IN AN OPTICAL ELEMENT, AND RELATED HEAT-MANAGEMENT METHOD
(71) Ecole Polytechnique, Route de Saclay, 91120 Palaiseau, FR
(72) ALBACH, Daniel, 97 chemin de la Hunière, F-91120 Palaiseau, FR
CHANTELOUP, Jean-Christophe, 17 rue Emile Zola, F-91400 Saclay, FR
LUCIANETTI, Antonio, Slovenska 23, 12000 Prague 2, CZ
NOVO, Thierry, 43 avenue des Molières, F-78470 Saint Remy Les Chevreuse, FR
VINCENT, Bernard, 1 ruelle de la Corne de l'Echaudé, F-91190 Gif Sur Yvette, FR
-
- (51) MKP
C12N 1/21 (2006.01) (97) **2655599 ***
C12N 5/10 (2006.01)
C12N 9/00 (2006.01)
C12N 15/52 (2006.01)
C12N 15/63 (2006.01)
C12P 7/16 (2006.01)
- (86) US2011066090 20.12.2011
(96) 11850766.4 30.10.2013
(87) WO2012088071, 20.12.2011
(97) 2655599, 30.10.2013 en
(54) DESIGNER CALVIN-CYCLE-CHANNELED AND HYDROGENOTROPHIC PRODUCTION OF BUTANOL AND RELATED HIGHER ALCOHOLS
(71) Lee, James Weifu, 6 Warren Manor Court, Cockeysville, MD 21030, US
(72) Lee, James Weifu, 6 Warren Manor Court, Cockeysville, MD 21030, US
-

(51) MKP
A61K 31/7088 (2006.01) (97) **2689013 ***
A61P 35/00 (2006.01)
C12N 15/113 (2010.01)
(86) US2012030626 26.03.2012
(96) 12728856.1 29.01.2014
(87) WO2012135152, 26.03.2012
(97) 2689013, 29.01.2014 en
(54) COMPOSITIONS FOR INHIBITING GENE EXPRESSION AND USES THEREOF
(71) Idera Pharmaceuticals, Inc., 167 Sidney Street, Cambridge, MA 02319, US
(72) AGRAWAL, Sudhir, 61 Lamplighter Drive, Shrewsbury, MA 01545, US
KANDIMALLA, Ekambar, 6 Candlewood Lane, Southboro, MA 01772, US
PUTTA, Mallikarjuna, 824 Arboretum Way, Burlington, MA 01803, US
LAN, Tao, 995 Massachusetts Avenue Apt. 206, Arlington, MA 02476, US
BHAGAT, Lakshmi, 1550 Worcester Street Unit 506, Framingham, MA 01702, US
WANG, Daqing, 7 Selfridge Road, Bedford, MA 01730, US
YU, Dong, 25 Indian Pond Road, Westboro, MA 01581, US

(51) MKP
A61K 38/28 (2006.01) (97) **2687542 ***
A61P 3/10 (2006.01)
C07K 1/107 (2006.01)
C07K 14/62 (2006.01)
C07K 17/08 (2006.01)
(86) CN2012000346 19.03.2012
(96) 12757506.6 22.01.2014
(87) WO2012122860, 19.03.2012
(97) 2687542, 22.01.2014 en
(54) HUMAN INSULIN AND ANALOG CONJUGATE THEREOF
(71) Chongqing Fagen Biomedical Inc., No.70, 4th Street Keyuan Jiulongpo District, Chongqing 400041, CN
(72) FAN, Kai, No. 70 4th Street Keyuan, Jiulongpo District Chongqing 400041, CN
CAO, Yu, No. 70 4th Street Keyuan, Jiulongpo District Chongqing 400041, CN
CHEN, Yong, No. 70 4th Street Keyuan, Jiulongpo District Chongqing 400041, CN
LI, Hongliang, No. 70 4th Street Keyuan, Jiulongpo District Chongqing 400041, CN
CHEN, Hairong, No. 70 4th Street Keyuan, Jiulongpo District Chongqing 400041, CN
WAN, Ying, No. 70 4th Street Keyuan, Jiulongpo District Chongqing 400041, CN

(51) MKP
C07H 21/02 (2006.01) (97) **2699583 ***
(86) US2012034550 20.04.2012
(96) 12773736.9 26.02.2014
(87) WO2012145697, 20.04.2012
(97) 2699583, 26.02.2014 en
(54) MODULATION OF HEPATITIS B VIRUS (HBV) EXPRESSION
(71) Isis Pharmaceuticals, Inc., 2855 Gazelle Court, Carlsbad, CA 92010, US
(72) SWAYZE, Eric, E., 2855 Gazelle Court, Carlsbad, CA 92010, US
FREIER, Susan, M., 2855 Gazelle Court, Carlsbad, CA 92010, US
MCCALEB, Michael, L., 2855 Gazelle Court, Carlsbad, CA 92010, US

(51) MKP
A61K 31/47 (2006.01) (97) **2648732 ***
(86) US2011063460 06.12.2011
(96) 11846599.6 16.10.2013
(87) WO2012078591, 06.12.2011
(97) 2648732, 16.10.2013 en
(54) USE OF LAQUINIMOD FOR REDUCING FATIGUE, IMPROVING FUNCTIONAL STATUS, AND IMPROVING QUALITY OF LIFE IN MULTIPLE SCLEROSIS PATIENTS
(71) Teva Pharmaceutical Industries Ltd., 5 Basel Street P.O. Box 3190, 49131 Petah Tiquva, IL
(72) TARCIC, Nora, Migdal David 29/1, Modiin, IL
BAR-ZOHAR, Dan, 10 Havazelet Street, 52365 Ramat-Gan, IL
KOFLEB, Dina, Hadafna24, Kadima-Zoran, IL

(51) MKP
G06F 15/16 (2006.01) (97) **2689353 ***
G06F 17/30 (2006.01)
H04L 9/32 (2006.01)
(86) IB2012000697 22.03.2012
(96) 12760123.5 29.01.2014
(87) WO2012127322, 22.03.2012
(97) 2689353, 29.01.2014 en
(54) SYSTEM AND METHOD FOR DATA MASKING
(71) Active-Base Ltd., Yad Haruztim 14, 67778 Tel Aviv, IL
(72) BOUKOBZA, Eric, Yad Haruztim 14, 67778 Tel Aviv, IL

(51) MKP
A61K 39/395 (2006.01) (97) **2699260 ***
A61P 35/00 (2006.01)
C07K 16/10 (2006.01)
C07K 16/28 (2006.01)
C07K 16/32 (2006.01)
C07K 16/46 (2006.01)
(86) EP2012057303 20.04.2012
(96) 12715407.8 26.02.2014
(87) WO2012143523, 20.04.2012
(97) 2699260, 26.02.2014 en
(54) BISPECIFIC ANTIBODIES AGAINST HER2
(71) Genmab A/S, Bredgade 34 E, 1260 Copenhagen K, DK
(72) DE GOEIJ, Bart, c/o Genmab B.V. Yalelaan 60, NL-3584 CM Utrecht, NL
VAN BERKEL, Patrick, Derde Westerparklaan 321, NL-3544 NH Utrecht, NL
STRUMANE, Kristin, c/o Genmab B.V. Yalelaan 60, NL-3584 CM Utrecht, NL
LABRIJN, Aran Frank, c/o Genmab B.V. Yalelaan 60, NL-3584 CM Utrecht, NL
NEIJSEN, Joost J., c/o Genmab B.V. Yalelaan 60, NL-3584 CM Utrecht, NL
MEESTERS, Joyce I., c/o Genmab B.V. Yalelaan 60, NL-3584 CM Utrecht, NL
PARREN, Paul, c/o Genmab B.V. Yalelaan 60, NL-3584 CM Utrecht, NL
SCHUURMAN, Janine, c/o Genmab B.V. Yalelaan 60, NL-3584 CM Utrecht, NL

(51) MKP
B64D 10/00 (2006.01) (97) **2640637 ***
(86) EP2011070433 18.11.2011
(96) 11799245.3 25.09.2013
(87) WO2012066114, 18.11.2011
(97) 2640637, 25.09.2013 de
(54) ACCELERATION PROTECTION SUIT
(71) G-Nius Ltd., 492 Airport Road Aeromedical Centre, Singapore 539945, SG
(72) REINHARD, Andreas, c/o iii solutions GmbH Rebmattli 9a, CH-6340 Baar, CH

(51) MKP
A61B 5/042 (2006.01) (97) **2699152 ***
(86) US2012027183 01.03.2012
(96) 12709741.8 26.02.2014
(87) WO2012145074, 01.03.2012
(97) 2699152, 26.02.2014 en
(54) BASKET STYLE CARDIAC MAPPING CATHETER HAVING AN ATRAUMATIC BASKET TIP FOR DETECTION OF CARDIAC RHYTHM DISORDERS
(71) Topera, Inc., 11445 E. Via Linda, Suite 2 P.O. Box 224, Scottsdale, AR 85259, US
(72) KORDIS, Thomas, F., C/o Topera Inc. 11445 E. Via Linda Suite 2 P.o. Box 224, Scottsdale, AZ 85259, US
JOHNSON, Eric, T., C/o Topera Inc. 11445 E. Via Linda Suite 2 P.o. Box 224, Scottsdale, AZ 85259, US
BURKE, Phillip, C., C/o Topera Inc. 11445 E. Via Linda Suite 2 P.o. Box 224, Scottsdale, AZ 85259, US
KENT, Darrin, J., C/o Topera Inc. 11445 E. Via Linda Suite 2 P.o. Box 224, Scottsdale, AZ 85259, US
RAGLAND, Robert, Ryan, C/o Topera Inc. 11445 E. Via Linda Suite 2 P.o. Box 224, Scottsdale, AZ 85259, US

(51) MKP
A21D 8/00 (2006.01)
A23C 9/152 (2006.01)
A23C 9/154 (2006.01)
A23F 3/16 (2006.01)
A23F 3/40 (2006.01)
A23F 5/24 (2006.01)
A23F 5/40 (2006.01)
A23G 1/40 (2006.01)
A23G 3/42 (2006.01)
A23G 9/34 (2006.01)
A23L 1/00 (2006.01)
A23L 1/06 (2006.01)
A23L 1/068 (2006.01)
A23L 1/09 (2006.01)
A23L 1/236 (2006.01)
A23L 1/30 (2006.01)
A23L 2/39 (2006.01)
A23L 2/60 (2006.01)
(96) 13168989.5 05.02.2014
(97) 2692243, 05.02.2014 de
(54) Composition for delayed resorption
(71) Krüger GmbH & Co. KG, Senefelderstrasse 44, 51469 Bergisch-Gladbach, DE
(72) Krüger, Willibert, Zaunkönigweg 5, 51467 Bergisch Gladbach, DE

(51) MKP
B60K 15/04 (2006.01)
(86) EP2011071103 28.11.2011
(96) 11790767.5 09.10.2013
(87) WO2012072529, 28.11.2011
(97) 2646270, 09.10.2013 de
(54) INSERT FOR A FILLER NECK OF A UREA CONTAINER
(71) Reutter GmbH, Hans-Paul-Kaysser-Straße 10, 71397 Leutenbach, DE
(72) BEHNAMRAD, Kazem, A-M-Guttenbrunnstraße 18, 71364 Winnenden, DE

(51) MKP
A61K 31/47 (2006.01)
A61P 37/00 (2006.01)
C07D 401/12 (2006.01)
C07D 403/12 (2006.01)
(86) EP2012053948 08.03.2012
(96) 12707342.7 15.01.2014
(87) WO2012123311, 08.03.2012
(97) 2683709, 15.01.2014 en
(54) PYRIDINYL- AND PYRAZINYL -METHYLOXY - ARYL DERIVATIVES USEFUL AS INHIBITORS OF SPLEEN TYROSINE KINASE (SYK)
(71) Glaxo Group Limited, Glaxo Wellcome House Berkeley Avenue Greenford, Middlesex UB6 0NN, GB
(72) ATKINSON, Francis, Louis, c/o GlaxoSmithKline Gunnels Wood Road, Stevenage Hertfordshire SG1 2NY, GB
BARKER, Michael David, GlaxoSmithKline Gunnels Wood Road, Stevenage Hertfordshire SG1 2NY, GB
LIDDLE, John, GlaxoSmithKline Gunnels Wood Road, Stevenage Hertfordshire SG1 2NY, GB
WILSON, David Matthew, GlaxoSmithKline Gunnels Wood Road, Stevenage Hertfordshire SG1 2NY, GB

(51) MKP
A61K 31/4152 (2006.01)
A61K 31/4155 (2006.01)
A61K 31/4523 (2006.01)
A61K 31/4725 (2006.01)
A61K 31/496 (2006.01)
A61K 31/5377 (2006.01)
A61P 29/00 (2006.01)
(86) EP2011071584 02.12.2011
(96) 11794082.5 09.10.2013
(87) WO2012072782, 02.12.2011
(97) 2646025, 09.10.2013 en
(54) USE OF SIGMA LIGANDS IN BONE CANCER PAIN
(71) Laboratorios del. Dr. Esteve, S.A., Avda Mare de Deu de Montserrat 221, 08041 Barcelona, ES
(72) ZAMANILLO-CASTANEDO, Daniel, Avda. Mare de Dèu de Montserrat n° 252 5º- 2ª, E-08041 Barcelona, ES
VELA-HERNÁNDEZ, José Miguel, Rambla Badal n° 153, 8º, 3ª, E- 08028 Barcelona, ES
PLATA-SALAMAN, Carlos, Ronda del Canigó A-11, 10, E-08950 Esplugues de Llobregat - Barcelona, ES

(51) MKP
C07K 16/24 (2006.01)
(86) US2011066130 20.12.2011
(96) 11820904.8 30.10.2013
(87) WO2012121775, 20.12.2011
(97) 2655417, 30.10.2013 en
(54) IL-1 -ALPHA AND -BETA BISPECIFIC DUAL VARIABLE DOMAIN IMMUNOGLOBULINS AND THEIR USE
(71) AbbVie Inc., 1 North Waukegan Road, North Chicago, IL 60064, US
(72) WU, Chengbin, 300 Jin Xiu Road 14 Apt. 602, Shanghai, CN

(51) MKP
A01N 43/54 (2006.01)
A61K 31/535 (2006.01)
C07D 277/00 (2006.01)
(86) US2012022724 26.01.2012
(96) 12739832.9 04.12.2013
(87) WO2012103336, 26.01.2012
(97) 2667873, 04.12.2013 en
(54) SMALL MOLECULE RNASE INHIBITORS AND METHODS OF USE
(71) University Of Rochester, 601 Elmwood Avenue Box OTT, Rochester, NY 14642, US
Board of Regents of the University of Nebraska, Varner Hall, 3835 Holdrege Street, Lincoln, Nebraska 68583-0745, US
Temple University - Of The Commonwealth System of Higher Education, Broad and Montgomery Avenue 1801 N. Broad Street, Philadelphia, PA 19122, US
(72) DUNMAN, Paul M., 695 West Bloomfield Road, Pittsford, NY 14534, US
OLSON, Patrick D., 4228 McPherson Avenue, No.312, St. Louis, MO 63108, US
CHILDERS, Wayne, 4 Hillside Lane, New Hope, PA 18938, US

(51) MKP
C04B 28/10 (2006.01)
C04B 28/18 (2006.01)
C04B 40/06 (2006.01)
C04B 103/10 (2006.01)
C04B 111/10 (2006.01)
(96) 11003110.1 11.01.2012
(97) 2404885, 11.01.2012 de
(54) New construction material mixtures
(71) Quick-Mix Gruppe GmbH & Co. KG, Mühleneschweg 6, 49090 Osnabrück, DE
(72) Kanig, Martin, Dr., Zur dünnen Hegge 13, 49565 Bramsche, DE
Simon, Walter, Ernteweg 18a, 56743 Mendig, DE

(51) MKP
A61K 31/506 (2006.01) (97) **2651918 ***
A61P 35/00 (2006.01)
C07D 401/12 (2006.01)
(86) US2011065030 15.12.2011
(96) 11806079.7 23.10.2013
(87) WO2012082972, 15.12.2011
(97) 2651918, 23.10.2013 en
(54) CRYSTALLINE FORMS OF 5-CHLORO-N2-(2-ISOPROPOXY-5-METHYL-4-PIPERIDIN-4-YL-PHENYL)-N4[2-(PROPANE-2-SULFONYL)-PHENYL]-PYRIMIDINE-2,4-DIAMINE
(71) Novartis AG, Lichtstrasse 35, 4056 Basel, CH
(72) FENG, Lili, Novartis Pharmaceuticals Corporation One Health Plaza, East Hanover, New Jersey 07936-1080, US
GONG, Baoqing, Novartis Pharmaceuticals Corporation One Health Plaza, East Hanover, New Jersey 07936-1080, US
KARPINSKI, Piotr H., Novartis Pharmaceuticals Corporation One Health Plaza, East Hanover, New Jersey 07936-1080, US
WAYKOLE, Liladhar Murlidhar, Novartis Pharmaceuticals Corporation One Health Plaza, East Hanover, New Jersey 07936-1080, US

(51) MKP
A61K 9/00 (2006.01) (97) **2665465 ***
A61K 9/14 (2006.01)
A61K 9/16 (2006.01)
A61K 9/20 (2006.01)
A61K 31/343 (2006.01)
A61P 25/18 (2006.01)
(86) JP2012051279 16.01.2012
(96) 12702894.2 27.11.2013
(87) WO2012099260, 16.01.2012
(97) 2665465, 27.11.2013 en
(54) ORALLY DISPERSIBLE TABLET
(71) Takeda Pharmaceutical Company Limited, 1-1 Doshomachi 4-chome Chuo-ku, Osaka-shi, Osaka 541-0045, JP
(72) TANOUÉ, Yutaka, c/o TAKEDA PHARMACEUTICAL COMPANY LIMITED 17-85 Jusohonmachi 2-chome Yodogawa-ku, Osaka-shi, Osaka 532-0024, JP
MATSUURA, Tetsuya, c/o TAKEDA PHARMACEUTICAL COMPANY LIMITED 17-85 Jusohonmachi 2-chome Yodogawa-ku, Osaka-shi, Osaka 532-0024, JP
YAMAGATA, Yutaka, c/o TAKEDA PHARMACEUTICAL COMPANY LIMITED 17-85 Jusohonmachi 2-chome Yodogawa-ku, Osaka-shi, Osaka 532-0024, JP
NAGAHARA, Naoki, c/o TAKEDA PHARMACEUTICAL COMPANY LIMITED 17-85 Jusohonmachi 2-chome Yodogawa-ku, Osaka-shi, Osaka 532-0024, JP

(51) MKP
C12N 15/82 (2006.01) (97) **2661498 ***
(86) EP2011073627 21.12.2011
(96) 11799713.0 13.11.2013
(87) WO2012093032, 21.12.2011
(97) 2661498, 13.11.2013 en
(54) FIBER SELECTIVE PROMOTERS
(71) Bayer CropScience NV, J.E. Mommaertslaan 14, 1831 Diegem, BE
Commonwealth Scientific and Industrial Research Organisation, Limestone Avenue, Campbell, Australian Capital Territory 2612, AU
(72) MEULEWAETER, Frank, Sparrenstraat 51, B-9820 Merelbeke, BE
LLEWELLYN, Danny, 6 Myall Street, O'Connor Australian Capital Territory 2602, AU

(51) MKP
A01N 59/02 (2006.01) (97) **2683247 ***
A01N 59/16 (2006.01)
A01P 7/04 (2006.01)
(86) IN2012000163 09.03.2012
(96) 12761182.0 15.01.2014
(87) WO2012127499, 09.03.2012
(97) 2683247, 15.01.2014 en
(54) AN AGROCHEMICAL COMPOSITION COMPRISING ZINC, SULFUR AND A PESTICIDAL ACTIVE INGREDIENT
(71) Shah, Deepak Pranjivandas, 501/502 Vandana Apartments Janki Kutir Juhu Church Road Juhu, Mumbai, Maharashtra 400 009, IN
(72) Shah, Deepak Pranjivandas, 501/502 Vandana Apartments Janki Kutir Juhu Church Road Juhu, Mumbai, Maharashtra 400 009, IN

(51) MKP
B29C 70/38 (2006.01) (97) **2675612 ***
B29C 70/54 (2006.01)
(86) MK2012000002 15.02.2012
(96) 12720997.1 25.12.2013
(87) WO2012112017, 15.02.2012
(97) 2675612, 25.12.2013 en
(54) MECHANISM FOR AUTOMATICALLY CUTTING AND PLACEMENT OF RESIN IMPREGNATED FIBERS
(71) Tekon D.O.O., Ul. Goce Delcev no., 37500 Prilep, MK
(72) SAMKOSKI, Blagoja, ul. Goce Delcev n°3, 7500 Prilep, MK
SOKOLOSKI, Zlatko, ul. Goce Delcev n°3 7500 Prilep, 7500 Prilep, MK
MANESKI, Gari, ul. Goce Delcev n°3, 7500 Prilep, MK

(51) MKP
A61K 39/395 (2006.01) (97) **2699601 ***
C07K 16/28 (2006.01)
(86) US2012034519 20.04.2012
(96) 12717027.2 26.02.2014
(87) WO2012145673, 20.04.2012
(97) 2699601, 26.02.2014 en
(54) ANTIBODY POLYPEPTIDES THAT ANTAGONIZE CD40
(71) Bristol-Myers Squibb Company, Route 206 and Province Line Road, Princeton, NJ 08540, US
Domantis Limited, 980 Great West Road, Brentford, Middlesex TW8 9GS, GB
(72) SURI, Anish, Bristol-Myers Squibb Company Route 206 & Province Line Road, Princeton, NJ 08543, US
SHERIFF, Steven, Bristol-Myers Squibb Company Route 206 & Province Line Road, Princeton, NJ 08543, US
SUCHARD, Suzanne, Bristol-Myers Squibb Company Route 206 & Province Line Road, Princeton, NJ 08543, US
YAMNIUK, Aaron, Bristol-Myers Squibb Company Route 206 & Province Line Road, Princeton, NJ 08543, US
KRYSTEK, Stanley, Bristol-Myers Squibb Company Route 206 & Province Line Road, Princeton, NJ 08543, US
TAMURA, James, Bristol-Myers Squibb Company Route 206 & Province Line Road, Princeton, NJ 08543, US
BRYSON, James, Bristol-Myers Squibb Company Route 206 & Province Line Road, Princeton, NJ 08543, US
GRANT, Steven, Domantis Limited 315 Cambridge Science Park, Cambridge Cambridgeshire CB4 0WG, GB
DREW, Philip, 315 Cambridge Science Park, Cambridge Cambridgeshire CB4 0WG, GB

(51) MKP
A01N 25/34 (2006.01) (97) **2683240 ***
A01N 59/08 (2006.01)
A61K 33/00 (2006.01)
(86) GB2012000228 08.03.2012
(96) 12712138.2 15.01.2014
(87) WO2012123695, 08.03.2012
(97) 2683240, 15.01.2014 en
(54) A STABLE COMPOSITION OF HOCI, PROCESSES FOR ITS PRODUCTION AND USES THEREOF
(71) Biomimetics Health Industries Limited, Apt 4 Villanueva Building 99 Hannieqa St, Ghaxaq GXQ 1025, MT
(72) MALLETT, Christopher, Apple Tree Cottage The Street, Marden, Wiltshire SN10 3RQ, GB
WEDERELL, Christopher, -, deceased, GB
SINDEN, Richard, 64 Sutton Park Road, Kidderminster, Worcestershire DY11 6LF, GB

- (51) MKP
C07C 69/96 (2006.01) (97) **2655314 ***
 (86) US2011066900 22.12.2011
 (96) 11850238.4 30.10.2013
 (87) WO2012088441, 22.12.2011
 (97) 2655314, 30.10.2013 en
 (54) MULTI-API LOADING PRODRUGS
 (71) Alkermes Pharma Ireland Limited, Connaught House 1
 Burlington Road, Dublin 4, IE
 (72) ZEIDAN, Tarek A., 296 Lexington Street, Watertown, MA 02472,
 US
 BLUMBERG, Laura Cook, 37 Mill Street, Lincoln, MA 01773,
 US

- (51) MKP
C07D 239/42 (2006.01) (97) **2646419 ***
 (86) HU2011000112 29.11.2011
 (96) 11808700.6 09.10.2013
 (87) WO2012073054, 29.11.2011
 (97) 2646419, 09.10.2013 en
 (54) METHOD FOR PREPARING ROSUVASTATIN SALTS
 (71) Egis Gyógyszergyár Nyilvánosan Működő Részvény-Társaság,
 Keresztúri út 30-38, 1106 Budapest, HU
 (72) PORCS-MAKKAY, Marta, Bem József u. 21, H-2013 Pomáz,
 HU
 BARTHA, Ferenc Lóránt, Kabay J. ut 3-5/5, H-4440
 Tiszavasvári, HU
 KRASZNAI, György, XIII. u. 38, H-1172 Budapest, HU
 VOLK, Balázs, Piliusi u. 54, H-1106 Budapest, HU
 RUZSICS, György, Dózsa György u. 21., H-7191 Hógyesz, HU
 PONGÓ, László, Hold u. 31, H-2144 Kerepes, HU
 LUKÁCS, Gyula, Bronz u. 5, H-1163 Budapest, HU
 SZABÓ, Tibor, Szentmihályi út 24/c, H1144 Budapest, HU
 BARKÓCZY, József, Szirom u. 4-6/b, H-1016 Budapest, HU
 DEBRECZENI, József, Harang utca 19, H-1037 Budapest, HU
 KESZTHELYI, Adrienn, Gyakorlo utca 16 2.em.11, H-1106
 Budapest, HU
 PANDUR, Angéla, Deák F. u. 24, H-2235 Mende, HU
 MOLNÁR, Enikő, Titkár u. 16, H-2030 Érd, HU
 MILEN, Mátyás, Ormánság utca 4/A 5.em.122., H-1144
 Budapest, HU
 TÓTHNÉ LAURITZ, Maria, Venetiánér u. 4/a, H-1042 Budapest,
 HU

- (51) MKP
A44C 5/08 (2006.01) (97) **2651257 ***
 (86) EP2012075551 14.12.2012
 (96) 12809725.0 23.10.2013
 (87) WO2013104487, 14.12.2012
 (97) 2651257, 23.10.2013 en
 (54) ELASTIC CHAIN AND ORNAMENTAL ITEM MADE WITH SAID
 ELASTIC CHAIN
 (71) Fope S.r.l., Via Zampieri, 31, 36100 Vicenza, IT
 Cazzola, Umberto, Strada Comunale Monte Crocetta, 50,
 36100 Vicenza, IT
 (72) CAZZOLA, Umberto, Strada Comunale Monte Crocetta, 50,
 36100 VICENZA, IT

- (51) MKP
E05B 15/02 (2006.01) (97) **2694763 ***
 (86) IT2011000106 08.04.2011
 (96) 11722929.4 12.02.2014
 (87) WO2012137230, 08.04.2011
 (97) 2694763, 12.02.2014 en
 (54) ADJUSTABLE STRIKE PLATE FOR LOCKS
 (71) CISA S.p.A., Via Oberdan 42, 48018 Faenza, IT
 (72) MISIROCCHI, Andrea, Via Bellini 3, I-48018 Faenza, IT
 FUSTINI, Fausto, Via degli Sminatori 68, I-40026 Imola, IT

- (51) MKP
A61K 31/53 (2006.01) (97) **2681218 ***
A61P 25/18 (2006.01)
C07D 487/04 (2006.01)
 (86) IB2012050589 09.02.2012
 (96) 12705448.4 08.01.2014
 (87) WO2012114222, 09.02.2012
 (97) 2681218, 08.01.2014 en
 (54) IMIDAZO[5,1-f][1,2,4]TRIAZINES FOR THE TREATMENT OF
 NEUROLOGICAL DISORDERS
 (71) Pfizer Inc, 235 East 42nd Street, New York, NY 10017, US
 (72) CHAPPIE, Thomas Allen, Pfizer Global Research and
 Development Eastern Point Road, Groton, Connecticut 06340,
 US
 HUMPHREY, John Michael, Pfizer Global Research and
 Development Eastern Point Road, Groton, Connecticut 06340,
 US
 VERHOEST, Patrick Robert, Pfizer Global Research and
 Development Eastern Point Road, Groton, Connecticut 06340,
 US
 YANG, Eddie, Pfizer Global Research and Development
 Eastern Point Road, Groton, Connecticut 06340, US
 HELAL, Christopher John, Pfizer Global Research and
 Development Eastern Point Road, Groton, Connecticut 06340,
 US

- (51) MKP
H04L 29/08 (2006.01) (97) **2678996 ***
 (86) US2012025947 21.02.2012
 (96) 12710817.3 01.01.2014
 (87) WO2012115970, 21.02.2012
 (97) 2678996, 01.01.2014 en
 (54) SYSTEMS AND METHODS FOR GEO-STAGING OF
 SENSOR DATA THROUGH DISTRIBUTED GLOBAL (CLOUD)
 ARCHITECTURE
 (71) Fedex Corporate Services, Inc., 30 FedEx Pkwy 1st Fl. Vertical,
 Collierville, TN 38017, US
 (72) SKAAKSRUD, Ole-Petter, 4114 East Fir Hill Drive, Lakeland, TN
 38002, US
 AINSWORTH, Miley, 1814 Tara Drive, Hernando, MS 38632,
 US

- (51) MKP
A61K 31/439 (2006.01) (97) **2696871 ***
A61P 11/00 (2006.01)
A61P 43/00 (2006.01)
 (86) EP2012056575 11.04.2012
 (96) 12712699.3 19.02.2014
 (87) WO2012140081, 11.04.2012
 (97) 2696871, 19.02.2014 en
 (54) ACLIDINIUM FOR USE IN IMPROVING THE QUALITY OF
 SLEEP IN RESPIRATORY PATIENTS
 (71) Almirall, S.A., Ronda del General Mitre 151, 08022 Barcelona,
 ES
 (72) GARCIA GIL, Maria, Esther, C/ Laureà Miró 408-410 Sant Feliu
 de Llobregat, E-08980 Barcelona, ES
 DE MIQUEL SERRA, Gonzalo, C/ Laureà Miró 408-410 Sant
 Feliu de Llobregat, E-08980 Barcelona, ES
 SALA PEINADO, Maria, Jose, C/ Laureà Miró 408-410 Sant
 Feliu de Llobregat, E-08980 Barcelona, ES

- (51) MKP
A61B 18/12 (2006.01) (97) **2606845**
A61B 18/14 (2006.01)
 (96) 11195633.0 26.06.2013
 (97) 2606845, 26.06.2013 en
 (54) Pulse generator
 (71) Lina Medical ApS, Formervangen 5, 2600 Glostrup, DK
 (72) Poulsen, Henrik Bisgaard, Bakkesvinget 15, 3550 Slangerup,
 DK

- (51) MKP
A61L 27/44 (2006.01) (97) **2668967**
A61L 27/46 (2006.01)
A61L 27/54 (2006.01)
 (96) 12169943.3 04.12.2013
 (97) 2668967, 04.12.2013 en
 (54) An implant
 (71) Skulle Implants OY, Hämeenkatu 26, 20700 Turku, FI
 (72) Vallittu, Pekka, Kylläisentie 23, 21620 Kuusisto, FI

(51) MKP
B65D 1/02 (2006.01) (97) **2683620 ***
B65D 51/28 (2006.01)
B65D 81/20 (2006.01)
B65D 81/24 (2006.01)
B65D 81/32 (2006.01)
C12H 1/14 (2006.01)
C12H 1/22 (2006.01)
(86) EP2012054084 09.03.2012
(96) 12708023.2 15.01.2014
(87) WO2012120109, 09.03.2012
(97) 2683620, 15.01.2014 en
(54) CLOSURE FOR A PRODUCT RETAINING CONTAINER
(71) Nomacorc LLC, 400 Vintage Park Drive, Zebulon, NC 27597, US
(72) AAGAARD, Olav Marcus, van Slingelandtlaan 32, NL-3051 HX Rotterdam, NL
CAMPBELL GLASGOW, Katherine, 1729 Gracechurch Street, Wake Forest, North Carolina 27587, US
THOMPSON, Malcolm Joseph, 112 Walcott Way, Cary, North Carolina 27519, US
KIRCH, Marco Josef Otto, 220 Caniff Lane, Cary, North Carolina 27519, US

(51) MKP
C07D 307/81 (2006.01) (97) **2691381 ***
(86) HU2012000021 27.03.2012
(96) 12716595.9 05.02.2014
(87) WO2012131410, 27.03.2012
(97) 2691381, 05.02.2014 en
(54) REDUCTIVE AMINATION PROCESS FOR PREPARATION OF DRONEDARONE USING AMINE INTERMEDIARY COMPOUND
(71) SANOFI, 54 rue La Boétie, 75008 Paris, FR
(72) FRIESZ, Antal, c/o Chinoin Gyógyszer és Vegyészeti Termékek Gyára Zrt. Iparjog, Tó u. 1-5, 1045 Budapest, HU
HUSZÁR, Csaba, c/o Chinoin Gyógyszer és Vegyészeti Termékek Gyára Zrt. Iparjog, Tó u. 1-5, 1045 Budapest, HU

(51) MKP
A61K 39/00 (2006.01) (97) **2694105 ***
A61K 39/395 (2006.01)
(86) US2012031648 30.03.2012
(96) 12763324.6 12.02.2014
(87) WO2012135740, 30.03.2012
(97) 2694105, 12.02.2014 en
(54) CD37-BINDING MOLECULES AND IMMUNOCONJUGATES THEREOF
(71) Immunogen, Inc., 830 Winter Street, Waltham, MA 02451, US
(72) DECKERT, Jutta, 16 Eaton Road, Lexington, MA 02420, US
SETIADY, Julianto, 132 Clocktower Drive Unit 4110, Waltham, MA 02452, US
PARK, Peter U., 25 Webster Avenue 301, Somerville, MA 02143, US

(51) MKP
A61K 39/395 (2006.01) (97) **2689787**
C07K 16/22 (2006.01)
C07K 16/28 (2006.01)
C07K 16/30 (2006.01)
C07K 16/40 (2006.01)
C12N 5/09 (2010.01)
(96) 13190308.0 29.01.2014
(97) 2689787, 29.01.2014 en
(54) Identification and enrichment of cell subpopulations
(71) Stem Centrx, Inc., 450 East Jamie Court, South San Francisco, CA 94080, US
(72) Dylla, Scott, J., 743 Wake Forest Drive, Mountain View, CA 94043, US
Santaguida, Marianne, 780 Upton Street, Redwood City, CA 94061, US
Anderson, Wade C., 5177 Pond Side Way, Fairfield, CA 94534, US

(51) MKP
C07J 63/00 (2006.01) (97) **2683731 ***
(86) US2012028569 09.03.2012
(96) 12709768.1 15.01.2014
(87) WO2012125488, 09.03.2012
(97) 2683731, 15.01.2014 en
(54) C4-MONOMETHYL TRITERPENOID DERIVATIVES AND METHODS OF USE THEREOF
(71) Reata Pharmaceuticals, Inc., 2801 Gateway Drive, Suite 150, Irving, TX 75063-2648, US
(72) ANDERSON, Eric, C/o 2801 Gateway Drive Suite 150, Irving, TX 75063-2648, US
JIANG, Xin, C/o 2801 Gateway Drive Suite 150, Irving, TX 75063-2648, US
VISNICK, Melean, C/o 2801 Gateway Drive Suite 150, Irving, TX 75063-2648, US
BENDER, Christopher, F., C/o 2801 Gateway Drive Suite 150, Irving, TX 75063-2648, US
LIU, Xiaofeng, C/o 2801 Gateway Drive Suite 150, Irving, TX 75063-2648, US

(51) MKP
A47J 27/00 (2006.01) (97) **2578323**
A47J 36/02 (2006.01)
B05D 3/12 (2006.01)
B05D 5/06 (2006.01)
B05D 5/08 (2006.01)
(96) 12183899.9 10.04.2013
(97) 2578323, 10.04.2013 en
(54) A decoration process of cooking vessels with sol-gel coating.
(71) Allufion S.p.A., Viale F.lli Rosselli 46, 61100 Pesaro, IT
(72) Montagna, Michele, Novilara, Strada Tre Sole, 28, 61122 Pesaro, IT

(51) MKP
C08J 5/24 (2006.01) (97) **2662425**
C08L 63/00 (2006.01)
C09D 163/00 (2006.01)
H05K 1/03 (2006.01)
(96) 13159025.9 13.11.2013
(97) 2662425, 13.11.2013 en
(54) Epoxy Resin Composition, and Prepreg and Copper Clad Laminate Made Therefrom
(71) Shengyi Technology Co., Ltd., 5 Industry West Road Northern Industrial Park Songshan Lake Sci. & Tech. Industry Park, 523000 Dongguan City Guangdong, CN
(72) Zeng, Xianping, c/o Shengyi Technology Co., Ltd. 5 Industry West Road, Northern Industrial Park, Songshan Lake Sci. & Tech. Industry Park, 523000 Dongguan City, CN
Tang, Junqi, c/o Shengyi Technology Co., Ltd. 5 Industry West Road, Northern Industrial Park, Songshan Lake Sci. & Tech. Industry Park, 523000 Dongguan City, CN

(51) MKP
E06B 3/36 (2006.01) (97) **2689086 ***
(86) EP2012055329 26.03.2012
(96) 12710728.2 29.01.2014
(87) WO2012127059, 26.03.2012
(97) 2689086, 29.01.2014 de
(54) SYSTEM FOR PRODUCING A DOUBLE LEAF WINDOW
(71) profine GmbH, Mülheimer Strasse 26, 53840 Troisdorf, DE
(72) WÜRTZ, Hans, Merkurstraße 13, 66954 Pirmasens, DE

- (51) MKP
C07H 21/04 (2006.01) (97) **2694683 ***
C12Q 1/68 (2006.01)
- (86) US2012032459 06.04.2012
(96) 12767656.7 12.02.2014
(87) WO2012138955, 06.04.2012
(97) 2694683, 12.02.2014 en
(54) CONFORMATIONALLY-PREORGANIZED, MiniPEG-CONTAINING GAMMA-PEPTIDE NUCLEIC ACIDS
(71) Carnegie Mellon University, Center for Technology Transfer And Enterprise Creation 4615 Forbes Avenue, Suite 302, Pittsburgh, PA 15213, US
(72) LY, Daniith, H., c/o Center for Technology Transfer & Enterprise, 4615 Forbes Avenue, Suite 302, Pittsburgh, PA 15213, US
RAPIREDDY, Srinivas, c/o Center for Technology Transfer & Enterprise, 4615 Forbes Avenue, Suite 302, Pittsburgh, PA 15213, US
SAHU, Bichismita, c/o Center for Technology Transfer & Enterprise, 4615 Forbes Avenue, Suite 302, Pittsburgh, PA 15213, US
-
- (51) MKP
A61K 39/395 (2006.01) (97) **2682475 ***
A61P 35/00 (2006.01)
C07K 16/18 (2006.01)
C12N 5/20 (2006.01)
C12Q 1/02 (2006.01)
C12Q 1/68 (2006.01)
G01N 33/577 (2006.01)
- (86) CN2012000227 22.02.2012
(96) 12749191.8 08.01.2014
(87) WO2012113266, 22.02.2012
(97) 2682475, 08.01.2014 en
(54) ANTIBODY AND ANTIGEN RECOGNIZING TUMOR-INITIATING CELLS AND USE THEREOF
(71) Beijing Institute for Cancer Research, 52 Fu-Cheng Road Haidian District, Beijing 100036, CN
(72) ZHANG, Zhiqian, 52 Fucheng Road, Haidian District Beijing 100142, CN
ZHAO, Wei, 52 Fucheng Road, Haidian District Beijing 100142, CN
WANG, Limin, 52 Fucheng Road, Haidian District Beijing 100142, CN
HAN, Haibo, 52 Fucheng Road, Haidian District Beijing 100142, CN
XING, Baocai, 52 Fucheng Road, Haidian District Beijing 100142, CN
-
- (51) MKP
A61K 31/5025 (2006.01) (97) **2694510 ***
A61P 35/00 (2006.01)
C07D 487/04 (2006.01)
- (86) EP2012056300 05.04.2012
(96) 12713963.2 12.02.2014
(87) WO2012136776, 05.04.2012
(97) 2694510, 12.02.2014 en
(54) IMIDAZOPYRIDAZINES AS AKT KINASE INHIBITORS
(71) Bayer Intellectual Property GmbH, Alfred-Nobel-Strasse 10, 40789 Monheim, DE
Bayer Pharma Aktiengesellschaft, Müllerstrasse 178, 13353 Berlin, DE
(72) BÄRFACKER, Lars, Walter-Flex-Str. 29, 46047 Oberhausen, DE
SCOTT, William Johnston, 210 Saddle Hill Drive, Guilford, CT 06437, DE
HÄGEBARTH, Andrea, An den Eldenaer Höfen 13, 10247 Berlin, DE
INCE, Stuart, Katteweg 27a, 14129 Berlin, DE
REHWINKEL, Hartmut, Blücherstr. 13, 10961 Berlin, DE
POLITZ, Oliver, Steenerbuschstr. 73, 16341 Panketal OT Zepernick, DE
NEUHAUS, Roland, Lauenburger Str. 28, 12157 Berlin, DE
BRIEM, Hans, Emser Str. 3, 10719 Berlin, DE
BÖMER, Ulf, Leipziger Str. 49, 16548 Glienicke, DE
-
- (51) MKP
F17C 7/02 (2006.01) (97) **2646738 ***
F17C 13/02 (2006.01)
- (86) US2011062564 30.11.2011
(96) 11794345.6 09.10.2013
(87) WO2012075096, 30.11.2011
(97) 2646738, 09.10.2013 en
(54) A LIQUID DISPENSER
(71) GP Strategies Corporation, 6095 Marshalee Drive, Suite 300, Elkridge, MD 21075, US
(72) MACKAY, Michael, 4553 Verde Mar De Ponderosa, San Diego CA 92123, US
-
- (51) MKP
A01K 61/00 (2006.01) (97) **2684450 ***
- (86) ES2012070155 08.03.2012
(96) 12754966.5 15.01.2014
(87) WO2012120180, 08.03.2012
(97) 2684450, 15.01.2014 en
(54) SHOCK-ABSORBING COUPLING FOR FLOATING STRUCTURES
(71) Española De Plataformas Marinas, S.L., Apartado 51 Campaña s/n Valga, 36645 Pontevedra, ES
(72) QUINTÁ CORTIÑAS, Andrés, Campaña, E-36645 Valga, ES
-
- (51) MKP
A61K 31/517 (2006.01) (97) **2694071 ***
C07D 239/70 (2006.01)
- (86) US2012031720 30.03.2012
(96) 12764184.3 12.02.2014
(87) WO2012135781, 30.03.2012
(97) 2694071, 12.02.2014 en
(54) COMBINATIONS OF AKT INHIBITOR COMPOUNDS AND CHEMOTHERAPEUTIC AGENTS, AND METHODS OF USE
(71) Genentech, Inc., One DNA Way, South San Francisco, CA 94080-4990, US
(72) LIN, Kui, 1 DNA Way, South San Francisco California 94080-4990, US
NANNINI, Michelle, 1 DNA Way, South San Francisco California 94080-4990, US
PUNNOOSE, Elizabeth, 1 DNA Way, South San Francisco California 94080-4990, US
SAMPATH, Deepak, 1 DNA Way, South San Francisco California 94080-4990, US
WALLIN, Jeffrey, 1 DNA Way, South San Francisco California 94080-4990, US
PATEL, Premal, 1 DNA Way, South San Francisco California 94080-4990, US
-
- (51) MKP
A61K 31/517 (2006.01) (97) **2670736 ***
A61P 11/00 (2006.01)
C07D 239/70 (2006.01)
C07D 403/12 (2006.01)
- (86) EP2012051298 27.01.2012
(96) 12702480.0 11.12.2013
(87) WO2012104206, 27.01.2012
(97) 2670736, 11.12.2013 de
(54) 9-[4-(3-CHLOR-2-FLUOR-PHENYLAMINO)-7-METHOXY-QUINAZOLIN-6-YLOXY]-1,4-DIAZA-SPIRO[5.5]UNDECAN-5-ONE DIMALEATE, USE THEREOF AS A DRUG, AND PRODUCTION THEREOF
(71) Boehringer Ingelheim International GmbH, Binger Strasse 173, 55216 Ingelheim am Rhein, DE
(72) OSTERMEIER, Markus, Boehringer Ingelheim GmbH Corporate Patents Binger Strasse 173, 55216 Ingelheim Am Rhein, DE
PFRENGLE, Waldemar, Boehringer Ingelheim GmbH Corporate Patents Binger Strasse 173, 55216 Ingelheim Am Rhein, DE
HUCHLER, Guenther, Boehringer Ingelheim GmbH Corporate Patents Binger Strasse 173, 55216 Ingelheim Am Rhein, DE
SIEGER, Peter, Boehringer Ingelheim GmbH Corporate Patents Binger Strasse 173, 55216 Ingelheim Am Rhein, DE

- (51) MKP
C07D 307/81 (2006.01) (97) **2691380 ***
 (86) HU2012000020 27.03.2012
 (96) 12716594.2 05.02.2014
 (87) WO2012131409, 27.03.2012
 (97) 2691380, 05.02.2014 en
 (54) PROCESS FOR PREPARATION OF DRONEDARONE BY N-BUTYLATION
 (71) SANOFI, 54 rue La Boétie, 75008 Paris, FR
 (72) FRIESZ, Antal, c/o Chinoin Gyógyszer és Vegyészeti Termékek Gyára Zrt. Iparjog Tó u. 1 -5., H-1045 Budapest, HU
 PÁRKÁNYI, Zsolt, c/o Chinoin Gyógyszer és Vegyészeti Termékek Gyára Zrt. Iparjog Tó u. 1 -5., H-1045 Budapest, HU
 DOMBRÁDY, Zsolt, c/o Chinoin Gyógyszer és Vegyészeti Termékek Gyára Zrt. Iparjog Tó u. 1 -5., H-1045 Budapest, HU

- (51) MKP
F16L 53/00 (2006.01) (97) **2668819 ***
F17D 1/18 (2006.01)
H05B 3/00 (2006.01)
H05B 6/10 (2006.01)
 (86) NO2012050010 30.01.2012
 (96) 12709186.6 04.12.2013
 (87) WO2012102624, 30.01.2012
 (97) 2668819, 04.12.2013 en
 (54) SYSTEM AND SYSTEM ELEMENTS FOR DIRECT ELECTRICAL HEATING OF SUBSEA PIPELINES
 (71) Sinvent AS, null, 7465 Trondheim, NO
 (72) KULBOTTEN, Harald, Ler Sentrum, 7234 Ler, NO
 LERVIK, Jens, Leirakken 6, 7228 Kvål, NO

- (51) MKP
A61K 31/505 (2006.01) (97) **2646420 ***
C07D 239/42 (2006.01)
 (86) HU2011000113 29.11.2011
 (96) 11819001.6 09.10.2013
 (87) WO2012073055, 29.11.2011
 (97) 2646420, 09.10.2013 en
 (54) METHOD FOR THE PREPARATION OF HIGH-PURITY PHARMACEUTICAL INTERMEDIATES
 (71) Egis Gyógyszergyár Nyilvánosan M Kód Részvénytársaság, Keresztúri út 30-38, 1106 Budapest, HU
 (72) KOVÁNYINÉ LAX, Györgyi, Mogyoródi út 110 2.em.3, H-1141 Budapest, HU
 SIMIG, Gyula, Holl sy S. u. 25., H-1126 Budapest, HU
 VOLK, Balázs, Piliusi u. 54, H-1106 Budapest, HU
 BARTHA, Ferenc Lóránt, Kabay J. út 3-5/5., H-4440 Tiszavasvári, HU
 KRASZNAI, György, XIII u. 38., H-1172 Budapest, HU
 RUZSICS, György, Dózsa György u. 21, H-7191 H gyész, HU
 SIPOS, Éva, Magyarhida utca 47, H-1172 Budapest, HU
 NAGY, Kálmán, Túrta út 2/a, H-1025 Budapest, HU
 MOROVJÁN, György, Pet fi u. 164., H-1196 Budapest, HU
 BARKÓCZY, József, Szirom u. 4-6/b, H-1016 Budapest, HU
 KESZTHELYI, Adrienn, Gyakorló u.16 em.11., H-1106 Budapest, HU
 IMRE, János, Tisza l. u. 22/b., H-1174 Budapest, HU
 BAGYINSZKI, Gábor, Présház u. 10., H-2100 Gődöll, HU

- (51) MKP
G01N 21/25 (2006.01) (97) **2684029 ***
G01N 21/59 (2006.01)
 (86) US2012027106 29.02.2012
 (96) 12757497.8 15.01.2014
 (87) WO2012125292, 29.02.2012
 (97) 2684029, 15.01.2014 en
 (54) IN VITRO MEASUREMENT OF SUNSCREEN PROTECTION
 (71) Suncare Research Laboratories, LLC, 2518 B Reynolda Road, Winston-Salem, NC 27106, US
 (72) STANFIELD, Joseph, W., 509 Boxthorne Court, Winston-Salem, NC 27106, US
 STANFIELD, William, J., III, 833 Bellview Street, Winston-Salem, NC 27106, US

- (51) MKP
A61M 5/24 (2006.01) (97) **2688613 ***
A61M 5/315 (2006.01)
 (86) EP2012055056 22.03.2012
 (96) 12710925.4 29.01.2014
 (87) WO2012130704, 22.03.2012
 (97) 2688613, 29.01.2014 en
 (54) DRUG DELIVERY DEVICE
 (71) Sanofi-Aventis Deutschland GmbH, Brüningstraße 50, 65929 Frankfurt, DE
 (72) PLUMPTRE, David, Aubrey, 36 Shire Way, Droitwich Spa, Worcestershire WR9 7RQ, GB
 SMITH, Christopher, James, 4 Elm Drive, Holmes Chapel, Cheshire CW4 7QG, GB

- (51) MKP
A61K 31/4155 (2006.01) (97) **2668183 ***
A61P 19/00 (2006.01)
A61P 29/00 (2006.01)
C07D 413/04 (2006.01)
C07D 413/14 (2006.01)
C07D 417/14 (2006.01)
 (86) EP2012051360 27.01.2012
 (96) 12703014.6 04.12.2013
 (87) WO2012101263, 27.01.2012
 (97) 2668183, 04.12.2013 en
 (54) IL17 AND IFN-GAMMA INHIBITION FOR THE TREATMENT OF AUTOIMMUNE INFLAMMATION
 (71) 4SC Discovery GmbH, Am Klopferspitz 19a, 82152 Planegg-Martinsried, DE
 (72) LEBAN, Johann, Pyrkergrasse 31 Apartment 10, A-1190 Wien, DE
 TASLER, Stefan, Friedinger Str. 18a, 82229 Seefeld, DE
 SAEB, Wael, Kopernikusweg 10, Martinsried 82152, DE
 CHEVRIER, Carine, Malerwinkel 1, München 81479, DE

- (51) MKP
A01H 5/00 (2006.01) (97) **2694658 ***
C12N 15/82 (2006.01)
 (86) EP2012056324 05.04.2012
 (96) 12712280.2 12.02.2014
 (87) WO2012136788, 05.04.2012
 (97) 2694658, 12.02.2014 en
 (54) SEED - SPECIFIC PROMOTER IN COTTON
 (71) Bayer CropScience NV, J.E. Mommaertslaan 14, 1831 Diegem, BE
 (72) SCHEIRLINCX, Marie-Therese, Langendries 19, 9620 Zottegem, BE
 MEULEWAETER, Frank, Sparrenstraat 51, 9820 Merelbeke, BE
 JACOBS, John, Wilgenstraat 4B, 9820 Merelbeke, BE

- (51) MKP
A61K 38/17 (2006.01) (97) **2646464 ***
A61K 38/21 (2006.01)
A61P 35/00 (2006.01)
C07K 14/56 (2006.01)
C07K 14/57 (2006.01)
C07K 14/705 (2006.01)
C12N 15/12 (2006.01)
C12N 15/21 (2006.01)
C12N 15/23 (2006.01)
C12N 15/62 (2006.01)
 (86) EP2011071719 05.12.2011
 (96) 11790636.2 09.10.2013
 (87) WO2012072815, 05.12.2011
 (97) 2646464, 09.10.2013 en
 (54) ANTICANCER FUSION PROTEIN
 (71) Adamed sp. z o.o., Pienków 149, 05-152 Czosnów k/Warszawy, PL
 (72) PIECZYKOLAN, Jerzy Szczepan, Gorajec - Zastawie 47, PL-22-463 Radezczyca, PL
 LEMKE, Krzysztof Kazimierz, ul. Batalionów Chłopskich 2A, PL-81-452 Gdynia, PL
 PAWLAK, Sebastian, ul. Majakowskiego 3/2, PL-01-420 Warszawa, PL
 ZEREK, Bartłomiej, ul. Południowa 45/4, PL-97-200 Dabrowa, PL

- (51) MKP
A01N 29/04 (2006.01) (97) **2654422 ***
A61K 31/025 (2006.01)
- (86) US2011066690 22.12.2011
(96) 11852103.8 30.10.2013
(87) WO2012088365, 22.12.2011
(97) 2654422, 30.10.2013 en
(54) BICYCLO[3.2.1]OCTYL AMIDE DERIVATIVES AND USES OF SAME
- (71) H. Lundbeck A/S, Ottiliavej 9, 2500 Valby-Copenhagen, DK
(72) LI, Guiying, 76 Rutgers Place Apt. 1, River Edge, NJ 07661, US
ZHOU, Hao, 325 Edstan Way, Paramus, NJ 07652, US
WEISS, Jesse, 169 South Park Drive, Woodbirdge, NJ 07095, US
DOLLER, Dario, 15 Quarterhorse Crossing, Sparta, NJ 07871, US
FORD, James, 11 Madison Street, Glen Ridge, NJ 07028, US

- (51) MKP
C07C 217/54 (2006.01) (97) **2668152 ***
- (86) US2012021181 13.01.2012
(96) 12701809.1 04.12.2013
(87) WO2012102875, 13.01.2012
(97) 2668152, 04.12.2013 en
(54) ANALGESIC COMPOUNDS, METHODS, AND FORMULATIONS
- (71) Eli Lilly and Company, Lilly Corporate Center, Indianapolis, IN 46285, US
(72) DEFAUW, Jean Marie, 5846 West Boulder Creek Court, New Palestine Indiana 46163, US
HOLMSTROM, Scott Dale, 14940 Silent Bluff Court, Fishers Indiana 46037, US
CHEN, Shuhui, 3789 Camino Codorniz, Calabasas California 91302, US
ZHANG, Yang, 79-701 399 JuFeng Road, Shanghai 200108, CN
WU, Wentao, 7-201 365 QingXi Road, Shanghai 200137, CN
PENG, Xian, 104-602 420 Linghe Road, Shanghai 200129, CN
MA, Yujian, 3-303 180 Jijing Road, Shanghai 200137, CN
LU, Lun, 63-401 995 JuFeng Road, Shanghai 201208, CN

- (51) MKP
A61K 31/4704 (2006.01) (97) **2697201 ***
C07D 215/56 (2006.01)
- (86) US2013039911 07.05.2013
(96) 13750833.9 19.02.2014
(87) WO2013169746, 07.05.2013
(97) 2697201, 19.02.2014 en
(54) N-ETHYL-4-HYDROXYL-1-METHYL-5-(METHYL(2,3,4,5,6-PENTAHYDROXYHEXYL) AMINO)-2-OXO-N-PHENYL-1,2-DIHYDROQUINOLINE-3-CARBOXAMIDE
- (71) Teva Pharmaceutical Industries Ltd., 5 Basel Street P.O. Box 3190, 49131 Petah Tiqva, IL
(72) LAXER, Avital, 26 Ben-Yosef St., Tel-Aviv 6912526, IL
ULANENKO, Konstantin, Beeri St. 69/1, Netanya 42258, IL

- (51) MKP
A61K 31/517 (2006.01) (97) **2694070 ***
A61P 35/00 (2006.01)
C07D 239/70 (2006.01)
- (86) US2012031671 30.03.2012
(96) 12763771.8 12.02.2014
(87) WO2012135753, 30.03.2012
(97) 2694070, 12.02.2014 en
(54) COMBINATIONS OF AKT INHIBITOR COMPOUNDS AND ERLOTINIB, AND METHODS OF USE
- (71) Genentech, Inc., One DNA Way, South San Francisco, CA 94080-4990, US
(72) NANNINI, Michelle, 1 DNA Way, South San Francisco California 94080, US
SAMPATH, Deepak, 1 DNA Way, South San Francisco California 94080, US

- (51) MKP
B65D 5/50 (2006.01) (97) **2423116**
B65D 81/07 (2006.01)
- (96) 11006109.0 29.02.2012
(97) 2423116, 29.02.2012 de
(54) Wing fixing packaging
(71) Emba-Protec GmbH & Co. KG, Alter Postweg 68, 32549 Bad Oeynhausen, DE
Hennesen + Potthoff GmbH, Tempelsweg 22, 47918 Tönisvorst, DE
United Parcel Service Deutschland Inc. & Co. OHG, Görlitzer Strasse 1, 41460 Neuss, DE
(72) Potthoff, Michael, Mohnstraße 1, 47800 Krefeld, DE
Hübner, Torsten, Granatweg 2, 41564 Kaarst, DE
Frankowski, Boris, Wokers Feld 45, 32549 Bad Oeynhausen, DE

- (51) MKP
A61K 31/506 (2006.01) (97) **2663557 ***
A61P 31/04 (2006.01)
C07D 405/14 (2006.01)
C07F 9/6558 (2006.01)
- (86) US2012021270 13.01.2012
(96) 12702920.5 20.11.2013
(87) WO2012097269, 13.01.2012
(97) 2663557, 20.11.2013 en
(54) PYRIMIDINE GYRASE AND TOPOISOMERASE IV INHIBITORS
- (71) Vertex Pharmaceuticals Incorporated, 130 Waverly Street, Cambridge, MA 02139, US
(72) LE TIRAN, Arnaud, 3 Hameau de l'Ormeray, F-78920 Croissy Sur Seine, FR
GRILLOT, Anne-laure, 242 Woodland Road, Milton MA 02186, US
CHARIFSON, Paul, S., 7 Dartmouth Drive, Framingham MA 01710, US
BENNANI, Youssef, Laafiret, 35 Chemin de Hombourg, Loraine Quebec J6Z 4N2, CA
O'DOWD, Hardwin, 21 Wormwood Street Unit 516, Boston MA 02210, US
PEROLA, Emanuele, 6 Lanark Road Unit 3, Brookline MA 02445, US

- (51) MKP
C07D 207/34 (2006.01) (97) **2673260 ***
C07D 231/12 (2006.01)
C07D 231/14 (2006.01)
C07D 231/16 (2006.01)
C07D 231/18 (2006.01)
C07D 231/54 (2006.01)
C07D 231/56 (2006.01)
C07D 233/61 (2006.01)
C07D 233/64 (2006.01)
C07D 233/68 (2006.01)
C07D 233/70 (2006.01)
C07D 233/84 (2006.01)
C07D 249/06 (2006.01)
C07D 249/08 (2006.01)
C07D 261/08 (2006.01)
(86) IB2012050349 25.01.2012
(96) 12704132.5 18.12.2013
(87) WO2012107850, 25.01.2012
(97) 2673260, 18.12.2013 en
(54) GLUCAGON RECEPTOR MODULATOR
(71) Pfizer Inc, 235 East 42nd Street, New York, NY 10017, US
(72) ASPNES, Gary Erik, Pfizer Global Research and Development Eastern Point Road, Groton, Connecticut 06340, US
DIDIUK, Mary Theresa, 61 Hickory Lane, Madison, Connecticut 06443, US
FILIPSKI, Kevin James, Pfizer Global Research and Development 87 Cambridge Park Drive, Cambridge, Massachusetts 02140, US
GUZMAN-PEREZ, Angel, 20 Gilmore Road, Belmont, Massachusetts 02478, US
LEE, Esther Cheng Yin, Pfizer Global Research and Development Eastern Point Road, Groton, Connecticut 06340, US
PFEFFERKORN, Jeffrey Allen, Pfizer Global Research and Development 87 Cambridge Park Drive, Cambridge, Massachusetts 02140, US
STEVENS, Benjamin Dawson, Pfizer Global Research and Development 87 Cambridge Park Drive, Cambridge, Massachusetts 02140, US
TU, Meihua Mike, Pfizer Global Research and Development 87 Cambridge Park Drive, Cambridge, Massachusetts 02140, US
-

- (51) MKP
A61K 9/16 (2006.01) (97) **2691083 ***
A61K 9/20 (2006.01)
A61K 31/4985 (2006.01)
(86) EP2012055736 29.03.2012
(96) 12711399.1 05.02.2014
(87) WO2012131005, 29.03.2012
(97) 2691083, 05.02.2014 en
(54) PHARMACEUTICAL COMPOSITION OF SITAGLIPTIN
(71) KRKA, Tovarna Zdravil, D.D., Novo Mesto, Smarjeska Cesta 6, 8501 Novo Mesto, SI
(72) PRESKAR, Maja, Bohoriceva 15, 8270 Krsko, SI
KROSELJ, Vesna, Ragovska 15b, 8000 Novo mesto, SI
TROST, Sabina, Ljubljanska cesta 31, 1330 Kocevje, SI
HVALEC, Lucija, Seidlova cesta 62, 8000 Novo mesto, SI
KLJAJIC, Alen, Smrekarjeva ulica 4, 3000 Celje, SI
BUKOVEC, Polona, Knezova ulica 18, 8000 Novo mesto, SI
-

- (51) MKP
A61P 39/02 (2006.01) (97) **2691156 ***
C07K 16/44 (2006.01)
(86) EP2012055397 27.03.2012
(96) 12710300.0 05.02.2014
(87) WO2012130834, 27.03.2012
(97) 2691156, 05.02.2014 en
(54) ANTICOAGULANT ANTIDOTES
(71) Boehringer Ingelheim International GmbH, Binger Strasse 173, 55216 Ingelheim, DE
(72) VAN RYN, Joanne, Boehringer Ingelheim GmbH Corporate Patents Binger Strasse 173, 55216 Ingelheim am Rhein, DE
CANADA, Keith, Boehringer Ingelheim Pharmaceuticals, Inc. 900 Ridgebury Road, Ridgefield, Connecticut 06877, US
COPENHAVER, Robert, Boehringer Ingelheim Pharmaceuticals, Inc. 900 Ridgebury Road, Ridgefield, Connecticut 06877, US
HAUEL, Norbert, Boehringer Ingelheim GmbH Corporate Patents Binger Strasse 173, 55216 Ingelheim am Rhein, DE
LITZENBURGER, Tobias, Boehringer Ingelheim GmbH Corporate Patents Binger Strasse 173, 55216 Ingelheim am Rhein, DE
SARKO, Christopher Ronald, Boehringer Ingelheim Pharmaceuticals, Inc. 900 Ridgebury Road, Ridgefield, Connecticut 06877, US
SINGH, Sanjaya, Boehringer Ingelheim Pharmaceuticals, Inc. 900 Ridgebury Road, Ridgefield, Connecticut 06877, US
WATERMAN, Alisa K., Boehringer Ingelheim Pharmaceuticals, Inc. 900 Ridgebury Road, Ridgefield, Connecticut 06877, US
-

- (51) MKP
C08L 25/10 (2006.01) (97) **2695916**
C08L 71/12 (2006.01)
(96) 13159035.8 12.02.2014
(97) 2695916, 12.02.2014 en
(54) Polyphenylene ether resin composition, and a prepreg and a copper clad laminate made therefrom
(71) Shengyi Technology Co., Ltd., 5 Industry West Road Northern Industrial Park Songshan Lake Sci. & Tech. Industry Park, 523000 Dongguan City Guangdong, CN
(72) Zeng, Xianping, c/o Shengyi Technology Co., Ltd. 5 Industry West Road, Northern Industrial Park, Songshan Lake Sci. & Tech. Industry Park, Dongguan City Guangdong 523000, CN
-

- (51) MKP
A61K 39/395 (2006.01) (97) **2649097 ***
A61P 35/00 (2006.01)
A61P 35/02 (2006.01)
C07K 16/28 (2006.01)
G01N 33/574 (2006.01)
(86) GB2011052421 07.12.2011
(96) 11794570.9 16.10.2013
(87) WO2012076883, 07.12.2011
(97) 2649097, 16.10.2013 en
(54) ANTI CCR4 ANTIBODIES AND USES THEREOF
(71) Affitech Research AS, Oslo Research Park Gaustadalléen 21, 0349 Oslo, NO
(72) HAGEMANN, Urs Beat, Bergslia 27, N-0870 Oslo, NO
GRIEP, Remko Albert, Odalsveien 31B, N-3470 Slemmestad, NO
REIERSEN, Herald, Njaards vei 5C, N-1412 Sofiemyr, NO
KIPRIJANOV, Sergej Michailovic, Hovseterveien 98, N-0768 Oslo, NO
-

- (51) MKP
A61K 39/00 (2006.01) (97) **2678032 ***
(86) EP2013059041 30.04.2013
(96) 13720364.2 01.01.2014
(87) WO2013174630, 30.04.2013
(97) 2678032, 01.01.2014 en
(54) LENTIVIRAL VECTORS CONTAINING AN MHC CLASS I PROMOTER
(71) Theravectys, 1 mail du Professeur Georges Mathé, 94800 Villejuif, FR
(72) SARRY, Emeline, 68, avenue Augustin Dumont, 92240 Malakoff, FR
BAUCHE, Cécile, 104, avenue de Choisy, 75013 Paris, FR
-

- (51) MKP
E03D 5/10 (2006.01) (97) **2683883 ***
(86) EP2012052834 20.02.2012
(96) 12708096.8 15.01.2014
(87) WO2012119849, 20.02.2012
(97) 2683883, 15.01.2014 de
(54) ELECTRONICALLY CONTROLLED FLUSH-MOUNTED TOILET FLUSHING VALVE
(71) Schell GmbH & Co. KG, Raiffeisenstrasse 31, 57462 Olpe, DE
(72) WEBER, Hanno, Knappenstraße 89a, 57581 Katzwinkel, DE
SIEBERHAGEN, Günter, Ascherothstraße 22, 58093 Hagen, DE
WEBER, Hanno, Knappenstraße 89a, 57581 Katzwinkel, DE
SIEBERHAGEN, Günter, Ascherothstraße 22, 58093 Hagen, DE
-
- (51) MKP
A43B 1/00 (2006.01) (97) **2532259**
A43B 3/00 (2006.01)
A43C 15/14 (2006.01)
(96) 12171142.8 12.12.2012
(97) 2532259, 12.12.2012 en
(54) Method for controlling a shifting mechanism of a spike in a shoe and a shoe functioning according to this method
(71) Sienvin Jalkine Oy, Korhosenkatu 24, 85310 Sievi as, FI
(72) Jokinen, Markku, Korhosenkatu 22, FI-85310 Sievi as, FI
Jokinen, Vesa, Latokankaankuja 17, FI-85310 Sievi as, FI
-
- (51) MKP
C07D 403/06 (2006.01) (97) **2678333 ***
(86) IB2012050791 21.02.2012
(96) 12709178.3 01.01.2014
(87) WO2012114273, 21.02.2012
(97) 2678333, 01.01.2014 en
(54) AN IMPROVED PROCESS FOR THE PREPARATION OF VORICONAZOLE AND INTERMEDIATES THEREOF
(71) Ranbaxy Laboratories Limited, 12th Floor Devika Tower 06 Nehru Place New Delhi, Delhi 110019, IN
(72) MAHESHWARI, Nitin, E/8-E DDA Flats (MIG) Maya Puri, New Delhi Delhi 110064, IN
MEDHANE, Roshan, Ramesh, Vishnupriya Plot No. 12, Vivekanand Nagar Pipeline Road Anandwali Gangapur Road, Nashik, Maharashtra 422002, IN
PRASAD, Mohan, D-50, Greenwoods City Sector 46, Gurgaon Haryana 122003, IN
ARORA, Sudershan, Kumar, A-3/803, Sahara Grace M.G. Road, Gurgaon Haryana 122001, IN
-
- (51) MKP
A61K 31/519 (2006.01) (97) **2655375 ***
A61P 25/00 (2006.01)
C07D 487/04 (2006.01)
A61P 7/02 (2006.01)
A61K 31/527 (2006.01)
A61P 19/02 (2006.01)
A61P 3/10 (2006.01)
C07D 233/44 (2006.01)
A61P 37/00 (2006.01)
C07D 239/12 (2006.01)
A61P 11/06 (2006.01)
A61P 35/00 (2006.01)
A61P 17/06 (2006.01)
A61P 3/00 (2006.01)
A61K 31/5377 (2006.01)
(86) EP2011073874 22.12.2011
(96) 11799724.7 30.10.2013
(87) WO2012085244, 22.12.2011
(97) 2655375, 30.10.2013 fr
(54) PYRIMIDINONE DERIVATIVES, PREPARATION THEREOF AND PHARMACEUTICAL USE THEREOF
(71) SANOFI, 54, rue de la Boétie, 75008 Paris, FR
(72) ARIGON, Jérôme, Sanofi Patent Department 174 avenue de France, F-75013 Paris, FR
BROLLO, Maurice, Sanofi Patent Department 174 avenue de France, F-75013 Paris, FR
CLEMENT, Jacques, Sanofi Patent Department 174 avenue de France, F-75013 Paris, FR
COMBET, Romain, Sanofi Patent Department 174 avenue de France, F-75013 Paris, FR
DURAND, Florence, Sanofi Patent Department 174 avenue de France, F-75013 Paris, FR
EL AHMAD, Youssef, Sanofi Patent Department 174 avenue de France, F-75013 Paris, FR
LABROSSE, Jean-Robert, Sanofi Patent Department 174 avenue de France, F-75013 Paris, FR
LETALLEC, Jean-Philippe, Sanofi Patent Department 174 avenue de France, F-75013 Paris, FR
RONAN, Baptiste, Sanofi Patent Department 174 avenue de France, F-75013 Paris, FR
-
- (51) MKP
G06K 9/00 (2006.01) (97) **2686808 ***
G06K 9/62 (2006.01)
G06T 7/00 (2006.01)
(86) EP2012054485 14.03.2012
(96) 12712602.7 22.01.2014
(87) WO2012123505, 14.03.2012
(97) 2686808, 22.01.2014 en
(54) METHOD AND DEVICE FOR EFFICIENT PARALLEL MESSAGE COMPUTATION FOR MAP INFERENCE
(71) ECOLE CENTRALE PARIS, Grand Voie des Vignes, 92295 Chatenay Malabry, FR
(72) PARAGIOS, Nikos, 1 rue des Vignerons, 94300 Vincennes, FR
SOTIRAS, Aristeidis, 79-81 avenue Pierre Brosolette, 92129 Montrouge, FR
ALCHATZIDIS, Stavros, 4 bis rue des Anglais, 91300 Massy, FR
-
- (51) MKP
G06Q 20/00 (2012.01) (97) **2678811 ***
(86) IB2012050770 20.02.2012
(96) 12719448.8 01.01.2014
(87) WO2012114260, 20.02.2012
(97) 2678811, 01.01.2014 en
(54) A MOBILE COMMUNICATION DEVICE FOR CONTACTLESS PAYMENTS, A PAYMENT METHOD
(71) Logomotion, s.r.o., Winterova 15, 921 01 Piestany, SK
(72) HUBINÁK, Emil, Beethovenova 4, 921 01 Piestany, SK
FLOREK, Miroslav, Sedmokraskova 4, 821 01 Bratislava, SK
MASARYK, Michal, Medzilaborecká 7, 821 01 Bratislava, SK
-

(51) MKP
F02D 41/38 (2006.01) (97) **2663764 ***
F02M 59/34 (2006.01)
F02M 59/36 (2006.01)
F02M 63/00 (2006.01)
F02M 63/02 (2006.01)
(86) EP2011070211 16.11.2011
(96) 11782162.9 20.11.2013
(87) WO2012095204, 16.11.2011
(97) 2663764, 20.11.2013 en
(54) VALVE ASSEMBLY
(71) Delphi Technologies Holding S.a.r.l., Avenue de Luxembourg, 4940 Bascharage, LU
(72) SMITH, Kenneth, 16 Parker Close, Rainham Kent ME8 9NQ, GB
JUDGE, Richard, 76 Second Avenue, Gillingham Kent ME7 2HS, GB

(51) MKP
A61C 8/00 (2006.01) (97) **2654602 ***
(86) EP2011073354 20.12.2011
(96) 11802921.4 30.10.2013
(87) WO2012084911, 20.12.2011
(97) 2654602, 30.10.2013 de
(54) DENTAL IMPLANT
(71) Spahn, Frank-Peter, Genkersteenweg 470, 3500 Hasselt, BE
(72) Spahn, Frank-Peter, Genkersteenweg 470, 3500 Hasselt, BE

(51) MKP
A61K 31/519 (2006.01) (97) **2688887 ***
A61P 35/00 (2006.01)
A61P 35/02 (2006.01)
C07D 471/14 (2006.01)
C07D 519/00 (2006.01)
(86) US2012030007 21.03.2012
(96) 12711738.0 29.01.2014
(87) WO2012129344, 21.03.2012
(97) 2688887, 29.01.2014 en
(54) FUSED TRICYCLIC DUAL INHIBITORS OF CDK 4/6 AND FLT3
(71) Amgen Inc., One Amgen Center Drive, Thousand Oaks, California 91320-1799, US
(72) CHEN, Xiaoqi, 970 Blair Court, Palo Alto California 94303, US
DAI, Kang, 619 Santa Fe Avenue, Albany California 94706, US
DUQUETTE, Jason, 1120 Veterans Blvd., South San Francisco California 94080, US
GRIBBLE, Michael W., Jr., 949 Capp Street, Apt 22, San Francisco California 94110, US
HUARD, Justin N., 6501 24th Ave NW 202, Seattle Washington 98117, US
KEEGAN, Kathleen S., 8264 NE Carmella Lane, Bainbridge Island, Washington 98110, US
LI, Zhihong, 467 Anita Drive, Millbrae California 94030, US
LIVELY, Sarah E., 1536 Eaton Avenue, San Carlos California 94070, US
MCGEE, Lawrence R., 39 Big Sur Way, Pacifica California 94044, US
RAGAINS, Mark L., 4109 S. Hulen Street, Apt. 312, Fort Worth Texas 76109, US
WANG, Xianghong, 4915 Shelton Street, Dublin California 94568, US
WEIDNER, Margaret F., 15726 160th Ave NE, Woodinville Washington 98072, US
ZHANG, Jian, 290 Pelican Court, Foster City California 94404, US

(51) MKP
C12Q 1/68 (2006.01) (97) **2694963 ***
C40B 40/08 (2006.01)
G01N 33/50 (2006.01)
(86) US2012031880 02.04.2012
(96) 12765931.6 12.02.2014
(87) WO2012135845, 02.04.2012
(97) 2694963, 12.02.2014 en
(54) GENE EXPRESSION SIGNATURE FOR WNT/B-CATENIN SIGNALING PATHWAY AND USE THEREOF
(71) Qiagen, 1201 Clopper Road, Gaithersburg, Maryland 20878, US
(72) WU, Zhong, 4910B Meridian Way 17, Frederick, Maryland 21703, US
DICARLO, John, 8804 Lowell Place, Bethesda, Maryland 20817, US
WANG, Yexun, 4442 Cross Country Drive, Ellicott City, Maryland 21042, US

(51) MKP
B05D 1/02 (2006.01) (97) **2687298**
B05D 3/02 (2006.01)
B05D 5/06 (2006.01)
(96) 13003071.1 22.01.2014
(97) 2687298, 22.01.2014 de
(54) Method for patinating products made of copper or a copper alloy as well as products produced by the said process
(71) KME Germany GmbH & Co. KG, Klosterstrasse 29, 49074 Osnabrück, DE
(72) Hoveling, Stefan, An der Martinskirche 21a, 49078 Osnabrück, DE
Zuther, Jens-Peter, Zum Österreich 10, 49179 Ostercappeln, DE

(51) MKP
F21V 5/04 (2006.01) (97) **2647906 ***
F21Y 101/02 (2006.01)
(86) KR2011008286 02.11.2011
(96) 11845044.4 09.10.2013
(87) WO2012074208, 02.11.2011
(97) 2647906, 09.10.2013 en
(54) WIDE ICICLE-TYPE LIGHT-ADJUSTING LENS FOR DIFFUSING THE LIGHT OF AN LED
(71) Hyun, Dong Hoon, 401dong 401ho Jugong Apartment 1843 Jeongwang dong, Siheung-si, Gyeonggi-do 429-752, KR
Noh, Myeong-Jae, B dong 801ho Younhwa Apartment 277-3 San-dong, Uiwang-si, Gyeonggi-do 437-815, KR
(72) Hyun, Dong Hoon, 401dong 401ho Jugong Apartment 1843 Jeongwang dong, Siheung-si, Gyeonggi-do 429-752, KR
Noh, Myeong-Jae, B dong 801ho Younhwa Apartment 277-3 San-dong, Uiwang-si, Gyeonggi-do 437-815, KR

(51) MKP
B29D 11/00 (2006.01) (97) **2652532 ***
G02B 1/04 (2006.01)
(86) US2011064568 13.12.2011
(96) 11808428.4 23.10.2013
(87) WO2012082704, 13.12.2011
(97) 2652532, 23.10.2013 en
(54) OPHTHALMIC LENSES MODIFIED WITH FUNCTIONAL GROUPS AND METHODS OF MAKING THEREOF
(71) Novartis AG, Lichtstrasse 35, 4056 Basel, CH
(72) DOMSCHKE, Angelika, Maria, 3379 Ennfield Way, Duluth Georgia 30096, US

(51) MKP
A61F 13/15 (2006.01) (97) **2565013**
B29C 55/06 (2006.01)
(96) 11179885.6 06.03.2013
(97) 2565013, 06.03.2013 de
(54) Method for stretching a sheet of film
(71) RKW SE, Nachtweideweg 1-7, 67227 Frankenthal, DE
(72) Börmann, Ludwig, Neudeck 44, 83547 Babensham, DE
Schreiner, Günter, Panoramaweg 7, 83530 Schnaitsee, DE

- (51) MKP
A61F 13/02 (2006.01) (97) **2654860 ***
A61M 5/42 (2006.01)
A61M 25/02 (2006.01)
- (86) DK2011050504 20.12.2011
(96) 11850251.7 30.10.2013
(87) WO2012083965, 20.12.2011
(97) 2654860, 30.10.2013 en
(54) COVER UNIT FOR USE WHEN INSERTING A PUNCTURE DEVICE IN AN ANATOMICAL STRUCTURE SUCH AS A VEIN OR AN ARTERY AND FOR MAINTAINING SAID PUNCTURE DEVICE IN THE ANATOMICAL STRUCTURE
- (71) US Enovacor ApS, Labingvej 14 Labing, 8462 Harlev J, DK
(72) SLOTH, Erik, Adelvej 14, DK-8240 Risskov, DK
BENDTSEN, Thomas Fichtner, Hellerupvej 3, DK-8000 Aarhus C, DK
KNUDSEN, Lars, Agrivej 6, DK-8240 Risskov, DK
-
- (51) MKP
A61K 9/20 (2006.01) (97) **2654729 ***
A61K 9/28 (2006.01)
A61K 31/401 (2006.01)
A61K 31/4422 (2006.01)
- (86) EP2011073884 22.12.2011
(96) 11805851.0 30.10.2013
(87) WO2012085249, 22.12.2011
(97) 2654729, 30.10.2013 en
(54) HOMOGENOUS PHARMACEUTICAL ORAL DOSAGE FORMS COMPRISING LERCANIDIPINE AND ENALAPRIL OR THEIR PHARMACEUTICALLY ACCEPTABLE SALTS
- (71) KRKA, d.d., Novo mesto, Smarjeska cesta 6, 8501 Novo mesto, SI
(72) SEDMAK, Gregor, Palmejeva 30, 1000 Ljubljana, SI
KROSELJ, Vesna, Ragovska 15b, 8000 Novo mesto, SI
SKUBE, Maja Kincl, Na Tratah 18, 8000 Novo mesto, SI
JURSIC, Urska, Stopice 97, 8322 Stopice, SI
-
- (51) MKP
C22B 9/02 (2006.01) (97) **2698438 ***
C22B 59/00 (2006.01)
C30B 25/00 (2006.01)
C30B 35/00 (2006.01)
F27B 14/10 (2006.01)
- (86) CN2012073688 10.04.2012
(96) 12770997.0 19.02.2014
(87) WO2012139484, 10.04.2012
(97) 2698438, 19.02.2014 en
(54) TANTALUM-MATERIAL MULTILEVEL DISTILLATION CRUCIBLE AND DISTILLATION PROCESS
- (71) Jiangxi Rare Earth & Rare Metals Tungsten Group Holding Co., Ltd., No. 118 Beijing West Road, Nanchang, Jiangxi 330046, CN
(72) YUAN, Ping, No. 118 Beijing West Road, Nanchang Jiangxi 330046, CN
TAO, Limin, No. 118 Beijing West Road, Nanchang Jiangxi 330046, CN
XU, Qihua, No. 118 Beijing West Road, Nanchang Jiangxi 330046, CN
-
- (51) MKP
A61K 9/14 (2006.01) (97) **2645995 ***
A61K 9/16 (2006.01)
A61K 9/48 (2006.01)
A61K 33/24 (2006.01)
- (86) US2011062716 30.11.2011
(96) 11802211.0 09.10.2013
(87) WO2012075194, 30.11.2011
(97) 2645995, 09.10.2013 en
(54) CAPSULE AND POWDER FORMULATIONS CONTAINING LANTHANUM COMPOUNDS
- (71) Shire LLC, 9200 Brookfield Court, Florence, KY 41042, US
(72) WITHINGTON, Roger, 58 Abbots Ride, Farnham Surrey GU9 8HZ, GB
PIERCE, David, 61 Lytton Avenue Letchworth Garden City, Hertfordshire SG6 3HY, GB
-
- (51) MKP
F04C 18/22 (2006.01) (97) **2647846 ***
F04C 29/02 (2006.01)
- (86) UA2011000059 26.07.2011
(96) 11818464.7 09.10.2013
(87) WO2012023916, 26.07.2011
(97) 2647846, 09.10.2013 en
(54) ROTARY PISTON COMPRESSOR
- (71) Olenich, Maksim Viktorovich, Ul. Ak. Proskury 5-d-11, Kharkov 61085, UA
Lukiantseva, Viktoriya Mykolaivna, Dniprovs'ka Naberezhna bud. 11-a, kv.84., Kyiv, 02098, UA
Soroka, Oleksandr Leonidovich, ul. Heroiv Dnipra bud. 42-b, kv.99., Kyiv, 04214, UA
(72) Olenich, Maksim Viktorovich, Ul. Ak. Proskury 5-d-11, Kharkov 61085, UA
Lukiantseva, Viktoriya Mykolaivna, Dniprovs'ka Naberezhna bud. 11-a, kv.84., Kyiv, 02098, UA
Soroka, Oleksandr Leonidovich, ul. Heroiv Dnipra bud. 42-b, kv.99., Kyiv, 04214, UA
-
- (51) MKP
E02B 9/04 (2006.01) (97) **2597201**
- (96) 12006496.9 29.05.2013
(97) 2597201, 29.05.2013 de
(54) Method for regulating the flow of rivers
- (71) RWE Technology GmbH, Huyssenallee 12-14, 45128 Essen, DE
(72) Thiele, Frank, Kantstrasse 5, 45721 Haltern am See, DE
Staubert, Mark, Brausewindhang 107, 45359 Essen, DE
Heinen, Martin, Gelderner Strasse 63, 41189 Mönchengladbach, DE
Brauer, Frank, Kuopiostrasse 30, 44577 Castrop-Rauxel, DE
-
- (51) MKP
C07F 9/09 (2006.01) (97) **2657241 ***
A61P 11/06 (2006.01)
A61P 43/00 (2006.01)
A61K 31/662 (2006.01)
A61P 27/02 (2006.01)
A61K 31/661 (2006.01)
A61P 13/12 (2006.01)
C07F 9/38 (2006.01)
A61P 9/10 (2006.01)
A61P 31/16 (2006.01)
A61P 9/00 (2006.01)
A61P 29/00 (2006.01)
A61P 7/02 (2006.01)
A61P 27/06 (2006.01)
A61P 11/00 (2006.01)
A61P 35/00 (2006.01)
A61P 9/06 (2006.01)
A61P 31/04 (2006.01)
- (86) JP2011007111 20.12.2011
(96) 11850843.1 30.10.2013
(87) WO2012086184, 20.12.2011
(97) 2657241, 30.10.2013 en
(54) DIPHENYL SULFIDE DERIVATIVE AND PHARMACEUTICAL PRODUCT WHICH CONTAINS SAME AS ACTIVE INGREDIENT
- (71) Kyorin Pharmaceutical Co., Ltd., 6, Kanda Surugadai 4-chome Chiyoda-ku, Tokyo 101-8311, JP
(72) ISHIKAWA, Kumi, c/o Discovery Research Laboratories Kyorin Pharmaceutical Co. Ltd. 2399-1 Nogi Nogi-machi, Shimotsugun Tochigi 329-0114, JP
KOGA, Shigeru, c/o Discovery Research Laboratories Kyorin Pharmaceutical Co. Ltd. 2399-1 Nogi Nogi-machi, Shimotsugun Tochigi 329-0114, JP
KOHNO, Yasushi, c/o Discovery Research Laboratories Kyorin Pharmaceutical Co. Ltd. 2399-1 Nogi Nogi-machi, Shimotsugun Tochigi 329-0114, JP
FUJII, Kiyoshi, c/o Discovery Research Laboratories Kyorin Pharmaceutical Co. Ltd. 2399-1 Nogi Nogi-machi, Shimotsugun Tochigi 329-0114, JP
YOSHIKAWA, Ken, c/o Discovery Research Laboratories Kyorin Pharmaceutical Co. Ltd. 2399-1 Nogi Nogi-machi, Shimotsugun Tochigi 329-0114, JP

(51) MKP
C08G 69/26 (2006.01) (97) **2662397 ***
C08L 77/06 (2006.01)
(86) JP2012050183 06.01.2012
(96) 12732338.4 13.11.2013
(87) WO2012093722, 06.01.2012
(97) 2662397, 13.11.2013 en
(54) COPOLYMER POLYAMIDE
(71) Asahi Kasei Chemicals Corporation, 1-105, Kanda Jinbocho Chiyoda-ku, Tokyo 101-8101, JP
(72) IEDA, Shinji, 1-105 Kanda Jinbocho Chiyoda-ku, Tokyo 101-8101, JP
TERADA, Kazunori, 1-105 Kanda Jinbocho Chiyoda-ku, Tokyo 101-8101, JP
NITTO, Yu, 1-105 Kanda Jinbocho Chiyoda-ku, Tokyo 101-8101, JP

(51) MKP
C07K 16/00 (2006.01) (97) **2688909 ***
C07K 16/46 (2006.01)
(86) IB2012051410 23.03.2012
(96) 12723743.6 29.01.2014
(87) WO2012131555, 23.03.2012
(97) 2688909, 29.01.2014 en
(54) HETERO-DIMERIC IMMUNOGLOBULINS
(71) Glenmark Pharmaceuticals S.A., Chemin de la Combeta, 5, 2300 La Chaux-de-Fonds, CH
(72) BLEIN, Stanislas, Chemin de la Combeta 5, CH-2300 La Chaux-de-Fonds, CH
SKEGRO, Darko, Chemin de la Combeta 5, CH-2300 La Chaux-de-Fonds, CH
WASSMANN, Paul, Chemin de la Combeta 5, CH-2300 La Chaux-de-Fonds, CH

(51) MKP
B29C 45/27 (2006.01) (97) **2670574 ***
(86) BE2012000008 01.02.2012
(96) 12716187.5 11.12.2013
(87) WO2012103604, 01.02.2012
(97) 2670574, 11.12.2013 en
(54) INJECTION MOLDING APPARATUS FOR MANUFACTURING HOLLOW OBJECTS, IN PARTICULAR PLASTIC PREFORMS, RESP. CONTAINERS AND METHOD THEREFOR
(71) Resilux, Damstraat 4, 9230 Wetteren, BE
(72) DIERICKX, William, Leenstraat 41, B-9070 Destelbergen, BE
DE CUYPER, Dirk, Molenweidestraat 5, B-9070 Destelbergen, BE

(51) MKP
C09D 7/00 (2006.01) (97) **2678395 ***
(86) EP2012053089 23.02.2012
(96) 12707260.1 01.01.2014
(87) WO2012113876, 23.02.2012
(97) 2678395, 01.01.2014 en
(54) COATING COMPOSITION COMPRISING SUBMICRON CALCIUM CARBONATE-COMPRISING PARTICLES, PROCESS TO PREPARE SAME AND USE OF SUBMICRON CALCIUM CARBONATE-COMPRISING PARTICLES IN COATING COMPOSITIONS
(71) Omya International AG, Baslerstrasse 42, 4665 Oftringen, CH
(72) MCJUNKINS, Joseph, 7269 Pleasant Street, Middleburg Heights, OH 44130, US
FREEMAN, Charles, 300 North Grove Street Unit No. 27, Rutland, VT 057011, US

(51) MKP
A61K 31/513 (2006.01) (97) **2658844 ***
A61P 35/00 (2006.01)
C07D 209/30 (2006.01)
C07D 401/14 (2006.01)
C07D 403/04 (2006.01)
C07D 403/06 (2006.01)
C07D 413/04 (2006.01)
C07D 413/14 (2006.01)
C07D 471/10 (2006.01)
C07D 493/10 (2006.01)
(86) EP2011073875 22.12.2011
(96) 11805849.4 06.11.2013
(87) WO2012089633, 22.12.2011
(97) 2658844, 06.11.2013 fr
(54) NOVEL PYRIMIDINE DERIVATIVES, PREPARATION THEREOF, AND PHARMACEUTICAL USE THEREOF AS AKT(PKB) PHOSPHORYLATION INHIBITORS
(71) SANOFI, 54, rue de la Boétie, 75008 Paris, FR
(72) BROLLO, Maurice, c/o Sanofi Département Brevets 174 avenue de France, F-75013 Paris, FR
CARRY, Jean-Christophe, c/o Sanofi-Aventis Département Brevets 174 avenue de France, F-75013 Paris, FR
CERTAL, Victor, c/o Sanofi Département Brevets 174 avenue de France, F-75013 Paris, FR
DIDIER, Eric, c/o Sanofi Département Brevets 174 avenue de France, F-75013 Paris, FR
DOERFLINGER, Gilles, c/o Sanofi-Aventis Département Brevets 174 avenue de France, F-75013 Paris, FR
EL AHMAD, Youssef, c/o Sanofi Département Brevets 174 avenue de France, F-75013 Paris, FR
FILOCHE-ROMME, Bruno, c/o Sanofi Département Brevets 174 avenue de France, F-75013 Paris, FR
HALLEY, Frank, c/o Sanofi Département Brevets 174 avenue de France, F-75013 Paris, FR
KARLSSON, Karl Andreas, c/o Sanofi Département Brevets 174 avenue de France, F-75013 Paris, FR
SCHIO, Laurent, c/o Sanofi-Aventis Département Brevets 174 avenue de France, F-75013 Paris, FR
THOMPSON, Fabienne, c/o Sanofi-Aventis Département Brevets 174 avenue de France, F-75013 Paris, FR

(51) MKP
A61F 13/15 (2006.01) (97) **2659869**
(96) 13166330.4 06.11.2013
(97) 2659869, 06.11.2013 en
(54) Single transfer insert placement method and apparatus with cross-direction insert placement control
(71) Curt G. Joa, Inc., 100 Crocker Avenue, Sheboygan Falls, Wisconsin 53085, US
(72) McCabe, John A, 1141 Partridge Run, Sheboygan Falls, WI Wisconsin 53085, US
Nelson, Chris, 75 Log Cabin Drive Apt. 921, Dallas, GA Georgia 30157, US
Andrews, Robert E, N7488 Sunset Circle Drive, Sheboygan, WI Wisconsin 53083, US

(51) MKP
E21B 43/26 (2006.01) (97) **2655794 ***
E21B 43/30 (2006.01)
(86) CA2011001383 16.12.2011
(96) 11852013.9 30.10.2013
(87) WO2012083429, 16.12.2011
(97) 2655794, 30.10.2013 en
(54) HIGH PRESSURE HYDROCARBON FRACTURING ON DEMAND METHOD AND RELATED PROCESS
(71) Nexen Inc., 2900 801 - 7th Avenue S.W., Calgary, Alberta T2P 3P7, CA
(72) PETTIGREW, Dana, 238 Canals Circle S.W., Airdrie, Alberta T4B 2Z6, CA

- (51) MKP
A61K 9/20 (2006.01) (97) **2646004 ***
(86) IB2011055316 27.11.2011
(96) 11805200.0 09.10.2013
(97) WO2012073170, 27.11.2011
(97) 2646004, 09.10.2013 fr
(54) GALENIC COMPOSITION SUITABLE FOR ADMINISTRATION TO A NON-HUMAN ANIMAL, USES THEREOF, AND ASSOCIATED METHODS
(71) Vetalis Sarl, Zone Industrielle de Lacou, 16130 Gente, FR
(72) CHERY, Laurent, 10 avenue d'Angouleme, F-16100 Chateaubernard, FR
WAJDA-DUBOS, Jean-Pierre, 9 rue Pradelles, F-16100 Saint Laurent De Cognac, FR
-
- (51) MKP
A61K 38/17 (2006.01) (97) **2646044 ***
A61P 3/00 (2006.01)
(86) DK2011050444 22.11.2011
(96) 11844130.2 09.10.2013
(87) WO2012072082, 22.11.2011
(97) 2646044, 09.10.2013 en
(54) METHODS FOR INCREASING INTRACELLULAR ACTIVITY OF HSP70
(71) Orphazyme APS, c/o COBIS A/S Ole Maaløes Vej 3, 2200 Copenhagen N, DK
(72) JENSEN, Thomas Kirkegaard, Ingemannsvej 30 4. th, DK-1964 Frederiksberg C, DK
HINSBY, Anders Mørkeberg, Vangehusvej 17 1., DK-2100 Copenhagen Ø, DK
-
- (51) MKP
A61K 31/4184 (2006.01) (97) **2655378 ***
A61K 31/4188 (2006.01)
A61K 31/4439 (2006.01)
A61K 31/506 (2006.01)
A61P 25/28 (2006.01)
C07D 235/02 (2006.01)
C07D 401/04 (2006.01)
C07D 401/12 (2006.01)
C07D 403/12 (2006.01)
C07D 405/12 (2006.01)
C07D 491/107 (2006.01)
C07D 491/20 (2006.01)
(86) SE2011051555 21.12.2011
(96) 11850232.7 30.10.2013
(87) WO2012087237, 21.12.2011
(97) 2655378, 30.10.2013 en
(54) COMPOUNDS AND THEIR USE AS BACE INHIBITORS
(71) AstraZeneca AB, null, 151 85 Södertälje, SE
(72) CSJERNYIK, Gabor, AstraZeneca R&D Södertälje, SE-151 85 Södertälje, SE
KARLSTRÖM, Sofia, AstraZeneca R&D Södertälje, SE-151 85 Södertälje, SE
KERS, Annika, AstraZeneca R&D Södertälje, SE-151 85 Södertälje, SE
KOLMODIN, Karin, AstraZeneca R&D Södertälje, SE-151 85 Södertälje, SE
NYLÖF, Martin, AstraZeneca R&D Södertälje, SE-151 85 Södertälje, SE
ÖHBERG, Liselotte, AstraZeneca R&D Södertälje, SE-151 85 Södertälje, SE
RAKOS, Laszlo, AstraZeneca R&D Södertälje, SE-151 85 Södertälje, SE
SANDBERG, Lars, AstraZeneca R&D Södertälje, SE-151 85 Södertälje, SE
SEHGELMEBLE, Fernando, AstraZeneca R&D Södertälje, SE-151 85 Södertälje, SE
SÖDERMAN, Peter, AstraZeneca R&D Södertälje, SE-151 85 Södertälje, SE
SWAHN, Britt-Marie, AstraZeneca R&D Södertälje, SE-151 85 Södertälje, SE
VON BERG, Stefan, AstraZeneca R&D Södertälje, SE-151 85 Södertälje, SE
-
- (51) MKP
G01N 33/564 (2006.01) (97) **2661627 ***
G01N 33/68 (2006.01)
(86) GB2012000014 09.01.2012
(96) 12700417.4 13.11.2013
(87) WO2012093254, 09.01.2012
(97) 2661627, 13.11.2013 en
(54) LIPOCALIN 2 AS A BIOMARKER FOR IL-17 INHIBITOR THERAPY EFFICACY
(71) UCB Pharma, S.A., 60, allée de la Recherche, 1070 Brussels, BE
(72) PLATT, Adam Samuel, c/o IPD UCB Celltech 208 Bath Road Slough, Berkshire SL1 3WE, GB
RAPECKI, Stephen Edward, c/o IPD UCB Celltech 208 Bath Road Slough, Berkshire SL1 3WE, GB
FORTUNATO, Mara, c/o IPD UCB Celltech 208 Bath Road Slough, Berkshire SL1 3 WE, GB
RUNDLE, Jon Leigh, c/o IPD UCB Celltech 208 Bath Road Slough, Berkshire SL1 3 WE, GB
SMITH, Paul Alfred, c/o IPD UCB Celltech 208 Bath Road Slough, Berkshire SL1 3 WE, GB
WATT, Gillian Sairfull, c/o IPD UCB Celltech 208 Bath Road Slough, Berkshire SL1 3 WE, GB
-
- (51) MKP
H01R 13/627 (2006.01) (97) **2688154**
H01R 13/635 (2006.01)
(96) 12425127.3 22.01.2014
(97) 2688154, 22.01.2014 en
(54) An industrial electric connector with push button for the fast unhooking of the complementary connector
(71) Facconi, Massimo, Via Urne di Sotto n. 40, 25024 Bagnolo Mella (BS), IT
(72) Facconi, Massimo, Via Urne di Sotto n. 40, 25024 Bagnolo Mella (BS), IT
-
- (51) MKP
G01N 33/68 (2006.01) (97) **2668506 ***
(86) EP2012000396 30.01.2012
(96) 12701835.6 04.12.2013
(87) WO2012100963, 30.01.2012
(97) 2668506, 04.12.2013 en
(54) SEED TRAIT PREDICTION BY ACTIVITY-BASED PROTEIN PROFILING
(71) Max-Planck-Gesellschaft zur Förderung der Wissenschaften e.V., Hofgartenstrasse 8, 80539 München, DE
Ninsar AgroSciences SL, Parc Científic de Barcelona C/ Baldiri Reixac 4 - 8, Office Ti04B6, 08028 Barcelona, ES
Gautier Semences, Route d'Avignon, 13630 Eyragues, FR
(72) VAN DER HOORN, Renier, A., L., Gut Lunigerhof 1, 50259 Pulheim-Freimersdorf, DE
GU, Christian, Kolibriweg 14, 50829 Köln, DE
FARNUSCH, Kaschani, Aachener Str. 1041, 50858 Köln, DE
MISAS, Johana, Unter Linden 12, 50859 Köln, DE
RICHAU, Kerstin, Dasselstr. 85, 50674 Köln, DE
KOLODZIEJEK, Izabella, Fröbelstr. 45, 50823 Köln, DE
MOQUET, Frédéric, Impasse des Arènes Routes des Palunettes, 13690 Graveson, FR
MALLIART, Capucine, 7 rue Trémoulet, 84000 Avignon, FR
BERTHET, Xavier, Caller Homero 55-57, 08023 Barcelona, ES
RAMOS, Oscar, Goni, AV7 General Peron 19 4 B, 28020 Madrid, ES
ELLUL, Philippe, Calle Paris, 125 Piso 2 Pta 1a, 08036 Barcelona, ES
-
- (51) MKP
D04H 1/70 (2012.01) (97) **2668327 ***
D04H 1/736 (2012.01)
D21F 11/04 (2006.01)
(86) US2012023147 30.01.2012
(96) 12704964.1 04.12.2013
(87) WO2012103547, 30.01.2012
(97) 2668327, 04.12.2013 en
(54) METHOD AND APPARATUS FOR FORMING A FIBROUS MEDIA
(71) Donaldson Company, Inc., 1400 West 94th Street P.O. Box 1299, Minneapolis, MN 55440-1299, US
(72) GUPTA, Hemant, 15601 Foliage Avenue Apt. 233 Apple Valley, Minnesota 55124, US
SINGH, Ajay, 15601 Foliage Avenue Apt. 317 Apple Valley, Minnesota 55124, US

(51) MKP
A61K 31/4184 (2006.01) (97) **2651927 ***
A61P 31/14 (2006.01)
C07D 403/10 (2006.01)
C07D 403/12 (2006.01)
C07D 403/14 (2006.01)
(86) US2011065242 15.12.2011
(96) 11849622.3 23.10.2013
(87) WO2012083059, 15.12.2011
(97) 2651927, 23.10.2013 en
(54) ANTI-VIRAL COMPOUNDS
(71) Abbvie Inc., 1 North Waukegan Road, North Chicago, IL 60064, US
(72) KRUEGER, Allan C., 7260 Presidential Drive, Gurnee Illinois 60031, US
KATI, Warren M., 152 Knob Hill Lane, Gurnee Illinois 60031, US
MARING, Clarence J., 1228 W. Borders Drive, Palatine Illinois 60067, US
WAGNER, Rolf, 42530 Sheridan Oaks Drive, Antioch Illinois 60002, US
HUTCHINS, Charles W., 31005 Prairie Ridge Rd, Green Oaks Illinois 600048, US

(51) MKP
C07K 1/34 (2006.01) (97) **2649088 ***
C07K 17/02 (2006.01)
C07K 19/00 (2006.01)
G01N 33/544 (2006.01)
(86) IB2011055564 09.12.2011
(96) 11846892.5 16.10.2013
(87) WO2012077080, 09.12.2011
(97) 2649088, 16.10.2013 en
(54) COMPOSITIONS FOR SEPARATION METHODS
(71) Thompson, Tracy, 11 Alan Street, Palmerston North, NZ
Rehm, Bernd Helmut Adam, 30 County Heights Drive RD1, Palmerston North 4471, NZ
Herbert, Andrew Brian, 24 Examiner Street, Nelson, NZ
Saravolac, Edward George, Unit 2 17 Centennial Drive, 4410 Palmerston North, NZ
(72) Thompson, Tracy, 11 Alan Street, Palmerston North, NZ
Rehm, Bernd Helmut Adam, 30 County Heights Drive RD1, Palmerston North 4471, NZ
Herbert, Andrew Brian, 24 Examiner Street, Nelson, NZ
Saravolac, Edward George, Unit 2 17 Centennial Drive, 4410 Palmerston North, NZ

(51) MKP
G05D 16/06 (2006.01) (97) **2656159 ***
(86) HU2011000128 19.12.2011
(96) 11808920.0 30.10.2013
(87) WO2012085607, 19.12.2011
(97) 2656159, 30.10.2013 en
(54) PRESSURE REGULATING DEVICE
(71) Eurojet Medical KFT., Horváth M. u. 2., 1151 Budapest, HU
(72) LINDMAYER, István, Homokhegy u. 12., H-7228 Döbrököz, HU

(51) MKP
B65D 51/16 (2006.01) (97) **2675721 ***
(86) US2012000091 15.02.2012
(96) 12747022.7 25.12.2013
(87) WO2012112228, 15.02.2012
(97) 2675721, 25.12.2013 en
(54) HOT BEVERAGE CONTAINER ASSEMBLY, INSERT, AND METHOD
(71) Savenok, Pavel, 102 E. Farnham Lane, Wheaton, IL 60189, US
(72) Savenok, Pavel, 102 E. Farnham Lane, Wheaton, IL 60189, US

(51) MKP
E01B 1/00 (2006.01) (97) **2675953 ***
(86) IT2011000038 14.02.2011
(96) 11715056.5 25.12.2013
(87) WO2012111031, 14.02.2011
(97) 2675953, 25.12.2013 en
(54) RAILWAY STRUCTURE AND ASSEMBLY METHOD
(71) Wegh Group S.P.A., Via di Vittorio 87, 43045 Fornovo di Taro (PR), IT
(72) SIGNORELLI, Raffaele, Viale G. Zavariti n. 210, 24020 Gorle (BG), IT
TOGNOLI, Marco, Via A. Negri n. 9/A, 24020 Gorle (BG), IT

(51) MKP
A61L 2/00 (2006.01) (97) **2583846**
B01D 46/00 (2006.01)
B60H 3/06 (2006.01)
(96) 12188744.2 24.04.2013
(97) 2583846, 24.04.2013 de
(54) Air purification device
(71) Behr GmbH & Co. KG, Mauserstr. 3, 70469 Stuttgart, DE
(72) Stiehler, Dipl.-Ing. Daniela, Johannes-Krämer-Straße 47, 70597 Stuttgart, DE
Gorges, Dr. rer. nat. Roger, 47 Hampton Court Road Harborne Birmingham, West Midlands B17 9AF, GB

(51) MKP
A61K 31/18 (2006.01) (97) **2648712 ***
A61K 31/4164 (2006.01)
A61K 45/06 (2006.01)
A61P 27/00 (2006.01)
(86) EP2011072306 09.12.2011
(96) 11794722.6 16.10.2013
(87) WO2012076685, 09.12.2011
(97) 2648712, 16.10.2013 en
(54) ARYLSULFONAMIDE DERIVATIVES FOR THE PREVENTION OR TREATMENT OF SPECIFIC OPHTHALMOLOGIC DISORDERS
(71) Fovea Pharmaceuticals, Institut de la Vision 17 Rue Moreau, 75012 Paris, FR
(72) BELICHARD, Pierre, c/o Fovea Pharmaceuticals Institut de la Vision 17 rue Moreau, F-75012 Paris, FR
PRUNEAU, Didier, c/o Fovea Pharmaceuticals Institut de la Vision 17 rue Moreau, F-75012 Paris, FR

(51) MKP
C01B 39/06 (2006.01) (97) **2673237 ***
(86) US2012024727 10.02.2012
(96) 12744254.9 18.12.2013
(87) WO2012109590, 10.02.2012
(97) 2673237, 18.12.2013 en
(54) MICROPOROUS ZIRCONIUM SILICATE FOR THE TREATMENT OF HYPERKALEMIA
(71) ZS Pharma, Inc, 1120 South Freeway, Fort Worth, Texas 76104, US
(72) KEYSER, Donald, Jeffrey, 1216 Wyndham Hill Lane, Southlake, Texas 76092, US
GUILLEM, Alvaro, F., 727 Lathrop Street, Lantana, Texas 76226, US

(51) MKP
A61K 39/10 (2006.01) (97) **2670431 ***
A61K 39/145 (2006.01)
A61K 39/215 (2006.01)
(86) IB2012050510 03.02.2012
(96) 12705437.7 11.12.2013
(87) WO2012104820, 03.02.2012
(97) 2670431, 11.12.2013 en
(54) COMPOSITIONS FOR CANINE RESPIRATORY DISEASE COMPLEX
(71) Zoetis LLC, 100 Campus Drive, Florham Park, NJ 07940, US
(72) ABDELMAGID, Omar, Yousif, Pfizer Global Research&Development 7000 Portage Road, Kalamazoo, MI 49001, US
BRICKER, Joseph, Michael, Pfizer Global Research&Development 7000 Portage Road, Kalamazoo, MI 49001, US
SHIELDS, Shelly, Lynn, Pfizer Global Research&Development 7000 Portage Road, Kalamazoo, MI 49001, US

(51) MKP
E01F 8/00 (2006.01) (97) **2655744 ***
(86) AT2011000495 14.12.2011
(96) 11815841.9 30.10.2013
(87) WO2012083319, 14.12.2011
(97) 2655744, 30.10.2013 de
(54) SOUND PROTECTION ELEMENT
(71) Kirchdorfer Fertigteillholding GmbH, Kirchdorfer Platz 1, 2752 Wöllersdorf, AT
(72) BARNAS, Alexander, Matthäusgasse 6/25, A-1030 Wien, AT

(51) MKP
A61K 39/104 (2006.01) (97) **2686339 ***
C07K 14/21 (2006.01)
C07K 16/12 (2006.01)
C07K 19/00 (2006.01)
(86) EP2012054783 19.03.2012
(96) 12711128.4 22.01.2014
(87) WO2012126879, 19.03.2012
(97) 2686339, 22.01.2014 en
(54) NOVEL OPRF/I FUSION PROTEINS, THEIR PREPARATION AND USE
(71) Valneva Austria GmbH, Campus Vienna Biocenter 3, 1030 Vienna, AT
(72) SCHLEGL, Robert, Rosental 63, A-2500 Siegenfeld, AT

(51) MKP
C07C 231/14 (2006.01) (97) **2661423 ***
C07C 233/18 (2006.01)
C07C 233/31 (2006.01)
C07D 209/48 (2006.01)
(86) FR2012000004 04.01.2012
(96) 12703857.8 13.11.2013
(87) WO2012093225, 04.01.2012
(97) 2661423, 13.11.2013 fr
(54) NOVEL PROCESS FOR SYNTHESIZING AGOMELATINE
(71) Les Laboratoires Servier, 35, rue de Verdun, 92284 Suresnes Cedex, FR
(72) ZARD, Samir, 6 impasse des 4 Vents, F-91190 Gif-Sur-Yvette, FR
SIRE, Béatrice, 2 rue du 11 Novembre - Bât. B., F-91120 Palaiseau, FR
BOUMEDIENE, Mehdi, 9 rue Albert 1er, F-94600 Choisy Le Roi, FR

(51) MKP
A61K 9/20 (2006.01) (97) **2688556 ***
A61K 9/28 (2006.01)
A61K 31/485 (2006.01)
A61K 47/10 (2006.01)
A61K 47/34 (2006.01)
(86) IB2012000595 22.03.2012
(96) 12717468.8 29.01.2014
(87) WO2012131463, 22.03.2012
(97) 2688556, 29.01.2014 en
(54) CONTROLLED RELEASE PHARMACEUTICAL DOSAGE FORMS
(71) Purdue Pharma L.P., One Stamford Forum 201 Tresser Boulevard, Stamford, CT 06901-3431, US
(72) HUANG, Haiyong Hugh, 5 Millar Court, Princeton, Junction, NJ 08550, US

(51) MKP
A01N 25/04 (2006.01) (97) **2663181 ***
B01F 3/08 (2006.01)
(86) US2012021075 12.01.2012
(96) 12734111.3 20.11.2013
(87) WO2012097149, 12.01.2012
(97) 2663181, 20.11.2013 en
(54) AGRICULTURAL COMPOSITIONS COMPRISING OIL-IN-WATER EMULSIONS
(71) Dow AgroSciences LLC, 9330 Zionsville Road, Indianapolis, IN 46268, US
(72) OUSE, David, George, 8315 Mockingbird Lane, Indianapolis IN 46356, US
TANK, Holger, 1172 Huntington Woods Point, Zionsville IN 46077, US
XU, Wen, 14021 Pecos Court, Carmel IN 46033, US

(51) MKP
E05F 3/10 (2006.01) (97) **2663717 ***
(86) DE2011075322 19.12.2011
(96) 11835304.4 20.11.2013
(87) WO2012095096, 19.12.2011
(97) 2663717, 20.11.2013 de
(54) UNDER LINTEL-MOUNTED OPERATOR FOR SINGLE-ACTING DOOR, OPERATOR ATTACHMENT FOR SINGLE-ACTING DOOR AND OPERATOR FOR SINGLE-ACTING DOOR
(71) Dorma GmbH + Co. KG, DORMA Platz 1, 58256 Ennepetal, DE
(72) MANKEL, Karl-Rudolf, Am Kaiser 14, 58256 Ennepetal, DE
GLANZ, Michael, Franziskaweg 2, 40764 Langenfeld, DE
BUSCH, Sven, Am Roggenfeld 12, 44227 Dortmund, DE
WILDFÖRSTER, Thomas, Beyenburgerstr. 11a, 58332 Schwelm, DE

(51) MKP
A61K 9/72 (2006.01) (97) **2691369 ***
A61K 38/05 (2006.01)
C07D 209/20 (2006.01)
C07K 5/037 (2006.01)
(86) CA2012000304 30.03.2012
(96) 12764373.2 05.02.2014
(87) WO2012129671, 30.03.2012
(97) 2691369, 05.02.2014 en
(54) PRODRUGS OF D-ISOGLUTAMYL-[D/L]-TRYPTOPHAN
(71) Apotex Technologies Inc., 150 Signet Drive, Toronto, ON M9L 1T9, CA
(72) TAM, Tim, Fat, 155 Veneto Drive, Vaughan Ontario L4L 8X6, CA
LEUNG-TOUNG, Regis, 5530 McFarren Blvd, Mississauga Ontario L5M 5X9, CA
WANG, Yingsheng, 63 Woodlot Crescent, Toronto Ontario M9W 6T3, CA
ZHAO, Yanqing, 9 Limelight Street, Richmond Hill Ontario L4E 0P9, CA
XIN, Tao, 158 Rossi Drive, Vaughan Ontario L4H 0M8, CA
LI, Wanren, 26 Kiskadee Dr., Toronto Ontario M9V 4P4, CA
WODZINSKA, Jolanta, Maria, 3494 Enniskillen Circle, Mississauga Ontario L5C 2N1, CA
RABADIA, Vrajlal, S., 28-7155 Mgistrate Terrace, Mississauga Ontario L5W 1Y7, CA
FEENEY, Christopher, John, 104 Sixteenth Street Unit 12, Toronto Ontario M8V 3K1, CA

(51) MKP
A63G 21/22 (2006.01) (97) **2620345**
B61B 12/02 (2006.01)
(96) 13000314.8 31.07.2013
(97) 2620345, 31.07.2013 en
(54) Device for sliding along cables
(71) ALUDESIGN S.p.A., Via Torchio, 22, 24034 Cisano Bergamasco BG, IT
(72) Paglioli, Carlo, c/o Aludesign S.P.A. Via Torchio, 22, I-24034 Cisano Bergamasco (BG), IT
Galletti, Davide, c/o Soluzioninventive S.R.L. Via Statale, 5/O, I-23807 Merate (LC), IT

(51) MKP
A61K 31/195 (2006.01) (97) **2682381 ***
A61P 25/18 (2006.01)
C07C 229/46 (2006.01)
(86) RU2012000146 29.02.2012
(96) 12752744.8 08.01.2014
(87) WO2012118409, 29.02.2012
(97) 2682381, 08.01.2014 en
(54) SPIROCYCLIC CYCLOPROPANOIC AMINO ACIDS - ANALOGUES OF GAMMA-AMINO BUTYRIC ACID, WITH LIMITED CONFORMATIONAL MOBILITY, AND DRUGS ON THE BASIS THEREOF
(71) Zapolsky, Maxim Eduardovich, ul. Serafimovicha 6 Tomilino, Moskovskaya obl. 140073, RU
(72) YASHIN, Nikolay Vladimirovich, ul. Sovetskaya 20-1 Zhizdra, Kaluzhskaya obl. 249340, RU
CHEMAGIN, Andrey Valerievich, 1-y Sovetskiy pereulok. 5-a-132 Shchelkovo, Moskovskaya obl. 141100, RU
KUZNETSOVA, Tamara Stepanovna, Michurinskiy prospekt 7-28, Moscow 119192, RU
ZEFIROV, Nikolay Serafimovich, Leninskiy prospekt 99-553, Moscow 119421, RU

(51) MKP
A61K 31/416 (2006.01) (97) **2649062 ***
A61K 31/423 (2006.01)
A61P 9/00 (2006.01)
C07D 401/04 (2006.01)
C07D 405/04 (2006.01)
C07D 413/04 (2006.01)
C07D 417/04 (2006.01)
(86) JP2011078010 29.11.2011
(96) 11802168.2 16.10.2013
(87) WO2012074126, 29.11.2011
(97) 2649062, 16.10.2013 en
(54) BICYCLIC COMPOUNDS AS INHIBITORS OF ACETYL-COA CARBOXYLASE (ACC)
(71) Takeda Pharmaceutical Company Limited, 1-1 Doshomachi 4-chome Chuo-ku, Osaka-shi, Osaka 541-0045, JP
(72) YASUMA, Tsuneo, c/o TAKEDA PHARMACEUTICAL COMPANY LIMITED 17-85 Jusohonmachi 2-chome Yodogawaku, Osaka-shi Osaka 532-0024, JP
KAMATA, Makoto, c/o TAKEDA PHARMACEUTICAL COMPANY LIMITED 26-1 Muraoka-Higashi 2-chome, Fujisawashi Kanagawa 251-0012, JP
YAMASHITA, Tohru, c/o TAKEDA PHARMACEUTICAL COMPANY LIMITED 26-1 Muraoka-Higashi 2-chome, Fujisawashi Kanagawa 251-0012, JP
HIROSE, Hideki, c/o TAKEDA PHARMACEUTICAL COMPANY LIMITED 26-1 Muraoka-Higashi 2-chome, Fujisawashi Kanagawa 251-0012, JP
MURAKAMI, Masataka, c/o TAKEDA PHARMACEUTICAL COMPANY LIMITED 26-1 Muraoka-Higashi 2-chome, Fujisawashi Kanagawa 251-0012, JP
KINA, Asato, c/o TAKEDA PHARMACEUTICAL COMPANY LIMITED 26-1 Muraoka-Higashi 2-chome, Fujisawashi Kanagawa 251-0012, JP
YONEMORI, Kazuko, c/o TAKEDA PHARMACEUTICAL COMPANY LIMITED 26-1 Muraoka-Higashi 2-chome, Fujisawashi Kanagawa 251-0012, JP
MIZOJIRI, Ryo, c/o TAKEDA PHARMACEUTICAL COMPANY LIMITED 26-1 Muraoka-Higashi 2-chome, Fujisawashi Kanagawa 251-0012, JP
FUJIMORI, Ikuo, c/o Takeda Pharmaceutical Company Limited 26-1, Muraoka-Higashi 2-chome, Fujisawa, Kanagawa 251-0012, JP
FUJIMOTO, Takuya, c/o TAKEDA PHARMACEUTICAL COMPANY LIMITED 26-1 Muraoka-Higashi 2-chome, Fujisawashi Kanagawa 251-0012, JP
IKEDA, Zenichi, c/o TAKEDA PHARMACEUTICAL COMPANY LIMITED 26-1 Muraoka-Higashi 2-chome, Fujisawashi Kanagawa 251-0012, JP

(51) MKP
C11C 5/00 (2006.01) (97) **2594627**
F23D 3/08 (2006.01)
(96) 12191762.9 22.05.2013
(97) 2594627, 22.05.2013 en
(54) Wooden wicks including a booster for a candle and method of making
(71) Delcotto, Melynda S., 19 Renaissance Drive, North Huntington, PA 15642, US
Damiani, Justin, 310 3rd Street, Youngwood, PA 15697, US
(72) Delcotto, Melynda S., 19 Renaissance Drive, North Huntington, PA 15642, US
Damiani, Justin, 310 3rd Street, Youngwood, PA 15697, US

(51) MKP
B62H 3/02 (2006.01) (97) **2673182 ***
B62M 6/45 (2010.01)
(86) EP2012052055 07.02.2012
(96) 12706215.6 18.12.2013
(87) WO2012107448, 07.02.2012
(97) 2673182, 18.12.2013 de
(54) MODULAR VEHICLE SYSTEM, ELECTRIC VEHICLE AND MODULE FOR CONNECTING TO AN ELECTRIC VEHICLE
(71) Energybus E.V., Koskauer Str. 100, 07922 Tanna, DE
(72) NEUPERT, Hannes, Koskauer Str. 98, 07922 Tanna, DE

(51) MKP
A61M 5/20 (2006.01) (97) **2667914 ***
A61M 5/32 (2006.01)
(86) US2012022432 24.01.2012
(96) 12702380.2 04.12.2013
(87) WO2012103140, 24.01.2012
(97) 2667914, 04.12.2013 en
(54) REMOVAL OF NEEDLE SHIELDS FROM SYRINGES AND AUTOMATIC INJECTION DEVICES
(71) AbbVie Biotechnology Ltd, Clarendon House 2, Church Street, HM 11 Hamilton, BM
Elcam Medical Agricultural Cooperative Association Ltd., Kibbutz Bar-Am, 13860, IL
(72) JULIAN, Joseph, F., 629 Dawes Street, Libertyville, IL 60048, US
LI, Chuan, 555 Longfellow Avenue, Deerfield, IL 60015, US
ANDERSON, Philip, D, 401 Buckingham Place, Libertyville, IL 60048, US
LAURUSONIS, Linas, 18858 Wooddale Trail, Lake Villa, IL 60046, US
RADAY, Lior, Kibbutz Bror Hayil, 79152 D.N. Ashkelon, IL
CARMEL, Ehud, 18 Ha'carmel Street, 55900 Ganey Tikva, IL
MARLI, Lior, 41 Mordechai Bashist Street, 76276 Rehovot, IL
DAILY, David, 11 Zalman Shneur Street, 46364 Herzelia, IL
KEENAN, Guy, 11 Namir Road, 63573 Tel Aviv, IL

(51) MKP
A61B 5/042 (2006.01) (97) **2699150 ***
(86) US2012027180 01.03.2012
(96) 12709739.2 26.02.2014
(87) WO2012145072, 01.03.2012
(97) 2699150, 26.02.2014 en
(54) BASKET STYLE CARDIAC MAPPING CATHETER HAVING A FLEXIBLE ELECTRODE ASSEMBLY FOR DETECTION OF CARDIAC RHYTHM DISORDERS
(71) Topera, Inc., 11445 E. Via Linda Suite 2, Scottsdale, AZ 85259, US
(72) KORDIS, Thomas, F., c/o Topera Inc. 11445 E. Via Linda Suite 2 P.O. Box 224, Scottsdale, AZ 85259, US
JOHNSON, Eric, T., c/o Topera Inc. 11445 E. Via Linda Suite 2 P.O. Box 224, Scottsdale, AZ 85259, US
BURKE, Phillip, C., c/o Topera Inc. 11445 E. Via Linda Suite 2 P.O. Box 224, Scottsdale, AZ 85259, US
KENT, Darrin, J., c/o Topera Inc. 11445 E. Via Linda Suite 2 P.O. Box 224, Scottsdale, AZ 85259, US
MAGRINI, Kevin, M., c/o Topera Inc. 11445 E. Via Linda Suite 2 P.O. Box 224, Scottsdale, AZ 85259, US
BURKE, Jeff, A., c/o Topera Inc. 11445 E. Via Linda Suite 2 P.O. Box 224, Scottsdale, AZ 85259, US
RAGLAND, Robert, Ryan, c/o Topera Inc. 11445 E. Via Linda Suite 2 P.O. Box 224, Scottsdale, AZ 85259, US

(51) MKP
G06Q 20/32 (2012.01) (97) **2697755 ***
(86) IB2012051849 13.04.2012
(96) 12724397.0 19.02.2014
(87) WO2012140625, 13.04.2012
(97) 2697755, 19.02.2014 en
(54) PAYMENT CARD, CASHLESS PAYMENT METHOD
(71) Logomotion, s.r.o., Winterova 15, 921 01 Piestany, SK
HUBINÁK, Emil, Beethovenova 4, 921 01 Piestany, SK
FLOREK, Miroslav, Sedmokraskova 4, 821 01 Bratislava, SK
MASARYK, Michal, Medzilaborecká 7, 821 01 Bratislava, SK

(51) MKP
E04B 5/00 (2006.01) (97) **2689075 ***
E04B 5/36 (2006.01)
E04B 5/40 (2006.01)
E04C 5/00 (2006.01)
(86) AU2012000307 23.03.2012
(96) 12760514.5 29.01.2014
(87) WO2012126065, 23.03.2012
(97) 2689075, 29.01.2014 en
(54) A BEAM AND METHOD FOR REINFORCING CONCRETE SLABS
(71) Entek Pty Ltd, Suite 8, 82-86 Pacific Highway, St. Leonards, NSW 2065, AU
(72) MANNING, Mark, Allan, c/- Suite 8 82-86 Pacific Highway, St. Leonard, New South Wales 2065, AU

- (51) MKP
A61P 35/00 (2006.01) (97) **2678075 ***
 (86) US2012025965 21.02.2012
 (96) 12789648.8 01.01.2014
 (87) WO2012161776, 21.02.2012
 (97) 2678075, 01.01.2014 en
 (54) SOLID FORMS OF A PHARMACEUTICALLY ACTIVE SUBSTANCE
 (71) Plexikon, Inc., 91 Bolivar Drive, Suite A, Berkeley, CA 94710, US
 F.Hoffmann-La Roche AG, Grenzacherstrasse 124, 4070 Basel, CH
 (72) DIODONE, Ralph, Rheintorstrasse 10 B, 79206 Breisach, DE
 FAEHNRIK, Karsten, Steingasse 16, 79639 Grenzach-Wyhlen, DE
 IBRAHIM, Prabha, N., 3380 Lubich Drive, Mountain View, CA 94040, US
 KUANG, Shan-ming, 1651 Jefferson Drive, Florence, SC 29501, US
 VISOR, Gary, Conard, 20018 Jensen Ranch Road, Castro Valley, CA 94552, US
 ZHAO, Baoshu, 2849 Founder Drive, Florence, SC 29501, US
 SCHWITTER, Urs, Oerinstrasse 15, 4153 Reinach, CH

- (51) MKP
E06B 3/667 (2006.01) (97) **2631409**
 (96) 13156709.1 28.08.2013
 (97) 2631409, 28.08.2013 de
 (54) Connector
 (71) CERA Handelsgesellschaft mbH, Gewerbepark - Fürgen 14., 87674 Ruderatshofen-Immenhofen, DE
 (72) Rafeld-Cech, Karin, Frohnschwenden 77, 87499 Wildpoldsried, DE

- (51) MKP
A61K 39/395 (2006.01) (97) **2683403 ***
 (86) US2011054257 30.09.2011
 (96) 11860324.0 15.01.2014
 (87) WO2012121754, 30.09.2011
 (97) 2683403, 15.01.2014 en
 (54) NON-AQUEOUS HIGH CONCENTRATION REDUCED VISCOSITY SUSPENSION FORMULATIONS OF ANTIBODIES
 (71) Janssen Biotech, Inc., 800/850 Ridgeview Drive, Horsham, PA 19044, US
 (72) DAI, Weiguo, 145 King of Prussia Road, Radnor, PA 19087, US
 HILL, Beth, 99 El Camino Real, Menlo Park, CA 94025, US
 LIU, Kui, 6500 Paseo Padre Parkway, Fremont, CA 94555, US
 MIECZKOWSKI, Carl, 145 King of Prussia Road, Radnor, PA 19087, US

- (51) MKP
A61K 31/4025 (2006.01) (97) **2651885 ***
A61K 31/4184 (2006.01)
A61K 31/4439 (2006.01)
A61P 31/12 (2006.01)
C07D 207/16 (2006.01)
C07D 403/04 (2006.01)
 (86) US2011065501 16.12.2011
 (96) 11806100.1 23.10.2013
 (87) WO2012083170, 16.12.2011
 (97) 2651885, 23.10.2013 en
 (54) ANTI-VIRAL COMPOUNDS
 (71) Abbvie Inc., 1 North Waukegan Road, North Chicago, IL 60064, US
 (72) KRUEGER, Allan, C., 7260 Presidential Drive, Gurnee Illinois 60031, US
 KATI, Warren, M., 152 Knob Hill Lane, Gurnee Illinois 60031, US
 CARROLL, William, A., 2325 Ridgeway Avenue, Evanston Illinois 60201, US
 PRATT, John, K., 8210 61st Avenue, Kenosha Wisconsin 53142, US
 HUTCHINSON, Douglas, K., 20A Botsford Hill Rd, Newtown CT 06470-2787, US

- (51) MKP
A61K 31/437 (2006.01) (97) **2699574 ***
A61K 31/4985 (2006.01)
A61K 31/519 (2006.01)
A61K 31/5383 (2006.01)
A61P 35/00 (2006.01)
C07D 471/04 (2006.01)
C07D 498/04 (2006.01)
 (86) GB2012050866 20.04.2012
 (96) 12717459.7 26.02.2014
 (87) WO2012143725, 20.04.2012
 (97) 2699574, 26.02.2014 en
 (54) BICYCLIC HETEROCYCLE COMPOUNDS AND THEIR USES IN THERAPY
 (71) Astex Therapeutics Limited, 436 Cambridge Science Park Milton Park Cambridge, Cambridgeshire CB4 0QA, GB
 (72) BUCK, Ildiko Maria, c/o Astex Therapeutics Limited 436 Cambridge Science Park Milton Road, Cambridge Cambridgeshire CB4 0QA, GB
 CHESSARI, Gianni, c/o Astex Therapeutics Limited 436 Cambridge Science Park Milton Road, Cambridge Cambridgeshire CB4 0QA, GB
 HOWARD, Steven, c/o Astex Therapeutics Limited 436 Cambridge Science Park Milton Road, Cambridge Cambridgeshire CB4 0QA, GB
 REES, David Charles, c/o Astex Therapeutics Limited 436 Cambridge Science Park Milton Road, Cambridge Cambridgeshire CB4 0QA, GB
 WOOLFORD, Alison Jo-Anne, c/o Astex Therapeutics Limited 436 Cambridge Science Park Milton Road, Cambridge Cambridgeshire CB4 0QA, GB

- (51) MKP
A01B 13/08 (2006.01) (97) **2672801 ***
A01B 15/02 (2006.01)
A01B 35/08 (2006.01)
A01B 35/26 (2006.01)
A01B 49/06 (2006.01)
 (86) EP2012051860 03.02.2012
 (96) 12704025.1 18.12.2013
 (87) WO2012107359, 03.02.2012
 (97) 2672801, 18.12.2013 en
 (54) A DUAL-PURPOSE AGRICULTURAL MACHINE
 (71) Dondi S.p.A., 94/102 Viale Europa Frazione Ospedaliccio, 06083 Bastia Umbra, PG, IT
 (72) PETTIROSSI, Antonio, 36 Frazione Costa di Trex, I-06081 Assisi (PG), IT

- (51) MKP
A61M 5/168 (2006.01) (97) **2691128 ***
 (86) EP2012055558 28.03.2012
 (96) 12710759.7 05.02.2014
 (87) WO2012130903, 28.03.2012
 (97) 2691128, 05.02.2014 en
 (54) DOSING MECHANISM
 (71) Sanofi-Aventis Deutschland GmbH, Brüningstraße 50, 65929 Frankfurt am Main, DE
 (72) MÜLLER-PATHLE, Stephan, Sanofi-Aventis Deutschland GmbH, 65926 Frankfurt am Main, DE

(51) MKP
A61K 9/00 (2006.01) (97) **2672957 ***
A61K 9/28 (2006.01)
A61K 9/48 (2006.01)
A61K 31/192 (2006.01)
A61K 31/343 (2006.01)
A61K 31/37 (2006.01)
A61K 31/4015 (2006.01)
A61K 31/404 (2006.01)
A61K 31/4174 (2006.01)
A61K 31/427 (2006.01)
A61K 31/437 (2006.01)
A61K 31/44 (2006.01)
A61K 31/444 (2006.01)
A61K 31/472 (2006.01)
A61K 31/498 (2006.01)
(86) EP2012051880 03.02.2012
(96) 12704027.7 18.12.2013
(87) WO2012107363, 03.02.2012
(97) 2672957, 18.12.2013 en
(54) NOVEL COMPOSITION FOR THE TREATMENT OF CYSTIC FIBROSIS
(71) SciPharm SàRL, 33, rue Hiehl, 6131 Junglinster, LU
(72) FREISSMUTH, Michael, Pharmakologisches Institut Waehringer Str. 13a, A-1090 Wien, AT
GLOECKEL, Christina, Pharmakologisches Institut Waehringer Str. 13a, A-1090 Wien, AT
KOENIG, Xaver, Pharmakologisches Institut Waehringer Str. 13a, 1090 Wien, AT
KEUERLEBER, Simon, Pharmakologisches Institut Waehringer Str. 13a, A-1090 Wien, AT

(51) MKP
A61K 31/353 (2006.01) (97) **2675810 ***
A61P 25/00 (2006.01)
C07D 491/00 (2006.01)
(86) US2012024918 13.02.2012
(96) 12704644.9 25.12.2013
(87) WO2012112462, 13.02.2012
(97) 2675810, 25.12.2013 en
(54) SPIRO-AMINO-IMIDAZO-FUSED HETEROCYCLIC COMPOUNDS AS BETA-SECRETASE MODULATORS AND METHODS OF USE
(71) Amgen Inc., One Amgen Center Drive Thousand Oaks, California 91320, US
(72) EPSTEIN, Oleg, 44 Trowbridge Street, Belmont, Massachusetts 02478, US
WHITE, Ryan, 34 Willow Avenue Unit 1, Somerville, Massachusetts 02144, US
PATEL, Vinod F., 3 Mossy Lane, Acton, Massachusetts 01720, US
HUMAN, Jason, 944 Dorchester Avenue, unit 19, Boston, Massachusetts 02125, US

(51) MKP
G06Q 50/00 (2012.01) (97) **2646968 ***
(86) US2011049817 31.08.2011
(96) 11844534.5 09.10.2013
(87) WO2012074589, 31.08.2011
(97) 2646968, 09.10.2013 en
(54) ENTERAL FEEDING APPARATUS
(71) Francis, Nathania A., 835 Nesconset Highway Apt. C12, Nesconset, NY 11767, US
(72) Francis, Nathania A., 835 Nesconset Highway Apt. C12, Nesconset, NY 11767, US

(51) MKP
B01J 31/00 (2006.01) (97) **2680967 ***
C07F 11/00 (2006.01)
(86) DE2012100047 23.02.2012
(96) 12721722.2 08.01.2014
(87) WO2012116695, 23.02.2012
(97) 2680967, 08.01.2014 de
(54) MOLYBDENUM AND TUNGSTEN METAL COMPLEXES AND USE THEREOF AS PRECATALYSTS FOR OLEFIN METATHESIS
(71) Studiengesellschaft Kohle MbH, Kaiser-Wilhelm-Platz 1, 45470 Mülheim an der Ruhr, DE
(72) FÜRSTNER, Alois, Arnoldstraße 33, 45478 Mülheim an der Ruhr, DE
HEPPEKAUSEN, Johannes, Dimbeck 22, 45470 Mülheim an der Ruhr, DE

(51) MKP
A61L 2/07 (2006.01) (97) **2596811**
A61L 11/00 (2006.01)
B01J 3/04 (2006.01)
B29B 17/00 (2006.01)
(96) 12191574.8 29.05.2013
(97) 2596811, 29.05.2013 en
(54) Apparatus and process for sterilising absorbent sanitary products
(71) Fater S.p.A., Via Alessandro Volta, 10, 65129 Pescara, IT
(72) SOMMA, Marcello, Viale Regina Elena, 74, I-65122 Pescara, IT
VACCARO, Giorgio, Via Primo Levi, 7, I-65010 Spoltore (Pescara), IT
MICHALEK, Jan K., 3762 Alward Road, Pataskala, OH Ohio 43062, US
THOMAS, Theodore, 864 Lookout Point Drive, Columbus, OH Ohio 43235, US

(51) MKP
F01K 25/10 (2006.01) (97) **2686627 ***
F25J 3/04 (2006.01)
(86) US2012029423 16.03.2012
(96) 12711516.0 22.01.2014
(87) WO2012125921, 16.03.2012
(97) 2686627, 22.01.2014 en
(54) CRYOGENIC AIR SEPARATION METHOD AND SYSTEM
(71) 8 Rivers Capital, LLC, 406 Blackwell Street, 4th Floor, Durham, North Carolina 27701, US
(72) ALLAM, Rodney John, Lanhill House Lanhill, Chippenham, Wiltshire SN14 6LY, GB
FETVEDT, Jeremy Eron, 4805 Dundee Place, Raleigh, North Carolina 27612, US

(51) MKP
C07D 401/14 (2006.01) (97) **2699563 ***
C07D 403/12 (2006.01)
C07D 405/14 (2006.01)
C07D 409/14 (2006.01)
C07D 411/14 (2006.01)
C07D 417/14 (2006.01)
(86) EP2012056875 16.04.2012
(96) 12713758.6 26.02.2014
(87) WO2012143317, 16.04.2012
(97) 2699563, 26.02.2014 en
(54) NOVEL PESTICIDAL PYRAZOLE COMPOUNDS
(71) BASF SE, null, 67056 Ludwigshafen, DE
(72) DEFIEBER, Christian, Tullastraße 13, 68165 Mannheim, DE
SÖRGEL, Sebastian, Marienstrasse 19, 67063 Ludwigshafen, DE
SÄLINGER, Daniel, Ludwigstrasse 49, 67059 Ludwigshafen, DE
LE VEZOUET, Ronan, Neckarpromenade 20, 68167 Mannheim, DE
KÖRBER, Karsten, Hintere Lisgewann 26, 69214 Eppelheim, DE
GRÖß, Steffen, Marie-Juchacz Allee 201, 67067 Ludwigshafen, DE
CULBERTSON, Deborah L., 6400 Vintage Ridge Lane, Fuquay Varina, NC 27526, US
GUNJIMA, Koshi, 322 Luke Meadow Lane, Cary, NC 27519, US

(51) MKP
A01H 5/08 (2006.01) (97) **2683832 ***
C12Q 1/68 (2006.01)
 (86) NL2012050149 12.03.2012
 (96) 12709981.0 15.01.2014
 (87) WO2012125025, 12.03.2012
 (97) 2683832, 15.01.2014 en
 (54) TYCLV RESISTANCE
 (71) Wageningen Universiteit, Droevendaalsesteeg 4, 6708 PB Wageningen, NL
 University of Florida Research Foundation, Incorporated, 223 Grinter Hall, Gainesville, Florida 32611, US
 (72) BAI, Yuling, Mondriaanlaan 91, NL-6708 NX Wageningen, NL
 VERLAAN, Maarten Gertjan, Herderplein 5-2, NL-3533 BL Utrecht, NL
 HUTTON, Samuel, 3901 W. Tacon Street, Tampa Florida 33629, US

(51) MKP
E01F 8/00 (2006.01) (97) **2673419 ***
 (86) IB2012050533 06.02.2012
 (96) 12707919.2 18.12.2013
 (87) WO2012107871, 06.02.2012
 (97) 2673419, 18.12.2013 en
 (54) NOISE BARRIER STRUCTURE WITH SOUND-ABSORBING AND SOUND-REDIRECTING PROPERTIES, AND HIGH PERFORMANCE SOUND ABSORBER FOR USE IN SUCH STRUCTURE
 (71) Urbantech S.p.A., Via Lombardia, 34 Z.I. Gello, 56025 Pontedera (Pisa), IT
 (72) TIZZONI, Giampaolo, Via de Gasperi 33, I-56025 Pontedera (Pisa), IT

(51) MKP
A61K 39/395 (2006.01) (97) **2688910 ***
C07K 16/22 (2006.01)
 (86) US2012030364 23.03.2012
 (96) 12711543.4 29.01.2014
 (87) WO2012135035, 23.03.2012
 (97) 2688910, 29.01.2014 en
 (54) ANTI - SCLEROSTIN ANTIBODY CRYSTALS AND FORMULATIONS THEREOF
 (71) Amgen Inc., One Amgen Center Drive, Thousand Oaks, California 91320-1799, US
 (72) CLOGSTON, Christi, L., 601 Country View Place, Camarillo, CA 93010, US
 CHRISTIAN, Twinkle, R., 1890 W. Hillcrest Drive Apt. 458, Newbury Park, CA 91320, US
 OSSLUND, Timothy, D., 475 Vista Montana, Camarillo, CA 93010, US
 FREEMAN, Elisabeth, 30229 Trois Valley Street, Murrieta, CA 92562, US

(51) MKP
H04N 1/00 (2006.01) (97) **2689581 ***
H04N 7/18 (2006.01)
 (86) IB2012000465 12.03.2012
 (96) 12717466.2 29.01.2014
 (87) WO2012131456, 12.03.2012
 (97) 2689581, 29.01.2014 en
 (54) SYSTEM AND METHOD FOR TRANSMITTING REAL-TIME IMAGES
 (71) Whisbi Technologies, S.L., C/ Tarragona 110, 08015 Barcelona, ES
 (72) CANTERO ESCOLÀ, José Luis, 3-4 C/ Santiago Rosinyol, 08750 Molins de Rei, ES
 BISBE TOSAT, Alex, C/ Clementina Arderiu 26 - 3° 1a, 08173 Sant Cugat Del Valles, ES

(51) MKP
G07F 17/32 (2006.01) (97) **2666149 ***
 (86) IB2012050297 23.01.2012
 (96) 12704914.6 27.11.2013
 (87) WO2012098532, 23.01.2012
 (97) 2666149, 27.11.2013 en
 (54) GAMING SYSTEM AND METHOD OF USE
 (71) Novomatic AG, Wiener Strasse 158, 2352 Gumpoldskirchen, AT
 (72) SVARICHEVSKY, Stanislav, c/o IP&legal department Wiener Strasse 158, A-2352 Gumpoldskirchen, AT
 ZAILINGER, Anton, c/o IP&legal department Wiener Strasse 158, A-2352 Gumpoldskirchen, AT
 CHYLA, Dariusz, c/o IP&legal department Wiener Strasse 158, A-2352 Gumpoldskirchen, AT
 CHYLA, Anna, c/o IP&legal department Wiener Strasse 158, A-2352 Gumpoldskirchen, AT
 FRIDRICH, Heinz, c/o IP&legal department Wiener Strasse 158, A-2352 Gumpoldskirchen, AT

(51) MKP
B08B 9/027 (2006.01) (97) **2502681**
B08B 9/04 (2006.01)
B08B 9/043 (2006.01)
B08B 9/051 (2006.01)
F16L 25/00 (2006.01)
F16L 33/00 (2006.01)
G03B 37/00 (2006.01)
 (96) 12160283.3 26.09.2012
 (97) 2502681, 26.09.2012 de
 (54) Device for investigating and cleaning tubes and lines
 (71) Riezler, Josef, Industriestrasse 53, 87448 Waltenhofen, DE
 (72) Riezler, Josef, Industriestrasse 53, 87448 Waltenhofen, DE

(51) MKP
G01N 33/49 (2006.01) (97) **2485049**
G01N 35/10 (2006.01)
 (96) 12154103.1 08.08.2012
 (97) 2485049, 08.08.2012 en
 (54) Identification of separated components in centrifuged blood using measured pressure
 (71) ORTHO-CLINICAL DIAGNOSTICS, INC., 1001 U.S. Route 202, Raritan, NJ 08869, US
 (72) Hyde, David D., 2597 Putnam Road, Ontario, NY 14519, US
 LaCourt, Michael W., 9 Walnut Hill Drive, Spencerport, NY 14559, US
 McDonald, Tracy, 265 Idlewood Road, Rochester, NY 14618, US
 Parobek, Christopher M., 86 West Main Street, Honeoye Falls, NY 14472, US

(51) MKP
B05B 15/12 (2006.01) (97) **2684613**
 (96) 12461528.7 15.01.2014
 (97) 2684613, 15.01.2014 en
 (54) Device for exchanging air with heat recovery, especially in spray booths
 (71) Zachodniopomorski Uniwersytet Technologiczny w Szczecinie, Aleja Piastów 17, 70-310 Szczecin, PL
 (72) Nikonczuk, Piotr, ul. Poniatowskiego 45/2, 71-112 Szczecin, PL
 Zakrzewski, Boguslaw, Zachodniopomorski Uniwersytet Technologiczny w Szczecinie ul. Sławomira 15/3, 71-606 Szczecin, PL

(51) MKP
A61K 9/00 (2006.01) (97) **2646036 ***
A61K 31/685 (2006.01)
A61K 31/728 (2006.01)
A61P 1/00 (2006.01)
A61P 1/02 (2006.01)
A61P 1/04 (2006.01)
 (86) IB2011055364 29.11.2011
 (96) 11805602.7 09.10.2013
 (87) WO2012073191, 29.11.2011
 (97) 2646036, 09.10.2013 en
 (54) TOPICAL COMPOSITIONS FOR PRESERVING OR RESTORING THE INTEGRITY OF MUCOSAE
 (71) RICERFARMA Srl, Via Egadi, 7, I-20144 Milano, IT
 (72) DI SCHIENA, Michele, Giuseppe, c/o RICERFARMA S.R.L. Via Egadi 7, I-20144 Milano, IT

(51) MKP
A01N 25/04 (2006.01) (97) **2561753**
A01N 47/44 (2006.01)
A01P 3/00 (2006.01)
(96) 12181421.4 27.02.2013
(97) 2561753, 27.02.2013 en
(54) AQUEOUS SUSPENSION CONCENTRATE COMPRISING AN ACID SALT OF DODECYLGUANIDINE
(71) Agriphar S.A., Rue de Renory 26/1, 4102 Ougrée, BE
(72) Pirotte, Alan, Cour de l'Abbaye 7, 6660 Houffalize, BE

(51) MKP
A61B 18/18 (2006.01) (97) **2680775 ***
(86) US2012027512 02.03.2012
(96) 12752309.0 08.01.2014
(87) WO2012119088, 02.03.2012
(97) 2680775, 08.01.2014 en
(54) CRYOGENIC MEDICAL SYSTEM
(71) Endocare, Inc., 9825 Spectrum Drive, Building 3, Austin, TX 78717, US
(72) CHEEKS, Roy, Route 1 Box 1207, Harper's Ferry, West Virginia 25425, US
ROBILOTTO, Anthony T, 17 Edgecomb Road, Binghamton, New York 13905, US
DOBSON, Melissa K, 290 Lackawanna Avenue, Owego, New York 13827, US
BAUST, John M, 234 Front Street, Owego, New York 13827, US
BAUST, John G, 175 Raish Hill Road, Candor, New York 13743, US
SNYDER, Kristi K, 124 Raish Hill Road, Candor, New York 13743, US
VAN BUSKIRK, Robert, 13 West Glann Road, Apalachin, New York 13732, US

(51) MKP
A61K 39/395 (2006.01) (97) **2658575 ***
A61K 47/12 (2006.01)
A61K 47/18 (2006.01)
A61K 47/22 (2006.01)
A61K 47/26 (2006.01)
C07K 16/24 (2006.01)
(86) EP2011074181 28.12.2011
(96) 11807947.4 06.11.2013
(87) WO2012089778, 28.12.2011
(97) 2658575, 06.11.2013 en
(54) PHARMACEUTICAL FORMULATION COMPRISING A BIOPHARMACEUTICAL DRUG
(71) Hexal AG, Industriestrasse 25, 83607 Holzkirchen, DE
(72) DANEK-BULIUS, Martina, Biochemiestrasse 10, A-6250 Kundl, AT
DEUTEL, Britta, Biochemiestrasse 10, A-6250 Kundl, AT
FÜRTINGER, Sabine, Biochemiestrasse 10, A-6250 Kundl, AT
PRAGL, Bernt, Biochemiestrasse 10, A-6250 Kundl, AT
KUZMAN, Drago, Kolodvorska 27, 1234 Menges, SI

(51) MKP
E02D 27/34 (2006.01) (97) **2683889 ***
E04H 9/02 (2006.01)
(86) IB2012000433 08.03.2012
(96) 12713289.2 15.01.2014
(87) WO2013050812, 08.03.2012
(97) 2683889, 15.01.2014 en
(54) PILLAR FOR BUILDING CONSTRUCTIONS
(71) Tecnostrutture SRL, Via Meucci 26, 30020 Noventa Di Piave VE, IT
(72) DANIELE, Franco, Via Coda di Gatto 53, I-30020 Eraclea, IT
CALVI, Gian Michele, Via Strada Nuova 79, I-27100 Pavia, IT

(51) MKP
A61K 31/519 (2006.01) (97) **2694509 ***
A61P 25/00 (2006.01)
A61P 35/00 (2006.01)
C07D 487/04 (2006.01)
(86) IB2012051363 22.03.2012
(96) 12713362.7 12.02.2014
(87) WO2012137089, 22.03.2012
(97) 2694509, 12.02.2014 en
(54) PYRROLO [2, 3 -D]PYRIMIDINE DERIVATIVES AS INHIBITORS OF TROPOMYOSIN- RELATED KINASES
(71) Pfizer Limited, Ramsgate Road, Sandwich, Kent CT13 9NJ, GB
(72) ANDREWS, Mark David, C/o Pfizer Global Research & Development Ramsgate Road, Sandwich, Kent CT13 9NJ, GB
BAGAL, Sharanjeet Kaur, C/o Pfizer Global Research & Development Ramsgate Road, Sandwich, Kent CT13 9NJ, GB
GIBSON, Karl Richard, C/o Pfizer Global Research & Development Ramsgate Road, Sandwich, Kent CT13 9NJ, GB
OMOTO, Kiyoyuki, C/o Pfizer Global Research & Development Ramsgate Road, Sandwich, Kent CT13 9NJ, GB
RYCKMANS, Thomas, C/o Pfizer Global Research & Development Ramsgate Road, Sandwich, Kent CT13 9NJ, GB
SKERRATT, Sarah Elizabeth, C/o Pfizer Global Research & Development Ramsgate Road, Sandwich, Kent CT13 9NJ, GB
STUPPLE, Paul Anthony, C/o Pfizer Global Research & Development Ramsgate Road, Sandwich, Kent CT13 9NJ, GB

(51) MKP
A61K 31/4545 (2006.01) (97) **2680843 ***
C07D 401/14 (2006.01)
(86) US2012027341 01.03.2012
(96) 12751813.2 08.01.2014
(87) WO2012119006, 01.03.2012
(97) 2680843, 08.01.2014 en
(54) DERIVATIVES OF PYRAZOLE-SUBSTITUTED AMINO-HETEROARYL COMPOUNDS
(71) Concert Pharmaceuticals Inc., 99 Hayden Avenue, Suite 500, Lexington, MA 02421, US
(72) MASSE, Craig, 122 Hamilton Street 2, Cambridge, MA 02139, US
PANDYA, Bhaumik, 28 Silk Street, Arlington, MA 02474, US
SILVERMAN, Ian, Robert, 36 Orvis Road, Arlington, MA 02474, US

(51) MKP
A61K 9/08 (2006.01) (97) **2676677 ***
A61K 39/395 (2006.01)
A61K 47/18 (2006.01)
A61K 47/34 (2006.01)
(86) JP2012053687 16.02.2012
(96) 12747045.8 25.12.2013
(87) WO2012111762, 16.02.2012
(97) 2676677, 25.12.2013 en
(54) HIGHLY CONCENTRATED ANTI-CD40 ANTIBODY PHARMACEUTICAL PREPARATION
(71) Kyowa Hakko Kirin Co., Ltd., 1-6-1, Ohtemachi Chiyoda-ku, Tokyo 100-8185, JP
(72) ENDO, Ryosuke, c/o Kyowa Hakko Kirin Co.,Ltd Bio Process Res. & Dev. Labs 100-1, Hagiwara-machi, Takasaki-shi Gunma 370-0013, JP
ISHIKAWA, Tomoyoshi, c/o Kyowa Hakko Kirin Co.,Ltd Bio Process Res. & Dev. Labs 100-1, Hagiwara-machi, Takasaki-shi Gunma 370-0013, JP
SUETOMO, Hiroyuki, c/o Kyowa Hakko Kirin Co.,Ltd Bio Process Res. & Dev. Labs 100-1, Hagiwara-machi, Takasaki-shi Gunma 370-0013, JP

- (51) MKP
B22D 27/08 (2006.01) (97) **2699515 ***
C01B 17/02 (2006.01)
C04B 28/36 (2006.01)
(86) EP2012057071 18.04.2012
(96) 12719306.8 26.02.2014
(87) WO2012143388, 18.04.2012
(97) 2699515, 26.02.2014 en
(54) PROCEDURE FOR THE PREPARATION OF SULPHUR-BASED ARTICLES OF MANUFACTURE
(71) Ausy S.r.L., Via Mezzano 9/11/13, 27039 Sannazzaro De' Burgondi (PV), IT
Falconieri, Antonio, Salvatore, Via L. Pasteur 4, 20871 Vimercate (MI), IT
(72) FALCONIERI, Antonio Salvatore, Via L. Pasteur 4, 20871 Vimercate, IT
FINOCCHIARO, Franco, Viale Bligny 36, 20136 Milano, IT
CECCHINI, Claudio Paolo, Via Sannio 20, 20135 Milano, IT

- (51) MKP
A61K 39/00 (2006.01) (97) **2672996 ***
A61K 39/395 (2006.01)
C07K 16/00 (2006.01)
(86) US2012024198 07.02.2012
(96) 12744935.3 18.12.2013
(87) WO2012109282, 07.02.2012
(97) 2672996, 18.12.2013 en
(54) METHODS AND SYSTEMS FOR TREATING OR PREVENTING PREGNANCY-RELATED HYPERTENSIVE DISORDERS
(71) Agamin Pharmaceuticals, LLC, 3960 Broadway Suite 330B, New York, NY 10032, US
(72) KUSSIE, Paul, 16 Hudson Street, New York, NY 10013, US
JOO, Woo, S., 115 East 96th Street, New York, NY 10128, US

- (51) MKP
H04B 7/185 (2006.01) (97) **2673896 ***
(86) US2012024158 07.02.2012
(96) 12744527.8 18.12.2013
(87) WO2012109254, 07.02.2012
(97) 2673896, 18.12.2013 en
(54) DISTRIBUTED MANAGEMENT OF LEO SATELLITE NETWORKS WITH MANAGEMENT AGILITY AND NETWORK EFFICIENCY
(71) Telcordia Technologies, Inc., 1 Telcordia Drive 5G116, Piscataway, NJ 08854-4157, US
(72) NATARAJAN, Narayanan, 4 Heron Drive, Marlboro, NJ 07746, US
BAGCHI, Anindo, 42 Meadows Lane, Ocean, NJ 07712, US
STEPHENS, William, E., 23536 Haas Avenue, Torrance, CA 90501, US
LEANHEART, Stephen, J., 11849 Farside Road, Ellicott City, MD 21042, US

- (51) MKP
C07K 16/36 (2006.01) (97) **2686350 ***
(86) US2012028770 12.03.2012
(96) 12757251.9 22.01.2014
(87) WO2012125559, 12.03.2012
(97) 2686350, 22.01.2014 en
(54) HUMAN TISSUE FACTOR ANTIBODY AND USES THEREOF
(71) Janssen Biotech, Inc., 800/850 Ridgeview Drive, Horsham, PA 19044, US
(72) ALMAGRO, Juan, Carlos, 75 Linden Street, Brookline, MA 02446, US
ANDERSON, Glenn, Mark, 145 King of Prussia Road, Radnor, PA 19087, US
CHI, Ellen, 3210 Merryfield Row, San Diego, CA 92121, US
MARTINEZ, Christian, 3210 Merryfield Row, San Diego, CA 92121, US
RAGHUNATHAN, Gopalan, 12620 Creekwood Court, San Diego, CA 92129, US
SWANSON, Ronald, 3210 Merryfield Row, San Diego, CA 92121, US
TEPLYAKOV, Alexey, 145 King of Prussia Road, Radnor, PA 19087, US
TSE, Kam-fai, 145 King of Prussia Road, Radnor, PA 19087, US
WU, Sheng-jium, 145 King of Prussia Road, Radnor, PA 19087, US
ZHOU, Hong, Mimi, 3210 Merryfield Row, San Diego, CA 92121, US

- (51) MKP
G01N 33/574 (2006.01) (97) **2646831 ***
(86) US2011063038 02.12.2011
(96) 11796888.3 09.10.2013
(87) WO2012075377, 02.12.2011
(97) 2646831, 09.10.2013 en
(54) IDENTIFICATION OF CANCER PATIENTS LIKELY TO BENEFIT FROM RADIATION THERAPY
(71) HistoRx, Inc., 35 Northeast Industrial Road, Branford CT 06405, US
UTI Limited Partnership, Suite 130 3553 - 31 Street N.W., Calgary, AB T2L 2K7, CA
(72) GUSTAVSON, Mark, 9 Quarry Dock Road, Niantic CT 06357, US
CHRISTIANSEN, Jason, 164 Weir Street, Glastonbury CT 06033, US
MAGLIOCCO, Anthony, Martin, 4903 W Bay Way Drive, Tampa Florida T2T 1M8, US

(51) MKP
A61K 31/506 (2006.01) (97) **2687523 ***
A61P 3/10 (2006.01)
A61P 9/00 (2006.01)
A61P 9/10 (2006.01)
A61P 9/12 (2006.01)
A61P 13/12 (2006.01)
A61P 25/18 (2006.01)
A61P 27/02 (2006.01)
A61P 43/00 (2006.01)
C07D 401/14 (2006.01)
C07D 413/14 (2006.01)
(86) JP2012001709 13.03.2012
(96) 12757676.7 22.01.2014
(87) WO2012124311, 13.03.2012
(97) 2687523, 22.01.2014 en
(54) NOVEL PHENYLPYRIDINE DERIVATIVE AND DRUG CONTAINING SAME
(71) Kowa Company Ltd., 6-29, Nishiki 3-chome, Naka-ku Nagoya-shi Aichi 460-8625, JP
(72) MIURA, Toru, c/o Tokyo New Drug Research Laboratories Kowa Co. Ltd. 2-17-43 Noguchi-cho, Higashimurayama-shi Tokyo 189-0022, JP
SATO, Seiichi, c/o Tokyo New Drug Research Laboratories Kowa Co. Ltd. 2-17-43 Noguchi-cho, Higashimurayama-shi Tokyo 189-0022, JP
YAMADA, Hajime, c/o Tokyo New Drug Research Laboratories Kowa Co. Ltd. 2-17-43 Noguchi-cho, Higashimurayama-shi Tokyo 189-0022, JP
TAGASHIRA, Junya, c/o Tokyo New Drug Research Laboratories Kowa Co. Ltd. 2-17-43 Noguchi-cho, Higashimurayama-shi Tokyo 189-0022, JP
WATANABE, Toshiaki, c/o Tokyo New Drug Research Laboratories Kowa Co. Ltd. 2-17-43 Noguchi-cho, Higashimurayama-shi Tokyo 189-0022, JP
SEKIMOTO, Ryohei, c/o Tokyo New Drug Research Laboratories Kowa Co. Ltd. 2-17-43 Noguchi-cho, Higashimurayama-shi Tokyo 189-0022, JP
ISHIDA, Rie, c/o Tokyo New Drug Research Laboratories Kowa Co. Ltd. 2-17-43 Noguchi-cho, Higashimurayama-shi Tokyo 189-0022, JP
AOKI, Hitomi, c/o Tokyo New Drug Research Laboratories Kowa Co. Ltd. 2-17-43 Noguchi-cho, Higashimurayama-shi Tokyo 189-0022, JP
OHGIYA, Tadaaki, c/o Tokyo New Drug Research Laboratories Kowa Co. Ltd. 2-17-43 Noguchi-cho, Higashimurayama-shi Tokyo 189-0022, JP

(51) MKP
A61K 9/08 (2006.01) (97) **2680817 ***
A61K 47/36 (2006.01)
A61K 47/38 (2006.01)
(86) EP2012053710 05.03.2012
(96) 12707101.7 08.01.2014
(87) WO2012117115, 05.03.2012
(97) 2680817, 08.01.2014 de
(54) USE OF A VISCOELASTIC FLUID FOR PRODUCING A MEDICINAL PRODUCT FOR SURGICALLY TREATING THE EYE
(71) Croma-Pharma GmbH, Industriezeile 15, 2100 Leobendorf, AT
(72) FINDL, Oliver, Sterngasse 2, A-1010 Wien, AT

(51) MKP
A61K 31/4196 (2006.01) (97) **2658846 ***
A61P 9/00 (2006.01)
C07D 249/12 (2006.01)
(86) US2011067657 28.12.2011
(96) 11853861.0 06.11.2013
(87) WO2012092395, 28.12.2011
(97) 2658846, 06.11.2013 en
(54) POLYMORPHIC FORMS OF 2-(5-BROMO-4-(4-CYCLOPROPYLNAPHTHALEN-1-YL)-4H-1,2,4-TRIAZOL-3-YLTHIO) ACETIC ACID AND USES THEREOF
(71) Ardea Biosciences, Inc., 4939 Directors Place, San Diego, CA 92121, US
(72) GALVIN, Gabriel, 13257 Via Santillana, San Diego, CA 92129, US
TREIBER, Laszlo, R., 16230 Nacido Court, San Diego, CA 92128, US
ZAMANSKY, Irina, 2539 Ivy Road, Oceanside, CA 92054, US
GIRARDET, Jean-Luc, 16763 Santa Corina Court, San Diego, CA 92127, US

(51) MKP
C07F 3/06 (2006.01) (97) **2655382 ***
(86) EP2011073714 21.12.2011
(96) 11811022.0 30.10.2013
(87) WO2012085168, 21.12.2011
(97) 2655382, 30.10.2013 en
(54) ORGANOZINC COMPLEXES AND PROCESSES FOR MAKING AND USING THE SAME
(71) Ludwig-Maximilians-Universität München, Geschwister-Scholl-Platz 1, 80539 München, DE
(72) KNOCHEL, Paul, Noestrasse 7, D-81479 Munich, DE
BERNHARDT, Sebastian, Neufrienheim Platz 1, D-81375 Munich, DE
MANOLIKAKES, Georg, Johann Wolfgang Goethe Universität Institut für Organische Chemie Max-von-Laue-Str. 7, D-60438 Frankfurt-am-Main, DE

(51) MKP
C12Q 1/68 (2006.01) (97) **2652153 ***
(86) US2011065640 16.12.2011
(96) 11848220.7 23.10.2013
(87) WO2012083249, 16.12.2011
(97) 2652153, 23.10.2013 en
(54) DNA SEQUENCING BY SYNTHESIS USING MODIFIED NUCLEOTIDES AND NANOPORE DETECTION
(71) The Trustees of Columbia University in the City of New York, West 116th Street and Broadway, New York, NY 10027, US
(72) JU, Jingyue, 267 Marietta Street, Englewood Cliffs, NJ 07632, US
KUMAR, Shiv, 21 Muirhead Court, Belle Mead, NJ 08502, US
LI, Zengmin, 29-10 137th Street, Suite LC, Flushing, NY 11354, US
TAO, Chuanjuan, 605 West 112 Street, Apt 6I, New York, NY 10025, US
CHIEN, Minchen, 273 Tenafly Road, Tenafly, NJ 07670, US
RUSSO, James, J., 60 Haven Avenue, Apt. 25E, New York, NY 10032, US
KALACHIKOV, Sergey, 620 W 171st Street, Apt.4D, New York, NY 10032, US
SHEPARD, Ken, 158 Evan Drive, Ossining, NY 10562, US
ROSENSTEIN, Jacob, Karl, 205 West 103rd St, Apt 6D, New York, NY 10025, US

(51) MKP
A47L 5/22 (2006.01) (97) **2596733**
(96) 11388005.8 29.05.2013
(97) 2596733, 29.05.2013 en
(54) Combined primary and secondary units
(71) Nilfisk-Advance A/S, Sognevej 25, DK-2605 Brøndby, DK
(72) Larsen, Nøhr Peter, Blabaervej 2, 2400 Copenhagen NV, DK
Gamtofte, Michael, Tjaerbyvej 121, 8930 Randers NØ, DK
Sørensen, Anton, Hybenholt 9, 9560 Hadsund, DK

(51) MKP
A61K 47/48 (2006.01) (97) **2683409 ***
A61P 35/00 (2006.01)
(86) EP2012001072 09.03.2012
(96) 12708251.9 15.01.2014
(87) WO2012119787, 09.03.2012
(97) 2683409, 15.01.2014 en
(54) AMATOXIN-CONJUGATES WITH IMPROVED LINKAGES
(71) Heidelberg Pharma GmbH, Schriesheimer Strasse 101, 68526 Ladenburg, DE
(72) SIMON, Werner, In der Leihwiese 29, 55595 Hüffelsheim, DE
LUTZ, Christian, Am Feldrain 36, 69469 Weinheim, DE
MÜLLER, Christoph, Mumbacher Str. 38, 69488 Birkenau, DE
ANDERL, Jan, Fichtenstrasse 7, 64397 Modautal, DE

- (51) MKP
A61M 5/28 (2006.01) (97) **2661299 ***
A61M 5/32 (2006.01)
A61M 5/50 (2006.01)
- (86) EP2011074276 30.12.2011
(96) 11802454.6 13.11.2013
(87) WO2012093071, 30.12.2011
(97) 2661299, 13.11.2013 en
(54) A SAFETY DEVICE FOR A PRE-FILLED SYRINGE AND AN INJECTION DEVICE
- (71) Sanofi-Aventis Deutschland GmbH, Brüningstraße 50, 65929 Frankfurt, DE
(72) ROBERTS, Gareth, Glendale Pen-y-cae Road Ruabon, Wrexham LL14 6EB, GB
EKMAN, Matthew, 59 Ecton Avenue Cheshire, Macclesfield Cheshire SK10 1RD, GB
-
- (51) MKP
A61K 39/395 (2006.01) (97) **2694106 ***
(86) US2012031544 30.03.2012
(96) 12764885.5 12.02.2014
(87) WO2012135675, 30.03.2012
(97) 2694106, 12.02.2014 en
(54) METHODS FOR INCREASING EFFICACY OF FOLR1 CANCER THERAPY
- (71) Immunogen, Inc., 830 Winter Street, Waltham, MA 02415, US
(72) CARRIGAN, Christina, N., 53A Dartmouth Street, Belmont, MA 02478, US
WHITEMAN, Kathleen, R., 512 Shawsheen Avenue, Wilmington, MA 01887, US
PAYNE, Gillian, 21 Oakvale Road, Waban, MA 02468, US
LADD, Sharron, 9970 Joslin Lake Road, Gregory, MI 48137-9766, US
-
- (51) MKP
F25D 11/00 (2006.01) (97) **2655990 ***
F25D 25/00 (2006.01)
F25D 29/00 (2006.01)
- (86) CA2011001425 20.12.2011
(96) 11850607.0 30.10.2013
(87) WO2012083444, 20.12.2011
(97) 2655990, 30.10.2013 en
(54) COMPARTMENTED TEMPERATURE AND HUMIDITY CONTROLLED MODULAR HOUSING FOR THE STORAGE AND PRESERVATION OF WINE BOTTLES
- (71) Intelligent Cellars Inc., 2784 rue de Poitier, Québec, Québec G1W 2B8, CA
(72) DOUCET, Guy, 2784 rue de Poitier, Québec Québec G1W 2B8, CA
SENÉE, Laurent, 3018 rue Sainte-Emilie, Jonquièrre Québec G7S 4M4, CA
-
- (51) MKP
A61K 31/496 (2006.01) (97) **2692725 ***
C07D 401/12 (2006.01)
C07D 401/14 (2006.01)
- (86) JP2012057949 27.03.2012
(96) 12763854.2 05.02.2014
(87) WO2012133416, 27.03.2012
(97) 2692725, 05.02.2014 en
(54) METHOD FOR PRODUCING PHENOXYPYRIDINE DERIVATIVE
- (71) Eisai R&D Management Co., Ltd., 6-10, Koishikawa 4-chome Bunkyo-ku, Tokyo 112-8088, JP
(72) TAKAHASHI, Masabumi, c/o EISAI Co., Ltd. Kashima Plant 22 Sunayama, Kamisu-shi Ibaraki 314-0255, JP
-
- (51) MKP
A47K 10/38 (2006.01) (97) **2583602**
- (96) 11008454.8 24.04.2013
(97) 2583602, 24.04.2013 en
(54) Dispenser for static center-feed coreless roll of sheet product
- (71) SCA TISSUE FRANCE, 60, avenue de l'Europe, 92270 Bois-Colombes, FR
(72) Marietta-Tondin, Julien, 15b, rue du Maréchal Joffre, 67390 Marckolsheim, FR
Cattacin, Gilles, 30, rue de Thann, 68000 Colmar, FR
Taylor, James, 5, avenue de Corses Boite 11, Ixelle 1050, BE
-
- (51) MKP
A01N 63/00 (2006.01) (97) **2694651 ***
C12N 13/00 (2006.01)
- (86) US2012031869 02.04.2012
(96) 12763497.0 12.02.2014
(87) WO2012135838, 02.04.2012
(97) 2694651, 12.02.2014 en
(54) METHODS AND COMPOSITIONS FOR LARGE-SCALE ISOLATION OF VERY SMALL EMBRYONIC-LIKE (VSEL) STEM CELLS
- (71) University Of Louisville Research Foundation, Inc., 201 E. Jefferson Street Suite 215, Louisville, KY 40202, US
(72) RATAJCZAK, Janina, 15311 Champion Lakes Place, Louisville, KY 40245, US
RATAJCZAK, Mariusz, 15311 Champion Lakes Place, Louisville, KY 40245, US
-
- (51) MKP
A61P 9/04 (2006.01) (97) **2678017 ***
A61P 3/06 (2006.01)
A61K 31/4468 (2006.01)
A61P 11/00 (2006.01)
A61P 25/00 (2006.01)
A61P 3/00 (2006.01)
A61P 5/48 (2006.01)
A61P 3/10 (2006.01)
A61P 3/08 (2006.01)
A61P 1/04 (2006.01)
C07D 211/58 (2006.01)
A61P 1/00 (2006.01)
A61P 9/12 (2006.01)
A61P 21/00 (2006.01)
A61P 9/10 (2006.01)
A61P 1/16 (2006.01)
A61P 9/00 (2006.01)
A61P 3/04 (2006.01)
A61P 25/30 (2006.01)
A61P 7/00 (2006.01)
- (86) US2012026315 23.02.2012
(96) 12749383.1 01.01.2014
(87) WO2012116176, 23.02.2012
(97) 2678017, 01.01.2014 en
(54) ASYMMETRIC UREAS AND MEDICAL USES THEREOF
- (71) Helsinn Healthcare S.A., Via Pian Scairolo, 9, 6912 Lugano / Pazzallo, CH
(72) GARCIA RUBIO, Silvina, 7 Bellflower Ct., Princeton, NJ 08540, US
PIETRA, Claudio, Via Scalabrini 56, Como, IT
GIULIANO, Claudio, Via Prudenzianna 28/A, Como, IT
LI, Zhiqiang, Room 601 (21) No768 Meihua Road Pudong District, Shanghai 201204, CN
-
- (51) MKP
G06Q 20/38 (2012.01) (97) **2695120 ***
- (86) AU2012000327 30.03.2012
(96) 12768412.4 12.02.2014
(87) WO2012135892, 30.03.2012
(97) 2695120, 12.02.2014 en
(54) FINANCIAL TRANSACTION SYSTEMS AND METHODS
- (71) My Life IT (Aust) Pty Ltd, 25 Canterbury Road, Blackburn, Victoria 3130, AU
(72) SMYTHE, Richard Stanley, 33 Olympus Drive, Lower Templestowe Victoria 3017, AU
-
- (51) MKP
C22C 21/02 (2006.01) (97) **2657360**
C22C 21/04 (2006.01)
- (96) 12165829.8 30.10.2013
(97) 2657360, 30.10.2013 de
(54) Pressure cast alloy on an Al-Si basis, comprising secondary aluminium
- (71) AUDI AG, null, 85045 Ingolstadt, DE
AMAG casting GmbH, Lamprechtshausener Straße 61, 5282 Ranshofen, AT
(72) Hauck, Jan, Sitzbuchweg 60, 69118 Heidelberg, DE

(51) MKP
C09C 1/02 (2006.01) (97) **2679638**
D21H 17/00 (2006.01)
(96) 12174196.1 01.01.2014
(97) 2679638, 01.01.2014 en
(54) High solids aqueous mineral and/or filler and/or pigment suspension in acidic pH environment
(71) Omya International AG, Baslerstrasse 42, 4665 Oftringen, CH
(72) Buri, Matthias, Mätteliweg 20, 4852 Rothrist, CH
Rentsch, Samuel, Burgpark 2, 4663 Aarburg, CH
Gane, Patrick A.C., Studenweg 8, 4852 Rothrist, CH

(51) MKP
A61K 31/18 (2006.01) (97) **2648713 ***
A61K 31/4164 (2006.01)
A61P 27/00 (2006.01)
(86) EP2011072305 09.12.2011
(96) 11797215.8 16.10.2013
(87) WO2012076684, 09.12.2011
(97) 2648713, 16.10.2013 en
(54) DOSAGES OF ARYLSULFONAMIDE DERIVATIVES
(71) Fovea Pharmaceuticals, Institut de la Vision 17 Rue Moreau, 75012 Paris, FR
(72) COMBAL, Jean-Philippe, Fovea Pharmaceuticals Insitut de la Vision 17 rue Moreau, F-75012 Paris, FR
LATOUR, Elisabeth, Fovea Pharmaceuticals Insitut de la Vision 17 rue Moreau, F-75012 Paris, FR

(51) MKP
A61K 31/438 (2006.01) (97) **2699576 ***
A61P 3/04 (2006.01)
A61P 3/10 (2006.01)
C07D 471/10 (2006.01)
C07D 519/00 (2006.01)
(86) IB2012051732 09.04.2012
(96) 12718387.9 26.02.2014
(87) WO2012143813, 09.04.2012
(97) 2699576, 26.02.2014 en
(54) PYRAZOLOSPIROKETONE DERIVATIVES FOR USE AS ACETYL - COA CARBOXYLASE INHIBITORS
(71) Pfizer Inc, 235 East 42nd Street, New York, NY 10017, US
(72) GRIFFITH, David, Andrew, 10 Barley Hill Road, Old Saybrook, CT 06475, US
DOW, Robert, Lee, 234 Shore Avenue, Groton, CT 06340, US
SOUTHERS JR., James, Alfred, 21 Carey Lane, Norwich, CT 06360, US
EDMONDS, David James, 21 Croft Court, Pawcatuck, CT 06379, US

(51) MKP
A61B 17/22 (2006.01) (97) **2696930 ***
A61B 17/221 (2006.01)
A61M 25/00 (2006.01)
A61M 25/06 (2006.01)
A61M 25/09 (2006.01)
(86) US2011064302 12.12.2011
(96) 11832157.9 19.02.2014
(87) WO2012141749, 12.12.2011
(97) 2696930, 19.02.2014 en
(54) DEVICE AND METHOD FOR CAPTURING GUIDEWIRES
(71) The Spectranetics Corporation, 9965 Federal Drive, Colorado Springs, CO 80921-3617, US
(72) ROTTENBERG, Dan, 117 Einstein Street, 34601 Haifa, IL
SACHER, Ronen, 31 Achi Dakar Street, 46702 Herzelia, IL

(51) MKP
C07H 21/04 (2006.01) (97) **2697243 ***
C12N 15/11 (2006.01)
(86) US2012031642 30.03.2012
(96) 12763390.7 19.02.2014
(87) WO2012135736, 30.03.2012
(97) 2697243, 19.02.2014 en
(54) MODULATION OF SIGNAL TRANSDUCER AND ACTIVATOR OF TRANSCRIPTION 3 (STAT3) EXPRESSION
(71) Isis Pharmaceuticals, Inc., 2855 Gazelle Court, Carlsbad, CA 92010, US
(72) SWAYZE, Eric E., 2855 Gazelle Court, Carlsbad, CA 92010, US
FREIER, Susan M., 2855 Gazelle Court, Carlsbad, CA 92010, US
MACLEOD, Robert A., 2855 Gazelle Court, Carlsbad, CA 92010, US
KIM, Youngsoo, 2855 Gazelle Court, Carlsbad, CA 92010, US

(51) MKP
C09C 1/02 (2006.01) (97) **2662416**
D21H 17/00 (2006.01)
(96) 12167650.6 13.11.2013
(97) 2662416, 13.11.2013 en
(54) Treatment of calcium carbonate containing materials for increased filler load in paper
(71) Omya International AG, Baslerstrasse 42, 4665 Oftringen, CH
Gantenbein, Daniel, Vogesenstraße 27, 4056 Basel, CH
Schoelkopf, Joachim, Buechbühlstraße 3, 8956 Killwangen, CH
Gane, Patrick A. C., Studenweg 8, 4852 Rothrist, CH

(51) MKP
A61K 31/437 (2006.01) (97) **2700403 ***
A61K 31/47 (2006.01)
A61P 35/00 (2006.01)
C07D 215/48 (2006.01)
C07D 471/04 (2006.01)
(86) JP2012060279 16.04.2012
(96) 12774278.1 26.02.2014
(87) WO2012144463, 16.04.2012
(97) 2700403, 26.02.2014 en
(54) THERAPEUTIC AGENT FOR TUMOR
(71) Eisai R&D Management Co., Ltd., 4-6-10 Koishikawa Bunkyo-ku, Tokyo 112-8088, JP
(72) NARITA Yusuke, c/o EISAI CO. LTD. Tsukuba Research Laboratories 1-3 Tokodai 5-chome, Tsukuba-shi Ibaraki 300-2635, JP
MATSUI Junji, c/o EISAI CO. LTD. Tsukuba Research Laboratories 1-3 Tokodai 5-chome, Tsukuba-shi Ibaraki 300-2635, JP
FUNAHASHI Yasuhiro, c/o EISAI Inc. 4 Corporate Drive, Andover, Massachusetts 01810, US

(51) MKP
A61K 31/4439 (2006.01) (97) **2672973 ***
A61P 25/00 (2006.01)
A61P 25/16 (2006.01)
(86) GB2011052056 21.10.2011
(96) 11785058.6 18.12.2013
(87) WO2012107708, 21.10.2011
(97) 2672973, 18.12.2013 en
(54) ADMINISTRATION REGIME FOR NITROCATECHOLS
(71) Bial-Portela & CA, S.A., À Avenida da Siderurgia Nacional Apartado 19, 4745-457 S. Mamede do Coronado, PT
SOARES DA SILVA, Patricio Manuel Vieira Araujo, A Av. da Siderurgia Nacional, P-4745-457 S. Mamede do Coronado, PT
NUNES, Teresa Lucia Silva Pereira, A Av. da Siderurgia Nacional, P-4745-457 S. Mamede do Coronado, PT
WRIGHT, Lyndon Christopher, A Av. da Siderurgia Nacional, P-4745-457 S. Mamede do Coronado, PT
PALMA, Pedro Nuno Leal, A Av. da Siderurgia Nacional, P-4745-457 S. Mamede do Coronado, PT
LEARMONTH, David Alexander, A Av. da Siderurgia Nacional, P-4745-457 S. Mamede do Coronado, PT

- (51) MKP
A24F 47/00 (2006.01) (97) **2672846 ***
(86) EP2012051981 06.02.2012
(96) 12708093.5 18.12.2013
(87) WO2012107414, 06.02.2012
(97) 2672846, 18.12.2013 de
(54) INHALATION DEVICE
(71) S.A.S.C. AG, Dorfstrasse 16, 6340 Baar, CH
(72) BURGHARDT, Thorsten, S nderlingstr. 22, 44581 Castrop-Rauxel, DE
-
- (51) MKP
A61P 35/00 (2006.01) (97) **2680925 ***
(86) US2012027615 02.03.2012
(96) 12751945.2 08.01.2014
(87) WO2012119129, 02.03.2012
(97) 2680925, 08.01.2014 en
(54) INTERROGATORY CELL-BASED ASSAYS AND USES THEREOF
(71) Berg LLC, 1845 Elm Hill Pike, Nashville, TN 37210, US
(72) NARAIN, Niven, Rajin, 73 Fresh Pond Parkway, Cambridge, MA 02138, US
SARANGARAJAN, Rangaprasad, 454 Central Street, Boylston, MA 01505, US
VISHNUDAS, Vivek, K., 8 Garden Circle Apt. 4, Waltham, MA 02452, US
-
- (51) MKP
A61K 31/437 (2006.01) (97) **2651936 ***
A61P 31/12 (2006.01)
C07D 471/04 (2006.01)
(86) EP2011073016 16.12.2011
(96) 11799682.7 23.10.2013
(87) WO2012080450, 16.12.2011
(97) 2651936, 23.10.2013 en
(54) AZAINDOLES AS RESPIRATORY SYNCYTIAL VIRUS ANTIVIRAL AGENTS
(71) Janssen R&D Ireland, Eastgate Village, Eastgate, Little Island, County Cork, IE
(72) COOYMANS, Ludwig Paul, Grote Beekstraat 24, B-2340 Beerse, BE
DEMIN, Samu l Dominique, Professor Claraplein 14, Bus 308, B-2018 Antwerpen, BE
HU, Lili, Vrouw van Mechelenstraat 28, B-2800 Mechelen, BE
JONCKERS, Tim Hugo Maria, Pastoor Wouterstraat 19, bus 5, B-2650 Edegem, BE
RABOISSON, Pierre Jean-Marie Bernard, Rue Jolie 3, B-1331 Rosieres, BE
TAHRI, Abdellah, Rue Maurice Albert Raskin 30, B-1070 Anderlecht, BE
VENDEVILLE, Sandrine Marie Helene, Rue du B mel 142, B-1150 Woluwe-Saint-Pierre, BE
-
- (51) MKP
A61C 5/06 (2006.01) (97) **2583635**
(96) 11186068.0 24.04.2013
(97) 2583635, 24.04.2013 en
(54) Mixing and dispensing container
(71) SDI Limited, 5-9 Brunson Street (PO Box 314), Bayswater, VIC 3153, AU
(72) Cheetham, Joshua James, 23 Lewisham Road, Windsor, Victoria 3181, AU
-
- (51) MKP
A61K 31/00 (2006.01) (97) **2666014 ***
A61K 38/00 (2006.01)
G01N 33/50 (2006.01)
(86) EP2012050814 19.01.2012
(96) 12700494.3 27.11.2013
(87) WO2012098203, 19.01.2012
(97) 2666014, 27.11.2013 en
(54) USE OF GLU-TUBULIN AS A BIOMARKER OF DRUG RESPONSE TO FURAZANOBENZIMIDAZOLES
(71) Basilea Pharmaceutica AG, Grenzacherstrasse 487, 4005 Basel, CH
(72) LANE, Heidi Alexandra, Kaltbrunnenweg 8, CH-4106 Therwil, CH
BACHMANN, Felix, Sierenzerstrasse 16, 4055 Basel, CH
-
- (51) MKP
C07D 309/28 (2006.01) (97) **2678324 ***
(86) IN2011000394 13.06.2011
(96) 11749558.0 01.01.2014
(87) WO2012114350, 13.06.2011
(97) 2678324, 01.01.2014 en
(54) PROCESS FOR THE PREPARATION OF ZANAMIVIR
(71) Cadila Healthcare Limited, Zydus Tower Satellite Cross Roads, Ahmedabad 380 015 Gujarat, IN
(72) CHARAN, Ganpat Dan, Shimbhu, Cadila Healthcare Limited Zydus Tower Satellite Cross Road Ahmedabad 380 015, Gujarat, IN
TEHARE, Ajay, Onkarsingh, Cadila Healthcare Limited Zydus Tower Satellite Cross Road Ahmedabad 380 015, Gujarat, IN
SINGH, Kumar, Kamlesh, Laxmi, Cadila Healthcare Limited Zydus Tower Satellite Cross Road Ahmedabad 380 015, Gujarat, IN
-
- (51) MKP
A61K 31/4162 (2006.01) (97) **2648723 ***
C07D 231/54 (2006.01)
(86) US2011063842 07.12.2011
(96) 11847759.5 16.10.2013
(87) WO2012078817, 07.12.2011
(97) 2648723, 16.10.2013 en
(54) BICYCLIC PYRAZOLE COMPOUNDS AS ALLOSTERIC MODULATORS OF MGLUR5 RECEPTORS
(71) Vanderbilt University, Office Of Technology Transfer 305 Kirkland Hall, Nashville, Tennessee 37240, US
(72) CONN, P., Jeffrey, 9012 Grey Point Ct., Brentwood, TN 37027, US
LINDSLEY, Craig, W., 401 Briery Court, Brentwood, TN 37027, US
STAUFFER, Shaun, R., 9500 Wexcroft Drive, Brentwood, TN 37027, US
JONES, Carrie, K., 7221 Highway 70 South Apt. 636, Nashville, TN 37221, US
CONDE-CEIDE, Susana, c/o Janssen-Cilag S.A. Calle Jarama 75 Poligono Industrial, E-45007 Toledo, ES
TONG, Han Min, c/o Janssen-Cilag S.A. Calle Jarama 75 Poligono Industrial, E-45007 Toledo, ES
BARTOLOME-NEBREDA, Jose, Manuel, c/o Janssen-Cilag S.A. Calle Jarama 75 Poligono Industrial, E-45007 Toledo, ES
MACDONALD, Gregor, James, c/o Janssen Pharmaceutica NV Turnhoutseweg 30, B-2340 Beerse, BE
-
- (51) MKP
C12N 5/071 (2010.01) (97) **2689007 ***
C12N 5/09 (2010.01)
(86) US2012030446 23.03.2012
(96) 12761150.7 29.01.2014
(87) WO2012129538, 23.03.2012
(97) 2689007, 29.01.2014 en
(54) COMPOSITIONS AND METHODS FOR CULTURING CELLS FROM NORMAL HUMAN TUBO-OVARIAN EPITHELIUM AND HUMAN TUBO-OVARIAN TUMORS
(71) Whitehead Institute For Biomedical Research, Nine Cambridge Center, Cambridge, MA 02142-1479, US
Brigham and Women's Hospital, Inc., 75 Francis Street, Boston, MA 02115, US
(72) INCE, Tan, A., One Winchester Street, Apt. 403, Brookline, MA 02446, US
-

(51) MKP
A61K 9/00 (2006.01) (97) **2648755 ***
A61K 38/08 (2006.01)
A61K 47/12 (2006.01)
(86) IN2011000825 05.12.2011
(96) 11818953.9 16.10.2013
(87) WO2012077131, 05.12.2011
(97) 2648755, 16.10.2013 en
(54) A STABLE READY-TO-USE CETRORELIX INJECTION
(71) Astron Research Limited, 10th Floor, Premier House, Bodakdev Opp. Gurudwara Sarkhej Gandhinagar Highway, Ahmedabad, 380 054 Gujarat, IN
(72) PATEL, Pankaj, Astron Research Limited 10th Floor Premier House Bodakdev Opp. Gurudwara Sarkhej-Gandhinagar Highway, Ahmedabad 380 054 Gujarat, IN
PATEL, Bhavesh, Astron Research Limited 10th Floor Premier House Bodakdev Opp. Gurudwara Sarkhej-Gandhinagar Highway, Ahmedabad 380 054 Gujarat, IN
SEHGAL, Ashish, Astron Research Limited 10th Floor Premier House Bodakdev Opp. Gurudwara Sarkhej-Gandhinagar Highway, Ahmedabad 380 054 Gujarat, IN
MANDAL, Jayanta, Kumar, Astron Research Limited 10th Floor Premier House Bodakdev Opp. Gurudwara Sarkhej-Gandhinagar Highway, Ahmedabad 380 054 Gujarat, IN

(51) MKP
A61M 5/20 (2006.01) (97) **2675509 ***
A61M 5/32 (2006.01)
(86) EP2012052639 16.02.2012
(96) 12706008.5 25.12.2013
(87) WO2012110572, 16.02.2012
(97) 2675509, 25.12.2013 en
(54) INJECTION DEVICE
(71) Sanofi-Aventis Deutschland GmbH, Brüningstraße 50, 65929 Frankfurt, DE
(72) BRERETON, Simon Francis, 75 De Freville Avenue, Cambridge Cambridgeshire CB4 1HP, GB
KEMP, Thomas, 3 Forresters Cottages High Steet, Ashwell Hertfordshire SG7 5NW, GB
BURNELL, Rosie, 56 Cavendish Avenue, Cambridge CB1 7UT, GB
EKMAN, Matthew, 59 Ecton Avenue Cheshire, Macclesfield Cheshire SK10 1RD, GB

(51) MKP
A61B 5/00 (2006.01) (97) **2581846**
A61M 1/36 (2006.01)
G06F 19/00 (2011.01)
(96) 11184981.6 17.04.2013
(97) 2581846, 17.04.2013 en
(54) A cardiopulmonary bypass or cpb monitoring tool
(71) Heartware BVBA, Molenstraat 15, 3140 Keerbergen, BE
(72) Janssenswillen, Eddy, Molenstraat 15, 3140 KEERBERGEN, BE

(51) MKP
A61K 38/17 (2006.01) (97) **2658979 ***
A61K 47/48 (2006.01)
A61P 19/08 (2006.01)
C07K 14/575 (2006.01)
C07K 19/00 (2006.01)
C12N 15/16 (2006.01)
C12N 15/62 (2006.01)
(86) CA2011050807 23.12.2011
(96) 11853820.6 06.11.2013
(87) WO2012088608, 23.12.2011
(97) 2658979, 06.11.2013 en
(54) COMPOSITIONS COMPRISING NATRIURETIC PEPTIDES AND METHODS OF USE THEREOF
(71) Alexion Pharma International SARL, Avenue du Tribunal Fédéral 34, 1005 Lausanne, CH
(72) CRINE, Philippe, 28 Avenue Claude-Champagne, Outremont Québec H2V 2X1, CA
JOURBERT, Simon, 4840 6e avenue 6, Montréal Québec H1Y 2P2, CA
PARAT, Marie, 4840 6e avenue 6, Montréal Québec H1Y 2P2, CA

(51) MKP
A61B 5/042 (2006.01) (97) **2699153 ***
(86) US2012027184 01.03.2012
(96) 12709742.6 26.02.2014
(87) WO2012145075, 01.03.2012
(97) 2699153, 26.02.2014 en
(54) FLEXIBLE ELECTRODE ASSEMBLY FOR INSERTION INTO BODY LUMEN OR ORGAN
(71) Topera, Inc., 11445 E. Via Linda, Suite 2 P.O. Box 224, Scottsdale, AZ 85259, US
(72) BURKE, Jeff, A., C/o Topera Inc. 11445 E. Via Linda Suite 2 P.O. Box 224, Scottsdale, AZ 85259, US
JOHNSON, Eric, T., C/o Topera Inc. 11445 E. Via Linda Suite 2 P.O. Box 224, Scottsdale, AZ 85259, US
KORDIS, Thomas, F., C/o Topera Inc. 11445 E. Via Linda Suite 2 P.O. Box 224, Scottsdale, AZ 85259, US
KENT, Darrin, J., C/o Topera Inc. 11445 E. Via Linda Suite 2 P.O. Box 224, Scottsdale, AZ 85259, US
MAGRINI, Kevin, M., C/o Topera Inc. 11445 E. Via Linda Suite 2 P.O. Box 224, Scottsdale, AZ 85259, US

(51) MKP
A61K 31/53 (2006.01) (97) **2692727 ***
A61P 31/04 (2006.01)
C07D 413/14 (2006.01)
(86) KR2012002314 29.03.2012
(96) 12764499.5 05.02.2014
(87) WO2012134188, 29.03.2012
(97) 2692727, 05.02.2014 en
(54) NOVEL OXAZOLIDINONE DERIVATIVE AND MEDICAL COMPOSITION CONTAINING SAME
(71) LegoChem Biosciences, Inc., 8-26, Munpyeongseo-ro Daedeok-gu, Daejeon 306-220, KR
(72) CHO, Young Lag, Legochem Biosciences, Inc. 8-26, Munpyeongseo-ro Daedeok-gu, Daejeon 305-390, KR
BAEK, Sung Yoon, Legochem Biosciences, Inc. 8-26, Munpyeongseo-ro Daedeok-gu, Daejeon 306-220, KR
CHAE, Sang Eun, Legochem Biosciences, Inc. 8-26, Munpyeongseo-ro Daedeok-gu, Daejeon 306-220, KR
KIM, Sun Young, Legochem Biosciences, Inc. 8-26, Munpyeongseo-ro Daedeok-gu, Daejeon 306-220, KR
LEE, Hong Bum, Legochem Biosciences, Inc. 8-26, Munpyeongseo-ro Daedeok-gu, Daejeon 306-220, KR
LEE, Hyang Sook, Legochem Biosciences, Inc. 8-26, Munpyeongseo-ro Daedeok-gu, Daejeon 306-220, KR
OH, Kyuman, Legochem Biosciences, Inc. 8-26, Munpyeongseo-ro Daedeok-gu, Daejeon 306-220, KR
HEO, Hye Jin, Legochem Biosciences, Inc. 8-26, Munpyeongseo-ro Daedeok-gu, Daejeon 306-220, KR
PARK, Tae Kyo, Legochem Biosciences, Inc. 8-26, Munpyeongseo-ro Daedeok-gu, Daejeon 306-220, KR
WOO, Sung Ho, Legochem Biosciences, Inc. 8-26, Munpyeongseo-ro Daedeok-gu, Daejeon 306-220, KR
KIM, Yong Zu, Legochem Biosciences, Inc. 8-26, Munpyeongseo-ro Daedeok-gu, Daejeon 306-220, KR

(51) MKP
C23C 2/06 (2006.01) (97) **2652166 ***
C23C 2/26 (2006.01)
C23C 2/40 (2006.01)
C23C 14/16 (2006.01)
C23C 14/58 (2006.01)
C23C 28/00 (2006.01)
(86) FR2010000848 17.12.2010
(96) 10810765.7 23.10.2013
(87) WO2012080581, 17.12.2010
(97) 2652166, 23.10.2013 fr
(54) STEEL SHEET INCLUDING A MULTILAYER COATING
(71) Arcelormittal Investigación y Desarrollo SL, CL/Chavarri, 6, 48910 Sestao, Bizkaia, ES
(72) MONNOYER, Maxime, 13 rue des Lilas, F-57255 Sainte-Marie-aux-Chenes, FR
CHALEIX, Daniel, 16 rue des Chenevières, F-57420 Verny, FR
ALLELY, Christian, 30 rue de l'Aubépine, F-57000 Metz, FR
JACQUES, Daniel, 55 rue des Viornes, F-57100 Thionville, FR
CHASSAGNE, Julie, 17 Bd Kleyer, B-4000 Liege, BE

- (51) MKP
A61K 31/7088 (2006.01) (97) **2683825 ***
A61K 31/7105 (2006.01)
A61P 35/00 (2006.01)
C07H 21/00 (2006.01)
C12N 15/113 (2010.01)
- (86) CA2012050147 12.03.2012
(96) 12757450.7 15.01.2014
(87) WO2012122645, 12.03.2012
(97) 2683825, 15.01.2014 en
(54) METHODS OF TREATING CANCER BY INHIBITION OF DNA REPAIR PROTEINS
- (71) Sarissa Inc., 121 Timber Drive, London, Ontario N6K 4A2, CA
(72) VINCENT, Mark, c/o London Regional Cancer Center 790 Commissioners Road East, London Ontario N6A 4L6, CA
FERGUSON, Peter J., 56 Killarney Road, London Ontario N5X 2A8, CA
RYTELEWSKI, Mateusz, c/o London Regional Cancer Center 790 Commissioners Road E., London Ontario N6A 4L6, CA

- (51) MKP
A61K 31/553 (2006.01) (97) **2673279 ***
A61K 31/554 (2006.01)
A61P 25/16 (2006.01)
A61P 25/28 (2006.01)
C07D 498/10 (2006.01)
C07D 498/20 (2006.01)
C07D 513/10 (2006.01)
- (86) US2012024029 06.02.2012
(96) 12705212.4 18.12.2013
(87) WO2012109165, 06.02.2012
(97) 2673279, 18.12.2013 en
(54) 5-AMINO-OXAZEPINE AND 5-AMINO-THIAZEPANE COMPOUNDS AS BETA-SECRETASE ANTAGONISTS AND METHODS OF USE
- (71) Amgen Inc., One Amgen Center Drive Thousand Oaks, California 91320, US
(72) DINEEN, Thomas, 36 Waterhouse Street, Somerville, Massachusetts 02144, US
WEISS, Matthew, 99 Revere Street, Boston, Massachusetts 02114, US
PATEL, Vinod F., 3 Mossy Lane, Acton, Massachusetts 01720, US
ZHENG, Xiao Mei, 19 Allison Way, Natick, Massachusetts 01760, US
WHITE, Ryan, 34 Willow Avenue Unit 1, Somerville, Massachusetts 02144, US

- (51) MKP
E06B 3/46 (2006.01) (97) **2602416**
- (96) 12191558.1 12.06.2013
(97) 2602416, 12.06.2013 en
(54) Interconnection device for retractable sliding doors
- (71) ECLISSE SRL, Via Sernaglia, 76, 31053 Pieve di Soligo TV, IT
(72) De Faveri, Luigi, Via Vittoria, 114, 31020 REFRONTOLO TV, IT

- (51) MKP
C02F 1/66 (2006.01) (97) **2651832 ***
- (86) EP2011073269 19.12.2011
(96) 11801735.9 23.10.2013
(87) WO2012080514, 19.12.2011
(97) 2651832, 23.10.2013 de
(54) METHOD FOR TREATING BODIES OF WATER
- (71) Rheinkalk GmbH, Am Kalkstein 1, 42489 Wülfrath, DE
(72) KÖNIG, Wolfgang, Lärchenweg 11, 42489 Wülfrath, DE
RABE, Wolfgang, Am Waldrand 10, 02994 Bernsdorf, DE
SCHOLZ, Günter, Waldstraße 21 a, 02977 Hoyerswerda, DE

- (51) MKP
C07C 231/02 (2006.01) (97) **2661422 ***
C07C 233/18 (2006.01)
C07C 253/30 (2006.01)
C07C 255/37 (2006.01)
C07C 255/40 (2006.01)
- (86) FR2012000005 04.01.2012
(96) 12703858.6 13.11.2013
(87) WO2012113999, 04.01.2012
(97) 2661422, 13.11.2013 fr
(54) PROCESS AND INTERMEDIATES FOR SYNTHESIZING AGOMELATINE
- (71) Les Laboratoires Servier, 35, rue de Verdun, 92284 Suresnes Cedex, FR
(72) ZARD, Samir, 6 impasse des 4 Vents, F-91190 Gif-Sur-Yvette, FR
SIRE, Béatrice, 2 rue du 11 Novembre - Bât. B., F-91120 Palaiseau, FR
BOUMEDIENE, Medhi, 9 rue Albert 1er, F-94600 Choisy Le Roi, FR

- (51) MKP
C07D 213/70 (2006.01) (97) **2678316 ***
C07D 309/14 (2006.01)
A61K 31/435 (2006.01)
C07D 213/57 (2006.01)
C07D 309/08 (2006.01)
A61K 31/42 (2006.01)
C07D 235/16 (2006.01)
A61P 35/00 (2006.01)
A61K 31/47 (2006.01)
C07D 231/12 (2006.01)
C07C 317/44 (2006.01)
C07D 215/36 (2006.01)
C07D 333/24 (2006.01)
C07D 263/32 (2006.01)
A61P 35/04 (2006.01)
C07D 263/56 (2006.01)
A61K 31/4164 (2006.01)
C07D 223/10 (2006.01)
C07D 271/07 (2006.01)
A61K 31/415 (2006.01)
- (86) US2012026274 23.02.2012
(96) 12709198.1 01.01.2014
(87) WO2012116151, 23.02.2012
(97) 2678316, 01.01.2014 en
(54) SUBSTITUTED AROMATIC SULFUR COMPOUNDS AND METHODS OF THEIR USE
- (71) Cephalon, Inc., 41 Moores Road P.O. Box 4011, Frazer, PA 19355, US
University of Hawaii, 2800 Woodlawn Drive Suite 280, Honolulu, HI 96822, US
University of Utah Research Foundation, 615 Arapeen Drive, Suite 310, Salt Lake City, UT 84108, US
(72) DORSEY, Bruce, 1213 Meetinghouse Road, Ambler, Pennsylvania 19002, US
KUWADA, Scott K., 7018 Hawaii Kai Drive, Honolulu, Hawaii 96813, US
THEROFF, Jay P., 9 Patrick Avenue, West Chester, Pennsylvania 19380, US
ZIFICSAK, Craig A., 7 Maple Street, Downingtown, Pennsylvania 19335, US

- (51) MKP
A61K 31/00 (2006.01) (97) **2666016 ***
G01N 33/50 (2006.01)
- (86) EP2012050818 19.01.2012
(96) 12701341.5 27.11.2013
(87) WO2012098207, 19.01.2012
(97) 2666016, 27.11.2013 en
(54) USE OF BUBR1 AS A BIOMARKER OF DRUG RESPONSE TO FURAZANOBENZIMIDAZOLES
- (71) Basilea Pharmaceutica AG, Grenzacherstrasse 487, 4005 Basel, CH
(72) LANE, Heidi Alexandra, Kaltbrunnenweg 8, CH-4106 Therwil, CH
BACHMANN, Felix, Sierenzerstrasse 16, CH-4055 Basel, CH
BREULEUX, Madlaina, Jurastrasse 52, CH-4053 Basel, CH
BOUTROS, Michael, Marstallstrasse 11, 69120 Heidelberg, DE
GILBERT, Daniel, Gaisbergstrasse 64a, 69115 Heidelberg, DE
ZHANG, Xian, Schorenweg 32, CH-4058 Basel, CH

- (51) MKP
A61K 9/20 (2006.01) (97) **2654734 ***
A61K 9/28 (2006.01)
A61K 31/485 (2006.01)
- (86) IB2011003152 21.12.2011
(96) 11815781.7 30.10.2013
(87) WO2012085656, 21.12.2011
(97) 2654734, 30.10.2013 en
(54) ENCASED TAMPER RESISTANT CONTROLLED RELEASE DOSAGE FORMS
(71) Purdue Pharma LP, One Stamford Forum 201 Tresser Boulevard, Stamford, CT 06901-3431, US
(72) HUANG, Haiyong, Hugh, 5 Millar Court, Princeton Junction NJ 08550, US
-
- (51) MKP
A61K 31/4184 (2006.01) (97) **2663562 ***
A61P 31/00 (2006.01)
C07D 413/14 (2006.01)
- (86) US2012021280 13.01.2012
(96) 12701811.7 20.11.2013
(87) WO2012097273, 13.01.2012
(97) 2663562, 20.11.2013 en
(54) SOLID FORMS OF GYRASE INHIBITOR (R)-1-ETHYL-3-[6-FLUORO-5-[2-(1-HYDROXY-1-METHYL-ETHYL)PYRIMIDIN-5-YL]-7-(TETRAHYDROFURAN-2-YL)-1H-BENZIMIDAZOL-2-YL]UREA
(71) Vertex Pharmaceuticals Incorporated, 130 Waverly Street, Cambridge, MA 02139, US
(72) SHANNON, Dean, 19 Stonybrook Lane, Milford, MA 01757, US
LUISE, Brian, 15 Gibbens Street, Somerville, MA 02143, US
KRAWIEC, Mariusz, 46 Littlefield Lane, Marlborough, MA 01752, US
KULDIPKUMAR, Anuj, K., 282 Fellsway West, Medford, MA 02155, US
-
- (51) MKP
H01H 3/16 (2006.01) (97) **2431990**
H01H 13/18 (2006.01)
H01H 13/48 (2006.01)
- (96) 11181325.9 21.03.2012
(97) 2431990, 21.03.2012 de
(54) Switch
(71) Huf Hülsbeck & Fürst GmbH & Co. KG, Steeger Strasse 17, 42551 Velbert, DE
(72) Buss, Wolfgang, Thalstrasse 54, 42697 Solingen, DE
-
- (51) MKP
H01R 13/52 (2006.01) (97) **2688152 ***
H04M 1/02 (2006.01)
- (86) JP2012001185 22.02.2012
(96) 12757456.4 22.01.2014
(87) WO2012124261, 22.02.2012
(97) 2688152, 22.01.2014 en
(54) CONNECTOR OF ELECTRONIC DEVICE, PLUG OF ELECTRONIC DEVICE, AND WATERPROOF STRUCTURE OF ELECTRONIC DEVICE
(71) EX Company Limited, 6-2 Kukodori 4-chome, Matsuyama-shi, Ehime 791-0054, JP
(72) YUDATE, Shinya, c/o EX Company Limited 6-2 Kukodori 4-chome, Matsuyama-shi Ehime 791-0054, JP
-
- (51) MKP
A61K 31/495 (2006.01) (97) **2694066 ***
- (86) US2012032544 06.04.2012
(96) 12861665.3 12.02.2014
(87) WO2013101281, 06.04.2012
(97) 2694066, 12.02.2014 en
(54) METHODS AND COMPOSITIONS FOR TREATING PARKINSON'S DISEASE
(71) ARIAD Pharmaceuticals, Inc, 26 Landsdowne Street, Cambridge, MA 02139, US
(72) SHAKESPEARE, William, C., 2 Hubley Lane, Southborough, MA 01772, US
-
- (51) MKP
A61K 9/10 (2006.01) (97) **2648696 ***
A61K 31/223 (2006.01)
A61K 31/265 (2006.01)
A61P 1/12 (2006.01)
- (86) EP2011072315 09.12.2011
(96) 11797216.6 16.10.2013
(87) WO2012076691, 09.12.2011
(97) 2648696, 16.10.2013 en
(54) NEW FORM OF ADMINISTRATION OF ENKEPHALINASE INHIBITOR
(71) Bioprojet, 30 rue des Francs Bourgeois, 75003 Paris, FR
(72) JULIEN, Jean-Stéphane, 24 rue de Preney, F-37540 Saint Cyr Sur Loire, FR
MAURY, Marc, 21 rue Louis Juvet, F-33160 Saint Medard En Jalles, FR
LECOMTE, Jeanne-Marie, 30 rue des Francs-Bourgeois, F-75003 Paris, FR
LIGNEAU, Xavier, 4 Square du Vivier Louis, F-35760 Saint Gregoire, FR
ROBERT, Philippe, 9 chemin de la Reine Iseult, F-35740 Pace, FR
SCHWARTZ, Jean-Charles, 9 villa Seurat, F-75014 Paris, FR
-
- (51) MKP
A61K 45/00 (2006.01) (97) **2655665 ***
C12Q 1/68 (2006.01)
C40B 30/04 (2006.01)
C40B 40/06 (2006.01)
- (86) IB2011003274 21.12.2011
(96) 11851642.6 30.10.2013
(87) WO2012085674, 21.12.2011
(97) 2655665, 30.10.2013 en
(54) SINGLE NUCLEOTIDE POLYMORPHISMS AND GENES ASSOCIATED WITH T2D-RELATED COMPLICATIONS
(71) Prognomix, Inc., 4101 Molson, Montreal, QC H1Y 3L1, CA
(72) HAMET, Pavel, 325 Ellerton, Ville Mont-Royal Québec H3P 1E1, CA
TREMBLAY, Johanne, 325 Ellerton, Ville Mont-Royal Québec H3P 1E1, CA
SEDA, Ondrej, 219 De Brullon, Boucherville Québec J4B 2J7, CA
MACMAHON, Stephen, 341 George Street, Sydney, NSW 2000, AU
CHALMERS, John, 341 George Street, Sydney, NSW 2000, AU
-
- (51) MKP
A61K 31/341 (2006.01) (97) **2668160 ***
A61K 31/381 (2006.01)
A61K 31/4025 (2006.01)
A61K 31/4402 (2006.01)
A61P 29/00 (2006.01)
C07D 207/323 (2006.01)
C07D 213/36 (2006.01)
C07D 307/52 (2006.01)
C07D 307/56 (2006.01)
C07D 333/20 (2006.01)
C07D 333/28 (2006.01)
- (86) EP2012051292 27.01.2012
(96) 12705078.9 04.12.2013
(87) WO2012101244, 27.01.2012
(97) 2668160, 04.12.2013 en
(54) TRPM8 RECEPTOR ANTAGONISTS
(71) Dompe' S.p.A., Via Campo Di Pile S.N.C., 67100 L'Aquila (AQ), IT
(72) MORICONI, Alessio, c/o DOMPE' S.P.A. Via Campo Di Pile S.N.C., I-67100 L'Aquila, IT
BIANCHINI, Gianluca, c/o DOMPE' S.P.A. Via Campo Di Pile S.N.C., I-67100 L'Aquila (AQ), IT
BRANDOLINI, Laura, c/o DOMPE' S.P.A. Via Campo Di Pile S.N.C., I-67100 L'Aquila (AQ), IT
ARAMINI, Andrea, c/o DOMPE' S.P.A. Via Campo Di Pile S.N.C., I-67100 L'Aquila (AQ), IT
LIBERATI, Chiara, c/o AXXAM S.P.A. San Raffaele Biomedical Science Park Via Olgettina 58, I-20132 Milano, IT
BOVOLENTA, Silvia, c/o AXXAM S.P.A. San Raffaele Biomedical Science Park Via Olgettina 58, I-20132 Milano, IT
BECCARI, Andrea, c/o Dompe' S.p.A. Località Campo di Pile SNC, I-67100 L'Aquila (AQ), IT
LORENZI, Simone, c/o DOMPE' S.P.A. Località Campo di Pile S.N.C., I-67100 L'Aquila (AQ), IT
-

- (51) MKP
F16G 11/00 (2006.01) (97) **2596266 ***
F16G 11/02 (2006.01)
- (86) FR2011000382 21.07.2011
(96) 11744036.2 29.05.2013
(87) WO2012010746, 21.07.2011
(97) 2596266, 29.05.2013 fr
(54) SELF-ALIGNING SOCKET FOR MOORING CABLE
(71) Arcelormittal Wire France, 25 Avenue de Lyon BP 96, 01000 Bourg en Bresse, FR
(72) BARON, Pierre-François, 72 rue Louison Bobet, F-01000 Saint-Denis les Bourg, FR
COUTAZ, Benjamin, 2 Clos du Village, F-01250 Ceyzériat, FR
BISCEGLIE, Serge, 220 chemin des Grandes Blanchés, F-01310 Saint-Remy, FR

- (51) MKP
D21F 1/44 (2006.01) (97) **2697423 ***
- (86) GB2012050833 16.04.2012
(96) 12719792.9 19.02.2014
(87) WO2012140448, 16.04.2012
(97) 2697423, 19.02.2014 en
(54) IMPROVEMENTS IN OR RELATING TO SECURITY OF DOCUMENTS
(71) Woollard And Henry Ltd., Stoneywood park Dyce Aberdeen, Aberdeenshire AB217DZ, GB
(72) BOWDEN, Frederick James, 17 Queens Den, Aberdeen AB15 8BW, GB

- (51) MKP
E05D 7/00 (2006.01) (97) **2586944**
- (96) 11186607.5 01.05.2013
(97) 2586944, 01.05.2013 de
(54) Hinge with adjustment elements and adjustment cap for these adjustment elements
(71) Hasler, Josef, Bächis 18, 9452 Hinterforst, CH
(72) Hasler, Josef, Bächis 18, 9452 Hinterforst, CH

- (51) MKP
C01F 11/18 (2006.01) (97) **2644568**
C09C 1/02 (2006.01)
D21H 19/38 (2006.01)
- (96) 12162765.7 02.10.2013
(97) 2644568, 02.10.2013 en
(54) Dispersed calcium carbonate containing material for an improved stability under alkaline conditions
(71) Omya International AG, Baslerstrasse 42, 4665 Oftringen, CH
(72) Gantenbein, Daniel, Vogesenstraße 27, 4056 Basel, CH
Gane, Patrick A. C., Studenweg 8, 4852 Rothrist, CH

- (51) MKP
A61K 31/19 (2006.01) (97) **2675771 ***
A61K 31/22 (2006.01)
A61P 21/00 (2006.01)
A61P 25/02 (2006.01)
A61P 25/20 (2006.01)
C07B 59/00 (2006.01)
C07C 59/01 (2006.01)
C07C 69/67 (2006.01)
- (86) US2012024974 14.02.2012
(96) 12704646.4 25.12.2013
(87) WO2012112492, 14.02.2012
(97) 2675771, 25.12.2013 en
(54) 4-HYDROXYBUTYRIC ACID DEUTERATED ANALOGS
(71) Concert Pharmaceuticals Inc., 99 Hayden Avenue, Lexington, MA 02421, US
(72) TUNG, Roger, D., 3 Burnham Road, Lexington, MA 02420, US
MORGAN, Adam, 14 Oak Ridge Lane, Ashland, MA 01721, US
SILVERMAN, I., Robert, 36 Orvis Road, Arlington, MA 02474, US

- (51) MKP
A61K 31/496 (2006.01) (97) **2694485 ***
C07D 239/70 (2006.01)
- (86) US2012031665 30.03.2012
(96) 12765234.5 12.02.2014
(87) WO2012135750, 30.03.2012
(97) 2694485, 12.02.2014 en
(54) COMBINATIONS OF AKT INHIBITOR COMPOUNDS AND VEMURAFENIB, AND METHODS OF USE
(71) Genentech, Inc., One DNA Way, South San Francisco, CA 94080-4990, US
(72) HOEFLICH, Klaus, 1 DNA Way, South San Francisco California 94080-4990, US
MERCHANT, Mark, 1 DNA Way, South San Francisco California 94080-4990, US

- (51) MKP
A61K 49/00 (2006.01) (97) **2667900 ***
- (86) US2011064670 13.12.2011
(96) 11810932.1 04.12.2013
(87) WO2012102799, 13.12.2011
(97) 2667900, 04.12.2013 en
(54) METHOD, COMPOSITION AND PACKAGE FOR BOWEL CLEANSING
(71) Shaver, William A., 2405 Broadway Ave., Lubbock, Texas 79401-2918, US
(72) Shaver, William A., 2405 Broadway Ave., Lubbock, Texas 79401-2918, US

- (51) MKP
A61K 38/17 (2006.01) (97) **2699592 ***
A61P 35/00 (2006.01)
C07K 14/705 (2006.01)
C12N 15/12 (2006.01)
C12N 15/62 (2006.01)
- (86) EP2012057219 19.04.2012
(96) 12715691.7 26.02.2014
(87) WO2012143477, 19.04.2012
(97) 2699592, 26.02.2014 en
(54) ANTICANCER FUSION PROTEIN
(71) Adamed sp. z o.o., Pienków 149, 05-152 Czosnów k/Warszawy, PL
(72) PIECZYKOLAN, Jerzy Szczepan, Gorajec - Zastawie 47, PL-22-463 Radeckznica, PL
PAWLAK, Sebastian Dominik, ul Majakowskiego 3/2, PL-01-420 Warszawa, PL
EREK, Bartłomiej Maciej, ul. Poludniowa 45/4, PL-97-200 Dabrowa, PL
RÓZGA, Piotr Kamil, ul. Bolesława Prusa 6/18, PL-96-100 Skierniewice, PL
SZAWŁOWSKA, Urszula Marta, ul. Klaudyny 16 m.8, PL-01-684 Warszawa, PL

- (51) MKP
A61K 9/70 (2006.01) (97) **2674154 ***
A61K 31/519 (2006.01)
- (86) KR2012001049 13.02.2012
(96) 12744173.1 18.12.2013
(87) WO2012108738, 13.02.2012
(97) 2674154, 18.12.2013 en
(54) SILDENAFIL-FREE BASE-CONTAINING FILM PREPARATION AND METHOD FOR PRODUCING SAME
(71) CTC Bio, Inc., 13 Jungdae-ro 40 gill Songpa-gu, Seoul 138-858, KR
(72) JEON, Hong-Ryeol, 202-1602 66 Maetan-ro 126 bungill Yeongtong-gu, Suwon-si Gyeonggi-do 443-793, KR
LEE, Bong-Sang, 106-308 27-9 Jungbu-daero 271 bungill Yeongtong-gu, Suwon-si Gyeonggi-do 443-757, KR
PARK, Su-Jun, 206-105 10 Dongcheon-ro 63 bungill Suji-gu, Yongin-si Gyeonggi-do 448-120, KR
CHA, Bong-Geun, 707-902 Haengjeong-dongro 101-1 Hyangnam-eup, Hwaseong-si Gyeonggi-do 445-823, KR
KIM, Jun-Ki, 401 Usin Villa Hyochon-Songam gill Namil-myeon, Cheongwon-gun Chungcheongbuk-do 363-844, KR

- (51) MKP
A61M 5/20 (2006.01) (97) **2661294 ***
A61M 5/32 (2006.01)
- (86) EP2011074277 30.12.2011
(96) 11811358.8 13.11.2013
(87) WO2012093072, 30.12.2011
(97) 2661294, 13.11.2013 en
(54) A SAFETY DEVICE FOR A PRE-FILLED SYRINGE AND AN INJECTION DEVICE
- (71) Sanofi-Aventis Deutschland GmbH, Brüningstraße 50, 65929 Frankfurt, DE
(72) ROBERTS, Gareth, Glendale Pen-y-cae Road Ruabon, Wrexham LL14 6EB, GB
SLEMMEN, John, 34 Empress Road Liscard Wallasey Wirral, Merseyside CH44 0AP, GB
EKMAN, Matthew, 59 Ecton Avenue, Macclesfield Cheshire SK10 1RD, GB
-
- (51) MKP
A01C 5/06 (2006.01) (97) **2675261 ***
A01C 7/20 (2006.01)
- (86) IB2012050758 20.02.2012
(96) 12710333.1 25.12.2013
(87) WO2012110992, 20.02.2012
(97) 2675261, 25.12.2013 en
(54) SEED DRILL WITH MULTI-ROW SOWING ELEMENTS
- (71) Maschio Gaspardo S.p.A., Via Marcello 73, 35011 Campodarsego (PD), IT
(72) MASCHIO, Egidio, Via Marcello 73, I-35011 Campodarsego (PD), IT
-
- (51) MKP
C02F 1/00 (2006.01) (97) **2691340 ***
- (86) US2011051236 12.09.2011
(96) 11862833.8 05.02.2014
(87) WO2012134526, 12.09.2011
(97) 2691340, 05.02.2014 en
(54) METHOD AND SYSTEM FOR TREATING WATER USED FOR INDUSTRIAL PURPOSES
- (71) Crystal Lagoons (Curaçao) B.V., Kaya W.F.G. (Jombi), Mensing 14, CW
(72) FISCHMANN T., Fernando, Avenida Kennedy, Vitacura, Santiago 8830, CL
-
- (51) MKP
F03D 1/04 (2006.01) (97) **2691645 ***
F03D 7/02 (2006.01)
- (86) US2012031490 30.03.2012
(96) 12714465.7 05.02.2014
(87) WO2012135638, 30.03.2012
(97) 2691645, 05.02.2014 en
(54) FLUID TURBINE WITH VARIABLE PITCH SHROUD SEGMENTS
- (71) Flodesign Wind Turbine Corp., 221 Crescent St. Suite 103a, Waltham, MA 02453, US
(72) PRESZ, Walter, M., Jr., 40 Grove Street, Wilbraham, MA 01095, US
WERLE, Michael, J., 4 Porter Drive, West Hartford, CT 06117, US
HJORT, Soren, Buskelundtoften 77, DK-8600 Silkeborg, DK
RUBAK, Rune, Heimdalsvej 3, DK-8600 Silkeborg, DK
LOVMAND, Bo, Ornevaenget 13, DK-8370 Hadsten, DK
DALSGAARD, Soren, Bakkevej 3 Lerbjerg, DK-8370 Hadsten, DK
-
- (51) MKP
B24D 3/00 (2006.01) (97) **2551057**
B24D 11/00 (2006.01)
- (96) 11175222.6 30.01.2013
(97) 2551057, 30.01.2013 de
(54) Method for producing a coated abrasive, coated abrasive and use of a coated abrasive
- (71) sia Abrasives Industries AG, Mühlewiesenstrasse 20, 8501 Frauenfeld, CH
(72) Schoch, Adrian, Sporengasse 8, 8532 Warth, CH
Oberhänkli, Bruno, Walzmühlestrasse 13, 8500 Frauenfeld, CH

- (51) MKP
A61K 31/436 (2006.01) (97) **2675451 ***
A61K 31/519 (2006.01)
A61K 45/06 (2006.01)
A61P 35/00 (2006.01)
A61P 35/02 (2006.01)
- (86) US2012025581 17.02.2012
(96) 12705608.3 25.12.2013
(87) WO2012112847, 17.02.2012
(97) 2675451, 25.12.2013 en
(54) mTOR/JAK INHIBITOR COMBINATION THERAPY
- (71) Novartis Pharma AG, Postfach, 4002 Basel, CH
Incyte Corporation, Experimental Station Route 141&Henry Clay Road Building E336, Wilmington, Delaware 19880, US
(72) VANNUCCHI, Alessandro, M., Viale Morgagni 85, I-50134 Florence, IT
BOGANI, Costanza, Viale Morgagni 85, I-50134 Florence, IT
GUGLIELMELLI, Paola, Viale Morgagni 85, I-50134 Florence, IT
-
- (51) MKP
E05F 3/04 (2006.01) (97) **2655770 ***
E05F 3/10 (2006.01)
E05F 3/22 (2006.01)
- (86) DE2011075267 11.11.2011
(96) 11837283.8 30.10.2013
(87) WO2012083941, 11.11.2011
(97) 2655770, 30.10.2013 de
(54) MOUNTING ASSEMBLY FOR A DOOR ACTUATOR FOR MOUNTING ON A MOUNTING PLATE WITHOUT THE USE OF CONNECTING MEANS
- (71) Dorma GmbH + Co. KG, DORMA Platz 1, 58256 Ennepetal, DE
(72) HELLWIG, Alexander, Leibnitzstr. 53, 58256 Ennepetal, DE
SALUTZKI, Thomas, Zu den Tannen 9, 58456 Witten, DE
-
- (51) MKP
B82Y 30/00 (2011.01) (97) **2657323 ***
C10M 103/06 (2006.01)
C10M 177/00 (2006.01)
- (86) UA2011000117 16.11.2011
(96) 11851873.7 30.10.2013
(87) WO2012087261, 16.11.2011
(97) 2657323, 30.10.2013 en
(54) NANOSTRUCTURE OF A REVITALIZING AGENT AND METHOD FOR PRODUCING A STABLE FORM OF A NANOSTRUCTURE OF A REVITALIZING AGENT
- (71) Zozulya, Vladimir Leonidovich, Per. 23 Avgusta, 4, Kharkov 61018, UA
Zozulya, Sergey Leonidovich, ul. Sumgait'skaya, 4-3, Kharkov, 61018, UA
Alexandrov, Sergey Nikolaevich, ul. 2-y Pyatiletky 18-54, Kharkov, 61007, UA
(72) Zozulya, Vladimir Leonidovich, Per. 23 Avgusta, 4, Kharkov 61018, UA
Zozulya, Sergey Leonidovich, ul. Sumgait'skaya, 4-3, Kharkov, 61018, UA
Alexandrov, Sergey Nikolaevich, ul. 2-y Pyatiletky 18-54, Kharkov, 61007, UA
-
- (51) MKP
A61K 9/16 (2006.01) (97) **2648699 ***
A61K 9/20 (2006.01)
A61P 25/04 (2006.01)
- (86) GB2011052455 09.12.2011
(96) 11808286.6 16.10.2013
(87) WO2012076907, 09.12.2011
(97) 2648699, 16.10.2013 en
(54) DOSAGE FORM
- (71) Euro-Celtique S.A., 2, avenue Charles de Gaulle, 1653 Luxembourg, LU
(72) MOHAMMAD, Hassan, c/o Mundipharma Research Limited 191 Cambridge Science Park Milton Road, Cambridge Cambridgeshire CB4 0GW, GB

- (51) MKP
A61K 39/04 (2006.01) (97) **2651437 ***
 (86) EP2011072816 14.12.2011
 (96) 11799673.6 23.10.2013
 (87) WO2012080369, 14.12.2011
 (97) 2651437, 23.10.2013 en
 (54) MYCOBACTERIUM ANTIGENIC COMPOSITION
 (71) GlaxoSmithKline Biologicals S.A., rue de l'Institut, 89, 1330 Rixensart, BE
 (72) GODART, Stephane Andre Georges, GlaxoSmithKline Biologicals s.a. rue de l'Institut 89, B-1330 Rixensart, BE
 LAANAN, Amina, GlaxoSmithKline Biologicals s.a. rue de l'Institut 89, B-1330 Rixensart, BE
 LEMOINE, Dominique Ingrid, GlaxoSmithKline Biologicals s.a. rue de l'Institut 89, B-1330 Rixensart, BE
-

- (51) MKP
C07K 16/00 (2006.01) (97) **2683735 ***
C07K 16/46 (2006.01)
 (86) US2012028607 09.03.2012
 (96) 12710414.9 15.01.2014
 (87) WO2012122528, 09.03.2012
 (97) 2683735, 15.01.2014 en
 (54) BISPECIFIC THREE-CHAIN ANTIBODY-LIKE MOLECULES
 (71) HCO Antibody, Inc., 2747 Ross Road Suite A, Palo Alto, CA 94303, US
 (72) BUELOW, Roland, 2747 Ross Road, Palo Alto, CA 94303, US
 VAN SCHOOTEN, Wim, 1444 Floyd Avenue, Sunnyvale, CA 94087, US
-

- (51) MKP
C07C 311/08 (2006.01) (97) **2688878 ***
C07C 311/21 (2006.01)
C07D 307/80 (2006.01)
C07D 307/84 (2006.01)
 (86) FR2012050606 23.03.2012
 (96) 12717364.9 29.01.2014
 (87) WO2012127173, 23.03.2012
 (97) 2688878, 29.01.2014 fr
 (54) PROCESS FOR SYNTHESIZING KETO-BENZOFURAN DERIVATIVES
 (71) SANOFI, 54 rue La Boétie, 75008 Paris, FR
 (72) GRIMAUD, Bernard, c/o Sanofi Patent Department 54 rue La Boétie, F-75008 Paris, FR
 GROSSI, Pierre-Jean, c/o Sanofi Patent Department 54 rue La Boétie, F-75008 Paris, FR
-

- (51) MKP
G01N 24/08 (2006.01) (97) **2686671 ***
 (86) US2012028759 12.03.2012
 (96) 12757887.0 22.01.2014
 (87) WO2012125553, 12.03.2012
 (97) 2686671, 22.01.2014 en
 (54) N-ACETYLHEXOSAMINE-CONTAINING N-GLYCANS IN GLYCOPROTEIN PRODUCTS
 (71) Momenta Pharmaceuticals, Inc., 675 West Kendall Street, Cambridge, MA 02142, US
 (72) WASHBURN, Nathaniel, 543 King Street, Littleton, MA 01460, US
 AREVALO, Enrique, 86 Walnut Street Apt. 3, Dorchester, MA 02122-3633, US
 MILLEA, Kevin, 142 Main Street, Saugus, MA 01906, US
 BOSQUES, Carlos J., 40 Brattle Street 7, Arlington, MA 02476, US
 DUFFNER, Jay, 29 Lawton Road, Shirley, MA 01464, US
 COLLINS, Brian Edward, 30 Country Club Drive, Arlington, MA 02474, US
-

- (51) MKP
E21B 43/26 (2006.01) (97) **2655795 ***
E21B 43/267 (2006.01)
 (86) CA2011050802 22.12.2011
 (96) 11850531.2 30.10.2013
 (87) WO2012083463, 22.12.2011
 (97) 2655795, 30.10.2013 en
 (54) MULTI-STAGE FRACTURE INJECTION PROCESS FOR ENHANCED RESOURCE PRODUCTION FROM SHALES
 (71) Dusseault, Maurice B., 246 Shakespeare Drive, Waterloo, Ontario N2L 2T6, CA
 Bilak, Roman, 49 MacEwan Park Close NW, Calgary, AB T3K 3Z6, CA
 (72) Dusseault, Maurice B., 246 Shakespeare Drive, Waterloo, Ontario N2L 2T6, CA
 Bilak, Roman, 49 MacEwan Park Close NW, Calgary, AB T3K 3Z6, CA
-

- (51) MKP
A61K 31/336 (2006.01) (97) **2646016 ***
A61P 3/04 (2006.01)
 (86) US2011062413 29.11.2011
 (96) 11794331.6 09.10.2013
 (87) WO2012075020, 29.11.2011
 (97) 2646016, 09.10.2013 en
 (54) TREATMENT OF OBESITY USING NON-DAILY ADMINISTRATION OF 6 - 0 - (4 - DIMETHYLAMINOETHOXY) CINNAMOYL FUMAGILLOL
 (71) Zafgen, Inc., One Broadway, 8th Floor, Cambridge, MA 02142, US
 (72) HUGHES, Thomas, E., 89 Wilson Road, Concord MA 01742, US
-

- (51) MKP
A61L 2/07 (2006.01) (97) **2694118 ***
 (86) EP2012001250 21.03.2012
 (96) 12713878.2 12.02.2014
 (87) WO2012136313, 21.03.2012
 (97) 2694118, 12.02.2014 de
 (54) METHOD FOR STEAM STERILIZATION OF MEDICAL ARTICLES
 (71) Klosterfrau Berlin GmbH, Motzener Straße 41, 12277 Berlin, DE
 (72) MEIER, Andreas, Rieppelstrasse 2, 13629 Berlin, DE
 MIETHING, Holger, Hochfeilerweg 8, 12107 Berlin, DE
-

(51) MKP
C07D 223/08 (2006.01) (97) **2683687 ***
C07D 405/12 (2006.01)
C07D 401/04 (2006.01)
A61K 31/445 (2006.01)
C07D 211/46 (2006.01)
C07D 403/04 (2006.01)
C07D 207/48 (2006.01)
C07D 401/14 (2006.01)
C07D 207/12 (2006.01)
C07D 401/10 (2006.01)
C07D 309/12 (2006.01)
C07D 207/273 (2006.01)
C07D 211/96 (2006.01)
C07D 403/10 (2006.01)
C07D 401/06 (2006.01)
(86) US2012027658 05.03.2012
(96) 12709453.0 15.01.2014
(87) WO2012122077, 05.03.2012
(97) 2683687, 15.01.2014 en
(54) PRIMARY AMINE DIAZENIUMDIOLATE HETEROCYCLIC DERIVATIVES
(71) Merck Sharp & Dohme Corp., 126 East Lincoln Avenue, Rahway NJ 07065-0907, US
(72) SHAH, Shrenik, K., 25 Denise Court, Metuchen, New Jersey 08840, US
ALI, Amjad, 126 East Lincoln Avenue, Rahway, New Jersey 07065-0907, US
LO, Michael Man-Chu, 126 East Lincoln Avenue, Rahway, New Jersey 07065-0907, US
WHITEHEAD, Brent, 126 East Lincoln Avenue, Rahway, New Jersey 07065-0907, US
HENDERSON, Timothy, J., 126 East Lincoln Avenue, Rahway, New Jersey 07065-0907, US
YAN, Lin, 126 East Lincoln Avenue, Rahway, New Jersey 07065-0907, US
GUO, Zhiqiang, 126 East Lincoln Avenue, Rahway, New Jersey 07065-0907, US

(51) MKP
C07K 14/435 (2006.01) (97) **2661496 ***
C07K 14/705 (2006.01)
C07K 14/78 (2006.01)
C12N 15/62 (2006.01)
(86) EP2012050145 05.01.2012
(96) 12700215.2 13.11.2013
(87) WO2012093158, 05.01.2012
(97) 2661496, 13.11.2013 en
(54) ANTICANCER FUSION PROTEIN
(71) Adamed Sp. z o.o., Pienków 149, 05-152 Czosnów k/Warszawy, PL
(72) PIECZYKOLAN, Jerzy Szczepan, Gorajec - Zastawie 47, 22-463 Radeckznica, PL
PAWLAK, Sebastian Dominik, ul Majakowskiego 3/2, 01-420 Warszawa, PL
ZEREK, Bartłomiej Maciej, ul. Poludniowa 45/4, 97-200 Dabrowa, PL
RÓZGA, Piotr Kamil, ul. Bolesława Prusa 6/18, 96-100 Skierniewice, PL

(51) MKP
A61K 31/21 (2006.01) (97) **2594556**
A61K 31/435 (2006.01)
C07C 233/47 (2006.01)
C07D 213/82 (2006.01)
C07D 239/36 (2006.01)
C07D 261/18 (2006.01)
C07D 271/06 (2006.01)
(96) 13151792.2 22.05.2013
(97) 2594556, 22.05.2013 en
(54) Substituted aminopropionic derivatives as neprilysin inhibitors
(71) Novartis AG, Lichtstrasse 35, 4056 Basel, CH
(72) Coppola, Gary Mark, 18 Aldersgate Circle, Budd Lake, NJ 07828, US
Iwaki, Yuki, Novartis Institutes for BioMedical Research Inc., 400 Technology Square, Cambridge, MA 02139, US
Karki, Rajeshri Ganesh, Novartis Institutes for BioMedical Research Inc., 100 Technology Square, Cambridge, MA Massachusetts 02139, US
Kawanami, Toshio, Novartis Institutes for BioMedical Research Inc., 100 Technology Square, Cambridge, MA 02139, US
Ksander, Gary Michael, Novartis Institutes for BioMedical Research Inc., 100 Technology Square, Cambridge, MA 02139, US
Mogi, Muneto, Novartis Institutes for BioMedical Research Inc., 100 Technology Square, Cambridge, MA 02139, US
Sun, Robert, Novartis Institutes for BioMedical Research Inc., 100 Technology Square, Cambridge, MA 02139, US

(51) MKP
H01L 21/00 (2006.01) (97) **2684210 ***
(86) US2011027479 08.03.2011
(96) 11860252.3 15.01.2014
(87) WO2012121706, 08.03.2011
(97) 2684210, 15.01.2014 en
(54) EFFICIENT BLACK SILICON PHOTOVOLTAIC DEVICES WITH ENHANCED BLUE RESPONSE
(71) Alliance for Sustainable Energy, LLC, 1617 Cole Blvd., Golden, CO 80401, US
(72) OH, Jihun, c/o National Renewable Energy Laboratory 1617 Cole Boulevard, Golden, CO 80401, US
BRANZ, Howard, M., c/o National Renewable Energy Laboratory 1617 Cole Boulevard, Golden, CO 80401, US
YUAN, Hao-Chih, c/o National Renewable Energy Laboratory 1617 Cole Boulevard, Golden, CO 80401, US

(51) MKP
A61K 9/00 (2006.01) (97) **2651390 ***
A61K 9/20 (2006.01)
A61K 31/437 (2006.01)
A61K 33/00 (2006.01)
A61K 33/10 (2006.01)
A61P 25/20 (2006.01)
(86) EP2011072918 15.12.2011
(96) 11794519.6 23.10.2013
(87) WO2012080399, 15.12.2011
(97) 2651390, 23.10.2013 en
(54) ZOLPIDEM-BASED ORODISPERSIBLE PHARMACEUTICAL TABLET
(71) Sanofi, 174 avenue de France, 75013 Paris, FR
(72) MARTINEZ, Annick, c/o Sanofi Patent Department 174 Avenue de France, F-75013 Paris, FR
ROUGEOT, Olivier, c/o Sanofi Patent Department 174 Avenue de France, F-75013 Paris, FR
YAGUCHI, Yoshikatsu, c/o Sanofi Patent Department 174 Avenue de France, F-75013 Paris, FR

(51) MKP
B23B 27/04 (2006.01) (97) **2656950 ***
B23B 27/16 (2006.01)
(86) JP2011077562 29.11.2011
(96) 11851906.5 30.10.2013
(87) WO2012086375, 29.11.2011
(97) 2656950, 30.10.2013 en
(54) CUTTING TOOL AND METHOD FOR MANUFACTURING CUT PRODUCT USING SAME
(71) Kyocera Corporation, 6, Takeda Tobadono-cho, Fushimi-ku, Kyoto-shi, Kyoto-fu 612-8501, JP
(72) INOUE, Yoshihiro, c/o KYOCERA CORPORATION Head Office 6, Takeda Tobadono-cho Fushimi-ku., Kyoto-shi Kyoto 612-8501, JP

(51) MKP
A61K 9/00 (2006.01) (97) **2594266**
A61K 31/192 (2006.01)
A61K 47/02 (2006.01)
(96) 11009132.9 22.05.2013
(97) 2594266, 22.05.2013 en
(54) Pharmaceutical solid compositions containing ibuprofen salts
(71) Zambon S.p.A., Via Lillo del Duca, 10, 20091 Bresso MI, IT
(72) Moretto, Alberto, Via Martiri di Cefalonia, 5, 35020 Ponte San Nicolò (Padova), IT
De Lazzari, Alessandra, Via Ivrea, 2, 35142 Padova, IT
Dicorato, Lucia, Piazzale della Stazione, 21, 35131 Padova, IT

(51) MKP
A61L 2/07 (2006.01) (97) **2596810**
A61L 11/00 (2006.01)
B01J 3/04 (2006.01)
B29B 17/00 (2006.01)
(96) 12191571.4 29.05.2013
(97) 2596810, 29.05.2013 en
(54) Method for sterilisation of used absorbent sanitary products
(71) Fater S.p.A., Via Alessandro Volta, 10, 65129 Pescara, IT
(72) SOMMA, Marcello, Viale Regina Elena, 74, I-65122 Pescara, IT
VACCARO, Giorgio, Via Primo Levi, 7, I-65010 Spoltore (Pescara), IT
MICHALEK, Jan K., 3762 Alward Road, Pataskala, OH Ohio 43062, US
THOMAS, Theodore, 864 Lookout Point Drive, Columbus, OH Ohio 43235, US

(51) MKP
C12N 5/0797 (2010.01) (97) **2663638 ***
(86) IB2012000030 12.01.2012
(96) 12701024.7 20.11.2013
(87) WO2012095730, 12.01.2012
(97) 2663638, 20.11.2013 en
(54) CULTURE METHOD TO OBTAIN AND MAINTAIN A PURE OR ENRICHED POPULATION OF MAMMALIAN NEURAL STEM CELLS AND/OR NEURAL PROGENITOR CELLS THAT ARE PRONE TO DIFFERENTIATE INTO OLIGODENDROCYTE-LINEAGE CELLS IN VITRO
(71) Kido, Tsuneo, 15620 Marathon Circle Suite 403, Gaithersburg, MD 20878, US
(72) Kido, Tsuneo, 15620 Marathon Circle Suite 403, Gaithersburg, MD 20878, US

(51) MKP
C12P 21/06 (2006.01) (97) **2649189 ***
(86) US2011063955 08.12.2011
(96) 11846172.2 16.10.2013
(87) WO2012078878, 08.12.2011
(97) 2649189, 16.10.2013 en
(54) TNF- BINDING PROTEINS
(71) AbbVie Inc., 1 North Waukegan Road, North Chicago, IL 60064, US
(72) HSIEH, Chung-ming, 22 Olde Field Road, Newton, Massachusetts 02459, US
GOODREAU, Carrie, 201 Stevens Street, Ludlow, Massachusetts 01056, US
GHAYUR, Tariq, 1014 Washington Street, Holliston, Massachusetts 01746, US
MOELLER, Achim, Im Zaunruecken 10, 67269 Gruenstadt, DE
BOSE, Sahana, 48 Frobos Avenue, Marlborough, Massachusetts 01752, US

(51) MKP
C21D 8/04 (2006.01) (97) **2689045 ***
C21D 9/46 (2006.01)
C22C 38/02 (2006.01)
C22C 38/04 (2006.01)
C22C 38/12 (2006.01)
C22C 38/14 (2006.01)
C23C 2/06 (2006.01)
(86) FR2012000104 23.03.2012
(96) 12714743.7 29.01.2014
(87) WO2012127136, 23.03.2012
(97) 2689045, 29.01.2014 fr
(54) HOT-ROLLED STEEL SHEET AND ASSOCIATED PRODUCTION METHOD
(71) Arcelormittal Investigación y Desarrollo SL, CL/Chavari, 6, 48910 Sestao, Bizkaia, ES
(72) PERLADE, Astrid, 49A rue Albert Bosch, F-57950 Montigny les Metz, FR
AMARD, Aurélie, 4 boucle des Frères Lumière, F-57100 Thionville, FR
PECHENOT, Florence, 9 rue des Prêles, F-57000 Metz, FR
STENBACK, Erik, 16 boulevard Clemenceau, F-57000 Metz, FR
PIPARD, Jean Marc, 4 derrière la Loi, F-57130 Vaux, FR
HASSANI, Farid, E., 925 Hawk Circle, Crown Point, IN 46307, US

(51) MKP
A01N 37/34 (2006.01) (97) **2663188 ***
A01N 41/06 (2006.01)
A01N 43/50 (2006.01)
A01P 3/00 (2006.01)
(86) JP2012051004 11.01.2012
(96) 12702619.3 20.11.2013
(87) WO2012096405, 11.01.2012
(97) 2663188, 20.11.2013 en
(54) METHOD FOR CONTROLLING CLUBROOT
(71) Ishihara Sangyo Kaisha, Ltd., 3-15 Edobori 1-chome Nishi-ku, Osaka-shi, Osaka 550-0002, JP
(72) HAYASHI, Hiroyuki, c/o Ishihara Sangyo Kaisha, Ltd. Chuo Kenkyusho, 3-1, Nishi-shibukawa 2-chome Kusatsu-shi Shiga 525-0025, JP
OHNO, Masanari, c/o Ishihara Sangyo Kaisha, Ltd. Chuo Kenkyusho, 3-1, Nishi-shibukawa 2-chome Kusatsu-shi Shiga 525-0025, JP

(51) MKP
A61M 1/14 (2006.01) (97) **2668497 ***
G01N 33/50 (2006.01)
G01N 33/53 (2006.01)
(86) US2012022028 20.01.2012
(96) 12739834.5 04.12.2013
(87) WO2012102963, 20.01.2012
(97) 2668497, 04.12.2013 en
(54) URINE BIOMARKERS FOR PREDICTION OF RECOVERY AFTER ACUTE KIDNEY INJURY : PROTEOMICS
(71) University of Pittsburgh of the Commonwealth System of Higher Education, 200 Gardner Steel Conference Center O'Hara & Thackeray Streets, Pittsburgh, PA 15260, US
(72) SINGBARTL, Kai, 413 S. Highland Avenue Apt. 2, Pittsburgh PA 15206, US
KELLUM, John, A., 5541 Hampton Street, Pittsburgh PA 15206, US

**INDEKS BROJEVA ZAHTJEVA ZA PROŠIRENJE EVROPSKIH PRIJAVA
PATENTA**
INDEX ON NUMBER OF REQUESTS FOR EXTENSION ON EUROPEAN PATENT
APPLICATIONS

Broj objave evropske prijave patenta (97)	MKP (51)	Broj objave evropske prijave patenta (97)	MKP (51)	Broj objave evropske prijave patenta (97)	MKP (51)
2690951 *	A01N 3/02 (2006.01) A01N 25/34 (2006.01) A01N 27/00 (2006.01) A23B 7/152 (2006.01) A23L 3/3445 (2006.01) C08F 2/46 (2006.01) C08J 7/04 (2006.01) C08K 5/01 (2006.01) C08K 5/101 (2006.01) C08K 5/16 (2006.01)	2696848 *	A61K 9/00 (2006.01) A61K 9/14 (2006.01) A61K 9/19 (2006.01)	2697199 *	A61K 31/4412 (2006.01) A61K 31/444 (2006.01) A61P 35/00 (2006.01) C07D 213/64 (2006.01) C07D 401/12 (2006.01) C07D 405/12 (2006.01) C07D 409/12 (2006.01) C07D 413/12 (2006.01) C07D 417/12 (2006.01) C07D 491/08 (2006.01) C07D 491/107 (2006.01)
2700648 *	A61K 38/10 (2006.01) A61P 31/00 (2006.01) C07K 1/04 (2006.01) C07K 1/06 (2006.01) C07K 7/08 (2006.01)	2672991 *	A61K 36/06 (2006.01) A61K 39/29 (2006.01) C07K 14/02 (2006.01)	2649888	A24B 13/00 (2006.01) A24B 15/30 (2006.01)
2697368 *	C12N 7/00 (2006.01)	2662388 *	C07K 16/22 (2006.01)	2683377 *	A61K 31/4184 (2006.01) A61K 31/4439 (2006.01) A61K 31/52 (2006.01) A61K 39/00 (2006.01) A61K 45/06 (2006.01) A61P 35/00 (2006.01) A61P 35/02 (2006.01)
2673712 *	G06F 1/32 (2006.01) G06F 11/30 (2006.01) H04L 12/24 (2006.01) H05K 7/14 (2006.01)	2686298 *	A61K 31/255 (2006.01) A61K 31/37 (2006.01) A61K 31/655 (2006.01) A61P 35/00 (2006.01) C07C 305/24 (2006.01) C07C 307/02 (2006.01) C07D 311/12 (2006.01)	2684916	C09C 1/02 (2006.01) D21H 17/00 (2006.01)
2663189 *	A01N 43/56 (2006.01)	2694859 *	F16L 53/00 (2006.01)	2656077 *	G01N 33/574 (2006.01)
2681231 *	C07K 1/18 (2006.01) C07K 14/47 (2006.01) C07K 14/52 (2006.01)	2672986 *	A61K 38/20 (2006.01) A61K 47/48 (2006.01)	2666764 *	A61K 31/295 (2006.01) A61P 3/12 (2006.01) C07C 51/41 (2006.01) C07C 59/265 (2006.01)

Broj objave evropske prijave patenta (97)	MKP (51)	Broj objave evropske prijave patenta (97)	MKP (51)	Broj objave evropske prijave patenta (97)	MKP (51)
2674162	A23L 1/30 (2006.01) A61K 35/74 (2006.01) A61L 29/08 (2006.01) A61L 29/16 (2006.01) A61P 1/00 (2006.01) A61P 19/06 (2006.01) A61P 31/04 (2006.01) C12R 1/225 (2006.01)	2699550 *	A61K 31/4706 (2006.01) A61K 31/4709 (2006.01) A61P 29/00 (2006.01) A61P 35/00 (2006.01) C07D 215/42 (2006.01) C07D 215/44 (2006.01) C07D 401/12 (2006.01)	2694160 *	A61K 31/435 (2006.01) A61P 31/18 (2006.01) C07D 491/06 (2006.01)
		2680831 *	A61K 31/4155 (2006.01) A61P 9/14 (2006.01) A61K 31/41 (2006.01) A61K 31/616 (2006.01) A61K 31/405 (2006.01) A61K 31/505 (2006.01) A61K 31/366 (2006.01) A61K 31/44 (2006.01) A61K 31/4015 (2006.01) A61K 31/47 (2006.01) A61K 31/416 (2006.01) A61K 31/122 (2006.01) A61K 31/422 (2006.01) A61K 31/415 (2006.01) A61P 9/10 (2006.01)	2694067 *	A61K 31/4985 (2006.01) A61K 31/5377 (2006.01) A61P 35/00 (2006.01) A61P 43/00 (2006.01) C07D 471/04 (2006.01)
2651933 *	A61K 31/437 (2006.01) A61P 31/12 (2006.01) C07D 471/04 (2006.01)			2513105 *	A61K 31/519 (2006.01) A61P 25/00 (2006.01) C07D 471/04 (2006.01) C07D 487/04 (2006.01)
2694038 *	A61K 9/20 (2006.01) A61K 9/50 (2006.01) A61K 31/198 (2006.01) A61K 47/48 (2006.01)			2675503 *	A61M 5/20 (2006.01) A61M 5/32 (2006.01)
2697385 *	A61K 39/02 (2006.01) C07K 14/195 (2006.01) C07K 14/34 (2006.01) C12P 21/00 (2006.01)			2694526 *	C07H 21/00 (2006.01) C12Q 1/68 (2006.01)
2648729 *	A61K 31/44 (2006.01) A61K 31/498 (2006.01) A61K 31/519 (2006.01) A61P 35/00 (2006.01)	2517648	A61B 17/072 (2006.01)	2661417 *	C03C 17/36 (2006.01)
2675697 *	B63B 35/32 (2006.01) E02B 15/04 (2006.01)	2681215 *	A61K 31/519 (2006.01) A61P 35/00 (2006.01) C07D 471/04 (2006.01)	2683242 *	A01N 43/00 (2006.01)
2692694 *	C02F 1/32 (2006.01) C02F 1/36 (2006.01)	2695883 *	C07D 487/18 (2006.01)	2690998 *	A47K 3/06 (2006.01)
2678013 *	A61K 31/4196 (2006.01) A61P 35/00 (2006.01)	2685989 *	A61K 31/4166 (2006.01) A61K 31/7088 (2006.01) A61P 5/28 (2006.01) A61P 35/00 (2006.01)	2624185	G06Q 10/08 (2012.01)
				2645896 *	A43B 7/12 (2006.01)
				2665658 *	B65D 19/38 (2006.01)

Broj objave evropske prijave patenta (97)	MKP (51)	Broj objave evropske prijave patenta (97)	MKP (51)	Broj objave evropske prijave patenta (97)	MKP (51)
2655595 *	A61K 35/74 (2006.01) A61P 17/00 (2006.01) C12N 1/20 (2006.01) C12R 1/36 (2006.01)	2670438 *	A61K 39/395 (2006.01)	2430014 *	A61K 31/4178 (2006.01) A61K 31/4188 (2006.01) A61P 31/12 (2006.01) C07D 401/14 (2006.01) C07D 403/04 (2006.01) C07D 403/14 (2006.01) C07D 405/14 (2006.01) C07D 409/14 (2006.01) C07D 413/04 (2006.01) C07D 417/04 (2006.01) C07D 417/14 (2006.01) C07D 495/04 (2006.01)
2679234	A61K 38/00 (2006.01) A61K 38/18 (2006.01) C07K 14/00 (2006.01) C07K 14/05 (2006.01) C07K 14/475 (2006.01) C07K 14/50 (2006.01) C07K 14/705 (2006.01)	2676345 *	H02G 1/12 (2006.01)	2683821 *	C12N 15/10 (2006.01)
2691779 *	A61B 5/024 (2006.01) G01C 22/00 (2006.01) G01P 13/00 (2006.01) G06F 3/01 (2006.01) G06F 3/033 (2013.01)	2688439 *	A44C 5/04 (2006.01) A44C 5/06 (2006.01) A44C 13/00 (2006.01)	2649099 *	A61K 31/66 (2006.01) A61K 31/7076 (2006.01) A61K 31/708 (2006.01) A61P 31/00 (2006.01) C07K 17/02 (2006.01)
2699261 *	A61K 39/395 (2006.01)	2689119 *	F01N 3/20 (2006.01)	2609830	A45D 34/04 (2006.01) A61K 8/02 (2006.01) A61K 9/20 (2006.01) A61Q 19/02 (2006.01) B65D 81/32 (2006.01)
2695653 *	B01D 11/04 (2006.01) C22B 3/02 (2006.01)	2675792 *	C07D 257/04 (2006.01) A61K 31/4192 (2006.01) C07D 249/18 (2006.01) A61K 31/4164 (2006.01) C07D 249/04 (2006.01) C07C 233/47 (2006.01) A61P 13/00 (2006.01) C07D 231/14 (2006.01) C07D 403/04 (2006.01) A61K 31/42 (2006.01) C07D 261/12 (2006.01) A61K 31/4196 (2006.01) C07D 249/10 (2006.01) A61K 31/415 (2006.01) C07D 239/36 (2006.01) C07C 233/46 (2006.01) A61P 9/00 (2006.01) C07D 231/20 (2006.01) C07D 471/04 (2006.01) A61K 31/405 (2006.01)	2654940 *	B01J 3/04 (2006.01) B01J 4/02 (2006.01) C01B 11/02 (2006.01)
2590275	H01R 43/052 (2006.01) H01R 43/28 (2006.01)	2675432 *	A61K 9/00 (2006.01) A61K 33/04 (2006.01) A61P 15/02 (2006.01)	2652544 *	G02C 7/04 (2006.01)
2675432 *	A61K 9/00 (2006.01) A61K 33/04 (2006.01) A61P 15/02 (2006.01)	2678338 *	C07D 471/04 (2006.01)		
2678338 *	C07D 471/04 (2006.01)	2587770	G06F 17/30 (2006.01) G09B 5/00 (2006.01) H04L 29/08 (2006.01) H04M 1/725 (2006.01)		

Broj objave evropske prijave patenta (97)	MKP (51)	Broj objave evropske prijave patenta (97)	MKP (51)	Broj objave evropske prijave patenta (97)	MKP (51)
2646051 *	A61K 9/08 (2006.01) A61K 31/70 (2006.01) A61K 39/15 (2006.01) A61K 48/00 (2006.01) A61P 31/12 (2006.01)	2668167 *	C07D 231/14 (2006.01) C07D 275/03 (2006.01)	2695661	B01D 53/14 (2006.01) B01D 53/62 (2006.01) B01J 20/12 (2006.01) C01F 5/24 (2006.01) C01F 11/18 (2006.01) C02F 1/66 (2006.01) C02F 5/06 (2006.01) C02F 5/08 (2006.01)
		2573739	G07D 7/00 (2006.01) G07D 7/12 (2006.01)		
2699558 *	A61K 31/428 (2006.01) A61K 31/436 (2006.01) A61P 31/18 (2006.01) C07D 277/62 (2006.01) C07D 277/64 (2006.01) C07D 277/82 (2006.01) C07D 417/04 (2006.01) C07D 491/06 (2006.01)	2683859 *	D01D 1/02 (2006.01) D01D 5/06 (2006.01) D01D 5/40 (2006.01) D01F 2/00 (2006.01) D01F 2/24 (2006.01) D21H 13/00 (2006.01) D21H 15/00 (2006.01)	2678330 *	A61K 31/416 (2006.01) A61P 29/00 (2006.01) C07D 403/04 (2006.01)
		2675276 *	A01N 43/42 (2006.01) A61K 31/44 (2006.01)	2686788 *	G06F 17/30 (2006.01)
2694064 *	A61K 31/495 (2006.01)			2655356 *	A61K 31/404 (2006.01) A61P 25/04 (2006.01) C07D 401/12 (2006.01) C07D 401/14 (2006.01) C07D 403/12 (2006.01) C07D 403/14 (2006.01) C07D 471/04 (2006.01)
2688568 *	A61K 31/445 (2006.01)	2668182 *	A61K 31/422 (2006.01) A61P 29/00 (2006.01) C07D 413/04 (2006.01)		
2665479 *	A61K 31/4436 (2006.01) C12Q 1/68 (2006.01)	2661424 *	A01N 43/36 (2006.01) C07D 207/36 (2006.01) C07D 307/12 (2006.01) C07D 317/34 (2006.01) C07D 401/12 (2006.01) C07D 405/12 (2006.01) C07D 409/12 (2006.01)	2686734 *	A61B 1/00 (2006.01) A61B 1/06 (2006.01) G01B 11/25 (2006.01) G03B 17/54 (2006.01) G03B 35/08 (2006.01) G03B 37/00 (2006.01)
2651920 *	A61K 31/4439 (2006.01) A61P 31/00 (2006.01) C07D 401/12 (2006.01) C07D 401/14 (2006.01)				
2646423 *	A61K 31/53 (2006.01) C07D 251/54 (2006.01)	2658580 *	A61K 51/00 (2006.01) A61M 36/14 (2006.01)	2689010 *	A61P 35/00 (2006.01) C07K 14/705 (2006.01) C07K 16/28 (2006.01) C07K 16/30 (2006.01) C12N 5/0783 (2010.01)
2681486 *	F21S 8/08 (2006.01) F21S 9/03 (2006.01) F21V 21/10 (2006.01) F21W 131/103 (2006.01)	2694938 *	F17D 5/02 (2006.01) G01M 3/24 (2006.01) G01M 3/32 (2006.01)		
2671189 *	G06K 9/00 (2006.01)	2662338 *	C02F 1/52 (2006.01)		

Broj objave evropske prijava patenta (97)	MKP (51)	Broj objave evropske prijava patenta (97)	MKP (51)	Broj objave evropske prijava patenta (97)	MKP (51)
2684342 *	H04L 29/08 (2006.01) H04L 29/12 (2006.01)	2686441 *	C12Q 1/68 (2006.01)	2678502 *	E05C 17/44 (2006.01) E05C 17/54 (2006.01) E05C 19/00 (2006.01) E05C 19/18 (2006.01)
2656345 *	G03D 15/00 (2006.01) G11B 23/50 (2006.01)	2668960 *	A61K 39/395 (2006.01)		
2675507 *	A61M 5/20 (2006.01) A61M 5/315 (2006.01) A61M 5/32 (2006.01) A61M 5/50 (2006.01)	2657547	F16B 25/00 (2006.01)	2651474 *	A61M 5/32 (2006.01)
2683706 *	A61K 31/336 (2006.01) A61P 3/04 (2006.01) C07D 303/22 (2006.01) C07D 303/32 (2006.01) C07D 303/34 (2006.01) C07D 303/36 (2006.01) C07D 491/10 (2006.01)	2383756	H01F 29/14 (2006.01) H02M 1/16 (2006.01)	2668211 *	A61K 39/395 (2006.01) A61P 3/06 (2006.01) C07K 16/40 (2006.01)
2649359 *	F16L 55/10 (2006.01)	2652422 *	F26B 5/14 (2006.01)	2645846 *	A01H 1/04 (2006.01) G06F 19/14 (2011.01) G06F 19/18 (2011.01)
2665485 *	A61K 38/17 (2006.01) A61P 3/10 (2006.01) C07K 14/775 (2006.01)	2684341 *	H04L 29/08 (2006.01) H04L 29/12 (2006.01)	2663299 *	A61K 31/155 (2006.01) A61K 31/194 (2006.01) A61K 31/327 (2006.01) A61K 31/4045 (2006.01) A61K 31/4745 (2006.01) A61K 31/65 (2006.01) A61K 31/7048 (2006.01) A61K 31/7056 (2006.01) A61K 33/30 (2006.01) A61K 45/06 (2006.01) A61P 17/10 (2006.01)
2678318 *	A61K 31/416 (2006.01) A61K 31/4439 (2006.01) A61K 31/497 (2006.01) A61K 31/661 (2006.01) A61P 29/00 (2006.01) C07D 231/54 (2006.01) C07D 401/04 (2006.01) C07D 401/14 (2006.01) C07D 403/04 (2006.01) C07D 405/14 (2006.01) C07F 9/09 (2006.01)	2614211 *	E21B 17/01 (2006.01)		
		2681242 *	C07K 16/22 (2006.01) G21C 17/017 (2006.01) G21C 19/14 (2006.01)		
		2652154 *	C12Q 1/68 (2006.01)		
		2686306 *	A61K 31/538 (2006.01) A61P 5/18 (2006.01) C07D 265/36 (2006.01) C07D 413/04 (2006.01)	2668283 *	C12P 21/08 (2006.01)
		2623284	B29B 13/02 (2006.01)	2649363 *	F21K 2/06 (2006.01)
		2685930 *	A61C 11/08 (2006.01)	2565140	B65H 75/14 (2006.01) B65H 75/22 (2006.01)
		2513147 *	C07K 16/28 (2006.01)	2691382 *	C07D 307/81 (2006.01)

Broj objave evropske prijave patenta (97)	MKP (51)	Broj objave evropske prijave patenta (97)	MKP (51)	Broj objave evropske prijave patenta (97)	MKP (51)
2694752 *	E04F 11/18 (2006.01) E04G 21/32 (2006.01)	2606795	A47K 10/38 (2006.01)	2694492 *	A61K 31/5355 (2006.01) A61P 25/00 (2006.01) C07D 401/12 (2006.01) C07D 405/12 (2006.01) C07D 413/12 (2006.01)
2686310 *	A61K 31/357 (2006.01) A61P 19/00 (2006.01) A61P 29/00 (2006.01) C07D 319/20 (2006.01) C07D 405/10 (2006.01) C07D 405/12 (2006.01) C07D 405/14 (2006.01) C07D 487/10 (2006.01)	2681219 *	A61K 31/4985 (2006.01) A61P 25/28 (2006.01) C07D 487/04 (2006.01)	2681321 *	A01H 5/12 (2006.01) A24B 15/10 (2006.01) C12N 15/82 (2006.01)
2678422 *	C09K 8/582 (2006.01) C12N 1/26 (2006.01) C12N 9/00 (2006.01)	2672835 *	A23G 1/32 (2006.01) A23K 1/16 (2006.01) A23L 1/03 (2006.01) A23L 2/52 (2006.01) A23L 2/60 (2006.01) A61Q 1/00 (2006.01) A61Q 11/00 (2006.01) C07C 259/06 (2006.01)	2676303 *	H01L 35/24 (2006.01) H01L 51/00 (2006.01)
2549845	F03D 11/00 (2006.01) H02B 1/04 (2006.01) H02B 1/40 (2006.01) H05K 7/18 (2006.01)	2694547 *	C07K 16/22 (2006.01)	2651410 *	A61K 9/00 (2006.01) A61K 9/70 (2006.01) A61K 31/27 (2006.01)
2697229 *	A61K 31/519 (2006.01) A61P 31/00 (2006.01) C07D 487/04 (2006.01)	2650274	C01B 25/14 (2006.01) C07B 45/00 (2006.01) C07C 325/02 (2006.01) C07C 327/44 (2006.01) C07D 207/24 (2006.01) C07D 209/30 (2006.01) C07D 211/72 (2006.01) C07D 211/84 (2006.01) C07D 213/06 (2006.01) C07D 213/63 (2006.01) C07D 239/93 (2006.01) C07D 241/06 (2006.01)	2695332 *	G06F 3/048 (2013.01) H04L 12/28 (2006.01)
2651184	H05B 7/09 (2006.01)	2672955 *	A61J 1/05 (2006.01) B65D 81/32 (2006.01)	2672955 *	A61K 9/00 (2006.01) A61K 31/167 (2006.01)
2602777	G01C 21/34 (2006.01) G08G 1/01 (2006.01) G08G 1/0968 (2006.01) G08G 1/14 (2006.01)	2668187 *		2668187 *	A61K 31/5517 (2006.01) A61P 31/10 (2006.01) C07D 487/04 (2006.01)
2681552 *	G01N 33/50 (2006.01) G01N 33/574 (2006.01)	2646422 *		2646422 *	C07B 57/00 (2006.01) C07D 251/10 (2006.01)
2685986 *	A61K 31/55 (2006.01)	2675457 *		2675457 *	A61K 9/00 (2006.01) A61K 31/4985 (2006.01) A61P 31/22 (2006.01)
		2658536 *		2658536 *	A61K 31/19 (2006.01) A61P 1/18 (2006.01)

Broj objave evropske prijave patenta (97)	MKP (51)	Broj objave evropske prijave patenta (97)	MKP (51)	Broj objave evropske prijave patenta (97)	MKP (51)
2658530 *	A61K 9/00 (2006.01) A61K 9/20 (2006.01) A61K 9/50 (2006.01) A61K 31/4439 (2006.01)	2673729 *	G01N 33/48 (2006.01) G06F 19/22 (2011.01)	2688403 *	A01N 43/16 (2006.01) A61K 31/35 (2006.01)
2684444 *	A01F 12/18 (2006.01)	2662418	A24D 1/00 (2006.01) C09C 1/02 (2006.01) D21H 17/00 (2006.01) D21H 17/26 (2006.01) D21H 17/69 (2006.01)	2699561 *	A61K 31/4164 (2006.01) A61P 35/00 (2006.01) C07D 401/04 (2006.01) C07D 403/04 (2006.01) C07D 403/12 (2006.01) C07D 413/12 (2006.01) C07D 413/14 (2006.01) C07D 471/04 (2006.01) C07D 487/04 (2006.01) C07D 513/04 (2006.01)
2685956 *	A61J 1/03 (2006.01) B65D 75/32 (2006.01)	2684999	C01F 11/18 (2006.01) C08K 3/20 (2006.01) C09C 1/02 (2006.01) C09C 3/10 (2006.01) D21H 17/69 (2006.01) D21H 19/38 (2006.01) D21H 19/42 (2006.01) D21H 19/44 (2006.01) D21H 21/14 (2006.01)	2651925 *	A61K 31/4427 (2006.01) A61P 31/12 (2006.01) C07D 401/12 (2006.01) C07D 403/04 (2006.01) C07D 403/14 (2006.01)
2678441 *	C12Q 1/68 (2006.01)	2667719 *	A01N 41/04 (2006.01) A01N 43/50 (2006.01) A01N 43/56 (2006.01) A01N 43/60 (2006.01) A01N 43/72 (2006.01) A01N 47/06 (2006.01) A01N 47/10 (2006.01) A01N 47/18 (2006.01) A01N 47/30 (2006.01) A01N 47/34 (2006.01) A01N 47/40 (2006.01) A01N 47/44 (2006.01) A01N 59/02 (2006.01)	2684337 *	H04L 29/08 (2006.01) H04L 29/12 (2006.01)
2694508 *	A61K 31/519 (2006.01) A61P 35/00 (2006.01) C07D 487/04 (2006.01)	2687506	A01N 41/04 (2006.01) A01N 43/50 (2006.01) A01N 43/56 (2006.01) A01N 43/60 (2006.01) A01N 43/72 (2006.01) A01N 47/06 (2006.01) A01N 47/10 (2006.01) A01N 47/18 (2006.01) A01N 47/30 (2006.01) A01N 47/34 (2006.01) A01N 47/40 (2006.01) A01N 47/44 (2006.01) A01N 59/02 (2006.01)	2549563	H01M 2/02 (2006.01) H01M 2/10 (2006.01)
2648739 *	A61K 35/20 (2006.01) A61P 15/02 (2006.01)	2687555 *	C07C 269/04 (2006.01) C07D 223/16 (2006.01) C12P 41/00 (2006.01)	2597584	G06F 19/00 (2011.01)
2687506	C07C 269/04 (2006.01) C07D 223/16 (2006.01) C12P 41/00 (2006.01)	2668169 *	A01N 41/04 (2006.01) A01N 43/50 (2006.01) A01N 43/56 (2006.01) A01N 43/60 (2006.01) A01N 43/72 (2006.01) A01N 47/06 (2006.01) A01N 47/10 (2006.01) A01N 47/18 (2006.01) A01N 47/30 (2006.01) A01N 47/34 (2006.01) A01N 47/40 (2006.01) A01N 47/44 (2006.01) A01N 59/02 (2006.01)	2668175 *	A61K 33/26 (2006.01) A61P 7/06 (2006.01) C07D 309/40 (2006.01)
2687555 *	C08G 69/26 (2006.01) C08K 3/00 (2006.01) C08L 77/06 (2006.01)	2695285 *	A61K 31/41 (2006.01) A61P 3/04 (2006.01) C07D 257/06 (2006.01)		
2668169 *	A61K 31/41 (2006.01) A61P 3/04 (2006.01) C07D 257/06 (2006.01)	2688846 *	H02K 3/32 (2006.01)		
2695285 *	H02K 3/32 (2006.01)		C03B 5/235 (2006.01) F23M 5/02 (2006.01) F27B 3/20 (2006.01)		
2688846 *	C03B 5/235 (2006.01) F23M 5/02 (2006.01) F27B 3/20 (2006.01)	2656827	A61F 13/15 (2006.01) A61F 13/49 (2006.01)		

Broj objave evropske prijave patenta (97)	MKP (51)	Broj objave evropske prijave patenta (97)	MKP (51)	Broj objave evropske prijave patenta (97)	MKP (51)
2654751 *	A61K 31/498 (2006.01) A61P 3/02 (2006.01) A61P 23/00 (2006.01) A61P 25/00 (2006.01) A61P 25/16 (2006.01) A61P 25/24 (2006.01) C07D 401/04 (2006.01) C07D 401/14 (2006.01)	2680838 *	A61K 31/405 (2006.01) A61K 31/47 (2006.01) A61K 31/22 (2006.01) A61K 31/416 (2006.01) A61K 31/4015 (2006.01) A61K 31/44 (2006.01) A61K 31/41 (2006.01) A61K 31/616 (2006.01) A61K 31/415 (2006.01) A61P 9/10 (2006.01) A61K 31/4155 (2006.01) A61K 31/366 (2006.01) A61K 31/422 (2006.01) A61K 31/122 (2006.01) A61K 31/505 (2006.01)	2655388 *	A61K 31/7056 (2006.01) C07D 513/04 (2006.01) C07H 9/06 (2006.01) C12Q 1/34 (2006.01) B01J 49/00 (2006.01) A61K 39/395 (2006.01) A61K 47/48 (2006.01) A61P 35/00 (2006.01) C07K 16/10 (2006.01) C07K 16/28 (2006.01) C07K 16/32 (2006.01) C07K 16/46 (2006.01)
2665930 *	F03D 11/00 (2006.01)			2651559 *	
2675452 *	A61K 9/00 (2006.01) A61K 31/439 (2006.01)			2699262 *	
2659491 *	G21G 1/10 (2006.01)			2661449 *	C07K 16/28 (2006.01)
2672958 *	A61K 9/00 (2006.01) A61K 9/127 (2006.01) A61K 38/00 (2006.01) A61K 38/47 (2006.01) A61K 47/24 (2006.01)	2672825 *	A01N 43/68 (2006.01)	2670401 *	A61K 31/00 (2006.01) A61K 31/506 (2006.01) A61P 35/00 (2006.01)
2659234 *	G01F 1/28 (2006.01)	2667874 *	A61K 31/5377 (2006.01)	2657175	B66C 1/34 (2006.01) F16B 21/12 (2006.01)
2694072 *	A61K 31/517 (2006.01) A61P 35/00 (2006.01) C07D 239/70 (2006.01)	2655604 *	A61K 39/12 (2006.01) A61K 39/235 (2006.01) C12N 7/01 (2006.01)	2649585 *	G06K 19/00 (2006.01) G06Q 50/24 (2012.01)
		2678794 *	G06F 21/00 (2013.01)	2654732 *	A61K 9/20 (2006.01) A61K 9/50 (2006.01)
		2665719 *	A61K 31/454 (2006.01) A61K 31/4545 (2006.01) A61K 31/497 (2006.01) A61K 31/506 (2006.01) A61P 3/10 (2006.01) A61P 5/50 (2006.01) C07D 407/14 (2006.01) C07D 413/14 (2006.01) C07D 491/048 (2006.01)	2573368	F02D 19/06 (2006.01) F02D 19/08 (2006.01) F02D 41/00 (2006.01) F02D 41/14 (2006.01) F02D 41/30 (2006.01)

Broj objave evropske prijave patenta (97)	MKP (51)	Broj objave evropske prijave patenta (97)	MKP (51)	Broj objave evropske prijave patenta (97)	MKP (51)
2694074 *	A61K 9/00 (2006.01) A61K 31/40 (2006.01) A61K 31/403 (2006.01) A61K 31/522 (2006.01) A61K 45/06 (2006.01) A61P 9/00 (2006.01) A61P 9/04 (2006.01) A61P 9/10 (2006.01)	2646432 *	A61K 31/502 (2006.01) A61P 35/00 (2006.01) C07D 403/04 (2006.01)	2678679 *	A61K 31/00 (2006.01) A61K 38/00 (2006.01) G01N 33/50 (2006.01)
		2694664 *	C12P 7/44 (2006.01)	2678015 *	A61K 31/422 (2006.01) A61P 31/04 (2006.01)
		2651892 *	C07D 211/34 (2006.01)	2655376 *	A61K 31/5025 (2006.01) A61P 25/00 (2006.01) C07D 487/04 (2006.01)
2656263 *	C07H 21/04 (2006.01) G06F 19/00 (2011.01)	2658545 *	A61K 31/57 (2006.01) A61P 15/00 (2006.01) A61P 29/00 (2006.01)	2685990 *	A61K 31/4162 (2006.01) A61K 31/7088 (2006.01) A61P 35/00 (2006.01)
2691155 *	A61K 47/48 (2006.01) A61P 35/00 (2006.01)	2691289 *	B63B 1/10 (2006.01) B63B 35/44 (2006.01)	2679242 *	A61K 9/02 (2006.01) A61K 9/06 (2006.01) A61K 9/14 (2006.01) A61K 9/70 (2006.01) A61K 39/00 (2006.01) A61K 39/39 (2006.01)
2691506 *	C12M 1/107 (2006.01)	2594258	A61K 9/00 (2006.01) A61K 31/495 (2006.01) A61K 47/10 (2006.01) A61K 47/38 (2006.01)		
2612606	A61B 17/02 (2006.01) A61B 19/00 (2006.01)	2655330 *	A61K 31/44 (2006.01) A61K 31/4439 (2006.01) A61P 25/00 (2006.01) C07D 213/75 (2006.01) C07D 401/02 (2006.01) C07D 401/12 (2006.01) C07D 401/14 (2006.01)	2694101 *	A61K 39/09 (2006.01) A61K 39/21 (2006.01) A61K 39/295 (2006.01) A61P 31/18 (2006.01)
2697241 *	A61K 31/7068 (2006.01) A61K 31/7072 (2006.01) A61K 38/21 (2006.01) A61P 31/14 (2006.01) C07H 19/06 (2006.01) C07H 19/067 (2006.01) C07H 19/073 (2006.01) C07H 19/10 (2006.01)	2678011 *	A61K 31/337 (2006.01) A61K 33/24 (2006.01) A61P 35/00 (2006.01)	2649358 *	F16K 1/18 (2006.01) F16L 23/036 (2006.01) F16L 55/10 (2006.01)
2592364	F24J 2/04 (2006.01) F24J 2/46 (2006.01) F24J 2/52 (2006.01) H01L 31/042 (2006.01) H01L 31/048 (2006.01)	2697725 *	G06F 17/30 (2006.01) G06K 9/62 (2006.01)	2671041 *	F41H 1/02 (2006.01)
		2596808	A61L 2/07 (2006.01) B01J 3/04 (2006.01)	2691918 *	A61B 5/11 (2006.01) G06K 9/00 (2006.01)

Broj objave evropske prijava patenta (97)	MKP (51)	Broj objave evropske prijava patenta (97)	MKP (51)	Broj objave evropske prijava patenta (97)	MKP (51)
2696929 *	A61M 25/06 (2006.01) A61M 25/09 (2006.01)	2648749 *	A61K 39/395 (2006.01) A61K 49/00 (2006.01) C07K 16/22 (2006.01) C07K 16/30 (2006.01) C07K 16/40 (2006.01) G01N 33/574 (2006.01)	2681103 *	B62D 21/00 (2006.01) B62D 21/02 (2006.01) B62D 21/10 (2006.01) B62D 31/00 (2006.01) B62D 63/02 (2006.01)
2667721 *	A01N 43/08 (2006.01) A01N 43/56 (2006.01) A01N 43/58 (2006.01) A01N 47/24 (2006.01) A01N 47/32 (2006.01) A01N 53/06 (2006.01) A01N 59/02 (2006.01)	2663558 *	A61K 31/506 (2006.01) C07D 407/04 (2006.01)	2465482	A61G 7/057 (2006.01)
2651421 *	A61K 35/37 (2006.01) A61L 2/00 (2006.01)	2670487 *	A61K 39/395 (2006.01) A61P 37/06 (2006.01)	2484337	A61K 8/25 (2006.01) A61K 8/58 (2006.01) A61K 8/891 (2006.01) A61K 8/895 (2006.01) A61Q 15/00 (2006.01)
2689383 *	G06Q 10/08 (2012.01) H04L 9/32 (2006.01) H04L 29/06 (2006.01) H04W 12/06 (2009.01)	2670774 *	A61K 38/55 (2006.01) A61P 25/28 (2006.01) C07K 14/81 (2006.01) C12N 9/64 (2006.01)	2678329 *	A61K 31/4709 (2006.01) A61P 29/00 (2006.01) C07D 401/06 (2006.01) C07D 471/04 (2006.01) C07D 519/00 (2006.01)
2675494 *	A61M 1/02 (2006.01) A61M 1/34 (2006.01) B01L 3/14 (2006.01) G01N 33/49 (2006.01)	2675480 *	A61K 47/48 (2006.01) A61P 35/00 (2006.01) C07D 487/04 (2006.01) C07D 519/00 (2006.01)	2655370 *	A61K 31/46 (2006.01) A61P 3/00 (2006.01) C07D 451/06 (2006.01) C07D 471/04 (2006.01) C07D 487/04 (2006.01)
2616443 *	A61K 31/4985 (2006.01) A61P 35/00 (2006.01) C07D 217/22 (2006.01) C07D 237/34 (2006.01) C07D 403/10 (2006.01) C07D 405/04 (2006.01) C07D 409/04 (2006.01) C07D 417/10 (2006.01) C07D 471/04 (2006.01)	2697288 *	A61K 47/48 (2006.01) C08G 83/00 (2006.01) C08G 85/00 (2006.01)	2671184 *	
		2697265 *	A61K 31/727 (2006.01) C08B 37/00 (2006.01)	2694493 *	A61K 31/4709 (2006.01) C07D 401/12 (2006.01)
		2699537 *	C07C 201/08 (2006.01) C07C 201/16 (2006.01) C07C 205/02 (2006.01)	2662028	A61B 10/00 (2006.01)
		2694075 *	A61K 31/535 (2006.01)		

Broj objave evropske prijave patenta (97)	MKP (51)	Broj objave evropske prijave patenta (97)	MKP (51)	Broj objave evropske prijave patenta (97)	MKP (51)
2686332 *	A61K 31/58 (2006.01) A61P 5/44 (2006.01) A61P 11/06 (2006.01) A61P 37/08 (2006.01) C07J 71/00 (2006.01)	2661470 *	C09C 1/02 (2006.01) C09C 1/36 (2006.01) C09C 1/40 (2006.01) C09C 1/42 (2006.01) C09C 3/10 (2006.01) D21H 17/00 (2006.01) G01N 21/25 (2006.01)	2688577 *	A61K 36/23 (2006.01) A61K 36/235 (2006.01) A61K 36/534 (2006.01) A61K 36/57 (2006.01) A61P 1/02 (2006.01)
2680710 *	A23K 1/16 (2006.01) A23K 1/175 (2006.01) A23K 1/18 (2006.01) C07C 19/07 (2006.01) C07C 211/65 (2006.01)	2691075 *	A61K 9/00 (2006.01) A61K 31/4418 (2006.01) A61K 47/12 (2006.01) A61P 7/02 (2006.01)	2661297 *	A61M 5/28 (2006.01) A61M 5/32 (2006.01)
2675692 *	B62D 1/22 (2006.01)	2646446 *	A61K 31/424 (2006.01) A61K 31/55 (2006.01) A61P 35/00 (2006.01) C07D 498/04 (2006.01) C07D 498/14 (2006.01)	2597160	C12Q 1/68 (2006.01)
2651259 *	A45C 11/00 (2006.01)	2646038 *	A61K 31/7056 (2006.01) A61K 38/13 (2006.01) A61K 38/21 (2006.01) A61P 31/14 (2006.01)	2661636 *	G01P 5/26 (2006.01)
2569010 *	A61K 39/395 (2006.01) A61K 47/12 (2006.01) C07K 16/22 (2006.01)	2335900	B29C 44/12 (2006.01)	2696684 *	A01N 43/64 (2006.01) A61K 9/14 (2006.01) A61K 9/48 (2006.01) A61K 31/53 (2006.01)
2685820 *	A01N 25/34 (2006.01)	2694504 *	A61K 31/519 (2006.01) A61P 25/00 (2006.01) C07D 413/14 (2006.01) C07D 471/04 (2006.01)	2691117 *	A61K 47/48 (2006.01) A61P 35/00 (2006.01)
2667890 *	A61K 39/12 (2006.01) C07K 14/025 (2006.01) C07K 14/235 (2006.01)	2664380 *	B01D 21/00 (2006.01) B01D 21/02 (2006.01) B01D 21/24 (2006.01) B01D 21/30 (2006.01) B01J 38/00 (2006.01) C10G 2/00 (2006.01)	2691181 *	A61L 9/16 (2006.01) B01D 49/00 (2006.01) B03C 3/16 (2006.01) B03C 3/45 (2006.01) B03C 3/47 (2006.01) C08J 5/04 (2006.01) C08K 7/06 (2006.01)
2658783 *	B65C 9/06 (2006.01) B67B 3/26 (2006.01) B67C 3/00 (2006.01)	2631654	G01N 33/567 (2006.01)	2646272 *	B60L 5/28 (2006.01) B60L 5/32 (2006.01)
2631654	G01N 33/567 (2006.01)	2696882 *	A61K 38/11 (2006.01) A61P 15/12 (2006.01)		

Broj objave evropske prijava patenta (97)	MKP (51)	Broj objave evropske prijava patenta (97)	MKP (51)	Broj objave evropske prijava patenta (97)	MKP (51)
2646052 *	A61K 9/08 (2006.01) A61K 31/70 (2006.01) A61K 39/15 (2006.01) A61K 48/00 (2006.01) A61P 31/00 (2006.01) A61P 31/12 (2006.01)	2694108 *	A61K 39/395 (2006.01) C12N 15/11 (2006.01)	2654719 *	A61K 9/00 (2006.01) A61K 9/08 (2006.01) A61K 31/136 (2006.01)
		2656825	A61F 13/15 (2006.01) A61F 13/49 (2006.01)	2604354	B21D 5/08 (2006.01)
		2657943	G21F 9/06 (2006.01) G21F 9/30 (2006.01)	2678279 *	C03B 3/02 (2006.01) C03B 5/225 (2006.01) C03C 1/02 (2006.01)
2675505 *	A61M 5/20 (2006.01) A61M 5/32 (2006.01)	2477195	H01B 7/18 (2006.01) H01B 7/40 (2006.01) H01B 13/22 (2006.01) H02G 11/02 (2006.01)	2658525 *	A61K 9/08 (2006.01) A61K 47/34 (2006.01)
2686065 *	A61N 2/12 (2006.01)			2594557	A61K 31/21 (2006.01) A61K 31/435 (2006.01) C07C 233/47 (2006.01) C07D 213/82 (2006.01) C07D 239/36 (2006.01) C07D 261/18 (2006.01) C07D 271/06 (2006.01)
2670753 *	A61K 31/519 (2006.01) A61P 35/00 (2006.01) C07D 487/04 (2006.01)	2689008 *	A61K 35/28 (2006.01) A61K 35/50 (2006.01) C12N 5/073 (2010.01) C12N 5/0775 (2010.01)		
2683858 *	D01D 1/02 (2006.01) D01D 5/04 (2006.01) D01D 5/40 (2006.01) D01F 2/00 (2006.01) D01F 2/24 (2006.01) D21H 13/00 (2006.01) D21H 15/00 (2006.01)	2691116 *	A61K 9/51 (2006.01) A61K 47/48 (2006.01) A61K 49/18 (2006.01)	2691800 *	F21S 4/00 (2006.01) F21V 13/04 (2006.01) F21Y 101/02 (2006.01) F21Y 105/00 (2006.01) G02B 6/00 (2006.01) G02F 1/13357 (2006.01)
2697240 *	A61K 31/7034 (2006.01) A61P 3/00 (2006.01) C07D 407/10 (2006.01) C07D 413/10 (2006.01) C07D 417/10 (2006.01) C07H 13/04 (2006.01) C07H 15/04 (2006.01) C07H 15/12 (2006.01) C07H 15/14 (2006.01) C07H 15/203 (2006.01) C07H 19/044 (2006.01) C07H 19/24 (2006.01)	2636617	B65G 15/32 (2006.01) B65G 15/48 (2006.01) B65G 23/06 (2006.01) F16G 3/02 (2006.01)	2684039 *	G01N 30/36 (2006.01)
		2649009 *	C01B 3/04 (2006.01) C01B 31/20 (2006.01) C04B 2/10 (2006.01) F27B 7/10 (2006.01) F27B 15/00 (2006.01)	2675438 *	A61K 9/00 (2006.01) A61K 9/50 (2006.01) A61K 31/4458 (2006.01)
		2416650 *	A61K 9/14 (2006.01) A61K 9/51 (2006.01) A61K 31/337 (2006.01)		

Broj objave evropske prijave patenta (97)	MKP (51)	Broj objave evropske prijave patenta (97)	MKP (51)	Broj objave evropske prijave patenta (97)	MKP (51)
2651900 *	C07D 231/20 (2006.01) C07D 249/12 (2006.01) C07D 249/04 (2006.01) C07D 237/24 (2006.01) C07D 261/18 (2006.01) C07D 231/40 (2006.01) C07D 257/04 (2006.01) C07D 231/14 (2006.01) C07D 249/10 (2006.01) C07D 239/54 (2006.01) C07D 263/38 (2006.01) C07D 231/22 (2006.01) C07D 249/18 (2006.01) C07D 239/36 (2006.01) C07D 263/34 (2006.01)	2649065 *	C07D 401/14 (2006.01) C07D 403/04 (2006.01) C07D 403/14 (2006.01) C07D 405/14 (2006.01) C07D 413/14 (2006.01) C07D 417/14 (2006.01) C07D 471/04 (2006.01) C07D 487/04 (2006.01) C07D 498/04 (2006.01) C07D 491/107 (2006.01) A61K 31/497 (2006.01) A61K 31/437 (2006.01) A61K 31/506 (2006.01) A61K 31/444 (2006.01) A61K 31/4709 (2006.01)	2683697 *	A61K 31/5377 (2006.01) A61P 3/14 (2006.01) A61P 5/20 (2006.01) C07D 265/30 (2006.01) C07D 265/32 (2006.01)
				2672546	B32B 27/32 (2006.01) H01M 2/16 (2006.01)
				2663564 *	A61K 31/4745 (2006.01) A61P 35/00 (2006.01) C07D 471/04 (2006.01)
				2655333 *	A01N 43/56 (2006.01) C07D 231/14 (2006.01)
				2668608 *	
2688404 *	A01N 43/38 (2006.01) A01N 43/90 (2006.01) A01N 45/00 (2006.01) A01P 21/00 (2006.01) C05F 11/10 (2006.01)	2666121 *	G06K 9/00 (2006.01)	2652145 *	C12Q 1/68 (2006.01)
		2678049 *	A61L 27/20 (2006.01) A61L 31/04 (2006.01)	2333542	G01N 27/327 (2006.01)
		2649697 *	H02J 5/00 (2006.01)		
		2581588	F02D 41/00 (2006.01)		
		2697191 *	A61K 31/195 (2006.01) A61P 9/00 (2006.01) C07C 233/55 (2006.01)		
		2700085 *	B05B 17/06 (2006.01) G01N 30/32 (2006.01) G01N 30/72 (2006.01) H01J 49/04 (2006.01)		

Broj objave evropske prijava patenta (97)	MKP (51)	Broj objave evropske prijava patenta (97)	MKP (51)	Broj objave evropske prijava patenta (97)	MKP (51)
2651896 *	C07D 233/26 (2006.01) C07D 257/04 (2006.01) C07D 233/90 (2006.01) C07D 261/18 (2006.01) C07D 241/24 (2006.01) C07D 271/06 (2006.01) C07D 239/34 (2006.01) C07D 263/34 (2006.01) C07D 249/04 (2006.01) C07D 213/81 (2006.01) C07D 249/10 (2006.01) C07D 231/14 (2006.01) C07D 249/18 (2006.01) C07D 237/24 (2006.01) C07D 261/20 (2006.01)	2492048	B23Q 17/20 (2006.01) G01B 5/20 (2006.01) G05B 19/401 (2006.01)	2663187 *	A01N 43/42 (2006.01)
		2672967 *	A61K 31/407 (2006.01)	2683375 *	A61K 9/00 (2006.01) A61K 31/375 (2006.01) A61K 47/10 (2006.01) A61P 1/10 (2006.01)
		2688614 *	A61M 5/24 (2006.01) A61M 5/315 (2006.01)	2673282 *	C07F 9/38 (2006.01) C07F 9/58 (2006.01) C07F 9/6506 (2006.01)
		2688696 *	B21D 51/30 (2006.01)	2675543 *	B01D 19/00 (2006.01) E21B 43/34 (2006.01)
		2677936 *	A61B 6/03 (2006.01) G01N 23/04 (2006.01) G01V 5/00 (2006.01) G06T 11/00 (2006.01)	2656728	A01G 7/04 (2006.01) A01G 9/20 (2006.01)
		2694404 *	B65D 85/812 (2006.01)	2699514 *	C01B 17/02 (2006.01)
2654736 *	A61K 9/20 (2006.01) A61K 9/28 (2006.01) A61K 31/519 (2006.01) A61P 35/00 (2006.01)	2664126 *	H04M 1/725 (2006.01) H04M 3/42 (2006.01) H04W 4/04 (2009.01)	2694627 *	C10L 1/02 (2006.01) F02B 1/02 (2006.01)
2688396 *	A01K 67/027 (2006.01)	2665366 *	A23F 3/16 (2006.01) A23F 3/32 (2006.01) A23L 1/236 (2006.01) A23L 2/395 (2006.01) A23L 2/60 (2006.01)	2697421 *	D06B 3/04 (2006.01) D06M 15/643 (2006.01) G01N 19/02 (2006.01)
2677886 *	A23L 1/30 (2006.01) A23L 1/308 (2006.01)			2664006 *	F24J 2/52 (2006.01) H01L 31/042 (2006.01)
2433870	B64F 1/32 (2006.01)	2694112 *	A61K 47/48 (2006.01) C12N 15/62 (2006.01) G01N 33/574 (2006.01)	2567959	A61K 31/437 (2006.01) A61P 3/10 (2006.01) A61P 9/00 (2006.01) A61P 25/00 (2006.01) A61P 35/00 (2006.01) C07D 471/04 (2006.01)
2676128 *	G01N 23/04 (2006.01)	2685821 *	A01N 27/00 (2006.01) A61K 31/015 (2006.01)		
2691416 *	C07K 16/00 (2006.01) C07K 16/24 (2006.01) C07K 16/28 (2006.01) C07K 16/32 (2006.01) C07K 16/46 (2006.01)	2683723 *	A01N 43/80 (2006.01) C07D 491/10 (2006.01)	2502622	A61K 9/48 (2006.01)

Broj objave evropske prijave patenta (97)	MKP (51)	Broj objave evropske prijave patenta (97)	MKP (51)	Broj objave evropske prijave patenta (97)	MKP (51)
2651436 *	A61K 39/04 (2006.01)	2680825 *	A61K 9/00 (2006.01) A61K 9/48 (2006.01) A61K 31/4525 (2006.01) A61K 47/14 (2006.01) A61K 47/26 (2006.01)	2459524 *	C07C 323/12 (2006.01) C07D 213/24 (2006.01) C07D 305/06 (2006.01) C07D 213/65 (2006.01) C07D 407/12 (2006.01) C07D 263/14 (2006.01) C07D 307/02 (2006.01) C07C 311/08 (2006.01) C07D 277/24 (2006.01) C07D 333/16 (2006.01)
2672970 *	A61K 9/28 (2006.01) A61K 31/4375 (2006.01) A61P 1/00 (2006.01) C07D 498/22 (2006.01)	2655374 *	A61K 31/52 (2006.01) A61P 35/00 (2006.01) C07D 473/32 (2006.01)		
2675453 *	A61K 9/00 (2006.01) A61K 31/4468 (2006.01)	2668278 *	A01H 5/00 (2006.01) C12N 15/82 (2006.01)		
2686308 *	A61K 31/4245 (2006.01) A61P 31/00 (2006.01) C07D 213/72 (2006.01) C07D 271/06 (2006.01) C07D 401/04 (2006.01)	2678862 *	G06F 17/30 (2006.01) G06Q 30/02 (2012.01) G06Q 30/06 (2012.01) G11B 27/034 (2006.01) G11B 27/036 (2006.01) G11B 27/11 (2006.01) G11B 27/34 (2006.01) G11B 27/36 (2006.01) H04N 21/258 (2011.01) H04N 21/442 (2011.01) H04N 21/658 (2011.01)		
2683884 *	E04B 2/24 (2006.01)			2645999 *	A61K 9/16 (2006.01) A61P 35/00 (2006.01)
2673187 *	B63B 27/14 (2006.01) E01D 15/24 (2006.01)			2665487 *	A61K 38/26 (2006.01) A61K 38/28 (2006.01) A61P 3/04 (2006.01) A61P 3/10 (2006.01)
2678021 *	A61K 31/675 (2006.01) A61P 35/00 (2006.01) C07F 9/58 (2006.01) C07F 9/6509 (2006.01) C07F 9/6558 (2006.01)	2568049	A01K 67/027 (2006.01) C07K 16/00 (2006.01) C07K 16/46 (2006.01) C12N 15/85 (2006.01)	2673262 *	A61K 31/47 (2006.01) A61P 35/00 (2006.01) C07D 215/227 (2006.01)
2699575 *	A61K 31/437 (2006.01) A61P 35/00 (2006.01) C07D 471/04 (2006.01)	2658407 *	A41D 1/06 (2006.01) A41D 13/00 (2006.01) A41D 17/00 (2006.01) A41F 17/04 (2006.01)	2646825 *	G01N 33/558 (2006.01) G01N 33/569 (2006.01)
2699322 *	A63B 49/02 (2006.01) A63B 49/04 (2006.01)	2608178	G08C 23/04 (2006.01)	2678327 *	A61K 31/381 (2006.01) A61P 25/28 (2006.01) C07D 333/22 (2006.01) C07D 409/04 (2006.01)

Broj objave evropske prijava patenta (97)	MKP (51)	Broj objave evropske prijava patenta (97)	MKP (51)	Broj objave evropske prijava patenta (97)	MKP (51)
2665732 *	A61K 31/542 (2006.01) A61P 3/00 (2006.01) A61P 25/00 (2006.01) C07D 513/04 (2006.01)	2686271 *	B82B 3/00 (2006.01) B82Y 40/00 (2011.01) B82Y 99/00 (2011.01) C01B 31/02 (2006.01) C10M 125/02 (2006.01) F01M 9/00 (2006.01) F16D 13/74 (2006.01) F16N 15/02 (2006.01)	2699151 *	A61B 5/042 (2006.01)
2697898 *	H02M 1/42 (2007.01)			2655342 *	C07D 241/02 (2006.01) C07D 471/04 (2006.01)
2667871 *	A61K 31/4439 (2006.01)			2663843 *	G01F 23/26 (2006.01)
2681230 *	C07K 1/18 (2006.01) C07K 14/47 (2006.01) C07K 14/52 (2006.01)	2686677 *	G01N 33/48 (2006.01)	2677941 *	A61B 17/04 (2006.01) A61B 17/08 (2006.01) A61B 17/11 (2006.01) A61F 2/08 (2006.01)
2691972 *	H01J 49/00 (2006.01)	2647381 *	A61K 9/24 (2006.01) A61K 9/26 (2006.01) A61K 31/4439 (2006.01) A61K 31/616 (2006.01) A61K 47/04 (2006.01) A61K 47/32 (2006.01) A61K 47/36 (2006.01) A61K 47/44 (2006.01) A61P 1/04 (2006.01) A61P 9/10 (2006.01) A61P 29/00 (2006.01) A61P 43/00 (2006.01)	2600050	F16L 19/02 (2006.01)
2683419 *	A61L 27/00 (2006.01) A61L 31/08 (2006.01) A61L 31/16 (2006.01) C07K 14/00 (2006.01) C07K 14/40 (2006.01)			2677452 *	H04L 9/14 (2006.01)
2581466	B21C 9/00 (2006.01) B21D 5/01 (2006.01) B21J 1/06 (2006.01) C22F 1/04 (2006.01)			2678357 *	C07K 16/18 (2006.01)
2665521 *	A61K 38/00 (2006.01) A61P 35/00 (2006.01)	2663577 *	C07K 16/24 (2006.01)	2670440 *	A61K 47/48 (2006.01) A61P 35/00 (2006.01) C07K 16/28 (2006.01)
2648615 *	A61B 5/103 (2006.01)	2591768	A61K 9/00 (2006.01) A61K 9/16 (2006.01) A61K 9/20 (2006.01) A61K 31/593 (2006.01) A61K 31/785 (2006.01) A61K 47/02 (2006.01) A61K 47/20 (2006.01) A61K 47/38 (2006.01) A61K 47/44 (2006.01)	2694092 *	A61K 38/18 (2006.01) A61P 3/00 (2006.01)
2675508 *	A61M 5/20 (2006.01) A61M 5/32 (2006.01)			2659868	A61F 13/15 (2006.01) B26D 1/00 (2006.01)
2694640 *	C12N 5/00 (2006.01)			2683253 *	A23K 1/10 (2006.01) A23K 1/16 (2006.01) A23K 1/175 (2006.01) A23K 1/18 (2006.01)
				2665478 *	A61K 31/443 (2006.01) A61P 25/18 (2006.01) A61P 25/28 (2006.01)

Broj objave evropske prijava patenta (97)	MKP (51)	Broj objave evropske prijava patenta (97)	MKP (51)	Broj objave evropske prijava patenta (97)	MKP (51)
2366673	C02F 3/28 (2006.01) C02F 3/30 (2006.01) C02F 11/04 (2006.01) C02F 11/12 (2006.01) C02F 101/16 (2006.01)	2678351 *	A61K 39/21 (2006.01) C07K 14/16 (2006.01) C12N 15/10 (2006.01) G01N 33/569 (2006.01) G01N 33/68 (2006.01)	2668198 *	A61K 31/737 (2006.01) A61P 17/02 (2006.01) C07H 15/04 (2006.01) C08B 37/00 (2006.01)
2696870 *	A61K 31/4184 (2006.01) A61P 25/02 (2006.01)	2673363 *	A61K 31/7088 (2006.01) C07H 21/00 (2006.01) C12N 15/113 (2010.01)	2672823 *	A01N 43/40 (2006.01) A61K 31/445 (2006.01)
2670392 *	A61K 9/107 (2006.01)	2699543 *	A61K 31/138 (2006.01) A61K 31/145 (2006.01) A61K 31/397 (2006.01) A61K 31/4453 (2006.01) A61P 25/14 (2006.01) A61P 25/16 (2006.01) A61P 25/18 (2006.01) C07C 317/22 (2006.01) C07D 205/04 (2006.01) C07D 295/088 (2006.01)	2672976 *	A61K 31/7056 (2006.01) A61K 31/715 (2006.01) A61P 7/02 (2006.01)
2694959 *	G01N 33/48 (2006.01)			2688886 *	A61K 31/433 (2006.01) A61K 31/4439 (2006.01) A61K 31/4745 (2006.01) A61K 31/496 (2006.01) A61P 35/00 (2006.01) C07D 413/14 (2006.01) C07D 417/04 (2006.01) C07D 417/14 (2006.01) C07D 487/04 (2006.01)
2698283	B60P 7/08 (2006.01) B60R 9/048 (2006.01)				
2578538	C01F 15/00 (2006.01) C01G 43/00 (2006.01) C01G 99/00 (2010.01)				
2596809	A61L 2/07 (2006.01) A61L 11/00 (2006.01) B01J 3/04 (2006.01) B02C 17/00 (2006.01) B02C 19/00 (2006.01) B29B 17/00 (2006.01)	2681201 *	C07D 235/26 (2006.01)	2646029 *	A61K 31/444 (2006.01) A61K 31/505 (2006.01) A61K 31/506 (2006.01) A61K 31/5377 (2006.01) A61K 31/541 (2006.01) A61P 7/06 (2006.01)
2651902 *	C07D 231/54 (2006.01)	2646453 *	A61K 31/7068 (2006.01) A61K 31/7072 (2006.01) A61K 31/7076 (2006.01) A61P 31/14 (2006.01) C07H 19/06 (2006.01) C07H 19/10 (2006.01) C07H 19/16 (2006.01) C07H 19/20 (2006.01) C07H 23/00 (2006.01)		
2655394 *	A61K 31/57 (2006.01) A61P 5/36 (2006.01) C07J 9/00 (2006.01)			2697432 *	E01B 7/12 (2006.01)
				2699109 *	A23L 1/30 (2006.01) A23L 1/308 (2006.01) A61K 31/702 (2006.01)

Broj objave evropske prijave patenta (97)	MKP (51)	Broj objave evropske prijave patenta (97)	MKP (51)	Broj objave evropske prijave patenta (97)	MKP (51)
2649184 *	A01K 67/027 (2006.01) C07K 16/00 (2006.01) C12N 9/64 (2006.01) C12N 15/85 (2006.01)	2513107 *	A61K 31/519 (2006.01) A61P 25/00 (2006.01) C07D 471/04 (2006.01) C07D 487/04 (2006.01)	2653469 *	A61P 1/00 (2006.01) A61P 25/18 (2006.01) A61K 31/444 (2006.01) A61P 25/14 (2006.01) A61P 29/00 (2006.01) C07D 401/14 (2006.01) A61P 9/12 (2006.01) A61P 25/24 (2006.01) A61P 5/00 (2006.01) A61P 25/22 (2006.01) A61K 31/506 (2006.01) A61P 25/16 (2006.01) A61K 31/4439 (2006.01) A61P 25/08 (2006.01) A61P 25/30 (2006.01) A61P 1/14 (2006.01) A61P 25/20 (2006.01) A61K 31/4192 (2006.01) A61P 25/04 (2006.01) A61P 25/28 (2006.01)
2651274 *	A47K 3/12 (2006.01)	2675502 *	A61M 5/20 (2006.01) A61M 5/32 (2006.01)	2675619 *	B32B 7/06 (2006.01) B32B 27/08 (2006.01) B32B 27/20 (2006.01) B32B 27/28 (2006.01) G09F 3/00 (2006.01)
2647614	C05F 9/04 (2006.01) C05F 17/00 (2006.01)	2694964 *	G01N 33/50 (2006.01)	2651399 *	A61K 9/20 (2006.01)
2573058	C04B 20/00 (2006.01) C04B 35/66 (2006.01) F27D 1/00 (2006.01)	2681308 *	C07K 14/55 (2006.01) C07K 14/765 (2006.01) C07K 14/79 (2006.01) C12N 1/19 (2006.01) C12N 9/00 (2006.01) C12N 9/04 (2006.01) C12N 9/90 (2006.01) C12N 15/81 (2006.01) C12P 21/02 (2006.01)	2680858 *	A61K 31/69 (2006.01) A61K 45/06 (2006.01) A61P 17/00 (2006.01) A61P 37/00 (2006.01)
2655619 *	C07H 21/04 (2006.01) C12N 15/11 (2006.01)	2655345 *	A61K 31/4192 (2006.01) A61P 35/00 (2006.01) C07D 249/06 (2006.01) C07D 413/12 (2006.01)	2680858 *	A61K 31/69 (2006.01) A61K 45/06 (2006.01) A61P 17/00 (2006.01) A61P 37/00 (2006.01)
2691088 *	A61K 31/12 (2006.01) A61K 31/216 (2006.01) A61P 31/12 (2006.01)	2680872 *	A61K 38/08 (2006.01) C07K 7/00 (2006.01)	2683549 *	B32B 27/10 (2006.01)
2584357	G01N 27/02 (2006.01) G01N 27/07 (2006.01) G01N 33/49 (2006.01) G01N 33/86 (2006.01)	2665043	G06F 3/048 (2013.01) G06T 19/20 (2011.01)		
2652491 *	B01D 15/36 (2006.01) C07K 1/18 (2006.01) C07K 14/755 (2006.01) G01N 30/34 (2006.01) G01N 30/80 (2006.01) G01N 30/96 (2006.01)	2605004	G01N 21/35 (2006.01) G01N 21/84 (2006.01) G01N 21/88 (2006.01) G01N 21/90 (2006.01) G01N 25/72 (2006.01)		
2700243 *	H04N 21/478 (2011.01)				

Broj objave evropske prijave patenta (97)	MKP (51)	Broj objave evropske prijave patenta (97)	MKP (51)	Broj objave evropske prijave patenta (97)	MKP (51)
2691533 *	C12Q 1/48 (2006.01) G01N 33/574 (2006.01) G01N 33/68 (2006.01)	2687507 *	A61K 31/498 (2006.01) A61P 9/10 (2006.01) A61K 31/454 (2006.01) A61P 1/16 (2006.01) C07D 217/06 (2006.01) A61K 31/497 (2006.01) A61P 9/10 (2006.01) A61K 31/472 (2006.01) A61P 3/04 (2006.01) C07D 217/22 (2006.01) A61K 31/506 (2006.01) A61P 9/12 (2006.01) A61K 31/4725 (2006.01) A61P 3/06 (2006.01) C07D 223/16 (2006.01) A61K 31/4035 (2006.01) A61K 31/55 (2006.01) C07D 217/04 (2006.01) C07D 209/44 (2006.01) A61K 31/538 (2006.01) A61P 43/00 (2006.01)	2482800 *	A61K 8/04 (2006.01) A61K 8/97 (2006.01) A61K 9/00 (2006.01) A61K 9/12 (2006.01) A61K 9/46 (2006.01) A61K 31/01 (2006.01) A61K 31/19 (2006.01) A61K 31/191 (2006.01) A61K 36/886 (2006.01) A61K 45/06 (2006.01) A61K 47/10 (2006.01) A61K 47/40 (2006.01) A61K 47/46 (2006.01) A61Q 19/00 (2006.01)
2695199 *	H01L 31/042 (2006.01)				
2658570 *	A61K 39/12 (2006.01) A61P 31/14 (2006.01)				
2608409	H03H 17/06 (2006.01)				
2678960 *	H04B 7/26 (2006.01) H04J 11/00 (2006.01)				
2651391 *	A61K 9/00 (2006.01) A61K 9/20 (2006.01) A61K 31/437 (2006.01) A61K 33/10 (2006.01) A61P 25/20 (2006.01)			2678055 *	A61B 17/54 (2006.01) A61C 17/02 (2006.01) A61M 5/30 (2006.01)
2654780 *	A61K 39/00 (2006.01)			2568157	F02M 47/02 (2006.01) F02M 61/12 (2006.01) F02M 63/00 (2006.01)
2658528 *	A61K 9/16 (2006.01) A61K 31/55 (2006.01)				
2686333 *	A61K 31/58 (2006.01) A61P 5/44 (2006.01) A61P 11/06 (2006.01) A61P 37/08 (2006.01) C07J 71/00 (2006.01)	2690107 *	C07K 7/06 (2006.01)	2646457 *	A61K 31/575 (2006.01) A61P 1/16 (2006.01) C07J 9/00 (2006.01)
		2655402 *	A61K 39/104 (2006.01) A61K 39/40 (2006.01) C07K 14/21 (2006.01) C07K 16/12 (2006.01) C07K 19/00 (2006.01)	2681199 *	A61K 31/439 (2006.01) A61P 25/00 (2006.01) C07D 221/20 (2006.01)
2661478 *	B01D 1/14 (2006.01) B01D 1/16 (2006.01) C08H 8/00 (2010.01) C10G 3/00 (2006.01) C13K 1/00 (2006.01)			2696889 *	A61K 38/18 (2006.01) C07K 14/475 (2006.01)

Broj objave evropske prijave patenta (97)	MKP (51)	Broj objave evropske prijave patenta (97)	MKP (51)	Broj objave evropske prijave patenta (97)	MKP (51)	
2649066 *	A61K 31/4178 (2006.01) A61K 31/4439 (2006.01) A61K 31/506 (2006.01) A61P 25/08 (2006.01) A61P 25/18 (2006.01) A61P 27/16 (2006.01) A61P 43/00 (2006.01) C07D 405/12 (2006.01) C07D 413/12 (2006.01) C07D 413/14 (2006.01)	2691370 *	A61K 31/404 (2006.01) A61K 38/03 (2006.01) C07D 209/20 (2006.01) C07K 5/037 (2006.01)	2694068 *	A61K 31/4985 (2006.01) A61K 31/501 (2006.01) A61K 31/5377 (2006.01) A61P 35/00 (2006.01) A61P 43/00 (2006.01) C07D 471/04 (2006.01)	
		2649053 *	C07D 239/36 (2006.01) C07D 239/47 (2006.01) C07D 239/52 (2006.01) C07D 239/56 (2006.01) C07D 401/06 (2006.01) C07D 401/12 (2006.01) C07D 401/14 (2006.01) C07D 403/06 (2006.01)	2672975 *	A61K 31/522 (2006.01) A61P 9/08 (2006.01) A61P 9/12 (2006.01)	
2655629 *	C12N 15/82 (2006.01)			2688884 *	A61K 31/404 (2006.01) A61P 25/24 (2006.01) C07D 405/14 (2006.01)	
2567958	A61K 31/427 (2006.01) A61P 9/06 (2006.01) A61P 9/10 (2006.01) C07D 417/12 (2006.01) C07D 417/14 (2006.01) C07D 471/04 (2006.01) C07D 487/04 (2006.01)		C07D 403/12 (2006.01) C07D 403/14 (2006.01) C07D 413/06 (2006.01) C07D 417/06 (2006.01)	2646010 *	A61K 31/00 (2006.01) A61K 31/198 (2006.01) A61K 31/20 (2006.01) A61K 31/375 (2006.01) A61K 31/403 (2006.01) A61K 31/505 (2006.01) A61K 31/519 (2006.01) A61K 31/70 (2006.01) A61K 31/714 (2006.01) A61K 33/06 (2006.01) A61K 33/14 (2006.01)	
		2672962 *	A61K 9/00 (2006.01) A61K 31/00 (2006.01) A61K 47/10 (2006.01) A61K 47/12 (2006.01)			
2529748	A61K 39/00 (2006.01) C07K 7/14 (2006.01)			2683326 *	A61F 2/00 (2006.01) A61F 2/02 (2006.01) A61F 2/04 (2013.01) A61L 27/18 (2006.01) A61L 27/54 (2006.01)	
2655668 *	A61K 39/02 (2006.01) C12R 1/00 (2006.01)				2607118	B60H 1/00 (2006.01) F24F 13/20 (2006.01) H05K 5/00 (2006.01)
2652218 *	E04B 1/76 (2006.01) E04F 13/08 (2006.01) F16B 7/02 (2006.01) F16B 13/06 (2006.01) F16B 13/08 (2006.01) F16B 19/00 (2006.01)	2597050	B65D 43/02 (2006.01) B65D 85/78 (2006.01)			
		2654726 *	A61K 9/16 (2006.01) A61K 9/48 (2006.01) A61K 31/495 (2006.01)			

Broj objave evropske prijave patenta (97)	MKP (51)	Broj objave evropske prijave patenta (97)	MKP (51)	Broj objave evropske prijave patenta (97)	MKP (51)
2658523 *	A61K 9/00 (2006.01) A61K 9/14 (2006.01) A61K 9/16 (2006.01) A61K 9/20 (2006.01) A61K 9/28 (2006.01) A61K 31/485 (2006.01) A61K 45/06 (2006.01) A61P 1/10 (2006.01) A61P 25/00 (2006.01) A61P 25/02 (2006.01) A61P 25/14 (2006.01) A61P 25/16 (2006.01)	2589790	F02M 63/00 (2006.01)	2678673 *	G01N 21/78 (2006.01) G01N 31/22 (2006.01)
		2670735 *	C07D 235/16 (2006.01)	2653880	G01R 31/40 (2006.01)
		2686323 *	C07D 487/08 (2006.01)	2610483	F03D 3/06 (2006.01) F03D 7/02 (2006.01)
		2670402 *	A61K 31/137 (2006.01)	2576096 *	B21D 22/02 (2006.01) B21D 53/78 (2006.01) F03D 1/06 (2006.01)
		2688939 *	C08H 7/00 (2011.01) C08H 8/00 (2010.01) D21C 5/00 (2006.01)	2623604	A61K 48/00 (2006.01) C12N 15/86 (2006.01)
2686442 *	C12Q 1/68 (2006.01)	2661292 *	A61M 5/20 (2006.01) A61M 5/32 (2006.01)	2646826 *	G01N 33/564 (2006.01) G01N 33/68 (2006.01)
2700401 *	A61K 9/70 (2006.01) A61K 31/435 (2006.01) A61K 31/551 (2006.01) A61K 47/12 (2006.01) A61K 47/32 (2006.01) A61K 47/34 (2006.01) A61P 11/02 (2006.01) A61P 17/04 (2006.01) A61P 37/08 (2006.01) A61P 43/00 (2006.01)	2658871 *	A61P 35/02 (2006.01) C07K 16/28 (2006.01)	2649248 *	E04B 1/00 (2006.01) E04F 17/08 (2006.01)
		2615723	H02K 1/27 (2006.01) H02K 15/03 (2006.01) H02K 21/12 (2006.01) H02K 29/03 (2006.01)	2690088 *	A61K 31/165 (2006.01) A61P 1/00 (2006.01) A61P 9/00 (2006.01) A61P 25/00 (2006.01) A61P 25/20 (2006.01) A61P 25/22 (2006.01) A61P 25/24 (2006.01) C07C 231/24 (2006.01) C07C 233/18 (2006.01)
		2675807 *	A61K 31/519 (2006.01) A61P 25/28 (2006.01) C07D 487/04 (2006.01)	2680839 *	A61K 31/357 (2006.01) A61K 39/395 (2006.01) A61P 35/00 (2006.01)
2649704 *	H02K 1/14 (2006.01) H02K 11/00 (2006.01) H02K 21/14 (2006.01) H02K 47/20 (2006.01)	2661427 *	C07B 57/00 (2006.01) C07D 241/04 (2006.01)		
		2670427 *	A61K 31/155 (2006.01) A61K 38/22 (2006.01) A61P 3/10 (2006.01) A61P 5/50 (2006.01)		
2656846 *	A61K 9/14 (2006.01) A61K 31/665 (2006.01) A61K 47/18 (2006.01) A61P 13/02 (2006.01) A61P 31/04 (2006.01)				

Broj objave evropske prijave patenta (97)	MKP (51)	Broj objave evropske prijave patenta (97)	MKP (51)	Broj objave evropske prijave patenta (97)	MKP (51)
2697227 *	A61K 31/4188 (2006.01) A61P 37/02 (2006.01) C07D 487/04 (2006.01)	2681041 *	B29C 35/00 (2006.01) B29C 53/56 (2006.01) B29C 53/64 (2006.01) B29C 70/32 (2006.01) B29D 23/00 (2006.01) F16L 9/16 (2006.01)	2667720 *	A01N 43/54 (2006.01) A01N 59/02 (2006.01) A01N 43/50 (2006.01) A01N 47/36 (2006.01) A01N 43/28 (2006.01) A01N 47/34 (2006.01) A01N 43/16 (2006.01) A01N 47/30 (2006.01) A01N 37/24 (2006.01) A01N 47/24 (2006.01) A01N 37/16 (2006.01) A01N 43/653 (2006.01) A01N 35/04 (2006.01) A01N 47/32 (2006.01) A01N 37/34 (2006.01)
2697362 *	C12N 5/00 (2006.01) C12N 5/077 (2010.01)	2680844 *	A61K 31/4709 (2006.01)	2678711 *	G01S 7/28 (2006.01) G01S 13/58 (2006.01) G01S 13/93 (2006.01) G01S 15/58 (2006.01) G01S 15/93 (2006.01) G01S 17/93 (2006.01)
2675394 *	A61F 2/18 (2006.01)	2667971 *	B02C 18/30 (2006.01) B02C 18/36 (2006.01)	2665638 *	B63B 1/24 (2006.01)
2688627 *	A61M 16/00 (2006.01)	2665937 *	E21B 43/26 (2006.01) F04D 1/06 (2006.01) F04D 29/16 (2006.01) F04D 29/44 (2006.01)		
2681415 *	F01B 3/00 (2006.01) F04B 1/22 (2006.01)	2652085 *	C09K 11/07 (2006.01) F21K 2/06 (2006.01)		
2604625	C07K 16/00 (2006.01) C07K 16/10 (2006.01) C07K 16/28 (2006.01) C07K 16/30 (2006.01) C07K 16/46 (2006.01)	2652535 *	G02B 6/122 (2006.01) G02F 1/19 (2006.01)		
2665901 *	B60K 15/04 (2006.01) F01N 3/20 (2006.01)	2684264 *	H02B 1/32 (2006.01)		
2694552 *	C07K 16/28 (2006.01)	2649087 *	C07K 1/18 (2006.01)		
2686015 *	A61K 31/00 (2006.01) A61K 33/00 (2006.01) A61K 39/395 (2006.01) C07K 16/32 (2006.01)	2651396 *	A61K 9/00 (2006.01) A61K 9/107 (2006.01) A61K 9/48 (2006.01) A61K 38/13 (2006.01) A61K 47/10 (2006.01) A61K 47/14 (2006.01) A61K 47/22 (2006.01) A61K 47/26 (2006.01)		
2583603	A47K 10/38 (2006.01)				
2661473 *	C09D 7/04 (2006.01) C09D 167/08 (2006.01)				
2658543 *	A61K 31/496 (2006.01) A61P 35/00 (2006.01)				

Broj objave evropske prijave patenta (97)	MKP (51)	Broj objave evropske prijave patenta (97)	MKP (51)	Broj objave evropske prijave patenta (97)	MKP (51)
2683689 *	A61K 31/4412 (2006.01) A61K 31/4427 (2006.01) A61K 31/4433 (2006.01) A61K 31/4439 (2006.01) A61P 31/00 (2006.01) C07D 213/64 (2006.01) C07D 213/69 (2006.01) C07D 401/04 (2006.01) C07D 401/10 (2006.01) C07D 405/04 (2006.01) C07D 405/12 (2006.01) C07D 413/10 (2006.01) C07D 417/12 (2006.01)	2567932	B60R 19/03 (2006.01) B60R 19/22 (2006.01) B60R 21/11 (2006.01) B60R 21/13 (2006.01) B62D 33/06 (2006.01) B66F 9/075 (2006.01) E02F 9/16 (2006.01)	2684963 *	C12N 15/09 (2006.01) C12Q 1/02 (2006.01)
		2651767 *	B65B 31/02 (2006.01)	2614812	A61K 8/23 (2006.01) A61K 8/43 (2006.01) A61K 8/67 (2006.01) A61K 8/73 (2006.01) A61Q 11/00 (2006.01)
		2651934 *	A61K 31/437 (2006.01) A61P 31/12 (2006.01) C07D 471/04 (2006.01) C07D 487/04 (2006.01)	2665601 *	B32B 17/10 (2006.01) B32B 17/12 (2006.01) B60Q 3/02 (2006.01) G02B 6/00 (2006.01)
2679585 *	A61K 31/444 (2006.01) A61P 25/24 (2006.01) A61P 25/04 (2006.01) A61P 43/00 (2006.01) A61K 31/4439 (2006.01) A61P 25/22 (2006.01) C07D 401/04 (2006.01) A61P 25/20 (2006.01) C07D 417/14 (2006.01) A61P 25/16 (2006.01) C07D 401/14 (2006.01) A61K 31/506 (2006.01) A61P 25/28 (2006.01) A61P 25/00 (2006.01) A61P 25/30 (2006.01) A61P 25/18 (2006.01) C07D 413/14 (2006.01)	2444304	B60G 9/02 (2006.01) B60G 17/016 (2006.01) B60R 21/013 (2006.01) B62D 49/08 (2006.01) B66F 9/06 (2006.01) E02F 9/22 (2006.01) G08B 19/00 (2006.01)	2651642 *	B32B 23/06 (2006.01) B32B 29/04 (2006.01) B65D 65/46 (2006.01)
		2670407 *	A61K 31/35 (2006.01) A61K 31/70 (2006.01) A61P 29/00 (2006.01) A61P 31/12 (2006.01)	2654733 *	A61K 9/20 (2006.01) A61K 31/485 (2006.01)
		2570415	A61K 31/4985 (2006.01) A61P 19/02 (2006.01) C07D 487/04 (2006.01)	2390204	B65G 1/137 (2006.01)
		2676137 *	G01N 33/564 (2006.01) G01N 33/94 (2006.01)	2671212 *	G09F 7/18 (2006.01)
2646757 *	F24J 2/04 (2006.01) F24J 2/52 (2006.01)			2670486 *	A61K 31/40 (2006.01) A61P 3/00 (2006.01)
				2574424	B05B 7/16 (2006.01) B23Q 11/10 (2006.01)
				2654792 *	A61K 39/395 (2006.01) C12P 21/08 (2006.01)
				2594775	F02D 41/22 (2006.01) F02M 25/07 (2006.01)

Broj objave evropske prijave patenta (97)	MKP (51)	Broj objave evropske prijave patenta (97)	MKP (51)	Broj objave evropske prijave patenta (97)	MKP (51)
2697196 *	A61K 31/402 (2006.01) A61K 31/415 (2006.01) A61P 9/10 (2006.01) C07D 207/34 (2006.01) C07D 231/14 (2006.01)	2688484 *	A61B 17/00 (2006.01) A61B 17/06 (2006.01) A61L 27/36 (2006.01) A61L 27/50 (2006.01) A61M 27/00 (2006.01)	2648725 *	A61K 31/4196 (2006.01) A61K 45/06 (2006.01) A61P 19/02 (2006.01) A61P 37/00 (2006.01)
2589547	B65D 75/58 (2006.01) B65D 75/62 (2006.01)	2562076	B63B 19/02 (2006.01)	2681824 *	E04H 12/00 (2006.01) F03D 9/00 (2006.01) F03D 11/04 (2006.01) H01L 31/042 (2006.01) H02J 3/38 (2006.01) H02J 4/00 (2006.01) H02J 13/00 (2006.01)
2695121 *	G06Q 20/40 (2012.01)	2666108 *	G06F 17/30 (2006.01)		
2675506 *	A61M 5/20 (2006.01) A61M 5/32 (2006.01)	2543276	A45D 40/06 (2006.01)		
2675916 *	C12Q 1/68 (2006.01)	2663642 *	C07H 21/00 (2006.01) C12N 15/63 (2006.01) G01N 33/53 (2006.01)	2683394 *	A61K 38/08 (2006.01)
2675759 *	C02F 1/68 (2006.01)	2661448 *	A61K 39/395 (2006.01) C07K 16/24 (2006.01)	2693879 *	A01N 43/02 (2006.01) A61K 31/335 (2006.01)
2692194 *	H04W 74/08 (2009.01)	2668529 *	B82Y 20/00 (2011.01) G02B 5/26 (2006.01)	2700680	C09C 1/02 (2006.01)
2651922 *	A61K 31/437 (2006.01) A61P 31/12 (2006.01) C07D 403/06 (2006.01) C07D 471/04 (2006.01)	2651928 *	A61K 31/4178 (2006.01) A61P 31/14 (2006.01) C07D 403/10 (2006.01) C07D 403/12 (2006.01) C07D 403/14 (2006.01)	2694056 *	A61K 31/337 (2006.01) A61K 31/519 (2006.01) A61P 35/00 (2006.01)
2683302 *	A61B 17/00 (2006.01) A61B 17/28 (2006.01) A61B 17/29 (2006.01) A61B 17/30 (2006.01) F16C 11/12 (2006.01)	2653440	A47J 31/36 (2006.01) A47J 31/40 (2006.01) A47J 31/41 (2006.01) B67D 1/00 (2006.01) B67D 7/02 (2010.01) B67D 7/62 (2010.01)	2654909 *	A63B 69/00 (2006.01) B60L 13/04 (2006.01) B63B 35/79 (2006.01)
2694505 *	C07D 473/34 (2006.01) C07D 473/40 (2006.01)				
2670254 *	A23G 3/00 (2006.01) A23G 3/52 (2006.01) A23L 1/00 (2006.01)	2694506 *	C07D 473/34 (2006.01)		

Broj objave evropske prijava patenta (97)	MKP (51)	Broj objave evropske prijava patenta (97)	MKP (51)	Broj objave evropske prijava patenta (97)	MKP (51)
2687524 *	A61K 31/4155 (2006.01) A61K 31/4196 (2006.01) A61K 31/422 (2006.01) A61K 31/4245 (2006.01) A61K 31/433 (2006.01) A61K 31/4439 (2006.01) A61K 31/506 (2006.01) A61K 31/5377 (2006.01) A61P 17/14 (2006.01) C07D 403/04 (2006.01) C07D 413/04 (2006.01) C07D 413/14 (2006.01) C07D 417/04 (2006.01)	2691346 *	A01M 29/34 (2011.01) C03C 25/10 (2006.01) C03C 25/24 (2006.01) C03C 25/26 (2006.01) C03C 25/30 (2006.01) C03C 25/40 (2006.01) C03C 25/54 (2006.01) D06M 13/00 (2006.01) D06M 15/00 (2006.01)	2651939 *	A61K 31/437 (2006.01) A61P 35/00 (2006.01) C07D 471/04 (2006.01)
		2649076 *	A61K 31/504 (2006.01) A61P 31/14 (2006.01) C07D 487/08 (2006.01) C07D 498/08 (2006.01) C07D 498/18 (2006.01)	2677869 *	A01N 43/58 (2006.01)
2653466	A61K 31/554 (2006.01) A61P 9/00 (2006.01) A61P 19/08 (2006.01) A61P 25/00 (2006.01) C07D 281/10 (2006.01)	2686340 *	C07K 14/435 (2006.01)	2573296	E04F 15/02 (2006.01) E04F 21/00 (2006.01)
		2699625 *	A61K 8/00 (2006.01) A61K 8/91 (2006.01) A61K 35/00 (2006.01) B82Y 5/00 (2011.01) B82Y 30/00 (2011.01) C08F 292/00 (2006.01) C08J 3/07 (2006.01)	2686009 *	A61K 39/00 (2006.01) A61K 47/48 (2006.01) C07K 9/00 (2006.01)
2647088 *	G01R 1/067 (2006.01) H01R 12/71 (2011.01) H01R 13/24 (2006.01) H01R 13/6599 (2011.01) H01R 43/20 (2006.01)	2584545		2646001 *	A61K 9/16 (2006.01) A61K 9/20 (2006.01) A61K 31/165 (2006.01) A61P 25/08 (2006.01) A61P 25/14 (2006.01) A61P 25/18 (2006.01)
2697870 *	H01R 13/523 (2006.01) H01R 13/627 (2006.01)	2683741 *	A61K 9/16 (2006.01) A61K 9/20 (2006.01) A61K 9/50 (2006.01)	2584545	G07F 17/32 (2006.01)
2688879 *	C07D 307/80 (2006.01) C07D 307/84 (2006.01)	2646819 *		2683741 *	A61K 39/395 (2006.01) A61P 35/00 (2006.01) C07K 16/32 (2006.01)
2674198 *	A62D 1/00 (2006.01) C08J 9/34 (2006.01)	2673456 *	E21B 19/084 (2006.01) E21B 19/086 (2006.01)	2646819 *	C12Q 1/48 (2006.01) G01N 33/50 (2006.01)
		2463031	B05D 5/06 (2006.01) B05D 7/02 (2006.01)	2665607 *	B42D 15/10 (2006.01)
				2671635 *	B01J 19/00 (2006.01) C10G 2/00 (2006.01)
				2678349 *	A61K 31/7048 (2006.01) A61P 31/04 (2006.01) C07H 17/08 (2006.01)

Broj objave evropske prijave patenta (97)	MKP (51)	Broj objave evropske prijave patenta (97)	MKP (51)	Broj objave evropske prijave patenta (97)	MKP (51)
2699491 *	B65B 31/04 (2006.01) B65D 81/24 (2006.01) B65D 85/00 (2006.01)	2691109 *	A61K 31/64 (2006.01) A61K 38/26 (2006.01) A61P 3/08 (2006.01)	2670754 *	A61K 31/519 (2006.01) A61P 25/00 (2006.01) C07D 487/04 (2006.01)
2673417 *	B63B 27/14 (2006.01) E01D 15/24 (2006.01)	2658589 *	A61M 5/145 (2006.01) A61M 5/24 (2006.01) A61M 5/315 (2006.01)	2691087 *	A61K 9/00 (2006.01) A61K 31/04 (2006.01) A61K 33/04 (2006.01) A61K 47/06 (2006.01) A61P 9/10 (2006.01) A61P 9/12 (2006.01) A61P 17/06 (2006.01) A61P 17/10 (2006.01) A61P 25/24 (2006.01) A61P 29/00 (2006.01) A61P 31/00 (2006.01)
2654665 *	A61K 8/04 (2006.01) A61K 8/34 (2006.01) A61K 8/55 (2006.01) A61K 8/86 (2006.01) A61Q 19/00 (2006.01) G01F 22/00 (2006.01) G01N 13/02 (2006.01)	2675479 *	A61K 47/48 (2006.01) A61P 35/00 (2006.01) C07D 487/04 (2006.01) C07D 519/00 (2006.01)		
		2691086 *	A61K 9/08 (2006.01) A61K 31/015 (2006.01) A61K 31/201 (2006.01) A61K 31/202 (2006.01) A61K 31/203 (2006.01) A61K 31/355 (2006.01) A61P 25/16 (2006.01) A61P 25/28 (2006.01) A61P 43/00 (2006.01)	2662419	C09C 1/02 (2006.01) D21H 17/00 (2006.01)
2699562 *	C07D 401/06 (2006.01) C07D 471/04 (2006.01) C07D 471/10 (2006.01)			2604604	A61K 31/497 (2006.01) A61K 31/506 (2006.01) A61P 3/04 (2006.01) A61P 3/10 (2006.01) C07D 405/14 (2006.01)
2699786 *	F02M 27/04 (2006.01)				
2573073	A61K 31/422 (2006.01) A61P 35/00 (2006.01) C07C 229/40 (2006.01) C07D 231/14 (2006.01) C07D 471/04 (2006.01)	2646448 *	A61K 31/497 (2006.01) C07F 9/40 (2006.01)		
		2697217 *	A61K 31/70 (2006.01) A61P 3/10 (2006.01) C07D 405/10 (2006.01)	2685013	E03C 1/122 (2006.01) E03F 5/08 (2006.01) F16K 17/19 (2006.01)
2683483 *	B01L 3/00 (2006.01)				
2650813 *	H04L 9/14 (2006.01)			2670253 *	A23G 1/56 (2006.01) A23L 1/236 (2006.01)
2651434 *	A61K 39/00 (2006.01) C07K 14/47 (2006.01) C07K 14/705 (2006.01)	2662075	A61K 9/16 (2006.01) A61K 47/44 (2006.01)		
		2670432 *	A61K 39/10 (2006.01) A61K 39/295 (2006.01) C07K 14/235 (2006.01)	2651238 *	A23J 1/14 (2006.01) A23J 3/16 (2006.01) C07K 1/14 (2006.01)

Broj objave evropske prijave patenta (97)	MKP (51)	Broj objave evropske prijave patenta (97)	MKP (51)	Broj objave evropske prijave patenta (97)	MKP (51)
2680837 *	A61K 31/201 (2006.01) A61K 31/231 (2006.01) A61P 3/06 (2006.01) A61P 9/00 (2006.01) A61P 9/10 (2006.01)	2654721 *	A61K 9/00 (2006.01) A61K 9/127 (2006.01) A61K 31/4425 (2006.01) A61K 31/4706 (2006.01) A61K 47/48 (2006.01) A61P 31/10 (2006.01) A61P 31/12 (2006.01) A61P 33/00 (2006.01) A61P 35/00 (2006.01)	2651926 *	A61K 31/4178 (2006.01) A61P 31/00 (2006.01) C07D 403/10 (2006.01) C07D 403/14 (2006.01) C07D 409/14 (2006.01)
2655408 *	A61K 38/18 (2006.01) C07K 14/475 (2006.01)			2694073 *	A61K 31/517 (2006.01) C07D 239/70 (2006.01)
2675278 *	A01N 57/00 (2006.01) A61K 31/665 (2006.01)	2689192 *	F24D 3/12 (2006.01) F24J 2/04 (2006.01)	2649453 *	A61K 31/343 (2006.01) G01N 33/68 (2006.01)
2670867 *	C12Q 1/68 (2006.01)			2694484 *	A61K 31/505 (2006.01) A61K 31/506 (2006.01) C07D 239/48 (2006.01) C07D 401/12 (2006.01) C07D 403/12 (2006.01) C07D 405/12 (2006.01) C07D 413/12 (2006.01) C07D 471/04 (2006.01)
2652288 *	F02B 75/32 (2006.01)	2592286	A47G 1/20 (2006.01) A47G 25/06 (2006.01) B25C 1/02 (2006.01) B25C 5/16 (2006.01) F16B 43/02 (2006.01)		
2447877	G06F 21/00 (2006.01)				
2697218 *	C07D 409/10 (2006.01) C07D 409/14 (2006.01)				
2654603 *	A61C 8/00 (2006.01)	2663931 *	G06F 9/44 (2006.01) G06F 9/445 (2006.01) G06F 9/46 (2006.01) G06F 11/30 (2006.01) G06F 17/00 (2006.01) G06F 17/30 (2006.01)	2670863 *	C12Q 1/68 (2006.01)
2675623 *	B41F 33/00 (2006.01)			2570810	G01N 1/22 (2006.01) G01N 33/543 (2006.01)
2551415	E03F 5/04 (2006.01)				
2661421 *	A61K 31/13 (2006.01) A61P 9/12 (2006.01) C07C 211/35 (2006.01)	2518359	F16D 27/112 (2006.01) F16D 27/14 (2006.01) F16D 28/00 (2006.01) F16D 43/25 (2006.01)	2668212 *	C07K 16/40 (2006.01)
2651903 *	A61K 31/4188 (2006.01) A61P 11/00 (2006.01) C07D 235/26 (2006.01) C07D 471/04 (2006.01)			2699596 *	C07K 16/00 (2006.01)
2586945	E05D 15/06 (2006.01)	2699586 *	C07K 14/005 (2006.01) C12N 7/00 (2006.01) G01N 33/68 (2006.01)		

Broj objave evropske prijava patenta (97)	MKP (51)	Broj objave evropske prijava patenta (97)	MKP (51)	Broj objave evropske prijava patenta (97)	MKP (51)
2657233 *	A61K 31/437 (2006.01) A61K 31/519 (2006.01) A61K 31/5377 (2006.01) A61P 35/00 (2006.01) A61P 35/02 (2006.01) A61P 43/00 (2006.01) C07D 471/04 (2006.01) C07D 487/04 (2006.01)	2690087 *	A61K 31/165 (2006.01) A61P 1/00 (2006.01) A61P 9/00 (2006.01) A61P 25/00 (2006.01) A61P 25/20 (2006.01) A61P 25/22 (2006.01) A61P 25/24 (2006.01) C07C 231/24 (2006.01) C07C 233/18 (2006.01)	2655421 *	C08B 37/10 (2006.01) C12N 9/00 (2006.01) C12P 19/04 (2006.01) C12P 19/18 (2006.01)
2683236 *	A01N 25/22 (2006.01) A01N 43/40 (2006.01) A01N 47/40 (2006.01) A01N 51/00 (2006.01) A01P 7/00 (2006.01)	2685016	E03F 5/042 (2006.01)	2683360 *	A61K 9/00 (2006.01) A61K 38/00 (2006.01)
2694518 *	A61K 31/495 (2006.01) A61P 9/00 (2006.01) C07D 495/04 (2006.01)	2685825 *	A01N 43/42 (2006.01)	2662417	C09C 1/02 (2006.01) D21H 17/00 (2006.01)
2648701 *	A61K 9/20 (2006.01) A61K 31/675 (2006.01) A61K 47/32 (2006.01) A61P 31/12 (2006.01)	2691524 *	C07H 19/06 (2006.01) C12N 15/11 (2006.01) C12Q 1/68 (2006.01)	2694069 *	A61K 31/517 (2006.01) A61P 35/00 (2006.01) G01N 33/48 (2006.01)
2660262 *	C08G 18/52 (2006.01) C08G 18/70 (2006.01) C08L 75/04 (2006.01) G02B 1/04 (2006.01) G02B 3/00 (2006.01)	2525107	E04G 5/04 (2006.01) F16B 13/00 (2006.01)	2679420	B60H 1/00 (2006.01) B60H 1/32 (2006.01) F04B 39/12 (2006.01)
		2699676 *	A61K 38/47 (2006.01) C12N 9/24 (2006.01)	2660224 *	C04B 41/61 (2006.01) C04B 111/27 (2006.01)
		2694109 *	A61K 39/00 (2006.01) A61K 39/395 (2006.01) A61K 51/10 (2006.01) A61P 11/00 (2006.01) A61P 19/02 (2006.01) A61P 25/28 (2006.01) A61P 27/02 (2006.01) C07K 16/18 (2006.01) C07K 16/46 (2006.01) C12P 21/02 (2006.01)	2646459 *	A61K 39/12 (2006.01) C07K 14/005 (2006.01) C07K 14/025 (2006.01) C07K 14/045 (2006.01) C07K 14/075 (2006.01) C07K 14/085 (2006.01) C07K 14/11 (2006.01) C07K 14/16 (2006.01) C07K 14/18 (2006.01)

Broj objave evropske prijava patenta (97)	MKP (51)	Broj objave evropske prijava patenta (97)	MKP (51)	Broj objave evropske prijava patenta (97)	MKP (51)
2695881 *	C07D 205/04 (2006.01) A61K 31/5377 (2006.01) A61P 9/10 (2006.01) A61K 31/495 (2006.01) A61P 1/16 (2006.01) A61K 31/506 (2006.01) A61P 9/00 (2006.01) A61K 31/426 (2006.01) A61K 31/551 (2006.01) A61P 9/12 (2006.01) A61K 31/4545 (2006.01) A61P 1/04 (2006.01) A61K 31/505 (2006.01) A61P 3/10 (2006.01) A61K 31/4402 (2006.01) A61P 1/02 (2006.01) A61P 11/00 (2006.01) A61K 31/496 (2006.01) A61P 3/04 (2006.01)	2700387 *	A61F 13/02 (2006.01) A61K 9/70 (2006.01)	2670415 *	A61K 36/00 (2006.01) A61K 36/28 (2006.01) A61K 36/45 (2006.01) A61K 36/53 (2006.01) A61K 36/539 (2006.01) A61K 36/73 (2006.01) A61K 36/734 (2006.01) A61K 36/77 (2006.01) A61P 3/02 (2006.01) A61P 29/00 (2006.01) A61P 39/06 (2006.01) C12Q 1/02 (2006.01) G01N 33/48 (2006.01)
		2697198 *	A61K 31/4427 (2006.01) A61P 35/00 (2006.01) C07D 213/64 (2006.01) C07D 401/12 (2006.01) C07D 401/14 (2006.01) C07D 407/12 (2006.01) C07D 409/12 (2006.01) C07D 413/12 (2006.01) C07D 413/14 (2006.01) C07D 491/10 (2006.01) C07D 491/113 (2006.01)	2673490 *	F02C 7/08 (2006.01)
		2699187 *	A61B 17/86 (2006.01) A61B 19/02 (2006.01) A61C 8/00 (2006.01) A61F 2/00 (2006.01) A61L 2/26 (2006.01)	2686602 *	F17C 13/08 (2006.01)
2697365 *	C12N 5/075 (2010.01)	2655336 *	A61K 31/4164 (2006.01) C07D 233/88 (2006.01) C07D 233/91 (2006.01)	2682927 *	G08G 1/08 (2006.01)
2661493 *	A61K 38/48 (2006.01) C12N 9/68 (2006.01)			2691762 *	B07C 5/12 (2006.01) G01N 21/90 (2006.01)
2606867	A61G 5/04 (2013.01)	2663561 *	A61K 31/5377 (2006.01) A61P 25/00 (2006.01) C07D 413/14 (2006.01) C07D 487/04 (2006.01)	2665716 *	C07D 307/22 (2006.01) C07D 498/04 (2006.01) C07D 513/04 (2006.01)
2678014 *	A61K 31/4196 (2006.01) A61K 31/661 (2006.01) A61K 45/06 (2006.01) A61P 35/00 (2006.01)	2694039 *	A61K 9/20 (2006.01) A61K 31/4188 (2006.01)	2575235	H02J 7/00 (2006.01)
2691345 *	C03C 25/24 (2006.01) C03C 25/26 (2006.01) C03C 25/40 (2006.01) C08J 5/08 (2006.01)			2658966 *	C12N 5/02 (2006.01) C12N 5/0735 (2010.01) C12N 5/079 (2010.01)
				2685017	E03F 5/042 (2006.01)

Broj objave evropske prijava patenta (97)	MKP (51)	Broj objave evropske prijava patenta (97)	MKP (51)	Broj objave evropske prijava patenta (97)	MKP (51)
2694972 *	G01N 33/574 (2006.01)	2693370 *	G06K 19/073 (2006.01)	2650361 *	A61K 35/12 (2006.01) A61K 49/00 (2006.01) A61P 29/00 (2006.01) A61P 31/00 (2006.01) A61P 35/00 (2006.01) A61P 37/06 (2006.01) A61P 37/08 (2006.01) A61P 43/00 (2006.01) C12N 5/0783 (2010.01) C12Q 1/02 (2006.01)
2683243 *	A01N 43/40 (2006.01) A61K 31/435 (2006.01) C07D 213/56 (2006.01) C07D 273/00 (2006.01)	2670690 *	B65G 47/31 (2006.01)		
		2688513 *	A61C 19/06 (2006.01) A61K 8/22 (2006.01) A61K 8/24 (2006.01) A61Q 11/00 (2006.01)		
2663575 *	A01K 67/027 (2006.01) C07K 14/54 (2006.01) C07K 14/715 (2006.01)	2686839 *	G08B 29/20 (2006.01)		
		2649086 *	A61K 39/00 (2006.01) C07H 21/04 (2006.01)	2691576 *	E01H 1/08 (2006.01)
2651923 *	A61K 31/4184 (2006.01) A61P 31/14 (2006.01) C07D 403/04 (2006.01) C07D 403/10 (2006.01) C07D 403/12 (2006.01) C07D 403/14 (2006.01)	2696694 *	A01N 43/54 (2006.01) A01N 43/56 (2006.01) A01N 43/58 (2006.01) A01N 43/653 (2006.01) A01N 43/76 (2006.01) A01N 43/82 (2006.01) A01N 43/84 (2006.01) A01N 43/90 (2006.01) A01N 47/36 (2006.01) A01P 13/00 (2006.01)	2675500 *	A61M 5/19 (2006.01)
				2678282 *	C03C 1/00 (2006.01) C03C 17/00 (2006.01)
2694491 *	C07D 407/14 (2006.01) C07D 513/04 (2006.01) C07D 409/12 (2006.01) A61K 31/381 (2006.01) C07D 407/12 (2006.01) C07D 495/04 (2006.01) C07D 413/12 (2006.01) C07D 409/14 (2006.01) A61K 31/422 (2006.01) C07D 333/58 (2006.01) C07D 417/14 (2006.01) C07D 321/10 (2006.01) C07D 417/12 (2006.01) C07D 409/04 (2006.01) A61K 31/357 (2006.01)	2672821 *	A01N 43/16 (2006.01) A61K 31/35 (2006.01)	2624115	G06F 3/023 (2006.01) G06F 3/048 (2013.01)
		2658360 *	A01C 15/02 (2006.01) A01C 23/02 (2006.01) A01G 7/06 (2006.01) A01G 29/00 (2006.01)	2697520 *	F16B 19/05 (2006.01)
2648671 *	A61G 5/10 (2006.01) A61G 7/10 (2006.01)			2681718 *	G06K 9/00 (2006.01) G06K 9/32 (2006.01) G06K 9/46 (2006.01) G06K 9/62 (2006.01) G06Q 30/00 (2012.01) G06T 7/20 (2006.01) G06T 19/00 (2011.01)

Broj objave evropske prijave patenta (97)	MKP (51)	Broj objave evropske prijave patenta (97)	MKP (51)	Broj objave evropske prijave patenta (97)	MKP (51)
2675795 *	C07D 471/04 (2006.01) A61K 31/405 (2006.01) C07D 261/12 (2006.01) A61K 31/42 (2006.01) C07D 249/10 (2006.01) A61K 31/4192 (2006.01) C07C 233/47 (2006.01) A61P 13/00 (2006.01) C07C 233/46 (2006.01) A61P 9/00 (2006.01) C07D 249/18 (2006.01) A61K 31/4196 (2006.01) C07D 249/04 (2006.01) A61K 31/4164 (2006.01) A61K 31/415 (2006.01)	2675774 *	C07C 25/02 (2006.01) C07C 43/205 (2006.01) C07D 307/80 (2006.01) C07F 15/00 (2006.01)	2668259 *	C05D 9/00 (2006.01) C12M 1/04 (2006.01) C12N 1/12 (2006.01) C12N 1/36 (2006.01) C12N 13/00 (2006.01) C12P 7/64 (2006.01) C12P 19/04 (2006.01) C12R 1/89 (2006.01)
		2340978	B62B 3/00 (2006.01) B62B 5/00 (2006.01)		
		2666015 *	A61K 31/00 (2006.01) G01N 33/50 (2006.01)	2612694	A62C 31/24 (2006.01) A62C 37/36 (2006.01) A62C 99/00 (2010.01)
		2665474 *	A61K 31/13 (2006.01) A61P 27/16 (2006.01)		
		2682208 *	B23B 27/04 (2006.01) B23B 27/14 (2006.01) B23B 27/22 (2006.01)	2687082	A01D 45/16 (2006.01)
2578358	B24B 19/20 (2006.01) B24B 27/00 (2006.01) B24B 27/04 (2006.01)	2655410 *	A61K 38/38 (2006.01) A61P 29/00 (2006.01) C07K 14/76 (2006.01) G01N 33/533 (2006.01) G01N 33/68 (2006.01)	2663313 *	A61K 31/5585 (2006.01) A61K 35/28 (2006.01) C12N 5/078 (2010.01)
				2684338 *	H04L 29/08 (2006.01) H04L 29/12 (2006.01)
2688611 *	A61M 5/24 (2006.01) A61M 5/315 (2006.01)			2670410 *	A61K 31/4375 (2006.01) A61K 31/444 (2006.01) A61K 31/4545 (2006.01) A61K 31/4709 (2006.01) A61K 31/496 (2006.01) A61K 31/506 (2006.01) A61K 38/12 (2006.01) A61P 31/04 (2006.01) C07D 455/02 (2006.01)
2573008	B65D 85/804 (2006.01)	2661485 *	C12M 1/34 (2006.01) C12M 1/38 (2006.01) C12Q 1/68 (2006.01)		
2648728 *	A61K 31/4196 (2006.01) A61K 31/437 (2006.01) A61K 31/495 (2006.01) A61K 31/496 (2006.01) A61P 17/00 (2006.01)	2646429 *	A61K 31/404 (2006.01) A61K 31/437 (2006.01) A61P 3/00 (2006.01) A61P 11/00 (2006.01) C07D 401/12 (2006.01) C07D 471/04 (2006.01)		
2657325 *	C10M 125/10 (2006.01) C10M 125/26 (2006.01) C10M 177/00 (2006.01)			2646385 *	C03C 17/34 (2006.01)

Broj objave evropske prijave patenta (97)	MKP (51)	Broj objave evropske prijave patenta (97)	MKP (51)	Broj objave evropske prijave patenta (97)	MKP (51)
2697346 *	C09D 5/08 (2006.01) C09D 191/00 (2006.01) C11B 3/06 (2006.01) C11D 1/04 (2006.01) C11D 13/00 (2006.01) C11D 17/08 (2006.01) C23F 11/12 (2006.01)	2700131 *	H01S 3/04 (2006.01) H01S 3/042 (2006.01) H01S 3/06 (2006.01) H01S 3/08 (2006.01) H01S 5/024 (2006.01)	2699260 *	A61K 39/395 (2006.01) A61P 35/00 (2006.01) C07K 16/10 (2006.01) C07K 16/28 (2006.01) C07K 16/32 (2006.01) C07K 16/46 (2006.01)
2681040 *	B29C 35/00 (2006.01) B29C 53/56 (2006.01) B29C 53/64 (2006.01) B29C 70/32 (2006.01) B29D 23/00 (2006.01) F16L 9/16 (2006.01)	2655599 *	C12N 1/21 (2006.01) C12N 5/10 (2006.01) C12N 9/00 (2006.01) C12N 15/52 (2006.01) C12N 15/63 (2006.01) C12P 7/16 (2006.01)	2640637 *	B64D 10/00 (2006.01)
2694479 *	C07D 215/14 (2006.01) C07D 401/04 (2006.01) C07D 405/04 (2006.01) C07D 409/04 (2006.01) C07D 417/04 (2006.01) C07D 491/06 (2006.01)	2689013 *	A61K 31/7088 (2006.01) A61P 35/00 (2006.01) C12N 15/113 (2010.01)	2699152 *	A61B 5/042 (2006.01)
2593109 *	A61K 9/00 (2006.01) A61K 9/20 (2006.01) A61K 9/22 (2006.01) A61K 31/7012 (2006.01) A61K 47/38 (2006.01) A61P 21/00 (2006.01)	2687542 *	A61K 38/28 (2006.01) A61P 3/10 (2006.01) C07K 1/107 (2006.01) C07K 14/62 (2006.01) C07K 17/08 (2006.01)	2692243	A21D 8/00 (2006.01) A23C 9/152 (2006.01) A23C 9/154 (2006.01) A23F 3/16 (2006.01) A23F 3/40 (2006.01) A23F 5/24 (2006.01) A23F 5/40 (2006.01) A23G 1/40 (2006.01) A23G 3/42 (2006.01) A23G 9/34 (2006.01) A23L 1/00 (2006.01) A23L 1/06 (2006.01) A23L 1/068 (2006.01) A23L 1/09 (2006.01) A23L 1/236 (2006.01) A23L 1/30 (2006.01) A23L 2/39 (2006.01) A23L 2/60 (2006.01)
2646557 *	C12N 5/16 (2006.01) C12N 15/67 (2006.01)	2699583 *	C07H 21/02 (2006.01)	2646270 *	B60K 15/04 (2006.01)
		2648732 *	A61K 31/47 (2006.01)	2683709 *	A61K 31/47 (2006.01) A61P 37/00 (2006.01) C07D 401/12 (2006.01) C07D 403/12 (2006.01)
		2689353 *	G06F 15/16 (2006.01) G06F 17/30 (2006.01) H04L 9/32 (2006.01)		

Broj objave evropske prijave patenta (97)	MKP (51)	Broj objave evropske prijave patenta (97)	MKP (51)	Broj objave evropske prijave patenta (97)	MKP (51)
2646025 *	A61K 31/4152 (2006.01) A61K 31/4155 (2006.01) A61K 31/4523 (2006.01) A61K 31/4725 (2006.01) A61K 31/496 (2006.01) A61K 31/5377 (2006.01) A61P 29/00 (2006.01)	2675612 *	B29C 70/38 (2006.01) B29C 70/54 (2006.01)	2683620 *	B65D 1/02 (2006.01) B65D 51/28 (2006.01) B65D 81/20 (2006.01) B65D 81/24 (2006.01) B65D 81/32 (2006.01) C12H 1/14 (2006.01) C12H 1/22 (2006.01)
2655417 *	C07K 16/24 (2006.01)	2699601 *	A61K 39/395 (2006.01) C07K 16/28 (2006.01)	2691381 *	C07D 307/81 (2006.01)
2667873 *	A01N 43/54 (2006.01) A61K 31/535 (2006.01) C07D 277/00 (2006.01)	2655314 *	C07C 69/96 (2006.01)	2694105 *	A61K 39/00 (2006.01) A61K 39/395 (2006.01)
2404885	C04B 28/10 (2006.01) C04B 28/18 (2006.01) C04B 40/06 (2006.01) C04B 103/10 (2006.01) C04B 111/10 (2006.01)	2646419 *	C07D 239/42 (2006.01)	2689787	A61K 39/395 (2006.01) C07K 16/22 (2006.01) C07K 16/28 (2006.01) C07K 16/30 (2006.01) C07K 16/40 (2006.01) C12N 5/09 (2010.01)
2651918 *	A61K 31/506 (2006.01) A61P 35/00 (2006.01) C07D 401/12 (2006.01)	2651257 *	A44C 5/08 (2006.01)	2683731 *	C07J 63/00 (2006.01)
2665465 *	A61K 9/00 (2006.01) A61K 9/14 (2006.01) A61K 9/16 (2006.01) A61K 9/20 (2006.01) A61K 31/343 (2006.01) A61P 25/18 (2006.01)	2678996 *	H04L 29/08 (2006.01)	2578323	A47J 27/00 (2006.01) A47J 36/02 (2006.01) B05D 3/12 (2006.01) B05D 5/06 (2006.01) B05D 5/08 (2006.01)
2661498 *	C12N 15/82 (2006.01)	2696871 *	A61K 31/439 (2006.01) A61P 11/00 (2006.01) A61P 43/00 (2006.01)	2662425	C08J 5/24 (2006.01) C08L 63/00 (2006.01) C09D 163/00 (2006.01) H05K 1/03 (2006.01)
2683247 *	A01N 59/02 (2006.01) A01N 59/16 (2006.01) A01P 7/04 (2006.01)	2606845	A61B 18/12 (2006.01) A61B 18/14 (2006.01)	2689086 *	E06B 3/36 (2006.01)
		2668967	A61L 27/44 (2006.01) A61L 27/46 (2006.01) A61L 27/54 (2006.01)	2694683 *	C07H 21/04 (2006.01) C12Q 1/68 (2006.01)

Broj objave evropske prijava patenta (97)	MKP (51)	Broj objave evropske prijava patenta (97)	MKP (51)	Broj objave evropske prijava patenta (97)	MKP (51)
2682475 *	A61K 39/395 (2006.01) A61P 35/00 (2006.01) C07K 16/18 (2006.01) C12N 5/20 (2006.01) C12Q 1/02 (2006.01) C12Q 1/68 (2006.01) G01N 33/577 (2006.01)	2688613 *	A61M 5/24 (2006.01) A61M 5/315 (2006.01)	2423116	B65D 5/50 (2006.01) B65D 81/07 (2006.01)
2694510 *	A61K 31/5025 (2006.01) A61P 35/00 (2006.01) C07D 487/04 (2006.01)	2668183 *	A61K 31/4155 (2006.01) A61P 19/00 (2006.01) A61P 29/00 (2006.01) C07D 413/04 (2006.01) C07D 413/14 (2006.01) C07D 417/14 (2006.01)	2663557 *	A61K 31/506 (2006.01) A61P 31/04 (2006.01) C07D 405/14 (2006.01) C07F 9/6558 (2006.01)
2646738 *	F17C 7/02 (2006.01) F17C 13/02 (2006.01)	2694658 *	A01H 5/00 (2006.01) C12N 15/82 (2006.01)	2673260 *	C07D 207/34 (2006.01) C07D 231/12 (2006.01) C07D 231/14 (2006.01) C07D 231/16 (2006.01) C07D 231/18 (2006.01) C07D 231/54 (2006.01) C07D 231/56 (2006.01) C07D 233/61 (2006.01) C07D 233/64 (2006.01) C07D 233/68 (2006.01) C07D 233/70 (2006.01) C07D 233/84 (2006.01) C07D 249/06 (2006.01) C07D 249/08 (2006.01) C07D 261/08 (2006.01)
2684450 *	A01K 61/00 (2006.01)	2646464 *	A61K 38/17 (2006.01) A61K 38/21 (2006.01) A61P 35/00 (2006.01) C07K 14/56 (2006.01) C07K 14/57 (2006.01) C07K 14/705 (2006.01) C12N 15/12 (2006.01) C12N 15/21 (2006.01) C12N 15/23 (2006.01) C12N 15/62 (2006.01)	2691083 *	A61K 9/16 (2006.01) A61K 9/20 (2006.01) A61K 31/4985 (2006.01)
2694071 *	A61K 31/517 (2006.01) C07D 239/70 (2006.01)	2654422 *	A01N 29/04 (2006.01) A61K 31/025 (2006.01)	2691156 *	A61P 39/02 (2006.01) C07K 16/44 (2006.01)
2670736 *	A61K 31/517 (2006.01) A61P 11/00 (2006.01) C07D 239/70 (2006.01) C07D 403/12 (2006.01)	2668152 *	C07C 217/54 (2006.01)	2695916	C08L 25/10 (2006.01) C08L 71/12 (2006.01)
2691380 *	C07D 307/81 (2006.01)	2697201 *	A61K 31/4704 (2006.01) C07D 215/56 (2006.01)		
2668819 *	F16L 53/00 (2006.01) F17D 1/18 (2006.01) H05B 3/00 (2006.01) H05B 6/10 (2006.01)	2694070 *	A61K 31/517 (2006.01) A61P 35/00 (2006.01) C07D 239/70 (2006.01)		
2646420 *	A61K 31/505 (2006.01) C07D 239/42 (2006.01)				
2684029 *	G01N 21/25 (2006.01) G01N 21/59 (2006.01)				

Broj objave evropske prijava patenta (97)	MKP (51)	Broj objave evropske prijava patenta (97)	MKP (51)	Broj objave evropske prijava patenta (97)	MKP (51)
2649097 *	A61K 39/395 (2006.01) A61P 35/00 (2006.01) A61P 35/02 (2006.01) C07K 16/28 (2006.01) G01N 33/574 (2006.01)	2678811 *	G06Q 20/00 (2012.01)	2654729 *	A61K 9/20 (2006.01) A61K 9/28 (2006.01) A61K 31/401 (2006.01) A61K 31/4422 (2006.01)
2678032 *	A61K 39/00 (2006.01)	2663764 *	F02D 41/38 (2006.01) F02M 59/34 (2006.01) F02M 59/36 (2006.01) F02M 63/00 (2006.01) F02M 63/02 (2006.01)	2698438 *	C22B 9/02 (2006.01) C22B 59/00 (2006.01) C30B 25/00 (2006.01) C30B 35/00 (2006.01) F27B 14/10 (2006.01)
2683883 *	E03D 5/10 (2006.01)	2654602 *	A61C 8/00 (2006.01)		
2532259	A43B 1/00 (2006.01) A43B 3/00 (2006.01) A43C 15/14 (2006.01)	2688887 *	A61K 31/519 (2006.01) A61P 35/00 (2006.01) A61P 35/02 (2006.01) C07D 471/14 (2006.01) C07D 519/00 (2006.01)	2645995 *	A61K 9/14 (2006.01) A61K 9/16 (2006.01) A61K 9/48 (2006.01) A61K 33/24 (2006.01)
2678333 *	C07D 403/06 (2006.01)				
2655375 *	A61K 31/519 (2006.01) A61P 25/00 (2006.01) C07D 487/04 (2006.01) A61P 7/02 (2006.01) A61K 31/527 (2006.01) A61P 19/02 (2006.01) A61P 3/10 (2006.01) C07D 233/44 (2006.01) A61P 37/00 (2006.01) C07D 239/12 (2006.01) A61P 11/06 (2006.01) A61P 35/00 (2006.01) A61P 17/06 (2006.01) A61P 3/00 (2006.01) A61K 31/5377 (2006.01)	2694963 *	C12Q 1/68 (2006.01) C40B 40/08 (2006.01) G01N 33/50 (2006.01)	2647846 *	F04C 18/22 (2006.01) F04C 29/02 (2006.01)
		2687298	B05D 1/02 (2006.01) B05D 3/02 (2006.01) B05D 5/06 (2006.01)	2597201	E02B 9/04 (2006.01)
		2647906 *	F21V 5/04 (2006.01) F21Y 101/02 (2006.01)		
		2652532 *	B29D 11/00 (2006.01) G02B 1/04 (2006.01)		
		2565013	A61F 13/15 (2006.01) B29C 55/06 (2006.01)		
2686808 *	G06K 9/00 (2006.01) G06K 9/62 (2006.01) G06T 7/00 (2006.01)	2654860 *	A61F 13/02 (2006.01) A61M 5/42 (2006.01) A61M 25/02 (2006.01)		

Broj objave evropske prijave patenta (97)	MKP (51)	Broj objave evropske prijave patenta (97)	MKP (51)	Broj objave evropske prijave patenta (97)	MKP (51)
2657241 *	C07F 9/09 (2006.01) A61P 11/06 (2006.01) A61P 43/00 (2006.01) A61K 31/662 (2006.01) A61P 27/02 (2006.01) A61K 31/661 (2006.01) A61P 13/12 (2006.01) C07F 9/38 (2006.01) A61P 9/10 (2006.01) A61P 31/16 (2006.01) A61P 9/00 (2006.01) A61P 29/00 (2006.01) A61P 7/02 (2006.01) A61P 27/06 (2006.01) A61P 11/00 (2006.01) A61P 35/00 (2006.01) A61P 9/06 (2006.01) A61P 31/04 (2006.01)	2658844 *	A61K 31/513 (2006.01) A61P 35/00 (2006.01) C07D 209/30 (2006.01) C07D 401/14 (2006.01) C07D 403/04 (2006.01) C07D 403/06 (2006.01) C07D 413/04 (2006.01) C07D 413/14 (2006.01) C07D 471/10 (2006.01) C07D 493/10 (2006.01)	2688154	H01R 13/627 (2006.01) H01R 13/635 (2006.01)
		2659869	A61F 13/15 (2006.01)	2668506 *	G01N 33/68 (2006.01)
		2655794 *	E21B 43/26 (2006.01) E21B 43/30 (2006.01)	2668327 *	D04H 1/70 (2012.01) D04H 1/736 (2012.01) D21F 11/04 (2006.01)
		2646004 *	A61K 9/20 (2006.01)	2651927 *	A61K 31/4184 (2006.01) A61P 31/14 (2006.01) C07D 403/10 (2006.01) C07D 403/12 (2006.01) C07D 403/14 (2006.01)
		2646044 *	A61K 38/17 (2006.01) A61P 3/00 (2006.01)	2649088 *	C07K 1/34 (2006.01) C07K 17/02 (2006.01) C07K 19/00 (2006.01) G01N 33/544 (2006.01)
2662397 *	C08G 69/26 (2006.01) C08L 77/06 (2006.01)	2655378 *	A61K 31/4184 (2006.01) A61K 31/4188 (2006.01) A61K 31/4439 (2006.01) A61K 31/506 (2006.01) A61P 25/28 (2006.01) C07D 235/02 (2006.01) C07D 401/04 (2006.01) C07D 401/12 (2006.01) C07D 403/12 (2006.01) C07D 405/12 (2006.01) C07D 491/107 (2006.01) C07D 491/20 (2006.01)	2656159 *	G05D 16/06 (2006.01)
2688909 *	C07K 16/00 (2006.01) C07K 16/46 (2006.01)			2675721 *	B65D 51/16 (2006.01)
2670574 *	B29C 45/27 (2006.01)			2675953 *	E01B 1/00 (2006.01)
2678395 *	C09D 7/00 (2006.01)			2583846	A61L 2/00 (2006.01) B01D 46/00 (2006.01) B60H 3/06 (2006.01)
		2661627 *	G01N 33/564 (2006.01) G01N 33/68 (2006.01)	2648712 *	A61K 31/18 (2006.01) A61K 31/4164 (2006.01) A61K 45/06 (2006.01) A61P 27/00 (2006.01)
				2673237 *	C01B 39/06 (2006.01)

Broj objave evropske prijave patenta (97)	MKP (51)	Broj objave evropske prijave patenta (97)	MKP (51)	Broj objave evropske prijave patenta (97)	MKP (51)
2670431 *	A61K 39/10 (2006.01) A61K 39/145 (2006.01) A61K 39/215 (2006.01)	2682381 *	A61K 31/195 (2006.01) A61P 25/18 (2006.01) C07C 229/46 (2006.01)	2651885 *	A61K 31/4025 (2006.01) A61K 31/4184 (2006.01) A61K 31/4439 (2006.01) A61P 31/12 (2006.01) C07D 207/16 (2006.01) C07D 403/04 (2006.01)
2655744 *	E01F 8/00 (2006.01)	2649062 *	A61K 31/416 (2006.01) A61K 31/423 (2006.01) A61P 9/00 (2006.01) C07D 401/04 (2006.01) C07D 405/04 (2006.01) C07D 413/04 (2006.01) C07D 417/04 (2006.01)	2699574 *	A61K 31/437 (2006.01) A61K 31/4985 (2006.01) A61K 31/519 (2006.01) A61K 31/5383 (2006.01) A61P 35/00 (2006.01) C07D 471/04 (2006.01) C07D 498/04 (2006.01)
2686339 *	A61K 39/104 (2006.01) C07K 14/21 (2006.01) C07K 16/12 (2006.01) C07K 19/00 (2006.01)	2594627	C11C 5/00 (2006.01) F23D 3/08 (2006.01)		
2661423 *	C07C 231/14 (2006.01) C07C 233/18 (2006.01) C07C 233/31 (2006.01) C07D 209/48 (2006.01)	2673182 *	B62H 3/02 (2006.01) B62M 6/45 (2010.01)	2672801 *	A01B 13/08 (2006.01) A01B 15/02 (2006.01) A01B 35/08 (2006.01) A01B 35/26 (2006.01) A01B 49/06 (2006.01)
2688556 *	A61K 9/20 (2006.01) A61K 9/28 (2006.01) A61K 31/485 (2006.01) A61K 47/10 (2006.01) A61K 47/34 (2006.01)	2667914 *	A61M 5/20 (2006.01) A61M 5/32 (2006.01)		
		2699150 *	A61B 5/042 (2006.01)	2691128 *	A61M 5/168 (2006.01)
2663181 *	A01N 25/04 (2006.01) B01F 3/08 (2006.01)	2697755 *	G06Q 20/32 (2012.01)		
2663717 *	E05F 3/10 (2006.01)	2689075 *	E04B 5/00 (2006.01) E04B 5/36 (2006.01) E04B 5/40 (2006.01) E04C 5/00 (2006.01)		
2691369 *	A61K 9/72 (2006.01) A61K 38/05 (2006.01) C07D 209/20 (2006.01) C07K 5/037 (2006.01)	2678075 *	A61P 35/00 (2006.01)		
2620345	A63G 21/22 (2006.01) B61B 12/02 (2006.01)	2631409	E06B 3/667 (2006.01)		
		2683403 *	A61K 39/395 (2006.01)		

Broj objave evropske prijava patenta (97)	MKP (51)	Broj objave evropske prijava patenta (97)	MKP (51)	Broj objave evropske prijava patenta (97)	MKP (51)
2672957 *	A61K 9/00 (2006.01) A61K 9/28 (2006.01) A61K 9/48 (2006.01) A61K 31/192 (2006.01) A61K 31/343 (2006.01) A61K 31/37 (2006.01) A61K 31/4015 (2006.01) A61K 31/404 (2006.01) A61K 31/4174 (2006.01) A61K 31/427 (2006.01) A61K 31/437 (2006.01) A61K 31/44 (2006.01) A61K 31/444 (2006.01) A61K 31/472 (2006.01) A61K 31/498 (2006.01)	2699563 *	C07D 401/14 (2006.01) C07D 403/12 (2006.01) C07D 405/14 (2006.01) C07D 409/14 (2006.01) C07D 411/14 (2006.01) C07D 417/14 (2006.01)	2646036 *	A61K 9/00 (2006.01) A61K 31/685 (2006.01) A61K 31/728 (2006.01) A61P 1/00 (2006.01) A61P 1/02 (2006.01) A61P 1/04 (2006.01)
		2683832 *	A01H 5/08 (2006.01) C12Q 1/68 (2006.01)	2561753	A01N 25/04 (2006.01) A01N 47/44 (2006.01) A01P 3/00 (2006.01)
		2673419 *	E01F 8/00 (2006.01)	2680775 *	A61B 18/18 (2006.01)
		2688910 *	A61K 39/395 (2006.01) C07K 16/22 (2006.01)	2658575 *	A61K 39/395 (2006.01) A61K 47/12 (2006.01) A61K 47/18 (2006.01) A61K 47/22 (2006.01) A61K 47/26 (2006.01) C07K 16/24 (2006.01)
		2689581 *	H04N 1/00 (2006.01) H04N 7/18 (2006.01)		
2675810 *	A61K 31/353 (2006.01) A61P 25/00 (2006.01) C07D 491/00 (2006.01)	2666149 *	G07F 17/32 (2006.01)		
		2502681	B08B 9/027 (2006.01) B08B 9/04 (2006.01) B08B 9/043 (2006.01) B08B 9/051 (2006.01) F16L 25/00 (2006.01) F16L 33/00 (2006.01) G03B 37/00 (2006.01)	2683889 *	E02D 27/34 (2006.01) E04H 9/02 (2006.01)
2646968 *	G06Q 50/00 (2012.01)			2694509 *	A61K 31/519 (2006.01) A61P 25/00 (2006.01) A61P 35/00 (2006.01) C07D 487/04 (2006.01)
2680967 *	B01J 31/00 (2006.01) C07F 11/00 (2006.01)				
2596811	A61L 2/07 (2006.01) A61L 11/00 (2006.01) B01J 3/04 (2006.01) B29B 17/00 (2006.01)	2485049	G01N 33/49 (2006.01) G01N 35/10 (2006.01)	2680843 *	A61K 31/4545 (2006.01) C07D 401/14 (2006.01)
2686627 *	F01K 25/10 (2006.01) F25J 3/04 (2006.01)	2684613	B05B 15/12 (2006.01)	2676677 *	A61K 9/08 (2006.01) A61K 39/395 (2006.01) A61K 47/18 (2006.01) A61K 47/34 (2006.01)

Broj objave evropske prijave patenta (97)	MKP (51)	Broj objave evropske prijave patenta (97)	MKP (51)	Broj objave evropske prijave patenta (97)	MKP (51)
2699515 *	B22D 27/08 (2006.01) C01B 17/02 (2006.01) C04B 28/36 (2006.01)	2596733	A47L 5/22 (2006.01)	2678017 *	A61P 9/04 (2006.01) A61P 3/06 (2006.01) A61K 31/4468 (2006.01) A61P 11/00 (2006.01) A61P 25/00 (2006.01) A61P 3/00 (2006.01) A61P 5/48 (2006.01) A61P 3/10 (2006.01) A61P 3/08 (2006.01) A61P 1/04 (2006.01) C07D 211/58 (2006.01) A61P 1/00 (2006.01) A61P 9/12 (2006.01) A61P 21/00 (2006.01) A61P 9/10 (2006.01) A61P 1/16 (2006.01) A61P 9/00 (2006.01) A61P 3/04 (2006.01) A61P 25/30 (2006.01) A61P 7/00 (2006.01)
2672996 *	A61K 39/00 (2006.01) A61K 39/395 (2006.01) C07K 16/00 (2006.01)	2683409 *	A61K 47/48 (2006.01) A61P 35/00 (2006.01)	2695120 *	G06Q 20/38 (2012.01)
2673896 *	H04B 7/185 (2006.01)	2661299 *	A61M 5/28 (2006.01) A61M 5/32 (2006.01) A61M 5/50 (2006.01)	2657360	C22C 21/02 (2006.01) C22C 21/04 (2006.01)
2686350 *	C07K 16/36 (2006.01)	2694106 *	A61K 39/395 (2006.01)	2679638	C09C 1/02 (2006.01) D21H 17/00 (2006.01)
2646831 *	G01N 33/574 (2006.01)	2655990 *	F25D 11/00 (2006.01) F25D 25/00 (2006.01) F25D 29/00 (2006.01)	2648713 *	A61K 31/18 (2006.01) A61K 31/4164 (2006.01) A61P 27/00 (2006.01)
2687523 *	A61K 31/506 (2006.01) A61P 3/10 (2006.01) A61P 9/00 (2006.01) A61P 9/10 (2006.01) A61P 9/12 (2006.01) A61P 13/12 (2006.01) A61P 25/18 (2006.01) A61P 27/02 (2006.01) A61P 43/00 (2006.01) C07D 401/14 (2006.01) C07D 413/14 (2006.01)	2692725 *	A61K 31/496 (2006.01) C07D 401/12 (2006.01) C07D 401/14 (2006.01)		
2680817 *	A61K 9/08 (2006.01) A61K 47/36 (2006.01) A61K 47/38 (2006.01)	2583602	A47K 10/38 (2006.01)		
2658846 *	A61K 31/4196 (2006.01) A61P 9/00 (2006.01) C07D 249/12 (2006.01)	2694651 *	A01N 63/00 (2006.01) C12N 13/00 (2006.01)		
2655382 *	C07F 3/06 (2006.01)				
2652153 *	C12Q 1/68 (2006.01)				

Broj objave evropske prijave patenta (97)	MKP (51)	Broj objave evropske prijave patenta (97)	MKP (51)	Broj objave evropske prijave patenta (97)	MKP (51)
2699576 *	A61K 31/438 (2006.01) A61P 3/04 (2006.01) A61P 3/10 (2006.01) C07D 471/10 (2006.01) C07D 519/00 (2006.01)	2666014 *	A61K 31/00 (2006.01) A61K 38/00 (2006.01) G01N 33/50 (2006.01)	2652166 *	C23C 2/06 (2006.01) C23C 2/26 (2006.01) C23C 2/40 (2006.01) C23C 14/16 (2006.01) C23C 14/58 (2006.01) C23C 28/00 (2006.01)
2696930 *	A61B 17/22 (2006.01) A61B 17/221 (2006.01) A61M 25/00 (2006.01) A61M 25/06 (2006.01) A61M 25/09 (2006.01)	2648723 *	A61K 31/4162 (2006.01) C07D 231/54 (2006.01)	2683825 *	A61K 31/7088 (2006.01) A61K 31/7105 (2006.01) A61P 35/00 (2006.01) C07H 21/00 (2006.01) C12N 15/113 (2010.01)
2697243 *	C07H 21/04 (2006.01) C12N 15/11 (2006.01)	2689007 *	C12N 5/071 (2010.01) C12N 5/09 (2010.01)	2673279 *	A61K 31/553 (2006.01) A61K 31/554 (2006.01) A61P 25/16 (2006.01) A61P 25/28 (2006.01) C07D 498/10 (2006.01) C07D 498/20 (2006.01) C07D 513/10 (2006.01)
2662416	C09C 1/02 (2006.01) D21H 17/00 (2006.01)	2675509 *	A61M 5/20 (2006.01) A61M 5/32 (2006.01)	2602416	E06B 3/46 (2006.01)
2700403 *	A61K 31/437 (2006.01) A61K 31/47 (2006.01) A61P 35/00 (2006.01) C07D 215/48 (2006.01) C07D 471/04 (2006.01)	2581846	A61B 5/00 (2006.01) A61M 1/36 (2006.01) G06F 19/00 (2011.01)	2651832 *	C02F 1/66 (2006.01)
2672973 *	A61K 31/4439 (2006.01) A61P 25/00 (2006.01) A61P 25/16 (2006.01)	2658979 *	A61K 38/17 (2006.01) A61K 47/48 (2006.01) A61P 19/08 (2006.01) C07K 14/575 (2006.01) C07K 19/00 (2006.01) C12N 15/16 (2006.01) C12N 15/62 (2006.01)	2661422 *	C07C 231/02 (2006.01) C07C 233/18 (2006.01) C07C 253/30 (2006.01) C07C 255/37 (2006.01) C07C 255/40 (2006.01)
2672846 *	A24F 47/00 (2006.01)	2699153 *	A61B 5/042 (2006.01)		
2680925 *	A61P 35/00 (2006.01)	2692727 *	A61K 31/53 (2006.01) A61P 31/04 (2006.01) C07D 413/14 (2006.01)		
2651936 *	A61K 31/437 (2006.01) A61P 31/12 (2006.01) C07D 471/04 (2006.01)				
2583635	A61C 5/06 (2006.01)				

Broj objave evropske prijava patenta (97)	MKP (51)	Broj objave evropske prijava patenta (97)	MKP (51)	Broj objave evropske prijava patenta (97)	MKP (51)
2678316 *	C07D 213/70 (2006.01) C07D 309/14 (2006.01) A61K 31/435 (2006.01) C07D 213/57 (2006.01) C07D 309/08 (2006.01) A61K 31/42 (2006.01) C07D 235/16 (2006.01) A61P 35/00 (2006.01) A61K 31/47 (2006.01) C07D 231/12 (2006.01) C07C 317/44 (2006.01) C07D 215/36 (2006.01) C07D 333/24 (2006.01) C07D 263/32 (2006.01) A61P 35/04 (2006.01) C07D 263/56 (2006.01) A61K 31/4164 (2006.01) C07D 223/10 (2006.01) C07D 271/07 (2006.01) A61K 31/415 (2006.01)	2688152 *	H01R 13/52 (2006.01) H04M 1/02 (2006.01)	2675771 *	A61K 31/19 (2006.01) A61K 31/22 (2006.01) A61P 21/00 (2006.01) A61P 25/02 (2006.01) A61P 25/20 (2006.01) C07B 59/00 (2006.01) C07C 59/01 (2006.01) C07C 69/67 (2006.01)
		2694066 *	A61K 31/495 (2006.01)		
		2648696 *	A61K 9/10 (2006.01) A61K 31/223 (2006.01) A61K 31/265 (2006.01) A61P 1/12 (2006.01)	2694485 *	A61K 31/496 (2006.01) C07D 239/70 (2006.01)
		2655665 *	A61K 45/00 (2006.01) C12Q 1/68 (2006.01) C40B 30/04 (2006.01) C40B 40/06 (2006.01)	2667900 *	A61K 49/00 (2006.01)
		2668160 *	A61K 31/341 (2006.01) A61K 31/381 (2006.01) A61K 31/4025 (2006.01) A61K 31/4402 (2006.01) A61P 29/00 (2006.01) C07D 207/323 (2006.01) C07D 213/36 (2006.01) C07D 307/52 (2006.01) C07D 307/56 (2006.01) C07D 333/20 (2006.01) C07D 333/28 (2006.01)	2699592 *	A61K 38/17 (2006.01) A61P 35/00 (2006.01) C07K 14/705 (2006.01) C12N 15/12 (2006.01) C12N 15/62 (2006.01)
				2674154 *	A61K 9/70 (2006.01) A61K 31/519 (2006.01)
2666016 *	A61K 31/00 (2006.01) G01N 33/50 (2006.01)			2661294 *	A61M 5/20 (2006.01) A61M 5/32 (2006.01)
2654734 *	A61K 9/20 (2006.01) A61K 9/28 (2006.01) A61K 31/485 (2006.01)			2675261 *	A01C 5/06 (2006.01) A01C 7/20 (2006.01)
		2596266 *	F16G 11/00 (2006.01) F16G 11/02 (2006.01)	2691340 *	C02F 1/00 (2006.01)
2663562 *	A61K 31/4184 (2006.01) A61P 31/00 (2006.01) C07D 413/14 (2006.01)	2697423 *	D21F 1/44 (2006.01)	2691645 *	F03D 1/04 (2006.01) F03D 7/02 (2006.01)
		2586944	E05D 7/00 (2006.01)		
2431990	H01H 3/16 (2006.01) H01H 13/18 (2006.01) H01H 13/48 (2006.01)	2644568	C01F 11/18 (2006.01) C09C 1/02 (2006.01) D21H 19/38 (2006.01)	2551057	B24D 3/00 (2006.01) B24D 11/00 (2006.01)

Broj objave evropske prijava patenta (97)	MKP (51)	Broj objave evropske prijava patenta (97)	MKP (51)	Broj objave evropske prijava patenta (97)	MKP (51)
2675451 *	A61K 31/436 (2006.01) A61K 31/519 (2006.01) A61K 45/06 (2006.01) A61P 35/00 (2006.01) A61P 35/02 (2006.01)	2683687 *	C07D 223/08 (2006.01) C07D 405/12 (2006.01) C07D 401/04 (2006.01) A61K 31/445 (2006.01) C07D 211/46 (2006.01) C07D 403/04 (2006.01) C07D 207/48 (2006.01) C07D 401/14 (2006.01) C07D 207/12 (2006.01) C07D 401/10 (2006.01) C07D 309/12 (2006.01) C07D 207/273 (2006.01) C07D 211/96 (2006.01) C07D 403/10 (2006.01) C07D 401/06 (2006.01)	2651390 *	A61K 9/00 (2006.01) A61K 9/20 (2006.01) A61K 31/437 (2006.01) A61K 33/00 (2006.01) A61K 33/10 (2006.01) A61P 25/20 (2006.01)
2655770 *	E05F 3/04 (2006.01) E05F 3/10 (2006.01) E05F 3/22 (2006.01)	2656950 *	B23B 27/04 (2006.01) B23B 27/16 (2006.01)	2594266	A61K 9/00 (2006.01) A61K 31/192 (2006.01) A61K 47/02 (2006.01)
2657323 *	B82Y 30/00 (2011.01) C10M 103/06 (2006.01) C10M 177/00 (2006.01)	2648699 *	A61K 9/16 (2006.01) A61K 9/20 (2006.01) A61P 25/04 (2006.01)	2596810	A61L 2/07 (2006.01) A61L 11/00 (2006.01) B01J 3/04 (2006.01) B29B 17/00 (2006.01)
2651437 *	A61K 39/04 (2006.01)	2661496 *	C07K 14/435 (2006.01) C07K 14/705 (2006.01) C07K 14/78 (2006.01) C12N 15/62 (2006.01)	2663638 *	C12N 5/0797 (2010.01)
2683735 *	C07K 16/00 (2006.01) C07K 16/46 (2006.01)	2594556	A61K 31/21 (2006.01) A61K 31/435 (2006.01) C07C 233/47 (2006.01) C07D 213/82 (2006.01) C07D 239/36 (2006.01) C07D 261/18 (2006.01) C07D 271/06 (2006.01)	2649189 *	C12P 21/06 (2006.01)
2688878 *	C07C 311/08 (2006.01) C07C 311/21 (2006.01) C07D 307/80 (2006.01) C07D 307/84 (2006.01)	2686671 *	G01N 24/08 (2006.01)	2689045 *	C21D 8/04 (2006.01) C21D 9/46 (2006.01) C22C 38/02 (2006.01) C22C 38/04 (2006.01) C22C 38/12 (2006.01) C22C 38/14 (2006.01) C23C 2/06 (2006.01)
2655795 *	E21B 43/26 (2006.01) E21B 43/267 (2006.01)	2684210 *	H01L 21/00 (2006.01)	2663188 *	A01N 37/34 (2006.01) A01N 41/06 (2006.01) A01N 43/50 (2006.01) A01P 3/00 (2006.01)
2646016 *	A61K 31/336 (2006.01) A61P 3/04 (2006.01)	2694118 *	A61L 2/07 (2006.01)		

Broj objave evropske prijava patenta (97)	MKP (51)
2668497 *	A61M 1/14 (2006.01) G01N 33/50 (2006.01) G01N 33/53 (2006.01)

**INDEKS KLASIFIKACIJSKIH OZNAKA BROJEVA ZAHTJEVA ZA PROŠIRENJE
EVROPSKIH PRIJAVA PATENTA PREMA MKP**
INDEX ON CLASSIFICATION MARKS ON REQUESTS FOR EXTENSION
OF EUROPEAN PATENT APPLICATION IN ACCORDANCE WITH THE
INTERNATIONAL PATENT CLASSIFICATION

MKP (51)	Broj objave evropske prijave patenta (97)	Naziv pronalaska (54)	MKP (51)	Broj objave evropske prijave patenta (97)	Naziv pronalaska (54)
A01N 3/02 (2006.01)	2690951 *	CYCLODEXTRIN COMPOSITIONS, ARTICLES, AND METHODS	C12N 7/00 (2006.01)	2697368 *	CLONAL STRAINS OF ATTENUATED VACCINIA VIRUSES AND METHODS OF USE THEREOF
A01N 25/34 (2006.01)	2690951 *	CYCLODEXTRIN COMPOSITIONS, ARTICLES, AND METHODS	G06F 1/32 (2006.01)	2673712 *	INFRASTRUCTURE CONTROL FABRIC SYSTEM AND METHOD
A01N 27/00 (2006.01)	2690951 *	CYCLODEXTRIN COMPOSITIONS, ARTICLES, AND METHODS	G06F 11/30 (2006.01)	2673712 *	INFRASTRUCTURE CONTROL FABRIC SYSTEM AND METHOD
A23B 7/152 (2006.01)	2690951 *	CYCLODEXTRIN COMPOSITIONS, ARTICLES, AND METHODS	H04L 12/24 (2006.01)	2673712 *	INFRASTRUCTURE CONTROL FABRIC SYSTEM AND METHOD
A23L 3/3445 (2006.01)	2690951 *	CYCLODEXTRIN COMPOSITIONS, ARTICLES, AND METHODS	H05K 7/14 (2006.01)	2673712 *	INFRASTRUCTURE CONTROL FABRIC SYSTEM AND METHOD
C08F 2/46 (2006.01)	2690951 *	CYCLODEXTRIN COMPOSITIONS, ARTICLES, AND METHODS	A01N 43/56 (2006.01)	2663189 *	COMBINATION
C08J 7/04 (2006.01)	2690951 *	CYCLODEXTRIN COMPOSITIONS, ARTICLES, AND METHODS	C07K 1/18 (2006.01)	2681231 *	METHOD FOR ISOLATING OSTEOPONTIN USING CONCENTRATED FEEDS
C08K 5/01 (2006.01)	2690951 *	CYCLODEXTRIN COMPOSITIONS, ARTICLES, AND METHODS	C07K 14/47 (2006.01)	2681231 *	METHOD FOR ISOLATING OSTEOPONTIN USING CONCENTRATED FEEDS
C08K 5/101 (2006.01)	2690951 *	CYCLODEXTRIN COMPOSITIONS, ARTICLES, AND METHODS	C07K 14/52 (2006.01)	2681231 *	METHOD FOR ISOLATING OSTEOPONTIN USING CONCENTRATED FEEDS
C08K 5/16 (2006.01)	2690951 *	CYCLODEXTRIN COMPOSITIONS, ARTICLES, AND METHODS	A61K 9/00 (2006.01)	2696848 *	FREEZE DRIED DRUG NANOSUSPENSIONS
A61K 38/10 (2006.01)	2700648 *	ANTIBIOTIC PEPTIDE AND PREPARATION METHOD THEREFOR AND APPLICATION THEREOF	A61K 9/14 (2006.01)	2696848 *	FREEZE DRIED DRUG NANOSUSPENSIONS
A61P 31/00 (2006.01)	2700648 *	ANTIBIOTIC PEPTIDE AND PREPARATION METHOD THEREFOR AND APPLICATION THEREOF	A61K 9/19 (2006.01)	2696848 *	FREEZE DRIED DRUG NANOSUSPENSIONS
C07K 1/04 (2006.01)	2700648 *	ANTIBIOTIC PEPTIDE AND PREPARATION METHOD THEREFOR AND APPLICATION THEREOF	E01F 7/04 (2006.01)	2652202 *	DEVICE FOR BREAKING UP SNOW CORNICES AND/OR TRIGGERING AVALANCHES
C07K 1/06 (2006.01)	2700648 *	ANTIBIOTIC PEPTIDE AND PREPARATION METHOD THEREFOR AND APPLICATION THEREOF	A61K 36/06 (2006.01)	2672991 *	YEAST-BASED THERAPEUTIC FOR CHRONIC HEPATITIS B INFECTION
C07K 7/08 (2006.01)	2700648 *	ANTIBIOTIC PEPTIDE AND PREPARATION METHOD THEREFOR AND APPLICATION THEREOF	A61K 39/29 (2006.01)	2672991 *	YEAST-BASED THERAPEUTIC FOR CHRONIC HEPATITIS B INFECTION
			C07K 14/02 (2006.01)	2672991 *	YEAST-BASED THERAPEUTIC FOR CHRONIC HEPATITIS B INFECTION
			B65D 5/42 (2006.01)	2675715 *	MEDICAL PRODUCT PACKAGE
			B65D 5/46 (2006.01)	2675715 *	MEDICAL PRODUCT PACKAGE

MKP (51)	Broj objave evropske prijave patenta (97)	Naziv pronalaska (54)	MKP (51)	Broj objave evropske prijave patenta (97)	Naziv pronalaska (54)
C07K 16/22 (2006.01)	2662388 *	RECOMBINANT ANTIBODIES TO THE VASCULAR ENDOTHELIAL GROWTH FACTOR (VEGF) WHICH ARE OBTAINED BY MEANS OF MUTAGENESIS OF VARIABLE REGIONS	C07D 417/12 (2006.01)	2697199 *	ARYL-OR HETEROARYL-SUBSTITUTED BENZENE COMPOUNDS
A61K 31/255 (2006.01)	2686298 *	SUBSTITUTED DIPHENYL DERIVATIVES	C07D 491/08 (2006.01)	2697199 *	ARYL-OR HETEROARYL-SUBSTITUTED BENZENE COMPOUNDS
A61K 31/37 (2006.01)	2686298 *	SUBSTITUTED DIPHENYL DERIVATIVES	C07D 491/107 (2006.01)	2697199 *	ARYL-OR HETEROARYL-SUBSTITUTED BENZENE COMPOUNDS
A61K 31/655 (2006.01)	2686298 *	SUBSTITUTED DIPHENYL DERIVATIVES	A24B 13/00 (2006.01)	2649888	A smokeless tobacco composition comprising non-tobacco fibers and a method for its manufacture.
A61P 35/00 (2006.01)	2686298 *	SUBSTITUTED DIPHENYL DERIVATIVES	A24B 15/30 (2006.01)	2649888	A smokeless tobacco composition comprising non-tobacco fibers and a method for its manufacture.
C07C 305/24 (2006.01)	2686298 *	SUBSTITUTED DIPHENYL DERIVATIVES	A61K 31/4184 (2006.01)	2683377 *	COMBINATION THERAPIES FOR HEMATOLOGIC MALIGNANCIES
C07C 307/02 (2006.01)	2686298 *	SUBSTITUTED DIPHENYL DERIVATIVES	A61K 31/4439 (2006.01)	2683377 *	COMBINATION THERAPIES FOR HEMATOLOGIC MALIGNANCIES
C07D 311/12 (2006.01)	2686298 *	SUBSTITUTED DIPHENYL DERIVATIVES	A61K 31/52 (2006.01)	2683377 *	COMBINATION THERAPIES FOR HEMATOLOGIC MALIGNANCIES
F16L 53/00 (2006.01)	2694859 *	CONNECTOR ELEMENT	A61K 39/00 (2006.01)	2683377 *	COMBINATION THERAPIES FOR HEMATOLOGIC MALIGNANCIES
A61K 38/20 (2006.01)	2672986 *	LYOPHILIZED FORMULATIONS	A61K 45/06 (2006.01)	2683377 *	COMBINATION THERAPIES FOR HEMATOLOGIC MALIGNANCIES
A61K 47/48 (2006.01)	2672986 *	LYOPHILIZED FORMULATIONS	A61P 35/00 (2006.01)	2683377 *	COMBINATION THERAPIES FOR HEMATOLOGIC MALIGNANCIES
A61K 31/4412 (2006.01)	2697199 *	ARYL-OR HETEROARYL-SUBSTITUTED BENZENE COMPOUNDS	A61P 35/02 (2006.01)	2683377 *	COMBINATION THERAPIES FOR HEMATOLOGIC MALIGNANCIES
A61K 31/444 (2006.01)	2697199 *	ARYL-OR HETEROARYL-SUBSTITUTED BENZENE COMPOUNDS	C09C 1/02 (2006.01)	2684916	Surface modified calcium carbonate containing minerals and its use
A61P 35/00 (2006.01)	2697199 *	ARYL-OR HETEROARYL-SUBSTITUTED BENZENE COMPOUNDS	D21H 17/00 (2006.01)	2684916	Surface modified calcium carbonate containing minerals and its use
C07D 213/64 (2006.01)	2697199 *	ARYL-OR HETEROARYL-SUBSTITUTED BENZENE COMPOUNDS	G01N 33/574 (2006.01)	2656077 *	DRUG SELECTION FOR MALIGNANT CANCER THERAPY USING ANTIBODY-BASED ARRAYS
C07D 401/12 (2006.01)	2697199 *	ARYL-OR HETEROARYL-SUBSTITUTED BENZENE COMPOUNDS	A61K 31/295 (2006.01)	2666764 *	FERRIC CITRATE CONTAINING SUBSTANTIALLY NO -OXIDIZED IRON HYDROXIDE
C07D 405/12 (2006.01)	2697199 *	ARYL-OR HETEROARYL-SUBSTITUTED BENZENE COMPOUNDS	A61P 3/12 (2006.01)	2666764 *	FERRIC CITRATE CONTAINING SUBSTANTIALLY NO -OXIDIZED IRON HYDROXIDE
C07D 409/12 (2006.01)	2697199 *	ARYL-OR HETEROARYL-SUBSTITUTED BENZENE COMPOUNDS	C07C 51/41 (2006.01)	2666764 *	FERRIC CITRATE CONTAINING SUBSTANTIALLY NO -OXIDIZED IRON HYDROXIDE
C07D 413/12 (2006.01)	2697199 *	ARYL-OR HETEROARYL-SUBSTITUTED BENZENE COMPOUNDS			

MKP (51)	Broj objave evropske prijave patenta (97)	Naziv pronalaska (54)	MKP (51)	Broj objave evropske prijave patenta (97)	Naziv pronalaska (54)
C07C 59/265 (2006.01)	2666764 *	FERRIC CITRATE CONTAINING SUBSTANTIALLY NO -OXIDIZED IRON HYDROXIDE	C12R 1/225 (2006.01)	2674162	NANOPRODUCT COMPRISING LACTOBACILLUS REUTERI DAN080 USEFUL IN PROPHYLAXIS AND MEDICINE, BOTH HUMAN AND VETERINARY AND MEDICAL USE OF THE SAME
A23L 1/30 (2006.01)	2674162	NANOPRODUCT COMPRISING LACTOBACILLUS REUTERI DAN080 USEFUL IN PROPHYLAXIS AND MEDICINE, BOTH HUMAN AND VETERINARY AND MEDICAL USE OF THE SAME	A61K 31/437 (2006.01)	2651933 *	AZABENZIMIDAZOLES AS RESPIRATORY SYNCYTIAL VIRUS ANTIVIRAL AGENTS
A61K 35/74 (2006.01)	2674162	NANOPRODUCT COMPRISING LACTOBACILLUS REUTERI DAN080 USEFUL IN PROPHYLAXIS AND MEDICINE, BOTH HUMAN AND VETERINARY AND MEDICAL USE OF THE SAME	A61P 31/12 (2006.01)	2651933 *	AZABENZIMIDAZOLES AS RESPIRATORY SYNCYTIAL VIRUS ANTIVIRAL AGENTS
A61L 29/08 (2006.01)	2674162	NANOPRODUCT COMPRISING LACTOBACILLUS REUTERI DAN080 USEFUL IN PROPHYLAXIS AND MEDICINE, BOTH HUMAN AND VETERINARY AND MEDICAL USE OF THE SAME	C07D 471/04 (2006.01)	2651933 *	AZABENZIMIDAZOLES AS RESPIRATORY SYNCYTIAL VIRUS ANTIVIRAL AGENTS
A61L 29/16 (2006.01)	2674162	NANOPRODUCT COMPRISING LACTOBACILLUS REUTERI DAN080 USEFUL IN PROPHYLAXIS AND MEDICINE, BOTH HUMAN AND VETERINARY AND MEDICAL USE OF THE SAME	A61K 9/20 (2006.01)	2694038 *	PHARMACEUTICAL COMPOSITION
A61P 1/00 (2006.01)	2674162	NANOPRODUCT COMPRISING LACTOBACILLUS REUTERI DAN080 USEFUL IN PROPHYLAXIS AND MEDICINE, BOTH HUMAN AND VETERINARY AND MEDICAL USE OF THE SAME	A61K 9/50 (2006.01)	2694038 *	PHARMACEUTICAL COMPOSITION
A61P 19/06 (2006.01)	2674162	NANOPRODUCT COMPRISING LACTOBACILLUS REUTERI DAN080 USEFUL IN PROPHYLAXIS AND MEDICINE, BOTH HUMAN AND VETERINARY AND MEDICAL USE OF THE SAME	A61K 31/198 (2006.01)	2694038 *	PHARMACEUTICAL COMPOSITION
A61P 31/04 (2006.01)	2674162	NANOPRODUCT COMPRISING LACTOBACILLUS REUTERI DAN080 USEFUL IN PROPHYLAXIS AND MEDICINE, BOTH HUMAN AND VETERINARY AND MEDICAL USE OF THE SAME	A61K 47/48 (2006.01)	2694038 *	PHARMACEUTICAL COMPOSITION
			A61K 39/02 (2006.01)	2697385 *	FERMENTATION PROCESS
			C07K 14/195 (2006.01)	2697385 *	FERMENTATION PROCESS
			C07K 14/34 (2006.01)	2697385 *	FERMENTATION PROCESS
			C12P 21/00 (2006.01)	2697385 *	FERMENTATION PROCESS
			A61K 31/44 (2006.01)	2648729 *	COMPOSITIONS COMPRISING A PI3K INHIBITOR AND A MEK INHIBITOR AND THEIR USE FOR TREATING CANCER
			A61K 31/498 (2006.01)	2648729 *	COMPOSITIONS COMPRISING A PI3K INHIBITOR AND A MEK INHIBITOR AND THEIR USE FOR TREATING CANCER
			A61K 31/519 (2006.01)	2648729 *	COMPOSITIONS COMPRISING A PI3K INHIBITOR AND A MEK INHIBITOR AND THEIR USE FOR TREATING CANCER
			A61P 35/00 (2006.01)	2648729 *	COMPOSITIONS COMPRISING A PI3K INHIBITOR AND A MEK INHIBITOR AND THEIR USE FOR TREATING CANCER
			B63B 35/32 (2006.01)	2675697 *	DEVICE AND METHOD FOR RECOVERING SOLID AND/ OR LIQUID SUBSTANCES FLOATING IN A LIQUID MASS

MKP (51)	Broj objave evropske prijave patenta (97)	Naziv pronalaska (54)	MKP (51)	Broj objave evropske prijave patenta (97)	Naziv pronalaska (54)
E02B 15/04 (2006.01)	2675697 *	DEVICE AND METHOD FOR RECOVERING SOLID AND/OR LIQUID SUBSTANCES FLOATING IN A LIQUID MASS	A61K 31/44 (2006.01)	2680831 *	TREATMENT OF ARTERIAL AGEING BY RAAS INHIBITOR
C02F 1/32 (2006.01)	2692694 *	DEVICE FOR REMOVING ORGANIC AND CHEMICAL MICROBIC POLLUTANTS FROM WATER	A61K 31/4015 (2006.01)	2680831 *	TREATMENT OF ARTERIAL AGEING BY RAAS INHIBITOR
C02F 1/36 (2006.01)	2692694 *	DEVICE FOR REMOVING ORGANIC AND CHEMICAL MICROBIC POLLUTANTS FROM WATER	A61K 31/47 (2006.01)	2680831 *	TREATMENT OF ARTERIAL AGEING BY RAAS INHIBITOR
A61K 31/4196 (2006.01)	2678013 *	COMBINATION THERAPY OF HSP90 INHIBITORY COMPOUNDS WITH RADIOTHERAPY	A61K 31/416 (2006.01)	2680831 *	TREATMENT OF ARTERIAL AGEING BY RAAS INHIBITOR
A61P 35/00 (2006.01)	2678013 *	COMBINATION THERAPY OF HSP90 INHIBITORY COMPOUNDS WITH RADIOTHERAPY	A61K 31/122 (2006.01)	2680831 *	TREATMENT OF ARTERIAL AGEING BY RAAS INHIBITOR
A61K 31/4706 (2006.01)	2699550 *	TETRAHYDROQUINOLINE DERIVATIVES USEFUL AS BROMODOMAIN INHIBITORS	A61K 31/422 (2006.01)	2680831 *	TREATMENT OF ARTERIAL AGEING BY RAAS INHIBITOR
A61K 31/4709 (2006.01)	2699550 *	TETRAHYDROQUINOLINE DERIVATIVES USEFUL AS BROMODOMAIN INHIBITORS	A61K 31/415 (2006.01)	2680831 *	TREATMENT OF ARTERIAL AGEING BY RAAS INHIBITOR
A61P 29/00 (2006.01)	2699550 *	TETRAHYDROQUINOLINE DERIVATIVES USEFUL AS BROMODOMAIN INHIBITORS	A61P 9/10 (2006.01)	2680831 *	TREATMENT OF ARTERIAL AGEING BY RAAS INHIBITOR
A61P 35/00 (2006.01)	2699550 *	TETRAHYDROQUINOLINE DERIVATIVES USEFUL AS BROMODOMAIN INHIBITORS	A61B 17/072 (2006.01)	2517648	Staple cartridge comprising a releasable portion
C07D 215/42 (2006.01)	2699550 *	TETRAHYDROQUINOLINE DERIVATIVES USEFUL AS BROMODOMAIN INHIBITORS	A61K 31/519 (2006.01)	2681215 *	SERINE/THREONINE KINASE INHIBITORS
C07D 215/44 (2006.01)	2699550 *	TETRAHYDROQUINOLINE DERIVATIVES USEFUL AS BROMODOMAIN INHIBITORS	A61P 35/00 (2006.01)	2681215 *	SERINE/THREONINE KINASE INHIBITORS
C07D 401/12 (2006.01)	2699550 *	TETRAHYDROQUINOLINE DERIVATIVES USEFUL AS BROMODOMAIN INHIBITORS	C07D 471/04 (2006.01)	2681215 *	SERINE/THREONINE KINASE INHIBITORS
A61K 31/4155 (2006.01)	2680831 *	TREATMENT OF ARTERIAL AGEING BY RAAS INHIBITOR	C07D 487/18 (2006.01)	2695883 *	TRICYCLIC DERIVATIVES OF N,N'-SUBSTITUTED 3,7-DIAZABICYCLO [3.3.1] NONANES AND DRUGS BASED THEREON
A61P 9/14 (2006.01)	2680831 *	TREATMENT OF ARTERIAL AGEING BY RAAS INHIBITOR	A61K 31/4166 (2006.01)	2685989 *	COMBINATION OF ANTI-CLUSTERIN OLIGONUCLEOTIDE WITH ANDROGEN RECEPTOR ANTAGONIST FOR THE TREATMENT OF PROSTATE CANCER
A61K 31/41 (2006.01)	2680831 *	TREATMENT OF ARTERIAL AGEING BY RAAS INHIBITOR	A61K 31/7088 (2006.01)	2685989 *	COMBINATION OF ANTI-CLUSTERIN OLIGONUCLEOTIDE WITH ANDROGEN RECEPTOR ANTAGONIST FOR THE TREATMENT OF PROSTATE CANCER
A61K 31/616 (2006.01)	2680831 *	TREATMENT OF ARTERIAL AGEING BY RAAS INHIBITOR	A61P 5/28 (2006.01)	2685989 *	COMBINATION OF ANTI-CLUSTERIN OLIGONUCLEOTIDE WITH ANDROGEN RECEPTOR ANTAGONIST FOR THE TREATMENT OF PROSTATE CANCER
A61K 31/405 (2006.01)	2680831 *	TREATMENT OF ARTERIAL AGEING BY RAAS INHIBITOR			
A61K 31/505 (2006.01)	2680831 *	TREATMENT OF ARTERIAL AGEING BY RAAS INHIBITOR			
A61K 31/366 (2006.01)	2680831 *	TREATMENT OF ARTERIAL AGEING BY RAAS INHIBITOR			

MKP (51)	Broj objave evropske prijave patenta (97)	Naziv pronalaska (54)	MKP (51)	Broj objave evropske prijave patenta (97)	Naziv pronalaska (54)
A61P 35/00 (2006.01)	2685989 *	COMBINATION OF ANTI-CLUSTERIN OLIGONUCLEOTIDE WITH ANDROGEN RECEPTOR ANTAGONIST FOR THE TREATMENT OF PROSTATE CANCER	C05G 3/00 (2006.01)	2649027 *	SOIL CONDITIONERS AND FERTILISERS HAVING DYNAMIC DISINTEGRATION, METHOD FOR MANUFACTURING SAME, AND USES THEREOF IN AGRICULTURE
A61K 31/435 (2006.01)	2694160 *	SOLID STATE FORMS OF HIV INHIBITOR	C03C 17/36 (2006.01)	2661417 *	SUBSTRATE PROVIDED WITH A STACK HAVING THERMAL PROPERTIES, IN PARTICULAR FOR MANUFACTURING HEATED GLASS
A61P 31/18 (2006.01)	2694160 *	SOLID STATE FORMS OF HIV INHIBITOR	A01N 43/00 (2006.01)	2683242 *	EFFECTIVE AMOUNTS OF (3AR)-1,3A,8-TRIMETHYL-1,2,3,3A,8,8A-HEXAHYDROPYRROLO[2,3-B]INDOL-5-YL PHENYL CARBAMATE AND METHODS THEREOF
C07D 491/06 (2006.01)	2694160 *	SOLID STATE FORMS OF HIV INHIBITOR	A47K 3/06 (2006.01)	2690998 *	REVERSIBLY EXTENDIBLE BATH TUB
A61K 31/4985 (2006.01)	2694067 *	PYRIDOPYRAZINE DERIVATIVES AND THEIR USE	G06Q 10/08 (2012.01)	2624185	Handheld device and method for determining the location of physical objects stored in storage containers
A61K 31/5377 (2006.01)	2694067 *	PYRIDOPYRAZINE DERIVATIVES AND THEIR USE	A43B 7/12 (2006.01)	2645896 *	WATERPROOF AND VAPOR-PERMEABLE SHOE, PROVIDED PREDOMINANTLY BY MEANS OF THE WORKING METHOD KNOWN AS "AGO LASTING"
A61P 35/00 (2006.01)	2694067 *	PYRIDOPYRAZINE DERIVATIVES AND THEIR USE	B65D 19/38 (2006.01)	2665658 *	PALLET LEADER BOARD SYSTEM
A61P 43/00 (2006.01)	2694067 *	PYRIDOPYRAZINE DERIVATIVES AND THEIR USE	A61K 35/74 (2006.01)	2655595 *	NOVEL BACTERIUM AND EXTRACTS OF SAID BACTERIUM AND THE USE OF SAME IN DERMATOLOGY
C07D 471/04 (2006.01)	2694067 *	PYRIDOPYRAZINE DERIVATIVES AND THEIR USE	A61P 17/00 (2006.01)	2655595 *	NOVEL BACTERIUM AND EXTRACTS OF SAID BACTERIUM AND THE USE OF SAME IN DERMATOLOGY
A61K 31/519 (2006.01)	2513105 *	2-ARYLIMIDAZOLE DERIVATIVES AS PDE10A ENZYME INHIBITORS	C12N 1/20 (2006.01)	2655595 *	NOVEL BACTERIUM AND EXTRACTS OF SAID BACTERIUM AND THE USE OF SAME IN DERMATOLOGY
A61P 25/00 (2006.01)	2513105 *	2-ARYLIMIDAZOLE DERIVATIVES AS PDE10A ENZYME INHIBITORS	C12R 1/36 (2006.01)	2655595 *	NOVEL BACTERIUM AND EXTRACTS OF SAID BACTERIUM AND THE USE OF SAME IN DERMATOLOGY
C07D 471/04 (2006.01)	2513105 *	2-ARYLIMIDAZOLE DERIVATIVES AS PDE10A ENZYME INHIBITORS	A61K 38/00 (2006.01)	2679234	Binding proteins that bind to human FGFR1C, human beta-klotho and both human FGFR1C and human beta-klotho
C07D 487/04 (2006.01)	2513105 *	2-ARYLIMIDAZOLE DERIVATIVES AS PDE10A ENZYME INHIBITORS	A61K 38/18 (2006.01)	2679234	Binding proteins that bind to human FGFR1C, human beta-klotho and both human FGFR1C and human beta-klotho
A61M 5/20 (2006.01)	2675503 *	AUTO-INJECTOR			
A61M 5/32 (2006.01)	2675503 *	AUTO-INJECTOR			
C07H 21/00 (2006.01)	2694526 *	MOLECULAR GRAM STAIN			
C12Q 1/68 (2006.01)	2694526 *	MOLECULAR GRAM STAIN			
C05D 3/02 (2006.01)	2649027 *	SOIL CONDITIONERS AND FERTILISERS HAVING DYNAMIC DISINTEGRATION, METHOD FOR MANUFACTURING SAME, AND USES THEREOF IN AGRICULTURE			

MKP (51)	Broj objave evropske prijave patenta (97)	Naziv pronalaska (54)	MKP (51)	Broj objave evropske prijave patenta (97)	Naziv pronalaska (54)
C07K 14/00 (2006.01)	2679234	Binding proteins that bind to human FGFR1C, human beta-klotho and both human FGFR1C and human beta-klotho	A61K 9/00 (2006.01)	2675432 *	PHARMACEUTICAL PREPARATION CONTAINING SELENITE OR SELENITE-CONTAINING COMPOUNDS FOR TREATING CERVICAL DYSPLASIA OR CARCINOMAS
C07K 14/05 (2006.01)	2679234	Binding proteins that bind to human FGFR1C, human beta-klotho and both human FGFR1C and human beta-klotho	A61K 33/04 (2006.01)	2675432 *	PHARMACEUTICAL PREPARATION CONTAINING SELENITE OR SELENITE-CONTAINING COMPOUNDS FOR TREATING CERVICAL DYSPLASIA OR CARCINOMAS
C07K 14/475 (2006.01)	2679234	Binding proteins that bind to human FGFR1C, human beta-klotho and both human FGFR1C and human beta-klotho	A61P 15/02 (2006.01)	2675432 *	PHARMACEUTICAL PREPARATION CONTAINING SELENITE OR SELENITE-CONTAINING COMPOUNDS FOR TREATING CERVICAL DYSPLASIA OR CARCINOMAS
C07K 14/50 (2006.01)	2679234	Binding proteins that bind to human FGFR1C, human beta-klotho and both human FGFR1C and human beta-klotho	C07D 471/04 (2006.01)	2678338 *	COMPOUNDS AND COMPOSITIONS AS TRK INHIBITORS
C07K 14/705 (2006.01)	2679234	Binding proteins that bind to human FGFR1C, human beta-klotho and both human FGFR1C and human beta-klotho	G06F 17/30 (2006.01)	2587770	A system for the display, by a user, of multimedia content items
A61B 5/024 (2006.01)	2691779 *	DEVICES, METHODS, AND APPARATUSES FOR INFERRING A POSITION OF A MOBILE DEVICE	G09B 5/00 (2006.01)	2587770	A system for the display, by a user, of multimedia content items
G01C 22/00 (2006.01)	2691779 *	DEVICES, METHODS, AND APPARATUSES FOR INFERRING A POSITION OF A MOBILE DEVICE	H04L 29/08 (2006.01)	2587770	A system for the display, by a user, of multimedia content items
G01P 13/00 (2006.01)	2691779 *	DEVICES, METHODS, AND APPARATUSES FOR INFERRING A POSITION OF A MOBILE DEVICE	H04M 1/725 (2006.01)	2587770	A system for the display, by a user, of multimedia content items
G06F 3/01 (2006.01)	2691779 *	DEVICES, METHODS, AND APPARATUSES FOR INFERRING A POSITION OF A MOBILE DEVICE	A61K 39/395 (2006.01)	2670438 *	SELECTION AND TREATMENT OF SUBJECTS
G06F 3/033 (2013.01)	2691779 *	DEVICES, METHODS, AND APPARATUSES FOR INFERRING A POSITION OF A MOBILE DEVICE	H02G 1/12 (2006.01)	2676345 *	DEVICE FOR INDUCTIVELY REMOVING THE INSULATION FROM WIRES AND/OR PROFILES
A61K 39/395 (2006.01)	2699261 *	METHOD FOR TREATING OSTEOPOROSIS	A61K 31/44 (2006.01)	2691371 *	BENZOIC ACID SALT OF OTAMIXABAN
B01D 11/04 (2006.01)	2695653 *	HEATER AND HEATING METHOD FOR WET EXTRACTION TANK	A61P 9/00 (2006.01)	2691371 *	BENZOIC ACID SALT OF OTAMIXABAN
C22B 3/02 (2006.01)	2695653 *	HEATER AND HEATING METHOD FOR WET EXTRACTION TANK	C07D 213/16 (2006.01)	2691371 *	BENZOIC ACID SALT OF OTAMIXABAN
H01R 43/052 (2006.01)	2590275	Circuit positioning device	A44C 5/04 (2006.01)	2688439 *	JEWELLERY ITEM
H01R 43/28 (2006.01)	2590275	Circuit positioning device	A44C 5/06 (2006.01)	2688439 *	JEWELLERY ITEM
			A44C 13/00 (2006.01)	2688439 *	JEWELLERY ITEM
			F01N 3/20 (2006.01)	2689119 *	REAGENT DOSING PUMP ASSEMBLY
			C07D 257/04 (2006.01)	2675792 *	SUBSTITUTED AMINOBUTYRIC DERIVATIVES AS NEPRILYSIN INHIBITORS

MKP (51)	Broj objave evropske prijave patenta (97)	Naziv pronalaska (54)	MKP (51)	Broj objave evropske prijave patenta (97)	Naziv pronalaska (54)
A61K 31/4192 (2006.01)	2675792 *	SUBSTITUTED AMINOBTYRIC DERIVATIVES AS NEPRILYSIN INHIBITORS	A61K 31/4188 (2006.01)	2430014 *	ANTIVIRAL COMPOUNDS
C07D 249/18 (2006.01)	2675792 *	SUBSTITUTED AMINOBTYRIC DERIVATIVES AS NEPRILYSIN INHIBITORS	A61P 31/12 (2006.01)	2430014 *	ANTIVIRAL COMPOUNDS
A61K 31/4164 (2006.01)	2675792 *	SUBSTITUTED AMINOBTYRIC DERIVATIVES AS NEPRILYSIN INHIBITORS	C07D 401/14 (2006.01)	2430014 *	ANTIVIRAL COMPOUNDS
C07D 249/04 (2006.01)	2675792 *	SUBSTITUTED AMINOBTYRIC DERIVATIVES AS NEPRILYSIN INHIBITORS	C07D 403/04 (2006.01)	2430014 *	ANTIVIRAL COMPOUNDS
C07C 233/47 (2006.01)	2675792 *	SUBSTITUTED AMINOBTYRIC DERIVATIVES AS NEPRILYSIN INHIBITORS	C07D 403/14 (2006.01)	2430014 *	ANTIVIRAL COMPOUNDS
A61P 13/00 (2006.01)	2675792 *	SUBSTITUTED AMINOBTYRIC DERIVATIVES AS NEPRILYSIN INHIBITORS	C07D 405/14 (2006.01)	2430014 *	ANTIVIRAL COMPOUNDS
C07D 231/14 (2006.01)	2675792 *	SUBSTITUTED AMINOBTYRIC DERIVATIVES AS NEPRILYSIN INHIBITORS	C07D 409/14 (2006.01)	2430014 *	ANTIVIRAL COMPOUNDS
C07D 403/04 (2006.01)	2675792 *	SUBSTITUTED AMINOBTYRIC DERIVATIVES AS NEPRILYSIN INHIBITORS	C07D 413/04 (2006.01)	2430014 *	ANTIVIRAL COMPOUNDS
A61K 31/42 (2006.01)	2675792 *	SUBSTITUTED AMINOBTYRIC DERIVATIVES AS NEPRILYSIN INHIBITORS	C07D 417/04 (2006.01)	2430014 *	ANTIVIRAL COMPOUNDS
C07D 261/12 (2006.01)	2675792 *	SUBSTITUTED AMINOBTYRIC DERIVATIVES AS NEPRILYSIN INHIBITORS	C07D 417/14 (2006.01)	2430014 *	ANTIVIRAL COMPOUNDS
A61K 31/4196 (2006.01)	2675792 *	SUBSTITUTED AMINOBTYRIC DERIVATIVES AS NEPRILYSIN INHIBITORS	C07D 495/04 (2006.01)	2430014 *	ANTIVIRAL COMPOUNDS
C07D 249/10 (2006.01)	2675792 *	SUBSTITUTED AMINOBTYRIC DERIVATIVES AS NEPRILYSIN INHIBITORS	C12N 15/10 (2006.01)	2683821 *	LOW FUCOSE CELL LINES AND USES THEREOF
A61K 31/415 (2006.01)	2675792 *	SUBSTITUTED AMINOBTYRIC DERIVATIVES AS NEPRILYSIN INHIBITORS	A61K 31/66 (2006.01)	2649099 *	SMALL-MOLECULE HYDROPHOBIC TAGGING OF FUSION PROTEINS AND INDUCED DEGRADATION OF SAME
C07D 239/36 (2006.01)	2675792 *	SUBSTITUTED AMINOBTYRIC DERIVATIVES AS NEPRILYSIN INHIBITORS	A61K 31/7076 (2006.01)	2649099 *	SMALL-MOLECULE HYDROPHOBIC TAGGING OF FUSION PROTEINS AND INDUCED DEGRADATION OF SAME
C07C 233/46 (2006.01)	2675792 *	SUBSTITUTED AMINOBTYRIC DERIVATIVES AS NEPRILYSIN INHIBITORS	A61K 31/708 (2006.01)	2649099 *	SMALL-MOLECULE HYDROPHOBIC TAGGING OF FUSION PROTEINS AND INDUCED DEGRADATION OF SAME
A61P 9/00 (2006.01)	2675792 *	SUBSTITUTED AMINOBTYRIC DERIVATIVES AS NEPRILYSIN INHIBITORS	A61P 31/00 (2006.01)	2649099 *	SMALL-MOLECULE HYDROPHOBIC TAGGING OF FUSION PROTEINS AND INDUCED DEGRADATION OF SAME
C07D 231/20 (2006.01)	2675792 *	SUBSTITUTED AMINOBTYRIC DERIVATIVES AS NEPRILYSIN INHIBITORS	C07K 17/02 (2006.01)	2649099 *	SMALL-MOLECULE HYDROPHOBIC TAGGING OF FUSION PROTEINS AND INDUCED DEGRADATION OF SAME
C07D 471/04 (2006.01)	2675792 *	SUBSTITUTED AMINOBTYRIC DERIVATIVES AS NEPRILYSIN INHIBITORS			
A61K 31/405 (2006.01)	2675792 *	SUBSTITUTED AMINOBTYRIC DERIVATIVES AS NEPRILYSIN INHIBITORS			
A61K 31/4178 (2006.01)	2430014 *	ANTIVIRAL COMPOUNDS			

MKP (51)	Broj objave evropske prijave patenta (97)	Naziv pronalaska (54)	MKP (51)	Broj objave evropske prijave patenta (97)	Naziv pronalaska (54)
A45D 34/04 (2006.01)	2609830	Apparatus and method for using effervescent tablets for cosmetic care	C07D 417/04 (2006.01)	2699558 *	BENZOTHIAZOLE COMPOUNDS AND THEIR PHARMACEUTICAL USE
A61K 8/02 (2006.01)	2609830	Apparatus and method for using effervescent tablets for cosmetic care	C07D 491/06 (2006.01)	2699558 *	BENZOTHIAZOLE COMPOUNDS AND THEIR PHARMACEUTICAL USE
A61K 9/20 (2006.01)	2609830	Apparatus and method for using effervescent tablets for cosmetic care	A61K 31/495 (2006.01)	2694064 *	METHODS AND COMPOSITIONS FOR TREATING NEURODEGENERATIVE DISEASES
A61Q 19/02 (2006.01)	2609830	Apparatus and method for using effervescent tablets for cosmetic care	A61K 31/445 (2006.01)	2688568 *	CYCLOPROPYLAMINES AS LSD1 INHIBITORS
B65D 81/32 (2006.01)	2609830	Apparatus and method for using effervescent tablets for cosmetic care	A61K 31/4436 (2006.01)	2665479 *	METHODS AND DRUG PRODUCTS FOR TREATING ALZHEIMER'S DISEASE
B01J 3/04 (2006.01)	2654940 *	METHOD FOR PRODUCING AN AQUEOUS STABLE CHLORINE DIOXIDE SOLUTION	C12Q 1/68 (2006.01)	2665479 *	METHODS AND DRUG PRODUCTS FOR TREATING ALZHEIMER'S DISEASE
B01J 4/02 (2006.01)	2654940 *	METHOD FOR PRODUCING AN AQUEOUS STABLE CHLORINE DIOXIDE SOLUTION	A61K 31/4439 (2006.01)	2651920 *	ANTI-VIRAL COMPOUNDS
C01B 11/02 (2006.01)	2654940 *	METHOD FOR PRODUCING AN AQUEOUS STABLE CHLORINE DIOXIDE SOLUTION	A61P 31/00 (2006.01)	2651920 *	ANTI-VIRAL COMPOUNDS
G02C 7/04 (2006.01)	2652544 *	COLORING CONTACT LENS	C07D 401/12 (2006.01)	2651920 *	ANTI-VIRAL COMPOUNDS
A61K 9/08 (2006.01)	2646051 *	LIQUID VIRAL FORMULATIONS	C07D 401/14 (2006.01)	2651920 *	ANTI-VIRAL COMPOUNDS
A61K 31/70 (2006.01)	2646051 *	LIQUID VIRAL FORMULATIONS	A61K 31/53 (2006.01)	2646423 *	NOVEL COMPOUNDS AS RESPIRATORY STIMULANTS FOR TREATMENT OF BREATHING CONTROL DISORDERS OR DISEASES
A61K 39/15 (2006.01)	2646051 *	LIQUID VIRAL FORMULATIONS	C07D 251/54 (2006.01)	2646423 *	NOVEL COMPOUNDS AS RESPIRATORY STIMULANTS FOR TREATMENT OF BREATHING CONTROL DISORDERS OR DISEASES
A61K 48/00 (2006.01)	2646051 *	LIQUID VIRAL FORMULATIONS	F21S 8/08 (2006.01)	2681486 *	POLE WITH SOLAR CELL PANELS
A61P 31/12 (2006.01)	2646051 *	LIQUID VIRAL FORMULATIONS	F21S 9/03 (2006.01)	2681486 *	POLE WITH SOLAR CELL PANELS
A61K 31/428 (2006.01)	2699558 *	BENZOTHIAZOLE COMPOUNDS AND THEIR PHARMACEUTICAL USE	F21V 21/10 (2006.01)	2681486 *	POLE WITH SOLAR CELL PANELS
A61K 31/436 (2006.01)	2699558 *	BENZOTHIAZOLE COMPOUNDS AND THEIR PHARMACEUTICAL USE	F21W 131/103 (2006.01)	2681486 *	POLE WITH SOLAR CELL PANELS
A61P 31/18 (2006.01)	2699558 *	BENZOTHIAZOLE COMPOUNDS AND THEIR PHARMACEUTICAL USE	G06K 9/00 (2006.01)	2671189 *	SYSTEMS AND METHODS FOR BIOMETRIC IDENTIFICATION
C07D 277/62 (2006.01)	2699558 *	BENZOTHIAZOLE COMPOUNDS AND THEIR PHARMACEUTICAL USE	C07D 231/14 (2006.01)	2668167 *	AMINO-SUBSTITUTED 3-HETEROAROYLAMINO-PROPIONIC ACID DERIVATIVES AND THEIR USE AS PHARMACEUTICALS
C07D 277/64 (2006.01)	2699558 *	BENZOTHIAZOLE COMPOUNDS AND THEIR PHARMACEUTICAL USE			
C07D 277/82 (2006.01)	2699558 *	BENZOTHIAZOLE COMPOUNDS AND THEIR PHARMACEUTICAL USE			

MKP (51)	Broj objave evropske prijave patenta (97)	Naziv pronalaska (54)	MKP (51)	Broj objave evropske prijave patenta (97)	Naziv pronalaska (54)
C07D 275/03 (2006.01)	2668167 *	AMINO-SUBSTITUTED 3-HETEROAROYLAMINO- PROPIONIC ACID DERIVATIVES AND THEIR USE AS PHARMACEUTICALS	C07D 207/36 (2006.01)	2661424 *	CHEMICAL COMPOUNDS
G07D 7/00 (2006.01)	2573739	Optically variable entity authenticating device and method	C07D 307/12 (2006.01)	2661424 *	CHEMICAL COMPOUNDS
G07D 7/12 (2006.01)	2573739	Optically variable entity authenticating device and method	C07D 317/34 (2006.01)	2661424 *	CHEMICAL COMPOUNDS
D01D 1/02 (2006.01)	2683859 *	METHOD FOR SPINNING ANIONICALLY MODIFIED CELLULOSE AND FIBRES MADE USING THE METHOD	C07D 401/12 (2006.01)	2661424 *	CHEMICAL COMPOUNDS
D01D 5/06 (2006.01)	2683859 *	METHOD FOR SPINNING ANIONICALLY MODIFIED CELLULOSE AND FIBRES MADE USING THE METHOD	C07D 405/12 (2006.01)	2661424 *	CHEMICAL COMPOUNDS
D01D 5/40 (2006.01)	2683859 *	METHOD FOR SPINNING ANIONICALLY MODIFIED CELLULOSE AND FIBRES MADE USING THE METHOD	C07D 409/12 (2006.01)	2661424 *	CHEMICAL COMPOUNDS
D01F 2/00 (2006.01)	2683859 *	METHOD FOR SPINNING ANIONICALLY MODIFIED CELLULOSE AND FIBRES MADE USING THE METHOD	A61K 51/00 (2006.01)	2658580 *	ARGINASE INHIBITORS AND METHODS OF USE THEREOF
D01F 2/24 (2006.01)	2683859 *	METHOD FOR SPINNING ANIONICALLY MODIFIED CELLULOSE AND FIBRES MADE USING THE METHOD	A61M 36/14 (2006.01)	2658580 *	ARGINASE INHIBITORS AND METHODS OF USE THEREOF
D21H 13/00 (2006.01)	2683859 *	METHOD FOR SPINNING ANIONICALLY MODIFIED CELLULOSE AND FIBRES MADE USING THE METHOD	F17D 5/02 (2006.01)	2694938 *	A METHOD AND MEANS FOR DETECTING LEAKAGES IN PIPE INSTALLATIONS
D21H 15/00 (2006.01)	2683859 *	METHOD FOR SPINNING ANIONICALLY MODIFIED CELLULOSE AND FIBRES MADE USING THE METHOD	G01M 3/24 (2006.01)	2694938 *	A METHOD AND MEANS FOR DETECTING LEAKAGES IN PIPE INSTALLATIONS
A01N 43/42 (2006.01)	2675276 *	PERIPHERIALLY ACTING μ OPIOID ANTAGONISTS	G01M 3/32 (2006.01)	2694938 *	A METHOD AND MEANS FOR DETECTING LEAKAGES IN PIPE INSTALLATIONS
A61K 31/44 (2006.01)	2675276 *	PERIPHERIALLY ACTING μ OPIOID ANTAGONISTS	C02F 1/52 (2006.01)	2662338 *	SYSTEM FOR PURIFYING POLLUTED WATER AND PURIFICATION METHOD
A61K 31/422 (2006.01)	2668182 *	IL17 AND IFN-GAMMA INHIBITION FOR THE TREATMENT OF AUTOIMMUNE INFLAMMATION	B01D 53/14 (2006.01)	2695661	Regeneratable ion exchange material for reducing the amount of CO ₂
A61P 29/00 (2006.01)	2668182 *	IL17 AND IFN-GAMMA INHIBITION FOR THE TREATMENT OF AUTOIMMUNE INFLAMMATION	B01D 53/62 (2006.01)	2695661	Regeneratable ion exchange material for reducing the amount of CO ₂
C07D 413/04 (2006.01)	2668182 *	IL17 AND IFN-GAMMA INHIBITION FOR THE TREATMENT OF AUTOIMMUNE INFLAMMATION	B01J 20/12 (2006.01)	2695661	Regeneratable ion exchange material for reducing the amount of CO ₂
A01N 43/36 (2006.01)	2661424 *	CHEMICAL COMPOUNDS	C01F 5/24 (2006.01)	2695661	Regeneratable ion exchange material for reducing the amount of CO ₂
			C01F 11/18 (2006.01)	2695661	Regeneratable ion exchange material for reducing the amount of CO ₂
			C02F 1/66 (2006.01)	2695661	Regeneratable ion exchange material for reducing the amount of CO ₂
			C02F 5/06 (2006.01)	2695661	Regeneratable ion exchange material for reducing the amount of CO ₂
			C02F 5/08 (2006.01)	2695661	Regeneratable ion exchange material for reducing the amount of CO ₂

MKP (51)	Broj objave evropske prijave patenta (97)	Naziv pronalaska (54)	MKP (51)	Broj objave evropske prijave patenta (97)	Naziv pronalaska (54)
A61K 31/416 (2006.01)	2678330 *	CRYSTALLINE FORMS AND PROCESSES FOR THE PREPARATION OF CONDENSED AZACYCLES (CANNABINOID RECEPTOR MODULATORS)	A61P 35/00 (2006.01)	2689010 *	METHOD AND COMPOSITIONS FOR CELLULAR IMMUNOTHERAPY
A61P 29/00 (2006.01)	2678330 *	CRYSTALLINE FORMS AND PROCESSES FOR THE PREPARATION OF CONDENSED AZACYCLES (CANNABINOID RECEPTOR MODULATORS)	C07K 14/705 (2006.01)	2689010 *	METHOD AND COMPOSITIONS FOR CELLULAR IMMUNOTHERAPY
C07D 403/04 (2006.01)	2678330 *	CRYSTALLINE FORMS AND PROCESSES FOR THE PREPARATION OF CONDENSED AZACYCLES (CANNABINOID RECEPTOR MODULATORS)	C07K 16/28 (2006.01)	2689010 *	METHOD AND COMPOSITIONS FOR CELLULAR IMMUNOTHERAPY
G06F 17/30 (2006.01)	2686788 *	SYSTEM AND METHOD FOR MEDIA FILE SYNCHRONIZATION	C07K 16/30 (2006.01)	2689010 *	METHOD AND COMPOSITIONS FOR CELLULAR IMMUNOTHERAPY
A61K 31/404 (2006.01)	2655356 *	FAAH INHIBITORS	C12N 5/0783 (2010.01)	2689010 *	METHOD AND COMPOSITIONS FOR CELLULAR IMMUNOTHERAPY
A61P 25/04 (2006.01)	2655356 *	FAAH INHIBITORS	H04L 29/08 (2006.01)	2684342 *	REMOTE ACCESS AND ADMINISTRATION OF DEVICE CONTENT AND CONFIGURATION USING HTTP PROTOCOL
C07D 401/12 (2006.01)	2655356 *	FAAH INHIBITORS	H04L 29/12 (2006.01)	2684342 *	REMOTE ACCESS AND ADMINISTRATION OF DEVICE CONTENT AND CONFIGURATION USING HTTP PROTOCOL
C07D 401/14 (2006.01)	2655356 *	FAAH INHIBITORS	G03D 15/00 (2006.01)	2656345 *	METHOD FOR RECONDITIONING DATA CARRIERS
C07D 403/12 (2006.01)	2655356 *	FAAH INHIBITORS	G11B 23/50 (2006.01)	2656345 *	METHOD FOR RECONDITIONING DATA CARRIERS
C07D 403/14 (2006.01)	2655356 *	FAAH INHIBITORS	A61M 5/20 (2006.01)	2675507 *	AUTO-INJECTOR
C07D 471/04 (2006.01)	2655356 *	FAAH INHIBITORS	A61M 5/315 (2006.01)	2675507 *	AUTO-INJECTOR
A61B 1/00 (2006.01)	2686734 *	DEVICE FOR RECORDING IMAGES OF THREE-DIMENSIONAL OBJECTS	A61M 5/32 (2006.01)	2675507 *	AUTO-INJECTOR
A61B 1/06 (2006.01)	2686734 *	DEVICE FOR RECORDING IMAGES OF THREE-DIMENSIONAL OBJECTS	A61M 5/50 (2006.01)	2675507 *	AUTO-INJECTOR
G01B 11/25 (2006.01)	2686734 *	DEVICE FOR RECORDING IMAGES OF THREE-DIMENSIONAL OBJECTS	A61K 31/336 (2006.01)	2683706 *	OXASPIRO [2.5]OCTANE DERIVATIVES AND ANALOGS
G03B 17/54 (2006.01)	2686734 *	DEVICE FOR RECORDING IMAGES OF THREE-DIMENSIONAL OBJECTS	A61P 3/04 (2006.01)	2683706 *	OXASPIRO [2.5]OCTANE DERIVATIVES AND ANALOGS
G03B 35/08 (2006.01)	2686734 *	DEVICE FOR RECORDING IMAGES OF THREE-DIMENSIONAL OBJECTS	C07D 303/22 (2006.01)	2683706 *	OXASPIRO [2.5]OCTANE DERIVATIVES AND ANALOGS
G03B 37/00 (2006.01)	2686734 *	DEVICE FOR RECORDING IMAGES OF THREE-DIMENSIONAL OBJECTS	C07D 303/32 (2006.01)	2683706 *	OXASPIRO [2.5]OCTANE DERIVATIVES AND ANALOGS
			C07D 303/34 (2006.01)	2683706 *	OXASPIRO [2.5]OCTANE DERIVATIVES AND ANALOGS
			C07D 303/36 (2006.01)	2683706 *	OXASPIRO [2.5]OCTANE DERIVATIVES AND ANALOGS
			C07D 491/10 (2006.01)	2683706 *	OXASPIRO [2.5]OCTANE DERIVATIVES AND ANALOGS

MKP (51)	Broj objave evropske prijave patenta (97)	Naziv pronalaska (54)	MKP (51)	Broj objave evropske prijave patenta (97)	Naziv pronalaska (54)
F16L 55/10 (2006.01)	2649359 *	DEVICE FOR AUTOMATIC CLOSURE OF CONTROL VALVES IN SEPARABLE CONNECTION UNITS FOR FLEXIBLE PIPES.	F26B 5/14 (2006.01)	2652422 *	METHODS OF DRYING BIOMASS AND CARBONACEOUS MATERIALS
A61K 38/17 (2006.01)	2665485 *	APOLIPOPROTEIN AIV AS AN ANTIDIABETIC PEPTIDE	H04L 29/08 (2006.01)	2684341 *	SYSTEM AND METHOD USING A WEB PROXY-SERVER TO ACCESS A DEVICE HAVING AN ASSIGNED NETWORK ADDRESS
A61P 3/10 (2006.01)	2665485 *	APOLIPOPROTEIN AIV AS AN ANTIDIABETIC PEPTIDE	H04L 29/12 (2006.01)	2684341 *	SYSTEM AND METHOD USING A WEB PROXY-SERVER TO ACCESS A DEVICE HAVING AN ASSIGNED NETWORK ADDRESS
C07K 14/775 (2006.01)	2665485 *	APOLIPOPROTEIN AIV AS AN ANTIDIABETIC PEPTIDE	A61K 39/00 (2006.01)	2655415 *	TRI-VARIABLE DOMAIN BINDING PROTEINS AND USES THEREOF
A61K 31/416 (2006.01)	2678318 *	CANNABINOID RECEPTOR MODULATORS	C07K 16/00 (2006.01)	2655415 *	TRI-VARIABLE DOMAIN BINDING PROTEINS AND USES THEREOF
A61K 31/4439 (2006.01)	2678318 *	CANNABINOID RECEPTOR MODULATORS	E21B 17/01 (2006.01)	2614211 *	RIGID HULL GAS-CAN BUOYS WITH VARIABLE BUOYANCY
A61K 31/497 (2006.01)	2678318 *	CANNABINOID RECEPTOR MODULATORS	C07K 16/22 (2006.01)	2681242 *	SCLEROSTIN AND DKK-1 BISPECIFIC BINDING AGENTS
A61K 31/661 (2006.01)	2678318 *	CANNABINOID RECEPTOR MODULATORS	G21C 17/017 (2006.01)	2681242 *	SCLEROSTIN AND DKK-1 BISPECIFIC BINDING AGENTS
A61P 29/00 (2006.01)	2678318 *	CANNABINOID RECEPTOR MODULATORS	G21C 19/14 (2006.01)	2681242 *	SCLEROSTIN AND DKK-1 BISPECIFIC BINDING AGENTS
C07D 231/54 (2006.01)	2678318 *	CANNABINOID RECEPTOR MODULATORS	C12Q 1/68 (2006.01)	2652154 *	UNIVERSAL REFERENCE DYE FOR QUANTITATIVE AMPLIFICATION
C07D 401/04 (2006.01)	2678318 *	CANNABINOID RECEPTOR MODULATORS	A61K 31/538 (2006.01)	2686306 *	BENZO [B][1, 4]OXAZIN DERIVATIVES AS CALCIUM SENSING RECEPTOR MODULATORS
C07D 401/14 (2006.01)	2678318 *	CANNABINOID RECEPTOR MODULATORS	A61P 5/18 (2006.01)	2686306 *	BENZO [B][1, 4]OXAZIN DERIVATIVES AS CALCIUM SENSING RECEPTOR MODULATORS
C07D 403/04 (2006.01)	2678318 *	CANNABINOID RECEPTOR MODULATORS	C07D 265/36 (2006.01)	2686306 *	BENZO [B][1, 4]OXAZIN DERIVATIVES AS CALCIUM SENSING RECEPTOR MODULATORS
C07D 405/14 (2006.01)	2678318 *	CANNABINOID RECEPTOR MODULATORS	C07D 413/04 (2006.01)	2686306 *	BENZO [B][1, 4]OXAZIN DERIVATIVES AS CALCIUM SENSING RECEPTOR MODULATORS
C07F 9/09 (2006.01)	2678318 *	CANNABINOID RECEPTOR MODULATORS	B29B 13/02 (2006.01)	2623284	Method and device for heating an end section of a plastic tube
C12Q 1/68 (2006.01)	2686441 *	METHODS AND COMPOSITIONS FOR PREDICTING RESPONSE TO ERIBULIN	A61C 11/08 (2006.01)	2685930 *	MODEL PLATE ARRAY FOR PRODUCING DENTURES
A61K 39/395 (2006.01)	2668960 *	COMPOUNDS FOR TREATING CARDIAC DAMAGE AFTER ISCHAEMIA/REPERFUSION	C07K 16/28 (2006.01)	2513147 *	NOVEL ANTAGONIST ANTIBODIES AND THEIR FAB FRAGMENTS AGAINST GPVI AND USES THEREOF
F16B 25/00 (2006.01)	2657547	Screw			
H01F 29/14 (2006.01)	2383756	Device for current amplification for electromagnetic pulse shaping and use			
H02M 1/16 (2006.01)	2383756	Device for current amplification for electromagnetic pulse shaping and use			

MKP (51)	Broj objave evropske prijave patenta (97)	Naziv pronalaska (54)	MKP (51)	Broj objave evropske prijave patenta (97)	Naziv pronalaska (54)
E05C 17/44 (2006.01)	2678502 *	DOOR BRACE	A61K 31/7048 (2006.01)	2663299 *	MELATONIN AND AN ANTIMICROBIAL OR ANTIBACTERIAL AGENT FOR THE TREATMENT OF ACNE
E05C 17/54 (2006.01)	2678502 *	DOOR BRACE	A61K 31/7056 (2006.01)	2663299 *	MELATONIN AND AN ANTIMICROBIAL OR ANTIBACTERIAL AGENT FOR THE TREATMENT OF ACNE
E05C 19/00 (2006.01)	2678502 *	DOOR BRACE	A61K 33/30 (2006.01)	2663299 *	MELATONIN AND AN ANTIMICROBIAL OR ANTIBACTERIAL AGENT FOR THE TREATMENT OF ACNE
E05C 19/18 (2006.01)	2678502 *	DOOR BRACE	A61K 45/06 (2006.01)	2663299 *	MELATONIN AND AN ANTIMICROBIAL OR ANTIBACTERIAL AGENT FOR THE TREATMENT OF ACNE
A61M 5/32 (2006.01)	2651474 *	INJECTION SUPPORTING DEVICE FOR A SYRINGE AND INJECTION DEVICE	A61K 45/06 (2006.01)	2663299 *	MELATONIN AND AN ANTIMICROBIAL OR ANTIBACTERIAL AGENT FOR THE TREATMENT OF ACNE
A61K 39/395 (2006.01)	2668211 *	PHARMACEUTICAL COMPOSITIONS COMPRISING HUMAN ANTIBODIES TO PCSK9	A61P 17/10 (2006.01)	2663299 *	MELATONIN AND AN ANTIMICROBIAL OR ANTIBACTERIAL AGENT FOR THE TREATMENT OF ACNE
A61P 3/06 (2006.01)	2668211 *	PHARMACEUTICAL COMPOSITIONS COMPRISING HUMAN ANTIBODIES TO PCSK9	C12P 21/08 (2006.01)	2668283 *	COMPOSITIONS CONTAINING GLYCOSYLATED ANTIBODIES AND USES THEREOF
C07K 16/40 (2006.01)	2668211 *	PHARMACEUTICAL COMPOSITIONS COMPRISING HUMAN ANTIBODIES TO PCSK9	F21K 2/06 (2006.01)	2649363 *	CHEMILUMINESCENT DEVICE WITH TIME DELAY ACTIVATION
A01H 1/04 (2006.01)	2645846 *	METHODS FOR INCREASING GENETIC GAIN IN A BREEDING POPULATION	B65H 75/14 (2006.01)	2565140	Cable holder
G06F 19/14 (2011.01)	2645846 *	METHODS FOR INCREASING GENETIC GAIN IN A BREEDING POPULATION	B65H 75/22 (2006.01)	2565140	Cable holder
G06F 19/18 (2011.01)	2645846 *	METHODS FOR INCREASING GENETIC GAIN IN A BREEDING POPULATION	C07D 307/81 (2006.01)	2691382 *	PROCESS FOR PREPARATION OF DRONEDARONE BY MESYLATION
A61K 31/155 (2006.01)	2663299 *	MELATONIN AND AN ANTIMICROBIAL OR ANTIBACTERIAL AGENT FOR THE TREATMENT OF ACNE	E04F 11/18 (2006.01)	2694752 *	A GUARDRAIL AND METHOD FOR ASSEMBLING IT
A61K 31/194 (2006.01)	2663299 *	MELATONIN AND AN ANTIMICROBIAL OR ANTIBACTERIAL AGENT FOR THE TREATMENT OF ACNE	E04G 21/32 (2006.01)	2694752 *	A GUARDRAIL AND METHOD FOR ASSEMBLING IT
A61K 31/327 (2006.01)	2663299 *	MELATONIN AND AN ANTIMICROBIAL OR ANTIBACTERIAL AGENT FOR THE TREATMENT OF ACNE	A61K 31/357 (2006.01)	2686310 *	BENZODIOXANE INHIBITORS OF LEUKOTRIENE PRODUCTION
A61K 31/4045 (2006.01)	2663299 *	MELATONIN AND AN ANTIMICROBIAL OR ANTIBACTERIAL AGENT FOR THE TREATMENT OF ACNE	A61P 19/00 (2006.01)	2686310 *	BENZODIOXANE INHIBITORS OF LEUKOTRIENE PRODUCTION
A61K 31/4745 (2006.01)	2663299 *	MELATONIN AND AN ANTIMICROBIAL OR ANTIBACTERIAL AGENT FOR THE TREATMENT OF ACNE	A61P 29/00 (2006.01)	2686310 *	BENZODIOXANE INHIBITORS OF LEUKOTRIENE PRODUCTION
A61K 31/65 (2006.01)	2663299 *	MELATONIN AND AN ANTIMICROBIAL OR ANTIBACTERIAL AGENT FOR THE TREATMENT OF ACNE	C07D 319/20 (2006.01)	2686310 *	BENZODIOXANE INHIBITORS OF LEUKOTRIENE PRODUCTION
			C07D 405/10 (2006.01)	2686310 *	BENZODIOXANE INHIBITORS OF LEUKOTRIENE PRODUCTION
			C07D 405/12 (2006.01)	2686310 *	BENZODIOXANE INHIBITORS OF LEUKOTRIENE PRODUCTION
			C07D 405/14 (2006.01)	2686310 *	BENZODIOXANE INHIBITORS OF LEUKOTRIENE PRODUCTION

MKP (51)	Broj objave evropske prijave patenta (97)	Naziv pronalaska (54)	MKP (51)	Broj objave evropske prijave patenta (97)	Naziv pronalaska (54)
C07D 487/10 (2006.01)	2686310 *	BENZODIOXANE INHIBITORS OF LEUKOTRIENE PRODUCTION	A61K 31/4985 (2006.01)	2681219 *	6,7-DIHYDRO- PYRAZOLO[1,5-A]PYRAZIN- 4-YLAMINE DERIVATIVES USEFUL AS INHIBITORS OF BETA-SECRETASE (BACE)
C09K 8/582 (2006.01)	2678422 *	ALKALINE MICROBIAL ENHANCED OIL RECOVERY	A61P 25/28 (2006.01)	2681219 *	6,7-DIHYDRO- PYRAZOLO[1,5-A]PYRAZIN- 4-YLAMINE DERIVATIVES USEFUL AS INHIBITORS OF BETA-SECRETASE (BACE)
C12N 1/26 (2006.01)	2678422 *	ALKALINE MICROBIAL ENHANCED OIL RECOVERY	C07D 487/04 (2006.01)	2681219 *	6,7-DIHYDRO- PYRAZOLO[1,5-A]PYRAZIN- 4-YLAMINE DERIVATIVES USEFUL AS INHIBITORS OF BETA-SECRETASE (BACE)
C12N 9/00 (2006.01)	2678422 *	ALKALINE MICROBIAL ENHANCED OIL RECOVERY	A23G 1/32 (2006.01)	2672835 *	SWEETNESS ENHANCERS, SWEETENER COMPOSITIONS, METHODS OF MAKING THE SAME AND CONSUMABLES CONTAINING THE SAME
F03D 11/00 (2006.01)	2549845	Switch cabinet for a pitch system	A23K 1/16 (2006.01)	2672835 *	SWEETNESS ENHANCERS, SWEETENER COMPOSITIONS, METHODS OF MAKING THE SAME AND CONSUMABLES CONTAINING THE SAME
H02B 1/04 (2006.01)	2549845	Switch cabinet for a pitch system	A23L 1/03 (2006.01)	2672835 *	SWEETNESS ENHANCERS, SWEETENER COMPOSITIONS, METHODS OF MAKING THE SAME AND CONSUMABLES CONTAINING THE SAME
H02B 1/40 (2006.01)	2549845	Switch cabinet for a pitch system	A23L 2/52 (2006.01)	2672835 *	SWEETNESS ENHANCERS, SWEETENER COMPOSITIONS, METHODS OF MAKING THE SAME AND CONSUMABLES CONTAINING THE SAME
H05K 7/18 (2006.01)	2549845	Switch cabinet for a pitch system	A23L 2/60 (2006.01)	2672835 *	SWEETNESS ENHANCERS, SWEETENER COMPOSITIONS, METHODS OF MAKING THE SAME AND CONSUMABLES CONTAINING THE SAME
A61K 31/519 (2006.01)	2697229 *	ANTIMICROBIAL COMPOUNDS AND METHODS OF MAKING AND USING THE SAME	A61Q 1/00 (2006.01)	2672835 *	SWEETNESS ENHANCERS, SWEETENER COMPOSITIONS, METHODS OF MAKING THE SAME AND CONSUMABLES CONTAINING THE SAME
A61P 31/00 (2006.01)	2697229 *	ANTIMICROBIAL COMPOUNDS AND METHODS OF MAKING AND USING THE SAME	A61Q 11/00 (2006.01)	2672835 *	SWEETNESS ENHANCERS, SWEETENER COMPOSITIONS, METHODS OF MAKING THE SAME AND CONSUMABLES CONTAINING THE SAME
C07D 487/04 (2006.01)	2697229 *	ANTIMICROBIAL COMPOUNDS AND METHODS OF MAKING AND USING THE SAME	C07C 259/06 (2006.01)	2672835 *	SWEETNESS ENHANCERS, SWEETENER COMPOSITIONS, METHODS OF MAKING THE SAME AND CONSUMABLES CONTAINING THE SAME
H05B 7/09 (2006.01)	2651184	Electrode paste for electrodes in binder-free graphite with hydrocarbon base			
G01C 21/34 (2006.01)	2602777	Method for guiding a vehicle driver searching for a parking space			
G08G 1/01 (2006.01)	2602777	Method for guiding a vehicle driver searching for a parking space			
G08G 1/0968 (2006.01)	2602777	Method for guiding a vehicle driver searching for a parking space			
G08G 1/14 (2006.01)	2602777	Method for guiding a vehicle driver searching for a parking space			
G01N 33/50 (2006.01)	2681552 *	PREDICTION OF DRUG SENSITIVITY OF LUNG TUMORS BASED ON MOLECULAR AND GENETIC SIGNATURES			
G01N 33/574 (2006.01)	2681552 *	PREDICTION OF DRUG SENSITIVITY OF LUNG TUMORS BASED ON MOLECULAR AND GENETIC SIGNATURES			
A61K 31/55 (2006.01)	2685986 *	GLUCOSYLCERAMIDE SYNTHASE INHIBITORS			
A47K 10/38 (2006.01)	2606795	Sheet product dispenser			

MKP (51)	Broj objave evropske prijave patenta (97)	Naziv pronalaska (54)	MKP (51)	Broj objave evropske prijave patenta (97)	Naziv pronalaska (54)
C07K 16/22 (2006.01)	2694547 *	ANTIBODIES THAT BIND TGF- ALPHA AND EPIREGULIN	A24B 15/10 (2006.01)	2681321 *	TOBACCO INBRED PLANTS ALBEX1F AND ALBEX1MS
C01B 25/14 (2006.01)	2650274	A thionation process and a thionating agent	C12N 15/82 (2006.01)	2681321 *	TOBACCO INBRED PLANTS ALBEX1F AND ALBEX1MS
C07B 45/00 (2006.01)	2650274	A thionation process and a thionating agent	H01L 35/24 (2006.01)	2676303 *	SEMICONDUCTING POLYMER
C07C 325/02 (2006.01)	2650274	A thionation process and a thionating agent	H01L 51/00 (2006.01)	2676303 *	SEMICONDUCTING POLYMER
C07C 327/44 (2006.01)	2650274	A thionation process and a thionating agent	A61K 9/00 (2006.01)	2651410 *	TRANSDERMAL THERAPEUTIC SYSTEM FOR ADMINISTERING AN ACTIVE SUBSTANCE
C07D 207/24 (2006.01)	2650274	A thionation process and a thionating agent	A61K 9/70 (2006.01)	2651410 *	TRANSDERMAL THERAPEUTIC SYSTEM FOR ADMINISTERING AN ACTIVE SUBSTANCE
C07D 209/30 (2006.01)	2650274	A thionation process and a thionating agent	A61K 31/27 (2006.01)	2651410 *	TRANSDERMAL THERAPEUTIC SYSTEM FOR ADMINISTERING AN ACTIVE SUBSTANCE
C07D 211/72 (2006.01)	2650274	A thionation process and a thionating agent	G06F 3/048 (2013.01)	2695332 *	METHOD AND APPARATUS FOR CREATING AND MODIFYING GRAPHICAL SCHEDULES
C07D 211/84 (2006.01)	2650274	A thionation process and a thionating agent	H04L 12/28 (2006.01)	2695332 *	METHOD AND APPARATUS FOR CREATING AND MODIFYING GRAPHICAL SCHEDULES
C07D 213/06 (2006.01)	2650274	A thionation process and a thionating agent	A61K 9/00 (2006.01)	2672955 *	STORAGE-STABLE FORMULATION OF PARACETAMOL IN AQUEOUS SOLUTION
C07D 213/63 (2006.01)	2650274	A thionation process and a thionating agent	A61K 31/167 (2006.01)	2672955 *	STORAGE-STABLE FORMULATION OF PARACETAMOL IN AQUEOUS SOLUTION
C07D 239/93 (2006.01)	2650274	A thionation process and a thionating agent	A61K 31/5517 (2006.01)	2668187 *	NOVEL ANTIFUNGAL 5,6-DIHYDRO-4H- PYRROLO[1,2-a][1,4]- BENZODIAZEPINES AND 6H-PYRROLO[1,2-a] [1,4]BENZODIAZEPINES SUBSTITUTED WITH BICYCLIC BENZENE DERIVATIVES
C07D 241/06 (2006.01)	2650274	A thionation process and a thionating agent	A61P 31/10 (2006.01)	2668187 *	NOVEL ANTIFUNGAL 5,6-DIHYDRO-4H- PYRROLO[1,2-a][1,4]- BENZODIAZEPINES AND 6H-PYRROLO[1,2-a] [1,4]BENZODIAZEPINES SUBSTITUTED WITH BICYCLIC BENZENE DERIVATIVES
A61J 1/05 (2006.01)	2671562 *	MULTI-CHAMBERED CONTAINER			
B65D 81/32 (2006.01)	2671562 *	MULTI-CHAMBERED CONTAINER			
A61K 31/5355 (2006.01)	2694492 *	NOVEL COMPOUNDS AS HISTAMINE H3 RECEPTOR LIGANDS			
A61P 25/00 (2006.01)	2694492 *	NOVEL COMPOUNDS AS HISTAMINE H3 RECEPTOR LIGANDS			
C07D 401/12 (2006.01)	2694492 *	NOVEL COMPOUNDS AS HISTAMINE H3 RECEPTOR LIGANDS			
C07D 405/12 (2006.01)	2694492 *	NOVEL COMPOUNDS AS HISTAMINE H3 RECEPTOR LIGANDS			
C07D 413/12 (2006.01)	2694492 *	NOVEL COMPOUNDS AS HISTAMINE H3 RECEPTOR LIGANDS			
A01H 5/12 (2006.01)	2681321 *	TOBACCO INBRED PLANTS ALBEX1F AND ALBEX1MS			

MKP (51)	Broj objave evropske prijave patenta (97)	Naziv pronalaska (54)	MKP (51)	Broj objave evropske prijave patenta (97)	Naziv pronalaska (54)
C07D 487/04 (2006.01)	2668187 *	NOVEL ANTIFUNGAL 5,6-DIHYDRO-4H- PYRROLO[1,2-a][1,4]- BENZODIAZEPINES AND 6H-PYRROLO[1,2-a] [1,4]BENZODIAZEPINES SUBSTITUTED WITH BICYCLIC BENZENE DERIVATIVES	C07D 487/04 (2006.01)	2694508 *	SUBSTITUTED 2,3-DIHYDROIMIDAZO[1,2-C] QUINAZOLINE SALTS
C07B 57/00 (2006.01)	2646422 *	SEPARATION OF TRIAZINE DERIVATIVES ENANTIOMERS USING TARTARIC ACID	A61K 35/20 (2006.01)	2648739 *	MULTIPURPOSE GEL FOR VAGINAL DRYNESS WITH DIRECT AND DELAYED EFFECT
C07D 251/10 (2006.01)	2646422 *	SEPARATION OF TRIAZINE DERIVATIVES ENANTIOMERS USING TARTARIC ACID	A61P 15/02 (2006.01)	2648739 *	MULTIPURPOSE GEL FOR VAGINAL DRYNESS WITH DIRECT AND DELAYED EFFECT
A61K 9/00 (2006.01)	2675457 *	PHARMACEUTICAL FORMULATION FOR TOPICAL ADMINISTRATION COMPRISING B220	C07C 269/04 (2006.01)	2687506	Method for enzymatic synthesis of (7S)-1-(3,4- dimethoxybicyclo[4.2.0]octa- 1,3,5-triene-7-yl) N-methyl methanamine, and use for the synthesis of ivabradine and the salts thereof
A61K 31/4985 (2006.01)	2675457 *	PHARMACEUTICAL FORMULATION FOR TOPICAL ADMINISTRATION COMPRISING B220	C07D 223/16 (2006.01)	2687506	Method for enzymatic synthesis of (7S)-1-(3,4- dimethoxybicyclo[4.2.0]octa- 1,3,5-triene-7-yl) N-methyl methanamine, and use for the synthesis of ivabradine and the salts thereof
A61P 31/22 (2006.01)	2675457 *	PHARMACEUTICAL FORMULATION FOR TOPICAL ADMINISTRATION COMPRISING B220	C12P 41/00 (2006.01)	2687506	Method for enzymatic synthesis of (7S)-1-(3,4- dimethoxybicyclo[4.2.0]octa- 1,3,5-triene-7-yl) N-methyl methanamine, and use for the synthesis of ivabradine and the salts thereof
A61K 31/19 (2006.01)	2658536 *	GEMCABENE AND DERIVATIVES FOR TREATING PANCREATITIS	C08G 69/26 (2006.01)	2687555 *	POLYAMIDE AND POLYAMIDE COMPOSITION
A61P 1/18 (2006.01)	2658536 *	GEMCABENE AND DERIVATIVES FOR TREATING PANCREATITIS	C08K 3/00 (2006.01)	2687555 *	POLYAMIDE AND POLYAMIDE COMPOSITION
A61K 9/00 (2006.01)	2658530 *	ORALLY DISINTEGRATING TABLET	C08L 77/06 (2006.01)	2687555 *	POLYAMIDE AND POLYAMIDE COMPOSITION
A61K 9/20 (2006.01)	2658530 *	ORALLY DISINTEGRATING TABLET	A61K 31/41 (2006.01)	2668169 *	TETRAZOLE COMPOUNDS AND METHODS OF MAKING AND USING SAME
A61K 9/50 (2006.01)	2658530 *	ORALLY DISINTEGRATING TABLET	A61P 3/04 (2006.01)	2668169 *	TETRAZOLE COMPOUNDS AND METHODS OF MAKING AND USING SAME
A61K 31/4439 (2006.01)	2658530 *	ORALLY DISINTEGRATING TABLET	C07D 257/06 (2006.01)	2668169 *	TETRAZOLE COMPOUNDS AND METHODS OF MAKING AND USING SAME
A01F 12/18 (2006.01)	2684444 *	CROP THRESHING METHOD	H02K 3/32 (2006.01)	2695285 *	LAMINATED CORE ASSEMBLY
A61J 1/03 (2006.01)	2685956 *	PACKAGING FOR UNIT PHARMACEUTICAL PRODUCTS	C03B 5/235 (2006.01)	2688846 *	MELTING DEVICE
B65D 75/32 (2006.01)	2685956 *	PACKAGING FOR UNIT PHARMACEUTICAL PRODUCTS	F23M 5/02 (2006.01)	2688846 *	MELTING DEVICE
C12Q 1/68 (2006.01)	2678441 *	SINGLE NUCLEOTIDE POLYMORPHISMS IN THE PROMOTER OF VEGFA GENE AND THEIR USE AS PREDICTIVE MARKERS FOR ANTI-VEGF TREATMENTS	F27B 3/20 (2006.01)	2688846 *	MELTING DEVICE
A61K 31/519 (2006.01)	2694508 *	SUBSTITUTED 2,3-DIHYDROIMIDAZO[1,2-C] QUINAZOLINE SALTS	G01N 33/48 (2006.01)	2673729 *	METHODS FOR NON- INVASIVE PRENATAL PLOIDY CALLING
A61P 35/00 (2006.01)	2694508 *	SUBSTITUTED 2,3-DIHYDROIMIDAZO[1,2-C] QUINAZOLINE SALTS			

MKP (51)	Broj objave evropske prijave patenta (97)	Naziv pronalaska (54)	MKP (51)	Broj objave evropske prijave patenta (97)	Naziv pronalaska (54)
G06F 19/22 (2011.01)	2673729 *	METHODS FOR NON- INVASIVE PRENATAL PLOIDY CALLING	D21H 21/14 (2006.01)	2684999	High solids and low viscous aqueous slurries of calcium carbonate-comprising materials with improved rheological stability under increased temperature
A24D 1/00 (2006.01)	2662418	Sustainable adsorbable polymers	A01N 41/04 (2006.01)	2667719 *	PESTICIDE COMPOSITION COMPRISING SULPHUR, AN INSECTICIDE AND AN AGROCHEMICAL EXCIPIENT.
C09C 1/02 (2006.01)	2662418	Sustainable adsorbable polymers	A01N 43/50 (2006.01)	2667719 *	PESTICIDE COMPOSITION COMPRISING SULPHUR, AN INSECTICIDE AND AN AGROCHEMICAL EXCIPIENT.
D21H 17/00 (2006.01)	2662418	Sustainable adsorbable polymers	A01N 43/56 (2006.01)	2667719 *	PESTICIDE COMPOSITION COMPRISING SULPHUR, AN INSECTICIDE AND AN AGROCHEMICAL EXCIPIENT.
D21H 17/26 (2006.01)	2662418	Sustainable adsorbable polymers	A01N 43/60 (2006.01)	2667719 *	PESTICIDE COMPOSITION COMPRISING SULPHUR, AN INSECTICIDE AND AN AGROCHEMICAL EXCIPIENT.
D21H 17/69 (2006.01)	2662418	Sustainable adsorbable polymers	A01N 43/72 (2006.01)	2667719 *	PESTICIDE COMPOSITION COMPRISING SULPHUR, AN INSECTICIDE AND AN AGROCHEMICAL EXCIPIENT.
C01F 11/18 (2006.01)	2684999	High solids and low viscous aqueous slurries of calcium carbonate-comprising materials with improved rheological stability under increased temperature	A01N 47/06 (2006.01)	2667719 *	PESTICIDE COMPOSITION COMPRISING SULPHUR, AN INSECTICIDE AND AN AGROCHEMICAL EXCIPIENT.
C08K 3/20 (2006.01)	2684999	High solids and low viscous aqueous slurries of calcium carbonate-comprising materials with improved rheological stability under increased temperature	A01N 47/10 (2006.01)	2667719 *	PESTICIDE COMPOSITION COMPRISING SULPHUR, AN INSECTICIDE AND AN AGROCHEMICAL EXCIPIENT.
C09C 1/02 (2006.01)	2684999	High solids and low viscous aqueous slurries of calcium carbonate-comprising materials with improved rheological stability under increased temperature	A01N 47/18 (2006.01)	2667719 *	PESTICIDE COMPOSITION COMPRISING SULPHUR, AN INSECTICIDE AND AN AGROCHEMICAL EXCIPIENT.
C09C 3/10 (2006.01)	2684999	High solids and low viscous aqueous slurries of calcium carbonate-comprising materials with improved rheological stability under increased temperature	A01N 47/30 (2006.01)	2667719 *	PESTICIDE COMPOSITION COMPRISING SULPHUR, AN INSECTICIDE AND AN AGROCHEMICAL EXCIPIENT.
D21H 17/69 (2006.01)	2684999	High solids and low viscous aqueous slurries of calcium carbonate-comprising materials with improved rheological stability under increased temperature	A01N 47/34 (2006.01)	2667719 *	PESTICIDE COMPOSITION COMPRISING SULPHUR, AN INSECTICIDE AND AN AGROCHEMICAL EXCIPIENT.
D21H 19/38 (2006.01)	2684999	High solids and low viscous aqueous slurries of calcium carbonate-comprising materials with improved rheological stability under increased temperature	A01N 47/40 (2006.01)	2667719 *	PESTICIDE COMPOSITION COMPRISING SULPHUR, AN INSECTICIDE AND AN AGROCHEMICAL EXCIPIENT.
D21H 19/42 (2006.01)	2684999	High solids and low viscous aqueous slurries of calcium carbonate-comprising materials with improved rheological stability under increased temperature	A01N 47/44 (2006.01)	2667719 *	PESTICIDE COMPOSITION COMPRISING SULPHUR, AN INSECTICIDE AND AN AGROCHEMICAL EXCIPIENT.
D21H 19/44 (2006.01)	2684999	High solids and low viscous aqueous slurries of calcium carbonate-comprising materials with improved rheological stability under increased temperature	A01N 59/02 (2006.01)	2667719 *	PESTICIDE COMPOSITION COMPRISING SULPHUR, AN INSECTICIDE AND AN AGROCHEMICAL EXCIPIENT.
			A61F 13/15 (2006.01)	2656827	Disposable Products Containing Parallel Flared Elastics
			A61F 13/49 (2006.01)	2656827	Disposable Products Containing Parallel Flared Elastics

MKP (51)	Broj objave evropske prijave patenta (97)	Naziv pronalaska (54)	MKP (51)	Broj objave evropske prijave patenta (97)	Naziv pronalaska (54)
A01N 43/16 (2006.01)	2688403 *	OPIOID RECEPTOR LIGANDS AND METHODS OF USING AND MAKING SAME	H01M 2/02 (2006.01)	2549563	System comprising a battery tray and a tray receiver for mounting the battery tray in a battery cabinet of a wind turbine
A61K 31/35 (2006.01)	2688403 *	OPIOID RECEPTOR LIGANDS AND METHODS OF USING AND MAKING SAME	H01M 2/10 (2006.01)	2549563	System comprising a battery tray and a tray receiver for mounting the battery tray in a battery cabinet of a wind turbine
A61K 31/4164 (2006.01)	2699561 *	ANDROGEN RECEPTOR MODULATING CARBOXAMIDES	G06F 19/00 (2011.01)	2597584	Apparatus, process and infrastructure of monitoring a plurality of patients affected by kidney failure
A61P 35/00 (2006.01)	2699561 *	ANDROGEN RECEPTOR MODULATING CARBOXAMIDES	A61K 33/26 (2006.01)	2668175 *	PROCESS
C07D 401/04 (2006.01)	2699561 *	ANDROGEN RECEPTOR MODULATING CARBOXAMIDES	A61P 7/06 (2006.01)	2668175 *	PROCESS
C07D 403/04 (2006.01)	2699561 *	ANDROGEN RECEPTOR MODULATING CARBOXAMIDES	C07D 309/40 (2006.01)	2668175 *	PROCESS
C07D 403/12 (2006.01)	2699561 *	ANDROGEN RECEPTOR MODULATING CARBOXAMIDES	A61K 31/498 (2006.01)	2654751 *	PHOSPHORUS-SUBSTITUTED QUINOXALINE-TYPE PIPERIDINE COMPOUNDS AND USES THEREOF
C07D 413/12 (2006.01)	2699561 *	ANDROGEN RECEPTOR MODULATING CARBOXAMIDES	A61P 3/02 (2006.01)	2654751 *	PHOSPHORUS-SUBSTITUTED QUINOXALINE-TYPE PIPERIDINE COMPOUNDS AND USES THEREOF
C07D 413/14 (2006.01)	2699561 *	ANDROGEN RECEPTOR MODULATING CARBOXAMIDES	A61P 23/00 (2006.01)	2654751 *	PHOSPHORUS-SUBSTITUTED QUINOXALINE-TYPE PIPERIDINE COMPOUNDS AND USES THEREOF
C07D 471/04 (2006.01)	2699561 *	ANDROGEN RECEPTOR MODULATING CARBOXAMIDES	A61P 25/00 (2006.01)	2654751 *	PHOSPHORUS-SUBSTITUTED QUINOXALINE-TYPE PIPERIDINE COMPOUNDS AND USES THEREOF
C07D 487/04 (2006.01)	2699561 *	ANDROGEN RECEPTOR MODULATING CARBOXAMIDES	A61P 25/16 (2006.01)	2654751 *	PHOSPHORUS-SUBSTITUTED QUINOXALINE-TYPE PIPERIDINE COMPOUNDS AND USES THEREOF
C07D 513/04 (2006.01)	2699561 *	ANDROGEN RECEPTOR MODULATING CARBOXAMIDES	A61P 25/24 (2006.01)	2654751 *	PHOSPHORUS-SUBSTITUTED QUINOXALINE-TYPE PIPERIDINE COMPOUNDS AND USES THEREOF
A61K 31/4427 (2006.01)	2651925 *	ANTI-VIRAL COMPOUNDS	C07D 401/04 (2006.01)	2654751 *	PHOSPHORUS-SUBSTITUTED QUINOXALINE-TYPE PIPERIDINE COMPOUNDS AND USES THEREOF
A61P 31/12 (2006.01)	2651925 *	ANTI-VIRAL COMPOUNDS	C07D 401/14 (2006.01)	2654751 *	PHOSPHORUS-SUBSTITUTED QUINOXALINE-TYPE PIPERIDINE COMPOUNDS AND USES THEREOF
C07D 401/12 (2006.01)	2651925 *	ANTI-VIRAL COMPOUNDS	F03D 11/00 (2006.01)	2665930 *	METHOD FOR DETERMINING THE INCLINATION OF A TOWER
C07D 403/04 (2006.01)	2651925 *	ANTI-VIRAL COMPOUNDS	A61K 9/00 (2006.01)	2675452 *	LIQUID PROPELLANT-FREE FORMULATION COMPRISING AN ANTIMUSCARINIC DRUG
C07D 403/14 (2006.01)	2651925 *	ANTI-VIRAL COMPOUNDS	A61K 31/439 (2006.01)	2675452 *	LIQUID PROPELLANT-FREE FORMULATION COMPRISING AN ANTIMUSCARINIC DRUG
H04L 29/08 (2006.01)	2684337 *	SYSTEM AND METHOD FOR ACCESSING A DEVICE HAVING AN ASSIGNED NETWORK ADDRESS			
H04L 29/12 (2006.01)	2684337 *	SYSTEM AND METHOD FOR ACCESSING A DEVICE HAVING AN ASSIGNED NETWORK ADDRESS			

MKP (51)	Broj objave evropske prijave patenta (97)	Naziv pronalaska (54)	MKP (51)	Broj objave evropske prijave patenta (97)	Naziv pronalaska (54)
G21G 1/10 (2006.01)	2659491 *	PROTON ENGINE	A61K 31/416 (2006.01)	2680838 *	TREATMENT OF ARTERIAL AGEING BY COMBINATION OF RAAS INHIBITOR AND HMG-CoA REDUCTASE INHIBITOR
A61K 9/00 (2006.01)	2672958 *	COMPOSITION AND LIPID FORMULATION OF A HYALURONAN-DEGRADING ENZYME AND THE USE THEREOF FOR TREATMENT OF BENIGN PROSTATIC HYPERPLASIA	A61K 31/4015 (2006.01)	2680838 *	TREATMENT OF ARTERIAL AGEING BY COMBINATION OF RAAS INHIBITOR AND HMG-CoA REDUCTASE INHIBITOR
A61K 9/127 (2006.01)	2672958 *	COMPOSITION AND LIPID FORMULATION OF A HYALURONAN-DEGRADING ENZYME AND THE USE THEREOF FOR TREATMENT OF BENIGN PROSTATIC HYPERPLASIA	A61K 31/44 (2006.01)	2680838 *	TREATMENT OF ARTERIAL AGEING BY COMBINATION OF RAAS INHIBITOR AND HMG-CoA REDUCTASE INHIBITOR
A61K 38/00 (2006.01)	2672958 *	COMPOSITION AND LIPID FORMULATION OF A HYALURONAN-DEGRADING ENZYME AND THE USE THEREOF FOR TREATMENT OF BENIGN PROSTATIC HYPERPLASIA	A61K 31/41 (2006.01)	2680838 *	TREATMENT OF ARTERIAL AGEING BY COMBINATION OF RAAS INHIBITOR AND HMG-CoA REDUCTASE INHIBITOR
A61K 38/47 (2006.01)	2672958 *	COMPOSITION AND LIPID FORMULATION OF A HYALURONAN-DEGRADING ENZYME AND THE USE THEREOF FOR TREATMENT OF BENIGN PROSTATIC HYPERPLASIA	A61K 31/616 (2006.01)	2680838 *	TREATMENT OF ARTERIAL AGEING BY COMBINATION OF RAAS INHIBITOR AND HMG-CoA REDUCTASE INHIBITOR
A61K 47/24 (2006.01)	2672958 *	COMPOSITION AND LIPID FORMULATION OF A HYALURONAN-DEGRADING ENZYME AND THE USE THEREOF FOR TREATMENT OF BENIGN PROSTATIC HYPERPLASIA	A61K 31/415 (2006.01)	2680838 *	TREATMENT OF ARTERIAL AGEING BY COMBINATION OF RAAS INHIBITOR AND HMG-CoA REDUCTASE INHIBITOR
G01F 1/28 (2006.01)	2659234 *	DEVICE FOR MEASURING THE FLOW RATE OF A FLUID	A61P 9/10 (2006.01)	2680838 *	TREATMENT OF ARTERIAL AGEING BY COMBINATION OF RAAS INHIBITOR AND HMG-CoA REDUCTASE INHIBITOR
A61K 31/517 (2006.01)	2694072 *	COMBINATIONS OF AKT INHIBITOR COMPOUNDS AND ABIRATERONE, AND METHODS OF USE	A61K 31/4155 (2006.01)	2680838 *	TREATMENT OF ARTERIAL AGEING BY COMBINATION OF RAAS INHIBITOR AND HMG-CoA REDUCTASE INHIBITOR
A61P 35/00 (2006.01)	2694072 *	COMBINATIONS OF AKT INHIBITOR COMPOUNDS AND ABIRATERONE, AND METHODS OF USE	A61K 31/366 (2006.01)	2680838 *	TREATMENT OF ARTERIAL AGEING BY COMBINATION OF RAAS INHIBITOR AND HMG-CoA REDUCTASE INHIBITOR
C07D 239/70 (2006.01)	2694072 *	COMBINATIONS OF AKT INHIBITOR COMPOUNDS AND ABIRATERONE, AND METHODS OF USE	A61K 31/422 (2006.01)	2680838 *	TREATMENT OF ARTERIAL AGEING BY COMBINATION OF RAAS INHIBITOR AND HMG-CoA REDUCTASE INHIBITOR
A61K 31/405 (2006.01)	2680838 *	TREATMENT OF ARTERIAL AGEING BY COMBINATION OF RAAS INHIBITOR AND HMG-CoA REDUCTASE INHIBITOR	A61K 31/122 (2006.01)	2680838 *	TREATMENT OF ARTERIAL AGEING BY COMBINATION OF RAAS INHIBITOR AND HMG-CoA REDUCTASE INHIBITOR
A61K 31/47 (2006.01)	2680838 *	TREATMENT OF ARTERIAL AGEING BY COMBINATION OF RAAS INHIBITOR AND HMG-CoA REDUCTASE INHIBITOR	A61K 31/505 (2006.01)	2680838 *	TREATMENT OF ARTERIAL AGEING BY COMBINATION OF RAAS INHIBITOR AND HMG-CoA REDUCTASE INHIBITOR
A61K 31/22 (2006.01)	2680838 *	TREATMENT OF ARTERIAL AGEING BY COMBINATION OF RAAS INHIBITOR AND HMG-CoA REDUCTASE INHIBITOR	A01N 43/68 (2006.01)	2672825 *	STABLE AGROCHEMICAL OIL DISPERSIONS
			A61K 31/5377 (2006.01)	2667874 *	INHIBITORS OF MTOR KINASA AS ANTI- VIRAL AGENTS
			A61K 39/12 (2006.01)	2655604 *	ADENOVIRUS SEROTYPE 26 AND SEROTYPE 35 FILOVIRUS VACCINES
			A61K 39/235 (2006.01)	2655604 *	ADENOVIRUS SEROTYPE 26 AND SEROTYPE 35 FILOVIRUS VACCINES
			C12N 7/01 (2006.01)	2655604 *	ADENOVIRUS SEROTYPE 26 AND SEROTYPE 35 FILOVIRUS VACCINES

MKP (51)	Broj objave evropske prijave patenta (97)	Naziv pronalaska (54)	MKP (51)	Broj objave evropske prijave patenta (97)	Naziv pronalaska (54)
G06F 21/00 (2013.01)	2678794 *	SYSTEMS AND METHODS FOR RULE-DRIVEN MANAGEMENT OF SENSOR DATA ACROSS GEOGRAPHIC AREAS AND DERIVED ACTIONS	B01J 49/00 (2006.01)	2651559 *	METHODS AND DEVICES FOR MEASURING THE CONCENTRATION OF AN ADDITIVE
A61K 31/454 (2006.01)	2665719 *	FUSED DIHYDROFURANS AS GPR119 MODULATORS FOR THE TREATMENT OF DIABETES, OBESITY AND RELATED DISORDERS	A61K 39/395 (2006.01)	2699262 *	BISPECIFIC ANTIBODIES AGAINST HER2 AND CD3
A61K 31/4545 (2006.01)	2665719 *	FUSED DIHYDROFURANS AS GPR119 MODULATORS FOR THE TREATMENT OF DIABETES, OBESITY AND RELATED DISORDERS	A61K 47/48 (2006.01)	2699262 *	BISPECIFIC ANTIBODIES AGAINST HER2 AND CD3
A61K 31/497 (2006.01)	2665719 *	FUSED DIHYDROFURANS AS GPR119 MODULATORS FOR THE TREATMENT OF DIABETES, OBESITY AND RELATED DISORDERS	A61P 35/00 (2006.01)	2699262 *	BISPECIFIC ANTIBODIES AGAINST HER2 AND CD3
A61K 31/506 (2006.01)	2665719 *	FUSED DIHYDROFURANS AS GPR119 MODULATORS FOR THE TREATMENT OF DIABETES, OBESITY AND RELATED DISORDERS	C07K 16/10 (2006.01)	2699262 *	BISPECIFIC ANTIBODIES AGAINST HER2 AND CD3
A61P 3/10 (2006.01)	2665719 *	FUSED DIHYDROFURANS AS GPR119 MODULATORS FOR THE TREATMENT OF DIABETES, OBESITY AND RELATED DISORDERS	C07K 16/28 (2006.01)	2699262 *	BISPECIFIC ANTIBODIES AGAINST HER2 AND CD3
A61P 5/50 (2006.01)	2665719 *	FUSED DIHYDROFURANS AS GPR119 MODULATORS FOR THE TREATMENT OF DIABETES, OBESITY AND RELATED DISORDERS	C07K 16/32 (2006.01)	2699262 *	BISPECIFIC ANTIBODIES AGAINST HER2 AND CD3
C07D 407/14 (2006.01)	2665719 *	FUSED DIHYDROFURANS AS GPR119 MODULATORS FOR THE TREATMENT OF DIABETES, OBESITY AND RELATED DISORDERS	C07K 16/46 (2006.01)	2699262 *	BISPECIFIC ANTIBODIES AGAINST HER2 AND CD3
C07D 413/14 (2006.01)	2665719 *	FUSED DIHYDROFURANS AS GPR119 MODULATORS FOR THE TREATMENT OF DIABETES, OBESITY AND RELATED DISORDERS	C07K 16/28 (2006.01)	2661449 *	LIGANDS THAT BIND TGF-BETA RECEPTOR II
C07D 491/048 (2006.01)	2665719 *	FUSED DIHYDROFURANS AS GPR119 MODULATORS FOR THE TREATMENT OF DIABETES, OBESITY AND RELATED DISORDERS	A61K 31/00 (2006.01)	2670401 *	METHODS OF USING ALK INHIBITORS
A61K 31/7056 (2006.01)	2655388 *	SELECTIVE GLYCOSIDASE INHIBITORS AND USES THEREOF	A61K 31/506 (2006.01)	2670401 *	METHODS OF USING ALK INHIBITORS
C07D 513/04 (2006.01)	2655388 *	SELECTIVE GLYCOSIDASE INHIBITORS AND USES THEREOF	A61P 35/00 (2006.01)	2670401 *	METHODS OF USING ALK INHIBITORS
C07H 9/06 (2006.01)	2655388 *	SELECTIVE GLYCOSIDASE INHIBITORS AND USES THEREOF	B66C 1/34 (2006.01)	2657175	Retaining Pin Assembly for a Lifting System.
C12Q 1/34 (2006.01)	2655388 *	SELECTIVE GLYCOSIDASE INHIBITORS AND USES THEREOF	F16B 21/12 (2006.01)	2657175	Retaining Pin Assembly for a Lifting System.
			G06K 19/00 (2006.01)	2649585 *	ELECTRONIC HEALTH RECORD WEB-BASED PLATFORM
			G06Q 50/24 (2012.01)	2649585 *	ELECTRONIC HEALTH RECORD WEB-BASED PLATFORM
			A61K 9/20 (2006.01)	2654732 *	COMPRESSED SOLID DOSAGE FORMS
			A61K 9/50 (2006.01)	2654732 *	COMPRESSED SOLID DOSAGE FORMS
			F02D 19/06 (2006.01)	2573368	METHOD FOR CONTROLLING IN PARTICULAR THE IGNITION OF THE COMBUSTION OF A GASOLINE DIRECT INJECTION INTERNAL COMBUSTION ENGINE

MKP (51)	Broj objave evropske prijave patenta (97)	Naziv pronalaska (54)	MKP (51)	Broj objave evropske prijave patenta (97)	Naziv pronalaska (54)
F02D 19/08 (2006.01)	2573368	METHOD FOR CONTROLLING IN PARTICULAR THE IGNITION OF THE COMBUSTION OF A GASOLINE DIRECT INJECTION INTERNAL COMBUSTION ENGINE	A61P 9/04 (2006.01)	2694074 *	USE OF A2B ADENOSINE RECEPTOR ANTAGONISTS FOR TREATING HEART FAILURE AND ARRHYTHMIA IN POST-MYOCARDIAL INFARCTION PATIENTS
F02D 41/00 (2006.01)	2573368	METHOD FOR CONTROLLING IN PARTICULAR THE IGNITION OF THE COMBUSTION OF A GASOLINE DIRECT INJECTION INTERNAL COMBUSTION ENGINE	A61P 9/10 (2006.01)	2694074 *	USE OF A2B ADENOSINE RECEPTOR ANTAGONISTS FOR TREATING HEART FAILURE AND ARRHYTHMIA IN POST-MYOCARDIAL INFARCTION PATIENTS
F02D 41/14 (2006.01)	2573368	METHOD FOR CONTROLLING IN PARTICULAR THE IGNITION OF THE COMBUSTION OF A GASOLINE DIRECT INJECTION INTERNAL COMBUSTION ENGINE	C07H 21/04 (2006.01)	2656263 *	METHODS FOR NON-INVASIVE PRENATAL PATERNITY TESTING
F02D 41/30 (2006.01)	2573368	METHOD FOR CONTROLLING IN PARTICULAR THE IGNITION OF THE COMBUSTION OF A GASOLINE DIRECT INJECTION INTERNAL COMBUSTION ENGINE	G06F 19/00 (2011.01)	2656263 *	METHODS FOR NON-INVASIVE PRENATAL PATERNITY TESTING
A61K 9/00 (2006.01)	2694074 *	USE OF A2B ADENOSINE RECEPTOR ANTAGONISTS FOR TREATING HEART FAILURE AND ARRHYTHMIA IN POST-MYOCARDIAL INFARCTION PATIENTS	A61K 47/48 (2006.01)	2691155 *	PREPARATION OF MAYTANSINOID ANTIBODY CONJUGATES BY A ONE-STEP PROCESS
A61K 31/40 (2006.01)	2694074 *	USE OF A2B ADENOSINE RECEPTOR ANTAGONISTS FOR TREATING HEART FAILURE AND ARRHYTHMIA IN POST-MYOCARDIAL INFARCTION PATIENTS	A61P 35/00 (2006.01)	2691155 *	PREPARATION OF MAYTANSINOID ANTIBODY CONJUGATES BY A ONE-STEP PROCESS
A61K 31/403 (2006.01)	2694074 *	USE OF A2B ADENOSINE RECEPTOR ANTAGONISTS FOR TREATING HEART FAILURE AND ARRHYTHMIA IN POST-MYOCARDIAL INFARCTION PATIENTS	C12M 1/107 (2006.01)	2691506 *	AN APPARATUS FOR WASTE SEPARATION
A61K 31/522 (2006.01)	2694074 *	USE OF A2B ADENOSINE RECEPTOR ANTAGONISTS FOR TREATING HEART FAILURE AND ARRHYTHMIA IN POST-MYOCARDIAL INFARCTION PATIENTS	A61B 17/02 (2006.01)	2612606	System and method for inhibiting injury to a patient during laparoscopic surgery
A61K 45/06 (2006.01)	2694074 *	USE OF A2B ADENOSINE RECEPTOR ANTAGONISTS FOR TREATING HEART FAILURE AND ARRHYTHMIA IN POST-MYOCARDIAL INFARCTION PATIENTS	A61B 19/00 (2006.01)	2612606	System and method for inhibiting injury to a patient during laparoscopic surgery
A61P 9/00 (2006.01)	2694074 *	USE OF A2B ADENOSINE RECEPTOR ANTAGONISTS FOR TREATING HEART FAILURE AND ARRHYTHMIA IN POST-MYOCARDIAL INFARCTION PATIENTS	A61K 31/7068 (2006.01)	2697241 *	1'-SUBSTITUTED PYRIMIDINE N-NUCLEOSIDE ANALOGS FOR ANTIVIRAL TREATMENT
			A61K 31/7072 (2006.01)	2697241 *	1'-SUBSTITUTED PYRIMIDINE N-NUCLEOSIDE ANALOGS FOR ANTIVIRAL TREATMENT
			A61K 38/21 (2006.01)	2697241 *	1'-SUBSTITUTED PYRIMIDINE N-NUCLEOSIDE ANALOGS FOR ANTIVIRAL TREATMENT
			A61P 31/14 (2006.01)	2697241 *	1'-SUBSTITUTED PYRIMIDINE N-NUCLEOSIDE ANALOGS FOR ANTIVIRAL TREATMENT
			C07H 19/06 (2006.01)	2697241 *	1'-SUBSTITUTED PYRIMIDINE N-NUCLEOSIDE ANALOGS FOR ANTIVIRAL TREATMENT
			C07H 19/067 (2006.01)	2697241 *	1'-SUBSTITUTED PYRIMIDINE N-NUCLEOSIDE ANALOGS FOR ANTIVIRAL TREATMENT
			C07H 19/073 (2006.01)	2697241 *	1'-SUBSTITUTED PYRIMIDINE N-NUCLEOSIDE ANALOGS FOR ANTIVIRAL TREATMENT
			C07H 19/10 (2006.01)	2697241 *	1'-SUBSTITUTED PYRIMIDINE N-NUCLEOSIDE ANALOGS FOR ANTIVIRAL TREATMENT
			F24J 2/04 (2006.01)	2592364	An integrated structural system for mounting of photovoltaic panels

MKP (51)	Broj objave evropske prijave patenta (97)	Naziv pronalaska (54)	MKP (51)	Broj objave evropske prijave patenta (97)	Naziv pronalaska (54)
F24J 2/46 (2006.01)	2592364	An integrated structural system for mounting of photovoltaic panels	A61K 47/10 (2006.01)	2594258	Oral gel comprising praziquantel
F24J 2/52 (2006.01)	2592364	An integrated structural system for mounting of photovoltaic panels	A61K 47/38 (2006.01)	2594258	Oral gel comprising praziquantel
H01L 31/042 (2006.01)	2592364	An integrated structural system for mounting of photovoltaic panels	A61K 31/44 (2006.01)	2655330 *	SUBSTITUTED PYRIDINES AS SODIUM CHANNEL BLOCKERS
H01L 31/048 (2006.01)	2592364	An integrated structural system for mounting of photovoltaic panels	A61K 31/4439 (2006.01)	2655330 *	SUBSTITUTED PYRIDINES AS SODIUM CHANNEL BLOCKERS
A61K 31/502 (2006.01)	2646432 *	SUBSTITUTED BENZOPYRAZIN DERIVATIVES AS FGFR KINASE INHIBITORS FOR THE TREATMENT OF CANCER DISEASES	A61P 25/00 (2006.01)	2655330 *	SUBSTITUTED PYRIDINES AS SODIUM CHANNEL BLOCKERS
A61P 35/00 (2006.01)	2646432 *	SUBSTITUTED BENZOPYRAZIN DERIVATIVES AS FGFR KINASE INHIBITORS FOR THE TREATMENT OF CANCER DISEASES	C07D 213/75 (2006.01)	2655330 *	SUBSTITUTED PYRIDINES AS SODIUM CHANNEL BLOCKERS
C07D 403/04 (2006.01)	2646432 *	SUBSTITUTED BENZOPYRAZIN DERIVATIVES AS FGFR KINASE INHIBITORS FOR THE TREATMENT OF CANCER DISEASES	C07D 401/02 (2006.01)	2655330 *	SUBSTITUTED PYRIDINES AS SODIUM CHANNEL BLOCKERS
C12P 7/44 (2006.01)	2694664 *	VINYL ACID MONOMER RECOVERY	C07D 401/12 (2006.01)	2655330 *	SUBSTITUTED PYRIDINES AS SODIUM CHANNEL BLOCKERS
C07D 211/34 (2006.01)	2651892 *	LOW-TEMPERATURE SYNTHESIS OF METHYLPHENIDATE HYDROCHLORIDE	C07D 401/14 (2006.01)	2655330 *	SUBSTITUTED PYRIDINES AS SODIUM CHANNEL BLOCKERS
A61K 31/57 (2006.01)	2658545 *	TREATMENT OF PAIN ASSOCIATED WITH DISLOCATION OF BASAL ENDOMETRIUM	A61K 31/337 (2006.01)	2678011 *	ANTITUMORAL COMBINATION COMPRISING CABAZITAXEL AND CISPLATIN
A61P 15/00 (2006.01)	2658545 *	TREATMENT OF PAIN ASSOCIATED WITH DISLOCATION OF BASAL ENDOMETRIUM	A61K 33/24 (2006.01)	2678011 *	ANTITUMORAL COMBINATION COMPRISING CABAZITAXEL AND CISPLATIN
A61P 29/00 (2006.01)	2658545 *	TREATMENT OF PAIN ASSOCIATED WITH DISLOCATION OF BASAL ENDOMETRIUM	A61P 35/00 (2006.01)	2678011 *	ANTITUMORAL COMBINATION COMPRISING CABAZITAXEL AND CISPLATIN
B63B 1/10 (2006.01)	2691289 *	MODULAR SEMI-SUBMERSIBLE STRUCTURE AND METHOD FOR MAKING SUCH STRUCTURE	G06F 17/30 (2006.01)	2697725 *	ROBUST FEATURE MATCHING FOR VISUAL SEARCH
B63B 35/44 (2006.01)	2691289 *	MODULAR SEMI-SUBMERSIBLE STRUCTURE AND METHOD FOR MAKING SUCH STRUCTURE	G06K 9/62 (2006.01)	2697725 *	ROBUST FEATURE MATCHING FOR VISUAL SEARCH
A61K 9/00 (2006.01)	2594258	Oral gel comprising praziquantel	A61L 2/07 (2006.01)	2596808	Apparatus and process for recycling absorbent sanitary products
A61K 31/495 (2006.01)	2594258	Oral gel comprising praziquantel	B01J 3/04 (2006.01)	2596808	Apparatus and process for recycling absorbent sanitary products
			A61K 31/00 (2006.01)	2678679 *	USE OF ACETYLATED TUBULIN AS A BIOMARKER OF DRUG RESPONSE TO FURAZANOBENZIMIDAZOLES
			A61K 38/00 (2006.01)	2678679 *	USE OF ACETYLATED TUBULIN AS A BIOMARKER OF DRUG RESPONSE TO FURAZANOBENZIMIDAZOLES
			G01N 33/50 (2006.01)	2678679 *	USE OF ACETYLATED TUBULIN AS A BIOMARKER OF DRUG RESPONSE TO FURAZANOBENZIMIDAZOLES

MKP (51)	Broj objave evropske prijave patenta (97)	Naziv pronalaska (54)	MKP (51)	Broj objave evropske prijave patenta (97)	Naziv pronalaska (54)
A61K 31/422 (2006.01)	2678015 *	USE OF NIFURATEL TO TREAT INFECTIONS CAUSED BY CLOSTRIDIUM SPECIES	A61K 9/70 (2006.01)	2679242 *	ADJUVANT FOR TRANSDERMAL OR TRANSMUCOSAL ADMINISTRATION AND PHARMACEUTICAL PREPARATION CONTAINING SAME
A61P 31/04 (2006.01)	2678015 *	USE OF NIFURATEL TO TREAT INFECTIONS CAUSED BY CLOSTRIDIUM SPECIES	A61K 39/00 (2006.01)	2679242 *	ADJUVANT FOR TRANSDERMAL OR TRANSMUCOSAL ADMINISTRATION AND PHARMACEUTICAL PREPARATION CONTAINING SAME
A61K 31/5025 (2006.01)	2655376 *	5,6-DIHYDRO-IMIDAZO[1,2-a]PYRAZIN-8-YLAMINE DERIVATIVES USEFUL AS INHIBITORS OF BETA-SECRETASE (BACE)	A61K 39/39 (2006.01)	2679242 *	ADJUVANT FOR TRANSDERMAL OR TRANSMUCOSAL ADMINISTRATION AND PHARMACEUTICAL PREPARATION CONTAINING SAME
A61P 25/00 (2006.01)	2655376 *	5,6-DIHYDRO-IMIDAZO[1,2-a]PYRAZIN-8-YLAMINE DERIVATIVES USEFUL AS INHIBITORS OF BETA-SECRETASE (BACE)	A61K 39/39 (2006.01)	2679242 *	ADJUVANT FOR TRANSDERMAL OR TRANSMUCOSAL ADMINISTRATION AND PHARMACEUTICAL PREPARATION CONTAINING SAME
C07D 487/04 (2006.01)	2655376 *	5,6-DIHYDRO-IMIDAZO[1,2-a]PYRAZIN-8-YLAMINE DERIVATIVES USEFUL AS INHIBITORS OF BETA-SECRETASE (BACE)	A61K 39/09 (2006.01)	2694101 *	PHARMACEUTICAL COMPOSITIONS FOR PREVENTING AND/OR TREATING AN HIV DISEASE IN HUMANS
A61K 31/4162 (2006.01)	2685990 *	COMBINATION OF ANTI-CLUSTERIN OLIGONUCLEOTIDE WITH HSP90 INHIBITOR FOR THE TREATMENT OF PROSTATE CANCER	A61K 39/21 (2006.01)	2694101 *	PHARMACEUTICAL COMPOSITIONS FOR PREVENTING AND/OR TREATING AN HIV DISEASE IN HUMANS
A61K 31/7088 (2006.01)	2685990 *	COMBINATION OF ANTI-CLUSTERIN OLIGONUCLEOTIDE WITH HSP90 INHIBITOR FOR THE TREATMENT OF PROSTATE CANCER	A61K 39/295 (2006.01)	2694101 *	PHARMACEUTICAL COMPOSITIONS FOR PREVENTING AND/OR TREATING AN HIV DISEASE IN HUMANS
A61P 35/00 (2006.01)	2685990 *	COMBINATION OF ANTI-CLUSTERIN OLIGONUCLEOTIDE WITH HSP90 INHIBITOR FOR THE TREATMENT OF PROSTATE CANCER	A61P 31/18 (2006.01)	2694101 *	PHARMACEUTICAL COMPOSITIONS FOR PREVENTING AND/OR TREATING AN HIV DISEASE IN HUMANS
A61K 9/02 (2006.01)	2679242 *	ADJUVANT FOR TRANSDERMAL OR TRANSMUCOSAL ADMINISTRATION AND PHARMACEUTICAL PREPARATION CONTAINING SAME	F16K 1/18 (2006.01)	2649358 *	CONTROL VALVE FOR SEPARABLE CONNECTION UNIT FOR FLEXIBLE PIPES.
A61K 9/06 (2006.01)	2679242 *	ADJUVANT FOR TRANSDERMAL OR TRANSMUCOSAL ADMINISTRATION AND PHARMACEUTICAL PREPARATION CONTAINING SAME	F16L 23/036 (2006.01)	2649358 *	CONTROL VALVE FOR SEPARABLE CONNECTION UNIT FOR FLEXIBLE PIPES.
A61K 9/14 (2006.01)	2679242 *	ADJUVANT FOR TRANSDERMAL OR TRANSMUCOSAL ADMINISTRATION AND PHARMACEUTICAL PREPARATION CONTAINING SAME	F16L 55/10 (2006.01)	2649358 *	CONTROL VALVE FOR SEPARABLE CONNECTION UNIT FOR FLEXIBLE PIPES.
			F41H 1/02 (2006.01)	2671041 *	BALLISTIC MATERIAL SYSTEM FOR TACTICAL BODY ARMOR
			A61B 5/11 (2006.01)	2691918 *	SYSTEMS, METHODS, AND APPARATUSES FOR CLASSIFYING USER ACTIVITY USING COMBINING OF LIKELIHOOD FUNCTION VALUES IN A MOBILE DEVICE

MKP (51)	Broj objave evropske prijave patenta (97)	Naziv pronalaska (54)	MKP (51)	Broj objave evropske prijave patenta (97)	Naziv pronalaska (54)
G06K 9/00 (2006.01)	2691918 *	SYSTEMS, METHODS, AND APPARATUSES FOR CLASSIFYING USER ACTIVITY USING COMBINING OF LIKELIHOOD FUNCTION VALUES IN A MOBILE DEVICE	A61M 1/02 (2006.01)	2675494 *	APPARATUS AND METHOD FOR ISOLATING LEUKOCYTES AND TUMOR CELLS BY FILTRATION
A61M 25/06 (2006.01)	2696929 *	NEEDLE AND GUIDEWIRE HOLDER	A61M 1/34 (2006.01)	2675494 *	APPARATUS AND METHOD FOR ISOLATING LEUKOCYTES AND TUMOR CELLS BY FILTRATION
A61M 25/09 (2006.01)	2696929 *	NEEDLE AND GUIDEWIRE HOLDER	B01L 3/14 (2006.01)	2675494 *	APPARATUS AND METHOD FOR ISOLATING LEUKOCYTES AND TUMOR CELLS BY FILTRATION
A01N 43/08 (2006.01)	2667721 *	PESTICIDE COMPOSITION COMPRISING SULPHUR, AN ACARICIDE AND AN AGROCHEMICAL EXCIPIENT	G01N 33/49 (2006.01)	2675494 *	APPARATUS AND METHOD FOR ISOLATING LEUKOCYTES AND TUMOR CELLS BY FILTRATION
A01N 43/56 (2006.01)	2667721 *	PESTICIDE COMPOSITION COMPRISING SULPHUR, AN ACARICIDE AND AN AGROCHEMICAL EXCIPIENT	A61K 31/4985 (2006.01)	2616443 *	PHTALAZINE DERIVATIVES AS JAK1 INHIBITORS
A01N 43/58 (2006.01)	2667721 *	PESTICIDE COMPOSITION COMPRISING SULPHUR, AN ACARICIDE AND AN AGROCHEMICAL EXCIPIENT	A61P 35/00 (2006.01)	2616443 *	PHTALAZINE DERIVATIVES AS JAK1 INHIBITORS
A01N 47/24 (2006.01)	2667721 *	PESTICIDE COMPOSITION COMPRISING SULPHUR, AN ACARICIDE AND AN AGROCHEMICAL EXCIPIENT	C07D 217/22 (2006.01)	2616443 *	PHTALAZINE DERIVATIVES AS JAK1 INHIBITORS
A01N 47/32 (2006.01)	2667721 *	PESTICIDE COMPOSITION COMPRISING SULPHUR, AN ACARICIDE AND AN AGROCHEMICAL EXCIPIENT	C07D 237/34 (2006.01)	2616443 *	PHTALAZINE DERIVATIVES AS JAK1 INHIBITORS
A01N 53/06 (2006.01)	2667721 *	PESTICIDE COMPOSITION COMPRISING SULPHUR, AN ACARICIDE AND AN AGROCHEMICAL EXCIPIENT	C07D 403/10 (2006.01)	2616443 *	PHTALAZINE DERIVATIVES AS JAK1 INHIBITORS
A01N 59/02 (2006.01)	2667721 *	PESTICIDE COMPOSITION COMPRISING SULPHUR, AN ACARICIDE AND AN AGROCHEMICAL EXCIPIENT	C07D 405/04 (2006.01)	2616443 *	PHTALAZINE DERIVATIVES AS JAK1 INHIBITORS
A61K 35/37 (2006.01)	2651421 *	VIRAL INACTIVATION USING IMPROVED SOLVENT- DETERGENT METHOD	C07D 409/04 (2006.01)	2616443 *	PHTALAZINE DERIVATIVES AS JAK1 INHIBITORS
A61L 2/00 (2006.01)	2651421 *	VIRAL INACTIVATION USING IMPROVED SOLVENT- DETERGENT METHOD	C07D 417/10 (2006.01)	2616443 *	PHTALAZINE DERIVATIVES AS JAK1 INHIBITORS
G06Q 10/08 (2012.01)	2689383 *	SYSTEMS AND METHODS FOR ELECTRONICALLY SIGNING FOR A DELIVERED PACKAGE	C07D 471/04 (2006.01)	2616443 *	PHTALAZINE DERIVATIVES AS JAK1 INHIBITORS
H04L 9/32 (2006.01)	2689383 *	SYSTEMS AND METHODS FOR ELECTRONICALLY SIGNING FOR A DELIVERED PACKAGE	A61K 39/395 (2006.01)	2648749 *	NOVEL MODULATORS AND METHODS OF USE
H04L 29/06 (2006.01)	2689383 *	SYSTEMS AND METHODS FOR ELECTRONICALLY SIGNING FOR A DELIVERED PACKAGE	A61K 49/00 (2006.01)	2648749 *	NOVEL MODULATORS AND METHODS OF USE
H04W 12/06 (2009.01)	2689383 *	SYSTEMS AND METHODS FOR ELECTRONICALLY SIGNING FOR A DELIVERED PACKAGE	C07K 16/22 (2006.01)	2648749 *	NOVEL MODULATORS AND METHODS OF USE
			C07K 16/30 (2006.01)	2648749 *	NOVEL MODULATORS AND METHODS OF USE
			C07K 16/40 (2006.01)	2648749 *	NOVEL MODULATORS AND METHODS OF USE
			G01N 33/574 (2006.01)	2648749 *	NOVEL MODULATORS AND METHODS OF USE

MKP (51)	Broj objave evropske prijave patenta (97)	Naziv pronalaska (54)	MKP (51)	Broj objave evropske prijave patenta (97)	Naziv pronalaska (54)
A61K 31/506 (2006.01)	2663558 *	SOLID FORMS OF GYRASE INHIBITOR (R)-1-ETHYL-3-[5-[2-{1-HYDROXY-1-METHYLETHYL}PYRIMIDIN-5-YL]-7-(TETRAHYDROFURAN-2-YL)-1H-BENZIMIDAZOL-2-YL] UREA	C08B 37/00 (2006.01)	2697265 *	POLYSACCHARIDES COMPRISING TWO ANTITHROMBIN III-BINDING SITES, PREPARATION THEREOF AND USE THEREOF AS ANTITHROMBOTIC MEDICAMENTS
C07D 407/04 (2006.01)	2663558 *	SOLID FORMS OF GYRASE INHIBITOR (R)-1-ETHYL-3-[5-[2-{1-HYDROXY-1-METHYLETHYL}PYRIMIDIN-5-YL]-7-(TETRAHYDROFURAN-2-YL)-1H-BENZIMIDAZOL-2-YL] UREA	C07C 201/08 (2006.01)	2699537 *	APPARATUS AND PROCESS FOR NITRATION SELECTIVITY FLEXIBILITY ENABLED BY AZEOTROPIC DISTILLATION
A61K 39/395 (2006.01)	2670487 *	USE OF AN ANTI-CD200 ANTIBODY FOR PROLONGING THE SURVIVAL OF ALLOGRAFTS	C07C 201/16 (2006.01)	2699537 *	APPARATUS AND PROCESS FOR NITRATION SELECTIVITY FLEXIBILITY ENABLED BY AZEOTROPIC DISTILLATION
A61P 37/06 (2006.01)	2670487 *	USE OF AN ANTI-CD200 ANTIBODY FOR PROLONGING THE SURVIVAL OF ALLOGRAFTS	C07C 205/02 (2006.01)	2699537 *	APPARATUS AND PROCESS FOR NITRATION SELECTIVITY FLEXIBILITY ENABLED BY AZEOTROPIC DISTILLATION
A61K 38/55 (2006.01)	2670774 *	CASPASE-2 INHIBITORS	A61K 31/535 (2006.01)	2694075 *	PHOSPHOINOSITIDE 3-KINASE INHIBITOR WITH A ZINC BINDING MOIETY
A61P 25/28 (2006.01)	2670774 *	CASPASE-2 INHIBITORS	B62D 21/00 (2006.01)	2681103 *	FLAT MODULAR CHASSIS, AND VEHICLE PROVIDED WITH SUCH A CHASSIS
C07K 14/81 (2006.01)	2670774 *	CASPASE-2 INHIBITORS	B62D 21/02 (2006.01)	2681103 *	FLAT MODULAR CHASSIS, AND VEHICLE PROVIDED WITH SUCH A CHASSIS
C12N 9/64 (2006.01)	2670774 *	CASPASE-2 INHIBITORS	B62D 21/10 (2006.01)	2681103 *	FLAT MODULAR CHASSIS, AND VEHICLE PROVIDED WITH SUCH A CHASSIS
A61K 47/48 (2006.01)	2675480 *	METHODS OF PREPARATION OF CONJUGATES	B62D 31/00 (2006.01)	2681103 *	FLAT MODULAR CHASSIS, AND VEHICLE PROVIDED WITH SUCH A CHASSIS
A61P 35/00 (2006.01)	2675480 *	METHODS OF PREPARATION OF CONJUGATES	B62D 63/02 (2006.01)	2681103 *	FLAT MODULAR CHASSIS, AND VEHICLE PROVIDED WITH SUCH A CHASSIS
C07D 487/04 (2006.01)	2675480 *	METHODS OF PREPARATION OF CONJUGATES	A61G 7/057 (2006.01)	2465482	INFLATABLE MATTRESS WITH DEFLATABLE DEVICE
C07D 519/00 (2006.01)	2675480 *	METHODS OF PREPARATION OF CONJUGATES	A61K 8/25 (2006.01)	2484337	Treatment of sweating
A61K 47/48 (2006.01)	2697288 *	DECORATED MACROMOLECULAR SCAFFOLDS	A61K 8/58 (2006.01)	2484337	Treatment of sweating
C08G 83/00 (2006.01)	2697288 *	DECORATED MACROMOLECULAR SCAFFOLDS	A61K 8/891 (2006.01)	2484337	Treatment of sweating
C08G 85/00 (2006.01)	2697288 *	DECORATED MACROMOLECULAR SCAFFOLDS	A61K 8/895 (2006.01)	2484337	Treatment of sweating
A61K 31/727 (2006.01)	2697265 *	POLYSACCHARIDES COMPRISING TWO ANTITHROMBIN III-BINDING SITES, PREPARATION THEREOF AND USE THEREOF AS ANTITHROMBOTIC MEDICAMENTS	A61Q 15/00 (2006.01)	2484337	Treatment of sweating
			A61K 31/4709 (2006.01)	2678329 *	TRIAZOLOPYRIDINE COMPOUNDS AS PIM KINASE INHIBITORS
			A61P 29/00 (2006.01)	2678329 *	TRIAZOLOPYRIDINE COMPOUNDS AS PIM KINASE INHIBITORS

MKP (51)	Broj objave evropske prijave patenta (97)	Naziv pronalaska (54)	MKP (51)	Broj objave evropske prijave patenta (97)	Naziv pronalaska (54)
C07D 401/06 (2006.01)	2678329 *	TRIAZOLOPYRIDINE COMPOUNDS AS PIM KINASE INHIBITORS	C07C 211/65 (2006.01)	2680710 *	ENHANCED BIOAVAILABLE IODINE MOLECULES
C07D 471/04 (2006.01)	2678329 *	TRIAZOLOPYRIDINE COMPOUNDS AS PIM KINASE INHIBITORS	B62D 1/22 (2006.01)	2675692 *	LOWER EXTREMITY VEHICLE NAVIGATION CONTROL SYSTEM
C07D 519/00 (2006.01)	2678329 *	TRIAZOLOPYRIDINE COMPOUNDS AS PIM KINASE INHIBITORS	A45C 11/00 (2006.01)	2651259 *	PRESSURE-VENTING CONTAINER FOR DISINFECTION AND STORAGE OF CONTACT LENSES
A61K 31/46 (2006.01)	2655370 *	COMPOSITIONS AND METHODS FOR MODULATING FXR	A61K 39/395 (2006.01)	2569010 *	HIGH CONCENTRATION ANTIBODY FORMULATIONS
A61P 3/00 (2006.01)	2655370 *	COMPOSITIONS AND METHODS FOR MODULATING FXR	A61K 47/12 (2006.01)	2569010 *	HIGH CONCENTRATION ANTIBODY FORMULATIONS
C07D 451/06 (2006.01)	2655370 *	COMPOSITIONS AND METHODS FOR MODULATING FXR	C07K 16/22 (2006.01)	2569010 *	HIGH CONCENTRATION ANTIBODY FORMULATIONS
C07D 471/04 (2006.01)	2655370 *	COMPOSITIONS AND METHODS FOR MODULATING FXR	A01N 25/34 (2006.01)	2685820 *	COMPOSITIONS AND METHODS FOR TREATMENT OF INFECTIONS
C07D 487/04 (2006.01)	2655370 *	COMPOSITIONS AND METHODS FOR MODULATING FXR	A61K 39/12 (2006.01)	2667890 *	CYAA-CARRIED POLYPEPTIDE(S) AND USE TO INDUCE BOTH THERAPEUTIC AND PROPHYLACTIC IMMUNE RESPONSES
A61K 31/4709 (2006.01)	2694493 *	METHOD FOR THE PREPARATION OF PROCESS INTERMEDIATES FOR THE SYNTHESIS OF ARGATROBAN MONOHYDRATE	C07K 14/025 (2006.01)	2667890 *	CYAA-CARRIED POLYPEPTIDE(S) AND USE TO INDUCE BOTH THERAPEUTIC AND PROPHYLACTIC IMMUNE RESPONSES
C07D 401/12 (2006.01)	2694493 *	METHOD FOR THE PREPARATION OF PROCESS INTERMEDIATES FOR THE SYNTHESIS OF ARGATROBAN MONOHYDRATE	C07K 14/235 (2006.01)	2667890 *	CYAA-CARRIED POLYPEPTIDE(S) AND USE TO INDUCE BOTH THERAPEUTIC AND PROPHYLACTIC IMMUNE RESPONSES
A61B 10/00 (2006.01)	2662028	Swab and container for taking biological samples and storing them in a sterile environment	B65C 9/06 (2006.01)	2658783 *	A DEVICE FOR DETECTING MOVING CONTAINERS
A61K 31/58 (2006.01)	2686332 *	ISOXAZOLIDINE DERIVATIVES	B67B 3/26 (2006.01)	2658783 *	A DEVICE FOR DETECTING MOVING CONTAINERS
A61P 5/44 (2006.01)	2686332 *	ISOXAZOLIDINE DERIVATIVES	B67C 3/00 (2006.01)	2658783 *	A DEVICE FOR DETECTING MOVING CONTAINERS
A61P 11/06 (2006.01)	2686332 *	ISOXAZOLIDINE DERIVATIVES	G01N 33/567 (2006.01)	2631654	Neuropeptide release assay for sodium channels
A61P 37/08 (2006.01)	2686332 *	ISOXAZOLIDINE DERIVATIVES	A61K 38/11 (2006.01)	2696882 *	PHARMACEUTICAL COMPOSITION
C07J 71/00 (2006.01)	2686332 *	ISOXAZOLIDINE DERIVATIVES	A61P 15/12 (2006.01)	2696882 *	PHARMACEUTICAL COMPOSITION
A23K 1/16 (2006.01)	2680710 *	ENHANCED BIOAVAILABLE IODINE MOLECULES	C09C 1/02 (2006.01)	2661470 *	PROCESS FOR WATER BASED MINERAL MATERIAL SLURRY SURFACE WHITENING
A23K 1/175 (2006.01)	2680710 *	ENHANCED BIOAVAILABLE IODINE MOLECULES			
A23K 1/18 (2006.01)	2680710 *	ENHANCED BIOAVAILABLE IODINE MOLECULES			
C07C 19/07 (2006.01)	2680710 *	ENHANCED BIOAVAILABLE IODINE MOLECULES			

MKP (51)	Broj objave evropske prijave patenta (97)	Naziv pronalaska (54)	MKP (51)	Broj objave evropske prijave patenta (97)	Naziv pronalaska (54)
C09C 1/36 (2006.01)	2661470 *	PROCESS FOR WATER BASED MINERAL MATERIAL SLURRY SURFACE WHITENING	A61P 25/00 (2006.01)	2694504 *	8-ETHYL-6-(ARYL)PYRIDO [2,3-D]PYRIMIDIN-7(8H)- ONES FOR THE TREATMENT OF NERVOUS SYSTEM DISORDERS AND CANCER
C09C 1/40 (2006.01)	2661470 *	PROCESS FOR WATER BASED MINERAL MATERIAL SLURRY SURFACE WHITENING	C07D 413/14 (2006.01)	2694504 *	8-ETHYL-6-(ARYL)PYRIDO [2,3-D]PYRIMIDIN-7(8H)- ONES FOR THE TREATMENT OF NERVOUS SYSTEM DISORDERS AND CANCER
C09C 1/42 (2006.01)	2661470 *	PROCESS FOR WATER BASED MINERAL MATERIAL SLURRY SURFACE WHITENING	C07D 471/04 (2006.01)	2694504 *	8-ETHYL-6-(ARYL)PYRIDO [2,3-D]PYRIMIDIN-7(8H)- ONES FOR THE TREATMENT OF NERVOUS SYSTEM DISORDERS AND CANCER
C09C 3/10 (2006.01)	2661470 *	PROCESS FOR WATER BASED MINERAL MATERIAL SLURRY SURFACE WHITENING	B01D 21/00 (2006.01)	2664380 *	CATALYST RECOVERY SYSTEM, HYDROCARBON SYNTHESIS REACTION APPARATUS, HYDROCARBON SYNTHESIS REACTION SYSTEM, AND CATALYST RECOVERY METHOD
D21H 17/00 (2006.01)	2661470 *	PROCESS FOR WATER BASED MINERAL MATERIAL SLURRY SURFACE WHITENING	B01D 21/02 (2006.01)	2664380 *	CATALYST RECOVERY SYSTEM, HYDROCARBON SYNTHESIS REACTION APPARATUS, HYDROCARBON SYNTHESIS REACTION SYSTEM, AND CATALYST RECOVERY METHOD
G01N 21/25 (2006.01)	2661470 *	PROCESS FOR WATER BASED MINERAL MATERIAL SLURRY SURFACE WHITENING	B01D 21/24 (2006.01)	2664380 *	CATALYST RECOVERY SYSTEM, HYDROCARBON SYNTHESIS REACTION APPARATUS, HYDROCARBON SYNTHESIS REACTION SYSTEM, AND CATALYST RECOVERY METHOD
A61K 9/00 (2006.01)	2691075 *	OTAMIXABAN FORMULATIONS WITH IMPROVED STABILITY	B01D 21/30 (2006.01)	2664380 *	CATALYST RECOVERY SYSTEM, HYDROCARBON SYNTHESIS REACTION APPARATUS, HYDROCARBON SYNTHESIS REACTION SYSTEM, AND CATALYST RECOVERY METHOD
A61K 31/4418 (2006.01)	2691075 *	OTAMIXABAN FORMULATIONS WITH IMPROVED STABILITY	B01J 38/00 (2006.01)	2664380 *	CATALYST RECOVERY SYSTEM, HYDROCARBON SYNTHESIS REACTION APPARATUS, HYDROCARBON SYNTHESIS REACTION SYSTEM, AND CATALYST RECOVERY METHOD
A61K 47/12 (2006.01)	2691075 *	OTAMIXABAN FORMULATIONS WITH IMPROVED STABILITY	C10G 2/00 (2006.01)	2664380 *	CATALYST RECOVERY SYSTEM, HYDROCARBON SYNTHESIS REACTION APPARATUS, HYDROCARBON SYNTHESIS REACTION SYSTEM, AND CATALYST RECOVERY METHOD
A61P 7/02 (2006.01)	2691075 *	OTAMIXABAN FORMULATIONS WITH IMPROVED STABILITY	A61K 36/23 (2006.01)	2688577 *	COMPOSITION FOR USE FOR DIGESTIVE PROBLEMS
A61K 31/424 (2006.01)	2646446 *	BROMODOMAIN INHIBITORS AND USES THEREOF	A61K 36/235 (2006.01)	2688577 *	COMPOSITION FOR USE FOR DIGESTIVE PROBLEMS
A61K 31/55 (2006.01)	2646446 *	BROMODOMAIN INHIBITORS AND USES THEREOF			
A61P 35/00 (2006.01)	2646446 *	BROMODOMAIN INHIBITORS AND USES THEREOF			
C07D 498/04 (2006.01)	2646446 *	BROMODOMAIN INHIBITORS AND USES THEREOF			
C07D 498/14 (2006.01)	2646446 *	BROMODOMAIN INHIBITORS AND USES THEREOF			
B29C 44/12 (2006.01)	2335900	Interior panel substrate for vehicle, foaming tool and method for producing a moulded interior panel			
A61K 31/519 (2006.01)	2694504 *	8-ETHYL-6-(ARYL)PYRIDO [2,3-D]PYRIMIDIN-7(8H)- ONES FOR THE TREATMENT OF NERVOUS SYSTEM DISORDERS AND CANCER			

MKP (51)	Broj objave evropske prijave patenta (97)	Naziv pronalaska (54)	MKP (51)	Broj objave evropske prijave patenta (97)	Naziv pronalaska (54)
A61K 36/534 (2006.01)	2688577 *	COMPOSITION FOR USE FOR DIGESTIVE PROBLEMS	A61L 9/16 (2006.01)	2691181 *	EROSION-RESISTANT CONDUCTIVE COMPOSITE MATERIAL COLLECTING ELECTRODE FOR WESP
A61K 36/57 (2006.01)	2688577 *	COMPOSITION FOR USE FOR DIGESTIVE PROBLEMS	B01D 49/00 (2006.01)	2691181 *	EROSION-RESISTANT CONDUCTIVE COMPOSITE MATERIAL COLLECTING ELECTRODE FOR WESP
A61P 1/02 (2006.01)	2688577 *	COMPOSITION FOR USE FOR DIGESTIVE PROBLEMS	B03C 3/16 (2006.01)	2691181 *	EROSION-RESISTANT CONDUCTIVE COMPOSITE MATERIAL COLLECTING ELECTRODE FOR WESP
A61M 5/28 (2006.01)	2661297 *	ADAPTOR MEANS FOR USE IN COMBINATION WITH A PRE-FILLED SYRINGE AND A SAFETY DEVICE, SAFETY DEVICE AND INJECTION DEVICE	B03C 3/45 (2006.01)	2691181 *	EROSION-RESISTANT CONDUCTIVE COMPOSITE MATERIAL COLLECTING ELECTRODE FOR WESP
A61M 5/32 (2006.01)	2661297 *	ADAPTOR MEANS FOR USE IN COMBINATION WITH A PRE-FILLED SYRINGE AND A SAFETY DEVICE, SAFETY DEVICE AND INJECTION DEVICE	B03C 3/47 (2006.01)	2691181 *	EROSION-RESISTANT CONDUCTIVE COMPOSITE MATERIAL COLLECTING ELECTRODE FOR WESP
C12Q 1/68 (2006.01)	2597160	Screening tool for anti-inflammatory drug discovery comprising the FPR2/ALX gene promoter	C08J 5/04 (2006.01)	2691181 *	EROSION-RESISTANT CONDUCTIVE COMPOSITE MATERIAL COLLECTING ELECTRODE FOR WESP
G01P 5/26 (2006.01)	2661636 *	METHOD AND DEVICE FOR DETERMINING THE MOVEMENTS OF A FLUID FROM REMOTE MEASUREMENTS OF RADIAL VELOCITIES	C08K 7/06 (2006.01)	2691181 *	EROSION-RESISTANT CONDUCTIVE COMPOSITE MATERIAL COLLECTING ELECTRODE FOR WESP
A01N 43/64 (2006.01)	2696684 *	SOLID PHARMACEUTICAL COMPOSITION	B60L 5/28 (2006.01)	2646272 *	COMMAND SYSTEM FOR THE ACTIVE AND DIAGNOSTIC CONTROL OF A RAILWAY PANTOGRAPH
A61K 9/14 (2006.01)	2696684 *	SOLID PHARMACEUTICAL COMPOSITION	B60L 5/32 (2006.01)	2646272 *	COMMAND SYSTEM FOR THE ACTIVE AND DIAGNOSTIC CONTROL OF A RAILWAY PANTOGRAPH
A61K 9/48 (2006.01)	2696684 *	SOLID PHARMACEUTICAL COMPOSITION	A61K 9/08 (2006.01)	2646052 *	LYOPHILIZED VIRAL FORMULATIONS
A61K 31/53 (2006.01)	2696684 *	SOLID PHARMACEUTICAL COMPOSITION	A61K 31/70 (2006.01)	2646052 *	LYOPHILIZED VIRAL FORMULATIONS
A61K 31/7056 (2006.01)	2646038 *	NEW TREATMENTS OF HEPATITIS C VIRUS INFECTION	A61K 39/15 (2006.01)	2646052 *	LYOPHILIZED VIRAL FORMULATIONS
A61K 38/13 (2006.01)	2646038 *	NEW TREATMENTS OF HEPATITIS C VIRUS INFECTION	A61K 48/00 (2006.01)	2646052 *	LYOPHILIZED VIRAL FORMULATIONS
A61K 38/21 (2006.01)	2646038 *	NEW TREATMENTS OF HEPATITIS C VIRUS INFECTION	A61P 31/00 (2006.01)	2646052 *	LYOPHILIZED VIRAL FORMULATIONS
A61P 31/14 (2006.01)	2646038 *	NEW TREATMENTS OF HEPATITIS C VIRUS INFECTION	A61P 31/12 (2006.01)	2646052 *	LYOPHILIZED VIRAL FORMULATIONS
A61K 47/48 (2006.01)	2691117 *	PROCESS FOR MANUFACTURING CONJUGATES OF IMPROVED HOMOGENEITY	A61M 5/20 (2006.01)	2675505 *	AUTO-INJECTOR
A61P 35/00 (2006.01)	2691117 *	PROCESS FOR MANUFACTURING CONJUGATES OF IMPROVED HOMOGENEITY	A61M 5/32 (2006.01)	2675505 *	AUTO-INJECTOR
			A61N 2/12 (2006.01)	2686065 *	DEVICE INCLUDING MOVING MAGNET CONFIGURATIONS
			A61K 31/519 (2006.01)	2670753 *	NOVEL HETEROCYCLIC DERIVATIVES

MKP (51)	Broj objave evropske prijave patenta (97)	Naziv pronalaska (54)	MKP (51)	Broj objave evropske prijave patenta (97)	Naziv pronalaska (54)
A61P 35/00 (2006.01)	2670753 *	NOVEL HETEROCYCLIC DERIVATIVES	C07H 15/12 (2006.01)	2697240 *	GLYCOSIDE DERIVATIVES AND USES THEREOF
C07D 487/04 (2006.01)	2670753 *	NOVEL HETEROCYCLIC DERIVATIVES	C07H 15/14 (2006.01)	2697240 *	GLYCOSIDE DERIVATIVES AND USES THEREOF
D01D 1/02 (2006.01)	2683858 *	METHOD FOR DRY SPINNING NEUTRAL AND ANIONICALLY MODIFIED CELLULOSE AND FIBRES MADE USING THE METHOD	C07H 15/203 (2006.01)	2697240 *	GLYCOSIDE DERIVATIVES AND USES THEREOF
D01D 5/04 (2006.01)	2683858 *	METHOD FOR DRY SPINNING NEUTRAL AND ANIONICALLY MODIFIED CELLULOSE AND FIBRES MADE USING THE METHOD	C07H 19/044 (2006.01)	2697240 *	GLYCOSIDE DERIVATIVES AND USES THEREOF
D01D 5/40 (2006.01)	2683858 *	METHOD FOR DRY SPINNING NEUTRAL AND ANIONICALLY MODIFIED CELLULOSE AND FIBRES MADE USING THE METHOD	C07H 19/24 (2006.01)	2697240 *	GLYCOSIDE DERIVATIVES AND USES THEREOF
D01F 2/00 (2006.01)	2683858 *	METHOD FOR DRY SPINNING NEUTRAL AND ANIONICALLY MODIFIED CELLULOSE AND FIBRES MADE USING THE METHOD	A61K 39/395 (2006.01)	2694108 *	METHODS FOR TREATING CONDITIONS ASSOCIATED WITH MASP-2 DEPENDENT COMPLEMENT ACTIVATION
D01F 2/24 (2006.01)	2683858 *	METHOD FOR DRY SPINNING NEUTRAL AND ANIONICALLY MODIFIED CELLULOSE AND FIBRES MADE USING THE METHOD	C12N 15/11 (2006.01)	2694108 *	METHODS FOR TREATING CONDITIONS ASSOCIATED WITH MASP-2 DEPENDENT COMPLEMENT ACTIVATION
D21H 13/00 (2006.01)	2683858 *	METHOD FOR DRY SPINNING NEUTRAL AND ANIONICALLY MODIFIED CELLULOSE AND FIBRES MADE USING THE METHOD	A61F 13/15 (2006.01)	2656825	Elastic Break Brake Apparatus and Method For Minimizing Broken Elastic Rethreading
D21H 15/00 (2006.01)	2683858 *	METHOD FOR DRY SPINNING NEUTRAL AND ANIONICALLY MODIFIED CELLULOSE AND FIBRES MADE USING THE METHOD	A61F 13/49 (2006.01)	2656825	Elastic Break Brake Apparatus and Method For Minimizing Broken Elastic Rethreading
A61K 31/7034 (2006.01)	2697240 *	GLYCOSIDE DERIVATIVES AND USES THEREOF	G21F 9/06 (2006.01)	2657943	A method for removing the 137 Cs from polluted EAF dusts
A61P 3/00 (2006.01)	2697240 *	GLYCOSIDE DERIVATIVES AND USES THEREOF	G21F 9/30 (2006.01)	2657943	A method for removing the 137 Cs from polluted EAF dusts
C07D 407/10 (2006.01)	2697240 *	GLYCOSIDE DERIVATIVES AND USES THEREOF	H01B 7/18 (2006.01)	2477195	Cable drum cable
C07D 413/10 (2006.01)	2697240 *	GLYCOSIDE DERIVATIVES AND USES THEREOF	H01B 7/40 (2006.01)	2477195	Cable drum cable
C07D 417/10 (2006.01)	2697240 *	GLYCOSIDE DERIVATIVES AND USES THEREOF	H01B 13/22 (2006.01)	2477195	Cable drum cable
C07H 13/04 (2006.01)	2697240 *	GLYCOSIDE DERIVATIVES AND USES THEREOF	H02G 11/02 (2006.01)	2477195	Cable drum cable
C07H 15/04 (2006.01)	2697240 *	GLYCOSIDE DERIVATIVES AND USES THEREOF	A61K 35/28 (2006.01)	2689008 *	METHODS FOR TREATING RADIATION OR CHEMICAL INJURY
			A61K 35/50 (2006.01)	2689008 *	METHODS FOR TREATING RADIATION OR CHEMICAL INJURY
			C12N 5/073 (2010.01)	2689008 *	METHODS FOR TREATING RADIATION OR CHEMICAL INJURY
			C12N 5/0775 (2010.01)	2689008 *	METHODS FOR TREATING RADIATION OR CHEMICAL INJURY
			A61K 9/51 (2006.01)	2691116 *	NANOPARTICLES LOADED WITH CHEMOTHERAPEUTIC ANTITUMORAL DRUG
			A61K 47/48 (2006.01)	2691116 *	NANOPARTICLES LOADED WITH CHEMOTHERAPEUTIC ANTITUMORAL DRUG

MKP (51)	Broj objave evropske prijave patenta (97)	Naziv pronalaska (54)	MKP (51)	Broj objave evropske prijave patenta (97)	Naziv pronalaska (54)
A61K 49/18 (2006.01)	2691116 *	NANOPARTICLES LOADED WITH CHEMOTHERAPEUTIC ANTITUMORAL DRUG	A61K 31/21 (2006.01)	2594557	Substituted aminopropionic derivatives as neprilysin inhibitors
B65G 15/32 (2006.01)	2636617	Transport system with endless element composed of flexible belt sections	A61K 31/435 (2006.01)	2594557	Substituted aminopropionic derivatives as neprilysin inhibitors
B65G 15/48 (2006.01)	2636617	Transport system with endless element composed of flexible belt sections	C07C 233/47 (2006.01)	2594557	Substituted aminopropionic derivatives as neprilysin inhibitors
B65G 23/06 (2006.01)	2636617	Transport system with endless element composed of flexible belt sections	C07D 213/82 (2006.01)	2594557	Substituted aminopropionic derivatives as neprilysin inhibitors
F16G 3/02 (2006.01)	2636617	Transport system with endless element composed of flexible belt sections	C07D 239/36 (2006.01)	2594557	Substituted aminopropionic derivatives as neprilysin inhibitors
C01B 3/04 (2006.01)	2649009 *	CARBON DIOXIDE PRODUCTION	C07D 261/18 (2006.01)	2594557	Substituted aminopropionic derivatives as neprilysin inhibitors
C01B 31/20 (2006.01)	2649009 *	CARBON DIOXIDE PRODUCTION	C07D 271/06 (2006.01)	2594557	Substituted aminopropionic derivatives as neprilysin inhibitors
C04B 2/10 (2006.01)	2649009 *	CARBON DIOXIDE PRODUCTION	F21S 4/00 (2006.01)	2691800 *	LIGHTING MODULE HAVING IMPROVED LIGHTING UNIFORMITY
F27B 7/10 (2006.01)	2649009 *	CARBON DIOXIDE PRODUCTION	F21V 13/04 (2006.01)	2691800 *	LIGHTING MODULE HAVING IMPROVED LIGHTING UNIFORMITY
F27B 15/00 (2006.01)	2649009 *	CARBON DIOXIDE PRODUCTION	F21Y 101/02 (2006.01)	2691800 *	LIGHTING MODULE HAVING IMPROVED LIGHTING UNIFORMITY
A61K 9/14 (2006.01)	2416650 *	NANOPARTICLE FORMULATIONS AND USES THEROF	F21Y 105/00 (2006.01)	2691800 *	LIGHTING MODULE HAVING IMPROVED LIGHTING UNIFORMITY
A61K 9/51 (2006.01)	2416650 *	NANOPARTICLE FORMULATIONS AND USES THEROF	G02B 6/00 (2006.01)	2691800 *	LIGHTING MODULE HAVING IMPROVED LIGHTING UNIFORMITY
A61K 31/337 (2006.01)	2416650 *	NANOPARTICLE FORMULATIONS AND USES THEROF	G02F 1/13357 (2006.01)	2691800 *	LIGHTING MODULE HAVING IMPROVED LIGHTING UNIFORMITY
A61K 9/00 (2006.01)	2654719 *	AQUEOUS SOLUTION OF AMBROXOL	G01N 30/36 (2006.01)	2684039 *	PEPTIDE DEFORMYLASE INHIBITORS
A61K 9/08 (2006.01)	2654719 *	AQUEOUS SOLUTION OF AMBROXOL	A61K 9/00 (2006.01)	2675438 *	EXTENDED RELEASE POWDER AND AQUEOUS SUSPENSION COMPRISING METHYLPHENIDATE
A61K 31/136 (2006.01)	2654719 *	AQUEOUS SOLUTION OF AMBROXOL	A61K 9/50 (2006.01)	2675438 *	EXTENDED RELEASE POWDER AND AQUEOUS SUSPENSION COMPRISING METHYLPHENIDATE
B21D 5/08 (2006.01)	2604354	Roller forming station, profiling system and method for forming a metal sheet or sheet metal strip	A61K 31/4458 (2006.01)	2675438 *	EXTENDED RELEASE POWDER AND AQUEOUS SUSPENSION COMPRISING METHYLPHENIDATE
C03B 3/02 (2006.01)	2678279 *	PROCESS FOR MELTING AND REFINING SODA-LIME GLASS	C07D 231/20 (2006.01)	2651900 *	NEPRILYSIN INHIBITORS
C03B 5/225 (2006.01)	2678279 *	PROCESS FOR MELTING AND REFINING SODA-LIME GLASS	C07D 249/12 (2006.01)	2651900 *	NEPRILYSIN INHIBITORS
C03C 1/02 (2006.01)	2678279 *	PROCESS FOR MELTING AND REFINING SODA-LIME GLASS			
A61K 9/08 (2006.01)	2658525 *	BIODEGRADABLE DRUG DELIVERY COMPOSITIONS			
A61K 47/34 (2006.01)	2658525 *	BIODEGRADABLE DRUG DELIVERY COMPOSITIONS			

MKP (51)	Broj objave evropske prijave patenta (97)	Naziv pronalaska (54)	MKP (51)	Broj objave evropske prijave patenta (97)	Naziv pronalaska (54)
C07D 249/04 (2006.01)	2651900 *	NEPRILYSIN INHIBITORS	C07D 403/14 (2006.01)	2649065 *	BICYCLIC COMPOUNDS AS PIM INHIBITORS
C07D 237/24 (2006.01)	2651900 *	NEPRILYSIN INHIBITORS	C07D 405/14 (2006.01)	2649065 *	BICYCLIC COMPOUNDS AS PIM INHIBITORS
C07D 261/18 (2006.01)	2651900 *	NEPRILYSIN INHIBITORS	C07D 413/14 (2006.01)	2649065 *	BICYCLIC COMPOUNDS AS PIM INHIBITORS
C07D 231/40 (2006.01)	2651900 *	NEPRILYSIN INHIBITORS	C07D 417/14 (2006.01)	2649065 *	BICYCLIC COMPOUNDS AS PIM INHIBITORS
C07D 257/04 (2006.01)	2651900 *	NEPRILYSIN INHIBITORS	C07D 471/04 (2006.01)	2649065 *	BICYCLIC COMPOUNDS AS PIM INHIBITORS
C07D 231/14 (2006.01)	2651900 *	NEPRILYSIN INHIBITORS	C07D 487/04 (2006.01)	2649065 *	BICYCLIC COMPOUNDS AS PIM INHIBITORS
C07D 249/10 (2006.01)	2651900 *	NEPRILYSIN INHIBITORS	C07D 498/04 (2006.01)	2649065 *	BICYCLIC COMPOUNDS AS PIM INHIBITORS
C07D 239/54 (2006.01)	2651900 *	NEPRILYSIN INHIBITORS	C07D 491/107 (2006.01)	2649065 *	BICYCLIC COMPOUNDS AS PIM INHIBITORS
C07D 263/38 (2006.01)	2651900 *	NEPRILYSIN INHIBITORS	A61K 31/497 (2006.01)	2649065 *	BICYCLIC COMPOUNDS AS PIM INHIBITORS
C07D 231/22 (2006.01)	2651900 *	NEPRILYSIN INHIBITORS	A61K 31/437 (2006.01)	2649065 *	BICYCLIC COMPOUNDS AS PIM INHIBITORS
C07D 249/18 (2006.01)	2651900 *	NEPRILYSIN INHIBITORS	A61K 31/506 (2006.01)	2649065 *	BICYCLIC COMPOUNDS AS PIM INHIBITORS
C07D 239/36 (2006.01)	2651900 *	NEPRILYSIN INHIBITORS	A61K 31/444 (2006.01)	2649065 *	BICYCLIC COMPOUNDS AS PIM INHIBITORS
C07D 263/34 (2006.01)	2651900 *	NEPRILYSIN INHIBITORS	A61K 31/4709 (2006.01)	2649065 *	BICYCLIC COMPOUNDS AS PIM INHIBITORS
A01N 43/38 (2006.01)	2688404 *	AUXIN PLANT GROWTH REGULATORS	G06K 9/00 (2006.01)	2666121 *	LEARNING SITUATIONS VIA PATTERN MATCHING
A01N 43/90 (2006.01)	2688404 *	AUXIN PLANT GROWTH REGULATORS	A61L 27/20 (2006.01)	2678049 *	IN SITU FORMATION OF A FILLER
A01N 45/00 (2006.01)	2688404 *	AUXIN PLANT GROWTH REGULATORS	A61L 31/04 (2006.01)	2678049 *	IN SITU FORMATION OF A FILLER
A01P 21/00 (2006.01)	2688404 *	AUXIN PLANT GROWTH REGULATORS	H02J 5/00 (2006.01)	2649697 *	POWER SUPPLIES FOR POOL AND SPA EQUIPMENT
C05F 11/10 (2006.01)	2688404 *	AUXIN PLANT GROWTH REGULATORS	F02D 41/00 (2006.01)	2581588	Method of fuel quality determination
C07D 401/14 (2006.01)	2649065 *	BICYCLIC COMPOUNDS AS PIM INHIBITORS	A61K 31/195 (2006.01)	2697191 *	BRANCHED 3-PHENYLPROPIONIC ACID DERIVATIVES AND THE USE THEREOF
C07D 403/04 (2006.01)	2649065 *	BICYCLIC COMPOUNDS AS PIM INHIBITORS	A61P 9/00 (2006.01)	2697191 *	BRANCHED 3-PHENYLPROPIONIC ACID DERIVATIVES AND THE USE THEREOF
			C07C 233/55 (2006.01)	2697191 *	BRANCHED 3-PHENYLPROPIONIC ACID DERIVATIVES AND THE USE THEREOF

MKP (51)	Broj objave evropske prijave patenta (97)	Naziv pronalaska (54)	MKP (51)	Broj objave evropske prijave patenta (97)	Naziv pronalaska (54)
B05B 17/06 (2006.01)	2700085 *	SAMPLE INTRODUCTION METHOD AND SYSTEM FOR ATOMIC SPECTROMETRY	C07D 231/14 (2006.01)	2655333 *	AMINOINDANES AMIDES HAVING A HIGH FUNGICIDAL ACTIVITY AND THEIR PHYTOSANITARY COMPOSITIONS
G01N 30/32 (2006.01)	2700085 *	SAMPLE INTRODUCTION METHOD AND SYSTEM FOR ATOMIC SPECTROMETRY	C12Q 1/68 (2006.01)	2652145 *	OLIGONUCLEOTIDE PROBE SET AND METHODS OF MICROBIOTA PROFILING
G01N 30/72 (2006.01)	2700085 *	SAMPLE INTRODUCTION METHOD AND SYSTEM FOR ATOMIC SPECTROMETRY	G01N 27/327 (2006.01)	2333542	Fill sufficiency method and system
H01J 49/04 (2006.01)	2700085 *	SAMPLE INTRODUCTION METHOD AND SYSTEM FOR ATOMIC SPECTROMETRY	C07D 233/26 (2006.01)	2651896 *	NEPRILYSIN INHIBITORS
A61K 31/5377 (2006.01)	2683697 *	SUBSTITUTED MORPHOLINES AS MODULATORS FOR THE CALCIUM SENSING RECEPTOR	C07D 257/04 (2006.01)	2651896 *	NEPRILYSIN INHIBITORS
A61P 3/14 (2006.01)	2683697 *	SUBSTITUTED MORPHOLINES AS MODULATORS FOR THE CALCIUM SENSING RECEPTOR	C07D 233/90 (2006.01)	2651896 *	NEPRILYSIN INHIBITORS
A61P 5/20 (2006.01)	2683697 *	SUBSTITUTED MORPHOLINES AS MODULATORS FOR THE CALCIUM SENSING RECEPTOR	C07D 261/18 (2006.01)	2651896 *	NEPRILYSIN INHIBITORS
C07D 265/30 (2006.01)	2683697 *	SUBSTITUTED MORPHOLINES AS MODULATORS FOR THE CALCIUM SENSING RECEPTOR	C07D 241/24 (2006.01)	2651896 *	NEPRILYSIN INHIBITORS
C07D 265/32 (2006.01)	2683697 *	SUBSTITUTED MORPHOLINES AS MODULATORS FOR THE CALCIUM SENSING RECEPTOR	C07D 271/06 (2006.01)	2651896 *	NEPRILYSIN INHIBITORS
B32B 27/32 (2006.01)	2672546	Polyolefin microporous membrane	C07D 239/34 (2006.01)	2651896 *	NEPRILYSIN INHIBITORS
H01M 2/16 (2006.01)	2672546	Polyolefin microporous membrane	C07D 263/34 (2006.01)	2651896 *	NEPRILYSIN INHIBITORS
A61K 31/4745 (2006.01)	2663564 *	IMIDAZO [4, 5 -C]QUINOLIN- 2 -ONE COMPOUND AND ITS USE AS PI3 KINASE / MTOR DUAL INHIBITOR	C07D 249/04 (2006.01)	2651896 *	NEPRILYSIN INHIBITORS
A61P 35/00 (2006.01)	2663564 *	IMIDAZO [4, 5 -C]QUINOLIN- 2 -ONE COMPOUND AND ITS USE AS PI3 KINASE / MTOR DUAL INHIBITOR	C07D 213/81 (2006.01)	2651896 *	NEPRILYSIN INHIBITORS
C07D 471/04 (2006.01)	2663564 *	IMIDAZO [4, 5 -C]QUINOLIN- 2 -ONE COMPOUND AND ITS USE AS PI3 KINASE / MTOR DUAL INHIBITOR	C07D 249/10 (2006.01)	2651896 *	NEPRILYSIN INHIBITORS
A01N 43/56 (2006.01)	2655333 *	AMINOINDANES AMIDES HAVING A HIGH FUNGICIDAL ACTIVITY AND THEIR PHYTOSANITARY COMPOSITIONS	C07D 231/14 (2006.01)	2651896 *	NEPRILYSIN INHIBITORS
			C07D 249/18 (2006.01)	2651896 *	NEPRILYSIN INHIBITORS
			C07D 237/24 (2006.01)	2651896 *	NEPRILYSIN INHIBITORS
			C07D 261/20 (2006.01)	2651896 *	NEPRILYSIN INHIBITORS
			A61K 9/20 (2006.01)	2654736 *	NOVEL PHARMACEUTICAL COMPOSITION
			A61K 9/28 (2006.01)	2654736 *	NOVEL PHARMACEUTICAL COMPOSITION

MKP (51)	Broj objave evropske prijave patenta (97)	Naziv pronalaska (54)	MKP (51)	Broj objave evropske prijave patenta (97)	Naziv pronalaska (54)
A61K 31/519 (2006.01)	2654736 *	NOVEL PHARMACEUTICAL COMPOSITION	A61M 5/315 (2006.01)	2688614 *	DOSE SETTING MECHANISM AND INJECTION DEVICE
A61P 35/00 (2006.01)	2654736 *	NOVEL PHARMACEUTICAL COMPOSITION	B21D 51/30 (2006.01)	2688696 *	STRESS CORROSION RESISTANT ALUMINUM BEVERAGE END CLOSURE
A01K 67/027 (2006.01)	2688396 *	METHOD FOR OBTAINING A TRIPLOID INTERSPECIFIC HYBRID OF MEAGRE AND RED DRUM	A61B 6/03 (2006.01)	2677936 *	IMAGE RECONSTRUCTION BASED ON PARAMETRIC MODELS
A23L 1/30 (2006.01)	2677886 *	INDIRECT SUBSTRATES FOR MICROORGANISMS METABOLIZING 1,2-PROPANEDIOL	G01N 23/04 (2006.01)	2677936 *	IMAGE RECONSTRUCTION BASED ON PARAMETRIC MODELS
A23L 1/308 (2006.01)	2677886 *	INDIRECT SUBSTRATES FOR MICROORGANISMS METABOLIZING 1,2-PROPANEDIOL	G01V 5/00 (2006.01)	2677936 *	IMAGE RECONSTRUCTION BASED ON PARAMETRIC MODELS
B64F 1/32 (2006.01)	2433870	Airport vehicle and method for its operation	G06T 11/00 (2006.01)	2677936 *	IMAGE RECONSTRUCTION BASED ON PARAMETRIC MODELS
G01N 23/04 (2006.01)	2676128 *	SYSTEM AND METHOD FOR MULTI-SCANNER X-RAY INSPECTION	B65D 85/812 (2006.01)	2694404 *	FASTENING ELEMENT FOR HANDLING AN INGREDIENT CONTAINER
C07K 16/00 (2006.01)	2691416 *	DUAL VARIABLE REGION ANTIBODY-LIKE BINDING PROTEINS HAVING CROSS-OVER BINDING REGION ORIENTATION	H04M 1/725 (2006.01)	2664126 *	DETERMINING A DYNAMIC USER PROFILE INDICATIVE OF A USER BEHAVIOR CONTEXT WITH A MOBILE DEVICE
C07K 16/24 (2006.01)	2691416 *	DUAL VARIABLE REGION ANTIBODY-LIKE BINDING PROTEINS HAVING CROSS-OVER BINDING REGION ORIENTATION	H04M 3/42 (2006.01)	2664126 *	DETERMINING A DYNAMIC USER PROFILE INDICATIVE OF A USER BEHAVIOR CONTEXT WITH A MOBILE DEVICE
C07K 16/28 (2006.01)	2691416 *	DUAL VARIABLE REGION ANTIBODY-LIKE BINDING PROTEINS HAVING CROSS-OVER BINDING REGION ORIENTATION	H04W 4/04 (2009.01)	2664126 *	DETERMINING A DYNAMIC USER PROFILE INDICATIVE OF A USER BEHAVIOR CONTEXT WITH A MOBILE DEVICE
C07K 16/32 (2006.01)	2691416 *	DUAL VARIABLE REGION ANTIBODY-LIKE BINDING PROTEINS HAVING CROSS-OVER BINDING REGION ORIENTATION	A23F 3/16 (2006.01)	2665366 *	REDUCED-CALORIE PREPARATIONS FOR PRODUCING INSTANT BEVERAGES AND THE PRODUCTION THEREOF
C07K 16/46 (2006.01)	2691416 *	DUAL VARIABLE REGION ANTIBODY-LIKE BINDING PROTEINS HAVING CROSS-OVER BINDING REGION ORIENTATION	A23F 3/32 (2006.01)	2665366 *	REDUCED-CALORIE PREPARATIONS FOR PRODUCING INSTANT BEVERAGES AND THE PRODUCTION THEREOF
B23Q 17/20 (2006.01)	2492048	Tolerance detection method and tolerance detection device for shape measuring apparatus	A23L 1/236 (2006.01)	2665366 *	REDUCED-CALORIE PREPARATIONS FOR PRODUCING INSTANT BEVERAGES AND THE PRODUCTION THEREOF
G01B 5/20 (2006.01)	2492048	Tolerance detection method and tolerance detection device for shape measuring apparatus	A23L 2/395 (2006.01)	2665366 *	REDUCED-CALORIE PREPARATIONS FOR PRODUCING INSTANT BEVERAGES AND THE PRODUCTION THEREOF
G05B 19/401 (2006.01)	2492048	Tolerance detection method and tolerance detection device for shape measuring apparatus	A23L 2/60 (2006.01)	2665366 *	REDUCED-CALORIE PREPARATIONS FOR PRODUCING INSTANT BEVERAGES AND THE PRODUCTION THEREOF
A61K 31/407 (2006.01)	2672967 *	COMPOUNDS AND METHODS FOR KINASE MODULATION, AND INDICATIONS THEREFOR			
A61M 5/24 (2006.01)	2688614 *	DOSE SETTING MECHANISM AND INJECTION DEVICE			

MKP (51)	Broj objave evropske prijave patenta (97)	Naziv pronalaska (54)	MKP (51)	Broj objave evropske prijave patenta (97)	Naziv pronalaska (54)
A61K 47/48 (2006.01)	2694112 *	ANTI-TUMOR ANTIBODY-TUMOR SUPPRESSOR FUSION PROTEIN COMPOSITIONS AND METHODS OF USE FOR THE TREATMENT OF CANCER	A01G 9/20 (2006.01)	2656728	A tilting horticultural light and method of plant cultivation
C12N 15/62 (2006.01)	2694112 *	ANTI-TUMOR ANTIBODY-TUMOR SUPPRESSOR FUSION PROTEIN COMPOSITIONS AND METHODS OF USE FOR THE TREATMENT OF CANCER	C01B 17/02 (2006.01)	2699514 *	PROCEDURE FOR THE STORAGE AND HANDLING OF SULPHUR BLOCKS
G01N 33/574 (2006.01)	2694112 *	ANTI-TUMOR ANTIBODY-TUMOR SUPPRESSOR FUSION PROTEIN COMPOSITIONS AND METHODS OF USE FOR THE TREATMENT OF CANCER	C10L 1/02 (2006.01)	2694627 *	A PROCESS FOR PREPARING A FUEL FOR AUTOMOTIVE APPLICATIONS, STATIONARY ENGINES AND MARINE APPLICATIONS BY CATALYTIC LIQUID PHASE ALCOHOL CONVERSION AND A COMPACT DEVICE FOR CARRYING OUT THE PROCESS
A01N 27/00 (2006.01)	2685821 *	NUCLEAR HORMONE RECEPTOR MODULATORS	F02B 1/02 (2006.01)	2694627 *	A PROCESS FOR PREPARING A FUEL FOR AUTOMOTIVE APPLICATIONS, STATIONARY ENGINES AND MARINE APPLICATIONS BY CATALYTIC LIQUID PHASE ALCOHOL CONVERSION AND A COMPACT DEVICE FOR CARRYING OUT THE PROCESS
A61K 31/015 (2006.01)	2685821 *	NUCLEAR HORMONE RECEPTOR MODULATORS	D06B 3/04 (2006.01)	2697421 *	YARN, METHOD FOR MANUFACTURING SAME, FACILITY FOR IMPLEMENTING THE METHOD, AND USE OF THE YARN
A01N 43/80 (2006.01)	2683723 *	SPIROCYCLIC ISOXAZOLINE DERIVATIVES AS ANTIPARASITIC AGENTS	D06M 15/643 (2006.01)	2697421 *	YARN, METHOD FOR MANUFACTURING SAME, FACILITY FOR IMPLEMENTING THE METHOD, AND USE OF THE YARN
C07D 491/10 (2006.01)	2683723 *	SPIROCYCLIC ISOXAZOLINE DERIVATIVES AS ANTIPARASITIC AGENTS	G01N 19/02 (2006.01)	2697421 *	YARN, METHOD FOR MANUFACTURING SAME, FACILITY FOR IMPLEMENTING THE METHOD, AND USE OF THE YARN
A01N 43/42 (2006.01)	2663187 *	COMPOSITIONS COMPRISING ENZYME-CLEAVABLE OXYCODONE PRODRUG	F24J 2/52 (2006.01)	2664006 *	PHOTOVOLTAIC MODULES AND MOUNTING SYSTEMS
A61K 9/00 (2006.01)	2683375 *	COLONOSCOPY - PREPARATION	H01L 31/042 (2006.01)	2664006 *	PHOTOVOLTAIC MODULES AND MOUNTING SYSTEMS
A61K 31/375 (2006.01)	2683375 *	COLONOSCOPY - PREPARATION	A61K 31/437 (2006.01)	2567959	6-(4-Hydroxy-phenyl)-3-styryl-1H-pyrazolo[3,4-b]pyridine-4-carboxylic acid amide derivatives as kinase inhibitors
A61K 47/10 (2006.01)	2683375 *	COLONOSCOPY - PREPARATION	A61P 3/10 (2006.01)	2567959	6-(4-Hydroxy-phenyl)-3-styryl-1H-pyrazolo[3,4-b]pyridine-4-carboxylic acid amide derivatives as kinase inhibitors
A61P 1/10 (2006.01)	2683375 *	COLONOSCOPY - PREPARATION	A61P 9/00 (2006.01)	2567959	6-(4-Hydroxy-phenyl)-3-styryl-1H-pyrazolo[3,4-b]pyridine-4-carboxylic acid amide derivatives as kinase inhibitors
C07F 9/38 (2006.01)	2673282 *	NOVEL PROCESS FOR THE PREPARATION OF DRONIC ACIDS	A61P 25/00 (2006.01)	2567959	6-(4-Hydroxy-phenyl)-3-styryl-1H-pyrazolo[3,4-b]pyridine-4-carboxylic acid amide derivatives as kinase inhibitors
C07F 9/58 (2006.01)	2673282 *	NOVEL PROCESS FOR THE PREPARATION OF DRONIC ACIDS			
C07F 9/6506 (2006.01)	2673282 *	NOVEL PROCESS FOR THE PREPARATION OF DRONIC ACIDS			
B01D 19/00 (2006.01)	2675543 *	GAS TRAP			
E21B 43/34 (2006.01)	2675543 *	GAS TRAP			
A01G 7/04 (2006.01)	2656728	A tilting horticultural light and method of plant cultivation			

MKP (51)	Broj objave evropske prijave patenta (97)	Naziv pronalaska (54)	MKP (51)	Broj objave evropske prijave patenta (97)	Naziv pronalaska (54)
A61P 35/00 (2006.01)	2567959	6-(4-Hydroxy-phenyl)-3-styryl-1H-pyrazolo[3,4-b]pyridine-4-carboxylic acid amide derivatives as kinase inhibitors	A61P 35/00 (2006.01)	2678021 *	PHOSPHORUS CONTAINING COMPOUNDS AS PROTEIN KINASE INHIBITORS
C07D 471/04 (2006.01)	2567959	6-(4-Hydroxy-phenyl)-3-styryl-1H-pyrazolo[3,4-b]pyridine-4-carboxylic acid amide derivatives as kinase inhibitors	C07F 9/58 (2006.01)	2678021 *	PHOSPHORUS CONTAINING COMPOUNDS AS PROTEIN KINASE INHIBITORS
A61K 9/48 (2006.01)	2502622	Pharmaceutical formulation comprising inositol	C07F 9/6509 (2006.01)	2678021 *	PHOSPHORUS CONTAINING COMPOUNDS AS PROTEIN KINASE INHIBITORS
A61K 39/04 (2006.01)	2651436 *	MYCOBACTERIUM ANTIGENIC COMPOSITION	C07F 9/6558 (2006.01)	2678021 *	PHOSPHORUS CONTAINING COMPOUNDS AS PROTEIN KINASE INHIBITORS
A61K 9/28 (2006.01)	2672970 *	FORMS OF RIFAXIMIN AND USES THEREOF	A61K 31/437 (2006.01)	2699575 *	TRIAZOLOPYRIDINES
A61K 31/4375 (2006.01)	2672970 *	FORMS OF RIFAXIMIN AND USES THEREOF	A61P 35/00 (2006.01)	2699575 *	TRIAZOLOPYRIDINES
A61P 1/00 (2006.01)	2672970 *	FORMS OF RIFAXIMIN AND USES THEREOF	C07D 471/04 (2006.01)	2699575 *	TRIAZOLOPYRIDINES
C07D 498/22 (2006.01)	2672970 *	FORMS OF RIFAXIMIN AND USES THEREOF	A63B 49/02 (2006.01)	2699322 *	NEXT-GENERATION WOODEN RACKET
A61K 9/00 (2006.01)	2675453 *	METHODS FOR CONTROLLING PAIN IN CANINES USING A TRANSDERMAL SOLUTION OF FENTANYL	A63B 49/04 (2006.01)	2699322 *	NEXT-GENERATION WOODEN RACKET
A61K 31/4468 (2006.01)	2675453 *	METHODS FOR CONTROLLING PAIN IN CANINES USING A TRANSDERMAL SOLUTION OF FENTANYL	A61K 9/00 (2006.01)	2680825 *	PRUCALOPRIDE ORAL SOLUTION
A61K 31/4245 (2006.01)	2686308 *	ANTIMICROBIAL AGENTS	A61K 9/48 (2006.01)	2680825 *	PRUCALOPRIDE ORAL SOLUTION
A61P 31/00 (2006.01)	2686308 *	ANTIMICROBIAL AGENTS	A61K 31/4525 (2006.01)	2680825 *	PRUCALOPRIDE ORAL SOLUTION
C07D 213/72 (2006.01)	2686308 *	ANTIMICROBIAL AGENTS	A61K 47/14 (2006.01)	2680825 *	PRUCALOPRIDE ORAL SOLUTION
C07D 271/06 (2006.01)	2686308 *	ANTIMICROBIAL AGENTS	A61K 47/26 (2006.01)	2680825 *	PRUCALOPRIDE ORAL SOLUTION
C07D 401/04 (2006.01)	2686308 *	ANTIMICROBIAL AGENTS	A61K 31/52 (2006.01)	2655374 *	N-(1-(SUBSTITUTED-PHENYL)ETHYL)-9H-PURIN-6-AMINES AS PI3K INHIBITORS
E04B 2/24 (2006.01)	2683884 *	STRUCTURAL ELEMENT FOR PRODUCING MASONRY	A61P 35/00 (2006.01)	2655374 *	N-(1-(SUBSTITUTED-PHENYL)ETHYL)-9H-PURIN-6-AMINES AS PI3K INHIBITORS
B63B 27/14 (2006.01)	2673187 *	RAMP FOR A MOVABLE PASSENGER BRIDGE FOR A SHIP	C07D 473/32 (2006.01)	2655374 *	N-(1-(SUBSTITUTED-PHENYL)ETHYL)-9H-PURIN-6-AMINES AS PI3K INHIBITORS
E01D 15/24 (2006.01)	2673187 *	RAMP FOR A MOVABLE PASSENGER BRIDGE FOR A SHIP	A01H 5/00 (2006.01)	2668278 *	USE OF THE RD29 PROMOTER OR FRAGMENTS THEREOF FOR STRESS-INDUCIBLE EXPRESSION OF TRANSGENES IN COTTON
A61K 31/675 (2006.01)	2678021 *	PHOSPHORUS CONTAINING COMPOUNDS AS PROTEIN KINASE INHIBITORS	C12N 15/82 (2006.01)	2668278 *	USE OF THE RD29 PROMOTER OR FRAGMENTS THEREOF FOR STRESS-INDUCIBLE EXPRESSION OF TRANSGENES IN COTTON

MKP (51)	Broj objave evropske prijave patenta (97)	Naziv pronalaska (54)	MKP (51)	Broj objave evropske prijave patenta (97)	Naziv pronalaska (54)
G06F 17/30 (2006.01)	2678862 *	SYSTEM AND METHOD FOR DATA MINING WITHIN INTERACTIVE	A41F 17/04 (2006.01)	2658407 *	ITEM OF CLOTHING HAVING A DEVICE FOR PROTECTION AGAINST PESTS, IN PARTICULAR TICKS
G06Q 30/02 (2012.01)	2678862 *	SYSTEM AND METHOD FOR DATA MINING WITHIN INTERACTIVE	G08C 23/04 (2006.01)	2608178	Device for control and connection via cable by remote control of two or more apparatuses
G06Q 30/06 (2012.01)	2678862 *	SYSTEM AND METHOD FOR DATA MINING WITHIN INTERACTIVE	C07C 323/12 (2006.01)	2459524 *	NOVEL COMPOUNDS AS MODULATORS OF GLUCOCORTICOID RECEPTORS
G11B 27/034 (2006.01)	2678862 *	SYSTEM AND METHOD FOR DATA MINING WITHIN INTERACTIVE	C07D 213/24 (2006.01)	2459524 *	NOVEL COMPOUNDS AS MODULATORS OF GLUCOCORTICOID RECEPTORS
G11B 27/036 (2006.01)	2678862 *	SYSTEM AND METHOD FOR DATA MINING WITHIN INTERACTIVE	C07D 305/06 (2006.01)	2459524 *	NOVEL COMPOUNDS AS MODULATORS OF GLUCOCORTICOID RECEPTORS
G11B 27/11 (2006.01)	2678862 *	SYSTEM AND METHOD FOR DATA MINING WITHIN INTERACTIVE	C07D 213/65 (2006.01)	2459524 *	NOVEL COMPOUNDS AS MODULATORS OF GLUCOCORTICOID RECEPTORS
G11B 27/34 (2006.01)	2678862 *	SYSTEM AND METHOD FOR DATA MINING WITHIN INTERACTIVE	C07D 407/12 (2006.01)	2459524 *	NOVEL COMPOUNDS AS MODULATORS OF GLUCOCORTICOID RECEPTORS
G11B 27/36 (2006.01)	2678862 *	SYSTEM AND METHOD FOR DATA MINING WITHIN INTERACTIVE	C07D 263/14 (2006.01)	2459524 *	NOVEL COMPOUNDS AS MODULATORS OF GLUCOCORTICOID RECEPTORS
H04N 21/258 (2011.01)	2678862 *	SYSTEM AND METHOD FOR DATA MINING WITHIN INTERACTIVE	C07D 307/02 (2006.01)	2459524 *	NOVEL COMPOUNDS AS MODULATORS OF GLUCOCORTICOID RECEPTORS
H04N 21/442 (2011.01)	2678862 *	SYSTEM AND METHOD FOR DATA MINING WITHIN INTERACTIVE	C07C 311/08 (2006.01)	2459524 *	NOVEL COMPOUNDS AS MODULATORS OF GLUCOCORTICOID RECEPTORS
H04N 21/658 (2011.01)	2678862 *	SYSTEM AND METHOD FOR DATA MINING WITHIN INTERACTIVE	C07D 277/24 (2006.01)	2459524 *	NOVEL COMPOUNDS AS MODULATORS OF GLUCOCORTICOID RECEPTORS
A01K 67/027 (2006.01)	2568049	Mice expressing an immunoglobulin hybrid light chain with a human variable region	C07D 333/16 (2006.01)	2459524 *	NOVEL COMPOUNDS AS MODULATORS OF GLUCOCORTICOID RECEPTORS
C07K 16/00 (2006.01)	2568049	Mice expressing an immunoglobulin hybrid light chain with a human variable region	A61K 31/18 (2006.01)	2459524 *	NOVEL COMPOUNDS AS MODULATORS OF GLUCOCORTICOID RECEPTORS
C07K 16/46 (2006.01)	2568049	Mice expressing an immunoglobulin hybrid light chain with a human variable region	C07D 231/12 (2006.01)	2459524 *	NOVEL COMPOUNDS AS MODULATORS OF GLUCOCORTICOID RECEPTORS
C12N 15/85 (2006.01)	2568049	Mice expressing an immunoglobulin hybrid light chain with a human variable region	C07D 309/12 (2006.01)	2459524 *	NOVEL COMPOUNDS AS MODULATORS OF GLUCOCORTICOID RECEPTORS
A41D 1/06 (2006.01)	2658407 *	ITEM OF CLOTHING HAVING A DEVICE FOR PROTECTION AGAINST PESTS, IN PARTICULAR TICKS			
A41D 13/00 (2006.01)	2658407 *	ITEM OF CLOTHING HAVING A DEVICE FOR PROTECTION AGAINST PESTS, IN PARTICULAR TICKS			
A41D 17/00 (2006.01)	2658407 *	ITEM OF CLOTHING HAVING A DEVICE FOR PROTECTION AGAINST PESTS, IN PARTICULAR TICKS			

MKP (51)	Broj objave evropske prijave patenta (97)	Naziv pronalaska (54)	MKP (51)	Broj objave evropske prijave patenta (97)	Naziv pronalaska (54)
C07D 261/08 (2006.01)	2459524 *	NOVEL COMPOUNDS AS MODULATORS OF GLUCOCORTICOID RECEPTORS	A61P 25/28 (2006.01)	2678327 *	HETEROARYL DERIVATIVES AS ALPHA7 NACHR MODULATORS
A61P 29/00 (2006.01)	2459524 *	NOVEL COMPOUNDS AS MODULATORS OF GLUCOCORTICOID RECEPTORS	C07D 333/22 (2006.01)	2678327 *	HETEROARYL DERIVATIVES AS ALPHA7 NACHR MODULATORS
A61K 9/16 (2006.01)	2645999 *	PHARMACEUTICAL COMPOSITIONS	C07D 409/04 (2006.01)	2678327 *	HETEROARYL DERIVATIVES AS ALPHA7 NACHR MODULATORS
A61P 35/00 (2006.01)	2645999 *	PHARMACEUTICAL COMPOSITIONS	A61K 31/542 (2006.01)	2665732 *	FUSED AMINODIHYDROTHIAZINE DERIVATIVES USEFUL AS BACE INHIBITORS
A61K 38/26 (2006.01)	2665487 *	COMBINATION OF ACYLATED GLUCAGON ANALOGUES WITH INSULIN ANALOGUES	A61P 3/00 (2006.01)	2665732 *	FUSED AMINODIHYDROTHIAZINE DERIVATIVES USEFUL AS BACE INHIBITORS
A61K 38/28 (2006.01)	2665487 *	COMBINATION OF ACYLATED GLUCAGON ANALOGUES WITH INSULIN ANALOGUES	A61P 25/00 (2006.01)	2665732 *	FUSED AMINODIHYDROTHIAZINE DERIVATIVES USEFUL AS BACE INHIBITORS
A61P 3/04 (2006.01)	2665487 *	COMBINATION OF ACYLATED GLUCAGON ANALOGUES WITH INSULIN ANALOGUES	C07D 513/04 (2006.01)	2665732 *	FUSED AMINODIHYDROTHIAZINE DERIVATIVES USEFUL AS BACE INHIBITORS
A61P 3/10 (2006.01)	2665487 *	COMBINATION OF ACYLATED GLUCAGON ANALOGUES WITH INSULIN ANALOGUES	H02M 1/42 (2007.01)	2697898 *	CIRCUIT ADAPTED TO SUPPLY A VOLTAGE TO AN ELECTRONIC DEVICE AND USES THEREOF
A61K 31/47 (2006.01)	2673262 *	PROCESSES FOR PREPARING QUINOLINE COMPOUNDS AND PHARMACEUTICAL COMPOSITIONS CONTAINING SUCH COMPOUNDS	A61K 31/4439 (2006.01)	2667871 *	COMBINATIONS
A61P 35/00 (2006.01)	2673262 *	PROCESSES FOR PREPARING QUINOLINE COMPOUNDS AND PHARMACEUTICAL COMPOSITIONS CONTAINING SUCH COMPOUNDS	C07K 1/18 (2006.01)	2681230 *	METHOD FOR ISOLATING OSTEOPONTIN USING FEEDS CONTAINING CMP OR CASEIN SPECIES
C07D 215/227 (2006.01)	2673262 *	PROCESSES FOR PREPARING QUINOLINE COMPOUNDS AND PHARMACEUTICAL COMPOSITIONS CONTAINING SUCH COMPOUNDS	C07K 14/47 (2006.01)	2681230 *	METHOD FOR ISOLATING OSTEOPONTIN USING FEEDS CONTAINING CMP OR CASEIN SPECIES
G01N 33/558 (2006.01)	2646825 *	RAPID TEST FOR THE QUALITATIVE AND/OR QUANTITATIVE ANALYSIS OF ANTIBODIES AGAINST HUMAN PAPILLOMA VIRUSES (HPV) PRESENT IN BODY FLUID, AND DEVICE FOR CARRYING OUT THE RAPID TEST	C07K 14/52 (2006.01)	2681230 *	METHOD FOR ISOLATING OSTEOPONTIN USING FEEDS CONTAINING CMP OR CASEIN SPECIES
G01N 33/569 (2006.01)	2646825 *	RAPID TEST FOR THE QUALITATIVE AND/OR QUANTITATIVE ANALYSIS OF ANTIBODIES AGAINST HUMAN PAPILLOMA VIRUSES (HPV) PRESENT IN BODY FLUID, AND DEVICE FOR CARRYING OUT THE RAPID TEST	H01J 49/00 (2006.01)	2691972 *	SYSTEM FOR QUANTITATIVE CHEMICAL ANALYSIS OF SAMPLES, IN PARTICULAR IN THE MEDICAL FIELD, WITH CALIBRATION OF THE INSTRUMENTAL RESPONSE, AND THE CORRESPONDING METHOD
A61K 31/381 (2006.01)	2678327 *	HETEROARYL DERIVATIVES AS ALPHA7 NACHR MODULATORS	A61L 27/00 (2006.01)	2683419 *	MOLECULES AND METHODS FOR INHIBITION AND DETECTION OF PROTEINS
			A61L 31/08 (2006.01)	2683419 *	MOLECULES AND METHODS FOR INHIBITION AND DETECTION OF PROTEINS
			A61L 31/16 (2006.01)	2683419 *	MOLECULES AND METHODS FOR INHIBITION AND DETECTION OF PROTEINS

MKP (51)	Broj objave evropske prijave patenta (97)	Naziv pronalaska (54)	MKP (51)	Broj objave evropske prijave patenta (97)	Naziv pronalaska (54)
C07K 14/00 (2006.01)	2683419 *	MOLECULES AND METHODS FOR INHIBITION AND DETECTION OF PROTEINS	C01B 31/02 (2006.01)	2686271 *	FACILE SYNTHESIS OF GRAPHENE, GRAPHENE DERIVATIVES AND ABRASIVE NANOPARTICLES AND THEIR VARIOUS USES, INCLUDING AS TRIBOLOGICALLY-BENEFICIAL LUBRICANT ADDITIVES
C07K 14/40 (2006.01)	2683419 *	MOLECULES AND METHODS FOR INHIBITION AND DETECTION OF PROTEINS	C10M 125/02 (2006.01)	2686271 *	FACILE SYNTHESIS OF GRAPHENE, GRAPHENE DERIVATIVES AND ABRASIVE NANOPARTICLES AND THEIR VARIOUS USES, INCLUDING AS TRIBOLOGICALLY-BENEFICIAL LUBRICANT ADDITIVES
B21C 9/00 (2006.01)	2581466	Method for producing a moulded part	F01M 9/00 (2006.01)	2686271 *	FACILE SYNTHESIS OF GRAPHENE, GRAPHENE DERIVATIVES AND ABRASIVE NANOPARTICLES AND THEIR VARIOUS USES, INCLUDING AS TRIBOLOGICALLY-BENEFICIAL LUBRICANT ADDITIVES
B21D 5/01 (2006.01)	2581466	Method for producing a moulded part	F16D 13/74 (2006.01)	2686271 *	FACILE SYNTHESIS OF GRAPHENE, GRAPHENE DERIVATIVES AND ABRASIVE NANOPARTICLES AND THEIR VARIOUS USES, INCLUDING AS TRIBOLOGICALLY-BENEFICIAL LUBRICANT ADDITIVES
B21J 1/06 (2006.01)	2581466	Method for producing a moulded part	F16N 15/02 (2006.01)	2686271 *	FACILE SYNTHESIS OF GRAPHENE, GRAPHENE DERIVATIVES AND ABRASIVE NANOPARTICLES AND THEIR VARIOUS USES, INCLUDING AS TRIBOLOGICALLY-BENEFICIAL LUBRICANT ADDITIVES
C22F 1/04 (2006.01)	2581466	Method for producing a moulded part	G01N 33/48 (2006.01)	2686677 *	A METHOD OF ANALYSING A BLOOD SAMPLE OF A SUBJECT FOR THE PRESENCE OF A DISEASE MARKER
A61K 38/00 (2006.01)	2665521 *	COMPOSITIONS AND METHODS FOR TREATING CANCER	A61K 9/24 (2006.01)	2647381 *	ORALLY DISINTEGRATING TABLET
A61P 35/00 (2006.01)	2665521 *	COMPOSITIONS AND METHODS FOR TREATING CANCER	A61K 9/26 (2006.01)	2647381 *	ORALLY DISINTEGRATING TABLET
A61B 5/103 (2006.01)	2648615 *	PHYSICAL ACTIVITY MONITORING SYSTEM	A61K 31/4439 (2006.01)	2647381 *	ORALLY DISINTEGRATING TABLET
A61M 5/20 (2006.01)	2675508 *	AUTO-INJECTOR	A61K 31/616 (2006.01)	2647381 *	ORALLY DISINTEGRATING TABLET
A61M 5/32 (2006.01)	2675508 *	AUTO-INJECTOR	A61K 47/04 (2006.01)	2647381 *	ORALLY DISINTEGRATING TABLET
C12N 5/00 (2006.01)	2694640 *	REVERSING THE EFFECTS OF THE TUMOR MICROENVIRONMENT USING CHIMERIC CYTOKINE RECEPTORS	A61K 47/32 (2006.01)	2647381 *	ORALLY DISINTEGRATING TABLET
B82B 3/00 (2006.01)	2686271 *	FACILE SYNTHESIS OF GRAPHENE, GRAPHENE DERIVATIVES AND ABRASIVE NANOPARTICLES AND THEIR VARIOUS USES, INCLUDING AS TRIBOLOGICALLY-BENEFICIAL LUBRICANT ADDITIVES	A61K 47/36 (2006.01)	2647381 *	ORALLY DISINTEGRATING TABLET
B82Y 40/00 (2011.01)	2686271 *	FACILE SYNTHESIS OF GRAPHENE, GRAPHENE DERIVATIVES AND ABRASIVE NANOPARTICLES AND THEIR VARIOUS USES, INCLUDING AS TRIBOLOGICALLY-BENEFICIAL LUBRICANT ADDITIVES			
B82Y 99/00 (2011.01)	2686271 *	FACILE SYNTHESIS OF GRAPHENE, GRAPHENE DERIVATIVES AND ABRASIVE NANOPARTICLES AND THEIR VARIOUS USES, INCLUDING AS TRIBOLOGICALLY-BENEFICIAL LUBRICANT ADDITIVES			

MKP (51)	Broj objave evropske prijave patenta (97)	Naziv pronalaska (54)	MKP (51)	Broj objave evropske prijave patenta (97)	Naziv pronalaska (54)
A61K 47/44 (2006.01)	2647381 *	ORALLY DISINTEGRATING TABLET	C07D 471/04 (2006.01)	2655342 *	HETEROCYCLIC COMPOUNDS AND THEIR USES
A61P 1/04 (2006.01)	2647381 *	ORALLY DISINTEGRATING TABLET	G01F 23/26 (2006.01)	2663843 *	DEVICE FOR MEASURING FLUID LEVEL IN A CONTAINER
A61P 9/10 (2006.01)	2647381 *	ORALLY DISINTEGRATING TABLET	A61B 17/04 (2006.01)	2677941 *	SUTURE MESH AND METHOD OF USE
A61P 29/00 (2006.01)	2647381 *	ORALLY DISINTEGRATING TABLET	A61B 17/08 (2006.01)	2677941 *	SUTURE MESH AND METHOD OF USE
A61P 43/00 (2006.01)	2647381 *	ORALLY DISINTEGRATING TABLET	A61B 17/11 (2006.01)	2677941 *	SUTURE MESH AND METHOD OF USE
C07K 16/24 (2006.01)	2663577 *	ANTIBODY MOLECULES WHICH BIND IL-17A AND IL- 17F	A61F 2/08 (2006.01)	2677941 *	SUTURE MESH AND METHOD OF USE
A61K 9/00 (2006.01)	2591768	Single unit dosage formulations of sevelamer and fat soluble vitamins and surface active agents	F16L 19/02 (2006.01)	2600050	Swivel coupling for barrel bung
A61K 9/16 (2006.01)	2591768	Single unit dosage formulations of sevelamer and fat soluble vitamins and surface active agents	H04L 9/14 (2006.01)	2677452 *	ENCRYPTION DEVICE AND METHOD FOR DEFENDING A PHYSICAL ATTACK
A61K 9/20 (2006.01)	2591768	Single unit dosage formulations of sevelamer and fat soluble vitamins and surface active agents	C07K 16/18 (2006.01)	2678357 *	METHOD OF PRODUCTION OF SIALYLATED ANTIBODIES
A61K 31/593 (2006.01)	2591768	Single unit dosage formulations of sevelamer and fat soluble vitamins and surface active agents	A61K 47/48 (2006.01)	2670440 *	HUMAN ANTIBODIES AND ANTIBODY-DRUG CONJUGATES AGAINST CD74
A61K 31/785 (2006.01)	2591768	Single unit dosage formulations of sevelamer and fat soluble vitamins and surface active agents	A61P 35/00 (2006.01)	2670440 *	HUMAN ANTIBODIES AND ANTIBODY-DRUG CONJUGATES AGAINST CD74
A61K 47/02 (2006.01)	2591768	Single unit dosage formulations of sevelamer and fat soluble vitamins and surface active agents	C07K 16/28 (2006.01)	2670440 *	HUMAN ANTIBODIES AND ANTIBODY-DRUG CONJUGATES AGAINST CD74
A61K 47/20 (2006.01)	2591768	Single unit dosage formulations of sevelamer and fat soluble vitamins and surface active agents	A61K 38/18 (2006.01)	2694092 *	METHOD OF TREATING OR AMELIORATING METABOLIC DISORDERS USING GROWTH DIFFERENTIATION FACTOR 15 (GDF-15)
A61K 47/38 (2006.01)	2591768	Single unit dosage formulations of sevelamer and fat soluble vitamins and surface active agents	A61P 3/00 (2006.01)	2694092 *	METHOD OF TREATING OR AMELIORATING METABOLIC DISORDERS USING GROWTH DIFFERENTIATION FACTOR 15 (GDF-15)
A61K 47/44 (2006.01)	2591768	Single unit dosage formulations of sevelamer and fat soluble vitamins and surface active agents	A61F 13/15 (2006.01)	2659868	Single transfer insert placement method and apparatus
A61B 5/042 (2006.01)	2699151 *	BASKET STYLE CARDIAC MAPPING CATHETER HAVING SPLINE BENDS FOR DETECTION OF CARDIAC RHYTHM DISORDERS	B26D 1/00 (2006.01)	2659868	Single transfer insert placement method and apparatus
C07D 241/02 (2006.01)	2655342 *	HETEROCYCLIC COMPOUNDS AND THEIR USES	A23K 1/10 (2006.01)	2683253 *	COMPOSITIONS AND METHODS FOR NUTRITIONAL SUPPLEMENTATION
			A23K 1/16 (2006.01)	2683253 *	COMPOSITIONS AND METHODS FOR NUTRITIONAL SUPPLEMENTATION
			A23K 1/175 (2006.01)	2683253 *	COMPOSITIONS AND METHODS FOR NUTRITIONAL SUPPLEMENTATION
			A23K 1/18 (2006.01)	2683253 *	COMPOSITIONS AND METHODS FOR NUTRITIONAL SUPPLEMENTATION

MKP (51)	Broj objave evropske prijave patenta (97)	Naziv pronalaska (54)	MKP (51)	Broj objave evropske prijave patenta (97)	Naziv pronalaska (54)
A61K 31/443 (2006.01)	2665478 *	TREATMENT OF COGNITIVE DYSFUNCTION IN SCHIZOPHRENIA	B02C 19/00 (2006.01)	2596809	Process for sterilising absorbent sanitary products
A61P 25/18 (2006.01)	2665478 *	TREATMENT OF COGNITIVE DYSFUNCTION IN SCHIZOPHRENIA	B29B 17/00 (2006.01)	2596809	Process for sterilising absorbent sanitary products
A61P 25/28 (2006.01)	2665478 *	TREATMENT OF COGNITIVE DYSFUNCTION IN SCHIZOPHRENIA	C07D 231/54 (2006.01)	2651902 *	PYRAZOLYL AND PYRIMIDINYL TRICYCLIC ENONES AS ANTIOXIDANT INFLAMMATION MODULATORS
C02F 3/28 (2006.01)	2366673	Method for biological purification of wastewater containing ammonium	A61K 31/57 (2006.01)	2655394 *	NOVEL 19-NOR-STERIODS AND THEIR USE FOR TREATING PROGESTERONE-DEPENDENT CONDITIONS
C02F 3/30 (2006.01)	2366673	Method for biological purification of wastewater containing ammonium	A61P 5/36 (2006.01)	2655394 *	NOVEL 19-NOR-STERIODS AND THEIR USE FOR TREATING PROGESTERONE-DEPENDENT CONDITIONS
C02F 11/04 (2006.01)	2366673	Method for biological purification of wastewater containing ammonium	C07J 9/00 (2006.01)	2655394 *	NOVEL 19-NOR-STERIODS AND THEIR USE FOR TREATING PROGESTERONE-DEPENDENT CONDITIONS
C02F 11/12 (2006.01)	2366673	Method for biological purification of wastewater containing ammonium	A61K 39/21 (2006.01)	2678351 *	RAPID SELECTION METHOD FOR HIV GP-120 VARIANTS
C02F 101/16 (2006.01)	2366673	Method for biological purification of wastewater containing ammonium	C07K 14/16 (2006.01)	2678351 *	RAPID SELECTION METHOD FOR HIV GP-120 VARIANTS
A61K 31/4184 (2006.01)	2696870 *	PARP INHIBITORS FOR THE TREATMENT OF CIPN	C12N 15/10 (2006.01)	2678351 *	RAPID SELECTION METHOD FOR HIV GP-120 VARIANTS
A61P 25/02 (2006.01)	2696870 *	PARP INHIBITORS FOR THE TREATMENT OF CIPN	G01N 33/569 (2006.01)	2678351 *	RAPID SELECTION METHOD FOR HIV GP-120 VARIANTS
A61K 9/107 (2006.01)	2670392 *	CAROTENOID PARTICLES AND USES THEREOF	G01N 33/68 (2006.01)	2678351 *	RAPID SELECTION METHOD FOR HIV GP-120 VARIANTS
G01N 33/48 (2006.01)	2694959 *	BIOMARKERS FOR PREDICTING SENSITIVITY TO CANCER TREATMENTS	A61K 31/7088 (2006.01)	2673363 *	TREATMENT OF ANGIOGENESIS DISORDERS
B60P 7/08 (2006.01)	2698283	Roof rack	C07H 21/00 (2006.01)	2673363 *	TREATMENT OF ANGIOGENESIS DISORDERS
B60R 9/048 (2006.01)	2698283	Roof rack	C12N 15/113 (2010.01)	2673363 *	TREATMENT OF ANGIOGENESIS DISORDERS
C01F 15/00 (2006.01)	2578538	A selective extraction of uranium and Protactinium from material containing thorium	A61K 31/138 (2006.01)	2699543 *	NOVEL MODULATORS OF CORTICAL DOPAMINERGIC- AND NMDA-RECEPTOR-MEDIATED GLUTAMATERGIC NEUROTRANSMISSION
C01G 43/00 (2006.01)	2578538	A selective extraction of uranium and Protactinium from material containing thorium	A61K 31/145 (2006.01)	2699543 *	NOVEL MODULATORS OF CORTICAL DOPAMINERGIC- AND NMDA-RECEPTOR-MEDIATED GLUTAMATERGIC NEUROTRANSMISSION
C01G 99/00 (2010.01)	2578538	A selective extraction of uranium and Protactinium from material containing thorium	A61K 31/397 (2006.01)	2699543 *	NOVEL MODULATORS OF CORTICAL DOPAMINERGIC- AND NMDA-RECEPTOR-MEDIATED GLUTAMATERGIC NEUROTRANSMISSION
A61L 2/07 (2006.01)	2596809	Process for sterilising absorbent sanitary products			
A61L 11/00 (2006.01)	2596809	Process for sterilising absorbent sanitary products			
B01J 3/04 (2006.01)	2596809	Process for sterilising absorbent sanitary products			
B02C 17/00 (2006.01)	2596809	Process for sterilising absorbent sanitary products			

MKP (51)	Broj objave evropske prijave patenta (97)	Naziv pronalaska (54)	MKP (51)	Broj objave evropske prijave patenta (97)	Naziv pronalaska (54)
A61K 31/4453 (2006.01)	2699543 *	NOVEL MODULATORS OF CORTICAL DOPAMINERGIC- AND NMDA-RECEPTOR-MEDIATED GLUTAMATERGIC NEUROTRANSMISSION	C07H 19/20 (2006.01)	2646453 *	COMPOUNDS
A61P 25/14 (2006.01)	2699543 *	NOVEL MODULATORS OF CORTICAL DOPAMINERGIC- AND NMDA-RECEPTOR-MEDIATED GLUTAMATERGIC NEUROTRANSMISSION	C07H 23/00 (2006.01)	2646453 *	COMPOUNDS
A61P 25/16 (2006.01)	2699543 *	NOVEL MODULATORS OF CORTICAL DOPAMINERGIC- AND NMDA-RECEPTOR-MEDIATED GLUTAMATERGIC NEUROTRANSMISSION	A61K 31/737 (2006.01)	2668198 *	FGF RECEPTOR-ACTIVATING 3-O-ALKYL OLIGOSACCHARIDES, PREPARATION THEREOF AND THERAPEUTIC USE THEREOF
A61P 25/18 (2006.01)	2699543 *	NOVEL MODULATORS OF CORTICAL DOPAMINERGIC- AND NMDA-RECEPTOR-MEDIATED GLUTAMATERGIC NEUROTRANSMISSION	A61P 17/02 (2006.01)	2668198 *	FGF RECEPTOR-ACTIVATING 3-O-ALKYL OLIGOSACCHARIDES, PREPARATION THEREOF AND THERAPEUTIC USE THEREOF
C07C 317/22 (2006.01)	2699543 *	NOVEL MODULATORS OF CORTICAL DOPAMINERGIC- AND NMDA-RECEPTOR-MEDIATED GLUTAMATERGIC NEUROTRANSMISSION	C07H 15/04 (2006.01)	2668198 *	FGF RECEPTOR-ACTIVATING 3-O-ALKYL OLIGOSACCHARIDES, PREPARATION THEREOF AND THERAPEUTIC USE THEREOF
C07D 205/04 (2006.01)	2699543 *	NOVEL MODULATORS OF CORTICAL DOPAMINERGIC- AND NMDA-RECEPTOR-MEDIATED GLUTAMATERGIC NEUROTRANSMISSION	C08B 37/00 (2006.01)	2668198 *	FGF RECEPTOR-ACTIVATING 3-O-ALKYL OLIGOSACCHARIDES, PREPARATION THEREOF AND THERAPEUTIC USE THEREOF
C07D 295/088 (2006.01)	2699543 *	NOVEL MODULATORS OF CORTICAL DOPAMINERGIC- AND NMDA-RECEPTOR-MEDIATED GLUTAMATERGIC NEUROTRANSMISSION	A01N 43/40 (2006.01)	2672823 *	S1P MODULATING AGENTS
C07D 235/26 (2006.01)	2681201 *	A METHOD OF MANUFACTURING 2-ETHOXY-1-((2'-((HYDROXYAMINO)IMINOMETHYL)BIPHENYL-4-YL)METHYL)-1H-BENZO [D]IMIDAZOLE-7-CARBOXYLIC ACID AND ITS ESTERS	A61K 31/445 (2006.01)	2672823 *	S1P MODULATING AGENTS
A61K 31/7068 (2006.01)	2646453 *	COMPOUNDS	A61K 31/7056 (2006.01)	2672976 *	IDRABIOTAPARINUX FOR THE TREATMENT OF PULMONARY EMBOLISM AND FOR THE SECONDARY PREVENTION OF VENOUS THROMBOEMBOLIC EVENTS
A61K 31/7072 (2006.01)	2646453 *	COMPOUNDS	A61K 31/715 (2006.01)	2672976 *	IDRABIOTAPARINUX FOR THE TREATMENT OF PULMONARY EMBOLISM AND FOR THE SECONDARY PREVENTION OF VENOUS THROMBOEMBOLIC EVENTS
A61K 31/7076 (2006.01)	2646453 *	COMPOUNDS	A61P 7/02 (2006.01)	2672976 *	IDRABIOTAPARINUX FOR THE TREATMENT OF PULMONARY EMBOLISM AND FOR THE SECONDARY PREVENTION OF VENOUS THROMBOEMBOLIC EVENTS
A61P 31/14 (2006.01)	2646453 *	COMPOUNDS	A61K 31/433 (2006.01)	2688886 *	AZOLE COMPOUNDS AS PIM INHIBITORS
C07H 19/06 (2006.01)	2646453 *	COMPOUNDS	A61K 31/4439 (2006.01)	2688886 *	AZOLE COMPOUNDS AS PIM INHIBITORS
C07H 19/10 (2006.01)	2646453 *	COMPOUNDS	A61K 31/4745 (2006.01)	2688886 *	AZOLE COMPOUNDS AS PIM INHIBITORS
C07H 19/16 (2006.01)	2646453 *	COMPOUNDS			

MKP (51)	Broj objave evropske prijave patenta (97)	Naziv pronalaska (54)	MKP (51)	Broj objave evropske prijave patenta (97)	Naziv pronalaska (54)
A61K 31/496 (2006.01)	2688886 *	AZOLE COMPOUNDS AS PIM INHIBITORS	C12N 15/85 (2006.01)	2649184 *	FERTILE TRANSGENIC ANIMALS USEFUL FOR PRODUCING ANTIBODIES BEARING HUMAN VARIABLE REGIONS
A61P 35/00 (2006.01)	2688886 *	AZOLE COMPOUNDS AS PIM INHIBITORS	A47K 3/12 (2006.01)	2651274 *	AID DEVICE FOR WASHING INFANTS, CHILDREN OR THE LIKE
C07D 413/14 (2006.01)	2688886 *	AZOLE COMPOUNDS AS PIM INHIBITORS	C05F 9/04 (2006.01)	2647614	Method for preparing activated plant complexes and plant/ organic matter complexes that are doped or overdoped, carbonated, and the uses thereof in particular in anaerobic digestion or biogas production
C07D 417/04 (2006.01)	2688886 *	AZOLE COMPOUNDS AS PIM INHIBITORS	C05F 17/00 (2006.01)	2647614	Method for preparing activated plant complexes and plant/ organic matter complexes that are doped or overdoped, carbonated, and the uses thereof in particular in anaerobic digestion or biogas production
C07D 417/14 (2006.01)	2688886 *	AZOLE COMPOUNDS AS PIM INHIBITORS	C04B 20/00 (2006.01)	2573058	Granulate containing agglomerated bulk material
C07D 487/04 (2006.01)	2688886 *	AZOLE COMPOUNDS AS PIM INHIBITORS	C04B 35/66 (2006.01)	2573058	Granulate containing agglomerated bulk material
A61K 31/444 (2006.01)	2646029 *	TREATMENT OF JAK2-MEDIATED CONDITIONS	F27D 1/00 (2006.01)	2573058	Granulate containing agglomerated bulk material
A61K 31/505 (2006.01)	2646029 *	TREATMENT OF JAK2-MEDIATED CONDITIONS	C07H 21/04 (2006.01)	2655619 *	AUTOPHAGY INDUCER AND INHIBITOR COMBINATION THERAPY FOR THE TREATMENT OF NEOPLASMS
A61K 31/506 (2006.01)	2646029 *	TREATMENT OF JAK2-MEDIATED CONDITIONS	C12N 15/11 (2006.01)	2655619 *	AUTOPHAGY INDUCER AND INHIBITOR COMBINATION THERAPY FOR THE TREATMENT OF NEOPLASMS
A61K 31/5377 (2006.01)	2646029 *	TREATMENT OF JAK2-MEDIATED CONDITIONS	A61K 31/12 (2006.01)	2691088 *	VIRAL INHIBITOR COMPOSITION FOR IN VIVO THERAPEUTIC USE
A61K 31/541 (2006.01)	2646029 *	TREATMENT OF JAK2-MEDIATED CONDITIONS	A61K 31/216 (2006.01)	2691088 *	VIRAL INHIBITOR COMPOSITION FOR IN VIVO THERAPEUTIC USE
A61P 7/06 (2006.01)	2646029 *	TREATMENT OF JAK2-MEDIATED CONDITIONS	A61P 31/12 (2006.01)	2691088 *	VIRAL INHIBITOR COMPOSITION FOR IN VIVO THERAPEUTIC USE
E01B 7/12 (2006.01)	2697432 *	FROG	G01N 27/02 (2006.01)	2584357	Platelet aggregation measuring device
A23L 1/30 (2006.01)	2699109 *	PREBIOTIC CARBOHYDRATE COMPOSITIONS	G01N 27/07 (2006.01)	2584357	Platelet aggregation measuring device
A23L 1/308 (2006.01)	2699109 *	PREBIOTIC CARBOHYDRATE COMPOSITIONS	G01N 33/49 (2006.01)	2584357	Platelet aggregation measuring device
A61K 31/702 (2006.01)	2699109 *	PREBIOTIC CARBOHYDRATE COMPOSITIONS	G01N 33/86 (2006.01)	2584357	Platelet aggregation measuring device
A01K 67/027 (2006.01)	2649184 *	FERTILE TRANSGENIC ANIMALS USEFUL FOR PRODUCING ANTIBODIES BEARING HUMAN VARIABLE REGIONS	B01D 15/36 (2006.01)	2652491 *	ELUATE COLLECTION USING CONDUCTIVITY GRADIENT
C07K 16/00 (2006.01)	2649184 *	FERTILE TRANSGENIC ANIMALS USEFUL FOR PRODUCING ANTIBODIES BEARING HUMAN VARIABLE REGIONS			
C12N 9/64 (2006.01)	2649184 *	FERTILE TRANSGENIC ANIMALS USEFUL FOR PRODUCING ANTIBODIES BEARING HUMAN VARIABLE REGIONS			

MKP (51)	Broj objave evropske prijave patenta (97)	Naziv pronalaska (54)	MKP (51)	Broj objave evropske prijave patenta (97)	Naziv pronalaska (54)
C07K 1/18 (2006.01)	2652491 *	ELUATE COLLECTION USING CONDUCTIVITY GRADIENT	C12N 15/81 (2006.01)	2681308 *	PROTEIN EXPRESSION
C07K 14/755 (2006.01)	2652491 *	ELUATE COLLECTION USING CONDUCTIVITY GRADIENT	C12P 21/02 (2006.01)	2681308 *	PROTEIN EXPRESSION
G01N 30/34 (2006.01)	2652491 *	ELUATE COLLECTION USING CONDUCTIVITY GRADIENT	A61K 31/4192 (2006.01)	2655345 *	ARYL TRIAZOLE COMPOUNDS WITH ANTITUMOURAL ACTIVITY
G01N 30/80 (2006.01)	2652491 *	ELUATE COLLECTION USING CONDUCTIVITY GRADIENT	A61P 35/00 (2006.01)	2655345 *	ARYL TRIAZOLE COMPOUNDS WITH ANTITUMOURAL ACTIVITY
G01N 30/96 (2006.01)	2652491 *	ELUATE COLLECTION USING CONDUCTIVITY GRADIENT	C07D 249/06 (2006.01)	2655345 *	ARYL TRIAZOLE COMPOUNDS WITH ANTITUMOURAL ACTIVITY
H04N 21/478 (2011.01)	2700243 *	AUGMENTED REALITY FOR LIVE EVENTS	C07D 413/12 (2006.01)	2655345 *	ARYL TRIAZOLE COMPOUNDS WITH ANTITUMOURAL ACTIVITY
A61K 31/519 (2006.01)	2513107 *	HETEROAROMATIC PHENYLIMIDAZOLE DERIVATIVES AS PDE10A ENZYME INHIBITORS	A61K 38/08 (2006.01)	2680872 *	COMPOSITIONS AND METHODS FOR TREATMENT OF INTRACELLULAR DAMAGE
A61P 25/00 (2006.01)	2513107 *	HETEROAROMATIC PHENYLIMIDAZOLE DERIVATIVES AS PDE10A ENZYME INHIBITORS	C07K 7/00 (2006.01)	2680872 *	COMPOSITIONS AND METHODS FOR TREATMENT OF INTRACELLULAR DAMAGE
C07D 471/04 (2006.01)	2513107 *	HETEROAROMATIC PHENYLIMIDAZOLE DERIVATIVES AS PDE10A ENZYME INHIBITORS	G06F 3/048 (2013.01)	2665043	Method and system for providing information from a patient-specific model of blood flow
C07D 487/04 (2006.01)	2513107 *	HETEROAROMATIC PHENYLIMIDAZOLE DERIVATIVES AS PDE10A ENZYME INHIBITORS	G06T 19/20 (2011.01)	2665043	Method and system for providing information from a patient-specific model of blood flow
A61M 5/20 (2006.01)	2675502 *	AUTO-INJECTOR	G01N 21/35 (2006.01)	2605004	Method and system for testing objects with a gas barrier coating
A61M 5/32 (2006.01)	2675502 *	AUTO-INJECTOR	G01N 21/84 (2006.01)	2605004	Method and system for testing objects with a gas barrier coating
G01N 33/50 (2006.01)	2694964 *	HIGH-THROUGHPUT SCREENING FOR COMPOUNDS MODULATING EXPRESSION OF CELLULAR MACROMOLECULES	G01N 21/88 (2006.01)	2605004	Method and system for testing objects with a gas barrier coating
C07K 14/55 (2006.01)	2681308 *	PROTEIN EXPRESSION	G01N 21/90 (2006.01)	2605004	Method and system for testing objects with a gas barrier coating
C07K 14/765 (2006.01)	2681308 *	PROTEIN EXPRESSION	G01N 25/72 (2006.01)	2605004	Method and system for testing objects with a gas barrier coating
C07K 14/79 (2006.01)	2681308 *	PROTEIN EXPRESSION	A61P 1/00 (2006.01)	2653469 *	PYRAZOLE DERIVATIVE
C12N 1/19 (2006.01)	2681308 *	PROTEIN EXPRESSION	A61P 25/18 (2006.01)	2653469 *	PYRAZOLE DERIVATIVE
C12N 9/00 (2006.01)	2681308 *	PROTEIN EXPRESSION	A61K 31/444 (2006.01)	2653469 *	PYRAZOLE DERIVATIVE
C12N 9/04 (2006.01)	2681308 *	PROTEIN EXPRESSION	A61P 25/14 (2006.01)	2653469 *	PYRAZOLE DERIVATIVE
C12N 9/90 (2006.01)	2681308 *	PROTEIN EXPRESSION			

MKP (51)	Broj objave evropske prijave patenta (97)	Naziv pronalaska (54)	MKP (51)	Broj objave evropske prijave patenta (97)	Naziv pronalaska (54)
A61P 29/00 (2006.01)	2653469 *	PYRAZOLE DERIVATIVE	A61K 9/20 (2006.01)	2651399 *	CONTROLLED RELEASE DOSAGE FORMS
C07D 401/14 (2006.01)	2653469 *	PYRAZOLE DERIVATIVE	A61K 31/69 (2006.01)	2680858 *	PROTEASOME INHIBITOR DELANZOMIB FOR USE IN THE TREATMENT OF LUPUS
A61P 9/12 (2006.01)	2653469 *	PYRAZOLE DERIVATIVE	A61K 45/06 (2006.01)	2680858 *	PROTEASOME INHIBITOR DELANZOMIB FOR USE IN THE TREATMENT OF LUPUS
A61P 25/24 (2006.01)	2653469 *	PYRAZOLE DERIVATIVE	A61P 17/00 (2006.01)	2680858 *	PROTEASOME INHIBITOR DELANZOMIB FOR USE IN THE TREATMENT OF LUPUS
A61P 5/00 (2006.01)	2653469 *	PYRAZOLE DERIVATIVE	A61P 37/00 (2006.01)	2680858 *	PROTEASOME INHIBITOR DELANZOMIB FOR USE IN THE TREATMENT OF LUPUS
A61P 25/22 (2006.01)	2653469 *	PYRAZOLE DERIVATIVE	B32B 27/10 (2006.01)	2683549 *	IMPROVED COMPOSITE SYSTEM FOR PACKAGING
A61K 31/506 (2006.01)	2653469 *	PYRAZOLE DERIVATIVE	C12Q 1/48 (2006.01)	2691533 *	USE OF PHOSPHO-AKT AS A BIOMARKER OF DRUG RESPONSE
A61P 25/16 (2006.01)	2653469 *	PYRAZOLE DERIVATIVE	G01N 33/574 (2006.01)	2691533 *	USE OF PHOSPHO-AKT AS A BIOMARKER OF DRUG RESPONSE
A61K 31/4439 (2006.01)	2653469 *	PYRAZOLE DERIVATIVE	G01N 33/68 (2006.01)	2691533 *	USE OF PHOSPHO-AKT AS A BIOMARKER OF DRUG RESPONSE
A61P 25/08 (2006.01)	2653469 *	PYRAZOLE DERIVATIVE	H01L 31/042 (2006.01)	2695199 *	SHINGLE-LIKE PHOTOVOLTAIC MODULES
A61P 25/30 (2006.01)	2653469 *	PYRAZOLE DERIVATIVE	A61K 39/12 (2006.01)	2658570 *	BOVINE VIRAL DIARRHEA VIRUS TYPE 1B VACCINE COMPOSITIONS AND METHODS
A61P 1/14 (2006.01)	2653469 *	PYRAZOLE DERIVATIVE	A61P 31/14 (2006.01)	2658570 *	BOVINE VIRAL DIARRHEA VIRUS TYPE 1B VACCINE COMPOSITIONS AND METHODS
A61P 25/20 (2006.01)	2653469 *	PYRAZOLE DERIVATIVE	H03H 17/06 (2006.01)	2608409	Multichannel sample rate converter
A61K 31/4192 (2006.01)	2653469 *	PYRAZOLE DERIVATIVE	H04B 7/26 (2006.01)	2678960 *	MULTIPLE APERIODIC CHANNEL STATE INFORMATION TRANSMISSION ON PUSCH
A61P 25/04 (2006.01)	2653469 *	PYRAZOLE DERIVATIVE	H04J 11/00 (2006.01)	2678960 *	MULTIPLE APERIODIC CHANNEL STATE INFORMATION TRANSMISSION ON PUSCH
A61P 25/28 (2006.01)	2653469 *	PYRAZOLE DERIVATIVE	A61K 9/00 (2006.01)	2651391 *	PHARMACEUTICAL COMPOSITION FOR ORAL ADMINISTRATION INTENDED TO PREVENT MISUSE
B32B 7/06 (2006.01)	2675619 *	RELEASE FILM HAVING A ROUGH SURFACE STRUCTURE	A61K 9/20 (2006.01)	2651391 *	PHARMACEUTICAL COMPOSITION FOR ORAL ADMINISTRATION INTENDED TO PREVENT MISUSE
B32B 27/08 (2006.01)	2675619 *	RELEASE FILM HAVING A ROUGH SURFACE STRUCTURE	A61K 31/437 (2006.01)	2651391 *	PHARMACEUTICAL COMPOSITION FOR ORAL ADMINISTRATION INTENDED TO PREVENT MISUSE
B32B 27/20 (2006.01)	2675619 *	RELEASE FILM HAVING A ROUGH SURFACE STRUCTURE			
B32B 27/28 (2006.01)	2675619 *	RELEASE FILM HAVING A ROUGH SURFACE STRUCTURE			
G09F 3/00 (2006.01)	2675619 *	RELEASE FILM HAVING A ROUGH SURFACE STRUCTURE			

MKP (51)	Broj objave evropske prijave patenta (97)	Naziv pronalaska (54)
A61K 33/10 (2006.01)	2651391 *	PHARMACEUTICAL COMPOSITION FOR ORAL ADMINISTRATION INTENDED TO PREVENT MISUSE
A61P 25/20 (2006.01)	2651391 *	PHARMACEUTICAL COMPOSITION FOR ORAL ADMINISTRATION INTENDED TO PREVENT MISUSE
A61K 39/00 (2006.01)	2654780 *	ACTIVE PROTEASE-RESISTANT ANTIBODY FC MUTANTS
A61K 9/16 (2006.01)	2658528 *	GRANULATES COMPRISING ESLICARBAZEPINE ACETATE
A61K 31/55 (2006.01)	2658528 *	GRANULATES COMPRISING ESLICARBAZEPINE ACETATE
A61K 31/58 (2006.01)	2686333 *	ISOXAZOLIDINE DERIVATIVES
A61P 5/44 (2006.01)	2686333 *	ISOXAZOLIDINE DERIVATIVES
A61P 11/06 (2006.01)	2686333 *	ISOXAZOLIDINE DERIVATIVES
A61P 37/08 (2006.01)	2686333 *	ISOXAZOLIDINE DERIVATIVES
C07J 71/00 (2006.01)	2686333 *	ISOXAZOLIDINE DERIVATIVES
B01D 1/14 (2006.01)	2661478 *	METHOD AND APPARATUS FOR EVAPORATING HYDROGEN HALIDE AND WATER FROM BIOMASS HYDROLYZATES CONTAINING HALOGEN ACID
B01D 1/16 (2006.01)	2661478 *	METHOD AND APPARATUS FOR EVAPORATING HYDROGEN HALIDE AND WATER FROM BIOMASS HYDROLYZATES CONTAINING HALOGEN ACID
C08H 8/00 (2010.01)	2661478 *	METHOD AND APPARATUS FOR EVAPORATING HYDROGEN HALIDE AND WATER FROM BIOMASS HYDROLYZATES CONTAINING HALOGEN ACID
C10G 3/00 (2006.01)	2661478 *	METHOD AND APPARATUS FOR EVAPORATING HYDROGEN HALIDE AND WATER FROM BIOMASS HYDROLYZATES CONTAINING HALOGEN ACID
C13K 1/00 (2006.01)	2661478 *	METHOD AND APPARATUS FOR EVAPORATING HYDROGEN HALIDE AND WATER FROM BIOMASS HYDROLYZATES CONTAINING HALOGEN ACID
A61K 31/498 (2006.01)	2687507 *	NITROGEN-CONTAINING CONDENSED HETEROCYCLIC COMPOUND

MKP (51)	Broj objave evropske prijave patenta (97)	Naziv pronalaska (54)
A61P 9/10 (2006.01)	2687507 *	NITROGEN-CONTAINING CONDENSED HETEROCYCLIC COMPOUND
A61K 31/454 (2006.01)	2687507 *	NITROGEN-CONTAINING CONDENSED HETEROCYCLIC COMPOUND
A61P 1/16 (2006.01)	2687507 *	NITROGEN-CONTAINING CONDENSED HETEROCYCLIC COMPOUND
C07D 217/06 (2006.01)	2687507 *	NITROGEN-CONTAINING CONDENSED HETEROCYCLIC COMPOUND
A61K 31/497 (2006.01)	2687507 *	NITROGEN-CONTAINING CONDENSED HETEROCYCLIC COMPOUND
A61P 3/10 (2006.01)	2687507 *	NITROGEN-CONTAINING CONDENSED HETEROCYCLIC COMPOUND
A61K 31/472 (2006.01)	2687507 *	NITROGEN-CONTAINING CONDENSED HETEROCYCLIC COMPOUND
A61P 3/04 (2006.01)	2687507 *	NITROGEN-CONTAINING CONDENSED HETEROCYCLIC COMPOUND
C07D 217/22 (2006.01)	2687507 *	NITROGEN-CONTAINING CONDENSED HETEROCYCLIC COMPOUND
A61K 31/506 (2006.01)	2687507 *	NITROGEN-CONTAINING CONDENSED HETEROCYCLIC COMPOUND
A61P 9/12 (2006.01)	2687507 *	NITROGEN-CONTAINING CONDENSED HETEROCYCLIC COMPOUND
A61K 31/4725 (2006.01)	2687507 *	NITROGEN-CONTAINING CONDENSED HETEROCYCLIC COMPOUND
A61P 3/06 (2006.01)	2687507 *	NITROGEN-CONTAINING CONDENSED HETEROCYCLIC COMPOUND
C07D 223/16 (2006.01)	2687507 *	NITROGEN-CONTAINING CONDENSED HETEROCYCLIC COMPOUND
A61K 31/4035 (2006.01)	2687507 *	NITROGEN-CONTAINING CONDENSED HETEROCYCLIC COMPOUND
A61K 31/55 (2006.01)	2687507 *	NITROGEN-CONTAINING CONDENSED HETEROCYCLIC COMPOUND
C07D 217/04 (2006.01)	2687507 *	NITROGEN-CONTAINING CONDENSED HETEROCYCLIC COMPOUND
C07D 209/44 (2006.01)	2687507 *	NITROGEN-CONTAINING CONDENSED HETEROCYCLIC COMPOUND
A61K 31/538 (2006.01)	2687507 *	NITROGEN-CONTAINING CONDENSED HETEROCYCLIC COMPOUND
A61P 43/00 (2006.01)	2687507 *	NITROGEN-CONTAINING CONDENSED HETEROCYCLIC COMPOUND

MKP (51)	Broj objave evropske prijave patenta (97)	Naziv pronalaska (54)	MKP (51)	Broj objave evropske prijave patenta (97)	Naziv pronalaska (54)
C07K 7/06 (2006.01)	2690107 *	CYCLIC PEPTIDES WITH AN ANTI-NEOPLASIC AND ANTI-ANGIOGENIC ACTIVITY	A61C 17/02 (2006.01)	2678055 *	A DEVICE FOR ADMINISTERING THERAPEUTIC SUBSTANCES USING A HIGH VELOCITY LIQUID-GAS STREAM
A61K 39/104 (2006.01)	2655402 *	OPRF/I AGENTS AND THEIR USE IN HOSPITALIZED AND OTHER PATIENTS	A61M 5/30 (2006.01)	2678055 *	A DEVICE FOR ADMINISTERING THERAPEUTIC SUBSTANCES USING A HIGH VELOCITY LIQUID-GAS STREAM
A61K 39/40 (2006.01)	2655402 *	OPRF/I AGENTS AND THEIR USE IN HOSPITALIZED AND OTHER PATIENTS	F02M 47/02 (2006.01)	2568157	Injection Nozzle
C07K 14/21 (2006.01)	2655402 *	OPRF/I AGENTS AND THEIR USE IN HOSPITALIZED AND OTHER PATIENTS	F02M 61/12 (2006.01)	2568157	Injection Nozzle
C07K 16/12 (2006.01)	2655402 *	OPRF/I AGENTS AND THEIR USE IN HOSPITALIZED AND OTHER PATIENTS	F02M 63/00 (2006.01)	2568157	Injection Nozzle
C07K 19/00 (2006.01)	2655402 *	OPRF/I AGENTS AND THEIR USE IN HOSPITALIZED AND OTHER PATIENTS	A61K 31/575 (2006.01)	2646457 *	OPTIMIZED SYNTHESIS OF PURE, NON-POLYMORPHIC, CRYSTALLINE BILE ACIDS WITH DEFINED PARTICLE SIZE
A61K 8/04 (2006.01)	2482800 *	COSMETIC FOAM	A61P 1/16 (2006.01)	2646457 *	OPTIMIZED SYNTHESIS OF PURE, NON-POLYMORPHIC, CRYSTALLINE BILE ACIDS WITH DEFINED PARTICLE SIZE
A61K 8/97 (2006.01)	2482800 *	COSMETIC FOAM	C07J 9/00 (2006.01)	2646457 *	OPTIMIZED SYNTHESIS OF PURE, NON-POLYMORPHIC, CRYSTALLINE BILE ACIDS WITH DEFINED PARTICLE SIZE
A61K 9/00 (2006.01)	2482800 *	COSMETIC FOAM	A61K 31/439 (2006.01)	2681199 *	(--)- HUPERZINE A PROCESSES AND RELATED COMPOSITIONS AND METHODS OF TREATMENT
A61K 9/12 (2006.01)	2482800 *	COSMETIC FOAM	A61P 25/00 (2006.01)	2681199 *	(--)- HUPERZINE A PROCESSES AND RELATED COMPOSITIONS AND METHODS OF TREATMENT
A61K 9/46 (2006.01)	2482800 *	COSMETIC FOAM	C07D 221/20 (2006.01)	2681199 *	(--)- HUPERZINE A PROCESSES AND RELATED COMPOSITIONS AND METHODS OF TREATMENT
A61K 31/01 (2006.01)	2482800 *	COSMETIC FOAM	A61K 38/18 (2006.01)	2696889 *	VARIANTS OF HUMAN GDNF
A61K 31/19 (2006.01)	2482800 *	COSMETIC FOAM	C07K 14/475 (2006.01)	2696889 *	VARIANTS OF HUMAN GDNF
A61K 31/191 (2006.01)	2482800 *	COSMETIC FOAM	A61K 31/4178 (2006.01)	2649066 *	HYDANTOIN DERIVATIVES USEFUL AS KV3 INHIBITORS
A61K 36/886 (2006.01)	2482800 *	COSMETIC FOAM	A61K 31/4439 (2006.01)	2649066 *	HYDANTOIN DERIVATIVES USEFUL AS KV3 INHIBITORS
A61K 45/06 (2006.01)	2482800 *	COSMETIC FOAM	A61K 31/506 (2006.01)	2649066 *	HYDANTOIN DERIVATIVES USEFUL AS KV3 INHIBITORS
A61K 47/10 (2006.01)	2482800 *	COSMETIC FOAM			
A61K 47/40 (2006.01)	2482800 *	COSMETIC FOAM			
A61K 47/46 (2006.01)	2482800 *	COSMETIC FOAM			
A61Q 19/00 (2006.01)	2482800 *	COSMETIC FOAM			
A61B 17/54 (2006.01)	2678055 *	A DEVICE FOR ADMINISTERING THERAPEUTIC SUBSTANCES USING A HIGH VELOCITY LIQUID-GAS STREAM			

MKP (51)	Broj objave evropske prijave patenta (97)	Naziv pronalaska (54)	MKP (51)	Broj objave evropske prijave patenta (97)	Naziv pronalaska (54)
A61P 25/08 (2006.01)	2649066 *	HYDANTOIN DERIVATIVES USEFUL AS KV3 INHIBITORS	E04B 1/76 (2006.01)	2652218 *	RETAINING UNIT FOR FIXING HEAT INSULATION ELEMENTS TO A SUPPORTING STRUCTURE
A61P 25/18 (2006.01)	2649066 *	HYDANTOIN DERIVATIVES USEFUL AS KV3 INHIBITORS	E04F 13/08 (2006.01)	2652218 *	RETAINING UNIT FOR FIXING HEAT INSULATION ELEMENTS TO A SUPPORTING STRUCTURE
A61P 27/16 (2006.01)	2649066 *	HYDANTOIN DERIVATIVES USEFUL AS KV3 INHIBITORS	F16B 7/02 (2006.01)	2652218 *	RETAINING UNIT FOR FIXING HEAT INSULATION ELEMENTS TO A SUPPORTING STRUCTURE
A61P 43/00 (2006.01)	2649066 *	HYDANTOIN DERIVATIVES USEFUL AS KV3 INHIBITORS	F16B 13/06 (2006.01)	2652218 *	RETAINING UNIT FOR FIXING HEAT INSULATION ELEMENTS TO A SUPPORTING STRUCTURE
C07D 405/12 (2006.01)	2649066 *	HYDANTOIN DERIVATIVES USEFUL AS KV3 INHIBITORS	F16B 13/08 (2006.01)	2652218 *	RETAINING UNIT FOR FIXING HEAT INSULATION ELEMENTS TO A SUPPORTING STRUCTURE
C07D 413/12 (2006.01)	2649066 *	HYDANTOIN DERIVATIVES USEFUL AS KV3 INHIBITORS	F16B 13/08 (2006.01)	2652218 *	RETAINING UNIT FOR FIXING HEAT INSULATION ELEMENTS TO A SUPPORTING STRUCTURE
C07D 413/14 (2006.01)	2649066 *	HYDANTOIN DERIVATIVES USEFUL AS KV3 INHIBITORS	F16B 19/00 (2006.01)	2652218 *	RETAINING UNIT FOR FIXING HEAT INSULATION ELEMENTS TO A SUPPORTING STRUCTURE
C12N 15/82 (2006.01)	2655629 *	BRASSICA PLANT COMPRISING A MUTANT ALCATRAZ ALLELE	A61K 31/404 (2006.01)	2691370 *	PRODRUGS OF D-GAMMA-GLUTAMYL-D-TRYPTOPHAN AND D-GAMMA- GLUTAMYL-L-TRYPTOPHAN
A61K 31/427 (2006.01)	2567958	Substituted 2-(chroman-6-yloxy)-thiazoles and their use as pharmaceuticals	A61K 38/03 (2006.01)	2691370 *	PRODRUGS OF D-GAMMA-GLUTAMYL-D-TRYPTOPHAN AND D-GAMMA- GLUTAMYL-L-TRYPTOPHAN
A61P 9/06 (2006.01)	2567958	Substituted 2-(chroman-6-yloxy)-thiazoles and their use as pharmaceuticals	C07D 209/20 (2006.01)	2691370 *	PRODRUGS OF D-GAMMA-GLUTAMYL-D-TRYPTOPHAN AND D-GAMMA- GLUTAMYL-L-TRYPTOPHAN
A61P 9/10 (2006.01)	2567958	Substituted 2-(chroman-6-yloxy)-thiazoles and their use as pharmaceuticals	C07K 5/037 (2006.01)	2691370 *	PRODRUGS OF D-GAMMA-GLUTAMYL-D-TRYPTOPHAN AND D-GAMMA- GLUTAMYL-L-TRYPTOPHAN
C07D 417/12 (2006.01)	2567958	Substituted 2-(chroman-6-yloxy)-thiazoles and their use as pharmaceuticals	C07D 239/36 (2006.01)	2649053 *	PYRIMIDINONE COMPOUNDS FOR USE IN THE TREATMENT OF DISEASES OR CONDITIONS MEDIATED BY LP - PLA2
C07D 417/14 (2006.01)	2567958	Substituted 2-(chroman-6-yloxy)-thiazoles and their use as pharmaceuticals	C07D 239/47 (2006.01)	2649053 *	PYRIMIDINONE COMPOUNDS FOR USE IN THE TREATMENT OF DISEASES OR CONDITIONS MEDIATED BY LP - PLA2
C07D 471/04 (2006.01)	2567958	Substituted 2-(chroman-6-yloxy)-thiazoles and their use as pharmaceuticals	C07D 239/52 (2006.01)	2649053 *	PYRIMIDINONE COMPOUNDS FOR USE IN THE TREATMENT OF DISEASES OR CONDITIONS MEDIATED BY LP - PLA2
C07D 487/04 (2006.01)	2567958	Substituted 2-(chroman-6-yloxy)-thiazoles and their use as pharmaceuticals	C07D 239/56 (2006.01)	2649053 *	PYRIMIDINONE COMPOUNDS FOR USE IN THE TREATMENT OF DISEASES OR CONDITIONS MEDIATED BY LP - PLA2
A61K 39/00 (2006.01)	2529748	Vaccine			
C07K 7/14 (2006.01)	2529748	Vaccine			
A61K 39/02 (2006.01)	2655668 *	NOVEL BACTERIUM AND EXTRACTS OF SAID BACTERIUM AND THE USE OF SAME IN THERAPY			
C12R 1/00 (2006.01)	2655668 *	NOVEL BACTERIUM AND EXTRACTS OF SAID BACTERIUM AND THE USE OF SAME IN THERAPY			

MKP (51)	Broj objave evropske prijave patenta (97)	Naziv pronalaska (54)	MKP (51)	Broj objave evropske prijave patenta (97)	Naziv pronalaska (54)
C07D 401/06 (2006.01)	2649053 *	PYRIMIDINONE COMPOUNDS FOR USE IN THE TREATMENT OF DISEASES OR CONDITIONS MEDIATED BY LP - PLA2	A61L 27/54 (2006.01)	2683326 *	HEMISPHERE FOR BLADDER EXPANSION IN PATIENTS WITH LOW COMPLIANCE
C07D 401/12 (2006.01)	2649053 *	PYRIMIDINONE COMPOUNDS FOR USE IN THE TREATMENT OF DISEASES OR CONDITIONS MEDIATED BY LP - PLA2	B65D 43/02 (2006.01)	2597050	Closure lid
C07D 401/14 (2006.01)	2649053 *	PYRIMIDINONE COMPOUNDS FOR USE IN THE TREATMENT OF DISEASES OR CONDITIONS MEDIATED BY LP - PLA2	B65D 85/78 (2006.01)	2597050	Closure lid
C07D 403/06 (2006.01)	2649053 *	PYRIMIDINONE COMPOUNDS FOR USE IN THE TREATMENT OF DISEASES OR CONDITIONS MEDIATED BY LP - PLA2	A61K 9/16 (2006.01)	2654726 *	SOLID DISPERSION FORMULATIONS AND METHODS OF USE THEREOF
C07D 403/12 (2006.01)	2649053 *	PYRIMIDINONE COMPOUNDS FOR USE IN THE TREATMENT OF DISEASES OR CONDITIONS MEDIATED BY LP - PLA2	A61K 9/48 (2006.01)	2654726 *	SOLID DISPERSION FORMULATIONS AND METHODS OF USE THEREOF
C07D 403/14 (2006.01)	2649053 *	PYRIMIDINONE COMPOUNDS FOR USE IN THE TREATMENT OF DISEASES OR CONDITIONS MEDIATED BY LP - PLA2	A61K 31/495 (2006.01)	2654726 *	SOLID DISPERSION FORMULATIONS AND METHODS OF USE THEREOF
C07D 413/06 (2006.01)	2649053 *	PYRIMIDINONE COMPOUNDS FOR USE IN THE TREATMENT OF DISEASES OR CONDITIONS MEDIATED BY LP - PLA2	A61K 31/4985 (2006.01)	2694068 *	PYRIDOPYRAZINE DERIVATIVES AND THEIR USE
C07D 417/06 (2006.01)	2649053 *	PYRIMIDINONE COMPOUNDS FOR USE IN THE TREATMENT OF DISEASES OR CONDITIONS MEDIATED BY LP - PLA2	A61K 31/501 (2006.01)	2694068 *	PYRIDOPYRAZINE DERIVATIVES AND THEIR USE
A61K 9/00 (2006.01)	2672962 *	NOVEL ANTIFUNGAL COMPOSITION	A61K 31/5377 (2006.01)	2694068 *	PYRIDOPYRAZINE DERIVATIVES AND THEIR USE
A61K 31/00 (2006.01)	2672962 *	NOVEL ANTIFUNGAL COMPOSITION	A61P 35/00 (2006.01)	2694068 *	PYRIDOPYRAZINE DERIVATIVES AND THEIR USE
A61K 47/10 (2006.01)	2672962 *	NOVEL ANTIFUNGAL COMPOSITION	A61P 43/00 (2006.01)	2694068 *	PYRIDOPYRAZINE DERIVATIVES AND THEIR USE
A61K 47/12 (2006.01)	2672962 *	NOVEL ANTIFUNGAL COMPOSITION	C07D 471/04 (2006.01)	2694068 *	PYRIDOPYRAZINE DERIVATIVES AND THEIR USE
A61F 2/00 (2006.01)	2683326 *	HEMISPHERE FOR BLADDER EXPANSION IN PATIENTS WITH LOW COMPLIANCE	A61K 31/522 (2006.01)	2672975 *	METHODS FOR TREATING PULMONARY HYPERTENSION
A61F 2/02 (2006.01)	2683326 *	HEMISPHERE FOR BLADDER EXPANSION IN PATIENTS WITH LOW COMPLIANCE	A61P 9/08 (2006.01)	2672975 *	METHODS FOR TREATING PULMONARY HYPERTENSION
A61F 2/04 (2013.01)	2683326 *	HEMISPHERE FOR BLADDER EXPANSION IN PATIENTS WITH LOW COMPLIANCE	A61P 9/12 (2006.01)	2672975 *	METHODS FOR TREATING PULMONARY HYPERTENSION
A61L 27/18 (2006.01)	2683326 *	HEMISPHERE FOR BLADDER EXPANSION IN PATIENTS WITH LOW COMPLIANCE	A61K 31/404 (2006.01)	2688884 *	AMORPHOUS FORM OF VILAZODONE HYDROCHLORIDE AND PROCESS FOR ITS PREPARATION
			A61P 25/24 (2006.01)	2688884 *	AMORPHOUS FORM OF VILAZODONE HYDROCHLORIDE AND PROCESS FOR ITS PREPARATION
			C07D 405/14 (2006.01)	2688884 *	AMORPHOUS FORM OF VILAZODONE HYDROCHLORIDE AND PROCESS FOR ITS PREPARATION

MKP (51)	Broj objave evropske prijave patenta (97)	Naziv pronalaska (54)	MKP (51)	Broj objave evropske prijave patenta (97)	Naziv pronalaska (54)
A61K 31/00 (2006.01)	2646010 *	FOLIC ACID - RAMIPRIL COMBINATION: CELLPROTECTIVE, NEUROPROTECTIVE AND RETINOPROTECTIVE OPHTHALMOLOGIC COMPOSITIONS	A61K 33/06 (2006.01)	2646010 *	FOLIC ACID - RAMIPRIL COMBINATION: CELLPROTECTIVE, NEUROPROTECTIVE AND RETINOPROTECTIVE OPHTHALMOLOGIC COMPOSITIONS
A61K 31/198 (2006.01)	2646010 *	FOLIC ACID - RAMIPRIL COMBINATION: CELLPROTECTIVE, NEUROPROTECTIVE AND RETINOPROTECTIVE OPHTHALMOLOGIC COMPOSITIONS	A61K 33/14 (2006.01)	2646010 *	FOLIC ACID - RAMIPRIL COMBINATION: CELLPROTECTIVE, NEUROPROTECTIVE AND RETINOPROTECTIVE OPHTHALMOLOGIC COMPOSITIONS
A61K 31/20 (2006.01)	2646010 *	FOLIC ACID - RAMIPRIL COMBINATION: CELLPROTECTIVE, NEUROPROTECTIVE AND RETINOPROTECTIVE OPHTHALMOLOGIC COMPOSITIONS	B60H 1/00 (2006.01)	2607118	Housing, in particular for a motor vehicle air conditioning device
A61K 31/375 (2006.01)	2646010 *	FOLIC ACID - RAMIPRIL COMBINATION: CELLPROTECTIVE, NEUROPROTECTIVE AND RETINOPROTECTIVE OPHTHALMOLOGIC COMPOSITIONS	F24F 13/20 (2006.01)	2607118	Housing, in particular for a motor vehicle air conditioning device
A61K 31/403 (2006.01)	2646010 *	FOLIC ACID - RAMIPRIL COMBINATION: CELLPROTECTIVE, NEUROPROTECTIVE AND RETINOPROTECTIVE OPHTHALMOLOGIC COMPOSITIONS	H05K 5/00 (2006.01)	2607118	Housing, in particular for a motor vehicle air conditioning device
A61K 31/505 (2006.01)	2646010 *	FOLIC ACID - RAMIPRIL COMBINATION: CELLPROTECTIVE, NEUROPROTECTIVE AND RETINOPROTECTIVE OPHTHALMOLOGIC COMPOSITIONS	A61K 9/00 (2006.01)	2658523 *	A COMBINATION OF AN OPIOID AGONIST AND AN OPIOID ANTAGONIST IN THE TREATMENT OF PARKINSON'S DISEASE
A61K 31/519 (2006.01)	2646010 *	FOLIC ACID - RAMIPRIL COMBINATION: CELLPROTECTIVE, NEUROPROTECTIVE AND RETINOPROTECTIVE OPHTHALMOLOGIC COMPOSITIONS	A61K 9/14 (2006.01)	2658523 *	A COMBINATION OF AN OPIOID AGONIST AND AN OPIOID ANTAGONIST IN THE TREATMENT OF PARKINSON'S DISEASE
A61K 31/70 (2006.01)	2646010 *	FOLIC ACID - RAMIPRIL COMBINATION: CELLPROTECTIVE, NEUROPROTECTIVE AND RETINOPROTECTIVE OPHTHALMOLOGIC COMPOSITIONS	A61K 9/16 (2006.01)	2658523 *	A COMBINATION OF AN OPIOID AGONIST AND AN OPIOID ANTAGONIST IN THE TREATMENT OF PARKINSON'S DISEASE
A61K 31/714 (2006.01)	2646010 *	FOLIC ACID - RAMIPRIL COMBINATION: CELLPROTECTIVE, NEUROPROTECTIVE AND RETINOPROTECTIVE OPHTHALMOLOGIC COMPOSITIONS	A61K 9/20 (2006.01)	2658523 *	A COMBINATION OF AN OPIOID AGONIST AND AN OPIOID ANTAGONIST IN THE TREATMENT OF PARKINSON'S DISEASE
			A61K 9/28 (2006.01)	2658523 *	A COMBINATION OF AN OPIOID AGONIST AND AN OPIOID ANTAGONIST IN THE TREATMENT OF PARKINSON'S DISEASE
			A61K 31/485 (2006.01)	2658523 *	A COMBINATION OF AN OPIOID AGONIST AND AN OPIOID ANTAGONIST IN THE TREATMENT OF PARKINSON'S DISEASE
			A61K 45/06 (2006.01)	2658523 *	A COMBINATION OF AN OPIOID AGONIST AND AN OPIOID ANTAGONIST IN THE TREATMENT OF PARKINSON'S DISEASE
			A61P 1/10 (2006.01)	2658523 *	A COMBINATION OF AN OPIOID AGONIST AND AN OPIOID ANTAGONIST IN THE TREATMENT OF PARKINSON'S DISEASE

MKP (51)	Broj objave evropske prijave patenta (97)	Naziv pronalaska (54)	MKP (51)	Broj objave evropske prijave patenta (97)	Naziv pronalaska (54)
A61P 25/00 (2006.01)	2658523 *	A COMBINATION OF AN OPIOID AGONIST AND AN OPIOID ANTAGONIST IN THE TREATMENT OF PARKINSON'S DISEASE	H02K 21/14 (2006.01)	2649704 *	ELECTROMECHANICAL MACHINE FOR REGULATING SUPPLIABLE ELECTRIC POWER
A61P 25/02 (2006.01)	2658523 *	A COMBINATION OF AN OPIOID AGONIST AND AN OPIOID ANTAGONIST IN THE TREATMENT OF PARKINSON'S DISEASE	H02K 47/20 (2006.01)	2649704 *	ELECTROMECHANICAL MACHINE FOR REGULATING SUPPLIABLE ELECTRIC POWER
A61P 25/14 (2006.01)	2658523 *	A COMBINATION OF AN OPIOID AGONIST AND AN OPIOID ANTAGONIST IN THE TREATMENT OF PARKINSON'S DISEASE	A61K 9/14 (2006.01)	2656846 *	PHOSPHOMYCIN PHARMACEUTICAL COMPOSITION
A61P 25/16 (2006.01)	2658523 *	A COMBINATION OF AN OPIOID AGONIST AND AN OPIOID ANTAGONIST IN THE TREATMENT OF PARKINSON'S DISEASE	A61K 31/665 (2006.01)	2656846 *	PHOSPHOMYCIN PHARMACEUTICAL COMPOSITION
C12Q 1/68 (2006.01)	2686442 *	FGFR AND LIGANDS THEREOF AS BIOMARKERS FOR BREAST CANCER IN HR POSITIVE SUBJECTS	A61K 47/18 (2006.01)	2656846 *	PHOSPHOMYCIN PHARMACEUTICAL COMPOSITION
A61K 9/70 (2006.01)	2700401 *	METHOD FOR PRODUCING ADHESIVE PATCH, AND ADHESIVE PATCH	A61P 13/02 (2006.01)	2656846 *	PHOSPHOMYCIN PHARMACEUTICAL COMPOSITION
A61K 31/435 (2006.01)	2700401 *	METHOD FOR PRODUCING ADHESIVE PATCH, AND ADHESIVE PATCH	A61P 31/04 (2006.01)	2656846 *	PHOSPHOMYCIN PHARMACEUTICAL COMPOSITION
A61K 31/551 (2006.01)	2700401 *	METHOD FOR PRODUCING ADHESIVE PATCH, AND ADHESIVE PATCH	F02M 63/00 (2006.01)	2589790	Plug assembly for high-pressure valve
A61K 47/12 (2006.01)	2700401 *	METHOD FOR PRODUCING ADHESIVE PATCH, AND ADHESIVE PATCH	C07D 235/16 (2006.01)	2670735 *	METHODS FOR THE PREPARATION OF BENDAMUSTINE
A61K 47/32 (2006.01)	2700401 *	METHOD FOR PRODUCING ADHESIVE PATCH, AND ADHESIVE PATCH	C07D 487/08 (2006.01)	2686323 *	MACROCYCLIC COMPOUNDS AS ALK, FAK AND JAK2 INHIBITORS
A61K 47/34 (2006.01)	2700401 *	METHOD FOR PRODUCING ADHESIVE PATCH, AND ADHESIVE PATCH	A61K 31/137 (2006.01)	2670402 *	ISOLATED COMPOUNDS FROM TURMERIC OIL AND METHODS OF USE
A61P 11/02 (2006.01)	2700401 *	METHOD FOR PRODUCING ADHESIVE PATCH, AND ADHESIVE PATCH	C08H 7/00 (2011.01)	2688939 *	METHOD FOR PRODUCING LIGNIN DERIVATIVES
A61P 17/04 (2006.01)	2700401 *	METHOD FOR PRODUCING ADHESIVE PATCH, AND ADHESIVE PATCH	C08H 8/00 (2010.01)	2688939 *	METHOD FOR PRODUCING LIGNIN DERIVATIVES
A61P 37/08 (2006.01)	2700401 *	METHOD FOR PRODUCING ADHESIVE PATCH, AND ADHESIVE PATCH	D21C 5/00 (2006.01)	2688939 *	METHOD FOR PRODUCING LIGNIN DERIVATIVES
A61P 43/00 (2006.01)	2700401 *	METHOD FOR PRODUCING ADHESIVE PATCH, AND ADHESIVE PATCH	F01D 21/00 (2006.01)	2689110 *	SHUT-OFF DEVICE WITH AUTOMATICALLY ACTIVATABLE LOCKING
H02K 1/14 (2006.01)	2649704 *	ELECTROMECHANICAL MACHINE FOR REGULATING SUPPLIABLE ELECTRIC POWER	A61M 5/20 (2006.01)	2661292 *	A SAFETY DEVICE FOR A PRE-FILLED SYRINGE AND AN INJECTION DEVICE
H02K 11/00 (2006.01)	2649704 *	ELECTROMECHANICAL MACHINE FOR REGULATING SUPPLIABLE ELECTRIC POWER	A61M 5/32 (2006.01)	2661292 *	A SAFETY DEVICE FOR A PRE-FILLED SYRINGE AND AN INJECTION DEVICE
			A61P 35/02 (2006.01)	2658871 *	ANTI-CD38 ANTIBODIES
			C07K 16/28 (2006.01)	2658871 *	ANTI-CD38 ANTIBODIES
			H02K 1/27 (2006.01)	2615723	A permanent magnet rotor for a rotary electric machine
			H02K 15/03 (2006.01)	2615723	A permanent magnet rotor for a rotary electric machine

MKP (51)	Broj objave evropske prijave patenta (97)	Naziv pronalaska (54)	MKP (51)	Broj objave evropske prijave patenta (97)	Naziv pronalaska (54)
H02K 21/12 (2006.01)	2615723	A permanent magnet rotor for a rotary electric machine	G01R 31/40 (2006.01)	2653880	Method and system for determining the performance of photovoltaic assemblies
H02K 29/03 (2006.01)	2615723	A permanent magnet rotor for a rotary electric machine	F03D 3/06 (2006.01)	2610483	Windkraftanlage mit vertikaler Achse
A61K 31/519 (2006.01)	2675807 *	6 - CYCLOBUTYL - 1, 5 - DIHYDRO - PYRAZOLO [3, 4-D]PYRIMIDIN- 4 - ONE DERIVATIVES THEIR USE AS PDE9A INHIBITORS	F03D 7/02 (2006.01)	2610483	Windkraftanlage mit vertikaler Achse
A61P 25/28 (2006.01)	2675807 *	6 - CYCLOBUTYL - 1, 5 - DIHYDRO - PYRAZOLO [3, 4-D]PYRIMIDIN- 4 - ONE DERIVATIVES THEIR USE AS PDE9A INHIBITORS	B21D 22/02 (2006.01)	2576096 *	FORMING PROCESS FOR HOT FORMING A STEEL SHEET OF A ROTOR BLADE TO BE PRODUCED FOR A WIND ENERGY PLANT
C07D 487/04 (2006.01)	2675807 *	6 - CYCLOBUTYL - 1, 5 - DIHYDRO - PYRAZOLO [3, 4-D]PYRIMIDIN- 4 - ONE DERIVATIVES THEIR USE AS PDE9A INHIBITORS	B21D 53/78 (2006.01)	2576096 *	FORMING PROCESS FOR HOT FORMING A STEEL SHEET OF A ROTOR BLADE TO BE PRODUCED FOR A WIND ENERGY PLANT
C07B 57/00 (2006.01)	2661427 *	METHOD FOR RESOLUTION OF 4-((1R,3S)-6-CHLORO-3-PHENYL-INDAN-1-YL)-1,2,2-TRIMETHYL-PIPERAZINE AND 1-((1R,3S)-6-CHLORO-3-PHENYL-INDAN, 1-YL)-3,3-DIMETHYL-PIPERAZINE	F03D 1/06 (2006.01)	2576096 *	FORMING PROCESS FOR HOT FORMING A STEEL SHEET OF A ROTOR BLADE TO BE PRODUCED FOR A WIND ENERGY PLANT
C07D 241/04 (2006.01)	2661427 *	METHOD FOR RESOLUTION OF 4-((1R,3S)-6-CHLORO-3-PHENYL-INDAN-1-YL)-1,2,2-TRIMETHYL-PIPERAZINE AND 1-((1R,3S)-6-CHLORO-3-PHENYL-INDAN, 1-YL)-3,3-DIMETHYL-PIPERAZINE	A61K 48/00 (2006.01)	2623604	Adenoviral-based biological delivery and expression system for use in the treatment of osteoarthritis
A61K 31/155 (2006.01)	2670427 *	PREVENTION OF HYPOGLYCAEMIA IN DIABETES MELLITUS TYPE 2 PATIENTS	C12N 15/86 (2006.01)	2623604	Adenoviral-based biological delivery and expression system for use in the treatment of osteoarthritis
A61K 38/22 (2006.01)	2670427 *	PREVENTION OF HYPOGLYCAEMIA IN DIABETES MELLITUS TYPE 2 PATIENTS	G01N 33/564 (2006.01)	2646826 *	METHOD FOR PROGNOSTICATING THE CLINICAL RESPONSE OF A PATIENT TO B-LYMPHOCYTE INHIBITING OR DEPLETING THERAPY IN INTERFERON DRIVEN DISEASES SUCH AS SLE
A61P 3/10 (2006.01)	2670427 *	PREVENTION OF HYPOGLYCAEMIA IN DIABETES MELLITUS TYPE 2 PATIENTS	G01N 33/68 (2006.01)	2646826 *	METHOD FOR PROGNOSTICATING THE CLINICAL RESPONSE OF A PATIENT TO B-LYMPHOCYTE INHIBITING OR DEPLETING THERAPY IN INTERFERON DRIVEN DISEASES SUCH AS SLE
A61P 5/50 (2006.01)	2670427 *	PREVENTION OF HYPOGLYCAEMIA IN DIABETES MELLITUS TYPE 2 PATIENTS	E04B 1/00 (2006.01)	2649248 *	A VERTICAL DUCT FOR BUILDING SERVICES LIKE GAS, WATER, ELECTRICITY, SAID DUCT BEING ACCESSIBLE FROM THE OUTSIDE OF THE BUILDING
G01N 21/78 (2006.01)	2678673 *	SOL-GEL BASED OPTICAL CHEMICAL SENSOR FOR DETECTION OF ORGANOPHOSPHATES AND METHOD FOR PREPARATION THEREOF	E04F 17/08 (2006.01)	2649248 *	A VERTICAL DUCT FOR BUILDING SERVICES LIKE GAS, WATER, ELECTRICITY, SAID DUCT BEING ACCESSIBLE FROM THE OUTSIDE OF THE BUILDING
G01N 31/22 (2006.01)	2678673 *	SOL-GEL BASED OPTICAL CHEMICAL SENSOR FOR DETECTION OF ORGANOPHOSPHATES AND METHOD FOR PREPARATION THEREOF			

MKP (51)	Broj objave evropske prijave patenta (97)	Naziv pronalaska (54)	MKP (51)	Broj objave evropske prijave patenta (97)	Naziv pronalaska (54)
A61K 31/165 (2006.01)	2690088 *	MIXED CRYSTAL AGOMELATINE (FORM-VIII), PREPARATION METHOD AND USE THEREOF AND PHARMACEUTICAL COMPOSITION CONTAINING SAME	A61K 31/357 (2006.01)	2680839 *	CO -ADMINISTRATION OF ERIBULIN AND FARLETUZUMAB FOR THE TREATMENT OF BREAST CANCER
A61P 1/00 (2006.01)	2690088 *	MIXED CRYSTAL AGOMELATINE (FORM-VIII), PREPARATION METHOD AND USE THEREOF AND PHARMACEUTICAL COMPOSITION CONTAINING SAME	A61K 39/395 (2006.01)	2680839 *	CO -ADMINISTRATION OF ERIBULIN AND FARLETUZUMAB FOR THE TREATMENT OF BREAST CANCER
A61P 9/00 (2006.01)	2690088 *	MIXED CRYSTAL AGOMELATINE (FORM-VIII), PREPARATION METHOD AND USE THEREOF AND PHARMACEUTICAL COMPOSITION CONTAINING SAME	A61P 35/00 (2006.01)	2680839 *	CO -ADMINISTRATION OF ERIBULIN AND FARLETUZUMAB FOR THE TREATMENT OF BREAST CANCER
A61P 25/00 (2006.01)	2690088 *	MIXED CRYSTAL AGOMELATINE (FORM-VIII), PREPARATION METHOD AND USE THEREOF AND PHARMACEUTICAL COMPOSITION CONTAINING SAME	A61K 31/4188 (2006.01)	2697227 *	FUSED IMIDAZOLE DERIVATIVES USEFUL AS IDO INHIBITORS
A61P 25/20 (2006.01)	2690088 *	MIXED CRYSTAL AGOMELATINE (FORM-VIII), PREPARATION METHOD AND USE THEREOF AND PHARMACEUTICAL COMPOSITION CONTAINING SAME	A61P 37/02 (2006.01)	2697227 *	FUSED IMIDAZOLE DERIVATIVES USEFUL AS IDO INHIBITORS
A61P 25/22 (2006.01)	2690088 *	MIXED CRYSTAL AGOMELATINE (FORM-VIII), PREPARATION METHOD AND USE THEREOF AND PHARMACEUTICAL COMPOSITION CONTAINING SAME	C07D 487/04 (2006.01)	2697227 *	FUSED IMIDAZOLE DERIVATIVES USEFUL AS IDO INHIBITORS
A61P 25/24 (2006.01)	2690088 *	MIXED CRYSTAL AGOMELATINE (FORM-VIII), PREPARATION METHOD AND USE THEREOF AND PHARMACEUTICAL COMPOSITION CONTAINING SAME	C12N 5/00 (2006.01)	2697362 *	METHODS AND SYSTEMS FOR HARVESTING CELLS
C07C 231/24 (2006.01)	2690088 *	MIXED CRYSTAL AGOMELATINE (FORM-VIII), PREPARATION METHOD AND USE THEREOF AND PHARMACEUTICAL COMPOSITION CONTAINING SAME	C12N 5/077 (2010.01)	2697362 *	METHODS AND SYSTEMS FOR HARVESTING CELLS
C07C 233/18 (2006.01)	2690088 *	MIXED CRYSTAL AGOMELATINE (FORM-VIII), PREPARATION METHOD AND USE THEREOF AND PHARMACEUTICAL COMPOSITION CONTAINING SAME	A61F 2/18 (2006.01)	2675394 *	BIOABSORBABLE MULTILAYER NASAL VALVE SPREADER GRAFT
			A61M 16/00 (2006.01)	2688627 *	BREATHING APPARATUS
			F01B 3/00 (2006.01)	2681415 *	FLUID ENERGY MACHINE HAVING TWO OPPOSITE CYLINDER ROTORS
			F04B 1/22 (2006.01)	2681415 *	FLUID ENERGY MACHINE HAVING TWO OPPOSITE CYLINDER ROTORS
			C07K 16/00 (2006.01)	2604625	Generation of binding molecules
			C07K 16/10 (2006.01)	2604625	Generation of binding molecules
			C07K 16/28 (2006.01)	2604625	Generation of binding molecules
			C07K 16/30 (2006.01)	2604625	Generation of binding molecules
			C07K 16/46 (2006.01)	2604625	Generation of binding molecules
			B60K 15/04 (2006.01)	2665901 *	FILLER NECK FOR A LIQUID TANK, IN PARTICULAR A UREA TANK, ON MOTOR VEHICLES

MKP (51)	Broj objave evropske prijave patenta (97)	Naziv pronalaska (54)	MKP (51)	Broj objave evropske prijave patenta (97)	Naziv pronalaska (54)
F01N 3/20 (2006.01)	2665901 *	FILLER NECK FOR A LIQUID TANK, IN PARTICULAR A UREA TANK, ON MOTOR VEHICLES	B29D 23/00 (2006.01)	2681041 *	METHOD FOR MANUFACTURING CONTINUOUS COMPOSITE TUBE, APPARATUS FOR MANUFACTURING CONTINUOUS COMPOSITE TUBE
C07K 16/28 (2006.01)	2694552 *	NOVEL EGFR BINDING PROTEINS	F16L 9/16 (2006.01)	2681041 *	METHOD FOR MANUFACTURING CONTINUOUS COMPOSITE TUBE, APPARATUS FOR MANUFACTURING CONTINUOUS COMPOSITE TUBE
A61K 31/00 (2006.01)	2686015 *	OVERCOMING RESISTANCE TO ERBB PATHWAY INHIBITORS	A61K 31/4709 (2006.01)	2680844 *	AMINO-QUINOLINES AS KINASE INHIBITORS
A61K 33/00 (2006.01)	2686015 *	OVERCOMING RESISTANCE TO ERBB PATHWAY INHIBITORS	B02C 18/30 (2006.01)	2667971 *	IMPROVEMENTS FOR A MINCING UNIT CUTTING GROUP
A61K 39/395 (2006.01)	2686015 *	OVERCOMING RESISTANCE TO ERBB PATHWAY INHIBITORS	B02C 18/36 (2006.01)	2667971 *	IMPROVEMENTS FOR A MINCING UNIT CUTTING GROUP
C07K 16/32 (2006.01)	2686015 *	OVERCOMING RESISTANCE TO ERBB PATHWAY INHIBITORS	E21B 43/26 (2006.01)	2665937 *	HIGH PRESSURE MULTISTAGE CENTRIFUGAL PUMP FOR FRACTURING HYDROCARBON RESERVES
A47K 10/38 (2006.01)	2583603	Portable sheet product dispenser	F04D 1/06 (2006.01)	2665937 *	HIGH PRESSURE MULTISTAGE CENTRIFUGAL PUMP FOR FRACTURING HYDROCARBON RESERVES
C09D 7/04 (2006.01)	2661473 *	ANTISKINNING COMPOSITIONS	F04D 29/16 (2006.01)	2665937 *	HIGH PRESSURE MULTISTAGE CENTRIFUGAL PUMP FOR FRACTURING HYDROCARBON RESERVES
C09D 167/08 (2006.01)	2661473 *	ANTISKINNING COMPOSITIONS	F04D 29/44 (2006.01)	2665937 *	HIGH PRESSURE MULTISTAGE CENTRIFUGAL PUMP FOR FRACTURING HYDROCARBON RESERVES
A61K 31/496 (2006.01)	2658543 *	THERAPEUTIC COMPOUNDS AND COMPOSITIONS	C09K 11/07 (2006.01)	2652085 *	VISCOUS CHEMILUMINESCENT COMPONENTS AND DISPENSING MEANS
A61P 35/00 (2006.01)	2658543 *	THERAPEUTIC COMPOUNDS AND COMPOSITIONS	F21K 2/06 (2006.01)	2652085 *	VISCOUS CHEMILUMINESCENT COMPONENTS AND DISPENSING MEANS
B29C 35/00 (2006.01)	2681041 *	METHOD FOR MANUFACTURING CONTINUOUS COMPOSITE TUBE, APPARATUS FOR MANUFACTURING CONTINUOUS COMPOSITE TUBE	G02B 6/122 (2006.01)	2652535 *	PHOTONIC CRYSTAL DEVICE WITH OFFSET ACTIVATION
B29C 53/56 (2006.01)	2681041 *	METHOD FOR MANUFACTURING CONTINUOUS COMPOSITE TUBE, APPARATUS FOR MANUFACTURING CONTINUOUS COMPOSITE TUBE	G02F 1/19 (2006.01)	2652535 *	PHOTONIC CRYSTAL DEVICE WITH OFFSET ACTIVATION
B29C 53/64 (2006.01)	2681041 *	METHOD FOR MANUFACTURING CONTINUOUS COMPOSITE TUBE, APPARATUS FOR MANUFACTURING CONTINUOUS COMPOSITE TUBE	H02B 1/32 (2006.01)	2684264 *	ELECTRICAL ENCLOSURE
B29C 70/32 (2006.01)	2681041 *	METHOD FOR MANUFACTURING CONTINUOUS COMPOSITE TUBE, APPARATUS FOR MANUFACTURING CONTINUOUS COMPOSITE TUBE	C07K 1/18 (2006.01)	2649087 *	ION EXCHANGE CHROMATOGRAPHY IN THE PRESENCE OF AN AMINO ACID
			A61K 9/00 (2006.01)	2651396 *	PHARMACEUTICAL COMPOSITIONS
			A61K 9/107 (2006.01)	2651396 *	PHARMACEUTICAL COMPOSITIONS

MKP (51)	Broj objave evropske prijave patenta (97)	Naziv pronalaska (54)	MKP (51)	Broj objave evropske prijave patenta (97)	Naziv pronalaska (54)
A61K 9/48 (2006.01)	2651396 *	PHARMACEUTICAL COMPOSITIONS	A01N 43/653 (2006.01)	2667720 *	PESTICIDAL COMPOSITION COMPRISING SULPHUR, A FUNGICIDE AND AN AGROCHEMICAL EXCIPIENT
A61K 38/13 (2006.01)	2651396 *	PHARMACEUTICAL COMPOSITIONS	A01N 35/04 (2006.01)	2667720 *	PESTICIDAL COMPOSITION COMPRISING SULPHUR, A FUNGICIDE AND AN AGROCHEMICAL EXCIPIENT
A61K 47/10 (2006.01)	2651396 *	PHARMACEUTICAL COMPOSITIONS	A01N 47/32 (2006.01)	2667720 *	PESTICIDAL COMPOSITION COMPRISING SULPHUR, A FUNGICIDE AND AN AGROCHEMICAL EXCIPIENT
A61K 47/14 (2006.01)	2651396 *	PHARMACEUTICAL COMPOSITIONS	A01N 37/34 (2006.01)	2667720 *	PESTICIDAL COMPOSITION COMPRISING SULPHUR, A FUNGICIDE AND AN AGROCHEMICAL EXCIPIENT
A61K 47/22 (2006.01)	2651396 *	PHARMACEUTICAL COMPOSITIONS	G01S 7/28 (2006.01)	2678711 *	PROXIMITY SENSOR
A61K 47/26 (2006.01)	2651396 *	PHARMACEUTICAL COMPOSITIONS	G01S 13/58 (2006.01)	2678711 *	PROXIMITY SENSOR
A01N 43/54 (2006.01)	2667720 *	PESTICIDAL COMPOSITION COMPRISING SULPHUR, A FUNGICIDE AND AN AGROCHEMICAL EXCIPIENT	G01S 13/93 (2006.01)	2678711 *	PROXIMITY SENSOR
A01N 59/02 (2006.01)	2667720 *	PESTICIDAL COMPOSITION COMPRISING SULPHUR, A FUNGICIDE AND AN AGROCHEMICAL EXCIPIENT	G01S 15/58 (2006.01)	2678711 *	PROXIMITY SENSOR
A01N 43/50 (2006.01)	2667720 *	PESTICIDAL COMPOSITION COMPRISING SULPHUR, A FUNGICIDE AND AN AGROCHEMICAL EXCIPIENT	G01S 15/93 (2006.01)	2678711 *	PROXIMITY SENSOR
A01N 47/36 (2006.01)	2667720 *	PESTICIDAL COMPOSITION COMPRISING SULPHUR, A FUNGICIDE AND AN AGROCHEMICAL EXCIPIENT	G01S 17/93 (2006.01)	2678711 *	PROXIMITY SENSOR
A01N 43/28 (2006.01)	2667720 *	PESTICIDAL COMPOSITION COMPRISING SULPHUR, A FUNGICIDE AND AN AGROCHEMICAL EXCIPIENT	B63B 1/24 (2006.01)	2665638 *	FOIL STRUCTURE FOR PROVIDING BUOYANCY AND LIFT
A01N 47/34 (2006.01)	2667720 *	PESTICIDAL COMPOSITION COMPRISING SULPHUR, A FUNGICIDE AND AN AGROCHEMICAL EXCIPIENT	A61K 31/4412 (2006.01)	2683689 *	FLUORO-PYRIDINONE DERIVATIVES USEFUL AS ANTIBACTERIAL AGENTS
A01N 43/16 (2006.01)	2667720 *	PESTICIDAL COMPOSITION COMPRISING SULPHUR, A FUNGICIDE AND AN AGROCHEMICAL EXCIPIENT	A61K 31/4427 (2006.01)	2683689 *	FLUORO-PYRIDINONE DERIVATIVES USEFUL AS ANTIBACTERIAL AGENTS
A01N 47/30 (2006.01)	2667720 *	PESTICIDAL COMPOSITION COMPRISING SULPHUR, A FUNGICIDE AND AN AGROCHEMICAL EXCIPIENT	A61K 31/4433 (2006.01)	2683689 *	FLUORO-PYRIDINONE DERIVATIVES USEFUL AS ANTIBACTERIAL AGENTS
A01N 37/24 (2006.01)	2667720 *	PESTICIDAL COMPOSITION COMPRISING SULPHUR, A FUNGICIDE AND AN AGROCHEMICAL EXCIPIENT	A61K 31/4439 (2006.01)	2683689 *	FLUORO-PYRIDINONE DERIVATIVES USEFUL AS ANTIBACTERIAL AGENTS
A01N 47/24 (2006.01)	2667720 *	PESTICIDAL COMPOSITION COMPRISING SULPHUR, A FUNGICIDE AND AN AGROCHEMICAL EXCIPIENT	A61P 31/00 (2006.01)	2683689 *	FLUORO-PYRIDINONE DERIVATIVES USEFUL AS ANTIBACTERIAL AGENTS
A01N 37/16 (2006.01)	2667720 *	PESTICIDAL COMPOSITION COMPRISING SULPHUR, A FUNGICIDE AND AN AGROCHEMICAL EXCIPIENT	C07D 213/64 (2006.01)	2683689 *	FLUORO-PYRIDINONE DERIVATIVES USEFUL AS ANTIBACTERIAL AGENTS
			C07D 213/69 (2006.01)	2683689 *	FLUORO-PYRIDINONE DERIVATIVES USEFUL AS ANTIBACTERIAL AGENTS
			C07D 401/04 (2006.01)	2683689 *	FLUORO-PYRIDINONE DERIVATIVES USEFUL AS ANTIBACTERIAL AGENTS

MKP (51)	Broj objave evropske prijave patenta (97)	Naziv pronalaska (54)	MKP (51)	Broj objave evropske prijave patenta (97)	Naziv pronalaska (54)
C07D 401/10 (2006.01)	2683689 *	FLUORO-PYRIDINONE DERIVATIVES USEFUL AS ANTIBACTERIAL AGENTS	A61P 25/18 (2006.01)	2679585 *	GLYCINE TRANSPORT INHIBITOR
C07D 405/04 (2006.01)	2683689 *	FLUORO-PYRIDINONE DERIVATIVES USEFUL AS ANTIBACTERIAL AGENTS	C07D 413/14 (2006.01)	2679585 *	GLYCINE TRANSPORT INHIBITOR
C07D 405/12 (2006.01)	2683689 *	FLUORO-PYRIDINONE DERIVATIVES USEFUL AS ANTIBACTERIAL AGENTS	F24J 2/04 (2006.01)	2646757 *	BUOYANT SOLAR PANEL, AND SOLAR POWER PLANT CONSISTING OF AN ASSEMBLY OF SAID PANELS
C07D 413/10 (2006.01)	2683689 *	FLUORO-PYRIDINONE DERIVATIVES USEFUL AS ANTIBACTERIAL AGENTS	F24J 2/52 (2006.01)	2646757 *	BUOYANT SOLAR PANEL, AND SOLAR POWER PLANT CONSISTING OF AN ASSEMBLY OF SAID PANELS
C07D 417/12 (2006.01)	2683689 *	FLUORO-PYRIDINONE DERIVATIVES USEFUL AS ANTIBACTERIAL AGENTS	B60R 19/03 (2006.01)	2567932	Impact deceleration device for material handling equipments.
A61K 31/444 (2006.01)	2679585 *	GLYCINE TRANSPORT INHIBITOR	B60R 19/22 (2006.01)	2567932	Impact deceleration device for material handling equipments.
A61P 25/24 (2006.01)	2679585 *	GLYCINE TRANSPORT INHIBITOR	B60R 21/11 (2006.01)	2567932	Impact deceleration device for material handling equipments.
A61P 25/04 (2006.01)	2679585 *	GLYCINE TRANSPORT INHIBITOR	B60R 21/13 (2006.01)	2567932	Impact deceleration device for material handling equipments.
A61P 43/00 (2006.01)	2679585 *	GLYCINE TRANSPORT INHIBITOR	B62D 33/06 (2006.01)	2567932	Impact deceleration device for material handling equipments.
A61K 31/4439 (2006.01)	2679585 *	GLYCINE TRANSPORT INHIBITOR	B66F 9/075 (2006.01)	2567932	Impact deceleration device for material handling equipments.
A61P 25/22 (2006.01)	2679585 *	GLYCINE TRANSPORT INHIBITOR	E02F 9/16 (2006.01)	2567932	Impact deceleration device for material handling equipments.
C07D 401/04 (2006.01)	2679585 *	GLYCINE TRANSPORT INHIBITOR	B65B 31/02 (2006.01)	2651767 *	DEVICE FOR VACUUM PACKAGING, PARTICULARLY OF FOOD PRODUCTS
A61P 25/20 (2006.01)	2679585 *	GLYCINE TRANSPORT INHIBITOR	A61K 31/437 (2006.01)	2651934 *	IMIDAZOPYRIDINES AS RESPIRATORY SYNCYTIAL VIRUS ANTIVIRAL AGENTS
C07D 417/14 (2006.01)	2679585 *	GLYCINE TRANSPORT INHIBITOR	A61P 31/12 (2006.01)	2651934 *	IMIDAZOPYRIDINES AS RESPIRATORY SYNCYTIAL VIRUS ANTIVIRAL AGENTS
A61P 25/16 (2006.01)	2679585 *	GLYCINE TRANSPORT INHIBITOR	C07D 471/04 (2006.01)	2651934 *	IMIDAZOPYRIDINES AS RESPIRATORY SYNCYTIAL VIRUS ANTIVIRAL AGENTS
C07D 401/14 (2006.01)	2679585 *	GLYCINE TRANSPORT INHIBITOR	C07D 487/04 (2006.01)	2651934 *	IMIDAZOPYRIDINES AS RESPIRATORY SYNCYTIAL VIRUS ANTIVIRAL AGENTS
A61K 31/506 (2006.01)	2679585 *	GLYCINE TRANSPORT INHIBITOR	B60G 9/02 (2006.01)	2444304	System and method for preventing overturning of land vehicles
A61P 25/28 (2006.01)	2679585 *	GLYCINE TRANSPORT INHIBITOR	B60G 17/016 (2006.01)	2444304	System and method for preventing overturning of land vehicles
A61P 25/00 (2006.01)	2679585 *	GLYCINE TRANSPORT INHIBITOR	B60R 21/013 (2006.01)	2444304	System and method for preventing overturning of land vehicles
A61P 25/30 (2006.01)	2679585 *	GLYCINE TRANSPORT INHIBITOR	B62D 49/08 (2006.01)	2444304	System and method for preventing overturning of land vehicles

MKP (51)	Broj objave evropske prijave patenta (97)	Naziv pronalaska (54)	MKP (51)	Broj objave evropske prijave patenta (97)	Naziv pronalaska (54)
B66F 9/06 (2006.01)	2444304	System and method for preventing overturning of land vehicles	A61K 8/73 (2006.01)	2614812	Mouthwash
E02F 9/22 (2006.01)	2444304	System and method for preventing overturning of land vehicles	A61Q 11/00 (2006.01)	2614812	Mouthwash
G08B 19/00 (2006.01)	2444304	System and method for preventing overturning of land vehicles	B32B 17/10 (2006.01)	2665601 *	LUMINOUS GLASS PANEL
A61K 31/35 (2006.01)	2670407 *	TREATMENT OF BACTERIAL INFECTIONS	B32B 17/12 (2006.01)	2665601 *	LUMINOUS GLASS PANEL
A61K 31/70 (2006.01)	2670407 *	TREATMENT OF BACTERIAL INFECTIONS	B60Q 3/02 (2006.01)	2665601 *	LUMINOUS GLASS PANEL
A61P 29/00 (2006.01)	2670407 *	TREATMENT OF BACTERIAL INFECTIONS	G02B 6/00 (2006.01)	2665601 *	LUMINOUS GLASS PANEL
A61P 31/12 (2006.01)	2670407 *	TREATMENT OF BACTERIAL INFECTIONS	B32B 23/06 (2006.01)	2651642 *	MULTILAYER BASED ON CELLULOSE AND DERIVATES THEREOF
A61K 31/4985 (2006.01)	2570415	N-[4-(1H-Pyrazolo[3,4-b]pyrazin-6-yl)-phenyl]-sulfonamides and their use as pharmaceuticals	B32B 29/04 (2006.01)	2651642 *	MULTILAYER BASED ON CELLULOSE AND DERIVATES THEREOF
A61P 19/02 (2006.01)	2570415	N-[4-(1H-Pyrazolo[3,4-b]pyrazin-6-yl)-phenyl]-sulfonamides and their use as pharmaceuticals	B65D 65/46 (2006.01)	2651642 *	MULTILAYER BASED ON CELLULOSE AND DERIVATES THEREOF
C07D 487/04 (2006.01)	2570415	N-[4-(1H-Pyrazolo[3,4-b]pyrazin-6-yl)-phenyl]-sulfonamides and their use as pharmaceuticals	A61K 9/20 (2006.01)	2654733 *	TAMPER RESISTANT SOLID ORAL DOSAGE FORMS
G01N 33/564 (2006.01)	2676137 *	ASSAYS FOR DETECTING AUTOANTIBODIES TO ANTI-TNF DRUGS	A61K 31/485 (2006.01)	2654733 *	TAMPER RESISTANT SOLID ORAL DOSAGE FORMS
G01N 33/94 (2006.01)	2676137 *	ASSAYS FOR DETECTING AUTOANTIBODIES TO ANTI-TNF DRUGS	B65G 1/137 (2006.01)	2390204	System for completing a warehouse for small articles
C12N 15/09 (2006.01)	2684963 *	METHOD FOR SCREENING FOR COMPOUND CAPABLE OF ENHANCING OR INHIBITING OATP1B1 TRANSPORT ACTIVITY, AND METHOD FOR DETERMINING EXPRESSION LEVEL OF OATP1B1	G09F 7/18 (2006.01)	2671212 *	HANGERS FOR DISPLAY MATERIAL
C12Q 1/02 (2006.01)	2684963 *	METHOD FOR SCREENING FOR COMPOUND CAPABLE OF ENHANCING OR INHIBITING OATP1B1 TRANSPORT ACTIVITY, AND METHOD FOR DETERMINING EXPRESSION LEVEL OF OATP1B1	A61K 31/40 (2006.01)	2670486 *	TREATMENT FOR LIPODYSTROPHY
A61K 8/23 (2006.01)	2614812	Mouthwash	A61P 3/00 (2006.01)	2670486 *	TREATMENT FOR LIPODYSTROPHY
A61K 8/43 (2006.01)	2614812	Mouthwash	B05B 7/16 (2006.01)	2574424	Method for cooling aerosols
A61K 8/67 (2006.01)	2614812	Mouthwash	B23Q 11/10 (2006.01)	2574424	Method for cooling aerosols
			A61K 39/395 (2006.01)	2654792 *	HALF IMMUNOGLOBULIN BINDING PROTEINS AND USES THEREOF
			C12P 21/08 (2006.01)	2654792 *	HALF IMMUNOGLOBULIN BINDING PROTEINS AND USES THEREOF
			F02D 41/22 (2006.01)	2594775	A method of assessing the functioning of an EGR cooler in an internal combustion engine
			F02M 25/07 (2006.01)	2594775	A method of assessing the functioning of an EGR cooler in an internal combustion engine
			A61K 31/402 (2006.01)	2697196 *	PRODRUGS OF INHIBITORS OF PLASMA KALLIKREIN

MKP (51)	Broj objave evropske prijave patenta (97)	Naziv pronalaska (54)	MKP (51)	Broj objave evropske prijave patenta (97)	Naziv pronalaska (54)
A61K 31/415 (2006.01)	2697196 *	PRODRUGS OF INHIBITORS OF PLASMA KALLIKREIN	F16C 11/12 (2006.01)	2683302 *	RESILIENT TOOLS
A61P 9/10 (2006.01)	2697196 *	PRODRUGS OF INHIBITORS OF PLASMA KALLIKREIN	C07D 473/34 (2006.01)	2694505 *	HSP90 INHIBITORS
C07D 207/34 (2006.01)	2697196 *	PRODRUGS OF INHIBITORS OF PLASMA KALLIKREIN	C07D 473/40 (2006.01)	2694505 *	HSP90 INHIBITORS
C07D 231/14 (2006.01)	2697196 *	PRODRUGS OF INHIBITORS OF PLASMA KALLIKREIN	A23G 3/00 (2006.01)	2670254 *	METHOD FOR PRODUCING AERATED FOOD PRODUCTS
B65D 75/58 (2006.01)	2589547	Flow wrap packaging	A23G 3/52 (2006.01)	2670254 *	METHOD FOR PRODUCING AERATED FOOD PRODUCTS
B65D 75/62 (2006.01)	2589547	Flow wrap packaging	A23L 1/00 (2006.01)	2670254 *	METHOD FOR PRODUCING AERATED FOOD PRODUCTS
G06Q 20/40 (2012.01)	2695121 *	TERMINAL AUTHENTICITY VERIFICATION	A61B 17/00 (2006.01)	2688484 *	A DEVICE
A61M 5/20 (2006.01)	2675506 *	AUTO-INJECTOR	A61B 17/06 (2006.01)	2688484 *	A DEVICE
A61M 5/32 (2006.01)	2675506 *	AUTO-INJECTOR	A61L 27/36 (2006.01)	2688484 *	A DEVICE
C12Q 1/68 (2006.01)	2675916 *	METHOD FOR LOCALIZED IN SITU DETECTION OF mRNA	A61L 27/50 (2006.01)	2688484 *	A DEVICE
C02F 1/68 (2006.01)	2675759 *	SUSTAINABLE METHOD AND SYSTEM FOR TREATING WATER BODIES AFFECTED BY BACTERIA AND MICROALGAE AT LOW COST	A61M 27/00 (2006.01)	2688484 *	A DEVICE
H04W 74/08 (2009.01)	2692194 *	SYSTEM AND METHOD FOR CLEAR CHANNEL ASSESSMENT THAT SUPPORTS SIMULTANEOUS TRANSMISSION BY MULTIPLE WIRELESS PROTOCOLS	B63B 19/02 (2006.01)	2562076	Glass pane assembly in an aquatic vehicle
A61K 31/437 (2006.01)	2651922 *	INDOLES AS RESPIRATORY SYNCYTIAL VIRUS ANTIVIRAL AGENTS	G06F 17/30 (2006.01)	2666108 *	SYSTEMS AND METHODS FOR PROVIDING A DISCOVER PROMPT TO AUGMENTED CONTENT OF A WEB PAGE
A61P 31/12 (2006.01)	2651922 *	INDOLES AS RESPIRATORY SYNCYTIAL VIRUS ANTIVIRAL AGENTS	A45D 40/06 (2006.01)	2543276	Lipstick tube
C07D 403/06 (2006.01)	2651922 *	INDOLES AS RESPIRATORY SYNCYTIAL VIRUS ANTIVIRAL AGENTS	C07H 21/00 (2006.01)	2663642 *	TREPONEMA PALLIDUM TRIPLET ANTIGEN
C07D 471/04 (2006.01)	2651922 *	INDOLES AS RESPIRATORY SYNCYTIAL VIRUS ANTIVIRAL AGENTS	C12N 15/63 (2006.01)	2663642 *	TREPONEMA PALLIDUM TRIPLET ANTIGEN
A61B 17/00 (2006.01)	2683302 *	RESILIENT TOOLS	G01N 33/53 (2006.01)	2663642 *	TREPONEMA PALLIDUM TRIPLET ANTIGEN
A61B 17/28 (2006.01)	2683302 *	RESILIENT TOOLS	A61K 39/395 (2006.01)	2661448 *	ANTI-IL-12/IL-23 ANTIBODIES AND USES THEREOF
A61B 17/29 (2006.01)	2683302 *	RESILIENT TOOLS	C07K 16/24 (2006.01)	2661448 *	ANTI-IL-12/IL-23 ANTIBODIES AND USES THEREOF
A61B 17/30 (2006.01)	2683302 *	RESILIENT TOOLS	B82Y 20/00 (2011.01)	2668529 *	PHOTONIC CRYSTAL DEVICE WITH INFILTRATING COMPONENT
			G02B 5/26 (2006.01)	2668529 *	PHOTONIC CRYSTAL DEVICE WITH INFILTRATING COMPONENT

MKP (51)	Broj objave evropske prijave patenta (97)	Naziv pronalaska (54)	MKP (51)	Broj objave evropske prijave patenta (97)	Naziv pronalaska (54)
A61K 31/4178 (2006.01)	2651928 *	ANTI-VIRAL COMPOUNDS	H01L 31/042 (2006.01)	2681824 *	METHODS, SYSTEMS, AND APPARATUS FOR NATURAL POWER COLLECTION AND DISTRIBUTION
A61P 31/14 (2006.01)	2651928 *	ANTI-VIRAL COMPOUNDS	H02J 3/38 (2006.01)	2681824 *	METHODS, SYSTEMS, AND APPARATUS FOR NATURAL POWER COLLECTION AND DISTRIBUTION
C07D 403/10 (2006.01)	2651928 *	ANTI-VIRAL COMPOUNDS	H02J 4/00 (2006.01)	2681824 *	METHODS, SYSTEMS, AND APPARATUS FOR NATURAL POWER COLLECTION AND DISTRIBUTION
C07D 403/12 (2006.01)	2651928 *	ANTI-VIRAL COMPOUNDS	H02J 13/00 (2006.01)	2681824 *	METHODS, SYSTEMS, AND APPARATUS FOR NATURAL POWER COLLECTION AND DISTRIBUTION
C07D 403/14 (2006.01)	2651928 *	ANTI-VIRAL COMPOUNDS	A61K 38/08 (2006.01)	2683394 *	ACTIVE AGENT PRODRUGS WITH HETEROCYCLIC LINKERS
A47J 31/36 (2006.01)	2653440	Beverage cartridge	A01N 43/02 (2006.01)	2693879 *	MIGRASTATINS AND USES THEREOF
A47J 31/40 (2006.01)	2653440	Beverage cartridge	A61K 31/335 (2006.01)	2693879 *	MIGRASTATINS AND USES THEREOF
A47J 31/41 (2006.01)	2653440	Beverage cartridge	C09C 1/02 (2006.01)	2700680	Process for manufacturing white pigment containing products
B67D 1/00 (2006.01)	2653440	Beverage cartridge	A61K 31/337 (2006.01)	2694056 *	THERAPEUTIC TREATMENT
B67D 7/02 (2010.01)	2653440	Beverage cartridge	A61K 31/519 (2006.01)	2694056 *	THERAPEUTIC TREATMENT
B67D 7/62 (2010.01)	2653440	Beverage cartridge	A61P 35/00 (2006.01)	2694056 *	THERAPEUTIC TREATMENT
C07D 473/34 (2006.01)	2694506 *	HSP90 INHIBITORS	A63B 69/00 (2006.01)	2654909 *	SURFING DEVICE AND METHOD
A61K 31/4196 (2006.01)	2648725 *	TREATMENT OF CHRONIC INFLAMMATION WITH A 1,2,4-TRIAZOLO [1,5a] PYRIDINE DERIVATIVE	B60L 13/04 (2006.01)	2654909 *	SURFING DEVICE AND METHOD
A61K 45/06 (2006.01)	2648725 *	TREATMENT OF CHRONIC INFLAMMATION WITH A 1,2,4-TRIAZOLO [1,5a] PYRIDINE DERIVATIVE	B63B 35/79 (2006.01)	2654909 *	SURFING DEVICE AND METHOD
A61P 19/02 (2006.01)	2648725 *	TREATMENT OF CHRONIC INFLAMMATION WITH A 1,2,4-TRIAZOLO [1,5a] PYRIDINE DERIVATIVE	A61K 31/4155 (2006.01)	2687524 *	AZOLE DERIVATIVE
A61P 37/00 (2006.01)	2648725 *	TREATMENT OF CHRONIC INFLAMMATION WITH A 1,2,4-TRIAZOLO [1,5a] PYRIDINE DERIVATIVE	A61K 31/4196 (2006.01)	2687524 *	AZOLE DERIVATIVE
E04H 12/00 (2006.01)	2681824 *	METHODS, SYSTEMS, AND APPARATUS FOR NATURAL POWER COLLECTION AND DISTRIBUTION	A61K 31/422 (2006.01)	2687524 *	AZOLE DERIVATIVE
F03D 9/00 (2006.01)	2681824 *	METHODS, SYSTEMS, AND APPARATUS FOR NATURAL POWER COLLECTION AND DISTRIBUTION	A61K 31/4245 (2006.01)	2687524 *	AZOLE DERIVATIVE
F03D 11/04 (2006.01)	2681824 *	METHODS, SYSTEMS, AND APPARATUS FOR NATURAL POWER COLLECTION AND DISTRIBUTION	A61K 31/433 (2006.01)	2687524 *	AZOLE DERIVATIVE

MKP (51)	Broj objave evropske prijave patenta (97)	Naziv pronalaska (54)	MKP (51)	Broj objave evropske prijave patenta (97)	Naziv pronalaska (54)
A61K 31/4439 (2006.01)	2687524 *	AZOLE DERIVATIVE	C07D 307/80 (2006.01)	2688879 *	METHOD FOR SYNTHESIZING KETO BENZOFURAN DERIVATIVES
A61K 31/506 (2006.01)	2687524 *	AZOLE DERIVATIVE	C07D 307/84 (2006.01)	2688879 *	METHOD FOR SYNTHESIZING KETO BENZOFURAN DERIVATIVES
A61K 31/5377 (2006.01)	2687524 *	AZOLE DERIVATIVE	A62D 1/00 (2006.01)	2674198 *	AUTONOMOUS FIRE- FIGHTING AGENT
A61P 17/14 (2006.01)	2687524 *	AZOLE DERIVATIVE	C08J 9/34 (2006.01)	2674198 *	AUTONOMOUS FIRE- FIGHTING AGENT
C07D 403/04 (2006.01)	2687524 *	AZOLE DERIVATIVE	A01M 29/34 (2011.01)	2691346 *	GLASS YARN PROVIDED WITH A POLYMER COATING, AND SCREEN CONTAINING SAID YARN
C07D 413/04 (2006.01)	2687524 *	AZOLE DERIVATIVE	C03C 25/10 (2006.01)	2691346 *	GLASS YARN PROVIDED WITH A POLYMER COATING, AND SCREEN CONTAINING SAID YARN
C07D 413/14 (2006.01)	2687524 *	AZOLE DERIVATIVE	C03C 25/24 (2006.01)	2691346 *	GLASS YARN PROVIDED WITH A POLYMER COATING, AND SCREEN CONTAINING SAID YARN
C07D 417/04 (2006.01)	2687524 *	AZOLE DERIVATIVE	C03C 25/26 (2006.01)	2691346 *	GLASS YARN PROVIDED WITH A POLYMER COATING, AND SCREEN CONTAINING SAID YARN
A61K 31/554 (2006.01)	2653466	Agents for treating disorders involving modulation of ryanodine receptors	C03C 25/30 (2006.01)	2691346 *	GLASS YARN PROVIDED WITH A POLYMER COATING, AND SCREEN CONTAINING SAID YARN
A61P 9/00 (2006.01)	2653466	Agents for treating disorders involving modulation of ryanodine receptors	C03C 25/40 (2006.01)	2691346 *	GLASS YARN PROVIDED WITH A POLYMER COATING, AND SCREEN CONTAINING SAID YARN
A61P 19/08 (2006.01)	2653466	Agents for treating disorders involving modulation of ryanodine receptors	C03C 25/54 (2006.01)	2691346 *	GLASS YARN PROVIDED WITH A POLYMER COATING, AND SCREEN CONTAINING SAID YARN
A61P 25/00 (2006.01)	2653466	Agents for treating disorders involving modulation of ryanodine receptors	D06M 13/00 (2006.01)	2691346 *	GLASS YARN PROVIDED WITH A POLYMER COATING, AND SCREEN CONTAINING SAID YARN
C07D 281/10 (2006.01)	2653466	Agents for treating disorders involving modulation of ryanodine receptors	D06M 15/00 (2006.01)	2691346 *	GLASS YARN PROVIDED WITH A POLYMER COATING, AND SCREEN CONTAINING SAID YARN
G01R 1/067 (2006.01)	2647088 *	ELECTRICAL CONNECTOR WITH EMBEDDED SHELL LAYER	A61K 31/504 (2006.01)	2649076 *	MACROCYCLIC INHIBITORS OF FLAVIVIRIDAE VIRUSES
H01R 12/71 (2011.01)	2647088 *	ELECTRICAL CONNECTOR WITH EMBEDDED SHELL LAYER	A61P 31/14 (2006.01)	2649076 *	MACROCYCLIC INHIBITORS OF FLAVIVIRIDAE VIRUSES
H01R 13/24 (2006.01)	2647088 *	ELECTRICAL CONNECTOR WITH EMBEDDED SHELL LAYER	C07D 487/08 (2006.01)	2649076 *	MACROCYCLIC INHIBITORS OF FLAVIVIRIDAE VIRUSES
H01R 13/6599 (2011.01)	2647088 *	ELECTRICAL CONNECTOR WITH EMBEDDED SHELL LAYER	C07D 498/08 (2006.01)	2649076 *	MACROCYCLIC INHIBITORS OF FLAVIVIRIDAE VIRUSES
H01R 43/20 (2006.01)	2647088 *	ELECTRICAL CONNECTOR WITH EMBEDDED SHELL LAYER	C07D 498/18 (2006.01)	2649076 *	MACROCYCLIC INHIBITORS OF FLAVIVIRIDAE VIRUSES
H01R 13/523 (2006.01)	2697870 *	SUBSEA ELECTRICAL CONNECTOR			
H01R 13/627 (2006.01)	2697870 *	SUBSEA ELECTRICAL CONNECTOR			

MKP (51)	Broj objave evropske prijave patenta (97)	Naziv pronalaska (54)	MKP (51)	Broj objave evropske prijave patenta (97)	Naziv pronalaska (54)
C07K 14/435 (2006.01)	2686340 *	POTENT AND SELECTIVE INHIBITORS OF NAV1.3 AND NAV1.7	A61P 35/00 (2006.01)	2651939 *	SUBSTITUTED N-(1H- INDAZOL-4-YL)IMIDAZO[1,2-a] PYRIDINE-3-CARBOXAMIDE COMPOUNDS AS TYPE III RECEPTOR TYROSINE KINASE INHIBITORS
A61K 8/00 (2006.01)	2699625 *	NANOPARTICLES COMPRISING ESTERS OF POLY (METHYL VINYL ETHER- CO-MALEIC ANHYDRIDE) AND USES THEREOF	C07D 471/04 (2006.01)	2651939 *	SUBSTITUTED N-(1H- INDAZOL-4-YL)IMIDAZO[1,2-a] PYRIDINE-3-CARBOXAMIDE COMPOUNDS AS TYPE III RECEPTOR TYROSINE KINASE INHIBITORS
A61K 8/91 (2006.01)	2699625 *	NANOPARTICLES COMPRISING ESTERS OF POLY (METHYL VINYL ETHER- CO-MALEIC ANHYDRIDE) AND USES THEREOF	A01N 43/58 (2006.01)	2677869 *	NOVEL CYCLIC AZABENZIMIDAZOLE DERIVATIVES USEFUL AS ANTI-DIABETIC AGENTS
A61K 35/00 (2006.01)	2699625 *	NANOPARTICLES COMPRISING ESTERS OF POLY (METHYL VINYL ETHER- CO-MALEIC ANHYDRIDE) AND USES THEREOF	E04F 15/02 (2006.01)	2573296	Leveling spacer for laying wall tiles, paving tiles and the like with the interposition of gaps
B82Y 5/00 (2011.01)	2699625 *	NANOPARTICLES COMPRISING ESTERS OF POLY (METHYL VINYL ETHER- CO-MALEIC ANHYDRIDE) AND USES THEREOF	E04F 21/00 (2006.01)	2573296	Leveling spacer for laying wall tiles, paving tiles and the like with the interposition of gaps
B82Y 30/00 (2011.01)	2699625 *	NANOPARTICLES COMPRISING ESTERS OF POLY (METHYL VINYL ETHER- CO-MALEIC ANHYDRIDE) AND USES THEREOF	A61K 39/00 (2006.01)	2686009 *	METHOD FOR PREPARING MULTIPLE ANTIGEN GLYCOPEPTIDE CARBOHYDRATE CONJUGATES
C08F 292/00 (2006.01)	2699625 *	NANOPARTICLES COMPRISING ESTERS OF POLY (METHYL VINYL ETHER- CO-MALEIC ANHYDRIDE) AND USES THEREOF	A61K 47/48 (2006.01)	2686009 *	METHOD FOR PREPARING MULTIPLE ANTIGEN GLYCOPEPTIDE CARBOHYDRATE CONJUGATES
C08J 3/07 (2006.01)	2699625 *	NANOPARTICLES COMPRISING ESTERS OF POLY (METHYL VINYL ETHER- CO-MALEIC ANHYDRIDE) AND USES THEREOF	C07K 9/00 (2006.01)	2686009 *	METHOD FOR PREPARING MULTIPLE ANTIGEN GLYCOPEPTIDE CARBOHYDRATE CONJUGATES
A61K 9/16 (2006.01)	2591772	New coated controlled release active agent carriers	A61K 9/16 (2006.01)	2646001 *	FORMULATION OF LACOSAMIDE
A61K 9/20 (2006.01)	2591772	New coated controlled release active agent carriers	A61K 9/20 (2006.01)	2646001 *	FORMULATION OF LACOSAMIDE
A61K 9/50 (2006.01)	2591772	New coated controlled release active agent carriers	A61K 31/165 (2006.01)	2646001 *	FORMULATION OF LACOSAMIDE
E21B 19/084 (2006.01)	2673456 *	DRILL RIG AND ASSOCIATED DRILL RIG TRAVERSE SYSTEM	A61P 25/08 (2006.01)	2646001 *	FORMULATION OF LACOSAMIDE
E21B 19/086 (2006.01)	2673456 *	DRILL RIG AND ASSOCIATED DRILL RIG TRAVERSE SYSTEM	A61P 25/14 (2006.01)	2646001 *	FORMULATION OF LACOSAMIDE
B05D 5/06 (2006.01)	2463031	Method of preparing sandwich composite coating on engineering plastic surface	A61P 25/18 (2006.01)	2646001 *	FORMULATION OF LACOSAMIDE
B05D 7/02 (2006.01)	2463031	Method of preparing sandwich composite coating on engineering plastic surface	G07F 17/32 (2006.01)	2584545	Device for displaying a device code of a coin-activated entertainment device
A61K 31/437 (2006.01)	2651939 *	SUBSTITUTED N-(1H- INDAZOL-4-YL)IMIDAZO[1,2-a] PYRIDINE-3-CARBOXAMIDE COMPOUNDS AS TYPE III RECEPTOR TYROSINE KINASE INHIBITORS	A61K 39/395 (2006.01)	2683741 *	USE OF INHIBITORS OF EGFR-FAMILY RECEPTORS IN THE TREATMENT OF HORMONE REFRACTORY BREAST CANCERS

MKP (51)	Broj objave evropske prijave patenta (97)	Naziv pronalaska (54)	MKP (51)	Broj objave evropske prijave patenta (97)	Naziv pronalaska (54)
A61P 35/00 (2006.01)	2683741 *	USE OF INHIBITORS OF EGFR-FAMILY RECEPTORS IN THE TREATMENT OF HORMONE REFRACTORY BREAST CANCERS	A61K 8/34 (2006.01)	2654665 *	METHOD FOR DEVELOPING A LIQUID COMPOSITION TO BE APPLIED TO THE SKIN AS A FOAM AND A COMPOSITION THAT CAN BE APPLIED TOPICALLY
C07K 16/32 (2006.01)	2683741 *	USE OF INHIBITORS OF EGFR-FAMILY RECEPTORS IN THE TREATMENT OF HORMONE REFRACTORY BREAST CANCERS	A61K 8/55 (2006.01)	2654665 *	METHOD FOR DEVELOPING A LIQUID COMPOSITION TO BE APPLIED TO THE SKIN AS A FOAM AND A COMPOSITION THAT CAN BE APPLIED TOPICALLY
C12Q 1/48 (2006.01)	2646819 *	ASSAYS AND BIOMARKERS FOR LRRK2	A61K 8/86 (2006.01)	2654665 *	METHOD FOR DEVELOPING A LIQUID COMPOSITION TO BE APPLIED TO THE SKIN AS A FOAM AND A COMPOSITION THAT CAN BE APPLIED TOPICALLY
G01N 33/50 (2006.01)	2646819 *	ASSAYS AND BIOMARKERS FOR LRRK2	A61Q 19/00 (2006.01)	2654665 *	METHOD FOR DEVELOPING A LIQUID COMPOSITION TO BE APPLIED TO THE SKIN AS A FOAM AND A COMPOSITION THAT CAN BE APPLIED TOPICALLY
B42D 15/10 (2006.01)	2665607 *	METHOD FOR PRODUCING A MULTILAYER DATA CARRIER AND DATA CARRIER PRODUCED BY SAID METHOD	G01F 22/00 (2006.01)	2654665 *	METHOD FOR DEVELOPING A LIQUID COMPOSITION TO BE APPLIED TO THE SKIN AS A FOAM AND A COMPOSITION THAT CAN BE APPLIED TOPICALLY
B01J 19/00 (2006.01)	2671635 *	TEMPERATURE CONTROL SYSTEM	G01N 13/02 (2006.01)	2654665 *	METHOD FOR DEVELOPING A LIQUID COMPOSITION TO BE APPLIED TO THE SKIN AS A FOAM AND A COMPOSITION THAT CAN BE APPLIED TOPICALLY
C10G 2/00 (2006.01)	2671635 *	TEMPERATURE CONTROL SYSTEM	C07D 401/06 (2006.01)	2699562 *	BICYCLIC HETEROCYCLE COMPOUNDS AND THEIR USES IN THERAPY
A61K 31/7048 (2006.01)	2678349 *	C-4" POSITION SUBSTITUTED MACROLIDE DERIVATIVE	C07D 471/04 (2006.01)	2699562 *	BICYCLIC HETEROCYCLE COMPOUNDS AND THEIR USES IN THERAPY
A61P 31/04 (2006.01)	2678349 *	C-4" POSITION SUBSTITUTED MACROLIDE DERIVATIVE	C07D 471/10 (2006.01)	2699562 *	BICYCLIC HETEROCYCLE COMPOUNDS AND THEIR USES IN THERAPY
C07H 17/08 (2006.01)	2678349 *	C-4" POSITION SUBSTITUTED MACROLIDE DERIVATIVE	F02M 27/04 (2006.01)	2699786 *	METHOD FOR OPTIMIZING COMBUSTION ENGINES
B65B 31/04 (2006.01)	2699491 *	IMPROVED FLAT PACKAGING OF PETRI DISHES FOR PROLONGED PRESERVATION AND METHOD OF PRODUCING THE SAME	A61K 31/422 (2006.01)	2573073	Pyrazoloquinolinone derivatives, preparation thereof and therapeutic use thereof
B65D 81/24 (2006.01)	2699491 *	IMPROVED FLAT PACKAGING OF PETRI DISHES FOR PROLONGED PRESERVATION AND METHOD OF PRODUCING THE SAME	A61P 35/00 (2006.01)	2573073	Pyrazoloquinolinone derivatives, preparation thereof and therapeutic use thereof
B65D 85/00 (2006.01)	2699491 *	IMPROVED FLAT PACKAGING OF PETRI DISHES FOR PROLONGED PRESERVATION AND METHOD OF PRODUCING THE SAME	C07C 229/40 (2006.01)	2573073	Pyrazoloquinolinone derivatives, preparation thereof and therapeutic use thereof
B63B 27/14 (2006.01)	2673417 *	A MOVABLE PASSENGER BRIDGE FOR A SHIP	C07D 231/14 (2006.01)	2573073	Pyrazoloquinolinone derivatives, preparation thereof and therapeutic use thereof
E01D 15/24 (2006.01)	2673417 *	A MOVABLE PASSENGER BRIDGE FOR A SHIP	C07D 471/04 (2006.01)	2573073	Pyrazoloquinolinone derivatives, preparation thereof and therapeutic use thereof
A61K 8/04 (2006.01)	2654665 *	METHOD FOR DEVELOPING A LIQUID COMPOSITION TO BE APPLIED TO THE SKIN AS A FOAM AND A COMPOSITION THAT CAN BE APPLIED TOPICALLY			

MKP (51)	Broj objave evropske prijave patenta (97)	Naziv pronalaska (54)	MKP (51)	Broj objave evropske prijave patenta (97)	Naziv pronalaska (54)
B01L 3/00 (2006.01)	2683483 *	DISPOSABLE CARTRIDGE FOR PREPARING A SAMPLE FLUID CONTAINING CELLS FOR ANALYSIS	A61K 31/201 (2006.01)	2691086 *	COMPOSITIONS FOR THE TREATMENT OF NEUROLOGIC DISORDERS
H04L 9/14 (2006.01)	2650813 *	DEVICE AND METHOD FOR GENERATING AN IDENTIFICATION KEY	A61K 31/202 (2006.01)	2691086 *	COMPOSITIONS FOR THE TREATMENT OF NEUROLOGIC DISORDERS
A61K 39/00 (2006.01)	2651434 *	HLA-BINDING PEPTIDES DERIVED FROM PROSTATE-ASSOCIATED ANTIGENIC MOLECULES AND METHODS OF USE THEREOF	A61K 31/203 (2006.01)	2691086 *	COMPOSITIONS FOR THE TREATMENT OF NEUROLOGIC DISORDERS
C07K 14/47 (2006.01)	2651434 *	HLA-BINDING PEPTIDES DERIVED FROM PROSTATE-ASSOCIATED ANTIGENIC MOLECULES AND METHODS OF USE THEREOF	A61K 31/355 (2006.01)	2691086 *	COMPOSITIONS FOR THE TREATMENT OF NEUROLOGIC DISORDERS
C07K 14/705 (2006.01)	2651434 *	HLA-BINDING PEPTIDES DERIVED FROM PROSTATE-ASSOCIATED ANTIGENIC MOLECULES AND METHODS OF USE THEREOF	A61P 25/16 (2006.01)	2691086 *	COMPOSITIONS FOR THE TREATMENT OF NEUROLOGIC DISORDERS
A61K 31/64 (2006.01)	2691109 *	PREVENTION OF HYPOGLYCAEMIA IN DIABETES MELLITUS TYPE 2 PATIENTS	A61P 25/28 (2006.01)	2691086 *	COMPOSITIONS FOR THE TREATMENT OF NEUROLOGIC DISORDERS
A61K 38/26 (2006.01)	2691109 *	PREVENTION OF HYPOGLYCAEMIA IN DIABETES MELLITUS TYPE 2 PATIENTS	A61P 43/00 (2006.01)	2691086 *	COMPOSITIONS FOR THE TREATMENT OF NEUROLOGIC DISORDERS
A61P 3/08 (2006.01)	2691109 *	PREVENTION OF HYPOGLYCAEMIA IN DIABETES MELLITUS TYPE 2 PATIENTS	A61K 31/497 (2006.01)	2646448 *	MACROCYCLIC KINASE INHIBITORS
A61M 5/145 (2006.01)	2658589 *	DEDICATED CARTRIDGE AND HOLDER	C07F 9/40 (2006.01)	2646448 *	MACROCYCLIC KINASE INHIBITORS
A61M 5/24 (2006.01)	2658589 *	DEDICATED CARTRIDGE AND HOLDER	A61K 31/70 (2006.01)	2697217 *	GLYCOSIDE DERIVATIVES AND THEIR USES FOR THE TREATMENT OF DIABETES
A61M 5/315 (2006.01)	2658589 *	DEDICATED CARTRIDGE AND HOLDER	A61P 3/10 (2006.01)	2697217 *	GLYCOSIDE DERIVATIVES AND THEIR USES FOR THE TREATMENT OF DIABETES
A61K 47/48 (2006.01)	2675479 *	CYTOTOXIC BENZODIAZEPINE DERIVATIVES	C07D 405/10 (2006.01)	2697217 *	GLYCOSIDE DERIVATIVES AND THEIR USES FOR THE TREATMENT OF DIABETES
A61P 35/00 (2006.01)	2675479 *	CYTOTOXIC BENZODIAZEPINE DERIVATIVES	A61K 9/16 (2006.01)	2662075	Taste masking compositions of praziquantel
C07D 487/04 (2006.01)	2675479 *	CYTOTOXIC BENZODIAZEPINE DERIVATIVES	A61K 47/44 (2006.01)	2662075	Taste masking compositions of praziquantel
C07D 519/00 (2006.01)	2675479 *	CYTOTOXIC BENZODIAZEPINE DERIVATIVES	A61K 39/10 (2006.01)	2670432 *	IMMUNOGENIC BORDETELLA BRONCHISEPTICA COMPOSITIONS
A61K 9/08 (2006.01)	2691086 *	COMPOSITIONS FOR THE TREATMENT OF NEUROLOGIC DISORDERS	A61K 39/295 (2006.01)	2670432 *	IMMUNOGENIC BORDETELLA BRONCHISEPTICA COMPOSITIONS
A61K 31/015 (2006.01)	2691086 *	COMPOSITIONS FOR THE TREATMENT OF NEUROLOGIC DISORDERS	C07K 14/235 (2006.01)	2670432 *	IMMUNOGENIC BORDETELLA BRONCHISEPTICA COMPOSITIONS
			A61K 31/519 (2006.01)	2670754 *	(1,2,4)TRIAZOLO[4,3-A] QUINOXALINE DERIVATIVES AS INHIBITORS OF PHOSPHODIESTERASES
			A61P 25/00 (2006.01)	2670754 *	(1,2,4)TRIAZOLO[4,3-A] QUINOXALINE DERIVATIVES AS INHIBITORS OF PHOSPHODIESTERASES
			C07D 487/04 (2006.01)	2670754 *	(1,2,4)TRIAZOLO[4,3-A] QUINOXALINE DERIVATIVES AS INHIBITORS OF PHOSPHODIESTERASES

MKP (51)	Broj objave evropske prijave patenta (97)	Naziv pronalaska (54)	MKP (51)	Broj objave evropske prijave patenta (97)	Naziv pronalaska (54)
A61K 9/00 (2006.01)	2691087 *	PHARMACEUTICAL COMPOSITION CONTAINING NO, PROCESS FOR THE PREPARATION AND USE THEREOF	A61K 31/506 (2006.01)	2604604	Benzofuranyl derivatives used as glucokinase inhibitors
A61K 31/04 (2006.01)	2691087 *	PHARMACEUTICAL COMPOSITION CONTAINING NO, PROCESS FOR THE PREPARATION AND USE THEREOF	A61P 3/04 (2006.01)	2604604	Benzofuranyl derivatives used as glucokinase inhibitors
A61K 33/04 (2006.01)	2691087 *	PHARMACEUTICAL COMPOSITION CONTAINING NO, PROCESS FOR THE PREPARATION AND USE THEREOF	A61P 3/10 (2006.01)	2604604	Benzofuranyl derivatives used as glucokinase inhibitors
A61K 47/06 (2006.01)	2691087 *	PHARMACEUTICAL COMPOSITION CONTAINING NO, PROCESS FOR THE PREPARATION AND USE THEREOF	C07D 405/14 (2006.01)	2604604	Benzofuranyl derivatives used as glucokinase inhibitors
A61P 9/10 (2006.01)	2691087 *	PHARMACEUTICAL COMPOSITION CONTAINING NO, PROCESS FOR THE PREPARATION AND USE THEREOF	E03C 1/122 (2006.01)	2685013	Pressure regulating device and use thereof
A61P 9/12 (2006.01)	2691087 *	PHARMACEUTICAL COMPOSITION CONTAINING NO, PROCESS FOR THE PREPARATION AND USE THEREOF	E03F 5/08 (2006.01)	2685013	Pressure regulating device and use thereof
A61P 17/06 (2006.01)	2691087 *	PHARMACEUTICAL COMPOSITION CONTAINING NO, PROCESS FOR THE PREPARATION AND USE THEREOF	F16K 17/19 (2006.01)	2685013	Pressure regulating device and use thereof
A61P 17/10 (2006.01)	2691087 *	PHARMACEUTICAL COMPOSITION CONTAINING NO, PROCESS FOR THE PREPARATION AND USE THEREOF	A23G 1/56 (2006.01)	2670253 *	REDUCED-CALORIE COMPOSITIONS FOR PRODUCING INSTANT DRINKS CONTAINING COCOA
A61P 25/24 (2006.01)	2691087 *	PHARMACEUTICAL COMPOSITION CONTAINING NO, PROCESS FOR THE PREPARATION AND USE THEREOF	A23L 1/236 (2006.01)	2670253 *	REDUCED-CALORIE COMPOSITIONS FOR PRODUCING INSTANT DRINKS CONTAINING COCOA
A61P 29/00 (2006.01)	2691087 *	PHARMACEUTICAL COMPOSITION CONTAINING NO, PROCESS FOR THE PREPARATION AND USE THEREOF	A23J 1/14 (2006.01)	2651238 *	SOY PROTEIN PRODUCTS OF IMPROVED WATER-BINDING CAPACITY
A61P 31/00 (2006.01)	2691087 *	PHARMACEUTICAL COMPOSITION CONTAINING NO, PROCESS FOR THE PREPARATION AND USE THEREOF	A23J 3/16 (2006.01)	2651238 *	SOY PROTEIN PRODUCTS OF IMPROVED WATER-BINDING CAPACITY
C09C 1/02 (2006.01)	2662419	Charge controlled PHCH	C07K 1/14 (2006.01)	2651238 *	SOY PROTEIN PRODUCTS OF IMPROVED WATER-BINDING CAPACITY
D21H 17/00 (2006.01)	2662419	Charge controlled PHCH	A61K 31/201 (2006.01)	2680837 *	COMPOSITIONS AND METHODS COMPRISING C16:1n7-PALMITOLEATE
A61K 31/497 (2006.01)	2604604	Benzofuranyl derivatives used as glucokinase inhibitors	A61K 31/231 (2006.01)	2680837 *	COMPOSITIONS AND METHODS COMPRISING C16:1n7-PALMITOLEATE
			A61P 3/06 (2006.01)	2680837 *	COMPOSITIONS AND METHODS COMPRISING C16:1n7-PALMITOLEATE
			A61P 9/00 (2006.01)	2680837 *	COMPOSITIONS AND METHODS COMPRISING C16:1n7-PALMITOLEATE
			A61P 9/10 (2006.01)	2680837 *	COMPOSITIONS AND METHODS COMPRISING C16:1n7-PALMITOLEATE
			A61K 38/18 (2006.01)	2655408 *	ROBO1-FC FUSION PROTEIN FOR USE IN THE TREATMENT OF HEPATOCARCINOMA
			C07K 14/475 (2006.01)	2655408 *	ROBO1-FC FUSION PROTEIN FOR USE IN THE TREATMENT OF HEPATOCARCINOMA
			A01N 57/00 (2006.01)	2675278 *	METHODS FOR SYNTHESIZING MOLYBDOPTERIN PRECURSOR Z DERIVATIVES

MKP (51)	Broj objave evropske prijave patenta (97)	Naziv pronalaska (54)	MKP (51)	Broj objave evropske prijave patenta (97)	Naziv pronalaska (54)
A61K 31/665 (2006.01)	2675278 *	METHODS FOR SYNTHESIZING MOLYBDOPTERIN PRECURSOR Z DERIVATIVES	E05D 15/06 (2006.01)	2586945	Carriage
C12Q 1/68 (2006.01)	2670867 *	A METHOD FOR DETECTING CHROMOSOME STRUCTURE AND GENE EXPRESSION SIMULTANEOUSLY IN SINGLE CELLS	A61K 9/00 (2006.01)	2654721 *	PHARMACEUTICAL COMPOSITIONS OF PYRIDINIUM AND QUINOLINIUM DERIVATIVES
F02B 75/32 (2006.01)	2652288 *	CRANKPIN INCLUDING CAM, CONNECTING ROD INCLUDING FOLLOWER, AND INTERNAL COMBUSTION ENGINE INCLUDING CRANKPIN AND CONNECTING ROD	A61K 9/127 (2006.01)	2654721 *	PHARMACEUTICAL COMPOSITIONS OF PYRIDINIUM AND QUINOLINIUM DERIVATIVES
G06F 21/00 (2006.01)	2447877	System and method for detection of malware and management of malware-related information	A61K 31/4425 (2006.01)	2654721 *	PHARMACEUTICAL COMPOSITIONS OF PYRIDINIUM AND QUINOLINIUM DERIVATIVES
C07D 409/10 (2006.01)	2697218 *	PROCESS FOR THE PREPARATION OF COMPOUNDS USEFUL AS INHIBITORS OF SGLT2	A61K 31/4706 (2006.01)	2654721 *	PHARMACEUTICAL COMPOSITIONS OF PYRIDINIUM AND QUINOLINIUM DERIVATIVES
C07D 409/14 (2006.01)	2697218 *	PROCESS FOR THE PREPARATION OF COMPOUNDS USEFUL AS INHIBITORS OF SGLT2	A61K 47/48 (2006.01)	2654721 *	PHARMACEUTICAL COMPOSITIONS OF PYRIDINIUM AND QUINOLINIUM DERIVATIVES
A61C 8/00 (2006.01)	2654603 *	CRESTAL IMPLANT AND METHOD FOR PROCESSING SAME	A61P 31/10 (2006.01)	2654721 *	PHARMACEUTICAL COMPOSITIONS OF PYRIDINIUM AND QUINOLINIUM DERIVATIVES
B41F 33/00 (2006.01)	2675623 *	METHOD AND DEVICE FOR THE CONTROL AND MANAGEMENT OF THE PRINTING PARAMETERS OF A PRINTING MACHINE, PARTICULARLY WITH A PLURALITY OF CONSECUTIVE PRINTING PROCESSES	A61P 31/12 (2006.01)	2654721 *	PHARMACEUTICAL COMPOSITIONS OF PYRIDINIUM AND QUINOLINIUM DERIVATIVES
E03F 5/04 (2006.01)	2551415	Process component	A61P 33/00 (2006.01)	2654721 *	PHARMACEUTICAL COMPOSITIONS OF PYRIDINIUM AND QUINOLINIUM DERIVATIVES
A61K 31/13 (2006.01)	2661421 *	NICOTINIC RECEPTOR NON-COMPETITIVE ANTAGONISTS	A61P 35/00 (2006.01)	2654721 *	PHARMACEUTICAL COMPOSITIONS OF PYRIDINIUM AND QUINOLINIUM DERIVATIVES
A61P 9/12 (2006.01)	2661421 *	NICOTINIC RECEPTOR NON-COMPETITIVE ANTAGONISTS	F24D 3/12 (2006.01)	2689192 *	A HEAT ENERGY SYSTEM FOR HEATING OR MAINTAINING THERMAL BALANCE IN THE INTERIORS OF BUILDINGS OR BUILDING PARTS
C07C 211/35 (2006.01)	2661421 *	NICOTINIC RECEPTOR NON-COMPETITIVE ANTAGONISTS	F24J 2/04 (2006.01)	2689192 *	A HEAT ENERGY SYSTEM FOR HEATING OR MAINTAINING THERMAL BALANCE IN THE INTERIORS OF BUILDINGS OR BUILDING PARTS
A61K 31/4188 (2006.01)	2651903 *	BENZIMIDAZOLE RESPIRATORY SYNCYTIAL VIRUS INHIBITORS	A47G 1/20 (2006.01)	2592286	Anchors and anchor systems for hanging objects, and a tool for installing such anchors
A61P 11/00 (2006.01)	2651903 *	BENZIMIDAZOLE RESPIRATORY SYNCYTIAL VIRUS INHIBITORS	A47G 25/06 (2006.01)	2592286	Anchors and anchor systems for hanging objects, and a tool for installing such anchors
C07D 235/26 (2006.01)	2651903 *	BENZIMIDAZOLE RESPIRATORY SYNCYTIAL VIRUS INHIBITORS	B25C 1/02 (2006.01)	2592286	Anchors and anchor systems for hanging objects, and a tool for installing such anchors
C07D 471/04 (2006.01)	2651903 *	BENZIMIDAZOLE RESPIRATORY SYNCYTIAL VIRUS INHIBITORS	B25C 5/16 (2006.01)	2592286	Anchors and anchor systems for hanging objects, and a tool for installing such anchors

MKP (51)	Broj objave evropske prijave patenta (97)	Naziv pronalaska (54)	MKP (51)	Broj objave evropske prijave patenta (97)	Naziv pronalaska (54)
F16B 43/02 (2006.01)	2592286	Anchors and anchor systems for hanging objects, and a tool for installing such anchors	C07D 239/70 (2006.01)	2694073 *	COMBINATIONS OF AKT AND MEK INHIBITOR COMPOUNDS, AND METHODS OF USE
G06F 9/44 (2006.01)	2663931 *	A SYSTEM AND METHOD FOR RUNNING APPLICATIONS ON A PLATFORM	A61K 31/343 (2006.01)	2649453 *	USE OF DRONEDARONE FOR THE PREPARATION OF A DRUG FOR USE IN THE MANAGEMENT OF THE RISK OF LIVER INJURY
G06F 9/445 (2006.01)	2663931 *	A SYSTEM AND METHOD FOR RUNNING APPLICATIONS ON A PLATFORM	G01N 33/68 (2006.01)	2649453 *	USE OF DRONEDARONE FOR THE PREPARATION OF A DRUG FOR USE IN THE MANAGEMENT OF THE RISK OF LIVER INJURY
G06F 9/46 (2006.01)	2663931 *	A SYSTEM AND METHOD FOR RUNNING APPLICATIONS ON A PLATFORM	A61K 31/505 (2006.01)	2694484 *	PYRIMIDINE DERIVATIVES FOR THE TREATMENT OF VIRAL INFECTIONS
G06F 11/30 (2006.01)	2663931 *	A SYSTEM AND METHOD FOR RUNNING APPLICATIONS ON A PLATFORM	A61K 31/506 (2006.01)	2694484 *	PYRIMIDINE DERIVATIVES FOR THE TREATMENT OF VIRAL INFECTIONS
G06F 17/00 (2006.01)	2663931 *	A SYSTEM AND METHOD FOR RUNNING APPLICATIONS ON A PLATFORM	C07D 239/48 (2006.01)	2694484 *	PYRIMIDINE DERIVATIVES FOR THE TREATMENT OF VIRAL INFECTIONS
G06F 17/30 (2006.01)	2663931 *	A SYSTEM AND METHOD FOR RUNNING APPLICATIONS ON A PLATFORM	C07D 401/12 (2006.01)	2694484 *	PYRIMIDINE DERIVATIVES FOR THE TREATMENT OF VIRAL INFECTIONS
F16D 27/112 (2006.01)	2518359	Coupling device for a vehicle assembly and control method	C07D 403/12 (2006.01)	2694484 *	PYRIMIDINE DERIVATIVES FOR THE TREATMENT OF VIRAL INFECTIONS
F16D 27/14 (2006.01)	2518359	Coupling device for a vehicle assembly and control method	C07D 405/12 (2006.01)	2694484 *	PYRIMIDINE DERIVATIVES FOR THE TREATMENT OF VIRAL INFECTIONS
F16D 28/00 (2006.01)	2518359	Coupling device for a vehicle assembly and control method	C07D 413/12 (2006.01)	2694484 *	PYRIMIDINE DERIVATIVES FOR THE TREATMENT OF VIRAL INFECTIONS
F16D 43/25 (2006.01)	2518359	Coupling device for a vehicle assembly and control method	C07D 471/04 (2006.01)	2694484 *	PYRIMIDINE DERIVATIVES FOR THE TREATMENT OF VIRAL INFECTIONS
C07K 14/005 (2006.01)	2699586 *	METHODS FOR ISOLATING AND QUANTIFYING ANTIGEN FROM VACCINES	C12Q 1/68 (2006.01)	2670863 *	METHODS OF IDENTIFYING MULTIPLE EPITOPES IN CELLS
C12N 7/00 (2006.01)	2699586 *	METHODS FOR ISOLATING AND QUANTIFYING ANTIGEN FROM VACCINES	G01N 1/22 (2006.01)	2570810	Method for examination of air for the presence of biological substances by means of removable multi-well strips on which an immunological assay is performed directly
G01N 33/68 (2006.01)	2699586 *	METHODS FOR ISOLATING AND QUANTIFYING ANTIGEN FROM VACCINES	G01N 33/543 (2006.01)	2570810	Method for examination of air for the presence of biological substances by means of removable multi-well strips on which an immunological assay is performed directly
A61K 31/4178 (2006.01)	2651926 *	ANTI-VIRAL COMPOUNDS	C07K 16/40 (2006.01)	2668212 *	HUMAN ANTIBODIES TO PCSK9 FOR USE IN METHODS OF TREATING PARTICULAR GROUPS OF SUBJECTS
A61P 31/00 (2006.01)	2651926 *	ANTI-VIRAL COMPOUNDS	C07K 16/00 (2006.01)	2699596 *	PROSTATE-SPECIFIC MEMBRANE ANTIGEN BINDING PROTEINS AND RELATED COMPOSITIONS AND METHODS
C07D 403/10 (2006.01)	2651926 *	ANTI-VIRAL COMPOUNDS			
C07D 403/14 (2006.01)	2651926 *	ANTI-VIRAL COMPOUNDS			
C07D 409/14 (2006.01)	2651926 *	ANTI-VIRAL COMPOUNDS			
A61K 31/517 (2006.01)	2694073 *	COMBINATIONS OF AKT AND MEK INHIBITOR COMPOUNDS, AND METHODS OF USE			

MKP (51)	Broj objave evropske prijave patenta (97)	Naziv pronalaska (54)	MKP (51)	Broj objave evropske prijave patenta (97)	Naziv pronalaska (54)
A61K 31/437 (2006.01)	2657233 *	3,5-DISUBSTITUTED ALKYNYLBENZENE COMPOUND AND SALT THEREOF	A61K 9/20 (2006.01)	2648701 *	HIGHLY STABLE COMPOSITIONS OF ORALLY ACTIVE NUCLEOTIDE ANALOGUES OR ORALLY ACTIVE NUCLEOTIDE ANALOGUE PRODRUGS
A61K 31/519 (2006.01)	2657233 *	3,5-DISUBSTITUTED ALKYNYLBENZENE COMPOUND AND SALT THEREOF	A61K 31/675 (2006.01)	2648701 *	HIGHLY STABLE COMPOSITIONS OF ORALLY ACTIVE NUCLEOTIDE ANALOGUES OR ORALLY ACTIVE NUCLEOTIDE ANALOGUE PRODRUGS
A61K 31/5377 (2006.01)	2657233 *	3,5-DISUBSTITUTED ALKYNYLBENZENE COMPOUND AND SALT THEREOF	A61K 47/32 (2006.01)	2648701 *	HIGHLY STABLE COMPOSITIONS OF ORALLY ACTIVE NUCLEOTIDE ANALOGUES OR ORALLY ACTIVE NUCLEOTIDE ANALOGUE PRODRUGS
A61P 35/00 (2006.01)	2657233 *	3,5-DISUBSTITUTED ALKYNYLBENZENE COMPOUND AND SALT THEREOF	A61P 31/12 (2006.01)	2648701 *	HIGHLY STABLE COMPOSITIONS OF ORALLY ACTIVE NUCLEOTIDE ANALOGUES OR ORALLY ACTIVE NUCLEOTIDE ANALOGUE PRODRUGS
A61P 35/02 (2006.01)	2657233 *	3,5-DISUBSTITUTED ALKYNYLBENZENE COMPOUND AND SALT THEREOF	C08G 18/52 (2006.01)	2660262 *	METHOD FOR MANUFACTURING RESIN FOR URETHANE-BASED OPTICAL MATERIAL, RESIN COMPOSITION FOR SAME, AND OPTICAL MATERIAL MANUFACTURED THEREBY
A61P 43/00 (2006.01)	2657233 *	3,5-DISUBSTITUTED ALKYNYLBENZENE COMPOUND AND SALT THEREOF	C08G 18/70 (2006.01)	2660262 *	METHOD FOR MANUFACTURING RESIN FOR URETHANE-BASED OPTICAL MATERIAL, RESIN COMPOSITION FOR SAME, AND OPTICAL MATERIAL MANUFACTURED THEREBY
C07D 471/04 (2006.01)	2657233 *	3,5-DISUBSTITUTED ALKYNYLBENZENE COMPOUND AND SALT THEREOF	C08L 75/04 (2006.01)	2660262 *	METHOD FOR MANUFACTURING RESIN FOR URETHANE-BASED OPTICAL MATERIAL, RESIN COMPOSITION FOR SAME, AND OPTICAL MATERIAL MANUFACTURED THEREBY
C07D 487/04 (2006.01)	2657233 *	3,5-DISUBSTITUTED ALKYNYLBENZENE COMPOUND AND SALT THEREOF	G02B 1/04 (2006.01)	2660262 *	METHOD FOR MANUFACTURING RESIN FOR URETHANE-BASED OPTICAL MATERIAL, RESIN COMPOSITION FOR SAME, AND OPTICAL MATERIAL MANUFACTURED THEREBY
A01N 25/22 (2006.01)	2683236 *	COMPOSITIONS AND METHODS FOR CONTROLLING PESTICIDE RESISTANT PESTS	G02B 3/00 (2006.01)	2660262 *	METHOD FOR MANUFACTURING RESIN FOR URETHANE-BASED OPTICAL MATERIAL, RESIN COMPOSITION FOR SAME, AND OPTICAL MATERIAL MANUFACTURED THEREBY
A01N 43/40 (2006.01)	2683236 *	COMPOSITIONS AND METHODS FOR CONTROLLING PESTICIDE RESISTANT PESTS	A61K 31/165 (2006.01)	2690087 *	NEW CRYSTAL FORM VII OF AGOMELATINE, PREPARATION METHOD AND USE THEREOF AND PHARMACEUTICAL COMPOSITION CONTAINING SAME
A01N 47/40 (2006.01)	2683236 *	COMPOSITIONS AND METHODS FOR CONTROLLING PESTICIDE RESISTANT PESTS			
A01N 51/00 (2006.01)	2683236 *	COMPOSITIONS AND METHODS FOR CONTROLLING PESTICIDE RESISTANT PESTS			
A01P 7/00 (2006.01)	2683236 *	COMPOSITIONS AND METHODS FOR CONTROLLING PESTICIDE RESISTANT PESTS			
A61K 31/495 (2006.01)	2694518 *	THIENO [2, 3 -D]PYRIMIDINE DERIVATIVES AND THEIR USE TO TREAT ARRHYTHMIA			
A61P 9/00 (2006.01)	2694518 *	THIENO [2, 3 -D]PYRIMIDINE DERIVATIVES AND THEIR USE TO TREAT ARRHYTHMIA			
C07D 495/04 (2006.01)	2694518 *	THIENO [2, 3 -D]PYRIMIDINE DERIVATIVES AND THEIR USE TO TREAT ARRHYTHMIA			

MKP (51)	Broj objave evropske prijave patenta (97)	Naziv pronalaska (54)	MKP (51)	Broj objave evropske prijave patenta (97)	Naziv pronalaska (54)
A61P 1/00 (2006.01)	2690087 *	NEW CRYSTAL FORM VII OF AGOMELATINE, PREPARATION METHOD AND USE THEREOF AND PHARMACEUTICAL COMPOSITION CONTAINING SAME	C07H 19/06 (2006.01)	2691524 *	STACKING NUCLEIC ACID AND METHODS FOR USE THEREOF
A61P 9/00 (2006.01)	2690087 *	NEW CRYSTAL FORM VII OF AGOMELATINE, PREPARATION METHOD AND USE THEREOF AND PHARMACEUTICAL COMPOSITION CONTAINING SAME	C12N 15/11 (2006.01)	2691524 *	STACKING NUCLEIC ACID AND METHODS FOR USE THEREOF
A61P 25/00 (2006.01)	2690087 *	NEW CRYSTAL FORM VII OF AGOMELATINE, PREPARATION METHOD AND USE THEREOF AND PHARMACEUTICAL COMPOSITION CONTAINING SAME	C12Q 1/68 (2006.01)	2691524 *	STACKING NUCLEIC ACID AND METHODS FOR USE THEREOF
A61P 25/20 (2006.01)	2690087 *	NEW CRYSTAL FORM VII OF AGOMELATINE, PREPARATION METHOD AND USE THEREOF AND PHARMACEUTICAL COMPOSITION CONTAINING SAME	E04G 5/04 (2006.01)	2525107	Scaffolding anchoring device
A61P 25/22 (2006.01)	2690087 *	NEW CRYSTAL FORM VII OF AGOMELATINE, PREPARATION METHOD AND USE THEREOF AND PHARMACEUTICAL COMPOSITION CONTAINING SAME	F16B 13/00 (2006.01)	2525107	Scaffolding anchoring device
A61P 25/24 (2006.01)	2690087 *	NEW CRYSTAL FORM VII OF AGOMELATINE, PREPARATION METHOD AND USE THEREOF AND PHARMACEUTICAL COMPOSITION CONTAINING SAME	A61K 38/47 (2006.01)	2699676 *	MODIFIED ACID ALPHA GLUCOSIDASE WITH ACCELERATED PROCESSING
C07C 231/24 (2006.01)	2690087 *	NEW CRYSTAL FORM VII OF AGOMELATINE, PREPARATION METHOD AND USE THEREOF AND PHARMACEUTICAL COMPOSITION CONTAINING SAME	C12N 9/24 (2006.01)	2699676 *	MODIFIED ACID ALPHA GLUCOSIDASE WITH ACCELERATED PROCESSING
C07C 233/18 (2006.01)	2690087 *	NEW CRYSTAL FORM VII OF AGOMELATINE, PREPARATION METHOD AND USE THEREOF AND PHARMACEUTICAL COMPOSITION CONTAINING SAME	A61K 39/00 (2006.01)	2694109 *	COMPOSITIONS AND METHODS FOR TREATING DISEASES OF PROTEIN AGGREGATION INVOLVING IC3B DEPOSITION
E03F 5/042 (2006.01)	2685016	Shut-off device and drain with such a device	A61K 39/395 (2006.01)	2694109 *	COMPOSITIONS AND METHODS FOR TREATING DISEASES OF PROTEIN AGGREGATION INVOLVING IC3B DEPOSITION
A01N 43/42 (2006.01)	2685825 *	SUBSTITUTED IMADAZOPYRIMIDIN-5(6H)-ONES AS ALLOSTERIC MODULATORS OF MGLUR5 RECEPTORS	A61K 51/10 (2006.01)	2694109 *	COMPOSITIONS AND METHODS FOR TREATING DISEASES OF PROTEIN AGGREGATION INVOLVING IC3B DEPOSITION
			A61P 11/00 (2006.01)	2694109 *	COMPOSITIONS AND METHODS FOR TREATING DISEASES OF PROTEIN AGGREGATION INVOLVING IC3B DEPOSITION
			A61P 19/02 (2006.01)	2694109 *	COMPOSITIONS AND METHODS FOR TREATING DISEASES OF PROTEIN AGGREGATION INVOLVING IC3B DEPOSITION
			A61P 25/28 (2006.01)	2694109 *	COMPOSITIONS AND METHODS FOR TREATING DISEASES OF PROTEIN AGGREGATION INVOLVING IC3B DEPOSITION
			A61P 27/02 (2006.01)	2694109 *	COMPOSITIONS AND METHODS FOR TREATING DISEASES OF PROTEIN AGGREGATION INVOLVING IC3B DEPOSITION
			C07K 16/18 (2006.01)	2694109 *	COMPOSITIONS AND METHODS FOR TREATING DISEASES OF PROTEIN AGGREGATION INVOLVING IC3B DEPOSITION

MKP (51)	Broj objave evropske prijave patenta (97)	Naziv pronalaska (54)	MKP (51)	Broj objave evropske prijave patenta (97)	Naziv pronalaska (54)
C07K 16/46 (2006.01)	2694109 *	COMPOSITIONS AND METHODS FOR TREATING DISEASES OF PROTEIN AGGREGATION INVOLVING IC3B DEPOSITION	B60H 1/00 (2006.01)	2679420	Motor-driven compressor
C12P 21/02 (2006.01)	2694109 *	COMPOSITIONS AND METHODS FOR TREATING DISEASES OF PROTEIN AGGREGATION INVOLVING IC3B DEPOSITION	B60H 1/32 (2006.01)	2679420	Motor-driven compressor
C08B 37/10 (2006.01)	2655421 *	CHEMOENZYMATIC SYNTHESIS OF STRUCTURALLY HOMOGENEOUS ULTRA-LOW MOLECULAR WEIGHT HEPARINS	F04B 39/12 (2006.01)	2679420	Motor-driven compressor
C12N 9/00 (2006.01)	2655421 *	CHEMOENZYMATIC SYNTHESIS OF STRUCTURALLY HOMOGENEOUS ULTRA-LOW MOLECULAR WEIGHT HEPARINS	C04B 41/61 (2006.01)	2660224 *	WATERPROOFING COMPOSITION
C12P 19/04 (2006.01)	2655421 *	CHEMOENZYMATIC SYNTHESIS OF STRUCTURALLY HOMOGENEOUS ULTRA-LOW MOLECULAR WEIGHT HEPARINS	C04B 111/27 (2006.01)	2660224 *	WATERPROOFING COMPOSITION
C12P 19/18 (2006.01)	2655421 *	CHEMOENZYMATIC SYNTHESIS OF STRUCTURALLY HOMOGENEOUS ULTRA-LOW MOLECULAR WEIGHT HEPARINS	A61K 39/12 (2006.01)	2646459 *	PEPTIDE SCAFFOLD DESIGN
A61K 31/433 (2006.01)	2699581 *	2-OXO-1-IMIDAZOLIDINYL IMIDAZOTHIADIAZOLE DERIVATIVES	C07K 14/005 (2006.01)	2646459 *	PEPTIDE SCAFFOLD DESIGN
A61P 25/08 (2006.01)	2699581 *	2-OXO-1-IMIDAZOLIDINYL IMIDAZOTHIADIAZOLE DERIVATIVES	C07K 14/025 (2006.01)	2646459 *	PEPTIDE SCAFFOLD DESIGN
C07D 513/04 (2006.01)	2699581 *	2-OXO-1-IMIDAZOLIDINYL IMIDAZOTHIADIAZOLE DERIVATIVES	C07K 14/045 (2006.01)	2646459 *	PEPTIDE SCAFFOLD DESIGN
A61K 9/00 (2006.01)	2683360 *	PEGYLATED APELIN AND USES THEREOF	C07K 14/075 (2006.01)	2646459 *	PEPTIDE SCAFFOLD DESIGN
A61K 38/00 (2006.01)	2683360 *	PEGYLATED APELIN AND USES THEREOF	C07K 14/085 (2006.01)	2646459 *	PEPTIDE SCAFFOLD DESIGN
C09C 1/02 (2006.01)	2662417	Starch-based PHCH	C07K 14/11 (2006.01)	2646459 *	PEPTIDE SCAFFOLD DESIGN
D21H 17/00 (2006.01)	2662417	Starch-based PHCH	C07K 14/16 (2006.01)	2646459 *	PEPTIDE SCAFFOLD DESIGN
A61K 31/517 (2006.01)	2694069 *	USE OF SUBSTITUTED 2,3-DIHYDROIMIDAZO[1,2-C] QUINAZOLINES	C07K 14/18 (2006.01)	2646459 *	PEPTIDE SCAFFOLD DESIGN
A61P 35/00 (2006.01)	2694069 *	USE OF SUBSTITUTED 2,3-DIHYDROIMIDAZO[1,2-C] QUINAZOLINES	C07D 205/04 (2006.01)	2695881 *	GUANIDINE COMPOUND
G01N 33/48 (2006.01)	2694069 *	USE OF SUBSTITUTED 2,3-DIHYDROIMIDAZO[1,2-C] QUINAZOLINES	A61K 31/5377 (2006.01)	2695881 *	GUANIDINE COMPOUND
			A61P 9/10 (2006.01)	2695881 *	GUANIDINE COMPOUND
			A61K 31/495 (2006.01)	2695881 *	GUANIDINE COMPOUND
			A61P 1/16 (2006.01)	2695881 *	GUANIDINE COMPOUND
			A61K 31/506 (2006.01)	2695881 *	GUANIDINE COMPOUND
			A61P 9/00 (2006.01)	2695881 *	GUANIDINE COMPOUND
			A61K 31/426 (2006.01)	2695881 *	GUANIDINE COMPOUND

MKP (51)	Broj objave evropske prijave patenta (97)	Naziv pronalaska (54)	MKP (51)	Broj objave evropske prijave patenta (97)	Naziv pronalaska (54)
A61K 31/551 (2006.01)	2695881 *	GUANIDINE COMPOUND	C08J 5/08 (2006.01)	2691345 *	FIBER GLASS STRANDS AND REINFORCED PRODUCTS COMPRISING THE SAME
A61P 9/12 (2006.01)	2695881 *	GUANIDINE COMPOUND	A61F 13/02 (2006.01)	2700387 *	ADHESIVE TAPE PACKAGING BAG
A61K 31/4545 (2006.01)	2695881 *	GUANIDINE COMPOUND	A61K 9/70 (2006.01)	2700387 *	ADHESIVE TAPE PACKAGING BAG
A61P 1/04 (2006.01)	2695881 *	GUANIDINE COMPOUND	A61K 31/4427 (2006.01)	2697198 *	SUBSTITUTED BENZENE COMPOUNDS
A61K 31/505 (2006.01)	2695881 *	GUANIDINE COMPOUND	A61P 35/00 (2006.01)	2697198 *	SUBSTITUTED BENZENE COMPOUNDS
A61P 3/10 (2006.01)	2695881 *	GUANIDINE COMPOUND	C07D 213/64 (2006.01)	2697198 *	SUBSTITUTED BENZENE COMPOUNDS
A61K 31/4402 (2006.01)	2695881 *	GUANIDINE COMPOUND	C07D 401/12 (2006.01)	2697198 *	SUBSTITUTED BENZENE COMPOUNDS
A61P 1/02 (2006.01)	2695881 *	GUANIDINE COMPOUND	C07D 401/14 (2006.01)	2697198 *	SUBSTITUTED BENZENE COMPOUNDS
A61P 11/00 (2006.01)	2695881 *	GUANIDINE COMPOUND	C07D 407/12 (2006.01)	2697198 *	SUBSTITUTED BENZENE COMPOUNDS
A61K 31/496 (2006.01)	2695881 *	GUANIDINE COMPOUND	C07D 409/12 (2006.01)	2697198 *	SUBSTITUTED BENZENE COMPOUNDS
A61P 3/04 (2006.01)	2695881 *	GUANIDINE COMPOUND	C07D 413/12 (2006.01)	2697198 *	SUBSTITUTED BENZENE COMPOUNDS
C12N 5/075 (2010.01)	2697365 *	COMPOSITIONS AND METHODS FOR AUTOLOGOUS GERMLINE MITOCHONDRIAL ENERGY TRANSFER	C07D 413/14 (2006.01)	2697198 *	SUBSTITUTED BENZENE COMPOUNDS
A61K 38/48 (2006.01)	2661493 *	PLASMINOGEN AND PLASMIN VARIANTS	C07D 491/10 (2006.01)	2697198 *	SUBSTITUTED BENZENE COMPOUNDS
C12N 9/68 (2006.01)	2661493 *	PLASMINOGEN AND PLASMIN VARIANTS	C07D 491/113 (2006.01)	2697198 *	SUBSTITUTED BENZENE COMPOUNDS
A61G 5/04 (2013.01)	2606867	Powered wheelchair	A61B 17/86 (2006.01)	2699187 *	MEDICAL ASSEMBLY COMPRISING A MEDICAL ARTICLE AND A PACKAGE CONTAINING SAID ARTICLE
A61K 31/4196 (2006.01)	2678014 *	PROSTATE CANCER THERAPY WITH HSP90 INHIBITORY COMPOUNDS	A61B 19/02 (2006.01)	2699187 *	MEDICAL ASSEMBLY COMPRISING A MEDICAL ARTICLE AND A PACKAGE CONTAINING SAID ARTICLE
A61K 31/661 (2006.01)	2678014 *	PROSTATE CANCER THERAPY WITH HSP90 INHIBITORY COMPOUNDS	A61C 8/00 (2006.01)	2699187 *	MEDICAL ASSEMBLY COMPRISING A MEDICAL ARTICLE AND A PACKAGE CONTAINING SAID ARTICLE
A61K 45/06 (2006.01)	2678014 *	PROSTATE CANCER THERAPY WITH HSP90 INHIBITORY COMPOUNDS	A61F 2/00 (2006.01)	2699187 *	MEDICAL ASSEMBLY COMPRISING A MEDICAL ARTICLE AND A PACKAGE CONTAINING SAID ARTICLE
A61P 35/00 (2006.01)	2678014 *	PROSTATE CANCER THERAPY WITH HSP90 INHIBITORY COMPOUNDS	A61L 2/26 (2006.01)	2699187 *	MEDICAL ASSEMBLY COMPRISING A MEDICAL ARTICLE AND A PACKAGE CONTAINING SAID ARTICLE
C03C 25/24 (2006.01)	2691345 *	FIBER GLASS STRANDS AND REINFORCED PRODUCTS COMPRISING THE SAME			
C03C 25/26 (2006.01)	2691345 *	FIBER GLASS STRANDS AND REINFORCED PRODUCTS COMPRISING THE SAME			
C03C 25/40 (2006.01)	2691345 *	FIBER GLASS STRANDS AND REINFORCED PRODUCTS COMPRISING THE SAME			

MKP (51)	Broj objave evropske prijave patenta (97)	Naziv pronalaska (54)	MKP (51)	Broj objave evropske prijave patenta (97)	Naziv pronalaska (54)
A61K 31/4164 (2006.01)	2655336 *	CANCER TARGETING USING CARBONIC ANHYDRASE ISOFORM IX INHIBITORS	A61P 3/02 (2006.01)	2670415 *	FUNCTIONAL FOODS AND BEVERAGES WITH SYNERGISTIC PROPERTIES TO PROMOTE HOMEOSTASIS
C07D 233/88 (2006.01)	2655336 *	CANCER TARGETING USING CARBONIC ANHYDRASE ISOFORM IX INHIBITORS	A61P 29/00 (2006.01)	2670415 *	FUNCTIONAL FOODS AND BEVERAGES WITH SYNERGISTIC PROPERTIES TO PROMOTE HOMEOSTASIS
C07D 233/91 (2006.01)	2655336 *	CANCER TARGETING USING CARBONIC ANHYDRASE ISOFORM IX INHIBITORS	A61P 39/06 (2006.01)	2670415 *	FUNCTIONAL FOODS AND BEVERAGES WITH SYNERGISTIC PROPERTIES TO PROMOTE HOMEOSTASIS
A61K 31/5377 (2006.01)	2663561 *	NOVEL HETEROCYCLIC DERIVATIVES AND THEIR USE IN THE TREATMENT OF NEUROLOGICAL DISORDERS	C12Q 1/02 (2006.01)	2670415 *	FUNCTIONAL FOODS AND BEVERAGES WITH SYNERGISTIC PROPERTIES TO PROMOTE HOMEOSTASIS
A61P 25/00 (2006.01)	2663561 *	NOVEL HETEROCYCLIC DERIVATIVES AND THEIR USE IN THE TREATMENT OF NEUROLOGICAL DISORDERS	G01N 33/48 (2006.01)	2670415 *	FUNCTIONAL FOODS AND BEVERAGES WITH SYNERGISTIC PROPERTIES TO PROMOTE HOMEOSTASIS
C07D 413/14 (2006.01)	2663561 *	NOVEL HETEROCYCLIC DERIVATIVES AND THEIR USE IN THE TREATMENT OF NEUROLOGICAL DISORDERS	F02C 7/08 (2006.01)	2673490 *	RADIATION SHIELD FOR A GAS TURBINE COMBUSTOR
C07D 487/04 (2006.01)	2663561 *	NOVEL HETEROCYCLIC DERIVATIVES AND THEIR USE IN THE TREATMENT OF NEUROLOGICAL DISORDERS	F17C 13/08 (2006.01)	2686602 *	ARRANGEMENT FOR STORING AND EXTRACTING COMPRESSED GAS
A61K 9/20 (2006.01)	2694039 *	SOLID PREPARATION	G08G 1/08 (2006.01)	2682927 *	VEHICLE TRAFFIC CONTROL METHOD AND DEVICE FOR IMPLEMENTING SAME
A61K 31/4188 (2006.01)	2694039 *	SOLID PREPARATION	B07C 5/12 (2006.01)	2691762 *	OPTICAL INSPECTION OF CONTAINERS
A61K 36/00 (2006.01)	2670415 *	FUNCTIONAL FOODS AND BEVERAGES WITH SYNERGISTIC PROPERTIES TO PROMOTE HOMEOSTASIS	G01N 21/90 (2006.01)	2691762 *	OPTICAL INSPECTION OF CONTAINERS
A61K 36/28 (2006.01)	2670415 *	FUNCTIONAL FOODS AND BEVERAGES WITH SYNERGISTIC PROPERTIES TO PROMOTE HOMEOSTASIS	H04N 7/18 (2006.01)	2681910 *	METHOD AND APPARATUS FOR REAL TIME VIDEO IMAGING OF THE SNOUT INTERIOR ON A HOT DIP COATING LINE
A61K 36/45 (2006.01)	2670415 *	FUNCTIONAL FOODS AND BEVERAGES WITH SYNERGISTIC PROPERTIES TO PROMOTE HOMEOSTASIS	C07D 307/22 (2006.01)	2665716 *	METHODS AND COMPOUNDS USEFUL IN THE SYNTHESIS OF FUSED AMINODIHYDROTHIAZINE DERIVATIVES
A61K 36/53 (2006.01)	2670415 *	FUNCTIONAL FOODS AND BEVERAGES WITH SYNERGISTIC PROPERTIES TO PROMOTE HOMEOSTASIS	C07D 498/04 (2006.01)	2665716 *	METHODS AND COMPOUNDS USEFUL IN THE SYNTHESIS OF FUSED AMINODIHYDROTHIAZINE DERIVATIVES
A61K 36/539 (2006.01)	2670415 *	FUNCTIONAL FOODS AND BEVERAGES WITH SYNERGISTIC PROPERTIES TO PROMOTE HOMEOSTASIS	C07D 513/04 (2006.01)	2665716 *	METHODS AND COMPOUNDS USEFUL IN THE SYNTHESIS OF FUSED AMINODIHYDROTHIAZINE DERIVATIVES
A61K 36/73 (2006.01)	2670415 *	FUNCTIONAL FOODS AND BEVERAGES WITH SYNERGISTIC PROPERTIES TO PROMOTE HOMEOSTASIS	H02J 7/00 (2006.01)	2575235	Battery control system
A61K 36/734 (2006.01)	2670415 *	FUNCTIONAL FOODS AND BEVERAGES WITH SYNERGISTIC PROPERTIES TO PROMOTE HOMEOSTASIS	C12N 5/02 (2006.01)	2658966 *	DIFFERENTIATION OF HUMAN PLURIPOTENT STEM CELLS TO MULTIPOTENT NEURAL CREST CELLS
A61K 36/77 (2006.01)	2670415 *	FUNCTIONAL FOODS AND BEVERAGES WITH SYNERGISTIC PROPERTIES TO PROMOTE HOMEOSTASIS	C12N 5/0735 (2010.01)	2658966 *	DIFFERENTIATION OF HUMAN PLURIPOTENT STEM CELLS TO MULTIPOTENT NEURAL CREST CELLS

MKP (51)	Broj objave evropske prijave patenta (97)	Naziv pronalaska (54)	MKP (51)	Broj objave evropske prijave patenta (97)	Naziv pronalaska (54)
C12N 5/079 (2010.01)	2658966 *	DIFFERENTIATION OF HUMAN PLURIPOTENT STEM CELLS TO MULTIPOTENT NEURAL CREST CELLS	C07D 513/04 (2006.01)	2694491 *	BENZODIOXEPINE AND BENZODIOXINE COMPOUNDS THAT INTERACT WITH GLUCOKINASE REGULATORY PROTEIN FOR THE TREATMENT OF DIABETES
E03F 5/042 (2006.01)	2685017	Bi-directional shut-off valve system, manhole assembly comprising such valve system and use of such valve system in a sewer network	C07D 409/12 (2006.01)	2694491 *	BENZODIOXEPINE AND BENZODIOXINE COMPOUNDS THAT INTERACT WITH GLUCOKINASE REGULATORY PROTEIN FOR THE TREATMENT OF DIABETES
G01N 33/574 (2006.01)	2694972 *	METHODS FOR PREDICTING AND IMPROVING THE SURVIVAL OF GASTRIC CANCER PATIENTS	A61K 31/381 (2006.01)	2694491 *	BENZODIOXEPINE AND BENZODIOXINE COMPOUNDS THAT INTERACT WITH GLUCOKINASE REGULATORY PROTEIN FOR THE TREATMENT OF DIABETES
A01N 43/40 (2006.01)	2683243 *	PI3 KINASE INHIBITORS AND USES THEREOF	C07D 407/12 (2006.01)	2694491 *	BENZODIOXEPINE AND BENZODIOXINE COMPOUNDS THAT INTERACT WITH GLUCOKINASE REGULATORY PROTEIN FOR THE TREATMENT OF DIABETES
A61K 31/435 (2006.01)	2683243 *	PI3 KINASE INHIBITORS AND USES THEREOF	C07D 495/04 (2006.01)	2694491 *	BENZODIOXEPINE AND BENZODIOXINE COMPOUNDS THAT INTERACT WITH GLUCOKINASE REGULATORY PROTEIN FOR THE TREATMENT OF DIABETES
C07D 213/56 (2006.01)	2683243 *	PI3 KINASE INHIBITORS AND USES THEREOF	C07D 413/12 (2006.01)	2694491 *	BENZODIOXEPINE AND BENZODIOXINE COMPOUNDS THAT INTERACT WITH GLUCOKINASE REGULATORY PROTEIN FOR THE TREATMENT OF DIABETES
C07D 273/00 (2006.01)	2683243 *	PI3 KINASE INHIBITORS AND USES THEREOF	C07D 409/14 (2006.01)	2694491 *	BENZODIOXEPINE AND BENZODIOXINE COMPOUNDS THAT INTERACT WITH GLUCOKINASE REGULATORY PROTEIN FOR THE TREATMENT OF DIABETES
A01K 67/027 (2006.01)	2663575 *	HUMANIZED IL-6 AND IL-6 RECEPTOR	C07D 413/12 (2006.01)	2694491 *	BENZODIOXEPINE AND BENZODIOXINE COMPOUNDS THAT INTERACT WITH GLUCOKINASE REGULATORY PROTEIN FOR THE TREATMENT OF DIABETES
C07K 14/54 (2006.01)	2663575 *	HUMANIZED IL-6 AND IL-6 RECEPTOR	C07D 409/14 (2006.01)	2694491 *	BENZODIOXEPINE AND BENZODIOXINE COMPOUNDS THAT INTERACT WITH GLUCOKINASE REGULATORY PROTEIN FOR THE TREATMENT OF DIABETES
C07K 14/715 (2006.01)	2663575 *	HUMANIZED IL-6 AND IL-6 RECEPTOR	A61K 31/422 (2006.01)	2694491 *	BENZODIOXEPINE AND BENZODIOXINE COMPOUNDS THAT INTERACT WITH GLUCOKINASE REGULATORY PROTEIN FOR THE TREATMENT OF DIABETES
A61K 31/4184 (2006.01)	2651923 *	ANTI-VIRAL COMPOUNDS	C07D 333/58 (2006.01)	2694491 *	BENZODIOXEPINE AND BENZODIOXINE COMPOUNDS THAT INTERACT WITH GLUCOKINASE REGULATORY PROTEIN FOR THE TREATMENT OF DIABETES
A61P 31/14 (2006.01)	2651923 *	ANTI-VIRAL COMPOUNDS	C07D 417/14 (2006.01)	2694491 *	BENZODIOXEPINE AND BENZODIOXINE COMPOUNDS THAT INTERACT WITH GLUCOKINASE REGULATORY PROTEIN FOR THE TREATMENT OF DIABETES
C07D 403/04 (2006.01)	2651923 *	ANTI-VIRAL COMPOUNDS			
C07D 403/10 (2006.01)	2651923 *	ANTI-VIRAL COMPOUNDS			
C07D 403/12 (2006.01)	2651923 *	ANTI-VIRAL COMPOUNDS			
C07D 403/14 (2006.01)	2651923 *	ANTI-VIRAL COMPOUNDS			
C07D 407/14 (2006.01)	2694491 *	BENZODIOXEPINE AND BENZODIOXINE COMPOUNDS THAT INTERACT WITH GLUCOKINASE REGULATORY PROTEIN FOR THE TREATMENT OF DIABETES			

MKP (51)	Broj objave evropske prijave patenta (97)	Naziv pronalaska (54)	MKP (51)	Broj objave evropske prijave patenta (97)	Naziv pronalaska (54)
C07D 321/10 (2006.01)	2694491 *	BENZODIOXEPINE AND BENZODIOXINE COMPOUNDS THAT INTERACT WITH GLUCOKINASE REGULATORY PROTEIN FOR THE TREATMENT OF DIABETES	A01N 43/54 (2006.01)	2696694 *	HERBICIDAL COMPOSITION COMPRISING FLAZASULFURON AND AN INHIBITOR OF PROTOPORPHYRINOGEN OXIDASE
C07D 417/12 (2006.01)	2694491 *	BENZODIOXEPINE AND BENZODIOXINE COMPOUNDS THAT INTERACT WITH GLUCOKINASE REGULATORY PROTEIN FOR THE TREATMENT OF DIABETES	A01N 43/56 (2006.01)	2696694 *	HERBICIDAL COMPOSITION COMPRISING FLAZASULFURON AND AN INHIBITOR OF PROTOPORPHYRINOGEN OXIDASE
C07D 409/04 (2006.01)	2694491 *	BENZODIOXEPINE AND BENZODIOXINE COMPOUNDS THAT INTERACT WITH GLUCOKINASE REGULATORY PROTEIN FOR THE TREATMENT OF DIABETES	A01N 43/58 (2006.01)	2696694 *	HERBICIDAL COMPOSITION COMPRISING FLAZASULFURON AND AN INHIBITOR OF PROTOPORPHYRINOGEN OXIDASE
A61K 31/357 (2006.01)	2694491 *	BENZODIOXEPINE AND BENZODIOXINE COMPOUNDS THAT INTERACT WITH GLUCOKINASE REGULATORY PROTEIN FOR THE TREATMENT OF DIABETES	A01N 43/653 (2006.01)	2696694 *	HERBICIDAL COMPOSITION COMPRISING FLAZASULFURON AND AN INHIBITOR OF PROTOPORPHYRINOGEN OXIDASE
A61G 5/10 (2006.01)	2648671 *	A CHAIR FOR DISABLED OR NON SELF-SUFFICIENT PEOPLE PROVIDED WITH AUTOMATIZED LIFTING OF THE SEAT.	A01N 43/76 (2006.01)	2696694 *	HERBICIDAL COMPOSITION COMPRISING FLAZASULFURON AND AN INHIBITOR OF PROTOPORPHYRINOGEN OXIDASE
A61G 7/10 (2006.01)	2648671 *	A CHAIR FOR DISABLED OR NON SELF-SUFFICIENT PEOPLE PROVIDED WITH AUTOMATIZED LIFTING OF THE SEAT.	A01N 43/82 (2006.01)	2696694 *	HERBICIDAL COMPOSITION COMPRISING FLAZASULFURON AND AN INHIBITOR OF PROTOPORPHYRINOGEN OXIDASE
G06K 19/073 (2006.01)	2693370 *	APPARATUS AND METHOD FOR GENERATING A DIGITAL VALUE	A01N 43/84 (2006.01)	2696694 *	HERBICIDAL COMPOSITION COMPRISING FLAZASULFURON AND AN INHIBITOR OF PROTOPORPHYRINOGEN OXIDASE
B65G 47/31 (2006.01)	2670690 *	IMPROVEMENTS IN AND RELATING TO LAMINATED BOARD	A01N 43/90 (2006.01)	2696694 *	HERBICIDAL COMPOSITION COMPRISING FLAZASULFURON AND AN INHIBITOR OF PROTOPORPHYRINOGEN OXIDASE
A61C 19/06 (2006.01)	2688513 *	DEVICE AND METHOD FOR TEETH BRIGHTENING	A01N 47/36 (2006.01)	2696694 *	HERBICIDAL COMPOSITION COMPRISING FLAZASULFURON AND AN INHIBITOR OF PROTOPORPHYRINOGEN OXIDASE
A61K 8/22 (2006.01)	2688513 *	DEVICE AND METHOD FOR TEETH BRIGHTENING	A01P 13/00 (2006.01)	2696694 *	HERBICIDAL COMPOSITION COMPRISING FLAZASULFURON AND AN INHIBITOR OF PROTOPORPHYRINOGEN OXIDASE
A61K 8/24 (2006.01)	2688513 *	DEVICE AND METHOD FOR TEETH BRIGHTENING	A01N 43/16 (2006.01)	2672821 *	CATHEPSIN C INHIBITORS
A61Q 11/00 (2006.01)	2688513 *	DEVICE AND METHOD FOR TEETH BRIGHTENING			
G08B 29/20 (2006.01)	2686839 *	METHOD FOR UPGRADING RFID READERS IN SITU			
A61K 39/00 (2006.01)	2649086 *	USE OF CHIMERIC ANTIGEN RECEPTOR-MODIFIED T CELLS TO TREAT CANCER			
C07H 21/04 (2006.01)	2649086 *	USE OF CHIMERIC ANTIGEN RECEPTOR-MODIFIED T CELLS TO TREAT CANCER			

MKP (51)	Broj objave evropske prijave patenta (97)	Naziv pronalaska (54)	MKP (51)	Broj objave evropske prijave patenta (97)	Naziv pronalaska (54)
A61K 31/35 (2006.01)	2672821 *	CATHEPSIN C INHIBITORS	A61P 43/00 (2006.01)	2650361 *	GALECTIN 9-SECRETING CELL, PRODUCTION METHOD FOR SAME, AND APPLICATION FOR SAME
A01C 15/02 (2006.01)	2658360 *	A TUBE SHAPED DEVICE FILLED WITH A LIQUID MEANS FOR THE PLANTS NUTRITION AND / OR PROTECTION, A PROCESS OF THIS DEVICE CONSTRUCTION AND ITS USAGE	C12N 5/0783 (2010.01)	2650361 *	GALECTIN 9-SECRETING CELL, PRODUCTION METHOD FOR SAME, AND APPLICATION FOR SAME
A01C 23/02 (2006.01)	2658360 *	A TUBE SHAPED DEVICE FILLED WITH A LIQUID MEANS FOR THE PLANTS NUTRITION AND / OR PROTECTION, A PROCESS OF THIS DEVICE CONSTRUCTION AND ITS USAGE	C12Q 1/02 (2006.01)	2650361 *	GALECTIN 9-SECRETING CELL, PRODUCTION METHOD FOR SAME, AND APPLICATION FOR SAME
A01G 7/06 (2006.01)	2658360 *	A TUBE SHAPED DEVICE FILLED WITH A LIQUID MEANS FOR THE PLANTS NUTRITION AND / OR PROTECTION, A PROCESS OF THIS DEVICE CONSTRUCTION AND ITS USAGE	E01H 1/08 (2006.01)	2691576 *	METHOD AND SYSTEM FOR THE SUSTAINABLE COOLING OF INDUSTRIAL PROCESSES
A01G 29/00 (2006.01)	2658360 *	A TUBE SHAPED DEVICE FILLED WITH A LIQUID MEANS FOR THE PLANTS NUTRITION AND / OR PROTECTION, A PROCESS OF THIS DEVICE CONSTRUCTION AND ITS USAGE	A61M 5/19 (2006.01)	2675500 *	DISPENSE INTERFACE FOR USE WITH A DRUG DELIVERY DEVICE FOR DELIVERY OF TWO OR MORE DRUG AGENTS
A61K 35/12 (2006.01)	2650361 *	GALECTIN 9-SECRETING CELL, PRODUCTION METHOD FOR SAME, AND APPLICATION FOR SAME	C03C 1/00 (2006.01)	2678282 *	HYBRID SOL-GEL COATED GLASS CONTAINERS
A61K 49/00 (2006.01)	2650361 *	GALECTIN 9-SECRETING CELL, PRODUCTION METHOD FOR SAME, AND APPLICATION FOR SAME	C03C 17/00 (2006.01)	2678282 *	HYBRID SOL-GEL COATED GLASS CONTAINERS
A61P 29/00 (2006.01)	2650361 *	GALECTIN 9-SECRETING CELL, PRODUCTION METHOD FOR SAME, AND APPLICATION FOR SAME	G06F 3/023 (2006.01)	2624115	Method and electronic system for user interface independent execution of functions
A61P 31/00 (2006.01)	2650361 *	GALECTIN 9-SECRETING CELL, PRODUCTION METHOD FOR SAME, AND APPLICATION FOR SAME	G06F 3/048 (2013.01)	2624115	Method and electronic system for user interface independent execution of functions
A61P 35/00 (2006.01)	2650361 *	GALECTIN 9-SECRETING CELL, PRODUCTION METHOD FOR SAME, AND APPLICATION FOR SAME	F16B 19/05 (2006.01)	2697520 *	CAPSULES COMPRISING AN EMULSIFIED SYRUP AND METHODS OF MAKING THE SAME
A61P 37/06 (2006.01)	2650361 *	GALECTIN 9-SECRETING CELL, PRODUCTION METHOD FOR SAME, AND APPLICATION FOR SAME	G06K 9/00 (2006.01)	2681718 *	DYNAMIC TEMPLATE TRACKING
A61P 37/08 (2006.01)	2650361 *	GALECTIN 9-SECRETING CELL, PRODUCTION METHOD FOR SAME, AND APPLICATION FOR SAME	G06K 9/32 (2006.01)	2681718 *	DYNAMIC TEMPLATE TRACKING
			G06K 9/46 (2006.01)	2681718 *	DYNAMIC TEMPLATE TRACKING
			G06K 9/62 (2006.01)	2681718 *	DYNAMIC TEMPLATE TRACKING
			G06Q 30/00 (2012.01)	2681718 *	DYNAMIC TEMPLATE TRACKING
			G06T 7/20 (2006.01)	2681718 *	DYNAMIC TEMPLATE TRACKING
			G06T 19/00 (2011.01)	2681718 *	DYNAMIC TEMPLATE TRACKING
			C07D 471/04 (2006.01)	2675795 *	SUBSTITUTED AMINOBUTYRIC DERIVATIVES AS NEPRILYSIN INHIBITORS
			A61K 31/405 (2006.01)	2675795 *	SUBSTITUTED AMINOBUTYRIC DERIVATIVES AS NEPRILYSIN INHIBITORS
			C07D 261/12 (2006.01)	2675795 *	SUBSTITUTED AMINOBUTYRIC DERIVATIVES AS NEPRILYSIN INHIBITORS

MKP (51)	Broj objave evropske prijave patenta (97)	Naziv pronalaska (54)	MKP (51)	Broj objave evropske prijave patenta (97)	Naziv pronalaska (54)
A61K 31/42 (2006.01)	2675795 *	SUBSTITUTED AMINOBTYRIC DERIVATIVES AS NEPRILYSIN INHIBITORS	A61K 31/495 (2006.01)	2648728 *	JANUS KINASE 2 (JAK2) INHIBITOR FOR THE TREATMENT OF LUPUS
C07D 249/10 (2006.01)	2675795 *	SUBSTITUTED AMINOBTYRIC DERIVATIVES AS NEPRILYSIN INHIBITORS	A61K 31/496 (2006.01)	2648728 *	JANUS KINASE 2 (JAK2) INHIBITOR FOR THE TREATMENT OF LUPUS
A61K 31/4192 (2006.01)	2675795 *	SUBSTITUTED AMINOBTYRIC DERIVATIVES AS NEPRILYSIN INHIBITORS	A61P 17/00 (2006.01)	2648728 *	JANUS KINASE 2 (JAK2) INHIBITOR FOR THE TREATMENT OF LUPUS
C07C 233/47 (2006.01)	2675795 *	SUBSTITUTED AMINOBTYRIC DERIVATIVES AS NEPRILYSIN INHIBITORS	C10M 125/10 (2006.01)	2657325 *	LUBRICATING COMPOSITION AND METHOD FOR THE PREPARATION THEREOF
A61P 13/00 (2006.01)	2675795 *	SUBSTITUTED AMINOBTYRIC DERIVATIVES AS NEPRILYSIN INHIBITORS	C10M 125/26 (2006.01)	2657325 *	LUBRICATING COMPOSITION AND METHOD FOR THE PREPARATION THEREOF
C07C 233/46 (2006.01)	2675795 *	SUBSTITUTED AMINOBTYRIC DERIVATIVES AS NEPRILYSIN INHIBITORS	C10M 177/00 (2006.01)	2657325 *	LUBRICATING COMPOSITION AND METHOD FOR THE PREPARATION THEREOF
A61P 9/00 (2006.01)	2675795 *	SUBSTITUTED AMINOBTYRIC DERIVATIVES AS NEPRILYSIN INHIBITORS	C07C 25/02 (2006.01)	2675774 *	PRODUCTION METHOD OF OPTICALLY ACTIVE DIHYDROBENZOFURAN DERIVATIVE
C07D 249/18 (2006.01)	2675795 *	SUBSTITUTED AMINOBTYRIC DERIVATIVES AS NEPRILYSIN INHIBITORS	C07C 43/205 (2006.01)	2675774 *	PRODUCTION METHOD OF OPTICALLY ACTIVE DIHYDROBENZOFURAN DERIVATIVE
A61K 31/4196 (2006.01)	2675795 *	SUBSTITUTED AMINOBTYRIC DERIVATIVES AS NEPRILYSIN INHIBITORS	C07D 307/80 (2006.01)	2675774 *	PRODUCTION METHOD OF OPTICALLY ACTIVE DIHYDROBENZOFURAN DERIVATIVE
C07D 249/04 (2006.01)	2675795 *	SUBSTITUTED AMINOBTYRIC DERIVATIVES AS NEPRILYSIN INHIBITORS	C07F 15/00 (2006.01)	2675774 *	PRODUCTION METHOD OF OPTICALLY ACTIVE DIHYDROBENZOFURAN DERIVATIVE
A61K 31/4164 (2006.01)	2675795 *	SUBSTITUTED AMINOBTYRIC DERIVATIVES AS NEPRILYSIN INHIBITORS	B62B 3/00 (2006.01)	2340978	A system for the mounting of shelves and the reduction of noise
A61K 31/415 (2006.01)	2675795 *	SUBSTITUTED AMINOBTYRIC DERIVATIVES AS NEPRILYSIN INHIBITORS	B62B 5/00 (2006.01)	2340978	A system for the mounting of shelves and the reduction of noise
B24B 19/20 (2006.01)	2578358	Grinding machine and method for processing the interiors of moulds	A61K 31/00 (2006.01)	2666015 *	USE OF STATHMIN AS A BIOMARKER OF DRUG RESPONSE TO FURAZANOBENZIMIDAZOLES
B24B 27/00 (2006.01)	2578358	Grinding machine and method for processing the interiors of moulds	G01N 33/50 (2006.01)	2666015 *	USE OF STATHMIN AS A BIOMARKER OF DRUG RESPONSE TO FURAZANOBENZIMIDAZOLES
B24B 27/04 (2006.01)	2578358	Grinding machine and method for processing the interiors of moulds	A61K 31/13 (2006.01)	2665474 *	NERAMEXANE FOR THE TREATMENT OR PREVENTION OF TINNITUS RELATED WITH STRESS OR ACUTE HEARING LOSS
A61M 5/24 (2006.01)	2688611 *	DOSE SETTING MECHANISM AND INJECTION DEVICE	A61P 27/16 (2006.01)	2665474 *	NERAMEXANE FOR THE TREATMENT OR PREVENTION OF TINNITUS RELATED WITH STRESS OR ACUTE HEARING LOSS
A61M 5/315 (2006.01)	2688611 *	DOSE SETTING MECHANISM AND INJECTION DEVICE	B23B 27/04 (2006.01)	2682208 *	CUTTING INSERT, CUTTING TOOL, AND METHOD FOR MANUFACTURING CUT PRODUCT USING CUTTING INSERT AND CUTTING TOOL
B65D 85/804 (2006.01)	2573008	Capsule for making an infused drink			
A61K 31/4196 (2006.01)	2648728 *	JANUS KINASE 2 (JAK2) INHIBITOR FOR THE TREATMENT OF LUPUS			
A61K 31/437 (2006.01)	2648728 *	JANUS KINASE 2 (JAK2) INHIBITOR FOR THE TREATMENT OF LUPUS			

MKP (51)	Broj objave evropske prijave patenta (97)	Naziv pronalaska (54)	MKP (51)	Broj objave evropske prijave patenta (97)	Naziv pronalaska (54)
B23B 27/14 (2006.01)	2682208 *	CUTTING INSERT, CUTTING TOOL, AND METHOD FOR MANUFACTURING CUT PRODUCT USING CUTTING INSERT AND CUTTING TOOL	C05D 9/00 (2006.01)	2668259 *	PROCESS FOR PRODUCTION OF MICROALGAE, CYANOBACTERIA AND METABOLITES THEREOF
B23B 27/22 (2006.01)	2682208 *	CUTTING INSERT, CUTTING TOOL, AND METHOD FOR MANUFACTURING CUT PRODUCT USING CUTTING INSERT AND CUTTING TOOL	C12M 1/04 (2006.01)	2668259 *	PROCESS FOR PRODUCTION OF MICROALGAE, CYANOBACTERIA AND METABOLITES THEREOF
A61K 38/38 (2006.01)	2655410 *	ANTI-INFLAMMATORY PROTEINS AND METHODS OF PREPARATION AND USE THEREOF	C12N 1/12 (2006.01)	2668259 *	PROCESS FOR PRODUCTION OF MICROALGAE, CYANOBACTERIA AND METABOLITES THEREOF
A61P 29/00 (2006.01)	2655410 *	ANTI-INFLAMMATORY PROTEINS AND METHODS OF PREPARATION AND USE THEREOF	C12N 1/36 (2006.01)	2668259 *	PROCESS FOR PRODUCTION OF MICROALGAE, CYANOBACTERIA AND METABOLITES THEREOF
C07K 14/76 (2006.01)	2655410 *	ANTI-INFLAMMATORY PROTEINS AND METHODS OF PREPARATION AND USE THEREOF	C12N 13/00 (2006.01)	2668259 *	PROCESS FOR PRODUCTION OF MICROALGAE, CYANOBACTERIA AND METABOLITES THEREOF
G01N 33/533 (2006.01)	2655410 *	ANTI-INFLAMMATORY PROTEINS AND METHODS OF PREPARATION AND USE THEREOF	C12P 7/64 (2006.01)	2668259 *	PROCESS FOR PRODUCTION OF MICROALGAE, CYANOBACTERIA AND METABOLITES THEREOF
G01N 33/68 (2006.01)	2655410 *	ANTI-INFLAMMATORY PROTEINS AND METHODS OF PREPARATION AND USE THEREOF	C12P 19/04 (2006.01)	2668259 *	PROCESS FOR PRODUCTION OF MICROALGAE, CYANOBACTERIA AND METABOLITES THEREOF
C12M 1/34 (2006.01)	2661485 *	ASSAY CARTRIDGES AND METHODS OF USING THE SAME	C12R 1/89 (2006.01)	2668259 *	PROCESS FOR PRODUCTION OF MICROALGAE, CYANOBACTERIA AND METABOLITES THEREOF
C12M 1/38 (2006.01)	2661485 *	ASSAY CARTRIDGES AND METHODS OF USING THE SAME	A62C 31/24 (2006.01)	2612694	An automatic fire extinguishing apparatus and a method for operating the same
C12Q 1/68 (2006.01)	2661485 *	ASSAY CARTRIDGES AND METHODS OF USING THE SAME	A62C 37/36 (2006.01)	2612694	An automatic fire extinguishing apparatus and a method for operating the same
A61K 31/404 (2006.01)	2646429 *	4-SUBSTITUTED-CYCLOHEXYLAMINO-4-PIPERIDINYL-ACETAMIDE ANTAGONISTS OF CCR2	A62C 99/00 (2010.01)	2612694	An automatic fire extinguishing apparatus and a method for operating the same
A61K 31/437 (2006.01)	2646429 *	4-SUBSTITUTED-CYCLOHEXYLAMINO-4-PIPERIDINYL-ACETAMIDE ANTAGONISTS OF CCR2	A01D 45/16 (2006.01)	2687082	Machine for cutting off tobacco leaves with stem holding for eastern type plants for harvesting, layering and collecting the leaves in collection containers
A61P 3/00 (2006.01)	2646429 *	4-SUBSTITUTED-CYCLOHEXYLAMINO-4-PIPERIDINYL-ACETAMIDE ANTAGONISTS OF CCR2	A61K 31/5585 (2006.01)	2663313 *	METHOD FOR ENHANCING ENGRAFTMENT OF HAEMATOPOETIC STEM CELLS
A61P 11/00 (2006.01)	2646429 *	4-SUBSTITUTED-CYCLOHEXYLAMINO-4-PIPERIDINYL-ACETAMIDE ANTAGONISTS OF CCR2	A61K 35/28 (2006.01)	2663313 *	METHOD FOR ENHANCING ENGRAFTMENT OF HAEMATOPOETIC STEM CELLS
C07D 401/12 (2006.01)	2646429 *	4-SUBSTITUTED-CYCLOHEXYLAMINO-4-PIPERIDINYL-ACETAMIDE ANTAGONISTS OF CCR2	C12N 5/078 (2010.01)	2663313 *	METHOD FOR ENHANCING ENGRAFTMENT OF HAEMATOPOETIC STEM CELLS
C07D 471/04 (2006.01)	2646429 *	4-SUBSTITUTED-CYCLOHEXYLAMINO-4-PIPERIDINYL-ACETAMIDE ANTAGONISTS OF CCR2			

MKP (51)	Broj objave evropske prijave patenta (97)	Naziv pronalaska (54)	MKP (51)	Broj objave evropske prijave patenta (97)	Naziv pronalaska (54)
H04L 29/08 (2006.01)	2684338 *	SYSTEM AND METHOD USING A CLIENT-LOCAL PROXY-SERVER TO ACCESS A DEVICE HAVING AN ASSIGNED NETWORK ADDRESS	C11B 3/06 (2006.01)	2697346 *	PROCESS FOR THE PROTECTIVE TREATMENT OF METALS BASED ON A WATER-SOLUBLE COMPOSITION OF SAPONIFIED PLANT OIL(S), AND PRODUCTS AND COMPOSITIONS OBTAINED
H04L 29/12 (2006.01)	2684338 *	SYSTEM AND METHOD USING A CLIENT-LOCAL PROXY-SERVER TO ACCESS A DEVICE HAVING AN ASSIGNED NETWORK ADDRESS	C11D 1/04 (2006.01)	2697346 *	PROCESS FOR THE PROTECTIVE TREATMENT OF METALS BASED ON A WATER-SOLUBLE COMPOSITION OF SAPONIFIED PLANT OIL(S), AND PRODUCTS AND COMPOSITIONS OBTAINED
A61K 31/4375 (2006.01)	2670410 *	ANTIMICROBIAL 4-OXOQUINOLIZINES	C11D 13/00 (2006.01)	2697346 *	PROCESS FOR THE PROTECTIVE TREATMENT OF METALS BASED ON A WATER-SOLUBLE COMPOSITION OF SAPONIFIED PLANT OIL(S), AND PRODUCTS AND COMPOSITIONS OBTAINED
A61K 31/444 (2006.01)	2670410 *	ANTIMICROBIAL 4-OXOQUINOLIZINES	C11D 17/08 (2006.01)	2697346 *	PROCESS FOR THE PROTECTIVE TREATMENT OF METALS BASED ON A WATER-SOLUBLE COMPOSITION OF SAPONIFIED PLANT OIL(S), AND PRODUCTS AND COMPOSITIONS OBTAINED
A61K 31/4545 (2006.01)	2670410 *	ANTIMICROBIAL 4-OXOQUINOLIZINES	C23F 11/12 (2006.01)	2697346 *	PROCESS FOR THE PROTECTIVE TREATMENT OF METALS BASED ON A WATER-SOLUBLE COMPOSITION OF SAPONIFIED PLANT OIL(S), AND PRODUCTS AND COMPOSITIONS OBTAINED
A61K 31/4709 (2006.01)	2670410 *	ANTIMICROBIAL 4-OXOQUINOLIZINES	B29C 35/00 (2006.01)	2681040 *	METHOD FOR MANUFACTURING CONTINUOUS COMPOSITE TUBE, APPARATUS FOR MANUFACTURING CONTINUOUS COMPOSITE TUBE
A61K 31/496 (2006.01)	2670410 *	ANTIMICROBIAL 4-OXOQUINOLIZINES	B29C 53/56 (2006.01)	2681040 *	METHOD FOR MANUFACTURING CONTINUOUS COMPOSITE TUBE, APPARATUS FOR MANUFACTURING CONTINUOUS COMPOSITE TUBE
A61K 31/506 (2006.01)	2670410 *	ANTIMICROBIAL 4-OXOQUINOLIZINES	B29C 53/64 (2006.01)	2681040 *	METHOD FOR MANUFACTURING CONTINUOUS COMPOSITE TUBE, APPARATUS FOR MANUFACTURING CONTINUOUS COMPOSITE TUBE
A61K 38/12 (2006.01)	2670410 *	ANTIMICROBIAL 4-OXOQUINOLIZINES	B29C 70/32 (2006.01)	2681040 *	METHOD FOR MANUFACTURING CONTINUOUS COMPOSITE TUBE, APPARATUS FOR MANUFACTURING CONTINUOUS COMPOSITE TUBE
A61P 31/04 (2006.01)	2670410 *	ANTIMICROBIAL 4-OXOQUINOLIZINES			
C07D 455/02 (2006.01)	2670410 *	ANTIMICROBIAL 4-OXOQUINOLIZINES			
C03C 17/34 (2006.01)	2646385 *	ANTICORROSIVE AND ANTIFOULING GLASS SUBSTRATE FOR USE IN A WET ATMOSPHERE			
C09D 5/08 (2006.01)	2697346 *	PROCESS FOR THE PROTECTIVE TREATMENT OF METALS BASED ON A WATER-SOLUBLE COMPOSITION OF SAPONIFIED PLANT OIL(S), AND PRODUCTS AND COMPOSITIONS OBTAINED			
C09D 191/00 (2006.01)	2697346 *	PROCESS FOR THE PROTECTIVE TREATMENT OF METALS BASED ON A WATER-SOLUBLE COMPOSITION OF SAPONIFIED PLANT OIL(S), AND PRODUCTS AND COMPOSITIONS OBTAINED			

MKP (51)	Broj objave evropske prijave patenta (97)	Naziv pronalaska (54)	MKP (51)	Broj objave evropske prijave patenta (97)	Naziv pronalaska (54)
B29D 23/00 (2006.01)	2681040 *	METHOD FOR MANUFACTURING CONTINUOUS COMPOSITE TUBE, APPARATUS FOR MANUFACTURING CONTINUOUS COMPOSITE TUBE	H01S 3/04 (2006.01)	2700131 *	DEVICE FOR MANAGING HEAT IN AN OPTICAL ELEMENT, AND RELATED HEAT-MANAGEMENT METHOD
F16L 9/16 (2006.01)	2681040 *	METHOD FOR MANUFACTURING CONTINUOUS COMPOSITE TUBE, APPARATUS FOR MANUFACTURING CONTINUOUS COMPOSITE TUBE	H01S 3/042 (2006.01)	2700131 *	DEVICE FOR MANAGING HEAT IN AN OPTICAL ELEMENT, AND RELATED HEAT-MANAGEMENT METHOD
C07D 215/14 (2006.01)	2694479 *	PROCESS FOR THE PREPARATION OF AN HIV INTEGRASE INHIBITOR	H01S 3/06 (2006.01)	2700131 *	DEVICE FOR MANAGING HEAT IN AN OPTICAL ELEMENT, AND RELATED HEAT-MANAGEMENT METHOD
C07D 401/04 (2006.01)	2694479 *	PROCESS FOR THE PREPARATION OF AN HIV INTEGRASE INHIBITOR	H01S 3/08 (2006.01)	2700131 *	DEVICE FOR MANAGING HEAT IN AN OPTICAL ELEMENT, AND RELATED HEAT-MANAGEMENT METHOD
C07D 405/04 (2006.01)	2694479 *	PROCESS FOR THE PREPARATION OF AN HIV INTEGRASE INHIBITOR	H01S 5/024 (2006.01)	2700131 *	DEVICE FOR MANAGING HEAT IN AN OPTICAL ELEMENT, AND RELATED HEAT-MANAGEMENT METHOD
C07D 409/04 (2006.01)	2694479 *	PROCESS FOR THE PREPARATION OF AN HIV INTEGRASE INHIBITOR	C12N 1/21 (2006.01)	2655599 *	DESIGNER CALVIN- CYCLE-CHANNELED AND HYDROGENOTROPHIC PRODUCTION OF BUTANOL AND RELATED HIGHER ALCOHOLS
C07D 417/04 (2006.01)	2694479 *	PROCESS FOR THE PREPARATION OF AN HIV INTEGRASE INHIBITOR	C12N 5/10 (2006.01)	2655599 *	DESIGNER CALVIN- CYCLE-CHANNELED AND HYDROGENOTROPHIC PRODUCTION OF BUTANOL AND RELATED HIGHER ALCOHOLS
C07D 491/06 (2006.01)	2694479 *	PROCESS FOR THE PREPARATION OF AN HIV INTEGRASE INHIBITOR	C12N 9/00 (2006.01)	2655599 *	DESIGNER CALVIN- CYCLE-CHANNELED AND HYDROGENOTROPHIC PRODUCTION OF BUTANOL AND RELATED HIGHER ALCOHOLS
A61K 9/00 (2006.01)	2593109 *	METHOD AND FORMULATIONS FOR TREATING SIALIC ACID DEFICIENCIES	C12N 15/52 (2006.01)	2655599 *	DESIGNER CALVIN- CYCLE-CHANNELED AND HYDROGENOTROPHIC PRODUCTION OF BUTANOL AND RELATED HIGHER ALCOHOLS
A61K 9/20 (2006.01)	2593109 *	METHOD AND FORMULATIONS FOR TREATING SIALIC ACID DEFICIENCIES	C12N 15/63 (2006.01)	2655599 *	DESIGNER CALVIN- CYCLE-CHANNELED AND HYDROGENOTROPHIC PRODUCTION OF BUTANOL AND RELATED HIGHER ALCOHOLS
A61K 9/22 (2006.01)	2593109 *	METHOD AND FORMULATIONS FOR TREATING SIALIC ACID DEFICIENCIES	C12P 7/16 (2006.01)	2655599 *	DESIGNER CALVIN- CYCLE-CHANNELED AND HYDROGENOTROPHIC PRODUCTION OF BUTANOL AND RELATED HIGHER ALCOHOLS
A61K 31/7012 (2006.01)	2593109 *	METHOD AND FORMULATIONS FOR TREATING SIALIC ACID DEFICIENCIES	A61K 31/7088 (2006.01)	2689013 *	COMPOSITIONS FOR INHIBITING GENE EXPRESSION AND USES THEREOF
A61K 47/38 (2006.01)	2593109 *	METHOD AND FORMULATIONS FOR TREATING SIALIC ACID DEFICIENCIES			
A61P 21/00 (2006.01)	2593109 *	METHOD AND FORMULATIONS FOR TREATING SIALIC ACID DEFICIENCIES			
C12N 5/16 (2006.01)	2646557 *	METHOD FOR CELLULAR RNA EXPRESSION			
C12N 15/67 (2006.01)	2646557 *	METHOD FOR CELLULAR RNA EXPRESSION			

MKP (51)	Broj objave evropske prijave patenta (97)	Naziv pronalaska (54)	MKP (51)	Broj objave evropske prijave patenta (97)	Naziv pronalaska (54)
A61P 35/00 (2006.01)	2689013 *	COMPOSITIONS FOR INHIBITING GENE EXPRESSION AND USES THEREOF	A61B 5/042 (2006.01)	2699152 *	BASKET STYLE CARDIAC MAPPING CATHETER HAVING AN ATRAUMATIC BASKET TIP FOR DETECTION OF CARDIAC RHYTHM DISORDERS
C12N 15/113 (2010.01)	2689013 *	COMPOSITIONS FOR INHIBITING GENE EXPRESSION AND USES THEREOF	A21D 8/00 (2006.01)	2692243	Composition for delayed resorption
A61K 38/28 (2006.01)	2687542 *	HUMAN INSULIN AND ANALOG CONJUGATE THEREOF	A23C 9/152 (2006.01)	2692243	Composition for delayed resorption
A61P 3/10 (2006.01)	2687542 *	HUMAN INSULIN AND ANALOG CONJUGATE THEREOF	A23C 9/154 (2006.01)	2692243	Composition for delayed resorption
C07K 11/107 (2006.01)	2687542 *	HUMAN INSULIN AND ANALOG CONJUGATE THEREOF	A23F 3/16 (2006.01)	2692243	Composition for delayed resorption
C07K 14/62 (2006.01)	2687542 *	HUMAN INSULIN AND ANALOG CONJUGATE THEREOF	A23F 3/40 (2006.01)	2692243	Composition for delayed resorption
C07K 17/08 (2006.01)	2687542 *	HUMAN INSULIN AND ANALOG CONJUGATE THEREOF	A23F 5/24 (2006.01)	2692243	Composition for delayed resorption
C07H 21/02 (2006.01)	2699583 *	MODULATION OF HEPATITIS B VIRUS (HBV) EXPRESSION	A23F 5/40 (2006.01)	2692243	Composition for delayed resorption
A61K 31/47 (2006.01)	2648732 *	USE OF LAQUINIMOD FOR REDUCING FATIGUE, IMPROVING FUNCTIONAL STATUS, AND IMPROVING QUALITY OF LIFE IN MULTIPLE SCLEROSIS PATIENTS	A23G 1/40 (2006.01)	2692243	Composition for delayed resorption
G06F 15/16 (2006.01)	2689353 *	SYSTEM AND METHOD FOR DATA MASKING	A23G 3/42 (2006.01)	2692243	Composition for delayed resorption
G06F 17/30 (2006.01)	2689353 *	SYSTEM AND METHOD FOR DATA MASKING	A23G 9/34 (2006.01)	2692243	Composition for delayed resorption
H04L 9/32 (2006.01)	2689353 *	SYSTEM AND METHOD FOR DATA MASKING	A23L 1/00 (2006.01)	2692243	Composition for delayed resorption
A61K 39/395 (2006.01)	2699260 *	BISPECIFIC ANTIBODIES AGAINST HER2	A23L 1/06 (2006.01)	2692243	Composition for delayed resorption
A61P 35/00 (2006.01)	2699260 *	BISPECIFIC ANTIBODIES AGAINST HER2	A23L 1/068 (2006.01)	2692243	Composition for delayed resorption
C07K 16/10 (2006.01)	2699260 *	BISPECIFIC ANTIBODIES AGAINST HER2	A23L 1/09 (2006.01)	2692243	Composition for delayed resorption
C07K 16/28 (2006.01)	2699260 *	BISPECIFIC ANTIBODIES AGAINST HER2	A23L 1/236 (2006.01)	2692243	Composition for delayed resorption
C07K 16/32 (2006.01)	2699260 *	BISPECIFIC ANTIBODIES AGAINST HER2	A23L 1/30 (2006.01)	2692243	Composition for delayed resorption
C07K 16/46 (2006.01)	2699260 *	BISPECIFIC ANTIBODIES AGAINST HER2	A23L 2/39 (2006.01)	2692243	Composition for delayed resorption
B64D 10/00 (2006.01)	2640637 *	ACCELERATION PROTECTION SUIT	A23L 2/60 (2006.01)	2692243	Composition for delayed resorption
			B60K 15/04 (2006.01)	2646270 *	INSERT FOR A FILLER NECK OF A UREA CONTAINER
			A61K 31/47 (2006.01)	2683709 *	PYRIDINYL- AND PYRAZINYL -METHYLOXY - ARYL DERIVATIVES USEFUL AS INHIBITORS OF SPLEEN TYROSINE KINASE (SYK)
			A61P 37/00 (2006.01)	2683709 *	PYRIDINYL- AND PYRAZINYL -METHYLOXY - ARYL DERIVATIVES USEFUL AS INHIBITORS OF SPLEEN TYROSINE KINASE (SYK)

MKP (51)	Broj objave evropske prijave patenta (97)	Naziv pronalaska (54)	MKP (51)	Broj objave evropske prijave patenta (97)	Naziv pronalaska (54)
C07D 401/12 (2006.01)	2683709 *	PYRIDINYL- AND PYRAZINYL -METHYLOXY - ARYL DERIVATIVES USEFUL AS INHIBITORS OF SPLEEN TYROSINE KINASE (SYK)	A61K 31/506 (2006.01)	2651918 *	CRYSTALLINE FORMS OF 5-CHLORO-N2-(2- ISOPROPOXY-5-METHYL- 4-PIPERIDIN-4-YL- PHENYL)-N4[2-(PROPANE- 2-SULFONYL)-PHENYL]- PYRIMIDINE-2,4-DIAMINE
C07D 403/12 (2006.01)	2683709 *	PYRIDINYL- AND PYRAZINYL -METHYLOXY - ARYL DERIVATIVES USEFUL AS INHIBITORS OF SPLEEN TYROSINE KINASE (SYK)	A61P 35/00 (2006.01)	2651918 *	CRYSTALLINE FORMS OF 5-CHLORO-N2-(2- ISOPROPOXY-5-METHYL- 4-PIPERIDIN-4-YL- PHENYL)-N4[2-(PROPANE- 2-SULFONYL)-PHENYL]- PYRIMIDINE-2,4-DIAMINE
A61K 31/4152 (2006.01)	2646025 *	USE OF SIGMA LIGANDS IN BONE CANCER PAIN	C07D 401/12 (2006.01)	2651918 *	CRYSTALLINE FORMS OF 5-CHLORO-N2-(2- ISOPROPOXY-5-METHYL- 4-PIPERIDIN-4-YL- PHENYL)-N4[2-(PROPANE- 2-SULFONYL)-PHENYL]- PYRIMIDINE-2,4-DIAMINE
A61K 31/4155 (2006.01)	2646025 *	USE OF SIGMA LIGANDS IN BONE CANCER PAIN	A61K 9/00 (2006.01)	2665465 *	ORALLY DISPERSIBLE TABLET
A61K 31/4523 (2006.01)	2646025 *	USE OF SIGMA LIGANDS IN BONE CANCER PAIN	A61K 9/14 (2006.01)	2665465 *	ORALLY DISPERSIBLE TABLET
A61K 31/4725 (2006.01)	2646025 *	USE OF SIGMA LIGANDS IN BONE CANCER PAIN	A61K 9/16 (2006.01)	2665465 *	ORALLY DISPERSIBLE TABLET
A61K 31/496 (2006.01)	2646025 *	USE OF SIGMA LIGANDS IN BONE CANCER PAIN	A61K 9/20 (2006.01)	2665465 *	ORALLY DISPERSIBLE TABLET
A61K 31/5377 (2006.01)	2646025 *	USE OF SIGMA LIGANDS IN BONE CANCER PAIN	A61K 31/343 (2006.01)	2665465 *	ORALLY DISPERSIBLE TABLET
A61P 29/00 (2006.01)	2646025 *	USE OF SIGMA LIGANDS IN BONE CANCER PAIN	A61P 25/18 (2006.01)	2665465 *	ORALLY DISPERSIBLE TABLET
C07K 16/24 (2006.01)	2655417 *	IL-1 -ALPHA AND -BETA BISPECIFIC DUAL VARIABLE DOMAIN IMMUNOGLOBULINS AND THEIR USE	C12N 15/82 (2006.01)	2661498 *	FIBER SELECTIVE PROMOTERS
A01N 43/54 (2006.01)	2667873 *	SMALL MOLECULE RNASE INHIBITORS AND METHODS OF USE	A01N 59/02 (2006.01)	2683247 *	AN AGROCHEMICAL COMPOSITION COMPRISING ZINC, SULFUR AND A PESTICIDAL ACTIVE INGREDIENT
A61K 31/535 (2006.01)	2667873 *	SMALL MOLECULE RNASE INHIBITORS AND METHODS OF USE	A01N 59/16 (2006.01)	2683247 *	AN AGROCHEMICAL COMPOSITION COMPRISING ZINC, SULFUR AND A PESTICIDAL ACTIVE INGREDIENT
C07D 277/00 (2006.01)	2667873 *	SMALL MOLECULE RNASE INHIBITORS AND METHODS OF USE	A01P 7/04 (2006.01)	2683247 *	AN AGROCHEMICAL COMPOSITION COMPRISING ZINC, SULFUR AND A PESTICIDAL ACTIVE INGREDIENT
C04B 28/10 (2006.01)	2404885	New construction material mixtures	B29C 70/38 (2006.01)	2675612 *	MECHANISM FOR AUTOMATICALLY CUTTING AND PLACEMENT OF RESIN IMPREGNATED FIBERS
C04B 28/18 (2006.01)	2404885	New construction material mixtures	B29C 70/54 (2006.01)	2675612 *	MECHANISM FOR AUTOMATICALLY CUTTING AND PLACEMENT OF RESIN IMPREGNATED FIBERS
C04B 40/06 (2006.01)	2404885	New construction material mixtures			
C04B 103/10 (2006.01)	2404885	New construction material mixtures			
C04B 111/10 (2006.01)	2404885	New construction material mixtures			

MKP (51)	Broj objave evropske prijave patenta (97)	Naziv pronalaska (54)	MKP (51)	Broj objave evropske prijave patenta (97)	Naziv pronalaska (54)
A61K 39/395 (2006.01)	2699601 *	ANTIBODY POLYPEPTIDES THAT ANTAGONIZE CD40	A61B 18/14 (2006.01)	2606845	Pulse generator
C07K 16/28 (2006.01)	2699601 *	ANTIBODY POLYPEPTIDES THAT ANTAGONIZE CD40	A61L 27/44 (2006.01)	2668967	An implant
A01N 25/34 (2006.01)	2683240 *	A STABLE COMPOSITION OF HOCI, PROCESSES FOR ITS PRODUCTION AND USES THEREOF	A61L 27/46 (2006.01)	2668967	An implant
A01N 59/08 (2006.01)	2683240 *	A STABLE COMPOSITION OF HOCI, PROCESSES FOR ITS PRODUCTION AND USES THEREOF	A61L 27/54 (2006.01)	2668967	An implant
A61K 33/00 (2006.01)	2683240 *	A STABLE COMPOSITION OF HOCI, PROCESSES FOR ITS PRODUCTION AND USES THEREOF	B65D 1/02 (2006.01)	2683620 *	CLOSURE FOR A PRODUCT RETAINING CONTAINER
C07C 69/96 (2006.01)	2655314 *	MULTI-API LOADING PRODRUGS	B65D 51/28 (2006.01)	2683620 *	CLOSURE FOR A PRODUCT RETAINING CONTAINER
C07D 239/42 (2006.01)	2646419 *	METHOD FOR PREPARING ROSUVASTATIN SALTS	B65D 81/20 (2006.01)	2683620 *	CLOSURE FOR A PRODUCT RETAINING CONTAINER
A44C 5/08 (2006.01)	2651257 *	ELASTIC CHAIN AND ORNAMENTAL ITEM MADE WITH SAID ELASTIC CHAIN	B65D 81/24 (2006.01)	2683620 *	CLOSURE FOR A PRODUCT RETAINING CONTAINER
E05B 15/02 (2006.01)	2694763 *	ADJUSTABLE STRIKE PLATE FOR LOCKS	B65D 81/32 (2006.01)	2683620 *	CLOSURE FOR A PRODUCT RETAINING CONTAINER
A61K 31/53 (2006.01)	2681218 *	IMIDAZO[5,1-f][1,2,4] TRIAZINES FOR THE TREATMENT OF NEUROLOGICAL DISORDERS	C12H 1/14 (2006.01)	2683620 *	CLOSURE FOR A PRODUCT RETAINING CONTAINER
A61P 25/18 (2006.01)	2681218 *	IMIDAZO[5,1-f][1,2,4] TRIAZINES FOR THE TREATMENT OF NEUROLOGICAL DISORDERS	C12H 1/22 (2006.01)	2683620 *	CLOSURE FOR A PRODUCT RETAINING CONTAINER
C07D 487/04 (2006.01)	2681218 *	IMIDAZO[5,1-f][1,2,4] TRIAZINES FOR THE TREATMENT OF NEUROLOGICAL DISORDERS	C07D 307/81 (2006.01)	2691381 *	REDUCTIVE AMINATION PROCESS FOR PREPARATION OF DRONEDARONE USING AMINE INTERMEDIARY COMPOUND
H04L 29/08 (2006.01)	2678996 *	SYSTEMS AND METHODS FOR GEO-STAGING OF SENSOR DATA THROUGH DISTRIBUTED GLOBAL (CLOUD) ARCHITECTURE	A61K 39/00 (2006.01)	2694105 *	CD37-BINDING MOLECULES AND IMMUNOCONJUGATES THEREOF
A61K 31/439 (2006.01)	2696871 *	ACLIDINIUM FOR USE IN IMPROVING THE QUALITY OF SLEEP IN RESPIRATORY PATIENTS	A61K 39/395 (2006.01)	2694105 *	CD37-BINDING MOLECULES AND IMMUNOCONJUGATES THEREOF
A61P 11/00 (2006.01)	2696871 *	ACLIDINIUM FOR USE IN IMPROVING THE QUALITY OF SLEEP IN RESPIRATORY PATIENTS	A61K 39/395 (2006.01)	2689787	Identification and enrichment of cell subpopulations
A61P 43/00 (2006.01)	2696871 *	ACLIDINIUM FOR USE IN IMPROVING THE QUALITY OF SLEEP IN RESPIRATORY PATIENTS	C07K 16/22 (2006.01)	2689787	Identification and enrichment of cell subpopulations
A61B 18/12 (2006.01)	2606845	Pulse generator	C07K 16/28 (2006.01)	2689787	Identification and enrichment of cell subpopulations
			C07K 16/30 (2006.01)	2689787	Identification and enrichment of cell subpopulations
			C07K 16/40 (2006.01)	2689787	Identification and enrichment of cell subpopulations
			C12N 5/09 (2010.01)	2689787	Identification and enrichment of cell subpopulations
			C07J 63/00 (2006.01)	2683731 *	C4-MONOMETHYL TRITERPENOID DERIVATIVES AND METHODS OF USE THEREOF

MKP (51)	Broj objave evropske prijave patenta (97)	Naziv pronalaska (54)	MKP (51)	Broj objave evropske prijave patenta (97)	Naziv pronalaska (54)
A47J 27/00 (2006.01)	2578323	A decoration process of cooking vessels with sol-gel coating.	A61K 31/5025 (2006.01)	2694510 *	IMIDAZOPYRIDAZINES AS AKT KINASE INHIBITORS
A47J 36/02 (2006.01)	2578323	A decoration process of cooking vessels with sol-gel coating.	A61P 35/00 (2006.01)	2694510 *	IMIDAZOPYRIDAZINES AS AKT KINASE INHIBITORS
B05D 3/12 (2006.01)	2578323	A decoration process of cooking vessels with sol-gel coating.	C07D 487/04 (2006.01)	2694510 *	IMIDAZOPYRIDAZINES AS AKT KINASE INHIBITORS
B05D 5/06 (2006.01)	2578323	A decoration process of cooking vessels with sol-gel coating.	F17C 7/02 (2006.01)	2646738 *	A LIQUID DISPENSER
B05D 5/08 (2006.01)	2578323	A decoration process of cooking vessels with sol-gel coating.	F17C 13/02 (2006.01)	2646738 *	A LIQUID DISPENSER
C08J 5/24 (2006.01)	2662425	Epoxy Resin Composition, and Prepreg and Copper Clad Laminate Made Therefrom	A01K 61/00 (2006.01)	2684450 *	SHOCK-ABSORBING COUPLING FOR FLOATING STRUCTURES
C08L 63/00 (2006.01)	2662425	Epoxy Resin Composition, and Prepreg and Copper Clad Laminate Made Therefrom	A61K 31/517 (2006.01)	2694071 *	COMBINATIONS OF AKT INHIBITOR COMPOUNDS AND CHEMOTHERAPEUTIC AGENTS, AND METHODS OF USE
C09D 163/00 (2006.01)	2662425	Epoxy Resin Composition, and Prepreg and Copper Clad Laminate Made Therefrom	C07D 239/70 (2006.01)	2694071 *	COMBINATIONS OF AKT INHIBITOR COMPOUNDS AND CHEMOTHERAPEUTIC AGENTS, AND METHODS OF USE
H05K 1/03 (2006.01)	2662425	Epoxy Resin Composition, and Prepreg and Copper Clad Laminate Made Therefrom	A61K 31/517 (2006.01)	2670736 *	9-[4-(3-CHLOR-2-FLUOR-PHENYLAMINO)-7-METHOXY-QUINAZOLIN-6-YLOXY]-1,4-DIAZA-SPIRO[5.5]UNDECAN-5-ONE DIMALEATE, USE THEREOF AS A DRUG, AND PRODUCTION THEREOF
E06B 3/36 (2006.01)	2689086 *	SYSTEM FOR PRODUCING A DOUBLE LEAF WINDOW	A61P 11/00 (2006.01)	2670736 *	9-[4-(3-CHLOR-2-FLUOR-PHENYLAMINO)-7-METHOXY-QUINAZOLIN-6-YLOXY]-1,4-DIAZA-SPIRO[5.5]UNDECAN-5-ONE DIMALEATE, USE THEREOF AS A DRUG, AND PRODUCTION THEREOF
C07H 21/04 (2006.01)	2694683 *	CONFORMATIONALLY-PREORGANIZED, MiniPEG-CONTAINING GAMMA-PEPTIDE NUCLEIC ACIDS	C07D 239/70 (2006.01)	2670736 *	9-[4-(3-CHLOR-2-FLUOR-PHENYLAMINO)-7-METHOXY-QUINAZOLIN-6-YLOXY]-1,4-DIAZA-SPIRO[5.5]UNDECAN-5-ONE DIMALEATE, USE THEREOF AS A DRUG, AND PRODUCTION THEREOF
C12Q 1/68 (2006.01)	2694683 *	CONFORMATIONALLY-PREORGANIZED, MiniPEG-CONTAINING GAMMA-PEPTIDE NUCLEIC ACIDS	C07D 403/12 (2006.01)	2670736 *	9-[4-(3-CHLOR-2-FLUOR-PHENYLAMINO)-7-METHOXY-QUINAZOLIN-6-YLOXY]-1,4-DIAZA-SPIRO[5.5]UNDECAN-5-ONE DIMALEATE, USE THEREOF AS A DRUG, AND PRODUCTION THEREOF
A61K 39/395 (2006.01)	2682475 *	ANTIBODY AND ANTIGEN RECOGNIZING TUMOR-INITIATING CELLS AND USE THEREOF	C07D 307/81 (2006.01)	2691380 *	PROCESS FOR PREPARATION OF DRONEDARONE BY N-BUTYLATION
A61P 35/00 (2006.01)	2682475 *	ANTIBODY AND ANTIGEN RECOGNIZING TUMOR-INITIATING CELLS AND USE THEREOF	F16L 53/00 (2006.01)	2668819 *	SYSTEM AND SYSTEM ELEMENTS FOR DIRECT ELECTRICAL HEATING OF SUBSEA PIPELINES
C07K 16/18 (2006.01)	2682475 *	ANTIBODY AND ANTIGEN RECOGNIZING TUMOR-INITIATING CELLS AND USE THEREOF			
C12N 5/20 (2006.01)	2682475 *	ANTIBODY AND ANTIGEN RECOGNIZING TUMOR-INITIATING CELLS AND USE THEREOF			
C12Q 1/02 (2006.01)	2682475 *	ANTIBODY AND ANTIGEN RECOGNIZING TUMOR-INITIATING CELLS AND USE THEREOF			
C12Q 1/68 (2006.01)	2682475 *	ANTIBODY AND ANTIGEN RECOGNIZING TUMOR-INITIATING CELLS AND USE THEREOF			
G01N 33/577 (2006.01)	2682475 *	ANTIBODY AND ANTIGEN RECOGNIZING TUMOR-INITIATING CELLS AND USE THEREOF			

MKP (51)	Broj objave evropske prijave patenta (97)	Naziv pronalaska (54)	MKP (51)	Broj objave evropske prijave patenta (97)	Naziv pronalaska (54)
F17D 1/18 (2006.01)	2668819 *	SYSTEM AND SYSTEM ELEMENTS FOR DIRECT ELECTRICAL HEATING OF SUBSEA PIPELINES	C12N 15/82 (2006.01)	2694658 *	SEED - SPECIFIC PROMOTER IN COTTON
H05B 3/00 (2006.01)	2668819 *	SYSTEM AND SYSTEM ELEMENTS FOR DIRECT ELECTRICAL HEATING OF SUBSEA PIPELINES	A61K 38/17 (2006.01)	2646464 *	ANTICANCER FUSION PROTEIN
H05B 6/10 (2006.01)	2668819 *	SYSTEM AND SYSTEM ELEMENTS FOR DIRECT ELECTRICAL HEATING OF SUBSEA PIPELINES	A61K 38/21 (2006.01)	2646464 *	ANTICANCER FUSION PROTEIN
A61K 31/505 (2006.01)	2646420 *	METHOD FOR THE PREPARATION OF HIGH-PURITY PHARMACEUTICAL INTERMEDIATES	A61P 35/00 (2006.01)	2646464 *	ANTICANCER FUSION PROTEIN
C07D 239/42 (2006.01)	2646420 *	METHOD FOR THE PREPARATION OF HIGH-PURITY PHARMACEUTICAL INTERMEDIATES	C07K 14/56 (2006.01)	2646464 *	ANTICANCER FUSION PROTEIN
G01N 21/25 (2006.01)	2684029 *	IN VITRO MEASUREMENT OF SUNSCREEN PROTECTION	C07K 14/57 (2006.01)	2646464 *	ANTICANCER FUSION PROTEIN
G01N 21/59 (2006.01)	2684029 *	IN VITRO MEASUREMENT OF SUNSCREEN PROTECTION	C07K 14/705 (2006.01)	2646464 *	ANTICANCER FUSION PROTEIN
A61M 5/24 (2006.01)	2688613 *	DRUG DELIVERY DEVICE	C12N 15/12 (2006.01)	2646464 *	ANTICANCER FUSION PROTEIN
A61M 5/315 (2006.01)	2688613 *	DRUG DELIVERY DEVICE	C12N 15/21 (2006.01)	2646464 *	ANTICANCER FUSION PROTEIN
A61K 31/4155 (2006.01)	2668183 *	IL17 AND IFN-GAMMA INHIBITION FOR THE TREATMENT OF AUTOIMMUNE INFLAMMATION	C12N 15/23 (2006.01)	2646464 *	ANTICANCER FUSION PROTEIN
A61P 19/00 (2006.01)	2668183 *	IL17 AND IFN-GAMMA INHIBITION FOR THE TREATMENT OF AUTOIMMUNE INFLAMMATION	C12N 15/62 (2006.01)	2646464 *	ANTICANCER FUSION PROTEIN
A61P 29/00 (2006.01)	2668183 *	IL17 AND IFN-GAMMA INHIBITION FOR THE TREATMENT OF AUTOIMMUNE INFLAMMATION	A01N 29/04 (2006.01)	2654422 *	BICYCLO[3.2.1]OCTYL AMIDE DERIVATIVES AND USES OF SAME
C07D 413/04 (2006.01)	2668183 *	IL17 AND IFN-GAMMA INHIBITION FOR THE TREATMENT OF AUTOIMMUNE INFLAMMATION	A61K 31/025 (2006.01)	2654422 *	BICYCLO[3.2.1]OCTYL AMIDE DERIVATIVES AND USES OF SAME
C07D 413/14 (2006.01)	2668183 *	IL17 AND IFN-GAMMA INHIBITION FOR THE TREATMENT OF AUTOIMMUNE INFLAMMATION	C07C 217/54 (2006.01)	2668152 *	ANALGESIC COMPOUNDS, METHODS, AND FORMULATIONS
C07D 417/14 (2006.01)	2668183 *	IL17 AND IFN-GAMMA INHIBITION FOR THE TREATMENT OF AUTOIMMUNE INFLAMMATION	A61K 31/4704 (2006.01)	2697201 *	N-ETHYL-4-HYDROXYL-1-METHYL-5-(METHYL(2,3,4,5,6-PENTAHYDROXYHEXYL) AMINO)-2-OXO-N-PHENYL-1,2-DIHYDROQUINOLINE-3-CARBOXAMIDE
A01H 5/00 (2006.01)	2694658 *	SEED - SPECIFIC PROMOTER IN COTTON	C07D 215/56 (2006.01)	2697201 *	N-ETHYL-4-HYDROXYL-1-METHYL-5-(METHYL(2,3,4,5,6-PENTAHYDROXYHEXYL) AMINO)-2-OXO-N-PHENYL-1,2-DIHYDROQUINOLINE-3-CARBOXAMIDE
			A61K 31/517 (2006.01)	2694070 *	COMBINATIONS OF AKT INHIBITOR COMPOUNDS AND ERLOTINIB, AND METHODS OF USE
			A61P 35/00 (2006.01)	2694070 *	COMBINATIONS OF AKT INHIBITOR COMPOUNDS AND ERLOTINIB, AND METHODS OF USE

MKP (51)	Broj objave evropske prijave patenta (97)	Naziv pronalaska (54)	MKP (51)	Broj objave evropske prijave patenta (97)	Naziv pronalaska (54)
C07D 239/70 (2006.01)	2694070 *	COMBINATIONS OF AKT INHIBITOR COMPOUNDS AND ERLOTINIB, AND METHODS OF USE	C07D 249/08 (2006.01)	2673260 *	GLUCAGON RECEPTOR MODULATOR
B65D 5/50 (2006.01)	2423116	Wing fixing packaging	C07D 261/08 (2006.01)	2673260 *	GLUCAGON RECEPTOR MODULATOR
B65D 81/07 (2006.01)	2423116	Wing fixing packaging	A61K 9/16 (2006.01)	2691083 *	PHARMACEUTICAL COMPOSITION OF SITAGLIPTIN
A61K 31/506 (2006.01)	2663557 *	PYRIMIDINE GYRASE AND TOPOISOMERASE IV INHIBITORS	A61K 9/20 (2006.01)	2691083 *	PHARMACEUTICAL COMPOSITION OF SITAGLIPTIN
A61P 31/04 (2006.01)	2663557 *	PYRIMIDINE GYRASE AND TOPOISOMERASE IV INHIBITORS	A61K 31/4985 (2006.01)	2691083 *	PHARMACEUTICAL COMPOSITION OF SITAGLIPTIN
C07D 405/14 (2006.01)	2663557 *	PYRIMIDINE GYRASE AND TOPOISOMERASE IV INHIBITORS	A61P 39/02 (2006.01)	2691156 *	ANTICOAGULANT ANTIDOTES
C07F 9/6558 (2006.01)	2663557 *	PYRIMIDINE GYRASE AND TOPOISOMERASE IV INHIBITORS	C07K 16/44 (2006.01)	2691156 *	ANTICOAGULANT ANTIDOTES
C07D 207/34 (2006.01)	2673260 *	GLUCAGON RECEPTOR MODULATOR	C08L 25/10 (2006.01)	2695916	Polyphenylene ether resin composition, and a prepreg and a copper clad laminate made therefrom
C07D 231/12 (2006.01)	2673260 *	GLUCAGON RECEPTOR MODULATOR	C08L 71/12 (2006.01)	2695916	Polyphenylene ether resin composition, and a prepreg and a copper clad laminate made therefrom
C07D 231/14 (2006.01)	2673260 *	GLUCAGON RECEPTOR MODULATOR	A61K 39/395 (2006.01)	2649097 *	ANTI CCR4 ANTIBODIES AND USES THEREOF
C07D 231/16 (2006.01)	2673260 *	GLUCAGON RECEPTOR MODULATOR	A61P 35/00 (2006.01)	2649097 *	ANTI CCR4 ANTIBODIES AND USES THEREOF
C07D 231/18 (2006.01)	2673260 *	GLUCAGON RECEPTOR MODULATOR	A61P 35/02 (2006.01)	2649097 *	ANTI CCR4 ANTIBODIES AND USES THEREOF
C07D 231/54 (2006.01)	2673260 *	GLUCAGON RECEPTOR MODULATOR	C07K 16/28 (2006.01)	2649097 *	ANTI CCR4 ANTIBODIES AND USES THEREOF
C07D 231/56 (2006.01)	2673260 *	GLUCAGON RECEPTOR MODULATOR	G01N 33/574 (2006.01)	2649097 *	ANTI CCR4 ANTIBODIES AND USES THEREOF
C07D 233/61 (2006.01)	2673260 *	GLUCAGON RECEPTOR MODULATOR	A61K 39/00 (2006.01)	2678032 *	LENTIVIRAL VECTORS CONTAINING AN MHC CLASS I PROMOTER
C07D 233/64 (2006.01)	2673260 *	GLUCAGON RECEPTOR MODULATOR	E03D 5/10 (2006.01)	2683883 *	ELECTRONICALLY CONTROLLED FLUSH- MOUNTED TOILET FLUSHING VALVE
C07D 233/68 (2006.01)	2673260 *	GLUCAGON RECEPTOR MODULATOR	A43B 1/00 (2006.01)	2532259	Method for controlling a shifting mechanism of a spike in a shoe and a shoe functioning according to this method
C07D 233/70 (2006.01)	2673260 *	GLUCAGON RECEPTOR MODULATOR	A43B 3/00 (2006.01)	2532259	Method for controlling a shifting mechanism of a spike in a shoe and a shoe functioning according to this method
C07D 233/84 (2006.01)	2673260 *	GLUCAGON RECEPTOR MODULATOR			
C07D 249/06 (2006.01)	2673260 *	GLUCAGON RECEPTOR MODULATOR			

MKP (51)	Broj objave evropske prijave patenta (97)	Naziv pronalaska (54)	MKP (51)	Broj objave evropske prijave patenta (97)	Naziv pronalaska (54)
A43C 15/14 (2006.01)	2532259	Method for controlling a shifting mechanism of a spike in a shoe and a shoe functioning according to this method	A61P 3/00 (2006.01)	2655375 *	PYRIMIDINONE DERIVATIVES, PREPARATION THEREOF AND PHARMACEUTICAL USE THEREOF
C07D 403/06 (2006.01)	2678333 *	AN IMPROVED PROCESS FOR THE PREPARATION OF VORICONAZOLE AND INTERMEDIATES THEREOF	A61K 31/5377 (2006.01)	2655375 *	PYRIMIDINONE DERIVATIVES, PREPARATION THEREOF AND PHARMACEUTICAL USE THEREOF
A61K 31/519 (2006.01)	2655375 *	PYRIMIDINONE DERIVATIVES, PREPARATION THEREOF AND PHARMACEUTICAL USE THEREOF	G06K 9/00 (2006.01)	2686808 *	METHOD AND DEVICE FOR EFFICIENT PARALLEL MESSAGE COMPUTATION FOR MAP INFERENCE
A61P 25/00 (2006.01)	2655375 *	PYRIMIDINONE DERIVATIVES, PREPARATION THEREOF AND PHARMACEUTICAL USE THEREOF	G06K 9/62 (2006.01)	2686808 *	METHOD AND DEVICE FOR EFFICIENT PARALLEL MESSAGE COMPUTATION FOR MAP INFERENCE
C07D 487/04 (2006.01)	2655375 *	PYRIMIDINONE DERIVATIVES, PREPARATION THEREOF AND PHARMACEUTICAL USE THEREOF	G06T 7/00 (2006.01)	2686808 *	METHOD AND DEVICE FOR EFFICIENT PARALLEL MESSAGE COMPUTATION FOR MAP INFERENCE
A61P 7/02 (2006.01)	2655375 *	PYRIMIDINONE DERIVATIVES, PREPARATION THEREOF AND PHARMACEUTICAL USE THEREOF	G06Q 20/00 (2012.01)	2678811 *	A MOBILE COMMUNICATION DEVICE FOR CONTACTLESS PAYMENTS, A PAYMENT METHOD
A61K 31/527 (2006.01)	2655375 *	PYRIMIDINONE DERIVATIVES, PREPARATION THEREOF AND PHARMACEUTICAL USE THEREOF	F02D 41/38 (2006.01)	2663764 *	VALVE ASSEMBLY
A61P 19/02 (2006.01)	2655375 *	PYRIMIDINONE DERIVATIVES, PREPARATION THEREOF AND PHARMACEUTICAL USE THEREOF	F02M 59/34 (2006.01)	2663764 *	VALVE ASSEMBLY
A61P 3/10 (2006.01)	2655375 *	PYRIMIDINONE DERIVATIVES, PREPARATION THEREOF AND PHARMACEUTICAL USE THEREOF	F02M 59/36 (2006.01)	2663764 *	VALVE ASSEMBLY
C07D 233/44 (2006.01)	2655375 *	PYRIMIDINONE DERIVATIVES, PREPARATION THEREOF AND PHARMACEUTICAL USE THEREOF	F02M 63/00 (2006.01)	2663764 *	VALVE ASSEMBLY
A61P 37/00 (2006.01)	2655375 *	PYRIMIDINONE DERIVATIVES, PREPARATION THEREOF AND PHARMACEUTICAL USE THEREOF	F02M 63/02 (2006.01)	2663764 *	VALVE ASSEMBLY
C07D 239/12 (2006.01)	2655375 *	PYRIMIDINONE DERIVATIVES, PREPARATION THEREOF AND PHARMACEUTICAL USE THEREOF	A61C 8/00 (2006.01)	2654602 *	DENTAL IMPLANT
A61P 11/06 (2006.01)	2655375 *	PYRIMIDINONE DERIVATIVES, PREPARATION THEREOF AND PHARMACEUTICAL USE THEREOF	A61K 31/519 (2006.01)	2688887 *	FUSED TRICYCLIC DUAL INHIBITORS OF CDK 4/6 AND FLT3
A61P 35/00 (2006.01)	2655375 *	PYRIMIDINONE DERIVATIVES, PREPARATION THEREOF AND PHARMACEUTICAL USE THEREOF	A61P 35/00 (2006.01)	2688887 *	FUSED TRICYCLIC DUAL INHIBITORS OF CDK 4/6 AND FLT3
A61P 17/06 (2006.01)	2655375 *	PYRIMIDINONE DERIVATIVES, PREPARATION THEREOF AND PHARMACEUTICAL USE THEREOF	A61P 35/02 (2006.01)	2688887 *	FUSED TRICYCLIC DUAL INHIBITORS OF CDK 4/6 AND FLT3
			C07D 471/14 (2006.01)	2688887 *	FUSED TRICYCLIC DUAL INHIBITORS OF CDK 4/6 AND FLT3
			C07D 519/00 (2006.01)	2688887 *	FUSED TRICYCLIC DUAL INHIBITORS OF CDK 4/6 AND FLT3
			C12Q 1/68 (2006.01)	2694963 *	GENE EXPRESSION SIGNATURE FOR WNT/B-CATENIN SIGNALING PATHWAY AND USE THEREOF

MKP (51)	Broj objave evropske prijave patenta (97)	Naziv pronalaska (54)	MKP (51)	Broj objave evropske prijave patenta (97)	Naziv pronalaska (54)
C40B 40/08 (2006.01)	2694963 *	GENE EXPRESSION SIGNATURE FOR WNT/B-CATENIN SIGNALING PATHWAY AND USE THEREOF	A61M 25/02 (2006.01)	2654860 *	COVER UNIT FOR USE WHEN INSERTING A PUNCTURE DEVICE IN AN ANATOMICAL STRUCTURE SUCH AS A VEIN OR AN ARTERY AND FOR MAINTAINING SAID PUNCTURE DEVICE IN THE ANATOMICAL STRUCTURE
G01N 33/50 (2006.01)	2694963 *	GENE EXPRESSION SIGNATURE FOR WNT/B-CATENIN SIGNALING PATHWAY AND USE THEREOF	A61K 9/20 (2006.01)	2654729 *	HOMOGENOUS PHARMACEUTICAL ORAL DOSAGE FORMS COMPRISING LERCANIDIPINE AND ENALAPRIL OR THEIR PHARMACEUTICALLY ACCEPTABLE SALTS
B05D 1/02 (2006.01)	2687298	Method for patinating products made of copper or a copper alloy as well as products produced by the said process	A61K 9/28 (2006.01)	2654729 *	HOMOGENOUS PHARMACEUTICAL ORAL DOSAGE FORMS COMPRISING LERCANIDIPINE AND ENALAPRIL OR THEIR PHARMACEUTICALLY ACCEPTABLE SALTS
B05D 3/02 (2006.01)	2687298	Method for patinating products made of copper or a copper alloy as well as products produced by the said process	A61K 31/401 (2006.01)	2654729 *	HOMOGENOUS PHARMACEUTICAL ORAL DOSAGE FORMS COMPRISING LERCANIDIPINE AND ENALAPRIL OR THEIR PHARMACEUTICALLY ACCEPTABLE SALTS
B05D 5/06 (2006.01)	2687298	Method for patinating products made of copper or a copper alloy as well as products produced by the said process	A61K 31/4422 (2006.01)	2654729 *	HOMOGENOUS PHARMACEUTICAL ORAL DOSAGE FORMS COMPRISING LERCANIDIPINE AND ENALAPRIL OR THEIR PHARMACEUTICALLY ACCEPTABLE SALTS
F21V 5/04 (2006.01)	2647906 *	WIDE ICICLE-TYPE LIGHT-ADJUSTING LENS FOR DIFFUSING THE LIGHT OF AN LED	C22B 9/02 (2006.01)	2698438 *	TANTALUM-MATERIAL MULTILEVEL DISTILLATION CRUCIBLE AND DISTILLATION PROCESS
F21Y 101/02 (2006.01)	2647906 *	WIDE ICICLE-TYPE LIGHT-ADJUSTING LENS FOR DIFFUSING THE LIGHT OF AN LED	C22B 59/00 (2006.01)	2698438 *	TANTALUM-MATERIAL MULTILEVEL DISTILLATION CRUCIBLE AND DISTILLATION PROCESS
B29D 11/00 (2006.01)	2652532 *	OPHTHALMIC LENSES MODIFIED WITH FUNCTIONAL GROUPS AND METHODS OF MAKING THEREOF	C30B 25/00 (2006.01)	2698438 *	TANTALUM-MATERIAL MULTILEVEL DISTILLATION CRUCIBLE AND DISTILLATION PROCESS
G02B 1/04 (2006.01)	2652532 *	OPHTHALMIC LENSES MODIFIED WITH FUNCTIONAL GROUPS AND METHODS OF MAKING THEREOF	C30B 35/00 (2006.01)	2698438 *	TANTALUM-MATERIAL MULTILEVEL DISTILLATION CRUCIBLE AND DISTILLATION PROCESS
A61F 13/15 (2006.01)	2565013	Method for stretching a sheet of film	F27B 14/10 (2006.01)	2698438 *	TANTALUM-MATERIAL MULTILEVEL DISTILLATION CRUCIBLE AND DISTILLATION PROCESS
B29C 55/06 (2006.01)	2565013	Method for stretching a sheet of film	A61K 9/14 (2006.01)	2645995 *	CAPSULE AND POWDER FORMULATIONS CONTAINING LANTHANUM COMPOUNDS
A61F 13/02 (2006.01)	2654860 *	COVER UNIT FOR USE WHEN INSERTING A PUNCTURE DEVICE IN AN ANATOMICAL STRUCTURE SUCH AS A VEIN OR AN ARTERY AND FOR MAINTAINING SAID PUNCTURE DEVICE IN THE ANATOMICAL STRUCTURE	A61K 9/16 (2006.01)	2645995 *	CAPSULE AND POWDER FORMULATIONS CONTAINING LANTHANUM COMPOUNDS
A61M 5/42 (2006.01)	2654860 *	COVER UNIT FOR USE WHEN INSERTING A PUNCTURE DEVICE IN AN ANATOMICAL STRUCTURE SUCH AS A VEIN OR AN ARTERY AND FOR MAINTAINING SAID PUNCTURE DEVICE IN THE ANATOMICAL STRUCTURE			

MKP (51)	Broj objave evropske prijave patenta (97)	Naziv pronalaska (54)	MKP (51)	Broj objave evropske prijave patenta (97)	Naziv pronalaska (54)
A61K 9/48 (2006.01)	2645995 *	CAPSULE AND POWDER FORMULATIONS CONTAINING LANTHANUM COMPOUNDS	A61P 9/00 (2006.01)	2657241 *	DIPHENYL SULFIDE DERIVATIVE AND PHARMACEUTICAL PRODUCT WHICH CONTAINS SAME AS ACTIVE INGREDIENT
A61K 33/24 (2006.01)	2645995 *	CAPSULE AND POWDER FORMULATIONS CONTAINING LANTHANUM COMPOUNDS	A61P 29/00 (2006.01)	2657241 *	DIPHENYL SULFIDE DERIVATIVE AND PHARMACEUTICAL PRODUCT WHICH CONTAINS SAME AS ACTIVE INGREDIENT
F04C 18/22 (2006.01)	2647846 *	ROTARY PISTON COMPRESSOR	A61P 7/02 (2006.01)	2657241 *	DIPHENYL SULFIDE DERIVATIVE AND PHARMACEUTICAL PRODUCT WHICH CONTAINS SAME AS ACTIVE INGREDIENT
F04C 29/02 (2006.01)	2647846 *	ROTARY PISTON COMPRESSOR	A61P 27/06 (2006.01)	2657241 *	DIPHENYL SULFIDE DERIVATIVE AND PHARMACEUTICAL PRODUCT WHICH CONTAINS SAME AS ACTIVE INGREDIENT
E02B 9/04 (2006.01)	2597201	Method for regulating the flow of rivers	A61P 11/00 (2006.01)	2657241 *	DIPHENYL SULFIDE DERIVATIVE AND PHARMACEUTICAL PRODUCT WHICH CONTAINS SAME AS ACTIVE INGREDIENT
C07F 9/09 (2006.01)	2657241 *	DIPHENYL SULFIDE DERIVATIVE AND PHARMACEUTICAL PRODUCT WHICH CONTAINS SAME AS ACTIVE INGREDIENT	A61P 11/00 (2006.01)	2657241 *	DIPHENYL SULFIDE DERIVATIVE AND PHARMACEUTICAL PRODUCT WHICH CONTAINS SAME AS ACTIVE INGREDIENT
A61P 11/06 (2006.01)	2657241 *	DIPHENYL SULFIDE DERIVATIVE AND PHARMACEUTICAL PRODUCT WHICH CONTAINS SAME AS ACTIVE INGREDIENT	A61P 35/00 (2006.01)	2657241 *	DIPHENYL SULFIDE DERIVATIVE AND PHARMACEUTICAL PRODUCT WHICH CONTAINS SAME AS ACTIVE INGREDIENT
A61P 43/00 (2006.01)	2657241 *	DIPHENYL SULFIDE DERIVATIVE AND PHARMACEUTICAL PRODUCT WHICH CONTAINS SAME AS ACTIVE INGREDIENT	A61P 9/06 (2006.01)	2657241 *	DIPHENYL SULFIDE DERIVATIVE AND PHARMACEUTICAL PRODUCT WHICH CONTAINS SAME AS ACTIVE INGREDIENT
A61K 31/662 (2006.01)	2657241 *	DIPHENYL SULFIDE DERIVATIVE AND PHARMACEUTICAL PRODUCT WHICH CONTAINS SAME AS ACTIVE INGREDIENT	A61P 31/04 (2006.01)	2657241 *	DIPHENYL SULFIDE DERIVATIVE AND PHARMACEUTICAL PRODUCT WHICH CONTAINS SAME AS ACTIVE INGREDIENT
A61P 27/02 (2006.01)	2657241 *	DIPHENYL SULFIDE DERIVATIVE AND PHARMACEUTICAL PRODUCT WHICH CONTAINS SAME AS ACTIVE INGREDIENT	C08G 69/26 (2006.01)	2662397 *	COPOLYMER POLYAMIDE
A61K 31/661 (2006.01)	2657241 *	DIPHENYL SULFIDE DERIVATIVE AND PHARMACEUTICAL PRODUCT WHICH CONTAINS SAME AS ACTIVE INGREDIENT	C08L 77/06 (2006.01)	2662397 *	COPOLYMER POLYAMIDE
A61P 13/12 (2006.01)	2657241 *	DIPHENYL SULFIDE DERIVATIVE AND PHARMACEUTICAL PRODUCT WHICH CONTAINS SAME AS ACTIVE INGREDIENT	C07K 16/00 (2006.01)	2688909 *	HETERO-DIMERIC IMMUNOGLOBULINS
C07F 9/38 (2006.01)	2657241 *	DIPHENYL SULFIDE DERIVATIVE AND PHARMACEUTICAL PRODUCT WHICH CONTAINS SAME AS ACTIVE INGREDIENT	C07K 16/46 (2006.01)	2688909 *	HETERO-DIMERIC IMMUNOGLOBULINS
A61P 9/10 (2006.01)	2657241 *	DIPHENYL SULFIDE DERIVATIVE AND PHARMACEUTICAL PRODUCT WHICH CONTAINS SAME AS ACTIVE INGREDIENT	B29C 45/27 (2006.01)	2670574 *	INJECTION MOLDING APPARATUS FOR MANUFACTURING HOLLOW OBJECTS, IN PARTICULAR PLASTIC PREFORMS, RESP. CONTAINERS AND METHOD THEREFOR
A61P 31/16 (2006.01)	2657241 *	DIPHENYL SULFIDE DERIVATIVE AND PHARMACEUTICAL PRODUCT WHICH CONTAINS SAME AS ACTIVE INGREDIENT			

MKP (51)	Broj objave evropske prijave patenta (97)	Naziv pronalaska (54)	MKP (51)	Broj objave evropske prijave patenta (97)	Naziv pronalaska (54)
C09D 7/00 (2006.01)	2678395 *	COATING COMPOSITION COMPRISING SUBMICRON CALCIUM CARBONATE-COMPRISING PARTICLES, PROCESS TO PREPARE SAME AND USE OF SUBMICRON CALCIUM CARBONATE-COMPRISING PARTICLES IN COATING COMPOSITIONS	C07D 471/10 (2006.01)	2658844 *	NOVEL PYRIMIDINE DERIVATIVES, PREPARATION THEREOF, AND PHARMACEUTICAL USE THEREOF AS AKT(PKB) PHOSPHORYLATION INHIBITORS
A61K 31/513 (2006.01)	2658844 *	NOVEL PYRIMIDINE DERIVATIVES, PREPARATION THEREOF, AND PHARMACEUTICAL USE THEREOF AS AKT(PKB) PHOSPHORYLATION INHIBITORS	C07D 493/10 (2006.01)	2658844 *	NOVEL PYRIMIDINE DERIVATIVES, PREPARATION THEREOF, AND PHARMACEUTICAL USE THEREOF AS AKT(PKB) PHOSPHORYLATION INHIBITORS
A61P 35/00 (2006.01)	2658844 *	NOVEL PYRIMIDINE DERIVATIVES, PREPARATION THEREOF, AND PHARMACEUTICAL USE THEREOF AS AKT(PKB) PHOSPHORYLATION INHIBITORS	A61F 13/15 (2006.01)	2659869	Single transfer insert placement method and apparatus with cross-direction insert placement control
C07D 209/30 (2006.01)	2658844 *	NOVEL PYRIMIDINE DERIVATIVES, PREPARATION THEREOF, AND PHARMACEUTICAL USE THEREOF AS AKT(PKB) PHOSPHORYLATION INHIBITORS	E21B 43/26 (2006.01)	2655794 *	HIGH PRESSURE HYDROCARBON FRACTURING ON DEMAND METHOD AND RELATED PROCESS
C07D 401/14 (2006.01)	2658844 *	NOVEL PYRIMIDINE DERIVATIVES, PREPARATION THEREOF, AND PHARMACEUTICAL USE THEREOF AS AKT(PKB) PHOSPHORYLATION INHIBITORS	E21B 43/30 (2006.01)	2655794 *	HIGH PRESSURE HYDROCARBON FRACTURING ON DEMAND METHOD AND RELATED PROCESS
C07D 403/04 (2006.01)	2658844 *	NOVEL PYRIMIDINE DERIVATIVES, PREPARATION THEREOF, AND PHARMACEUTICAL USE THEREOF AS AKT(PKB) PHOSPHORYLATION INHIBITORS	A61K 9/20 (2006.01)	2646004 *	GALENIC COMPOSITION SUITABLE FOR ADMINISTRATION TO A NON-HUMAN ANIMAL, USES THEREOF, AND ASSOCIATED METHODS
C07D 403/06 (2006.01)	2658844 *	NOVEL PYRIMIDINE DERIVATIVES, PREPARATION THEREOF, AND PHARMACEUTICAL USE THEREOF AS AKT(PKB) PHOSPHORYLATION INHIBITORS	A61K 38/17 (2006.01)	2646044 *	METHODS FOR INCREASING INTRACELLULAR ACTIVITY OF HSP70
C07D 413/04 (2006.01)	2658844 *	NOVEL PYRIMIDINE DERIVATIVES, PREPARATION THEREOF, AND PHARMACEUTICAL USE THEREOF AS AKT(PKB) PHOSPHORYLATION INHIBITORS	A61P 3/00 (2006.01)	2646044 *	METHODS FOR INCREASING INTRACELLULAR ACTIVITY OF HSP70
C07D 413/14 (2006.01)	2658844 *	NOVEL PYRIMIDINE DERIVATIVES, PREPARATION THEREOF, AND PHARMACEUTICAL USE THEREOF AS AKT(PKB) PHOSPHORYLATION INHIBITORS	A61K 31/4184 (2006.01)	2655378 *	COMPOUNDS AND THEIR USE AS BACE INHIBITORS
C07D 413/14 (2006.01)	2658844 *	NOVEL PYRIMIDINE DERIVATIVES, PREPARATION THEREOF, AND PHARMACEUTICAL USE THEREOF AS AKT(PKB) PHOSPHORYLATION INHIBITORS	A61K 31/4188 (2006.01)	2655378 *	COMPOUNDS AND THEIR USE AS BACE INHIBITORS
			A61K 31/4439 (2006.01)	2655378 *	COMPOUNDS AND THEIR USE AS BACE INHIBITORS
			A61K 31/506 (2006.01)	2655378 *	COMPOUNDS AND THEIR USE AS BACE INHIBITORS
			A61P 25/28 (2006.01)	2655378 *	COMPOUNDS AND THEIR USE AS BACE INHIBITORS
			C07D 235/02 (2006.01)	2655378 *	COMPOUNDS AND THEIR USE AS BACE INHIBITORS
			C07D 401/04 (2006.01)	2655378 *	COMPOUNDS AND THEIR USE AS BACE INHIBITORS

MKP (51)	Broj objave evropske prijave patenta (97)	Naziv pronalaska (54)	MKP (51)	Broj objave evropske prijave patenta (97)	Naziv pronalaska (54)
C07D 401/12 (2006.01)	2655378 *	COMPOUNDS AND THEIR USE AS BACE INHIBITORS	C07K 17/02 (2006.01)	2649088 *	COMPOSITIONS FOR SEPARATION METHODS
C07D 403/12 (2006.01)	2655378 *	COMPOUNDS AND THEIR USE AS BACE INHIBITORS	C07K 19/00 (2006.01)	2649088 *	COMPOSITIONS FOR SEPARATION METHODS
C07D 405/12 (2006.01)	2655378 *	COMPOUNDS AND THEIR USE AS BACE INHIBITORS	G01N 33/544 (2006.01)	2649088 *	COMPOSITIONS FOR SEPARATION METHODS
C07D 491/107 (2006.01)	2655378 *	COMPOUNDS AND THEIR USE AS BACE INHIBITORS	G05D 16/06 (2006.01)	2656159 *	PRESSURE REGULATING DEVICE
C07D 491/20 (2006.01)	2655378 *	COMPOUNDS AND THEIR USE AS BACE INHIBITORS	B65D 51/16 (2006.01)	2675721 *	HOT BEVERAGE CONTAINER ASSEMBLY, INSERT, AND METHOD
G01N 33/564 (2006.01)	2661627 *	LIPOCALIN 2 AS A BIOMARKER FOR IL-17 INHIBITOR THERAPY EFFICACY	E01B 1/00 (2006.01)	2675953 *	RAILWAY STRUCTURE AND ASSEMBLY METHOD
G01N 33/68 (2006.01)	2661627 *	LIPOCALIN 2 AS A BIOMARKER FOR IL-17 INHIBITOR THERAPY EFFICACY	A61L 2/00 (2006.01)	2583846	Air purification device
H01R 13/627 (2006.01)	2688154	An industrial electric connector with push button for the fast unhooking of the complementary connector	B01D 46/00 (2006.01)	2583846	Air purification device
H01R 13/635 (2006.01)	2688154	An industrial electric connector with push button for the fast unhooking of the complementary connector	B60H 3/06 (2006.01)	2583846	Air purification device
G01N 33/68 (2006.01)	2668506 *	SEED TRAIT PREDICTION BY ACTIVITY-BASED PROTEIN PROFILING	A61K 31/18 (2006.01)	2648712 *	ARYLSULFONAMIDE DERIVATIVES FOR THE PREVENTION OR TREATMENT OF SPECIFIC OPHTHALMOLOGIC DISORDERS
D04H 1/70 (2012.01)	2668327 *	METHOD AND APPARATUS FOR FORMING A FIBROUS MEDIA	A61K 31/4164 (2006.01)	2648712 *	ARYLSULFONAMIDE DERIVATIVES FOR THE PREVENTION OR TREATMENT OF SPECIFIC OPHTHALMOLOGIC DISORDERS
D04H 1/736 (2012.01)	2668327 *	METHOD AND APPARATUS FOR FORMING A FIBROUS MEDIA	A61K 45/06 (2006.01)	2648712 *	ARYLSULFONAMIDE DERIVATIVES FOR THE PREVENTION OR TREATMENT OF SPECIFIC OPHTHALMOLOGIC DISORDERS
D21F 11/04 (2006.01)	2668327 *	METHOD AND APPARATUS FOR FORMING A FIBROUS MEDIA	A61P 27/00 (2006.01)	2648712 *	ARYLSULFONAMIDE DERIVATIVES FOR THE PREVENTION OR TREATMENT OF SPECIFIC OPHTHALMOLOGIC DISORDERS
A61K 31/4184 (2006.01)	2651927 *	ANTI-VIRAL COMPOUNDS	C01B 39/06 (2006.01)	2673237 *	MICROPOROUS ZIRCONIUM SILICATE FOR THE TREATMENT OF HYPERKALEMIA
A61P 31/14 (2006.01)	2651927 *	ANTI-VIRAL COMPOUNDS	A61K 39/10 (2006.01)	2670431 *	COMPOSITIONS FOR CANINE RESPIRATORY DISEASE COMPLEX
C07D 403/10 (2006.01)	2651927 *	ANTI-VIRAL COMPOUNDS	A61K 39/145 (2006.01)	2670431 *	COMPOSITIONS FOR CANINE RESPIRATORY DISEASE COMPLEX
C07D 403/12 (2006.01)	2651927 *	ANTI-VIRAL COMPOUNDS	A61K 39/215 (2006.01)	2670431 *	COMPOSITIONS FOR CANINE RESPIRATORY DISEASE COMPLEX
C07D 403/14 (2006.01)	2651927 *	ANTI-VIRAL COMPOUNDS			
C07K 1/34 (2006.01)	2649088 *	COMPOSITIONS FOR SEPARATION METHODS			

MKP (51)	Broj objave evropske prijave patenta (97)	Naziv pronalaska (54)	MKP (51)	Broj objave evropske prijave patenta (97)	Naziv pronalaska (54)
E01F 8/00 (2006.01)	2655744 *	SOUND PROTECTION ELEMENT	C07D 209/20 (2006.01)	2691369 *	PRODRUGS OF D-ISOGLUTAMYL-[D/L]- TRYPTOPHAN
A61K 39/104 (2006.01)	2686339 *	NOVEL OPRF/I FUSION PROTEINS, THEIR PREPARATION AND USE	C07K 5/037 (2006.01)	2691369 *	PRODRUGS OF D-ISOGLUTAMYL-[D/L]- TRYPTOPHAN
C07K 14/21 (2006.01)	2686339 *	NOVEL OPRF/I FUSION PROTEINS, THEIR PREPARATION AND USE	A63G 21/22 (2006.01)	2620345	Device for sliding along cables
C07K 16/12 (2006.01)	2686339 *	NOVEL OPRF/I FUSION PROTEINS, THEIR PREPARATION AND USE	B61B 12/02 (2006.01)	2620345	Device for sliding along cables
C07K 19/00 (2006.01)	2686339 *	NOVEL OPRF/I FUSION PROTEINS, THEIR PREPARATION AND USE	A61K 31/195 (2006.01)	2682381 *	SPIROCYCLIC CYCLOPROPANOIC AMINO ACIDS - ANALOGUES OF GAMMA-AMINOBUTYRIC ACID, WITH LIMITED CONFORMATIONAL MOBILITY, AND DRUGS ON THE BASIS THEREOF
C07C 231/14 (2006.01)	2661423 *	NOVEL PROCESS FOR SYNTHESIZING AGOMELATINE	A61P 25/18 (2006.01)	2682381 *	SPIROCYCLIC CYCLOPROPANOIC AMINO ACIDS - ANALOGUES OF GAMMA-AMINOBUTYRIC ACID, WITH LIMITED CONFORMATIONAL MOBILITY, AND DRUGS ON THE BASIS THEREOF
C07C 233/18 (2006.01)	2661423 *	NOVEL PROCESS FOR SYNTHESIZING AGOMELATINE	C07C 229/46 (2006.01)	2682381 *	SPIROCYCLIC CYCLOPROPANOIC AMINO ACIDS - ANALOGUES OF GAMMA-AMINOBUTYRIC ACID, WITH LIMITED CONFORMATIONAL MOBILITY, AND DRUGS ON THE BASIS THEREOF
C07C 233/31 (2006.01)	2661423 *	NOVEL PROCESS FOR SYNTHESIZING AGOMELATINE	A61K 31/416 (2006.01)	2649062 *	BICYCLIC COMPOUNDS AS INHIBITORS OF ACETYL-COA CARBOXYLASE (ACC)
C07D 209/48 (2006.01)	2661423 *	NOVEL PROCESS FOR SYNTHESIZING AGOMELATINE	A61K 31/423 (2006.01)	2649062 *	BICYCLIC COMPOUNDS AS INHIBITORS OF ACETYL-COA CARBOXYLASE (ACC)
A61K 9/20 (2006.01)	2688556 *	CONTROLLED RELEASE PHARMACEUTICAL DOSAGE FORMS	A61P 9/00 (2006.01)	2649062 *	BICYCLIC COMPOUNDS AS INHIBITORS OF ACETYL-COA CARBOXYLASE (ACC)
A61K 9/28 (2006.01)	2688556 *	CONTROLLED RELEASE PHARMACEUTICAL DOSAGE FORMS	C07D 401/04 (2006.01)	2649062 *	BICYCLIC COMPOUNDS AS INHIBITORS OF ACETYL-COA CARBOXYLASE (ACC)
A61K 31/485 (2006.01)	2688556 *	CONTROLLED RELEASE PHARMACEUTICAL DOSAGE FORMS	C07D 405/04 (2006.01)	2649062 *	BICYCLIC COMPOUNDS AS INHIBITORS OF ACETYL-COA CARBOXYLASE (ACC)
A61K 47/10 (2006.01)	2688556 *	CONTROLLED RELEASE PHARMACEUTICAL DOSAGE FORMS	C07D 413/04 (2006.01)	2649062 *	BICYCLIC COMPOUNDS AS INHIBITORS OF ACETYL-COA CARBOXYLASE (ACC)
A61K 47/34 (2006.01)	2688556 *	CONTROLLED RELEASE PHARMACEUTICAL DOSAGE FORMS	C07D 417/04 (2006.01)	2649062 *	BICYCLIC COMPOUNDS AS INHIBITORS OF ACETYL-COA CARBOXYLASE (ACC)
A01N 25/04 (2006.01)	2663181 *	AGRICULTURAL COMPOSITIONS COMPRISING OIL-IN-WATER EMULSIONS	C11C 5/00 (2006.01)	2594627	Wooden wicks including a booster for a candle and method of making
B01F 3/08 (2006.01)	2663181 *	AGRICULTURAL COMPOSITIONS COMPRISING OIL-IN-WATER EMULSIONS	F23D 3/08 (2006.01)	2594627	Wooden wicks including a booster for a candle and method of making
E05F 3/10 (2006.01)	2663717 *	UNDER LINTEL-MOUNTED OPERATOR FOR SINGLE- ACTING DOOR, OPERATOR ATTACHMENT FOR SINGLE ACTING DOOR AND OPERATOR FOR SINGLE- ACTING DOOR			
A61K 9/72 (2006.01)	2691369 *	PRODRUGS OF D-ISOGLUTAMYL-[D/L]- TRYPTOPHAN			
A61K 38/05 (2006.01)	2691369 *	PRODRUGS OF D-ISOGLUTAMYL-[D/L]- TRYPTOPHAN			

MKP (51)	Broj objave evropske prijave patenta (97)	Naziv pronalaska (54)	MKP (51)	Broj objave evropske prijave patenta (97)	Naziv pronalaska (54)
B62H 3/02 (2006.01)	2673182 *	MODULAR VEHICLE SYSTEM, ELECTRIC VEHICLE AND MODULE FOR CONNECTING TO AN ELECTRIC VEHICLE	C07D 207/16 (2006.01)	2651885 *	ANTI-VIRAL COMPOUNDS
B62M 6/45 (2010.01)	2673182 *	MODULAR VEHICLE SYSTEM, ELECTRIC VEHICLE AND MODULE FOR CONNECTING TO AN ELECTRIC VEHICLE	C07D 403/04 (2006.01)	2651885 *	ANTI-VIRAL COMPOUNDS
A61M 5/20 (2006.01)	2667914 *	REMOVAL OF NEEDLE SHIELDS FROM SYRINGES AND AUTOMATIC INJECTION DEVICES	A61K 31/437 (2006.01)	2699574 *	BICYCLIC HETEROCYCLE COMPOUNDS AND THEIR USES IN THERAPY
A61M 5/32 (2006.01)	2667914 *	REMOVAL OF NEEDLE SHIELDS FROM SYRINGES AND AUTOMATIC INJECTION DEVICES	A61K 31/4985 (2006.01)	2699574 *	BICYCLIC HETEROCYCLE COMPOUNDS AND THEIR USES IN THERAPY
A61B 5/042 (2006.01)	2699150 *	BASKET STYLE CARDIAC MAPPING CATHETER HAVING A FLEXIBLE ELECTRODE ASSEMBLY FOR DETECTION OF CARDIAC RHYTHM DISORDERS	A61K 31/519 (2006.01)	2699574 *	BICYCLIC HETEROCYCLE COMPOUNDS AND THEIR USES IN THERAPY
G06Q 20/32 (2012.01)	2697755 *	PAYMENT CARD, CASHLESS PAYMENT METHOD	A61K 31/5383 (2006.01)	2699574 *	BICYCLIC HETEROCYCLE COMPOUNDS AND THEIR USES IN THERAPY
E04B 5/00 (2006.01)	2689075 *	A BEAM AND METHOD FOR REINFORCING CONCRETE SLABS	A61P 35/00 (2006.01)	2699574 *	BICYCLIC HETEROCYCLE COMPOUNDS AND THEIR USES IN THERAPY
E04B 5/36 (2006.01)	2689075 *	A BEAM AND METHOD FOR REINFORCING CONCRETE SLABS	C07D 471/04 (2006.01)	2699574 *	BICYCLIC HETEROCYCLE COMPOUNDS AND THEIR USES IN THERAPY
E04B 5/40 (2006.01)	2689075 *	A BEAM AND METHOD FOR REINFORCING CONCRETE SLABS	C07D 498/04 (2006.01)	2699574 *	BICYCLIC HETEROCYCLE COMPOUNDS AND THEIR USES IN THERAPY
E04C 5/00 (2006.01)	2689075 *	A BEAM AND METHOD FOR REINFORCING CONCRETE SLABS	A01B 13/08 (2006.01)	2672801 *	A DUAL-PURPOSE AGRICULTURAL MACHINE
A61P 35/00 (2006.01)	2678075 *	SOLID FORMS OF A PHARMACEUTICALLY ACTIVE SUBSTANCE	A01B 15/02 (2006.01)	2672801 *	A DUAL-PURPOSE AGRICULTURAL MACHINE
E06B 3/667 (2006.01)	2631409	Connector	A01B 35/08 (2006.01)	2672801 *	A DUAL-PURPOSE AGRICULTURAL MACHINE
A61K 39/395 (2006.01)	2683403 *	NON-AQUEOUS HIGH CONCENTRATION REDUCED VISCOSITY SUSPENSION FORMULATIONS OF ANTIBODIES	A01B 35/26 (2006.01)	2672801 *	A DUAL-PURPOSE AGRICULTURAL MACHINE
A61K 31/4025 (2006.01)	2651885 *	ANTI-VIRAL COMPOUNDS	A01B 49/06 (2006.01)	2672801 *	A DUAL-PURPOSE AGRICULTURAL MACHINE
A61K 31/4184 (2006.01)	2651885 *	ANTI-VIRAL COMPOUNDS	A61M 5/168 (2006.01)	2691128 *	DOSING MECHANISM
A61K 31/4439 (2006.01)	2651885 *	ANTI-VIRAL COMPOUNDS	A61K 9/00 (2006.01)	2672957 *	NOVEL COMPOSITION FOR THE TREATMENT OF CYSTIC FIBROSIS
A61P 31/12 (2006.01)	2651885 *	ANTI-VIRAL COMPOUNDS	A61K 9/28 (2006.01)	2672957 *	NOVEL COMPOSITION FOR THE TREATMENT OF CYSTIC FIBROSIS
			A61K 9/48 (2006.01)	2672957 *	NOVEL COMPOSITION FOR THE TREATMENT OF CYSTIC FIBROSIS
			A61K 31/192 (2006.01)	2672957 *	NOVEL COMPOSITION FOR THE TREATMENT OF CYSTIC FIBROSIS
			A61K 31/343 (2006.01)	2672957 *	NOVEL COMPOSITION FOR THE TREATMENT OF CYSTIC FIBROSIS

MKP (51)	Broj objave evropske prijave patenta (97)	Naziv pronalaska (54)	MKP (51)	Broj objave evropske prijave patenta (97)	Naziv pronalaska (54)
A61K 31/37 (2006.01)	2672957 *	NOVEL COMPOSITION FOR THE TREATMENT OF CYSTIC FIBROSIS	A61L 11/00 (2006.01)	2596811	Apparatus and process for sterilising absorbent sanitary products
A61K 31/4015 (2006.01)	2672957 *	NOVEL COMPOSITION FOR THE TREATMENT OF CYSTIC FIBROSIS	B01J 3/04 (2006.01)	2596811	Apparatus and process for sterilising absorbent sanitary products
A61K 31/404 (2006.01)	2672957 *	NOVEL COMPOSITION FOR THE TREATMENT OF CYSTIC FIBROSIS	B29B 17/00 (2006.01)	2596811	Apparatus and process for sterilising absorbent sanitary products
A61K 31/4174 (2006.01)	2672957 *	NOVEL COMPOSITION FOR THE TREATMENT OF CYSTIC FIBROSIS	F01K 25/10 (2006.01)	2686627 *	CRYOGENIC AIR SEPARATION METHOD AND SYSTEM
A61K 31/427 (2006.01)	2672957 *	NOVEL COMPOSITION FOR THE TREATMENT OF CYSTIC FIBROSIS	F25J 3/04 (2006.01)	2686627 *	CRYOGENIC AIR SEPARATION METHOD AND SYSTEM
A61K 31/437 (2006.01)	2672957 *	NOVEL COMPOSITION FOR THE TREATMENT OF CYSTIC FIBROSIS	C07D 401/14 (2006.01)	2699563 *	NOVEL PESTICIDAL PYRAZOLE COMPOUNDS
A61K 31/44 (2006.01)	2672957 *	NOVEL COMPOSITION FOR THE TREATMENT OF CYSTIC FIBROSIS	C07D 403/12 (2006.01)	2699563 *	NOVEL PESTICIDAL PYRAZOLE COMPOUNDS
A61K 31/444 (2006.01)	2672957 *	NOVEL COMPOSITION FOR THE TREATMENT OF CYSTIC FIBROSIS	C07D 405/14 (2006.01)	2699563 *	NOVEL PESTICIDAL PYRAZOLE COMPOUNDS
A61K 31/472 (2006.01)	2672957 *	NOVEL COMPOSITION FOR THE TREATMENT OF CYSTIC FIBROSIS	C07D 409/14 (2006.01)	2699563 *	NOVEL PESTICIDAL PYRAZOLE COMPOUNDS
A61K 31/498 (2006.01)	2672957 *	NOVEL COMPOSITION FOR THE TREATMENT OF CYSTIC FIBROSIS	C07D 411/14 (2006.01)	2699563 *	NOVEL PESTICIDAL PYRAZOLE COMPOUNDS
A61K 31/353 (2006.01)	2675810 *	SPIRO-AMINO-IMIDAZO-FUSED HETEROCYCLIC COMPOUNDS AS BETA-SECRETASE MODULATORS AND METHODS OF USE	C07D 417/14 (2006.01)	2699563 *	NOVEL PESTICIDAL PYRAZOLE COMPOUNDS
A61P 25/00 (2006.01)	2675810 *	SPIRO-AMINO-IMIDAZO-FUSED HETEROCYCLIC COMPOUNDS AS BETA-SECRETASE MODULATORS AND METHODS OF USE	A01H 5/08 (2006.01)	2683832 *	TYCLV RESISTANCE
C07D 491/00 (2006.01)	2675810 *	SPIRO-AMINO-IMIDAZO-FUSED HETEROCYCLIC COMPOUNDS AS BETA-SECRETASE MODULATORS AND METHODS OF USE	C12Q 1/68 (2006.01)	2683832 *	TYCLV RESISTANCE
G06Q 50/00 (2012.01)	2646968 *	ENTERAL FEEDING APPARATUS	E01F 8/00 (2006.01)	2673419 *	NOISE BARRIER STRUCTURE WITH SOUND-ABSORBING AND SOUND-REDIRECTING PROPERTIES, AND HIGH PERFORMANCE SOUND ABSORBER FOR USE IN SUCH STRUCTURE
B01J 31/00 (2006.01)	2680967 *	MOLYBDENUM AND TUNGSTEN METAL COMPLEXES AND USE THEREOF AS PRECATALYSTS FOR OLEFIN METATHESIS	A61K 39/395 (2006.01)	2688910 *	ANTI - SCLEROSTIN ANTIBODY CRYSTALS AND FORMULATIONS THEREOF
C07F 11/00 (2006.01)	2680967 *	MOLYBDENUM AND TUNGSTEN METAL COMPLEXES AND USE THEREOF AS PRECATALYSTS FOR OLEFIN METATHESIS	C07K 16/22 (2006.01)	2688910 *	ANTI - SCLEROSTIN ANTIBODY CRYSTALS AND FORMULATIONS THEREOF
A61L 2/07 (2006.01)	2596811	Apparatus and process for sterilising absorbent sanitary products	H04N 1/00 (2006.01)	2689581 *	SYSTEM AND METHOD FOR TRANSMITTING REAL-TIME IMAGES
			H04N 7/18 (2006.01)	2689581 *	SYSTEM AND METHOD FOR TRANSMITTING REAL-TIME IMAGES
			G07F 17/32 (2006.01)	2666149 *	GAMING SYSTEM AND METHOD OF USE

MKP (51)	Broj objave evropske prijave patenta (97)	Naziv pronalaska (54)	MKP (51)	Broj objave evropske prijave patenta (97)	Naziv pronalaska (54)
B08B 9/027 (2006.01)	2502681	Device for investigating and cleaning tubes and lines	A01P 3/00 (2006.01)	2561753	AQUEOUS SUSPENSION CONCENTRATE COMPRISING AN ACID SALT OF DODECYLGUANIDINE
B08B 9/04 (2006.01)	2502681	Device for investigating and cleaning tubes and lines	A61B 18/18 (2006.01)	2680775 *	CRYOGENIC MEDICAL SYSTEM
B08B 9/043 (2006.01)	2502681	Device for investigating and cleaning tubes and lines	A61K 39/395 (2006.01)	2658575 *	PHARMACEUTICAL FORMULATION COMPRISING A BIOPHARMACEUTICAL DRUG
B08B 9/051 (2006.01)	2502681	Device for investigating and cleaning tubes and lines	A61K 47/12 (2006.01)	2658575 *	PHARMACEUTICAL FORMULATION COMPRISING A BIOPHARMACEUTICAL DRUG
F16L 25/00 (2006.01)	2502681	Device for investigating and cleaning tubes and lines	A61K 47/18 (2006.01)	2658575 *	PHARMACEUTICAL FORMULATION COMPRISING A BIOPHARMACEUTICAL DRUG
F16L 33/00 (2006.01)	2502681	Device for investigating and cleaning tubes and lines	A61K 47/22 (2006.01)	2658575 *	PHARMACEUTICAL FORMULATION COMPRISING A BIOPHARMACEUTICAL DRUG
G03B 37/00 (2006.01)	2502681	Device for investigating and cleaning tubes and lines	A61K 47/26 (2006.01)	2658575 *	PHARMACEUTICAL FORMULATION COMPRISING A BIOPHARMACEUTICAL DRUG
G01N 33/49 (2006.01)	2485049	Identification of separated components in centrifuged blood using measured pressure	C07K 16/24 (2006.01)	2658575 *	PHARMACEUTICAL FORMULATION COMPRISING A BIOPHARMACEUTICAL DRUG
G01N 35/10 (2006.01)	2485049	Identification of separated components in centrifuged blood using measured pressure	E02D 27/34 (2006.01)	2683889 *	PILLAR FOR BUILDING CONSTRUCTIONS
B05B 15/12 (2006.01)	2684613	Device for exchanging air with heat recovery, especially in spray booths	E04H 9/02 (2006.01)	2683889 *	PILLAR FOR BUILDING CONSTRUCTIONS
A61K 9/00 (2006.01)	2646036 *	TOPICAL COMPOSITIONS FOR PRESERVING OR RESTORING THE INTEGRITY OF MUCOSAE	A61K 31/519 (2006.01)	2694509 *	PYRROLO [2, 3 -D] PYRIMIDINE DERIVATIVES AS INHIBITORS OF TROPOMYOSIN- RELATED KINASES
A61K 31/685 (2006.01)	2646036 *	TOPICAL COMPOSITIONS FOR PRESERVING OR RESTORING THE INTEGRITY OF MUCOSAE	A61P 25/00 (2006.01)	2694509 *	PYRROLO [2, 3 -D] PYRIMIDINE DERIVATIVES AS INHIBITORS OF TROPOMYOSIN- RELATED KINASES
A61K 31/728 (2006.01)	2646036 *	TOPICAL COMPOSITIONS FOR PRESERVING OR RESTORING THE INTEGRITY OF MUCOSAE	A61P 35/00 (2006.01)	2694509 *	PYRROLO [2, 3 -D] PYRIMIDINE DERIVATIVES AS INHIBITORS OF TROPOMYOSIN- RELATED KINASES
A61P 1/00 (2006.01)	2646036 *	TOPICAL COMPOSITIONS FOR PRESERVING OR RESTORING THE INTEGRITY OF MUCOSAE	C07D 487/04 (2006.01)	2694509 *	PYRROLO [2, 3 -D] PYRIMIDINE DERIVATIVES AS INHIBITORS OF TROPOMYOSIN- RELATED KINASES
A61P 1/02 (2006.01)	2646036 *	TOPICAL COMPOSITIONS FOR PRESERVING OR RESTORING THE INTEGRITY OF MUCOSAE	A61K 31/4545 (2006.01)	2680843 *	DERIVATIVES OF PYRAZOLE-SUBSTITUTED AMINO-HETEROARYL COMPOUNDS
A61P 1/04 (2006.01)	2646036 *	TOPICAL COMPOSITIONS FOR PRESERVING OR RESTORING THE INTEGRITY OF MUCOSAE	C07D 401/14 (2006.01)	2680843 *	DERIVATIVES OF PYRAZOLE-SUBSTITUTED AMINO-HETEROARYL COMPOUNDS
A01N 25/04 (2006.01)	2561753	AQUEOUS SUSPENSION CONCENTRATE COMPRISING AN ACID SALT OF DODECYLGUANIDINE			
A01N 47/44 (2006.01)	2561753	AQUEOUS SUSPENSION CONCENTRATE COMPRISING AN ACID SALT OF DODECYLGUANIDINE			

MKP (51)	Broj objave evropske prijave patenta (97)	Naziv pronalaska (54)	MKP (51)	Broj objave evropske prijave patenta (97)	Naziv pronalaska (54)
A61K 9/08 (2006.01)	2676677 *	HIGHLY CONCENTRATED ANTI-CD40 ANTIBODY PHARMACEUTICAL PREPARATION	A61P 9/00 (2006.01)	2687523 *	NOVEL PHENYLPYRIDINE DERIVATIVE AND DRUG CONTAINING SAME
A61K 39/395 (2006.01)	2676677 *	HIGHLY CONCENTRATED ANTI-CD40 ANTIBODY PHARMACEUTICAL PREPARATION	A61P 9/10 (2006.01)	2687523 *	NOVEL PHENYLPYRIDINE DERIVATIVE AND DRUG CONTAINING SAME
A61K 47/18 (2006.01)	2676677 *	HIGHLY CONCENTRATED ANTI-CD40 ANTIBODY PHARMACEUTICAL PREPARATION	A61P 9/12 (2006.01)	2687523 *	NOVEL PHENYLPYRIDINE DERIVATIVE AND DRUG CONTAINING SAME
A61K 47/34 (2006.01)	2676677 *	HIGHLY CONCENTRATED ANTI-CD40 ANTIBODY PHARMACEUTICAL PREPARATION	A61P 13/12 (2006.01)	2687523 *	NOVEL PHENYLPYRIDINE DERIVATIVE AND DRUG CONTAINING SAME
B22D 27/08 (2006.01)	2699515 *	PROCEDURE FOR THE PREPARATION OF SULPHUR-BASED ARTICLES OF MANUFACTURE	A61P 25/18 (2006.01)	2687523 *	NOVEL PHENYLPYRIDINE DERIVATIVE AND DRUG CONTAINING SAME
C01B 17/02 (2006.01)	2699515 *	PROCEDURE FOR THE PREPARATION OF SULPHUR-BASED ARTICLES OF MANUFACTURE	A61P 27/02 (2006.01)	2687523 *	NOVEL PHENYLPYRIDINE DERIVATIVE AND DRUG CONTAINING SAME
C04B 28/36 (2006.01)	2699515 *	PROCEDURE FOR THE PREPARATION OF SULPHUR-BASED ARTICLES OF MANUFACTURE	A61P 43/00 (2006.01)	2687523 *	NOVEL PHENYLPYRIDINE DERIVATIVE AND DRUG CONTAINING SAME
A61K 39/00 (2006.01)	2672996 *	METHODS AND SYSTEMS FOR TREATING OR PREVENTING PREGNANCY-RELATED HYPERTENSIVE DISORDERS	C07D 401/14 (2006.01)	2687523 *	NOVEL PHENYLPYRIDINE DERIVATIVE AND DRUG CONTAINING SAME
A61K 39/395 (2006.01)	2672996 *	METHODS AND SYSTEMS FOR TREATING OR PREVENTING PREGNANCY-RELATED HYPERTENSIVE DISORDERS	C07D 413/14 (2006.01)	2687523 *	NOVEL PHENYLPYRIDINE DERIVATIVE AND DRUG CONTAINING SAME
C07K 16/00 (2006.01)	2672996 *	METHODS AND SYSTEMS FOR TREATING OR PREVENTING PREGNANCY-RELATED HYPERTENSIVE DISORDERS	A61K 9/08 (2006.01)	2680817 *	USE OF A VISCOELASTIC FLUID FOR PRODUCING A MEDICINAL PRODUCT FOR SURGICALLY TREATING THE EYE
H04B 7/185 (2006.01)	2673896 *	DISTRIBUTED MANAGEMENT OF LEO SATELLITE NETWORKS WITH MANAGEMENT AGILITY AND NETWORK EFFICIENCY	A61K 47/36 (2006.01)	2680817 *	USE OF A VISCOELASTIC FLUID FOR PRODUCING A MEDICINAL PRODUCT FOR SURGICALLY TREATING THE EYE
C07K 16/36 (2006.01)	2686350 *	HUMAN TISSUE FACTOR ANTIBODY AND USES THEREOF	A61K 47/38 (2006.01)	2680817 *	USE OF A VISCOELASTIC FLUID FOR PRODUCING A MEDICINAL PRODUCT FOR SURGICALLY TREATING THE EYE
G01N 33/574 (2006.01)	2646831 *	IDENTIFICATION OF CANCER PATIENTS LIKELY TO BENEFIT FROM RADIATION THERAPY	A61K 31/4196 (2006.01)	2658846 *	POLYMORPHIC FORMS OF 2-(5-BROMO-4-(4-CYCLOPROPYLNAPHTHALEN-1-YL)-4H-1,2,4-TRIAZOL-3-YLTHIO) ACETIC ACID AND USES THEREOF
A61K 31/506 (2006.01)	2687523 *	NOVEL PHENYLPYRIDINE DERIVATIVE AND DRUG CONTAINING SAME	A61P 9/00 (2006.01)	2658846 *	POLYMORPHIC FORMS OF 2-(5-BROMO-4-(4-CYCLOPROPYLNAPHTHALEN-1-YL)-4H-1,2,4-TRIAZOL-3-YLTHIO) ACETIC ACID AND USES THEREOF
A61P 3/10 (2006.01)	2687523 *	NOVEL PHENYLPYRIDINE DERIVATIVE AND DRUG CONTAINING SAME	C07D 249/12 (2006.01)	2658846 *	POLYMORPHIC FORMS OF 2-(5-BROMO-4-(4-CYCLOPROPYLNAPHTHALEN-1-YL)-4H-1,2,4-TRIAZOL-3-YLTHIO) ACETIC ACID AND USES THEREOF
			C07F 3/06 (2006.01)	2655382 *	ORGANOZINC COMPLEXES AND PROCESSES FOR MAKING AND USING THE SAME

MKP (51)	Broj objave evropske prijave patenta (97)	Naziv pronalaska (54)	MKP (51)	Broj objave evropske prijave patenta (97)	Naziv pronalaska (54)
C12Q 1/68 (2006.01)	2652153 *	DNA SEQUENCING BY SYNTHESIS USING MODIFIED NUCLEOTIDES AND NANOPORE DETECTION	C12N 13/00 (2006.01)	2694651 *	METHODS AND COMPOSITIONS FOR LARGE-SCALE ISOLATION OF VERY SMALL EMBRYONIC-LIKE (VSEL) STEM CELLS
A47L 5/22 (2006.01)	2596733	Combined primary and secondary units	A61P 9/04 (2006.01)	2678017 *	ASYMMETRIC UREAS AND MEDICAL USES THEREOF
A61K 47/48 (2006.01)	2683409 *	AMATOXIN-CONJUGATES WITH IMPROVED LINKAGES	A61P 3/06 (2006.01)	2678017 *	ASYMMETRIC UREAS AND MEDICAL USES THEREOF
A61P 35/00 (2006.01)	2683409 *	AMATOXIN-CONJUGATES WITH IMPROVED LINKAGES	A61K 31/4468 (2006.01)	2678017 *	ASYMMETRIC UREAS AND MEDICAL USES THEREOF
A61M 5/28 (2006.01)	2661299 *	A SAFETY DEVICE FOR A PRE-FILLED SYRINGE AND AN INJECTION DEVICE	A61P 11/00 (2006.01)	2678017 *	ASYMMETRIC UREAS AND MEDICAL USES THEREOF
A61M 5/32 (2006.01)	2661299 *	A SAFETY DEVICE FOR A PRE-FILLED SYRINGE AND AN INJECTION DEVICE	A61P 25/00 (2006.01)	2678017 *	ASYMMETRIC UREAS AND MEDICAL USES THEREOF
A61M 5/50 (2006.01)	2661299 *	A SAFETY DEVICE FOR A PRE-FILLED SYRINGE AND AN INJECTION DEVICE	A61P 3/00 (2006.01)	2678017 *	ASYMMETRIC UREAS AND MEDICAL USES THEREOF
A61K 39/395 (2006.01)	2694106 *	METHODS FOR INCREASING EFFICACY OF FOLR1 CANCER THERAPY	A61P 5/48 (2006.01)	2678017 *	ASYMMETRIC UREAS AND MEDICAL USES THEREOF
F25D 11/00 (2006.01)	2655990 *	COMPARTMENTED TEMPERATURE AND HUMIDITY CONTROLLED MODULAR HOUSING FOR THE STORAGE AND PRESERVATION OF WINE BOTTLES	A61P 3/10 (2006.01)	2678017 *	ASYMMETRIC UREAS AND MEDICAL USES THEREOF
F25D 25/00 (2006.01)	2655990 *	COMPARTMENTED TEMPERATURE AND HUMIDITY CONTROLLED MODULAR HOUSING FOR THE STORAGE AND PRESERVATION OF WINE BOTTLES	A61P 3/08 (2006.01)	2678017 *	ASYMMETRIC UREAS AND MEDICAL USES THEREOF
F25D 29/00 (2006.01)	2655990 *	COMPARTMENTED TEMPERATURE AND HUMIDITY CONTROLLED MODULAR HOUSING FOR THE STORAGE AND PRESERVATION OF WINE BOTTLES	A61P 1/04 (2006.01)	2678017 *	ASYMMETRIC UREAS AND MEDICAL USES THEREOF
A61K 31/496 (2006.01)	2692725 *	METHOD FOR PRODUCING PHENOXYPYRIDINE DERIVATIVE	C07D 211/58 (2006.01)	2678017 *	ASYMMETRIC UREAS AND MEDICAL USES THEREOF
C07D 401/12 (2006.01)	2692725 *	METHOD FOR PRODUCING PHENOXYPYRIDINE DERIVATIVE	A61P 1/00 (2006.01)	2678017 *	ASYMMETRIC UREAS AND MEDICAL USES THEREOF
C07D 401/14 (2006.01)	2692725 *	METHOD FOR PRODUCING PHENOXYPYRIDINE DERIVATIVE	A61P 9/12 (2006.01)	2678017 *	ASYMMETRIC UREAS AND MEDICAL USES THEREOF
A47K 10/38 (2006.01)	2583602	Dispenser for static center-feed coreless roll of sheet product	A61P 21/00 (2006.01)	2678017 *	ASYMMETRIC UREAS AND MEDICAL USES THEREOF
A01N 63/00 (2006.01)	2694651 *	METHODS AND COMPOSITIONS FOR LARGE-SCALE ISOLATION OF VERY SMALL EMBRYONIC-LIKE (VSEL) STEM CELLS	A61P 9/10 (2006.01)	2678017 *	ASYMMETRIC UREAS AND MEDICAL USES THEREOF
			A61P 1/16 (2006.01)	2678017 *	ASYMMETRIC UREAS AND MEDICAL USES THEREOF
			A61P 9/00 (2006.01)	2678017 *	ASYMMETRIC UREAS AND MEDICAL USES THEREOF
			A61P 3/04 (2006.01)	2678017 *	ASYMMETRIC UREAS AND MEDICAL USES THEREOF
			A61P 25/30 (2006.01)	2678017 *	ASYMMETRIC UREAS AND MEDICAL USES THEREOF
			A61P 7/00 (2006.01)	2678017 *	ASYMMETRIC UREAS AND MEDICAL USES THEREOF
			G06Q 20/38 (2012.01)	2695120 *	FINANCIAL TRANSACTION SYSTEMS AND METHODS
			C22C 21/02 (2006.01)	2657360	Pressure cast alloy on an Al-Si basis, comprising secondary aluminium
			C22C 21/04 (2006.01)	2657360	Pressure cast alloy on an Al-Si basis, comprising secondary aluminium

MKP (51)	Broj objave evropske prijave patenta (97)	Naziv pronalaska (54)	MKP (51)	Broj objave evropske prijave patenta (97)	Naziv pronalaska (54)
C09C 1/02 (2006.01)	2679638	High solids aqueous mineral and/or filler and/or pigment suspension in acidic pH environment	C09C 1/02 (2006.01)	2662416	Treatment of calcium carbonate containing materials for increased filler load in paper
D21H 17/00 (2006.01)	2679638	High solids aqueous mineral and/or filler and/or pigment suspension in acidic pH environment	D21H 17/00 (2006.01)	2662416	Treatment of calcium carbonate containing materials for increased filler load in paper
A61K 31/18 (2006.01)	2648713 *	DOSAGES OF ARYLSULFONAMIDE DERIVATIVES	A61K 31/437 (2006.01)	2700403 *	THERAPEUTIC AGENT FOR TUMOR
A61K 31/4164 (2006.01)	2648713 *	DOSAGES OF ARYLSULFONAMIDE DERIVATIVES	A61K 31/47 (2006.01)	2700403 *	THERAPEUTIC AGENT FOR TUMOR
A61P 27/00 (2006.01)	2648713 *	DOSAGES OF ARYLSULFONAMIDE DERIVATIVES	A61P 35/00 (2006.01)	2700403 *	THERAPEUTIC AGENT FOR TUMOR
A61K 31/438 (2006.01)	2699576 *	PYRAZOLOSPIROKETONE DERIVATIVES FOR USE AS ACETYL - COA CARBOXYLASE INHIBITORS	C07D 215/48 (2006.01)	2700403 *	THERAPEUTIC AGENT FOR TUMOR
A61P 3/04 (2006.01)	2699576 *	PYRAZOLOSPIROKETONE DERIVATIVES FOR USE AS ACETYL - COA CARBOXYLASE INHIBITORS	C07D 471/04 (2006.01)	2700403 *	THERAPEUTIC AGENT FOR TUMOR
A61P 3/10 (2006.01)	2699576 *	PYRAZOLOSPIROKETONE DERIVATIVES FOR USE AS ACETYL - COA CARBOXYLASE INHIBITORS	A61K 31/4439 (2006.01)	2672973 *	ADMINISTRATION REGIME FOR NITROCATECHOLS
C07D 471/10 (2006.01)	2699576 *	PYRAZOLOSPIROKETONE DERIVATIVES FOR USE AS ACETYL - COA CARBOXYLASE INHIBITORS	A61P 25/00 (2006.01)	2672973 *	ADMINISTRATION REGIME FOR NITROCATECHOLS
C07D 519/00 (2006.01)	2699576 *	PYRAZOLOSPIROKETONE DERIVATIVES FOR USE AS ACETYL - COA CARBOXYLASE INHIBITORS	A61P 25/16 (2006.01)	2672973 *	ADMINISTRATION REGIME FOR NITROCATECHOLS
A61B 17/22 (2006.01)	2696930 *	DEVICE AND METHOD FOR CAPTURING GUIDEWIRES	A24F 47/00 (2006.01)	2672846 *	INHALATION DEVICE
A61B 17/221 (2006.01)	2696930 *	DEVICE AND METHOD FOR CAPTURING GUIDEWIRES	A61P 35/00 (2006.01)	2680925 *	INTERROGATORY CELL-BASED ASSAYS AND USES THEREOF
A61M 25/00 (2006.01)	2696930 *	DEVICE AND METHOD FOR CAPTURING GUIDEWIRES	A61K 31/437 (2006.01)	2651936 *	AZAINDOLES AS RESPIRATORY SYNCYTIAL VIRUS ANTIVIRAL AGENTS
A61M 25/06 (2006.01)	2696930 *	DEVICE AND METHOD FOR CAPTURING GUIDEWIRES	A61P 31/12 (2006.01)	2651936 *	AZAINDOLES AS RESPIRATORY SYNCYTIAL VIRUS ANTIVIRAL AGENTS
A61M 25/09 (2006.01)	2696930 *	DEVICE AND METHOD FOR CAPTURING GUIDEWIRES	C07D 471/04 (2006.01)	2651936 *	AZAINDOLES AS RESPIRATORY SYNCYTIAL VIRUS ANTIVIRAL AGENTS
C07H 21/04 (2006.01)	2697243 *	MODULATION OF SIGNAL TRANSDUCER AND ACTIVATOR OF TRANSCRIPTION 3 (STAT3) EXPRESSION	A61C 5/06 (2006.01)	2583635	Mixing and dispensing container
C12N 15/11 (2006.01)	2697243 *	MODULATION OF SIGNAL TRANSDUCER AND ACTIVATOR OF TRANSCRIPTION 3 (STAT3) EXPRESSION	A61K 31/00 (2006.01)	2666014 *	USE OF GLU-TUBULIN AS A BIOMARKER OF DRUG RESPONSE TO FURAZANOBENZIMIDAZOLES
			A61K 38/00 (2006.01)	2666014 *	USE OF GLU-TUBULIN AS A BIOMARKER OF DRUG RESPONSE TO FURAZANOBENZIMIDAZOLES
			G01N 33/50 (2006.01)	2666014 *	USE OF GLU-TUBULIN AS A BIOMARKER OF DRUG RESPONSE TO FURAZANOBENZIMIDAZOLES
			C07D 309/28 (2006.01)	2678324 *	PROCESS FOR THE PREPARATION OF ZANAMIVIR

MKP (51)	Broj objave evropske prijave patenta (97)	Naziv pronalaska (54)	MKP (51)	Broj objave evropske prijave patenta (97)	Naziv pronalaska (54)
A61K 31/4162 (2006.01)	2648723 *	BICYCLIC PYRAZOLE COMPOUNDS AS ALLOSTERIC MODULATORS OF MGLUR5 RECEPTORS	C12N 15/16 (2006.01)	2658979 *	COMPOSITIONS COMPRISING NATRIURETIC PEPTIDES AND METHODS OF USE THEREOF
C07D 231/54 (2006.01)	2648723 *	BICYCLIC PYRAZOLE COMPOUNDS AS ALLOSTERIC MODULATORS OF MGLUR5 RECEPTORS	C12N 15/62 (2006.01)	2658979 *	COMPOSITIONS COMPRISING NATRIURETIC PEPTIDES AND METHODS OF USE THEREOF
C12N 5/071 (2010.01)	2689007 *	COMPOSITIONS AND METHODS FOR CULTURING CELLS FROM NORMAL HUMAN TUBO-OVARIAN EPITHELIUM AND HUMAN TUBO-OVARIAN TUMORS	A61B 5/042 (2006.01)	2699153 *	FLEXIBLE ELECTRODE ASSEMBLY FOR INSERTION INTO BODY LUMEN OR ORGAN
C12N 5/09 (2010.01)	2689007 *	COMPOSITIONS AND METHODS FOR CULTURING CELLS FROM NORMAL HUMAN TUBO-OVARIAN EPITHELIUM AND HUMAN TUBO-OVARIAN TUMORS	A61K 31/53 (2006.01)	2692727 *	NOVEL OXAZOLIDINONE DERIVATIVE AND MEDICAL COMPOSITION CONTAINING SAME
A61K 9/00 (2006.01)	2648755 *	A STABLE READY-TO-USE CETRORELIX INJECTION	A61P 31/04 (2006.01)	2692727 *	NOVEL OXAZOLIDINONE DERIVATIVE AND MEDICAL COMPOSITION CONTAINING SAME
A61K 38/08 (2006.01)	2648755 *	A STABLE READY-TO-USE CETRORELIX INJECTION	C07D 413/14 (2006.01)	2692727 *	NOVEL OXAZOLIDINONE DERIVATIVE AND MEDICAL COMPOSITION CONTAINING SAME
A61K 47/12 (2006.01)	2648755 *	A STABLE READY-TO-USE CETRORELIX INJECTION	C23C 2/06 (2006.01)	2652166 *	STEEL SHEET INCLUDING A MULTILAYER COATING
A61M 5/20 (2006.01)	2675509 *	INJECTION DEVICE	C23C 2/26 (2006.01)	2652166 *	STEEL SHEET INCLUDING A MULTILAYER COATING
A61M 5/32 (2006.01)	2675509 *	INJECTION DEVICE	C23C 2/40 (2006.01)	2652166 *	STEEL SHEET INCLUDING A MULTILAYER COATING
A61B 5/00 (2006.01)	2581846	A cardiopulmonary bypass or cpb monitoring tool	C23C 14/16 (2006.01)	2652166 *	STEEL SHEET INCLUDING A MULTILAYER COATING
A61M 1/36 (2006.01)	2581846	A cardiopulmonary bypass or cpb monitoring tool	C23C 14/58 (2006.01)	2652166 *	STEEL SHEET INCLUDING A MULTILAYER COATING
G06F 19/00 (2011.01)	2581846	A cardiopulmonary bypass or cpb monitoring tool	C23C 28/00 (2006.01)	2652166 *	STEEL SHEET INCLUDING A MULTILAYER COATING
A61K 38/17 (2006.01)	2658979 *	COMPOSITIONS COMPRISING NATRIURETIC PEPTIDES AND METHODS OF USE THEREOF	A61K 31/7088 (2006.01)	2683825 *	METHODS OF TREATING CANCER BY INHIBITION OF DNA REPAIR PROTEINS
A61K 47/48 (2006.01)	2658979 *	COMPOSITIONS COMPRISING NATRIURETIC PEPTIDES AND METHODS OF USE THEREOF	A61K 31/7105 (2006.01)	2683825 *	METHODS OF TREATING CANCER BY INHIBITION OF DNA REPAIR PROTEINS
A61P 19/08 (2006.01)	2658979 *	COMPOSITIONS COMPRISING NATRIURETIC PEPTIDES AND METHODS OF USE THEREOF	A61P 35/00 (2006.01)	2683825 *	METHODS OF TREATING CANCER BY INHIBITION OF DNA REPAIR PROTEINS
C07K 14/575 (2006.01)	2658979 *	COMPOSITIONS COMPRISING NATRIURETIC PEPTIDES AND METHODS OF USE THEREOF	C07H 21/00 (2006.01)	2683825 *	METHODS OF TREATING CANCER BY INHIBITION OF DNA REPAIR PROTEINS
C07K 19/00 (2006.01)	2658979 *	COMPOSITIONS COMPRISING NATRIURETIC PEPTIDES AND METHODS OF USE THEREOF	C12N 15/113 (2010.01)	2683825 *	METHODS OF TREATING CANCER BY INHIBITION OF DNA REPAIR PROTEINS
			A61K 31/553 (2006.01)	2673279 *	5-AMINO-OXAZEPINE AND 5-AMINO-THIAZEPANE COMPOUNDS AS BETA-SECRETASE ANTAGONISTS AND METHODS OF USE

MKP (51)	Broj objave evropske prijave patenta (97)	Naziv pronalaska (54)	MKP (51)	Broj objave evropske prijave patenta (97)	Naziv pronalaska (54)
A61K 31/554 (2006.01)	2673279 *	5-AMINO-OXAZEPINE AND 5-AMINO-THIAZEPANE COMPOUNDS AS BETA- SECRETASE ANTAGONISTS AND METHODS OF USE	C07D 213/57 (2006.01)	2678316 *	SUBSTITUTED AROMATIC SULFUR COMPOUNDS AND METHODS OF THEIR USE
A61P 25/16 (2006.01)	2673279 *	5-AMINO-OXAZEPINE AND 5-AMINO-THIAZEPANE COMPOUNDS AS BETA- SECRETASE ANTAGONISTS AND METHODS OF USE	C07D 309/08 (2006.01)	2678316 *	SUBSTITUTED AROMATIC SULFUR COMPOUNDS AND METHODS OF THEIR USE
A61P 25/28 (2006.01)	2673279 *	5-AMINO-OXAZEPINE AND 5-AMINO-THIAZEPANE COMPOUNDS AS BETA- SECRETASE ANTAGONISTS AND METHODS OF USE	A61K 31/42 (2006.01)	2678316 *	SUBSTITUTED AROMATIC SULFUR COMPOUNDS AND METHODS OF THEIR USE
C07D 498/10 (2006.01)	2673279 *	5-AMINO-OXAZEPINE AND 5-AMINO-THIAZEPANE COMPOUNDS AS BETA- SECRETASE ANTAGONISTS AND METHODS OF USE	C07D 235/16 (2006.01)	2678316 *	SUBSTITUTED AROMATIC SULFUR COMPOUNDS AND METHODS OF THEIR USE
C07D 498/20 (2006.01)	2673279 *	5-AMINO-OXAZEPINE AND 5-AMINO-THIAZEPANE COMPOUNDS AS BETA- SECRETASE ANTAGONISTS AND METHODS OF USE	A61P 35/00 (2006.01)	2678316 *	SUBSTITUTED AROMATIC SULFUR COMPOUNDS AND METHODS OF THEIR USE
C07D 513/10 (2006.01)	2673279 *	5-AMINO-OXAZEPINE AND 5-AMINO-THIAZEPANE COMPOUNDS AS BETA- SECRETASE ANTAGONISTS AND METHODS OF USE	A61K 31/47 (2006.01)	2678316 *	SUBSTITUTED AROMATIC SULFUR COMPOUNDS AND METHODS OF THEIR USE
E06B 3/46 (2006.01)	2602416	Interconnection device for retractable sliding doors	C07D 231/12 (2006.01)	2678316 *	SUBSTITUTED AROMATIC SULFUR COMPOUNDS AND METHODS OF THEIR USE
C02F 1/66 (2006.01)	2651832 *	METHOD FOR TREATING BODIES OF WATER	C07C 317/44 (2006.01)	2678316 *	SUBSTITUTED AROMATIC SULFUR COMPOUNDS AND METHODS OF THEIR USE
C07C 231/02 (2006.01)	2661422 *	PROCESS AND INTERMEDIATES FOR SYNTHESIZING AGOMELATINE	C07D 215/36 (2006.01)	2678316 *	SUBSTITUTED AROMATIC SULFUR COMPOUNDS AND METHODS OF THEIR USE
C07C 233/18 (2006.01)	2661422 *	PROCESS AND INTERMEDIATES FOR SYNTHESIZING AGOMELATINE	C07D 333/24 (2006.01)	2678316 *	SUBSTITUTED AROMATIC SULFUR COMPOUNDS AND METHODS OF THEIR USE
C07C 253/30 (2006.01)	2661422 *	PROCESS AND INTERMEDIATES FOR SYNTHESIZING AGOMELATINE	C07D 263/32 (2006.01)	2678316 *	SUBSTITUTED AROMATIC SULFUR COMPOUNDS AND METHODS OF THEIR USE
C07C 255/37 (2006.01)	2661422 *	PROCESS AND INTERMEDIATES FOR SYNTHESIZING AGOMELATINE	A61P 35/04 (2006.01)	2678316 *	SUBSTITUTED AROMATIC SULFUR COMPOUNDS AND METHODS OF THEIR USE
C07C 255/40 (2006.01)	2661422 *	PROCESS AND INTERMEDIATES FOR SYNTHESIZING AGOMELATINE	C07D 263/56 (2006.01)	2678316 *	SUBSTITUTED AROMATIC SULFUR COMPOUNDS AND METHODS OF THEIR USE
C07D 213/70 (2006.01)	2678316 *	SUBSTITUTED AROMATIC SULFUR COMPOUNDS AND METHODS OF THEIR USE	A61K 31/4164 (2006.01)	2678316 *	SUBSTITUTED AROMATIC SULFUR COMPOUNDS AND METHODS OF THEIR USE
C07D 309/14 (2006.01)	2678316 *	SUBSTITUTED AROMATIC SULFUR COMPOUNDS AND METHODS OF THEIR USE	C07D 223/10 (2006.01)	2678316 *	SUBSTITUTED AROMATIC SULFUR COMPOUNDS AND METHODS OF THEIR USE
A61K 31/435 (2006.01)	2678316 *	SUBSTITUTED AROMATIC SULFUR COMPOUNDS AND METHODS OF THEIR USE	C07D 271/07 (2006.01)	2678316 *	SUBSTITUTED AROMATIC SULFUR COMPOUNDS AND METHODS OF THEIR USE
			A61K 31/415 (2006.01)	2678316 *	SUBSTITUTED AROMATIC SULFUR COMPOUNDS AND METHODS OF THEIR USE
			A61K 31/00 (2006.01)	2666016 *	USE OF BUBR1 AS A BIOMARKER OF DRUG RESPONSE TO FURAZANOBENZIMIDAZOLES
			G01N 33/50 (2006.01)	2666016 *	USE OF BUBR1 AS A BIOMARKER OF DRUG RESPONSE TO FURAZANOBENZIMIDAZOLES

MKP (51)	Broj objave evropske prijave patenta (97)	Naziv pronalaska (54)	MKP (51)	Broj objave evropske prijave patenta (97)	Naziv pronalaska (54)
A61K 9/20 (2006.01)	2654734 *	ENCASED TAMPER RESISTANT CONTROLLED RELEASE DOSAGE FORMS	A61K 31/265 (2006.01)	2648696 *	NEW FORM OF ADMINISTRATION OF ENKEPHALINASE INHIBITOR
A61K 9/28 (2006.01)	2654734 *	ENCASED TAMPER RESISTANT CONTROLLED RELEASE DOSAGE FORMS	A61P 1/12 (2006.01)	2648696 *	NEW FORM OF ADMINISTRATION OF ENKEPHALINASE INHIBITOR
A61K 31/485 (2006.01)	2654734 *	ENCASED TAMPER RESISTANT CONTROLLED RELEASE DOSAGE FORMS	A61K 45/00 (2006.01)	2655665 *	SINGLE NUCLEOTIDE POLYMORPHISMS AND GENES ASSOCIATED WITH T2D-RELATED COMPLICATIONS
A61K 31/4184 (2006.01)	2663562 *	SOLID FORMS OF GYRASE INHIBITOR (R)-1-ETHYL- 3-[6-FLUORO-5-[2-(1- HYDROXY-1-METHYL- ETHYL) PYRIMIDIN-5-YL]- 7-(TETRAHYDROFURAN-2- YL)-1H-BENZIMIDAZOL-2-YL] UREA	C12Q 1/68 (2006.01)	2655665 *	SINGLE NUCLEOTIDE POLYMORPHISMS AND GENES ASSOCIATED WITH T2D-RELATED COMPLICATIONS
A61P 31/00 (2006.01)	2663562 *	SOLID FORMS OF GYRASE INHIBITOR (R)-1-ETHYL- 3-[6-FLUORO-5-[2-(1- HYDROXY-1-METHYL- ETHYL) PYRIMIDIN-5-YL]- 7-(TETRAHYDROFURAN-2- YL)-1H-BENZIMIDAZOL-2-YL] UREA	C40B 30/04 (2006.01)	2655665 *	SINGLE NUCLEOTIDE POLYMORPHISMS AND GENES ASSOCIATED WITH T2D-RELATED COMPLICATIONS
C07D 413/14 (2006.01)	2663562 *	SOLID FORMS OF GYRASE INHIBITOR (R)-1-ETHYL- 3-[6-FLUORO-5-[2-(1- HYDROXY-1-METHYL- ETHYL) PYRIMIDIN-5-YL]- 7-(TETRAHYDROFURAN-2- YL)-1H-BENZIMIDAZOL-2-YL] UREA	C40B 40/06 (2006.01)	2655665 *	SINGLE NUCLEOTIDE POLYMORPHISMS AND GENES ASSOCIATED WITH T2D-RELATED COMPLICATIONS
H01H 3/16 (2006.01)	2431990	Switch	A61K 31/341 (2006.01)	2668160 *	TRPM8 RECEPTOR ANTAGONISTS
H01H 13/18 (2006.01)	2431990	Switch	A61K 31/381 (2006.01)	2668160 *	TRPM8 RECEPTOR ANTAGONISTS
H01H 13/48 (2006.01)	2431990	Switch	A61K 31/4025 (2006.01)	2668160 *	TRPM8 RECEPTOR ANTAGONISTS
H01R 13/52 (2006.01)	2688152 *	CONNECTOR OF ELECTRONIC DEVICE, PLUG OF ELECTRONIC DEVICE, AND WATERPROOF STRUCTURE OF ELECTRONIC DEVICE	A61K 31/4402 (2006.01)	2668160 *	TRPM8 RECEPTOR ANTAGONISTS
H04M 1/02 (2006.01)	2688152 *	CONNECTOR OF ELECTRONIC DEVICE, PLUG OF ELECTRONIC DEVICE, AND WATERPROOF STRUCTURE OF ELECTRONIC DEVICE	A61P 29/00 (2006.01)	2668160 *	TRPM8 RECEPTOR ANTAGONISTS
A61K 31/495 (2006.01)	2694066 *	METHODS AND COMPOSITIONS FOR TREATING PARKINSON'S DISEASE	C07D 207/323 (2006.01)	2668160 *	TRPM8 RECEPTOR ANTAGONISTS
A61K 9/10 (2006.01)	2648696 *	NEW FORM OF ADMINISTRATION OF ENKEPHALINASE INHIBITOR	C07D 213/36 (2006.01)	2668160 *	TRPM8 RECEPTOR ANTAGONISTS
A61K 31/223 (2006.01)	2648696 *	NEW FORM OF ADMINISTRATION OF ENKEPHALINASE INHIBITOR	C07D 307/52 (2006.01)	2668160 *	TRPM8 RECEPTOR ANTAGONISTS
			C07D 307/56 (2006.01)	2668160 *	TRPM8 RECEPTOR ANTAGONISTS
			C07D 333/20 (2006.01)	2668160 *	TRPM8 RECEPTOR ANTAGONISTS
			C07D 333/28 (2006.01)	2668160 *	TRPM8 RECEPTOR ANTAGONISTS
			F16G 11/00 (2006.01)	2596266 *	SELF-ALIGNING SOCKET FOR MOORING CABLE

MKP (51)	Broj objave evropske prijave patenta (97)	Naziv pronalaska (54)	MKP (51)	Broj objave evropske prijave patenta (97)	Naziv pronalaska (54)
F16G 11/02 (2006.01)	2596266 *	SELF-ALIGNING SOCKET FOR MOORING CABLE	C07K 14/705 (2006.01)	2699592 *	ANTICANCER FUSION PROTEIN
D21F 1/44 (2006.01)	2697423 *	IMPROVEMENTS IN OR RELATING TO SECURITY OF DOCUMENTS	C12N 15/12 (2006.01)	2699592 *	ANTICANCER FUSION PROTEIN
E05D 7/00 (2006.01)	2586944	Hinge with adjustment elements and adjustment cap for these adjustment elements	C12N 15/62 (2006.01)	2699592 *	ANTICANCER FUSION PROTEIN
C01F 11/18 (2006.01)	2644568	Dispersed calcium carbonate containing material for an improved stability under alkaline conditions	A61K 9/70 (2006.01)	2674154 *	SILDENAFIL-FREE BASE-CONTAINING FILM PREPARATION AND METHOD FOR PRODUCING SAME
C09C 1/02 (2006.01)	2644568	Dispersed calcium carbonate containing material for an improved stability under alkaline conditions	A61K 31/519 (2006.01)	2674154 *	SILDENAFIL-FREE BASE-CONTAINING FILM PREPARATION AND METHOD FOR PRODUCING SAME
D21H 19/38 (2006.01)	2644568	Dispersed calcium carbonate containing material for an improved stability under alkaline conditions	A61M 5/20 (2006.01)	2661294 *	A SAFETY DEVICE FOR A PRE-FILLED SYRINGE AND AN INJECTION DEVICE
A61K 31/19 (2006.01)	2675771 *	4-HYDROXYBUTYRIC ACID DEUTERATED ANALOGS	A61M 5/32 (2006.01)	2661294 *	A SAFETY DEVICE FOR A PRE-FILLED SYRINGE AND AN INJECTION DEVICE
A61K 31/22 (2006.01)	2675771 *	4-HYDROXYBUTYRIC ACID DEUTERATED ANALOGS	A01C 5/06 (2006.01)	2675261 *	SEED DRILL WITH MULTI-ROW SOWING ELEMENTS
A61P 21/00 (2006.01)	2675771 *	4-HYDROXYBUTYRIC ACID DEUTERATED ANALOGS	A01C 7/20 (2006.01)	2675261 *	SEED DRILL WITH MULTI-ROW SOWING ELEMENTS
A61P 25/02 (2006.01)	2675771 *	4-HYDROXYBUTYRIC ACID DEUTERATED ANALOGS	C02F 1/00 (2006.01)	2691340 *	METHOD AND SYSTEM FOR TREATING WATER USED FOR INDUSTRIAL PURPOSES
A61P 25/20 (2006.01)	2675771 *	4-HYDROXYBUTYRIC ACID DEUTERATED ANALOGS	F03D 1/04 (2006.01)	2691645 *	FLUID TURBINE WITH VARIABLE PITCH SHROUD SEGMENTS
C07B 59/00 (2006.01)	2675771 *	4-HYDROXYBUTYRIC ACID DEUTERATED ANALOGS	F03D 7/02 (2006.01)	2691645 *	FLUID TURBINE WITH VARIABLE PITCH SHROUD SEGMENTS
C07C 59/01 (2006.01)	2675771 *	4-HYDROXYBUTYRIC ACID DEUTERATED ANALOGS	B24D 3/00 (2006.01)	2551057	Method for producing a coated abrasive, coated abrasive and use of a coated abrasive
C07C 69/67 (2006.01)	2675771 *	4-HYDROXYBUTYRIC ACID DEUTERATED ANALOGS	B24D 11/00 (2006.01)	2551057	Method for producing a coated abrasive, coated abrasive and use of a coated abrasive
A61K 31/496 (2006.01)	2694485 *	COMBINATIONS OF AKT INHIBITOR COMPOUNDS AND VEMURAFENIB, AND METHODS OF USE	A61K 31/436 (2006.01)	2675451 *	mTOR/JAK INHIBITOR COMBINATION THERAPY
C07D 239/70 (2006.01)	2694485 *	COMBINATIONS OF AKT INHIBITOR COMPOUNDS AND VEMURAFENIB, AND METHODS OF USE	A61K 31/519 (2006.01)	2675451 *	mTOR/JAK INHIBITOR COMBINATION THERAPY
A61K 49/00 (2006.01)	2667900 *	METHOD, COMPOSITION AND PACKAGE FOR BOWEL CLEANSING	A61K 45/06 (2006.01)	2675451 *	mTOR/JAK INHIBITOR COMBINATION THERAPY
A61K 38/17 (2006.01)	2699592 *	ANTICANCER FUSION PROTEIN	A61P 35/00 (2006.01)	2675451 *	mTOR/JAK INHIBITOR COMBINATION THERAPY
A61P 35/00 (2006.01)	2699592 *	ANTICANCER FUSION PROTEIN	A61P 35/02 (2006.01)	2675451 *	mTOR/JAK INHIBITOR COMBINATION THERAPY

MKP (51)	Broj objave evropske prijave patenta (97)	Naziv pronalaska (54)	MKP (51)	Broj objave evropske prijave patenta (97)	Naziv pronalaska (54)
E05F 3/04 (2006.01)	2655770 *	MOUNTING ASSEMBLY FOR A DOOR ACTUATOR FOR MOUNTING ON A MOUNTING PLATE WITHOUT THE USE OF CONNECTING MEANS	G01N 24/08 (2006.01)	2686671 *	N-ACETYLHEXOSAMINE-CONTAINING N-GLYCANS IN GLYCOPROTEIN PRODUCTS
E05F 3/10 (2006.01)	2655770 *	MOUNTING ASSEMBLY FOR A DOOR ACTUATOR FOR MOUNTING ON A MOUNTING PLATE WITHOUT THE USE OF CONNECTING MEANS	E21B 43/26 (2006.01)	2655795 *	MULTI-STAGE FRACTURE INJECTION PROCESS FOR ENHANCED RESOURCE PRODUCTION FROM SHALES
E05F 3/22 (2006.01)	2655770 *	MOUNTING ASSEMBLY FOR A DOOR ACTUATOR FOR MOUNTING ON A MOUNTING PLATE WITHOUT THE USE OF CONNECTING MEANS	E21B 43/267 (2006.01)	2655795 *	MULTI-STAGE FRACTURE INJECTION PROCESS FOR ENHANCED RESOURCE PRODUCTION FROM SHALES
B82Y 30/00 (2011.01)	2657323 *	NANOSTRUCTURE OF A REVITALIZING AGENT AND METHOD FOR PRODUCING A STABLE FORM OF A NANOSTRUCTURE OF A REVITALIZING AGENT	A61K 31/336 (2006.01)	2646016 *	TREATMENT OF OBESITY USING NON-DAILY ADMINISTRATION OF 6 - 0 - (4 - DIMETHYLAMINOETHOXY) CINNAMOYL FUMAGILLOL
C10M 103/06 (2006.01)	2657323 *	NANOSTRUCTURE OF A REVITALIZING AGENT AND METHOD FOR PRODUCING A STABLE FORM OF A NANOSTRUCTURE OF A REVITALIZING AGENT	A61P 3/04 (2006.01)	2646016 *	TREATMENT OF OBESITY USING NON-DAILY ADMINISTRATION OF 6 - 0 - (4 - DIMETHYLAMINOETHOXY) CINNAMOYL FUMAGILLOL
C10M 177/00 (2006.01)	2657323 *	NANOSTRUCTURE OF A REVITALIZING AGENT AND METHOD FOR PRODUCING A STABLE FORM OF A NANOSTRUCTURE OF A REVITALIZING AGENT	A61L 2/07 (2006.01)	2694118 *	METHOD FOR STEAM STERILIZATION OF MEDICAL ARTICLES
A61K 9/16 (2006.01)	2648699 *	DOSAGE FORM	C07D 223/08 (2006.01)	2683687 *	PRIMARY AMINE DIAZENIUMDIOLATE HETEROCYCLIC DERIVATIVES
A61K 9/20 (2006.01)	2648699 *	DOSAGE FORM	C07D 405/12 (2006.01)	2683687 *	PRIMARY AMINE DIAZENIUMDIOLATE HETEROCYCLIC DERIVATIVES
A61P 25/04 (2006.01)	2648699 *	DOSAGE FORM	C07D 401/04 (2006.01)	2683687 *	PRIMARY AMINE DIAZENIUMDIOLATE HETEROCYCLIC DERIVATIVES
A61K 39/04 (2006.01)	2651437 *	MYCOBACTERIUM ANTIGENIC COMPOSITION	A61K 31/445 (2006.01)	2683687 *	PRIMARY AMINE DIAZENIUMDIOLATE HETEROCYCLIC DERIVATIVES
C07K 16/00 (2006.01)	2683735 *	BISPECIFIC THREE-CHAIN ANTIBODY-LIKE MOLECULES	C07D 211/46 (2006.01)	2683687 *	PRIMARY AMINE DIAZENIUMDIOLATE HETEROCYCLIC DERIVATIVES
C07K 16/46 (2006.01)	2683735 *	BISPECIFIC THREE-CHAIN ANTIBODY-LIKE MOLECULES	C07D 403/04 (2006.01)	2683687 *	PRIMARY AMINE DIAZENIUMDIOLATE HETEROCYCLIC DERIVATIVES
C07C 311/08 (2006.01)	2688878 *	PROCESS FOR SYNTHESIZING KETO-BENZOFURAN DERIVATIVES	C07D 207/48 (2006.01)	2683687 *	PRIMARY AMINE DIAZENIUMDIOLATE HETEROCYCLIC DERIVATIVES
C07C 311/21 (2006.01)	2688878 *	PROCESS FOR SYNTHESIZING KETO-BENZOFURAN DERIVATIVES	C07D 401/14 (2006.01)	2683687 *	PRIMARY AMINE DIAZENIUMDIOLATE HETEROCYCLIC DERIVATIVES
C07D 307/80 (2006.01)	2688878 *	PROCESS FOR SYNTHESIZING KETO-BENZOFURAN DERIVATIVES	C07D 207/12 (2006.01)	2683687 *	PRIMARY AMINE DIAZENIUMDIOLATE HETEROCYCLIC DERIVATIVES
C07D 307/84 (2006.01)	2688878 *	PROCESS FOR SYNTHESIZING KETO-BENZOFURAN DERIVATIVES			

MKP (51)	Broj objave evropske prijave patenta (97)	Naziv pronalaska (54)	MKP (51)	Broj objave evropske prijave patenta (97)	Naziv pronalaska (54)
C07D 401/10 (2006.01)	2683687 *	PRIMARY AMINE DIAZENIUMDIOLATE HETEROCYCLIC DERIVATIVES	A61K 9/00 (2006.01)	2651390 *	ZOLPIDEM-BASED ORODISPERSIBLE PHARMACEUTICAL TABLET
C07D 309/12 (2006.01)	2683687 *	PRIMARY AMINE DIAZENIUMDIOLATE HETEROCYCLIC DERIVATIVES	A61K 9/20 (2006.01)	2651390 *	ZOLPIDEM-BASED ORODISPERSIBLE PHARMACEUTICAL TABLET
C07D 207/273 (2006.01)	2683687 *	PRIMARY AMINE DIAZENIUMDIOLATE HETEROCYCLIC DERIVATIVES	A61K 31/437 (2006.01)	2651390 *	ZOLPIDEM-BASED ORODISPERSIBLE PHARMACEUTICAL TABLET
C07D 211/96 (2006.01)	2683687 *	PRIMARY AMINE DIAZENIUMDIOLATE HETEROCYCLIC DERIVATIVES	A61K 33/00 (2006.01)	2651390 *	ZOLPIDEM-BASED ORODISPERSIBLE PHARMACEUTICAL TABLET
C07D 403/10 (2006.01)	2683687 *	PRIMARY AMINE DIAZENIUMDIOLATE HETEROCYCLIC DERIVATIVES	A61K 33/10 (2006.01)	2651390 *	ZOLPIDEM-BASED ORODISPERSIBLE PHARMACEUTICAL TABLET
C07D 401/06 (2006.01)	2683687 *	PRIMARY AMINE DIAZENIUMDIOLATE HETEROCYCLIC DERIVATIVES	A61P 25/20 (2006.01)	2651390 *	ZOLPIDEM-BASED ORODISPERSIBLE PHARMACEUTICAL TABLET
C07K 14/435 (2006.01)	2661496 *	ANTICANCER FUSION PROTEIN	B23B 27/04 (2006.01)	2656950 *	CUTTING TOOL AND METHOD FOR MANUFACTURING CUT PRODUCT USING SAME
C07K 14/705 (2006.01)	2661496 *	ANTICANCER FUSION PROTEIN	B23B 27/16 (2006.01)	2656950 *	CUTTING TOOL AND METHOD FOR MANUFACTURING CUT PRODUCT USING SAME
C07K 14/78 (2006.01)	2661496 *	ANTICANCER FUSION PROTEIN	A61K 9/00 (2006.01)	2594266	Pharmaceutical solid compositions containing ibuprofen salts
C12N 15/62 (2006.01)	2661496 *	ANTICANCER FUSION PROTEIN	A61K 31/192 (2006.01)	2594266	Pharmaceutical solid compositions containing ibuprofen salts
A61K 31/21 (2006.01)	2594556	Substituted aminopropionic derivatives as neprilysin inhibitors	A61K 47/02 (2006.01)	2594266	Pharmaceutical solid compositions containing ibuprofen salts
A61K 31/435 (2006.01)	2594556	Substituted aminopropionic derivatives as neprilysin inhibitors	A61L 2/07 (2006.01)	2596810	Method for sterilisation of used absorbent sanitary products
C07C 233/47 (2006.01)	2594556	Substituted aminopropionic derivatives as neprilysin inhibitors	A61L 11/00 (2006.01)	2596810	Method for sterilisation of used absorbent sanitary products
C07D 213/82 (2006.01)	2594556	Substituted aminopropionic derivatives as neprilysin inhibitors	B01J 3/04 (2006.01)	2596810	Method for sterilisation of used absorbent sanitary products
C07D 239/36 (2006.01)	2594556	Substituted aminopropionic derivatives as neprilysin inhibitors	B29B 17/00 (2006.01)	2596810	Method for sterilisation of used absorbent sanitary products
C07D 261/18 (2006.01)	2594556	Substituted aminopropionic derivatives as neprilysin inhibitors	C12N 5/0797 (2010.01)	2663638 *	CULTURE METHOD TO OBTAIN AND MAINTAIN A PURE OR ENRICHED POPULATION OF MAMMALIAN NEURAL STEM CELLS AND/ OR NEURAL PROGENITOR CELLS THAT ARE PRONE TO DIFFERENTIATE INTO OLIGODENDROCYTE- LINEAGE CELLS IN VITRO
C07D 271/06 (2006.01)	2594556	Substituted aminopropionic derivatives as neprilysin inhibitors	C12P 21/06 (2006.01)	2649189 *	TNF- BINDING PROTEINS
H01L 21/00 (2006.01)	2684210 *	EFFICIENT BLACK SILICON PHOTOVOLTAIC DEVICES WITH ENHANCED BLUE RESPONSE	C21D 8/04 (2006.01)	2689045 *	HOT-ROLLED STEEL SHEET AND ASSOCIATED PRODUCTION METHOD
			C21D 9/46 (2006.01)	2689045 *	HOT-ROLLED STEEL SHEET AND ASSOCIATED PRODUCTION METHOD

MKP (51)	Broj objave evropske prijave patenta (97)	Naziv pronalaska (54)
C22C 38/02 (2006.01)	2689045 *	HOT-ROLLED STEEL SHEET AND ASSOCIATED PRODUCTION METHOD
C22C 38/04 (2006.01)	2689045 *	HOT-ROLLED STEEL SHEET AND ASSOCIATED PRODUCTION METHOD
C22C 38/12 (2006.01)	2689045 *	HOT-ROLLED STEEL SHEET AND ASSOCIATED PRODUCTION METHOD
C22C 38/14 (2006.01)	2689045 *	HOT-ROLLED STEEL SHEET AND ASSOCIATED PRODUCTION METHOD
C23C 2/06 (2006.01)	2689045 *	HOT-ROLLED STEEL SHEET AND ASSOCIATED PRODUCTION METHOD
A01N 37/34 (2006.01)	2663188 *	METHOD FOR CONTROLLING CLUBROOT
A01N 41/06 (2006.01)	2663188 *	METHOD FOR CONTROLLING CLUBROOT
A01N 43/50 (2006.01)	2663188 *	METHOD FOR CONTROLLING CLUBROOT
A01P 3/00 (2006.01)	2663188 *	METHOD FOR CONTROLLING CLUBROOT
A61M 1/14 (2006.01)	2668497 *	URINE BIOMARKERS FOR PREDICTION OF RECOVERY AFTER ACUTE KIDNEY INJURY : PROTEOMICS
G01N 33/50 (2006.01)	2668497 *	URINE BIOMARKERS FOR PREDICTION OF RECOVERY AFTER ACUTE KIDNEY INJURY : PROTEOMICS
G01N 33/53 (2006.01)	2668497 *	URINE BIOMARKERS FOR PREDICTION OF RECOVERY AFTER ACUTE KIDNEY INJURY : PROTEOMICS

INDEKS PODNOSITELJA ZAHTEVA ZA PROŠIRENJE EVROPSKIH PRIJAVA PATENTA

INDEX ON NUMBER OF APPLICATIONS FOR EXTENSION OF EUROPEAN PATENT APPLICATION

Podnosilac evropske prijave patenta (71)	MKP (51)	Broj objave evropske prijave patenta (97)	Naziv pronalaska (54)
Cellresin Technologies, LLC	A01N 3/02 (2006.01)	2690951 *	CYCLODEXTRIN COMPOSITIONS, ARTICLES, AND METHODS
	A01N 25/34 (2006.01)		
	A01N 27/00 (2006.01)		
	A23B 7/152 (2006.01)		
	A23L 3/3445 (2006.01)		
	C08F 2/46 (2006.01)		
	C08J 7/04 (2006.01)		
	C08K 5/01 (2006.01)		
	C08K 5/101 (2006.01)		
	C08K 5/16 (2006.01)		
Jiangsu Protelight Pharmaceutical & Biotechnology Co., Ltd	A61K 38/10 (2006.01)	2700648 *	ANTIBIOTIC PEPTIDE AND PREPARATION METHOD THEREFOR AND APPLICATION THEREOF
	A61P 31/00 (2006.01)		
	C07K 1/04 (2006.01)		
	C07K 1/06 (2006.01)		
	C07K 7/08 (2006.01)		
Chen, Yuxin	A61K 38/10 (2006.01)	2700648 *	ANTIBIOTIC PEPTIDE AND PREPARATION METHOD THEREFOR AND APPLICATION THEREOF
	A61P 31/00 (2006.01)		
	C07K 1/04 (2006.01)		
	C07K 1/06 (2006.01)		
	C07K 7/08 (2006.01)		
Genelux Corporation	C12N 7/00 (2006.01)	2697368 *	CLONAL STRAINS OF ATTENUATED VACCINIA VIRUSES AND METHODS OF USE THEREOF
Avocent Huntsville Corporation	G06F 1/32 (2006.01)	2673712 *	INFRASTRUCTURE CONTROL FABRIC SYSTEM AND METHOD
	G06F 11/30 (2006.01)		
	H04L 12/24 (2006.01)		
	H05K 7/14 (2006.01)		
GlaxoSmithKline LLC	A01N 43/56 (2006.01)	2663189 *	COMBINATION
Arla Foods Amba	C07K 1/18 (2006.01)	2681231 *	METHOD FOR ISOLATING OSTEOPOINTIN USING CONCENTRATED FEEDS
	C07K 14/47 (2006.01)		
	C07K 14/52 (2006.01)		
Janssen Pharmaceutica N.V.	A61K 9/00 (2006.01)	2696848 *	FREEZE DRIED DRUG NANOSUSPENSIONS
	A61K 9/14 (2006.01)		
	A61K 9/19 (2006.01)		
STRACKE, Markus	E01F 7/04 (2006.01)	2652202 *	DEVICE FOR BREAKING UP SNOW CORNICES AND/OR TRIGGERING AVALANCHES
Maculan, Alexander	E01F 7/04 (2006.01)	2652202 *	DEVICE FOR BREAKING UP SNOW CORNICES AND/OR TRIGGERING AVALANCHES
Stracke, Matthias	E01F 7/04 (2006.01)	2652202 *	DEVICE FOR BREAKING UP SNOW CORNICES AND/OR TRIGGERING AVALANCHES
Globeimmune, Inc.	A61K 36/06 (2006.01)	2672991 *	YEAST-BASED THERAPEUTIC FOR CHRONIC HEPATITIS B INFECTION
	A61K 39/29 (2006.01)		
	C07K 14/02 (2006.01)		
Sanofi-Aventis U.S. LLC	B65D 5/42 (2006.01)	2675715 *	MEDICAL PRODUCT PACKAGE
	B65D 5/46 (2006.01)		
Centro De Ingenieria Genetica Y Biotecnologia	C07K 16/22 (2006.01)	2662388 *	RECOMBINANT ANTIBODIES TO THE VASCULAR ENDOTHELIAL GROWTH FACTOR (VEGF) WHICH ARE OBTAINED BY MEANS OF MUTAGENESIS OF VARIABLE REGIONS
	C07K 16/22 (2006.01)		
Biorec S.A.	C07K 16/22 (2006.01)	2662388 *	RECOMBINANT ANTIBODIES TO THE VASCULAR ENDOTHELIAL GROWTH FACTOR (VEGF) WHICH ARE OBTAINED BY MEANS OF MUTAGENESIS OF VARIABLE REGIONS

Podnosilac evropske prijave patenta (71)	MKP (51)	Broj objave evropske prijave patenta (97)	Naziv pronalaska (54)
Creative Therapeutics GmbH	A61K 31/255 (2006.01) A61K 31/37 (2006.01) A61K 31/655 (2006.01) A61P 35/00 (2006.01) C07C 305/24 (2006.01) C07C 307/02 (2006.01) C07D 311/12 (2006.01)	2686298 *	SUBSTITUTED DIPHENYL DERIVATIVES
Delphi Technologies Holding S.a.r.l.	F16L 53/00 (2006.01)	2694859 *	CONNECTOR ELEMENT
GlaxoSmithKline LLC	A61K 38/20 (2006.01) A61K 47/48 (2006.01)	2672986 *	LYOPHILIZED FORMULATIONS
Epizyme, Inc.	A61K 31/4412 (2006.01) A61K 31/444 (2006.01) A61P 35/00 (2006.01) C07D 213/64 (2006.01) C07D 401/12 (2006.01) C07D 405/12 (2006.01) C07D 409/12 (2006.01) C07D 413/12 (2006.01) C07D 417/12 (2006.01) C07D 491/08 (2006.01) C07D 491/107 (2006.01)	2697199 *	ARYL-OR HETEROARYL-SUBSTITUTED BENZENE COMPOUNDS
Swedish Match North Europe AB	A24B 13/00 (2006.01) A24B 15/30 (2006.01)	2649888	A smokeless tobacco composition comprising non-tobacco fibers and a method for its manufacture.
Gilead Calistoga LLC	A61K 31/4184 (2006.01) A61K 31/4439 (2006.01) A61K 31/52 (2006.01) A61K 39/00 (2006.01) A61K 45/06 (2006.01) A61P 35/00 (2006.01) A61P 35/02 (2006.01)	2683377 *	COMBINATION THERAPIES FOR HEMATOLOGIC MALIGNANCIES
Omya International AG	C09C 1/02 (2006.01) D21H 17/00 (2006.01)	2684916	Surface modified calcium carbonate containing minerals and its use
Nestec S.A.	G01N 33/574 (2006.01)	2656077 *	DRUG SELECTION FOR MALIGNANT CANCER THERAPY USING ANTIBODY-BASED ARRAYS
Japan Tobacco, Inc.	A61K 31/295 (2006.01) A61P 3/12 (2006.01) C07C 51/41 (2006.01) C07C 59/265 (2006.01)	2666764 *	FERRIC CITRATE CONTAINING SUBSTANTIALLY NO -OXIDIZED IRON HYDROXIDE
Kruszewska, Danuta	A23L 1/30 (2006.01) A61K 35/74 (2006.01) A61L 29/08 (2006.01) A61L 29/16 (2006.01) A61P 1/00 (2006.01) A61P 19/06 (2006.01) A61P 31/04 (2006.01) C12R 1/225 (2006.01)	2674162	NANOPRODUCT COMPRISING LACTOBACILLUS REUTERI DAN080 USEFUL IN PROPHYLAXIS AND MEDICINE, BOTH HUMAN AND VETERINARY AND MEDICAL USE OF THE SAME
Janssen R&D Ireland	A61K 31/437 (2006.01) A61P 31/12 (2006.01) C07D 471/04 (2006.01)	2651933 *	AZABENZIMIDAZOLES AS RESPIRATORY SYNCYTIAL VIRUS ANTIVIRAL AGENTS
Sovic Brkicic, Ljiljana	A61K 9/20 (2006.01) A61K 9/50 (2006.01) A61K 31/198 (2006.01) A61K 47/48 (2006.01)	2694038 *	PHARMACEUTICAL COMPOSITION
Brkicic, Cvjetko	A61K 9/20 (2006.01) A61K 9/50 (2006.01) A61K 31/198 (2006.01) A61K 47/48 (2006.01)	2694038 *	PHARMACEUTICAL COMPOSITION
GlaxoSmithKline Biologicals S.A.	A61K 39/02 (2006.01) C07K 14/195 (2006.01) C07K 14/34 (2006.01) C12P 21/00 (2006.01)	2697385 *	FERMENTATION PROCESS

Podnosilac evropske prijave patenta (71)	MKP (51)	Broj objave evropske prijave patenta (97)	Naziv pronalaska (54)
SANOFI	A61K 31/44 (2006.01) A61K 31/498 (2006.01) A61K 31/519 (2006.01) A61P 35/00 (2006.01)	2648729 *	COMPOSITIONS COMPRISING A PI3K INHIBITOR AND A MEK INHIBITOR AND THEIR USE FOR TREATING CANCER
Merck Patent GmbH	A61K 31/44 (2006.01) A61K 31/498 (2006.01) A61K 31/519 (2006.01) A61P 35/00 (2006.01)	2648729 *	COMPOSITIONS COMPRISING A PI3K INHIBITOR AND A MEK INHIBITOR AND THEIR USE FOR TREATING CANCER
Perrella, Luigi	B63B 35/32 (2006.01) E02B 15/04 (2006.01)	2675697 *	DEVICE AND METHOD FOR RECOVERING SOLID AND/OR LIQUID SUBSTANCES FLOATING IN A LIQUID MASS
Obshchestvo S Ogranichenoy Otvetstvennostyu «Plazma-Pro»	C02F 1/32 (2006.01) C02F 1/36 (2006.01)	2692694 *	DEVICE FOR REMOVING ORGANIC AND CHEMICAL MICROBIC POLLUTANTS FROM WATER
Synta Pharmaceuticals Corp.	A61K 31/4196 (2006.01) A61P 35/00 (2006.01)	2678013 *	COMBINATION THERAPY OF HSP90 INHIBITORY COMPOUNDS WITH RADIOTHERAPY
Glaxosmithkline LLC	A61K 31/4706 (2006.01) A61K 31/4709 (2006.01) A61P 29/00 (2006.01) A61P 35/00 (2006.01) C07D 215/42 (2006.01) C07D 215/44 (2006.01) C07D 401/12 (2006.01)	2699550 *	TETRAHYDROQUINOLINE DERIVATIVES USEFUL AS BROMODOMAIN INHIBITORS
Farmicom Pharmaceutical Company D.O.O.	A61K 31/4155 (2006.01) A61P 9/14 (2006.01) A61K 31/41 (2006.01) A61K 31/616 (2006.01) A61K 31/405 (2006.01) A61K 31/505 (2006.01) A61K 31/366 (2006.01) A61K 31/44 (2006.01) A61K 31/4015 (2006.01) A61K 31/47 (2006.01) A61K 31/416 (2006.01) A61K 31/122 (2006.01) A61K 31/422 (2006.01) A61K 31/415 (2006.01) A61P 9/10 (2006.01)	2680831 *	TREATMENT OF ARTERIAL AGEING BY RAAS INHIBITOR
Ethicon Endo-Surgery, Inc.	A61B 17/072 (2006.01)	2517648	Staple cartridge comprising a releasable portion
Array Biopharma, Inc.	A61K 31/519 (2006.01) A61P 35/00 (2006.01) C07D 471/04 (2006.01)	2681215 *	SERINE/THREONINE KINASE INHIBITORS
Genentech, Inc.	A61K 31/519 (2006.01) A61P 35/00 (2006.01) C07D 471/04 (2006.01)	2681215 *	SERINE/THREONINE KINASE INHIBITORS
Zapolsky, Maxim Eduardovich	C07D 487/18 (2006.01)	2695883 *	TRICYCLIC DERIVATIVES OF N,N'-SUBSTITUTED 3,7-DIAZABICYCLO [3.3.1]NONANES AND DRUGS BASED THEREON
The University of British Columbia	A61K 31/4166 (2006.01) A61K 31/7088 (2006.01) A61P 5/28 (2006.01) A61P 35/00 (2006.01)	2685989 *	COMBINATION OF ANTI-CLUSTERIN OLIGONUCLEOTIDE WITH ANDROGEN RECEPTOR ANTAGONIST FOR THE TREATMENT OF PROSTATE CANCER
Gilead Sciences, Inc.	A61K 31/435 (2006.01) A61P 31/18 (2006.01) C07D 491/06 (2006.01)	2694160 *	SOLID STATE FORMS OF HIV INHIBITOR
Æterna Zentaris GmbH	A61K 31/4985 (2006.01) A61K 31/5377 (2006.01) A61P 35/00 (2006.01) A61P 43/00 (2006.01) C07D 471/04 (2006.01)	2694067 *	PYRIDOPYRAZINE DERIVATIVES AND THEIR USE

Podnosilac evropske prijave patenta (71)	MKP (51)	Broj objave evropske prijave patenta (97)	Naziv pronalaska (54)
H. Lundbeck A/S	A61K 31/519 (2006.01) A61P 25/00 (2006.01) C07D 471/04 (2006.01) C07D 487/04 (2006.01)	2513105 *	2-ARYLIMIDAZOLE DERIVATIVES AS PDE10A ENZYME INHIBITORS
Sanofi-Aventis Deutschland GmbH	A61M 5/20 (2006.01) A61M 5/32 (2006.01)	2675503 *	AUTO-INJECTOR
AdvanDx, Inc.	C07H 21/00 (2006.01) C12Q 1/68 (2006.01)	2694526 *	MOLECULAR GRAM STAIN
Omya International AG	C05D 3/02 (2006.01) C05G 3/00 (2006.01)	2649027 *	SOIL CONDITIONERS AND FERTILISERS HAVING DYNAMIC DISINTEGRATION, METHOD FOR MANUFACTURING SAME, AND USES THEREOF IN AGRICULTURE
Saint-Gobain Glass France	C03C 17/36 (2006.01)	2661417 *	SUBSTRATE PROVIDED WITH A STACK HAVING THERMAL PROPERTIES, IN PARTICULAR FOR MANUFACTURING HEATED GLASS
QR Pharma Inc.	A01N 43/00 (2006.01)	2683242 *	EFFECTIVE AMOUNTS OF (3AR)-1,3A,8-TRIMETHYL-1,2,3,3A,8,8A-HEXAHYDROPYRROLO[2,3-B]INDOL-5-YL PHENYL CARBAMATE AND METHODS THEREOF
Lastella, Michele	A47K 3/06 (2006.01)	2690998 *	REVERSIBLY EXTENDIBLE BATH TUB
Rotho Kunststoff AG	G06Q 10/08 (2012.01)	2624185	Handheld device and method for determining the location of physical objects stored in storage containers
Geox S.p.A.	A43B 7/12 (2006.01)	2645896 *	WATERPROOF AND VAPOR-PERMEABLE SHOE, PROVIDED PREDOMINANTLY BY MEANS OF THE WORKING METHOD KNOWN AS "AGO LASTING"
Whiteford, Bede	B65D 19/38 (2006.01)	2665658 *	PALLET LEADER BOARD SYSTEM
Pierre Fabre Dermo-Cosmétique	A61K 35/74 (2006.01) A61P 17/00 (2006.01) C12N 1/20 (2006.01) C12R 1/36 (2006.01)	2655595 *	NOVEL BACTERIUM AND EXTRACTS OF SAID BACTERIUM AND THE USE OF SAME IN DERMATOLOGY
Université Pierre et Marie Curie (Paris 6)	A61K 35/74 (2006.01) A61P 17/00 (2006.01) C12N 1/20 (2006.01) C12R 1/36 (2006.01)	2655595 *	NOVEL BACTERIUM AND EXTRACTS OF SAID BACTERIUM AND THE USE OF SAME IN DERMATOLOGY
Centre National de la Recherche Scientifique CNRS	A61K 35/74 (2006.01) A61P 17/00 (2006.01) C12N 1/20 (2006.01) C12R 1/36 (2006.01)	2655595 *	NOVEL BACTERIUM AND EXTRACTS OF SAID BACTERIUM AND THE USE OF SAME IN DERMATOLOGY
Amgen Inc.	A61K 38/00 (2006.01) A61K 38/18 (2006.01) C07K 14/00 (2006.01) C07K 14/05 (2006.01) C07K 14/475 (2006.01) C07K 14/50 (2006.01) C07K 14/705 (2006.01)	2679234	Binding proteins that bind to human FGFR1C, human beta-klotho and both human FGFR1C and human beta-klotho
Qualcomm Incorporated	A61B 5/024 (2006.01) G01C 22/00 (2006.01) G01P 13/00 (2006.01) G06F 3/01 (2006.01) G06F 3/033 (2013.01)	2691779 *	DEVICES, METHODS, AND APPARATUSES FOR INFERRING A POSITION OF A MOBILE DEVICE
Amgen Inc.	A61K 39/395 (2006.01)	2699261 *	METHOD FOR TREATING OSTEOPOROSIS
Jiangxi Rare Earth & Rare Metals Tungsten Group Holding Co., Ltd.	B01D 11/04 (2006.01) C22B 3/02 (2006.01)	2695653 *	HEATER AND HEATING METHOD FOR WET EXTRACTION TANK
Schleuniger Holding AG	H01R 43/052 (2006.01) H01R 43/28 (2006.01)	2590275	Circuit positioning device
Selo Medical GmbH	A61K 9/00 (2006.01) A61K 33/04 (2006.01) A61P 15/02 (2006.01)	2675432 *	PHARMACEUTICAL PREPARATION CONTAINING SELENITE OR SELENITE-CONTAINING COMPOUNDS FOR TREATING CERVICAL DYSPLASIA OR CARCINOMAS

Podnositelj evropske prijave patenta (71)	MKP (51)	Broj objave evropske prijave patenta (97)	Naziv pronalaska (54)
IRM LLC	C07D 471/04 (2006.01)	2678338 *	COMPOUNDS AND COMPOSITIONS AS TRK INHIBITORS
Rotas Italia S.r.l.	G06F 17/30 (2006.01) G09B 5/00 (2006.01) H04L 29/08 (2006.01) H04M 1/725 (2006.01)	2587770	A system for the display, by a user, of multimedia content items
Santarus, Inc.	A61K 39/395 (2006.01)	2670438 *	SELECTION AND TREATMENT OF SUBJECTS
Wobben Properties GmbH	H02G 1/12 (2006.01)	2676345 *	DEVICE FOR INDUCTIVELY REMOVING THE INSULATION FROM WIRES AND/OR PROFILES
SANOFI	A61K 31/44 (2006.01) A61P 9/00 (2006.01) C07D 213/16 (2006.01)	2691371 *	BENZOIC ACID SALT OF OTAMIXABAN
Barbazza Fratelli Sas - Di Barbazza Roberto E C.	A44C 5/04 (2006.01) A44C 5/06 (2006.01) A44C 13/00 (2006.01)	2688439 *	JEWELLERY ITEM
Delphi Technologies Holding S.a.r.l.	F01N 3/20 (2006.01)	2689119 *	REAGENT DOSING PUMP ASSEMBLY
Theravance, Inc.	C07D 257/04 (2006.01) A61K 31/4192 (2006.01) C07D 249/18 (2006.01) A61K 31/4164 (2006.01) C07D 249/04 (2006.01) C07C 233/47 (2006.01) A61P 13/00 (2006.01) C07D 231/14 (2006.01) C07D 403/04 (2006.01) A61K 31/42 (2006.01) C07D 261/12 (2006.01) A61K 31/4196 (2006.01) C07D 249/10 (2006.01) A61K 31/415 (2006.01) C07D 239/36 (2006.01) C07C 233/46 (2006.01) A61P 9/00 (2006.01) C07D 231/20 (2006.01) C07D 471/04 (2006.01) A61K 31/405 (2006.01)	2675792 *	SUBSTITUTED AMINOBUTYRIC DERIVATIVES AS NEPRILYSIN INHIBITORS
Gilead Sciences, Inc.	A61K 31/4178 (2006.01) A61K 31/4188 (2006.01) A61P 31/12 (2006.01) C07D 401/14 (2006.01) C07D 403/04 (2006.01) C07D 403/14 (2006.01) C07D 405/14 (2006.01) C07D 409/14 (2006.01) C07D 413/04 (2006.01) C07D 417/04 (2006.01) C07D 417/14 (2006.01) C07D 495/04 (2006.01)	2430014 *	ANTIVIRAL COMPOUNDS
Merck Serono SA	C12N 15/10 (2006.01)	2683821 *	LOW FUCOSE CELL LINES AND USES THEREOF
Yale University	A61K 31/66 (2006.01) A61K 31/7076 (2006.01) A61K 31/708 (2006.01) A61P 31/00 (2006.01) C07K 17/02 (2006.01)	2649099 *	SMALL-MOLECULE HYDROPHOBIC TAGGING OF FUSION PROTEINS AND INDUCED DEGRADATION OF SAME
Pollogen Ltd	A45D 34/04 (2006.01) A61K 8/02 (2006.01) A61K 9/20 (2006.01) A61Q 19/02 (2006.01) B65D 81/32 (2006.01)	2609830	Apparatus and method for using effervescent tablets for cosmetic care
A.P.F. Aqua System AG	B01J 3/04 (2006.01) B01J 4/02 (2006.01) C01B 11/02 (2006.01)	2654940 *	METHOD FOR PRODUCING AN AQUEOUS STABLE CHLORINE DIOXIDE SOLUTION
Novartis AG	G02C 7/04 (2006.01)	2652544 *	COLORLED CONTACT LENS

Podnosilac evropske prijave patenta (71)	MKP (51)	Broj objave evropske prijave patenta (97)	Naziv pronalaska (54)
Oncolytics Biotech Inc.	A61K 9/08 (2006.01) A61K 31/70 (2006.01) A61K 39/15 (2006.01) A61K 48/00 (2006.01) A61P 31/12 (2006.01)	2646051 *	LIQUID VIRAL FORMULATIONS
Gilead Sciences, Inc.	A61K 31/428 (2006.01) A61K 31/436 (2006.01) A61P 31/18 (2006.01) C07D 277/62 (2006.01) C07D 277/64 (2006.01) C07D 277/82 (2006.01) C07D 417/04 (2006.01) C07D 491/06 (2006.01)	2699558 *	BENZOTHAZOLE COMPOUNDS AND THEIR PHARMACEUTICAL USE
Ariad Pharmaceuticals, Incorporated	A61K 31/495 (2006.01)	2694064 *	METHODS AND COMPOSITIONS FOR TREATING NEURODEGENERATIVE DISEASES
GlaxoSmithKline Intellectual Property Development Limited	A61K 31/445 (2006.01)	2688568 *	CYCLOPROPYLAMINES AS LSD1 INHIBITORS
Zinfandel Pharmaceuticals, Inc.	A61K 31/4436 (2006.01) C12Q 1/68 (2006.01)	2665479 *	METHODS AND DRUG PRODUCTS FOR TREATING ALZHEIMER'S DISEASE
Takeda Pharmaceutical Company Limited	A61K 31/4436 (2006.01) C12Q 1/68 (2006.01)	2665479 *	METHODS AND DRUG PRODUCTS FOR TREATING ALZHEIMER'S DISEASE
Abbvie Inc.	A61K 31/4439 (2006.01) A61P 31/00 (2006.01) C07D 401/12 (2006.01) C07D 401/14 (2006.01)	2651920 *	ANTI-VIRAL COMPOUNDS
Galleon Pharmaceuticals, Inc.	A61K 31/53 (2006.01) C07D 251/54 (2006.01)	2646423 *	NOVEL COMPOUNDS AS RESPIRATORY STIMULANTS FOR TREATMENT OF BREATHING CONTROL DISORDERS OR DISEASES
Scotialight APS	F21S 8/08 (2006.01) F21S 9/03 (2006.01) F21V 21/10 (2006.01) F21W 131/103 (2006.01)	2681486 *	POLE WITH SOLAR CELL PANELS
Gannon Technologies Group LLC	G06K 9/00 (2006.01)	2671189 *	SYSTEMS AND METHODS FOR BIOMETRIC IDENTIFICATION
SANOFI	C07D 231/14 (2006.01) C07D 275/03 (2006.01)	2668167 *	AMINO-SUBSTITUTED 3-HETEROAROYLAMINO-PROPIONIC ACID DERIVATIVES AND THEIR USE AS PHARMACEUTICALS
SICPA HOLDING SA	G07D 7/00 (2006.01) G07D 7/12 (2006.01)	2573739	Optically variable entity authenticating device and method
Sappi Services Netherlands b.v.	D01D 1/02 (2006.01) D01D 5/06 (2006.01) D01D 5/40 (2006.01) D01F 2/00 (2006.01) D01F 2/24 (2006.01) D21H 13/00 (2006.01) D21H 15/00 (2006.01)	2683859 *	METHOD FOR SPINNING ANIONICALLY MODIFIED CELLULOSE AND FIBRES MADE USING THE METHOD
Alkermes, Inc.	A01N 43/42 (2006.01) A61K 31/44 (2006.01)	2675276 *	PERIPHERIALLY ACTING μ OPIOID ANTAGONISTS
4SC Discovery GmbH	A61K 31/422 (2006.01) A61P 29/00 (2006.01) C07D 413/04 (2006.01)	2668182 *	IL17 AND IFN-GAMMA INHIBITION FOR THE TREATMENT OF AUTOIMMUNE INFLAMMATION
Tasler, Stefan	A61K 31/422 (2006.01) A61P 29/00 (2006.01) C07D 413/04 (2006.01)	2668182 *	IL17 AND IFN-GAMMA INHIBITION FOR THE TREATMENT OF AUTOIMMUNE INFLAMMATION
Syngenta Participations AG	A01N 43/36 (2006.01) C07D 207/36 (2006.01) C07D 307/12 (2006.01) C07D 317/34 (2006.01) C07D 401/12 (2006.01) C07D 405/12 (2006.01) C07D 409/12 (2006.01)	2661424 *	CHEMICAL COMPOUNDS

Podnosilac evropske prijave patenta (71)	MKP (51)	Broj objave evropske prijave patenta (97)	Naziv pronalaska (54)
Corridor Pharmaceuticals, Inc.	A61K 51/00 (2006.01) A61M 36/14 (2006.01)	2658580 *	ARGINASE INHIBITORS AND METHODS OF USE THEREOF
Dantaet A/S	F17D 5/02 (2006.01) G01M 3/24 (2006.01) G01M 3/32 (2006.01)	2694938 *	A METHOD AND MEANS FOR DETECTING LEAKAGES IN PIPE INSTALLATIONS
Bioener Bierzo, S.L.	C02F 1/52 (2006.01)	2662338 *	SYSTEM FOR PURIFYING POLLUTED WATER AND PURIFICATION METHOD
Omya International AG	B01D 53/14 (2006.01) B01D 53/62 (2006.01) B01J 20/12 (2006.01) C01F 5/24 (2006.01) C01F 11/18 (2006.01) C02F 1/66 (2006.01) C02F 5/06 (2006.01) C02F 5/08 (2006.01)	2695661	Regeneratable ion exchange material for reducing the amount of CO2
Arena Pharmaceuticals, Inc.	A61K 31/416 (2006.01) A61P 29/00 (2006.01) C07D 403/04 (2006.01)	2678330 *	CRYSTALLINE FORMS AND PROCESSES FOR THE PREPARATION OF CONDENSED AZACYCLES (CANNABINOID RECEPTOR MODULATORS)
Remote Media, LLC	G06F 17/30 (2006.01)	2686788 *	SYSTEM AND METHOD FOR MEDIA FILE SYNCHRONIZATION
Ironwood Pharmaceuticals, Inc.	A61K 31/404 (2006.01) A61P 25/04 (2006.01) C07D 401/12 (2006.01) C07D 401/14 (2006.01) C07D 403/12 (2006.01) C07D 403/14 (2006.01) C07D 471/04 (2006.01)	2655356 *	FAAH INHIBITORS
a.tron3d GmbH	A61B 1/00 (2006.01) A61B 1/06 (2006.01) G01B 11/25 (2006.01) G03B 17/54 (2006.01) G03B 35/08 (2006.01) G03B 37/00 (2006.01)	2686734 *	DEVICE FOR RECORDING IMAGES OF THREE-DIMENSIONAL OBJECTS
Fred Hutchinson Cancer Research Center	A61P 35/00 (2006.01) C07K 14/705 (2006.01) C07K 16/28 (2006.01) C07K 16/30 (2006.01) C12N 5/0783 (2010.01)	2689010 *	METHOD AND COMPOSITIONS FOR CELLULAR IMMUNOTHERAPY
Qualcomm Incorporated	H04L 29/08 (2006.01) H04L 29/12 (2006.01)	2684342 *	REMOTE ACCESS AND ADMINISTRATION OF DEVICE CONTENT AND CONFIGURATION USING HTTP PROTOCOL
Österreichische Akademie der Wissenschaften	G03D 15/00 (2006.01) G11B 23/50 (2006.01)	2656345 *	METHOD FOR RECONDITIONING DATA CARRIERS
Sanofi-Aventis Deutschland GmbH	A61M 5/20 (2006.01) A61M 5/315 (2006.01) A61M 5/32 (2006.01) A61M 5/50 (2006.01)	2675507 *	AUTO-INJECTOR
Zafgen, Inc.	A61K 31/336 (2006.01) A61P 3/04 (2006.01) C07D 303/22 (2006.01) C07D 303/32 (2006.01) C07D 303/34 (2006.01) C07D 303/36 (2006.01) C07D 491/10 (2006.01)	2683706 *	OXASPIRO [2.5]OCTANE DERIVATIVES AND ANALOGS
MIB ITALIANA S.p.A.	F16L 55/10 (2006.01)	2649359 *	DEVICE FOR AUTOMATIC CLOSURE OF CONTROL VALVES IN SEPARABLE CONNECTION UNITS FOR FLEXIBLE PIPES.
University Of Cincinnati	A61K 38/17 (2006.01) A61P 3/10 (2006.01) C07K 14/775 (2006.01)	2665485 *	APOLIPOPROTEIN AIV AS AN ANTIDIABETIC PEPTIDE

Podnosilac evropske prijave patenta (71)	MKP (51)	Broj objave evropske prijave patenta (97)	Naziv pronalaska (54)
Arena Pharmaceuticals, Inc.	A61K 31/416 (2006.01) A61K 31/4439 (2006.01) A61K 31/497 (2006.01) A61K 31/661 (2006.01) A61P 29/00 (2006.01) C07D 231/54 (2006.01) C07D 401/04 (2006.01) C07D 401/14 (2006.01) C07D 403/04 (2006.01) C07D 405/14 (2006.01) C07F 9/09 (2006.01)	2678318 *	CANNABINOID RECEPTOR MODULATORS
Eisai R&D Management Co., Ltd.	C12Q 1/68 (2006.01)	2686441 *	METHODS AND COMPOSITIONS FOR PREDICTING RESPONSE TO ERIBULIN
Fundacion Centro Nacional De Investigaciones Cardiovasculares Carlos III (CINC)	A61K 39/395 (2006.01)	2668960 *	COMPOUNDS FOR TREATING CARDIAC DAMAGE AFTER ISCHAEMIA/REPERFUSION
Nedschroef Fraulautern GmbH	F16B 25/00 (2006.01)	2657547	Screw
Helmholtz-Zentrum Dresden - Rossendorf e.V.	H01F 29/14 (2006.01) H02M 1/16 (2006.01)	2383756	Device for current amplification for electromagnetic pulse shaping and use
GTL Energy Holdings Pty Limited	F26B 5/14 (2006.01)	2652422 *	METHODS OF DRYING BIOMASS AND CARBONACEOUS MATERIALS
Qualcomm Incorporated	H04L 29/08 (2006.01) H04L 29/12 (2006.01)	2684341 *	SYSTEM AND METHOD USING A WEB PROXY-SERVER TO ACCESS A DEVICE HAVING AN ASSIGNED NETWORK ADDRESS
AbbVie Inc.	A61K 39/00 (2006.01) C07K 16/00 (2006.01)	2655415 *	TRI-VARIABLE DOMAIN BINDING PROTEINS AND USES THEREOF
Yemington, Charles R.	E21B 17/01 (2006.01)	2614211 *	RIGID HULL GAS-CAN BUOYS WITH VARIABLE BUOYANCY
Amgen Inc.	C07K 16/22 (2006.01) G21C 17/017 (2006.01) G21C 19/14 (2006.01)	2681242 *	SCLEROSTIN AND DKK-1 BISPECIFIC BINDING AGENTS
Bio-Rad Laboratories, Inc.	C12Q 1/68 (2006.01)	2652154 *	UNIVERSAL REFERENCE DYE FOR QUANTITATIVE AMPLIFICATION
Lupin Limited	A61K 31/538 (2006.01) A61P 5/18 (2006.01) C07D 265/36 (2006.01) C07D 413/04 (2006.01)	2686306 *	BENZO [B][1, 4]OXAZIN DERIVATIVES AS CALCIUM SENSING RECEPTOR MODULATORS
Lüers Maschinen- und Stahlbau GmbH	B29B 13/02 (2006.01)	2623284	Method and device for heating an end section of a plastic tube
Heraeus Kulzer GmbH	A61C 11/08 (2006.01)	2685930 *	MODEL PLATE ARRAY FOR PRODUCING DENTURES
SANOFI	C07K 16/28 (2006.01)	2513147 *	NOVEL ANTAGONIST ANTIBODIES AND THEIR FAB FRAGMENTS AGAINST GPVI AND USES THEREOF
ST. James, Steve	E05C 17/44 (2006.01) E05C 17/54 (2006.01) E05C 19/00 (2006.01) E05C 19/18 (2006.01)	2678502 *	DOOR BRACE
Sanofi-Aventis Deutschland GmbH	A61M 5/32 (2006.01)	2651474 *	INJECTION SUPPORTING DEVICE FOR A SYRINGE AND INJECTION DEVICE
SANOFI	A61K 39/395 (2006.01) A61P 3/06 (2006.01) C07K 16/40 (2006.01)	2668211 *	PHARMACEUTICAL COMPOSITIONS COMPRISING HUMAN ANTIBODIES TO PCSK9
Syngenta Participations AG	A01H 1/04 (2006.01) G06F 19/14 (2011.01) G06F 19/18 (2011.01)	2645846 *	METHODS FOR INCREASING GENETIC GAIN IN A BREEDING POPULATION

Podnosilac evropske prijave patenta (71)	MKP (51)	Broj objave evropske prijave patenta (97)	Naziv pronalaska (54)
NOVAERA S.r.l.	A61K 31/155 (2006.01) A61K 31/194 (2006.01) A61K 31/327 (2006.01) A61K 31/4045 (2006.01) A61K 31/4745 (2006.01) A61K 31/65 (2006.01) A61K 31/7048 (2006.01) A61K 31/7056 (2006.01) A61K 33/30 (2006.01) A61K 45/06 (2006.01) A61P 17/10 (2006.01)	2663299 *	MELATONIN AND AN ANTIMICROBIAL OR ANTIBACTERIAL AGENT FOR THE TREATMENT OF ACNE
Abbvie Inc.	C12P 21/08 (2006.01)	2668283 *	COMPOSITIONS CONTAINING GLYCOSYLATED ANTIBODIES AND USES THEREOF
Cyalume Technologies, Inc	F21K 2/06 (2006.01)	2649363 *	CHEMILUMINESCENT DEVICE WITH TIME DELAY ACTIVATION
Imballaggi San Felice SRL	B65H 75/14 (2006.01) B65H 75/22 (2006.01)	2565140	Cable holder
SANOFI	C07D 307/81 (2006.01)	2691382 *	PROCESS FOR PREPARATION OF DRONEDARONE BY MESYLATION
Lasse Ramskov Holding Aps	E04F 11/18 (2006.01) E04G 21/32 (2006.01)	2694752 *	A GUARDRAIL AND METHOD FOR ASSEMBLING IT
Boehringer Ingelheim International GmbH	A61K 31/357 (2006.01) A61P 19/00 (2006.01) A61P 29/00 (2006.01) C07D 319/20 (2006.01) C07D 405/10 (2006.01) C07D 405/12 (2006.01) C07D 405/14 (2006.01) C07D 487/10 (2006.01)	2686310 *	BENZODIOXANE INHIBITORS OF LEUKOTRIENE PRODUCTION
Geo Fossil Fuels, LLC	C09K 8/582 (2006.01) C12N 1/26 (2006.01) C12N 9/00 (2006.01)	2678422 *	ALKALINE MICROBIAL ENHANCED OIL RECOVERY
Moog Unna GmbH	F03D 11/00 (2006.01) H02B 1/04 (2006.01) H02B 1/40 (2006.01) H05K 7/18 (2006.01)	2549845	Switch cabinet for a pitch system
Melinta Therapeutics, Inc.	A61K 31/519 (2006.01) A61P 31/00 (2006.01) C07D 487/04 (2006.01)	2697229 *	ANTIMICROBIAL COMPOUNDS AND METHODS OF MAKING AND USING THE SAME
Italgghisa S.p.A.	H05B 7/09 (2006.01)	2651184	Electrode paste for electrodes in binder-free graphite with hydrocarbon base
Skobbler GmbH	G01C 21/34 (2006.01) G08G 1/01 (2006.01) G08G 1/0968 (2006.01) G08G 1/14 (2006.01)	2602777	Method for guiding a vehicle driver searching for a parking space
Nestec S.A.	G01N 33/50 (2006.01) G01N 33/574 (2006.01)	2681552 *	PREDICTION OF DRUG SENSITIVITY OF LUNG TUMORS BASED ON MOLECULAR AND GENETIC SIGNATURES
Genzyme Corporation	A61K 31/55 (2006.01)	2685986 *	GLUCOSYLCERAMIDE SYNTHASE INHIBITORS
SCA TISSUE FRANCE	A47K 10/38 (2006.01)	2606795	Sheet product dispenser
Janssen Pharmaceutica, N.V.	A61K 31/4985 (2006.01) A61P 25/28 (2006.01) C07D 487/04 (2006.01)	2681219 *	6,7-DIHYDRO-PYRAZOLO[1,5-A]PYRAZIN-4-YLAMINE DERIVATIVES USEFUL AS INHIBITORS OF BETA-SECRETASE (BACE)
Nutrinova Nutrition Specialties & Food Ingredients GmbH	A23G 1/32 (2006.01) A23K 1/16 (2006.01) A23L 1/03 (2006.01) A23L 2/52 (2006.01) A23L 2/60 (2006.01) A61Q 1/00 (2006.01) A61Q 11/00 (2006.01) C07C 259/06 (2006.01)	2672835 *	SWEETNESS ENHANCERS, SWEETENER COMPOSITIONS, METHODS OF MAKING THE SAME AND CONSUMABLES CONTAINING THE SAME
Eli Lilly and Company	C07K 16/22 (2006.01)	2694547 *	ANTIBODIES THAT BIND TGF-ALPHA AND EPIREGULIN

Podnosilac evropske prijave patenta (71)	MKP (51)	Broj objave evropske prijave patenta (97)	Naziv pronalaska (54)
Vironova AB	C01B 25/14 (2006.01) C07B 45/00 (2006.01) C07C 325/02 (2006.01) C07C 327/44 (2006.01) C07D 207/24 (2006.01) C07D 209/30 (2006.01) C07D 211/72 (2006.01) C07D 211/84 (2006.01) C07D 213/06 (2006.01) C07D 213/63 (2006.01) C07D 239/93 (2006.01) C07D 241/06 (2006.01)	2650274	A thionation process and a thionating agent
Ajinomoto Co., Inc.	A61J 1/05 (2006.01) B65D 81/32 (2006.01)	2671562 *	MULTI-CHAMBERED CONTAINER
Suven Life Sciences Limited	A61K 31/5355 (2006.01) A61P 25/00 (2006.01) C07D 401/12 (2006.01) C07D 405/12 (2006.01) C07D 413/12 (2006.01)	2694492 *	NOVEL COMPOUNDS AS HISTAMINE H3 RECEPTOR LIGANDS
Altria Client Services Inc.	A01H 5/12 (2006.01) A24B 15/10 (2006.01) C12N 15/82 (2006.01)	2681321 *	TOBACCO INBRED PLANTS ALBEX1F AND ALBEX1MS
United Arab Emirates University	H01L 35/24 (2006.01) H01L 51/00 (2006.01)	2676303 *	SEMICONDUCTING POLYMER
Acino AG	A61K 9/00 (2006.01) A61K 9/70 (2006.01) A61K 31/27 (2006.01)	2651410 *	TRANSDERMAL THERAPEUTIC SYSTEM FOR ADMINISTERING AN ACTIVE SUBSTANCE
Savant Systems LLC	G06F 3/048 (2013.01) H04L 12/28 (2006.01)	2695332 *	METHOD AND APPARATUS FOR CREATING AND MODIFYING GRAPHICAL SCHEDULES
Neogen N.V.	A61K 9/00 (2006.01) A61K 31/167 (2006.01)	2672955 *	STORAGE-STABLE FORMULATION OF PARACETAMOL IN AQUEOUS SOLUTION
Janssen Pharmaceutica, N.V.	A61K 31/5517 (2006.01) A61P 31/10 (2006.01) C07D 487/04 (2006.01)	2668187 *	NOVEL ANTIFUNGAL 5,6-DIHYDRO-4H-PYRROLO[1,2-a][1,4]-BENZODIAZEPINES AND 6H-PYRROLO[1,2-a][1,4]BENZODIAZEPINES SUBSTITUTED WITH BICYCLIC BENZENE DERIVATIVES
Poxel	C07B 57/00 (2006.01) C07D 251/10 (2006.01)	2646422 *	SEPARATION OF TRIAZINE DERIVATIVES ENANTIOMERS USING TARTARIC ACID
Vironova AB	A61K 9/00 (2006.01) A61K 31/4985 (2006.01) A61P 31/22 (2006.01)	2675457 *	PHARMACEUTICAL FORMULATION FOR TOPICAL ADMINISTRATION COMPRISING B220
Michigan Life Therapeutics LLC	A61K 31/19 (2006.01) A61P 1/18 (2006.01)	2658536 *	GEMCABENE AND DERIVATIVES FOR TREATING PANCREATITIS
Takeda Pharmaceutical Company Limited	A61K 9/00 (2006.01) A61K 9/20 (2006.01) A61K 9/50 (2006.01) A61K 31/4439 (2006.01)	2658530 *	ORALLY DISINTEGRATING TABLET
Republican Public Enterprise "Kazakh National Agrarian University" of Ministry of Education and Science of the Republic of Kazakhstan	A01F 12/18 (2006.01)	2684444 *	CROP THRESHING METHOD
SANOFI	A61J 1/03 (2006.01) B65D 75/32 (2006.01)	2685956 *	PACKAGING FOR UNIT PHARMACEUTICAL PRODUCTS
SANOFI	C12Q 1/68 (2006.01)	2678441 *	SINGLE NUCLEOTIDE POLYMORPHISMS IN THE PROMOTER OF VEGFA GENE AND THEIR USE AS PREDICTIVE MARKERS FOR ANTI-VEGF TREATMENTS
Bayer Intellectual Property GmbH	A61K 31/519 (2006.01) A61P 35/00 (2006.01) C07D 487/04 (2006.01)	2694508 *	SUBSTITUTED 2,3-DIHYDROIMIDAZO[1,2-C]QUINAZOLINE SALTS

Podnosilac evropske prijave patenta (71)	MKP (51)	Broj objave evropske prijave patenta (97)	Naziv pronalaska (54)
Zambon S.p.A.	A61K 35/20 (2006.01) A61P 15/02 (2006.01)	2648739 *	MULTIPURPOSE GEL FOR VAGINAL DRYNESS WITH DIRECT AND DELAYED EFFECT
Les Laboratoires Servier	C07C 269/04 (2006.01) C07D 223/16 (2006.01) C12P 41/00 (2006.01)	2687506	Method for enzymatic synthesis of (7S)-1-(3,4-dimethoxybicyclo[4.2.0]octa-1,3,5-triene-7-yl) N-methylmethanamine, and use for the synthesis of Ivabradine and the salts thereof
Asahi Kasei Chemicals Corporation	C08G 69/26 (2006.01) C08K 3/00 (2006.01) C08L 77/06 (2006.01)	2687555 *	POLYAMIDE AND POLYAMIDE COMPOSITION
Zafgen, Inc.	A61K 31/41 (2006.01) A61P 3/04 (2006.01) C07D 257/06 (2006.01)	2668169 *	TETRAZOLE COMPOUNDS AND METHODS OF MAKING AND USING SAME
Wobben Properties GmbH	H02K 3/32 (2006.01)	2695285 *	LAMINATED CORE ASSEMBLY
Messer Hungarogaz Kft.	C03B 5/235 (2006.01) F23M 5/02 (2006.01) F27B 3/20 (2006.01)	2688846 *	MELTING DEVICE
Messer Austria GmbH	C03B 5/235 (2006.01) F23M 5/02 (2006.01) F27B 3/20 (2006.01)	2688846 *	MELTING DEVICE
Natera, Inc.	G01N 33/48 (2006.01) G06F 19/22 (2011.01)	2673729 *	METHODS FOR NON-INVASIVE PRENATAL PLOIDY CALLING
Omya International AG	A24D 1/00 (2006.01) C09C 1/02 (2006.01) D21H 17/00 (2006.01) D21H 17/26 (2006.01) D21H 17/69 (2006.01)	2662418	Sustainable adsorbable polymers
Omya International AG	C01F 11/18 (2006.01) C08K 3/20 (2006.01) C09C 1/02 (2006.01) C09C 3/10 (2006.01) D21H 17/69 (2006.01) D21H 19/38 (2006.01) D21H 19/42 (2006.01) D21H 19/44 (2006.01) D21H 21/14 (2006.01)	2684999	High solids and low viscous aqueous slurries of calcium carbonate-comprising materials with improved rheological stability under increased temperature
Shah, Deepak Pranjivandas	A01N 41/04 (2006.01) A01N 43/50 (2006.01) A01N 43/56 (2006.01) A01N 43/60 (2006.01) A01N 43/72 (2006.01) A01N 47/06 (2006.01) A01N 47/10 (2006.01) A01N 47/18 (2006.01) A01N 47/30 (2006.01) A01N 47/34 (2006.01) A01N 47/40 (2006.01) A01N 47/44 (2006.01) A01N 59/02 (2006.01)	2667719 *	PESTICIDE COMPOSITION COMPRISING SULPHUR, AN INSECTICIDE AND AN AGROCHEMICAL EXCIPIENT.
Curt G. Joa, Inc.	A61F 13/15 (2006.01) A61F 13/49 (2006.01)	2656827	Disposable Products Containing Parallel Flared Elastics
Trevena, Inc.	A01N 43/16 (2006.01) A61K 31/35 (2006.01)	2688403 *	OPIOID RECEPTOR LIGANDS AND METHODS OF USING AND MAKING SAME
Orion Corporation	A61K 31/4164 (2006.01) A61P 35/00 (2006.01) C07D 401/04 (2006.01) C07D 403/04 (2006.01) C07D 403/12 (2006.01) C07D 413/12 (2006.01) C07D 413/14 (2006.01) C07D 471/04 (2006.01) C07D 487/04 (2006.01) C07D 513/04 (2006.01)	2699561 *	ANDROGEN RECEPTOR MODULATING CARBOXAMIDES

Podnosilac evropske prijave patenta (71)	MKP (51)	Broj objave evropske prijave patenta (97)	Naziv pronalaska (54)
Abbvie Inc.	A61K 31/4427 (2006.01) A61P 31/12 (2006.01) C07D 401/12 (2006.01) C07D 403/04 (2006.01) C07D 403/14 (2006.01)	2651925 *	ANTI-VIRAL COMPOUNDS
Qualcomm Incorporated	H04L 29/08 (2006.01) H04L 29/12 (2006.01)	2684337 *	SYSTEM AND METHOD FOR ACCESSING A DEVICE HAVING AN ASSIGNED NETWORK ADDRESS
Moog Unna GmbH	H01M 2/02 (2006.01) H01M 2/10 (2006.01)	2549563	System comprising a battery tray and a tray receiver for mounting the battery tray in a battery cabinet of a wind turbine
Gambro Lundia AB	G06F 19/00 (2011.01)	2597584	Apparatus, process and infrastructure of monitoring a plurality of patients affected by kidney failure
Iron Therapeutics Holdings AG	A61K 33/26 (2006.01) A61P 7/06 (2006.01) C07D 309/40 (2006.01)	2668175 *	PROCESS
Purdue Pharma L.P.	A61K 31/498 (2006.01) A61P 3/02 (2006.01) A61P 23/00 (2006.01) A61P 25/00 (2006.01) A61P 25/16 (2006.01) A61P 25/24 (2006.01) C07D 401/04 (2006.01) C07D 401/14 (2006.01)	2654751 *	PHOSPHORUS-SUBSTITUTED QUINOXALINE-TYPE PIPERIDINE COMPOUNDS AND USES THEREOF
GL Garrad Hassan Deutschland GmbH	F03D 11/00 (2006.01)	2665930 *	METHOD FOR DETERMINING THE INCLINATION OF A TOWER
Chiesi Farmaceutici S.p.A.	A61K 9/00 (2006.01) A61K 31/439 (2006.01)	2675452 *	LIQUID PROPELLANT-FREE FORMULATION COMPRISING AN ANTIMUSCARINIC DRUG
Ross, Owen Venmore	G21G 1/10 (2006.01)	2659491 *	PROTON ENGINE
Halozyme, Inc.	A61K 9/00 (2006.01) A61K 9/127 (2006.01) A61K 38/00 (2006.01) A61K 38/47 (2006.01) A61K 47/24 (2006.01)	2672958 *	COMPOSITION AND LIPID FORMULATION OF A HYALURONAN-DEGRADING ENZYME AND THE USE THEREOF FOR TREATMENT OF BENIGN PROSTATIC HYPERPLASIA
Ingegnerie Toscane S.r.l.	G01F 1/28 (2006.01)	2659234 *	DEVICE FOR MEASURING THE FLOW RATE OF A FLUID
BRE ELETTRONICA S.r.l.	G01F 1/28 (2006.01)	2659234 *	DEVICE FOR MEASURING THE FLOW RATE OF A FLUID
Genentech, Inc.	A61K 31/517 (2006.01) A61P 35/00 (2006.01) C07D 239/70 (2006.01)	2694072 *	COMBINATIONS OF AKT INHIBITOR COMPOUNDS AND ABIRATERONE, AND METHODS OF USE
Nannini, Michelle	A61K 31/517 (2006.01) A61P 35/00 (2006.01) C07D 239/70 (2006.01)	2694072 *	COMBINATIONS OF AKT INHIBITOR COMPOUNDS AND ABIRATERONE, AND METHODS OF USE
Sampath, Deepak	A61K 31/517 (2006.01) A61P 35/00 (2006.01) C07D 239/70 (2006.01)	2694072 *	COMBINATIONS OF AKT INHIBITOR COMPOUNDS AND ABIRATERONE, AND METHODS OF USE
Farmicom Pharmaceutical Company D.O.O.	A61K 31/405 (2006.01) A61K 31/47 (2006.01) A61K 31/22 (2006.01) A61K 31/416 (2006.01) A61K 31/4015 (2006.01) A61K 31/44 (2006.01) A61K 31/41 (2006.01) A61K 31/616 (2006.01) A61K 31/415 (2006.01) A61P 9/10 (2006.01) A61K 31/4155 (2006.01) A61K 31/366 (2006.01) A61K 31/422 (2006.01) A61K 31/122 (2006.01) A61K 31/505 (2006.01)	2680838 *	TREATMENT OF ARTERIAL AGEING BY COMBINATION OF RAAS INHIBITOR AND HMG-CoA REDUCTASE INHIBITOR
Dow AgroSciences LLC	A01N 43/68 (2006.01)	2672825 *	STABLE AGROCHEMICAL OIL DISPERSIONS

Podnosilac evropske prijave patenta (71)	MKP (51)	Broj objave evropske prijave patenta (97)	Naziv pronalaska (54)
THE TRUSTEES OF PRINCETON UNIVERSITY	A61K 31/5377 (2006.01)	2667874 *	INHIBITORS OF MTOR KINASA AS ANTI- VIRAL AGENTS
Kadmon Corporation, LLC	A61K 31/5377 (2006.01)	2667874 *	INHIBITORS OF MTOR KINASA AS ANTI- VIRAL AGENTS
The Government of The United States of America as represented by The Secretary of The Department of Health and Human Services	A61K 39/12 (2006.01) A61K 39/235 (2006.01) C12N 7/01 (2006.01)	2655604 *	ADENOVIRUS SEROTYPE 26 AND SEROTYPE 35 FILOVIRUS VACCINES
Crucell Holland B.V.	A61K 39/12 (2006.01) A61K 39/235 (2006.01) C12N 7/01 (2006.01)	2655604 *	ADENOVIRUS SEROTYPE 26 AND SEROTYPE 35 FILOVIRUS VACCINES
Fedex Corporate Services, Inc.	G06F 21/00 (2013.01)	2678794 *	SYSTEMS AND METHODS FOR RULE-DRIVEN MANAGEMENT OF SENSOR DATA ACROSS GEOGRAPHIC AREAS AND DERIVED ACTIONS
Boehringer Ingelheim International GmbH	A61K 31/454 (2006.01) A61K 31/4545 (2006.01) A61K 31/497 (2006.01) A61K 31/506 (2006.01) A61P 3/10 (2006.01) A61P 5/50 (2006.01) C07D 407/14 (2006.01) C07D 413/14 (2006.01) C07D 491/048 (2006.01)	2665719 *	FUSED DIHYDROFURANS AS GPR119 MODULATORS FOR THE TREATMENT OF DIABETES, OBESITY AND RELATED DISORDERS
Alectos Therapeutics Inc.	A61K 31/7056 (2006.01) C07D 513/04 (2006.01) C07H 9/06 (2006.01) C12Q 1/34 (2006.01)	2655388 *	SELECTIVE GLYCOSIDASE INHIBITORS AND USES THEREOF
Merck Sharp & Dohme Corp.	A61K 31/7056 (2006.01) C07D 513/04 (2006.01) C07H 9/06 (2006.01) C12Q 1/34 (2006.01)	2655388 *	SELECTIVE GLYCOSIDASE INHIBITORS AND USES THEREOF
Ferrate Treatment Technologies, LLC	B01J 49/00 (2006.01)	2651559 *	METHODS AND DEVICES FOR MEASURING THE CONCENTRATION OF AN ADDITIVE
Genmab A/S	A61K 39/395 (2006.01) A61K 47/48 (2006.01) A61P 35/00 (2006.01) C07K 16/10 (2006.01) C07K 16/28 (2006.01) C07K 16/32 (2006.01) C07K 16/46 (2006.01)	2699262 *	BISPECIFIC ANTIBODIES AGAINST HER2 AND CD3
Glaxo Group Limited	C07K 16/28 (2006.01)	2661449 *	LIGANDS THAT BIND TGF-BETA RECEPTOR II
IRM LLC	A61K 31/00 (2006.01) A61K 31/506 (2006.01) A61P 35/00 (2006.01)	2670401 *	METHODS OF USING ALK INHIBITORS
The Crosby Group LLC	B66C 1/34 (2006.01) F16B 21/12 (2006.01)	2657175	Retaining Pin Assembly for a Lifting System.
Lese, Gail Bronwyn	G06K 19/00 (2006.01) G06Q 50/24 (2012.01)	2649585 *	ELECTRONIC HEALTH RECORD WEB-BASED PLATFORM
Laboratorios del. Dr. Esteve, S.A.	A61K 9/20 (2006.01) A61K 9/50 (2006.01)	2654732 *	COMPRESSED SOLID DOSAGE FORMS
IFP Energies Nouvelles	F02D 19/06 (2006.01) F02D 19/08 (2006.01) F02D 41/00 (2006.01) F02D 41/14 (2006.01) F02D 41/30 (2006.01)	2573368	METHOD FOR CONTROLLING IN PARTICULAR THE IGNITION OF THE COMBUSTION OF A GASOLINE DIRECT INJECTION INTERNAL COMBUSTION ENGINE

Podnosilac evropske prijave patenta (71)	MKP (51)	Broj objave evropske prijave patenta (97)	Naziv pronalaska (54)
Gilead Sciences, Inc.	A61K 9/00 (2006.01) A61K 31/40 (2006.01) A61K 31/403 (2006.01) A61K 31/522 (2006.01) A61K 45/06 (2006.01) A61P 9/00 (2006.01) A61P 9/04 (2006.01) A61P 9/10 (2006.01)	2694074 *	USE OF A2B ADENOSINE RECEPTOR ANTAGONISTS FOR TREATING HEART FAILURE AND ARRHYTHMIA IN POST-MYOCARDIAL INFARCTION PATIENTS
Natera, Inc.	C07H 21/04 (2006.01) G06F 19/00 (2011.01)	2656263 *	METHODS FOR NON-INVASIVE PRENATAL PATERNITY TESTING
Immunogen, Inc.	A61K 47/48 (2006.01) A61P 35/00 (2006.01)	2691155 *	PREPARATION OF MAYTANSINOID ANTIBODY CONJUGATES BY A ONE-STEP PROCESS
Rainbowtec Environmental Solutions 2010 Ltd.	C12M 1/107 (2006.01)	2691506 *	AN APPARATUS FOR WASTE SEPARATION
Langlois, David Allen	A61B 17/02 (2006.01) A61B 19/00 (2006.01)	2612606	System and method for inhibiting injury to a patient during laparoscopic surgery
Schembri, Lawrence	A61B 17/02 (2006.01) A61B 19/00 (2006.01)	2612606	System and method for inhibiting injury to a patient during laparoscopic surgery
Gilead Sciences, Inc.	A61K 31/7068 (2006.01) A61K 31/7072 (2006.01) A61K 38/21 (2006.01) A61P 31/14 (2006.01) C07H 19/06 (2006.01) C07H 19/067 (2006.01) C07H 19/073 (2006.01) C07H 19/10 (2006.01)	2697241 *	1'-SUBSTITUTED PYRIMIDINE N-NUCLEOSIDE ANALOGS FOR ANTIVIRAL TREATMENT
D.Motica S.R.L.	F24J 2/04 (2006.01) F24J 2/46 (2006.01) F24J 2/52 (2006.01) H01L 31/042 (2006.01) H01L 31/048 (2006.01)	2592364	An integrated structural system for mounting of photovoltaic panels
Astex Therapeutics Limited	A61K 31/502 (2006.01) A61P 35/00 (2006.01) C07D 403/04 (2006.01)	2646432 *	SUBSTITUTED BENZOPYRAZIN DERIVATIVES AS FGFR KINASE INHIBITORS FOR THE TREATMENT OF CANCER DISEASES
University of New Hampshire	C12P 7/44 (2006.01)	2694664 *	VINYL ACID MONOMER RECOVERY
Itaconix, LLC	C12P 7/44 (2006.01)	2694664 *	VINYL ACID MONOMER RECOVERY
Rhodes Technologies	C07D 211/34 (2006.01)	2651892 *	LOW-TEMPERATURE SYNTHESIS OF METHYLPHENIDATE HYDROCHLORIDE
PregLem S.A.	A61K 31/57 (2006.01) A61P 15/00 (2006.01) A61P 29/00 (2006.01)	2658545 *	TREATMENT OF PAIN ASSOCIATED WITH DISLOCATION OF BASAL ENDOMETRIUM
Fincantieri Cantieri Navali Italiani S.p.A.	B63B 1/10 (2006.01) B63B 35/44 (2006.01)	2691289 *	MODULAR SEMI-SUBMERSIBLE STRUCTURE AND METHOD FOR MAKING SUCH STRUCTURE
Veterinärmedizinische Universität Wien	A61K 9/00 (2006.01) A61K 31/495 (2006.01) A61K 47/10 (2006.01) A61K 47/38 (2006.01)	2594258	Oral gel comprising praziquantel
Purdue Pharma LP	A61K 31/44 (2006.01) A61K 31/4439 (2006.01) A61P 25/00 (2006.01) C07D 213/75 (2006.01) C07D 401/02 (2006.01) C07D 401/12 (2006.01) C07D 401/14 (2006.01)	2655330 *	SUBSTITUTED PYRIDINES AS SODIUM CHANNEL BLOCKERS
Aventis Pharma S.A.	A61K 31/337 (2006.01) A61K 33/24 (2006.01) A61P 35/00 (2006.01)	2678011 *	ANTITUMORAL COMBINATION COMPRISING CABAZITAXEL AND CISPLATIN
Qualcomm Incorporated	G06F 17/30 (2006.01) G06K 9/62 (2006.01)	2697725 *	ROBUST FEATURE MATCHING FOR VISUAL SEARCH

Podnosilac evropske prijave patenta (71)	MKP (51)	Broj objave evropske prijave patenta (97)	Naziv pronalaska (54)
Fater S.p.A.	A61L 2/07 (2006.01) B01J 3/04 (2006.01)	2596808	Apparatus and process for recycling absorbent sanitary products
Basilea Pharmaceutica AG	A61K 31/00 (2006.01) A61K 38/00 (2006.01) G01N 33/50 (2006.01)	2678679 *	USE OF ACETYLATED TUBULIN AS A BIOMARKER OF DRUG RESPONSE TO FURAZANOBENZIMIDAZOLES
Polichem SA	A61K 31/422 (2006.01) A61P 31/04 (2006.01)	2678015 *	USE OF NIFURATEL TO TREAT INFECTIONS CAUSED BY CLOSTRIDIUM SPECIES
Janssen Pharmaceutica NV	A61K 31/5025 (2006.01) A61P 25/00 (2006.01) C07D 487/04 (2006.01)	2655376 *	5,6-DIHYDRO-IMIDAZO[1,2-a]PYRAZIN-8-YLAMINE DERIVATIVES USEFUL AS INHIBITORS OF BETA-SECRETASE (BACE)
The University of British Columbia	A61K 31/4162 (2006.01) A61K 31/7088 (2006.01) A61P 35/00 (2006.01)	2685990 *	COMBINATION OF ANTI-CLUSTERIN OLIGONUCLEOTIDE WITH HSP90 INHIBITOR FOR THE TREATMENT OF PROSTATE CANCER
Hisamitsu Pharmaceutical Co., Inc.	A61K 9/02 (2006.01) A61K 9/06 (2006.01) A61K 9/14 (2006.01) A61K 9/70 (2006.01) A61K 39/00 (2006.01) A61K 39/39 (2006.01)	2679242 *	ADJUVANT FOR TRANSDERMAL OR TRANSMUCOSAL ADMINISTRATION AND PHARMACEUTICAL PREPARATION CONTAINING SAME
Biovaxim Limited	A61K 39/09 (2006.01) A61K 39/21 (2006.01) A61K 39/295 (2006.01) A61P 31/18 (2006.01)	2694101 *	PHARMACEUTICAL COMPOSITIONS FOR PREVENTING AND/OR TREATING AN HIV DISEASE IN HUMANS
Université Paris Descartes	A61K 39/09 (2006.01) A61K 39/21 (2006.01) A61K 39/295 (2006.01) A61P 31/18 (2006.01)	2694101 *	PHARMACEUTICAL COMPOSITIONS FOR PREVENTING AND/OR TREATING AN HIV DISEASE IN HUMANS
Institut De Recherche Pour Le Développement (IRD)	A61K 39/09 (2006.01) A61K 39/21 (2006.01) A61K 39/295 (2006.01) A61P 31/18 (2006.01)	2694101 *	PHARMACEUTICAL COMPOSITIONS FOR PREVENTING AND/OR TREATING AN HIV DISEASE IN HUMANS
MIB ITALIANA S.p.A.	F16K 1/18 (2006.01) F16L 23/036 (2006.01) F16L 55/10 (2006.01)	2649358 *	CONTROL VALVE FOR SEPARABLE CONNECTION UNIT FOR FLEXIBLE PIPES.
Barrday Corporation	F41H 1/02 (2006.01)	2671041 *	BALLISTIC MATERIAL SYSTEM FOR TACTICAL BODY ARMOR
Qualcomm Incorporated	A61B 5/11 (2006.01) G06K 9/00 (2006.01)	2691918 *	SYSTEMS, METHODS, AND APPARATUSES FOR CLASSIFYING USER ACTIVITY USING COMBINING OF LIKELIHOOD FUNCTION VALUES IN A MOBILE DEVICE
The Spectranetics Corporation	A61M 25/06 (2006.01) A61M 25/09 (2006.01)	2696929 *	NEEDLE AND GUIDEWIRE HOLDER
Shah, Deepak Pranjivandas	A01N 43/08 (2006.01) A01N 43/56 (2006.01) A01N 43/58 (2006.01) A01N 47/24 (2006.01) A01N 47/32 (2006.01) A01N 53/06 (2006.01) A01N 59/02 (2006.01)	2667721 *	PESTICIDE COMPOSITION COMPRISING SULPHUR, AN ACARICIDE AND AN AGROCHEMICAL EXCIPIENT
Baxter International Inc	A61K 35/37 (2006.01) A61L 2/00 (2006.01)	2651421 *	VIRAL INACTIVATION USING IMPROVED SOLVENT-DETERGENT METHOD
Baxter Healthcare SA	A61K 35/37 (2006.01) A61L 2/00 (2006.01)	2651421 *	VIRAL INACTIVATION USING IMPROVED SOLVENT-DETERGENT METHOD
Fedex Corporate Services, Inc.	G06Q 10/08 (2012.01) H04L 9/32 (2006.01) H04L 29/06 (2006.01) H04W 12/06 (2009.01)	2689383 *	SYSTEMS AND METHODS FOR ELECTRONICALLY SIGNING FOR A DELIVERED PACKAGE
Nestec S.A.	A61M 1/02 (2006.01) A61M 1/34 (2006.01) B01L 3/14 (2006.01) G01N 33/49 (2006.01)	2675494 *	APPARATUS AND METHOD FOR ISOLATING LEUKOCYTES AND TUMOR CELLS BY FILTRATION

Podnosilac evropske prijave patenta (71)	MKP (51)	Broj objave evropske prijave patenta (97)	Naziv pronalaska (54)
Exelixis, Inc.	A61K 31/4985 (2006.01) A61P 35/00 (2006.01) C07D 217/22 (2006.01) C07D 237/34 (2006.01) C07D 403/10 (2006.01) C07D 405/04 (2006.01) C07D 409/04 (2006.01) C07D 417/10 (2006.01) C07D 471/04 (2006.01)	2616443 *	PHTALAZINE DERIVATIVES AS JAK1 INHIBITORS
Stem Centrx, Inc.	A61K 39/395 (2006.01) A61K 49/00 (2006.01) C07K 16/22 (2006.01) C07K 16/30 (2006.01) C07K 16/40 (2006.01) G01N 33/574 (2006.01)	2648749 *	NOVEL MODULATORS AND METHODS OF USE
Vertex Pharmaceuticals Incorporated	A61K 31/506 (2006.01) C07D 407/04 (2006.01)	2663558 *	SOLID FORMS OF GYRASE INHIBITOR (R)-1-ETHYL-3-[5-[2-{1-HYDROXY-1-METHYL-ETHYL}PYRIMIDIN-5-YL]-7-(TETRAHYDROFURAN-2-YL)-1H-BENZIMIDAZOL-2-YL]UREA
Alexion Pharmaceuticals, Inc.	A61K 39/395 (2006.01) A61P 37/06 (2006.01)	2670487 *	USE OF AN ANTI-CD200 ANTIBODY FOR PROLONGING THE SURVIVAL OF ALLOGRAFTS
Chiesi Farmaceutici S.p.A.	A61K 38/55 (2006.01) A61P 25/28 (2006.01) C07K 14/81 (2006.01) C12N 9/64 (2006.01)	2670774 *	CASPASE-2 INHIBITORS
ImmunoGen, Inc.	A61K 47/48 (2006.01) A61P 35/00 (2006.01) C07D 487/04 (2006.01) C07D 519/00 (2006.01)	2675480 *	METHODS OF PREPARATION OF CONJUGATES
UNIVERSITE DE GENEVE	A61K 47/48 (2006.01) C08G 83/00 (2006.01) C08G 85/00 (2006.01)	2697288 *	DECORATED MACROMOLECULAR SCAFFOLDS
SANOFI	A61K 31/727 (2006.01) C08B 37/00 (2006.01)	2697265 *	POLYSACCHARIDES COMPRISING TWO ANTITHROMBIN III-BINDING SITES, PREPARATION THEREOF AND USE THEREOF AS ANTITHROMBOTIC MEDICAMENTS
Dow Global Technologies LLC	C07C 201/08 (2006.01) C07C 201/16 (2006.01) C07C 205/02 (2006.01)	2699537 *	APPARATUS AND PROCESS FOR NITRATION SELECTIVITY FLEXIBILITY ENABLED BY AZEOTROPIC DISTILLATION
ANGUS Chemical Company	C07C 201/08 (2006.01) C07C 201/16 (2006.01) C07C 205/02 (2006.01)	2699537 *	APPARATUS AND PROCESS FOR NITRATION SELECTIVITY FLEXIBILITY ENABLED BY AZEOTROPIC DISTILLATION
Curis, Inc.	A61K 31/535 (2006.01)	2694075 *	PHOSPHOINOSITIDE 3-KINASE INHIBITOR WITH A ZINC BINDING MOIETY
Courb	B62D 21/00 (2006.01) B62D 21/02 (2006.01) B62D 21/10 (2006.01) B62D 31/00 (2006.01) B62D 63/02 (2006.01)	2681103 *	FLAT MODULAR CHASSIS, AND VEHICLE PROVIDED WITH SUCH A CHASSIS
MKS Innovatech S.r.l.	A61G 7/057 (2006.01)	2465482	INFLATABLE MATTRESS WITH DEFLATABLE DEVICE
Janssen Pharmaceuticals, Inc.	A61K 8/25 (2006.01) A61K 8/58 (2006.01) A61K 8/891 (2006.01) A61K 8/895 (2006.01) A61Q 15/00 (2006.01)	2484337	Treatment of sweating
Array Biopharma, Inc.	A61K 31/4709 (2006.01) A61P 29/00 (2006.01) C07D 401/06 (2006.01) C07D 471/04 (2006.01) C07D 519/00 (2006.01)	2678329 *	TRIAZOLOPYRIDINE COMPOUNDS AS PIM KINASE INHIBITORS

Podnosilac evropske prijave patenta (71)	MKP (51)	Broj objave evropske prijave patenta (97)	Naziv pronalaska (54)
IRM LLC	A61K 31/46 (2006.01) A61P 3/00 (2006.01) C07D 451/06 (2006.01) C07D 471/04 (2006.01) C07D 487/04 (2006.01)	2655370 *	COMPOSITIONS AND METHODS FOR MODULATING FXR
MCCI Corporation		2671184 *	SECURITY ARRANGEMENTS FOR EXTENDED USB PROTOCOL STACK OF A USB HOST SYSTEM
Lundbeck Pharmaceuticals Italy S.p.A.	A61K 31/4709 (2006.01) C07D 401/12 (2006.01)	2694493 *	METHOD FOR THE PREPARATION OF PROCESS INTERMEDIATES FOR THE SYNTHESIS OF ARGATROBAN MONOHYDRATE
Riess, Nathanael	A61B 10/00 (2006.01)	2662028	Swab and container for taking biological samples and storing them in a sterile environment
Chiesi Farmaceutici S.p.A.	A61K 31/58 (2006.01) A61P 5/44 (2006.01) A61P 11/06 (2006.01) A61P 37/08 (2006.01) C07J 71/00 (2006.01)	2686332 *	ISOXAZOLIDINE DERIVATIVES
Zinpro Corporation	A23K 1/16 (2006.01) A23K 1/175 (2006.01) A23K 1/18 (2006.01) C07C 19/07 (2006.01) C07C 211/65 (2006.01)	2680710 *	ENHANCED BIOAVAILABLE IODINE MOLECULES
United Arab Emirates University	B62D 1/22 (2006.01)	2675692 *	LOWER EXTREMITY VEHICLE NAVIGATION CONTROL SYSTEM
Novartis AG	A45C 11/00 (2006.01)	2651259 *	PRESSURE-VENTING CONTAINER FOR DISINFECTION AND STORAGE OF CONTACT LENSES
Amgen, Inc	A61K 39/395 (2006.01) A61K 47/12 (2006.01) C07K 16/22 (2006.01)	2569010 *	HIGH CONCENTRATION ANTIBODY FORMULATIONS
Thompson Cooper Laboratories, LLC	A01N 25/34 (2006.01)	2685820 *	COMPOSITIONS AND METHODS FOR TREATMENT OF INFECTIONS
Gentical	A61K 39/12 (2006.01) C07K 14/025 (2006.01) C07K 14/235 (2006.01)	2667890 *	CYAA-CARRIED POLYPEPTIDE(S) AND USE TO INDUCE BOTH THERAPEUTIC AND PROPHYLACTIC IMMUNE RESPONSES
Makro Labelling S.r.l.	B65C 9/06 (2006.01) B67B 3/26 (2006.01) B67C 3/00 (2006.01)	2658783 *	A DEVICE FOR DETECTING MOVING CONTAINERS
Regeneron Pharmaceuticals, Inc.	G01N 33/567 (2006.01)	2631654	Neuropeptide release assay for sodium channels
Peptonic Medical AB	A61K 38/11 (2006.01) A61P 15/12 (2006.01)	2696882 *	PHARMACEUTICAL COMPOSITION
Omya International AG	C09C 1/02 (2006.01) C09C 1/36 (2006.01) C09C 1/40 (2006.01) C09C 1/42 (2006.01) C09C 3/10 (2006.01) D21H 17/00 (2006.01) G01N 21/25 (2006.01)	2661470 *	PROCESS FOR WATER BASED MINERAL MATERIAL SLURRY SURFACE WHITENING
SANOFI	A61K 9/00 (2006.01) A61K 31/4418 (2006.01) A61K 47/12 (2006.01) A61P 7/02 (2006.01)	2691075 *	OTAMIXABAN FORMULATIONS WITH IMPROVED STABILITY
Constellation Pharmaceuticals, Inc.	A61K 31/424 (2006.01) A61K 31/55 (2006.01) A61P 35/00 (2006.01) C07D 498/04 (2006.01) C07D 498/14 (2006.01)	2646446 *	BROMODOMAIN INHIBITORS AND USES THEREOF
Bayerische Motorenwerke AG	B29C 44/12 (2006.01)	2335900	Interior panel substrate for vehicle, foaming tool and method for producing a moulded interior panel
FRIMO Group GmbH	B29C 44/12 (2006.01)	2335900	Interior panel substrate for vehicle, foaming tool and method for producing a moulded interior panel

Podnosilac evropske prijave patenta (71)	MKP (51)	Broj objave evropske prijave patenta (97)	Naziv pronalaska (54)
Afraxis Holdings, Inc.	A61K 31/519 (2006.01) A61P 25/00 (2006.01) C07D 413/14 (2006.01) C07D 471/04 (2006.01)	2694504 *	8-ETHYL-6-(ARYL)PYRIDO [2,3-D]PYRIMIDIN-7(8H)-ONES FOR THE TREATMENT OF NERVOUS SYSTEM DISORDERS AND CANCER
Japan Oil, Gas and Metals National Corporation	B01D 21/00 (2006.01) B01D 21/02 (2006.01) B01D 21/24 (2006.01) B01D 21/30 (2006.01) B01J 38/00 (2006.01) C10G 2/00 (2006.01)	2664380 *	CATALYST RECOVERY SYSTEM, HYDROCARBON SYNTHESIS REACTION APPARATUS, HYDROCARBON SYNTHESIS REACTION SYSTEM, AND CATALYST RECOVERY METHOD
INPEX Corporation	B01D 21/00 (2006.01) B01D 21/02 (2006.01) B01D 21/24 (2006.01) B01D 21/30 (2006.01) B01J 38/00 (2006.01) C10G 2/00 (2006.01)	2664380 *	CATALYST RECOVERY SYSTEM, HYDROCARBON SYNTHESIS REACTION APPARATUS, HYDROCARBON SYNTHESIS REACTION SYSTEM, AND CATALYST RECOVERY METHOD
JX Nippon Oil & Energy Corporation	B01D 21/00 (2006.01) B01D 21/02 (2006.01) B01D 21/24 (2006.01) B01D 21/30 (2006.01) B01J 38/00 (2006.01) C10G 2/00 (2006.01)	2664380 *	CATALYST RECOVERY SYSTEM, HYDROCARBON SYNTHESIS REACTION APPARATUS, HYDROCARBON SYNTHESIS REACTION SYSTEM, AND CATALYST RECOVERY METHOD
Japan Petroleum Exploration Co., Ltd.	B01D 21/00 (2006.01) B01D 21/02 (2006.01) B01D 21/24 (2006.01) B01D 21/30 (2006.01) B01J 38/00 (2006.01) C10G 2/00 (2006.01)	2664380 *	CATALYST RECOVERY SYSTEM, HYDROCARBON SYNTHESIS REACTION APPARATUS, HYDROCARBON SYNTHESIS REACTION SYSTEM, AND CATALYST RECOVERY METHOD
Cosmo Oil Co., Ltd.	B01D 21/00 (2006.01) B01D 21/02 (2006.01) B01D 21/24 (2006.01) B01D 21/30 (2006.01) B01J 38/00 (2006.01) C10G 2/00 (2006.01)	2664380 *	CATALYST RECOVERY SYSTEM, HYDROCARBON SYNTHESIS REACTION APPARATUS, HYDROCARBON SYNTHESIS REACTION SYSTEM, AND CATALYST RECOVERY METHOD
Nippon Steel & Sumikin Engineering Co., Ltd.	B01D 21/00 (2006.01) B01D 21/02 (2006.01) B01D 21/24 (2006.01) B01D 21/30 (2006.01) B01J 38/00 (2006.01) C10G 2/00 (2006.01)	2664380 *	CATALYST RECOVERY SYSTEM, HYDROCARBON SYNTHESIS REACTION APPARATUS, HYDROCARBON SYNTHESIS REACTION SYSTEM, AND CATALYST RECOVERY METHOD
Maria Clementine Martin Klosterfrau Vertriebsgesellschaft mbH	A61K 36/23 (2006.01) A61K 36/235 (2006.01) A61K 36/534 (2006.01) A61K 36/57 (2006.01) A61P 1/02 (2006.01)	2688577 *	COMPOSITION FOR USE FOR DIGESTIVE PROBLEMS
Sanofi-Aventis Deutschland GmbH	A61M 5/28 (2006.01) A61M 5/32 (2006.01)	2661297 *	ADAPTOR MEANS FOR USE IN COMBINATION WITH A PRE-FILLED SYRINGE AND A SAFETY DEVICE, SAFETY DEVICE AND INJECTION DEVICE
Universita' Degli Studi "G. d'Annunzio" Chieti-Pescara	C12Q 1/68 (2006.01)	2597160	Screening tool for anti-inflammatory drug discovery comprising the FPR2/ALX gene promoter
Leosphere	G01P 5/26 (2006.01)	2661636 *	METHOD AND DEVICE FOR DETERMINING THE MOVEMENTS OF A FLUID FROM REMOTE MEASUREMENTS OF RADIAL VELOCITIES
Aria Technologies	G01P 5/26 (2006.01)	2661636 *	METHOD AND DEVICE FOR DETERMINING THE MOVEMENTS OF A FLUID FROM REMOTE MEASUREMENTS OF RADIAL VELOCITIES
Endocyte, Inc.	A01N 43/64 (2006.01) A61K 9/14 (2006.01) A61K 9/48 (2006.01) A61K 31/53 (2006.01)	2696684 *	SOLID PHARMACEUTICAL COMPOSITION
Novartis AG	A61K 31/7056 (2006.01) A61K 38/13 (2006.01) A61K 38/21 (2006.01) A61P 31/14 (2006.01)	2646038 *	NEW TREATMENTS OF HEPATITIS C VIRUS INFECTION

Podnosilac evropske prijave patenta (71)	MKP (51)	Broj objave evropske prijave patenta (97)	Naziv pronalaska (54)
Immugen, Inc.	A61K 47/48 (2006.01) A61P 35/00 (2006.01)	2691117 *	PROCESS FOR MANUFACTURING CONJUGATES OF IMPROVED HOMOGENEITY
MEGTEC TurboSonic Inc.	A61L 9/16 (2006.01) B01D 49/00 (2006.01) B03C 3/16 (2006.01) B03C 3/45 (2006.01) B03C 3/47 (2006.01) C08J 5/04 (2006.01) C08K 7/06 (2006.01)	2691181 *	EROSION-RESISTANT CONDUCTIVE COMPOSITE MATERIAL COLLECTING ELECTRODE FOR WESP
Contact S.r.L.	B60L 5/28 (2006.01) B60L 5/32 (2006.01)	2646272 *	COMMAND SYSTEM FOR THE ACTIVE AND DIAGNOSTIC CONTROL OF A RAILWAY PANTOGRAPH
Oncolytics Biotech Inc.	A61K 9/08 (2006.01) A61K 31/70 (2006.01) A61K 39/15 (2006.01) A61K 48/00 (2006.01) A61P 31/00 (2006.01) A61P 31/12 (2006.01)	2646052 *	LYOPHILIZED VIRAL FORMULATIONS
Sanofi-Aventis Deutschland GmbH	A61M 5/20 (2006.01) A61M 5/32 (2006.01)	2675505 *	AUTO-INJECTOR
University Of Technology, Sydney	A61N 2/12 (2006.01)	2686065 *	DEVICE INCLUDING MOVING MAGNET CONFIGURATIONS
Novartis AG	A61K 31/519 (2006.01) A61P 35/00 (2006.01) C07D 487/04 (2006.01)	2670753 *	NOVEL HETEROCYCLIC DERIVATIVES
SAPPI Netherlands Services B.V.	D01D 1/02 (2006.01) D01D 5/04 (2006.01) D01D 5/40 (2006.01) D01F 2/00 (2006.01) D01F 2/24 (2006.01) D21H 13/00 (2006.01) D21H 15/00 (2006.01)	2683858 *	METHOD FOR DRY SPINNING NEUTRAL AND ANIONICALLY MODIFIED CELLULOSE AND FIBRES MADE USING THE METHOD
Novartis AG	A61K 31/7034 (2006.01) A61P 3/00 (2006.01) C07D 407/10 (2006.01) C07D 413/10 (2006.01) C07D 417/10 (2006.01) C07H 13/04 (2006.01) C07H 15/04 (2006.01) C07H 15/12 (2006.01) C07H 15/14 (2006.01) C07H 15/203 (2006.01) C07H 19/044 (2006.01) C07H 19/24 (2006.01)	2697240 *	GLYCOSIDE DERIVATIVES AND USES THEREOF
University Of Leicester	A61K 39/395 (2006.01) C12N 15/11 (2006.01)	2694108 *	METHODS FOR TREATING CONDITIONS ASSOCIATED WITH MASP-2 DEPENDENT COMPLEMENT ACTIVATION
Omeros Corporation	A61K 39/395 (2006.01) C12N 15/11 (2006.01)	2694108 *	METHODS FOR TREATING CONDITIONS ASSOCIATED WITH MASP-2 DEPENDENT COMPLEMENT ACTIVATION
Curt G. Joa, Inc.	A61F 13/15 (2006.01) A61F 13/49 (2006.01)	2656825	Elastic Break Brake Apparatus and Method For Minimizing Broken Elastic Rethreading
Cianchi, Aldo	G21F 9/06 (2006.01) G21F 9/30 (2006.01)	2657943	A method for removing the 137 Cs from polluted EAF dusts
Degetto, Sandro	G21F 9/06 (2006.01) G21F 9/30 (2006.01)	2657943	A method for removing the 137 Cs from polluted EAF dusts
Feller GmbH	H01B 7/18 (2006.01) H01B 7/40 (2006.01) H01B 13/22 (2006.01) H02G 11/02 (2006.01)	2477195	Cable drum cable
Pluristem Ltd.	A61K 35/28 (2006.01) A61K 35/50 (2006.01) C12N 5/073 (2010.01) C12N 5/0775 (2010.01)	2689008 *	METHODS FOR TREATING RADIATION OR CHEMICAL INJURY

Podnosilac evropske prijave patenta (71)	MKP (51)	Broj objave evropske prijave patenta (97)	Naziv pronalaska (54)
BioAlliance Pharma	A61K 9/51 (2006.01) A61K 47/48 (2006.01) A61K 49/18 (2006.01)	2691116 *	NANOPARTICLES LOADED WITH CHEMOTHERAPEUTIC ANTITUMORAL DRUG
Rychiger AG	B65G 15/32 (2006.01) B65G 15/48 (2006.01) B65G 23/06 (2006.01) F16G 3/02 (2006.01)	2636617	Transport system with endless element composed of flexible belt sections
Rockfuel Innovations Limited	C01B 3/04 (2006.01) C01B 31/20 (2006.01) C04B 2/10 (2006.01) F27B 7/10 (2006.01) F27B 15/00 (2006.01)	2649009 *	CARBON DIOXIDE PRODUCTION
Abraxis BioScience, LLC	A61K 9/14 (2006.01) A61K 9/51 (2006.01) A61K 31/337 (2006.01)	2416650 *	NANOPARTICLE FORMULATIONS AND USES THEROF
LECTIO Pharmaentwicklungs- und Verwertungs GmbH	A61K 9/00 (2006.01) A61K 9/08 (2006.01) A61K 31/136 (2006.01)	2654719 *	AQUEOUS SOLUTION OF AMBROXOL
Kronenberg Profil GmbH	B21D 5/08 (2006.01)	2604354	Roller forming station, profiling system and method for forming a metal sheet or sheet metal strip
Owens-Brockway Glass Container INC.	C03B 3/02 (2006.01) C03B 5/225 (2006.01) C03C 1/02 (2006.01)	2678279 *	PROCESS FOR MELTING AND REFINING SODA-LIME GLASS
Medincell	A61K 9/08 (2006.01) A61K 47/34 (2006.01)	2658525 *	BIODEGRADABLE DRUG DELIVERY COMPOSITIONS
Novartis AG	A61K 31/21 (2006.01) A61K 31/435 (2006.01) C07C 233/47 (2006.01) C07D 213/82 (2006.01) C07D 239/36 (2006.01) C07D 261/18 (2006.01) C07D 271/06 (2006.01)	2594557	Substituted aminopropionic derivatives as neprilysin inhibitors
GB Developpement	F21S 4/00 (2006.01) F21V 13/04 (2006.01) F21Y 101/02 (2006.01) F21Y 105/00 (2006.01) G02B 6/00 (2006.01) G02F 1/13357 (2006.01)	2691800 *	LIGHTING MODULE HAVING IMPROVED LIGHTING UNIFORMITY
Glaxosmithkline Intellectual Property (No. 2) Limited	G01N 30/36 (2006.01)	2684039 *	PEPTIDE DEFORMYLASE INHIBITORS
Tris Pharma, Inc.	A61K 9/00 (2006.01) A61K 9/50 (2006.01) A61K 31/4458 (2006.01)	2675438 *	EXTENDED RELEASE POWDER AND AQUEOUS SUSPENSION COMPRISING METHYLPHENIDATE
Theravance, Inc.	C07D 231/20 (2006.01) C07D 249/12 (2006.01) C07D 249/04 (2006.01) C07D 237/24 (2006.01) C07D 261/18 (2006.01) C07D 231/40 (2006.01) C07D 257/04 (2006.01) C07D 231/14 (2006.01) C07D 249/10 (2006.01) C07D 239/54 (2006.01) C07D 263/38 (2006.01) C07D 231/22 (2006.01) C07D 249/18 (2006.01) C07D 239/36 (2006.01) C07D 263/34 (2006.01)	2651900 *	NEPRILYSIN INHIBITORS
The Governors Of The University Of Alberta	A01N 43/38 (2006.01) A01N 43/90 (2006.01) A01N 45/00 (2006.01) A01P 21/00 (2006.01) C05F 11/10 (2006.01)	2688404 *	AUXIN PLANT GROWTH REGULATORS

Podnosilac evropske prijave patenta (71)	MKP (51)	Broj objave evropske prijave patenta (97)	Naziv pronalaska (54)
Amgen Inc.	C07D 401/14 (2006.01) C07D 403/04 (2006.01) C07D 403/14 (2006.01) C07D 405/14 (2006.01) C07D 413/14 (2006.01) C07D 417/14 (2006.01) C07D 471/04 (2006.01) C07D 487/04 (2006.01) C07D 498/04 (2006.01) C07D 491/107 (2006.01) A61K 31/497 (2006.01) A61K 31/437 (2006.01) A61K 31/506 (2006.01) A61K 31/444 (2006.01) A61K 31/4709 (2006.01)	2649065 *	BICYCLIC COMPOUNDS AS PIM INHIBITORS
Qualcomm Incorporated	G06K 9/00 (2006.01)	2666121 *	LEARNING SITUATIONS VIA PATTERN MATCHING
Merz Pharma GmbH & Co. KGaA	A61L 27/20 (2006.01) A61L 31/04 (2006.01)	2678049 *	IN SITU FORMATION OF A FILLER
Hayward Industries, Inc.	H02J 5/00 (2006.01)	2649697 *	POWER SUPPLIES FOR POOL AND SPA EQUIPMENT
Delphi Technologies Holding S.à.r.l.	F02D 41/00 (2006.01)	2581588	Method of fuel quality determination
Bayer Intellectual Property GmbH	A61K 31/195 (2006.01) A61P 9/00 (2006.01) C07C 233/55 (2006.01)	2697191 *	BRANCHED 3-PHENYLPROPIONIC ACID DERIVATIVES AND THE USE THEREOF
PerkinElmer Health Sciences, Inc.	B05B 17/06 (2006.01) G01N 30/32 (2006.01) G01N 30/72 (2006.01) H01J 49/04 (2006.01)	2700085 *	SAMPLE INTRODUCTION METHOD AND SYSTEM FOR ATOMIC SPECTROMETRY
Lupin Limited	A61K 31/5377 (2006.01) A61P 3/14 (2006.01) A61P 5/20 (2006.01) C07D 265/30 (2006.01) C07D 265/32 (2006.01)	2683697 *	SUBSTITUTED MORPHOLINES AS MODULATORS FOR THE CALCIUM SENSING RECEPTOR
Asahi Kasei E-materials Corporation	B32B 27/32 (2006.01) H01M 2/16 (2006.01)	2672546	Polyolefin microporous membrane
Eli Lilly and Company	A61K 31/4745 (2006.01) A61P 35/00 (2006.01) C07D 471/04 (2006.01)	2663564 *	IMIDAZO [4, 5 -C]QUINOLIN- 2 -ONE COMPOUND AND ITS USE AS PI3 KINASE / MTOR DUAL INHIBITOR
Stichting I-F Product Collaboration	A01N 43/56 (2006.01) C07D 231/14 (2006.01)	2655333 *	AMINOINDANES AMIDES HAVING A HIGH FUNGICIDAL ACTIVITY AND THEIR PHYTOSANITARY COMPOSITIONS
L-3 Communications Corporation		2668608 *	INTERNET ISOLATION FOR AVOIDING INTERNET SECURITY THREATS
Genetic Analysis AS	C12Q 1/68 (2006.01)	2652145 *	OLIGONUCLEOTIDE PROBE SET AND METHODS OF MICROBIOTA PROFILING
Lifescan Scotland Ltd	G01N 27/327 (2006.01)	2333542	Fill sufficiency method and system
Theravance, Inc.	C07D 233/26 (2006.01) C07D 257/04 (2006.01) C07D 233/90 (2006.01) C07D 261/18 (2006.01) C07D 241/24 (2006.01) C07D 271/06 (2006.01) C07D 239/34 (2006.01) C07D 263/34 (2006.01) C07D 249/04 (2006.01) C07D 213/81 (2006.01) C07D 249/10 (2006.01) C07D 231/14 (2006.01) C07D 249/18 (2006.01) C07D 237/24 (2006.01) C07D 261/20 (2006.01)	2651896 *	NEPRILYSIN INHIBITORS

Podnosilac evropske prijave patenta (71)	MKP (51)	Broj objave evropske prijave patenta (97)	Naziv pronalaska (54)
Glaxosmithkline Intellectual Property (No. 2) Limited	A61K 9/20 (2006.01) A61K 9/28 (2006.01) A61K 31/519 (2006.01) A61P 35/00 (2006.01)	2654736 *	NOVEL PHARMACEUTICAL COMPOSITION
Scea Les Poissons Du Soleil	A01K 67/027 (2006.01)	2688396 *	METHOD FOR OBTAINING A TRIPLOID INTERSPECIFIC HYBRID OF MEAGRE AND RED DRUM
BIOGAIA AB	A23L 1/30 (2006.01) A23L 1/308 (2006.01)	2677886 *	INDIRECT SUBSTRATES FOR MICROORGANISMS METABOLIZING 1,2-PROPANEDIOL
Losch Airport Equipment GmbH	B64F 1/32 (2006.01)	2433870	Airport vehicle and method for its operation
Smiths Heimann GmbH	G01N 23/04 (2006.01)	2676128 *	SYSTEM AND METHOD FOR MULTI-SCANNER X-RAY INSPECTION
SANOFI	C07K 16/00 (2006.01) C07K 16/24 (2006.01) C07K 16/28 (2006.01) C07K 16/32 (2006.01) C07K 16/46 (2006.01)	2691416 *	DUAL VARIABLE REGION ANTIBODY-LIKE BINDING PROTEINS HAVING CROSS-OVER BINDING REGION ORIENTATION
Mitutoyo Corporation	B23Q 17/20 (2006.01) G01B 5/20 (2006.01) G05B 19/401 (2006.01)	2492048	Tolerance detection method and tolerance detection device for shape measuring apparatus
Plexxikon, Inc.	A61K 31/407 (2006.01)	2672967 *	COMPOUNDS AND METHODS FOR KINASE MODULATION, AND INDICATIONS THEREFOR
Sanofi-Aventis Deutschland GmbH	A61M 5/24 (2006.01) A61M 5/315 (2006.01)	2688614 *	DOSE SETTING MECHANISM AND INJECTION DEVICE
Ball Corporation	B21D 51/30 (2006.01)	2688696 *	STRESS CORROSION RESISTANT ALUMINUM BEVERAGE END CLOSURE
Smiths Heimann GmbH	A61B 6/03 (2006.01) G01N 23/04 (2006.01) G01V 5/00 (2006.01) G06T 11/00 (2006.01)	2677936 *	IMAGE RECONSTRUCTION BASED ON PARAMETRIC MODELS
Hrvatina, Ales	B65D 85/812 (2006.01)	2694404 *	FASTENING ELEMENT FOR HANDLING AN INGREDIENT CONTAINER
Nadizar, Branko	B65D 85/812 (2006.01)	2694404 *	FASTENING ELEMENT FOR HANDLING AN INGREDIENT CONTAINER
Qualcomm Incorporated	H04M 1/725 (2006.01) H04M 3/42 (2006.01) H04W 4/04 (2009.01)	2664126 *	DETERMINING A DYNAMIC USER PROFILE INDICATIVE OF A USER BEHAVIOR CONTEXT WITH A MOBILE DEVICE
Krüger GmbH & Co. KG	A23F 3/16 (2006.01) A23F 3/32 (2006.01) A23L 1/236 (2006.01) A23L 2/395 (2006.01) A23L 2/60 (2006.01)	2665366 *	REDUCED-CALORIE PREPARATIONS FOR PRODUCING INSTANT BEVERAGES AND THE PRODUCTION THEREOF
Memorial Sloan-Kettering Cancer Center	A61K 47/48 (2006.01) C12N 15/62 (2006.01) G01N 33/574 (2006.01)	2694112 *	ANTI-TUMOR ANTIBODY-TUMOR SUPPRESSOR FUSION PROTEIN COMPOSITIONS AND METHODS OF USE FOR THE TREATMENT OF CANCER
AbbVie Inc.	A01N 27/00 (2006.01) A61K 31/015 (2006.01)	2685821 *	NUCLEAR HORMONE RECEPTOR MODULATORS
Zoetis LLC	A01N 43/80 (2006.01) C07D 491/10 (2006.01)	2683723 *	SPIROCYCLIC ISOXAZOLINE DERIVATIVES AS ANTIPARASITIC AGENTS
Signature Therapeutics, Inc.	A01N 43/42 (2006.01)	2663187 *	COMPOSITIONS COMPRISING ENZYME-CLEAVABLE OXYCODONE PRODRUG
Norgine B.V.	A61K 9/00 (2006.01) A61K 31/375 (2006.01) A61K 47/10 (2006.01) A61P 1/10 (2006.01)	2683375 *	COLONOSCOPY - PREPARATION
Richter Gedeon Nyrt.	C07F 9/38 (2006.01) C07F 9/58 (2006.01) C07F 9/6506 (2006.01)	2673282 *	NOVEL PROCESS FOR THE PREPARATION OF DRONIC ACIDS
Gas Trap, LLC	B01D 19/00 (2006.01) E21B 43/34 (2006.01)	2675543 *	GAS TRAP

Podnosilac evropske prijave patenta (71)	MKP (51)	Broj objave evropske prijave patenta (97)	Naziv pronalaska (54)
Valoya Oy	A01G 7/04 (2006.01) A01G 9/20 (2006.01)	2656728	A tilting horticultural light and method of plant cultivation
Ausy S.r.L.	C01B 17/02 (2006.01)	2699514 *	PROCEDURE FOR THE STORAGE AND HANDLING OF SULPHUR BLOCKS
Falconieri, Antonio, Salvatore	C01B 17/02 (2006.01)	2699514 *	PROCEDURE FOR THE STORAGE AND HANDLING OF SULPHUR BLOCKS
Haldor Topsøe A/S	C10L 1/02 (2006.01) F02B 1/02 (2006.01)	2694627 *	A PROCESS FOR PREPARING A FUEL FOR AUTOMOTIVE APPLICATIONS, STATIONARY ENGINES AND MARINE APPLICATIONS BY CATALYTIC LIQUID PHASE ALCOHOL CONVERSION AND A COMPACT DEVICE FOR CARRYING OUT THE PROCESS
Massebeuf Textiles	D06B 3/04 (2006.01) D06M 15/643 (2006.01) G01N 19/02 (2006.01)	2697421 *	YARN, METHOD FOR MANUFACTURING SAME, FACILITY FOR IMPLEMENTING THE METHOD, AND USE OF THE YARN
Nuvosun, Inc.	F24J 2/52 (2006.01) H01L 31/042 (2006.01)	2664006 *	PHOTOVOLTAIC MODULES AND MOUNTING SYSTEMS
SANOFI	A61K 31/437 (2006.01) A61P 3/10 (2006.01) A61P 9/00 (2006.01) A61P 25/00 (2006.01) A61P 35/00 (2006.01) C07D 471/04 (2006.01)	2567959	6-(4-Hydroxy-phenyl)-3-styryl-1H-pyrazolo[3,4-b]pyridine-4-carboxylic acid amide derivatives as kinase inhibitors
LO. LI. Pharma S.r.l.	A61K 9/48 (2006.01)	2502622	Pharmaceutical formulation comprising inositol
GlaxoSmithKline Biologicals S.A.	A61K 39/04 (2006.01)	2651436 *	MYCOBACTERIUM ANTIGENIC COMPOSITION
Salix Pharmaceuticals, Ltd.	A61K 9/28 (2006.01) A61K 31/4375 (2006.01) A61P 1/00 (2006.01) C07D 498/22 (2006.01)	2672970 *	FORMS OF RIFAXIMIN AND USES THEREOF
ELI LILLY AND CO.	A61K 9/00 (2006.01) A61K 31/4468 (2006.01)	2675453 *	METHODS FOR CONTROLLING PAIN IN CANINES USING A TRANSDERMAL SOLUTION OF FENTANYL
Rib-X Pharmaceuticals, Inc.	A61K 31/4245 (2006.01) A61P 31/00 (2006.01) C07D 213/72 (2006.01) C07D 271/06 (2006.01) C07D 401/04 (2006.01)	2686308 *	ANTIMICROBIAL AGENTS
Pall, Hans	E04B 2/24 (2006.01)	2683884 *	STRUCTURAL ELEMENT FOR PRODUCING MASONRY
FMT INTERNATIONAL TRADE AB	B63B 27/14 (2006.01) E01D 15/24 (2006.01)	2673187 *	RAMP FOR A MOVABLE PASSENGER BRIDGE FOR A SHIP
Jiangsu Hansoh Pharmaceutical Co., Ltd.	A61K 31/675 (2006.01) A61P 35/00 (2006.01) C07F 9/58 (2006.01) C07F 9/6509 (2006.01) C07F 9/6558 (2006.01)	2678021 *	PHOSPHORUS CONTAINING COMPOUNDS AS PROTEIN KINASE INHIBITORS
Bayer Intellectual Property GmbH	A61K 31/437 (2006.01) A61P 35/00 (2006.01) C07D 471/04 (2006.01)	2699575 *	TRIAZOLOPYRIDINES
Lacoste	A63B 49/02 (2006.01) A63B 49/04 (2006.01)	2699322 *	NEXT-GENERATION WOODEN RACKET
Shire-Movetis N.V.	A61K 9/00 (2006.01) A61K 9/48 (2006.01) A61K 31/4525 (2006.01) A61K 47/14 (2006.01) A61K 47/26 (2006.01)	2680825 *	PRUCALOPRIDE ORAL SOLUTION
Incyte Corporation	A61K 31/52 (2006.01) A61P 35/00 (2006.01) C07D 473/32 (2006.01)	2655374 *	N-(1-(SUBSTITUTED-PHENYL)ETHYL)-9H-PURIN-6-AMINES AS PI3K INHIBITORS
Bayer CropScience NV	A01H 5/00 (2006.01) C12N 15/82 (2006.01)	2668278 *	USE OF THE RD29 PROMOTER OR FRAGMENTS THEREOF FOR STRESS-INDUCIBLE EXPRESSION OF TRANSGENES IN COTTON

Podnosilac evropske prijave patenta (71)	MKP (51)	Broj objave evropske prijave patenta (97)	Naziv pronalaska (54)
JBF Interlude (2009) Ltd.	G06F 17/30 (2006.01) G06Q 30/02 (2012.01) G06Q 30/06 (2012.01) G11B 27/034 (2006.01) G11B 27/036 (2006.01) G11B 27/11 (2006.01) G11B 27/34 (2006.01) G11B 27/36 (2006.01) H04N 21/258 (2011.01) H04N 21/442 (2011.01) H04N 21/658 (2011.01)	2678862 *	SYSTEM AND METHOD FOR DATA MINING WITHIN INTERACTIVE
Regeneron Pharmaceuticals, Inc.	A01K 67/027 (2006.01) C07K 16/00 (2006.01) C07K 16/46 (2006.01) C12N 15/85 (2006.01)	2568049	Mice expressing an immunoglobulin hybrid light chain with a human variable region
Blücher GmbH	A41D 1/06 (2006.01) A41D 13/00 (2006.01) A41D 17/00 (2006.01) A41F 17/04 (2006.01)	2658407 *	ITEM OF CLOTHING HAVING A DEVICE FOR PROTECTION AGAINST PESTS, IN PARTICULAR TICKS
Teleco S.P.A.	G08C 23/04 (2006.01)	2608178	Device for control and connection via cable by remote control of two or more apparatuses
Cadila Healthcare Limited	C07C 323/12 (2006.01) C07D 213/24 (2006.01) C07D 305/06 (2006.01) C07D 213/65 (2006.01) C07D 407/12 (2006.01) C07D 263/14 (2006.01) C07D 307/02 (2006.01) C07C 311/08 (2006.01) C07D 277/24 (2006.01) C07D 333/16 (2006.01) A61K 31/18 (2006.01) C07D 231/12 (2006.01) C07D 309/12 (2006.01) C07D 261/08 (2006.01) A61P 29/00 (2006.01)	2459524 *	NOVEL COMPOUNDS AS MODULATORS OF GLUCOCORTICOID RECEPTORS
KARO BIO AB	C07C 323/12 (2006.01) C07D 213/24 (2006.01) C07D 305/06 (2006.01) C07D 213/65 (2006.01) C07D 407/12 (2006.01) C07D 263/14 (2006.01) C07D 307/02 (2006.01) C07C 311/08 (2006.01) C07D 277/24 (2006.01) C07D 333/16 (2006.01) A61K 31/18 (2006.01) C07D 231/12 (2006.01) C07D 309/12 (2006.01) C07D 261/08 (2006.01) A61P 29/00 (2006.01)	2459524 *	NOVEL COMPOUNDS AS MODULATORS OF GLUCOCORTICOID RECEPTORS
Novartis AG	A61K 9/16 (2006.01) A61P 35/00 (2006.01)	2645999 *	PHARMACEUTICAL COMPOSITIONS
Zealand Pharma A/S	A61K 38/26 (2006.01) A61K 38/28 (2006.01) A61P 3/04 (2006.01) A61P 3/10 (2006.01)	2665487 *	COMBINATION OF ACYLATED GLUCAGON ANALOGUES WITH INSULIN ANALOGUES
Exelixis, Inc.	A61K 31/47 (2006.01) A61P 35/00 (2006.01) C07D 215/227 (2006.01)	2673262 *	PROCESSES FOR PREPARING QUINOLINE COMPOUNDS AND PHARMACEUTICAL COMPOSITIONS CONTAINING SUCH COMPOUNDS
Hilfrich, Ralf	G01N 33/558 (2006.01) G01N 33/569 (2006.01)	2646825 *	RAPID TEST FOR THE QUALITATIVE AND/OR QUANTITATIVE ANALYSIS OF ANTIBODIES AGAINST HUMAN PAPILLOMA VIRUSES (HPV) PRESENT IN BODY FLUID, AND DEVICE FOR CARRYING OUT THE RAPID TEST

Podnosilac evropske prijave patenta (71)	MKP (51)	Broj objave evropske prijave patenta (97)	Naziv pronalaska (54)
Lupin Limited	A61K 31/381 (2006.01) A61P 25/28 (2006.01) C07D 333/22 (2006.01) C07D 409/04 (2006.01)	2678327 *	HETEROARYL DERIVATIVES AS ALPHA7 NACHR MODULATORS
Eisai R&D Management Co., Ltd.	A61K 31/542 (2006.01) A61P 3/00 (2006.01) A61P 25/00 (2006.01) C07D 513/04 (2006.01)	2665732 *	FUSED AMINODIHYDROTHIAZINE DERIVATIVES USEFUL AS BACE INHIBITORS
Mancic, Milan	H02M 1/42 (2007.01)	2697898 *	CIRCUIT ADAPTED TO SUPPLY A VOLTAGE TO AN ELECTRONIC DEVICE AND USES THEREOF
GlaxoSmithKline Intellectual Property Limited	A61K 31/4439 (2006.01)	2667871 *	COMBINATIONS
Board of Regents, The University of Texas System	A61K 31/4439 (2006.01)	2667871 *	COMBINATIONS
Arla Foods Amba	C07K 1/18 (2006.01) C07K 14/47 (2006.01) C07K 14/52 (2006.01)	2681230 *	METHOD FOR ISOLATING OSTEOPOINTIN USING FEEDS CONTAINING CMP OR CASEIN SPECIES
Florida, Matteo	H01J 49/00 (2006.01)	2691972 *	SYSTEM FOR QUANTITATIVE CHEMICAL ANALYSIS OF SAMPLES, IN PARTICULAR IN THE MEDICAL FIELD, WITH CALIBRATION OF THE INSTRUMENTAL RESPONSE, AND THE CORRESPONDING METHOD
Cristoni, Simone	H01J 49/00 (2006.01)	2691972 *	SYSTEM FOR QUANTITATIVE CHEMICAL ANALYSIS OF SAMPLES, IN PARTICULAR IN THE MEDICAL FIELD, WITH CALIBRATION OF THE INSTRUMENTAL RESPONSE, AND THE CORRESPONDING METHOD
VIB VZW	A61L 27/00 (2006.01) A61L 31/08 (2006.01) A61L 31/16 (2006.01) C07K 14/00 (2006.01) C07K 14/40 (2006.01)	2683419 *	MOLECULES AND METHODS FOR INHIBITION AND DETECTION OF PROTEINS
Vrije Universiteit Brussel	A61L 27/00 (2006.01) A61L 31/08 (2006.01) A61L 31/16 (2006.01) C07K 14/00 (2006.01) C07K 14/40 (2006.01)	2683419 *	MOLECULES AND METHODS FOR INHIBITION AND DETECTION OF PROTEINS
Katholieke Universiteit Leuven K.U. Leuven R&D	A61L 27/00 (2006.01) A61L 31/08 (2006.01) A61L 31/16 (2006.01) C07K 14/00 (2006.01) C07K 14/40 (2006.01)	2683419 *	MOLECULES AND METHODS FOR INHIBITION AND DETECTION OF PROTEINS
Universiteit Gent	A61L 27/00 (2006.01) A61L 31/08 (2006.01) A61L 31/16 (2006.01) C07K 14/00 (2006.01) C07K 14/40 (2006.01)	2683419 *	MOLECULES AND METHODS FOR INHIBITION AND DETECTION OF PROTEINS
voestalpine Automotive GmbH	B21C 9/00 (2006.01) B21D 5/01 (2006.01) B21J 1/06 (2006.01) C22F 1/04 (2006.01)	2581466	Method for producing a moulded part
The Trustees Of The University Of Pennsylvania	A61K 38/00 (2006.01) A61P 35/00 (2006.01)	2665521 *	COMPOSITIONS AND METHODS FOR TREATING CANCER
Ez As A Drink Productions, Inc.	A61B 5/103 (2006.01)	2648615 *	PHYSICAL ACTIVITY MONITORING SYSTEM
Sanofi-Aventis Deutschland GmbH	A61M 5/20 (2006.01) A61M 5/32 (2006.01)	2675508 *	AUTO-INJECTOR
Baylor College Of Medicine	C12N 5/00 (2006.01)	2694640 *	REVERSING THE EFFECTS OF THE TUMOR MICROENVIRONMENT USING CHIMERIC CYTOKINE RECEPTORS

Podnositelj evropske prijave patenta (71)	MKP (51)	Broj objave evropske prijave patenta (97)	Naziv pronalaska (54)
Peerless Worldwide, LLC	B82B 3/00 (2006.01) B82Y 40/00 (2011.01) B82Y 99/00 (2011.01) C01B 31/02 (2006.01) C10M 125/02 (2006.01) F01M 9/00 (2006.01) F16D 13/74 (2006.01) F16N 15/02 (2006.01)	2686271 *	FACILE SYNTHESIS OF GRAPHENE, GRAPHENE DERIVATIVES AND ABRASIVE NANOPARTICLES AND THEIR VARIOUS USES, INCLUDING AS TRIBOLOGICALLY-BENEFICIAL LUBRICANT ADDITIVES
Vereniging voor Christelijk Hoger Onderwijs, Wetenschappelijk Onderzoek en Patiëntenzorg	G01N 33/48 (2006.01)	2686677 *	A METHOD OF ANALYSING A BLOOD SAMPLE OF A SUBJECT FOR THE PRESENCE OF A DISEASE MARKER
Stichting VU-VUmc	G01N 33/48 (2006.01)	2686677 *	A METHOD OF ANALYSING A BLOOD SAMPLE OF A SUBJECT FOR THE PRESENCE OF A DISEASE MARKER
Takeda Pharmaceutical Company Limited	A61K 9/24 (2006.01) A61K 9/26 (2006.01) A61K 31/4439 (2006.01) A61K 31/616 (2006.01) A61K 47/04 (2006.01) A61K 47/32 (2006.01) A61K 47/36 (2006.01) A61K 47/44 (2006.01) A61P 1/04 (2006.01) A61P 9/10 (2006.01) A61P 29/00 (2006.01) A61P 43/00 (2006.01)	2647381 *	ORALLY DISINTEGRATING TABLET
UCB Pharma, S.A.	C07K 16/24 (2006.01)	2663577 *	ANTIBODY MOLECULES WHICH BIND IL-17A AND IL-17F
Deva Holding Anonim Sirketi	A61K 9/00 (2006.01) A61K 9/16 (2006.01) A61K 9/20 (2006.01) A61K 31/593 (2006.01) A61K 31/785 (2006.01) A61K 47/02 (2006.01) A61K 47/20 (2006.01) A61K 47/38 (2006.01) A61K 47/44 (2006.01)	2591768	Single unit dosage formulations of sevelamer and fat soluble vitamins and surface active agents
Topera, Inc.	A61B 5/042 (2006.01)	2699151 *	BASKET STYLE CARDIAC MAPPING CATHETER HAVING SPLINE BENDS FOR DETECTION OF CARDIAC RHYTHM DISORDERS
Amgen Inc.	C07D 241/02 (2006.01) C07D 471/04 (2006.01)	2655342 *	HETEROCYCLIC COMPOUNDS AND THEIR USES
Strauss Water Ltd	G01F 23/26 (2006.01)	2663843 *	DEVICE FOR MEASURING FLUID LEVEL IN A CONTAINER
Kumar, Avinash	A61B 17/04 (2006.01) A61B 17/08 (2006.01) A61B 17/11 (2006.01) A61F 2/08 (2006.01)	2677941 *	SUTURE MESH AND METHOD OF USE
Jehle, Georg	F16L 19/02 (2006.01)	2600050	Swivel coupling for barrel bung
IUCF-HYU (Industry-University Cooperation Foundation Hanyang University)	H04L 9/14 (2006.01)	2677452 *	ENCRYPTION DEVICE AND METHOD FOR DEFENDING A PHYSICAL ATTACK
SANOFI	C07K 16/18 (2006.01)	2678357 *	METHOD OF PRODUCTION OF SIALYLATED ANTIBODIES
Genmab A/S	A61K 47/48 (2006.01) A61P 35/00 (2006.01) C07K 16/28 (2006.01)	2670440 *	HUMAN ANTIBODIES AND ANTIBODY-DRUG CONJUGATES AGAINST CD74
Amgen Inc.	A61K 38/18 (2006.01) A61P 3/00 (2006.01)	2694092 *	METHOD OF TREATING OR AMELIORATING METABOLIC DISORDERS USING GROWTH DIFFERENTIATION FACTOR 15 (GDF-15)

Podnosilac evropske prijave patenta (71)	MKP (51)	Broj objave evropske prijave patenta (97)	Naziv pronalaska (54)
Curt G. Joa, Inc.	A61F 13/15 (2006.01) B26D 1/00 (2006.01)	2659868	Single transfer insert placement method and apparatus
Olympic Seafood AS	A23K 1/10 (2006.01) A23K 1/16 (2006.01) A23K 1/175 (2006.01) A23K 1/18 (2006.01)	2683253 *	COMPOSITIONS AND METHODS FOR NUTRITIONAL SUPPLEMENTATION
Targacept, Inc.	A61K 31/443 (2006.01) A61P 25/18 (2006.01) A61P 25/28 (2006.01)	2665478 *	TREATMENT OF COGNITIVE DYSFUNCTION IN SCHIZOPHRENIA
Cyklar-stulz Abwassertechnik GmbH	C02F 3/28 (2006.01) C02F 3/30 (2006.01) C02F 11/04 (2006.01) C02F 11/12 (2006.01) C02F 101/16 (2006.01)	2366673	Method for biological purification of wastewater containing ammonium
Abbvie Inc.	A61K 31/4184 (2006.01) A61P 25/02 (2006.01)	2696870 *	PARP INHIBITORS FOR THE TREATMENT OF CIPN
IP Science Limited	A61K 9/107 (2006.01)	2670392 *	CAROTENOID PARTICLES AND USES THEREOF
Genentech, Inc.	G01N 33/48 (2006.01)	2694959 *	BIOMARKERS FOR PREDICTING SENSITIVITY TO CANCER TREATMENTS
Lin, Kui	G01N 33/48 (2006.01)	2694959 *	BIOMARKERS FOR PREDICTING SENSITIVITY TO CANCER TREATMENTS
Punnoose, Elizabeth	G01N 33/48 (2006.01)	2694959 *	BIOMARKERS FOR PREDICTING SENSITIVITY TO CANCER TREATMENTS
Seshagiri, Somasekar	G01N 33/48 (2006.01)	2694959 *	BIOMARKERS FOR PREDICTING SENSITIVITY TO CANCER TREATMENTS
ROLIX S.p.r.l.	B60P 7/08 (2006.01) B60R 9/048 (2006.01)	2698283	Roof rack
Instytut Chemii i Techniki Jadrowej	C01F 15/00 (2006.01) C01G 43/00 (2006.01) C01G 99/00 (2010.01)	2578538	A selective extraction of uranium and Protactinium from material containing thorium
Fater S.p.A.	A61L 2/07 (2006.01) A61L 11/00 (2006.01) B01J 3/04 (2006.01) B02C 17/00 (2006.01) B02C 19/00 (2006.01) B29B 17/00 (2006.01)	2596809	Process for sterilising absorbent sanitary products
Reata Pharmaceuticals, Inc.	C07D 231/54 (2006.01)	2651902 *	PYRAZOLYL AND PYRIMIDINYL TRICYCLIC ENONES AS ANTIOXIDANT INFLAMMATION MODULATORS
Repros Therapeutics Inc.	A61K 31/57 (2006.01) A61P 5/36 (2006.01) C07J 9/00 (2006.01)	2655394 *	NOVEL 19-NOR-STERIODS AND THEIR USE FOR TREATING PROGESTERONE-DEPENDENT CONDITIONS
Laboratorios del. Dr. Esteve, S.A.	A61K 39/21 (2006.01) C07K 14/16 (2006.01) C12N 15/10 (2006.01) G01N 33/569 (2006.01) G01N 33/68 (2006.01)	2678351 *	RAPID SELECTION METHOD FOR HIV GP-120 VARIANTS
Fundació Privada Institut de Recerca de la SIDA-Caixa	A61K 39/21 (2006.01) C07K 14/16 (2006.01) C12N 15/10 (2006.01) G01N 33/569 (2006.01) G01N 33/68 (2006.01)	2678351 *	RAPID SELECTION METHOD FOR HIV GP-120 VARIANTS
The Rockefeller University	A61K 31/7088 (2006.01) C07H 21/00 (2006.01) C12N 15/113 (2010.01)	2673363 *	TREATMENT OF ANGIOGENESIS DISORDERS

Podnosilac evropske prijave patenta (71)	MKP (51)	Broj objave evropske prijave patenta (97)	Naziv pronalaska (54)
Integrative Research Laboratories Sweden AB	A61K 31/138 (2006.01) A61K 31/145 (2006.01) A61K 31/397 (2006.01) A61K 31/4453 (2006.01) A61P 25/14 (2006.01) A61P 25/16 (2006.01) A61P 25/18 (2006.01) C07C 317/22 (2006.01) C07D 205/04 (2006.01) C07D 295/088 (2006.01)	2699543 *	NOVEL MODULATORS OF CORTICAL DOPAMINERGIC- AND NMDA-RECEPTOR-MEDIATED GLUTAMATERGIC NEUROTRANSMISSION
Zentiva, K.S.	C07D 235/26 (2006.01)	2681201 *	A METHOD OF MANUFACTURING 2-ETHOXY-1-((2'-(HYDROXYAMINO) IMINOMETHYL)BIPHENYL-4-YL)METHYL)-1H-BENZO [D]IMIDAZOLE-7-CARBOXYLIC ACID AND ITS ESTERS
Gilead Pharmasset LLC	A61K 31/7068 (2006.01) A61K 31/7072 (2006.01) A61K 31/7076 (2006.01) A61P 31/14 (2006.01) C07H 19/06 (2006.01) C07H 19/10 (2006.01) C07H 19/16 (2006.01) C07H 19/20 (2006.01) C07H 23/00 (2006.01)	2646453 *	COMPOUNDS
SANOFI	A61K 31/737 (2006.01) A61P 17/02 (2006.01) C07H 15/04 (2006.01) C08B 37/00 (2006.01)	2668198 *	FGF RECEPTOR-ACTIVATING 3-O-ALKYL OLIGOSACCHARIDES, PREPARATION THEREOF AND THERAPEUTIC USE THEREOF
Biogen Idec MA Inc.	A01N 43/40 (2006.01) A61K 31/445 (2006.01)	2672823 *	S1P MODULATING AGENTS
SANOFI	A61K 31/7056 (2006.01) A61K 31/715 (2006.01) A61P 7/02 (2006.01)	2672976 *	IDRABIOTAPARINUX FOR THE TREATMENT OF PULMONARY EMBOLISM AND FOR THE SECONDARY PREVENTION OF VENOUS THROMBOEMBOLIC EVENTS
Amgen Inc.	A61K 31/433 (2006.01) A61K 31/4439 (2006.01) A61K 31/4745 (2006.01) A61K 31/496 (2006.01) A61P 35/00 (2006.01) C07D 413/14 (2006.01) C07D 417/04 (2006.01) C07D 417/14 (2006.01) C07D 487/04 (2006.01)	2688886 *	AZOLE COMPOUNDS AS PIM INHIBITORS
YM BioSciences Australia Pty Ltd	A61K 31/444 (2006.01) A61K 31/505 (2006.01) A61K 31/506 (2006.01) A61K 31/5377 (2006.01) A61K 31/541 (2006.01) A61P 7/06 (2006.01)	2646029 *	TREATMENT OF JAK2-MEDIATED CONDITIONS
DT- Vyhybkárna A Strojirna, A.S.	E01B 7/12 (2006.01)	2697432 *	FROG
Deutsches Milchkontor eG	A23L 1/30 (2006.01) A23L 1/308 (2006.01) A61K 31/702 (2006.01)	2699109 *	PREBIOTIC CARBOHYDRATE COMPOSITIONS
Kymab Limited	A01K 67/027 (2006.01) C07K 16/00 (2006.01) C12N 9/64 (2006.01) C12N 15/85 (2006.01)	2649184 *	FERTILE TRANSGENIC ANIMALS USEFUL FOR PRODUCING ANTIBODIES BEARING HUMAN VARIABLE REGIONS
Mattei, Alessandro	A47K 3/12 (2006.01)	2651274 *	AID DEVICE FOR WASHING INFANTS, CHILDREN OR THE LIKE
Mezy, Marcel Léon	C05F 9/04 (2006.01) C05F 17/00 (2006.01)	2647614	Method for preparing activated plant complexes and plant/organic matter complexes that are doped or overdoped, carbonated, and the uses thereof in particular in anaerobic digestion or biogas production

Podnosilac evropske prijave patenta (71)	MKP (51)	Broj objave evropske prijave patenta (97)	Naziv pronalaska (54)
Rheinkalk GmbH	C04B 20/00 (2006.01) C04B 35/66 (2006.01) F27D 1/00 (2006.01)	2573058	Granulate containing agglomerated bulk material
Genentech, Inc.	C07H 21/04 (2006.01) C12N 15/11 (2006.01)	2655619 *	AUTOPHAGY INDUCER AND INHIBITOR COMBINATION THERAPY FOR THE TREATMENT OF NEOPLASMS
Cesa Alliance S.A.	A61K 31/12 (2006.01) A61K 31/216 (2006.01) A61P 31/12 (2006.01)	2691088 *	VIRAL INHIBITOR COMPOSITION FOR IN VIVO THERAPEUTIC USE
CHRONO-LOG CORPORATION	G01N 27/02 (2006.01) G01N 27/07 (2006.01) G01N 33/49 (2006.01) G01N 33/86 (2006.01)	2584357	Platelet aggregation measuring device
Baxter International Inc	B01D 15/36 (2006.01) C07K 1/18 (2006.01) C07K 14/755 (2006.01) G01N 30/34 (2006.01) G01N 30/80 (2006.01) G01N 30/96 (2006.01)	2652491 *	ELUATE COLLECTION USING CONDUCTIVITY GRADIENT
Baxter Healthcare SA	B01D 15/36 (2006.01) C07K 1/18 (2006.01) C07K 14/755 (2006.01) G01N 30/34 (2006.01) G01N 30/80 (2006.01) G01N 30/96 (2006.01)	2652491 *	ELUATE COLLECTION USING CONDUCTIVITY GRADIENT
Qualcomm Incorporated	H04N 21/478 (2011.01)	2700243 *	AUGMENTED REALITY FOR LIVE EVENTS
H. Lundbeck A/S	A61K 31/519 (2006.01) A61P 25/00 (2006.01) C07D 471/04 (2006.01) C07D 487/04 (2006.01)	2513107 *	HETEROAROMATIC PHENYLIMIDAZOLE DERIVATIVES AS PDE10A ENZYME INHIBITORS
Sanofi-Aventis Deutschland GmbH	A61M 5/20 (2006.01) A61M 5/32 (2006.01)	2675502 *	AUTO-INJECTOR
The Scripps Research Institute	G01N 33/50 (2006.01)	2694964 *	HIGH-THROUGHPUT SCREENING FOR COMPOUNDS MODULATING EXPRESSION OF CELLULAR MACROMOLECULES
VTU Holding GmbH	C07K 14/55 (2006.01) C07K 14/765 (2006.01) C07K 14/79 (2006.01) C12N 1/19 (2006.01) C12N 9/00 (2006.01) C12N 9/04 (2006.01) C12N 9/90 (2006.01) C12N 15/81 (2006.01) C12P 21/02 (2006.01)	2681308 *	PROTEIN EXPRESSION
SIGMA-TAU Research Switzerland S.A.	A61K 31/4192 (2006.01) A61P 35/00 (2006.01) C07D 249/06 (2006.01) C07D 413/12 (2006.01)	2655345 *	ARYL TRIAZOLE COMPOUNDS WITH ANTITUMOURAL ACTIVITY
Bioincept LLC	A61K 38/08 (2006.01) C07K 7/00 (2006.01)	2680872 *	COMPOSITIONS AND METHODS FOR TREATMENT OF INTRACELLULAR DAMAGE
Heartflow, Inc.	G06F 3/048 (2013.01) G06T 19/20 (2011.01)	2665043	Method and system for providing information from a patient-specific model of blood flow
Finattec Holding AG	G01N 21/35 (2006.01) G01N 21/84 (2006.01) G01N 21/88 (2006.01) G01N 21/90 (2006.01) G01N 25/72 (2006.01)	2605004	Method and system for testing objects with a gas barrier coating

Podnosilac evropske prijave patenta (71)	MKP (51)	Broj objave evropske prijave patenta (97)	Naziv pronalaska (54)
Taisho Pharmaceutical Co., Ltd.	A61P 1/00 (2006.01) A61P 25/18 (2006.01) A61K 31/444 (2006.01) A61P 25/14 (2006.01) A61P 29/00 (2006.01) C07D 401/14 (2006.01) A61P 9/12 (2006.01) A61P 25/24 (2006.01) A61P 5/00 (2006.01) A61P 25/22 (2006.01) A61K 31/506 (2006.01) A61P 25/16 (2006.01) A61K 31/4439 (2006.01) A61P 25/08 (2006.01) A61P 25/30 (2006.01) A61P 1/14 (2006.01) A61P 25/20 (2006.01) A61K 31/4192 (2006.01) A61P 25/04 (2006.01) A61P 25/28 (2006.01)	2653469 *	PYRAZOLE DERIVATIVE
Huhtamaki Films Germany GmbH & Co. KG	B32B 7/06 (2006.01) B32B 27/08 (2006.01) B32B 27/20 (2006.01) B32B 27/28 (2006.01) G09F 3/00 (2006.01)	2675619 *	RELEASE FILM HAVING A ROUGH SURFACE STRUCTURE
Purdue Pharma LP	A61K 9/20 (2006.01)	2651399 *	CONTROLLED RELEASE DOSAGE FORMS
Cephalon, Inc.	A61K 31/69 (2006.01) A61K 45/06 (2006.01) A61P 17/00 (2006.01) A61P 37/00 (2006.01)	2680858 *	PROTEASOME INHIBITOR DELANZOMIB FOR USE IN THE TREATMENT OF LUPUS
Deutsche SiSi-Werke Betriebs GmbH	B32B 27/10 (2006.01)	2683549 *	IMPROVED COMPOSITE SYSTEM FOR PACKAGING
Basilea Pharmaceutica AG	C12Q 1/48 (2006.01) G01N 33/574 (2006.01) G01N 33/68 (2006.01)	2691533 *	USE OF PHOSPHO-AKT AS A BIOMARKER OF DRUG RESPONSE
Nuvosun, Inc.	H01L 31/042 (2006.01)	2695199 *	SHINGLE-LIKE PHOTOVOLTAIC MODULES
Eli Lilly and Company	A61K 39/12 (2006.01) A61P 31/14 (2006.01)	2658570 *	BOVINE VIRAL DIARRHEA VIRUS TYPE 1B VACCINE COMPOSITIONS AND METHODS
Televic Conference NV	H03H 17/06 (2006.01)	2608409	Multichannel sample rate converter
ZTE Corporation	H04B 7/26 (2006.01) H04J 11/00 (2006.01)	2678960 *	MULTIPLE APERIODIC CHANNEL STATE INFORMATION TRANSMISSION ON PUSCH
ZTE (USA) Inc.	H04B 7/26 (2006.01) H04J 11/00 (2006.01)	2678960 *	MULTIPLE APERIODIC CHANNEL STATE INFORMATION TRANSMISSION ON PUSCH
Sanofi	A61K 9/00 (2006.01) A61K 9/20 (2006.01) A61K 31/437 (2006.01) A61K 33/10 (2006.01) A61P 25/20 (2006.01)	2651391 *	PHARMACEUTICAL COMPOSITION FOR ORAL ADMINISTRATION INTENDED TO PREVENT MISUSE
Janssen Biotech, Inc.	A61K 39/00 (2006.01)	2654780 *	ACTIVE PROTEASE-RESISTANT ANTIBODY FC MUTANTS
Bial-Portela & CA, S.A.	A61K 9/16 (2006.01) A61K 31/55 (2006.01)	2658528 *	GRANULATES COMPRISING ESLICARBAZEPINE ACETATE
Chiesi Farmaceutici S.p.A.	A61K 31/58 (2006.01) A61P 5/44 (2006.01) A61P 11/06 (2006.01) A61P 37/08 (2006.01) C07J 71/00 (2006.01)	2686333 *	ISOXAZOLIDINE DERIVATIVES
Green Sugar GmbH, Produktinnovationen Aus Biomasse	B01D 1/14 (2006.01) B01D 1/16 (2006.01) C08H 8/00 (2010.01) C10G 3/00 (2006.01) C13K 1/00 (2006.01)	2661478 *	METHOD AND APPARATUS FOR EVAPORATING HYDROGEN HALIDE AND WATER FROM BIOMASS HYDROLYZATES CONTAINING HALOGEN ACID

Podnosilac evropske prijave patenta (71)	MKP (51)	Broj objave evropske prijave patenta (97)	Naziv pronalaska (54)
Taisho Pharmaceutical Co., Ltd.	A61K 31/498 (2006.01)	2687507 *	NITROGEN-CONTAINING CONDENSED HETEROCYCLIC COMPOUND
	A61P 9/10 (2006.01)		
	A61K 31/454 (2006.01)		
	A61P 1/16 (2006.01)		
	C07D 217/06 (2006.01)		
	A61K 31/497 (2006.01)		
	A61P 3/10 (2006.01)		
	A61K 31/472 (2006.01)		
	A61P 3/04 (2006.01)		
	C07D 217/22 (2006.01)		
	A61K 31/506 (2006.01)		
	A61P 9/12 (2006.01)		
	A61K 31/4725 (2006.01)		
	A61P 3/06 (2006.01)		
	C07D 223/16 (2006.01)		
	A61K 31/4035 (2006.01)		
A61K 31/55 (2006.01)			
C07D 217/04 (2006.01)			
C07D 209/44 (2006.01)			
A61K 31/538 (2006.01)			
A61P 43/00 (2006.01)			
Centro De Ingenieria Genetica Y Biotecnologia	C07K 7/06 (2006.01)	2690107 *	CYCLIC PEPTIDES WITH AN ANTI-NEOPLASIC AND ANTI-ANGIOGENIC ACTIVITY
Intercell Austria AG	A61K 39/104 (2006.01)	2655402 *	OPRF/I AGENTS AND THEIR USE IN HOSPITALIZED AND OTHER PATIENTS
	A61K 39/40 (2006.01)		
	C07K 14/21 (2006.01)		
	C07K 16/12 (2006.01)		
C07K 19/00 (2006.01)			
Stiefel Research Australia Pty Ltd	A61K 8/04 (2006.01)	2482800 *	COSMETIC FOAM
	A61K 8/97 (2006.01)		
	A61K 9/00 (2006.01)		
	A61K 9/12 (2006.01)		
	A61K 9/46 (2006.01)		
	A61K 31/01 (2006.01)		
	A61K 31/19 (2006.01)		
	A61K 31/191 (2006.01)		
	A61K 36/886 (2006.01)		
	A61K 45/06 (2006.01)		
	A61K 47/10 (2006.01)		
	A61K 47/40 (2006.01)		
A61K 47/46 (2006.01)			
A61Q 19/00 (2006.01)			
Tavtech Ltd.	A61B 17/54 (2006.01)	2678055 *	A DEVICE FOR ADMINISTERING THERAPEUTIC SUBSTANCES USING A HIGH VELOCITY LIQUID-GAS STREAM
	A61C 17/02 (2006.01)		
	A61M 5/30 (2006.01)		
Delphi Technologies Holding S.à.r.l.	F02M 47/02 (2006.01)	2568157	Injection Nozzle
	F02M 61/12 (2006.01)		
	F02M 63/00 (2006.01)		
Dr. Falk Pharma GmbH	A61K 31/575 (2006.01)	2646457 *	OPTIMIZED SYNTHESIS OF PURE, NON-POLYMORPHIC, CRYSTALLINE BILE ACIDS WITH DEFINED PARTICLE SIZE
	A61P 1/16 (2006.01)		
	C07J 9/00 (2006.01)		
Yale University	A61K 31/439 (2006.01)	2681199 *	(-)- HUPERZINE A PROCESSES AND RELATED COMPOSITIONS AND METHODS OF TREATMENT
	A61P 25/00 (2006.01)		
	C07D 221/20 (2006.01)		
Eli Lilly and Company	A61K 38/18 (2006.01)	2696889 *	VARIANTS OF HUMAN GDNF
	C07K 14/475 (2006.01)		

Podnosilac evropske prijave patenta (71)	MKP (51)	Broj objave evropske prijave patenta (97)	Naziv pronalaska (54)
Autifony Therapeutics Limited	A61K 31/4178 (2006.01) A61K 31/4439 (2006.01) A61K 31/506 (2006.01) A61P 25/08 (2006.01) A61P 25/18 (2006.01) A61P 27/16 (2006.01) A61P 43/00 (2006.01) C07D 405/12 (2006.01) C07D 413/12 (2006.01) C07D 413/14 (2006.01)	2649066 *	HYDANTOIN DERIVATIVES USEFUL AS KV3 INHIBITORS
Bayer CropScience NV	C12N 15/82 (2006.01)	2655629 *	BRASSICA PLANT COMPRISING A MUTANT ALCATRAZ ALLELE
SANOFI	A61K 31/427 (2006.01) A61P 9/06 (2006.01) A61P 9/10 (2006.01) C07D 417/12 (2006.01) C07D 417/14 (2006.01) C07D 471/04 (2006.01) C07D 487/04 (2006.01)	2567958	Substituted 2-(chroman-6-yloxy)-thiazoles and their use as pharmaceuticals
Affiris AG	A61K 39/00 (2006.01) C07K 7/14 (2006.01)	2529748	Vaccine
Pierre Fabre Dermo-Cosmétique	A61K 39/02 (2006.01) C12R 1/00 (2006.01)	2655668 *	NOVEL BACTERIUM AND EXTRACTS OF SAID BACTERIUM AND THE USE OF SAME IN THERAPY
Pierre Fabre Medicament	A61K 39/02 (2006.01) C12R 1/00 (2006.01)	2655668 *	NOVEL BACTERIUM AND EXTRACTS OF SAID BACTERIUM AND THE USE OF SAME IN THERAPY
Fazakas, Gábor	E04B 1/76 (2006.01) E04F 13/08 (2006.01) F16B 7/02 (2006.01) F16B 13/06 (2006.01) F16B 13/08 (2006.01) F16B 19/00 (2006.01)	2652218 *	RETAINING UNIT FOR FIXING HEAT INSULATION ELEMENTS TO A SUPPORTING STRUCTURE
Fazakas, Zsolt	E04B 1/76 (2006.01) E04F 13/08 (2006.01) F16B 7/02 (2006.01) F16B 13/06 (2006.01) F16B 13/08 (2006.01) F16B 19/00 (2006.01)	2652218 *	RETAINING UNIT FOR FIXING HEAT INSULATION ELEMENTS TO A SUPPORTING STRUCTURE
Györfi, László	E04B 1/76 (2006.01) E04F 13/08 (2006.01) F16B 7/02 (2006.01) F16B 13/06 (2006.01) F16B 13/08 (2006.01) F16B 19/00 (2006.01)	2652218 *	RETAINING UNIT FOR FIXING HEAT INSULATION ELEMENTS TO A SUPPORTING STRUCTURE
Pirityi, László	E04B 1/76 (2006.01) E04F 13/08 (2006.01) F16B 7/02 (2006.01) F16B 13/06 (2006.01) F16B 13/08 (2006.01) F16B 19/00 (2006.01)	2652218 *	RETAINING UNIT FOR FIXING HEAT INSULATION ELEMENTS TO A SUPPORTING STRUCTURE
Apotex Technologies Inc.	A61K 31/404 (2006.01) A61K 38/03 (2006.01) C07D 209/20 (2006.01) C07K 5/037 (2006.01)	2691370 *	PRODRUGS OF D-GAMMA-GLUTAMYL-D-TRYPTOPHAN AND D-GAMMA- GLUTAMYL-L-TRYPTOPHAN
Glaxo Group Limited	C07D 239/36 (2006.01) C07D 239/47 (2006.01) C07D 239/52 (2006.01) C07D 239/56 (2006.01) C07D 401/06 (2006.01) C07D 401/12 (2006.01) C07D 401/14 (2006.01) C07D 403/06 (2006.01) C07D 403/12 (2006.01) C07D 403/14 (2006.01) C07D 413/06 (2006.01) C07D 417/06 (2006.01)	2649053 *	PYRIMIDINONE COMPOUNDS FOR USE IN THE TREATMENT OF DISEASES OR CONDITIONS MEDIATED BY LP - PLA2

Podnosilac evropske prijave patenta (71)	MKP (51)	Broj objave evropske prijave patenta (97)	Naziv pronalaska (54)
Moberg Pharma AB	A61K 9/00 (2006.01) A61K 31/00 (2006.01) A61K 47/10 (2006.01) A61K 47/12 (2006.01)	2672962 *	NOVEL ANTIFUNGAL COMPOSITION
Sambusseti, Antonio	A61F 2/00 (2006.01) A61F 2/02 (2006.01) A61F 2/04 (2013.01) A61L 27/18 (2006.01) A61L 27/54 (2006.01)	2683326 *	HEMISPHERE FOR BLADDER EXPANSION IN PATIENTS WITH LOW COMPLIANCE
Nestec S.A.	B65D 43/02 (2006.01) B65D 85/78 (2006.01)	2597050	Closure lid
Zalicus Pharmaceuticals Ltd.	A61K 9/16 (2006.01) A61K 9/48 (2006.01) A61K 31/495 (2006.01)	2654726 *	SOLID DISPERSION FORMULATIONS AND METHODS OF USE THEREOF
Æterna Zentaris GmbH	A61K 31/4985 (2006.01) A61K 31/501 (2006.01) A61K 31/5377 (2006.01) A61P 35/00 (2006.01) A61P 43/00 (2006.01) C07D 471/04 (2006.01)	2694068 *	PYRIDOPYRAZINE DERIVATIVES AND THEIR USE
The Medicines Company	A61K 31/522 (2006.01) A61P 9/08 (2006.01) A61P 9/12 (2006.01)	2672975 *	METHODS FOR TREATING PULMONARY HYPERTENSION
Cadila Healthcare Limited	A61K 31/404 (2006.01) A61P 25/24 (2006.01) C07D 405/14 (2006.01)	2688884 *	AMORPHOUS FORM OF VILAZODONE HYDROCHLORIDE AND PROCESS FOR ITS PREPARATION
Rekik, Raouf	A61K 31/00 (2006.01) A61K 31/198 (2006.01) A61K 31/20 (2006.01) A61K 31/375 (2006.01) A61K 31/403 (2006.01) A61K 31/505 (2006.01) A61K 31/519 (2006.01) A61K 31/70 (2006.01) A61K 31/714 (2006.01) A61K 33/06 (2006.01) A61K 33/14 (2006.01)	2646010 *	FOLIC ACID - RAMIPRIL COMBINATION: CELLPROTECTIVE, NEUROPROTECTIVE AND RETINOPROTECTIVE OPHTHALMOLOGIC COMPOSITIONS
Behr GmbH & Co. KG	B60H 1/00 (2006.01) F24F 13/20 (2006.01) H05K 5/00 (2006.01)	2607118	Housing, in particular for a motor vehicle air conditioning device
Euro-Celtique S.A.	A61K 9/00 (2006.01) A61K 9/14 (2006.01) A61K 9/16 (2006.01) A61K 9/20 (2006.01) A61K 9/28 (2006.01) A61K 31/485 (2006.01) A61K 45/06 (2006.01) A61P 1/10 (2006.01) A61P 25/00 (2006.01) A61P 25/02 (2006.01) A61P 25/14 (2006.01) A61P 25/16 (2006.01)	2658523 *	A COMBINATION OF AN OPIOID AGONIST AND AN OPIOID ANTAGONIST IN THE TREATMENT OF PARKINSON'S DISEASE
Novartis AG	C12Q 1/68 (2006.01)	2686442 *	FGFR AND LIGANDS THEREOF AS BIOMARKERS FOR BREAST CANCER IN HR POSITIVE SUBJECTS
Hisamitsu Pharmaceutical Co., Inc.	A61K 9/70 (2006.01) A61K 31/435 (2006.01) A61K 31/551 (2006.01) A61K 47/12 (2006.01) A61K 47/32 (2006.01) A61K 47/34 (2006.01) A61P 11/02 (2006.01) A61P 17/04 (2006.01) A61P 37/08 (2006.01) A61P 43/00 (2006.01)	2700401 *	METHOD FOR PRODUCING ADHESIVE PATCH, AND ADHESIVE PATCH

Podnosilac evropske prijave patenta (71)	MKP (51)	Broj objave evropske prijave patenta (97)	Naziv pronalaska (54)
Electrogen Research & Development S.r.L.	H02K 1/14 (2006.01) H02K 11/00 (2006.01) H02K 21/14 (2006.01) H02K 47/20 (2006.01)	2649704 *	ELECTROMECHANICAL MACHINE FOR REGULATING SUPPLIABLE ELECTRIC POWER
Arafarma Group, S.A.	A61K 9/14 (2006.01) A61K 31/665 (2006.01) A61K 47/18 (2006.01) A61P 13/02 (2006.01) A61P 31/04 (2006.01)	2656846 *	PHOSPHOMYCIN PHARMACEUTICAL COMPOSITION
Delphi Technologies Holding S.à.r.l.	F02M 63/00 (2006.01)	2589790	Plug assembly for high-pressure valve
Cephalon, Inc.	C07D 235/16 (2006.01)	2670735 *	METHODS FOR THE PREPARATION OF BENDAMUSTINE
Cephalon, Inc.	C07D 487/08 (2006.01)	2686323 *	MACROCYCLIC COMPOUNDS AS ALK, FAK AND JAK2 INHIBITORS
Cognition Therapeutics, Inc.	A61K 31/137 (2006.01)	2670402 *	ISOLATED COMPOUNDS FROM TURMERIC OIL AND METHODS OF USE
Annikki GmbH	C08H 7/00 (2011.01) C08H 8/00 (2010.01) D21C 5/00 (2006.01)	2688939 *	METHOD FOR PRODUCING LIGNIN DERIVATIVES
JPB Systeme	F01D 21/00 (2006.01)	2689110 *	SHUT-OFF DEVICE WITH AUTOMATICALLY ACTIVATABLE LOCKING
Sanofi-Aventis Deutschland GmbH	A61M 5/20 (2006.01) A61M 5/32 (2006.01)	2661292 *	A SAFETY DEVICE FOR A PRE-FILLED SYRINGE AND AN INJECTION DEVICE
Takeda Pharmaceutical Company Limited	A61P 35/02 (2006.01) C07K 16/28 (2006.01)	2658871 *	ANTI-CD38 ANTIBODIES
Montanari Giulio&C. S.r.l.	H02K 1/27 (2006.01) H02K 15/03 (2006.01) H02K 21/12 (2006.01) H02K 29/03 (2006.01)	2615723	A permanent magnet rotor for a rotary electric machine
Boehringer Ingelheim International GmbH	A61K 31/519 (2006.01) A61P 25/28 (2006.01) C07D 487/04 (2006.01)	2675807 *	6 - CYCLOBUTYL - 1, 5 - DIHYDRO - PYRAZOLO [3, 4-D]PYRIMIDIN- 4 - ONE DERIVATIVES THEIR USE AS PDE9A INHIBITORS
H. Lundbeck A/S	C07B 57/00 (2006.01) C07D 241/04 (2006.01)	2661427 *	METHOD FOR RESOLUTION OF 4-((1R,3S)-6-CHLORO-3-PHENYL-INDAN-1-YL)-1,2,2-TRIMETHYL-PIPERAZINE AND 1-((1R,3S)-6-CHLORO-3-PHENYL-INDAN, 1-YL)-3,3-DIMETHYL-PIPERAZINE
Sanofi-Aventis Deutschland GmbH	A61K 31/155 (2006.01) A61K 38/22 (2006.01) A61P 3/10 (2006.01) A61P 5/50 (2006.01)	2670427 *	PREVENTION OF HYPOGLYCAEMIA IN DIABETES MELLITUS TYPE 2 PATIENTS
Ios, In Titut Za Okoljevarstvo In Senzorje, D.O.O.	G01N 21/78 (2006.01) G01N 31/22 (2006.01)	2678673 *	SOL-GEL BASED OPTICAL CHEMICAL SENSOR FOR DETECTION OF ORGANOPHOSPHATES AND METHOD FOR PREPARATION THEREOF
Vodermayer, Christian	G01R 31/40 (2006.01)	2653880	Method and system for determining the performance of photovoltaic assemblies
Société Financière Gérard Allot	F03D 3/06 (2006.01) F03D 7/02 (2006.01)	2610483	Windkraftanlage mit vertikaler Achse
Wobben Properties GmbH	B21D 22/02 (2006.01) B21D 53/78 (2006.01) F03D 1/06 (2006.01)	2576096 *	FORMING PROCESS FOR HOT FORMING A STEEL SHEET OF A ROTOR BLADE TO BE PRODUCED FOR A WIND ENERGY PLANT
Baylor College Of Medicine	A61K 48/00 (2006.01) C12N 15/86 (2006.01)	2623604	Adenoviral-based biological delivery and expression system for use in the treatment of osteoarthritis
Vereniging Voor Christelijk Hoger Onderwijs, Wetenschappelijk Onderzoek en Patienten Zorg	G01N 33/564 (2006.01) G01N 33/68 (2006.01)	2646826 *	METHOD FOR PROGNOSTICATING THE CLINICAL RESPONSE OF A PATIENT TO B-LYMPHOCYTE INHIBITING OR DEPLETING THERAPY IN INTERFERON DRIVEN DISEASES SUCH AS SLE

Podnosilac evropske prijave patenta (71)	MKP (51)	Broj objave evropske prijave patenta (97)	Naziv pronalaska (54)
Honeywell Technologies Sarl	E04B 1/00 (2006.01) E04F 17/08 (2006.01)	2649248 *	A VERTICAL DUCT FOR BUILDING SERVICES LIKE GAS, WATER, ELECTRICITY, SAID DUCT BEING ACCESSIBLE FROM THE OUTSIDE OF THE BUILDING
Les Laboratoires Servier	A61K 31/165 (2006.01) A61P 1/00 (2006.01) A61P 9/00 (2006.01) A61P 25/00 (2006.01) A61P 25/20 (2006.01) A61P 25/22 (2006.01) A61P 25/24 (2006.01) C07C 231/24 (2006.01) C07C 233/18 (2006.01)	2690088 *	MIXED CRYSTAL AGOMELATINE (FORM-VIII), PREPARATION METHOD AND USE THEREOF AND PHARMACEUTICAL COMPOSITION CONTAINING SAME
Shanghai Institute Of Pharmaceutical Industry	A61K 31/165 (2006.01) A61P 1/00 (2006.01) A61P 9/00 (2006.01) A61P 25/00 (2006.01) A61P 25/20 (2006.01) A61P 25/22 (2006.01) A61P 25/24 (2006.01) C07C 231/24 (2006.01) C07C 233/18 (2006.01)	2690088 *	MIXED CRYSTAL AGOMELATINE (FORM-VIII), PREPARATION METHOD AND USE THEREOF AND PHARMACEUTICAL COMPOSITION CONTAINING SAME
Morphotek, Inc.	A61K 31/357 (2006.01) A61K 39/395 (2006.01) A61P 35/00 (2006.01)	2680839 *	CO -ADMINISTRATION OF ERIBULIN AND FARLETUZUMAB FOR THE TREATMENT OF BREAST CANCER
Newlink Genetics Corporation	A61K 31/4188 (2006.01) A61P 37/02 (2006.01) C07D 487/04 (2006.01)	2697227 *	FUSED IMIDAZOLE DERIVATIVES USEFUL AS IDO INHIBITORS
Pluristem Ltd.	C12N 5/00 (2006.01) C12N 5/077 (2010.01)	2697362 *	METHODS AND SYSTEMS FOR HARVESTING CELLS
Ethicon, Inc.	A61F 2/18 (2006.01)	2675394 *	BIOABSORBABLE MULTILAYER NASAL VALVE SPREADER GRAFT
Insleep Technologies, LLC	A61M 16/00 (2006.01)	2688627 *	BREATHING APPARATUS
Völkerer, Klaus	F01B 3/00 (2006.01) F04B 1/22 (2006.01)	2681415 *	FLUID ENERGY MACHINE HAVING TWO OPPOSITE CYLINDER ROTORS
Eidler, Willibald	F01B 3/00 (2006.01) F04B 1/22 (2006.01)	2681415 *	FLUID ENERGY MACHINE HAVING TWO OPPOSITE CYLINDER ROTORS
Past, Arno	F01B 3/00 (2006.01) F04B 1/22 (2006.01)	2681415 *	FLUID ENERGY MACHINE HAVING TWO OPPOSITE CYLINDER ROTORS
Koglbauer, Josef	F01B 3/00 (2006.01) F04B 1/22 (2006.01)	2681415 *	FLUID ENERGY MACHINE HAVING TWO OPPOSITE CYLINDER ROTORS
Merus B.V.	C07K 16/00 (2006.01) C07K 16/10 (2006.01) C07K 16/28 (2006.01) C07K 16/30 (2006.01) C07K 16/46 (2006.01)	2604625	Generation of binding molecules
Reutter GmbH	B60K 15/04 (2006.01) F01N 3/20 (2006.01)	2665901 *	FILLER NECK FOR A LIQUID TANK, IN PARTICULAR A UREA TANK, ON MOTOR VEHICLES
Amgen Inc.	C07K 16/28 (2006.01)	2694552 *	NOVEL EGFR BINDING PROTEINS
Merrimack Pharmaceuticals, Inc.	A61K 31/00 (2006.01) A61K 33/00 (2006.01) A61K 39/395 (2006.01) C07K 16/32 (2006.01)	2686015 *	OVERCOMING RESISTANCE TO ERBB PATHWAY INHIBITORS
SCA TISSUE FRANCE	A47K 10/38 (2006.01)	2583603	Portable sheet product dispenser
OMG UK Technology Limited	C09D 7/04 (2006.01) C09D 167/08 (2006.01)	2661473 *	ANTISKINNING COMPOSITIONS
Agios Pharmaceuticals, Inc.	A61K 31/496 (2006.01) A61P 35/00 (2006.01)	2658543 *	THERAPEUTIC COMPOUNDS AND COMPOSITIONS

Podnosilac evropske prijave patenta (71)	MKP (51)	Broj objave evropske prijave patenta (97)	Naziv pronalaska (54)
Airborne International B.V.	B29C 35/00 (2006.01) B29C 53/56 (2006.01) B29C 53/64 (2006.01) B29C 70/32 (2006.01) B29D 23/00 (2006.01) F16L 9/16 (2006.01)	2681041 *	METHOD FOR MANUFACTURING CONTINUOUS COMPOSITE TUBE, APPARATUS FOR MANUFACTURING CONTINUOUS COMPOSITE TUBE
GlaxoSmithKline Intellectual Property Development Limited	A61K 31/4709 (2006.01)	2680844 *	AMINO-QUINOLINES AS KINASE INHIBITORS
Evolution S.r.l.	B02C 18/30 (2006.01) B02C 18/36 (2006.01)	2667971 *	IMPROVEMENTS FOR A MINCING UNIT CUTTING GROUP
Nexen Energy ULC	E21B 43/26 (2006.01) F04D 1/06 (2006.01) F04D 29/16 (2006.01) F04D 29/44 (2006.01)	2665937 *	HIGH PRESSURE MULTISTAGE CENTRIFUGAL PUMP FOR FRACTURING HYDROCARBON RESERVES
Cyalume Technologies, Inc	C09K 11/07 (2006.01) F21K 2/06 (2006.01)	2652085 *	VISCOUS CHEMILUMINESCENT COMPONENTS AND DISPENSING MEANS
Opalux Incorporated	G02B 6/122 (2006.01) G02F 1/19 (2006.01)	2652535 *	PHOTONIC CRYSTAL DEVICE WITH OFFSET ACTIVATION
Ericson Manufacturing Company	H02B 1/32 (2006.01)	2684264 *	ELECTRICAL ENCLOSURE
Amgen Inc.	C07K 1/18 (2006.01)	2649087 *	ION EXCHANGE CHROMATOGRAPHY IN THE PRESENCE OF AN AMINO ACID
Novartis AG	A61K 9/00 (2006.01) A61K 9/107 (2006.01) A61K 9/48 (2006.01) A61K 38/13 (2006.01) A61K 47/10 (2006.01) A61K 47/14 (2006.01) A61K 47/22 (2006.01) A61K 47/26 (2006.01)	2651396 *	PHARMACEUTICAL COMPOSITIONS
Debiopharm S.A.	A61K 9/00 (2006.01) A61K 9/107 (2006.01) A61K 9/48 (2006.01) A61K 38/13 (2006.01) A61K 47/10 (2006.01) A61K 47/14 (2006.01) A61K 47/22 (2006.01) A61K 47/26 (2006.01)	2651396 *	PHARMACEUTICAL COMPOSITIONS
Shah, Deepak Pranjivandas	A01N 43/54 (2006.01) A01N 59/02 (2006.01) A01N 43/50 (2006.01) A01N 47/36 (2006.01) A01N 43/28 (2006.01) A01N 47/34 (2006.01) A01N 43/16 (2006.01) A01N 47/30 (2006.01) A01N 37/24 (2006.01) A01N 47/24 (2006.01) A01N 37/16 (2006.01) A01N 43/653 (2006.01) A01N 35/04 (2006.01) A01N 47/32 (2006.01) A01N 37/34 (2006.01)	2667720 *	PESTICIDAL COMPOSITION COMPRISING SULPHUR, A FUNGICIDE AND AN AGROCHEMICAL EXCIPIENT
CY.PAG. S.r.l.	G01S 7/28 (2006.01) G01S 13/58 (2006.01) G01S 13/93 (2006.01) G01S 15/58 (2006.01) G01S 15/93 (2006.01) G01S 17/93 (2006.01)	2678711 *	PROXIMITY SENSOR
Aeromarine Innovations Inc.	B63B 1/24 (2006.01)	2665638 *	FOIL STRUCTURE FOR PROVIDING BUOYANCY AND LIFT

Podnosilac evropske prijave patenta (71)	MKP (51)	Broj objave evropske prijave patenta (97)	Naziv pronalaska (54)
Pfizer Inc	A61K 31/4412 (2006.01) A61K 31/4427 (2006.01) A61K 31/4433 (2006.01) A61K 31/4439 (2006.01) A61P 31/00 (2006.01) C07D 213/64 (2006.01) C07D 213/69 (2006.01) C07D 401/04 (2006.01) C07D 401/10 (2006.01) C07D 405/04 (2006.01) C07D 405/12 (2006.01) C07D 413/10 (2006.01) C07D 417/12 (2006.01)	2683689 *	FLUORO-PYRIDINONE DERIVATIVES USEFUL AS ANTIBACTERIAL AGENTS
Taisho Pharmaceutical Co., Ltd.	A61K 31/444 (2006.01) A61P 25/24 (2006.01) A61P 25/04 (2006.01) A61P 43/00 (2006.01) A61K 31/4439 (2006.01) A61P 25/22 (2006.01) C07D 401/04 (2006.01) A61P 25/20 (2006.01) C07D 417/14 (2006.01) A61P 25/16 (2006.01) C07D 401/14 (2006.01) A61K 31/506 (2006.01) A61P 25/28 (2006.01) A61P 25/00 (2006.01) A61P 25/30 (2006.01) A61P 25/18 (2006.01) C07D 413/14 (2006.01)	2679585 *	GLYCINE TRANSPORT INHIBITOR
Active Innovation Management	F24J 2/04 (2006.01) F24J 2/52 (2006.01)	2646757 *	BUOYANT SOLAR PANEL, AND SOLAR POWER PLANT CONSISTING OF AN ASSEMBLY OF SAID PANELS
Ingenieursbureau Wuylens BVBA	B60R 19/03 (2006.01) B60R 19/22 (2006.01) B60R 21/11 (2006.01) B60R 21/13 (2006.01) B62D 33/06 (2006.01) B66F 9/075 (2006.01) E02F 9/16 (2006.01)	2567932	Impact deceleration device for material handling equipments.
Blu Pack Di Scolaro Mauro	B65B 31/02 (2006.01)	2651767 *	DEVICE FOR VACUUM PACKAGING, PARTICULARLY OF FOOD PRODUCTS
Extru SA	B65B 31/02 (2006.01)	2651767 *	DEVICE FOR VACUUM PACKAGING, PARTICULARLY OF FOOD PRODUCTS
Janssen R&D Ireland	A61K 31/437 (2006.01) A61P 31/12 (2006.01) C07D 471/04 (2006.01) C07D 487/04 (2006.01)	2651934 *	IMIDAZOPYRIDINES AS RESPIRATORY SYNCYTIAL VIRUS ANTIVIRAL AGENTS
CNH Italia S.p.A.	B60G 9/02 (2006.01) B60G 17/016 (2006.01) B60R 21/013 (2006.01) B62D 49/08 (2006.01) B66F 9/06 (2006.01) E02F 9/22 (2006.01) G08B 19/00 (2006.01)	2444304	System and method for preventing overturning of land vehicles
Optimer Pharmaceuticals, Inc.	A61K 31/35 (2006.01) A61K 31/70 (2006.01) A61P 29/00 (2006.01) A61P 31/12 (2006.01)	2670407 *	TREATMENT OF BACTERIAL INFECTIONS
SANOFI	A61K 31/4985 (2006.01) A61P 19/02 (2006.01) C07D 487/04 (2006.01)	2570415	N-[4-(1H-Pyrazolo[3,4-b]pyrazin-6-yl)-phenyl]-sulfonamides and their use as pharmaceuticals
Nestec S.A.	G01N 33/564 (2006.01) G01N 33/94 (2006.01)	2676137 *	ASSAYS FOR DETECTING AUTOANTIBODIES TO ANTI-TNF DRUGS

Podnosilac evropske prijave patenta (71)	MKP (51)	Broj objave evropske prijave patenta (97)	Naziv pronalaska (54)
Eisai R&D Management Co., Ltd.	C12N 15/09 (2006.01) C12Q 1/02 (2006.01)	2684963 *	METHOD FOR SCREENING FOR COMPOUND CAPABLE OF ENHANCING OR INHIBITING OATP1B1 TRANSPORT ACTIVITY, AND METHOD FOR DETERMINING EXPRESSION LEVEL OF OATP1B1
Castellaccio, Restituta	A61K 8/23 (2006.01) A61K 8/43 (2006.01) A61K 8/67 (2006.01) A61K 8/73 (2006.01) A61Q 11/00 (2006.01)	2614812	Mouthwash
Saint-Gobain Glass France	B32B 17/10 (2006.01) B32B 17/12 (2006.01) B60Q 3/02 (2006.01) G02B 6/00 (2006.01)	2665601 *	LUMINOUS GLASS PANEL
B.B.S. S.p.A.	B32B 23/06 (2006.01) B32B 29/04 (2006.01) B65D 65/46 (2006.01)	2651642 *	MULTILAYER BASED ON CELLULOSE AND DERIVATES THEREOF
Purdue Pharma LP	A61K 9/20 (2006.01) A61K 31/485 (2006.01)	2654733 *	TAMPER RESISTANT SOLID ORAL DOSAGE FORMS
Ferrometal OY	B65G 1/137 (2006.01)	2390204	System for completing a warehouse for small articles
Würth Industrie Service GmbH & Co. KG	B65G 1/137 (2006.01)	2390204	System for completing a warehouse for small articles
AUGUSTUS MARTIN LIMITED	G09F 7/18 (2006.01)	2671212 *	HANGERS FOR DISPLAY MATERIAL
Cadila Healthcare Limited	A61K 31/40 (2006.01) A61P 3/00 (2006.01)	2670486 *	TREATMENT FOR LIPODYSTROPHY
Rother Technologie GmbH & Co. KG	B05B 7/16 (2006.01) B23Q 11/10 (2006.01)	2574424	Method for cooling aerosols
AbbVie Inc.	A61K 39/395 (2006.01) C12P 21/08 (2006.01)	2654792 *	HALF IMMUNOGLOBULIN BINDING PROTEINS AND USES THEREOF
Delphi Technologies Holding S.à.r.l.	F02D 41/22 (2006.01) F02M 25/07 (2006.01)	2594775	A method of assessing the functioning of an EGR cooler in an internal combustion engine
Activesite Pharmaceuticals, Inc.	A61K 31/402 (2006.01) A61K 31/415 (2006.01) A61P 9/10 (2006.01) C07D 207/34 (2006.01) C07D 231/14 (2006.01)	2697196 *	PRODRUGS OF INHIBITORS OF PLASMA KALLIKREIN
Nestec S.A.	B65D 75/58 (2006.01) B65D 75/62 (2006.01)	2589547	Flow wrap packaging
Kanngard, Lars Olof	G06Q 20/40 (2012.01)	2695121 *	TERMINAL AUTHENTICITY VERIFICATION
Sanofi-Aventis Deutschland GmbH	A61M 5/20 (2006.01) A61M 5/32 (2006.01)	2675506 *	AUTO-INJECTOR
Leica Biosystems Newcastle Limited	C12Q 1/68 (2006.01)	2675916 *	METHOD FOR LOCALIZED IN SITU DETECTION OF mRNA
Crystal Lagoons (Curaçao) B.V.	C02F 1/68 (2006.01)	2675759 *	SUSTAINABLE METHOD AND SYSTEM FOR TREATING WATER BODIES AFFECTED BY BACTERIA AND MICROALGAE AT LOW COST
QUALCOMM Incorporated	H04W 74/08 (2009.01)	2692194 *	SYSTEM AND METHOD FOR CLEAR CHANNEL ASSESSMENT THAT SUPPORTS SIMULTANEOUS TRANSMISSION BY MULTIPLE WIRELESS PROTOCOLS
Janssen R&D Ireland	A61K 31/437 (2006.01) A61P 31/12 (2006.01) C07D 403/06 (2006.01) C07D 471/04 (2006.01)	2651922 *	INDOLES AS RESPIRATORY SYNCYTIAL VIRUS ANTIVIRAL AGENTS
EMPA Eidgenössische Materialprüfungs- und Forschungsanstalt	A61B 17/00 (2006.01) A61B 17/28 (2006.01) A61B 17/29 (2006.01) A61B 17/30 (2006.01) F16C 11/12 (2006.01)	2683302 *	RESILIENT TOOLS

Podnosilac evropske prijave patenta (71)	MKP (51)	Broj objave evropske prijave patenta (97)	Naziv pronalaska (54)
Sloan-kettering Institute For Cancer Research	C07D 473/34 (2006.01) C07D 473/40 (2006.01)	2694505 *	HSP90 INHIBITORS
DuPont Nutrition Biosciences ApS	A23G 3/00 (2006.01) A23G 3/52 (2006.01) A23L 1/00 (2006.01)	2670254 *	METHOD FOR PRODUCING AERATED FOOD PRODUCTS
Keighleycolo Ltd	A61B 17/00 (2006.01) A61B 17/06 (2006.01) A61L 27/36 (2006.01) A61L 27/50 (2006.01) A61M 27/00 (2006.01)	2688484 *	A DEVICE
TILSE Industrie- und Schiffstechnik GmbH	B63B 19/02 (2006.01)	2562076	Glass pane assembly in an aquatic vehicle
Vibrant Media, Inc.	G06F 17/30 (2006.01)	2666108 *	SYSTEMS AND METHODS FOR PROVIDING A DISCOVER PROMPT TO AUGMENTED CONTENT OF A WEB PAGE
Doig, Toby	G06F 17/30 (2006.01)	2666108 *	SYSTEMS AND METHODS FOR PROVIDING A DISCOVER PROMPT TO AUGMENTED CONTENT OF A WEB PAGE
Gooding, Craig	G06F 17/30 (2006.01)	2666108 *	SYSTEMS AND METHODS FOR PROVIDING A DISCOVER PROMPT TO AUGMENTED CONTENT OF A WEB PAGE
Il Makiage Ltd	A45D 40/06 (2006.01)	2543276	Lipstick tube
ORTHO-CLINICAL DIAGNOSTICS, INC.	C07H 21/00 (2006.01) C12N 15/63 (2006.01) G01N 33/53 (2006.01)	2663642 *	TREPONEMA PALLIDUM TRIPLET ANTIGEN
AbbVie Inc.	A61K 39/395 (2006.01) C07K 16/24 (2006.01)	2661448 *	ANTI-IL-12/IL-23 ANTIBODIES AND USES THEREOF
Opalux Incorporated	B82Y 20/00 (2011.01) G02B 5/26 (2006.01)	2668529 *	PHOTONIC CRYSTAL DEVICE WITH INFILTRATING COMPONENT
Abbvie Inc.	A61K 31/4178 (2006.01) A61P 31/14 (2006.01) C07D 403/10 (2006.01) C07D 403/12 (2006.01) C07D 403/14 (2006.01)	2651928 *	ANTI-VIRAL COMPOUNDS
Koninklijke Douwe Egberts B.V.	A47J 31/36 (2006.01) A47J 31/40 (2006.01) A47J 31/41 (2006.01) B67D 1/00 (2006.01) B67D 7/02 (2010.01) B67D 7/62 (2010.01)	2653440	Beverage cartridge
Sloan-kettering Institute For Cancer Research	C07D 473/34 (2006.01)	2694506 *	HSP90 INHIBITORS
Cephalon, Inc.	A61K 31/4196 (2006.01) A61K 45/06 (2006.01) A61P 19/02 (2006.01) A61P 37/00 (2006.01)	2648725 *	TREATMENT OF CHRONIC INFLAMMATION WITH A 1,2,4-TRIAZOLO [1,5a]PYRIDINE DERIVATIVE
Peck, Gordon	E04H 12/00 (2006.01) F03D 9/00 (2006.01) F03D 11/04 (2006.01) H01L 31/042 (2006.01) H02J 3/38 (2006.01) H02J 4/00 (2006.01) H02J 13/00 (2006.01)	2681824 *	METHODS, SYSTEMS, AND APPARATUS FOR NATURAL POWER COLLECTION AND DISTRIBUTION
Signature Therapeutics, Inc.	A61K 38/08 (2006.01)	2683394 *	ACTIVE AGENT PRODRUGS WITH HETEROCYCLIC LINKERS
Sloan Kettering Institute For Cancer Research	A01N 43/02 (2006.01) A61K 31/335 (2006.01)	2693879 *	MIGRASTATINS AND USES THEREOF
Omya International AG	C09C 1/02 (2006.01)	2700680	Process for manufacturing white pigment containing products
AstraZeneca AB	A61K 31/337 (2006.01) A61K 31/519 (2006.01) A61P 35/00 (2006.01)	2694056 *	THERAPEUTIC TREATMENT

Podnosilac evropske prijave patenta (71)	MKP (51)	Broj objave evropske prijave patenta (97)	Naziv pronalaska (54)
Kriticos, Stephen Con	A63B 69/00 (2006.01) B60L 13/04 (2006.01) B63B 35/79 (2006.01)	2654909 *	SURFING DEVICE AND METHOD
Taisho Pharmaceutical Co., Ltd.	A61K 31/4155 (2006.01) A61K 31/4196 (2006.01) A61K 31/422 (2006.01) A61K 31/4245 (2006.01) A61K 31/433 (2006.01) A61K 31/4439 (2006.01) A61K 31/506 (2006.01) A61K 31/5377 (2006.01) A61P 17/14 (2006.01) C07D 403/04 (2006.01) C07D 413/04 (2006.01) C07D 413/14 (2006.01) C07D 417/04 (2006.01)	2687524 *	AZOLE DERIVATIVE
Les Laboratoires Servier	A61K 31/554 (2006.01) A61P 9/00 (2006.01) A61P 19/08 (2006.01) A61P 25/00 (2006.01) C07D 281/10 (2006.01)	2653466	Agents for treating disorders involving modulation of ryanodine receptors
Armgo Pharma, Inc.	A61K 31/554 (2006.01) A61P 9/00 (2006.01) A61P 19/08 (2006.01) A61P 25/00 (2006.01) C07D 281/10 (2006.01)	2653466	Agents for treating disorders involving modulation of ryanodine receptors
INTERCONNECT DEVICES INC	G01R 1/067 (2006.01) H01R 12/71 (2011.01) H01R 13/24 (2006.01) H01R 13/6599 (2011.01) H01R 43/20 (2006.01)	2647088 *	ELECTRICAL CONNECTOR WITH EMBEDDED SHELL LAYER
Subsea Technologies Limited	H01R 13/523 (2006.01) H01R 13/627 (2006.01)	2697870 *	SUBSEA ELECTRICAL CONNECTOR
SANOFI	C07D 307/80 (2006.01) C07D 307/84 (2006.01)	2688879 *	METHOD FOR SYNTHESIZING KETOBENZOFURAN DERIVATIVES
Obschestvo s Ogranichennoy Otvetstvennostyu "Pirochimica-Center"	A62D 1/00 (2006.01) C08J 9/34 (2006.01)	2674198 *	AUTONOMOUS FIRE-FIGHTING AGENT
Saint-Gobain Adfors	A01M 29/34 (2011.01) C03C 25/10 (2006.01) C03C 25/24 (2006.01) C03C 25/26 (2006.01) C03C 25/30 (2006.01) C03C 25/40 (2006.01) C03C 25/54 (2006.01) D06M 13/00 (2006.01) D06M 15/00 (2006.01)	2691346 *	GLASS YARN PROVIDED WITH A POLYMER COATING, AND SCREEN CONTAINING SAID YARN
Gilead Sciences, Inc.	A61K 31/504 (2006.01) A61P 31/14 (2006.01) C07D 487/08 (2006.01) C07D 498/08 (2006.01) C07D 498/18 (2006.01)	2649076 *	MACROCYCLIC INHIBITORS OF FLAVIVIRIDAE VIRUSES
Selcia Ltd	A61K 31/504 (2006.01) A61P 31/14 (2006.01) C07D 487/08 (2006.01) C07D 498/08 (2006.01) C07D 498/18 (2006.01)	2649076 *	MACROCYCLIC INHIBITORS OF FLAVIVIRIDAE VIRUSES
Amgen Inc.	C07K 14/435 (2006.01)	2686340 *	POTENT AND SELECTIVE INHIBITORS OF NAV1.3 AND NAV1.7

Podnosilac evropske prijave patenta (71)	MKP (51)	Broj objave evropske prijave patenta (97)	Naziv pronalaska (54)
Bionanoplus, S.L.	A61K 8/00 (2006.01) A61K 8/91 (2006.01) A61K 35/00 (2006.01) B82Y 5/00 (2011.01) B82Y 30/00 (2011.01) C08F 292/00 (2006.01) C08J 3/07 (2006.01)	2699625 *	NANOPARTICLES COMPRISING ESTERS OF POLY (METHYL VINYL ETHER-CO-MALEIC ANHYDRIDE) AND USES THEREOF
Omya International AG	A61K 9/16 (2006.01) A61K 9/20 (2006.01) A61K 9/50 (2006.01)	2591772	New coated controlled release active agent carriers
Strange Investments (WA) Pty Ltd	E21B 19/084 (2006.01) E21B 19/086 (2006.01)	2673456 *	DRILL RIG AND ASSOCIATED DRILL RIG TRAVERSE SYSTEM
Xiamen Runner Industrial Corporation	B05D 5/06 (2006.01) B05D 7/02 (2006.01)	2463031	Method of preparing sandwich composite coating on engineering plastic surface
Array Biopharma, Inc.	A61K 31/437 (2006.01) A61P 35/00 (2006.01) C07D 471/04 (2006.01)	2651939 *	SUBSTITUTED N-(1H-INDAZOL-4-YL) IMIDAZO[1,2-a]PYRIDINE-3-CARBOXAMIDE COMPOUNDS AS TYPE III RECEPTOR TYROSINE KINASE INHIBITORS
Merck Sharp & Dohme Corp.	A01N 43/58 (2006.01)	2677869 *	NOVEL CYCLIC AZABENZIMIDAZOLE DERIVATIVES USEFUL AS ANTI-DIABETIC AGENTS
Progress Profiles SPA	E04F 15/02 (2006.01) E04F 21/00 (2006.01)	2573296	Leveling spacer for laying wall tiles, paving tiles and the like with the interposition of gaps
Institut Pasteur	A61K 39/00 (2006.01) A61K 47/48 (2006.01) C07K 9/00 (2006.01)	2686009 *	METHOD FOR PREPARING MULTIPLE ANTIGEN GLYCOPEPTIDE CARBOHYDRATE CONJUGATES
Centre National de la Recherche Scientifique	A61K 39/00 (2006.01) A61K 47/48 (2006.01) C07K 9/00 (2006.01)	2686009 *	METHOD FOR PREPARING MULTIPLE ANTIGEN GLYCOPEPTIDE CARBOHYDRATE CONJUGATES
UCB Pharma GmbH	A61K 9/16 (2006.01) A61K 9/20 (2006.01) A61K 31/165 (2006.01) A61P 25/08 (2006.01) A61P 25/14 (2006.01) A61P 25/18 (2006.01)	2646001 *	FORMULATION OF LACOSAMIDE
adp Gauselmann GmbH	G07F 17/32 (2006.01)	2584545	Device for displaying a device code of a coin-activated entertainment device
Merrimack Pharmaceuticals, Inc.	A61K 39/395 (2006.01) A61P 35/00 (2006.01) C07K 16/32 (2006.01)	2683741 *	USE OF INHIBITORS OF EGFR-FAMILY RECEPTORS IN THE TREATMENT OF HORMONE REFRACTORY BREAST CANCERS
Genentech, Inc.	C12Q 1/48 (2006.01) G01N 33/50 (2006.01)	2646819 *	ASSAYS AND BIOMARKERS FOR LRRK2
Trüb AG	B42D 15/10 (2006.01)	2665607 *	METHOD FOR PRODUCING A MULTILAYER DATA CARRIER AND DATA CARRIER PRODUCED BY SAID METHOD
Japan Oil, Gas and Metals National Corporation	B01J 19/00 (2006.01) C10G 2/00 (2006.01)	2671635 *	TEMPERATURE CONTROL SYSTEM
INPEX Corporation	B01J 19/00 (2006.01) C10G 2/00 (2006.01)	2671635 *	TEMPERATURE CONTROL SYSTEM
JX Nippon Oil & Energy Corporation	B01J 19/00 (2006.01) C10G 2/00 (2006.01)	2671635 *	TEMPERATURE CONTROL SYSTEM
Japan Petroleum Exploration Co., Ltd.	B01J 19/00 (2006.01) C10G 2/00 (2006.01)	2671635 *	TEMPERATURE CONTROL SYSTEM
Cosmo Oil Co., Ltd.	B01J 19/00 (2006.01) C10G 2/00 (2006.01)	2671635 *	TEMPERATURE CONTROL SYSTEM
Nippon Steel & Sumikin Engineering Co., Ltd.	B01J 19/00 (2006.01) C10G 2/00 (2006.01)	2671635 *	TEMPERATURE CONTROL SYSTEM
Taisho Pharmaceutical Co., Ltd.	A61K 31/7048 (2006.01) A61P 31/04 (2006.01) C07H 17/08 (2006.01)	2678349 *	C-4" POSITION SUBSTITUTED MACROLIDE DERIVATIVE

Podnosilac evropske prijave patenta (71)	MKP (51)	Broj objave evropske prijave patenta (97)	Naziv pronalaska (54)
Meiji Seika Pharma Co., Ltd.	A61K 31/7048 (2006.01) A61P 31/04 (2006.01) C07H 17/08 (2006.01)	2678349 *	C-4" POSITION SUBSTITUTED MACROLIDE DERIVATIVE
Barnhizer, Bret T.	B65B 31/04 (2006.01) B65D 81/24 (2006.01) B65D 85/00 (2006.01)	2699491 *	IMPROVED FLAT PACKAGING OF PETRI DISHES FOR PROLONGED PRESERVATION AND METHOD OF PRODUCING THE SAME
FMT INTERNATIONAL TRADE AB	B63B 27/14 (2006.01) E01D 15/24 (2006.01)	2673417 *	A MOVABLE PASSENGER BRIDGE FOR A SHIP
MIKA Pharma Gesellschaft für die Entwicklung und Vermarktung pharmazeutischer Produkte mbH	A61K 8/04 (2006.01) A61K 8/34 (2006.01) A61K 8/55 (2006.01) A61K 8/86 (2006.01) A61Q 19/00 (2006.01) G01F 22/00 (2006.01) G01N 13/02 (2006.01)	2654665 *	METHOD FOR DEVELOPING A LIQUID COMPOSITION TO BE APPLIED TO THE SKIN AS A FOAM AND A COMPOSITION THAT CAN BE APPLIED TOPICALLY
Astex Therapeutics Limited	C07D 401/06 (2006.01) C07D 471/04 (2006.01) C07D 471/10 (2006.01)	2699562 *	BICYCLIC HETEROCYCLE COMPOUNDS AND THEIR USES IN THERAPY
Titano S.R.L.	F02M 27/04 (2006.01)	2699786 *	METHOD FOR OPTIMIZING COMBUSTION ENGINES
SANOFI	A61K 31/422 (2006.01) A61P 35/00 (2006.01) C07C 229/40 (2006.01) C07D 231/14 (2006.01) C07D 471/04 (2006.01)	2573073	Pyrazoloquinolinone derivatives, preparation thereof and therapeutic use thereof
Pixcell Medical Technologies Ltd.	B01L 3/00 (2006.01)	2683483 *	DISPOSABLE CARTRIDGE FOR PREPARING A SAMPLE FLUID CONTAINING CELLS FOR ANALYSIS
ICTK Co., Ltd.	H04L 9/14 (2006.01)	2650813 *	DEVICE AND METHOD FOR GENERATING AN IDENTIFICATION KEY
Immatics Biotechnologies GmbH	A61K 39/00 (2006.01) C07K 14/47 (2006.01) C07K 14/705 (2006.01)	2651434 *	HLA-BINDING PEPTIDES DERIVED FROM PROSTATE-ASSOCIATED ANTIGENIC MOLECULES AND METHODS OF USE THEREOF
Sanofi-Aventis Deutschland GmbH	A61K 31/64 (2006.01) A61K 38/26 (2006.01) A61P 3/08 (2006.01)	2691109 *	PREVENTION OF HYPOGLYCAEMIA IN DIABETES MELLITUS TYPE 2 PATIENTS
Sanofi-Aventis Deutschland GmbH	A61M 5/145 (2006.01) A61M 5/24 (2006.01) A61M 5/315 (2006.01)	2658589 *	DEDICATED CARTRIDGE AND HOLDER
Immunogen, Inc.	A61K 47/48 (2006.01) A61P 35/00 (2006.01) C07D 487/04 (2006.01) C07D 519/00 (2006.01)	2675479 *	CYTOTOXIC BENZODIAZEPINE DERIVATIVES
Palupa Medical Ltd.	A61K 9/08 (2006.01) A61K 31/015 (2006.01) A61K 31/201 (2006.01) A61K 31/202 (2006.01) A61K 31/203 (2006.01) A61K 31/355 (2006.01) A61P 25/16 (2006.01) A61P 25/28 (2006.01) A61P 43/00 (2006.01)	2691086 *	COMPOSITIONS FOR THE TREATMENT OF NEUROLOGIC DISORDERS
OSI Pharmaceuticals, LLC	A61K 31/497 (2006.01) C07F 9/40 (2006.01)	2646448 *	MACROCYCLIC KINASE INHIBITORS
Novartis AG	A61K 31/70 (2006.01) A61P 3/10 (2006.01) C07D 405/10 (2006.01)	2697217 *	GLYCOSIDE DERIVATIVES AND THEIR USES FOR THE TREATMENT OF DIABETES
Lavet Gyogyszergyarto es Szolgaltato Kft.	A61K 9/16 (2006.01) A61K 47/44 (2006.01)	2662075	Taste masking compositions of praziquantel
Zoetis LLC	A61K 39/10 (2006.01) A61K 39/295 (2006.01) C07K 14/235 (2006.01)	2670432 *	IMMUNOGENIC BORDETELLA BRONCHISEPTICA COMPOSITIONS

Podnosilac evropske prijave patenta (71)	MKP (51)	Broj objave evropske prijave patenta (97)	Naziv pronalaska (54)
Boehringer Ingelheim International GmbH	A61K 31/519 (2006.01) A61P 25/00 (2006.01) C07D 487/04 (2006.01)	2670754 *	(1,2,4)TRIAZOLO[4,3-A]QUINOXALINE DERIVATIVES AS INHIBITORS OF PHOSPHODIESTERASES
Szabó László Gábor	A61K 9/00 (2006.01) A61K 31/04 (2006.01) A61K 33/04 (2006.01) A61K 47/06 (2006.01) A61P 9/10 (2006.01) A61P 9/12 (2006.01) A61P 17/06 (2006.01) A61P 17/10 (2006.01) A61P 25/24 (2006.01) A61P 29/00 (2006.01) A61P 31/00 (2006.01)	2691087 *	PHARMACEUTICAL COMPOSITION CONTAINING NO, PROCESS FOR THE PREPARATION AND USE THEREOF
Piller, István	A61K 9/00 (2006.01) A61K 31/04 (2006.01) A61K 33/04 (2006.01) A61K 47/06 (2006.01) A61P 9/10 (2006.01) A61P 9/12 (2006.01) A61P 17/06 (2006.01) A61P 17/10 (2006.01) A61P 25/24 (2006.01) A61P 29/00 (2006.01) A61P 31/00 (2006.01)	2691087 *	PHARMACEUTICAL COMPOSITION CONTAINING NO, PROCESS FOR THE PREPARATION AND USE THEREOF
Omya International AG	C09C 1/02 (2006.01) D21H 17/00 (2006.01)	2662419	Charge controlled PHCH
Pfizer Inc	A61K 31/497 (2006.01) A61K 31/506 (2006.01) A61P 3/04 (2006.01) A61P 3/10 (2006.01) C07D 405/14 (2006.01)	2604604	Benzofuranyl derivatives used as glucokinase inhibitors
Planet Patent S.A.	E03C 1/122 (2006.01) E03F 5/08 (2006.01) F16K 17/19 (2006.01)	2685013	Pressure regulating device and use thereof
Krüger GmbH & Co. KG	A23G 1/56 (2006.01) A23L 1/236 (2006.01)	2670253 *	REDUCED-CALORIE COMPOSITIONS FOR PRODUCING INSTANT DRINKS CONTAINING COCOA
Burcon Nutrascience (MB) Corp.	A23J 1/14 (2006.01) A23J 3/16 (2006.01) C07K 1/14 (2006.01)	2651238 *	SOY PROTEIN PRODUCTS OF IMPROVED WATER-BINDING CAPACITY
Tersus Pharmaceuticals, LLC	A61K 31/201 (2006.01) A61K 31/231 (2006.01) A61P 3/06 (2006.01) A61P 9/00 (2006.01) A61P 9/10 (2006.01)	2680837 *	COMPOSITIONS AND METHODS COMPRISING C16:1n7-PALMITOLEATE
Sanofi	A61K 38/18 (2006.01) C07K 14/475 (2006.01)	2655408 *	ROBO1-FC FUSION PROTEIN FOR USE IN THE TREATMENT OF HEPATOCARCINOMA
Alexion Pharma International SARL	A01N 57/00 (2006.01) A61K 31/665 (2006.01)	2675278 *	METHODS FOR SYNTHESIZING MOLYBDOPTERIN PRECURSOR Z DERIVATIVES
The Trustees of The University of Pennsylvania	C12Q 1/68 (2006.01)	2670867 *	A METHOD FOR DETECTING CHROMOSOME STRUCTURE AND GENE EXPRESSION SIMULTANEOUSLY IN SINGLE CELLS
Wilkins, Larry C.	F02B 75/32 (2006.01)	2652288 *	CRANKPIN INCLUDING CAM, CONNECTING ROD INCLUDING FOLLOWER, AND INTERNAL COMBUSTION ENGINE INCLUDING CRANKPIN AND CONNECTING ROD
Kaspersky Lab, ZAO	G06F 21/00 (2006.01)	2447877	System and method for detection of malware and management of malware-related information
Janssen Pharmaceutica, N.V.	C07D 409/10 (2006.01) C07D 409/14 (2006.01)	2697218 *	PROCESS FOR THE PREPARATION OF COMPOUNDS USEFUL AS INHIBITORS OF SGLT2
Spahn, Frank-Peter	A61C 8/00 (2006.01)	2654603 *	CRESTAL IMPLANT AND METHOD FOR PROCESSING SAME

Podnosilac evropske prijave patenta (71)	MKP (51)	Broj objave evropske prijave patenta (97)	Naziv pronalaska (54)
Nuova Gidue S.R.L.	B41F 33/00 (2006.01)	2675623 *	METHOD AND DEVICE FOR THE CONTROL AND MANAGEMENT OF THE PRINTING PARAMETERS OF A PRINTING MACHINE, PARTICULARLY WITH A PLURALITY OF CONSECUTIVE PRINTING PROCESSES
Dallmer GmbH & Co. KG	E03F 5/04 (2006.01)	2551415	Process component
Targacept, Inc.	A61K 31/13 (2006.01) A61P 9/12 (2006.01) C07C 211/35 (2006.01)	2661421 *	NICOTINIC RECEPTOR NON-COMPETITIVE ANTAGONISTS
Janssen R&D Ireland	A61K 31/4188 (2006.01) A61P 11/00 (2006.01) C07D 235/26 (2006.01) C07D 471/04 (2006.01)	2651903 *	BENZIMIDAZOLE RESPIRATORY SYNCYTIAL VIRUS INHIBITORS
ECLISSE SRL	E05D 15/06 (2006.01)	2586945	Carriage
Traslational Cancer Drugs Pharma, S.L.	A61K 9/00 (2006.01) A61K 9/127 (2006.01) A61K 31/4425 (2006.01) A61K 31/4706 (2006.01) A61K 47/48 (2006.01) A61P 31/10 (2006.01) A61P 31/12 (2006.01) A61P 33/00 (2006.01) A61P 35/00 (2006.01)	2654721 *	PHARMACEUTICAL COMPOSITIONS OF PYRIDINIUM AND QUINOLINIUM DERIVATIVES
Gutai, Mátyás	F24D 3/12 (2006.01) F24J 2/04 (2006.01)	2689192 *	A HEAT ENERGY SYSTEM FOR HEATING OR MAINTAINING THERMAL BALANCE IN THE INTERIORS OF BUILDINGS OR BUILDING PARTS
Hip Innovations, LLC	A47G 1/20 (2006.01) A47G 25/06 (2006.01) B25C 1/02 (2006.01) B25C 5/16 (2006.01) F16B 43/02 (2006.01)	2592286	Anchors and anchor systems for hanging objects, and a tool for installing such anchors
Tse, Ronald Henry	G06F 9/44 (2006.01) G06F 9/445 (2006.01) G06F 9/46 (2006.01) G06F 11/30 (2006.01) G06F 17/00 (2006.01) G06F 17/30 (2006.01)	2663931 *	A SYSTEM AND METHOD FOR RUNNING APPLICATIONS ON A PLATFORM
Behr Thermot-tronik GmbH	F16D 27/112 (2006.01) F16D 27/14 (2006.01) F16D 28/00 (2006.01) F16D 43/25 (2006.01)	2518359	Coupling device for a vehicle assembly and control method
Bayerische Motoren Werke Aktiengesellschaft	F16D 27/112 (2006.01) F16D 27/14 (2006.01) F16D 28/00 (2006.01) F16D 43/25 (2006.01)	2518359	Coupling device for a vehicle assembly and control method
Baxter International Inc.	C07K 14/005 (2006.01) C12N 7/00 (2006.01) G01N 33/68 (2006.01)	2699586 *	METHODS FOR ISOLATING AND QUANTIFYING ANTIGEN FROM VACCINES
Baxter Healthcare SA	C07K 14/005 (2006.01) C12N 7/00 (2006.01) G01N 33/68 (2006.01)	2699586 *	METHODS FOR ISOLATING AND QUANTIFYING ANTIGEN FROM VACCINES
Abbvie Inc.	A61K 31/4178 (2006.01) A61P 31/00 (2006.01) C07D 403/10 (2006.01) C07D 403/14 (2006.01) C07D 409/14 (2006.01)	2651926 *	ANTI-VIRAL COMPOUNDS
Genentech, Inc.	A61K 31/517 (2006.01) C07D 239/70 (2006.01)	2694073 *	COMBINATIONS OF AKT AND MEK INHIBITOR COMPOUNDS, AND METHODS OF USE
Sanofi	A61K 31/343 (2006.01) G01N 33/68 (2006.01)	2649453 *	USE OF DRONEDARONE FOR THE PREPARATION OF A DRUG FOR USE IN THE MANAGEMENT OF THE RISK OF LIVER INJURY

Podnosilac evropske prijave patenta (71)	MKP (51)	Broj objave evropske prijave patenta (97)	Naziv pronalaska (54)
Janssen R&D Ireland	A61K 31/505 (2006.01) A61K 31/506 (2006.01) C07D 239/48 (2006.01) C07D 401/12 (2006.01) C07D 403/12 (2006.01) C07D 405/12 (2006.01) C07D 413/12 (2006.01) C07D 471/04 (2006.01)	2694484 *	PYRIMIDINE DERIVATIVES FOR THE TREATMENT OF VIRAL INFECTIONS
Apprise Bio, Inc.	C12Q 1/68 (2006.01)	2670863 *	METHODS OF IDENTIFYING MULTIPLE EPITOPES IN CELLS
BMA Labor Gbr	G01N 1/22 (2006.01) G01N 33/543 (2006.01)	2570810	Method for examination of air for the presence of biological substances by means of removable multi-well strips on which an immunological assay is performed directly
SANOFI	C07K 16/40 (2006.01)	2668212 *	HUMAN ANTIBODIES TO PCSK9 FOR USE IN METHODS OF TREATING PARTICULAR GROUPS OF SUBJECTS
Emergent Product Development Seattle, LLC	C07K 16/00 (2006.01)	2699596 *	PROSTATE-SPECIFIC MEMBRANE ANTIGEN BINDING PROTEINS AND RELATED COMPOSITIONS AND METHODS
Taiho Pharmaceutical Co., Ltd.	A61K 31/437 (2006.01) A61K 31/519 (2006.01) A61K 31/5377 (2006.01) A61P 35/00 (2006.01) A61P 35/02 (2006.01) A61P 43/00 (2006.01) C07D 471/04 (2006.01) C07D 487/04 (2006.01)	2657233 *	3,5-DISUBSTITUTED ALKYNILBENZENE COMPOUND AND SALT THEREOF
Rothamsted Research Limited	A01N 25/22 (2006.01) A01N 43/40 (2006.01) A01N 47/40 (2006.01) A01N 51/00 (2006.01) A01P 7/00 (2006.01)	2683236 *	COMPOSITIONS AND METHODS FOR CONTROLLING PESTICIDE RESISTANT PESTS
Endura S.p.A.	A01N 25/22 (2006.01) A01N 43/40 (2006.01) A01N 47/40 (2006.01) A01N 51/00 (2006.01) A01P 7/00 (2006.01)	2683236 *	COMPOSITIONS AND METHODS FOR CONTROLLING PESTICIDE RESISTANT PESTS
Xention Limited	A61K 31/495 (2006.01) A61P 9/00 (2006.01) C07D 495/04 (2006.01)	2694518 *	THIENO [2, 3 -D]PYRIMIDINE DERIVATIVES AND THEIR USE TO TREAT ARRHYTHMIA
Sigmapharm Laboratories, LLC	A61K 9/20 (2006.01) A61K 31/675 (2006.01) A61K 47/32 (2006.01) A61P 31/12 (2006.01)	2648701 *	HIGHLY STABLE COMPOSITIONS OF ORALLY ACTIVE NUCLEOTIDE ANALOGUES OR ORALLY ACTIVE NUCLEOTIDE ANALOGUE PRODRUGS
Koc Solution Co.,LTD.	C08G 18/52 (2006.01) C08G 18/70 (2006.01) C08L 75/04 (2006.01) G02B 1/04 (2006.01) G02B 3/00 (2006.01)	2660262 *	METHOD FOR MANUFACTURING RESIN FOR URETHANE-BASED OPTICAL MATERIAL, RESIN COMPOSITION FOR SAME, AND OPTICAL MATERIAL MANUFACTURED THEREBY
Les Laboratoires Servier	A61K 31/165 (2006.01) A61P 1/00 (2006.01) A61P 9/00 (2006.01) A61P 25/00 (2006.01) A61P 25/20 (2006.01) A61P 25/22 (2006.01) A61P 25/24 (2006.01) C07C 231/24 (2006.01) C07C 233/18 (2006.01)	2690087 *	NEW CRYSTAL FORM VII OF AGOMELATINE, PREPARATION METHOD AND USE THEREOF AND PHARMACEUTICAL COMPOSITION CONTAINING SAME

Podnosilac evropske prijave patenta (71)	MKP (51)	Broj objave evropske prijave patenta (97)	Naziv pronalaska (54)
Shanghai Institute Of Pharmaceutical Industry	A61K 31/165 (2006.01) A61P 1/00 (2006.01) A61P 9/00 (2006.01) A61P 25/00 (2006.01) A61P 25/20 (2006.01) A61P 25/22 (2006.01) A61P 25/24 (2006.01) C07C 231/24 (2006.01) C07C 233/18 (2006.01)	2690087 *	NEW CRYSTAL FORM VII OF AGOMELATINE, PREPARATION METHOD AND USE THEREOF AND PHARMACEUTICAL COMPOSITION CONTAINING SAME
Planet Patent S.A.	E03F 5/042 (2006.01)	2685016	Shut-off device and drain with such a device
Vanderbilt University	A01N 43/42 (2006.01)	2685825 *	SUBSTITUTED IMADAZOPYRIMIDIN-5(6H)-ONES AS ALLOSTERIC MODULATORS OF MGLUR5 RECEPTORS
Quantibact A/S	C07H 19/06 (2006.01) C12N 15/11 (2006.01) C12Q 1/68 (2006.01)	2691524 *	STACKING NUCLEIC ACID AND METHODS FOR USE THEREOF
Henning GmbH & Co. KG	E04G 5/04 (2006.01) F16B 13/00 (2006.01)	2525107	Scaffolding anchoring device
Genzyme Corporation	A61K 38/47 (2006.01) C12N 9/24 (2006.01)	2699676 *	MODIFIED ACID ALPHA GLUCOSIDASE WITH ACCELERATED PROCESSING
Neotope Biosciences Limited	A61K 39/00 (2006.01) A61K 39/395 (2006.01) A61K 51/10 (2006.01) A61P 11/00 (2006.01) A61P 19/02 (2006.01) A61P 25/28 (2006.01) A61P 27/02 (2006.01) C07K 16/18 (2006.01) C07K 16/46 (2006.01) C12P 21/02 (2006.01)	2694109 *	COMPOSITIONS AND METHODS FOR TREATING DISEASES OF PROTEIN AGGREGATION INVOLVING IC3B DEPOSITION
The University Of North Carolina At Chapel Hill	C08B 37/10 (2006.01) C12N 9/00 (2006.01) C12P 19/04 (2006.01) C12P 19/18 (2006.01)	2655421 *	CHEMOENZYMATIC SYNTHESIS OF STRUCTURALLY HOMOGENEOUS ULTRA-LOW MOLECULAR WEIGHT HEPARINS
UCB Pharma, S.A.	A61K 31/433 (2006.01) A61P 25/08 (2006.01) C07D 513/04 (2006.01)	2699581 *	2-OXO-1-IMIDAZOLIDINYL IMIDAZOTHIADIAZOLE DERIVATIVES
Genzyme Corporation	A61K 9/00 (2006.01) A61K 38/00 (2006.01)	2683360 *	PEGYLATED APELIN AND USES THEREOF
Omya International AG	C09C 1/02 (2006.01) D21H 17/00 (2006.01)	2662417	Starch-based PHCH
Bayer Pharma Aktiengesellschaft	A61K 31/517 (2006.01) A61P 35/00 (2006.01) G01N 33/48 (2006.01)	2694069 *	USE OF SUBSTITUTED 2,3-DIHYDROIMIDAZO[1,2-C]QUINAZOLINES
Kabushiki Kaisha Toyota Jidoshokki	B60H 1/00 (2006.01) B60H 1/32 (2006.01) F04B 39/12 (2006.01)	2679420	Motor-driven compressor
Mischenko, Valentyn Nikolayevich	C04B 41/61 (2006.01) C04B 111/27 (2006.01)	2660224 *	WATERPROOFING COMPOSITION
Lykhoded, Yuriy Anatolevich	C04B 41/61 (2006.01) C04B 111/27 (2006.01)	2660224 *	WATERPROOFING COMPOSITION
Melnik, Stefaniya Stefanovna	C04B 41/61 (2006.01) C04B 111/27 (2006.01)	2660224 *	WATERPROOFING COMPOSITION
Shimanskiy, Arkadiy Petrovich	C04B 41/61 (2006.01) C04B 111/27 (2006.01)	2660224 *	WATERPROOFING COMPOSITION

Podnosilac evropske prijave patenta (71)	MKP (51)	Broj objave evropske prijave patenta (97)	Naziv pronalaska (54)
Bionor Immuno AS	A61K 39/12 (2006.01) C07K 14/005 (2006.01) C07K 14/025 (2006.01) C07K 14/045 (2006.01) C07K 14/075 (2006.01) C07K 14/085 (2006.01) C07K 14/11 (2006.01) C07K 14/16 (2006.01) C07K 14/18 (2006.01)	2646459 *	PEPTIDE SCAFFOLD DESIGN
Astellas Pharma Inc.	C07D 205/04 (2006.01) A61K 31/5377 (2006.01) A61P 9/10 (2006.01) A61K 31/495 (2006.01) A61P 1/16 (2006.01) A61K 31/506 (2006.01) A61P 9/00 (2006.01) A61K 31/426 (2006.01) A61K 31/551 (2006.01) A61P 9/12 (2006.01) A61K 31/4545 (2006.01) A61P 1/04 (2006.01) A61K 31/505 (2006.01) A61P 3/10 (2006.01) A61K 31/4402 (2006.01) A61P 1/02 (2006.01) A61P 11/00 (2006.01) A61K 31/496 (2006.01) A61P 3/04 (2006.01)	2695881 *	GUANIDINE COMPOUND
The General Hospital Corporation	C12N 5/075 (2010.01)	2697365 *	COMPOSITIONS AND METHODS FOR AUTOLOGOUS GERMLINE MITOCHONDRIAL ENERGY TRANSFER
ThromboGenics N.V.	A61K 38/48 (2006.01) C12N 9/68 (2006.01)	2661493 *	PLASMINOGEN AND PLASMIN VARIANTS
Brandale SAGL	A61G 5/04 (2013.01)	2606867	Powered wheelchair
Synta Pharmaceuticals Corp.	A61K 31/4196 (2006.01) A61K 31/661 (2006.01) A61K 45/06 (2006.01) A61P 35/00 (2006.01)	2678014 *	PROSTATE CANCER THERAPY WITH HSP90 INHIBITORY COMPOUNDS
PPG Industries Ohio, Inc.	C03C 25/24 (2006.01) C03C 25/26 (2006.01) C03C 25/40 (2006.01) C08J 5/08 (2006.01)	2691345 *	FIBER GLASS STRANDS AND REINFORCED PRODUCTS COMPRISING THE SAME
Hisamitsu Pharmaceutical Co., Inc.	A61F 13/02 (2006.01) A61K 9/70 (2006.01)	2700387 *	ADHESIVE TAPE PACKAGING BAG
Epizyme, Inc.	A61K 31/4427 (2006.01) A61P 35/00 (2006.01) C07D 213/64 (2006.01) C07D 401/12 (2006.01) C07D 401/14 (2006.01) C07D 407/12 (2006.01) C07D 409/12 (2006.01) C07D 413/12 (2006.01) C07D 413/14 (2006.01) C07D 491/10 (2006.01) C07D 491/113 (2006.01)	2697198 *	SUBSTITUTED BENZENE COMPOUNDS
Selenium Medical	A61B 17/86 (2006.01) A61B 19/02 (2006.01) A61C 8/00 (2006.01) A61F 2/00 (2006.01) A61L 2/26 (2006.01)	2699187 *	MEDICAL ASSEMBLY COMPRISING A MEDICAL ARTICLE AND A PACKAGE CONTAINING SAID ARTICLE
STICHTING MAASTRICHT RADIATION ONCOLOGY "MAASTRO CLINIC"	A61K 31/4164 (2006.01) C07D 233/88 (2006.01) C07D 233/91 (2006.01)	2655336 *	CANCER TARGETING USING CARBONIC ANHYDRASE ISOFORM IX INHIBITORS

Podnosilac evropske prijave patenta (71)	MKP (51)	Broj objave evropske prijave patenta (97)	Naziv pronalaska (54)
CNRS Centre National de la Recherche Scientifique	A61K 31/4164 (2006.01) C07D 233/88 (2006.01) C07D 233/91 (2006.01)	2655336 *	CANCER TARGETING USING CARBONIC ANHYDRASE ISOFORM IX INHIBITORS
Supuran, Claudiu	A61K 31/4164 (2006.01) C07D 233/88 (2006.01) C07D 233/91 (2006.01)	2655336 *	CANCER TARGETING USING CARBONIC ANHYDRASE ISOFORM IX INHIBITORS
Novartis AG	A61K 31/5377 (2006.01) A61P 25/00 (2006.01) C07D 413/14 (2006.01) C07D 487/04 (2006.01)	2663561 *	NOVEL HETEROCYCLIC DERIVATIVES AND THEIR USE IN THE TREATMENT OF NEUROLOGICAL DISORDERS
Takeda Pharmaceutical Company Limited	A61K 9/20 (2006.01) A61K 31/4188 (2006.01)	2694039 *	SOLID PREPARATION
Justbio Inc.	A61K 36/00 (2006.01) A61K 36/28 (2006.01) A61K 36/45 (2006.01) A61K 36/53 (2006.01) A61K 36/539 (2006.01) A61K 36/73 (2006.01) A61K 36/734 (2006.01) A61K 36/77 (2006.01) A61P 3/02 (2006.01) A61P 29/00 (2006.01) A61P 39/06 (2006.01) C12Q 1/02 (2006.01) G01N 33/48 (2006.01)	2670415 *	FUNCTIONAL FOODS AND BEVERAGES WITH SYNERGISTIC PROPERTIES TO PROMOTE HOMEOSTASIS
ICR Turbine Engine Corporation	F02C 7/08 (2006.01)	2673490 *	RADIATION SHIELD FOR A GAS TURBINE COMBUSTOR
Messer GasPack GmbH	F17C 13/08 (2006.01)	2686602 *	ARRANGEMENT FOR STORING AND EXTRACTING COMPRESSED GAS
Wystrach GmbH	F17C 13/08 (2006.01)	2686602 *	ARRANGEMENT FOR STORING AND EXTRACTING COMPRESSED GAS
Matsur, Igor Yurievich	G08G 1/08 (2006.01)	2682927 *	VEHICLE TRAFFIC CONTROL METHOD AND DEVICE FOR IMPLEMENTING SAME
Owens-Brockway Glass Container Inc.	B07C 5/12 (2006.01) G01N 21/90 (2006.01)	2691762 *	OPTICAL INSPECTION OF CONTAINERS
Arcelormittal Investigación y Desarrollo SL	H04N 7/18 (2006.01)	2681910 *	METHOD AND APPARATUS FOR REAL TIME VIDEO IMAGING OF THE SNOUT INTERIOR ON A HOT DIP COATING LINE
Connors Industrial, Inc	H04N 7/18 (2006.01)	2681910 *	METHOD AND APPARATUS FOR REAL TIME VIDEO IMAGING OF THE SNOUT INTERIOR ON A HOT DIP COATING LINE
Eisai R&D Management Co., Ltd.	C07D 307/22 (2006.01) C07D 498/04 (2006.01) C07D 513/04 (2006.01)	2665716 *	METHODS AND COMPOUNDS USEFUL IN THE SYNTHESIS OF FUSED AMINODIHYDROTHIAZINE DERIVATIVES
Nilfisk-Advance A/S	H02J 7/00 (2006.01)	2575235	Battery control system
University of Georgia Research Foundation, Inc.	C12N 5/02 (2006.01) C12N 5/0735 (2010.01) C12N 5/079 (2010.01)	2658966 *	DIFFERENTIATION OF HUMAN PLURIPOTENT STEM CELLS TO MULTIPOTENT NEURAL CREST CELLS
Planet Patent S.A.	E03F 5/042 (2006.01)	2685017	Bi-directional shut-off valve system, manhole assembly comprising such valve system and use of such valve system in a sewer network
Nestec S.A.	G01N 33/574 (2006.01)	2694972 *	METHODS FOR PREDICTING AND IMPROVING THE SURVIVAL OF GASTRIC CANCER PATIENTS
Celgene Avilomics Research, Inc.	A01N 43/40 (2006.01) A61K 31/435 (2006.01) C07D 213/56 (2006.01) C07D 273/00 (2006.01)	2683243 *	PI3 KINASE INHIBITORS AND USES THEREOF
Regeneron Pharmaceuticals, Inc.	A01K 67/027 (2006.01) C07K 14/54 (2006.01) C07K 14/715 (2006.01)	2663575 *	HUMANIZED IL-6 AND IL-6 RECEPTOR

Podnosilac evropske prijave patenta (71)	MKP (51)	Broj objave evropske prijave patenta (97)	Naziv pronalaska (54)
Abbvie Inc.	A61K 31/4184 (2006.01) A61P 31/14 (2006.01) C07D 403/04 (2006.01) C07D 403/10 (2006.01) C07D 403/12 (2006.01) C07D 403/14 (2006.01)	2651923 *	ANTI-VIRAL COMPOUNDS
Amgen Inc.	C07D 407/14 (2006.01) C07D 513/04 (2006.01) C07D 409/12 (2006.01) A61K 31/381 (2006.01) C07D 407/12 (2006.01) C07D 495/04 (2006.01) C07D 413/12 (2006.01) C07D 409/14 (2006.01) A61K 31/422 (2006.01) C07D 333/58 (2006.01) C07D 417/14 (2006.01) C07D 321/10 (2006.01) C07D 417/12 (2006.01) C07D 409/04 (2006.01) A61K 31/357 (2006.01)	2694491 *	BENZODIOXEPINE AND BENZODIOXINE COMPOUNDS THAT INTERACT WITH GLUCOKINASE REGULATORY PROTEIN FOR THE TREATMENT OF DIABETES
Ciotti, Giancarlo	A61G 5/10 (2006.01) A61G 7/10 (2006.01)	2648671 *	A CHAIR FOR DISABLED OR NON SELF-SUFFICIENT PEOPLE PROVIDED WITH AUTOMATIZED LIFTING OF THE SEAT.
ICTK Co., Ltd.	G06K 19/073 (2006.01)	2693370 *	APPARATUS AND METHOD FOR GENERATING A DIGITAL VALUE
Corcel IP Limited	B65G 47/31 (2006.01)	2670690 *	IMPROVEMENTS IN AND RELATING TO LAMINATED BOARD
Klox Technologies Inc.	A61C 19/06 (2006.01) A61K 8/22 (2006.01) A61K 8/24 (2006.01) A61Q 11/00 (2006.01)	2688513 *	DEVICE AND METHOD FOR TEETH BRIGHTENING
Assa Abloy Ab	G08B 29/20 (2006.01)	2686839 *	METHOD FOR UPGRADING RFID READERS IN SITU
The Trustees Of The University Of Pennsylvania	A61K 39/00 (2006.01) C07H 21/04 (2006.01)	2649086 *	USE OF CHIMERIC ANTIGEN RECEPTOR-MODIFIED T CELLS TO TREAT CANCER
Ishihara Sangyo Kaisha, Ltd.	A01N 43/54 (2006.01) A01N 43/56 (2006.01) A01N 43/58 (2006.01) A01N 43/653 (2006.01) A01N 43/76 (2006.01) A01N 43/82 (2006.01) A01N 43/84 (2006.01) A01N 43/90 (2006.01) A01N 47/36 (2006.01) A01P 13/00 (2006.01)	2696694 *	HERBICIDAL COMPOSITION COMPRISING FLAZASULFURON AND AN INHIBITOR OF PROTOPORPHYRINOGEN OXIDASE
GlaxoSmithKline Intellectual Property Development Limited	A01N 43/16 (2006.01) A61K 31/35 (2006.01)	2672821 *	CATHEPSIN C INHIBITORS
Kostic, Marko	A01C 15/02 (2006.01) A01C 23/02 (2006.01) A01G 7/06 (2006.01) A01G 29/00 (2006.01)	2658360 *	A TUBE SHAPED DEVICE FILLED WITH A LIQUID MEANS FOR THE PLANTS NUTRITION AND / OR PROTECTION, A PROCESS OF THIS DEVICE CONSTRUCTION AND ITS USAGE
Galpharma Co., Ltd.	A61K 35/12 (2006.01) A61K 49/00 (2006.01) A61P 29/00 (2006.01) A61P 31/00 (2006.01) A61P 35/00 (2006.01) A61P 37/06 (2006.01) A61P 37/08 (2006.01) A61P 43/00 (2006.01) C12N 5/0783 (2010.01) C12Q 1/02 (2006.01)	2650361 *	GALECTIN 9-SECRETING CELL, PRODUCTION METHOD FOR SAME, AND APPLICATION FOR SAME

Podnosilac evropske prijave patenta (71)	MKP (51)	Broj objave evropske prijave patenta (97)	Naziv pronalaska (54)
Crystal Lagoons (Curaçao) B.V.	E01H 1/08 (2006.01)	2691576 *	METHOD AND SYSTEM FOR THE SUSTAINABLE COOLING OF INDUSTRIAL PROCESSES
Sanofi-Aventis Deutschland GmbH	A61M 5/19 (2006.01)	2675500 *	DISPENSE INTERFACE FOR USE WITH A DRUG DELIVERY DEVICE FOR DELIVERY OF TWO OR MORE DRUG AGENTS
Owens-Brockway Glass Container INC.	C03C 1/00 (2006.01) C03C 17/00 (2006.01)	2678282 *	HYBRID SOL-GEL COATED GLASS CONTAINERS
basycs GmbH Technische Unternehmens- und Managementberatung	G06F 3/023 (2006.01) G06F 3/048 (2013.01)	2624115	Method and electronic system for user interface independent execution of functions
R.P. Scherer Technologies, LLC	F16B 19/05 (2006.01)	2697520 *	CAPSULES COMPRISING AN EMULSIFIED SYRUP AND METHODS OF MAKING THE SAME
Qualcomm Incorporated	G06K 9/00 (2006.01) G06K 9/32 (2006.01) G06K 9/46 (2006.01) G06K 9/62 (2006.01) G06Q 30/00 (2012.01) G06T 7/20 (2006.01) G06T 19/00 (2011.01)	2681718 *	DYNAMIC TEMPLATE TRACKING
Theravance, Inc.	C07D 471/04 (2006.01) A61K 31/405 (2006.01) C07D 261/12 (2006.01) A61K 31/42 (2006.01) C07D 249/10 (2006.01) A61K 31/4192 (2006.01) C07C 233/47 (2006.01) A61P 13/00 (2006.01) C07C 233/46 (2006.01) A61P 9/00 (2006.01) C07D 249/18 (2006.01) A61K 31/4196 (2006.01) C07D 249/04 (2006.01) A61K 31/4164 (2006.01) A61K 31/415 (2006.01)	2675795 *	SUBSTITUTED AMINO BUTYRIC DERIVATIVES AS NEPRILYSIN INHIBITORS
Schweisstechnik Düsseldorf GmbH & Co. KG	B24B 19/20 (2006.01) B24B 27/00 (2006.01) B24B 27/04 (2006.01)	2578358	Grinding machine and method for processing the interiors of moulds
Sanofi-Aventis Deutschland GmbH	A61M 5/24 (2006.01) A61M 5/315 (2006.01)	2688611 *	DOSE SETTING MECHANISM AND INJECTION DEVICE
Capitani S.r.l.	B65D 85/804 (2006.01)	2573008	Capsule for making an infused drink
Cephalon, Inc.	A61K 31/4196 (2006.01) A61K 31/437 (2006.01) A61K 31/495 (2006.01) A61K 31/496 (2006.01) A61P 17/00 (2006.01)	2648728 *	JANUS KINASE 2 (JAK2) INHIBITOR FOR THE TREATMENT OF LUPUS
Zozulya, Vladimir Leonidovich	C10M 125/10 (2006.01) C10M 125/26 (2006.01) C10M 177/00 (2006.01)	2657325 *	LUBRICATING COMPOSITION AND METHOD FOR THE PREPARATION THEREOF
Zozulya, Sergey Leonidovich	C10M 125/10 (2006.01) C10M 125/26 (2006.01) C10M 177/00 (2006.01)	2657325 *	LUBRICATING COMPOSITION AND METHOD FOR THE PREPARATION THEREOF
Alexandrov, Sergey Nikolaevich	C10M 125/10 (2006.01) C10M 125/26 (2006.01) C10M 177/00 (2006.01)	2657325 *	LUBRICATING COMPOSITION AND METHOD FOR THE PREPARATION THEREOF
Takeda Pharmaceutical Company Limited	C07C 25/02 (2006.01) C07C 43/205 (2006.01) C07D 307/80 (2006.01) C07F 15/00 (2006.01)	2675774 *	PRODUCTION METHOD OF OPTICALLY ACTIVE DIHYDROBENZOFURAN DERIVATIVE
Container Centralen A/S	B62B 3/00 (2006.01) B62B 5/00 (2006.01)	2340978	A system for the mounting of shelves and the reduction of noise
Basilea Pharmaceutica AG	A61K 31/00 (2006.01) G01N 33/50 (2006.01)	2666015 *	USE OF STATHMIN AS A BIOMARKER OF DRUG RESPONSE TO FURAZANOBENZIMIDAZOLES

Podnosilac evropske prijave patenta (71)	MKP (51)	Broj objave evropske prijave patenta (97)	Naziv pronalaska (54)
Merz Pharma GmbH & Co. KGaA	A61K 31/13 (2006.01) A61P 27/16 (2006.01)	2665474 *	NERAMEXANE FOR THE TREATMENT OR PREVENTION OF TINNITUS RELATED WITH STRESS OR ACUTE HEARING LOSS
Kyocera Corporation	B23B 27/04 (2006.01) B23B 27/14 (2006.01) B23B 27/22 (2006.01)	2682208 *	CUTTING INSERT, CUTTING TOOL, AND METHOD FOR MANUFACTURING CUT PRODUCT USING CUTTING INSERT AND CUTTING TOOL
ManukaMed Limited	A61K 38/38 (2006.01) A61P 29/00 (2006.01) C07K 14/76 (2006.01) G01N 33/533 (2006.01) G01N 33/68 (2006.01)	2655410 *	ANTI-INFLAMMATORY PROTEINS AND METHODS OF PREPARATION AND USE THEREOF
Meso Scale Technologies, LLC	C12M 1/34 (2006.01) C12M 1/38 (2006.01) C12Q 1/68 (2006.01)	2661485 *	ASSAY CARTRIDGES AND METHODS OF USING THE SAME
Higgins, Stephen	C12M 1/34 (2006.01) C12M 1/38 (2006.01) C12Q 1/68 (2006.01)	2661485 *	ASSAY CARTRIDGES AND METHODS OF USING THE SAME
Kovacs, Sandor	C12M 1/34 (2006.01) C12M 1/38 (2006.01) C12Q 1/68 (2006.01)	2661485 *	ASSAY CARTRIDGES AND METHODS OF USING THE SAME
Kumar, Sudeep	C12M 1/34 (2006.01) C12M 1/38 (2006.01) C12Q 1/68 (2006.01)	2661485 *	ASSAY CARTRIDGES AND METHODS OF USING THE SAME
Page, Kenneth	C12M 1/34 (2006.01) C12M 1/38 (2006.01) C12Q 1/68 (2006.01)	2661485 *	ASSAY CARTRIDGES AND METHODS OF USING THE SAME
Roth, Kristian	C12M 1/34 (2006.01) C12M 1/38 (2006.01) C12Q 1/68 (2006.01)	2661485 *	ASSAY CARTRIDGES AND METHODS OF USING THE SAME
Sigal, George	C12M 1/34 (2006.01) C12M 1/38 (2006.01) C12Q 1/68 (2006.01)	2661485 *	ASSAY CARTRIDGES AND METHODS OF USING THE SAME
Janssen Pharmaceutica, N.V.	A61K 31/404 (2006.01) A61K 31/437 (2006.01) A61P 3/00 (2006.01) A61P 11/00 (2006.01) C07D 401/12 (2006.01) C07D 471/04 (2006.01)	2646429 *	4-SUBSTITUTED-CYCLOHEXYLAMINO-4-PIPERIDINYL-ACETAMIDE ANTAGONISTS OF CCR2
Algaecytes Limited	C05D 9/00 (2006.01) C12M 1/04 (2006.01) C12N 1/12 (2006.01) C12N 1/36 (2006.01) C12N 13/00 (2006.01) C12P 7/64 (2006.01) C12P 19/04 (2006.01) C12R 1/89 (2006.01)	2668259 *	PROCESS FOR PRODUCTION OF MICROALGAE, CYANOBACTERIA AND METABOLITES THEREOF
GearTeam ApS	A62C 31/24 (2006.01) A62C 37/36 (2006.01) A62C 99/00 (2010.01)	2612694	An automatic fire extinguishing apparatus and a method for operating the same
V.I.T S.A Processing Equipment	A01D 45/16 (2006.01)	2687082	Machine for cutting off tobacco leaves with stem holding for eastern type plants for harvesting, layering and collecting the leaves in collection containers
SciPharm SàRL	A61K 31/5585 (2006.01) A61K 35/28 (2006.01) C12N 5/078 (2010.01)	2663313 *	METHOD FOR ENHANCING ENGRAFTMENT OF HAEMATOPOETIC STEM CELLS
Qualcomm Incorporated	H04L 29/08 (2006.01) H04L 29/12 (2006.01)	2684338 *	SYSTEM AND METHOD USING A CLIENT-LOCAL PROXY-SERVER TO ACCESS A DEVICE HAVING AN ASSIGNED NETWORK ADDRESS

Podnosilac evropske prijave patenta (71)	MKP (51)	Broj objave evropske prijave patenta (97)	Naziv pronalaska (54)
Evolva SA	A61K 31/4375 (2006.01) A61K 31/444 (2006.01) A61K 31/4545 (2006.01) A61K 31/4709 (2006.01) A61K 31/496 (2006.01) A61K 31/506 (2006.01) A61K 38/12 (2006.01) A61P 31/04 (2006.01) C07D 455/02 (2006.01)	2670410 *	ANTIMICROBIAL 4-OXOQUINOLIZINES
Saint-Gobain Glass France	C03C 17/34 (2006.01)	2646385 *	ANTICORROSIVE AND ANTIFOULING GLASS SUBSTRATE FOR USE IN A WET ATMOSPHERE
Laboratoires Labema	C09D 5/08 (2006.01) C09D 191/00 (2006.01) C11B 3/06 (2006.01) C11D 1/04 (2006.01) C11D 13/00 (2006.01) C11D 17/08 (2006.01) C23F 11/12 (2006.01)	2697346 *	PROCESS FOR THE PROTECTIVE TREATMENT OF METALS BASED ON A WATER-SOLUBLE COMPOSITION OF SAPONIFIED PLANT OIL(S), AND PRODUCTS AND COMPOSITIONS OBTAINED
Université de Lorraine	C09D 5/08 (2006.01) C09D 191/00 (2006.01) C11B 3/06 (2006.01) C11D 1/04 (2006.01) C11D 13/00 (2006.01) C11D 17/08 (2006.01) C23F 11/12 (2006.01)	2697346 *	PROCESS FOR THE PROTECTIVE TREATMENT OF METALS BASED ON A WATER-SOLUBLE COMPOSITION OF SAPONIFIED PLANT OIL(S), AND PRODUCTS AND COMPOSITIONS OBTAINED
Airborne International B.V.	B29C 35/00 (2006.01) B29C 53/56 (2006.01) B29C 53/64 (2006.01) B29C 70/32 (2006.01) B29D 23/00 (2006.01) F16L 9/16 (2006.01)	2681040 *	METHOD FOR MANUFACTURING CONTINUOUS COMPOSITE TUBE, APPARATUS FOR MANUFACTURING CONTINUOUS COMPOSITE TUBE
Gilead Sciences, Inc.	C07D 215/14 (2006.01) C07D 401/04 (2006.01) C07D 405/04 (2006.01) C07D 409/04 (2006.01) C07D 417/04 (2006.01) C07D 491/06 (2006.01)	2694479 *	PROCESS FOR THE PREPARATION OF AN HIV INTEGRASE INHIBITOR
Ultragenyx Pharmaceutical Inc.	A61K 9/00 (2006.01) A61K 9/20 (2006.01) A61K 9/22 (2006.01) A61K 31/7012 (2006.01) A61K 47/38 (2006.01) A61P 21/00 (2006.01)	2593109 *	METHOD AND FORMULATIONS FOR TREATING SIALIC ACID DEFICIENCIES
Biontech AG	C12N 5/16 (2006.01) C12N 15/67 (2006.01)	2646557 *	METHOD FOR CELLULAR RNA EXPRESSION
Translationale Onkologie an der Universitätsmedizin der JGU Mainz gGmbH (TRON)	C12N 5/16 (2006.01) C12N 15/67 (2006.01)	2646557 *	METHOD FOR CELLULAR RNA EXPRESSION
Universitätsmedizin der Johannes Gutenberg-Universität Mainz	C12N 5/16 (2006.01) C12N 15/67 (2006.01)	2646557 *	METHOD FOR CELLULAR RNA EXPRESSION
Ecole Polytechnique	H01S 3/04 (2006.01) H01S 3/042 (2006.01) H01S 3/06 (2006.01) H01S 3/08 (2006.01) H01S 5/024 (2006.01)	2700131 *	DEVICE FOR MANAGING HEAT IN AN OPTICAL ELEMENT, AND RELATED HEAT-MANAGEMENT METHOD
Lee, James Weifu	C12N 1/21 (2006.01) C12N 5/10 (2006.01) C12N 9/00 (2006.01) C12N 15/52 (2006.01) C12N 15/63 (2006.01) C12P 7/16 (2006.01)	2655599 *	DESIGNER CALVIN-CYCLE-CHANNELED AND HYDROGENOTROPHIC PRODUCTION OF BUTANOL AND RELATED HIGHER ALCOHOLS

Podnosilac evropske prijave patenta (71)	MKP (51)	Broj objave evropske prijave patenta (97)	Naziv pronalaska (54)
Idera Pharmaceuticals, Inc.	A61K 31/7088 (2006.01) A61P 35/00 (2006.01) C12N 15/113 (2010.01)	2689013 *	COMPOSITIONS FOR INHIBITING GENE EXPRESSION AND USES THEREOF
Chongqing Fagen Biomedical Inc.	A61K 38/28 (2006.01) A61P 3/10 (2006.01) C07K 1/107 (2006.01) C07K 14/62 (2006.01) C07K 17/08 (2006.01)	2687542 *	HUMAN INSULIN AND ANALOG CONJUGATE THEREOF
Isis Pharmaceuticals, Inc.	C07H 21/02 (2006.01)	2699583 *	MODULATION OF HEPATITIS B VIRUS (HBV) EXPRESSION
Teva Pharmaceutical Industries Ltd.	A61K 31/47 (2006.01)	2648732 *	USE OF LAQUINIMOD FOR REDUCING FATIGUE, IMPROVING FUNCTIONAL STATUS, AND IMPROVING QUALITY OF LIFE IN MULTIPLE SCLEROSIS PATIENTS
Active-Base Ltd.	G06F 15/16 (2006.01) G06F 17/30 (2006.01) H04L 9/32 (2006.01)	2689353 *	SYSTEM AND METHOD FOR DATA MASKING
Genmab A/S	A61K 39/395 (2006.01) A61P 35/00 (2006.01) C07K 16/10 (2006.01) C07K 16/28 (2006.01) C07K 16/32 (2006.01) C07K 16/46 (2006.01)	2699260 *	BISPECIFIC ANTIBODIES AGAINST HER2
G-Nius Ltd.	B64D 10/00 (2006.01)	2640637 *	ACCELERATION PROTECTION SUIT
Topera, Inc.	A61B 5/042 (2006.01)	2699152 *	BASKET STYLE CARDIAC MAPPING CATHETER HAVING AN ATRAUMATIC BASKET TIP FOR DETECTION OF CARDIAC RHYTHM DISORDERS
Krüger GmbH & Co. KG	A21D 8/00 (2006.01) A23C 9/152 (2006.01) A23C 9/154 (2006.01) A23F 3/16 (2006.01) A23F 3/40 (2006.01) A23F 5/24 (2006.01) A23F 5/40 (2006.01) A23G 1/40 (2006.01) A23G 3/42 (2006.01) A23G 9/34 (2006.01) A23L 1/00 (2006.01) A23L 1/06 (2006.01) A23L 1/068 (2006.01) A23L 1/09 (2006.01) A23L 1/236 (2006.01) A23L 1/30 (2006.01) A23L 2/39 (2006.01) A23L 2/60 (2006.01)	2692243	Composition for delayed resorption
Reutter GmbH	B60K 15/04 (2006.01)	2646270 *	INSERT FOR A FILLER NECK OF A UREA CONTAINER
Glaxo Group Limited	A61K 31/47 (2006.01) A61P 37/00 (2006.01) C07D 401/12 (2006.01) C07D 403/12 (2006.01)	2683709 *	PYRIDINYL- AND PYRAZINYL -METHYLOXY - ARYL DERIVATIVES USEFUL AS INHIBITORS OF SPLEEN TYROSINE KINASE (SYK)
Laboratorios del. Dr. Esteve, S.A.	A61K 31/4152 (2006.01) A61K 31/4155 (2006.01) A61K 31/4523 (2006.01) A61K 31/4725 (2006.01) A61K 31/496 (2006.01) A61K 31/5377 (2006.01) A61P 29/00 (2006.01)	2646025 *	USE OF SIGMA LIGANDS IN BONE CANCER PAIN
AbbVie Inc.	C07K 16/24 (2006.01)	2655417 *	IL-1 -ALPHA AND -BETA BISPECIFIC DUAL VARIABLE DOMAIN IMMUNOGLOBULINS AND THEIR USE
University Of Rochester	A01N 43/54 (2006.01) A61K 31/535 (2006.01) C07D 277/00 (2006.01)	2667873 *	SMALL MOLECULE RNASE INHIBITORS AND METHODS OF USE

Podnosilac evropske prijave patenta (71)	MKP (51)	Broj objave evropske prijave patenta (97)	Naziv pronalaska (54)
Board of Regents of the University of Nebraska	A01N 43/54 (2006.01) A61K 31/535 (2006.01) C07D 277/00 (2006.01)	2667873 *	SMALL MOLECULE RNASE INHIBITORS AND METHODS OF USE
Temple University - Of The Commonwealth System of Higher Education	A01N 43/54 (2006.01) A61K 31/535 (2006.01) C07D 277/00 (2006.01)	2667873 *	SMALL MOLECULE RNASE INHIBITORS AND METHODS OF USE
Quick-Mix Gruppe GmbH & Co. KG	C04B 28/10 (2006.01) C04B 28/18 (2006.01) C04B 40/06 (2006.01) C04B 103/10 (2006.01) C04B 111/10 (2006.01)	2404885	New construction material mixtures
Novartis AG	A61K 31/506 (2006.01) A61P 35/00 (2006.01) C07D 401/12 (2006.01)	2651918 *	CRYSTALLINE FORMS OF 5-CHLORO-N2-(2-ISOPROPOXY-5-METHYL-4-PIPERIDIN-4-YL-PHENYL)-N4[2-(PROPANE-2-SULFONYL)-PHENYL]-PYRIMIDINE-2,4-DIAMINE
Takeda Pharmaceutical Company Limited	A61K 9/00 (2006.01) A61K 9/14 (2006.01) A61K 9/16 (2006.01) A61K 9/20 (2006.01) A61K 31/343 (2006.01) A61P 25/18 (2006.01)	2665465 *	ORALLY DISPERSIBLE TABLET
Bayer CropScience NV	C12N 15/82 (2006.01)	2661498 *	FIBER SELECTIVE PROMOTERS
Commonwealth Scientific and Industrial Research Organisation	C12N 15/82 (2006.01)	2661498 *	FIBER SELECTIVE PROMOTERS
Shah, Deepak Pranjivandas	A01N 59/02 (2006.01) A01N 59/16 (2006.01) A01P 7/04 (2006.01)	2683247 *	AN AGROCHEMICAL COMPOSITION COMPRISING ZINC, SULFUR AND A PESTICIDAL ACTIVE INGREDIENT
Tekon D.O.O.	B29C 70/38 (2006.01) B29C 70/54 (2006.01)	2675612 *	MECHANISM FOR AUTOMATICALLY CUTTING AND PLACEMENT OF RESIN IMPREGNATED FIBERS
Bristol-Myers Squibb Company	A61K 39/395 (2006.01) C07K 16/28 (2006.01)	2699601 *	ANTIBODY POLYPEPTIDES THAT ANTAGONIZE CD40
Domantis Limited	A61K 39/395 (2006.01) C07K 16/28 (2006.01)	2699601 *	ANTIBODY POLYPEPTIDES THAT ANTAGONIZE CD40
Biomimetics Health Industries Limited	A01N 25/34 (2006.01) A01N 59/08 (2006.01) A61K 33/00 (2006.01)	2683240 *	A STABLE COMPOSITION OF HOCl, PROCESSES FOR ITS PRODUCTION AND USES THEREOF
Alkermes Pharma Ireland Limited	C07C 69/96 (2006.01)	2655314 *	MULTI-API LOADING PRODRUGS
Egis Gyógyszergyár Nyilvánosan Működő Részvény-Társaság	C07D 239/42 (2006.01)	2646419 *	METHOD FOR PREPARING ROSUVASTATIN SALTS
Fope S.r.l.	A44C 5/08 (2006.01)	2651257 *	ELASTIC CHAIN AND ORNAMENTAL ITEM MADE WITH SAID ELASTIC CHAIN
Cazzola, Umberto	A44C 5/08 (2006.01)	2651257 *	ELASTIC CHAIN AND ORNAMENTAL ITEM MADE WITH SAID ELASTIC CHAIN
CISA S.p.A.	E05B 15/02 (2006.01)	2694763 *	ADJUSTABLE STRIKE PLATE FOR LOCKS
Pfizer Inc	A61K 31/53 (2006.01) A61P 25/18 (2006.01) C07D 487/04 (2006.01)	2681218 *	IMIDAZO[5,1-f][1,2,4]TRIAZINES FOR THE TREATMENT OF NEUROLOGICAL DISORDERS
Fedex Corporate Services, Inc.	H04L 29/08 (2006.01)	2678996 *	SYSTEMS AND METHODS FOR GEO-STAGING OF SENSOR DATA THROUGH DISTRIBUTED GLOBAL (CLOUD) ARCHITECTURE
Almirall, S.A.	A61K 31/439 (2006.01) A61P 11/00 (2006.01) A61P 43/00 (2006.01)	2696871 *	ACLIDINIUM FOR USE IN IMPROVING THE QUALITY OF SLEEP IN RESPIRATORY PATIENTS
Lina Medical ApS	A61B 18/12 (2006.01) A61B 18/14 (2006.01)	2606845	Pulse generator

Podnosilac evropske prijave patenta (71)	MKP (51)	Broj objave evropske prijave patenta (97)	Naziv pronalaska (54)
Skulle Implants OY	A61L 27/44 (2006.01) A61L 27/46 (2006.01) A61L 27/54 (2006.01)	2668967	An implant
Nomacorc LLC	B65D 1/02 (2006.01) B65D 51/28 (2006.01) B65D 81/20 (2006.01) B65D 81/24 (2006.01) B65D 81/32 (2006.01) C12H 1/14 (2006.01) C12H 1/22 (2006.01)	2683620 *	CLOSURE FOR A PRODUCT RETAINING CONTAINER
SANOFI	C07D 307/81 (2006.01)	2691381 *	REDUCTIVE AMINATION PROCESS FOR PREPARATION OF DRONEDARONE USING AMINE INTERMEDIARY COMPOUND
Immunogen, Inc.	A61K 39/00 (2006.01) A61K 39/395 (2006.01)	2694105 *	CD37-BINDING MOLECULES AND IMMUNOCONJUGATES THEREOF
Stem Centrx, Inc.	A61K 39/395 (2006.01) C07K 16/22 (2006.01) C07K 16/28 (2006.01) C07K 16/30 (2006.01) C07K 16/40 (2006.01) C12N 5/09 (2010.01)	2689787	Identification and enrichment of cell subpopulations
Reata Pharmaceuticals, Inc.	C07J 63/00 (2006.01)	2683731 *	C4-MONOMETHYL TRITERPENOID DERIVATIVES AND METHODS OF USE THEREOF
Allufflon S.p.A.	A47J 27/00 (2006.01) A47J 36/02 (2006.01) B05D 3/12 (2006.01) B05D 5/06 (2006.01) B05D 5/08 (2006.01)	2578323	A decoration process of cooking vessels with sol-gel coating.
Shengyi Technology Co., Ltd.	C08J 5/24 (2006.01) C08L 63/00 (2006.01) C09D 163/00 (2006.01) H05K 1/03 (2006.01)	2662425	Epoxy Resin Composition, and Prepreg and Copper Clad Laminate Made Therefrom
profine GmbH	E06B 3/36 (2006.01)	2689086 *	SYSTEM FOR PRODUCING A DOUBLE LEAF WINDOW
Carnegie Mellon University	C07H 21/04 (2006.01) C12Q 1/68 (2006.01)	2694683 *	CONFORMATIONALLY-PREORGANIZED, MiniPEG-CONTAINING GAMMA-PEPTIDE NUCLEIC ACIDS
Beijing Institute for Cancer Research	A61K 39/395 (2006.01) A61P 35/00 (2006.01) C07K 16/18 (2006.01) C12N 5/20 (2006.01) C12Q 1/02 (2006.01) C12Q 1/68 (2006.01) G01N 33/577 (2006.01)	2682475 *	ANTIBODY AND ANTIGEN RECOGNIZING TUMOR-INITIATING CELLS AND USE THEREOF
Bayer Intellectual Property GmbH	A61K 31/5025 (2006.01) A61P 35/00 (2006.01) C07D 487/04 (2006.01)	2694510 *	IMIDAZOPYRIDAZINES AS AKT KINASE INHIBITORS
Bayer Pharma Aktiengesellschaft	A61K 31/5025 (2006.01) A61P 35/00 (2006.01) C07D 487/04 (2006.01)	2694510 *	IMIDAZOPYRIDAZINES AS AKT KINASE INHIBITORS
GP Strategies Corporation	F17C 7/02 (2006.01) F17C 13/02 (2006.01)	2646738 *	A LIQUID DISPENSER
Española De Plataformas Marinas, S.L.	A01K 61/00 (2006.01)	2684450 *	SHOCK-ABSORBING COUPLING FOR FLOATING STRUCTURES
Genentech, Inc.	A61K 31/517 (2006.01) C07D 239/70 (2006.01)	2694071 *	COMBINATIONS OF AKT INHIBITOR COMPOUNDS AND CHEMOTHERAPEUTIC AGENTS, AND METHODS OF USE
Boehringer Ingelheim International GmbH	A61K 31/517 (2006.01) A61P 11/00 (2006.01) C07D 239/70 (2006.01) C07D 403/12 (2006.01)	2670736 *	9-[4-(3-CHLOR-2-FLUOR-PHENYLAMINO)-7-METHOXY-QUINAZOLIN-6-YLOXY]-1,4-DIAZASPIRO[5.5]UNDECAN-5-ONE DIMALEATE, USE THEREOF AS A DRUG, AND PRODUCTION THEREOF

Podnosilac evropske prijave patenta (71)	MKP (51)	Broj objave evropske prijave patenta (97)	Naziv pronalaska (54)
SANOFI	C07D 307/81 (2006.01)	2691380 *	PROCESS FOR PREPARATION OF DRONEDARONE BY N-BUTYLATION
Sinvent AS	F16L 53/00 (2006.01) F17D 1/18 (2006.01) H05B 3/00 (2006.01) H05B 6/10 (2006.01)	2668819 *	SYSTEM AND SYSTEM ELEMENTS FOR DIRECT ELECTRICAL HEATING OF SUBSEA PIPELINES
Egis Gyógyszergyár Nyilvánosan M Köd Részvénytársaság	A61K 31/505 (2006.01) C07D 239/42 (2006.01)	2646420 *	METHOD FOR THE PREPARATION OF HIGH-PURITY PHARMACEUTICAL INTERMEDIATES
Suncare Research Laboratories, LLC	G01N 21/25 (2006.01) G01N 21/59 (2006.01)	2684029 *	IN VITRO MEASUREMENT OF SUNSCREEN PROTECTION
Sanofi-Aventis Deutschland GmbH	A61M 5/24 (2006.01) A61M 5/315 (2006.01)	2688613 *	DRUG DELIVERY DEVICE
4SC Discovery GmbH	A61K 31/4155 (2006.01) A61P 19/00 (2006.01) A61P 29/00 (2006.01) C07D 413/04 (2006.01) C07D 413/14 (2006.01) C07D 417/14 (2006.01)	2668183 *	IL17 AND IFN-GAMMA INHIBITION FOR THE TREATMENT OF AUTOIMMUNE INFLAMMATION
Bayer CropScience NV	A01H 5/00 (2006.01) C12N 15/82 (2006.01)	2694658 *	SEED - SPECIFIC PROMOTER IN COTTON
Adamed sp. z o.o.	A61K 38/17 (2006.01) A61K 38/21 (2006.01) A61P 35/00 (2006.01) C07K 14/56 (2006.01) C07K 14/57 (2006.01) C07K 14/705 (2006.01) C12N 15/12 (2006.01) C12N 15/21 (2006.01) C12N 15/23 (2006.01) C12N 15/62 (2006.01)	2646464 *	ANTICANCER FUSION PROTEIN
H. Lundbeck A/S	A01N 29/04 (2006.01) A61K 31/025 (2006.01)	2654422 *	BICYCLO[3.2.1]OCTYL AMIDE DERIVATIVES AND USES OF SAME
Eli Lilly and Company	C07C 217/54 (2006.01)	2668152 *	ANALGESIC COMPOUNDS, METHODS, AND FORMULATIONS
Teva Pharmaceutical Industries Ltd.	A61K 31/4704 (2006.01) C07D 215/56 (2006.01)	2697201 *	N-ETHYL-4-HYDROXYL-1-METHYL-5-(METHYL(2,3,4,5,6-PENTAHYDROXYHEXYL)AMINO)-2-OXO-N-PHENYL-1,2-DIHYDROQUINOLINE-3-CARBOXAMIDE
Genentech, Inc.	A61K 31/517 (2006.01) A61P 35/00 (2006.01) C07D 239/70 (2006.01)	2694070 *	COMBINATIONS OF AKT INHIBITOR COMPOUNDS AND ERLOTINIB, AND METHODS OF USE
Emba-Protec GmbH & Co. KG	B65D 5/50 (2006.01) B65D 81/07 (2006.01)	2423116	Wing fixing packaging
Hennessen + Potthoff GmbH	B65D 5/50 (2006.01) B65D 81/07 (2006.01)	2423116	Wing fixing packaging
United Parcel Service Deutschland Inc. & Co. OHG	B65D 5/50 (2006.01) B65D 81/07 (2006.01)	2423116	Wing fixing packaging
Vertex Pharmaceuticals Incorporated	A61K 31/506 (2006.01) A61P 31/04 (2006.01) C07D 405/14 (2006.01) C07F 9/6558 (2006.01)	2663557 *	PYRIMIDINE GYRASE AND TOPOISOMERASE IV INHIBITORS

Podnosilac evropske prijave patenta (71)	MKP (51)	Broj objave evropske prijave patenta (97)	Naziv pronalaska (54)
Pfizer Inc	C07D 207/34 (2006.01) C07D 231/12 (2006.01) C07D 231/14 (2006.01) C07D 231/16 (2006.01) C07D 231/18 (2006.01) C07D 231/54 (2006.01) C07D 231/56 (2006.01) C07D 233/61 (2006.01) C07D 233/64 (2006.01) C07D 233/68 (2006.01) C07D 233/70 (2006.01) C07D 233/84 (2006.01) C07D 249/06 (2006.01) C07D 249/08 (2006.01) C07D 261/08 (2006.01)	2673260 *	GLUCAGON RECEPTOR MODULATOR
KRKA, Tovarna Zdravil, D.D., Novo Mesto	A61K 9/16 (2006.01) A61K 9/20 (2006.01) A61K 31/4985 (2006.01)	2691083 *	PHARMACEUTICAL COMPOSITION OF SITAGLIPTIN
Boehringer Ingelheim International GmbH	A61P 39/02 (2006.01) C07K 16/44 (2006.01)	2691156 *	ANTICOAGULANT ANTIDOTES
Shengyi Technology Co., Ltd.	C08L 25/10 (2006.01) C08L 71/12 (2006.01)	2695916	Polyphenylene ether resin composition, and a prepreg and a copper clad laminate made therefrom
Affitech Research AS	A61K 39/395 (2006.01) A61P 35/00 (2006.01) A61P 35/02 (2006.01) C07K 16/28 (2006.01) G01N 33/574 (2006.01)	2649097 *	ANTI CCR4 ANTIBODIES AND USES THEREOF
Theravectys	A61K 39/00 (2006.01)	2678032 *	LENTIVIRAL VECTORS CONTAINING AN MHC CLASS I PROMOTER
Schell GmbH & Co. KG	E03D 5/10 (2006.01)	2683883 *	ELECTRONICALLY CONTROLLED FLUSH-MOUNTED TOILET FLUSHING VALVE
Sienvin Jalkine Oy	A43B 1/00 (2006.01) A43B 3/00 (2006.01) A43C 15/14 (2006.01)	2532259	Method for controlling a shifting mechanism of a spike in a shoe and a shoe functioning according to this method
Ranbaxy Laboratories Limited	C07D 403/06 (2006.01)	2678333 *	AN IMPROVED PROCESS FOR THE PREPARATION OF VORICONAZOLE AND INTERMEDIATES THEREOF
SANOFI	A61K 31/519 (2006.01) A61P 25/00 (2006.01) C07D 487/04 (2006.01) A61P 7/02 (2006.01) A61K 31/527 (2006.01) A61P 19/02 (2006.01) A61P 3/10 (2006.01) C07D 233/44 (2006.01) A61P 37/00 (2006.01) C07D 239/12 (2006.01) A61P 11/06 (2006.01) A61P 35/00 (2006.01) A61P 17/06 (2006.01) A61P 3/00 (2006.01) A61K 31/5377 (2006.01)	2655375 *	PYRIMIDINONE DERIVATIVES, PREPARATION THEREOF AND PHARMACEUTICAL USE THEREOF
ECOLE CENTRALE PARIS	G06K 9/00 (2006.01) G06K 9/62 (2006.01) G06T 7/00 (2006.01)	2686808 *	METHOD AND DEVICE FOR EFFICIENT PARALLEL MESSAGE COMPUTATION FOR MAP INFERENCE
Logomotion, s.r.o.	G06Q 20/00 (2012.01)	2678811 *	A MOBILE COMMUNICATION DEVICE FOR CONTACTLESS PAYMENTS, A PAYMENT METHOD
Delphi Technologies Holding S.a.r.l.	F02D 41/38 (2006.01) F02M 59/34 (2006.01) F02M 59/36 (2006.01) F02M 63/00 (2006.01) F02M 63/02 (2006.01)	2663764 *	VALVE ASSEMBLY
Spahn, Frank-Peter	A61C 8/00 (2006.01)	2654602 *	DENTAL IMPLANT

Podnosilac evropske prijave patenta (71)	MKP (51)	Broj objave evropske prijave patenta (97)	Naziv pronalaska (54)
Amgen Inc.	A61K 31/519 (2006.01) A61P 35/00 (2006.01) A61P 35/02 (2006.01) C07D 471/14 (2006.01) C07D 519/00 (2006.01)	2688887 *	FUSED TRICYCLIC DUAL INHIBITORS OF CDK 4/6 AND FLT3
Qiagen	C12Q 1/68 (2006.01) C40B 40/08 (2006.01) G01N 33/50 (2006.01)	2694963 *	GENE EXPRESSION SIGNATURE FOR WNT/B-CATENIN SIGNALING PATHWAY AND USE THEREOF
KME Germany GmbH & Co. KG	B05D 1/02 (2006.01) B05D 3/02 (2006.01) B05D 5/06 (2006.01)	2687298	Method for patinating products made of copper or a copper alloy as well as products produced by the said process
Hyun, Dong Hoon	F21V 5/04 (2006.01) F21Y 101/02 (2006.01)	2647906 *	WIDE ICICLE-TYPE LIGHT-ADJUSTING LENS FOR DIFFUSING THE LIGHT OF AN LED
Noh, Myeong-Jae	F21V 5/04 (2006.01) F21Y 101/02 (2006.01)	2647906 *	WIDE ICICLE-TYPE LIGHT-ADJUSTING LENS FOR DIFFUSING THE LIGHT OF AN LED
Novartis AG	B29D 11/00 (2006.01) G02B 1/04 (2006.01)	2652532 *	OPHTHALMIC LENSES MODIFIED WITH FUNCTIONAL GROUPS AND METHODS OF MAKING THEREOF
RKW SE	A61F 13/15 (2006.01) B29C 55/06 (2006.01)	2565013	Method for stretching a sheet of film
US Enovacor ApS	A61F 13/02 (2006.01) A61M 5/42 (2006.01) A61M 25/02 (2006.01)	2654860 *	COVER UNIT FOR USE WHEN INSERTING A PUNCTURE DEVICE IN AN ANATOMICAL STRUCTURE SUCH AS A VEIN OR AN ARTERY AND FOR MAINTAINING SAID PUNCTURE DEVICE IN THE ANATOMICAL STRUCTURE
KRKA, d.d., Novo mesto	A61K 9/20 (2006.01) A61K 9/28 (2006.01) A61K 31/401 (2006.01) A61K 31/4422 (2006.01)	2654729 *	HOMOGENOUS PHARMACEUTICAL ORAL DOSAGE FORMS COMPRISING LERCANIDIPINE AND ENALAPRIL OR THEIR PHARMACEUTICALLY ACCEPTABLE SALTS
Jiangxi Rare Earth & Rare Metals Tungsten Group Holding Co., Ltd.	C22B 9/02 (2006.01) C22B 59/00 (2006.01) C30B 25/00 (2006.01) C30B 35/00 (2006.01) F27B 14/10 (2006.01)	2698438 *	TANTALUM-MATERIAL MULTILEVEL DISTILLATION CRUCIBLE AND DISTILLATION PROCESS
Shire LLC	A61K 9/14 (2006.01) A61K 9/16 (2006.01) A61K 9/48 (2006.01) A61K 33/24 (2006.01)	2645995 *	CAPSULE AND POWDER FORMULATIONS CONTAINING LANTHANUM COMPOUNDS
Olenich, Maksim Viktorovich	F04C 18/22 (2006.01) F04C 29/02 (2006.01)	2647846 *	ROTARY PISTON COMPRESSOR
Lukiantseva, Viktoriya Mykolaivna	F04C 18/22 (2006.01) F04C 29/02 (2006.01)	2647846 *	ROTARY PISTON COMPRESSOR
Soroka, Oleksandr Leonidovich	F04C 18/22 (2006.01) F04C 29/02 (2006.01)	2647846 *	ROTARY PISTON COMPRESSOR
RWE Technology GmbH	E02B 9/04 (2006.01)	2597201	Method for regulating the flow of rivers
Kyorin Pharmaceutical Co., Ltd.	C07F 9/09 (2006.01) A61P 11/06 (2006.01) A61P 43/00 (2006.01) A61K 31/662 (2006.01) A61P 27/02 (2006.01) A61K 31/661 (2006.01) A61P 13/12 (2006.01) C07F 9/38 (2006.01) A61P 9/10 (2006.01) A61P 31/16 (2006.01) A61P 9/00 (2006.01) A61P 29/00 (2006.01) A61P 7/02 (2006.01) A61P 27/06 (2006.01) A61P 11/00 (2006.01) A61P 35/00 (2006.01) A61P 9/06 (2006.01) A61P 31/04 (2006.01)	2657241 *	DIPHENYL SULFIDE DERIVATIVE AND PHARMACEUTICAL PRODUCT WHICH CONTAINS SAME AS ACTIVE INGREDIENT

Podnositelj evropske prijave patenta (71)	MKP (51)	Broj objave evropske prijave patenta (97)	Naziv pronalaska (54)
Asahi Kasei Chemicals Corporation	C08G 69/26 (2006.01) C08L 77/06 (2006.01)	2662397 *	COPOLYMER POLYAMIDE
Glenmark Pharmaceuticals S.A.	C07K 16/00 (2006.01) C07K 16/46 (2006.01)	2688909 *	HETERO-DIMERIC IMMUNOGLOBULINS
Resilux	B29C 45/27 (2006.01)	2670574 *	INJECTION MOLDING APPARATUS FOR MANUFACTURING HOLLOW OBJECTS, IN PARTICULAR PLASTIC PREFORMS, RESP. CONTAINERS AND METHOD THEREFOR
Omya International AG	C09D 7/00 (2006.01)	2678395 *	COATING COMPOSITION COMPRISING SUBMICRON CALCIUM CARBONATE-COMPRISING PARTICLES, PROCESS TO PREPARE SAME AND USE OF SUBMICRON CALCIUM CARBONATE-COMPRISING PARTICLES IN COATING COMPOSITIONS
SANOFI	A61K 31/513 (2006.01) A61P 35/00 (2006.01) C07D 209/30 (2006.01) C07D 401/14 (2006.01) C07D 403/04 (2006.01) C07D 403/06 (2006.01) C07D 413/04 (2006.01) C07D 413/14 (2006.01) C07D 471/10 (2006.01) C07D 493/10 (2006.01)	2658844 *	NOVEL PYRIMIDINE DERIVATIVES, PREPARATION THEREOF, AND PHARMACEUTICAL USE THEREOF AS AKT(PKB) PHOSPHORYLATION INHIBITORS
Curt G. Joa, Inc.	A61F 13/15 (2006.01)	2659869	Single transfer insert placement method and apparatus with cross-direction insert placement control
Nexen Inc.	E21B 43/26 (2006.01) E21B 43/30 (2006.01)	2655794 *	HIGH PRESSURE HYDROCARBON FRACTURING ON DEMAND METHOD AND RELATED PROCESS
Vetalis Sarl	A61K 9/20 (2006.01)	2646004 *	GALENIC COMPOSITION SUITABLE FOR ADMINISTRATION TO A NON-HUMAN ANIMAL, USES THEREOF, AND ASSOCIATED METHODS
Orphazyme APS	A61K 38/17 (2006.01) A61P 3/00 (2006.01)	2646044 *	METHODS FOR INCREASING INTRACELLULAR ACTIVITY OF HSP70
AstraZeneca AB	A61K 31/4184 (2006.01) A61K 31/4188 (2006.01) A61K 31/4439 (2006.01) A61K 31/506 (2006.01) A61P 25/28 (2006.01) C07D 235/02 (2006.01) C07D 401/04 (2006.01) C07D 401/12 (2006.01) C07D 403/12 (2006.01) C07D 405/12 (2006.01) C07D 491/107 (2006.01) C07D 491/20 (2006.01)	2655378 *	COMPOUNDS AND THEIR USE AS BACE INHIBITORS
UCB Pharma, S.A.	G01N 33/564 (2006.01) G01N 33/68 (2006.01)	2661627 *	LIPOCALIN 2 AS A BIOMARKER FOR IL-17 INHIBITOR THERAPY EFFICACY
Facconi, Massimo	H01R 13/627 (2006.01) H01R 13/635 (2006.01)	2688154	An industrial electric connector with push button for the fast unhooking of the complementary connector
Max-Planck-Gesellschaft zur Förderung der Wissenschaften e.V.	G01N 33/68 (2006.01)	2668506 *	SEED TRAIT PREDICTION BY ACTIVITY-BASED PROTEIN PROFILING
Ninsar AgroSciences SL	G01N 33/68 (2006.01)	2668506 *	SEED TRAIT PREDICTION BY ACTIVITY-BASED PROTEIN PROFILING
Gautier Semences	G01N 33/68 (2006.01)	2668506 *	SEED TRAIT PREDICTION BY ACTIVITY-BASED PROTEIN PROFILING
Donaldson Company, Inc.	D04H 1/70 (2012.01) D04H 1/736 (2012.01) D21F 11/04 (2006.01)	2668327 *	METHOD AND APPARATUS FOR FORMING A FIBROUS MEDIA

Podnosilac evropske prijave patenta (71)	MKP (51)	Broj objave evropske prijave patenta (97)	Naziv pronalaska (54)
Abbvie Inc.	A61K 31/4184 (2006.01) A61P 31/14 (2006.01) C07D 403/10 (2006.01) C07D 403/12 (2006.01) C07D 403/14 (2006.01)	2651927 *	ANTI-VIRAL COMPOUNDS
Thompson, Tracy	C07K 1/34 (2006.01) C07K 17/02 (2006.01) C07K 19/00 (2006.01) G01N 33/544 (2006.01)	2649088 *	COMPOSITIONS FOR SEPARATION METHODS
Rehm, Bernd Helmut Adam	C07K 1/34 (2006.01) C07K 17/02 (2006.01) C07K 19/00 (2006.01) G01N 33/544 (2006.01)	2649088 *	COMPOSITIONS FOR SEPARATION METHODS
Herbert, Andrew Brian	C07K 1/34 (2006.01) C07K 17/02 (2006.01) C07K 19/00 (2006.01) G01N 33/544 (2006.01)	2649088 *	COMPOSITIONS FOR SEPARATION METHODS
Saravolac, Edward George	C07K 1/34 (2006.01) C07K 17/02 (2006.01) C07K 19/00 (2006.01) G01N 33/544 (2006.01)	2649088 *	COMPOSITIONS FOR SEPARATION METHODS
Eurojet Medical KFT.	G05D 16/06 (2006.01)	2656159 *	PRESSURE REGULATING DEVICE
Savenok, Pavel	B65D 51/16 (2006.01)	2675721 *	HOT BEVERAGE CONTAINER ASSEMBLY, INSERT, AND METHOD
Wegh Group S.P.A.	E01B 1/00 (2006.01)	2675953 *	RAILWAY STRUCTURE AND ASSEMBLY METHOD
Behr GmbH & Co. KG	A61L 2/00 (2006.01) B01D 46/00 (2006.01) B60H 3/06 (2006.01)	2583846	Air purification device
Fovea Pharmaceuticals	A61K 31/18 (2006.01) A61K 31/4164 (2006.01) A61K 45/06 (2006.01) A61P 27/00 (2006.01)	2648712 *	ARYLSULFONAMIDE DERIVATIVES FOR THE PREVENTION OR TREATMENT OF SPECIFIC OPHTHALMOLOGIC DISORDERS
ZS Pharma, Inc	C01B 39/06 (2006.01)	2673237 *	MICROPOROUS ZIRCONIUM SILICATE FOR THE TREATMENT OF HYPERKALEMIA
Zoetis LLC	A61K 39/10 (2006.01) A61K 39/145 (2006.01) A61K 39/215 (2006.01)	2670431 *	COMPOSITIONS FOR CANINE RESPIRATORY DISEASE COMPLEX
Kirchdorfer Fertigteilverteilung GmbH	E01F 8/00 (2006.01)	2655744 *	SOUND PROTECTION ELEMENT
Valneva Austria GmbH	A61K 39/104 (2006.01) C07K 14/21 (2006.01) C07K 16/12 (2006.01) C07K 19/00 (2006.01)	2686339 *	NOVEL OPRF/I FUSION PROTEINS, THEIR PREPARATION AND USE
Les Laboratoires Servier	C07C 231/14 (2006.01) C07C 233/18 (2006.01) C07C 233/31 (2006.01) C07D 209/48 (2006.01)	2661423 *	NOVEL PROCESS FOR SYNTHESIZING AGOMELATINE
Purdue Pharma L.P.	A61K 9/20 (2006.01) A61K 9/28 (2006.01) A61K 31/485 (2006.01) A61K 47/10 (2006.01) A61K 47/34 (2006.01)	2688556 *	CONTROLLED RELEASE PHARMACEUTICAL DOSAGE FORMS
Dow AgroSciences LLC	A01N 25/04 (2006.01) B01F 3/08 (2006.01)	2663181 *	AGRICULTURAL COMPOSITIONS COMPRISING OIL-IN-WATER EMULSIONS
Dorma GmbH + Co. KG	E05F 3/10 (2006.01)	2663717 *	UNDER LINTEL-MOUNTED OPERATOR FOR SINGLE-ACTING DOOR, OPERATOR ATTACHMENT FOR SINGLE ACTING DOOR AND OPERATOR FOR SINGLE-ACTING DOOR
Apotex Technologies Inc.	A61K 9/72 (2006.01) A61K 38/05 (2006.01) C07D 209/20 (2006.01) C07K 5/037 (2006.01)	2691369 *	PRODRUGS OF D-ISOGLUTAMYL-[D/L]-TRYPTOPHAN

Podnosilac evropske prijave patenta (71)	MKP (51)	Broj objave evropske prijave patenta (97)	Naziv pronalaska (54)
ALUDESIGN S.p.A.	A63G 21/22 (2006.01) B61B 12/02 (2006.01)	2620345	Device for sliding along cables
Zapolsky, Maxim Eduardovich	A61K 31/195 (2006.01) A61P 25/18 (2006.01) C07C 229/46 (2006.01)	2682381 *	SPIROCYCLIC CYCLOPROPANOIC AMINO ACIDS - ANALOGUES OF GAMMA-AMINOBUTYRIC ACID, WITH LIMITED CONFORMATIONAL MOBILITY, AND DRUGS ON THE BASIS THEREOF
Takeda Pharmaceutical Company Limited	A61K 31/416 (2006.01) A61K 31/423 (2006.01) A61P 9/00 (2006.01) C07D 401/04 (2006.01) C07D 405/04 (2006.01) C07D 413/04 (2006.01) C07D 417/04 (2006.01)	2649062 *	BICYCLIC COMPOUNDS AS INHIBITORS OF ACETYL-COA CARBOXYLASE (ACC)
Delcotto, Melynda S.	C11C 5/00 (2006.01) F23D 3/08 (2006.01)	2594627	Wooden wicks including a booster for a candle and method of making
Damiani, Justin	C11C 5/00 (2006.01) F23D 3/08 (2006.01)	2594627	Wooden wicks including a booster for a candle and method of making
Energybus E.V.	B62H 3/02 (2006.01) B62M 6/45 (2010.01)	2673182 *	MODULAR VEHICLE SYSTEM, ELECTRIC VEHICLE AND MODULE FOR CONNECTING TO AN ELECTRIC VEHICLE
AbbVie Biotechnology Ltd	A61M 5/20 (2006.01) A61M 5/32 (2006.01)	2667914 *	REMOVAL OF NEEDLE SHIELDS FROM SYRINGES AND AUTOMATIC INJECTION DEVICES
Elcam Medical Agricultural Cooperative Association Ltd.	A61M 5/20 (2006.01) A61M 5/32 (2006.01)	2667914 *	REMOVAL OF NEEDLE SHIELDS FROM SYRINGES AND AUTOMATIC INJECTION DEVICES
Topera, Inc.	A61B 5/042 (2006.01)	2699150 *	BASKET STYLE CARDIAC MAPPING CATHETER HAVING A FLEXIBLE ELECTRODE ASSEMBLY FOR DETECTION OF CARDIAC RHYTHM DISORDERS
Logomotion, s.r.o.	G06Q 20/32 (2012.01)	2697755 *	PAYMENT CARD, CASHLESS PAYMENT METHOD
Entek Pty Ltd	E04B 5/00 (2006.01) E04B 5/36 (2006.01) E04B 5/40 (2006.01) E04C 5/00 (2006.01)	2689075 *	A BEAM AND METHOD FOR REINFORCING CONCRETE SLABS
Plexxikon, Inc.	A61P 35/00 (2006.01)	2678075 *	SOLID FORMS OF A PHARMACEUTICALLY ACTIVE SUBSTANCE
F.Hoffmann-La Roche AG	A61P 35/00 (2006.01)	2678075 *	SOLID FORMS OF A PHARMACEUTICALLY ACTIVE SUBSTANCE
CERA Handelsgesellschaft mbH	E06B 3/667 (2006.01)	2631409	Connector
Janssen Biotech, Inc.	A61K 39/395 (2006.01)	2683403 *	NON-AQUEOUS HIGH CONCENTRATION REDUCED VISCOSITY SUSPENSION FORMULATIONS OF ANTIBODIES
Abbvie Inc.	A61K 31/4025 (2006.01) A61K 31/4184 (2006.01) A61K 31/4439 (2006.01) A61P 31/12 (2006.01) C07D 207/16 (2006.01) C07D 403/04 (2006.01)	2651885 *	ANTI-VIRAL COMPOUNDS
Astex Therapeutics Limited	A61K 31/437 (2006.01) A61K 31/4985 (2006.01) A61K 31/519 (2006.01) A61K 31/5383 (2006.01) A61P 35/00 (2006.01) C07D 471/04 (2006.01) C07D 498/04 (2006.01)	2699574 *	BICYCLIC HETEROCYCLE COMPOUNDS AND THEIR USES IN THERAPY
Dondi S.p.A.	A01B 13/08 (2006.01) A01B 15/02 (2006.01) A01B 35/08 (2006.01) A01B 35/26 (2006.01) A01B 49/06 (2006.01)	2672801 *	A DUAL-PURPOSE AGRICULTURAL MACHINE

Podnosilac evropske prijave patenta (71)	MKP (51)	Broj objave evropske prijave patenta (97)	Naziv pronalaska (54)
Sanofi-Aventis Deutschland GmbH	A61M 5/168 (2006.01)	2691128 *	DOSING MECHANISM
SciPharm SaRL	A61K 9/00 (2006.01) A61K 9/28 (2006.01) A61K 9/48 (2006.01) A61K 31/192 (2006.01) A61K 31/343 (2006.01) A61K 31/37 (2006.01) A61K 31/4015 (2006.01) A61K 31/404 (2006.01) A61K 31/4174 (2006.01) A61K 31/427 (2006.01) A61K 31/437 (2006.01) A61K 31/44 (2006.01) A61K 31/444 (2006.01) A61K 31/472 (2006.01) A61K 31/498 (2006.01)	2672957 *	NOVEL COMPOSITION FOR THE TREATMENT OF CYSTIC FIBROSIS
Amgen Inc.	A61K 31/353 (2006.01) A61P 25/00 (2006.01) C07D 491/00 (2006.01)	2675810 *	SPIRO-AMINO-IMIDAZO-FUSED HETEROCYCLIC COMPOUNDS AS BETA-SECRETASE MODULATORS AND METHODS OF USE
Francis, Nathania A.	G06Q 50/00 (2012.01)	2646968 *	ENTERAL FEEDING APPARATUS
Studiengesellschaft Kohle MbH	B01J 31/00 (2006.01) C07F 11/00 (2006.01)	2680967 *	MOLYBDENUM AND TUNGSTEN METAL COMPLEXES AND USE THEREOF AS PRECATALYSTS FOR OLEFIN METATHESIS
Fater S.p.A.	A61L 2/07 (2006.01) A61L 11/00 (2006.01) B01J 3/04 (2006.01) B29B 17/00 (2006.01)	2596811	Apparatus and process for sterilising absorbent sanitary products
8 Rivers Capital, LLC	F01K 25/10 (2006.01) F25J 3/04 (2006.01)	2686627 *	CRYOGENIC AIR SEPARATION METHOD AND SYSTEM
BASF SE	C07D 401/14 (2006.01) C07D 403/12 (2006.01) C07D 405/14 (2006.01) C07D 409/14 (2006.01) C07D 411/14 (2006.01) C07D 417/14 (2006.01)	2699563 *	NOVEL PESTICIDAL PYRAZOLE COMPOUNDS
Wageningen Universiteit	A01H 5/08 (2006.01) C12Q 1/68 (2006.01)	2683832 *	TYCLV RESISTANCE
University of Florida Research Foundation, Incorporated	A01H 5/08 (2006.01) C12Q 1/68 (2006.01)	2683832 *	TYCLV RESISTANCE
Urbantech S.p.A.	E01F 8/00 (2006.01)	2673419 *	NOISE BARRIER STRUCTURE WITH SOUND-ABSORBING AND SOUND-REDIRECTING PROPERTIES, AND HIGH PERFORMANCE SOUND ABSORBER FOR USE IN SUCH STRUCTURE
Amgen Inc.	A61K 39/395 (2006.01) C07K 16/22 (2006.01)	2688910 *	ANTI - SCLEROSTIN ANTIBODY CRYSTALS AND FORMULATIONS THEREOF
Whisbi Technologies, S.L.	H04N 1/00 (2006.01) H04N 7/18 (2006.01)	2689581 *	SYSTEM AND METHOD FOR TRANSMITTING REAL-TIME IMAGES
Novomatic AG	G07F 17/32 (2006.01)	2666149 *	GAMING SYSTEM AND METHOD OF USE
Riezler, Josef	B08B 9/027 (2006.01) B08B 9/04 (2006.01) B08B 9/043 (2006.01) B08B 9/051 (2006.01) F16L 25/00 (2006.01) F16L 33/00 (2006.01) G03B 37/00 (2006.01)	2502681	Device for investigating and cleaning tubes and lines
ORTHO-CLINICAL DIAGNOSTICS, INC.	G01N 33/49 (2006.01) G01N 35/10 (2006.01)	2485049	Identification of separated components in centrifuged blood using measured pressure
Zachodniopomorski Uniwersytet Technologiczny w Szczecinie	B05B 15/12 (2006.01)	2684613	Device for exchanging air with heat recovery, especially in spray booths

Podnosilac evropske prijave patenta (71)	MKP (51)	Broj objave evropske prijave patenta (97)	Naziv pronalaska (54)
RICERFARMA Srl	A61K 9/00 (2006.01) A61K 31/685 (2006.01) A61K 31/728 (2006.01) A61P 1/00 (2006.01) A61P 1/02 (2006.01) A61P 1/04 (2006.01)	2646036 *	TOPICAL COMPOSITIONS FOR PRESERVING OR RESTORING THE INTEGRITY OF MUCOSAE
Agriphar S.A.	A01N 25/04 (2006.01) A01N 47/44 (2006.01) A01P 3/00 (2006.01)	2561753	AQUEOUS SUSPENSION CONCENTRATE COMPRISING AN ACID SALT OF DODECYLGUANIDINE
Endocare, Inc.	A61B 18/18 (2006.01)	2680775 *	CRYOGENIC MEDICAL SYSTEM
Hexal AG	A61K 39/395 (2006.01) A61K 47/12 (2006.01) A61K 47/18 (2006.01) A61K 47/22 (2006.01) A61K 47/26 (2006.01) C07K 16/24 (2006.01)	2658575 *	PHARMACEUTICAL FORMULATION COMPRISING A BIOPHARMACEUTICAL DRUG
Tecnostrutture SRL	E02D 27/34 (2006.01) E04H 9/02 (2006.01)	2683889 *	PILLAR FOR BUILDING CONSTRUCTIONS
Pfizer Limited	A61K 31/519 (2006.01) A61P 25/00 (2006.01) A61P 35/00 (2006.01) C07D 487/04 (2006.01)	2694509 *	PYRROLO [2, 3 -D]PYRIMIDINE DERIVATIVES AS INHIBITORS OF TROPOMYOSIN- RELATED KINASES
Concert Pharmaceuticals Inc.	A61K 31/4545 (2006.01) C07D 401/14 (2006.01)	2680843 *	DERIVATIVES OF PYRAZOLE-SUBSTITUTED AMINO-HETEROARYL COMPOUNDS
Kyowa Hakko Kirin Co., Ltd.	A61K 9/08 (2006.01) A61K 39/395 (2006.01) A61K 47/18 (2006.01) A61K 47/34 (2006.01)	2676677 *	HIGHLY CONCENTRATED ANTI-CD40 ANTIBODY PHARMACEUTICAL PREPARATION
Ausy S.r.L.	B22D 27/08 (2006.01) C01B 17/02 (2006.01) C04B 28/36 (2006.01)	2699515 *	PROCEDURE FOR THE PREPARATION OF SULPHUR-BASED ARTICLES OF MANUFACTURE
Falconieri, Antonio, Salvatore	B22D 27/08 (2006.01) C01B 17/02 (2006.01) C04B 28/36 (2006.01)	2699515 *	PROCEDURE FOR THE PREPARATION OF SULPHUR-BASED ARTICLES OF MANUFACTURE
Agamin Pharmaceuticals, LLC	A61K 39/00 (2006.01) A61K 39/395 (2006.01) C07K 16/00 (2006.01)	2672996 *	METHODS AND SYSTEMS FOR TREATING OR PREVENTING PREGNANCY-RELATED HYPERTENSIVE DISORDERS
Telcordia Technologies, Inc.	H04B 7/185 (2006.01)	2673896 *	DISTRIBUTED MANAGEMENT OF LEO SATELLITE NETWORKS WITH MANAGEMENT AGILITY AND NETWORK EFFICIENCY
Janssen Biotech, Inc.	C07K 16/36 (2006.01)	2686350 *	HUMAN TISSUE FACTOR ANTIBODY AND USES THEREOF
HistoRx, Inc.	G01N 33/574 (2006.01)	2646831 *	IDENTIFICATION OF CANCER PATIENTS LIKELY TO BENEFIT FROM RADIATION THERAPY
UTI Limited Partnership	G01N 33/574 (2006.01)	2646831 *	IDENTIFICATION OF CANCER PATIENTS LIKELY TO BENEFIT FROM RADIATION THERAPY
Kowa Company Ltd.	A61K 31/506 (2006.01) A61P 3/10 (2006.01) A61P 9/00 (2006.01) A61P 9/10 (2006.01) A61P 9/12 (2006.01) A61P 13/12 (2006.01) A61P 25/18 (2006.01) A61P 27/02 (2006.01) A61P 43/00 (2006.01) C07D 401/14 (2006.01) C07D 413/14 (2006.01)	2687523 *	NOVEL PHENYLPYRIDINE DERIVATIVE AND DRUG CONTAINING SAME
Croma-Pharma GmbH	A61K 9/08 (2006.01) A61K 47/36 (2006.01) A61K 47/38 (2006.01)	2680817 *	USE OF A VISCOELASTIC FLUID FOR PRODUCING A MEDICINAL PRODUCT FOR SURGICALLY TREATING THE EYE

Podnosilac evropske prijave patenta (71)	MKP (51)	Broj objave evropske prijave patenta (97)	Naziv pronalaska (54)
Ardea Biosciences, Inc.	A61K 31/4196 (2006.01) A61P 9/00 (2006.01) C07D 249/12 (2006.01)	2658846 *	POLYMORPHIC FORMS OF 2-(5-BROMO-4-(4-CYCLOPROPYLNAPHTHALEN-1-YL)-4H-1,2,4-TRIAZOL-3-YLTHIO) ACETIC ACID AND USES THEREOF
Ludwig-Maximilians-Universität München	C07F 3/06 (2006.01)	2655382 *	ORGANOZINC COMPLEXES AND PROCESSES FOR MAKING AND USING THE SAME
The Trustees of Columbia University in the City of New York	C12Q 1/68 (2006.01)	2652153 *	DNA SEQUENCING BY SYNTHESIS USING MODIFIED NUCLEOTIDES AND NANOPORE DETECTION
Nilfisk-Advance A/S	A47L 5/22 (2006.01)	2596733	Combined primary and secondary units
Heidelberg Pharma GmbH	A61K 47/48 (2006.01) A61P 35/00 (2006.01)	2683409 *	AMATOXIN-CONJUGATES WITH IMPROVED LINKAGES
Sanofi-Aventis Deutschland GmbH	A61M 5/28 (2006.01) A61M 5/32 (2006.01) A61M 5/50 (2006.01)	2661299 *	A SAFETY DEVICE FOR A PRE-FILLED SYRINGE AND AN INJECTION DEVICE
Immunogen, Inc.	A61K 39/395 (2006.01)	2694106 *	METHODS FOR INCREASING EFFICACY OF FOLR1 CANCER THERAPY
Intelligent Cellars Inc.	F25D 11/00 (2006.01) F25D 25/00 (2006.01) F25D 29/00 (2006.01)	2655990 *	COMPARTMENTED TEMPERATURE AND HUMIDITY CONTROLLED MODULAR HOUSING FOR THE STORAGE AND PRESERVATION OF WINE BOTTLES
Eisai R&D Management Co., Ltd.	A61K 31/496 (2006.01) C07D 401/12 (2006.01) C07D 401/14 (2006.01)	2692725 *	METHOD FOR PRODUCING PHENOXYPYRIDINE DERIVATIVE
SCA TISSUE FRANCE	A47K 10/38 (2006.01)	2583602	Dispenser for static center-feed coreless roll of sheet product
University Of Louisville Research Foundation, Inc.	A01N 63/00 (2006.01) C12N 13/00 (2006.01)	2694651 *	METHODS AND COMPOSITIONS FOR LARGE-SCALE ISOLATION OF VERY SMALL EMBRYONIC-LIKE (VSEL) STEM CELLS
Helsinn Healthcare S.A.	A61P 9/04 (2006.01) A61P 3/06 (2006.01) A61K 31/4468 (2006.01) A61P 11/00 (2006.01) A61P 25/00 (2006.01) A61P 3/00 (2006.01) A61P 5/48 (2006.01) A61P 3/10 (2006.01) A61P 3/08 (2006.01) A61P 1/04 (2006.01) C07D 211/58 (2006.01) A61P 1/00 (2006.01) A61P 9/12 (2006.01) A61P 21/00 (2006.01) A61P 9/10 (2006.01) A61P 1/16 (2006.01) A61P 9/00 (2006.01) A61P 3/04 (2006.01) A61P 25/30 (2006.01) A61P 7/00 (2006.01)	2678017 *	ASYMMETRIC UREAS AND MEDICAL USES THEREOF
My Life IT (Aust) Pty Ltd	G06Q 20/38 (2012.01)	2695120 *	FINANCIAL TRANSACTION SYSTEMS AND METHODS
AUDI AG	C22C 21/02 (2006.01) C22C 21/04 (2006.01)	2657360	Pressure cast alloy on an Al-Si basis, comprising secondary aluminium
AMAG casting GmbH	C22C 21/02 (2006.01) C22C 21/04 (2006.01)	2657360	Pressure cast alloy on an Al-Si basis, comprising secondary aluminium
Omya International AG	C09C 1/02 (2006.01) D21H 17/00 (2006.01)	2679638	High solids aqueous mineral and/or filler and/or pigment suspension in acidic pH environment
Fovea Pharmaceuticals	A61K 31/18 (2006.01) A61K 31/4164 (2006.01) A61P 27/00 (2006.01)	2648713 *	DOSAGES OF ARYLSULFONAMIDE DERIVATIVES

Podnosilac evropske prijave patenta (71)	MKP (51)	Broj objave evropske prijave patenta (97)	Naziv pronalaska (54)
Pfizer Inc	A61K 31/438 (2006.01) A61P 3/04 (2006.01) A61P 3/10 (2006.01) C07D 471/10 (2006.01) C07D 519/00 (2006.01)	2699576 *	PYRAZOLOSPIROKETONE DERIVATIVES FOR USE AS ACETYL - COA CARBOXYLASE INHIBITORS
The Spectranetics Corporation	A61B 17/22 (2006.01) A61B 17/221 (2006.01) A61M 25/00 (2006.01) A61M 25/06 (2006.01) A61M 25/09 (2006.01)	2696930 *	DEVICE AND METHOD FOR CAPTURING GUIDEWIRES
Isis Pharmaceuticals, Inc.	C07H 21/04 (2006.01) C12N 15/11 (2006.01)	2697243 *	MODULATION OF SIGNAL TRANSDUCER AND ACTIVATOR OF TRANSCRIPTION 3 (STAT3) EXPRESSION
Omya International AG	C09C 1/02 (2006.01) D21H 17/00 (2006.01)	2662416	Treatment of calcium carbonate containing materials for increased filler load in paper
Eisai R&D Management Co., Ltd.	A61K 31/437 (2006.01) A61K 31/47 (2006.01) A61P 35/00 (2006.01) C07D 215/48 (2006.01) C07D 471/04 (2006.01)	2700403 *	THERAPEUTIC AGENT FOR TUMOR
Bial-Portela & CA, S.A.	A61K 31/4439 (2006.01) A61P 25/00 (2006.01) A61P 25/16 (2006.01)	2672973 *	ADMINISTRATION REGIME FOR NITROCATECHOLS
S.A.S.C. AG	A24F 47/00 (2006.01)	2672846 *	INHALATION DEVICE
Berg LLC	A61P 35/00 (2006.01)	2680925 *	INTERROGATORY CELL-BASED ASSAYS AND USES THEREOF
Janssen R&D Ireland	A61K 31/437 (2006.01) A61P 31/12 (2006.01) C07D 471/04 (2006.01)	2651936 *	AZAINDOLES AS RESPIRATORY SYNCYTIAL VIRUS ANTIVIRAL AGENTS
SDI Limited	A61C 5/06 (2006.01)	2583635	Mixing and dispensing container
Basilea Pharmaceutica AG	A61K 31/00 (2006.01) A61K 38/00 (2006.01) G01N 33/50 (2006.01)	2666014 *	USE OF GLU-TUBULIN AS A BIOMARKER OF DRUG RESPONSE TO FURAZANOBENZIMIDAZOLES
Cadila Healthcare Limited	C07D 309/28 (2006.01)	2678324 *	PROCESS FOR THE PREPARATION OF ZANAMIVIR
Vanderbilt University	A61K 31/4162 (2006.01) C07D 231/54 (2006.01)	2648723 *	BICYCLIC PYRAZOLE COMPOUNDS AS ALLOSTERIC MODULATORS OF MGLUR5 RECEPTORS
Whitehead Institute For Biomedical Research	C12N 5/071 (2010.01) C12N 5/09 (2010.01)	2689007 *	COMPOSITIONS AND METHODS FOR CULTURING CELLS FROM NORMAL HUMAN TUBO-OVARIAN EPITHELIUM AND HUMAN TUBO-OVARIAN TUMORS
Brigham and Women's Hospital, Inc.	C12N 5/071 (2010.01) C12N 5/09 (2010.01)	2689007 *	COMPOSITIONS AND METHODS FOR CULTURING CELLS FROM NORMAL HUMAN TUBO-OVARIAN EPITHELIUM AND HUMAN TUBO-OVARIAN TUMORS
Astron Research Limited	A61K 9/00 (2006.01) A61K 38/08 (2006.01) A61K 47/12 (2006.01)	2648755 *	A STABLE READY-TO-USE CETRORELIX INJECTION
Sanofi-Aventis Deutschland GmbH	A61M 5/20 (2006.01) A61M 5/32 (2006.01)	2675509 *	INJECTION DEVICE
Heartware BVBA	A61B 5/00 (2006.01) A61M 1/36 (2006.01) G06F 19/00 (2011.01)	2581846	A cardiopulmonary bypass or cpb monitoring tool
Alexion Pharma International SARL	A61K 38/17 (2006.01) A61K 47/48 (2006.01) A61P 19/08 (2006.01) C07K 14/575 (2006.01) C07K 19/00 (2006.01) C12N 15/16 (2006.01) C12N 15/62 (2006.01)	2658979 *	COMPOSITIONS COMPRISING NATRIURETIC PEPTIDES AND METHODS OF USE THEREOF

Podnosilac evropske prijave patenta (71)	MKP (51)	Broj objave evropske prijave patenta (97)	Naziv pronalaska (54)
Topera, Inc.	A61B 5/042 (2006.01)	2699153 *	FLEXIBLE ELECTRODE ASSEMBLY FOR INSERTION INTO BODY LUMEN OR ORGAN
LegoChem Biosciences, Inc.	A61K 31/53 (2006.01) A61P 31/04 (2006.01) C07D 413/14 (2006.01)	2692727 *	NOVEL OXAZOLIDINONE DERIVATIVE AND MEDICAL COMPOSITION CONTAINING SAME
Arcelormittal Investigación y Desarrollo SL	C23C 2/06 (2006.01) C23C 2/26 (2006.01) C23C 2/40 (2006.01) C23C 14/16 (2006.01) C23C 14/58 (2006.01) C23C 28/00 (2006.01)	2652166 *	STEEL SHEET INCLUDING A MULTILAYER COATING
Sarissa Inc.	A61K 31/7088 (2006.01) A61K 31/7105 (2006.01) A61P 35/00 (2006.01) C07H 21/00 (2006.01) C12N 15/113 (2010.01)	2683825 *	METHODS OF TREATING CANCER BY INHIBITION OF DNA REPAIR PROTEINS
Amgen Inc.	A61K 31/553 (2006.01) A61K 31/554 (2006.01) A61P 25/16 (2006.01) A61P 25/28 (2006.01) C07D 498/10 (2006.01) C07D 498/20 (2006.01) C07D 513/10 (2006.01)	2673279 *	5-AMINO-OXAZEPINE AND 5-AMINO-THIAZEPANE COMPOUNDS AS BETA-SECRETASE ANTAGONISTS AND METHODS OF USE
ECLISSE SRL	E06B 3/46 (2006.01)	2602416	Interconnection device for retractable sliding doors
Rheinkalk GmbH	C02F 1/66 (2006.01)	2651832 *	METHOD FOR TREATING BODIES OF WATER
Les Laboratoires Servier	C07C 231/02 (2006.01) C07C 233/18 (2006.01) C07C 253/30 (2006.01) C07C 255/37 (2006.01) C07C 255/40 (2006.01)	2661422 *	PROCESS AND INTERMEDIATES FOR SYNTHESIZING AGOMELATINE
Cephalon, Inc.	C07D 213/70 (2006.01) C07D 309/14 (2006.01) A61K 31/435 (2006.01) C07D 213/57 (2006.01) C07D 309/08 (2006.01) A61K 31/42 (2006.01) C07D 235/16 (2006.01) A61P 35/00 (2006.01) A61K 31/47 (2006.01) C07D 231/12 (2006.01) C07C 317/44 (2006.01) C07D 215/36 (2006.01) C07D 333/24 (2006.01) C07D 263/32 (2006.01) A61P 35/04 (2006.01) C07D 263/56 (2006.01) A61K 31/4164 (2006.01) C07D 223/10 (2006.01) C07D 271/07 (2006.01) A61K 31/415 (2006.01)	2678316 *	SUBSTITUTED AROMATIC SULFUR COMPOUNDS AND METHODS OF THEIR USE

Podnosilac evropske prijave patenta (71)	MKP (51)	Broj objave evropske prijave patenta (97)	Naziv pronalaska (54)
University of Hawaii	C07D 213/70 (2006.01) C07D 309/14 (2006.01) A61K 31/435 (2006.01) C07D 213/57 (2006.01) C07D 309/08 (2006.01) A61K 31/42 (2006.01) C07D 235/16 (2006.01) A61P 35/00 (2006.01) A61K 31/47 (2006.01) C07D 231/12 (2006.01) C07C 317/44 (2006.01) C07D 215/36 (2006.01) C07D 333/24 (2006.01) C07D 263/32 (2006.01) A61P 35/04 (2006.01) C07D 263/56 (2006.01) A61K 31/4164 (2006.01) C07D 223/10 (2006.01) C07D 271/07 (2006.01) A61K 31/415 (2006.01)	2678316 *	SUBSTITUTED AROMATIC SULFUR COMPOUNDS AND METHODS OF THEIR USE
University of Utah Research Foundation	C07D 213/70 (2006.01) C07D 309/14 (2006.01) A61K 31/435 (2006.01) C07D 213/57 (2006.01) C07D 309/08 (2006.01) A61K 31/42 (2006.01) C07D 235/16 (2006.01) A61P 35/00 (2006.01) A61K 31/47 (2006.01) C07D 231/12 (2006.01) C07C 317/44 (2006.01) C07D 215/36 (2006.01) C07D 333/24 (2006.01) C07D 263/32 (2006.01) A61P 35/04 (2006.01) C07D 263/56 (2006.01) A61K 31/4164 (2006.01) C07D 223/10 (2006.01) C07D 271/07 (2006.01) A61K 31/415 (2006.01)	2678316 *	SUBSTITUTED AROMATIC SULFUR COMPOUNDS AND METHODS OF THEIR USE
Basilea Pharmaceutica AG	A61K 31/00 (2006.01) G01N 33/50 (2006.01)	2666016 *	USE OF BUBR1 AS A BIOMARKER OF DRUG RESPONSE TO FURAZANOBENZIMIDAZOLES
Purdue Pharma LP	A61K 9/20 (2006.01) A61K 9/28 (2006.01) A61K 31/485 (2006.01)	2654734 *	ENCASED TAMPER RESISTANT CONTROLLED RELEASE DOSAGE FORMS
Vertex Pharmaceuticals Incorporated	A61K 31/4184 (2006.01) A61P 31/00 (2006.01) C07D 413/14 (2006.01)	2663562 *	SOLID FORMS OF GYRASE INHIBITOR (R)-1-ETHYL-3-[6-FLUORO-5-[2-(1-HYDROXY-1-METHYLETHYL) PYRIMIDIN-5-YL]-7-(TETRAHYDROFURAN-2-YL)-1H-BENZIMIDAZOL-2-YL]UREA
Huf Hülbeck & Fürst GmbH & Co. KG	H01H 3/16 (2006.01) H01H 13/18 (2006.01) H01H 13/48 (2006.01)	2431990	Switch
EX Company Limited	H01R 13/52 (2006.01) H04M 1/02 (2006.01)	2688152 *	CONNECTOR OF ELECTRONIC DEVICE, PLUG OF ELECTRONIC DEVICE, AND WATERPROOF STRUCTURE OF ELECTRONIC DEVICE
ARIAD Pharmaceuticals, Inc	A61K 31/495 (2006.01)	2694066 *	METHODS AND COMPOSITIONS FOR TREATING PARKINSON'S DISEASE
Bioprojet	A61K 9/10 (2006.01) A61K 31/223 (2006.01) A61K 31/265 (2006.01) A61P 1/12 (2006.01)	2648696 *	NEW FORM OF ADMINISTRATION OF ENKEPHALINASE INHIBITOR
Prognomix, Inc.	A61K 45/00 (2006.01) C12Q 1/68 (2006.01) C40B 30/04 (2006.01) C40B 40/06 (2006.01)	2655665 *	SINGLE NUCLEOTIDE POLYMORPHISMS AND GENES ASSOCIATED WITH T2D-RELATED COMPLICATIONS

Podnosilac evropske prijave patenta (71)	MKP (51)	Broj objave evropske prijave patenta (97)	Naziv pronalaska (54)
Dompe' S.p.A.	A61K 31/341 (2006.01) A61K 31/381 (2006.01) A61K 31/4025 (2006.01) A61K 31/4402 (2006.01) A61P 29/00 (2006.01) C07D 207/323 (2006.01) C07D 213/36 (2006.01) C07D 307/52 (2006.01) C07D 307/56 (2006.01) C07D 333/20 (2006.01) C07D 333/28 (2006.01)	2668160 *	TRPM8 RECEPTOR ANTAGONISTS
Arcelormittal Wire France	F16G 11/00 (2006.01) F16G 11/02 (2006.01)	2596266 *	SELF-ALIGNING SOCKET FOR MOORING CABLE
Woollard And Henry Ltd.	D21F 1/44 (2006.01)	2697423 *	IMPROVEMENTS IN OR RELATING TO SECURITY OF DOCUMENTS
Hasler, Josef	E05D 7/00 (2006.01)	2586944	Hinge with adjustment elements and adjustment cap for these adjustment elements
Omya International AG	C01F 11/18 (2006.01) C09C 1/02 (2006.01) D21H 19/38 (2006.01)	2644568	Dispersed calcium carbonate containing material for an improved stability under alkaline conditions
Concert Pharmaceuticals Inc.	A61K 31/19 (2006.01) A61K 31/22 (2006.01) A61P 21/00 (2006.01) A61P 25/02 (2006.01) A61P 25/20 (2006.01) C07B 59/00 (2006.01) C07C 59/01 (2006.01) C07C 69/67 (2006.01)	2675771 *	4-HYDROXYBUTYRIC ACID DEUTERATED ANALOGS
Genentech, Inc.	A61K 31/496 (2006.01) C07D 239/70 (2006.01)	2694485 *	COMBINATIONS OF AKT INHIBITOR COMPOUNDS AND VEMURAFENIB, AND METHODS OF USE
Shaver, William A.	A61K 49/00 (2006.01)	2667900 *	METHOD, COMPOSITION AND PACKAGE FOR BOWEL CLEANSING
Adamed sp. z o.o.	A61K 38/17 (2006.01) A61P 35/00 (2006.01) C07K 14/705 (2006.01) C12N 15/12 (2006.01) C12N 15/62 (2006.01)	2699592 *	ANTICANCER FUSION PROTEIN
CTC Bio, Inc.	A61K 9/70 (2006.01) A61K 31/519 (2006.01)	2674154 *	SILDENAFIL-FREE BASE-CONTAINING FILM PREPARATION AND METHOD FOR PRODUCING SAME
Sanofi-Aventis Deutschland GmbH	A61M 5/20 (2006.01) A61M 5/32 (2006.01)	2661294 *	A SAFETY DEVICE FOR A PRE-FILLED SYRINGE AND AN INJECTION DEVICE
Maschio Gaspardo S.p.A.	A01C 5/06 (2006.01) A01C 7/20 (2006.01)	2675261 *	SEED DRILL WITH MULTI-ROW SOWING ELEMENTS
Crystal Lagoons (Curaçao) B.V.	C02F 1/00 (2006.01)	2691340 *	METHOD AND SYSTEM FOR TREATING WATER USED FOR INDUSTRIAL PURPOSES
Flodesign Wind Turbine Corp.	F03D 1/04 (2006.01) F03D 7/02 (2006.01)	2691645 *	FLUID TURBINE WITH VARIABLE PITCH SHROUD SEGMENTS
sia Abrasives Industries AG	B24D 3/00 (2006.01) B24D 11/00 (2006.01)	2551057	Method for producing a coated abrasive, coated abrasive and use of a coated abrasive
Novartis Pharma AG	A61K 31/436 (2006.01) A61K 31/519 (2006.01) A61K 45/06 (2006.01) A61P 35/00 (2006.01) A61P 35/02 (2006.01)	2675451 *	mTOR/JAK INHIBITOR COMBINATION THERAPY
Incyte Corporation	A61K 31/436 (2006.01) A61K 31/519 (2006.01) A61K 45/06 (2006.01) A61P 35/00 (2006.01) A61P 35/02 (2006.01)	2675451 *	mTOR/JAK INHIBITOR COMBINATION THERAPY
Dorma GmbH + Co. KG	E05F 3/04 (2006.01) E05F 3/10 (2006.01) E05F 3/22 (2006.01)	2655770 *	MOUNTING ASSEMBLY FOR A DOOR ACTUATOR FOR MOUNTING ON A MOUNTING PLATE WITHOUT THE USE OF CONNECTING MEANS

Podnosilac evropske prijave patenta (71)	MKP (51)	Broj objave evropske prijave patenta (97)	Naziv pronalaska (54)
Zozulya, Vladimir Leonidovich	B82Y 30/00 (2011.01) C10M 103/06 (2006.01) C10M 177/00 (2006.01)	2657323 *	NANOSTRUCTURE OF A REVITALIZING AGENT AND METHOD FOR PRODUCING A STABLE FORM OF A NANOSTRUCTURE OF A REVITALIZING AGENT
Zozulya, Sergey Leonidovich	B82Y 30/00 (2011.01) C10M 103/06 (2006.01) C10M 177/00 (2006.01)	2657323 *	NANOSTRUCTURE OF A REVITALIZING AGENT AND METHOD FOR PRODUCING A STABLE FORM OF A NANOSTRUCTURE OF A REVITALIZING AGENT
Alexandrov, Sergey Nikolaevich	B82Y 30/00 (2011.01) C10M 103/06 (2006.01) C10M 177/00 (2006.01)	2657323 *	NANOSTRUCTURE OF A REVITALIZING AGENT AND METHOD FOR PRODUCING A STABLE FORM OF A NANOSTRUCTURE OF A REVITALIZING AGENT
Euro-Celtique S.A.	A61K 9/16 (2006.01) A61K 9/20 (2006.01) A61P 25/04 (2006.01)	2648699 *	DOSAGE FORM
GlaxoSmithKline Biologicals S.A.	A61K 39/04 (2006.01)	2651437 *	MYCOBACTERIUM ANTIGENIC COMPOSITION
HCO Antibody, Inc.	C07K 16/00 (2006.01) C07K 16/46 (2006.01)	2683735 *	BISPECIFIC THREE-CHAIN ANTIBODY-LIKE MOLECULES
SANOFI	C07C 311/08 (2006.01) C07C 311/21 (2006.01) C07D 307/80 (2006.01) C07D 307/84 (2006.01)	2688878 *	PROCESS FOR SYNTHESIZING KETO-BENZOFURAN DERIVATIVES
Momenta Pharmaceuticals, Inc.	G01N 24/08 (2006.01)	2686671 *	N-ACETYLHEXOSAMINE-CONTAINING N-GLYCANS IN GLYCOPROTEIN PRODUCTS
Dusseault, Maurice B.	E21B 43/26 (2006.01) E21B 43/267 (2006.01)	2655795 *	MULTI-STAGE FRACTURE INJECTION PROCESS FOR ENHANCED RESOURCE PRODUCTION FROM SHALES
Bilak, Roman	E21B 43/26 (2006.01) E21B 43/267 (2006.01)	2655795 *	MULTI-STAGE FRACTURE INJECTION PROCESS FOR ENHANCED RESOURCE PRODUCTION FROM SHALES
Zafgen, Inc.	A61K 31/336 (2006.01) A61P 3/04 (2006.01)	2646016 *	TREATMENT OF OBESITY USING NON-DAILY ADMINISTRATION OF 6 - 0 - (4 - DIMETHYLAMINOETHOXY) CINNAMOYL FUMAGILLOL
Klosterfrau Berlin GmbH	A61L 2/07 (2006.01)	2694118 *	METHOD FOR STEAM STERILIZATION OF MEDICAL ARTICLES
Merck Sharp & Dohme Corp.	C07D 223/08 (2006.01) C07D 405/12 (2006.01) C07D 401/04 (2006.01) A61K 31/445 (2006.01) C07D 211/46 (2006.01) C07D 403/04 (2006.01) C07D 207/48 (2006.01) C07D 401/14 (2006.01) C07D 207/12 (2006.01) C07D 401/10 (2006.01) C07D 309/12 (2006.01) C07D 207/273 (2006.01) C07D 211/96 (2006.01) C07D 403/10 (2006.01) C07D 401/06 (2006.01)	2683687 *	PRIMARY AMINE DIAZENIUMDIOLATE HETEROCYCLIC DERIVATIVES
Adamed Sp. z o.o.	C07K 14/435 (2006.01) C07K 14/705 (2006.01) C07K 14/78 (2006.01) C12N 15/62 (2006.01)	2661496 *	ANTICANCER FUSION PROTEIN
Novartis AG	A61K 31/21 (2006.01) A61K 31/435 (2006.01) C07C 233/47 (2006.01) C07D 213/82 (2006.01) C07D 239/36 (2006.01) C07D 261/18 (2006.01) C07D 271/06 (2006.01)	2594556	Substituted aminopropionic derivatives as neprilysin inhibitors

Podnosilac evropske prijave patenta (71)	MKP (51)	Broj objave evropske prijave patenta (97)	Naziv pronalaska (54)
Alliance for Sustainable Energy, LLC	H01L 21/00 (2006.01)	2684210 *	EFFICIENT BLACK SILICON PHOTOVOLTAIC DEVICES WITH ENHANCED BLUE RESPONSE
Sanofi	A61K 9/00 (2006.01) A61K 9/20 (2006.01) A61K 31/437 (2006.01) A61K 33/00 (2006.01) A61K 33/10 (2006.01) A61P 25/20 (2006.01)	2651390 *	ZOLPIDEM-BASED ORODISPERSIBLE PHARMACEUTICAL TABLET
Kyocera Corporation	B23B 27/04 (2006.01) B23B 27/16 (2006.01)	2656950 *	CUTTING TOOL AND METHOD FOR MANUFACTURING CUT PRODUCT USING SAME
Zambon S.p.A.	A61K 9/00 (2006.01) A61K 31/192 (2006.01) A61K 47/02 (2006.01)	2594266	Pharmaceutical solid compositions containing ibuprofen salts
Fater S.p.A.	A61L 2/07 (2006.01) A61L 11/00 (2006.01) B01J 3/04 (2006.01) B29B 17/00 (2006.01)	2596810	Method for sterilisation of used absorbent sanitary products
Kido, Tsuneo	C12N 5/0797 (2010.01)	2663638 *	CULTURE METHOD TO OBTAIN AND MAINTAIN A PURE OR ENRICHED POPULATION OF MAMMALIAN NEURAL STEM CELLS AND/OR NEURAL PROGENITOR CELLS THAT ARE PRONE TO DIFFERENTIATE INTO OLIGODENDROCYTE-LINEAGE CELLS IN VITRO
AbbVie Inc.	C12P 21/06 (2006.01)	2649189 *	TNF- BINDING PROTEINS
Arcelormittal Investigación y Desarrollo SL	C21D 8/04 (2006.01) C21D 9/46 (2006.01) C22C 38/02 (2006.01) C22C 38/04 (2006.01) C22C 38/12 (2006.01) C22C 38/14 (2006.01) C23C 2/06 (2006.01)	2689045 *	HOT-ROLLED STEEL SHEET AND ASSOCIATED PRODUCTION METHOD
Ishihara Sangyo Kaisha, Ltd.	A01N 37/34 (2006.01) A01N 41/06 (2006.01) A01N 43/50 (2006.01) A01P 3/00 (2006.01)	2663188 *	METHOD FOR CONTROLLING CLUBROOT
University of Pittsburgh of the Commonwealth System of Higher Education	A61M 1/14 (2006.01) G01N 33/50 (2006.01) G01N 33/53 (2006.01)	2668497 *	URINE BIOMARKERS FOR PREDICTION OF RECOVERY AFTER ACUTE KIDNEY INJURY : PROTEOMICS

**OBJAVA POVUČENIH ZAHTEVA ZA PROŠIRENJE EVROPSKIH PRIJAVA
PATENTA**
**PUBLICATION OF WITHDRAWN REQUESTS FOR EXTENSION OF EUROPEAN
PATENT APPLICATION**

Broj objave evropske prijava patenta (97)	MKP (51)	Datum kada je zahtev za proširenje evropske prijave patenta povučen	Zahtev objav- ljen u CGIS-u broj	Naziv pronalaska (54)	Podnosilac evropske prijave patenta (71)
2570810	G01N 1/22 G01N 33/543	27.09.2013	2/2014	Method for examination of air for the presence of biological substances by means of removable multi-well strips on which an immunological assay is performed directly	BMA Labor Gbr

OBJAVA PROŠIRENIH EUROPSKIH PATENATA
PUBLICATION OF EXTENDED EUROPEAN PATENTS

- (51) **C09C 1 02 /** ²⁰⁰⁶⁰¹ (11) **01499**
C09C 3 04 / ²⁰⁰⁶⁰¹ (21) **P-2012-58**
D21H 1767/ ²⁰⁰⁶⁰¹
- (22) 15. 06. 2009
(30)
(96) EP/09162738.0/15. 06. 2009
(97) EP 2264109/22. 12. 2010/en/2010/51
EP 2264109/25. 01. 2012/en/2012/04
- (54) me **POSTUPAK ZA DOBIJANJE POVRŠINSKI IZREAGOVANOG KALCIJUM
KARBONATA I NJEGOVA UPOTREBA**
en PROCESS FOR PREPARING SURFACE-REACTED CALCIUM CARBONATE AND ITS USE
- (73) Omya Development AG, Baslerstrasse 42, 4665 Oftringen, CH,
(72) Gane, Patrick A.C., Studenweg 8, 4852 Rothrist, CH,
Gerard, Daniel E., Riehenring 7, 4058 Basel, CH,
Schoelkopf, Joachim, Buechbuhlstrasse 3, 8956 Killwangen, CH,
(74) Lutovac Branislav, Bulevar Crnojevića 93, Podgorica ME
- (57) Postupak za pripremanje površinski izreagovanog kalcijum karbonata u vodenoj sredini, koji obuhvata sledeće stupnje: a) obezbeđivanje kalcijum karbonata; b) obezbeđivanje 5 tež. % do 50 tež. % u odnosu na težinu kalcijum karbonata bar jedne kiseline sa vrednošću pKa koja je manja ili jednaka 2.5, pri čemu odgovarajući kiselinski anjon može da gradi vodonerastvorne kalcijumove soli; c) obezbeđivanje gasovitog CO₂; d) obezbeđivanje bar jedne vodorastvorne nepolimerne organske i/ili neorganske slabe kiseline i/ili hidrogen soli navedene bar jedne vodorastvorne nepolimerne organske i/ili neorganske slabe kiseline; i e) dovodjenje u kontakt navedenog kalcijum karbonata sa navedenom bar jednom kiselinom sa pKa vrednošću manjom od ili jednakom 2.5 iz stupnja b), sa gasovitim CO₂ iz stupnja c) i sa navedenom bar jednom vodorastvornom nepolimernom organskom i/ili neorganskom slabom kiselinom i/ili vodonikovom solju navedene bar jedne vodorastvorne nepolimerne organske i/ili neorganske slabe kiseline iz stupnja d); pri čemu navedena bar jedna vodorastvorna nepolimerna organska i/ili neorganska slaba kiselina ima pKa vrednost veću od 2.5 i pri čemu odgovarajući kiselinski anjon može graditi vodonerastvorne kalcijumove soli.
Patent sadrži još 22 patentna zahtjeva

- (51) **C07D215/56**²⁰⁰⁶⁰¹
A61K31/47²⁰⁰⁶⁰¹
A61P 31/18²⁰⁰⁶⁰¹
- (11) **01476**
(21) **P-2012-91**
- (22) 19. 05. 2005
(30) 20040150979 20. 05. 2004 JP
(96) EP/05726243.8/19. 05. 2005
(97) WO/PCT/JP2005/009604
WO 2005/113508/01. 12. 2005/en/2005/48
EP 1636190/22. 03. 2006/en/2006/12
EP 1636190/27. 06. 2012/en/2012/26
- (54) me **STABILNI KRISTALI JEDINJENJA 4-OKSOHINOLINA**
en STABLE CRYSTAL OF 4-OXOQUINOLINE COMPOUND
- (73) Japan Tobacco, Inc., 2-1, Toranomom 2-chome, Minato-ku, Tokyo 105-8422, JP,
(72) SATOH, Motohide c/o Central Pharmaceut. Res.Inst., Japan Tobacco Inc., 1-1, Murasaki-cho, Takatsuki-shi, Osaka 5691125, JP,
MOTOMURA, Takahisa c/o Central Pharm. Res. Inst., Japan Tobacco Inc., 1-1, Murasaki-cho, Takatsuki-shi, Osaka 5691125, JP,
MATSUDA, Takashi c/o Central Pharm. Res. Inst., Japan Tobacco Inc., 1-1, Murasaki-cho, Takatsuki-shi, Osaka 5691125, JP,
KONDO, Kentaro c/o Central Pharm. Res. Inst., Japan Tobacco Inc., 1-1, Murasaki-cho, Takatsuki, Osaka 5691125, JP,
ANDO, Koji c/o Central Pharmaceut. Res. Inst., Japan Tobacco Inc., 1-1, Murasaki-cho, Takatsuki-shi, Osaka 5691125, JP,
MATSUDA, Koji c/o Central Pharmaceut. Res. Inst., Japan Tobacco Inc., 1-1, Murasaki-cho, Takatsuki-shi, Osaka 5691125, JP,
MIYAKE, Shuji c/o Central Pharmaceut. Res. Inst., Japan Tobacco Inc., 1-1, Murasaki-cho, Takatsuka-shi, Osaka 5691125, JP,
UEHARA, Hideto c/o Central Pharmaceut. Res. Inst., Japan Tobacco Inc., 1-1, Murasaki-cho, Takatsuka-shi, Osaka 5691125, JP,
- (74) AOD "Ćupić", Dalmatinska 10, Podgorica ME,
(57) Kristal (kristalni oblik II) 6-(3-hlor-2-fluorbenzil)-H(SH- hidrosimetil-2-metilpropil]-7-metoksi-4-okso-1, 4-dihidrohlinol-3-karboksilne kiseline, naznačen time, što ima rendgenski dijagram praha sa karakterističnim difrakcionim pikovima pri uglovima difrakcije 20(°) od 6.56, 13.20, 19.86, 20.84, 21.22, 25.22° kao stoje mereno rendgenskom difraktometrijom praha.
Preostalih patentnih zahtjeva je 9.

(51) **A01N43 56 /** ²⁰⁰⁶⁰¹(11) **01481**(21) **P-2012-94**

(22) 23. 04. 2008

(30) 20070008370 25. 04. 2007 EP

(96) EP/10157585.0/23. 04. 2008

(97) EP 2229814/22. 09. 2010/en/2010/38

EP 2229814/16. 05. 2012/en/2012/20

(54) me **FUNGICIDNE KOMPOZICIJE**
en **FUNGICIDAL COMPOSITIONS**

(73) Syngenta Participations AG, Schwarzwaldallee 215, 4058 Basel, CH,

(72) Tobler, Hans, Birsigstrasse 129, 4054, Basel, CH,

Walter, Harald, Syngenta Crop Protection Münchwilen AG, Schaffhau, 4332, Basel, CH,

Haas, Ulrich Johannes, Syngenta Crop Protection Münchwilen AG, Schaffhau, 4332, Stein, CH,

(74) Radulović Božidar, Jovana Tomaševića 9/III, Podgorica ME

(57) Metod za kontrolu bolesti rde kod biljaka soje, naznačen time, da obuhvata nanošenje na pomenute korisne biljke, na njihov lokus ili na njihov rasplodni materijal neku kompoziciju koja sadrži jedinjenje sa formulom (I) (I), gde Ri je difluorometil ili trifluorometil, a X je hloro, fluoro ili bromo.

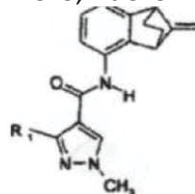

Preostalih patentnih zahtjeva je 5.

- (51) **C07D215 22** / ^{2006.01}
A61K3147 / ^{2006.01}
A61P3106 / ^{2006.01}
- (22) 03. 12. 2007
- (30) 20060125443 05. 12. 2006 EP
- (96) EP/07847697.5/03. 12. 2007
- (97) WO/PCT/EP2007/063186
 WO 2008/068231 /12. 06. 2008/en/2008/24
 EP 2086940/12. 08. 2009/en/2009/33
 EP 2086940/16. 05. 2012/en/2012/20
- (54) me **FUMARATNA SO (ALFA S, BETA R)-6-BROMO-ALFA-[2-(DIMETILAMINO) ETIL]-2-METOKSI-ALFA-1-NAFTALENIL-BETA-FENIL-3-KINOLINETANOLA**
 en FUMARATE SALT OF (ALPHA S, BETA R)-6-BROMO-ALPHA-[2-(DIMETHYLAMINO) ETHYL]-2-METHOXY-ALPHA-1-NAPHTHALENYL-BETA-PHENYL-3-QUINOLINEETHANOL
- (73) Janssen Pharmaceutica NV, Turnhoutseweg 30, 2340 Beerse, BE,
- (72) HEGYI, Jean François Alexandre Lucas,
 Janssen Pharmaceutica N.V., Turnhoutseweg 30, 2340 Beerse, BE,
 AELTERMAN, Wim Albert Alex, Janssen Pharmaceutica N.V., Turnhoutseweg 30, 2340 Beerse, BE,
 LANG, Yolande Lydia, Janssen Pharmaceutica N.V., Turnhoutseweg 30, 2340 Beerse, BE,
 STOKBROEKX, Sigrid Carl Maria, Janssen Pharmaceutica N.V., Turnhoutseweg 30, 2340 Beerse, BE,
 LEYS, Carina, Janssen Pharmaceutica N.V., Turnhoutseweg 30, 2340 Beerse, BE,
 VAN REMOORTERE, Peter Jozef Maria, 44 Western Way, Princeton, NJ 08540, US,
 FAURE, Anne, Janssen Pharmaceutica N.V., Turnhoutseweg 30, 2340 Beerse, BE,
- (74) Radulović Božidar, Jovana Tomaševića 9/III, Podgorica ME
- (57) Fumaratna so, naznačena time, da je to so (alfa S, beta R)-6-bromo-alfa-[2-(dimetilamino) etil]-2-metoksi-alfa-i-naftalenil-beta-fenil-3-kinolinetanoil.
 Preostalih patentnih zahtjeva je 21.

- (51) **A61K9 48/**⁰⁰⁶⁰¹
A61K9 14/²⁰⁰⁶⁰¹
A61K314184 /²⁰⁰⁶⁰¹
C07D23506 /²⁰⁰⁶⁰¹
- (22) 26. 03. 2009
(30) 20080040372 28. 03. 2008 US
(96) EP/09726304.0/26. 03. 2009
(97) WO/PCT/GB2009/050293
WO 2009/118562/01. 10. 2009/en/2009/40
EP 2271321 /12. 01. 2011/en/2011/02
EP 2271321 /13. 06. 2012/en/2012/24
- (54) me **FARMACEUTSKA SMESA 271**
en PHARMACEUTICAL COMPOSITION 271
- (73) AstraZeneca AB, 151 85 Södertälje, SE,
Array Biopharma, Inc., 3200 Walnut Street, Boulder, CO 80301, US,
- (72) BATEMAN, Nicola, Frances, AstraZeneca, Charter Way, Macclesfield, Cheshire SK10 2NA,
GB,
GELLERT, Paul, Richard, AstraZeneca R&D Alderley, Alderley Park, Macclesfield, Cheshire
SK10 4TG, GB
HILL, Kathryn, Jane, AstraZeneca R&D Alderley, Alderley Park, Macclesfield, Cheshire SK10
4TG, GB,
- (74) Radulović Božidar, Jovana Tomaševića 9/III, Podgorica ME
- (57) Farmaceutska smeša koja sadrži hidrogen sulfatnu so (2-hidroksi-etoksi)-amida
6-(4-bromo-2-hloro-fenilamino)-7-fluoro-3-metil-3//-benzoimidazol-5-karboksilne kiseline,
te matricu nosača, naznačena time što se matrica nosača sastoji isključivo od jednog ili
više farmaceutski prihvatljivih nosača koji su izabrani iz sledeće grupe: (a) d-alfa-tokoferil
polietilen glikol 1000 sukcinat; (b) poliglikolizovani gliceridi; i (c) polietilen glikoli (PEG-
ovi); pri čemu je hidrogen sulfatna so (2-hidroksi-etoksi)-amida 6-(4-bromo-2-hloro-
fenilamino)-7-fluoro-3-metil-3//-benzoimidazol-5-karboksilne kiseline dispergovana u
matrici nosača.
Preostalih patentnih zahtjeva je 24.

(51) **A61K38 22/**²⁰⁰⁶⁰¹

(11) **01473**

(21) **P-2012-101**

(22) 12. 04. 2007

(30) A61K38/22 02. 05. 2006 EP

(96) EP/07728041 .0/12. 04. 2007

(97) WO/PCT/EP2007/053574

WO 2007/128647/15. 11. 2007/en/2007/46

EP 2012816/14. 01. 2009/en/2009/03

EP 2012816/27. 06. 2012/en/2012/26

(54) me **PRIMJENA TIMOZINA 1, SAMOG ILI U KOMBINACIJI SA PTX3 ILI GANCIKLOVIROM, ZA LIJEČENJE INFEKCIJE CITOMEGALOVIRUSOM**

en USE OF THYMOSIN 1, ALONE OR IN COMBINATION WITH PTX3 OR GANCICLOVIR, FOR THE TREATMENT OF CYTOMEGALOVIRUS INFECTION

(73) SIGMA-TAU Industrie Farmaceutiche Riunite S.p.A., Viale Shakespeare 47, 00144 Roma, IT

(72) ROMANI, Luigina, Via del Villaggio S. Livia, 1, 06123 Perugia, IT,

BISTONI, Francesco, Via Briganti, 85, 06127 Perugia, IT, GARACI, Enrico, Istituto Superiore di Sanit, 00161 Rome, IT,

(74) Đakonović Vido, Bajova 9, Cetinje ME

(57) Primjena timozina a1, za dobijanje lijeka za prevenciju i/ili liječenje herpes virusnih bolesti kod subjekta koji je sisar.

Preostalih patentnih zahtjeva je 3.

(51) **C07D213 79 /** ⁽²⁰⁰⁶⁰¹⁾
C07D21380 / ⁽²⁰⁰⁶⁰¹⁾
A61K31465 / ⁽²⁰⁰⁶⁰¹⁾
A61P35 00 / ⁽²⁰⁰⁶⁰¹⁾

(11) **01475**
(21) **P-2012-104**

(22) 21. 12. 2007

(30) 20060003250 22. 12. 2006 ES
20070001086 23. 04. 2007 ES

(96) EP/07866261.6/21. 12. 2007

(97) WO/PCT/EP2007/011401

WO 2008/077639/03. 07. 2008/en/2008/27

EP 2121614/25. 11. 2009/en/2009/48

EP 2121614/20. 06. 2012/en/2012/25

(54) me **DERIVATI AMINO NIKOTINSKE IIZONIKOTINSKE KISELINE KAO
INHIBITORI DHODH**

en AMINO NICOTINIC AND ISONICOTINIC ACID DERIVATIVES AS DHODH INHIBITORS

(73) Almirall, S.A., Ronda del General Mitre 151, 08022 Barcelona, ES,

(72) CASTRO PALOMINO LARIA, Julio Cesar, c/ Enrique Granados 29, 4, E-08330 Premia De Mar
(barcelona), ES,

ERRA SOLA, Montserrat, Riera Blanca 46, Atico 1a, Esc. A, E-08903 L' Hospitalet (Barcelona),
ES

LOZOYA TORIBIO, Maria Estrella, C/ Brodadores, 6F E-08100 Mollet del Valles (Barcelona),
ES,

NAVARRO ROMERO, Eloisa, c/Comte d'Urgell 20, 1 2 E-08011 Barcelona, ES,

(74) Đakonović Vido, Bajova 9, Cetinje ME

(57) Jedinjenje formule IA: IA gde A je aril, ili heteroaril; R⁷ je: H ili halo; ili -O-C1-6alkil, koji je opciono supstituisan; ili -NR⁶R⁷, gde svaki od R⁶ i R⁷ je nezavisno izabran iz grupe koju čine H, ili Cl-6alkil, C₂₋₆-6alkenil, i C₂₋₆-6alkinil; od kojih je svaki opciono supstituisan, R² je Cl-6alkil, C₂₋₆-alkenil, C₂₋₆-alkinil, -C(=O)Cl-6alkil, -C(=O)C₂₋₆-alkenil, -C(=O)C₂₋₆-alkinil, -S(=O)C1-6alkil, -S(=O)C₂₋₆-alkenil, -S(=O)C₂₋₆-alkinil, SO₂C1-6alkil, SO₂C₂₋₆-alkenil, SO₂C₂₋₆-alkinil, -CO₂C1-6alkil, -CO₂C₂₋₆-alkenil, ili -CO₂C₂₋₆-alkinil, od kojih je dvaki opciono supstituisan; gde opciono supstituisani znači da je grupa opciono supstituisana sa jednim ili više 5 supstituenata, poželjno 1, 2, ili 3 supstituenta, nezavisno izabranih iz grupe koju čine halo, halo(Ci₆)alkil, halo₂(C1-6)alkil, halo₃(C1-6)alkil, aril, heteroaril, cikloalkil, heterocikloalkil, C1-6alkil, C₂₋₆-alkenil, C₂₋₆-alkinil, aril(C1-6)alkil, aril(C2.6)alkenil, aril(C2.6)alkinil, cikloalkil(C1-6)alkil, heterociklo(C1-6)alkil, hidroksil(C1-6)alkil, amino(C1-6)alkil, karboksi(C1-6)alkil, alkoksi(C1-6)alkil, nitro, amino, ureido, cijano, alkilkarbonilamino, 10 hidroksil, tiol, alkilkarboniloksi, azido, alkoksi, karboksi, aminokarbonil, i C1-6alkiltiol, a poželjno supstituisan je sa halo, halo(C1-6)alkil, halo₂(C1-6)alkil, halo₃(C1-6)alkil, hidroksil(C1-6)alkil, amino(C1-6)alkil, hidroksil, nitro, C1-6alkil, C1-6alkoksi i amino, Bje (CH₂)_m gde je m celi broj od 0 do 12, i poželjno 1, 2 ili 3; R³ i R⁴ svaki nezavisno su izabrani iz grupe koju čine aril i heteroaril; 15 R⁵ je H, C1-6alkil, -C(=O)NHC1-6alkil, -C(=O)N(C1-6alkil)₂, ili alkilaminokarbonil; i njegove farmaceutske prihvatljive soli i solvati.

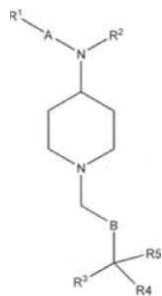

Preostalih patentnih zahtjeva je 14.

- (51) **A61K31485** / ²⁰⁰⁶⁰¹
A61K9 22 / ²⁰⁰⁶⁰¹
A61K9 32 / ²⁰⁰⁶⁰¹
- (22) 24. 08. 2007
(30) 20060840244P 25. 08. 2006 US
(96) EP/10192627.7/24. 08. 2007
(97) EP 2311459/20. 04. 2011/en/2011/16
EP 2311459/27. 06. 2012/en/2012/26
- (54) me **FARMACEUTSKI DOZNI OBLICI REZISTENTNI NA ZLOUPOTREBU KOJI SADRŽE OPIOIDNI ANALGETIK**
en TAMPER RESISTANT ORAL PHARMACEUTICAL DOSAGE FORMS COMPRISING AN OPIOID ANALGESIC
- (73) Purdue Pharma L.P., One Stamford Forum 201 Tresser Boulevard, Stamford, CT 06901-3431, US
- (72) Mannion, Richard Owen, 3860 Green Ridge Road, Furlong, PA 18925, US,
Huang, Haiyong Hugh, 33 Ketley Place, Princeton, NJ 08540, US,
McKenna, William Henry, 10 Longmeadow Road, Yonkers, NY 10704, US,
O'Donnell, Edward, P., 38 Chestnut Court, Basking Ridge, NJ 07920, US,
- (74) Lutovac Branislav, Bulevar Crnojevića 93, Podgorica ME
- (57) Čvrst oralni farmaceutski dozni oblik sa produženim oslobađanjem, koji sadrži formulaciju matrice sa produženim oslobađanjem sa kompozicijom koja sadrži (1) najmanje jedan polietilen oksid koji n osnovu reoloških merenja ima približnu molekulsku težinu od najmanje 1, 000, 000; i (2) oksikodon hidrohlorid, gde pomenuta kompozicija u pomenutom doznom obliku sadrži 10 mg oksikodon hidrohlorida i bar oko 85 mas.% polietilen oksida; ili pomenuta kompozicija u pomenutom doznom obliku sadrži 15 mg ili 20 mg oksikodon hidrohlorida i bar oko 80 mas.% polietilen oksida, ili pomenuta kompozicija u pomenutom doznom obliku sadrži 40 mg oksikodon hidrohlorida i bar oko 65 mas.% polietilen oksida, ili pomenuta kompozicija u pomenutom doznom obliku sadrži 60 mg ili 80 mg oksikodon hidrohlorida i bar oko 60 mas.% polietilen oksida
Preostalih patentnih zahtjeva 19.

- (51) **A61K9/16**²⁰⁰⁶⁰¹
A61K31/4439²⁰⁰⁶⁰¹
A61K47/12²⁰⁰⁶⁰¹
A61K47/26²⁰⁰⁶⁰¹
A61K47/36²⁰⁰⁶⁰¹
A61K9/10²⁰⁰⁶⁰¹
A61K9/14²⁰⁰⁶⁰¹
- (11) **01458**
(21) **P-2012-106**
- (22) 20. 12. 2005
- (30) 20040638435P 22. 12. 2004 US
- (96) EP/05820824.0/20. 12. 2005
- (97) US/PCT/US2006/006334/21. 02. 2006
WO 2006/068596/29. 06. 2006/en/2006/26
EP 1830816/12. 09. 2007/en/2007/37
EP 1830816/01. 08. 2012/en/2012/31
- (54) me **KRUTA DOZNA FORMA KOJA SADRŽI INHIBITOR PROTONSKE PUMPE I NJENA SUSPENZIJA**
en SOLID DOSAGE FORM COMPRISING PROTON PUMP INHIBITOR AND SUSPENSION MADE THEREOF
- (73) AstraZeneca AB, 151 85 Sodertalje, SE,
(72) PERSSON, Eva, AstraZeneca R & D Lund, 221 87 Lund, SE,
TROFAST, Eva, AstraZeneca R & D Lund, 221 87 Lund, SE,
(74) Radulović Božidar, Jovana Tomaševića 9/III, Podgorica ME
- (57) Oralna farmaceutska dozna forma koja je mešavina krutog granulata koji brzo stvara gel, prikladna za pripremu suspenzije koja obuhvata I) neki kiselo-osetljivi inhibitor protonske pumpe, koji je ezomeprazol, neku njegovu alkalnu so ili neku hidratnu formu od pomenutih kao aktivni sastojak koji je distribuiran kao mnoštvo entero-zaštićenih peleta i II) granulat, naznačena time, da pomenuti granulat je neki granulat koji modifikuje suspenziju i koji sadrži razređivač koji se brzo rastvara i koji je izabran iz glikoze i saharoze i iz njihovih hidrata, agens za stvaranje gela koji je izabran iz ksantanskih guma, agens za regulisanje kiselog pH, veznik i ponekad agens za raspadanje pri čemu pomenuti granulat ne sadrži bikarbonatne i/ili karbonatne soli i gde omer među pomenutog veznika i agensa za stvaranje gela u pomenutom granulatu (II) se kreće od 1:2 do 1:3, w/w. Dozna forma u skladu sa zahtevom.
Preostalih patentnih zahtjeva je 19.

- (51) **A61M 1500**/²⁰⁰⁶⁰¹
B05B 11 02/²⁰⁰⁶⁰¹
B05B 11 00/²⁰⁰⁶⁰¹
F04B 53 16/²⁰⁰⁶⁰¹
- (11) **01459**
(21) **P-2012-107**
- (22) 23. 10. 2006
(30) 20051052898 03. 11. 2005 DE
(96) EP/06806455.9/23. 10. 2006
(97) /PCT/EP2006/010177
WO 2007051536/10. 05. 2007/en/2007/19
EP 1942967/16. 07. 2008/en/2008/29
EP 1942967/01. 08. 2012/en/2012/31
- (54) me **POSTUPAK ZA DOZIRANJE MEDIKAMENATA**
en METHOD FOR METERING MEDICAMENTS
- (73) Boehringer Ingelheim Pharma GmbH & Co. KG, Binger Strasse 173, 55216 Ingelheim am Rhein, DE
- (72) BOECK, Georg, Ahornweg 48, 88471 Laupheim, DE,
GESER, Johannes, Vorderer Boehl 23, 55218 Ingelheim am Rhein, DE,
HAUSMANN, Matthias, Kaemperdick 5, 46459 Rees, DE,
KOELBEL, Hans-Juergen, Aggerstrasse 4, 53721 Siegburg, DE,
EICHER, Joachim, Gustav-Korthen-Allee 24, 44227 Dortmund, DE,
FEIERTAG, Christian, Ostermanns Holz 31, 45549 Sprockhoevel, DE,
- (74) Radulović Božidar, Jovana Tomaševića 9/III, Podgorica ME
- (57) Postupak sastavljanja uređaja (1) za dostavu medikamenta, prvenstveno u obliku aerosol (A), sa poboljšanim preciznim doziranjem, gde je predviđena bar jedna prva i jedna druga komponenta, koje su zaptivanjem dovedene u vezu jedna sa drugom ili su postavljene jedna naspram druge, gde se prva komponenta proizvodi u serijama, gde je bar jedna karakteristična veličina prve komponente u svakoj seriji određena samo jednostavnim uzorkovanjem, gde je bar jedna odlučujuća karakteristična veličina za sve prve komponente odgovarajuće serije određena iz bar jedne karakteristične veličine, gde je druga komponenta podeljena u grupe, koje se razlikuju, po bar jednoj osnovnoj veličini druge komponente, gde u zavisnosti od bar jedne odlučujuće karakteristične veličine grupa koja se poredi sa odgovarajućom odlučujućom karakterističnom veličinom a, prema tome, i sa odgovarajućom serijom je odabrana, gde se prva komponenta serije kombinuje sa drugom komponentom grupe koja se poredi sa ovom serijom, kako bi se postiglo optimalno zaptivanje između ove dve komponente u cilju poboljšanja preciznog doziranja, i gde se ove dve komponente kreću jedna u odnosu na drugu za proces dostave.

(51) **B65D51 28/** ⁽²⁰⁰⁶⁰¹⁾(11) **01474**(21) **P-2012-108**

(22) 20. 06. 2008

(30) 20070000312 16. 07. 2007 HR

(96) EP/08762649/20. 06. 2008

(97) WO/WO2008HR00021

WO 2009010809/22. 01. 2009/en/2009/04

EP 2167395/31. 03. 2010/en/2010/13

EP 2167395/20. 06. 2012/en/2012/25

(54) me **ZATVARAČ ZA PRIPREMU NAPITAKA**

en CAP FOR BOTTLES WITH BOX FOR POWDER MATERIAL FOR PREPARATION OF BEVERAGES

(73) Cedevisa D.o.o., Planinska b.b., 10000 Zagreb, HR,

(72) Van den Broek Lucas Karel Johannes, Klein Hoefblad 15, 3893 GH Zeewolde, NL,
Van Amerongen Gerard, Diedenweg 4, 6721 HR Bennekom, NL,

(74) Đakonović Vido, Bajova 9, Cetinje ME

(57) Zatvarač za pripremu napitaka i zatvaranje boce ili osnovnog spremišta koje sadrži prvu ili osnovnu materiju i koji se sastoji od spremišta (1) koje sadrži praškasti materijal, pri čemu se prva ili osnovna materija i praškasti materijal mješaju neposredno prije upotrebe smjese i pri čemu se zatvarač sastoji od spremišta (1), kose klapne (9) i poklopca (2), te pri čemu spremište (1) u osnovi ima oblik cijevi koja u donjoj polovini ima oblik dvostrukog cilindra koji se sastoji od spoljnog cilindra (3) i unutrašnjeg cilindra (6), koji se spajaju u jedan cilindar, koji, na unutrašnjoj površini spoljnog cilindra (3), ima navoje (4) za navijanje spremišta (1) na otvor boce ili osnovnog spremišta, naznačen sa savitljivim zubima (5) izvedenim ispod navoja (4) za sprečavanje odvijanja spremišta (1) s boce ili s osnovnog spremišta i navedenim spremištem (1) koje, na vrhu spoljne površine unutrašnjeg cilindra (6), ima zaptivnu površinu (7) kojom spremište (1) nepropusno naleže na gornji dio unutrašnje površine otvora boce ili osnovnog spremišta, pri čemu je spremište (1) s donje strane zatvoreno aluminijumskom folijom (8) koja je nepropusno naljepljena na rub otvora spremišta (1) i dio spoljnog omotača unutrašnjeg cilindra (6) i pri čemu navedeno spremište (1) ima, u unutrašnjem cilindru (6), kosu klapnu (9) koja ima oblik elipsaste pločice konstantne debljine, nastale presjekom unutrašnje površine unutrašnjeg cilindra (6) sa ravni koja pod oštrim uglom u odnosu na vodoravnu ravan u cjelosti zatvara unutrašnji cilindar (6), te navedenom klapnom (9) koja je u gornjem delu nerastavljivo vezana zglobnim pregibnim spojem s osom rotacije (O) za unutrašnju površinu unutrašnjeg cilindra (6), pri čemu navedena klapna (9) na donjem dijelu ima trn (10) za probijanje aluminijumske folije (8) i pri čemu navedenu klapnu (9) u krajnjem otvorenom položaju drže dva zuba (18) izvedena na unutrašnjoj površini unutrašnjeg cilindra (6), te pri čemu ta klapna (9) na gornjoj površini ima nerastavljivo vezanu jednokraku vertikalnu savitljivu polugu (11) u obliku konzole konstantne debljine, a promjenjivog poprečnog preseka, čiji je vrh (12) pravougaonog preseka, te navedenim poklopcem (2) koji na jednoj polovini unutrašnje površine dna ima unutrašnji, vertikalni, koncentrični polukružni ispust (13) i, u odnosu na njega, djelomično koncentričan spoljni ispust (13), čiji je kraj (15) ravan i povijen prema osi poklopca (2), pri čemu je poprečno na spoljnom omotaču spoljnog ispusta (14) izvedena vertikalna prepreka (17), te pri čemu navedeni unutrašnji ispust (13) i navedeni spoljni ispust (14) čine kanal (16) i pri čemu se za vreme navijanja poklopca (2) na spremište (1) u prvom smjeru okretanja (N1), vrh (12) poluge (11) kreće od ulaznog, šireg dela kanala (16) prema izlaznom, užem delu kanala (16) i pri čemu se za vreme odvijanja do kraja navijenog poklopca (2) sa spremišta (1) u drugom smjeru okretanja

(N2) krivolinijsko kretanje poklopca (2) pretvara u krivolinijsko kretanje klapne (9), tako što se vrh (12) poluge (11) kreće klizajući po spoljnoj površini kraja (15) spoljnog ispusta (14) do vertikalne prepreke (17) koja elastično savija polugu (11) stvarajući u njoj moment sile koji zakreće klapnu (9) oko ose rotacije (O) zglobnog pregibnog spoja tako probijajući aluminijumsku foliju (8).

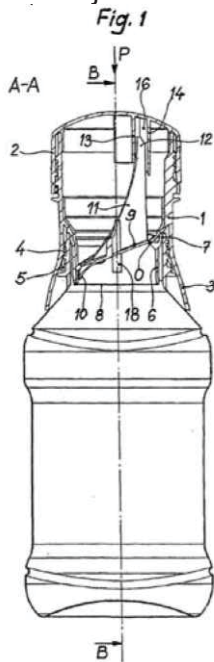

Preostalih patentnih zahtjeva je 0.

- (51) **C07D48704** / ²⁰⁰⁶⁰¹
A 61K31 519 / ²⁰⁰⁶⁰¹
A61P9 10 / ²⁰⁰⁶⁰¹
- (11) **01486**
(21) **P-2012-109**

- (22) 05. 12. 2005
(30) 20040002972 06. 12. 2004 SE
20050001093 13. 05. 2005 SE
(96) EP/05812036.1/05. 12. 2005
(97) /PCT/SE2005/001835
WO 2006062465/15. 06. 2006/en/2006/24
EP 1824855/29. 08. 2007/en/2007/35
EP 1824855/08. 08. 2012/en/2012/32

- (54) me **NOVI PIROLO [3, 2-D]PIRIMIDIN-4-ON DERIVATI I NJIHOVA PRIMJENA U TERAPIJI**

en **NOVEL PYRROLO [3, 2-D]PYRIMIDIN-4-ONE DERIVATIVES AND THEIR USE IN THERAPY**

- (73) AstraZeneca AB, 151 85 Södertälje, SE,
(72) BÖGEVIG, Anders, AstraZeneca R & D Södertälje, S-151 85 Södertälje, SE,
LO-ALFREDSSON, Yvonne, AstraZeneca R & D Södertälje, S-151 85 Södertälje, SE, PIVONKA, Donald AstraZeneca Wilmington, 1800 Concord Pike, P.O. Box 15437, Wilmington, DE 19850-5437, US
TIDEN, Anna-Karin, AstraZeneca R & D Södertälje, S-151 85 Södertälje, SE,
(74) Radulović Božidar, Jovana Tomaševića 9/III, Podgorica ME
(57) Jedinjenje, naznačeno time. da ima formulu (I)

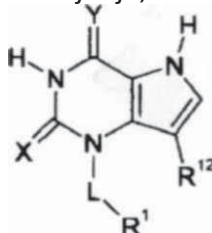

gde: X predstavlja S, a Y predstavlja O; L predstavlja C 1 do 7 alkilen, a pomenuti alkilen ponekad uključuje neki heteroatom koji je izabran iz O, S(O)_n i NR⁶, pomenuti alkilen ponekad uključuje jednu ili dve, dvostruke veze ugljenik-ugljenik, pomenuti alkilen je ponekad supstituisan sa jednim ili više supstituenata nezavisno izabranih iz OH, halogena, CN i NR^{4R5}, Cl do 6 alkila i Cl do 6 alkoksi, pomenuti alkoksi ponekad uključuje neki karbonil koji je susedan kiseoniku; n predstavlja neki celi broj 0, 1 ili 2; R¹ predstavlja vodonik, ili i) neki zasićeni ili delimično nezasićeni 3 do 7-člani prsten koji ponekad uključuje jedan ili dva heteroatoma nezavisno izabrana iz O, N i S, a ponekad uključuje neku karbonilnu grupu, ponekad supstituisan sa jednim ili više supstituenata nezavisno izabranih iz halogena, SO₂R⁹, SO₂NR^{9R10}, OH, Cl do 7 alkila, Cl do 7 alkoksi, CN, CONR^{2R3}, NR²COR³ i COR³, pomenuti alkoksi je ponekad dodatno supstituisan sa Cl do 6 alkoksi, a pomenuti alkoksi ponekad uključuje neki karbonil koji je susedan kiseoniku, a pomenuti alkil je ponekad dodatno supstituisan uz pomoć hidroksi ili Cl do 6 alkoksi, a pomenuti alkil ili alkoksi ponekad uključuju neki karbonil koji je susedan kiseonikom ili je na bilo kojoj poziciji u alkilu; ili ii) neki aromatski prstenski sistem izabran iz fenila, bifenila, naftila ili neka monociklička ili biciklička heteroaromatčka prstenska struktura koja sadrži 1 do 3 heteroatoma nezavisno izabrana iz O, N i S, pomenuti aromatski prstenski sistem je ponekad supstituisan sa jednim ili više supstituenata koja su nezavisno izabrani iz halogena, SO₂R⁹, SO₂NR^{9R10}, OH, Cl do 7 alkila, Cl do 7 alkoksi, CN, CONR^{2R3}, NR²COR³ i COR³; pomenuti alkoksi je ponekad dodatno supstituisan sa Cl do 6 alkoksi i pomenuti alkoksi ponekad uključuje neki karbonil koji je susedan kiseoniku, a po-

menuti alkil je ponekad dodatno supstituisan sa hidroksi ili Cl do 6 alkoksi i pomenuti alkil ili alkoksi ponekad uključuje neki karbonil koji je susedan kiseoniku ili je na bilo kojoj poziciji u alkilu; R^{12} predstavlja vodonik ili halogen ili neki ugljenik koji je ponekad supstituisan sa jednim do tri halogena atoma; u svakom slučaju, R^2 , R^3 , R^4 , R^5 , R^6 , R^9 i R nezavisno predstavljaju vodonik, Cl do 6 alkil ili Cl do 6 alkoksi, a pomenuti alkoksi ponekad uključuje neki karbonil koji je susedan kiseoniku, pomenuti alkil je ponekad dodatno supstituisan sa halogenom, Cl do 6 alkoksi, CHO, C2 do 6 alkanoilom, OH, $CONR^7R^8$ i NR^7COR^8 ; ili grupe NR^2R^3 , NR^4R^5 i NR^9R^{10} , svaka nezavisno, predstavljaju neki 5 do 7-člani zasićeni azaciklički prsten koji ponekad uključuje neki dodatni heteroatom koji je, izabran iz O, S i NR^{11} , pomenuti prsten je ponekad dodatno supstituisan sa halogenom, Cl do 6 alkoksi, CHO, C2 do 6 alkanoilom, OH, $CONR^7R^8$ i NR^7COR^8 ; u svakom slučaju R^7 , R^8 i R^{11} nezavisno predstavljaju vodonik ili Cl do 6 alkil, ili grupa N R^7R^8 predstavlja neki 5- do 7-člani zasićeni azaciklički prsten koji ponekad uključuje dodatni heteroatom izabran iz O, S i NR^{11} ; i njegove farmaceutske prihvatljive soli. Preostalih patentnih zahtjeva je 21.

- (51) **A61L 2 18/** ²⁰⁰⁶⁰¹
A 61B 19 00 / ²⁰⁰⁶⁰¹
C11D3 04/ ²⁰⁰⁶⁰¹
C11D3 06/ ²⁰⁰⁶⁰¹
C11D3 30/ ²⁰⁰⁶⁰¹
B08B3 08 / ²⁰⁰⁶⁰¹
- (11) **01489**
(21) **P-2012-111**
- (22) 06. 04. 2006
(30) 20050007557 06. 04. 2005 EP
(96) EP/06724082/06. 04. 2006
(97) WO/PCT/EP2006/003137
WO 2006105967/12. 10. 2006/de/2006/41
EP 1865998/19. 12. 2007/de/2007/51
EP 186599807. 2012/de/2012/28
- (54) me **MAŠINSKA DEZINFEKCIJA PREDMETA**
en MECHANIZED DISINFECTION OF ARTICLES
- (73) Chemische Fabrik Dr. Weigert GmbH & Co. KG, Mühlenhagen 85, 20539 Hamburg, DE
(72) STAFFELDT, Jürgen, Schlehenweg 25, 21423 Winsen, DE,
WAGEMANN, Wolfgang, Beektwiete 2a, 22967 Tremsbüttel, DE,
SCHMIDT, Verona, Ohnsorweg 40, 22605 Hamburg, DE,
(74) Lutovac Branislav, Bulevar Crnojevića 93, Podgorica ME
(57) Upotreba sredstva za čišćenje koje sadrži najmanje dve različite površinski aktivne materije izabrane iz najmanje dve od tri grupe katjonskih, nejonskih i amfoternih površinski aktivnih materija, koje spremno za upotrebu, razblaženo u vodenom rastvoru ima pH-vrednost od najmanje 10, 5, za uništavanje/inaktivaciju mikroorganizama iz grupe koja se sastoji od bakterija, virusa i gljivica za mašinsku dezinfekciju predmeta. Preostalih patentnih zahtjeva je 27.

- (51) **C07D40312** / ²⁰⁰⁶⁰¹
A61K31 517 / ²⁰⁰⁶⁰¹
A61P 11 00 / ²⁰⁰⁶⁰¹

- (11) **01461**
(21) **P-2012-112**

- (22) 05. 02. 2009
(30) 20080101353 07. 02. 2008 EP
(96) EP/09707435.5/05. 02. 2009
(97) /PCT/EP2009/000805
WO 2009098061 /13. 08. 2009/de/2009/33
EP 2245026/03. 11. 2010/de/2010/44
EP 2245026/01. 08. 2012/de/2012/31

- (54) me **SPIROCIKLIČNI HETEROCIKLI, IJEKOVI KOJI SADRŽE NAVEDENO JEDINJENJE, NJIHOVA PRIMJENA I POSTUPAK ZA NJIHOVU PROIZVODNJU**
en SPIROCYCLIC HETEROCYCLES, MEDICAMENTS CONTAINING SAID COMPOUNDS, USE THEREOF AND METHOD FOR THEIR PRODUCTION

- (73) Boehringer Ingelheim International GmbH, Binger Strasse 173, 55216 Ingelheim am Rhein, DE,
(72) HIMMELSBACH, Frank, Boehringer Ingelheim GMBH, CD Patents, Binger Str. 173, 55216 Ingelheim Am Rhein, DE,
JUNG, Birgit, Boehringer Ingelheim GMBH, CD Patents, Binger Str. 173, 55216 Ingelheim Am Rhein, DE,
LOTZ, Ralf, Boehringer Ingelheim GMBH, CD Patents, Binger Str. 173, 55216 Ingelheim Am Rhein, DE,
(74) Radulović Božidar, Jovana Tomaševića 9/III, Podgorica ME
(57) Jedinjenja opšte formule (I)

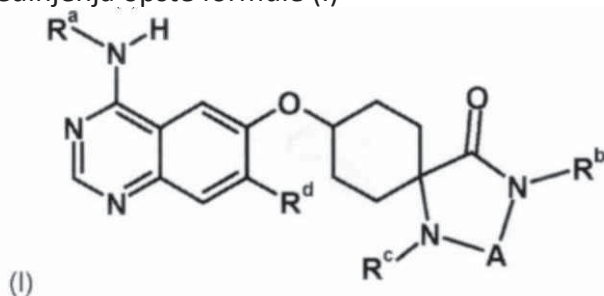

naznačena time što R^a označava fenil ili 1-feniletil grupu, pri čemu je fenil jezgro uvek supstituisano sa grupama R^1 do R^3 , pri čemu R^1 i R^2 koji mogu biti identični ili različiti, označavaju vodonik ili grupu koja je izabrana između F, Cl, Br, I, OCH₂F, OCHF₂, OCF₃, CH₂F, CHF₂, CF₃, CN, NO₂, NH₂ i OH, ili grupu koja je izabrana između C₁₋₄-alkila, C₁₋₄-alkil-O-, C₂₋₃-alkenila, C₂₋₃-alkinila, fenila, fenil-O-, fenil-C₁₋₃-alkila-, fenil-C₁₋₃-alkil-O-, heteroarila, heteroaril-O-, heteroaril-d-s-alkila i heteroaril-C₁₋₃-alkil-O-, pri čemu su gore navedene fenil grupe mono- ili disupstituisane sa grupama R^5 , R^3 označava vodonik, ili grupu koja je izabrana između F, Cl, Br, I, OH, C₁₋₄-alkila, C₁₋₄-alkil-O-, C₁₋₂-alkil-O supstituisanog sa 1 do 3 atoma fluora, C₃₋₇-cikloalkil-O-, C₃₋₇-cikloalkil-C₁₋₄-alkil-O-, tetrahidrofuran-3-il-O-, tetrahidropiran-3-il-O-, tetrahidropiran-4-il-O-, tetrahidrofuranil-C₁₋₄-alkil-O- i tetrahidropiranil-C₁₋₄-alkil-O-, ili R^4 -C₁₋₄-alkil-, pri čemu se vezivanje grupe R^4 može izvršiti preko svakog C atoma alkil grupe, ili R^4 -C₂₋₄-alkil-O-, pri čemu je grupa

R⁴ razdvojena od atoma kiseonika sa najmanje 2 C atoma, ili grupu koja je izabrana između pirolidin-2-il-C1-4-alkil-O-, pirolidin-3-il-C1-4-alkil-O-, piperidin-2-il- C1-4 alkil-O-, piperidin-3-il- C1-4 -alkil-O-, piperidin-4-il- C1-4 -alkil-O-, azepan-2-il- C1-4-alkil-O-, azepan-3-il- C1-4 -alkil-O-, azepan-4-il-C1-4-alkil-O-, morfolin-2-il- C1-4-alkil-O-, morfolin-3-il- C1-4-alkil-O-, 1 -(C1-3-alkil)-pirolidin-2-il- C1-4-alkil-O-, 1 -(C1-3 -alkil)-pirolidin-3-il-C1-4-alkil-O-, 1 -(C1-3 -alkil)-piperidin-2-il-C1-4-alkil-3-il-C1-4-0-, alkiO-piperidin-5-il- C1-4-alkil-O-, 1-(C1-3-alkil)-piperidin-4-il-C1-4-alkil-O-, alkiL-O-azepanA-il- C1-4-alkil-O, 1 -(C1-3 -alkiO-azepan-S-il- dA-alkil-O-, 1 -(d.3-alkil)-azepan-4-il- C1-4-alkil-O, 4-(C1-3-alkil)-morfolin-2-il-C1-4-alkil-O- i 4-(C1-3-alkil)-morfolin-3-il- C1-4 -alkil-O-, pri čemu R⁴ označava grupu, koja može biti identična ili različita, izabranu između OH, C1-3-alkil-O-, C3.6-cikloalkil-O-, NH₂, C1-3-alkil-NH-, (C1-3-alkil)2N-, (2-metoksietil)2N-, pirolidin-1 -ila, piperidin-1 -ila, azepan-1 -ila, morfolin-4-ila, 1, 4-oksazepan-4-ila, 2-oksa-5-aza-biciklo[2, 2, 1]hept-5-ila, 3-oksa-8-aza-biciklo[3.2.1]okt-8-ila, 8-oksa-3-aza-biciklo[3.2.1]okt-3-ila, piperazin-1 -ila, 4-(C1-3-alkil)-piperazin-1 -ila, 1, 4-diazepan-1 -ila, 4-(C1-3 -alkil)-1, 4-diazepan-1-ila, HCO-NH-, C1-3 -alkil-CO-NH-, C1-3-alkil-O- C1-3 -alkil-CO-NH-, C1-3-alkil-O-CO-NH-, HNCONH-, C1-3-alkil-NH-CO-NH-, (C1-3-alkil)2N-CONN-, pirolidin-1-il-CO-NH-, piperidin-1-il-CO-NH-, piperazin-1 -il-CO-NH-, 4-(C1-3-alkil)-piperazin-1 -il-CO-NH-, morfolin-4-il-CO-NH- i C1-3-alkil-SO₂-NH-, pri čemu svaka od pirolidinil, piperidinil, azepan-1 -il, piperazinil, 1, 4-diazepan-1 -il, morfolinil- i 1, 4-oksazepan-4-il grupa koje su navedene gore u definiciji grupe R^d može biti dodatno supstituisana sa jednom ili dve C1-3-alkil grupe, i pri čemu fenil grupe koje su gore navedene u definiciji grupe R^d mono- ili disupstituisane sa grupama R⁵, pri čemu R⁵ označava vodonik, ili grupu, koja može biti identična ili različita, izabranu između F, Cl, Br, I, OH, CN, C1-3-alkila, C1-3-alkil-O-, CHF₂, CF₃, -O-CHF₂ i -O-CF₃, osim ukoliko nije drugačije navedeno, gore navedene alkil grupe mogu biti pravog lanca ili razgranate, A označava -CO ili -C₁-C₃-alkilen, pri čemu - C₁-C₃ -alkilen-grupa može biti 1-, 2-, 3- ili 4-supstituisana sa grupom R⁶, R⁶ koje može biti identično ili različito, označava vodonik, ili grupu koja je izabrana između OH, C1-C4-alkila i -O- C1-C4 -alkila, eventualno u obliku tautomera, racemata, enantiomera, diastereomera i njihovih smeša, i eventualno njihovih farmakološki prihvatljivih kiselih adicijonih soli. Preostalih patentnih zahtjeva je 15.

- (51) **C07D49504** / ^{211/11} (11) **01465**
C07D239 70 / ^{2011/181} (21) **P-2012-113**

(22) 07. 05. 2009
 (30) 20080052816P 13. 05. 2008 US
 (96) EP/09736709.8/07. 05. 2009
 (97) /PCT/US2009/043068
 WO 2009/140127/19. 11. 2009/en/2009/47
 EP 2315755/04. 05. 2011/en/2011/18
 EP 2315755/08. 08. 2012/en/2012/32

(54) me **SINTEZA DIHIDROTIENO[3, 2-D]PIRIMIDIN DIOLA I SLICNIH PIRIMIDIN DIOLA**

en SYNTHESIS OF DIHYDROTHIENO[3, 2-D]PYRIMIDINE DIOLS AND SIMILAR PYRIMIDINE DIOLS

- (73) Boehringer Ingelheim International GmbH, Binger Strasse 173, 55216 Ingelheim, DE,
 (72) FRUTOS, Rogelio, Perez, Boehringer Ingelheim Pharmaceuticals Inc., 900 Ridgebury Road, P.O. Box 368, Ridgefield, CT 06877-0368,
 TAMPONE, Thomas, G., Boehringer Ingelheim Pharmaceuticals Inc., 900 Ridgebury Road, P.O. Box 368, Ridgefield, CT 06877-0368,
 MULDER, Jason, Alan, Boehringer Ingelheim Pharmaceuticals Inc., 900 Ridgebury Road, P.O. Box 368, Ridgefield, CT 06877-0368,
 KRISHNAMURTHY, Dhileepkumar, Boehringer Ingelheim Pharmaceuticals Inc., 900 Ridgebury Road, P.O. Box 368, Ridgefield, CT 06877-0368,
 SENANAYAKE, Chris, Hugh, Boehringer Ingelheim Pharmaceuticals Inc., 900 Ridgebury Road, P.O. Box 368, Ridgefield, CT 06877-0368,
 (74) Radulović Božidar, Jovana Tomaševića 9/III, Podgorica ME
 (57) Sinteza dihidrotieno[3, 2-d]pirimidin diola i sličnih pirimidin diola 1 : Postupak za dobijanje jedinjenja formule I:

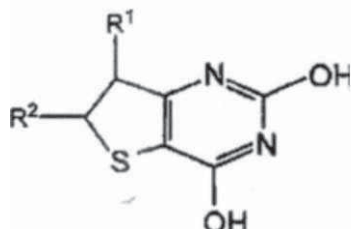

koji obuhvata: (a) reakciju početnog jedinjenja formule II R1

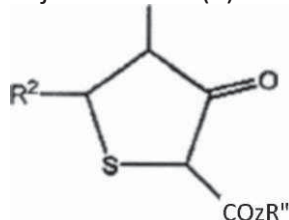

sa ureom, u prisustvu kiseline, kako bi se dobio intermedijer formule IV

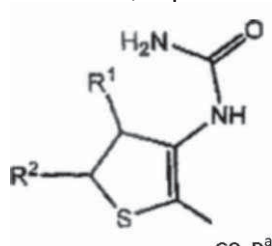

heterocikloalkoksi, $-NO_2$, $-NRR'$, haloalkila, haloalkoksi, $-SH$, $-S$ -alkila, $-SO_2$ -alkila, $-SO_2NH_2$, $-SO_2NH$ -alkila, i $-SO_2N(alkil)_2$; gde su R i R' svaki nezavisno odabrani od H ili alkila; i gde je R^a odabran iz grupe koja sadrži H, halogen, alkil, i aril. (b) ciklizaciju intermedijera formule IV sa bazom, kako bi se dobio finalni proizvod formule I, gde su R¹ i R² nezavisno odabrani od H, alkila, cikloalkila, arila, heteroarila, heterocikloalkila, halogena, alkoksi, ariloksi, cikloalkoksi, heteroariloksi, Preostalih patentnih zahtjeva je 20.

- (51) **C12N 1 18** / ^{006 01}
A61K5104 / ²⁰⁰⁶⁰¹
C07B59 00 / ²⁰⁰⁶⁰¹
C12P33 00 / ²⁰⁰⁶⁰¹
- (22) 02. 05. 2005
(30) 20040004890 06. 05. 2004 FR
(96) EP/05763706.8/02. 05. 2005
(97) WO/PCT/FR2005/001090
WO 2005/121315/22. 12. 2005/fr/2005/51
EP 1745123/24. 01. 2007/fr/2007/04
EP 174512307. 2012/fr/2012/28
- (54) me **SOJEVI KVASCA KOJI PROIZVODE HOLESTEROL I NJIHOVE UPOTREBE**
en CHOLESTEROL-PRODUCING YEAST STRAINS AND USES THEREOF
- (73) Aventis Pharma S.A., 20, avenue Raymond Aron, 92160 Antony, FR,
(72) POMPON, Denis, 9 place du Marché Neuf, F-91190 Gif Sur Yvette, FR,
DUMAS, Bruno, 15 rue de Versailles, F-91300 Massy, FR,
SPAGNOLI, Roberto, 39 rue des Vignes, F-75016 Paris, FR,
(74) AOD «Ćupić», Dalmatinska 10, Podgorica ME
- (57) Soj kvasca koji autonomno proizvodi holesterol iz izvora prostog ugljenika, naznačen time, što eksprimira heterologe enzima 7-dehidroholesterol reduktaze i 3B-hidroksisterol A24 -reduktaze, i stoje enzim sterol 24-C- metiltransferaza inaktiviran.
Preostalih patentnih zahtjeva je 14.

(51) **B65D21/04**²⁰⁰⁶⁰¹

(11) **01499**

(21) **P-2012-116**

(22) 25. 05. 2007

(30) 20061025198 29. 05. 2006 DE

(96) EP/07725559/25. 05. 2007

(97) /PCT/EP2007/004663/25. 05. 2007

WO 2007137774/06. 12. 2007/de/2007/49

EP 2024242 /18. 02. 2009/de/2009/08

EP 2024242 /25. 07. 2012/de/2012/30

(54) me **SISTEMSKA KUTIJA, NAROČITO ZA TRANSPORT SVJEŽE RIBE**

en SYSTEM CRATE, IN PARTICULAR FOR TRANSPORTING FRESH FISH

(73) "Deutsche See" GmbH, Maifischstrasse 3-9, 27572 Bremerhaven, DE,

(72) FELDMANN, André, Plaggenkamp 13, 22395 Hamburg, DE,
SCHULTCHEN, Arne, Schemmannstrasse 66, 22359 Hamburg, DE,

(74) Radulović Božidar, Jovana Tomaševića 9/III, Podgorica ME

(57) Kutija (2) sistema kutija za transport svježe ribe, koja ima otvor sa gornje strane i čija je obodna oblast gornjeg otvora (10), kao i oblast dna (8), izvedena tako da kada se oblast dna (8) postavi na obodni dio gornjeg otvora (10) jedne identične kutije dolazi do uzdužnog držanja (uklapanja) zahvaljujući obliku; pa se kutije (2) zahvaljujući tome mogu slagati jedna na drugu; i gornja kutija se može postaviti u donju kutiju kada je zakrenuta oko vertikalne ose za 180°; zatim kutije (2) se mogu slagati jedna u drugu kada su prazne (zakretne složive kutije), pri čemu je obodna oblast gornjeg otvora (10) bar djelomično izvedena u obliku kanala (22) i zid (4) kutije, koji se sa spoljašnje strane odozdo graniči sa obodnom oblašću, ima bar jedan prvi odvodni otvor (28); dok dno (6) kutije ima drugi odvodni otvor (30), tako da tečnost iz kutije može da ističe kroz drugi odvodni otvor (30) u oblast u obliku kanala (22) jedne ispod postavljene identične kutije (2), a zatim kroz prvi otvor (28) ispod postavljene kutije iz oblasti izvedene u obliku kanala (22) u spoljašnjost niz zid (4) kutije, koji je ispod obodne oblasti, naznačena time, što su bočne spoljašnje ivice i/ili površine (20) sa spoljašnjim konturama, koje su valovitog oblika, izvedene tako da kada se bočno postave uz bočne spoljašnje ivice i/ili površine (20) jedne identične kutije obrazuju vezu zahvaljujući obliku (uklapaju se) koja osigurava od bpčnog klizanja, pri čemu su spoljašnje konture bočnih spoljašnjih ivica i/ili površina (20) dvije identične kutije, postavljene bočno jedna uz drugu, izvedene valovito i komplementarno tako da se uklapaju.

Preostalih patentnih zahtjeva je 13.

(51) **C07D41704** / ²⁰⁰⁶⁰¹(11) **01454**(21) **P-2012-119**

(22) 28. 07. 2006

(30) 05107057 29. 07. 2005 EP 06113097 25. 04. 2006 EP

(96) EP/06764268.6/28. 07. 2006

(97) /PCT/EP2006/064822

WO 2007/014927/08. 02. 2007/2007/06

EP 1912981 /23. 04. 2008/en/2008/17

EP 1912981/20. 01. 2010/en/2010/03

(54) me **MAKROCIKLIČKI INHIBITORI VIRUSA HEPATITISA E**en **MACROCYCLIC INHIBITORS OF HEPATITIS E VIRUS**(73) Tibotec Pharmaceuticals, Eastgate Village Eastgate Little Island, Co Cork, IE,
MEDIVIR AB, Lunastigen 7, 141 44 Huddinge, SE,(72) RABOISSON, Pierre, Jean-Marie, Bernard, Sint Pancratiuslaan 26, B-1933 Sterrebeek, BE,
DE KOCK, Herman, Augustinus, Wolfseind 10, B-2370 Arendonk, BE,

HU, Lili, Vrouw Van Mechelenstraat 28, 2800 Mechelen, BE,

SIMMEN, Kenneth, Alan, Boterbloemenlaan 35, B-3080 Tervuren, BE,

LINDQUIST, Karin Charlotta, c/o MEDIVIR AB Lunastigen 7 S-141 44 Huddingen, SE,

LINDSTRÖM, Mats Stefan, Medivir AB Lunastigen 7, S-141 44 Huddingen, SE,

BELFRAGE, Anna Karin Gertrud Linnea, Medivir AB Lunastigen 7, S-141 44 Huddinge, SE,

WÄHLING, Horst Jürgen, Medivir AB Lunastigen 7, S-141 44 Huddinge, SE,

NILSSON, Karl Magnus, Medivir AB Lunastigen 7, S-141 44 Huddinge, SE,

SAMUELSSON, Bengt Bertil, Medivir AB Lunastigen 7, S-141 44 Huddinge, SE,

ROSENQUIST, Asa Annica Kristina, Medivir AB Lunastigen 7, S-141 44 Huddinge, SE,

SAHLBERG, Sven Crister, Medivir AB Lunastigen 7, S-141 44 Huddinge, SE,

WALLBERG, Hans, Kristian, Medivir AB Lunastigen 7, S-141 44 Huddinge, SE,

KAHNBERG, Pia, Cecilia, Medivir AB Lunastigen 7, S-141 44 Huddinge, SE,

CLASSON, Björn, Olof, Medivir AB Lunastigen 7, S-141 44 Huddinge, SE,

(74) Radulović Božidar, Jovana Tomaševića 9/III, Podgorica ME

(57) Jedinjenje formule I: i N-oksidi, soli i

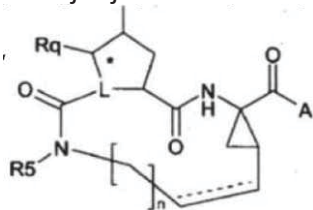

stereoizomeri od toga, naznačeno time da: A je OR^1 , $NHS(=O)_pR^2$; u čemu; R^1 je vodonik, $Cl-C_6$ alkil, $Co-C_3$ alkilienkarbociklil, $Co-C_3$ alkilienheterociklil; R^2 je $Cl-C_6$ alkil, C_0-C_3 alkilienkarbociklil, $Co-C_3$ alkilienheterociklil; p je nezavisno 1 ili 2; n je 3, 4, 5 ili 6; ' označava dvostruku vezu po izboru; L je N ili CRz; Rz je H ili formira dvostruku vezu sa ugljenikom obeleženim asteriskom; Rq je H ili kada L je CRz, Rq može također da bude $Cl-C_6$ alkil; Rr je kvinazolinil, po izboru supstituisan sa jednim, dva ili tri supstituenta, vaki nezavisno izabran između C_1-C_6 alkil, C_1-C_6 alkoksi, hidroksil, halo, haloCpCćalkil, amino, mono- ili dialkilamino, mono- ili dialkilaminokarbonil, C_1-C_6 alkilkarbonilamino, $Co-C_3$ alkilienkarbociklil i C_0-C_3 alkilienheterociklil; R^5 je vodonik, C_1-C_6 alkil, C_1-C_6 alkoksi- C_6 alkil ili C_3-C_7 cikloalkil; i u čemu svaki C_1-C_6 alkil, $Co-C_3$ alkilienkarbocikil ili $Co-C_3$ alkilienheterociklil je po izboru supstituisan sa 1 do 3 supstituenta nezavisno izabrana iz grupe koja se sastoji od halo, okso, nitril, azido, nitro, C_1-C_6 alkil, C_0-C_3 alkilienkarbociklil, C_0-C_3 alkilienheterociklil, $NH_2C(=O)-$, $Y-NRaRb$, $Y-O-Rb$, $Y-C(=O)Rb$, $Y-C(=O)NRaRb$, $Y-NRaC(=O)Rb$, $Y-NHS(=O)_pRb$. $Y-S(=O)_pRb$ i $Y-S(=O)_pNRaRb$, $Y-C(=O)ORb$,

Y-NR_aC(= O)OR_b; Y je nezavisno veza ili C1-C3alkilen; R_a je nezavisno H, C1-C6alkoksi, C1-C3alkil ili; R_b je nezavisno H, C1-C6alkil, C1-C6alkoksi, Co-C3alkilen-karbociklil ili Co-C3alkilenheterociklil; ili R_a i R_b zajedno sa azotom na kojeg su vezani formiraju heterociklilnu grupu.

Preostalih patentnih zahtjeva je 27.

- (51) **C10B7 02** / ²⁰⁰⁶¹
C10B49 02 / ²⁰⁰⁶¹
C 10B53 02 / ²⁰⁰⁶¹
C10L5 40 / ²⁰⁰⁶¹
C10L 9 08 / ²⁰⁰⁶¹
F26B 17 00 / ²⁰⁰⁶¹
F26B23 02 / ²⁰⁰⁶¹
F27B9 18 / ²⁰⁰⁶¹
- (11) **01483**
(21) **P-2012-123**
- (22) 15. 07. 2011
(30) 20101036425 15. 07. 2010 DE
(96) EP/11738428.9/15. 07. 2011
(97) WO/PCT/EP2011/062131
WO 2012/007574/19. 01. 2012/de/2012/03
EP 2424955/07. 03. 2012/de/2012/10
EP 2424955/05. 09. 2012/de/2012/36
- (54) me **UREĐAJ I POSTUPAK ZA SUŠENJE I TOREFAKCIJU NAJMANJE JEDNE STRUJE MATERIJALA KOJI SADRŽI UGLJENIK U VIŠEKOMORNOJ PEĆI**
en DEVICE AND METHOD FOR DRYING AND TORREIFYING AT LEAST ONE CARBON-CONTAINING SUBSTANCE STREAM IN A MULTIPLE-HEARTH FURNACE
- (73) ThyssenKrupp Polysius AG, Graf-Galen-Strasse 17, 59269 Beckum, DE,
(72) LAMPE, Karl, Martinstr. 12, 59320 Ennigerloh, DE,
DENKER, Jürgen, Hansaring 33, 59269 Beckum, DE,
BEYER, Christoph, Dürerstr. 9, 48147 Münster, DE,
ERPELDING, Richard, F. Schauer Weg 3, 59494 Soest, DE,
(74) Đakonović Vido, Bajova 9, Cetinje ME
- (57) Uređaj za sušenje i torefakciju najmanje jedne struje (10) materijala koji sadrži ugljenik u višekomornoj peći (1), koji sadrži a. zonu (2) sušenja, koja sadrži dovodni uređaj (11) za dovođenje struje (10) materijala koji sadrži ugljenik, izlaz (14) za odvođenje struje (13) gasa za sušenje koji sadrži vodenu paru i ulaz (15) za recirkulaciju bar dijela struje gasa za sušenje, b. zonu (3) torefakcije za degaziranje struje materijala osušenog u zoni (2) sušenja, koja sadrži izlaz (27) za odvođenje torefikovane struje (10') materijala, najmanje jedan ulaz (19, 20) za izduvni gas i jedan izlaz (18) za struju (17) torefikovanog gasa, c. izmjenjivač (4) toplote za zagrijavanje struje (13) gasa za sušenje, pri čemu je izlaz (14) zone sušenja povezan preko izmjenjivača toplote sa ulazom (15) zone sušenja, d. sklop gorionika (5), pri čemu je ispušna tačka (18) zone (3) torefakcije povezana preko agregata (5) za sagorevanje i izmjenjivača (4) toplote sa ulazom (19, 20) zone (3) torefakcije, e. pri čemu struja (17) gasa za torefakciju koja se odvodi preko izlaza (18) zone (3) torefakcije sagorijeva u agregatu (5) za sagorijevanje i nastali izduvni gas se u izmjenjivaču (4) toplote upotrebljava za zagrijavanje struje (13) gasa za sušenje i dovodi se do zone (3) torefakcije, f. pri čemu zona (2) sušenja i zona (3) torefakcije sadrže dva odvojena gasna.



Preostalih patentnih zahtjeva je 14.

(51) **C07D475/00**^(2006.01)(11) **01470**(21) **P-2012-124**

(22) 02. 12. 2004

(30) 102004058337 02. 12. 2004 DE

(96) EP/05823799.1/29. 11. 2005

(97) PCT/2005EP56291/29. 11. 2005

WO 2006058876/08. 06. 2006/de/2006/23

EP 1819706/22. 08. 2007/de/2007/34

EP 1819706/19. 09. 2012/de/2012/38

(54) me **POSTUPAK ZA DOBIJANJE ANELACIJSKIH PIPERAZIN-2-ON DERIVATA I INTERMEDIJERA NAVEDENOG POSTUPKA**

en METHOD FOR PRODUCING ANNELATED PIPERAZIN-2-ONE DERIVATIVES AND INTERMEDIATES OF SAID METHOD

(73) Boehringer Ingelheim International GmbH, Binger Strasse 173, 55216 Ingelheim am Rhein, DE,

(72) DURAN, Adil, Kastanienweg 8, 88400 Biberach, DE,
LINZ, Guenter, Eschenweg 6, 88441 Mittelbiberach, DE,

(74) Radulović Božidar, Jovana Tomaševića 9/III, Podgorica ME

(57) Postupak za dobijanje jedinjenja opšte formule Iu

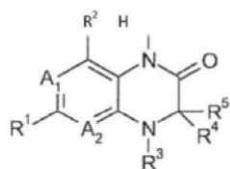

(I)

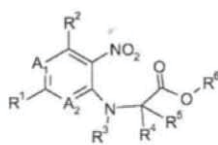

II

kojoj R¹ označava grupu odabranu iz grupe koja se sastoji od hlora, fluora, broma, metansulfonila, etansulfonila, trifluorometansulfonila, para-toluensulfonila, CH₃S(=O)- i fenilS(=O)-, R² označava vodonik ili C1-C3-alkil grupu, R³ označava vodonik ili grupu odabranu iz grupe koja se sastoji od opciono supstituisane C1-C12-alkil, C2-C12-alkenil, C2-C12-alkinil i C6-C14-aril grupe, ' ili grupu odabranu iz grupe koja se sastoji od opciono supstituisane i/ili povezane mostom C3-C12-cikloalkil, C3-C12-cikloalkenil, C7-C12-policikloalkil, C7-C12-policikloalkenil, C5-C12-spirocikloalkil grupe i zasićene ili nezasićene C3-C12-heterocikloalkil grupe, koja sadrži 1 do 2 heteroatoma, R⁴, R⁵ koji mogu biti identični ili različiti označavaju vodonik ili opciono supstituisanu Ci-C6-alkil grupu, ili R⁴ i R⁵ zajedno označavaju 2- do 5-očlanu alkil grupu povezanu mostom, koja može da sadrži 1 do 2 heteroatoma, ili R⁴ i R³ ili R⁵ i R³ zajedno označavaju zasićenu ili nezasićenu C3-C4-alkil grupu povezanu mostom, koja može opciono sadržati 1 heteroatom, i At i A₂ označava -N=, naznačen time, što je jedinjenje formule II u kojoj R¹ do R⁵, A₁ i A₂ imaju značenja koja su data u zahtjevu 1 i R⁶ označava C1-C4-alkil grupu, hidrogenizovana sa vodonikom u prisustvu hidrogenizacionih katalizatora i dodato je jedinjenje bakra, gvožđa ili vanadijuma, pri čemu se koraci a) i b) mogu odvijati istovremeno ili uzastopno.

Preostalih patentnih zahtjeva je 13.

- (51) **A61K3147** / ²⁰⁰⁶⁰¹
A61P3104 / ²⁰⁰⁶⁰¹
C07D215 22 / ²⁰⁰⁶⁰¹

- (11) **01484**
(21) **P-2012-127**

- (22) 26. 06. 2006
(30) 20050105762 28. 06. 2005 EP
(96) EP/06763889.0/26. 06. 2006
(97) /PCT /EP2006/063553
WO 2007000435/04. 01. 2007/en/2007/01
EP 1898914/19. 03. 2008/en/2008/12
EP 1898914/15. 08. 2012/en/2012/33

- (54) me **KINOLINSKI DERIVATI KAO ANTIBAKTERIJSKI AGENSI**
en QUINOLINE DERIVATIVES AS ANTIBACTERIAL AGENTS

- (73) Janssen Pharmaceutica NV, Turnhoutseweg 30, 2340 Beerse, BE,
(72) ANDRIES, Koenraad J.L.M., c/o Janssen Pharmaceutica N.V., Turnhoutseweg 30, 2340 Beerse, BE,
KOUL, Anil, c/o Janssen Pharmaceutica N.V., Turnhoutseweg 30, 2340 Beerse, BE,
GUILLEMONT, Jérôme E.G., c/o Johnson & Johnson Pharmaceutical, Research and Development, A division of Janssen-Cilag, Campus Ma
LANÇOIS, David F.A., c/o Johnson & Johnson Pharmaceutical, Research and Development, A division of Janssen-Cilag, Campus Ma MOTTE, Magali
M.S., c/o Johnson & Johnson Pharmaceutical, Research and Development, A division of Janssen-Cilag, Campus Ma DORANGE, Ismet, Sickla alle, 21, 13165 Nacka, SE,
BACKX, Leo J.J., c/o Janssen Pharmaceutica N.V., Turnhoutseweg 30, 2340 Beerse, BE,
MEERPOEL, Lieven, c/o Janssen Pharmaceutica N.V., Turnhoutseweg 30, 2340 Beerse, BE,
(74) Radulović Božidar, Jovana Tomaševića 9/III, Podgorica ME
(57) Upotreba nekog jedinjenja za proizvodnju nekog leka za tretman neke bakterijske infekcije, naznačena time, da je pomenuto jedinjenje neko jedinjenje sa formulom (Ia) ili (Ib)

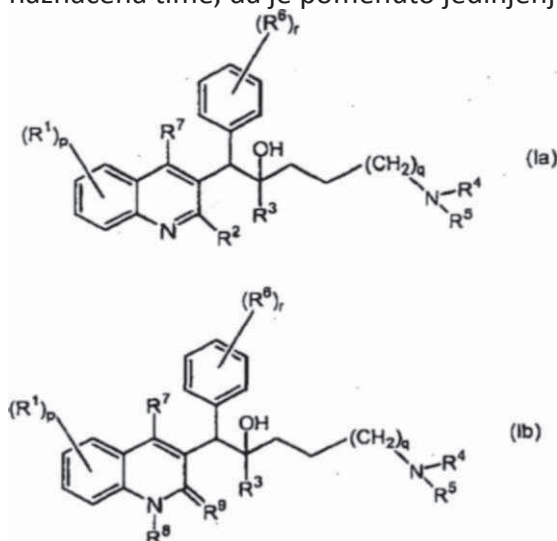

neka njegova farmaceutski prihvatljiva kisela ili bazna adiciona so, neka njegova' stereohe-
mijski izomerna forma, neka njegova tautomerna forma ili njegov N-oksid, gde R^1 je vodo-
nik, halo, haloalkil, cijano, hidroksi, Ar, Het, alkil, alkiloksi, alkiltio, alkiloksialkil, alkiltioalkil,
Ar-alkil ili di(Ar)alkil; p je celi broj jednak 1, 2, 3 ili 4; R je vodonik, hidroksi, merkpto, alki-
loksi, alkiloksialkiloksi, alkiltio, mono ili di(alkil)amino ili radikal sa formulom

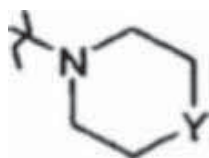

gde Y je CH_2 , O, S, NH ili JV-alkil; R^3 je alkil, Ar, Ar-alkil, Het ili Het-alkil; q je celi broj jednak 1, 2 ili 3; R^4 i R^5 svaki nezavisno su vodonik, alkil ili benzil; ili R^4 i R^5 zajedno i uključujući N na kojeg su spojeni mogu da formiraju radikal koji je izabran iz grupe koja obuhvata piroolidinil, 2-pirolinil, 3-pirolinil, pirolil, imidazolidinil, pirazolidinil, 2-imidazolinil, 2-pirazolinil, imidazolil, pirazolil, triazolil, piperidinil, piridinil, piperazinil, piridazinil, pirimidinil, pirazinil, triazinil, morfolinil i tiomorfolinil, ponekad supstituisani sa alkilom, halo, haloalkilom, hidroksi, alkiloksi, amino, mono- ili dialkilamino, alkiltio, alkiloksialkilom, alkiltioalkilom ili pirimidinilom; R^6 je vodonik, halo, haloalkil, hidroksi, Ar, alki 1. alkiloksi, alkiltio, alkiloksialkil, alkiltioalkil. Ar-alkil ili di(Ar) alkil; ili dva susedna R^6 radikala mogu da zajedno formiraju bivalentni radikal sa formulom $-\text{CH}=\text{CH}-\text{CH}=\text{CH}-$; r je celi broj jednak 1, 2, 3, 4 ili 5; R^7 je vodonik, alkil, Ar ili Het; R^8 je vodonik ili alkil; R^9 je okso; ili R^8 i R^9 zajedno formiraju radikal $-\text{CH}=\text{CH}-\text{N}=\text{}$; alkil je ravno-lančani ili razgranati zasićeni ugljovodonikov radikal koji ima od 1 do 6 atoma ugljenika; ili je ciklički zasićeni ugljovodonikov radikal koji sadrži od 3 do 6 atoma ugljenika; ili je ciklički zasićeni ugljovodonikov radikal koji ima od 3 do 6, atoma ugljenika koji su spojeni na ravno-lančani ili razgranati zasićeni ugljovodonikov radikal koji sadrži od 1 do 6 atoma ugljenika; gde svaki ugljenikov atom može ponekad da bude supstituisan sa hidroksi, alkiloksi ili okso; Ar je homocikal koji je izabran iz grupe koja obuhvata fenil, naftil, acenaftil, tetrahidronaftil, a svaki homocikal je ponekad supstituisan sa 1, 2 ili 3 supstituenta, od koji je svaki nezavisno izabran iz grupe koja obuhvata hidroksi, halo, cijano, nitro, amino, mono- ili dialkilamino, alkil, haloalkil, alkiloksi, haloalkiloksi, karboksil, alkiloksikarbonil, aminokarbonil, morfolinil i mono- ili dialkilaminokarbonil; Het je monociklički heterocikal koji je izabran iz grupe koja obuhvata N-fenoksipiperidinil, piperidinil, pirolil, pirazolil, imidazolil, furanil, tienil, oksazolil, izoksazolil, tiazolil, izotiazolil, piridinil, pirimidinil, pirazinil i piridazinil; ili je biciklički heterocikal koji je izabran iz grupe koja obuhvata kinolinil, kinoksalinil, indolil, benzimidazolil, benzoksazolil, benzizoksazolil, benzotiazolil, benzizotiazolil, benzofuranil, benzotienil, 2, 3-dihidrobenzo[1, 4]dioksinil i benzo[1, 3]dioksolil; a svaki monociklički ili biciklički heterocikal može ponekad da bude supstituisan sa 1, 2 ili 3 supstituenta, a svaki supstituenat je nezavisno izabran iz grupe koja obuhvata halo, hidroksi, alkil, alkiloksi i Ar-karbonil; halo je supstituenat koji je izabran iz grupe koja obuhvata fluoro, hloro, bromo i jodo; i haloalkil je ravno-lančani ili razgranati zasićeni ugljovodonikov radikal koji sadrži od 1 do 6 atoma ugljenika ili je ciklički zasićeni ugljovodonikov radikal koji sadrži od 3 do 6 atoma ugljenika ili ciklički zasićeni ugljovodonikov radikal koji sadrži od 3 do 6 atoma ugljenika koji su spojeni na ravnolančani ili razgranati zasićeni ugljovodonikov radikal koji ima od 1 do 6 atoma ugljenika; gde jedan ili više atoma ugljenika je supstituisano sa jednim ili više halo atoma; pod uslovom da je pomenuta bakterijska infekcija različita od infekcije sa Mycobacteria.

Preostalih patentnih zahtjeva je 35.

- (51) **C07D49122** / ²⁰⁰⁶⁰¹ (11) **01495**
(21) **P-2012-128**
- (22) 16. 12. 2005
- (30) 20040030246 21. 12. 2004 EP
- (96) EP/05849781.9/16. 12. 2005
- (97) WO/PCT/EP2005/056849
WO 2006/067092/29. 06. 2006/en/2006/26 EP 1828196/05. 09. 2007/en/2007/36 EP 1828196/17. 10. 2012/en/2012/42
- (54) me **STEREOSELEKT IVNI POSTUPAK I KRISTALNI OBLICI KAMPTOTECINA**
en STEREOSELECTIVE PROCESS AND CRYSTALLINE FORMS OF A CAMPTOTHECIN
- (73) SIGMA-TAU Industrie Farmaceutiche Riunite S.p.A., Viale Shakespeare 47, 00144 Roma, IT
- (72) CARMINATI, Paolo, SIGMA-TAU Ind. Farmac. Riunite Spa, Viale Shakespeare, 47, I-00144 Rome, IT,
TINTI, Maria Ornella, SIGMA-TAU Ind. Farmac. Riunite Spa, Viale Shakespeare, 47, I-00144 Rome, IT,
MARZI, Mauro, SIGMA-TAU Ind. Farmac. Riunite Spa, Viale Shakespeare, 47, I-00144 Rome, IT,
GIORGI, Fabrizio, SIGMA-TAU Ind. Farmac. Riunite Spa, Viale Shakespeare, 47, I-00144 Rome, IT,
CABRI, Walter, c/o ANTIBIOTICOS S.p.A., Strada Rivoltana, Km 6/7, I-20090 Rodano (mi), IT,
ALPEGIANI, Marco, c/o ANTIBIOTICOS S.p.A., Strada Rivoltana, Km 6/7, I-20090 Rodano (mi), IT,
VERGANI, Domenico, c/o ANTIBIOTICOS S.p.A., Strada Rivoltana, Km 6/7, I-20090 Rodano (mi), IT,
GHETTI, Paolo, c/o ANTIBIOTICOS S.p.A., Strada Rivoltana, Km 6/7, I-20090 Rodano (mi), IT,
- (74) Đakonović Vido, Bajova 9, Cetinje ME
- (57) Postupak stereoselektivnog dobijanja 7-[(E)-t-butiloksiiminometil]-kamptotecina koji se sastoji od reakcije u odsustvu organske baze i u kiselim uslovima acetala 7-formil-kamptotecina sa O-t-butilhidroksilamin hidrohloridom u nekom polarnom protičnom ili aprotičnom rastvaraču.
Preostalo patentnih zahtjeva 9.

- (51) **A61K39008** / ²⁰⁰⁶⁰¹
A61K39015 / ²⁰⁰⁶⁰¹
G01N33 569 / ²⁰⁰⁶⁰¹
A61P33 02 / ²⁰⁰⁶⁰¹
- (22) 04. 11. 2004
- (30) PCT/EP03/12421 05. 11. 2003
PCT/EP2004/001782 23. 02. 2004
- (96) EP/04799038.7/04. 11. 2004
- (97) WO/PCT/IB2004/004078
WO 2005/044301 /19. 05. 2005/en/2005/20
EP 1687023/09. 08. 2006/en/2006/32
EP 1687023/03. 10. 2012/en/2012/40
- (54) me **PRIMJENA SPECIFIČNIH HISTONA ZA LIJEČENJE PARAZITNIH BOLESTI**
en USE OF SPECIFIC HISTONES FOR THE TREATMENT OF PARASITIC DISEASES
- (73) Laboratorios LETI, S.L., Calle del Sol, 5, 28760 Tres Cantos Madrid, ES,
C.B.F. Leti, S.L. Unipersonal, Calle del Sol No. 5, 28760 Tres Cantos-Madrid, ES,
- (72) ALVAREZ, Manuel, Soto, La Rioja 141-4b, E-28915 Madrid, ES,
IBORRA, Salvador, Cardenosa 4-1 d, E-28053 Madrid, ES,
REQUENA, José, Maria, c/o Calle Gran via de les Corts Catalanes, 184 7, E-08038
Barcelona, ES
BEDATE, Carlos, Alonso, Alberto Aguilera 21, E-200015 Madrid, ES,
- (74) Đakonović Vido, Bajova 9, Cetinje ME
- (57) Primjena sva četiri Leishmania histona H2A, H2B, H3 i H4 za dobijanje lijeka za liječenje ili prevenciju lajšmanioze, pri čemu je lajšmanioza izazvana onim vrstama Leishmania koje su različite od vrsta od kojih su dobijeni histoni.
Preostalo patentnih zahtjeva 11.

- (51) **C07D48708** / ²⁰⁰⁶⁰¹ (11) **01488**
C07D41304 / ²⁰⁰⁶⁰¹ (21) **P-2012-131**

- (22) 05. 06. 2008
 (30) 20070942553P 07. 06. 2007 US
 (96) EP/08779348.5/05. 06. 2008
 (97) WO/PCT/SE2008/050666
 WO 200815023312. 2008/en/2008/50
 EP 2167502/31. 03. 2010/en/2010/13
 EP 2167502/19. 09. 2012/en/2012/38
 EP 2167502/10. 07. 2013/en/2013/28

- (54) me **DERIVATI OKSADIAZOLA I NJIHOVO KORIŠĆENJE KAO POTENCIJATORA METABOTROPNIH GLUTAMATNIH RECEPTORA-842**

en OXADIAZOLE DERIVATIVES AND THEIR USE AS METABOTROPIC GLUTAMATE RECEPTOR POTENTIATORS - 842

- (73) AstraZeneca AB, 151 85 Sodertalje, SE,
 (72) CLAYTON, Joshua, 1156 Pilgrims Way, Oakville, Ontario L6M 1H1, CA,
 EGLE, Ian, 36 Webster Way, Georgetown, Ontario L7G 5J7, CA,
 EMPFIELD, James, AstraZeneca Wilmington, 1800 Concord Pike, P.O. Box 15437, Wilmington, Delaware 19850-5437, US,
 FOLMER, James, AstraZeneca Wilmington, 1800 Concord Pike, P.O. Box 15437, Wilmington, Delaware 19850-5437, US,
 ISAAC, Methvin, 17 Reynolds Ave, Brampton, Ontario L6P 2C1, CA,
 MA, Fupeng, Unit 315-1 Oak Grove Ave., Melrose, Massachusetts 02176, US,
 SLASSI, Abdelmalik, 4780 Fulwell Road, Mississauga, Ontario L5M 7J7, CA,
 (74) Radulović Božidar, Jovana Tomaševića 9/III, Podgorica ME
 (57) Jedinjenje prema Formuli 1:

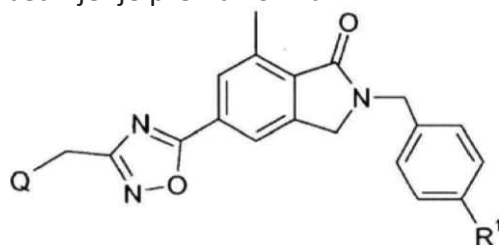

Formula I

naznačeno time. što R¹ predstavlja halo ili Ci-haloalkoksil; Q predstavlja

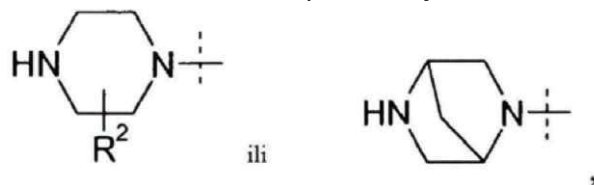

R² predstavlja vodonik ili Ciⁿalkil; ili farmaceutski prihvatljiva so, optički izomer, ili kombinacija navedenog jedi nj enja ili soli.
 Preostalo patentnih zahtjeva 14.

(51) **C07D47506** / ²⁰⁰⁶⁰¹
C07D47508 / ²⁰⁰⁶⁰¹
C07D48704 / ²⁰⁰⁶⁰¹
A61K31495 / ²⁰⁰⁶⁰¹
A 61P35 00 / ²⁰⁰⁶⁰¹

(11) **01487**
(21) **P-2012-134**

(22) 20. 11. 2006

(30) 20050738902P 22. 11. 2005 US
20050024047 25. 11. 2005 GB
20060823308P 23. 08. 2006
US 20060823309P 23. 08. 2006 US

(96) EP/06808609.9/20. 11. 2006

(97) /PCT/GB2006/004327
WO 2007/060404/31. 05. 2007/en/2007/22
EP 1954699/13. 08. 2008/en/2008/33
EP 1954699/19. 09. 2012/en/2012/38

(54) me **PIRIDO-, PIRAZO-I PIRIMIDOPIRIMIDINSKI DERIVATI KAO mTOR INHIBITORI**

en PYRIDO-, PYRAZO- AND PYRIMIDOPYRIMIDINE DERIVATIVES AS mTOR INHIBITORS

(73) Kudus Pharmaceuticals Ltd, 15 Stanhope Gate, London W1K 1LN, GB,

(72) HUMMERSONE, Marc, Geoffrey, KuDOS Horsham Limited, 26 Foundry Lane, Horsham Sussex RH13 5PX, GB,
GOMEZ, Sylvie, KuDOS Horsham Limited, 26 Foundry Lane, Horsham Sussex RH13 5PX, GB,
MENEAR, Keith, Allan, KuDOS Horsham Limited, 26 Foundry Lane, Horsham Sussex RH13 5PX, GB,
SMITH, Graeme, Cameron, Murray, KuDOS Pharmaceuticals Limited, 327 Cambridge Science Park, Milton Road, Cambridge Cambridgeshire CB4 1
MALAGU, Karine, KuDOS Horsham Limited, 26 Foundry Lane, Horsham Sussex RH13 5PX, GB,
DUGGAN, Heather, Mary, Ellen, KuDOS Horsham Limited, 26 Foundry Lane, Horsham Sussex RH13 5PX, GB,
COCKCROFT, Xiao-Ling Fan, KuDOS Horsham Limited, 26 Foundry Lane, Horsham Sussex RH13 5PX, GB,
HERMANN, Gesine, Johanna, KuDOS Horsham Limited, 26 Foundry Lane, Horsham Sussex RH13 5PX, GB,

(74) Radulović Božidar, Jovana Tomaševića 9/III, Podgorica ME

(57) Jedinjenje sa formulom I:

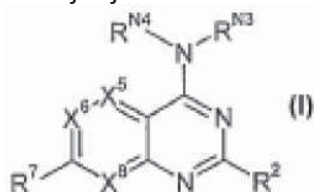

naznačeno time da: b X⁸ je N, i X⁵ i X⁶ su CH; R⁷ je C₅₋₂₀ arilna grupa po izboru supstituisana sa jednom ili više grupa izabranih iz grupe koja sadrži halo, hidroksil, nitro, cijano, karboksi, i tiol, ili Ci-7alkil, C₂₋₇alkenil, C₂₋₇alkinil, C₃₋₇cikloalkil, C₃₋₇cikloalkenil, C₃₋₇oheterociklil, C₅₋₂₀oaril, C₅₋₂₀oheteroaril, etar, acil, estar, amido, amino, acilamido, ureido, aciloksi, tioetar, sulfoksid, sulfonil, tioamido i sulfonamino (svaka po izboru supstituisana sa jednom ili više izabranih iz grupe koja sadrži halo, hidroksil, nitro, cijano, karboksi, tiol, Ci-₇alkil, C₂₋₇alkenil, C₂₋₇alkinil, C₃₋₇cikloalkil, C₃₋₇cikloalkenil, C₃₋₇oheterociklil, C₅₋₂₀oaril, C₅₋₂₀oheteroaril,

etar, acil, estar, amido, amino, acilamido, ureido, aciloksi, tioetar, sulfoksid, sulfonil. tioamido i sulfonamino); R^{N3} i R^{N4} zajedno sa azotom na kojeg su povezani, grade heterociklični prsten koji sadrži između 3 i 8 atoma u prstenu po izboru supstituisanih sa jednom ili više grupa izabranih iz grupe koja sadrži halo, hidroksil, nitro, cijano, karboksi, i tiol, ili C_{1-7} alkil, C_{2-7} alkenil, C_{2-7} alkinil, C_{3-7} cikloalkil, C_{3-7} cikloalkenil, C_{3-2} oheterociklil, C_{5-2} oaril, C_{5-2} oheteroaril, etar, acil, estar, amido, amino, acilamido, ureido, aciloksi, tioetar, sulfoksid, sulfonil, tioamido i sulfonamino (svaka po izboru supstituisana sa jednom ili više izabranih iz grupe koja sadrži halo, hidroksil, nitro, cijano, karboksi, tiol, C_{1-7} alkil, C_{2-7} alkenil, C_{2-7} alkinil, C_{3-7} cikloalkil, C_{3-7} cikloalkenil, C_{3-2} oheterociklil, C_{5-2} oaril, C_{5-2} oheteroaril, etar, acil, estar, amido, amino, acilamido, ureido, aciloksi, tioetar, sulfoksid, sulfonil, tioamido i sulfonamino (svaka po izboru supstituisana sa jednom ili više izabranih iz grupe koja sadrži halo, hidroksil, nitro, cijano, karboksi, tiol, C_{1-7} alkil, C_{2-7} alkenil, C_{2-7} alkinil, C_{3-7} cikloalkil, C_{3-7} cikloalkenil, C_{3-2} oheterociklil, C_{5-2} oaril, C_{5-2} oheteroaril, etar, acil, estar, amido, amino, acilamido, ureido, aciloksi, tioetar, sulfoksid, sulfonil, tioamido i sulfonamino), te C_{5-2} oarilne grupe po izboru supstituisane sa jednom ili više grupa izabranih iz grupe koja sadrži halo, hidroksil, nitro, cijano, karboksi, i tiol, ili C_{1-7} alkil, C_{2-7} alkenil, C_{2-7} alkinil, C_{3-7} cikloalkil, C_{3-7} cikloalkenil, C_{3-2} oheterociklil, C_{5-2} oaril, C_{5-2} oheteroaril, etar, acil, estar, amido, amino, acilamido, ureido, aciloksi, tioetar, sulfoksid, sulfonil, tioamido i sulfonamino (svaka po izboru supstituisana sa jednom ili više izabranih iz grupe koja sadrži halo, hidroksil, nitro, cijano, karboksi, tiol, C_{1-7} alkil, C_{2-7} alkenil, C_{2-7} alkinil, C_{3-7} cikloalkil, C_{3-7} cikloalkenil, C_{3-2} oheterociklil, C_{5-2} oaril, C_{5-2} oheteroaril, etar, acil, estar, amido, amino, acilamido, ureido, aciloksi, tioetar, sulfoksid, sulfonil, tioamido i sulfonamino), pri čemu R^{N5} i R^{N6} su nezavisno izabrani iz skupine koja sadrži H, C_{1-7} alkilnu grupu, C_{5-2} oheteroarilnu grupu, i C_{5-20} arilnu grupu, ili R^{N5} i R^{N6} zajedno sa azotom na kojeg su povezani grade heterociklični prsten koji sadrži između 3 i 8 atoma u prstenu gde svaki C_{1-7} alkil, C_{5-2} oheteroaril, C_{5-2} oaril ili heterociklični prstenje po izboru supstituisan sa jednom ili više grupa izabranih iz grupe koja sadrži halo, hidroksil, nitro, cijano, karboksi, i tiol, ili C_{1-7} alkil, C_{2-7} alkenil, C_{2-7} alkinil, C_{3-7} cikloalkil, C_{3-7} cikloalkenil, C_{3-2} oheterociklil, C_{5-2} oaril, C_{5-2} oheteroaril, etar, acil, estar, amido, amino, acilamido, ureido, aciloksi, tioetar, sulfoksid, sulfonil, tioamido i sulfonamino (svaka po izboru supstituisana sa jednom ili više izabranih iz grupe koja sadrži halo, hidroksil, nitro, cijano, karboksi, tiol, C_{1-7} alkil, C_{2-7} alkenil, C_{2-7} alkinil, C_{3-7} cikloalkil, C_{3-7} cikloalkenil, C_{3-2} oheterociklil, C_{5-2} oaril, C_{5-2} oheteroaril, etar, acil, estar, amido, amino, acilamido, ureido, aciloksi, tioetar, sulfoksid, sulfonil, tioamido i sulfonamino), ili njihova farmaceutski prihvatljiva so, i pri čemu "C5-20 aril" kako se ovde koristi, odnosi se na monovalentnu grupu dobijenu uklanjanjem atoma vodonika iz atoma aromatičnog prstena iz C_{5-20} aromatičnog jedinjenja, pomenuto jedinjenje ima jedan prsten, ili dva ili više prstena (npr., kondenzovana), te ima od 5 do 20 atoma u prstenu, te pri čemu najmanje jedan pomenuti prstenje aromatični prsten i gde atomi u prstenu mogu da obuhvataju jedan ili više heteroatoma, uključujući ali nije ograničeno na kiseonik, azot i sumpor; "alkil 1" kako se ovde koristi, odnosi se na monovalentnu grupu dobijenu uklanjanjem atoma vodonika sa atoma ugljenika iz jedinjenja ugljovodonika koje ima 1 do 20 atoma ugljenika (osim ako nije drugačije navedeno), koja može da bude alifatska ili aliciklična, te koja može da bude zasićena ili nezasićena (npr. delimično nezasićena, potpuno nezasićena); "alkenil", kako se ovde koristi, odnosi se na alkilnu grupu koja ima jednu ili više duplih veza ugljenik-ugljenik; "alkinil", kako se ovde koristi, odnosi se na alkilnu grupu koja ima

jednu ili više trostrukih veza ugljenik-ugljenik; "cikloalkil", kako se ovde koristi, odnosi se na alkilnu grupu koja je takođe ciklilna grupa; to jest, monovalentnu grupu dobijenu uklanjanjem atoma vodonika sa atoma alicikličnog prstena iz karbocikličnog prstena karbocikličnog jedinjenja, pomenuti karbociklični prsten može da bude zasićen ili nezasićen (npr. delimično nezasićen, potpuno nezasićen), pomenuta grupa ima od 3 do 20 atoma ugljenika (osim ako nije drugačije navedeno), uključujući od 3 do 20 atoma u prstenu; "etar", kako se ovde koristi, odnosi se na -OR grupu, pri čemu R je C1-7 alkilna grupa, C3-20 heterociklilna grupa, ili C5-20 arilna grupa; "acil", kako se ovde koristi, odnosi se na -C(=O)R grupu, pri čemu R je H, C1.7 alkilna grupa, C3-20 heterociklilna grupa, ili C5.20 arilna grupa; "estar", kako se ovde koristi, odnosi se na -C(=O)OR grupu, pri čemu R je C1-7 alkilna grupa, C3.20 heterociklilna grupa, ili C5.20 arilna grupa; "amido", kako se ovde koristi, odnosi se na -C(=O)NR'R² grupu, pri čemu R¹ i R² su nezavisno vodonik, C1.7 alkilna grupa, C3-20 heterociklilna grupa, ili C5.20 arilna grupa, ili R¹ i R², uzeti zajedno sa atomom azota na koji su vezani, grade heterociklični prsten koji ima od 4 do 8 atoma u prstenu; "amino", kako se ovde koristi, odnosi se na -NR¹R² grupu, pri čemu R¹ i R² su nezavisno vodonik, C1.7 alkilna grupa, C3-20 heterociklilna grupa, ili C₅₋₂₀ arilna grupa, ili R¹ i R², uzeti zajedno sa atomom azota na koji su vezani, grade heterociklični prsten koji ima od 4 do 8 atoma u prstenu; "acilamido", kako se ovde koristi, odnosi se na -NR'C(=O)R² grupu, pri čemu R¹ je vodonik, C1-7 alkilna grupa, C₃₋₂₀ heterociklilna grupa, ili C₅₋₂₀ arilna grupa, R² je C1-7 alkilna grupa, C₃₋₂₀ heterociklilna grupa, ili C₅₋₂₀ arilna grupa, ili R¹ i R² mogu da zajedno sa atomima na koje su povezani grade sukcinimidil, maleimidil i ftalimidil grupu; "ureido", kako se ovde koristi, odnosi se na grupu, pri čemu R² i R³ su nezavisno vodonik, C1-7 alkilna grupa, C₃₋₂₀ heterociklilna grupa, ili C₅₋₂₀ arilna grupa, ili R² i R³, uzeti zajedno sa atomom azota na koji su vezani, grade heterociklični prsten koji ima od 4 do 8 atoma u prstenu, i R¹ je vodonik, C1-7 alkilna grupa, C₃₋₂₀ heterociklilna grupa, ili C₅₋₂₀ arilna grupa; "aciloksi", kako se ovde koristi, odnosi se na -OC(=O)R grupu, pri čemu R je C₁₋₇ alkilna grupa, C₃₋₂₀ heterociklilna grupa, ili C₅₋₂₀ arilna grupa; "tioetar", kako se ovde koristi, odnosi se na -SR grupu, pri čemu R je C1.7 alkilna grupa, C₃₋₂₀ heterociklilna grupa, ili C₅₋₂₀ arilna grupa; "sulfoksid", kako se ovde koristi, odnosi se na -S(=O)R grupu, pri čemu R je C1-7 alkilna grupa, C₃₋₂₀ heterociklilna grupa, ili C₅₋₂₀ arilna grupa; "sulfonil", kako se ovde koristi, odnosi se na -S(=O)₂R grupu, pri čemu R je C₁₋₇ alkilna grupa, C3-20 heterociklilna grupa, ili C₅₋₂₀ arilna grupa; "tioamido", kako se ovde koristi, odnosi se na -C(=S)NR'R² grupu, pri čemu R¹ i R² su nezavisno vodonik, C1-7 alkilna grupa, C3.20 heterociklilna grupa, ili C₅₋₂₀ arilna grupa, ili R¹ i R², uzeti zajedno sa atomom azota na koji su vezani, grade heterociklični prsten koji ima od 4 do 8 atoma u prstenu; "sulfonamino", kako se ovde koristi, odnosi se na -NR'S(=O)₂R grupu, pri čemu R¹ je vodonik, C1.7 alkilna grupa, C₃₋₂₀ heterociklilna grupa, ili C₅₋₂₀ arilna grupa, i R je C₁₋₇ alkilna grupa, C₃₋₂₀ heterociklilna grupa, ili C₅₋₂₀ arilna grupa; i uz uslov da kada R² je nesupstituisani morfolino, R^{N3} i R^{N4} zajedno sa atomom azota na koji su vezani formiraju nesupstituisani morfolino, R⁷ nije nesupstituisani fenil, i kada R² je nesupstituisani piperidinil, R^{N3} i R^{N4} zajedno sa atomom azota na koji su vezani grade nesupstituisani piperidinil, R⁷ nije nesupstituisani fenil.

Preostalih patentnih zahtjeva je 12.

- (51) **C07D47104** / ^{2011/121} (11) **01480**
C07D48704 / ^{2011/21} (21) **P-2012-138**
- (22) 23. 03. 2011
- (30) 20040174770 11. 06. 2004 JP
 20040327111 10. 11. 2004 JP
- (96) EP/10013055/10. 06. 2005
- (97) EP 2298768/23. 03. 2011/en/2011/12
 EP 2298768/14. 11. 2012/en/2012/46
 EP 2298768/24. 04. 2013/2013/17
- (54) me **DERIVATI S-AMINO-2, 4, 7-TRIOKS0-3, 4, 7, 8-TETRAHIDRO-2H-PIRIDO[2, 3-d]PIRIMIDINA I SRODNI SPOJEVI, NAMIJENJENI LIJEČENJU RAKA**
 en 5-AMINO-2, 4, 7-TRIOXO-3, 4, 7, 8-TETRAHYDRO-2H-PYRIDO [2, 3-D]PYRIMIDINE DERIVATIVES AND RELATED COMPOUNDS FOR THE TREATMENT OF CANCER
- (73) Japan Tobacco, Inc., 2-1, Toranomom 2-chome, Minato-ku, Tokyo 105-8422, JP,
- (72) Kawasaki, Hisashi, Cen.Pharm.Res.Inst.of Japan Tobacco Inc., 1-1, Murasaki-cho, Takatsuki-shi Osaka 5691125, JP,
 Abe, Hiroyuki, Cen. Pharm. Res. Inst. of Japan Tobacco Inc., 1-1, Murasaki-cho, Takatsuki-shi Osaka 5691125, JP,
 Hayakawa, Kazuhide, Cen. Pharm. Res. Inst. of Japan Tobacco Inc., 1-1, Murasaki-cho, Takatsuki-shi Osaka 5691125, JP,
 Iida, Tetsuya, Cen. Pharm. Res. Inst. of Japan Tobacco Inc., 1-1, Murasaki-cho, Takatsuki-shi Osaka 5691125, JP, Kikuchi, Shinichi, Cen. Pharm. Res. Inst. of Japan Tobacco Inc., 1-1, Murasaki-cho, Takatsuki-shi Osaka 5691125, JP,
 Yamaguchi, Takayuki, Cen. Pharm. Res. Inst. of Japan Tobacco Inc., 1-1, Murasaki-cho, Takatsuki-shi Osaka 5691125, JP,
 Nanayama, Toyomichi, Cen. Pharm. Res. Inst. of Japan Tobacco Inc., 1-1, Murasaki-cho, Takatsuki-shi Osaka 5691125, JP,
 Kurachi, Hironori, Cen. Pharm. Res. Inst. of Japan Tobacco Inc., 1-1, Murasaki-cho, Takatsuki-shi Osaka 5691125, JP,
 Tamaru, Masahiro, Cen. Pharm. Res. Inst. of Japan Tobacco Inc., 1-1, Murasaki-cho, Takatsuki-shi Osaka 5691125, JP,
 Hori, Yoshikazu, Cen. Pharm. Res. Inst. of Japan Tobacco Inc., 1-1, Murasaki-cho, Takatsuki-shi Osaka 5691125, JP,
 Takahashi, Mitsuru, Cen. Pharm. Res. Inst. of Japan Tobacco Inc., 1-1, Murasaki-cho, Takatsuki-shi Osaka 5691125, JP,
 Yoshida, Takayuki, Cen. Pharm. Res. Inst. of Japan Tobacco Inc., 13-2, Fukuura 1-chome, Kanazawa-ku, Yokohama-shi Kanagaw Sakai, Toshiyuki, 28-11, Kowaki-cho, Matsugasaki, Sakyo-ku, Kyoto-shi Kyoto 6060957, JP,
- (74) AOD "ĆUPIĆ", Dalmatinska 20, Podgorica ME,
- (57) Jedinjenje opšte formule (I) ili njegova farmaceutski prihvatljiva so za upotrebu kao antifgljivični agens; gde A je :
- -(CH₂)_m-C₃-C₈ cikloalkil,
 - -(CH₂VW-X₂,
 - -(CH₂)_m-W-CH₂-X_i, ili
 - -(CH₂)_m-CHRg-(CH₂)_m-X_i; pri čemu X_i je:
 - -aril, po izboru supstituisan jednim, dva ili tri R₄,
 - -heterocikl, po izboru supstituisan jednim ili dva R₅,
 - -C₁-C₈ alkil,
 - -CH(OH)-fenil,

- -S-fenil,
- -NHSO₂-fenil,
- -CN,
- -OH,
- -C₃-C₈cikloalkil, ili
- -4-cijano-2, 3, 4, 5-tetrafluorfenil; gde X₂ je :
- -aril,
- -heterocikl,
- -C₁-C₈alkil,
- -CH(OH)-fenil, ili
- -C₃-C₈ cikloalkil; gde W je :
- -NH-,
- -O-, ili
- -S-; gde aril je:
- fenil,
- naftil,
- bifenil,
- tetrahidro-naftil, ili
- fluorenil;

pri čemu heterocikl je 5-, 6- ili 7-člani zasićen ili nezasićen prsten koji sadrži od jedan do tri heteroatoma odabrana iz grupe koju čine azot, kiseonik i sumpor i sadrži bilo koju bicikličnu grupu u kojoj je jedan od prethodno pomenutih heterocikličnih prstenova kondenzovan za benzenski prsten ili za drugi heterociklični prsten; gde -cikloalkil je zasićen ili nezasićen ugljovodonični prsten uključujući bilo koju bicikličnu grupu u kojoj je prethodno naveden prsten vezan za prsten benzena, heterociklični prsten ili ugljovodonični prsten; gde R_g je :

- -C₁-C₇ alkil,
- -C₃-C₈ cikloalkil,
- -C(O)R_n,
- -C(O)NHR_n,
- -C(OH)R₁₁,
- -CH₂OH,
- -CO₂R₁₁, ili
- -aril, ; gde R₁₁ je:
- -H,
- -C₁-C₇ alkil,
- -(CH₂)_mX₁, ili
- -(CH₂)_m-C₃-C₈ cikloalkil; gde R₄ je:
- -F,
- -Cl,
- -Br,
- -I,
- -NO₂,
- -CF₃,
- -CN,
- -CH₂OH
- -C₁-C₆ alkil,
- -W-R₁₀
- -(CH₂)_m-aril,
- -(CH₂)_m-heterocikl,

- -(CH₂)_m-C₃-C₈ cikloalkil
 - -SO₂-NH-heterocikl,
 - -(CH₂)_m-NR₁₄R₁₅,
 - -(SO₂)-NR₁₄R₁₅,
 - -(C=O)-NR_i₄R_i₅, ili
- gde R₅ je:
- -H,
 - -F,
 - -Cl,
 - -Br,
 - -CF₃,
 - -W-R₁₀,
 - -C₁-C₆ alkil,
 - -(CH₂)_m-aril,
 - -(CH₂)_m-heterocikl, ili
 - -(CH₂)_m-C₃-C₈ cikloalkil; gde R₁₀ je:
 - -H,
 - -C₁-C₆ alkil,
 - -(CH₂)_m-aril
 - -(CH₂)_m-heterocikl,
 - -(CH₂)_m-C₃-C₈ cikloalkil, ili
 - -CH^(R)₁₂^R₁₃; pri čemu R₁₂ je :
 - -H,
 - -(CH₂)_mCO₂-C₁-C₆ alkil,
 - -(CH₂)_m-fenil,
 - -(CH₂)_m-heterocikl,
 - -C₁-C₆ alkil,
 - -C₁-C₄ alkil NH-COOCH₂-benzil, ili
 - -C₁-C₄ alkil-S-CH₃; gde R₁₃ je:
 - -NH-CO₂C(CH₃)₃,
 - -CN,
 - -COOH, ili
 - -CO₂R₁₁;

gde su R₁₄ i R₁₅, nezavisno jedan od drugog, odabrani od:

- -H,
- -Ci-Ce alkil,
- -(CH₂)_m-aril,
- -(CH₂)_m-cikloalkil,
- -(CH₂)_m-heterocikl,
- -(CH₂)_m-W-Rio,
- -(CH₂)_m-CN,

zajedno sa atomom azota za koji su vezani obrazuju po izboru susptituisan 5-do 8-člani heteromonocikl koji sadrži od jedan do tri heteroatoma odabrana iz grupe koju čine azot, kiseonik i sumpor, ili zajedno sa atomom azota za koji su vezani obrazuju po izboru susptituisan 5-do 8-člani heteromonocikl koji je kondenzovan sa jednim ili dva po izboru supsttituisana zasićena ili nezasićena prstena ili za druge po izboru supsttituisane heterocikle koji sadrže jedan do tri heteroatoma odabrana iz grupe koju čine azot, kiseonik i sumpor; gde m je broj od 0 do 6.

Preostalo patent ih zahtjeva 18.

(51) **CO7D223/16** ^{2006.01}
CO7C235/16 ^{2006.01}
CO7C323/60 ^{2006.01}

(11) **01464**
(21) **P-2012-139**

(22) 16. 02. 2011
(30) 20100000657 17. 02. 2010 FR
(96) EP/11290091/16. 02. 2011
(97) EP 2364972/19. 09. 2012/fr
EP 2364972 /14. 09. 2011/fr

(54) me **NOVI POSTUPAK ZA SINTETIZIRANJE IVABRADINA I NJEGOVIH ADICIJSKIH SOLI**

en NEW METHOD FOR SYNTHESISING IVABRADINE AND ITS ADDITION SALTS

(73) Les Laboratoires Servier, 35, rue de Verdun, 92284 Suresnes Cedex, FR,
(72) Peglion, Jean-Louis, 5, allée des Bégonias, 78110 Le Vesinet, FR,
Caignard, Pascal, 34, avenue Gallieni, 93800 Epinay-sur-Seine, FR,
(74) Jusić Jasna, Crnogorskih serdara bb, Podgorica ME
(57) Postupak sinteze ivabradina formule (i)

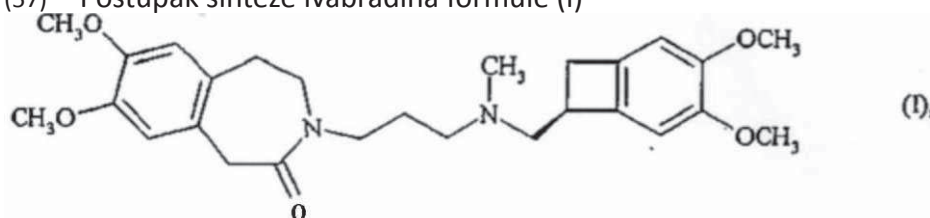

naznačen time, da je spoj formule (VI):

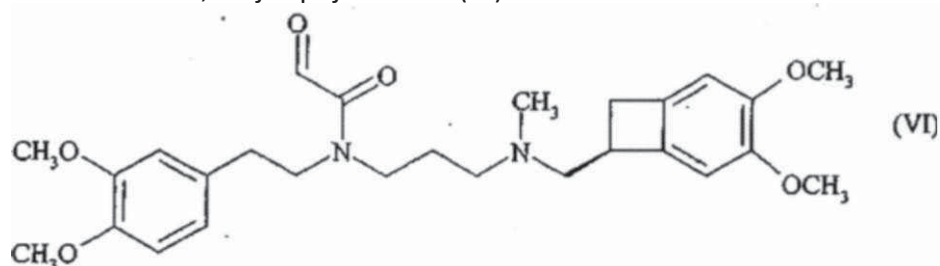

izložen djelovanju tiola u organskom otapalu kako bi se dobio hemitioacetal formule (VII):

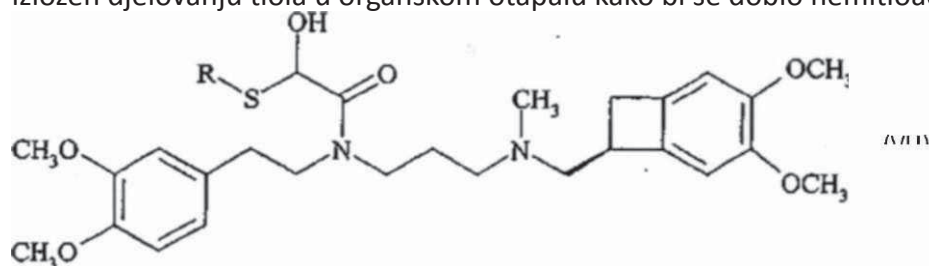

pri čemu R predstavlja supstituiranu ili nesupstituiranu, po izboru perfluoriniranu, ravnu ili razgrananu alkilnu skupinu, supstituiranu ili nesupstituiranu arilnu skupinu, supstituiranu ili nesupstituiranu benzilnu skupinu ili skupinu ChbCCbEt, koja je izložena reakciji ciklizacije kako bi se dobio spoj formule (VIII):

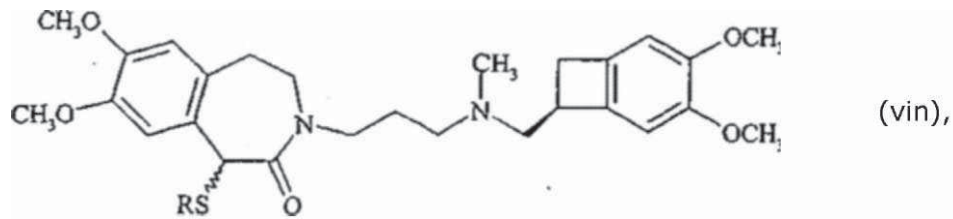

pri čemu je R ranije gore definiran, koji je izložen redukcijskoj reakciji kako bi se dobio ivabradin formule (I), koji po izboru može biti konvertiran u njihove adicijske soli s farmaceutski prihvatljivom kiselinom odabranom od klorovodične kiseline, bromovodične kiseline, sumporne kiseline, fosforne kiseline, octane kiseline, trifluoroctene kiseline, mliječne kiseline, piruvinske kiseline, malonske kiseline, sukcijske kiseline, glutarne kiseline, fumarne kiseline, tartarne kiseline, jabučne kiseline, limunske kiseline, askorbinske kiseline, oksalne kiseline, metanesulfonske kiseline, benzenesulfonske kiseline i kamforne kiseline i u njihove hidrate.

Preostalih patentnih zahtjeva je 11.

(51) **C07D40304** / ²⁰⁰⁶⁰¹
A61 K31 498 / ^{2006.01}
A61 P2504 / ^{2006.01}

(11) **01490**
 (21) **P-2012-143**

(22) 20. 07. 2009

(30) 20080082482P 21. 07. 2008 US

(96) EP/09786064/20. 07. 2009

(97) WO/PCT/IB2009/006356

WO 2010010458/28. 01. 2010/en/2010/04

EP 2324013/25. 05. 2011/en/2011/21

EP 2324013/19. 09. 2012/en/2012/38

(54) me **JEDINJENJA TIPA SUPSTITUISANOG HINOKSALINA SA PREMOŠĆENIM PIPERIDINOM I NJIHOVA UPOTREBA**

en **SUBSTITUTED-QUINOXALINE-TYPE BRIDGED-PIPERIDINE COMPOUNDS AND THE USES THEREOF**

(73) Purdue Pharma LP, One Stamford Forum 201 Tresser Boulevard, Stamford, CT 06901-3431, US

Shionogi & Co., Ltd., 1-8 Doshomachi 3-chome Chuo-ku Osaka-shi, Osaka 541-0045, JP,

(72) YAO, Jiangchao, 10 Bellflower CT, Princeton, NJ 08540, US,

WHITEHEAD, John, W., F., 155 North State Street, Newtown PA 18940, US,

TSUNO, Naoki, c/o Shionogi & Co., Ltd., 12-4, Sagisu 5-chome, Fukushima-ku, Osaka-shi, Osaka 553-0002, JP

FUCHINO, Kouki, 12-4 Sagisu 5-chome, Fukushima-ku, Osaka 553-0002, JP,

(74) Lutovac Branislav, Bulevar Crnojevića 93, Podgorica ME

(57) Jedinjenje formule (II):

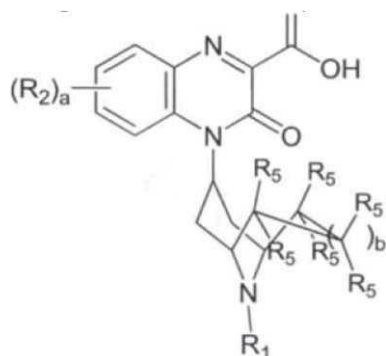

ili njegov farmaceutski prihvaljiv derivat gde: svaki R₂ je nezavisno izabran od -halo; a je ceo broj izabran od 0, 1 ili 2; b je ceo broj izabran od 0 ili 1; svaki R₅ je nezavisno izabran od -H, -OH, -(C₁-C₃)alkil, -C(halo)₃, ili -halo; R, je -(C₉-C₁₄)cikloalkil ili -(C₉-C₁₄)bicikloalkil, od kojih je svaki supstituisan sa 1, 2 ili 3 nezavisno izabrane R₃ (57) grupe; svaki R₃ je nezavisno izabran od -(C₁-C₄)alkil, -(C₂-C₆)alkenil, -(C₂-C₆)alkinil, ili -(C₃-C₆)cikloalkil, i gde je farmaceutsko prihvatljiv derivat izabran iz grupe koju čine farmaceutsko prihvatljive soli, solvati, radioaktivno obeleženi, stereoizomer, enantiomer, diastereoizomer, racemska smeša i tautomer. Preostalo još patentnih zahtjeva 28.

- (51) **B05B 11 00** / ²⁰⁰⁶⁰¹
A61M 1500 / ²⁰⁰⁶⁰¹
G06M3 02 / ²⁰⁰⁶⁰¹
- (11) **01477**
(21) **P-2012-144**
- (22) 14. 08. 2006
(30) 102005039921 24. 08. 2005 DE
(96) EP/06776839.0/14. 08. 2006
(97) /PCT/EP2006/008029
WO 2007/022898/01. 03. 2007/en/2007/09
EP 1917108/07. 05. 2008/en/2008/19
EP 1917108/03. 10. 2012/en/2012/40
- (54) me **ATOMIZER KOJI SADRŽI BROJAČ I BLOKADU DALJEG AKTIVIRANJA**
en ATOMISER COMPRISING A COUNTER AND AN END OF OPERATION LOCK
- (73) Boehringer Ingelheim International GmbH, Binger Strasse 173, 55216 Ingelheim am Rhein, DE,
(72) GESER, Johannes, Vorderer Boehl 23, 55218 Ingelheim, DE,
METZGER, Burkhard P., Hausgartenstrasse 24, 55218 Ingelheim, DE,
GOLBERG, Christian, Bergmannstrasse 191 c, 45886 Gelsenkirchen, DE,
SCHYRA, Michael, Giselastrasse 35, 42111 Wuppertal, DE,
THOEMMES, Ralf, Honschaftsweg 2, 47877 Willich, DE,
WESTMEIER, Birgit, Kuekenhoeher Weg 78, 44357 Dortmund, DE,
SCHMIEDEL, Guido, Wischlinger Weg 242, 44379 Dortmund, DE,
KUNZE, Hubert, Walter-Berg-Weg 1, 44227 Dortmund, DE,
BOECK, Georg, Ahornweg 48, 88471 Laupheim, DE,
(74) Radulović Božidar, Jovana Tomaševića 9/III, Podgorica ME
- (57) Atomizer (1) za fluid (2), sa kontejnerom (3) sa fluidom (2) koji se može umetnuti i koji se može zamijeniti, sa brojačkom napravom (23) koja sadrži prvi brojač (31) za brojanje aktiviranja atomizera (1) i prvenstveno sa dijelom (18) kućišta koji može biti montiran na atomizeru (1) ili se može skinuti sa njega, radi umetanja i/ili zamijene kontejnera (3), pri čemu je prvi brojač (31) naročito postavljen na dijelu (18) kućišta i izveden je tako da je atomizer (1) blokiran protiv dalje upotrebe kada se dostigne ili kada se pređe određeni broj aktiviranja atomizera (1), koji se naziva prvim blokiranim stanjem, naznačen time, što se kontejner (3) ne može skinuti sa prvog brojača (31), tako da se kontejner (3) može zamijeniti ili izmijeniti samo sa prvim brojačem (31).

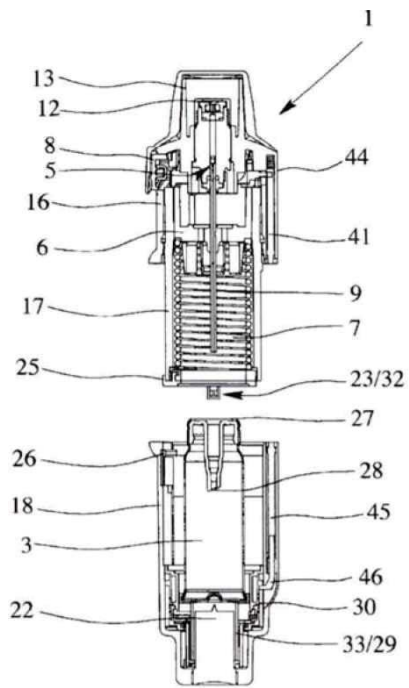

Preostalih patentnih zahtjeva je 31.

- (51) **C07D215 26** / ⁰⁰⁶⁰¹
A61K314704 / ²⁰⁰⁶⁰¹
A61P 11 00 / ²⁰⁰⁶⁰¹
- (22) 15. 12. 2009
(30) 08382082 22. 12. 2008 EP
(96) EP/09793472.3/15. 12. 2009
(97) WO/PCT/EP2009/008970
WO 2010/072354/01. 07. 2010/en/2010/26
EP 2367796/28. 09. 2011/en/2011/39
EP 2367796/24. 10. 2012/en/2012/43
- (54) me **MEZILAT SO 5-(2-{[6-(2, 2-DIFLUORO-2-FENILETOKSI)HEKSIL]AMINO
HYDROKSJETIL)-8-HIDROKSIHINOLIN-2(1 H)-ONA KAO ANTAGONIST BETA 2
ADRENERGICKOG RECEPTORA**
en MESYLATE SALT OF 5-(2-{[6-(2, 2-DIFLUORO-2-PHENYLETHOXY)HEXYL]AMINO
HYDROXYETHYL)-8-HYDROXYQUINOLIN-2(1H)-ONE AS AGONIST OF THE BETA 2 ADRENER-
GIC RECEPTOR
- (73) Almirall, S.A., Ronda del General Mitre 151, 08022 Barcelona, ES,
(72) CARRERA CARRERA, Francesc, C/ Laureà Miró 408-410, E-08980 Sant Feliu de Llobregat,
ES,
PUIG DURAN, Carlos, C/ Laureà Miró 408-410, E-08980 Sant Feliu de Llobregat, ES,
MARCHUETA HEREU, Iolanda, C/ Laureà Miró 408-410, E-08980 Sant Feliu de Llobregat,
ES,
MOYES VALLS, Enrique, C/ Laureà Miró 408-410, E-08980 Sant Feliu de Llobregat, ES,
(74) Đakonović Vido, Bajova 9, Cetinje ME
(57) Mezilat so 5-(2-{[6-(2, 2-difluoro-2-feniletoksi)heksil]amino}-1-hidroksietil)-8-hidroksihi-
nolin-2(1/-)-on i njeni farmaceutski prihvatljivi rastvarači.
Preostalo još 13 patentnih zahtjeva

- (51) **A61K314709** / ²⁰⁰⁶⁰¹
A61P3104 / ²⁰⁰⁶⁰¹
C07D41306 / ²⁰⁰⁶⁰¹

- (11) **01485**
(21) **P-2012-146**

- (22) 31. 07. 2006
(30) 20050107155 03. 08. 2005 EP
(96) EP/06792614.7/31. 07. 2006
(97) /PCT/EP2006/064847
WO 2007014934/08. 02. 2007/en/2007/06
EP 1912649/23. 04. 2008/en/2008/17
EP 1912649/10. 10. 2012/en/2012/41

- (54) me **KINOLINSKI DERIVATI KAO ANTIBAKTERIJSKI AGENSI**
en QUINOLINE DERIVATIVES AS ANTIBACTERIAL AGENTS

- (73) Janssen Pharmaceutica NV, Turnhoutseweg 30, 2340 Beerse, BE,
(72) ANDRIES, Koenraad Jozef Lodewijk Marcel, c/o Janssen Pharmaceutica N.V.,
Turnhoutseweg 30, 2340 Beerse, BE,
KOUL, Anil, c/o Janssen Pharmaceutica N.V., Turnhoutseweg 30, 2340 Beerse, BE,
GUILLEMONT, Jérôme Emile, Georges, c/o Johnson & Johnson Pharm., A Div. of Janssen-ci-
lag, Campus De Maigremont BP 615 27106 Val de Rueil C<
PASQUIER, Elisabeth, Thérèse, Jeanne, c/o Johnson & Johnson Pharm., A Div. of Janssen-ci-
lag, Campus De Maigremont BP 615 27106 Val de Rueil C<
(74) Radulović Božidar, Jovana Tomaševića 9/III, Podgorica ME
(57) Upotreba jedinjenja za proizvodnju leka za tretman bakterijske infekcije, naznačena time,
da pomenuto jedinjenje je jedinjenje sa Formulom (Ia) i (Ib)

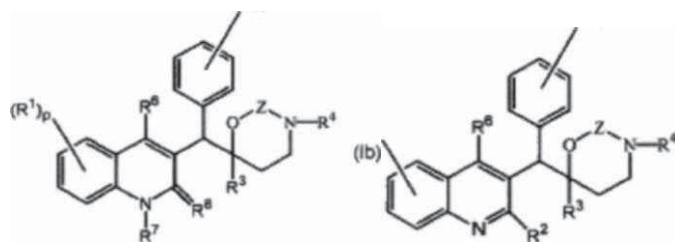

neka njegova farmaceutski prihvatljiva kisela ili bazna adiciona so, njegov kvaternarni amin, neka njegova stereohemijski izomerička forma, njegova tautomerna forma ili njegov iV-oksid, gde R¹ je vodonik, halo, haloalkil, cijano, hidroksi, Ar, Het, alkil, alkiloksi, alkiltio, alkiloksialkil, alkiltioalkil, Ar-alkil ili di(Ar)alkil; p je ceo i broj jednak 1, 2, 3 ili 4; R je vodonik, hidroksi, merkapto, alkiloksi, alkiloksialkiloksi, alkiltio, mono ili di(alkil)amino ili neki radikal sa formulom

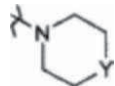

gde Y je CH₂, O, S, NH ili N-alkil; R³ je alkil, Ar, Ar-alkil, Het ili Het-alkil; R⁴ je vodonik, alkil ili benzil; R⁵ je vodonik, halo, haloalkil, hidroksi, Ar, alkil, alkiloksi, alkiltio, alkiloksialkil, alkiltioalkil, Ar-alkil ili di(Ar)alkil; ili dva susedna R⁵ radikala mogu da zajedno sa fenilnim prstenom, na kojeg su spojeni, formiraju neki a naftil; r je celi broj jednak 1, 2, 3, 4 ili 5; a R⁶ je vodonik, alkil, Ar ili Het; R⁷ je vodonik ili alkil; R⁸ je okso; ili R⁷ i R⁸ zajedno formiraju radikal -CH=CH-N = ; Z je CH₂ ili C(=O); alkil je neki ravno-lančani ili razgranati zasićeni ugljovodonikov radikal koji sadrži od 1 do 6 atoma ugljenika; ili je neki ciklički zasićeni ugljovodonikov radikal koji sadrži od 3 do 6 atoma ugljenika; ili je neki ciklički zasićeni ugljovodonikov radikal koji sadrži od 3 do 6 atoma ugljenika koji su spojeni na ravno-lančani ili na razgranati zasićeni ugljovo-

donikov radikal koji ima 1 do 6 atoma ugljenika; a gde svaki atom ugljenika može ponekad da bude supstituisan sa hidroksi, alkiloksi ili okso; Ar je neki homocikal koji je izabran iz grupe koja obuhvata fenil, naftil, acenaftil, tetrahidronaftil, a svaki je ponekad supstituisan sa 1, 2 ili 3 supstituenata, a svaki supstituenat je nezavisno izabran iz grupe koja obuhvata * hidroksi, halo, cijano, nitro, amino, mono- ili dialkilamino, alkil, haloalkil, alkiloksi, haloalkiloksi, karboksil, alkiloksikarbonil, aminokarbonil, morfolinil i mono- ili dialkilaminokarbonil; Het je neki monociklički heterocikal koji je izabran iz grupe koja obuhvata N-fenoksipiperidinil, piperidinil, pirolil, pirazolil, imidazolil, furanil, tienil, oksazolil, izoksazolil, tiazolil, izotiazolil, piridinil, pirimidinil, pirazinil i piridazinil; ili neki biciklički heterocikal koji je izabran iz grupe koja obuhvata kinolinil, kinoksalinil, indolil, benzimidazolil, benzoksazolil, benzizoksazolil, benzotiazolil, benzizotiazolil, benzofuranil, benzotienil, 2, 3-dihidrobenzo[1, 4]dioksinil ili benzo[1, 3]dioksolil; a svaki monociklički i biciklički heterocikal može ponekad da bude supstituisan na nekom atomu ugljenika sa 1, 2 ili 3 supstituenata, a svaki supstituenat nezavisno je izabran iz grupe koja obuhvata halo, hidroksi, alkil ili alkiloksi; halo je neki supstituenat koji je izabran iz grupe koja obuhvata fluoro, hloro, bromo i jodo; i haloalkil je neki ravno-lančani ili razgranati zasićeni ugljovodonikov radikal koji ima od 1 do 6 atoma ugljenika ili neki ciklički zasićeni ugljovodonikov radikal koji sadrži od 3 do 6 atoma ugljenika ili neki ciklički zasićeni ugljovodonikov radikal koji sadrži od 3 do 6 atoma ugljenika koji su spojeni na neki ravno-lančani ili razgranati zasićeni ugljovodonikov radikal koji sadrži od 1 do 6 atoma ugljenika; a gde jedan ili više atoma ugljenika je supstituisano sa jednim ili više halo atoma; pod uslovom daje bakterijska infekcija drugačija od one koju uzrokuju Mycobacteria. Preostalih patentnih zahtjeva je 22.

(51) **A47J 31/00**⁽²⁰⁰⁶⁰⁾
A47J 31/04⁽²⁰⁰⁶⁰⁾
A47J 31/40⁽²⁰⁰⁶⁰⁾
A47J 31/30⁽²⁰⁰⁶⁰⁾

(11) **01468**
(21) **P-2012-148**

(22) 28. 12. 2012

(96) EP/08875227.4/24. 10. 2008

(97) WO/PCT/EP2008/064456/24. 10. 2008

WO 2010/045983/29. 04. 2010/en

EP 2365771 /21. 09. 2011/en

EP 2365771 /26. 09. 2012/en

(54) me **UREĐAJ ZA IMPROVIZOVANO PRIPREMANJE PIĆA OD RASTVORLJIVIH PRAHOVA**

en **DEVICE FOR EXTEMPORANEOUSLY PREPARING A HOT BEVERAGE FROM A SOLUBLE POWDER**

(73) Alistella S.a., Via Cantonale 19, 6901 Lugano, CH,

(72) BRIZIO, Adriana, Via Sole, 18, CH-6977 Ruvigliana (Lugano), CH,

(74) AOD "Ćupić", Dalmatinska 10, Podgorica ME

(57) Uređaj (101; 201; 301; 401) za improvizovano pripremanje toplog napitka (40), bilo gde i bilo kada od rastvorljivog praha, koji sadrži posudu (10) koja ima zid (20), dno (22) i poklopac (24) koji se može ukloniti, pri čemu je unutrašnji deo podeljen na gornju šupljinu (12) i donju šupljinu (14) pregradom (28), unutrašnja šupljina (14) sadrži tečnost za piće (32), dok gornja šupljina sadrži rastvorljivi prah (30) koji je u stanju da napravi navedeni napitak (40), obezbeđen je izduženi šuplji element (16, 26; 26B), koji je otvoren na svoja dva kraja i koji prenosi navedenu tečnost za piće iz donje šupljine (14) do gornje šupljine (12), otvoreni gornji kraj (46; 46A) izduženog elementa (16, 26; 16B) ima nivo koji je viši od nivoa (41) navedenog napitka (40) u gornjoj šupljini (12), obezbeđena su zaptivna sredstva (34; 35; 36) za sprečavanje spoja između gornje (12) šupljine i donje (14) šupljine kroz izduženi element (16, 26; 26B), pri čemu se ova zaptivna sredstva (34; 35; 36) mogu učiniti neefikasnim intervencijom korisnika ili pošto su postignuti unapred određeni pritisak na tečnost ili unapred određena temperatura.

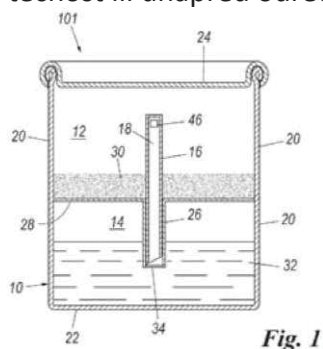

Fig. 1

Preostalih patentnih zahtjeva je 14.

- (51) **A61K9 14/**⁰⁰⁶⁰¹ (11) **01453**
A61K3141 /²⁰⁰⁶⁰¹ (21) **P-2012-149**
- (22) 23. 12. 2005
- (30) 20040030782 24. 12. 2004 EP
20050004433 01. 03. 2005 EP
- (96) EP/08165631.6/23. 12. 2005
- (97) EP 203362903. 2009/en/2009/11
EP 2033629/14. 11. 2012/en/2012/46
- (54) me **ČVRSTE FARMACEUTSKE KOMPOZICIJE KOJE SADRŽE VALSARTAN**
en **SOLID PHARMACEUTICAL COMPOSITION COMPRISING VALSARTAN**
- (73) KRKA, Tovarna Zdravil D.d., Novo mesto Smarjeska cesta 6, 8501 Novo mesto, SI,
(72) Vrbinc, Miha, Gotna Vas 20, 8000, Novo Mesto, SI,
Slanc Vovk, Janika, Jurckova cesta 21/C, 1000, Ljubljana, SI,
Rangus, Marija, Gorenje Gradisce 1, 8310, Sentjernej, SI,
Zupancic, Silvo, Zupnca 4 B, 8000, Novo Mesto, SI,
Bevec, Franci, Grm 20, 8210, Trebnje, SI,
Cernosa, Lidija, Ljubljanska 29 A, 8311, Kostanjevica Na Krki, SI,
- (74) AOD «Ćupić», Dalmatinska 10, Podgorica ME,
- (57) Postupak za dobijanje farmaceutske kompozicije koja sadrži valsartan, a koji obuhvata sledeće faze: -obezbeđivanje čestica valsartana sa maksimalnim prečnikom od 1100 um, - granulaciju smeše valsartana i ekscipijenasu pomoću vode ili vodene disperzije kao tečnosti za granulaciju pri čemu se dobija granulat, -dodavanje dodatne količine ekscipijenasu u granulat pri čemu se dobija smeša za komprimovanje, - komprimovanje smeše za komprimovanje u željeni oblik, i - po izboru, nanošenje obloge, i pri čemu kompozicija kao ekscipijens sadrži umreženu natrijum karboksimetilcelulozu.
Preostalih patentnih zahtjeva 12

- (51) **A61K31/132**^{2006.01}
A61K31/4412^{2006.01}
A61K31/506^{2006.01}
A61K31/53^{2006.01}
A61K33/24^{2006.01}
A61P35/00^{2006.01}
A61K31/282^{2006.01}
- (11) **01460**
(21) **P-2013-2**
- (22) 02. 06. 2005
(30) 20040171520 09. 06. 2004 JP
(96) EP/05745983.6/02. 06. 2005
(97) WO/PCT/JP2005/010182/02. 06. 2005
WO 2005/120480/22. 12. 2005/en/2005/51
EP 1757283/28. 02. 2007/en/2007/09
EP 1757283/17. 10. 2012/en/2012/42
- (54) me **POJAČIVAČ ANTITUMORNOG EFEKTA, ANTITUMORNO SREDSTVO I POSTUPAK LIJEČENJA KANCERA**
en ANTITUMOR EFFECT FORTIFIER, ANTITUMOR AGENT AND METHOD OF THERAPY FOR CANCER
- (73) TAIHO PHARMACEUTICAL CO., LTD., 1-27, Kandanishiki-cho, Chiyoda-ku, Tokyo 101-0054, JP,
(72) KOIZUMI, Katsuhisa c/o TAIHO PHARMACEUTICAL. CO., LTD., 224-2, Hiraishi Ebisuno, Kawauchi-cho, Tokushima-shi, Tokushima 7710194, JP,
UCHIDA, Junji c/o TAIHO PHARMACEUTICAL. CO., LTD., 224-2, Hiraishi Ebisuno, Kawauchi-cho, Tokushima-shi, Tokushima 7710194, JP,
TAKECHI, Teiji c/o TAIHO PHARMACEUTICAL. CO., LTD., 224-2, Hiraishi Ebisuno, Kawauchi-cho, Tokushima-shi, Tokushima 7710194, JP,
NUKATSUKA, Mamoru c/o TAIHO PHARMACEUTICAL. CO., LTD., 224-2, Hiraishi Ebisuno, Kawauchi-cho, Tokushima-shi, Tokushima 7710194, JP,
- (74) AOD "Ćupić", Dalmatinska 10, Podgorica ME,
(57) Cis-oksalat(1 R, 2R- diaminocikloheksan)platina(II) za upotrebu u postupku pojačavanja antitumorne aktivnosti kompozicije, naznačen time što uključuje
- terapeutski efektivnu količinu tegafura,
 - glimeracil u količini za pojačavanje antitumornog efekta i
 - oteracil kalijum u količini efikasnoj za inhibiciju sporednog efekta.
- Patent sadrži jos 9 patentnih zahtjeva.

- (51) **AC07D471 /04**²⁰⁰⁶⁰¹ (11) **01469**
AC07D213/28²⁰⁰⁶⁰¹ (21) **P-2013-4**
AC07D233/56²⁰⁰⁶⁰¹
AA61K31 /437²⁰⁰⁶⁰¹
C A61P25/00²⁰⁰⁶⁰¹
C A61P 19/00²⁰⁰⁶⁰¹
C A61P35/00²⁰⁰⁶⁰¹

- (22) 20. 03. 2009
(30) 0801580 21. 03. 2008 FR
(96) EP/09754041/20. 03. 2009
(97) FR/PCT/FR2009/000297/20. 03. 2009
WO 2009144391 /03. 12. 2009/fr/2009/49
EP 2262803/22. 12. 2010/fr/2010/51
EP 2262803/17. 10. 2012/fr/2012/42
FR WO2009/144391

(54) me **POLISUPSTITUISANI DERIVATI 2-ARIL-6-FENIL-IMIDAZO[1, 2-a]PIRIDINA I NJIHOVO DOBIJANJE I TERAPEUTSKA UPOTREBA**

en POLYSUBSTITUTED DERIVATIVES OF 2-ARYL-6-PHENYL-IMIDAZO[L, 2-A] PYRIDINES, AND PREPARATION AND THERAPEUTIC USE THEREOF

- (73) SANOFI, 54, rue La Boétie, 75008 Paris, FR,
(72) DE PERETTI, Danielle, c/o Sanofi-aventis, Département Brevets, 174 avenue de France, F-75013 Paris, FR,
EVANNO, Yannick, c/o Sanofi-aventis, Département Brevets, 174 avenue de France, F-75013 Paris, FR,
(74) AOD „Ćupić“, Dalmatinska 10, Podgorica ME
(57) Jedinjenje formule (I)

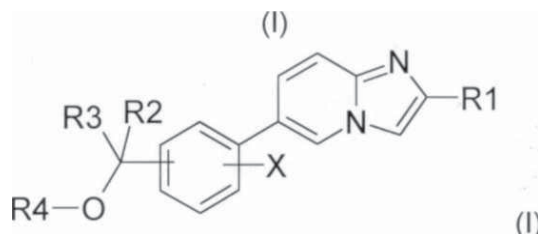

u kojoj: R₁ predstavlja : fenil grupu ili naftil grupu, moguće je za ove dvije grupe po izboru da budu supstituisane jednim ili više atoma ili grupa odabranih, nezavisno jedan od drugog, od sledećih atoma ili grupa: halogena, (C₁-C₁₀)alkil, halo(C₁-C₁₀)alkil, (C₁-C₁₀)alkoksi, halo(C₁-C₁₀)alkoksi, (C₁-C₁₀)tioalkN, -S(O)(C₁-C₁₀)alkil, -S(O)₂(C₁-C₁₀)alkil, hidroksil, cijano, nitro, hidroksi (C₁-C₁₀)alkilen, NRaRb(C₁-C₁₀)alkilen, (C₁-C₁₀)alkoksi (C₁-C₁₀)alkilenoksi, NRaRb, CONRaRb, SO₂NRaRb, NRcCORd, OC(O)NRaRb, OCO(C₁-C₁₀)alkil, NRcC(O)ORe, NRcSO₂Re, aril(C₁-C₁₀)alkilen, monociklični aril ili monociklični heteroaril, monociklični aril ili monociklični heteroaril su po izboru supstituisani jednim ili više supstituenata odabranih od halogena ili (C₁-C₁₀)alkil, halo(C₁-C₁₀)alkil, (C₁-C₁₀)alkoksi, halo(C₁-C₁₀)alkoksi, NRaRb, hidroksil, okso, nitro, cijano ili OCO(C₁-C₁₀)alkil grupa ; X predstavlja od 1 do 4 supstituenta koji su isti ili koji se razlikuju jedan od drugog i koji su odabrani od halogena, (C₁-C₁₀)alkila, (C₁-C₁₀)alkoksi, NRaRb, cijano ili nitro, moguće je za (C₁-C₁₀)alkil da bude po izboru supstituisan jednom ili više grupa odabranih od halogena, (C₁-C₁₀)alkoksi, halo(C₁-C₁₀)alkoksi, NRaRb ili hidroksila; R₂ i R₃ predstavljaju, nezavisno jedan od drugog, atom vodonika, (C₁-C₁₀)alkil grupu, ova grupa je po izboru supstituisan sa R_f grupom; aril grupu, koja je po izboru supstituisana

jednim ili više supstituenata odabranih od halogena ili (C1-C10)alkil, halo(C1-C10)alkil, (C1-C₁₀)alkoksi, halo(C₁-C₁₀)alkoksi, NRaRb, hidroksil, nitro ili cijano grupe; R₂ i X mogu zajedno da formiraju, sa tomima ugljenika koji ih nose, ugljenični prsten od 5 do 7 atoma ugljenika; R₄ predstavlja: atom vodonika, (C1-C10)alkil grupu, ova grupa je po izboru supstituisana sa Rf grupom; aril grupu, koja je po izboru supstituisana jednim ili više supstituenata odabranih od halogena ili (C₁-C₁₀)alkil, halo(C₁-C₁₀)alkil, (C₁-C₁₀)alkoksi, halo(C₁-C₁₀)alkoksi, NRaRb, hidroksil, nitro, cijano, (C1-C10)alkil(CO)-, CONRaRb, NRcCORd, OC(O)NRaRb, OCO(C1-C10)alkil, NRcC(O)ORe ili aril grupu, gde je aril po izboru supstituisan jednim ili više supstituenata odabranih od halogena ili (C1-C10)alkil, halo(C1-C10)alkil, (C1-C10)alkoksi, halo(C1-C10)alkoksi, NRaRb, hidroksil, nitro ili cijano grupa; Ra i Rb predstavljaju, nezavisno jedan od drugog, atom vodonika ili (C1-C10)alkil, aril(C1-C10)alkilen ili aril grupu; ili Ra i Rb zajedno formiraju, sa atomom azota za koji su vezani, azetidin, pirolidin, piperidin, azepin, morfolin, tiomorfolin, piperazin ili homopiperazin grupu, ova grupa je po izboru supstituisan (C1-C10)alkil, aril ili ahl(Ci-Ci0)alkilen grupom; Rc i Rd predstavljaju, nezavisno jedan od drugog, atom vodonika ili (C1-C10)alkil, aril(C1-C10)alkilen ili aril grupu; ili Rc i Rd zajedno formiraju (C2-C5)alkilen grupu; Re predstavlja (C1-C10)alkil, aril(C1-C10)alkilen ili aril grupu; ili Rc i Re zajedno formiraju (C2-C5)alkilen grupu; Rf predstavlja atom halogena ili (C1-C10)alkoksi, halo(C1-C10)alkoksi, hidroksil, cijano, NRaRb, C(O)NRaRb, NRcCORd, OC(O)NRaRb, OCO(C1-C10)alkil, NRcCOORe, SO₂NRaRb, NRcSO₂Re, aril(C1-C10)alkilen ili aril grupu, aril je po izboru supstituisan jednim ili više supstituenata odabranih od halogena ili (C1-C10)alkil, halo(C1-C10)alkil, (C1-C10)alkoksi, halo(C1-C10)alkoksi, NRaRb, hidroksil, nitro, cijano ili OCO(C1-C10)alkil grupa; * u obliku baze ili adicione soli sa kiselinom.

Patent sadrži još 26 patentnih zahtjeva.

(51) **C08K3 34** / ²⁰⁰⁶⁰¹
C08K7 00 / ²⁰⁰⁶⁰¹
C08L 95 00 / ²⁰⁰⁶⁰¹

(11) **01471**
(21) **P-2013-09**

(22) 11. 06. 2010
(30) 2009MI01062 16. 06. 2009 IT
(96) EP/10165657.7/11. 06. 2010
(97) EP 2264092/24. 10. 2012/2010/51
EP 2264092/24. 10.2012/2012/43

(54) me **HIDROIZOLACIONE MEMBRANE BAZIRANE NA BITUMENU
MODIFIKOVANOM SA POLIMERIMA KOJI SADRŽE KENOSFERE ALUMINIJUM-
SILIKATA**

en WATERPROOFING MEMBRANES BASED ON BITUMEN MODIFIED WITH POLYMERS
CONTAINING ALUMINIUM SILICATE CENOSPHERES.

(73) Polyglass S.p.A., Viale Edoardo Jenner, 4, 20159 Milano, IT,
(72) Drigo, Michele, c/o Polyglass S.p.A., Via dell' Artigianato, 34, 31047, PONTE DI PIAVE (TV),
IT,
Pascon, Daniele, Vicolo del Grano, 5, 31040, SALGAREDA (TV), IT,
Zaffaroni, Pasquale, Viale Edoardo Jenner, 4, 20159, Milano, IT,
(74) Radulović Božidar, Jovana Tomaševića 9/III, Podgorica ME,
(57) Hidroizolacione membrane koje se sastoje od ojačanog materijala impregniranog
bituminoznom formulom koja se sastoji od industrijskog bitumena, mineralnog punila,
termoplastičnog polimera ili smeše termoplastičnih polimera, karakterisane time da je
mineralno punilo izgrađeno od aluminijum-silikata u formi kenosfera sa gustinom između
0.6 i 0.85 g/cm³ i sa veličinom između 5 i 300pm, a radije između 5 i 106 pm.
Patent sadrži još 8 patentnih zahtjeva.

(51) **C 08K7 00** / ²⁰⁰⁶⁰¹
C08L 95 00 / ²⁰⁰⁶⁰¹
C08K7 28 / ²⁰⁰⁶⁰¹

(11) **01472**
(21) **P-2013-10**

(22) 11. 06. 2010

(30) 2009MI01063 16. 06. 2009 IT

(96) EP/10165659/11. 06. 2010

(97) EP 2264094/22. 12. 2010/en/2010/51

EP 2264094/24. 10. 2012/en/2012/43

(54) me **HIDROIZOLACIONE MEMBRANE BAZIRANE NA BITUMENU
MODIFIKOVANOM SA POLIMERIMA KOJI SADRŽE ŠUPLJE STAKLENE
MIKROSFERE**

en WATERPROOFING MEMBRANE BASED ON BITUMEN MODIFIED WITH POLYMERS
CONTAINING HOLLOW GLASS MICROSPHERES

(73) Polyglass S.p.A., Viale Edoardo Jenner, 4, 20159 Milano, IT,

(72) Drigo, Michele, c/o Polyglass S.p.A., Via dell'Artigianato, 34, 31047, PONTE DI PIAVE (TV),
IT,

Pascon, Daniele, Vicolo del Grano, 5, 31040, SALGAREDA (TV), IT,

(74) Radulović Božidar, Jovana Tomaševića 9/III, Podgorica ME,

(57) Hidroizolacione membrane koje se sastoje od ojačanog materijala impregniranog
bituminoznom formulom koja se sastoji od industrijskog bitumena, mineralnog punila,
termoplastičnog polimera ili smeše termoplastičnih polimera, koje karakteriše mineralno
punilo izgrađeno od šupljih staklenih mikrosfera sa gustinom između 0.1 i 0.14 g/cm³ i sa
veličinom manjom od 120 pm.

Patent sadrži još 8 patentnih zahtjeva.

- (51) **A61K3144** / ²⁰⁰⁶⁰¹
A61K31445 / ²⁰⁰⁶⁰¹
A61K31495 / ²⁰⁰⁶⁰¹
A61K31496 / ²⁰⁰⁶⁰¹
A61K31404 / ²⁰⁰⁶⁰¹
- (11) **01493**
(21) **P-2013-13**
- (22) 21. 12. 2005
(30) 20040030770 24. 12. 2004 EP
(96) EP/05823930.2/21. 12. 2005
(97) WO/PCT/EP2005/057002
WO 2006/067165/29. 06. 2006/en/2006/26
EP 1830843/12. 09. 2007/en/2007/37
EP 1830843/07. 11. 2012/en/2012/45
- (54) me **DERIVATI INDOLIDONA ZA LIJEČENJE ILI PREVENCIJU FIBROZNIH
OBOLJENJA**
en LNDOLIDONE DERIVATIVES FOR THE TREATMENT OR PREVENTION OF FIBROTIC DISE-
ASES
- (73) Boehringer Ingelheim International GmbH, Binger Strasse 173, 55216 Ingelheim am Rhein,
DE,
(72) PARK, John, Edward, Erlenweg 22, 88447 Warthausen, DE,
ROTH, Gerald, Jürgen, Akazienweg 47, 88400 Biberach, DE,
HECKEL, Armin, Geschwister-scholl-str. 71, 88400 Biberach, DE, CHAUDHARY, Nveed, 13 Da-
gmar Avenue, Wembley, Middlesex HA9 8DG, DE,
BRANDL, Trixi, Murbacherstr.27, CH-4056 Basel, CH, DAHMANN, Georg, Bahnhofstrasse 14,
88448 Attenweiler, DE,
GRAUERT, Matthias, Osterbergstr. 10, 88400 Biberach, DE,
(74) Radulović Božidar, Jovana Tomaševića 9/III, Podgorica ME
(57) Jedinjenje 3-Z-[1-(4-(N-((4-metil-piperazin-1-M)-metMkarbonM)-N-metM-amino)-
aniMno)-1-fenilmetilen]-6-metoksikarbonil-2-indolinon ili njegov tautomer, diastereomer,
enantiomer, njegove smješe ili njegova so, za primjenu u prevenciji ili liječenju idiopatske
plućne fibroze.
Patent sadrži još 1 patentni zahtjev.

- (51) **C07D215 26** / ⁽²⁰⁰⁶¹⁾
A61K314704 / ⁽²⁰⁰⁶¹⁾
A61P 11/00 ⁽²⁰⁰⁶¹⁾

- (11) **01467**
(21) **P-2013-14**

- (22) 12. 03. 2010
(30) 09382030 12. 03. 2009 EP
(96) EP/10708935.1/12. 03. 2010
(97) WO/PCT/EP2010/001582
WO 2010/102831 /16. 09. 2010/en/2010/37
EP 2406227 /18. 01. 2012/en/2012/03
EP 2406227 /28. 11. 2012/en/2012/48

- (54) me **POSTUPAK ZA PROIZVODNJU 5-(2-{{6-(2, 2-DIFLUORO-2-FENILETOKSI) HEKSIL}AMINO}-1 -HIDROKSJETIL)-8-HIDROKSIHINOLIN-2(1 H)-ONA**
en **PROCESS FOR MANUFACTURING 5-(2-{{6-(2, 2-DIFLUORO-2-PHENYLETHOXY) HEXYL AMI NO}-1- HYDROXYETHYL)-8-HYDROXYQU I NOLI N-2(1 H)-ONE**
- (73) Almirall S.A., Ronda del General Mitre, 151, 08022 Barcelona, ES,
(72) MARCHUETA HEREU, Iolanda, C/Laurea Miro 408-410, E-08980 Sant Feliu de Llobregat, ES,
MOYES VALLS, Enrique, C/Laurea Miro 408-410, E-08980 Sant Feliu de Llobregat, ES,
(74) Čejović Vladimir, 13. jula 21, Podgorica ME
(57) Postupak za izradu jedinjenja 5-(2-{{6-(2, 2-difluoro-2-feniletoksi)heksil}amino}-1-hidroksietil)-8-hidroksihinolin-2(1H)-ona sa formulom (I), iii njegove farmaceutski prihvatljive soli,

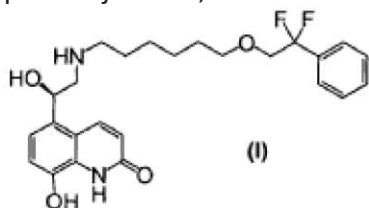

pri čemu postupak obuhvata: reakciju, u ksilenskom rastvaraču, jedinjenja sa formulom (V)

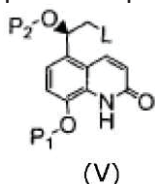

pri čemu P1 i P2 predstavljaju hidroksi zaštitne grupe, a L je odlazeća grupa, sa 6-(2, 2-difluoro-2-feniletoksi)heksan-1-aminom formule (IV),

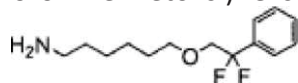

da bi se dobilo jedinjenje formule (III)

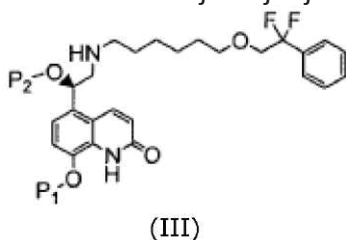

b) izvođenje koraka uklanjanja zaštite P1 i koraka uklanjanje zaštite P2, da bi se odstranile

zaštitne grupe P1 i P2 i dobilo jedinjenje formule (I) .
Patent sadrži još 13 patentnih zahtjeva.

- (51) **A61K315 06** / ²⁰⁰⁶⁰¹
A61K38 05 / ²⁰⁰⁶⁰¹
A61P35 00 / ²⁰⁰⁶⁰¹
A61K31 69 / ²⁰⁰⁶⁰¹
A61K45 06 / ²⁰⁰⁶⁰¹

(11) **01514**(21) **P-2013-15**

- (22) 11. 09. 2007
(30) 20060120726 15. 09. 2006 EP
20070915895P 03. 05. 2007 US
(96) EP/07803397.4/11. 09. 2007
(97) PCT/EP2007/059518/11.09.2007.
WO 2008/031817/20. 03. 2008/en/2008/12
EP 2066327/10. 06. 2009/en/2009/24
EP 2066327 /14. 11. 2012/en/2012/46

- (54) me **INHIBITORI HISTONSKE DEACETILAZE SA SPOJENOM AKTIVNOSTI
PROTIV HISTONSKIH DEACETILAZA KLASE-L I KLASE-IIB U KOMBINACIJI SA
INHIBITORIMA PROTEASOMA**

en HISTONE DEACETYLASE INHIBITORS WITH COMBINED ACTIVITY ON CLASS-L AND CLASS-LL B HISTONE DEACETYLASES IN COMBINATION WITH PROTEASOME INHIBITORS

- (73) Janssen Pharmaceutica NV, Turnhoutseweg 30, 2340 Beerse, BE,
(72) ARTS, Janine, Janssen Pharmaceutica NV, Turnhoutseweg 30, 2340 Beerse, BE,
HELLEMANS, Peter Willem Jan, Turnhoutseweg 30, 2340 Beerse, BE,
JANICOT, Michel Marie François, Janssen Pharmaceutica NV, Turnhoutseweg 30, 2340 Beerse, BE,
PAGE, Martin John, Janssen Pharmaceutica NV, Turnhoutseweg 30, 2340 Beerse, BE,
(74) Radulović Božidar, Jovana Tomaševića 9/III, Podgorica ME
(57) Kombinacija, naznačena time, da obuhvata inhibitor proteasoma, pri čemu je pomenuti inhibitor proteasoma bortezomib, i inhibitor histonske deacetilaze, pri čemu je pomenuti inhibitor histonske deacetilaze jedinjenje Br. 1a (JNJ26481585)

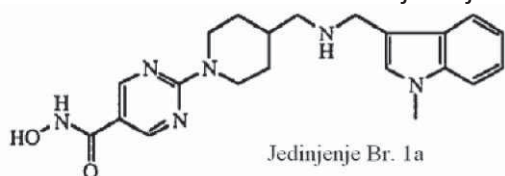

njegove farmaceutski prihvatljive kisele i bazne adicione soli i stereohemijski izomerne forme.

Patent sadrži još 7 patentnih zahtjeva.

(51) **C07D249 12** / ²⁰⁰⁶⁰¹
C07D40104 / ²⁰⁰⁶⁰¹
C07D405 04 / ²⁰⁰⁶⁰¹
C07D403 04 / ²⁰⁰⁶⁰¹
A61K314196 / ²⁰⁰⁶⁰¹
A61P3500 / ²⁰⁰⁶⁰¹

(11) **01498**
(21) **P-2013-16**

(22) 17. 11. 2005

(30) 628979P 18. 11. 2004 US

709358P 18. 08. 2005 US

725044P 06. 10. 2005 US

(96) EP/05851788.9/17. 11. 2005

(97) /PCT/US2005/041779

WO 2006/055760/26. 05. 2006/en/2006/21

EP 1817295/15. 08. 2007/en/2007/33

EP 1817295/07. 11. 2012/en/2012/45

(54) me **JEDINJENJA TRIAZOLA KOJA MODULISU AKTIVNOST HSP90**
en TRIAZOLE COMPOUNDS THAT MODULATE HSP90 ACTIVITY

(73) Synta Pharmaceuticals Corp., 45 Hartwell Avenue, Lexington, MA 02421, US,

(72) YING, Weiwen, 31 Bayberry Road, Groton, MA 01450, US,

JAMES, David, 346 Congress Street Unit 514, Boston, MA 02210, US,

ZHANG, Shijie, 27 Lojko Drive, Nashua, New Hampshire 03062, US,

PRZEWLOKA, Teresa, 23 Merrimack Meadows Lane, Tewksbury, Massachusetts 01876, US,

CHAE, Junghyun, Woosung 4-cha Apartment 402-203, Shingil-2Dong, 102-8, Youngdengpo-gu, Seoul 150-774, KR,

CHIMMANAMADA, Dinesh, U., 79 Summer Street, Unit 4A, Arlington, MA 02474, US,

LEE, Chi-Wan, 240 Magill Drive, Grafton, Massachusetts 01519, US,

KOSTIK, Elena, 32 School Street, Arlington, MA 02476, US,

NG, Howard, P., 18 Euclid Avenue, Apartment 4, Summit, NJ 07901, US,

FOLEY, Kevin, 67 Black Bear Drive No. 1515, Waltham, MA 02451, US,

DU, Zhenjian, 18 Overlock Drive, Northborough, Massachusetts 01532, US,

BARSOUM, James, 6 Moreland Avenue, Lexington, Massachusetts 02421, US,

(74) Lutovac Branislav, Bulevar Crnojevića 93, Podgorica ME

(57) Jedinjenje prikazano sledećom strukturnom formulom:

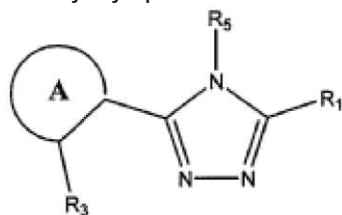

ili njegov tautomer, farmaceutski prihvatljiva so, solvat ili klatrat, gde prsten A je aril ili heteroaril, gde su aril ili heteroaril opciono još supstituisani sa jednim ili više supstituenata pored R₃; Rp R₃ su nezavisno -OH, -SH, -NR₇H, -OR₂₆, -SR₂₆, -NHR₂₆, -O(CH₂)mOH, -O(CH₂)mSH, -O(CH₂)mNR₇H, -S(CH₂)mOH, -S(CH₂)mSH, -S(CH₂)mNR₇H, -OC(O)NR_{10R_n}, -SC(O)N R_{10R₁₁}, -NR₇C(O)N R_{10R₁₁}, -OC(O)R₇, -SC(O)R₇, -NR₇C(O)R₇, -OC(O)OR₇, -SC(O)OR₇, -NR₇C(O)OR₇, -OCH₂C(O)R₇, -NR₇CH₂C(O)R₇, -OCH₂C(O)OR₇, -NR₇CH₂C(O)OR₇, -OCH₂C(O) N R_{10R₁₁}, -NR₇CH₂C(O)N R_{10R₁₁}, -OS(O)pR₇, -SS(O)pR₇, -S(O)pOR₇, -NR₇S(O)pR₇, -OS(O)pN R_{10R₁₁}, -SS(O)pN R_{10R₁₁}, -NR₇S(O)pN R_{10R₁₁}, -OS(O)pOR₇, -SS(O)pOR₇, -NR₇S(O)pOR₇, -OC(S)R₇, -SC(S)R₇, -NR₇C(S)R₇, -OC(S)OR₇, -SC(S)OR₇, -NR₇C(S)OR₇, -

OC(S)N R10R11, -Sc(s)N R10R11, -NR7C(S)N R10Rh, -OC(MR.8)R7, -SC(Nr8)R7, -NR7C(Nr8)R7, -OC(NR8)OR7, -SC(NRs)OR7, -NR7C(NR8)OR7, -OC(NR3)N R10R11, -SC(NR8)N R10R11, -NR7C(NR8)N R10R11, -OP(O)(OR7)2, ili -SP(O)(OR7)2; R5 je opciono supstituisani heteroaril ili opciono supstituisani 8 do 14-člani aril; R₇ i R₈ su u svakom slučaju nezavisno, -H, opciono supstituisani alkil, opciono supstituisani alkenil, opciono supstituisani alkinil, opciono supstituisani cikloalkil, opciono supstituisani cikloalkenil, opciono supstituisani heterociklil, opciono supstituisani aril, opciono supstituisani heteroaril, opciono supstituisani aralkil ili opciono supstituisani heteraralkil; R₁₀ i R₁₁, su u svakom slučaju nezavisno -H, opciono supstituisani alkil, opciono supstituisani alkenil, opciono supstituisani alkinil, opciono supstituisani cikloalkil, opciono supstituisani cikloalkenil, opciono supstituisani heterociklil, opciono supstituisani aril, opciono supstituisani heteroaril, opciono supstituisani aralkil, ili opciono supstituisani heteraralkil; ili R₁₀ i R₁₁ obrazuju zajedno sa azotom za koji su vezani opciono supstituisani heterociklil ili opciono supstituisani heteroaril; R26 je C1-C6alkil; p je u svakom slučaju nezavisno 0, 1 ili 2; m je u svakom slučaju nezavisno 1, 2, 3 ili 4. uz uslov da prsten A jedinjenja formule (I) nije supstituisani [1;2, 3]triazol i uz uslov da jedinjenje predstavljeno formulom (I) ne obuhvata 3-(2, 4-dihidroksi-fenil) -4- (nafta len-1-il)-S-merk apto-triazol. Patent sadrži još 53 patentna zahtjeva.

- (51) **F16L 2103** / ²⁰⁰⁶⁰¹ (11) **01511**
F16L 2108 / ²⁰⁰⁶⁰¹ (21) **P-2013-17**

(22) 28. 06. 2007

(30) 20061031582 30. 06. 2006 DE

(96) EP/07764916.8/28. 06. 2007

(97) WO/PCT/EP2007/005729

WO 2008000472/03. 01. 2008/de/2008/01

EP 2035736/18. 03. 2009/de/2009/12

EP 2035736/28. 11. 2012/de/2012/48

(54) me **NAGLAVNI SPOJ**
 en SPIGOT-AND-SOCKET JOINT

(73) Duktus S.A., Niederlassung Österreich., Innsbruckerstrasse 51, 6060 Hall in Tirol, AT,

(72) MUTSCHLECHNER, Hermann, Langer Graben 15b, 60603 Rum, AT,

MAURER, Reinhold, Defreggerstrasse 35, 6020 Innsbruck, AT,

(74) Radulović Božidar, Jovana Tomaševića 9/III, Podgorica ME,

(57) Naglavni spoj za spajanje dve cevi, cevnih fittinga ili sličnog, koji sadrži: naglavni kraj (16) koji pripada jednoj cevi (14), u koji se može umetnuti usadni kraj (60) druge cevi, koja ima noseći venac, pri čemu naglavni kraj (16) ima ivicu (20) koja se pruža radialna prema unutrašnjosti sa najmanje jednim udubljenjem u obliku prstenastog segmenta (26 - 29), i sredstvo (40) za blokiranje namenjena za blokiranje usadnog kraja (60) u naglavnom kraju (16), tako da se noseći venac (64) naslanja na sredstvo za blokiranje i da se pomenuto sredstvo za blokiranje naslanja na ivicu (20), pri čemu sredstvo (40) za blokiranje sadrži najmanje dva elementa (42, 44) za blokiranje u obliku prstenastih segmenata, naznačen time, što se na ivici (20) nalaze najmanje četiri udubljenja (26 - 29) i što su raspoređena na jednakim rastojanjima u obimnom smeru, i što oba elementa (42, 44) za blokiranje imaju dva dela (52, 54) za blokiranje u obliku prstenastih segmenata koji su međusobno spojeni preko odgovarajuće lamele (56), pri čemu rastojanje između dva dela (52, 54) za blokiranje odgovara rastojanju između dva susedna udubljenja (26 - 29).

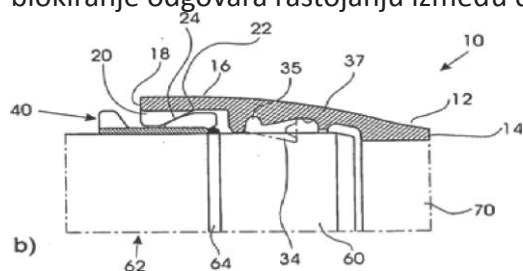

Patent sadrži još 12 patentnih zahtjeva.

(51) **A61K314196** / ²⁰⁰⁶⁰¹
C 07D24908 / ²⁰⁰⁶⁰¹
A61P 31 18 / ²⁰⁰⁶⁰¹

(11) **01512**
(21) **P-2013-18**

(22) 25. 08. 2005
(30) 20040604219P 25. 08. 2004 US
20040604220P 25. 08. 2004 US
20050686351P 31. 05. 2005 US
(96) EP/11177941/25. 08. 2005
(97) EP 2402011 /04. 01. 2012/en/2012/01
EP 2402011 /14. 11. 2012/en/2012/46

(54) me **S-TRIAZOLIL ALFA-MERKAPTOACETANILIDA KAO INHIBITORI HIV REVERSNJE TRANSKRIPTAZE**

en **S-TRIAZOLYL ALPHA-MERCAPTOACETANILIDES AS INHIBITORS OF HIV REVERSE TRANSCRIPTASE**

(73) Ardea Biosciences, Inc., 4939 Directors Place, San Diego, CA 92121, US,
(72) Girardet, Jean-Luc, 16763 Santa Corina Court, San Diego California 92127, US,
Koh, Yung-Hyo, 22 Oakhurst Road, Irvin, CA California 92620, US,
(74) Radulović Božidar, Jovana Tomaševića 9/III, Podgorica ME
(57) A jedinjenje predstavljeno formulom:

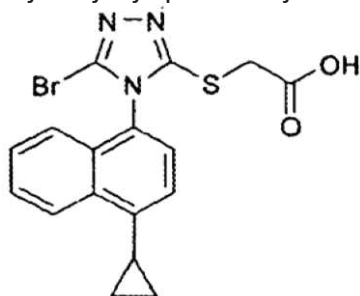

Patent sadrži još 1 patentni zahtjev.

(51) **C07D40104** / ²⁰⁰⁶⁰¹(11) **01513**(21) **P-2013-20**

(22) 29. 06. 2006

(30) 20050696224P 30. 06. 2005 US

(96) EP/06786385.2/29. 06. 2006

(97) WO/PCT/US2006/026210

WO 2007/00597201. 2007/en/2007/02

EP 1907373/09. 04. 2008/en/2008/15

EP 1907373/09. 01. 2013/en/2013/02

(54) me **POSTUPAK DOBIJANJA SPOJEVA 4-AMINO-2-(2, 6-DIOKSOPIPERIDIN-3-IL)IZOINDOLIN-1, 3-DIONA**

en PROCESSES FOR THE PREPARATION OF 4-AMINO-2-(2, 6-DIOXOPIPERIDIN-3-YL)ISOINDOLINE-1, 3-DIONE COMPOUNDS

(73) CELGENE CORPORATION, 86 Morris Avenue, Summit, NJ 07901, US,

(72) MULLER, George, W., P.O. Box 3688, Rancho Santa Fe, CA 92067, US,

SAINDANE, Manohar, T., 20 Arbutus Way, Monmouth Junction, NJ 08852, US,

GE, Chuansheng, 9 Breckenridge Court, Belle Mead, NJ 08502, US,

CHEN, Roger, 110 Christie St., Edison, NJ 08820, US,

(74) AOD "Ćupić", Dalmatinska 10, Podgorica ME,

(57) Postupak dobivanja spoja Formule (I):

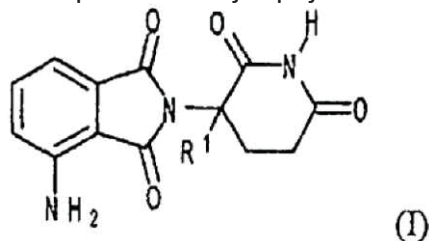

ili njegove farmaceutski prihvatljive soli, solvata, polimorfa ili stereo izomera, naznačen time što se sastoj i u koraku reakcije 3-aminofthalne kiseline, ili njezine soli, sa spojem 3-aminoglutaramida Formule (X), ili njegovom solju:

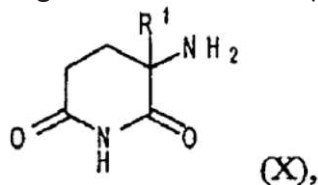

u otapalu i u prisutnosti trietilamina i octene kiseline, gdje R¹ je H, F, benzil, (C₁-C₈)alkil, (C₂-C₈)alkenil ili (C₂-C₈)alkinil.

Patent sadrži još 4 patentna zahtjeva.

- (51) **C07D401 12** / ²⁰⁰⁶⁰¹ (11) **01466**
C07D239 12 / ²⁰⁰⁶⁰¹ (21) **P-2013-21**
- (22) 27. 09. 2006
- (30) 0519879 30. 09. 2005 GB
- (96) GB/PCT /GB2006/003587/30. 09. 2005
- (97) WO/WO2006GB03587
 EP/06794582/27. 09. 2006
 WO 2007036713/05. 04. 2007/2007/14
 EP 1943240/16. 07. 2008/en/2008/29
 EP 194324011. 2009/en/2009/46
- (54) me **HEMIJSKI PROCES**
 en CHEMICAL PROCESS
- (73) AstraZeneca AB, S-151 85 Södertälje, SE,
- (72) BLIXT, Jörgen, AstraZeneca R&D Södertälje, S-151 85 Södertälje, SE,
 GOLDEN, Michael, David, AstraZeneca Charter Way Macclesfield, Cheshire SK10 2NA, GB,
 HOGAN, Philip, John, AstraZeneca Charter Way Macclesfield, Cheshire SK10 2NA, GB,
 MARTIN, David, Michael, Glanville, AstraZeneca Charter Way Macclesfield, Cheshire SK10
 2NA, GB,
 MONTGOMERY, Francis, Joseph, AstraZeneca Charter Way, Macclesfield Cheshire SK10
 2NA, GB,
 PATEL, Zakariya, AstraZeneca R&D Charnwood Bakewell Road Loughborough, Leicestershire
 LE11 5RH, GB,
 PITTAM, John, David, AstraZeneca Charter Way Macclesfield, Cheshire SK10 2NA, GB,
 SEPENDA, George, Joseph, AstraZeneca Charter Way Macclesfield, Cheshire SK10 2NA, GB,
 SQUIRE, Christopher, John, AstraZeneca Charter Way Macclesfield, Cheshire SK10 2NA, GB,
 WRIGHT, Nicholas, Cartwright, Alexander, AstraZeneca Charter Way Macclesfield, Cheshire
 SK10 2NA, GB,
- (74) Radulović Božidar, Jovana Tomaševića 9/III, Podgorica ME
- (57) Proces za proizvodnju jedinjenja sa Formulom VI naznačen time, da pomenuti proces obuhvata: (g) reakciju jedinjenja sa Formulom VII sa prikladnim agensom za hlorovanje u prisutnosti prikladne baze i prikladnog rastvarača, gde je reakcija provodi uz pomoć: (g-1) dodavanja mešavine jedinjenja sa Formulom VII i baze u rastvaraču u mešavinu agensa za hlorovanje u rastvaraču na temperaturi u rasponu od 60 do 90° C tokom perioda od oko 60 min; ili (g-2) dodavanja agensa za hlorovanje u mešavinu jedinjenja sa Formulom VII i baze u rastvaraču na ambijentalnoj temperaturi tokom perioda od oko 15 min, a tada uz pomoć grejanja reakcione mešavine tokom perioda od oko 90 min na temperaturi u rasponu od 70 do 90° C i uz mešanje reakcione mešavine na istoj temperaturi od oko 1 h; ili (g-3) dodavanja agensa za hlorovanje u mešavinu jedinjenja sa Formulom VII i baze u rastvaraču na temperaturi u rasponu od 60 do 110° C tokom perioda od oko 15 min, a sa ciljem dobijanja jedinjenja sa Formulom VIII: i (h) reakciju jedinjenja sa Formulom VIII sa 4-bromo-2-fluoroanilinom in situ u prisutnosti rastvarača koji se koristi u koraku (g) sa ciljem nastajanja hlorovodonične soli jedinjenja sa Formulom VI; i gde jedinjenje sa Formulom VI, dobiveno u formi hlorovodonične soli, može da se konvertuje u slobodnu bazu ili u formu neke alternativne soli, ako je potrebno.

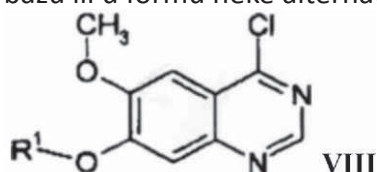

Patent sadrži još 27 patentnih zahtjeva.

- (51) **A61K9 46/** ⁰⁰⁶⁰¹
A61K31 58 / ²⁰⁰⁶⁰¹
- (22) 02. 07. 2009
- (30) 08013091 21. 07. 2008 EP
- (96) EP/09800023/02. 07. 2009
- (97) WO/PCT/EP2009/058320
WO 2010009961 /28. 01. 2010/de/2010/04 EP 2306988/13. 04. 2011/de/2011/15 EP
2306988/09. 01. 2013/de/2013/02
- (54) me **FARMACEUTSKA FORMULACIJA ZA LIJEČENJE GORNJEG DIGESTIVNOG TRAKTA**
en PHARMACEUTICAL FORMULATION FOR TREATING THE UPPER DIGESTIVE TRACT
- (73) Dr. Falk Pharma GmbH, Leinenweberstr. 5, 79041 Freiburg, DE,
(72) WILHELM, Rudolf, Feuerkirschenweg 2A, 76476 Bischweier, DE,
PRÖLS, Markus, Johann-von-Weerth-Str. 11, 79100 Freiburg/Breisgau, DE,
(74) Lutovac Branislav, Bulevar Crnojevića 93, Podgorica ME
- (57) Šumeća tableta koja sadrži budesonid za pripremanje rastvara za ispiranje usta za oralnu primenu koji se koristi u lečenju upalnih promena gornjeg digestivnog trakta .
Patent sadrži još 9 patentnih zahtjeva.

- (51) **C 07D23948/** ^{2006.01}
A61K31505 / ^{2006.01}
A61 P11 00/ ^{2006.01}
A61 P1700/ ^{2006.01}
A61 P2714/ ^{2006.01}
A61 P31 00/ ^{2006.01}
A61 P3500/ ^{2006.01}
C 07D23949/ ^{2006.01}
C 07D40110/ ^{2006.01}
C 07D40112/ ^{2006.01}
C 07D40310/ ^{2006.01}
C 07D40312/ ^{2006.01}
C 07D41710/ ^{2006.01}
- (22) 21. 11. 2008
- (30) 20070002577 22. 11. 2007 SE
20070013699P 14. 12. 2007 US
- (96) EP/08851708.1/21. 11. 2008
- (97) WO/PCT/SE2008/051334
WO 2009/067081 /28. 05. 2009/en/2009/22
EP 2222648/01. 09. 2010/en/2010/35
EP 2222648/09. 01. 2013/en/2013/02
- (54) me **PIRIMIDINSKI DERIVATI ZA TRETMAN ASTME, HOBP, ALERGIJSKOG RINITISA, ALERGIJSKOG KONJUNKTIVITISA, ATOPIČNOG DERMATITISA, RAKA, HEPATITISA B, HEPATITISA C, HIV-a, HPV-a, BAKTERIJSKIH INFEKCIJA I DERMATOZE**
en PYRIMIDINE DERIVATIVES FOR THE TREATMENT OF ASTHMA, COPD, ALLERGIC RHINITIS, ALLERGIC CONJUNCTIVITIS, ATOPIC DERMATITIS, CANCER, HEPATITIS B, HEPATITIS C, HIV, HPV, BACTERIAL INFECTIONS AND DERMATOSIS
- (73) AstraZeneca AB, 151 85 Södertälje, SE,
Dainippon Sumitomo Pharma Co., Ltd., 6-8, Dosho-machi 2-chome Chuo-ku Osaka-shi, Osaka 541-8524, JP
- (72) BENNETT, Nicholas, J., AstraZeneca R&D Charnwood, Bakewell Road, Loughborough, Leicestershire LE11 5RH, GB,
MCINALLY, Thomas, AstraZeneca R&D Charnwood, Bakewell Road, Loughborough, Leicestershire LE11 5RH, GB,
MOCHEL, Tobias, AstraZeneca R&D Charnwood, Bakewell Road, Loughborough, Leicestershire LE11 5RH, GB,
THOM, Stephen, AstraZeneca R&D Charnwood, Bakewell Road, Loughborough, Leicestershire LE11 5RH, GB,
TIDEN, Anna-Karin, AstraZeneca R&D Charnwood, Bakewell Road, Loughborough Leicestershire LE11 5RH, GB,
- (74) Radulović Božidar, Jovana Tomaševića 9/III, Podgorica ME
- (57) Jedinjenje, naznačeno time, da ima formulu (I) gde R¹ predstavlja C1-C6alkil, C1-C6alkoksi ili C1-C6alkiltio; R² predstavlja ili

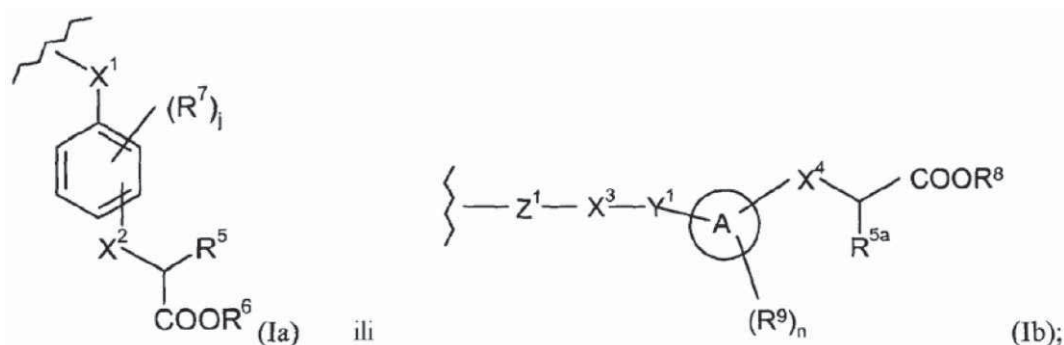

R³ predstavlja atom vodonika ili C1-C3alkilnu grupu; R⁴ predstavlja, (i) C3-C8cikloalkil, C1-C8alkil, C2-C8alkenil ili C2-C8alkinil, a svaki od njih može ponekad da bude supstituisan sa jednim ili više supstituenata nezavisno izabranih iz halogena, hidroksila, C1-C6alkoksi, C1-C6alkiltio i C3-C6cikloalkil, ili (ii) grupu

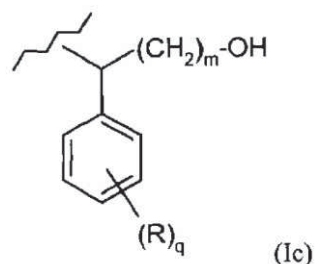

gde m je 1 ili 2, q je 0, 1 ili 2, a svaki R nezavisno predstavlja halogeni atom ili hidroksilnu, metil, cijano, trifluorometilnu, S(O)h-metilnu ili metoksi grupu; X¹ predstavlja atom kiseonika ili sumpora ili grupu NH ili CH₂; X² i X⁴svaki nezavisno predstavljaju vezu ili atom kiseonika ili sumpora; R⁵ i R^{5a} svaki nezavisno predstavljaju atom vodonika ili C1-C3alkilnu grupu; R⁶ predstavlja Ci-C6alkilnu grupu koja je ponekad supstituisana sa jednim ili više supstituenata nezavisno izabranih iz halogena, cijano, hidroksila, C1-C3alkoksi, metilsulfonila, metiltiazolila i NR¹⁰R¹¹, ili R⁶ predstavlja zasićeni heterociklički prsten ponekad supstituisan sa C1-C6alkilom; j je 1 ili 2; svaki R⁷ nezavisno predstavlja atom vodonika ili halogena ili hidroksilnu, metilnu, cijano, halometoksi ili metoksi grupu; Z¹ predstavlja C2-C6alkilensku ili C3-C8cikloalkilensku grupu; X₃ predstavlja NR¹², >N-COR¹², CONR¹², NR¹²CO, SC₂NR¹², >N-SO₂R¹², NR¹²SO₂, NR¹²CONR¹³ ili NR¹³CONR¹², S(O)p ili O; p₁ je 0, 1 ili 2; V¹ predstavlja jednostruku vezu ili C1-C6alkilen; A predstavlja monocikličku ili bicikličku C6-Ooarilnu ili monocikličku ili bicikličku C5-C12heteroarilnu grupu koja sadrži 1 do 3 prstenska heteroatoma; R⁸ predstavlja C1-C6alkilnu grupu koja je ponekad supstituisana sa jednim ili više supstituenata nezavisno izabranih iz halogena, cijano, hidroksila, NR¹⁰R¹¹ i C1-C3alkoksi; n je 0, 1 ili 2; svaki R⁹ nezavisno predstavlja halogen, cijano, hidroksi, tiol, C1-C3alkil, C1-C3hidroksialkil, C1-C3haloalkil, C1-C3alkoksi, C1-C3haloalkoksi, C1-C3alkiltio, C1-C3alkilsulfonil ili C1-C3alkilsulfinil; R¹⁰ i R¹¹ svaki nezavisno predstavljaju vodonik, C1-C6alkil ili C3-C6cikloalkil, ili R¹⁰ i R¹¹ zajedno sa atomom azota na kojeg su spojeni formiraju 4- do 7-člani zasićeni heterociklički prsten koji ponekad sadrži dodatni prstenski heteroatom koji je izabran iz kiseonika, S(O)v ili NR³⁶, a heterociklički prsten je ponekad supstituisan sa C1-C6alkilom (koji je sam za sebe ponekad supstituisan sa C1-C6alkoksi) ili di-C1-C6alkilamino; R¹²predstavlja atom vodonika, 3- do 8-člani zasićeni ili nezasićeni heterociklički prsten koji obuhvata najmanje jednu prstensku grupu O, S(O)t, N ili NR¹⁴, C1-C6alkilnu grupu ili C3-C6cikloalkilnu grupu, a poslednje dve grupe su ponekad supstituisane sa jednim ili više supstituenata nezavisno izabranih iz NR¹⁵ R¹⁶ i R¹⁷, ili R¹²je C1-C6alkilen koji može da bude spojen na atom ugljenika iz C2-C6alkilenske grupe Z¹ tako da formira zasićeni 4- do 7-člani prsten koji sadrži azot; R¹⁴, R²² i R³⁵ svaki nezavisno predstavljaju atom vodonika, CO₂R¹⁸, S(O)wR¹⁸, COR¹⁹, ili C1-C6alkilnu, C2-C6alkenilnu, C2-

C6alkilnu ili C3-C8cikloalkilnu grupu, a svaki od njih može ponekad da bude supstituisan sa jednim ili više supstituenata koji su nezavisno izabrani iz halogena, cijano, OR²⁰ i NR²⁰ R²¹; R¹⁵ i R¹⁶ svaki nezavisno predstavljaju atom vodonika, 3- do 8-člani zasićeni heterociklički prsten koji sadrži atom azota u prstenu, a ponekad jedan ili više dodatnih prstenskih heteroatoma nezavisno izabranih iz azota, kiseonika, sumpora i sulfonila, a heterociklički prsten je ponekad supstituisan sa jednim ili više supstituenata nezavisno izabranih iz halogena, cijano, S(O)dR²⁷, OR²⁷, CO2R²⁷, COR²⁷, OC(O)R²⁷, SO2NR²⁷R²⁸, CONR²⁷R²⁸, NR²⁷R²⁸, NR²⁷SO2, R²⁹, NR²⁷COR²⁸, C1-C6haloalkila, C3-C8cikloalkila, C1-C6alkila, arila i heteroarila, a poslednje četiri grupe su ponekad supstituisane sa jednim ili više supstituenata nezavisno izabranih iz halogena, cijano, S(O)fR³⁰, OR³⁰, CO2R³⁰, SO2NR³⁰R³¹, CONR³⁰R³¹ i NR³⁰R³¹; R¹⁷ predstavlja halogen, cijano, C1-C3haloalkoksi, CO2R³², S(O)gR³², OR³², SO2NR³²R³⁴, CONR³²R³⁴, NR³²SO2R³³, NR³²CO2R³³, NR³²COR³⁴ ili 3- do 8-člani zasićeni heterociklički prsten koji obuhvata prstensku grupu NR³⁵; a, b, d, f, g, h, t, v, w i z svaki nezavisno predstavljaju 0, 1 ili 2; R¹⁸, R²⁶, R²⁹ i R³³ svaki nezavisno predstavljaju C₁-C₆alkilnu ili C₃-C₆cikloalkilnu grupu; R¹³, R¹⁹, R²⁰, R²¹, R²³, R²⁴, R²⁵, R²⁷, R²⁸, R³⁰, R³¹, R³² i R³⁴ svaki nezavisno predstavljaju atom vodonika ili C1-C6alkilnu ili C3-C6cikloalkilnu grupu; i R³⁶ predstavlja atom vodonika ili C1-C3alkilnu grupu; ili neka njegova farmaceutski prihvatljiva so.

Patent sadrži još 30 patentnih zahtjeva.

- (51) **C07D21365** / ²⁰⁰⁶⁰¹
A61P25 00 / ²⁰⁰⁶⁰¹
A61K3144 / ²⁰⁰⁶⁰¹
- (22) 09. 11. 2005
- (30) 626751P 10. 11. 2004 US
- (96) EP/11002581.4/09. 11. 2005
- (97) EP 2371818/05. 10. 2011/en/2011/40
EP 2371818/26. 12. 2012/en/2012/52
- (54) me **HIDROBENZOATNE SOLI JEDINJENJA METANIKOTINA**
en HYDROXYBENZOATE SAL TS OF METANICOTINE COMPOUNDS
- (73) Targacept, Inc., 100 North Main Street, Suite 1510, Winston-Salem, NC 27101, US
- (72) Munoz, Julio A., 214 Lakeside Drive, Walnut Cove North Carolina 27052, US,
Genus, John, 313 Tollesbury Court, Winston-Salem North Carolina 27127, US,
Moore, James R., 39 Flinthill Drive, Newark Delaware 19702, US,
- (74) Lutovac Branislav, Bulevar Crnojevića 93, Podgorica ME
- (57) Jedinjenje p-hidroksibenzoat (25)-(4E)-N-metM-5-(S-izopropoksi-3-pindinM)-4-penten-2-
amina.
Patent sadrži još 8 patentnih zahtjeva.

(51) **A61K314245** / ^{2006.01}
C07D27108 / ^{2006.01}
C 07D41312 / ^{2006.01}
C 07 D41314 / ^{2006.01}

(11) **01506**
(21) **P-2013-26**

(22) 09. 05. 2006
(30) 679507 10. 05. 2005 US
(96) EP/06759438.2/09. 05. 2006
(97) PCT/US2006/017983
WO 2006/122150/16. 11. 2006/2006/46
EP 1879573/23. 01. 2008/en/2008/04
EP 1879573/19. 12. 2012/en/2012/51

(54) me **MODULATORI INDOLAMIN 2, 3-DIOKSIKSENAZE I POSTUPCI UPOTREBE ISTIH**

en **MODULATORS OF INDOLEAMINE 2, 3-DIOXYGENASE AND METHODS OF USING THE SAME**

(73) Incyte Corporation, Wilmington, DE 19880, US,
(72) COMBS, Andrew, P., Kennett, Square, Pennsylvania 19348, US, YUE, Eddy, W., Landenberg, Pennsylvania 19350, US,
(74) Radulović Božidar, Jovana Tomaševića 9/III, Podgorica ME,
(57) Jedinjenje formule

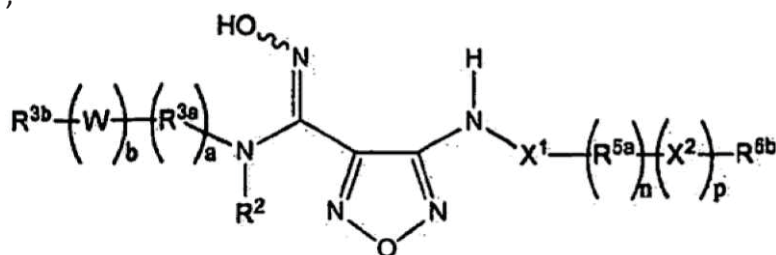

ili njegova farmaceutski prihvatljiva so, naznačena time, što: W, X¹ i X² su nezavisno izbrani iz grupe koju čine (CR^aR^b)t, (CR^aR^b)uO(CR^aR^b)v, (CR^aR^b)uC(O)(CR^aR^b)v, (CR^aR^b)uC(O)NR^c(CR^aR^b)v, (CR^aR^b)uC(O)O(CR^aR^b)v, (CR^aR^b)uC(S)(CR^aR^b)u, (CR^aR^b)uC(S)NR^c(CR^aR^b)v, (CR^aR^b)uS(O)(CR^aR^b)v, (CR^aR^b)uS(O)NR^c(CR^aR^b)v, (CR^aR^b)uS(O)2(CR^aR^b)v, (CR^aR^b)uS(O)2NR^c(CR^aR^b)v, (CR^aR^b)uNR^c(CR^aR^b)v i (CR^aR^b)uC(=NR^d)NR^c(CR^aR^b)v grupa; R² predstavlja H, Ci-6 alkil ili C3-7 cikloalkil grupu; R^{3a} i R^{3b} su nezavisno izbrani iz grupe koju čine C₁₋₈ alkil, C₂₋₈ alkenil, C₂₋₈ alkinil, aril, cikloalkil, heteroaril i heterocikloalkil grupa od kojih svaka može biti opciono supstituisana sa 1, 2, 3, 4 ili 5 supstituenata nezavisno izbranih iz grupe koju čine halogena, C₁₋₆ alkil, C₂₋₆ alkinil, C1-4 haloalkil, cijanin¹, cijanid NO₂, OR^{e1}, SR^{e1}, C(O)R^{f1}, C(O)NR^{g1}R^{h1}, C(O)OR^{e1}, OC(O)R^{f1}, OC(O)NR^{g1}R^{h1}, NR^{g1}C(O)NR^{g1}R^{h1}, NR^{g1}R^{h1}, NR^{g1}C(O)R^{f1}, NR^{g1}C(O)OR^{e1}, C(=NRⁱ)NR^{g1}R^{h1}, NR^{g1}C(=NRⁱ)NR^{g1}R^{h1}, P(R^{f1})₂, P(OR^{e1})₂, P(O)R^{e1}R^{f1}, P(O)OR^{e1}OR^{f1}, S(O)R^{f1}, S(O)NR^{g1}R^{h1}, S(O)2R^{f1} i S(O)2NR^{g1}R^{h1} grupa; R^{3b} predstavlja aril ili heteroaril grupu od kojih svaka može biti opciono supstituisana sa 1, 2, 3, 4 ili 5 supstituenata nezavisno izbranih iz grupe koju čine halogena, C1-6 alkil, C2-6 alkenil, C2-6 alkinil, C1-4 haloalkil, C1-4 hidroksialkil, cijanin², cijanid, NO₂, OR^{e1}, SR^{e1}, C(O)R^{f1}, C(O)NR^{g1}R^{h1}, C(O)OR^{e1}, OC(O)R^{f1}, OC(O)NR^{g1}R^{h1}, NR^{g1}C(O)NR^{g1}R^{h1}, NR^{g1}R^{h1}, NR^{g1}C(O)R^{f1}, NR^{g1}C(O)OR^{e1}, C(=NRⁱ)NR^{g1}R^{h1}, NR^{g1}C(=NRⁱ)NR^{g1}R^{h1}, P(R^{f1})₂, P(OR^{e1})₂, P(O)R^{e1}R^{f1}, P(O)OR^{e1}OR^{f1}, S(O)R^{f1}, S(O)NR^{g1}R^{h1}, S(O)2R^{f1} i S(O)2NR^{g1}R^{h1} grupa; R^{5b} predstavlja H, C1-8 alkil, C2-8 alkenil, C2-8 alkinil, aril, cikloalkil, heteroaril ili heterocikloalkil grupu, naznačenu time, što svaka pomenuta C₁₋₈ alkil, C₂₋₈ alkenil, C₂₋₈ alkinil, aril, cikloalkil, heteroaril ili heterocikloalkil grupa može biti opciono supstituisana sa 1, 2, 3,

4 ili 5 supstituenata nezavisno izbranih iz grupe koju čine halogena, C1-6 alkil, C2-6 alkenil, C2-6 alkinil, C₁₋₄ haloalkil, C₁₋₄ hidroksialkil, cijanin², cijanid NO₂, OR^{e1}, SR^{e1}, C(O)R^{f1}, C(O)NR^{g1R^{h1}}, C(O)OR^{e1}, OC(O)R^{f1}, OC(O)NR^{g1R^{h1}}, NR^{g1C(O)NR^{g1R^{h1}}}, NR^{g1R^{h1}}, NR^{g1C(O)R^{f1}}, NR^{g1C(O)OR^{e1}}, C(=NRⁱ)NR^{g1R^{h1}}, NR^{g1C(=NRⁱ)NR^{g1R^{b1}}}, P(R^{f1})₂, P(OR^{e1})₂, P(O)R^{e1R^{f1}}, P(O)OR^{e1OR^{f1}}, S(O)R^{f1}, S(O)NR^{g1R^{h1}}, S(O)2R^{f1} i S(O)₂NR^{g1R^{h1}} grupa; cijanin¹ i cijanin² su nezavisno izbrani iz grupe koju čine aril, heteroaril, cikloalkil i heterocikloalkil grupa od kojih svaka može biti opciono supstituisana sa 1, 2, 3, 4 ili 5 supstituenata nezavisno izbranih iz grupe koju čine halogena, C1-4 alkil, C2-4 alkenil, C2-4 alkinil, C1-4 haloalkil, cijanid, NO₂, OR^{e3}, SR^{e3}, C(O)R^{f3}, C(O)NR^{g3R^{h3}}, C(O)OR^{e3}, OC(O)R^{f3}, OC(O)NR^{g3R^{h3}}, NR^{g3R^{h3}}, NR^{g3C(O)R^{h3}}, NR^{g3C(O)OR^{e3}}, C(=NRⁱ)NR^{g1R^{h1}}, NR^{g1C(=NRⁱ)NR^{g1R^{h1}}}, P(R^{f3})₂, P(OR^{e3})₂, P(O)R^{e3R^{f3}}, P(O)OR^{e3OR^{f3}}, S(O)R^{f3}, S(O)NR^{g3R^{h3}}, S(O)2R^{f3} i S(O)2NR^{g3R^{h3}} grupa; R^a i R^b su nezavisno izbrani iz grupe koju čine H, halogena, C₁₋₆ alkil, C₂₋₆ alkenil, C₂₋₆ alkinil, C₁₋₄ haloalkil, aril, cikloalkil, heteroaril, heterocikloalkil, arilalkil, cikloalkilalkil, heteroarilalkil, heterocikloalkilalkil, cijanid, NO₂, OR^{e4}, SR^{e4}, C(O)R^{f4}, C(O)NR^{g4R^{h4}}, C(O)OR^{e4}, OC(O)R^{f4}, OC(O)NR^{g4R^{h4}}, NR^{g4R^{h4}}, NR^{g4C(O)R^{h4}}, NR^{g4C(O)OR^{e4}}, C(=NRⁱ)NR^{g1R^{h1}}, NR^{g1C(=NRⁱ)NR^{g1R^{h1}}}, P(R^{f4})₂, P(OR^{e4})₂, P(O)R^{e4R^{f4}}, P(O)OR^{e4OR^{f4}}, S(O)R^{f4}, S(O)NR^{g4R^{h4}}, S(O)2R^{f4} i S(O)2NR^{g4R^{h4}} grupa; R^c predstavlja H, C1-6alkil, C1-6haloalkil, C2-6 alkenil, C2-6 alkinil, aril, cikloalkil, arilalkil ili cikloalkilalkil grupu; R^d predstavlja H, OR^{d1}, cijanid ili NO₂ grupu; R^{d1} predstavlja H, C₁₋₆ alkil, C₁₋₆ haloalkil, C₂₋₆ alkenil, C₂₋₆ alkinil, aril, cikloalkil, arilalkil ili cikloalkilalkil grupu; R^{e1}, R^{e3} i R^{e4} su nezavisno izbrani iz grupe koju čine H, C1-6alkil, C1-6haloalkil, C2-6 alkenil, (C1-6 alkoksi)C1-6 alkil, C2-6 alkinil, aril, cikloalkil, heteroaril, heterocikloalkil, arilalkil, cikloalkilalkil, heteroarilalkil i heterocikloalkilalkil grupa; R^{f1}, R^{f3} i R^{f4} su nezavisno izbrani iz grupe koju čine H, C1-6 alkil, C1-6 haloalkil, C2-6 alkenil, C2-6 alkinil, aril, cikloalkil, heteroaril i heterocikloalkil grupa; R^{g1}, R^{g3} i R^{g4} su nezavisno izbrani iz grupe koju čine H, C₁₋₆ alkil, C₁₋₆ haloalkil, C₂₋₆ alkenil, C2-6 alkinil, aril, cikloalkil, arilalkil i cikloalkilalkil grupa; R^{h1}, R^{h3} i R^{h4} su nezavisno izbrani iz grupe koju čine H, C1-6 alkil, C1-6 haloalkil, C2-6 alkenil, C2-6 alkinil, aril, cikloalkil, arilalkil i cikloalkilalkil grupa; ili R^{g1} i R^{h1}, zajedno sa atomom azota za koji su vezani, formiraju heterocikloalkilnu grupu sa 4, 5, 6 ili 7 članova ; ili R^{g3} i R^{h3}, zajedno sa atomom azota za koji su vezani, formiraju heterocikloalkilnu grupu sa 4, 5, 6 ili 7 članova ; ili R^{g4} i R^{h4}, zajedno sa atomom azota za koji su vezani, formiraju heterocikloalkilnu grupu sa 4, 5, 6 ili 7 članova ; Rⁱ predstavlja H, cijanid ili NO₂ grupu; a predstavlja 0 ili 1; b predstavlja 0 ili 1 ; n predstavlja 0 ili 1; p predstavlja 0 ili 1; t predstavlja 1, 2, 3, 4, 5 ili 6; u predstavlja 0, 1, 2, 3, 4, 5 ili 6; i v predstavlja 0, 1, 2, 3, 4, 5 ili 6.

Patent sadrži još 37 patentnih zahtjeva.

(51) **C07D281 16** / ²⁰⁰⁶⁰¹
A61K31554 / ²⁰⁰⁶⁰¹
A61P 25 18 / ²⁰⁰⁶⁰¹
A61P25 24 / ²⁰⁰⁶⁰¹
A61P25 22 / ²⁰⁰⁶⁰¹

(11) **01516**
(21) **P-2013-27**

(22) 18. 06. 2009
(30) 20080074417P 20. 06. 2008 US
(96) EP/09766953.5/18. 06. 2009
(97) PCT/SE2009/050763
WO 2009/154563/23. 12. 2009/en/2009/52
EP 2307389/13. 04. 2011/en/2011/15
EP 2307389 /23. 01. 2013/en/2013/04

(54) me **DERIVAT DIBENZOTIAZEPINA I NJEGOVA UPOTREBA**
en DIBENZOTHIAZEPINE DERIVATIVE AND USE THEREOF

(73) AstraZeneca AB, 151 85 Södertälje, SE,
(72) BROWN, Dean, AstraZeneca R&D Boston, 35 Gatehouse Drive, Waltham, MA 02451, US,
DAMEWOOD, James R., AstraZeneca R&D Wilmington, 1800 Concord Pike, P.O. Box 15437,
Wilmington, Delaware 19850-5437, US,
EDWARDS, Phil, c/o AstraZeneca Intellectual Property, AstraZeneca R&D Wilmington, 1800
Concord Pike,, P.O. Box 15437,
W HULSIZER, James, c/o Astrazeneca Intellectual Property, AstraZeneca R&D Wilmington,
1800 Concord Pike,, P.O. Box 15437,
W MUIR, James Campbell, AstraZeneca, Charter Way, Macclesfield Cheshire SK10 2NA,
GB,
PIERSON JR., M. Edward, AstraZeneca R&D Wilmington, 1800 Concord Pike, P.O. Box
15437, Wilmington, Delaware 19850-5437, US,
SHENVI, Ashokkumar Bhikkappa, AstraZeneca R&D Wilmington, c/o Astrazeneca
Intellectual Property, 1800 Concord Pike,, P.O. Box 15437,
W WESOLOWSKI, Steven, AstraZeneca R&D Boston, 35 Gatehouse Drive, Waltham, MA
02451, US,
WIDZOWSKI, Dan, AstraZeneca R&D Boston, 35 Gatehouse Drive, Waltham, MA 02451,
US,
WOOD, Michael, AstraZeneca R&D Wilmington, 1800 Concord Pike, P.O. Box 15437,
Wilmington, DE 19850-5437, US,

(74) Radulović Božidar, Jovana Tomaševića 9/III, Podgorica ME

(57) Jedinjenje prema formuli I:

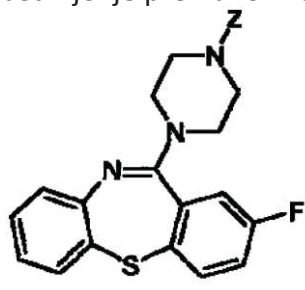

I

naznačeno time, gde je Z jednako H, dakle radi se o 2-fluoro-11-(piperazin-1-il)dibenzo[b, f]
[1, 4]tiazepinu ili njegovoj farmaceutski prihvatljivoj soli.
Patent sadrži još 5 patentnih zahtjeva.

- (51) **C07D453/02**²⁰⁰⁶⁰¹
C07D471 /08²⁰⁰⁶⁰¹
C07D487/08²⁰⁰⁶⁰¹
A61K31/444²⁰⁰⁶⁰¹
A61P25/00²⁰⁰⁶⁰¹
A61P25/02²⁰⁰⁶⁰¹
A61P 25/14²⁰⁰⁶⁰¹
A61P 25/16²⁰⁰⁶⁰¹
A61P 25/18²⁰⁰⁶⁰¹
A61P25/22²⁰⁰⁶⁰¹
A61P25/24²⁰⁰⁶⁰¹
A61P25/28²⁰⁰⁶⁰¹
A61P29/00²⁰⁰⁶⁰¹
A61P35/00²⁰⁰⁶⁰¹
A61P43/00²⁰⁰⁶⁰¹
- (22) 01. 08. 2008
- (30) 953610P02. 08. 2007 US
953613P 02. 08. 2007 US
953614P 02. 08. 2007 US
971654P 12. 09. 2007 US
- (96) EP/08782584.0/01. 08. 2008
- (97) WO/PCT/US2008/071872/01. 08. 2008
WO 2009/018505/05. 02. 2009/2009/06
EP 2182949/12. 05. 2010/en/2010/19
EP 2182949/02. 01. 2013/en/2013/01
- (54) me **(2S, 3R)-N-(2-((3-PIRIDINIL)METIL)-1-AZABICIKLO[2.2.2]OKT-3-IL) BENZOFURAN-2-KARBOKSAMID, NOVI OBLICI SOLI I POSTUPCI ZA NJIHOVU UPOTREBU**
en (2S, 3R)-N-(2-((3-PYRIDINYL)METHYL)-1-AZABICYCLO[2.2.2]OCT-3-YL)BENZOFURAN-2-CARBOXAMIDE, NOVEL SALT FORMS, AND METHODS OF USE THEREOF
- (73) Targacept, Inc., 100 North Main Street, Suite 1510, Winston-Salem, NC 27101, US,
- (72) BENCHERIF, Merouane, 104 Brampton Court, Winston-Salem, North Carolina 27106, US,
BENSON, Lisa, 688 Pecan Ridge Circle, Kernersville, North Carolina 27284, US,
DULL, Gary Maurice, 6025 Shallowford Road, Lewisville, North Carolina 27023, US,
FEDOROV, Nikolai, 3950 Tonbridge Lane, Winston-Salem, North Carolina 27106, US,
GATTO, Gregory J., 1148 S. Hawthorne Road, Winston-Salem, North Carolina 27103, US,
GENUS, John, 313 Tollesbury Court, Winston-Salem, North Carolina 27127, US,
JORDAN, Kristen G., 1869 Curraghmore Road, Clemmons, North Carolina 27012, US,
MATHEW, Jacob, 3830 Stillmere Drive, Winston-salem, North Carolina 27101, US,
MAZUROV, Anatoly A., 3704 Timberoak Drive, Greensboro, North Carolina 27410, US,
MIAO, Lan, 226 March Ferry Road, Advance, North Carolina 27006, US,
MUNOZ, Julio A., 214 Lakeside Drive, Walnut Cove, North Carolina 27052, US,
PFEIFFER, Inigo, 2616 Antler Trail, Kernersville, North Carolina 27284, US,
PFEIFFER, Sondra, 2616 Antler Trail, Kernersville, North Carolina 27284, US,
PHILLIPS, Teresa Y., 4713 Whitby Place, Greensboro, North Carolina 27406, US,
- (74) Lutovac Branislav, Bulevar Crnojevića 93, Podgorica ME

- (57) (2S, 3R)-N-(2-((3-pindiml)metM-1 -azabiciklo[2, 2, 2]okt-3-il)benzofuran-2-karboksamid hidrohlorid ili njegov hidrat ili solvat.
Patent sadrži još 12 patentnih zahtjeva.

- (51) **C07D20944/**
C 07D209 08/
C 07D21508/
C 07D49110/
C 07D47104/
C 07D47110/
C 07D49108/
C 07D40104/
C 07D40112/
A61K31438/
A61K31439/
A61K31403/
- (22) 13.04.2006.
- (30) 20050007474 13. 04. 2005 GB
 20050670897P 13. 04. 2005 US
 20060004111 01. 03. 2006 GB
 20060777989P 01. 03. 2006 US
- (96) EP/06726780.7/13. 04. 2006
- (97) /PCT/GB2006/001382/13. 04. 2006
 WO 2006/109085/19. 10. 2006/en
 EP 1877379/16. 01. 2008/en/2008/03
 EP 1877379/16. 01. 2013/en/2013/03
- (54) me **DERIVATI HIDROKSIBENZAMIDA I NJIHOVA PRIMJENA KAO INHIBITORA HSP90**
 en HYDROXYBENZAMIDE DERIVATIVES AND THEIR USE AS IN HIBITOR OF HSP90
- (73) Astex Therapeutics Limited, 436 Cambridge Science Park Milton Park Cambridge, Cambridgeshire CB4 0QA, C
- (72) CHESSARI, Gianni, 436 Cambridge Science Park, Milton Road, Cambridge CB4 0QA, GB,
 CONGREVE, Miles, Stuart, 436 Cambridge Science Park, Milton Road, Cambridge CB4 0QA, GB,
 NAVARRO, Eva, Figueroa, 436 Cambridge Science Park, Milton Road, Cambridge CB4 0QA, GB,
 FREDERICKSON, Martyn, 436 Cambridge Science Park, Milton Road, Cambridge CB4 0QA, GB,
 MURRAY, Christopher, 436 Cambridge Science Park, Milton Road, Cambridge CB4 0QA, GB,
 WOOLFORD, Alison, Jo-Anne, 436 Cambridge Science Park, Milton Road, Cambridge CB4 0QA, GB,
 CARR, Maria, Grazia, 436 Cambridge Science Park, Milton Road, Cambridge CB4 0QA, GB,
 DOWNHAM, Robert, 436 Cambridge Science Park, Milton Road, Cambridge CB4 0QA, GB,
 O'BRIEN, Michael, Alistair, 436 Cambridge Science Park, Milton Road, Cambridge CB4 0QA, GB,
 PHILLIPS, Theresa, Rachel, 3 Cumberland Drive, Bollington, Macclesfield SK10 5BR, GB,
 WOODHEAD, Andrew, James, 436 Cambridge Science Park, Milton Road, Cambridge CB4 0QA, GB,
- (74) Đakonović Vido, Bajova 9, Cetinje ME
- (57) Jedinj enje formule (VI):

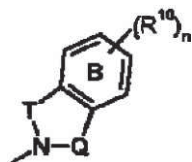

pri čemu n je 0, 1, 2 ili 3; R^1 i R^{2a} su oba hidroksi; R^3 je izabran između izopropila, sek.-butila, terc. -butila, 1, 2-dimetilalila, 1, 2-dimetilpropila i ciklopropila; ili njegova so, solvat, tautomer ili N-oksidi; pri čemu je biciklična grupa: R^{4a} je izabran između vodonika, fluora, hlora i metoksi; R^8 je izabran između vodonika i fluora; i R^{10} je izabran između: halogena; hidroksi; tri fluorometila; cijano; nitro; karboksi; amino; mono- ili di- C_{1-4} hidrokarbil amino; karbocikličnih i heterocikličnih grupa koje imaju od 3 do 12 članova prstena; i grupe R^a-R^b ; pri čemu: R^aj e veza, O, CO, $X^1C(X^2)$, $C(X^2)X^1$, $X^1C(X^2)X^1$, S, SO, SO₂, NR^c, SO₂NR^c ili NR^cSO₂; i izabrana između struktura C1, C5 i C6; R^b je izabran između vodonika; karbocikličnih i heterocikličnih grupa koje imaju od 3 do 12 članova prstena; i C1-12 hidrokarbila opciono supstituisanog sa jednim ili više supstituenata izabranih između hidroksi, okso, halogena, cijana, nitro, karboksi, amino, mono- ili di- C_{1-8} nearomatičnog hidrokarbila-mino, i karbocikličnih i heterocikličnih grupa koje imaju od 3 do 12 članova prstena i pri čemu jedan ili više atoma ugljenika C1-12 hidrokarbil grupe mogu opciono biti zamenjeni sa O, S, S_cO, SO₂, N R^c, $X^1C(X^2)$, $C(X^2)X^1$ ili $X^1C(X^2)X^1$; R^c je izabran između R^b, vodonika i C1-4 hidrokarbila; i X^1 je O, S ili NR^c i X^2 je =O, =S ili =NR^c.

Patent sadrži još 38 patentnih zahtjeva.

- (51) **A61K47 10** / ²⁰⁰⁶⁰¹
A61K47 16 / ²⁰⁰⁶⁰¹
A61 P31 18 / ^{2006.01}
A61 K31 505 / ^{2006.01}
- (22) 04. 04. 2006
(30) 20050102616 04. 04. 2005 EP
(96) EP/06725539.8/04. 04. 2006
(97) PCT/EP2006/061303/04. 04. 2006
WO 2006/106103/12. 10. 2006/en/2006/41
EP 1881848/30. 01. 2008/en/2008/05
EP 1881848/16. 01. 2013/en/2013/03
- (54) me **PREVENCIJA INFEKCIJE HIV-OM S TMC278**
en PREVENTION OF HIV-INFECTION WITH TMC278
- (73) Janssen R&D Ireland, Eastgate Village, Eastgate, Little Island, County Cork, IE,
(72) BAERT, Lieven, Elvire, Colette, Jozef Van Wallegemstraat 11, B-8200 Brugge 2, BE,
LEWI, Paulus, Joannes, Pater Van Mierlostraat 18, B-2300 Turnhout, BE,
HEERES, Jan, Leemskuilen 18, B-2350 Vosselaar, BE,
(74) Radulović Božidar, Jovana Tomaševića 9/III, Podgorica ME
- (57) Ovaj pronalazak odnosi se na upotrebu parenteralne formulacije koja sadrži NNRTI TMC278 za dugotrajnu prevenciju infekcije HIV-om za subjekt koji je izložen riziku da bude inficiran HIV-om, što obuhvata intermitentnu primenu (primenu s prekidima) navedene formulacije u dugim vremenskim intervalima Upotreba parenteralne formulacije koja sadrži efektivnu količinu TMC278 ili njegove farmaceutski prihvatljive kisele adicione soli i nosača, naznačena time što se koristi za proizvodnju medikamenta za dugotrajnu prevenciju infekcije HIV-om za subjekt koji ima rizik da bude zaražen HIV-om, pri čemu se medikament primenjuje supkutano ili intramuskularno i s prekidima u vremenskim intervalima od bar dve sedmice.
Patent sadrži još 25 patentnih zahtjeva.

(51) **C07C 23912/**²⁰⁰⁶⁰¹(11) **01518**(21) **P-2013-31**

(22) 01. 12. 2009

(30) 2008DE02764 05. 12. 2008 IN

(96) EP/09793495.4/01. 12. 2009

(97) PCT/2009EP/066119

WO 2010/063700/10. 06. 2010/en/2010/23

EP 2364293/14. 09. 2011/en/2011/37

EP 2364293/23. 01. 2013/en/2013/04

(54) me **NOVI PIRAZOL-4-N-ALKOKSIKARBOKSAMIDI KAO MIKROBIOCIDI**en **NOVEL PYRAZOLE-4-N-ALKOXYCARBOXAMIDES AS MICROBIOCIDES**

(73) Syngenta Participations AG, Schwarzwaldallee 215, 4058 Basel, CH,

(72) RAJAN, Ramya, Syngenta Biosciences Private Limited, Santa Monica Works, Corlim Ilhas Goa, Goa 403 110, IN,

WALTER, Harald, Syngenta Crop Protection Münchwilen AG, Schaffhauserstrasse, CH-4332 Stein, CH,

STIERLI, Daniel, Syngenta Crop Protection Münchwilen AG, Schaffhauserstrasse, CH-4332 Stein, CH,

(74) Radulović Božidar, Jovana Tomaševića 9/III, Podgorica ME

(57) Jedinjenje, naznačeno time, da ima formulu I R₃ je vodonik ili halogen; R₄ je vodonik, C₁-C₄alkil ili C₁-C₄halogenalkil; R₅, R_a, R_a, R₉ i R₁₀ su, nezavisno jedan od drugoga, vodonik, halogen, Ci-C₄alkil ili C₁-C₄haloalkil; R₇ je vodonik, halogen, C₁-C₄alkil, C₂-C_aalkenil ili C₃-C_aalkinil; R₁₁ je vodonik, halogen ili C₁-Caalkil; R₁₂ je vodonik, halogen, Ci-Caalkil, C₂-Caalkenil, C₃-Caalkinil, C₃-Cacikloalkii-C₃-C_aalkinil, halofenoksi, halofenii-C₃-C_aalkinil, C(C₁-C₄alkii) = NO-C₁-C₄alkil, C₁-C_ahaloalkil, C₁-Cahaloalkoksi, C₂-Cahaloalkenil ili C₂-Cahaloalkeniloksi; R₁₃ je vodonik, halogen, C₁-Caalkil; X je kiseonik, sumpor ili nije prisutan; pod uslovom da R₇ je različit od halogena ako je X kiseonik ili sumpor; n je 0 ili 1 ; njegove agronomski prihvatljive soli/stereoizomeri/dijastereoizomeri/enantiomeri/tautomeri i N-oksidi.

Patent sadrži još 13 patentnih zahtjeva.

- (51) **C07D401 14** / ²⁰⁰⁶⁰¹
A61K314439 / ²⁰⁰⁶⁰¹
- (11) **01462**
(21) **P-2013-32**
- (22) 04. 05. 2010
- (30) 20090176290P 07. 05. 2009 US
20100301416P 04. 02. 2010 US
- (96) EP/10717402/04. 05. 2010
- (97) WO/PCT/US2010/033487
WO 201012950911. 2010/en/2010/45
EP 2427449/14. 03. 2012/en/2012/11
EP 2427449/03. 04. 2013/en/2013/14
- (54) me **VINILINDAZOLILNA JEDINJENJA**
en VINYL INDAZOL YL COMPOUNDS
- (73) Eli Lilly and Company, Lilly Corporate Center, Indianapolis, IN 46285, US,
- (72) CHEN, Daohong, Eli Lilly and Company, Lilly Corporate Center, Indianapolis, Indiana 46285, US,
LI, Hong-Yu, Eli Lilly and Company, Lilly Corporate Center, Indianapolis, Indiana 46285, US
ZHAO, Genshi, Eli Lilly and Company, Lilly Corporate Center, Indianapolis, Indiana 46285, US,
- (74) AOD "Ćupić", Dalmatinska 10, Podgorica ME,
- (57) Spoj, naznačen time što je (f)-2-(4-(2-(5-(1-(3, 5-diklorpiridin-4-il)etoksi)-1W-indazol-3-il)vinil)-1W-pirazol-1-il)etanol, ili njegova farmaceutske prihvatljiva sol.
Preostalih patentnih zahtjeva 7.

(51) C07D 40112/
C07D 40114 /
C07D 40312/
C07D 40314/
C07D 41314/
C07D 41714/
A61K 31404/
A61P 3500/

(11) 01491
(21) P-2013-33

(22) 03. 08. 2010

(30) 0903839 04. 08. 2009 FR

(96) EP/10290436/03. 08. 2010

(97) EP 2281822/09. 02. 2011/fr/2011/06

EP 2281822/16. 01. 2013/fr/2013/03

(54) me **NOVI DERIVATI DIHIDROINDOLONA, POSTUPAK ZA NJIHOVU PRIPREMU I FARMACEUTSKI SPOJEVI KOJI IH SADRŽAVAJU**

en NEW DIHYDROINDOLONE DERIVATIVES, METHOD OF PREPARING SAME AND PHARMACEUTICAL COMPOSITIONS CONTAINING THEM

(73) Les Laboratoires Servier, 35, rue de Verdun, 92284 Suresnes Cedex, FR,

(72) Ortuno, Jean-Claude, 78390 Bois d'Arcy, FR,
Cordi, Alexis, 92150 Suresnes, FR,
Lacoste, Jean-Michel, pokojni, FR,
Fejes, Imre, 1012 Budapest, HU,
Burbridge, Michael, 78480 Verneuil sur Seine, FR,
Hickman, John, 75017 Paris, FR,
Pierre, Alain, 78580 Les Alluets Le Roi, FR,

(74) Jusić Jasna, Crnogorskih serdara bb, Podgorica ME

(57) Spojevi prema formuli (I):

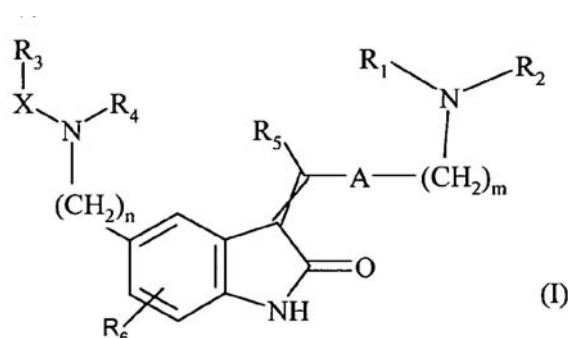

naznačeni time, da □ m predstavlja 1 ili 2, □ n predstavlja 1 ili 2, □ A predstavlja pirolil skupinu koja je nesupstituirana ili supstituirana s 1 do 3 ravnim ili razgrananim (C₁-C₆)alkilnim skupinama, □ X predstavlja C(O), S(O) ili SO₂ grupu, □ R₁ i R₂, koji su isti ili različiti, svaki predstavlja linearnu ili razgranatu (C₁-C₆)alkil skupinu, ili R₁ i R₂, zajedno s atomom dušika koji ih nosi, tvore heterocikličku skupinu, □ R₃ i R₄, zajedno s atomima koji ih nose, tvore heterocikličku skupinu, □ R₅ predstavlja atom vodika ili linearnu ili razgranatu (C₁-C₆) alkil skupinu, □ R₆ predstavlja atom vodika ili atom halogena, podrazumijeva se da: - "Heterociklička skupina" označava mono-ili bi-cikličku skupinu koja može sadržavati 5-8 atoma, koji mogu sadržavati jedan do tri hetero atoma odabranih između dušika, kisika i sumpora, i koji može sadržavati jednu ili više nezasićenih veza, a tako definirana heterociklička skupina može se biti nesupstituirana ili supstituirana sa jednom ili više skupina odabranih iz linearnog ili raz-

granatog (C1-C6)alkila, linearnog ili razgranatog (C2- C6) alkenila, okso, hidroksi, linearnog ili razgranatog (C2- C6) alkoksi, arila, arilalkila i arilalkenila, - "Aril" znači fenolnu skupinu koja je nesupstituirana ili supstituirana sa jednom ili više skupina odabranih od atoma halogena i linearne iii razgranate (C1-C6)alkil skupine, - Notacija >< znači da dvostruka veza ima Z ili E konfiguraciju, njihovi optički i geometrijski izomeri, a takoder i njihove adicijske soli s farmaceutski prihvatljivom kiselinom iii bazom.

Patent sadrži još 22 patentna zahtjeva.

(51) **A61K31 198** / ²⁰⁰⁶⁰¹
A61K31519 / ²⁰⁰⁶⁰¹
C07D48704 / ²⁰⁰⁶⁰¹

(11) **01507**
 (21) **P-2013-35**

(22) 19. 11. 2007

(30) 20060860840P 22. 11. 2006 US

20060861459P 29. 11. 2006 US

20070957236P 22. 08. 2007 US

(96) EP/07864592.6

(97) /PCT/US2007/085100

WO 2008/064157/29. 05. 2008/en/2008/22

EP 2099447/16. 09. 2009/en/2009/38

EP 2099447 /07. 11. 2012/en/2012/45

(54) me **IMIDAZOTRIAZINI I IMIDAZOPIRIMIDINI KAO INHIBITORI KINAZE**
 en **IMIDAZOTRIAZINES AND IMIDAZOPYRIMIDINES AS KINASE INHIBITORS**

(73) Incyte Corporation, Experimental Station E336/205, Route 141 & Henry Clay Road, Wilmington, Delaware 19

(72) ZHUO, Jincong, 17 Forwood Drive, Boothwyn, Pennsylvania 19061, US,

METCALF, Brian, 297 Lakefield Place, Moraga, California 94556, US,

XU, Meizhong, 8 Fritze Court, Hockessin, Delaware 19707, US,

HE, Chunhong, 34 Overlook Circle, Boothwyn, Pennsylvania 19061, US,

ZHANG, Colin, 309 Daniel Drive, Ambler, Pennsylvania 19002, US,

QIAN, Ding-quan, 10 Donald Preston Drive, Newark, Delaware 19702, US,

BURNS, David M., 7525 Claridge Street, Philadelphia, Pennsylvania 19111, US,

LI, Yunlong, 709 Willington Square Way, Newark, Delaware 19711, US,

YAO, Wenqing, 748 Meadowbank Road, Kennett Square, Pennsylvania 19348, US,

(74) Radulović Božidar, Jovana Tomaševića 9/III, Podgorica ME

(57)

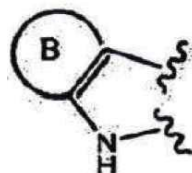
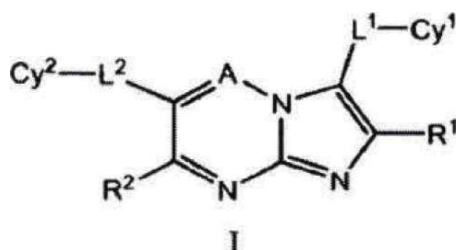

Patent sadrži još 65 patentnih zahtjeva.

(51) **E04C 3 08** / ²⁰⁰⁶⁰¹(11) **01492****E04C 3 09** / ²⁰⁰⁶⁰¹(21) **P-2013-36**

(22) 27. 09. 2010

(30) 20091047958 01. 10. 2009 DE

20091048152 02. 10. 2009 DE

20101026320 07. 07. 2010 DE

(96) EP/10766241.3/27. 09. 2010

(97) WO/PCT/EP2010/005891

WO 2011038879/07. 04. 2011/de/2011/14

EP 2483492/08. 08. 2012/de/2012/32

EP 2483492 /13. 02. 2013/de/2013/07

(54) me **TANKOSTIJENI HLADNO - PREOBLIKOVANI PROFILNI ELEMENT LAKE****GRADNJE I POSTUPAK ZA IZRADU TAKVOG PROFILNOG ELEMENTA**en **THIN-WALLED, COLD-FORMED LIGHTWEIGHT STRUCTURAL PROFILE ELEMENT AND METHOD FOR PRODUCING SUCH A PROFILE ELEMENT**

(73) Protektorwerk Florenz Maisch GmbH & Co. KG, Viktoriastrasse 58, 76571 Gaggenau, DE,

(72) MAISCH, Christof, Baden-Badener Strasse 15, 76571 Gaggenau, DE,

(74) Radulović Božidar, Jovana Tomaševića 9/III, Podgorica ME

(57) Tankostijeni hladno-preoblikovani profilni element lake gradnje, posebno građevinski profil, na primjer, profil suhe gradnje, nosača fasade, žbuke, soklova, eštriha, pločica ili kablova ili šine regala ili odvodnjavanja, sa izduženim profilnim tijelom (2) posebno metalnim ili koji se sastoji od plastike, u kojem je formirano mnoštvo otvora (5), pri čemu profilno tijelo (2) obuhvata barem dva posebno oblikovana uzdužna dijela (10, 11); pri čemu svaki uzdužni dio (10, 11) obuhvata jednu vijugavu uzdužnu ivicu (12, 13); pri čemu uzdužni dijelovi obuhvataju dugo pruženi segment (16, 17) kao i mnogo dijelova spajanja (14, 15, 23, 24, 37, 38, 45, 46, 47, 48) koji strše bočno iznad ispruženog dijela (16, 17), koji su omeđeni vijugavom uzdužnom ivicom (12, 13); pri čemu su dijelovi spajanja (14, 23, 37, 45, 47) jednog uzdužnog dijela (10) okrenuti dijelovima spajanja (15, 24, 38, 46, 48) drugog uzdužnog dijela (11) i zavareni su sa njima sučeljeno ili su međusobno povezani duž savijenih udarnih ivica (56); i pri čemu su otvori (5) barem u nekim područjima oivičeni segmentima vijugastih uzdužnih ivica (12, 13), naznačen time, da su u uzdužnim dijelovima (10, 11) formirani žlijebovi ukrućenja (31) koji idu u uzdužnom pravcu uzdužnih dijelova (10, 11) kao i žlijebovi ukrućenja (30) koji idu poprečno, da su žlijebovi ukrućenja (30) koji idu poprečno spojeni sa žlijebovima ukrućenja (31) koji idu u uzdužnom pravcu, i da se žlijebovi ukrućenja (30) koji idu poprijeko pružaju u dijelove spajanja (14, 15, 23, 24, 37, 38, 45, 46, 47, 48) i iznad šavova zavarivanja između dijelova spajanja (14, 15, 23, 24, 37, 38, 45, 46, 47, 48).

Patent sadrži još 14 patentnih zahtjeva.

(51) G07G9 00/ 200601

(11) 01519

G07F 1 00/ 200601

(21) P-2013-37

(22) 26. 10. 2007

(30) 20071042706 07. 09. 2007 DE

(96) EP/07020973.9/26. 10. 2007

(97) EP 203445503. 2009/de/2009/11

EP 2034455/01. 09. 2010/2010/35

EP 2034455/23. 01. 2013/de/2013/04

(54) me **MEHANIZAM ZA UVOĐENJE NOVČIĆA U OTVOR ZA PRIJEM NOVČIĆA
KOD AUTOMATA KOJI SE AKTIVIRAJU NOVČIĆIMA**

en DEVICE FOR FEEDING COINS INTO THE APERTURE IN A COIN -OPERATED APPARATUS

(73) adp Gauselmann GmbH, Merkur-Allee 1-15, 32339 Espelkamp, DE,

(72) Gauselmann Paul, Moorweg 11, 32339 Espelkamp, DE,

(74) Radulović Božidar, Jovana Tomaševića 9/III, Podgorica ME,

(57) Mehaniizam za uvođenje novčića u otvor za prijem novčića (7) na automatu koji se aktivira novčićima, sa servo-pogonom, koji je povezan sa žetonjerom (10) naznačen time da žetonjera (10) izrađena u obliku kadice na dnu ima proreze (13) koji se protežu duž žetonjere (10) i da su prorezi (13) povezani valjcima (14) koji se pogone servo-pogonima (15) sa pomoćnim napajanjem.

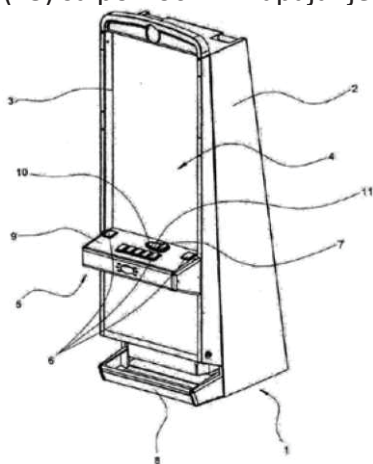

Slika 1

Patent sadrži još 4 patentna zahtjeva.

(51) **C07D213 64** / ²⁰⁰⁶⁰¹

(11) **01520**

(21) **P-2013-40**

(22) OS. 07. 2005

(30) 20040198709 06. 07. 2004 JP

(96) EP/05758232.2/05. 07. 2005

(97) PCT/JP2005/012388

WO 2006/004107/12. 01. 2006/en/2006/02

EP 1764361 /21. 03. 2007/en/2007/12

EP 1764361 /30. 01. 2013/en/2013/05

(54) me **KRISTAL JEDINJENJA 1, 2-DIHIDROPIRIDINA I METOD ZA NJEGOVU PROIZVODNJU**

en CRYSTAL OF 1, 2-DIHYDROPYRIDINE COMPOUND AND METHOD FOR PRODUCING SAME

(73) Eisai R&D Management Co., Ltd., 6-10, Koishikawa 4-chome, Bunkyo-ku, Tokyo 112-8088, JP,

(72) ARIMOTO, Itaru, Eisai Co., Ltd., 6-10, Koishikawa 4-chome, Bunkyo-ku, Tokyo 1128088, JP, NAGATO, Satoshi, Eisai Co., Ltd., 6-10, Koishikawa 4-chome, Bunkyo-ku, Tokyo 1128088, JP, SUGAYA, Yukiko, EISAI Co., Ltd., Tsukuba Laboratory, 1-3, Tokodai S-chome, Tsukuba-shi, Ibaraki 300263S, JP,

URAWA, Yoshio, EISAI Co., Ltd., Kashima Plant, 22, Sunayama, Kamisu-shi, Ibaraki 31402SS, JP,

ITO, Koichi, EISAI Co., Ltd., Tsukuba Laboratory, 1-3, Tokodai S-chome, Tsukuba-shi, Ibaraki 300263S, JP,

NAKA, Hiroyuki, EISAI Co., Ltd., Kashima Plant, 22, Sunayama, Kamisu-shi, Ibaraki 31402SS, JP,

OMAE, Takao, EISAI Co., Ltd., Tsukuba Laboratory, 1-3, Tokodai S-chome, Tsukuba-shi, Ibaraki 300263S, JP,

(74) Radulović Božidar, Jovana Tomaševića 9/III, Podgorica ME

(57) Kristal 3-(2-djanofenN)-5-(2-pindN)-1-fenM-1, 2-dihidropindin-2-on hidrata, naznačen time, da poseduje difrakcioni šiljak kod difrakcionog ugla ($20 \pm 0.2^\circ$) od 8.7° kod difrakcije X-zraka na puderu.

Fig.1

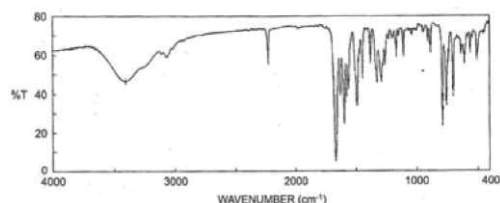

Patent sadrži još patentnih zahtjeva.

(51) C07D22316 / ²⁰⁰⁶⁰¹

(11) 01479

C07C 21100 / ²⁰⁰⁶⁰¹

(21) P-2013-41

(22) 13. 02. 2012

(30) 1100446 14. 02. 2011 FR

(96) EP/12290050.9/13. 02. 2012

(97) EP 2487158/15. 08. 2012/fr/2012/33

EP 2487158/20. 02. 2013/fr/2013/08

(54) me **NOVI POSTUPAK ZA SINTEZU IVABRADINA I NJегоVIH DODANIH SOLI S FARMACUTSKI PRIHVATLJIVOM KISJELINOM**en NEW METHOD FOR SYNTHESISING IVABRADINE AND ITS ADDED SALTS WITH A PHARMACEUTICAL[^] ACCEPTABLE ACID

(73) Les Laboratoires Servier, 35, rue de Verdun, 92284 Suresnes Cedex, FR,

(72) Peglion, Jean-Louis, 5, allée des Bégonias, 78110 Le Vesinet, FR,

Dessinges, Aimée, Appt. 47, 8 Boulevard du Général de Gaulle, 92500 Rueil-Malmaison, FR,

(74) Jusić Jasna, Crnogorskih serdara bb, Podgorica ME

(57) Proces za sintezu ivabradina formule (I):

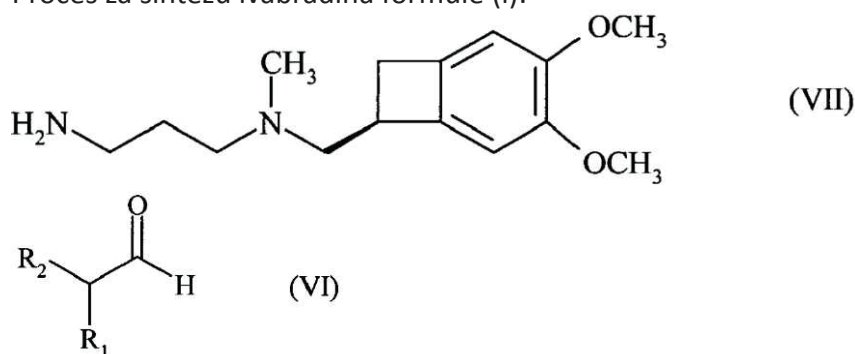

pri čemu su R_1 i R_2 , koji su jsti jli različiti, predstavljaju ravne ili razgranane (C₁-C₆)alkoksi skupine ili zajedno s atomom ugljika koji ih nosi tvore 1, 3-dioksanski, 1, 3-dioksolanski ili 1, 3-dioksopanski prsten, izloženi redukcijskoj aminacijskoj reakciji sa spojem formule (VII): pri čemu su R_1 i R_2 ranije gore navedeni, koji je izložen kondenzacijskoj reakciji sa spojem formule (IX): u nazočnosti lužine u organskom otapalu, kako bi se dobio spoj formule (X): pri čemu su R_1 i R_2 ranije gore navedeni, u nazočnosti redukcijskog sredstva, u organskom otapalu, smjesi organskih otapala ili smjesi organskih otapalo(a) i vodi, kako bi se dobio spoj formule (VIII):

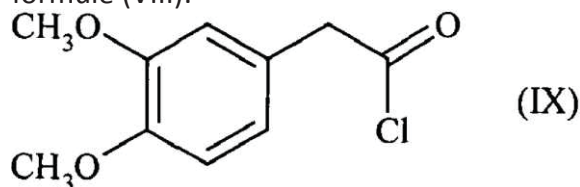

u nazočnosti lužine u organskom otapalu, kako bi se dobio spoj formule (X) : koji je izložen kondenzacijskoj reakciji sa spojem formule (IX):

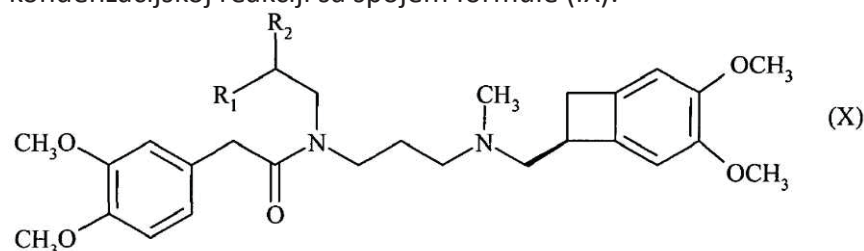

prj čemu su R_1 i R_2 ranije gore navedeni, koji je izložen ciklizacijskoj reakciji u kiselom mediju

kako bi se dobilo spoj formule (V):

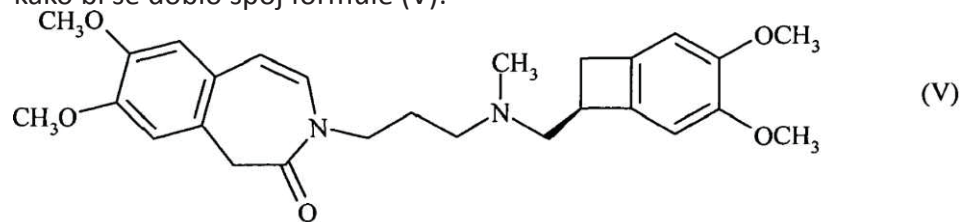

koji je izložen reakciji hidrogenacije kako bi se dobio ivabradin formule (I), koji se po izboru može konvertirati u njegove dodatne soli s farmaceutski prihvatljivom kiselinom odabranom od klorovodične kiseline, bromovodične kiseline, sumporne kiseline, fosforne kiseline, octene kiseline, trifluoroctene kiseline, mliječne kiseline, piruvinske kiseline, malonske kiseline, sukcininske kiseline, glutarne kiseline, fumarne kiseline, tartarne kiseline, jabučne kiseline, limunske kiseline, askorbinske kiseline, oksalne kiseline, metansulfonske kiseline, benzensulfonske kiseline i kamforne kiseline te u njihove hidrate.

Patent sadrži još 16 patentnih zahtjeva.

(51) **C07D209 52** / ^{2006.01}
A61K31403 / ^{2006.01}
A61P25 00 / ^{2006.01}

(11) **01504**
(21) **P-2013-42**

(22) 08. 12. 2010

(30) 0905957 09. 12. 2009 FR

(96) EP/10290642.7/08. 12. 2010

(97) EP 2332910/15. 06. 2011/fr/2011/24

EP 2332910/30. 01. 2013/fr/2013/05

(54) me **NOVI DERIVATI AZABICIKLO[3.2.0]HEPT-3-ILA, POSTUPAK ZA PRIPREMU ISTIH I FARMACEUTSKE SMJEŠE KOJE IH SADRŽE**

en NEW DERIVATIVES OF AZABICYCLO[3.2.0]HEPT-3-YL, METHOD FOR PREPARING THE SAME AND PHARMACEUTICAL COMPOSITIONS CONTAINING THEM

(73) Les Laboratoires Servier 35, rue de Verdun, 92284 Suresnes Cedex, FR,

(72) Casara, Patrick, 78670 Villennes sur Seine, FR,

Chollet, Anne-Marie 78230 Le Pecq, FR,

Dhainaut, Alain, 78400 Chatou, FR,

Lestage, Pierre 78170 La Celle Saint Cloud, FR,

Panayi, Fany 75018 Paris, FR,

(74) Jusić Jasna, Črnogorskih serdara bb, Podgorica ME

(57) Spoj formule (1):

naznačen time, da: □ ALK predstavlja lanac alkilena, □ W predstavlja skupinu

u kojem R i R', svaki neovisno jedan od drugoga, predstavljaju atom vodika ili ravnu ili razgrananu (Ci-C₆)alkilnu skupinu po izboru supstituiranu s jednim ili više skupina odabranih od halogena, hidroksi i alkoksi, pri čemu treba razumjeti da: - određenje "alkilen" označava ravni ili razgranani dvovalentni radikal koji se sastoji od 2 do 6 atoma ugljika, - određenje "alkoksi" označava alkil-oksi skupinu u kojoj lanac alkila, koji je ravni ili razgranani, sadrži od 1 do 6 atoma ugljika, njihovi enantiomeri i dijastereoizomeri te također njihove adicijske soli s farmaceutski prihvatljivom kiselinom ili lužinom.

Patent sadrži još 24 patentna zahtjeva.

(51) **C07D215 22** / ²⁰⁰⁶⁰¹
C07D40106 / ²⁰⁰⁶⁰¹
C07D401 10 / ²⁰⁰⁶⁰¹
C07D40506 / ²⁰⁰⁶⁰¹
C07D40510 / ²⁰⁰⁶⁰¹
C07D40910 / ²⁰⁰⁶⁰¹
A61K31435 / ²⁰⁰⁶⁰¹
A61P3100 / ²⁰⁰⁶⁰¹

(11) **01521**
(21) **P-2013-43**

(22) 04. 12. 2007
(30) 20060125510 06. 12. 2006 EP
(96) EP/07847812.0/04. 12. 2007
(97) PCT/EP2007/063314/04. 12. 2007
WO 2008/068268/12. 06. 2008/en/2008/24
EP 2099760/16. 09. 2009/en/2009/38
EP 2099760/20. 02. 2013/en/2013/08

(54) me **ANTIBAKTERIJSKI KINOLINSKI DERIVATI**
en ANTIBACTERIAL QUINOLINE DERIVATIVES

(73) Janssen Pharmaceutica NV, Turnhoutseweg 30, 2340 Beerse, BE,
(72) GUILLEMONT, Jérôme Emile Georges, Johnson & Johnson, Pharmaceutical Research and Development, A division of Janssen-Cilag, Campus de DORANGE, Ismet, Sickla alle 21, 13165 Nacka, SE,
MOTTE, Magali Madeleine Simone, Johnson & Johnson, Pharmaceutical Research and Development, A division of Janssen-Cilag,, Campus de ANDRIES, Koenraad Jozef Lodewijk Marcel, Janssen Pharmaceutica N.V., Turnhoutseweg 30, 2340 Beerse, BE,
KOUL, Anil, Janssen Pharmaceutica N.V., Turnhoutseweg 30, 2340 Beerse, BE,
(74) Radulović Božidar, Jovana Tomaševića 9/III, Podgorica ME
(57) Jedinjenje, naznačeno time, da ima formulu (Ia) ili (Ib)

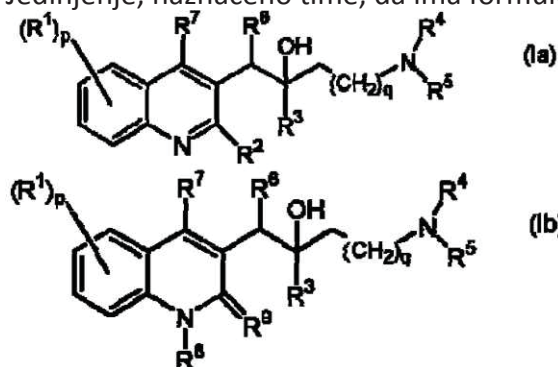

uključujući bilo koju njegovu stereohemijski izomernu formu, gde p je celi broj jednak 1, 2, 3 ili 4; q je celi broj jednak nuli, 1, 2, 3 ili 4; R¹ je vodik, cijano, halo, alkil, haloalkil, hidroksi, alkiloksi, alkiltio, alkiltioalkil, arilalkil, di(aril)alkil, aril ili Het; R² je vodonik, alki loksi, aril, ariloksi, hidroksi, merkpto, alkiloksialkiloksi, alkiltio, mono ili di(alkil)amino, pirolidino ili neki radikal sa formulom

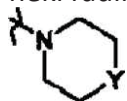

gde Y je CH₂, O, S, NH ili N-alkil; R³ je alkil, arilalkil, aril-O-alkil, aril-alkil-O-alkil, aril, aril-aril, Het, Het-alkil, Het-Oalkil, Het-alkil-O-alkil ili

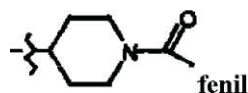

R⁴ i R⁵ svaki nezavisno su vodonik, alkil ili benzil; ili R⁴ i R⁵ zajedno i uključujući N na kojeg su spojeni mogu da formiraju radikal koji je izabran iz grupe koja obuhvata pirolidinil, 2-pirolinil, 3-pirolinil, pirolil, imidazolidinil, pirazolidinil, 2-imidazo linil, 2-pirazolinil, imidazolil, pirazolil, triazolil, piperidinil, piridinil, piperazinil, imidazolidinil, piridazinil, pirimidinil, pirazinil, triazinil, morfolinil i tiomorfolinil, a svaki radikal je ponekad supstituisan sa alkilom, halo, haloalkilom, hidroksi, alkiloksi, amino, mono- ili dialkilamino, alkiltio, alkiloksialkilom, alkiltioalkilom i pirimidinilom; R⁶ je aril¹ ili Het; R⁷ je vodonik, halo, alkil, aril ili Het; R⁸ je vodonik ili alkil; R⁹ je okso; ili R⁸ i R⁹ zajedno formiraju radikal -CH=CH-N=; aril je homocikal izabran iz fenila, naftila, acenaftila ili tetrahidronaftila, a svaki je ponekad supstituisan sa 1, 2 ili 3 supstituenta, a svaki supstituentje nezavisno izabran iz hidroksi, halo, cijano, nitro, amino, mono- ili dialkilamino, alkila, C₂₋₆ alkenila ponekad supstituisanog sa fenilom, haloalkila, alkiloksi, haloalkiloksi, karboksila, alkiloksikarbonila, aminokarbonila, morfolinila ili mono- ili dialkilaminokarbonila; aril 1 je homocikal koji je izabran iz fenila, naftila, acenaftila ili tetrahidronaftila, a svaki je ponekad supstituisan sa 1, 2 ili 3 supstituenta, a svaki supstituent je nezavisno izabran iz hidroksi, halo, cijano, nitro, amino, mono- ili dialkilamino, alkila, haloalkila, alkiloksi, alkiltio, haloalkiloksi, karboksila, alkiloksikarbonila, aminokarbonila, morfolinila, Het ili mono- ili dialkilaminokarbonila; Het je monociklički heterocikal koji je izabran iz N-fenoksipiperidinila, piperidinila, pirolila, pirazolila, imidazolila, furanila, tienila, oksazolila, izoksazolila, tiazolila, izotiazolila, piridinila, pirimidinila, pirazinila ili piridazinila; ili je biciklički heterocikal koji je izabran iz kinolinila, kinoksalinila, indolila, benzimidazolila, benzoksazolila, benzizoksazolila, benzotiazolila, benzizotiazolila, benzofuranila, benzotienila, 2, 3-dihidrobenzo[1, 4]dioksinila ili benzo[1, 3]dioksolila; a svaki monociklički i biciklički heterocikal je ponekad supstituisan sa 1, 2 ili 3 supstituenta, a svaki supstituentje nezavisno izabran iz halo, hidroksi, alkila ili alkiloksi; pod uslovom da ako R₃ je alkil, arilalkil, aril, Het, Het-alkil ili

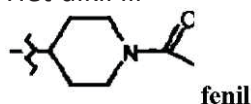

tada R⁶ je Het; fenil supstituisan sa Het; naftil supstituisan sa Het; ili acenaftil ili tetrahidronaftil, a svaki je ponekad supstituisan sa 1, 2 ili 3 supstituenta, a svaki je supstituent nezavisno izabran iz hidroksi, halo, cijano, nitro, amino, mono- ili dialkilamino, alkila, haloalkila, alkiloksi, alkiltio, haloalkiloksi, karboksila, alkiloksikarbonila, aminokarbonila, morfolinila, Het ili mono- ili dialkilaminokarbonila; njegov A/-oksid, njegova farmaceutski prihvatljiva so i rastvorljiva materija, i gde alkil, kada se ovde koristi, predstavlja ravan ili razgranat zasićen ugljovodonični radikal koji ima od 1 do 6 atoma ugljenika; ili je ciklički zasićeni ugljovodonični radikal koji ima od 3 do 6 atoma ugljenika; ili je ciklički zasićeni ugljovodonični radikal koji ima od 3 do 6 atoma ugljenika koji su spojeni na ravan ili razgranat zasićeni ugljovodonični radikal koji ima od 1 do 6 atoma ugljenika; i gde svaki atom ugljenika može ponekad da bude supstituisan sa cijana, hidroksi, C₁₋₆alkiloksi ili okso.

Patent sadrži još 28 patentnih zahtjeva.

- (51) **C07D21162** / ²⁰⁰⁶⁰¹
C07D21381 / ²⁰⁰⁶⁰¹
C07D233 90 / ²⁰⁰⁶⁰¹
C07D239 28 / ²⁰⁰⁶⁰¹
C07D261 18 / ²⁰⁰⁶⁰¹
C07D271 10 / ²⁰⁰⁶⁰¹
C07D239 557 / ²⁰⁰⁶⁰¹
C07D207 277 / ²⁰⁰⁶⁰¹
C07D237 24 / ²⁰⁰⁶⁰¹
A61K31 165 / ²⁰⁰⁶⁰¹
A61K3144 / ²⁰⁰⁶⁰¹
A61K31505 / ²⁰⁰⁶⁰¹
A61K31506 / ²⁰⁰⁶⁰¹
C07D401 12 / ²⁰⁰⁶⁰¹
C07D405 12 / ²⁰⁰⁶⁰¹
- (22) 23. 02. 2010
(30) 090153778 26. 02. 2009 EP
(96) EP/10711628.7/23. 02. 2010
(97) PCT/EP2010/052232/23. 02. 2010
WO 2010/097372/02. 09. 2010/de/2010/35
EP 2401256/04. 01. 2012/de/2012/01
EP 2401256/17. 04. 2013/de/2013/16
- (54) me **JEDINJENJA KAO B1 ANTAGONISTI BRADIKININA**
en COMPOUNDS AS BRADYKININ B1 ANTAGONISTS
- (73) Boehringer Ingelheim International GmbH, Binger Strasse 173, 55216 Ingelheim am Rhein, DE,
(72) HAUDEL, Norbert, Boehringer Ingelheim GmbH, CD Patents, Binger Strasse 173, 55216 Ingelheim am Rhein, DE,
CECI, Angelo, Boehringer Ingelheim GmbH, CD Patents, Binger Strasse 173, 55216 Ingelheim am Rhein, DE,
DOODS, Henri, Boehringer Ingelheim GmbH, CD Patents, Binger Strasse 173, 55216 Ingelheim am Rhein, DE,
KONETZKI, Ingo, Boehringer Ingelheim GmbH, CD Patents, Binger Strasse 173, 55216 Ingelheim am Rhein, DE,
MACK, Juergen, Boehringer Ingelheim GmbH, CD Patents, Binger Strasse 173, 55216 Ingelheim am Rhein, DE,
PRIEPKE, Henning, Boehringer Ingelheim GmbH, CD Patents, Binger Strasse 173, 55216 Ingelheim am Rhein, DE,
SCHULER-METZ, Annette, Boehringer Ingelheim GmbH, CD Patents, Binger Strasse 173, 55216 Ingelheim am Rhein, DE,
WALTER, Rainer, Boehringer Ingelheim GmbH, CD Patents, Binger Strasse 173, 55216 Ingelheim am Rhein, DE,
WIEDENMAYER, Dieter, Boehringer Ingelheim GmbH, CD Patents, Binger Strasse 173, 55216 Ingelheim am Rhein, DE,
- (74) Radulović Božidar, Jovana Tomaševića 9/III, Podgorica ME,
(57) Jedinjenja opšte formule I gdje n označava brojeve 0, 1 ili 2 R¹ označava (a) C₁₋₆-alkil grupu opciono supstituisanu sa grupom R¹¹, (b) C₁₋₃-alkil grupu gdje svaka metilen grupa može

biti supstituisana sa 1 ili 2 atoma fluora, i svaka metil grupa može biti supstituisana sa 1, 2 ili 3 atoma fluora,

(c) supstituisanu C_{3-6} -cikloalkil grupu opciono supstituisanu sa grupom $R^{1.2}$ gde $-CH_2$ -jedinica može biti zamjenjena sa $-C(O)$ - grupom, (d) aril- C_{0-2} -alkilen grupu opciono supstituisanu sa 1, 2 ili 3 grupe $R^{1.3}$, (e) petočlanu heteroaril- C_{0-2} -alkilen grupu opciono supstituisanu sa 1, 2 ili 3 grupe $R^{1.4}$, koja sadrži bar jedan N, O ili S atom i koje opciono dodatno sadrže jedan, dva ili tri dodatna N-atoma i koje dodatno mogu biti benzo-kondenzovane, (f) šestočlanu heteroaril- C_{0-2} -alkilen grupu opciono supstituisanu sa 1 ili 2 grupe $R^{1.4}$, koje sadrže jedan, dva ili tri N-atoma i koje dodatno mogu biti benzo-kondenzovane, (g) devet- ili deset-očlanu heteroaril grupu opciono supstituisanu sa 1 ili 2 grupe $R^{1.4}$, koje sadrže jedan, dva ili tri N-atoma, (h) 5- ili 6-očlanu heterocikličnu grupu opciono supstituisanu sa 1 ili 2 grupe $R^{1.4}$, gdje $-CH_2$ -jedinica može biti zamjenjena sa $-C(O)$ - grupom, (i) $-O-R^{1.1.1}$, (j) $-NR^{1.1.3}R^{1.1.4}$ ili (k) $-C(=NR^{1.5})-CN$, $r^{1'1}$ označava halogen, $-NO_2$, $-CN$, C3-a-cikloalkil, $-Or^{1'1'1}$, $-Sr^{1'1'1}$, $-C(O)R^{1'1'1}$, $-S(O)_2-R^{1'1'2}$, $-O-S(O)_2-R^{1'1'1}$, $-CO_2R^{1'1'1}$, $-O-C(O)-R^{1'1'1}$, $-NR^{1'1'3}R^{1'1'4}$, $-NR^{1'1'3}-C(O)-R^{1'1'1}$, $-Nr^{1'1'3}-C(O)-r^{1'1'1}$, $-NR^{1'1'3}-CO_2-R^{1'1'1}$ ili $-C(O)-NR^{1'1'3}R^{1'1'4}$, $r^{1'1'1}$ označava (a) H, (b) C1-4-alkil, (c) C1-3-alkil grupu gdje svaka metilen grupa može biti supstituisana sa 1 ili 2 atoma fluora i svaka metil grupa može biti supstituisana sa 1, 2 ili 3 atoma fluora, (d) fenil grupu opciono supstituisanu sa 1, 2 ili 3 grupe $R^{1'1'1'1}$, (e) C3-a-cikloalkil ili (f) piridil grupu opciono supstituisanu sa 1, 2 ili 3 grupe $R^{1'1'1'2}$, $ri'1'1$ nezavisno jedna od druge označava (a) halogen, $-NO_2$, $-CN$, $-OH$, $-O-C1-4$ -alkil, C3-a-cikloalkil, C1-4-alkil ili (b) C_{1-3} -alkil grupu gdje svaka metilen grupa može biti supstituisana sa 1 ili 2 atoma fluora i svaka metil grupa može biti supstituisana sa 1, 2 ili 3 atoma fluora, $ri'1'1'2$ nezavisno jedna od druge označava halogen ili C_{1-4} -alkil, $r^{1'1'2}$ označava (a) C1-4-alkil, (b) C1-3-alkil grupu gdje svaka metilen grupa može biti supstituisana sa 1 ili 2 atoma fluora i svaka metil grupa može biti supstituisana sa 1, 2 ili 3 atoma fluora, (c) $-O-C1-4$ -alkil ili (d) fenil grupu opciono supstituisana sa 1, 2 ili 3 grupe $R^{1'1'1'1}$, $r^{1'1'4}$ nezavisno jedna od druge označava (a) H, (b) C_{1-4} -alkil grupu opciono supstituisanu sa 1, 2 ili 3 grupe $R^{1'1'4'1}$, (c) fenil grupu opciono supstituisanu sa 1, 2 ili 3 grupe $R^{1'1'1'1}$, (d) C_{3-6} -cikloalkil, ili $r^{1'1'3}$ i $r^{1'1'4}$ zajedno sa atomom N za koji su vezani obrazuju 5- ili 6-očlani heterociklični prsten, koji može dodatno sadržati druge heteroatome odabrane od N, O i S, ili $r^{1'1'3}$ i $r^{1'1'4}$ zajedno sa atomom N za koji su vezani, obrazuju ciklični imid, $R^{1'1'4'1}$ nezavisno jedna od druge označava halogen, $-NH_2$, $-NH(C_{1-4}$ -alkil), $-N(C_{1-4}$ -alkil) $_2$ ili $-SO_2$, $r^{1'2}$ označava halogen, $-NO_2$, $-CN$, OH , $-O-CH_3$ ili fenil, $r^{1'3}$ označava (a) halogen, $-NO_2$, $-CN$, $-Or^{1'1'1}$, $-Sr^{1'1'1}$, $-CO_2R^{1'1'1}$, C1-6-alkil ili (b) C1-3-alkil grupu gdje svaka metilen grupa može biti supstituisana sa 1 ili 2 atoma fluora i svaka metil grupa može biti supstituisana sa 1, 2 ili 3 atoma fluora, $r^{1'4}$ nezavisno jedna od druge označava (a) halogen, $-NO_2$, $-CN$, $-Or^{1'1'1}$, $-Sr^{1'1'1}$, $-S(O)-R^{1'1'2}$, $-S(O)_2-R^{1'1'2}$, $-NR^{1'1'3}R^{1'1'4}$, $-N(r^{1'4'1})-C(O)-C1-4$ -alkil, C1-6-alkil, (b) C1-3-alkil grupu gdje svaka metilen grupa može biti supstituisana sa 1 ili 2 atoma fluora i svaka metil grupa može biti supstituisana sa 1, 2 ili 3 atoma fluora, ili (c) okso grupu, $r^{1'4'1}$ označava H ili C_{1-4} -alkil, $r^{1'5}$ označava $-OH$ ili $-O-C_{1-3}$ -alkil, r^2 označava (a) H, (b) C1-4-alkil, (c) C1-4-alkil- $C(O)-R^3$ i R^4 zajedno sa atomom ugljenika za koji su vezani označavaju C3-a-cikloalkilen grupu opciono supstituisanu sa grupom $R^{3'1}$ gde $-CH_2$ -jedinica može biti zamjenjena sa heteroatomom O, N, S ili sa grupom CO, SO ili SO $_2$, $R^{3'1}$ označava H, $-OH$, R^5 označava (a) H, (b) C1-4-alkil, (c) C1-3-alkil grupu gdje svaka metilen grupa može biti supstituisana sa 1 ili 2 atoma fluora i svaka metil grupa može biti supstituisana sa 1, 2 ili 3 atoma fluora, R^6 nezavisno jedna od druge označava (a) H, halogen, $-CN$, $-OH$, C_{1-a} -alkil, C_{3-7} -cikloalkil, $-O-C_{1-4}$ -alkil, $-O-CF_3$, $-O-C_{3-a}$ -cikloalkil, $-N(C1-3-alkil)_2$, $-C(O)-NH_2$, $-(SO_2)NH_2$, $-SO_2-C1-3-alkil$, ili (b) C1-3-alkil grupu gdje svaka metilen grupa može biti supstituisana sa 1 ili 2 atoma fluora i svaka metil grupa može biti supstituisana sa 1, 2 ili 3 atoma fluora, R^7 označava (a) H, halogen, $-CN$, $-OH$, (b) C1-alkil, (c) C1-3-alkil ili $-O-C1-3$ -alkil, gdje svaka metilen grupa može biti supstituisana sa 1 ili

2 atoma fluora i svaka metil grupa može biti supstituisana sa 1, 2 ili 3 atoma fluora, (d) C3-7-cikloalkil, (e) -O-C1-a-alkil, (f) -O-C3-7-cikloalkil, (g) -NH₂, -NH(C1-3-alkil), -N(C1-3-alkil)₂, (h) -C(O)-R⁷¹, (i) -S-C1-4-alkil, -SO₂-r⁷², (j) petočlanu heteroaril grupu opciono supstituisanu sa jednom ili dvije C1-3-alkil grupe koja je odabrana između pirolila, oksazolila, izoksazolila, oksadiazolila, tiazolila, izotiazolila, tiadiazolila, imidazolila, pirazolila, triazolila i tetrazolila, ili (k) šestočlanu heteroaril grupu opciono supstituisanu sa jednom ili dvije C1-3-alkil grupe koje su odabrane između piridila, pirimidinila, pirazinila, piridazinila i triazinila, r⁷¹ označava -NH₂, -NH(C₁₋₆-alkil), -N(C₁₋₆-alkil)₂, N-acetidinil, N-pirolidinil, N-piperidinil, N-morfolinil, -OH, -O-C1-8-alkil ili -O-C3-7-cikloalkil, r⁷² označava -NH₂, -NH(C₁₋₆-alkil), -N(C₁₋₆-alkil)₂, N-acetidinil, N-pirolidinil, N-piperidinil ili N-morfolinil i r⁸ označava H, halogen, C₁₋₄-alkil, r⁹ označava (a) H, halogen, -CN, -OH, (b) C1-6-alkil, (c) C1-3-alkil ili -O-C1-3-alkil, gdje svaka metilen grupa može biti supstituisana sa 1 ili 2 atoma fluora i svaka metil grupa može biti supstituisana sa 1, 2 ili 3 atoma fluora, (d) C3-7-cikloalkil, (e) C2-4-alkinil, (f) -O-C1-6-alkil, (g) -O-C3-7-cikloalkil, (h) -NH₂, -NH(C1-3-alkil), -N(C1-3-alkil)₂, (i) -C(O)-r⁹¹, (j) -S-C1-4-alkil, -SO-C1-4-alkil, -SO₂-C1-4-alkil, r⁹¹ označava -NH₂, -NH(C₁₋₆-alkil), -N(C₁₋₆-alkil)₂, N-acetidinil, N-pirolidinil, N-piperidinil, N-morfolinil, -OH, -OC1-8-alkil ili -O-C3-7-cikloalkil, r¹⁰ označava H, halogen, C₁₋₄-alkil, r¹¹ označava (a) H, halogen, -CN, -OH, (b) C1-6-alkil, (c) C₁₋₃-alkil ili -O-C₁₋₃-alkil, gdje svaka metilen grupa može biti supstituisana sa 1 ili 2 atoma fluora i svaka metil grupa može biti supstituisana sa 1, 2 ili 3 atoma fluora, (d) C3-7-cikloalkil, (e) -O-C1-6-alkil, (f) -O-C3-7-cikloalkil, (g) -NH₂, -NH(C1-3-alkil), -N(C1-3-alkil)₂, (h) -C(O)-r¹¹¹, (i) -S-C1-3-alkil, -SO₂-r¹¹², (j) petočlanu heteroaril grupu opciono supstituisanu sa jednom ili dvije C1-3-alkil grupe koja je odabrana između pirolila, oksazolila, izoksazolila, oksadiazolila, tiazolila, izotiazolila, tiadiazolila, imidazolila, pirazolila, triazolila i tetrazolila, ili (k) šestočlanu heteroaril grupu opciono supstituisanu sa jednom ili dvije C1-3-alkil grupe koje su odabrane između piridila, pirimidinila, pirazinila, piridazinila i triazinila, r¹¹¹ označava -NH₂, -NH(C₁₋₆-alkil), -N(C₁₋₆-alkil)₂, N-acetidinil, N-pirolidinil, N-piperidinil, N-morfolinil, -OH, -OC1-8-alkil ili -O-C3-7-cikloalkil, r¹¹² označava -NH₂, -NH(C₁₋₆-alkil), -N(C₁₋₆-alkil)₂, N-acetidinil, N-pirolidinil, N-piperidinil ili N-morfolinil i x nezavisno jedna od druge označava C-r⁶ ili N, njihove enantiomere, diastereomere, smješe i soli.

Patent sadrži još 33 patentna zahtjeva.

(51) **F 16H3310/** ^{2006.01}(11) **01522**(21) **P-2013-45**

(22) 17. 04. 2008

(30)

(96) EP/08735274.6/17. 04. 2008

(97) /PCT/EP2008/003028

WO 2009/127228/22. 10. 2009/en/2009/43

EP 2265843/29. 12. 2010/en/2010/52

EP 2265843/17. 04. 2013/en/2013/16

(54) me **PRENOSNI/TRANSMISIONI/MEHANIZAM I NAČIN POSTIZANJA
OBRTNOG KRETANJA**

en GEAR DEVICE AND METHOD FOR PROVIDING A ROTARY MOTION

(73) Erke Erke Arastirmalari Ve Muhendislik A.S., Halkali Merkez Mah. Basin Ekspres Yolu, No. 5/A, 34303 Kucukce

(72) OZTURK, Mustafa, Naci, Halkali Merkez Mah. Basin Ekspres Yolu No. 5/A, 34303 K.cekmece/Istanbul, TR,

(74) Radulović Božidar, Jovana Tomaševića 9/III, Podgorica ME

(57) A) Prenosni mehanizam, bolje rečeno motorni uređaj, za snabdijevanje rotacijom oko najmanje jedne izlazne ose, gdje spomenuti mehanizam sadrži: B) tijelo (2) montirano za rotiranje oko prve ose (4) i rotiranje oko druge ose (11) i rotaciju oko treće ose (16); prva osa (4) je usmjerena u izvjesnom pogledu prema drugoj osi (11) u uglu nagiba (0), druga osa (11) odnosno treća osa (16) sadrži najmanje jednu vanjsku osu navedenog mehanizma, u kojem rotacija tijela (2) oko treće ose (16) daje povećanje za promjenu u uglu nagiba (0), C) sredstvo (15) za primjenu obrtne sile (21) na tijelo (2) oko treće ose (16), u smislu povećanja ugla nagiba (0) kad je prva osa (4) pri odabranom uglu nagiba (0), u odnosu na drugu osu (11) koja je veća od 0 stepeni, a manja od 90 stepeni, i D) sredstvo (210) za ograničenje rotacije na tijelu (2) oko treće ose (16) u smislu smanjenja ugla nagiba (0) tako da ugao nagiba (0) prve ose (4) s obzirom na drugu osu (11) ostaje veći od 0 stepeni i manji od 90 stepeni, E) navedeni mehanizam je tako strukturiran da omogućava da izvor pogona bude spojen sa tijelom (2) da izazove tijelo (2) da rotira oko prve ose (4), i F) kako je rotacija tijela (2) oko prve ose (4) pri ugaonoj brzini (ω_{spin}) većoj od kritične ugaone brzine (ω_c) tako se došlo do konstante ili smanjenja ugla nagiba (0), pomoću toga da inicira ili poveća izlaznu brzinu ugla (ω_{out}) i/ili izlaznu obrtnu silu rotacije tijela (2) oko druge ose (11) odnosno oko treće ose (16), kao što je rečeno, najmanje jedne izlazne ose, G) pomoću toga, tijelo (2) ima specifičnu kritičnu ugaonu brzinu (U_c , spec) manju od 20.000 obrtaja u minuti, po mogućnosti da se time poveća izlazna snaga oko najmanje jedne izlazne ose, u skladu s time navedena specifična kritična ugaona brzina (U_c , spec) je definirana kako slijedi: specifična kritična ugaona brzina (U_c , spec) je kritična ugaona brzina (U_c) tijela (2), kad je ugao nagiba (0) prve ose (4), s obzirom na drugu osu (11), 45 stepeni, kad prva osa (4) stvarno prolazi kroz centar mase (CM) tijela (2), kad je tijelo (2) usmjereno tako da je moment inercije tijela (2) stvarno doveden do maksimuma, kada, ako tijelo (2) nije simetrično oko ravni koja prolazi kroz centar mase (CM) tijela (2) i koje je ortogonalno odnosno pod pravim uglom u odnosu na prvu osu (4), među mogućim montažnim pravcima montaže tijela (2), na prvoj osi (4), jedna je odabrana koja ima za rezultat manji razmak između centra mase (CM) tijela (2) i treće ose (16), i kad je dužina spojnog kraka (tc) a) 5 mm ako je masa tijela (2) manja od 0.1 kg, b) 25 mm ako je masa tijela (2) jednaka ili veća od 0.1 kg, a manja od 100 kg, c) 50 mm ako je masa tijela (2) jednaka ili veća od 100 kg i manja od 1.000 kg, i d) 100 mm ako je masa tijela (2) jednaka ili veća od 1.000 kg, u skladu sa kojom navedena dužina spojnog kraka (tc) je udaljenost

tačke presijecanja spojne ravni (P_c) i prve ose (4) do treće ose (16), kako je navedena spojna ravan (P_c) ravan koja je pog pravim uglom u odnosu na prvu osu (4) i presijeca tijelo (2) i ima minimalnu udaljenost u odnosu na ugaonu osu (16).

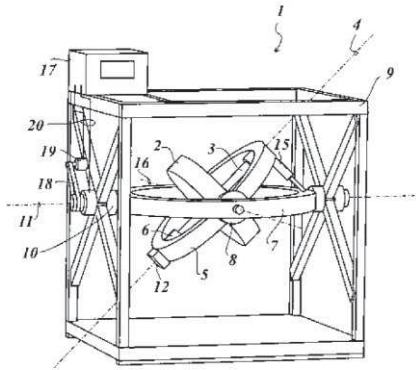
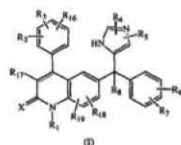

Fig. 1

Patent sadrži još 65 patentnih zahtjeva.

- (51) **G01N33 50** / 00601 (11) **01509**
A61K314709 / 200601 (21) **P-2013-46**
A61P 7 00 / 200601
- (22) 02. 11. 2005
(30) 625204P 05. 11. 2004 US 708075P 12. 08. 2005 US
(96) EP/05851365.6/02. 11. 2005
(97) WO/PCT/US2005/039948
WO 2006/052718/18. 05. 2006/en/2006/20
EP 1815247/08. 08. 2007/en/2007/32
EP 1815247/20. 02. 2013/en/2013/08
- (54) me **TERAPEUTSKA UPOTREBA INHIBITORA FARNEZILTRANSFERAZE I
POSTUPCI PRAĆENJA NJIHOVE EFIKASNOSTI**
en **THERAPEUTIC USE OF FARNESYLTRANSFERASE INHIBITORS AND METHODS OF MONI-
TORING THE EFFICACY THEREOF**
- (73) Janssen Pharmaceutica NV, Turnhoutseweg 30, 2340 Beerse, BE,
(72) FOURIE, Anne, 13060 Callcott Way, San Diego, California 92130, US,
(74) Radulović Božidar, Jovana Tomaševića 9/III, Podgorica ME

1. Inhibitor farneziltransferaze za upotrebu u tretmanu sepse ili septičkog šoka, naznačen time, što inhibitor farneziltransferaze predstavlja jedinjenje formule (I):



njegovu stereoisomernu formu, farmaceutski prihvatljivu kiselo ili baznu adicijom so, naznačenu time, što tačkasta linija predstavlja moguću dvostruku vezu.

X predstavlja kiseonik ili sumpor;

R¹ predstavlja vodonik, C₁₋₂₀alkil, Ar¹, Ar²C₁₋₆alkil, kvinolinilC₁₋₆alkil, piridilC₁₋₆alkil, hidroksiC₁₋₆alkil, C₁₋₆alkiloksiC₁₋₆alkil, mono- ili di(C₁₋₆alkil)aminoC₁₋₆alkil, aminoC₁₋₆alkil grupu ili radikal formule -Alk¹-C(O)-R¹ - Alk¹-S(O)-R¹ ili -Alk¹-S(O)₂-R¹, naznačen time, što Alk¹ predstavlja C₁₋₆alkandil grupu, R² predstavlja hidroksi, C₁₋₆alkil, C₁₋₆alkiloksi, amino, C₁₋₆alkilamino grupu ili C₁₋₆alkilamino grupu supstituisanu sa C₁₋₆alkiloksisarbonil grupom;

R³, R⁴, R⁵ i R⁶ svaki nezavisno predstavlja vodonik, hidroksi, halogenu, cijano, C₁₋₆alkil, C₁₋₆alkiloksi, hidroksiC₁₋₆alkiloksi, C₁₋₆alkiloksiC₁₋₆alkiloksi, amino-C₁₋₆alkiloksi, mono- ili di(C₁₋₆alkil)aminoC₁₋₆alkiloksi, Ar², Ar²C₁₋₆alkil, Ar²oksi, Ar²C₁₋₆alkiloksi, hidroksikarbonil, C₁₋₆alkiloksisarbonil, trihalometil, trihalometoksi, C₂₋₆alkenil, 4,4-dimetiloksazolil grupu; ili R³ i R⁴ zajedno, kada su na susjednim pozicijama, mogu da formiraju bivalentni radikal formule



ili



R⁷ i R⁸ svaki nezavisno predstavlja vodonik, halogenu, Ar¹, C₁₋₆alkil, hidroksi-C₁₋₆alkil, C₁₋₆alkiloksiC₁₋₆alkil, C₁₋₆alkiloksi, C₁₋₆alkiloksi, amino, hidroksikarbonil, C₁₋₆alkiloksisarbonil, C₁₋₆alkilS(O)C₁₋₆alkil ili C₁₋₆alkilS(O)₂C₁₋₆alkil grupu;

R⁹ i R¹⁰ svaki nezavisno predstavlja vodonik, halogenu, cijano, C₁₋₆alkil, C₁₋₆alkiloksi, Ar²oksi, trihalometil, C₁₋₆alkiloksi, di(C₁₋₆alkil)amino grupu ili R⁹ i R¹⁰ zajedno, kada su na susjednim pozicijama, mogu da formiraju bivalentni radikal formule



ili



R¹¹ predstavlja vodonik, C₁₋₆alkil, cijano, hidroksikarbonil, C₁₋₆alkiloksisarbonil, C₁₋₆alkilkarbonilC₁₋₆alkil, cijanoC₁₋₆alkil, C₁₋₆alkiloksisarbonilC₁₋₆alkil, karboksilC₁₋₆alkil, hidroksiC₁₋₆alkil, aminoC₁₋₆alkil, mono- ili di(C₁₋₆alkil)aminoC₁₋₆alkil, imidazolil, haloC₁₋₆alkil, C₁₋₆alkiloksiC₁₋₆alkil, aminokarbonilC₁₋₆alkil grupu ili radikal formule

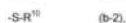

naznačen time, što R¹⁰ predstavlja vodonik, C₁₋₆alkil, C₁₋₆alkilkarbonil, Ar², Ar²C₁₋₆alkil, C₁₋₆alkiloksisarbonilC₁₋₆alkil grupu ili radikal formule -Alk²-OR¹⁰ ili -Alk²-NR¹¹R¹²;

R¹¹ predstavlja vodonik, C₁₋₆alkil, Ar² ili Ar²C₁₋₆alkil grupu;

R¹² predstavlja vodonik, C₁₋₆alkil, C₁₋₆alkilkarbonil, C₁₋₆alkiloksisarbonil, C₁₋₆alkilaminokarbonil, Ar², Ar²C₁₋₆alkil, C₁₋₆alkilkarbonilC₁₋₆alkil grupu, pirrolidnu aminokiselinu, Ar²karbonil, Ar²C₁₋₆alkilkarbonil, aminokarbonilkarbonil, C₁₋₆alkiloksiC₁₋₆alkilkarbonil, hidroksi, C₁₋₆alkiloksi, aminokarbonil, di(C₁₋₆alkil)aminoC₁₋₆alkilkarbonil, amino, C₁₋₆alkilamino, C₁₋₆alkilkarbonilamino grupu ili radikal formule -Alk²-OR¹² ili -Alk²-NR¹¹R¹²; naznačen time, što Alk² predstavlja C₁₋₆alkandil grupu; R¹³ predstavlja vodonik, C₁₋₆alkil, C₁₋₆alkilkarbonil, hidroksiC₁₋₆alkil, Ar² ili Ar²C₁₋₆alkil grupu; R¹⁴ predstavlja vodonik, C₁₋₆alkil, Ar² ili Ar²C₁₋₆alkil grupu; R¹⁵ predstavlja vodonik, C₁₋₆alkil, C₁₋₆alkilkarbonil, Ar² ili Ar²C₁₋₆alkil grupu;

R¹⁶ predstavlja vodonik, halogenu, cijano, C₁₋₆alkil, C₁₋₆alkiloksisarbonil ili Ar² grupu;

R¹⁷ predstavlja vodonik, C₁₋₆alkil, C₁₋₆alkiloksi ili halogenu grupu;

R¹⁸ predstavlja vodonik ili C₁₋₆alkil grupu;

Ar¹ predstavlja fenil grupu ili fenil grupu supstituisanu sa C₁₋₆alkil, hidroksi, amino, C₁₋₆alkiloksi ili halogenom grupom; i Ar² predstavlja fenil grupu ili fenil grupu supstituisanu sa C₁₋₆alkil, hidroksi, amino, C₁₋₆alkiloksi ili halogenom grupom.

- (51) **C07H 19 06/** ^{2006.1} (11) **01478**
C07H 19 10/ ^{2006.1} (21) **P-2013-47**
A 61K 317072/ ^{2006.1}

- (22) 11. 05. 2010
 (30) 09160215 14. 05. 2009 EP
 (96) EP/10718207/11. 05. 2010
 (97) PCT/EP2010/056438
 WO 2010/130726/18. 11. 2010/en/2010/46
 EP 2430035/21. 03. 2012/en/2012/12
 EP 2430035/03. 04. 2013/en/2013/14

- (54) me **URACIL SPIROOKSETANSKI NUKLEOZIDI**
 en URACYL SPIROOXETANE NUCLEOSIDES

- (73) Janssen Products, L.P., 800/850 Ridgeway Drive, Horsham PA 19044, US,
 Medivir AB, Lunastigen 7, 141 44 Huddinge, SE,
 (72) JONCKERS, Tim, Hugo, Maria, Pastoor Wouterstraat 19 bus 5, B-2650 Edegem, BE,
 RABOISSON, Pierre, Jean-Marie, Bernard, Rue Jolie 3, B-1331 Rosieres, BE,
 VANDYCK, Koen, Deurnestraat 74, B-3583 Paal-Beringen, BE,
 VAN HOOFF, Steven, Maurice, Paula, Hundelgemsesteenweg 804, B-9820 Merelbeke, BE,
 HU, Lili, Vrouw van Mechelenstraat 28, B-2800 Mechelen, BE,
 TAHRI, Abdellah, Rue Maurice Albert Raskin 30, B-1070 Anderlecht, BE,
 (74) Radulović Božidar, Jovana Tomaševića 9/III, Podgorica ME
 (57) Jedinjenje, naznačeno time, daje predstavljeno sa formulom I

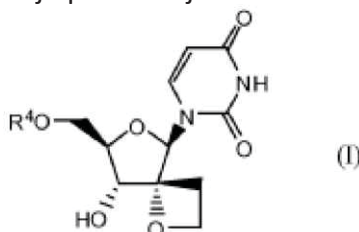

uključujući sve njegove moguće stereoizomere, gdje: R⁴ je monofosfat, difosfat ili trifosfat ester; ili R⁴ je grupa sa formulom ili

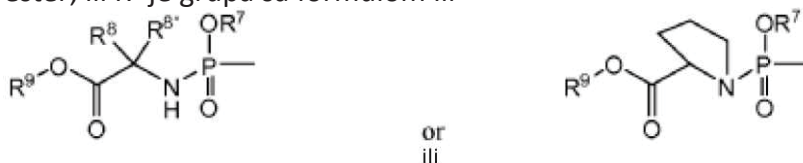

R⁷ je fenil, ponekad supstituisan sa 1, 2 ili sa 3 supstituenta od kojih je svaki nezavisno izabran iz halo, Ci-C₆alkila, C₃-C₆alkenila, Ci-C₆alkoksi, hidroksi i amino; ili R⁷ je naftil, ponekad supstituisan sa 1, 2 ili sa 3 supstituenta od kojih je svaki nezavisno izabran iz halo, Ci-C₆alkila, C₃-C₆alkenila, Ci-C₆alkoksi, hidroksi i amino; ili R⁷ je indolil, ponekad supstituisan sajednom C₁-C₆alkiloksi-karbonilnom grupom, a ponekad dodatno sa 1, 2 ili sa 3 supstituenta od kojih je svaki nezavisno izabran iz halo, C₁-C₆alkila, C₃-C₆alkenila, C₁-C₆alkoksi, hidroksi i amino; R⁸ je vodonik, C₁-C₆alkil, benzil ili fenil; R^{8'} je vodonik, C₁-C₆alkil, benzil ili fenil; ili R⁸ i R^{8'} zajedno sa atomom ugljenika na kojeg su vezani formiraju C₃-C₇cikloalkil; R₉ je C₁-C₁₀alkil, C₃-C₇cikloalkil ili fenil-C₁-C₆alkil, gde pomenuti fenilni ostatak u fenil u ili fenil- C₁-C₆alkilu je ponekad supstituisan sa 1, 2 ili 3 supstituenta od kojih je svaki nezavisno izabran iz hidroksi, C₁-C₆alkoksi, amino, mono- i diC₁-C₆alkilamino;ili njegova farmaceutski prihvatljiva so ili solvat.

Patent sadrži još 13 patentnih zahtjeva.

- (51) **A61K31522** / ²⁰⁰⁶⁰¹
A61K31 519 / ²⁰⁰⁶⁰¹
A61 P2528 / ^{2006.01}
- (22) 22. 08. 2008
- (30) 957525P 23. 08. 2007 US
957523P 23. 08. 2007 US
- (96) EP/08794174.6
- (97) /PCT/SE2008/050950
WO 2009/025618/26. 02. 2009/2009/09
EP 2200616/30. 06. 2010/en/2010/26
EP 2200616/26. 12. 2012/en/2012/52
- (54) me **MIPO INHIBITORI ZA TRETIRANJE HUNTINGTONOVE BOLESTI I
MULTIPLE SISTEMSKJE ATROFIJE**
en MIPO INHIBITORS FOR THE TREATMENT OF HUNTINGTON'S DISEASE AND MULTIPLE
SYSTEM ATROPHY
- (73) AstraZeneca AB, 151 85 Södertälje, SE,
- (72) ERIKSSON, Håkan, AstraZeneca R&D Södertälje, S-151 85 Södertälje, SE,
POEWE, Werner, Medical University Of Innsbruck, Department of Neurology, Anichstrasse
35, A-6020 Innsbruck, AT,
- (74) Radulović Božidar, Jovana Tomaševića 9/III, Podgorica ME
- (57) Upotreba l-(2-izopropoksietil)-2-tioksol, 2, 3, 5-tetrahidro-pirol[3, 2-d]pirimidin-4-ona
ili njegove farmaceutski prihvatljive soli, naznačena time što se odnosi na proizvodnju
medikamenta za tretiranje multiple sistemske atrofije (MSA).
Patent sadrži još 2 patentna zahtjeva.

(51) **A61K31 517** / ²⁰⁰⁶⁰¹
A61K47 38 / ²⁰⁰⁶⁰¹
A61K47 02 / ²⁰⁰⁶⁰¹

(11) **01505**
(21) **P-2013-50**

(22) 18. 05. 2005

(30) 0411378 21. 05. 2004 GB

(96) EP/05744858.1/18. 05. 2005

(97) WO/PCT/GB2005/001931

WO 2005/112934/01. 12. 2005/2005/48

EP 1753431/21. 02. 2007/en/2007/08

EP 1753431/19. 08. 2009/en/2009/34

(54) me **FARMACEUTSKE KOMPOZICIJE KOJE SADRŽE ZD6474**

en PHARMACEUTICAL COMPOSITIONS COMPRISING ZD6474

(73) AstraZeneca AB, 151 85 Södertälje, SE,

(72) STOTT, Paul. William, c/o AstraZeneca, Charter Way, Macclesfield, Cheshire SK10 2NA, GB,

(74) Radulović Božidar, Jovana Tomaševića 9/III, Podgorica ME

(57) Farmaceutska kompozicija, naznačena time, da obuhvata ZD6474 ili njegovu farmaceutski prihvatljivu so, krhki razređivač i drugi razređivač koji je praktički nerastvoriv u vodi i poseduje karakteristike rastegljivosti kompresije.

Patent sadrži još 4 patentna zahtjeva.

(51) **C07D401 12** / ²⁰⁰⁶⁰¹
C07D239 94 / ²⁰⁰⁶⁰¹
C07D211 16 / ²⁰⁰⁶⁰¹

(11) **01531**
(21) **P-2013-51**

(22) 27. 09. 2006
(30) 0519879 30. 09. 2005 GB
(96) EP/09152654.1/27. 09. 2006
(97) PCT/GB2006/003587/27. 09. 2006
WO 2007/036713/05. 04. 2007
EP 2053048/29. 04.2009/2009/18
EP 2053048/15. 09.2010/2010/37

(54) me **HEMIJSKI IN SITU POSTUPAK SULFONIRANJA**
en CHEMICAL IN SITU SULPHONATING PROCESS

(73) AstraZeneca AB, 151 85 Södertälje, SE,
(72) Blixt, Jörgen, AstraZeneca R&D Södertälje, SE-151 85, Södertälje, SE,
Golden, Michael, David, AstraZeneca Charter Way, Macclesfield, Cheshire SK10 2NA, GB,
Hogan, Philip, John, AstraZeneca Charter Way, Macclesfield, Cheshire SK10 2NA, GB,
Martin, David, Michael, Glanville, AstraZeneca Charter Way, Macclesfield, Cheshire SK10
2NA, GB,
Montgomery, Francis, Joseph, AstraZeneca Charter Way, Macclesfield, Cheshire SK10 2NA,
GB,
Patel, Zakariya, AstraZeneca R&D Charnwood Bakewell Road, Loughborough, Leicestershire
LE11 5RH, GB,
Pittam, John, David, AstraZeneca Charter Way, Macclesfield, Cheshire SK10 2NA, GB,
Sependa, George, Joseph, AstraZeneca Charter Way, Macclesfield, Cheshire SK10 2NA, GB
Squire, Christopher, John, AstraZeneca Charter Way, Macclesfield, Cheshire SK10 2NA, GB
Wright, Nicholas, Cartwright, Alexander, AstraZeneca Charter Way, Macclesfield, Cheshire
SK10 2NA, GB,
(74) Radulović Božidar, Jovana Tomaševića 9/III, Podgorica ME
(57) Postupak za dobivanje jedinjenja formule IIa:

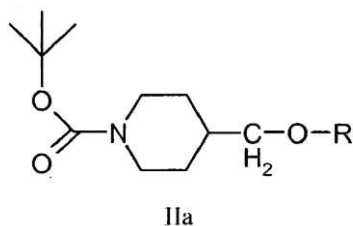

naznačen time što je R pogodni sulfonatni ester; iz (C₁-C₆)alkil-4-piperidinkarboksilatnog jedinjenja prema formuli III:

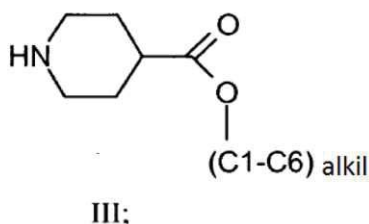

Pri čemu postupak uključuje sledeće korake: (b) uklanjanje viška terc-butanola iz prve smeše; (a) reakciju (C₁-C₆)alkil-4-piperidinkarboksilatnog jedinjenja prema formuli III s di-terc-butil dikarbonatom uz prisutnost toluena ili ksilena koji daju prvu smešu koja sadrži toluen

ili ksilen, terc-butanol i jedinjenje prema formuli IV:

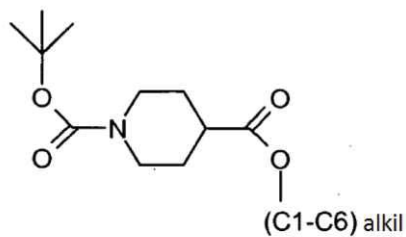

IV;

(c) reakciju jedinjenja prema formuli IV s pogodnim agensom za redukciju in situ uz prisutnost toluena ili ksilena koji daju drugu smešu koja sadrži toluen, redukcijske nuzproizvode uključujući alkoholne nuzproizvode i jedinjenje prema formuli V:

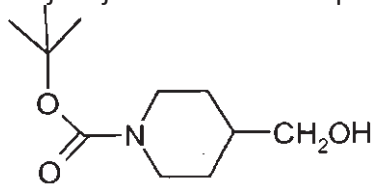

V;

(d) uklanjanje viška alkoholnih nuzproizvoda iz druge smeše; i (e) reakciju jedinjenja prema formuli V s pogodnim agensom za sulfoniranje in situ što daje sulfonatni ester uz prisutnost pogodne baze i toluena koji daju jedinjenje prema formuli IIa.

Patent sadrži još 7 patentnih zahtjeva.

(51) **C07D49810** / ²⁰⁰⁶⁰¹
A61K31357 / ²⁰⁰⁶⁰¹
A61P 11 06 / ²⁰⁰⁶⁰¹
A61P 11 08 / ²⁰⁰⁶⁰¹

(11) **01532**
(21) **P-2013-52**

(22) 04. 02. 2009

(30) 0802192 06. 02. 2008 GB 0822437 09. 12. 2008 GB

(96) EP/09709068.2/04. 02. 2009

(97) PCT/GB2009/000298/04. 02. 2009

WO 2009/098448/13. 08. 2009/en/2009/33

EP 2242759/27. 10. 2010/en/2010/43

EP 2242759/12. 09. 2012/en/2012/37

(54) me **JEDINJENJA**
en COMPOUNDS

(73) AstraZeneca AB, 151 85 Sodertalje, SE,
Pulmagen Therapeutics (Synergy) Limited, The Coach House Grenville Court, Britwell Road,
Burnham, Slough

(72) ALCARAZ, Lilian,
AstraZeneca R&D Charnwood, Bakewell Road, Loughborough Leicestershire E11 5RH, GB,
BAILEY, Andrew, AstraZeneca R&D Charnwood, Bakewell Road, Loughborough Leicestershire E11 5RH, GB,
BULL, Richard, James, Argenta Discovery Limited, 8/9 Spire Green Centre, Flex Meadow,
Harlow, Essex CM19 5TR, GB,
JOHNSON, Timothy, AstraZeneca R&D Charnwood, Bakewell Road, Loughborough Leicestershire E11 5RH, GB,
KINDON, Nicholas, David, AstraZeneca R&D Charnwood, Bakewell Road, Loughborough Leicestershire LE11 5RH, GB,
LISTER, Andrew, Stuart, AstraZeneca R&D Charnwood, Bakewell Road, Loughborough Leicestershire E11 5RH, GB,
ROBBINS, Andrew, James, AstraZeneca R&D Charnwood, Bakewell Road, Loughborough Leicestershire E11 5RH, GB,
STOCKS, Michael, John, AstraZeneca R&D Charnwood, Bakewell Road, Loughborough Leicestershire E11 5RH, GB,
TEOBALD, Barry, John, AstraZeneca R&D Charnwood, Bakewell Road, Loughborough Leicestershire E11 5RH, GB,

(74) Radulović Božidar, Jovana Tomaševića 9/III, Podgorica ME

(57) Jedinjenje, naznačeno time, da ima formulu I

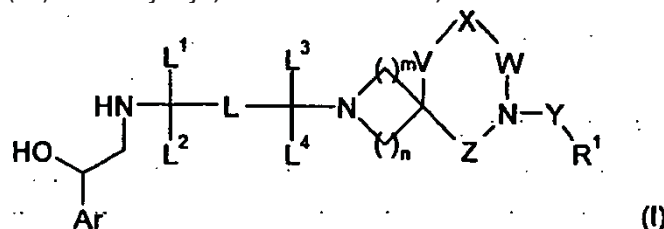

gde Ar predstavlja P-adrenoceptor vezna grupa; L predstavlja linker koji obuhvata ravno-lančani ili razgranati hidrokarbilni lanac od najviše 15 atoma ugljenika; gde najviše tri od pomenutih atoma ugljenika u pomenutom lancu su ponekad supstituisani sa najviše četiri supstituenta koji su nezavisno izabrani iz halogena, S(O)O-2R⁵⁶, NR⁵⁸, S(O)2NR⁵⁹R⁶⁰, C(O)NR⁶¹R⁶², C(O)OR⁶³, NR⁶⁴S(O)2R⁶⁵, NR⁶⁶C(O)R⁶⁷, NR⁶⁸C(O)OR⁶⁹, NR⁷⁰C(O)NR⁷¹R⁷², OR⁷³, C^{alkil} i C³-6cikloalkila i gde C^{alkil} i C³-6cikloalkil mogu da ponekad budu supstituisani sa najviše

tri supstituenta koja su nezavisno izabrana iz halogena, hidroksila i C_{1-6} alkoksi; gde najviše pet atoma ugljenika iz pomenutog lanca može da bude zamenjeno sa grupama koje su nezavisno izabrane iz O, NR^{45} , S, $S(O)$, $S(O)_2$, $C(O)O$, $OC(O)$, $NR^{46}C(O)$, $C(O)NR^{47}$, $NR^{48}S(O)_2$, $S(O)_2NR^{49}$, $NR^{50}C(O)NR$, $NR^{52}S(O)_2NR^{53}$, $OC(O)NR^{54}$, $NR^{55}C(O)O$, pod uslovom da bilo koja od pomenutih grupa u pomenutom lancu je odvojena sa najmanje 2 atoma ugljenika; i gde najviše šest atoma ugljenika u pomenutom lancu može da formira deo nekog mono- ili bicikličkog alifatskog, heteroalifatskog, aromatskog ili heteroaromatskog prstena koji ima najviše četiri heteroatoma koji su nezavisno izabrana iz N, O ili S, a pomenuti prsten sadrži najviše 10 atoma i gde pomenuti prsten je ponekad supstituisan sa najviše tri supstituenta koja su nezavisno izabrana iz halogena, $S(O)O$ - $2R^{56}$, $NR^{57}R^{58}$, $S(O)_2NR^{59}R^{60}$, $C(O)NR^{61}R^{62}$, $C(O)OR^{63}$, $NR^{64}S(O)_2R^{65}$, $NR^{66}C(O)R^{67}$, $NR^{68}C(O)OR^{69}$, $NR^{70}C(O)NR^{71}R^{72}$, OR^{73} , C^{\wedge} alkila i C_{3-6} cikloalkila, a gde C^{\wedge} alkil i C_{3-6} cikloalkil mogu ponekad da budu supstituisani sa najviše tri supstituenta koja su nezavisno izabrana iz halogena, hidroksila i C_{1-6} alkoksi; i pomenuti lanac može da obuhvata najviše tri takva prstena od kojih je svaki izabran nezavisno; gde R^{56} , R^{65} i R^{69} svaki nezavisno predstavljaju C_{1-6} alkil ili C_{3-6} cikloalkil gde pomenuti C_{1-6} alkil i C_{3-6} cikloalkil mogu ponekad da budu supstituisani sa najviše tri supstituenta nezavisno izabrana iz halogena, hidroksila, C_{1-6} alkoksi; i R^{45} , R^{46} , R^{47} , R^{48} , R^{49} , R^{50} , R^{51} , R^{52} , R^{53} , R^{54} , R^{55} , R^{57} , R^{58} , R^{59} , R^{60} , R^{61} , R^{62} , R^{63} , R^{64} , R^{66} , R^{67} , R^{68} , R^{70} , R^{71} , R^{72} i R^{73} svaki nezavisno predstavljaju vodonik, C_{1-6} alkil ili C_{3-6} cikloalkil, gde pomenuti C_{1-6} alkil i C_{3-6} cikloalkil može ponekad da bude supstituisan sa najviše tri supstituenta nezavisno izabrana iz halogena, hidroksila, C_{1-6} alkoksi; ili bilo koji od R^{57} i R^{58} , R^{59} i R^{60} , R^{61} i R^{62} ili R^{71} i R^{72} , zajedno sa atomom azota na kojeg su oba spojeni, mogu da formiraju 4 do 8-člani alifatski heterociklički prsten, gde pomenuti heterociklički prsten može da obuhvata najviše tri heteroatoma nezavisno izabrana iz N, O i S, gde pomenuti prsten može ponekad da bude supstituisan sa najviše tri supstituenta nezavisno izabrana iz halogena, hidroksila, C_{1-6} alkila ili C_{3-6} cikloalkila, gde pomenuti C_{1-6} alkil i C_{3-6} cikloalkil mogu ponekad da budu supstituisani sa najviše tri supstituenta nezavisno izabrana iz halogena, hidroksila i C_{1-6} alkoksi; i gde pomenuti lanac može dodatno da obuhvata najviše tri ugljenik-ugljenik dvostruke veze; gde pomenuti lanac može dodatno da obuhvata najviše tri ugljenik-ugljenik trostruke veze; L i L nezavisno predstavljaju vodonik, C_{1-6} alkil ili C_{3-6} cikloalkil; nezavisno predstavljaju vodonik, C_{1-6} alkil ili C_{3-6} cikloalkil, gde pomenuti C_{1-6} alkil i C_{3-6} cikloalkil mogu ponekad da budu supstituisani sa najviše tri supstituenta nezavisno izabrana iz halogena, hidroksila i C_{1-6} alkoksi; dodatno, L^1 i/ili L^3 mogu da budu spojeni na atome ugljenika iz hidrokarbilnog lanca u linkeru L sa ciljem da formiraju alifatske prstene od najviše 6 atoma, gde svaki prsten može da obuhvata najviše tri heteroatoma nezavisno izabrana iz N, O i S; R predstavlja fenilni prsten, 4 do 8-člani heteroalifatski prsten, 3 do 8-člani alifatski prsten ili 5 do 6-člani heteroarilni prsten, a svaki od njih ima najviše četiri heteroatoma nezavisno izabrana iz N, O ili S, a svaki od pomenutih prstena može ponekad da bude supstituisan sa najviše tri supstituenta nezavisno izabrana iz halogena, cijano, nitro, SH, $S(O)O$ - R^5 , NR^6R^7 , $S(O)_2NR^8R^9$, $C(O)NR^{10}R^{11}$, $C(O)OR^{12}$, $NR^{13}S(O)_2R$, $NR^{15}C(O)R^{16}$, $NR^{17}C(O)OR^{18}$, $NR^{19}C(O)NR^{20}R^{21}$, OR^{22} , C_{1-7} alkila ili C_{3-8} cikloalkila (svaki od pomenutih C_{1-7} alkil i C_{3-8} cikloalkil mogu da ponekad budu supstituisani sa najviše šest supstituenta nezavisno izabranih iz halogena, cijano, nitro, SH, $S(O)O$ - $2R^5$, NR^6R^7 , $S(O)_2NR^8R^9$, $C(O)NR^{10}R^{11}$, $C(O)OR^{12}$, $NR^{13}S(O)_2R^{14}$, $NR^{15}C(O)R^{16}$, $NR^{17}C(O)OR^{18}$, $NR^{19}C(O)NR^{20}R^{21}$, OR^{22}), fenilni prsten, 4 do 8-člani heteroalifatski prsten, 5 do 6-člani heteroarilni prsten, a svaki od njih ima najviše četiri heteroatoma nezavisno izabrana iz N, O ili S, a svaki od pomenutih: fenilni prsten, 4 do 8-člani heteroalifatski prsten, 3 do 8-člani alifatski prsten ili 5 do 6-člani heteroarilni prsten može ponekad da bude supstituisan sa najviše tri supstituenta nezavisno izabrana iz halogena, cijano, nitro, SH, $S(O)O$ - R^5 , $S(O)_2NR^8R^9$, $C(O)NR^{10}R^{11}$, $C(O)OR^{12}$, OR^{22} , Ci -6alkila ili $C3$ -6cikloalkila gde pomenuti Ci -6alkil i $C3$ -6cikloalkil mogu ponekad da budu supstituisani sa najviše tri supstituenta nezavisno

izabrana iz halogena, hidroksila, C₁₋₆ alkoksi, cijano, nitro, NH₂, NH(C₁₋₆ alkil) i N(C₁₋₆ alkil)₂; ili R¹ predstavlja fuzionisani alifatski, fuzionisani heteroalifatski, fuzionisani aromatski ili fuzionisani heteroarilni prsten od najviše 10 atoma koji ima najviše četiri heteroatoma nezavisno izabrana iz N, O ili S, a svaki od pomenutih prstena može da ponekad bude supstituisan sa najviše tri supstituenata nezavisno izabrana iz halogena, cijano, nitro, SH, S(O)₀₋₂R⁵, NR⁶R⁷, S(O)_{1,9}NR⁸R⁹, C₂(O₂)₁NR¹⁰R¹¹, C(O)OR¹², NR¹³S(O)2R¹⁴, NR¹⁵C(O)R¹⁶, NR¹⁷C(O)R¹⁸, NR¹⁹C(O)NR²⁰R²¹, OR²², C₁₋₆ alkila ili C₃₋₆ cikloalkila gde pomenuti C₁₋₆ alkil i C₃₋₆ cikloalkil mogu ponekad da budu supstituisani sa najviše tri supstituenta nezavisno izabrana iz halogena, hidroksila, C₁₋₆ alkoksi, NH₂, NH(C₁₋₆ alkil) i N(C₁₋₆ alkil)₂; ili R¹ dodatno predstavlja C₁₋₆ alkilni lanac gde jedan ili dva atoma ugljenika mogu da budu zamenjena sa O, S ili N, i gde R¹ može da bude supstituisan sa najviše tri C₁₋₃ alkilna lanca, a dva takva lanca mogu da budu spojena sa ciljem da formiraju neki C₃₋₈ cikloalkilni lanac gde pomenuti C₁₋₃ alkilni i C₃₋₈ cikloalkilni lanci mogu da ponekad budu supstituisani sa najviše tri supstituenta nezavisno izabrana iz halogena, cijano, nitro, SH, S(O)0-2R⁵, NR⁶R⁷, S(O)2NR⁸R⁹, C(O)NR¹⁰R¹¹, C(O)OR¹², NR¹³S(O)2R¹⁴, NR¹⁵C(O)R¹⁶, NR¹⁷C(O)OR¹⁸, NR¹⁹C(O)NR²⁰R²¹, OR²², i gde pomenuti C₁₋₆ alkilni lanac je dodatno ponekad supstituisan sa najviše tri supstituenta nezavisno izabrana iz halogena, cijano, nitro, SH, S(O)₀₋₂R⁵, NR⁶R⁷, S(O)2NR⁸R⁹, C(O)NR¹⁰R¹¹, C(O)OR¹², NR¹³S(O)2R¹⁴, NR¹⁵C(O)R¹⁶, NR¹⁷C(O)OR¹⁸, NR¹⁹C(O)NR²⁰R²¹, OR²², fenilnim prstenom, 4 do 8-članim heteroalifatskim prstenom, 3 do 8-članim alifatskim prstenom, 5 do 6-članim heteroarilnim prstenom od kojih svi imaju najviše četiri heteroatoma nezavisno izabrana iz N, O ili S, i gde svaki prsten je ponekad supstituisan sa najviše tri supstituenta nezavisno izabrana iz halogena, cijano, nitro, S(O)₀₋₂R⁵, S(O)₂NR⁸R⁹, C(O)NR¹⁰R¹¹, C(O)OR¹², OR²², C₁₋₇ alkila ili C₃₋₇ cikloalkila (svaki od pomenutih C₁₋₇ alkil i C₃₋₇ cikloalkil mogu ponekad da budu supstituisani sa najviše šest supstituenata nezavisno izabranih iz halogena, cijano, nitro, SH, S(O)_{1,7}0-2R⁵, NR⁶R⁷, S_{1,9}(O)2NR⁸R⁹, C₂(O)NR¹⁰R¹¹, C(O)OR¹², NR¹³S(O)2R¹⁴, NR¹⁵C(O)R¹⁶, NR¹⁷C(O)OR¹⁸, NR¹⁹C(O)NR²⁰R²¹, OR²²), fenilnog prstena, 4 do 8-članog heteroalifatskog prstena, 3 do 8-članog alifatskog prstena, 5 do 6-članog heteroarilnog prstena od kojih svaki ima najviše četiri heteroatoma nezavisno izabrana iz N, O ili S, a svaki od njih: fenilni prsten, 4 do 8-člani heteroalifatski prsten, 3 do 8-člani alifatski prsten ili 5 do 6-člani heteroarilni prsten može da ponekad bude supstituisan sa najviše tri supstituenta nezavisno izabrana iz halogena, cijano, nitro, S(O)0-2R⁵, S(O)2NR⁸R⁹, C(O)NR¹⁰R¹¹, C(O)OR¹², OR²², C[^]alkila ili C₃₋₆ cikloalkila, gde C₁₋₆ alkil i C₃₋₆ cikloalkil mogu svaki da ponekad budu supstituisani sa najviše tri supstituenta nezavisno izabrana iz halogena, hidroksila, C₁₋₆ alkoksi, NH₂, NH(C₁₋₆ alkil) i N(C₁₋₆ alkil)₂; ili pomenuti C₁₋₆ alkilni lanac može da bude supstituisan sa fuzionisanim alifatskim, fuzionisanim heteroalifatskim, fuzionisanim aromatskim ili fuzionisanim heteroarilnim prstenom od najviše 10 atoma i koji ima najviše četiri heteroatoma nezavisno izabrana iz N, O ili S, a svaki pomenuti prsten može da ponekad bude supstituisan sa najviše tri supstituenta nezavisno izabrana iz halogena, cijano, nitro, SH, S(O)0-2R⁵, NR⁶R⁷, S(O)2NR⁸R⁹, C(O)NR¹⁰R¹¹, C(O)OR¹², NR¹³S(O)2R¹⁴, NR¹⁵C(O)R¹⁶, NR¹⁷C(O)OR¹⁸, NR¹⁹C(O)NR²⁰R²¹, OR²², C[^]alkila ili C₃₋₆ cikloalkila gde pomenuti C₁₋₆ alkil i C₃₋₆ cikloalkil mogu da ponekad budu supstituisani sa najviše tri supstituenta nezavisno izabrana iz halogena, hidroksila, C₁₋₆ alkoksi, NH₂, NH(C₁₋₆ alkil) i N₅(C₁₋₆ alkil)₂; R⁵, R¹⁴ i R⁸ nezavisno predstavljaju C₁₋₆ alkil ili C₃₋₆ cikloalkil, gde pomenuti C₁₋₆ alkil i C₃₋₆ cikloalkil mogu da ponekad budu supstituisani sa jednim ili više supstituenta nezavisno izabranih iz halogena, hidroksila, C₁₋₆ alkoksi, NH₂, NH(C₁₋₆ alkil) i N(C₁₋₆ alkil)₂; i R⁶, R⁷, R⁸, R⁹, R¹⁰, R¹¹, R¹², R¹³, R¹⁵, R¹⁶, R¹⁷, R¹⁹, R²⁰, R²¹ i R²² svaki nezavisno predstavljaju vodonik, C₁₋₆ alkil ili C₃₋₆ cikloalkil, gde pomenuti C₁₋₆ alkil ili C₃₋₆ cikloalkil može ponekad da bude supstituisan sa jednim ili više supstituenata nezavisno izabranih iz halogena, hidroksila, C₁₋₆ alkoksi, NH₂, NH(C₁₋₆ alkil) i N(C₁₋₆ alkil)₂; ili bilo koji od R⁶ i R⁷, R⁸ i R⁹, R¹⁰ i R¹¹ ili R²⁰ i R²¹ zajedno sa atomom azota na kojemu su oba spojena, mogu da formiraju 4 do 8-člani alifatski heterociklički

prsten, gde pomenuti heterociklički prsten može ponekad da bude supstituisan sa jednim ili više supstituenata nezavisno izabranih iz halogena, hidroksila, C₁₋₆alkila, C₁₋₆cikloalkila i C₁₋₆alkoksi, gde pomenuti C₁₋₆alkil, C₁₋₆cikloalkil ili C₁₋₆alkoksi mogu ponekad da budu supstituisani sa jednim ili više supstituenata nezavisno izabranih iz halogena, hidroksila i C1-6alkoksi, NH₂, NH(C1-6alkil) i N(C1-6alkil)₂; X predstavlja O, S, S(O)_n ili CR²⁵R²⁶; m = 0, 1, 2 ili 3; n = 1, 2, 3 ili 4; pod uslovom da m + n je veći ili jednak na 2 o = 1, 2; W predstavlja CR²⁷R²⁸CR²⁹R³⁰ ili CR³¹R³²CR³³R³⁴CR³⁵R³⁶; V i Z nezavisno predstavljaju neku vezu, CR³⁷R³⁸ ili CR³⁹R⁴⁰CR⁴¹R⁴², pod uslovom da kada X predstavlja O, S ili S(O)_n, tada m, V i Z su takvi da svi pomenuti heteroatomi u pomenutim prstenima su odvojeni sa najmanje dva atoma ugljenika (na primer, kada V je veza, tada m nije 0, a Z nije veza); Y predstavlja CO, CONR⁴³, SO₂ ili SO₂NR⁴⁴; R, R²⁶, R²¹, R²⁸, R²⁹, R³⁰, R³¹, R³², R³³, R³⁴, R³⁵, R³⁶, R³⁷, R³⁸, R³⁹, R⁴⁰, R⁴¹, R⁴² svaki nezavisno predstavlja vodonik, fluor ili C₁₋₆alkil ili C₃₋₆cikloalkil; a kada pomenuti ne predstavljaju vodonik ili fluor, R²⁵ i R²⁶, R²⁷ i R²⁸, R²⁹ i R³⁰, R³¹ i R³², R³³ i R³⁴, R³⁵ i R³⁶, R³⁷ i R³⁸, R³⁹ i R⁴⁰ ili R⁴¹ i R⁴² zajedno sa atomom ugljenika na kojeg su oba spojena, mogu dodatno da formiraju 3 do 6-člani alifatski prsten; R⁴³ i R⁴⁴ svaki nezavisno predstavljaju vodonik, C₁₋₆alkil ili C₃₋₆cikloalkil i njegove farmaceutski prihvatljive soli.

Patent sadrži još 30 patentnih zahtjeva.

(51) **C14B3 00** / ⁰⁰⁶⁰¹
C 14C 1500 / ²⁰⁰⁶⁰¹ (11) **01533**
 (21) **P-2013-53**

(22) 28. 01. 2011

(96) EP/11000700.2/28. 01. 2011

(97) EP 2481821 /01. 08. 2012/en/2012/31

EP 2481821 /20. 03. 2013/en/2013/12

(54) me **POSTUPAK ZA OBRADU PRERAĐENE KOŽE**
 en PROCESS FOR TREATING LEATHER

(73) Boxmark Leather proizvodnja in trgovina d.o.o., Industrijsko naselje 10, 2325 Kidricevo, SI

(72) Herga, Davorin, Moskanjci 88a, 2272 Gorisnica, SI,

(74) Đakonović Vido, Bajova 9, Cetinje ME

(57) Postupak za obradu prerađene kože, sastoji se od mljevenja sirove kože u rotacionom bubnju naznačen time što obuhvata sljedeće korake: a. Pomenuto mljevenje sirovih koža (2) u rotacionom bubnju (1) još obuhvata i sljedeće podpostupke: i. početno mljevenje pomenutih sirovih koža (2) u pomenutom rotacionom bubnju(1); ii . prskanje pomenutih sirovih koža (2) mješavinom hemikalija kroz mlaznicu (4) ili velikog broja ovih koža u pomenutom bubnju (1); iii. podvrgavanje pomenutih sirovih koža (2) u pomenutom rotacionom bubnju (1) regulaciji klime, poželjno grijanju, tako da poslije ovog postupka sirove kože (2) imaju između 30% i 40% apsolutne vlažnosti ; b. Sušenje pomenutih sirovih koža (2); c.Mljevenje pomenutih sirovih koža (2) u pomenutom rotacionom bubnju (1) u vremenskom periodu koji traje između 5 i 10 sati.

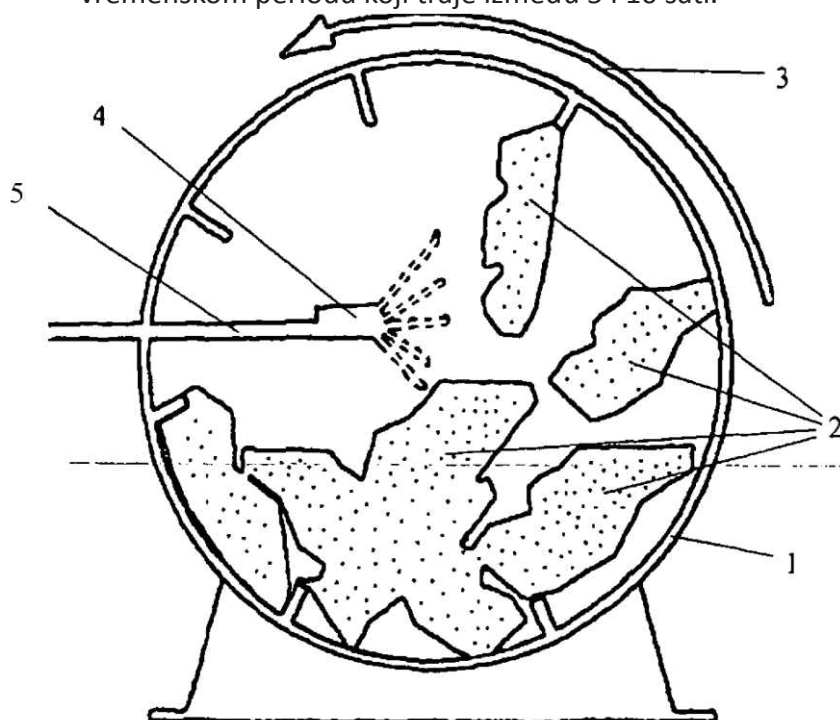

Fig. 1

Patent sadrži još 7 patentnih zahtjeva.

- (51) **A61K31485** / ²⁰⁰⁶⁰¹
A61K9 22 / ²⁰⁰⁶⁰¹
A61K9 32 / ²⁰⁰⁶⁰¹
- (22) 24. 08. 2007
- (30) 840244P 25. 08. 2006 US
- (96) EP/11157003.2/24. 08. 2007
- (97) EP 2384754/09. 11. 2011/en/2011/45
EP 2384754/20. 03. 2013/en/2013/12
- (54) me **FARMACEUTSKI DOZNI OBLICI**
en PHARMACEUTICAL DOSAGE FORMS
- (73) Purdue Pharma LP, One Stamford Forum, 201 Tresser Boulevard, Stamford, CT 06901, US
- (72) Mannion, Richard Owen, 3860 Green Ridge Road, Furlong, PA 18925, US,
Huang, Haiyong Hugh, 33 Ketley Place, Princeton, NJ 08540, US,
McKenna, William Henry, 10 Longmeadow Road, Yonkers, NY 10704, US,
O'Donnell, Edward, P., 38 Chestnut Court, Basking Ridge, NJ 07920, US,
- (74) Lutovac Branislav, Bulevar Crnojevića 93, Podgorica ME
- (57) Čvrst oralni farmaceutski dozni oblik sa produženim oslobađanjem, koji sadrži formulaciju matrice sa produženim oslobađanjem, a formulacija matrice sa produženim oslobađanjem sadrži kompoziciju koja sadrži bar jedan aktivan agens i bar jedan polietilen oksid koji na osnovu reoloških merenja ima približnu molekulsku težinu od najmanje 1, 000, 000; i gde formulacija matrice sa produženim oslobađanjem očvršćava na temperaturi od bar oko 60°C u toku vremenskog perioda od bar oko 1 minuta u obliku tablete ili zrnaca, gde tableta ili pojedinačna zrnca mogu biti bar zdrobljena bez lomljenja, naznačen time, što debljina tablete ili pojedinačnog zrnca posle ovog gnječenja, nije veća od oko 60% debljine te tablete ili pojedinačnog zrnca pre nego što su zgnječeni, pri čemu pomenuta zgnječena tableta ili zgnječena zrnca imaju brzinu rastvaranja in vitro, merenu u aparatu USP Apparatus 1 (sa korpom), pri 1 00 o/min, u 900 ml simuliranog želudačnog fluida bez enzima (SŽF), na 37° C, naznačen time, što procenat oslobođene aktivne supstance tokom 0, 5 sati rastvaranja, ne odstupa više od oko 20% od odgovarajuće brzine oslobađanja in vitro referentne tablete ili referentnih zrnaca koji nisu zgnječeni.
Patent sadrži još 26 patentnih zahtjeva.

- (51) **A61K31485** / ²⁰⁰⁶⁰¹
A61K9 22 / ²⁰⁰⁶⁰¹
A61K932 / ^{2006.01}
- (22) 24. 08. 2007
- (30) 0840244P 25. 08. 2006 US
- (96) EP/11156997.6/24. 08. 2007
- (97) EP 2343071 /13. 07. 2011/en/2011/28
EP 2343071 /20. 03. 2013/en/2013/12
- (54) me **FARMACEUTSKI DOZNI OBLICI**
en PHARMACEUTICAL DOSAGE FORMS
- (73) Purdue Pharma LP, One Stamford Forum, 201 Tresser Boulevard, Stamford, CT 06901, US
- (72) Mannion, Richard Owen, 3860 Green Ridge Road, Furlong, PA 18925, US,
Huang, Haiyong Hugh, 33 Ketley Place, Princeton, NJ 08540, US,
McKenna, William Henry, 10 Longmeadow Road, Yonkers, NY 10704, US,
O'Donnell, Edward, P., 38 Chestnut Court, Basking Ridge, NJ 07920, US,
- (74) Lutovac Branislav, Bulevar Crnojevića 93, Podgorica ME
- (57) Postupak za dobijanje čvrstog oralnog farmaceutskog doznog oblika sa produženim oslobađanjem, koji bar obuhvata korake: (a) kombinovanja bar (1) najmanje jednog polietilen-oksida, koji na osnovu reoloških merenja ima približnu molekulsku težinu od najmanje 800, 000, i (2) najmanje jednog aktivnog agensa, formirajući kompoziciju; (b) oblikovanja ove kompozicije uz formiranje formulacije matrice za produženo oslobađanje ; i (c) očvršćavanja pomenute formulacije matrice za produženo oslobađanje, koje se sastoji najmanje od koraka očvršćavanja, podvrgavanjem formulacijematrice za produženo oslobađanje temperaturi koja je najmanje jednaka temperaturi omekšavanja pomenutog polietilen-oksida, tokom periodavremena od najmanje oko 1 min.
Patent sadrži još 81 patentni zahtjev.

(51) **A47J 4506/** ²⁰⁰⁶⁰¹(11) **01547**(21) **P-2013-61**

(22) 07. 06. 2010

(30) MI20090187U 08. 06. 2009 IT

(96) EP/10724496.4/07. 06. 2010

(97) PCT/EP2010/057913/07.06.2010

WO 2010/142636/16. 12. 2010/en/2010/50

EP 2440096/18. 04. 2012/en/2012/16

EP 2440096/08. 05. 2013/en/2013/19

(54) me **TIGANJ SA SUPROTNO SAVIJENOM DRŠKOM**

en PAN WITH AN INVERTED CURVED HANDLE

(73) SANMIRO S.R.L., Via Raffaello, 4, 23861 Cesana Brianza (LC), IT,

(72) FULIGNO, Daniele, Via Carnevali 6, 61122 Pesaro (PU), IT,

(74) AOD "Ćupić", Dalmatinska 10, Podgorica ME

(57) Tiganj (1) sa savijenom drškom (2) ima slobodan završetak (8), dok je krivina drške (2) kontinualna bez promena u konkavnosti u oblasti sučeljavanja sa površinom (3) za pripremanje hrane, a slobodan završetak (8) je na visini (h) u odnosu na horizontalnu oslonu ravan tiganja (1), koja je viša od visine pričvršćenog završetka (6) drške (2), pri čemu drška ima početak na pričvršćenom završetku (5, 6) tiganja (1) prvom sekcijom (4), koja se pruža ka spoljašnjosti u odnosu na težište tiganja (1) i koja je povezana sa drugom sekcijom (7) za držanje, gde se ona pruža ka unutrašnjosti iznad prve sekcije (4), naznačen time, što se slobodan završetak (8) završava pre ulaska u prostor (30, 31) iznad površine (3) za pripremu hrane tako da se tačka (100) hvatanja nalazi unutar razmaka između vezne zone (11) u kojoj se spajaju navedene sekcije (4, 7) i ivice (31) tiganja (1), a na rastojanju od ivice (31) površine (3) za pripremanje hrane jednakom polovini rastojanja od zone (11) spajanja navedenih sekcija (4, 7) i ivice (31) tiganja (1), pri čemu je druga sekcija (7) nagnuta u odnosu na horizontalnu liniju na takav način da ugao (200) zahvata između podlaktice (31 O) i šake (303) u suštini iznosi 0° i na takav način u odnosu na horizontalnu liniju da ugao između ruke (311) i podlaktice (310) iznosi oko 90°.

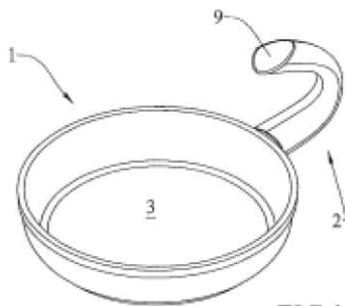

FIG.1

- (51) **H04M3/22**²⁰⁰⁶⁰¹ (11) **01557**
H04M3 /42²⁰⁰⁶⁰¹ (21) **P-2013-63**
- (22) 08. 04. 2011
(30)
(96) EP/11161703.1/08. 04. 2011
(97) EP 2509294/10. 10. 2012/en/2012/41
EP 2509294/03. 04. 2013/en/2013/14
- (54) me **SISTEM ZA DETEKCIJU BAJPASA TELEKOMUNIKACIONE MREŽE SA SMANJENIM RIZIKOM OD KONTRA-DETEKCIJE**
en A TELECOMMUNICATION NETWORK BYPASS DETECTION SYSTEM WITH REDUCED CO-UNTER DETECTION RISK
- (73) Meucci Solutions NV, Bellevue 5 - 601, 9050 Gent-Ledeberg, BE,
(72) Van der Meeren, Guy, Heerweg Zuid 62, 9052, GENT, BE,
Tuytte, Conrad, Haenhoutstraat 149, 9070, DESTELBERGEN, BE,
De Bontridder, Lieven, Zarlardingestraat 128, 9500, GERAARDSBERGEN, BE,
Philips, Peter, Guido Gezellelaan 37, 1910, KAMPENHOUT, BE,
Mouton, Kenneth, Ottergemsesteenweg 172, 9000, GENT, BE,
Verlinde, Dirk, Poelkappellestraat 16 C, 8650, HOUTHULST, BE,
(74) Đakonović Vido, Bajova 9, Cetinje ME
- (57) Sistem (I) za detekciju ba j pasa (540) interkonekcije (530) ka telekomunikacionoj Mreži (50) koja se testira, pri čemu pomenuti sistem (I) obuhvata: -sredstvo (10) prilagođeno da inicira testni poziv ka pomenutoj telekomunikacionoj mreži (50) koja se testira izvan telekomunikacione mreže (50) koja se testira; -bar jednu prijemnu sondu (20) na terminirajućem pretplatničkom broju (80) za terminiranje pomenutog testnog poziva; i -kontrolni sistem (40) konfigurisan da:
- inicira testni poziv;
 - prima sa prijemne sonde (20) informacije o pozivu koje obuhvataju primljenu identifikaciju pozivajućeg pretplatnika, CLI, testnog poziva; i
 - analizira primljenu identifikaciju pozivajućeg pretplatnika, CLI, tako da se može otkriti prisustvo bajpasa (540), naznačen time što - pomenuti sistem (1) dalje obuhvata:
 - ne-kaskadirani skup virtuelnih brojeva (81) konfigurisanih tako da se pomenuti testni pozivi terminiraju u jednoj fazi na pomenutom terminišućem pretplatničkom broju (80); i
 - sredstvo (11) konfigurisano za manipulaciju identifikacije pozivajućeg pretplatnika, CLI, i pri čemu pomenuti kontrolni sistem (40) je dalje konfigurisan:
 - da koristi pomenuti ne-kaskadirani skup virtuelnh brojeva (81) kao pozivanu stranu za pomenute testne pozive; i
 - da uspostavi testne pozive ka pomenutom skupu virtuelnih brojeva (81) sa pomenu-tog sredstva (11) konfigurisanog za manipulaciju identifikacije pozivajućeg pretplatnika, CLI, kroz pomenuto sredstvo (10) za iniciranje testnog poziva, - pomenuti skup virtuelnih brojeva (81) ili manipulisanih CLI podeljenih u podskupove koji se koriste uzastopno rotirajućim redosledom
- Patent sadrži još 10 patentnih zahtjeva.

- (51) **C 07J 3100/** ²⁰⁰⁶⁰¹
C07J4100 / ²⁰⁰⁶⁰¹
A61K31567 / ²⁰⁰⁶⁰¹
A61P 5 36/ ²⁰⁰⁶⁰¹

- (11) **01534**
(21) **P-2013-69**

- (22) 07. 07. 2010
(30) 102009034362 20. 07. 2009 DE
(96) EP/10735198.3/07. 07. 2010
(97) PCT/EP2010/004149/07. 07. 2010
WO 2011/009531 /27. 01. 2011/de/2011/04
EP 2432798/28. 03. 2012/de/2012/13
EP 2432798/03. 04. 2013/de/2013/14

- (54) me **17-HIDROKSI-17-PENTAFLUORETIL-ESTRA-4, 9(10)-DIEN -11-ARIL-
DERIVAT, POSTUPAK NJEGOVE PROIZVODNJE I NJEGOVA UPOTREBA U
TERAPIJI BOLESTI**

en 17-HYDROXY-17-PENTAFLUORETHYL-ESTRA-4, 9(10)-DIEN-11-ARYL DERIVATIVE, MET-
HODS FOR THE PRODUCTION THEREOF AND USE THEREOF FOR TREATING DISEASES

- (73) Bayer Intellectual Property GmbH, Alfred-Nobel-Strasse 10, 40789 Monheim, DE,
(72) SCHWEDE, Wolfgang, Magdeburger Str. 41a, 16548 Glienicke, DE,
KLAR, Ulrich, Isegrimsteig 8, 13503 Berlin, DE,
MÖLLER, Carsten, Pflugstr. 9a, 10115 Berlin, DE,
ROTGERI, Andrea, Damwildsteig 21, 13503 Berlin, DE,
BONE, Wilhelm, Drewitzer Str. 46, 13467 Berlin, DE,
(74) Radulović Božidar, Jovana Tomaševića 9/III, Podgorica ME
(57) Jedinjenje naznačeno time da je (11β, 17 β)-17-hidroksi- 11-[4-(metilsulfonyl)fenil]-17-

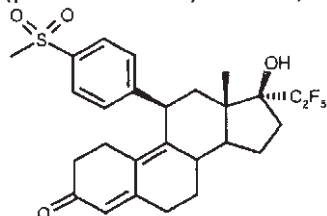

i njegove soli.

Patent sadrži još 1 patentni zahtjev.

- (51) **A61K31485** / ²⁰⁰⁶⁰¹
A61K9 22 / ²⁰⁰⁶⁰¹
A61K9 32 / ²⁰⁰⁶⁰¹
- (11) **01551**
(21) **P-2013-75**
- (22) 24. 08. 2007
(30) 20060840244P 25. 08. 2006 US
(96) EP/11157013.1/24. 08. 2007
(97) EP 2399580/28. 12. 2011/en/2011/52
EP 2399580/03. 04. 2013/en/2013/14
- (54) me **FARMACEUTSKI DOZNI OBLICI**
en PHARMACEUTICAL DOSAGE FORMS
- (73) Purdue Pharma L.P., One Stamford Forum, 201 Tresser Boulevard, Stamford, CT 06901, US
(72) Mannion, Richard Owen, 3860 Green Ridge Road, Furlong, PA 18925, US,
Huang, Haiyong Hugh, 33 Ketley Place, Princeton, NJ 08540, US,
McKenna, William Henry, 10 Longmeadow Road, Yonkers, NY 10704, US,
O'Donnell, Edward, P., 38 Chestnut Court, Basking Ridge, NJ 07920, US,
(74) Lutovac Branislav, Bulevar Crnojevića 93, Podgorica ME
(57) Čvrst oralni farmaceutski dozni oblik sa produženim oslobađanjem, koji sadrži formulaciju matrice sa produženim oslobađanjem, a formulacija matrice sa produženim oslobađanjem sadrži kompoziciju koja sadrži bar
- (1) najmanje jedan aktivni agens izabran od opioidnih analgetika;
 - (2) najmanje jedan polietilen oksid koji na osnovu reoloških merenja ima približnu molekulsku težinu od najmanje 1, 000, 000; i
 - (3) najmanje jedan polietilen oksid koji na osnovu reoloških merenja ima približnu molekulsku težinu manju od 1, 000, 000;
- gde kompozicija sadrži bar oko 80 mas. % polietilen oksida i bar oko 50 mas.% polietilen oksida koji ima na osnovu reoloških merenja molekulsku težinu bar 1, 000, 000.
Patent sadrži još 25 patentnih zahtjeva.

(51) **C07D23364** / ²⁰⁰⁶⁰¹
C07D23384 / ²⁰⁰⁶⁰¹
C07D40106 / ²⁰⁰⁶⁰¹

(11) **01529**
(21) **P-2013-113**

(22) 11. 05. 2010

(30) 20090290366 15. 05. 2009 EP

(96) EP/10721758.0/11. 05. 2010

(97) PCT/PCT/EP2010/056426

WO 2010/130718/18. 11. 2010/en

EP 2430002/21. 03. 2012/en/2012/12

EP 2430002 /24. 07. 2013/en/2013/30

(54) me **POSTUPAK ZA DOBIJANJE JEDINJENJA KOJE JE KORISNO KAO
INHIBITOR TAFIA**

en PROCESS FOR THE PREPARATION OF A COMPOUND USEFUL AS AN INHIBITOR OF TA-
FIA

(73) SANOFI, 54, rue La Boétie, 75008 Paris, FR,

(72) ROSSEN, Kai, c/o Sanofi-Aventis Deutschland GmbH, 65926 Frankfurt am Main, DE,
KRAFT, Volker, c/o Sanofi-Aventis Deutschland GmbH, 65926 Frankfurt am Main, DE,
WEHLAN, Hermut, c/o Sanofi-Aventis Deutschland GmbH, 65926 Frankfurt am Main, DE,
BIGOT, Antony, c/o sanofi-aventis, Département Brevets, 174 Avenue de France, F-75013
Paris, FR

CROCQ-STUERGA, Véronique, c/o sanofi-aventis, Département Brevets, 174 Avenue de
France, F-75013 Paris, FR,

(74) AOD "Ćupić", Dalmatinska 10, Podgorica ME,

(57) Jedinjenje 3-Z-[1-(4-(N-((4-metil-piperazin-1-il)-metilkarbonil)-N-metil-amino)-anilino)-
1-fenilmetilen]-6-metoksikarbonil-2-indolinon ili njegov tautomer, diastereomer,
enantiomer, njegove smješe ili njegova so, za primjenu u prevenciji ili liječenju idiopatske
plućne fibroze.

Patent sadrži još 1 patentni zahtjev.

- (51) **C07D495 20** / ²⁰⁰⁶⁰¹
A61K31444 / ²⁰⁰⁶⁰¹
A61P25 00 / ²⁰⁰⁶⁰¹
- (11) **01537**
(21) **P-2013-118**
- (22) 10. 11. 2010
(30) 20090382246 16. 11. 2009 EP
20100298629P 27. 01. 2010 US
(96) EP/10782482/10. 11. 2010
(97) PCT/2010US/056180/10. 11. 2010
WO 2011/060035/19. 05. 2011/en/2011/20
EP 2501703/26. 09. 2012/en/2012/39
EP 2501703/18. 09. 2013/en/2013/38
- (54) me **SPOJEVI SPIROPIPERIDONA KAO ANTAGONISTI RECEPTORA ORL-I**
en SPIROPIPERIDINE COMPOUNDS AS ORL-1 RECEPTOR ANTAGONISTS
- (73) Eli Lilly and Company, Lilly Corporate Center, Indianapolis, IN 46285, US,
(72) BENITO COLLADO, Ana Belen, Lilly S.A., Avendia de la Industria 30, 28108 Alcobendas Madrid, ES

- DIAZ BUEZO, Nuria, Lilly S.A., Avendia de la Industria 30, Madrid, ES,
JIMENEZ-AGUADO, Alma Maria, Lilly S.A., Avendia de la Industria 30, Madrid, ES,
LAFUENTE BLANCO, Celia, Lilly S.A., Avendia de la Industria 30, Madrid, ES,
MARTINEZ-GRAU, Maria Angeles, Lilly S.A., Avendia de la Industria 30, Madrid, ES,
PEDREGAL-TERCERO, Concepcion, Lilly S.A., Avendia de la Industria 30, Madrid, ES,
TOLEDO ESCRIBANO, Miguel Angel, Lilly S.A., Avendia de la Industria 30, Madrid, ES,
- (74) AOD „Ćupić“, Dalmatinska 10, Podgorica ME
- (57) Spoj formule: naznačen time što Rije fluór ili klor; svaki od R^{2a} i R^{2b} je vodik ili fluor; R³ je vodik, metil, hidroksimetil ili (C₁-C₃) alkoksimetil; R⁴ se bira iz skupine koju čine fluor, klor, cijano, cijanometil, (C₁-C₃) alkil, ciklopropil, hidroksimetil, metoksi, ciklopropilmetoksi, aminokarbonilmetoksi, (C₁-C₃) alkoksimetil, ciklopropiloksimetil, ciklopropilmetoksimetil, 1 -hidroksi-1 -metiletil, aminokarboniloksimetil, metilaminokarboniloksimetil, dimetilaminokarboniloksimetil, aminokarbonil, aminokarbonilmetil, -CH₂-NR⁵R⁶, hidroksiimin, metoksiimin, morfolin-4-il, morfolin-4-ilmetil, Ari, -CEkAri, tetrahidrofuran-2-il, 3 -oksomorfolin-4-ilmetil, 2-oksopiperidin-l-ilmetil i 2-oksopiperidin-l-ilmetil; R⁵ je vodik, C₁-C₃ alkil, cijanometil, -C(0)CH₃, ili aminokarbonilmetil; R⁶ je vodik ili metil; i An je ostatak kojeg se bira iz skupine koju čine imidizol-1-il, imidizol-2-il, 2-metilimidizol-1-il, pirazol- 1, 2, 3-triazol-1-il; 1, 2, 3-triazol-2-il; 1, 2, 4-triazol-1-il, isoksazol-3-il, oksazol-5-il, i 3-metil-1, 2, 4-oksadiazol-5-il; ili njegova farmaceutski prihvatljiva sol.

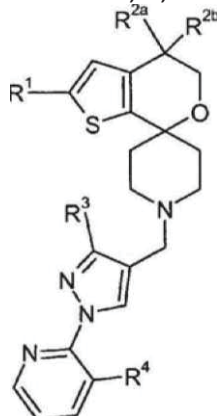

Preostalih patentnih zahtjeva 14.

(51) **C07D235 26** / ²⁰⁰⁶⁰¹
C07D47104 / ²⁰⁰⁶⁰¹
A61K314745 / ²⁰⁰⁶⁰¹
A61 P3500 / ^{2006.01}

(11) **01542**
(21) **P-2013-121**

(22) 17. 05. 2010
(30) 20090002392 18. 05. 2009 FR
(96) EP/10728768.2/17. 05. 2010
(97) PCT/2010FR/050948/17. 05. 2010
WO 2010/133794/25. 11. 2010/fr/2010/47
EP 2432766/28. 03. 2012/fr/2012/13
EP 2432766/17. 07. 2013/fr/2013/29

(54) me **ANTIKANCEROZNO JEDINJENJE I FARMACEUTSKA KOMPOZICIJA KOJA GA SADRŽI**

en ANTICANCER COMPOUND AND PHARMACEUTICAL COMPOSITION CONTAINING THE SAME

(73) SANOFI, 54, rue La Boétie, 75008 Paris, FR,

(72) CARRY, Jean-Christophe,

Sanofi-Aventis, Département Brevets, 174 Avenue de France, F-75013 Paris, FR,
CHEVE, Michel, Sanofi-Aventis, Département Brevets, 174 Avenue de France, F-75013 Paris, FR,

CLERC, François, Sanofi-Aventis, Département Brevets, 174 Avenue de France, F-75013 Paris, FR,

COMBEAU, Cécile, Sanofi-Aventis, Département Brevets, 174 Avenue de France, F-75013 Paris, FR,

GONTIER, Sylvie, Sanofi-Aventis, Département Brevets, 174 Avenue de France, F-75013 Paris, FR,

KRICK, Alain, Sanofi-Aventis, Département Brevets, 174 Avenue de France, F-75013 Paris, FR,

LACHAUD, Sylvette, Sanofi-Aventis, Département Brevets, 174 Avenue de France, F-75013 Paris, FR

SCHIO, Laurent, Sanofi-Aventis, Département Brevets, 174 Avenue de France, F-75013 Paris, FR,

(74) AOD "Ćupić", Dalmatinska 10, Podgorica ME,

(57) Jedinjenje formule (I) :

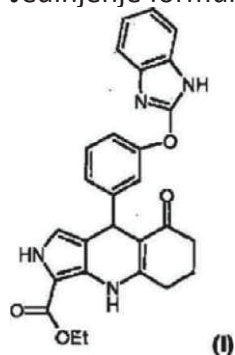

Preostalo patentnih zahtjeva 14.

(51) **C07D24910** / ²⁰⁰⁶⁰¹
A61K314196 / ²⁰⁰⁶⁰¹
A61 P2500 / ^{2006.01}

(11) **01539**
(21) **P-2013-122**

(22) 15. 12. 2010
(30) 20100305239P 17. 02. 2010 US
20090382290 21. 12. 2009 EP
(96) EP/10798419.7/15. 12. 2010
(97) PCT/2010US/060371/15. 12. 2010
WO 2011/084437/14. 07. 2011/en/2011/28
EP 2516406/31. 10. 2012/en/2012/44
EP 2516406/18. 09. 2013/en/2013/38

(54) me **AGONISTI MGLU2**
en MGLU2 AGONISTS

(73) Eli Lilly and Company, Lilly Corporate Center, Indianapolis, IN 46285, US

(72) MONN, James, Allen, Indianapolis, Indiana 46285, US,
PRIETO, Lourdes, Indianapolis, Indiana 46285, US,
TABOADA MARTINEZ, Lorena, Indianapolis, Indiana 46285, US,
MONTERO SALGADO, Carlos, Indianapolis, Indiana 46285, US,
SHAW, Bruce William, Indianapolis, Indiana 46285, US,

(74) AOD „Ćupić“, Dalmatinska 10, Podgorica ME,

(57) Spoj formule, naznačen time što R₁ je vodik, R₂ je vodik i R₃ je vodik; R₁ je vodik, R₂ je (2>S)-2-aminopropanoil, a R₃ je vodik; R₁ je vodik, R₂ je (2S)-2-amino-4-metilsulfanilbutanoil, a R₃ je vodik; R₁ je vodik, R₂ je (2S)-2-amino-4-metilpentanoil, a R₃ je vodik; R₁ je vodik, R₂ je 2-aminoacetil, a R₃ je vodik; R₁ je benzil, R₂ je vodik, a R₃ je benzil; ili R₁ je (2-fluorfenil)metil, R₂ je vodik, a R₃ je (2-fluorfenil)metil; ili njegova farmaceutski prihvatljiva sol ili solvat soli.

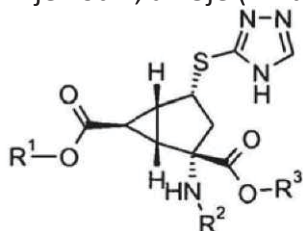

Preostalo patentnih zahtjeva 24.

(51) **C07D513 04** / ²⁰⁰⁶⁰¹

A61K3147 / ²⁰⁰⁶⁰¹

A61P3500 / ²⁰⁰⁶⁰¹

(22) 27. 05. 2010

(30) 20090181786P 28. 05. 2009 US

(96) EP/10721904.0/27. 05. 2010

(97) PCT/2010US/036312/27. 05. 2010

WO 2010/138665/02. 12. 2010/en/2010/48

EP/04. 04. 2012/10721904.0/en/2012/14

EP 2435443/31. 07. 2013/en/2013/31

(54) me **AMINOPIRAZOL TRIAZOLOTIADIAZOL INHIBITORI C-MET PROTEIN KINAZE**

en AMINOPYRAZOLE TRIAZOLOTHIADIAZOLE INHIBITORS OF C-MET PROTIEN KINASE

(73) Vertex Pharmaceuticals Inc., Cambridge, MA 02139, US,

(72) LAUFFER, David, Stow MA 01775, US,

LI, Pan, Lexington MA 02421, US, McGINTY, Kira, Schenectady NY 12304, US,

(74) Popović Miladin, Đoka Miraševića 21/III, Podgorica ME

(57) Jedinjenje koje ima formulu ili njegova farmaceutske prihvatljiva so u kome R¹ je Ci-3 alifatik; R² je vodonik, fluoro ili metil; R je vodonik, fluoro ili metil; svaki R⁴ je, nezavisno, vodonik ili fluoro; i R⁵ je vodonik, hloro, ciklopropil ili C1-4 alifatik, izborno supstituisan sa 1-3 atoma fluora.

Preostalo patentnih zahtjeva 16

- (51) **A61K31/382**²⁰⁰⁶⁰¹
A61K31/1555²⁰⁰⁶⁰¹
A61K31/4439²⁰⁰⁶⁰¹
A61K31/64²⁰⁰⁶⁰¹
A61K45/00²⁰⁰⁶⁰¹
A61P 3 /10²⁰⁰⁶⁰¹
A61P 5/50²⁰⁰⁶⁰¹
A61P 9 /10²⁰⁰⁶⁰¹
A61P9/14²⁰⁰⁶⁰¹
A61P 13/12²⁰⁰⁶⁰¹
A61P25/00²⁰⁰⁶⁰¹
A61P27/02²⁰⁰⁶⁰¹
A61P43/00²⁰⁰⁶⁰¹
C07D335/02²⁰⁰⁶⁰¹
- (11) **01555**
(21) **P-2013-137**
- (22) 16. 04. 2010
(30) 20090100210 16. 04. 2009 JP
(96) EP/10764570/16. 04. 2010
(97) WO/WO2010JP57196
WO 2010119990/21. 10. 2010/en/2010/42
EP 2419097/22. 02. 2012/en/2012/08
EP 2419097/25. 09. 2013/en/2013/39
- (54) me **FARMACEUTSKI PREPARAT KOJI SADRŽI {IS}-1, 5-ANHIDRO-1-[5-{4-ETOKSIBENZIL)-2-METOKSI-4-METILFENIL]-1- TIO-D-GLUCITOL I METFORMIN I NJEGOVE UPOTREBE U LIJEČENJU DIJABETESA**
en PHARMACEUTICAL COMPOSITION COMPRISING {IS}-1, 5-ANHYDRO-1-[5-{4-ETHOXYBENZYL)-2-METHOXY-4-METHYLPHENYL]-1-THIO-D-GLUCITOL AND METFORMIN AND USES THEREOF IN THE TREATMENT OF DIABETES
- (73) Taisho Pharmaceutical Co., Ltd., 24-1, Takada 3-chome Toshima-ku, Tokyo 170-8633, JP,
(72) TAKAHASHI, Teisuke, c/o Taisho Pharmaceutical Co. Ltd., 24-1 Takada 3-chome, Toshima-ku, Tokyo 170-8633, JP,
UCHIDA, Saeko, c/o Taisho Pharmaceutical Co. Ltd., 24-1 Takada 3-chome, Toshima-ku, Tokyo 170-8633, JP,
(74) Radulović Božidar, Jovana Tomaševića 9/III, Podgorica ME
(57) Farmaceutski preparat naznačen time što sadrži kombinaciju: (A) (1S)-1, 5-anhidro-1-[5-(4-etoksibenzil)-2-metoksi-4-metilfenil]-1-tio-D-glucitola ili njegove farmaceutski prihvatljive soli ili hidrata takvog jedinjenja ili takve soli; i (B) metformina. Preostalo patentnih zahtjeva 5.

- (51) **C07D21548** / ^{2006.01}
C07D401 12 / ^{2006.01}
C 07D40712 / ^{2006.01}
C07D40912 / ^{2006.01}
C07D41312 / ^{2006.01}
C 07D41712 / ^{2006.01}
A61K314709 / ^{2006.01}
A 61 P 31 10 / ^{2006.01}
- (22) 28. 12. 2010
(30) 20090180899 29. 12. 2009 EP
(96) EP/10798128.4/28. 12. 2010
(97) PCT/2010EP/070791/28. 12. 2010
WO 2011/080265/07. 07. 2011/en/2011/27
EP 2519503/07. 11. 2012/en/2012/45
EP 2519503/23. 10. 2013/en/2013/43
- (54) me **DERIVATI SEKUNDARNIH 8-HIDROKSIHINOLIN-7-KARBOKSAMIDA ZA UPOTREBU KAO ANTIGLJIVIČNI AGENSI**
en SECONDARY 8-HYDROXYQUINOLINE-7-CARBOXAMIDE DERIVATIVES FOR USE AS ANTIFUNGAL AGENTS
- (73) POLICHEM S.A., 50 Val Fleuri, 1526 Luxembourg, LU,
(72) GAGLIARDI, Stefania, Via Passirano 24, I-20059 Vimercate (MB), IT,
DEL SORDO, Simone, Piazza Carlo Alberto dalla Chiesa 22, I-24047 Treviglio (BG), IT,
MAILLAND, Federico, Strada Regina 10, CH-6900 Lugano, CH,
LEGORA, Michela, Via Castellazzo 1/B, I-22070 Appiano Gentile (CO), IT,
(74) AOD "Čupić", Dalmatinska 10, Podgorica ME
(57) Jedinjenje opšte formule (I) ili njegova farmaceutski prihvatljiva so, za upotrebu kao antifgljivični agens; gde A je :
- -(CH₂)_m-C₃-C₈ cikloalkil,
 - -(CH₂VW-X₂,
 - -(CH₂)_m-W-CH₂-X_i, ili
 - -(CH₂)_m-CHR_g-(CH₂)_m-X_i; pri čemu X_i je:
 - -aril, po izboru supstituisan jednim, dva ili tri R₄,
 - -heterocikl, po izboru supstituisan jednim ili dva R₅,
 - -C₁-C₈ alkil,
 - -CH(OH)-fenil,
 - -S-fenil,
 - -NHSO₂-fenil,
 - -CN,
 - -OH,
 - -C₃-C₈cikloalkil, ili
 - -4-cijano-2, 3, 4, 5-tetrafluorfenil; gde X₂ je :
 - -aril,
 - -heterocikl,
 - -C₁-C₈alkil,
 - -CH(OH)-fenil, ili
 - -C₃-C₈ cikloalkil; gde W je :
 - -NH-,
 - -O-, ili

- -S-; gde aril je:
- fenil,
- naftil,
- bifenil,
- tetrahidro-naftil, ili
- fluorenil;

pri čemu heterocikl je 5-, 6- ili 7-člani zasićen ili nezasićen prsten koji sadrži od jedan do tri heteroatoma odabrana iz grupe koju čine azot, kiseonik i sumpor i sadrži bilo koju bicikličnu grupu u kojoj je jedan od prethodno pomenutih heterocikličnih prstenova kondenzovan za benzenski prsten ili za drugi heterociklični prsten; gde -cikloalkil je zasićen ili nezasićen ugljovodonični prsten uključujući bilo koju bicikličnu grupu u kojoj je prethodno naveden prsten vezan za prsten benzena, heterociklični prsten ili ugljovodonični prsten; gde Rg je :

- -C1-C7 alkil,
- -C3-C8 cikloalkil,
- -C(O)Rn,
- -C(O)NHRn,
- -C(OH)R11,
- -CH2OH,
- -CO2R11, ili
- -aril, ; gde R11 je:
- -H,
- -C1-C7 alkil,
- -(CH2)mX1, ili
- -(CH2)m-C3-C8 cikloalkil; gde R4 je:
- -F,
- -Cl,
- -Br,
- -I,
- -NO2,
- -CF3,
- -CN,
- -CH2OH
- -C1-C6 alkil,
- -W-R10
- -(CH2)m-aril,
- -(CH2)m-heterocikl,
- -(CH2)m-C3-C8 cikloalkil
- -SO2-NH-heterocikl,
- -(CH2VNR14R15,
- -(C=O)-NR14R15, ili

gde R5je:

- -H,
- -F,
- -Cl,
- -Br,
- -CF3,
- -W-R10,
- -C1-C6 alkil,
- -(CH2)m-aril,

- $-(CH_2)_m$ -heterocikl, ili
- $-(CH_2)_m$ -C3-C8 cikloalkil; gde R10 je:
- -H,
- -C1-C6 alkil,
- $-(CH_2)_m$ -aril
- $-(CH_2)_m$ -heterocikl,
- $-(CH_2)_m$ -C3-C8 cikloalkil, ili
- $-CH(R_{12})R_{13}$; pri čemu R12 je :
- -H,
- $-(CH_2)_mCO_2$ -C1-C6 alkil,
- $-(CH_2)_m$ -heterocikl,
- -C1-C6 alkil,
- -C1-C4 alkil NH-COOCH₂-benzil, ili
- -C1-C4 alkil-S-CH₃; gde R13 je:
- -NH-CO₂C(CH₃)₃,
- -CN,
- -COOH, ili
- -CO₂R₁₁;

gde su R14 i R15, nezavisno jedan od drugog, odabrani od:

- -H,
- -Ci-Ce alkil,
- $-(CH_2)_m$ -aril,
- $-(CH_2)_m$ -cikloalkil,
- $-(CH_2)_m$ -heterocikl,
- $-(CH_2)_m$ -W-Rio,
- $-(CH_2)_m$ -CN,
- zajedno sa atomom azota za koji su vezani obrazuju po izboru susptituisan 5-do 8-člani heteromonocikl koji sadrži od jedan do tri heteroatoma odabrana iz grupe koju čine azot, kiseonik i sumpor, ili zajedno sa atomom azota za koji su vezani obrazuju po izboru susptituisan 5-do 8-člani heteromonocikl koji je kondenzovan sa jednim ili dva po izboru supstituisana zasićena ili nezasićena prstena ili za druge po izboru supstituisane heterocikle koji sadrže jedan do tri heteroatoma odabrana iz grupe koju čine azot, kiseonik i sumpor; gde m je broj od 0 do 6.

Preostalo patent ih zahtjeva 18.

- (51) **C07D47104** / ²⁰⁰⁶⁰¹
A61K314196 / ²⁰⁰⁶⁰¹
A61K31437 / ²⁰⁰⁶⁰¹
A61P 25 18 / ²⁰⁰⁶⁰¹
A61P 25 28 / ²⁰⁰⁶⁰¹

- (11) **01556**
(21) **P-2013-146**

- (22) 15. 12. 2010
(30) 20090001340 17. 12. 2009 DK
20090287321P 17. 12. 2009 US
(96) EP/10797991.6/15. 12. 2010
(97) PCT/2010DK/50344/15. 12. 2010
WO 2011072697/23. 06. 2011/en/2011/25
EP 2513106/24. 10. 2012/en/2012/43
EP 2513106/06. 11. 2013/en/2013/45

- (54) me **DERIVATI HETEROAROMATIČNOG ARIL TRIAZOLA KAO INHIBITORI PDE10A ENZIMA**

en HETEROAROMATIC ARYL TRIAZOLE DERIVATIVES AS PDE10A ENZYME INHIBITORS

- (73) H. Lundbeck A/S, Ottiliavej 9, 2500 Valby, DK,
(72) PUSCHL, Ask, Harsdorffsvej 7A, 4.tv., DK-1874 Frederiksberg C, DK,
NIELSEN, Jacob, Dannebrogsgade 17, t.th., DK-1660 København V, DK,
KEHLER, Jan, Nymollevej 28 DK-2800 Lyngby, DK,
KILBURN, John, Paul, Kaersgærdvej 7 DK-4690 Haslev, DK,
MARIGO, Mauro, Jyttevej 23 DK-2740 Skovlunde, DK,
LANGGARD, Morten, Ržgevej 20 DK-2600 Glostrup, DK,
(74) Radulović Božidar, Jovana Tomaševića 9/III, Podgorica ME
(57) Jedinjenje strukturne formule I

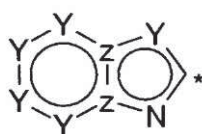
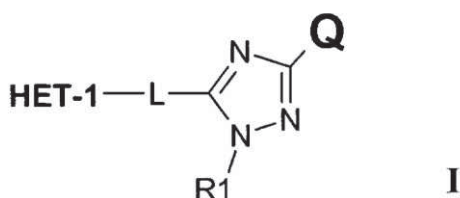

gde je HET-1 heteroaromatična grupa formule II koja sadrži od 2 do 4 atoma azota: gde Y može da bude N ili CH, Z može da bude N ili C, a gde HET-1 može opciono da bude supstituisan sa do tri supstituenta R2-R4 pojedinačno odabrani između vodonika, Ci-C₆ alkila; halogena; ciano, halo(Ci-C₆)alkila; arila, alkoksi i Ci-C₆ hidroksialkila, i gde * označava položaj vezivanja, Q je fenil, opciono supstituisan sa jednim do pet supstituenata, ili monociklična 5-člana ili 6-člana heteroaromatična grupa koja sadrži 1 ili 2 heteroatoma, -L- je veznik odabran između -S-CH₂-, -CH₂-S-, -CH₂-CH₂-, -CH=CH- i -C=C-, R₁ je odabran između H, C₁-C₆ alkila; C₁-C₆ alkil(C₁-C₈)cikloalkila; C₁-C₆ hidroksialkila, CH₂CN, CH₂C(O)NH₂, C₁-C₆ arilalkila,

i C₁-C₆ alkilheterocikloalkila, pod uslovom da jedinjenje I nije 1H-benzimidazol, 2-[[[3-fenil-1H-1, 2, 4-triazol-5-il]tio]metil]-; 1H-benzimidazol, 2-[[[3-(2-pirazinil)-1H-1, 2, 4-triazol-5-il]metil]tio]-; 1H-benzimidazol, 2-[[[3-fenil-1H-1, 2, 4-triazol-5-il]metil]tio]-; 1H-benzimidazol, 1-etil-5-(1-piperidinilsulfonyl)-2-[[[3-(2-tienil)-1H-1, 2, 4-triazol-5-il]tio]metil]-; 1H-benzimidazol, 6-metil-2-[[[3-fenil-1H-1, 2, 4-triazol-5-il]tio]metil]-; 1H-benzimidazol, 2-[[[3-(3-piridinil)-1H-1, 2, 4-triazol-5-il]metil]tio]-; imidazo[1, 2-a]piridin, 8-metil-2-[[[3-fenil-1H-1, 2, 4-triazol-5-il]tio]metil]-; imidazo[1, 2-a]piridin, 6-hloro-2-[[[3-(2-tienil)-1H-1, 2, 4-triazol-5-il]tio]metil]-; 1H-benzimidazol, 2-[[[3-(4-piridinil)-1H-1, 2, 4-triazol-5-il]metil]tio]-; imidazo[1, 2-a]piridin, 6-metil-2-[[[3-fenil-1H-1, 2, 4-triazol-5-il]tio]metil]-; 1H-benzimidazol, 2-[[[3-(2-piridinil)-1H-1, 2, 4-triazol-5-il]metil]tio]-; imidazo[1, 2-a]piridin, 6-hloro-2-[[[3-fenil-1H-1, 2, 4-triazol-5-il]tio]metil]-; 3H-imidazo[4, 5-b]piridin, 2-[[[3-fenil-1H-1, 2, 4-triazol-5-il]tio]metil]-; ili 1H-benzimidazol, 2-[[[3-(2-furanil)-1H-1, 2, 4-triazol-5-il]metil]tio]-; i njegovi tautomeri i farmaceutski prihvatljive soli, kao i njegove polimorfne oblike, pod uslovom da kada je veznik (L) CH₂-S- onda HET-1 nije ni imidazo[1, 2-a]piridin, niti imidazo[1, 2-a]pirimidin.

Preostalih patentnih zhtjeva 14.

- (51) **A61KS11SS**/^{2006.01}
A61KS8 26 /^{2006.01}
A61KS8 28 /^{2006.01}
A61K4S06 /^{2006.01}
- (11) **01546**
(21) **P-2012-147**
- (22) 15. 11. 2009
(96) EP/0917S877.1/15. 11. 2009
(97) EP 2S29848/08. 06. 2011/en/2011/25
EP 2S29848/24. 10. 2012/en/2012/45
- (54) me **LIKSISENATID KAO DODATNA TERAPIJA INSULIN GLARGINU I METFORMINU ZA LIJEČENJE DIJABETESA TIPA 2**
en LIXISENATIDE AS ADD-ON THERAPY TO INSULIN GLARGINE AND METFORMIN FOR TREATING TYPE 2 DIABETES
- (73) Sanofi-Aventis Deutschland GmbH, Brüningstrasse 50, 6S929 Frankfurt am Main, DE,
(72) Silvestre, Louise, c/o Sanofi-Aventis, Département Brevets, 174, Avenue de France, 7S01S Paris, FR,
Souhami, Elisabeth, c/o Sanofi-Aventis, Département Brevets, 174, Avenue de France, 7S01S Paris, FR,
Wei, Xiaodan, c/o Sanofi-Aventis, 1041 Route 202-206, Mail Code: BWD-SOSA, Bridgewater, NJ 08807, US,
- (74) AOD "Ćupić", Dalmatinska 10, Podgorica ME
- (57) Kombinacija za upotrebu u lečenju dijabetes melitusa tipa 2, naznačena time, što sadrži (a) desPro³⁶Eksendin-4(1-39)-I_{ys₆}-NH₂ i/ili a njegovu farmaceutski prihvatljivu so, (b) insulin glargine i/ili njegovu farmaceutski prihvatljivu so, i (c) metformin i/ili njegovu farmaceutski prihvatljivu so.
Preostalo patentnih zahtjeva 11.

(51) **C07D471 10** / ²⁰⁰⁶⁰¹
A61K31438 / ²⁰⁰⁶⁰¹
A61P 3 10 / ²⁰⁰⁶⁰¹
A61P 1 16 / ²⁰⁰⁶⁰¹

(11) **01544**
(21) **P-2014-1**

(22) 29. 10. 2010
(30) 259823P 10. 11. 2009 US
(96) EP/10776438.3/29. 10. 2010
(97) PCT/IB2010/054908/29. 10. 2010
WO 2011/058474/19. 05. 2011/en/2011/20
EP 2499139/19. 09. 2012/en/2012/38
EP 249913912. 2013/en/2013/50

(54) me **N1-PIRAZOLOSPIROKETONSKI INHIBITORI ACETIL-CoA-KARBOKSILAZE**
en **N1-PYRAZOLOSPIROKETONE ACETYL-COA CARBOXYLASE INHIBITORS**

(73) Pfizer Inc., 235 East 42nd Street, New York, NY 10017, US,
(72) BAGLEY, Scott, William, Pfizer Global Research&Development, Eastern Point Road, Groton, Connecticut 06340, US,
GRIFFITH, David, Andrew, Pfizer Global Research&Development, Eastern Point Road, Groton, Connecticut 06340, US,
KUNG, Daniel, Wei-Shung, Pfizer Global Research&Development, Eastern Point Road, Groton, Connecticut 06340, US,
(74) AOD "Ćupić", Dalmatinska 10, Podgorica ME,
(57) Spoj Formule (I)

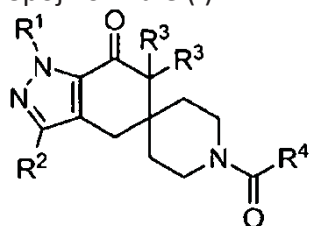

naznačen time što R¹ je (C₁-C₆)alkil, (C₃-C₇)cikloalkM, tetrahidrofuranil ili oksetanil; gdje je navedeni (C₁-C₆)alkil izborno supstituiran s 1 do 2 supstituenta, koje se neovisno bira između (C₁-C₃)alkoksi, hidroksi, fluora, fenila, tetrahidrofuranila ili oksetanila; R² je vodik, halogen, (C₁-C₃)alkil ili cijano; R³ su svaki neovisno vodik ili (C₁-C₃)alkil; R⁴ je (C₆-C₁₀)aril, 5- do 12-eročlani heteroaril ili 8- do 12-eročlani kondenzirani heterociklički aril; gdje je svaki od navedenih (C₆-C₁₀)arila, 5- do 12-eročlanog heteroarila ili 8- do 12-eročlanog kondenziranog heterocikličkog arila izborno supstituiran s jednim do tri supstituenta, koje se neovisno bira između (C₁-C₃)alkila, (C₁-C₃)alkoksi, halogena, amino, (C₁-C₃)alkilamino, di(C₁-C₃)alkilamino, hidroksi, cijano, amido, fenila, 5- do 6-eročlanog heteroarila ili 5- do 6-eročlanog heterociklila; ili njegova farmaceutski prihvatljiva sol.

Patent sadrži još 18 patentnih zahtjeva.

- (51) **C07D498/04**²⁰⁰⁶⁰¹ (11) **01548**
A61K31/551²⁰⁰⁶⁰¹ (21) **P-2014-5**
- (22) 07. 03. 2012
 (30) 1100682 08. 03. 2011 FR
 (96) EP/12290077.2/07. 03. 2012
 (97) EP 2497774/12. 09. 2012/fr/2012/37
 EP 2497774/16. 10. 2013/fr/2013/42

(54) me **DERIVATI DIHIDRO-OKSAZOLOBENZODIAZEPINONA, POSTUPCI ZA NJIHOVU PROIZVODNJU I FARMACEUTSKE SMJEŠE KOJE SADRŽE OVA JEDINJENJA**

en DIHYDRO-OXAZOLOBENZODIAZEPINONE DERIVATIVES, PROCESSES FOR THEIR PREPARATION AND PHARMACEUTICAL COMPOSITIONS COMPRISING THESE COMPOUNDS

- (73) Les Laboratoires Servier, 35, rue de Verdun, 92284 Suresnes Cedex, FR,
 EGIS Gyogyszergyar Nyrt, Kereszturi ut 30-38, H-1106 Budapest, HU,
 (72) Ling, Istvan, 1141 Budapest, HU,
 Barkoczy, Jozsef, 1016 Budapest, HU,
 Antoni, Ferenc, EH10 5RW Edinburgh, GB,
 Gacsalyi, Istvan, 1201 Budapest, HU,
 Levay, Gydrgy, 2092 Budakeszi, HU,
 Spedding, Michael, 78110 le Vesinet, FR,
 Harsing, Laszlo, H-1025 Budapest, HU,
 (74) Jusić Jasna, Crnogorskih serdara bb, Podgorica ME
 (57) Jedinjenja formule (I) :

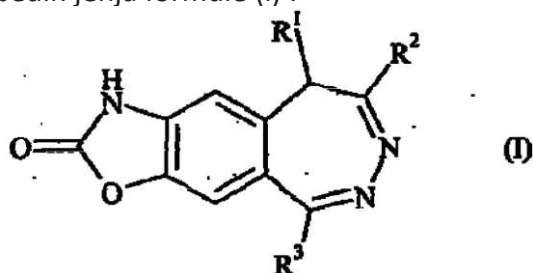

u kojoj :

- > R¹ predstavlja atom vodonika ili ravnolančanu ili razgranatu alkil (C₁-C₄) grupu;
- > R² predstavlja ravnolančanu ili razgranatu alkil (C₁-C₄) grupu;
- > R³ predstavlja arilnu ili heteroarilnu grupu;

njihove položajne izomere, njihove enantiomere, njihove diastereoizomere, kao i njihove adicione soli sa farmaceutski prihvatljivom kiselinom, njihove solvate, njihove komplekse i njihove hidrate.

Patent sadrži još 15 patentnih zahtjeva.

- (51) **C07D48704** / ²⁰⁰⁶⁰¹
A61K31/51961
K31 519 / ^{2006.01}
- (22) 26. 03. 2010
(30) VE2009/000574 31. 03. 2009
PCT EP2009/053907 01. 04. 2009
PCT 09171906 30. 09. 2009 EP
(96) EP/10711065.2/26. 03. 2010
(97) PCT/EP2010/054050/26.03.2010.
WO 2010/112437/07. 10. 2010/en/2010/40
EP 2414363/08. 02. 2012/en/2012/06
EP 2414363/08. 01. 2014/en/2014/02
- (54) me **DERIVATI 1-HETEROCIKLIL-1, 5-DIHIDRO-PIRAZOLO[3, 4-D]PIRIMIDIN-4-ONA I NJIHOVA PRIMJENA U VIDU PDE9A MODULATORA**
en 1-HETEROCYCLYL-1, 5-DIHYDRO-PYRAZOLO[3, 4-D]PYRIMIDIN-4-ONE DERIVATIVES AND THEIR USE AS PDE9A MODULATORS
- (73) Boehringer Ingelheim International GmbH, Binger Strasse 173, 55216 Ingelheim am Rhein, DE,
(72) GIOVANNINI, Riccardo, Boehringer Ingelheim GmbH, CD Patents, Binger Strasse 173, 55216 Ingelheim Am Rhein, DE,
DORNER-CIOSSEK, Cornelia, Boehringer Ingelheim GmbH, CD Patents, Binger Strasse 173, 55216 Ingelheim Am Rhein, DE,
EICKMEIER, Christian, Boehringer Ingelheim GmbH, CD Patents, Binger Strasse 173, 55216 Ingelheim Am Rhein, DE,
FIEGEN, Dennis, Boehringer Ingelheim GmbH, CD Patents, Binger Strasse 173, 55216 Ingelheim Am Rhein, DE,
FOX, Thomas, Boehringer Ingelheim GmbH, CD Patents, Binger Strasse 173, 55216 Ingelheim Am Rhein, DE,
FUCHS, Klaus, Boehringer Ingelheim GmbH, CD Patents, Binger Strasse 173, 55216 Ingelheim Am Rhein, DE,
HEINE, Niklas, Boehringer Ingelheim GmbH, CD Patents, Binger Strasse 173, 55216 Ingelheim Am Rhein, DE,
OSENBRÖCK, Holger, Boehringer Ingelheim GmbH, CD Patents, Binger Strasse 173, 55216 Ingelheim Am Rhein, DE,
SCHAENZLE, Gerhard, Boehringer Ingelheim GmbH, CD Patents, Binger Strasse 173, 55216 Ingelheim Am Rhein, DE,
(74) Radulović Božidar, Jovana Tomaševića 9/III, Podgorica ME
(57) Jedinjenje prema opštoj formuli (I)

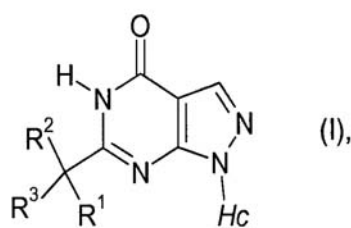

Hc je tetrahidropirani-, gdje njegov jedan ili više atoma ugljenika u prstenu mogu opcionalno biti supstituisani sa jednim ili sa dva supstituenta nezavisno odabrani iz grupe fluora, NC-, F3C-, HF2C-, FH2C-, F3C-CH2-, Ci-6-alkil-, Ci-6-alkil-O- i do jednog atoma ugljenika u prstenu može biti supstituisano sa okso;

R^1 je grupa V - W - * u kojoj W je odabran iz grupe fenila ili heteroarila; V je odabran iz grupe fenila ili heteroarila; - * je tačka vezivanja, gdje je W vezan za CR^2R^3 grupu u formuli (I); u kojoj W i V nezavisno jedan od drugoga opciono mogu biti supstituisani sa jednim ili više supstituenata odabrani iz grupe fluora, hlora, broma, Ci-6-alkil-, F_3C- , HF_2C- , FH_2C- , F_3C-CH_2- , F_3C-O- , HF_2C-O- , C_{3-7} -heterocikloalkil-, $H-O-C_{1-6}$ -alkil-, C_{1-6} -alkil- $O-C_{1-6}$ -alkil-, C_{3-7} -cikloalkil- $O-C_{1-6}$ -alkil-, C_3-7 -cikloalkil- C_1-3 -alkil- $O-C_1-6$ -alkil-, fenil- $O-C_1-6$ -alkil-, benzil- $O-C_1-6$ -alkil-, $H-O-$, C_1-6 -alkil- $O-$, C_3-7 -cikloalkil- $O-$, C_3-7 -cikloalkil- C_1-3 -alkil- $O-$, fenil- $O-$, benzil- $O-$, N-morfolinila, i NC-; R^2 je odabran iz grupe H-, fluora, F_3C- , HF_2C- , FH_2C- , i C_{1-3} -alkil-, prvenstveno R^2 je H; R^3 je odabran iz grupe H-, fluora, F_3C- , HF_2C- , FH_2C- , i C_{1-3} -alkil-, prvenstveno R^3 je H.

Patent sadrži još 34 patentna zahtjeva.

- (51) **C07D401 12** / ^{2006.01}
C 07D471 04 / ^{2006.01}
A61 K31 437 / ^{2006.01}
A61 K31 4439 / ^{2006.01}

- (11) **01553**
(21) **P-2014-8**

- (22) 19. 10. 2010
(30) 253590P 21. 10. 2009 US
(96) EP/10768356.7/19. 10. 2010
(97) PCT/US2010/053142/19.10.2010.
WO 2011/049917/28. 04. 2011/en/2011/17
EP 2491028/29. 08. 2012/en/2012/35
EP 2491028/11. 12. 2013/en/2013/50

- (54) me **JEDINJENJA INDAZOLA I PIRAZOLOPIRIDINA KAO CCR1 RECEPTOR ANTAGONISTI**

en INDAZOLE AND PYRAZOLOPYRIDINE COMPOUNDS AS CCR1 RECEPTOR ANTAGONISTS

- (73) Boehringer Ingelheim International GmbH, Binger Strasse 173, 55216 Ingelheim am Rhein, DE,
(72) COOK, Brian Nicholas, Boehringer Ingelheim Pharmaceuticals Inc., 900 Ridgebury Road, P.O. Box 368, Ridgefield, Connecticut
KUZMICH, Daniel, Boehringer Ingelheim Pharmaceuticals Inc., 900 Ridgebury Road, P.O. Box 368, Ridgefield, Connecticut
MAO, Can, Boehringer Ingelheim Pharmaceuticals Inc., 900 Ridgebury Road, P.O. Box 368, Ridgefield, Connecticut
RAZAVI, Hossein, Boehringer Ingelheim Pharmaceuticals Inc., 900 Ridgebury Road, P.O. Box 368, Ridgefield, Connecticut
(74) Radulović Božidar, Jovana Tomaševića 9/III, Podgorica ME
(57) Jedinjenje formule (I)

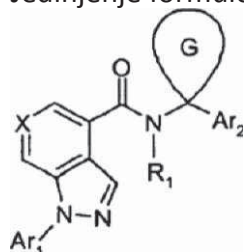

gdje X je azot ili, C-R₂; An je karbocikl, heteroaril ili heterociklil, svaki opciono supstituisan sa jednim do tri R_a; Ar₂ je karbocikl, heteroaril ili heterociklil, svaki opciono supstituisan sa jednim do tri R_b; Ciklični G je karbocikl, ili heterociklil, svaki opciono supstituisan sa jednim do dva R_g; Ri je vodonik, C₁₋₆ alkil ili C₁₋₆ alkoksiC₁₋₆ alkil; R₂ je vodonik ili R_a; R_a je C₁₋₆ alkil, C₃₋₁₀ cikloalkil, C₁₋₆ alkoksi, C₁₋₆ alkiltio, C₁₋₆ alkilsulfonil, C₁₋₆ alkoksikarbonil, amino, mono- ili di-C₁₋₆ alkilamino, C₃₋₆ cikloalkilamino, C₁₋₆ alkilaminokarbonil, C₁₋₆ acil, C₁₋₆ acilamino, C₁₋₆ dialkilaminokarbonil, hidroksil, halogen, cijano, nitro, okso, R₃-S(O)_m-NH-, R₃-NH-S(O)_m-, aril ili karboksil; R_b je hidroksil, karboksil, halogen, -(CH₂)_n-CO₂C₁₋₆alkil, nitro, -SO₃H, C₁₋₆ alkil, C₂₋₆ alkenil, C₂₋₆ alkinil, C₃₋₁₀ cikloalkil, C₁₋₆ alkoksi, C₁₋₆alkilC(O)-, -(CH₂)_n-NR_cR_d, R₃-S(O)_m(CH₂)₀₋₁-, R₃-S(O)_m-NRe-, R_s-NRe-S(O)_m(CH₂)₀₋₁-, -NR_f-C(O)-Re, -(CH₂)_y-C(O)-(CH₂)_n-NR_cR_d, heterociklil, aril ili heteroaril, svaki R_b, gdje je moguće, je opciono halogenovan ili supstituisan sa 1 do 3 C₁₋₆ alkila, hidroksila, C₁₋₆ acila, C₁₋₆ alkoksikarbonila, C₁₋₆ alkil-S(O)_m-, arila ili karboksila; svaki R_c, R_d su nezavisno vodonik, C₁₋₆ alkil, C₁₋₆ acil, C₃₋₁₀ cikloalkil, C₁₋₆ alkoksi, hidroksi-C₁₋₆ alkil, cijano-C₁₋₆ alkil, C₁₋₆ alkilC₁₋₆ alkoksi, C₁₋₆ alkilsulfonil, C₁₋₆ alkoksikarbonilC₀₋₃alkil, C₁₋₆alkoksikarbonilC₃₋₁₀cikloalkil, -(CH₂)_n-C(O)-NR_eR_fili -(CH₂)_n-NreR_f svaki R_e, R_f su nezavisno vodonik, C₁₋₆ alkil, C₃₋₁₀ cikloalkil, C₁₋₆ alkoksi, C₁₋₆

alkoksiC₁₋₆alkil, mono- ili di-C₁₋₆alkilaminoC₁₋₆alkil, hidroksiC₁₋₆ alkil ili C₁₋₆ acil; R_g je C₁₋₆ alkil, gdje je C₁₋₆ alkil opciono djelimično ili upotpunosti halogenovan, C₂₋₆ alkenil, karbocikl, C₁₋₆ alkoksi, karbociklil-C₁₋₆ alkoksi, karbociklil-C₁₋₆ alkil, hidroksiC₁₋₆ alkil, hidroksil, -(CH₂)_n-CO₂C₁₋₆ alkil ili okso; R₃ je vodonik, C₁₋₆ alkil, C₃₋₆ cikloalkil, heterociklil(CH₂)₀₋₁, mono- ili di-C₁₋₆ alkilamino, mono- ili di-C₁₋₆alkilamino(CH₂)₂₋₃N(R_e)-, aril ili heteroaril, svaki opciono supstituisan sa 1 do 3 C₁₋₆ alkila, C₃₋₆ cikloalkila, C₁₋₆alkoksi, halogena, hidroksila, okso, karboksila, -C(O)NReRf, amina, mono- ili di-C₁₋₆ alkilamina, C₁₋₆ alkoksikarbonila ili C₁₋₆ acilamina; svakin, y su nezavisno 0-3; svaki m je nezavisno 0-2; ili njegova farmaceutski prihvatljiva so. Patent sadrži još 15 patentnih zahtjeva.

(51) **C07D495/04**²⁰⁰⁶⁰¹
A61K31/33²⁰⁰⁶⁰¹
A61P 3 /10²⁰⁰⁶⁰¹

(11) **01558**
 (21) **P-2014-10**

(22) 28. 12. 2010
 (30) 09306344 29. 12. 2009 EP
 (96) EP/10800766.7/28. 12. 2010
 (97) PCT/2010/070811/28. 12. 2010
 WO 2011/080277/07. 07. 2011/en/2011/27
 EP 2519527/07. 11. 2012/en/2012/45
 EP 2519527/18. 12. 2013/en/2013/51

(54) me **TIENO [2, 3-B] PIRIDINDION AMPK AKTIVATORI I NJIHOVE
 TERAPEUTSKE UPOTREBE**

en THIENO[2, 3-b] PYRIDINEDIONE ACTIVATORS OF AMPK AND THERAPEUTIC USES THEREOF

- (73) Poxel, 200 avenue Jean Jaurès, 69007 Lyon, FR,
 (72) CRAVO, Daniel, 18 bis chemin des Murgers, F-78360 Montesson, FR,
 HALLAKOU-BOZEC, Sophie, 166 avenue Henri Ginoux, F-92120 Montrouge, FR,
 BOLZE, Sébastien, 382 chemin des Dorriers, F-01600 Massieux, FR,
 LEPIFRE, Franck, 3 rue Arthur Rimbaud, F-91400 Saclay,
 FAVERIEL, Laurent, 27 rue Copernic, F-91160 Longjumeau, FR,
 DURAND, Jean-Denis, 85 rue de Paris, F-93100 Montreuil-Sous-Bois, FR,
 CHARON, Christine, 1 chemin de la Justice, F-91940 Gometz-Le-Chatel, FR,
 (74) Radulović Božidar, Jovana Tomaševića 9/III, Podgorica ME
 (57) Jedinjenje formule (1)

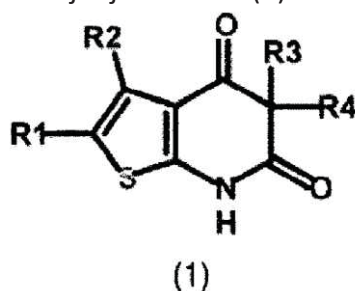

u kojoj R1 predstavlja atom vodonika, alkil grupu ili atom halogena; R2 predstavlja aril ili heteroaril grupu; R3 i R4 nezavisno predstavljaju atom halogena, alkil, aril, cikoalkil, heterocikloalkil, alkoksi, cijano, aralkil, heteroaril, CO₂RS, ili CONR₆R₇ grupu; i R5, R6 i R7 nezavisno predstavljaju atom vodonika ili alkil grupu; R6 i R7 mogu biti fuzionisani kako bi formirali prsten koji sadrži atom azota, ili geometrijski isomer, tautomer, epimer, enantiomer, stereoisomer, diastereoizomer, racemat, njihovu farmaceutski prihvatljivu so ili solvat. Patent sadrži još 11 patentnih zahtjeva.

- (51) **C 07 B 45 00/** ²⁰⁰⁶⁰¹
C 01 B 25 14/ ^{2006 01}
C07D21306 / ²⁰⁰⁶⁰¹
C 07 C 325 02/ ^{2006 01}
C 07C 32744/ ^{2006 01}
C 07D20724/ ^{2006 01}
C 07 D 209 30/ ²⁰⁰⁶⁰¹
C 07D211 72/ ^{2006 01}
C 07 D 21184/ ²⁰⁰⁶⁰¹
C 07D21363/ ^{2006 01}
C 07D23993/ ^{2006 01}
C 07D241 06/ ^{2006 01}
- (22) 03. 02. 2012
- (30) 11153421 04.02.2011 EP
201161439522P 04. 02. 2011 US
- (96) EP/12702531.0/03. 02. 2012
- (97) WO/PCT/EP2012/051864/03. 02. 2012
WO 2012/104415/09. 08. 2012/en/2012/32
EP 2569263/20. 03. 2013/en/2013/12
EP 2569263/13. 11. 2013/en/2013/46
- (54) me **PROCES TIONACIJE I TIONACIJSKI AGENS**
en A THIONATION PROCESS AND A THIONATING AGENT
- (73) Vironova Thionation AB, Gavlegatan 22, 113 30 Stockholm, SE,
- (72) PETTERSSON, Birgitta, Mellanbergsvagen 11, S-126 42 Hagersten, SE,
HASIMBEGOVIC, Vedran, Ršundavagen 75 S-169 57 Solna, SE,
SVENSSON, Per, H., Fatburs Brunngata 18, S-118 28 Stockholm, SE,
BERGMAN, Jan, Lekgrand 5, S-163 46 Spžnga, SE,
- (74) Radulović S. Božidar, Studentska bb, Lamela 3/18, Podgorica ME
- (57) Proces za transformaciju grupe >C=O (I) u jedinjenju u grupu >C=S (II) iii u tautomerski oblik grupe (II) u reakciji koja daje proizvod tionijske reakcije, upotrebom kristalnog P₂S₅-2 C₅H₅N kao tionijskog agensa, navedeni tionijski agens se izdvaja iz piridinske matične tečnosti u kojoj je pripremljen.
Patent sadrži još 10 patentnih zahtjeva.
- (11) **01570**
(21) **P-2014-13**

(51) **C07D487 04** / ²⁰⁰⁶⁰¹
A61K 3155 / ²⁰⁰⁶⁰¹
A61P 3500 / ²⁰⁰⁶⁰¹
A61P 4300 / ²⁰⁰⁶⁰¹

(11) **01554**
(21) **P-2014-17**

(22) 06. 08. 2010
(30) 0919433 05. 11. 2009 GB
20100010509 22. 06. 2010 GB
(96) EP/10740654.8/06. 08. 2010
(97) PCT/EP2010/061518
WO 2011/054553/12. 05. 2011/en/2011/19
EP 2496580/12. 09. 2012/en/2012/37
EP 249658012. 2013/en/2013/50

(54) me **BENZODIAZEPINSKI INHIBITORBROMODOMENA**
en BENZODIAZEPINE BROMODOMAIN INHIBITOR

- (73) GlaxoSmithKline LLC, Corporation Service Company, 2711 Centreville Road, Suite 400, Wilmington, Delaware
- (72) GOSMINI, Romain Luc Marie, c/o Laboratoire GlaxoSmithKline, Centre de Recherches, Z.A. de Courtboeuf, 25 Avenue du Quebec, F-9 MIRGUET, Olivier, Laboratoire GlaxoSmithKline, Centre de Recherches, Z.A. de Courtaboeuf, 25 Avenue du Quebec, F-919
- (74) Lutovac Branislav, Bulevar Crnojevića 93, Podgorica ME
- (57) Jedinjenje formule (I) koje je 2-[(4S)-6-(4-hlorofenM)-1-metM-8-(metMoksi)-4H-[1, 2, 4] triazolo[4, 3-a] [1, 4] benzodiazepi n-4-ii]-N-etilacetam id

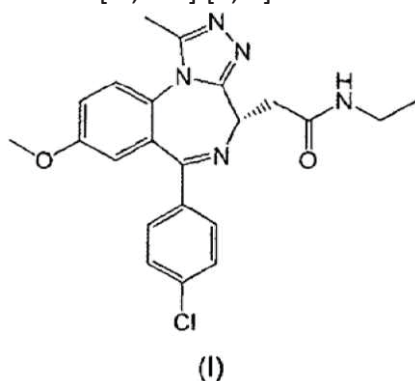

ili njegova so.

Patent sadrži još 13 patentnih zahtjeva.

- (51) **AA61K31 /765**²⁰⁰⁶⁰¹⁰¹ (11) **01559**
AA61P31 /22^{20 60 01} (21) **P-2014-18**
- (22) 08. 07. 2011
- (30) 362329P08. 07. 2010 US
- (96) EP/11754919.6/08. 07. 2011
- (97) PCT/IB2011/001919/08. 07. 2011
WO 2012/004669/12. 01. 2012/en/2012/02
EP 2563374/06. 03. 2013/en/2013/10
EP 2563374/13. 11. 2013/en/2013/46
- (54) me **POLIETILEN GLIKOLNI PREPARATI U KONTROLI RELAPSA HERPES LABIALIS-a, HERPES GENITALIS-a I HERPES ZOSTER-a**
en POLYETHYLENE GLYCOL COMPOSITIONS FOR CONTROLLING RELAPSE OF HERPES LABIALIS, HERPES GENITALIS, AND HERPES ZOSTER
- (73) Devirex AG, Sagenstrasse 4c, 6318 Walchwil, CH,
- (72) VITINS, Peter, Gheidweg 1CH-5452 Oberohdorf, CH,
LANGENAUER, Marcel, Enerholzstrasse 10 CH-4712 Laupersdorf, CH,
SCHERER, Paul, Martin, Sagenstrasse 4c, CH-6318 Walchwil, CH,
- (74) Radulović S. Božidar, Studentska bb, Lamela 3/18, Podgorica ME
- (57) Polietilen glikol za korišćenje u smanjenju stope relapsa, odlaganju relapsa, i/ili sprečavanju relapse herpesa labialisa površinskom primenom; gde je period primene najmanje 4 nedelje.
Patent sadrži još 31 patentni zahtjev.

- (51) **A 61 K 38 /02** ^{2006.01} (11) **01536**
A 61 K 38 /16 ^{2006.01} (21) **P-2013-81**
A 61 P 25 /28 ^{2006.01}
- (22) 19. 08. 2010
- (30) 20100337612P 11. 02. 2010 US
20090274687P 20. 08. 2009 US
- (96) EP /10810282.3/19. 08. 2010
- (97) US /PCT/US2010/002283/19. 08. 2010
WO 2011/022063 /24. 02. 2011/en/2011/08
EP 2405749 /18. 01. 2012/en/2012/03
EP 2405749 /08. 05. 2013/en/2013/19
- (54) me **NISKOFREKVENTNA TERAPIJA GLATIRAMER ACETATOM**
en LOW FREQUENCY GLATIRAMER ACETATE THERAPY
- (73) Yeda Research and Development Co., Ltd., P.O.Box 95,76100 Rehovot, IL
- (72) KLINGER, Ety, 16 Agadati Street, 39930 Tel Aviv, IL
- (74) Radulović S. Božidar, Studentska bb, Lamela 3/18, Podgorica ME
- (57) Medikament koji sadrži glatiramer acetat za upotrebu u lečenju pacijenta koji pati od multiple skleroze sa recidivima i remisijama ili koji je doživeo prvi klinički napad i koji je pod visokim rizikom od razvoja klinički definitivne multiple skleroze, naznačen time što navedeni medikament treba da se primenjuje u režimu od tri potkožne injekcije doze od 40 mg glatiramer acetata na svakih sedam dana, pri čemu između svake dve potkožne injekcije treba da prođe najmanje jedan dan.
Preostalo patentnih zahtjeva 14.

- (51) **CA 61 K 47 /48** ^{2006.01} (11) **01565**
AC 07 D 487 /04 ^{2006.01} (21) **P-2013-116**
CA 61 P 35 /00 ^{2006.01}

- (22) 15. 04. 2011
 (30) 20100016802 06. 10. 2010 GB
 20100006341 15. 04. 2010 GB
 (96) EP /11716146.3/15. 04. 2011
 (97) US /PCT/US2011/032632/15. 04. 2011
 WO 2011/130598 /20. 10. 2011/en/2011/42
 EP 2528625 /05. 12. 2012/en/2012/49
 EP 2528625 /10. 07. 2013/en/2013/28

(54) me **PIROLOBENZODIAZEPINI I NJIHOVI KONJUGATI**

en PYRROLOBENZODIAZEPINES AND CONJUGATES THEREOF

- (73) Spirogen Sàrl, Chemin de la Pacottaz 1, c/o Michael Forer, 1806, St-Légier-La Chiésaz, CH
 (72) HOWARD, Philip, Wilson, Spirogen Limited, School Of Pharmacy, 29/39 Brunswick Square, London WC1N 1AX, GB ,
 MASTERSON, Luke, Spirogen Limited, School Of Pharmacy, 29/39 Brunswick Square, London WC1N 1AX, GB ,
 TIBERGHEN, Arnaud, Spirogen Limited, School Of Pharmacy, 29/39 Brunswick Square, London WC1N 1AX, GB
 FLYGARE, John, A., Genentech Inc., 1 Dna Way, South San Francisco, CA 94080, US ,
 GUNZNER, Janet, L., Genentech Inc., 1 Dna Way, South San Francisco, CA 94080, US ,
 POLAKIS, Paul, Genentech Inc., 1 Dna Way, South San Francisco, CA 94080, US ,
 POLSON, Andrew, Genentech Inc., 1 Dna Way, South San Francisco, CA 94080, US ,
 RAAB, Helga, E., Genentech Inc., 1 Dna Way, South San Francisco, CA 94080, US
 SPENCER, Susan, D., Genentech Inc., 1 Dna Way, South San Francisco, CA 94080, US
 (74) Radulović S. Božidar, Studentska bb, Lamela 3/18, Podgorica ME
 (57) Konjugat formule (AB) ili (AC):

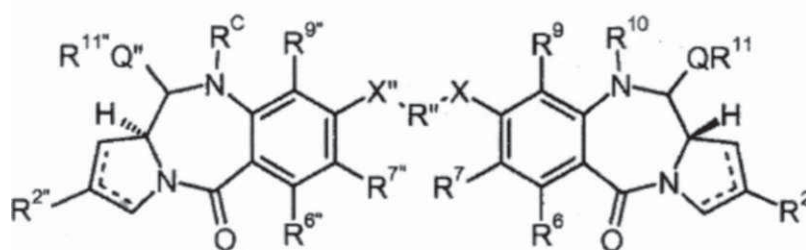

AB

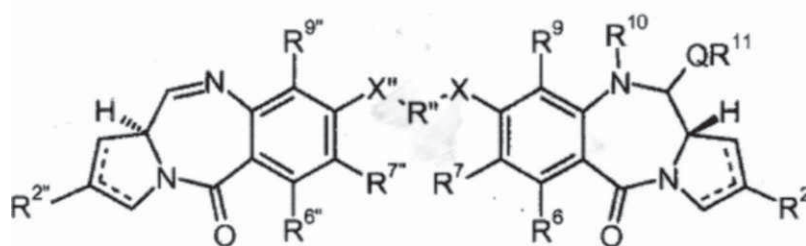

tačkaste linije ukazuju na optimalno prisustvo dvostruke veze između C1 i C2 ili C2 i C3; R² je nezavisno odabrana među H, OH, O, =CH₂, CN, R, OR, =CH-RD, =C(RD)₂, O-SO₂-R, CO₂R_f

COR, i opciono nadalje odabrana između halo i dihalo; gde je RD nezavisno odabrana među R, CO₂R, COR, CHO, CO₂H i halo; R⁶ i R'' su nezavisno odabrane među H, R, OH, OR, SH, SR, NH[^] NHR, NRR', NO₂, Me₃Sn i halo; R⁷ je nezavisno odabrana među H, R, OH, OR, SH, SR, NH[^] NHR, NRR', NO₂, Me₃Sn i halo; R¹⁰ je linker povezan sa agensom ćelijskog vezivanja odbranog među antitelima, fragmentom antitela koji sadrži najmanje jedno vezujuće mesto i ciklični polipeptid; Q je nezavisno odabrana među O, S i NH; R¹¹ je ili H, ili R ili, gde je Q O, SO₃M, gde je M metalni katjon; R i R' su obe nezavisno odabrane među opciono zamenjenim C_{M2} alkil, C₃₋₂₀ heterociklil i C₅₋₂₀ aril grupama, i opciono su u relaciji sa grupom NRR', R i R' zajedno sa atomom azota za koji je zakačena formira opciono zamenjen 4-, 5-, 6- ili 7-člani heterosiklični prsten; R'' je C₃₋₁₂ alkilen grupa na čiji lanac može biti dodat jedan ili više heteroatoma, npr. O, S, N(H), NMe i/ili aromatičnih prstenova, npr. benzenski i piridinski, čiji su prstenovi opciono zamenjeni sa NH₂; svaki X je O, S ili N(H); i gde je R^{2''}, R^{6''}, R^{7''}, R^{9''}, X'', Q'' i R^{1''} definisani shodno R², R⁶, R⁷, R'', X, Q i R'' redom, i R^c je pokrivaća grupa.

OBJAVA UPISA PROMJENA
PUBLICATION OF RECORD OF CHANGES

Objava prenosna patenta Publication of patent assignment		
RegistarSKI broj patenta (11)	IME NOSIOCA PATENTA NAME OF THE OWNER OF PATENT (73)	IME NOSIOCA PATENTA NAME OF THE OWNER OF PATENT (73)
00045	Pfizer Products Inc., Eastern Point Road, Groton, CT 06340 US	PAH USA 15 LLC, 235 East 42nd Street, New York, NY 10017-5755 US
00130	ABBOTT LABORATORIES Dept. 377 Bldg AP6A-1, 100 Abbott Park Road, Abbott Park, IL 60064-6008 US	AbbVie Inc., 1 North Waukegan Road, North Chicago, Illinois 60064 US
01030	F. Hoffmann-La Roche AG, Grenzacherstrasse 124, CH-4070 Basel CH	Evotec International GmbH, Essener Bogen 7, D-22419 Hamburg DE
00204	Medarex, Inc., 707 State Road, Princeton, New Jersey 08540 US	Medarex, L.L.C., Route 206 and Province Line Road, Princeton, New Jersey 08540 US
00044	Pfizer Limited, Ramsgate Road, Sandwich, Kent CT13 9NJ GB	Pfizer Animal Health UK 1 Limited, 5th Floor, 6 St. Andrew Street, London, EC4A 3AE GB
Objava promjene adrese Publication of change of address		
RegistarSKI broj patenta (11)	IME NOSIOCA PATENTA NAME OF THE OWNER OF PATENT (73)	IME NOSIOCA PATENTA NAME OF THE OWNER OF PATENT (73)
00045	Zoetis P LLC, 235 East 42nd Street, New York, NY 10017-5755 US	Zoetis P LLC, 100 Campus Drive, Florham Park, New Jersey 07932 US
00229	GLAXO GROUP LIMITED Glaxo Wellcome House, Berkeley Avenue, Greenford, Middlesex UB6 ONN, GB	GLAXO GROUP LIMITED 980 Great West Road, Brentford, Middlesex TWS 9GS, GB
Objava promjene imena i adrese Publication of change of name and address		
RegistarSKI broj patenta (11)	IME NOSIOCA PATENTA NAME OF THE OWNER OF PATENT (73)	IME NOSIOCA PATENTA NAME OF THE OWNER OF PATENT (73)
00145	Schering Corporation, 2000 Galloping Hill Road, Kenilworth, NJ 07033 US	MERCK SHARP & DOHME CORP., 126 East Lincoln Avenue, Rahway, New Jersey 07065 US

00211	Schering Corporation 2000 Galloping Hill Road, Kenilworth, New Jersey 07033-0530 US	Merck Sharp & Dohme Corp. 126 East Lincoln Avenue, Rahway, New Jersey 07065 US
Objava promjene imena nosioca patenta Publication of change of name of the owner of patent		
Registarski broj patenta (11)	IME NOSIOCA PATENTA NAME OF THE OWNER OF PATENT (73)	IME NOSIOCA PATENTA NAME OF THE OWNER OF PATENT (73)
00045	PAH USA 15 LLC, 235 East 42nd Street, New York, NY 10017-5755 US	ZOETIS P LLC, 235 East 42nd Street, New York, NY 10017-5755 US
00041	RIB LOC AUSTRALIA PTY. LTD. 587 Grand Junction Road, Gepps Cross, S.A. 5094 AU	SEKISUI RIB LOC AUSTRALIA PTY. LTD. 587 Grand Junction Road, Gepps Cross, S.A. 5094 AU
00042	RIB LOC AUSTRALIA PTY LIM- ITED 587 Grand Junction Road, Gepps Cross, S.A. 5094 AU	SEKISUI RIB LOC AUSTRALIA PTY LIMITED 587 Grand Junction Road, Gepps Cross, S.A. 5094 AU
00044	Pfizer Animal Health UK 1 Limited 5th Floor, 6 St. Andrew Street London, EC4A 3AE GB	Zoetis UK Limited, 5th Floor, 6 St. Andrew Street, London, EC4A 3AE GB



ŽIGOVI

TRADEMARKS

Službeni glasnik Zavoda za intelektualnu svojinu Crne Gore
Official Gazette of the Montenegrin Intellectual Property Office

14/2014



Zavod za intelektualnu svojinu Crne Gore
ul. Rimski trg br. 46,
81000 Podgorica,
Crna Gora



**MEĐUNARODNI KODOVI ZA IDENTIFIKACIJU BIBLIOGRAFSKIH
PODATAKA O ŽIGOVIMA PREMA WIPO ST 60**
RECOMMENDATION CONCERNING BIBLIOGRAFIC DATA RELATING TO
TRADEMARKS- WIPO-ST. 60

CRNOGORSKI	MDK	ENGLESKI
REGISTRARSKI BROJ	111	NUMBER OF THE REGISTRATION
DATUM REGISTRACIJE	151	DATE OF THE REGISTRATION
OČEKIVANI DATUM PRESTANKA VAŽENJA ŽIGA	181	EXPECTED EXPIRATION DATE OF THE REGISTRATION
BROJ PRIJAVE	210	NUMBER OF THE APPLICATION
DATUM PODNOŠENJA PRIJAVE	220	DATE OF FILING OF THE APPLICATION
PODACI O IZLOŽBENOM PRAVU PRVENSTVA	230	DATA CONCERNING EXHIBITIONS
PODACI O PRAVU PRVENSTVA NA OSNOVU PARISKE KONVENCIJE	300	DATA RELATING TO PRIORITU UNDER THE PARIS CONVENTION
DATUM OBJAVLJIVANJA PRIJAVE	442	DATA OF PUBLICATION OF APPLICATION
SPISAK ROBA I USLUGA PREMA NIČANSKOJ KLASIFIKACIJI ROBA I USLUGA	511	LIST OF GOODS AND SERVICES ACCORDING THE NICE CLASSIFICATION OF GOODS AND SERVICE
IZJAVA PODNOSIOCA PRIJAVE DA NE TRAŽE EKSKLUZIVNO PRAVO ZA POJEDINE NEDINSTIKTIVNE ELEMENTE ZNAKA	526	DISCLAIMER
IZGLED ZNAKA	540	REPRODUCTION OF THE MARK
NAZNAKA O PRIRODI ILI VRSTI ZNAKA	550	INDICATION RELATING TO THE NATURE OR KIND OF MARK
INFORMACIJA O ZATRAŽENIM BOJAMA NA ZNAKU	591	INFORMATION CONCERNING THE COLORS CLAIMED
PODACI O PODNOSIOCU PRIJAVE	731	NAME AND ADRESS OF THE APPLICANT
IME I ADRESA NOSIOCA ŽIGA	732	NAME AND ADDRESS OF THE HOLDER OF THE REGISTRATION
INFORMACIJA O ZATRAŽENIM BOJAMA NA ZNAKU	591	INFORMATION CONCERNING THE COLORS CLAIMED
PODACI O PODNOSIOCU PRIJAVE	731	NAME AND ADRESS OF THE APPLICANT
IME I ADRESA NOSIOCA ŽIGA	732	NAME AND ADDRESS OF THE HOLDER OF THE REGISTRATION
IME I ADRESA PUNOMOĆNIKA	740	NAME AND ADDRESS OF THE REPRESENTATIVE



OBAVJEŠTENJE NOTICE

Obavještavamo korisnike da se od 7-og broja Crnogorskog glasnika za intelektualnu svojinu koji se objavljuje na web stranici Zavoda za intelektualnu svojinu Crne Gore, u elektronskoj formi, odnosno od 20.12.2011 godine (Glasnik broj 7/2011) uvodi objava prijave za registraciju žiga. Stupanjem na snagu Pravilnika o postupku za priznanje, promjenama, obnovi i međunarodnoj registraciji žiga ("Sl. list CG" broj 55/11) stekli su se uslovi da Zavod postupa u skladu sa odredbom člana 29 stav 1 Zakona o žigu i uredne prijave, za koje nije utvrđen razlog za odbijanje registracije iz člana 28 ovog zakona, objavi u Službenom glasilu.

Od dana objavljivanja prijave u Službenom glasilu, shodno odredbi člana 30 stav 1 Zakona o žigu, pravna i fizička lica ili udruženja proizvođača roba ili usluga, pružaoci usluga, trgovci i potrošači mogu, u roku od 90 dana od datuma objavljivanja prijave, dostaviti Zavodu obrazloženo mišljenje u pisanoj formi o apsolutnim razlozima za odbijanje registracije iz člana 6 Zakona o žigu.

U roku od 90 dana od dana objavljivanja prijave u Službenom glasilu, nosilac ranijeg žiga ili sticalac licence, na osnovu ovlašćenja nosioca žiga, mogu zbog razloga iz čl. 7 i 8 Zakona o žigu, u roku od 90 dana od dana objavljivanja prijave, shodno odredbi člana 31 stav 1 i 2 Zakona o žigu podnijeti Zavodu Prigovor za odbijanje registracije žiga.



(210) **2010-372**(442) **20.04.2014.**

(220) 10/18/2010

(731) **GLOSARIJ DOO**, VOJISLAVLJEVIĆA 76 PODGORICA ME

FLONIDAN®

(540)

(550) I

(511) **Klasa 05:** Farmaceutski preparat.(210) **2010-425**(442) **20.04.2014.**

(220) 11/11/2010

(731) **CESTA DR.FRANJE TUĐMANA BB**, 21212 KAŠTEL ŠUĆURAC HR

DALMACIJACEMENT BIJELI CEMENT

(540)

(550) I

(740) Božović Vesko, Rimski trg 50/11, Podgorica ME

(511) **Klasa 06:** metalni građevinski materijali kao što su: skele/građa za skele, čelična vrata, rešetke, prozori, vrata, metalne prenosive konstrukcije kao što su: nosači stupovi, rešetkaste konstrukcije, metalni spremnici kao što su: silosi, spremnici za cement i beton.**Klasa 19:** ploče od umjetnih materijala, ploče od drva, asfalt, katran i bitumen.(210) **2011-175**(442) **20.04.2014.**

(220) 4/11/2011

(731) **SANRIO COMPANY, LTD**, TOKYO1-6-1 OSAKI, SHINAGAWA-KU JP

Sanrio

(540)

(550) I

(511) **Klasa 03:** Preparati za izbeljivanje i drugi preparati za pranje veša; preparati za čišćenje, poliranje, ribanje i abrazivni preparati (za nagrivanje); sapuni; parfimerija, eterična ulja, kozmetika, losioni za kosu; paste (preparati) za zube; sredstva za higijenu (preparati za kupatilo), preparati za manikir; proizvodi i preparati za negu i čišćenje kose i kože; lepila za kozmetičke potrebe; losioni za posle brijanja; preparati protiv znojenja; antistatički preparati za kućnu

upotrebu; aromatični preparati; kora kvilaje za pranje; soli za kupku; kozmetički preparati za kupanje; maske za lice; soli za izbeljivanje; soda za izbeljivanje; plavila za veš; hemikalije za izbeljivanje veša namenjene za upotrebu u domaćinstvu; preparati za uklanjanje boja; kozmetički pribor; kozmetički preparati namenjeni gubitku telesne težine; kozmetički preparati za životinje; pamučni štapići za kozmetičku upotrebu; vata za kozmetičke svrhe; kozmetičke kreme; kreme za izbeljivanje kože; kreme za kožnu galanteriju, ; sredstva za uklanjanje masnoće; sredstva za poliranje proteza; preparati za čišćenje proteza; dezodoransi; deterdženti; kozmetičke boje; kolonjske vodiče; toaletna voda; kreme za kosu; gel za kosu; šamponi; kondicioneri za kosu i preparati za vlažnost kose; parfemi; karmini; kreme i losioni za kožu i kosu; veštački nokti; lakovi za nokte i acetoni; kreme za zaštitu od sunca; preparati za beljenje (skidanje boje) za kozmetičke potrebe; arome za kolače (esencijalna ulja); mleko za čišćenje za toaletnu upotrebu; kozmetika za obrve; olovke za obrve; oplemenjivači rublja (za upotrebu u perionicama); veštačke trepavice; vosak za pod; boje za kosu; lakovi za kosu; preparati za kovrdžanje kose; izbeljivači za veš; preparati za natapanje u perionicama; štirak za veš; losioni za kozmetičke potrebe; šminka; puder za šminku; preparati za šminkanje; preparati za skidanje šminke; maskara; preparati za ispiranje usta, ne za medicinske svrhe; preparati za negu noktiju; kozmetičke olovke; preparati za poliranje nameštaja i podova; pomade za kozmetičke svrhe; potpuri (ugodni mirisi); kamen za glačanje; šmirgla; šmirgla papir; mirisno drvo; šamponi za kućne ljubimce; krema za cipele; krema za poliranje cipela; vosak za cipele; preparati za štirkanje; sapun za izbeljivanje tekstila; štirak za veš; preparati za sunčanje; mirišljave maramice; preparati za uklanjanje laka; vosak za depilaciju; vosak za veš; vosak za poliranje; vosak za kožu; preparati za depilaciju; želatin (petrolej) za kozmetičke svrhe; ukrasi koji se skidaju za kozmetičke svrhe; (štapići od tamjana (joss štapići); mirisi sve uključeno u klasu 3.

Klasa 04: Industrijska ulja i masti; maziva; jedinjenja za skupljanje prašine vlaženjem i vezivanjem; goriva (uključujući motorna tečna goriva) i materije za osvetljavanje; sveće, fitilji; sveće za Božićnu jelku; preparati za uklanjanje prašine; mast za kaiševe; mast za čizme; mast za kožu; mast za cipele; fitilji za lampe; sveće preparati koji daju neelastičnost kaiševima; ulje za održavanje kožnih proizvoda; ulje za boje; cepke za osvetljenje; uređaji za čišćenje koji skupljaju prašinu; fitilji za sveće; dizel ulje; benzin; kerozin; nafta; sve uključeno u klasu 4.

Klasa 05: Farmaceutski, veterinarski i sanitarni preparati; dijetetske supstance prilagođene medicinskoj upotrebi, hrana za bebe; flasteri, materijali za zavijanje; materijali za plombiranje zuba, zubarska smola; dezinfekciona sredstva; preparati za uništavanje štetočina; fungicidi; herbicidi; upijajući pamuk; upijajuća vata; lepljive trake za medicinske svrhe; lepljivi flasteri; lepljive trake za medicinsku upotrebu; preparati za osvežavanje vazduha; preparati za prečišćavanje vazduha; albuminski dodaci hrani za medicinske svrhe; albuminsko mleko za medicinske svrhe; preparati za pranje životinja; antiseptički vata; antiseptici; melemi za medicinske svrhe; higijenski zavoji; ulošci za menstruaciju; zavoji za zavijanje; terapijski preparati za kupanje; preparati za kupanje, medicinski; soli za kupanje za medicinske svrhe; kupke od kiseonika; soli za kupke od mineralne vode; pojasevi za higijenske uloške (salvete); narukvice (kodirane identifikacije) za medicinske svrhe; grudni ulošci kod dojenja; medicinski slatkiši; kapsule za lekove; kapsule za farmaceutske svrhe; guma za žvakanje za medicinske svrhe; antiparazitske ogrlice za životinje; medicinske poslastice; sredstva za dezinfekciju, ispiranje, čuvanje i čišćenje kontaktnih sočiva; lubrikanti i sredstva za kontaktna sočiva ili za upotrebu sa kontaktnim sočivima; hemijska kontraceptivna sredstva; lekovi za žuljeve; prstenovi za žuljeve na stopalima; pamuk za medicinske svrhe; flaster lepljivi; farmaceutski preparati za sprečavanje peruti; dezodoransi koji nijesu za ljude i životinje; deterdženti za medicinske svrhe; dijetetska pića prilagođena medicinskim svrhama; dijetetska hrana; dijetetske supstance; dezinfekciona sredstva za hemijske toalete; losioni za pse; preparati za

pranje pasa; preparati za odbijanje insekata kod pasa; medicinska pića; sredstva za ispiranje očiju; kutije za prvu pomoć (napunjene); lepкови za hvatanje mušica; papir za hvatanje mušica; preparati za uništavanje mušica; lepak za mušice; preparati protiv znojenja stopala; gaza za zavoje; germicidi; kedrovo drvo koje služi za odbijanje insekata; masti za medicinske svrhe; medicinske infuzije; sredstva za odbranu od insekata; insekticidi; petrolejski gel za medicinske svrhe; gaće za menstruaciju; higijenske gaće; mleko u prahu (za bebe); laktoza za medicinske svrhe; maramice sa farmaceutskim losionima, losioni za farmaceutske svrhe; losioni za veterinarske svrhe; pastile; pića od mlečnog slada za medicinske svrhe; medicinski alkohol; lekovito bilje; lekovito ulje; medicinski čaj; medicinske torbe (male, napunjene); lekovi za ljudsku upotrebu; jastučići za menstruaciju; tamponi; mentol; pomade; mineralni dodaci za hranu; papir za suzbijanje moljaca; preparati za suzbijanje moljaca; preparati za ispiranje usta; blato za kupanje; pelene za inkontenciju; nutricionistički dodaci za medicinske svrhe; sanitarne maramice; sanitarni ulošci; sanitarni jastučići, sanitarne gaćice; gaćice, upijajuće, za mokrenje; higijenski ulošci za svaki dan; paraziticidi; pilule za farmaceutske potrebe; hemijski preparati za dijagnostikovanje trudnoće; čaj za mršavljenje za medicinske svrhe; lekovi protiv znojenja; matični mleč (za medicinske svrhe); sanitarni peškiri; farmaceutski preparati za negu kože; mirišljave soli; preparati za sterilizaciju; pomada protiv opekotina od sunca; preparati protiv opekotina od sunca za farmaceutske svrhe; sirupi za farmaceutske svrhe; vitaminski preparati; pamučni štapići za medicinske svrhe; kreme za sunčanje za zaštitu od sunca; kašne obloge; kompresioni zavoj; kašne obloge i/ili kompresioni zavoji za snižavanje telesne temperature ili za ublažavanje groznice ili glavobolje; zavoji (za medicinske svrhe); lekovi za medicinske svrhe; medikamenti za snižavanje telesne temperature; biljni čajevi; kašne obloge od slačice; medicinski preparati za potrebe mršavljenja; sve uključeno u klasu 5.

Klasa 08: Ručni alati i sprave (kojima se ručno upravlja); pribor za jelo; hladno oružje; žileti, makaze za bradu; otvarači za flaše; otvarači za konzerve; kutije za brijače; pincete, za zanoktice; makaze za zanoktice; sekači; pribor za rezanje; sredstva za pretakanje tečnosti; aparati za depilaciju; utiskivači; grickalice (električne ili neelektrične); uređaj za vađenje eksera; aparati za poliranje noktiju; viljuške; alat za baštu šišači; ručna sredstva za kovrdžanje kose; pinceta za uklanjanje dlaka; šiljak za razbijanje leda; bušilice; noževi; makaze za travu; kožni kaiš za oštrenje brijača; dizalice; turpije; turpije, električne; izvlakači eksera; sprave za uvlačenje konca u iglu; numeracioni probojci; klešta za orahe i lešnike, ne od plemenitih metala; otvarači sa oštricom; set za pedikir; aparati za ubijanje biljnih parazita; žileti; kaiš za oštrenje brijača; brijači, električni ili ne; makaze; instrumenti za oštrenje; kašike; sprejevi; markeri za utiskivanje (ručni alati); hvataljke za kocke šećera; stono posuđe; otvarači za konzerve; seckači za meso i povrće, noževi, sekači i rezači i delovi i dodaci koji se koriste za te svrhe; makaze za porublivanje; gvozdeni savijači; klješta za uvijanje; setovi za manikir; pribor za brijanje; pincete; kutlače za vino; (rezači jaja, (neelektrični); sekač za sir (neelektrični); sekač za picu (neelektrični); tučak; aparat za uvijanje trepavica; zlatno i srebrno posuđe (pribor za jelo, viljuške i kašike); sve uključeno u klasu 8.

Klasa 09: Aparati i instrumenti naučni, nautički geodetski, električni, fotografski, kinematografski, optički, za vaganje, za merenje, signalizaciju, kontrolu (nadgledanje), za spasavanje života i za obuku; aparati za snimanje, prenos, reprodukciju zvuka ili slike; magnetni nosioci podataka, diskovi za snimanje; automatske mašine za prodaju i mehanizmi za aparate koji se pokreću ubacivanjem novca; registar kase; računске mašine; oprema za obradu podataka i kompjuteri; aparati za gašenje požara; računaljke; električni uređaji za privlačenje i uništavanje insekata; audio i vizuelni aparati namenjeni za podučavanje; baterije; kutije za baterije; aparati namenjeni za punjenje dopunljivih baterija; dvogledi, durbini; kalkulatori; kamere, kamere namenjene za kinematografske potrebe i delovi i dodaci za njih; sočiva

za kamere; instrumenti za merenje kapaciteta; animirani crtani filmovi; kasetofoni; lančići za naočare; kinematografski filmovi; (prikazani); časovnici; aparati namenjeni reprodukciju kompakt diskova; kompakt diskovi (audio-video); kompakt diskovi (za čitanje podataka); memorija namenjena čitanju); kompjuterski operativni programi, snimljeni; kompjuterski programi; kompjuterski softveri (snimljeni); kompjuterski štampači za kompjutere; kontaktna sočiva; kutijice za kontaktna sočiva; aparati namenjeni za obradu podataka; krojački pribor za merenje; električna zvana za ulazna vrata; džepni elektronski prevodioci; aparati za gašenje požara; filmovi, izloženi; blicevi; alarmni sistem protiv požara; okviri za dijapozitive u fotografiji; aparati za igre, namenjeni da se upotrebljavaju zajedno sa televizijskim prijemnicima; aparati za uvijanje kose, električni; aparati za regulisanje toplote; džu-boksovi; optička sočiva; skale za merenje veličine slova; pojasevi za spasavanje; plutače za spasavanje; sigurnosne jakne; splavovi za spašavanje; brave, električne; magnetni nosač podataka; magnetne kodirane kartice; magnetni dekoderi; magneti; uveličavajuća stakla; električni uređaji za skidanje šminke; aparati, uređaji i instrumenti za merenje; mikrofoni; mikroskopi; neonski znaci; laptopovi; elektronske olovke; gramofonske ploče; fotokopir aparati; džepni kalkulatori; aparati za projekciju; ekrani namenjeni potrebama projekcije; radio uređaji; gramofoni; daljinski upravljači; lenjiri (merni instrumenti); skale (merne); smart kartice; detektori dima; utičnice, utikači i ostali kontakti; aparati namenjeni za snimanje zvuka; diskovi namenjeni za snimanje zvuka; aparati namenjeni za reprodukciju zvuka; aparati namenjeni za prenos zvuka; kutije za naočare; okviri za naočare; stakla za naočare; naočare; naočare za sunce; pojasevi za plivanje; odela za plivanje; prekidači električni; kasetofoni; telefonski aparati, prijemnici, transmiteri, žice; teleskopi; televizori; televizijski prijemnici; indikatori temperature; instalirani sistemi namenjeni prevenciji provala, električni; termometri; termostati; video kasete, kertridži za video igre; video zapisi; video trake; video ekrani; video rekorderi; plovci za vodu; obrađivači teksta; video i kompakt diskovi; digitalni multimedijalni (video) diskovi; video kompakt diskovi i digitalni multimedijalni (video) disk plejeri; audio i video aparati, sa aparatima za prenos zvuka (pevajući uređaji); držači, nosači, kutije za audio i video kasete, kompakt diskove, laserske diskove; video diskovi i digitalni multimedijalne (video) diskovi; diskovi; podloga za miš; telefoni, bežični telefoni, mobilni telefoni i delovi i dodaci uz njih; futrole i maske za mobilne telefone; pejdžeri i delovi i dodaci uz njih; futrole i maske za pejdžere; torbe, pokrivači, kutijice, nosači i držači za mobilne telefone i pejdžere; slušalice; slušalice za uši; slušalice za uši i mikrofoni/spikeri za telefon, za razgovor mobilnim telefonima, koje se upotrebljavaju sa mobilnim telefonom; indikatori poziva za telephone, mobilne telefone i pejdžere; mobilni telefoni i pejdžeri; uređaji za igranje video igrice; maske, koje se nose preko očiju radi zaštite od svetlosti; elektronske agende (programi rada); električna alarmna zvana; alarmi; čitači bar-kodova; barometri; zujalice; električne zujalice; procesor (čip), centralna jedinica za obradu podataka; čipovi (integrisana kola); hronografi (aparati za beleženje vremena), upaljači za cigare i/ ili cigarete za automobile; kompjuterske tastature, kompjuterske periferne sprave; akustične spojnice; spojnice (oprema za obradu podataka); optički nosači za podatke; optički diskovi; diskovi (magnetni); mašine namenjene automatskoj distribuciji; ronilačka oprema; ronilačke maske; ronilačka odela; elektronske oglasne table; elektronske olovke (za video-displeje); uređaji za funkcionisanje liftova; vrpce za naočare; okulari; naočare za spavanje; faksimil mašine; filteri (fotografije); kućne pegle, električne; plovci za kupanje i plivanje; flopi diskovi; trake za čišćenje glava za snimanje; higrometri (za merenje vlažnosti); integrisana kola; aparati za internu komunikaciju; interfejsi (za kompjuter); mašine za fakturisanje; poklopci za objektivne; aparati za upravljanje liftovima; jedinice za magnetne trake (za kompjutere); magnetne trake; kašike za merenje; metronomi; mikroprocesori; moderni; mašine za brojanje i sortiranje novčanica; monitori (kompjuterska oprema); monitori (kompjuterski program); miš (oprema za obradu podata-

ka); optička vlakna; optička stakla; optička roba; optička sočiva; parking metri; kompjuterska pomoćna oprema; uglomeri (merni instrumenti); radio-telegrafski kompleti; radio-telefonski kompleti; skeneri (oprema za obradu podataka); poluprovodnici; slajdovi (fotografija); mašine za prorezivanje, automatske; trake za snimanje zvuka; demagnetizirajući aparat za magnetne trake; telegrafске žice; telegrafski aparati; teleprinteri; telekomunikacioni aktivatori; teleprinteri; izdavači karata; transmiiteri (telekomunikacije); paket za transmisiiju (telekomunikacije); vakuum metri; video ekrani; video telefoni; video rekorderi; piskavi alarmi; plutajuće sprave za plivanje; (čepovi za uši, ronilački čepovi za uši; jajoliki satovi; sportske naočare; zaštitne kacige za sport; aparati za navigaciju za automobile (unutrašnji računari); program za kompjuterske igrice; metronomi; elektronske publikacije (koje mogu da se preuzmu sa interneta); kompjuterski programi (softveri koji mogu da se preuzmu sa interneta); stereo, vokmen; sateliti za naučne svrhe; oslonci za ručni zglob za upotrebu sa kompjuterima; vrpce za nošenje mobilnih telefon; postolja za portabl telefone; nalepnice za portabl telefon; poklopci za antene za portabl telefon; elektronska kola i cd-romovi, koji omogućavaju snimanje automatskog programa za muziku, namenjeni upotrebi elektronskih muzičkih instrumenata; čepovi za uši, sve uključeno u klasu 9

Klasa 10: Hirurški, medicinski, zubarski i veterinarski aparati i instrumenti, veštački udovi, oči i zubi; ortopedska pomagala; hirurški materijali za zašivanje; aparati za merenje krvnog pritiska; flašice za bebe; cucle za bebe; zavoji; električna čebad za medicinsku upotrebu; kondomi; kontraceptivna sredstva, nehemijska; zubarski aparati; veštačke dojke za bebe; štapići za uši; aparati za estetske masaže; cucle za flašice za bebe; ventili za flaše za hranjenje; flašice za hranjenje; ulošci za ravne tabane; ortopedska obuća; pincete; rukavice za masažu; rukavice za medicinsku upotrebu; slušni aparati za gluve; štitnici za uši (sluh); terapijski aparati na bazi vrućeg vazduha; pakovanja leda za medicinsku upotrebu; inkubatori za bebe; aparati za masažu; porodiljski pojasevi; dušeci za porođaj; ortopedska pomagala; ulošci za trbuh; električni termofori (Uastuci), za medicinsku upotrebu; uspavljujući jastuci za nesanicu; hirurški sunđer; dozer kašike za medicinsku upotrebu; stetoskopi; nosila; toplotna pakovanja za prvu pomoć; strugači za jezik; veterinarski aparati i instrumenti; maske za usta; termometri za medicinske svrhe; bolesničke guske (lopate); pakovanja vode za medicinske svrhe; (prstenovi za pravilno nicanje zuba); medicinski jastuci ili preparati za testiranje telesne temperature; sve uključeno u klasu 10.

Klasa 11: Aparati za osvetljavanje, grejanje, proizvodnju pare, kuvanje, hlađenje, sušenje, ventilaciju, snabdevanje vodom i za sanitarne svrhe, klima uređaja, osveživači vazduha; isušivači vazduha; aparati i mašine za prečišćavanje vazduha; ulošci za slavine koji sprečavaju prskanje vode; aparati za filtriranje akvarijuma; grejači akvarijuma; osvetljenje za akvarijum; peći; roštilji; oprema i instalacije za kupatilo; grejači za kupatila; grejači za krevete; aparati za rashlađivanje pića; osvetljenje za bicikl; električna čebad; bojleri; tosteri za hleb; električno grejane, prostirke; plafonjere; lusteri; električne sijalice za jelke; električni filter aparati za kafu; mašine za kafu; filteri za kafu; sprave za prženje kafe; rashladni kontejneri, (hladnjače); šporeti; aparata i uređaji za kuvanje; kuhinjske sprave, električne; rashladni uređaji za tečnosti i instalacije za taloženje u duvanskoj industriji; grejni jastuci; prigušivači (za paru); grejači (jastučići); amortizeri (grejanje); friteze, na struju, aparati za dezinfekciju; zidni držači dezinfekcionih sredstava za toalete, aparati za destilaciju; fenovi za sušenje kose; filteri vode za piće; aparati za sušenje stočne hrane; električne lampe; ukrasne lampice za svečanu dekoraciju; ventilatori (erkondišn aparati); električni ventilatori; grejalice, električne, za flašice, za hranjenje; aparati za ispiranje; ukrasne fontane; zamrzivači; pržionice za voće; upaljači na gas; električni roštilji; roštilji; aparati u perionicama za ručno sušenje; oprema za kupatila sa toplim vazduhom; peći za topao vazduh; ringle; boce za toplu vodu; svetleći kućni brojevi; prečišćivač vazduha; kutije za led (ledomati); sanduci za led (ledomati); maši-

ne i aparati za led; električni čajnici; ramovi za lampe; staklena cev za lampe; vitraž lampe; kugle lampi; visiljke za lampe; abažuri za lampe; reflektori; abažuri; lampe; nosači abažura; fenjeri; električni sušaći veša; sijalice; instalacija za osvetljenje; mikrotalasne pećnice; uređaji za hlađenje mleka; slavine za spajanje za cevi za vodu; pločasti grejači (plotne); džepna baterijska lampa; džepni reflektori; džepni grejači; električni lonci za kuvanje pod pritiskom; tankovi sa vodom pod pritiskom; električni radiatorji; rashladne vitrine; rashladne komore; frižideri; pekači; aparati za pečenje; sprave za prženje; ražanj; roštilji; sigurnosne lampe; tuš kabine; tuševi; sudopere; grla električnih sijalica; solarni kolektori (grejanje); tosteri; lavaboji za toalete; WC šolje; prekrivači za WC šolje; toaleti, pokretni; lampe; pisoari; sprava za pečenje vafila, električna; sprave za pečenje/za kuvanje, električne; posude za zagrevanje; lavaboji; grejači vode; aparati i mašine za prečišćavanje vode; sterilizatori vode; džepne lampe; električni prečišćivači vazduha; oprema protiv zaslepljivanja za automobile; oprema protiv zaslepljivanja za vozila; lampe sa svetlosnim lukom, električni ekspres lonci (autoklavi); kade za kupanje; kineski fenjeri (lampe); zaštitni uređaji za osvetljenje; rasipači, difuzori svetla; upaljači; svetla za automobile; svetla za vozila; peći; peći (grejni aparati); (lonci za pirinač); sve uključeno u klasu 11.

Klasa 12: Vozila; aparati za kretanje po zemlji, vazduhu ili vodi; sprave protiv zaslepljivanja za vozila; sprave protiv zaslepljivanja za vozila; alarmi, protiv krađe za vozila; protivprovalni proizvodi za vozila; nosiljke za bebe; pokrivači za nosiljke za bebe, zvana za bicikle, tricikl ili; bicikle i tricikl, i delovi i oprema za njih; kola; trolejbusi; navlake sedišta za vozila; zaštitna odeća (štitnici) za bicikle, motorcikle ili tricikle; kola za golf; kolica, okretna za istovar robe; ručna kolica; nasloni za glavu za sedišta u vozilima; kabanice za dečija kolica; haube (poklopci) za vozila; sirene za vozila; sirene za vozila; radkapne; centralni rotirajući deo točka vozila; nosači prtljaga za vozila (gepek); mreže za prtljag kod vozila; teretni kamioni; blatobrani; uređaji koji sprečavaju proklizavanje guma; vesla za kanue; vesla; pedale za motorcikle; dečija kolica; pumpe za bicikle, motorcikle ili tricikle; navlake za dečija kolica; cerade za dečija kolica; dečija kolica navlake za sedišta za bicikl, tricikl ili motocikle; sigurnosni pojasevi za vozila; sigurnosna sedišta za decu (za vozila); sedišta za vozila; sigurnosni pojasevi za vozila; roletne (zaštite od sunca) prilagođene za automobile; gume za vozila; tapacir za vozila; pokrivači za motorna vozila (oblikovani); invalidska kolica; brisači vetrobrana; držači za sitnice u vozilima; kutije za arome i ugodne mirise za korišćenje u vozilima; avioni; vazdušni jastuci (sigurnosni delovi za automobile); vazdušni baloni; automobili; motorne kočije; retrovizori; motorni autobusi; motorna vozila; motorcikli; kolica za kupovinu; kolica za bebe; gume za bicikle, tricikl ili motocikle; električna vozila; vodena vozila; (navlake za ručke automobila; pokrivači točkova) sve uključeno u klasu 12.

Klasa 14: Dragoceni metali i njihove legure i proizvodi od dragocenih metala i njihovih legura, ili premazani s njima; nakit, imitacije nakita i ukrasa; drago kamenje; časovničarski i hronometrijski instrumenti; broševi; lančići; amajlije; kovani novčići; ukrasi, imenovane medalje i/ili kovani novčići; dugmad za manžetne; minduše; zlatne niti; ukrasi (od dragocenih metala); predmeti od imitacije zlata; kutije za dragulje; kutijice za nakit; ogrlice; špenadle, igle (nakit); igle za revere; prstenje; statue i statuete od dragocenih metala; šnale za kravate; časovnici, satovi i delovi i pribor za njih; kaiševi za satove; trake za satove, lanci za satove; kutije za satove; štoperice; ukrasi; ukrasne igle; igle za kravate; medalje; privesci za ključeve, obični ili ukrasni; lanci za ključeve i futrole/ nosači za ključeve od dragocenih metala i/ili od dragog kamenja; privesci; narukvice (nakit); kutije za ručne satove (prezentacione); kutije za satove; časovnici i satovi, električni; sunčani satovi; dijamanti; nakit za kostime; polu drago kamenje; umetnička djela, od dragocenih metala; budilnici; baršunasta dugmad za manžetne; duple igle (igle za kravate); figurice (statuete) od dragocenih metala; kutijice za nakit; sve uključeno u klasu 14.

Klasa 16: Hartija karton i proizvodi od njih, koji nisu uključeni u druge klase; štampane stvari; knjigovezački materijal; fotografije; kancelarijski materijal; lepila za kancelarijske i kućne potrebe; umetnički alati i materijali; slikarske četkice; pisaće mašine i kancelarijski rekviziti; materijali za obuku i nastavu; plastični materijali za pakovanje (koji nisu uključeni u druge klase); štamparska slova; štamparski blokovi; kalendari, knjige, katalozi, dopisnice, razglednice, poster, časopisi, štampana publikacija novine i magazini; čestitke; razglednice; pisaći pribor; gumeni pečati; marke i pečati; jastučići za pečate, jastučići za mastilo; foto albumi; podmetači za uramljivanje slika ili fotografija; stalak za slikarska platna; uljani upijajući papir za kožu; postolja za fotografije; mastila; maramice, toalet papir, salvete od papira za uklanjanje šminke; papirni peškiri (ubrusi); podmetači podmetači za čaše od papira ili kartona; papir za uvijanje, papir za pakovanje, materijal za pakovanje; umetničke akvarel boje; grafičke reprodukcije, portreti; litografije; pera, olovke, vrhovi pera, hemijske olovke, nalivpera; držači za olovke; držači za pera; dopune za pera i instrumenti za pisanje; grafiti za olovke; olovke za bojenje, krede u boji; kutije za pera i olovke; zarezajući za olovke; mašine za oštrenje olovaka; spajalice; pritiskači za papir; igle za papir, igle za crtanje; voštane boje; lepila za kancelarijske i kućne potrebe; papirna galanterija; posude i stalci za pisma; držači za pisma; otvarači pisama; lepljive trake i držači za lepljive trake; pribor za crtanje, table, olovke i instrumenti; setovi za crtanje; albumi za torbe i koverta; upijajući papir; držači knjiga i obeleživači stranica za knjige; markeri knjiga; ormani za kancelarijski materijal; platno za slikanje; notesi; dnevници; fascikle; podloge za pisanje; podloge za beleške; papir za pisanje; papir za crtanje; kutije za pisanje; krede, školske table, table za plakate; futrole za pasoše; držači za čekovne knjižice; elastične trake; slike; matrice; proizvodi za brisanje, gumice, korektori; električni otvarači pisama; muzičke note; table za brisanje; ukrasi i dekoracija od papira i/ili kartona; toalet papir; salvete od papira; torbe za ručak; kartonske kutije i sanduci; bojanke; fascikle za izveštaje; povezi za papir; džepne sveske; flomasteri; trake za knjige; setovi crnih grafitnih olovaka; setovi olovaka u boji boji; lenjiri; podmetači za pisanje; knjige za autogram; klipse; heftalice, makaze za trake; znaci upozorenja; sekači; mašine i aparati za plastificiranje; električni toplotni zaptivači za zaštitni omot za dokumente i fotografije; držači kartica i predmeta; ukrasi od papira za kutije za hranu; albumi; pelene za bebe od papira i celuloze (za jednokratnu upotrebu); torbe (koverta, kese) od papira ili plastike, za pakovanje; spajalice (veze) za slobodne listove; kutije od kartona ili papira; karte; držači i kutije za markice i pečate; stripovi; šestari; papirne trake i karte za upis kompjuterskih programa; papir za kopiranje (pribor); korektori (kancelarijski rekviziti); fajlovi dokumenata; naprstci (kancelarijski rekviziti); zastave (od papira); folderi (kancelarijski); fascikle za papire; gumirane trake; maramice od papira; indeks kartice; mastiljave trake; omoti za papir; nalepnice, ne od tekstila; mape; muzičke čestitke; bilteni; podloge, jastučići (kancelarijski materijal); kutije za boje (predmeti za upotrebu u školi); brošure; sekač papira (za upotrebu u kancelariji); držači za grafitne olovke; poštanske marke, stikeri; salvete od papira; pribadače; karte; trake za pisaće mašine; pisaće mašine (električne ili ne-električne); omoti; četke za pisanje; krede za pisanje; table za pisanje; prekrivači (kancelarijski); tacne za saksije od papira; noževi za papir (kancelarijski rekviziti); portikle od papira; kese za mikrotalasno kuvanje; papir filteri za kafu; brošure; vezeni dizajni (šabloni); noževi za papir (kancelarijski rekviziti); stolnjaci od papira; viseće firme (reklame) od papira ili kartona; metalni vrh za indeksne karte; lotovi papira; upijajući papiri za lice; nalepnice za prenosive telefone; sve uključeno u klasu 16.

Klasa 18: Koža i imitacija kože, i proizvodi izrađeni od ovih materijala koji nisu uključeni u druge klase; životinjska koža, krzno; sanduci i putne torbe; kišobrani, suncobrani i štapovi za hodanje; bičevi (kamdžije), saračka oprema i sedlarska roba; torbe, tašne i novčanici, kutije, prtljag, kese; akt-tašne; rančevi; torbe za odeću; torbe za kupovinu; trake od kože; rameni kaiševi; kaiševi; štapovi od trske; omoti i korice za blokove (beležnice); okovratnici za

životinje ili kućne ljubimce; futrole za ključeve; pertle od kože ili od imitacije kože; ukrasne kutije; brnjice; školske torbe; kaiševi; ručke za kofer; koferi; putni kompleti; putnički kovčezi (sanduci); futrole za kišobrane; drške od kišobrana; štapovi za hodanje (šetnju) sa sedištem (stolice koje po potrebi mogu biti štapovi za šetnju); kaiševi za prtljag; torbe za plažu; akt tašne, sanduci i kutije, od kože ili kožnih tabli; ručne torbe; kožni kaiševi planinarski štapovi; muzike kutije; torbe od mreže za kupovinu; ruksaci; školske torbe; torbe za alat od kože ili imitacije kože (prazne); putne torbe; lovačke torbe; torbe, koverte i vrećice od kože, za pakovanje; prekrivači nameštaja od kože ili imitacije kože; ramovi za ručne torbe; torbe za nošenje dece sa naramenicama; torbe za kupovinu sa točkovima; sve uključeno u klasu 18

Klasa 20: Nameštaj, ogledala, okviri za slike; proizvodi (koji nisu obuhvaćeni drugim klasama) od drveta, plute, trske, pruća, rogova, kosti, slonovače, kitove kosti, školjki, ćilibara, sedefa, morske pene i zamene svih ovih materijala, ili od plastike; jastučići na naduvavanje; dušeci na naduvavanje; jastuci na naduvavanje; vreće za spavanje; zavesa od perli, ukrasna; za delovi za krevete, nemetalni; rublje za krevete (osim prekrivača); kreveti za kućne ljubimce; korpe, ne od metala; zatvarači za boce; stalak za flaše; čepovi (pluta) za flaše, plastične ključ-kartice; komode; viseća zvana; vešalice za odeću; čiviluci, čiviluci; čiviluci; kontejneri, posude koji nisu od metala (za skladištenje, transport); držači zavesa; kuke za zavesu, šipke za zavesu; alke za zavesu; šipke za zavesu; valjci za zavesu; omče i petlje za zavesu; jastuci; držači za peškire; kavezi za kućne ljubimce; krevet, nameštaj, vrata, oprema, ramovi za vez; ventilatori (neelektrični); statue od drveta, voska, gipsa ili plastike; zakloni za vatru; postolja za saksije; postolja za saksije za cveće; postolja za šešire; visoke stolice za bebe; kućni brojevi, ne od metala, nesvetleći; legla i kućice za ljubimce; identifikacione pločice, koje nisu od metala; indeks kabineti; šetalice za bebe; naduvani reklamni predmeti; kutije za nakit; poštanski sandučići; stalci za pisma; stalci za novine; dušeci; kontejneri, posude od plastike za svrhu pakovanja; jastuci; stalci, postolja, štandovi; stalci za šoljice; registarske tablice; viseće firme (reklame); drške alata; poslužavnici; pletarski radovi, od pruća; ramovi za fotografije; dekorativne ivice traka od plastike i/ili drveta za upotrebu sa opremom za prozore; ornamenti i ukrasi za prozore ili vrata od plastike, voska, drveta, plute, trske, pruća, roga, kosti, slonovače, kitove kosti, školjki, ćilibara, sedefa, morske pene i zamene ovih materijala; zaptivači za kese; plastične posude za arome i mirise; nasloni za glavu na naduvavanje; dekoracije od plastike za hranu i kutije za ručak; privesci i lanci za ključeve, ne od metala; graničnici za zaustavljanje vrata; fotelje; korpe, ne od metala; kreveti; klupe (nameštaj); kutije od drveta ili od plastike; stolarska roba ormari; stolovi na točkice za računare (nameštaj); sanduci od drveta ili plastike; stolice; sanduci za igračke; čepovi; pokrivači odeće (ostava); kolvke; zavesu od bambusa; stolice za pisaće stolove; pisaći stolovi; nameštaj za vagon restorane; slamke za piće; nasloni za glavu (nameštaj); table za kačenje ključeva; police u biblioteci; sefovi; brave (osim električnih), ne od metala; krojačke lutke; stalci (nameštaj); okviri za fotografije; okviri za slike; nogare za sečenje drva; školski nameštaj; sedišta; sofe; stolovi; kolica za serviranje čaja; ručna kolica za serviranje, čaja; pokretni stolovikolica za računare (nameštaj); postolja za kišobrane; dečiji kreveti; plakari; oglasne table; odvodi (ventili) od plastike; toaletni stočići; hoklice i stolice bez naslona; korpe za rublje sa poklopcem; kuke za odeću; merdevine od drveta ili plastike; ormarići za lekove; podmetači, prenosivi, za sudopere; table sa imenima, ne od metala; table sa brojevima, ne od metala; klinovi i igle (ne od metala); ogradice za bebe; greda za češanje za mačke; police; unutrašnje prozorske roletne (za zamračenje) (nameštaj); umetnička dela, statuete i figurica i sitni ukrasi ili ukrasa od drveta, plute, trske, pruća, roga kosti, slonovače, kitove kosti, školjki, ćilibara, sedefa, morske pene i zamene ovih materijala, ili od voska, gipsa ili plastike; kutijice za pilule (od drveta, plastike); zatvarači za flaše; sve uključeno u klasu 20.

Klasa 21: Kućne ili kuhinjske sprave i posude (ne od dragocenih metala ili sa prevlakom od

njih); češljevi i sunđereri; četke; materijali za pravljenje četki; artikli koji se koriste pri čišćenju; čelična vuna; neprerađeno ili poluprerado staklo; staklarija, porcelan i grnčarije koji nisu uključeni u druge klase; kade za kupanje beba (prenosive); korpe za domaćinstvo; pehari; kavezi za ptice; ne-električni blenderi; daske za peglanje; izuvači za čizme; otvarači za flaše; zatvarači za flaše napravljene od keramike, porcelana, stakla, kristala, grnčarije, i terakote; boce, flaše; činije; kutije za sapun; daske za sečenje hleba; vedra i kofe; kafanski poslužavnici; kavezi za kućne ljubimce; kalupi za torte (modle); kalupi za vafle; sprave za gašenje sveća; ukrasi za sveće u obliku prstena; svećnjaci; kutije za slatkiše; futrole za češljeve; ornamenti od porcelana; porcelanska roba; štapići za jelo (sprave za kuvanje); stalci za rublje; vešalice za odeću; tkanine za čišćenje; podmetači; posude za mešanje koktela; filter aparati za kafu; mlinovi za kafu; mašine za filter kafu; servisi za kafu; džezve; električni češljevi; češljevi za životinje; vreće, torbe za poslastice; kuharske modle; kuhinjsko posuđe; kuhinjske igle za ražanj; kante za led; prenosni mali frižideri; uređaji za hlađenje hrane koji sadrže tečnost za razmenu toplote, za upotrebu u domaćinstvu; vadičep; kozmetički pribor; pokrivači za sudove; pokrivači za vazne za cveće; grnčarija; šoljice; kuhinjske daske za seckanje; stoni, dekorativni bokali, boce; ne-električne friteze; posude za sapun; držači za sapune; čuture za piće, čaše, pojilice, sudovi; sušilice za veš; kante za smeće; čaše za jaja; korita za hranjenje; vazne za cveće; hvataljke za muve; rukavice za upotrebu u domaćinstvu; pehari; renda za sečenje; neelektrični roštilji; toplotno-izolacione posude; grejači za flašice za hranjenje, neelektrični; posude za cveće i biljke; tople posude; kote za led; kalupi za led; navlake za daske za peglanje; krčazi; čajnici; postolja za noževe; dugmad od porcelana; veliki kružni poslužavnik za hranu; kompleti za liker; kutije za hranu; držači za jelovnike; male kote, vojničke porcije; kašike za mešanje; mop, brisač poda sa resama od tkanine; držači salveta; prstenovi za salvete; mlaznice za kante za zalivanje; sunđereri za čišćenje; posude; papirni tanjiri; pribor za sečenje kolača; mlin za biber; parfemi, arome, eterična ulja, posudice sa svećom za sago-revanje mirisa; prskalice za mirise; mirisni isparivi raspršivači; piknik korpe; štedne kasice; poklopci za lonce; lonci; ekspres lonci; kante za đubre; slanici; bibernici; posude; tacne; kutlače, lopatice; jastučići za čišćenje, ribanje; četkice za brijanje; rastezači za košulje; četke za cipele; rogovi za cipele (za očuvanje izgleda cipela); kalupi za cipele; sita; prečišćivači dima za kućne potrebe; činije za supu; setovi za začine; držači za sunđere; sunđereri za kućne potrebe; držači za četke za brijanje; statuete, kipovi od porcelana terakote ili stakla; cediljke; prskalice za zalivanje cveća i biljaka; stono posuđe; vrčevi i krigle; čaj, jajaste posude za kuvanje čaja; kutijice za čaj; čajnici; servis za čaj; čajnici; četke za toalet; neseseri sa priborom (toaletni); držači za toalet papir; toaletni sunđereri; toaletni pribor; četkice za zube; četkice za zube, električne; držači za čačkalice koji nisu od dragocenih metala; čačkalice; kante za smeće; posude za nuždu; poslužavnici za domaćinstvo; tronošci; presa za pantalone; rastezači za pantalone; vakumirane boce; neseseri sa priborom; vaze; sprava za pravljenje vafli i palačinki, neelektrična; sprave za kuvanje i pečenje, neelektrične; daske za pranje; korita za pranje veša; kante za zalivanje; uređaji za zalivanje; aparati za poliranje voskom; umetnička dela od porcelana, terakote ili stakla; ukrasi za prozore ili vrata od keramike, porcelana, stakla, kristala, zemlje, terakote ili porcelana; kutije ili posude za hranu (ne od dragocenih metala); zamke za miševе; konac za čišćenje zuba; pojasi/trake za kutije za hranu i posude za domaćinstvo ili kuhinju; posude za arome i mirise; rashladne boce (termosi); kutije od stakla; metle; četkarska roba; posude za maslac; poklopac za posude za maslac; kotlovi; instrumenti za čišćenje (ručni); vešalice, kuke za veš; ručni frižideri, neelektrični; tegle za kolačiće; posuđe za kuvanje, ne-električno; četke za obrve; četke za obuću; tiganji; levci; baštenske rukavice; staklene boce (kontejneri); izolacione čaturice i boce; pufna za pudriranje; ručni mikseri (za koktele); cediljke za čaj, ne od plemenitih metala; višenamenske postave i čaršavi za upotrebu u domaćinstvu ili kuhinji; metlice, mutilice, neelektrične; posude od metala za

pravljenje leda i ledenih napitaka; sekači za kolačiće (biskvite); bočice, stalci za bočice; krpe za brisanje prašine; koktel šejkeri; kutijice za puder u prahu, ne od plemenitih metala; kutije za pilule ili tablete; omoti za kutije od toalet papira od drveta ili plastike; stalak za četkice za zube; konac za čišćenje zuba; držač za konac za čišćenje zuba; bolesničke guske (lopate); posude za domaćinstvo od plemenitih metala; kućne potrepštine od dragocenih metala; servisi za kafu od dragocenih metala; džezve za kafu, neelektrične, od dragocenih metala; držači salveta i prstenovi za salvete od dragocenih metala; pudrijere od plemenitih metala; stono posuđe od dragocenih metala; sanduci i kutije od dragocenih metala; sve uključeno u klasu 21

Klasa 22: Užad, ka napi, mreže, šatori, tende, cirade, jedra, vreće i torbe (koje nisu uključene u druge klase); materijali za postavljanje i punjenje (osim od gume ili plastike); sirovi vlaknasti tekstilni materijali; prekrivači za flaše; viseće mreže za ležanje; trake za pakovanje ili spajanje, ne od metala; presvlake za vozila (nestandardniL (trake, ne od metala, za pakovanje ili spajanje) sve uključeno u klasu 22.

Klasa 23: Predivo i konac; pamučno predivo i konac; konac i prediva za vez; konac i prediva za šivenje; konac i prediva za predenje; vuna za predenje; vuneni konac i predivo; sve uključeno u klasu 23.

Klasa 24: Tekstil i tekstilni proizvodi, tkanine, koji nisu uključeni u druge klase; maramice; salvete; prekrivači za krevete i stolnjaci; zastava, barjak; platna, rublje za kupatilo, posteljina; prostirke za krevete; ćebad za krevete; zastori od tekstila; platno, štof; prekrivači za nameštaj od tekstila; prekrivači za nameštaj od plastike; navlake za jastuke; vratne zavese; tkanine od imitacije životinjske kože; peškiri; zastave; toalet rukavice; tkanine za domaćinstvo; etikete od platna; maramice za skidanje šminke; otirači; pokrivači za madrace; rukavice za pranje bez prstiju; mreže za komarce; zavese; jastučnice; plastični materijali (zamena za tkaninu); kiltovi; prekrivači za putovanja; čaršafi (tekstilni); zastori; svila; tkanine od svile; vreće za spavanje; stolnjaci i salvete; podmetači za stolove; salvete za stolove; tapiserija; vlakna za tapaciranje; tapiserija (zidna) od tekstila; rublje za krevet; prekrivači od tekstila za držače salveta ili maramica; prekrivači za kvake; navlake za sedišta toalet šolje; prekrivači za daske na toaletnim posudama; držači zavesa ili povezi za njih od tekstila; podmetači (stona platno); pamučne tkanine; zastirači za krevete; tkanine za tekstilnu upotrebu; peškiri za lice od tekstila; filc; friz (čupava tkanina od vune); vlakna od konoplje; navlake za stolove (ne od papira); somot; sukno; maramice od tekstila za uklanjanje šminke; (prekrivači od tekstila za kartonske kutije; prekrivači od tkanine za kvake; omotači od tkanine za PET flaše; etikete za oznaku imena; tkane etikete; platnene torbice ili od svile za priveske) sve uključeno u klasu 24.

Klasa 25: Odevni predmeti; obuća; kape; kecelje; odeća za plažu; odeća za kupanje; kupaći kostimi; sportska odeća; voodootporna odeća; rukavice; rukavice bez prstiju; pojas, kaiševi; odeća za decu, muškarce i žene; odeća za bebe; platnene maramice za bebe; portikle, ne od papira; donje rublje; odeća za spavanje i pidžame; bademantili; naramenice, podvezice; šeširi; kape; sunce viziri; beretke; kape za kupanje i tuširanje; mufovi; štitnici za uši; odeća za vrat; kravate; okovratnici; mašna; leptir mašne; čarape; hulahop čarape; podvezice; čarape i podvezice za hulahop čarape; obuća; sportska obuća; papuče; obuća za plažu; kostimi za maskiranje; radni rukavi; maramice; maramice za vrat; papuče (sandale) za kupatilo; papuče za kupanje; ski čizme; čizme; naramenice za odeću; (tregeri); brushalteri; kratke pantalone (bermude); prsluci, grudnjaci; kaputi; manžetne; krznene šalovi; vrpce za glavu (odeća); pokrivači za glavu; jakne (odeća); dresovi (odeća); džemper (vezeni prednji delovi košulja); pletena odeća; radna odeća (za poljske radove); mantili; kaputi; pantalone; jakna (odeća za zimu); džemper; sandale, šalovi; ešarpe; bluze; košulje; podsuknja (rublje); radnička bluza; nazuvci; čizme za sport; sportski dresovi; odela kostimi za kupanje; majice; pantalone; do-

nji veš; uniforme; prsluci; gumirana odeća za skijanje na vodi; manžetne košulja (odeća); žensko rublje; gimnastičke patike; bodi (rublje); odeća za gimnastiku; pojas od tkanine; sve uključeno u klasu 25.

Klasa 26: Čipka i vez; trake (pantljike) i gajtani; dugmad; kopče i petlje; špenadle i igle; veštačko cveće; veštačko voće; veštački venci; ukrasni noviteti, značke, kopče i broševi; značke, koje nisu od dragocenih metala; rajsferšlusi za torbe; elastične trake za držanje rukava; trake za kosu; šnale; kopče za kaiš; kopče za bluze; pantljike za kosu; kutije za pribor za šivenje; kutije za igle; kaiševi, pojasevi; gajtani; broševi; kopče; šnale za cipele; jastuci za igle; jastuci za igle, čiode; aplikacije (toplotno lepljive) za dekoraciju tekstilnih artikala (galanterija); spojnice za cipele; patentne spojnice (rajsferšlusi); spojnice za odeću; kopče za podvezice, naramenice; venci od veštačkog cveća; zlatni vez; galanterija; klipse za kosu; kapa za farbanje kose; vikleri; igle za uvijanje kose; ukosnice; mreže za kosu; ukrasi za kosu; igle za kosu; šnale za kosu; ukrasi za šešire; spojnice za korsete; igle za pletenje; ukrasi za obuću; trake za medalje; rozete; šivaće igle; za šivenje naprstci; kukice za obuću; pertle; kićanke; prekrivači za čajnike; umeci za kosu (ukrasne kićanke); čipka od vune; rajsferšlusi; držači za konjski rep; sigurnosne igle; spalalice i kopče za portikle i kecelje; nabori, ukrasi (čipkani); (primeniti); uzice i povodci za decu; bedževi od plemenitih metala; sve uključeno u klasu 26.

Klasa 27: Tepisi i asure; prostirke i otirači; linoleum i drugi materijali za pokrivanje podova; tapiserija (zidna) koja nije od tekstila; tepisi za automobile; prostirke za kupatila; prekrivači za podove; otirači za vrata; strunjače (prostirke za gimnastiku); prostirke za gimnastiku; tapiserije; vinil podne obloge; tapete; tapete od vinila; mustre za tapete; prostirke za igraonice (igru); prostirke za plažu; sve uključeno u klasu 27.

Klasa 28: Igre i igračke; lutke; plišane igračke; plišane mede; igračke figurice i setovi sličnih igračaka; gimnastički i sportski proizvodi; lopte i baloni; dekoracije proslava i ukrasi; nakit i ukrasi za božićne jelke; poklončići; igračke automobili; električni automobili (igračke); daske za surfovanje; daske za snowboard; roleri; klizaljke; skejtbordovi; štitnici za sport i igre; vazdušni pištolji (igračke); triktrak igre- dama igre; lopte za igru; zvona za jelke (božićne; bilijar kugle; bilijar stolovi; kocke (material) za gradjenje (igračke); igre na tabli; praskave bombone čizme za skijanje sa skijama; oprema za kuglanje; građevinske igre; držači sveća za jelke; table za igru dame; dame (igra); šah; šahovske table; veštačke jelke; mađioničarski uređaji; prskalice (vatromet igračke); šolja za mešanje kockica; pikado; kockice; kreveti za lutke; odeća za lutke; kuće za lutke; sobe za lutke; domine; gimnastički tegovi; štitnici za zglobove (sportski artikli); sprave za vežbanje (razvlačenje); jahaonica; flašice za lutke; udice za pečenje; ribolovački pribor (igračka); peraja za plivanje; plovci za ribolov; frizbiji (igračke); automatske igre; palice za igru; uređaji za elektronske igre različiti od onih prilagođenih samo za televizore; torbe za golf; štapovi za golf; rukavice za golf; rukavice; rukavice za igre i sport; praktične šale (noviteti), zezalice; namotaji za zmajeve; zmajevi; štitnike za kolene (sportska oprema); puzzle od kockica; klikeri za igru; marionete; pozorišne maske; maske (igračke); sobni viseći ukrasi (igračke); modeli vozila u srazmeri; noviteti za zabave i plesove; zaštitni jastučići (delovi sportske opreme); salonske igre; detonirajuće kapisle (igračke); pištolji igračke; igračke lopte za igranje; lutke; reketi; zvečke (igračke); igre sa obručima; konjići za ljuljanje; rolšue; daske za jedrenje; skije; sanke (sportska oprema); klizaljke (igračke); duvalice za pravljenje mehurića od sapuna (igračke); čigra (igračke); daska za skakanje (sportski proizvod); sobni bicikl za vežbanje; bazeni (proizvodi za igru); peraja za plivanje; ljuljaške; stolovi za stoni tenis; igračke za kućne ljubimce; skije za vodu; proizvodi za igru tokom kupanja; igre u vodi; sportovi i aktivnosti; lopte za plažu, automatske igre (strojevi) uz prethodno plaćanje; navlake specijalno dizajnirane za skije i daske za skijanje; bingo kartica; kartice; mreže za leptire; karte za igranje; konfete; roleri; pazle (slagalice); kaleidoskopi; jarboli za daske za jedrenje; meredovi; igračke vozila sa radio rulet (okretna ploča za rulet); snežne

kugle; krplje za sneg; japanske karte za igranje; sve uključeno u klasu 28.

Klasa 29: Meso, riba, živina i divljač; mesne prerađevine; konzervirano, sušeno i kuvano voće i povrće; želei; džemovi; kompoti; jaja; mleko i mlečni proizvodi; jestiva ulja i masti; goveđa supa, bujon; koncentracije za bujon; goveđa supa; koncentracije za goveđu supu; puter; kavijar; sir; sir grickalice; mlečni proizvodi; prehrambeni proizvodi od ribe; hrana spremljena od ribe; smrznuto voće; zaleđeno voće; čips od voća margarin; marmelada; želei od mesa; konzervirano meso; napici od mleka; konzervisane pečurke; obrađen lešnik; jetrena pašteta; pašteta; puter od kikirikija; prerađeni kikiriki; grašak, obrađen; voćna pulpa; krompir čips; hrskavi krompir; krompir uštipci; salata; kiseli kupus; kobasice; susamovo ulje; preparati za pravljenje supa; supe; tofu; salate od povrća; preparati od povrća za pravljenje supa; šlag; jogurt; instant obroci; proizvodi od hrane začinjeni karijem, pakovanje instant obroka; mali obroci; morska trava (za ishranu); obrađeno i konzervirano meso, riba, živina i divljač; slanina; preparati za pravljenje bujana; puter od oraha sa čokoladom; svinjski suhomesnati proizvodi; kroketi; kristalizovano voće; žele od voća; konzervirana riba; kukuruzno ulje; maslinovo ulje za ishranu; suvo grožđe; paradajz pire; povrće konzervirano; plodovi mora (ne živi); obrađeni i upakovani morski plodovi; morski plodovi (konzervirani), prehrambeni proizvodi spremljeni od morskih plodova; sve uključeno u klasu 29.

Klasa 30: Kafa, čaj, kakao, šećer, pirinač, tapioka, saga, zamena za kafu; brašno i preparati od žitarica, hleb, kolač i poslastice, led; med, melasa; kvasac, prašak za pečivo; so, senf; sirće, sosovi i umaci; mirodija, začini; led; biskviti; prah za kolače (prašak za pečivo); jestivi ukrasi za kolače; arome za kolače; pite od pirinča; slatkiši i bombone; čokolada; napici od mleka i čokolade; napici na bazi čokolade; slatkiši za ukrašavanje novogodišnje jelke; kakao napici sa mlekom; kako proizvodi; napici na bazi kakaoa; napici od kafe; arome kafe; mešavine i proizvodi koji se koriste kao zamena za kafu; napici na bazi kafe; kolačići; kokice; kornfleks; sladoledi; kari; krem od vanile; pahuljice od žitarica; arome, osim eteričnih ulja; poslastičarski led; voćni želei; kolačići od đumbira; sirupi; infuzije; kečap; slatki koren; pastile; pite od mesa; omekšivači za meso, za upotrebu u domaćinstvu; palačinke; bombone; kolači; biber; pice; pudinzi; ravioli; matični mleč za ljudsku ishranu; šećer; vasabi paste; umak, soja sos; paste; rezanci, testenina i tanki rezanci; udan (japanski rezanci); suši; vanila; vafli; zamrznut jogurt; perece; mali obroci; slatkiši od badema; aromatični preparati za hranu; vezivni agensi za sladoled (jestivi led); peciva; kiflice; kolači; karamele (slatkiši); žvake, ne za medicinsku upotrebu; kukuruzno brašno, krupno; krekeri, jestivi led; šećerni sirup (melasa) - zlatni sirup; led, prirodni ili veštački; makarone; marcipan; majonez; ovseno brašno; biber, začini; pite; slatkiši raznih aroma; dvopek; so za kuvanje; sendviči; paradajz sos; začini; šerbet (leden); špageti; slatkiši; tart; pšenično brašno; preliv za salate; sos od mesa; sve uključeno u klasu 30.

Klasa 32: Pivo, mineralne vode i vode zasićene ugljenikom (gazirane) i bezalkoholna pića i napici; pića od voća i voćni sokovi; pića i sokovi od povrća; sirupi, koncentracije i drugi preparati za proizvodnju pića; izotonični napici; voćni nektar (bezalkoholni); tablete za šumeće napitke; soda vode; sirupi za pića; flaširana voda; voda (napitak); surutka (piće); bezalkoholna pića; kokteli (bezalkoholni); aperitivi (bezalkoholni); sve uključeno u klasu 32

Klasa 33: Alkohol od pirinča; alkoholna pića (osim piva); aperitivi; alkoholna pića koja sadrže voće; brendi; jabukovača; kokteli; liker; sake; alkoholna pića; viski; vino; sve uključeno u klasu 33.

Klasa 34: Duvan; artikli za pušače; šibice; pepeljare; papir za cigarete; tabakere za cigarete; tabakere za cigarete; mehanizam za seckanje kraja cigara; filteri za cigarete; usnici muštikle cigareta; držači cigareta; vrhovi za cigarete; cigarete; cigarete koje sadrže supstitut duvana; cigarilosi; cigare; upaljači; kutije za šibice; držači za šibice; šibice; čistači za lule; stalak za

lule; lule; kese za duvan; kutije za burmut; posude za duvan; sve uključeno u klasu 34

Klasa 35: Sakupljanje u korist drugih, čitavog niza roba (transport nije uključen), omogućavajući kupcima dobar pregled i kupovinu proizvoda; takve usluge mogu pružati maloprodaje, veleprodaje; kroz naručivanje poštom preko kataloga ili putem elektronskih medija, na primer preko web sajta ili televizijskih programa za kupovinu; Trgovina na veliko i malo i naručivanje putem pošte vezanih za prodaju svećanih dekoracija i ukrasa, poklona i novih proizvoda, sapuna, parfema, eteričnih ulja, kozmetike, losiona za kosu, proizvoda za negu kose, toaletni preparati; paste za zube; sredstva za ličnu higijenu; sredstva za čišćenje, poliranje i abrazivna sredstva; sredstva za upotrebu u perionicama; pribor za negu noktiju; preparati za negu noktiju; lakovi za nokte; veštački nokti; dijetetski proizvodi; hrana za bebe; sanitarni preparati; sveće; fitilji; tečnost za osvetljenje; masti; lubrikanti; ulja za boje; pribor za jelo; grnčarija; set za manikir; aparat za brijanje, brijači; mašine i mašinski alati za kuhinju ili upotrebu u domaćinstvu, ručni alat; filmovi; kamere; foto diskovi; video rekorderi; audio i video proizvodi, audio i video kasete; ploče i diskovi, instrumenti i aparati za snimanje, prenos i/ili reprodukcija zvuka i/ili slike, televizori, kasetofoni i/ili rekorderi, video kasete i/ili CD plejeri i/ili rekorderi, radio aparati, telefon, bežični telefon, mobilni telefon, futrole za mobilne telefone, ukrasi i trake za telefone; poziv indikatori; uređaji za računanje, kalkulatori, elektronske i kompjuterske igre; kinematografski filmovi, svetla, ventilatori, kuhinjske sprave, kalupi za kolače i peciva, tosteri, peći, kuhinjski pribor, pribor i posude za serviranje i čuvanje hrane i/ili napitaka, štapići za hranu, instrumenti za sečenje, porcelan, posuđe od porcelana, posuđe od kristala, emajlirano posuđe, posuđe od srebra, posuđe od stakla, grnčarija, keramika, aparati za sušenje kose, lampe, abadžuri i njihovi delovi i dodaci, nosiljke za bebe, baloni, sirene za bicikla, satovi i časovnici i njihova oprema i delovi i dodaci, nakit i imitacije nakita, ornamenti, proizvodi od dragocenih metala ili presvučeni njima, muzičke kutije, muzički instrumenti, slike, fotografije, kancelarijski materijal, papir i karton i proizvodi napravljeni od ovih materijala, umetnički pribor, četke za slikanje, pisaći pribor, štampani materijal, knjige, novine, magazini i periodične publikacije, čestitke (i Božićne), karte za igru, materijali za uvijanje i pakovanje, okviri i ramovi za slike, lepak za kancelarijske i kućne potrebe, proizvodi od kože i/ili imitacije kože, torbe i koferi, tašne i novčanici, kišobrani, štampovi (pomoć pri hodanju), nameštaj, ogledala, vešalice i čiviluci, kutije i kontejneri, pločice za ime, mali kućni dodaci, sprave i pribor za domaćinstvo ili kuhinju, češljevi, sunđer, četke, proizvodi za čišćenje, naočare, okviri za naočare i naočare za sunce i kutije za naočare i pribor za njih, tekstil i tekstilni proizvodi, posteljina i stolnjak i prekrivači za stolove, salvete, podmetači za stolove, nameštaj, galanterija, maramice, odevni predmeti, obuća i kape, dugmad, bedževi, trake i vrpce, čipka i vez, šnale i ukrasi za kosu, naramenice, ukrasi za cipele, ukrasi za šešire, rajsferšlusi, tepisi, ćilimi i prostirke, igre, igračke i, lutke, figurice, sportski artikli, ukrasi za Božićne jelke, hrana i piće, poslastice, biljni proizvodi, slatkiši, konditorski proizvodi, šibice, tompusi i cigarete i proizvodi za pušače, reklamiranje (oglašavanje); organizovanje izložbi za privredne ili reklamne potrebe; izdavanje reklamnih tekstova (oglasa); promotivne prodaje (za druge); marketinške agencije; poslovno upravljanje predstavama, umetničkim; agencije za uvoz i izvoz; sastavljanje, sakupljanje informacija u kompjutersku bazu podataka; reklamiranje putem pošte; poslovno upravljanje hotelima; marketing istraživanja; lepljenje oglasa; pronalaženje osoblja; reklamne agencije; oglašavanje (reklamiranje) putem radija; oglašavanje preko televizije; (reklamiranje na informatičkoj mreži; vršenje raznih usluga nabavki za druge (kupovina proizvoda i usluga za druge proizvođače); iznajmljivanje vremena za reklamiranje u svim sredstvima komunikacije; iznajmljivanje kancelarijskih mašina i oprema; iznajmljivanje aparata za prodaju); sve uključeno u klasu 35.

Klasa 41: Razonoda; zabava; zabavni parkovi, tematski parkovi; zabavne arkadne usluge; usluge obrazovanja; organizovanje, proizvodnja i izvođenje programa koncerata, nastupa uživo,

pozorišnih predstava, izložbi, sportskih takmičenja, sportskih i kulturnih aktivnosti; koncertne dvorane; bioskopi; kabarei; usluge filmskih studija; usluge diskoteka; usluge klubova; objavljivanje knjiga, tekstova, magazina, novina i časopisa; usluge biblioteka; obezbeđivanje opreme za zabavu (razonodu), izložbe, koncerte, predstave, performanse, sportske aktivnosti, igre, rekreaciju i kulturne aktivnosti; usluge fitnes centara; usluge kampa za odmor; pružanje informacija koje se odnose na obrazovanje, zabavu, rekreaciju, sport i kulturu; televizijska i radio zabava; proizvodnja radio i televizijskih programa; filmske i video produkcije; iznajmljivanje kino-filmova, filmova, video kasete, laserskih diskova, video diskova i raznovrsnih digitalnih (video) diskova; iznajmljivanje aparata za snimanje zvuka, iznajmljivanje scenskog i pozorišnog dekora; obdanište, jasle; klubovi i sale sa instaliranim audio i vizuelnim muzičkim uređajima; sobe i saloni za razonodu; organizovanje takmičenja lepote; cirkusi; kursevi korespondencije; usluge zabavljača; organizovanje dešavanja kulturnog i edukativnog karaktera; aparati za igre; uputstva u vezi gimnastike; obezbeđivanje opreme za muzeje (prezentacije, izložbe); rukovođenje lutrijama; orkestarske usluge; planiranje zabava; usluge pisanja scenarija; pozorišna predstave; zoološki vrtovi; usluge digitalnog snimanja; elektronsko izdavaštvo; usluga elektronskog igranja (iz informatičke mreže); tumačenje jezika znakova; profesionalna orijentacija (obrazovanje i saveti pri obuci); mikrofilmovanje; komponovanje usluge; noćni klubovi; fotografisanje; produkcija filmova na video trakama; priređivanje karaoka usluga (stavljane na raspolaganje opreme za karaoke); elektronske publikacije (usluge iskorišćavanja elektronskih publikacija koje se ne mogu kopirati); objavljivanje knjiga i časopisa, elektronsko; snimanje videorekorderom; kuglane; stadion za udaranje loptice ili stadion za bejzbol (igre); elektronsko prikazivanje filmova; organizovanje venčanja; sve uključeno u klasu 41.

Klasa 43: Usluge obezbeđivanja hrane i pića, privremeni smeštaj, restorani, kafe - restorani, kafeterije (kafići), barovi, marketi sa prehrambenim proizvodima; kantine, catering usluge, samouslužni restorani snek barovi; koktel barovi, pružanje informacija koje se odnose na prethodno navedeno i na hranu i piće; obezbeđenje i rezervacija privremenog smeštaja i smeštajni objekti, hotelske usluge, motelske usluge, pansionske usluge i pružanje informacija u vezi sa tim uslugama; smeštajne usluge u kampovima za odmor; restorani, kafe - restorani, kafeterije (kafići), barovi, marketi sa prehrambenim proizvodima, kantine i sale sa audio i vizuelni muzičkim uređajima; usluge brige o deci; usluge dnevnih obdaništa; kuće za smeštaj turista; usluge barova; aranžiranje hrane i pića za svadbene prijeme; sve uključeno u klasu 43.

Klasa 44: Medicinske usluge; veterinarske usluge; higijenska zaštita i nega lepote za ljude i životinje; agrikulturne, hortikulturne i šumarske usluge; saloni lepote (za ulepšavanje); frizerski saloni; timarenje (nega) životinja; aranžiranje cveća; baštovanstvo; održavanje zelenih površina; četkanje kućnih ljubimaca; (usluge aromaterapija; pravljenje venaca; bolničke usluge; zubarske usluge; tetoviranje - usluge tetovaže) sve uključeno u klasu 44.

(210) **2011-176**

(442) **20.04.2014.**

(220) 4/11/2011

(731) **SANRIO COMPANY LTD**, TOKYO1-6-1 OSAKI, SHINAGAWA-KU JP



(540)

(550) I

(511) **Klasa 03:** Preparati za izbeljivanje i drugi preparati za pranje veša; preparati za čišćenje, poliranje, ribanje i abrazivni preparati (za nagrivanje); sapuni; parfimerija, eterična ulja, kozmetika, losioni za kosu; paste (preparati) za zube; sredstva za higijenu (preparati za kupatilo), preparati za manikir; proizvodi i preparati za negu i čišćenje kose i kože; lepila za kozmetičke potrebe; losioni za posle brijanja; preparati protiv znojenja; antistatički preparati za kućnu upotrebu; aromatični preparati; kora kvilaje za pranje; soli za kupku; kozmetički preparati za kupanje; maske za lice; soli za izbeljivanje; soda za izbeljivanje; plavila za veš; hemikalije za izbeljivanje veša namenjene za upotrebu u domaćinstvu; preparati za uklanjanje boja; kozmetički pribor; kozmetički preparati namenjeni gubitku telesne težine; kozmetički preparati za životinje; pamučni štapići za kozmetičku upotrebu; vata za kozmetičke svrhe; kozmetičke kreme; kreme za izbeljivanje kože; kreme za kožnu galanteriju; sredstva za uklanjanje masnoće; sredstva za poliranje proteza; preparati za čišćenje proteza; dezodoransi; deterdženti; kozmetičke boje; kolonjske vodiče; toaletna voda; kreme za kosu; gel za kosu; šamponi; kondicioneri za kosu i preparati za vlažnost kose; parfemi; karmini; kreme i losioni za kožu i kosu; veštački nokti; lakovi za nokte i acetoni; kreme za zaštitu od sunca; preparati za beljenje (skidanje boje) za kozmetičke potrebe; arome za kolače (esencijalna ulja); mleko za čišćenje za toaletnu upotrebu; kozmetika za obrve; olovke za obrve; oplemenjivači rublja (za upotrebu u perionicama); veštačke trepavice; vosak za pod; boje za kosu; lakovi za kosu; preparati za kovrdžanje kose; izbeljivači za veš; preparati za natapanje u perionicama; štirak za veš; losioni za kozmetičke potrebe; šminka; puder za šminku; preparati za šminkanje; preparati za skidanje šminke; maskara; preparati za ispiranje usta, ne za medicinske svrhe; preparati za negu noktiju; kozmetičke olovke; preparati za poliranje nameštaja i podova; pomade za kozmetičke svrhe; potpuri (ugodni mirisi); kamen za glačanje; šmirgla; šmirgla papir; mirisno drvo; šamponi za kućne ljubimce; krema za cipele; krema za poliranje cipela; vosak za cipele; preparati za štirkanje; sapun za izbeljivanje tekstila; štirak za veš; preparati za sunčanje; mirišljave maramice; preparati za uklanjanje laka; vosak za depilaciju; vosak za veš; vosak za poliranje; vosak za kožu; preparati za depilaciju; želatin (petrolej) za kozmetičke svrhe; ukrasi koji se skidaju za kozmetičke svrhe; (štapići od tamjana (joss štapići); mirisi sve uključeno u klasu 3.

Klasa 04: Industrijska ulja i masti; maziva; jedinjenja za skupljanje prašine vlaženjem i vezivanjem; goriva (uključujući motorna tečna goriva) i materije za osvetljavanje; sveće, fitilji; sveće za Božićnu jelku; preparati za uklanjanje prašine; mast za kaiševе; mast za čizme; mast za kožu; mast za cipele; fitilji za lampe; sveće preparati koji daju neelastičnost kaiševima; ulje za održavanje kožnih proizvoda; ulje za boje; cepke za osvetljenje; uređaji za čišćenje koji skupljaju prašinu; fitilji za sveće; dizel ulje; benzin; kerozin; nafta; sve uključeno u klasu 4.

Klasa 05: Farmaceutski, veterinarski i sanitarni preparati; dijetetske supstance prilagođene medicinskoj upotrebi, hrana za bebe; flasteri, materijali za zavijanje; materijali za plombira-

nje zuba, zubarska smola; dezinfekciona sredstva; preparati za uništavanje štetočina; fungicidi; herbicidi; upijajući pamuk; upijajuća vata; lepljive trake za medicinske svrhe; lepljivi flasteri; lepljive trake za medicinsku upotrebu; preparati za osvežavanje vazduha; preparati za prečišćavanje vazduha; albuminski dodaci hrani za medicinske svrhe; albuminsko mleko za medicinske svrhe; preparati za pranje životinja; antiseptički vata; antiseptici; melemi za medicinske svrhe; higijenski zavoji; ulošci za menstruaciju; zavoji za zavijanje; terapijski preparati za kupanje; preparati za kupanje, medicinski; soli za kupanje za medicinske svrhe; kupke od kiseonika; soli za kupke od mineralne vode; pojasevi za higijenske uloške (salvete); narukvice (kodirane identifikacije) za medicinske svrhe; grudni ulošci kod dojenja; medicinski slatkiši; kapsule za lekove; kapsule za farmaceutske svrhe; guma za žvakanje za medicinske svrhe; antiparazitske ogrlice za životinje; medicinske poslastice; sredstva za dezinfekciju, ispiranje, čuvanje i čišćenje kontaktnih sočiva; lubrikanti i sredstva za kontaktna sočiva ili za upotrebu sa kontaktnim sočivima; hemijska kontraceptivna sredstva; lekovi za žuljeve; prstenovi za žuljeve na stopalima; pamuk za medicinske svrhe; flaster lepljivi; farmaceutski preparati za sprečavanje peruti; dezodoransi koji nijesu za ljude i životinje; deterdženti za medicinske svrhe; dijetetska pića prilagođena medicinskim svrhama; dijetetska hrana; dijetetske supstance; dezinfekciona sredstva za hemijske toalete; losioni za pse; preparati za pranje pasa; preparati za odbijanje insekata kod pasa; medicinska pića; sredstva za ispiranje očiju; kutije za prvu pomoć (napunjene); lepкови za hvatanje mušica; papir za hvatanje mušica; preparati za uništavanje mušica; lepак za mušice; preparati protiv znojenja stopala; gaza za zavoje; germicidi; kedrovo drvo koje služi za odbijanje insekata; masti za medicinske svrhe; medicinske infuzije; sredstva za odbranu od insekata; insekticidi; petrolejski gel za medicinske svrhe; gaće za menstruaciju; higijenske gaće; mleko u prahu (za bebe); laktoza za medicinske svrhe; maramice sa farmaceutskim losionima; losioni za farmaceutske svrhe; losioni za veterinarske svrhe; pastile; pića od mlečnog slada za medicinske svrhe; medicinski alkohol; lekovito bilje; lekovito ulje; medicinski čaj; medicinske torbe (male, napunjene); lekovi za ljudsku upotrebu; jastučići za menstruaciju; tamponi; mentol; pomade; mineralni dodaci za hranu; papir za suzbijanje moljaca; preparati za suzbijanje moljaca; preparati za ispiranje usta; blato za kupanje; pelene za inkontenciju; nutricionistički dodaci za medicinske svrhe; sanitarne maramice; sanitarni ulošci; sanitarni jastučići, sanitarne gaćice; gaćice, upijajuće, za mokrenje; higijenski ulošci za svaki dan; parazitocidi; pilule za farmaceutske potrebe; hemijski preparati za dijagnostikovanje trudnoće; čaj za mršavljenje za medicinske svrhe; lekovi protiv znojenja; matični mleč (za medicinske svrhe); sanitarni peškiri; farmaceutski preparati za negu kože; mirišljave soli; preparati za sterilizaciju; pomada protiv opekotina od sunca; preparati protiv opekotina od sunca za farmaceutske svrhe; sirupi za farmaceutske svrhe; vitaminski preparati; pamučni štapići za medicinske svrhe; kreme za sunčanje za zaštitu od sunca; kašne obloge; kompresioni zavoj; kašne obloge i/ili kompresioni zavoji za snižavanje telesne temperature ili za ublažavanje groznice ili glavobolje; zavoji (za medicinske svrhe); lekovi za medicinske svrhe; medikamenti za snižavanje telesne temperature; biljni čajevi; kašne obloge od slačice; medicinski preparati za potrebe mršavljenja; sve uključeno u klasu 5.

Klasa 08: Ručni alati i sprave (kojima se ručno upravlja); pribor za jelo; hladno oružje; žileti, makaze za bradu; otvarači za flaše; otvarači za konzerve; kutije za brijače; pincete, za zanoktice; makaze za zanoktice; sekači; pribor za rezanje; sredstva za pretakanje tečnosti; aparati za depilaciju; utiskivači; grickalice (električne ili neelektrične); uređaj za vađenje eksera; aparati za poliranje noktiju; viljuške; alat za baštu šišači; ručna sredstva za kovrdžanje kose; pinceta za uklanjanje dlaka; šiljak za razbijanje leda; bušilice; noževi; makaze za travu; kožni kaiš za oštrenje brijača; dizalice; turpije; turpije, električne; izvlakači eksera; sprave za uvlačenje konca u iglu; numeracioni probojci; klešta za orahe i lešnike, ne od plemenitih metala;

otvarači sa oštricom; set za pedikir; aparati za ubijanje biljnih parazita; žileti; kaiš za oštrenje brijanja; brijajući, električni ili ne; makaze; instrumenti za oštrenje; kašike; sprejevi; markeri za utiskivanje (ručni alati); hvataljke za kocke šećera; stono posuđe; otvarači za konzerve; seckači za meso i povrće, noževi, sekači i rezači i delovi i dodaci koji se koriste za te svrhe; makaze za porublivanje; gvozdeni savijači; klješta za uvijanje; setovi za manikir; pribor za brijanje; pincete; kutlače za vino; (rezači jaja, (neelektrični); sekač za sir (neelektrični); sekač za picu (neelektrični); tučak; aparat za uvijanje trepavica; zlatno i srebrno posuđe (pribor za jelo, viljuške i kašike); sve uključeno u klasu 8.

Klasa 09: Aparati i instrumenti naučni, nautički geodetski, električni, fotografski, kinematografski, optički, za vaganje, za merenje, signalizaciju, kontrolu (nadgledanje), za spasavanje života i za obuku; aparati za snimanje, prenos, reprodukciju zvuka ili slike; magnetni nosioci podataka, diskovi za snimanje; automatske mašine za prodaju i mehanizmi za aparate koji se pokreću ubacivanjem novca; registar kase; računске mašine; oprema za obradu podataka i kompjuteri; aparati za gašenje požara; računaljke; električni uređaji za privlačenje i uništavanje insekata; audio i vizuelni aparati namenjeni za podučavanje; baterije; kutije za baterije; aparati namenjeni za punjenje dopunljivih baterija; dvogledi, durbini; kalkulatori; kamere, kamere namenjene za kinematografske potrebe i delovi i dodaci za njih; sočiva za kamere; instrumenti za merenje kapaciteta; animirani crtani filmovi; kasetofoni; lančići za naočare; kinematografski filmovi; (prikazani); časovnici; aparati namenjeni reprodukciju kompaktnih diskova; kompaktni diskovi (audio-video); kompaktni diskovi (za čitanje podataka); memorija namenjena čitanju; kompjuterski operativni programi, snimljeni; kompjuterski programi; kompjuterski softveri (snimljeni); kompjuterski štampači za kompjutere; kontaktne sočiva; kutijice za kontaktne sočiva; aparati namenjeni za obradu podataka; krojački pribor za merenje; električna zvona za ulazna vrata; džepni elektronski prevodioci; aparati za gašenje požara; filmovi, izloženi; blicevi; alarmni sistem protiv požara; okviri za dijapozitive u fotografiji; aparati za igre, namenjeni da se upotrebljavaju zajedno sa televizijskim prijemnicima; aparati za uvijanje kose, električni; aparati za regulisanje toplote; džuboksovi; optička sočiva; skale za merenje veličine slova; pojasevi za spasavanje; plutače za spasavanje; sigurnosne jakne; splavovi za spašavanje; brave, električne; magnetni nosač podataka; magnetne kodirane kartice; magnetni dekoderi; magneti; uveličavajuća stakla; električni uređaji za skidanje šminke; aparati, uređaji i instrumenti za merenje; mikrofoni; mikroskopi; neonski znaci; laptopovi; elektronske olovke; gramofonske ploče; fotokopir aparati; džepni kalkulatori; aparati za projekciju; ekrani namenjeni potrebama projekcije; radio uređaji; gramofoni; daljinski upravljači; lenjiri (merni instrumenti); skale (merne); smart kartice; detektor dima; utičnice, utikači i ostali kontakti; aparati namenjeni za snimanje zvuka; diskovi namenjeni za snimanje zvuka; aparati namenjeni za reprodukciju zvuka; aparati namenjeni za prenos zvuka; kutije za naočare; okviri za naočare; stakla za naočare; naočare; naočare za sunce; pojasevi za plivanje; odela za plivanje; prekidači električni; kasetofoni; telefonski aparati, prijemnici, transmiteri, žice; teleskopi; televizori; televizijski prijemnici; indikatori temperature; instalirani sistemi namenjeni prevenciji provala, električni; termometri; termostati; video kasete, kertridži za video igre; video zapisi; video trake; video ekrani; video rekorderi; plovci za vodu; obrađivači teksta; video i kompaktni diskovi; digitalni multimedijalni (video) diskovi; video kompaktni diskovi i digitalni multimedijalni (video) disk plejeri; audio i video aparati, sa aparatima za prenos zvuka (pevući uređaji); držači, nosači, kutije za audio i video kasete, kompaktni diskove, laserske diskove; video diskovi i digitalni multimedijalni (video) diskovi; diskovi; podloga za miš; telefoni, bežični telefoni, mobilni telefoni i delovi i dodaci uz njih; futrole i maske za mobilne telefone; pejdžeri i delovi i dodaci uz njih; futrole i maske za pejdžere; torbe, pokrivači, kutijice, nosači i držači za mobilne telefone i pejdžere; slušalice; slušalice za uši; slušalice za uši i mikrofoni/spikeri za telefon, za razgovor mobilnim

telefonima, koje se upotrebljavaju sa mobilnim telefonom; indikatori poziva za telefone, mobilne telefone i pejdžere; mobilni telefoni i pejdžeri; uređaji za igranje video igrice; maske, koje se nose preko očiju radi zaštite od svetlosti; elektronske agende (programi rada); električna alarmna zvana; alarmi; čitači bar-kodova; barometri; zujalice; električne zujalice; procesor (čip), centralna jedinica za obradu podataka; čipovi (integrisana kola); hronografi (aparati za beleženje vremena); upaljači za cigare i/ ili cigarete za automobile; kompjuterske tastature, kompjuterske periferne sprave; akustične spojnice; spojnice (oprema za obradu podataka); optički nosači za podatke; optički diskovi; diskovi (magnetni); mašine namenjene automatskoj distribuciji; ronilačka oprema; ronilačke maske; ronilačka odela; elektronske oglasne table; elektronske olovke (za video-displeje); uređaji za funkcionisanje liftova; vrpce za naočare; okulari; naočare za spavanje; faksimil mašine; filteri (fotografije); kućne pegle, električne; plovci za kupanje i plivanje; flopi diskovi; trake za čišćenje glava za snimanje; higrometri (za merenje vlažnosti); integrisana kola; aparati za internu komunikaciju; interfejsi (za kompjuter); mašine za fakturisanje; poklopci za objektivne; aparati za upravljanje liftovima; jedinice za magnetne trake (za kompjutere); magnetne trake; kašike za merenje; metronomi; mikroprocesori; moderni; mašine za brojanje i sortiranje novčanica; monitori (kompjuterska oprema); monitori (kompjuterski program); miš (oprema za obradu podataka); optička vlakna; optička stakla; optička roba; optička sočiva; parking metri; kompjuterska pomoćna oprema; uglomeri (merni instrumenti); radio-telegrafski kompleti; radio-telefonski kompleti; skeneri (oprema za obradu podataka); poluprovodnici; slajdovi (fotografija); mašine za prorezivanje, automatske; trake za snimanje zvuka; demagnetizirajući aparat za magnetne trake; telegrafске žice; telegrafski aparati; teleprinteri; telekomunikacioni aktivatori; teleprinteri; izdavači karata; transmitteri (telekomunikacije); paket za transmisiiju (telekomunikacije); vakuum metri; video ekrani; video telefoni; video rekorderi; piskavi alarmi; plutajuće sprave za plivanje; (čepovi za uši, ronilački čepovi za uši; jajoliki satovi; sportske naočare; zaštitne kacige za sport; aparati za navigaciju za automobile (unutrašnji računari); program za kompjuterske igrice; metronomi; elektronske publikacije (koje mogu da se preuzmu sa interneta); kompjuterski programi (softveri koji mogu da se preuzmu sa interneta); stereo, vokmeni; sateliti za naučne svrhe; oslonci za ručni zglobovi, za upotrebu sa kompjuterima; vrpce za nošenje mobilnih telefon; postolja za portabl telefone; nalepnice za portabl telefon; poklopci za antene za portabl telefon; elektronska kola i cd-romovi, koji omogućavaju snimanje automatskog programa za muziku, namenjeni upotrebi elektronskih muzičkih instrumenata; čepovi za uši; sve uključeno u klasu 9

Klasa 10: Hirurški, medicinski, zubarski i veterinarski aparati i instrumenti, veštački udovi, oči i zubi; ortopedska pomagala; hirurški materijali za zašivanje; aparati za merenje krvnog pritiska; flašice za bebe; cucle za bebe; zavoji; električna čebad za medicinsku upotrebu; kondomi; kontraceptivna sredstva, nehemijska; zubarski aparati; veštačke dojke za bebe; štapići za uši; aparati za estetske masaže; cucle za flašice za bebe; ventili za flaše za hranjenje; flašice za hranjenje; ulošci za ravne tabane; ortopedska obuća; pincete; rukavice za masažu; rukavice za medicinsku upotrebu; slušni aparati za gluve; štitnici za uši (sluh); terapijski aparati na bazi vrućeg vazduha; pakovanja leda za medicinsku upotrebu; inkubatori za bebe; aparati za masažu; porodiljski pojasevi; dušeci za porođaj; ortopedska pomagala; ulošci za trbuh; električni termofori (ustuci), za medicinsku upotrebu; uspavljajući jastuci za nesanicu; hirurški sunđer; dozer kašike za medicinsku upotrebu; stetoskopi; nosila; toplotna pakovanja za prvu pomoć; strugači za jezik; veterinarski aparati i instrumenti; maske za usta; termometri za medicinske svrhe; bolesničke guske (lopate); pakovanja vode za medicinske svrhe; (prstenovi za pravilno nicanje zuba); medicinski jastuci ili preparati za testiranje telesne temperature; sve uključeno u klasu 10

Klasa 11: Aparati za osvetljavanje, grejanje, proizvodnju pare, kuvanje, hlađenje, sušenje, ven-

tilaciju, snabdevanje vodom i za sanitarne svrhe, klima uređaja, osveživači vazduha; isušivači vazduha; aparati i mašine za prečišćavanje vazduha; ulošci za slavine koji sprečavaju prskanje vode; aparati za filtriranje akvarijuma; grejači akvarijuma; osvetljenje za akvarijum; peći; roštilji; oprema i instalacije za kupatilo; grejači za kupatila; grejači za krevete; aparati za rashlađivanje pića; osvetljenje za bicikl; električna ćebad; bojleri; tosteri za hleb; električno grejane, prostirke; plafonjere; lusteri; električne sijalice za jelke; električni filter aparati za kafu; mašine za kafu; filteri za kafu; sprave za prženje kafe; rashladni kontejneri, (hladnjače); šporeti; aparata i uređaji za kuvanje; kuhinjske sprave, električne; rashladni uređaji za tečnosti i instalacije za taloženje u duvanskoj industriji; grejni jastuci; prigušivači (za paru); grejači (jastučići); amortizeri (grejanje); friteze, na struju, aparati za dezinfekciju; zidni držači dezinfekcionih sredstava za toalete, aparati za destilaciju; fenovi za sušenje kose; filteri vode za piće; aparati za sušenje stočne hrane; električne lampe; ukrasne lampice za svečanu dekoraciju; ventilatori (erkondišni aparati); električni ventilatori; grejalice, električne, za flašice za hranjenje; aparati za ispiranje; ukrasne fontane; zamrzivači; pržionice za voće; upaljači na gas; električni roštilji; roštilji; aparati u perionicama za ručno sušenje; oprema za kupatila sa toplim vazduhom; peći za topao vazduh; ringle; boce za toplu vodu; svetleći kućni brojevi; prečišćivač vazduha; kutije za led (ledomati); sanduci za led (ledomati); mašine i aparati za led; električni čajnici; ramovi za lampe; staklena cev za lampe; vitraž lampe; kugle lampi; visiljke za lampe; abažuri za lampe; reflektori; abažuri; lampe; nosači abažura; fenjeri; električni sušaći veša; sijalice; instalacija za osvetljenje; mikrotalasne pećnice; uređaji za hlađenje mleka; slavine za spajanje za cevi za vodu; pločasti grejači (plotne); džepna baterijska lampa; džepni reflektori; džepni grejači; električni lonci za kuvanje pod pritiskom; tankovi sa vodom pod pritiskom; električni radijatori; rashladne vitrine; rashladne komore; frižideri; pekači; aparati za pečenje; sprave za prženje; ražanj; roštilji; sigurnosne lampe; tuš kabine; tuševi; sudopere; grla električnih sijalica; solarni kolektori (grejanje); tosteri; lavaboji za toalete; WC šolje; prekrivači za WC šolje; toaleti, pokretni; lampe; pisoari; sprava za pečenje vafli, električna; sprave za pečenje/za kuvanje, električne; posude za zagrevanje; lavaboji; grejači vode; aparati i mašine za prečišćavanje vode; sterilizatori vode; džepne lampe; električni prečišćivači vazduha; oprema protiv zaslepljivanja za automobile; oprema protiv zaslepljivanja za vozila; lampe sa svetlosnim lukom, električni ekspres lonci (autoklavi); kade za kupanje; kineski fenjeri (lampe); zaštitni uređaji za osvetljenje; rasipači, difuzori svetla; upaljači; svetla za automobile; svetla za vozila; peći; peći (grejni aparati); (lonci za pirinač); sve uključeno u klasu 11

Klasa 12: Vozila; aparati za kretanje po zemlji, vazduhu ili vodi; sprave protiv zaslepljivanja za vozila; sprave protiv zaslepljivanja za vozila; alarmi, protiv krađe za vozila; protivprovalni proizvodi za vozila; nosiljke za bebe; pokrivači za nosiljke za bebe zvona za bicikle, tricikl ili bicikle i tricikl, i delovi i oprema za njih; kola; trolejbusi; navlake sedišta za vozila; zaštitna odeća (štitnici) za bicikle, motorcikle ili tricikle; kola za golf; kolica, okretna za istovar robe; ručna kolica; nasloni za glavu za sedišta u vozilima; kabanice za dečija kolica; haube (poklopci) za vozila; sirene za vozila; sirene za vozila; radkapne; centralni rotirajući deo točka vozila; nosači prtljaga za vozila (gepek); mreže za prtljag kod vozila; teretni kamioni; blatobrani; uređaji koji sprečavaju proklizavanje guma; vesla za kanue; vesla; pedale za motorcikle; dečija kolica; pumpe za bicikle, motorcikle ili tricikle; navlake za dečija kolica; cerade za dečija kolica; dečija kolica navlake za sedišta za bicikl, tricikl ili motocikle; sigurnosni pojasevi za vozila; sigurnosna sedišta za decu (za vozila); sedišta za vozila; sigurnosni pojasevi za vozila; roletne (zaštite od sunca) prilagođene za automobile; gume za vozila; tapacir za vozila; pokrivači za motorna vozila (oblikovani); invalidska kolica; brisači vetrobrana; držači za sitnice u vozilima; kutije za arome i ugodne mirise za korišćenje u vozilima; avioni; vazdušni jastuci (sigurnosni delovi za automobile); vazdušni baloni; automobili; motorne kočije; retrovizori;

motorni autobusi; motorna vozila; motorcikli; kolica za kupovinu; kolica za bebe; gume za bicikle, tricikl ili motocikle; električna vozila; vodena vozila; (navlake za ručke automobila; pokrivači točkova) sve uključeno u klasu 12

Klasa 14: Dragoceni metali i njihove legure i proizvodi od dragocenih metala i njihovih legura, ili premazani s njima; nakit, imitacije nakita i ukrasa; drago kamenje; časovničarski i hronometrijski instrumenti; broševi; lančići; amajlije; kovani novčići; ukrasi, imenovane medalje i/ili kovani novčići; dugmad za manžetne; minduše; zlatne niti; ukrasi (od dragocenih metala); predmeti od imitacije zlata; kutije za dragulje; kutijice za nakit; ogrlice; špenadle, igle (nakit); igle za revere; prstenje; statue i statuete od dragocenih metala; šnale za kravate; časovnici, satovi i delovi i pribor za njih; kaiševi za satove; trake za satove, lanci za satove; kutije za satove; štoperice; ukrasi; ukrasne igle; igle za kravate; medalje; privesci za ključeve, obični ili ukrasni; lanci za ključeve i futrole/ nosači za ključeve od dragocenih metala i/ili od dragog kamenja; privesci; narukvice (nakit); kutije za ručne satove (prezentacione); kutije za satove; časovnici i satovi, električni; sunčani satovi; dijamanti; nakit za kostime; polu drago kamenje; umetnička dela od dragocenih metala; budilnici; baršunasta dugmad za manžetne; duple igle (igle za kravate); figurice (statuete) od dragocenih metala; kutijice za nakit; sve uključeno u klasu 14

Klasa 16: Hartija karton i proizvodi od njih, koji nisu uključeni u druge klase; štampane stvari; knjigovezački materijal; fotografije; kancelarijski materijal; lepila za kancelarijske i kućne potrebe; umetnički alati i materijali; slikarske četkice; pisaće mašine i kancelarijski rekviziti; materijali za obuku i nastavu; plastični materijali za pakovanje (koji nisu uključeni u druge klase); štamparska slova; štamparski blokovi; kalendari, knjige, katalogi, dopisnice, razglednice, poster, časopisi, štampana publikacija novine i magazini; čestitke; razglednice; pisači pribor; gumeni pečati; marke i pečati; jastučići za pečate, jastučići za mastilo; foto albumi; podmetači za uramljivanje slika ili fotografija; stalak za slikarska platna; uljani upijajući papir za kožu; postolja za fotografije; mastila; maramice, toalet papir, salvete od papira za uklanjanje šminke; papirni peškiri (ubrusi); podmetači podmetači za čaše od papira ili kartona; papir za uvijanje, papir za pakovanje, materijal za pakovanje; umetničke akvarel boje; grafičke reprodukcije, portreti; litografije; pera, olovke, vrhovi pera, hemijske olovke, nalivpera; držači za olovke; držači za pera; dopune za pera i instrumenti za pisanje; grafiti za olovke; olovke za bojenje, krede u boji; kutije za pera i olovke; zarezajući za olovke; mašine za oštrenje olovaka; spajalice; pritiskači za papir; igle za papir, igle za crtanje; voštane boje; lepila za kancelarijske i kućne potrebe; papirna galanterija; posude i stalci za pisma; držači za pisma; otvarači pisama; lepljive trake i držači za lepljive trake; pribor za crtanje, table, olovke i instrumenti; setovi za crtanje; albumi za torbe i koverta; upijajući papir; držači knjiga i obeleživači stranica za knjige; markeri knjiga; ormani za kancelarijski materijal; platno za slikanje; notesi; dnevnik; fascikle; podloge za pisanje; podloge za beleške; papir za pisanje; papir za crtanje; kutije za pisanje; krede, školske table, table za plakate; futrole za pasoše; držači za čekovne knjižice; elastične trake; slike; matrice; proizvodi za brisanje, gumice, korektori; električni otvarači pisama; muzičke note; table za brisanje; ukrasi i dekoracija od papira i/ili kartona; toalet papir; salvete od papira; torbe za ručak; kartonske kutije i sanduci; bojanke; fascikle za izveštaje; povezi za papir; džepne sveske; flomasteri; trake za knjige; setovi crnih grafitnih olovaka; setovi olovaka u boji boji; lenjiri; podmetači za pisanje; knjige za autograme; klipse; heftalice, makaze za trake; znaci upozorenja; sekači; mašine i aparati za plastificiranje; električni toplotni zaptivači za zaštitni omot za dokumente i fotografije; držači kartica i predmeta; ukrasi od papira za kutije za hranu; albumi; pelene za bebe od papira i celuloze (za jednokratnu upotrebu); torbe (koverta, kese) od papira ili plastike, za pakovanje; spajalice (veze) za slobodne listove; kutije od kartona ili papira; karte; držači i kutije za markice i pečate; stripovi; šestari; papirne trake i karte za upis kompjuterskih programa;

papir za kopiranje (pribor); korektori (kancelarijski rekviziti); fajlovi dokumenata; naprstci (kancelarijski rekviziti); zastave (od papira); folderi (kancelarijski); fascikle za papire; gumirane trake; maramice od papira; indeks kartice; mastiljave trake; omoti za papir; nalepnice, ne od tekstila; mape; muzičke čestitke; bilteni; podloge, jastučići (kancelarijski materijal); kutije za boje (predmeti za upotrebu u školi); brošure; sekač papira (za upotrebu u kancelariji); držači za grafitne olovke; poštanske marke, stikeri; salvete od papira; pribadače; karte; trake za pisaće mašine; pisaće mašine (električne ili ne-električne); omoti; četke za pisanje; krede za pisanje; table za pisanje; prekrivači (kancelarijski); tacne za saksije od papira; noževi za papir (kancelarijski rekviziti); portikle od papira; kese za mikrotalasno kuvanje; papir filteri za kafu; brošure; vezeni dizajni (šabloni); noževi za papir (kancelarijski rekviziti); stolnjaci od papira; viseće firme (reklame) od papira ili kartona; metalni vrh za indeksne karte; lotovi papira; upijajući papiri za lice; nalepnice za prenosive telefone; sve uključeno u klasu 16

Klasa 18: Koža i imitacija kože, i proizvodi izrađeni od ovih materijala koji nisu uključeni u druge klase; životinjska koža, krzno; sanduci i putne torbe; kišobrani, suncobrani i štapovi za hodanje; bičevi (kamdžije), saračka oprema i sedlarska roba; torbe, tašne i novčanici, kutije, prtljag, kese; akt-tašne; rančevi; torbe za odeću; torbe za kupovinu; trake od kože; rameni kaiševi; kaiševi; štapovi od trske; omoti i korice za blokove (beležnice); okovratnici za životinje ili kućne ljubimce; futrole za ključeve; pertle od kože ili od imitacije kože; ukrasne kutije; brnjice; školske torbe; kaiševi; ručke za kofer; koferi; putni kompleti; putnički kovčezi (sanduci); futrole za kišobrane; drške od kišobrana; štapovi za hodanje (šetnju) sa sedištem (stolice koje po potrebi mogu biti štapovi za šetnju); kaiševi za prtljag; torbe za plažu; akt tašne, sanduci i kutije, od kože ili kožnih tabli; ručne torbe; kožni kaiševi planinarski štapovi; muzike kutije; torbe od mreže za kupovinu; ruksaci; školske torbe; torbe za alat od kože ili imitacije kože (prazne); putne torbe; lovačke torbe; torbe, koverte i vrećice od kože, za pakovanje; prekrivači nameštaja od kože ili imitacije kože; ramovi za ručne torbe; torbe za nošenje dece sa naramenicama; torbe za kupovinu sa točkovima; sve uključeno u klasu 18.

Klasa 20: Nameštaj, ogledala, okviri za slike; proizvodi (koji nisu obuhvaćeni drugim klasama) od drveta, plute, trske, pruća, rogova, kosti, slonovače, kitove kosti, školjki, ćilibara, sedefa, morske pene i zamene svih ovih materijala, ili od plastike; jastučići na naduvavanje; dušeci na naduvavanje; jastuci na naduvavanje; vreće za spavanje; zavesa od perli, ukrasna; za delovi za krevete, nemetalni; rublje za krevete (osim prekrivača); kreveti za kućne ljubimce; korpe, ne od metala; zatvarači za boce; stalak za flaše; čepovi (pluta) za flaše, plastične ključ-kartice; komode; viseća zvana; vešalice za odeću; čiviluci, čiviluci; čiviluci; kontejneri, posude koji nisu od metala (za skladištenje, transport); držači zavesa; kuke za zavesu, šipke za zavesu; alke za zavesu; šipke za zavesu; valjci za zavesu; omče i petlje za zavesu; jastuci; držači za peškire; kavezi za kućne ljubimce; krevet, nameštaj, vrata, oprema, ramovi za vez; ventilatori (neelektrični); statue od drveta, voska, gipsa ili plastike; zakloni za vatru; postolja za saksije; postolja za saksije za cveće; postolja za šešire; visoke stolice za bebe; kućni brojevi, ne od metala, nesvetleći; legla i kućice za ljubimce; identifikacione pločice, koje nisu od metala; indeks kabineti; šetalice za bebe; naduvani reklamni predmeti; kutije za nakit; poštanski sandučići; stalci za pisma; stalci za novine; dušeci; kontejneri, posude od plastike za svrhe pakovanja; jastuci; stalci, postolja, štandovi; stalci za šoljice; registarske tablice; viseće firme (reklame); drške alata; poslužavnici; pletarski radovi, od pruća; ramovi za fotografije; dekorativne ivice traka od plastike i/ili drveta za upotrebu sa opremom za prozore; ornamenti i ukrasi za prozore ili vrata od plastike, voska, drveta, plute, trske, pruća, roga, kosti, slonovače, kitove kosti, školjki, ćilibara, sedefa, morske pene i zamene ovih materijala; zaptivači za kese; plastične posude za arome i mirise; nasloni za glavu na naduvavanje; dekoracije od plastike za hranu i kutije za ručak; privesci i lanci za ključeve, ne od metala; graničnici za zaustavljanje vrata; fotelje; korpe, ne od metala; kreveti; klupe (nameštaj); kutije

od drveta ili od plastike; stolarska roba ormari; stolovi na točkice za računare (nameštaj); sanduci od drveta ili plastike; stolice; sanduci za igračke; čepovi; pokrivači odeće (ostava); kolevke; zavese od bambusa; stolice za pisaće stolove; pisaći stolovi; nameštaj za vagon restorane; slamke za piće; nasloni za glavu (nameštaj); table za kačenje ključeva; police u biblioteci; sefovi; brave (osim električnih), ne od metala; krojačke lutke; stalci (nameštaj); okviri za fotografije; okviri za slike; nogare za sečenje drva; školski nameštaj; sedišta; sofe; stolovi; kolica za serviranje čaja; ručna kolica za serviranje čaja; pokretni stolovikolica za računare (nameštaj); postolja za kišobrane; dečiji kreveti; plakari; oglasne table; odvodi (ventili) od plastike; toaletni stočići; hoklice i stolice bez naslona; korpe za rublje sa poklopcem; kuke za odeću; merdevine od drveta ili plastike; ormarići za lekove; podmetači, prenosivi, za sudopere; table sa imenima, ne od metala; table sa brojevima, ne od metala; klinovi i igle (ne od metala); ogradice za bebe; greda za češanje za mačke; police; unutrašnje prozorske roletne (za zamračenje) (nameštaj); umetnička dela, statuete i figurica i sitni ukrasi ili ukrasa od drveta, plute, trske, pruća, roga kosti, slonovače, kitove kosti, školjki, ćilibara, sedefa, morske pene i zamene ovih materijala, ili od voska, gipsa ili plastike; kutijice za pilule (od drveta, plastike); zatvarači za flaše; sve uključeno u klasu 20

Klasa 21: Kućne ili kuhinjske sprave i posude (ne od dragocenih metala ili sa prevlakom od njih); češljevi i sunđereri; četke; materijali za pravljenje četki; artikli koji se koriste pri čišćenju; čelična vuna; neprerađeno ili poluprerado staklo; staklarija, porcelan i grnčarije koji nisu uključeni u druge klase; kade za kupanje beba (prenosive); korpe za domaćinstvo; pehari; kavezi za ptice; ne-električni blenderi; daske za peglanje; izuvači za čizme; otvarači za flaše; zatvarači za flaše napravljene od keramike, porcelana, stakla, kristala, grnčarije, i terakote; boce, flaše; činije; kutije za sapun; daske za sečenje hleba; vedra i kofe; kafanski poslužavnici; kavezi za kućne ljubimce; kalupi za torte (modle); kalupi za vafle; sprave za gašenje sveća; ukrasi za sveće u obliku prstena; svećnjaci; kutije za slatkiše; futrole za češljeve; ornamenti od porcelana; porcelanska roba; štapići za jelo (sprave za kuvanje); stalci za rublje; vešalice za odeću; tkanine za čišćenje; podmetači; posude za mešanje koktela; filter aparati za kafu; mlinovi za kafu; mašine za filter kafu; servisi za kafu; džezve; električni češljevi; češljevi za životinje; vreće, torbe za poslastice; kuvarske modle; kuhinjsko posuđe; kuhinjske igle za ražanj; kante za led; prenosni mali frižideri; uređaji za hlađenje hrane koji sadrže tečnost za razmenu toplote, za upotrebu u domaćinstvu; vadičep; kozmetički pribor; pokrivači za sudove; pokrivači za vazne za cveće; grnčarija; šoljice; kuhinjske daske za seckanje; stoni, dekorativni bokali, boce; ne-električne friteze; posude za sapun; držači za sapune; čuture za piće, čaše, pojilice, sudovi; sušilice za veš; kante za smeće; čaše za jaja; korita za hranjenje; vazne za cveće; hvataljke za muve; rukavice za upotrebu u domaćinstvu; pehari; renda za sečenje; neelektrični roštilji; toplotno-izolacione posude; grejači za flašice za hranjenje, neelektrični; posude za cveće i biljke; tople posude; kote za led; kalupi za led; navlake za daske za peglanje; krčazi; čajnici; postolja za noževe; dugmad od porcelana; veliki kružni poslužavnik za hranu; kompleti za liker; kutije za hranu; držači za jelovnike; male kote, vojničke porcije; kašike za mešanje; mop, brisač poda sa resama od tkanine; držači salveta; prstenovi za salvete; mlaznice za kante za zalivanje; sunđereri za čišćenje; posude; papirni tanjiri; pribor za sečenje kolača; mlin za biber; parfemi, arome, eterična ulja, posudice sa svećom za sago-revanje mirisa; prskalice za mirise; mirisni isparivi raspršivači; piknik korpe; štedne kasice; poklopci za lonce; lonci; ekspres lonci; kante za đubre; slanici; bibernici; posude; tacne; kutlače, lopatice; jastučići za čišćenje, ribanje; četkice za brijanje; rastezači za košulje; četke za cipele; rogovi za cipele (za očuvanje izgleda cipela); kalupi za cipele; sita; prečišćivači dima za kućne potrebe; činije za supu; setovi za začine; držači za sunđere; sunđereri za kućne potrebe; držači za četke za brijanje; statuete, kipovi od porcelana terakote ili stakla; cediljke; prskalice za zalivanje cveća i biljaka; stono posuđe; vrčevi i krigle; čaj, jajaste posude za ku-

vanje čaja; kutijice za čaj; čajnici; servis za čaj; čajnici; četke za toalet; neseseri sa priborom (toaletni); držači za toalet papir; toaletni sunđer; toaletni pribor; četkice za zube; četkice za zube, električne; držači za čačkalice koji nisu od dragocenih metala; čačkalice; kante za smeće; posude za nuždu; poslužavnici za domaćinstvo; tronošci; presa za pantalone; rastezači za pantalone; vakumirane boce; neseseri sa priborom; vaze; sprava za pravljenje vafla i palačinki, neelektrična; sprave za kuvanje i pečenje, neelektrične; daske za pranje; korita za pranje veša; kante za zalivanje; uređaji za zalivanje; aparati za poliranje voskom; umetnička dela od porcelana, terakote ili stakla; ukrasi za prozore ili vrata od keramike, porcelana, stakla, kristala, zemlje, terakote ili porcelana; kutije ili posude za hranu (ne od dragocenih metala); zamke za mišev; konac za čišćenje zuba; pojasi/trake za kutije za hranu i posude za domaćinstvo ili kuhinju; posude za arome i mirise; rashladne boce (termosi); kutije od stakla; metle; četkarska roba; posude za maslac; poklopac za posude za maslac; kotlovi; instrumenti za čišćenje (ručni); vešalice, kuke za veš; ručni frižideri, neelektrični; tegle za kolačiće; posuđe za kuvanje, ne-električno; četke za obrve; četke za obuću; tiganji; levci; baštenske rukavice; staklene boce (kontejneri); izolacione čuturice i boce; pufna za pudriranje; ručni mikseri (za koktele); cediljke za čaj, ne od plemenitih metala; višenamenske postave i čaršavi za upotrebu u domaćinstvu ili kuhinji; metlice, mutilice, neelektrične; posude od metala za pravljenje leda i ledenih napitaka; sekači za kolačiće (biskvite); bočice, stalci za bočice; krpe za brisanje prašine; koktel šejkeri; kutijice za puder u prahu, ne od plemenitih metala; kutije za pilule ili tablete; omoti za kutije od toalet papira od drveta ili plastike; stalak za četkice za zube; konac za čišćenje zuba; držač za konac za čišćenje zuba; bolesničke guske (lopate); posude za domaćinstvo od plemenitih metala; kućne potrepštine od dragocenih metala; servisi za kafu od dragocenih metala; džezve za kafu, neelektrične, od dragocenih metala; držači salveta i prstenovi za salvete od dragocenih metala; pudrijere od plemenitih metala; stono posuđe od dragocenih metala; sanduci i kutije od dragocenih metala; sve uključeno u klasu 21

Klasa 22: Užad, ka napi, mreže, šatori, tende, cirade, jedra, vreće i torbe (koje nisu uključene u druge klase); materijali za postavljanje i punjenje (osim od gume ili plastike); sirovi vlaknasti tekstilni materijali; prekrivači za flaše; viseće mreže za ležanje; trake za pakovanje ili spajanje, ne od metala; presvlake za vozila (nestandardni) (trake, ne od metala, za pakovanje ili spajanje) sve uključeno u klasu 22.

Klasa 23: Predivo i konac; pamučno predivo i konac; konac i prediva za vez; konac i prediva za šivenje; konac i prediva za pređenje; vuna za pređenje; vuneni konac i predivo; sve uključeno u klasu 23

Klasa 24: Tekstil i tekstilni proizvodi, tkanine, koji nisu uključeni u druge klase; maramice; salvete; prekrivači za krevete i stolnjaci; zastava, barjak; platna, rublje za kupatilo posteljina; prostirke za krevete; ćebad za krevete; zastori od tekstila; platno, štof; prekrivači za nameštaj od tekstila; prekrivači za nameštaj od plastike; navlake za jastuke; vratne zavese; tkanine od imitacije životinjske kože; peškiri; zastave; toalet rukavice; tkanine za domaćinstvo; etikete od platna; maramice za skidanje šminke; otirači; pokrivači za madrace; rukavice za pranje bez prstiju; mreže za komarce; zavese; jastučnice; plastični materijali (zamena za tkaninu); kiltovi; prekrivači za putovanja; čaršafi (tekstilni); zastori; svila; tkanine od svile; vreće za spavanje; stolnjaci i salvete; podmetači za stolove; salvete za stolove; tapiserija; vlakna za tapaciranje; tapiserija (zidna) od tekstila; rublje za krevet; prekrivači od tekstila za držače salveta ili maramica; prekrivači za kvake; navlake za sedišta toalet šolje; prekrivači za daske na toaletnim posudama; držači zavesa ili povezi za njih od tekstila; podmetači (stona platno); pamučne tkanine; zastirači za krevete; tkanine za tekstilnu upotrebu; peškiri za lice od tekstila; filc; friz (čupava tkanina od vune); vlakna od konoplje; navlake za stolove (ne od papira); somot; sukno; maramice od tekstila za uklanjanje šminke; (prekrivači od tekstila za

kartonske kutije; prekrivači od tkanine za kvake; omotači od tkanine za PET flaše; etikete za oznaku imena; tkane etikete; platnene torbice ili od svile za priveske) sve uključeno u klasu 24

Klasa 25: Odevni predmeti; obuća; kape; kecelje; odeća za plažu; odeća za kupanje; kupaći kostimi; sportska odeća; vodootporna odeća; rukavice; rukavice bez prstiju; pojas, kaiševi; odeća za decu, muškarce i žene; odeća za bebe; platnene maramice za bebe; portikle, ne od papira; donje rublje; odeća za spavanje i pidžame; bademantili; naramenice, podvezice; šeširi; kape; sunce viziri; beretke; kape za kupanje i tuširanje; mufovi; štيتnici za uši; odeća za vrat; kravate; okovratnici; mašna; leptir mašne; čarape; hulahop čarape; podvezice; čarape i podvezice za hulahop čarape; obuća; sportska obuća; papuče; obuća za plažu; kostimi za maskiranje; radni rukavi; marama; marama za vrat; papuče (sandale) za kupatilo; papuče za kupanje; ski čizme; čizme; naramenice za odeću; (tregeri); brushalteri; kratke pantalone (bermude); prsluci, grudnjaci; kaputi; manžetne; krzneni šalovi; vrpce za glavu (odeća); pokrivači za glavu; jakne (odeća); dresovi (odeća); džemper (vezeni prednji delovi košulja); pletena odeća; radna odeća (za poljske radove); mantili; kaputi; pantalone; jakna (odeća za zimu); džemper; sandale, šalovi; ešarpe; bluze; košulje; podsuknja (rublje); radnička bluza; nazuvci; čizme za sport; sportski dresovi; odela kostimi za kupanje; majice; pantalone; donji veš; uniforme; prsluci; gumirana odeća za skijanje na vodi; manžetne košulja (odeća); žensko rublje; gimnastičke patike; bodi (rublje); odeća za gimnastiku; pojas od tkanine; sve uključeno u klasu 25

Klasa 26: Čipka i vez; trake (pantljičke) i gajtani; dugmad; kopče i petlje; špenadle i igle; veštačko cveće; veštačko voće; veštački venci; ukrasni noviteti, značke, kopče i broševi; značke, koje nisu od dragocenih metala; rajsferšlusi za torbe; elastične trake za držanje rukava; trake za kosu; šnale; kopče za kaiš; kopče za bluze; pantljičke za kosu; kutije za pribor za šivenje; kutije za igle; kaiševi, pojasevi; gajtani; broševi; kopče; šnale za cipele; jastuci za igle; jastuci za igle, čiode; aplikacije (toplotno lepljive) za dekoraciju tekstilnih artikala (galanterija); spojnice za cipele; patentne spojnice (rajsferšlusi); spojnice za odeću; kopče za podvezice, naramenice; venci od veštačkog cveća; zlatni vez; galanterija; klipse za kosu; kapa za farbanje kose; vikleri; igle za uvijanje kose; ukosnice; mreže za kosu; ukrasi za kosu; igle za kosu; šnale za kosu; ukrasi za šešire; spojnice za korsete; igle za pletenje; ukrasi za obuću; trake za medalje; rozete; šivaće igle; za šivenje naprstci; kukice za obuću; pertle; kićanke; prekrivači za čajnike; umeci za kosu (ukrasne kićanke); čipka od vune; rajsferšlusi; držači za konjski rep; sigurnosne igle; spjalice i kopče za portikle i kecelje; nabori, ukrasi (čipkani); (primeniti); uzice i povodci za decu; bedževi od plemenitih metala; sve uključeno u klasu 26

Klasa 27: Tepisi i asure; prostirke i otirači; linoleum i drugi materijali za pokrivanje podova; tapiserija (zidna) koja nije od tekstila; tepisi za automobile; prostirke za kupatila; prekrivači za podove; otirači za vrata; strunjače (prostirke za gimnastiku); prostirke za gimnastiku; tapiserije; vinil podne obloge; tapete; tapete od vinila; mustre za tapete; prostirke za igraonice (igru); prostirke za plažu; sve uključeno u klasu 27

Klasa 28: Igre i igračke; lutke; plišane igračke; plišane mede; igračke figurice i setovi sličnih igračkica; gimnastički i sportski proizvodi; lopte i baloni; dekoracije proslava i ukrasi; nakit i ukrasi za božićne jelke; poklončići; igračke automobili; električni automobili (igračke); daske za surfovanje; daske za snowboard; roleri; klizaljke; skejtbordovi; štيتnici za sport i igre; vazdušni pištolji (igračke); triktrak igre- dama igre; lopte za igru; zvona za jelke (božićne; bilijar kugle; bilijar stolovi; kocke (material) za gradjenje (igračke); igre na tabli; praskave bombone čizme za skijanje sa skijama; oprema za kuglanje; građevinske igre; držači sveća za jelke; table za igru dame; dame (igra); šah; šahovske table; veštačke jelke; mađioničarski uređaji; prskalice (vatromet igračke); šolja za mešanje kockica; pikado; kockice; kreveti za lutke; odeća za lutke; kuće za lutke; sobe za lutke; domine; gimnastički tegovi; štيتnici za zglobove

(sportski artikli); sprave za vežbanje (razvlačenje); jahaonica; flašice za lutke; udice za pecanje; ribolovački pribor (igračka); peraja za plivanje; plovci za ribolov; frizbiji (igračke); automatske igre; palice za igru; uređaji za elektronske igre različiti od onih prilagođenih samo za televizore; torbe za golf; štapovi za golf; rukavice za golf; rukavice; rukavice za igre i sport; praktične šale (noviteti), zezalice; namotaji za zmajevе; zmajevi; štitnike za kolene (sportska oprema); puzle od kockica; klikeri za igru; marionete; pozorišne maske; maske (igračke); sobni viseći ukrasi (igračke); modeli vozila u srazmeri; noviteti za zabave i plesove; zaštitni jastučići (delovi sportske opreme); salonske igre; detonirajuće kapisle (igračke); pištolji igračke; igračke lopte za igranje; lutke; reketi; zvečke (igračke); igre sa obručima; konjići za ljuljanje; rolšue; daske za jedrenje; skije; sanke (sportska oprema); klizaljke (igračke); duvalice za pravljenje mehurića od sapuna (igračke); čigra (igračke); daska za skakanje (sportski proizvod); sobni bicikl za vežbanje; bazeni (proizvodi za igru); peraja za plivanje; ljuljaške; stolovi za stoni tenis; igračke za kućne ljubimce; skije za vodu; proizvodi za igru tokom kupanja; igre u vodi; sportovi i aktivnosti; lopte za plažu, automatske igre (strojevi) uz prethodno plaćanje; navlake specijalno dizajnirane za skije i daske za skijanje; bingo kartica; kartice; mreže za leptire; karte za igranje; konfete; roleri; pazle (slagalice); kaleidoskopi; jarboli za daske za jedrenje; meredovi; igračke vozila sa radio rulet (okretna ploča za rulet); snežne kugle; krplice za sneg; japanske karte za igranje; sve uključeno u klasu 28.

Klasa 29: Meso, riba, živina i divljač; mesne prerađevine; konzervirano, sušeno i kuvano voće i povrće; želei; džemovi; kompoti; jaja; mleko i mlečni proizvodi; jestiva ulja i masti; goveđa supa, bujon; koncentрати za bujon; goveđa supa; koncentрати za goveđu supu; puter; kavijar; sir; sir grickalice; mlečni proizvodi; prehrambeni proizvodi od ribe; hrana spremljena od ribe; smrznuto voće; zaleđeno voće; čips od voća, margarin; marmelada; želei od mesa; konzervirano meso; napici od mleka; konzervisane pečurke; obrađen lešnik; jetrena pašteta; pašteta; puter od kikirikija; prerađeni kikiriki; grašak, obrađen; voćna pulpa; krompir čips; hrskavi krompir; krompir ušticipci; salata; kiseli kupus; kobasice; susamovo ulje; preparati za pravljenje supa; supe; tofu; salate od povrća; preparati od povrća za pravljenje supa; šlag; jogurt; instant obroci; proizvodi od hrane začinjeni karijem, pakovanje instant obroka; mali obroci; morska trava (za ishranu); obrađeno i konzervirano meso, riba, živina i divljač; slanina; preparati za pravljenje bujana; puter od oraha sa čokoladom; svinjski suhomesnati proizvodi; kroketi; kristalizovano voće; žele od voća; konzervirana riba; kukuruzno ulje; maslinovo ulje za ishranu; suvo grožđe; paradajz pire; povrće konzervirano; plodovi mora (ne živi); obrađeni i upakovani morski plodovi; morski plodovi (konzervirani), prehrambeni proizvodi spremljeni od morskih plodova; sve uključeno u klasu 29

Klasa 30: Kafa, čaj, kakao, šećer, pirinač, tapioka, saga, zamena za kafu; brašno i preparati od žitarica, hleb, kolač i poslastice, led; med, melasa; kvasac, prašak za pečivo; so, senf; sirće, sosovi i umaci; mirodija, začini; led; biskviti; prah za kolače (prašak za pečivo); jestivi ukrasi za kolače; arome za kolače; pite od pirinča; slatkiši i bombone; čokolada; napici od mleka i čokolade; napici na bazi čokolade; slatkiši za ukrašavanje novogodišnje jelke; kakao napici sa mlekom; kako proizvodi; napici na bazi kakaoa; napici od kafe; arome kafe; mešavine i proizvodi koji se koriste kao zamena za kafu; napici na bazi kafe; kolačići; kokice; kornfleks; sladoledi; kari; krem od vanile; pahuljice od žitarica; arome, osim eteričnih ulja; poslastičarski led; voćni želei; kolačići od đumbira; sirupi; infuzije; kečap; slatki koren; pastile; pite od mesa; omekšivači za meso, za upotrebu u domaćinstvu; palačinke; bombone; kolači; biber; pice; pudinzi; ravioli; matični mleč za ljudsku ishranu; šećer; vasabi paste; umak, soja sos; paste; rezanci, testenina i tanki rezanci; udan (japanski rezanci); suši; vanila; vafli; zamrznut jogurt; perece; mali obroci; slatkiši od badema; aromatični preparati za hranu; vezivni agensi za sladoled (jestivi led); peciva; kiflice; kolači; karamele (slatkiši); žvake, ne za medicinsku upotrebu; kukuruzno brašno, krupno; krekeri, jestivi led; šećerni sirup (melasa) - zlatni si-

rup; led, prirodni ili veštački; makarone; marcipan; majonez; ovseno brašno; biber, začini; pite; slatkiši raznih aroma; dvopek; so za kuvanje; sendviči; paradajz sos; začini; šerbet (leden); špageti; slatkiši; tart; pšenično brašno; preliv za salate; sos od mesa; sve uključeno u klasu 30

Klasa 32: Pivo, mineralne vode i vode zasićene ugljenikom (gazirane) i bezalkoholna pića i napici; pića od voća i voćni sokovi; pića i sokovi od povrća; sirupi, koncentracije i drugi preparati za proizvodnju pića; izotonični napici; voćni nektar (bezalkoholni); tablete za šumeće napitke; soda vode; sirupi za pića; flaširana voda; voda (napitak); surutka (piće); bezalkoholna pića; kokteli (bezalkoholni); aperitivi (bezalkoholni); sve uključeno u klasu 32

Klasa 33: Alkohol od pirinča; alkoholna pića (osim piva); aperitivi; alkoholna pića koja sadrže voće; brendi; jabukovača; kokteli; likeri; sake; alkoholna pića; viski; vino; sve uključeno u klasu 33

Klasa 34: Duvan; artikli za pušače; šibice; pepeljare; papir za cigarete; tabakere za cigare; tabakere za cigarete; mehanizam za seckanje kraja cigara; filteri za cigarete; usnici muštikle cigareta; držači cigareta; vrhovi za cigarete; cigarete; cigarete koje sadrže supstitut duvana; cigarilosi; cigare; upaljači; kutije za šibice; držači za šibice; šibice; čistači za lule; stalak za lule; lule; kese za duvan; kutije za burmut; posude za duvan; sve uključeno u klasu 34

Klasa 35: Sakupljanje u korist drugih, čitavog niza roba (transport nije uključen), omogućavajući kupcima dobar pregled i kupovinu proizvoda; takve usluge mogu pružati maloprodaje, veleprodaje; kroz naručivanje poštom preko kataloga ili putem elektronskih medija, na primer preko web sajta ili televizijskih programa za kupovinu; Trgovina na veliko i malo i naručivanje putem pošte vezanih za prodaju svećanih dekoracija i ukrasa, poklona i novih proizvoda, sapuna, parfema, eteričnih ulja, kozmetike, losiona za kosu, proizvoda za negu kose, toaletni preparati; paste za zube; sredstva za ličnu higijenu; sredstva za čišćenje, poliranje i abrazivna sredstva; sredstva za upotrebu u perionicama; pribor za negu noktiju; preparati za negu noktiju; lakovi za nokte; veštački nokti; dijetetski proizvodi; hrana za bebe; sanitarni preparati; sveće; fitilji; tečnost za osvetljenje; masti; lubrikanti; ulja za boje; pribor za jelo; grnčarija; set za manikir; aparat za brijanje, brijači; mašine i mašinski alati za kuhinju ili upotrebu u domaćinstvu, ručni alat; filmovi; kamere; foto diskovi; video rekorderi; audio i video proizvodi, audio i video kasete; ploče i diskovi, instrumenti i aparati za snimanje, prenos i/ili reprodukcija zvuka i/ili slike, televizori, kasetofoni i/ili rekorderi, video kasete i/ili CD plejeri i/ili rekorderi, radio aparati, telefon, bežični telefon, mobilni telefon, futrole za mobilne telefone, ukrasi i trake za telefone; poziv indikatori; uređaji za računanje, kalkulatori, elektronske i kompjuterske igre; kinematografski filmovi, svetla, ventilatori, kuhinjske sprave, kalupi za kolače i peciva, tosteri, peći, kuhinjski pribor, pribor i posude za serviranje i čuvanje hrane i/ili napitaka, štapići za hranu, instrumenti za sečenje, porcelan, posuđe od porcelana, posuđe od kristala, emajlirano posuđe, posuđe od srebra, posuđe od stakla, grnčarija, keramika, aparati za sušenje kose, lampe, abažuri i njihovi delovi i dodaci, nosiljke za bebe, baloni, sirene za bicikla, satovi i časovnici i njihova oprema i delovi i dodaci, nakit i imitacije nakita, ornamenti, proizvodi od dragocenih metala ili presvučeni njima, muzičke kutije, muzički instrumenti, slike, fotografije, kancelarijski materijal, papir i karton i proizvodi napravljeni od ovih materijala, umetnički pribor, četke za slikanje, pisači pribor, štampani materijal, knjige, novine, magazini i periodične publikacije, čestitke (i Božićne), karte za igru, materijali za uvijanje i pakovanje, okviri i ramovi za slike, lepak za kancelarijske i kućne potrebe, proizvodi od kože i/ili imitacije kože, torbe i koferi, tašne i novčanici, kišobrani, štampovi (pomoć pri hodanju), nameštaj, ogledala, vešalice i čiviluci, kutije i kontejneri, pločice za ime, mali kućni dodaci, sprave i pribor za domaćinstvo ili kuhinju, češljevi, sunđer, četke, proizvodi za čišćenje, naočare, okviri za naočare i naočare za sunce i kutije za naočare i pribor za njih, tekstil i tekstilni proizvodi, posteljina i stolnjak i prekrivači za stolove, salvete, podmetači za

stolove, nameštaj, galanterija, maramice, odevni predmeti, obuća i kape, dugmad, bedževi, trake i vrpce, čipka i vez, šnale i ukrasi za kosu, naramenice, ukrasi za cipele, ukrasi za šešire, rajferšlusi, tepisi, ćilimi i prostirke, igre, igračke i, lutke, figurice, sportski artikli, ukrasi za Božićne jelke, hrana i piće, poslastice, biljni proizvodi, slatkiši, konditorski proizvodi, šibice, tompusi i cigarete i proizvodi za pušače, reklamiranje(oglašavanje); organizovanje izložbi za privredne ili reklamne potrebe; izdavanje reklamnih tekstova (oglasa); promotivne prodaje (za druge); marketinške agencije; poslovno upravljanje predstavama, umetničkim; agencije za uvoz i izvoz; sastavljanje, sakupljanje informacija u kompjutersku bazu podataka; reklamiranje putem pošte; poslovno upravljanje hotelima; marketing istraživanja; lepljenje oglasa; pronalaženje osoblja; reklamne agencije; oglašavanje (reklamiranje) putem radija; oglašavanje preko televizije; (reklamiranje na informatičkoj mreži; vršenje raznih usluga nabavki za druge (kupovina proizvoda i usluga za druge proizvođače); iznajmljivanje vremena za reklamiranje u svim sredstvima komunikacije; iznajmljivanje kancelarijskih mašina i oprema; iznajmljivanje aparata za prodaju); sve uključeno u klasu 35.

Klasa 41: Razonoda; zabava; zabavni parkovi, tematski parkovi; zabavne arkadne usluge; usluge obrazovanja; organizovanje, proizvodnja i izvođenje programa koncerata, nastupa uživo, pozorišnih predstava, izložbi, sportskih takmičenja, sportskih i kulturnih aktivnosti; koncertne dvorane; bioskopi; kabarei; usluge filmskih studija; usluge diskoteka; usluge klubova; objavljivanje knjiga, tekstova, magazina, novina i časopisa; usluge biblioteka; obezbeđivanje opreme za zabavu (razonodu), izložbe, koncerte, predstave, performanse, sportske aktivnosti, igre, rekreaciju i kulturne aktivnosti; usluge fitnes centara; usluge kampa za odmor; pružanje informacija koje se odnose na obrazovanje, zabavu, rekreaciju, sport i kulturu; televizijska i radio zabava; proizvodnja radio i televizijskih programa; filmske i video produkcije; iznajmljivanje kino-filmova, filmova, video kasete, laserskih diskova, video diskova i raznovrsnih digitalnih (video) diskova; iznajmljivanje aparata za snimanje zvuka, iznajmljivanje scenskog i pozorišnog dekora; obdanište, jasle; klubovi i sale sa instaliranim audio i vizuelnim muzičkim uređajima; sobe i saloni za razonodu; organizovanje takmičenja lepote; cirkusi; kursevi korespondencije; usluge zabavljača; organizovanje dešavanja kulturnog i edukativnog karaktera; aparati za igre; uputstva u vezi gimnastike; obezbeđivanje opreme za muzeje (prezentacije, izložbe); rukovođenje lutrijama; orkestarske usluge; planiranje zabava; usluge pisanja scenarija; pozorišna predstave; zoološki vrtovi; usluge digitalnog snimanja; elektronsko izdavaštvo; usluga elektronskog igranja (iz informatičke mreže); tumačenje jezika znakova; profesionalna orijentacija (obrazovanje i saveti pri obuci); mikrofilmovanje; komponovanje usluge; noćni klubovi; fotografisanje; produkcija filmova na video trakama; priređivanje karaoka usluga (stavljane na raspolaganje opreme za karaoke); elektronske publikacije (usluge iskorišćavanja elektronskih publikacija koje se ne mogu kopirati); objavljivanje knjiga i časopisa, elektronsko; snimanje videorekorderom; kuglane; stadion za udaranje loptice ili stadion za bejzbol (igre); elektronsko prikazivanje filmova; organizovanje venčanja; sve uključeno u klasu 41

Klasa 43: Usluge obezbeđivanja hrane i pića, privremeni smeštaj, restorani, kafe - restorani, kafeterije (kafići), barovi, marketi sa prehrambenim proizvodima; kantine, catering usluge, samslužni restorani snek barovi; koktel barovi, pružanje informacija koje se odnose na prethodno navedeno i na hranu i piće; obezbeđenje i rezervacija privremenog smeštaja i smeštajni objekti, hotelske usluge, motelske usluge, pansionske usluge i pružanje informacija u vezi sa tim uslugama; smeštajne usluge u kampovima za odmor; restorani, kafe - restorani, kafeterije (kafići), barovi, marketi sa prehrambenim proizvodima, kantine i sale sa audio i vizuelni muzičkim uređajima; usluge brige o deci; usluge dnevnih obdaništa; kuće za smeštaj turista; usluge barova; aranžiranje hrane i pića za svadbene prijeme; sve uključeno u klasu 43.

Klasa 44: Medicinske usluge; veterinarske usluge; higijenska zaštita i nega lepote za ljude i životinje; agrikulturne, hortikulturne i šumarske usluge; saloni lepote (za ulepšavanje); frizerski saloni; timarenje (nega) životinja; aranžiranje cveća; baštovanstvo; održavanje zelenih površina; četkanje kućnih ljubimaca; (usluge aromaterapija; pravljenje venaca; bolničke usluge; zubarske usluge; tetoviranje - usluge tetovaže) sve uključeno u klasu 44.

(210) **2011-177** (442) **20.04.2014.**
(220) 4/11/2011

(731) **SANRIO COMPANY LTD**, TOKYO1-6-1 OSAKI, SHINAGAWA-KU JP

HELLO KITTY

(540)

(550) I

(511) **Klasa 03:** Preparati za izbeljivanje i drugi preparati za pranje veša; preparati za čišćenje, poliranje, ribanje i abrazivni preparati (za nagrizanje); sapuni; parfimerija, eterična ulja, kozmetika, losioni za kosu; paste (preparati) za zube; sredstva za higijenu (preparati za kupatilo), preparati za manikir; proizvodi i preparati za negu i čišćenje kose i kože; lepila za kozmetičke potrebe; losioni za posle brijanja; preparati protiv znojenja; antistatički preparati za kućnu upotrebu; aromatični preparati; kora kvilaje za pranje; soli za kupku; kozmetički preparati za kupanje; maske za lice; soli za izbeljivanje; soda za izbeljivanje; plavila za veš; hemikalije za izbeljivanje veša namenjene za upotrebu u domaćinstvu; preparati za uklanjanje boja; kozmetički pribor; kozmetički preparati namenjeni gubitku telesne težine; kozmetički preparati za životinje; pamučni štapići za kozmetičku upotrebu; vata za kozmetičke svrhe; kozmetičke kreme; kreme za izbeljivanje kože; kreme za kožnu galanteriju; sredstva za uklanjanje masnoće; sredstva za poliranje proteza; preparati za čišćenje proteza; dezodoransi; deterdženti; kozmetičke boje; kolonjske vodiče; toaletna voda; kreme za kosu; gel za kosu; šamponi; kondicioneri za kosu i preparati za vlažnost kose; parfemi; karmini; kreme i losioni za kožu i kosu; veštački nokti; lakovi za nokte i acetoni; kreme za zaštitu od sunca; preparati za beljenje (skidanje boje) za kozmetičke potrebe; arome za kolače (esencijalna ulja); mleko za čišćenje za toaletnu upotrebu; kozmetika za obrve; olovke za obrve; oplemenjivači rublja (za upotrebu u perionicama); veštačke trepavice; vosak za pod; boje za kosu; lakovi za kosu; preparati za kovrdžanje kose; izbeljivači za veš; preparati za natapanje u perionicama; štirak za veš; losioni za kozmetičke potrebe; šminka; puder za šminku; preparati za šminkanje; preparati za skidanje šminke; maskara; preparati za ispiranje usta, ne za medicinske svrhe; preparati za negu noktiju; kozmetičke olovke; preparati za poliranje nameštaja i podova; pomade za kozmetičke svrhe; potpuri (ugodni mirisi); kamen za glačanje; šmirgla; šmirgla papir; mirisno drvo; šamponi za kućne ljubimce; krema za cipele; krema za poliranje cipela; vosak za cipele; preparati za štirkanje; sapun za izbeljivanje tekstila; štirak za veš; preparati za sunčanje; mirišljave maramice; preparati za uklanjanje laka; vosak za depilaciju; vosak za veš; vosak za poliranje; vosak za kožu; preparati za depilaciju; želatin (petrolej) za kozmetičke svrhe; ukrasi koji se skidaju za kozmetičke svrhe; (štapići od tamjana (joss štapići); mirisi) sve uključeno u klasu 3.

Klasa 04: Industrijska ulja i masti; maziva; jedinjenja za skupljanje prašine vlaženjem i vezivanjem; goriva (uključujući motorna tečna goriva) i materije za osvetljavanje; sveće, fitilji; sveće za Božićnu jelku; preparati za uklanjanje prašine; mast za kaiševе; mast za čizme; mast za kožu; mast za cipele; fitilji za lampe; sveće preparati koji daju neelastičnost kaiševima; ulje za održavanje kožnih proizvoda; ulje za boje; cepke za osvetljenje; uređaji za čišćenje koji skupljaju prašinu; fitilji za sveće; dizel ulje; benzin; kerozin; nafta; sve uključeno u klasu 4

Klasa 05: Farmaceutski, veterinarski i sanitarni preparati; dijetetske supstance prilagođene medicinskoj upotrebi, hrana za bebe; flasteri, materijali za zavijanje; materijali za plombiranje zuba, zubarska smola; dezinfekciona sredstva; preparati za uništavanje štetočina; fungicidi; herbicidi; upijajući pamuk; upijajuća vata; lepljive trake za medicinske svrhe; lepljivi flasteri; lepljive trake za medicinsku upotrebu; preparati za osvežavanje vazduha; preparati za prečišćavanje vazduha; albuminski dodaci hrani za medicinske svrhe; albuminsko mleko za medicinske svrhe; preparati za pranje životinja; antiseptički vata; antiseptici; melemi za medicinske svrhe; higijenski zavoji; ulošci za menstruaciju; zavoji za zavijanje; terapijski preparati za kupanje; preparati za kupanje, medicinski; soli za kupanje za medicinske svrhe; kupke od kiseonika; soli za kupke od mineralne vode; pojasevi za higijenske uloške (salvete); narukvice (kodirane identifikacije) za medicinske svrhe; grudni ulošci kod dojenja; medicinski slatkiši; kapsule za lekove; kapsule za farmaceutske svrhe; guma za žvakanje za medicinske svrhe; antiparazitske ogrlice za životinje; medicinske poslastice; sredstva za dezinfekciju, ispiranje, čuvanje i čišćenje kontaktnih sočiva; lubrikanti i sredstva za kontaktna sočiva ili za upotrebu sa kontaktnim sočivima; hemijska kontraceptivna sredstva; lekovi za žuljeve; prstenovi za žuljeve na stopalima; pamuk za medicinske svrhe; flaster lepljivi; farmaceutski preparati za sprečavanje peruti; dezodoransi koji nijesu za ljude i životinje; deterdženti za medicinske svrhe; dijetetska pića prilagođena medicinskim svrhama; dijetetska hrana; dijetetske supstance; dezinfekciona sredstva za hemijske toalete; losioni za pse; preparati za pranje pasa; preparati za odbijanje insekata kod pasa; medicinska pića; sredstva za ispiranje očiju; kutije za prvu pomoć (napunjene); lepkovi za hvatanje mušica; papir za hvatanje mušica; preparati za uništavanje mušica; lepak za mušice; preparati protiv znojenja stopala; gaza za zavoje; germicidi; kedrovo drvo koje služi za odbijanje insekata; masti za medicinske svrhe; medicinske infuzije; sredstva za odbranu od insekata; insekticidi; petrolejski gel za medicinske svrhe; gaće za menstruaciju; higijenske gaće; mleko u prahu (za bebe); laktoza za medicinske svrhe; maramice sa farmaceutskim losionima; losioni za farmaceutske svrhe; losioni za veterinarske svrhe; pastile; pića od mlečnog slada za medicinske svrhe; medicinski alkohol; lekovito bilje; lekovito ulje; medicinski čaj; medicinske torbe (male, napunjene); lekovi za ljudsku upotrebu; jastučići za menstruaciju; tamponi; mentol; pomade; mineralni dodaci za hranu; papir za suzbijanje moljaca; preparati za suzbijanje moljaca; preparati za ispiranje usta; blato za kupanje; pelene za inkontenciju; nutricionistički dodaci za medicinske svrhe; sanitarne maramice; sanitarni ulošci; sanitarni jastučići, sanitarne gaćice; gaćice, upijajuće, za mokrenje; higijenski ulošci za svaki dan; parazitocidi; pilule za farmaceutske potrebe; hemijski preparati za dijagnostikovanje trudnoće; čaj za mršavljenje za medicinske svrhe; lekovi protiv znojenja; matični mleč (za medicinske svrhe); sanitarni peškiri; farmaceutski preparati za negu kože; mirišljave soli; preparati za sterilizaciju; pomada protiv opekotina od sunca; preparati protiv opekotina od sunca za farmaceutske svrhe; sirupi za farmaceutske svrhe; vitaminski preparati; pamučni štapići za medicinske svrhe; kreme za sunčanje za zaštitu od sunca; kašne obloge; kompresioni zavoj; kašne obloge i/ili kompresioni zavoji za snižavanje telesne temperature ili za ublažavanje groznice ili glavobolje; zavoji (za medicinske svrhe); lekovi za medicinske svrhe; medikamenti za snižavanje telesne temperature; biljni čajevi; kašne obloge od slačice; medicinski preparati za potrebe mršavljenja; sve uključeno u klasu 5.

Klasa 08: Ručni alati i sprave (kojima se ručno upravlja); pribor za jelo; hladno oružje; žileti; makaze za bradu; otvarači za flaše; otvarači za konzerve; kutije za brijače; pincete za zanoktice; makaze za zanoktice; sekači; pribor za rezanje; sredstva za pretakanje tečnosti; aparati za depilaciju; utiskivači; grickalice (električne ili neelektrične); uređaj za vađenje eksera; aparati za poliranje noktiju; viljuške; alat za baštu šišači; ručna sredstva za kovrdžanje kose; pinceta za uklanjanje dlaka; šiljak za razbijanje leda; bušilice; noževi; makaze za travu; kožni kaiš za oštrenje brijača; dizalice; turpije; turpije, električne; izvlakači eksera; sprave za uvlačenje konca u iglu; numeracioni probojci; klešta za orahe i lešnike, ne od plemenitih metala; otvarači sa oštricom; set za pedikir; aparati za ubijanje biljnih parazita; žileti; kaiš za oštrenje brijača; brijači, električni ili ne; makaze; instrumenti za oštrenje; kašike; sprejevi; markeri za utiskivanje (ručni alati); hvataljke za kocke šećera; stono posuđe; otvarači za konzerve; seckači za meso i povrće, noževi, sekači i rezači i delovi i dodaci koji se koriste za te svrhe; makaze za porublivanje; gvozdeni savijači; klješta za uvijanje; setovi za manikir; pribor za brijanje; pincete; kutlače za vino; (rezači jaja, (neelektrični); sekač za sir (neelektrični); sekač za picu (neelektrični); tučak; aparat za uvijanje trepavica; zlatno i srebrno posuđe (pribor za jelo, viljuške i kašike); sve uključeno u klasu 8

Klasa 09: Aparati i instrumenti naučni, nautički geodetski, električni, fotografski, kinematografski, optički, za vaganje, za merenje, signalizaciju, kontrolu (nadgledanje), za spasavanje života i za obuku; aparati za snimanje, prenos, reprodukciju zvuka ili slike; magnetni nosioci podataka, diskovi za snimanje; automatske mašine za prodaju i mehanizmi za aparate koji se pokreću ubacivanjem novca; registar kase; računске mašine; oprema za obradu podataka i kompjuteri; aparati za gašenje požara; računaljke; električni uređaji za privlačenje i uništavanje insekata; audio i vizuelni aparati namenjeni za podučavanje; baterije; kutije za baterije; aparati namenjeni za punjenje dopunljivih baterija; dvogledi, durbini; kalkulatori; kamere, kamere namenjene za kinematografske potrebe i delovi i dodaci za njih; sočiva za kamere; instrumenti za merenje kapaciteta; animirani crtani filmovi; kasetofoni; lančići za naočare; kinematografski filmovi; (prikazani); časovnici; aparati namenjeni reprodukciju kompakt diskova; kompakt diskovi (audio-video); kompakt diskovi (za čitanje podataka); memorija namenjena čitanju); kompjuterski operativni programi, snimljeni; kompjuterski programi; kompjuterski softveri (snimljeni); kompjuterski štampači za kompjutere; kontaktna sočiva; kutijice za kontaktna sočiva; aparati namenjeni za obradu podataka; krojački pribor za merenje; električna zvona za ulazna vrata; džepni elektronski prevodioci; aparati za gašenje požara; filmovi, izloženi; blicevi; alarmni sistem protiv požara; okviri za dijapozitive u fotografiji; aparati za igre, namenjeni da se upotrebljavaju zajedno sa televizijskim prijemnicima; aparati za uvijanje kose, električni; aparati za regulisanje toplote; džu-boksovi; optička sočiva; skale za merenje veličine slova; pojasevi za spasavanje; plutače za spasavanje; sigurnosne jakne; splavovi za spašavanje; brave, električne; magnetni nosač podataka; magnetne kodirane kartice; magnetni dekoderi; magneti; uveličavajuća stakla; električni uređaji za skidanje šminke; aparati, uređaji i instrumenti za merenje; mikrofoni; mikroskopi; neonski znaci; laptopovi; elektronske olovke; gramofonske ploče; fotokopir aparati; džepni kalkulatori; aparati za projekciju; ekrani namenjeni potrebama projekcije; radio uređaji; gramofoni; daljinski upravljači; lenjiri (merni instrumenti); skale (merne); smart kartice; detektor dima; utičnice, utikači i ostali kontakti; aparati namenjeni za snimanje zvuka; diskovi namenjeni za snimanje zvuka; aparati namenjeni za reprodukciju zvuka; aparati namenjeni za prenos zvuka; kutije za naočare; okviri za naočare; stakla za naočare; naočare; naočare za sunce; pojasevi za plivanje; odela za plivanje; prekidači električni; kasetofoni; telefonski aparati, prijemnici, transmiteri, žice; teleskopi; televizori; televizijski prijemnici; indikatori temperature; instalirani sistemi namenjeni prevenciji provala, električni; termometri; termostati; video kasete, kertridži za video igre; video zapisi; video trake; video ekrani; video

rekorderi; plovci za vodu; obrađivači teksta; video i kompakt diskovi; digitalni multimedijalni (video) diskovi; video kompakt diskovi i digitalni multimedijalni (video) disk plejeri; audio i video aparati, sa aparatima za prenos zvuka (pevujući uređaji); držači, nosači, kutije za audio i video kasete, kompakt diskove, laserske diskove; video diskovi i digitalni multimedijalne (video) diskovi; diskovi; podloga za miš; telefoni, bežični telefoni, mobilni telefoni i delovi i dodaci uz njih; futrole i maske za mobilne telefone; pejdžeri i delovi i dodaci uz njih; futrole i maske za pejdžere; torbe, pokrivači, kutijice, nosači i držači za mobilne telefone i pejdžere; slušalice; slušalice za uši; slušalice za uši i mikrofoni/spikeri za telefon, za razgovor mobilnim telefonima, koje se upotrebljavaju sa mobilnim telefonom; indikatori poziva za telefone, mobilne telefone i pejdžere; mobilni telefoni i pejdžeri; uređaji za igranje video igrice; maske, koje se nose preko očiju radi zaštite od svetlosti; elektronske agende (programi rada); električna alarmna zvana; alarmi; čitači bar-kodova; barometri; zujalice; električne zujalice; procesor (čip), centralna jedinica za obradu podataka; čipovi (integrisana kola); hronografi (aparati za beleženje vremena); upaljači za cigare i/ ili cigarete za automobile; kompjuterske tastature; kompjuterske periferne sprave; akustične spojnice; spojnice (oprema za obradu podataka); optički nosači za podatke; optički diskovi; diskovi (magnetni); mašine namenjene automatskoj distribuciji; ronilačka oprema; ronilačke maske; ronilačka odela; elektronske oglasne table; elektronske olovke (za video-displeje); uređaji za funkcionisanje liftova; vrpce za naočare; okulari; naočare za spavanje; faksimil mašine; filteri (fotografije); kućne pegle, električne; plovci za kupanje i plivanje; flopi diskovi; trake za čišćenje glava za snimanje; higrometri (za merenje vlažnosti); integrisana kola; aparati za internu komunikaciju; interfejsi (za kompjuter); mašine za fakturisanje; poklopci za objektivne; aparati za upravljanje liftovima; jedinice za magnetne trake (za kompjutere); magnetne trake; kašike za merenje; metronomi; mikroprocesori; moderni; mašine za brojanje i sortiranje novčanica; monitori (kompjuterska oprema); monitori (kompjuterski program); miš (oprema za obradu podataka); optička vlakna; optička stakla; optička roba; optička sočiva; parking metri; kompjuterska pomoćna oprema; uglomeri (merni instrumenti); radio-telegrafski kompleti; radio-telefonski kompleti; skeneri (oprema za obradu podataka); poluprovodnici; slajdovi (fotografija); mašine za prorezivanje, automatske; trake za snimanje zvuka; demagnetizirajući aparat za magnetne trake; telegrafske žice; telegrafski aparati; teleprinteri; telekomunikacioni aktivatori; teleprinteri; izdavači karata; transmiteri (telekomunikacije); paket za transmisiiju (telekomunikacije); vakuum metri; video ekrani; video telefoni; video rekorderi; piskavi alarmi; plutajuće sprave za plivanje; čepovi za uši, ronilački čepovi za uši; jajoliki satovi; sportske naočare; zaštitne kacige za sport; aparati za navigaciju za automobile (unutrašnji računari); program za kompjuterske igrice; metronomi; elektronske publikacije (koje mogu da se preuzmu sa interneta); kompjuterski programi (softveri koji mogu da se preuzmu sa interneta); stereo, vokmeni; sateliti za naučne svrhe; oslonci za ručni zglob, za upotrebu sa kompjuterima; vrpce za nošenje mobilnih telefon; postolja za portabl telefone; nalepnice za portabl telefon; poklopci za antene za portabl telefon; elektronska kola i cd-romovi, koji omogućavaju snimanje automatskog programa za muziku, namenjeni upotrebi elektronskih muzičkih instrumenata; čepovi za uši; sve uključeno u klasu 9.

Klasa 10: Hirurški, medicinski, zubarski i veterinarski aparati i instrumenti, veštački udovi, oči i zubi; ortopedska pomagala; hirurški materijali za zašivanje; aparati za merenje krvnog pritiska; flašice za bebe; cucle za bebe; zavoji; električna čebad za medicinsku upotrebu; kondomi; kontraceptivna sredstva, nehemijska; zubarski aparati; veštačke dojke za bebe; štapići za uši; aparati za estetske masaže; cucle za flašice za bebe; ventili za flaše za hranjenje; flašice za hranjenje; ulošci za ravne tabane; ortopedska obuća; pincete; rukavice za masažu; rukavice za medicinsku upotrebu; slušni aparati za gluve; štitnici za uši (sluh); terapijski aparati na bazi vrućeg vazduha; pakovanja leda za medicinsku upotrebu; inkubatori za bebe;

aparati za masažu; porodiljski pojasevi; dušeci za porođaj; ortopedska pomagala; ulošci za trbuh; električni termofori (Uastuci), za medicinsku upotrebu; uspavljajući jastuci za nesanicu; hirurški sunđer; dozer kašike za medicinsku upotrebu; stetoskopi; nosila; toplotna pakovanja za prvu pomoć; strugači za jezik; veterinarski aparati i instrumenti; maske za usta; termometri za medicinske svrhe; bolesničke guske (lopate); pakovanja vode za medicinske svrhe; (prstenovi za pravilno nicanje zuba); medicinski jastuci ili preparati za testiranje telesne temperature; sve uključeno u klasu 10.

Klasa 11: Aparati za osvetljavanje, grejanje, proizvodnju pare, kuvanje, hlađenje, sušenje, ventilaciju, snabdevanje vodom i za sanitarne svrhe, klima uređaja, osveživači vazduha; isušivači vazduha; aparati i mašine za prečišćavanje vazduha; ulošci za slavine koji sprečavaju prskanje vode; aparati za filtriranje akvarijuma; grejači akvarijuma; osvetljenje za akvarijum; peći; roštilji; oprema i instalacije za kupatilo; grejači za kupatila; grejači za krevete; aparati za rashlađivanje pića; osvetljenje za bicikl; električna čebad; bojleri; tosteri za hleb; električno grejane, prostirke; plafonjere; lusteri; električne sijalice za jelke; električni filter aparati za kafu; mašine za kafu; filteri za kafu; sprave za prženje kafe; rashladni kontejneri (hladnjače); šporeti; aparata i uređaji za kuvanje; kuhinjske sprave, električne; rashladni uređaji za tečnosti i instalacije za taloženje u duvanskoj industriji; grejni jastuci; prigušivači (za paru); grejači (jastučići); amortizeri (grejanje); friteze, na struju, aparati za dezinfekciju; zidni držači dezinfekcionih sredstava za toalete, aparati za destilaciju; fenovi za sušenje kose; filteri vode za piće; aparati za sušenje stočne hrane; električne lampe; ukrasne lampice za svečanu dekoraciju; ventilatori (erkondišni aparati); električni ventilatori; grejalice, električne, za flašice za hranjenje; aparati za ispiranje; ukrasne fontane; zamrzivači; pržionice za voće; upaljači na gas; električni roštilji; roštilji; aparati u perionicama za ručno sušenje; oprema za kupatila sa toplim vazduhom; peći za topao vazduh; ringle; boce za toplu vodu; svetleći kućni brojevi; prečišćivač vazduha; kutije za led (ledomati); sanduci za led (ledomati); mašine i aparati za led; električni čajnici; ramovi za lampe; staklena cev za lampe; vitraž lampe; kugle lampi; visiljke za lampe; abažuri za lampe; reflektori; abažuri; lampe; nosači abažura; fenjeri; električni sušači veša; sijalice; instalacija za osvetljenje; mikrotalasne pećnice; uređaji za hlađenje mleka; slavine za spajanje za cevi za vodu; pločasti grejači (plotne); džepna baterijska lampa; džepni reflektori; džepni grejači; električni lonci za kuvanje pod pritiskom; tankovi sa vodom pod pritiskom; električni radijatori; rashladne vitrine; rashladne komore; frižideri; pekači; aparati za pečenje; sprave za prženje; ražanj; roštilji; sigurnosne lampe; tuš kabine; tuševi; sudopere; grla električnih sijalica; solarni kolektori (grejanje); tosteri; lavaboi za toalete; WC šolje; prekrivači za WC šolje; toaleti, pokretni; lampe; pisoari; sprava za pečenje vafli, električna; sprave za pečenje/za kuvanje, električne; posude za zagrevanje; lavaboi; grejači vode; aparati i mašine za prečišćavanje vode; sterilizatori vode; džepne lampe; električni prečišćivači vazduha; oprema protiv zaslepljivanja za automobile; oprema protiv zaslepljivanja za vozila; lampe sa svetlosnim lukom, električni ekspres lonci (autoklavi); kade za kupanje; kineski fenjeri (lampe); zaštitni uređaji za osvetljenje; rasipači, difuzori svetla; upaljači; svetla za automobile; svetla za vozila; peći; peći (grejni aparati); (lonci za pirinač); sve uključeno u klasu 11.

Klasa 12: Vozila; aparati za kretanje po zemlji, vazduhu ili vodi; sprave protiv zaslepljivanja za vozila; sprave protiv zaslepljivanja za vozila; alarmi, protiv krađe za vozila; protivprovalni proizvodi za vozila; nosiljke za bebe; pokrivači za nosiljke za bebe; zvona za bicikle, tricikl ili bicikle i tricikl, i delovi i oprema za njih; kola; trolejbusi; navlake zasedišta za vozila; zaštitna odeća (štitnici) za bicikle, motorcikle ili tricikle; kola za golf; kolica, okretna za istovar robe; ručna kolica; nasloni za glavu za sedišta u vozilima; kabanice za dečija kolica; haube (poklopci) za vozila; sirene za vozila; sirene za vozila; radkapne; centralni rotirajući deo točka vozila; nosači prtljaga za vozila (gepek); mreže za prtljag kod vozila; teretni kamioni; blatobrani;

uređaji koji sprečavaju proklizavanje guma; vesla za kanue; vesla; pedale za motorcikle; dečja kolica; pumpe za bicikle, motorcikle ili tricikle; navlake za dečija kolica; cerade za dečija kolica; dečija kolica navlake za sedišta za bicikl, tricikl ili motocikle; sigurnosni pojasevi za vozila; sigurnosna sedišta za decu (za vozila); sedišta za vozila; sigurnosni pojasevi za vozila; roletne (zaštite od sunca) prilagođene za automobile; gume za vozila; tapacir za vozila; pokrivači za motorna vozila (oblikovani); invalidska kolica; brisači vetrobrana; držači za sitnice u vozilima; kutije za arome i ugodne mirise za korišćenje u vozilima; avioni; vazdušni jastuci (sigurnosni delovi za automobile); vazdušni baloni; automobili; motorne kočije; retrovizori; motorni autobusi; motorna vozila; motorcikli; kolica za kupovinu; kolica za bebe; gume za bicikle, tricikl ili motocikle; električna vozila; vodena vozila; (navlake za ručke automobila; pokrivači točkova) sve uključeno u klasu 12

Klasa 14: Dragoceni metali i njihove legure i proizvodi od dragocenih metala i njihovih legura, ili premazani s njima; nakit, imitacije nakita i ukrasa; drago kamenje; časovničarski i hronometrijski instrumenti; broševi; lančići; amajlije; kovani novčići; ukrasi, imenovane medalje i/ili kovani novčići; dugmad za manžetne; minduše; zlatne niti; ukrasi (od dragocenih metala); predmeti od imitacije zlata; kutije za dragulje; kutijice za nakit; ogrlice; špenadle, igle (nakit); igle za revere; prstenje; statue i statuete od dragocenih metala; šnale za kravate; časovnici, satovi i delovi i pribor za njih; kaiševi za satove; trake za satove, lanci za satove; kutije za satove; štoperice; ukrasi; ukrasne igle; igle za kravate; medalje; privesci za ključeve, obični ili ukrasni; lanci za ključeve i futrole/ nosači za ključeve od dragocenih metala i/ili od dragog kamenja; privesci; narukvice (nakit); kutije za ručne satove (prezentacione); kutije za satove; časovnici i satovi, električni; sunčani satovi; dijamanti; nakit za kostime; polu drago kamenje; umetnička dela od dragocenih metala; budilnici; baršunasta dugmad za manžetne; duple igle (igle za kravate); figurice (statuete) od dragocenih metala; kutijice za nakit; sve uključeno u klasu 14

Klasa 16: Hartija karton i proizvodi od njih, koji nisu uključeni u druge klase; štampane stvari; knjigovezački materijal; fotografije; kancelarijski materijal; lepila za kancelarijske i kućne potrebe; umetnički alati i materijali; slikarske četkice; pisaće mašine i kancelarijski rekviziti; materijali za obuku i nastavu; plastični materijali za pakovanje (koji nisu uključeni u druge klase); štamparska slova; štamparski blokovi; kalendari, knjige, katalozi, dopisnice, razglednice, poster, časopisi, štampana publikacija novine i magazini; čestitke; razglednice; pisaći pribor; gumeni pečati; marke i pečati; jastučići za pečate, jastučići za mastilo; foto albumi; podmetači za uramljivanje slika ili fotografija; stalak za slikarska platna; uljani upijajući papir za kožu; postolja za fotografije; mastila; maramice, toalet papir, salvete od papira za uklanjanje šminke; papirni peškiri (ubrusi); podmetači podmetači za čaše od papira ili kartona; papir za uvijanje, papir za pakovanje, materijal za pakovanje; umetničke akvarel boje; grafičke reprodukcije, portreti; litografije; pera, olovke, vrhovi pera, hemijske olovke, nalivpera; držači za olovke; držači za pera; dopune za pera i instrumenti za pisanje; grafiti za olovke; olovke za bojenje, krede u boji; kutije za pera i olovke; zarezaci za olovke; mašine za oštrenje olovaka; spjalice; pritiskači za papir; igle za papir, igle za crtanje; voštane boje; lepila za kancelarijske i kućne potrebe; papirna galanterija; posude i stalci za pisma; držači za pisma; otvarači pisama; lepljive trake i držači za lepljive trake; pribor za crtanje, table, olovke i instrumenti; setovi za crtanje; albumi za torbe i koverta; upijajući papir; držači knjiga i obeleživači stranica za knjige; markeri knjiga; ormani za kancelarijski materijal; platno za slikanje; notesi; dnevници; fascikle; podloge za pisanje; podloge za beleške; papir za pisanje; papir za crtanje; kutije za pisanje; krede, školske table, table za plakate; futrole za pasoše; držači za čekovne knjižice; elastične trake; slike; matrice; proizvodi za brisanje, gumice, korektori; električni otvarači pisama; muzičke note; table za brisanje; ukrasi i dekoracija od papira i/ili kartona; toalet papir; salvete od papira; torbe za ručak; kartonske kutije i sanduci; bojanke;

fascikle za izveštaje; povezi za papir; džepne sveske; flomasteri; trake za knjige; setovi crnih grafitnih olovaka; setovi olovaka u boji; lenjiri; podmetači za pisanje; knjige za autograme; klipse; heftalice, makaze za trake; znaci upozorenja; sekači; mašine i aparati za plastificiranje; električni toplotni zaptivači za zaštitni omot za dokumente i fotografije; držači kartica i predmeta; ukrasi od papira za kutije za hranu; albumi; pelene za bebe od papira i celuloze (za jednokratnu upotrebu); torbe (koverte, kese) od papira ili plastike, za pakovanje; spajalice (veze) za slobodne listove; kutije od kartona ili papira; karte; držači i kutije za markice i pečate; stripovi; šestari; papirne trake i karte za upis kompjuterskih programa; papir za kopiranje (pribor); korektori (kancelarijski rekviziti); fajlovi dokumenata; naprstci (kancelarijski rekviziti); zastave (od papira); folderi (kancelarijski); fascikle za papire; gumirane trake; maramice od papira; indeks kartice; mastiljave trake; omoti za papir; nalepnice, ne od tekstila; mape; muzičke čestitke; bilteni; podloge, jastučići (kancelarijski materijal); kutije za boje (predmeti za upotrebu u školi); brošure; sekač papira (za upotrebu u kancelariji); držači za grafitne olovke; poštanske marke, stikeri; salvete od papira; pribadače; karte; trake za pisaće mašine; pisaće mašine (električne ili ne-električne); omoti; četke za pisanje; krede za pisanje; table za pisanje; prekrivači (kancelarijski); tacne za saksije od papira; noževi za papir (kancelarijski rekviziti); portikle od papira; kese za mikrotalasno kuvanje; papir filteri za kafu; brošure; vezeni dizajni (šabloni); noževi za papir (kancelarijski rekviziti); stolnjaci od papira; viseće firme (reklame) od papira ili kartona; metalni vrh za indeksne karte; lotovi papira; upijajući papiri za lice; nalepnice za prenosive telefone; sve uključeno u klasu 16

Klasa 18: Koža i imitacija kože, i proizvodi izrađeni od ovih materijala koji nisu uključeni u druge klase; životinjska koža, krzno; sanduci i putne torbe; kišobrani, suncobrani i štapovi za hodanje; bičevi (kamdžije), saračka oprema i sedlarska roba; torbe, tašne i novčanici, kutije, prtljag, kese; akt-tašne; rančevi; torbe za odeću; torbe za kupovinu; trake od kože; rameni kaiševi; kaiševi; štapovi od trske; omoti i korice za blokove (beležnice); okovratnici za životinje ili kućne ljubimce; futrole za ključeve; pertle od kože ili od imitacije kože; ukrasne kutije; brnjice; školske torbe; kaiševi; ručke za kofer; koferi; putni kompleti; putnički kovčezi (sanduci); futrole za kišobrane; drške od kišobrana; štapovi za hodanje (šetnju) sa sedištem (stolice koje po potrebi mogu biti štapovi za šetnju); kaiševi za prtljag; torbe za plažu; akt tašne, sanduci i kutije, od kože ili kožnih tabli; ručne torbe; kožni kaiševi; planinarski štapovi; muzike kutije; torbe od mreže za kupovinu; ruksaci; školske torbe; torbe za alat od kože ili imitacije kože (prazne); putne torbe; lovačke torbe; torbe, koverte i vrećice od kože, za pakovanje; prekrivači nameštaja od kože ili imitacije kože; ramovi za ručne torbe; torbe za nošenje dece sa naramenicama; torbe za kupovinu sa točkovima; sve uključeno u klasu 18

Klasa 20: Nameštaj, ogledala, okviri za slike; proizvodi (koji nisu obuhvaćeni drugim klasama) od drveta, plute, trske, pruća, rogova, kosti, slonovače, kitove kosti, školjki, čilibara, sedefa, morske pene i zamene svih ovih materijala, ili od plastike; jastučići na naduvavanje; dušeci na naduvavanje; jastuci na naduvavanje; vreće za spavanje; zavesa od perli, ukrasna; za delovi za krevete, nemetalni; rublje za krevete (osim prekrivača); kreveti za kućne ljubimce; korpe, ne od metala; zatvarači za boce; stalak za flaše; čepovi (pluta) za flaše, plastične ključ-kartice; komode; viseća zvana; vešalice za odeću; čiviluci, čiviluci; čiviluci; kontejneri, posude koji nisu od metala (za skladištenje, transport); držači zavesa; kuke za zavesu, šipke za zavesu; alke za zavesu; šipke za zavesu; valjci za zavesu; omče i petlje za zavesu; jastuci; držači za peškire; kavezi za kućne ljubimce; krevet, nameštaj, vrata, oprema, ramovi za vez; ventilatori (neelektrični); statue od drveta, voska, gipsa ili plastike; zakloni za vatru; postolje za saksije; postolja za saksije za cveće; postolja za šešire; visoke stolice za bebe; kućni brojevi, ne od metala, nesvetleći; legla i kućice za ljubimce; identifikacione pločice, koje nisu od metala; indeks kabineti; šetalice za bebe; naduvani reklamni predmeti; kutije za nakit; poštanski sandučići; stalci za pisma; stalci za novine; dušeci; kontejneri, posude od plastike

za svrhe pakovanja; jastuci; stalci, postolja, štandovi; stalci za šoljice; registarske tablice; viseće firme (reklame); drške alata; poslužavnici; pletarski radovi, od pruća; ramovi za fotografije; dekorativne ivice traka od plastike i/ili drveta za upotrebu sa opremom za prozore; ornamenti i ukrasi za prozore ili vrata od plastike, voska, drveta, plute, trske, pruća, roga, kosti, slonovače, kitove kosti, školjki, ćilibara, sedefa, morske pene i zamene ovih materijala; zaptivači za kese; plastične posude za arome i mirise; nasloni za glavu na naduvavanje; dekoracije od plastike za hranu i kutije za ručak; privesci i lanci za ključeve, ne od metala; graničnici za zaustavljanje vrata; fotelje; korpe, ne od metala; kreveti; klupe (nameštaj); kutije od drveta ili od plastike; stolarska roba, ormari; stolovi na točkiće za računare (nameštaj); sanduci od drveta ili plastike; stolice; sanduci za igračke; čepovi; pokrivači odeće (ostava); kolvke; zavese od bambusa; stolice za pisaće stolove; pisaći stolovi; nameštaj za vagon restorane; slamke za piće; nasloni za glavu (nameštaj); table za kačenje ključeva; police u biblioteci; sefovi; brave (osim električnih), ne od metala; krojačke lutke; stalci (nameštaj); okviri za fotografije; okviri za slike; nogare za sečenje drva; školski nameštaj; sedišta; sofe; stolovi; kolica za serviranje čaja; ručna kolica za serviranje čaja; pokretni stolovikolica za računare (nameštaj); postolja za kišobrane; dečiji kreveti; plakari; oglasne table; odvodi (ventili) od plastike; toaletni stočići; hoklice i stolice bez naslona; korpe za rublje sa poklopcem; kuke za odeću; merdevine od drveta ili plastike; ormarići za lekove; podmetači, prenosivi, za sudopere; table sa imenima, ne od metala; table sa brojevima, ne od metala; klinovi i igle (ne od metala); ogradice za bebe; greda za češanje za mačke; police; unutrašnje prozorske roletne (za zamračenje) (nameštaj); umetnička dela, statuete i figurica i sitni ukrasi ili ukrasa od drveta, plute, trske, pruća, roga kosti, slonovače, kitove kosti, školjki, ćilibara, sedefa, morske pene i zamene ovih materijala, ili od voska, gipsa ili plastike; kutijice za pilule (od drveta, plastike); zatvarači za flaše; sve uključeno u klasu 20.

Klasa 21: Kućne ili kuhinjske sprave i posude (ne od dragocenih metala ili sa prevlakom od njih); češljevi i sunđeri; četke; materijali za pravljenje četki; artikli koji se koriste pri čišćenju; čelična vuna; neprerađeno ili poluprerađeno staklo; staklarija, porcelan i grnčarije koji nisu uključeni u druge klase; kade za kupanje beba (prenosive); korpe za domaćinstvo; pehari; kavezi za ptice; ne-električni blenderi; daske za peglanje; izuvači za čizme; otvarači za flaše; zatvarači za flaše napravljene od keramike, porcelana, stakla, kristala, grnčarije, i terakote; boce, flaše; činije; kutije za sapun; daske za sečenje hleba; vedra i kofe; kafanski poslužavnici; kavezi za kućne ljubimce; kalupi za torte (modle); kalupi za vafle; sprave za gašenje sveća; ukrasi za sveće u obliku prstena; svećnjaci; kutije za slatkiše; futrole za češljeve; ornamenti od porcelana; porcelanska roba; štapići za jelo (sprave za kuvanje); stalci za rublje; vešalice za odeću; tkanine za čišćenje; podmetači; posude za mešanje koktela; filter aparati za kafu; mlinovi za kafu; mašine za filter kafu; servisi za kafu; džezve; električni češljevi; češljevi za životinje; vreće, torbe za poslastice; kuvarske modle; kuhinjsko posuđe; kuhinjske igle za ražanj; kante za led; prenosni mali frižideri; uređaji za hlađenje hrane koji sadrže tečnost za razmenu toplote, za upotrebu u domaćinstvu; vadičep; kozmetički pribor; pokrivači za sudove; pokrivači za vazne za cveće; grnčarija; šoljice; kuhinjske daske za seckanje; stoni, dekorativni bokali, boce; ne-električne friteze; posude za sapun; držači za sapune; čture za piće, čaše, pojilice, sudovi; sušilice za veš; kante za smeće; čaše za jaja; korita za hranjenje; vazne za cveće; hvataljke za muve; rukavice za upotrebu u domaćinstvu; pehari; renda za sečenje; neelektrični roštilji; toplotno-izolacione posude; grejači za flašice za hranjenje, neelektrični; posude za cveće i biljke; tople posude; kote za led; kalupi za led; navlake za daske za peglanje; krčazi; čajnici; postolja za noževe; dugmad od porcelana; veliki kružni poslužavnik za hranu; kompleti za liker; kutije za hranu; držači za jelovnike; male kote, vojničke porcije; kašike za mešanje; mop, brisač poda sa resama od tkanine; držači salveta; prstenovi za salvete; mlaznice za kante za zalivanje; sunđeri za čišćenje; posude; papirni tanjiri; pribor

za sečenje kolača; mlin za biber; parfemi, arome, eterična ulja, posudice sa svećom za sago-revanje mirisa; prskalice za mirise; mirisni isparivi raspršivači; piknik korpe; štedne kasice; poklopci za lonce; lonci; ekspres lonci; kante za đubre; slanici; bibernici; posude; tacne; kutlače, lopatice; jastučići za čišćenje, ribanje; četkice za brijanje; rastezači za košulje; četke za cipele; rogovi za cipele (za očuvanje izgleda cipela); kalupi za cipele; sita; prečišćivači dima za kućne potrebe; činije za supu; setovi za začine; držači za sunđere; sunđeri za kućne potrebe; držači za četke za brijanje; statuete, kipovi od porcelana terakote ili stakla; cediljke; prskalice za zalivanje cveća i biljaka; stono posuđe; vrčevi i krigle; čaj, jajaste posude za kuvanje čaja; kutijice za čaj; čajnici; servis za čaj; čajnici; četke za toalet; neseseri sa priborom (toaletni); držači za toalet papir; toaletni sunđeri; toaletni pribor; četkice za zube; četkice za zube, električne; držači za čačkalice koji nisu od dragocenih metala; čačkalice; kante za smeće; posude za nuždu; poslužavnici za domaćinstvo; tronošci; presa za pantalone; rastezači za pantalone; vakumirane boce; neseseri sa priborom; vaze; sprava za pravljenje vafla i palačinki, neelektrična; sprave za kuvanje i pečenje, neelektrične; daske za pranje; korita za pranje veša; kante za zalivanje; uređaji za zalivanje; aparati za poliranje voskom; umetnička dela od porcelana, terakote ili stakla; ukrasi za prozore ili vrata od keramike, porcelana, stakla, kristala, zemlje, terakote ili porcelana; kutije ili posude za hranu (ne od dragocenih metala); zamke za miševе; konac za čišćenje zuba; pojasi/trake za kutije za hranu i posude za domaćinstvo ili kuhinju; posude za arome i mirise; rashladne boce (termosi); kutije od stakla; metle; četkarska roba; posude za maslac; poklopac za posude za maslac; kotlovi; instrumenti za čišćenje (ručni); vešalice, kuke za veš; ručni frižideri, neelektrični; tegle za kolačiće; posuđe za kuvanje, ne-električno; četke za obrve; četke za obuću; tiganji; levci; baštenske rukavice; staklene boce (kontejneri); izolacione čuturice i boce; pufna za pudriranje; ručni mikseri (za koktele); cediljke za čaj, ne od plemenitih metala; višenamenske postave i čaršavi za upotrebu u domaćinstvu ili kuhinji; metlice, mutilice, neelektrične; posude od metala za pravljenje leda i ledenih napitaka; sekači za kolačiće (biskvite); bočice, stalci za bočice; krpe za brisanje prašine; koktel šejkeri; kutijice za puder u prahu, ne od plemenitih metala; kutije za pilule ili tablete; omoti za kutije od toalet papira od drveta ili plastike; stalak za četkice za zube; konac za čišćenje zuba; držač za konac za čišćenje zuba; bolesničke guske (lopate); posude za domaćinstvo od plemenitih metala; kućne potrepštine od dragocenih metala; servisi za kafu od dragocenih metala; džezve za kafu, neelektrične, od dragocenih metala; držači salveta i prstenovi za salvete od dragocenih metala; pudrijere od plemenitih metala; stono posuđe od dragocenih metala; sanduci i kutije od dragocenih metala; sve uključeno u klasu 21

Klasa 22: Užad, ka napi, mreže, šatori, tende, cirade, jedra, vreće i torbe (koje nisu uključene u druge klase); materijali za postavljanje i punjenje (osim od gume ili plastike); sirovi vlaknasti tekstilni materijali; prekrivači za flaše; viseće mreže za ležanje; trake za pakovanje ili spajanje, ne od metala; presvlake za vozila (nestandardniL (trake, ne od metala, za pakovanje ili spajanje) sve uključeno u klasu 22

Klasa 23: Predivo i konac; pamučno predivo i konac; konac i prediva za vez; konac i prediva za šivenje; konac i prediva za predenje; vuna za predenje; vuneni konac i predivo; sve uključeno u klasu 23.

Klasa 24: Tekstil i tekstilni proizvodi, tkanine, koji nisu uključeni u druge klase; maramice; salvete; prekrivači za krevete i stolnjaci; zastava, barjak; platna, rublje za kupatilo posteljina; prostirke za krevete; ćebad za krevete; zastori od tekstila; platno, štof; prekrivači za nameštaj od tekstila; prekrivači za nameštaj od plastike; navlake za jastuke; vratne zavese; tkanine od imitacije životinjske kože; peškiri; zastave; toalet rukavice; tkanine za domaćinstvo; etikete od platna; maramice za skidanje šminke; otirači; pokrivači za madrace; rukavice za pranje bez prstiju; mreže za komarce; zavese; jastučnice; plastični materijali (zamena za

tkaninu); kiltovi; prekrivači za putovanja; čaršafi (tekstilni); zastori; svila; tkanine od svile; vreće za spavanje; stolnjaci i salвете; podmetači za stolove; salвете za stolove; tapiserija; vlakna za tapaciranje; tapiserija (zidna) od tekstila; rublje za krevet; prekrivači od tekstila za držače salвета ili maramica; prekrivači za kvake; navlake za sedišta toalet šolje; prekrivači za daske na toaletnim posudama; držači zavesa ili povezi za njih od tekstila; podmetači (stona platno); pamučne tkanine; zastirači za krevete; tkanine za tekstilnu upotrebu; peškiri za lice od tekstila; filc; friz (čupava tkanina od vune); vlakna od konoplje; navlake za stolove (ne od papira); somot; sukno; maramice od tekstila za uklanjanje šminke; (prekrivači od tekstila za kartonske kutije; prekrivači od tkanine za kvake; omotači od tkanine za PET flaše; etikete za oznaku imena; tkane etikete; platnene torbice ili od svile za priveske) sve uključeno u klasu 24

Klasa 25: Odevni predmeti; obuća; kape; kecelje; odeća za plažu; odeća za kupanje; kupaći kostimi; sportska odeća; voodootporna odeća; rukavice; rukavice bez prstiju; pojas, kaiševi; odeća za decu, muškarce i žene; odeća za bebe; platnene maramice za bebe; portikle, ne od papira; donje rublje; odeća za spavanje i pidžame; bademantili; naramenice, podvezice; šeširi; kape; sunce viziri; beretke; kape za kupanje i tuširanje; mufovi; štitnici za uši; odeća za vrat; kravate; okovratnici; mašna; leptir mašne; čarape; hulahop čarape; podvezice; čarape i podvezice za hulahop čarape; obuća; sportska obuća; papuče; obuća za plažu; kostimi za maskiranje; radni rukavi; maramice; maramice za vrat; papuče (sandale) za kupatilo; papuče za kupanje; ski čizme; čizme; naramenice za odeću; (tregeri); brushalteri; kratke pantalone (bermude); prsluci, grudnjaci; kaputi; manžetne; krzneni šalovi; vrpce za glavu (odeća); pokrivači za glavu; jakne (odeća); dresovi (odeća); džemper (vezeni prednji delovi košulja); pletena odeća; radna odeća (za poljske radove); mantili; kaputi; pantalone; jakna (odeća za zimu); džemper; sandale, šalovi; ešarpe; bluže; košulje; podsuknja (rublje); radnička bluza; nazuvci; čizme za sport; sportski dresovi; odela kostimi za kupanje; majice; pantalone; donji veš; uniforme; prsluci; gumirana odeća za skijanje na vodi; manžetne košulja (odeća); žensko rublje; gimnastičke patike; bodi (rublje); odeća za gimnastiku; pojas od tkanine; sve uključeno u klasu 25

Klasa 26: Čipka i vez; trake (pantljike) i gajtani; dugmad; kopče i petlje; špenadle i igle; veštačko cveće; veštačko voće; veštački venci; ukrasni noviteti, značke, kopče i broševi; značke, koje nisu od dragocenih metala; rajsferšlusi za torbe; elastične trake za držanje rukava; trake za kosu; šnale; kopče za kaiš; kopče za bluže; pantljike za kosu; kutije za pribor za šivenje; kutije za igle; kaiševi, pojasevi; gajtani; broševi; kopče; šnale za cipele; jastuci za igle; jastuci za igle, čiode; aplikacije (toplotno lepljive) za dekoraciju tekstilnih artikala (galanterija); spojnice za cipele; patentne spojnice (rajsferšlusi); spojnice za odeću; kopče za podvezice, naramenice; venci od veštačkog cveća; zlatni vez; galanterija; klipse za kosu; kapa za farbanje kose; vikleri; igle za uvijanje kose; ukosnice; mreže za kosu; ukrasi za kosu; igle za kosu; šnale za kosu; ukrasi za šešire; spojnice za korsete; igle za pletenje; ukrasi za obuću; trake za medalje; rozete; šivaće igle; za šivenje naprstci; kukice za obuću; pertle; kićanke; prekrivači za čajnike; umeci za kosu (ukrasne kićanke); čipka od vune; rajsferšlusi; držači za konjski rep; sigurnosne igle; spajalice i kopče za portikle i kecelje; nabori, ukrasi (čipkani); (primeniti); uzice i povodci za decu; bedževi od plemenitih metala; sve uključeno u klasu 26.

Klasa 27: Tepisi i asure; prostirke i otirači; linoleum i drugi materijali za pokrivanje podova; tapiserija (zidna) koja nije od tekstila; tepisi za automobile; prostirke za kupatila; prekrivači za podove; otirači za vrata; strunjače (prostirke za gimnastiku); prostirke za gimnastiku; tapiserije; vinil podne obloge; tapete; tapete od vinila; mustre za tapete; prostirke za igraonice (igru); prostirke za plažu; sve uključeno u klasu 27;

Klasa 28: Igre i igračke; lutke; plišane igračke; plišane mede; igračke figurice i setovi sličnih igračaka; gimnastički i sportski proizvodi; lopte i baloni; dekoracije proslava i ukrasi; nakit i

ukrasi za božićne jelke; poklončići; igračke automobili; električni automobili (igračke); daske za surfovanje; daske za snowboard; roleri; klizaljke; skejtbordovi; štitnici za sport i igre; vazdušni pištolji (igračke); triktrak igre- dama igre; lopte za igru; zvona za jelke (božićne; bilijar kugle; bilijar stolovi; kocke (material) za gradjenje (igračke); igre na tabli; praskave bombone čizme za skijanje sa skijama; oprema za kuglanje; građevinske igre; držači sveća za jelke; table za igru dame; dame (igra); šah; šahovske table; veštačke jelke; mađioničarski uređaji; prskalice (vatromet igračke); šolja za mešanje kockica; pikado; kockice; kreveti za lutke; odeća za lutke; kuće za lutke; sobe za lutke; domine; gimnastički tegovi; štitnici za zglobove (sportski artikli); sprave za vežbanje (razvlačenje); jahaonica; flašice za lutke; udice za pecanje; ribolovački pribor (igračka); peraja za plivanje; plovci za ribolov; frizbiji (igračke); automatske igre; palice za igru; uređaji za elektronske igre različiti od onih prilagođenih samo za televizore; torbe za golf; štapovi za golf; rukavice za golf; rukavice; rukavice za igre i sport; praktične šale (noviteti), zezalice; namotaji za zmajeve; zmajevi; štitnike za kolene (sportska oprema); puzzle od kockica; klikeri za igru; marionete; pozorišne maske; maske (igračke); sobni viseći ukrasi (igračke); modeli vozila u srazmeri; noviteti za zabave i plesove; zaštitni jastučići (delovi sportske opreme); salonske igre; detonirajuće kapisle (igračke); pištolji igračke; igračke lopte za igranje; lutke; reketi; zvečke (igračke); igre sa obručima; konjići za ljuljanje; rolšue; daske za jedrenje; skije; sanke (sportska oprema); klizaljke (igračke); duvalice za pravljenje mehurića od sapuna (igračke); čigra (igračke); daska za skakanje (sportski proizvod); sobni bicikl za vežbanje; bazeni (proizvodi za igru); peraja za plivanje; ljuljaške; stolovi za stoni tenis; igračke za kućne ljubimce; skije za vodu; proizvodi za igru tokom kupanja; igre u vodi; sportovi i aktivnosti; lopte za plažu, automatske igre (strojevi) uz prethodno plaćanje; navlake specijalno dizajnirane za skije i daske za skijanje; bingo kartica; kartice; mreže za leptire; karte za igranje; konfete; roleri; pazle (slagalice); kaleidoskopi; jarboli za daske za jedrenje; meredovi; igračke vozila sa radio rulet (okretna ploča za rulet); snežne kugle; krplice za sneg; japanske karte za igranje; sve uključeno u klasu 28.

Klasa 29: Meso, riba, živina i divljač; mesne prerađevine; konzervirano, sušeno i kuvano voće i povrće; želei; džemovi; kompoti; jaja; mleko i mlečni proizvodi; jestiva ulja i masti; goveđa supa, bujon; koncentрати za bujon; goveđa supa; koncentрати za goveđu supu; puter; kavijar; sir; sir grickalice; mlečni proizvodi; prehrambeni proizvodi od ribe; hrana spremljena od ribe; smrznuto voće; zaleđeno voće; čips od voća, margarin; marmelada; želei od mesa; konzervirano meso; napici od mleka; konzervisane pečurke; obrađen lešnik; jetrena pašteta; pašteta; puter od kikirikija; prerađeni kikiriki; grašak, obrađen; voćna pulpa; krompir čips; hrskavi krompir; krompir uštupci; salata; kiseli kupus; kobasice; susamovo ulje; preparati za pravljenje supa; supe; tofu; salate od povrća; preparati od povrća za pravljenje supa; šlag; jogurt; instant obroci; proizvodi od hrane začinjeni karijem, pakovanje instant obroka; mali obroci; morska trava (za ishranu); obrađeno i konzervirano meso, riba, živina i divljač; slanina; preparati za pravljenje bujana; puter od oraha sa čokoladom; svinjski suhomesnati proizvodi; kroketi; kristalizovano voće; žele od voća; konzervirana riba; kukuruzno ulje; maslinovo ulje za ishranu; suvo grožđe; paradajz pire; povrće konzervirano; plodovi mora (ne živi); obrađeni i upakovani morski plodovi; morski plodovi (konzervirani), prehrambeni proizvodi spremljeni od morskih plodova; sve uključeno u klasu 29.

Klasa 30: Kafa, čaj, kakao, šećer, pirinač, tapioka, saga, zamena za kafu; brašno i preparati od žitarica, hleb, kolač i poslastice, led; med, melasa; kvasac, prašak za pečivo; so, senf; sirće, sosovi i umaci; mirodija, začini; led; biskviti; prah za kolače (prašak za pečivo); jestivi ukrasi za kolače; arome za kolače; pite od pirinča; slatkiši i bombone; čokolada; napici od mleka i čokolade; napici na bazi čokolade; slatkiši za ukrašavanje novogodišnje jelke; kakao napici sa mlekom; kako proizvodi; napici na bazi kakaoa; napici od kafe; arome kafe; mešavine i proizvodi koji se koriste kao zamena za kafu; napici na bazi kafe; kolačići; kokice; kornfleks;

sladoledi; kari; krem od vanile; pahuljice od žitarica; arome, osim eteričnih ulja; poslastičarski led; voćni želei; kolačići od đumbira; sirupi; infuzije; kečap; slatki koren; pastile; pite od mesa; omekšivači za meso, za upotrebu u domaćinstvu; palačinke; bombone; kolači; biber; pice; pudinzi; ravioli; matični mleč za ljudsku ishranu; šećer; vasabi paste; umak, soja sos; paste; rezanci, testenina i tanki rezanci; udan (japanski rezanci); suši; vanila; vafli; zamrznut jogurt; perece; mali obroci; slatkiši od badema; aromatični preparati za hranu; vezivni agensi za sladoled (jestivi led); peciva; kiflice; kolači; karamele (slatkiši); žvake, ne za medicinsku upotrebu; kukuruzno brašno, krupno; krekeri, jestivi led; šećerni sirup (melasa) - zlatni sirup; led, prirodni ili veštački; makarone; marcipan; majonez; ovseno brašno; biber, začini; pite; slatkiši raznih aroma; dvopek; so za kuvanje; sendviči; paradajz sos; začini; šerbet (leden) špageti; slatkiši; tart; pšenično brašno; preliv za salate; sos od mesa; sve uključeno u klasu 30

Klasa 32: Pivo, mineralne vode i vode zasićene ugljenikom (gazirane) i bezalkoholna pića i napici; pića od voća i voćni sokovi; pića i sokovi od povrća; sirupi, koncentрати i drugi preparati za proizvodnju pića; izotonični napici; voćni nektar (bezalkoholni); tablete za šumeće napitke; soda vode; sirupi za pića; flaširana voda; voda (napitak); surutka (piće); bezalkoholna pića; kokteli (bezalkoholni); aperitivi (bezalkoholni); sve uključeno u klasu 32

Klasa 33: Alkohol od pirinča; alkoholna pića (osim piva); aperitivi; alkoholna pića koja sadrže voće; brendi; jabukovača; kokteli; likeri; sake; alkoholna pića; viski; vino; sve uključeno u klasu 33

Klasa 34: Duvan; artikli za pušače; šibice; pepeljare; papir za cigarete; tabakere za cigare; tabakere za cigarete; mehanizam za seckanje kraja cigara; filteri za cigarete; usnici muštikle cigareta; držači cigareta; vrhovi za cigarete; cigarete; cigarete koje sadrže supstitut duvana; cigarilosi; cigare; upaljači; kutije za šibice; držači za šibice; šibice; čistači za lule; stalak za lule; lule; kese za duvan; kutije za burmut; posude za duvan; sve uključeno u klasu 34.

Klasa 35: Sakupljanje u korist drugih, čitavog niza roba (transport nije uključen), omogućavajući kupcima dobar pregled i kupovinu proizvoda; takve usluge mogu pružati maloprodaje, veleprodaje; kroz naručivanje poštom preko kataloga ili putem elektronskih medija, na primer preko web sajta ili televizijskih programa za kupovinu; Trgovina na veliko i malo i naručivanje putem pošte vezanih za prodaju svećanih dekoracija i ukrasa, poklona i novih proizvoda, sapuna, parfema, eteričnih ulja, kozmetike, losiona za kosu, proizvoda za negu kose, toaletni preparati; paste za zube; sredstva za ličnu higijenu; sredstva za čišćenje, poliranje i abrazivna sredstva; sredstva za upotrebu u perionicama; pribor za negu noktiju; preparati za negu noktiju; lakovi za nokte; veštački nokti; dijetetski proizvodi; hrana za bebe; sanitarni preparati; sveće; fitilji; tečnost za osvetljenje; masti; lubrikanti; ulja za boje; pribor za jelo; grnčarija; set za manikir; aparat za brijanje, brijači; mašine i mašinski alati za kuhinju ili upotrebu u domaćinstvu, ručni alat; filmovi; kamere; foto diskovi; video rekorderi; audio i video proizvodi, audio i video kasete; ploče i diskovi, instrumenti i aparati za snimanje, prenos i/ili reprodukcija zvuka i/ili slike, televizori, kasetofoni i/ili rekorderi, video kasete i/ili CD plejeri i/ili rekorderi, radio aparati, telefon, bežični telefon, mobilni telefon, futrole za mobilne telefone, ukrasi i trake za telefone; poziv indikatori; uređaji za računanje, kalkulatori, elektronske i kompjuterske igre; kinematografski filmovi, svetla, ventilatori, kuhinjske sprave, kalupi za kolače i peciva, tosteri, peći, kuhinjski pribor, pribor i posude za serviranje i čuvanje hrane i/ili napitaka, štapići za hranu, instrumenti za sečenje, porcelan, posuđe od porcelana, posuđe od kristala, emajlirano posuđe, posuđe od srebra, posuđe od stakla, grnčarija, keramika, aparati za sušenje kose, lampe, abadžuri i njihovi delovi i dodaci, nosiljke za bebe, baloni, sirene za bicikla, satovi i časovnici i njihova oprema i delovi i dodaci, nakit i imitacije nakita, ornamenti, proizvodi od dragocenih metala ili presvučeni njima, muzičke kutije, muzički instrumenti, slike, fotografije, kancelarijski materijal, papir i karton i proizvodi napravljeni

od ovih materijala, umetnički pribor, četke za slikanje, pisaći pribor, štampani materijal, knjige, novine, magazini i periodične publikacije, čestitke (i Božićne), karte za igru, materijali za uvijanje i pakovanje, okviri i ramovi za slike, lepak za kancelarijske i kućne potrebe, proizvodi od kože i/ili imitacije kože, torbe i koferi, tašne i novčanici, kišobrani, štapovi (pomoć pri hodanju), nameštaj, ogledala, vešalice i čiviluci, kutije i kontejneri, pločice za ime, mali kućni dodaci, sprave i pribor za domaćinstvo ili kuhinju, češljevi, sunđereri, četke, proizvodi za čišćenje, naočare, okviri za naočare i naočare za sunce i kutije za naočare i pribor za njih, tekstil i tekstilni proizvodi, posteljina i stolnjak i prekrivači za stolove, salvete, podmetači za stolove, nameštaj, galanterija, maramice, odevni predmeti, obuća i kape, dugmad, bedževi, trake i vrpce, čipka i vez, šnale i ukrasi za kosu, naramenice, ukrasi za cipele, ukrasi za šešire, rajsferšlusi, tepisi, ćilimi i prostirke, igre, igračke i, lutke, figurice, sportski artikli, ukrasi za Božićne jelke, hrana i piće, poslastice, biljni proizvodi, slatkiši, konditorski proizvodi, šibice, tompusi i cigarete i proizvodi za pušače, reklamiranje (oglašavanje); organizovanje izložbi za privredne ili reklamne potrebe; izdavanje reklamnih tekstova (oglasa); promotivne prodaje (za druge); marketinške agencije; poslovno upravljanje predstavama, umetničkim; agencije za uvoz i izvoz; sastavljanje, sakupljanje informacija u kompjutersku bazu podataka; reklamiranje putem pošte; poslovno upravljanje hotelima; marketing istraživanja; lepljenje oglasa; pronalaženje osoblja; reklamne agencije; oglašavanje (reklamiranje) putem radija; oglašavanje preko televizije; (reklamiranje na informatičkoj mreži; vršenje raznih usluga nabavki za druge (kupovina proizvoda i usluga za druge proizvođače); iznajmljivanje vremena za reklamiranje u svim sredstvima komunikacije; iznajmljivanje kancelarijskih mašina i oprema; iznajmljivanje aparata za prodaju); sve uključeno u klasu 35.

Klasa 41: Razonoda; zabava; zabavni parkovi, tematski parkovi; zabavne arkadne usluge; usluge obrazovanja; organizovanje, proizvodnja i izvođenje programa koncerata, nastupa uživo, pozorišnih predstava, izložbi, sportskih takmičenja, sportskih i kulturnih aktivnosti; koncertne dvorane; bioskopi; kabarei; usluge filmskih studija; usluge diskoteka; usluge klubova; objavljivanje knjiga, tekstova, magazina, novina i časopisa; usluge biblioteka; obezbeđivanje opreme za zabavu (razonodu), izložbe, koncerte, predstave, performanse, sportske aktivnosti, igre, rekreaciju i kulturne aktivnosti; usluge fitnes centara; usluge kampa za odmor; pružanje informacija koje se odnose na obrazovanje, zabavu, rekreaciju, sport i kulturu; televizijska i radio zabava; proizvodnja radio i televizijskih programa; filmske i video produkcije; iznajmljivanje kino-filmova, filmova, video kasete, laserskih diskova, video diskova i raznovrsnih digitalnih (video) diskova; iznajmljivanje aparata za snimanje zvuka, iznajmljivanje scenskog i pozorišnog dekora; obdanište, jaslje; klubovi i sale sa instaliranim audio i vizuelnim muzičkim uređajima; sobe i saloni za razonodu; organizovanje takmičenja lepote; cirkusi; kursevi korespondencije; usluge zabavljača; organizovanje dešavanja kulturnog i edukativnog karaktera; aparati za igre; uputstva u vezi gimnastike; obezbeđivanje opreme za muzeje (prezentacije, izložbe); rukovođenje lutrijama; orkestarske usluge; planiranje zabava; usluge pisanja scenarija; pozorišna predstave; zoološki vrtovi; usluge digitalnog snimanja; elektronsko izdavaštvo; usluga elektronskog igranja (iz informatičke mreže); tumačenje jezika znakova; profesionalna orijentacija (obrazovanje i saveti pri obuci); mikrofilmovanje; komponovanje usluge; noćni klubovi; fotografisanje; produkcija filmova na video trakama; priređivanje karaoka usluga (stavljanje na raspolaganje opreme za karaoke); elektronske publikacije (usluge iskorišćavanja elektronskih publikacija koje se ne mogu kopirati); objavljivanje knjiga i časopisa, elektronsko; snimanje videorekorderom; kuglane; stadion za udaranje loptice ili stadion za bejzbol (igre); elektronsko prikazivanje filmova; organizovanje venčanja; sve uključeno u klasu 41.

Klasa 43: Usluge obezbeđivanja hrane i pića, privremeni smeštaj, restorani, kafe - restorani, kafeterije (kafići), barovi, marketi sa prehrambenim proizvodima; kantine, catering usluge,

samouslužni restorani snek barovi; koktel barovi, pružanje informacija koje se odnose na prethodno navedeno i na hranu i piće; obezbeđenje i rezervacija privremenog smeštaja i smeštajni objekti, hotelske usluge, motelske usluge, pansionerske usluge i pružanje informacija u vezi sa tim uslugama; smeštajne usluge u kampovima za odmor; restorani, kafe - restorani, kafeterije (kafići), barovi, marketi sa prehrambenim proizvodima, kantine i sale sa audio i vizuelni muzičkim uređajima; usluge brige o deci; usluge dnevnih obdaništa; kuće za smeštaj turista; usluge barova; aranžiranje hrane i pića za svadbene prijeme; sve uključeno u klasu 43

Klasa 44: Medicinske usluge; veterinarske usluge; higijenska zaštita i nega lepote za ljude i životinje; agrikulturne, hortikulturne i šumarske usluge; saloni lepote (za ulepšavanje); frizerski saloni; timarenje (nega) životinja; aranžiranje cveća; baštovanstvo; održavanje zelenih površina; četkanje kućnih ljubimaca; (usluge aromaterapija; pravljenje venaca; bolničke usluge; zubarske usluge; tetoviranje - usluge tetovaže) sve uključeno u klasu 44

(210) **2011-192**

(442) **20.04.2014.**

(220) 4/18/2011

(731) **AVOCENT HUNTSVILLE CORP.**, 4991 CORPORATE DRIVE, HUNTSVILLE, ALABAMA 35805 US

TRELLIS

(540)

(550) I

(740) AOD "Ćupić", Dalmatinska 10, Podgorica ME

(511) **Klasa 09:** Kompjuterski programi za upravljanje infrastrukturom data centra; softver za praćenje fizičkih sredstava; softver za analizu uticaja i upotrebe; softver za izvještavanje inventara i planiranja; softver za automatizaciju i praćenje sredstava; softver za vizuelno modeliranje; hardver; firmver (mikro program); prekidači; transfer prekidači; snabdjevanje napajanja; izvor neprekidnog napajanja (UPS); prigušivač prenapona; rekovi; served; blejd served; virtuelni serveri; served rekova; baterije; jedinice za distribuciju struje (PDU); kontrolori; kontrolori pumpa za gašenje požara; kabineti; konzole; konzole sa displejom od tečnog kristala (LCD); sistemi za upravljanje informacija; moduli; regulatori napajanja; kontrolori ventilatori; panel vrata; monitori; zaštita prednapona; sistem za upravljanje informacijama iz data centra koji sadrži kompjutere; kompjuterski hardver i softver; sistemi grijanja, ventilacije, prečišćavanja vazduha/hlađenja (HVAC/R) za upotrebu sa data centrima i kompjuterskim sobama, serverske hardvere i softvere, firmvere, prekidače, transfer prekidače, prigušivače prenapona, sisteme za napajanje, neprekidne dovode napajanja, kabinete, rekove, baterije, kontrolore, kontrolore za pumpe za gašenje požara, jedinice za distribuciju napajanja, konzole sa displejom od tečnog kristala (LCD).

Klasa 11: Sistemi za grijanje, ventilaciju, prečišćavanje vazduha/hlađenje (HVAC/R); aparati za kontrolu okoline; kondenzatori; kompresori; uređaji za suvo hlađenje; klima uređaji; sistemi za hlađenje.

Klasa 35: Distribucija kompjuterskog softvera.

Klasa 37: Održavanje i popravka infrastrukture i sistema i opreme data centra.

Klasa 38: Usluge telekomunikacije.

Klasa 42: Praćenje, mjerenje i upravljanje infrastrukture; upravljanje i mjerenje energije; praćenje i upravljanje data centrom; kompjuterske usluge, naime, usluge praćenja sajta, praćenja opreme, praćenja sistema, prostornog mapiranja i informacione i tehnološke usluge;

usluge konsaltinga; kompjuterske usluge, naime, softver kao usluga; usluge obrade podataka; usluge pružanja upotrebe on-lajn softvera koji se ne može daljinski preuzeti (downloadovati); softverske usluge, usluge upravljanja sistema informacionog data centra; kompjuterske usluge.

(210) **2011-31** (442) **20.04.2014.**
(220) 1/25/2011

(731) **MARS**, INCORPORATED, 6885 ELM STREET, MCLEAN, VA 22101-3883 US



(540)

(550) I

(740) Čejović Vladimir, 13. jula 21, Podgorica ME

(511) **Klasa 29:** Meso, riba, živina i divljač; mesne prerađevine; konzervisano, sušeno i kuvano voće i povrće; jaja; mlječni proizvodi; želei, džemovi, kompoti; mlijeko i mlječni napitci; proizvodi pripremljeni za konzumiranje i koji se sastoje uglavnom od gore navedenih proizvoda.

Klasa 30: Kafa i zamjena kafe; čaj, kakao, čokolada za piće; šećer, pirinač, tapioka, sago; brašno i proizvodi od žitarica; hljeb, biskviti, kolači, pecivo, čokolada i slatkiši; sladoled; led, smrznute poslastice; med, melasa; so, snef; sirće, sosevi; dodaci jelima; biljni začini; začini; proizvodi pripremljeni za konzumiranje i koji se sastoje uglavnom od gore navedenih proizvoda.

(210) **2011-346** (442) **20.04.2014.**
(220) 7/1/2011

(731) **BROWN-FORMAN POLSKA** SP.Z.O.O A POLISH LIMITED COMPANY, GANDHIEGO 3, WARSZAWA, 02-645 PL



(540)

(550) I

(740) AOD "Ćupić", Dalmatinska 10, Podgorica ME

(511) **Klasa 33;** Alkoholna pića; uključujući žestoka pića.

(210) **2011-512** (442) **20.04.2014.**
(220) 10/17/2011

(731) **New Wave Group Licenising SA**, ORREKULLA INDUSTIGATA 61, 425 36 HISINGS KARRA SE

NEW WAVE

(540)

(550) I

(740) Čejović Vladimir, 13. jula 21, Podgorica ME

(511) **Klasa 25:** Ženska i muška konfekcija odjeća i obuća.

(210) **2011-513**

(442) **20.04.2014.**

(220) 10/17/2011

(731) **New Wave Group Licensing**, ORREKULLA INDUSTIGATA 61, 425 36 HISING KARRA SE

CLIQUE

(540)

(550) I

(740) Čejović Vladimir, 13. jula 21, Podgorica ME

(511) **Klasa 25:** Odjeća i obuća.

(210) **2011-518**

(442) **20.04.2014.**

(220) 10/21/2011

(300) 07.01.2011. 1065337 IR

(731) **HILDING ANDERS INTERNATIONAL AB**, OSTRÅ VARVSGATAN 4 21119 MALMÖ SE

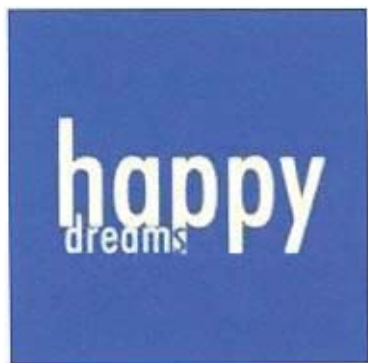

(540)

(550) I

(740) Čejović Vladimir, 13. jula 21, Podgorica ME

(511) **Klasa 20:** Namještaj, kreveti, posteljina (izuzev lanene); ramovi za krevete; jastuci; ušeci;

ogledala; okviri za slike; kauči; divani.

Klasa 24: Prekrivači za krevet, čaršavi (od tekstila), jastučnice, ćebad za krevete, jorgani, prekrivači, tekstil, tkanine za tapaciranje, prekrivači za dušeke, prekrivači za namještaj, ukrasni jastučići, prekrivači za krevete od papira.

Klasa 35: Usluge marketinga i maloprodaje vezane za nameštaj i pokućstvo, uključujući krevete i drugi namještaj za spavaću sobu, posteljinu, ramove za krevete, kauče, dušeke, jastuke, prekrivače za krevet, prekrivače, tkanine za tapaciranje i prekrivače za dušeke.

(210) **2011-545**

(442) **20.04.2014.**

(220) 11/9/2011

(731) **YANMAR CO., LTD**, 1-9, Tsurunocho, Kita-ku, Osaka JP



(540)

(550) I

(740) AOD "Ćupić", Dalmatinska 10, Podgorica ME

(511) **Klasa 4:** Mineralna ulja i maziva za industrijsku upotrebu (osim za goriva); ne-mineralna ulja i maziva za industrijsku upotrebu (osim za goriva); goriva; voskovi (sirovi materijal); čvrsta maziva; sirovo ulje ili rafinisano ulje; industrijsko ulje; motorno ulje; lubrikanti; dizel ulje za sagorijevanje; lako ulje; ulje za motore sa unutrašnjim sagorijevanjem; ulje za sagorijevanje.

Klasa 7: Generatori struje sa sistemima za iskorišćenje otpadne toplote; poljoprivredne alatke (osim onih koji se ručno upravlja); poljoprivredne mašine kao što su kombajni, rasadivači pirinča, vezači, pokretne vršalice, aparati i uređaji za razdvajanja opne od zrna pirinča, motorni orači, sjekači za grmlje, rasađivači i sijačice za povrće; kosačice; motori i pogonske mašine (osim za suvozemna vozila); djelovi i oprema za sve vrste motora i pogonske mašine svih vrsta (osim za suvozemna vozila); dizel motori; benzinski motori; motori za plovila; kompresori za plovila; ležaj osovine klipa; klipovi; osovine klipa; karike; klipni prsteni; filteri za gorivo; pumpe, pumpe - mašine; gasne toplotne pumpe; generatori struje kao što su dizel generatori, benzinski generatori, gasni generatori; građevinske mašine i aparati; mašine i aparati za utovar-istovar; djelovi i oprema za iste; građevinske mašine i aparati; mašine i alati za utovar-istovar; delovi i oprema za iste, sve u klasi 7; ekskavatori; utovarivači, kopačice, buldožeri; nosači (mašine); plugovi za snijeg; potopivi uređaji za čišćenje ribarskih mreža.

Klasa 11: Klima uređaji; gasne toplotne pumpe - sistemi klima uređaja; bojleri; uređaji i instalacije za rashlađivanje; kućišta za rashlađivanje; aparati za sušenje stočne hrane; izmjenjivači toplote; pokretni uređaji za osvjetljavanje.

Klasa 12: Motorizovani nosači za sve terene; motori i strojevi za suvozemna vozila; plovila kao što su jahte i pecaroški brodovi i njihovi djelovi i oprema; traktori; i traktori za poljoprivredu.

Klasa 16: Kutije od papira ili kartona; papir za pakovanje; kese (koverte, vrećice) za pakovanje od papira ili plastike.

(210) **2011-556**

(442) **20.04.2014.**

(220) 11/15/2011

(731) **VIANEX S.A.**, TATOIOU STR., 18TH NATIONAL ROAD ATHENS-LAMIA, 14610 NEA ERYTHREA ATTIKIS GR

IRITEC

(540)

(550) I

(740) Prelević Dragan, ulica Slobode 74, Podgorica ME

(511) **Klasa 5;** Farmaceutski preparati i supstance za liječenje raka bilo koje vrste.

(210) **2011-557**

(442) **20.04.2014.**

(220) 11/15/2011

(731) **VIANEX S.A.**, TATOIOU STR., 18TH NATIONAL ROAD ATHENS-LAMIA, 14610 NEA ERYTHREA ATTIKIS GR

PAXATEL

(540)

(550) I

(740) Prelević Dragan, ulica Slobode 74, Podgorica ME

(511) **Klasa 5;** Farmaceutski i veterinarski preparati; Sanitarni preparati za medicinsku upotrebu; Dijetetske supstance prilagođene za upotrebu u medicini, hrana za bebe; Flasteri, materijali za zavijanje; Materijali za plombiranje zuba, zubarska smola; Dezinfekciona sredstva; Preparati za uništavanje štetočina; Fungicidi; Herbicidi.

(210) **2011-558**

(442) **20.04.2014.**

(220) 11/15/2011

(731) **VIANEX S.A.**, TATOIOU STR., 18TH NATIONAL ROAD ATHENS-LAMIA, 14610 NEA ERYTHREA ATTIKIS GR

VOXIN

(540)

(550) I

(740) Prelević Dragan, ulica Slobode 74, Podgorica ME

(511) **Klasa 5;** Farmaceutski i veterinarski preparati; Sanitarni preparati za medicinsku upotre-

bu; Dijetetske supstance prilagođene za upotrebu u medicini, hrana za bebe; Flasteri, materijali za zavijanje; Materijali za plombiranje zuba, zubarska smola; Dezinfekciona sredstva; Preparati za uništavanje štetočina; Fungicidi; Herbicidi.

(210) **2011-559** (442) **20.04.2014.**
(220) 11/15/2011

(731) **VIANEX S.A.**, TATOIOU STR., 18TH NATIONAL ROAD ATHENS-LAMIA, 14610 NEA ERYTHREA ATTIKIS GR

GEMNIL

(540)

(550) I

(740) Prelević Dragan, ulica Slobode 74, Podgorica ME

(511) **Klasa 5;** Farmaceutski i veterinarski preparati; Sanitarni preparati za medicinsku upotrebu; Dijetetske supstance prilagođene za upotrebu u medicini, hrana za bebe; Flasteri, materijali za zavijanje; Materijali za plombiranje zuba, zubarska smola; Dezinfekciona sredstva; Preparati za uništavanje štetočina; Fungicidi; Herbicidi.

(210) **2011-561** (442) **20.04.2014.**
(220) 11/16/2011

(731) **JANSSEN R&D IRELAND**, EASTGATE VILLAGE, EASTAGE, LITTLE ISLAND, COUNTRY CORK IE

SCIELO

(540)

(550) I

(740) Radulović Božidar, Jovana Tomaševića 9/III, Podgorica ME

(511) **Klasa 5;** Farmaceutski preparati za humanu upotrebu.

(210) **2011-566** (442) **20.04.2014.**
(220) 11/21/2011

(300) 32 85427476 20.09.2011. US

(731) **MONSTER ENERGY COMPANY**, 1 MONSTER WAY, CORONA, CALIFORNIA 92879 US

SIZE DOES MATTER!

(540)

(550) I

(740) Ćosović Dejan, 13. jula 1/5, Budva ME

(511) **Klasa 5;** Dodaci ishrani.

Klasa 32; Bezalkoholna pića.

(210) **2011-567**

(442) **20.04.2014.**

(220) 11/22/2011

(731) **13 JUL-PLANTAŽE A.D.,** PODGORICA ME

Montenegro, Small Country of Great Wines

(540) I

(550) I

(511) **Klasa 33;** Alkoholna pića(izuzev piva).

Klasa 35; Oglašavanje i reklamiranje; Vođenje komercijalnih poslova; Komercijalna administracija; Kancelarijski poslovi; Prodaja na veliko i malo vina.

(210) **2011-568**

(442) **20.04.2014.**

(220) 11/22/2011

(731) **13 JUL-PLANTAŽE A.D.,** PODGORICA ME

Crna Gora, mala zemlja velikih vina

(540) I

(550) I

(511) **Klasa 33;** Alkoholna pića(izuzev piva).

Klasa 35; Oglašavanje i reklamiranje; Vođenje komercijalnih poslova; Komercijalna administracija; Kancelarijski poslovi; Prodaja na veliko i malo vina.

(210) **2011-574**

(442) **20.04.2014.**

(220) 11/23/2011

(731) **THE HERSHEY COMPANY,** 100 CRYSTAL A DRIVE HERSHEY PENNSYLVANIA 17033 US



(540)

(550) I

(740) Popović Miladin, Đoka Miraševića 21/III, Podgorica ME

(511) **Klasa 30:** Čokolade; proizvodi od čokolade; bombone, slatkiši; poslastice; kakao; proizvo-

di od kakaoa; keksi, biskviti; poslastice od čokolade za pečenje; komadići, ljustice i kriške za pečenje; instant čokoladni miks (za hladne i tople napitke); čokoladni premazi; bezalkoholni čokoladni likeri; čokoladom obloženi orasi; aromatizovani sirupi, naime, čokoladni sirupi, sirupi od jagode, karamel sirupi, butterscotch sirupi, aromatizovani sirupi od kikiriki putera; konditorski prelive za sladolede i za deserte; kolači, pecivo, sladoled; poslastice od sladoleđa; smrznute poslastice; ne-mlečni, bezalkoholni napici na bazi čokolade; table od žitarica.

(210) **2011-65** (442) **20.04.2014.**

(220) 2/8/2011

(731) **BOSNALIJEK**, FARMACEUTSKA I HEMIJSKA INDUSTRIJA, DD,
JUKIĆEVA 53, 71000 SARAJEVO BA

RODAVAN N

(540)

(550) I

(740) Radulović Božidar, Jovana Tomaševića 9/III, Podgorica ME

(511) **Klasa 5**; Farmaceutski proizvodi.

(210) **2011-653** (442) **20.04.2014.**

(220) 12/15/2011

(731) **MUZIČKA ASOCIJACIJA CRNE GORE**, RIMSKI TRG 50 PODGORICA ME

MACG
MUZIČKA ASOCIJACIJA CRNE GORE

(540)

(550) I, F

(511) **Klasa 41**: Usluge kojima je osnovni cilj zabavljanje drugih lica, Priređivanje, vođenje seminara, konferencija, koncerata, Organizovanje izložbe ili prezentacija knjiga (književne večeri) u kulturno obrazovne svrhe, Izdavanje tekstova i knjiga, Izdavanje muzičkih CD-a i DVD izdanja, kao i ostalih nosača zvuka i slike.

(210) **2011-654** (442) **20.04.2014.**

(220) 12/15/2011

(731) **MUZIČKA ASOCIJACIJA CRNE GORE**, RIMSKI TRG 50 PODGORICA ME

MACG
MUZIČKA ASOCIJACIJA CRNE GORE

(540)

(550) I, F

(511) **Klasa 41:** Usluge kojima je osnovni cilj zabavljanje drugih lica, Priređivanje, vođenje seminara, konferencija, koncerata, Organizovanje izložbe ili prezentacija knjiga (književne večeri) u kulturno obrazovne svrhe, Izdavanje tekstova i knjiga, Izdavanje muzičkih CD-a i DVD izdanja, kao i ostalih nosača zvuka i slike.

(210) **2011-655**

(442) **20.04.2014.**

(220) 12/15/2011

(731) **MUZIČKA ASOCIJACIJA CRNE GORE**, RIMSKI TRG 50 PODGORICA ME



(540)

(550) I, F

(511) **Klasa 41:** Usluge kojima je osnovni cilj zabavljanje drugih lica, Priređivanje, vođenje seminara, konferencija, koncerata, Organizovanje izložbe ili prezentacija knjiga (književne večeri) u kulturno obrazovne svrhe, Izdavanje tekstova i knjiga, Izdavanje muzičkih CD-a i DVD izdanja, kao i ostalih nosača zvuka i slike.

(210) **2011-656**

(442) **20.04.2014.**

(220) 12/15/2011

(731) **MUZIČKA ASOCIJACIJA CRNE GORE**, RIMSKI TRG 50 PODGORICA ME



(540)

(550) I, F

(511) **Klasa 41:** Usluge kojima je osnovni cilj zabavljanje drugih lica, Priređivanje, vođenje seminara, konferencija, koncerata, Organizovanje izložbe ili prezentacija knjiga (književne večeri) u kulturno obrazovne svrhe, Izdavanje tekstova i knjiga, Izdavanje muzičkih CD-a i DVD izdanja, kao i ostalih nosača zvuka i slike.

(210) **2011-664**

(442) **20.04.2014.**

(220) 12/16/2011

(731) **ESPRIT INTERNATIONAL**, 1370 BROADWAY, NEW YORK, NY 10018 US

de.corp
ESPRIT URBAN CASUAL

(540)

(550) I

(740) Mihailović Vojislav, Hilendarska 5, Beograd SR

(511) **Klasa 03:** mirisi, parfemi i kolonske vode, losion posle brijanja, deodoransi, sredstva protiv znojenja, kreme za brijanje; kozmetika, preparati za negu noktiju, lak za nokte, maskara, proizvodi šminke, preparati za skidanje šminke; ovlaživači, sredstva za čišćenje, toneri, losioni, kreme za oči, kreme za lice i telo, pilinzi za kožu, piling za lice, maske za telo, sredstva za potapanje i soli za kupanje; preparati za negu kože; ne-medicinski preparati za negu kože; sapuni, toaletni sapuni, sapuni za kožu i telo; esencijalna ulja, ulja za kupanje; preparati za negu kose, losioni za kosu, šamponi za kosu, učvršćivači, toaletni preparati; paste za zube; preparati za negu od sunca; preparati za zaštitu od sunca; sprejovi za samopotamnivanje kože, kreme i gelovi; kreme za telo, losioni za telo, puder za telo, parfimisani proizvodi, gelovi za tuširanje, gelovi za kupanje; razni artikli koji se koriste u pranju, šminkanju; preparati za beljenje i druge supstance koje se koriste za rublje; preparati za čišnjenje, poliranje, ribanje i abrazivna sredstva.

Klasa 09: telefoni, mobilni telefoni, pribor za mobilne telefone; MP3 i 4 plejeri, DVD plejeri; naočare (cvikeri, monokli, dalekovidna sredstva, sredstva za gledanje pod vodom i zaštitna sredstva za navedene svrhe), optički okviri, naočare za sunce, kutije za naočare, naočare za

sport i zaštitu, naočare za vodene sportove; aparati i instrumenti naučni, nautički, za preme-
ravanje, fotografisanje, kinematografiju, za optiku, merenje, signalizaciju, pregled/proveru
(nadzor), spasavanje i podučavanje; nosači magnetnih podataka, diskovi za snimanje, auto-
matske mašine i mehanizmi koji rade na ubacivanje novca; aparati za snimanje, transmisiju
ili reprodukciju zvuka ili slike; elektronska oprema; audio i vizuelna snimanja/snimci u svim
medijima; audio i vizuelni plejeri za sve medije; registar kase; računске mašine; oprema za
obradu podataka; kompjuteri; programi kompjuterskih igara; kompjuterski softver; kompj-
uterski hardver; kompjuterski periferni uređaji; elektronski aparati za široku potrošnju; aparati
za transmisiju podataka preko telefonske mreže; aparati za gašenje požara; aparati i instru-
menti za provođenje, skretanje, transformisanje, akumulaciju, regulisanje ili kontrolu stru-
je; kutije/sanduci adaptirani za elektronsku opremu; delovi i fitinzi za gore navedenu robu.

Klasa 14: plemeniti metali i njihove legure i roba od plemenitih metala ili njima obložena/
presvučena, a koji nisu uključeni u druge klase; nakit, drago kamenje; satni/časovničarski i
hronometrijski instrumenti, naročito satovi i ručni satovi, budilnici, amajlije, lanci za satove,
kaiševi za satove, šnale za kravate, dugmeta za manžetne; naušnice, odnosno nakit za uši,
alke za ključeve sa visuljcima ili privescima, ukrasne igle, veštački nakit, nakit za odeću, bi-
žuterija, imitacija zlata (predmeti načinjeni od toga ili sa tim); kutije/futrole za nakit; kovčezi
za nakit koji nisu od metala, kožni nakit i kutije za pribor.

Klasa 16: oštrači, pribadači/nalepnice, hartije za umotavanje poklona, etikete, kese za slatki-
še/bombone, kese (koverte, torbe) od hartije ili plastike za pakovanje, kutije za poklone,
trake/pantljike za umotavanje poklona, karte za pozdrave/čestitke, instrumenti za pisanje
i crtanje, mastilo i mastila za punjenje pera, pritiskači (za hartiju), dopisnice, kalendari, re-
gistratori (ne od kože, ne od najlona/plastike), adresari, pesmarice, hokus-pokus predmeti
od papira, kutije za vizit karte (ne od kože, ne od najlona/plastike), sigurnosne kutije za
CD (ne od kože, ne od najlona/plastike), kutije za olovke, meke kutije za olovke, papirne
salvete, hartija, karton i roba napravljena od ovih materijala, koji nisu uključeni u druge
klase; štampane stvari, knjigovezački materijal; fotografije; kancelarijski materijal; lepila za
kancelarijske i kućne svrhe; materijal za umetnike; kistovi-četkice za slikanje; pisaće mašine
i kancelarijski rekviziti (sem nameštaja); materijali za nastavu i podučavanje (osim aparata);
plastični materijali za pakovanje (koji nisu uključeni u druge klase); štampana slova (vrste
štampanja/razni tipovi i vrste štampanja/tipovi/ vrste/načini odštampavanja); klišei.

Klasa 18: koža i imitacija kože i roba napravljena od ovih materijala koja nije uključena u druge
klase; životinjske kože, koža odrana, sirova ili štavljena, krzno; ručne tašne; putnički sandu-
ci/koferi; putničke torbe; torbe za nošenje; vreće za odeću; vreće za cipele; torbe koje se
nose na leđima; sportske torbe; gimnastičke torbe; ruksaci, ranci; torbe za nošenje preko
ramena; vreće od grubog sukna; velike torbe, vreće koje se nose u rukama ili preko ramena;
torbe za kupovinu (cegeri); torbe/vreće za kampere i penjače; školske torbe; torbe koje se
nose na kaišu; torbe za plažu; putnički prtljag; privesak (sa imenom i adresom) za prtljag;
mali putnički koferi; ataše torbe; novčanik za držanje papirnih novčanica; kese; lisnice; nov-
čanici; akti-tašne; torbe za nošenje doručka; kesicalfutrola za sitan novac; torbe za nošenje
oko struka; toaletne torbe i koferi; futrole/torbice za ključeve; odeća za kućne ljubimce; ogr-
lice za životinje; kišobrani, suncobrani i štapovi za šetnju; bičevi, oprema za konje i sedlarski
proizvodi; sve uključeno u klasu 18.

Klasa 24: tekstil i tekstilna roba koja nije uključena u druge klase; štof/sukno, tkanina, plastični
materijal (zamena za tkanine), filc, tkanina od konoplje, elastični tkani materijal, svila
(materijal), somot, platno za domaćinstvo, pleteni i heklani prekrivači ili šalovi napravljeni
od kvadrata ili trake, oprema od tekstila za kupatila; tekstilni stolnjaci (ne od papira), čar-
šavi, gotovi čaršavi, tkanine za kupatila, krevetski čaršavi, debeli, mekani jorgani, jorgani,
pokrivači, jorganski pokrivači, putni prekrivači, jorgani ispunjeni paperjem, stoinjaci, uzani

stolnjaci/nadstoljanjaci, tekstilni podmetači, stoni podmetači (koji nisu od hartije), podmeti za čaše, salvete, salvete od tkanine, tekstilne stonice salvete, tekstilni peškiri za lice, toaletne rukavice, peškiri za kupanje, peškiri za ruke, krpa za pranje sudova, peškiri za plažu od tkanine sa nesečenim petljama ili ćubastom tkaninom, kuhinjski peškiri, peškiri, tekstilni peškiri, maramice, maramice od tekstila, etikete/trake od tkanine, odbojnici za dečje krevete; navlake za jastuke (jastučnice), punjena prekrivka za krevet, svilene/damastne zavese/ukrasne kratke zavese iznad vrha prozora, prekrivke za krevet i navlake za jastuke, zavese, opšivci za krevete, krevetski čaršavi/prostirke, zastave i tekstilne mornaričke zastave, zidne zavese i držači zavesa od tekstilnog materijala, zavese za kupatila od tekstila ili plastike, tekstilni pokrivači, pokrivači za krevet i sto, mekani, debeli pokrivači, punjeni pokrivači, prekrivke za krevet, odgovarajući/podešeni i nepodešeni tekstilni pokrivači za nameštaj, prekrivke za nameštaj, prekrivači za jastuke, tkanine (komadna roba), krevetsko rublje, roletne/zavese, tkanine za tekstilnu upotrebu, tkanine za tapaciranje, pribor za tekstilnu odeću, bičevi i fina tkanja od štofa/sukna, barjaci i zastave (ne od hartije).

Klasa 25: odeća, obuća i pokrivke za glavu; odeća za muškarce, žene i decu; spoljna odeća; svečana odeća; neformalna odeća; odeća za slobodno vreme; sportska odeća; voodootporna odeća; odeća za kišu; odela, prsluci, kaputi, ogrtači, parke, žaketi, kratki kaputi, vetrovke i top-majice (za nošenje), bluze, muške košulje, T-košulje, košulje za polo, gornji deo trenerke, sportske košulje, košulje za golf, košulje za ragbi, tunike, grudnjaci, odela za džogiranje, odela za sneg, pletena odeća, žersej (odeća), sviteri, puloveri, kardigani, pantalone, džins, kratke pantalone, čakšire, donji deo trenerke, šorcevi, dresovi, haljine, suknje, ženske pantalone (obično kratke) krojene da izgledaju kao suknja, sokne, helanke, čarape hula-hopke; odeća za spavanje, pidžame, muške spavaćice, spavaćice/spavaće košulje, sobne haljine; bademantili; odeća za plivanje, kupaći kostimi, gaće za kupanje, gaćice za kupanje, odeća za plažu; čarape; žensko donje rublje; prslučići, gaćice, slipovi; donje rublje; kostimi, uniforme; radničke bluze; mašne/marame, pelerine, šalovi; šeširi, kape, toke, zaštitnici od sunca; zaštitnici za uši; okovratnici/mašne; rukavice (odeća); kaiševi (odeća); znojne trake, trake za glavu (odeća), znojnice (za ručni zglob); kaiševi za pantalone; obuća za svakodnevnu upotrebu, za upotrebu u sportu, čizme, (sportske) patike, mokasine, cipele\cipele za slobodno veme, sandale, papuče; cipele i obuća za golf; sve uključeno u klasu 25.

Klasa 35: usluge maloprodaje, usluge maloprodaje robnih kuća, usluge maloprodaje supermarketu, usluge naručivanja, usluge prodaje na veliko, distributerske maloprodajne usluge i usluge maloprodaje on line u pogledu vrlo raznolikih vrsta robe uključujući parfeme, kozmetiku, toaletne proizvode za kozmetiku i pranje, uključujući higijenske proizvode za ličnu upotrebu, proizvode za ličnu negu i ulepšavanje, sanitarne preparate, paste za zube, supstance koje se koriste za rublje, preparate za čišćenje, poliranje i abrazivna sredstva, sve što spada u klasu 3, uključujući naočare, optičku robu, kućna električna sredstva/pribor, elektronske proizvode za široku potrošnju, audi-vizuelne aparate i pribor, audio vizuelna snimanja u svim medijima, uređaje za vezu, kompjutere, kompjuterske proizvode i pribor, sve što spada u klasi 9, robe od plemenitih metala ili njima obložene, nakit, časovničarske i hronometrijske instrumente, drago kamenje, sve što spada u klasu 14, pisaći pribor, sredstava za pisanje, hartije i proizvode od hartije, štampane stvari, materijale za uvijanje poklona i trake, sve što spada u klasu 16, robe napravljene od kože i imitacije kože, torbe, putničke sanduke/kofere, putničke torbe, kišobrane, sve što spada u klasu 18, tekstil; tekstilne robe, tkanine za nameštaj domaćinstva, laneno platno za domaćinstvo, krevetnine, sve što spada u klasu 24; odeću i modni aksesor, obuću, pokrivke za glavu, sve što spada u klasu 25; usluge oglašavanja/reklamiranja i marketinga; usluge agencija za oglašavanje/reklamiranje; deljenje reklamnog materijala; oglašavanje/reklamiranje putem pošte; usluge on-line prodaje, reklamiranja/oglašavanja i marketinga; prezentacija robe; distribucija uzoraka; aranžiranje izloga;

organizovanje izložbi; promocija i izlaganje u reklamne svrhe; fotokopiranje; poslovna ispitivanja/istraživanja; poslovno istraživanje i proučavanje marketinga; statističke informacije poslovanja i marketinga; uređivanje/pripremanje objavljivanja tekstova, publikacija; pripremanje; pretplata za novine za druga lica; ocenjivanje/određivanje vrednosti posla, pomoć u poslovnom menadžmentu; konsalting poslovnog menadžmenta i organizacije; agencije za uvoz-izvoz; pomoć u industrijskom menadžmentu; konsultacije personalnog menadžmenta; odnosi sa javnošću; proizvodnja, priprema i prezentacija reklamnih materijala; iznajmljivanje reklamnog prostora; usluge odgovaranja telefonom i usluge prijema i prosleđivanja poruka; konsalting usluge koje se odnose na franšizu; prodaja na licitacijama; analiza cena troškova; kompilacija i iznajmljivanje spiskova slanja pošte; poslovno istraživanje; usluge obezbeđivanja informacija, konsultacija i savetovanje za gore navedene usluge.

(210) **2011-667** (442) **20.04.2014.**
(220) 12/16/2011

(731) **ESPRIT INTERNATIONAL**, 1370 BROADWAY, NEW YORK, NY 10018 US



(540)

(550) I, F

(740) Mihailović Vojislav, Hilendarska 5, Beograd SR

(511) **Klasa 03:** kozmetika i parfimerija; sapuni i toaletni preparati; isključujući proizvode za bojenje i samotenanje.

Klasa 09: okviri za naočare, naočare za sunce, kutije (etuii) za naočare, senke za oči, zaštitnici za oči i zaštitnici za oči za sport, naočare.

Klasa 14: nakit koji pripada klasi 14 uključujući nakit od plemenitih i neplemenitih metala; časovnici, satovi i hronometri.

Klasa 18: koža i imitacija kože i roba koja je napravljena od ovih materijala i koja nije uključena u druge klase; sanduci za nošenje, torbe, prtljag, koferi, kišobrani, ručne torbe, novčanici, futrole za ključeve, putne kese za odeću, torbe za plažu, kaiševi i lisnice (novčanici za papirni novac).

Klasa 24: sve vrste stonih pokrivki, salvete i stone prostirke; pokrivači za krevet, krevetnina, uključujući čaršave i jastučnice; peškiri i peškirići za pranje/kupanje, prostirke za kupatila i tekstilni komadni proizvodi i tekstilni proizvodi za domaćinstvo koji nisu uključeni u druge klase.

Klasa 25: odeća, obuća i pokrivke za glavu.

Klasa 35: usluge reklamiranja i objavljivanja i usluge prodavnica na malo.

Klasa 39: usluge putnih aranžmana.

(210) **2011-669** (442) **20.04.2014.**
(220) 12/20/2011

(731) **MERCK SHARP & DOHME CORP.** A NEW JERSEY CORPORATION, ONE MERCK DRIVE, WHITEHOUSE STATION, NEW JERSEY 08889-0100 US

GARIXEDE

- (540)
 (550) I
 (740) AOD "Ćupić", Dalmatinska 10, Podgorica ME
 (511) **Klasa 5;** Vakcine za ljudsku upotrebu.

(210) **2011-670** (442) **20.04.2014.**
 (220) 12/20/2011

- (731) **MERCK SHARP & DOHME CORP.** A NEW JERSEY CORPORATION, ONE MERCK DRIVE, WHITEHOUSE STATION, NEW JERSEY 08889-0100 US

REVGASIL

- (540)
 (550) I
 (740) AOD "Ćupić", Dalmatinska 10, Podgorica ME
 (511) **Klasa 5;** Vakcine za ljudsku upotrebu.

(210) **2011-675** (442) **20.04.2014.**
 (220) 12/21/2011

- (731) RABBIT RECORDS D.O.O., BOKEŠKA 10, PODGORICA ME



- (540)
 (550) I
 (511) **Klasa 09:** Aparati za snimanje, prenos i reprodukovanje zvuka ili slike Magnetni nosioci podataka, diskovi za snimanje; Automatske mašine i mehanizmi za aparate koji se pokreću novcem ili žetonom, registar klase, računске mašine, opreemu za obradu podataka i kompjutere.

Klasa 16: Hartija, karton i proizvodi od njih, koji nijesu uključeni u drage klase, štampane stvari,

fotografije, kancelarijski materijal, umjetnički materijali, kičice pisane mašine i kancelarijski rekviziti, plastični materijal za pakovanje (koji nije uključen u druge klase) štamparska slova, klišeji .

Klasa 35: Oglašavanje, vođenje poslova, poslovno upravljanje, kancelarijski poslovi.

(210) **2011-691**

(442) **20.04.2014.**

(220) 12/21/2011

(731) **COLGATE PALMOLIVE COMPANY**, A DELAWARE CORPORATION, 300 PARK AVENUE, NEW YORK, NY 10022 US

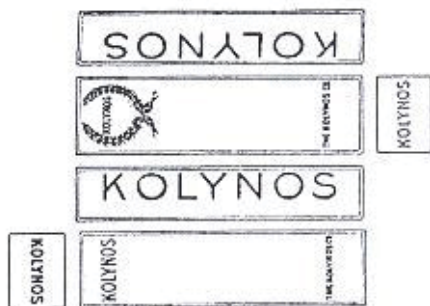

(540)

(550) I

(740) Kojić Ivana, Serdara Jola Piletića bb, Podgorica ME

(511) **Klasa 1:** Hemijski proizvodi;

Klasa 2: Boje, pigmenti i bajcevi;

Klasa 3: Pasta za tube, krem za zube, prašak za vještačke vilice; sredstva za pranje zuba i usta; sredstva za čišćenje zuba; parfemi; kozmetička sredstva za toaletu; preparati za kožu i kosu; sapuni; kremovi, vodiče za kožu i oči; praškovi (puderi) za lice i tijelo; praškovi (puderi) za toaletu; puter čvrstom (komprimiranom) stanju; ruževi; pisaljke (ruževi) za usne; masti i pisaljke za obrve; soli za kupanje; kristali za kupanje, brilijantini; masti za kosu; tonikumi za kosu, pomade za kosu; sredstva za uklanjanje mirisa i dlaka; sredstva za glačanje nakita; alkohol za brijanje; kremovi i sapuni za brijanje; preparati za bojenje, lakiranje i frizuru;

Klasa 5: Pribor za zubare; preparati za njegu zuba, desni i usta; sredstva za punjenje (plombiranje) zuba; farmaceutski i medicinski preparati; antiseptični rastvori i dezinfekciona sredstva za uništavanje klica; mirisne soli; masti protiv opekotina od sunca; vodiče protiv opekotina od sunca;

Klasa 8: Pribor za manikiranje; brijачi i sečiva za brijачe: nožarska roba i instrumenti;

Klasa 10: Veštački zubi i vilice;

Klasa 18: Torbice za kozmetiku; kišobrani i suncobrani; kožna roba;

Klasa 20: Lepeze za ličnu upotrebu;

Klasa 21: Pufne za puder; četkice za zube; četke i češljevi za kosu;

Klasa 25: Gotova odela; obuća; šiveni šeširi, ukrasni detalji za odjeću; roba za modistkinje; rukavice; ukrasne trake;

Klasa 26: Dugmad.

(210) 2011-727

(442) 20.04.2014.

(220) 12/27/2011

(731) **AVON PRODUCTS, INC**, WORLD HEADQUARTERS, 1345 AVENUE OF THE AMERICAS, NEW YORK, NY 10105-0196 US

BE YOUR BEST WITH THE BEST

(540)

(550) I

(740) AOD "Ćupić", Dalmatinska 10, Podgorica ME

(511) **Klasa 35:** Oglašavanje; vođenje poslova; poslovno upravljanje; kancelarijski poslovi; usluge distribucije; maloprodajne usluge u prodavnicama, prodaja od vrata do vrata, direktnom prodajom putem prodajnih predstavnika, putem telefona, putem kataloga i putem globalne kompjuterske informacione mreže, sve vezano za estetsku njegu, odjeću, parfimeriju, kozmetiku, nakit, proizvode za ličnu njegu, prehrambene dodatke, opremu za vježbanje i fitnes, sportsku opremu, knjige, snimljene audio i video kasete, CD-ove i poklone; usluge promocije i oglašavanja na polju regrutovanja nezavisnih predstavnika prodaje.

Klasa 41: Obrazovne usluge; pripremanje obuke; razonoda; sportske i kulturne aktivnosti; usluge poslovnog školovanja i vježbi za razvijanje i omogućavanje prilagođenog upravljanja; programi poslovnog školovanja za izvršioce, zaposlene, pomoćnike i predstavnike; poslovna obuka; usluge konsultacija u vezi sa poslovnom obukom; usluge školovanja putem časova, seminara, konferencija i radionica na polju usluga maloprodaje i brendiranja proizvoda i distribucije materijala za obuku s tim u vezi; usluge školovanja putem časova, seminara, konferencija i radionica na polju zdravlja, ishrane, fitnesa, finansija, vježbe, stila, uljepšavanja i/ili ljepote.

(210) **2011-748**

(442) **20.04.2014.**

(220) 12/30/2011

(731) **13 JUL-PLATAŽE A.D.**, PODGORICA ME



(540)

(550) I

(511) **Klasa 33:** Alkoholna pića (izuzev piva).

(210) **2011-749**

(442) **20.04.2014.**

(220) 12/30/2011

(731) **13 JUL-PLATAŽE A.D.**, PODGORICA ME



(540)

(550) I

(511) **Klasa 33:** Alkoholna pića (izuzev piva).

(210) **2011-96**

(442) **20.04.2014.**

(220) 2/28/2011

(731) **LJUBOMIR ĐERKOVIĆ**, KOZARAČKA 135, PODGORICA ME



(540)

(550) I

(511) **Klasa 41:** obrazovne usluge; pripremanje obuke; razonoda; sportske i kulturne aktivnosti. usluge koje pružaju lica ili institucije u razvijanju mentalnih sposobnosti drugih lica (obrazovanje) ili životinja (obuka, dresiranje); usluge kojima je cilj zabavljanje drugih lica, privlačenje pažnje, rekreacija; organizovanje (priredivanje) i vođenje seminara, konferencija, kongresa; organizovanje izložbi u kulturne i obrazovne svrhe, sportskih takmičenja; izdavanje tekstova i knjiga.

(210) **2012-164**

(442) **20.04.2014.**

(220) 3/28/2012

(731) **DDI D.O.O. BUSOVAČA**, LUKA BB, 72260 BUSOVAČA BA



(540)

(550) I

(740) Popović Miladin, Đoka Miraševića 21/III, Podgorica ME

(511) **Klasa 29:** Meso, riba, perad i divljač; mesni ekstrakti; konzervisano, sušeno i kuvano voće i povrće: hladetina (želei), džemovi, kompoti; jaja, mlijeko i mliječni proizvodi; jestiva ulja i masti.

Klasa 30: Kafa, čaj, kakao, šećer, pirinac, tapioka, sago, zamjena kafe; brašno i proizvodi od žitarica, hleb, kolači, poslastice, bombone; sladoled; med, sirup od melase; kvasac, prašak za dizanje; so, slastica (senf); sirce, umaci (začini); mirodije; led za hlađenje; naročito proizvodi od voća, povrća, orašastih plodova ili ostalih djelova biljaka; proizvodi od škroba; poslastičarski proizvodi; poboljšivaci i ostali proizvodi za pekarstvo, proizvodi od kakaoa, fil višnja, fil jabuka, fil šumsko voće, fil marelica, pica sos (proizvod od paradajza), kremi kraf (punjenje za krofnе na bazi kakaoa), eurokrem više vrsta (termostabilni, za punjenje), poboljšivaci za pekarstvo, nadjevi (praškasta punjenja na bazi maka, oraha, lješnika), boje za hlјeb (na bazi raževe sladi), posipi za pekarstvo (susam, lan, zobeni pahuljice, suncokret), škrob, šećer mljeveni, krofan (koncentrat na bazi brašna i jaja);

Klasa 31: Poljoprivredni, povrtlarski, šumski proizvodi i bobice, koji nijesu obuhvaćeni drugim klasama; žive životinje; svježe voće i povrće; sjeme, prirodne biljke i cvijeće; hrana za životinje, slad.

(210) **2012-168**(442) **20.04.2014.**

(220) 4/4/2012

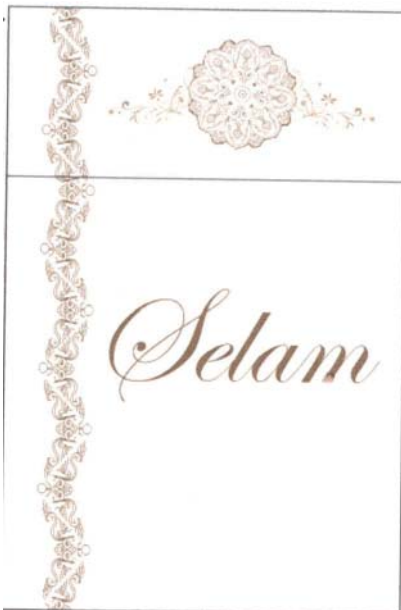
(731) **ZORAN ĐURKOVIĆ**, MARŠALA TITA 24, BAR ME

(540)

(550) I

(511) **Klasa 16:** Hartija karton i proizvodi od njih koji nijesu uključeni u njih; druge klase, Štampane stvari; Knjigovezački material; Fotografije; Kancelarijski material; Lepila za kancelarijske i kućnu upotrebu; Umjetnički materijali; Kičice; Pisaće mašine i kancelarijski rekviziti izuzev namještaj; Materijali za obuku i nastavu izuzev aparata; Plastični material za pakovanje koji nije uključen u druge klase; Štamparska slova; Klišei;

Klasa 18: Koža i imitacija kože, proizvodi izrađeni od ovih materijala koji nisu uključeni u druge klase; Životinjska koža, krzno; Koferi i putne torbe; Kišobrani, suncobrani i štapovi za hodanje;

Klasa 34: Duvan; Artikli za pušače; Šibice.

(210) **2012-169**

(442) **20.04.2014.**

(220) 4/4/2012

(731) **ZORAN DJURKOVIC**, MARŠALA TITA 24 8500, BAR ME



Merhaba

(540)

(550) I

(511) **Klasa 16:** Hartija karton i proizvodi od njih koji nijesu uključeni u njih; druge klase, Štampane stvari; Knjigovezački material; Fotografije; Kancelarijski material; Lepila za kancelarijske i kućnu upotrebu; Umjetnički materijali; Kičice; Pisaće mašine i kancelarijski rekviziti izuzev namještaj; Materijali za obuku i nastavu izuzev aparata; Plastični material za pakovanje koji nije uključen u druge klase; Štamparska slova; Klišei;

Klasa 18: Koža i imitacija kože, proizvodi izrađeni od ovih materijala koji nisu uključeni u druge klase; Životinjska koža, krzno; Koferi i putne torbe; Kišobrani, suncobrani i štapovi za hodanje;

Klasa 34: Duvan; Artikli za pušače; Šibice.;

(210) **2012-178**

(442) **20.04.2014.**

(220) 4/9/2012

(731) **S.C.JOHNSON & SON, INC**, 1525 HOWE STREET, RACINE, WISCONSIN 53403-2236 US

(540) DURABLE DEFENSE

(550) I

(740) Čejović Vladimir, 13. jula 21, Podgorica ME

(511) **Klasa 5:** Preparati za uništavanje korova i štetočina; insekticidi; preparati za zaštitu od moljaca; sredstva koja odbijaju insekte, fungicidi; deratizatori.

(210) **2012-181**

(442) **20.04.2014.**

(220) 4/11/2012

(731) MIHAILO TOMANOVIĆ, UL. NARODNE OMLADINE T20, NIKŠIĆ ME
MILOŠ ILIĆ, UL. JANKA VUKOTIĆA BR. 30. NIKŠIĆ ME



(540)

(550) I

(740) Božović Vesko, Rimski trg 50/11, Podgorica ME

(511) **Klasa 35:** Oglašavanje; vođenje poslova; poslovno upravljanje kancelarijski poslovi.**Klasa 43:** Usluge obezbjeđivanja hrane i pića; privremeni smeštaj.(210) **2012-182**(442) **20.04.2014.**

(220) 4/11/2012

(731) **PATRON SPIRITS INTERNATIONAL AG**, QUAISTRASSE 11, 8200 SCHAFFHAUSEN CH

(540) ULTIMAT

(550) I

(740) Lutovac Branislav, Bulevar Crnojevića 93, Podgorica ME

(511) **Klasa 33:** alkoholna pića, destilovana alkoholna pića, i votka;(210) **2012-208**(442) **20.04.2014.**

(220) 4/20/2012

(731) **MOLNLYCKE HEALTH CARE AB**, GAMLESTADSVAGEN 3C, GOTEORG, 402 52 SE

(540) HIBICET

(550) I

(740) Čejović Vladimir, 13. jula 21, Podgorica ME

(511) **Klasa 5:** Farmaceutski, veterinarski i sanitarni preparati; sredstva za dezinfekciju.(210) **2012-216**(442) **20.04.2014.**

(220) 4/27/2012

(731) **DOO RED FENIKS MONTENEGRO**, KAMELIJA BR. 3 TIVAT ME

Red Feniks



— REAL ESTATE —
since 2003

(540)

(550) I

(511) **Klasa 36:** broj 360004 Lizing nepokretnosti,

Klasa 36: broj 360007 Agencija za promet nepokretnosti,

Klasa 36: broj 360008 Posredovanje u trgovini nekretninama;

(210) **2012-226** (442) **20.04.2014.**
(220) 5/4/2012

(731) **HANKOOK TIRE WORLDWIDE CO., LTD**, #647-15, YOKSAM-DONG, KANGNAM-GU, SEUL KR

(540)  **HANKOOK KINERGY**

(550) I

(740) Radulović Božidar, Jovana Tomaševića 9/III, Podgorica ME

(511) **Klasa 12:** Automobilske gume; Unutrašnje gume za točkove automobila; Gume za točkove vozila; Unutrašnje gume za gume automobila; Pneumatske gume; Gume, čvrste za točkove vozila; Gume za točkove vozila.;

(210) **2012-229** (442) **20.04.2014.**
(220) 5/8/2012

(731) **NIPPON KAYAKU KABUSHIKI KAISHA**, 11-2, FUJIMI 1-CHOME, CHIYODA-KU, TOKYO JP

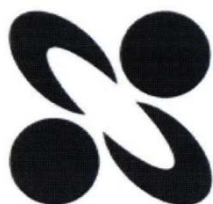

(540)

(550) I

(511) **Klasa 05:** farmaceutski preparati.

(210) **2012-230** (442) **20.04.2014.**
(220) 5/8/2012

(731) **NIPPON KAYAKU KABUSHIKI KAISHA**, 11-2, FUJIMI 1-CHOME, CHIYODA-KU, TOKYO JP

(540) NIPPON KAYAKU

(550) I

(511) **Klasa 05:** farmaceutski preparati.

(210) **2012-236** (442) **20.04.2014.**
(220) 5/10/2012

(731) **PARAMOUNT PICTURES CORPORATION**, 5555 MELROSE AVENUE, HOLLYWOOD, CALIFORNIA, 90038 US

(540) PARAMOUNT CHANNEL

(550) I

(740) Lutovac Branislav, Bulevar Crnojevića 93, Podgorica ME

(511) **Klasa 09:** Naučni, pomorski, geodetski, fotografski, kinemetografski, optički, vaganje, mjerenje, signalizacija, kontrola (inspekcija), spasilacki aparati za podučavanje i instrumenti, aparati i instrumenti za sprovođenje, prekidanje, transformaciju, akumulaciju, regulisanje

ili kontrolu električne energije; aparati za čuvanje, snimanje, prenos i reprodukciju zvuka ili slike; magnetni nosioci podataka. diskovi za snimanje; kase, računarske mašine, oprema za obradu podataka i kompjuteri; aparati za gašenje požara; filmski i TV filmovi, animirani filmovi i crtani filmovi, aparati za čuvanje ili pružanje zvuka ili slike; filmovi, filmske trake i video kasete, videodisk i snimljene magnetne trake sa zvukom i/ili slikom; aparati za zabavu koji se koriste uz televizijske prijarnike, računari, računarski programi; kompjuterski softveri; interaktivni računarski sistemi; magnetni i optički nosioci podataka; zvučni, video i aparati za snimanje i reprodukciju podataka, aparati za snimanje, prenos i reprodukciju zvuka i/ili slike; aparati za računarske igre, softveri i programi, aparati za video igre, softveri i programi; CD-ROM igre, audio izlaz igre, ketridži za igre za upotrebu sa elektronskim aparatima, zvučni i video snimci, naočare za sunce, aparati za obuku i nastavu i instrumenti; fonografski snimci, zapisi, diskovi, trake, kasete, ketridži, karte i drugi nosači, koji svi sadrže ili su za upotrebu da nose zvučne snimke, video zapise, podatke, slike, igre, grafike, tekstove, programe ili informacije; fonografski zapisi i diskovi; kompakt diskovi; ketidži za kompjuterske igre i uređaje za video igre koje se igraju preko output izlaza, kasete za kompjuterske igre, programi za kompjuterske igre; trake za kompjuterske igre; memorijski nosači, interaktivni kompakt diskovi i CD ROM-ovi, video trake, video diskovi, video kasete, laserski diskovi i digitalni video diskovi (DVD), digitalni diskovi visoke definicije, CD-ROM-ovi i svi drugi medijski formati koji sadrže igre, interaktivne igre, filmove, sportski program, televizijske serije, šou programe, rialiti programe, animacije i druge preformanse; snimljene magnetofonske trake sa zvcima i/ili slikama; bežična oprema i dodaci za mobilne telefone, maske za mobilne telefone, melodije; melodije koje se mogu preuzeti, muzika, mp3, grafika, igre i video igre za mobilne bežične komunikacione uređaje; zvuk, muzika i video zapisi, elektronske igre i melodije mobilnih telefona, interaktivne igre koje se igraju na kompjuterima ili mobilnim telefonima, kućnim sistemima za zabavu; aparati za snimanje i reprodukciju zvuka, videa i podataka.za čuvanje, snimanje, prenos i reprodukciju zvuka i/ili slike; računarski softver; kompakt diskovi sa igrama koji se ne brišu sa memorije; igre preko audio izlaza; ketridže za kompjuterske video igre i uređaji za video igre koje se igraju preko video izlaza; kasete za kompjuterske igre; programi za kompjuterske igre; trake za kompjuterske igre, zvučni i video snimci; fonografski zapisi, snimci; kinematografski i fotografski filmovi, filmske i video kasete; CD plejere, digitalne kamere, bežična oprema i dodaci za mobilne telefone i pribor, uključujući i maske za mobilne telefone; melodije koje se mogu preuzeti, muzika, mp3, grafika, slike i video igre za bežične mobilne (omunikacione uređaje; uređaji bežične transmisije i mobilne komunikacije koji dozvoljavaju llasanje i primanje govornih i tekstualnih poruka sa drugih bežičnih mobilnih komunikacionih redaja; naočare za sunce, naočare, laserski diskovi, video diskovi, kompakt diskovi, CD-OM, CD-L; digitalni verstalni diskovi (DVD-a), trake, kasete, ketridži, kartice koje sadrže move, vijesti, sportski program i televizijske serije, dokumentarni program, zabavne igre, limacije, koncerti i druge priredbe; memorijske nosače; interaktivni kompakt diskovi i CD DM-ovi (kompakt diskovi koji se ne brišu sa memorije); torbe za kasete i kompakt-diskove; Braktivne elektronske igre za korišćenje na kompjuterima.

Klasa 38: Radiodifuzne i telekomunikacione usluge; kablovske i satelitske usluge prenosa; bežične usluge za mobilne telefone; pružanje usluga preuzimanja melodija, muzike, mp3, grafike, igrice, slika i informacija za bežične mobilne uređaje; pružanje usluga bežičnog prenosa pri upload-ovanju i dovvnload-ovanju melodija, glasova, muzike, mp3, grafika, igrice, slika, informacija i novosti preko globalne kompjuterske mreže do mobilnog uredjaja sa bežičnom komunikacijom; pružanje komunikacionih usluga za glasanje i anketiranje preko mobilnog uredjaja sa bezicnom komunikacijom; slanje i primanje glasova preko mobilnog uredjaja, slanje i primanje zvučnih i tekstualnih poruka izmedju mobilnih uredjaja sa bežičnom ko-

munikacijom; omogućavanje komunikacionih usluga sistema za online glasanja preko interneta ili uređaja za bežičnu komunikaciju, internet usluge uključujući usluge komunikacije, usluge transmisije strimovanih zvukova i zvučno-vizuelnih snimaka preko interneta, omogućavanje preuzimanja strimova u vidu filmova, trejlera, televizijskih programa, muzike i igara preko globalne kompjuterske mreže i komunikacionih mreža; iznajmljivanja uređaja za prenos i prijem kinematografskih filmova, zvuka ili videa; komunikacione usluge; televizijski programi, usluge emitovanja; bežični prenos i emitovanje televizijskog programa, kablovski, satelitski i direktno do korisnika prenosa i distribucije televizijskog programa; kablovska televizija, video, putem pretplate televizijski i radio programi, emitovanje i transmisija; komunikaciona mreža kompjutera, prenos i prijem podataka i informacija, satelitski prenos, kompjuterska mreža komunikacionih usluga; usluge elektronske pošte; teletext usluge; usluge televizijskog prenosa uz plaćanje; transmisija videa na zahtjev, iznajmljivanje, lizing ili rentiranje uređaja, instrumenata, instalacija za emitovanje ili komunikaciju ili komponenata za upotrebu i pružanje svih pomenutih usluga; savjetovanje, informativne i savjetodavne usluge u vezi sa svim navedenim uslugama.

Klasa 41: Zabava, usluge obrazovanja i podučavanja; sportskih i kulturnih aktivnosti; radio i televizijskih zabavnih usluga, film, muzika, sport, video i pozorišne usluge, proizvodnja, priprema, prezentacija, distribucija, izložba, umnožavanje, umrežavanje i iznajmljivanje televizijskih i radio programa i filmova, animiranih filmova i audio i video snimaka, proizvodnja živih zabavnih programa, proizvodnja televizijskih zabavnih programa; filmska zabava, televizijska zabava i živi nastupi i emisije, proizvodnja knjiga, časopisa i periodičnih publikacija, izrada i iznajmljivanje obrazovnih i nastavnih materijala, izdavaštvo, organizacija, proizvodnja i prezentacija događaja za obrazovne, kulturne ili zabavne svrhe; organizacija, produkcija i prezentacija takmičenja, nadmetanja, igara, kvizova, dana zabave, izložbi, sportskih događaja, šou programa, putujućih programa, javne priredbe, pozorišne predstave, koncerti, živi nastupi i događaji sa prisustvom publike; on line informacione usluge u vezi sa elektronskim igrama koje se pružaju putem interneta ili mobilnih telefona, pružanje digitalne muzike (bez downloadovanja) za internet ili mobilne telefone; on line informacione usluge koji se odnose na zabavu, sportske i kulturne događaje koje se pružaju putem kompjuterske baze podataka ili se pružaju drugim sredstvima; usluge elektronskih igara iz kompjuterske baze podataka ili putem interneta ili mobilnih telefona, pružanje on line elektronskih publikacija; objavljivanje elektronskih knjiga i časopisa na mreži, objavljivanje tekstova u elektronskom formatu ili na drugi način; usluge izlaganja; vijesti programski servisi za prenos preko interneta ili mobilnih telefona, organizovanje i vođenje konferencija; zabavne usluge; arkadne zabavne usluge; pružanje informacija o uslugama za razonodu više korisnika preko svjetske kompjuterske mreže, preko interneta, preko drugih mrežnih baza podataka, ili putem mobilnih telefona; proizvodnja plesnih šou programa, muzičkih šou programa i video programa uz dodjelu nagrada; komicne emisije, programi sa igrama i sportskim događajima pred živom publikom koji se emituje uživo ili snima za kasnije emitovanje; živi muzički koncerti, TV vijesti, organizovanje takmičenja talenata, i događaja uz dodjelu muzičkih i televizijskih nagrada; organizovanje i prikazivanje revija i zabavnih programa koji se odnose na stil i modu; pružanje informacija u oblasti zabave putem globalnih računarskih mreža ili mobilnih telefona; omogućavanje sistema on line glasanja preko interneta ili bežičnih komunikacionih uređaja u svrhu zabave; vijesti i informacione usluge o tekucim događajima, pružanje informacija u oblasti zabave za jednog ili više ljudi preko interneta na jednom sajtu korišćenjem kafea i barova, kafeterija, bistroa, restorana ili mjesta za pijenje kafe, usluge zabave u vidu produkcije i distribucije filmova, produkcije i distribucije televizijskog programa, produkcije i distribucije snimljenih video kaseti, digitalnih verbalnih diskova (DVD) i snimljenih audio diskova i medija za skladištenje digitalnih podataka koji nisu diskovi; pružanje sadržaja koje

se mogu dovnloadovati bežičnim putem zabavnog sadržaja u vidu audiovizuelnih radova. filmova, trejlera, televizijskog programa, muzike i igara putem globalne kompjuterske mreže i komunikacione mreže; pružanje informacija u oblasti zabave, filmova, igara i muzike preko kompjuterskih mreža i globalnih komunikacionih mreža ili mobilnih telefona; pružanje on line igrara, uključujući interaktivne igre; usluge filmskih i televizijskih studija; iznajmljivanja filmske i televizijske scenografije i opreme; obezbjedjivanja bisokopskih ili pozorišnih instalacija; iznajmljivanje uređaja za modifikovanje, editovanje ili reprodukciju kinematografskih filmova, zvuka ili video; usluge modifikovanja, editovanja ili reprodukovanja za film, zvuk i video; pružanje igara za igranje online, na bežičnim uređajima, uključujući mobilne telefone, na kompjuterima, ili na igračkim konzolama; zabavne usluge u obliku produkcije i distribucije animiranih vizuelnih efekata i kompjuterske grafike za filmove i televiziju; produkcija animiranih filmova; produkcija, priprema, prikazivanje, distribucija i iznajmljivanje televizijskih i radio programa i filmova, animiranih filmova i audio i video zapisa putem interaktivnih medija, uključujući internet; produkcija živih zabavnih sadržaja, produkcija televizijskih zabavnih sadržaja; TV programi muzickog sadržaja; objavljivanje knjiga, časopisa i periodičnih izdanja; proizvodnja i iznajmljivanje obrazovnih i nastavnih materijala; organizacija, proizvodnja i prezentacija događaja u obrazovne, kulturne ili zabavne svrhe putem interaktivnih medija; organizacija, produkcija i prezentacija takmičenja, nadmetanja, igara, kvizova, izložbi, sportskih događaja, šou programa, putujućih programa, javnih priredbi, pozorišne predstave, koncerti, živi nastupi i događaji sa prisustvom publike; organizacija interaktivnih igara; produkcija SMS kviz programa; obrazovne usluge; produkcija, distribucija i prikazivanje TV programa, filmova, zabavnog sadržaja uživo, animirani filmovi, televizijske serije i televizijski sadržaji; produkcija, distribucija i prezentacija snimljenih ili zabeleženih audio snimaka, vizuelnih i audio vizuelnih materijala; produkcija, distribucija i prezentacija video traka, video kasete, video diskova, laserskih diskova, zapisa, traka i kasete; zabavne usluge u vezi sa filmovima i televizijom; objavljivanje časopisa i periodičnih izdanja; postavljanje i vođenje izložbi; pružanje studijskog snimanja i sredstava za produkciju; usluge zabavnih parkova; usluge živih nastupa; koncertne usluge; usluge produkcije televizijskih emisija; konsultantske usluge, informacione i savjetodavne usluge u vezi sa svim navedenim uslugama.

(210) **2012-237**

(442) **20.04.2014.**

(220) 5/10/2012

(731) **PARAMOUNT PICTURES CORPORATION**, 5555 MELROSE AVENUE, HOLLYWOOD, CALIFORNIA, 90038 US



(540)

(550) I

(740) Lutovac Branislav, Bulevar Crnojevića 93, Podgorica ME

(511) **Klasa 09:** Naučni, pomorski, geodetski, fotografski, kinemetografski, optički, vaganje, mjerenje, signalizacija, kontrola (inspekcija), spasilacki aparati za podučavanje i instrumenti, aparati i instrumenti za sprovođenje, prekidanje, transformaciju, akumulaciju, regulisanje ili kontrolu električne energije; aparati za čuvanje, snimanje, prenos i reprodukciju zvuka ili slike; magnetni nosioci podataka, diskovi za snimanje; kase, računarske mašine, oprema za obradu podataka i kompjuteri; aparati za gašenje požara; filmski i TV filmovi, animirani filmovi i crtani filmovi, aparati za čuvanje ili pružanje zvuka ili slike; filmovi, filmske trake i video kasete, videodisk i snimljene magnetne trake sa zvukom i/ili slikom; aparati za zabavu koji se koriste uz televizijske prijarnike, računari, računarski programi; kompjuterski softveri; interaktivni računarski sistemi; magnetni i optički nosioci podataka; zvučni, video i aparati za snimanje i reprodukciju podataka, aparati za snimanje, prenos i reprodukciju zvuka i/ili slike; aparati za računarske igre, softveri i programi, aparati za video igre, softveri i programi; CD-ROM igre, audio izlaz igre, ketridži za igre za upotrebu sa elektronskim aparatima, zvučni i video snimci, naočare za sunce, aparati za obuku i nastavu i instrumenti; fonografski snimci, zapisi, diskovi, trake, kasete, ketridži, karte i drugi nosači koji svi sadrže ili su za upotrebu da nose zvučne snimke, video zapise, podatke, slike, igre, grafike, tekstove, programe ili informacije; fonografski zapisi i diskovi; kompakt diskovi; ketidži za kompjuterske igre i uređaje za video igre koje se igraju preko output izlaza, kasete za kompjuterske igre, programi za kompjuterske igre; trake za kompjuterske igre; memorijski nosači, interaktivni kompakt diskovi i CD ROM-ovi, video trake, video diskovi, video kasete, laserski diskovi i digitalni video diskovi (DVD), digitalni diskovi visoke definicije, CD-ROM-ovi i svi drugi medijski formati koji sadrže igre, interaktivne igre, filmove, sportski program, televizijske serije, šou programe, rialiti programe, animacije i druge preformanse; snimljene magnetofonske trake sa zvcima i/ili slikama; bežična oprema i dodaci za mobilne telefone, maske za mobilne telefone, melodije; melodije koje se mogu preuzeti, muzika, mp3, grafika, igre i video igre za mobilne bežične komunikacione uređaje; zvuk, muzika i video zapisi, elektronske igre i melodije mobilnih telefona, interaktivne igre koje se igraju na kompjuterima ili mobilnim telefonima, kućnim sistemima za zabavu; aparati za snimanje i reprodukciju zvuka, videa i podataka za čuvanje, snimanje, prenos i reprodukciju zvuka i/ili slike; računarski softver; kompakt diskovi sa igrama koji se ne brišu sa memorije; igre preko audio izlaza; ketridže za kompjuterske video igre i uređaji za video igre koje se igraju preko video izlaza; kasete za kompjuterske igre; programi za kompjuterske igre; trake za kompjuterske igre, zvučni i video snimci; fonografski zapisi, snimci; kinematografski i fotografski filmovi, filmske i video kasete; CD plejere, digitalne kamere, bežična oprema i dodaci za mobilne telefone i pribor, uključujući i maske za mobilne telefone; melodije koje se mogu preuzeti, muzika, mp3, grafika, slike i video igre za bežične mobilne (omunikacione uređaje; uređaji bežične transmisije i mobilne komunikacije koji dozvoljavaju llasanje i primanje govornih i tekstualnih poruka sa drugih bežičnih mobilnih komunikacionih redaja; naočare za sunce, naočare, laserski diskovi, video diskovi, kompakt diskovi, CD-OM, CD-L; digitalni verstalni diskovi (DVD-a), trake, kasete, ketridži, kartice koje sadrže move, vijesti, sportski program i televizijske serije, dokumentarni program, zabavne igre, limacije, koncerti i druge priredbe; memorijske nosače; interaktivni kompakt diskovi i CD DM-ovi (kompakt diskovi koji se ne brišu sa memorije); torbe za kasete i kompakt-diskove; Braktivne elektronske igre za korišćenje na kompjuterima.

Klasa 38: Radiodifuzne i telekomunikacione usluge; kablovske i satelitske usluge prenosa; bežične usluge za mobilne telefone; pružanje usluga preuzimanja melodija, muzike, mp3, grafike, igrice, slika i informacija za bežične mobilne uređaje; pružanje usluga bežičnog prenosa pri upload-ovanju i dovvnload-ovanju melodija, glasova, muzike, mp3, grafika, igrice, slika,

informacija i novosti preko globalne kompjuterske mreže do mobilnog uređaja sa bežičnom komunikacijom; pružanje komunikacionih usluga za glasanje i anketiranje preko mobilnog uređaja sa bezicnom komunikacijom; slanje i primanje glasova preko mobilnog uređaja, slanje i primanje zvučnih i tekstualnih poruka izmedju mobilnih uređaja sa bežičnom komunikacijom; omogućavanje komunikacionih usluga sistema za online glasanja preko interneta ili uređaja za bežičnu komunikaciju, internet usluge uključujući usluge komunikacije, usluge transmisije strimovanih zvukova i zvučno-vizuelnih snimaka preko interneta, omogućavanje preuzimanja strimova u vidu filmova, trejlera, televizijskih programa, muzike i igara preko globalne kompjuterske mreže i komunikacionih mreža; iznajmljivanja uređaja za prenos i prijem kinematografskih filmova, zvuka ili videa; komunikacione usluge; televizijski programi, usluge emitovanja; bežični prenos i emitovanje televizijskog programa, kablovski, satelitski i direktno do korisnika prenosa i distribucije televizijskog programa; kablovska televizija, video, putem pretplate telivizijski i radio programi, emitovanje i transmisija; komunikaciona mreža kompjutera, prenos i prijem podataka i informacija, satelitski prenos, kompjuterska mreža komunikacijsih usluga; usluge elektronske pošte; teletekst usluge; usluge televizijskog prenosa uz plaćanje; transmisija videa na zahtjev, ; iznajmljivanje, lizing ili rentiranje uređaja, instrumenata, instalacija za emitovanje ili komunikaciju ili komponenata za upotrebu i pružanje svih pomenutih usluga; savjetovanje, informativne i savjetodavne usluge u vezi sa svim navedenim uslugama.

Klasa 41: Zabava, usluge obrazovanja i podučavanja; sportskih i kulturnih aktivnosti; radio i televizijskih zabavnih usluga, film, muzika, sport, video i pozorišne usluge, proizvodnja, priprema, prezentacija, distribucija, izložba, umnožavanje.umrežavanje i iznajmljivanje televizijskih i radio programa i filmova, animiranih filmova i audio i video snimaka, proizvodnja živih zabavnih programa, proizvodnja televizijskih zabavnih programa; filmska zabava, televizijska zabava i živi nastupi i emisije, proizvodnja knjiga, časopisa i periodičnih publikacija, izrada i iznajmljivanje obrazovnih i nastavnih materijala, izdavaštvo, organizacija, proizvodnja i prezentacija događaja za obrazovne, kulturne ili zabavne svrhe; organizacija, produkcija i prezentacija takmičenja, nadmetanja, igara, kvizova, dana zabave, izložbi, sportskih događaja, šou programa, putujucih programa, javne priredbe, pozorišne predstave, koncerti, živi nastupi i događaji sa prisustvom publike; on line informacione usluge u vezi sa elektronskim igrama koje se pružaju putem interneta ili mobilnih telefona, pružanje digitalne muzike (bez downloadovanja) za internet ili mobilne telefone; on line informacione usluge koji se odnose na zabavu, sportske i kulturne događaje koje se pružaju putem kompjuterske baze podataka ili se pružaju drugim sredstvima; usluge elektronskih igara iz kompjuterske baze podataka ili putem interneta ili mobilnih telefona, pružanje on line elektronskih publikacija; objavljivanje elektronskih knjiga i časopisa na mreži, objavljivanje tekstova u elektronskom formatu ili na drugi način; usluge izlaganja; vijesti programski servisi za prenos preko interneta ili mobilnih telefona, organizovanje i vođenje konferencija; zabavne usluge; arkadne zabavne usluge; pružanje informacija o uslugama za rasonodu više korisnika preko svjetske kompjuterske mreže, preko interneta, preko drugih mrežnih baza podataka, ili putem mobilnih telefona; proizvodnja plesnih šou programa, muzickih šou programa i video programa uz dodjelu nagrada; komicne emisije, programi sa igrama i sportskim događajima pred živom publikom koji se emituje uživo ili snima za kasnije emitovanje; živi muzicki koncerti, TV vijesti, organizovanje takmičenja talenata, i događaja uz dodjelu muzickih i televizijskih nagrada; organizivanje i prikazivanje revija i zabavnih programa koji se odnose na stil i modu; pružanje informacija u oblasti zabave putem globalnih računarskih mreža ili mobilnih telefona; omogućavanje sistema on line glasanja preko interneta ili bežičnih komunikacijskih uređaja u svrhu zabave; vijesti i informacione usluge o tekucim događajima, pružanje informacija u oblasti zabave za jednog ili više ljudi preko interneta na jednom sajtu korišćenjem

kafea i barova, kafeterija, bistroa, restorana ili mjesta za pijenje kafe, usluge zabave u vidu produkcije i distribucije filmova, produkcije i distribucije televizijskog programa, produkcije i distribucije snimljenih video kaseti, digitalnih verbalnih diskova (DVD) i snimljenih audio diskova i medija za skladištenje digitalnih podataka koji nisu diskovi; pružanje sadržaja koje se mogu downloadovati bežičnim putem zabavnog sadržaja u vidu audiovizuelnih radova, filmova, trejlera, televizijskog programa, muzike i igara putem globalne kompjuterske mreže i komunikacione mreže; pružanje informacija u oblasti zabave, filmova, igara i muzike preko kompjuterskih mreža i globalnih komunikacionih mreža ili mobilnih telefona; pružanje on line igrara, uključujući interaktivne igre; usluge filmskih i televizijskih studija; iznajmljivanje filmske i televizijske scenografije i opreme; obezbjedjivanje bisokopskih ili pozorišnih instalacija; iznajmljivanje uređaja za modifikovanje, editovanje ili reprodukciju kinematografskih filmova, zvuka ili video; usluge modifikovanja, editovanja ili reprodukcija za film, zvuk i video; pružanje igara za igranje online, na bežičnim uređajima, uključujući mobilne telefone, na kompjuterima, ili na igračkim konzolama; zabavne usluge u obliku produkcije i distribucije animiranih vizuelnih efekata i kompjuterske grafike za filmove i televiziju; produkcija animiranih filmova; produkcija, priprema, prikazivanje, distribucija i iznajmljivanje televizijskih i radio programa i filmova, animiranih filmova i audio i video zapisa putem interaktivnih medija, uključujući internet; produkcija živih zabavnih sadržaja, produkcija televizijskih zabavnih sadržaja; TV programi muzickog sadržaja; objavljivanje knjiga, časopisa i periodičnih izdanja; proizvodnja i iznajmljivanje obrazovnih i nastavnih materijala; organizacija, proizvodnja i prezentacija događaja u obrazovne, kulturne ili zabavne svrhe putem interaktivnih medija; organizacija, produkcija i prezentacija takmičenja, nadmetanja, igara, kvizova, izložbi, sportskih događaja, šou programa, putujućih programa, javnih priredbi, pozorišne predstave, koncerti, živi nastupi i događaji sa prisustvom publike; organizacija interaktivnih igara; produkcija SMS kviz programa; obrazovne usluge; produkcija, distribucija i prikazivanje TV programa, filmova, zabavnog sadržaja uživo, animirani filmovi, televizijske serije i televizijski sadržaji; produkcija, distribucija i prezentacija snimljenih ili zabeleženih audio snimaka, vizuelnih i audio vizuelnih materijala; produkcija, distribucija i prezentacija video traka, video kaseti, video diskova, laserskih diskova, zapisa, traka i kaseti; zabavne usluge u vezi sa filmovima i televizijom; objavljivanje časopisa i periodičnih izdanja; postavljanje i vođenje izložbi; pružanje studijskog snimanja i sredstava za produkciju; usluge zabavnih parkova; usluge živih nastupa; koncertne usluge; usluge produkcije televizijskih emisija; konsultantske usluge, informacione i savjetodavne usluge u vezi sa svim navedenim uslugama.

(210) **2012-249**

(442) **20.04.2014.**

(220) 5/30/2012

(731) **MERCK KGAA**, FRANKFURTER STRASSE 250, 64293 DARMSTADT DE

(540) BION

(550) V

(740) Radulović Božidar, Jovana Tomaševića 9/III, Podgorica ME

(511) **Klasa 05:** Farmaceutski preparati; dijetetski preparati i dodaci hrani za upotrebu u medicini.

Klasa 29: Dijetetski preparati i dodaci hrani koji se ne koriste za upotrebu u medicini, koji su uključeni u ovu klasu.

Klasa 30: Dijetetski preparati i dodaci hrani koji se ne koriste za upotrebu u medicini, koji su uključeni u ovu klasu.

(210) **2012-252**(442) **20.04.2014.**

(220) 6/1/2012

(731) **IDEA D.O.O.**, AUTO PUT ZA ZAGREB 11/A, BEOGRAD RS

(540) MISLI NA VAS

(550) I

(511) **Klasa 35:** oglašavanje, vođenje poslova, poslovno upravljanje, kancelarijski poslovi;(210) **2012-253**(442) **20.04.2014.**

(220) 6/1/2012

(731) **IDEA D.O.O.**, AUTO PUT ZA ZAGREB 11/A, BEOGRAD RS

(540) MISLI O VAMA

(550) I

(511) **Klasa 35:** oglašavanje, vođenje poslova, poslovno upravljanje, kancelarijski poslovi;(210) **2012-254**(442) **20.04.2014.**

(220) 6/1/2012

(731) **TOYOTA JIDOSHA KABUSHIKI KAISHA** (ALSO TRADING AS TOYOTA MOTOR CORPORATION), 1, TOYOTA-CHO, TOYOTA-SHI, AICHI-KEN JP

(540)

(550) I

(740) Čejović Vladimir, 13. jula 21, Podgorica ME

(511) **Klasa 12:** automobili i njihovi strukturni djelovi;(210) **2012-255**(442) **20.04.2014.**

(220) 6/4/2012

(731) **TAVFIK GENERAL TRADING L.L.C.**, OFFICE NO.104, AL HUDA BUILDING, DIERA, DUBAI UAE

(540) PALACE

(550) I

(740) Radulović Božidar, Jovana Tomaševića 9/III, Podgorica ME

(511) **Klasa 34:** duvan, cigarete, filteri za cigarete i šibice;(210) **2012-256**(442) **20.04.2014.**

(220) 6/4/2012

(731) **TAVFIK GENERAL TRADING L.L.C.**, OFFICE NO.104, AL HUDA BUILDING, DIERA, DUBAI UAE

(540) AVALON

(550) I

(740) Radulović Božidar, Jovana Tomaševića 9/III, Podgorica ME

(511) **Klasa 34:** duvan, cigarete, filteri za cigarete i šibice;

(210) **2012-258** (442) **20.04.2014.**
(220) 6/4/2012

(731) **NISSAN JIDOSHA KABUSHIKI KAISHA** (ALSO TRADING AS NISSAN MOTOR CO., LTD), NO.2 TAKARACHO, KANAGAWA-KU, YOKOHAMA-SHI, KANAGAWA-KEN JP

(540) Nissan.Innovation that Excites.

(550) I

(740) Popović Miladin, Đoka Miraševića 21/III, Podgorica ME

(511) **Klasa 12:** Brodovi/čamci i dijelovi i oprema za iste; automobili, električna voz električne automobile, karavani, teretnjaci, kombiji, terenska vozila autobusi, rekreativna vozila (RV), sportski automobili, trkački auto, viljuškari, i traktori za vuču (traktori), i strukturni dijelovi i oprema za i vozila na dva tocka, bicikli i dijelovi i oprema za iste; kolica; auto-kiperi; aparati za vuču automobila; traktori (mašine za vuču); motori i mašine za vozila; osovine za vozila; prijenosnici snage i zupčanici za mašine; kočnice; motori na naizmjeničnu struju/jednosmernu struju, za kopnena vozila, provalni alarmi za vozila; samolepljive gumene zakrpe za popravku unutrašnjih i spoljašnjih guma; sve uključeno u međunarodnu klasu 12.

Klasa 35: Usluge maloprodaje i veleprodaje različitih roba, naime automobila, njihovih dijelovi i opreme (isključujući njihov transport); usluge reklamiranja i publiciteta automobile; promovisanje u svijesti javnosti električnih motornih vozila i promjen načinu života koje oni proizvode; pružanje korisnicima proizvoda usluge vebsajtova koji pružaju informacije o električnim automobilima i informacije koje se odnose na kupovinu takvih automobila; zastupništva u oblasti motornih vozila; pružanje informacija u vezi sa električnim vozilima, naime, potrošačke informacije o proizvodu i poređenje cijena; promovisanje roba i usluga drugih kroz administriranje podsticajnih nagradnih programa koji uključuju distribuciju EV (električnih vozila) i kreditiranje kilometara vožnje; informacione usluge, naime, pružanje informacija u oblasti poređenja cijena na polju benzina.

Klasa 37: Popravljanje ili održavanje automobila, električnih vozila uključujući električne automobile, karavane, kamione, kombije, terenska (SUV) vozila, autobuse, rekreativna vozila, sportske automobile, trkačke automobile, vagonete, viljuškare, i traktore za vuču (traktore), i strukturnih dijelova i opreme za njih; pružanje informacija u vezi sa popravljanjem ili održavanjem automobila, električnih vozila uključujući električne automobile, karavane, kamione, kombije, terenska (SUV) vozila, autobuse, rekreativna vozila, sportske automobile, trkačke automobile, vagonete, viljuškare, i traktore za vuču (traktore), i strukturnih dijelova i opreme za njih; popravljanje ili održavanje mašina i instrumenata za mjerenje ili testiranje; popravljanje ili održavanje mašina i aparata za distribuciju električne energije i kontrolu; popravljanje ili održavanje rotacionih konvertora; popravljanje ili održavanje modifikatora faze; popravljanje ili održavanje punjača; popravljanje ili održavanje baterija i ćelija; popravljanje ili održavanje motora sa unutrašnjim sagorijevanjem; popravljanje ili održavanje dijelova motora sa unutrašnjim sagorijevanjem; popravljanje ili održavanje anlasera za motore i mašine, ne za kopnena vozila; popravljanje ili održavanje dijelova AC motora i DC motora; popravljanje ili održavanje Ac generatora i DC generatora; popravljanje ili održavanje agregata; popravljanje ili održavanje električnih žica i kablova; popravljanje ili održavanje telekomunikacionih uređaja i aparata; popravljanje ili održavanje telefonskih aparata; popravljanje ili održavanje dijelova i dodatne opreme za telekomunikacione mašine i aparate; popravljanje ili održavanje telematskih aparata za vozila; popravljanje ili održavanje aparata za automatsko obavještanje o završetku punjenja; popravljanje ili održavanje navigacionih sistema za vozila, popravljanje ili održavanje elektronskih mašina, aparata, i njihovih di-

jelova; popravljanje ili održavanje sistema na daljinsku kontrolu; popravljanje ili održavanje elektroda; popravljanje ili održavanje magnetnih jezgra; popravljanje ili održavanje otpornosti žica; pružanje usluga pomoći na putu, naročito odgovaranje na telefonske pozive za pomoć pored puta, brzo mijenjanje guma, hitno snabdijevanje gorivom, punjenje baterija i hitno snabdijevanje baterijama; pružanje informacija o stanju vozila, naime status punjenja, potrebno vrijeme za potpuno punjenje, isključen status, napunjen; pružanje informacija o stanju vozila, naime status punjenja, potrebno vrijeme za potpuno punjenje, isključen status, napunjen; pružanje informacija o stanju vozila, naime, podsjećanje vozača da uključi vozilo radi punjenja baterija; usluge održavanja vozila, naime, pružanje elektronskih upozorenja putem interneta koja obavještavaju vlasnike vozila o terminu za održavanje vozila.

(210) **2012-259**

(442) **20.04.2014.**

(220) 6/5/2012

(731) **OLD NAVY (ITM) INC.**, 2 FOLSOM STREET, SAN FRANCISCO, CALIFORNIA, 94105 US

(540) OLD NAVY

(550) I

(740) Lutovac Branislav, Bulevar Crnojevića 93, Podgorica ME

(511) **Klasa 18:** Koža i imitacija kože, proizvodi izrađeni od ovih materijala koji nisu uključeni u druge klase; životinjska koža, krzno; koferi i putne torbe; kišobrani i suncobrani; štapovi za hodanje; bičevi, saračka i sedlarska oprema.

(210) **2012-260**

(442) **20.04.2014.**

(220) 6/5/2012

(731) **OLD NAVY (ITM) INC.**, 2 FOLSOM STREET, SAN FRANCISCO, CALIFORNIA, 94105 US

(540) OLD NAVY

(550) I

(740) Lutovac Branislav, Bulevar Crnojevića 93, Podgorica ME

(511) **Klasa 35:** Oglašavanje; vođenje poslova; poslovno upravljanje; kancelarijski poslovi.

(210) **2012-262**

(442) **20.04.2014.**

(220) 6/8/2012

(731) **JAKKS PACIFIC, INC.**, 22619 PACIFIC COAST HIGHWAY, MALIBU, CALIFORNIA 90265 US

(540) MONSUNO

(550) I

(740) Čejović Vladimir, 13. jula 21, Podgorica ME

(511) **Klasa 16:** Papir za umjetnike; četkice za umjetnike; umjetnički pribor za crtanje i slikanje i glineni pribor za crtanje i slikanje; blanko kartice; dnevници; korice za knjige; obilježivači za knjige; četkice za šablone; kalendari; krede; dječije knjige; olovke i hemijske olovke u boji; kolaž papir; pribadače za table od plute; umjetnički papir; bojice; materijali sa slikama koje mogu da se prenose na druge površine; lenjiri za crtanje i skiciranje; četkice za crtanje; papir za crtanje; kovertе; gumice; poklon kartice; čestitke; praznične čestitke; kese za ručak; markeri; podsjetnici; materijali za modeliranje i mase za dječiju upotrebu; mase za oblikovanje, naime, glina za modeliranje; bilježnice; kartice za bilješke; blokčići; četkice za slikanje; setovi za slikanje za djecu; papirne etikete; pasteli; šabloni za pravljenje odjeće; držači za hemijske olovke; kutije za olovke i hemijske olovke; grafiti za olovke; ukrasi za olovke; hemijske olovke; foto albumi; prenosni pultovi i pultovi koji mogu da se drže u krilu; poster; reprodukcije; pribadače; papirne trake; gumene pečati; školski pribor koji sadrži različite kombinacije odabranih školskih potrepština, naime, šablone, naljepnice i instrumente za pisanje; albumi;

albumi sa markicama; šabloni; stikeri; albumi sa stikerima; privremene tetovaže; slikovne kartice; četkice za pisanje; instrumenti za pisanje; knjige, naime, dječije knjige, stripovi, knjige koje podstiču aktivnost djeteta, bojanke, knjige koje brzim okretanjem stranica stvaraju animaciju i zvučne dječije knjige; knjige iz oblasti stripova, animirani televizijski šou programi; časopisi iz oblasti stripova, animirani televizijski šou programi; časopisi, naime, dječiji časopisi, časopisi sa stripovima; stripovi.

Klasa 28: Igračke, igre i igračke, djelovi igrica koji se skupljaju u kolekcionarske svrhe, kolekcionarske figure, reklamne karte za igru; akcione figure, setovi za igru i prateća oprema za njih; karte za igru; igre sa slikovnim karticama, uređaji koji se drže u rukama za igranje elektronskih igara; dječije igračke sa više aktivnosti; elektronske igračke za učenje; društvene igre, akcione igre vještine, i slagalice.

Klasa 41: Usluge zabave u vidu televizijskog programa koji je u toku, u oblasti zabave za djecu; usluge zabave, naime, obezbjeđivanje televizijskog programa u oblasti zabave za djecu putem globalne kompjuterske mreže, televizije i video medija; usluge zabave, naime obezbjeđivanje zabave u oblasti interaktivnih igrica putem globalne kompjuterske mreže; usluge zabave, naime, obezbjeđivanje onlajn interaktivnih kompjuterskih igrica; obezbjeđivanje sajta edukativnog i zabavnog karaktera za djecu; produkcija televizijskih programa; usluge zabave, naime, televizijski program koji je u toku, sa karakteristikama dječije zabave koji je obezbijeden putem televizije, interneta, satelita, kablovskog i video medija; zabave za djecu i zabavni centri, naime, interaktivni prostori za igru; obrazovne i usluge zabave, naime, obezbjeđivanje onlajn interaktivnih prica za djecu; usluge zabave, naime, obezbjeđivanje onlajn igara, onlajn takmičenja i onlajn informacija igrama i igračkama, namijenjene potrošačima svih starosnih dobi; usluge zabave, naime, obezbjeđivanje onlajn kompjuterskih igara i interaktivnih kompjuterskih igara za više igrača putem globalne mreže; organizovanje i sprovođenje onlajn turnira u igrama i izložbi; obezbjeđivanje emitovanja onlajn kompjuterskih igara putem interneta, satelitskog, kablovskog, audio i video medija; usluge zabave, naime, obezbjeđivanje kompjuterskih igara i video igrica kojima se može pristupiti i koje se mogu igrati putem interaktivne televizijske, širokopojasne, satelitske i kablovske televizijske mreže.

(210) **2012-263** (442) **20.04.2014.**
(220) 6/11/2012

(731) **KIRBY BUILDING SYSTEMS KUWAIT COMPANY S.A.K. (C)**, P.O. BOX 23933, SAFAT-13100 KW

(540) Kirby-graf

(550) I

(740) Čejović Vladimir, 13. jula 21, Podgorica ME

(511) **Klasa 06:** Obični metali i njihove legure; metalni građevinski materijali; metalne prenosive konstrukcije; materijali od metala za željezničke šine; neelektrični kablovi i žice od običnog metala; bravarski proizvodi, mali metalni gvoždarski proizvodi; cjevčice i cijevi od metala; sefovi; proizvodi od obicnih metala koji nisu uključeni u druge klase; rude.

Klasa 37: Građevinsko konstruisanje; popravljanje; usluge instaliranja (postavljanja).

(210) **2012-264** (442) **20.04.2014.**
(220) 6/12/2012

(731) **VIIV HEALTHACARE UK LIMITED**, 980 GREAT WEST ROAD, BRENTFORD, MIDDLESEX TW8 9GS, ENGLAND GB

(540) TIVICAY

(550) I

(740) Lutovac Branislav, Bulevar Crnojevića 93, Podgorica ME

(511) **Klasa 05:** Farmaceutski preparati i supstance za liječenje infektivnih bolesti; farmaceutski preparati i supstance za liječenje virusnih oboljenja i poremećaja.

(210) **2012-265**

(442) **20.04.2014.**

(220) 6/12/2012

(731) **VIIV HEALTHACARE UK LIMITED**, 980 GREAT WEST ROAD, BRENTFORD, MIDDLESEX TW8 9GS, ENGLAND GB

(540) DAZRAY

(550) I

(740) Lutovac Branislav, Bulevar Crnojevića 93, Podgorica ME

(511) **Klasa 05:** Farmaceutski preparati i supstance za liječenje infektivnih bolesti; farmaceutski preparati i supstance za liječenje virusnih oboljenja i poremećaja.

(210) **2012-266**

(442) **20.04.2014.**

(220) 6/12/2012

(731) **KERZNER INTERNATIONAL LIMITED**, ATLANTIS PARADISE ISLAND, CORAL TOWERS EXECUTIVE OFFICE P.O. BOX N4777 NASSAU BS ES

One&Only
(®)

(540)

(550) I

(740) Čejović Vladimir, 13. jula 21, Podgorica ME

(511) **Klasa 36:** Osiguranje; finansijski poslovi; novčani (monetarni) poslovi; poslovi vezani za nepokretnosti; zakup nepokretnosti za kompleks koji čine tržni centri, restorani, pozorišta, i maloprodajne radnje, noćni klubovi i kazina; usluge upravljanja nekretninama.

Klasa 39: Transportne usluge; pakovanje i skladištenje robe; organizovanje putovanja; organizacija putovanja, naime organizovanje i vođenje turističkih obilazaka i pružanje informacija u oblasti turističkih putovanja; usluge turističke agencije, naime rezervisanje i bukiranje prevoza; usluge avio prevoza, naime carter i redovne putničke usluge i usluge kargo avio prevoza; organizovanje ekskurzija za turiste u oblasti podvodnog ronjenja i snorkinga; usluge krstarenja brodom i zakupljivanja broda; ekskurzije razgledanja i uluge marine.

Klasa 41: Obrazovne usluge; pripremanje obuke; razonoda; sportske i kulturne aktivnosti; usluge zabave; zabava u noćnim klubovima; obezbjeđivanje kazino sadržaja i usluga; sportovi na vodi; usluge teretane, pružanje instrukcija i opreme u oblasti fizičkih vježbi; obezbjeđivanje sportskih objekata i teniskih terena; razonoda u vidu turnira u golfu i tenisu, pružajući usluge golf kluba i usluge nosača palica koje su u vezi sa radom golf objekata; konjički objekti; pružanje usluga dječijeg kampa.

Klasa 43: Usluge obezbjeđivanja hrane i pića; privremeni smještaj; obezbjeđivanje usluga odmarališta i prenoćišta; obezbjeđivanje privremenog smještaja; obezbjeđivanje hotelskog smještaja; usluge hotela; usluge resort hotela; organizovanje smještaja u odmaralištima; usluge restorana i barova; obezbjeđivanje kongresnih objekata, obezbjeđivanje objekata (za smještaj) za sastanke i u druge svrhe; usluge turističkih agencija, naime rezervisanje i bukiranje za privremena prenoćišta, rezervisanje i bukiranje za ručavanje;

Klasa 44: Medicinske usluge; veterinarske usluge; higijenska zaštita i njega ljepote za ljude ili životinje; agrikulturne, hortikulturne i šumarske usluge; usluge spa centra i salona ljepote, rezervisanje i bukiranje tretmana u spa centrima i salonima ljepote za druge.

(210) **2012-269** (442) **20.04.2014.**
(220) 6/14/2012

(731) **NOVARTIS AG**, 4002 BASEL CH

(540) LINEXBIO

(550) I

(511) **Klasa 05:** Farmaceutski proizvodi;

(210) **2012-270** (442) **20.04.2014.**
(220) 6/15/2012

(731) **THE COLA-COLA COMPANY**, ONE COLA-COLA PLAZA, ATLANTA, GEORGIA 30313 US

(540) C-GRAF

(550) I

(740) Popović Miladin, Đoka Miraševića 21/III, Podgorica ME

(511) **Klasa 16:** Hartija, karton i proizvodi napravljeni od ovih materijala, koji nijesu uključeni u druge klase; štampane stvari; knjigovezački materijal; fotografije; kancelarijski materijal; ljepila za kancelarijske ili kućne potrebe; umjetnički materijali; Kičice; pisaće mašine i kancelarijski rekviziti (izuzev namještaja); materijali za obuku i nastavu (izuzev aparata); Plastični materijal za pakovanje (koji nije uključen u druge klase); štamparska slova; klišeji.

Klasa 21: Kućne ili kuhinjske sprave i posude; češljevi i sunđereri; četke (izuzev kičica); materijali za pravljenje četki; artikli koji se koriste pri čišćenju; čelična vuna; neprerađeno ili polupreradaeno staklo (osim stakla koje se koristi u građevinarstvu); staklarija, porcelan i grncarija koja nije uključena u druge klase.

Klasa 25: Odjeća, obuća, pokrivala za glavu.

Klasa 28: Igre i igračke; gimnastički i sportski artikli koji nijesu obuhvaćeni drugim klasama; ukrasi za jelke.

Klasa 32: Piva; mineralne i sodne vode i ostala bezalkoholna pića; voćna pića i voćni sokovi; sirupi i drugi preparati za proizvodnju pića.

(210) **2012-271** (442) **20.04.2014.**
(220) 6/18/2012

(731) **D.O.O. UDACA**, 81304 GORIČANI BB, GOLUBOVCI, PODGORICA ME

(540) Mediterranean Conference on Embedded Computing (MECO)

(550) I

(511) **Klasa 35:** Oglašavanje; vođenje poslova; poslovno upravljanje; kancelarijski poslovi.

Klasa 41: Obrazovne usluge; pripremanje obuke, razonoda; sportske i kulturne aktivnosi.

Klasa 42: Naučne i tehnološke usluge i istraživanje i projektovanje u vezi navedenih usluga; usluge industrijske analize i istraživanja; projektovanje i razvoj kompjuterskog hardvera i softvera.

(210) **2012-272** (442) **20.04.2014.**
(220) 6/18/2012

(731) **JOHNSON & JOHNSON (NEW JERSEY CORPRATION)**, ONE JONHSON & JOHN-

SON PLAZA, NEW BRUNSWICK, NEW JERSEY US

ACUVUE[®]
BRAND CONTACT LENSES

SEE WHAT COULD BE™

(540)

(550) I, V

(740) Radulović Božidar, Jovana Tomaševića 9/III, Podgorica ME

(511) **Klasa 09:** Sočiva za korekciju vida, naročito, kontaktna sočiva i sočiva za naočare; kompjuterski softver, naročito multimedijalni softver nasnimljen na CD-ROM-u koji sadrži informacije o nezi očiju i o korekciji vida.

(210) **2012-273**

(442) **20.04.2014.**

(220) 6/18/2012

(731) **AGRIUM INC.**, 13131 LAKE FRASER DRIVE S.E., CALGARY, ALBERTA T2J 7 E8 CA

(540) AGRIUM

(550) I

(740) Čejović Vladimir, 13. jula 21, Podgorica ME

(511) **Klasa 01:** Đubriva, obložena đubriva, đubriva sa kontrolom otpuštanja hranljivih materija, hemijski i biološki sastojci za upotrebu u proizvodnji đubriva.

Klasa 05: Pesticidi, herbicidi, fungicidi, insekticidi i rodenticidi.

Klasa 44: Proizvodnja sjemena i usluge prerade, usluge načina primjene, naime primjene đubriva i drugih poljoprivrednih hemijskih sredstava; konsultantske usluge iz oblasti agronomije.

(210) **2012-274**

(442) **20.04.2014.**

(220) 6/18/2012

(731) **AGRIUM INC.**, 13131 LAKE FRASER DRIVE S.E., CALGARY, ALBERTA T2J 7 E8 CA

Agrium

(540)

(550) I

(740) Čejović Vladimir, 13. jula 21, Podgorica ME

(511) **Klasa 01:** Đubriva, obložena đubriva, đubriva sa kontrolom otpuštanja hranljivih materija, hemijski i biološki sastojci za upotrebu u proizvodnji đubriva.

Klasa 05: Pesticidi, herbicidi, fungicidi, insekticidi i rodenticidi.

Klasa 44: Proizvodnja sjemena i usluge prerade, usluge načina primjene, naime primjene đubriva i drugih poljoprivrednih hemijskih sredstava; konsultantske usluge iz oblasti agronomije.

(210) **2012-275**

(442) **20.04.2014.**

(220) 6/19/2012

(731) **SADARA CHEMICAL COMPANY**, ALTURKI BUSINESS PARK, 7448 KING SUAD ROAD, SUITE 1, DHAHRAN 34455-4088 SA



(540)

(550) I, F

(740) Radulović Božidar, Jovana Tomaševića 9/III, Podgorica ME

(511) **Klasa 01:** hemikalije i neobrađene plastike za daljnu proizvodnju;

(210) **2012-276** (442) **20.04.2014.**
(220) 6/19/2012

(731) **SADARA CHEMICAL COMPANY**, ALTURKI BUSINESS PARK, 7448 KING SUAD ROAD, SUITE 1, DHAHRAN 34455-4088 SA



(540)

(550) I, F

(740) Radulović Božidar, Jovana Tomaševića 9/III, Podgorica ME

(511) **Klasa 01:** hemikalije i neobrađene plastike za daljnu proizvodnju;

(210) **2012-277** (442) **20.04.2014.**
(220) 6/20/2012

(731) **OPEN ENGLISH LLC**, CALLES 50 Y AGUILINO DE LA GUARDIA PLAZA BANCO GENERAL PISO 14 PA

OpenEnglish™

(540)

(550) I

(740) Čejović Vladimir, 13. jula 21, Podgorica ME

(511) **Klasa 41:** Usluge obrazovanja i jezičke nastave, posebno, vođenje neformalnih onlajn programa za učenje jezika i dostavu materijala. Usluge obrazovanja, naime, obezbjeđivanje kurseva na srednjoškolskom nivou i distribuiranje materijala u vezi sa ovim kursevima, obezbjeđujući sredstva za obrazovnu i jezičku nastavu.

(210) **2012-278** (442) **20.04.2014.**
(220) 6/20/2012

(731) **JOHNSON & JOHNSON (NEW JERSEY CORPORATION)**, ONE JOHNSON & JOHNSON PLAZA, NEW BRUNSWICK, NEW JERSEY US

(540) LISTERINE ULTRACLEAN

(550) I

(740) Radulović Božidar, Jovana Tomaševića 9/III, Podgorica ME

(511) **Klasa 03:** Ne-medicinske vodice za usta;

Klasa 05: Medicinske vodice za usta; vodice za usta sa fluoridom.

(210) 2012-280

(442) 20.04.2014.

(220) 6/22/2012

(731) DŽEK POT DOO, RIMSKI TRG 50 PODGORICA ME



(540)

(550) I

(740) Božović Vesko, Rimski trg 50/11, Podgorica ME

(511) **Klasa 09:** Aparati i instrumenti naučni, pomorski, geodetski, fotografski, kinematografski, optički, za vaganje, merenje, signalizaciju, kontrolu (inspekciju), spasavanje i nastavu; aparati i instrumenti za provođenje, prekid, transformaciju, akumulaciju, regulisanje ili kontrolu električne energije; aparati za snimanje, prenos i reprodukovanje zvuka ili slike; magnetni nosioci podataka, diskovi za snimanje; automatske mašine i mehanizmi za aparate koji se pokreću novcem ili žetonom; kancelarijske mašine sa perforiranim karticama; aparati za razonodu koji koriste spoljni ekran ili monitor; svi kompjuterski programi i softveri bez obzira na medijum na koji su snimljeni ili način diseminacije tj. softver snimljen na magnetnim nosačima podataka ili učitani sa udaljene kompjuterske mreže.

Klasa 28: Igre i igračke; opremu za različite sportove i igre, karte za igru.

Klasa 41: Obrazovne usluge; pripremanje obuke; razonoda; sportske i kulturne aktivnosti.

(210) 2012-281

(442) 20.04.2014.

(220) 6/22/2012

(731) DŽEK POT DOO, RIMSKI TRG 50 PODGORICA ME



(540)

(550) I

(740) Božović Vesko, Rimski trg 50/11, Podgorica ME

(511) **Klasa 09:** Aparati i instrumenti naučni, pomorski, geodetski, fotografski, kinematografski, optički, za vaganje, merenje, signalizaciju, kontrolu (inspekciju), spasavanje i nastavu; aparati i instrumenti za provođenje, prekid, transformaciju, akumulaciju, regulisanje ili kontrolu električne energije; aparati za snimanje, prenos i reprodukovanje zvuka ili slike; magnetni nosioci podataka, diskovi za snimanje; automatske mašine i mehanizmi za aparate koji se pokreću novcem ili žetonom; kancelarijske mašine sa perforiranim karticama; aparati za razonodu koji koriste spoljni ekran ili monitor; svi kompjuterski programi i softveri bez obzira na medijum na koji su snimljeni ili način diseminacije tj. softver snimljen na magnetnim nosačima podataka ili učitani sa udaljene kompjuterske mreže.

Klasa 28: Igre i igračke; opremu za različite sportove i igre, karte za igru.

Klasa 41: Obrazovne usluge; pripremanje obuke; razonoda; sportske i kulturne aktivnosti.

(210) **2012-282** (442) **20.04.2014.**

(220) 6/22/2012

(731) **DŽEK POT DOO**, RIMSKI TRG 50, PODGORICA ME



(540)

(550) I

(740) Božović Vesko, Rimski trg 50/11, Podgorica ME

(511) **Klasa 09:** Aparati i instrumenti naučni, pomorski, geodetski, fotografski, kinematografski, optički, za vaganje, merenje, signalizaciju, kontrolu (inspekciju), spasavanje i nastavu; aparati i instrumenti za provođenje, prekid, transformaciju, akumulaciju, regulisanje ili kontrolu električne energije; aparati za snimanje, prenos i reprodukovanje zvuka ili slike; magnetni nosioci podataka, diskovi za snimanje; automatske mašine i mehanizmi za aparate koji se pokreću novcem ili žetonom; kancelarijske mašine sa perforiranim karticama; aparati za razonodu koji koriste spoljni ekran ili monitor; svi kompjuterski programi i softveri bez obzira na medijum na koji su snimljeni ili način diseminacije tj. softver snimljen na magnetnim nosačima podataka ili učitani sa udaljene kompjuterske mreže.

Klasa 28: Igre i igračke; opremu za različite sportove i igre, karte za igru.

Klasa 41: Obrazovne usluge; pripremanje obuke; razonoda; sportske i kulturne aktivnosti.

(210) **2012-283** (442) **20.04.2014.**

(220) 6/22/2012

(731) **CADBURY UK LIMITED** A COMPANY INCORPORATED UNDER THE LAWS OF THE UK, P.O.BOX 12, BOURNVILLE LANE, BOURNVILLE, BIRMINGHAM B30 2LU UK

(540) BOURNVILLE

(550) I

(740) AOD "Ćupić", Dalmatinska 10, Podgorica ME

(511) **Klasa 30:** Čokolada, čokoladni proizvodi, ne-medicinski konditorski proizvodi, konditorski proizvodi sa šećerom, keks i biskviti, napolitanke, kolači, pecivo, cerealne pločice, proizvodi od žitarica, grickalice, čokoladni napitci, preparati od kakaoa za pravljenje napitaka na bazi kakaoa ili čokolade, sladoled i ledene poslastice, dezerti obuhvaćeni ovom klasom.

(210) **2012-284** (442) **20.04.2014.**

(220) 6/22/2012

(731) **CADBURY UK LIMITED** A COMPANY INCORPORATED UNDER THE LAWS OF THE UK, P.O.BOX 12, BOURNVILLE LANE, BOURNVILLE, BIRMINGHAM B30 2LU UK

(540) CADBURY

(550) I

(740) AOD "Ćupić", Dalmatinska 10, Podgorica ME

(511) **Klasa 30:** Čokolada, čokoladni proizvodi, ne-medicinski konditorski proizvodi, konditorski proizvodi sa šećerom, keks i biskviti, napolitanke, kolači, pecivo, cerealne pločice, proizvodi od žitarica, grickalice, čokoladni napitci, preparati od kakaoa za pravljenje napitaka na bazi kakaoa ili čokolade, sladoled i ledene poslastice, dezerti obuhvaćeni ovom klasom.

(210) **2012-285** (442) **20.04.2014.**

(220) 6/22/2012

(731) **CADBURY UK LIMITED** A COMPANY INCORPORATED UNDER THE LAWS OF THE UK, P.O.BOX 12, BOURNVILLE LANE, BOURNVILLE, BIRMINGHAM B30 2LU UK

(540) CADBURY CHOCLAIRS

(550) I

(740) AOD "Ćupić", Dalmatinska 10, Podgorica ME

(511) **Klasa 30:** Čokolada, čokoladni proizvodi, ne-medicinski konditorski proizvodi, konditorski proizvodi sa šećerom, keks i biskviti, napolitanke, kolači, pecivo, cerealne pločice, proizvodi od žitarica, grickalice, čokoladni napitci, preparati od kakaoa za pravljenje napitaka na bazi kakaoa ili čokolade, sladoled i ledene poslastice, dezerti obuhvaćeni ovom klasom.

(210) **2012-286** (442) **20.04.2014.**

(220) 6/22/2012

(731) **INTERNATIONAL GREAT BRANDS LLC**, 100 DEFOREST AVENUE, EAST HANOVER, NJ 07936 US

(540) DENTYNE ICE

(550) I

(740) AOD "Ćupić", Dalmatinska 10, Podgorica ME

(511) **Klasa 30:** ne-medicinski konditorski proizvodi, konditorski proizvodi sa šećerom, uključujući gume za žvakanje.

(210) **2012-287** (442) **20.04.2014.**

(220) 6/22/2012

(731) **INTERNATIONAL GREAT BRANDS LLC**, 100 DEFOREST AVENUE, EAST HANOVER, NJ 07936 US

(540) HALLS BREEZ

(550) I

(740) AOD "Ćupić", Dalmatinska 10, Podgorica ME

(511) **Klasa 30:** ne-medicinski konditorski proizvodi, konditorski proizvodi sa šećerom, uključujući

jući gume za žvakanje.

(210) **2012-288** (442) **20.04.2014.**
(220) 6/22/2012

(731) **INTERNATIONAL GREAT BRANDS LLC**, 100 DEFOREST AVENUE, EAST HANOVER, NJ 07936 US

(540) HALLS CENTERS

(550) I

(740) AOD "Ćupić", Dalmatinska 10, Podgorica ME

(511) **Klasa 30:** ne-medicinski konditorski proizvodi, konditorski proizvodi sa šećerom, uključujući gume za žvakanje.

(210) **2012-289** (442) **20.04.2014.**
(220) 6/22/2012

(731) **INTERNATIONAL GREAT BRANDS LLC**, 100 DEFOREST AVENUE, EAST HANOVER, NJ 07936 US

(540) MAXAIR

(550) I

(740) AOD "Ćupić", Dalmatinska 10, Podgorica ME

(511) **Klasa 30:** ne-medicinski konditorski proizvodi, konditorski proizvodi sa šećerom, uključujući gume za žvakanje.

(210) **2012-29** (442) **20.04.2014.**
(220) 1/23/2012

(300) 302011040062 22.07.2011. DE

(731) **DEUTCHE TELEKOM AG**, FRIEDRICH-EBERT-ALLEE 140 53113 BONN DE

Cloud Center

(540)

(550) I

(740) Popović Miladin, Đoka Miraševića 21/III, Podgorica ME

(511) **Klasa 09:** Aparati i instrumenti naučni, pomorski, geodetski, fotografski, kinematografski, optički, za vaganje, merenje, signalizaciju, kontrolu (inspekciju), spašavanje i nastavu; aparati i instrumenti za provođenje, prekid, transformaciju, akumulaciju, regulisanje ili kontrolu elektriciteta; aparati za snimanje, prenos, obradu i reprodukovanje zvuka, slika ili podataka; magnetni nosioci podataka, automatske mašine i mehanizmi za aparate koji se pokreću novcem ili žetonom; računске mašine, oprema za obradu podataka i kompjuteri; snimljeni i nesnimljeni nosioci podataka (koji su uključeni u ovu klasu), kompjuterski programi (snimljeni), elektronski sačuvani podaci (koji se mogu daunlodovati); elektronske publikacije (koje se mogu preuzeti), elektronske publikacije (koje se mogu preuzeti);

Klasa 35: Oglašavanje; vođenje poslova; poslovno upravljanje; kancelarijski, poslovi prikupljanje, sistematizacija, sastavljanje i stručna poslovna analiza podataka i informacija u kompjuterskim bazama podataka; usluge maloprodaje (uključujući putem interneta i drugih komunikacijskih mreža) roba iz klasa 9 i 16;

Klasa 38: Telekomunikacije, usluge novinskih agencija; usluge iznajmljivanja, opreme za tele-

komunikacije; usluge informisanja u vezi sa telekomunikacijama.

Klasa 42: Naučne i tehnološke usluge i istraživanje i projektovanje u vezi sa njima; usluge industrijske analize i istraživanja; projektovanje i razvoj kompjuterskog hardvera, softvera i baza podataka; održavanje kompjuterskog softvera; tehnicke konsultacije; kompjuterske usluge u vezi sa elektronskim čuvanjem podataka; iznajmljivanje opreme za obradu podataka; dizajniranje veb stranica za druge.

(210) **2012-290** (442) **20.04.2014.**
(220) 6/22/2012

(731) **GENERAL MOTORS LLC**, 300 RENAISSANCE CENTER, DETROIT, MICHIGAN 48265-3000 US

(540) LTS

(550) I, V

(740) Radulović Božidar, Jovana Tomaševića 9/III, Podgorica ME

(511) **Klasa 12:** motorna vozila i djelovi za njih;

(210) **2012-292** (442) **20.04.2014.**
(220) 6/25/2012

(731) **SRPSKO-CRNOGORSKI POSLOVNI KLUB**, UL. JOVANA TOMAŠEVIĆA 9 PODGORICA ME



**SRPSKO CRNOGORSKI
POSLOVNI KLUB**

(540)

(550) I, V

(511) **Klasa 35:** klasifikacije usluga, Oglašavanje; Vođenje poslova; Poslovno upravljanje; Kancelarijski poslovi

(210) **2012-294** (442) **20.04.2014.**
(220) 6/25/2012

(731) **UNI-CHARM CORPRATION**, 182 SHIMOBUN, KINSEI-CHO, SHIKOKUCHUO-CHI, EHIME-KEN JP

(540) unichram

(550) I, V

(740) Radulović Božidar, Jovana Tomaševića 9/III, Podgorica ME

(511) **Klasa 03:** Sredstva za beljenje i druge supstance za upotrebu pri pranju; preparati za čišćenje, poliranje, ribanje i nagrizanje; sapuni; parfimerija, eterična ulja, kozmetika, losioni za kosu; paste za zube; naročito ubrusi za bebe (vlažni ili impregnirani ubrusi za brisanje), vlažne maramice (vlažne ili impregnirane maramice za brisanje).

Klasa 05: Farmaceutski i veterinarski preparati; sanitarni proizvodi za upotrebu u medicini; dijetetska hrana i supstance prilagođene za upotrebu u medicini ili veterinarsku upotrebu, hrana za bebe; dijetetski dodaci (dodaci ishrani) za ljude i životinje; flasteri, materijali za zavijanje; materijali za plombiranje zuba, zubarska smola; dezinfekciona sredstva; preparati za uništavanje štetočina; fungicidi, herbicidi; naročito higijenski ulošci; dnevni ulošci (higijenski); tamponi za menstruaciju; higijenske gaćice; pelene; pelene za bebe u obliku gaćica;

jednokratne pelene od papira ili celuloze za bebe; pelene od papira ili celuloze u obliku gaćica za bebe; pelene za bebe; pelene za inkontinenciju; pelene za inkontinenciju od papira ili celuloze u obliku gaća; ulošci za inkontinenciju; tanki ulošci za inkontinenciju; gaće za inkontinenciju; ulošci za grudi za dojilje; muške gaće za inkontinenciju; higijenske maske; zavoji za previjanje; lepljivi flasteri; upijajući pamuk; gaze za previjanje; nauljeni papirza medicinske svrhe; farmaceutski nosač za tablete u obliku filma; laktoza (mlečni šećer); mleko u prahu (za bebe); obloge za oko za medicinske svrhe; zavoji za uši; vlažne maramice (maramice impregnirane farmaceutskim losionom).

Klasa 16: Hartija, karton i proizvodi od njih, koji nisu uključeni u druge klase; štampane stvari; knjigovezački materijal; fotografije; kancelarijski materijal; lepkovi za kancelarijske i kućne potrebe; umetnički materijali; Kičice; pisaće mašine i kancelarijski pribor (izuzev nameštaja); materijali za obuku i nastavu (izuzev aparata); Plastični materijal za pakovanje (koji nije uključen u druge klase); štamparska slova; klišei; naročito vlažne maramice; ubrusi za bebe; toaletni papir; kancelarijski pribor i materijal za učenje; kuhinjski papir; papirne krpe za prašinu; magazini (publikacije); industrijske kutije od papira za pakovanje; higijenski ubrusi za ruke od papira; papirni ubrusi; papirni stolnjaci; ubrusi za ruke od papira; papirne maramice.

(210) **2012-295** (442) **20.04.2014.**
(220) 6/26/2012

(731) **AKZO NOBEL COATINGS INTERNATIOANL B.V.**, VELPERWEG 76, 6824 BM ARNHEM NL

(540) WEATHERSHIELD

(550) I, V

(740) AOD "Ćupić", Dalmatinska 10, Podgorica ME

(511) **Klasa 02:** Boje, firnajzi, lakovi; razređivači, materije za boje, svi kao dodaci za boje, firnajze ili lakove; sredstva za zaštitu od rđe i truljenja drveta; osnovni premazi (u smislu boja); boje za drvo.

(210) **2012-296** (442) **20.04.2014.**
(220) 6/26/2012

(731) PHILIP MORRIS BRANDS SARL, QUAI JEANRENAUD 3 NEUCHATEL, 2000 CH



(540)

(550) I, F

(511) **Klasa 34:** Duvan, sirov ili prerađen; proizvodi od duvana, naročito cigare, cigarete, cigarilosi/male cigarete, duvan za uvijanje cigareta, duvan za lule, duvan za žvakanje, duvan za šmrkanje, kretek; snus (mokri duvanski prah kao duvanski proizvod); zamena za duvan (za nemedicinsku upotrebu); proizvodi za pušače, naročito: papir za cigarete i lule, filteri za cigarete, kutije za duvan (od neplemenitih metala), kutije za cigarete i pepeljare (od neplemenitih metala), lule, ručni aparati/spravice za uvijanje cigareta, upaljači, šibice.

(210) **2012-298** (442) **20.04.2014.**
(220) 6/26/2012

(731) **GOOGLE INC.**, 1600 AMPHITHEATRE PARKWAY, MOUNTAIN VIEW, CA 94043 US

(540) GLASS

(550) I, V

(740) AOD "Ćupić", Dalmatinska 10, Podgorica ME

(511) **Klasa 09:** Kompjuterski hardver; kompjuterski periferni uređaji; nosivi kompjuterski periferni uređaji; periferni uređaji za mobilne aparate; nosivi periferni uređaji za mobilne aparate; kompjuterski hardver za daljinski pristup podacima i prenos podataka; kompjuterski periferni uređaji za daljinski pristup podacima i prenos podataka; periferni uređaji za mobilne aparate za daljinski pristup podacima i prenos podataka; kompjuterski hardver za prikazivanje podataka i video zapisa; kompjuterski periferni uređaji za prikazivanje podataka i video zapisa; periferni uređaji za mobilne aparate za prikazivanje podataka i video zapisa; kompjuterski softver.

(210) **2012-299**

(442) **20.04.2014.**

(220) 6/26/2012

(731) **MERCK SHARP & DOHME CORP.** A NEW JERSEY CORPRATION, ONE MERCK DRIVE, WHITEHOUSE STATION, NJ 08889 US

(540) DIPROBABY

(550) I, V

(740) AOD "Ćupić", Dalmatinska 10, Podgorica ME

(511) **Klasa 03:** Ne-medicinski preparati za kožu.

Klasa 05: Medicinski preparati za kožu.

(210) **2012-300**

(442) **20.04.2014.**

(220) 6/26/2012

(731) **MERCK SHARP & DOHME CORP.** A NEW JERSEY CORPRATION, ONE MERCK DRIVE, WHITEHOUSE STATION, NJ 08889 US

(540) ELOBABY

(550) I, V

(740) AOD "Ćupić", Dalmatinska 10, Podgorica ME

(511) **Klasa 03:** Ne-medicinski preparati za kožu.

Klasa 05: Medicinski preparati za kožu.

(210) **2012-302**

(442) **20.04.2014.**

(220) 6/26/2012

(731) **DRUŠTVO ZA ZASTUPANJE U OSIGURANJU SAFE INVEST CG.D.O.O.**, BULEVAR SVETOG PETRA CETINJSKOG 1 A PODGORICA ME



(540)

(550) I

(511) **Klasa 36:** osiguranje i finasijski poslovi;(210) **2012-303**(442) **20.04.2014.**

(220) 6/26/2012

(731) **DRUŠTVO ZA ZASTUPANJE U OSIGURANJU SAFE INVEST CG.D.O.O.**, BULEVAR SVETOG PETRA CETINJSKOG 1 A PODGORICA ME

(540)

(550) I

(511) **Klasa 36:** osiguranje i finasijski poslovi;(210) **2012-304**(442) **20.04.2014.**

(220) 6/26/2012

(731) **DRUŠTVO ZA ZASTUPANJE U OSIGURANJU SAFE INVEST CG.D.O.O.**, BULEVAR SVETOG PETRA CETINJSKOG 1 A PODGORICA ME

(540)

(550) I

(511) **Klasa 36:** osiguranje i finasijski poslovi;(210) **2012-306**(442) **20.04.2014.**

(220) 6/29/2012

(731) **ZORAN IVANOVIĆ**, ZLATICA BB 20000 PODGORICA ME

(540)

(550) I

(511) **Klasa 33:** Alkoholna pića;

(210) **2012-307**(442) **20.04.2014.**

(220) 6/29/2012

(731) **MILAN BABOVIĆ**, 13.JUL S 70, 85310 BUDVA ME

(540)

(550) I

(511) **Klasa 25:** Odjeća, obuća, pokrivala za glavu.**Klasa 35:** Oglašavanje; vođenje poslova; poslovno upravljanje; kancelarijski poslovi.**Klasa 40:** Obradivanje materijala.- usluge koje se odnose na transformaciju objekta ili supstance i na bilo koji proces koji uključuje promjene esencijalnih svojstava (na primjer: bojenje odeće); shodno tome, usluge održavanja, iako obično u klasi 37, uključene su u klasu 40, ako podrazumijevaju takvu promjenu (na primjer hromiranje branika motornih vozila); usluge materijalnog tretmana tokom proizvodnje bilo koje supstance ili objekta izuzev u građevini, na primer usluge koje uključuju sečenje, oblikovanje, poliranje abrazijom ili oblaganje metalom.(210) **2012-312**(442) **20.04.2014.**

(220) 6/29/2012

(300) 2012-627 14.06.2012. RM

(731) **RM SH.P.K**, LAGNJA NR.4, SARANDE 9701 AL

(540)

(550) I

(740) Radulović Božidar, Jovana Tomaševića 9/III, Podgorica ME

(511) **Klasa 05:** Veterinarski i sanitarni preparati, za upotrebu u medicini, dezinfekciona sredstva, preparati za uništavanje štetočina, fungicidi, herbicidi.**Klasa 08:** Sprej protiv muva i svih drugih vrsta insekata.

(210) 2012-313

(442) 20.04.2014.

(220) 7/2/2012

(731) **KABUSHIKI KAISHA HITACHI SEISAKUSHO** (D.B.A.HITACHI, LTD), 6-6, MARU-NOICHI 1-CHOME, CHIYODA-KU, TOKYO JP

(540)

(550) I, F

(740) Radulović Božidar, Jovana Tomaševića 9/III, Podgorica ME

(511) **Klasa 03:** Sredstva za beljenje i druge supstance za upotrebu pri pranju; preparati za čišćenje, poliranje, ribanje i nagrizanje; sapuni; parfimerija, eterična ulja, kozmetika, losioni za kosu; paste za zube.**Klasa 04:** Industrijska ulja i masti; maziva; jedinjenja za skupljanje, vlaženje i vezivanje prašine; goriva (uključujući motorna tečna goriva) i materije za osvetljavanje; sveće i fitilji za osvetljavanje.**Klasa 05:** Farmaceutski i veterinarski preparati; sanitarni proizvodi za upotrebu u medicini; dijetetska hrana i supstance prilagođene za upotrebu u medicini ili veterinarsku upotrebu, hrana za bebe; dijetetski dodaci (dodaci ishrani) za ljude i životinje; flasteri, materijali za zavijanje; materijali za plombiranje zuba, zubarska smola; dezinfekciona sredstva; preparati za uništavanje štetočina; fungicidi, herbicidi.**Klasa 11:** Aparati za osvetljavanje, grejanje, proizvodnju pare, kuvanje, hlađenje, sušenje, ventilaciju, snabdevanje vodom i za sanitarne svrhe, naročito instalacije i uređaji za tretman otpada i otpadnih voda, Sistemi za tretman dimnih gasova, Sistemi za odsumporavanje dimnih gasova, Sistemi za uklanjanje NOx, Spalionice otpada, Delovi i oprema uključeni u klasu 11 za svu gore navedenu robu, Akumulatori (toplote), Akumulatori (pare), Acetilenski gorionici, Acetilenske baklje, Generatori acetilena, Klima uređaji za automobile, Klimatizacioni uređaji, Klimatizaciona postrojenja, Uređaji za hlađenje vazduha, Uređaji za dezodoriranje vazduha, Uređaji za sušenje vazduha (sušaci), Postrojenja za filtriranje vazduha, Jonizujućii uređaji za tretman vazduha ili vode, Uređaji i mašine za prečišćavanje vazduha, Dогреваči vazduha, Sterilizatori vazduha, Ispusni ventili za uređaje parnog grejanja, Svetlosni uređaji za vazduhoplove, Alkoholni gorionici, Protivzaslepljujuci uređaji za automobile, Antirefleksijki uređaji za automobile (pribor za svetla), Nastavci za slavine za sprečavanje prskanja, Uređaji za filtriranje akvarijuma, Grejači akvarijuma, Svetla za akvarijume, Lučne lampe, Posude za pepeo iz peći, Automatski uređaji za transport pepela, Odlagališta pepela iz peći, nuklearni reaktor (sa grafitnim jezgrom + uranijum), Autoklavi (električne visokopritisne peci), Automobilaska svetla, Protivzaslepljujuci uređaji za automobile, Pekarske peći, Kamenje lave za korišćenje u roštiljima, Roštilji, Oprema za kupatila, Oprema za kupatila sa vrucim

vazduhom, Instalacije za kupatila, Instalacije za kupatila za saune, Obloge za kupatila, Vodovodna instalacija u kupatilima, Kade za kupatila, Sedežne kade, Grejači za kupatila, Posude za spa - kupatila, Grejači za krevet, Uređaji za hlađenje napitaka, Svetla za bicikle, Bidei, Električna čebad (ne za medicinsku upotrebu), Kotlovske cevi instalacija za grejanje, Kotlovi (koji nisu delovi mašina), Nosači za gasne gorionike, Aparati za pečenje hleba, Tosteri, Aparati za pravljenje hleba, Gorionici, Acetilenski gorionici, Gorionici za svetiljke, Gasni gorionici, Germicidalni gorionici, Gorionici sa užarenim nitima, Laboratorijski gorionici, Ugljenik za lučne lampe, Električno grejani tepisi, Plafonska svetla, Radijatori za centralno grejanje, Sterilne komore (sanitarne instalacije), Lusteri, Ventilatori dimnjaka, Kanali dimnjaka, Staklene cevi za lampe, Kineske lampe, Električne svetiljke za novogodišnje drvo, Hromatografski uređaj za industrijsku namenu, Sterilne komore (sanitarne instalacije), Filteri za kafu (električni), Aparati za kafu (električni), Posude za pripremu kafe (električne), Aparati za prženje kafe, Spiralne cevi (delovi instalacija za destilaciju, grejanje ili hlađenje), Gasni kondenzatori (koji nisu delovi mašina), Postrojenja za klimatizacija vazduha, Rashladne posude, Šporeti, Uređaji i instalacije za kuvanje, Ringle za kuvanje, Električne naprave za kuvanje, Hladnjaci za peći, Aparati i postrojenja za hlađenje, Instalacije i mašine za hlađenje, Postrojenja za hlađenje tečnosti, Postrojenja za hlađenje duvana, Postrojenja za hlađenje vode, Kabine za tuširanje, Uvijena lampa, Električno grejani jastuci (ne za medicinsku upotrebu), Svetla za bicikle, Žaluzine (klapne) za grejanje, Električne friteze, Uređaji za odležavanje u vozilima, Grejni uređaji za odmrzavanje prozora vozila, Uređaji za dehidrataciju prehrambenih organskih proizvoda, Zubarske peći, Uređaji za dezodoriranje (ne za ličnu upotrebu), Postrojenja za desalinaciju, Aparati za sušenje, Raspršivači svetla, Cevi za električno pražnjenje za rasvetu, Uređaji za dezinfekciju, Dezinfekcioni dozatori za toalete, Dezinfekcioni raspršivači za toalete, Rashladne vitrine, Jednokratne vrećice za sterilizaciju, Uređaj za destilaciju, Destilacijske cevi(kolone), Svetla za ronjenje, Sušaci vazduha, Sušaci za kosu, Filteri za vodu za piće, Uređaji za navodnjavanje kapljanjem (pribor za navodnjavanje), Sušaci vazduha, Sušaci za kosu, Aparati za sušenje, Uređaji i instalacije za sušenje, Uređaji za sušenje krmiva, Ekonomajzeri za gorivo, Električni uređaji za proizvodnju jogurta, Električne lampe, Električno grejani tepisi, Grejni elementi, Isparivači, Ekspanzioni sudovi instalacija za centralno grejanje, Usisne nape za kuhinje, Ukrasne svetiljke za svecanu dekoraciju, Ventilatori za klimatizaciju, Električni ventilatori za ličnu upotrebu, Ventilatori (kao delovi instalacije za klimatizaciju), Slavine za cevi, Uređaji za punjenje kotlova/bojlera za grejanje, Električni grejači za flaše sa cuclom, Električna grejana vlakna, Vlakna za električne lampe, Magnezijumska vlakna za rasvetu, Električni filteri (za kafu), Filteri za klima uređaje, Filteri za vodu za piće, Filteri (kao delovi instalacije domaćinstva ili industrijske instalacije), Rešetke kamina, Kamini (kućni), Oprema za kupatila, Oblikovani pribor za peći, Oblikovani pribor za rerne, Dimnjački gorionik/baklja za upotrebu u naftnoj industriji, Baklje, Svetiljke (lampe), Dimnički kanali, Kanali kotlova za grejanje, Uređaji za ispiranje, Rezervoari za ispiranje, Električni grejači za stopala, Grejači za stopala (električni i ne-električni), Uređaji za sušenje krmiva, Prenosive kovačnice/železare, Fontane, Ukrasne fontane, Metalni okvir za peći, Zamrzivači, Upaljači sa kremenom za paljenje gasa, Uređaji za prženje voća, Ekonomajzeri goriva, Uređaj za nadimljavanje (ne za medicinsku upotrebu), Posude za pepeo iz peći, Rešetke peći, Hladnjaci za peći, Rashladne posude za peći, Uređaji za punjenje peći, Peći (koje nisu za laboratorijsku upotrebu), Oblikovani pribor za peći, Regulaciona i sigurnosna oprema za gasne uređaje, Gasni bojleri, Gasni gorionici, Nosači za gasne gorionike, Gasni kondenzatori (koji nisu deo mašina), Gasne lampe, Gasni upaljači, Regulaciona i sigurnosna oprema za cevi za gas, Skruberi (kao deo gasne instalacije), Uređaji za prečišćavanje gasa, Acetilenski generatori, Germicidalni gorionici, Germicidalne lampe za prečišćavanje vazduha, Uređaji za grejanje lepka, Rešetke za peći, Roštilj (aparati za kuvanje), Gril (aparati za kuvanje), Sušaci kose, Aparati za sušenje ruku,

Prednji farovi za automobile, Ognjišta, Akumulatori toplote, Razmenjivači toplote (koji nisu deo mašina), Toplotne pumpe, Rekuperatori, Električni grejači za flaše sa cuclom, Grejači za kupatila, Grejači za pegle, Grejači za vozila, Uronjivi grejači, Uređaji za grejanje, Električni uređaji za grejanje, Grejni uređaji za odleđivanje prozora vozila, Uređaji za grejanje čvrstih, tečnih ili gasovitih goriva, Kotlovi za grejanje, Električni grejani jastuci (ne za medicinsku upotrebu), Grejni elementi, Grejana vlakna (električna), Instalacije za grejanje, Instalacije za grejanje tople vode, Instalacije za grejanje vode, Ploče za grejanje, Usisne nape za kuhinje, Uređaji za topli vazduh, Oprema za kupatila sa toplim vazduhom, Peći sa vrućim vazduhom, Grejuće ploče, Termofori, Svetleći kućni brojevi, Vlažioci vazduha za radijatore centralnog grejanja, Hidranti, Uređaji hidromasažnih kada, Posude za led, Sanduci za led, Mašine i uređaji za pravljenje leda, Uronjeni grejači, Gorionici sa užarenim nitima, Spalionice otpada, Jonizujući uređaji za tretman vode ili vazduha, Grejač vode (električni), Postolja za punjenje u pećima za sušenje, Peći za sušenje, Kuhinjske peći, Laboratorijski gorionici, Laboratorijske lampe, Kućišta lampi, Lampe sa staklenim cevima, Staklene lampe, Lampe sa staklenim kuglama, Omotač/ogrtac za lampe, Reflektorske lampe, Abadžuri, Lampe, Gorionici za lampe, Električne lampe, Automobilske lampe za pokazivače pravca, staklene kugle za lampe, Držači abažura, Fenjeri za rasvetu, Uređaji sa sušenje veša (električni), Kotlovi za perionice veša, Kamenje lave za korišćenje u roštiljima, Ventili za kontrolu nivoa u rezervoarima, Sijalice, Sijalice (električne), Sijalice za pokazivače pravca u vozilima, Raspršivači svetla, Diode za emitovanje svetla (LED) svetlosnih uređaja, Upaljači, Gasni upaljači, Uređaji i instalacije za rasvetu, Uređaji za rasvetu u vozilima, Instalacije za rasvetu za zračna vozila, Ronilačka svetla, Električne svetiljke za novogodišnje drvo, Svetla za automobile, Svetla za vozila, Uređaji za punjenje peći, Svetleći kućni brojevi, Svetleće cevi za rasvetu, Magnezijumska vlakna za rasvetu, Pržionik slada, Mikrotalasna pećnica (aparati za kuvanje), Mikrotalasne pećnice za industrijsku upotrebu, Instalacije za hlađenje mleka, Rudarske lampe, Mešajuće slavine za vodovodne cevi, Nastavci protiv prskanja za slavine, Instalacije za obradu nuklearnog goriva i nuklearnih moderatora, Nuklearni reaktori, Uljni gorionici, Uljne lampe, Uređaji za prečišćavanje ulja, Ukrasne fontane, Pribor za peći израđen od šamota, Mikrotalasne pećnice za industrijsku upotrebu, Peći (koje nisu za laboratorijsku upotrebu), Oblikovani pribor za peći, Hidro-oksigeni gorionici, Električno grekani jastuci (ne za medicinsku upotrebu), Pasterizatori, Električne posude za kuvanje kafe, Petrolejski gorionici, Slavine za cevovode, Cevi (kao deo sanitarnih instalacija), Pločasti zagrejači, Grejuće ploče, Džepne lampe, Džepne svetiljke (električne), Džepni zagrejači, Postrojenja za polimerizaciju, Jednokratne vrećice za sterilizaciju, Visokopritisne peći - autoklavi (električni), Električne posude za kuvanje pod pritiskom, Rezervoari za vodu pod pritiskom, Uređaji za obradu goriva i nuklearnog moderatora, Lampe projektora, Postrojenja za prečišćavanje otpadne vode, Čepovi za radijatore, Radijatori (električni), Radijatori za grejanje, Nuklearni reaktori, Tornjevi za prečišćavanje za destilaciju, Reflektorske lampe, Reflektori za vozila, Rashladni uređaji i mašine, Rashladni aparati i instalacije, Rashladni ormari, Rashladne komore, Rashladne posude, Rashladne vitrine, Hladnjaci, Rekuperatori toplote, Regulacijska oprema za uređaje i cevi za vodu ili gas, Regulacijska i sigurnosna oprema za gasne uređaje, Regulacijska i sigurnosna oprema za gasovode, Regulacijska i sigurnosna oprema za uređaje za vodu, Dogrevači vazduha, Uređaji za prženje, Uređaji za prženje kafe, Aparatura za prženje, Uređaji za obrtanje ražnja, Ražnjevci, Uređaji za pecenje na ražnju, Sigurnosna oprema za uređaje i cevi za vodu ili gas, Sigurnosne lampe, Sanitarni uređaji i instalacije, Posude za kuvanje pod pritiskom (električne), Postrojenja za saunu, Skruberi (kao deo gasnih instalacija), Reflektori (bacaci svetlosti), Klozetske daske, Postrojenje za prečišćavanje otpadnih voda, Tuš kabine, Tuševi, Lavaboi, Sedežne kade, Grla za električne sijalice, Uređaji za omekšavanje voda, Solarne peći, Solarni kolektori za grejanje, Posude za spa - kupatila, Dimnjački gorionik za upotrebu u naftnoj in-

dustriji, Standardne lampe, Akumulatori pare, Parni kotlovi (koji nisu deo mašina), Uređaji za parenje lica (saune), Postrojenja za proizvodnju pare, Pegle na paru za tekstil, Sterilizatori, Destilacijske posude, Peci, Peci (uređaji za grejanje), Ulične lampe, Armature za peći, Uređaji za hlorisanje bazena, Uređaji za potamnivanje (solarijum), Slavine za cevovod, Slavine, Termostatski ventili (kao deo instalacije za grejanje), Tosteri, Postrojenja za hlađenje duvana, Uređaji za prženje duvana, Klozetske školjke, Klozetske daske, Prenosivi toaleti, Toaleti (WC), Svetiljke za rasvetu, Električne džepne svetiljke, Cevi za električno pražnjenje za rasvetu, Svetleće cevi za rasvetu, Prenosiva turska kupatila, Ultraljubičaste lampe (ne za medicinsku upotrebu), Pisoari (sanitarna oprema), Ventili (za kontrolu nivoa) u rezervoarima, Termostatski ventili (kao deo instalacije za grejanje), Prednji farovi vozila, Reflektori za vozila, Klima uređaji za vozila, Protivzaslepljujući uređaji za vozila, Uređaji za odmrzavanje vozila, Grejani uređaji za odmrzavanje prozora vozila, Uređaji za rasvetu vozila, Svetla za vozila, Uređaji i instalacija za provetravanje (klimatizacija), Uređaji za provetravanje (klimatizacija) za vozila, Nape za ventilaciju, Nape za ventilaciju laboratorija, Električni kalupi za kolače, Rashladne komore, Grejači za krevet, Prstenovi za slavine za vodu, Umivaonik za ruke (kao deo sanitarnih instalacija), Posuda za umivanje ruku (kao deo sanitarnih instalacija), Kotlovi za umivaonice, Aparati za sušenje ruku u toaletima, Toaleti (WC), Vodovodne instalacije, Instalacije za distribuciju vode, Uređaji za filtriranje vode, Instalacije za ispuštanje vode, Grejači vode, Uređaji za grejanje vode, Uređaji za prihvatanje vode, Regulaciona oprema za uređaje i cevi za vodu ili gas, Sigurnosna oprema za uređaje i cevi za vodu ili gas, Postrojenja za prečišćavanje vode, Uređaji i mašine za prečišćavanje vode, Uređaji i instalacije za omekšavanje vode, Sterilizatori vode, Instalacije za vodosnabdevanje, Automatske instalacije za navodnjavanje, Mašine za navodnjavanje za poljoprivredne svrhe, Vodovodne cevi za sanitarne instalacije, Uređaji za vrtloženje vode, Električni uređaji za proizvodnju jogurta.

(210) **2012-314**

(442) **20.04.2014.**

(220) 7/2/2012

(731) **KABUSHIKI KAISHA HITACHI SEISAKUSHO** (D.B.A.HITACHI, LTD), 6-6, MARU-NOICHI 1-CHOME, CHIYODA-KU, TOKYO JP

(540) HITACHI

(550) I, F

(740) Radulović Božidar, Jovana Tomaševića 9/III, Podgorica ME

(511) **Klasa 03:** Sredstva za beljenje i druge supstance za upotrebu pri pranju; preparati za čišćenje, poliranje, ribanje i nagrizanje; sapuni; parfimerija, eterična ulja, kozmetika, losioni za kosu; paste za zube.

Klasa 04: Industrijska ulja i masti; maziva; jedinjenja za skupljanje, vlaženje i vezivanje prašine; goriva (uključujući motorna tečna goriva) i materije za osvetljavanje; sveće i fitilji za osvetljavanje.

Klasa 05: Farmaceutski i veterinarski preparati; sanitarni proizvodi za upotrebu u medicini; dijetetska hrana i supstance prilagođene za upotrebu u medicini ili veterinarsku upotrebu, hrana za bebe; dijetetski dodaci (dodaci ishrani) za ljude i životinje; flasteri, materijali za zavijanje; materijali za plombiranje zuba, zubarska smola; dezinfekciona sredstva; preparati za uništavanje štetočina; fungicidi, herbicidi.

Klasa 11: Aparati za osvetljavanje, grejanje, proizvodnju pare, kuvanje, hlađenje, sušenje, ventilaciju, snabdevanje vodom i za sanitarne svrhe, naročito Instalacije i uređaji za tretman otpada i otpadnih voda, Sistemi za tretman dimnih gasova, Sistemi za odsumporavanje dimnih gasova, Sistemi za uklanjanje NOx, Spalionice otpada, Delovi i oprema uključeni u klasu 11 za svu gore navedenu robu, Akumulatori (toplote), Akumulatori (pare), Acetilenski

gorionici, Acetilenske baklje, Generatori acetilena, Klima uređaji za automobile, Klimatizacioni uređaji, Klimatizaciona postrojenja, Uređaji za hlađenje vazduha, Uređaji za dezodoriranje vazduha, Uređaji za sušenje vazduha (sušaci), Postrojenja za filtriranje vazduha, Jonizujućii uređaji za tretman vazduha ili vode, Uređaji i mašine za prečišćavanje vazduha, Dогреваči vazduha, Sterilizatori vazduha, Ispusni ventili za uređaje parnog grejanja, Svetlosni uređaji za vazduhoplove, Alkoholni gorionici, Protivzaslepljujuci uređaji za automobile, Antirefleksijki uređaji za automobile (pribor za svetla), Nastavci za slavine za sprečavanje prskanja, Uređaji za filtriranje akvarijuma, Grejači akvarijuma, Svetla za akvarijume, Lučne lampe, Posude za pepeo iz peći, Automatski uređaji za transport pepela, Odlagališta pepela iz peći, nuklearni reaktor (sa grafitnim jezgrom + uranijum), Autoklavi (električne visokopritisne peći), Automobilska svetla, Protivzaslepljujuci uređaji za automobile, Pekarske peći, Kamenje lave za korišćenje u roštiljima, Roštilji, Oprema za kupatila, Oprema za kupatila sa vrućim vazduhom, Instalacije za kupatila, Instalacije za kupatila za saune, Obloge za kupatila, Vodovodna instalacija u kupatilima, Kade za kupatila, Sedežne kade, Grejači za kupatila, Posude za spa - kupatila, Grejači za krevet, Uređaji za hlađenje napitaka, Svetla za bicikle, Bidei, Električna čebad (ne za medicinsku upotrebu), Kotlovske cevi instalacija za grejanje, Kotlovi (koji nisu delovi mašina), Nosači za gasne gorionike, Aparati za pečenje hleba, Tosteri, Aparati za pravljenje hleba, Gorionici, Acetilenski gorionici, Gorionici za svetiljke, Gasni gorionici, Germicidalni gorionici, Gorionici sa užarenim nitima, Laboratorijski gorionici, Ugljenik za lučne lampe, Električno grejani tepisi, Plafonska svetla, Radijatori za centralno grejanje, Sterilne komore (sanitarne instalacije), Lusteri, Ventilatori dimnjaka, Kanali dimnjaka, Staklene cevi za lampe, Kineske lampe, Električne svetiljke za novogodišnje drvo, Hromatografski uređaj za industrijsku namenu, Sterilne komore (sanitarne instalacije), Filteri za kafu (električni), Aparati za kafu (električni), Posude za pripremu kafe (električne), Aparati za prženje kafe, Spiralne cevi (delovi instalacija za destilaciju, grejanje ili hlađenje), Gasni kondenzatori (koji nisu delovi mašina), Postrojenja za klimatizacija vazduha, Rashladne posude, Šporeti, Uređaji i instalacije za kuvanje, Ringle za kuvanje, Električne naprave za kuvanje, Hladnjaci za peći, Aparati i postrojenja za hlađenje, Instalacije i mašine za hlađenje, Postrojenja za hlađenje tečnosti, Postrojenja za hlađenje duvana, Postrojenja za hlađenje vode, Kabine za tuširanje, Uvijena lampa, Električno grejani jastuci (ne za medicinsku upotrebu), Svetla za bicikle, Žaluzine (klapne) za grejanje, Električne friteze, Uređaji za odleđivanje u vozilima, Grejni uređaji za odmrzavanje prozora vozila, Uređaji za dehidraciju prehrambenih organskih proizvoda, Zubarske peći, Uređaji za dezodoriranje (ne za ličnu upotrebu), Postrojenja za desalinaciju, Aparati za sušenje, Raspršivači svetla, Cevi za električno pražnjenje za rasvetu, Uređaji za dezinfekciju, Dezinfekcioni dozatori za toalete, Dezinfekcioni raspršivači za toalete, Rashladne vitrine, Jednokratne vrećice za sterilizaciju, Uređaj za destilaciju, Destilacijske cevi (kolone), Svetla za ronjenje, Sušaci vazduha, Sušaci za kosu, Filteri za vodu za piće, Uređaji za navodnjavanje kapljanjem (pribor za navodnjavanje), Sušaci vazduha, Sušaci za kosu, Aparati za sušenje, Uređaji i instalacije za sušenje, Uređaji za sušenje krmiva, Ekonomajzeri za gorivo, Električni uređaji za proizvodnju jogurta, Električne lampe, Električno grejani tepisi, Grejni elementi, Isparivači, Ekspanzioni sudovi instalacija za centralno grejanje, Usisne nape za kuhinje, Ukrasne svetiljke za svecanu dekoraciju, Ventilatori za klimatizaciju, Električni ventilatori za ličnu upotrebu, Ventilatori (kao delovi instalacije za klimatizaciju), Slavine za cevi, Uređaji za punjenje kotlova/bojlera za grejanje, Električni grejači za flaše sa cuclom, Električna grejana vlakna, Vlakna za električne lampe, Magnezijumska vlakna za rasvetu, Električni filteri (za kafu), Filteri za klima uređaje, Filteri za vodu za piće, Filteri (kao delovi instalacije domaćinstva ili industrijske instalacije), Rešetke kamina, Kamini (kućni), Oprema za kupatila, Oblikovani pribor za peći, Oblikovani pribor za rerne, Dimnjački gorionik/baklja za upotrebu u naftnoj industriji, Baklje, Svetiljke (lampe), Dimnički kanali, Kanali

kotlova za grejanje, Uređaji za ispiranje, Rezervoari za ispiranje, Električni grejači za stopala, Grejači za stopala (električni i ne-električni), Uređaji za sušenje krmiva, Prenosive kovačnice/železare, Fontane, Ukrasne fontane, Metalni okvir za peći, Zamrzivači, Upaljači sa kremenom za paljenje gasa, Uređaji za prženje voća, Ekonomajzeri goriva, Uređaj za nadimljavanje (ne za medicinsku upotrebu), Posude za pepeo iz peći, Rešetke peći, Hladnjaci za peći, Rashladne posude za peći, Uređaji za punjenje peći, Peći (koje nisu za laboratorijsku upotrebu), Oblikovani pribor za peći, Regulaciona i sigurnosna oprema za gasne uređaje, Gasni bojleri, Gasni gorionici, Nosači za gasne gorionike, Gasni kondenzatori (koji nisu deo mašina), Gasne lampe, Gasni upaljači, Regulaciona i sigurnosna oprema za cevi za gas, Skruberi (kao deo gasne instalacije), Uređaji za prečišćavanje gasa, Acetilenski generatori, Germicidalni gorionici, Germicidalne lampe za prečišćavanje vazduha, Uređaji za grejanje lepka, Rešetke za peći, Roštilj (aparati za kuvanje), Gril (aparati za kuvanje), Sušaci kose, Aparati za sušenje ruku, Prednji farovi za automobile, Ognjišta, Akumulatori toplote, Razmenjivaci toplote (koji nisu deo mašina), Toplotne pumpe, Rekuperatori, Električni grejači za flaše sa cuclom, Grejači za kupatila, Grejači za pegle, Grejači za vozila, Uronjivi grejači, Uređaji za grejanje, Električni uređaji za grejanje, Grejni uređaji za odleđivanje prozora vozila, Uređaji za grejanje čvrstih, tečnih ili gasovitih goriva, Kotlovi za grejanje, Električni grejani jastuci (ne za medicinsku upotrebu), Grejni elementi, Grejana vlakna (električna), Instalacije za grejanje, Instalacije za grejanje tople vode, Instalacije za grejanje vode, Ploče za grejanje, Usisne nape za kuhinje, Uređaji za topli vazduh, Oprema za kupatila sa toplim vazduhom, Peci sa vrućim vazduhom, Grejuće ploče, Termofori, Svetleći kućni brojevi, Vlažiocci vazduha za radijatore centralnog grejanja, Hidranti, Uređaji hidromasažnih kada, Posude za led, Sanduci za led, Mašine i uređaji za pravljenje leda, Uronjeni grejači, Gorionici sa užarenim nitima, Spalionice otpada, Jonizujućii uređaji za tretman vode ili vazduha, Grejač vode (električni), Postolja za punjenje u pecima za sušenje, Peci za sušenje, Kuhinjske peci, Laboratorijski gorionici, Laboratorijske lampe, Kučišta lampi, Lampe sa staklenim cevima, Staklene lampe, Lampe sa staklenim kuglama, Omotač/ogrtič za lampe, Reflektorske lampe, Abažuri, Lampe, Gorionici za lampe, Električne lampe, Automobilске lampe za pokazivače pravca, staklene kugle za lampe, Držači abažura, Fenjeri za rasvetu, Uređaji za sušenje veša (električni), Kotlovi za perionice veša, Kamenje lave za korišćenje u roštiljima, Ventili za kontrolu nivoa u rezervoarima, Sijalice, Sijalice (električne), Sijalice za pokazivače pravca u vozilima, Raspršivači svetla, Diode za emitovanje svetla (LED) svetlosnih uređaja, Upaljači, Gasni upaljači, Uređaji i instalacije za rasvetu, Uređaji za rasvetu u vozilima, Instalacije za rasvetu za zračna vozila, Ronilacka svetla, Električne svetiljke za novogodišnje drvo, Svetla za automobile, Svetla za vozila, Uređaji za punjenje peći, Svetleći kućni brojevi, Svetleće cevi za rasvetu, Magnezijumska vlakna za rasvetu, Pržionik slada, Mikrotalasna pecnica (aparati za kuvanje), Mikrotalasne pećnice za industrijsku upotrebu, Instalacije za hlađenje mleka, Rudarske lampe, Mešajuće slavine za vodovodne cevi, Nastavci protiv prskanja za slavine, Instalacije za obradu nuklearnog goriva i nuklearnih moderatora, Nuklearni reaktori, Uljni gorionici, Uljne lampe, Uređaji za prečišćavanje ulja, Ukrasne fontane, Pribor za peći izracen od šamota, Mikrotalasne pećnice za industrijsku upotrebu, Peci (koje nisu za laboratorijsku upotrebu), Oblikovani pribor za peći, Hidro-oksigenški gorionici, Električno grekani jastuci (ne za medicinsku upotrebu), Pasterizatori, Električne posude za kuvanje kafe, Petrolejski gorionici, Slavine za cevovode, Cevi (kao deo sanitarnih instalacija), Plocasti zagrejači, Grejuće ploče, Džepne lampe, Džepne svetiljke (električne), Džepni zagrejači, Postrojenja za polimerizaciju, Jednokratne vrećice za sterilizaciju, Visokopritisne peci - autoklavi (električni), Električne posude za kuvanje pod pritiskom, Rezervoari za vodu pod pritiskom, Uređaji za obradu goriva i nuklearnog moderatora, Lampe projektora, Postrojenja za prečišćavanje otpadne vode, Čepovi za radijatore, Radijatori (električni), Radijatori za grejanje, Nuklearni reaktori, Tornjevi za prečišćavanje za

destilaciju, Reflektorske lampe, Reflektori za vozila, Rashladni uređaji i mašine, Rashladni aparati i instalacije, Rashladni ormari, Rashladne komore, Rashladne posude, Rashladne vitrine, Hladnjaci, Rekuperatori toplote, Regulacijska oprema za uređaje i cevi za vodu ili gas, Regulacijska i sigurnosna oprema za gasne uređaje, Regulacijska i sigurnosna oprema za gasovode, Regulacijska i sigurnosna oprema za uređaje za vodu, Dogrevači vazduha, Uređaji za prženje, Uređaji za prženje kafe, Aparatura za prženje, Uređaji za obrtanje ražnja, Ražnjevi, Uređaji za pečenje na ražnju, Sigurnosna oprema za uređaje i cevi za vodu ili gas, Sigurnosne lampe, Sanitarni uređaji i instalacije, Posude za kuvanje pod pritiskom (električne), Postrojenja za saunu, Skruberi (kao deo gasnih instalacija), Reflektori (bacaci svetlosti), Klozetske daske, Postrojenje za prečišćavanje otpadnih voda, Tuš kabine, Tuševi, Lavaboi, Sedežne kade, Grla za električne sijalice, Uređaji za omekšavanje voda, Solarne peći, Solarni kolektori za grejanje, Posude za spa - kupatila, Dimnjački gorionik za upotrebu u naftnoj industriji, Standardne lampe, Akumulatori pare, Parni kotlovi (koji nisu deo mašina), Uređaji za parenje lica (saune), Postrojenja za proizvodnju pare, Pegle na paru za tekstil, Sterilizatori, Destilacijske posude, Peći, Peći (uređaji za grejanje), Ulične lampe, Armature za peći, Uređaji za hlorisanje bazena, Uređaji za potamnivanje (solarijum), Slavine za cevovod, Slavine, Termostatski ventili (kao deo instalacije za grejanje), Tosteri, Postrojenja za hlađenje duvana, Uređaji za prženje duvana, Klozetske školjke, Klozetske daske, Prenosivi toaleti, Toaleti (WC), Svetiljke za rasvetu, Električne džepne svetiljke, Cevi za električno pražnjenje za rasvetu, Svetleće cevi za rasvetu, Prenosiva turska kupatila, Ultraljubičaste lampe (ne za medicinsku upotrebu), Pisoari (sanitarna oprema), Ventili (za kontrolu nivoa) u rezervoarima, Termostatski ventili (kao deo instalacije za grejanje), Prednji farovi vozila, Reflektori za vozila, Klima uređaji za vozila, Protivzaslepljujući uređaji za vozila, Uređaji za odmrzavanje vozila, Grejani uređaji za odmrzavanje prozora vozila, Uređaji za rasvetu vozila, Svetla za vozila, Uređaji i instalacija za provetravanje (klimatizacija), Uređaji za provetravanje (klimatizacija) za vozila, Nape za ventilaciju, Nape za ventilaciju laboratorija, Električni kalupi za kolace, Rashladne komore, Grejači za krevet, Prstenovi za slavine za vodu, Umivaonik za ruke (kao deo sanitarnih instalacija), Posuda za umivanje ruku (kao deo sanitarnih instalacija), Kotlovi za umivaonice, Aparati za sušenje ruku u toaletima, Toaleti (WC), Vodovodne instalacije, Instalacije za distribuciju vode, Uređaji za filtriranje vode, Instalacije za ispuštanje vode, Grejači vode, Uređaji za grejanje vode, Uređaji za prihvatanje vode, Regulaciona oprema za uređaje i cevi za vodu ili gas, Sigurnosna oprema za uređaje i cevi za vodu ili gas, Postrojenja za prečišćavanje vode, Uređaji i mašine za prečišćavanje vode, Uređaji i instalacije za omekšavanje vode, Sterilizatori vode, Instalacije za vodosnabdevanje, Automatske instalacije za navodnjavanje, Mašine za navodnjavanje za poljoprivredne svrhe, Vodovodne cevi za sanitarne instalacije, Uređaji za vrtloženje vode, Električni uređaji za proizvodnju jogurta.

(210) **2012-315** (442) **20.04.2014.**
(220) 7/4/2012

(731) **PHARMACEUTICAL CHEMICAL COSMETIC INDUSTRY ALKALOID AD-
SKOPLJE**, BUL.ALEKSANDAR MAKEDONSKI 12, 1000 SKOPLJE RM

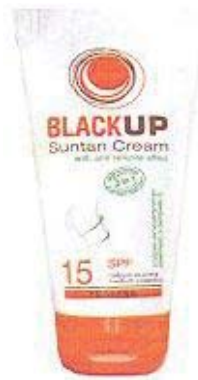

(540)

(550) F

(740) Popović Miladin, Đoka Miraševića 21/III, Podgorica ME

(511) **Klasa 03:** krema za sunčanje sa anticelulit efektom;(210) **2012-316**(442) **20.04.2014.**

(220) 7/5/2012

(731) **THE PROCTER & GAMBLE COMPANY ONE PROCTER & GAMBLE PLAZA, CINCINNATI, OHIO 45202 US**

(540)

(550) I

(740) Lutovac Branislav, Bulevar Crnojevića 93, Podgorica ME

(511) **Klasa 03:** Impregnirane (vlažne) maramice i ubrusi od papira i/ili celuloze.**Klasa 05:** Higijenski proizvodi; pelene za jednokratnu upotrebu od papira i/ili celuloze;**Klasa 25:** Odjevni predmeti.(210) **2012-317**(442) **20.04.2014.**

(220) 7/6/2012

(731) **R & A BAILY & CO, NANGOR HOUSE, WESTERN ESTATE, NANGOR ROAD, DUBLIN 12 IE**

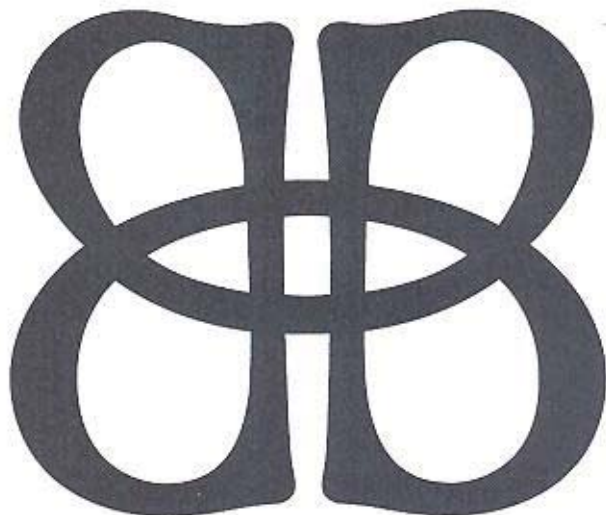

(540)

(550) I

(740) Čejović Vladimir, 13. jula 21, Podgorica ME

(511) **Klasa 33:** Alkoholna pića (izuzev piva);(210) **2012-318**(442) **20.04.2014.**

(220) 7/6/2012

(731) **URION D.O.O.**, PERA ŠOĆA BB, PODGORICA ME

(540) HOSPASOL

(550) I

(511) **Klasa 05:** farmaceutski i veterinarski preparati; sanitarni preparati za medicinsku upotrebu; dijetetske supstance prilagođene za upotrebu u medicini, hrana za bebe; flasteri, materijali za zavijanje; materijali za plombiranje zuba, zubarska smola; dezinfekciona sredstva; preparati za uništavanje štetočina; fungicidi, herbicidi. Obuhvata: sanitarne preparate za upotrebu u medicini i za ličnu higijenu; dezodoranse koji nisu za ličnu upotrebu; cigarete bez duvana za medicinske svrhe. Ne obuhvata: sanitarne preparate (kl. 3); dezodoranse za ličnu upotrebu (kl. 3); potporne zavoje (kl. 10).

(210) **2012-319**(442) **20.04.2014.**

(220) 7/9/2012

(731) **THE PROCTER & GAMBLE COMPANY ONE PROCTER & GAMBLE PLAZA**, CINCINITI, OHIO 45202 US



(540)

(550) I

(740) Lutovac Branislav, Bulevar Crnojevića 93, Podgorica ME

(511) **Klasa 03:** Impregnirane (vlažne) maramice i ubrusi od papira i/ili celuloze.**Klasa 05:** Higijenski proizvodi; pelene za jednokratnu upotrebu od papira i/ili celuloze.**Klasa 25:** Odjevni predmeti.(210) **2012-322**(442) **20.04.2014.**

(220) 7/16/2012

(731) **ZOETIS PRODUCTS LLC**, 100 CAMPUS DRIVE, FLORHAM PARK, NEW JERSEY 07932
US

(540)

(550) I

(740) Čejović Vladimir, 13. jula 21, Podgorica ME

(511) **Klasa 05:** Veterinarski proizvodi za sprečavanje i liječenje parazitskih infekcija, upala i upalnih bolesti, disajnih i zaraznih bolesti, imunoloških, bakterijskih, virusnih i gljivičnih bolesti, osteoporoze, kardiovaskularnih bolesti, bolesti i poremećaja centralnog nervnog sistema, uroloških, urogenitalnih i urinarnih poremećaja, poremećaja probavnog sistema, mišićno koštanih poremećaja, alergija, šećerne bolesti (dijabetesa), hipertenzije, moždanog udara, raka, poremećaja u krvi, poremećaja boli, poremećaja debljine, probavnih poremećaja, oftalmoloških poremećaja, poremećaja u ponašanju, reproduktivnih poremećaja, dermatoloških poremećaja, zubnog karijesa, osjetljivosti zuba, zapaljenja desni, poremećaja kod zadaha iz usta i parodontnih poremećaja, za oporavak kože i tkiva i za smanjenje holesterola; nutritivni aditivi i dodaci za hranu koji se koriste u medicinske svrhe; veterinarske vaccine i supstance, dijagnostički setovi koji se koriste kod testiranja bolesti, kod proizvoda za dijagnosticiranje za medicinske i veterinarske potrebe, svi ispred navedeni proizvodi se koriste za liječenje mačaka, pasa, goveda, svinja, konja, lama, kunica, glodara, ptica, lasica, živine, koza, ovaca i vodenih životinja.

Klasa 31: Dodaci za životinjsku hranu za nemedicinske potrebe.**Klasa 44:** Usluge pružanja informacija i savjetovanja u području zdravlja životinja i veterinarske medicine.(210) **2012-323**(442) **20.04.2014.**

(220) 7/16/2012

(731) **ZOETIS PRODUCTS LLC**, 100 CAMPUS DRIVE, FLORHAM PARK, NEW JERSEY 07932
US

(540) ZOETIS

(550) I

(740) Čejović Vladimir, 13. jula 21, Podgorica ME

(511) **Klasa 05:** Veterinarski proizvodi za sprečavanje i liječenje parazitskih infekcija, upala i upalnih bolesti, disajnih i zaraznih bolesti, imunoloških, bakterijskih, virusnih i gljivičnih bolesti, osteoporoze, kardiovaskularnih bolesti, bolesti i poremećaja centralnog nervnog sistema, uroloških, urogenitalnih i urinarnih poremećaja, poremećaja probavnog sistema, mišićno koštanih poremećaja, alergija, šećerne bolesti (dijabetesa), hipertenzije, moždanog udara, raka, poremećaja u krvi, poremećaja boli, poremećaja debljine, probavnih poremećaja, oftalmoloških poremećaja, poremećaja u ponašanju, reproduktivnih poremećaja, dermatoloških poremećaja, zubnog karijesa, osjetljivosti zuba, zapaljenja desni, poremećaja kod zadaha iz usta i parodontnih poremećaja, za oporavak kože i tkiva i za smanjenje holesterola; nutritivni aditivi i dodaci za hranu koji se koriste u medicinske svrhe; veterinarske vaccine i supstance, dijagnostički setovi koji se koriste kod testiranja bolesti, kod proizvoda za dijagnosticiranje za medicinske i veterinarske potrebe, svi ispred navedeni proizvodi se koriste za liječenje mačaka, pasa, goveda, svinja, konja, lama, kunica, glodara, ptica, lasica, živine, koza, ovaca i vodenih životinja.

Klasa 31: Dodaci za životinjsku hranu za nemedicinske potrebe.

Klasa 44: Usluge pružanja informacija i savjetovanja u području zdravlja životinja i veterinarske medicine.

(210) **2012-324** (442) **20.04.2014.**

(220) 7/18/2012

(731) **GDC ALIMENTOS S.A.**, RUA EUGENIO PEZZINI, 500, CORDEIROS ITAJAI, SANTA CATARINA BR



(540)

(550) I

(740) Čejović Vladimir, 13. jula 21, Podgorica ME

(511) **Klasa 29:** Hrana pripremljena od ribe, morskih plodova, maslinovog ulja, riblje paštete, konzervisane ribe, usoljene ribe, ribe u konzervi, ribljih fileta.

(210) **2012-327** (442) **20.04.2014.**

(220) 6/19/2012

(731) **SHANTA BIOTECHNICS LIMITED**, 3RD & 4TH FLOOR, VASANTHA CHAMBERS FATEH MAIDAN ROAD BASHEERBAGH HYDERABAD 500 004 ANDHRA PRADESH IN

(540) SHANCHOL

(550) I

(740) Popović Miladin, Đoka Miraševića 21/III, Podgorica ME

(511) **Klasa 05:** Farmaceutski preparati, vackine;

(210) **2012-328** (442) **20.04.2014.**

(220) 7/23/2012

(731) **SOCIETA NATIONALE D'EXPLOITATION INDUSTRIELLE DES TABACS ET ALLUMETTES**, SAS 143 BOULEVARD ROMAIN ROLLAND, CEDEX 14, PARIS 75685 FR



ROYALE

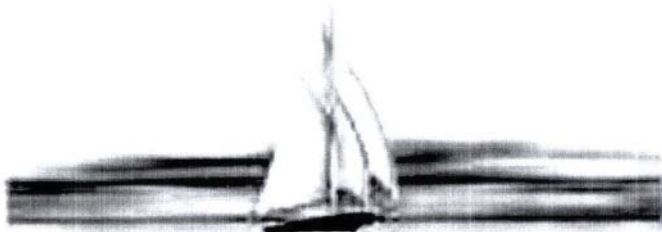

(540)

(550) I

(740) Ćosović Dejan, 13. jula 1/5, Budva ME

(511) **Klasa 34:** Duvan, prerađen i neprerađen; duvanski proizvodi; zamjena za duvan, ne ona koja je medicinskog ili terapijskog karaktera; cigarete; cigarilosi; cigare; mašine/ručne motalice za pravljenje cigareta; tube za cigarete (tzv cigarette tubes); filteri za cigarete; cigaret papir; šibice i artikli za pušače.

(210) **2012-329**

(442) **20.04.2014.**

(220) 7/23/2012

(731) **PEKOVIĆ ŽARKO**, CETINJSKI PUT BB, BUDVA ME



(540)

(550) I

(511) **Klasa 12:** aparati za kretanje po zemlji, vazduhu ili vodi.

Klasa 39: Transportne usluge; pakovanje i skladištenje robe; organizovanje putovanja.

(210) **2012-330**

(442) **20.04.2014.**

(220) 7/24/2012

(731) **24 KITCHEN TELEVISION B.V.**, DE PASSAGE 144, 1101 AX AMSTERDAM ZUIDOOST NL

(540) 24KITCHEN

(550) I

(740) Čejović Vladimir, 13. jula 21, Podgorica ME

(511) **Klasa 09:** Aparati i instrumenti naučni, pomorski, geodetski, fotografski, kinematografski, optički, za vaganje, mjerenje, signalizaciju, kontrolu (inspekciju), spasavanje i nastavu; aparati i instrumenti za provođenje, prekid, transformaciju, akumulaciju, regulisanje ili kontrolu električne energije; aparati za snimanje, prenos i reprodukovanje zvuka ili slika; magnetni nosači podataka, diskovi za snimanje; kompakt diskovi, DVD i drugi digitalni nosači podataka; mehanizmi koji se pokreću novcem ili žetonom; registar kase, računске mašine, oprema za obradu podataka, kompjuteri; kompjuterski softver; aparati za gašenje požara; melodije za zvono, grafike, pozadine, igrice, i muzika koje se mogu preuzimati preko globalne kompjuterske mreže i bežičnih uređaja; filmovi, televizijski programi i audio-vizuelni sadržaj sa filmovima i televizijskim zabavnim programima koji se mogu preuzimati; audio i video snimci sa filmovima i televizijskim zabavnim programima koji se mogu preuzimati; kompjuterski softver i aplikacije; snimljene video kasete, DVD-jevi i CD-i sa filmovima i televizijskim zabavnim programima; podloge za miša; ukrasni magneti; naočari za sunce.

Klasa 16: Hartija, karton i proizvodi od ovih materijala, koji nisu uključeni u druge klase; štampane stvari; knjigovezački materijal; fotografije; kancelarijski materijal; lijepkovi za kancelarijske i kućne potrebe; umjetnički materijali; Kičice; pisaće mašine i kancelarijski pribor (izuzev namještaja); materijali za obuku i nastavu (izuzev aparata); Plastični materijali za pakovanje (koji nisu uključeni u druge klase); štamparska slova; klišeji; magazini, časopisi, knjige; proizvodi od hartije; instrumenti za pisanje; posterji; razglednice; registri; bilježnice; fascikle; blokovi; prazni dnevnicji za pisanje; podsetnici; adresari; rokovnici sa datumima; korice za knjige; naljepnice za branike; naljepnice; albumi za naljepnice (albumi sa slicicama); stoni kalendari; zidni kalendari; obilježivači za knjige; kolekcionarske kartice (sličice); foto albumi; montirane i nemontirane fotografije; čestitke.

Klasa 35: Usluge oglašavanja; vođenje poslova; poslovno upravljanje; kancelarijski poslovi; usluge promocije i marketinga; usluge obezbjeđivanja on-lajn kompjuterske baze podataka i on-lajn baze podataka koja se može pretraživati sa povjerljivim reklamnim listinzima za robe i usluge; usluge on-lajn maloprodaje koja sadrži robe i usluge koje se mogu preuzimati; širenje oglašavanja za druge putem interneta; obezbjeđivanje i iznajmljivanje reklamnog prostora na internetu; usluge on-lajn oglašavanja i marketinga; usluge obezbjeđivanja on-lajn aukcija; on-lajn promocije.

Klasa 38: Telekomunikacije; usluge televizijskog emitovanja i televizijskog prenosa; usluge radijskog emitovanja.

Klasa 41: Obrazovne usluge; obezbjeđivanje obuke; zabava; sportske i kulturne aktivnosti.

Klasa 42: Naučne i tehnološke usluge i usluge istraživanja i projektovanja u vezi sa njima; usluge industrijskih analiza i istraživanja; projektovanje i razvoj kompjuterskog hardvera i softvera; kompjuterske usluge u vidu prilagođenih veb stranica sa korisničkim informacijama, ličnim profilima i informacijama; kompjuterske usluge, naime, hosting on-lajn veb sredstava za racun drugih lica za organizovanje i sprovođenje onlajn sastanaka, okupljanja i interaktivnih diskusija; obezbjeđivanje on-lajn datoteka, baza podataka i uređaja za pretraživanje za pribavljanje podataka o najrazličitijim temama i poljima od opšteg interesa putem interneta; hosting digitalnog sadržaja na internetu, naime, on-lajn dnevnicji i blogovi; obezbjeđivanje privremenog korišćenja kompjuterskog softvera koji se ne može preuzimati za upotrebu u stvaranju i publikaciji on-lajn dnevnika i blogova; usluge veb-sajt hostinga; kompjuterske usluge, naime, obezbjeđivanje uređaja za pretraživanje za pribavljanje podataka na globalnoj kompjuterskoj mreži.

(210) 2012-331

(442) 20.04.2014.

(220) 7/24/2012

(731) 24 KITCHEN TELEVISION B.V., DE PASSAGE 144, 1101 AX AMSTERDAM ZUIDOOST NL



(540)

(550) I

(740) Čejović Vladimir, 13. jula 21, Podgorica ME

(511) **Klasa 09:** Aparati i instrumenti naučni, pomorski, geodetski, fotografski, kinematografski, optički, za vaganje, mjerenje, signalizaciju, kontrolu (inspekciju), spasavanje i nastavu; aparati i instrumenti za provođenje, prekid, transformaciju, akumulaciju, regulisanje ili kontrolu električne energije; aparati za snimanje, prenos i reprodukovanje zvuka ili slika; magnetni nosači podataka, diskovi za snimanje; kompakt diskovi, DVD i drugi digitalni nosači podataka; mehanizmi koji se pokreću novcem ili žetonom; registar kase, računске mašine, oprema za obradu podataka, kompjuteri; kompjuterski softver; aparati za gašenje požara; melodije za zvonu, grafike, pozadine, igrice, i muzika koje se mogu preuzimati preko globalne kompjuterske mreže i bežičnih uređaja; filmovi, televizijski programi i audio-vizuelni sadržaj sa filmovima i televizijskim zabavnim programima koji se mogu preuzimati; audio i video snimci sa filmovima i televizijskim zabavnim programima koji se mogu preuzimati; kompjuterski softver i aplikacije; snimljene video kasete, DVD-jevi i CD-i sa filmovima i televizijskim zabavnim programima; podloge za miša; ukrasni magneti; naočari za sunce.

Klasa 16: Hartija, karton i proizvodi od ovih materijala, koji nisu uključeni u druge klase; štampane stvari; knjigovezački materijal; fotografije; kancelarijski materijal; lijepkovi za kancelarijske i kućne potrebe; umjetnički materijali; Kičice; pisaće mašine i kancelarijski pribor (izuzev namještaja); materijali za obuku i nastavu (izuzev aparata); Plastični materijali za pakovanje (koji nisu uključeni u druge klase); štamparska slova; klišei; magazini, časopisi, knjige; proizvodi od hartije; instrumenti za pisanje; poster; razglednice; registri; bilježnice; fascikle; blokovi; prazni dnevnik za pisanje; podsetnici; adresari; rokovnici sa datumima; korice za knjige; naljepnice za branike; naljepnice; albumi za naljepnice (albumi sa slicicama); stoni kalendari; zidni kalendari; obilježivači za knjige; kolekcionarske kartice (sličice); foto albumi; montirane i nemontirane fotografije; čestitke.

Klasa 35: Usluge oglašavanja; vođenje poslova; poslovno upravljanje; kancelarijski poslovi; usluge promocije i marketinga; usluge obezbjeđivanja on-lajn kompjuterske baze podataka i on-lajn baze podataka koja se može pretraživati sa povjerljivim reklamnim listinzima za robe i usluge; usluge on-lajn maloprodaje koja sadrži robe i usluge koje se mogu preuzimati; širenje oglašavanja za druge putem interneta; obezbjeđivanje i iznajmljivanje reklamnog prostora na internetu; usluge on-lajn oglašavanja i marketinga; usluge obezbjeđivanja on-lajn aukcija; on-lajn promocije.

Klasa 38: Telekomunikacije; usluge televizijskog emitovanja i televizijskog prenosa; usluge radijskog emitovanja;

Klasa 41: Obrazovne usluge; obezbjeđivanje obuke; zabava; sportske i kulturne aktivnosti.

Klasa 42: Naučne i tehnološke usluge i usluge istraživanja i projektovanja u vezi sa njima; usluge industrijskih analiza i istraživanja; projektovanje i razvoj kompjuterskog hardvera i softvera; kompjuterske usluge u vidu prilagođenih veb stranica sa korisničkim informacijama, ličnim

profilima i informacijama; kompjuterske usluge, naime, hosting on-lajn veb sredstava za racun drugih lica za organizovanje i sprovođenje onlajn sastanaka, okupljanja i interaktivnih diskusija; obezbjeđivanje on-lajn datoteka, baza podataka i uređaja za pretraživanje za pribavljanje podataka o najrazličitijim temama i poljima od opšteg interesa putem interneta; hosting digitalnog sadržaja na internetu, naime, on-lajn dnevnic i blogovi; obezbjeđivanje privremenog korišćenja kompjuterskog softvera koji se ne može preuzimati za upotrebu u stvaranju i publikaciji on-lajn dnevnika i blogova; usluge veb-sajt hostinga; kompjuterske usluge, naime, obezbjeđivanje uređaja za pretraživanje za pribavljanje podataka na globalnoj kompjuterskoj mreži.

(210) **2012-332** (442) **20.04.2014.**
(220) 7/26/2012

(731) **DRAŠKO VUČINIĆ**, ROGAMI BB, PODGORICA ME
(540) ZENATA
(550) I
(511) **Klasa 33:** alkoholna pića (vino i rakija od grozđa);

(210) **2012-333** (442) **20.04.2014.**
(220) 7/26/2012

(731) **DRAŠKO VUČINIĆ**, ROGAMI BB, PODGORICA ME



(540)
(550) I
(511) **Klasa 33:** alkoholna pića (vino i rakija od grozđa);

(210) **2012-334** (442) **20.04.2014.**
(220) 7/30/2012

(731) **VATERPOLO I PLIVAČKI SAVEZ CRNE GORE**, PO BOX 33, 85330 KOTOR ME



(540)
(550) I
(511) **Klasa 03:** preparati za čišćenje, poliranje, ribanje i nagrizanje; sapuni; parfimerija, eterična ulja, kozmetika, losioni za kosu; paste za zube; deterdženti za pranje veša.
Klasa 16: Hartija, karton i proizvodi od njih; štampane stvari; knjigovezački materijal; fotografije; kancelarijski materijal; ljepkovi za kancelarijske i kućne potrebe; umjetnički materijali;

Kičice; pisaće mašine i kancelarijski pribor; materijali za obuku i nastavu; Plastični materijal za pakovanje.

Klasa 20: Namještaj, ogledala, okviri za slike.

Klasa 21: Kućne ili kuhinjske sprave i posude, češljevi i sunđerri; četke; materijali za pravljenje četki; pribor za čišćenje; čelična vuna; neprerađeno ili poluprerađeno staklo; staklarija, porcelan i grnčarija; suveniri od stakla, keramike i porcelana.

Klasa 25: Odjeća, obuća, pokrivala za glavu.

Klasa 28: Igre i igračke; gimnastički i sportski artikli (lopte, rekviziti...); ukrasi za jelke.

Klasa 32: Pivo; mineralne i sodne vode i druga bezalkoholna pića; voćni napici i voćni sokovi; sirupi i drugi preparati za proizvodnju pića; energetske napici.

(210) **2012-335** (442) **20.04.2014.**
(220) 7/30/2012

(731) **THE GILLETTE COMPANY**, ONE GILLETTE PARK, BOSTON, MA 02127 US

(540) SILVERTOUCH

(550) I

(740) Lutovac Branislav, Bulevar Crnojevića 93, Podgorica ME

(511) **Klasa 08:** Brijači i nožici za brijače; automati (dozeri), kasete, držači i ulošci koji su svi posebno dizajnirani za, i sadrže, nožice za brijače; i strukturni delovi za sve navedene proizvode;

(210) **2012-338** (442) **20.04.2014.**
(220) 8/1/2012

(731) **KOS CORPRATION**, A DELAWARE CORPRATION, 4129 NORTH PORT WASHINGTON AVENUE, MILWAUKEE, WISCONSIN 53212-1052 US



(540)

(550) I

(740) Đakonović Vido, Bajova 9, Cetinje ME

(511) **Klasa 09:** uređaji za audio reprodukciju; uređaji za video reprodukciju; slušalice; zvučnici; telefonske naglavne slušalice sa mikrofonom; radio aparati; slušalice za bežični prijem audio podataka; digitalni audio hardver koji sadrži prijemnik i predajnik; digitalni video hardver koji sadrži prijemnik i predajnik; uređaji za striming digitalnog sadržaja, a posebno, prijemnici i predajnici za isporuku digitalnog videa, digitalnog audija, i audio striming; uređaji za bežičnu komunikaciju, a posebno, bežični prenosivi medija plejeri koji reprodukuju audio sadržaj i bežični prenosivi medija plejeri koji reprodukuju video sadržaj; dodatna oprema za digitalni audio hardver, a posebno, kablovi i postolja za prenosne računare; dodatna oprema za digitalni video hardver, a posebno, kablovi i postolja za prenosne računare; softver, a posebno, softver za slušanje audija i gledanje videa; računarski hardver i računarske periferije.

Klasa 38: Telekomunikacije; prenos informacija preko globalne računarske mreže koji se odnosi na funkcionisanje i konfigurisanje audio uređaja; prenos informacija preko globalne računarske mreže koji se odnosi na funkcionisanje i konfigurisanje video uređaja; realizacija veza prema sajtovim koji obezbeđuju elektronske isporuke audio i video sadržaja; realizacija

Internet veb sajt portala koji obezbeđuju veze za audio striming, vizuelni, i audiovizuelni materijal drugih; realizacija veb sajtova koji sadrže veze prema sajtovima koji obezbeđuju elektronske isporuke audio i video sadržaja drugih.

Klasa 41: Obrazovne usluge; pripremanje obuke; razonoda; sportske i kulturne aktivnosti; usluge zabave u oblasti obezbjeđivanja personalizovanog programiranja za audio na globalnoj računarskoj mreži; informacije iz oblasti zabave, a posebno, on-lajn vodič koji sadrži informacije o programiranju za audio koji se ne može preuzeti; usluge zabave u oblasti obezbjeđivanja personalizovanog programiranja za video na globalnoj računarskoj mreži; informacije iz oblasti zabave, a posebno, on-lajn vodič koji sadrži informacije o programiranju za video koji se ne može preuzeti.

Klasa 42: Naučne i tehnološke usluge, kao i usluge istraživanja i projektovanja u vezi sa njima; usluge industrijskih analiza i istraživanja; projektovanje i razvoj računarskog hardvera i softvera; uređaji za on-lajn upravljanje uslugama koje dozvoljavaju korisnicima da daljinski upravljaju informacijama na video uređajima i da konfiguriraju njihova podešavanja preko globalne računarske mreže; uređaji za on-lajn upravljanje uslugama koje dozvoljavaju korisnicima da daljinski upravljaju informacijama na audio uređajima i da konfiguriraju njihova;

(210) **2012-339**

(442) **20.04.2014.**

(220) 8/1/2012

(731) **KOS CORPRATION**, A DELAWARE CORPRATION, 4129 NORTH PORT WASHINGTON AVENUE, MILWAUKEE, WISCONSIN 53212-1052 US

KOSS

(540)

(550) I

(740) Đakonović Vido, Bajova 9, Cetinje ME

(511) **Klasa 09:** uređaji za audio reprodukciju; uređaji za video reprodukciju; slušalice; zvučnici; telefonske naglavne slušalice sa mikrofonom; radio aparati; slušalice za bežični prijem audio podataka; digitalni audio hardver koji sadrži prijemnik i predajnik; digitalni video hardver koji sadrži prijemnik i predajnik; uređaji za striming digitalnog sadržaja, a posebno, prijemnici i predajnici za isporuku digitalnog videa, digitalnog audija, i audio striming; uređaji za bežičnu komunikaciju, a posebno, bežični prenosivi medija plejeri koji reprodukuju audio sadržaj i bežični prenosivi medija plejeri koji reprodukuju video sadržaj; dodatna oprema za digitalni audio hardver, a posebno, kablovi i postolja za prenosne računare; dodatna oprema za digitalni video hardver, a posebno, kablovi i postolja za prenosne računare; softver, a posebno, softver za slušanje audija i gledanje videa; računarski hardver i računarske periferije.

Klasa 38: Telekomunikacije; prenos informacija preko globalne računarske mreže koji se odnosi na funkcionisanje i konfigurisanje audio uređaja; prenos informacija preko globalne računarske mreže koji se odnosi na funkcionisanje i konfigurisanje video uređaja; realizacija veza prema sajtovima koji obezbeđuju elektronske isporuke audio i video sadržaja; realizacija Internet veb sajt portala koji obezbeđuju veze za audio striming, vizuelni, i audiovizuelni materijal drugih; realizacija veb sajtova koji sadrže veze prema sajtovima koji obezbeđuju elektronske isporuke audio i video sadržaja drugih.

Klasa 41: Obrazovne usluge; pripremanje obuke; razonoda; sportske i kulturne aktivnosti; us-

luge zabave u oblasti obezbjeđivanja personalizovanog programiranja za audio na globalnoj računarskoj mreži; informacije iz oblasti zabave, a posebno, on-lajn vodič koji sadrži informacije o programiranju za audio koji se ne može preuzeti; usluge zabave u oblasti obezbjeđivanja personalizovanog programiranja za video na globalnoj računarskoj mreži; informacije iz oblasti zabave, a posebno, on-lajn vodič koji sadrži informacije o programiranju za video koji se ne može preuzeti;

Klasa 42: Naučne i tehnološke usluge, kao i usluge istraživanja i projektovanja u vezi sa njima; usluge industrijskih analiza i istraživanja; projektovanje i razvoj računarskog hardvera i softvera; uređaji za on-lajn upravljanje uslugama koje dozvoljavaju korisnicima da daljinski upravljaju informacijama na video uređajima i da konfiguriraju njihova podešavanja preko globalne računarske mreže; uređaji za on-lajn upravljanje uslugama koje dozvoljavaju korisnicima da daljinski upravljaju informacijama na audio uređajima i da konfiguriraju njihova;

(210) **2012-340**

(442) **20.04.2014.**

(220) 8/1/2012

(731) **KOS CORPRATION**, A DELAWARE CORPRATION, 4129 NORTH PORT WASHINGTON AVENUE, MILWAUKEE, WISCONSIN 53212-1052 US

(540) KOSS

(550) I

(740) Đakonović Vido, Bajova 9, Cetinje ME

(511) **Klasa 09:** uređaji za audio reprodukciju; uređaji za video reprodukciju; slušalice; zvučnici; telefonske naglavne slušalice sa mikrofonom; radio aparati; slušalice za bežični prijem audio podataka; digitalni audio hardver koji sadrži prijemnik i predajnik; digitalni video hardver koji sadrži prijemnik i predajnik; uređaji za striming digitalnog sadržaja, a posebno, prijemnici i predajnici za isporuku digitalnog videa, digitalnog audija, i audio striming; uređaji za bežičnu komunikaciju, a posebno, bežični prenosivi medija plejeri koji reprodukuju audio sadržaj i bežični prenosivi medija plejeri koji reprodukuju video sadržaj; dodatna oprema za digitalni audio hardver, a posebno, kablovi i postolja za prenosne računare; dodatna oprema za digitalni video hardver, a posebno, kablovi i postolja za prenosne računare; softver, a posebno, softver za slušanje audija i gledanje videa; računarski hardver i računarske periferije.

Klasa 38: Telekomunikacije; prenos informacija preko globalne računarske mreže koji se odnosi na funkcionisanje i konfigurisanje audio uređaja; prenos informacija preko globalne računarske mreže koji se odnosi na funkcionisanje i konfigurisanje video uređaja; realizacija veza prema sajtovima koji obezbeđuju elektronske isporuke audio i video sadržaja; realizacija Internet veb sajt portala koji obezbeđuju veze za audio striming, vizuelni, i audiovizuelni materijal drugih; realizacija veb sajtova koji sadrže veze prema sajtovima koji obezbeđuju elektronske isporuke audio i video sadržaja drugih.

Klasa 41: Obrazovne usluge; pripremanje obuke; razonoda; sportske i kulturne aktivnosti; usluge zabave u oblasti obezbjeđivanja personalizovanog programiranja za audio na globalnoj računarskoj mreži; informacije iz oblasti zabave, a posebno, on-lajn vodič koji sadrži informacije o programiranju za audio koji se ne može preuzeti; usluge zabave u oblasti obezbjeđivanja personalizovanog programiranja za video na globalnoj računarskoj mreži; informacije iz oblasti zabave, a posebno, on-lajn vodič koji sadrži informacije o programiranju za video koji se ne može preuzeti.

Klasa 42: Naučne i tehnološke usluge, kao i usluge istraživanja i projektovanja u vezi sa njima; usluge industrijskih analiza i istraživanja; projektovanje i razvoj računarskog hardvera i softvera; uređaji za on-lajn upravljanje uslugama koje dozvoljavaju korisnicima da daljinski

upravljaju informacijama na video uređajima i da konfiguriraju njihova podešavanja preko globalne računarske mreže; uređaji za on-lajn upravljanje uslugama koje dozvoljavaju korisnicima da daljinski upravljaju informacijama na audio uređajima i da konfiguriraju njihova;

(210) **2012-347** (442) **20.04.2014.**
(220) 8/6/2012

(731) **GENERAL MOTORS LLC**, 300 RENAISSANCE CENTER, DETROIT, MICHIGAN 48265-3000 US
(540) CHEVROLET SONIC
(550) I, V
(740) Radulović Božidar, Jovana Tomaševića 9/III, Podgorica ME
(511) **Klasa 12:** automobili;

(210) **2012-348** (442) **20.04.2014.**
(220) 8/9/2012

(731) **ADVOKAT ĆUPIĆ BRANISLAV**, DALMATINSKA 10, PODGORICA ME



(540)
(550) I
(740) AOD "Ćupić", Dalmatinska 10, Podgorica ME
(511) **Klasa 45:** pravne usluge; konsultacije o intelektualnoj svojini; konsultacije u vezi intelektualne svojine; menadžment autorskih prava; menadžment, upravljanje autorskim pravima; intelektualna svojina (usluge nadgledanja, kontrole intelektualne svojine); pravna istraživanja; licenciranje intelektualne svojine; parnične usluge (usluge parničnih kancelarija); licenciranje računarskog softvera (pravne usluge); ustupanje licence, zaključivanje ugovora o licenci za softvere (pravne usluge); registracija imena domena (pravne usluge).

(210) **2012-349** (442) **20.04.2014.**
(220) 8/9/2012

(731) **MERCK SHARP & DOHME CORP.**, ONE MERCK DRIVE, WHITEHOUSE STATION, NEW JERSEY 08889 US
(540) TANRIOS
(550) I
(740) AOD "Ćupić", Dalmatinska 10, Podgorica ME
(511) **Klasa 05:** farmaceutski preparati za ljudsku upotrebu;

(210) **2012-350** (442) **20.04.2014.**
(220) 8/9/2012

(731) **MERCK SHARP & DOHME CORP.**, ONE MERCK DRIVE, WHITEHOUSE STATION, NEW JERSEY 08889 US
(540) VIMASCEND

(550) I

(740) AOD "Ćupić", Dalmatinska 10, Podgorica ME

(511) **Klasa 05:** farmaceutski preparati za ljudsku upotrebu;

(210) **2012-351**

(442) **20.04.2014.**

(220) 8/9/2012

(731) **MERCK SHARP & DOHME CORP.**, ONE MERCK DRIVE, WHITEHOUSE STATION, NEW JERSEY 08889 US

(540) RAZCORTA

(550) I

(740) AOD "Ćupić", Dalmatinska 10, Podgorica ME

(511) **Klasa 05:** farmaceutski preparati za ljudsku upotrebu;

(210) **2012-352**

(442) **20.04.2014.**

(220) 8/13/2012

(731) VUK PETROL D.O.O. KOTOR, BENZINSKA PUMPA, 85318 RADANOVIĆI ME

Vuk Petrol



(540)

(550) I

(740) Božović Vesko, Rimski trg 50/11, Podgorica ME

(511) **Klasa 04:** industrijska ulja i masti; maziva; jedinjenja za skupljanje prašine vlaženjem i vezivanjem; goriva (uključujući motorna tečna goriva) i materije za osvetljavanje; sveće i fitilji za osvetljavanje.

Klasa 39: transportne usluge; pakovanje i skladištenje robe; organizovanje putovanja. Obuhvata: usluge koje se pružaju pri transportu ljudi ili robe sa jednog mesta na drugo (bilo kojim sredstvom prevoza) kao i usluge koje su obavezno povezane sa ovakvim transportom (špeditorske usluge); usluge skladištenja u cilju čuvanja ili obezbeđenja; usluge koje pružaju preduzeća koja koriste mostove, železničke pruge, feribote i sva druga sredstva koja koristi prevoznik; usluge vezane za najam transportnih vozila; usluge vezane za brodsku vuču, istovar robe, funkcionisanje dokova, spašavanje potonulih tereta; usluge funkcionisanja aerodroma; usluge pakovanja i sortiranja robe pre odpremanja; usluge koje pružaju turističke agencije a sastoje se u davanju informacija o putovanjima ili transportu robe, informacije o tarifama, redu vožnje i načinima transporta; usluge kontrole prevoznih sredstava ili robe pre transporta.

Klasa 43: usluge obezbeđivanja hrane i pića; privremeni smeštaj. Obuhvata: usluge koje pru-

žaju lica ili ustanove čija je namena pripremanje hrane i pića za potrošnju i uslugama obezbjeđivanja ishrane i smještaja u hotelima, pansionima ili drugim ustanovama koje obezbjeđuju privremeni smještaj;

(210) **2012-402** (442) **20.04.2014.**

(220) 10/4/2012

(731) **KRAFT FOODS SCHWEIZ HOLDING GMBH**, CHOLLERSTRASSE 4, 6301 ZUG CH



(540)

(550) I

(740) AOD "Ćupić", Dalmatinska 10, Podgorica ME

(511) **Klasa 30:** Kakao, čokolada, napitci od kakaoa, napitci od čokolade i preparati za takve napitke; keksi i biskviti, pekarski proizvodi, poslastice i konditorski proizvodi, naročito šećerni i čokoladni konditorski proizvodi, proizvodi od tijesta, proizvodi od žitarica, jestivi led, sladoled.

(210) **2012-403** (442) **20.04.2014.**

(220) 10/4/2012

(731) **EMILIO PUCCI IN INTERNATIONAL B.V.**, OUDE UTRECHTSEWEG 22-24, 3743 KN BAARN NL

(540) EMILIO PUCCI

(550) I

(740) Popović Miladin, Đoka Miraševića 21/III, Podgorica ME

(511) **Klasa 03:** Parfemi, toaletne vode, kolonjske vode; sapuni za ličnu upotrebu; eterična ulja za kozmetičke svrhe; dezodoransi za ličnu upotrebu; kozmetika, kozmetički gelovi i preparati za kupanje i tuširanje, kozmetičke kreme i losioni za kosu, lice i tijelo; šamponi, preparati za brijanje, losioni za posle brijanja, balzami i gelovi.

Klasa 09: Naočare, naočare za sunce i kutije za naočare.

Klasa 14: Nakit, naime minduše, dugmad za manžetne, narukvice, broševi, ogrlice, privjesci, prstenje, privjesci za ključeve; satovi, kaiševi za satove i kutije za satove.

Klasa 18: Kutije od kože ili od imitacije kože; putne torbe, putni setovi (proizvodi od kože), kese, kese za odjeću za putne namjene; torbice za šminku (neopremljene); ruksaci, ručne torbe; aktentašne načinjene od kože; novčanici, torbice za sitni novac, futrole za ključeve (proizvodi od kože); kišobrani.

Klasa 25: Odjeća i donji veš, naime košulje, majice kratkih rukava, puloveri, suknje, haljine, pantalone, kaputi, jakne, kaiševi (odjevni), šalovi, ešarpe, rukavice, kravate, čarape, ženski donji veš, kupaći kostimi, noćno rublje, obuća; pokrivala za glavu.

Klasa 35: Usluge maloprodaje u prodajnim objektima i on-line usluge maloprodaje u vezi sa odjećom, obucom, pokrivalima za glavu, proizvodima od kože, naočarima, nakitom, satovima i prtljagom; prezentacija robe (odjeće, obuće, pokrivala za glavu, proizvoda od kože, na-

očara, nakita, satova i prtljaga) putem svih sredstava komunikacije za potrebe maloprodaje.

(210) **2012-404** (442) **20.04.2014.**
(220) 10/4/2012

(731) **EMILIO PUCCI IN INTERNATIONAL B.V.**, OUDE UTRECHTSEWEG 22-24, 3743 KN BAARN NL

(540) PUCCI

(550) I

(740) Popović Miladin, Đoka Miraševića 21/III, Podgorica ME

(511) **Klasa 03:** Parfemi, toaletne vode, kolonjske vode; sapuni za ličnu upotrebu; eterična ulja za kozmetičke svrhe; dezodoransi za ličnu upotrebu; kozmetika, kozmetički gelovi i preparati za kupanje i tuširanje, kozmetičke kreme i losioni za kosu, lice i tijelo; šamponi, preparati za brijanje, losioni za posle brijanja, balzami i gelovi.

Klasa 09: Naočare, naočare za sunce i kutije za naočare.

Klasa 14: Nakit, naime minduše, dugmad za manžetne, narukvice, broševi, ogrlice, privjesci, prstenje, privjesci za ključeve; satovi, kaiševi za satove i kutije za satove.

Klasa 18: Kutije od kože ili od imitacije kože; putne torbe, putni setovi (proizvodi od kože), kese, kese za odjeću za putne namjene; torbice za šminku (neopremljene); ruksaci, ručne torbe; aktentašne načinjene od kože; novčanici, torbice za sitni novac, futrole za ključeve (proizvodi od kože); kišobrani.

Klasa 25: Odjeća i donji veš, naime košulje, majice kratkih rukava, puloveri, suknje, haljine, pantalone, kaputi, jakne, kaiševi (odjevni), šalovi, ešarpe, rukavice, kravate, čarape, ženski donji veš, kupaći kostimi, noćno rublje, obuća; pokrivala za glavu.

Klasa 35: Usluge maloprodaje u prodajnim objektima i on-line usluge maloprodaje u vezi sa odjecom, obucom, pokrivalima za glavu, proizvodima od kože, naočarima, nakitom, satovima i prtljagom; prezentacija robe (odjeće, obuće, pokrivala za glavu, proizvoda od kože, naočara, nakita, satova i prtljaga) putem svih sredstava komunikacije za potrebe maloprodaje.

(210) **2012-405** (442) **20.04.2014.**
(220) 10/5/2012

(731) **DOW AGROSCIENCES LLC**, 9330 ZIONSVILLE ROAD, INDIANAPOLIS, IN 4626 US



(540)

(550) I, F

(740) Radulović Božidar, Jovana Tomaševića 9/III, Podgorica ME

(511) **Klasa 05:** pesticidi, preparati za unistavanje štetočina, fungicidi, herbicidi i insektidi.

(210) **2012-406** (442) **20.04.2014.**
(220) 10/8/2012

(731) **TDR D.O.O. ROVINJ**, OBALA VLADIMIRA NAZORA 1. 52210 ROVINJ HRVATSKA HR

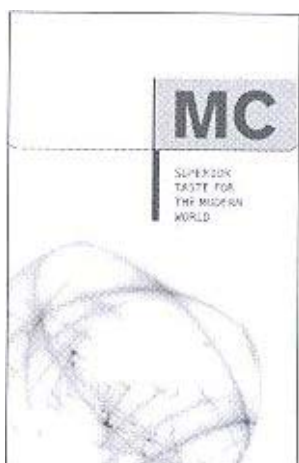

(540)

(550) I

(740) Vukotić Petar, Novaka Miloševa, Podgorica ME

(511) **Klasa 34:** duvan sirov i prerađen, proizvodi od duvana, cigare, cigarete, filter, cigarete, cigarilosi, artikli za pušače, upaljači, šibice.

Klasa 35: usluge u vezi sa prometom robe, posebno usluge u prometu duvana i duvanskih proizvoda; oglašavanje; vođenje poslova; poslovno upravljanje; kancelarijski poslovi; komercijalno zastupanje; propagandne i reklamne usluge; marketing; usluge istraživanja tržišta; usluge promocije, posebno promovisnje ili reklamiranje kulturnih i zabavnih događaja, sportskih takmičenja i modnih revija; organizovanje i vođenje sajмова i izložbi u reklamne i komercijalne svrhe; naprijed navedene usluge koje pripadaju ovoj klasi koje se obavljaju putem interneta; davanje i širenje informacija u vezi sa gore navedenim uslugama.

(210) **2012-407**(442) **20.04.2014.**

(220) 10/8/2012

(731) **TDR D.O.O. ROVINJ**, OBALA VLADIMIRA NAZORA 1. 52210 ROVINJ HRVATSKA HR

Walter Wolf

(540)

(550) I

(740) Vukotić Petar, Novaka Miloševa, Podgorica ME

(511) **Klasa 34:** duvan sirov i prerađen, proizvodi od duvana, cigare, cigarete, filter, cigarete, cigarilosi, artikli za pušače, upaljači, šibice.

Klasa 35: usluge u vezi sa prometom robe, posebno usluge u prometu duvana i duvanskih proizvoda; oglašavanje; vođenje poslova; poslovno upravljanje; kancelarijski poslovi; komercijalno zastupanje; propagandne i reklamne usluge; marketing; usluge istraživanja tržišta; usluge promocije, posebno promovisnje ili reklamiranje kulturnih i zabavnih događaja, sportskih takmičenja i modnih revija; organizovanje i vođenje sajмова i izložbi u reklamne i komercijalne svrhe; naprijed navedene usluge koje pripadaju ovoj klasi koje se obavljaju putem interneta; davanje i širenje informacija u vezi sa gore navedenim uslugama.

(210) **2012-408**(442) **20.04.2014.**

(220) 10/10/2012

(731) **COLGATE-PALMOLIVE COMPANY**, 300 PARK AVENUE, NEW YORK, NY 10022, US



(540)
 (550) I
 (740) AOD "Ćupić", Dalmatinska 10, Podgorica ME
 (511) **Klasa 03:** pasta za zube;

(210) **2012-409** (442) **20.04.2014.**
 (220) 10/11/2012

(731) **DEMETRIOS LICENSING, LTD.**, 222 WEST 37TH STREET, NEW YORK, NY 10018 US
 (540) DEMETRIOS
 (550) I
 (740) Popović Miladin, Đoka Miraševića 21/III, Podgorica ME
 (511) **Klasa 25:** odjeća, pokrivala za glavu, obuća, svadbena oprema;

(210) **2012-410** (442) **20.04.2014.**
 (220) 10/15/2012

(731) **TRANSATLANTIC HOLDINGS, INC.**, 80 PINE STREET, NEW YORK, NY 10005 US
 (540) TRANSRE
 (550) I
 (740) AOD "Ćupić", Dalmatinska 10, Podgorica ME
 (511) **Klasa 36:** Osiguranje, reosiguranje i usluge upravljanja osiguranjima;

(210) **2012-411** (442) **20.04.2014.**
 (220) 10/15/2012

(731) **TRANSATLANTIC HOLDINGS, INC.**, 80 PINE STREET, NEW YORK, NY 10005 US



(540)
 (550) I
 (740) AOD "Ćupić", Dalmatinska 10, Podgorica ME
 (511) **Klasa 36:** Osiguranje, reosiguranje i usluge upravljanja osiguranjima;

(210) **2012-412** (442) **20.04.2014.**
 (220) 10/15/2012

(731) **TOYOTA JIDOSHA KABUSHIKI KAISHA** (ALSO TRADING AS TOYOTA MOTOR CORPORATION), 1, TOYOTA-CHO, TOYOTA-SHI, AICHI-KEN JP
 (540) NX200t
 (550) I
 (740) Čejović Vladimir, 13. jula 21, Podgorica ME
 (511) **Klasa 12:** automobili i njihovi strukturni djelovi;

(210) **2012-413** (442) **20.04.2014.**
 (220) 10/15/2012

- (731) **TOYOTA JIDOSHA KABUSHIKI KAISHA** (ALSO TRADING AS TOYOTA MOTOR CORPORATION), 1, TOYOTA-CHO, TOYOTA-SHI, AICHI-KEN JP
 (540) NX300h
 (550) I
 (740) Čejović Vladimir, 13. jula 21, Podgorica ME
 (511) **Klasa 12:** automobili i njihovi strukturni djelovi;

- (210) **2012-414** (442) **20.04.2014.**
 (220) 10/16/2012
 (731) **HYSON TEAS (PVT) LIMITED**, NO.190/1, SIRISUMANAMAWATHA, KELANIMULLA, ANGODA LK

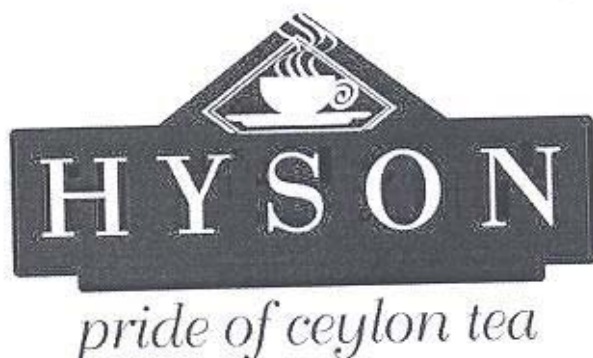

- (540)
 (550) I, F
 (511) **Klasa 30:** Čaj, čaj kao piće, ledeni čaj, biljni čaj, voćni čaj, vrećice za čaj, proizvodi čaja, esencija čaja, ekstrakti čaja, crni čaj, zeleni čaj, beli čaj, instant čaj, čaj sa ukusima, organski čaj.

- (210) **2012-415** (442) **20.04.2014.**
 (220) 10/17/2012
 (731) **SOCIETE DES PRODUITS NESTLE S.A.**, 1800 VEVEY CH
 (540) TRICOLORE
 (550) I
 (740) Lutovac Branislav, Bulevar Crnojevića 93, Podgorica ME
 (511) **Klasa 30:** jestivi led i sladoled;

- (210) **2012-416** (442) **20.04.2014.**
 (220) 10/17/2012
 (731) **PHARMACEUTICAL CHEMICAL COSMETIC INDUSTRY ALKALOID AD-SKOPLJE**, BLVD.ALEKSANDAR MAKEDONSKI 12 1000 SKOPLJE RM

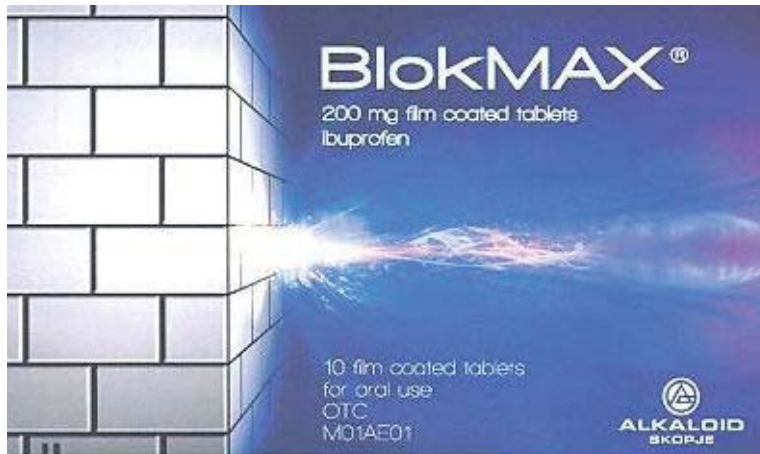

(540)

(550) I, F

(740) Popović Miladin, Đoka Miraševića 21/III, Podgorica ME

(511) **Klasa 05:** antiinflamatorni i antireumatski proizvodi, nesteroidni;(210) **2012-417**(442) **20.04.2014.**

(220) 10/17/2012

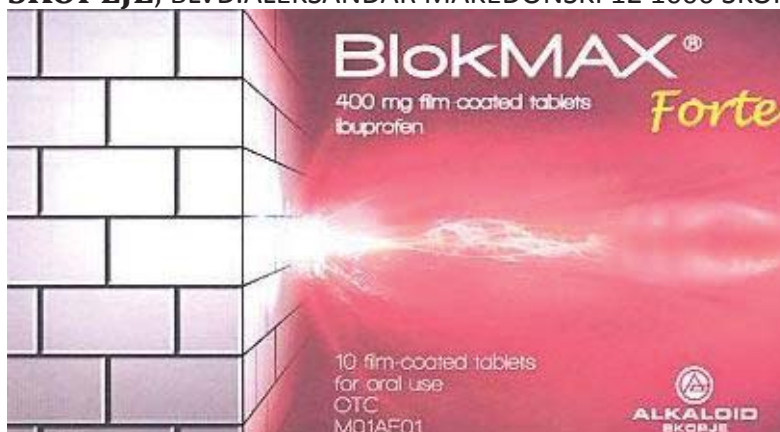
(731) **PHARMACEUTICAL CHEMICAL COSMETIC INDUSTRY ALKALOID AD-SKOPLJE**, BLVD.ALEKSANDAR MAKEDONSKI 12 1000 SKOPLJE RM

(540)

(550) I, F

(740) Popović Miladin, Đoka Miraševića 21/III, Podgorica ME

(511) **Klasa 05:** antiinflamatorni i antireumatski proizvodi, nesteroidni;(210) **2012-418**(442) **20.04.2014.**

(220) 10/17/2012

(731) **PHARMACEUTICAL CHEMICAL COSMETIC INDUSTRY ALKALOID AD-SKOPLJE**, BLVD.ALEKSANDAR MAKEDONSKI 12 1000 SKOPLJE RM



(540)

(550) I, F

(740) Popović Miladin, Đoka Miraševića 21/III, Podgorica ME

(511) **Klasa 05:** antiinflamatorni i antireumatski proizvodi, nesteroidni;(210) **2012-419**(442) **20.04.2014.**

(220) 10/18/2012

(731) **PHARMACEUTICAL CHEMICAL COSMETIC INDUSTRY ALKALOID AD-SKOPLJE**, BLVD.ALEKSANDAR MAKEDONSKI 12 1000 SKOPLJE RM

(540) YMANA

(550) I, V

(740) Popović Miladin, Đoka Miraševića 21/III, Podgorica ME

(511) **Klasa 05:** lijekovi protiv demencije.(210) **2012-420**(442) **20.04.2014.**

(220) 10/18/2012

(731) **HERO INVESTCORP LIMITED**, HERO CR DIVISION, SUA ROAD, HERO NAGAR, LUDHIANA-141 003 IN

Hero

(540)

(550) I, F

(740) Radulović Božidar, Jovana Tomaševića 9/III, Podgorica ME

(511) **Klasa 04:** Ulja za podmazivanje u automobilizmu uključujući motorna ulja; automobilska maziva, lubrikanti, goriva i aditivi.

Klasa 09: Kacige za automobilizam; brzinometri, sajle i kablovi za iste; električni aparati, pribor, žice, kablovi, snopovi kablova, prekidači, senzori, osigurači, akumulatori i baterije, kalemovi, sirene, starteri, konektori, mjerači, konzole (armature) i instrumenti; sve navedeno za upotrebu u automobilizmu.

Klasa 12: Vozila, svi dijelovi, oprema i pribor za vozila; aparati za kretanje po zemlji, vodi ili vazduhu, i njihovi dijelovi, pribor i oprema (osim bicikla, tricikla, i njihovih dijelova i pribora za njih (uključujući gume i cijevi za bicikle i tricikle), i šasije i prenosnici za sve vrste vozila i automobila, električna/ekološki prihvatljiva vozila (t.j. vozila za kretanje po zemlji koja nisu

na gorivo i njihove komponente).

Klasa 16: Štampane stvari, kancelarijski materijal i pribor, publikacije, naime, uputstva, priručnici, knjige, časopisi, prospekti, brošure, pamfleti, naljepnice, poster, sve navedeno za automobilizam.

Klasa 25: Odjeća, obuća, pokrivala za glavu.

Klasa 28: Igre i igračke; gimnastički i sportski rekviziti koji nisu uključeni u druge klase.

Klasa 35: Poslovni menadžment, administracija i konsalting, istraživanje i analiza, sve u oblasti automobilizma; usluge veleprodaje i maloprodaje u vezi sa vozilima i njihovim dijelovima, opremom i priborom; oglašavanje, marketing i promocija, usluge u vezi sa poštanskim porudžbinama putem kataloga i elektronskih medija, kao što su internet strane, televizijski šoping programi, sve navedeno vezano za automobilizam.

Klasa 37: Usluge u vezi sa održavanjem i popravkama u automobilizmu; uključujući hitne službe za pomoć na putu.

(210) **2012-421**

(442) **20.04.2014.**

(220) 10/18/2012

(731) **HERO INVESTCORP LIMITED**, HERO CR DIVISION, SUA ROAD, HERO NAGAR, LUDHIANA-141 003 IN

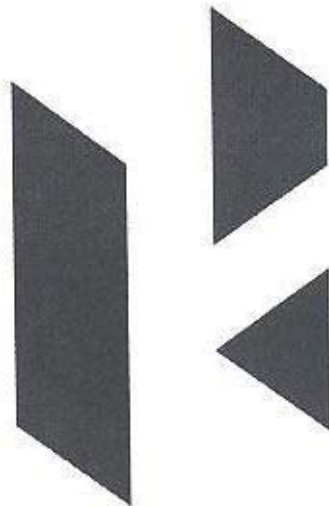

(540)

(550) I, F

(740) Radulović Božidar, Jovana Tomaševića 9/III, Podgorica ME

(511) **Klasa 04:** Ulja za podmazivanje u automobilizmu uključujući motorna ulja; automobilska maziva, lubrikanti, goriva i aditivi.

Klasa 09: Kacige za automobilizam; brzinometri, sajle i kablovi za iste; električni aparati, pribor, žice, kablovi, snopovi kablova, prekidači, senzori, osigurači, akumulatori i baterije, kalemovi, sirene, starteri, konektori, mjerači, konzole (armature) i instrumenti; sve navedeno za upotrebu u automobilizmu.

Klasa 12: Vozila, svi dijelovi, oprema i pribor za vozila; aparati za kretanje po zemlji, vodi ili vazduhu, i njihovi dijelovi, pribor i oprema (osim bicikla, tricikla, i njihovih dijelova i pribora za njih (uključujući gume i cijevi za bicikle i tricikle), i šasije i prenosnici za sve vrste vozila i automobila, električna/ekološki prihvatljiva vozila (t.j. vozila za kretanje po zemlji koja nisu na gorivo i njihove komponente).

Klasa 16: Štampane stvari, kancelarijski materijal i pribor, publikacije, naime, uputstva, priručnici, knjige, časopisi, prospekti, brošure, pamfleti, naljepnice, poster, sve navedeno za automobilizam.

Klasa 25: Odjeća, obuća, pokrivala za glavu.

Klasa 28: Igre i igračke; gimnastički i sportski rekviziti koji nisu uključeni u druge klase.

Klasa 35: Poslovni menadžment, administracija i konsalting, istraživanje i analiza, sve u oblasti automobilizma; usluge veleprodaje i maloprodaje u vezi sa vozilima i njihovim dijelovima, opremom i priborom; oglašavanje, marketing i promocija, usluge u vezi sa poštanskim porudžbinama putem kataloga i elektronskih medija, kao što su internet strane, televizijski šoping programi, sve navedeno vezano za automobilizam.

Klasa 37: Usluge u vezi sa održavanjem i popravkama u automobilizmu; uključujući hitne službe za pomoć na putu.

(210) **2012-422** (442) **20.04.2014.**

(220) 10/22/2012

(731) **ATHLETA (ITM) INC.**, 2 FOLSOM STREET, SAN FRANCISCO, CALIFORNIA 94105 US

(540) ATHLETA

(550) I

(740) Lutovac Branislav, Bulevar Crnojevića 93, Podgorica ME

(511) **Klasa 25:** Odjeća, obuća, pokrivala za glavu.

(210) **2012-423** (442) **20.04.2014.**

(220) 10/22/2012

(731) **GLAXO GROUP LIMITED**, 980 GREAT WEST ROAD, BRENTFORD, MIDDLESEX, TW8 9GS GB

(540) LAVENTAIR

(550) I

(740) Lutovac Branislav, Bulevar Crnojevića 93, Podgorica ME

(511) **Klasa 05:** Farmaceutski i medicinski preparati i supstance;

(210) **2012-424** (442) **20.04.2014.**

(220) 10/22/2012

(731) **GLAXO GROUP LIMITED**, 980 GREAT WEST ROAD, BRENTFORD, MIDDLESEX, TW8 9GS GB

(540) VOURAGE

(550) I

(740) Lutovac Branislav, Bulevar Crnojevića 93, Podgorica ME

(511) **Klasa 05:** Farmaceutski i medicinski preparati i supstance;

(210) **2012-425** (442) **20.04.2014.**

(220) 10/22/2012

(731) **PLIVA HRVATSKA D.O.O**, PRILAZ BARUNA FILIPOVIĆA 25, 10 000 ZAGREB HR

(540) AVOMIT

(550) I

(740) Radulović Božidar, Jovana Tomaševića 9/III, Podgorica ME

(511) **Klasa 05:** farmaceutski proizvodi;

(210) **2012-426** (442) **20.04.2014.**

(220) 10/24/2012

(731) **MONTECCO INC D.O.O.**, BANDIĆI B.B.81412 SPUŽ ME



(540)

(550) I

(511) **Klasa 05:** Preparati od Aloe Vera za farmaceutsku namjenu;

Klasa 29: Aloe Vera pripremljena za ljudsku upotrebu;

Klasa 32: Aloe Vera pića;

(210) **2012-427**

(442) **20.04.2014.**

(220) 10/24/2012

(731) **JDB INTERNATIONAL GROUP COMPANY LIMITED**, PALM GROVE HOUSE PO BOX 438 ROAD TOWN TORTOLA BRITISH VG

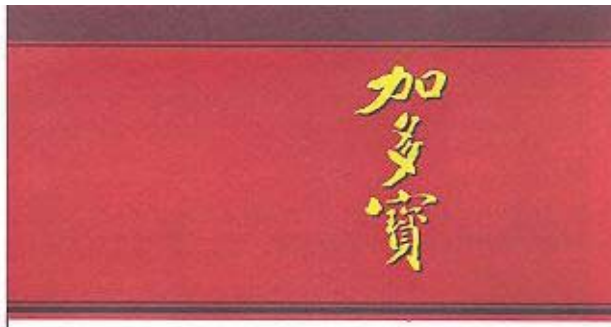

(540)

(550) I

(740) Radulović Božidar, Jovana Tomaševića 9/III, Podgorica ME

(511) **Klasa 05:** Kineska medicina i ljekovito bilje, farmaceutski i veterinarski preparati; sanitarni preparati za medicinske svrhe; dijetetske supstance prilagođene za medicinsku upotrebu, hrana za bebe; flasteri, materijali za zavijanje; materijali za plombiranje zuba, zubarska smola; dezinfekciona sredstva; preparati za uništavanje štetočina, fungicidi, herbicidi.

Klasa 30: Čaj ili biljnom čaju slični proizvodi; kafa, kakao, šećer, pirinac, tapioka, sago, zamena kafe, brašno i proizvodi od žitarica, hljeb, peciva i poslastice, sladoledi; med, melasa, kvasac, prašak za pećivo, so, senf; sirce, sosovi (kao dodaci); začini, led.

Klasa 32: Pića; preparati za proizvodnju pića, piva, mineralne i gazirane vode i druga bezalkoholna pića; voćna pića i voćni sokovi, sirupi i drugi preparati za proizvodnju pića.

(210) **2012-428**

(442) **20.04.2014.**

(220) 10/25/2012

(731) **FARMACEUTSKA HEMISKA KOZMETIČKA INDUSTRIJA ALKALOID AD-SKOPLJE**, BUL.ALEKSANDAR MAKEDONSKI 12 1000 SKOPLJE RM

(540) Valdocef

(550) I, V

(740) Popović Miladin, Đoka Miraševića 21/III, Podgorica ME

(511) **Klasa 5:** Antiinfektivni za sistemacku upotrebu.

- (210) **2012-429** (442) **20.04.2014.**
(220) 10/26/2012
- (731) **VISA INTERNATIONAL SERVICE ASSOCIATION**, 900 METRO CENTER BOULEVARD, FOSTER CITY CALIFORNIA 94404 US
- (540) VISANET
(550) I
- (740) Čejović Vladimir, 13. jula 21, Podgorica ME
- (511) **Klasa 38:** Telekomunikacije, telekomunikacione usluge, prenos poruka, naročito u vezi sa finansijskim transakcijama, pristup kompjuterskim mrežama, uključujući prodajna bankarska mjesta i mreže za automatsku distribuciju gotovine; telekomunikacije, multi-medijalne komunikacije, digitalne komunikacione usluge; prenos poruka i slika putem kompjutera i sredstava za obradu podataka; komunikacija putem telefonskih prenosnih medija, prenos informacija, podataka, poruka i slika, naročito u vezi sa finansijskim transakcijama, online putem globalne kompjuterske mreže ili putem telekomunikacija, mobilnih ili bežičnih uređaja; obrada finansijskih transakcija online preko globalne kompjuterske mreže ili putem telekomunikacija, mobilnih ili bežičnih uređaja.

- (210) **2012-431** (442) **20.04.2014.**
(220) 10/30/2012
- (731) **GRENDENE S.A.**, AV.PIMENTEL GOMES, 214 BAIRRO: EXPECTATIVA, 62040-050 SOBRALCE BR

Ipanema

- (540)
(550) I
- (740) Čejović Vladimir, 13. jula 21, Podgorica ME
- (511) **Klasa 25:** Muška, ženska i dječija obuća, naime sandale, cipele za plažu, papuče, papuče za kupanje, čizme i cipele uopšte.

- (210) **2012-432** (442) **20.04.2014.**
(220) 10/30/2012
- (300) 201270584 08.05.2012. SI
- (731) **GRENKI LIST LICENCIRANJE D.O.O.** DUNAJSKA CESTA 22, LJUBLJANA SI
- (540) LAROUCCI VODA VODA
(550) I
- (740) Radulović Božidar, Jovana Tomaševića 9/III, Podgorica ME
- (511) **Klasa 16:** štampane etikete za vodu i za bezalkoholna pića;
Klasa 32: mineralne i gazirane vode i stone vode za pića i bezalkoholna pića;
Klasa 35: trgovina na veliko i malo vodom i bezalkoholnim pićima;

- (210) **2012-98** (442) **20.04.2014.**
(220) 2/16/2012

(731) **CRNOGORSKA KOMERCIJALNA BANKA AD PODGORICA**, MOSKOVSKA BB
ME

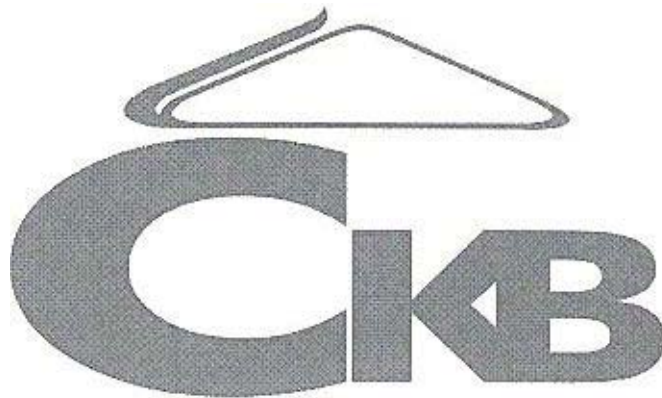

CRNOGORSKA KOMERCIJALNA BANKA

(540) *member of otn group*

(550) I

(511) **Klasa 35:** Oglašavanje; vođenje poslova; poslovno upravljanje; kancelarijski poslovi

Klasa 36: Osiguranje, finansijski poslovi; novčani (monetarni) poslovi; poslovi vezani za nepokretnosti.

Klasa 38: Telekomunikacije.

(210) **2013-100**

(442) **20.04.2014.**

(220) 3/18/2013

(731) **DRUŠTVO ZA TELEKOMUNIKACIJE MTEL DOO**, KRALJA NIKOLE 27A PODGORICA
ME



(540)

(550) I

(511) **Klasa 38:** Telekomunikacije, usluge mobilne radiotelefonije, GSM (Globalni sistem za mobilne komunikacije) i UMTS (Univerzalni mobilni telekomunikacioni sistem) mobilne radio usluge, prenos vijesti i slike posebno pomoću SMS i MMS servisa, omogućavanje pristupa internetu takođe putem mobilnih radio veza

(210) **2013-101**

(442) **20.04.2014.**

(220) 3/20/2013

(300) 840322550 06.11.2012.

(731) **GENERAL MOTORS LLC**, KOMPANIJA ORGANIZOVANA PO PROPISIMA DRŽAVE DELAWARE, 300 RENAISSANCE CENTER, DETROIT, MICHIGAN 48265-3000/ US

(540) SPIN ACTIV

(550) I

(740) Radulović Božidar, Jovana Tomaševića 9/III, Podgorica ME

(511) **Klasa 12:** motorna vozila;

(210) **2013-102**(442) **20.04.2014.**

(220) 3/20/2013

(300) 840322542 06.11.2012.

(731) **GENERAL MOTORS LLC**, KOMPANIJA ORGANIZOVANA PO PROPISIMA DRŽAVE DELAWARE, 300 RENAISSANCE CENTER, DETROIT, MICHIGAN 48265-3000/ US

(540) SPARK ACTIV

(550) I

(740) Radulović Božidar, Jovana Tomaševića 9/III, Podgorica ME

(511) **Klasa 12:** motorna vozila;(210) **2013-103**(442) **20.04.2014.**

(220) 3/20/2013

(300) 976326 IR (77352048 14.12.2007. US)

(731) **RETRACTABLE TECHNOLOGIES, INC.**, 511 LOBO LANE, LITTLE ELM, TEXAS 75068 US

(540) PORTPREP

(550) I

(740) Čejović Vladimir, 13. jula 21, Podgorica ME

(511) **Klasa 05:** sanitarni preparati za medicinske uređaje;(210) **2013-105**(442) **20.04.2014.**

(220) 3/21/2013

(731) **CT GROUP D.O.O.**, UL. DALMATINSKA BR.78 PODGORICA ME

(540)

(550) I

(511) **Klasa 41:** podrazumjeva: Organizovanje sajmova i zabavnih aktivnosti. Osim navednog podrazumjeva i sledece: Obrazovne usluge; pripremanje obuke; razonoda; sportske i kulturne aktivnosti Opis usluga: razvijanje mentalnih sposobnosti drugih lica (obrazovanje) ili životinja (obuka, dresiranje) kao i usluge kojima je cilj zabavljanje drugih lica ili privlačenje pažnje. Ova klasa uključuje posebno: usluge koje pružaju sve vrste edukacije lica (obrazovanje) ili životinja (obuka, dresiranje); usluge kojima je osnovni cilj zabavljanje drugih lica, rekreacija; organizovanje (priredivanje) i vođenje seminara, konferencija, kongresa; organizovanje izložbi ili prezentacije knjiga (književne večeri) u kulturne i obrazovne svrhe, sportskih takmičenja; izdavanje tekstova i knjiga.

(210) **2013-106**(442) **20.04.2014.**

(220) 3/21/2013

(731) **CT GROUP D.O.O.**, UL. DALMATINSKA BR.78 PODGORICA ME



(540)

(550) I

(511) **Klasa 41:** podrazumjeva: Organizovanje sajмова i zabavnih aktivnosti. Osim navednog podrazumjeva i sledece: Obrazovne usluge; pripremanje obuke; razonoda; sportske i kulturne aktivnosti, Opis usluga: razvijanje mentalnih sposobnosti drugih lica (obrazovanje) ili životinja (obuka, dresiranje) kao i usluge kojima je cilj zabavljanje drugih lica ili privlačenje pažnje. Ova klasa uključuje posebno: usluge koje pružaju sve vrste edukacije lica (obrazovanje) ili životinja (obuka, dresiranje); usluge kojima je osnovni cilj zabavljanje drugih lica, rekreacija; organizovanje (priređivanje) i vođenje seminara, konferencija, kongresa; organizovanje izložbi ili prezentacije knjiga (književne večeri) u kulturne i obrazovne svrhe, sportskih takmičenja; izdavanje tekstova i knjiga.

(210) **2013-107**(442) **20.04.2014.**

(220) 3/22/2013

(731) **HARI UNO D.O.O.**, TRŽNI CENTAR BULEVAR MARŠALA TITA 85360 ULCINJ ME

(540)

(550) I

(511) **Klasa 25:** Odjeća, obuća i pokrivala za glavu;(210) **2013-110**(442) **20.04.2014.**

(220) 3/22/2013

(731) **HARI UNO D.O.O.**, TRŽNI CENTAR BULEVAR MARŠALA TITA 85360 ULCINJ ME

(540)

(550) I

(511) **Klasa 25:** Odjeća, obuća i pokrivala za glavu;(210) **2013-111**(442) **20.04.2014.**

(220) 3/22/2013

(731) **HARI UNO D.O.O.**, TRŽNI CENTAR BULEVAR MARŠALA TITA 85360 ULCINJ ME



(540)

(550) I

(511) **Klasa 25:** Odjeća, obuća i pokrivala za glavu;(210) **2013-112**(442) **20.04.2014.**

(220) 3/22/2013

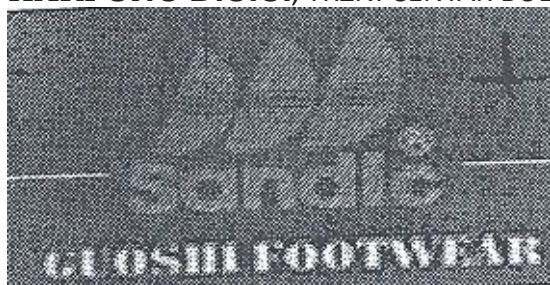
(731) **HARI UNO D.O.O.**, TRŽNI CENTAR BULEVAR MARŠALA TITA 85360 ULCINJ ME

(540)

(550) I

(511) **Klasa 25:** Odjeća, obuća i pokrivala za glavu;(210) **2013-113**(442) **20.04.2014.**

(220) 3/26/2013

(731) **SHULTON, INC.**, ONE PROCTER & GAMBLE PLAZA, CINCINNATI, OHIO 45202 US**NO FADE NO FAIL**

(540)

(550) I

(740) Lutovac Branislav, Bulevar Crnojevića 93, Podgorica ME

(511) **Klasa 03:** Antiperspiranti i deodoransi; preparati za brijanje, uključujući kreme za brijanje, losione za brijanje i gelove za brijanje; preparati za upotrebu posle brijanja; parfemi; mirisi; sprejevi za tijelo; sapun; sredstva za pranje ruku, lica i tijela i drugi proizvodi za ličnu higijenu; preparati za čišćenje, njegu, tretiranje i uljepšavanje kože, tjemena i kose.(210) **2013-114**(442) **20.04.2014.**

(220) 3/26/2013

(731) **SOUTHERN COMFORT PROPERTIES, INC.** A CALIFORNIA, USA CORPORATION, 4040 CIVIC CENTER DRIVE, SUITE 528, SAN RAFAEL, CA94903 US



- (540)
 (550) I
 (740) AOD "Ćupić", Dalmatinska 10, Podgorica ME
 (511) **Klasa 33:** alkoholna pića, uključujući žestoka pića;

(210) **2013-115** (442) **20.04.2014.**
 (220) 3/26/2013

(731) **PHILIP MORRIS BRANDS SARL**, QUAI JEANRENAUD 3, NEUCHATEL, 2000 CH



- (540)
 (550) I
 (511) **Klasa 34:** Duvan, sirov ili prerađen; proizvodi od duvana, naročito cigare, cigarete, cigari-
 losi, duvan za uvijanje cigareta, duvan za lule, duvan za žvakanje, duvan za šmrkanje, kretek;
 snus; zamena za duvan (za nemedicinsku upotrebu); proizvodi za pušače, naročito: papir
 za cigarete i lule, filteri za cigarete, kutije za duvan, kutije za cigarete i pepeljare, lule, ručni
 aparati/spravice za uvijanje, cigareta, upaljači, šibice.

(210) **2013-116** (442) **20.04.2014.**
 (220) 3/27/2013

(731) **COLLECTIVE BRANDS COOPERATIEF U.A.**, LUNA ARENA, HERIKERBERGWEG
 238, 1101 CM AMSTERDAM ZUIDOOST NL

ABOVE THE RIM

- (540)
 (550) I
 (740) Radulović Božidar, Jovana Tomaševića 9/III, Podgorica ME
 (511) **Klasa 25:** Odjeća, obuća i pokrivala za glavu;

(210) **2013-117**(442) **20.04.2014.**

(220) 3/27/2013

(731) **Collective Brands Cooperatief U.A.**, Luna Arena, Herikerbergweg 238, 1101 CM Amsterdam Zuidoost, The Netherlands/NL, ;

ATR

(540)

(550) I

(740) Radulović Božidar, Jovana Tomaševića 9/III, Podgorica ME

(511) **Klasa 25:** Odjeća, obuća i pokrivala za glavu;(210) **2013-118**(442) **20.04.2014.**

(220) 3/29/2013

(731) **THE TURNER CORPORATION** (DELAWARE CORPRATION), 375 HUDSON STREET, NEW YORK, NY 10014 US

TURNER INTERNATIONAL

(540)

(550) I

(740) Radulović Božidar, Jovana Tomaševića 9/III, Podgorica ME

(511) **Klasa 37:** Komercijalno građevinsko konstruisanje i popravljanje; usluge upravljanja građevinskim konstruisanjem; konsultantske usluge u oblasti građevinskog konstruisanja.(210) **2013-119**(442) **20.04.2014.**

(220) 4/1/2013

(731) **FARMACEUTSKA HEMISKA KOZMETIČKA INDUSTRIJA ALKALOID AD-SKOPLJE**, BUL. ALEKSANDAR MAKEDONSKI 12 1000 SKOPLJE RM

(540)

(550) I, F

(740) Popović Miladin, Đoka Miraševića 21/III, Podgorica ME

(511) **Klasa 29:** sušeno voće;

Klasa 30: musli, mješavine žitarica;

Klasa 31: sušene sjemenke;

(210) **2013-120**

(442) **20.04.2014.**

(220) 4/1/2013

(731) **FARMACEUTSKA HEMISKA KOZMETIČKA INDUSTRIJA ALKALOID AD-SKOPLJE, BUL. ALEKSANDAR MAKEDONSKI 12 1000 SKOPLJE RM**

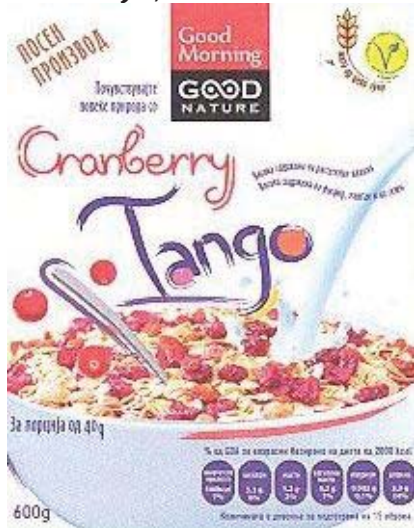

(540) 600g

(550) I, F

(740) Popović Miladin, Đoka Miraševića 21/III, Podgorica ME

(511) **Klasa 29:** sušeno voće;

Klasa 30: musli, mješavine žitarica;

Klasa 31: sušene sjemenke;

(210) **2013-121**

(442) **20.04.2014.**

(220) 4/1/2013

(731) **FARMACEUTSKA HEMISKA KOZMETIČKA INDUSTRIJA ALKALOID AD-SKOPLJE, BUL. ALEKSANDAR MAKEDONSKI 12 1000 SKOPLJE RM**

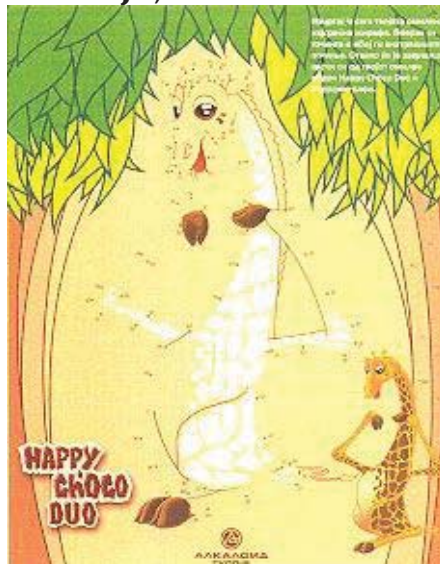

(540)

(550) I, F

(740) Popović Miladin, Đoka Miraševića 21/III, Podgorica ME

(511) **Klasa 29:** sušeno voće;

Klasa 30: musli, mješavine žitarica;

Klasa 31: sušene sjemenke;

(210) **2013-122**

(442) **20.04.2014.**

(220) 4/2/2013

(731) H-D U.S.A., LLC, 3700 WEST JUNEAU AVENUE, 53208 MILWAUKEE, WI US

BAR & SHIELD

(540)

(550) I

(740) Čejović Vladimir, 13. jula 21, Podgorica ME

(511) **Klasa 14:** Nakit, narukvice koje se nose oko zgloba, narukvice, minđuše, ogrlice, igle za kravate, ukrasne igle za revere, ukrasne igle, časovnici, satovi, prstenje, privjesci, ukrasni privjesci za ključeve, kopče za kaiš od plemenitih metala, kaiševi (narukvice) za satove, štikaljke za novae, ukrasi za kragne, lanci za čizme, igle za šešire, ploče od kalaja, figure od plemenitih metala, medaljoni.

Klasa 18: Sedla, tašne, novčanici, rančevi, torbe od grubog sukna, bisage za motocikle, ukrasni privjesci za ključeve i držači za ključeve napravljeni od kože, torbe za odjeću, futrole za ključeve, koferi, velike torbe za nošenje na rame, aktentašne, tašne za isprave, korice za blokove sa čekovima, torbe za prtljag, putne torbe, kožni držači za ambalažu sa pićem, ručne tašne, torbe koje se nose oko kukova, naprtnjače, školske torbe, rančevi, kišobrani i suncobrani, ručni kovčezi, putni kovčežići, vreće i držači za podsjetnike napravljeni od kože.

Klasa 25: Gornja odjeća, džemperi, tregeri, marame, ešarpe, jakne, kaputi, prsluci, rukavice, farmerke, kaubojske pantalone, majice, šortsevi, kape, kačketi, pokrivala za glavu za nošenje, kaiševi, trake koje se nose oko ručnog zgloba, kombinezoni, čarape, majice (topovi) koje se nose oko vrata, kravate, noćne košulje, noćne haljine, pidžame, pantalone, gaće, odijela za kišu, kišni kaputi, košulje, dukserice, trenerke pantalone, majice bez rukava, majice, donji veš, trake za glavu, grijači za noge, kecelje, rukavice, rublje, kožna odjeća, kupaći kostimi, suknje, portikle, obuća, naime, cipele i čizme, kao i djelovi obuće, naime vrhovi za čizme, ploče za potplatu, štitnici za pete.

Klasa 26: Ukrasi za kosu i odjeću koji nisu od plemenitih metala, kopče za kaiš koje nisu od plemenitih metala, vez, dugmad, patent-zatvarači, igle, osim nakita, bedževi, medaljoni, vezene zakrpe, dekorativni kaiševi za čizme.

(210) **2013-123**

(442) **20.04.2014.**

(220) 4/3/2013

(731) **SHULTON, INC.**, ONE PROCTER & GAMBLE PLAZA, CINCINNATI, OHIO 45202 US

OLD SPICE NOIR

(540)

(550) I

(740) Lutovac Branislav, Bulevar Crnojevića 93, Podgorica ME

(511) **Klasa 3:** Sredstva za bijeljenje i druge supstance za upotrebu u pranju; preparati za čišćenje, poliranje, ribanje, abrazivna sredstva; sapuni; parfimerija, eterična ulja, kozmetika, losioni za kosu; proizvodi za njegu zuba.

(210) **2013-124**

(442) **20.04.2014.**

(220) 4/3/2013

(731) **HONGTA TOBACCO (GROUP) CO., LTD.** (ACHINESE LIMITED COMPANY), NO.118, HONGTA AVENUE, HONGTA DISTRICT, YUXI, YUNNAN CN



(540)

(550) I

(740) Radulović Božidar, Jovana Tomaševića 9/III, Podgorica ME

(511) **Klasa 34:** Duvan; duvan za žvakanje; cigare; cigarete koje sadrže zamjene duvana za ne-medicinske potrebe; cigarete; cigarilosi (male cigare); trave za pušenje; šmrkanje (duvan za šmrkanje); rezani duvan; otpaci duvana; vrhovi od čilibara za muštikle za cigare ili cigarete; duvan (vrećice za duvan); vrhovi cigarete (čibuci); lule, cigare (sjeckalice za cigare); kutije za cigare; kutije za cigarete; cigarnici (držači cigara); džepne sprave za savijanje cigareta; cigaretnici (držači cigareta); usnici za muštikle za cigarete; četkice za čišćenje lula (pribor za lule); stalci za duvanske lule; cupovi za duvan; kutije za šmrkanje; pepeljare za pušače; pljuvaonice za duvanske korisnike; kutije za cigare opremljene ovlaživačem; šibice; stalci za šibice; kutije za šibice; upaljači za pušače; kontejneri plina za upaljače za cigare; kremen za upaljače; butagas držač za upotrebu kod upaljača; butagas (za potrebe pušenja); filteri za cigarete; blokovi (svežnjevi) cigaret papira; papir, upijajući za lule; papir za cigarete; kompleti filterskih vlakana za cigarete.

(210) **2013-125**

(442) **20.04.2014.**

(220) 4/3/2013

(731) CBS BROADCASTING INC. A NEW YORK CORPORATION, 51 WEST 52ND STREET, NEW YORK, NY 10019 US



(540)

(550) I

(740) AOD "Ćupić", Dalmatinska 10, Podgorica ME

(511) **Klasa 38:** Usluge emitovanja, usluge kablovskog i satelitskog prenosa; pružanje video snimaka i podataka za bežične mobilne komunikacijske uređaje, pružanje bežičnog prenosa učitavanja i preuzimanja video snimaka, informacija i vijesti putem globalne računarske mreže na bežične mobilne komunikacijske uređaje, internetske usluge pod kojim se podrazumijevaju obuhvaćenim i komunikacijske usluge, naročito prenos strimovanih zvučnih i audio-vizuelnih snimaka putem Interneta; pružanje pristupa informacijama u području razonode; usluge audio i video emitovanja putem Interneta ili drugih komunikacijskih mreža, naročito, učitavanje, postavljanje, pokazivanje, prikazivanje, označavanje i elektronski prenos podataka, audio i video snimaka; pružanje pristupa informacijama, audio i video putem web stranica, foruma, chat soba, list servera i blogova na internetu; pružanje on-line chat soba i elektronskih oglasnih ploča za prenos poruka među korisnicima u područjima od opšteg interesa.

(210) **2013-126**(442) **20.04.2014.**

(220) 4/3/2013

(731) **CBS BROADCASTING INC.** A NEW YORK CORPORATION, 51 WEST 52ND STREET, NEW YORK, NY 10019 US



(540)

(550) I

(740) AOD "Ćupić", Dalmatinska 10, Podgorica ME

(511) **Klasa 41:** Usluge razonode, naime, proizvodnja i distribucija filmova, komedija, mjuzikla, reality programa, vijesti i dramskih televizijskih serija, dokumentarnih filmova i televizijskih serija koje sadrže sportske događaje, a koji se prenose posredstvom televizije, kablovski, putem satelita, radio, telefonskih i širokopojasnih (broadband) sistema, putem interneta, te prenosnih i bežičnih komunikacijskih uređaja koje spadaju u ovu klasu; pružanje informacija u području zabave koje su prenesene putem interneta i prenosnih i bežičnih komunikacijskih uređaja.

(210) **2013-127**(442) **20.04.2014.**

(220) 4/4/2013

(731) **PHARMACEUTICAL CHEMICAL COSMETIC INDUSTRY ALKALOID AD-SKOPLJE**, BLVD.ALEKSANDAR MAKEDONSKI 12 1000 SKOPLJE RM

Red OMEGA 3

(540)

(550) I

(740) Popović Miladin, Đoka Miraševića 21/III, Podgorica ME

(511) **Klasa 05:** farmaceutski preparati, dodaci ishrani;

(210) **2013-128** (442) **20.04.2014.**
(220) 4/4/2013

(731) **TOYOTA JIDOSHA KABUSHIKI KAISHA** (ALSO TRADING AS TOYOTA MOTOR CORPORATION), 1, TOYOTA-CHO, TOYOTA-SHI, AICHI-KEN JP

LEXUS RX200t

(540)

(550) I

(740) Čejović Vladimir, 13. jula 21, Podgorica ME

(511) **Klasa 12:** automobili i njihovi strukturalni djelovi;

(210) **2013-129** (442) **20.04.2014.**
(220) 4/5/2013

(731) **RECKITT BENCKISER LLC** MORRIS CORPORATE CENTER IV, 399 INTERPACE PARKWAY PARSIPPANY NEW JERSEY 07054-0225 US

(540) MEGARED

(550) I

(740) Popović Miladin, Đoka Miraševića 21/III, Podgorica ME

(511) **Klasa 05:** Dijetetski dodaci; dijetetski dodaci ishrani; prehrambeni dodaci; vitamini vitaminski preparati; minerali i mineralni preparati; omega-3 masne kisjeline fosfolipidi i antioksidanti za unaprijeđenje zdravlja.

(210) **2013-130** (442) **20.04.2014.**
(220) 4/8/2013

(731) **TDR D.O.O. ROVINJ**, OBALA VLADIMIRA NAZORA 1.52210 ROVINJ HR



(540)

(550) I

(740) Vukotić Petar, Novaka Miloševa, Podgorica ME

(511) **Klasa 34:** duvan sirov i prerađen, proizvodi od duvana, cigare, cigarete, filter, cigarete, cigarilosi, artikli za pušače, upaljači, šibice.

Klasa 35: usluge u vezi sa prometom robe, posebno usluge u prometu duvana i duvanskih proizvoda; oglašavanje; vođenje poslova; poslovno upravljanje; kancelarijski poslovi; komercijalno zastupanje; propagandne i reklamne usluge; marketing; usluge istraživanja tržišta; usluge promocije, posebno promovisnje ili reklamiranje kulturnih i zabavnih događaja, sportskih takmičenja i modnih revija; organizovanje i vođenje sajмова i izložbi u reklamne i komercijalne svrhe; naprijed navedene usluge koje pripadaju ovoj klasi koje se obavljaju putem interneta; davanje i širenje informacija u vezi sa gore navedenim uslugama.

(210) **2013-131** (442) **20.04.2014.**

(220) 4/8/2013

(731) **TDR D.O.O. ROVINJ**, OBALA VLADIMIRA NAZORA 1.52210 ROVINJ HR

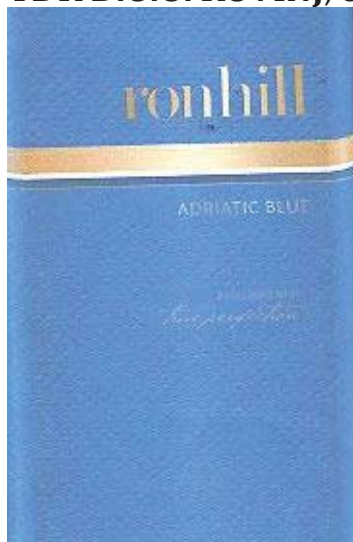

(540)

(550) I

(740) Vukotić Petar, Novaka Miloševa, Podgorica ME

(511) **Klasa 34:** duvan sirov i prerađen, proizvodi od duvana, cigare, cigarete, filter, cigarete, cigarilosi, artikli za pušače, upaljači, šibice.

Klasa 35: usluge u vezi sa prometom robe, posebno usluge u prometu duvana i duvanskih proizvoda; oglašavanje; vođenje poslova; poslovno upravljanje; kancelarijski poslovi; komercijalno zastupanje; propagandne i reklamne usluge; marketing; usluge istraživanja tržišta; usluge promocije, posebno promovisnje ili reklamiranje kulturnih i zabavnih događaja, sportskih takmičenja i modnih revija; organizovanje i vođenje sajмова i izložbi u reklamne i komercijalne svrhe; naprijed navedene usluge koje pripadaju ovoj klasi koje se obavljaju putem interneta; davanje i širenje informacija u vezi sa gore navedenim uslugama.

(210) **2013-132** (442) **20.04.2014.**

(220) 4/8/2013

(731) **TDR D.O.O. ROVINJ**, OBALA VLADIMIRA NAZORA 1. 52210 ROVINJ HR

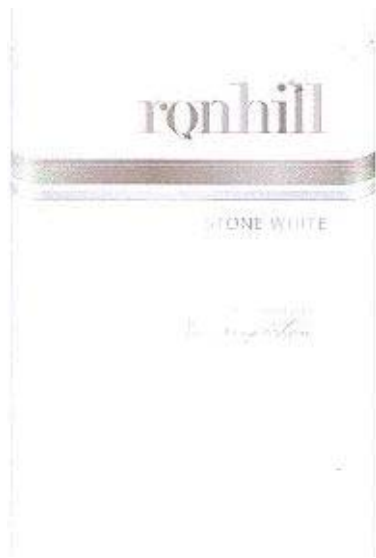

(540)

(550) I

(740) Vukotić Petar, Novaka Miloševa, Podgorica ME

(511) **Klasa 34:** duvan sirov i prerađen, proizvodi od duvana, cigare, cigarete, filter, cigarete, cigarilosi, artikli za pušače, upaljači, šibice.

Klasa 35: usluge u vezi sa prometom robe, posebno usluge u prometu duvana i duvanskih proizvoda; oglašavanje; vođenje poslova; poslovno upravljanje; kancelarijski poslovi; komercijalno zastupanje; propagandne i reklamne usluge; marketing; usluge istraživanja tržišta; usluge promocije, posebno promovisanje ili reklamiranje kulturnih i zabavnih događaja, sportskih takmičenja i modnih revija; organizovanje i vođenje sajmova i izložbi u reklamne i komercijalne svrhe; naprijed navedene usluge koje pripadaju ovoj klasi koje se obavljaju putem interneta; davanje i širenje informacija u vezi sa gore navedenim uslugama.

(210) **2013-133**(442) **20.04.2014.**

(220) 4/8/2013

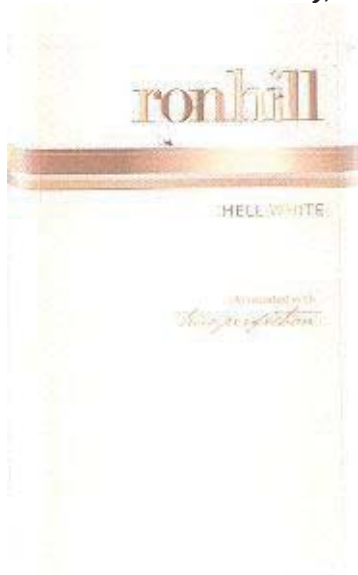
(731) **TDR D.O.O. ROVINJ**, OBALA VLADIMIRA NAZORA 1.52210 ROVINJ HR

(540)

(550) I

(740) Vukotić Petar, Novaka Miloševa, Podgorica ME

(511) **Klasa 34:** duvan sirov i prerađen, proizvodi od duvana, cigare, cigarete, filter, cigarete, cigarilosi, artikli za pušače, upaljači, šibice.

Klasa 35: usluge u vezi sa prometom robe, posebno usluge u prometu duvana i duvanskih proizvoda; oglašavanje; vođenje poslova; poslovno upravljanje; kancelarijski poslovi; komercijalno zastupanje; propagandne i reklamne usluge; marketing; usluge istraživanja tržišta; usluge promocije, posebno promovisanje ili reklamiranje kulturnih i zabavnih događaja, sportskih takmičenja i modnih revija; organizovanje i vođenje sajmova i izložbi u reklamne i komercijalne svrhe; naprijed navedene usluge koje pripadaju ovoj klasi koje se obavljaju putem interneta; davanje i širenje informacija u vezi sa gore navedenim uslugama.

(210) **2013-134**

(442) **20.04.2014.**

(220) 4/8/2013

(731) **TDR D.O.O. ROVINJ**, OBALA VLADIMIRA NAZORA 1.52210 ROVINJ HR

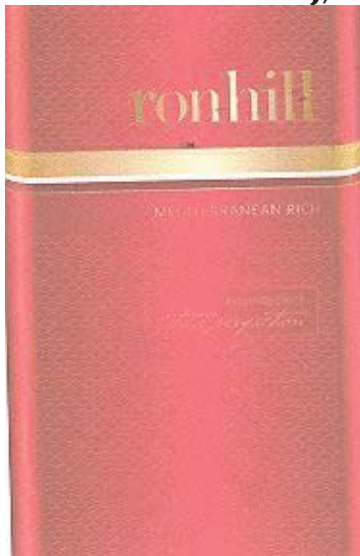

(540)

(550) I

(740) Vukotić Petar, Novaka Miloševa, Podgorica ME

(511) **Klasa 34:** duvan sirov i prerađen, proizvodi od duvana, cigare, cigarete, filter, cigarete, cigarilosi, artikli za pušaće, upaljači, šibice.

Klasa 35: usluge u vezi sa prometom robe, posebno usluge u prometu duvana i duvanskih proizvoda; oglašavanje; vođenje poslova; poslovno upravljanje; kancelarijski poslovi; komercijalno zastupanje; propagandne i reklamne usluge; marketing; usluge istraživanja tržišta; usluge promocije, posebno promovisanje ili reklamiranje kulturnih i zabavnih događaja, sportskih takmičenja i modnih revija; organizovanje i vođenje sajmova i izložbi u reklamne i komercijalne svrhe; naprijed navedene usluge koje pripadaju ovoj klasi koje se obavljaju putem interneta; davanje i širenje informacija u vezi sa gore navedenim uslugama.

(210) **2013-135**

(442) **20.04.2014.**

(220) 4/8/2013

(731) **TDR D.O.O. ROVINJ**, OBALA VLADIMIRA NAZORA 1.52210 ROVINJ HR

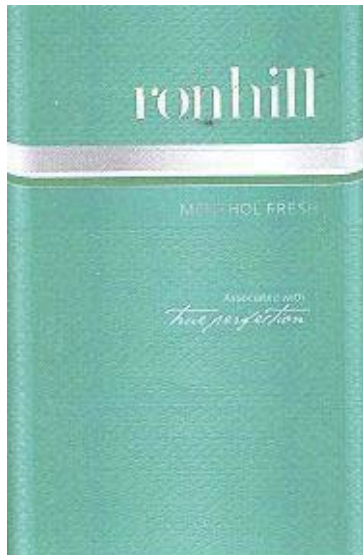

(540)

(550) I

(740) Vukotić Petar, Novaka Miloševa, Podgorica ME

(511) **Klasa 34:** duvan sirov i prerađen, proizvodi od duvana, cigare, cigarete, filter, cigarete, cigarilosi, artikli za pušaće, upaljači, šibice.

Klasa 35: usluge u vezi sa prometom robe, posebno usluge u prometu duvana i duvanskih proizvoda; oglašavanje; vođenje poslova; poslovno upravljanje; kancelarijski poslovi; komercijalno zastupanje; propagandne i reklamne usluge; marketing; usluge istraživanja tržišta; usluge promocije, posebno promovisanje ili reklamiranje kulturnih i zabavnih događaja, sportskih takmičenja i modnih revija; organizovanje i vođenje sajmova i izložbi u reklamne i komercijalne svrhe; naprijed navedene usluge koje pripadaju ovoj klasi koje se obavljaju putem interneta; davanje i širenje informacija u vezi sa gore navedenim uslugama.

(210) **2013-136**(442) **20.04.2014.**

(220) 4/9/2013

(731) SHULTON, INC ONE PROCTER & GAMBLE PLAZA, CINCINNATI, OHIO 45202 US

LIONPRIDE

(540)

(550) I

(740) Lutovac Branislav, Bulevar Crnojevića 93, Podgorica ME

(511) **Klasa 03:** Antiperspiranti i dezodoransi, preparati za njegu kose, nemedicinski preparati za njegu kože, preparati za brijanje, mirisi, kupke, sapuni i gelovi za tuširanje.(210) **2013-137**(442) **20.04.2014.**

(220) 4/9/2013

(731) SHULTON, INC ONE PROCTER & GAMBLE PLAZA, CINCINNATI, OHIO 45202 US

DANGER ZONE

(540)

(550) I

(740) Lutovac Branislav, Bulevar Crnojevića 93, Podgorica ME

(511) **Klasa 03:** Antiperspiranti, dezodoransi za ličnu upotrebu, kupke, preparati za brijanje i mirišljavi sprejevi za tijelo.

(210) **2013-138**

(442) **20.04.2014.**

(220) 4/9/2013

(731) **SHULTON, INC** ONE PROCTER & GAMBLE PLAZA, CINCINNATI, OHIO 45202 US

BEARGLOVE

(540)

(550) I

(740) Lutovac Branislav, Bulevar Crnojevića 93, Podgorica ME

(511) **Klasa 03:** Antiperspiranti i dezodoransi, preparati za njegu kose, nemedicinski preparati za njegu kože, preparati za brijanje, mirisi, kupke, sapuni i gelovi za tuširanje.

(210) **2013-139**

(442) **20.04.2014.**

(220) 4/9/2013

(300) 38 85/749, 037 09.10.2012. US

41 85/749, 032 09.10.2012. US

(731) **VIACOM INTERNATIONAL INC.,** 1515 BROADWAY NEW YORK, NY, 10036 US

(540)

(550) I, F

(740) Popović Miladin, Đoka Miraševića 21/III, Podgorica ME

(511) **Klasa 38:** Usluge emitovanja i telekomunikacija; usluge kablovskog i satelitskog prenosa; usluge bežične mobilne telefonije; usluge preuzimanja melodija za telefonska zvana, muzike, mp3 formata, grafika, igrica, video zapisa i informacija za uređaje za bežičnu mobilnu komunikaciju; usluge bežičnog prenosa melodija za telefonska zvana, glasova, muzike, mp3 formata, grafika, igrica, video zapisa, informacija i vesti, koje se mogu prebacivati i preuzimati putem globalne kompjuterske mreže na uređaje za bežičnu mobilnu komunikaciju; glasanje i biranje putem uređaja za bežičnu mobilnu komunikaciju; slanje i prijem glasovnih

i tekstualnih poruka između bežičnih mobilnih komunikacija; usluge on-line sistema glasanja putem interneta ili uređaja za bežičnu mobilnu komunikaciju; internet usluge koje treba razumeti tako da uključuju komunikacione usluge, odnosno da direktno prenose zvučne i audio-vizuelne snimke putem interneta.

Klasa 41: Obrazovanje; stručno osposobljavanje; sportske i kulturne aktivnosti; usluge zabavnog karaktera; proizvodnja, priprema, izlaganje, distribucija i iznajmljivanje televizijskih i radio programa i filmova, animiranih filmova i zvučnih i video zapisa posredstvom ili ne posredstvom interaktivnih medija, među kojima i interneta; produkcija zabavnog karaktera uživo, televizijska produkcija zabavnog karaktera; tv programiranje koje sadrži muziku; objavljivanje knjiga, magazina i časopisa; obezbjeđivanje ne-preuzimljivih elektronskih publikacija o različitim temama; štampani materijal i objavljivanje i uređivanje časopisa; objavljivanje interaktivnih multimedija; proizvodnja i iznajmljivanje obrazovnih i nastavnih materijala; organizacija, proizvodnja i prezentacija obrazovnih, kulturnih ili zabavnih događaja, posredstvom ili ne posredstvom interaktivnih medija; organizacija, proizvodnja i prezentacija takmičenja, nadmetanja, igara, kvizova, izložbi, sportskih događaja, emisija, turneja, priredbi, pozorišnih nastupa, koncerata, nastupa uživo i događaja u kojima učestvuje publika; organizacija interaktivnih igara; proizvodnja sms-kviz programa; razonoda i obrazovanje; sve navedene usluge takođe omogućene putem globalne računarske mreže i drugih (interaktivnih) komunikacionih mreža, uključujući internet.

(210) **2013-140** (442) **20.04.2014.**
(220) 4/9/2013

(731) **FARMACEUTSKO-HEMIJSKA INDUSTRIJA ZDRAVLJE AD**, VLAJKOVA 199,
16000 LESKOVAC RS

TELMIKOR

(540)

(550) I, V

(740) Popović Miladin, Đoka Miraševića 21/III, Podgorica ME

(511) **Klasa 05:** Farmaceutski i veterinarski proizvodi; higijenski proizvodi za upotrebu u medicini; dijetalne materije za medicinske potrebe, hrana za bebe; flasteri, materijal za previjanje; materijali za plombiranje zuba i za zubne otiske; dezinfekciona sredstva; proizvodi za uništavanje životinjskih štetočina; fungicidi, herbicidi.

(210) **2013-141** (442) **20.04.2014.**
(220) 4/9/2013

(731) **FARMACEUTSKO-HEMIJSKA INDUSTRIJA ZDRAVLJE AD**, VLAJKOVA 199,
16000 LESKOVAC RS

ONZAPIN

(540)

(550) I, V

(740) Popović Miladin, Đoka Miraševića 21/III, Podgorica ME

(511) **Klasa 05:** Farmaceutski i veterinarski proizvodi; higijenski proizvodi za upotrebu u medicini; dijetalne materije za medicinske potrebe, hrana za bebe; flasteri, materijal za previjanje; materijali za plombiranje zuba i za zubne otiske; dezinfekciona sredstva; proizvodi za uništavanje životinjskih štetočina; fungicidi, herbicidi.

(210) **2013-142**(442) **20.04.2014.**

(220) 4/9/2013

(731) **FARMACEUTSKO-HEMIJSKA INDUSTRIJA ZDRAVLJE AD**, VLAJKOVA 199,
16000 LESKOVAC RS

TELMIKOR Plus

(540)

(550) I, V

(740) Popović Miladin, Đoka Miraševića 21/III, Podgorica ME

(511) **Klasa 05:** Farmaceutski i veterinarski proizvodi; higijenski proizvodi za upotrebu u medicini; dijetalne materije za medicinske potrebe, hrana za bebe; flasteri, materijal za previjanje; materijali za plombiranje zuba i za zubne otiske; dezinfekciona sredstva; proizvodi za uništavanje životinjskih štetočina; fungicidi, herbicidi.(210) **2013-143**(442) **20.04.2014.**

(220) 4/9/2013

(300) 20121722A 11.10.2012. HR

(731) **B.S.A.**, 33 AVENUE DU MAINE-TOUR MAINE MONTPARNASSE, 75015 PARIS FR

(540)

(550) I, T

(740) Radulović Božidar, Jovana Tomaševića 9/III, Podgorica ME

(511) **Klasa 29:** meso, riba, živina i divljač; mesni ekstrakti, jaja; mlijeko i mliječni proizvodi, puter, sir, jogurt, pavlaka (mliječni proizvodi), sojino mlijeko (zamjena za mlijeko); jestiva ulja i masti; napitci na bazi mlijeka u kojima preovladuje mlijeko; mješavine i pripremljena jela koja sadrže navedene proizvode, poimenice meso, ribu, živinu i divljač, mesne ekstrakte, jaja, mlijeko i mliječne proizvode, puter, sir, jogurt, pavlaku (mliječni proizvodi), sojino mlijeko (zamjena za mlijeko).(210) **2013-144**(442) **20.04.2014.**

(220) 4/10/2013

(731) **BUDGET RENT A CAR SYSTEM, INC**, 6 SYLVAN WAY, PARSIPPANY, NEW JERSEY
07054 US

BUDGET

(540)

(550) I

(740) AOD "Ćupić", Dalmatinska 10, Podgorica ME

(511) **Klasa 09:** Satelitski radio aparati; oprema za telekomunikacije i prenos podataka, naime, uređaji za prenos i agregaciju komunikacija glasom, podacima i videom preko višestrukih mrežnih infrastruktura i komunikacionih protokola.**Klasa 12:** Motorni autobusi; autobusi i njihovi strukturni djelovi; okviri registarskih tablica; strukturni djelovi za motorna vozila, naime, automobile, kamione, kombije, sportsko-rekreativna vozila; prikolice.**Klasa 16:** Turističke brošure; knjige namjenjene putovanjima; štampani formulari; štampane stvari, naime, papirni znakovi, knjige, uputstva, programi, informacione karte i brošure na polju putovanja, iznajmljivanje vozila i transport.**Klasa 35:** Poslovna administracija na polju transporta i dostave; upravljanje ugovorima za vozila u javnom sektoru; usluge upravljanja transportom, naime, planiranje i koordinacija transporta ljudi za druge.**Klasa 39:** Usluge šofera; transport putnika; obezbjeđivanje onlajn (on-line) kompjuterske baze podataka sa informacijama o putovanju, sa mogućnošću pretraživanja; klubovi za putovanja; usluge voženja vozila.(210) **2013-145**(442) **20.04.2014.**

(220) 4/10/2013

(300) US 85842894 06.02.2013

(731) **BUDGET RENT A CAR SYSTEM, INC**, 6 SYLVAN WAY, PARSIPPANY, NEW JERSEY 07054 US

BUDGET

(540)

(550) I

(740) AOD "Ćupić", Dalmatinska 10, Podgorica ME

(511) **Klasa 09:** Električni i naučni uređaji; kompjuterski softver za upotrebu u kancelarijama za najam vozila kako bi se pratile rezervacije i vozila, i održavanje podataka u vezi sa vozilima, klijentima i najmovima; kompjuterski softver vezan za najam vozila, sačuvan; softver koji se može skinuti (download) u formi mobilne aplikacije za najam vozila ili usluge lizinga; globalni sistem pozicioniranja (GPS); interaktivni kompjuterski kiosci koji se sastoje od kompjutera, kompjuterskog hardvera, kompjuterskih periferija i kompjuterskih operativnih sistema, za upotrebu kod najma vozila ili usluga lizinga; navigacioni uređaji za vozila.

Klasa 12: Vozila; automobili; motorna vozila, naime, automobili, kamioni, kombiji, sportsko-rekreativna vozila.

(210) 2013-146 (442) 20.04.2014.

(220) 4/10/2013

(300) US 85750549 10 10 2012

(731) **BUDGET RENT A CAR SYSTEM, INC**, 6 SYLVAN WAY, PARSIPPANY, NEW JERSEY 07054 US



(540)

(550) I

(740) AOD "Ćupić", Dalmatinska 10, Podgorica ME

(511) **Klasa 09:** Električni i naučni uređaji; kompjuterski softver za upotrebu u kancelarijama za najam vozila kako bi se pratile rezervacije i vozila, i održavanje podataka u vezi sa vozilima, klijentima i najmovima; kompjuterski softver vezan za najam vozila, sačuvan; softver koji se može skinuti (download) u formi mobilne aplikacije za najam vozila ili usluge lizinga; globalni sistem pozicioniranja (GPS); interaktivni kompjuterski kiosci koji se sastoje od kompjutera, kompjuterskog hardvera, kompjuterskih periferija i kompjuterskih operativnih sistema, za upotrebu kod najma vozila ili usluga lizinga; navigacioni uređaji za vozila.

Klasa 12: Vozila; automobili; motorna vozila, naime, automobili, kamioni, kombiji, sportsko-rekreativna vozila.

Klasa 16: Papirna roba i štampane stvari; brošure iz oblasti putovanja, najma vozila, transporta; kalendari; časopisi koji se odnose na putovanja; olovke; mape; bilteni.

Klasa 35: Usluge oglašavanja i vodenja poslova; usluge dobijanja lojalnosti potrošača i usluge potrošačkog kluba, za komercijalne, promotivne svrhe i svrhe oglašavanja; pružanje asistencije pri upravljanju poslovima kod osnivanja i/ili rada objekata za najam i lizing vozila; usluge onlajn (on-line) maloprodaje u vezi sa motornim vozilima; pružanje stimulativnih programa nagrada za klijente putem izdavanja i procesiranja bodova lojalnosti za onlajn (on-line) kupovinu firmine robe i usluga; pružanje stimulativnih programa nagrada za klijente putem izdavanja i procesiranja kupona lojalnosti za čestu upotrebu preduzeća koja učestvuju; usluge obezbjeđivanja transportne dokumentacije za druge; usluge maloprodaje u vezi sa motornim vozilima.

Klasa 36: Finansijske usluge; obezbjeđivanje vaučera za plaćanje transportnih troškova; usluge osiguranja, naime osiguranje vozila.

Klasa 37: Usluge popravke, usluge pomoći na putu, naime odgovaranje na pozive za pomoć na putu, zamjene gume, hitna dostava goriva i paljenja automobila.

Klasa 39: Usluge transporta i skladištenja; organizovanje putnih tura; autobuski prevoz; iznajmljivanje automobila; prevoz automobilom; koordiniranje individualnim i grupnim putovanjima; usluge pomoći na putu, naime šlepovanje, izvlačenje i dostava ključeva; lizing auto-

mobila; lizing kamiona; lizing vozila; pravljenje rezervacija i knjiženje za transport; onlajn (on-line) usluge rezervacija za transport; pružanje informacija o putovanjima; rezervacija automobila za iznajmljivanje; iznajmljivanje kombija za selidbe; iznajmljivanje GPS opreme u navigacione svrhe; iznajmljivanje kamiona; iznajmljivanje vozila; transport putnika; usluge konsultacija o prevozu; usluge informacije o prevozu; usluge putničkih agencija, naime, pravljenje rezervacija i knjiženje za transport; usluge rezervacija transporta; planiranje rute putovanja.

Klasa 41: Obrazovane usluge i razonoda; usluge članovima kluba.

Klasa 42: Kompjuterske i naučne usluge; obezbjeđivanje veb-sajta (web-site) sa tehnologijom koja omogućava korisnicima da rezervišu putovanja.

(210) **2013-147**

(442) **20.04.2014.**

(220) 4/10/2013

(300) US 85750569 10.10.2012

(731) **BUDGET RENT A CAR SYSTEM, INC**, 6 SYLVAN WAY, PARSIPPANY, NEW JERSEY 07054 US



(540)

(550) I

(740) AOD "Ćupić", Dalmatinska 10, Podgorica ME

(511) **Klasa 09:** Električni i naučni uređaji; kompjuterski softver za upotrebu u kancelarijama za najam vozila kako bi se pratile rezervacije i vozila, i održavanje podataka u vezi sa vozilima, klijentima i najmovima; kompjuterski softver vezan za najam vozila, sačuvan; softver koji se može skinuti (download) u formi mobilne aplikacije za najam vozila ili usluge lizinga; globalni sistem pozicioniranja (GPS); interaktivni kompjuterski kiosci koji se sastoje od kompjutera, kompjuterskog hardvera, kompjuterskih periferija i kompjuterskih operativnih sistema, za upotrebu kod najma vozila ili usluga lizinga; navigacioni uređaji za vozila.

Klasa 12: Vozila; automobili; motorna vozila, naime, automobili, kamioni, kombiji, sportsko-rekreativna vozila.

Klasa 16: Papirna roba i štampane stvari; brošure iz oblasti putovanja, najma vozila, transporta; kalendari; časopisi koji se odnose na putovanja; olovke; mape; bilteni.

Klasa 35: Usluge oglašavanja i vodenja poslova; usluge dobijanja lojalnosti potrošača i usluge potrošačkog kluba, za komercijalne, promotivne svrhe i svrhe oglašavanja; pružanje asistencije pri upravljanju poslovima kod osnivanja i/ili rada objekata za najam i lizing vozila; usluge onlajn (on-line) maloprodaje u vezi sa motornim vozilima; pružanje stimulativnih programa nagrada za klijente putem izdavanja i procesiranja bodova lojalnosti za onlajn (on-line) kupovinu firmine robe i usluga; pružanje stimulativnih programa nagrada za klijente putem izdavanja i procesiranja kupona lojalnosti za cestu upotrebu preduzeća koja učestvuju; usluge obezbjeđivanja transportne dokumentacije za druge; usluge maloprodaje u vezi sa motornim vozilima.

Klasa 36: Finansijske usluge; obezbjeđivanje vaučera za plaćanje transportnih troškova; usluge osiguranja, naime osiguranje vozila.

Klasa 37: Usluge popravke, usluge pomoći na putu, naime odgovaranje na pozive za pomoć na putu, zamjene gume, hitna dostava goriva i paljenja automobila.

Klasa 39: Usluge transporta i skladištenja; organizovanje putnih tura; autobuski prevoz; iznaj-

mljivanja automobila; prevoz automobilom; koordiniranje individualnim i grupnim putovanjima; usluge pomoći na putu, naime šlepovanje, izvlačenje i dostava ključeva; lizing automobila; lizing kamiona; lizing vozila; pravljenje rezervacija i knjiženje za transport; onlajn (on-line) usluge rezervacija za transport; pružanje informacija o putovanjima; rezervacija automobila za iznajmljivanje; iznajmljivanje kombija za selidbe; iznajmljivanje GPS opreme u navigacione svrhe; iznajmljivanje kamiona; iznajmljivanje vozila; transport putnika; usluge konsultacija o prevozu; usluge informacije o prevozu; usluge putničkih agencija, naime, pravljenje rezervacija i knjiženje za transport; usluge rezervacija transporta; planiranje rute putovanja.

Klasa 41: Obrazovane usluge i razonoda; usluge članovima kluba.

Klasa 42: Kompjuterske i naučne usluge; obezbjeđivanje veb-sajta (web-site) sa tehnologijom koja omogućava korisnicima da rezervišu putovanja.

(210) **2013-148**

(442) **20.04.2014.**

(220) 4/10/2013

(300) US 85750577 10.10.2012

(731) **BUDGET RENT A CAR SYSTEM, INC**, 6 SYLVAN WAY, PARSIPPANY, NEW JERSEY 07054 US



(540)

(550) I

(740) AOD "Ćupić", Dalmatinska 10, Podgorica ME

(511) **Klasa 09:** Električni i naučni uređaji; kompjuterski softver za upotrebu u kancelarijama za najam vozila kako bi se pratile rezervacije i vozila, i održavanje podataka u vezi sa vozilima, klijentima i najmovima; kompjuterski softver vezan za najam vozila, sačuvan; softver koji se može skinuti (download) u formi mobilne aplikacije za najam vozila ili usluge lizinga; globalni sistem pozicioniranja (GPS); interaktivni kompjuterski kiosci koji se sastoje od kompjutera, kompjuterskog hardvera, kompjuterskih periferija i kompjuterskih operativnih sistema, za upotrebu kod najma vozila ili usluga lizinga; navigacioni uređaji za vozila.

Klasa 12: Vozila; automobili; motorna vozila, naime, automobili, kamioni, kombiji, sportsko-rekreativna vozila.

Klasa 16: Papirna roba i štampane stvari; brošure iz oblasti putovanja, najma vozila, transporta; kalendari; časopisi koji se odnose na putovanja; olovke; mape; bilteni.

Klasa 35: Usluge oglašavanja i vodenja poslova; usluge dobijanja lojalnosti potrošača i usluge potrošačkog kluba, za komercijalne promotivne svrhe i svrhe oglašavanja; pružanje asistencije pri upravljanju poslovima kod osnivanja i/ili rada objekata za najam i lizing vozila; usluge onlajn (on-line) maloprodaje u vezi sa motornim vozilima; pružanje stimulativnih programa nagrada za klijente putem izdavanja i procesiranja bodova lojalnosti za onlajn (on-line) kupovinu firmine robe i usluga; pružanje stimulativnih programa nagrada za klijente putem izdavanja i procesiranja kupona lojalnosti za cestu upotrebu preduzeća koja učestvuju; usluge obezbjeđivanja transportne dokumentacije za druge; usluge maloprodaje u vezi sa motornim vozilima.

Klasa 36: Finansijske usluge; obezbjeđivanje vaučera za plaćanje transportnih troškova; usluge osiguranja, naime osiguranje vozila.

Klasa 37: Usluge popravke, usluge pomoći na putu, naime odgovaranje na pozive za pomoć na

putu, zamjene gume, hitna dostava goriva i paljenja automobila.

Klasa 39: Usluge transporta i skladištenja; organizovanje putnih tura; autobuski prevoz; iznajmljivanja automobila; prevoz automobilom; koordiniranje individualnim i grupnim putovanjima; usluge pomoći na putu, naime šlepanje, izvlačenje i dostava ključeva; lizing automobila; lizing kamiona; lizing vozila; pravljenje rezervacija i knjiženje za transport; onlajn (on-line) usluge rezervacija za transport; pružanje informacija o putovanjima; rezervacija automobila za iznajmljivanje; iznajmljivanje kombija za selidbe; iznajmljivanje GPS opreme u navigacione svrhe; iznajmljivanje kamiona; iznajmljivanje vozila; transport putnika; usluge konsultacija o prevozu; usluge informacije o prevozu; usluge putničkih agencija, naime, pravljenje rezervacija i knjiženje za transport; usluge rezervacija transporta; planiranje rute putovanja.

Klasa 41: Obrazovane usluge i razonoda; usluge članovima kluba.

Klasa 42: Kompjuterske i naučne usluge; obezbjeđivanje veb-sajta (web-site) sa tehnologijom koja omogućava korisnicima da rezervišu putovanja.

(210) **2013-149**

(442) **20.04.2014.**

(220) 4/11/2013

(731) **THE TURNER CORPORATION** (DELAWARE CORPRATION), 357 HUDSON STREET, NEW YORK, NY 10014 US

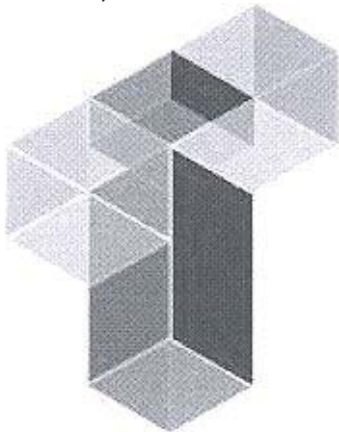

(540)

(550) I

(740) Radulović Božidar, Jovana Tomaševića 9/III, Podgorica ME

(511) **Klasa 37:** Komercijalno građevinsko konstruisanje; građevinsko konstruisanje i popravljavanje; usluge upravljanja građevinskim konstruisanjem; usluge građevinskog konstruisanja od strane preduzimaca. (prioritet: 27.11.2012. US 85/788, 493).

Klasa 41: Obrazovne usluge, naročito održavanje predavanja i konferencija iz oblasti građevinskog konstruisanja i distribucija obrazovnog materijala u vezi sa tim. (prioritet: 27.11.2012. US 85/788, 501).

(210) **2013-150**

(442) **20.04.2014.**

(220) 4/11/2013

(300) 85/788, 501 27.11.2012. US

(731) **THE TURNER CORPORATION** (DELAWARE CORPRATION), 357 HUDSON STREET, NEW YORK, NY 10014 US

TURNER INNOVATION

(540)

(550) I

(740) Radulović Božidar, Jovana Tomaševića 9/III, Podgorica ME

(511) **Klasa 37:** Komercijalno građevinsko konstruisanje; građevinsko konstruisanje i popravljavanje; usluge upravljanja građevinskim konstruisanjem; usluge građevinskog konstruisanja od strane preduzimaca. (prioritet: 27.11.2012. US 85/788, 493).

Klasa 41: Obrazovne usluge, naročito održavanje predavanja i konferencija iz oblasti građevinskog konstruisanja i distribucija obrazovnog materijala u vezi sa tim.

(210) **2013-151**(442) **20.04.2014.**

(220) 4/12/2013

(731) SHIMANO INC., 3-77 OIMATSU-CHO, SAKAI CITY, OSAKA JP

SORA

(540)

(550) I

(740) Popović Miladin, Đoka Miraševića 21/III, Podgorica ME

(511) **Klasa 12:** Električne bicikle, bicikle, djelovi i oprema za bicikle, naime, glavčine, unutrašnje glavčine mjenjaca, glavčine dinamama za bicikle, glavčine za brzo otpuštanje poluge mjenjaca, otpusne poluge mjenjaca, poluge za mijenjanje brzina, prednji prenosni mehanizmi, zadnji prenosni mehanizmi, vodiče lanca, pomoćni zupčanici za mijenjanje brzina (skretaci lanaca), zupčanici, dizalice za bicikle, lanci za bicikle, sajle, obrtaljke, komplet obrtaljka, prednji lančanici za točak, pedale za bicikle, klipseri (korpice za stopala), poluge kočnica, prednje kočnice, zadnje kočnice, sajle za kočnice, kočne papuče, kočioni diskovi, kočione pločice, obruci, točkovi, lanci za kocenje, klipovi za kocenje, donje sponje, nosači za sjedište, mehanizmi za brzo otpuštanje nosača sjedišta, glavni djelovi za sklapanje rama viljuški, amortizeri, upravljači, drške upravljača, ručice upravljača, krajevi drške upravljača, uporišta sjedišta, sjedišta, prenosni mehanizmi kojima upravlja kompjuter, pokazivači pozicije brzine bicikla.

(210) **2013-152**(442) **20.04.2014.**

(220) 4/12/2013

(731) SHIMANO INC., 3-77 OIMATSU-CHO, SAKAI CITY, OSAKA JP

SHIMANO 105

(540)

(550) I

(740) Popović Miladin, Đoka Miraševića 21/III, Podgorica ME

(511) **Klasa 12:** Električne bicikle, bicikle, djelovi i oprema za bicikle, naime, glavčine, unutrašnje glavčine mjenjaca, glavčine dinamama za bicikle, glavčine za brzo otpuštanje poluge mjenjaca, otpusne poluge mjenjaca, poluge za mijenjanje brzina, prednji prenosni mehanizmi, zadnji prenosni mehanizmi, vodiče lanca, pomoćni zupčanici za mijenjanje brzina (skretaci lanaca), zupčanici, dizalice za bicikle, lanci za bicikle, sajle, obrtaljke, komplet obrtaljka, prednji lančanici za točak, pedale za bicikle, klipseri (korpice za stopala), poluge kočnica, prednje kočnice, zadnje kočnice, sajle za kočnice, kočne papuče, kočioni diskovi, kočione pločice, obruci, točkovi, lanci za kocenje, klipovi za kocenje, donje sponje, nosači za sjedište,

šte, mehanizmi za brzo otpuštanje nosača sjedišta, glavni djelovi za sklapanje rama viljuški, amortizeri, upravljači, drške upravljača, ručice upravljača, krajevi drške upravljača, uporišta sjedišta, sjedišta, prenosni mehanizmi kojima upravlja kompjuter, pokazivači pozicije brzine bicikla.

(210) **2013-153** (442) **20.04.2014.**
(220) 4/12/2013

(731) **LISETTE LIMOGES AGENCIES INC.**, 9250 AVENUE DE PARC, SUITE 300, H2N1Z2 MONTREAL, QUEBEC CA

LISETTE L

(540)

(550) I

(740) Čejović Vladimir, 13. jula 21, Podgorica ME

(511) **Klasa 25:** odjeća, pokrivala za glavu, obuća;

(210) **2013-154** (442) **20.04.2014.**
(220) 4/12/2013

(731) **PFIZER INC.**, 235 EAST 42 STREET, NEW YORK, NY 10017 US

XELJANZ

(540)

(550) I

(740) Čejović Vladimir, 13. jula 21, Podgorica ME

(511) **Klasa 05:** Farmaceutski i veterinarski preparati; sanitarni preparati za upotrebu u medicini; dijetetska hrana i supstance prilagođene za upotrebu u medicini ili veterinarsku upotrebu; hrana za bebe; dijetetski dodaci za ljude i životinje; flasteri, materijali za zavijanje; materijali za plombiranje zuba, zubarska smola; dezinfekciona sredstva; preparati za uništavanje štetočina; fungicidi, herbicidi.

(210) **2013-155** (442) **20.04.2014.**
(220) 4/12/2013

(731) **COLGATE-PALMOLIVE COMPANY**, 300 PARK AVENUE, NEW YORK, NY 10022 US

PALMOLIVE
MEDITERRANEAN
MOMENTS

(540)

(550) I

(740) AOD "Ćupić", Dalmatinska 10, Podgorica ME

(511) **Klasa 03:** Preparati za bjeljenje i druge supstance za upotrebu u praonicama; preparati za čišćenje, poliranje, ribanje i nagrizanje; sapuni; parfimerija, eterična ulja, kozmetika, losioni za kosu; sredstva za njegu zuba; abrazivni papir; abrazivna sredstva; ljepila za pričvršćivanje lažnih trepavica; ljepila za pričvršćivanje vještačke kose; ljepila u kozmetičke svrhe; losioni za posle brijanja; preparati za osvježavanje vazduha; bademovo mlijeko u kozmetičke svrhe; bademovo ulje; bademov sapun; preparati od aloe-vere u kozmetičke svrhe; alunit (sredstv koje zateže); ćilibar (parfem); amonijak (isparljiva alkalija) (deterdžent); antiperspirantni sapuni; antiperspiranti (toaletna sredstva); antistatički preparati za kućnu upotrebu; aromatična sredstva (eterična ulja); sredstva koja zatežu u kozmetičke svrhe; Badian esencija (esencija od zvjezdastog anisa); melemi osim u medicinske svrhe; baze za cvjetne parfeme; soli za kupke, ne u medicinske svrhe; boje za farbanje brade; maske za njegu ljepote; Bergamotova ulja; sredstva za bjeljenje (odstranjivanje boja) u kozmetičke svrhe; soli za bjeljenje; soda bikarbona za bjeljenje; sprejevi za osvježavanje daha; tralice za osvježavanje daha; arome za kolace (eterična ulja); okrugli sapuni; komprimovani vazduh u konzervama u svrhe čišćenja i brisanja prašine; metalni karbidi (abrazivna sredstva); kreda za čišćenje; preparati za čišćenje; mlijeko za čišćenje u toaletne svrhe; krpe impregnirane sa deterdžentom za čišćenje; vosak za obućare; hemijska sredstva za oživljavanje boja u kućne svrhe (rublje); preparati za uklanjanje boja; sredstva za bojenje u toaletne svrhe; korund (abrazivno sredstvo), kozmetičke kreme; boje u kozmetičke svrhe; kozmetički pribor; kozmetičke olovke; kozmetički preparati za kupke; kozmetički preparati za trepavice; kozmetički preparati za njegu kože; kozmetički preparati za mršavljenje; kozmetika; kozmetika za životinje; pamucni štapići u kozmetičke svrhe; vata u kozmetičke svrhe; dekorativne naljepnice u kozmetičke svrhe; odmaščivaci osim za upotrebu u proizvodnji; gelovi za izbjeljivanje zuba; sredstva za njegu zuba; sredstva za poliranje zubne proteze; deodorantski sapuni; deodoranti za ljude ili životinje; deodoranti za kućne ljubimce; sredstva za depilaciju; vosak za depilaciju; deterdženti osim za upotrebu u proizvodnim procesima i u medicinske svrhe; abrazivna sredstva u formi dijamanta; dezinfekcioni sapun; preparati za tuširanje za ličnu higijenu ili u deodorantske svrhe (toaletna sredstva); preparati za suvo pranje; šamponi za suvo pranje; agensi za sušenje za mašine za sudove; kolonjske vode; šmirgla; brusna tkanina; brusni papir; eterična ulja od kedrovine; eterična ulja od citrusa; eterična ulja od limuna; eterične esencije; eterična ulja; ekstrakti cvjetova (parfemi); kozmetika za obrve; olovke za obrve; omekšivači za rublje; vještačke trepavice; vještački nokti; arome za napitke (eterična ulja); vosak za podove; sredstva za odstranjivanje podnog voska (preparati za ribanje); preparati za neutralisanje dima (parfemi); preparati za postizanje sjaja; ulje Gaultheria-e; Geraniol; krpe za stakla; masnoce u kozmetičke svrhe; preparati za brušenje; boje za kosu; losioni za kosu; lakovi za kosu; preparati za talase u kosi; heliotropin; kana (kozmetička boja); vodonik peroksid u kozmetičke svrhe; kadulje; jononi (parfimerija); ulje jasmína; javelle (žavel) voda; mirišljavi štapići; preparati za skidanje laka; izbjeljivaci za rublje; vešplav (plavilo za rublje); impregnacija rublja; preparati za rublje; preparati za potapanje veša; štirak za veš; vosak za veš; ulje lavande; vodiča od lavande; preparati za izbjeljivanje kože; sredstva za zaštitu kože (politure); sjajevi za usne; karmini; losioni u kozmetičke svrhe; šminka; puderi za šminkanje; preparati za šminkanje; preparati za skidanje šminke; maskare; gelovi za masažu, ne u medicinske svrhe; medicinski sapun; esencije mente (eterična ulja); menta za parfimeriju; sredstva za ispiranje usta, ne u medicinske svrhe; mošus (parfimerija); vosak za brkove; naljepnice za nokte; preparati za njegu noktiju; lakovi za nokte; neutralizatori za trajnu ondulaciju; tečnosti za podove koje sprecajaju klizanje; neklizajući vosak za podove; terpentinsko ulje za odmaščivanje; ulja u svrhe čišćenja; ulja u kozmetičke svrhe; ulja za parfeme i mirise; ulja u toaletne svrhe;

preparati za skidanje farbe; paste za kaiševе za oštrenje brijača; parfimerija; parfemi; vazelin u kozmetičke svrhe; politure za namještaj i podove; kreme za poliranje; papir za poliranje; preparati za poliranje; sredstva za poliranje na bazi vještačkog oksida gvoždja; kamen za poliranje; vosak za poliranje; pomade u kozmetičke svrhe; potpuri (mirisi); preparati za čišćenje zubnih proteza; preparati za otpušavanje vodovodnih cjevi; preparati za sjaj listova na biljkama; kamen za pete; kora Quillajaceae za pranje; ružino ulje; preparati za uklanjanje rde; vrećice za parfimisanje posteljine; safrol; šmirgle; papir za šmirglanje; preparati za skidanje kamenca za kućnu upotrebu; mirisne vodiče; mirišljivo drvo; rastvori za ribanje; šamponi; šamponi za kućne ljubimce; preparati za brijanje; sapun za brijanje; kamen za brijanje (zatvaranje pora); preparati za davanje sjaja (politura); krema za cipele; sjaj za cipele; vosak za cipele; obučarski vosak; silicijumkarbid (abraziv); kreme za bjeljenje kože; preparati za glacanje (štirak); kamen za glacanje; sapun; sapun za osvježavanje boja na tekstilu; sapun protiv znojenja stopala; lužina sode; sredstva za odstranjivanje fleka; impregnacije od štirka za rublje; preparati za sunčanje (kozmetika); preparati za zaštitu od sunca; vošak za krojace; talk, u toaletne svrhe; terpeni (eterična ulja); maramice impregnirane kozmetičkim losionima; toaletne vode; toaletna sredstva; Tripoli kamen za poliranje; terpentini za odmaščivanje; preparati za skidanje laka; vulkanski pepeo za čišćenje; preparati za čišćenje tapeta; soda za pranje; vosak za kožu; bjelila; tečnosti za čišćenje vjetrobrana. Klasa 5: Farmaceutski i veterinarski preparati; sanitarni preparati u medicinske svrhe; dijetetska hrana i supstance prilagođene za upotrebu u medicini ili veterinarsku upotrebu, hrana za bebe; dijetetski dodaci za ljude i životinje; flasteri, materijali za zavijanje; materijali za plombiranje zuba, zubarski vosak; dezinfekciona sredstva; preparati za uništavanje štetočina; fungicidi, herbicidi; upijajuća vata (tupferi); akaricidi; acetati u farmaceutske svrhe; kiseline u farmaceutske svrhe; akonitin; ljepljive trake u medicinske svrhe; ljepljivi flasteri; ljepila za zubne proteze; adjuvansi u medicinske svrhe; preparati za osvježavanje vazduha; preparati za prečišćavanje vazduha; dijetetski dodaci na bazi albumina; namirnice sa albuminom u medicinske svrhe; preparati sa albuminom u medicinske svrhe; alkohol u farmaceutske svrhe; aldehidi u farmaceutske svrhe; algicidi; dijetetski dodaci na bazi alginata; alginati u farmaceutske svrhe; alkalni jodid u farmaceutske svrhe; alkaloidi u medicinske svrhe; legure plemenitih metala u zubarske svrhe; preparati aloe vere u farmaceutske svrhe; aluminijum acetat u farmaceutske svrhe; amino kiseline u medicinske svrhe; amino kiseline u veterinarske svrhe; anestetici; analgetici; kora angosture u medicinske svrhe; sredstva za pranje životinja; anti-reumatske narukvice; anti-reumatsko prstenje; preparati protiv stvaranja mokracne kiseline; antibiotici; antikriptogamni preparati; antioksidantne tablete; antiparazitske ogrlice za životinje; antiparazitski preparati; antiseptička vata; antiseptici; tablete za smanjenje apetita; sredstva za smanjenje apetita u medicinske svrhe; sredstva protiv glavobolje; aseptična vata; čaj za astmaticare; gaćice za bebe; pelene za bebe; bakterijski otrovi; bakterijski preparati u medicinske i veterinarske svrhe; medijum bakterioloških kultura; bakteriološki preparati u medicinske i veterinarske svrhe; melemi u medicinske svrhe; balsamični preparati u medicinske svrhe; zavoji; kore drveta u farmaceutske svrhe; preparati za kupke, medicinski; soli za kupke u medicinske svrhe; trake-držači za sanitarne uloške; soda bikarbona u farmaceutske svrhe; biocidi; biološki preparati u medicinske svrhe; biološki preparati u veterinarske svrhe; biološke kulture tkiva u medicinske svrhe; biološke kulture tkiva u veterinarske svrhe; preparati bizmuta u farmaceutske svrhe; subnitrat bizmuta u farmaceutske svrhe; krv u medicinske svrhe; krvna plazma; cement za kosti u hirurške i ortopedske svrhe; narukvice u medicinske svrhe; tuferi za dojenje; brom u farmaceutske svrhe; bronhodilatatori; preparati; jastučići za cukljeve; nusproizvodi dobijeni preradom žitarica u dijetetske ili medicinske svrhe; kapsule u farmaceutske svrhe; pastile u farmaceutske svrhe; kalomel; kamfor u medicinske svrhe; ulje kamfora u medicinske svrhe; bombone u medicinske svrhe; bombone,

medicinske; kapsule za medikamente; karbolineum (paraziticidi); kazeinski dijetetski dodaci; ricinusovo ulje u medicinske svrhe; sredstva za pranje stoke; kausticne olovke; kaustici u farmaceutske svrhe; kedrovina koja se koristi za odbijanje insekata; estri celuloze u farmaceutske svrhe; etri celuloze u farmaceutske svrhe; cement za životinjska kopita; ugalj u farmaceutske svrhe; hemijski provodnici za elektrokardiografske elektrode; hemijska kontraceptivna sredstva; hemijski preparati u medicinske svrhe; hemijski preparati u farmaceutske svrhe; hemijski preparati za dijagnostiku trudnoce; hemijski preparati za lečenje phylloxerae; hemijski preparati u veterinarske svrhe; hemijski preparati za tretiranje budi; hemijski preparati za tretiranje žitaricnog sneta; hemijski reagensi u medicinske i veterinarske svrhe; hemijsko-farmaceutski preparati; žvake u medicinske svrhe; preparati protiv promrzlina; hinolin u medicinske svrhe; hloroform; cinchona u medicinske svrhe; kokain; ulje jetre bakalara; kolodijum u farmaceutske svrhe; collvrium; komprese; kora conduranga u medicinske svrhe; preparati za čišćenje sočiva; sprejovi za hlađenje u medicinske svrhe; sredstva protiv žuljeva i kurjih očiju; prstenasti flasteri za žuljeve i kurje oci na stopalima; pamuk u medicinske svrhe; vinski streš u farmaceutske svrhe; kreozot u farmaceutske svrhe; kora krotona; kulture mikroorganizama u medicinske i veterinarske svrhe; kurare; esencije u farmaceutske svrhe; abrazivna sredstva za zube; zubni amalgami; zubni amalgami od zlata; zubni cementi; materijali za uzimanje zubnih otisaka; zubni lakovi; zubne smole; deodoranti za odjecu i tekstil; deodoranti, osim za ljude ili životinje; sredstva za čišćenje; deterdženti u medicinske svrhe; hleb za dijabeticare, adaptiran za medicinske svrhe; dijagnostički preparati u medicinske svrhe; pelene za kućne ljubimce; dijastaza u medicinske svrhe; dijetetska vlakna; dijetetski dodaci za životinje; dijetetski napici prilagođeni za medicinske svrhe; dijetetska hrana prilagođena za medicinske svrhe; dijetetske substance, prilagođene za medicinske svrhe; digestivi u farmaceutske svrhe; digitalin; ulje mirodije u medicinske svrhe; dezinfekciona sredstva za hemijske toalete; dezinfekciona sredstva u higijenske svrhe; losioni za pse; sredstva za pranje pasa; preparati za tuširanje u medicinske svrhe; medicinski zavoji; lijekovi u medicinske svrhe;

(210) **2013-157** (442) **20.04.2014.**

(220) 4/16/2013

(731) **HENKEL AG & CO.KGAA**, HENKELSTRASSE 67, 40589 DUSSELDORF DE

Svežina Mediterana

(540)

(550) I

(740) Radulović Božidar, Jovana Tomaševića 9/III, Podgorica ME

(511) **Klasa 03:** Sredstva za bijeljenje i ostale supstance za korišćenje pri pranju, sredstva za ispiranje veša, stoljnjaka, salveta, posudja, omekšivači tkanina, štirak i ostali učvršćivači veša, agensi za uklanjanje mrlja, sredstva i preparati za pranje, poliranje, ribanje, nagrizanje, sapuni, esencijalna ulja kao mirisni dodaci za korišćenje pri pranju.

(210) **2013-158** (442) **20.04.2014.**

(220) 4/17/2013

(731) **ICENTAR D.O.O.PODGORICA**, UL.RADOJA BAKIĆA BB, PODGORICA ME

ICENTAR

(540)

(550) I, V

(511) **Klasa 09:** Aparati i instrumenti naučni, pomorski, geodetski, fotografski, kinematografski, optički, za vaganje, merenje, signalizaciju, kontrolu (inspekciju), spasavanje i nastavu; aparati i instrumenti za provođenje, prekid, transformaciju, akumulaciju, regulisanje ili kontrolu električne energije; aparati za snimanje, prenos i reprodukovanje zvuka ili slike; magnetni nosioci podataka, diskovi za snimanje; automatske mašine i mehanizmi za aparate koji se pokreću novcem ili žetonom; registar kase, računске mašine, oprema za obradu podataka i kompjuteri; aparati za gašenje požara.

Klasa 35: Oglašavanje; vođenje poslova; poslovno upravljanje; kancelarijski poslovi.

Klasa 36: Osiguranje; finansijski poslovi; novčani (monetarni) poslovi; poslovi vezani za nepokretnosti.

Klasa 37: Građevinsko konstruisanje; popravljavanje; usluge instaliranja (instalacione usluge).

Klasa 41: Obrazovne usluge; pripremanje obuke; razonoda; sportske i kulturne aktivnosti.

Klasa 42: Naučne i tehnološke usluge i istraživanje i projektovanje u vezi navedenih usluga; usluge industrijske analize i istraživanja; projektovanje i razvoj kompjuterskog hardvera i softvera.

(210) 2013-159

(442) 20.04.2014.

(220) 4/17/2013

(731) ICENTAR D.O.O.PODGORICA, UL.RADOJA BAKIĆA BB, PODGORICA ME



(540)

(550) I

(511) **Klasa 09:** Aparati i instrumenti naučni, pomorski, geodetski, fotografski, kinematografski, optički, za vaganje, merenje, signalizaciju, kontrolu (inspekciju), spasavanje i nastavu; aparati i instrumenti za provođenje, prekid, transformaciju, akumulaciju, regulisanje ili kontrolu električne energije; aparati za snimanje, prenos i reprodukovanje zvuka ili slike; magnetni nosioci podataka, diskovi za snimanje; automatske mašine i mehanizmi za aparate koji se pokreću novcem ili žetonom; registar kase, računске mašine, oprema za obradu podataka i kompjuteri; aparati za gašenje požara.

Klasa 35: Oglašavanje; vođenje poslova; poslovno upravljanje; kancelarijski poslovi.

Klasa 36: Osiguranje; finansijski poslovi; novčani (monetarni) poslovi; poslovi vezani za nepokretnosti.

Klasa 37: Građevinsko konstruisanje; popravljavanje; usluge instaliranja (instalacione usluge).

Klasa 38: Telekomunikacije.

Klasa 41: Obrazovne usluge; pripremanje obuke; razonoda; sportske i kulturne aktivnosti;

Klasa 42: Naučne i tehnološke usluge i istraživanje i projektovanje u vezi navedenih usluga; usluge industrijske analize i istraživanja; projektovanje i razvoj kompjuterskog hardvera i softvera.

(210) **2013-160**

(442) **20.04.2014.**

(220) 4/17/2013

(731) **ICENTAR D.O.O.PODGORICA**, UL.RADOJA BAKIĆA BB, PODGORICA ME

iCentar

(540)

(550) I

(511) **Klasa 09:** Aparati i instrumenti naučni, pomorski, geodetski, fotografski, kinematografski, optički, za vaganje, merenje, signalizaciju, kontrolu (inspekciju), spasavanje i nastavu; aparati i instrumenti za provođenje, prekid, transformaciju, akumulaciju, regulisanje ili kontrolu električne energije; aparati za snimanje, prenos i reprodukovanje zvuka ili slike; magnetni nosioci podataka, diskovi za snimanje; automatske mašine i mehanizmi za aparate koji se pokreću novcem ili žetonom; registar kase, računске mašine, oprema za obradu podataka i kompjuteri; aparati za gašenje požara.

Klasa 35: Oglašavanje; vođenje poslova; poslovno upravljanje; kancelarijski poslovi.

Klasa 36: Osiguranje; finansijski poslovi; novčani (monetarni) poslovi; poslovi vezani za nepokretnosti.

Klasa 37: Građevinsko konstruisanje; popravljanje; usluge instaliranja (instalacione usluge).

Klasa 38: Telekomunikacije.

Klasa 41: Obrazovne usluge; pripremanje obuke; razonoda; sportske i kulturne aktivnosti;

Klasa 42: Naučne i tehnološke usluge i istraživanje i projektovanje u vezi navedenih usluga; usluge industrijske analize i istraživanja; projektovanje i razvoj kompjuterskog hardvera i softvera.

(210) **2013-161**

(442) **20.04.2014.**

(220) 4/17/2013

(731) **MORITZ EIS D.O.O. TIVAT**, TEUTA BB, PORTO MONTENEGRO ME

MORITZ
EIS

(540)

(550) I

(511) **Klasa 12:** Vozila; aparati za kretanje po zemlji, vazduhu ili vodi.

Klasa 25: Odeća, obuća, pokrivala za glavu.

Klasa 29: Meso, riba, živina i divljač; mesne prerađevine; konzervisano, zamrznuto, sušeno i kuvano voće i povrće; želei, džemovi, kompoti; jaja, mleko i mlečni proizvodi; jestiva ulja i masti;

Klasa 30: Kafa, čaj, kakao, šećer, pirinac, tapioka, sago, zamena kafe; brašno i proizvodi od žitarica, hleb, kolači i poslastice, sladoledi; med, melasa; kvasac, prašak za pećivo; so, senf; sirce, sosovi (kao dodaci); začini; ; Pivo; mineralne i sodne vode i druga bezalkoholna pića; pića od voća i voćni sokovi; sirupi i drugi preparati za proizvodnju pića.

Klasa 33: Alkoholna pića (izuzev piva).

(210) **2013-162**

(442) **20.04.2014.**

(220) 4/19/2013

(731) **TRANSATLANIC HOLDINGS, INC.**, 80 PINE STREET, NEW YORK, NY 10005 US

TRANSRE LONDON

(540)

(550) I

(740) AOD "Ćupić", Dalmatinska 10, Podgorica ME

(511) **Klasa 36:** osiguranje, reosiguranje i usluge upravljanja osiguranjima;

(210) **2013-163**

(442) **20.04.2014.**

(220) 4/25/2013

(300) 201300011 31.01.2013. SM

(731) **INTEL CORPORATION**, 2200 MISSION COLLEGE BOULEVARD, 95052-8119 SANTA CLARA, CALIFORNIA US

LOOK INSIDE

(540)

(550) I

(511) **Klasa 09:** kompjuteri; ručni kompjuteri; mini kompjuteri; kompjuterski hardver; integrisana kola; memorije integrisanih kola; čipovi integrisanih kola; kompleti kompjuterskih cipova; poluprovodnički procesori; čipovi poluprovodničkih procesora; poluprovodnički čipovi; mikroprocesori; ploče štampanih kola; štampana kola, odnosno ploče integrisanih kola, ploče štampanih kola i ploče električnih kola; ploče elektronskih kola; kompjuterske matične ploče; kompjuterske memorije; operativni sistemi; mikrokontrolori; procesori podataka; centralne procesorske jedinice; uređaji sa | poluprovodničkom memorijom, odnosno, poluprovodničke memorije i jedinice poluprovodničkih memorija; softverski procesori koji se mogu programirati; digitalni i optički mikroprocesori; kompjuterske periferije; ploče sa video kolima; ploče sa audio kolima; ploče sa audio-video kolima; video graficki akceleratori; multimedijalni akceleratori; video procesori, ploče sa videoprocessorima; memorije sa podacima; elektronski sigurnosni uređaj i uređaj za nadzor, odnosno kompjuterski hardver,

kompjuterski čipovi i mikroprocesori optimizirani za elektronski bezbjednosni nadzor; algoritamski softverski programi za rad i kontrolu kompjutera; softver kompjuterskog operativnog sistema; kompjuterski operativni sistemi; proširenja kompjuterskih sistema, alati i uređaji u oblasti aplikativnog softvera za povezivanje personalnih kompjutera, mreža, telekomunikacionih uređaja i globalnih kompjuterskih mrežnih aplikacija; kompjuterizovane telekomunikacije i oprema za umrežavanja koja se sastoji od softvera operativnog sistema; kompjuterski hardver i softver za pojačavanje i obezbjeđivanje prenosa, slanja, prijema, obrade i digitalizacije audio i video grafičkih informacija u realnom vremenu; kompjuterski firmvare, odnosno softver kompjuterskog operativnog sistema, softver kompjuterskog modula i drugi kompjuterski softver koji se koristi za održavanje i rad kompjuterskih sistema; kompjuterske instalacije; memorijske ploče; personalni digitalni asistenti; prenosivi i ručni elektronski personalni organajzeri; uređaji za smještaj podataka, odnosno (razni USB uređaji, veličine palca ili privjeska za ključeve, prim.prev) jump drives, flash drives i thumb drives; bezbjednosni sistemi za kompjuterski hardver i softver, odnosno, firewalls (zaštitni zidovi), hardver servera za pristup mreži za kreiranje i održavanje firewalls (zaštitnih zidova), kompjuterski hardver za virtuelnu privatnu mrežu (VPN) i operativni softver kompjuterskog servera za kreiranje i održavanje firewalls (zaštitnih zidova); softver za osiguranje bezbjednosti kompjuterskih mreža; softver za kontrolu i bezbjednost pristupa; kompjuterski hardver i softver za korištenje za zaštitu kompjuterskih mreža od krađe ili oštećenja podataka od strane neovlašćenih korisnika; komponente za kompjutere; kompjuterske ploče za ubrzanje glasa; kompjuterske ploče za ubrzanje glasa, podataka, slika i video zapisa; fleš memorijske ploče i fleš memorijske kartice; telekomunikaciona oprema i kompjuterske mreže, odnosno procesni i operativni sistemi; telekomunikacioni uređaji i instrumenti, odnosno kompjuterski ruteri, uticnice, serveri i prekidači; kompjuterski hardver i softver za razvoj, održavanje i korištenje lokalnih i širokopojasnih kompjuterskih mreža; set-top kutije; elektronski kontrolni uređaji za interfejs i kontrolu kompjutera i globalnih kompjuterskih i telekomunikacionih mreža sa televizijskim i kablovskim emitovanjem i opremom; uređaj za testiranje i programiranje integrisanih kola; kompjuterski aparati i uređaji sa preriferom memorijom; kompjuterski serveri sa fiksnom funkcijom; kompjuterski mrežni hardver; kompjuterski hardver i softver za kreiranje, omogućavanje i upravljanje daljinskim pristupom i komunikacijom sa lokalnim mrežama (LANS), virtualnim privatnim mrežama (VPN), širokopojasnim mrežama (VVANS) i globalnim kompjuterskim mrežama; ruter, prekidač, uticnica i serverski operativni softver; kompjuterski softver i hardver za omogućavanje pristupa većem broju korisnika globalnoj kompjuterskoj informativnoj mreži za potrebe pretraživanja, pronalazanja, prenosa, manipulacije i diseminacije širokog opsega informacija; kompjuterski softverski alati za omogućavanje softverskih aplikacija od strane trećih lica; kompjuterski hardver i softver za bežične mrežne komunikacije; elektronske publikacije koje se mogu preuzimati u vidu biltena, knjiga, časopisa, žurnala, brošura i bijelih knjiga iz oblasti elektronike, poluprovodnika, integrisanih elektronskih aparata i uređaja, kompjutera, telekomunikacija, zabava, telefonije i žičnih i bežičnih telekomunikacija; konstrukcioni djelovi i oprema za sve gorepomenute robe; uputstva za korištenje koja se prodaju uz gorepomenute robe i elektronska uputstva za korištenje koja se mogu preuzeti sa globalne kompjuterske mreže; naučni, nautički, inspekcijski, fotografski, kinematografski, optički aparati i instrumenti, aparati i instrumenti za mjerenje težine i dužine, aparati i instrumenti za signalizaciju, provjeru (nadzor), spašavanje života i podučavanja; aparati i instrumenti za sprovođenje, preciziranje, transformisanje, akumulaciju, regulaciju ili kontrolu elektriciteta; aparati za snimanje, prenos ili reprodukciju zvuka ili slika; magnetni nosači podataka, diskovi za snimanje; kompaktni diskovi; DVDjevi i drugi mediji za snimanje; mehanizmi za aparate na metalni novac; registarske kase, računarske mašine, oprema za obradu podataka, kompjuteri; kom-

pjuterski softver; protivpožarni aparati. KLASA 41: usluge obuke u oblasti mreža, kreiranja mrežnog sistema, mrežnih operacija, održavanja mreža, testiranja mreža, mrežnih protokola, upravljanja mrežama, mrežnog inženjeringa, kompjutera, softvera, mikroprocesora i informacione tehnologije; usluge zabave, odnosno, organizovanje izložbi za kompjuterske igrice, obezbjeđivanje onlajn kompjuterskih igrica i organizovanje sportskih i kulturnih događaja u zajednici; obezbjeđivanje onlajn publikacija u vidu časopisa, biltena, žurnala, knjiga i brošura iz oblasti fotografije, snimanja i srodnih roba i usluga; usluge edukacije, odnosno, pružanje seminara, kurseva i tutorskih sesija u oblasti digitalnog snimanja putem globalnih kompjuterskih mreža; onlajn obezbjeđivanje baze digitalnih slika za korištenje od strane potrošača; obezbjeđivanje onlajn biblioteke digitalnih slika koje korisnici mogu međusobno razmjenjivati, fotografske usluge i usluge biblioteke slika; kompjuterizovane onlajn edukativne usluge, odnosno, održavanje casova, seminara, tutorskih sesija, konferencija i radionica iz oblasti kompjutera, kompjuterskog hardvera, mikroprocesora, softvera i kompjuterskih mreža; usluge kompjuterizovane onlajn obuke iz oblasti kompjutera, kompjuterskog hardvera, mikroprocesora, softvera i kompjuterskih mreža; usluge edukacije, odnosno, pružanje interaktivnih tutorskih sesija i kurseva u vidu vodiča, savjeta i tehnika, stručnog usmjerenja i savjetovanja, sve to u vezi sa kupovinom, korištenjem, čuvanjem, održavanjem, podrškom, nadogradnjom, ažuriranjem i konfigurisanjem kompjuterskog hardvera, kompjuterskog softvera, kompjuterskih mreža, telekonferencijskih i komunikacionih roba i usluga; usluge iz oblasti edukacije, odnosno, održavanje casova, seminara, konferencija i onlajn edukativnih foruma iz oblasti korištenja kompjutera i softvera, navigacija putem globalnih kompjuterskih mreža, kompjuterske nauke i tehnologije, kompjuterskog upravljanja i distribucija nastavnog materijala u vezi sa svim tim; izrada i diseminacija edukativnog materijala izradenog u cilju povećanja tehnološke pismenosti među ucenicima; usluge obuke na mrežnom hardveru i softveru; usluge obuke u oblasti onlajn poslovnih rješenja; edukacija; pružanje obuke; zabava; sportske i kulturne aktivnosti. KLASA 42: usluge upravljanja kompjuterskim mrežama, odnosno, monitoring mrežnih sistema za tehnicke namjene; hosting digitalnog sadržaja na internetu; usluge kompjuterskog mrežnog monitoringa, odnosno, pružanje informacija o funkcionisanju kompjuterskih mreža; prilagodavanje web softvera i kreiranje kompjuterskog korisničkog interfejsa za druge; usluge konsaltinga u oblasti kompjutera i bežičnog racunanja; omogućavanje privremenog korištenje softvera koji se ne može preuzimati za poboljšanje i obezbjeđivanje prenosa, slanja, prijema, obrade i digitalizacije audio i video graficke informacije u realnom vremenu; omogućavanje privremenog korištenje softvera koji se ne može preuzimati za obradu, smještanje, pronalaženje, slanje, prikazivanje, unos, iznos, komprimovanje, dekomprimovanje, modifikovanje, emitovanje i štampanje podataka; omogućavanje privremenog korištenje softvera koji se ne može preuzimati za obezbjeđivanje sigurnosti kompjuterskih mreža, za kontrolu pristupa i bezbjednost i za korištenje u svrhu zaštite kompjuterskih mreža od krađe podataka ili oštećenja od strane neovlašćenih korisnika; omogućavanje privremenog korištenje softvera koji se ne može preuzimati za razvoj, održavanje i korištenje lokalnih i širokopojsnih kompjuterskih mreža; omogućavanje privremenog korištenje softvera koji se ne može preuzimati za prijem, prikaz i korištenje video, audio i signala digitalnih podataka za emitovanje; omogućavanje privremenog korištenje softvera koji se ne može preuzimati za kreiranje, omogućavanje i upravljanje daljinskim pristupom i komunikaciji sa lokalnim mrežama (LANS), virtualnim privatnim mrežama (VPN), širokopojsnim mrežama (WANS) i globalnim kompjuterskim mrežama; omogućavanje privremenog korištenje softvera koji se ne može preuzimati za korištenje u obezbjeđivanju pristupa više korisnika globalnoj informativnoj mreži za pretraživanje, pronalaženje, slanje, podešavanje i diseminaciju velikog opsega informacija; omogućavanje privremenog korištenje softverskih alata koji se ne može preuzimati da bi se omogućile softverske aplikacije.

cije trećih strana; omogućavanje privremenog korištenje softvera koji se ne može preuzimati za bežične mrežne komunikacije; usluge razvoja kompjuterskog softvera i hardvera prilagođenog potrebama korisnika, dizajna i usluge konsaltinga; kreiranje i razvoj standarda za druge u kreiranju i implementaciji kompjuterskog softvera, kompjuterskog hardvera i telekomunikacione opreme; obezbjeđivanje informacija klijentima i tehničarima u vezi sa upravljanjem kompjuterskim projektom; naučni i tehnološki servisi i istraživanje i kreiranje u vezi sa tim; industrijska analiza i usluge istraživanja; kreiranje i razvoj kompjuterskog hardvera i softvera.

(210) **2013-164**

(442) **20.04.2014.**

(220) 4/25/2013

(731) **INTEL CORPORATION**, 2200 MISSION COLLEGE BOULEVARD, 95052-8119 SANTA CLARA, CALIFORNIA US



(540)

(550) I

(511) **Klasa 09:** kompjuteri; ručni kompjuteri; mini kompjuteri; kompjuterski hardver; integrisana kola; memorije integrisanih kola; čipovi integrisanih kola; kompleti kompjuterskih cipova; poluprovodnički procesori; čipovi poluprovodničkih procesora; poluprovodnički čipovi; mikroprocesori; ploče štampanih kola; štampana kola, odnosno ploče integrisanih kola, ploče štampanih kola i ploče električnih kola; ploče elektronskih kola; kompjuterske matične ploče; kompjuterske memorije; operativni sistemi; mikrokontrolori; procesori podataka; centralne procesorske jedinice; uređaji sa poluprovodničkom memorijom, odnosno, poluprovodničke memorije i jedinice poluprovodničkih memorija; softverski procesori koji se mogu programirati; digitalni i optički mikroprocesori; kompjuterske periferije; ploče sa video kolima; ploče sa audio kolima; ploče sa audio-video kolima; video grafički akceleratori; multimedijalni akceleratori; video procesori, ploče sa videoprocetorima; memorije sa podacima; elektronski sigurnosni uređaj i uređaj za nadzor, odnosno kompjuterski hardver, kompjuterski čipovi i mikroprocesori optimizirani za elektronski bezbjednosni nadzor; algoritamski softverski programi za rad i kontrolu kompjutera; softver kompjuterskog operativnog sistema; kompjuterski operativni sistemi; proširenja kompjuterskih sistema, alati i uređaji u oblasti aplikativnog softvera za povezivanje personalnih kompjutera, mreža, telekomunikacionih uređaja i globalnih kompjuterskih mrežnih aplikacija; kompjuterizovane telekomunikacije i oprema za umrežavanja koja se sastoji od softvera operativnog sistema; kompjuterski hardver i softver za pojačavanje i obezbjeđivanje prenosa, slanja, prijema, obrade i digitalizacije audio i video grafičkih informacija u realnom vremenu; kompjuterski

firmvare, odnosno softver kompjuterskog operativnog sistema, softver kompjuterskog modula i drugi kompjuterski softver koji se koristi za održavanje i rad kompjuterskih sistema; kompjuterske instalacije; memorijske ploče; personalni digitalni asistenti; prenosivi i ručni elektronski personalni organajzeri; uređaji za smještaj podataka, odnosno (razni USB uređaji, veličine palca ili privjeska za ključeve, prim.prev) jump drives, flash drives i thumb drives; bezbjednosni sistemi za kompjuterski hardver i softver, odnosno, firewalls (zaštitni zidovi), hardver servera za pristup mreži za kreiranje i održavanje firewalls (zaštitnih zidova), kompjuterski hardver za virtuelnu privatnu mrežu (VPN) i operativni softver kompjuterskog servera za kreiranje i održavanje firewalls (zaštitnih zidova); softver za osiguranje bezbjednosti kompjuterskih mreža; softver za kontrolu i bezbjednost pristupa; kompjuterski hardver i softver za korištenje za zaštitu kompjuterskih mreža od krađe ili oštećenja podataka od strane neovlaštenih korisnika; komponente za kompjutere; kompjuterske ploče za ubrzanje glasa; kompjuterske ploče za ubrzanje glasa, podataka, slika i video zapisa; fleš memorijske ploče i fleš memorijske kartice; telekomunikaciona oprema i kompjuterske mreže, odnosno procesni i operativni sistemi; telekomunikacioni uređaji i instrumenti, odnosno kompjuterski ruteri, uticnice, serveri i prekidači; kompjuterski hardver i softver za razvoj, održavanje i korištenje lokalnih i širokopojasnih kompjuterskih mreža; set-top kutije; elektronski kontrolni uređaji za interfejs i kontrolu kompjutera i globalnih kompjuterskih i telekomunikacionih mreža sa televizijskim i kablovskim emitovanjem i opremom; uređaj za testiranje i programiranje integrisanih kola; kompjuterski aparati i uređaji sa priferenom memorijom; kompjuterski serveri sa fiksnom funkcijom; kompjuterski mrežni hardver; kompjuterski hardver i softver za kreiranje, omogućavanje i upravljanje daljinskim pristupom i komunikacijom sa lokalnim mrežama (LANS), virtualnim privatnim mrežama (VPN), širokopojasnim mrežama (VVANS) i globalnim kompjuterskim mrežama; ruter, prekidač, uticnica i serverski operativni softver; kompjuterski softver i hardverza omogućavanje pristupa većem broju korisnika globalnoj kompjuterskoj informativnoj mreži za potrebe pretraživanja, pronalaženja, prenosa, manipulacije i diseminacije širokog opsega informacija; kompjuterski softverski alati za omogućavanje softverskih aplikacija od strane trećih lica; kompjuterski hardver i softver za bežične mrežne komunikacije; elektronske publikacije koje se mogu preuzimati u vidu biltena, knjiga, časopisa, žurnala, brošura i bijelih knjiga iz oblasti elektronike, poluprovodnika, integrisanih elektronskih aparata i uređaja, kompjutera, telekomunikacija, zabava, telefonije i žičnih i bežičnih telekomunikacija; konstrukcioni djelovi i oprema za sve gorepomenute robe; uputstva za korištenje koja se prodaju uz gorepomenute robe i elektronska uputstva za korištenje koja se mogu preuzeti sa globalne kompjuterske mreže; naučni, nautički, inspekcijski, fotografski, kinematografski, optički aparati i instrumenti, aparati i instrumenti za mjerenje težine i dužine, aparati i instrumenti za signalizaciju, provjeru (nadzor), spašavanje života i podučavanja; aparati i instrumenti za sprovođenje, prebacivanje, transformisanje, akumulaciju, regulaciju ili kontrolu elektriciteta; aparati za snimanje, prenos ili reprodukciju zvuka ili slika; magnetni nosači podataka, diskovi za snimanje; kompaktni diskovi; DVDjevi i drugi mediji za snimanje; mehanizmi za aparate na metalni novac; registarske kase, računarske mašine, oprema za obradu podataka, kompjuteri; kompjuterski softver; protivpožarni aparati. KLASA 41: usluge obuke u oblasti mreža, kreiranja mrežnog sistema, mrežnih operacija, održavanja mreža, testiranja mreža, mrežnih protokola, upravljanja mrežama, mrežnog inženjeringa, kompjutera, softvera, mikroprocesora i informacione tehnologije; usluge zabave, odnosno, organizovanje izložbi za kompjuterske igrice, obezbjeđivanje onlajn kompjuterskih igrica i organizovanje sportskih i kulturnih događaja u zajednici; obezbjeđivanje onlajn publikacija u vidu časopisa, biltena, žurnala, knjiga i brošura iz oblasti fotografije, snimanja i srodnih roba i usluga; usluge edukacije, odnosno, pružanje seminara, kurseva i tutorskih sesija u oblasti digitalnog snimanja putem globalnih

kompjuterskih mreža; onlajn obezbjeđivanje baze digitalnih slika za korištenje od strane potrošača; obezbjeđivanje onlajn biblioteke digitalnih slika koje korisnici mogu međusobno razmjenjivati, fotografske usluge i usluge biblioteke slika; kompjuterizovane onlajn edukativne usluge, odnosno, održavanje casova, seminara, tutorskih sesija, konferencija i radionica iz oblasti kompjutera, kompjuterskog hardvera, mikroprocesora, softvera i kompjuterskih mreža; usluge kompjuterizovane onlajn obuke iz oblasti kompjutera, kompjuterskog hardvera, mikroprocesora, softvera i kompjuterskih mreža; usluge edukacije, odnosno, pružanje interaktivnih tutorskih sesija i kurseva u vidu vodiča, savjeta i tehnika, stručnog usmjerenja i savjetovanja, sve to u vezi sa kupovinom, korištenjem, čuvanjem, održavanjem, podrškom, nadogradnjom, ažuriranjem i konfiguriranjem kompjuterskog hardvera, kompjuterskog softvera, kompjuterskih mreža, telekonferencijskih i komunikacionih roba i usluga; usluge iz oblasti edukacije, odnosno, održavanje casova, seminara, konferencija i onlajn edukativnih foruma iz oblasti korištenja kompjutera i softvera, navigacija putem globalnih kompjuterskih mreža, kompjuterske nauke i tehnologije, kompjuterskog upravljanja i distribucija nastavnog materijala u vezi sa svim tim; izrada i diseminacija edukativnog materijala izradenog u cilju povećanja tehnološke pismenosti među ucenicima; usluge obuke na mrežnom hardveru i softveru; usluge obuke u oblasti onlajn poslovnih rješenja; edukacija; pružanje obuke; zabava; sportske i kulturne aktivnosti. KLASA 42: usluge upravljanja kompjuterskim mrežama, odnosno, monitoring mrežnih sistema za tehnicke namjene; hosting digitalnog sadržaja na internetu; usluge kompjuterskog mrežnog monitoringa, odnosno, pružanje informacija o funkcionisanju kompjuterskih mreža; prilagodavanje web softvera i kreiranje kompjuterskog korisnickog interfejsa za druge; usluge konsaltinga u oblasti kompjutera i bežičnog racunanja; omogućavanje privremenog korištenje softvera koji se ne može preuzimati za poboljšanje i obezbjeđivanje prenosa, slanja, prijema, obrade i digitalizacije audio i video graficke informacije u realnom vremenu; omogućavanje privremenog korištenje softvera koji se ne može preuzimati za obradu, smještanje, pronalaženje, slanje, prikazivanje, unos, iznos, komprimovanje, dekomprimovanje, modifikovanje, emitovanje i štampanje podataka; omogućavanje privremenog korištenje softvera koji se ne može preuzimati za obezbjeđivanje sigurnosti kompjuterskih mreža, za kontrolu pristupa i bezbjednost i za korištenje u svrhu zaštite kompjuterskih mreža od krađe podataka ili oštećenja od strane neovlašćenih korisnika; omogućavanje privremenog korištenje softvera koji se ne može preuzimati za razvoj, održavanje i korištenje lokalnih i širokopoljanskih kompjuterskih mreža; omogućavanje privremenog korištenje softvera koji se ne može preuzimati za prijem, prikaz i korištenje video, audio i signala digitalnih podataka za emitovanje; omogućavanje privremenog korištenje softvera koji se ne može preuzimati za kreiranje, omogućavanje i upravljanje daljinskim pristupom i komunikaciji sa lokalnim mrežama (LANS), virtualnim privatnim mrežama (VPN), širokopoljanskih mrežama (WANS) i globalnim kompjuterskim mrežama; omogućavanje privremenog korištenje softvera koji se ne može preuzimati za korištenje u obezbjeđivanju pristupa više korisnika globalnoj informativnoj mreži za pretraživanje, pronalaženje, slanje, podešavanje i diseminaciju velikog opsega informacija; omogućavanje privremenog korištenje softverskih alata koji se ne može preuzimati da bi se omogućile softverske aplikacije trećih strana; omogućavanje privremenog korištenje softvera koji se ne može preuzimati za bežične mrežne komunikacije; usluge razvoja kompjuterskog softvera i hardvera prilagođenog potrebama korisnika, dizajna i usluge konsaltinga; kreiranje i razvoj standarda za druge u kreiranju i implementaciji kompjuterskog softvera, kompjuterskog hardvera i telekomunikacione opreme; obezbjeđivanje informacija klijentima i tehničarima u vezi sa upravljanjem kompjuterskim projektom; naučni i tehnološki servisi i istraživanje i kreiranje u vezi sa tim; industrijska analiza i usluge istraživanja; kreiranje i razvoj kompjuterskog hardvera i softvera.

(210) **2013-165**

(442) **20.04.2014.**

(220) 4/29/2013

(731) **ZUMBA FITNES, LLC**, 800 SILKS RUN, SUITE 2310 HALLANDALE, FLORIDA 33009 US



(540)

(550) I

(740) Popović Miladin, Đoka Miraševića 21/III, Podgorica ME

(511) **Klasa 09:** pokrivanje digitalnih medija, naime, unaprijed snimljenih video kaseti, digitalnih video diskova, digitalnih obostranih diskova, audio i video zapisa koji se mogu preuzeti, DVD-ova, muzičkih CD-ova, zvučnih zapisa i digitalnih diskova visoke rezolucije; aparati za video igre za upotrebu sa televizorima, softver za video igre koji se može preuzeti; programi za elektronske igre; softver za elektronske igre; softver za elektronske igre za bežične uređaje; interaktivni programi za video igre; programi za kompjuterske i video igre; diskovi za video igre; softver za video igre; elektronske publikacije, naime, knjige, časopisi, priručnici koji sadrže priče i edukativni materijal, kinematografski filmovi koji sadrže dječje priče.

Klasa 25: obuća, odjeća i pokrivala za glavu,

Klasa 41: obrazovanje, obezbjeđivanje obuke; uputstva za vježbanje i fitnes; razonoda; sportske, plesne i kulturne aktivnosti; obezbjeđivanje časova, radionica, seminara i humanitarnih događaja u oblasti fitnesa, vježbanja, velnesa i zdravlja; razonoda u smislu televizijskih emisija i TV serija

(210) **2013-167**

(442) **20.04.2014.**

(220) 4/30/2013

(731) **RECKIT & COLMAN (OVERSEAS) LIMITED**, DANSOM LANE, HULL, HU8 7DS, ENGLJESKA GB



(540)

(550) I, F

(740) Popović Miladin, Đoka Miraševića 21/III, Podgorica ME

(511) **Klasa 01:** Hemijske supstance kao sastojci sredstava za higijenu i preparata za njegu kože; hemijski dodaci za upotrebu kao sastavni dio sredstava za higijenu i preparata za njegu kože.

Klasa 03: Nemedicinski toaletni preparati; kozmetički preparati i preparati za uljepšavanje; hidratantne kreme, losioni, pene i gelovi; pilinzi; preparati za čišćenje kože; preparati za izbjeljivanje sve za ličnu upotrebu; preparati za depilaciju; voskovi za depilaciju; inhibitori za rast kose; preparati, uključujući kreme, gelove i pene, za upotrebu prije, tokom i nakon brijanja ili uklanjanja dlačica; maramice za depilaciju; impregnirane maramice za depilaciju i jastučići za njegu kože.

Klasa 08: Brijaći; sečiva za brijanje; epilatori; uređaji za uklanjanje dlačica, naime, aparati za epilaciju; ručni instrumenti za upotrebu kod brijanja ili depilacije, naime, aparati za epilaciju, neelektrični brijaći; lopatica za nanošenje toplog voska i preparati za depilaciju; djelovi i oprema za gore navedenu robu.

(210) **2013-168**(442) **20.04.2014.**

(220) 4/30/2013

(731) **RECKITT & COLMAN (OVERSEAS) LIMITED**, DANSOM LANE, HULL, HU8 7DS, ENGLJESKA GB



(540)

(550) I, F

(740) Popović Miladin, Đoka Miraševića 21/III, Podgorica ME

(511) **Klasa 01:** Hemijske supstance kao sastojci sredstava za higijenu i preparata za njegu kože; hemijski dodaci za upotrebu kao sastavni dio sredstava za higijenu i preparata za njegu kože.

Klasa 03: Nemedicinski toaletni preparati; kozmetički preparati i preparati za uljepšavanje; hidratantne kreme, losioni, pene i gelovi; pilinzi; preparati za čišćenje kože; preparati za izbjeljivanje sve za ličnu upotrebu; preparati za depilaciju; voskovi za depilaciju; inhibitori

za rast kose; preparati, uključujući kreme, gelove i pene, za upotrebu prije, tokom i nakon brijanja ili uklanjanja dlačica; maramice za depilaciju; impregnirane maramice za depilaciju i jastučići za njegu kože.

Klasa 08: Brijачi; sečiva za brijanje; epilatori; uređaji za uklanjanje dlačica, naime, aparati za epilaciju; ručni instrumenti za upotrebu kod brijanja ili depilacije, naime, aparati za epilaciju, neelektrični brijачi; lopatica za nanošenje toplog voska i preparati za depilaciju; djelovi i oprema za gore navedenu robu.

(210) **2013-169** (442) **20.04.2014.**
(220) 5/7/2013

(731) **THE PROCTER & GAMBLE COMPANY**, ONE PROCTER & GAMBLE PLAZA, CINCINNATI, OHIO 45202 US

OLAY

(540)

(550) I

(740) Lutovac Branislav, Bulevar Crnojevića 93, Podgorica ME

(511) **Klasa 08:** Brijачi i nožići za brijanje; automati (dozeri), kasete, držači i ulošci koji su svi posebno dizajnirani za, i sadrže, nožice za brijanje; djelovi i oprema za naprije;

(210) **2013-20** (442) **20.04.2014.**
(220) 1/16/2013

(731) **EXPO COMMERCE DOO KOTOR**, INDUSTRIJSKA ZONA BB, KOTOR ME

AROMA

(540)

(550) I

(511) **Klasa 35:** oglašavanje, vođenje poslova, poslovno upravljanje, kancelarijski poslovi, usluge prodaje na malo u oblasti hrane i pića, naročito mesa, ribe, mesnih i ribuih prerađevina, mlijeka i mliječnih proizvoda, jaja, jestivih ulja i masti, smrznutog voća, povrća, ribe, mesa i tijesta, sladoleda, brašna, šećera, kakaoa, pudinga, šlaga, začina, gotovih supa, majoneza, kečapa, senfa, margarina, konditorskih proizvoda, svježeg voća i povrća; polugotovih i gotovih jela; hleba i peciva, zdrave i dijetalne hrane; hrane za bebe, bezalkoholnih i alkoholnih pića i napitaka, kafe, čajeva, usluge prodaje na malo u oblasti elektronike i kućnog namještaja, naročito malih kućnih aparata, baterija, sijalica, sobnog namještaja, kanta, krpa, čaša, posuđa, usluge prodaje na malo u oblasti kućne hemije, kozmetike i proizvoda za ličnu higijenu, naročito deterdženata, sredstava za čišćenje i poliranje, parfema, sapuna, šampona, maramica, pelena, pudera, ulja i mlijeka za tijelo, dezodoransa, usluge prodaje na malo u oblasti duvana i duvanskih proizvoda, usluge prodaje na malo u oblasti štampanih medija, časopisa i knjiga.

(210) **2013-21** (442) **20.04.2014.**

(220) 1/16/2013

(731) EXPO COMMERCE, INDUSTRIJSKA ZONA BB, KOTOR ME

(540) Miriše na bolje

(550) I

(511) **Klasa 35:** oglašavanje, vođenje poslova, poslovno upravljanje, kancelarijski poslovi, usluge prodaje na malo u oblasti hrane i pića, naročito mesa, ribe, mesnih i ribuih prerađevina, mlijeka i mliječnih proizvoda, jaja, jestivih ulja i masti, smrznutog voća, povrća, ribe, mesa i tijesta, sladoleda, brašna, šećera, kakaoa, pudinga, šlaga, začina, gotovih supa, majoneza, kečapa, senfa, margarina, konditorskih proizvoda, svježeg voća i povrća; polugotovih i gotovih jela; hleba i peciva, zdrave i dijetalne hrane; hrane za bebe, bezalkoholnih i alkoholnih pića i napitaka, kafe, čajeva, usluge prodaje na malo u oblasti elektronike i kućnog namještaja, naročito malih kućnih aparata, baterija, sijalica, sobnog namještaja, kanta, krpa, čaša, posuđa, usluge prodaje na malo u oblasti kućne hemije, kozmetike i proizvoda za ličnu higijenu, naročito deterdženata, sredstava za čišćenje i poliranje, parfema, sapuna, šampona, maramica, pelena, pudera, ulja i mlijeka za tijelo, dezodoransa, usluge prodaje na malo u oblasti duvana i duvanskih proizvoda, usluge prodaje na malo u oblasti štampanih medija, časopisa i knjiga.

(210) **2013-22** (442) **20.04.2014.**

(220) 1/17/2013

(731) **DOO KOLUM NIKŠIĆ**, POPOVIĆ RATKO UL. GOJKA GARČEVIĆA BR.1/17 NIKŠIĆ ME



(540)

(550) I

(511) **Klasa 5:** Cigarete, džepne sprave za savijanje cigareta, cigarete (filteri za cigarete), cigarete (kutije za cigarete), cigarete (papir za cigarete), cigarete (vrhovi za cigarete), cigaretnici (držači cigareta), cigarilosi (male cigare), duvan, duvan (kutije za duvan), duvan (vrećice za duvan), cigare, papirići za cigarete, filteri za cigarete, kutije za cigare, kutije za cigarete.

(210) **2013-23** (442) **20.04.2014.**

(220) 1/17/2013

(731) **DOO KOLUM NIKŠIĆ**, POPOVIĆ RATKO UL. GOJKA GARČEVIĆA BR.1/17 NIKŠIĆ ME

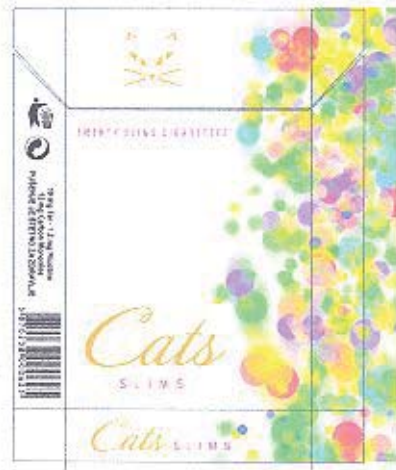

(540)

(550) I

(511) **Klasa 5:** Cigarete, džepne sprave za savijanje cigareta, cigarete (filteri za cigarete), cigarete (kutije za cigarete), cigarete (papir za cigarete), cigarete (vrhovi za cigarete), cigaretnici (držači cigareta), cigarilosi (male cigare), duvan, duvan (kutije za duvan), duvan (vrećice za duvan), cigare, papirići za cigarete, filteri za cigarete, kutije za cigare, kutije za cigarete.

(210) **2013-24**(442) **20.04.2014.**

(220) 1/21/2013

(731) **AL-ZAWRA'A FOR TOBACCO AND CIGARETTES TRADING**, P.O.BOX 941936
AMMAN 11194 JO



(540)

(550) I, F

(740) Prelević Dragan, ulica Slobode 74, Podgorica ME

(511) **Klasa 04:** ugalj, ugljeni briketi, ugljena prašina (gorivo); ćumur, ćumur (gorivo); briketi od ćumura; svijeće; briketi (zapaljivi); koks; lignit; katran; nafta, antracit; drveni briketi; fitilji za svijeće; mast i vosak za svijeće; svijeće i fitilji za osvjetljenje; mirisne svijeće; svijeće; noćno osvjetljenje (svijeće); industrijski vosak.

Klasa 16: papir, karton i proizvodi napravljeni od ovih materijala, koji nisu obuhvaćeni drugim klasama; štampana stvar; knjigovezački materijal; fotografije; kancelarijski material; ljepila za kancelarijske i kućne potrebe; umjetnički materijal; Kičice; pisaće mašine i kancelarijski rekviziti (osim namještaja); materijali za obuku i nastavu (osim aparata); Plastični materijali za pakovanje (koji nisu obuhvaćeni drugim klasama); štamparska slova; klišeji.

Klasa 34: sirovi i prerađeni duvan; cigarete; melasa (duvan za nargilu); aromatizovani duvan; supstance za pušenje, uključujući i melasu, koje se ne koriste u medicinske i ljekovite svrhe; aromatizovane mješavine duvana i melase za nargile; artikli za pušače; upaljači; šibice; nargile; oprema za nargile (uključujući i posude i vrhove nargile, crijevo, pipke i filtere, vrhove za crijevo nargile, postolja za nargile, torbe i kutije za nargile; posude za nargilu).

(210) **2013-25** (442) **20.04.2014.**
(220) 1/21/2013

(300) 2012 116 30.07.2012. AZ

(731) **BRITISH AMERICAN TOBACCO (BRANDS) INC.**, 2711 CENTERVILLE ROAD SUITE 300 WILMINGTON DELAWARE 19808 US



(540)

(550) I, F,

(740) Popović Miladin, Đoka Miraševića 21/III, Podgorica ME

(511) **Klasa 34:** Cigarette; duvan; proizvodi od duvana; upaljači; šibice; artikli za pušače.

(210) **2013-26** (442) **20.04.2014.**
(220) 1/22/2013

(731) **SHIMANO INC.**, 3-77 OIMATSU-CHO SAKAI-KU SAKAI CITY OSAKA JP

(540) ICE-TECHNOLOGIES

(550) I, V

(740) Popović Miladin, Đoka Miraševića 21/III, Podgorica ME

(511) **Klasa 12:** Oprema i delovi za bicikle, naročito: kočnice, kočioni kablovi, kočione papučice, kočiona creva, kočione poluge, kočioni rotori i kočione pločice.

(210) **2013-27** (442) **20.04.2014.**
(220) 1/22/2013

(731) **SHIMANO INC.**, 3-77 OIMATSU-CHO SAKAI-KU SAKAI CITY OSAKA JP

(540) I-SPEC

(550) I, V

(740) Popović Miladin, Đoka Miraševića 21/III, Podgorica ME

(511) **Klasa 12:** Oprema i delovi za bicikle, naročito: poluge za menjanje brzina i kočione poluge.

(210) **2013-28** (442) **20.04.2014.**
(220) 1/28/2013

(731) **MEGGLE AG**, MEGGLESTABE 6-12, 83512 WASSERBURG DE



Najbolje od mleka.

(540)

(550) I

(740) Lutovac Branislav, Bulevar Crnojevića 93, Podgorica ME

(511) **Klasa 29:** Mlijeko i mliječni proizvodi i u prahu; jestiva ulja i masti; namazi ili paste na bazi mlijeka, proteina, masti i/ili ugljenih hidrata; preparati od soje u obliku namaza ili pasti; dodatak za kafu i čaj, uglavnom na bazi ugljenih hidrata, protein i/ili masti; kakao puter; unaprijed pripremljeni deserti ili deserti u prahu i drugi slični obroci na bazi mlijeka; supe; surutka i njeni sastojci koji se koriste za ishranu; koncentracije surutke, mliječnog šećera, voća ili protein za prehrambenu industriju; sva naprijed navedena roba (gdje je moguće) i u prahu, koja se koristi za prehranu; sokovi od voća i povrća koji se koriste u kulinarstvu; voćni sokovi, marmalade, džemovi; životinjska i/ili biljna mast u prahu, zamjena za jaja, mliječni proteini, kazein, kazeinat, albumen koji se koriste za prehranu; mlijeko, surutka i/ili kazein-hidrolizati, kao i njihove mješavine ili sa aditivima koji se koriste za prehranu.

Klasa 30: Majonez; sosovi, uključujući prelive za salate i umake; sosovi na bazi bilja, začini; koncentracije od kakaosa za prehrambenu industriju; hleb i hlebni proizvodi, punjeni, namazani ili preliveni puterom, proizvodima od putera, sirevima, proizvodima od sira i/ili proizvodima od soje; kolači i poslastice; jestivi led; jestiva so; prirodni zaslađivači; poslastičarski proizvodi.

Klasa 32: Sokovi od voća i povrća koji se koriste kao pića i/ili za proizvodnju pića ili za dodavanje pićima; drugi bezalkoholni napici, naročito napici sa dodatkom mlijeka ili mliječnih proizvoda; sirupi i drugi preparati za proizvodnju pića.

(210) **2013-29**

(442) **20.04.2014.**

(220) 1/28/2013

(731) **KRAFT FOODS SCHWEIY HOLDING GMBH**, CHOLLERSTRASSE 4, 6301 ZUG CH

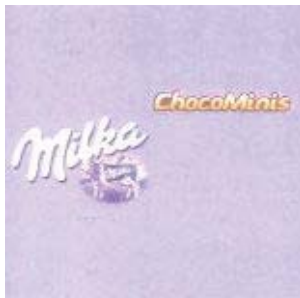

(540)

(550) I

(740) AOD "Ćupić", Dalmatinska 10, Podgorica ME

(511) **Klasa 30:** Kakao, čokolada, napitci od kakaoa, napitci od čokolade i preparati za takve

napitke; keksi i biskviti, pekarski proizvodi, poslastice konditorski proizvodi, naročito šećerni i čokoladni konditorski proizvodi, proizvodi od tijesta, proizvodi od žitarica, jestivi led, sladoled.

(210) **2013-30** (442) **20.04.2014.**

(220) 1/28/2013

(731) **KRAFT FOODS SCHWEIY HOLDING GMBH**, CHOLLERSTRASSE 4, 6301 ZUG CH



(540)

(550) I

(740) AOD "Ćupić", Dalmatinska 10, Podgorica ME

(511) **Klasa 30:** Kakao, čokolada, napitci od kakaoa, napitci od čokolade i preparati za takve napitke; keksi i biskviti, pekarski proizvodi, poslastice konditorski proizvodi, naročito šećerni i čokoladni konditorski proizvodi, proizvodi od tijesta, proizvodi od žitarica, jestivi led, sladoled.

(210) **2013-31** (442) **20.04.2014.**

(220) 1/28/2013

(731) **CELGENE CORPRATION**, 86 MORRIS AVENUE, SUMMIT, NJ 07901 US

(540) POMALIST

(550) I

(740) Čejović Vladimir, 13. jula 21, Podgorica ME

(511) **Klasa 05:** Farmaceutski preparati, naime, citokinski inhibitorni lijekovi; farmaceutski preparati koji moduliraju imuni sistem; farmaceutski preparati za liječenje određenih vrsta raka i bolesti krvi.

(210) **2013-32** (442) **20.04.2014.**

(220) 1/29/2013

(731) **VELEL DOO** ZA USLUGE PRIMANJA I POSLUŽIVANJA PIĆA, MARKA MILJANOVA 46 81000 PODGORICA ME



(540)

(550) I

(511) **Klasa 43:** Usluge obezbeđenja hrane i pića, privremeni smještaj;(210) **2013-33**(442) **20.04.2014.**

(220) 1/30/2013

(731) **KRAFT FOODS SCHWEIY HOLDING GMBH**, CHOLLERSTRASSE 4, 6301 ZUG CH

(540) USUDI SE DA POKAŽES NJEŽNOST

(550) I

(740) AOD "Ćupić", Dalmatinska 10, Podgorica ME

(511) **Klasa 30:** Kakao, čokolada, napitci od kakaoa, napitci od čokolade i preparati za takve napitke; keksi i biskviti, pekarski proizvodi, poslastice konditorski proizvodi, naročito šećerni i čokoladni konditorski proizvodi, proizvodi od tijesta, proizvodi od žitarica, jestivi led, sladoled.(210) **2013-34**(442) **20.04.2014.**

(220) 1/30/2013

(731) **TURNER NETWORK TELEVISION, INC**, 1050 TECHWOOD DRIVE, 30318 ATLANTA, GEORGIA US

(540) WE KNOW DRAMA

(550) I

(740) Čejović Vladimir, 13. jula 21, Podgorica ME

(511) **Klasa 38:** Komunikacijske usluge; usluge televizije, kablovske televizije, digitalne televizije, satelitske televizije, i usluge radio emitovanja; obezbjeđivanje telekomunikacionih pristupa integrisanoj digitalnoj platformi u obezbijedene kompjuterske mrežeširokog frekventnog opsega za proizvodnju, distribuciju, prenos, i manipulaciju filmova, televizije i drugog sadržaja medija.**Klasa 41:** Usluge obrazovanja i zabave, uključujući proizvodnju i/ili distribuciju i/ili prikazivanje programa za televiziju, kablovsku televiziju, digitalnu televiziju, satelitsku televiziju i radio emitovanje; usluge u vidu serijala komedija, drama, akcionih, avanturističkih i/ili animiranih programa i proizvodnje dugometražnog filma koje se obezbjeđuju preko kablovske televizije, emitterske televizije, emitterskih radio stanica i globalne kompjuterske informacione mreže.(210) **2013-35**(442) **20.04.2014.**

(220) 1/31/2013

(731) **BASF SE**, CARL-BOSCH-STRASSE 38 LUDWIGSHAFEN AM RHEIN DE

(540) LORICA

(550) I

(740) Stanković Mugoša Ana, Trg Republike 13, Podgorica ME

(511) **Klasa 01:** Hemikalije koje se koriste u poljoprivredi, hortikulturi i šumarstvu, naročito preparati za jačanje biljaka, hemijski i/ili biološki preparati za kontrolu stresa kod biljaka, preparati za regulisanje rasta biljaka, hemijski preparati za tretiranje sjemena, površinski-aktivna sredstva, prirodne ili vještačke hemikalije koje se koriste kao seksualni mamci ili agensi za zbunjivanje insekata.**Klasa 05:** Preparati za uništavanje i suzbijanje štetočina, insekticidi, fungicidi, herbicidi, pesticidi.(210) **2013-36**(442) **20.04.2014.**

(220) 1/31/2013

(731) **AMGEN INC.** (DELAWARE CORPRATION), ONE AMGEN CENTER DRIVE, THOSAND OAKS, CALIFORNIA 91320-1799 US

(540) IMLYGIC

(550) I

(740) Radulović Božidar, Jovana Tomaševića 9/III, Podgorica ME

(511) **Klasa 05:** Farmaceutski preparati(210) **2013-37**(442) **20.04.2014.**

(220) 1/31/2013

(731) **AMGEN INC.** (DELAWARE CORPRATION), ONE AMGEN CENTER DRIVE, THOSAND OAKS, CALIFORNIA 91320-1799 US

(540) OMLIVUT

(550) I

(740) Radulović Božidar, Jovana Tomaševića 9/III, Podgorica ME

(511) **Klasa 05:** Farmaceutski preparati(210) **2013-38**(442) **20.04.2014.**

(220) 1/31/2013

(731) **AMGEN INC.** (DELAWARE CORPRATION), ONE AMGEN CENTER DRIVE, THOSAND OAKS, CALIFORNIA 91320-1799 US

(540) TLOGEX

(550) I

(740) Radulović Božidar, Jovana Tomaševića 9/III, Podgorica ME

(511) **Klasa 05:** Farmaceutski preparati(210) **2013-39**(442) **20.04.2014.**

(220) 1/31/2013

(731) **WM.WRIGLEY JR.COMPANY**, 1132 WEST BLACKHAWK STREET, CHICAGO. ILLINOIS 60642 US



(540)

(550) I

(740) Čejović Vladimir, 13. jula 21, Podgorica ME

(511) **Klasa 30:** Konditorski proizvodi, žvakaće gume, žvakaće gume od kojih mogu da se prave veliki baloni, bombone, dražeje peperminta, mali okrugli bomboni (drops) i pastile.(210) **2013-40**(442) **20.04.2014.**

(220) 1/31/2013

(731) **WM.WRIGLEY JR.COMPANY**, 1132 WEST BLACKHAWK STREET, CHICAGO. ILLINOIS 60642 US

(540)

(550) I

(740) Čejović Vladimir, 13. jula 21, Podgorica ME

(511) **Klasa 30:** Konditorski proizvodi, žvakaće gume, žvakaće gume od kojih mogu da se prave veliki baloni, bombone, dražeje peperminta, mali okrugli bomboni (drops) i pastile.(210) **2013-41**(442) **20.04.2014.**

(220) 1/31/2013

(731) **WM.WRIGLEY JR.COMPANY**, 1132 WEST BLACKHAWK STREET, CHICAGO. ILLINOIS 60642 US

(540)

(550) I

(740) Čejović Vladimir, 13. jula 21, Podgorica ME

(511) **Klasa 30:** Konditorski proizvodi, žvakaće gume, žvakaće gume od kojih mogu da se prave veliki baloni, bombone, dražeje peperminta, mali okrugli bomboni (drops) i pastile.

(210) **2013-42**

(442) **20.04.2014.**

(220) 1/31/2013

(731) **WM.WRIGLEY JR.COMPANY**, 1132 WEST BLACKHAWK STREET, CHICAGO. ILLINOIS 60642 US

(540) STIMULATE YOUR SENSES

(550) I

(740) Čejović Vladimir, 13. jula 21, Podgorica ME

(511) **Klasa 30:** Konditorski proizvodi, žvakaće gume, žvakaće gume od kojih mogu da se prave veliki baloni, bombone, dražeje peperminta, mali okrugli bomboni (drops) i pastile.

(210) **2013-43**

(442) **20.04.2014.**

(220) 2/1/2013

(300) 20121723A 11.10.2012. HR

(731) **B.S.A.**, 33 AVENUE DU MAINE, TOUR MAINE MONTPARNASSE, 75015 PARIZ FR

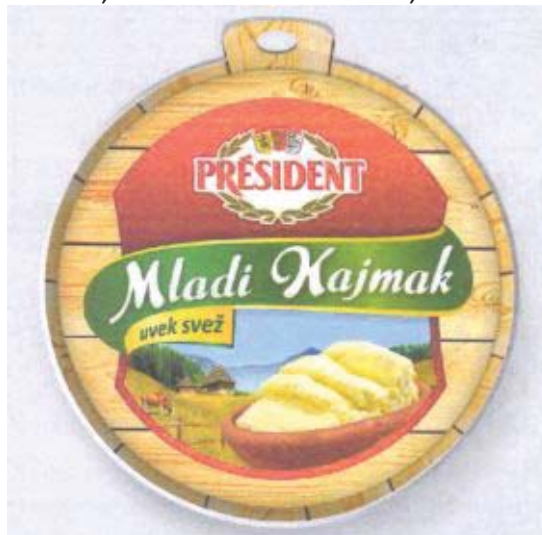

(540)

(550) I, F

(740) Popović Miladin, Đoka Miraševića 21/III, Podgorica ME

(511) **Klasa 29:** Meso, riba, živina i divljač; mesni ekstrakti; jaja; mlijeko i mliječni proizvodi, puter, sir, jogurt, kajmak (mliječni proizvodi), mlijeko od soje (zamene za mlijeko); jestiva ulja i masti; napici na bazi mlijeka u kojima preovladuje mlijeko; mješavine i pripremljena jela koja sadrže pomenute proizvode, naime meso, ribu, živinu i divljač, mesne ekstrakte, jaja, mlijeko i mliječne proizvode, puter, sir, jogurt, kajmak (mliječne proizvode), mlijeko od soje (zamene za mlijeko).

(210) **2013-44**

(442) **20.04.2014.**

(220) 2/1/2013

(731) **DRAGICA BOJOVIĆ**, UL. STEVA BOLJEVIĆA 64, PODGORICA ME

(540) VASILA3

(550) I

(511) **Klasa 5:** Farmaceutski i veterinarski preparati; sanitarni preparati za medicinsku upotre-

bu; dijetetske supstance prilagođene za upotrebu u medicini, hrana za bebe; flasteri, materijali za zavijanje; materijali za plombiranje zuba, zubarska smola; dezinfekciona sredstva; preparati za uništavanje štetočina; fungicidi, herbicidi.

(210) **2013-45** (442) **20.04.2014.**
(220) 2/1/2013

(731) **DOO EXPORT-IMPORT KOLUM NIKŠIĆ**, POPOVIĆ RATKO UL. GOJKA GARČEVIĆA BR.1/17, NIKŠIĆ ME



(540)

(550) I

(511) **Klasa 34:** cigarete;

(210) **2013-47** (442) **20.04.2014.**
(220) 2/7/2013

(731) **TEVA BRANDED PHARMACEUTICAL PRODUCTS R&D. INC**, 425 PRIVET ROAD, HORSHAM, PA 19044 US

(540) MYLINAX

(550) I

(740) Popović Miladin, Đoka Miraševića 21/III, Podgorica ME

(511) **Klasa 05:** farmaceutski preparati za liječenje multiple skleroze;

(210) **2013-48** (442) **20.04.2014.**
(220) 2/8/2013

(731) **RETIAL ROYALTY COMPANY** (NEVADA CORPRATION), 101 CONVENTION CENTER DRIVE, LAS VEGAS, NEVADA 89109 US

(540) AE

(550) I

(740) Radulović Božidar, Jovana Tomaševića 9/III, Podgorica ME

(511) **Klasa 18:** torbe, ruksaci, kišobrani, novčanici i tašne;

(210) **2013-49** (442) **20.04.2014.**
(220) 2/12/2013

(731) **BIOGEN IDEC MA INC.**, 14 CAMBRIDGE CENTER.02142 CAMBRIDGE, MA US

(540) TECFIDERA

(550) I

(740) Čejović Vladimir, 13. jula 21, Podgorica ME

(511) **Klasa 05:** farmaceutski preparati za liječenje neuroloških poremećaja;

(210) **2013-50** (442) **20.04.2014.**

(220) 2/12/2013

(731) **BIOGEN IDEC MA INC.**, 14 CAMBRIDGE CENTER.02142 CAMBRIDGE, MA US



(540)

(550) I

(740) Čejović Vladimir, 13. jula 21, Podgorica ME

(511) **Klasa 05:** farmaceutski preparati za liječenje neuroloških poremećaja;

(210) **2013-51** (442) **20.04.2014.**

(220) 2/12/2013

(731) **TOYOTA JIDOSHA KABUSHIKI KAISHA** (ALSO TRADING AS TOYOTA MOTOR CORPORATION), 1, TOYOTA-CHO, TOYOTA-SHI, AICHI-KEN JP

(540) GS300h

(550) I

(740) Čejović Vladimir, 13. jula 21, Podgorica ME

(511) **Klasa 12:** automobili i njihovi strukturni djelovi;

(210) **2013-52** (442) **20.04.2014.**

(220) 2/12/2013

(731) **GALENIKA A.D.**, BATAJNIČKI DRUM BB, 11080 BEOGRAD RS

(540) TIVORAL

(550) I

(740) Kovačević Aleksandar, Kružni put bb, Cetinje ME

(511) **Klasa 05:** Farmaceutski preparati

(210) **2013-53** (442) **20.04.2014.**

(220) 2/12/2013

(731) **GALENIKA A.D.**, BATAJNIČKI DRUM BB, 11080 BEOGRAD RS

(540) AMRACIN

(550) I

(740) Kovačević Aleksandar, Kružni put bb, Cetinje ME

(511) **Klasa 05:** Farmaceutski preparati

(210) **2013-54** (442) **20.04.2014.**

(220) 2/12/2013

(731) **GALENIKA A.D.**, BATAJNIČKI DRUM BB, 11080 BEOGRAD RS
(540) RIFAMOR
(550) I
(740) Kovačević Aleksandar, Kružni put bb, Cetinje ME
(511) **Klasa 05:** Farmaceutski preparati

(210) **2013-55** (442) **20.04.2014.**
(220) 2/12/2013
(731) **GALENIKA A.D.**, BATAJNIČKI DRUM BB, 11080 BEOGRAD RS
(540) IZOPAMIL
(550) I
(740) Kovačević Aleksandar, Kružni put bb, Cetinje ME
(511) **Klasa 05:** Farmaceutski preparati

(210) **2013-56** (442) **20.04.2014.**
(220) 2/12/2013
(731) **GALENIKA A.D.**, BATAJNIČKI DRUM BB, 11080 BEOGRAD RS
(540) SOLTRIK
(550) I
(740) Kovačević Aleksandar, Kružni put bb, Cetinje ME
(511) **Klasa 05:** Farmaceutski preparati

(210) **2013-57** (442) **20.04.2014.**
(220) 2/12/2013
(731) **GALENIKA A.D.**, BATAJNIČKI DRUM BB, 11080 BEOGRAD RS
(540) TRIAGIL
(550) I
(740) Kovačević Aleksandar, Kružni put bb, Cetinje ME
(511) **Klasa 05:** Farmaceutski preparati

(210) **2013-58** (442) **20.04.2014.**
(220) 2/12/2013
(731) **GALENIKA A.D.**, BATAJNIČKI DRUM BB, 11080 BEOGRAD RS
(540) DAKTANOL
(550) I
(740) Kovačević Aleksandar, Kružni put bb, Cetinje ME
(511) **Klasa 05:** Farmaceutski preparati

(210) **2013-59** (442) **20.04.2014.**
(220) 2/12/2013
(731) **GALENIKA A.D.**, BATAJNIČKI DRUM BB, 11080 BEOGRAD RS
(540) GINO-DAKTANOL
(550) I
(740) Kovačević Aleksandar, Kružni put bb, Cetinje ME
(511) **Klasa 05:** Farmaceutski preparati

(210) **2013-60** (442) **20.04.2014.**
(220) 2/12/2013
(731) **GALENIKA A.D.**, BATAJNIČKI DRUM BB, 11080 BEOGRAD RS
(540) GALIPEKS
(550) I
(740) Kovačević Aleksandar, Kružni put bb, Cetinje ME
(511) **Klasa 05:** Farmaceutski preparati

(210) **2013-61** (442) **20.04.2014.**
(220) 2/12/2013
(731) **GALENIKA A.D.**, BATAJNIČKI DRUM BB, 11080 BEOGRAD RS
(540) ORTOGAL
(550) I
(740) Kovačević Aleksandar, Kružni put bb, Cetinje ME
(511) **Klasa 05:** Farmaceutski preparati

(210) **2013-62** (442) **20.04.2014.**
(220) 2/12/2013
(731) **GALENIKA A.D.**, BATAJNIČKI DRUM BB, 11080 BEOGRAD RS
(540) TOPIRAT
(550) I
(740) Kovačević Aleksandar, Kružni put bb, Cetinje ME
(511) **Klasa 05:** Farmaceutski preparati

(210) **2013-63** (442) **20.04.2014.**
(220) 2/12/2013
(731) **GALENIKA A.D.**, BATAJNIČKI DRUM BB, 11080 BEOGRAD RS
(540) BEDOXIN
(550) I
(740) Kovačević Aleksandar, Kružni put bb, Cetinje ME
(511) **Klasa 05:** Farmaceutski preparati

(210) **2013-64** (442) **20.04.2014.**
(220) 2/12/2013
(731) **GALENIKA A.D.**, BATAJNIČKI DRUM BB, 11080 BEOGRAD RS
(540) LANOPROGAL
(550) I
(740) Kovačević Aleksandar, Kružni put bb, Cetinje ME
(511) **Klasa 05:** Farmaceutski preparati

(210) **2013-65** (442) **20.04.2014.**
(220) 2/12/2013
(731) **CT GROUP D.O.O.**, UL. DALMATINSKA BR.78, PODGORICA ME

family days
PORODIČNI SAJAM

(540)

(550) I

(511) **Klasa 41:** podrazumjeva: Organizovanje sajmova i zabavnih aktivnosti. Osim navednog podrazumjeva i sledeće: Obrazovne usluge; pripremanje obuke; razonoda; sportske i kulturne aktivnosti Opis usluga: razvijanje mentalnih sposobnosti drugih lica (obrazovanje) ili životinja (obuka, dresiranje) kao i usluge kojima je cilj zabavljanje drugih lica ili privlačenje pažnje. Ova klasa uključuje posebno: usluge koje pružaju sve vrste edukacije lica (obrazovanje) ili životinja (obuka, dresiranje); usluge kojima je osnovni cilj zabavljanje drugih lica, rekreacija; organizovanje (priređivanje) i vođenje seminara, konferencija, kongresa; organizovanje izložbi ili prezentacije knjiga (književne večeri) u kulturne i obrazovne svrhe, sportskih takmičenja; izdavanje tekstova i knjiga.

(210) **2013-66**(442) **20.04.2014.**

(220) 2/13/2013

(731) **VASOVIČ PETAR**, BABIN DO BB, 32000 BUDVA ME

Primorske
novine

(540)

(550) I

(511) **Klasa 35:** usluge oglašavanja i reklamiranja putem elektronskih i štampanih medija, usluge agencija za oglašavanje kao i usluge distribuiranja prospekata direktno ili postom ili distribuiranje uzoraka i oglašavanje u vezi s drugim uslugama vezi bankarskih zajmova i osiguranja.

Klasa 38: Telekomunikacije, usluge koje omogućavaju prenos vizuelnih i govornih poruka putem elektronskih (web site) i štampanih medija;

Klasa 41: Usluge edukativnog i zabavnog karaktera, usluge prikazivanja javnosti umjetničkih i literarnih djela u kulturne i obrazovne;

(210) **2013-67**(442) **20.04.2014.**

(220) 2/14/2013

(731) **NOBEL ILAC SANAYII VE TICARET ANONIM SIRKETI**, INKILAP MAH., AKCAKOCA SK. NO.10, UMRANIE, INSTANBUL TR

(540) Ultrox

(550) I

(740) Božović Vesko, Rimski trg 50/11, Podgorica ME

(511) **Klasa 05:** farmaceutski proizvodi;(210) **2013-68**(442) **20.04.2014.**

(220) 2/15/2013

(731) **NBA PROPERTIES, INC.**OLYMPIC TOWER BLDG., 645 FIFTH AVENUE NEW YORK, NY 10022 US



(540)

(550) I, F

(740) Popović Miladin, Đoka Miraševića 21/III, Podgorica ME

(511) **Klasa 25:** Odjeća, naime čarape, obuća, cipele za košarku, patike za košarku, majice, košulje, polo majice, dukserice, donji djelovi trenerke, pantalone, majice na bretele, džemperi, kratke pantalone, pidžame, sportske majice, ragbi majice, vunene majice, kaiševi, kravate, spavacice, šeširi, kape, štitnici na kasketima, trenerke, donji djelovi trenerki, dresovi, jakne, vetrovke, kišne krznene jakne, kaputi, portikle za bebe ne od papira, trake za glavu, narukvice, kecelje, donje rublje, bokserice, široke pantalone, štitnici za uši, rukavice, bokzerske rukavice, šalovi, pletene i štrikane majice, trikotažne haljine, haljine, dresovi i uniforme za navijalice, odjeća za plivanje, odijela za kupanje, kupaci kostimi, bikini, tamkini kupaci kostimi, gaćice za plivanje, gaćice za kupanje, šorcevi za surfovanje, šorcevi za kupanje, marama za plažu, pokrivala za kupaci kostim, ogrtaci za kupaci kostim, sandale, sandale za plažu, šeširi za plažu, štitnici za sunce, kape za plivanje, kape za kupanje, nova pokrivala za glavu sa prikacanim umecima.

Klasa 28: Igračke, igre i sportske stvari, naime košarkaške lopte, loptice za golf, lopte za igralište, sportske lopte, gumene lopte i pjenaste lopte, plišane lopte za igru, plastične lopte za igru, mrežice za košarku, table za košarku, minijaturne table za košarku, pumpe i igle za naduvavanje košarkaških lopti; štapovi za golf, torbe za golf, podmetaci za golf, oprema za golf, naime, alat za popravku golf terena, kupice na koje se stavlja lopta, markeri lopti, torbe za golf opremu, pokrivala za glave golf štapova, rukavice za golf, kutije za golf lopte, posebna zelena staza za golf, peškiri za golf; držači za bilijarske štapove, kugle za bilijar, trouglovi za bilijar, pikado ormari, elektronske table za košarkaške igrice na tabli, table za košarkaške igrice, košarkaške igrice, akcione igrice, društvene igrice za odrasle i djecu, trivia informacione igrice i elektronske video arkada igrice, košarkaška torbica koja se sastoji od mrežice i zviždaljke, lutke, dekorativne lutke, lutke za kolekciju, akcione figure za igru, akcione figure karikature, punjene igračke, plišane igračke, puzzle, montažni blokovi za igre, ukrasi za Božićnu jelku i Božićne čarape; vozila za igru u obliku automobila, kamiona, vozova i kombija, svi sa temom košarke, nove pjenaste igračke u obliku prsta ili trofeja, igrački trofeji, karte za igru, igrice sa kartama, igračke koje prave zvuk, igračke za kućne ljubimce; igračke za plažu, naime lopte za plažu, lopte na naduvavanje, kantice za igru, lopatice za igru, igračke za pijesak, kutijice za pesak, gumene igračke za vodu; oprema za bazen, naime plivačka oprema za plutanje, oprema za plutanje u bazenu, igračke za splavarenje na vodi, penasta oprema za plutanje, gume za plivanje, gume za plivanje u bazenu, penaste gume, daske za plivanje, da-

ske za surfovanje, peraja za plivanje, peraja za surfovanje, mišici za plutanje i krila za pomoć pri plivanju u rekreativne svrhe; odbojkaške torbice za igru koje se sastoje od lopte, mrežice, sporednih stvari i zviždaljke, i vaterpolo torbice za igru koje se sastoje od lopte, mrežice i zviždaljke; dekorativne igračke od tkanine koje se puštaju da lete na vetru.

Klasa 41: Razonoda i obrazovne usluge u smislu televizijskih događaja i radio programa u polju košarke i prikazivanja uživo košarkaških igara i košarkaških priredbi; usluge produkcije i distribucije radio i televizijskih šou programa o košarkaškim igrama, košarkaškim događajima i programima iz oblasti košarke; usluge vodenja i organizovanja košarkaških klinika i kampova, klinika i kampova za trenere, klinika i kampova za plesne timove i košarkaške igre; usluge razonode u vidu ličnog pojavljivanja u kostimiziranim maskotama ili u plesnim timovima na košarkaškim igrama i priredbama, klinikama, kampovima, promocijama i drugim događajima, specijalnim događajima i žurkama vezanim za košarku; usluge kluba obožavalaca; usluge razonode, naime one koje pružaju vebsajt predstavljanje multimedijjskih sadržaja u vidu najvažnijih televizijskih događaja, interaktivnih najvažnijih televizijskih događaja, video snimaka, video strim snimaka, interaktivnih video izbora najvažnijih događaja, radio programa, najvažnijih radijskih događaja i audio snimaka u polju košarke; usluge obezbjeđivanja vesti i informacija u vidu statistika i drugih stvari u polju košarke; onlajn igrice koje se ne mogu preuzimati, naime kompjuterske igrice, video igrice, interaktivne video igrice, akcione igrice, arkadne igrice, društvene igrice za odrasle i decu, igre na tabli, puzle, trivia igrice; usluge elektronskog izdavaštva, naime, izdavanje magazina, vodiča, biltena, bojanki i igrica kod kojih se igrači određuju putem interneta, sve u vezi sa košarkom; usluge obezbjeđivanja onlajn kompjuterske baze podataka u polju košarke.

(210) **2013-69** (442) **20.04.2014.**
(220) 2/18/2013

(731) **MINERVA GMBH**, KONIGINSTRABE 73, 80539 MUNCHEN DE

(540) lamoda

(550) I, V

(740) Popović Miladin, Đoka Miraševića 21/III, Podgorica ME

(511) **Klasa 18:** Koža i imitacije kože, i proizvodi od tih materijala koji nijesu obuhvaćeni drugim klasama; životinjske kože, krzna; koferi i putne torbe, torbe, ručne torbe, novčanici, torbice, torbice za ključeve, ruksaci, vrećice; kišobrani, suncobrani, i štapovi za hodanje; bičevi i sedlarsko remenarski proizvodi.

Klasa 25: Odjeća, obuća, pokrivala za glavu.

Klasa 35: oglašavanje i reklamiranje; vođenje komercijalnih poslova; komercijalna administracija; kancelarijski poslovi; usluge maloprodaje, uključujući prodaju putem vebsajtova i teleshoppinga, a u vezi sa odjecom, obućom, pokrivalima za glavu, preparatima za izbjeljivanje i drugim supstancama za pranje veša, preparatima za čišćenje, poliranje, odmašćivanje i abraziju, sapunima, parfimerijom, etericnim uljima, kozmetikom, losionima za kosu, pasta za zube, suncanim naočarima, plemenitim metalima i njihovim legurama i proizvodima od plemenitih metala ili obloženih istima, nakitom, dragim kamenjem, casovnicarskim i hronometrijskim instrumentima, kožom i imitacijom kože, i proizvodima izradenim od ovih materijala, životinjskom kožom, krznima, koferima i putnim torbama, torbama, ručnim torbama, novčanicima, torbicama, torbicama za ključeve, ruksacima, vrećicama, kišobranima, suncobranima i štapovima za hodanje, bičevima i sedlarsko remenarskim proizvodima; organizovanje, postavljanje, pomaganje i vođenje promotivnih događaja i programa za lojalnost potrošača.

(210) 2013-70

(442) 20.04.2014.

(220) 2/19/2013

(731) BIOGUARD DOO, BULEVAR PERA ČETKOVIĆA 11/3, PODGORICA ME

 The logo for MOSQUITALL features the brand name in a bold, sans-serif font with a distressed, slightly irregular texture. A registered trademark symbol (®) is positioned to the upper right of the text.

(540)

(550) I, F

(511) **Klasa 05:** sredstva za zaštitu od komaraca, krpelja, muva, moljaca i ostalih insekata, za djecu i odrasle;

(210) 2013-71

(442) 20.04.2014.

(220) 2/20/2013

(731) NISSAN JIDOSHA KABUSHIKI KAISHA (ALSO TRADING AS NISSAN MOTOR CO., LTD), NO.2 TAKARACHO, KANAGAWA-KU, YOKOHAMA-KEN JP



(540)

(550) I

(740) Čejović Vladimir, 13. jula 21, Podgorica ME

(511) **Klasa 09:** Uređaji i instrumenti za provođenje, prekid, transformaciju, akumulaciju, regulisanje ili kontrolu električne energije; aparati za snimanje, prenos, reprodukovanje zvuka ili slika; oprema za obradu podataka i računara; mjerni uređaji, mjerni instrumenti, brojila, uređaji za bilježenje vremena; razvodne table (struja); razvodne kutije (struja); distributivne konzole (struja), elektronski pretvaraci, punjači, punjači baterija, transformatori (struja); uređaji na daljinsko upravljanje; baterije i celije; gorivne celije; uređaji za medusobnu vezu; telefonski aparati; pametni telefoni; aparati za transportnu telematiku; odašiljaci i prijmnici podataka kojima su opremljeni automobili; navigacijski uređaji za vozila; indikator o napunjenosti baterije i motori; elektronske naprave za obavješavanje o informacijama o baterijama; integrisana kola; štampane ploče; računari; računarski softver; računarski programi; zvuk koji se može preuzeti; električni kablovi; električne žice; elektronski dokumenti; uputstvo za elektronski servis; inverteri (struja); alarmi protiv krađe; elektrode za baterije; magneti; zaštitni uređaji za ličnu upotrebu od posljedica nesrećnog slučaja; električne uređaji protiv krađe; signalizacioni trouglovi za vozila u kvaru; regulatori napona vozila; solarne baterije; kartice sa integrisanim kolima (pametne kartice); odvodnici; futrole za računare, torbe za računare, futrole za kodirane ključeve; novčanici za pohranjivanje memorije; dodatna oprema za mobilne telefone; futrole za mobilne telefone; olovke za panele na dodir; uređaji za memoriju računara; fleš diskovi; računarski periferni uređaji; miš; podloge za

miša; programi za kompjuterske igrice; kompakt diskovi (memorija samo za čitanje); naočare; naočare za sunce; futrole za naočare; mehanizmi za uređaje koji se pokreću uz prethodno plaćanje; mehanizmi za uređaje koji se pokreću ubacivanjem žetona; trake za mobilne telefone; trake za prenosne uređaje; zaštitne kacige; trake za držanje naočara; aparati za snimanje zvuka i slike; aparati za reprodukciju zvuka i slike.

Klasa 37: Pružanje informacije o popravci ili održavanju motornih vozila; popravka ili održavanje mašina i instrumenata za mjerenje ili testiranje; popravka ili održavanje mašina i uređaja za distribuciju ili kontrolu električne energije; popravka ili održavanje punjača; popravka ili održavanje baterija i celija; popravka ili održavanje motora s unutrašnjim sagorijevanjem; popravka ili održavanje djelova motora s unutrašnjim sagorijevanjem; popravka ili održavanje startera za motore i mašine, a ne za kopnena vozila; popravka ili održavanje djelova za motore, popravka ili održavanje generatora; popravka ili održavanje telekomunikacionih uređaja i aparata; popravka ili održavanje elektroničkih mašina, uređaja i njihovih djelova; pomoć pri kvaru na automobilu (popravka); pružanje informacija o stanju vozila, naime status punjenja, potrebno puno vrijeme punjenja, status kada je isključeno, napunjeno.

(210) **2013-72** (442) **20.04.2014.**
(220) 2/21/2013

(731) **KOVACS GABOR**, MATIJE GUPCA 5, SUBOTICA RS

MiniPani

(540)

(550) I, M

(511) **Klasa 16:** ambalaža (karton i papir za pakovanje, papirne i plastične kese, torbe, koverta od papira i plastike, materijali za pakovanje od skroba).

Klasa 30: brašno i proizvodi od žitarica.

Klasa 35: oglašavanje.

Klasa 39: pakovanje i skladištenje robe.

Klasa 42: tehnološke usluge.

Klasa 43: usluge obezbjeđivanja hrane i pića.

(210) **2013-73** (442) **20.04.2014.**
(220) 2/25/2013

(731) **BIOGUARD DOO**, BULEVAR PERA ČETKOVIĆA 11, PODGORICA ME

MOSQUITALL

(540)

(550) I, V

(511) **Klasa 05:** sredstva za zaštitu od komaraca, krpelja, muva, moljaca i ostalih insekata, za djecu i odrasle;

(210) **2013-74** (442) **20.04.2014.**
(220) 2/25/2013

(300) 01532761 OD DANA 20.12.2012

(731) **MERKUR GAMING GMBH**, BORSIGSTRASSE 26, 32312, LUBBECKE DE

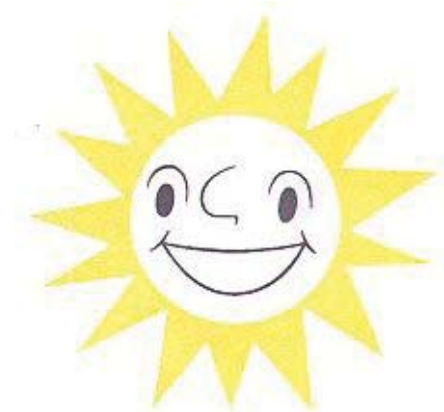

(540)

(550) I, F

(740) Prelević Dragan, ulica Slobode 74, Podgorica ME

(511) **Klasa 09:** Kompjuterski softver; Softver za računarske i video igrice; Softver igrice za upotrebu na svakoj računarskoj platformi, uključujući elektronsku zabavu i konzole za igrice; Programi računarskih igrice; Operativni programi za električne i elektronske igrice, razonodu i/ili zabavu; Automatske mašine za lutriju; Računarski softver za igranje igara na i putem interneta; Online igrice(softver); Računarski softver u formi aplikacije za mobilne uređaje i računare; Računarski hardver i softver za kazino i arkadne igre; mašine sa igrama; slot mašine, mašine sa igrama video lutrije i igre na sreću putem interneta; Električni, elektronski, optički ili automatski aparati, za identifikaciju nosilaca podataka, ličnih karata, kreditnih kartica, novčanica i kovanica.

Klasa 28: Igre; Igračke; Aparati za igre(uključujući aparate koji se pokreću kovanicama); Mašine i aparati za arkadne i video igre koje se pokreću kovanicama i novčanicama; Arkadne igre za zabavu(uključene u klasu 28); Aparati i mašine za video igre; Automatske mašine i mašine za igru koje se pokreću kovanicama, posebno za arkadne igre; Elektronski ili elektrotehnički aparati za igru, mašine za igru i slot mašine koje se pokreću kovanicama, žetonima, novčanicama, tiketima ili putem elektronskog, magnetnog ili biometrijskog nosača podataka; Kućišta za mašine sa igrama, aparati za igre i automatske mašine za igre, koje se pokreću kovanicama ili drugacije, izradene od metala, Plastičnih materijala i /ili drveta. Igre; Igračke; Aparati za igre(uključujući aparate koji se pokreću kovanicama); Mašine i aparati za arkadne i video igre koje se pokreću kovanicama i novčanicama; Arkadne igre za zabavu(uključene u klasu 28); Aparati i mašine za video igre; Automatske mašine i mašine za igru koje se pokreću kovanicama, posebno za arkadne igre; Elektronski ili elektrotehnički aparati za igru, mašine za igru i slot mašine koje se pokreću kovanicama, žetonima, novčanicama, tiketima ili putem elektronskog, magnetnog ili biometrijskog nosača podataka; Kućišta za mašine sa igrama, aparati za igre i automatske mašine za igre, koje se pokreću kovanicama ili drugacije, izradene od metala, Plastičnih materijala i /ili drveta.

(210) **2013-75**

(442) **20.04.2014.**

(220) 2/25/2013

(731) **CJ CORPRATION** (KOREAN CORPRATION), 12, SOWOL-RO 2-GIL JUNG-GU SEOUL KR



(540)

(550) I, F

(740) Popović Miladin, Đoka Miraševića 21/III, Podgorica ME

(511) **Klasa 29:** Meso, riba, živina i divljač; mesni ekstrakti; konzervirano, smrznuto, sušeno i kuvano voće i povrće; želei, džemovi, kompoti; jaja, mlijeko i mliječni proizvodi; jestiva ulja i masti; Susamovo jestivo ulje; Prepržena alga; Pasulj, konzervirani; Prerađeno povrće; Prerađeni žen-šen; Fermentisana povrćna hrana (kimchi); Kisjele rotkvice; Voćni želei; Prerađeno kestenje; Konzervirano voće; Očuvano voće; Supe; Tofu; Mesne prerađevine; Konzervirano meso; Kobasice; Pića sa bakterijama mliječne kiseline; Maslac; Sojino ulje; Prerađeni plodovi mora; Riblji kolači; Alge za ishranu (prerađene).

(210) **2013-76**

(442) **20.04.2014.**

(220) 2/25/2013

(731) **CJ CORPRATION** (KOREAN CORPRATION), 12, SOWOL-RO 2-GIL JUNG-GU SEOUL KR



(540)

(550) I, F

(740) Popović Miladin, Đoka Miraševića 21/III, Podgorica ME

(511) **Klasa 30:** Kafa, čaj, kakao i zamjena za kafu; riža; tapioka i sago; brašno i proizvodi od žitarica; hljeb, kolači i poslastice; sladoledi; šećer, med, sirup od melase; kvasac, prašak za pećivo; so; senf; sirće, sosovi (dodaci); razni začini; led za hlađenje; Rafinirane žitarice; Pšenično brašno (jestivo); Brašno za prženje; Riža; Prerađena hrana na bazi žitarica; Rezanci; Supa od žitarica; Kuvana riža; Knedle; Sirup; Prirodni zaslađivači; Soja sos; Fermentisano tijesto sa ljutom paprikom; Soja tijesto (dodatak); Začin; Kari u prahu (začin); Špageti; Pice; Sladoled.

(210) **2013-77**

(442) **20.04.2014.**

(220) 2/25/2013

(731) **CJ CORPRATION** (KOREAN CORPRATION), 12, SOWOL-RO 2-GIL JUNG-GU SEOUL KR

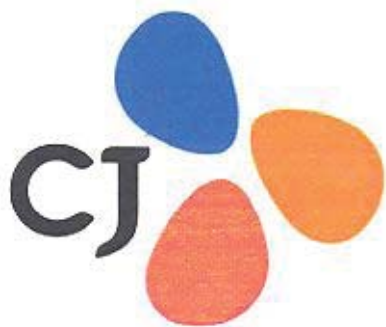

(540)

(550) I, F

(740) Popović Miladin, Đoka Miraševića 21/III, Podgorica ME

(511) **Klasa 32:** Pivo; mineralne i gazirane vode i ostala bezalkoholna pića; pića od voća i voćni sokovi; sirupi i ostali preparati za pripremanje napitaka; Preparati za pripremu šumećih pića; Bezalkoholna pića; Soda pop; Pića od soka od grožđa; Pića od soka od jabuke; Pića od soka od pomorandže; Limunade; Napici od svježeg voća i povrća; Punc od riže; Sirupi za pića; Pića od soka žen-šena; Praškovi od žen-šena za pića; Sok od povrća (napitak); Napici na bazi vode; imitacija piva.

(210) **2013-78**

(442) **20.04.2014.**

(220) 2/27/2013

(731) **KT & G CORPRATION**, 100 PYONG CHON-DONG DAEDEOG-GU DAEJEON RK



(540)

(550) I, F

(740) Popović Miladin, Đoka Miraševića 21/III, Podgorica ME

(511) **Klasa 34:** Duvan; Cigarete; Cigare; Burmut; Papir za cigarete; Lule za duvan, ne od plemenitih metala; Filteri za cigarete; Kutije za cigarete, ne od plemenitih metala; Kesice za duvan; Upaljači, ne od plemenitih metala; Šibice; Sredstva za čišćene lula za duvan; Pepeljare za pušače, ne od plemenitih metala; Rezači za cigare.

(210) **2013-79**

(442) **20.04.2014.**

(220) 2/27/2013

(731) **SOUTH BEACH BEVERAGE COMPANY, INC.**, 40 RICHARDS AVENUE, NORWALK,

CONNECTICUT 06854 US

(540) ADRENALINE RUSH

(550) I

(740) Čejović Vladimir, 13. jula 21, Podgorica ME

(511) **Klasa 32:** Mineralne i gazirane vode i ostala bezalkoholna pića; pića od voća i voćni sokovi; sirupi i ostali preparati za pripremanje napitaka.

(210) **2013-80**

(442) **20.04.2014.**

(220) 2/28/2013

(731) **INTERNATIONAL TRADE MARK AGENCY LTD**, GLOBAL GATEWAY BR.8, RUE DE LA PERLE, PROVIDENCE, MAHE SC

(540) HILTON HOTELS & RESORTS

(550) I

(511) **Klasa 35:** Oglašavanje. Vođenje poslova; poslovno upravljanje; kancelarijski poslovi.

Klasa 39: Organizovanje putovanja.

Klasa 41: Usluge koje pružaju sve vrste edukacije lica, organizovanje i vođenje seminara, konferencija i kongresa.

Klasa 42: Usluge smeštaja, hotelske, ugostiteljske i barske usluge, catering usluge za snabdevanje hranom i/ili pićem, usuge rezervacija hotelskih soba;

Klasa 43: Usluge hotela, odmarališta; motela; usluge privremenog smeštaja; usluge putnih agencija u vezi sa rezervacijom hotelskog smeštaja; specijalizovane hotelske usluge kao deo programa za stalne goste hotela; usluge restorana, barova i koktel barova; usluge sneg barova; obezbjeđivanje kapaciteta za održavanje proslava i društvenih događaja za specijalne prilike; catering za potrebe snabdevanja hrane i pića; obezbjeđivanje kapaciteta za konferencije, izložbe i sastanke; iznajmljivanje konferencijskih sala.

(210) **2013-81**

(442) **20.04.2014.**

(220) 2/28/2013

(731) **INTERNATIONAL TRADE MARK AGWNCY LTD**. GLOBAL GAREWAY BR. 8 RUE DE LA PERLE, PROVIDENCE, MAHE SC

(540) HILTON

(550) I

(511) **Klasa 35:** Oglašavanje. Vođenje poslova; poslovno upravljanje; kancelarijski poslovi.

Klasa 39: Organizovanje putovanja.

Klasa 41: Usluge koje pružaju sve vrste edukacije lica, organizovanje i vođenje seminara, konferencija i kongresa.

Klasa 42: Usluge smeštaja, hotelske, ugostiteljske i barske usluge, catering usluge za snabdevanje hranom i/ili pićem, usuge rezervacija hotelskih soba;

Klasa 43: Usluge hotela, odmarališta; motela; usluge privremenog smeštaja; usluge putnih agencija u vezi sa rezervacijom hotelskog smeštaja; specijalizovane hotelske usluge kao deo programa za stalne goste hotela; usluge restorana, barova i koktel barova; usluge sneg barova; obezbjeđivanje kapaciteta za održavanje proslava i društvenih događaja za specijalne prilike; catering za potrebe snabdevanja hrane i pića; obezbjeđivanje kapaciteta za konferencije, izložbe i sastanke; iznajmljivanje konferencijskih sala.

(210) **2013-82**

(442) **20.04.2014.**

(220) 3/1/2013

(300) 11476074 09.01.2013. CTM

(731) **IDEXX LABORATORIES, INC.**, ONE IDEXX DRIVE, WESBROOK, MAINE 04092 US

(540) PETLY

(550) I

(740) Čejović Vladimir, 13. jula 21, Podgorica ME

(511) **Klasa 35:** Usluge oglašavanja; usluge komercijalne administracije; kancelarijski poslovi; pisarske usluge za zakazivanje; prikupljanje, skadištenje, upravljanje, administracija, održavanje, obrada i pretraživanje podataka u bazama podataka; upravljanje i održavanje datoteka i podataka sa veterinarskom informacijama; maloprodajne usluge u vezi sa prodajom proizvoda za veterinu, njegu životinja, zdravlje životinja, higijenu životinja i proizvoda za njegu ljepote životinja; informacije, savjeti i konsultacije u vezi sa gore pomenutim uslugama.

Klasa 38: Usluge telekomunikacija; obezbjeđivanje pristupa kompjuterskim mrežama; obezbjeđivanje pristupa kompjuterskim bazama podataka; obezbjeđivanje pristupa podacima, informacijama i porukama na kompjuterskim mrežama, naročito ako su ti podaci, informacije i poruke vezane za njegu životinja, zdravlje životinja, higijenu životinja i njegu ljepote životinja; prenos podataka, informacija i poruka u vezi sa njegom životinja, zdravljem životinja, higijenom životinja i njegom ljepote životinja; informacije, savjeti i konsultacije u vezi sa svim gore pomenutim uslugama.

Klasa 41: Obrazovne usluge u vezi sa njegom životinja, zdravljem životinja, higijenom životinja i njegom ljepote životinja; usluge stručnog osposobljavanja na polju njege životinja, zdravlja životinja, higijene životinja i njegu ljepote životinja; Usluge obrazovnih informacija na poljima njege životinja, zdravlja životinja, higijene životinja i njegom ljepote životinja; usluge zabave u vezi sa životinjama; usluge zabave za životinje; sportske i kulturne aktivnosti u vezi sa životinjama; organizacija priredbi sa životinjama u obrazovne i zabavne svrhe; informacija, savjeti i konsultacije u vezi sa svim gore pomenutim uslugama.

Klasa 44: Veterinarske usluge; usluge veterinarskog testiranja; higijenske i usluge Ljepote za životinje; usluge veterinarske informacije, savjeta i konsultacija; informacija, savjeti i konsultacije u vezi sa njegom životinja, zdravljem životinja, higijenom životinja i njegom ljepote životinja; usluge pracenja zdravlja životinja; informacija, savjeti i konsultacije u vezi sa svim gore pomenutim uslugama.

(210) **2013-83**

(442) **20.04.2014.**

(220) 3/4/2013

(731) **THE GOODYEAR TIRE & RUBBER COMPANY**, 200 INNOVATION WAY, AKRON, OHIO 44316 US

(540) TREADMAX

(550) I

(740) Čejović Vladimir, 13. jula 21, Podgorica ME

(511) **Klasa 12:** Gume, unutašnje gume za točkove, gume za motocikle, gume za kopnena vozila, gume za automobile, gume za kamione, gume za traktore; gume za točkove vozila; gusjenice vozila; gazišta za vozila; gotova gazišta za gume, trake za izmjenu gumenih točkova na vozilima; materijali za zamjenu guma; točkovi; felge za točkove, kvačila, poklopci na točkovima; klapne za vozila; materijali i alati za popravku guma i cijevi, protivklizne sprave za točkove vozila; kočnice; cijevi za vozila; olovni tegovi za balansiranje točkova vozila; aparati za napumpavanje guma vozila; oprema za gume; amortizeri; djelovi za vozila izrađeni uglavnom od gume, djelovi i oprema za sve gore navedene robe.

Klasa 35: Reklamiranje i promovisanje guma, guma za točkove vozila, gusjenica vozila, gazišta za vozila, traka za izmjenu gumenih točkova na vozilima, točkova, kvačila, poklopaca za toč-

kove, materijala za popravku guma i cijevi i djelovi i pribor za motorna vozila; reklamiranje i promoviranje gume, guma za točkove vozila, gusjenica vozila, gazišta za vozila, traka za izmjenu gumenih točkova na vozilima, točkova, kvačila, poklopaca za točkove, materijala za popravku guma i cijevi i djelovi i pribor za motorna vozila pomoću elektronskih komunikacionih mreža, Internet, ekstranet, Intranet i LANs; usluge nabavke koje pomažu trećim licima da nabave gume, gume za točkove vozila, gusjenice vozila, gazišta za vozila, trake za izmjenu gumenih točkova na vozilima, točkove, kvačila, poklopce za točkove, materijale za popravku guma i cijevi i djelovi i pribor za motorna vozila; usluge nabavke elektronskim putem koje pomažu trećim licima da nabave gume, gume za točkove vozila, gusjenice vozila, gazišta za vozila, trake za izmjenu gumenih točkova na vozilima, točkove, kvačila, poklopce za točkove, materijale za popravku guma i cijevi i djelovi i pribor za motorna vozila; usluge maloprodaje i veleprodaje koje se odnose na gume, gume za točkove vozila, gusjenice vozila, gazišta za vozila, trake za izmjenu gumenih točkova na vozilima, točkove, kvačila, poklopce za točkove, materijale za popravku guma i cijevi i djelovi i pribor za motorna vozila; sakupljanje, za dobrobit drugih, raznih roba (isključujući prevoz istih), naime gume za točkove vozila, gusjenice vozila, gazišta za vozila, trake za izmjenu gumenih točkova na vozilima, točkove, kvačila, poklopce za točkove, materijale za popravku guma i cijevi i djelovi i pribor za motorna vozila koje obezbjeđuju maloprodajni objekti, veleprodajni outlet-i , putem web stranica ili televizijskih šoping programa; poslovno savjetovanje i predlog u vezi sa gumama, gusjenicama vozila, gazištima za vozila, trakama za izmjenu gumenih točkova na vozilima, točkovima, kvačilima, poklopcima za točkove, materijalima za popravku guma i cijevi i djelovima i priborom za motorna vozila; usluge maloprodajnih prodavnica guma; usluge maloprodaje guma; informacije dostupne na internetu koje se odnose na gore pomenuto; konsultacije i informacije koje se odnose na gore navedene usluge; pružanje gore navedenih usluga putem interneta i drugih elektronskih komunikacionih mreža; komercijalne usluge koje se odnose na gume, komercijalne usluge koje se odnose na zamjenu guma, usluge upravljanja koje se odnose na gume, poslovno upravljanje, poslovna administracija, reklamiranje, kancelarijske djelatnosti, savjetovanje, komercijalna ili industrijska pomoć oko upravljanja, komercijalna ili industrijska pomoć oko upravljanja koja se odnosi na gume, demonstracija proizvoda, unapređenje prodaje, usluge nabavke za druge.

Klasa 37: Usluge održavanja i popravke vozila; usluge popravke guma; zamjena guma; montaža guma; konsultacije, savjetovanje i pribavljanje informacija koje se odnose na popravku, strukturu, zamjenu, sastav, održavanje, montažu i postavljanje guma, gusjenica vozila, gazišta za vozila, traka za izmjenu gumenih točkova na vozilima, točkova, kvačila, poklopaca za točkove; konsultacije, savjetovanje i pribavljanje informacija koje se odnose na popravku i zamjenu guma i cijevi koristeći

(210) **2013-84** (442) **20.04.2014.**
(220) 3/6/2013

(300) 30 2012 048 119.1/38 06.09.2012 DE

(731) **DEUTSCHE TELEKOM AG**, FRIEDRICH-EBERT-ALLEE 140 53113 BONN DE

(540) FABBING

(550) I

(740) Popović Miladin, Đoka Miraševića 21/III, Podgorica ME

(511) **Klasa 35:** Oglašavanje; vođenje komercijalnih poslova; komercijalna administracija; kancelarijski poslovi; Obrada materijala; Naučne i tehnološke usluge i istraživanje i projektovanje u vezi sa tim, usluge industrijske analize i istraživanja; projektovanje i razvoj kompjuterskog hardvera i softvera; Pravne usluge, sigurnosne usluge za zaštitu imovine i lica; lične i društvene usluge koje pružaju drugi, namijenjene za zadovoljenje ljudskih potreba.

(210) **2013-85**(442) **20.04.2014.**

(220) 3/7/2013

(731) **NISSAN JIDOSHA KABUSHIKI KAISHA**(ALSO TRADING AS NISSAN MOTOR CO., LTD), NO.2 TAKARACHO KANAGAWA-KU YOKOHAMA-SHI KANAGAWA-KEN JP

(540) NISMO

(550) I, V

(740) Popović Miladin, Đoka Miraševića 21/III, Podgorica ME

(511) **Klasa 12:** Vozila za kretanje po kopnu, vazduhu, vodi ili željeznici; Automobili; Električna vozila; Vagoni; Kamioni; Kombiji (vozila); Terenska vozila (SUV); Motorni autobusi; Vozila za rekreaciju (prikolice); Sportski automobili; Trkački automobili; Kamioni sa prikolicom; Viljuškari; Traktori uključujući traktore za vuču; Prikolice i poluprikolice za vozila; Djelovi vozila koja se kreću po kopnu, vazduhu i vodi; Aparati za kretanje po kopnu, vazduhu ili vodi; Mašine za kopnena vozila; Motori za kopnena vozila; Karoserije za vozila; Šasije vozila; Upravljački prenosnici za kopnena vozila; Djelovi upravljačkih prenosnika za kopnena vozila; Prenosne osovine za kopnena vozila; Mjenjači za kopnena vozila; Kvačila za kopnena vozila; Osovine za vozila; Amortizeri za vozila; Amortizacione opruge za vozila; Točkovi za vozila; Gume za točkove za vozila; Zglobovi za točkove vozila; Ljepljive gumene smese za opravku unutrašnjih pneumatika; Kočnice za vozila; Kočione pločice za automobile; Vjetrobrani; Brisači za vozila; Branici za vozila; Upravljači za kopnena vozila; Sirene za vozila; Migavci za vozila; Sjedišta za vozila; Sigurnosni pojasevi za sjedišta vozila; Nasloni za glavu za sjedišta vozila; Alarmi za kretanje unazad za vozila; Protivprovalni uređaji za vozila; Vazdušni jastuci (sigurnosni uređaji za automobile); Retrovizori; Podizaci zadnjih vrata automobila (djelovi kopnenih vozila); Oprema za vozila; Spojleri za vozila; Nosači prtljaga za vozila; Blatobrani; Lanci protiv proklizavanja; Tende za vozila (krojene); Presvlake (za sjedišta) za vozila; Vazdušne pumpe (oprema za vozila); Nosači skija, za vozila; Upaljači za cigare za automobile; Sigurnosna sjedišta za djecu; Svemirska vozila; Avioni; Hidroavioni; Letjelice; Kolica; Motocikli; Čamci; Trajekti; Brodovi; Jahte; Bicikli; Zvona za bicikle; Lanci za bicikle; Motori zabicikle; Sjedišta zabicikle; Blatobrani za bicikle.

(210) **2013-86**(442) **20.04.2014.**

(220) 3/8/2013

(731) **INDUSTRIJA PIVA I SOKOVA TREBJESA AD NIKŠIĆ**, NJEGOŠEVA BR.18, NIKŠIĆ ME

(540)

(550) I

(740) Božović Vesko, Rimski trg 50/11, Podgorica ME

(511) **Klasa 32:** pivo, mineralne i sodne vode i druga bezalkoholna pića; pića od voća i voćni sokovi; sirupi i drugi preparati za proizvodnju pića.

Klasa 35: oglašavanje; vođenje poslova; poslovno upravljanje; kancelarijski poslovi. Obuhvata: usluge koje pružaju lica ili organizacije u pomoći u radu ili upravljanju preduzećima i u vođenju poslova preduzeća; usluge koje pružaju preuzeća koja se bave oglašavanjem (reklamiranjem), tako što, za račun drugih lica, komuniciraju sa javnošću (reklama) putem prenosa bilo

kakvih informacija o proizvodima i uslugama omogućavajući potrošačima prigodan pogled na te proizvode i usluge; usluge koje se sastoje od upisivanja, uređivanja, obrade, prerade ili sistematizacije pisanih informacija i zapisa; usluge reklamnih agencija; distribuciju prospekata i uzoraka direktno ili poštom; izradu i korišćenje matematičkih i statističkih podataka; organizovanje sajмова i izložbi u komercijalne ili reklamne svrhe.

(210) **2013-87** (442) **20.04.2014.**
(220) 3/8/2013

(731) **INDUSTRIJA PIVA I SOKOVA TREBJESA AD NIKŠIĆ**, NJEGOŠEVA BR.18, NIKŠIĆ ME



(540)

(550) I

(740) Božović Vesko, Rimski trg 50/11, Podgorica ME

(511) **Klasa 32:** pivo, mineralne i sodne vode i druga bezalkoholna pića; pića od voća i voćni sokovi; sirupi i drugi preparati za proizvodnju pića.

Klasa 35: oglašavanje; vođenje poslova; poslovno upravljanje; kancelarijski poslovi. Obuhvata: usluge koje pružaju lica ili organizacije u pomoći u radu ili upravljanju preduzećima i u vođenju poslova preduzeća; usluge koje pružaju preuzeća koja se bave oglašavanjem (reklamiranjem), tako što, za račun drugih lica, komuniciraju sa javnošću (reklama) putem prenosa bilo kakvih informacija o proizvodima i uslugama omogućavajući potrošačima prigodan pogled na te proizvode i usluge; usluge koje se sastoje od upisivanja, uređivanja, obrade, prerade ili sistematizacije pisanih informacija i zapisa; usluge reklamnih agencija; distribuciju prospekata i uzoraka direktno ili poštom; izradu i korišćenje matematičkih i statističkih podataka; organizovanje sajмова i izložbi u komercijalne ili reklamne svrhe.

(210) **2013-88** (442) **20.04.2014.**
(220) 3/12/2013

(731) **MEGA DISPOSABLES S.A.**, 148 DEKELIAS STREET, 136 78 AHARNES GR

(540) SANI

(550) I

(740) Radulović Božidar, Jovana Tomaševića 9/III, Podgorica ME

(511) **Klasa 05:** pelene za inkontinenciju;

(210) **2013-89** (442) **20.04.2014.**
(220) 3/13/2013

(731) **SAMKWANG GLASS CO., LTD**, 18TH FL.INTERNATIONAL ELECTRONICS BUILDING, 1445-3 SEOCHO-DONG SEOCHO-GU, SEUL, 137-728 KR



(540)

(550) I, F

(740) Popović Miladin, Đoka Miraševića 21/III, Podgorica ME

(511) **Klasa 21:** raspršivači aerosoli, ne za medicinske svrhe; abrazivni jastučići za kuhinjsku potrebu; abrazivni jastučići za kuhinjsku upotrebu; abrazivni sunđerri za ribanje kože abrazivni jastučići za kuhinjsku upotrebu; raspršivači aerosoli, ne za medicinske svrhe; životinjske čekinje [četke]; aparati za potiranje voskom, neelektrični; haube za akvarijume; autoklave [ekspres lonci], eelektrični I ekspres lonci [autoklave], neelektrični; kadice za kupanje beba, prenosive; tvrde prostirke; zdjele [posude]; korpe za domaću upotrebu; kašike za serviranje, za kuhinjsku upotrebu; mučkalice, neelektrične; krigle za pivo; fontane za ptice; kavezi za ptice; blenderi, neelektrični, za upotrebu u domaćinstvima; držači za čizme; drveni kalupi za čizme [kalupi]; otvarači za flaše; flaše; činije [zdjele] I zdjele [činije]; kutije za doziranje papirnih ubrusa; kutije za staklo; korpe za hleb, domaće; kutije za hleb; daske za hleb; metle; proizvodi za četkanje; četke za obuću; četke; četke za čišćenje rezervoara i kontejnera; korpe napravljene od tkanina; korpe I kofe; biste od porcelana, keramike, gmčarije ili stakla; činije za puter; poklopci za činije za puter; kopče za dugmad; kabarei [tacne]; kavezi za kućne ljubimce; modle za kolače [kalupi]; kandelabri [svijećnjaci] I svijećnjaci; sprave za gašenje svijeća; prsteni za svijeće; kutije za bombone I kutije za slatkiše; praheri za tepihe [ručni instrument] I praheri za tepihe, koji nijesu mašine; čistači za tepihe; kotlovi; keramika za upotrebu u domaćinstvu; keramički lonci; divikozina koža za čišćenje I jelenska koža za čišćenje I kože od divokoze za čišćenje; poklopci za posude za sir; kineski ornamenti; štapići za jelo; cjediljke [za upotrebu u domaćinstvima]; instrumenti za čišćenje, kojima se ručno rukuje; kućina za čišćenje; zatvarači za poklopce; krpa za čišćenje podova; platnene vreće, za sušenje; štikaljke za veš I igle za odjeću; kalupi za odjeću I kalupi za odjeću; podmetači, ne od papira i ne od stonog platna; mješalice za koktel; filteri za kafu, neelektrični; mlinovi za kafu, kojima se ručno rukuje; cjediljke za kafu, neelektrične; servisi za kafu [stono posuđe]; lončići za kafu, neelektrični; futrole za češljeve; češljevi; češljevi za životinje; poslastičarske ukrasne kese [kese za peciva]; posude za upotrebu u domaćinstvima ili u kuhinjama; kulinarske modle [kalupi]; sejkači za kolače [biskvit]; tegle za kolačiće; set lonaca; lonci Ža kuvanje; ražanj za pečenje, metalni I štapići za ražnjice od metala; kuhinjska oprema, neelektrična; vadičepi; kozmetička oprema; komadići pamučne tkanine za čišćenje; setovi bočica za ulje i sirće; bočice; đubrovnici; kristal [staklarija]; šolje; papirne ili plastične šolje; češagija; kuhinjske daske za sječenje; flaše; friteze za duboko prženje, neelektrične; pletare I bidoni; aparati za dezodorisanje za ličnu upotrebu; poklopci za jelo I poklopci za činije; činije; četke za pranje sudova; stoni tanjiri za jednokratnu upotrebu; boce za piće namijenjene putnicima I boce od tikvica; čaše za piće; rogovi za piće; korita za piće; posude za piće; sušilice za veš; kante za smeće I korpe za smeće I kante za đubre I kontejneri I kontejneri za smeće; aparati za prašinu, neelektrični; krpe za čišćenje prašine [starudija]; gmčarija I kuhinjski porcalan; zemljana šerpa sa drškom; šoljice za jaja; električni uređaji za primamljivanje i ubijanje insekata; električne četke, izuzev djelova za mašine; električni češljevi; emajlirano staklo; zdjele za ukras na stolu; četkice za obrve; pomagalo za čišćenje prašine od perja; korito; fiberglas, izuzev za izolaciju ili za upotrebu u tekstilnoj industriji I fiberglas, izuzev za izolaciju ili za upotrebu u tekstilnoj industriji; vlakna fiberglasa, ne za tekstilnu upotrebu I vlakna

fiberglassa, ne za tekstilnu upotrebu; figurine (statuete) od porcelana, keramike, gmčarije ili stakla I statuete od porcelana, keramike, gmčarije ili stakla; opremljene korpe za piknik, uključujući posuđe; pljosnate boce; ravna postolja od gvožđa; konac za zube; saksije za cijeće; navlake za saksije za cvijeće, ne od papira I navlake, ne od papira, za saksije za cvijeće; muvalice I hvataljke za muve [zamke ili mreže]; uređaji za hlađenje hrane koji sadrže tečnosti za razmjenu toplote, za upotrebu u domaćinstvu; čaše za voće sa poklopcem; prese za voće, neelektrične, za upotrebu u domaćinstvu ; tiganji; lijevci; čistači prašine za namještaj; topljeni silicijum [polupreradeni proizvod], izuzev za građevine; baštenske rukavice; prese za bijeli luk [kuhinjski pribor]; staklo [posude]; staklene zdjele; staklene činije [posude] I staklene bočice [posude]; staklene pljosnate boce [ambalaža]; staklo za automobilske prozore [poluproizvodi]; staklo sa električnim provodnicima; staklene tegle [bidoni]; stakleni zapušači I čepovi od stakla; staklena vuna izuzev za izolaciju; staklo, sirovo ili polupreradeno, izuzev stakla za građevine; kalupi za rukavice; rukavice za upotrebu u domaćinstvu; posude za lijepak; rende [kuhinjski pribor]; držači za roštilj I držači za rešetke od roštilja; roštilji [posuđe za kuvanje] I roštilji sa ravnom pločom [posuđe za kuvanje]; dlaka za četke; toplotno izolovani spremnici za piće; grijači za boce za hranjenje, neelektrični; toplotno izolovani spremnici; držači za cvijeće i biljke [za aranžiranje cvijećem]; četke za konje; vrući lonci, koji se ne zagrijavaju električno; kantice za led I hladnjaci [kantice za led] I kantice za led; modle za kockice leda [kalupi] I modle za kockice leda I kalupi za kockice leda; akvarijum za zatvoreni prostor I rezervoari [akvarijumi za zatvoreni prostor]; terrarium za zatvoreni prostor [uzgajanje biljaka]; terrarium za zatvoreni prostor [vivarium]; zamke za insekte; izolovane pljosnate boce I vakum boce; navlake za daske za peglanje, oblikovane; daske za peglanje; izotermičke torbe; ćupovi I krčazi; kazani, neelektrični; kuhinski spremnici; kuhinjski pribor; držači za noževе na stolu; četke za lampe od stakla; češljevi sa dugim zupcima za kosu; stalci za sto; set za likere; posude za toalet kućnih ljubimaca (plitko korito) I plitko korito za toalet kućnih ljubimaca; posude za ručak; majolika; sprave za uklanjanje šminke; jaslice za životinje; materijal za prav ljenje četki; držači za menije; pekači; mlinovi za upotrebu u domaćinstvu, kojima se ručno rukuje; mikseri, ručni [šejkeri za koktele] I šejkeri; mašine za miksanje, neelektrične, za kuhinjsku upotrebu I rende, neelektrične I kuhinjski mikseri, neelektrični; varjače [kuhinjski pribor]; aparati za mop; mop; vitraž, ne za građevine; kalupi [kuhinjski pribor] I modle [kuhinjski pribor]; mišolovka; šolje; četke za nokte; držači za salvete; prsteni za salvete; trava za jaja, vještačka; neelektrične ručne pokretne kutije za hlađenje I ne električni pokretni frižideri ; mašine za tjesteninu, kojima se ručno rukuje; pištolj za crijevo za vodu, mlaznice za kante za zalivanje ---:--I rupičasto sito za kante za zalivanje; staklo od opala; opalescentno staklo; oslikana staklarija; papirni tanjiri ; sjekači za pecivo; mlinovi za biber, kojima se ručno rukuje; kutijica za biber; gorionici za parfeme; isparivači za parfeme I sprejevi za parfeme; poslužavnici za pite I lopatice za voćne kolače; svinjske čekinje; kasice prasice; pipete [degustatori za vino] I degustatori za vino [sifoni]; staklene ploče [sirovina]; posude za sprječavanje kipljenja mlijeka; vakum guma za otčepijavanje odvoda; aparati i mašine za poliranje, za upotrebu u domaćinstvu, neelektrični; rukavice za poliranje; koža za poliranje; materijali za poliranje za dobijanje sjaja, osim preparati, papir i kamen; porculansko posuđe; poklopci za posuđe; lonci; posuđe; prstenje za živinu; kompaktni puderi; pufne za puder; dekorativno staklo u prahu; krpe [tkanine] za čišćenje I tkanine za čišćenje; krpe za čišćenje; zamke za pacove; rashladne boce; prstenje za ptice; oklagije, za upotrebu u domaćinstvu; zdjele za salatu; zdjelice za so I slanici; metalne žice za pranje šerpi; tanjirići; lopatice [posuđe]; abrizivni jastučići I jastučići za čišćenje; četke za ribanje; servisi [posuđe]; stalci za četke za brijanje; stalci za četke za brijanje; četke za brijanje; kašike za obuvanje obuće; kalupi za obuću [kalupi]; sita [posuđe za domaćinstvo]; cjediljke [posuđe za domaćinstvo]; ploče za natpise od porcelana ili stakla; sifoni za gaziranu vodu; apsorberi za dim za

domaćinstvo; kutije za sapun; bočice za tečni sapun; držači za sapun I zdjele za sapun; zdjele za supu; lopatice [posuđe]; setovi za začine; držači za sunđer; sunđeri za upotrebu u domaćinstvu; slavine; prskalice; statue od porcelana, keramike, grnačrije ili od stakla; čelična vuna za čišćenje; posude za gulaš; cjediljke; cjediljke za upotrebu u domaćinstvu ; slamke za piće I slamke za piće; činije za šećer; špricevi za zalivanje cvijeća i biljaka I prskalice za zalivanje cvijeća i biljaka; stono posuđe; posuđe, osim noževa, viljuški i kašika; krigle; četke za katran, sa dugom ručkom; zdjelica za čaj; čajnici; infuzeri za čaj I loptice za čaj; servisi za čaj [posuđe]; cjediljke za čaj; čajnici; termički izolovane posude za hranu; prese za kravate; držači za toaletni papir; WC četke; toaletni pribor I opremljeni neseseri; dozeri toaletnog papira; toaletni sunđeri; toaletni pribor; četkice za zube; četkice za zube, električne; držači za čačkalice za zube; čačkalice za zube; klizači i kolutovi za peškire I klizači i kolutovi za peškire; poslužavnici za upotrebu u domaćinstvu; poslužavnici za upotrebu u domaćinstvu, papirni; podmetači [pribor za jelo]; prese za glačanje pantalona; urne; posuđe za domaćinstvo; vaze; posude za povrće; posude od metala za pripremu sladoleda i ledenih pića; staklasta silikonska vlakna [niti], ne za tekstilnu upotrebu; prese za vafle, neelektrične; daske za pranje; korita za pranje; korpe za papirni otpad; vodeni aparati za čišćenje zuba i desni ; kante za zalivanje; uređaji za zalivanje I uređaji za prskanje; aparati za poliranje voskom, neelektrični, za cipele; mutilice, neelektrične, za upotrebu u domaćinstvu ; žardinjere; vuneni otpad za čišćenje; umjetnička djela od porcelana, keramike, gmčarije ili stakla.

(210) **2013-90**(442) **20.04.2014.**

(220) 3/13/2013

(731) **NISAN JIDOSHA KABUSHIKI KAISHA** (ALSO TRADING AS NISSAN MOTOR CO., LTD), NO.2 TAKARACHO KANAGAWA-KU YOKOHAMA-SHI KANAGAWA-KEN JP

I N F I N I T I

(540)

(550) I, F,

(740) Popović Miladin, Đoka Miraševića 21/III, Podgorica ME

(511) **Klasa 09:** Aparati i instrumenti za provođenje, prekid, transformaciju, akumulaciju, regulisanje i kontrolu električne enegrije; aparati za snimanje, prenos ili reprodukovanje zvuka ili slike; oprema i kompjuteri za obradu podataka; Aparati za mjerenje; Instrumenti za mjerenje; Brojaci; Aparati za snimanje vremena; Table sa osiguračima (električne energije); Kutije sa osiguračima (električne energije); Konzole za distribuciju (električne energije); Konvertori, električni; Punjači; Punjači za baterije; Transformatori (električne energije); Aparati za daljinsko upravljanje; Baterije i celije; Celije za gorivo; Aparati za medukomunikaciju; Telefonski aparati; Pametni telefoni; Aparati za saobračajnu telematiku; Predajnici i primaoci podataka za automobile; Navigacijski aparati za vozila; Pokazivači za punjenje baterije i monitori; Elektronski aparati za pokazivanje informacije o bateriji; Integrisana kola; Stampana kola; Kompjuteri; Kompjuterski softveri; Kompjuterski programi; Zvuci koji se preuzimaju; Kablovi, električni; žice, električne; elektronski dokumenti; elektronski servis za korisnike; Invertori (električne energije); Protivprovalni uređaji; Elektrode za baterije; Magneti; Zaštitni uređaji za ličnu upotrebu protiv nezgoda; Protivprovalne instalacije, električne; trouglovi za upozoravanje o kvaru na vozilu; Regulatori napona za vozila; Solarne baterije; Kartice za integrisana kola (pametne kartice); Ispuštaci; Futrole za kompjutere; Torbe za kompjutere; Futrole za kodirane ključeve; Futrole za medije; Dodaci za mobilne telefone; Futrole za mobilne telefone; Olovke za mobilne telefone sa ekranom osjetljivim na dodir; Memorijski uređaji za kompjutere; Fleš drajvovi; Kompjuterski periferni uređaji; Miševi; Podloge za miš;

Kompjuterski programi za igrice; Kompakt diskovi (read-only memorija); Naočare; Naočare za sunce; Futrole za naočare; Mehanizmi za aparate koji se pokreću novcem; Mehanizmi za aparate koji se pokreću žetonom; Trake za držanje mobilnih telefona oko vrata; Trake za pokretne uređaje; Zaštitne kacige; Trakice za držanje naočara oko vrata; Aparati za snimanje zvuka i slika; Aparati za reprodukciju zvuka i slika.

(210) **2013-91** (442) **20.04.2014.**
(220) 3/13/2013

(731) **NISAN JIDOSHA KABUSHIKI KAISHA** (ALSO TRADING AS NISSAN MOTOR CO., LTD), NO.2 TAKARACHO KANAGAWA-KU YOKOHAMA-SHI KANAGAWA-KEN JP



(540)

(550) I, F

(740) Popović Miladin, Đoka Miraševića 21/III, Podgorica ME

(511) **Klasa 09:** Aparati i instrumenti za provođenje, prekid, transformaciju, akumulaciju, regulisanje i kontrolu električne energije; aparati za snimanje, prenos ili reprodukovanje zvuka ili slike; oprema i kompjuteri za obradu podataka; Aparati za mjerenje; Instrumenti za mjerenje; Brojaci; Aparati za snimanje vremena; Table sa osiguračima (električne energije); Kutije sa osiguračima (električne energije); Konzole za distribuciju (električne energije); Konvertori, električni; Punjači; Punjači za baterije; Transformatori (električne energije); Aparati za daljinsko upravljanje; Baterije i celije; Celije za gorivo; Aparati za međukomunikaciju; Telefonski aparati; Pametni telefoni; Aparati za saobračajnu telematiku; Predajnici i primaoci podataka za automobile; Navigacijski aparati za vozila; Pokazivači za punjenje baterije i monitori; Elektronski aparati za pokazivanje informacije o bateriji; Integrisana kola; Stampana kola; Kompjuteri; Kompjuterski softveri; Kompjuterski programi; Zvuci koji se preuzimaju; Kablovi, električni; žice, električne; elektronski dokumenti; elektronski servis za korisnike; Invertori (električne energije); Protivprovalni uređaji; Elektrode za baterije; Magneti; Zaštitni uređaji za ličnu upotrebu protiv nezgoda; Protivprovalne instalacije, električne; trouglovi za upozoravanje o kvaru na vozilu; Regulatori napona za vozila; Solarne baterije; Kartice za integrisana kola (pametne kartice); Ispuštaci; Futrole za kompjutere; Torbe za kompjutere; Futrole za kodirane ključeve; Futrole za medije; Dodaci za mobilne telefone; Futrole za mobilne telefone; Olovke za mobilne telefone sa ekranom osjetljivim na dodir; Memorijski uređaji za kompjutere; Fleš drajvovi; Kompjuterski periferni uređaji; Miševi; Podloge za miš; Kompjuterski programi za igrice; Kompakt diskovi (read-only memorija); Naočare; Naočare za sunce; Futrole za naočare; Mehanizmi za aparate koji se pokreću novcem; Mehanizmi za aparate koji se pokreću žetonom; Trake za držanje mobilnih telefona oko vrata; Trake za pokretne uređaje; Zaštitne kacige; Trakice za držanje naočara oko vrata; Aparati za snimanje zvuka i slika; Aparati za reprodukciju zvuka i slika.

(210) **2013-92** (442) **20.04.2014.**
(220) 3/13/2013

- (731) **ADCOCK INGRAM INTELLECTUAL (PROPRITARY) LIMITED**, A SOUTH AFRICAN COMPANY, 1 NEW ROAD, CORNER OF NEW ROAD & 7TH STREET, MIDRAND ZA



(540)

(550) I, V

(740) Radulović Božidar, Jovana Tomaševića 9/III, Podgorica ME

- (511) **Klasa 05:** farmaceutske preparate i supstance, uključujući vitaminske i pomoćne preparate; vitaminski, mineralni i biljni preparati i dodaci; dijetetska hrana prilagođena za medicinsku upotrebu; dijetetske supstance prilagođene za medicinsku upotrebu.

(210) **2013-93**

(442) **20.04.2014.**

(220) 3/15/2013

- (731) **SYMANTEC CORPORATION (DELAWARE CORPRATION)**, 350 ELLIS STREET, MOUNTAIN VIEW, CALIFORNIA 94043 US



(540)

(550) I, F

(740) Radulović Božidar, Jovana Tomaševića 9/III, Podgorica ME

- (511) **Klasa 09:** Antivirus softver za računare; računarski softver za obezbeđivanje softvera za otkrivanje upada; internet bezbednosni softver; bezbednosni softver za firme; fajervol softver; softver za zaštitu privatnosti; softver za filtriranje sadržaja; softver za kloniranje, naročito softver za kloniranje računarskih hard diskova, softver za kloniranje računarskih operativnih sistema, softver za kloniranje fajlova sa podacima, softver za rekonfiguraciju personalnih računara; računarski softver za kreiranje virtuelne privatne mreže; računarski softver i računarski softver koji se može daunlodovati (snimiti sa interneta), naročito uslužni softver; računarski uslužni softver za uklanjanje kompjuterskih aplikacija i softvera; računarski uslužni softver za omogućavanje upotrebe računara na daljinu i za omogućavanje računarske komunikacije između mobilnih korisnika preko mreže; računarski softver, naročito posredni softver za povezivanje aplikacija klijenata i mrežnih baza podataka ili baza podataka na hostu; računarski softver i računarski softver koji se može daunlodovati za upotrebu u ažuriranju drugih računarskih softvera; računarski softver za upotrebu u mrežnim aplikacijama; računarski softver za prijem faksimila sa računara; računarski softver za povezivanje sa i upravljanje udaljenim računara, za sinhronizaciju fajlova putem elektronske pošte, za pružanje obezbeđenja korisnicima udaljenih računara, za implementaciju mera obezbeđenja računara, softvera i mreža za korisnike udaljenih računara; računarski softver za upravljanje fajlovima i njihov transfer; računarski softver za rad na daljinu, naročito za povezivanje sa i upotrebu udaljene računarske mreže, udaljenog računara i prenosivih uređaja; računarski softver za upotrebu sa kućnom ili udaljenom kancelarijom za poveziva-

nje korisnika računarskih mreža sa globalnim mrežama; računarski softver i baze podataka za upotrebu u dijagnozi, popravkama i konfigurisanju računara, računarskog softvera i računarskih perifernih komponenti; računarski hardver; računarski hardverski uređaji koji obezbeđuju fajervol, filtriranje sadržaja, uzbuñivanje pri neovlašćenom pristupu, zaštitu od virusa, virtuelna privatno umrežavanje i druge bezbednosne funkcije; računarski programi za aplikacije za razmenu podataka, kao i za enkripciju i autentifikaciju (potvrdu verodostojnosti) elektronskih podataka; računarski softver; računarski softver u oblasti kriptografskog obezbeđenja mreža i funkcija bezbednosti podataka; računarski softver za integrisanje informacione logike i podataka između računarskih mreža; računarski softver za automatizovanje procesa za autentifikaciju (potvrdu) identiteta primenom postojećih baza podataka u vezi sa izdavanjem i upravljanjem digitalnim sertifikatima koji se koriste za autentifikaciju ili enkripciju digitalnih komunikacija, ili autentifikaciju digitalnog potpisa u elektronskoj transakciji ili komunikaciji, preko interneta i drugih računarskih mreža; računarski softver, posebno, softver za enkripciju kojom se omogućava bezbedno prenošenje digitalnih informacija, posebno poverljivih, finansijskih ili informacija o kreditnim karticama preko interneta, kao i putem drugih načina komunikacije između računarskih uređaja; računarski softver za integrisanje bezbednosnim servisima kojima se upravlja, posebno servisima za infrastrukturu javnih ključeva (PKI), izdavanje digitalnih sertifikata, verifikaciju, upravljanje i integraciju poslovnog softvera, sa postojećim mrežama za komunikaciju, softverom i servisima; računarski softver za upotrebu u analizi i izveštavanju o log podacima fajervola; računarska softverska platforma za premošćavanje internet i telefonskih servisa i omogućavanje korisnicima da brže komuniciraju i sprovedu poslovne transakcije korišćenjem više različitih mreža, putem zemaljskih telefonskih linija, mobilnih telefona, ličnih računara, PDA uređaja i drugih ličnih elektronskih uređaja; računarska softverska platforma za obezbeđivanje brzih internet veza, bržeg rešavanja problema sa veb sajtovima i dostavljanjem elektronske pošte; računarski softver za obezbeđenje identiteta; računarski softver za autentifikaciju i obezbeđenje informacija o upravljanju identitetom; računarski softver za pristup digitalnim informacijama i podacima; računarski softver za detekciju prevare u vezi sa identitetom; računarski softver i firmver za upravljanje, prenos i čuvanje podataka i informacija; računarski softver za upotrebu u umrežavanju računara; računarski softver za upotrebu u računarskim emulacijama; računarski softver za upotrebu u obezbeđenju funkcionisanja elektronske pošte; računarski softver za upotrebu u obezbeđenju funkcionisanja glasovne pošte i glasovnih poruka; računarski softver za upotrebu u upravljanju bazama podataka; računarski softver za upotrebu u praćenju računara iz bezbednosnih razloga; računarski softver za upotrebu sa računarskim serverima za kontrolu i upravljanje serverskih aplikacija; softver za računarsku telefoniju; računarski softver za upotrebu u pristupu bazama podataka; elektronske publikacije koje se mogu daunlodovati u obliku uputstava, belih knjiga, članaka i uputstava sa tehničkom dokumentacijom u oblasti računarskog hardvera i softvera, digitalnih telekomunikacija, elektronskih uređaja široke potrošnje i informacionih tehnologija; periferni računarski uređaji za upotrebu sa mrežnim i internet bezbednosnim podacima i za zaštitu sistema, kao i za čuvanje takvih podataka; elektronske publikacije koje se mogu daunlodovati u obliku referenci, uputstava i informativnih lista za upotrebu sa računarskim softverom, hardverom, perifernim uređajima i firmverom, kao i elektronske publikacije koje se mogu daunlodovati u obliku blagova, obrazovnih materijala, informativnih pisama, magazina, novina, knjiga, pamfleta u oblasti računarskog softvera i onlajn bezbednosti.

Klasa 16: Računarska uputstva za upotrebu u oblasti računara, računarskog hardvera, računarskog softvera, računarskih perifernih uređaja, računarske bezbednosti, računarskih servisa i računarskih mreža; štampani materijali i publikacije, posebno knjige, magazini, informativna pisma, radne sveske, kratka uputstva za brzu konsultaciju, tehnička uputstva i materijali za

konferencije, u oblasti računara, računarskog hardvera, računarskog softvera, računarskih perifernih uređaja i računarskih mreža; oznake i holografske oznake.

Klasa 38: Obezbeđivanje foruma na internetu za prenos poruka među korisnicima računara o računarima, računarskom hardveru, računarskom softveru, računarskim perifernim uređajima, računarskim sistemima, računarskim mrežama, računarskoj opremi, računarskoj bezbednosti, informacionim tehnologijama, tehnologijama elektronske trgovine i tehnologijama globalne računarske mreže, mobilnim računarskim uređajima, komunikacionim mrežama i uređajima i opremi za telekomunikaciju; obezbeđenje internet pričaonica za prenos poruka među korisnicima računara o računarima, računarskom hardveru, računarskom softveru, računarskim perifernim uređajima, računarskim sistemima, računarskim mrežama, računarskoj opremi, računarskoj bezbednosti, informacionim tehnologijama, tehnologijama elektronske trgovine i tehnologijama globalne računarske mreže, mobilnim računarskim uređajima, komunikacionim mrežama i uređajima i opremi za telekomunikaciju; prenos softvera za skeniranje protiv virusa i drugih softvera za računarsku bezbednost putem globalne računarske mreže i elektronski prenos komunikacija elektronske pošte i podataka u kojima ulogu igra enkripcija i dekripcija putem upravljanja i filtriranja pošte poslate putem globalne računarske mreže; informacije i konsultantske usluge koje se odnose na prethodno pomenute servise.

Klasa 42: Usluge tehničke podrške, posebno rešavanja problema sa računarskim hardverom i softverom; usluge instalacije računarskog softvera; programiranje; dizajn računarskog softvera za treća lica; tehničke konsultacije u oblasti instalacije i održavanja računarskog softvera; obaveštavanje i dostavljanje poboljšanja i ispravki softvera; obezbeđenje autentifikacije identiteta; izdavanje digitalnih sertifikata za autentifikaciju ili enkripciju digitalnih komunikacija, ili za autentifikaciju digitalnih potpisa u elektronskim transakcijama ili komunikacijama, putem interneta i drugih računarskih mreža i upravljanje takvim sertifikatima; kao i pružanje tehničke podrške i podrške klijentima s tim u vezi; razvoj, projektovanje, implementacija, testiranje, analiza i konsultantske usluge u oblasti bezbednosti, pristupa, autorizacije (ovlašćenja), autentifikacije, enkripcije i sistema za identifikaciju za računare, računarski hardver i računarske mreže; razvoj, integracija i obezbeđenje funkcionisanja računarskih sistema za podršku izdavanju digitalnih sertifikata i upravljanje istim; kreiranje i implementacija procedura i praksi za izdavanje digitalnih sertifikata i upravljanje istim; usluge u vezi s računarima, naročito usluge u vezi sa nadgledanim računarskim mrežama i internet bezbednosti, proverom, autentifikacijom, distribucijom i upravljanjem infrastrukturom javnih ključeva (PKI), izdavanjem, proverom i upravljanjem digitalnim sertifikatima, te integracijom poslovnog softvera; računarske usluge, posebno obezbeđivanje pretraživača za dobijanje podataka na globalnoj računarskoj mreži; računarske konsultantske usluge koje se odnose na računarske mreže i interne računarske mreže, bezbednosne usluge za računarske mreže i interne računarske mreže, posebno instalacija, dizajn i prilagođavanje softvera za internet i mrežni fajervol za treća lica; računarske konsultantske usluge u oblasti bezbednosnih integracija, mrežne bezbednosti, mrežne arhitekture, tehnologije enkripcije i računarske bezbednosti; bezbednosna provera fajervolova na računarskim mrežama, servera i drugih mrežnih uređaja za sprečavanje neovlašćenog pristupa, posebno analiza ranjivosti globalne informacione računarske mreže i interne računarske mreže; računarske konsultantske usluge za razvoj softverskih aplikacija; projektovanje i programiranje komunikacionih sistema sa računarskom kontrolom; obezbeđivanje servisa za pristup podacima, sakupljanje, čuvanje, razmenu, ponovno dobijanje i dostavljanje podataka; usluge virtuelnih privatnih mreža; hosting za aplikacije; hosting za internet prezentacije; i usluge elektronske trgovine na principu "ključ u ruke"; računarski servisi, posebno, obezbeđenje računarske softverske platforme za premošćavanje internet i telefonskih servisa i omogućavanje korisnicima da brže komuni-

raju i sprovode poslovne transakcije korišćenjem više različitih mreža, putem zemaljskih telefonskih linija, mobilnih telefona, ličnih računara, PDA uređaja i drugih ličnih elektronskih uređaja; obezbeđenje računarske softverske platforme za obezbeđivanje brzih internet veza, bržeg rešavanja problema sa veb sajtovima i dostavljanjem elektronske pošte; usluge za podršku pri organizacionoj socijalizaciji, formatiranju, distribuciji, prevodu i posredovanju između digitalnih sadržaja za distribuciju putem mreža; servisi za stvaranje direktorijuma, detekciju i razmenu podataka u vezi sa radiofrekventnom identifikacijom (RFID) i mrežom za elektronsko šifriranje proizvoda (EPC); provajder usluga za aplikacije (ASP) koji podrazumeva softver za slanje računa i upravljanje odnosima s klijentima za provajdere bežičnih usluga; usluga za automatizaciju i prikupljanje podataka koja koristi licencirani softver za evaluaciju, analizu i prikupljanje servisnih podataka sa komunikacionih tokova; konverzija podataka iz računarskih programa ili informacija iz komunikacionih tokova; provajder usluga za aplikacije (ASP), naročito, hostovanje aplikacija računarskog softvera za treća lica; konverzija digitalnog sadržaja sa različitih platformi u druge oblike digitalnog sadržaja za distribuciju putem mreža; obezbeđenje privremene upotrebe on-lajn softvera koji se ne može daunlodovati, za čuvanje, upravljanje, praćenje i analiziranje podataka u oblasti radiofrekventne identifikacije (RFID) i elektronskog šifriranja proizvoda (EPC); dizajn, kreiranje i održavanje računarskih programa za računarske mreže koji koriste radiofrekventnu identifikaciju (RFID) i elektronsko šifriranje proizvoda (EPC); hostovanje digitalnog sadržaja na internetu za upotrebu u bežičnim komunikacijama i sa opremom i aparatima za bežične komunikacije; usluge istraživanja u vezi sa računarskim hardverom i računarskim softverom; usluge računarske podrške, posebno tehničke podrške i ažuriranja softvera; konsultantske računarske usluge koje se odnose na računarske proizvode i usluge; obezbeđenje informacija u oblasti novih primena računarskog softvera, upotrebom računara na udaljenim lokacijama i drugih pitanja koja se odnose na računare i tehnologiju; usluge provajdera servisa za aplikacije, posebno obezbeđenje on-lajn softvera koji se ne može daunlodovati za ispitivanje računarske bezbednosti u oblasti računarske i internet bezbednosti; naučne i tehnološke usluge, posebno tehnološke konsultacije u oblasti računara, računarskog hardvera, računarskog softvera, računarskih perifernih uređaja, računarskih sistema, računarskih mreža, računarske bezbednosti, informacionih tehnologija, tehnologija elektronske trgovine i tehnologija globalne računarske mreže, komunikacionih mreža i uređaja, elektronskih uređaja široke potrošnje, mobilnog računarstva i telekomunikacione opreme i uređaja; obezbeđivanje konsultanata koji će pomoći pri puštanju u rad, nadgledati i upravljati projektima u oblasti informacionih tehnologija; obezbeđenje informacija u oblasti informacionih tehnologija koje se odnose na uređaje za komunikaciju, računare, računarski hardver, računarski softver, računarske periferne uređaje i računarske mreže; obezbeđenje hostinga za servise elektronske pošte i trenutne razmene poruka; računarske usluge, naročito usluge povraćaja izgubljenih podataka; usluge tehničke podrške, naročito programi i servisi za bek-up (arhiviranje dodatnih kopija); usluge zaštite od računarskih virusa; konsultantske usluge u oblasti dizajna, odabira, implementacije i primene računarskog hardvera i softverskih sistema za treća lica; ažuriranje, objavljivanje i održavanje softvera za mreže i pojedinačne računare u oblasti bezbednosti, upravljanja bazama podataka i zaštite od virusa, kao i nadgledanje bezbednosnih sistema; obezbeđenje on-lajn baza podataka o računarima, računarskom hardveru, računarskom softveru, računarskim mrežama, računarskim servisima i uslugama, upravljanju čuvanjem podataka, upravljanju poslovnim podacima i on-lajn analitičkoj obradi podataka (OLAP); kategorizacija internet sadržaja i usluge filtriranja; računarske usluge; usluge mrežne i internet bezbednosti; računarske konsultacije; računarske konsultacije u oblasti računarske bezbednosti; računarski dijagnostički servisi; razvoj softvera za mreže i pojedinačne računare u oblasti bezbednosti, upravljanja bazama podataka i zaštiti od virusa, kao i

nadgledanja bezbednosnih sistema; obezbeđivanje informacija u oblasti mrežne i internet bezbednosti; obezbeđivanje tehničkih informacija u oblasti primene računarskog softvera; usluge provajdera za aplikacije; obezbeđenje informacija o računarima, računarskom hardveru, računarskom softveru, računarskim mrežama, računarskim servisima i uslugama, upravljanju čuvanjem podataka, upravljanju poslovnim informacijama i on-lajn analitičkoj obradi podataka (OLAP); nadgledanje računarskih sistema sa udaljene lokacije ili na licu mesta; praćenje računarskih sistema trećih lica i obezbeđenje programa i servisa za arhiviranje dodatnih kopija (bek-ap); integrisanje računarskih sistema i mreža; računarske usluge, posebno pružanje informacija o enkripciji i autentifikaciji elektronskih podataka; konsultantske usluge u oblasti digitalnih medija, enkripcije podataka, računarske bezbednosti, bezbednosti komunikacija i računarskog softvera; enkripcija i dekripcija podataka i komunikacija; elektronsko čuvanje fajlova, kako bi klijenti mogli da čuvaju i ponovo pristupaju podacima putem globalne računarske mreže; usluge arhiviranja elektronskih dokumenata i elektronske pošte.

Klasa 45: Bezbednosni nadzor računarskih sistema; poslovne usluge u obliku servisa nadgledane infrastrukture javnih ključeva (PKI), posebno bezbednosne usluge za aplikacije i mrežnu infrastrukturu; obezbeđenje usluga autentifikacije korisnika u transakcijama elektronske trgovine; poslovna uprava, posebno izdavanje digitalnih sertifikata za autentifikaciju; obezbeđenje informacija u oblasti bezbednosti globalne računarske mreže i lokalne mreže (LAN), sprečavanje širenja računarskih virusa i primene hardvera i softvera u bezbednosne svrhe.

(210) **2013-94**

(442) **20.04.2014.**

(220) 3/18/2013

(300) 85/816654 07.01.2013. US

(731) **GENERAL MOTORS LLC.** KOMPANIJA ORGANIZOVANA PO PROPISIMA DRŽAVE DELAWARE, 300 RENAISSANCE CENTER, DETRIT, MICHIGAN 48265-3000 US

(540) FIND NEW ROADS

(550) I, V

(740) Radulović Božidar, Jovana Tomaševića 9/III, Podgorica ME

(511) **Klasa 09:** Antivirus softver za računara; računarski softver za obezbeđivanje softvera za otkrivanje upada; internet bezbednosni softver; bezbednosni softver za firme; fajrevol softver; softver za zaštitu privatnosti; softver za filtriranje sadržaja; softver za kloniranje, naročito softver za kloniranje računarskih hard diskova, softver za kloniranje računarskih operativnih sistema, softver za kloniranje fajlova sa podacima, softver za rekonfiguraciju personalnih računara; računarski softver za kreiranje virtuelne privatne mreže; računarski softver i računarski softver koji se može daunlodovati (snimiti sa interneta), naročito uslužni softver; računarski uslužni softver za uklanjanje kompjuterskih aplikacija i softvera; računarski uslužni softver za omogućavanje upotrebe računara na daljinu i za omogućavanje računarske komunikacije između mobilnih korisnika preko mreže; računarski softver, naročito posredni softver za povezivanje aplikacija klijenata i mrežnih baza podataka ili baza podataka na hostu; računarski softver i računarski softver koji se može daunlodovati za upotrebu u ažuriranju drugih računarskih softvera; računarski softver za upotrebu u mrežnim aplikacijama; računarski softver za prijem faksimila sa računara; računarski softver za povezivanje sa i upravljanje udaljenim računara, za sinhronizaciju fajlova putem elektronske pošte, za pružanje obezbeđenja korisnicima udaljenih računara, za implementaciju mera obezbeđenja računara, softvera i mreža za korisnike udaljenih računara; računarski softver za upravljanje fajlovima i njihov transfer; računarski softver za rad na daljinu, naročito za povezivanje sa i upotrebu udaljene računarske mreže, udaljenog računara i prenosivih uređaja; računarski softver za upotrebu sa kućnom ili udaljenom kancelarijom za poveziva-

nje korisnika računarskih mreža sa globalnim mrežama; računarski softver i baze podataka za upotrebu u dijagnozi, popravkama i konfigurisanju računara, računarskog softvera i računarskih perifernih komponenti; računarski hardver; računarski hardverski uređaji koji obezbeđuju fajervol, filtriranje sadržaja, uzbunjivanje pri neovlašćenom pristupu, zaštitu od virusa, virtuelna privatno umrežavanje i druge bezbednosne funkcije; računarski programi za aplikacije za razmenu podataka, kao i za enkripciju i autentifikaciju (potvrdu verodostojnosti) elektronskih podataka; računarski softver; računarski softver u oblasti kriptografskog obezbeđenja mreža i funkcija bezbednosti podataka; računarski softver za integrisanje informacione logike i podataka između računarskih mreža; računarski softver za automatizovanje procesa za autentifikaciju (potvrdu) identiteta primenom postojećih baza podataka u vezi sa izdavanjem i upravljanjem digitalnim sertifikatima koji se koriste za autentifikaciju ili enkripciju digitalnih komunikacija, ili autentifikaciju digitalnog potpisa u elektronskoj transakciji ili komunikaciji, preko interneta i drugih računarskih mreža; računarski softver, posebno, softver za enkripciju kojom se omogućava bezbedno prenošenje digitalnih informacija, posebno poverljivih, finansijskih ili informacija o kreditnim karticama preko interneta, kao i putem drugih načina komunikacije između računarskih uređaja; računarski softver za integrisanje bezbednosnim servisima kojima se upravlja, posebno servisima za infrastrukturu javnih ključeva (PKI), izdavanje digitalnih sertifikata, verifikaciju, upravljanje i integraciju poslovnog softvera, sa postojećim mrežama za komunikaciju, softverom i servisima; računarski softver za upotrebu u analizi i izveštavanju o log podacima fajervola; računarska softverska platforma za premošćavanje internet i telefonskih servisa i omogućavanje korisnicima da brže komuniciraju i sprovedu poslovne transakcije korišćenjem više različitih mreža, putem zemaljskih telefonskih linija, mobilnih telefona, ličnih računara, PDA uređaja i drugih ličnih elektronskih uređaja; računarska softverska platforma za obezbeđivanje brzih internet veza, bržeg rešavanja problema sa veb sajtovima i dostavljanjem elektronske pošte; računarski softver za obezbeđenje identiteta; računarski softver za autentifikaciju i obezbeđenje informacija o upravljanju identitetom; računarski softver za pristup digitalnim informacijama i podacima; računarski softver za detekciju prevare u vezi sa identitetom; računarski softver i firmver za upravljanje, prenos i čuvanje podataka i informacija; računarski softver za upotrebu u umrežavanju računara; računarski softver za upotrebu u računarskim emulacijama; računarski softver za upotrebu u obezbeđenju funkcionisanja elektronske pošte; računarski softver za upotrebu u obezbeđenju funkcionisanja glasovne pošte i glasovnih poruka; računarski softver za upotrebu u upravljanju bazama podataka; računarski softver za upotrebu u praćenju računara iz bezbednosnih razloga; računarski softver za upotrebu sa računarskim serverima za kontrolu i upravljanje serverskih aplikacija; softver za računarsku telefoniju; računarski softver za upotrebu u pristupu bazama podataka; elektronske publikacije koje se mogu daunlodovati u obliku uputstava, belih knjiga, članaka i uputstava sa tehničkom dokumentacijom u oblasti računarskog hardvera i softvera, digitalnih telekomunikacija, elektronskih uređaja široke potrošnje i informacionih tehnologija; periferni računarski uređaji za upotrebu sa mrežnim i internet bezbednosnim podacima i za zaštitu sistema, kao i za čuvanje takvih podataka; elektronske publikacije koje se mogu daunlodovati u obliku referenci, uputstava i informativnih lista za upotrebu sa računarskim softverom, hardverom, perifernim uređajima i firmverom, kao i elektronske publikacije koje se mogu daunlodovati u obliku blagova, obrazovnih materijala, informativnih pisama, magazina, novina, knjiga, pamfleta u oblasti računarskog softvera i onlajn bezbednosti.

Klasa 16: Računarska uputstva za upotrebu u oblasti računara, računarskog hardvera, računarskog softvera, računarskih perifernih uređaja, računarske bezbednosti, računarskih servisa i računarskih mreža; štampani materijali i publikacije, posebno knjige, magazini, informativna pisma, radne sveske, kratka uputstva za brzu konsultaciju, tehnička uputstva i materijali za

konferencije, u oblasti računara, računarskog hardvera, računarskog softvera, računarskih perifernih uređaja i računarskih mreža; oznake i holografske oznake.

Klasa 38: Obezbeđivanje foruma na internetu za prenos poruka među korisnicima računara o računarima, računarskom hardveru, računarskom softveru, računarskim perifernim uređajima, računarskim sistemima, računarskim mrežama, računarskoj opremi, računarskoj bezbednosti, informacionim tehnologijama, tehnologijama elektronske trgovine i tehnologijama globalne računarske mreže, mobilnim računarskim uređajima, komunikacionim mrežama i uređajima i opremi za telekomunikaciju; obezbeđenje internet pričaonica za prenos poruka među korisnicima računara o računarima, računarskom hardveru, računarskom softveru, računarskim perifernim uređajima, računarskim sistemima, računarskim mrežama, računarskoj opremi, računarskoj bezbednosti, informacionim tehnologijama, tehnologijama elektronske trgovine i tehnologijama globalne računarske mreže, mobilnim računarskim uređajima, komunikacionim mrežama i uređajima i opremi za telekomunikaciju; prenos softvera za skeniranje protiv virusa i drugih softvera za računarsku bezbednost putem globalne računarske mreže i elektronski prenos komunikacija elektronske pošte i podataka u kojima ulogu igra enkripcija i dekripcija putem upravljanja i filtriranja pošte poslate putem globalne računarske mreže; informacije i konsultantske usluge koje se odnose na prethodno pomenute servise.

Klasa 42: Usluge tehničke podrške, posebno rešavanja problema sa računarskim hardverom i softverom; usluge instalacije računarskog softvera; programiranje; dizajn računarskog softvera za treća lica; tehničke konsultacije u oblasti instalacije i održavanja računarskog softvera; obaveštavanje i dostavljanje poboljšanja i ispravki softvera; obezbeđenje autentifikacije identiteta; izdavanje digitalnih sertifikata za autentifikaciju ili enkripciju digitalnih komunikacija, ili za autentifikaciju digitalnih potpisa u elektronskim transakcijama ili komunikacijama, putem interneta i drugih računarskih mreža i upravljanje takvim sertifikatima; kao i pružanje tehničke podrške i podrške klijentima s tim u vezi; razvoj, projektovanje, implementacija, testiranje, analiza i konsultantske usluge u oblasti bezbednosti, pristupa, autorizacije (ovlašćenja), autentifikacije, enkripcije i sistema za identifikaciju za računare, računarski hardver i računarske mreže; razvoj, integracija i obezbeđenje funkcionisanja računarskih sistema za podršku izdavanju digitalnih sertifikata i upravljanje istim; kreiranje i implementacija procedura i praksi za izdavanje digitalnih sertifikata i upravljanje istim; usluge u vezi s računarima, naročito usluge u vezi sa nadgledanim računarskim mrežama i internet bezbednosti, proverom, autentifikacijom, distribucijom i upravljanjem infrastrukturom javnih ključeva (PKI), izdavanjem, proverom i upravljanjem digitalnim sertifikatima, te integracijom poslovnog softvera; računarske usluge, posebno obezbeđivanje pretraživača za dobijanje podataka na globalnoj računarskoj mreži; računarske konsultantske usluge koje se odnose na računarske mreže i interne računarske mreže, bezbednosne usluge za računarske mreže i interne računarske mreže, posebno instalacija, dizajn i prilagođavanje softvera za internet i mrežni fajervol za treća lica; računarske konsultantske usluge u oblasti bezbednosnih integracija, mrežne bezbednosti, mrežne arhitekture, tehnologije enkripcije i računarske bezbednosti; bezbednosna provera fajervolova na računarskim mrežama, servera i drugih mrežnih uređaja za sprečavanje neovlašćenog pristupa, posebno analiza ranjivosti globalne informacione računarske mreže i interne računarske mreže; računarske konsultantske usluge za razvoj softverskih aplikacija; projektovanje i programiranje komunikacionih sistema sa računarskom kontrolom; obezbeđivanje servisa za pristup podacima, sakupljanje, čuvanje, razmenu, ponovno dobijanje i dostavljanje podataka; usluge virtuelnih privatnih mreža; hosting za aplikacije; hosting za internet prezentacije; i usluge elektronske trgovine na principu "ključ u ruke"; računarski servisi, posebno, obezbeđenje računarske softverske platforme za premošćavanje internet i telefonskih servisa i omogućavanje korisnicima da brže komuni-

raju i sprovode poslovne transakcije korišćenjem više različitih mreža, putem zemaljskih telefonskih linija, mobilnih telefona, ličnih računara, PDA uređaja i drugih ličnih elektronskih uređaja; obezbeđenje računarske softverske platforme za obezbeđivanje brzih internet veza, bržeg rešavanja problema sa veb sajtovima i dostavljanjem elektronske pošte; usluge za podršku pri organizacionoj socijalizaciji, formatiranju, distribuciji, prevodu i posredovanju između digitalnih sadržaja za distribuciju putem mreža; servisi za stvaranje direktorijuma, detekciju i razmenu podataka u vezi sa radiofrekventnom identifikacijom (RFID) i mrežom za elektronsko šifriranje proizvoda (EPC); provajder usluga za aplikacije (ASP) koji podrazumeva softver za slanje računa i upravljanje odnosima s klijentima za provajdere bežičnih usluga; usluga za automatizaciju i prikupljanje podataka koja koristi licencirani softver za evaluaciju, analizu i prikupljanje servisnih podataka sa komunikacionih tokova; konverzija podataka iz računarskih programa ili informacija iz komunikacionih tokova; provajder usluga za aplikacije (ASP), naročito, hostovanje aplikacija računarskog softvera za treća lica; konverzija digitalnog sadržaja sa različitih platformi u druge oblike digitalnog sadržaja za distribuciju putem mreža; obezbeđenje privremene upotrebe on-lajn softvera koji se ne može daunlodovati, za čuvanje, upravljanje, praćenje i analiziranje podataka u oblasti radiofrekventne identifikacije (RFID) i elektronskog šifriranja proizvoda (EPC); dizajn, kreiranje i održavanje računarskih programa za računarske mreže koji koriste radiofrekventnu identifikaciju (RFID) i elektronsko šifriranje proizvoda (EPC); hostovanje digitalnog sadržaja na internetu za upotrebu u bežičnim komunikacijama i sa opremom i aparatima za bežične komunikacije; usluge istraživanja u vezi sa računarskim hardverom i računarskim softverom; usluge računarske podrške, posebno tehničke podrške i ažuriranja softvera; konsultantske računarske usluge koje se odnose na računarske proizvode i usluge; obezbeđenje informacija u oblasti novih primena računarskog softvera, upotrebom računara na udaljenim lokacijama i drugih pitanja koja se odnose na računare i tehnologiju; usluge provajdera servisa za aplikacije, posebno obezbeđenje on-lajn softvera koji se ne može daunlodovati za ispitivanje računarske bezbednosti u oblasti računarske i internet bezbednosti; naučne i tehnološke usluge, posebno tehnološke konsultacije u oblasti računara, računarskog hardvera, računarskog softvera, računarskih perifernih uređaja, računarskih sistema, računarskih mreža, računarske bezbednosti, informacionih tehnologija, tehnologija elektronske trgovine i tehnologija globalne računarske mreže, komunikacionih mreža i uređaja, elektronskih uređaja široke potrošnje, mobilnog računarstva i telekomunikacione opreme i uređaja; obezbeđivanje konsultanata koji će pomoći pri puštanju u rad, nadgledati i upravljati projektima u oblasti informacionih tehnologija; obezbeđenje informacija u oblasti informacionih tehnologija koje se odnose na uređaje za komunikaciju, računare, računarski hardver, računarski softver, računarske periferne uređaje i računarske mreže; obezbeđenje hostinga za servise elektronske pošte i trenutne razmene poruka; računarske usluge, naročito usluge povraćaja izgubljenih podataka; usluge tehničke podrške, naročito programi i servisi za bek-up (arhiviranje dodatnih kopija); usluge zaštite od računarskih virusa; konsultantske usluge u oblasti dizajna, odabira, implementacije i primene računarskog hardvera i softverskih sistema za treća lica; ažuriranje, objavljivanje i održavanje softvera za mreže i pojedinačne računare u oblasti bezbednosti, upravljanja bazama podataka i zaštite od virusa, kao i nadgledanje bezbednosnih sistema; obezbeđenje on-lajn baza podataka o računarima, računarskom hardveru, računarskom softveru, računarskim mrežama, računarskim servisima i uslugama, upravljanju čuvanjem podataka, upravljanju poslovnim podacima i on-lajn analitičkoj obradi podataka (OLAP); kategorizacija internet sadržaja i usluge filtriranja; računarske usluge; usluge mrežne i internet bezbednosti; računarske konsultacije; računarske konsultacije u oblasti računarske bezbednosti; računarski dijagnostički servisi; razvoj softvera za mreže i pojedinačne računare u oblasti bezbednosti, upravljanja bazama podataka i zaštiti od virusa, kao i

nadgledanja bezbednosnih sistema; obezbeđivanje informacija u oblasti mrežne i internet bezbednosti; obezbeđivanje tehničkih informacija u oblasti primene računarskog softvera; usluge provajdera za aplikacije; obezbeđenje informacija o računarima, računarskom hardveru, računarskom softveru, računarskim mrežama, računarskim servisima i uslugama, upravljanju čuvanjem podataka, upravljanju poslovnim informacijama i on-lajn analitičkoj obradi podataka (OLAP); nadgledanje računarskih sistema sa udaljene lokacije ili na licu mesta; praćenje računarskih sistema trećih lica i obezbeđenje programa i servisa za arhiviranje dodatnih kopija (bek-ap); integrisanje računarskih sistema i mreža; računarske usluge, posebno pružanje informacija o enkripciji i autentifikaciji elektronskih podataka; konsultantske usluge u oblasti digitalnih medija, enkripcije podataka, računarske bezbednosti, bezbednosti komunikacija i računarskog softvera; enkripcija i dekripcija podataka i komunikacija; elektronsko čuvanje fajlova, kako bi klijenti mogli da čuvaju i ponovo pristupaju podacima putem globalne računarske mreže; usluge arhiviranja elektronskih dokumenata i elektronske pošte.

Klasa 45: Bezbednosni nadzor računarskih sistema; poslovne usluge u obliku servisa nadgledane infrastrukture javnih ključeva (PKI), posebno bezbednosne usluge za aplikacije i mrežnu infrastrukturu; obezbeđenje usluga autentifikacije korisnika u transakcijama elektronske trgovine; poslovna uprava, posebno izdavanje digitalnih sertifikata za autentifikaciju; obezbeđenje informacija u oblasti bezbednosti globalne računarske mreže i lokalne mreže (LAN), sprečavanje širenja računarskih virusa i primene hardvera i softvera u bezbednosne svrhe.

(210) **2013-95** (442) **20.04.2014.**
(220) 3/18/2013

(731) **MERCK SHARP & DOHME CORP.**, ONE MERCK DRIVE, WHITEHOUSE STATION, NEW JERSEY 08889 US

(540) CEDAX

(550) I

(740) AOD "Ćupić", Dalmatinska 10, Podgorica ME

(511) **Klasa 05:** farmaceutski preparati za ljudsku upotrebu;

(210) **2013-96** (442) **20.04.2014.**
(220) 3/18/2013

(731) **MERCK SHARP & DOHME CORP.**, ONE MERCK DRIVE, WHITEHOUSE STATION, NEW JERSEY 08889 US

(540) DIPROSALIC

(550) I

(740) AOD "Ćupić", Dalmatinska 10, Podgorica ME

(511) **Klasa 05:** farmaceutski preparati za ljudsku upotrebu;

(210) **2013-97** (442) **20.04.2014.**
(220) 3/18/2013

(731) **MERCK SHARP & DOHME CORP.**, ONE MERCK DRIVE, WHITEHOUSE STATION, NEW JERSEY 08889 US

(540) ELOBASE

(550) I

(740) AOD "Ćupić", Dalmatinska 10, Podgorica ME

(511) **Klasa 03:** ne-medicinski preparati za njegu kože;

Klasa 05: medicinski preparati za njegu kože;

(210) **2013-98** (442) **20.04.2014.**
(220) 3/18/2013

(731) **MERCK SHARP & DOHME CORP.**, ONE MERCK DRIVE, WHITEHOUSE STATION, NEW JERSEY 08889 US

(540) FREEDERM

(550) I

(740) AOD "Ćupić", Dalmatinska 10, Podgorica ME

(511) **Klasa 05:** dermatološki preparati;

(210) **2013-99** (442) **20.04.2014.**
(220) 3/18/2013

(731) **LOOK UP DOO**, AUTOPUT BR. 20 LOKAL 18, 11000 BEOGRAD RS



(540)

(550) I

(740) AOD "Ćupić", Dalmatinska 10, Podgorica ME

(511) **Klasa 18:** Koža i imitacija kože, proizvodi izradeni od ovih materijala koji nisu uključeni u druge klase; životinjska koža; koferi i putne torbe; torbe, kišobrani, suncobrani i štapovi za hodanje; bičevi, saračka i sedlarska roba.

Klasa 24: Tekstil i tekstilni proizvodi koji nisu obuhvaćeni drugim klasama, prekrivači za krevete i stolove.

Klasa 25: Odjeća, obuća, pokrivala za glavu.

(210) **2010-380** (442) **20.04.2014.**
(220) 09/12/2012

(731) **DRUŠTVO SA OGRANIČENOM ODGOVORNOŠĆU ZA PROIZVODNJU I DISTRIBUCIJU VODE BANJA VRUJCI**, LAROUCCI VODA D.O.O., MIONICA, GORNJA TOPLICA, RS

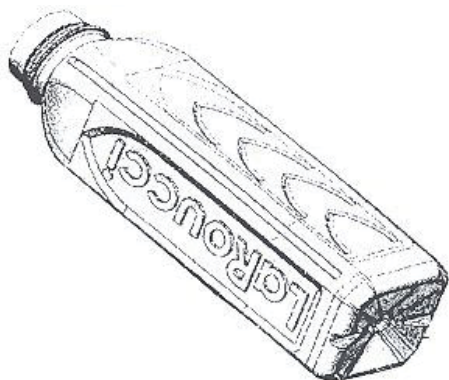

(540)

(550) I, T

(740) Anđelić Branko, Svetozara Markovića 12, 81000 Podgorica ME

(511) **Klasa 05:** Mineralna voda za medicinsku upotrebu, termalne vode.

Klasa 32: mineralne i sodne vode i druga bezalkoholna pića; pića od voća i voćni sokovi; sirupi i preparati za proizvodnju pića, preparati za proizvodnju pića, preparati za proizvodnju mineralnih voda, pijaća voda.

Klasa 35: oglašavanje, poslovno upravljanje, kancelarijsko poslovanje; usluge reklamiranja; usluge reklamiranja na internetu; usluge distribucije prospekata direktno ili preko pošte; usluge marketinga.

(210) **2013-104**

(442) **20.04.2014.**

(220) 03/21/2013

(731) **CT GROUP D.O.O.**, ULICA DALMATINSKA BR 78 PODGORICA, ME



(540)

(550) I

(511) **Klasa 41:** Organizovanje sajmova i zabavnih aktivnosti. Osim navedenog podrazumjeva i sledeće; obrazovne usluge, pripremanje obuke, razonoda, sportske i kulturne aktivnosti. Opis usluga; razvijanje mentalnih sposobnosti drugih lica (obrazovanje) ili životinja (obuka, dresiranje) kao i usluge kojima je cilj zabavljanje drugih lica ili privlačenje pažnje. Ova klasa uključuje posebno: usluge koje pružaju sve vrste edukacija lica (obrazovanje) ili životinja (obuka, dresiranje), usuge kojima je osnovni cilj zabavljanje drugih lica, rekreacija, organizovanje (priredivanje) i vođenje seminara, konferencija, kongresa; organizovanje izložbi ili prezentacije knjiga (književne večeri) u kulturne i obrazovne svrhe, sportskih takmičenja; izdavanje tekstova i knjiga.



- (111) 10465 (151) 28.12.2013.
 (210) **2009-447** (442) **20.03.2012**
 (220) 08.07.2009
 (732) **PARK AG DOO**; BOŽE JANKOVIĆA 33 BEOGRAD RS

Neutrosol

- (540)
 (550) I
 (740) Stanković Mugoša Ana, Trg Republike br.13 81000 Podgorica ME
 (511) **Klasa 03:** Kozmetički proizvodi, a naročito kreme, mlijeka, losioni, ulja, suva ulja za negu i zaštitu kože od sunca namenjena osobama sa osjetljivom kožom sklonoj alergijama.

- (111) 10830 (151) 05.03.2014.
 (210) **2010-392** (442) **20.03.2013**
 (220) 25.10.2010
 (732) **KARBON GRADJEVINSKI MATERIJALID.O.O.TOPOLA**, BULEVAR VOŽDA KARADORĐA 126, 3431 TOPOLA RS

SIPROKOL

- (540)
 (550) I
 (511) **Klasa 01:** Hemijski proizvodi koji se upotrebljavaju u industriji, nauci, fotografiji, poljoprivredi, hortikulturi i šumarstvu; neprerađene plastične materije, đubriva; smeše za gašenje vatre, preparati za kaljenje i zavarivanje, hemijske supstance za očuvanje namirnica, materije za štavljenje;
Klasa 02: Boje, firnajzi, lakovi; sredstva za zaštitu od rđe i truljenja drveta; materije za bojenje; sredstva za nagrizanje; sirove prirodne smole; metali u obliku listova i praha za slikare, dekoratere, štampare i umjetnike.
Klasa 19: Građevinski materijali (nemetalni); čvrste nemetalne cijevi za građevine; asfalt, crna smola i bitumen; nemetalne prenosne građevine; spomenici, koji nisu od metala.

- (111) 10805 (151) 17.02.2014.
 (210) **2011-91** (442) **20.03.2013**
 (220) 24.2.2011
 (300) 1883/10-62237-25.01 2011 16.11.2010. RS
 (732) **GALENKA AD.**, BATAJNICKI DRUM BB BEOGRAD RS

NIDOKA

НИДОКСА

(540)

(550) I

(511) **Klasa 5:** Farmaceutski proizvodi.

(111) 10828

(151) 05.03.2014.

(210) **2011-218**

(442) **20.06.2013**

(220) 05.05.2011

(732) **MONSTER ENERGY COMPANY (A DELAWARE)** 550 MONICA CIRCLE, SUITE 201
CORONA, CALIFORNIA 92880 US

UNLEASH THE BEAST!

(540)

(550) I

(740) Radulović Božidar, Jovana Tomaševića 9/III, Podgorica (ME)

(511) **Klasa 05:** Nutricioni dodaci.

Klasa 32: Bezalkoholna pića.

(111) 10785

(151) 17.02.2014.

(210) **2011-247**

(442) **20.06.2013**

(220) 20.05.2011

(732) **GLAXO GROUOP LIMITED**, GLAXO WELLCOME HOUSE, BERKELEY AVENUE, GREEN-
FORD, MIDDLESEX UB6 0NN, ENGLAND GB

NILACEF

(540)

(550) I

(740) Lutovac Branislav, Bulevar Crnojevića 93, Podgorica (ME)

(511) **Klasa 05:** Farmaceutski i medicinski preparati i supstance.

(111) 10786

(151) 17.02.2014.

(210) **2011-253**

(442) **20.06.2013**

(220) 24.05.2011.

(732) **GLAXO GROUP LIMITED**, GLAXO WELLCOME HOUSE, BERKELEY AVENUE, GREENFORD, MIDDLESEX UB6 ONN, ENGLAND GB

MODUTAB

(540)

(550) I

(740) Lutovac Branislav, Bulevar Crnojevića 93, Podgorica (ME)

(511) **Klasa 05:** Farmaceutski preparati i supstance.

(111) 10745

(151) 17.06.2010.

(210) **2012-221**

(442) **18.12.2009.**

(220) 03.05.2012.

(732) **Ironwood Pharmaceuticals, Inc.;** 301 Binney Street Cambridge, Massachusetts 02142, Sjedinjene Američke Države

(540) CONSTELLA

(550) I

(511) **Klasa 5:** Farmaceutski preparati za upotrebu kod liječenja hronične konstipacije, sindroma razdražljivog crijeva, poremećaja gastrointestinalnog motiliteta i drugih gastrointestinalnih poremećaja.

(111) 08860

(151) 21.11.2013.

(210) **2011-309**

(442) **20.06.2013**

(220) 28.6.2011

(732) **THE PROCTER & GAMBLE COMPANY**, ONE PROCTER & GAMBLE PLAZA, CINCINNATI, OHIO 45202 US



(540)

(550) I

(740) Lutovac Branislav, Bulevar Crnojevića 93, Podgorica (ME)

(511) **Klasa 16:** Pelene za jednokratnu upotrebu.

(111) 08953

(151) 21.11.2013

(210) **2011-421**(442) **20.06.2013**

(220) 22.08.2011

(732) **ALKALOID AD SKOPLJE**, BUL.ALEKSANDAR MAKEDONSKI 12, SKOPLJE, MK

(540) ma Nižanskoj klasifikaciji:

(550) I

(740) Popović Miladin, Đoka Miraševića 21/III, Podgorica (ME)

(511) **Klasa 03:** Krema protiv bora.

(111) 08480

(151) 20.11.2013.

(210) **2011-491**(442) **20.03.2013.**

(220) 10.10.2011.

(732) **MEGGLE AG**, MEGGLESTRASSE 6-12,83512 WASSERBURG DE

(540)

(550) I

(740) Čejović Vladimir, 13. jula 21, Podgorica (ME)

(511) **Klasa 29:** Mlijeko i mliječni proizvodi; maslac i proizvodi od maslaca; pavlaka i proizvodi od pavlake, sir i proizvodi od sira, namazi i prelive za hljeb na bazi mliječnih proizvoda; proizvodi na bazi mlijeka i jogurta, mliječni napici sa povećanim sadržajem mlijeka, mliječni napici na bazi surutke, sve sa ili bez dodatog voća, sirupa; jestiva ulja i masti; proizvodi od soje, naime tofu, sojino mlijeko, sojin jogurt; napici na bazi sojinog mlijeka, deserti i slične

namirnice na bazi soje (sadržane u klasi 29); jogurt; deserti i slične namirnice na bazi mliječnih proizvoda, takođe u obliku praha; supe; surutka, laktoza voćni i proteinski koncentrati za prehrambenu industriju; voćni sosovi; marmelade; džemovi, kompoti; konzervisano, sušeno i kuvano voće, želatini (želei).

Klasa 30: Majonez; sosovi, uključujući i prelive za salatu i umake; začinki sosovi, začini, začinski preparati; proizvodi od soje, naime soja sos, začinski preparati na bazi soje, majonez na bazi soje, surogat kafe na bazi soje (sadržane u klasi 30); sva gore navedena roba, takođe u obliku praha; kakao; čokolada, čokoladni proizvodi, takođe u obliku praha; čokoladni napici; hljeba i peciva, takođe sa namazima ili prelivima, fina peciva i kolači; sladoled, sladoled u prahu; soli za kuvanje; prirodni zaslađivači; proizvodi od šećera.

Klasa 32: Bezalkoholni napici sa niskim sadržajem mlijeka i mliječnih komponenti; napici na bezi surutke sa ili bez dodatog voća i sirupa; voćni napici i voćni sokovi; sirupi i drugi preparati za pripremu pića.

(111) 10309

(151) 24.12.2013.

(210) **2011-440**

(442) **20.06.2013.**

(220) 01.09.2011.

(732) **GOODYEAR DUNLOP TIRES GERMANY GMBH**, DUNLOPSTRASSE 2,63450 HANAU, DE

KRISTALL

(540)

(550) I

(740) Čejović Vladimir, 13. jula 21, Podgorica (ME)

(511) **Klasa 12:** Gume.

(111) 08990

(151) 22.11.2013.

(210) **2011-311**

(442) **20.06.2013**

(220) 28.06.2011.

(732) **PROCTER & GAMBLE HOLDING GMBH**, 40-50 SULZBACHER STRASSE, 65824 SCHWALBACH, DE

blend-a-med 
PRO·EXPERT

(540)

(550) I

(740) Lutovac Branislav, Bulevar Crnojevića 93, Podgorica (ME)

(511) **Klasa 03:** Preparati za njegu i higijenu usta, zuba, grla, desni i usne duplje, preparati za ispiranje zaprevenciju kamenca i karijesa, preparati za čišćenje zuba, preparati za njegu zuba,

paste za zube, sredstva za ispiranje usta, sprejevi za usta, gelovi za zube, gelovi sa fluorom, sredstva za ispiranje usta sa fluorom, praškovi za čišćenje, tablete za bojenje kamenca.

Klasa 21: Četkice za zube; električne četkice za zube; materijali pripremljeni za pravljenje četki-
ca, neelektrični instrumenti i materijali za čišćenje usta, zuba i usne duplje; djelovi i oprema
za naprijed navedenu robu; zubni konac, držači za zubnikonac, čačkalice, držači za čačkalice,
četke; držači i kutije za automatsko izdavanje (dispenseri) za naprijed navedenu robu; četki-
ce za desni, interdentalne četkice.

(111) 09021

(151) 21.11.2013

(210) **2011-365**

(442) **20.06.2013**

(220) 18.07.2011.

(732) **BERLIN-CHEMIE AG**, GLIENICKER WEG 125, D-12489, BERLIN, DE

SILTION

(540)

(550) I

(740) Radulović Božidar, Jovana Tomaševića 9/III, Podgorica (ME)

(511) **Klasa 05:** Farmaceutski proizvodi, dijetetske supstance prilagodjene za upotrebu u medi-
cine.

(111) 09022

(151) 22.11.2013

(210) **2011-407**

(442) **20.06.2013**

(220) 09.08.2011.

(732) **SANDVIK INTELLECTUAL PROPERTY AB**, SE-811 81 SANDVIKEN, SE

KANTHAL

(540)

(550) I

(740) Radulović Božidar, Jovana Tomaševića 9/III, Podgorica (ME)

(511) **Klasa 09:** materijal za električne otpornike: u obliku žica, traka i cijevi, termoelementi,
bimetali, elementi od folija, električni i elektronski mjerni aparati i instrumenti, električni
uređaji za paljenje, električni uređaji za paljenje i kontrolu za gasne i uljne gorionike

(111) 09023

(151) 21.11.2013

(210) **2011-406**

(442) **20.06.2013**

(220) 09.08.2011.

(732) **SANDVIK INTELLECTUAL PROPERTY AB**, SE-811 81 SANDVIKEN, SE

SANDVIK

(540)

(550) I

(740) Radulović Božidar, Jovana Tomaševića 9/III, Podgorica (ME)

(511) **Klasa 06:** čelik i gvožđe u blokovima, cijevima, trakama i žicama, opruge i gibnjevi (gvoždarska roba), drugi proizvodi od gvožđa i čelika, kaljenog ili nekaljenog, hladno valjanog ili usijano valjanog.

(111) 09012

(151) 21.11.2013

(210) **2011-372**

(442) **20.06.2013**

(220) 20.07.2011.

(732) **NO FEAR INTERNATIONAL LIMITED**, UNIT A, BROOK PARK EAST SHIREBROOK NG20 8 RY UK, GB

NO FEAR

(540)

(550) I

(740) Popović Miladin, Đoka Miraševića 21/III, Podgorica (ME)

(511) **Klasa 16:** Hartija, karton i proizvodi od njih, koji nisu uključeni u druge klase; štampane stvari; knjigovezački materijal; fotografije; kancelarijski materijal; lepila za kancelarijske i kućne potrebe; umetnički materijali; kičice; pisaće mašine i kancelarijski rekviziti (izuzev nameštaja); materijali za obuku i nastavu (izuzev aparata); plastični materijal za pakovanje (koji nije uključen u druge klase); štamparska slova; klišeji.

Klasa 18: Koža i imitacija kože, proizvodi izrađeni od ovih materijala koji nisu uključeni u druge klase; životinjska koža, krzno; koferi i putne torbe; kišobrani, suncobrani i štapovi za hodanje; bičevi, saračka i sedlarska oprema

Klasa 25: Odeća, obuća, pokrivala za glavu.

Klasa 32: Pivo; mineralne isodne vode idroga bezalkoholna pića; pića od voća i voćni sokovi; sirupi i drugi pre parati za proizvodnju pića.

(111) 08850

(151) 21.11.2013

(210) **2011-312**

(442) **20.06.2013**

(220) 28.06.2011.

(732) **THE PROCTER & GAMBLE COMPANY**, ONE PROCTER & GAMBLE PLAZA, CINCINNATI, OHIO 45202 US

COLOUR THERAPY

(540)

(550) I

(740) Lutovac Branislav, Bulevar Crnojevića 93, Podgorica (ME)

(511) **Klasa 03:** Kozmetički preparati za kosu, losioni za kosu, preparati za čišćenje, njegu i uljepšavanje kože glave i kose, proizvodi za oblikovanje frizure, preparati za nijansiranje, blajhanje, farbanje i kolorisanje kose.

(111) 08861

(151) 21.11.2013

(210) **2011-305**(442) **20.06.2013**

(220) 23.06.2011.

(732) **THE PROCTER & GAMBLE COMPANY**, ONE PROCTER & GAMBLE PLAZA, CINCINNATI, OHIO 45202 US

(540)

(550) I

(740) Lutovac Branislav, Bulevar Crnojevića 93, Podgorica (ME)

(511) **Klasa 03:** Preparati za negu i ulepšavanje tkanina; mirišljava sredstva za kađenje; ulja za parfeme i mirise; mirišljava voda za upotrebu u domaćinstvu i na tkaninama; osveživači tkanina; mirišljivo drvo; aromatični preparati, eterična ulja; preparati za nadimljavanje koji se ispuštaju u vazduh, atmosferu ili na tkanine u obliku dima, pare ili gasa; mirisni ili parfimisani preparati za vazduh i tkanine.**Klasa 05:** Osveživači vazduha; preparati za prečišćavanje vazduha; osveživači vazduha za sobnu upotrebu; dezodoransi za tkanine i vazduh, preparati za neutralisanje mirisa.**Klasa 11:** Aparati i instrumenti za ispuštanje mirisa, prečišćavanje ili osvežavanje atmosfere; delovi i oprema za svu napred navedenu robu; jedinice za aromaterapiju i prečišćavanje vazduha koje rade na baterije ili na struju, kao i punjenja za takve jedinice; samostalni uređaji i filteri koji ne ispuštaju mirise ni druge supstance, za otklanjanje neprijatnih mirisa iz frižidera i drugih malih prostora.

(111) 08827

(151) 20.11.2013.

(210) **2011-318**(442) **20.06.2013.**

(220) 28.06.2011.

(732) **THE PROCTER & GAMBLE COMPANY**, ONE PROCTER & GAMBLE PLAZA, CINCINNATI, OHIO 45202 US

HELLO HYDRATION

(540)

(550) I

(740) Lutovac Branislav, Bulevar Crnojevića 93, Podgorica (ME)

(511) **Klasa 03:** Sapuni, parfimerija, eterična ulja, kozmetički preparati, losioni za kosu, preparati za čišćenje, njegu i uljepšavanje kože, kože glave i kose, proizvodi za oblikovanje frizure, preparati za nijansiranje, blajhanje, farbanje i kolorisanje kose.

(111) 08847

(151) 21.11.2013

(210) **2011-308**(442) **20.06.2013**

(220) 28.06.2011.

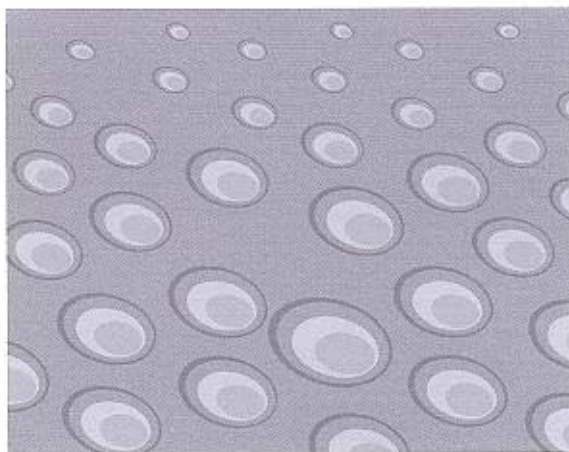
(732) **THE PROCTER & GAMBLE COMPANY**, ONE PROCTER & GAMBLE PLAZA, CINCINNATI, OHIO 45202 US

(540)

(550) I

(740) Lutovac Branislav, Bulevar Crnojevića 93, Podgorica (ME)

(511) **Klasa 03:** Sredstva za pranje i bijeljenje za upotrebu u domaćinstvu; preparati za njegu, tretiranje i uljepšavanje tkanina; preparati za čišćenje, poliranje, ribanje i nagrizanje; tamjan; ulja za parfeme i mirise; mirišljava voda za upotrebu u domaćinstvu i na tkaninama; eterična ulja; mirišljava sredstva za osvježavanje vazduha i tkanina.

(111) 09041

(151) 02.12.2013.

(210) **2011-395**(442) **20.06.2013**

(220) 05.08.2011.

(732) **DEUTCHE TELEKOM AG**, FRIEDRICH-EBERT-ALLEE 140 53113 BONN DE

Travel & Surf

(540)

(550) I

(740) Popović Miladin, Đoka Miraševića 21/III, Podgorica (ME)

(511) **Klasa 09:** Aparati i instrumenti naučni, pomorski, geodetski, fotografski, kinematografski, optički, za vaganje, merenje, signalizaciju, kontrolu (inspekciju), spasavanje i nastavu; aparati i instrumenti za provođenje, prekid, transformaciju, akumulaciju, regulisanje ili kontrolu elektriciteta; aparati za snimanje, prenos, obradu i reprodukovanje zvuka, slika ili podataka; magnetni nosioci podataka; automatske mašine i mehanizmi za aparate koji se pokreću novcem ili žetonom; računске mašine, oprema za obradu podataka i kompjuteri; snimljeni i prazni nosioci podataka svih vrsta (uključeni u klasu 9); kompjuterski programi (snimljeni); elektronskim putem snimljeni podaci (koji se mogu preuzimati); elektronska izdanja (koja se mogu preuzimati).

Klasa 38: Telekomunikacije; usluge novinskih agencija; iznajmljivanje telekomunikacione opreme; informacije o telekomunikacijama.

Klasa 42: Naučne i tehnološke usluge i usluge istraživanja i dizajna s tim u vezi; usluge industrijske analize i istraživanja; dizajn i razvoj kompjuterskog hardvera, softvera i baza podataka; održavanje kompjuterskog softvera; tehničke konsultacije; kompjuterske usluge u vezi sa elektronskim čuvanjem podataka; iznajmljivanje kompjutera; usluge dizajniranja web strana za druge.

(111) 08841 (151) 20.11.2013.
 (210) **2012-117** (442) **20.06.2013**
 (220) 24.02.2012.
 (732) **ADRIATIC MARINAS doo**, Obala bb 85320 Tivat ME

CASINO ROYALE

(540)
 (550) I
 (740) Đjurovc Savo, Dom Vojske, Seljanovo b.b. Tivat (ME)
 (511) **Klasa 36:** Osiguranje ; finansijski poslovi; novčani (monetarni) poslovi; poslovi vezani za nepokretnosti.
Klasa 39: Transportne usluge; pakovanje i skladištenje roba; organizovanje putovanja.
Klasa 41: Obrazovne usluge; pripremanje obuke; razonoda; sportske i kulturne aktivnosti.
Klasa 43: Usluge obezbjeđivanje hrane i pića; privremeni smještaj.
Klasa 43: Medicinske usluge; veterinarske usluge; higijenska zaštita i njega ljepote za ljude i životinje; agrikulture, hortikulture i šumarske usluge.

(111) 10308 (151) 24.12.2013.
 (210) **2011-441** (442) **20.06.2013**
 (220) 01.09.2011.
 (732) **GEOGRAFIA-PACIFIC CONSUMER PRODUCTS LP**, 133 PEACHTREE STREET NE, ATLANTA, GEORGIA 30303, US

SERIE 3000

(540)
 (550) I

(740) Čejović Vladimir, 13. jula 21, Podgorica (ME)

(511) **Klasa 21:** Dispenseri za osvježivače vazduha, za sredstva za čišćenje dasaka za WC šolje, za kante za otpatke.

(111) 10311

(151) 24.12.2013.

(210) **2011-445**

(442) **20.06.2013**

(220) 07.09.2011.

(732) **JT INTERNATIONAL S.A.**, 1, RUE DE LA GABELE, 1211 GENEVA 26, CH

SOBRANIE CREATIONS BEYOND COMPARE

(540)

(550) I

(740) Čejović Vladimir, 13. jula 21, Podgorica (ME)

(511) **Klasa 34:** Duvan, koji je prerađen ili neprerađen; duvan za pušenje, duvan za lule, duvan za savijanje, duvan za žvakanje, duvan za sisanje; cigarete, cigare, cigarilosi; supstance za pušenje koje se prodaju odvojeno ili izmiješane sa duvanom, i koje nijesu za medicinsku ili svrhu liječenja; burmut; artikli za pušače uključeni u klasu 34; papir za cigarete; fišeci za cigarete i šibice.

(111) 10313

(151) 24.12.2013.

(210) **2011-413**

(442) **20.06.2013**

(220) 10.08.2011.

(732) **TOYOTA JIDOSHA KABUSHIKI KAISHA**, 1, TOYOTA-SHO, TOYOTA-SHI, AICHI-KEN, JP

GT86

(540)

(550) I

(740) Čejović Vladimir, 13. jula 21, Podgorica (ME)

(511) **Klasa 12:** Automobili i njihovi strukturni djelovi.

(111) 08960

(151) 20.11.2013.

(210) **2011-435**

(442) **20.06.2013**

(220) 26.08.2011.

(732) **AMERICAN-CIGARETTE COMPANY (OVERSEAS) LIMITED**, ZAEHLERWEG 4, ZUG 6300 CH

FOLIES

(540)

(550) I

(740) Popović Miladin, Đoka Miraševića 21/III, Podgorica (ME)

(511) **Klasa 34:** Cigarete, duvan; proizvodi od duvana; upaljači; šibice; artikli za pušače.

(111) 08864

(151) 21.11.2013

(210) **2011-325**

(442) **20.06.2013**

(220) 28.06.2011.

(732) **THE PROCTER & GAMBLE COMPANY**, ONE PROCTER & GAMBLE PLAZA, CINCINNATI, OHIO 45202 US

BREAK'S OVER

(540)

(550) I

(740) Lutovac Branislav, Bulevar Crnojevića 93, Podgorica (ME)

(511) **Klasa 03:** Sapuni, parfimerija, eterična ulja, kozmetički preparati, losioni za kosu, preparati za čišćenje, njegu i uljepšavanje kože, kože glave i kose, proizvodi za oblikovanje frizure, preparati za nijansiranje, blajhanje, farbanje i kolorisanje kose.

(111) 09039

(151) 02.12.2013.

(210) **2011-394**

(442) **20.06.2013**

(220) 05.08.2011.

(732) **LRC PRODUCTS LIMITED**, 103-105 BATH ROAD SLOUGH, SL1 3UH GB

POCKET BALLERINA

(540)

(550) I

(740) Popović Miladin, Đoka Miraševića 21/III, Podgorica (ME)

(511) **Klasa 03:** Nemedicinski preparati za negu stopala, tela i kože i za ulepšavanje; kreme, gelovi, losioni, ulja, balsami, puderi, puderi u talku i sprejevi za upotrebu na stopalima, telu i koži; nemedicinski preparati za tretman, negu, čišćenje, umirivanje, revitalizaciju i relaksaciju stopala, tela i kože; nemedicinski preparati za kupanje u obliku soli, ulja i kupki; kupke u obliku tableta; nemedicinski toaletni preparati; dezodoransi; mirisne kreme, gelovi, losioni, puderi, puderi u talku i sprejevi; dezodoransi impregnirani u uloške; dezodoransi za stopala.

Klasa 25: Odeća, obuća, pokrivala za glavu; oprema za obuću, higijenska obuća, uključujući cipele, papuče, čizme, sandale, klompe; duge i kratke čarape; đonovi; papuče, ulošci za obuću; ulošci sa jastučićima za obuću; pletene čarape.

(111) 09014

(151) 21.11.2013.

(210) **2011-351**

(442) **20.06.2013.**

(220) 11.07.2011.

(732) **THE GILLETTE COMPANY**, ONE GILLETTE PARK, BOSTON, MA 02127, US

GILLETTE PRO

(540)

(550) I

(740) Lutovac Branislav, Bulevar Crnojevića 93, Podgorica (ME)

(511) **Klasa 03:** Sredstva za pranje tijela; anti-perspiranti i dezodoransi za ličnu upotrebu; sredstva za brijanje, naročito kreme za brijanje, gelovi za brijanje, losioni za brijanje i pjene za brijanje; sredstva za posle brijanja („after-šejv“), losioni, melemi i gelovi za posle brijanja; sredstva za pranje lica i piling lica prije brijanja; preparati za njegu kože, naročito hidratantne kreme; i toaletne vodice.

(111) 08999

(151) 22.11.2013

(210) **2011-375**

(442) **20.06.2013.**

(220) 22.07.2011.

(732) **SOCIETE DES PRODUCTS NESTLES.A.**, 1800 VEVEY, CH

računara



(540)

(550) I

(740) Lutovac Branislav, Bulevar Crnojevića 93, Podgorica (ME)

(511) **Klasa 30:** Sladoled.

(111) 09034

(151) 02.12.2013.

(210) **2011-354**

(442) **20.06.2013**

(220) 12.07.2011.

(732) **TDR ROVINJ**, OBALA VLADIMIRA NAZORA 1, 52210 ROVINJ, HR



(540) članskoj klasifikaciji:

(550) I

(740) Vukotić Petar, Novaka Miloševa, Podgorica (ME)

(511) **Klasa 34:** duvan sirov i preraden, proizvodi od duvana. cigare, cigarete, filter, cigarete, cigarilosi. artikli za pušaće, upaljači, šibice.

Klasa 35: usluge u vezi sa prometom robe, posebno usluge u prometu duvana i duvanskih proizvoda; oglašavanje; vođenje poslova; poslovno upravljanje; kancelarijski poslovi; komercijalno zastupanje; propagandne i reklamne usluge; marketing; usluge istraživanja tržišta; usluge promocije, posebno promovisnje ili reklamiranje kulturnih i zabavnih događaja, sportskih takmičenja i modnih revija; organizovanje i vodenje sajмова i izložbi u reklamne i komercijalne svrhe; naprijed navedene usluge koje pripadaju ovoj klasi koje se obavljaju putem interneta; davanje i širenje informacija u vezi sa gore navedenim uslugama.

(111) 09555

(151) 16.12.2013.

(210) **2011-376**

(442) **20.06.2013**

(220) 22.07.2011.

(732) **TAIHO PHARMACEUTICAL CO.LTD**, 1-27 KANDANISHIKI-CHO, CHIYODA-KU, TOKYO 101-8444, JP

TEYSUNO

(540)

(550) I

(740) Čejović Vladimir, 13. jula 21, Podgorica (ME)

(511) **Klasa 01:** Hemijski proizvodi koji se upotrebljavaju u industriji, nauci, fotografiji, poljoprivredi, hortikulturi i šumarstvu; neprerađene vještačke smole, neprerađene plastične materije; đubriva; smješe za gašenje vatre; preparati za kaljenje i zavarivanje; hemijske supstance za očuvanje namirnica; materije za štavljenje; ljepljive supstance koje se upotrebljavaju u industriji. Hemijski proizvodi; preparati i supstance za upotrebu u proizvodnji lijekova protiv raka, reagensi koji se koriste za naučno ili medicinsko istraživanje na području onkologije.

Klasa 05: Preparati protiv raka; agensi protiv raka, hemijski reagensi za medicinske svrhe na području onkologije.

-
- (111) 09013 (151) 21.11.2013.
 (210) **2011-360** (442) **20.06.2013.**
 (220) 15.07.2011.
 (732) **UNIPHARM.INC**, 350 FIFTH AVE., STE.6701 NEW YORK, NY 10118. US

VITRUM

- (540)
 (550) I
 (740) AOD "Ćupić", Dalmatinska 10, Podgorica ME
 (511) **Klasa 05:** Aminokiseline za medicinske potrebe; bujoni (hranjive podloge za bakterije) za bakteriološke kulture; balzami za medicinske potrebe; medicinske narukvice; pamuk za medicinske potrebe; dijetne tvari za medicinske potrebe; mineralne vode za medicinske potrebe; nehranjiva jestiva biljna vlakna; dezodorirajuća sredstva osim onih za biljnu upotrebu; ulje iz bakalareve jetre; jod za farmaceutsku upotrebu; alkalni jod za farmaceutsku upotrebu; kapsule za lijekove; kapsule za farmaceutuske potrebe; šećer za medicinske potrebe; slatkiši za farmaceutske potrebe; kore za farmaceutske potrebe; ljekovito korijenje; flasteri (court plaster); losioni za farmaceutsku upotrebu; masti za farmaceutske potrebe; ulje za medicinske potrebe; materijal za zavijanje rana; hrana u prahu za dojenčad; brašno za farmaceutske potrebe; dijetni napici za medicinske potrebe; medicinske infuzije; uvarci za farmaceutske potrebe (dekokti); flasteri za medicinske potrebe; bakteriološki preparati za medicinske ili veterinarske potrebe; biološki preparati za medicinske potrebe; veterinarski proizvodi; vitaminski pripravci; sredstva za osvježavanje zraka; proizvodi za pročišćavanje zraka; ogrlica protiv nametnika za životinje; herbicidi; parazitocidi; farmaceutuski proizvodi za njegu kože; medicinske kupke; medicinski pripravci za rast kose; preparati mikroelemenata za ljudsku i životinjsku prehranu; farmaceutuski proizvodi; hemijsko-farmaceutuski proizvodi; hemijski preparati za medicinske potrebe; namirnice na osnovi bjelančevina za medicinske potrebe; hrana za dojenčad; dijetna hrana za medicinske potrebe; žvakaća guma za medicinske potrebe; higijenski ubrusići za mjesječnicu; higijenski ulošci; natopljeni medicinski ubrusići; sirupi za farmaceutske potrebe; cigarete bez duvana za medicinske potrebe; soli za medicinske kupke; soli za medicinske potrebe; dezinfekcijska sredstva za higijenske potrebe; sredstva za smanjenje apetita za medicinske svrhe; dijetne tvari za medicinske potrebe; medicinski proizvodi za njegu usta; deterdženti za medicinske potrebe; digestivna sredstva za farmaceutske potrebe; tonici za medicinske potrebe; trave za pušenje za medicinske svrhe; čaj od trava za medicinske potrebe; biljni čajevi za medicinske potrebe; farmaceutuski proizvodi.

-
- (111) 09036 (151) 02.12.2013.
 (210) **2011-327** (442) **20.06.2013**
 (220) 29.06.2011.
 (732) **THE PROCTER & GAMBLE COMPANY**, ONE PROCTER & GAMBLE PLAZA, CINCINNATI, OHIO 45202 US

NO FLAKIN' WAY

(540)

(550) I

(740) Lutovac Branislav, Bulevar Crnojevića 93, Podgorica (ME)

(511) **Klasa 03:** Sapuni, parfimerija, eterična ulja, kozmetički preparati, losioni za kosu, preparati za čišćenje, njegu i uljepšavanje kože, kože glave i kose, proizvodi za oblikovanje frizure, preparati za nijansiranje, blajhanje, farbanje i kolorisanje kose.

(111) 09015

(151) 21.11.2013.

(210) **2011-449**

(442) **20.06.2013**

(220) 12.09.2011.

(732) **ROTHMANS OF PALL MALL LIMITED**, ZAEHLERWEG 4, ZUG, CH 6300 CH

CONSULATE

(540)

(550) I

(740) Popović Miladin, Đoka Miraševića 21/III, Podgorica (ME)

(511) **Klasa 34:** Cigarete, duvan; proizvodi od duvana; upaljači; šibice; artikli za pušače.

(111) 09143

(151) 10.12.2013.

(210) **2011-429**

(442) **20.06.2013**

(220) 23.08.2011.

(732) **INDUSTRIJA PIVA I SOKOVA TREBJESA AD NIKŠIĆ**, NJEGOŠEVA BR. 18 NIKŠIĆ, ME

najbolji izgovor znaka: a verbalni znak, otkucati masinom ili
uz pomoć računara



(540) za Ničanskoj klasifikaciji:
Klasa 34: Cigarete, duvan; proizvodi od duvana; upaljači; šibice; artikli za pušače.

(550) I

(740) Božović Vesko, Rimski trg 50/11, Podgorica (ME)

(511) **Klasa 32:** Pivo, mineralne i sodne vode i druga bezalkoholna pica; pica od voća i voćni sokovi; sirupi i drugi preparati za proizvodnju pica.

Klasa 35: Oglašavanje; vođenje poslova; poslovno upravljanje; kancelarijski poslovi. Obuhvata: usluge koje pružaju lica ili organizacije u pomoći u radu ili upravljanju preduzećima i u vođenju poslova preduzeća; usluge koje pružaju preuzeća koja se bave oglašavanjem (reklamiranjem), tako što, za račun drugih lica, komuniciraju sa javnošću (reklama) putem prenosa bilo kakvih informacija o proizvodima i uslugama omogućavajući potrošačima prigodan pogled na te proizvode i usluge; usluge koje se sastoje od upisivanja, uređivanja, obrade, prerade ili sistematizacije pisanih informacija i zapisa; usluge reklamnih agencija; distribuciju prospekata i uzoraka direktno ili poštom; izradu i korišćenje matematičkih i statističkih podataka; organizovanje sajmova i izložbi u komercijalne ili reklamne svrhe.

(111) 09024

(151) 21.11.2013.

(210) **2011-410**(442) **20.06.2013**

(220) 09.08.2011.

(732) **SECO TOOLS AB**, SE-7637 82 FAGERSTA, SE

(540)

(550) I

(740) Radulović Božidar, Jovana Tomaševića 9/III, Podgorica (ME)

(511) **Klasa 07:** mašinski alati na mašinski pogon; alati i ulošci za alate koji sadrže cementirane karbide za upotrebu u mašinskim alatima na mašinski pogon.

(111) 09028

(151) 21.11.2013.

(210) **2011-366**(442) **20.06.2013.**

(220) 18.07.2011.

(732) **BERLIN-CHEMIE AG**, GLIENICKER WEG 125, D-12489, BERLIN, DE

ZITON

(540)

(550) I

(740) Radulović Božidar, Jovana Tomaševića 9/III, Podgorica (ME)

(511) **Klasa 05:** Farmaceutski proizvodi, dijetetske supstance prilagođene za upotrebu u medicini.

(111) 08964

(151) 20.11.2013.

(210) **2011-422**(442) **20.06.2013**

(220) 22.08.2011.

(732) **ALKALOID AD SKOPLJE**, BUL. ALEKSANDAR MAKEDONSKI 12, SKOPLJE, MK

(540) a Ničanskoj klasifikaciji:

(550) I

(740) Popović Miladin, Đoka Miraševića 21/III, Podgorica (ME)

(511) **Klasa 03:** Krema sa voćnim kiselinama.

(111) 08868

(151) 21.11.2013.

(210) **2011-304**(442) **20.06.2013**

(220) 23.06.2011.

(732) **THE PROCTER & GAMBLE COMPANY**, ONE PROCTER & GAMBLE PLAZA, CINCINNATI, OHIO 45202 US

AMBI PUR FRESHELLE

(540) I

(550) I

(740) Lutovac Branislav, Bulevar Crnojevića 93, Podgorica (ME)

(511) **Klasa 03:** Sredstva za pranje i bijeljenje i druge supstance za upotrebu pri pranju; preparati za negu, tretiranje i ulepšavanje tkanina; preparati za čišćenje, poliranje, ribanje i nagrižanje; potpuri; tamjan; ulja za parfeme i mirise; mirišljava voda za upotrebu u domaćinstvu i na tkaninama; mirišljivo drvo; aromatični preparati; eterična ulja; preparati za nadimljavanje koji se ispuštaju u vazduh, atmosferu ili na tkanine u obliku dima, pare ili gasa; mirisni ili parfimisani preparati za vazduh.

Klasa 04: Jedinjenja za skupljanje prašine vlaženjem i vezivanjem; svijeće, mirišljave ili parfimisane svijeće, svijeće koje ispuštaju u atmosferu mirise ili parfeme; materije za osvetljavanje; vosak za osvetljavanje; tanke svijeće; svijeće u posudama i fitilji.

Klasa 05: Osveživači vazduha; preparati za prečišćavanje vazduha; osveživači vazduha za sobnu upotrebu; dezodoransi za tkanine i vazduh; preparati za neutralisanje mirisa.

Klasa 11: Aparati i instrumenti za ispuštanje mirisa, prečišćavanje ili osvežavanje atmosfere; djelovi i oprema za svu naprijed navedenu robu; jedinice za aromaterapiju i prečišćavanje vazduha koje rade na baterije ili na struju, kao i punjenja za takve jedinice; samostalni uređaji i filteri za dezodorisanje vazduha koji ne ispuštaju mirise ni druge supstance.

Klasa 21: Kuhinjske sprave i posude (koje nisu od dragocjenih metala ili presvučene istim); gorionici za ulja i mirise; aparati za grijanje ulja za parfeme i za ispuštanje mirisa u okolnu atmosferu; dozeri i aparati za raspršivanje parfimerijskih proizvoda, eteričnih ulja i proizvoda za osvežavanje vazduha u okolnu atmosferu; aparati za dezodorisanje; aparati i posude za ispuštanje mirisa u atmosferu ili za raspršivanje parfema, preparata za osvježavanje vazduha ili preparata za prečišćavanje vazduha u okolnu atmosferu; proizvodi od stakla; porcelan i grnčarija.

(111) 08821

(151) 20.11.2013.

(210) **2011-419**

(442) **20.06.2013.**

(220) 19.08.2011.

(732) **THE GILLETTE COMPANY**, ONE GILLETTE PARK, BOSTON, MA 02127 US

ORANGE BURST

(540)

(550) I

(740) Lutovac Branislav, Bulevar Crnojevića 93, Podgorica (ME)

(511) **Klasa 03:** Kolonjske i toaletne vode.

(111) 08825

(151) 20.11.2013.

(210) **2011-320**

(442) **20.06.2013.**

(220) 28.06.2011.

(732) **THE PROCTER & GAMBLE COMPANY**, ONE PROCTER & GAMBLE PLAZA, CINCINNATI, OHIO 45202 US

IGNITE MY COLOUR

(540)

(550) I

(740) Lutovac Branislav, Bulevar Crnojevića 93, Podgorica (ME)

(511) **Klasa 03:** Sapuni, parfimerija, eterična ulja, kozmetički preparati, losioni za kosu, preparati za čišćenje, njegu i uljepšavanje kože, kože glave i kose, proizvodi za oblikovanje frizure, preparati za nijansiranje, blajhanje, farbanje i kolorisanje kose.

(111) 08824

(151) 20.11.2013.

(210) **2011-321**(442) **20.06.2013.**

(220) 28.06.2011.

(732) **THE PROCTER & GAMBLE COMPANY**, ONE PROCTER & GAMBLE PLAZA, CINCINNATI, OHIO 45202 US**INFRIZZABLE WOMAN**

(540)

(550) I

(740) Lutovac Branislav, Bulevar Crnojevića 93, Podgorica (ME)

(511) **Klasa 03:** Sapuni, parfimerija, eterična ulja, kozmetički preparati, losioni za kosu, preparati za čišćenje, njegu i uljepšavanje kože, kože glave i kose, proizvodi za oblikovanje frizure, preparati za nijansiranje, blajhanje, farbanje i kolorisanje kose.

(111) 09017

(151) 21.11.2013.

(210) **2011-436**(442) **20.06.2013**

(220) 26.08.2011.

(732) **AMERICAN-CIGARETTEE COMPANY (OVERSEAS) LIMITED**, ZAEHLERWEG 4,ZUG 6300 CH**FRISSON**

(540)

(550) I

(740) Popović Miladin, Đoka Miraševića 21/III, Podgorica (ME)

(511) **Klasa 34:** Cigarete, duvan; proizvodi od duvana; upaljači; šibice; artikli za pušače.

(111) 08993

(151) 22.11.2013.

(210) **2011-367**(442) **20.06.2013.**

(220) 19.07.2011.

(732) **TOBACANA LJUBLJANA DOO**, CESTA 24,JUNIJA 90 LJUBLJANA-ČRNUČE 1231, SI

BOSS



(540) asifikaciji:

(550) I

(740) AOD "Ćupić", Dalmatinska 10, Podgorica ME

(511) **Klasa 34:** Duvan, prerađen ili neprerađen; proizvodi od duvana; zamjene za duvan koja nisu za upotrebu u medicinske svrhe ili svrhe liječenja; cigarete, cigarilosi; cigare; ručne mašine za pravljenje cigareta; tube za cigarete; filteri za cigarete; papir za cigarete; šibice i artikli za pušače.

(111) 08961

(151) 20.11.2013.

(210) **2011-396**

(442) **20.06.2013**

(220) 05.08.2011.

(732) **GREAT WALL MOTOR COMPANY LIMITED**, 2266 CHAOYANG SOUTH STREET, BAODING, HEBEI 071000, CN

STEED

(540)

(550) I

(740) Đakonović Vido, Bajova 8, Cetinje, (ME)

(511) **Klasa 37:** Održavanje i popravka motornih vozila; stanice za servisiranje vozila (pumpe za gorivo i za održavanje); popravka Sara na gumama; čišćenje vozila; podmazivanje vozila; zaštita vozila od rde; poliranje vozila; popravka vozila; pranje vozila.

(111) 08871

(151) 21.11.2013.

(210) **2011-389**

(442) **20.06.2013**

(220) 01.08.2011.

(732) **PLIVA HRVATSKA D.O.O.**, PRILAZ BARUNA FILIPOVIĆA 25 10 000 ZAGREB, HR

ULOM

(540)

(550) I

(740) Radulović Božidar, Jovana Tomaševića 9/III, Podgorica (ME)

(511) **Klasa 05:** Farmaceutski proizvodi.

(111) 08958

(151) 21.11.2013.

(210) **2011-451**

(442) **20.06.2013**

(220) 14.09.2011.

(732) **RECKITT BENCKISER N.V.**, SIRIUSDREEF 14,2132 WT HOOFDORP, NL



(540)

(550) I

(740) Popović Miladin, Đoka Miraševića 21/III, Podgorica (ME)

(511) **Klasa 03:** preparati i šamponi za čišćenje tepiha; deterdženti za veš, dodaci za pranje veša, preparati za uklanjanje mrlja sa tkanina i tepiha.

(111) 08866

(151) 21.11.2013.

(210) **2011-343**

(442) **20.06.2013**

(220) 01.07.2011.

(732) **THE PROCTER & GAMBLE COMPANY**, ONE PROCTER & GAMBLE PLAZA, CINCINNATI, OHIO 45202, US

VICKS

(540)

(550) I

(740) Lutovac Branislav, Bulevar Crnojevića 93, Podgorica (ME)

(511) **Klasa 03:** Kozmetički proizvodi, sredstva za ispiranje usta i njegu zuba.

Klasa 05: Farmaceutski proizvodi, veterinarski proizvodi, sredstva za dezinfekciju i sterilizaciju i održavanje u sterilizovanom stanju, tablete i sirupi protiv kašlja

Klasa 10: Pipete za lijekove

Klasa 30: Hranljivi proizvodi, biskviti, kolači, poslastice

(111) 08848

(151) 21.11.2013.

(210) **2011-314**

(442) **20.06.2013**

(220) 28.06.2011.

(732) **THE PROCTER & GAMBLE COMPANY**, ONE PROCTER & GAMBLE PLAZA, CINCINNATI, OHIO 45202 US

FIRED DANDRUFF

(540)

(550) I

(740) Lutovac Branislav, Bulevar Crnojevića 93, Podgorica (ME)

(511) **Klasa 03:** Sapuni, parfimerija, eterična ulja, kozmetički preparati, losioni za kosu, preparati za čišćenje, njegu i uljepšavanje kože, kože glave i kose, proizvodi za oblikovanje frizure, preparati za nijansiranje, blajhanje, farbanje i kolorisanje kose.

(111) 08822

(151) 20.11.2013.

(210) **2011-323**

(442) **20.06.2013**

(220) 28.06.2011.

(732) **THE PROCTER & GAMBLE COMPANY**, ONE PROCTER & GAMBLE PLAZA, CINCINNATI, OHIO 45202 US

BODY ENVY

(540)

(550) I

(740) Lutovac Branislav, Bulevar Crnojevića 93, Podgorica (ME)

(511) **Klasa 03:** Sapuni, parfimerija, eterična ulja, kozmetički preparati, losioni za kosu, preparati za čišćenje, njegu i uljepšavanje kože, kože glave i kose, proizvodi za oblikovanje frizure, preparati za nijansiranje, blajhanje, farbanje i kolorisanje kose.

(111) 08846

(151) 20.11.2013.

(210) **2011-315**

(442) **20.06.2013**

(220) 28.06.2011.

(732) **THE PROCTER & GAMBLE COMPANY**, ONE PROCTER & GAMBLE PLAZA, CINCINNATI, OHIO 45202 US

CLAIROL HERBAL ESSENCES DAZZLING SHINE

(540)

(550) I

(740) Lutovac Branislav, Bulevar Crnojevića 93, Podgorica (ME)

(511) **Klasa 03:** Sapuni, parfimerija, eterična ulja, kozmetički preparati, losioni za kosu, preparati za čišćenje, njegu i uljepšavanje kože, kože glave i kose, proizvodi za oblikovanje frizure, preparati za nijansiranje, blajhanje, farbanje i kolorisanje kose.

(111) 08828

(151) 20.11.2013.

(210) **2011-317**(442) **20.06.2013**

(220) 28.06.2011.

(732) **THE PROCTER & GAMBLE COMPANY**, ONE PROCTER & GAMBLE PLAZA, CINCINNATI, OHIO 45202 US

HAPPY COLOUR

(540)

(550) I

(740) Lutovac Branislav, Bulevar Crnojevića 93, Podgorica (ME)

(511) **Klasa 03:** Sapuni, parfimerija, eterična ulja, kozmetički preparati, losioni za kosu, preparati za čišćenje, njegu i uljepšavanje kože, kože glave i kose, proizvodi za oblikovanje frizure, preparati za nijansiranje, blajhanje, farbanje i kolorisanje kose.

(111) 08829

(151) 20.11.2013.

(210) **2011-355**(442) **20.06.2013.**

(220) 12.07.2011.

(732) **JOHNSON CONTROLS HYBRID AND RECYCLING GMBH**, AM LEINNEUFER, 30419 DE

(540)

(550) I

(740) Popović Miladin, Đoka Miraševića 21/III, Podgorica (ME)

(511) **Klasa 07:** Mašine za proizvodnju baterija, naročito baterija za motorna vozila.

Klasa 09: Aparati za provodjenje, distribuciju, transformaciju, akumulaciju, regulisanje i kontrolu električne energije; akumulatori, baterije i punjači za baterije, uključujući automobil-ske akumulatorne i punjače; uređaji za kontrolu baterija.

(111) 08869

(151) 21.11.2013

(210) **2011-303**

(442) **20.06.2013.**

(220) 23.06.2011.

(732) **THE PROCTER & GAMBLE COMPANY**, ONE PROCTER & GAMBLE PLAZA, CINCINNATI, OHIO 45202 US

ARIEL PRO-ZIM

(540)

(550) I

(740) Lutovac Branislav, Bulevar Crnojevića 93, Podgorica (ME)

(511) **Klasa 03:** Sredstva za bijeljenje i druge supstance za upotrebu kod pranja veša; preparati za čišćenje, poliranje, ribanje i nagrizanje.

(111) 09971

(151) 24.12.2013

(210) **2011-411**

(442) **20.06.2013.**

(220) 09.08.2011.

(732) **SECO TOOLS AB**, SE-7637 82 FAGERSTA, SE

SECOLOR

(540)

(550) I

(740) Radulović Božidar, Jovana Tomaševića 9/III, Podgorica (ME)

(511) **Klasa 07:** masinski alati pokretani mašinski; alati i alatni dodaci koji u sebi sadrže cementirane karbide za upotrebu u mašinskim alatima pokretanim mašinski

(111) 10676

(151) 31.12.2013.

(210) **2011-442**

(442) **20.06.2013.**

(220) 02.09.2011.

(732) **REEBOK INTERNATIONAL LIMITED**, MOOR LANE MILL, LANCASTER, LA1 1GF, GB

REEBOK

(540)

(550) I

(740) Radulović Božidar, Jovana Tomaševića 9/III, Podgorica (ME)

(511) **Klasa 28:** Igračke, igre, proizvodi za sport.

(111) 09003

(151) 22.11.2013

(210) **2011-431**

(442) **20.06.2013.**

(220) 23.08.2011.

(732) **JT INTERNTIONAL S.A.**, 1, RUE DE LA GABELLE, 1211 GENEVA 26, CH

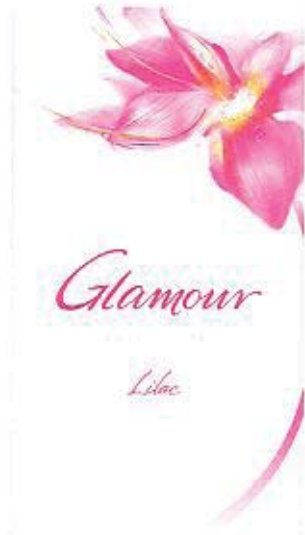

(540)

(550) I

(740) Čejović Vladimir, 13. jula 21, Podgorica (ME)

(511) **Klasa 34:** Duvan, koji je prerađen ili neprerađen; duvan za pušenje, duvan za lule, duvan za savijanje, duvan za žvakanje, duvan za sisanje; cigarete, cigare, cigarilosi; supstance za pušenje koje se prodaju odvojeno ili izmiješane sa duvanom, i koje nijesu za medicinsku ili svrhu liječenja; burmut; artikli za pušaće uključeni u klasu 34; papir za cigarete, fišeci za cigarete i šibice.

(111) 09551

(151) 16.12.2013.

(210) **2011-415**

(442) **20.06.2013**

(220) 15.08.2011.

(732) **NIMCRO DOO ZAGREB**, METALČEVA 5, ZAGREB HR

MORETTO

(540)

(550) I

(740) Božović Vesko, Rimski trg 50/11, Podgorica (ME)

(511) **Klasa 33:** Alkoholna pića (izuzev piva).

(111) 08873

(151) 21.11.2013.

(210) **2011-392**

(442) **20.06.2013.**

(220) 02.08.2011.

(732) **IRONWOOD PHARMACEUTICALS, INC.**, 301 BINNEY STREET CAMBRIDGE, MASSACHUSETTS 02142 US

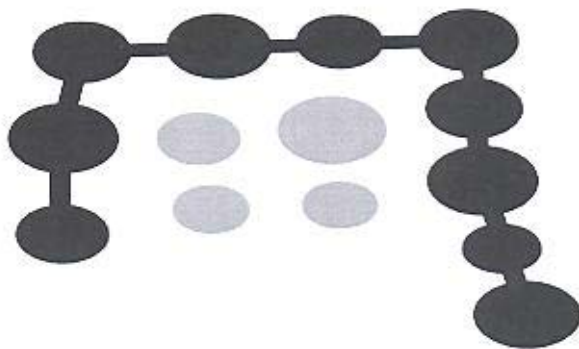

(540)

(550) I

(740) Popović Miladin, Đoka Miraševića 21/III, Podgorica (ME)

(511) **Klasa 05:** Farmaceutski preparati za upotrebu kod lečenja hronične konstipacije, sindroma razdražljivog creva, poremećaja gastrointestinalnog motiliteta i drugih gastrointestinalnih poremećaja.

(111) 08954

(151) 21.11.2013.

(210) **2011-427**

(442) **20.06.2013.**

(220) 22.08.2011.

(732) **ALKALOID AD SKOPLJE**, BUL. ALEKSANDAR MAKEDONSKI 12, SKOPLJE MK



(540)

(550) I

(740) Popović Miladin, Đoka Miraševića 21/III, Podgorica (ME)

(511) **Klasa 03:** Noćna krema.

(111) 08959

(151) 21.11.2013.

(210) **2011-417**

(442) **20.06.2013.**

(220) 17.08.2011.

(732) **ALKALOID AD SKOPLJE**, BUL. ALEKSANDAR MAKEDONSKI 12 SKOPLJE MK



(540) _____

(550) I

(740) Popović Miladin, Đoka Miraševića 21/III, Podgorica (ME)

(511) **Klasa 03:** Sapuni; parfimerija, eterična ulja, kozmetika, losioni za kosu; paste za zube.

Klasa 05: Farmaceutski preparati; dijetetske supstance prilagodene za medicinsku upotrebu, hrana za bebe; flasteri, materijali za zavijanje;

Klasa 16: Pelene za bebe, kartoni i robe napravljene od ovih materijala, koji nisu uključeni u druge klase.

(111) 08966

(151) 22.11.2013.

(210) **2011-331**

(442) **20.06.2013.**

(220) 29.06.2011.

(732) **THE PROCTER & GAMBLE COMPANY**, ONE PROCTER & GAMBLE PLAZA, CINCINNATI, OHIO 45202 US



(540)

(550) I

(740) Lutovac Branislav, Bulevar Crnojevića 93, Podgorica (ME)

(511) **Klasa 03:** Sapuni, parfimerija, eterična ulja, kozmetički preparati, losioni za kosu, preparati za čišćenje, njegu i uljepšavanje kože, kože glave i kose, proizvodi za oblikovanje frizure, preparati za nijansiranje, blajhanje, farbanje i kolorisanje kose.

(111) 08856

(151) 21.11.2013.

(210) **2011-423**

(442) **20.06.2013.**

(220) 22.08.2011.

(732) **ALKALOID AD SKOPLJE**, BUL ALEKSANDAR MAKEDONSKI 12, SKOPLJE, MK



(540)

(550) I

(740) Popović Miladin, Đoka Miraševića 21/III, Podgorica (ME)

(511) **Klasa 03:** Krema sa vitaminom C.

(111) 08842

(151) 20.11.2013.

(210) **2011-399**

(442) **20.06.2013.**

(220) 08.08.2011.

(732) **SOCIETE DES PRODUITS NESTLE S.A.**, 1800 VEVEY, CH

(540)

(550) I

(740) Lutovac Branislav, Bulevar Crnojevića 93, Podgorica (ME)

(511) **Klasa 30:** Sladoled.

(111) 09010

(151) 22.11.2013.

(210) **2011-416**(442) **20.06.2013**

(220) 16.08.2011.

(732) **PET INCORPORATED(DELAWARE CORPORATION)**, NUMBER ONE GENERAL MILLS BOULEVARD, MENNEAPOLIS MINNESOTA 55426 US

OLD EL PASO

(540)

(550) I

(740) Radulović Božidar, Jovana Tomaševića 9/III, Podgorica (ME)

(511) **Klasa 29:** Meso, riba, živina i divljač; mesne prerađevine; smrznuto, konzervisano, sušeno i kuvano voće i povrće; želei, džemovi, kompoti; jaja, mleko i mlečni proizvodi; jestiva ulja i masti**Klasa 30:** Kafa, čaj, kakao, šećer, pirinač, tapioka, sago, zamena kafe; brašno i proizvodi od žitarica, hleb, kolači, poslastice, sladoledi; med, melasa; kvasac, prašak za pecivo; so, senf; sirće, sosovi (kao začini); začini; led.

(111) 08996

(151) 22.11.2013.

(210) **2011-381**(442) **20.03.2013**

(220) 25.07.2011

(300) 2583955 08.06.2011. GB

(732) **FIL LIMITED ABERMUDA COMPANY**, PEMBROKE HALL, 42 CROW LANE, PEMBROKE HM 19, P.O.BOX HM 670, HAMILTON HMCX BM



(540)

(550) I

(740) AOD "Ćupić", Dalmatinska 10, Podgorica ME

(511) **Klasa 05:** Farmaceutski i veterinarski preparati; sanitarni preparati za medicinsku upotrebu; dijetetske supstance prilagođene za upotrebu u medicini, hrana za bebe; flasteri, materijali za zavijanje; materijali za plombiranje zuba, zubarska smola; dezinfekciona sredstva; preparati za uništavanje štetočina; fungicidi, herbicidi.

Klasa 10: Hirurški, medicinski, zubarski i veterinarski aparati i instrumenti, veštački udovi, oči i zubi; ortopedski artikli; hirurški materijali za zašivanje.

(111) 08876

(151) 21.11.2013.

(210) **2011-380**

(442) **20.06.2013**

(220) 25.07.2011

(300) 2583956 08.06.2011. GB

(732) **FIL LIMITED A BERMUDA COMPANY**, PEMBROKE HALL, 42 CROW LANE, PEMBROKE HM 19, P.O.BOX HM 670, HAMILTON HMCX, BERMUDA, BM



(540) *nišavski klasifikaciji*

(550) I

(740) AOD "Ćupić", Dalmatinska 10, Podgorica ME

(511) **Klasa 36:** Finansijske usluge; usluge osiguranja; usluge u oblasti investicija; usluge u vezi sa međunarodnim i domaćim investicijama; usluge diskrecionog upravljanja investicijama; savjetodavne usluge u vezi sa investicijama; zajednički fondovi i usluge u vezi sa njima; penzioni fondovi i usluge u vezi sa njima; brokerske usluge u oblasti hartija od vrijednosti i

usluge u vezi sa njima; bankarski poslovi i usluge u vezi sa njima; trustovi i usluge u vezi s njima; usluge vođenja portfolia, zajedničkih fondova, penzionih fondova i trustova; finansijsko upravljanje i planiranje; finansijsko savjetovanje; kreditne usluge; bankarske usluge u vezi sa investicijama; usluge u oblasti poslovnih finansija i kapitala za poslovne projekte; usluge u vezi sa privatnim investicijama (private equity); usluge u vezi sa nekretninama; usluge vezi sa investiranjem u nekretnine; usluge davanja garancija za hartije od vrijednosti; usluge vezane za tržište strane valute i finansijskih derivata; pružanje informacija, davanje savjeta i konsalting u vezi sa hartijama od vrijednosti, finansijama i investicijama; usluge pružanja informacija iz interaktivne baze podataka u vezi sa hartijama od vrijednosti, finansijama i investicijama; usluge u vezi sa kreditnim i debitnim karticama; usluge novčanih plaćanja; davanje kredita uz garancije ili bez garancija; mjenjački poslovi; procjena antikviteta; brokerske usluge; davanje garancija; prikupljanje sredstava za dobrotvorne fondove; davanje zajmova na osnovu hartija od vrijednosti; davanje zajmova na rate; usluge hipotekarnog bankarstva; usluge poslovne likvidacije; usluge berzanskih kotacija; naplata zakupa; pružanje informacija, davanje savjeta i konsalting u vezi sa svim navedenim uslugama.

(111) 08870

(151) 21.11.2013.

(210) **2011-344**

(442) **20.06.2013**

(220) 01.07.2011.

(732) **THE GILLETTE COMPANY**, ONE GILLETTE PARK, BOSTON, MASSACHUSETTS 02127, US

VENUS OCEANA

(540)

(550) I

(740) Lutovac Branislav, Bulevar Crnojevića 93, Podgorica (ME)

(511) **Klasa 08:** Brijači za jednokratnu upotrebu.

(111) 08862

(151) 21.11.2013.

(210) **2011-341**

(442) **20.06.2013**

(220) 01.07.2011.

(732) **THE PROCTER & GAMBLE COMPANY**, ONE PROCTER & GAMBLE PLAZA, CINCINNATI, OHIO 45202 US

UPLIFTING VOLUME

(540)

(550) I

(740) Lutovac Branislav, Bulevar Crnojevića 93, Podgorica (ME)

(511) **Klasa 03:** Sapuni, parfimerija, eterična ulja, kozmetički preparati, losioni za kosu, preparati za čišćenje, njegu i uljepšavanje kože, kože glave i kose, proizvodi za oblikovanje frizure, preparati za nijansiranje, blajhanje, farbanje i kolorisanje kose.

(111) 08844

(151) 20.11.2013.

(210) **2011-306**(442) **20.06.2013**

(220) 23.06.2011.

(732) **THE PROCTER & GAMBLE COMPANY**, ONE PROCTER & GAMBLE PLAZA, CINCINNATI, OHIO 45202 US

(540)

(550) I

(740) Lutovac Branislav, Bulevar Crnojevića 93, Podgorica (ME)

(511) **Klasa 03:** Sredstva za pranje i bijeljenje za upotrebu u domaćinstvu; preparati za njegu, tretiranje i ulepšavanje tkanina; preparati za čišćenje, poliranje, ribanje i nagrzanje; tamjan; ulja za parfeme i mirise; mirišljava voda za upotrebu u domaćinstvu i na tkaninama; eterična ulja; mirisni preparati za osvežavanje vazduha i tkanina.

(111) 09016

(151) 21.11.2013.

(210) **2011-363**(442) **20.06.2013**

(220) 18.07.2011.

(300) Z201170116 31.01.2011. SI

(732) **TOBACNA LJUBLJANA DOO**, CESTA 24, JUNIJA 90 LJUBLJANA-ČRNUČE 1231, SI

(540)

(550) I

(740) AOD "Ćupić", Dalmatinska 10, Podgorica ME

(511) **Klasa 34:** Duvan, prerađen ili neprerađen; proizvodi od duvana; zamjene za duvan koja nisu za upotrebu u medicinske svrhe ili svrhe liječenja; cigarete, cigarilos; cigare; ručne mašine za pravljenje cigareta; tube za cigarete; filteri za cigarete; papir za cigarete; šibice i

artikli za pušače.

-
- (111) 08967 (151) 22.11.2013.
 (210) **2011-336** (442) **20.06.2013**
 (220) 30.06.2011.
 (732) **SLAĐANA RAIČKOVIĆ**, BEOGRADSKA 7 PODGORICA, ME

financeplus

- (540)
 (550) I
 (511) **Klasa 35:** Oglašavanje Vođenje poslova Poslovno upravljanje Kancelarijski poslovi.
Klasa 36: Osiguranje Finansijski poslovi Novčani (monetarni poslovi) Poslovi vezani za nepokretnosti.
Klasa 41: Obrazovne usluge Pripremanje obuke Razonoda Sportske i kulturne aktivnosti.
Klasa 42: Naučne i tehnološke usluge i istraživanje i projektovanje u vezi navedenih usluga Usluge industrijske analize i istraživanja Projektovanje i razvoj kompjuterskog hardvera i softvera.
Klasa 45: Pravne usluge Usluge obezbjeđenja radi zaštite imovine i lica Individualne i društvene usluge koje pružaju drugi, radi zadovoljenja potreba pojedinaca.

-
- (111) 09009 (151) 22.11.2013.
 (210) **2011-348** (442) **20.06.2013**
 (220) 06.07.2011.
 (732) **MITSUBISHI JIDOSHA KOGYO KABUSHIKI KAISHA**, 33-8, SHIBA 5-CHOME, MINATO-KU, TOKYO JP

MIEV

- (540)
 (550) I
 (740) Radulović Božidar, Jovana Tomaševića 9/III, Podgorica (ME)
 (511) **Klasa 12:** Automobili i njihovi dijelovi i oprema; motocikli i njihovi dijelovi i oprema; bicikli i njihovi dijelovi i oprema; motori (ne-električni) za kopnena vozila; plovila i njihovi dijelovi i oprema; letilice i njihovi dijelovi i oprema; transmisioni elementi i zupčasti prenosnici za kopnena vozila; amortizeri za kopnena vozila; opruge za kopnena vozila.

(111) 09029
(210) **2011-408**

(151) 21.11.2013.
(442) **20.06.2013**
(220) 09.08.2011.

(732) **SECO TOOLS AB**, SE-7637 82 FAGERSTA, SE

SECO

(540)
(550) I

(740) Radulović Božidar, Jovana Tomaševića 9/III, Podgorica (ME)

(511) **Klasa 07:** mašinski alati na motorni pogon, uključujući alate za struganje, alati za rezanje i alati za bušenje, te alati ulošci za takve alate.

(111) 09020
(210) **2011-364**

(151) 22.11.2013.
(442) **20.06.2013**
(220) 18.07.2011.

(732) **BERLIN-CHEMIE AG**, GLIENICKER WEG 125, D-12489, BERLIN, DE

PROMARON

(540)
(550) I

(740) Radulović Božidar, Jovana Tomaševića 9/III, Podgorica (ME)

(511) **Klasa 05:** Farmaceutski proizvodi, dijetetske supstance prilagodjene za upotrebu u medicini.

(111) 09011
(210) **2011-398**

(151) 22.11.2013.
(442) **20.06.2013**
(220) 05.08.2011.

(732) **GENERAL MOTORS LLC**, 300 RENAISSANCE CENTER DETROIT, MICHIGAN 48265-3000 US

DURAMAX

(540)
(550) I

(740) Radulović Božidar, Jovana Tomaševića 9/III, Podgorica (ME)

(511) **Klasa 12:** Dizel motori za motorna vozila za kretanje po zemlji.

(111) 08970
(210) **2011-329**

(151) 22.11.2013.
(442) **20.06.2013**

(220) 29.06.2011.

(732) **THE PROCTER & GAMBLE COMPANY**, ONE PROCTER & GAMBLE PLAZA, CINCINNATI, OHIO 45202 US

LENOR SUBTILE

(540)

(550) I

(740) Lutovac Branislav, Bulevar Crnojevića 93, Podgorica (ME)

(511) **Klasa 03:** Sredstva za pranje i bijeljenje i druge supstance za upotrebu kod pranja veša; preparati za njegu, tretiranje i uljepšavanje tkanina; preparati za čišćenje, poliranje, ribanje i nagrizanje; parfemski ili mirišljavi preparati za osvežavanje vazduha.

(111) 08969

(151) 22.11.2013.

(210) **2011-340**

(442) **20.06.2013**

(220) 01.07.2011.

(732) **THE PROCTER & GAMBLE COMPANY**, ONE PROCTER & GAMBLE PLAZA, CINCINNATI, OHIO 45202, US

TOTALLY TWISTED

(540)

(550) I

(740) Lutovac Branislav, Bulevar Crnojevića 93, Podgorica (ME)

(511) **Klasa 03:** Sapuni, parfimerija, eterična ulja, kozmetički preparati, losioni za kosu, preparati za čišćenje, njegu i uljepšavanje kože, kože glave i kose, proizvodi za oblikovanje frizure, preparati za nijansiranje, blajhanje, farbanje i kolorisanje kose.

(111) 08992

(151) 22.11.2013.

(210) **2011-333**

(442) **20.06.2013**

(220) 30.06.2011.

(732) **THE PROCTER & GAMBLE COMPANY**, ONE PROCTER & GAMBLE PLAZA, CINCINNATI, OHIO 45202 US



(540)

(550) I

(740) Lutovac Branislav, Bulevar Crnojevića 93, Podgorica (ME)

(511) **Klasa 03:** Sapuni, parfimerija, eterična ulja, kozmetički preparati, losioni za kosu, preparati za čišćenje, njegu i uljepšavanje kože, kože glave i kose, proizvodi za oblikovanje frizure, preparati za nijansiranje, blajhanje, farbanje i kolorisanje kose.

(111) 08986

(151) 22.11.2013.

(210) **2011-337**(442) **20.06.2013**

(220) 01.07.2011.

(732) **THE PROCTER & GAMBLE COMPANY**, ONE PROCTER & GAMBLE PLAZA, CINCINNATI, OHIO 45202, US

SASSOON

(540)

(550) I

(740) Lutovac Branislav, Bulevar Crnojevića 93, Podgorica (ME)

(511) **Klasa 03:** Sapuni, parfimerija, esencijalna ulja, kozmetika, losioni za kosu, preparati za čišćenje, njegu, tretiranje i uljepšavanje kože, kože glave i kose, uključujući šampone, regeneratore, pjene, gelove i lakove za kosu; sredstva za bijeljenje, farbanje i kolorisanje kose.

Klasa 11: Fenovi za kosu i djelovi i oprema za njih.

Klasa 21: Četke (osim kičica) i češljevi (uključujući električne i one koje se pokreću baterijama) kao i djelovi i pribor za iste.

Klasa 41: Frizerske škole.

Klasa 42: Usluge frizerskih salona.

(111) 08968

(151) 22.11.2013.

(210) **2011-332**(442) **20.06.2013**

(220) 30.06.2011.

(732) **THE PROCTER & GAMBLE COMPANY**, ONE PROCTER & GAMBLE PLAZA, CINCINNATI, OHIO 45202 US



(540) -----

(550) |

(740) Lutovac Branislav, Bulevar Crnojevića 93, Podgorica (ME)

(511) **Klasa 03:** Sapuni, parfimerija, eterična ulja, kozmetički preparati, losioni za kosu, preparati za čišćenje, njegu i uljepšavanje kože, kože glave i kose, proizvodi za oblikovanje frizure, preparati za nijansiranje, blajhanje, farbanje i kolorisanje kose.

(111) 08867

(151) 21.11.2013.

(210) **2011-434**

(442) **20.06.2013**

(220) 26.08.2011.

(732) **THE GILLETTE COMPANY**, ONE GILLETTE PARK, BOSTON, MA 02127, US

PROGLIDE STYLER

(540)

(550) |

(740) Lutovac Branislav, Bulevar Crnojevića 93, Podgorica (ME)

(511) **Klasa 08:** Brijači i noževi za brijanje; dozne, kasete, držači i patrone koje sadrže nozeve za brijanje; i strukturni delovi za napred navedeno.

(111) 08865

(151) 21.11.2013

(210) **2011-339**

(442) **20.06.2013**

(220) 01.07.2011.

(732) **THE PROCTER & GAMBLE COMPANY**, ONE PROCTER & GAMBLE PLAZA, CINCINNATI, OHIO 45202, US

SCENT TOUCH

(540)

(550) |

(740) Lutovac Branislav, Bulevar Crnojevića 93, Podgorica (ME)

(511) **Klasa 03:** Sredstva za pranje i bijeljenje i druge supstance z upotrebu kod pranja veša; preparati za čišćenje, poliranje nagrizajuća sredstva, abrazivna sredstva; sapuni parfimerija, eterična ulja, kozmetika, losioni za kosu proizvodi za njegu zuba.

(111) 08863

(151) 21.11.2013.

(210) **2011-335**

(442) **20.06.2013**

(220) 30.06.2011.

(732) **THE PROCTER & GAMBLE COMPANY**, ONE PROCTER & GAMBLE PLAZA, CINCINNATI, OHIO 45202 US



(540)

(550) I

(740) Lutovac Branislav, Bulevar Crnojevića 93, Podgorica (ME)

(511) **Klasa 03:** Sapuni, parfimerija, eterična ulja, kozmetički preparati, losioni za kosu, preparati za čišćenje, njegu i uljepšavanje kože, kože glave i kose.

(111) 08845

(151) 20.11.2013.

(210) **2011-342**

(442) **20.06.2013**

(220) 01.07.2011

(732) **THE PROCTER & GAMBLE COMPANY**, ONE PROCTER & GAMBLE PLAZA, CINCINNATI, OHIO 45202, US

VAPORUB

(540)

(550) I

(740) Lutovac Branislav, Bulevar Crnojevića 93, Podgorica (ME)

(511) **Klasa 03:** Kozmetički proizvodi, sredstva za ispiranje usta i njegu zuba.

Klasa 05: Farmaceutski proizvodi, veterinarski proizvodi, sredstva za dezinfekciju i sterilizaciju i održavanje u sterilizovanom stanju, tablete i sirupi protiv kašlja

Klasa 10: Pipete za lijekove

Klasa 30: Hranljivi proizvodi, biskviti, kolači, poslastice

- (111) 09025 (151) 21.11.2013.
 (210) **2011-405** (442) **20.06.2013**
 (220) 09.08.2011.
 (732) **SANDVIK INTELLECTUAL PROPERTY AB**, SE-811 81 SANDVIKEN, SE

COROMANT

- (540)
 (550) I
 (740) Radulović Božidar, Jovana Tomaševića 9/III, Podgorica (ME)
 (511) **Klasa 07:** proizvodi od karbonskih legura, kao što su valjci, vretena za izvlačenje, kalupi za izvlačenje, naprave vodilje, dizne za vazdušne duvaljke, glave mašina; metalne opruge (dijelovi mašina); makaze (mašinski alat); mašinski alati, poljoprivredni alati i mašine, električne mašine, uključujući njihove dijelove i pribor; (mašinski) alati za obradu metala, kamena, lima, kosti i vještačkih materijala.

- (111) 08859 (151) 21.11.2013.
 (210) **2011-310** (442) **20.06.2013**
 (220) 28.06.2011.
 (732) **THE PROCTER & GAMBLE COMPANY**, ONE PROCTER & GAMBLE PLAZA, CINCINNATI, OHIO 45202 US
 računara

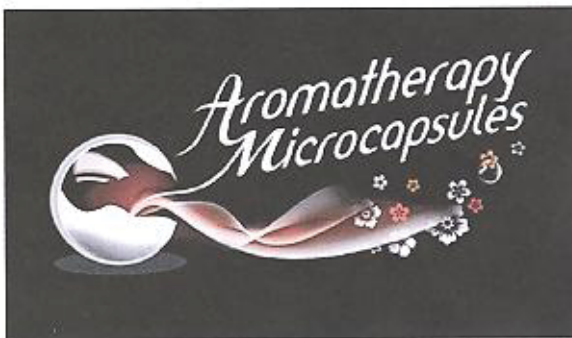

- (540)
 (550) I
 (740) Lutovac Branislav, Bulevar Crnojevića 93, Podgorica (ME)
 (511) **Klasa 03:** Sredstva za pranje, bijeljenje i druga sredstva za upotrebu kod pranja veša; preparati za čišćenje, poliranje, ribanje i nagrizanje; omekšivači tkanina; sapuni za upotrebu u domaćinstvu.

- (111) 08849 (151) 21.11.2013.
 (210) **2011-313** (442) **20.06.2013**
 (220) 28.06.2011.

(732) **THE PROCTER & GAMBLE COMPANY**, ONE PROCTER & GAMBLE PLAZA, CINCINNATI, OHIO 45202 US

DAZZLING SHINE

(540)

(550) I

(740) Lutovac Branislav, Bulevar Crnojevića 93, Podgorica (ME)

(511) **Klasa 03:** Sapuni, parfimerija, eterična ulja, kozmetički preparati, losioni za kosu, preparati za čišćenje, njegu i uljepšavanje kože, kože glave i kose, proizvodi za oblikovanje frizure, preparati za nijansiranje, blajhanje, farbanje i kolorisanje kose.

(111) 08994

(151) 22.11.2013.

(210) **2011-371**

(442) **20.06.2013**

(220) 20.07.2011.

(732) **NO FEAR INTERNATIONAL LIMITED**, UNIT A, BROOK PARK EAST SHIREBROOK NG20 8 RY UK, GB



(540)

(550) I

(740) Popović Miladin, Đoka Miraševića 21/III, Podgorica (ME)

(511) **Klasa 18:** Koža i imitacija kože, proizvodi izrađeni od ovih materijala koji nisu uključeni u druge klase; životinjska koža, krzno; koferi i putne torbe; kišobrani, suncobrani i štapovi za hodanje; bičevi, saračka i sedlarska oprema.

Klasa 25: Odeća, obuća, pokrivala za glavu.

Klasa 32: Pivo; mineralne i sodne vode i druga bezalkoholna pica; pića od voća i voćni sokovi; sirupi i drugi preparati za proizvodnju pića.

(111) 08955

(151) 21.11.2013.

(210) **2011-428**

(442) **20.06.2013**

(220) 22.08.2011.

(732) **ALKALOID AD SKOPLJE**, BUL.ALEKSANDAR MAKEDONSKI 12, SKOPLJE MK



(540) nižarokai klasifikacija:

(550) I

(740) Popović Miladin, Đoka Miraševića 21/III, Podgorica (ME)

(511) **Klasa 03:** Noćna polivitaminska krema.

(111) 08998

(151) 22.11.2013.

(210) **2011-334**

(442) **20.06.2013**

(220) 30.06.2011

(732) **THE PROCTER & GAMBLE COMPANY**, ONE PROCTER & GAMBLE PLAZA, CINCINNATI, OHIO 45202 US



(540) _____

(550) I

(740) Lutovac Branislav, Bulevar Crnojevića 93, Podgorica (ME)

(511) **Klasa 03:** Sapuni, parfimerija, eterična ulja, kozmetički preparati, losioni za kosu, preparati za čišćenje, njegu i uljepšavanje kože, kože glave i kose, proizvodi za oblikovanje frizure, preparati za nijansiranje, blajhanje, farbanje i kolorisanje kose.

(111) 08826

(151) 20.11.2013.

(210) **2011-319**(442) **20.06.2013**

(220) 28.06.2011.

(732) **THE PROCTER & GAMBLE COMPANY**, ONE PROCTER & GAMBLE PLAZA, CINCINNATI, OHIO 45202 US**HERBAL ESSENCES**

(540)

(550) I

(740) Lutovac Branislav, Bulevar Crnojevića 93, Podgorica (ME)

(511) **Klasa 03:** Sapuni, parfimerija, eterična ulja, kozmetički preparati, losioni za kosu, preparati za čišćenje, njegu i uljepšavanje kože, kože glave i kose, proizvodi za oblikovanje frizure, preparati za nijansiranje, blajhanje, farbanje i kolorisanje kose.

(111) 08874

(151) 21.11.2013.

(210) **2011-393**(442) **20.06.2013**

(220) 03.08.2011.

(732) **EDEL WEISS GMBH & CO.KG**, OBERSTDORFER STRASSE 7,87435 KEMPTEN, DE**EDELWEISS**

(540)

(550) I

(740) Lutovac Branislav, Bulevar Crnojevića 93, Podgorica (ME)

(511) **Klasa 29:** Mlijeko, sir; puter i mliječni proizvodi; jaja; jestiva ulja i masti.

(111) 08988

(151) 22.11.2013.

(210) **2011-430**(442) **20.06.2013**

(220) 23.08.2011.

(732) **CELGENE CORPORATION**, 86 MORRIS AVENUE, SUMMIT, NEW JERSEY 07901, US**ИМНОВИД**

(540)

(550) I

(740) Čejović Vladimir, 13. jula 21, Podgorica (ME)

(511) **Klasa 05:** Farmaceutski preparati, naime, lijekovi inhibitori citokina; farmaceutski preparati koji modulišu imuni sistem; farmaceutski preparati za liječenje pojedinih vrsta raka i

oboljenja krvi.

(111) 08989

(151) 22.11.2013.

(210) **2011-432**

(442) **20.06.2013**

(220) 23.08.2011.

(732) **JT INTERNATIONAL S.A.**, 1, RUE DE LA GABELLE, 1211 GENEVA 26, CH

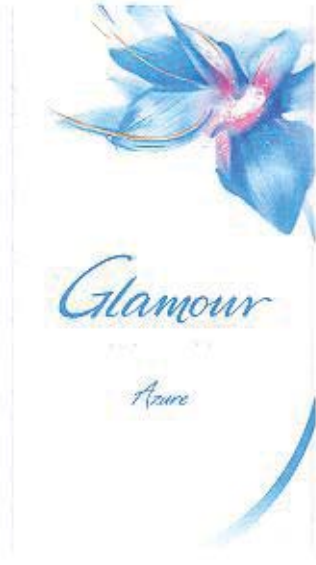

(540) **ni klasifikaciji:**

(550) I

(740) Čolović Branko, Mediteranska br 2 Budva (ME)

(511) **Klasa 34:** Duvan, koji je prerađen ili neprerađen; duvan za pušenje, duvan za lule, duvan za savijanje, duvan za žvakanje, duvan za sisanje; cigarete, cigare, cigarilosi; supstance za pušenje koje se prodaju odvojeno ili izmiješane sa duvanom, i koje nijesu za medicinsku ili svrhu liječenja; burmut; artikli za pušaće uključeni u klasu 34; papir za cigarete, fišeci za cigarete i šibice.

(111) 08991

(151) 22.11.2013.

(210) **2011-330**

(442) **20.06.2013**

(220) 29.06.2011.

(732) **THE PROCTER & GAMBLE COMPANY**, ONE PROCTER & GAMBLE PLAZA, CINCINNATI, OHIO 45202 US

*premium
care*

(540) |

(550) I

(740) Lutovac Branislav, Bulevar Crnojevića 93, Podgorica (ME)

(511) **Klasa 03:** Maramice impregnirane sredstvima za ličnu higijenu ili kozmetičkim preparatima.

Klasa 16: Pelene za jednokratnu upotrebu od papira i/ili celuloze; papirnati proizvodi za ličnu upotrebu i upotrebu u domaćinstvu kao što su papirni ubrusi, papirne salvete, toalet papir, maramice za lice i drugi mekani papirnati proizvodi.

(111) 08965

(151) 20.11.2013.

(210) **2011-420**

(442) **20.06.2013**

(220) 22.08.2011.

(732) **ALKALOID AD SKOPLJE**, BUL. ALEKSANDAR MAKEDONSKI 12, SKOPLJE MK



(540)

(550) I

(740) Popović Miladin, Đoka Miraševića 21/III, Podgorica (ME)

(511) **Klasa 03:** Noćna regenerativna krema.

(111) 08823

(151) 20.11.2013.

(210) **2011-322**

(442) **20.06.2013**

(220) 28.06.2011.

(732) **THE PROCTER & GAMBLE COMPANY**, ONE PROCTER & GAMBLE PLAZA, CINCINNATI, OHIO 45202 US

IT'S A CURL THING

(540)

(550) I

(740) Lutovac Branislav, Bulevar Crnojevića 93, Podgorica (ME)

(511) **Klasa 03:** Sapuni, parfimerija, eterična ulja, kozmetički preparati, losioni za kosu, preparati za čišćenje, njegu i uljepšavanje kože, kože glave i kose, proizvodi za oblikovanje frizure, preparati za nijansiranje, blajhanje, farbanje i kolorisanje kose.

(111) 09556

(151) 16.12.2013.

(210) **2011-377**(442) **20.06.2013**

(220) 25.07.2011.

(732) **IL CAMMINO SH.P.K.**, RRUGA E QELQIT TEKISH TERRITORII FABRIKES SE QELGIT, GODINE 1 KATESHE, KOMBINAT, TIRANA, AL

(540)

(550) I

(740) Đakonović Vido, Bajova 8, Cetinje, (ME)

(511) **Klasa 25:** Obuća za plažu; čizme; odjeća; obuća; polučizme; sportska obuća; sandale; cipele; pokrivala za glavu

(111) 09040

(151) 02.12.2013.

(210) **2011-350**(442) **20.06.2013**

(220) 08.07.2011

(732) **FOOD INDUSTRY DOO PODGORICA**, PUT RADOMIRA IVANOVIĆA BR.2, PODGORICA ME

(540)

(550) I

(511) **Klasa 30:** Kafa, čaj, kakao, šećer, pirinač, apioka, sago, zamjena kafe; brašno i proizvodi ožitarica, hleb, kolači i poslastice, sladoledi med, melasa, kvasac, prašak za pecivo, so, senf, sirće, sosovi (kao dodaci); začini, led.

(111) 08872

(151) 21.11.2013.

(210) **2011-388**(442) **20.06.2013**

(220) 29.07.2011

(732) **KENTUCKY FRIED CHIKEN INTERNATIONAL HOLDINGS, INC**, 1441 GARDINER LANE, LOUSSVILLE, KENTUCKY 40213, US



sogood

(540)

(550) I

(740) Čejović Vladimir, 13. jula 21, Podgorica (ME)

(511) **Klasa 29:** Meso, riba, živina i divljač; mesne prerađevine; konzervisano, zamrznuto, sušeno i kuvano voće i povrće; želei, džemovi, kompoti; jaja, mlijeko i mliječni proizvodi; jestiva ulja i masti.

Klasa 30: Kafa, čaj, kakao, šećer, pirinač, tapioka, sago, zamjena kafe; brašno i proizvodi od žitarica, hljeb, kolači i poslastice, sladoledi; med, melasa; kvasac, prašak za pecivo; so, senf; sirće, sosevi (kao začini); začini; led.

Klasa 32: Pivo, mineralne i sodne vode i druga bezalkoholna pica; pica od voća i voćnih sokova; sirupi i drugi preparati za proizvodnju pica.

Klasa 43: Usluge obezbjedjivanja hrane i pica, privremeni smještaj.

(111) 08957

(151) 21.11.2013.

(210) **2011-424**

(442) **20.06.2013**

(220) 22.08.2011

(732) **ALKALOID AD SKOPLJE**, BUL. ALEKSANDAR MAKEDONSKI 12, SKOPLJE, MK



(540)

(550) I

(740) Popović Miladin, Đoka Miraševića 21/III, Podgorica (ME)

(511) **Klasa 03:** Dnevna krema.

(111) 08963

(151) 20.11.2013.

(210) 2011-426

(442) 20.06.2013

(220) 22.08.2011.

(732) **ALKALOID AD SKOPLJE**, BUL. ALEKSANDAR MAKEDONSKI 12, SKOPLJE MK

(540)

(550) I

(740) Popović Miladin, Đoka Miraševića 21/III, Podgorica (ME)

(511) **Klasa 03:** Regenerativna dnevna krema.

(111) 08581

(151) 20.11.2013.

(210) 2011-492

(442) 20.03.2013

(220) 10.10.2011

(732) **MEGGLE AG**, MEGGLESTRASSE 6-12, 83512 WASSERBURG DE

(540)

(550) I

(740) Čejović Vladimir, 13. jula 21, Podgorica (ME)

(511) **Klasa 29:** Mlijeko i mliječni proizvodi; maslac i proizvodi od maslaca; pavlaka i proizvodi od pavlake, sir i proizvodi od sira, namazi i prelive za hljeb na bazi mliječnih proizvoda; proizvodi na bazi mlijeka i jogurta, mliječni napici sa povećanim sadržajem mlijeka, mliječni napici na bazi surutke, sve sa ili bez dodatog voća, sirupa; jestiva ulja i masti; proizvodi od soje, naime tofu, sojino mlijeko, sojin jogurt; napici na bazi sojinog mlijeka, deserti i slične namirnice na bazi soje (sadržane u klasi 29); jogurt; deserti i slične namirnice na bazi mliječ-

nih proizvoda, takođe u obliku praha; supe; surutka, laktoza voćni i proteinski koncentrat i za prehrambenu industriju; voćni sosovi; marmelade; džemovi, kompoti; konzervisano, sušeno i kuvano voće, želatini (želei).

Klasa 30: Majonez; sosovi, uključujući i prelive za salatu i umake; začinki sosovi, začini, začinski preparati; proizvodi od soje, naime soja sos, začinski preparati na bazi soje, majonez na bazi soje, surogat kafe na bazi soje (sadržane u klasi 30); sva gore navedena roba, takođe u obliku praha; kakao; čokolada, čokoladni proizvodi, takođe u obliku praha; čokoladni napici; hljeba i peciva, takođe sa namazima ili prelivima, fina peciva i kolači; sladoled, sladoled u prahu; soli za kuvanje; prirodni zaslađivači; proizvodi od šećera.

Klasa 32: Bezalkoholni napici sa niskim sadržajem mlijeka i mliječnih komponenti; napici na bazi surutke sa ili bez dodatog voća i sirupa; voćni napici i voćni sokovi; sirupi i drugi preparati za pripremu pića.

(111) 09552

(151) 16.12.2013.

(210) **2011-347**

(442) **20.06.2013**

(220) 05.07.2011

(300) 212272/2011 09.03.2011. GR

(732) **CHIPITA INDUSTRIAL AND COMMERCIAL COMPANY S.A.**, 12 KM NATIONAL ROAD ATHENS-LAMIA, METAMOFOSI, 14452, GR



(540)

(550) I

(740) Đakonović Vido, Bajova 8, Cetinje, (ME)

(511) **Klasa 29:** Proizvodi od krompira bilo koje vrste; Grickalice na bazi krompira; Čips od krompira.

Klasa 30: Slane grickalice; Ekstrudirane grickalice; Grickalice sa ukusom sira; Grickalice na bazi pirinča, izuzev žitarica za doručak i štapića na bazi žitarica; grickalice na bazi pšenice, izuzev žitarica za doručak i cerealnih štapića; grickalice na bazi kukuruza, izuzev žitarica za doručak i cerealnih štapića.

(111) 08997

(151) 22.11.2013.

(210) **2011-307**

(442) **20.06.2013**

(220) 27.06.2011

(732) **ALKALOID AD SKOPLJE**, BUL.ALEKSANDAR MAKEDONSKI 12,1000 SKOPLJE MK



(540)

(550) I

(740) Popović Miladin, Đoka Miraševića 21/III, Podgorica (ME)

(511) **Klasa 29:** Sušeno voće.**Klasa 31:** Sušeno sjeme-sjeme suncokreta, sjeme bundeve, sjeme badema, sjeme lješnika.

(111) 08962

(151) 20.11.2013.

(210) **2011-450**(442) **20.06.2013**

(220) 13.09.2011

(732) **TOTO LTD.**, 1-1, NAKASHIMA 2-CHOME, KOKURAKITA-KU, KITAKYSHU-SHI, JP

NEOREST

(540)

(550) I

(740) Lutovac Branislav, Bulevar Crnojevića 93, Podgorica (ME)

(511) **Klasa 06:** Gradjevinski materijali od metala, metalne ploče, metalne pločice za oblaganje i pokrivanje; metalne podne pločice; metalni okviri za zgrade; metalne opiate; podovi od metala; tavanice od metala; metalna vrata; metalni okviri za prozore i prozori za zgrade; stepenište od metala; krovovi od metala; krovne obloge od metala jkapije od metala; ograde od metala; škure od metala; zaštitne ograde od metala; znakovi, ne-svjetleći i ne-mehanički, od metala; rešetke i paravani od metala; spoljašnje roletne od metala; metalne grobnice ; prenosive zgrade od metala; paneli od metala; metalni znakovi i natpisi; metalni kontejneri (za skladištenje, transport); metalni zidovi nepropusni na zvuk (odn. zvučno izolovani); metalne šipke za peškire; metalne kuke; metalni rukohvati (gelenderi); razdjelnici za peškire, fiksirani, ne-metalni; mašina za pranje od metala; odvodne cijevi od metala; metalne cijevi za vodu; metalne cijevi; metalni mufovi za cijevi; metalne spona za cijevi; držači cijevi od metala; metalni odvodni trapovi; elementi za cjevovode od metala; razvodni sklopovi za cjevovode od metala; sva ostala roba uključena u ovu klasu.

Klasa 20: Postolja za pranje; stolovi za oblačenje; ogledala (toaletna ogledala); namještaj (1 to, stalci za peškire, prečke, kuhinjski ormarići, pobočni ormarići (ormari za posuđe), toaletni ormarići) ; namještaj za kupatilo (i to: pultovi, ormarići, police); merdevine, ne-metalne;

pultovi (stolovi); postolje za lavabo; toaletni pultovi; kuhinjske površine; pobočne kuhinjske površine /kuhinjski pultovi/ ormarići uključujući sudopere ali ne gasne gorionike; klupe; sjedišta za djecu (namještaj); dječija stolica (namještaj); šipke za peškire, ne-metalne; kuke, ne-metalne; navrtke, ne-metalne; odvodni zaklopci od plastike; dispenser/ razdjelnici za peškire, fiksirani, ne-metalni; plastični ventili za cijevi za vodu; jastučići; jastuci; kreveti; krevetske prostirke i pokrivači, izuzev posteljine; sva ostala roba uključena u ovu klasu.

Klasa 21: Držači za toaletni papir ; dispenser/razdjelnici za toaletni papir ; držači za papirne presvlake za toaletnu dasku; metalne kutije, za držanje papirnatih ubrusa; dispenser/razdjelnici za toaletne ubruse; držači i kutije za sapun; dispenser/razdjelnici za sapun; toaletne kutije; držači i kutije za četkice za zube; čaše za vodu i držači za case za vodu; kupatilske četke i držači; nosači za peškire u obliku prečki i prstenova; rukohvati, nemetalni; kante za smeće; noćne posude; uređaji na vodu za čišćenje zuba i desni; pribor za čišćenje (ručno pokretane); kade za djecu (prenosne); krpe (tkanine) za čišćenje ; sva ostala roba uključena u ovu klasu.

(111) 09031	(151) 02.12.2013.
(210) 2011-378	(442) 20.06.2013
	(220) 25.07.2011
(300) 302011004752.9 26.01.2011. DE	
(732) DAIMLER AG , MERCEDESSTRASSE 137 70327 STUTTGART, DE	

BIGSPACE

(540)
 (550) I
 (511) **Klasa 12:** Motorna vozila i njihovi djelovi.

(111) 09030	(151) 02.12.2013.
(210) 2011-359	(442) 20.06.2013
	(220) 15.07.2011.
(732) ABBOTT PRODUCTS OPERATIONS AG , HEGENHEIMERMATTWEG 127, 4123 ALLSCHWIL, CH	

TEVEZIDE

(540)
 (550) I
 (740) Čejović Vladimir, 13. jula 21, Podgorica (ME)
 (511) **Klasa 05:** Kardiovaskularni preparati sa eprosartanom kao aktivnim sastojkom.

(111) 09026	(151) 21.11.2013.
(210) 2011-412	(442) 20.06.2013
	(220) 09.08.2011

(732) **DIAMOND INNOVATIONS INC**, 6325 HANTLEY ROAD, WORTHINGTON, OHIO 46085
US

BORAZON

(540)

(550) I

(740) Radulović Božidar, Jovana Tomaševića 9/III, Podgorica (ME)

(511) **Klasa 03:** Industrijska mehanička sredstva za brušenje.

Klasa 08: Tocila.

(111) 09027

(151) 21.11.2013.

(210) **2011-409**

(442) **20.06.2013**

(220) 09.08.2011

(732) **SECO TOOLS AB**, SE-7637 82 FAGERSTA, SE

SNAP-TAP

(540)

(550) I

(740) Radulović Božidar, Jovana Tomaševića 9/III, Podgorica (ME)

(511) **Klasa 07:** navojni nastavci za strugove i prated pribor, naročito automatske reverzibilne jedinice i rotirajući centralni elementi, karbidni ulošci, držači alata i alati za brušenje.

(111) 10310

(151) 24.12.2013.

(210) **2011-437**

(442) **20.06.2013**

(220) 29.08.2011

(732) **CHONGPING YUAN INNOVATION TECHNOLOGY CO,LTD.**, FENGHUANG,
SHAPINGBA DISTRICT, CHONGPING, CN

SOKON

(540)

(550) I

(740) Čejović Vladimir, 13. jula 21, Podgorica (ME)

(511) **Klasa 12:** Lokomotive; cyclecar vozila; automobili; motorna vozila; amortizeri za vozila; točkovi za vozila; motori za kopnena vozila; amortizeri za automobile; motocikli; bicikli.

Klasa 37: Usluge građevinskog informisanja; izgradnja fabrika; građevinske usluge; usluge rudarskih iskopa; tapaciranje; održavanje i popravka motornih vozila; pranje vozila; usluge servisnih stanica za vozila (dosipanje goriva i održavanje); reparacija guma; usluge instaliranja, održavanja i popravke mašinerije.

(111) 09035	(151) 02.12.2013.
(210) 2011-391	(442) 20.06.2013
	(220) 02.08.2011

(732) **SHIMANO INC.**, 3-77 OIMATSU-CHO, SAKAI CITY, OSAKA JP

ZEE

(540)
 (550) I
 (740) Popović Miladin, Đoka Miraševića 21/III, Podgorica (ME)
 (511) **Klasa 12:** Električne bicikle, bicikle, delovi i oprema za bicikle, naime: glavčine, unutrašnje glavčine menjača, glavčine dinamama za bicikle, glavčine za brzo otpuštanje poluge menjača, otpusne poluge menjača, poluge za menjanje brzina, prednji prenosni mehanizmi, zadnji prenosni mehanizmi, vođice lanca, pomoćni zupčanici za menjanje brzina (skretači lanca), zupčanici, dizalice za bicikle, lanci za bicikle, sajle, obrtaljke, komplet obrtaljka, prednji lančanici za točak, pedale za bicikle, klipseri (korpice za stopala), poluge kočnica, prednje kočnice, zadnje kočnice, sajle za kočnice, kočne papuče, obruči, točkovi, lanci za kočenje, klipovi za kočenje, donje spona, nosači za sedišta, mehanizmi za brzo otpuštanje nosača sedišta, glavni delovi za sklapanje rama viljuški, amortizeri, upravljači, drške upravljača, ručice upravljača, krajevi drške upravljača, uporišta sedišta, sedišta, prenosni mehanizmi kojima upravlja kompjuter, vreće za točkove bicikla, pokazivači pozicije brzine bicikla.

(111) 08830	(151) 20.11.2013.
(210) 2011-357	(442) 20.06.2013
	(220) 15.07.2011

(300) 9984436 20.05.2011. CTM
 (732) **BRITISH AMERICAN TOBACCO (BRANDS) INC.**, 2711 CENTERVILLE ROAD, SUITE 300, WILMINGTON, DELAWARE 19808 US



(540)

(550) I

(740) Popović Miladin, Đoka Miraševića 21/III, Podgorica (ME)

(511) **Klasa 34:** Cigarete; duvan; proizvodi od duvana; upaljači; šibice; artikli za pušače.

(111) 08843

(151) 20.11.2013.

(210) **2011-362**

(442) **20.06.2013**

(220) 18.7.2011

(732) **ALDO GROUP INTERNATIONAL**, LINDENSTRASSE 8 6340 BAAR, ZG CH

CALL IT SPRING

(540)

(550) I

(740) Popović Miladin, Đoka Miraševića 21/III, Podgorica (ME)

(511) **Klasa 03:** Kozmetika; parfimerija; eterična ulja i sapuni; preparati za održavanje obuće i odeće, naime, preparati za poliranje cipela, preparati za čišćenje na bazi aerosoli i bez aerosoli i preparati za zaštitu kože, jelenske kože i tkanine.

Klasa 09: Naočare za sunce.

Klasa 14: Modna oprema, naime, nakit, satovi i privesci za ključeve.

Klasa 18: Torbe za nošenje svih namena, naime, ručne torbe, torbe preko ramena, velike ručne torbe, sportske putne torbe, rančevi, torbe za kompjuter i torbe za nošenje cipela; novčanici; kišobrani.

Klasa 25: Obuća, naime, cipele, čizme, mokasine, cipele za šetnju, patike, atletske cipele, sandale i papuče; oprema za obuću, naime, unutrašnji đonovi za cipele, umeci za cipele, dodaci protiv klizanja za cipele; odeća, naime, kaputi, jakne, prsluci, kupaći kostimi, šalovi, rukavice, rukavice bez prstiju sa palcem, šeširi, kaiševi, kravate, pletene čarape; koža i jelenske kože, naime, kaputi, jakne, kaiševi, rukavice.

Klasa 26: Ukrasi za kosu, trake za kosu, šnale za kosu, držači za pletenice.

Klasa 35: Maloprodajne usluge, online maloprodajne i veleprodajne usluge u oblasti kozmetike, parfimerije; eteričnih ulja, sapuna preparata za održavanje obuće i odeće, naočara za sunce, modne opreme, torbi, obuće, opreme za obuću, odeće, kože i jelenskih koža, ukrasa za kosu.

-
- (111) 09032 (151) 20.11.2013.
 (210) **2011-452** (442) **20.06.2013**
 (220) 15.09.2011
 (732) **E.MISHAN & SONS, INC(NEW YORK CORPORATON)**, 230 FIFTH AVENUE, SUITE 800, NEW YORK, NY 10001 US

DR_xlevine's

- (540)
 (550) I
 (740) Čejović Vladimir, 13. jula 21, Podgorica (ME)
 (511) **Klasa 10:** ortopedske trake za koljena, ortopedski zavoj za članke, ortopedski zavoj za vrat, ortopedski zavoj za ručne zglobove, ortopedski zavoj za ramena, ortopedski pojasi za leđa, ortopedski ulošci za cipele, ortopedski podvezi, podupirači za leđa, članke, vrat i ramena koji se koriste u medicinske potrebe, ortopedski steznici za koljena, ortopedski rastezljivi podupirači za koljena, steznici za leđa koji se koriste za medicinske svrhe, medicinski uređaji i instrumenti, terapijski galvanski uređaji, medicinski uređaji za magnetnu terapiju koji spadaju u klasu 10.

-
- (111) 08875 (151) 21.11.2013.
 (210) **2011-387** (442) **20.06.2013**
 (220) 29.07.2011
 (732) **S.C. COMCEH S.A.**, STRADA BUURESTI, N.358 910048 CALARASI RO

VOLARE

- (540)
 (550) I
 (740) Popović Miladin, Đoka Miraševića 21/III, Podgorica (ME)
 (511) **Klasa 16:** Krep papir i gladak papir; proizvodi od papira i/ili celuloze za kućnu upotrebu, za čišćenje za ličnu upotrebu, higijenu i njegu uključujući maramice, maramice za lice, stolnjake, salvete za stolove, kuhinjske ubruse i toaletni papir, u pakovanjima za domaćinstvo i za upotrebu u industriji i šire.

-
- (111) 08995 (151) 22.11.2013.

(210) **2011-345**(442) **20.06.2013**

(220) 01.07.2011

(732) **COORS BREWING COMPANY**, 1225 17 STREET, SUITE 3200 DENVER, COLORADO, 80202 US

(540)

(550) I

(740) AOD "Ćupić", Dalmatinska 10, Podgorica ME

(511) **Klasa 25:** Odjeća, obuća, pokrivala za glavu.**Klasa 32:** Piva, tamna piva, svijetla piva, crna i laka piva; mineralne i sodne vode i druga bezalkoholna piva; voćna piva i voćni sokovi; sirupi i drugi preparati za proizvodnju piva.**Klasa 33:** Alkoholna piva (izuzev piva).

(111) 09144

(151) 10.12.2013.

(210) **2011-456**(442) **20.06.2013**

(220) 19.09.2011

(732) **FRES & CO. DOO**, IVANA GORANA KOVAČIĆA 3, SUBOTICA 24000 RS

(540)

(550) I

(740) Popović Miladin, Đoka Miraševića 21/III, Podgorica (ME)

(511) **Klasa 32:** Piva; mineralne i sodne vode i druga bezalkoholna piva; piva od voća i voćni sokovi; sirupi i drugi preparati za proizvodnju piva.

(111) 09554

(151) 16.12.2013.

(210) **2011-447**(442) **20.06.2013**

(220) 08.09.2011

(300) 10200699 17.082011. CTM

(732) **MARS, INCORPORATED**, 6885 ELM STREET, MCLEAN, VA 22101-3883 US

(540)

(550) I

(740) Čejović Vladimir, 13. jula 21, Podgorica (ME)

(511) **Klasa 29:** Meso, riba, živina i divljač; mesne prerađevine; konzervisano, sušeno i kuvano voće i povrće; jaja; mlječni proizvodi; želei, džemovi, kompoti; mlijeko i mlječni napitci; proizvodi pripremljeni za konzumiranje i koji se sastoje uglavnom od gore navedenih proizvoda.

Klasa 30: Kafa i zamjena kafe; čaj, kakao, čokolada za piće; šećer, pirinač, tapioka, sago; brašno i proizvodi od žitarica; hljeb, biskviti, kolači, pecivo, čokolada i slatkiši; sladoled; led, led sa dodatkom voćnog soka i šećera u vidu dezerta; med, melasa; so, sent; sirće, sosevi; pesto; dodaci jelima; bilje; začini; proizvodi pripremljeni za konzumiranje i koji se sastoje uglavnom od gore navedenih proizvoda.

(111) 09553

(151) 16.12.2013.

(210) **2011-270**(442) **20.06.2013**

(220) 31.05.2011.

(732) **SHOKO HOLDING LIMITED OF CRAIGMUIR CHAMBERS**, ROAD TOWN, TORTOLA, BRITISH VIRGIN ISLANDS, NL



(540)

(550) I

(740) Čejović Vladimir, 13. jula 21, Podgorica (ME)

(511) **Klasa 43:** Usluge obezbjeđivanja hrane i pića; privremeni smještaj.



INDEKS NOSILACA ŽIGOVA
INDEX OF THE HOLDER OF THE REGISTRATION

(732)	(111)	(210)
ABBOTT PRODUCTS OPERATIONS AG	09030	2011-359
ADRIATIC MARINAS doo	08841	2012-117
ALDO GROUP INTERNATIONAL	08843	2011-362
ALKALOID AD SKOPLJE	08856	2011-423
ALKALOID AD SKOPLJE	08953	2011-421
ALKALOID AD SKOPLJE	08954	2011-427
ALKALOID AD SKOPLJE	08955	2011-428
ALKALOID AD SKOPLJE	08957	2011-424
ALKALOID AD SKOPLJE	08959	2011-417
ALKALOID AD SKOPLJE	08963	2011-426
ALKALOID AD SKOPLJE	08964	2011-422
ALKALOID AD SKOPLJE	08965	2011-420
ALKALOID AD SKOPLJE	08997	2011-307
AMERICAN-CIGARETTE COMPANY (OVERSEAS) LIMITED	08960	2011-435
AMERICAN-CIGARETTEE COMPANY (OVERSEAS) LIMITED	09017	2011-436
BERLIN-CHEMIE AG	09020	2011-364
BERLIN-CHEMIE AG	09021	2011-365
BERLIN-CHEMIE AG	09028	2011-366
BRITISH AMERICAN TOBACCO (BRANDS) INC.	08830	2011-357
CELGENE CORPORATION	08988	2011-430
CHIPITA INDUSTRIAL AND COMMERCIAL COMPANY S.A.	09552	2011-347
CHONGPING YUAN INNOVATION TECHNOLOGY CO	10310	2011-437
COORS BREEWING COMPANY	08995	2011-345
DAIMLER AG	09031	2011-378
DEUTCHE TELEKOM AG	09041	2011-395
DIAMOND INNOVATIONS INC	09026	2011-412
E.MISHAN & SONS, INC(NEW YORK CORPORATON)	09032	2011-452
EDEL WEISS GMBH & CO.KG	08874	2011-393
FIL LIMITED A BERMUDA COMPANY	08876	2011-380
FIL LIMITED ABERMUDA COMPANY	08996	2011-381
FOOD INDUSTRY DOO PODGORICA	09040	2011-350
FRES & CO. DOO	09144	2011-456
GALENKA AD.	10805	2011-91
GENERAL MOTORS LLC	09011	2011-398
GEOGRAFIA-PACIFIC CONSUMER PRODUCTS LP	10308	2011-441
GLAXO GROUOP LIMITED	10785	2011-247
GLAXO GROUP LIMITED	10786	2011-253
GOODYEAR DUNLOP TIRES GERMANY GMBH	10309	2011-440
GREAT WALL MOTOR COMPANY LIMITED	08961	2011-396

(732)	(111)	(210)
IL CAMMINO SH.P.K.	09556	2011-377
INDUSTRIJA PIVA I SOKOVA TREBJESA AD NIKŠIĆ	09143	2011-429
Ironwood Pharmaceuticals, Inc.	10745	2012-221
IRONWOOD PHARMACEUTICALS, INC.	08873	2011-392
JOHNSON CONTROLS HYBRID AND RECYCLING GMBH	08829	2011-355
JT INTERNATIONAL S.A.	08989	2011-432
JT INTERNATIONAL S.A.	10311	2011-445
JT INTERNTIONAL S.A.	09003	2011-431
KARBON GRADJEVINSKI MATERIJALID.O.O.TOPOLA	10830	2010-392
KENTUCKY FRIED CHIKEN INTERNATIONAL HOLDINGS	08872	2011-388
LRC PRODUCTS LIMITED	09039	2011-394
MARS, INCORPORATED	09554	2011-447
MEGGLE AG	08480	2011-491
MEGGLE AG	08581	2011-492
MITSUBISHI JIDOSHA KOGYO KABUSHIKI KAISHA	09009	2011-348
MONSTER ENERGY COMPANY (A DELAWARE)	10828	2011-218
NIMCRO DOO ZAGREB	09551	2011-415
NO FEAR INTERNATIONAL LIMITED	08994	2011-371
NO FEAR INTERNATIONAL LIMITED	09012	2011-372
PARK AG DOO	10465	2009-447
PET INCORPORATED(DELAWARE CORPORATION)	09010	2011-416
PLIVA HRVATSKA D.O.O.	08871	2011-389
PROCTER & GAMBLE HOLDING GMBH	08990	2011-311
RECKITT BENCKISER N.V.	08958	2011-451
REEBOK INTERNATIONAL LIMITED	10676	2011-442
ROTHMANS OF PALL MALL LIMITED	09015	2011-449
S.C. COMCEH S.A.	08875	2011-387
SANDVIK INTELLECTUAL PROPERTY AB	09022	2011-407
SANDVIK INTELLECTUAL PROPERTY AB	09023	2011-406
SANDVIK INTELLECTUAL PROPERTY AB	09025	2011-405
SECO TOOLS AB	09024	2011-410
SECO TOOLS AB	09027	2011-409
SECO TOOLS AB	09029	2011-408
SECO TOOLS AB	09971	2011-411
SHIMANO INC	09035	2011-391
SHOKO HOLDING LIMITED OF CRAIGMUIR CHAMBERS	09553	2011-270
SLAĐANA RAIČKOVIĆ	08967	2011-336
SOCIETE DES PRODUCTS NESTLES.A.	08999	2011-375
SOCIETE DES PRODUITS NESTLE S.A.	08842	2011-399
TAIHO PHARMACEUTICAL CO.LTD	09555	2011-376
TDR ROVINJ	09034	2011-354
THE GILLETE COMPANY	09014	2011-351
THE GILLETTE COMPANY	08821	2011-419

(732)	(111)	(210)
THE GILLETTE COMPANY	08870	2011-344
THE GILLETTE COMPANY	08867	2011-434
THE PROCTER & GAMBLE COMPANY	08822	2011-323
THE PROCTER & GAMBLE COMPANY	08823	2011-322
THE PROCTER & GAMBLE COMPANY	08824	2011-321
THE PROCTER & GAMBLE COMPANY	08825	2011-320
THE PROCTER & GAMBLE COMPANY	08826	2011-319
THE PROCTER & GAMBLE COMPANY	08827	2011-318
THE PROCTER & GAMBLE COMPANY	08828	2011-317
THE PROCTER & GAMBLE COMPANY	08844	2011-306
THE PROCTER & GAMBLE COMPANY	08845	2011-342
THE PROCTER & GAMBLE COMPANY	08846	2011-315
THE PROCTER & GAMBLE COMPANY	08847	2011-308
THE PROCTER & GAMBLE COMPANY	08848	2011-314
THE PROCTER & GAMBLE COMPANY	08849	2011-313
THE PROCTER & GAMBLE COMPANY	08850	2011-312
THE PROCTER & GAMBLE COMPANY	08859	2011-310
THE PROCTER & GAMBLE COMPANY	08860	2011-309
THE PROCTER & GAMBLE COMPANY	08861	2011-305
THE PROCTER & GAMBLE COMPANY	08862	2011-341
THE PROCTER & GAMBLE COMPANY	08863	2011-335
THE PROCTER & GAMBLE COMPANY	08864	2011-325
THE PROCTER & GAMBLE COMPANY	08865	2011-339
THE PROCTER & GAMBLE COMPANY	08866	2011-343
THE PROCTER & GAMBLE COMPANY	08868	2011-304
THE PROCTER & GAMBLE COMPANY	08869	2011-303
THE PROCTER & GAMBLE COMPANY	08966	2011-331
THE PROCTER & GAMBLE COMPANY	08968	2011-332
THE PROCTER & GAMBLE COMPANY	08969	2011-340
THE PROCTER & GAMBLE COMPANY	08970	2011-329
THE PROCTER & GAMBLE COMPANY	08986	2011-337
THE PROCTER & GAMBLE COMPANY	08991	2011-330
THE PROCTER & GAMBLE COMPANY	08992	2011-333
THE PROCTER & GAMBLE COMPANY	08998	2011-334
THE PROCTER & GAMBLE COMPANY	09036	2011-327
TOBACANA LJUBLJANA DOO	08993	2011-367
TOBACNA LJUBLJANA DOO	09016	2011-363
TOTO LTD	08962	2011-450
TOYOTA JIDOSHA KABUSHIKI KAISHA	10313	2011-413
UNIPHARM.INC	09013	2011-360



INDEKS BROJEVA ŽIGOVA
INDEX OF THE TRADEMARK NUMBERS

(210)	(111)	(210)	(111)	(210)	(111)
2009-447	10465	2011-347	09552	2011-417	08959
2010-392	10830	2011-348	09009	2011-419	08821
2011-91	10805	2011-350	09040	2011-420	08965
2011-218	10828	2011-351	09014	2011-421	08953
2011-247	10785	2011-354	09034	2011-422	08964
2011-253	10786	2011-355	08829	2011-423	08856
2011-270	09553	2011-357	08830	2011-424	08957
2011-303	08869	2011-359	09030	2011-426	08963
2011-304	08868	2011-360	09013	2011-427	08954
2011-305	08861	2011-362	08843	2011-428	08955
2011-306	08844	2011-363	09016	2011-429	09143
2011-307	08997	2011-364	09020	2011-430	08988
2011-308	08847	2011-365	09021	2011-431	09003
2011-309	08860	2011-366	09028	2011-432	08989
2011-310	08859	2011-367	08993	2011-434	08867
2011-311	08990	2011-371	08994	2011-435	08960
2011-312	08850	2011-372	09012	2011-436	09017
2011-313	08849	2011-375	08999	2011-437	10310
2011-314	08848	2011-376	09555	2011-440	10309
2011-315	08846	2011-377	09556	2011-441	10308
2011-317	08828	2011-378	09031	2011-442	10676
2011-318	08827	2011-380	08876	2011-445	10311
2011-319	08826	2011-381	08996	2011-447	09554
2011-320	08825	2011-387	08875	2011-449	09015
2011-321	08824	2011-388	08872	2011-450	08962
2011-322	08823	2011-389	08871	2011-451	08958
2011-323	08822	2011-391	09035	2011-452	09032
2011-325	08864	2011-392	08873	2011-456	09144
2011-327	09036	2011-393	08874	2011-491	08480
2011-329	08970	2011-394	09039	2011-492	08581
2011-330	08991	2011-395	09041	2012-117	08841
2011-331	08966	2011-396	08961	2012-221	10745
2011-332	08968	2011-398	09011		
2011-333	08992	2011-399	08842		
2011-334	08998	2011-405	09025		
2011-335	08863	2011-406	09023		
2011-336	08967	2011-407	09022		
2011-337	08986	2011-408	09029		
2011-339	08865	2011-409	09027		
2011-340	08969	2011-410	09024		
2011-341	08862	2011-411	09971		
2011-342	08845	2011-412	09026		
2011-343	08866	2011-413	10313		
2011-344	08870	2011-415	09551		
2011-345	08995	2011-416	09010		



INDEKS PO KLASAMA NIČANSKE KLASIFIKACIJE ROBA I USLUGA
INDEX ACCORDING TO THE NICE CLASSIFICATION OF GOODS AND SERVICES

Klasa 01	08969	09025	09012	08872
09555	08970	09027		08999
10830	08986	09029	Klasa 19	09010
	08990	09971	10830	09040
Klasa 02	08991			09552
10830	08992	Klasa 08	Klasa 20	09554
	08998	08867	08962	
Klasa 03	09014	08870		Klasa 31
08821	09026	09026	Klasa 21	08997
08822	09036		08868	
08823	09039	Klasa 09	08962	Klasa 32
08824	10465	08829	08986	08480
08825		08843	08990	08581
08826	Klasa 04	09022	10308	08872
08827	08868	09041		08994
08828			Klasa 25	08995
08843	Klasa 05	Klasa 10	08843	09012
08844	08845	08845	08994	09143
08845	08861	08866	08995	09144
08846	08866	08996	09012	10828
08847	08868	09032	09039	
08848	08871		09556	Klasa 33
08849	08873	Klasa 11		08995
08850	08959	08861	Klasa 26	09551
08856	08988	08868	08843	
08859	08996	08986		Klasa 34
08861	09013		Klasa 28	08830
08862	09020	Klasa 12	10676	08960
08863	09021	09009		08989
08864	09028	09011	Klasa 29	08993
08865	09030	09031	08480	09003
08866	09555	09035	08581	09015
08868	10745	10309	08872	09016
08869	10785	10310	08874	09017
08953	10786	10313	08997	09034
08954	10805		09010	10311
08955	10828	Klasa 14	09552	
08957		08843	09554	Klasa 35
08958	Klasa 06			08843
08959	08962	Klasa 16	Klasa 30	08967
08963	09023	08843	08480	09034
08964			08581	09143
08965	Klasa 07	Klasa 18	08842	
08966	08829	08843	08845	Klasa 36
08968	09024	08994	08866	08841

08876

08967

Klasa 37

08961

10310

Klasa 38

09041

Klasa 39

08841

Klasa 41

08841

08967

08986

Klasa 42

08967

08986

09041

Klasa 43

08841

08841

08872

09553

Klasa 45

08967

**OBJAVA ISPRAVKI
CORRECTIONS**

U „Crnogorskom glasniku intelektualne svojine“ broj 13. od 20.12.2013. godine objavljeni su pogrešni podaci za žig 2012-79

Pogrešni podaci

(740) Radulović Božidar, Jovana Tomaševića 9/III, Podgorica ME

Ispravni podaci

(740) Popović Miladin, Đoka Miraševića 21/III, Podgorica ME

U „Crnogorskom glasniku intelektualne svojine“ broj 13. od 20.12.2013. godine objavljeni su pogrešni podaci za žig 2012-80

Pogrešni podaci

(740) Radulović Božidar, Jovana Tomaševića 9/III, Podgorica ME

Ispravni podaci

(740) Popović Miladin, Đoka Miraševića 21/III, Podgorica ME



OBAVJEŠTENJE NOTICE

Objava upisa u Registar žigova CG priznatih žigova, registrovanih u Zavodu SCG, odnosno Zavodu Srbije, prije otvaranja Zavoda CG

Članom 65 stav 1 Zakona o žigu ("Sl.list CG", br. 72/10) priznata su prava na žigovima koji su registrovani i upisani u Registar žigova u Zavodu za intelektualnu svojinu Srbije i Crne Gore, odnosno Zavodu za intelektualnu svojinu Srbije do 28. maja 2008. godine (do dana otvaranja Zavoda za intelektualnu svojinu Crne Gore) do isteka njihovog trajanja.

Zavod je implementirao odredbu člana 65 stav 2 Zakona o žigu i izvršio upis u Registar, po službenoj dužnosti žigove za koje je izdao uvjerenja o važenju žiga u formi zabilješke u 2008. godini.

Zavod je implementirao odredbu stava 4 istog člana i donio rješenja o upisu u Registar žigova za koje su podnijeti zahtjevi u 2008. godini za obnovu važnosti žiga, prenos prava i promjenu imena i adrese shodno koja propisuje da se ti zahtjevi smatraju kao zahtjevi za upis u registar.

MEĐUNARODNI KODOVI ZA IDENTIFIKACIJU BIBLIOGRAFSKIH PODATAKA O ŽIGOVIMA PREMA WIPO ST 60 RECOMMENDATION CONCERNING BIBLIOGRAFIC DATA RELATING TO TRADEMARKS- WIPO-ST. 60

CRNOGORSKI	MDK	ENGLISKI
REGISTARSKI BROJ CG	111	NUMBER OF THE REGISTRATION CG
REGISTARSKI BROJ SCG	111	NUMBER OF THE REGISTRATION SCG
BROJ PRIJAVE	210	NUMBER OF THE APPLICATION
IME I ADRESA NOSIOCA ŽIGA	732	NAME AND ADDRESS OF THE HOLDER OF THE REGISTRATION



(111) CG	(210) Ž	(732)	(111) SCG
08601	1979-360	PHILIP MORRIS PRODUCTS S.A. ; Quai Jeanrenaud 3, CH-2000 Neuchatel, CH	26863
08686	2001-1781	CASTROL LIMITED ; Wakefield House, Pipers Way, Swindon, Wiltshire SN3 IRE, Engleska, GB	47427
08687	1994-536	DUVANSKA INDUSTRIJA VRANJE AD ; STEFANA PRVOVENČANOG BR.209, VRANJE, RS	40762
08684	1991-808	THE CONCENTRATE MANUFACTURING COMPANY OF IRELAND (SEVEN-UP INTERNATIONAL) ; 20 REID STREET, WILLIAMS HOUSE, HAMILTON 5-33, BM	37918
08685	1968-765	MONSANTO TECHNOLOGY LLC ; 800 NORTH LINDBERGH BOULEVARD, COUNTY OF ST. LOUIS, MISSOURI, US	19152
08688	2004-1	1. Duvanska industrija "Vranje" A.D. ; Stefana Prvovenčanog 209 Vranje; 2. DIN "Fabrika duvana" A.D. ; 12.februar br. 74, Niš, YU	50255
08930	1964-21	COLGATE-PALMOLIVE COMPANY ; 300 PARK AVENUE, NEW YORK, N.Y., US	16546
08931	1967-330	COLGATE-PALMOLIVE COMPANY ; 300 PARK AVENUE, NEW YORK, NEW YORK 10022, US	17458
08932	1973-6	COLGATE-PALMOLIVE COMPANY ; 300 PARK AVENUE, NEW YORK, NEW YORK 10022-7499, US	22537
08618	1958-207	ELI LILLY AND COMPANY ; LILLY CORPORATE CENTER, INDIANAPOLIS, INDIANA, US	14452
08928	1927-20	COLGATE-PALMOLIVE COMPANY ; 300 PARK AVENUE, NEW YORK, NEW YORK 10022, US	5114
08929	1964-18	COLGATE-PALMOLIVE COMPANY ; 300 PARK AVENUE, NEW YORK, N.Y., US	16545
08927	2007-435	COLGATE-PALMOLIVE COMPANY (a Delaware Corporation) ; 300 Park Avenue, New York, New York 10022, US	54920
08744	1980-794	SANKYO CO., LTD. (JOINT-STOCK COMPANY OF JAPAN) ; 5-1 NIHONBASHI-HONCHO, 3-CHOME, CHUO-KU, TOKYO, JP	31349
08907	2003-1501	AD APATINSKA PIVARA ; Trg oslobođenja 5, 25260 Apatin, YU	49556
08751	1996-857	CASIO KEISANKI KABUSHIKI KAISHA (CASIO COMPUTER CO., LTD.) and Casio Keisanki Kabushiki Kaisha (Casio Computer co., Ltd.) ; 6-1, 2-CHOME, NISHI SHINJUKU, SHINJUKU-KU, TOKYO, JP and 6-2, Hon-machi 1-chome, Shibuya-ku, Tokyo, JP	41786
08936	2003-456	NBA Properties, Inc. ; 645 Fifth Avenue New York, New York 10022,, US	48738
08939	1997-524	AWI LICENSING COMPANY ; 802 West Street, Wilmington, Delaware 19801, US	42655
08938	1997-1067	TEVA PHARMACEUTICAL INDUSTRIES LTD. ; SCIENCE BASED INDUSTRIES CAMPUS, HAR HOTZVIM, P.O.BOX 1142, JERUSALEM 91010, IL	42753
08950	2003-443	NBA Properties, Inc. ; 645 Fifth Avenue New York, New York 10022,, US	48737
08947	2001-1784	NBA Properties, Inc. ; 645 Fifth Avenue, New York, New York 10022, US	47641
08750	2005-1073	Al Ahram Beverages Company S.A.E. and Fayrouz International AG ; 2 Sarwat Street, Giza, Cairo, Egypt, EG and Zone industrielle Le Planchy, 1628 Vuadens, Switzerland , CH	51773
08942	2003-317	Violeta DOO ; Kolo bb,80240 Tomislavgrad,Bosna i Hercegovina	48735
08937	2004-684	NBA Properties, Inc. ; 645 Fifth Avenue, New York, New York 10022, US	50808
08951	2003-794	NBA Properties, Inc. ; 645 Fifth Avenue New York, New York 10022, US	48923
08941	2002-1271	Norton Healthcare Limited ; Regent House,5-7-Broadhurst Gardens,Swiss Cottage,london NW6 3RZ,GB	48525
08948	2003-696	NBA Properties, Inc ; 645 Fifth Avenue, New York, New York 10022, US	49330
08943	1997-1204	COLGATE-PALMOLIVE COMPANY, a Delaware Corporation, ; 300 PARK AVENUE, NEW YORK, NEW YORK, US	42943
08949	2005-916	NBA PROPERTIES, Inc. ; 645 Fifth Avenue, New York, New York 10022, US	51449
08748	1970-913	KUREHA KAGAKU KOGYO KABUSHIKI KAISHA and Kureha Corporation ; TOKYO, JP and 3-3-2, Nihonbashi Hamacho, Chuo-ku, Tokyo, JP	20391
08940	2002-1269	Norton Healthcare Limited ; Regent House,5-7-Broadhurst Gardens,Swiss Cottage,london NW6 3RZ,GB	48523

08944	1997-1205	COLGATE-PALMOLIVE COMPANY, a Delaware Corporation; 300 PARK AVENUE, NEW YORK, NEW YORK, US	42944
08945	1997-1233	COLGATE-PALMOLIVE COMPANY, A DELAWARE CORPORATION; 300 PARK AVENUE, NEW YORK, NEW YORK, US	43024
08747	1998-251	SCANIA CV AKTIEBOLAG (Swedish limited liability company); 151 87 Sodertalje, Švedska, SE	44050
08952	1991-113	COLGATE PALMOLIVE ITALIA S.R.L.; VIALE PALMOLIVE N. 18, LOCALITA PADIGLIONE, ANZIO (RM), IT	37681
08946	1997-510	COLGATE-PALMOLIVE COMPANY; 300 PARK AVENUE, NEW YORK, NY 10022-7499, US	43416
08752	1982-205	APEX BRANDS,INC; 1000 Lufkin Road,Apex,North Carolina 27539,US	30116
08972	1991-1005	THE PROCTER & GAMBLE COMPANY; ONE PROCTER & GAMBLE PLAZA, CINCINNATI, OHIO, US	38002
08984	1985-349	WAGNER INTERNATIONAL AG; INDUSTRIESTRASSE 40, CH 9450 ALTSTATTEN, CH	32995
08759	2004-1659	SESAME WORKSHOP, a New York non-profit corporation; One Lincoln Plaza, New York, NY 10023, US	52047
08760	2004-1660	SESAME WORKSHOP, a New York non-profit corporation; One Lincoln Plaza, New York, NY 10023, US	52048
08756	2005-1221	DIAGER LEADER; Rue Claude Nicolas Ledoux, 39800 Poligny, France, FR	53396
09019	1972-691	BRIDGESTONE LICENSING SERVICES,INC; 535 MARRIOTT DRIVE NASHVILLE,TENNESSEE 37214, US	22895
08758	1970-207	SHELL BRANDS INTERNATIONAL AG; Baarermatte, 6340 Baar Switzerland, CH	19439
09005	1977-1233	LEVI STRAUSS & CO.; 1155 BATTERZ STREET, SAN FRANCISCO, CALIFORNIA 94106, US	26019
08985	1991-1852	ELI LILLY AND COMPANY; LILLY CORPORATE CENTER, INDIANAPOLIS, INDIANA, US	38621
09007	2001-551	K.B. VISIONS, INC.; 1837 Grist Stone Ct., Atlanta, Georgia 30307., US	46821
09002	1976-56	THALES CORPORATE SERVICES LIMITED; 2 DASHWOOD LANG ROAD, THE BOURNE BUSINESS PARK, ADDLESTONE, WEYBRIDGE, SURREY KT 15 2NX, GB	25043
08753	2006-438	InkTec Co., Ltd; 1124. Shingil-dong, Danwon-gu, Ansan-si Kyungki-do, 425-839, KR	53027
09004	1964-329	LINK " BELT CONSTRUCTION EQUIPMENT COMPANY, L.P., LLP; 2651 Palumbo Drive, P.O.Box 13600, Lexington, Kentucky 40509 , US	16519
08755	2003-1483	DVS Shoe Co., Inc. (California corporation); 955 Francisco Street Torrance, California 90502, US	49359
08763	1979-192	DALE CARNEGIE & ASSOCIATES, INC.; 290 MOTOR PARKWAY HAUPPAUGE, NEW YORK 11788, US	26736
09018	1972-690	BRIDGESTONE LICENSING SERVICES,INC; 535 MARRIOTT DRIVE NASHVILLE,TENNESSEE 37214, US	23314
08774	1964-199	NRG SCANDINAVIA A/S; EJBY INDUSTRIVEJ 2, DK-2600 GLOSTRUP, DANSKA, DK	16452
08779	2004-413	Nektar d.o.o.; Novosadski put bb, 21000 Bačka Palanka, RS	53598
08777	2003-815	L'OREAL S.A.; 14 rue Royale F-75008 Paris, FR	48962
08790	2006-860	LG Electronics Inc.; 20, Yoido-dong, Yongdungpo-gu, Seoul, KOREA, KR	52610
08799	1997-292	HERMES INTERNATIONAL, SOCIETE EN COMMANDITE PAR ACTIONS; 24, RUE DU FAUBOURG SAINT HONORE, 75008 PARIS, FR	43218
08798	2004-874	Preduzeće "BONES GROUP" d.o.o.; Kumodraška 260, Beograd, YU	48241
08800	1997-690	HERMES INTERNATIONAL, SOCIETE EN COMMANDITE PAR ACTIONS; 24, RUE DU FAUBOURG SAINT HONORE, 75008 PARIS, FR	43076
08797	2004-971	Preduzeće "BONES GROUP" doo.; Kumodraška 260, Beograd, RS	51510
06591	1983-272	Sandvik Mining and Construction Oy; Pihtisulunkatu 9 (PO BOX 100), SF-33310 Tampere (SF-33311 Tampere), FI	29929
09033	1984-396	ANHEUSER-BUSCH, INCORPORATED; ONE BUSCH PLACE, ST. LOUIS, MISSOURI 63118, US	29916

03428	2001-80	PREPARADOS ALIMENTICIOS, S.A.; JOSEP TARRADELLAS 38 E-08029 BARCELONA, ES	47028
09037	1991-2378	TATUNG COMPANY; NO. 22, SEC.3, CHUNG SHAN N. TAIPEI, TW	38789
08809	2005-795	LG CORP.; of 20, Yoido-dong, Youngdungpo-gu, Seoul, Republic of Korea, KP	51803
09038	1991-1593	HELIOS, TOVARNA BARV, LAKOV IN UMETNIH SMOL, D.O.O.; DOMŽALE, KOLIČEVO 65, SI	36624
08808	2005-794	LG CORP.; of 20, Yoido-dong, Youngdungpo-gu, Seoul, Republic of Korea, KP	51802





DIZAJN

DESIGNS

Službeni glasnik Zavoda za intelektualnu svojinu Crne Gore
Official Gazette of the Montenegrin Intellectual Property Office

14/2014



Zavod za intelektualnu svojinu Crne Gore
ul. Rimski trg br. 46,
81000 Podgorica,
Crna Gora

**MEĐUNARODNI KODOVI ZA IDENTIFIKACIJU BIBLIOGRAFSKIH
PODATAKA O DIZAJNU PREMA WIPO CT.80**
RECOMMENDATION CONCERNING BIBLIOGRAPHIC DATA RELATING TO
INDUSTRIAL DESIGNS WIPO CT.80

CRNOGORSKI	MDK	ENGLESKI
Registarski broj	11	Number of registration
Datum registracije	15	Date of the registration
Očekivani datum isteka registracije	18	Expected expiration date of the registration
Broj prijave	21	Number of the application
Datum podnošenja prijave	22	Date of filing of the application
Podaci o izložbenom pravu prvenstva	23	Exhibition priority data
Broj prijavljenih dizajna	28	Number of industrial designs included in the application
Podaci o pravu prvenstva na osnovu Pariske konvencije	30	Data relating to priority under the Paris Convention
Klasa i podklasa Lokarnske klasifikacije	51	Class and subclass of the Locarno Classification
Naziv dizajna	54	Title of the industrial design
Prikaz	55	Reproduction of the industrial design (e.g., drawing, photograph) and explanations relating to the reproduction
Ime autora dizajna	72	Name of the creator
Ime i adresa nosioca prava	73	Name and address of the owner
Ime i adresa punomoćnika	74	Name and address of the representative

OBJAVE DIZAJNA
PUBLICATION OF DESIGNS

(11) **00112**

(21) D-2011/10

(22) 27.05.2011.

(28) 1

(54) **KEKS**

(72) Slobodan Babić, Landža bb, Danilovgrad ME

(73) CRNAGORACOOP AD-u stečaju, Landža bb, Danilovgrad ME

(74) Jusić Jasna, Crnogorskih serdara bb, Podgorica ME

(55)

(51) **01-01**

(15) 23.12.2013.

(18) 27.05.2016.



1.1

(11) **00113**
(21) D-2010/21
(22) 23.07.2010.
(28) 1

(51) **09-01**
(15) 23.12.2013
(18) 23.07.2015.

(54) **BOCA**

(72) Piotr Kania Pruszkowska Str. 29b/91, 02-119 Warsaw PL

(73) V&S Luksusowa Zielona Gora S.A. Ul. Jednosci 59, 65018 ZIELONA GORA PL

(74) Čejović Vladimir, 13. jula 21, Podgorica ME

(55)

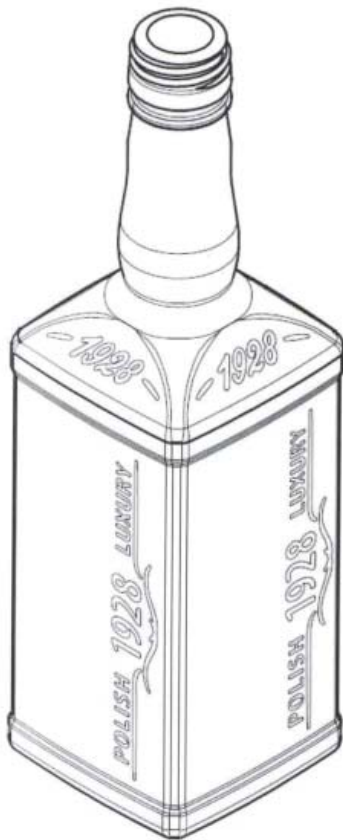

1.1



1.2

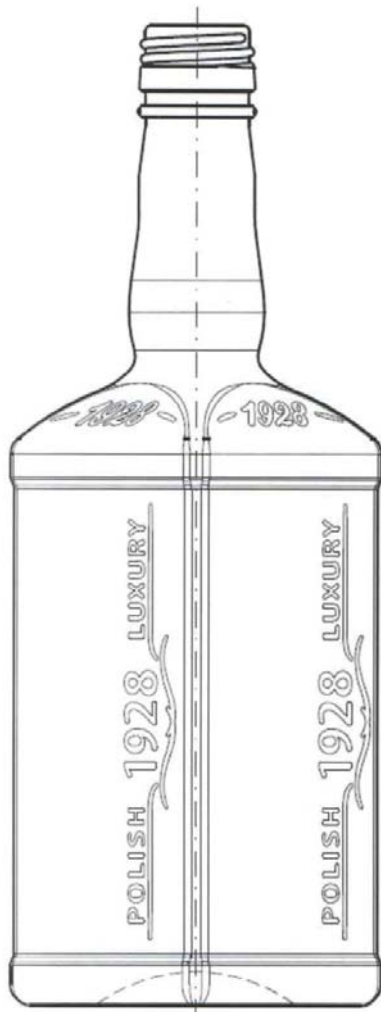

1.3

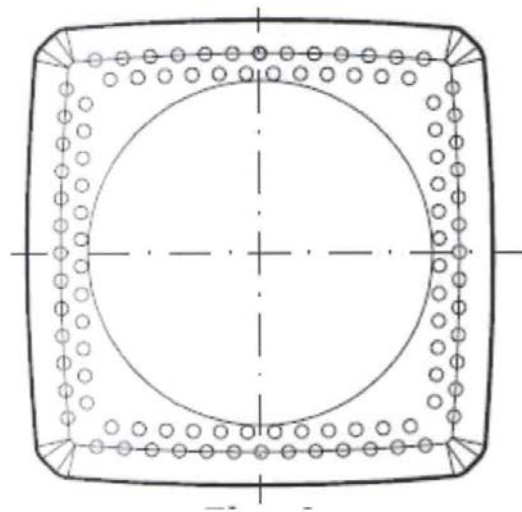

1.4

(11) **00114**

(21) D-2011/20

(22) 15.12.2011

(28) 4

(54) **POSUDA**

(72) Sue Wilson, c/o Mars UK Ltd, Inc., 315 Cool Springs Boulevard, Franklin, Tennessee 37067 US

Adam Watkins, c/o Mars Petcare US, Inc., 315 Cool Springs Boulevard, Franklin, Tennessee 37067 US

Bryan Cole, c/o Mars Petcare US, Inc., 315 Cool Springs Boulevard, Franklin, Tennessee 37067 US

Jonathan Smith, c/o Mars Petcare US, Inc., 315 Cool Springs Boulevard, Franklin, Tennessee 37067 US

Neil Willcocks, c/o Mars Petcare US, Inc., 315 Cool Springs Boulevard, Franklin, Tennessee 37067 US

(73) Mars, Incorporated 6885 Elm Street, McLean, VA 22101-3883 US

(74) Jusić Jasna, Crnogorskih serdara bb, Podgorica ME

(51) **09-01**

(15) 21.03.2014.

(18) 15.12.2016.

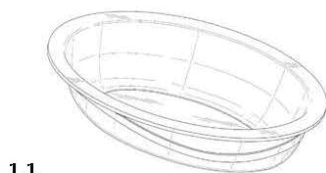

1.1



1.2

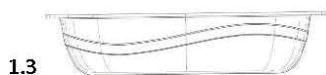

1.3

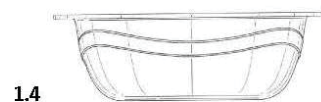

1.4

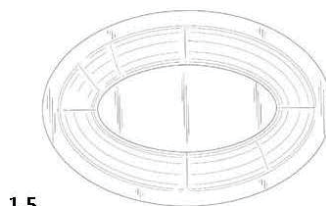

1.5

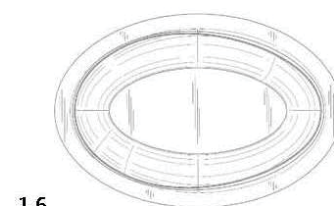

1.6

(55)

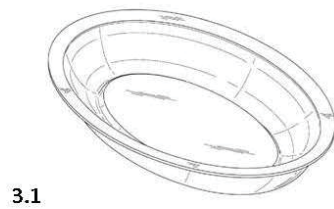
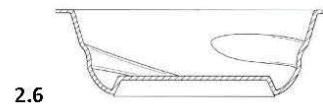
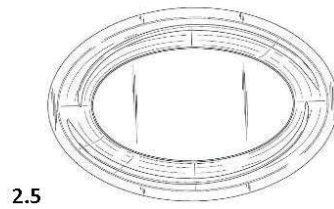
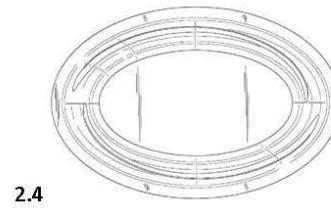
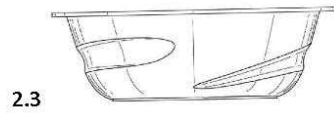
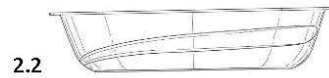
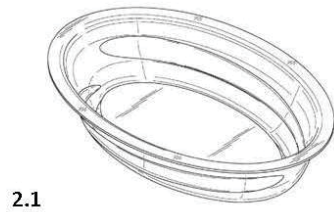

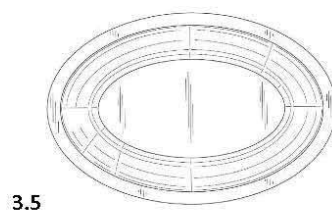
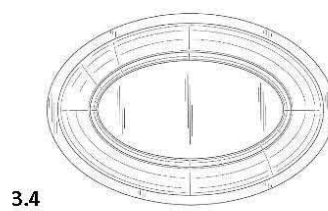
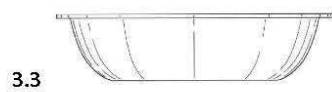

INDEKS NOSILACA DIZAJNA
INDEX OF INDUSTRIAL DESIGNS OWERS

(73)	(51)	(21)	(22)	(11)
CRNAGORACOOP AD	01-01	D-2011/10	27.05.2011.	00112
Mars	09-01	D-2011/20	15.12.2011.	00114
V&S Luksusowa Zielona Gora S.A.	09-01	D-2010/21	23.07.2010.	00113

INDEX BROJEVA DIZAJNA
INDEX OF INDUSTRIAL DESIGNS NUMBERS

(11)	(21)
------	------

00112 D-2011-10

00113 D-2010-21

00114 D-2011/20

INDEKS PO KLASAMA I PODKLASAMA LOKARNSKE KLASIFIKACIJE
INDEX ACCORDING TO CLASSES SUBCLASSEN THE LOCARNO
CLASSIFICATION

(21)	(11)
D-2010/21	00113
D-2011/10	00112
D-2011/20	00114

OBJAVE OBNOVE VAŽENJA INDUSTRIJSKOG DIZAJNA PUBLICATION OF INDUSTRIAL DESIGN RENEWAL

Registarski broj dizajna CG (11)	Ime i adresa nosioca industrijskog dizajna (73)	Datum do kojeg važi obnova industrijskog dizajna (18)	Registarski broj dizajna SCG (11)
00020 PP	SONY COMPUTER ENTERTAINMENT INC., 2-6-21, Minami-Aoyama, Minato-ku, Tokyo 107-0062 JP	24.09.2014.	(10311)
00021 PP	SONY COMPUTER ENTERTAINMENT INC., 2-6-21, Minami-Aoyama, Minato-ku, Tokyo 107-0062 JP	24.09.2014.	(10312)
00022 PP	SONY COMPUTER ENTERTAINMENT INC., 2-6-21, Minami-Aoyama, Minato-ku, Tokyo 107-0062 JP	10.11.2014.	(10313)
00023 PP	SONY COMPUTER ENTERTAINMENT INC., 2-6-21, Minami-Aoyama, Minato-ku, Tokyo 107-0062 JP	10.11.2014.	(10314)
00008 PP	SONY COMPUTER ENTERTAINMENT INC., 2-6-21, Minami-Aoyama, Minato-ku, Tokyo 107-0062 JP	12.11.2018.	(10279)
00007 PP	SONY COMPUTER ENTERTAINMENT INC., 2-6-21, Minami-Aoyama, Minato-ku, Tokyo 107-0062 JP	12.11.2018.	(10278)
00027 PP	SONY COMPUTER ENTERTAINMENT INC., 2-6-21, Minami-Aoyama, Minato-ku, Tokyo 107-0062 JP	11.11.2014.	(10344)
00018 PP	SONY COMPUTER ENTERTAINMENT INC., 1-1, Akasaka 7-chome, Minato-ku, Tokyo JP	08.12.2014.	(9835)
00024	PETER OPSVIK AS, Pilestredet 27 H, N-0164 Oslo NO	08.07.2018.	
00025	Honda Motor Co., Ltd. 1-1, Minami-Aoyama 2-Chome, Minato-ku, Tokyo JP	17.07.2018.	
00026	Mars Incorporated 6885 Elm Street, McLean, VA 22101-3883 US	23.10.2018.	
00014 PP	Rudolf Wild GmbH & Co. KG, Rudolf-Wild-Strasse 4-6, 69214 Eppelheim DE	19.11.2018.	(10265)
00035	Allied Domecq Spirits & Wine Limited Chivas House, 72 Chancellors Road, London W69RS UK	07.08.2018.	
00036	PETER OPSVIK AS, Pilestredet 27 H, N-0164 NO	04.09.2018.	
00004 PP	AVI ALPENLÄNDISCHE VEREDELUNGS-INDUSTRIE GESELLSCHAFT m.b.H., Gustinus-Ambrosi-strasse 1-3, A-8074 Raaba AT	28.07.2018.	(10168)
00032 PP	MERCK SHARP & DOHME CORP. 126 East Lincoln Avenue , Rahway, New Jersey 07065 US	01.06.2018.	(9475)
00019 PP	PEPSICO, INC., 700 Anderson Hill Road, Purchase, NY 10577, US	25.12.2018.	(10266)
00010 PP	STOKKE AS, Hahjem, N-6260 Skodje NO	31.12.2018.	(10260)
00011 PP	STOKKE AS, Hahjem, N-6260 Skodje NO	31.12.2018.	(10261)
00037	Honda Motor Co., Ltd., 1-1, Minami-Aoyama 2-chome, Minato-ku, Tokyo JP	29.01.2019.	
00056	Mars Incorporated 6885 Elm Street, McLean, VA 22101-3883 US	13.02.2019.	
00029 PP	SONY COMPUTER ENTERTAINMENT INC. 2-6-21, Minami-Aoyama, Minato-ku, Tokyo, 107-0062 JP	14.03.2015.	(10323)
00030 PP	SONY COMPUTER ENTERTAINMENT INC. 2-6-21, Minami-Aoyama, Minato-ku, Tokyo, 107-0062 JP	14.03.2015.	(10322)
00031 PP	SONY COMPUTER ENTERTAINMENT INC. 2-6-21, Minami-Aoyama, Minato-ku, Tokyo, 107-0062 JP	14.03.2015.	(10321)
00032 PP	MERCK SHARP & DOHME CORP. 126 East Lincoln Avenue, Rahway, New Jersey 07065 US	01.06.2018.	(9475)
00001	OHARA Nariko, 538-18, Ayameikeminami 7-chome, Nara-shi, Nara 631-0033, (JP) i TAKAMATSU Kuniaki, 34-22, Oaza, Shinchaya, Meiwa-cho, Taki-gun, Mie 515-0314 JP	01.07.2018.	

00002 OHARA Nariko, 538-18, Ayameikeminami 7-chome, Nara-shi, Nara 631- 19.08.2018.
0033, (JP) i TAKAMATSU Kuniaki, 34-22, Oaza, Shinchaya, Meiwa-cho,
Taki-gun, Mie 515-0314 JP

OBJAVE UPISA PROMJENA DIZAJNA
PUBLICATION OF RECORD OF CHANGES

Registarski broj dizajna (11)	Ime i adresa ranijeg nosioca prava (73)	Ime i adresa novog nosioca prava (73)
00004 PP (10168)	AVI ALPENLÄNDISCHE VEREDELUNGS-INDUSTRIE GESELLSCHAFT m.b.H., Gustinus-Ambrosi-strasse 1-3, A-8074 Raaba AT	BSTG, Drahtwaren Produktions-und Handels-GmbH FN 79259h Köglstrasse 11, 4017 Linz AT
00033 PP (10257)	AVI ALPENLÄNDISCHE VEREDELUNGS-INDUSTRIE GESELLSCHAFT m.b.H., Gustinus-Ambrosi-strasse 1-3, A-8074 Raaba AT	BSTG, Drahtwaren Produktions-und Handels-GmbH FN 79259h Köglstrasse 11, 4017 Linz AT
00032 PP (9475)	SCHERING CORPORATION 2000 Galloping Hill Road, Kenilworth, New Jersey 07033 US	MERCK SHARP & DOHME CORP. 126 East Lincoln Avenue, Rahway, New Jersey 07065, US



INFORMATOR

INFORMATION

Službeni glasnik Zavoda za intelektualnu svojinu Crne Gore
Official Gazette of the Montenegrin Intellectual Property Office

14/2014



Zavod za intelektualnu svojinu Crne Gore
ul. Rimski trg br. 46,
81000 Podgorica,
Crna Gora

INTELEKTUALNA SVOJINA

AUTORSKO PRAVO I SRODNA PRAVA

INDUSTRIJSKA SVOJINA

- * Patenti
- * Žigovi
- * Industrijski dizajn
- * Oznake geografskog porijekla roba i usluga
- * Topografija integriranih kola

AUTORSKO PRAVO

(Koje se odnosi na duhovne tvorevine)

- Kao što su naročito:
- * Književna djela
(pisana, govorna, kompjuterski programi)
 - * Muzička djela
 - * Dramska i dramsko-muzička djela
 - * Koreografska i pantomimska djela
 - * Djela likovnih umjetnosti iz područja slikarstva, vajarstva i arhitekture
 - * Djela primjenjenih umjetnosti
 - * Fotografiska djela
 - * Kinematografska djela
 - * Prevodi, obrade i druge prerade djela
 - * Zbirke autorskih djela, podataka ili druge građe

SRODNA PRAVA

- Koja se odnose:
- * Izvođenja umjetnika izvođača
 - * Fonograme
 - * Emitovanja radija I televizije

CIP - Каталогizacija u publikaciji
Централна народна библиотека Црне Горе, Цетиње

347.77/78(497.16)

CRNOGORSKI glasnik intelektualne svojine : Službeni glasnik
Zavoda za Intelektualnu svojinu Crne Gore = Journal of intel-
lectual properti in Montenegro = Official Gazete of the Intellec-
tual Property Office of Montenegro / glavni i odgovorni urednik
Novak Adžić - 2014, br.14 - 820. - Podgorica (Bulevar Revolucije
9) : Zavod za intelektualnu svojinu Crne Gore, 2010. - 30 cm

Tromjesečno.

ISSN 1800-8003 = Crnogorski glasnik intelektualne svojine
(Podgorica)

COBISS.CG-ID 15168784

