

ISSN 1800-8003

**CRNOGORSKI  
GLASNIK  
INTELEKTUALNE  
SVOJINE**

INTELLECTUAL PROPERTY GAZETTE OF MONTENEGRO

**29/2019**

MINISTARSTVO EKONOMIJE  
Rimski trg broj 46  
Podgorica, Crna Gora

# **CRNOGORSKI GLASNIK INTELEKTUALNE SVOJINE**

**Godina IX**

**Datum objavljivanja 20.01.2019.**

*Izdavač:*

MINISTARSTVO EKONOMIJE  
Rimski trg br. 46,  
Podgorica, Crna Gora

*Za izdavača:*

**Dragica Sekulić**

*Glavni i odgovorni urednik:*

**Valentina Radulović Šćepanović**

*Urednički odbor:*

Vesna Nikčević  
Anica Zindović  
Lidija Martić

Crnogorski glasnik intelektualne svojine službeno je glasilo. U Glasniku se objavljuju sve relevantnim zakonima i pravilnicima propisane informacije iz postupka dodjele prava industrijskog vlasništva, informacije o dodijeljenim pravima te o kasnijim promjenama u vezi s tim pravima, kao i ostale službene informacije.

The Montenegrijan intellectual property gazette is the official gazette. The Gazette publishes all the information, prescribed by the relevant laws and regulations, relating to the industrial property granting procedure concerning granted rights and subsequent changes made in connection with such right, as well as other official information.

## SADRŽAJ

DVOSLOVNE OZNAKE ZEMALJA, TERITORIJA I MEĐUNARODNIH ORGANIZACIJA / TWO LETTER CODE COUNTRIES, TERRITORIES AND INTERNATIONAL ORGANIZATIONS

**PATENTI / PATENTS** .....

MEĐUNARODNI KODOVI ZA IDENTIFIKACIJU BIBLIOGRAFSKIH PODATAKA O PATENTIMA PREMA WIPO STANDARDU ST. 9 / RECOMMENDATION CONCERNING BIBLIOGRAFIC DATA ON AND RELATING TO PATENTS- WIPO-ST. 9

**OBJAVE PRIJAVA PATENATA** / PUBLICATION OF PATENT APPLICATIONS

**OBJAVA PROŠIRENIH EUROPSKIH PATENATA** / PUBLICATION OF EXTENDED EUROPEAN PATENTS

**OBJAVE ZAHTJEVA ZA PROŠIRENJE EVROPSKIH PRIJAVA PATENATA** / PUBLICATION OF REQUEST FOR THE EXTENSION OF THE EFFECTS OF EUROPEAN PATENT APPLICATIONS

**INDEKS BROJEVA ZAHTJEVA ZA PROŠIRENJE EVROPSKIH PRIJAVA PATENTA** / INDEX ON NUMBER OF REQUESTS FOR EXTENSION ON EUROPEAN PATENT APPLICATION.

**INDEKS KLASIFIKACIJSKIH OZNAKA BROJEVA ZAHTJEVA ZA PROŠIRENJE EVROPSKIH PRIJAVA PATENTA PREMA MKP** / INDEX ON CLASSIFICATION MARKS ON REQUESTS FOR EXTENSION OF EUROPEAN PATENT APPLICATION IN ACCORDANCE WITH THE INTERNATIONAL PATENT CLASSIFICATION

**INDEKS PODNOSITELJA ZAHTJEVA ZA PROŠIRENJE EVROPSKIH PRIJAVA PATENTA** / INDEX ON NUMBER OF APPLICATIONS FOR EXTENSION OF EUROPEAN PATENT APPLICATION

**OBJAVA UPISA PROMJENA** / PUBLICATION OF RECORD OF CHANGES

**OBJAVA ISPRAVKI** / CORRECTIONS

**ŽIGOVI / TRADEMARKS** .....

MEĐUNARODNI KODOVI ZA IDENTIFIKACIJU BIBLIOGRAFSKIH PODATAKA O ŽIGOVIMA PREMA WIPO ST 60/ RECOMMENDATION CONCERNING BIBLIOGRAFIC DATA RELATING TO TRADEMARKS- WIPO-ST. 60

**OBJAVA PRIJAVA ŽIGOVA** / PUBLICATION OF TRADEMARK APPLICATIONS

**OBJAVA ŽIGOVA** / PUBLICATION OF TRADEMARKS

**OBJAVA UPISA PROMJENA U REGISTAR ŽIGOVA** / PUBLICATION OF RECORD OF CHANGES TO THE TRADEMARK REGISTER

**OBJAVA ISPRAVKI** / CORRECTIONS



## DVOSLOVNE OZNAKE ZEMALJA, TERITORIJA I MEĐUNARODNIH ORGANIZACIJA (prema WIPO standardu ST. 3)

<b>AD</b> Andora	<b>CG</b> Kongo	Zaliva (GCC)
<b>AE</b> Ujedinjeni Arapski Emirati	<b>CH</b> Švajcarska	<b>GD</b> Grenada
<b>AF</b> Afganistan	<b>CI</b> Obala Bjelokosti	<b>GE</b> Gruzija
<b>AG</b> Antigva i Barbuda	<b>CK</b> Kukova ostrva	<b>GG</b> Guernsey
<b>AI</b> Angvila	<b>CL</b> Čile	<b>GH</b> Gana
<b>AL</b> Albanija	<b>CM</b> Kamerun	<b>GI</b> Gibraltar
<b>AM</b> Armenija	<b>CN</b> Kina	<b>GL</b> Grenland
<b>AN</b> Holandski Antili	<b>CO</b> Kolumbija	<b>GM</b> Gambija
<b>AO</b> Angola	<b>CR</b> Kostarika	<b>GN</b> Gvineja
<b>AP</b> Afrička regionalna organizacija za industrijsko vlasništvo (ARIPO)	<b>CU</b> Kuba	<b>GQ</b> Ekvatorska Gvineja
<b>AR</b> Argentina	<b>CV</b> Kabo Verde	<b>GR</b> Grčka
<b>AT</b> Austrija	<b>CY</b> Kipar	<b>GS</b> Južna Džordžija i Ostrva Južni Sendvič
<b>AU</b> Australija	<b>CZ</b> Češka Republika	<b>GT</b> Gvatemala
<b>AW</b> Aruba	<b>DE</b> Njemačka	<b>GW</b> Gvineja-Bisao
<b>AZ</b> Azerbejdžan	<b>DJ</b> Džibuti	<b>GY</b> Gvajana
<b>BA</b> Bosna i Hercegovina	<b>DK</b> Danska	<b>HK</b> Hongkong – Posebna administrativna regija
<b>BB</b> Barbados	<b>DM</b> Dominika	NR Kine
<b>BD</b> Bangladeš	<b>DO</b> Dominikanska Republika	<b>HN</b> Honduras
<b>BE</b> Belgija	<b>DZ</b> Alžir	<b>HR</b> Hrvatska
<b>BF</b> Burkina Faso	<b>EA</b> Evroazijska patentna organizacija (EAPO)	<b>HT</b> Haiti
<b>BG</b> Bugarska	<b>EC</b> Ekvador	<b>HU</b> Mađarska
<b>BH</b> Bahrein	<b>EE</b> Estonija	<b>IB</b> Međunarodna kancelarija Svjetske organizacije za intelektualno vlasništvo (WIPO)
<b>BI</b> Burundi	<b>EG</b> Egipat	<b>ID</b> Indonezija
<b>BJ</b> Benin	<b>EH</b> Zapadna Sahara	<b>IE</b> Irska
<b>BM</b> Bermudi	<b>EM</b> Kancelarija za harmonizaciju Unutrašnjeg tržišta (žigovi i dizajn) (OHIM)	<b>IL</b> Izrael
<b>BN</b> Brunej Darussalam	<b>EP</b> Evropska patentna kancelarija (EPO)	<b>IM</b> Ostrvo Man
<b>BO</b> Bolivija	<b>ER</b> Eritreja	<b>IN</b> Indija
<b>BR</b> Brazil	<b>ES</b> Španija	<b>IQ</b> Irak
<b>BS</b> Bahami	<b>ET</b> Etiopija	<b>IR</b> Iran (Islamska Republika)
<b>BT</b> Butan	<b>FI</b> Finska	<b>IS</b> Island
<b>BV</b> Ostrvo Buve	<b>FJ</b> Fidži	<b>IT</b> Italija
<b>BW</b> Bocvana	<b>FK</b> Foklandska ostrva (Malvini)	<b>JE</b> Džersi
<b>BX</b> Kancelarija za intelektualno vlasništvo Beneluksa (BOIP)	<b>FO</b> Farska Ostrva	<b>JM</b> Jamajka
<b>BY</b> Bjelorusija	<b>FR</b> Francuska	<b>JO</b> Jordan
<b>BZ</b> Belize	<b>GA</b> Gabon	<b>JP</b> Japan
<b>CA</b> Kanada	<b>GB</b> Velika Britanija	<b>KE</b> Kenija
<b>CD</b> Demokratska Republika Kongo	<b>GC</b> Patentna kancelarija Savjeta za saradnju država Arapskog	<b>KG</b> Kirgistan
<b>CF</b> Centralna Afrička Republika		<b>KH</b> Kambodža
		<b>KI</b> Kiribati
		<b>KM</b> Komori

**KN** Sveti Kristofor i Nevis  
**KP** Demokratska Narodna  
Republika Koreja  
**KR** Republika Koreja  
**KW** Kuvajt  
**KY** Kajmanska Ostrva  
**KZ** Kazahstan  
**LA** Narodna Demokratska  
Republika Laos  
**LB** Libanon  
**LC** Sveta Lucija  
**LI** Lihtenštajn  
**LK** Šri Lanka  
**LR** Liberija  
**LS** Lesoto  
**LT** Litva  
**LU** Luksemburg  
**LV** Latvija  
**LY** Libijska Arapska  
Džamahirija  
**MA** Maroko  
**MC** Monako  
**MD** Republika Moldavija  
**ME** Crna Gora  
**MG** Madagaskar  
**MK** Bivša Jugoslovenska  
Republika Makedonija  
**ML** Mali  
**MM** Mianmar  
**MN** Mongolija  
**MO** Makao  
**MP** Sjeverna Marijanska  
Ostrva  
**MR** Mauritanija  
**MS** Montserrat  
**MT** Malta  
**MU** Mauricijus  
**MV** Maldivi  
**MW** Malavi  
**MX** Meksiko  
**MY** Malezija  
**MZ** Mozambik  
**NA** Namibija  
**NE** Niger  
**NG** Nigerija  
**NI** Nikaragva  
**NL** Holandija  
**NO** Norveška  
**NP** Nepal  
**NR** Nauru  
**NZ** Novi Zeland  
**OA** Afrička organizacija  
za intelektualno

vlasništvo (OAPI)  
**OM** Oman  
**PA** Panama  
**PE** Peru  
**PG** Papuanska Nova  
Gvineja  
**PH** Filipini  
**PK** Pakistan  
**PL** Poljska  
**PT** Portugal  
**PW** Palau  
**PY** Paragvaj  
**QA** Katar  
**QZ** Kancelarija Zajednice  
za biljne sorte  
(Evropska Unija)  
(CPVO)  
**RO** Rumunija  
**RS** Srbija  
**RU** Ruska Federacija  
**RW** Ruanda  
**SA** Saudijska Arabija  
**SB** Solomonska Ostrva  
**SC** Sejšeli  
**SD** Sudan  
**SE** Švedska  
**SG** Singapur  
**SH** Sveta Jelena  
**SI** Slovenija  
**SK** Slovačka  
**SL** Sijera Leone  
**SM** San Marino  
**SN** Senegal  
**SO** Somalija  
**SR** Surinam  
**ST** Sveti Toma i Princip  
**SV** Salvador  
**SY** Sirijska Arapska  
Republika  
**SZ** Svazi  
**TC** Turska i Kajkoska  
Ostrva  
**TD** Čad  
**TG** Togo  
**TH** Tajland  
**TJ** Tadžikistan  
**TL** Istočni Timor  
**TM** Turkmenistan  
**TN** Tunis  
**TO** Tonga  
**TR** Turska  
**TT** Trinidad i Tobago  
**TV** Tuvalu

**TW** Tajvan, Kineska  
Pokrajina  
**TZ** Ujedinjena Republika  
Tanzanija  
**UA** Ukrajina  
**UG** Uganda  
**US** Sjedinjene Američke  
Države  
**UY** Urugvaj  
**UZ** Uzbekistan  
**VA** Sveta Stolica (Vatikan)  
**VC** Sveti Vincent i  
Grenadini  
**VE** Venecuela  
**VG** Britanska Djevičanska  
Ostrva  
**VN** Vijetnam  
**VU** Vanuatu  
**WO** Svjetska organizacije  
za intelektualno  
vlasništvo (WIPO)  
(Međunarodna  
kancelarija)  
**WS** Samoa  
**XN** Nordijski institut za  
patente (NPI)  
**YE** Jemen  
**ZA** Južnoafrička  
Republika  
**ZM** Zambija  
**ZW** Zimbabve

**PATENTI**  
**PATENTS**

MEĐUNARODNI KODOVI ZA IDENTIFIKACIJU BIBLIOGRAFSKIH PODATAKA O PATENTIMA PREMA  
WIPO STANDARDU ST. 9 / RECOMMENDATION CONCERNING BIBLIOGRAFIC DATA ON  
AND RELATING TO PATENTS- WIPO-ST. 9

<b>CRNOGORSKI</b>	<b>MDK</b>	<b>ENGLESKI</b>
IDENTIFIKATOR DOKUMENTA	<b>10</b>	IDENTIFICATION OF THE PATENT
BROJ DOKUMENTA	<b>11</b>	NUMBER OF THE PATENT
VRSTA DOKUMENTA	<b>13</b>	KIND-OF-DOCUMENT CODE ACCORDING TO WIPO STANDARD
BROJ PRIJAVE	<b>21</b>	NUMBER(S) ASSIGNED TO THE APPLICATION(S)
DATUM PODNOŠENJA PRIJAVE	<b>22</b>	DATE(S) OF FILING THE APPLICATION(S)
DATUM IZLAGANJA NA MEĐUNARODNOJ IZLOŽBI	<b>23</b>	DATE OF EXHIBITING AT THE INTERNATIONAL EXHIBITION
PODACI O PRAVU PRVJENSTVA	<b>30</b>	PRIORITY DATA
DATUM OBJAVLJIVANJA PRIJAVE	<b>43</b>	PUBLICATION DATE OF THE UNEXAMINED APPLICATION
DATUM OBJAVLJIVANJA PATENTA	<b>45</b>	PUBLICATION DATE OF REGISTERED PATENT
MEĐUNARODNA KLASIFIKACIJA PATENATA	<b>51</b>	INTERNATIONAL PATENT CLASSIFICATION CODE
NAZIV PRONALASKA	<b>54</b>	TITLE OF THE INVENTION
APSTRAKT ILI PATENTNI ZAHTJEV	<b>57</b>	ABSTRACT OR CLAIM
BROJ OSNOVNE PRIJAVE (ILI PATENTA) ZA KOJI SE PODNOSI DOPUNSKA PRIJAVA	<b>61</b>	NUMBER OF THE EARLIER APPLICATION (OR PATENT) TO WHICH THE PRESENT DOCUMENT IS AN ADDITION
BROJ PRVOBITNE PRIJAVE IZ KOJE JE PRIJAVA IZDVOJENA	<b>62</b>	NUMBER OF THE EARLIER APPLICATION FROM WHICH THE PRESENT DOCUMENT HAS BEEN DIVIDED UP
IME PODNOSIOCA PRIJAVE	<b>71</b>	NAME OF THE APPLICANT
IME PRONALAZAČA	<b>72</b>	NAME OF THE INVENTOR
IME NOSIOCA PATENTA	<b>73</b>	NAME OF THE OWNER OF PATENT
IME PUNOMOĆNIKA	<b>74</b>	NAME OF THE REPRESENTATIVE
BROJ I DATUM PODNOŠENJA MEĐUNARODNE PRIJAVE	<b>86</b>	NUMBER AND FILING DATE OF THE INTERNATIONAL APPLICATION
BROJ I DATUM MEĐUNARODNE OBJAVE	<b>87</b>	NUMBER AND DATE OF THE PUBLICATION OF THE INTERNATIONAL APPLICATION

**OBJAVE PRIJAVA PATENATA**  
**PUBLICATION OF PATENT APPLICATIONS**

(11) **03099** (13) **B**

(51) **B64C7/00**<sup>(2006.01)</sup>

(21) P-2017-37

(22) 08.02.2017

(54) me **UZDUŽNO KRILLO ZA AVIONE**  
en **LONGITUDINALLY WING FOR AIRPLANES**

(73) ILINČIĆ, Zoran M.

Milivoja Bulatovića 15, Kolašin, 81210 / ME

(72) ILINČIĆ, Zoran M.

Milivoja Bulatovića 15, Kolašin, 81210 / ME

(57) Uzdužno krilo za avione

Ako se iza Mlaznog motora (3) aviona postavi Uzdužna krilo za avione (1), može se iskoristiti veliki dio kinetičke energije gasova koji izlaze iz Mlaznog motora (3). Konstrukcione karakteristike Uzdužnog krila za avione (1) su takve da su stvoreni uslovi da na Donjoj površini uzdužnog krila za avione (8) bude veći pritisak nego na Gornjoj površini uzdužnog krila za avione (7), što rezultira pojavom sile uzgona. To se postiže tako što se napravi Uzdužna krilo za avione (1) slično polovini uzdužna po osi prerezane konusne cijevi, omotača valjka ili sl. Uzdužna krilo za avione (1) treba da se na pogodan način pričvrsti za krilo ili trup aviona i to iza mlaznog motora. Da bi se poboljšala fiksasnost Uzdužnog krila za avione (1) korisno je na njega postaviti jedno ili više Dodatnih krila (6).

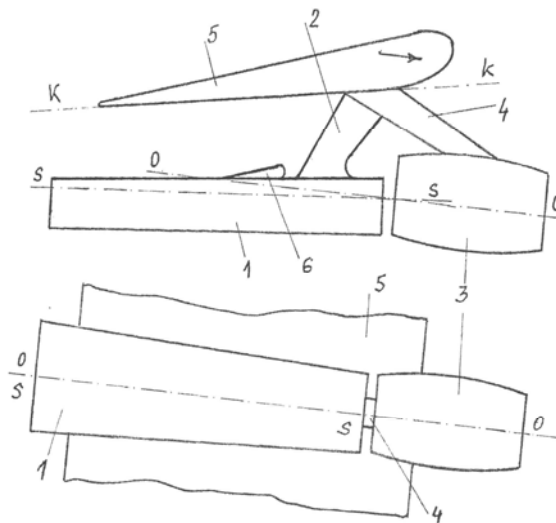

Slika 1.



(11) **03064** (13) **B**

(51) **H03K 9/10**<sup>(2006.01)</sup>

**H03K 17/78**<sup>(2006.01)</sup>

(21) P-2017-58

(22) 08.03.2017

(54) me **DETEKTOR RADIOFREKVENTNOG ELEKTROSMOGA I AKTIVNOSTI MOBILNIH TELEFONA ZA STALNI MONITORING SA SVJETLOSNO SIGNALIZACIJOM**  
en **DETECTOR RADIOFREQUENCY electro-SMOG AND ACTIVITIES OF MOBILE PHONES FOR PERMANENT MONITORING WITH SIGNAL LIGHT**

(73) DERVIĆ, Kemal

Lovčenska 10, Pljevlja, 84210/ ME

(72) DERVIĆ, Kemal

Lovčenska 10, Pljevlja, 84210/ ME

(57) Detektor radiofrekventnog elektrosмога i aktivnosti mobilnih telefona spada u oblast primjenjene elektronike, odnosno oblast detektora radiofrekventnog zračenja, pri čemu se predmet pronalaska konkretno odnosi na poboljšanu verziju dosadašnjih detektora ove vrste a u smislu znatno proširenog frekventnog spektra od 10 MHz do 5,7GHz sa mogućnošću detektovanja svih vrsta modulacija CDMA, WCDMA, TDMA kao i posebnih sisteme prenosa OFDM koji se koriste u savremenim komunikacijama. Detektor, koji je predmet ovog pronalaska odlikuje se i originalnim dizajnom jer je cijeli sistem smješten u providnu kuglurasvjetnog tijela- lustera, tako da je optimalno transparentan i prilagođen za stalni monitoring radiofrekventnog zračenja i aktivnosti mobilnih telefona na određenom prostoru. Blok šema ovog detektora prikazana je na slici 1. asastoji se od širokopojasne antene, ulaznog radiobloka koji je opremljen sa specijalnim logaritamskim detektorom na čijem se izlazu dobija DC napon koji je proporcionalan jačini radiofrekventnog polja. Ovaj napon poslije pojačanja i obrade polarizacije se dovodi na stepen za svjetlosnu signalizaciju koji pobuđuje pojačavačesa 9 grupa LED dioda koje su smještene u 9 prstenova a čija je svjetlost i boja proporcionalna jačini i detektovanog radiofrekventnog elektrosмога ili mobilnog telefona u rad

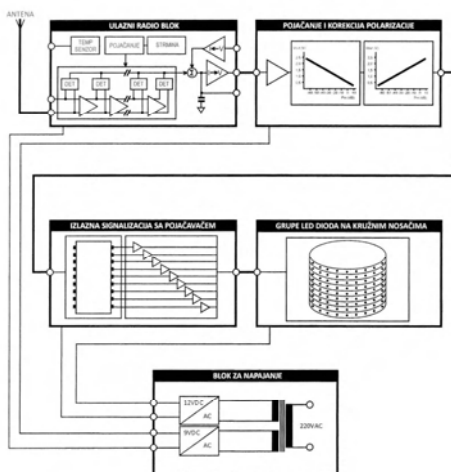

Slika 1.

(11) **03013** (13) **B**

(51) **B01D21/30**<sup>(2006.01)</sup>

**C02F1/00**<sup>(2006.01)</sup>

**C02F1/76**<sup>(2006.01)</sup>

**B01D61/04**<sup>(2006.01)</sup>

**C02F1/52**<sup>(2006.01)</sup>

**C02F9/02**<sup>(2006.01)</sup>

(21) P-2017-78

(22) 24.03.2017

(54) me **SISTEM ZA PRERADU VODE KOJA SE KORISTI U INDUSTRIJSKE SVRHE**  
en **SYSTEM FOR TREATING WATER USED FOR INDUSTRIAL PURPOSES**

(73) CRYSTAL LAGOONS(CURAÇAO ) B.V.

Kaya W.F.G. (Jombi), Mensing 14, Kurasao/ CW

(72) FISCHMANN, T. Fernando

Av. Kennedy 9070, 12th. Floor,, Vitacura, Santiago/ CL

(74) Advokat POPOVIĆ, Miladin

Đoka Miraševića 21/III , Podgorica, 81000 / ME

(57) Aparatura konstruisana prema principima predmetnog pronalaska prečišćava vodu i uklanja suspendovane čvrste supstance, metale, alge, bakterije i druge sastojke iz vode uz veoma male troškove, i bez potrebe za filtriranjem ukupne zapremine vode. Samo mala frakcija ukupne zapremine vode se filtrira, i do 200 puta manja od količine koja se filtrira kod klasičnih sistema za preradu vode filtracijom. Prerađena voda se koristi kao sirovina u industrijske svrhe.

(11) **03087** (13) **B**

(51) **A45C 15/00**<sup>(2006.01)</sup>

(21) P-2017-80

(22) 27.03.2017

(54) me **KUTIJA ZA ČUVANJE SITNIH STVARI SA SIGURONOSNOM NARUKVICOM**  
en **SAFETY BOX WITH SECURITY BRACELET**

(73) JOVANOVIĆ, Nikola

Serdara Jola Piletića br. 6, Podgorica, 81000/ ME

(72) JOVANOVIĆ, Nikola

Serdara Jola Piletića br. 6, Podgorica, 81000/ ME

(57) Kutija za čuvanje ličnih stvari na javnim mjestima spada u oblast proizvoda namijenjenih za bezbjednost i sigurnost korisnika i stvari. Konkretno mehanizam 3 koji sadrži narukvica 1, napravljena od gume i silikona, ovog pronalaska omogućava sigurnost i bezbjednost ključa 2 što i jeste poenta pronalaska. Ključ 2 se nalazi u kućistu 4 koje je sačinjeno od silikona, i pomoću mehanizma 3 je sposoban rotirati se pod uglom od 360 stepeni što mu ujedno daje na sigurnosti ali i fleksibilnosti. Kutija sl.4 i sl. 5 napravljena od pvc plastike u sebi sadrži par pregrada i omogućava svom svojom površinom prostor za odlaganje ličnih predmeta manjeg gabarita. Na desnoj bočnoj strani kutije sl. 4 i sl. 5 se nalazi brava 10 koja zauzima mali prostor u površini kutije a služi njenoj sigurnosti.

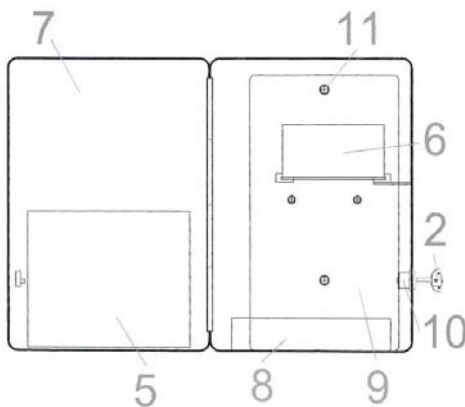

Slika 4

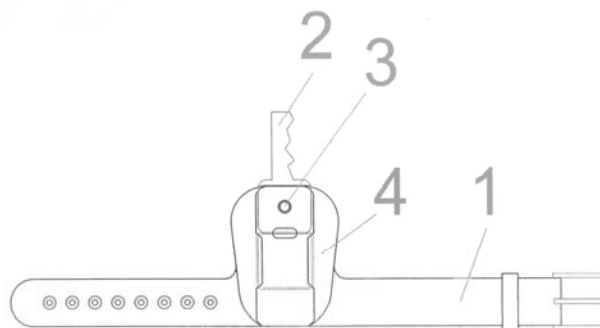

Slika 1

(11) **03097** (13) **B**

(51) **H02M 5/12**<sup>(2006.01)</sup>

**H02M 5/14**<sup>(2006.01)</sup>

**H02M 5/16**<sup>(2006.01)</sup>

(21) P-2018-203

(22) 08.08.2018

(54) me **DOBIJANJE STRUJE IZ ZEMLJE POMOĆU TRANSFORMATORA**  
en **GETTING ELECTRICITY FROM THE GROUND USING A TRANSFORMER**

(73) BOJOVIĆ, Milan

Njegoševa 4 , Žabljak, 84220 / ME

SAVOVIĆ, Zoran

Đura Petrovića 25 , Lovćenac , 24322 / RS

ČABARKAPA, Obrad

Vojvode Stepe 135/H, Beograd , 11000 / RS

ĐURAŠEVIĆ, Željko

Vukice Mitrović bb, Sveti Stefan, 85315/ ME

Mr. PETROV, Vojislav

Bate Brkića 10A, Novi Sad, 21000/ RS

(72) BOJOVIĆ, Milan

Njegoševa 4 , Žabljak, 84220 / ME

SAVOVIĆ, Zoran

Đura Petrovića 25, Lovćenac , 24322/ RS

ČABARKAPA, Obrad

Vojvode Stepe 135/H, Beograd , 11000 / RS

ĐURAŠEVIĆ, Željko

Vukice Mitrović bb, Sveti Stefan, 85315/ ME

Mr. PETROV, Vojislav

Bate Brkića 10A, Novi Sad, 21000/ RS

(57) Novo konstruktivno rješenje uređaja koji transformiše energiju dobijenu iz zemlje, posredstvom magnetne indukcije, bez ikakvih pokretnih djelova.

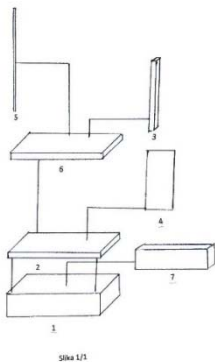

Konstrukcija se sastoji u tome: što se u tačku 1 postavi tačka 7 i tačka 6. Postavi se na tačku 1 tačka 2. Tačka 3 postavi se u zemlju sa tačkom 4 i poveže se međusobno tačkom 5 i čini jednu kompletnu cjelinu.

(11) **03098** (13) **B**

(51) **H99Z 99/00<sup>0</sup>**

(21) P-2018-204

(22) 08.08.2011

(54) me **ZELENA ENERGETSKA UŠTEDA**  
en **GES - GREEN ENERGY SAVING**

(73) BOJOVIĆ, Milan

Njegoševa 4 , Žabljak, 84220 / ME

SAVOVIĆ, Zoran

Đura Petrovića 25, Lovćenac , 24322/ RS

ČABARKAPA, Obrad

Vojvode Stepe 135/H, Beograd , 11000 / RS

ĐURAŠEVIĆ, Željko

Vukice Mitrović bb, Sveti Stefan, 85315/ ME

KAČALOVIĆ, Damir

Do 12, Bihać, 77000/ BA

(72) BOJOVIĆ, Milan

Njegoševa 4 , Žabljak, 84220 / ME

SAVOVIĆ, Zoran

Đura Petrovića 25, Lovćenac , 24322/ RS

ČABARKAPA, Obrad

Vojvode Stepe 135/H, Beograd , 11000 / RS

ĐURAŠEVIĆ, Željko

Vukice Mitrović bb, Sveti Stefan, 85315/ ME

KAČALOVIĆ, Damir

Do 12, Bihać, 77000/ BA

(74) BOJOVIĆ, Milan

Njegoševa 4 , Žabljak , 84220/ ME

(57) Konstruktivno rješenje uređaja koji smanjuje potrošnju električne energije, posredstvom jakih magnetnih struja uz pomoć transformatora smanji potrošnju iz postojećih izvora energije a potrošačima ne naruši njihov energetska bilans.

Konstrukcija se sastoji u tome što se u tačku 1 postavi tačka 3. Postavi tačka 2 i fiksira za tačku 1. Na tačku 2 montira tačka 6, tačka 4, tačka 5 i na kraju se montira tačka 7. Sve što čini jednu kompletnu cjelinu uređaja koji se postavlja poslije mjernog mjesta

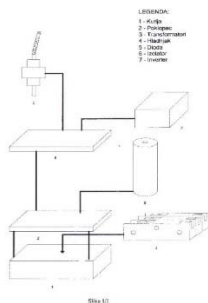

**OBJAVA PROŠIRENIH EUROPSKIH PATENATA**  
PUBLICATION OF EXTENDED EUROPEAN PATENTS

- (11) **03061** (13) **B**
- (51) **C07D 333/64**<sup>(2006.01)</sup> **C07D 333/66**<sup>(2006.01)</sup>  
**C07D 409/04**<sup>(2006.01)</sup> **C07D 409/10**<sup>(2006.01)</sup>  
**C07D 409/12**<sup>(2006.01)</sup> **C07D 413/04**<sup>(2006.01)</sup>  
**C07D 413/12**<sup>(2006.01)</sup> **C07D 417/12**<sup>(2006.01)</sup>  
**A61K 31/381**<sup>(2006.01)</sup> **A61P 35/00**<sup>(2006.01)</sup>
- (21) P-2018-102  
(22) 12.02.2014  
(30) 201361766439 P 19.02.2013 US  
(96) 14708992.4/12.02.2014  
(86) US PCT/US2014/015938/12.02.2014  
(87) WO 2014/130310/28.08.2014/2014/35  
(97) EP 2958907/30.12.2015/201553  
EP 2958907/28.02.2018/201809
- (54) me **DERIVATI BENZOTIOFENA I NJIHOVE KOMPOZICIJE KAO SELEKTIVNI DEGRADERI ESTROGENSKOG RECEPTORA**  
en **BENZOTHIOPHENE DERIVATIVES AND COMPOSITIONS THEREOF AS SELECTIVE ESTROGEN RECEPTOR DEGRADERS**
- (73) NOVARTIS AG  
Lichtstrasse 35, Basel, 4056/ CH
- (72) BURKS, Heather Elizabeth  
250 Massachusetts Avenue, Cambridge, Massachusetts 02139/ US  
DECHANTSREITER, Michael A.  
250 Massachusetts Avenue, Cambridge, Massachusetts 02139/ US  
HE, Guo  
.250 Massachusetts Avenue, Cambridge, Massachusetts 02139/ US  
NUNEZ, Jill  
250 Massachusetts Avenue, Cambridge, Massachusetts 02139/ US  
PEUKERT, Stefan  
250 Massachusetts Avenue, Cambridge, Massachusetts 02139/ US  
SPRINGER, Clayton  
400 Technology Square, Cambridge, Massachusetts 02139/ US  
SUN, Yingchuan  
250 Massachusetts Avenue, Cambridge, Massachusetts 02139/ US  
THOMSEN, Noel Marie-France  
250 Massachusetts Avenue, Cambridge, Massachusetts 02139/ US  
TRIA, George Scott  
250 Massachusetts Avenue, Cambridge, Massachusetts 02139/ US  
YU, Bing  
250 Massachusetts Avenue, Cambridge, Massachusetts 02139/ US
- (57) 1. Jedinjenje formule I:



gde tačkasta linija označava tačku spajanja sa benzotiofenskim jezgrom; gde je pomenuti C<sub>6-10</sub>aril ili heteroaril iz R<sub>5</sub> supstituisan sa 1 do 3 grupe koje su odabrane od -X<sub>3</sub>-R<sub>5a</sub> i R<sub>5a</sub>; gde X<sub>3</sub> predstavlja metilen; gde je R<sub>5a</sub> odabran od hidroksi, amino, C<sub>1-4</sub>alkil, halo, nitro, cijano, halo-supstituisani-C<sub>1-4</sub>alkil, cijano-supstituisani-C<sub>1-4</sub>alkil, hidroksi-supstituisani-C<sub>1-4</sub>alkil, halo-supstituisani-C<sub>1-4</sub>alkoksi, C<sub>1-4</sub>alkoksi, -SF<sub>5</sub>, -NR<sub>11a</sub>R<sub>11b</sub>, -C(O)R<sub>11a</sub>, C<sub>3-8</sub>cikloalkil i 4-7-očlani zasićeni, nezasićeni ili delimično zasićeni prsten koji sadrži jedan do 4 heteroatoma ili grupa koje su odabrane od O, NH, C(O) i S(O)<sub>0-2</sub>; gde su R<sub>11a</sub> i R<sub>11b</sub> svaki za sebe odabrani od vodonika i C<sub>1-4</sub>alkila; ili R<sub>11a</sub> i R<sub>11b</sub> zajedno sa azotom za koji su oba vezana grade 4 do 7-očlani zasićeni prsten koji sadrži jedan drugi heteroatom ili grupu odabranu od O, NH, i S(O)<sub>0-2</sub>; gde pomenuti 4-7-očlani prsten od R<sub>5a</sub> može biti nesupstituisan ili supstituisan C<sub>1-4</sub>alkilom, ili njegova farmaceutska prihvatljiva so.

**Patent sadrži još 20 patentnih zahtjeva**



- (11) **03062** (13) **B**  
 (51) **C07D 223/16**<sup>(2006.01)</sup>  
 (21) P-2018-103  
 (22) 06.05.2015  
 (30) 20140054081 06.05.2014 FR  
 (96) 15725827.8/06.05.2015  
 (86) FR PCT/FR2015/051201/06.05.2015  
 (87) WO 2015/170053/12.11.2015/2015/45  
 (97) EP 3140287/15.03.2017/2017/11  
 EP 3140287/07.03.2018/2018/10  
 (54) me **NOVA SOL IVABRADINA SOL I POSTUPAK NJEGOVE PRIPREME**  
 en **NOVEL IVABRADINE SALT AND METHOD FOR PREPARING SAME**  
 (73) LES LABORATOIRES SERVIER  
 35 rue de Verdun, Suresnes, 92284 / FR  
 (72) LYNCH, Michael  
 74 Rue des Chaises, Saint Jean de la Ruelle, F-45140 / FR  
 COINTEPAS, Patrick  
 70 Rue Croix Baudu, Saint Jean de la Ruelle, F-45140/ FR  
 LAFARGUE, David  
 9 Rue du Ballon, Saint Jean le Blanc, F-45650 / FR  
 BRIAULT, Gilles  
 6 Rue de la Tuilerie, Saint Peravy Epreux, F-45480 / FR  
 (74) Advokat JUSIĆ, Jasna  
 Dalmatinska 2, Podgorica, 81000 / ME

(57) **1.** Ivabradin hemipamoat, **naznačen time**, da je riječ o spoju formule (I):

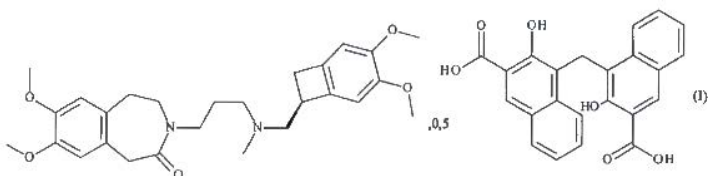

i njegovi hidrati.

**Patent sadrži još 3 patentnih zahtjeva**

(11) **03063** (13) **B**

(51) **C07C 235/46**<sup>(2006.01)</sup>

**C07C 311/29**<sup>(2006.01)</sup>

**A61K 31/18**<sup>(2006.01)</sup>

**A61P 29/00**<sup>(2006.01)</sup>

**C07C 237/30**<sup>(2006.01)</sup>

**C07C 323/62**<sup>(2006.01)</sup>

**A61K 31/166**<sup>(2006.01)</sup>

(21) P-2018-104

(22) 05.04.2013

(30) 201261641814 P 02.05.2012 US

(96) 13784562.4/05.04.2013

(86) AU PCT/AU2013/000356/05.04.2013

(87) WO 2013/163675/07.11.2013/2013/45

(97) EP 2844637/11.03.2015/2015/11

EP 2844637/28.03.2018/2018/13

(54) me **SUPSTITUISANI 3-HALOALILAMIN INHIBITORI SSAO I NJIHOVE PRIMENE**  
en **SUBSTITUTED 3-HALOALLYLAMINE INHIBITORS OF SSAO AND USES THEREOF**

(73) BOEHRINGER INGELHEIM INTERNATIONAL GMBH

Binger Strasse 173, Ingelheim am Rhein, 55216/ DE

(72) DEODHAR, Mandar

20 Rodborough Road, Frenchs Forest, NSW 2086/ AU  
FINDLAY, Alison Dorothy

20 Rodborough Road, Frenchs Forest, NSW 2086/ AU  
FOOT, Jonathan Stuart

20 Rodborough Road, Frenchs Forest, NSW 2086/ AU  
JAROLIMEK, Wolfgang

20 Rodborough Road, Frenchs Forest, NSW 2086/ AU  
MCDONALD, Ian Alexander

20 Rodborough Road, Frenchs Forest, NSW 2086/ AU  
ROBERTSON, Alan

20 Rodborough Road, Frenchs Forest, NSW 2086/ AU  
TURNER, Craig Ivan

20 Rodborough Road, Frenchs Forest, NSW 2086/ AU

(74) Advokat RADULOVIĆ, Božidar S.

Studentska bb, Lamela 3/18 , Podgorica, 81000 / ME

(57) Jedinjenje Formule II:

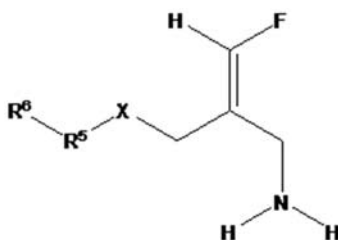

**Formula II**

ili njegova farmaceutski prihvatljiva so, njegov solvat ili polimorfni oblik; pri čemu:

R<sub>5</sub> je nesupstituisana fenilen grupa ili fenilen grupa supstituisana sa jednom ili više grupa nezavisno odabrane između alkil, halo, alkoksi i haloalkil;

R<sub>6</sub> je odabran između



;

R<sub>7</sub> i R<sub>8</sub> su nezavisno odabrani između grupe koja se sastoji od vodonika, opciono supstituisanog C<sub>1-6</sub> alkila i opciono supstituisanog C<sub>3-7</sub> cikloalkila; i X je kiseonik; pri čemu termin "alkil" se odnosi na monovalentni pravi lanac ili razgranati lanac zasićenih ugljovodoničnih radikala koji imaju od 1 do 6 atoma ugljenika, i pri čemu termin "halo" se odnosi na fluorin, hlorin, bromin i jodin, i pri čemu termin "alkoksi" se odnosi na pravi lanac ili razgranate alkiloksi grupe, pri čemu alkil je prethodno definisan, i pri čemu termin "opciono supstituisan" označava grupu na koju se ovaj termin odnosi može biti nesupstituisana, ili može biti supstituisana sa jednom ili više grupa nezavisno odabrane između halogen, C<sub>1</sub>-C<sub>6</sub> alkil, C<sub>2</sub>-C<sub>6</sub> alkenil, C<sub>1</sub>-C<sub>6</sub> haloalkil, C<sub>1</sub>-C<sub>6</sub> alkoksi, hidroksi(C<sub>1-6</sub>)alkil, C<sub>3</sub>-C<sub>6</sub> cikloalkil, C(O)H, C(O)OH, NHC(O)H, NHC(O)C<sub>1</sub>-C<sub>4</sub> alkil, C(O)C<sub>1</sub>-C<sub>4</sub> alkil, NH<sub>2</sub>, NHC<sub>1</sub>-C<sub>4</sub> alkil, N(C<sub>1</sub>-C<sub>4</sub> alkil)<sub>2</sub>, NO<sub>2</sub>, OH i CN.

**Patent sadrži još 17 patentnih zahtjeva**

- (11) **03065 (13) B**
- (51) **C07D271/08**<sup>(2006.01)</sup> **C07D413/04**<sup>(2006.01)</sup>  
**C07D413/12**<sup>(2006.01)</sup> **A61K31/4245**<sup>(2006.01)</sup>  
**A61P1/00**<sup>(2006.01)</sup> **A61P11/00**<sup>(2006.01)</sup>  
**A61P17/00**<sup>(2006.01)</sup> **A61P19/00**<sup>(2006.01)</sup>  
**A61P25/00**<sup>(2006.01)</sup> **A61P27/00**<sup>(2006.01)</sup>  
**A61P29/00**<sup>(2006.01)</sup> **A61P31/00**<sup>(2006.01)</sup>  
**A61P35/00**<sup>(2006.01)</sup> **A61P37/00**<sup>(2006.01)</sup>  
**A61P43/00**<sup>(2006.01)</sup> **A61K39/395**<sup>(2006.01)</sup>  
**A61K39/00**<sup>(2006.01)</sup>
- (21) P-2018-108  
(22) 07.07.2009  
(30) 78876P 08.07.2008 US  
150873P 09.02.2009 US  
(96) 14175271.7/07.07.2009  
(97) EP 2824100/14.01.2015/2015/03  
EP 2824100/21.02.2018/2018/08  
(54) me **1,2,5-OXSADIAZOLI KAO INHIBITORI INDOLAMIN 2,3-DIOKSIGENAZE**  
en **1,2,5-OXADIAZOLES AS IN H IBITORS OF INDOLEAMINE 2,3-DIOXYGENASE**
- (73) INCYTE HOLDINGS CORPORATION  
1801 Augustine Cut-Off, Wilmington, DE 19803/ US
- (72) COMBS, Andrew, P.  
329 East Doe Run Road, Kennett Square, PA 19348/ US  
YUE, Eddy, W.  
9 Altemus Drive, Landenberg, PA 19350 / US  
SPARKS, Richard, B.  
2616 Larkin Road, Boothwyn, PA 19061 / US  
ZHU , Wenyu  
21 Abel Place, Media, PA 19063/ US  
ZHOU, Jiacheng  
46 Bay Boulevard, Newark, DE 19702/ US  
LIN, Qiyang  
6 Henlopen Court, Newark, DE 19711 / US  
WENG, Lingkai  
28 Landmark Drive, Malvern, PA 19355 / US  
YUE, Tai-Yuen  
501 Blackbird Drive, Hockessin, DE 19707 / US  
LIU, Pingli  
205 Pilot Court, Newark, DE 19702/ US
- (74) Advokat LUTOVAC, Branislav  
Bulevar Ivana Crnojevica 93 , Podgorica , 81000 / ME
- (57) 1.Jedinjenje formule 1:

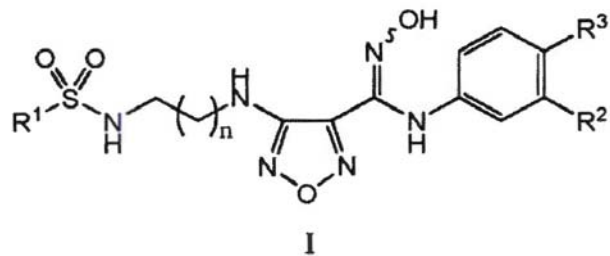

ili njegova farmaceutski prihodljiva so, u kombinaciji sa anti-PD-antitelom za upotrebu u lečenju kancera;što:

R<sup>1</sup> je NH<sub>2</sub> ili CH<sub>3</sub>;

R<sup>2</sup> je Cl, Br, CF<sub>3</sub>, CH<sub>3</sub>, ili CN;

R<sup>3</sup> je H ili F;

n je 1 ili 2.

**Patent sadrži još 20 patentnih zahtjeva**

(11) **03066** (13) **B**

(51) **C07D 209/44**<sup>(2006.01)</sup>

**A61K 31/454**<sup>(2006.01)</sup>

**C07D 401/06**<sup>(2006.01)</sup>

**A61K 31/4035**<sup>(2006.01)</sup>

**C07D 407/10**<sup>(2006.01)</sup>

**C07D 407/06**<sup>(2006.01)</sup>

(21) P-2018-109

(22) 06.07.2015

(30) 201462021844 P 08.07.2014 US

201462064615 P 16.10.2014 US

201562134616 P 18.03.2015 US

(96) 15742106.6/06.07.2015

(86) IB PCT/IB2015/055095/06.07.2015

(87) WO 2016/005878/14.01.2016/2016/02

(97) EP 3166925/17.05.2017/201720

EP 3166925/14.03.2018/201811

(54) me **DERIVATI IZOINDOLINA ZA UPOTREBU U LEČENJU VIRUSNE INFEKCIJE**  
en **ISOINDOLINE DERIVATIVES FOR USE IN THE TREATMENT OF A VIRAL INFECTION**

(73) VIIV HEALTHCARE UK LIMITED

980 Great West Road, Brentford, Middlesex TW8 9GS/ GB

(72) JOHNS, Brian Alvin

Five Moore Drive, Research Triangle Park, North Carolina 27709/ US

VELTHUISEN, Emile Johann

Five Moore Drive, Research Triangle Park, North Carolina 27709/ US

WEATHERHEAD, Jason Gordon

Five Moore Drive, Research Triangle Park, North Carolina 27709/ US

SUWANDI, Lita

Five More Drive, Research Triangle Park, North Carolina 27709/ US

TEMELKOFF, David

Five Moore Drive, Research Triangle Park, North Carolina 27709/ US

(57) 1. Jedinjenje Formule I:

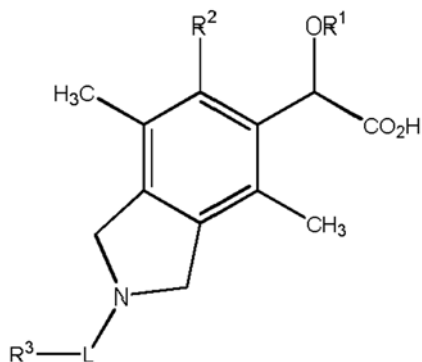

Formula I

gde:

R<sub>1</sub> je C<sub>1-6</sub>alkil; R<sub>2</sub> je C<sub>5-14</sub>aril, C<sub>3-7</sub>cikloalkil, C<sub>3-7</sub>cikloalkenil, C<sub>2-9</sub>heterocikl, ili C<sub>2-9</sub>heteroaril, gde svaka R<sub>2</sub> grupa je opciono supstituisana sa jednim do četiri supstituenata koji se biraju od halo, C<sub>1-6</sub>alkil, C<sub>1-6</sub>heteroalkil, ili C<sub>1-6</sub>alkilen ili C<sub>1-6</sub>heteroalkilen gde pomenuti C<sub>1-6</sub>alkilen ili C<sub>1-6</sub>heteroalkilen

su vezani za susedne ugljenikove atome na pomenutim C<sub>5-14</sub>aril, C<sub>3-7</sub>cikloalkil, C<sub>3-7</sub>cikloalkenil, C<sub>3-9</sub>heterociklu, ili C<sub>5-9</sub>heteroarilu da se obrazuje kondenzovani prsten;

L je veza, -CH<sub>2</sub>(CO)-, -C<sub>1-3</sub>alkilen-, -SO<sub>2</sub>-, -C(O)-, -C(S)-, -C(NH)-, -C(O)NH-, -C(O)NHCH<sub>2</sub>-, -C(O)N-,

-C(O)OCH<sub>2</sub>-, -C(O)O-, -C(O)C(O)-, -SO<sub>2</sub>-NH-, ili -CH<sub>2</sub>C(O)-;

R<sub>3</sub> je H, CN, C<sub>1-6</sub>alkil, C<sub>5-14</sub>aril, CH<sub>2</sub>C<sub>5-14</sub>aril, CH<sub>2</sub>C<sub>3-7</sub>cikloalkil, C<sub>3-7</sub>cikloalkil, C<sub>3-7</sub>spirocikloalkil, C<sub>3-7</sub>cikloalkenil, C<sub>2-9</sub>heterocikl, ili C<sub>2-9</sub>heteroaril, gde svaka R<sub>3</sub> grupa je opciono supstituisana sa jednim do četiri supstituenata koji se biraju od halo, C<sub>1-6</sub>alkil, C<sub>2-8</sub>premošćeni heterocikl, C<sub>3-7</sub>cikloalkil, C<sub>1-3</sub>fluoroalkil, -OC<sub>1-6</sub>alkil, -C(O)R<sub>4</sub>, -C(O)NR<sub>4</sub>, -C(O)NHR<sub>4</sub>, C<sub>5-14</sub>aril, C<sub>1-6</sub>heteroalkil, -B(OH)<sub>2</sub>, C<sub>2-9</sub>heterocikl, C<sub>1-6</sub>heteroaril, -C(O)OC<sub>1-6</sub>alkil, ili dva supstituenata koji su vezani za susedne atome mogu međusobno da se vežu da se obrazuje kondenzovani prsten i taj kondenzovani prsten može opciono da bude supstituisan sa R<sub>4</sub>;

R<sub>4</sub> je CN, halo, -OC<sub>1-6</sub>alkil, C<sub>1-6</sub>alkil, C<sub>3-7</sub>cikloalkil, C<sub>2-9</sub>heterocikl, ili C<sub>5-14</sub>aril;

i gde svaki heterocikl, heteroaril, heteroalkil, i heteroalkilen sadrži jedan do tri heteroatoma koji se biraju od S, N, B, ili O.

**Patent sadrži još 15 patentnih zahtjeva**

(11) 03090 (13) B

(51) C07D 231/12<sup>(2006.01)</sup>

A61P 3/00<sup>(2006.01)</sup>

A61P 3/10<sup>(2006.01)</sup>

A61P 9/10<sup>(2006.01)</sup>

A61P 13/12<sup>(2006.01)</sup>

A61P 27/02<sup>(2006.01)</sup>

A61P 43/00<sup>(2006.01)</sup>

A61K 31/415<sup>(2006.01)</sup>

A61P 3/04<sup>(2006.01)</sup>

A61P 9/04<sup>(2006.01)</sup>

A61P 11/00<sup>(2006.01)</sup>

A61P 25/00<sup>(2006.01)</sup>

A61P 27/12<sup>(2006.01)</sup>

(21) P-2018-110

(22) 14.03.2018

(30) 201361791164 P 15.03.2013 US

2013053195 15.03.2013 JP

2013127318 18.06.2013 JP

(96) 14763385.3/14.03.2014

(86) JP PCT/JP2014/056825/14.03.2014

(87) WO 2014/142290/18.09.2014/2014/38

(97) EP 2975028/20.01.2016/2016/03

EP 2975028/21.02.2018/2018/08

(54) me **PIRAZOLAMIDNI SPOJ I NJEGOVA UPOTREBA U MEDICINI**  
en **PYRAZOLE-AMIDE COMPOUND AND MEDICINAL USES THEREFOR**

(73) JAPAN TOBACCO, INC.

2-1, Toranomom 2-chome Minato-ku, Tokyo 105-8422/ JP

(72) MOTOMURA, Takahisa

1-1 Murasaki-cho, Takatsuki-shi Osaka 569-1125/ JP

SHOMI, Gakujun

1-1 Murasaki-cho, Takatsuki-shi Osaka 569-1125/ JP

(74) AOD "ČUPIĆ"

Bulevar Džordža Vašigtona 79, PODGORICA, 81000/ ME

(57) 1. Spoj prikazan formulom [I]:

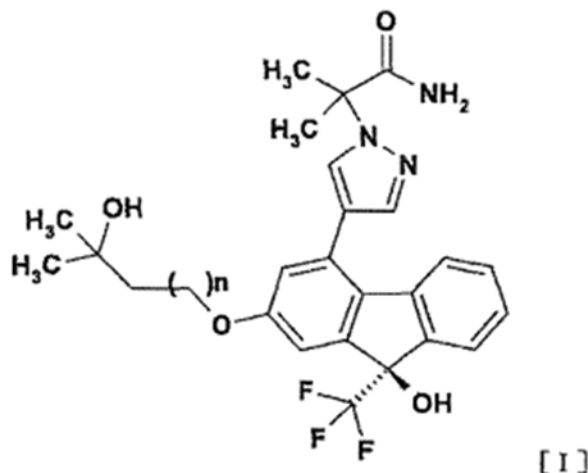

naznačen time što je n 1 ili 2,

ili njegova farmaceutski prihvatljiva sol, ili njegov solvat.

**Patent sadrži još 18 patentnih zahtjeva**





(11) **03091** (13) **B**

(51) **A61K 9/127**<sup>(2006.01)</sup>

**A61K 31/7105**<sup>(2006.01)</sup>

**A61K 48/00**<sup>(2006.01)</sup>

**C07H 21/02**<sup>(2006.01)</sup>

(21) P-2018-113

(22) 30.11.2010

(30) 20090265653P 01.12.2009 US

(96) 10835016.6/30.11.2010

(86) US PCT/US2010/058457/30.11.2010

(87) WO 2011/068810/09.06.2011/2011/23

(97) EP 2506857/10.10.2012/2012/41

EP 2506857/14.02.2018/2018/07

(54) me **ISPORUKA IRNK ZA POVEĆANJE EKSPRESIJE PROTEINA I ENZIMA U HUMANIM GENETSKIM OBOLJENJIMA**  
en **DELIVERY OF MRNA FOR THE AUGMENTATION OF PROTEINS AND ENZYMES IN HUMAN GENETIC DISEASES**

(73) TRANSLATE BIO, INC.

200 Sidney Street, Suite 310, Cambridge, MA 02139/ US

(72) GUILD, Braydon Charles

109 Riverdale Road, Concord MA 01742/ US

DEROSA, Frank

26 Mount Auburn Street, Chelmsford MA 01824/ US

HEARTLEIN, Michael

167 Reed Farm Road, Boxborough MA 01719/ US

CONCINO, Michael

297 Long Hill Road, Bolton, MA 01740/ US

(57) 1. Farmaceutska kompozicija za upotrebu u postupku lečenja bolesti kod subjekta koja je rezultat deficijencije proteina, farmaceutska kompozicija koja sadrži: nosač transfera i najmanje jedan iRNK molekul koji kodira navedeni protein, nosač transfera koji sadrži jedan ili više katjonskih lipida, jedan ili više nekatjonskih lipida i jedan ili više lipida modifikovanih sa PEG, pri čemu je nosač transfera lipozom, a veličina nosača transfera je manja od 100 nm, i pri čemu se farmaceutska kompozicija preferencijalno distribuira u ćelije jetre nakon primene subjektu, a kodirani protein se eksprimira u ćelijama jetre subjekta.

**Patent sadrži još 19 patentnih zahtjeva**

(11) **03092** (13) **B**

(51) **B65D 75/58**<sup>(2006.01)</sup>

**A47K 5/12**<sup>(2006.01)</sup>

**B65D 41/02**<sup>(2006.01)</sup>

(21) P-2018-114

(22) 15.12.2014

(30) 9752013 20.12.2013 AT

(96) 16182792.8/15.12.2014

(97) EP 3115313/11.01.2017/2017/02

EP 3115313/14.02.2018/2018/07

(54) me **SISTEM ZA DOZIRANJE**

en **DISPENSING SYSTEM**

(73) HAGLEITNER, Hans Georg

Lindenallee 11, Zell am See, 5700/ AT

(72) HAGLEITNER, Hans Georg

Lindenallee 11, Zell am See, 5700 / AT

(57) 1. Sistem za doziranje za proizvod sposoban da teče sa dozatorom opremljenim sa najmanje jednim prihvatom (40) i sa najmanje jednim rezervoarom (1) koji sadrži proizvod sposoban da teče, koji ima zatvarač (10) koji se može ukloniti pomeranjem rezervoara (1) i koji se drži naglavačke u prihvatu (40) za rezervoar posle uklanjanja zatvarača (10), **naznačen time**, što su na zatvaraču (11) i prihvatu (40) predviđeni elementi (11, 41) vođenja iste vrste koji se prilikom postavljanja zatvorenog rezervoara međusobno dopunjuju odnosno produžavaju, i što je pre prihvata (40) napravljen spremnik (23) za zatvarač (10) koji zadržava zatvarač (10) u poziciji mirovanja u toku pomeranja rezervoara (1).

**Patent sadrži još 11 patentnih zahtjeva**

- (11) **03095** (13) **B**
- (51) **C07D 401/14**<sup>(2006.01)</sup> **C07D 401/04**<sup>(2006.01)</sup>  
**C07D 403/10**<sup>(2006.01)</sup> **C07D 213/82**<sup>(2006.01)</sup>  
**A61K 31/4439**<sup>(2006.01)</sup> **A61P 35/00**<sup>(2006.01)</sup>
- (21) P-2018-117  
(22) 09.05.2013  
(30) 201261647174 P 15.05.2012 US  
201361790967 P 15.03.2013 US  
(96) 13730652.8/09.05.2013  
(86) IB PCT/IB2013/053768/09.05.2013  
(87) WO 2013/171639/21.11.2013/2013/47  
(97) EP 2861579/22.04.2015/2015/17  
EP 2861579/21.02.2018/2018/08  
(54) me **DERIVATI BENZAMIDA ZA INHIBIRANJE AKTIVNOSTI ABL1, ABL2 I BCR-ABL1**  
en **BENZAMIDE DERIVATIVES FOR INHIBITING THE ACTIVITY OF ABL1, ABL2 AND BCR-ABL1**
- (73) NOVARTIS AG  
Lichtstrasse 35, Basel, 4056/ CH
- (72) DODD, Stephanie Kay  
250 Massachusetts Avenue,, Cambridge, Massachusetts 02139/ US  
FURET, Pascal  
Werk Klybeck Postfach,, 4002 Basel/ CH  
GROTZFELD, Robert Martin  
Forum 1 Novartis Campus,, 4056 Basel/ CH  
JONES, Darryl Brynley  
Forum 1 Novartis Campus,, 4056 Basel/ CH  
MANLEY, Paul  
Werk Klybeck Postfach,, 4002 Basel/ CH  
MARZINZIK, Andreas  
Werk Klybeck Postfach,, 4002 Basel/ CH  
PELLE, Xavier Francois Andre  
Forum 1 Novartis Campus,, 4056 Basel/ CH  
SALEM, Bahaa  
Werk Klybeck Postfach,, 4002 Basel/ CH  
SCHOEPFER, Joseph  
Werk Klybeck Postfach,, 4002 Basel/ CH  
JAHNKE, Wolfgang  
Postfach,, 4002 Basel/ CH

(57) 1. Jedinjenje formule (I):

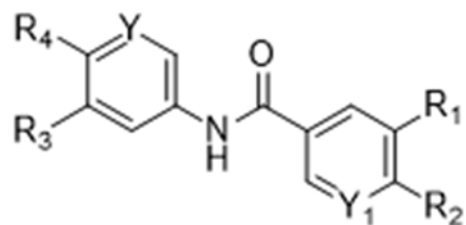

(I)

u kojoj:

R<sub>1</sub> predstavlja pirazolil; gde pomenuti pirazolil može da bude nesupstituisan ili supstituisan sa 1 do 2 R<sub>6</sub> grupe;

R<sub>2</sub> predstavlja pirolidinil; gde pomenuti pirolidinil može biti supstituisan sa jednom R<sub>7</sub> grupom;

gde je R<sub>3</sub> odabran od vodonika i halo;

gde je R<sub>4</sub> odabran od -SF<sub>5</sub> i -Y<sub>2</sub>-CF<sub>2</sub>-Y<sub>3</sub>;

gde je R<sub>6</sub> pri svakom javljanju nezavisno odabran iz grupe koju čine vodonik, hidroksi, metil, metoksi, cijano, trifluorometil, hidroksi-metil, halo, amino, fluoro-etil, etil i ciklopropil;

gde je R<sub>7</sub> odabran od hidroksi, metil, halo, metoksi, hidroksi-metil, amino, metil-amino, amino-metil, trifluorometil, 2-hidroksiopropan-2-il, metil-karbonil-amino, dimetil-amino, 2-amino-3-metilbutanoil)oksi, karboksi, metoksi-karbonil, fosfonooksi, cijano i amino-karbonil;

gde je Y odabran od CH i N;

gde je Y<sub>1</sub> odabran od CH i N;

gde je Y<sub>2</sub> odabran od CF<sub>2</sub>, O i S(O)<sub>0-2</sub>; i

gde je Y<sub>3</sub> odabran od vodonika, hloro, fluoro, metil, difluorometil i trifluorometil, ili njegove farmaceutski prihvatljive soli.

**Patent sadrži još 17 patentnih zahtjeva**

(11) **03058** (13) **B**

(51) **A61K 31/5365**<sup>(2006.01)</sup>

**A61K 31/505**<sup>(2006.01)</sup>

**A61P 31/18**<sup>(2006.01)</sup>

(21) P-2018-131

(22) 24.01.2011

(30) 298589 P 27.01.2010 US

(96) 15164931.6/24.01.2011

(97) EP 2932970/21.10.2015/2015/43

EP 2932970/21.03.2018/2018/12

(54) me **ANTIVIRUSNA TERAPIJA**

en **ANTIVIRAL THERAPY**

(73) VIIV HEALTHCARE COMPANY

251 Little Falls Drive, Wilmington, DE 19808/ US

(72) UNDERWOOD, Mark Richard

Five Moore Drive, Research Triangle Park, NC North Carolina 27709/ US

(74) Advokat LUTOVAC, Vuk

Bulevar Ivana Crnojevića 93 , Podgorica, 81000 / ME

Advokat LUTOVAC, Branislav

Bulevar Ivana Crnojevica 93 , Podgorica , 81000 / ME

(57) 1. Kombinacija koja sadrži jedinjenje formule (I)

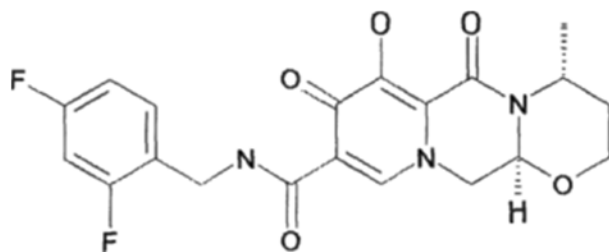

ili njegovu farmaceutski prihvatljivu so, i rilpivirin ili njegovu farmaceutski prihvatljivu so.

**Patent sadrži još 17 patentnih zahtjeva**

(11) **03073** (13) **B**

(51) **A61K 39/00**<sup>(2006.01)</sup>

**C07K 16/14**<sup>(2006.01)</sup>

**C07K 16/24**<sup>(2006.01)</sup>

(21) P-2018-135

(22) 19.10.2012

(30) 11185763 19.10.2011 EP

201161548744 P 19.10.2011 US

(96) 12775247.5/19.10.2012

(86) EP PCT/EP2012/070736/19.10.2012

(87) WO 2013/057241/25.04.2013/2013/17

(97) EP 2768859/27.08.2014/2014/35

EP 2768859/21.02.2018/2018/08

(54) me **ANT AGONISTI IL17C ZA LEČENJE ZAPALJENSKIH POREMEĆAJA**

en **ANTAGONISTS OF IL17C FOR THE TREATMENT OF INFLAMMATORY DISORDERS**

(73) MORPHOSYS AG

Semmelweisstrasse 7, Planegg, 82152/ DE

GALAPAGOS N.V.

Generaal de Wittelaan L11 A3, Mechelen, 2800 / BE

(72) BÜLTMANN,, Andreas

Josef von Hirsch Str. 46, Planegg, 82152/ DE

MÜHLBACHER, Robert

Buchbergerstr. 1a, Geretsried/Gelting, 82538/ DE

GARCIA, Teresa

Galapagos SASU 102 Avenue Gaston Roussel, Romainville, F-93230/ FR

BRYs,, Reginald Christophe Xavier

Galapagos SASU 102 Avenue Gaston Roussel, Romainville, F-93230/ FR

NELLES, Luc

Galapagos NV Industriepark Mechelen Noord Generaal De Wittelaan L11 A3, Mechelen, B-2800/ BE

CONRATH, Katja

Galapagos NV Industriepark Mechelen Noord Generaal De Wittelaan L11 A3, Mechelen, B-2800/ BE

(74) Advokat POPOVIĆ, Miladin

Đoka Miraševića 21/III , Podgorica, 81000 / ME

(57) 1. Izolovano antitelo ili fragment antitela specifičan za IL17C, **naznačen time**, što se upotrebljava za lečenje zapaljenskog poremećaja, gde je pomenuti zapaljenski poremećaj zapaljenje pluća, reumatoidni artritis i/ili hronična opstruktivna bolest pluća (COPD), pri čemu se IL17C sastoji od amino-kiselina SEQ. ID No.: 181, i gde pomenuto antitelo blokira vezivanje IL17C za IL17RE.

**Patent sadrži još 6 patentnih zahtjeva**

(11) **03074** (13) **B**

(51) **A61K 31/4965**<sup>(2006.01)</sup>

**A61K 31/497**<sup>(2006.01)</sup>

**A61P 7/06**<sup>(2006.01)</sup>

(21) P-2018-144

(22) 03.05.2012

(30) 201161482171 P 03.05.2011 US

(96) 12722013.5/03.05.2012

(86) US PCT/US2012/036412/03.05.2012

(87) WO 2012/151451/08.11.2012/2012/45

(97) EP 2704721/12.03.2014/2014/11

EP 2704721/11.04.2018/20181/5

(54) me **AKTIVATORI PIRUVAT KINAZE ZA UPOTREBU U TERAPIJI**

en **PYRUVATE KINASE ACTIVATORS FOR USE IN THERAPY**

(73) AGIOS PHARMACEUTICALS, INC.

88 Sidney Street, Cambridge, Massachusetts 02139/ US

(72) SU, Shin-San, Michael

346 Hartman Road, Newton, MA 02459/ US

(74) Advokat POPOVIĆ, Miladin

Đoka Miraševića 21/III , Podgorica, 81000 / ME

(57) 1. Jedinjenje za upotrebu u postupku za povećanje veka trajanja crvenih krvnih ćelija (RBCs) kod pacijenta sa deficijencom piruvat kinaze (PKD) kod koga postoji potreba za tim koji sadrži dovođenje u kontakt krvi sa efikasnom količinom (1) jedinjenja formule I ili njegove farmaceutski prihvatljive soli; ili (2) farmaceutski prihvatljive kompozicije koja sadrži jedinjenje formule I ili njegovu farmaceutski prihvatljivu so, i farmaceutski prihvatljiv nosač, pri čemu, deficijenca piruvat kinaze je deficijenca piruvat kinaze R, gde:

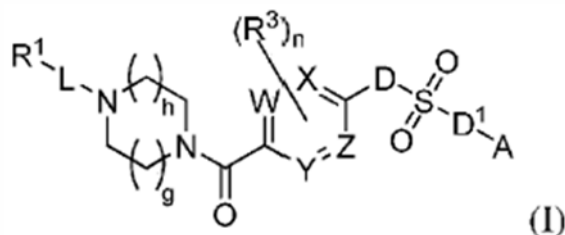

W, X, Y i Z su svaki nezavisno izabrani od CH ili N;

D i D<sub>1</sub> su nezavisno izabrani od veze ili NR<sub>b</sub>;

A je izborno supstituisani aril ili izborno supstituisani heteroaril;

L je veza, -C(O)-, -(CR<sub>c</sub>R<sub>c</sub>)<sub>m</sub>-, -OC(O)-, -(CR<sub>c</sub>R<sub>c</sub>)<sub>m</sub>-OC(O)-, -(CR<sub>c</sub>R<sub>c</sub>)<sub>m</sub>-C(O)-, -NR<sub>b</sub>C(S)- ili -NR<sub>b</sub>C(O)- (gde je tačka vezivanja za R<sub>1</sub> na levoj strani);

R<sub>1</sub> je izabran od alkila, cikloalkila, arila, heteroarila i heterociklila; od kojih je svaki supstituisan sa 0-5 slučaja R<sub>d</sub>;

svaki R<sub>3</sub> je nezavisno izabran od halo, haloalkila, alkila, hidroksila i -OR<sub>a</sub>, ili dva susedna R<sub>3</sub> uzeta zajedno sa atomima ugljenika za koje su vezani formiraju izborno supstituisani heterociklil;

svaki R<sub>a</sub> je nezavisno izabran od alkila, acila, hidroksialkila i haloalkila;

svaki R<sub>b</sub> je nezavisno izabran od vodonika i alkila;



svaki  $R_c$  je nezavisno izabran od vodonika, halo, alkila, alkoksi i halo alkoksi ili dva  $R_c$  uzeta zajedno sa atomima ugljenika za koje su vezani formiraju izborno supstituisani cikloalkil;  
svaki  $R_d$  je nezavisno izabran od halo, haloalkila, haloalkoksi, alkila, alkinila, nitro, cijano, hidroksila,  $-C(O)R_a$ ,  $-OC(O)R_a$ ,  $-C(O)OR_a$ ,  $-SR_a$ ,  $-NR_aR_b$  i  $-OR_a$ , ili dva  $R_d$  uzeta zajedno sa atomima ugljenika za koje su vezani formiraju izborno supstituisani heterociklil;

$n$  je 0, 1 ili 2;

$m$  je 1, 2 ili 3;

$h$  je 0, 1, 2; i

$g$  je 0, 1 ili 2.

**Patent sadrži još 20 patentnih zahtjeva**

(11) **03075** (13) **B**

(51) **C07K16/28**<sup>(2006.01)</sup>

**A61K39/395**<sup>(2006.01)</sup>

**A61P35/00**<sup>(2006.01)</sup>

(21) P-2018-146

(22) 23.12.2013

(30) 201261745707P 24.12.2012 US

(96) 13821368.1/23.12.2013

(86) US PCT/2013US/077452/23.12.2013

(87) WO 2014/105810 A1/03.07.2014/2014/27

(97) EP 2935331/28.10.2015/2015/44

EP 2935331/28.02.2018/2018/09

(54) me **PROLAKTIN RECEPTOR VEZUJUĆI PROTEINI I NJIHOVA UPOTREBA**  
en **PROLACTIN RECEPTOR BINDING PROTEINS AND USES THEREOF**

(73) ABBVIE INC.

1 North Waukegan Road, North Chicago IL 60064/ US

(72) ANDERSON, Mark

410 Sommerset Street, Grayslake, IL 60030 / US

WANG, Jieyi

2317 Hastings Drive, Belmont, CA 94002 / US

THAKUR, Archana

8378 Moller Ranch Drive, Pleasanton, CA 94588/ US

CHAO, Debra

4846 Balthazar Terrace, Fremont, CA 94555 / US

HSIEH, Chung-Ming

22 Olde Field Road, Newton, MA 02459 / US

ZHANG, Qian

210 White Fence Court, Vernon Hills, IL 60061/ US

REILLY, Edward, B.

1136 Winners Circle, Libertyville, IL 60048/ US

DIGIAMMARINO, Enrico, L.

161 Rose Tree Lane, Lindenhurst, IL 60046/ US

LONGENECKER, Kenton, L.

1371 Osage Orange Road, Grayslake, IL 60030/ US

JUDGE, Russell, A.

5186 Alder Court, Gurnee, IL 60031/ US

EGAN, David, A.

4023 Kenwood Avenue, Gurnee, IL 60031/ US

HUTCHINS, Charles, W.

31005 Prairie Ridge Road

(57) 1. Antitelo ili njegov antigen vezujuć fragment koji je u stanju da veže prolaktin receptor (PRLR), sadrži antigen vezujuć domen sa bar dva CDR kompleta varijabilnog domena izabrana iz grupe koja se sastoji od: (1) ili od CDR kompleta varijabilnog domena teškog lanca SEQ ID Nos:40, 41 i 42 ili SEQ ID Nos:46, 47 i 42, i CDR kompleta varijabilnog domena lakog lanca SEQ ID Nos:49, 50 i 51; (2) ili od CDR kompleta varijabilnog domena teškog lanca SEQ ID Nos:56, 57 i 58 ili SEQ ID Nos: 62, 63 i 58, i CDR kompleta varijabilnog domena lakog lanca SEQ ID Nos 65, 66 i 67; (3) ili od CDR kompleta varijabilnog domena teškog lanca SEQ ID Nos: 71, 72 i 73 ili SEQ ID Nos: 71, 77 i 73, i CDR kompleta varijabilnog domena lakog lanca SEQ ID Nos: 79,80 i 81; i (4) ili od CDR kompleta varijabilnog domena teškog lanca

SEQ ID Nos:85, 86 i 87 ili SEQ ID Nos: 149, 150 i 87, i CDR kompleta varijabilnog domena lakog lanca  
SEQ ID Nos: 92, 93 i 94.

**Patent sadrži još 33 patentnih zahtjeva**

(11) **03076 (13) B**

(51) **A61K 45/06**<sup>(2006.01)</sup>

**A61K 47/06**<sup>(2006.01)</sup>

**A61M 39/22**<sup>(2006.01)</sup>

**A61K 9/00**<sup>(2006.01)</sup>

**B65D 83/54**<sup>(2006.01)</sup>

**A61K 31/40**<sup>(2006.01)</sup>

**A61K 47/08**<sup>(2006.01)</sup>

**A61K 31/573**<sup>(2006.01)</sup>

**A61K 47/02**<sup>(2006.01)</sup>

**A61K 45/08**<sup>(2006.01)</sup>

**B65D 83/14**<sup>(2006.01)</sup>

**A61M 15/00**<sup>(2006.01)</sup>

**A61K 31/167**<sup>(2006.01)</sup>

**A61K 31/537**<sup>(2006.01)</sup>

**A61K 47/10**<sup>(2006.01)</sup>

(21) P-2018-149

(22) 23.12.2014

(30) 13199783 30.12.2013 EP

(96) 14827449.1/23.12.2014

(86) EP PCT/EP2014/079258/23.12.2014

(87) WO 2015/101575/09.07.2015/2015/27

(97) EP 3096737/30.11.2016/2016/48

EP 3096737/04.04.2018/2018/14

(54) me **STABILNA POD PRITISKOM KOMPOZICIJA AEROSOLNOG RASTVORA  
GLIKOPIRONIJUM BROMIDA I KOMBINACIJE FORMOTEROLA**  
en **STABLE PRESSURISED AEROSOL SOLUTION COMPOSITION OF GLYCOPYRRONIUM  
BROMIDE AND FORMOTEROL COMBINATION**

(73) CHIESI FARMACEUTICI S.p.A.

Via Palermo, 26/A , Parma, I-43100 / IT

(72) BONELLI, Sauro

c/o Chiesi Farmaceutici S.p.A. Via Palermo 26/A, I-43100 Parma/ IT

COPELLI, Diego

c/o Chiesi Farmaceutici S.p.A. Via Palermo 26/A, I-43100 Parma/ IT

DAGLI ALBERI, Massimiliano

c/o Chiesi Farmaceutici S.p.A. Via Palermo 26/A, I-43100 Parma/ IT

USBERTI, Francesca

c/o Chiesi Farmaceutici S.p.A. Via Palermo 26/A, I-43100 Parma/ IT

ZAMBELLI, Enrico

c/o Chiesi Farmaceutici S.p.A. Via Palermo 26/A, I-43100 Parma/ IT

(74) Advokat RADULOVIĆ, Božidar S.

Studentska bb, Lamela 3/18 , Podgorica, 81000 / ME

(57) 1. Farmaceutska kompozicija aerosolnog rastvora namenjena za upotrebu u inhalatoru sa mernom dozom pod pritiskom, sadržavajući:

(a) glikopironijum bromid u dozi u rasponu od 5 do 26 µg po aktivaciji;

(b) formoterol, ili njegovu so ili solvat pomenute soli, u dozi u rasponu od 1 do 25 µg po aktivaciji;

(c) HFA propelant;

(d) ko-rastvarač;

(e) stabilizirajuću količinu mineralne kiseline;

pomenuta kompozicija sadržana u aerosolu može se obezbediti ventilom za doziranje koji ima najmanje zaptivku od butil gume.

**Patent sadrži još 17 patentnih zahtjeva**

(11) **03077** (13) **B**

(51) **A61K 38/00**<sup>(2006.01)</sup>

**A61K 35/741**<sup>(2006.01)</sup>

**A61K 39/02**<sup>(2006.01)</sup>

**C07K 14/195**<sup>(2006.01)</sup>

(21) P-2018-150

(22) 22.12.2015

(30) 201423083 23.12.2014 GB

(96) 15819853.1/22.12.2015

(86) GB PCT/GB2015/054113/22.12.2015

(87) WO 2016/102951/30.06.2016/2016/26

(97) EP 3193901/26.07.2017/2017/30

EP 3193901/04.04.2018/2018/14

(54) me **PIRINSKI POLIPEPTID I IMUNSKA MODULACIJA**  
en **PIRIN POLYPEPTIDE AND IMMUNE MODULATION**

(73) 4D PHARMA RESEARCH LIMITED

Life Sciences Innovation Building Cornhill Road, Aberdeen AB25 2ZS/ GB

(72) KELLY, Denise

Life Sciences Innovation Building Cornhill Road, Aberdeen Aberdeenshire AB25 2ZS/ GB

(74) Advokat LUTOVAC, Vuk

Bulevar Ivana Crnojevića 93 , Podgorica, 81000 / ME

Advokat LUTOVAC, Branislav

Bulevar Ivana Crnojevića 93 , Podgorica , 81000 / ME

(57) 1. Polipeptid HP ili polinukleotidna sekvenca koja kodira polipeptid HP za upotrebu u lečenju i/ili prevencijiporemećaja kod subjekta;gde je pomenutiporemećaj inflamatorni poremećaj i/ili autoimunski poremećaj; što pomenuti polipeptid je najmanje 7S% identičan sa SEQ ID NO 2,SEQ ID NO 4 ili SEQ ID NO 6 i gde pomenuta sekvenca polinukleotida kodira polipeptid koji ima najmanje 7S% identičnosti sa SEQ ID NO 2, SEQ ID NO 4 ili SEQ ID NO 6 i/ili gde pomenuta sekvenca polinukleotida ima najmanje 7S% identičnosti sa SEQ ID NO 1,SEQ ID NO 3 ili SEQ ID NO 5.

**Patent sadrži još 11 patentnih zahtjeva**

(11) **03078 (13) B**

(51) **C07D 401/12**<sup>(2006.01)</sup>

**A61P 25/00**<sup>(2006.01)</sup>

**A61K 31/454**<sup>(2006.01)</sup>

(21) P-2018-154

(22) 29.05.2013

(30) 201209587 30.05.2012 GB

(96) 13728238.0/29.05.2013

(86) GB PCT/GB2013/051415/29.05.2013

(87) wo 2013/179024/05.12.2013/2013/49

(97) EP 2855449/08.04.2015/201515

EP 2855449/07.03.2018/201810

(54) me **DERIVATI SULFONIL PIPERIDINA I NJIHOVA UPOTREBA ZA LEČENJE BOLESTI**

**POSREDOVANIH PREKO PROKINETICINA**

en **SULFONYL PIPERIDINE DERIVATIVES AND THEIR USE FOR TREATING PROKINETICIN**

**MEDIATED DISEASES**

(73) TAKEDA PHARMACEUTICAL COMPANY LIMITED

1-1 Doshomachi 4-chome Chuo-ku, Osaka-shi, Osaka 541-0045/ JP

(72) CARROLL, Colm

Rue Washington 25 B31 Ixelles, Brussels, B1050/ BE

GOLDBY, Anne

Takeda Cambridge Limited 418 Cambridge Science Park Milton Road, Cambridge Cambridgeshire

CB4 0PA/ GB

TEALL, Martin

Takeda Cambridge Limited 418 Cambridge Science Park Milton Road, Cambridge Cambridgeshire

CB4 0PA/ GB

(57) 1. Jedinjenje formule (Ia) ili njegova farmaceutski prihvatljiva so

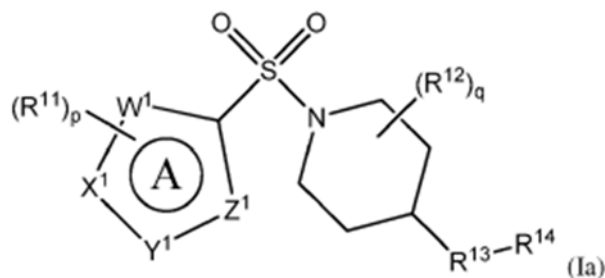

gde

W<sub>1</sub>, X<sub>1</sub>, Y<sub>1</sub> i Z<sub>1</sub> svaki nezavisno predstavlja N, NH ili CH, pri čemu najmanje dva od W<sub>1</sub>, X<sub>1</sub>, Y<sub>1</sub> i Z<sub>1</sub> predstavlja N ili NH;

P je 0, 1, 2 ili 3;

svaki R<sub>11</sub> nezavisno predstavlja halogen, cijano, C<sub>1</sub>-C<sub>6</sub> alkoksi, C<sub>1</sub>-C<sub>6</sub> haloalkil, C<sub>1</sub>-C<sub>6</sub> haloalkoksi, C<sub>1</sub>-C<sub>6</sub> alkiltio, C<sub>1</sub>-C<sub>6</sub>alkilkarbonil ili C<sub>1</sub>-C<sub>6</sub> alkil izborno supstituisan sa karboksil ili C<sub>1</sub>-C<sub>6</sub> alkoksikarbonil;

q je 0, 1, 2, 3 ili 4;

svaki R<sub>12</sub> nezavisno predstavlja halogen, cijano, karboksil, hidroksil, C<sub>1</sub>-C<sub>6</sub> alkil, C<sub>1</sub>-C<sub>6</sub> haloalkil, C<sub>1</sub>-C<sub>6</sub> alkoksi, C<sub>1</sub>-C<sub>6</sub>hidroksialkil, C<sub>1</sub>-C<sub>6</sub> alkoksikarbonil, C<sub>1</sub>-C<sub>6</sub> alkoksiC<sub>1</sub>-C<sub>6</sub> alkil ili 5- do 9-člani heterociklični sistem prstena;

R<sub>13</sub> predstavlja atom kiseonika ili grupu C=O, NR<sub>15</sub> ili CR<sub>16</sub>R<sub>17</sub>, uz uslove da (i) kada R<sub>13</sub> predstavlja CO ili NH i prsten A predstavlja pirazol-4-il ili imidazol-4-il, tada p mora biti 3 i R<sub>14</sub> predstavlja supstituisani fenil, piridinil ili naftil sistem prstena, i (ii) kada R<sub>13</sub> predstavlja CH<sub>2</sub> i prsten A predstavlja pirazol-4-il ili imidazol-4-il, tada ili p je 3 ili p je 2 i q je najmanje 1;

R<sub>15</sub> predstavlja atom vodonika ili C<sub>1</sub>-C<sub>6</sub> alkil grupu;

R<sub>16</sub> i R<sub>17</sub> svaki nezavisno predstavljaju atom vodonika ili halogena ili cijano, karboksil, hidroksil, C<sub>1</sub>-C<sub>6</sub> alkil, C<sub>1</sub>-C<sub>6</sub> haloalkil, C<sub>1</sub>-C<sub>6</sub> alkoksi, C<sub>1</sub>-C<sub>6</sub> hidroksialkil, C<sub>1</sub>-C<sub>6</sub> alkoksikarbonil, C<sub>1</sub>-C<sub>6</sub>alkoksiC<sub>1</sub>-C<sub>6</sub> alkil ili 5- do 9-člani heterociklični sistem prsten;

R<sub>14</sub> predstavlja fenil, piridinil ili naftil sistem prstena, pri čemu je sam sistem prstena izborno supstituisan sa najmanje jednim supstituentom izabranim od halogena, hidroksila, cijano, okso, C<sub>1</sub>-C<sub>6</sub>alkila, C<sub>2</sub>-C<sub>6</sub> alkenila, C<sub>2</sub>-C<sub>6</sub> alkinila, C<sub>1</sub>-C<sub>6</sub> haloalkila, C<sub>1</sub>-C<sub>6</sub>hidroksialkila, C<sub>1</sub>-C<sub>6</sub> alkoksi, C<sub>1</sub>-C<sub>6</sub> haloalkoksi, C<sub>1</sub>-C<sub>6</sub> alkiltio, C<sub>1</sub>-C<sub>6</sub> alkilsulfonila, C<sub>1</sub>-C<sub>6</sub> alkilsulfonila, C<sub>1</sub>-C<sub>6</sub> alkilkarbonila, C<sub>1</sub>-C<sub>6</sub> alkilkarboniloksi, C<sub>1</sub>-C<sub>6</sub> alkoksikarbonil, amino, -CON(R<sub>18</sub>)<sub>2</sub>, C<sub>1</sub>-C<sub>6</sub> alkilamino, di-(C<sub>1</sub>-C<sub>6</sub> alkil)amino, C<sub>3</sub>-C<sub>6</sub> cikloalkila, C<sub>3</sub>-C<sub>6</sub>cikloalkiloksi ili C<sub>3</sub>-C<sub>6</sub> cikloalkilmetila; i svaki R<sub>18</sub> nezavisno predstavlja atom vodonika ili C<sub>1</sub>-C<sub>6</sub>alkil grupu; ali isključujući sledeća jedinjenja:

- 1) 1-[(3,5-dimetil-1*H*-pirazol-4-il)sulfonil]-4-(4-metilfenoksi)piperidin,
- 2) 1-[(3,5-dimetil-1*H*-pirazol-4-il)sulfonil]-4-(4-fluorofenoksi)piperidin,
- 3) 1-[(3,5-dimetil-1*H*-pirazol-4-il)sulfonil]-4-(4-metoksifenoksi)piperidin,
- 4) 1-[(3,5-dimetil-1*H*-pirazol-4-il)sulfonil]-4-fenoksipiperidin,
- 5) 1-[(3,5-dimetil-1*H*-pirazol-4-il)sulfonil]-4-(3-etilfenoksi)piperidin,
- 6) 4-fenoksi-1-(1*H*-pirazol-4-ilsulfonil)piperidin,
- 7) 4-(3-hlorofenoksi)-1-[(3,5-dimetil-1*H*-pirazol-4-il)sulfonil]piperidin,
- 8) [1-[(5-hloro-1,3-dimetil-1*H*-pirazol-4-il)sulfonil]-4-piperidinil](4-metoksifenil)metanon,
- 9) 1-[(3,5-dimetil-1*H*-pirazol-4-il)sulfonil]-4-(2-metilfenoksi)piperidin,
- 10) 1-[(3,5-dimetil-1*H*-pirazol-4-il)sulfonil]-4-[[2-(trifluorometil)fenil]metil]-4-piperidinmetanol,
- 11) 1-[(3,5-dimetil-1*H*-pirazol-4-il)sulfonil]-4-[(4-metoksifenil)metil]-4-piperidinkarboksilna kiselina, etil estar,
- 12) 4-[[1-[(1-metil-1*H*-pirazol-4-il)sulfonil]-4-piperidinil]oksi]benzonitril,
- 13) *N*-(2-metilfenil)-1-[(1,3,5-trimetil-1*H*-pirazol-4-il)sulfonil]-4-piperidinamin,
- 14) 1-[[1-(difluorometil)-3-metil-1*H*-pirazol-4-il]sulfonil]-4-(4-fluorofenoksi)piperidin,
- 15) 4-(3-fluorofenoksi)-1-[(3-metil-1-propil-1*H*-pirazol-4-il)sulfonil]piperidin,
- 16) 1-[[1-(difluorometil)-3,5-dimetil-1*H*-pirazol-4-il]sulfonil]-4-(2-fluorofenoksi)piperidin,
- 17) 1-[(5-hloro-1,3-dimetil-1*H*-pirazol-4-il)sulfonil]-4-(fenilmetil)piperidin,
- 18) 1-[[1-(difluorometil)-3,5-dimetil-1*H*-pirazol-4-il]sulfonil]-4-(fenilmetil)piperidin,
- 19) 1-[(1-etil-3,5-dimetil-1*H*-pirazol-4-il)sulfonil]-4-(fenilmetil)piperidin,
- 20) (4-(4-Metoksibenzil)-1-(1,3,5-trimetil-1*H*-pirazol-4-il)sulfonil)piperidin-4-il)metanol,
- 21) (4-(4-Hlorobenzil)-1-(1,3,5-trimetil-1*H*-pirazol-4-il)sulfonil)piperidin-4-il)metanol,
- 22) 1-[(5-hloro-1,3-dimetil-1*H*-pirazol-4-il)sulfonil]-4-[(4-metoksifenil)metil]-4-piperidinmetanol,
- 23) 4-(fenilmetil)-1-[(1,3,5-trimetil-1*H*-pirazol-4-il)sulfonil]piperidin,
- 24) [1-[(5-hloro-1,3-dimetil-1*H*-pirazol-4-il)sulfonil]-4-piperidinil](4-fluorofenil)metanon,

- 25) 1-[(1-metil-1*H*-imidazol-4-il)sulfonil]-4-(2-naftaleniloksi)piperidin,  
26) 4-((fenil)(metoksi)metil)-1-((3,5-dimetil-1*H*-pirazol-4-il)sulfonil)piperidin i  
27) 4-(fenilmetil)-1-(1*H*-imidazol-5-il)sulfonil)piperidin.

**Patent sadrži još 24 patentnih zahtjeva**



(11) **03079** (13) **B**

(51) **C07K 14/52**<sup>(2006.01)</sup>

**C07K 14/55**<sup>(2006.01)</sup>

**C07K 14/715**<sup>(2006.01)</sup>

(21) P-2018-155

(22) 06.06.2013

(30) 201261657378 P 08.06.2012 US

201261657264 P 08.06.2012 US

201261657285 P 08.06.2012 US

201261723081 P 06.11.2012 US

201361778575 P 13.03.2013 US

201361778812 P 13.03.2013 US

(96) 13801437.8/06.06.2013

(86) US PCT/US2013/044556/06.06.2013

(87) WO/2013/184942/12.12.2013/50/2013

(97) EP 2859015/15.04.2015/2015/16

EP 2859015/21.03.2018/2018/12

(54) me **LIGANDI MODIFIKOVANI CIRKULARNOM PERMUTACIJOM KAO AGONISTI I ANTAGONISTI**

en **LIGANDS MODIFIED BY CIRCULAR PERMUTATION AS AGONISTS AND ANTAGONISTS**

(73) ALKERMES PHARMA IRELAND LIMITED

852 Winter Street, Waltham, MA 02451/ US

(72) ALVAREZ, Juan

6 Wyndbrook Lane, Chelmsford, MA 01824/ US

CHAMOUN, Jean

109 Myrtle Street Apt. 3, Waltham, MA 02453/ US

(57) 1. Fuzioni polipeptid koji sadrži aminokiseline 1 do 303 od SEQ ID NO: 26, ili aminokiselinsku sekvencu koja joj je homologa, sa najmanje 70% identičnosti sekvence na aminokiselinskom nivou koji sadrži cirkularno permutovan IL-2 i ima poboljšanu selektivnost za IL-2R $\beta\gamma$  u odnosu na IL-2R $\alpha\beta\gamma$  u poređenju sa divljim tipom IL-2.

**Patent sadrži još 6 patentnih zahtjeva**

(11) **03080** (13) **B**

(51) **C07K 16/28**<sup>(2006.01)</sup>

**A61P 35/00**<sup>(2006.01)</sup>

**A61K 39/395**<sup>(2006.01)</sup>

**C07K 16/00**<sup>(2006.01)</sup>

(21) P-2018-157

(22) 07.01.2014

(30) TO20130012 09.01.2013 IT

(96) 14701430.2/07.01.2014

(86) IB PCT/IB2014/058098/07.01.2014

(87) WO 2014/108829/17.07.2014/2014/29

(97) EP 2943510/18.11.2015/2015/47

EP 2943510/23.05.2018/2018/21

(54) me **NOVI FRAGMENTI ANTITELA, NJIHOVE MEŠAVINE I PRIMENE**  
en **NEW ANTIBODY FRAGMENTS, COMPOSITIONS AND USES THEREOF**

(73) METIS PRECISION MEDICINE SB S.R.L.

Via Magenta 35, Torino (TO), 10128/ IT

(72) VIGNA, Elisa

Via dei Platani 29/2, Villarbasse (Torino), I-10090 / IT

MICHIELI, Paolo

Via Vincenzo Bellini 66/1, Rivalta di Torino (Torino), I-10040/ IT

COMOGLIO, Paolo Maria

Strada Val Salice 183/8, Torino, I-10133/ IT

(57) 1. Fragment antitela koji obuhvata prvipolipeptid koji obuhvata varijabilni domen lakog lanca idva konstantna domena idrugi polipeptid koji obuhvata varijabilni domen teškog lanca idva konstantna domena, u kojem dva konstantna domena su konstantni domen lakog lanca, a dva konstantna domena su CH konstantni domen teškog lanca, pri čemu pomenuti fragment antitela ima produženi *in vivo* polu-život u odnosu na Fab fragment koji obuhvata pomenute varijabilne domene lakog i teškog lanca, pri čemu prvipolipeptid obuhvata jedan varijabilni domen lakog lanca idva humana konstantna domena lakog lanca, pri čemu je varijabilni domen lakog lanca fuzionisan sa prvim humanim konstantnim domenom lakog lanca koji je fuzionisan sa drugim konstantnim domenom lakog lanca u N-do (-terminalnom pravcu, čime se generiše VL-CL-CH1 imernilakilanac, i : pri čemu drugipolipeptid obuhvata jedan varijabilni domen teškog lanca idva humana konstantna domena teškog lanca, pri čemu je varijabilni domen teškog lanca fuzionisan sa prvim humanim CH konstantnim domenom teškog lanca koji je fuzionisan sa drugim humanim CH1 konstantnim domenom teškog lanca u N- do e-terminalnom pravcu, čime se generiše VH-CHI-CHI himernilteškilanac.

**Patent sadrži još 17 patentnih zahtjeva**

(11) **03081** (13) **B**

(51) **C07D 401/04**<sup>(2006.01)</sup>

**A61K 31/4184**<sup>(2006.01)</sup>

**A61K 31/4439**<sup>(2006.01)</sup>

**A61P 35/00**<sup>(2006.01)</sup>

(21) P-2018-158

(22) 04.06.2013

(30) 201261656888 P 07.06.2012 US

(96) 13800681.2/04.06.2013

(86) US PCT/US2013/044116/04.06.2013

(87) WO 2013/184681/12.12.2013/2013/50

(97) EP 2858985/15.04.2015/2015/16

EP 2858985/18.04.2018/2018/16

(54) me **MODULATORA RECEPTORA ANDROGENA PATENTNI ZAHTEVI**  
en **CRYSTALLINE FORMS OF AN ANDROGEN RECEPTOR MODULATOR**

(73) ARAGON PHARMACEUTICALS, INC.

12780 El Camino Real Suite 301, San Diego, CA 92130/ US

SLOAN-KETTERING INSTITUTE FOR CANCER RESEARCH

1275 York Avenue, New York, NY 10065/ US

(72) SMITH,, Nicholas, D.

1204 Beryl Street, San Diego, CA 92109/ US

HERBERT, Mark, R.

4180 Amoroso St., San Diego, CA 92111/ US

OUERFELLI, Ouathek

2077 Center Avenue Apt. 3J, Fort Lee, NJ 07024/ US

DILHAS, Anna

Häsingerstrasse 32, Basel, 4055/ CH

(57) 1. Kristalni Oblik B 4-[7-(6-cijano-5-trifluorometilpiridin-3-il)-8-okso-6-tio-5,7-diazaspiro[3.4]okt-5-il]-2-fluoro-N-metilbenzamida, naznačen time, što ima najmanje jedan od: (a) spektar difrakcije X-zraka praha (XRPD), isti kao što je pokazan na Slici 2; (b) spektar difrakcije X-zraka praha (XRPD), sa karakterističnim pikovima na  $12.1 \pm 0.1$  2-teta,  $16.0 \pm 0.1$  2-teta,  $16.7 \pm 0.1$  2-teta,  $20.1 \pm 0.1$  2-teta,  $20.3 \pm 0.1$  2-teta; (e) parametre jedinične ćelije, koji su jednaki sledećim, na  $-173^\circ\text{C}$ :

Kristalni sistem	Monoklinski				
Prostorna grupa	P2 <sub>1</sub> /c	a	17,7796(4) Å	ci	90°
		b	12,9832 (3) Å		100.897(2)°
		c	18,4740(4) Å	y	90°
V	4187,57(16) Å <sup>3</sup>				
Z	8				
Dc	1,515 g cm <sup>-3</sup>				

(d) isti spektar difrakcije X-zraka praha (XRPD) kao što su (a) ili (b), posle najmanje nedelju dana skladištenja na  $40^\circ\text{C}$  i 75% RV; ili (e) isti spektar difrakcije X-zraka praha (XRPD) kao što su (a) ili (b), posle 12 dana skladištenja na  $25^\circ\text{C}$  i 92% RH.

**Patent sadrži još 14 patentnih zahtjeva**

(11) 03082 (13) B

(51) C07J 9/00<sup>(2006.01)</sup>

A61K 31/575<sup>(2006.01)</sup>

C07J 71/00<sup>(2006.01)</sup>

C07J 41/00<sup>(2006.01)</sup>

A61P 1/16<sup>(2006.01)</sup>

C07J 31/00<sup>(2006.01)</sup>

(21) P-2018-159

(22) 14.05.2014

(30) 201361823169 P 14.05.2013 US

(96) 14723820.8/14.05.2014

(86) EP PCT/EP2014/059896/14.05.2014

(87) WO 2014/184271/20.11.2014/2014/47

(97) EP 2997035/23.03.2016/2016/12

EP 2997035/28.03.2018/2018/13

(54) me **11-HIDROKSIL-6-SUPSTITUISANI-DERIVATI ŽUČNIH KISELINA I NJIHOVI AMINOKISELINSKI KONJUGATI KAO MODULATORI RECEPTORA ZA FARNEZOID X**  
en **11-HYDROXYL-DERIVATIVES OF BILE ACIDS AND AMINO ACID CONJUGATES THEREOF AS FARNESOID X RECEPTOR MODULATORS**

(73) INTERCEPT PHARMACEUTICALS, INC.

450 W. 15th Street Suite 505, Floor 5, New York, NY 10011/ US

(72) PELLICCIARI, Roberto

TES Pharma S.r.l. via Settevalli 556, I-06129 Perugia/ IT

(57) 1. Jedinjenje formule I:

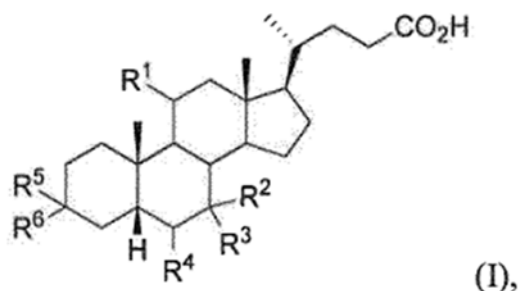

ili njegova farmaceutski prihvatljivu so, solvat ili aminokiselinski konjugat, naznačeno time što: R<sub>1</sub> je hidroksil; R<sub>2</sub> je vodonik, hidroksil, alkil ili halogen, pri čemu je navedeni alkil nesupstituisan ili supstituisan sa jednim ili više R<sub>a</sub>; R<sub>3</sub> je vodonik, hidroksil, alkil ili halogen, pri čemu je navedeni alkil nesupstituisan ili supstituisan sa jednim ili više R<sub>b</sub>; R<sub>4</sub> je alkil, alkenil, alkinil ili halogen, pri čemu je navedeni alkil nesupstituisan ili supstituisan sa jednim ili više R<sub>c</sub>;

R<sub>a</sub>, R<sub>b</sub> i R<sub>c</sub> su svaki nezavisno halogen ili hidroksil; R<sub>5</sub> je hidroksil, OSO<sub>3</sub>H, OSO<sub>3</sub><sup>-</sup>, OCOCH<sub>3</sub>, OPO<sub>3</sub>H<sub>2</sub>, OPO<sub>3</sub><sup>2-</sup>, ili vodonik; i R<sub>6</sub> je hidroksil, OSO<sub>3</sub>H, OSO<sub>3</sub><sup>-</sup>, OCOCH<sub>3</sub>, OPO<sub>3</sub>H<sub>2</sub>, OPO<sub>3</sub><sup>2-</sup>, ili vodonik; ili uzeti zajedno R<sub>5</sub> i R<sub>6</sub> sa atomom ugljenika za koji su vezani formiraju karbonil.

**Patent sadrži još 19 patentnih zahtjeva**

- (11) **03083** (13) **B**  
(51) **A61F 2/00**<sup>(2006.01)</sup>  
(21) P-2018-160  
(22) 08.06.2015  
(30) MI20141175 27.06.2014 IT  
(96) 15732430.2/08.06.2015  
(86) IB PCT/IB2015/054320/08.06.2015  
(87) WO 2015/198179/30.12.2015/2015/52  
(97) EP 3160386/03.05.2017/2017/18  
EP 3160386/25.04.2018/2018/17  
(54) me **VEŠTAČKI SFINKTER**  
en **ARTIFICIAL SPHINCTER**  
(73) Sambusseti, Antonio  
Via San Predengo, 13, 26100 Cremona (CR)/ IT  
Cancarini, Gianni  
Via Corfù, 53, 25124 Brescia (BS)/ IT  
(72) Sambusseti, Antonio  
Via San Predengo, 13, 26100 Cremona/ IT  
Cancarini, Gianni  
Via Corfù 53, 25124 Brescia/ IT

(57) 1. Veštački sfinkter koji sadrži najmanje dva elementa (2), koji su međusobno povezani i šuplji radi prihvatanja fluida pod pritiskom; pri čemu su pomenuti elementi (2) konfigurisani tako da se postavljaju sa suprotnih strana uretre pacijenta; svaki element (2) ima odgovarajuću kontaktnu površinu (3) sa uretrom, suštinski polu-cilindričnog oblika; naznačen time što svaki element (2) ima polu-konusnu površinu (5) nasuprot kontaktnoj površini (3).

**Patent sadrži još 8 patentnih zahtjeva**

(11) **03084** (13) **B**

(51) **C07D 417/14**<sup>(2006.01)</sup>

(21) P-2018-161

(22) 03.01.2013

(30) 201261582760 P 03.01.2012 US

(96) 16189661.8/03.01.2013

(97) EP 3133073/22.02.2017/2017/08

EP 3133073/02.05.2018/2018/18

(54) me **INHIBITORI INHIBITORA PROTEINA APOPTOZE**  
en **INHIBITORS OF IAP**

(73) CURIS, INC.

4 Maguire Road, Lexington, MA 02421/ US

GENENTECH, INC.

1 DNA Way, South San Francisco, CA 94080-4990/ US

(72) COHEN, , Frederick

1551 24th Avenue, San Francisco, CA California 94122/ US

FLYGARE,, John A.

1419 Vancouver Avenue, Burlingame, CA California 94010/ US

GAZZARD, Lewis J.

2552 Belmont Canyon Road, Belmont, CA California 94002/ US

TSUI, Vickie Hsiao-Wei

2626 Martinez Drive, Burlingame, CA California 94010-5829/ US

(57)

1. Postupak za dobijanje jedinjenja iz formulel

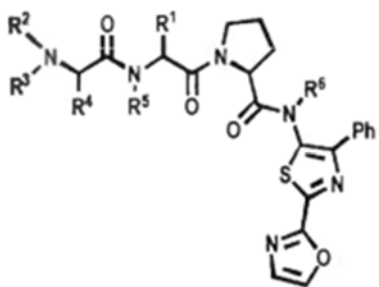

pričemu Ph je fenil; R1 je C3-7Cikloalkil;

R2,R3,R4,R5,iR6susvakinezavisno u svakojpojaviHiliC1- salkil;ilinjegovafarmaceutskiprihvatljiva so, obuhvatakorakespajanjaaminomzaštićenoganalogaaostatka amino kiselineiuklanjanjezaštitesaistog.

**Patent sadrži još 14 patentnih zahtjeva**

(11) 03085 (13) B

(51) A61K 31/422<sup>(2006.01)</sup>

A61K 31/433<sup>(2006.01)</sup>

C07D 285/135<sup>(2006.01)</sup>

C07D 237/20<sup>(2006.01)</sup>

C07D 241/20<sup>(2006.01)</sup>

C07D 277/40<sup>(2006.01)</sup>

C07D 417/12<sup>(2006.01)</sup>

C07D 271/113<sup>(2006.01)</sup>

C07D 261/14<sup>(2006.01)</sup>

C07D 413/12<sup>(2006.01)</sup>

A61K 31/4245<sup>(2006.01)</sup>

C07D 285/08<sup>(2006.01)</sup>

C07D 213/73<sup>(2006.01)</sup>

C07D 239/42<sup>(2006.01)</sup>

C07D 263/48<sup>(2006.01)</sup>

C07D 401/12<sup>(2006.01)</sup>

C07D 271/07<sup>(2006.01)</sup>

C07D 253/07<sup>(2006.01)</sup>

C07D 285/12<sup>(2006.01)</sup>

(21) P-2018-163

(22) 27.07.2011

(30) 11160738 31.03.2011 EP

11160731 31.03.2011 EP

11160728 31.03.2011 EP

10171342 29.07.2010 EP

(96) 11749119.1/27.07.2011

(86) EP PCT/EP2011/062949/27.07.2011

(87) WO 2012/013728/02.02.2012/2012/05

(97) EP 2598482/05.06.2013/2013/23

EP 2598482/04.04.2018/2018/14

(54) me **DEMILAZA INHIBITORI LSD1 ZASNOVANI NA ARILCIKLOPROPILAMINU I NJIHOVA  
MEDICINSKA PRIMJENA**  
en **ARYLCYCLOPROPYLAMINE BASED DEMETHYLASE INHIBITORS OF LSD1 AND THEIR  
MEDICAL USE**

(73) Oryzon Genomics, S.A.

Carrera de San Jerónimo 15, 2nd Floor, 28014 Madrid/ ES

(72) ORTEGA MUÑOZ, Alberto

Oryzon Genomics S.A. C/Sant Ferran 74, E-08940 Cornellà de Llobregat Barcelona/ ES  
FYFE, Matthew, Colin, Thor

Oryzon Genomics S.A. C/Sant Ferran 74, E-08940 Cornellà de Llobregat Barcelona/ ES  
MARTINELL PEDEMONTE, Marc

Oryzon Genomics S.A. C/Sant Ferran 74, E-08940 Cornellà de Llobregat Barcelona/ ES  
TIRAPU FERNANDEZ DE LA CUESTA, Iñigo

Oryzon Genomics S.A. C/Sant Ferran 74, E-08940 Cornellà de Llobregat Barcelona/ ES  
ESTIARTE-MARTÍNEZ, Maria de los Ángeles

Oryzon Genomics S.A. C/Sant Ferran 74, E-08940 Cornellà de Llobregat Barcelona/ ES

(57) 1. Jedinjenje formule (I) ili njegova farmaceutski prihvatljiva so ili solvat

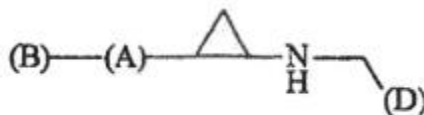

(I)

gde,

(A) je aril ili heteroaril grupa, gde navedena aril grupa ili heteroaril grupa ima n supstituenata (R3);

(B) je -O-CH<sub>2</sub>-fenil ili fenil, gde navedeni fenil ili fenilni **ostatak** sadržan u navedenom -O-CH<sub>2</sub>-fenilu ima n supstituenata (R2);

(D) je monociklična heteroaril grupa, gde navedena heteroaril grupa ima jedan supstituent (R1), i još je navedena heteroaril grupa kovalentno vezana za ostatak molekula preko C atoma iz prstena;

(R1) je -NH<sub>2</sub>;

svaki (R2) je nezavisno odabran od alkil, alkenil, alkinil, ciklil, amino, amido, C-amido, alkilamino, hidroksi, nitro, halo, haloalkil, haloalkoksi, cijano, sulfinil, sulfonil, sulfonamid, alkoksi, acil, karboksil, karbamat ili urea;

svaki (R3) je nezavisno odabran od alkil, alkenil, alkinil, ciklil, amino, amido, C-amido, alkilamino, hidroksil, nitro, halo, haloalkil, haloalkoksi, cijano, sulfinil, sulfonil, sulfonamid, alkoksi, acil, karboksil, karbamat ili urea; i

n je nezavisno 0, 1, 2, 3 ili 4.

**Patent sadrži još 28 patentnih zahtjeva**



(11) **03096** (13) **B**

(51) **A62D 1/00**<sup>(2006.01)</sup>

**C08W 9/34**<sup>(2006.01)</sup>

(21) P-2018-168

(22) 09.02.2012

(30) 2011104729 10.02.2011 RU

(96) 12744457.8/09.02.2012

(86) IB PCT/IB2012/00012/09.02.2012

(87) WO2012/107825/16.08.2012/2012/33

(97) EP 2674198/18.12.2013/2013/51

EP 2674198/04.04.2018/2018/14

(54) me **Autonomno sredstvo za gašenje požara**  
en **AUTONOMOUS FIRE-FIGHTING AGENT**

(73) Independent Fire Suppression Technologies; Inc.  
4047 MT Everest Way, Katy, Texas 77449/ US

(72) BLIZNETS, Igor

ul. Khabarovskaia 14/2-133, Moscow 107589/ RU

SEREGIN, Victor

ul. Oktiabrskaja 4-10 Sergiev-Posad, Moskovskaya obl. 141300/ RU

(57) Autonomno sredstvo za ga enje požara (10) proizvedeno od materijala sa svojstvima ga enja požara koji obuhvata mikrokapsule (2) ispunjene jedinjenjem za ga enje požara čije dimenzije se kreću od 2 do 100 Am, a navedene mikrokapsule ispunjene su halougljenikom u polimernom omotaču od poliuree i/ili poliuretana, i vezivnim sredstvom (3), pri čemu vezivno sredstvo (3) predstavlja kompozitni materijal koji čine polimerna komponenta i mineralna vlakna (5) i/ili čestice.

**Patent sadrži još 9 patentnih zahtjeva**

(11) **03093** (13) **B**

(51) **C07D 487/04**<sup>(2006.01)</sup>

**A61P 35/00**<sup>(2006.01)</sup>

**A61K 31/519**<sup>(2006.01)</sup>

(21) P-2018-171

(22) 14.11.2014

(30) PCT/CA2013/000957 15.11.2013 WO

(96) 14861448.0/14.11.2014

(86) CA PCT/CA2014/051091/14.11.2014

(87) WO 2015/070349/21.05.2015/2015/20

(97) EP 3068786/21.09.2016/2016/38

EP 3068786/06.06.2018/2018/23

(54) me **PIRAZOLOPIRIMIDINSKA JEDINJENJA**

en **PYRAZOLOPYRIMIDINE COMPOUNDS**

(73) University Health Network

190 Elizabeth Street R. Fraser Elliott Building - Room 1S-417, Toronto, Ontario M5G 2C4/ CA

(72) LAUFER, Radoslaw

2145 Meadowglen Drive, Oakville, Ontario L6M 4C8/ CA

NG., Grace

23 Staglin Court, Markham, Ontario L6C 0K8/ CA

LI, Sze-Wan

509 Roselawn Avenue, Toronto, Ontario M5N 1K2/ CA

PAULS, Heinz W.

460 Fourth Line, Oakville, Ontario L6L 5A4/ CA

LIU, Yong

1066 Harcroft Court, Oakville, Ontario L6H 3K5/ CA

PATEL, Narendra Kumar B.

21 Beachsurf Road, Brampton, Ontario L6R 2R4/ CA

(57) 1. Jedinjenje predstavljeno sledećom strukturnom formulom:

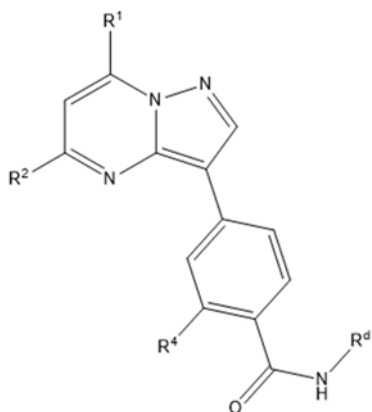

(I);

ili njegova farmaceutski prihvatljiva so, pri čemu:

R<sub>1</sub> je -NH□CH<sub>2</sub>□Cy;

Cy je ciklopropil ili ciklobutil, pri čemu je ciklopropil ili ciklobutil opciono supstituisan sa jednom ili dve grupe izabrane između alkila i hidroksila;

R<sub>2</sub> je -O-piridinil; -NH□(C<sub>2</sub>-C<sub>6</sub>)hidroksialkil opciono supstituisan sa ciklopropilom ili izopropilom; ili -NH□(C<sub>3</sub>-C<sub>6</sub>)cikloalkil opciono supstituisan sa hidroksilom ili (C<sub>1</sub>-C<sub>2</sub>)hidroksilalkilom;

R<sub>4</sub> je izabran između vodonika, halogena, i (C<sub>1</sub>-C<sub>3</sub>)alkila; i

R<sub>d</sub> je ciklopropil.

**Patent sadrži još 8 patentnih zahtjeva**

(11) **03094** (13) **B**

(51) **C07K 16/18**<sup>(2006.01)</sup>

**C07K 16/24**<sup>(2006.01)</sup>

(21) P-2018-173

(22) 05.03.2014

(30) 201361792800 P 15.03.2013 US

(96) 14711899.6/05.03.2014

(86) US PCT/US2014/020605/05.03.2014

(87) WO 2014/149733/25.09.2014/2014/39

(97) EP 2970447/20.01.2016/2016/03

EP 2970447/16.05.2018/2018/20

(54) me **PROTUTIJELA PROTIV KEMOKINA PAN-ELR+ CXC**  
en **PAN-ELR+ CXC CHEMOKINE ANTIBODIES**

(73) ELI LILLY AND COMPANY

Lilly Corporate Center, Indianapolis IN 46285/ US

(72) BEIDLER, Catherine Brautigam

c/o Eli Lilly and Company P. O. Box 6288, Indianapolis Indiana 46206-6288/ US

KIKLY, Kristine Kay

c/o Eli Lilly and Company P. O. Box 6288, Indianapolis Indiana 46206-6288/ US

STRIFLER, Beth Ann

c/o Eli Lilly and Company P. O. Box 6288, Indianapolis Indiana 46206-6288/ US

WITCHER, Derrick Ryan

c/o Eli Lilly and Company P. O. Box 6288, Indianapolis Indiana 46206-6288/ US

BOYLES, Jeffrey Streetman

c/o Eli Lilly and Company P. O. Box 6288, Indianapolis Indiana 46206-6288/ US

(57) 1. Protutijelo koje se veže na ljudski Gro-a, Gro-p, Gro-y, ENA-78, GCP-2, NAP-2, i IL-8, naznačeno time što protutijelo sadrži laki lanac i teški lanac, gdje laki lanac sadrži varijabilno područje lakog lanca (LCVR), a teški lanac sadrži varijabilno područje teškog lanca (HCVR), gdje LCVR sadrži LCDRI, LCDR2, LCDR3, a HCVR sadrži HCDRI, HCDR2, HCDR3, gdje je LCDRI RASQISNNLH (SEQ ID NO: 7), LCDR2 je YTSRSVS (SEQ ID NO: 8), LCDR3 je GQNNEWPEV (SEQ ID NO: 9), HCDRI je GYEFTSYWIH (SEQ ID NO: JO), HCDR2 je NISPNSGSANYNEKFKS (SEQ ID NO: II), a HCDR3 je EGPYSYPSRXaaYYGSDL (SEQ ID NO: 20), gdje je Xaa E ili Q.

**Patent sadrži još 11 patentnih zahtjeva**

(11) **03086** (13) **B**

(51) **C12P 19/34**<sup>(2006.01)</sup>

**A61K 48/00**<sup>(2006.01)</sup>

**C07K 14/435**<sup>(2006.01)</sup>

(21) P-2018-175

(22) 24.01.2014

(30) 201361756777 P 25.01.2013 US

201361757389 P 28.01.2013 US

(96) 14743871.7/24.01.2014

(86) US PCT/US2014/012932/24.01.2014

(87) WO 2014/116937/31.07.2014/2015/49

(97) EP 2948559/02.12.2015/2015/49

EP 2948559/02.05.2018/2018/18

(54) me **ANTAGONISTI KV1.3 I POSTUPCI ZA UPOTREBU**  
en **KV1.3 ANTAGONISTS AND METHODS OF USE**

(73) Janssen Biotech, Inc.

800/850 Ridgeview Drive Horsham, PA 19044/ US

(72) CHI, Ellen

3210 Merryfield Row, San Diego, California 92121/ US

EDWARDS, Wilson

3210 Merryfield Row, San Diego, California 92121/ US

HUANG, Chichi

1400 McKean Road, Spring House, Pennsylvania 19477/ US

LEUNG, Wai-Ping

3210 Merryfield Row, San Diego, California 92121/ US

SWANSON, Ronald

3210 Merryfield Row, San Diego, California 92121/ US

WICKENDEN, Alan

3210 Merryfield Row, San Diego, California 92121/ US

(57) 1. Izolovani peptidni antagonist Kv1.3 koji ima sekvencu aminokiselina koja sadrži sekvencu aminokiselina koja je najmanje 84% identična sa SEQ ID NO: I, koja dalje ima supstituciju glicina sa izoleucinom u položaju 10 (GIOI).

**Patent sadrži još 14 patentnih zahtjeva**

- (11) **03069** (13) **B**  
(51) **C07K 16/24**<sup>(2006.01)</sup>  
(21) P-2018-182  
(22) 21.11.2011  
(30) 20100416495P 23.11.2010 US  
(96) 11785424.8/21.11.2011  
(86) EP PCT/EP2011/070604/21.11.2011  
(87) WO 2012/069433/31.05.2012/2012/22  
(97) EP 2643352/02.10.2013/2013/40  
EP 2643352/02.05.2018/2018/18  
(54) me **ANTIGEN VEZUJUĆI PROTEINI ZA ONKOSTATIN M (OSM)**  
en **ANTIGEN BINDING PROTEINS TO ONCOSTATIN M (OSM)**  
(73) GLAXO GROUP LIMITED  
980 Great West Road, Brentford, Middlesex TW8 9GS/ GB  
(72) BEMBRIDGE, Gary Peter  
Gunnels Wood Road, Stevenage Herfordshire SG1 2NY/ GB  
CHUNG, Chun-wa  
Gunnels Wood Road, Stevenage Herfordshire SG1 2NY/ GB  
FEENEY, Maria  
Gunnels Wood Road, Stevenage Herfordshire SG1 2NY/ GB  
FORD, Susannah Karen  
Gunnels Wood Road, Stevenage Herfordshire SG1 2NY/ GB  
KIRBY, Ian  
Gunnels Wood Road, Stevenage Herfordshire SG1 2NY/ GB  
MCADAM, Ruth  
Gunnels Wood Road, Stevenage, Hertfordshire SC1 2NY/ GB  
(74) Advokat LUTOVAC, Branislav  
Bulevar Ivana Crnojevića 93 , Podgorica , 81000 / ME  
Advokat LUTOVAC, Vuk  
Bulevar Ivana Crnojevića 93 , Podgorica, 81000 / ME

(57) 1. Antitelo koje se specifično vezuje za OSM i koje inhibira vezivanje OSM za gp130 receptor ali ne interaguje direktno sa ostacima na mestu II i gde antitelo sadrži CDRH3 od SEQ ID NO.3 ili varijantu SEQ ID NO.3, gde je položaj 98 supstituisan za Leu, i gde antitelo sadrži:

- i) CDRH2 kao što je prikazano u SEQ ID NO. 2
- ii) CDRL1 kao što je prikazano u SEQ ID NO. 4 i
- iii) CDRL3 kao što je prikazano u SEQ ID NO. 6:

i gde se antitelo vezuje za oba OSM i od Marmozeta i čoveka sa afinitetom koji je jači od 1nM kada se meri sa Biacore ili kinexa.

**Patent sadrži još 16 patentnih zahtjeva**

(11) **03070** (13) **B**

(51) **A61K 31/00**<sup>(2006.01)</sup>  
**A61K 31/675**<sup>(2006.01)</sup>  
**C07H 1/00**<sup>(2006.01)</sup>  
**C07H 15/18**<sup>(2006.01)</sup>  
**C07D 519/00**<sup>(2006.01)</sup>  
**A61P 31/14**<sup>(2006.01)</sup>

**A61K 31/53**<sup>(2006.01)</sup>  
**A61K 31/685**<sup>(2006.01)</sup>  
**C07H 11/00**<sup>(2006.01)</sup>  
**C07D 487/04**<sup>(2006.01)</sup>  
**C07H 1/02**<sup>(2006.01)</sup>

(21) P-2018-183

(22) 29.10.2015

(30) 201462072331P 29.10.2014 US  
201562105619P 20.01.2015 US

(96) 15797205.0/29.10.2015

(86) US PCT/US2015/057933/29.10.2015

(87) WO 2016/069826/06.05.2016/2016/18

(97) EP 3212174/06.09.2017/2017/36

EP 3212174/16.05.2018/2018/20

(54) me **POSTUPCI LIJEČENJA VIRUSNIH FILOVIRIDAE INFEKCIJA**  
en **METHODS FOR TREATING FILOVIRIDAE VIRUS INFECTIONS**

(73) GILEAD SCIENCES, INC.

333 Lakeside Drive, Foster City, CA 94404/ US

(72) CHUN, Byoung, Kwon

333 Lakeside Drive, Foster City, CA 94404/ US

CLARKE, Michael, O'Neil Hanrahan

333 Lakeside Drive, Foster City, CA 94404/ US

DOERFFLER, Edward

333 Lakeside Drive, Foster City, CA 94404/ US

HUI, Hon, Chung

333 Lakeside Drive, Foster City, CA 94404/ US

JORDAN, Robert

333 Lakeside Drive, Foster City, CA 94404/ US

MACKMAN, Richard, L.

333 Lakeside Drive, Foster City, CA 94404/ US

PARRISH, Jay, P.

333 Lakeside Drive, Foster City, CA 94404/ US

RAY, Adrian, S.

333 Lakeside Drive, Foster City, CA 94404/ US

SIEGEL, Dustin

333 Lakeside Drive, Foster City, CA 94404/ US

(74) Advokat LUTOVAC, Branislav

Bulevar Ivana Crnojevića 93 , Podgorica , 81000 / ME

Advokat LUTOVAC, Vuk

Bulevar Ivana Crnojevića 93 , Podgorica, 81000 / ME

(57) 1. Jedinjenje koje ima strukturu:

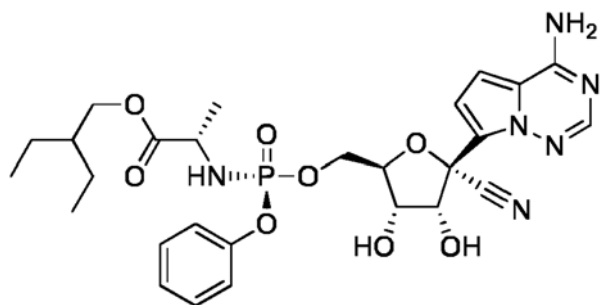

ili njegova farmaceutski prihvatljiva so.

**Patent sadrži još 7 patentnih zahtjeva**



- (11) **03072** (13) **B**
- (51) **C07D409/10**<sup>(2006.01)</sup> **C07D409/14**<sup>(2006.01)</sup>  
**C07D417/14**<sup>(2006.01)</sup> **A61K31/381**<sup>(2006.01)</sup>  
**A61P3/00**<sup>(2006.01)</sup>
- (21) P-2018-23  
(22) 09.09.2008  
(30) 20070971067P 10.09.2007 US  
20080018822 03.01.2008 US  
(96) 08831144.4/09.09.2008  
(86) US PCT/2008US/075700/09.09.2008  
(87) WO 2009/035969 A1/19.03.2009/2009/12  
(97) EP 2200606/30.06.2010/2010/26  
EP 2200606/25.10.2017/2017/43  
(54) me **POSTUPAK ZA DOBIJANJE JEDINJENJA KOJA SU KORISNA KAO INHIBITORI SGL T**  
en **PROCESS FOR THE PREPARATION OF COMPOUNDS USEFUL AS INHIBITORS OF SGLT**
- (73) JANSSEN PHARMACEUTICA, N.V.  
Turnhoutseweg 30, Beerse, 2340 / BE  
MITSUBISHI TANABE PHARMA CORPORATION  
3-2-10, Dosho-machi, Chuo-ku, Osaka-shi, Osaka 541 -8505/ JP
- (72) ABDEL-MAGID, Ahmed F.  
1383 Jasper Drive, Ambler Pennsylvania 19002/ US  
CHISHOLM, Maureen  
119 Arabian Road, Schwenksville Pennsylvania 19473/ US  
MEHRMAN, Steven  
1468 Sunflower Court, Quakertown Pennsylvania 18951/ US  
SCOTT, Lorraine  
135 Red Haven Drive, North Wales Pennsylvania 19454/ US  
WELLS, Kenneth M.  
12 Norz Drive, Hillsborough New Jersey 08844/ US  
ZHANG-PLASKET, Fan  
1726 North Hills Avenue, Willow Grove Pennsylvania 19090/ US  
NOMURA, Sumihiro  
2-10 Dosho-machi 3-chome, Chuo-ku Osaka-shi Osaka 54 1-8505/ JP  
HONGU, Mitsuya  
2-10 Dosho-machi 3-chome, Chuo-ku Osaka-shi Osaka 54 1-8505/ JP  
KOGA, Yuichi  
2-10 Dosho-machi 3-chome, Chuo-ku Osaka-shi Osaka 54 1-8505/ JP
- (74) Advokat LUTOVAC, Vuk  
Bulevar Ivana Crnojevića 93 , Podgorica, 81000 / ME  
Advokat LUTOVAC, Branislav  
Bulevar Ivana Crnojevica 93 , Podgorica , 81000 / ME
- (57) 1. Postupak za dobijanje jedinjenja formule (I)

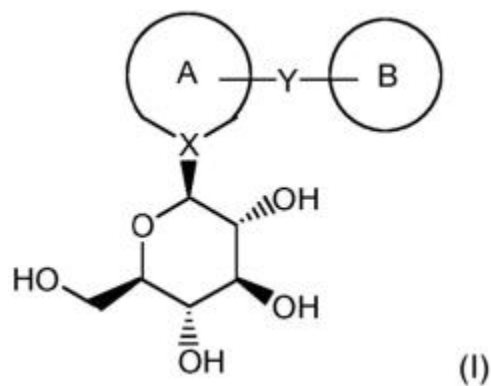

gde su prsten A i prsten B jedan od sledećih:

- (1) prsten A je opciono supstituisani nezasićeni monociklični heterociklični prsten, i prsten B je opciono supstituisani nezasićeni monociklični heterociklični prsten, opciono supstituisani nezasićeni kondenzovani hetero-biciklični prsten, ili opciono supstituisani benzenov prsten; ili
- (2) prsten A je opciono supstituisani benzenov prsten, i prsten B je opciono supstituisani nezasićeni monociklični heterociklični prsten, ili opciono supstituisani nezasićeni kondenzovani heterobiciklični prsten, gde je Y vezan za heterociklični prsten kondenzovanog heterobicikličnog prstena; ili
- (3) prsten A je opciono supstituisani nezasićeni kondenzovani heterobiciklični prsten, gde su šećerni deo X-(šećer) i deo -Y-(prsten B) oba na istom heterocikličnom prstenu kondenzovanog heterobicikličnog prstena, i prsten B je opciono supstituisani nezasićeni monociklični heterociklični prsten, opciono supstituisani nezasićeni kondenzovani heterobiciklični prsten, ili opciono supstituisani benzenov prsten;

X je ugljenikov atom;

Y je  $-(CH_2)_n-$ ; gde n je 1 ili 2;

uz uslov da u prstenu A, X je deo nezasićene veze;

ili njegova farmaceutski prihvatljiva so;

koji obuhvata

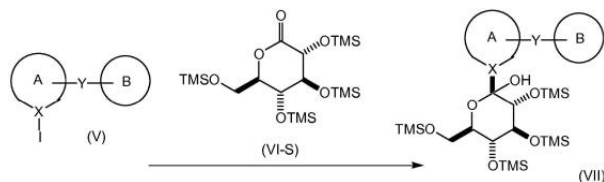

reagovanje jedinjenja formule (V) sa jedinjenjem formule (VI-S), u prisutvu alkil litijuma izabranog iz grupe koji čine grupa koju čini (trimetilsilil)metil litijum, 2,4,6-trimetilfenil litijum i (trietilsilil)metil litijum u organskom rastvaraču, na temperaturi u opsegu od 0°C do -78°C; da bi se dobilo odgovarajuće jedinjenje formule (VII);

i gde je alkil litijum dodat u smešu jedinjenja formule (V) i jedinjenja formule (VI-S);

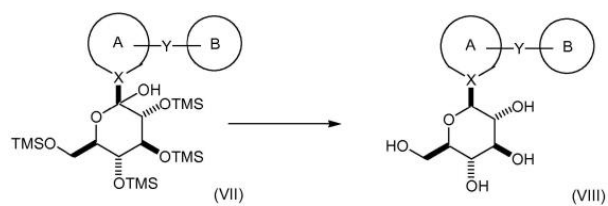

reagovanje jedinjenja formule (VII) sa  $\text{BF}_3\text{OEt}_2$ , u prisustvu trialkilsilana u organskom rastvaraču, da bi se dobilo odgovarajuće jedinjenje formule (VIII);

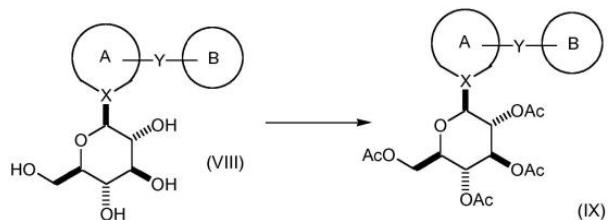

reagovanje jedinjenja formule (VIII) sa acetanhidridom ili acetil hloridom, u prisustvu organske baze, čiste ili u organskom rastvaču, da bi se dobilo odgovarajuće jedinjenje formule (IX); i

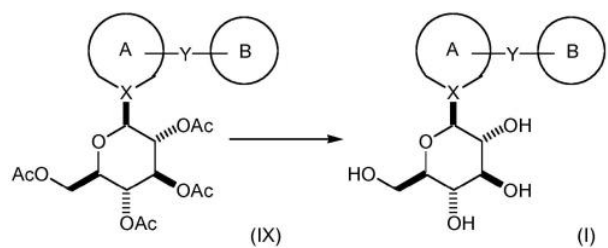

skidanje zaštite sa jedinjenja formule (IX), da bi se dobilo odgovarajuće jedinjenje formule (I).

**Patent sadrži još 17 patentnih zahtjeva**

(11) **03057** (13) **B**

(51) **C07K16/24**<sup>(2006.01)</sup>

**A61K39/395**<sup>(2006.01)</sup>

(21) P-2018-41

(22) 08.12.2008

(30) 20070012362P 07.12.2007 US

(96) 14175301 .2/08.12.2008

(97) EP 2796466/29.10.2014/2014/44

EP 2796466/22.11.2017/2017/47

(54) me **MOLEKULI HUMANIZOVANIH ANTITELA SPECIFIČNI ZA IL-31**  
en **HUMANIZED ANTIBODY MOLECULES SPECIFIC FOR IL-31**

(73) ZYMOGENETICS, INC.

1201 Eastlake Avenue East, Seattle , WA 98102/ US

MERCK SERONO S.A.

9 Chemin des Mines, 1201 Geneva/ CH

(72) BONDENSGAARD, Kent

Elmevej 4, DK-3500 Vrerløse/ DK

BECKMANN, Roland

Zehenthofgasse 35/4, 1190 Wien/ AT

(74) MSA IP-MILOJEVIĆ, SEKULIĆ ADVOKATI

Karađorđeva 65, Beograd , 11000/ RS

(57) 1. Izolovano monoklonsko antitelo ili njegov antigen-vezujući fragment koji se specifično vezuje za humani IL-31 koji sadrži humanizovani varijabilni domen teškog lanca i humanizovani varijabilni domen lakog lanca, gde humanizovani varijabilni domen teškog lanca sadrži CDR1, CDR2 i CDR3 koji se sastoje od aminokiselinskih sekvenci sa SEK ID BROJEVIMA: 1, 2 i 3, redom, i okvirne regione FR1, FR2, FR3, i FR4 koji imaju aminokiselinsku sekvencu koja je barem 90% identična aminokiselinskoj sekvenci sa SEK ID BROJEM:12 (FR1), SEK ID BROJEM:13 (FR2), SEK ID BROJEM:14 (FR3) i SEK ID BROJEM:15 (FR4) redom; i gde humanizovani varijabilni domen lakog lanca sadrži CDR1, CDR2 i CDR3 koji se sastoje od aminokiselinskih sekvenci sa SEK ID BROJEVIMA: 5, 6 i 7, redom, i okvirne regione FR5, FR6, FR7, i FR8 koji imaju aminokiselinsku sekvencu koja je barem 90% identična aminokiselinskoj sekvenci sa SEK ID BROJEM:17 (FR5), SEK ID BROJEM:18 (FR6), SEK ID BROJEM:19 (FR7) i SEK ID BROJEM:20 (FR8) redom; gde aminokiselinski ostatak na poziciji 29 SEKVENCE SA ID BROJEM:12 (FR1) je leucin, aminokiselinski ostatak na poziciji 8 SEKVENCE SA ID BROJEM:14 (FR3) je lizin, aminokiselinski ostatak na poziciji 32 SEKVENCE SA ID BROJEM:14 (FR3) je fenilalanin i aminokiselinski ostatak na poziciji 15 SEKVENCE SA ID BROJEM:19 (FR7) je tirozin.

**Patent sadrži još 7 patentnih zahtjeva**

(11) **03059** (13) **B**

(51) **C07K16/24**<sup>(2006.01)</sup>

**A61K39/395**<sup>(2006.01)</sup>

(21) P-2018-49

(22) 30.03.2011

(30) 20100341458P 30.03.2010 US

20100319260P 31.03.2010 US

(96) 11763357.8/30.03.2011

(86) US PCT/2011US/030469/30.03.2011

(87) WO 2011/123507 A1/06.10.2011/2011/40

(97) EP 2552961/06.02.2013/2013/06

EP 2552961/20.12.2017/2017/51

(54) me **HUMANIZOVNA IL-25 ANTITELA**

en **HUMANIZED IL-25 ANTIBODIES**

(73) JANSSEN BIOTECH, INC.

800/850 Ridgeview Drive, Horsham, PA 19044/ US

(72) ALMAGRO, Juan, Carlos

44 Harvard Avenue, no. 5, Brookljne, MA 02446,/ US

BRANIGAN, Patrick

145 King Of Prussia Road, Radnor, PA 19087,/ US

KANE, Colleen

145 King Of Prussia Road, Radnor, PA 19087,/ US

STROHL, William

145 King of Prussia Road, Radnor, PA 19087/ US

TAUDTE, Susann

145 King Of Prussia Road, Radnor, PA 19087/ US

TORNETTA, Mark

145 King Of Prussia Road, Radnor, PA 19087/ US

WHEELER, John

145 King Of Prussia Road, Radnor, PA 19087/ US

(57) 1. Humanizovano antitelo ili njegov fragment koji vezuje antigen, koji se vezuju za IL-25, gde antitelo ili njegov fragment koji vezuje antigen sadrže: a) VL domen antitela koji sadrži CDR1 aminokiselinske sekvence SASQGISNYLN (SEQ ID NO:6), CDR2 aminokiselinske sekvence YTSSLHS (SEQ ID NO:7) i CDR3 aminokiselinske sekvence QQYLAFPTYTF (SEQ ID NO:8); i b) VH domen antitela koji sadrži CDR1 aminokiselinske sekvence GYTMN (SEQ ID NO:10), CDR2 aminokiselinske sekvence LINPYNGGTSYNQNFKG (SEQ ID NO:11) i CDR3 aminokiselinske sekvence EDYDGYLYFAMDY (SEQ ID NO:12), pri čemu antitelo ili njegov fragment koji vezuje antigen ispoljavaju afinitet vezivanja za IL-25 koji je manji ili jednak 53 pM što je utvrđeno upotrebom *Biacore* testa.

**Patent sadrži još 12 patentnih zahtjeva**

(11) **03067** (13) **B**

(51) **H03G 9/02**<sup>(2006.01)</sup>  
**G10L 19/002**<sup>(2013.01)</sup>

**G10L 19/16**<sup>(2013.01)</sup>  
**H03G 9/00**<sup>(2006.01)</sup>

(21) P-2018-52

(22) 15.01.2014

(30) 201361754882 P 21.01.2013 US  
201361824010 P 16.05.2013 US

(96) 14740284.6/15.01.2014

(86) US PCT/US2014/011672/15.01.2014

(87) WO 2014/113465/24.07.2014/2014/30

(97) EP 2901449/05.08.2015/2015/32  
EP 2901449/03.01.2018/2018/01

(54) me **KODER I DEKODER ZVUČNOG ZAPISA SA METAPODACIMA O GLASNOĆI I GRANICAMA PROGRAMA**  
en **AUDIO ENCODER AND DECODER WITH PROGRAM LOUDNESS AND BOUNDARY METADATA**

(73) DOLBY LABORATORIES LICENSING CORPORATION  
1275 Market Street, San Francisco, CA 94103/ US

(72) GRANT, Michael

c/o Dolby Laboratories Inc. 100 Potrero Avenue, San Francisco, California 94103-4813/ US

NORCROSS, Scott Gregory

c/o Dolby Laboratories Inc. 100 Potrero Avenue, San Francisco, California 94103-4813/ US

RIEDMILLER, Jeffrey

c/o Dolby Laboratories Inc. 100 Potrero Avenue, San Francisco, California 94103-4813/ US

WARD, Michael

c/o Dolby Laboratories Inc. 100 Potrero Avenue, San Francisco, California 94103-4813/ US

(74) Advokat RADULOVIĆ, Božidar S.

Studentska bb, Lamela 3/18 , Podgorica, 81000 / ME

(57) 1. 1. Jedinica za obradu zvučnog zapisa (100, 200) koja sadrži:bafer memoriju (110, 201) za skladištenje bar jednog okvira kodirane povorke bitova zvučnog zapisa, gde kodirana povorka bitova zvučnog zapisa sadrži podatke zvučnog zapisa i segment metapodataka, gde segment metapodataka predstavlja podatke odvojene i različite od podataka zvučnog zapisa i sadrži zaglavlje, jedan ili više korisnih metapodataka i zaštitne podatke;dekoder zvučnog zapisa (101, 202) spojen sa bafer memorijom (110, 201) za dekodiranje podataka zvučnog zapisa; i raščlanjivač (111, 205) spojen sa ili integrisan u dekoderu zvučnog zapisa (101, 202) za raščlanjivanje kodirane povorke bitova, gde zaglavlje sadrži sinhronizovanu reč koja identifikuje početak segmenta metapodataka, jedan ili više korisnih metapodataka opisuje program zvučnog zapisa povezan sa podacima zvučnog zapisa, zaštitni podaci smešteni su nakon jednog ili više korisnih metapodataka i zaštitni podaci u stanju su da se upotrebe za verifikaciju integriteta segmenta metapodataka i jednog ili više korisnih podataka unutar segmenta metapodataka.

**Patent sadrži još 14 patentnih zahtjeva**

(11) **03068** (13) **B**

(51) **C07D 489/08**<sup>(2006.01)</sup>

**A61K 31/485**<sup>(2006.01)</sup>

**A61P 29/00**<sup>(2006.01)</sup>

(21) P-2018-71

(22) 30.03.2005

(30) 20040557492P 30.03.2004 US

20040601534P 13.08.2004 US

20040620072P 18.10.2004 US

20050648625P 31.01.2005 US

20050651778P 10.02.2005 US

(96) 10011788.6/30.03.2005

(97) EP 2316837/04.05.2011/2011/18

EP 2316837/10.01.2018/2018/02

(54) me **PROCES ZA DOBIJANJE OKSIKODON HIDROHLORIDA SA MANJE OD 25ppm 14-HIDROKSIKODEINONA**

en **PROCES FOR PREPARING OXYCODONE HYDROCHLORIDE HAVING LESS THAN 25ppm 14-HYDROXYCODEINONE**

(73) EURO-CELTIQUE S.A.

1, rue Jean Piret, 2350 Luxembourg / LU

(72) Chapman, Robert

4 Jefferson Court, Downingtown, PA 19335 / US

Rider, Lonn S.

18 Barbs Hill Road, Foster RI 02825 / US

Qi, Hong

31 Grape Shot Road, Sharon MA 02607/ US

KYLE, Donald

173 N. Main Street, Yardley, PA 19067/ US

KUPPER, Robert

755 Major Potter Road, East Greenwich RI 02818/ US

(74) Advokat LUTOVAC, Branislav

Bulevar Ivana Crnojevića 93 , Podgorica , 81000 / ME

Advokat LUTOVAC, Vuk

Bulevar Ivana Crnojevića 93 , Podgorica, 81000 / ME

(57) 1. Proces za smanjenje količine 14-hidroksikodeinona u kompoziciji oksikodon hidrohlorida do nivoa manjeg od 25 ppm kako je određeno HPLC postupkom u Primeru 6, postupak obuhvata reagovanje kompozicije oksikodon hidrohlorida sa katalitički efikasnom količinom katalizatora pladijum-ugljenika i gasovitim vodonikom, tako hidrogenovanjem 14-hidroksikodeinona.

**Patent sadrži još 3 patentnih zahtjeva**

(11) 03088 (13) B

(51) A61K 47/50<sup>(2017.01)</sup>

A61K 31/4184<sup>(2006.01)</sup>

A61K 31/16<sup>(2006.01)</sup>

A61K 9/19<sup>(2006.01)</sup>

C07D 235/16<sup>(2006.01)</sup>

A61K 47/40<sup>(2006.01)</sup>

A61K 31/4164<sup>(2006.01)</sup>

A61P 35/00<sup>(2006.01)</sup>

A61K 9/00<sup>(2006.01)</sup>

(21) P-2018-92

(22) 14.09.2012

(30) 201161536038 P 18.09.2011 US

201261602408 P 23.02.2012 US

(96) 12831417.6/14.09.2012

(86) US PCT/US2012/055277/14.09.2012

(87) WO 2013/040286/21.03.2013/2013/12

(97) EP 2758052/30.07.2014/2014/31

EP 2758052/14.02.2018/2018/07

(54) me **POSTUPAK ZA PROIZVODNJU STABILNOG, INJEKTABILNOG RASTVORA NORADRENALINA NISKE KONCENTRACIJE**  
en **PHARMACEUTICAL COMPOSITION COMPRISING AN HDAC INHIBITOR AND A CYCLOPOLYSACCHARIDE**

(73) EURO-CELTIQUE S.A.

1, rue Jean Piret, Luxembourg, 2350 / LU

(72) CHEN, Yu

5078 Kingston Way, San Jose, CA 95130/ US

YANG, Lan

108 Yuhangtang Road, Hangzhou Zhejiang Province 310011/ CN

FENG, Feiyu

108 Yuhangtang Road, Hangzhou Zhejiang Province 310011/ US

GE, Qiufu

108 Yuhangtang Road, Hangzhou Zhejiang Province 310011/ CN

GUO, Dianwu

108 Yuhangtang Road, Hangzhou Zhejiang Province 310011/ CN

CHEN, Yi

44 Emerson Gardens Road, Lexington, MA 02420/ US

(74) Advokat POPOVIĆ, Miladin

Doka Miraševića 21/III , Podgorica, 81000 / ME

(57) 1. Farmaceutska kompozicija koja sadrži (a) ciklopolisaharid, i (b) jedinjenje Formule (II)

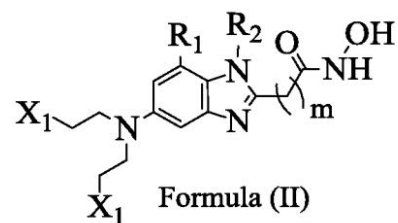

gde je  $R_1$  i  $R_2$  nezavisno, H, alkil, alkenil, alkinil, cikloalkil, heterocikloalkil, halo,  $-C=NH$ , amin, cijano, hidroksi, ili alkoksi, ili njihova farmaceutski prihvatljiva so:

gde



m je 5, 6, 7, 8, 9, 10, 11, 12, 13, 14, 15, ili 16; i

X1 je halo ili OSO<sub>2</sub>R<sub>c</sub>, gde R<sub>c</sub> je alkil, alkenil, ili alkinil.

**Patent sadrži još 21 patentnih zahtjeva**

(11) **03071 (13) B**

(51) **C07K 16/28**<sup>(2006.01)</sup>

**A61K 39/395**<sup>(2006.01)</sup>

(21) P-2018-94

(22) 20.04.2012

(30) 201161477904 P 21.04.2011 US

(96) 12717027.2/20.04.2012

(86) US PCT/US2012/034519/20.04.2012

(87) WO 2012/145673/26.10.2012/2012/43

(97) EP 2699601/26.02.2014/2014/09

EP 2699601/17.01.2018/2018/03

(54) me **POLIPEPTIDI ANTITELA KOJI ANTAGONIZUJU CD40**  
en **ANTIBODY POLYPEPTIDES THAT ANTAGONIZE CD40**

(73) BRISTOL-MYERS SQUIBB COMPANY

Route 206 and Province Line Road, Princeton, NJ 08543/ US

DOMANTIS LIMITED

980 Great West Road, Brentford, Middlesex TW8 9GS/ GB

(72) SURI, Anish

Route 206 & Province Line Road, Princeton, NJ 08543/ US

SHERIFF, Steven

Route 206 & Province Line Road, Princeton, NJ 08543/ US

SUCHARD, Suzanne

Route 206 & Province Line Road, Princeton, NJ 08543/ US

YAMNIUK, Aaron

Route 206 & Province Line Road, Princeton, NJ 08543/ US

KRYSTEK, Stanley

Route 206 & Province Line Road, Princeton, NJ 08543/ US

TAMURA, James

Route 206 & Province Line Road, Princeton, NJ 08543/ US

BRYSON, James

Route 206 & Province Line Road, Princeton, NJ 08543/ US

GRANT, Steven

315 Cambridge Science Park, Cambridge Cambridgeshire CB4 0WG/ GB

DREW, Philip

315 Cambridge Science Park, Cambridge Cambridgeshire CB4 0WG/ GB

(57) 1. · Polipeptid antitela koji sadrži prvi varijabilni domen koji je pojedinačni varijabilni domen, gde je aminokiselinska sekvenca prvog varijabilnog domena odabrana od aminokiselinskih sekvenci BMS3h-56-201 prikazana u SEKVENCI SA IDENTIFIKACIONIM BROJEM: 9 (SEQ ID NO: 9), BMS3h-56-202 prikazana u SEKVENCI SA IDENTIFIKACIONIM BROJEM: 350, BMS3h-56-203 prikazana u SEKVENCI SA IDENTIFIKACIONIM BROJEM: 351, BMS3h-56-206 prikazana u SEKVENCI SA IDENTIFIKACIONIM BROJEM: 354, BMS3h-56-215 prikazana u SEKVENCI SA IDENTIFIKACIONIM BROJEM: 363, BMS3h-56-217 prikazana u SEKVENCI SA IDENTIFIKACIONIM BROJEM: 365, BMS3h-56-224 prikazana u SEKVENCI SA IDENTIFIKACIONIM BROJEM: 372, BMS3h-56-232 prikazana u SEKVENCI SA IDENTIFIKACIONIM BROJEM: 380, BMS3h-56-239 prikazana u SEKVENCI SA IDENTIFIKACIONIM BROJEM: 387, BMS3h-56-243 prikazana u SEKVENCI SA IDENTIFIKACIONIM BROJEM: 391, BMS3h-56-244 prikazana u SEKVENCI SA IDENTIFIKACIONIM BROJEM: 392, BMS3h-56-246 prikazana u SEKVENCI SA IDENTIFIKACIONIM BROJEM: 394, BMS3h-56-248 prikazana u SEKVENCI SA

IDENTIFIKACIONIM BROJEM: 396, BMS3h-56-253 prikazana u SEKVENCI SA IDENTIFIKACIONIM BROJEM: 401, BMS3h-56-258 prikazana u SEKVENCI SA IDENTIFIKACIONIM BROJEM: 10, BMS3h-56-261 prikazana u SEKVENCI SA IDENTIFIKACIONIM BROJEM: 409, BMS3h-56-262 prikazana u SEKVENCI SA IDENTIFIKACIONIM BROJEM: 410, BMS3h-56-265 prikazana u SEKVENCI SA IDENTIFIKACIONIM BROJEM: 413, BMS3h-56-266 prikazana u SEKVENCI SA IDENTIFIKACIONIM BROJEM: 414, BMS3h-56-269 prikazana u SEKVENCI SA IDENTIFIKACIONIM BROJEM: 417 i BMS3h-56-270 prikazana u SEKVENCI SA IDENTIFIKACIONIM BROJEM: 418,

gde se polipeptid antitela vezuje za CD40, i gde vezivanje polipeptida antitela za CD40 antagonizuje CD40 aktivnost.

**Patent sadrži još 15 patentnih zahtjeva**

(11) **03089** (13) **B**

(51) **C07D487/04**<sup>(2006.01)</sup>

**A61K31/41**<sup>(2006.01)</sup>

**C07H19/23**<sup>(2006.01)</sup>

**A61P31/12**<sup>(2006.01)</sup>

**A61K31/395**<sup>(2006.01)</sup>

**A61K31/4188**<sup>(2006.01)</sup>

**A61K31/7052**<sup>(2006.01)</sup>

(21) P-2018-95

(22) 22.04.2009

(30) 47263 P 23.04.2008 US

139449 P 19.12.2008 US

(96) 15155479.7/22.04.2009

(97) EP 2937350/28.10.2015/2015/44

EP 2937350/10.01.2018/2018/02

(54) me **1' -SUPSTITUISANI KARBA-NUKLEOZIDNI ANALOZI ZA ANTIVIRUSNU TERAPIJU**  
en **1' -SUBSTITUTED CARBA-NUCLEOSIDE ANALOGS FOR ANTIVIRAL TREATMENT**

(73) GILEAD SCIENCES, INC.

333 Lakeside Drive, Foster City , California 94404/ US

(72) Butler, Thomas

601 Baltic Circle 605, Redwood City, CA 94065 / US

CHO, Aesop

1656 Notre Dame Drive, Mountain View, CA 94040/ US

Kim, Choung, U.

1750 Elizabeth Street, San Carlos, CA 94070/ US

Saunders, Oliver, L.

615 Port Drive 202, San Mateo, CA 94404 / US

Zhang, Lijun

12525 Minorca Ct., Los Altos Hills, CA 94022 / US

Parrish, Jay

760 Bair Island Rd., 100, Redwood City, CA 94063 / US

(74) MSA IP-MILOJEVIĆ, SEKULIĆ ADVOKATI

Karađorđeva 65, Beograd , 11000/ RS

(57) 1. Jedinjenje sa Formulom III:

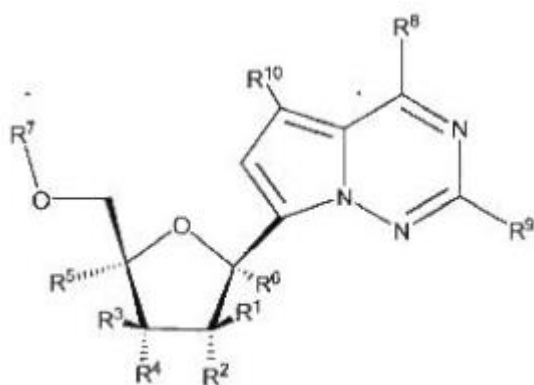

Formula III

ili farmaceutski prihvatljiva so, istog;

gde:

R1 je H ili CH<sub>3</sub>;

R2 je OH;

R3 je H;

R4 je OH;

R5 je H;

R6 je CN;

R7 je H, ili

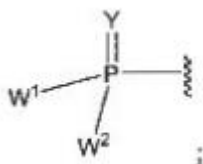

svako Y ili Y1 je, nezavisno, O, S, NR, +N(O)(R), N(OR), +N(O)(OR), ili N-NR<sub>2</sub>;

W1 i W2, kada su uzeti zajedno, su -Y<sub>3</sub>(C(R<sub>y</sub>)<sub>2</sub>)<sub>3</sub>Y<sub>3</sub>-; ili jedan od W1 ili W2 zajedno sa ili R3 ili

R4 je -Y<sub>3</sub> i drugi od W1 ili W2 je Formula Ia; ili W1 ili W2 su svaki, nezavisno, grupa sa Formulom Ia:

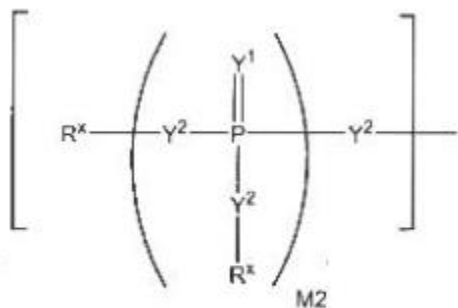

Formula Ia

gde:

svako Y<sub>2</sub> je nezavisno veza, O, CR<sub>2</sub>, NR, +N(O)(R), N(OR), +N(O)(OR), N-NR<sub>2</sub>, S, S-S, S(O), ili S(O)<sub>2</sub>;

svako Y<sub>3</sub> je nezavisno O, S, ili NR;

M<sub>2</sub> je 0, 1 ili 2;

svako R<sub>x</sub> je nezavisno R<sub>Y</sub> ili formula:

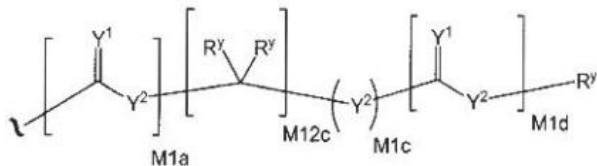

gde:

svako M1 a, M1c, i M1d je nezavisno 0 ili 1;

M12c je 0, 1, 2, 3, 4, 5, 6, 7, 8, 9, 10, 11 ili 12;

svako R<sub>Y</sub> je nezavisno H, F, Cl, Br, I, OH, R, -C(=Y<sub>1</sub>)R, -C(=Y<sub>1</sub>)OR, -C(=Y<sub>1</sub>)N(R)<sub>2</sub>, -N(R)<sub>2</sub>, -N(R)<sub>3</sub>, -SR, -S(O)R, -S(O)<sub>2</sub>R, -S(O)(OR), -S(O)<sub>2</sub>(OR), -OC(=Y<sub>1</sub>)R, -OC(=Y<sub>1</sub>)OR, -OC(=Y<sub>1</sub>)(N(R)<sub>2</sub>), -SC(=Y<sub>1</sub>)R, -SC(=Y<sub>1</sub>)OR, -SC(=Y<sub>1</sub>)(N(R)<sub>2</sub>), -N(R)C(=Y<sub>1</sub>)R, -N(R)C(=Y<sub>1</sub>)OR,

-N(R)C(=Y<sub>1</sub>)N(R)<sub>2</sub>, -SO<sub>2</sub>NR<sub>2</sub>, -CN, -N<sub>3</sub>, -NO<sub>2</sub>, -OR, ili W<sub>3</sub>; ili kada su uzeti zajedno, dva R<sub>Y</sub> na istom atomu ugljenika formiraju karbociklični prsten od 3 do 7 atoma ugljenika;

svako R je nezavisno H, (C<sub>1</sub>-C<sub>8</sub>) alkil, (C<sub>1</sub>-C<sub>8</sub>) supstituisan alkil, (C<sub>2</sub>-C<sub>8</sub>) alkenil, (C<sub>1</sub>-C<sub>8</sub>)

supstituisan alkenil, (C<sub>1</sub>-C<sub>8</sub>) alkinil, (C<sub>1</sub>-C<sub>8</sub>) supstituisan alkinil, C<sub>6</sub>-C<sub>20</sub> aril, C<sub>6</sub>-

C<sub>20</sub> supstituisan aril, C<sub>2</sub>-C<sub>20</sub> heterociklil, C<sub>2</sub>-C<sub>20</sub> supstituisan heterociklil, arilalkil ili supstituisan arilalkil;

W<sub>3</sub> je W<sub>4</sub> ili W<sub>5</sub>; W<sub>4</sub> je R, -C(Y<sub>1</sub>)R<sub>Y</sub>, -C(Y<sub>1</sub>)W<sub>5</sub>, -SO<sub>2</sub>R<sub>Y</sub>, ili -SO<sub>2</sub>W<sub>5</sub>; i W<sub>5</sub> je karbocikl ili heterocikl gde

W<sub>5</sub> je nezavisno supstituisan sa 0 do 3 R<sub>Y</sub> grupe;

R<sub>8</sub> je NR<sub>11</sub>R<sub>12</sub>;

svako R<sub>9</sub> ili R<sub>10</sub> je nezavisno H;

svako R<sub>11</sub> ili R<sub>12</sub> je nezavisno H.

**Patent sadrži još 8 patentnih zahtjeva**

(11) **03060** (13) **B**

(51) **H04W 56/00**<sup>(2009.01)</sup>

**H04W 72/02**<sup>(2009.01)</sup>

**H04W 74/08**<sup>(2009.01)</sup>

(21) P-2018-98

(22) 14.08.2015

(30) 201462043634 P 29.08.2014 US

201514825843 13.08.2015 US

(96) 15754387.7/14.08.2015

(86) US PCT/US2015/045302/14.08.2015

(87) WO 2016/032776/03.03.2016/2016/09

(97) EP 3187010/05.07.2017/2017/27

EP 3187010/21.03.2018/2018/12

(54) me **UPRAVLJANJE RESINHRONIZACIJOM U LTE/LTE-A MREŽI SA NELICENCIRANIM  
SPEKTROM**

en **RE-SYNCHRONIZATION MANAGEMENT IN LTE/LTE-A WITH UNLICENSED SPECTRUM**

(73) QUALCOMM INCORPORATED

5775 Morehouse Drive, San Diego, CA 92121-1714/ US

(72) LUO, Tao

5775 Morehouse Drive, San Diego, CA 92121-1714/ US

CHEN, Wanshi

5775 Morehouse Drive, San Diego, CA 92121-1714/ US

DAMNJANOVIC, Aleksandar

5775 Morehouse Drive, San Diego, CA 92121-1714/ US

(74) Advokat POPOVIĆ, Miladin

Doka Miraševića 21/III , Podgorica, 81000 / ME

(57) 1. Postupak bežične komunikacije koji podrazumeva: prijem, na strani korisničkog uređaja (UE), indikacije koja identifikuje proceduru za resinhronizaciju uplink-a radi korišćenja u nelicenciranom delu spektra; izvršavanje, od strane korisničkog uređaja (UE), provere radi procene proširenog slobodnog kanala (ECCA) kao posledice određivanja da postoje podaci za prenos; odlaganje prenosa, od strane korisničkog uređaja (UE), kao posledice uspešno završene ECCA provere pre dostizanja granice resinhronizacije koja je definisana procedurom za resinhronizaciju uplink-a;

zvršavanje, od strane korisničkog uređaja (UE), provere radi procene slobodnog kanala (CCA) u pod-frejmu koji prethodi granici resinhronizacije; i

prenosa, od strane korisničkog uređaja (UE), podataka koji počinju na granici resinhronizacije kao posledica uspešno završene CCA provere.

**Patent sadrži još 14 patentnih zahtjeva**





## Objava zahtjeva za proširenje evropskih prijava patenata

---

(51) MKP  
**B26B 21/22 2006 (97) EP 3022022**  
**B26B 21/52 2006**

(96) EP 14739408.4 7/11/2014  
(97) EP 3022022, 7/18/2018 201829, de

(31) 102013213881 (32) 16.07.2013 (33) DE

(54) RAZOR HAVING FREE MOVABILITY OF THE RAZOR HEAD  
(72) GERS-BARLAG, Heinrich, Kiebitzgrund 11, 25495 Kummerfeld, DE  
NEUMANN, Yvonne, Erlenstrasse 4, 22529 Hamburg, DE

---

(51) MKP  
**B23K 26/12 2014 (97) EP 2929976**  
**B23K 26/14 2014**  
**B23K 26/34 2014**  
**B23K 35/38 2006**  
**B23K 103/04 2006**

(96) EP 15162765.0 4/8/2015  
(97) EP 2929976, 8/22/2018 201834, de

(31) 102014005194 (32) 08.04.2014 (33) DE

(54) METHOD FOR CO2 LASER WELDING OF HIGH ALLOY STEELS  
(72) Rockser, Mario, Feldstr. 35a, 17498 Hinrichshagen, DE  
Wankum, Achim, Buschdonk 75, 47809 Krefeld, DE  
Wolters, Michael, Malteserstr. 2, 47058 Duisburg, DE

---

(51) MKP  
**B23K 26/12 2014 (97) EP 2929977**  
**B23K 35/38 2006**

(96) EP 15162772.6 4/8/2015  
(97) EP 2929977, 9/12/2018 201837, de

(31) 102014005193 (32) 08.04.2014 (33) DE

(54) METHOD FOR CO2 LASER WELDING OF LOW ALLOY STEELS  
(72) Rockser, Mario, Feldstr. 35a, 17498 Hinrichshagen, DE  
Wankum, Achim, Buschdonk 75, 47809 Krefeld, DE  
Wolters, Michael, Malteserstr. 2, 47058 Duisburg, DE

---

(51) MKP  
**F16B 23/00 2006 (97) EP 2476919**  
**F16B 25/00 2006**  
**F16B 37/12 2006**

(96) EP 11194539.0 12/20/2011  
(97) EP 2476919, 8/15/2018 201833, de

(31) 102011002637 (32) 13.01.2011 (33) DE

(54) Screw anchor and method for manufacturing a screw anchor  
(71) HILTI Aktiengesellschaft, Feldkircherstrasse 100, 9494 Schaan, LI  
(72) Roessner, Marcel, Sigmund-Nachbaurstrasse 17, 6830 Rankweil, AT

---

(51) MKP  
**B60L 11/18 2006 (97) EP 2708403**  
**H02J 3/14 2006**

(96) EP 13004505.7 9/16/2013  
(97) EP 2708403, 7/18/2018 201829, en

(31) 201216494 (32) 14.09.2012 (33) GB

(54) System and method for managing load on a power grid

(71) POD Point Holding Ltd, 4th Floor Cityside House 40 Adler Street, London E1 1EE, GB  
(72) Fairbairn, David Erik, 63 Queen Street, Coggeshall, Essex CO6 1UE, GB  
Large, Stephen, 27 Rayleigh Road Hutton,, Brentwood, Essex CM13 1AB, GB  
Baptista Ochoa, Rafael, Emmanuel College St Andrew's Street, Cambridge, CB2 3AP, GB

---

(51) MKP  
**F23J 1/02 2006 (97) EP 2375154**

(96) EP 11450048.1 4/5/2011

(97) EP 2375154, 8/8/2018 201832, de

(31) 5582010 (32) 07.04.2010 (33) AT

(54) Heating device

(71) KWB - Kraft und Wärme aus Biomasse Gesellschaft m.b.H., Industriestrasse 235, 8321 St. Margarethen/Raab, AT

(72) Salmhofer, Manfred, Wolfgruben 88, 8211 Großspesendorf, AT  
Steinbauer, Robert, Falkenstein 29, 8673 Ratten, DE

---

(51) MKP  
**A23L 3/375 2006 (97) EP 2657631**

**F25D 3/10 2006**

**F25D 3/12 2006**

(96) EP 13163041.0 4/10/2013

(97) EP 2657631, 8/8/2018 201832, de

(31) 102012008593 (32) 27.04.2012 (33) DE

(54) Method and device for cooling products

(72) Emir, Tebib, 17 Allee d'Apollon, F-77410 Gressy, FR  
Gockel, Frank, Schubertstr. 44, 42553 Velbert, DE

---

(51) MKP  
**F25D 3/10 2006 (97) EP 2657630**

**F25D 3/12 2006**

(96) EP 13163580.7 4/12/2013

(97) EP 2657630, 8/8/2018 201832, de

(31) 102012008591 (32) 27.04.2012 (33) DE

(54) Method and device for producing cooled products

(72) Tebib, Emir, 17 Allee d'Apollon, 77410 Gressy, FR  
Gockel, Frank, Schubertstr. 44, 42553 Velbert, DE

---

(51) MKP  
**F23N 1/02 2006 (97) EP 2741002**

(96) EP 13195541.1 12/3/2013

(97) EP 2741002, 8/15/2018 201833, de

(31) 102012023749 (32) 04.12.2012 (33) DE

(54) Device and method for detecting and controlling the flow of a fluid medium in a controlled system

(72) Demuth, Dr. Martin, Badenerstr 37/5, 2352 Gumpoldskirchen, AT

---

(51) MKP  
**F02D 41/00 2006 (97) EP 2730769**

**F02D 41/02 2006**

(96) EP 13189757.1 10/22/2013

(97) EP 2730769, 11/14/2018 201846, de

(31) 102012022154 (32) 10.11.2012 (33) DE

(54) Method for operating a combustion engine with high pressure and low pressure exhaust gas recovery

(72) Pott, Dr. Ekkehard, Westring 33, 38518 Gifhorn, DE  
Hahne, Bernd, Jägersruh 46, 38126 Braunschweig, DE

---

(51) MKP  
**A23L 27/40 2016 (97) EP 3349594**

**A23L 33/165 2016**

**A61P 9/12 2006**

(96) EP 15781394.0 9/14/2015

(97) EP 3349594, 7/25/2018 201830, en

(54) SALT SUBSTITUTE COMPOSITION, PREPARATION AND USE THEREOF  
(71) PODRAVKA d.d., A. Starcevic 32, 48000 Koprivnica, HR  
(72) CEPANEC, Ivica, Zagorska 28 Bunjani, 10314 Kriz, HR  
RANILOVIC Jasmina, Trg kralja Zvonimira 21, 48000 Koprivnica, HR  
CVETKOVIC, Tanja, Ulica Hrvatske drzavnosti 55 Heresin, 48000 Koprivnica, HR  
VUGRINEC, Sassenka, Trg kralja Tomislava 7, 48000 Koprivnica, HR

---

(51) MKP  
**A61K 31/7068 2006 (97) EP 3359163**  
**A61P 35/00 2006**  
(96) EP 15781699.2 10/5/2015  
(97) EP 3359163, 8/15/2018 201833, en  
(54) COMBINATION THERAPY  
(71) NuCana plc, 3 Lochside Way, Edinburgh EH12 9DT, GB  
(72) GRIFFITH, Hugh, c/o NuCana plc 3 Lochside Way, Edinburgh EH12 9DT, GB

---

(51) MKP  
**A61K 33/06 2006 (97) EP 3349765**  
**A61K 36/185 2006**  
**A61K 36/28 2006**  
**A61K 36/53 2006**  
(96) EP 15767086.0 9/4/2015  
(97) EP 3349765, 7/25/2018 201830, fr  
(54) COMBINATION PRODUCT FOR ASSISTING WITH RELAXATION AND SLEEP  
(71) URGO RECHERCHE INNOVATION ET DEVELOPPEMENT, 42 rue de Longvic, 21300 Chenôve, FR  
(72) GENTILHOMME, Marilyn, 44 Rue Magenta, F-21000 Dijon, FR  
BRICOUT, Tiphaine, 7bis Rue de Dijon, F-21121 Fontaine les Dijon, FR

---

(51) MKP  
**B65D 51/24 2006 (97) EP 3247650**  
**C12G 1/08 2006**  
(96) EP 15716592.9 1/20/2015  
(97) EP 3247650, 7/25/2018 201830, en  
(54) A DEVICE FOR ELIMINATING FERMENTATION RESIDUES IN AN ALCOHOLIC BEVERAGE  
(71) Gins S.r.l., Via Prov.le di Mercatale 203, 50053 Vinci (FI), IT  
(72) GINI, Lorenzo, Via San Rocco 15, I-50053 Empoli (FI), IT  
CARLI, Marco, Via sul Vincio 10, I-50050 loc. Lazzaretto - Cerreto Guidi (FI), IT

---

(51) MKP  
**C12G 1/032 2006 (97) EP 3170887**  
(96) EP 16154548.8 2/5/2016  
(97) EP 3170887, 12/12/2018 201850, en  
(31) UB20155643 (32) 17.11.2015 (33) IT  
(54) IMPROVED FERMENTER  
(71) Castle Commercial Enterprises Limited, Harcourt Centre Block 3 Harcourt Road, Dublin 2, IE  
(72) MARIN, Francesco, VIA SAN FRANCESCO 1/A, 33097 SPILIMBERGO, PORDENONE, IT

---

(51) MKP  
**A23K 10/00 2016 (97) EP 3358965**  
(96) EP 15797717.4 10/9/2015  
(97) EP 3358965, 8/15/2018 201833, en  
(54) BIRD FEED AND IN PARTICULAR POULTRY FEED, COMPRISING SYNTHETIC CAPSAICINOID DERIVATIVES AND SUCH FEED FOR PROHYLACTIC USE OR TREATMENT OF SALMONELLA INFECTION  
(71) Axichem AB, Vestre Torggate 1, 5015 Bergen, NO  
(72) HELSING, Torsten, Kleppevegen 39, N-5300 Kleppetstø, NO

---

(51) MKP  
**A61B 5/145 2006 (97) EP 3359038**  
**A61B 5/1455 2006**  
(96) EP 15798174.7 10/5/2015  
(97) EP 3359038, 8/15/2018 201833, en

(54) DEVICE FOR NON-INVASIVE MEASUREMENT OF BLOOD SUGAR LEVEL  
(71) Dia-Vit Ltd., 71-75 Shelton Street Covent Garden, London WC2H 9JQ, GB  
(72) ARKO, Zoran, Litijaska cesta 186e, 1000 Ljubljana, SI  
TOFANT, Tadej, Rimska ploscad 14, 2250 Ptuj, SI

---

(51) MKP  
**B64C 13/50 2006 (97) EP 3109168**  
**B64D 45/00 2006**  
**G05D 1/00 2006**  
**H04B 7/185 2006**

(96) EP 16172237.6 5/31/2016

(97) EP 3109168, 11/14/2018 201846, en

(31) 201514727105 (32) 01.06.2015 (33) US

(54) METHOD AND APPARATUS FOR AUGMENTED PILOT OPERATIONS OF FLY-BY-WIRE VEHICLES

(71) Schultz, Douglas Allen, 3313 Sunset Key Circle Unit 406, Punta Gorda, FL 33955, US

(72) Schultz, Douglas Allen, 3313 Sunset Key Circle Unit 406, Punta Gorda, FL 33955, US

---

(51) MKP  
**B42D 1/00 2006 (97) EP 3254861**

(96) EP 16173833.1 6/9/2016

(97) EP 3254861, 7/25/2018 201830, en

(54) PRINTING BOOK INCLUDING A FIRST ATTACHMENT DEVICE

(71) Rosomanov, Zoran, Partizanski Odredi 17/1-30, 1000 Skopje, MK

(72) Rosomanov, Zoran, Partizanski Odredi 17/1-30, 1000 Skopje, MK

---

(51) MKP  
**F23J 7/00 2006 (97) EP 3260776**  
**F23J 15/00 2006**  
**F23J 15/04 2006**

(96) EP 16175167.2 6/20/2016

(97) EP 3260776, 8/1/2018 201831, de

(54) LANCE SYSTEM, BOILER- CONTAINING LANCE SYSTEM AND METHOD FOR REDUCING NOX

(72) Hamel, Stefan, Dr., Im Obstgarten 13a, 57482 Wenden, DE

---

(51) MKP  
**B21F 15/08 2006 (97) EP 3260231**  
**B23K 37/04 2006**  
**B23K 101/32 2006**  
**B25J 15/00 2006**  
**B25J 15/02 2006**

(96) EP 16175331.4 6/20/2016

(97) EP 3260231, 8/8/2018 201832, de

(54) GRIPPER AND METHOD FOR GRIPPING ENDS OF WIRES AND WIRE WELDING MACHINE AND ROBOT WITH SUCH GRIPPERS

(71) Ideal-Werk C. & E. Jungeblodt GmbH & Co.KG, Bunsenstrasse 1, 59557 Lippstadt, DE

(72) JUNGBLODT, Max Clemens, Kleiststrasse 14, 59555 Lippstadt, DE

---

(51) MKP  
**A23L 29/00 2016 (97) EP 3260114**  
**A61K 8/00 2006**  
**A61K 9/16 2006**

(96) EP 16175590.5 6/21/2016

(97) EP 3260114, 12/19/2018 201851, en

(54) METHOD FOR THE PRODUCTION OF A DOSAGE FORM

(72) DIAZ QUIJANO, Carolina, c/o Omya International AG Baslerstrasse 42, 4665 Oftringen, CH

DE MIGUEL, Laura, c/o Omya International AG Baslerstrasse 42, 4665 Oftringen, CH

SCHOELKOPF, Joachim, Dyshofweg 3, 5727 Oberkulm, CH

---

(51) MKP  
**A23L 29/00 2016 (97) EP 3260115**  
**A61K 8/00 2006**  
**A61K 9/16 2006**

(96) EP 16175595.4 6/21/2016  
(97) EP 3260115, 12/19/2018 201851, en  
(54) METHOD FOR THE PRODUCTION OF A DOSAGE FORM  
(72) DIAZ QUIJANO, Carolina, c/o Omya International AG Baslerstrasse 42, 4665 Oftringen, CH  
DE MIGUEL, Laura, c/o Omya International AG Baslerstrasse 42, 4665 Oftringen, CH  
SCHOELKOPF, Joachim, Dyshofweg 3, 5727 Oberkulm, CH

---

(51) MKP  
**F04B 53/14 2006 (97) EP 3405704**  
**F15B 15/14 2006**  
**F16F 9/48 2006**  
**F16J 3/06 2006**  
**F16J 10/00 2006**

(96) EP 15834794.8 11/24/2015  
(97) EP 3405704, 11/28/2018 201848, en  
(54) PISTON-CHAMBER COMBINATION  
(71) NVB Propulsion International Ltd, 1st Fl. West Wing Davidson House Forbury Square Reading, Berkshire RG1 3EU, GB  
Van Der Blom, Nicolaas, Postlagernd, 6314 Unterägeri, CH  
(72) VAN DER BLOM, Nicolaas, Postlagernd, CH-6314 Unterägeri, CH

---

(51) MKP  
**A47L 5/38 2006 (97) EP 2534989**  
**A47L 9/00 2006**  
**A47L 9/24 2006**

(96) EP 12172218.5 6/15/2012  
(97) EP 2534989, 8/29/2018 201835, de  
(31) 8772011 (32) 16.06.2011 (33) AT  
(54) Central vacuum cleaner assembly  
(71) ZentorgA Zentralstaubsauganlagen GmbH, Braunauer Straße 43, 4950 Altheim, AT  
(72) Gahleitner, Günther, Ruholding 19, 4794 Kopfing, AT  
Ortner, Ewald, Steinmauerweg 7, 5165 Berndorf, AT

---

(51) MKP  
**F16L 21/06 2006 (97) EP 3287682**  
**F16L 31/00 2006**

(96) EP 16185296.7 8/23/2016  
(97) EP 3287682, 9/12/2018 201837, de  
(54) HOLDING DEVICE FOR THE DETACHABLE, COAXIAL JOINING OF FLEXIBLE TUBING  
(71) Streitmaier, Horst, 12.Februar Straße 54, 8770 St. Michael, AT  
(72) Streitmaier, Horst, 12.Februar Straße 54, 8770 St. Michael, AT

---

(51) MKP  
**B29C 65/68 2006 (97) EP 3287710**  
**B60H 1/00 2006**  
**F24H 3/04 2006**  
**H01R 4/72 2006**  
**H05B 3/40 2006**

(96) EP 16185719.8 8/25/2016  
(97) EP 3287710, 10/3/2018 201840, en  
(54) ELECTRIC HEATER  
(72) Marlier, Eric, 12, rue principal, 67120 Kolbsheim, FR

---

(51) MKP  
**B62K 5/00 2013 (97) EP 3290315**  
**B62K 5/10 2013**  
**B62K 7/04 2006**

(96) EP 16186158.8 8/29/2016  
(97) EP 3290315, 8/29/2018 201835, en  
(54) LEANING CARGO MULTI-WHEELER  
(71) Babbøe B.V., Xenonweg 45, 3812 SZ Amersfoort, NL  
(72) Markvoort, Hendrikus Cornelis, Adriaen van Ostadelaan 53bis, 3583 AB Utrecht, NL

---

(51) MKP  
**A23L 33/195 2016 (97) EP 3290436**  
**A61K 38/00 2006**  
**C07K 14/195 2006**  
(96) EP 16186895.5 9/1/2016  
(97) EP 3290436, 8/15/2018 201833, en  
(54) PHENYLALANINE-FREE PROTEIN FOR THE TREATMENT OF PKU  
(71) metaX Institut für Diätetik GmbH, Am Strassbach 5, 61169 Friedberg (Hessen), DE  
(72) HOFFMANN, Bernhard, Danziger Str. 12a, 61191 Rosbach v.d.H., DE  
MÜCKE, Yvonne, Marienstr. 12, 61206 Wöllstadt, DE  
RASCHKE, Stefan, Höfchensweg 96, 52066 Aachen, DE  
JABLONKA, Natalia, Buschstrasse 4, 52355 Düren, DE  
SCHILLBERG, Stefan, Dreiländerweg 107, 52074 Aachen, DE

---

(51) MKP  
**F24H 1/00 2006 (97) EP 3290819**  
**F24H 9/00 2006**  
**F24H 9/18 2006**  
**H05B 1/02 2006**  
**H05B 3/48 2006**  
(96) EP 16187349.2 9/6/2016  
(97) EP 3290819, 10/17/2018 201842, de  
(54) ELECTRIC HEATING DEVICE  
(72) Cmelik, Alain, 6, rue de l'Oberfeld, 68760 Willer-sur-Thur, FR  
Kohl, Michael, Südstraße 23, 74321 Bietigheim-Bissingen, DE  
Krumbach, Karl-Gerd, Fliederweg 5, 71576 Burgstetten, DE  
Seewald, Wolfgang, Schumannstraße 18, 71732 Tamm, DE

---

(51) MKP  
**A61B 17/072 2006 (97) EP 3150136**  
(96) EP 16191670.5 9/30/2016  
(97) EP 3150136, 11/14/2018 201846, en  
(31) 201514871176 (32) 30.09.2015 (33) US  
(54) PROGRESSIVELY RELEASABLE IMPLANTABLE ADJUNCT FOR USE WITH A SURGICAL STAPLING INSTRUMENT  
(71) Ethicon Endo-Surgery, LLC, 475 Street C Los Frailes Industrial Park, 00969 Guaynabo, PR  
(72) SCHELLIN, Emily A., 4545 Creek Road, Cincinnati, OH 45242, US  
WEANER, Lauren S., 4545 Creek Road, Cincinnati, OH 45242, US  
VENDELY, Michael J., 4545 Creek Road, Cincinnati, OH 45242, US  
ARONHALT, Taylor W., 4545 Creek Road, Cincinnati, OH 45242, US  
BARTON, Trevor J., 4545 Creek Road, Cincinnati, OH 45242, US

---

(51) MKP  
**A23L 29/231 2016 (97) EP 3376880**  
(96) EP 15802207.9 11/20/2015  
(97) EP 3376880, 9/26/2018 201839, en  
(54) ALCOHOLIC FOAM  
(71) IBEX SARL, 3 Rue de la Mairie, 73000 Jacob-Bellecombette, FR  
DURDEN CONCEPT SARL, Rue Agasse 54, 1208 Genève, CH  
(72) PERRIER, Cédric, Rue de Beauregard 26, 2740 Moutier, CH  
MARMET, Olivier, 3 Rue de la Mairie, 73000 Jacob-Bellecombette, FR  
LASSIS-LAVY, Guillaume, 12 Boulevard de Paris, 73100 Aix-les-Bains, FR

---

(51) MKP  
**A01M 1/02 2006 (97) EP 3254559**  
**A01M 1/10 2006**  
**A01M 1/20 2006**  
(96) EP 16382265.3 6/10/2016  
(97) EP 3254559, 7/18/2018 201829, en  
(54) INSECT TRAP  
(71) Sociedad Española de Desarrollos Quimicos, S.L. (SEDQ), C/ Marie Curie, 33, 08210 Barbera del Valles (Barcelona), ES  
(72) COLL KLEIN, Francis, Sociedad Española de Desarrollos Quimicos, S.L. (SEDQ) c/ Marie Curie, 33, 08210 Barbera del Valles (Barcelona), ES

---

- (51) MKP  
**A23L 21/20 2016 (97) EP 3278798**  
**A23L 33/10 2016**  
**A61K 31/192 2006**  
**A61K 35/644 2015**  
**A61P 31/10 2006**
- (96) EP 16382378.4 8/1/2016  
(97) EP 3278798, 9/5/2018 201836, en
- (54) SYNERGISTIC COMPOSITION COMPRISING PROPOLIS AND CARNOSIC ACID FOR USE THEREOF IN TREATING AND PREVENTING INFECTIONS CAUSED BY SPECIES OF THE CRYPTOCOCCUS NEOFORMANS FUNGUS
- (71) VITALGAIA ESPAÑA, S.L., Calle Acisclo Diaz N°2 Escalera B, Entresuelo 2°, 30005 Murcia, ES  
(72) Lozano Teruel, José Antonio, CALLE ACÍSCLO DÍAZ N°2, ESCALERA B, ENTRESUELO 2°, 30005 MURCIA, ES  
Argüelles Ordóñez, Juan Carlos, CALLE ACÍSCLO DÍAZ N°2, ESCALERA B, ENTRESUELO 2°, 30005 MURCIA, ES  
Argüelles Prieto, Alejandra, CALLE ACÍSCLO DÍAZ N°2, ESCALERA B, ENTRESUELO 2°, 30005 MURCIA, ES  
Sánchez-Fresneda Pinto, Ruth, CALLE ACÍSCLO DÍAZ N°2, ESCALERA B, ENTRESUELO 2°, 30005 MURCIA, ES  
Guirao Abad, José Pedro, CALLE ACÍSCLO DÍAZ N°2, ESCALERA B, ENTRESUELO 2°, 30005 MURCIA, ES  
Albuquerque Gonzalez, Begoña, CALLE ACÍSCLO DÍAZ N°2, ESCALERA B, ENTRESUELO 2°, 30005 MURCIA, ES
- 

- (51) MKP  
**B27H 5/04 2006 (97) EP 3301170**  
**B27M 1/06 2006**  
**C12G 3/07 2006**  
**C12J 1/00 2006**
- (96) EP 16425093.8 9/30/2016  
(97) EP 3301170, 11/14/2018 201846, en
- (54) DEVICE AND METHOD OF HEATING/BENDING/FORMING AND HEATING/TOASTING BARRELS, CASKS, VATS AND THE LIKE FOR REFINING, CONDITIONING AND AGEING ALCOHOLIC BEVERAGES AND OTHER FOODS
- (71) G. & P. Garbellotto S.p.A., Viale Italia, 200, 31015 Conegliano, Treviso, IT  
(72) Battistutta, Franco, c/o G. & P. Garbellotto S.P.A. Viale Italia, 200, I-31015 Conegliano, Treviso, IT  
Tonizzo, Andrea, c/o G. & P. Garbellotto S.P.A. Viale Italia, 200, I-31015 Conegliano, Treviso, IT
- 

- (51) MKP  
**F01D 5/00 2006 (97) EP 3318716**  
**F01D 5/30 2006**  
**F01D 25/28 2006**
- (96) EP 16461568.4 11/4/2016  
(97) EP 3318716, 12/19/2018 201851, en
- (54) INSTALLATION OR REMOVAL OF TURBINE BLADE AT TURBINE BLADE BASE
- (71) General Electric Company, 1 River Road, Schenectady, NY 12345, US  
(72) WOJTOWICZ, Hubert Karol, al. Krakowska 110/114 CTG Building, 02-256 Warszawa, PL  
KOLVICK, Sandra Beverly, 300 Garlington Road, Greenville, South Carolina 29615, US  
SULLIVAN, Wayne David, 300 Garlington Road, Greenville, South Carolina 29602, US
- 

- (51) MKP  
**A61K 38/00 2006 (97) EP 3245224**  
**A61K 38/20 2006**  
**C07K 14/54 2006**
- (96) EP 16700424.1 1/12/2016  
(97) EP 3245224, 7/18/2018 201829, en
- (31) 15150786 (32) 12.01.2015 (33) EP
- (54) IL-17A-BINDING POLYPEPTIDES
- (71) Affibody AB, Gunnar Asplunds Allé 24, 171 69 Solna, SE  
(72) FREJD, Fredrik, Skillinggränd 5, 112 20 Stockholm, SE  
FELDWISCH, Joachim, Korallvägen 16, 135 42 Tyresö, SE  
KLINT, Susanne, Olöf Dalins Väg 16, 112 52 Stockholm, SE  
GUDMUNSDOTTER, Lindvi, Fatburs Kvarngata 17, 118 64 Stockholm, SE
- 

- (51) MKP  
**A61K 39/00 2006 (97) EP 3242892**  
**A61K 39/395 2006**  
**A61P 37/00 2006**  
**C07K 16/28 2006**
- (96) EP 16700803.6 1/8/2016

(97) EP 3242892, 8/22/2018 201834, en  
 (31) 2014108 (32) 09.01.2015 (33) NL  
 (54) ALTERED APRIL BINDING ANTIBODIES  
 (72) VAN EENENNAAM, Hans, Bandoengstraat 12, 6524 KZ Nijmegen, NL  
 VAN ELSAS, Andrea, Ruusbroecgaarde 139, 5343 JL Oss, NL  
 MEDEMA, Jan Paul, Goudensteinpark 12, 2151 HC Nieuw Vennepe, NL  
 HULSIK, David Lutje, Graafseweg 47 G, 6512 BR Nijmegen, NL

---

(51) MKP  
**A23L 2/52 2006 (97) EP 3250050**  
**A23L 2/60 2006**  
**A23L 27/12 2016**  
 (96) EP 16702364.7 1/26/2016  
 (97) EP 3250050, 9/12/2018 201837, en  
 (31) 201500903 (32) 27.01.2015 (33) TR  
 (54) A NATURAL SWEETENING COMPOSITION  
 (72) TOKSÖZ, Ahmet, Montero Gida Sanayi Ve Ticaret A.S. Balabandere Cad. Ilac Sanayi Yolu No: 14 Istinye, 34460 Istanbul, TR  
 TOKSÖZ, Zafer, Montero Gida Sanayi Ve Ticaret A.S. Balabandere Cad. Ilac Sanayi Yolu No: 14 Istinye, 34460 Istanbul, TR  
 MUTLU, Onur, Montero Gida Sanayi Ve Ticaret A.S. Balabandere Cad. Ilac Sanayi Yolu No: 14 Istinye, 34460 Istanbul, TR

---

(51) MKP  
**A23L 2/52 2006 (97) EP 3250051**  
**A23L 2/60 2006**  
**A23L 27/12 2016**  
 (96) EP 16702366.2 1/26/2016  
 (97) EP 3250051, 7/18/2018 201829, en  
 (31) 201500903 (32) 27.01.2015 (33) TR  
 201502736 06.03.2015 TR  
 (54) A NATURAL SWEETENING COMPOSITION OF LUO HAN GUO AND APPLE  
 (71) Montero Gida Sanayi Ve Ticaret A.S., Balabandere Cad. Ilac Sanayi No:14 Istinye Sariyer, 34460 Istanbul, TR  
 (72) TOKSÖZ, Ahmet, Montero Gida Sanayi Ve Ticaret A.S. Balabandere Cad. Ilac Sanayi Yolu No: 14 Istinye, 34460 Istanbul, TR  
 TOKSÖZ, Zafer, Montero Gida Sanayi Ve Ticaret A.S. Balabandere Cad. Ilac Sanayi Yolu No: 14 Istinye, 34460 Istanbul, TR  
 MUTLU, Onur, Montero Gida Sanayi Ve Ticaret A.S. Balabandere Cad. Ilac Sanayi Yolu No: 14 Istinye, 34460 Istanbul, TR  
 TÜRKYILMAZ, Ali, Montero Gida Sanayi Ve Ticaret A.S. Balabandere Cad. Ilac Sanayi Yolu No: 14 Istinye, 34460 Istanbul, TR  
 YELKEN, Gülay, Montero Gida Sanayi Ve Ticaret A.S. Balabandere Cad. Ilac Sanayi Yolu No: 14 Istinye, 34460 Istanbul, TR  
 ZAN, Merve, Montero Gida Sanayi Ve Ticaret A.S. Balabandere Cad. Ilac Sanayi Yolu No: 14 Istinye, 34460 Istanbul, TR

---

(51) MKP  
**A61K 39/00 2006 (97) EP 3242684**  
**A61K 39/395 2006**  
**A61P 1/00 2006**  
**C07K 16/28 2006**  
 (96) EP 16702586.5 1/6/2016  
 (97) EP 3242684, 9/19/2018 201838, en  
 (31) 201562101877 P (32) 09.01.2015 (33) US  
 201562263197 P 04.12.2015 US  
 201562263910 P 07.12.2015 US  
 (54) DOSAGE REGIMEN FOR MADCAM ANTAGONISTS  
 (72) CATALDI, Fabio, 53 Preston Place, Beverly, MA 01915, US  
 CLARE, Robert A., 1656 Stephens Drive, Wayne, PA 19087, US  
 COMER, Gail M., 111 Brimful Drive, Phoenixville, PA 19460, US  
 PRADHAN, Vivekananda, 41 Parker Street, Acton, MA 01720, US  
 AHMAD, Alaa, 17 Park Circle, Arlington, MA 02476, US  
 HASSAN-ZAHRAEE, Mina, 16 Fort Washington Place, Cambridge, MA 02139, US  
 TILLEY, Mera Krishnan, 100 High Street Apt. 203, Medford, MA 02155, US  
 ZHANG, Weidong, 4 Kennedy Lane, Acton, MA 01720, US  
 BANERJEE, Anindita, 14 Endicott Place, Canton, MA 02021, US  
 PAGE, Karen Michelle, 36 Patten Road, Merrimack, NH 03054, US  
 VINCENT, Michael Steven, 147 Lake Avenue, Newton, MA 02459, US  
 VON SCHACK, David J., 10 Cheviot Road, Arlington, MA 02474, US

---

(51) MKP



**A62B 35/00 2006 (97) EP 3402577**  
**A62B 35/04 2006**  
(96) EP 16704047.6 1/15/2016  
(97) EP 3402577, 11/21/2018 201847, en  
(54) FALL ARRESTER WITH TORSIONAL ENERGY ABSORBING MEANS  
(71) DALEKOVOD PROIZVODNJA d.o.o., Ulica Trnoscica 17, 10370 Dugo Selo, HR  
(72) KIRIN Damir, Zagrebacka 50, 10417 Busevec, HR  
DOLIC, Dario, Zelinska 5, 10000 Zagreb, HR

---

(51) MKP  
**A61K 31/4439 2006 (97) EP 3256127**  
**A61P 27/00 2006**  
(96) EP 16704171.4 2/10/2016  
(97) EP 3256127, 11/21/2018 201847, en  
(31) 15154764 (32) 11.02.2015 (33) EP  
(54) METHOD OF PREVENTING OR TREATING HEARING LOSS  
(71) Support-Venture GmbH, Lautengartenstrasse 14, 4052 Basel, CH  
(72) BAUSCH, Alexander, Stettenweg 16, 4125 Riehen, CH

---

(51) MKP  
**A61K 39/395 2006 (97) EP 3247393**  
**C07K 16/28 2006**  
(96) EP 16704511.1 1/20/2016  
(97) EP 3247393, 10/3/2018 201840, en  
(31) 201562105490 P (32) 20.01.2015 (33) US  
201562258015 P 20.11.2015 US  
201662278713 P 14.01.2016 US  
(54) MATRIX METALLOPROTEASE-CLEAVABLE AND SERINE PROTEASE CLEAVABLE SUBSTRATES AND METHODS OF USE THEREOF  
(72) MOORE, Stephen James, 218 Country Meadows Lane, Danville, California 94506, US  
NGUYEN, Margaret Thy Luu, 501 6th Avenue Unit 1, San Francisco, California 94118, US  
HOSTETTER, Daniel R., 3909 Park Blvd., Palo Alto, California 94306, US  
VASILJEVA, Olga, 20080 Rodrigues Ave. D, Cupertino, California 95104, US  
SAGERT, Jason Gary, 231 Laurie Meadows Rd Apt 153, San Mateo, California 94403, US  
TERRETT, Jonathan Alexander, 10678 Maplewood Road, Cupertino, California 95014, US  
WEST, James William, 724 Laurel Ave. Apt 404, San Mateo, California 94401, US

---

(51) MKP  
**A61K 31/18 2006 (97) EP 3259250**  
**A61K 31/4402 2006**  
**A61K 31/47 2006**  
**A61K 31/505 2006**  
**A61P 31/00 2006**  
**C07C 311/00 2006**  
**C07D 213/71 2006**  
**C07D 215/36 2006**  
**C07D 217/22 2006**  
**C07D 239/42 2006**  
**C07D 239/47 2006**  
**C07D 239/48 2006**  
**C07D 251/22 2006**  
**C07D 311/20 2006**  
**C07D 487/04 2006**  
(96) EP 16704945.1 2/11/2016  
(97) EP 3259250, 11/7/2018 201845, en  
(31) 150014 P (32) 13.02.2015 (33) LV  
160006 P 10.02.2016 LV  
(54) NOVEL N-ACYL-ARYLSULFONAMIDE DERIVATIVES AS AMINOACYL-TRNA SYNTHETASE INHIBITORS  
(71) Oxford Drug Design Limited, The Walbrook Building 25 Walbrook, London EC4N 8AF, GB  
(72) JIRGENSONS, Aigars, Hospitalu Street 3-103, LV-1013 Riga, LV  
LOZA, Einars, Kr.Valdemara Street 109-28, LV-1013 Riga, LV  
CHARLTON, Michael, c/o Oxford Centre for Innovation New Road, Oxford, OX1 1BY, GB  
FINN, Paul William, c/o Oxford Centre for Innovation New Road, Oxford, OX1 1BY, GB  
RIBAS DE POUPLANA, Lluís, IBR Barcelona C/ Baldiri Reixac 10, 08028 Barcelona, ES  
SAINT-LEGER, Adelaide, C/ Orient 13 3-2, 08904 Hospitalet de Llobregat, ES

---

(51) MKP  
**A61K 31/551 2006 (97) EP 3253747**  
**A61K 31/553 2006**  
**A61P 35/00 2006**  
**C07D 243/14 2006**  
**C07D 267/12 2006**  
**C07D 403/06 2006**  
**C07D 413/06 2006**

(96) EP 16706457.5 2/2/2016  
(97) EP 3253747, 10/24/2018 201843, en

(31) 201562110716 P (32) 02.02.2015 (33) US  
201562205438 P 14.08.2015 US

(54) 3-ALKYL-4-AMIDO-BICYCLIC [4,5,0]HYDROXAMIC ACIDS AS HDAC INHIBITORS  
(72) ZHENG, Xiaozhang, 9 Paddock Lane, Lexington, Massachusetts 02421, US  
NG, Pui Yee, 220 Grove Street Unit 1, Waltham, Massachusetts 02453, US  
HAN, Bingsong, 55 North Avenue, North Haven, Connecticut 06473, US  
THOMASON, Jennifer R., 148 Water Street, Clinton, Massachusetts 01510, US  
ZABLOCKI, Mary-Margaret, 36 Butler Street, Revere, Massachusetts 02151, US  
LIU, Cuixian, 22 Blueberry Hill Drive, Madison, Connecticut 06443, US  
DAVIS, Heather, 202 Morgan Drive, Haverhill, Massachusetts 01832, US  
RUDNITSKAYA, Aleksandra, 345 Belgrade Avenue Unit 12, Roslindale, Massachusetts 02131, US  
LANCIA JR., David, Jr., 45 W Broadway Unit 111, Boston, Massachusetts 02127, US  
BAIR, Kenneth W., 41 Cartwright Road, Wellesly, Massachusetts 02482, US  
MILLAN, David S., c/o Forma Therapeutics Inc. 500 Arsenal Street Suite 100, Watertown, Massachusetts 02472, US  
MARTIN, Matthew W., 98 Forest Street, Arlington, Massachusetts 02474, US

---

(51) MKP  
**A61K 9/16 2006 (97) EP 3256107**  
**A61K 31/265 2006**

(96) EP 15819831.7 12/23/2015  
(97) EP 3256107, 10/24/2018 201843, en

(31) TO20150086 (32) 09.02.2015 (33) IT

(54) PHARMACEUTICAL FORMULATION OF RACECADOTRIL  
(72) POLI, Piero, c/o RIVOPHARM SA CENTRO INSEMA, 6928 Manno Lugano, CH  
FIORINO, Alessandro, c/o RIVOPHARM SA CENTRO INSEMA, 6928 Manno Lugano, CH  
PIAZZOLLA, Tommaso Roberto, c/o RIVOPHARM SA CENTRO INSEMA, 6928 Manno Lugano, CH

---

(51) MKP  
**E04C 1/00 2006 (97) EP 3384100**  
**E04C 2/04 2006**

(96) EP 15823311.4 12/18/2015  
(97) EP 3384100, 10/10/2018 201841, en

(31) 102015015301 (32) 30.11.2015 (33) DE

(54) BUILDING PRODUCTS COMPRISING GRAPHENE OR GRAPHENE OXIDE IN THE BULK MATERIAL AND METHOD FOR PRODUCING SUCH BUILDING PRODUCTS  
(72) WIETESKA, Marcin, Goctawska 9/34, PL-03-810 Warszawa, PL  
KIEDRZYN, Grzegorz, Drohobycka 28E, PL-54-620 Wroclaw, PL

---

(51) MKP  
**E04C 2/04 2006 (97) EP 3374577**

(96) EP 15823312.2 12/18/2015  
(97) EP 3374577, 9/19/2018 201838, en

(31) 102015014513 (32) 11.11.2015 (33) DE

(54) BUILDING PRODUCTS WITH GRAPHENE OR GRAPHENE OXIDE  
(72) BRÜCKNER, Sylvia, Salvatorstrasse 15B, 97074 Würzburg, DE

---

(51) MKP  
**B65D 51/28 2006 (97) EP 3397568**

(96) EP 15823343.7 12/31/2015  
(97) EP 3397568, 11/7/2018 201845, en

- (54) CONTAINER WITH MULTI DEPRESSIBLE CAP PRESS TOP  
(71) Teamplast B.V., Poort van midden Gelderland Rood 11, 6666 ZH Heteren, NL  
(72) VERSLUIJS, Richard, Patrick, Witmolen 17, 2645 GE Delfgauw, NL  
VAN AMERONGEN, Gerard, Diedenweg 4, 6721 HR Bennekom, NL
- 

- (51) MKP  
**A61N 5/06 2006 (97) EP 3402570**
- (96) EP 15823403.9 11/30/2015  
(97) EP 3402570, 12/12/2018 201850, en
- (54) COMPACT UVB LIGHT THERAPY DEVICE FOR TREATING DERMAL CONDITIONS  
(71) Comin SP. Z O.O., Ceramiczna 18/639, 03-126 Warszawa, PL  
(72) SZOSTKIEWICZ, Lukasz, ul. Waska 8a/10, 97-100 Torun, PL  
NAPIERALA, Marek, ul. Lazurowa 185a/55, 01-476 Warszawa, PL  
NASIŁOWSKI, Tomasz, ul. Dzika 15/12, 00-172 Warszawa, PL  
STANCZYK, Tomasz, ul. Gen. Grochowskiego 12/74, 05-500 Piaseczno, PL  
KUKLINSKA, Malgorzata, Pawlowa 61, 20-455 Lublin, PL  
ZIOŁOWICZ, Anna, Ołowiana 7, 25-752 Kielce, PL  
PYTEL, Anna, ul. Sotta Sokola Kazimierza 1a/20, 02-790 Warszawa, PL  
PAWLIK, Katarzyna, ul. Ceramiczna 18/639, 03-126 Warszawa, PL  
HOLDYNSKI, Zbigniew, ul. Pustola 22/11, 01-129 Warszawa, PL  
LIPINSKI, Stanislaw, ul. Prusa 4, 13-240 Iłowo, PL  
FILIPOWICZ, Marta, ul. Lecha 7/17, 05-400 Otwock, PL  
WAJNCHOLD, Barbara, ul. Slonskiego 15/25, 33-176 Kraków, PL
- 

- (51) MKP  
**C12N 9/74 2006 (97) EP 3253870**  
**G01N 33/48 2006**
- (96) EP 15880760.2 2/6/2015  
(97) EP 3253870, 7/11/2018 201828, en
- (54) METHOD FOR PREPARATION OF THROMBIN  
(71) Guangzhou Bioseal Biotech Co., Ltd., No. 5 Ruitai Road No. 5 Ruitai Road Science Park High Tech Industrial Development Zone Guogang District, Guangzhou, Guangdong 510620, CN  
(72) WEISSMAN, Lior, 13B Alon Street, 7420917 Ness-Ziona, IL  
SELLA, Dana, 3 Sipora Tov, 7634939 Rehovot, IL  
NUR, Israel, 13 Choshen Street, 7403769 Nes-Ziona, IL  
JIANG, Caixia, Room 703 No. 4 Baoshengshadi Street Fengyuan Road Liwan District, Guangzhou Guangdong 510150, CN  
AN, Baochang, Room 406 No. 232 Kaifa Avenue Luogang District, Guangzhou Guangdong 510730, CN
- 

- (51) MKP  
**B65D 81/34 2006 (97) EP 3395716**
- (96) EP 15911243.2 12/23/2015  
(97) EP 3395716, 10/31/2018 201844, en
- (54) BAG FOR COOKING CORN GRAINS IN A MICROWAVE  
(71) DODE, S.A., Alcalde Ramon Escayola, 66. Valldoreix, 08197 Sant Cugat Del Valles (Barcelona), ES  
(72) GALCERAN MARTORELL, Carlos, Encija S/N P.I. Sant Isidre, 08272 Sant Fruitos de Bages (Barcelona), ES
- 

- (51) MKP  
**A61K 31/496 2006 (97) EP 3344620**  
**A61P 25/34 2006**  
**C07D 403/12 2006**
- (96) EP 16758212.1 9/1/2016  
(97) EP 3344620, 7/11/2018 201828, en
- (31) 15382436 (32) 02.09.2015 (33) EP
- (54) 1-(4-(2-((1-(3,4-DIFLUOROPHENYL)-1H-PYRAZOL-3-YL)METHOXY)ETHYL) PIPERAZIN-1-YL)ETHANONE SALTS  
(72) TORRENS-JOVER, Antoni, Carrer del Raco 8 2º 2ª, E-08221 Terrassa Barcelona, ES  
ALMANSA ROSALES, Carmen, Teodora Lamadrid 41 Entresuelo 4ª, E-08022 Barcelona, ES
- 

- (51) MKP  
**A61K 31/713 2006 (97) EP 3344769**  
**C12N 15/113 2010**
- (96) EP 16758345.9 8/22/2016  
(97) EP 3344769, 7/11/2018 201828, en

(31) 201562213224 P (32) 02.09.2015 (33) US  
(54) PROGRAMMED CELL DEATH 1 LIGAND 1 (PD-L1) iRNA COMPOSITIONS AND METHODS OF USE THEREOF  
(72) HINKLE, Gregory, 300 Third Street, 3rd Floor, Cambridge, MA 02142, US

---

(51) MKP  
**A61K 31/575 2006 (97) EP 3394081**  
**A61P 1/16 2006**  
**C07J 9/00 2006**  
**C07J 17/00 2006**  
**C07J 51/00 2006**

(96) EP 16714049.0 1/8/2016  
(97) EP 3394081, 10/31/2018 201844, en

(31) 201514979005 (32) 22.12.2015 (33) US

(54) POLYMORPHIC CRYSTALLINE FORMS OF OBETICHOLIC ACID  
(72) STEINER, André, PharmaZell GmbH Rosenheimer Str. 43, 83064 Raubling, DE  
WAENERLUND POULSEN, Heidi, FeF Chemicals A/S Kobenbavnsvej 216, 4600 Køge, DK  
JOLIBOIS, Emilie, Pharmorphix Ltd. 250 Cambriade Science Park Milton Road, Cambridge CB4 0WE, GB  
REWOLINSKI, Melissa, 4350 La Jolla Village Drive Suite 960, San Diego, CA 92122, US  
GROSS, Ralf, PharmaZell GmbH Rosenheimer Str. 43, 83064 Raubling, DE  
SHARP, Emma, Pharmorphix Ltd. 250 Cambridge Science Park Milton Road, Cambridge CB4 0WE, GB  
DUBAS-FISHER, Fiona, Pharmorphix Ltd. 250 Cambridge Science Park Milton Road, Cambridge CB4 0WE, GB  
EBERLIN, Alex, Pharmorphix Ltd. 250 Cambridge Science Park Milton Road, Cambridge CB4 0WE, GB

---

(51) MKP  
**A22C 21/00 2006 (97) EP 3250039**

(96) EP 16715358.4 1/25/2016  
(97) EP 3250039, 9/5/2018 201836, en

(31) 2014197 (32) 27.01.2015 (33) NL

(54) DEVICE FOR MAKING A PREPARATORY INCISION LONGITUDINALLY OF AN ANIMAL EXTREMITY PART WITH FIRST AND SECOND BONES ARTICULATED BY A JOINT

(71) Foodmate B.V., Einsteinstraat 26, 3281 NJ Numansdorp, NL  
(72) STOOKER, Dirk Cornelis, c/o Einsteinstraat 26, 3281 NJ Numansdorp, NL

---

(51) MKP  
**A47C 7/02 2006 (97) EP 3373769**  
**A47C 7/28 2006**  
**A47C 31/02 2006**  
**B68G 7/00 2006**  
**D03D 15/04 2006**

(96) EP 16717159.4 4/19/2016  
(97) EP 3373769, 9/19/2018 201838, de

(31) 102016003418 (32) 23.03.2016 (33) DE  
102016003494 24.03.2016 DE  
102016106446 08.04.2016 DE

(54) METHOD FOR PRODUCING A TEXTILE COMPOSITE MATERIAL AND TEXTILE COMPOSITE MATERIAL PRODUCED ACCORDING TO SAID METHOD

(72) SALZMANN, Oliver, Hursterhöfe 26, 47877 Willich, DE

---

(51) MKP  
**A01K 67/027 2006 (97) EP 3165540**  
**A61K 39/395 2006**  
**A61P 35/00 2006**  
**A61P 37/02 2006**  
**C07K 14/705 2006**  
**C07K 16/28 2006**

(96) EP 16193133.2 4/13/2011  
(97) EP 3165540, 11/21/2018 201847, en

(31) 323720 P (32) 13.04.2010 (33) US  
201161471459 P 04.04.2011 US

(54) ANTIBODIES THAT BIND HUMAN CD27 AND USES THEREOF  
(72) KELER, Tibor, 198 Cafferty Rd, Pipersville, PA 18947-1613, US  
MARSH, Henry C., 297 Summer Avenue, Reading, MA 01867, US

HE, Lizhen, 1675 Ridgeview Drive, Allentown, PA 18104, US  
VITALE, Laura A., 5574 Bittersweet Lane, Doylestown, PA 18902, US  
THOMAS, Lawrence J., 1 Fox Ridge Road, Easton, MA 02375, US

---

(51) MKP  
**G06T 15/08 2011 (97) EP 3156975**  
**G06T 17/20 2006**  
**G06T 19/00 2011**  
(96) EP 16193486.4 10/12/2016  
(97) EP 3156975, 9/12/2018 201837, en  
(31) 201514881192 (32) 13.10.2015 (33) US  
(54) VOXELIZATION OF A TRIDIMENSIONAL MESH  
(72) COHEN, Benjamin, Biosense Webster (Israel) Ltd. 4 HATNUFA STREET P.O. Box 275, YOKNEAM 2066717, IL  
ZAR, Lior, Biosense Webster (Israel) Ltd. 4 HATNUFA STREET P.O. Box 275, YOKNEAM 2066717, IL  
KATZ, Natan Sharon, Biosense Webster (Israel) Ltd. 4 HATNUFA STREET P.O. Box 275, YOKNEAM 2066717, IL

---

(51) MKP  
**B01D 24/36 2006 (97) EP 3159314**  
**B01D 24/46 2006**  
**C02F 3/08 2006**  
**C02F 3/12 2006**  
(96) EP 16195169.4 10/21/2016  
(97) EP 3159314, 10/17/2018 201842, de  
(31) 102015118166 (32) 23.10.2015 (33) DE  
(54) CLARIFICATION UNIT, METHOD AND USE  
(71) Lorch, Roland, Weilerstraße 4, 88348 Bad Saulgau, DE  
Schaible, Jürgen, Vogelhaldeweg 13, 88299 Leutkirch im Allgäu, DE  
(72) Lorch, Roland, Weilerstraße 4, 88348 Bad Saulgau, DE  
Schaible, Jürgen, Vogelhaldeweg 13, 88299 Leutkirch im Allgäu, DE

---

(51) MKP  
**A61K 39/395 2006 (97) EP 3156073**  
**C07K 16/24 2006**  
(96) EP 16195503.4 3/1/2013  
(97) EP 3156073, 10/31/2018 201844, en  
(31) 201261607671 P (32) 07.03.2012 (33) US  
(54) IL-17 ANTIBODY FORMULATION  
(72) CORVARI, Vincent John, c/o Eli Lilly and Company PO Box 6288, Indianapolis, Indiana 46206-6288, US  
WILLIAMS, Barbara Ann, c/o Eli Lilly and Company PO Box 6288, Indianapolis, Indiana 46206-6288, US  
DONOVAN, Patrick Daniel, c/o Eli Lilly and Company PO Box 6288, Indianapolis, Indiana 46206-6288, US  
MARKHAM, Aaron Paul, c/o Eli Lilly and Company PO Box 6288, Indianapolis, Indiana 46206-6288, US

---

(51) MKP  
**B23D 65/00 2006 (97) EP 3321020**  
**B24B 7/17 2006**  
**B24B 21/04 2006**  
(96) EP 16198460.4 11/11/2016  
(97) EP 3321020, 12/26/2018 201852, de  
(54) DEVICE FOR THE POST-TREATMENT OF BUTT-WELDED WORKPIECES, IN PARTICULAR SAW BANDS OR BAND KNIVES  
(72) Jungeblo, Max, Clemens, Kleiststraße 14, 59555 Lippstadt, DE

---

(51) MKP  
**H01M 2/02 2006 (97) EP 3321990**  
**H01M 4/86 2006**  
**H01M 4/88 2006**  
**H01M 12/06 2006**  
**H01M 12/08 2006**  
(96) EP 16198551.0 11/13/2016  
(97) EP 3321990, 12/26/2018 201852, en  
(54) FLOW BATTERY, PROCESS FOR THE MANUFACTURE, AND USE THEREOF  
(71) Haq, Manan, Fuchswaldstrasse 70, 70569 Stuttgart, DE  
(72) Haq, Manan, Fuchswaldstrasse 70, 70569 Stuttgart, DE

---

(51) MKP  
**C02F 1/00 2006 (97) EP 3153474**  
**C02F 1/44 2006**  
**C02F 1/50 2006**  
**C02F 1/66 2006**  
**C02F 1/76 2006**  
**C02F 1/78 2006**  
**C02F 5/14 2006**  
**C02F 103/42 2006**  
**E04H 4/12 2006**

(96) EP 16198841.5 9/12/2011  
(97) EP 3153474, 10/31/2018 201844, en

(31) 201161469548 P (32) 30.03.2011 (33) US  
201113136458 01.08.2011 US

(54) SUSTAINABLE SYSTEM FOR TREATING WATER BODIES AFFECTED BY BACTERIA AND MICROALGAE AT LOW COST  
(72) Fischmann, T. Fernando, Avenida Kennedy, 8830 Vitacura, Santiago, CL

---

(51) MKP  
**B01D 21/30 2006 (97) EP 3156111**  
**B01D 61/04 2006**  
**C02F 1/00 2006**  
**C02F 1/24 2006**  
**C02F 1/44 2006**  
**C02F 1/50 2006**  
**C02F 1/52 2006**  
**C02F 1/56 2006**  
**C02F 1/72 2006**  
**C02F 1/76 2006**  
**C02F 1/78 2006**  
**C02F 5/08 2006**  
**C02F 9/02 2006**  
**C02F 101/20 2006**  
**C02F 103/02 2006**  
**C02F 103/08 2006**  
**C02F 103/10 2006**

(96) EP 16198842.3 9/12/2011  
(97) EP 3156111, 7/11/2018 201828, en

(31) 201161469537 P (32) 30.03.2011 (33) US  
201113136474 01.08.2011 US

(54) METHOD FOR TREATING WATER USED FOR INDUSTRIAL PURPOSES  
(72) Fischmann, T. Fernando, Avenida Kennedy, 8830 Vitacura, Santiago, CL

---

(51) MKP  
**G01N 27/72 2006 (97) EP 3173825**  
**G01V 3/10 2006**

(96) EP 16200034.3 11/22/2016  
(97) EP 3173825, 8/1/2018 201831, en

(31) 201562259661 P (32) 25.11.2015 (33) US

(54) METHODS AND APPARATUS FOR COLLOCATING ELECTROMAGNETIC COILS AND ELECTRONIC CIRCUITS  
(72) ROSENFELD, Jonathan, Itshak elkhanan 5/1 street, 4721805 Ramat hasharon, IL

---

(51) MKP  
**A47F 1/12 2006 (97) EP 3332672**  
**G07F 9/10 2006**  
**G07F 11/04 2006**  
**G07F 11/16 2006**  
**G07F 11/22 2006**  
**G07F 11/42 2006**

(96) EP 16203490.4 12/12/2016  
(97) EP 3332672, 10/17/2018 201842, en

(54) MOBILE MAGAZINE  
(71) smark - Philipp Hoening & Maximilian Ittermann GbR, Dürrstraße 25, 70193 Stuttgart, DE

(72) Hoening, Philipp, Senefelderstraße 100, 70176 Stuttgart, DE  
Ittermann, Maximilian, Reinsburgstraße 77, 70197 Stuttgart, DE

---

(51) MKP

**A01K 67/027 2006 (97) EP 3165086**  
**C07K 16/00 2006**  
**C07K 16/28 2006**  
**C12N 15/85 2006**

(96) EP 16203839.2 3/5/2013

(97) EP 3165086, 7/25/2018 201830, en

(31) 201213412936 (32) 06.03.2012 (33) US

(54) COMMON LIGHT CHAIN MOUSE

(71) REGENERON PHARMACEUTICALS, INC., 777 Old Saw Mill River Road, Tarrytown, NY 10591-6707, US

(72) BABB, Robert, 292 Voorhis Ave, River Edge, NJ New Jersey 07661, US

McWHIRTER, John, 2152 Crescent Drive, Tarrytown, NY New York 10591, US

MACDONALD, Lynn, 16 Gedney Way, White Plains, NY New York 10505, US

STEVENS, Sean, 3954 Camino Calma, San Diego, CA California 92122-1909, US

DAVIS, Samuel, 332 West 88th Street Apt. B2, New York, NY New York 10024, US

BUCKLER, David, c/o Regeneron Pharmaceuticals, Inc. 777 Old Saw Mill River Road, Tarrytown, NY 10591, US

MEAGHER, Karolina, A., 211 Benjamin Blvd, Yorktown, NY 10598-3846, US

MURPHY, Andrew, J., 10 Newton Court, Croton-on-Hudson, NY New York 10520, US

---

(51) MKP

**B23P 19/02 2006 (97) EP 3348346**  
**B23P 21/00 2006**

(96) EP 17151216.3 1/12/2017

(97) EP 3348346, 7/18/2018 201829, de

(54) METHOD AND DEVICE FOR PRODUCING CONNECTION HOSES

(71) KNAPEIDE GmbH Hydraulik-Systeme, Daimlerring 1, 59269 Beckum, DE

(72) Mischke, Wolfgang, Natz-Thier-Straße 3, 48727 Billerbeck, DE

Knappeide, Kai Uwe, Marienstraße 9, 59269 Beckum, DE

---

(51) MKP

**G02B 19/00 2006 (97) EP 3214477**  
**G02B 27/09 2006**  
**G02B 27/14 2006**  
**H01S 5/40 2006**

(96) EP 17153069.4 1/25/2017

(97) EP 3214477, 8/15/2018 201833, de

(31) 102016102591 (32) 15.02.2016 (33) DE

(54) DEVICE FOR SHAPING LASER RADIATION

(71) LIMO GmbH, Bookenburgweg 4 - 8, 44319 Dortmund, DE

(72) Bagschik, Klaus, Elisabeth-Schwarzhaupt-Strasse 17, 53125 Bonn, DE

---

(51) MKP

**C01F 11/18 2006 (97) EP 3354622**  
**C09C 1/02 2006**

(96) EP 17153420.9 1/26/2017

(97) EP 3354622, 8/1/2018 201831, en

(54) PROCESS FOR THE PREPARATION OF FRAGMENTED NATURAL CALCIUM CARBONATE WITH A REDUCED CONTENT OF IMPURITIES AND PRODUCTS OBTAINED THEREOF

(72) TAVAKKOLI, Bahman, Zauchenweg 8, 9722 Gummern, AT

RUHDORFER, David, Höflingerstraße 15, 9584 Finkenstein, AT

---

(51) MKP

**A61K 8/02 2006 (97) EP 3360601**  
**A61K 8/19 2006**  
**A61K 8/29 2006**  
**A61Q 17/04 2006**

(96) EP 17155425.6 2/9/2017

(97) EP 3360601, 8/15/2018 201833, en

(54) FUNCTIONALIZED CALCIUM CARBONATE FOR SUN PROTECTION BOOSTING

(72) BUDDÉ, Tanja, Grubenring 3, 4805 Brittnau, CH  
HECKER, Anaïs, Neugasse 9, 4665 Oftringen, CH

---

(51) MKP  
**C08J 7/04 2006 (97) EP 3366740**  
**C09D 151/02 2006**

(96) EP 17157947.7 2/24/2017

(97) EP 3366740, 8/29/2018 201835, en

(54) MINERAL OIL BARRIER

(72) ROHÉ, Ramon, Zollweg 21, 5034 Suhr, CH

---

(51) MKP  
**C07C 303/04 2006 (97) EP 3366671**  
**C07C 309/22 2006**

(96) EP 17158522.7 2/28/2017

(97) EP 3366671, 9/26/2018 201839, de

(54) PROCESS FOR THE PREPARATION OF SULFO-SUCCINIC ACID AND USE THEREOF

(71) ESIM Chemicals GmbH, St.-Peter-Str. 25, 4020 Linz, AT

(72) STÖGLEHNER, Alex, Schulfeld 1/2, 4210 Gallneukirchen, AT  
KASSLER, Alexander, Mariahilferstraße 143/10, 1150 Wien, AT

KÖNIG, Michael, Pfarrgasse 10, 4020 Linz, AT

KOGLER, Martina, Orionstraße 87, 4030 Linz, AT

HINTERWIRTH, Helmut, Humboldtstraße 17/1, 4020 Linz, AT

SCHUECKER, Raffael, Wienerstasse 175/32, 4020 Linz, AT

HÄUBL, Martin, Im Meierhof 7, 4040 Linz, AT

DOMKE, Lutz, Liststraße 15, 4020 Linz, AT

HOLUB, Bernhard, Winklfeld 2, 4072 Strassham, AT

---

(51) MKP  
**A61B 5/145 2006 (97) EP 3410936**  
**A61B 5/1486 2006**

(96) EP 16722712.3 2/5/2016

(97) EP 3410936, 12/12/2018 201850, en

(54) MEASURING DEVICE FOR BLOOD AND/OR LIQUID INTERSTITIAL ANALYTES

(71) Sensor Health S.R.L., Via Giacinto Gallina 4, 34122 Trieste, IT

(72) FOUROGHALZAMAN, Katouziantherani Moghadam, c/o DELTA INSTRUMENTS S.r.l. Via Udine 23, 34132 Trieste, IT

---

(51) MKP  
**F41C 33/02 2006 (97) EP 3411654**

(96) EP 16723538.1 2/1/2016

(97) EP 3411654, 12/12/2018 201850, en

(54) A HOLSTER FOR A FIREARM WITH AN ELECTRONIC DEVICE FOR DETECTING AND SENDING DATA

(72) TOSCHI, Francesco, Via Bocciardi 115, 56029 Santa Croce sull'Arno (PI), IT

---

(51) MKP  
**C07C 273/10 2006 (97) EP 3411356**

(96) EP 16724479.7 2/3/2016

(97) EP 3411356, 12/12/2018 201850, en

(54) A CARBON NEUTRAL PROCESS AND RELATING APPARATUS TO PRODUCE UREA FROM MUNICIPAL OR INDUSTRIAL WASTES WITH ZERO EMISSIONS

(71) Processi Innovativi Srl, Via G. Polidoro, 1, 67100 L'Aquila (AQ), IT

(72) ANTONETTI, Elena, Via della Marranella 139, 00176 Roma, IT

IAQUANIELLO, Gaetano, Via Annia Faustina 27, 00153 Roma, IT

SALLADINI, Annarita, Via Ciro Romualdi 94, 64026 Teramo, IT

---

(51) MKP  
**A61K 31/5386 2006 (97) EP 3377500**  
**A61P 25/32 2006**  
**A61P 25/34 2006**  
**A61P 25/36 2006**  
**C07D 498/10 2006**



(96) EP 16797458.3 11/15/2016  
(97) EP 3377500, 9/26/2018 201839, en  
(31) 15382566 (32) 16.11.2015 (33) EP  
(54) OXADIAZASPIRO COMPOUNDS FOR THE TREATMENT OF DRUG ABUSE AND ADDICTION  
(71) ESTEVE PHARMACEUTICALS, S.A., Passeig de la Zona Franca, 109, 4ª Planta, 08038 Barcelona, ES  
(72) VIRGILI-BERNADO, Marina, C/ Baldiri Reixac 10, 08028 Barcelona, ES  
ALMANSA-ROSALES, Carmen, C/ Teodora Lamadrid no. 41 Ent. 4a, 08022 Barcelona, ES  
ALEGRET-MOLINA, Carlos, C/ Baldiri Reixac 10, 08028 Barcelona, ES

---

(51) MKP  
**A43B 13/04 2006 (97) EP 3347416**  
**C08J 9/00 2006**  
**C08J 9/04 2006**  
**C08K 5/10 2006**  
**C08L 67/02 2006**  
(96) EP 16797635.6 9/8/2016  
(97) EP 3347416, 7/18/2018 201829, en  
(31) UB20153516 (32) 09.09.2015 (33) IT  
(54) POLYMER COMPOSITION BASED ON THERMOPLASTIC COPOLYESTER ELASTOMER, MANUFACTURED ARTICLE MADE WITH SUCH POLYMER COMPOSITION AND PRODUCTION PROCESS OF SUCH POLYMER COMPOSITION  
(71) SO.F.TER. SPA, Via Mastro Giorgio 1, 47122 Forlì (Forlì-Cesena), IT  
(72) GRECHI, Denis, c/o SO.F.TER. S.P.A. Via Mastro Giorgio 1, 47122 Forlì (Forlì-Cesena), IT  
ZOCCA, Stefano, c/o SO.F.TER. S.P.A. Via Mastro Giorgio 1, 47122 Forlì (Forlì-Cesena), IT

---

(51) MKP  
**E04B 1/16 2006 (97) EP 3347535**  
**E04B 1/20 2006**  
**E04B 1/24 2006**  
**E04B 2/56 2006**  
**E04B 2/74 2006**  
**E04G 23/02 2006**  
**E04H 9/02 2006**  
(96) EP 16797657.0 9/9/2016  
(97) EP 3347535, 7/18/2018 201829, en  
(31) UB20153496 (32) 09.09.2015 (33) IT  
(54) BUILDING SYSTEM WITH A LOAD-RESISTING FRAME MADE OF REINFORCED CONCRETE OR STEEL INTEGRATED WITH WOODEN INFILL PANELS  
(71) Università degli Studi "G. d'Annunzio" CHIETI-PESCARA, Via dei Vestini, 31, 66013 Chieti Scalo (Chieti), IT  
(72) VSKOVIC, Alberto, c/o Università Degli Studi "G. D'Annunzio" Chieti-Pescara Via dei Vestini 31, 66013 Chieti Scalo (Chieti), IT  
RADOGNA, Donatella, c/o Università Degli Studi "G. D'Annunzio" Chieti-Pescara Via dei Vestini 31, 66013 Chieti Scalo (Chieti), IT  
FORLANI, M., Cristina, c/o Università Degli Studi "G. D'Annunzio" Chieti-Pescara Via dei Vestini 31, 66013 Chieti Scalo (Chieti), IT  
ROMANO, Manuela, c/o Università Degli Studi "G. D'Annunzio" Chieti-Pescara Via dei Vestini 31, 66013 Chieti Scalo (Chieti), IT

---

(51) MKP  
**A61K 39/00 2006 (97) EP 3377094**  
**A61K 39/02 2006**  
(96) EP 16797930.1 11/17/2016  
(97) EP 3377094, 9/26/2018 201839, en  
(31) 15195490 (32) 19.11.2015 (33) EP  
(54) VIRULENCE ATTENUATED BACTERIA FOR TREATMENT OF MALIGNANT SOLID TUMORS  
(71) Universität Basel, Petersgraben 35, 4001 Basel, CH  
(72) ITTIG, Simon, Zehntenfreistrasse 32, 4103 Bottmingen, CH  
AMSTUTZ, Marlise, Wittlingerstr. 140, 4058 Basel, CH  
KASPER, Christoph, Ruttigerweg 4, 4600Olten, CH  
CORNELIS, Guy R., Rue Jassogne 5, 5332 Crupet, BE

---

(51) MKP  
**A61K 31/445 2006 (97) EP 3377478**  
**A61P 37/08 2006**  
**C07D 401/04 2006**  
(96) EP 16797941.8 11/18/2016  
(97) EP 3377478, 9/26/2018 201839, en

(31) 15382577 (32) 20.11.2015 (33) EP  
(54) CO-CRYSTALS OF BENZIMIDAZOLE COMPOUNDS  
(72) HERNÁNDEZ HERRERO, Gonzalo, Faes Farma S.A. Autonomía 10, E-48940 Leioa (Vizcaya), ES  
RUBIO ROYO, Víctor, Faes Farma S.A. Autonomía 10, E-48940 Leioa (Vizcaya), ES  
GARCÍA DOMÍNGUEZ, Neftalí, Faes Farma S.A. Autonomía 10, E-48940 Leioa (Vizcaya), ES  
CANAL MORI, Gonzalo, Faes Farma S.A. Autonomía 10, E-48940 Leioa (Vizcaya), ES  
TESSON, Nicolas, Enantia S.L. Parc Científic de Barcelona Baldiri Reixac 10, E-08028 Barcelona, ES  
JIMÉNEZ GONZÁLEZ, Carme, Enantia S.L. Parc Científic de Barcelona Baldiri Reixac 10, E-08028 Barcelona, ES  
DE MIER VINUE, Jordi, Enantia S.L. Parc Científic de Barcelona Baldiri Reixac 10, E-08028 Barcelona, ES

---

(51) MKP  
A61K 9/20 2006 (97) EP 3346995  
A61K 9/24 2006  
A61K 9/28 2006  
A61K 31/513 2006  
A61K 31/5365 2006  
A61K 31/553 2006  
A61K 31/675 2006  
A61P 31/18 2006  
(96) EP 16798063.0 11/8/2016  
(97) EP 3346995, 7/18/2018 201829, en  
(31) 201562253042 P (32) 09.11.2015 (33) US  
201662399999 P 26.09.2016 US  
(54) THERAPEUTIC COMPOSITIONS FOR TREATMENT OF HUMAN IMMUNODEFICIENCY VIRUS  
(72) HONG, Lei, c/o Gilead Sciences Inc. 333 Lakeside Drive, Foster City, CA 94404, US  
COLLMAN, Benjamin, Micah, c/o Gilead Sciences Inc. 333 Lakeside Drive, Foster City, CA 94404, US  
KOZIARA, Joanna, M., c/o Gilead Sciences Inc. 333 Lakeside Drive, Foster City, CA 94404, US

---

(51) MKP  
C12N 7/00 2006 (97) EP 3380605  
C12N 15/85 2006  
C12N 15/86 2006  
(96) EP 16798223.0 11/21/2016  
(97) EP 3380605, 10/3/2018 201840, en  
(31) 201520764 (32) 24.11.2015 (33) GB  
201609354 26.05.2016 GB  
(54) TRANSIENT TRANSFECTION METHOD FOR RETROVIRAL PRODUCTION  
(72) JOHNSON, Sabine, GlaxoSmithKline Gunnels Wood Road, Stevenage Hertfordshire SG1 2NY, GB  
PALLANT, Celeste, GlaxoSmithKline Gunnels Wood Road, Stevenage Hertfordshire SG1 2NY, GB  
VAMVA, Eirini, c/o GlaxoSmithKline Gunnels Wood Road, Stevenage Hertfordshire SG1 2NY, GB  
VINK, Conrad, GlaxoSmithKline Gunnels Wood Road, Stevenage Hertfordshire SG1 2NY, GB

---

(51) MKP  
H02J 9/00 2006 (97) EP 3365957  
H02J 9/06 2006  
(96) EP 16798280.0 10/19/2016  
(97) EP 3365957, 8/29/2018 201835, en  
(31) 41445515 (32) 22.10.2015 (33) PL  
(54) METHOD OF SUPPLYING AN EMERGENCY SUPPLY MODULE AND EMERGENCY SUPPLY MODULE WITH REDUCED POWER CONSUMPTION  
(71) TM TECHNOLOGIE spolka z ograniczona odpowiedzialnoscia, Morawica 355, 32-084 Morawica, PL  
(72) KACZOR, Tomasz, Wola Radziszowska 75, 32-053 Wola Radziszowska, PL  
ZOLCINSKI, Maciej, Sledziejowice 347, 32-020 Sledziejowice, PL

---

(51) MKP  
A61K 31/445 2006 (97) EP 3371164  
A61K 31/4545 2006  
A61P 25/16 2006  
A61P 25/18 2006  
A61P 25/28 2006  
C07D 211/26 2006  
C07D 211/40 2006  
C07D 401/12 2006

(96) EP 16798333.7 11/4/2016  
(97) EP 3371164, 9/12/2018 201837, en  
(31) 201562252179 P (32) 06.11.2015 (33) US  
201662275708 P 06.01.2016 US  
(54) N-[2-(1 -BENZYLPIPERIDIN-4-YL)ETHYL]-4-(PYRAZIN-2-YL)-PIPERAZINE-1 -CARBOXAMIDE DERIVATIVES AND RELATED COMPOUNDS  
AS MUSCARINIC RECEPTOR 4 (M4) ANTAGONISTS FOR TREATING NEUROLOGICAL DISEASES  
(72) HARRIOTT, Nicole, 11340 Squamish Road, San Diego, California 92126, US  
PAGANO, Nicholas, 1512 La Playa Avenue Apartment 312, San Diego, California 92109, US

---

(51) MKP  
**A01N 25/30 2006 (97) EP 3373896**  
**A61K 8/34 2006**  
**A61K 8/892 2006**  
**A61K 8/97 2017**  
**A61Q 5/02 2006**  
**A61Q 5/12 2006**  
**A61Q 19/10 2006**

(96) EP 16798342.8 11/9/2016  
(97) EP 3373896, 9/19/2018 201838, en  
(31) 201562252958 P (32) 09.11.2015 (33) US  
(54) PET CARE CLEANSING COMPOSITION  
(72) HANSEN, Eric, Anthony, 2099 Mckinnley Road Nw, Atlanta, GA 30318, US

---

(51) MKP  
**A61B 17/00 2006 (97) EP 3376968**  
**A61B 17/068 2006**  
**A61F 2/00 2006**

(96) EP 16798346.9 11/9/2016  
(97) EP 3376968, 9/26/2018 201839, en  
(31) 201514943165 (32) 17.11.2015 (33) US  
(54) APPLICATOR INSTRUMENTS FOR DISPENSING SURGICAL FASTENERS HAVING ARTICULATING SHAFTS AND ARTICULATION  
CONTROL ELEMENTS  
(72) CARDINALE, Michael, Route 22 West, Somerville, New Jersey 08876, US  
FERREIRA, Daniel Paul, 145 Zion Hill Road, Milford, Connecticut 06461, US  
SOULS, Doug, Route 22 West, Somerville, New Jersey 08876, US  
COHN, Simon, Route 22 West, Somerville, New Jersey 08876, US  
GUO, Jianxin, Route 22 West, Somerville, New Jersey 08876, US

---

(51) MKP  
**F42B 12/32 2006 (97) EP 3414514**

(96) EP 16798379.0 10/28/2016  
(97) EP 3414514, 12/19/2018 201851, en  
(31) 11221116 (32) 08.02.2016 (33) BG  
(54) A FRAGMENTATION SHOT WITH READY DESTRUCTIVE ELEMENTS  
(71) Petkov, Stancho Petkov, 11, George Nikolov Str., 4330 Sopot, BG  
Transmobil Ltd, 65, Botyo Petkov Str, 1517 Sofia, BG  
(72) PETKOV, Stancho Petkov, 11, George Nikolov Str., 4330 Sopot, BG

---

(51) MKP  
**C12N 5/10 2006 (97) EP 3380604**  
**C12N 7/02 2006**  
**C12N 7/04 2006**  
**C12N 15/85 2006**

(96) EP 16798512.6 11/21/2016  
(97) EP 3380604, 10/3/2018 201840, en  
(31) 201520761 (32) 24.11.2015 (33) GB  
201609303 26.05.2016 GB  
(54) STABLE CELL LINES FOR RETROVIRAL PRODUCTION  
(72) JOHNSON, Sabine, GlaxoSmithKline Gunnels Wood Road, Stevenage Hertfordshire SG1 2NY, GB  
PALLANT, Celeste, GlaxoSmithKline Gunnels Wood Road, Stevenage Hertfordshire SG1 2NY, GB  
VAMVA, Eirini, c/o GlaxoSmithKline Gunnels Wood Road, Stevenage Hertfordshire SG1 2NY, GB  
VINK, Conrad, GlaxoSmithKline Gunnels Wood Road, Stevenage Hertfordshire SG1 2NY, GB

---

(51) MKP  
**C07C 231/12 2006 (97) EP 3371147**  
**C07C 237/46 2006**

(96) EP 16798573.8 11/2/2016  
(97) EP 3371147, 9/12/2018 201837, en

(31) 201562250720 P (32) 04.11.2015 (33) US

(54) INNOVATIVE PREPARATION AND CRYSTALLIZATION OF IOSIMENOL  
(72) MALINAK, Jiri, K Satalce 891, 252 42 Jesenice, CZ  
HLAVACEK, Ivan, Naardenska 668/19, 162 00 Praha 6, CZ  
PROKOP, Jiri, Za sidlistem 2144/9, 143 00 Praha 12, CZ  
MASUDA, Yoshito, c/o OTSUKA PHARMACEUTICAL CO. LTD. 3-2-27 Otedori Chuo-ku, Osaka-shi Osaka 540-0021, JP

---

(51) MKP  
**A43B 13/12 2006 (97) EP 3379963**  
**A43B 13/18 2006**

(96) EP 16798795.7 11/23/2016  
(97) EP 3379963, 10/3/2018 201840, en

(31) UB20155851 (32) 24.11.2015 (33) IT

(54) SOLE, PARTICULARLY FOR SHOES  
(72) MASON, Angelo, Via Monte Grappa 180, 31031 Caerano Di San Marco, IT  
POLEGATO MORETTI, Enrico, Via G. Fantin 90, 31035 Crocetta Del Montello, IT

---

(51) MKP  
**B65D 77/20 2006 (97) EP 3383762**

(96) EP 16800871.2 10/19/2016  
(97) EP 3383762, 10/10/2018 201841, de

(31) 510372015 (32) 02.12.2015 (33) AT  
500032016 05.01.2016 AT

(54) TWO-LAYER CIRCUIT BOARD  
(71) Constantia Teich GmbH, Mühlhofen 4, 3205 Weinburg, AT  
(72) MACHERHAMMER GEB. BRAUNBRUCK, Marie, Juchgasse 6/16, 1030 Wien, AT  
AFFLENZER, Robert, Grub 2, 3205 Weinburg, AT  
KLAUSER, Christoph, Lehargasse 2/4/2, 3205 Dietmannsdorf, AT  
WEGENBERGER, Alfred, Mittelberg 7, 3550 Langenlois, AT  
EGER, Frank, Neureutherstrasse 4, 80799 München, DE  
CERRI, Igor, Bossi Gasse 37, 1130 Wien, AT

---

(51) MKP  
**A61K 39/00 2006 (97) EP 3374397**  
**A61K 39/395 2006**  
**C07K 16/28 2006**  
**G01N 33/53 2006**

(96) EP 16800902.5 11/10/2016  
(97) EP 3374397, 9/19/2018 201838, en

(31) 201562253318 P (32) 10.11.2015 (33) US

(54) ANTIGEN-BINDING POLYPEPTIDES DIRECTED AGAINST CD38  
(71) University Medical Center Hamburg - Eppendorf, Martinistrasse 52, 20246 Hamburg, DE  
(72) NOLTE, Friedrich, Paulsenplatz 11, 22767 Hamburg, DE  
BANNAS, Peter, Fettstrasse 33-A, 20357 Hamburg, DE  
SCHÜTZE, Kerstin, Isfeldstrasse 22, 22589 Hamburg, DE  
FUMEY, William, Geschwister Schollstrasse 21, 20251 Hamburg, DE  
SCHRIEWER, Levin, Rübenkamp 58, 22307 Hamburg, DE  
MENZEL, Stephan, Hohe Weide 66, 20253 Hamburg, DE  
STORTELERS, Catelijne, Nekkersputstraat 259, 9000 Gent, BE

---

(51) MKP  
**A01N 43/653 2006 (97) EP 3390372**  
**A01N 43/713 2006**  
**A01N 43/82 2006**  
**C07D 249/14 2006**

**C07D 257/06 2006**  
**C07D 271/04 2006**  
**C07D 271/07 2006**  
(96) EP 16800977.7 11/24/2016  
(97) EP 3390372, 10/24/2018 201843, en  
(31) 15200842 (32) 17.12.2015 (33) EP  
16193193 11.10.2016 EP  
(54) BENZAMIDE COMPOUNDS AND THEIR USE AS HERBICIDES  
(72) KORDES, Markus, Carl-Bosch-Strasse 38, 67056 Ludwigshafen, DE  
SEITZ, Thomas, Carl-Bosch-Strasse 38, 67056 Ludwigshafen, DE  
ZIERKE, Thomas, Carl-Bosch-Strasse 38, 67056 Ludwigshafen, DE  
MASSA, Dario, Speyerer Straße 2, 67117 Limburgerhof, DE  
NEWTON, Trevor William, Speyerer Straße 2, 67117 Limburgerhof, DE  
CALO, Frederick, Oertelstrasse 12, 40225 Düsseldorf, DE

---

(51) MKP  
**A61K 31/519 2006 (97) EP 3377494**  
**A61P 25/28 2006**  
**A61P 35/00 2006**  
**C07D 487/04 2006**  
(96) EP 16801015.5 11/16/2016  
(97) EP 3377494, 9/26/2018 201839, en  
(31) 201520499 (32) 20.11.2015 (33) GB  
(54) PYRROPYRIMIDINE COMPOUNDS AS MNKS INHIBITORS  
(71) LifeArc, 7th Floor Lynton House 7-12 Tavistock Square, London, Greater London WC1H 9LT, GB  
(72) WINTER-HOLT, Jon James, c/o Medical Research Council Technology 7th Floor Lynton House 7-12 Tavistock Square, London Greater London WC1H 9LT, GB  
MCIVER, Edward Giles, c/o Medical Research Council Technology 7th Floor Lynton House 7-12 Tavistock Square, London Greater London WC1H 9LT, GB  
LEWIS, Stephen, c/o Medical Research Council Technology 7th Floor Lynton House 7-12 Tavistock Square, London Greater London WC1H 9LT, GB  
OSBORNE, Joanne, c/o Medical Research Council Technology 7th Floor Lynton House 7-12 Tavistock Square, London Greater London WC1H 9LT, GB

---

(51) MKP  
**A61K 31/429 2006 (97) EP 3377501**  
**A61K 31/519 2006**  
**A61P 25/28 2006**  
**A61P 35/00 2006**  
**C07D 513/04 2006**  
**C07D 519/00 2006**  
(96) EP 16801016.3 11/16/2016  
(97) EP 3377501, 9/26/2018 201839, en  
(31) 201520500 (32) 20.11.2015 (33) GB  
(54) FUSED THIAZOLOPYRIMIDINE DERIVATIVES AS MNKS INHIBITORS  
(72) WINTER-HOLT, Jon James, c/o Medical Research Council Technology 7th Floor Lynton House 7-12 Tavistock Square, London Greater London WC1H 9LT, GB  
MCIVER, Edward Giles, c/o Medical Research Council Technology 7th Floor Lynton House 7-12 Tavistock Square, London Greater London WC1H 9LT, GB  
AMBLER, Martin, c/o Medical Research Council Technology 7th Floor Lynton House 7-12 Tavistock Square, London Greater London WC1H 9LT, GB  
LEWIS, Stephen, c/o Medical Research Council Technology 7th Floor Lynton House 7-12 Tavistock Square, London Greater London WC1H 9LT, GB  
OSBORNE, Joanne, c/o Medical Research Council Technology 7th Floor Lynton House 7-12 Tavistock Square, London Greater London WC1H 9LT, GB  
WEBB-SMITH, Kayleigh, c/o Medical Research Council Technology 7th Floor Lynton House 7-12 Tavistock Square, London Greater London WC1H 9LT, GB

---

(51) MKP  
**A61K 9/70 2006 (97) EP 3377048**  
**A61K 31/485 2006**  
**A61P 25/04 2006**  
(96) EP 16801029.6 11/18/2016  
(97) EP 3377048, 9/26/2018 201839, en

(31)	201520390	(32)	19.11.2015	(33)	GB
(54)	ABUSE RESISTANT TRANSDERMAL DELIVERY DEVICES AND COMPOSITIONS COMPRISING AN OPIOID AGONIST AND A NON-TRANSDERMALLY DELIVERED N-OXIDE DERIVATIVE OF AN OPIOID ANTAGONIST FOR THE TREATMENT OF PAIN				
(72)	WHITELOCK, Steve, Mundipharma Research Limited 191 Cambridge Science Park Milton Road, Cambridge Cambridgeshire CB4 0GW, GB				

---

(51)	MKP				
	<b>A61K 35/744</b>	<b>2015</b>	<b>(97) EP 3377082</b>		
	<b>A61P 29/00</b>	<b>2006</b>			
	<b>A61P 35/00</b>	<b>2006</b>			
	<b>A61P 37/00</b>	<b>2006</b>			
(96)	EP 16801036.1 11/21/2016				
(97)	EP 3377082, 9/26/2018 201839, en				
(31)	201520497	(32)	20.11.2015	(33)	GB
(54)	COMPOSITIONS COMPRISING BACTERIAL STRAINS				
(72)	MULDER, Imke Elisabeth, c/o 4D Pharma Research Limited Life Sciences Innovation Building Cornhill Road, Aberdeen Aberdeenshire AB25 2ZS, GB				
	HOLT, Amy Beth, c/o 4D Pharma Research Limited Life Sciences Innovation Building Cornhill Road, Aberdeen Aberdeenshire AB25 2ZS, GB				
	MCCLUSKEY, Seanin Marie, c/o 4D Pharma Research Limited Life Sciences Innovation Building Cornhill Road, Aberdeen Aberdeenshire AB25 2ZS, GB				
	LENNON, Grainne Clare, c/o 4D Pharma Research Limited Life Sciences Innovation Building Cornhill Road, Aberdeen Aberdeenshire AB25 2ZS, GB				
	AHMED, Suaad, c/o 4D Pharma Research Limited Life Sciences Innovation Building Cornhill Road, Aberdeen Aberdeenshire AB25 2ZS, GB				

---

(51)	MKP				
	<b>C04B 28/02</b>	<b>2006</b>	<b>(97) EP 3374327</b>		
	<b>C04B 28/04</b>	<b>2006</b>			
	<b>C04B 38/00</b>	<b>2006</b>			
	<b>C04B 111/00</b>	<b>2006</b>			
	<b>C04B 111/22</b>	<b>2006</b>			
	<b>C04B 111/26</b>	<b>2006</b>			
(96)	EP 16801154.2 11/10/2016				
(97)	EP 3374327, 9/19/2018 201838, en				
(31)	20151535	(32)	10.11.2015	(33)	NO
(54)	CALCIUM NITRATE FOR REDUCING THE PORE SIZE DISTRIBUTION OF A HARDENED CEMENTITIOUS COMPOSITION AND STEEL REINFORCED CONCRETE HAVING AN ELEVATED RESISTANCE TOWARDS CARBONATION				
(72)	FRANKE, Wolfram, Vidsynvegen 15, 3917 Porsgrunn, NO				
	CILLUFFO, Giuseppe, Via Isonzo 22 G, 20024 Garbagnate Milanese (MI), IT				
	TORABZADEGAN, Mehrdad, Regimentvegen 1A, 3734 Skien, NO				

---

(51)	MKP				
	<b>B41M 3/14</b>	<b>2006</b>	<b>(97) EP 3380669</b>		
	<b>B42D 25/29</b>	<b>2014</b>			
	<b>B42D 25/30</b>	<b>2014</b>			
	<b>D21H 19/82</b>	<b>2006</b>			
	<b>D21H 21/40</b>	<b>2006</b>			
	<b>D21H 21/42</b>	<b>2006</b>			
	<b>D21H 21/44</b>	<b>2006</b>			
	<b>D21H 21/48</b>	<b>2006</b>			
(96)	EP 16801206.0 11/24/2016				
(97)	EP 3380669, 10/3/2018 201840, en				
(31)	15196085	(32)	24.11.2015	(33)	EP
	201562261354 P		01.12.2015		US
(54)	METHOD OF TAGGING A SUBSTRATE				
(72)	BOLLSTRÖM, Roger, Ackerstrasse 11, 4800 Zofingen, CH				
	HUNZIKER, Philipp, 1337 Harbor Cove, Loveland, OH 45140, US				
	GANE, Patrick A.C., Studenweg 8, 4852 Rothrist, CH				

---

(51)	MKP				
	<b>B27N 3/02</b>	<b>2006</b>	<b>(97) EP 3383604</b>		
(96)	EP 16801229.2 11/24/2016				
(97)	EP 3383604, 10/10/2018 201841, en				
(31)	15196997	(32)	30.11.2015	(33)	EP

- (54) CALCIUM CARBONATE FOR PARTICLE BOARDS  
 (72) SCHRUL, Christopher, Oltnerstrasse 18, 4663 Aarburg, CH  
 KRITZINGER, Johannes, Langhagstrasse 28, 4600 Olten, CH  
 OZYHAR, Tomasz, Buhnrain 12, 8052 Zürich, CH  
 HUNZIKER, Philipp, 1337 Harbor Cove, Loveland, OH 45140, US
- 

- (51) MKP  
**A61K 31/506 2006 (97) EP 3380467**  
**A61K 31/53 2006**  
**A61P 31/14 2006**  
**C07D 403/04 2006**  
**C07D 487/04 2006**  
 (96) EP 16801246.6 11/25/2016  
 (97) EP 3380467, 10/3/2018 201840, en  
 (31) 15196811 (32) 27.11.2015 (33) EP  
 (54) HETEROCYCLIC INDOLES FOR USE IN INFLUENZA VIRUS INFECTION  
 (72) JONCKERS, Tim Hugo Maria, c/o Janssen Pharmaceutica NV Turnhoutseweg 30, 2340 Beerse, BE  
 MC GOWAN, David Craig, c/o Janssen Pharmaceutica NV Turnhoutseweg 30, 2340 Beerse, BE  
 GUILLEMONT, Jérôme Émile Georges, c/o Janssen-Cilag 1 Rue Camille Desmoulins TSA 91003, 92787 Issy-les-Moulineaux Cedex 9, FR  
 COOYMANS, Ludwig Paul, c/o Janssen Pharmaceutica NV Turnhoutseweg 30, 2340 Beerse, BE  
 EMBRECHTS, Werner Constant Johan, c/o Janssen Pharmaceutica NV Turnhoutseweg 30, 2340 Beerse, BE  
 BUYCK, Christophe Francis Robert Nestor, c/o Janssen Pharmaceutica NV Turnhoutseweg 30, 2340 Beerse, BE  
 BALEMANS, Wendy Mia Albert, c/o Janssen Pharmaceutica NV Turnhoutseweg 30, 2340 Beerse, BE  
 RABOISSON, Pierre Jean-Marie Bernard, c/o Janssen Pharmaceutica NV Turnhoutseweg 30, 2340 Beerse, BE
- 

- (51) MKP  
**C12N 5/0783 2010 (97) EP 3365434**  
**G01N 1/30 2006**  
 (96) EP 16801293.8 10/20/2016  
 (97) EP 3365434, 8/29/2018 201835, en  
 (31) 201562245261 P (32) 22.10.2015 (33) US  
 201562245252 P 22.10.2015 US  
 (54) METHODS FOR CULTURING CELLS AND KITS AND APPARATUS FOR SAME  
 (72) GERMERTH, Lothar, Rudolf Wissell-Strasse 28, 37079 Göttingen, DE  
 STEMBERGER, Christian, Rudolf Wissell-Strasse 28, 37079 Göttingen, DE  
 GRÄF, Patricia, Rudolf Wissell-Strasse 28, 37079 Göttingen, DE  
 BASHOUR, Keenan, 400 Dexter Avenue North Suite 1200, Seattle, WA 98109, US
- 

- (51) MKP  
**D04B 15/88 2006 (97) EP 3374555**  
**D04B 35/34 2006**  
 (96) EP 16801304.3 10/12/2016  
 (97) EP 3374555, 9/19/2018 201838, en  
 (31) UB20155508 (32) 12.11.2015 (33) IT  
 (54) OPEN-TYPE CIRCULAR KNITTING MACHINE FOR THE OPEN AND WIDTH-VARIABLE WEB PRODUCTION  
 (72) LONATI, Ettore, Via Sott'acqua 32, 25082 Botticino (BS), IT  
 LONATI, Fausto, Via Mediana 12, 25123 Brescia BS, IT  
 LONATI, Andrea, Via del Goletto 48, 25123 Brescia, IT
- 

- (51) MKP  
**A23L 3/04 2006 (97) EP 3368422**  
**B65B 55/02 2006**  
**B65B 55/04 2006**  
**B65B 55/10 2006**  
 (96) EP 16801553.5 10/26/2016  
 (97) EP 3368422, 9/5/2018 201836, de  
 (31) 102015013914 (32) 27.10.2015 (33) DE  
 (54) FOOD-PROCESSING PLANT HAVING A PLURALITY OF SURROUNDED CHAMBERS, BETWEEN WHICH A CONTAINER CONVEYOR IS ARRANGED  
 (71) Hipp & Co, Brünigstrasse 141, 6072 Sachseln, CH

(72) MOSER, Gerhard, Mühlbach 68, 4801 Traunkirchen, AT  
MOSER, Martin, Mühlbach 68, 4801 Traunkirchen, AT

---

(51) MKP  
**A61K 8/891 2006 (97) EP 3394176**  
**C08L 83/04 2006**  
(96) EP 16801764.8 11/25/2016  
(97) EP 3394176, 10/31/2018 201844, de  
(31) 102015226221 (32) 21.12.2015 (33) DE  
(54) SILOXANE ELASTOMERS HAVING AN IMMEDIATE OPTICAL AND SENSORIAL SMOOTHING EFFECT AND TOPICAL SKIN-CARE COMPOSITIONS CONTAINING SUCH SILICONE ELASTOMERS  
(72) PRUNS, Julia, Helene-Lange-Str. 10, 20144 Hamburg, DE  
PESCHKE, Lisa, Gebtsattelstraße 14, 97616 Bad Neustadt, DE  
RASCHKE, Thomas, Eichhörnchenweg 6, 25421 Pinneberg, DE  
KUHLMANN, Imke, Hellbrookstraße 86 c, 22305 Hamburg, DE

---

(51) MKP  
**A61K 31/501 2006 (97) EP 3380468**  
**A61P 35/00 2006**  
**C07D 403/14 2006**  
(96) EP 16801774.7 11/25/2016  
(97) EP 3380468, 10/3/2018 201840, en  
(31) 201520959 (32) 27.11.2015 (33) GB  
(54) BIS-PYRIDAZINE COMPOUNDS AND THEIR USE IN TREATING CANCER  
(71) Cancer Research Technology Ltd., Angel Building 407 St. John Street, London EC1V 4AD, GB  
(72) FINLAY, Maurice, Raymond, Verschoyle, AstraZeneca R&D Cambridge Darwin Building Cambridge Science Park Milton Road, Cambridge Cambridgeshire CB4 0FZ, GB

---

(51) MKP  
**A61K 9/00 2006 (97) EP 3377108**  
**A61K 9/14 2006**  
**A61K 31/00 2006**  
**A61K 47/12 2006**  
**A61K 47/26 2006**  
(96) EP 16801982.6 11/14/2016  
(97) EP 3377108, 9/26/2018 201839, en  
(31) 15194660 (32) 16.11.2015 (33) EP  
(54) A PROCESS FOR PREPARING A DRY POWDER FORMULATION COMPRISING AN ANTICHOLINERGIC, A CORTICOSTEROID AND A BETA-ADRENERGIC  
(72) CAFIERO, Claudio, c/o CHIESI FARMACEUTICI S.p.A. Via Palermo 26/A, 43122 Parma, IT  
ORTENZI, Leonardo, c/o CHIESI FARMACEUTICI S.p.A. Via Palermo 26/A, 43122 Parma, IT  
SCHIARETTI, Francesca, c/o CHIESI FARMACEUTICI S.p.A. Via Palermo 26/A, 43122 Parma, IT

---

(51) MKP  
**A61K 9/00 2006 (97) EP 3377109**  
**A61K 9/14 2006**  
**A61K 31/00 2006**  
**A61K 47/12 2006**  
**A61K 47/26 2006**  
(96) EP 16801984.2 11/14/2016  
(97) EP 3377109, 9/26/2018 201839, en  
(31) 15194661 (32) 16.11.2015 (33) EP  
(54) A PROCESS FOR PREPARING A DRY POWDER FORMULATION COMPRISING AN ANTICHOLINERGIC, A CORTICOSTEROID AND A BETA-ADRENERGIC  
(72) CAFIERO, Claudio, c/o CHIESI FARMACEUTICI S.p.A. Via Palermo 26/A, 43122 Parma, IT  
ORTENZI, Leonardo, c/o CHIESI FARMACEUTICI S.p.A. Via Palermo 26/A, 43122 Parma, IT

---

(51) MKP  
**A43B 7/14 2006 (97) EP 3379962**  
(96) EP 16802018.8 11/23/2016  
(97) EP 3379962, 10/3/2018 201840, en



(31) UB20155843 (32) 24.11.2015 (33) IT  
(54) MID-SOLE, OR INSOLE, PARTICULARLY FOR SHOES  
(72) MASON, Angelo, Via Monte Grappa 180, 31031 Caerano Di San Marco, IT  
POLEGATO MORETTI, Enrico, Via G. Fantin 90, 31035 Crocetta Del Montello, IT

---

(51) MKP  
A61K 38/17 2006 (97) EP 3394084  
A61K 39/00 2006  
C07K 7/06 2006  
C07K 7/08 2006  
C07K 14/47 2006  
C07K 16/28 2006  
(96) EP 16802063.4 11/29/2016  
(97) EP 3394084, 10/31/2018 201844, en  
(31) 201522667 (32) 22.12.2015 (33) GB  
201562270968 P 22.12.2015 US  
(54) PEPTIDES AND COMBINATION OF PEPTIDES FOR USE IN IMMUNOTHERAPY AGAINST BREAST CANCER AND OTHER CANCERS  
(72) MAHR, Andrea, Kirschenweg 22, 72076 Tübingen, DE  
WEINSCHENK, Toni, Im Morgenrain 15, 73773 Aichwald, DE  
HÖRZER, Helen, Untere Straße 20, 72070 Tübingen, DE  
SCHOOR, Oliver, Eichhaldenstrasse 19, 72074 Tübingen, DE  
FRITSCHKE, Jens, Lärchenweg 11, 72144 Dusslingen, DE  
SINGH, Harpreet, 5122 Morningside Drive Apt. 525, Houston, Texas 77005, US

---

(51) MKP  
A61K 31/501 2006 (97) EP 3383871  
A61K 31/53 2006  
A61P 35/00 2006  
C07D 417/14 2006  
(96) EP 16802102.0 11/30/2016  
(97) EP 3383871, 10/10/2018 201841, en  
(31) 201562260787 P (32) 30.11.2015 (33) US  
(54) 1,3,4-THIADIAZOLE COMPOUNDS AND THEIR USE IN TREATING CANCER  
(72) FINLAY, Maurice, Raymond, Verschoyle, AstraZeneca R&D Cambridge Darwin Building Cambridge Science Park Milton Road, Cambridge  
Cambridgeshire CB4 0WG, GB  
NISSINK, Johannes, Wilhelmus, Maria, AstraZeneca Darwin Building Cambridge Science Park Milton Road, Cambridge Cambridgeshire CB4  
0WG, GB  
CHARLES, Mark, David, CRT Discovery Laboratories Jonas Webb Building Babraham Research Campus, Cambridge Cambridgeshire CB22  
3AT, GB  
WOOD, James, Matthew, AstraZeneca UG22 Redesmere Silk Road Business Park Charter Way, Macclesfield Cheshire SK10 2NX, GB

---

(51) MKP  
A61K 38/13 2006 (97) EP 3370756  
A61K 38/26 2006  
A61P 9/10 2006  
(96) EP 16802132.7 11/4/2016  
(97) EP 3370756, 9/12/2018 201837, en  
(31) 20150100486 (32) 06.11.2015 (33) GR  
(54) COMBINATION  
(71) Genesis Pharma SA, 270 Kifissias Avenue, 15232 Athens, GR  
(72) VOGIATZIS, George, Genesis Pharma SA 270 Kifissias Avenue, 15232 Athens, GR

---

(51) MKP  
C07K 14/005 2006 (97) EP 3374374  
C07K 14/54 2006  
C12N 7/00 2006  
(96) EP 16802193.9 11/8/2016  
(97) EP 3374374, 9/19/2018 201838, en  
(31) 201562252877 P (32) 09.11.2015 (33) US  
201562261655 P 01.12.2015 US  
(54) COMPOSITIONS COMPRISING LENTIVIRAL VECTORS EXPRESSING IL-12 AND METHODS OF USE THEREOF

(72) TER MEULEN, Jan, Henrik, 3842 West Mercer Way, Mercer Island, WA 98040, US  
BERGLUND, Peter, Lars Aksel, 1616 Eastlake Avenue E. Suite 310, Seattle, WA 98102, US  
ALBERSHARDT, Tinglan, Tina, 1616 Eastlake Avenue E. Suite 310, Seattle, WA 98102, US

---

(51) MKP  
**A61K 39/395 2006 (97) EP 3374398**  
**C07K 16/28 2006**  
**G01N 33/574 2006**

(96) EP 16802197.0 11/10/2016

(97) EP 3374398, 9/19/2018 201838, en

(31) 201562253371 P (32) 10.11.2015 (33) US  
201562253774 P 11.11.2015 US

(54) BINDING MOLECULES SPECIFIC FOR ASCT2 AND USES THEREOF

(72) PORE, Nabendu, c/o MedImmune LLC One MedImmune Way, Gaithersburg, MD 20878, US  
BORROK, Martin, J., III, c/o MedImmune LLC One MedImmune Way, Gaithersburg, MD 20878, US  
CHOWDHURY, Partha, c/o MedImmune LLC One MedImmune Way, Gaithersburg, MD 20878, US  
MICHELOTTI, Emil, F., c/o MedImmune LLC One MedImmune Way, Gaithersburg, MD 20878, US  
TICE, David, A., c/o MedImmune LLC One MedImmune Way, Gaithersburg, MD 20878, US  
HOLLINGSWORTH, Robert, E., c/o MedImmune LLC One MedImmune Way, Gaithersburg, MD 20878, US  
CHANG, Chien-Ying, c/o MedImmune LLC One MedImmune Way, Gaithersburg, MD 20878, US

---

(51) MKP  
**A47F 3/04 2006 (97) EP 3379977**

(96) EP 16804868.4 11/24/2016

(97) EP 3379977, 10/3/2018 201840, en

(31) 201520795 (32) 25.11.2015 (33) GB

(54) IMPROVEMENTS IN REFRIGERATORS

(71) Aerofoil Energy Limited, Suite B1.2 Clarence Mill Business Centre, Bollington, Cheshire SK10 5JZ, GB  
(72) MCANDREW, Paul Francis, Bracken Lea The Coppice, Poynton Cheshire SK12 1SR, GB  
BURKE, Matthew Piers, Millers Barn Foley Farm Stockcross, Newbury Berkshire RG20 8JX, GB  
TURNER, Ian Stuart, 4 Vicarage Road, Oxford Oxfordshire OX1 4RB, GB

---

(51) MKP  
**A61K 9/14 2006 (97) EP 3377045**  
**A61K 9/50 2006**  
**A61K 31/7056 2006**

(96) EP 16804910.4 11/18/2016

(97) EP 3377045, 9/26/2018 201839, en

(31) 201562256868 P (32) 18.11.2015 (33) US

(54) PHARMACEUTICAL COMPOSITIONS OF RIBAVIRIN

(71) Liquidia Technologies, Inc., 419 Davis Drive Suite 100, Morrisville, NC 27560, US  
(72) DELL'ORCO, Philip Charles, 709 Swedeland Road, King of Prussia, PA 19406, US  
FARRER, Brian T., 419 Davis Drive Suite 100, Morrisville, NC 27560, US  
HONG, Zhi, Five Moore Drive, Durham, NC 27709, US  
ROBERTS, Christopher D., 21 Bradford Road, Belmont, MA 02478, US  
SAVAGE, John Robert, 419 Davis Drive Suite 100, Morrisville, NC 27560, US  
SPRAGUE, Jacob J., 419 Davis Drive Suite 100, Morrisville, NC 27560, US  
WANG, Yongcai, 419 Davis Drive Suite 100, Morrisville, NC 27560, US

---

(51) MKP  
**A61K 31/437 2006 (97) EP 3371186**  
**A61P 11/00 2006**  
**C07D 471/04 2006**

(96) EP 16804947.6 11/2/2016

(97) EP 3371186, 9/12/2018 201837, en

(31) 201562250113 P (32) 03.11.2015 (33) US

(54) JAK KINASE INHIBITOR COMPOUNDS FOR TREATMENT OF RESPIRATORY DISEASE

(72) FATHEREE, Paul R., 921 Minnesota Street, San Francisco, California 94107, US  
JACOBSEN, John R., 16 Oak Valley Road, San Mateo, California 94402, US  
BEAUSOLEIL, Anne-Marie, 600 Brewster Avenue Apt. 306, Redwood City, California 94063, US  
BRANDT, Gary E.L., 2160 Buena Vista Avenue, Alameda, California 94501, US  
FLEURY, Melissa, 47D Joy Avenue, Brisbane, California 94005, US

JIANG, Lan, 788 Santa Maria Lane, Foster City, California 94404, US  
SMITH, Cameron, 4256 Shelter Creek Lane, San Bruno, California 94066, US  
SULLIVAN, Steven D.E., 1417 17th Avenue, San Francisco, California 94122, US  
VAN ORDEN, Lori Jean, 362 Park Street, San Francisco, California 94110, US  
COLSON, Pierre-Jean, 301 Bryant Street 403, San Francisco, California 94107, US  
FASS, Gene Timothy, 998 Burnett Avenue, San Francisco, California 94131, US  
RAPTA, Miroslav, 1240 Highland Court, San Carlos, California 94070, US  
BENJAMIN, Noah, 509 30th Street, San Francisco, California 94131-2201, US  
DABROS, Marta, 888 Foster City Boulevard Apt. Q2, Foster City, California 94404, US  
THALLADI, Venkat R., 888 Foster City Boulevard Apt. E3, Foster City, California 94404, US

---

- (51) MKP  
**A61K 31/433 2006 (97) EP 3383872**  
**A61P 35/00 2006**  
**C07D 417/14 2006**
- (96) EP 16805078.9 11/30/2016  
(97) EP 3383872, 10/10/2018 201841, en
- (31) 201562260784 P (32) 30.11.2015 (33) US
- (54) 1,3,4-THIADIAZOLE COMPOUNDS AND THEIR USE IN TREATING CANCER  
(72) FINLAY, Maurice, Raymond, Verschoyle, AstraZeneca R&D Cambridge Darwin Building Cambridge Science Park Milton Road, Cambridge Cambridgeshire CB4 0FZ, GB  
PERKINS, David, Robert, AstraZeneca Block 11S Mereside Alderley Park, Macclesfield Cheshire SK10 4TG, GB  
NISSINK, Johannes, Wilhelmus, Maria, AstraZeneca Darwin Building Cambridge Science Park Milton Road, Cambridge Canbridgeshire CB4 0WG, GB  
RAUBO, Piotr, Antoni, AstraZeneca Hodgkin Building Chesterford Research Campus Little Chesterford Saffron Walden, Cambridge Cambridgeshire CB10 1XL, GB  
SMITH, Peter, Duncan, AstraZeneca Early Chemical Development Pharmaceutical Sciences Etherow F40/4 Silk Road Business Park Charter Way, Macclesfield Cheshire SK10 2NA, GB  
BAILEY, Andrew, AstraZeneca Alderley Park, Macclesfield Cheshire SK10 4TG, GB
- 

- (51) MKP  
**A61K 31/519 2006 (97) EP 3371190**  
**A61P 25/00 2006**  
**A61P 35/00 2006**  
**A61P 37/00 2006**  
**C07D 487/04 2006**  
**C07D 519/00 2006**
- (96) EP 16805238.9 11/4/2016  
(97) EP 3371190, 9/12/2018 201837, en
- (31) 201562252050 P (32) 06.11.2015 (33) US
- (54) HETEROCYCLIC COMPOUNDS AS PI3K-GAMMA INHIBITORS  
(72) SHVARTSBART, Artem, Incyte Corporation 1801 Augustine Cut-Off, Wilmington, Delaware 19803, US  
SHEPARD, Stacey, Incyte Corporation 1801 Augustine Cut-Off, Wilmington, Delaware 19803, US  
COMBS, Andrew P., Incyte Corporation 1801 Augustine Cut-Off, Wilmington, Delaware 19803, US  
SHAO, Lixin, Incyte Corporation 1801 Augustine Cut-Off, Wilmington, Delaware 19803, US  
FALAHATPISHEH, Nikoo, Incyte Corporation 1801 Augustine Cut-Off, Wilmington, Delaware 19803, US  
ZOU, Ge, Incyte Corporation 1801 Augustine Cut-Off, Wilmington, Delaware 19803, US  
BUESKING, Andrew W., Incyte Corporation 1801 Augustine Cut-Off, Wilmington, Delaware 19803, US  
SPARKS, Richard B., Incyte Corporation 1801 Augustine Cut-Off, Wilmington, Delaware 19803, US  
YUE, Eddy W., Incyte Corporation 1801 Augustine Cut-Off, Wilmington, Delaware 19803, US  
JALLURI, Ravi, Incyte Corporation 1801 Augustine Cut-Off, Wilmington, Delaware 19803, US
- 

- (51) MKP  
**C07K 14/47 2006 (97) EP 3387008**
- (96) EP 16805348.6 11/24/2016  
(97) EP 3387008, 10/17/2018 201842, en
- (31) 201521746 (32) 10.12.2015 (33) GB  
201562265615 P 10.12.2015 US
- (54) NOVEL PEPTIDES AND COMBINATION OF PEPTIDES FOR USE IN IMMUNOTHERAPY AGAINST CLL AND OTHER CANCERS  
(72) MAHR, Andrea, Kirschenweg 22, 72076 Tübingen, DE  
WEINSCHENK, Toni, Im Morgenrain 15, 73773 Aichwald, DE  
WIEBE, Anita, Quellenstrasse 49, 72124 Ruebgarten, DE  
SCHOOR, Oliver, Eichhaldenstrasse 19, 72074 Tübingen, DE

(51) MKP  
**A61K 31/7088 2006 (97) EP 3380615**  
**A61P 29/00 2006**  
**C12N 15/113 2010**  
(96) EP 16805351.0 11/25/2016  
(97) EP 3380615, 10/3/2018 201840, en  
(31) 201562260076 P (32) 25.11.2015 (33) US  
(54) IL-34 ANTISENSE OLIGONUCLEOTIDES AND METHODS OF USING SAME  
(72) MCNULTY, Marie, Unit 8 Harmony Court Harmony Row, Dublin 2, IE  
VITI, Francesca, Via Stradone 34, 6872 Salorino, CH  
BELLIN VIA, Salvatore, Viale Turconi 19, 6850 Mendrisio, CH

---

(51) MKP  
**C07K 16/18 2006 (97) EP 3380517**  
**C07K 16/28 2006**  
**C07K 16/46 2006**  
(96) EP 16805359.3 11/28/2016  
(97) EP 3380517, 10/3/2018 201840, en  
(31) 201562260411 P (32) 27.11.2015 (33) US  
201662345967 P 06.06.2016 US  
(54) POLYPEPTIDES INHIBITING CD40L  
(72) PATTYN, Els, Beertegemstraat 46, 9750 Huise, BE  
SOMPEL, Ariella Van de, Hollenaarstraat 94, 9401 Oostakker, BE  
MEERTS, Peter, Nieuwe Molenstraat 27B, 9160 Lokeren, BE  
BUYSE, Marie-Ange, Burgemeester Edmond Ronsestraat 23, 9820 Merelbeke, BE  
DEWILDE, Maarten, Bergemeersenstraat 109, 9300 Aalst, BE  
BESTE, Gerald, Jozef Kluyskensstraat 25 Bus 20, 9000 Gent, BE  
VLACH, Jaromir, 2 Steeple Chase Circle, Westford, Massachusetts 01886, US  
HSU, Jonathan, 51 Taylor Street Apt. 4, Waltham, Massachusetts 02453, US

---

(51) MKP  
**A61K 39/395 2006 (97) EP 3383905**  
**C07K 16/28 2006**  
**C07K 16/30 2006**  
**C07K 16/46 2006**  
(96) EP 16805416.1 12/1/2016  
(97) EP 3383905, 10/10/2018 201841, en  
(31) 201500771 (32) 01.12.2015 (33) DK  
201500787 07.12.2015 DK  
201500788 07.12.2015 DK  
201600701 10.11.2016 DK  
201600702 10.11.2016 DK  
(54) ANTI-DEATH RECEPTOR ANTIBODIES AND METHODS OF USE THEREOF  
(71) GENMAB B.V., Uppsalalaan 15, 3584 CT Utrecht, NL  
(72) BEURSKENS, Frank, C/O Genmab B.V. Yalelaan 60, 3584-CM Utrecht, NL  
OVERDIJK, Marije, C/O Genmab B.V. Yalelaan 60, 3584-CM Utrecht, NL  
DE JONG, Rob, C/O Genmab B.V. Yalelaan 60, 3584-CM Utrecht, NL  
SATIJN, David, C/O Genmab B.V. Yalelaan 60, 3584-CM Utrecht, NL  
STRUMANE, Kristin, C/O Genmab B.V. Yalelaan 60, 3584-CM Utrecht, NL  
SCHUURMAN, Janine, C/O Genmab B.V. Yalelaan 60, 3584-CM Utrecht, NL  
PARREN, Paul, C/O Genmab B.V. Yalelaan 60, 3584-CM Utrecht, NL

---

(51) MKP  
**A61K 39/395 2006 (97) EP 3383906**  
**C07K 16/28 2006**  
**C07K 16/30 2006**  
**C07K 16/46 2006**  
**C12N 15/13 2006**  
(96) EP 16805417.9 12/1/2016  
(97) EP 3383906, 10/10/2018 201841, en

(31)	201500771	(32)	01.12.2015	(33)	DK
	201500787		07.12.2015		DK
	201500788		07.12.2015		DK
	201600701		10.11.2016		DK
	201600702		10.11.2016		DK

(54) ANTI-DR5 ANTIBODIES AND METHODS OF USE THEREOF  
(72) OVERDIJK, Marije, C/O Genmab B.V. Yalelan 60, NL 3584-CM Utrecht, NL  
STRUMANE, Kristin, C/O Genmab B.V. Yalelaan 60, 3584-CM Utrecht, NL  
RADEMAKER, Rik, C/O Genmab B.V. Yalelaan 60, 3584-CM Utrecht, NL  
BREIJ, Esther, C/O Genmab B.V. Yalelaan 60, 3584-CM Utrecht, NL  
SCHUURMAN, Janine, C/O Genmab B.V. Yalelaan 60, 3584 CM Utrecht, NL  
PARREN, Paul, C/O Genmab B.V. Yalelaan 60, 3584-CM Utrecht, NL

---

(51) MKP  
**C12N 15/86 2006 (97) EP 3365453**

(96) EP 16805495.5 10/20/2016  
(97) EP 3365453, 8/29/2018 201835, en

(31)	201562245265 P	(32)	22.10.2015	(33)	US
	201662305989 P		09.03.2016		US
	201662369020 P		29.07.2016		US

(54) METHODS, KITS, AGENTS AND APPARATUSES FOR TRANSDUCTION  
(71) Juno Therapeutics GmbH, Rudolf-Wissell-Str. 28, 37079 Göttingen, DE  
(72) TAREEN, Semih, U., 400 Dexter Avenue North Suite 1200, Seattle, WA 98109, US  
BASHOUR, Keenan, 400 Dexter Avenue North Suite 300, Seattle, WA 98109, US

---

(51) MKP  
**A61K 31/4523 2006 (97) EP 3370775**  
**A61K 31/496 2006**  
**A61K 45/06 2006**  
**A61P 35/00 2006**

(96) EP 16805576.2 11/3/2016  
(97) EP 3370775, 9/12/2018 201837, en

(31)	201562250231 P	(32)	03.11.2015	(33)	US
	201562263082 P		04.12.2015		US

(54) COMBINATION OF BCL-2 INHIBITOR AND MEK INHIBITOR FOR THE TREATMENT OF CANCER  
(72) MERCHANT, Mark, Genentech Inc. 1 DNA Way, South San Francisco, California 94080, US  
SAMPATH, Deepak, Genentech Inc. 1 DNA Way, South San Francisco, California 94080, US  
KONOPLEVA, Marina Yurievna, M.D. Anderson Cancer Center 1515 Holcombe Blvd., Houston, Texas 77030, US  
HAN, Lina, M.D. Anderson Cancer Center 1515 Holcombe Blvd., Houston, Texas 77030, US

---

(51) MKP  
**A61K 39/395 2006 (97) EP 3377526**  
**C07K 16/18 2006**  
**C07K 16/28 2006**

(96) EP 16805653.9 11/17/2016  
(97) EP 3377526, 9/26/2018 201839, en

(31)	201562256985 P	(32)	18.11.2015	(33)	US
------	----------------	------	------------	------	----

(54) PD1/CTLA4 Binders  
(72) PUNNONEN, Juha, 901 S. California Avenue, Palo Alto, California 94304, US  
BOWMAN, Edward, 901 S. California Avenue, Palo Alto, California 94304, US  
BEAUMONT, Maribel, 901 S. California Avenue, Palo Alto, California 94304, US  
BUYSE, Marie-Ange, Technologiepark 21, 9052 Zwijnaarde, BE  
BOUTTON, Carlo, Technologiepark 21, 9052 Zwijnaarde, BE  
DOMBRECHT, Bruno, Technologiepark 21, 9052 Zwijnaarde, BE  
VICTOR, Bjorn, Technologiepark 21, 9052 Zwijnaarde, BE  
VLERICK, David, Technologiepark 21, 9052 Zwijnaarde, BE  
KASTELEIN, Robert A., 116 Brookside Drive, Portola Valley, California 94028, US

---

(51) MKP  
**A61K 39/395 2006 (97) EP 3377527**  
**C07K 16/18 2006**  
**C07K 16/28 2006**

(96) EP 16805654.7 11/17/2016  
(97) EP 3377527, 9/26/2018 201839, en  
(31) 201562257001 P (32) 18.11.2015 (33) US  
(54) CTLA4 BINDERS  
(72) PUNNONEN, Juha, 901 S. California Avenue, Palo Alto, California 94304, US  
BEAUMONT, Maribel, 901 S. California Avenue, Palo Alto, California 94304, US  
BUYSE, Marie-Ange, Technologiepark 21, 9052 Zwijnaarde, BE  
BOUTTON, Carlo, Technologiepark 21, 9052 Zwijnaarde, BE  
DOMBRECHT, Bruno, Technologiepark 21, 9052 Zwijnaarde, BE  
VICTOR, Bjorn, Technologiepark 21, 9052 Zwijnaarde, BE  
KASTELEIN, Robert A., 116 Brookside Drive, Portola Valley, CA 94028, US

---

(51) MKP  
**C07K 16/18 2006 (97) EP 3377531**  
**C07K 16/28 2006**  
(96) EP 16805655.4 11/17/2016  
(97) EP 3377531, 9/26/2018 201839, en  
(31) 201562257009 P (32) 18.11.2015 (33) US  
(54) PD1 AND/OR LAG3 BINDERS  
(72) BOWMAN, Edward, 901 S. California Avenue, Palo Alto, California 94304, US  
BEAUMONT, Maribel, 901 S. California Avenue, Palo Alto, California 94304, US  
BUYSE, Marie-Ange, Technologiepark 21, 9052 Zwijnaarde, BE  
BOUTTON, Carlo, Technologiepark 21, 9052 Zwijnaarde, BE  
DOMBRECHT, Bruno, Technologiepark 21, 9052 Zwijnaarde, BE  
VLERICK, David, Technologiepark 21, 9052 Zwijnaarde, BE  
KASTELEIN, Robert A., 16 Brookside Drive, Portola Valley, CA 94028, US

---

(51) MKP  
**A61K 31/423 2006 (97) EP 3377488**  
**A61K 31/428 2006**  
**A61K 31/4355 2006**  
**A61K 31/4985 2006**  
**A61P 31/12 2006**  
**A61P 35/00 2006**  
**C07D 263/57 2006**  
**C07D 413/10 2006**  
**C07D 413/12 2006**  
**C07D 413/14 2006**  
**C07D 417/10 2006**  
**C07D 491/04 2006**  
**C07D 498/04 2006**  
(96) EP 16805690.1 11/18/2016  
(97) EP 3377488, 9/26/2018 201839, en  
(31) 201562257342 P (32) 19.11.2015 (33) US  
201662332632 P 06.05.2016 US  
201662385099 P 08.09.2016 US  
(54) HETEROCYCLIC COMPOUNDS AS IMMUNOMODULATORS  
(72) LI, Jingwei, 225 Welch Way, Westfield, New Jersey 07090, US  
WU, Liangxing, c/o Incyte Corporation 1801 Augustine Cut-Off, Wilmington, Delaware 19803, US  
YAO, Wenqing, 45 Magnolia Way, Chadds Ford, Pennsylvania 19317, US

---

(51) MKP  
**A61K 31/416 2006 (97) EP 3380466**  
**A61P 9/00 2006**  
**A61P 11/00 2006**  
**A61P 17/04 2006**  
**A61P 25/00 2006**  
**C07D 231/56 2006**  
**C07D 401/04 2006**  
**C07D 401/14 2006**  
**C07D 403/04 2006**  
**C07D 403/06 2006**  
**C07D 403/12 2006**

**C07D 405/04 2006**  
**C07D 405/14 2006**  
(96) EP 16805708.1 11/22/2016  
(97) EP 3380466, 10/3/2018 201840, en  
(31) 201562260113 P (32) 25.11.2015 (33) US  
(54) SUBSTITUTED BENZAMIDES USEFUL AS SODIUM CHANNEL BLOCKERS  
(72) CHEN, Chien-an, 1 DNA Way, South San Francisco California 94080-4990, US  
CHOWDHURY, Sultan, 200-3650 Gilmore Way, Burnaby British Columbia V5G 4W8, CA  
DECKER, Shannon Marie, 200-3650 Gilmore Way, Burnaby British Columbia V5G 4W8, CA  
DEHNHARDT, Christoph Martin, 200-3650 Gilmore Way, Burnaby British Columbia V5G 4W8, CA  
HEMEON, Ivan William, 200-3650 Gilmore Way, Burnaby British Columbia V5G 4W8, CA  
MCKERRALL, Steven, 1 DNA Way, South San Francisco California 94080-4990, US  
SAFINA, Brian, 1 DNA Way, South San Francisco California 94080-4990, US  
SHENG, Tao, 200-3650 Gilmore Way, Burnaby British Columbia V5G 4W8, CA  
SUTHERLIN, Dan, 1 DNA Way, South San Francisco California 94080-4990, US

---

(51) MKP  
**A61L 29/06 2006 (97) EP 3377127**  
**A61L 29/08 2006**  
(96) EP 16805718.0 11/15/2016  
(97) EP 3377127, 9/26/2018 201839, de  
(31) 102015014912 (32) 18.11.2015 (33) DE  
(54) COATING FOR A MEDICAL INSTRUMENT, METHOD FOR THE COATING THEREOF, AND MEDICAL INSTRUMENT COATED USING SAID METHOD  
(71) Urotech GmbH, Medi-Globe-Strasse 1-5, 83101 Rohrdorf-Achenmühle, DE  
(72) MUSCAT, Dirk, Bürgermeister-Wild-Straße 36, 85521 Ottobrunn, DE  
VOIT, Johann, Oberfeldstraße 22, 82110 Germering, DE  
HEFENBROCK, Sophia, Birkenriedstraße 16B, 83071 Stephanskirchen, DE

---

(51) MKP  
**A61K 31/223 2006 (97) EP 3383385**  
**A61K 31/573 2006**  
(96) EP 16805792.5 12/1/2016  
(97) EP 3383385, 10/10/2018 201841, en  
(31) 201521217 (32) 01.12.2015 (33) GB  
(54) MELFLUFEN DOSAGE REGIMENS FOR CANCER  
(72) LINDBERG, Jakob, c/o Oncopeptides AB Västra Trädgårdsgatan 15, S-111 53 Stockholm, SE

---

(51) MKP  
**A61K 31/501 2006 (97) EP 3383873**  
**A61K 31/53 2006**  
**A61P 35/00 2006**  
**C07D 417/14 2006**  
(96) EP 16806028.3 11/30/2016  
(97) EP 3383873, 10/10/2018 201841, en  
(31) 201562260789 P (32) 30.11.2015 (33) US  
(54) 1,3,4-THIADIAZOLE COMPOUNDS AND THEIR USE IN TREATING CANCER  
(72) FINLAY, Maurice, Raymond, Verschoyle, AstraZeneca R&D Cambridge Darwin Building Cambridge Science Park Milton Road, Cambridge Cambridgeshire CB4 0FZ, GB  
NISSINK, Johannes, Wilhelmus, Maria, AstraZeneca R&D Cambridge Darwin Building Cambridge Science Park Milton Road, Cambridge Cambridgeshire CB4 0FZ, GB  
CHARLES, Mark, David, CRT Discovery Laboratories Jonas Webb Building Babraham Research Campus, Cambridge Cambridgeshire CB22 3AT, GB

---

(51) MKP  
**D21D 1/02 2006 (97) EP 3384080**  
**D21D 1/20 2006**  
(96) EP 16806085.3 12/5/2016  
(97) EP 3384080, 10/10/2018 201841, en  
(31) 15198088 (32) 04.12.2015 (33) EP  
(54) PROCESS TO REDUCE THE OVERALL ENERGY CONSUMPTION IN THE PRODUCTION OF NANOCELLULOSE

(72) MOMIN, Saschi, 7 Warren Crescent Edmonton, London Greater London N9 9JF, GB  
JANSEN, Adrianus Johannes Ernst, Seringenlaan 42, 6163 EX Geleen, NL

---

(51) MKP  
**B29B 7/00 2006 (97) EP 3386703**  
**B29B 7/16 2006**  
**B29B 7/28 2006**  
**B29B 7/90 2006**  
**B29B 9/14 2006**

(96) EP 16806086.1 12/5/2016

(97) EP 3386703, 10/17/2018 201842, en

(31) 15198308 (32) 07.12.2015 (33) EP

(54) PROCESS FOR MANUFACTURING A PRECURSOR MATERIAL

(72) HENDRIX, Sandra, Vlijtingerbank 12, 6213 KB Maastricht, NL

BALLET, Wim, Stopstraat 25, 3770 Riemst, BE

MALETRAS, Lucile, Seestrasse 90, 8810 Horgen, NL

---

(51) MKP  
**A61K 9/00 2006 (97) EP 3370699**  
**A61K 31/4245 2006**  
**A61K 39/395 2006**  
**A61K 45/06 2006**  
**A61P 35/00 2006**

(96) EP 16806334.5 11/4/2016

(97) EP 3370699, 9/12/2018 201837, en

(31) 201562250968 P (32) 04.11.2015 (33) US

(54) PHARMACEUTICAL COMPOSITIONS AND METHODS FOR INDOLEAMINE 2,3-DIOXYGENASE INHIBITION AND INDICATIONS THEREFOR

(72) YELESWARAM, Krishnaswamy, Incyte Corporation 1801 Augustine Cut-Off, Wilmington, Delaware 19803, US

SHI, Jack Guoen, Incyte Corporation 1801 Augustine Cut-Off, Wilmington, Delaware 19803, US

---

(51) MKP  
**A01N 25/02 2006 (97) EP 3379928**  
**A01N 25/30 2006**  
**A01N 43/40 2006**  
**A01N 47/02 2006**  
**A01N 49/00 2006**  
**A01P 7/00 2006**  
**A01P 7/02 2006**  
**A61K 31/415 2006**

(96) EP 16806371.7 11/16/2016

(97) EP 3379928, 10/3/2018 201840, en

(31) 201520724 (32) 24.11.2015 (33) GB

(54) VETERINARY FORMULATIONS

(72) JEANNIN, Philippe, 144 Chemin De La Croix Berthet, 69110 Sainte Foy Les Lyon, FR

---

(51) MKP  
**B29C 51/26 2006 (97) EP 3216594**  
**B31B 50/59 2017**  
**B31F 1/00 2006**

(96) EP 17160215.4 3/9/2017

(97) EP 3216594, 12/19/2018 201851, de

(31) 102016104375 (32) 10.03.2016 (33) DE

(54) APPARATUS FOR CLAMPING, HOLDING AND GUIDING FLAT MATERIAL AND PROCESS FOR OPERATING THE APPARATUS

(72) Haug, Hans, Am Meierhof 12, 87730 Bad Grönenbach, DE

---

(51) MKP  
**A01N 43/38 2006 (97) EP 3246027**  
**A61K 31/405 2006**  
**A61K 31/444 2006**  
**A61K 31/496 2006**  
**A61K 31/501 2006**  
**A61K 31/506 2006**



**A61K 31/5377 2006**  
**A61K 31/5383 2006**  
**A61K 31/541 2006**  
**A61K 31/551 2006**  
**A61P 35/00 2006**  
**C07D 401/14 2006**  
**C07D 405/14 2006**  
(96) EP 17162229.3 5/5/2011  
(97) EP 3246027, 11/21/2018 201847, en  
(31) 332309 P (32) 07.05.2010 (33) US  
(54) INDOLE DERIVATIVES FOR THE TREATMENT OF CANCER  
(72) BRACKLEY, James, 1250 South Collegeville Road, Collegeville, PA Pennsylvania 19426, US  
BURGESS, Joelle Lorraine, 1250 South Collegeville Road, Collegeville, PA Pennsylvania 19426, US  
GRANT, Seth, 1250 South Collegeville Road, Collegeville, PA Pennsylvania 19426, US  
JOHNSON, Neil, 1250 South Collegeville Road, Collegeville, PA Pennsylvania 19426, US  
KNIGHT, Steven D., 1250 South Collegeville Road, Collegeville, PA Pennsylvania 19426, US  
LaFRANCE, Louis, 1250 South Collegeville Road, Collegeville, PA Pennsylvania 19426, US  
MILLER, William H., 1250 South Collegeville Road, Collegeville, PA Pennsylvania 19426, US  
NEWLANDER, Kenneth, 1250 South Collegeville Road, Collegeville, PA Pennsylvania 19426, US  
ROMERIL, Stuart, 1250 South Collegeville Road, Collegeville, PA Pennsylvania 19426, US  
ROUSE, Meagan B., 1250 South Collegeville Road, Collegeville, PA Pennsylvania 19426, US  
TIAN, Xinrong, 1250 South Collegeville Road, Collegeville, PA Pennsylvania 19426, US  
VERMA, Sharad Kumar, 1250 South Collegeville Road, Collegeville, PA Pennsylvania 19426, US

---

(51) MKP  
**A61L 15/18 2006 (97) EP 3378502**  
**A61L 15/46 2006**  
(96) EP 17162567.6 3/23/2017  
(97) EP 3378502, 9/26/2018 201839, en  
(54) USE OF ZINC TREATED PRECIPITATED CALCIUM CARBONATE IN HYGIENIC PRODUCTS  
(72) OHR, Steffen, Christoph-Schnyder-Strasse 15c, 6210 Sursee, CH  
SCHRUL, Christopher, Oltnerstrasse 18, 4663 Aarburg, CH

---

(51) MKP  
**C09C 1/02 2006 (97) EP 3385335**  
**D21H 17/67 2006**  
(96) EP 17164661.5 4/3/2017  
(97) EP 3385335, 10/10/2018 201841, en  
(54) PIGMENT COMPOSITION COMPRISING SURFACE MODIFIED CALCIUM CARBONATE AND GROUND NATURAL CALCIUM CARBONATE  
(72) WERNER, Dennis, Friedensstrasse 85, 4600 Olten, CH  
FOUAL, Djillali, Obere Hauptstrasse 60, 4665 Oftringen, CH

---

(51) MKP  
**B27N 3/02 2006 (97) EP 3385046**  
**B27N 3/04 2006**  
**B27N 3/06 2006**  
**B27N 3/10 2006**  
**B27N 3/12 2006**  
**B27N 7/00 2006**  
**B44C 5/04 2006**  
(96) EP 17165463.5 4/7/2017  
(97) EP 3385046, 10/10/2018 201841, en  
(54) IN-LINE COATED DECORATIVE WOOD-BASED BOARDS  
(72) SCHRUL, Christopher, Oltnerstrasse 18, 4663 Aarburg, CH  
OZYHAR, Tomasz, Buhnrain 12, 8052 Zürich, CH

---

(51) MKP  
**A61K 38/17 2006 (97) EP 3290439**  
**A61P 3/00 2006**  
**C07K 14/475 2006**  
**C07K 14/705 2006**  
(96) EP 17166621.7 6/8/2010  
(97) EP 3290439, 10/17/2018 201842, en

(31) 268420 P (32) 12.06.2009 (33) US  
 280543 P 03.11.2009 US  
 (54) TRUNCATED ACTRIIB-FC FUSION PROTEINS  
 (72) SEEHRA,, Jasbir, 3 Lincoln Terrace, Lexington, MA Massachusetts 02421-6818, US  
 KUMAR,, Ravindra, 421 Arlington Street, Acton, MA Massachusetts 01720, US

---

(51) MKP  
**A61K 31/343 2006 (97) EP 3252044**  
**A61P 29/00 2006**  
**A61P 35/00 2006**  
**C07D 307/85 2006**  
 (96) EP 17166690.2 3/3/2014  
 (97) EP 3252044, 7/18/2018 201829, fr  
 (31) 1351898 (32) 04.03.2013 (33) FR  
 201361772191 P 04.03.2013 US  
 (54) PREPARATION METHOD OF ABEXINOSTAT TOSYLATE SALT AND ASSOCIATED CRYSTALLINE FORM  
 (72) PIMONT-GARRO, Anne, 39 avenue des Etats-Unis, F-78000 Versailles, FR  
 LETELLIER, Philippe, 25 rue de Faubourg Saint Jean, F-45000 Orleans, FR

---

(51) MKP  
**B64C 1/10 2006 (97) EP 3263444**  
**B64D 11/00 2006**  
**B64D 11/06 2006**  
 (96) EP 16177293.4 6/30/2016  
 (97) EP 3263444, 9/19/2018 201838, en  
 (54) CABIN MODULE AND LAYOUT FOR A PASSENGER AIRCRAFT  
 (71) Cathay Pacific Airways Limited, 35th Floor Two Pacific Place 88 Queensway, Admiralty, HK  
 (72) LEE, James, c/o Cathay Pacific Airways Limited 35th Floor Two Pacific Place 88 Queensway, Admiralty, HK

---

(51) MKP  
**A61K 38/00 2006 (97) EP 3244932**  
**A61K 48/00 2006**  
**C07H 21/04 2006**  
**C12N 15/00 2006**  
 (96) EP 16737885.0 1/14/2016  
 (97) EP 3244932, 7/18/2018 201829, en  
 (31) 201562103354 P (32) 14.01.2015 (33) US  
 201562238288 P 07.10.2015 US  
 (54) RNA GUIDED ERADICATION OF HERPES SIMPLEX TYPE I AND OTHER RELATED HERPESVIRUSES  
 (72) ROEHM, Pamela, C., 211 Meetinghouse Road, Jenkintown, PA 19046, US  
 KHALILI, Kamel, 190 Presidential Boulevard 718, Bala Cynwyd, PA 19004, US  
 SHEKARABI, Sayed, Masoud, 423 Horseshoe Curve Drive, Lansdale, PA 19446, US  
 WOLLEBO, Hassen, 3173 Richmond Street, Philadelphia, PA 19134, US

---

(51) MKP  
**G06F 17/30 2006 (97) EP 3245601**  
**G06F 19/10 2011**  
**G06Q 50/22 2012**  
**G16H 10/60 2018**  
 (96) EP 16738030.2 1/16/2016  
 (97) EP 3245601, 8/29/2018 201835, en  
 (31) 201562104532 P (32) 16.01.2015 (33) US  
 (54) HEALTHCARE DATA INTERCHANGE SYSTEM AND METHOD  
 (71) PricewaterhouseCoopers LLP, 300 Madison Avenue, New York, NY 10017, US  
 (72) MYNHIER, Mark, 4950 E. Crescent Drive, Anaheim, CA 92807, US  
 PATHAK, Dhiraj, 22 Pine Drive, Great Neck, NY 11021, US

---

(51) MKP  
**A61K 9/00 2006 (97) EP 3370692**  
**A61K 31/047 2006**  
**A61K 31/731 2006**  
**A61K 33/14 2006**

**A61K 45/06 2006**  
**A61P 11/02 2006**  
**A61P 31/16 2006**  
 (96) EP 16738419.7 7/12/2016  
 (97) EP 3370692, 9/12/2018 201837, en  
 (31) 15176670 (32) 14.07.2015 (33) EP  
 (54) STUFFY NOSE DEBLOCKING COMPOSITION HAVING ANTIVIRAL ACTIVITY  
 (72) GRASSAUER, Andreas, Josef Flandorferstrasse 20, 1210 Wien, AT  
 PRIESCHL-GRASSAUER, Eva, Josef Flandorferstrasse 20, 1210 Wien, AT  
 BODENTEICH, Angelika, Schopenhauerstrasse 47/7, 1180 Wien, AT  
 KOLLER, Christiane, Gartengasse 20, 2201 Seyring/Gerasdorf, AT  
 MOROKUTTI-KURZ, Martina, Josef Schuster Gasse 37, 1130 Wien, AT

---

(51) MKP  
**C04B 20/10 2006 (97) EP 3393994**  
**C04B 26/06 2006**  
 (96) EP 16740961.4 6/23/2016  
 (97) EP 3393994, 10/31/2018 201844, en  
 (31) 15003627 (32) 21.12.2015 (33) EP  
 (54) COMPOSITION FOR A PASTY FILLER MATERIAL, PASTY FILLER, AND METHOD FOR PRODUCING A PASTY FILLER MATERIAL  
 (72) WINGS, Norbert, Nacker Str. 11, 55234 Wendelsheim, DE

---

(51) MKP  
**D06M 15/248 2006 (97) EP 3225733**  
**D06M 15/263 2006**  
**D06M 15/564 2006**  
**D06M 23/16 2006**  
**E06B 9/24 2006**  
 (96) EP 16163610.5 4/2/2016  
 (97) EP 3225733, 7/11/2018 201828, en  
 (54) TRANSPARENT TEXTILE WITH SELF-ADHESIVE PROPERTIES FOR DAMP ENVIRONMNTS  
 (71) Lampe Textiles, Kanegemstraat 29, 8700 Tielt, BE  
 (72) LAMPE, Philippe, Kanegemstraat 29, 8700 Tielt, BE

---

(51) MKP  
**A61K 31/4375 2006 (97) EP 3259269**  
**A61K 31/444 2006**  
**A61K 31/519 2006**  
**A61K 31/5377 2006**  
**A61K 31/541 2006**  
**A61P 19/00 2006**  
**A61P 35/00 2006**  
**C07D 471/04 2006**  
 (96) EP 16706767.7 2/19/2016  
 (97) EP 3259269, 10/31/2018 201844, en  
 (31) 201562118698 P (32) 20.02.2015 (33) US  
 201562170936 P 04.06.2015 US  
 (54) BICYCLIC HETEROCYCLES AS FGFR INHIBITORS  
 (72) LU, Liang, 605 Sunflower Circle, Hockessin, Delaware 19707, US  
 SHEN, Bo, 15 Martins Court, Garnet Valley, Pennsylvania 19060, US  
 SOKOLSKY, Alexander, 1 Academy Circle Apt. 208, Philadelphia, Pennsylvania 19146, US  
 WANG, Xiaozhao, 2303 Larchmont Place, Mt. Laurel, New Jersey 08054, US  
 WU, Liangxing, 108 Sassafrass Court, Wilmington, Delaware 19808, US  
 YAO, Wenqing, 45 Magnolia Way, Cadds Ford, Pennsylvania 19317, US  
 YE, Yingda, 2506 Cedar Tree Drive Apt. 3D, Wilmington, Delaware 19810, US

---

(51) MKP  
**A61K 9/00 2006 (97) EP 3247331**  
**A61K 31/137 2006**  
**A61K 31/56 2006**  
**A61P 11/00 2006**  
 (96) EP 16706919.4 1/20/2016  
 (97) EP 3247331, 9/26/2018 201839, en

(31) 201562105479 P (32) 20.01.2015 (33) US  
(54) DRY POWDER INHALER COMPRISING FLUTICASONE PROPIONATE AND SALMETEROL XINAFOAT  
(71) Teva Branded Pharmaceutical Products R & D, Inc., 41 Moores Road, Frazer, Pennsylvania 19355, US  
(72) DALVI, Mukul, 845 Verona Lake Drive, Weston, FL 33326, US  
TEE, Seah Kee, 1888 Aspen Lane, Weston, FL 33327, US

---

(51) MKP  
A47K 5/12 2006 (97) EP 3413769  
B01F 3/08 2006  
B01F 13/00 2006  
B01F 15/00 2006  
B01F 15/02 2006

(96) EP 16707205.7 2/8/2016  
(97) EP 3413769, 12/19/2018 201851, en  
(54) METHOD AND SHAKER FOR MIXING LIQUIDS  
(71) SUPAN, Carlota, Korte 116, Izola 6310, SI  
(72) SUPAN, Carlota, Korte 116, Izola 6310, SI

---

(51) MKP  
H04R 7/04 2006 (97) EP 3406086

(96) EP 16707953.2 1/22/2016  
(97) EP 3406086, 11/28/2018 201848, en  
(54) METHOD AND APPARATUS FOR PLAYING AUDIO BY MEANS OF PLANAR ACOUSTIC TRANSDUCERS  
(71) Glauk S.r.l., Via Antonio Locatelli 17/R, 50134 Firenze, IT  
(72) BOLLINI, Alessandro, Via Lame 9, 50025 Montespertoli, IT

---

(51) MKP  
B65D 81/26 2006 (97) EP 3250640  
C08K 3/24 2006  
C08K 5/00 2006  
C08K 5/09 2006  
C08L 67/02 2006  
C08L 71/02 2006

(96) EP 16708773.3 1/28/2016  
(97) EP 3250640, 8/22/2018 201834, en

(31) 201562110004 P (32) 30.01.2015 (33) US  
(54) DURABLE OXYGEN SCAVENGING PLASTIC CONTAINERS  
(72) AKKAPEDDI, Murali K., 118 Farmhouse Lane, York, PA 17408, US  
LYNCH, Brian A., 22 Woodward Road, Merrimack, NH 03054, US

---

(51) MKP  
A61K 9/00 2006 (97) EP 3411013  
A61K 9/107 2006  
A61K 31/454 2006  
A61K 31/496 2006  
A61K 31/5377 2006  
A61K 47/24 2006

(96) EP 16708789.9 2/1/2016  
(97) EP 3411013, 12/12/2018 201850, en  
(54) EMULSION COMPRISING AN NK-1 RECEPTOR ANTAGONIST  
(71) Heron Therapeutics, Inc., 123 Saginaw Drive, Redwood City, CA 94063, US  
(72) OTTOBONI, Thomas, B., 1211 North Road, Belmont, CA 94002, US  
HAN, Han, 2209 Hastings Drive Apt. 60, Belmont, CA 94002, US

---

(51) MKP  
A61K 35/00 2006 (97) EP 3250695  
A61K 35/12 2015  
A61K 35/14 2015  
A61K 35/17 2015  
A61K 45/06 2006  
A61K 48/00 2006  
C07K 14/705 2006

**C07K 14/725 2006**  
**C07K 16/28 2006**  
**C07K 16/32 2006**  
**C12N 15/85 2006**  
(96) EP 16743974.4 1/26/2016  
(97) EP 3250695, 8/15/2018 201833, en  
(31) 201562107804 P (32) 26.01.2015 (33) US  
(54) UNIVERSAL IMMUNE CELLS FOR CANCER IMMUNOTHERAPY  
(72) AHMED, Nabil, M., 3414 Norris Drive, Houston, TX 77025, US  
BIELAMOWICZ, Kevin, One Baylor Plaza, Houston, TX 77030, US  
FOUSEK, Kristen, One Baylor Plaza, Houston, TX 77030-3411, US

---

(51) MKP  
**G03G 15/00 2006 (97) EP 3255508**  
**G03G 21/16 2006**  
**G03G 21/18 2006**  
(96) EP 16746742.2 2/5/2016  
(97) EP 3255508, 11/14/2018 201846, en  
(31) 2015021649 (32) 05.02.2015 (33) JP  
2016020213 04.02.2016 JP  
(54) CARTRIDGE, PHOTORECEPTOR UNIT, ELECTROPHOTOGRAPHIC IMAGE FORMING DEVICE  
(72) KAMOSHIDA, Shigemi, c/o CANON KABUSHIKI KAISHA 30-2 Shimomaruko 3-chome Ohta-ku, Tokyo 146-8501, JP  
KAWAKAMI, Takuya, c/o CANON KABUSHIKI KAISHA 30-2 Shimomaruko 3-chome Ohta-ku, Tokyo 146-8501, JP  
OGINO, Hiroki, c/o CANON KABUSHIKI KAISHA 30-2 Shimomaruko 3-chome Ohta-ku, Tokyo 146-8501, JP  
KANNO, Kazuhiko, c/o CANON KABUSHIKI KAISHA 30-2 Shimomaruko 3-chome Ohta-ku, Tokyo 146-8501, JP

---

(51) MKP  
**A61K 39/395 2006 (97) EP 3253412**  
**C07K 16/28 2006**  
(96) EP 16747111.9 2/2/2016  
(97) EP 3253412, 8/1/2018 201831, en  
(31) 201562111261 P (32) 03.02.2015 (33) US  
(54) ANTI-CD40L ANTIBODIES AND METHODS FOR TREATING CD40L-RELATED DISEASES OR DISORDERS  
(71) ALS Therapy Development Institute, 300 Technology Square Suite 400, Cambridge, Massachusetts 02139, US  
(72) LINCECUM, John, M., 19 Kenton Road, Jamaica Plain, MA 02130, US  
JIANG, Bingbing, 1455 Commonwealth Avenue Apt. 417, Brighton, MA 02135, US  
PERRIN, Steven, N., 100 Northern Boulevard, Newbury, MA 01951, US  
GILL, Alan, 6 Heather Drive, Reading, MA 01867-3959, US  
GILL, Cynthia, A., 6 Heather Drive, Reading, MA 01867-3959, US  
VIEIRA, Fernando G., 139A Charles Street ,337, Boston, MA 02114, US

---

(51) MKP  
**A61K 9/48 2006 (97) EP 3253401**  
**A61K 38/08 2006**  
**A61P 5/06 2006**  
(96) EP 16747195.2 2/3/2016  
(97) EP 3253401, 11/14/2018 201846, en  
(31) 201562111369 P (32) 03.02.2015 (33) US  
201562136012 P 20.03.2015 US  
(54) METHOD OF TREATING DISEASES  
(71) Chiasma Inc., 275 Wyman Street Suite 250, Waltham, MA 02451, US  
(72) MAMLUK, Roni, Hagefen 3, Mazkeret Batya, IL

---

(51) MKP  
**A43B 1/00 2006 (97) EP 3352606**  
**A43B 7/00 2006**  
**A43B 7/12 2006**  
**A43B 23/07 2006**  
**A62B 17/00 2006**  
(96) EP 16747483.2 7/29/2016  
(97) EP 3352606, 8/1/2018 201831, de  
(31) 102015015286 (32) 30.11.2015 (33) DE

- (54) FUNCTIONAL FOOTWEAR UNIT  
 (72) BAGGEN, Brigitte, c/o Blücher GmbH Mettmanner Strasse 25, 40699 Erkrath, DE  
 FISCHER, Rainer, c/o Blücher GmbH Mettmanner Strasse 25, 40699 Erkrath, DE  
 BENCH-WIEBER, Angela, c/o Blücher GmbH Mettmanner Strasse 25, 40699 Erkrath, DE  
 ROGMANN, Carina, c/o Blücher GmbH Mettmanner Strasse 25, 40699 Erkrath, DE
- 

- (51) MKP  
**G16H 10/60 2018 (97) EP 3257017**  
**G16H 20/10 2018**  
**G16H 40/63 2018**  
 (96) EP 16748931.9 2/10/2016  
 (97) EP 3257017, 8/29/2018 201835, en  
 (31) 201562114787 P (32) 11.02.2015 (33) US  
 (54) SYSTEMS, DEVICES, AND METHODS FOR INGESTIBLE EVENT SENSING AND ANALYSIS  
 (72) DOCHERTY, John P., 200 Central Park South, Apartment 9/10 I, New York, New York 10019, US  
 HATCH, Ainslie, 61 Rosedale Lane., Princeton, New Jersey 08540, US  
 ROSS, Ruth, 228 Black Rock Mountain Lane, Independence, Virginia 24348, US  
 VELLIGAN, Dawn L., 6400 Bluebird Drive, San Antonio, Texas 78240, US  
 WEIDEN, Peter, 491 Chestnut Street, Newton, Massachusetts 02468, US
- 

- (51) MKP  
**G06F 15/16 2006 (97) EP 3256954**  
**H04L 12/58 2006**  
**H04L 29/12 2006**  
 (96) EP 16749596.9 1/29/2016  
 (97) EP 3256954, 10/10/2018 201841, en  
 (31) 201562116409 P (32) 14.02.2015 (33) US  
 (54) CENTRALIZED VALIDATION OF EMAIL SENDERS VIA EHLO NAME AND IP ADDRESS TARGETING  
 (72) GOLDSTEIN, Peter, Martin, c/o Valimail Inc. 180 Montgomery Street, 18th Floor, San Francisco, CA 94104, US
- 

- (51) MKP  
**A61K 31/185 2006 (97) EP 3347002**  
**A61K 31/205 2006**  
**C07C 309/02 2006**  
 (96) EP 16845181.3 9/9/2016  
 (97) EP 3347002, 7/18/2018 201829, en  
 (31) 201562216404 P (32) 10.09.2015 (33) US  
 201662290287 P 02.02.2016 US  
 201662302027 P 01.03.2016 US  
 201662365809 P 22.07.2016 US  
 (54) METHODS OF TREATING NEURODEGENERATIVE DISORDERS IN A PARTICULAR PATIENT POPULATION  
 (71) Alzheon, Inc., 111 Speen Street Suite 306, Framingham, MA 01701, US  
 (72) ABUSHAKRA, Susan, c/o Alzheon Inc. 111 Speen Street Suite 306, Framingham, Massachusetts 01701, US  
 POWER, Aidan, c/o Alzheon Inc. 111 Speen Street Suite 306, Framingham, Massachusetts 01701, US  
 TOLAR, Martin, c/o Alzheon Inc. 111 Speen Street Suite 306, Framingham, Massachusetts 01701, US  
 HEY, John, c/o Alzheon Inc. 111 Speen Street Suite 306, Framingham, Massachusetts 01701, US  
 YU, Jeremy, c/o Alzheon Inc. 111 Speen Street Suite 306, Framingham, Massachusetts 01701, US  
 KOCIS, Petr, c/o Alzheon Inc. 111 Speen Street Suite 306, Framingham, Massachusetts 01701, US
- 

- (51) MKP  
**A61K 47/50 2017 (97) EP 3362098**  
 (96) EP 16845348.8 10/12/2016  
 (97) EP 3362098, 8/22/2018 201834, en  
 (31) 500652015 (32) 15.10.2015 (33) SK  
 (54) A METHOD FOR ALTERING THE FUNCTIONAL STATE OF MRNA ALLOWING ITS SELECTIVE AND SPECIFIC RECOGNITION  
 (71) Ústav Polymérov Sav, Dúbravská cesta 9, 842 36 Bratislava, SK  
 (72) RÁZGA, Filip, Sokolská 15, 90301 Senec, SK  
 NÉMETHOVÁ, Veronika, Vajanského 7, 94001 Nové Zámky, SK
- 

- (51) MKP

**B64G 1/40 2006 (97) EP 3350442**  
**F03H 1/00 2006**  
(96) EP 16845382.7 9/9/2016  
(97) EP 3350442, 7/25/2018 201830, en  
(31) 2015903748 (32) 15.09.2015 (33) AU  
(54) INTERNAL WIRE-TRIGGERED PULSED CATHODIC ARC PROPULSION SYSTEM  
(71) Neumann Space PTY Ltd, 1/41 Wood Avenue, Brompton, SA 5007, AU  
(72) NEUMANN, Patrick, 2/57 Mary Street, Auburn, New South Wales 2144, AU  
BILEK, Marcela, 2 Kurrajong Street, Sutherland, New South Wales 2232, AU  
MCKENZIE, David, 23 Tindale Road, Artarmon, New South Wales 2064, AU

---

(51) MKP  
**A61B 5/08 2006 (97) EP 3349831**  
**A61K 9/72 2006**  
**A61K 49/00 2006**  
**A61M 15/00 2006**  
(96) EP 16845786.9 9/16/2016  
(97) EP 3349831, 7/25/2018 201830, en  
(31) 201562219214 P (32) 16.09.2015 (33) US  
(54) DRY POWDER DELIVERY SYSTEM AND METHOD  
(71) 1355540 Ontario Inc., 34 Chapperton Street, Barrie, Ontario L4M 1G6, CA  
(72) STENZLER, Alex, 771 Terraine Avenue, Long Beach, CA 90804, US  
HAN, Steve, 18768 Ashford Lane, Huntington Beach, CA 92648, US

---

(51) MKP  
**C08K 3/34 2006 (97) EP 3351595**  
**C08K 9/04 2006**  
**C08L 23/02 2006**  
**C08L 53/00 2006**  
**C08L 91/00 2006**  
**C08L 101/02 2006**  
**C08L 101/12 2006**  
(96) EP 16846147.3 8/4/2016  
(97) EP 3351595, 7/25/2018 201830, en  
(31) 2015184491 (32) 17.09.2015 (33) JP  
2016098268 16.05.2016 JP  
(54) THERMOPLASTIC ELASTOMER COMPOSITION AND METHOD FOR PREPARING SAME  
(72) CHINO Keisuke, c/o JXTG Nippon Oil&Energy Corporation 1-2, Otemachi 1-chome, Chiyoda-ku, Tokyo 1008162, JP  
SUZUKI Hiroaki, c/o JXTG Nippon Oil&Energy Corporation 1-2, Otemachi 1-chome, Chiyoda-ku, Tokyo 1008162, JP  
JIN Zhengzhe, c/o JXTG Nippon Oil&Energy Corporation 1-2, Otemachi 1-chome, Chiyoda-ku, Tokyo 1008162, JP  
MATSUO Yusuke, c/o JXTG Nippon Oil&Energy Corporation 1-2, Otemachi 1-chome, Chiyoda-ku, Tokyo 1008162, JP

---

(51) MKP  
**A61K 33/24 2006 (97) EP 3351580**  
**A61P 35/00 2006**  
**C07F 15/00 2006**  
**C08G 65/333 2006**  
**C08G 65/337 2006**  
**C08G 69/10 2006**  
**C08G 69/40 2006**  
**C08G 69/48 2006**  
(96) EP 16846368.5 9/8/2016  
(97) EP 3351580, 7/25/2018 201830, en  
(31) 2015180875 (32) 14.09.2015 (33) JP  
(54) POLYMER CONJUGATE OF HEXA-COORDINATED PLATINUM COMPLEX  
(72) NAKAMURA Masaharu, c/o NIPPON KAYAKU KABUSHIKI KAISHA Pharmaceuticals Research Laboratories 31-12 Shimo 3-chome Kita-ku, Tokyo 115-8588, JP  
FUKUDA Tsuyoshi, c/o NIPPON KAYAKU KABUSHIKI KAISHA Pharmaceuticals Research Laboratories 31-12 Shimo 3-chome Kita-ku, Tokyo 115-8588, JP  
KIKUCHI Yusaku, c/o NIPPON KAYAKU KABUSHIKI KAISHA Pharmaceuticals Research Laboratories 31-12 Shimo 3-chome Kita-ku, Tokyo 115-8588, JP  
WATANABE Chihiro, c/o NIPPON KAYAKU KABUSHIKI KAISHA Pharmaceuticals Research Laboratories 31-12 Shimo 3-chome Kita-ku, Tokyo 115-8588, JP

(51) MKP  
**A61K 31/5377 2006 (97) EP 3351542**  
**A61P 29/00 2006**  
**A61P 37/08 2006**  
**A61P 43/00 2006**  
**C07D 401/12 2006**  
(96) EP 16846662.1 9/16/2016  
(97) EP 3351542, 7/25/2018 201830, en  
(31) 2015184022 (32) 17.09.2015 (33) JP  
(54) NEW CRYSTAL OF PIPERAZINE COMPOUND  
(72) AOKI, Shinichi, c/o TAIHO PHARMACEUTICAL CO. LTD. 200-22 Aza Toyohara Oaza Motohara Kamikawamachi, Kodama-gun Saitama 367-0241, JP

(51) MKP  
**A61K 31/404 2006 (97) EP 3349750**  
**C07D 209/30 2006**  
(96) EP 16847099.5 9/12/2016  
(97) EP 3349750, 7/25/2018 201830, en  
(31) 201516411 (32) 16.09.2015 (33) GB  
(54) PHARMACEUTICAL COMPOUND  
(71) Iomet Pharma Ltd., 9 Edinburgh Bioquater Little France Road, Edinburgh EH16 4UX, GB  
(72) COWLEY, Phillip, M., 9 Edinburgh Bioquarter Little France Road, Edinburgh Midlothian EH16 4UX, GB  
HAN, Yongxin, 33 Avenue Louis Pasteur, Boston, Massachusetts 02115-5727, US

(51) MKP  
**A61K 38/16 2006 (97) EP 3350337**  
**C07K 14/005 2006**  
**C07K 14/195 2006**  
**C12N 15/74 2006**  
**C12P 21/00 2006**  
(96) EP 16847136.5 9/13/2016  
(97) EP 3350337, 7/25/2018 201830, en  
(31) 201562218884 P (32) 15.09.2015 (33) US  
(54) MANUFACTURING METHOD OF AN IMMUNOTHERAPEUTIC FORMULATION COMPRISING A RECOMBINANT LISTERIA STRAIN  
(72) WALLECHA, Anu, 201 WildflowerCircle, Yardley, Pennsylvania 19067, US  
PATERSON, Yvonne, 1425 Locust St. Unit 11C, Philadelphia, Pennsylvania 19102, US

(51) MKP  
**A61K 39/395 2006 (97) EP 3349794**  
**C07K 16/28 2006**  
(96) EP 16847356.9 9/16/2016  
(97) EP 3349794, 7/25/2018 201830, en  
(31) 201562219578 P (32) 16.09.2015 (33) US  
201562220147 P 17.09.2015 US  
(54) ANTI-CD115 ANTIBODIES  
(71) Ablexis, LLC, 533 Airport Boulevard Suite 400, Burlingame, California 94010, US  
(72) LIPPINCOTT, John, c/o Ablexis LLC 533 Airport Boulevard Suite 400, Burlingame, California 94010, US  
DUEY, Dana, c/o Ablexis LLC 533 Airport Boulevard Suite 400, Burlingame, California 94010, US

(51) MKP  
**A61K 39/395 2006 (97) EP 3349796**  
**C07K 16/28 2006**  
**C07K 16/30 2006**  
**C07K 16/46 2006**  
(96) EP 16847437.7 9/16/2016  
(97) EP 3349796, 7/25/2018 201830, en  
(31) 201562220028 P (32) 17.09.2015 (33) US  
201562242669 P 16.10.2015 US  
201562250756 P 04.11.2015 US  
(54) THERAPEUTIC COMBINATIONS COMPRISING ANTI-FOLR1 IMMUNOCONJUGATES



(72) PONTE, Jose, 83 Cottage Lane, Weymouth, Massachusetts 02188, US  
PINKAS, Jan, 397 Pleasant Street, Belmont, Massachusetts 02478, US  
RUIZ-SOTO, Rodrigo R., 1 SaintGeorge Street Apartment 4A, Boston, Massachusetts 02118, US

---

(51) MKP  
**A61K 31/16 2006 (97) EP 3350158**  
**C07C 233/55 2006**  
**C07C 233/63 2006**  
**C07C 255/60 2006**  
**C07D 305/06 2006**  
**C07D 309/06 2006**

(96) EP 16847451.8 9/16/2016  
(97) EP 3350158, 7/25/2018 201830, en  
(31) 201562219422 P (32) 16.09.2015 (33) US

(54) FARNESOID X RECEPTOR AGONISTS AND USES THEREOF  
(71) Metacrine, Inc., 3985 Sorrento Valley Blvd., Suite C, San Diego, CA 92121, US  
(72) SMITH, Nicholas D., 1204 Beryl Street, San Diego, California 92109, US  
GOVEK, Steven P., 13216 Via Santillana, San Diego, California 92129, US  
NAGASAWA, Johnny Y., 15083 Barolo Court, San Diego, California 92127, US

---

(51) MKP  
**A61K 31/16 2006 (97) EP 3350165**  
**A61K 31/4412 2006**  
**A61K 31/4418 2006**  
**C07D 207/12 2006**  
**C07D 213/63 2006**

(96) EP 16847452.6 9/16/2016  
(97) EP 3350165, 7/25/2018 201830, en  
(31) 201562219430 P (32) 16.09.2015 (33) US

(54) FARNESOID X RECEPTOR AGONISTS AND USES THEREOF  
(72) SMITH, Nicholas D., 1204 Beryl Street, San Diego, California 92109, US  
GOVEK, Steven P., 13216 Via Santillana, San Diego, California 92129, US  
NAGASAWA, Johnny Y., 15083 Barolo Court, San Diego, California 92127, US

---

(51) MKP  
**A61K 31/4418 2006 (97) EP 3350164**  
**A61K 31/4465 2006**  
**C07C 233/55 2006**  
**C07C 233/63 2006**  
**C07D 211/10 2006**  
**C07D 213/04 2006**  
**C07D 213/06 2006**

(96) EP 16847455.9 9/16/2016  
(97) EP 3350164, 7/25/2018 201830, en  
(31) 201562219427 P (32) 16.09.2015 (33) US  
201662333560 P 09.05.2016 US

(54) FARNESOID X RECEPTOR AGONISTS AND USES THEREOF  
(72) SMITH, Nicholas D., 1204 Beryl Street, San Diego, California 92109, US  
GOVEK, Steven P., 13216 Via Santillana, San Diego, California 92129, US  
DOUGLAS, Karen L., 14954 Avenida Venusto, No. 92, San Diego, California 92128, US

---

(51) MKP  
**A61K 31/404 2006 (97) EP 3350166**  
**A61K 31/44 2006**  
**A61K 31/444 2006**  
**A61K 31/47 2006**  
**C07D 213/72 2006**  
**C07D 213/75 2006**  
**C07D 217/12 2006**  
**C07D 401/12 2006**

(96) EP 16847456.7 9/16/2016  
(97) EP 3350166, 7/25/2018 201830, en  
(31) 201562219428 P (32) 16.09.2015 (33) US

(54) FARNESOID X RECEPTOR AGONISTS AND USES THEREOF  
(72) SMITH, Nicholas D., 1204 Beryl Street, San Diego, California 92109, US  
GOVEK, Steven P., 13216 Via Santillana, San Diego, California 92129, US

---

(51) MKP  
**A61K 39/00 2006 (97) EP 3349789**  
**A61K 39/02 2006**  
**A61K 48/00 2006**  
(96) EP 16847487.2 9/16/2016  
(97) EP 3349789, 7/25/2018 201830, en  
(31) 201562219961 P (32) 17.09.2015 (33) US  
(54) RECOMBINANT LISTERIA VACCINE STRAINS AND METHODS OF USING THE SAME IN CANCER IMMUNOTHERAPY  
(72) PETIT, Robert, 149 Parsons Lane, Newtown, Pennsylvania 18940, US  
MAURO, David J., 36 Terrell Drive, Washington Crossing, Pennsylvania 18977, US

---

(51) MKP  
**A61K 31/282 2006 (97) EP 3350196**  
**A61K 33/24 2006**  
**C07J 9/00 2006**  
(96) EP 16847559.8 9/19/2016  
(97) EP 3350196, 7/25/2018 201830, en  
(31) 201562219998 P (32) 17.09.2015 (33) US  
(54) CARBORANE COMPOUNDS AND METHODS OF USE THEREOF  
(71) Institute of Molecular Genetics of ASCR, v.v.i., Videnska 1083, 142 20 Prague 4, CZ  
(72) TJARKS, Werner, 624 S. Lazelle Street, Columbus, Ohio 43206, US  
BARTUNEK, Petr, Dusni 1, 110 00 Prague 1, CZ  
SEDLAK, David, Bubenska 17, 170 00 Prague 7, CZ

---

(51) MKP  
**C02F 1/32 2006 (97) EP 3398400**  
**H05B 3/00 2006**  
(96) EP 16847601.8 12/28/2016  
(97) EP 3398400, 11/7/2018 201845, en  
(31) UB20159319 (32) 29.12.2015 (33) IT  
(54) TUBULAR CONCENTRATOR FOR CONCENTRIC RADIATION OF ELECTROMAGNETIC WAVES  
(71) Rupnik, Carlo, Ulica Ive Lole Ribara 14, Becici 85316 Budva, ME  
(72) Rupnik, Carlo, Ulica Ive Lole Ribara 14, Becici 85316 Budva, ME

---

(51) MKP  
**A61K 31/427 2006 (97) EP 3353175**  
**A61P 31/04 2006**  
**C07D 417/14 2006**  
(96) EP 16848099.4 9/20/2016  
(97) EP 3353175, 8/1/2018 201831, en  
(31) 201562222430 P (32) 23.09.2015 (33) US  
(54) SALTS AND SOLID FORMS OF MONOBACTAM ANTIBIOTIC  
(72) AUBIN, Eric, Novartis Pharma AG St. Johann Postfach Forum 1 Novartis Campus, 4056 Basel, CH  
FISCH, Andreas, Novartis Pharma AG WSJ-340.8.69A Novartis Campus, 4056 Basel, CH  
MUTZ, Michael, Novartis Pharma AG Werk Klybeck Postfach, 4002 Basel, CH  
RIEBESEHL, Bernd Ulrich, Novartis Pharma AG Postfach, 4002 Basel, CH  
SCHOENHENTZ, Marc, Novartis Pharma AG St. Johann Postfach Forum 1 Novartis Campus, 4056 Basel, CH  
CASAREZ, Anthony, Novartis Institutes for BioMedical Research Inc. 5300 Chiron Way, Emeryville, CA 94608, US  
LI, Zaixing, Beijing Novartis Pharma Co. Ltd. China 4218 Jinke Road Zhangjiang Hi-Tech Park Pudong New Area, Shanghai 201203, CN  
LINDVALL, Mika, Novartis Institutes for BioMedical Research Inc. 5300 Chiron Way, Emeryville, CA 94608, US  
MOSER, Heinz Ernst, Novartis Institutes for BioMedical Research Inc. 5300 Chiron Way, Emeryville, CA 94608, US  
RECK, Folkert, Novartis Institutes for BioMedical Research Inc. 5300 Chiron Way, Emeryville, CA 94608, US  
SETHURAMAN, Vijay, Novartis Institutes for BioMedical Research Inc. 5300 Chiron Way, Emeryville, CA 94608, US  
SIMMONS, Robert Lowell, Novartis Institutes for BioMedical Research Inc. 5300 Chiron Way, Emeryville, CA 94608, US

---

(51) MKP  
**C04B 35/528 2006 (97) EP 3353841**  
**C04B 35/63 2006**

**C04B 35/632 2006**  
**H01M 4/36 2006**  
**H01M 4/587 2010**  
**H01M 10/052 2010**  
**H01M 10/0568 2010**  
**H01M 10/0569 2010**  
(96) EP 16849358.3 9/14/2016  
(97) EP 3353841, 8/1/2018 201831, en  
(31) 201510608018 (32) 22.09.2015 (33) CN  
201615262407 12.09.2016 US  
(54) METHOD OF PREPARING AND APPLICATION OF CARBON-SELENIUM COMPOSITES  
(71) Institute of Chemistry, Chinese Academy of Science, No. 2 Zhongguancun North First Street Haidian District, Beijing 100190, CN  
(72) GUO, Yu-Guo, No. 4-701 Building 956 Zhongguancun Third South Street Haidian District, Beijing Hebei 100190, CN  
ZHANG, Shuaifeng, Room 405 Building 5 ICCAS Zhongguancun North First Street 2 Haidian District, Beijing Hebei 100190, CN  
YIN, Yaxia, No. 1-402 Building 7 Yuhuixili Xiaoying Road Chaoyang District, Beijing Hebei 100101, CN

---

(51) MKP  
**A61K 38/44 2006 (97) EP 3352781**  
**C12N 1/20 2006**  
(96) EP 16849385.6 9/19/2016  
(97) EP 3352781, 8/1/2018 201831, en  
(31) 201562222304 P (32) 23.09.2015 (33) US  
201662302452 P 02.03.2016 US  
(54) 4'-SUBSTITUTED NUCLEOSIDE REVERSE TRANSCRIPTASE INHIBITORS AND PREPARATIONS THEREOF  
(72) GIRIJAVALLABHAN, Vinay, M., 126 East Lincoln Avenue, Rahway, New Jersey 07065-0907, US  
MCLAUGHLIN, Mark, 126 East Lincoln Avenue, Rahway, New Jersey 07065-0907, US  
CLEATOR, Edward, Hertford Road, Hoddesdon Hertfordshire EN11 9BU, GB  
KONG, Jongrock, 126 East Lincoln Avenue, Rahway, New Jersey 07065-0907, US  
GIBSON, Andrew William, Hertford Road, Hoddesdon Hertfordshire EN11 9BU, GB  
LIEBERMAN, David, R., Hertford Road, Hoddesdon Hertfordshire EN11 9BU, GB  
DIEGUEZ VAZQUEZ, Alejandro, Hertford Road, Hoddesdon Hertfordshire EN11 9BU, GB  
KEEN, Stephen Philip, Hertford Road, Hoddesdon Hertfordshire EN11 9BU, GB  
WILLIAMS, Michael, J., 126 East Lincoln Avenue, Rahway, New Jersey 07065-0907, US  
MOORE, Jeffrey, C., 126 East Lincoln Avenue, Rahway, New Jersey 07065-0907, US  
MILCZEK, Erika, M., 107 Thompson Street, Apt. 2C, New York, New York 10012, US  
PENG, Feng, 126 East Lincoln Avenue, Rahway, New Jersey 07065-0907, US  
BELYK, Kevin, M., 126 East Lincoln Avenue, Rahway, New Jersey 07065-0907, US  
SONG, Zhiguo Jake, 126 East Lincoln Avenue, Rahway, New Jersey 07065-0907, US

---

(51) MKP  
**A61K 39/145 2006 (97) EP 3353192**  
**A61K 39/39 2006**  
**C07K 14/005 2006**  
**C12N 9/24 2006**  
**C12N 15/63 2006**  
(96) EP 16849471.4 9/21/2016  
(97) EP 3353192, 8/1/2018 201831, en  
(31) 201562221336 P (32) 21.09.2015 (33) US  
(54) DESIGN AND CHARACTERIZATION OF INFLUENZA VACCINES  
(71) Oregon Health & Science University, 2525 SW First Avenue, Portland, Oregon 97201, US  
(72) ROSS, Ted Milburn, 1070 Churchill Lane, Watkinsville, Georgia 30677, US  
WONG, Terianne Maiko, 116 Ashley Circle Apt. 1, Athens, Georgia 30605, US  
CARTER, Donald Martin, Jr., 1191 Beverly Drive, Athens, Georgia 30606, US

---

(51) MKP  
**A61K 31/56 2006 (97) EP 3352768**  
**A61K 31/58 2006**  
**A61K 31/79 2006**  
(96) EP 16849506.7 9/21/2016  
(97) EP 3352768, 8/1/2018 201831, en  
(31) 201562221324 P (32) 21.09.2015 (33) US  
(54) METHODS OF PROMOTING HEPATIC REGENERATION

(72) JANSSEN, Peter Leonardus Maria, Rijksweg 21, 9752 AA Haren, NL  
OLDE DAMINK, Stephanus Willibroodus Maria, Groot Welsden 45, 6269 ET Margraten, NL  
SCHAAP, Franciscus Gerardus, Boschweg 2-A, 6241 EL Bunde, NL  
LECLERO, Isabelle Anne, Avenue Général Lartigue, 1200 Brussels, BE

---

(51) MKP  
**A61K 31/47 2006 (97) EP 3352757**  
**C07D 215/56 2006**

(96) EP 16849524.0 9/21/2016

(97) EP 3352757, 8/1/2018 201831, en

(31)	201562221531 P	(32)	21.09.2015	(33)	US
	201562238511 P		07.10.2015		US
	201662348855 P		10.06.2016		US

(54) ADMINISTRATION OF DEUTERATED CFTR POTENTIATORS

(71) Vertex Pharmaceuticals (Europe) Limited, 86-88 Jubilee Avenue, Milton Park Abingdon, Oxfordshire OX14 4RW, GB

(72) BRAMAN, Virginia, 171 Swanton Street Unit 52, Winchester, MA 01890, US

---

(51) MKP  
**C07K 14/705 2006 (97) EP 3353197**  
**C07K 14/725 2006**  
**C07K 19/00 2006**

(96) EP 16849585.1 9/22/2016

(97) EP 3353197, 8/1/2018 201831, en

(31)	201562222132 P	(32)	22.09.2015	(33)	US
	201562253790 P		11.11.2015		US

(54) METHOD OF REDIRECTING T CELLS TO TREAT HIV INFECTION

(71) The Trustees of The University of Pennsylvania, 3160 Chestnut Street, Suite 200, Philadelphia, PA 19104, US

(72) RILEY, James L., 435 Creekside Drive, Downingtown, Pennsylvania 19335, US

LEIBMAN, Rachel, 2417 Madison Square, Philadelphia, Pennsylvania 19146, US

PAYNE, Aimee S., 536 Hamilton Road, Merion Station, Pennsylvania 19066, US

ELLEBRECHT, Christoph T., 415 S. 13th Street, Philadelphia, Pennsylvania 19147, US

MILONE, Michael C., 314 Surrey Road, Cherry Hill, New Jersey 08002, US

---

(51) MKP  
**A61K 31/20 2006 (97) EP 3352749**  
**A61K 47/34 2017**

(96) EP 16849641.2 9/22/2016

(97) EP 3352749, 8/1/2018 201831, en

(31)	201562222095 P	(32)	22.09.2015	(33)	US
------	----------------	------	------------	------	----

(54) COMPOUNDS AND COMPOSITIONS FOR THE TREATMENT OF OCULAR DISORDERS

(71) Graybug Vision, Inc., 275 Shoreline Drive Suite 450, Redwood City, CA 94065, US

(72) CLELAND, Jeffrey, L., c/o Graybug Vision Inc. 275 Shoreline Drive Suite 450, Redwood City, CA 94065, US

YANG, Ming, c/o Graybug Vision Inc. 275 Shoreline Drive Suite 450, Redwood City, CA 94065, US

BAUMAN, John, c/o Graybug Vision Inc. 275 Shoreline Drive Suite 450, Redwood City, CA 94065, US

HOANG, Nu, c/o Graybug Vision Inc. 275 Shoreline Drive Suite 450, Redwood City, CA 94065, US

CUNNINGHAM, Emmett, c/o Graybug Vision Inc. 275 Shoreline Drive Suite 450, Redwood City, CA 94065, US

---

(51) MKP  
**A61K 31/435 2006 (97) EP 3352758**  
**A61K 31/47 2006**  
**A61K 31/4704 2006**  
**A61K 31/472 2006**  
**A61P 11/12 2006**  
**C07D 215/00 2006**  
**C07D 215/16 2006**  
**C07D 215/56 2006**  
**C07D 471/04 2006**

(96) EP 16849692.5 9/23/2016

(97) EP 3352758, 8/1/2018 201831, en

(31)	201562232834 P	(32)	25.09.2015	(33)	US
------	----------------	------	------------	------	----

(54) DEUTERATED CFTR POTENTIATORS

(72) MORGAN, Adam, J., C/o Concert Pharmaceuticals Inc. 99 Hayden Avenue Suite 500, Lexington, MA 02421, US

TUNG, Roger, D., 3 Burnham Road, Lexington, MA 02420, US

---

(51) MKP  
**A61K 31/7088 2006 (97) EP 3353328**  
**C07H 21/04 2006**  
**C12N 15/113 2010**  
**C12Q 1/68 2018**

(96) EP 16849701.4 9/23/2016  
(97) EP 3353328, 8/1/2018 201831, en

(31) 201562232120 P (32) 24.09.2015 (33) US

(54) MODULATORS OF KRAS EXPRESSION  
(72) REVENKO, Alexey, 2855 Gazelle Ct., Carlsbad, CA 92010, US  
FREIER, Susan M., 2855 Gazelle Ct., Carlsbad, CA 92010, US  
MACLEOD, Robert A., 2855 Gazelle Ct., Carlsbad, CA 92010, US

---

(51) MKP  
**C07C 281/16 2006 (97) EP 3353153**  
**C07D 223/14 2006**

(96) EP 16849738.6 9/23/2016  
(97) EP 3353153, 8/1/2018 201831, en

(31) 201562232626 P (32) 25.09.2015 (33) US

(54) THE TOTAL SYNTHESIS OF GLUCOSEPANE AND COMPOUNDS OBTAINED THEREFROM  
(72) SPIEGEL, David, 94 Morris Cove Road, New Haven, CT 06512, US

---

(51) MKP  
**A61K 31/575 2006 (97) EP 3353189**  
**A61P 1/16 2006**  
**A61P 9/10 2006**  
**A61P 13/12 2006**  
**C07J 9/00 2006**  
**C07J 31/00 2006**

(96) EP 16849770.9 9/23/2016  
(97) EP 3353189, 8/1/2018 201831, en

(31) 201562222943 P (32) 24.09.2015 (33) US

(54) METHODS AND INTERMEDIATES FOR THE PREPARATION BILE ACID DERIVATIVES  
(72) SCHAAB, Kevin, 4275 Orchard Drive, Spring Valley, CA 91977, US  
WHITLEY, Paul, E., 590 Throne Dr. 362, Eugene, OR 97402, US  
CHAVEZ, Flavio, 1700 Jefferson Drive, Florence, SC 29501, US  
IORGA, Kayla, R., 2825 Stamey Livestock Road, Dalzell, SC 29040, US

---

(51) MKP  
**A61K 31/496 2006 (97) EP 3352761**  
**A61K 31/5377 2006**

(96) EP 16849837.6 9/26/2016  
(97) EP 3352761, 8/1/2018 201831, en

(31) 201562233146 P (32) 25.09.2015 (33) US  
201562252188 P 06.11.2015 US

(54) METHOD OF TREATING MALIGNANT RHABDOID TUMOR OF THE OVARY (MRTO)/SMALL CELL CANCER OF THE OVARY OF THE  
HYPERCALCEMIC TYPE (SCCOHT) WITH AN EZH2 INHIBITOR  
(72) KEILHACK, Heike, 3 Falmouth Street, Belmont, Massachusetts 02478, US

---

(51) MKP  
**C07B 53/00 2006 (97) EP 3357901**  
**C07B 61/00 2006**  
**C07C 51/09 2006**  
**C07C 57/58 2006**

(96) EP 16851813.2 9/29/2016  
(97) EP 3357901, 8/8/2018 201832, en

(31) 2015194284 (32) 30.09.2015 (33) JP

(54) METHOD FOR PRODUCING OPTICALLY ACTIVE 2-(2-FLUOROBIPHENYL-4-YL) PROPANOIC ACID  
(72) OTAKE, Norikazu, c/o Taisho Pharmaceutical Co. Ltd. 24-1 Takada 3-chome Toshima-ku, Tokyo 170-8633, JP  
MATSUDA, Daisuke, c/o Taisho Pharmaceutical Co. Ltd. 24-1 Takada 3-chome Toshima-ku, Tokyo 170-8633, JP

---

SHIMONO, Rie, c/o Taisho Pharmaceutical Co. Ltd. 24-1 Takada 3-chome Toshima-ku, Tokyo 170-8633, JP  
TABUSE, Hideaki, c/o Taisho Pharmaceutical Co. Ltd. 24-1 Takada 3-chome Toshima-ku, Tokyo 170-8633, JP  
MORIYA, Minoru, c/o Taisho Pharmaceutical Co. Ltd. 24-1 Takada 3-chome Toshima-ku, Tokyo 170-8633, JP  
KOBASHI, Yohei, c/o Taisho Pharmaceutical Co. Ltd. 24-1 Takada 3-chome Toshima-ku, Tokyo 170-8633, JP  
MATSUDA, Yohei, c/o Taisho Pharmaceutical Co. Ltd. 24-1 Takada 3-chome Toshima-ku, Tokyo 170-8633, JP  
TAMAOKI, Tomokazu, c/o Taisho Pharmaceutical Co. Ltd. 24-1 Takada 3-chome Toshima-ku, Tokyo 170-8633, JP

---

(51) MKP  
**B65D 85/00 2006 (97) EP 3357837**  
**B65D 88/00 2006**  
**F17C 13/00 2006**  
(96) EP 16852167.2 9/30/2016  
(97) EP 3357837, 8/8/2018 201832, en  
(31) 2015141773 (32) 01.10.2015 (33) RU  
(54) PALLET FOR CYLINDERS, METHOD FOR ARRANGING CYLINDERS IN A PALLET, AND PALLET WITH CYLINDERS  
(71) Sorokin, Konstantin Vladimirovich, Olimpiyskiy Prospect, 22-58, Moscow 129110, RU  
(72) KLUNIN, Oleg Stanislavovich, der. Staraya 2a, Vsevolozhskiy r-n Leningradskaya obl. 188680, RU  
BOGACHEK, Oleg Evgenievich, Nevskiy pr-kt 62 litera A, St.Petersburg 191023, RU

---

(51) MKP  
**G01N 33/543 2006 (97) EP 3356833**  
**G01N 33/94 2006**  
(96) EP 16852398.3 9/27/2016  
(97) EP 3356833, 8/8/2018 201832, en  
(31) 201562235194 P (32) 30.09.2015 (33) US  
(54) ANTIBODIES THAT BIND HUMAN CANNABINOID 1 (CB1) RECEPTOR  
(71) BIRD ROCK BIO, INC., 2223 Avenida de la Playa, Suite 205, La Jolla, CA 92037, US  
(72) KRETZ-ROMMEL, Anke, 4535 Kensington Drive, San Diego, CA 92116, US  
FERRINI, Roger, 325 S. Sierra Avenue 23, Solana Beach, CA 92075, US

---

(51) MKP  
**A61K 9/00 2006 (97) EP 3355954**  
**A61M 5/00 2006**  
(96) EP 16852411.4 9/27/2016  
(97) EP 3355954, 8/8/2018 201832, en  
(31) 201562234340 P (32) 29.09.2015 (33) US  
(54) DELIVERY METHODS AND COMPOSITIONS  
(71) Agenovir Corporation, 329 Oyster Point Boulevard 3rd Floor, South San Francisco, California 94080, US  
(72) QUAKE, Stephen, R., c/o Agenovir Corporation 329 Oyster Point Boulevard 3rd Floor, South San Francisco, CA 94080, US

---

(51) MKP  
**C12N 9/14 2006 (97) EP 3356528**  
**C12N 9/22 2006**  
**C12N 15/11 2006**  
**C12N 15/63 2006**  
(96) EP 16852413.0 9/27/2016  
(97) EP 3356528, 8/8/2018 201832, en  
(31) 201562234345 P (32) 29.09.2015 (33) US  
(54) COMPOSITIONS AND METHODS FOR LATENT VIRAL TRANSCRIPTION REGULATION  
(72) QUAKE, Stephen, R., C/o Agenovir Corporation 329 Oyster Point Boulevard 3rd Floor, South San Francisco, CA 94080, US

---

(51) MKP  
**A61K 31/495 2006 (97) EP 3355991**  
**A61K 31/522 2006**  
**A61P 31/14 2006**  
(96) EP 16852646.5 9/29/2016  
(97) EP 3355991, 8/8/2018 201832, en  
(31) 201562234408 P (32) 29.09.2015 (33) US  
201662299338 P 24.02.2016 US  
201662353708 P 23.06.2016 US  
201662365541 P 22.07.2016 US

(54) COMBINATION THERAPY REGIMEN FOR TREATMENT OF HCV  
 (72) BEUMONT, Maria Gloria, c/o Janssen-Cilag 1 Rue Camille Desmoulins TSA 91003, 92787 Issy-les-Moulineaux Cedex 9, FR  
 BIJNENS, Lieve, c/o Janssen Pharmaceutica NV Turnhoutseweg 30, B-2340 Beerse, BE  
 BLATT, Lawrence, M., c/o Alios Biopharma Inc. 260 E. Grand Avenue 2nd Floor, San Francisco, CA 94080, US  
 CHANDA, Sushmita, Mukherjee, c/o Alios Biopharma Inc. 260 E. Grand Avenue 2nd Floor, San Francisco, CA 94080, US  
 FRY, John, c/o Alios Biopharma Inc. 260 E. Grand Avenue 2nd Floor, San Francisco, CA 94080, US  
 JANS, Eugene, c/o Janssen Pharmaceutica NV Turnhoutseweg 30, B-2340 Beerse, BE  
 KAKUDA, Thomas, Naoki, c/o Alios Biopharma Inc. 260 E. Grand Avenue 2nd Floor, San Francisco, CA 94080, US  
 MAHADEVAN, Sivi, c/o Janssen Pharmaceutica NV Turnhoutseweg 30, B-2340 Beerse, BE  
 MERTENS, Roel, c/o Janssen Pharmaceutica NV Turnhoutseweg 30, B-2340 Beerse, BE  
 PICCHIO, Gaston, Rafael, c/o Janssen Research&Development LLC 920 US Route 202 P.O. Box 300, Raritan, NJ 08869, US  
 VAN DIJCK, Alex, c/o Janssen Pharmaceutica NV Turnhoutseweg 30, B-2340 Beerse, BE  
 VAN REMOORTERE, Peter, c/o Janssen Research&Development LLC 920 US Route 202 P.O. Box 300, Raritan, NJ 08869, US  
 APELIAN, David, c/o Achillion Pharmaceuticals Inc. 300 George Street, New Haven, CT 06511, US  
 CHEN, Dawei, c/o Achillion Pharmaceuticals Inc. 300 George Street, New Haven, CT 06511, US  
 DESHPANDE, Milind, c/o Achillion Pharmaceuticals Inc. 300 George Street, New Haven, CT 06511, US  
 HUI, James, c/o Achillion Pharmaceuticals Inc. 300 George Street, New Haven, CT 06511, US  
 PHADKE, Avinash, c/o Achillion Pharmaceuticals Inc. 300 George Street, New Haven, CT 06511, US

---

(51) MKP  
**A61K 31/4439 2006 (97) EP 3355890**  
**A61K 31/519 2006**  
**C07D 405/12 2006**  
 (96) EP 16852664.8 9/30/2016  
 (97) EP 3355890, 8/8/2018 201832, en  
 (31) 201562235754 P (32) 01.10.2015 (33) US  
 (54) HUMAN PLASMA KALLIKREIN INHIBITORS  
 (72) KOTIAN, Pravin, L., 1139 Magnolia Run, Hoover, AL 35226, US  
 BABU, Yarlagadda, S., 4836 Southlake Parkway, Birmingham, AL 35244, US  
 KUMAR, V., Satish, 809 Mayapple Court, Birmingham, AL 35244, US  
 ZHANG, Weihe, 2645 Manchester Court, Vestavia, AL 35226, US  
 VOGETI, Lakshminarayana, 905 Congressional Drive, Lawrence, KS 66049, US

---

(51) MKP  
**A61K 39/395 2006 (97) EP 3355921**  
**A61P 1/00 2006**  
**A61P 37/00 2006**  
 (96) EP 16852679.6 9/30/2016  
 (97) EP 3355921, 8/8/2018 201832, en  
 (31) 201562234812 P (32) 30.09.2015 (33) US  
 (54) ANTAGONISTIC ANTIBODIES SPECIFICALLY BINDING HUMAN CD40 AND METHODS OF USE  
 (72) BABBE, Holger, 1400 McKean Road, Spring House, Pennsylvania 19477, US  
 FELIX, Nathan, 1400 McKean Road, Spring House, Pennsylvania 19477, US  
 FRANSSON, Johan, 101 College Street TMDT 11-301, Toronto, Ontario M5G 1L7, CA  
 KIM, Paul, 3210 Merryfield Row, San Diego, California 92121, US  
 SCULLY, Michael, 1400 McKean Road, Spring House, California 19477, US  
 ZHOU, Hong, 3210 Merryfield Row, San Diego, California 92121, US

---

(51) MKP  
**C12N 15/113 2010 (97) EP 3356529**  
 (96) EP 16852695.2 9/30/2016  
 (97) EP 3356529, 8/8/2018 201832, en  
 (31) 201562235816 P (32) 01.10.2015 (33) US  
 201662346304 P 06.06.2016 US  
 201662383221 P 02.09.2016 US  
 (54) COMPOSITIONS AND METHODS FOR INHIBITING GENE EXPRESSION OF LPA  
 (71) Arrowhead Pharmaceuticals, Inc., 225 South Lake Avenue Suite 1050, Pasadena, CA 91101, US  
 (72) MELQUIST, Stacey, Arrowhead Pharmaceuticals, Inc. 502 S. Rosa Road, Madison, WI 53719, US  
 KANNER, Steven, Caribou Biosciences, Inc. 2929 7th Street, Suite 105, Berkeley, CA 94710, US  
 ROZEMA, David, B., 4361 Gills Way, Cross Plains, WI 53528, US  
 LEWIS, David, L., 2930 Lakeland Avenue, Madison, WI 53704, US  
 ALMEIDA, Lauren, J., 490 Togstad Glenn, Madison, WI 53711, US  
 WAKEFIELD, Darren, H., 5236 Stoneman Drive, Fitchburg, WI 53711, US

TRUBETSKOY, Vladimir, S., 7435 Hunters Court., Middleton, WI 53562, US  
PEI, Tao, Arrowhead Pharmaceuticals 502 S. Rosa Road Suite C, Madison, WI 53719, US  
LI, Zhen, Arrowhead Pharmaceuticals, Inc. 502 S. Rosa Road, Madison, WI 53719, US  
ALMEIDA, Aaron, 490 Togstad Glenn., Madison, WI 57311, US

---

(51) MKP  
**A61K 39/395 2006 (97) EP 3356532**  
**A61P 35/00 2006**  
**A61P 35/02 2006**  
**C12N 15/13 2006**  
(96) EP 16852707.5 9/30/2016  
(97) EP 3356532, 8/8/2018 201832, en  
(31) 201562234812 P (32) 30.09.2015 (33) US  
(54) AGONISTIC ANTIBODIES SPECIFICALLY BINDING HUMAN CD40 AND METHODS OF USE  
(72) FRANSSON, Johan, 101 College Street TMDT 11-301, Toronto, Ontario M5G 1L7, CA  
KIM, Paul, 1400 McKean Road, Spring House, Pennsylvania 19477, US  
QUIGLEY, Michael, 142 Swedesford Road, Ambler, Pennsylvania 19002, US  
SMITH, Andressa, 1400 McKean Road, Spring House, Pennsylvania 19477, US  
TEPLYAKOV, Alexey, 65 Sheffield Court, Phoenixville, Pennsylvania 19460, US  
ZHOU, Hong, 3210 Merryfield Row, San Diego, California 92121, US

---

(51) MKP  
**C07K 14/525 2006 (97) EP 3356561**  
**C07K 14/54 2006**  
**C07K 16/28 2006**  
**C12Q 1/68 2018**  
**G01N 33/50 2006**  
(96) EP 16852729.9 9/30/2016  
(97) EP 3356561, 8/8/2018 201832, en  
(31) 201562236514 P (32) 02.10.2015 (33) US  
(54) THERAPEUTIC AND DIAGNOSTIC METHODS FOR AUTOIMMUNE DISEASES AND/OR INFLAMMATION  
(71) Momenta Pharmaceuticals, Inc., 301 Binney Street, Cambridge, MA 02142, US  
(72) WASHBURN, Nathaniel, 675 West Kendall Street, Cambridge, MA 02412, US  
HALVEY, Patrick, 675 West Kendall Street, Cambridge, MA 02142, US  
MCCONNELL, Kevin, 675 West Kendall Street, Cambridge, MA 02142, US  
FARUTIN, Victor, 675 West Kendall Street, Cambridge, MA 02142, US  
CAPILA, Ishan, 675 West Kendall Street, Cambridge, MA 02142, US  
LING, Leona, E., 675 West Kendall Street, Cambridge, MA 02142, US  
MANNING, Anthony, 675 West Kendall Street, Cambridge, MA 02142, US

---

(51) MKP  
**C12N 15/09 2006 (97) EP 3356525**  
**C12N 15/11 2006**  
**C12N 15/63 2006**  
**C12N 15/67 2006**  
**C12Q 1/68 2018**  
(96) EP 16852823.0 10/3/2016  
(97) EP 3356525, 8/8/2018 201832, en  
(31) 201562236477 P (32) 02.10.2015 (33) US  
201562263404 P 04.12.2015 US  
(54) COMPOSITIONS FOR ADJUSTABLE RIBOSOME TRANSLATION SPEED AND METHODS OF USE  
(71) University of Utah Research Foundation, 615 Arapeen Drive Suite 301, Salt Lake City, UT 84108, US  
(72) HUGHES, Kelly T., 1534 Bryan Avenue, Salt Lake City, Utah 84105, US  
CHEVANCE, Fabienne, 1534 Bryan Avenue, Salt Lake City, Utah 84105, US

---

(51) MKP  
**A61K 48/00 2006 (97) EP 3389724**  
**C07K 14/47 2006**  
(96) EP 16852859.4 12/13/2016  
(97) EP 3389724, 10/24/2018 201843, en  
(31) 201562266789 P (32) 14.12.2015 (33) US  
(54) GENE THERAPY FOR OCULAR DISORDERS



(72) BENNETT, Jean, 182 Fishers Road, Bryn Mawr PA 19010, US  
BENNICELLI, Jeannette, 4602 Springfield Ave., Philadelphia PA 19143, US  
SUN, Junwei, 607 Christian Street, Philadelphia, PA 19147, US

---

(51) MKP  
**A01N 37/46 2006 (97) EP 3360415**  
**A01N 43/10 2006**  
**A01N 43/24 2006**  
**A01N 43/40 2006**  
**A01N 43/42 2006**  
**A01N 43/56 2006**  
**A01N 43/60 2006**  
**A01N 43/653 2006**  
**A01N 43/72 2006**  
**A01N 43/80 2006**  
**A01N 43/90 2006**  
**A01N 47/12 2006**  
**A01P 3/00 2006**

(96) EP 16853637.3 10/5/2016

(97) EP 3360415, 8/15/2018 201833, en

(31) 2015201240 (32) 09.10.2015 (33) JP

(54) AGRICULTURAL AND HORTICULTURAL FUNGICIDAL COMPOSITION

(72) NISHIMURA Satoshi, c/o Odawara Research Center Nippon Soda Co. Ltd. 345 Takada, Odawara-shi Kanagawa 250-0280, JP  
FUJII Takayuki, c/o Odawara Research Center Nippon Soda Co. Ltd. 345 Takada, Odawara-shi Kanagawa 250-0280, JP

---

(51) MKP  
**C07D 211/86 2006 (97) EP 3371175**  
**C07D 405/12 2006**  
**C07D 405/14 2006**

(96) EP 16854241.3 10/5/2016

(97) EP 3371175, 9/12/2018 201837, en

(31) 201562238074 P (32) 06.10.2015 (33) US  
201662299312 P 24.02.2016 US

(54) METHOD OF TREATING MEDULLOBLASTOMA WITH AN EZH2 INHIBITOR

(71) The Regents of the University of Colorado, a body corporate, 1800 Grant Street, 8th Floor, Denver, CO 80203, US

(72) KEILHACK, Heike, 3 Falmouth Street, Belmont, MA 02478, US

WATERS, Nigel, J., 87 Douglas Road, Belmont, MA 02478, US

VIBHAKAR, Rajeev, 9187 East 35th Avenue, Denver, CO 80238, US

---

(51) MKP  
**A61K 35/04 2006 (97) EP 3359192**  
**A61K 39/395 2006**  
**C07K 16/18 2006**  
**C07K 16/28 2006**

(96) EP 16854320.5 10/6/2016

(97) EP 3359192, 8/15/2018 201833, en

(31) 201562239020 P (32) 08.10.2015 (33) US

(54) COMBINATION THERAPY FOR THE TREATMENT OF CANCER

(72) VASSELLI, James, 9704 Medical Center Drive, Rockville, MD 20850, US

WIGGINTON, Jon, Marc, 9704 Medical Center Drive, Rockville, MD 20850, US

BONVINI, Ezio, 11136 Powder Horn Drive, Potomac, MD 20854, US

KOENIG, Scott, 10901 Ralston Road, Rockville, MD 20852, US

---

(51) MKP  
**E02D 17/20 2006 (97) EP 3359745**  
**E02D 29/02 2006**

(96) EP 16854328.8 10/6/2016

(97) EP 3359745, 8/15/2018 201833, en

(31) 201562239416 P (32) 09.10.2015 (33) US

(54) GEOGRID MADE FROM A COEXTRUDED MULTILAYERED POLYMER

(71) Tensar Corporation, LLC, 2500 Northwinds Parkway Suite 500, Alpharetta, Georgia 30009, US

(72) SHELTON, William Stanley, 3526 Fox Hound Run, Lithonia, Georgia 30038-1600, US

TYAGI, Manoj Kumar, 216 Otter Circle, Fayetteville, Georgia 30215, US

---

(51) MKP  
**A61K 31/56 2006 (97) EP 3359160**  
**A61K 31/57 2006**  
**A61K 31/575 2006**  
**C07J 9/00 2006**  
**C07J 43/00 2006**

(96) EP 16854420.3 10/7/2016  
(97) EP 3359160, 8/15/2018 201833, en  
(31) 201562238246 P (32) 07.10.2015 (33) US

(54) FARNESOID X RECEPTOR MODULATORS  
(72) PELLICCIARI, Roberto, via Ulisse Rocchi 60, 06100 Perugia, IT  
GIOIELLO, Antimo, via A. Pesenti 51, 06125 Perugia, IT

---

(51) MKP  
**A61K 31/64 2006 (97) EP 3359162**

(96) EP 16854422.9 10/7/2016  
(97) EP 3359162, 8/15/2018 201833, en  
(31) 201562238461 P (32) 07.10.2015 (33) US

(54) METHODS OF TREATING INJURIES OR CONDITIONS RELATED TO CNS EDEMA  
(72) JACOBSON, Sven Martin, 800 6th Avenue Apt. 17B, New York, New York 10001, US

---

(51) MKP  
**A61K 31/7125 2006 (97) EP 3359668**  
**C07H 21/04 2006**  
**C12N 15/113 2010**

(96) EP 16854468.2 10/7/2016  
(97) EP 3359668, 8/15/2018 201833, en  
(31) 201562239812 P (32) 09.10.2015 (33) US

(54) COMPOSITIONS AND METHODS FOR TREATING DUCHENNE MUSCULAR DYSTROPHY AND RELATED DISORDERS  
(72) DICKSON, George, 12 Tretawn Gardens, London NW7 4NR, GB

---

(51) MKP  
**C12N 5/0789 2010 (97) EP 3359648**  
**C12N 5/0793 2010**

(96) EP 16854481.5 10/7/2016  
(97) EP 3359648, 8/15/2018 201833, en  
(31) 201562238531 P (32) 07.10.2015 (33) US

(54) IN VITRO METHODS OF IDENTIFYING MODULATORS OF NEUROMUSCULAR JUNCTION ACTIVITY  
(72) STUDER, Lorenz, 415 E. 68th Street, New York, NY 10065, US  
STEINBECK, Julius, Hoehenbergstrasse 23, 82340 Feldafing, DE

---

(51) MKP  
**C07F 7/02 2006 (97) EP 3362456**

(96) EP 16856007.6 10/10/2016  
(97) EP 3362456, 8/22/2018 201834, en  
(31) 201514883428 (32) 14.10.2015 (33) US

(54) EXTENDED USE ZIRCONIUM SILICATE COMPOSITIONS AND METHODS OF USE THEREOF  
(71) ZS Pharma, Inc., 508 Wrangler Drive, Suite 100, Coppell, Texas 75019, US  
(72) KEYSER, Donald Jeffrey, 1216 Wyndham Hill Lane, Southlake, Texas 76092, US  
GUILLEM, Alvaro F., 727 Lathrop Street, Lantana, US 76226, US

---

(51) MKP  
**B65H 43/02 2006 (97) EP 3362389**  
**B65H 51/30 2006**  
**G05B 11/01 2006**  
**G05B 11/32 2006**  
**G05B 21/02 2006**  
**G06Q 30/06 2012**  
**G06Q 50/04 2012**

(96) EP 16856037.3 10/11/2016  
(97) EP 3362389, 8/22/2018 201834, en  
(31) 201562240622 P (32) 13.10.2015 (33) US  
(54) DISPOSABLE PRODUCT ASSEMBLY SYSTEMS AND METHODS  
(72) ANDREWS, Robert, E., N7488 Sunset Circle Drive, Sheboygan, WI 53083, US  
FOLLEN, Sean, P., N1985 Ebbers Road Cedar Grove, WI 53013, US

---

(51) MKP  
**A61K 31/415 2006 (97) EP 3373951**  
**A61K 38/08 2006**  
**A61K 38/12 2006**  
**A61P 17/02 2006**  
(96) EP 16856265.0 10/14/2016  
(97) EP 3373951, 9/19/2018 201838, en  
(31) 201562241485 P (32) 14.10.2015 (33) US  
(54) METHODS AND COMPOSITIONS FOR THE TREATMENT OF EPIDERMOLYSIS BULLOSA  
(71) Tarix Pharmaceuticals Ltd., 12 Bow Street, Cambridge, MA 02138, US  
(72) FRANKLIN, Richard, 12 Bow Street, Cambridge, MA 02138, US

---

(51) MKP  
**A61K 31/4439 2006 (97) EP 3362065**  
**C07H 19/06 2006**  
(96) EP 16856274.2 10/14/2016  
(97) EP 3362065, 8/22/2018 201834, en  
(31) 201562242267 P (32) 15.10.2015 (33) US  
201562255253 P 13.11.2015 US  
(54) COMBINATION THERAPY FOR TREATING MALIGNANCIES  
(72) AGRESTA, Samuel, V., 24 Coolidge Road, Lexington, MA 02420, US

---

(51) MKP  
**A61K 31/4439 2006 (97) EP 3362066**  
**A61P 35/00 2006**  
**C07H 19/12 2006**  
(96) EP 16856278.3 10/14/2016  
(97) EP 3362066, 8/22/2018 201834, en  
(31) 201562242282 P (32) 15.10.2015 (33) US  
(54) COMBINATION THERAPY FOR TREATING MALIGNANCIES  
(72) AGRESTA, Samuel, V., 24 Coolidge Road, Lexington, MA 02420, US  
VISWANADHAN, Krishnan, 19 Michael Lane, East Hanover, NJ 07936, US  
DIMARTINO, Jorge, 1610 Fairway Drive, Belmont, CA 94002, US  
CHOPRA, Vivek Saroj, Kumar, 12 Highcrest Lane South, San Francisco, CA 94080, US  
MACBETH, Kyle, J., 1356 Stevenson Street, San Francisco, CA 94103, US  
KNIGHT, Robert, Douglas, 543 Plainfield Avenue, Berkeley Hts., NJ 07922, US  
KENVIN, Laurie, 130 Summerhill Court, New Hope, PA 18938, US  
XU, Qiang, 40 Bernard Drive, Basking Ridge, NJ 07920, US

---

(51) MKP  
**A61K 31/425 2006 (97) EP 3371176**  
**C07D 405/06 2006**  
**C07D 407/06 2006**  
(96) EP 16856299.9 10/14/2016  
(97) EP 3371176, 9/12/2018 201837, en  
(31) 201562242702 P (32) 16.10.2015 (33) US  
(54) EPOTHILONE ANALOGS, METHODS OF SYNTHESIS, METHODS OF TREATMENT, AND DRUG CONJUGATES THEREOF  
(71) William Marsh Rice University, 6100 Main Street, Houston, TX 77005, US  
(72) NICOLAOU, Kyriacos, C., c/o Rice University Dept. Of Chemistry Wiess School Of Natural Sciences Bioscience Research Collaborative (brc) 6500 Main St. MS 602, Houston, TX 77030, US  
RHOADES, Derek, c/o Rice University Dept. Of Chemistry Wiess School Of Natural Sciences Bioscience Research Collaborative (brc) 6500 Main St. MS 602, Houston, TX 77030, US  
WANG, Yanping, c/o Rice University Dept. Of Chemistry Wiess School Of Natural Sciences Bioscience Research Collaborative (brc) 6500 Main St. MS 602, Houston, TX 77030, US  
TOTOKOTSOPOULOS, Sotirios, 538 Alta Vista Lane, Hendersonville, NC 28791, US

---

(51) MKP  
**A61K 9/16 2006 (97) EP 3362053**  
**A61K 9/22 2006**  
**A61K 31/52 2006**  
**A61K 31/522 2006**

(96) EP 16856304.7 10/14/2016  
(97) EP 3362053, 8/22/2018 201834, en

(31) 201562242891 P (32) 16.10.2015 (33) US  
201662332943 P 06.05.2016 US

(54) TREATMENT OF NON-ALCOHOLIC FATTY LIVER DISEASE OR NON-ALCOHOLIC STEATOHEPATITIS WITH DELAYED-RELEASE 6-MERCAPTOPYRIMIDINE

(71) Hadasit Medical Research Services and Development Ltd., Jerusalem BioPark Hadassah Ein Kerem Medical Center P.O. Box 12000, 9112001 Jerusalem, IL

(72) ILAN, Yaron, Hadasit Medical Research Services and Development Ltd. Jerusalem Biopark Hadassah Ein Kerem Medical Center P.O. Box 12000, Jerusalem 9112001, IL  
HAYDEN, Michael, 5 Basel Street P.O. Box 3190, 49131 Petach-Tikva, IL  
ROMAN, Doina, Cosma, 19191 W Lake View Avenue, Mundelein, IL 60060, US  
AMIT-ROMACH, Einat, 8 Yosefzon Street, Rehovot, IL

---

(51) MKP  
**A61K 39/00 2006 (97) EP 3368675**  
**A61K 39/02 2006**  
**A61K 39/12 2006**  
**A61K 39/39 2006**  
**C07K 14/005 2006**  
**C07K 14/195 2006**  
**C12N 15/74 2006**

(96) EP 16856367.4 10/14/2016  
(97) EP 3368675, 9/5/2018 201836, en

(31) 201562241712 P (32) 14.10.2015 (33) US

(54) RECOMBINANT LISTERIA VACCINE STRAINS AND METHODS OF USING THE SAME IN CANCER IMMUNOTHERAPY

(72) PETIT, Robert, 149 Parsons Lane, Newtown, Pennsylvania 18940, US  
PERRY, Kyle, 2233 Town Court North, Lawrenceville, NJ 08648, US

---

(51) MKP  
**A61K 31/453 2006 (97) EP 3362067**  
**A61P 43/00 2006**  
**C07D 311/02 2006**

(96) EP 16856394.8 10/17/2016  
(97) EP 3362067, 8/22/2018 201834, en

(31) 201562242457 P (32) 16.10.2015 (33) US

(54) METHODS AND COMPOSITIONS FOR TREATING TRAUMATIC BRAIN INJURY

(71) Scythian Biosciences Inc., 100 King Street West, Suite 5600, Toronto, Ontario M5X 1C9, CA  
(72) SCHRADER, David A., 411 East 53rd Street 2G, New York, NY 10022, US

---

(51) MKP  
**G01N 33/92 2006 (97) EP 3373014**

(96) EP 16857448.1 10/19/2016  
(97) EP 3373014, 9/12/2018 201837, en

(31) 2015206004 (32) 20.10.2015 (33) JP

(54) DIAGNOSTIC MARKER FOR CORONARY ARTERY DISEASE

(72) ONO, Takashi, c/o Shionogi&Co. Ltd. 1-1 Futabacho 3-chome, Toyonaka-shi Osaka 561-0825, JP  
HAMADA, Tadateru, c/o Shionogi&Co. Ltd. 1-1 Futabacho 3-chome, Toyonaka-shi Osaka 561-0825, JP  
SHIGAKI, Shuhei, c/o Shionogi&Co. Ltd. 1-1 Futabacho 3-chome, Toyonaka-shi Osaka 561-0825, JP  
MORITA, Atsushi, c/o Shionogi&Co. Ltd. 1-1 Futabacho 3-chome, Toyonaka-shi Osaka 561-0825, JP

---

(51) MKP  
**A61B 17/70 2006 (97) EP 3366243**  
**A61B 17/72 2006**

**A61B 17/86 2006**  
**A61F 2/44 2006**  
(96) EP 16857632.0 6/23/2016  
(97) EP 3366243, 8/29/2018 201835, en  
(31) 20150145414 (32) 19.10.2015 (33) KR  
(54) SURGICAL SCREW AND FUSION DEVICE USING SAME  
(71) L & K Biomed Co. Ltd., Daewoo Frontier Valley1, Jungang-dong 201, 16-25 Dongbaekjungang-ro 16beon-gil Giheung-gu, Yongin-si, Gyeonggi-do 17015, KR  
(72) KANG, Gook-Jin, (Songpa-dong Hanyang Apt.) 907 2dong 187 Garak-ro Songpa-gu, Seoul 05664, KR  
CHOI, Sun Kak, (Yangbeol-ri Donga Palace) 102 1dong 238-9 Marudeul-gil Opo-eup, Gwangju-si Gyeonggi-do 12797, KR

---

(51) MKP  
**A61B 17/70 2006 (97) EP 3366244**  
**A61B 17/72 2006**  
**A61B 17/86 2006**  
**A61F 2/44 2006**  
(96) EP 16857633.8 6/23/2016  
(97) EP 3366244, 8/29/2018 201835, en  
(31) 20150145418 (32) 19.10.2015 (33) KR  
(54) SURGICAL SCREW AND FUSION DEVICE USING SAME  
(71) L&K Biomed Co., Ltd., 201 16-25 Dongbaekjungang-ro 16beon-gil Giheung-gu, Yongin-si, Gyeonggi-do 17015, KR  
(72) KANG, Gook-Jin, (Songpa-dong Hanyang Apt.) 907 2dong 187 Garak-ro Songpa-gu, Seoul 05664, KR  
CHOI, Sun Kak, (Yangbeol-ri Donga Palace) 102 1dong 238-9 Marudeul-gil Opo-eup, Gwangju-si Gyeonggi-do 12797, KR

---

(51) MKP  
**A61K 9/08 2006 (97) EP 3354271**  
**A61K 31/737 2006**  
**A61K 35/32 2015**  
**A61K 35/60 2006**  
**A61K 47/10 2017**  
**A61P 19/02 2006**  
(96) EP 16857874.8 10/10/2016  
(97) EP 3354271, 8/1/2018 201831, en  
(31) 2015144704 (32) 19.10.2015 (33) RU  
(54) AGENT FOR TREATING ARTHROLOGICAL DISEASES  
(71) Limited Liability Company "Diamed-Farma", Ul. Sovetskaya 31 Pervomayskiy, Korolev, Moskovskaya obl. 141069, RU  
(72) SHESTAKOV, Vladislav Nikolaevich, ul. Tsyurupy d. 18 korp.1 kv. 72, Moscow 117418, RU  
PERSANOVA, Lyudmila Vasil'evna, Leningradskoe shosse d. 21 kv. 131, Moscow 125171, RU  
SAVEL'EVA, Kristina Romanovna, ul. Metallurgov 171 Kol'chugino, Vladimirskaya obl. 601787, RU  
ANDREEVICHEVA, Tat'yana Yur'evna, Kronshtadskiy bul'var 37 build. 1 app. 36, Moscow 125499, RU

---

(51) MKP  
**A61K 31/375 2006 (97) EP 3366288**  
**A61K 31/4415 2006**  
**A61K 31/51 2006**  
**A61P 25/24 2006**  
(96) EP 16857875.5 10/10/2016  
(97) EP 3366288, 8/29/2018 201835, en  
(31) 2015145777 (32) 23.10.2015 (33) RU  
(54) AGENT EXHIBITING ANTI-STRESS, ANXIOLYTIC AND ANTI-DEPRESSION ACTIVITY, AND COMPOSITION BASED THEREON  
(71) Obshchestvo S Ogranichennoy Otvetstvennostyu "Normfarm", Ul. Lenina d. 3 p. 1N, Respublika Khakasiya, Abaza 655012, RU  
(72) RASTASHANSKIY, Viacheslav Valerievich, ul. Yartsevskaya d. 27 k. 1 kv. 3, Moscow 121552, RU  
OSTRENKO, Konstantin Sergeevich, pr. Lenina d. 160 kv. 78, Kaluzhskaya obl. Obninsk 149034, RU

---

(51) MKP  
**E04B 1/21 2006 (97) EP 3365505**  
**E04B 1/24 2006**  
**E04B 1/41 2006**  
**E04B 1/58 2006**  
**F16B 13/04 2006**  
**F16S 3/00 2006**  
(96) EP 16857892.0 10/6/2016  
(97) EP 3365505, 8/29/2018 201835, en

(31) 10201508699Y (32) 21.10.2015 (33) SG  
(54) SUPPORT APPARATUS AND ITS COMPONENTS  
(71) 2Elms Pte. Ltd., 896 Dunearn Road 03-08 Sime Derby Centre, Singapore 589472, SG  
(72) NG, Wee Beng, 56 Coronation Road West 05-04 Astrid Meadows, Singapore 269269, SG  
WYATT, Gary Donald, 4 Riverpark Drive, Wantirna South, Victoria 3152, AU

---

(51) MKP  
**A61K 31/53 2006 (97) EP 3365336**  
**A61P 35/00 2006**  
**C07D 401/14 2006**  
(96) EP 16857961.3 9/16/2016  
(97) EP 3365336, 8/29/2018 201835, en  
(31) 201562244267 P (32) 21.10.2015 (33) US  
(54) DEUTERATED COMPOUNDS FOR TREATING HEMATOLOGIC MALIGNANCIES, AND COMPOSITIONS AND METHODS THEREOF  
(71) Neufarm Pharmaceuticals, Inc., 1661 Worcester Road Suite 102, Framingham, MA 01701, US  
(72) HUANG, Chaoran, 92 West Pine Street, Auburndale, MA 02466, US  
CHENG, Changfu, 207 Howard Street, Northborough, MA 01532, US

---

(51) MKP  
**A01M 1/00 2006 (97) EP 3370515**  
**C12Q 1/68 2018**  
**G01N 33/50 2006**  
**G01N 33/563 2006**  
**G01N 33/566 2006**  
**G06F 7/00 2006**  
(96) EP 16858381.3 10/21/2016  
(97) EP 3370515, 9/12/2018 201837, en  
(31) 201562244188 P (32) 21.10.2015 (33) US  
(54) BED BUGS DETECTION DEVICE  
(71) Zin, Benedict Louis, 14531 Arroyo Hondo, San Diego, California 92127, US  
(72) HALL, William John, 3586 Horizons Way,, Harrisonburg, Virginia 22802, US  
ZIN, Benedict Louis, 14531 Arroso Hondo,, San Diego California 92127, US  
STURMAN, Andy, 4022 Carmel Springs Way,, San Diego, California 92130, US  
WANG, Min, 9924 Mesa Rim Road,, San Diego, California 92130, US

---

(51) MKP  
**A61K 31/7105 2006 (97) EP 3364980**  
**A61P 31/22 2006**  
**C12N 15/38 2006**  
(96) EP 16858384.7 10/21/2016  
(97) EP 3364980, 8/29/2018 201835, en  
(31) 201562245031 P (32) 22.10.2015 (33) US  
201562245234 P 22.10.2015 US  
201562247697 P 28.10.2015 US  
201662335348 P 12.05.2016 US  
(54) NUCLEIC ACID VACCINES FOR VARICELLA ZOSTER VIRUS (VZV)  
(72) CIARAMELLA, Giuseppe, 1 Hawes Road, Sudbury, MA 01776, US

---

(51) MKP  
**C07K 16/18 2006 (97) EP 3365367**  
**C12N 5/12 2006**  
**C12N 5/20 2006**  
**G01N 33/563 2006**  
**G01N 33/569 2006**  
**G01N 33/577 2006**  
(96) EP 16858386.2 10/21/2016  
(97) EP 3365367, 8/29/2018 201835, en  
(31) 201562244189 P (32) 21.10.2015 (33) US  
(54) ANTI-BED BUG MONOCLONAL ANTIBODIES AND METHODS OF MAKING AND USES THEREOF  
(71) Redcoat Solutions, Inc., 3060 North Valley Pike, Harrisonburg, VI 22802, US  
(72) HALL, William John, 3586 Horizons Way, Harrisonburg, Virginia 22802, US  
WANG, Min, 9924 Mesa Rim Road, San Diego, California 92121, US

(51) MKP  
**A61K 31/7105 2006 (97) EP 3364981**  
**A61K 31/7115 2006**  
**A61K 39/245 2006**  
**A61P 31/22 2006**

(96) EP 16858393.8 10/21/2016  
(97) EP 3364981, 8/29/2018 201835, en

(31) 201562245031 P (32) 22.10.2015 (33) US  
201562245166 P 22.10.2015 US  
201562247614 P 28.10.2015 US

(54) HUMAN CYTOMEGALOVIRUS VACCINE  
(72) CIARAMELLA, Giuseppe, 1 Hawes Road, Sudbury, Massachusetts 01776, US  
JOHN, Shinu, 318 Rindge Avenue Unit 403, Cambridge, Massachusetts 02140, US  
MOUSAVI, Kambiz, 128 Parker Street Unit 4B, Acton, Massachusetts 01720, US

(51) MKP  
**A61K 31/015 2006 (97) EP 3364956**  
**A61K 31/56 2006**  
**A61K 45/06 2006**  
**C07J 63/00 2006**

(96) EP 16858395.3 10/21/2016  
(97) EP 3364956, 8/29/2018 201835, en

(31) 201562245356 P (32) 23.10.2015 (33) US

(54) ANALOGS OF CELASTROL  
(71) ERX Pharmaceuticals, Inc., 53 Fresh Pond Lane, Cambridge, MA 02138, US  
(72) MAZITSCHK, Ralph, 67 Bright Road, Belmont, MA 02478, US  
DING, Yanbing, 4-8071 Bennett Road, Richmond, BC V6T 1N4, CA  
SHEN, Kaisheng, Room 701 Bldg. 11 Lane 635 Pusan Road, Shanghai 200125, CN

(51) MKP  
**A61K 31/7105 2006 (97) EP 3364982**  
**A61K 31/7115 2006**  
**A61K 39/12 2006**  
**A61P 31/14 2006**

(96) EP 16858396.1 10/21/2016  
(97) EP 3364982, 8/29/2018 201835, en

(31) 201562245031 P (32) 22.10.2015 (33) US  
201562244884 P 22.10.2015 US  
201562244822 P 22.10.2015 US  
201562247418 P 28.10.2015 US  
201562247374 P 28.10.2015 US

(54) SEXUALLY TRANSMITTED DISEASE VACCINES  
(72) CIARAMELLA, Giuseppe, 1 Hawes Road, Sudbury, MA 01776, US  
HIMANSU, Sunny, 23 Fernway, Winchester, MA 01890, US

(51) MKP  
**A61K 9/10 2006 (97) EP 3364949**  
**A61K 39/00 2006**  
**A61K 48/00 2006**

(96) EP 16858398.7 10/21/2016  
(97) EP 3364949, 8/29/2018 201835, en

(31) 201562245031 P (32) 22.10.2015 (33) US  
201562245129 P 22.10.2015 US  
201562247472 P 28.10.2015 US  
201562247317 P 28.10.2015 US  
201662368810 P 29.07.2016 US

(54) CANCER VACCINES  
(72) VALIANTE, Nicholas, 70 Norfolk Street, Cambridge, MA 02139, US  
ZAKS, Tal, 122 Bellevue Street, Newton, MA 02458, US  
HUANG, Eric, Yi-Chun, 90 Wareham Street Apartment 302, Boston, MA 02118, US  
CIARAMELLA, Giuseppe, 1 Hawes Road, Sudbury MA 01776, US

---

(51) MKP  
**A61K 9/51 2006 (97) EP 3365007**  
**A61K 39/145 2006**  
**A61P 31/16 2006**

(96) EP 16858400.1 10/21/2016  
(97) EP 3365007, 8/29/2018 201835, en

(31)	201562245031 P	(32)	22.10.2015	(33)	US
	201562245225 P		22.10.2015		US
	201562247501 P		28.10.2015		US
	201562248248 P		29.10.2015		US

(54) BROAD SPECTRUM INFLUENZA VIRUS VACCINE  
(72) CIARAMELLA, Giuseppe, 1 Hawes Road, Sudbury, MA 01776, US  
HUANG, Eric, Yi-Chun, 90 Wareham Street Apartment 302, Boston, MA 02118, US  
BABAOGLU, Kerim, 2209 Wentz Church Road, Lansdale, PA 19446, US  
FLYNN, Jessica, Anne, 1347 Michael Way, Lansdale, PA 19446, US  
ZHANG, Lan, 65 Kulp Road W, Chalfont, PA 18914, US

---

(51) MKP  
**A61K 31/7105 2006 (97) EP 3365008**  
**A61K 31/7115 2006**  
**A61K 39/155 2006**  
**A61P 31/14 2006**

(96) EP 16858402.7 10/21/2016  
(97) EP 3365008, 8/29/2018 201835, en

(31)	201562245208 P	(32)	22.10.2015	(33)	US
	201562245031 P		22.10.2015		US
	201562247563 P		28.10.2015		US
	201562248250 P		29.10.2015		US

(54) RESPIRATORY SYNCYTIAL VIRUS VACCINE  
(72) CIARAMELLA, Giuseppe, 1 Hawes Road, Sudbury, MA 01776, US  
BAHL, Kapil, 4 Ellis Avenue, Medford, MA 02155, US  
ESPESETH, Amy, 219 Holly Drive, Chalfont, PA 18914, US  
WANG, Dai, 204 Hazeltine Circle, Blue Bell, PA 19422, US  
BETT, Andrew, J., 834 Collins Avenue, Lansdale, PA 19446, US

---

(51) MKP  
**A61K 31/7105 2006 (97) EP 3365009**  
**A61K 31/7115 2006**  
**A61K 39/245 2006**  
**A61P 31/22 2006**

(96) EP 16858403.5 10/21/2016  
(97) EP 3365009, 8/29/2018 201835, en

(31)	201562245031 P	(32)	22.10.2015	(33)	US
	201562245159 P		22.10.2015		US
	201562247576 P		28.10.2015		US
	201562248252 P		29.10.2015		US

(54) HERPES SIMPLEX VIRUS VACCINE  
(72) CIARAMELLA, Giuseppe, 1 Hawes Road, Sudbury, MA 01776, US  
JOHN, Shinu, 318 Rindge Avenue Unit 403, Cambridge, MA 02140, US  
BETT, Andrew, J., 834 Collins Avenue, Lansdale, PA 19446, US  
CASIMIRO, Danilo, R., 626 Westbourne Road, Harleysville, PA 19438, US

---

(51) MKP  
**A61K 9/10 2006 (97) EP 3364950**  
**A61K 39/00 2006**  
**A61K 39/12 2006**  
**A61K 48/00 2006**

(96) EP 16858404.3 10/21/2016  
(97) EP 3364950, 8/29/2018 201835, en

(31)	201562244814 P	(32)	22.10.2015	(33)	US
	201562245031 P		22.10.2015		US
	201562244950 P		22.10.2015		US



	201562244937 P		22.10.2015		US
	201562245207 P		22.10.2015		US
	201562247347 P		28.10.2015		US
	201562247595 P		28.10.2015		US
	201562247390 P		28.10.2015		US
	201562247445 P		28.10.2015		US
	201662351255 P		16.06.2016		US
(54)	TROPICAL DISEASE VACCINES				
(72)	CIARAMELLA, Giuseppe, 1 Hawes Road, Sudbury, MA 01776, US				
	HIMANSU, Sunny, 23 Fernway, Winchester, MA 01890, US				
	HUANG, Eric, Yi-Chun, 90 Wareham Street Apartment 302, Boston, MA 02118, US				
	ZAKS, Tal, 122 Bellevue Street, Newton, MA 02458, US				
(51)	MKP				
	<b>A61K 31/7105</b>	<b>2006</b>	<b>(97) EP 3364983</b>		
	<b>A61K 31/7115</b>	<b>2006</b>			
	<b>A61K 39/12</b>	<b>2006</b>			
	<b>A61P 11/00</b>	<b>2006</b>			
(96)	EP 16858406.8 10/21/2016				
(97)	EP 3364983, 8/29/2018 201835, en				
(31)	201562245031 P	(32)	22.10.2015	(33)	US
	201562244813 P		22.10.2015		US
	201562244946 P		22.10.2015		US
	201562244802 P		22.10.2015		US
	201562244837 P		22.10.2015		US
	201562247362 P		28.10.2015		US
	201562247483 P		28.10.2015		US
	201562247394 P		28.10.2015		US
	201562247297 P		28.10.2015		US
(54)	RESPIRATORY VIRUS VACCINES				
(72)	CIARAMELLA, Giuseppe, 1 Hawes Road, Sudbury, MA 01776, US				
	HIMANSU, Sunny, 23 Fernway, Winchester, MA 01890, US				
(51)	MKP				
	<b>A61K 9/16</b>	<b>2006</b>	<b>(97) EP 3368030</b>		
	<b>A61K 31/225</b>	<b>2006</b>			
	<b>A61K 31/616</b>	<b>2006</b>			
(96)	EP 16859177.4 10/27/2016				
(97)	EP 3368030, 9/5/2018 201836, en				
(31)	3504DE2015	(32)	28.10.2015	(33)	IN
(54)	PHARMACEUTICAL COMPOSITIONS OF DIMETHYL FUMARATE				
(71)	Sun Pharmaceutical Industries Limited, Sun House Plot No. 201 B/1 Western Express Highway Goregaon (E), Mumbai Maharashtra 400 063, IN				
(72)	GARGOTE, Chandrashekhar, House No. 551 Second Floor Sector - 17, Gurgaon Haryana 122001, IN				
	GARG, Lalit, D-II 222 Kidwai Nagar West, New Delhi Delhi 110023, IN				
	HODGE, Shrikant Vaijanathappa, At Post: Hanegaon Taluka: Degloor, Nanded Maharashtra 431741, IN				
	DESHMUKH, Subodh, 54 Scotch Cap Road, Quaker Hill Connecticut 06375, US				
	SINGH, Romi, Barat, A-14 Badshah Bagh, Varanasi Uttar Pradesh 221002, IN				
	BATRA, Vikas, House No. 556 Sector - 13 Extn, Karnal Haryana 132001, IN				
	JAIN, Som Akshay, 224 Bahubali Colony, Sagar Madhya Pradesh 470002, IN				
(51)	MKP				
	<b>G06F 19/18</b>	<b>2011</b>	<b>(97) EP 3396573</b>		
	<b>G06F 19/22</b>	<b>2011</b>			
	<b>G06F 19/28</b>	<b>2011</b>			
(96)	EP 16860219.1 10/26/2016				
(97)	EP 3396573, 10/31/2018 201844, en				
(31)	20150148717	(32)	26.10.2015	(33)	KR
(54)	METHOD AND SYSTEM FOR SELECTING CUSTOMIZED DRUG USING GENOMIC NUCLEOTIDE SEQUENCE VARIATION INFORMATION AND SURVIVAL INFORMATION OF CANCER PATIENT				
(71)	CIPHEROME, 335-2, 1, Gwanak-ro Gwanak-gu, Seoul 08826, KR				
(72)	KIM, Ju Han, 262-1101 135 Olympic-ro Songpa-gu, Seoul 05502, KR				

(51) MKP  
**A61K 31/44 2006 (97) EP 3368036**  
**A61K 31/4418 2006**  
**A61K 31/4427 2006**  
**C07D 213/02 2006**  
**C07D 213/04 2006**  
**C07D 401/06 2006**

(96) EP 16860556.6 10/24/2016  
(97) EP 3368036, 9/5/2018 201836, en  
(31) 201562248075 P (32) 29.10.2015 (33) US

(54) FACTOR XIA INHIBITORS  
(72) XU, Jiayi, 126 East Lincoln Avenue, Rahway, New Jersey 07065-0907, US  
ALI, Amjad, 2000 Galloping Hill Road, Kenilworth, New Jersey 07033, US  
ZHOU, Wei, 2000 Galloping Hill Road, Kenilworth, New Jersey 07033, US  
GAO, Ying-Duo, 2000 Galloping Hill Road, Kenilworth, New Jersey 07033, US  
EDMONDSON, Scott, D., 32 Dorset Drive, Clark, New Jersey 07066, US  
MERTZ, Eric, 5-25 3rd Street, Fair Lawn, New Jersey 07410, US  
NEELAMKAVIL, Santhosh, F., 2000 Galloping Hill Road, Kenilworth, New Jersey 07033, US  
LIU, Weiguo, 2000 Galloping Hill Road, Kenilworth, New Jersey 07033, US  
SUN, Wanying, 2000 Galloping Hill Road, Kenilworth, New Jersey 07033, US  
SHEN, Dong-Ming, 4 Five Acre Drive, Edison, New Jersey 08820, US  
HARPER, Bart, 2000 Galloping Hill Road, Kenilworth, New Jersey 07033, US  
ZHU, Cheng, 2000 Galloping Hill Road, Kenilworth, New Jersey 07033, US  
BARA, Thomas, 2000 Galloping Hill Road, Kenilworth, New Jersey 07033, US  
LIM, Yeon-Hee, 126 East Lincoln Avenue, Rahway, New Jersey 07065-0907, US  
YANG, Meng, 2000 Galloping Hill Road, Kenilworth, New Jersey 07033, US

---

(51) MKP  
**A61K 9/00 2006 (97) EP 3368027**  
**A61K 9/20 2006**  
**A61K 31/167 2006**  
**A61K 45/06 2006**

(96) EP 16860593.9 10/25/2016  
(97) EP 3368027, 9/5/2018 201836, en  
(31) 201514922362 (32) 26.10.2015 (33) US

(54) METHODS OF TREATING PAIN OR FEVER USING PHARMACEUTICALLY ACTIVE ACETAMINOPHEN DIMERS LINKED THROUGH PHENOLIC HYDROXYL GROUPS  
(72) SINGH, Nikhilesh, Nihala, 806 Denise Court, Mill Valley, CA 94941, US

---

(51) MKP  
**A61K 9/10 2006 (97) EP 3368038**  
**A61K 31/439 2006**  
**A61K 31/485 2006**

(96) EP 16860598.8 10/25/2016  
(97) EP 3368038, 9/5/2018 201836, en  
(31) 201562246211 P (32) 26.10.2015 (33) US

(54) ETHYLENE GLYCOL ETHER OF BUPRENORPHINE  
(72) SINGH, Nikhilesh, Nihala, 806 Denise Court, Mill Valley, CA 94941, US

---

(51) MKP  
**B01J 49/00 2017 (97) EP 3369097**  
**G21G 4/08 2006**

(96) EP 16860608.5 10/25/2016  
(97) EP 3369097, 9/5/2018 201836, en  
(31) 201562248473 P (32) 30.10.2015 (33) US  
201562269174 P 18.12.2015 US

(54) COMPOSITE EXTRACTANT-ENHANCED POLYMER RESIN, METHOD OF MAKING THE SAME, AND ITS USAGE FOR EXTRACTION OF VALUABLE METAL(S)  
(72) XU, Wen-Qing, 20 Hearthstone Drive, Medfield, Massachusetts 02052, US  
MATTERA, Vincent, D., Jr., 601 Applehill Court, Gibsonia, Pennsylvania 15044, US  
ABELLA, Marie Ysabel, R., 32 Carlos Magalona St E.B. Magalona, Negros Occidental 6118, PH  
ABRENICA, Gomer, M., Brgy. Baguinay, Manaoag Pangasinan 2430, PH  
PATKAR, Shailesh, 114 Dolores Drive, Irwin, Pennsylvania 15642, US

---

(51) MKP  
**A61K 8/44 2006 (97) EP 3368157**  
**A61K 31/16 2006**  
**A61K 38/46 2006**  
**A61P 3/10 2006**  
**C12N 9/14 2006**  
**C12N 15/113 2010**  
**C12Q 1/68 2018**  
**G01N 33/50 2006**

(96) EP 16860861.0 10/28/2016  
(97) EP 3368157, 9/5/2018 201836, en

(31) 201562248007 P (32) 29.10.2015 (33) US  
201562248365 P 30.10.2015 US  
201662355120 P 27.06.2016 US  
201662395735 P 16.09.2016 US

(54) METHODS FOR IDENTIFICATION, ASSESSMENT, PREVENTION, AND TREATMENT OF METABOLIC DISORDERS USING PM20D1 AND N-LIPIDATED AMINO ACIDS

(71) Spiegelman, Bruce, M., 271 Waban Avenue, Waban, MA 02468, US  
Long, Jonathan, Z., 108 Jersey Street Apt. C, Boston, MA 02215, US

(72) SPIEGELMAN, Bruce, M., 271 Waban Avenue, Waban, MA 02468, US  
LONG, Jonathan, Z., 108 Jersey Street Apt. C, Boston, MA 02215, US

---

(51) MKP  
**A61K 31/69 2006 (97) EP 3368541**  
**A61P 35/00 2006**  
**C07D 207/16 2006**  
**C07F 5/02 2006**  
**C07F 5/04 2006**

(96) EP 16860883.4 10/28/2016  
(97) EP 3368541, 9/5/2018 201836, en

(31) 201562248632 P (32) 30.10.2015 (33) US  
201662281964 P 22.01.2016 US  
201662323034 P 15.04.2016 US

(54) COMPOSITIONS AND METHODS FOR INHIBITING ARGINASE ACTIVITY

(72) SJOGREN, Eric, B., 442 Dell Avenue, Mountain View, CA 94043, US  
LI, Jim, 56 Otsego Avenue, San Francisco, CA 94112, US  
VAN ZANDT, Michael, 91 Golden Hill Drive, Guilford, CT 06437, US  
WHITEHOUSE, Darren, 40 Fishing Brook Road, Westbrook, CT 06498, US

---

(51) MKP  
**A61M 1/02 2006 (97) EP 3368097**  
**A61M 1/14 2006**  
**A61M 1/16 2006**  
**A61M 1/18 2006**  
**A61M 5/307 2006**  
**A61M 5/315 2006**

(96) EP 16861005.3 10/28/2016  
(97) EP 3368097, 9/5/2018 201836, en

(31) 201562248837 P (32) 30.10.2015 (33) US

(54) APPARATUS AND METHODS FOR DISPENSING ORAL TRANSMUCOSAL DOSAGE FORMS

(71) AcelRx Pharmaceuticals, Inc., 351 Galveston Dr, Redwood City, CA 94063, US

(72) DOMINGO, Casidy, 617 H Woodside Way, San Mateo, California 94401, US  
CHIU, Edmond, 1672 Funston Avenue, San Francisco, California 94122, US  
BLACKWOOD, Bradley, 1910 Jeneane Marie Circle, San Jose, California 95122, US

---

(51) MKP  
**A61K 39/395 2006 (97) EP 3368077**  
**A61K 45/00 2006**  
**A61P 35/00 2006**  
**C07K 16/18 2006**  
**C07K 16/28 2006**  
**C12P 21/08 2006**

(96) EP 16861006.1 10/28/2016  
(97) EP 3368077, 9/5/2018 201836, en  
(31) 201562249183 P (32) 30.10.2015 (33) US  
(54) COMPOSITIONS AND METHODS FOR TUMOR TRANSDUCTION  
(71) Aleta Biotherapeutics Inc., 2 Mercer Road, Natick, MA 01760, US  
(72) LOBB, Roy, 580 Washington Street Apt. 304, Wellesley, Massachusetts 02482, US  
RENNERT, Paul, 205 Underwood Street, Holliston, Massachusetts 01746, US

---

(51) MKP  
**C07K 14/705 2006 (97) EP 3368559**  
**C07K 16/28 2006**  
**C07K 19/00 2006**  
(96) EP 16861008.7 10/28/2016  
(97) EP 3368559, 9/5/2018 201836, en  
(31) 201562249144 P (32) 30.10.2015 (33) US  
201662331010 P 03.05.2016 US  
201662396783 P 19.09.2016 US  
(54) COMPOSITIONS AND METHODS FOR TREATMENT OF CANCER  
(72) LOBB, Roy, 580 Washington Street Apt. 304, Wellesley, Massachusetts 02482, US  
RENNERT, Paul, 205 Underwood Street, Holliston, Massachusetts 01746, US

---

(51) MKP  
**A61K 35/76 2015 (97) EP 3382010**  
**A61K 39/145 2006**  
**A61P 31/16 2006**  
**A61P 35/00 2006**  
**C12N 7/01 2006**  
**C12N 15/86 2006**  
(96) EP 16862552.3 11/3/2016  
(97) EP 3382010, 10/3/2018 201840, en  
(31) 2015147703 (32) 06.11.2015 (33) RU  
(54) ATTENUATED INFLUENZA VECTORS FOR THE PREVENTION AND/OR TREATMENT OF INFECTIOUS DISEASES AND FOR THE TREATMENT OF ONCOLOGICAL DISEASES  
(71) «PHARMENTERPRISES BIOTECH» LIMITED LIABILITY COMPANY, Bolshoi Bulvar, 42, bldg. 1, 1st Floor Part of Office 335 Innovation Center «Skolkovo», Moscow, 143026, RU  
(72) EGOROV, Andrei Yurievich, Svetlanovskiy prospekt 99/1-19, St.Petersburg 195269, RU  
FERKO, Boris, Difenbahgasse 58/10, 1150 Vienna, AT  
KROKHIN, Artem Alexandrovich, ul. Krasikova 27 c. Otradnoe Bakhchisaraysky rayon, the Crimea 298414, RU  
ROMANOVA, Yulia Romanovna, ul. Korablestroiteley 16/1-289, St.Petersburg 199226, RU

---

(51) MKP  
**A61K 31/575 2006 (97) EP 3370728**  
**C07J 9/00 2006**  
**C07J 31/00 2006**  
(96) EP 16862750.3 10/28/2016  
(97) EP 3370728, 9/12/2018 201837, en  
(31) 201562252077 P (32) 06.11.2015 (33) US  
(54) METHODS FOR THE PREPARATION OF OBETICHOLIC ACID AND DERIVATIVES THEREOF  
(72) GALVIN, Gabriel, M., 13222 Salmon River Rd., San Diego, CA 92129, US

---

(51) MKP  
**A61K 39/00 2006 (97) EP 3370768**  
**A61K 39/395 2006**  
(96) EP 16862773.5 11/1/2016  
(97) EP 3370768, 9/12/2018 201837, en  
(31) 201562250095 P (32) 03.11.2015 (33) US  
(54) ANTIBODIES SPECIFICALLY BINDING PD-1 AND THEIR USES  
(72) VERONA, Raluca, 1400 McKean Road, Spring House, Pennsylvania 19477, US  
POWERS, Gordon, 1400 McKean Road, Spring House, Pennsylvania 19477, US  
SABINS, Nina Chi, 1400 McKean Road, Spring House, Pennsylvania 19477, US  
DEANGELIS, Nikki A., 1400 McKean Road, Spring House, Pennsylvania 19477, US  
SANTULLI-MAROTTO, Sandra, 169 Harbor Way, San Francisco, California 94080, US

WIEHAGEN, Karla R., 1400 McKean Road, Spring House, Pennsylvania 19477, US  
WU, Sheng-Jiun, 1400 McKean Road, Spring House, Pennsylvania 19477, US  
FERRANTE, Catherine, 1400 McKean Road, Spring House, Pennsylvania 19477, US  
UBANI, Enrique-Zudaire, 1400 McKean Road, Spring House, Pennsylvania 19477, US

---

(51) MKP  
**A61K 31/198 2006 (97) EP 3370770**  
**A61K 31/4439 2006**  
**A61K 31/573 2006**  
**A61K 31/69 2006**  
**A61K 39/395 2006**  
**C07K 16/28 2006**  
(96) EP 16862791.7 11/1/2016  
(97) EP 3370770, 9/12/2018 201837, en  
(31) 201562250016 P (32) 03.11.2015 (33) US  
(54) SUBCUTANEOUS FORMULATIONS OF ANTI-CD38 ANTIBODIES AND THEIR USES  
(72) JANSSON, Richard, 3041 Ursulas Way, Doylestown, Pennsylvania 18902, US  
KUMAR, Vineet, 1400 McKean Road, Spring House, Pennsylvania 19477, US

---

(51) MKP  
**A61K 33/20 2006 (97) EP 3370738**  
**A61P 25/28 2006**  
**C01B 11/10 2006**  
(96) EP 16862799.0 11/1/2016  
(97) EP 3370738, 9/12/2018 201837, en  
(31) 201562249846 P (32) 02.11.2015 (33) US  
(54) TREATMENT OF NEURODEGENERATIVE DISEASE WITH SODIUM CHLORITE  
(71) Neuraltus Pharmaceuticals, Inc., 1111 Bayhill Drive Suite 210, San Bruno, CA 94066, US  
(72) NORVIEL, Vernon A., 4321 Hortensia Street, San Diego, California 92103, US  
MCGRATH, Michael S., 1452 Benito Avenue, Burlingame, California 94010, US

---

(51) MKP  
**A61K 39/00 2006 (97) EP 3370763**  
**A61K 39/39 2006**  
**C07K 7/06 2006**  
**C07K 7/08 2006**  
(96) EP 16862903.8 11/2/2016  
(97) EP 3370763, 9/12/2018 201837, en  
(31) 201562250376 P (32) 03.11.2015 (33) US  
(54) CD200 INHIBITORS AND METHODS OF USE THEREOF  
(71) Regents of the University of Minnesota, 600 McNamara Alumni Center 200 Oak St. SE, Minneapolis, MN 55455, US  
(72) OLIN, Michael, 600 McNamara Alumni Center 200 Oak Street SE, Minneapolis, Minnesota 55455, US

---

(51) MKP  
**A61K 35/15 2015 (97) EP 3370741**  
**A61K 35/17 2015**  
**A61K 45/06 2006**  
**A61K 48/00 2006**  
**A61P 35/00 2006**  
**A61P 35/02 2006**  
(96) EP 16862941.8 11/3/2016  
(97) EP 3370741, 9/12/2018 201837, en  
(31) 201562250561 P (32) 04.11.2015 (33) US  
(54) METHODS AND COMPOSITIONS FOR GENE EDITING IN HEMATOPOIETIC STEM CELLS  
(72) GILL, Saar, 30 North Third Street Apt. 4A, Philadelphia, Pennsylvania 19106, US  
KIM, Miriam, 2400 Chestnut Street Apt. 2604, Philadelphia, Pennsylvania 19103, US

---

(51) MKP  
**C01B 17/02 2006 (97) EP 3371100**  
**C01B 17/04 2006**  
**C01B 17/50 2006**  
(96) EP 16862948.3 11/3/2016

(97) EP 3371100, 9/12/2018 201837, en  
(31) 201514931766 (32) 03.11.2015 (33) US  
(54) METHOD FOR REDUCING ELEMENTAL SULFUR IN GYPSUM PRODUCTS  
(72) COLLEGE, John W., 963 Highview Drive, Pittsburgh, Pennsylvania 15234, US  
LEE, Sang-Ho, 9 Goddard Road, Northboro, Massachusetts 01532, US  
HILTON, Chris, Annacis Island 1070 Derwent Way, Vancouver, British Columbia V3M5R1, CA  
KIANG, Yu-Zhi, 1070 Derwent Way Annacis Island New Westminster, Vancouver, British Columbia V3M 5R1, CA  
LAI, Choung-Houng, 6 Till Drive, Acton, Massachusetts 01720, US  
GLAVIN, George, 9 Goddard Road, Northboro, Massachusetts 01532-1545, US  
ILYASHENKO, Helen, 9 Goddard Road, Northboro, Massachusetts 01532-1545, US

---

(51) MKP  
A61K 31/194 2006 (97) EP 3370713  
A61P 1/18 2006  
(96) EP 16863170.3 11/7/2016  
(97) EP 3370713, 9/12/2018 201837, en  
(31) 201562252147 P (32) 06.11.2015 (33) US  
201562252195 P 06.11.2015 US  
(54) TREATMENT OF MIXED DYSLIPIDEMIA  
(72) BISGAIER, Charles, L., 3605 Tanglewood Drive, Ann Arbor, MI 48105-9563, US  
ONICIU, Daniela, Carmen, 148 Chemin De Nicol, 31200 Toulouse, FR

---

(51) MKP  
A61K 31/4433 2006 (97) EP 3370725  
A61K 31/4436 2006  
A61K 31/497 2006  
A61K 31/5355 2006  
A61P 35/00 2006  
(96) EP 16863176.0 11/7/2016  
(97) EP 3370725, 9/12/2018 201837, en  
(31) 201562252190 P (32) 06.11.2015 (33) US  
(54) PEDIATRIC DOSING FOR TREATMENT OF CANCER WITH AN EZH2 INHIBITOR  
(72) KEILHACK, Heike, 3 Falmouth Street, Belmont, Massachusetts 02478, US  
KNUTSON, Sarah K., 24 Bay State Road Unit 22, Cambridge, Massachusetts 02138, US  
WATERS, Nigel, 87 Douglas Road, Belmont, Massachusetts 02478, US

---

(51) MKP  
E21B 23/01 2006 (97) EP 3374592  
E21B 23/10 2006  
(96) EP 16863256.0 11/10/2016  
(97) EP 3374592, 9/19/2018 201838, en  
(31) 201562253448 P (32) 10.11.2015 (33) US  
201662355063 P 27.06.2016 US  
201662402505 P 30.09.2016 US  
(54) APPARATUSES AND METHODS FOR LOCATING WITHIN A WELLBORE  
(72) WERRIES, Michael, c/o NCS Multistage Inc. 222 11929 - 40 Street SE, Calgary, Alberta T2Z 4M8, CA  
MONTERO, Juan, c/o NCS Multistage Inc. 222 11929 - 40 Street SE, Calgary, Alberta T2Z 4M8, CA

---

(51) MKP  
A61K 31/4375 2006 (97) EP 3378863  
A61K 31/444 2006  
A61K 31/497 2006  
A61K 31/506 2006  
A61P 9/10 2006  
A61P 21/02 2006  
A61P 25/00 2006  
A61P 25/04 2006  
A61P 25/08 2006  
A61P 25/14 2006  
A61P 25/16 2006  
A61P 25/18 2006  
A61P 25/22 2006  
A61P 25/24 2006

**A61P 25/28 2006**  
**A61P 25/30 2006**  
**C07D 491/147 2006**  
(96) EP 16864249.4 11/9/2016  
(97) EP 3378863, 9/26/2018 201839, en  
(31) 2015222805 (32) 13.11.2015 (33) JP  
(54) PYRANODIPYRIDINE COMPOUND  
(72) KUROKAWA Toshiki, c/o Eisai Co. Ltd. Tsukuba Research Laboratories 5-1-3 Tokodai, Tsukuba-shi Ibaraki 300-2635, JP  
YOSHIDA Yu, c/o Eisai Co. Ltd. Tsukuba Research Laboratories 5-1-3 Tokodai, Tsukuba-shi Ibaraki 3002635, JP  
SHIN Kogyoku, c/o Eisai Co. Ltd. Kashima Plant 22, Sunayama Kamisu-shi, Ibaraki 3140255, JP  
KOBAYASHI Yoshihisa, c/o Eisai Co. Ltd. 4-6-10 Koishikawa Bunkyo-ku, Tokyo 112-8088, JP  
FUKUMOTO Hironori, c/o Eisai Co. Ltd. Tsukuba Research Laboratories 5-1-3 Tokodai, Tsukuba-shi Ibaraki 300-2635, JP  
TAKEDA Kunitoshi, c/o Eisai Co. Ltd. Tsukuba Research Laboratories 5-1-3 Tokodai, Tsukuba-shi Ibaraki 300-2635, JP  
OHASHI Yoshiaki, c/o Eisai Co. Ltd. Tsukuba Research Laboratories 5-1-3 Tokodai, Tsukuba-shi Ibaraki 300-2635, JP  
KOTAKE Makoto, c/o Eisai Co. Ltd. Tsukuba Research Laboratories 5-1-3 Tokodai, Tsukuba-shi Ibaraki 300-2635, JP  
SHIBUGUCHI Tomoyuki, c/o Eisai Co. Ltd. Tsukuba Research Laboratories 5-1-3 Tokodai, Tsukuba-shi Ibaraki 300-2635, JP  
WATANABE Toru, c/o Eisai Co. Ltd. Tsukuba Research Laboratories 5-1-3 Tokodai, Tsukuba-shi Ibaraki 300-2635, JP  
KITA Yoichi, c/o Eisai Co. Ltd. Tsukuba Research Laboratories 5-1-3 Tokodai, Tsukuba-shi Ibaraki 300-2635, JP  
HIROTA Shinsuke, c/o Eisai Co. Ltd. Tsukuba Research Laboratories 5-1-3 Tokodai, Tsukuba-shi Ibaraki 300-2635, JP  
FUKUYAMA Takashi, c/o Eisai Co. Ltd. Tsukuba Research Laboratories 5-1-3 Tokodai, Tsukuba-shi Ibaraki 300-2635, JP  
KAMADA Yasuaki, c/o Eisai Co. Ltd. Tsukuba Research Laboratories 5-1-3 Tokodai, Tsukuba-shi Ibaraki 300-2635, JP

(51) MKP  
**A61K 31/427 2006 (97) EP 3375782**  
**A61K 31/497 2006**  
**C07D 417/12 2006**  
**C07D 417/14 2006**  
(96) EP 16864614.9 11/11/2016  
(97) EP 3375782, 9/19/2018 201838, en  
(31) 20150159637 (32) 13.11.2015 (33) KR  
(54) SODIUM CHANNEL BLOCKER  
(71) Daewoong Pharmaceutical Co., Ltd., 35-14, Jeyakongdan 4-gil, Hyangnam-eup, Hwaseong-si Gyeonggi-do 18623, KR  
(72) LEE, Hyung-Geun, B-402 42-12 Pogok-ro 61beon-gil Pogok-eup Cheoin-gu, Yongin-si Gyeonggi-do 17027, KR  
KIM, Il-Hwan, 105-302 17 Daenong-ro Heungdeok-gu, Cheongju-si Chungcheongbuk-do 28424, KR  
JUNG, Myunggi, 302 325 Bundang-ro Bundang-gu, Seongnam-si Gyeonggi-do 13584, KR  
KIM, Hyo Shin, 102-1602 80 Convensia-daero 130beon-gil Yeonsu-gu, Incheon 22003, KR  
LEE, Chun Ho, 103-1203 57 Seochojungang-ro 24-gil Seocho-gu, Seoul 06603, KR  
JUN, Sun Ah, 201-603 15 Hanteo-ro 152beon-gil Cheoin-gu, Yongin-si Gyeonggi-do 17149, KR  
YOON, Ji Sung, 506-601 60 Daeji-ro 15beon-gil Suji-gu, Yongin-si Gyeonggi-do 16871, KR  
KIM, Sung-Young, 102-401 19 Dugye-ro Pogok-eup Cheoin-gu, Yongin-si Gyeonggi-do 17028, KR

(51) MKP  
**A61K 39/00 2006 (97) EP 3373963**  
**A61K 39/395 2006**  
**A61P 7/02 2006**  
**A61P 37/02 2006**  
**C07K 16/40 2006**  
(96) EP 16864904.4 11/9/2016  
(97) EP 3373963, 9/19/2018 201838, en  
(31) 201562252814 P (32) 09.11.2015 (33) US  
201662406726 P 11.10.2016 US  
(54) METHODS FOR TREATING CONDITIONS ASSOCIATED WITH MASP-2 DEPENDENT COMPLEMENT ACTIVATION  
(71) University of Leicester, University Road, Leicester LE1 7RH, GB  
(72) DEMOPULOS, Gregory, A., 36 The Green, Mountsorrel, Leicestershire LE18 3GF, US  
DUDLER, Thomas, 36 The Green, Mountsorrel, Leicestershire LE18 3GF, US  
SCHWAEBLE, Hans-Wilhelm, 36 The Green, Mountsorrel, Leicestershire LE18 3GF, GB

(51) MKP  
**A61K 9/14 2006 (97) EP 3373978**  
**A61K 9/50 2006**  
**A61K 47/50 2017**  
(96) EP 16865170.1 11/11/2016  
(97) EP 3373978, 9/19/2018 201838, en  
(31) 201562254707 P (32) 12.11.2015 (33) US

	201562257608 P		19.11.2015		US
	201662276530 P		08.01.2016		US

(54) AGGREGATING MICROPARTICLES FOR THERAPY  
(72) YU, Yun, c/o Graybug Vision Inc. 275 Shoreline Drive Suite 450, Redwood City, CA 94065, US  
KAYS, Joshua, c/o Graybug Vision Inc. 275 Shoreline Drive Suite 450, Redwood City, CA 94065, US  
YANG, Ming, c/o Graybug Vision Inc. 275 Shoreline Drive Suite 450, Redwood City, CA 94065, US  
CLELAND, Jeffrey, L., c/o Graybug Vision Inc. 275 Shoreline Drive Suite 450, Redwood City, CA 94065, US

---

(51) MKP  
**A61K 9/00 2006 (97) EP 3377069**  
**A61K 31/47 2006**  
**A61K 31/568 2006**  
**A61P 43/00 2006**

(96) EP 16867004.0 11/16/2016  
(97) EP 3377069, 9/26/2018 201839, en

(31)	201514943607	(32)	17.11.2015	(33)	US
------	--------------	------	------------	------	----

(54) PHEROMONE COMPOSITION TO STIMULATE REPRODUCTION IN FEMALE SUIDS AND METHODS OF USE  
(71) Texas Tech University System, 1308 Indiana Avenue 204 Animal And Food Science Bldg., Lubbock, Texas 79409, US  
(72) MCGLONE, John J., c/o Texas Tech University 1308 Indiana Ave. 204 Animal&Food Sciences Bldg., Lubbock, Texas 79409, US

---

(51) MKP  
**A61K 35/30 2015 (97) EP 3377078**  
**A61K 35/545 2015**  
**A61P 25/00 2006**

(96) EP 16867026.3 11/16/2016  
(97) EP 3377078, 9/26/2018 201839, en

(31)	201562256823 P	(32)	18.11.2015	(33)	US
------	----------------	------	------------	------	----

(54) NEURAL CELL EXTRACELLULAR VESSICLES  
(71) University Of Georgia Research Foundation, Inc., Boyd Graduate Studies Research Center D.W. Brooks Dr., Athens, GA 30602-7411, US  
Aruna Biomedical, Inc., 425 River Road Georgia Business Center, Athens, GA 30602, US  
(72) STICE, Steven, L., 380 River Bottom Road, Athens, GA 30606-6433, US  
WEBB, Robin, Lynn, 1186 Robert Hardeman Rd., Winterville, GA 30683, US  
STICE, Tracy, A., Traycy A. Stice 380 River Bottom Road, Athens, GA 30606, US

---

(51) MKP  
**A61K 31/341 2006 (97) EP 3383386**  
**C07C 225/20 2006**

(96) EP 16867098.2 11/17/2016  
(97) EP 3383386, 10/10/2018 201841, en

(31)	201562257389 P	(32)	19.11.2015	(33)	US
	20166227711 P		12.01.2016		US

(54) MODULATORS OF CHEMOKINE RECEPTORS  
(72) CHEN, Xi, 1198 Beech Street, E. Palo Alto, CA 94303, US  
DRAGOLI, Dean, R., 24645 Summerhill Avenue, Los Altos, CA 94024, US  
FAN, Junfa, 2492 Wilkie Way H, Palo Alto, CA 94306, US  
KALISIAK, Jaroslaw, 1031 Crestview Drive Apt. 104, Mountain View, CA, US  
KRASINSKI, Antoni, 746 W. Knickerbocker Drive, Sunnyvale, CA 94087, US  
LELETI, Manmohan, Reddy, 4205 Kelton Street, Dublin, CA 94568, US  
MALI, Venkat, 20800 Valley Green Drive 427, Cupertino, CA 95014, US  
MCMAHON, Jeffrey, 15 Alta Mar Way, San Francisco, CA 94121, US  
SINGH, Rajinder, 1832 Hillman Avenue, Belmont, CA 94002, US  
TANAKA, Hiroko, 600 Rainbow Drive 148, Mountain View, CA 94041, US  
YANG, Ju, 966 Clara Drive, Palo Alto, CA 94303, US  
YU, Chao, 555 E. Washington Avenue Apt. 1105, Sunnyvale, CA 94086, US  
ZHANG, Penglie, 1036 Jamaica Street, Foster City, CA 94404, US

---

(51) MKP  
**A61K 31/404 2006 (97) EP 3377059**  
**A61K 31/407 2006**  
**A61K 31/5377 2006**

(96) EP 16867099.0 11/17/2016  
(97) EP 3377059, 9/26/2018 201839, en

(31)	201562257529 P	(32)	19.11.2015	(33)	US
------	----------------	------	------------	------	----



(54) INHIBITORS OF CXCR2  
(72) CHEN, Xi, 1198 Beech Street, E. Palo Alto, CA 94303, US  
DRAGOLI, Dean, R., 24645 Summerhill Avenue, Los Altos, CA 94024, US  
FAN, Junfa, 4292 Wilkie Way H, Palo Alto, CA 94306, US  
KALISIAK, Jaroslaw, 1031 Crestview Drive Apt. 104, Mountain View, CA, US  
LELETI, Manmohan, Reddy, 4205 Kelton Street, Dublin, CA 94568-4298, US  
MALATHONG, Viengkham, 121988 San Luis Avenue 3, Mountain View, CA 94043, US  
MCMAHON, Jeffrey, 15 Alta Mar Way, San Francisco, CA 94121, US  
TANKAKA, Hiroko, 600 Rainbow Drive 148, Mountain View, CA 94041, US  
YANG, Ju, 966 Clara Drive, Palo Alto, CA 94303, US  
YU, Chao, 555 E. Washington Avenue Apt. 1105, Sunnyvale, CA 94086, US  
ZHANG, Penglie, 1036 Jamaica Street, Foster City, CA 94404, US  
MALI, Venkat, 20800 Valley Green Drive 427, Cupertino, CA 95014, US

---

(51) MKP  
**A61K 35/44 2015 (97) EP 3377079**  
**C07K 16/28 2006**  
(96) EP 16867220.2 11/18/2016  
(97) EP 3377079, 9/26/2018 201839, en  
(31) 201562257606 P (32) 19.11.2015 (33) US  
201662420319 P 10.11.2016 US  
(54) NOVEL ANTI-EMR2 ANTIBODIES AND METHODS OF USE  
(72) KARSUNKY, Holger, 2764 Delaware Avenue, Redwood City, California 94061, US  
FERNANDO, Hanan, 309 Genevieve Avenue, Pacifica, California 94044, US  
FRANKLIN, Casey, 380 Talbot Avenue Apt. 110, Pacifica, California 94044, US  
STULL, Robert A., 1519 Fifth Street, Alameda, California 94501, US  
LIU, David, 300 Santa Rosa Avenue Apt. 1, San Francisco, California 94112, US

---

(51) MKP  
**A61K 39/00 2006 (97) EP 3377516**  
**C07K 7/08 2006**  
**C07K 14/47 2006**  
(96) EP 16867262.4 11/18/2016  
(97) EP 3377516, 9/26/2018 201839, en  
(31) 201562258134 P (32) 20.11.2015 (33) US  
(54) METHODS AND COMPOSITIONS FOR TREATING CANCER  
(71) Memorial Sloan Kettering Cancer Center, Office of Industrial Affairs 1275 York Avenue, New York, NY 10065, US  
(72) SCHEINBERG, David, 415 E. 68th St. 19th Floor, New York, New York 10025, US

---

(51) MKP  
**A61K 31/56 2006 (97) EP 3377070**  
**A61K 31/57 2006**  
**A61K 31/573 2006**  
(96) EP 16867267.3 11/18/2016  
(97) EP 3377070, 9/26/2018 201839, en  
(31) 201562258222 P (32) 20.11.2015 (33) US  
(54) COMPOUNDS AND METHODS OF THEIR USE  
(72) DOHERTY, James, J., 7foster Rd., Bedford, MA 01730, US

---

(51) MKP  
**A61K 39/00 2006 (97) EP 3377636**  
**A61K 39/015 2006**  
**A61K 39/04 2006**  
**A61K 39/12 2006**  
**A61K 48/00 2006**  
**C12N 15/86 2006**  
(96) EP 16867316.8 11/20/2016  
(97) EP 3377636, 9/26/2018 201839, en  
(31) 201562258393 P (32) 20.11.2015 (33) US  
201662365259 P 21.07.2016 US  
(54) CMV VECTORS COMPRISING MICRORNA RECOGNITION ELEMENTS

(72) NELSON, Jay, Office of Technology Transfer and Business Development 0690 SW Bancroft Street Mail Code L106TT, Portland, OR 97239, US  
HANSEN, Scott, Office of Technology Transfer and Business Development 0690 SW Bancroft Street Mail Code L106TT, Portland, OR 97239, US  
HANCOCK, Meaghan, H., Office of Technology Transfer and Business Development 0690 SW Bancroft Street Mail Code L106TT, Portland, OR 97239, US  
PICKER, Louis, Office of Technology Transfer and Business Development 0690 SW Bancroft Street Mail Code L106TT, Portland, OR 97239, US  
FRUEH, Klaus, Office of Technology Transfer and Business Development 0690 SW Bancroft Street Mail Code L106TT, Portland, OR 97239, US

---

(51) MKP  
**A61K 31/197 2006 (97) EP 3389655**  
**A61K 31/437 2006**  
**A61K 31/4422 2006**  
**A61K 31/506 2006**  
**A61K 31/519 2006**  
**A61K 31/5377 2006**  
**A61K 45/06 2006**  
**A61P 1/00 2006**  
(96) EP 16867373.9 12/13/2016  
(97) EP 3389655, 10/24/2018 201843, en  
(31) 201562266988 P (32) 14.12.2015 (33) US  
(54) USE OF sGC STIMULATORS FOR THE TREATMENT OF GASTROINTESTINAL SPHINCTER DYSFUNCTION  
(72) CARLSON, Kenneth E., 221 Beacon Street Unit 5, Somerville Massachusetts 02143, US  
JUNG, Joon, 111 Wendell Road, Newton Massachusetts 02459, US  
CURRIE, MarkG., 197 8th Street, Boston Massachusetts 02129, US

---

(51) MKP  
**A61K 39/395 2006 (97) EP 3390441**  
**C07K 16/10 2006**  
(96) EP 16867376.2 12/14/2016  
(97) EP 3390441, 10/24/2018 201843, en  
(31) 201561267652 P (32) 15.12.2015 (33) US  
(54) HUMAN IMMUNODEFICIENCY VIRUS NEUTRALIZING ANTIBODIES  
(72) BALAKRISHNAN, Mini, c/o Gilead Sciences Inc. 333 Lakeside Drive, Foster City, CA 94404, US  
CARR, Brian A., c/o Gilead Sciences Inc. 333 Lakeside Drive, Foster City, CA 94404, US  
CORBIN, John, 5816 Mendocino Avenue, Oakland, CA 94618, US  
PACE, Craig S., c/o Gilead Sciences Inc. 333 Lakeside Drive, Foster City, CA 94404, US  
THOMSEN, Nathan D., c/o Gilead Sciences Inc. 333 Lakeside Drive, Foster City, CA 94404, US  
ZHANG, Xue, c/o Gilead Sciences Inc. 333 Lakeside Drive, Foster City, CA 94404, US

---

(51) MKP  
**B32B 7/00 2006 (97) EP 3386746**  
**B32B 7/12 2006**  
**B32B 15/00 2006**  
**B32B 15/01 2006**  
**B32B 15/08 2006**  
**B32B 15/20 2006**  
**B62D 29/00 2006**  
**C22C 1/00 2006**  
**C22C 23/00 2006**  
(96) EP 16828815.7 12/9/2016  
(97) EP 3386746, 10/17/2018 201842, en  
(31) 201562266314 P (32) 11.12.2015 (33) US  
(54) COMPOSITE STEEL  
(72) COMSTOCK, Robert, James, 509 Southwick Place, Trenton, OH 45067, US  
ALDER, Jeffrey, Douglas, 805 Brande Drive, Eaton, OH 45320, US

---

(51) MKP  
**A61B 17/32 2006 (97) EP 3389515**  
**A61B 18/14 2006**  
(96) EP 16828818.1 12/14/2016  
(97) EP 3389515, 10/24/2018 201843, en  
(31) 201514972995 (32) 17.12.2015 (33) US  
(54) ULTRASONIC SURGICAL INSTRUMENT WITH CLEANING PORT

(72) OTREMBIAK, Candice, 4545 Creek Road, Cincinnati Ohio 45242, US  
SCHEIB, Charles J., 4545 Creek Road, Cincinnati Ohio 45242, US  
BOYD, Benjamin M., 4545 Creek Road, Cincinnati Ohio 45242, US  
PIERCE, Amelia A., 4545 Creek Road, Cincinnati Ohio 45242, US  
RUIZ ORTIZ, Rafael J., 4545 Creek Road, Cincinnati Ohio 45242, US

---

(51) MKP

**A61B 17/32 2006 (97) EP 3389516**  
**A61B 18/14 2006**

(96) EP 16828819.9 12/14/2016

(97) EP 3389516, 10/24/2018 201843, en

(31) 201514970632 (32) 16.12.2015 (33) US

(54) SURGICAL INSTRUMENT WITH MULTI-FUNCTION BUTTON

(72) HIBNER, John A., 4545 Creek Road, Cincinnati Ohio 45242, US  
HOUSER, Kevin L., 4545 Creek Road, Cincinnati Ohio 45242, US  
MONROE, David A., 4545 Creek Road, Cincinnati Ohio 45242, US  
CAGLE, David J., 4545 Creek Road, Cincinnati Ohio 45242, US  
STROBL, Geoffrey S., 4545 Creek Road, Cincinnati Ohio 45242, US  
LESSEK, Timothy P., 4545 Creek Road, Cincinnati Ohio 45242, US  
ALDRIDGE, Jeffrey L., 4545 Creek Road, Cincinnati Ohio 45242, US  
ASHER, Ryan M., 4545 Creek Road, Cincinnati Ohio 45242, US  
MOOTOO, Mary E., 4545 Creek Road, Cincinnati Ohio 45242, US  
SMITH, Eric B., 4545 Creek Road, Cincinnati Ohio 45242, US  
JOHNSON, Gregory W., 4545 Creek Road, Cincinnati Ohio 45242, US  
LOCKE, David M., 4545 Creek Road, Cincinnati Ohio 45242, US

---

(51) MKP

**A61B 17/32 2006 (97) EP 3389517**  
**A61B 18/14 2006**

(96) EP 16828820.7 12/14/2016

(97) EP 3389517, 10/24/2018 201843, en

(31) 201514970778 (32) 16.12.2015 (33) US

(54) SURGICAL INSTRUMENT WITH FUNCTION SELECTOR

(72) RIESTENBERG, Paul F., 4545 Creek Road, Cincinnati Ohio 45242, US  
BOYD, Benjamin M., 4545 Creek Road, Cincinnati Ohio 45242, US  
GEE, Jacob S., 4545 Creek Road, Cincinnati Ohio 45242, US  
FALLER, Craig N., 4545 Creek Road, Cincinnati Ohio 45242, US  
SCHEIB, Charles J., 4545 Creek Road, Cincinnati Ohio 45242, US  
GALLMEYER, Thomas C., 4545 Creek Road, Cincinnati Ohio 45242, US  
KRAMER, Katelynn, 4545 Creek Road, Cincinnati Ohio 45242, US  
ASHER, Ryan M., 4545 Creek Road, Cincinnati Ohio 45242, US  
MUHLENKAMP, Tylor C., 4545 Creek Road, Cincinnati Ohio 45242, US  
STROBL, Geoffrey S., 4545 Creek Road, Cincinnati Ohio 45242, US  
MONROE, David A., 4545 Creek Road, Cincinnati Ohio 45242, US

---

(51) MKP

**A61B 17/32 2006 (97) EP 3393378**  
**A61B 18/14 2006**

(96) EP 16828821.5 12/14/2016

(97) EP 3393378, 10/31/2018 201844, en

(31) 201514976087 (32) 21.12.2015 (33) US

(54) SURGICAL INSTRUMENT WITH VARIABLE CLAMPING FORCE

(72) MADAN, Ashvani K., 4545 Creek Road, Cincinnati, Ohio 45242, US  
GROENE, David C., 4545 Creek Road, Cincinnati, Ohio 45242, US  
BOYD, Benjamin M., 4545 Creek Road, Cincinnati, Ohio 45242, US  
FALLER, Craig N., 4545 Creek Road, Cincinnati, Ohio 45242, US  
GEE, Jacob S., 4545 Creek Road, Cincinnati, Ohio 45242, US  
RIESTENBERG, Paul F., 4545 Creek Road, Cincinnati, Ohio 45242, US

---

(51) MKP

**A61K 31/19 2006 (97) EP 3397253**  
**A61K 31/192 2006**  
**A61K 31/395 2006**

**A61K 31/55 2006**  
**A61P 25/08 2006**  
(96) EP 16828906.4 12/30/2016  
(97) EP 3397253, 11/7/2018 201845, en  
(31) 201562273187 P (32) 30.12.2015 (33) US  
(54) METHODS AND COMPOSITIONS FOR THE TREATMENT OF SEIZURE-RELATED DISORDERS  
(71) Adamas Pharmaceuticals, Inc., 1900 Powell Street, Suite 750, Emeryville, CA 94608, US  
(72) NGUYEN, Jack, 2436 Oregon Street, Berkeley, California 94705, US  
CHERNOFF, David, 219 West Street, Sausalito, California 94965, US  
GHOSH, Sangita, 983 Lurline Drive, Foster City, California 94404, US  
WENT, Gregory T., 257 Buena Vista, Mill Valley, California 94941, US  
FULTZ, Timothy J., 10152 Big Canoe, Jasper, Georgia 30143, US

---

(51) MKP  
**A61K 31/421 2006 (97) EP 3397619**  
**A61P 17/00 2006**  
**C07D 263/32 2006**  
(96) EP 16828990.8 12/27/2016  
(97) EP 3397619, 11/7/2018 201845, en  
(31) 2015256784 (32) 28.12.2015 (33) JP  
(54) OINTMENT  
(72) MURAKAMI, Yoshihiro, c/o OTSUKA PHARMACEUTICAL CO. LTD. 3-2-27 Otedori Chuo-ku, Osaka-shi Osaka 540-0021, JP  
MATSUSHITA, Hitoshi, c/o OTSUKA PHARMACEUTICAL CO. LTD. 3-2-27 Otedori Chuo-ku, Osaka-shi Osaka 540-0021, JP  
MATSUMOTO, Kengo, c/o OTSUKA PHARMACEUTICAL CO. LTD. 3-2-27 Otedori Chuo-ku, Osaka-shi Osaka 540-0021, JP  
OKADA, Minoru, c/o OTSUKA PHARMACEUTICAL CO. LTD. 3-2-27 Otedori Chuo-ku, Osaka-shi Osaka 540-0021, JP  
YUKI, Yohei, c/o OTSUKA PHARMACEUTICAL CO. LTD. 3-2-27 Otedori Chuo-ku, Osaka-shi Osaka 540-0021, JP  
KOYAMA, Noriyuki, c/o OTSUKA PHARMACEUTICAL CO. LTD. 3-2-27 Otedori Chuo-ku, Osaka-shi Osaka 540-0021, JP  
KANAI, Naohiko, c/o OTSUKA PHARMACEUTICAL CO. LTD. 3-2-27 Otedori Chuo-ku, Osaka-shi Osaka 540-0021, JP

---

(51) MKP  
**C07K 14/705 2006 (97) EP 3383892**  
(96) EP 16829013.8 12/2/2016  
(97) EP 3383892, 10/10/2018 201841, en  
(31) 201562262911 P (32) 03.12.2015 (33) US  
201662348130 P 09.06.2016 US  
(54) MODIFIED CHIMERIC RECEPTORS AND RELATED COMPOSITIONS AND METHODS  
(72) THOMPSON, Lucas, James, 400 Dexter Avenue North Suite 1200, Seattle, WA 98109, US  
DUBOSE, Robert, F., 400 Dexter Avenue North Suite 1200, Seattle, WA 98109, US  
BRAHMANDAM, Archana, 400 Dexter Avenue North Suite 1200, Seattle, WA 98109, US

---

(51) MKP  
**A01N 31/08 2006 (97) EP 3393247**  
**A01N 35/08 2006**  
**A01N 43/40 2006**  
**A01N 43/80 2006**  
**A01N 59/00 2006**  
**A01N 59/06 2006**  
**A01N 59/16 2006**  
**A01P 1/00 2006**  
**D21H 21/36 2006**  
(96) EP 16829074.0 12/20/2016  
(97) EP 3393247, 10/31/2018 201844, en  
(31) 15202030 (32) 22.12.2015 (33) EP  
201562272157 P 29.12.2015 US  
(54) METAL OXIDES AND/OR HYDRATES THEREOF FOR STABILISING AN AQUEOUS PREPARATION AGAINST MICROBIAL GROWTH  
(72) URWYLER, Simon, Engehaldenstrasse 71, 3012 Bern, CH  
GLAUBITZ, Joachim, Parkweier 1, 6264 Pfaffnau, CH  
ZUMSTEG, Anita, Seestrasse 687, 8706 Meilen, CH

---

(51) MKP  
**B32B 33/00 2006 (97) EP 3393801**  
**B32B 37/18 2006**

**B32B 37/20 2006**  
**B42D 25/328 2014**  
**G03H 1/18 2006**  
(96) EP 16829078.1 12/22/2016  
(97) EP 3393801, 10/31/2018 201844, de  
(31) 102015226604 (32) 22.12.2015 (33) DE  
(54) METHOD FOR INTEGRATING A HOLOGRAM INTO THE BODY OF A SECURITY DOCUMENT AND SECURITY DOCUMENT BODY  
(71) Bundesdruckerei GmbH, Kommandantenstraße 18, 10969 Berlin, DE  
Covestro Deutschland AG, Kaiser-Wilhelm-Allee 60, 51373 Leverkusen, DE  
(72) STASIAK, Michael, Pirschgang 11 c, 15711 Königs Wusterhausen, DE  
KNEBEL, Michael, Zur Ringallee 57, 13086 Berlin, DE  
LEOPOLD, André, Angermünder Straße 11, 10119 Berlin, DE  
KULIKOVSKA, Olga, Rombsweg 2, 14165 Berlin, DE  
RÖLLE, Thomas, Neuenkamp 60, 51381 Leverkusen, DE  
HOVESTADT, Wieland, Brückerfeld 11, 42799 Leichlingen, DE  
HÖNEL, Dennis, In der Höhle 20, 53909 Zülpich-Wichterich, DE  
ORSELLI, Enrico, Elsassstrasse 38, 50677 Köln, DE

---

(51) MKP  
**C07D 307/20 2006 (97) EP 3405463**  
**C07D 319/12 2006**  
**C07H 19/10 2006**  
(96) EP 16829130.0 11/3/2016  
(97) EP 3405463, 11/28/2018 201848, en  
(31) 5940CH2015 (32) 03.11.2015 (33) IN  
(54) PROCESS FOR THE PREPARATION OF SOFOSBUVIR  
(72) JAYACHANDRA, Sureshbabu, Mylan Laboratories Ltd Plot No 564/A/22 Road No 92 Jubilee Hills, Hyderabad 500033, IN  
KAUSHIK, Vipin Kumar, Mylan Laboratories Ltd Plot No 564/A/22 Road No 92 Jubilee Hills, Hyderabad 500033, IN  
RAVI, Vijaya Krishna, Mylan Laboratories Limited Plot No 564/A/22 Road No 92 Jubilee Hills, Hyderabad 500033, IN  
DEV, Vikas Chandra, Mylan Laboratories Limited Plot No 564/A/22 Road No 92 Jubilee Hills, Hyderabad 500033, IN  
KOTTOLLA, Saiprasad, Mylan Laboratories Limited Plot No 564/A/22 Road No 92 Jubilee Hills, Hyderabad 500033, IN  
RAO, Potla Venkata Srinivasa, Mylan Laboratories Limited Plot No 564/A/22 Road No 92 Jubilee Hills, Hyderabad 500033, IN  
VAKITI, Srinivas, Mylan Laboratories Limited Plot No 564/A/22 Road No 92 Jubilee Hills, Hyderabad 500033, IN  
MUGGU, Chaitanya, Mylan Laboratories Limited Plot No 564/A/22 Road No 92 Jubilee Hills, Hyderabad 500033, IN  
DANDALA, Subramanyam, Mylan Laboratories Limited Plot No 564/A/22 Road No 92 Jubilee Hills, Hyderabad 500033, IN

---

(51) MKP  
**A61B 17/32 2006 (97) EP 3389518**  
(96) EP 16829163.1 12/14/2016  
(97) EP 3389518, 10/24/2018 201843, en  
(31) 201514972920 (32) 17.12.2015 (33) US  
(54) SURGICAL INSTRUMENT WITH MULTI-FUNCTIONING TRIGGER  
(72) SCHEIB, Charles J., 4545 Creek Road, Cincinnati Ohio 45242, US  
BOYD, Benjamin M., 4545 Creek Road, Cincinnati Ohio 45242, US  
RIESTENBERG, Paul F., 4545 Creek Road, Cincinnati Ohio 45242, US  
FALLER, Craig N., 4545 Creek Road, Cincinnati Ohio 45242, US  
HAMILTON, Allison, 4545 Creek Road, Cincinnati Ohio 45242, US  
SWINDON, Patrick J., 4545 Creek Road, Cincinnati Ohio 45242, US  
CHERMSIDE-SCABBO, Christopher J., 4545 Creek Road, Cincinnati Ohio 45242, US  
HOUSER, Kevin L., 4545 Creek Road, Cincinnati Ohio 45242, US  
CAGLE, David J., 4545 Creek Road, Cincinnati Ohio 45242, US  
STROBL, Geoffrey S., 4545 Creek Road, Cincinnati Ohio 45242, US  
DANZIGER, Benjamin J., 4545 Creek Road, Cincinnati Ohio 45242, US  
NOBIS, Rudolph H., 4545 Creek Road, Cincinnati Ohio 45242, US

---

(51) MKP  
**A61K 38/46 2006 (97) EP 3386534**  
**A61K 38/47 2006**  
**A61P 43/00 2006**  
**C12N 9/40 2006**  
**C12N 9/42 2006**  
(96) EP 16829343.9 12/8/2016  
(97) EP 3386534, 10/17/2018 201842, en

(31) 201562264702 P (32) 08.12.2015 (33) US  
201662379629 P 25.08.2016 US  
(54) COMPOSITIONS AND METHODS FOR INTERNALIZING ENZYMES  
(72) BAIK, Andrew, 777 Old Saw Mill River Road, Tarrytown New York 10591, US  
CYGNAR, Katherine, 777 Old Saw Mill River Road, Tarrytown New York 10591, US

---

(51) MKP  
**A01N 43/72 2006 (97) EP 3397638**  
**C07D 273/00 2006**  
**C07D 413/14 2006**  
**C07K 11/02 2006**  
(96) EP 16829348.8 12/14/2016  
(97) EP 3397638, 11/7/2018 201845, en  
(31) 201562272040 P (32) 28.12.2015 (33) US  
(54) ANTHELMINTIC DEPSIPEPTIDE COMPOUNDS  
(72) LE HIR DE FALLOIS, Loic, 2259 Fairhaven Circle NE, Atlanta GA 30305, US  
PACOFISKY, Gregory, 510 Polk Street, Raleigh NY 27604, US  
LONG, Alan, 5914 Stuart Drive, Flowery Branch GA 30542, US  
MENG, Charles, 7158 Belcrest Drive, Johns Creek GA 30097, US  
LEE, Hyoung, Ik, 103 Roundtop Road, Cary NC 27519, US

---

(51) MKP  
**C07K 16/28 2006 (97) EP 3390453**  
(96) EP 16829362.9 12/16/2016  
(97) EP 3390453, 10/24/2018 201843, en  
(31) 201562268570 P (32) 17.12.2015 (33) US  
(54) ANTIBODIES SPECIFICALLY BINDING HLA-DR AND THEIR USES  
(72) MARTINEZ, Christian, 3210 Merryfield Row, San Diego California 92121, US  
CHEN, Qiang, 3210 Merryfield Row, San Diego California 92121, US  
SWIECKI, Melissa, 1400 McKean Road, Spring House Pennsylvania 19477, US  
KUHN, Robert, 1400 McKean Road, Spring House Pennsylvania 19477, US  
ZHOU, Hong, 3210 Merryfield Row, San Diego California 92121, US  
DUFFY, Karen, 1400 McKean Road, Spring House Pennsylvania 19477, US  
BECART, Stephane, 3210 Merryfield Row, San Diego California 92121, US  
HUANG, Chichi, 1400 McKean Road, Spring House Pennsylvania 19477, US  
LIN-SCHMIDT, Xiefan, 1400 McKean Road, Spring House Pennsylvania 19477, US  
WU, Sheng-Jiun, 1400 McKean Road, Spring House Pennsylvania 19477, US  
LUO, Jinquan, 1400 McKean Road, Spring House Pennsylvania 19477, US  
OBMOLOVA, Galina, 65 Sheffield Court, Phoenixville, Pennsylvania 19460, US  
ERNST, Robin, 1400 McKean Road, Spring House Pennsylvania 19477, US

---

(51) MKP  
**E04B 1/21 2006 (97) EP 3394358**  
**E04H 9/02 2006**  
(96) EP 16831581.0 12/5/2016  
(97) EP 3394358, 10/31/2018 201844, en  
(31) UB20159737 (32) 21.12.2015 (33) IT  
(54) ANTI-SEISMIC CONNECTION JOINT HAVING A SLOTTED HOLE  
(72) BULFERETTI, Giovanni, c/o BULFERETTI GIOVANNI Via Vittorio Trainini 38, I-25133 Brescia, IT

---

(51) MKP  
**A61K 31/4725 2006 (97) EP 3394045**  
**A61P 35/00 2006**  
**C07C 55/08 2006**  
**C07C 57/145 2006**  
**C07C 59/245 2006**  
**C07C 59/265 2006**  
**C07C 59/54 2006**  
**C07C 65/05 2006**  
**C07C 65/10 2006**  
**C07D 401/14 2006**  
(96) EP 16831645.3 12/22/2016

(97) EP 3394045, 10/31/2018 201844, en  
(31) 2015252658 (32) 24.12.2015 (33) JP  
(54) COCRYSTAL, PRODUCTION METHOD THEREOF, AND MEDICAMENT CONTAINING COCRYSTAL  
(72) KIMOTO, Koya, c/o TAKEDA PHARMACEUTICAL COMPANY LIMITED 26-1 Muraoka-Higashi 2-chome, Fujisawa-shi Kanagawa 251-0012, JP  
YAMAMOTO, Mitsuo, c/o TAKEDA PHARMACEUTICAL COMPANY LIMITED 26-1 Muraoka-Higashi 2-chome, Fujisawa-shi Kanagawa 251-0012, JP  
KITAYAMA, Masato, c/o TAKEDA PHARMACEUTICAL COMPANY LIMITED 17-85 Jusohonmachi 2-chome Yodogawa-ku, Osaka-shi Osaka 532-0024, JP  
SAWAI, Yasuhiro, c/o TAKEDA PHARMACEUTICAL COMPANY LIMITED 17-85 Jusohonmachi 2-chome Yodogawa-ku, Osaka-shi Osaka 532-0024, JP  
HOHOKABE, Miyuki, c/o TAKEDA PHARMACEUTICAL COMPANY LIMITED 17-85 Jusohonmachi 2-chome Yodogawa-ku, Osaka-shi Osaka 532-0024, JP  
IWATA, Kentaro, c/o TAKEDA PHARMACEUTICAL COMPANY LIMITED 26-1 Muraoka-Higashi 2-chome, Fujisawa-shi Kanagawa 251-0012, JP

---

(51) MKP  
**E04H 9/02 2006 (97) EP 3390747**  
**F16F 1/38 2006**  
**F16F 7/00 2006**  
**F16F 7/04 2006**  
(96) EP 16831725.3 12/5/2016  
(97) EP 3390747, 10/24/2018 201843, en  
(31) UB20159414 (32) 16.12.2015 (33) IT  
(54) ANTI-SEISMIC CONNECTION JOINT  
(71) Bulferetti, Giovanni, Via Vittorio Trainini 38, 25133 Brescia, IT  
(72) BULFERETTI, Giovanni, c/o BULFERETTI GIOVANNI Via Vittorio Trainini 38, I-25133 Brescia, IT

---

(51) MKP  
**A23L 3/3472 2006 (97) EP 3373946**  
**A61K 8/97 2017**  
**A61K 36/48 2006**  
**A61K 36/575 2006**  
**A61Q 17/00 2006**  
(96) EP 16831945.7 11/9/2016  
(97) EP 3373946, 9/19/2018 201838, en  
(31) 201562252987 P (32) 09.11.2015 (33) US  
201615345006 07.11.2016 US  
(54) NATURAL PRESERVATIVES AND ANTIMICROBIAL AGENTS, INCLUDING COMPOSITIONS THEREOF  
(72) JIAO, Ping, 14709 SE 80th Court, Newcastle, Washington 98059, US  
JIA, Qi, 3922 Pennant Court NW, Olympia, Washington 98502, US  
HONG, Mei Feng, 3520 27th Place C122, Seattle, Washington 98199, US  
KIM, Misun, 3005 1st Avenue, Seattle, Washington 98121, US

---

(51) MKP  
**A61K 38/26 2006 (97) EP 3394104**  
**A61K 39/395 2006**  
**A61P 3/10 2006**  
**C07K 16/28 2006**  
(96) EP 16831950.7 12/21/2016  
(97) EP 3394104, 10/31/2018 201844, en  
(31) 201562387486 P (32) 23.12.2015 (33) US  
201662337799 P 17.05.2016 US  
201662420415 P 10.11.2016 US  
(54) METHOD OF TREATING OR AMELIORATING METABOLIC DISORDERS USING BINDING PROTEINS FOR GASTRIC INHIBITORY PEPTIDE RECEPTOR (GIPR) IN COMBINATION WITH GLP-1 AGONISTS  
(72) YIE, Junming, 4 Sugarwood Way, Warren New Jersey 07059, US  
SHI, Donghui, 3198 Rickey Court, Thousand Oaks California 91362, US  
LLOYD, David J., 458 Via Gregorio, Thousand Oaks California 91320, US  
WANG, Jinghong, 1540 Escobita Avenue, Palo Alto California 94306, US  
SIVITS, JR., Glenn N., 1347 Alessandro Drive, Newbury Park California 91320, US  
VENIANT-ELLISON, Murielle M., 645 Camino Manzanitas, Thousand Oaks California 91360, US  
KOMOROWSKI, Renee, 370 Chapel Drive, Ventura California 93003, US  
AGRAWAL, Neeraj, 2608 Stearns Hill Road, Waltham, MA 02451, US  
BATES, Darren L., 238 Saint Croix Court, Oak Park California 91377, US

CLAVETTE, Brandon C. P., 3487 Princeton Avenue, Coquitlam British Columbia V3E 0K5, CA  
FOLTZ, Ian N., 2108 Knightswood Place, Burnaby British Columbia V5A 4B9, CA  
HO, Shu-yin, 472 Cosmos Court, Thousand Oaks California 91360, US  
MURAWSKY, Christopher, 1141 Edmonds Road, Roberts Creek British Columbia V0N 2W0, CA  
MIN, Xiaoshan, 2108 Clarice Lane, Burlingame, CA 94010, US  
WANG, Zhulun, 660 Glenbrook Drive, Palo Alto California 94306, US

---

(51) MKP  
**A01N 25/04 2006 (97) EP 3386299**  
**A01N 25/12 2006**  
**A01N 25/30 2006**  
**A01N 43/707 2006**  
**A01N 43/78 2006**  
**A01N 47/04 2006**  
**A01N 51/00 2006**  
**C09D 5/00 2006**  
**C09D 11/00 2014**  
(96) EP 16834028.9 12/9/2016  
(97) EP 3386299, 10/17/2018 201842, en  
(31) 201562265725 P (32) 10.12.2015 (33) US  
(54) POLYELECTROLYTE-LAYER FORMING BLOCK COPOLYMERS AND COMPOSITIONS AND USED THEREOF  
(71) Rhodia Operations, 25 rue de Clichy, 75009 Paris, FR  
(72) SILBERT, Gilad, Kibutz Dorot, IL  
BERKOVITCH, Michael, 108/25 Kineret Street, 77700 Ashdod, IL  
WILSON, David, James, 19 Route de Lamorlaye, Coyo la Foret, FR

---

(51) MKP  
**B62D 21/16 2006 (97) EP 3393889**  
**B62D 29/04 2006**  
**B62D 31/00 2006**  
**B62D 63/02 2006**  
(96) EP 16834045.3 12/21/2016  
(97) EP 3393889, 10/31/2018 201844, fr  
(31) PCT/IB2015/059980 (32) 24.12.2015 (33) WO  
(54) VEHICLE ARCHITECTURE  
(71) Softcar SA, Passage du Cardinal, 1700 Fribourg, CH  
(72) THULIEZ, Jean-Luc, Jolimont 48, 2525 Le Landeron, CH  
CROZIER, Etienne, Ruelle de l'Hôtel de Ville 3, 2520 La Neuveville, CH

---

(51) MKP  
**C07K 16/00 2006 (97) EP 3390440**  
(96) EP 16834067.7 12/16/2016  
(97) EP 3390440, 10/24/2018 201843, en  
(31) 201562269138 P (32) 18.12.2015 (33) US  
(54) C-TERMINAL LYSINE CONJUGATED IMMUNOGLOBULINS  
(72) SPIDEL, Jared, 100 Wildbrier Road, Downingtown PA 19335, US  
ALBONE, Earl, 2105 Whitpain Hills, Blue Bell PA 19422, US

---

(51) MKP  
**C07D 275/06 2006 (97) EP 3397620**  
(96) EP 16834183.2 12/28/2016  
(97) EP 3397620, 11/7/2018 201845, en  
(31) 201631000081 (32) 01.01.2016 (33) IN  
(54) PROCESS FOR PREPARING 1.1.3-TRIOXO-1.2-BENZOTHIAZOLE-6-CARBOXAMIDE  
(71) Adama Agan Ltd., P.O. Box 262 Northern Industrial Zone, 7710201 Ashdod, IL  
(72) YACOVAN, Avihai, 4 Gegen Street, 7680400 Mazkeret Batya, IL  
BARDA, Yaniv, 14 Herzog Street, 7631045 Rehovot, IL  
MIRILASHVILI, Sima, 10 Sigalon Street, 7151010 Lod, IL  
BARON, Shmuel, A., 26/17 Bialik Street, 7763226 Ashdod, IL

---

(51) MKP



**C04B 28/14 2006 (97) EP 3397600**

- (96) EP 16834257.4 12/29/2016  
(97) EP 3397600, 11/7/2018 201845, en  
(31) 201514986237 (32) 31.12.2015 (33) US  
(54) FIRE RESISTANT BUILDING BOARDS WITH INCREASED AMOUNTS OF ANTI-SHRINKAGE ADDITIVES AND DECREASED DENSITIES  
(72) BROOKS, Laura, East Leake Technical Building, Loughborough Leicestershire LE12 6HS, GB  
SHINKODA, Pamela, 1340 Falgarwood Drive, Oakville Ontario L6H 2L9, CA  
BOUTEILLER, Bernard, 550 Avenue Alphonse Jauffret, 84300 Cavailon, FR  
SELLIER, Julien, 39 Quai Lucien Lefranc, 93303 Aubervilliers Cedex, FR
- 

(51) MKP  
**A61K 31/202 2006 (97) EP 3389647**

- A61P 3/08 2006**  
**A61P 17/06 2006**  
**A61P 25/00 2006**  
**A61P 29/00 2006**  
**A61P 35/00 2006**  
(96) EP 16834282.2 12/19/2016  
(97) EP 3389647, 10/24/2018 201843, en  
(31) 201562269280 P (32) 18.12.2015 (33) US  
(54) COMPOSITIONS COMPRISING 15-HEPE AND METHODS OF USING THE SAME  
(72) COUGHLAN, David, C/o Trintech Building South County Business Park, Leopardstown Dublin 18, IE  
CLIMAX, John, C/o Trintech Building South County Business Park, Leopardstown Dublin 18, IE
- 

(51) MKP  
**C12N 9/64 2006 (97) EP 3380610**

- C12N 9/72 2006**  
**C12N 9/74 2006**  
(96) EP 16834290.5 11/25/2016  
(97) EP 3380610, 10/3/2018 201840, en  
(31) 15196291 (32) 25.11.2015 (33) EP  
(54) RECOMBINANT SERINE PROTEASES  
(72) VERHOEF, Daniël, c/o Einthoven Laboratory of Experimental Vascular Medicine Department of Trombosis and Hemostasis LUMC Albinusdreef 2, 2333 ZA Leiden, NL  
REITSMA, Pieter H., c/o Einthoven Laboratory of Experimental Vascular Medicine Department of Trombosis and Hemostasis LUMC Albinusdreef 2, 2333 ZA Leiden, NL  
BOS, Mettine H.A., c/o Einthoven Laboratory of Experimental Vascular Medicine Department of Trombosis and Hemostasis LUMC Albinusdreef 2, 2333 ZA Leiden, NL
- 

(51) MKP  
**A61B 17/32 2006 (97) EP 3393379**

- A61B 90/70 2016**  
(96) EP 16834294.7 12/14/2016  
(97) EP 3393379, 10/31/2018 201844, en  
(31) 201514976483 (32) 21.12.2015 (33) US  
(54) ULTRASONIC SURGICAL INSTRUMENT WITH BLADE CLEANING FEATURE  
(72) DENZINGER, Kristen G., 4545 Creek Road, Cincinnati, Ohio 45242, US  
MADAN, Ashvani K., 4545 Creek Road, Cincinnati, Ohio 45242, US  
KIMBALL, Cory G., 4545 Creek Road, Cincinnati, Ohio 45242, US  
KEMERLING, Robert A., 4545 Creek Road, Cincinnati, Ohio 45242, US  
HIBNER, John A., 4545 Creek Road, Cincinnati, Ohio 45242, US  
RUIZ ORTIZ, Rafael J., 4545 Creek Road, Cincinnati, Ohio 45242, US  
CORBETT, Catherine A., 4545 Creek Road, Cincinnati, Ohio 45242, US  
LAMPING, Michael R., 4545 Creek Road, Cincinnati, Ohio 45242, US  
REMM, Thomas B., 4545 Creek Road, Cincinnati, Ohio 45242, US
- 

(51) MKP  
**A61B 18/02 2006 (97) EP 3389526**

- A61B 34/10 2016**  
(96) EP 16836090.7 12/12/2016  
(97) EP 3389526, 10/24/2018 201843, en  
(31) UB20159658 (32) 14.12.2015 (33) IT

- (54) A MACHINERY FOR SURGICAL INTERVENTIONS OF CRYOABLATION WITH CLOSED CYCLE AND MULTIPURPOSE  
 (71) Narducci, Leo Aldo, Via Orsini 1A/17, 16146 Genova, IT  
 Avalue, Leopoldo, Via Murcarolo 6/9, 16167 Genova, IT  
 Penco, Andrea, Via Volturmo 7/26, 16129 Genova, IT  
 (72) AVALLE, Leopoldo, via Murcarolo 6/9, 16147 Genova, IT
- 

- (51) MKP  
**B82Y 30/00 2011 (97) EP 3393967**  
**C08J 5/18 2006**  
**C08L 23/08 2006**  
**C09D 123/08 2006**  
 (96) EP 16836094.9 12/22/2016  
 (97) EP 3393967, 10/31/2018 201844, en  
 (31) UB20159175 (32) 23.12.2015 (33) IT  
 (54) ANTIMICROBIAL POLYMER COMPOSITION  
 (71) Materie Plastiche Pisane S.r.L., Via della Vecchia Stazione 1, 56031 Bientina (Pisa), IT  
 (72) CORSI, Leopoldo, Via delle Colline per Legoli 1, 56038 Ponsacco (Pisa), IT  
 LOMBARDI, Luca, Via Marini 15D, 51100 Pistoia, IT  
 RUZZANTE, Marco, Via Don Milani 26, 51013 Chiesina Uzzanese (Pistoia), IT
- 

- (51) MKP  
**A61K 31/336 2006 (97) EP 3411363**  
**A61K 31/5375 2006**  
**A61K 38/07 2006**  
**C07D 303/36 2006**  
**C07K 5/10 2006**  
 (96) EP 16836116.0 12/10/2016  
 (97) EP 3411363, 12/12/2018 201850, en  
 (31) 6647CH2015 (32) 11.12.2015 (33) IN  
 (54) CRYSTALLINE AND AMORPHOUS FORMS OF CARFILZOMIB  
 (72) GORE, Vinayak G, Mylan Laboratories Limited Plot No 564/A/22 Road No 92 Jubilee Hills, Hyderabad 500033, IN  
 SHUKLA, Vinay Kumar, Mylan Laboratories Ltd Plot No 564/A/22 Road No 92 Jubilee Hills, Hyderabad 500033, IN  
 SANGVIKAR, Yogesh, Mylan Laboratories Limited Plot No 564/A/22 Road No 92 Jubilee Hills, Hyderabad 500033, IN  
 KOKANE, Dattatrey, Mylan Laboratories Limited Plot No 564/A/22 Road No 92 Jubilee Hills, Hyderabad 500033, IN  
 GHARAT, Sushant, Mylan Laboratories Limited Plot No 564/A/22 Road No 92 Jubilee Hills, Hyderabad 500033, IN
- 

- (51) MKP  
**C07D 275/06 2006 (97) EP 3397621**  
 (96) EP 16836152.5 12/28/2016  
 (97) EP 3397621, 11/7/2018 201845, en  
 (31) 201631000085 (32) 01.01.2016 (33) IN  
 (54) PROCESS FOR PREPARING 1,1,3-TRIOXO-1,2-BENZOTHAZOLE-6-CARBOXAMIDE  
 (72) PILLAI, Bijukumar, Gopinathan, C-101 Shree Balaji Residency Motera-Sabarmati, Gujarat 380005, IN  
 MIRILASHVILI, Sima, 10 Sigalon Street, 7151010 Lod, IL  
 BARDA, Yaniv, 14 Herzog Street, 7631045 Rehovot, IL  
 HAMIRANI, Bhavinkumar, P., D-203 Sanskrut Residency Gorwa Vadodara, Gujarat 390016, IN  
 MEKA, Bhoopal, Flat No-304 Block-a Vertex Pleasant Brindavan C Nizampet Road Kphb Hyderabad, Telengana 500072, IN  
 MANNAM, Sreedevi, Flat No D8/4 BITS-Pilani Hyderabad Campus Jawahar Nagar Shameerpet (Mandal), Hyderabad, Telengana 500078, IN
- 

- (51) MKP  
**A61B 17/28 2006 (97) EP 3397179**  
**A61B 17/29 2006**  
**A61B 17/32 2006**  
 (96) EP 16836186.3 12/14/2016  
 (97) EP 3397179, 11/7/2018 201845, en  
 (31) 201514982129 (32) 29.12.2015 (33) US  
 (54) SNAP FIT CLAMP PAD FOR ULTRASONIC SURGICAL INSTRUMENT  
 (72) RIESTENBERG, Paul F., 4545 Creek Road, Cincinnati Ohio 45242, US  
 SEPULVEDA-LEYVA, David, 4545 Creek Road, Cincinnati Ohio 45242, US  
 DICKERSON, Benjamin D., 4545 Creek Road, Cincinnati Ohio 45242, US  
 FALLER, Craig N., 4545 Creek Road, Cincinnati Ohio 45242, US

---

(51) MKP  
**A61K 31/501 2006 (97) EP 3345909**  
**A61K 31/5377 2006**  
**A61P 25/04 2006**  
**A61P 25/18 2006**  
**A61P 25/28 2006**  
**A61P 29/00 2006**  
**C07D 491/044 2006**

(96) EP 16837160.7 8/18/2016  
(97) EP 3345909, 7/11/2018 201828, en

(31) 2015162320 (32) 19.08.2015 (33) JP

(54) TETRAHYDROOXEPINOPYRIDINE COMPOUND

(72) KOGANEMARU, Yohei, c/o Astellas Pharma Inc. 5-1 Nihonbashi-Honcho 2-chome Chuo-ku, Tokyo 103-8411, JP  
MIYAMOTO, Satoshi, c/o Astellas Pharma Inc. 5-1 Nihonbashi-Honcho 2-chome Chuo-ku, Tokyo 103-8411, JP  
NAGASHIMA, Shinya, c/o Astellas Pharma Inc. 5-1 Nihonbashi-Honcho 2-chome Chuo-ku, Tokyo 103-8411, JP  
KAMIKAWA, Akio, c/o Astellas Pharma Inc. 5-1 Nihonbashi-Honcho 2-chome Chuo-ku, Tokyo 103-8411, JP  
YONEZAWA, Koichi, c/o Astellas Pharma Inc. 5-1 Nihonbashi-Honcho 2-chome Chuo-ku, Tokyo 103-8411, JP  
KOIZUMI, Yuka, c/o Astellas Pharma Inc. 5-1 Nihonbashi-Honcho 2-chome Chuo-ku, Tokyo 103-8411, JP  
AOKI, Satoshi, c/o Astellas Pharma Inc. 5-1 Nihonbashi-Honcho 2-chome Chuo-ku, Tokyo 103-8411, JP  
OGIYAMA, Takashi, c/o Astellas Pharma Inc. 5-1 Nihonbashi-Honcho 2-chome Chuo-ku, Tokyo 103-8411, JP  
KAWAKAMI, Shimpei, c/o Astellas Pharma Inc. 5-1 Nihonbashi-Honcho 2-chome Chuo-ku, Tokyo 103-8411, JP  
KUNIKAWA, Shigeki, c/o Astellas Pharma Inc. 5-1 Nihonbashi-Honcho 2-chome Chuo-ku, Tokyo 103-8411, JP  
SATO, Ryo, c/o Astellas Pharma Inc. 5-1 Nihonbashi-Honcho 2-chome Chuo-ku, Tokyo 103-8411, JP  
SHISHIKURA, Junichi, c/o Astellas Pharma Inc. 5-1 Nihonbashi-Honcho 2-chome Chuo-ku, Tokyo 103-8411, JP  
KAKIMOTO, Shuichirou, c/o Astellas Pharma Inc. 5-1 Nihonbashi-Honcho 2-chome Chuo-ku, Tokyo 103-8411, JP  
YAMADA, Hiroshi, c/o Astellas Pharma Inc. 5-1 Nihonbashi-Honcho 2-chome Chuo-ku, Tokyo 103-8411, JP  
TAMAKI, Keisuke, c/o Astellas Pharma Inc. 5-1 Nihonbashi-Honcho 2-chome Chuo-ku, Tokyo 103-8411, JP

---

(51) MKP  
**A01G 1/00 2006 (97) EP 3397054**  
**A01G 3/06 2006**  
**A01G 29/00 2006**  
**A01N 25/04 2006**  
**A01N 25/26 2006**  
**A01P 21/00 2006**  
**C05G 3/00 2006**  
**C05G 3/04 2006**  
**C05G 3/06 2006**

(96) EP 16837980.8 12/21/2016  
(97) EP 3397054, 11/7/2018 201845, en

(31) 201562271862 P (32) 28.12.2015 (33) US

(54) CONTROLLED RELEASE AGROCHEMICAL DELIVERY UNITS, THEIR MANUFACTURE AND USE

(72) VITNER, Asher, 2/60 Kadish Loz St., 91390 Jerusalem, IL  
MILLER, Zvi, 14 A Haemek St., 36084 Kiryat Tivon, IL  
BEN-MOSHE, Matti, 2 Sheizaf St., 71-799 Reut, IL  
SHANI, Uri, 5 Avshalom Haviv St., Tel Aviv, IL  
BARNEA, Zach, 16/1 Mordechai Caspi St., Jerusalem, IL  
SEGAL, Eran, Pob 207, 76842 Hulda, IL  
LEMBERGER, Nitay, 28 Haportzim St., 9254113 Jerusalem, IL

---

(51) MKP  
**D06N 3/00 2006 (97) EP 3397804**  
**D06N 3/18 2006**

(96) EP 16838033.5 12/29/2016  
(97) EP 3397804, 11/7/2018 201845, en

(31) UB20159810 (32) 30.12.2015 (33) IT

(54) PROCESS OF TREATING A NON-WOVEN MICROFIBROUS MATRIX MATERIAL WITH RESIN

(71) Naum S.r.l., Via Luciano Zuccoli 26, 20125 Milano, IT  
(72) BORSANI, Carlo, via Luciano Zuccoli 26, 20125 Milano, IT  
SECCO D'ARAGONA, Marco, via Luciano Zuccoli 26, 20125 Milano, IT

---

(51) MKP

**A61K 31/44 2006 (97) EP 3390361**  
**A61K 31/4545 2006**  
**A61P 31/00 2006**  
**A61P 35/00 2006**  
**A61P 37/04 2006**  
**C07D 213/81 2006**  
**C07D 213/84 2006**  
**C07D 237/24 2006**  
**C07D 239/28 2006**  
**C07D 241/24 2006**  
**C07D 401/06 2006**  
**C07D 401/12 2006**  
**C07D 401/14 2006**  
**C07D 405/12 2006**  
**C07D 405/14 2006**  
(96) EP 16840349.1 12/16/2016  
(97) EP 3390361, 10/24/2018 201843, en  
(31) 201562268680 P (32) 17.12.2015 (33) US  
201662347817 P 09.06.2016 US  
201662385048 P 08.09.2016 US  
(54) N-PHENYL-PYRIDINE-2-CARBOXAMIDE DERIVATIVES AND THEIR USE AS PD-1/PD-L1 PROTEIN/PROTEIN INTERACTION  
MODULATORS  
(72) WU, Liangxing, Incyte Corporation 1801 Augustine Cut-Off, Wilmington DE 19803, US  
YU, Zhiyong, Incyte Corporation 1801 Augustine Cut-Off, Wilmington DE 19803, US  
ZHANG, Fenglei, Incyte Corporation 1801 Augustine Cut-Off, Wilmington DE 19803, US  
YAO, Wenqing, Incyte Corporation 1801 Augustine Cut-Off, Wilmington DE 19803, US

---

(51) MKP  
**F25B 21/02 2006 (97) EP 3346209**  
**H05K 7/14 2006**  
**H05K 7/20 2006**  
(96) EP 16840871.4 8/9/2016  
(97) EP 3346209, 7/11/2018 201828, en  
(31) 201531240 (32) 31.08.2015 (33) ES  
(54) COMPUTER WITH SPECIAL OUTER CASING ALLOWING THE SITUATION THEREOF IN EXPLOSIVE ATMOSPHERES  
(71) LFK Global Technology Services, S.L., Juan Ramón Jiménez 10, 41720 Los Palacios Y Vfca. (Sevilla), ES  
(72) LEO GARCIA, Juan, Juan Ramón Jiménez 10, 41720 Los Palacios Y Vfca. (sevilla), ES

---

(51) MKP  
**A61K 31/519 2006 (97) EP 3345907**  
**A61P 35/00 2006**  
**C07D 487/04 2006**  
(96) EP 16841868.9 8/31/2016  
(97) EP 3345907, 7/11/2018 201828, en  
(31) 2015172354 (32) 01.09.2015 (33) JP  
(54) NOVEL PYRAZOLO[3,4-d]PYRIMIDINE COMPOUND OR SALT THEREOF  
(72) KAWAI, Yuichi, c/o Taiho Pharmaceutical Co., Ltd. 3 Okubo, Tsukuba-shi Ibaraki 300-2611, JP  
IRIE, Hiroki, c/o Taiho Pharmaceutical Co., Ltd. 3 Okubo, Tsukuba-shi Ibaraki 300-2611, JP  
SAGARA, Takeshi, c/o Taiho Pharmaceutical Co., Ltd. 3 Okubo, Tsukuba-shi Ibaraki 300-2611, JP  
MIYADERA, Kazutaka, c/o Taiho Pharmaceutical Co., Ltd. 1-27 Kandanishiki-cho Chiyoda-ku, Tokyo 101-8444, JP

---

(51) MKP  
**A61K 31/4439 2006 (97) EP 3344613**  
**A61K 31/497 2006**  
**C07D 401/04 2006**  
**C07D 403/04 2006**  
(96) EP 16842297.0 8/31/2016  
(97) EP 3344613, 7/11/2018 201828, en  
(31) 201562212520 P (32) 31.08.2015 (33) US  
(54) HETEROARYL COMPOUNDS AND THEIR USE AS THERAPEUTIC DRUGS  
(71) Dong-A Socio Holdings Co., Ltd., 64, Cheonho-daero Dongdaemun-gu, Seoul 02587, KR  
(72) KIM, Myeong-Seop, 5412-1104 65 Docheong-ro Yeongtong-gu, Suwon-si Gyeonggi-do 16509, KR  
KIM, Sumin, 301 1963 Nambusunhwan-ro Gwanak-gu, Seoul 08802, KR

KIM, Jin Kwan, 946-1501 20 Deogyong-daero 1555beon-gil Yeongtong-gu, Suwon-si Gyeonggi-do 16700, KR  
 KIM, Hadong, 101-903 133-15 Gaebong-ro 2-gil Guro-gu, Seoul 08331, KR  
 RYU, Ki Moon, 210-1303 66 Yonggu-daero 2771beon-gil Suji-gu, Yongin-si Gyeonggi-do 16865, KR  
 PARK, Seong Jin, 12 Sajik-ro 2-gil Jongno-gu, Seoul 03026, KR  
 PARK, Taesun, 302 16-1 Geumhwa-ro 105beon-gil Giheung-gu, Yongin-si Gyeonggi-do 17073, KR  
 SHEEN, Joon-Ho, 3-2 Daehak-ro 5-gil Jongno-gu, Seoul 03082, KR  
 YOON, Taeyoung, 26-8 Seochojungang-ro 6-gil Seocho-gu, Seoul 06643, KR  
 JANG, Mi Yeon, 102-201 10 Sinchon-ro 73beon-gil Giheung-gu, Yongin-si Gyeonggi-do 16904, KR

- (51) MKP  
**B21D 51/04 2006 (97) EP 3344564**  
**B21D 51/44 2006**  
**B41F 17/28 2006**  
**B65G 47/24 2006**  
**B65G 47/244 2006**  
**B65G 47/248 2006**
- (96) EP 16842455.4 5/16/2016  
 (97) EP 3344564, 7/11/2018 201828, en
- (31) 201514844789 (32) 03.09.2015 (33) US
- (54) APPARATUS AND METHOD FOR ORIENTING A BEVERAGE CONTAINER END CLOSURE AND APPLYING INDICIA IN A PREDETERMINED LOCATION
- (72) ELLEFSON, Dean, C., 8317 Swadley Court, Arvada, CO 80005, US  
 ARCHER, Edward, D., 9010 Iron Horse Lane, Sebring, FL 33875, US  
 CONINGSBY, Gregg, 2824 Ne 28th Street, Fort Lauderdale, FL 33306, US

- (51) MKP  
**A61K 31/445 2006 (97) EP 3344248**  
**A61P 25/00 2006**  
**C07D 211/00 2006**
- (96) EP 16842832.4 8/30/2016  
 (97) EP 3344248, 7/11/2018 201828, en
- (31) 201562213203 P (32) 02.09.2015 (33) US
- (54) 6-MEMBERED AZA-HETEROCYCLIC CONTAINING DELTA-OPIOID RECEPTOR MODULATING COMPOUNDS, METHODS OF USING AND MAKING THE SAME
- (72) SPEERSCHNEIDER, Aimee Crombie, 1018 West 8th Avenue Suite A, King of Prussia, Pennsylvania 19406, US  
 YAMASHITA, Dennis Shinji, 1018 West 8th Avenue Suite A, King of Prussia, Pennsylvania 19406, US  
 PITIS, Philip Michael, 1018 West 8th Avenue Suite A, King of Prussia, Pennsylvania 19406, US  
 HAWKINS, Michael John, 1018 West 8th Avenue Suite A, King of Prussia, Pennsylvania 19406, US  
 LIU, Guodong, 1018 West 8th Avenue Suite A, King of Prussia, Pennsylvania 19406, US  
 MISKOWSKI DAUBERT, Tamara Ann, 1018 West 8th Avenue Suite A, King of Prussia, Pennsylvania 19406, US  
 YUAN, Catherine C.K., 1018 West 8th Avenue Suite A, King of Prussia, Pennsylvania 19406, US  
 BORBO KARGBO, Robert, 1018 West 8th Avenue Suite A, King of Prussia, Pennsylvania 19406, US  
 HERR, Robert Jason, 1018 West 8th Avenue Suite A, King of Prussia, Pennsylvania 19406, US  
 ROMERO, Donna, 1018 West 8th Avenue Suite A, King of Prussia, Pennsylvania 19406, US  
 PACOFSKY, Gregory J., 1018 West 8th Avenue Suite A, King of Prussia, Pennsylvania 19406, US

- (51) MKP  
**A61K 38/47 2006 (97) EP 3344337**  
**A61P 3/00 2006**
- (96) EP 16842895.1 8/31/2016  
 (97) EP 3344337, 7/11/2018 201828, en
- (31) 201562212389 P (32) 31.08.2015 (33) US  
 201562220701 P 18.09.2015 US  
 201562244399 P 21.10.2015 US  
 201662295931 P 16.02.2016 US  
 201662331225 P 03.05.2016 US  
 201662331166 P 03.05.2016 US
- (54) METHODS AND COMPOSITIONS FOR THE TREATMENT OF CYTOPPLASMIC GLYCOGEN STORAGE DISORDERS
- (71) Duke University, 2812 Erwin Road, Durham, NC 27705, US
- (72) KISHNANI, Priya, Department of Pediatrics Duke University Box 103856, Durham, NC 27710, US  
 SUN, Baodong, Department of Pediatrics Duke University Box 103856, Durham, NC 27710, US  
 KOEBERL, Dwight D., Department of Pediatrics Duke University Box 103856, Durham, NC 27710, US

(51) MKP  
**A61K 31/05 2006 (97) EP 3344271**  
**A61K 36/55 2006**  
(96) EP 16842946.2 8/31/2016  
(97) EP 3344271, 7/11/2018 201828, en  
(31) 201562212898 P (32) 01.09.2015 (33) US  
(54) USE OF SECOISOLARICIRE SINOL DIGLUCOSIDES (SDGs) AND RELATED COMPOUNDS FOR PROTECTION AGAINST RADIATION DAMAGE  
(72) CHRISTOFIDOU-SOLOMIDOU, Melpo, 7017 Windswept Lane, Eagleville, Pennsylvania 19403, US

---

(51) MKP  
**A61K 31/437 2006 (97) EP 3344614**  
**A61K 31/4439 2006**  
**A61K 31/444 2006**  
**C07D 401/06 2006**  
**C07D 471/12 2006**  
**C07D 471/18 2006**  
(96) EP 16842971.0 9/1/2016  
(97) EP 3344614, 7/11/2018 201828, en  
(31) 201562214727 P (32) 04.09.2015 (33) US  
201562214734 P 04.09.2015 US  
(54) THERAPEUTIC COMPOUNDS FOR PAIN AND SYNTHESIS THEREOF  
(72) DECORTE, Bart Lieven Daniel, 920 U.S. Route 202, Raritan, New Jersey 08969, US  
RUSSCHER, Jacob Cornelis, Kerkenbos 1013, 6546 BB Nijmegen, NL  
MONNEE, Menno Cornelis Franciscus, Kerkenbos 1013, 6546 BB Nijmegen, NL

---

(51) MKP  
**A61K 31/336 2006 (97) EP 3344626**  
**A61K 31/437 2006**  
**A61K 31/46 2006**  
**C07D 471/12 2006**  
**C07D 471/18 2006**  
**C07D 491/147 2006**  
(96) EP 16842973.6 9/1/2016  
(97) EP 3344626, 7/11/2018 201828, en  
(31) 201562214727 P (32) 04.09.2015 (33) US  
201562214734 P 04.09.2015 US  
(54) THERAPEUTIC COMPOUNDS FOR PAIN AND SYNTHESIS THEREOF  
(72) DECORTE, Bart Lieven Daniel, 920 U.S. Route 202, Raritan, New Jersey 08969, US  
RUSSCHER, Jacob Cornelis, Kerkenbos 1013, 6546 BB Nijmegen, NL  
MONNEE, Menno Cornelis Franciscus, Kerkenbos 1013, 6546 BB Nijmegen, NL

---

(51) MKP  
**A61K 31/437 2006 (97) EP 3344627**  
**A61K 31/4375 2006**  
**C07D 471/12 2006**  
**C07D 471/18 2006**  
(96) EP 16842975.1 9/1/2016  
(97) EP 3344627, 7/11/2018 201828, en  
(31) 201562214727 P (32) 04.09.2015 (33) US  
201562214734 P 04.09.2015 US  
(54) THERAPEUTIC COMPOUNDS FOR PAIN AND SYNTHESIS THEREOF  
(72) DECORTE, Bart Lieven Daniel, 920 U.S. Route 202, Raritan, New Jersey 08969, US  
RUSSCHER, Jacob Cornelis, Kerkenbos 1013, 6546 BB Nijmegen, NL  
MONNEE, Menno Cornelis Franciscus, Kerkenbos 1013, 6546 BB Nijmegen, NL

---

(51) MKP  
**A61K 31/336 2006 (97) EP 3344628**  
**A61K 31/437 2006**  
**A61K 31/46 2006**  
**C07D 471/12 2006**  
**C07D 471/18 2006**  
**C07D 491/147 2006**

(96) EP 16842976.9 9/1/2016  
(97) EP 3344628, 7/11/2018 201828, en  
(31) 201562214727 P (32) 04.09.2015 (33) US  
201562214734 P 04.09.2015 US  
(54) THERAPEUTIC COMPOUNDS AND SYNTHESIS  
(72) DECORTE, Bart Lieven Daniel, 920 U.S. Route 202, Raritan, New Jersey 08969, US  
RUSSCHER, Jacob Cornelis, Kerkenbos 1013, 6546 BB Nijmegen, NL  
MONNEE, Menno Cornelis Franciscus, Kerkenbos 1013, 6546 BB Nijmegen, NL

---

(51) MKP  
**A61J 1/03 2006 (97) EP 3344212**  
**A61J 7/02 2006**  
**A61J 7/04 2006**  
(96) EP 16842977.7 9/1/2016  
(97) EP 3344212, 7/11/2018 201828, en  
(31) 201562213226 P (32) 02.09.2015 (33) US  
(54) MEDICATION PACKAGING AND DOSE REGIMEN SYSTEM  
(72) WARDEN, Jeffrey, 717 Kenmare Road, Bala Cynwyd, PA 19004, US  
RICHARDSON, Eric, 4621 East Bent Tree Drive, Cave Creek, AZ 85331, US  
TERHUNE, JoAnna, 1125 Orion Drive, Pittsburgh, PA 15235, US  
SCOUVART, Michael, 329 Buckingham Drive, Venetia, PA 15367, US  
MAURO, Anthony, R., 800 Davis School Road, Washington, PA 15301, US  
MALIK, Rajiv, 605 Grandview Drive, Pittsburgh, PA 15044, US

---

(51) MKP  
**A61K 31/336 2006 (97) EP 3344629**  
**A61K 31/36 2006**  
**A61K 31/437 2006**  
**C07D 317/46 2006**  
**C07D 471/12 2006**  
**C07D 471/18 2006**  
**C07D 491/147 2006**  
(96) EP 16842981.9 9/1/2016  
(97) EP 3344629, 7/11/2018 201828, en  
(31) 201562214727 P (32) 04.09.2015 (33) US  
201562214734 P 04.09.2015 US  
(54) THERAPEUTIC COMPOUND FOR PAIN AND SYNTHESIS THEREOF  
(72) DECORTE, Bart Lieven Daniel, 920 U.S. Route 202, Raritan, New Jersey 08969, US  
RUSSCHER, Jacob Cornelis, Kerkenbos 1013, 6546 BB Nijmegen, NL  
MONNEE, Menno Cornelis Franciscus, Kerkenbos 1013, 6546 BB Nijmegen, NL

---

(51) MKP  
**A61K 35/52 2015 (97) EP 3344265**  
**A61P 31/12 2006**  
(96) EP 16843016.3 9/1/2016  
(97) EP 3344265, 7/11/2018 201828, en  
(31) 201562214038 P (32) 03.09.2015 (33) US  
(54) TOPICAL ANTIVIRAL COMPOSITIONS  
(71) Topical Remedy, LLC, 5285 Meadows Drive Suite 161, Lake Oswego, Oregon 97035, US  
(72) KONOWALCHUK, Thomas W., 1070 N.E. 7th Drive, Newport, Oregon 97365, US

---

(51) MKP  
**A01H 5/00 2018 (97) EP 3394269**  
**A01N 63/00 2006**  
**A01N 63/02 2006**  
**C07K 14/195 2006**  
**C12N 15/82 2006**  
(96) EP 16843278.9 12/16/2016  
(97) EP 3394269, 10/31/2018 201844, en  
(31) 201562270742 P (32) 22.12.2015 (33) US  
201662412619 P 25.10.2016 US  
(54) PESTICIDAL GENES AND METHODS OF USE

(71) AgBiome, Inc., 104 T.W. Alexander Drive, Building 1, Research Triangle Park, NC 27709, US  
(72) PARKS, Jessica, 5433 Wade Park Boulevard Apt. 2201, Raleigh, North Carolina 27607, US  
ROBERTS, Kira, Bulazel, 7810 Roxboro Road, Bahama, North Carolina 27503, US  
THAYER, Rebecca, E., 100 Hammond Wood Place, Morrisville, North Carolina 27560, US

---

(51) MKP  
**A61K 39/395 2006 (97) EP 3348572**  
**A61P 21/02 2006**  
**A61P 43/00 2006**  
**C07K 16/28 2006**  
**C12N 15/09 2006**  
(96) EP 16844327.3 9/6/2016  
(97) EP 3348572, 7/18/2018 201829, en  
(31) 2015177081 (32) 08.09.2015 (33) JP  
(54) ANTI-EPHA4 ANTIBODY  
(72) TAGUCHI, Ryota, c/o KAN Research Institute Inc. 6-8-2 Minatojima-minamimachi Chuo-ku, Kobe-shi Hyogo 650-0047, JP  
IMAI, Toshio, c/o KAN Research Institute Inc. 6-8-2 Minatojima-minamimachi Chuo-ku, Kobe-shi Hyogo 650-0047, JP  
INOUE, Eiji, c/o KAN Research Institute Inc. 6-8-2 Minatojima-minamimachi Chuo-ku, Kobe-shi Hyogo 650-0047, JP  
YAMADA, Akio, c/o KAN Research Institute Inc. 6-8-2 Minatojima-minamimachi Chuo-ku, Kobe-shi Hyogo 650-0047, JP  
NAKATANI, Aki, c/o KAN Research Institute Inc. 6-8-2 Minatojima-minamimachi Chuo-ku, Kobe-shi Hyogo 650-0047, JP  
HIRAYAMA, Toshifumi, c/o KAN Research Institute Inc. 6-8-2 Minatojima-minamimachi Chuo-ku, Kobe-shi Hyogo 650-0047, JP  
ONO, Yuichi, c/o KAN Research Institute Inc. 6-8-2 Minatojima-minamimachi Chuo-ku, Kobe-shi Hyogo 650-0047, JP  
ITO, Shunsuke, c/o KAN Research Institute Inc. 6-8-2 Minatojima-minamimachi Chuo-ku, Kobe-shi Hyogo 650-0047, JP

---

(51) MKP  
**B60P 3/40 2006 (97) EP 2687403**  
**B62D 53/02 2006**  
(96) EP 13176445.8 7/15/2013  
(97) EP 2687403, 11/21/2018 201847, de  
(31) 102012106563 (32) 19.07.2012 (33) DE  
(54) Transport system for long loads  
(71) Hubtex Maschinenbau GmbH & Co. Kg, Werner-von-Siemens-Straße 8, 36041 Fulda, DE  
(72) Otterbein, Achim, Friedrichstraße 26, 36137 Großenlüder, DE

---

(51) MKP  
**A61K 31/437 2006 (97) EP 3356363**  
**A61P 25/16 2006**  
**A61P 25/28 2006**  
**A61P 35/00 2006**  
**C07D 471/04 2006**  
(96) EP 16774682.5 9/30/2016  
(97) EP 3356363, 8/8/2018 201832, en  
(31) 1559252 (32) 30.09.2015 (33) FR  
(54) NEW IMIDAZO[4,5-B]PYRIDINE DERIVATIVES AS DUAL DYRK1/CLK1 INHIBITORS  
(72) BÁLINT, Balázs, Lehel utca 18, 2151 Fót, HU  
KOTSCHY, András, Álmos Vezér u.4, 2045 Törökbálint, HU  
SIPOS, Melinda, Honfoglalás utca 40B C3ép., 1029 Budapest, HU  
WÉBER, Csaba, Szentendrei utca 9, 2009 Pilisszentlászló, HU  
FOLOPPE, Nicolas, 14 Janes Court, Cambridge Cambridgeshire CB1 3JJ, GB  
WALMSLEY, David, 65 Collier Close, Ely Cambridgeshire CB6 3WQ, GB  
BURBRIDGE, Michaël, Frank, 13 rue Emile Zola, 78480 Verneuil Sur Seine, FR  
CRUZALEGUI, Francisco Humberto, 26 rue de Lapiacères, 31490 Brax, FR

---

(51) MKP  
**A61K 31/437 2006 (97) EP 3356364**  
**A61K 31/519 2006**  
**A61P 25/16 2006**  
**A61P 25/28 2006**  
**A61P 35/00 2006**  
**C07D 471/04 2006**  
**C07D 487/04 2006**  
(96) EP 16774684.1 9/30/2016  
(97) EP 3356364, 8/8/2018 201832, en



(31) 1559259 (32) 30.09.2015 (33) FR  
(54) NEW PYRROLO[2,3-D]PYRIMIDINE DERIVATIVES AS DUAL DYRK1/CLK1 INHIBITORS  
(72) FIUMANA, Andrea, 16 Langham Way, Ely Cambridgeshire CB6 1DZ, GB  
FOLOPPE, Nicolas, 14 Janes Court, Cambridge Cambridgeshire CB1 3JJ, GB  
RAY, Stuart, 5 Daniels Park Milton, Cambridgeshire CB24 6UD, GB  
WALMSLEY, David, 65 Collier Close, Ely Cambridgeshire CB6 3WQ, GB  
KOTSCHY, András, Álmos Vezér u.4, 2045 Törökbálint, HU  
BURBRIDGE, Michaël, Frank, 13 rue Emile Zola, 78480 Verneuil-sur-Seine, FR  
CRUZALEGUI, Francisco, Humberto, 26 rue de Laspiacères, 31490 Brax, FR

---

(51) MKP  
**A61K 38/17 2006 (97) EP 3359560**  
**A61K 39/00 2006**  
**C07K 7/06 2006**  
**C07K 14/47 2006**  
**G01N 33/574 2006**  
(96) EP 16774689.0 9/30/2016  
(97) EP 3359560, 8/15/2018 201833, en  
(31) 201517538 (32) 05.10.2015 (33) GB  
201562237091 P 05.10.2015 US  
(54) PEPTIDES AND COMBINATION OF PEPTIDES FOR USE IN IMMUNOTHERAPY AGAINST SMALL CELL LUNG CANCER AND OTHER  
CANCERS  
(72) MAHR, Andrea, Kirschenweg 22, 72076 Tübingen, DE  
WEINSCHENK, Toni, Im Morgenrain 15, 73773 Aichwald, DE  
GOLDFINGER, Valentina, Marienburger Strasse 9, 72072 Tübingen, DE  
SCHOOR, Oliver, Eichhaldenstrasse 19, 72074 Tübingen, DE  
FRITSCH, Jens, Lärchenweg 11, 72144 Dusslingen, DE  
SINGH, Harpreet, 5122 Morningside Dr, Apt. 525, Houston, Texas 77005, US

---

(51) MKP  
**A61P 37/06 2006 (97) EP 3350223**  
**C07K 16/28 2006**  
(96) EP 16774750.0 9/16/2016  
(97) EP 3350223, 7/25/2018 201830, en  
(31) 201562220442 P (32) 18.09.2015 (33) US  
(54) ANTIBODIES THAT SPECIFICALLY BIND TO TL1A  
(72) POULTON, Lynn, Dorothy, Level 2 37 Epping Road, Macquarie Park, NSW 2113, AU  
POLLARD, Matthew, Level 2 37 Epping Road, Macquarie Park, NSW 2113, AU  
DOYLE, Anthony, G., Level 2 37 Epping Road, Macquarie Park, NSW 2113, AU  
COOKSEY, Bridget, Ann, Level 2 37 Epping Road, Macquarie Park, NSW 2113, AU  
PANDE, Vanya, Level 2 37 Epping Road, Macquarie Park, NSW 2113, AU  
CLARKE, Adam, William, Level 2 37 Epping Road, Macquarie Park, NSW 2113, AU

---

(51) MKP  
**A61K 31/41 2006 (97) EP 3353167**  
**A61K 31/433 2006**  
**C07D 235/30 2006**  
**C07D 263/48 2006**  
**C07D 263/58 2006**  
**C07D 277/80 2006**  
**C07D 285/08 2006**  
**C07D 403/12 2006**  
**C07D 413/12 2006**  
**C07D 417/12 2006**  
(96) EP 16774992.8 9/22/2016  
(97) EP 3353167, 8/1/2018 201831, en  
(31) 201562222880 P (32) 24.09.2015 (33) US  
(54) MODULATORS OF INDOLEAMINE 2,3-DIOXYGENASE  
(72) CHONG, Pek Yoke, Five Moore Drive Research Triangle Park, North Carolina 27709, US  
DE LA ROSA, Martha, Five Moore Drive Research Triangle Park, North Carolina 27709, US  
DICKSON, Hamilton, Five Moore Drive Research Triangle Park, North Carolina 27709, US  
KAZMIERSKI, Wieslaw Mieczyslaw, Five Moore Drive Research Triangle Park, North Carolina 27709, US  
SAMANO, Vicente, Five Moore Drive Research Triangle Park, North Carolina 27709, US  
TAI, Vincent Wing-Fai, Five Moore Drive Research Triangle Park, North Carolina 27709, US

---

(51) MKP  
**A61K 31/421 2006 (97) EP 3353151**  
**A61K 31/426 2006**  
**A61K 31/433 2006**  
**A61K 31/44 2006**  
**A61P 31/18 2006**  
**C07D 213/74 2006**  
**C07D 235/30 2006**  
**C07D 239/42 2006**  
**C07D 241/20 2006**  
**C07D 253/06 2006**  
**C07D 263/48 2006**  
**C07D 263/58 2006**  
**C07D 277/82 2006**  
**C07D 285/00 2006**  
**C07D 307/66 2006**  
**C07D 309/14 2006**  
**C07D 333/20 2006**

(96) EP 16774993.6 9/22/2016  
(97) EP 3353151, 8/1/2018 201831, en  
(31) 201562222862 P (32) 24.09.2015 (33) US

(54) MODULATORS OF INDOLEAMINE 2,3-DIOXYGENASE  
(72) CHONG, Pek Yoke, Five Moore Drive Research Triangle Park, North Carolina 27709, US  
DE LA ROSA, Martha, Five Moore Drive Research Triangle Park, North Carolina 27709, US  
DICKSON, Hamilton, Five Moore Drive Research Triangle Park, North Carolina 27709, US  
KAZMIERSKI, Wieslaw Mieczyslaw, Five Moore Drive Research Triangle Park, North Carolina 27709, US  
SAMANO, Vicente, Five Moore Drive Research Triangle Park, North Carolina 27709, US  
TAI, Vincent Wing-Fai, Five Moore Drive Research Triangle Park, North Carolina 27709, US

---

(51) MKP  
**B28B 1/52 2006 (97) EP 3383606**  
**C04B 28/14 2006**  
**C04B 111/52 2006**

(96) EP 16775077.7 9/13/2016  
(97) EP 3383606, 10/10/2018 201841, en  
(31) 102015015299 (32) 30.11.2015 (33) DE

(54) SOUND-ABSORBING GYPSUM FIBRE BOARD AND METHOD FOR MANUFACTURING SUCH A GYPSUM FIBRE BOARD  
(72) BURCZEK, Jürgen, Merowingerstr. 6, 97340 Segnitz, DE  
TSVETANOV, Vladimir Stefanov, Petko Karavelov 3 ap. 13, 3700 Vidin, BG  
IVANOVA-TSANEVA, Vanya Stancheva, Bononia 21 entrance V ap. 1, 3700 Vidin, BG  
VLAHOV, Ventzislav, K. Draganov 120 ap. 34, 1220 Sofia, BG  
AMZOVA, Elizabeta, Krum Bachvarov 10 entrance G ap. 85, 3700 Vidin, BG

---

(51) MKP  
**A61K 9/00 2006 (97) EP 3352734**  
**A61K 31/519 2006**  
**A61P 17/14 2006**

(96) EP 16775134.6 9/22/2016  
(97) EP 3352734, 8/1/2018 201831, en  
(31) 15186644 (32) 24.09.2015 (33) EP  
2015190849 29.09.2015 JP

(54) TREATMENT OF ALOPECIA AREATA  
(72) SIERRA, Michael, c/o LEO Pharma A/S Industriparken 55, 2750 Ballerup, DK  
LABUDA, Tord, c/o LEO Pharma A/S Industriparken 55, 2750 Ballerup, DK  
TANIMOTO, Atsuo, c/o Japan Tobacco Inc. 2-1 Toranomom 2-chome Minato-ku, Tokyo 105-8422, JP  
SHINOZAKI, Yuichi, c/o Japan Tobacco Inc. 2-1 Toranomom 2-chome Minato-ku, Tokyo 105-8422, JP

---

(51) MKP  
**A61K 31/443 2006 (97) EP 3350175**  
**A61P 29/00 2006**  
**A61P 37/00 2006**  
**C07D 405/06 2006**

**C07D 405/14 2006**  
**C07D 413/14 2006**  
**C07D 417/14 2006**  
(96) EP 16775485.2 9/13/2016  
(97) EP 3350175, 7/25/2018 201830, en  
(31) 15185283 (32) 15.09.2015 (33) EP  
(54) NON-STEROIDAL GLUCOCORTICOID RECEPTOR MODULATORS FOR LOCAL DRUG DELIVERY  
(72) JOHNSON, Patrick Stephen, c/o LEO Pharma A/S Industriparken 55, 2750 Ballerup, DK  
DACK, Kevin Neil, c/o LEO Pharma A/S Industriparken 55, 2750 Ballerup, DK  
HENRIKSSON, Krister, c/o LEO Pharma A/S Industriparken 55, 2750 Ballerup, DK

---

(51) MKP  
**C12Q 1/68 2018 (97) EP 3350346**  
(96) EP 16775507.3 9/16/2016  
(97) EP 3350346, 7/25/2018 201830, en  
(31) 201562219698 P (32) 17.09.2015 (33) US  
(54) NOVEL BIOMARKERS AND METHODS OF TREATING CANCER  
(72) VALDERAS, Alvaro, Avivar, AstraZeneca Alderley Park, Macclesfield Cheshire SK10 4TG, GB  
CRUZALEGUI, Francisco, Humberto, AstraZeneca Alderley Park, Macclesfield Cheshire SK10 4TG, GB  
HUDSON, Kevin, AstraZeneca Alderley Park, Macclesfield Cheshire SK10 4TG, GB  
MCEWEN, Robert, Kenneth, AstraZeneca Alderley Park, Macclesfield Cheshire SK10 4TG, GB

---

(51) MKP  
**A61K 38/43 2006 (97) EP 3356542**  
**A61K 38/47 2006**  
**C12P 21/00 2006**  
**C12P 21/02 2006**  
(96) EP 16775701.2 9/30/2016  
(97) EP 3356542, 8/8/2018 201832, en  
(31) 15187877 (32) 01.10.2015 (33) EP  
(54) MODIFIED LYSOSOMAL PROTEIN AND PRODUCTION THEREOF  
(72) NORDLING, Erik, Sportstugevägen 14A, 182 35 Danderyd, SE  
STRÖMBERG, Patrik, Kamomillvägen 6, 191 64 Sollentuna, SE  
SVENSSON GELIUS, Stefan, Segeltorpsvägen 48, 125 53 Älvsjö, SE

---

(51) MKP  
**A61K 31/473 2006 (97) EP 3352759**  
**A61K 31/49 2006**  
**A61K 31/517 2006**  
**A61K 31/5377 2006**  
**A61K 39/395 2006**  
**A61K 45/00 2006**  
**A61P 25/28 2006**  
(96) EP 16775842.4 9/23/2016  
(97) EP 3352759, 8/1/2018 201831, en  
(31) 201516905 (32) 24.09.2015 (33) GB  
(54) TREATMENT OF NEURODEGENERATIVE DISEASES  
(71) Benevolentai Bio Limited, 40 Churchway, London, Greater London NW1 1LW, GB  
(72) RICHARDSON, Peter, BenevolentAI 40 Churchway, London Greater London NW1 1LW, GB  
MEAD, Richard, University of Sheffield SITraN 385a Glossop Road, Sheffield South Yorkshire S10 2HQ, GB  
FERRAIUOLO, Laura, University of Sheffield SITraN 385a Glossop Road, Sheffield South Yorkshire S10 2HQ, GB  
MULVANY, Kenneth Patrick, 40 Churchway, London NW1 1LW, GB

---

(51) MKP  
**A61L 27/36 2006 (97) EP 3349813**  
**A61L 27/56 2006**  
**A61L 27/60 2006**  
(96) EP 16775926.5 9/16/2016  
(97) EP 3349813, 7/25/2018 201830, en  
(31) 201562220227 P (32) 17.09.2015 (33) US  
201662334440 P 10.05.2016 US  
(54) COMPOSITIONS DERIVED FROM PLACENTA AND METHODS OF PRODUCING THE SAME

(72) DANIEL, John, 1225 Northmeadow Parkway Suite 104, Roswell, Georgia 30076, US  
GRIFFITHS, Sarah, 1225 Northmeadow Parkway Suite 104, Roswell, Georgia 30076, US  
BERG, Richard A., 1225 Northmeadow Parkway Suite 104, Roswell, Georgia 30076, US

---

(51) MKP  
**G01C 21/34 2006 (97) EP 3353722**  
**G01C 21/36 2006**  
**G06Q 10/04 2012**  
**G06Q 10/06 2012**  
**G06Q 50/30 2012**  
**H04W 4/02 2009**  
**H04W 4/04 2009**

(96) EP 16777548.5 9/16/2016

(97) EP 3353722, 8/1/2018 201831, en

(31) 201562221289 P (32) 21.09.2015 (33) US

(54) METHOD, APPARATUS AND SYSTEM FOR DESTINATION RECOMMENDATION AND SELECTION

(71) Nokia Solutions and Networks Oy, Karaportti 3, 02610 Espoo, FI

(72) HARRIS, John, 4919 N. Elkhart Avenue, Whitefish Bay, Wisconsin 53217, US

MOORE, Brian, 718 N. Bon Aire Drive, Palatine, Illinois 60074, US

KAKINADA, Umamaheswar, 3401 Pine Circle, Carpentersville, Illinois 60110, US

STEPHENS, Paul, 3414 E Mardan Dr, Long Grove, Illinois 60047, US

---

(51) MKP  
**C07K 14/725 2006 (97) EP 3359563**  
**C07K 16/28 2006**

(96) EP 16777681.4 10/5/2016

(97) EP 3359563, 8/15/2018 201833, en

(31) PCT/EP2015/073156 (32) 07.10.2015 (33) WO

(54) ANTIGEN RECEPTORS AND USES THEREOF

(72) VOSS, Ralf Holger, Lotharstrasse 32, 55218 Ingelheim, DE

SAHIN, Ugur, Philipp-von-Zabern-Platz 1, 55116 Mainz, DE

THEOBALD, Matthias, Uferstrasse 15, 55116 Mainz, DE

SIMON, Petra, Silvanerstrasse 33a, 55129 Mainz, DE

BIRTEL, Matthias, Boppstrasse 1, 55118 Mainz, DE

---

(51) MKP  
**A61K 31/454 2006 (97) EP 3356344**

**A61K 31/506 2006**

**A61K 35/00 2006**

**C07B 59/00 2006**

**C07D 401/06 2006**

**C07D 401/14 2006**

**C07D 403/06 2006**

**C07D 403/14 2006**

**C07D 405/14 2006**

**C07D 407/14 2006**

**C07D 409/14 2006**

**C07D 413/14 2006**

**C07D 417/14 2006**

**C07D 487/04 2006**

**C07D 487/08 2006**

(96) EP 16777769.7 9/29/2016

(97) EP 3356344, 8/8/2018 201832, en

(31) 201517216 (32) 29.09.2015 (33) GB

(54) ISOINDOLINONE INHIBITORS OF THE MDM2-P53 INTERACTION HAVING ANTICANCER ACTIVITY

(72) CHESSARI, Gianni, Astex Therapeutics Ltd. 436 Cambridge Science Park Milton Road, Cambridge Cambridgeshire CB4 0QA, GB

HOWARD, Steven, Astex Therapeutics Ltd. 436 Cambridge Science Park Milton Road, Cambridge Cambridgeshire CB4 0QA, GB

BUCK, Ildiko Maria, Astex Therapeutics Ltd. 436 Cambridge Science Park Milton Road, Cambridge Cambridgeshire CB4 0QA, GB

CONS, Benjamin David, Astex Therapeutics Ltd. 436 Cambridge Science Park Milton Road, Cambridge Cambridgeshire CB4 0QA, GB

JOHNSON, Christopher Norbert, Astex Therapeutics Ltd. 436 Cambridge Science Park Milton Road, Cambridge Cambridgeshire CB4 0QA, GB

HOLVEY, Rhian Sara, Astex Therapeutics Ltd. 436 Cambridge Science Park Milton Road, Cambridge Cambridgeshire CB4 0QA, GB

REES, David Charles, Astex Therapeutics Ltd. 436 Cambridge Science Park Milton Road, Cambridge Cambridgeshire CB4 0QA, GB

ST. DENIS, Jeffrey David, Astex Therapeutics Ltd. 436 Cambridge Science Park Milton Road, Cambridge Cambridgeshire CB4 0QA, GB

TAMANINI, Emiliano, Astex Therapeutics Ltd. 436 Cambridge Science Park Milton Road, Cambridge Cambridgeshire CB4 0QA, GB

GOLDING, Bernard Thomas, School of Chemistry Bedson Building Newcastle University, Newcastle Upon Tyne, Tyne and Wear, NE1 7RU, GB  
HARDCASTLE, Ian Robert, School of Chemistry Bedson Building Newcastle University, Newcastle Upon Tyne, Tyne and Wear, NE1 7RU, GB  
CANO, Celine Florence, School of Chemistry Bedson Building Newcastle University, Newcastle Upon Tyne, Tyne and Wear, NE1 7RU, GB  
MILLER, Duncan Charles, School of Chemistry Bedson Building Newcastle University, Newcastle Upon Tyne, Tyne and Wear, NE1 7RU, GB  
NOBLE, Martin Edward Mäntylä, Paul O'gorman Building Newcastle University Medical School Framlington Place, Newcastle Upon Tyne, Tyne and Wear, NE2 4HH, GB  
OSBORNE, James Daniel, Biofocus DPO Limited Chesterford Research Park, Saffron Walden Essex CB10 1XL, GB  
PEACH, Joanne, Biofocus DPI Limited Chesterford Research Park, Saffron Walden Essex CB10 1XL, GB  
LEWIS, Arwel, Biofocus DPI Limited Chesterford Research Park, Saffron Walden Essex CB10 1XL, GB  
HIRST, Kim Louise, Biofocus DPI Limited Chesterford Research Park, Saffron Walden Essex CB10 1XL, GB  
WHITTAKER, Benjamin Paul, Biofocus DPI Limited Chesterford Research Park, Saffron Walden Essex CB10 1XL, GB  
WATSON, David Wyn, Biofocus DPI Limited Chesterford Research Park, Saffron Walden Essex CB10 1XL, GB  
MITCHELL, Dale Robert, Biofocus DPI Limited Chesterford Research Park, Saffron Walden Essex CB10 1XL, GB

(51) MKP

**A61K 31/4035 2006 (97) EP 3356350**  
**A61P 35/00 2006**  
**C07B 59/00 2006**  
**C07D 209/48 2006**  
**C07D 403/06 2006**  
**C07D 403/12 2006**  
**C07D 405/12 2006**  
**C07D 405/14 2006**  
**C07D 413/06 2006**  
**C07D 413/12 2006**  
**C07F 9/572 2006**

(96) EP 16777770.5 9/29/2016

(97) EP 3356350, 8/8/2018 201832, en

(31) 201517217

(32) 29.09.2015

(33) GB

(54) ISOINDOLINONE INHIBITORS OF THE MDM2-P53 INTERACTION HAVING ANTICANCER ACTIVITY

(71) Cancer Research Technology Limited, Angel Building 407 St. John Street, London EC1V 4AD, GB

(72) CHESSARI, Gianni, Astex Therapeutics Ltd. 436 Cambridge Science Park Milton Road, Cambridge Cambridgeshire CB4 0QA, GB

HOWARD, Steven, Astex Therapeutics Ltd. 436 Cambridge Science Park Milton Road, Cambridge Cambridgeshire CB4 0QA, GB

BUCK, Ildiko Maria, Astex Therapeutics Ltd. 436 Cambridge Science Park Milton Road, Cambridge Cambridgeshire CB4 0QA, GB

CONS, Benjamin David, Astex Therapeutics Ltd. 436 Cambridge Science Park Milton Road, Cambridge Cambridgeshire CB4 0QA, GB

JOHNSON, Christopher Norbert, Astex Therapeutics Ltd. 436 Cambridge Science Park Milton Road, Cambridge Cambridgeshire CB4 0QA, GB

HOLVEY, Rhian Sara, Astex Therapeutics Ltd. 436 Cambridge Science Park Milton Road, Cambridge Cambridgeshire CB4 0QA, GB

REES, David Charles, Astex Therapeutics Ltd. 436 Cambridge Science Park Milton Road, Cambridge Cambridgeshire CB4 0QA, GB

ST. DENIS, Jeffrey David, Astex Therapeutics Ltd. 436 Cambridge Science Park Milton Road, Cambridge Cambridgeshire CB4 0QA, GB

TAMANINI, Emiliano, Astex Therapeutics Ltd. 436 Cambridge Science Park Milton Road, Cambridge Cambridgeshire CB4 0QA, GB

GOLDING, Bernard Thomas, School of Chemistry Bedson Building Newcastle University, Newcastle Upon Tyne, Tyne and Wear, NE1 7RU, GB

HARDCASTLE, Ian Robert, School of Chemistry Bedson Building Newcastle University, Newcastle Upon Tyne, Tyne and Wear, NE1 7RU, GB

CANO, Celine Florence, School of Chemistry Bedson Building Newcastle University, Newcastle Upon Tyne, Tyne and Wear, NE1 7RU, GB

MILLER, Duncan Charles, School of Chemistry Bedson Building Newcastle University, Newcastle Upon Tyne, Tyne and Wear, NE1 7RU, GB

CULLY, Sarah, Centre For Biomolecular Sciences University of Nottingham University Park, Nottingham Nottinghamshire NG7 2RD, GB

NOBLE, Martin Edward Mäntylä, Paul O'gorman Building Newcastle University Medical School Framlington Place, Newcastle Upon Tyne, Tyne and Wear, NE2 4HH, GB

OSBORNE, James Daniel, Biofocus Dpi Limited Chesterford Research Park, Saffron Walden Essex CB10 1XL, GB

PEACH, Joanne, Biofocus Dpi Limited Chesterford Research Park, Saffron Walden Essex CB10 1XL, GB

LEWIS, Arwel, Biofocus Dpi Limited Chesterford Research Park, Saffron Walden Essex CB10 1XL, GB

HIRST, Kim Louise, Biofocus Dpi Limited Chesterford Research Park, Saffron Walden Essex CB10 1XL, GB

WHITTAKER, Benjamin Paul, Biofocus Dpo Limited Chesterford Research Park, Saffron Walden Essex CB10 1XL, GB

WATSON, David Wyn, Biofocus Dpi Limited Chesterford Research Park, Saffron Walden Essex CB10 1XL, GB

MITCHELL, Dale Robert, Biofocus Dpi Limited Chesterford Research Park, Saffron Walden Essex CB10 1XL, GB

GRIFFIN, Roger John, "-", deceased, GB

(51) MKP

**F24J 2/52 2018 (97) EP 3411638**  
**H02S 20/10 2014**

(96) EP 16777892.7 8/22/2016

(97) EP 3411638, 12/12/2018 201850, de

(31) 507302015

(32) 21.08.2015

(33) AT

507542015

03.09.2015

AT

(54) PHOTOVOLTAIC MODULE

(71) Guger Forschungs GmbH, Unter St. Thomas 7, 4364 St. Thomas am Blasenstein, AT

(72) TUCKOVÁ, Eva, Strazna 9E, 83101 Bratislava, SK

---

(51) MKP

**A61K 31/397 2006 (97) EP 3359533**  
**A61K 31/4025 2006**  
**A61K 31/498 2006**  
**A61K 31/4985 2006**  
**C07D 241/14 2006**  
**C07D 401/04 2006**  
**C07D 401/06 2006**  
**C07D 403/04 2006**  
**C07D 403/06 2006**  
**C07D 403/12 2006**  
**C07D 403/14 2006**  
**C07D 413/04 2006**  
**C07D 413/06 2006**  
**C07D 417/06 2006**  
**C07D 471/04 2006**  
**C07D 487/02 2006**  
**C07D 491/10 2006**  
**C07D 498/10 2006**  
**C07D 513/10 2006**

(96) EP 16778024.6 10/7/2016

(97) EP 3359533, 8/15/2018 201833, en

(31) 15189163 (32) 09.10.2015 (33) EP  
16174710 16.06.2016 EP

(54) QUINOXALINE AND PYRIDOPYRAZINE DERIVATIVES AS PI3KBETA INHIBITORS

(72) ANGI BAUD, Patrick, René, Janssen-Cilag 1 rue Camille Desmoulins TSA 91003, 92787 Issy-les Moulineaux Cedex 9, FR  
QUEROLLE, Olivier, Alexis, Georges, Janssen-Cilag 1 rue Camille Desmoulins TSA 91003, 92787 Issy-les Moulineaux Cedex 9, FR  
BERTHELOT, Didier, Jean-Claude, Janssen-Cilag 1 rue Camille Desmoulins TSA 91003, 92787 Issy-les Moulineaux Cedex 9, FR  
MEYER, Christophe, Janssen-Cilag 1 rue Camille Desmoulins TSA 91003, 92787 Issy-les Moulineaux Cedex 9, FR  
WILLOT, Matthieu, Philippe, Victor, Jahnstrasse 15, 40215 Düsseldorf, DE  
MEERPOEL, Lieven, Janssen Pharmaceutica NV Turnhoutseweg 30, 2340 Beerse, BE  
JOUSSEAUME, Thierry, François, Alain, Jean, c/o Cilag AG Hochstrasse 201, 8200 Schaffhausen, CH

---

(51) MKP

**A61K 9/20 2006 (97) EP 3359137**  
**A61K 31/426 2006**

(96) EP 16778026.1 10/7/2016

(97) EP 3359137, 8/15/2018 201833, de

(31) PCT/EP2015/002887 (32) 09.10.2015 (33) WO

(54) ORAL FEBUXOSTAT TABLET

(71) STADA Arzneimittel AG, Stadastrasse 2-18, 61118 Bad Vilbel, DE  
(72) SCHÖNBORN, Jessica, Glossop-Ring 4a Hessen, 61118 Bad Vilbel, DE  
WINTER, Sven, Krokusweg 18b Hessen, 61381 Friedrichsdorf, DE

---

(51) MKP

**A61K 31/438 2006 (97) EP 3359542**  
**A61P 35/00 2006**  
**C07D 471/22 2006**  
**C07D 487/22 2006**

(96) EP 16778038.6 10/7/2016

(97) EP 3359542, 8/15/2018 201833, en

(31) 15189210 (32) 09.10.2015 (33) EP

(54) SPIRO[3H-INDOLE-3,2'-PYRROLIDIN]-2(1H)-ONE COMPOUNDS AND DERIVATIVES AS MDM2-P53 INHIBITORS

(72) GOLLNER, Andreas, Boehringer Ingelheim GmbH/ Corporate Patents Binger Strasse 173, 55216 Ingelheim Am Rhein, DE  
BROEKER, Joachim, Boehringer Ingelheim GmbH/ Corporate Patents Binger Strasse 173, 55216 Ingelheim Am Rhein, DE  
KERRES, Nina, Boehringer Ingelheim GmbH/ Corporate Patents Binger Strasse 173, 55216 Ingelheim Am Rhein, DE  
KOFINK, Christiane, Boehringer Ingelheim GmbH/ Corporate Patents Binger Strasse 173, 55216 Ingelheim Am Rhein, DE  
RAMHARTER, Juergen, Boehringer Ingelheim GmbH/ Corporate Patents Binger Strasse 173, 55216 Ingelheim Am Rhein, DE  
WEINSTABL, Harald, Boehringer Ingelheim GmbH/ Corporate Patents Binger Strasse 173, 55216 Ingelheim Am Rhein, DE  
GILLE, Annika, Boehringer Ingelheim GmbH/ Corporate Patents Binger Strasse 173, 55216 Ingelheim Am Rhein, DE  
GOEPPER, Stefan, Boehringer Ingelheim GmbH/ Corporate Patents Binger Strasse 173, 55216 Ingelheim Am Rhein, DE

(51) MKP  
**A61K 31/19 2006 (97) EP 3386496**  
**A61K 31/728 2006**  
**A61P 19/02 2006**  
(96) EP 16778078.2 9/26/2016  
(97) EP 3386496, 10/17/2018 201842, fr  
(31) 1502545 (32) 07.12.2015 (33) FR  
(54) NOVEL INJECTABLE COMPOSITION; METHOD FOR PREPARING SAID COMPOSITION; USE OF SAID COMPOSITION  
(71) KH Medtech Sàrl, Rue de la Cité, 1, 1204 Genève, CH  
(72) TAUZIN, Bénédicte Vincente, 5 Lotissement Les Chaix, 74250 Bogeve, FR

---

(51) MKP  
**A61K 31/4412 2006 (97) EP 3359531**  
**A61K 31/4439 2006**  
**A61P 35/00 2006**  
**C07D 213/82 2006**  
**C07D 401/12 2006**  
**C07D 401/14 2006**  
(96) EP 16778310.9 10/3/2016  
(97) EP 3359531, 8/15/2018 201833, en  
(31) 201562237002 P (32) 05.10.2015 (33) US  
(54) 2-OXO-1,2-DIHYDROPYRIDINE-3,5-DICARBOXAMIDE COMPOUNDS AS BROMODOMAIN INHIBITORS  
(72) ATKINSON, Stephen, John, GlaxoSmithKline Gunnels Wood Road, Stevenage Hertfordshire SG1 2NY, GB  
DEMONT, Emmanuel, Hubert, GlaxoSmithKline Gunnels Wood Road, Stevenage Hertfordshire SG1 2NY, GB  
HARRISON, Lee, Andrew, GlaxoSmithKline Gunnels Wood Road, Stevenage Hertfordshire SG1 2NY, GB  
HAYHOW, Thomas, George, Christopher, c/o GlaxoSmithKline Gunnels Wood Road, Stevenage Hertfordshire SG1 2NY, GB  
LINDON, Matthew, J., GlaxoSmithKline Gunnels Wood Road, Stevenage Hertfordshire SG1 2NY, GB  
PRESTON, Alexander, G., GlaxoSmithKline Gunnels Wood Road, Stevenage Hertfordshire SG1 2NY, GB  
SEAL, Jonathan, Thomas, GlaxoSmithKline Gunnels Wood Road, Stevenage Hertfordshire SG1 2NY, GB  
WALL, Ian, David, GlaxoSmithKline Gunnels Wood Road, Stevenage Hertfordshire SG1 2NY, GB  
WATSON, Robert, J., GlaxoSmithKline Gunnels Wood Road, Stevenage Hertfordshire SG1 2NY, GB  
WOOLVEN, James, Michael, GlaxoSmithKline Gunnels Wood Road, Stevenage Hertfordshire SG1 2NY, GB

---

(51) MKP  
**G10L 19/008 2013 (97) EP 3360133**  
(96) EP 16778365.3 10/7/2016  
(97) EP 3360133, 8/15/2018 201833, en  
(31) 15306589 (32) 08.10.2015 (33) EP  
15306653 15.10.2015 EP  
201662361461 P 12.07.2016 US  
201662361416 P 12.07.2016 US  
(54) LAYERED CODING FOR COMPRESSED SOUND OR SOUND FIELD REPRESENTATIONS  
(72) KORDON, Sven, Mühlenkampstrasse 50 A, 31515 Wunstorf DE, DE  
KRUEGER, Alexander, Feuerbachstrasse 16, 30655 Hannover, DE

---

(51) MKP  
**G10L 19/008 2013 (97) EP 3360134**  
(96) EP 16778366.1 10/7/2016  
(97) EP 3360134, 8/15/2018 201833, en  
(31) 15306591 (32) 08.10.2015 (33) EP  
201662361863 P 13.07.2016 US  
(54) LAYERED CODING AND DATA STRUCTURE FOR COMPRESSED HIGHER-ORDER AMBISONICS SOUND OR SOUND FIELD REPRESENTATIONS  
(72) KORDON, Sven, Mühlenkampstrasse 50 A, 31515 Wunstorf, DE  
KRUEGER, Alexander, Feuerbachstrasse 16, 30655 Hannover, DE

---

(51) MKP

**A61K 31/506 2006 (97) EP 3353179**  
**A61P 35/00 2006**  
**C07D 471/04 2006**  
(96) EP 16778538.5 9/19/2016  
(97) EP 3353179, 8/1/2018 201831, en  
(31) 201562221508 P (32) 21.09.2015 (33) US  
(54) HETEROCYCLIC COMPOUNDS AND USES THEREOF  
(71) Plexxikon Inc., 91 Bolivar Drive, Suite A, Berkeley, CA 94710, US  
(72) IBRAHIM, Prabha N., c/o Plexxikon Inc. 91 Bolivar Drive Suite A, Berkeley, California 94710, US  
SPEVAK, Wayne, c/o Plexxikon Inc. 91 Bolivar Drive Suite A, Berkeley, California 94710, US  
ZHANG, Jiazhong, c/o Plexxikon Inc. 91 Bolivar Drive Suite A, Berkeley, California 94710, US  
SHI, Songyuan, c/o Plexxikon Inc. 91 Bolivar Drive Suite A, Berkeley, California 94710, US  
POWELL, Ben, c/o Plexxikon Inc. 91 Bolivar Drive Suite A, Berkeley, California 94710, US  
MA, Yan, c/o Plexxikon Inc. 91 Bolivar Drive Suite A, Berkeley, California 94710, US

---

(51) MKP  
**A61M 37/00 2006 (97) EP 3352836**  
**A61N 7/00 2006**  
(96) EP 16778575.7 9/21/2016  
(97) EP 3352836, 8/1/2018 201831, en  
(31) 201562221889 P (32) 22.09.2015 (33) US  
(54) DEVICES AND METHODS FOR ENHANCING THE TOPICAL APPLICATION OF A BENEFIT AGENT  
(72) PATURI, Jyotsna, 199 Grandview Road, Skillman, New Jersey 08558, US  
PAUNESCU, Alexandru, 199 Grandview Road, Skillman, New Jersey 08558, US

---

(51) MKP  
**A61M 37/00 2006 (97) EP 3352853**  
**A61N 7/00 2006**  
(96) EP 16778576.5 9/21/2016  
(97) EP 3352853, 8/1/2018 201831, en  
(31) 201562221889 P (32) 22.09.2015 (33) US  
(54) METHODS FOR ENHANCING TOPICAL APPLICATION OF A BENEFIT AGENT  
(72) PAUNESCU, Alexandru, 199 Grandview Road, Skillman, New Jersey 08558, US  
SUN, Ying, 199 Grandview Road, Skillman, New Jersey 08558, US  
PATURI, Jyotsna, 199 Grandview Road, Skillman, New Jersey 08558, US  
WU, Jeffrey M., 199 Grandview Road, Skillman, New Jersey 08558, US

---

(51) MKP  
**A61K 9/28 2006 (97) EP 3355865**  
**A61K 31/4409 2006**  
(96) EP 16778627.6 9/28/2016  
(97) EP 3355865, 8/8/2018 201832, en  
(31) 201562234455 P (32) 29.09.2015 (33) US  
(54) SUSTAINED RELEASE COMPOSITIONS OF 4-AMINOPYRIDINE  
(72) COBB, Joseph E. Jr., 404 Westhaven Road, Greenville, NC 27834, US  
GOLD, Thomas B., 3405 Dunhaven Drive, Greenville, NC 27834, US  
D'SOUZA, Rohini, 31 Ravenna Drive, Pomona, NY 10970, US  
WAY, Susan L., 36 Apple Blossom Lane, Danbury, CT 06811, US

---

(51) MKP  
**A61K 39/00 2006 (97) EP 3356413**  
**C07K 16/28 2006**  
(96) EP 16778648.2 9/29/2016  
(97) EP 3356413, 8/8/2018 201832, en  
(31) 201562235990 P (32) 01.10.2015 (33) US  
(54) ANTI-TIGIT ANTIGEN-BINDING PROTEINS AND METHODS OF USE THEREOF  
(71) Potenza Therapeutics, Inc., 1030 Massachusetts Avenue Suite 210, Cambridge, Massachusetts 02138, US  
(72) HICKLIN, Daniel, 1030 Massachusetts Avenue Suite 210, Cambridge, Massachusetts 02138, US  
WINSTON, William, 1030 Massachusetts Avenue Suite 210, Cambridge, Massachusetts 02138, US  
SEIDEL-DUGAN, Cynthia, 1030 Massachusetts Avenue Suite 210, Cambridge, Massachusetts 02138, US  
NIELSON, Nels P., 7 Lucent Drive, Lebanon, New Hampshire 03766, US

---



(51) MKP  
**A61K 31/7068 2006 (97) EP 3356414**  
**A61P 35/00 2006**  
**C07K 16/28 2006**  
**C07K 16/30 2006**  
**C12N 5/095 2010**  
**G01N 33/574 2006**

(96) EP 16778732.4 9/29/2016  
(97) EP 3356414, 8/8/2018 201832, en  
(31) 201562235144 P (32) 30.09.2015 (33) US

(54) COMPOSITIONS AND METHODS FOR INHIBITING CANCER STEM CELLS  
(72) HURT, Elaine, M, MedImmune LLC One MedImmune Way, Gaithersburg, MD 20878, US  
MINTER, Ralph, MedImmune Limited Milstein Building Granta Park, Cambridge Cambridgeshire CB21 6GH, GB  
RUST, Steven, MedImmune Limited Milstein Building Granta Park, Cambridge Cambridgeshire CB21 6GH, GB  
SANDERCOCK, Alan, MedImmune Limited Milstein Building Granta Park, Cambridge Cambridgeshire CB21 6GH, GB  
KARATHANASIS, Sotirios, MedImmune LLC One MedImmune Way, Gaithersburg, MD 20878, US

---

(51) MKP  
**A61K 31/00 2006 (97) EP 3355919**  
**A61K 39/395 2006**  
**C07K 16/22 2006**  
**C07K 16/28 2006**  
**G01N 33/50 2006**  
**G01N 33/574 2006**

(96) EP 16778750.6 9/30/2016  
(97) EP 3355919, 8/8/2018 201832, en  
(31) 201517531 (32) 02.10.2015 (33) GB  
201607801 29.04.2016 GB

(54) COMBINATION THERAPY USING INHIBITORS OF HUMAN GROWTH AND DIFFERENTIATION FACTOR 15 (GDF-15) AND IMMUNE CHECKPOINT BLOCKERS  
(72) WISCHHUSEN, Jörg, Leutfresserweg 14a, 97082 Würzburg, DE  
HAAKE, Markus, Dürerstraße 37, 97230 Estenfeld, DE  
DUMMER, Reinhard, Krähbühlstraße 78, 8044 Zürich, CH  
MEHLING, Matthias, Schauenburgerstraße 14, 4052 Basel, CH  
SCHÄFER, Tina, Sterenstrasse 10, 97074 Würzburg, DE  
SELLE, Martina, Tiepolostraße 2b, 97070 Würzburg, DE

---

(51) MKP  
**A61L 27/22 2006 (97) EP 3359210**

(96) EP 16778808.2 10/7/2016  
(97) EP 3359210, 8/15/2018 201833, en  
(31) 201562238901 P (32) 08.10.2015 (33) US

(54) PERIOSTIN FRAGMENTS AND USE THEREOF  
(72) FERRARI, Serge, 90a route des Chevaliers de Malte, 1228 Saconnex d'Arve / Genève, CH  
BONNET, Nicolas, 88 chemin du Lavoir, 74380 Cranves-Sales, FR  
SPELLMAN, Daniel S., PO Box 4 770 Sumneytown Pike, West Point, Pennsylvania 19486, US

---

(51) MKP  
**A23L 29/30 2016 (97) EP 3359173**  
**A23L 33/135 2016**  
**A23P 10/43 2016**  
**A61K 35/741 2015**  
**A61K 35/745 2015**  
**A61K 35/747 2015**

(96) EP 16779069.0 10/7/2016  
(97) EP 3359173, 8/15/2018 201833, en  
(31) 15188842 (32) 07.10.2015 (33) EP

(54) PROBIOTIC FORMULATION  
(71) Bifodan A/S, Bogbinderivej 6, 3390 Hundested, DK  
(72) WENNIKE, Kasper Hallestad, Østre Alle 6, 3500 Værløse, DK  
YASSINE, Suzanne Ali, Frederikssundsvej 74D 4.tv., 2400 Copenhagen NV, DK

---

(51) MKP  
**A61K 39/00 2006 (97) EP 3359564**  
**A61K 39/42 2006**  
**C07K 14/005 2006**  
**C07K 16/08 2006**  
**C07K 16/10 2006**  
(96) EP 16779075.7 10/7/2016  
(97) EP 3359564, 8/15/2018 201833, en  
(31) PCT/EP2015/001970 (32) 07.10.2015 (33) WO  
(54) ANTIBODIES THAT POTENTLY NEUTRALIZE HEPATITIS B VIRUS AND USES THEREOF  
(71) Humabs Biomed S.A., Via Mirasole 1, 6500 Bellinzona, CH  
(72) CORTI, Davide, Via Mirasole 1, 6500 Bellinzona, CH

---

(51) MKP  
**A01H 5/10 2018 (97) EP 3361858**  
**C12N 9/06 2006**  
**C12N 15/82 2006**  
(96) EP 16781127.2 10/13/2016  
(97) EP 3361858, 8/22/2018 201834, en  
(31) 15190256 (32) 16.10.2015 (33) EP  
(54) BRASSICA PLANTS WITH ALTERED PROPERTIES IN SEED PRODUCTION  
(72) LAMMERTYN, Freya, Stationsstraat 119, 9185 Wachtebeke, BE  
BOTS, Marc, Prof. Hugo de Vrieslaan 25, 3571 GE, Utrecht, NL  
LAGA, Benjamin, Rakestraat 4, 8750 Wingene, BE  
SCHMIDT, Ralf-Christian, Wijngaard 7, 9831 Deurle, BE  
SCHMIDT, Julia, Wijngaard 7, 9831 Deurle, BE  
MOUCHEL, Celine, Elsboslaan 45, 9840 De Pinte, BE

---

(51) MKP  
**C07K 16/28 2006 (97) EP 3353212**  
**C07K 16/30 2006**  
(96) EP 16781236.1 9/23/2016  
(97) EP 3353212, 8/1/2018 201831, en  
(31) 201562222605 P (32) 23.09.2015 (33) US  
(54) OPTIMIZED ANTI-CD3 BISPECIFIC ANTIBODIES AND USES THEREOF  
(72) SMITH, Eric, c/o Regeneron Pharmaceuticals Inc. 777 Old Saw Mill River Road, Tarrytown, New York 10591-6707, US  
HABER, Lauric, c/o Regeneron Pharmaceuticals Inc. 777 Old Saw Mill River Road, Tarrytown, New York 10591-6707, US  
BABB, Robert, c/o Regeneron Pharmaceuticals Inc. 777 Old Saw Mill River Road, Tarrytown, New York 10591-6707, US  
CHEN, Gang, c/o Regeneron Pharmaceuticals Inc. 777 Old Saw Mill River Road, Tarrytown, New York 10591-6707, US  
MACDONALD, Douglas, c/o Regeneron Pharmaceuticals Inc. 777 Old Saw Mill River Road, Tarrytown, New York 10591-6707, US

---

(51) MKP  
**A63B 43/00 2006 (97) EP 3344350**  
**A63B 43/02 2006**  
**A63B 69/00 2006**  
(96) EP 16781275.9 8/31/2016  
(97) EP 3344350, 7/11/2018 201828, en  
(31) 201531482 U (32) 03.09.2015 (33) CZ  
(54) A DEVICE FOR TRAINING AND REHABILITATION  
(71) Nimrichtr, Václav, Jesenského 2703, 390 02 Tábor, CZ  
(72) Nimrichtr, Václav, Jesenského 2703, 390 02 Tábor, CZ

---

(51) MKP  
**B01F 7/00 2006 (97) EP 3393646**  
**B01F 7/18 2006**  
**B01F 15/00 2006**  
**B01F 15/06 2006**  
**B01J 8/08 2006**  
**B01J 8/10 2006**  
**B01J 20/20 2006**  
**B01J 20/30 2006**  
**B01J 20/32 2006**

**F26B 11/16 2006**  
**F26B 25/04 2006**  
(96) EP 16781321.1 10/4/2016  
(97) EP 3393646, 10/31/2018 201844, de  
(31) 102015016686 (32) 22.12.2015 (33) DE  
102016101213 25.01.2016 DE  
(54) DEVICE AND METHOD FOR MODIFYING POROUS SOLID SUBSTANCES  
(72) GIEBELHAUSEN, Jann-Michael, c/o Blücher GmbH Mettmanner Strasse 25, 40699 Erkrath, DE  
SCHRAGE, Christian, Dr., c/o Blücher GmbH Mettmanner Strasse 25, 40699 Erkrath, DE  
FICHTNER, Sven, Dr., c/o Blücher GmbH Mettmanner Strasse 25, 40699 Erkrath, DE

---

(51) MKP  
**D21C 5/02 2006 (97) EP 3362600**  
**D21H 19/40 2006**  
**D21H 19/44 2006**  
**D21H 19/52 2006**  
**D21H 19/54 2006**  
(96) EP 16781357.5 10/10/2016  
(97) EP 3362600, 8/22/2018 201834, en  
(31) 15189268 (32) 12.10.2015 (33) EP  
(54) PROCESS FOR THE DEINKING OF COATED PAPER OR PAPERBOARD  
(72) GANE, Patrick A.C., Studenweg 8, 4852 Rothrist, CH  
RENTSCH, Samuel, Gurtengartenstrasse 1, 3095 Spiegel bei Bern, CH  
WELKER, Matthias, 11 rue des Rossignols, 68220 Héisingue, FR  
RIDGWAY, Catherine Jean, Wannenberg 12, 4812 Mühlethal, CH

---

(51) MKP  
**A63H 33/04 2006 (97) EP 3362161**  
**A63H 33/06 2006**  
**A63H 33/10 2006**  
**E04B 1/343 2006**  
(96) EP 16781368.2 10/10/2016  
(97) EP 3362161, 8/22/2018 201834, en  
(31) 15189422 (32) 12.10.2015 (33) EP  
(54) HOLDING DEVICE  
(71) RnD by Us B.V., Gezichtslaan 59, 3723 GC Bilthoven, NL  
(72) BRANDWIJK, Arie Quirinus Bastiaan, Gezichtslaan 59, 3723 GC Bilthoven, NL

---

(51) MKP  
**A61K 31/195 2006 (97) EP 3364975**  
**A61K 31/496 2006**  
**A61K 45/06 2006**  
**A61P 25/02 2006**  
**A61P 25/04 2006**  
(96) EP 16781816.0 10/17/2016  
(97) EP 3364975, 8/29/2018 201835, en  
(31) 15191024 (32) 22.10.2015 (33) EP  
(54) COMBINATION OF TRAZODONE AND GABAPENTIN FOR THE TREATMENT OF PAIN  
(72) GARRONE, Beatrice, Via Tacito 50, 00193 Roma, IT  
DURANDO, Lucia, Via Ferdinando Palasciano 96, 00151 Roma, IT  
CALISTI, Fabrizio, Via Tito Omboni 148, 00147Roma, IT

---

(51) MKP  
**A61M 37/00 2006 (97) EP 3352837**  
**A61N 7/00 2006**  
(96) EP 16781904.4 9/21/2016  
(97) EP 3352837, 8/1/2018 201831, en  
(31) 201562221889 P (32) 22.09.2015 (33) US  
(54) METHODS FOR ENHANCING TOPICAL APPLICATION OF A BENEFIT AGENT  
(72) PATURI, Jyotsna, 199 Grandview Road, Skillman, New Jersey 08558, US  
PAUNESCU, Alexandru, 199 Grandview Road, Skillman, New Jersey 08558, US  
SUN, Ying, 199 Grandview Road, Skillman, New Jersey 08558, US

---

(51) MKP  
**F04D 29/42 2006 (97) EP 3269984**  
**F04D 29/60 2006**

(96) EP 17177919.2 6/26/2017  
(97) EP 3269984, 8/1/2018 201831, en

(31) 201600072971 (32) 13.07.2016 (33) IT

(54) PUMP EQUIPPED WITH IMPROVED FLANGES

(71) CALPEDA S.p.A., Via Roggia di Mezzo, 39, I-36050 Montorso Vicentino (VI), IT  
(72) MATTEAZZI, Giuliano, Via G.B. Vico, 50, 36040 BRENDOLA (VI), IT  
SAVEGNAGO, Alberto, Via Don L. Sturzo, 2B, 36073 CORNEDO VICENTINO (VI), IT  
ZAMBERLAN, Fiorenzo, Piazza Mazzini, 16, 36070 TRISSINO (VI), IT

---

(51) MKP  
**A61K 31/4025 2006 (97) EP 3252037**  
**A61P 5/10 2006**  
**C07D 207/22 2006**

(96) EP 17177956.4 7/25/2014  
(97) EP 3252037, 7/11/2018 201828, en

(31) 13183723 (32) 10.09.2013 (33) EP

(54) PYRROLIDINE DERIVATIVES AS OXYTOCIN / VASOPRESSIN V1A RECEPTORS ANTAGONISTS

(72) CHOLLET, André, c/o ObsEva S.A. 12, chemin des Aulx, 1228 Plan-les-Ouates, CH

---

(51) MKP  
**C07D 401/12 2006 (97) EP 3263566**

(96) EP 17178046.3 12/22/2011  
(97) EP 3263566, 8/8/2018 201832, en

(31) 201061426379 P (32) 22.12.2010 (33) US

(54) BICYCLO[3.2.1]OCTYL AMIDE DERIVATIVES AS ALLOSTERIC MODULATORS OF THE METABOTROPIC GLUTAMATE RECEPTOR 5 (MGLU5 OR MGLUR5) FOR THE TREATMENT OF CENTRAL NERVOUS SYSTEM (CNS) DISORDERS

(72) LI, Guiying, 76 Rutgers Place, Apt. No. 1, River Edge, NJ 07661, US  
ZHOU, Hao, 325 Edstan Way, Paramus, NJ 07652, US  
WEISS, Jesse, 169 South Park Drive, Woodbridge, NJ 07095, US  
DOLLER, Dario, 15 Quarterhorse Crossing, Sparta, NJ 07871, US  
BURNS, James, Ford, 11 Madison Street, Glen Ridge, NJ 07028, US

---

(51) MKP  
**A61K 38/46 2006 (97) EP 3272356**  
**C12N 9/22 2006**

(96) EP 17178186.7 2/22/2013  
(97) EP 3272356, 8/29/2018 201835, en

(31) 201261603231 P (32) 24.02.2012 (33) US

(54) COMPOSITIONS AND METHODS FOR THE TREATMENT OF HEMOGLOBINOPATHIES

(72) BENDER, Michael A., 6729 Beach Drive S.W., Seattle, WA 98136, US  
GROUDINE, Mark T., c/o Fred Hutchinson Cancer Research Center 1100 Fairview Ave N, Seattle, WA 98109, US  
STODDARD, Barry L., 5260 116th Place S.E., Bellevue, WA 98006, US  
TAKEUCHI, Ryo, 3004 NE 100th St, Seattle, WA 98125, US

---

(51) MKP  
**G01B 11/06 2006 (97) EP 3264033**  
**G02B 1/04 2006**

(96) EP 17178231.1 6/27/2017  
(97) EP 3264033, 8/1/2018 201831, en

(31) 201662355753 P (32) 28.06.2016 (33) US

(54) SYSTEMS AND METHODS OF USING ABSORPTIVE AND NON ABSORPTIVE IMAGING METROLOGY TO MEASURE THE THICKNESS OF OPHTHALMIC LENSES

(72) WIDMAN, Michael F., 7500 Centurion Parkway, Jacksonville, FL 32256, US  
SITES, Peter W., 7500 Centurion Parkway, Jacksonville, FL 32256, US  
LAFERRIERE, Jasmin G., 199 Grandview Road, Skillman, NJ 08558, US  
DEWALD, D. Scott, 6540 Harvest Glen Drive, Dallas, TX 75248, US  
WALKER, Bradley W., 6906 Blackwood Drive, Dallas, TX 75231, US

---

(51) MKP  
**A61K 31/4418 2006 (97) EP 3255041**  
**A61P 25/08 2006**  
**C07D 233/90 2006**  
**C07D 401/12 2006**  
**C07D 401/14 2006**  
**C07D 403/04 2006**  
**C07D 403/12 2006**  
**C07D 405/12 2006**  
**C07D 405/14 2006**

(96) EP 17179551.1 8/31/2012  
(97) EP 3255041, 7/18/2018 201829, en

(31) 201161530678 P (32) 02.09.2011 (33) US  
201261651611 P 25.05.2012 US

(54) PYRIMIDINES AS SODIUM CHANNEL BLOCKERS  
(72) NI, Chiyou, 5 Ford Court, Belle Mead, NJ 08502, US  
PARK, Minnie, 22 Warwick Road, Princeton Junction, NJ 08550, US  
SHAO, Bin, 23 Shelbourne Road, Richboro, PA 18954, US  
TAFESSE, Laykea, 8 Windward Way, Robbinsville, NJ 08690, US  
YAO, Jiangchao, 10 Bellflower Court, Princeton, NJ 08540, US  
YOUNGMAN, Mark, 110 Franklin Court, North Wales, PA 19454, US

(51) MKP  
**C12Q 1/18 2006 (97) EP 3399050**  
**G01N 33/487 2006**

(96) EP 17179602.2 7/4/2017  
(97) EP 3399050, 11/7/2018 201845, en

(31) 201706407 (32) 02.05.2017 (33) TR

(54) A TEST STRIP FOR MINIMAL INHIBITION CONCENTRATION (MIC) DETECTION  
(71) Kuleoglu, Mustafa Remzi, Ivedik Organize Sanayi Bolgesi 1333.Cadde No:9 Yenimahalle, Ankara, TR  
Kuleoglu, Enver Ali, Ivedik Osb Agac Isleri 1377.Sok. No:5, Ankara, TR  
(72) Kuleoglu, Mustafa Remzi, Ivedik Organize Sanayi Bolgesi 1333.Cadde No:9 Yenimahalle, Ankara, TR  
Kuleoglu, Enver Ali, Ivedik Osb Agac Isleri 1377.Sok. No:5, Ankara, TR

(51) MKP  
**A61B 17/28 2006 (97) EP 3263054**  
**A61B 17/32 2006**  
**A61B 18/14 2006**

(96) EP 17179625.3 7/12/2010  
(97) EP 3263054, 8/8/2018 201832, en

(31) 503766 (32) 15.07.2009 (33) US  
503769 15.07.2009 US  
503770 15.07.2009 US

(54) ULTRASONIC SURGICAL INSTRUMENTS HAVING CLAMP  
(72) WIENER, Eitan T., 9519 Croton Drive, Cincinnati, OH 45242, US  
WAN, Shan, 5667 Richmond Park Drive, Mason, OH 45040, US  
PRICE, Daniel W., 185 Overlook Drive, Loveland, OH 45140, US  
NORVELL, David K., 570 Doverdale Drive, Monroe, OH 45050, US  
GIORDANO, James R., 5647 Chestnutview Lane, Milford, OH 45150, US  
DINARDO, Brian, 10052 Old Farm Court, Cincinnati, OH 45242, US  
YATES, David C., 7534 Galway Court, West Chester, OH 45069, US  
MESSERLY, Jeffrey D., 2181 Telegraph Court, Cincinnati, OH 45244, US  
WITT, David A., 1187 Chaucer Place, Maineville, OH 45039, US  
ALDRIDGE, Jeffrey L., 106 W. Concord Drive, Lebanon, OH 45036, US

(51) MKP  
**A61K 9/00 2006 (97) EP 3263178**  
**A61K 9/19 2006**  
**A61K 39/00 2006**  
**A61K 39/395 2006**  
**A61K 47/18 2017**  
**A61K 47/26 2006**

**A61P 1/00 2006**  
**C07K 16/28 2006**  
(96) EP 17180246.5 5/2/2012  
(97) EP 3263178, 8/8/2018 201832, en  
(31) 201161481533 P (32) 02.05.2011 (33) US  
201161550545 P 24.10.2011 US  
201261585859 P 12.01.2012 US  
(54) FORMULATION FOR ANTI-ALPHA4BETA7 ANTIBODY  
(72) DILUZIO, Willow, 31 Castle View Drive, Gloucester, MA 01930, US  
TRUONG, Nobel T., 26 Stailbrook Road, Milford, MA 01757, US  
VARGA, Csanad M., 83 Commonwealth Park W, Newton, MA 02459, US  
PALANIAPPAN, Vaithianathan, 7 Spruce Circle, Andover, MA 01810, US  
BROWN, Jason, 10 September Lane, Burlington, MA 01803, US  
FOX, Irving H., 111 Livingston Road, Wellesley, MA 02482, US  
SCHOLZ, Catherine, 1 Nashua Street, Woburn, MA 01801, US

---

(51) MKP  
**A61K 9/00 2006 (97) EP 3311834**  
**A61K 39/395 2006**  
**A61K 47/12 2006**  
**A61K 47/14 2017**  
**A61K 47/18 2017**  
**A61K 47/26 2006**  
(96) EP 17180247.3 5/2/2012  
(97) EP 3311834, 12/5/2018 201849, en  
(31) 201161481522 P (32) 02.05.2011 (33) US  
201161544054 P 06.10.2011 US  
(54) FORMULATION FOR ANTI-ALPHA4BETA7 ANTIBODY  
(72) DILUZIO, Willow, 31 Castle View Drive, Gloucester MA 01930, US  
NGUYEN, Phong M., 126 Gore Street, 4, Cambridge, MA Massachusetts 02141, US  
VARGA, Csanad M., 83 Commonwealth Park W., Newton, MA 02459, US  
PALANIAPPAN, Vaithianathan, 7 Spruce Circle, Andover, MA Massachusetts 01810, US  
BROWN, Jason, 10 September Lane, Burlington, MA Massachusetts 01803, US  
FOX, Irving H., 111 Livingston Road, Wellesley, MA Massachusetts 02482, US  
SCHOLZ, Catherine, 1 Nashua Street, Woburn, MA Massachusetts 01801, US  
JENKINS, Erica Helen, 32 Rooks Street, Cottenham, Cambridgeshire CB24 8RB, GB  
ROSARIO, Maria, 6 School Street, Apt. 19, Mystic, CT Connecticut 06355, US

---

(51) MKP  
**F01M 1/18 2006 (97) EP 3269950**  
**F01M 5/00 2006**  
**F01P 3/06 2006**  
**F01P 7/14 2006**  
**F16K 31/06 2006**  
(96) EP 17180999.9 7/12/2017  
(97) EP 3269950, 8/22/2018 201834, de  
(31) 102016113003 (32) 14.07.2016 (33) DE  
(54) CONTROL VALVE FOR SUPPLYING ONE OR MORE NOZZLES WITH A PRESSURIZED FLUID  
(71) Wagner GmbH & Co. KG, Frankfurter Straße 80-88, 36043 Fulda, DE  
(72) Reinhard, Manuel, Magnus-Hartmann-Str. 17, 86093 Künzell, DE

---

(51) MKP  
**A61J 1/10 2006 (97) EP 3409259**  
**A61J 1/20 2006**  
**F26B 5/06 2006**  
(96) EP 17181049.2 7/12/2017  
(97) EP 3409259, 12/5/2018 201849, en  
(31) 201715609870 (32) 31.05.2017 (33) US  
(54) MULTI CHAMBER FLEXIBLE BAG AND METHODS OF USING SAME  
(71) ADIENNE Pharma & Biotech SA, Via Zurigo 46, 6900 Lugano, CH  
(72) DI NARO,, Antonio Francesco, 7 Via San Bartolomee, CH 6922 Morcote, CH

---

(51) MKP

**A61K 9/00 2006 (97) EP 3311845**  
**A61K 9/51 2006**  
**A61K 31/00 2006**  
**A61K 47/12 2006**  
 (96) EP 17181565.7 9/12/2014  
 (97) EP 3311845, 12/5/2018 201849, en  
 (31) 201361878227 P (32) 16.09.2013 (33) US  
 201461939332 P 13.02.2014 US  
 (54) THERAPEUTIC POLYMERIC NANOPARTICLES AND METHODS OF MAKING AND USING SAME  
 (72) ASHFORD, Marianne, Bernice, AstraZeneca, Charter Way Macclesfield, Macclesfield, Cheshire SK10 2NA, GB  
 NOLAN, James, Martin III, BIND Therapeutics Inc. 325 Vassar Street, Cambridge, Massachusetts MA 02139, US  
 SHIN, Eyoung, BIND Therapeutics Inc 325 Vassar Street, Cambridge, Massachusetts MA 02139, US  
 SONG, Young-Ho, BIND Therapeutics Inc 325 Vassar Street, Cambridge, Massachusetts 02139, US  
 TROIANO, Greg, BIND Therapeutics Inc 325 Vassar Street, Cambridge, Massachusetts MA 02139, US  
 WANG, Hong, BIND Therapeutics Inc 325 Vassar Street, Cambridge, Massachusetts MA 02139, US

---

(51) MKP  
**A61K 9/08 2006 (97) EP 3257498**  
**A61K 47/34 2017**  
 (96) EP 17181676.2 12/29/2011  
 (97) EP 3257498, 7/25/2018 201830, en  
 (31) 201061428007 P (32) 29.12.2010 (33) US  
 (54) BIODEGRADABLE DRUG DELIVERY COMPOSITIONS  
 (72) GAUDRIAULT, Georges, 25, rue Louis-Martin Berthoud, 34080 MONTPELLIER, FR

---

(51) MKP  
**A61K 31/585 2006 (97) EP 3296313**  
**A61P 35/00 2006**  
**C07J 19/00 2006**  
 (96) EP 17181707.5 1/14/2011  
 (97) EP 3296313, 10/24/2018 201843, en  
 (31) 295177 P (32) 15.01.2010 (33) US  
 (54) CERTAIN CHEMICAL ENTITIES, COMPOSITIONS, AND METHODS  
 (72) QIAN, Xiangping, 114 Mira St., Foster City, CA California 94404, US

---

(51) MKP  
**B29D 11/00 2006 (97) EP 3273293**  
**G02C 7/04 2006**  
 (96) EP 17181713.3 7/17/2017  
 (97) EP 3273293, 8/29/2018 201835, en  
 (31) 201615212542 (32) 18.07.2016 (33) US  
 (54) MOLD FOR CONTACT LENS WITH NON-ROTATIONALLY SYMMETRIC RIM OR EDGE  
 (72) DAMODHARAN, Radhakrishnan, 7500 Centurion Parkway, Jacksonville, FL 32256, US  
 JUBIN, Philippe, 7500 Centurion Parkway, Jacksonville, FL 32256, US  
 HEINRICH, Matias, 309 Magnolia Street, Neptune Beach, FL 32266, US

---

(51) MKP  
**E01C 5/00 2006 (97) EP 3272937**  
**E01C 11/22 2006**  
**E01F 9/529 2016**  
 (96) EP 17181722.4 7/17/2017  
 (97) EP 3272937, 8/29/2018 201835, de  
 (31) 506552016 (32) 20.07.2016 (33) AT  
 (54) STREET SHOULDER SLAB  
 (71) Lederer, Adolf, Mühlgasse 85, 8200 Gleisdorf, AT  
 (72) Lederer, Adolf, Mühlgasse 85, 8200 Gleisdorf, AT

---

(51) MKP  
**G01N 33/68 2006 (97) EP 3290922**  
 (96) EP 17182174.7 8/6/2014  
 (97) EP 3290922, 10/17/2018 201842, en

(31) 201361863299 P (32) 07.08.2013 (33) US  
201361913180 P 06.12.2013 US  
(54) ATYPICAL HEMOLYTIC UREMIC SYNDROME (AHUS) BIOMARKER PROTEINS  
(72) MCKNIGHT, Susan Faas, 14 Stonewood Drive, Old Lyme, CT 06371, US  
COFIELL, Roxanne, 83 Needletree Lane, Glastonbury, CT 06033, US  
KUKREJA, Anjli, 30 Memory Lane, Fairfield, CT 06824, US  
BEDARD, Krystin A., -, deceased, US  
YAN, Yan, 18 North Pond Road, Cheshire, CT 06410, US

---

(51) MKP  
**A61K 31/4188 2006 (97) EP 3272754**  
**A61P 35/00 2006**  
**C07D 487/04 2006**  
(96) EP 17182338.8 1/25/2013  
(97) EP 3272754, 8/29/2018 201835, en  
(31) 201261591001 P (32) 26.01.2012 (33) US  
201261669902 P 10.07.2012 US  
PCT/CN2012/086703 14.12.2012 WO  
(54) IMIDAZOPYRROLIDINONE COMPOUNDS  
(72) FURET, Pascal, Novartis Pharma AG Werk Klybeck Postfach, 4002 Basel, CH  
GUAGNANO, Vito, Novartis Pharma AG Werk Klybeck Postfach, 4002 Basel, CH  
HOLZER, Philipp, Novartis Pharma AG Werk Klybeck Postfach, 4002 Basel, CH  
KALLEN, Joerg, Novartis Pharma AG Postfach, 4002 Basel, CH  
LIAO, Lv, Shanghai Novartis Trading Ltd. No.4218 Jinke Road Zhangjiang Pudong, Shanghai, 201203, CN  
MAH, Robert, Novartis Pharma AG Werk Klybeck Postfach, 4002 Basel, CH  
MAO, Liang, Beijing Novartis Pharma Co. Ltd. Room 402, Pu Ruan Building No. 2 Boyun Road, 201203 Shanghai, CH  
MASUYA, Keiichi, Novartis Pharma AG Werk Klybeck Postfach, 4002 Basel, CH  
SCHLAPBACH, Achim, Novartis Pharma AG Postfach, 4002 Basel, CH  
STUTZ, Stefan, Novartis Pharma AG Werk Klybeck Postfach, 4002 Basel, CH  
VAUPEL, Andrea, Novartis Pharma AG Werk Klybeck Postfach, 4002 Basel, CH

---

(51) MKP  
**C12N 5/074 2010 (97) EP 3282015**  
**C12N 5/16 2006**  
**C12N 9/12 2006**  
**C12N 15/63 2006**  
**C12N 15/67 2006**  
(96) EP 17182410.5 12/2/2011  
(97) EP 3282015, 9/19/2018 201838, en  
(31) PCT/EP2010/007362 (32) 03.12.2010 (33) WO  
(54) METHOD FOR CELLULAR RNA EXPRESSION  
(71) Translationale Onkologie an der Universitätsmedizin der JGU Mainz gGmbH (TRON), Freiligrathstrasse 12, 55131 Mainz, DE  
(72) SAHIN, Ugur, Philipp-von-Zabern-Platz 1, 55116 Mainz, DE  
BEISSERT, Tim, Edith-Stein-Weg 4, 64521 Gross-Gerau, DE  
POLEGANOV, Marco, Bruchfeldstrasse 32, 60528 Frankfurt, DE  
HERZ, Stephanie, Weinbergstrasse 7, 54317 Kasel, DE

---

(51) MKP  
**B21D 13/04 2006 (97) EP 3287208**  
**B21D 22/10 2006**  
**B21H 8/00 2006**  
**B44B 5/00 2006**  
(96) EP 17182448.5 7/20/2017  
(97) EP 3287208, 9/12/2018 201837, en  
(31) 201600079293 (32) 28.07.2016 (33) IT  
(54) A MACHINE FOR SHAPING A METAL SHEET AND SHEET SO OBTAINED  
(71) Steel Color SpA, Via Per Pieve Terzagni 15, 26033 Perscarolo ED Uniti (CR), IT  
(72) GUINDANI, Cristoforo, Quartiere Salmistro, 33, 25020 Pralboino (BS), IT  
RICCI, Stefano, Via Malta , 13, 26039 Vescovato (CR), IT

---

(51) MKP  
**C07D 211/96 2006 (97) EP 3312160**



(96) EP 17182494.9 12/21/2012  
 (97) EP 3312160, 12/5/2018 201849, en  
 (31) 201161578716 P (32) 21.12.2011 (33) US  
 201261709331 P 03.10.2012 US  
 (54) HEPATITIS B ANTIVIRAL AGENTS  
 (72) HARTMAN, George D., c/o Novira Therapeutics, Inc. 3805 Old Easton Road, Doylestown, PA 18902, US  
 FLORES, Osvaldo A., c/o Novira Therapeutics, Inc. 3805 Old Easton Road, Doylestown, PA 18902, US

---

(51) MKP  
**C12Q 1/68 2018 (97) EP 3263717**  
**G01N 33/50 2006**  
 (96) EP 17183112.6 5/26/2010  
 (97) EP 3263717, 8/8/2018 201832, en  
 (31) 474017 (32) 28.05.2009 (33) US  
 (54) NOVEL TISSUE PROTECTIVE ERYTHROPOIETIN RECEPTOR (NEPOR) AND METHODS OF USE  
 (72) Jackson, David B., Hauptstr. 238, 69117 Heidelberg, DE  
 Stein, Martin, Lissaer Weg 9, 68307 Mannheim, DE  
 Voss, Hartmut, Madonnenbergweg 19, 69198 Schriesheim, DE  
 Brock, Stephan, Talstr. 10/1, 69469 Weinheim, DE  
 Danes, Christopher G., 4122 Glenshire Street, Houston, TX 77025, US  
 Sood, Anil, 2719 Lakecrest Drive, Pearland, TX 77584, US

---

(51) MKP  
**B61G 9/02 2006 (97) EP 3275761**  
**B61G 9/04 2006**  
 (96) EP 17183126.6 7/25/2017  
 (97) EP 3275761, 8/8/2018 201832, fr  
 (31) 1657383 (32) 29.07.2016 (33) FR  
 (54) TRACTION ASSEMBLY FOR RAILWAY COUPLING AND RAILWAY VEHICLE INCLUDING SUCH AN ASSEMBLY  
 (71) TITAGARH WAGONS AFR, 12 rue de la Chaussée d'Antin, 75009 Paris, FR  
 (72) VEN, Jean-Michel, 13 avenue du Président Kennedy, 59800 Lille, FR

---

(51) MKP  
**B61F 1/08 2006 (97) EP 3275760**  
 (96) EP 17183137.3 7/25/2017  
 (97) EP 3275760, 8/8/2018 201832, fr  
 (31) 1657378 (32) 29.07.2016 (33) FR  
 (54) UNDERFRAME SIDE SILL AND RAILWAY VEHICLE COMPRISING SUCH A SIDE SILL  
 (72) VEN, Jean-Michel, 13 avenue du Président Kennedy, 59800 LILLE, FR

---

(51) MKP  
**E06B 7/215 2006 (97) EP 3290627**  
 (96) EP 17184657.9 8/3/2017  
 (97) EP 3290627, 10/17/2018 201842, de  
 (31) 16184708 (32) 18.08.2016 (33) EP  
 16193807 13.10.2016 EP  
 16193809 13.10.2016 EP  
 17178820 29.06.2017 EP  
 (54) SEAL WITH A LIMIT ON THE MOVEMENT OF THE SEALING STRIP  
 (72) Kowski, Julian, Auf der Burg 32, 59494 Soest, DE  
 Ludwig, Maico, Wallburgerstraße 2, 59494 Soest, DE

---

(51) MKP  
**B61C 9/38 2006 (97) EP 3279054**  
 (96) EP 17184784.1 8/3/2017  
 (97) EP 3279054, 9/12/2018 201837, en  
 (31) 201600082605 (32) 04.08.2016 (33) IT  
 (54) MOTOR ASSEMBLY FOR A RAILWAY AXLE HAVING A CONTINUOUS VARIATION WITH AN ENERGY RECOVERY, AND RAILWAY WAGON  
 (71) SRT SOCIETA' A RESPONSABILITA' LIMITATA CON UNICO SOCIO, Via di Pietralata 140, 00158 Roma (RM), IT

(72) SALCICCIA, Gilberto, c/o SRT SOCIETA' A RESPONSABILITA' LIMITATA CON SOCIO UNICO Via Di Pietralata, 140, 00158 ROMA, IT

---

(51) MKP

**A61K 9/00 2006 (97) EP 3415163**  
**A61K 9/08 2006**  
**A61K 31/167 2006**  
**A61K 31/728 2006**  
**A61K 31/737 2006**  
**A61K 45/06 2006**  
**A61K 47/02 2006**  
**A61K 47/36 2006**  
**A61P 13/02 2006**  
**A61P 13/10 2006**

(96) EP 17184970.6 8/4/2017

(97) EP 3415163, 12/19/2018 201851, de

(31) 17001000 (32) 13.06.2017 (33) EP

(54) COMPOSITION WITH TOPICAL ANAESTHETIC EFFECT AND THE USE THEREOF

(72) SODHA, Frank, c/o Farco-Pharma GmbH Gereonsmühlengasse 1-11, 50670 Köln, DE

MEIER, Andreas, c/o Farco-Pharma GmbH Gereonsmühlengasse 1-11, 50670 Köln, DE

---

(51) MKP

**A61K 31/4375 2006 (97) EP 3266782**  
**A61K 31/444 2006**  
**A61K 31/506 2006**  
**A61K 45/06 2006**  
**A61P 3/10 2006**  
**A61P 27/00 2006**  
**C07D 471/04 2006**

(96) EP 17186012.5 2/7/2014

(97) EP 3266782, 8/15/2018 201833, en

(31) 201361762087 P (32) 07.02.2013 (33) US

201361900706 P 06.11.2013 US

(54) FLUORINATED INTEGRIN ANTAGONISTS

(71) SciFluor Life Sciences, Inc., 300 Technology Square, Level 2, Cambridge, MA 02139, US

(72) ASKEW, Ben, C., 266 Arrow Head Road, Marshfield, MA Massachusetts 02050, US

HEIDEBRECHT, Richard, W., 222 Willow Ave. 2, Somerville, MA Massachusetts 02144, US

FURUYA, Takeru, 91 Sidney St, Apt. 302, Cambridge, MA 02139, US

DUGGAN, Mark, E., One Brookdale Avenue, Wellesley, MA Massachusetts 02482, US

EDWARDS, D., Scott, Two Hillcrest Road, Bedford, MA Massachusetts 01730, US

---

(51) MKP

**C07H 21/02 2006 (97) EP 3312189**

(96) EP 17186598.3 4/20/2012

(97) EP 3312189, 12/5/2018 201849, en

(31) 201161478040 P (32) 21.04.2011 (33) US

201161478038 P 21.04.2011 US

201261596692 P 08.02.2012 US

201261596690 P 08.02.2012 US

(54) MODULATION OF HEPATITIS B VIRUS (HBV) EXPRESSION

(72) SWAYZE, Eric E., 2855 Gazelle Court, Carlsbad, CA 92010, US

FREIER, Susan M., 2855 Gazelle Court, Carlsbad, CA 92010, US

MCCALED, Michael, L., 2855 Gazelle Court, Carlsbad, CA 92010, US

---

(51) MKP

**A47J 31/40 2006 (97) EP 3298933**  
**A47J 31/56 2006**

(96) EP 17186928.2 8/18/2017

(97) EP 3298933, 11/7/2018 201845, de

(31) 102016118142 (32) 26.09.2016 (33) DE

(54) METHOD AND DEVICE FOR PROVIDING A HOT DRINK

(72) Baumann, Wolfgang, Pater-Rahmann-Str. 5, 59494 Ense, DE

(51) MKP  
**G09F 17/00 2006 (97) EP 3291211**

(96) EP 17187027.2 8/21/2017  
(97) EP 3291211, 9/19/2018 201838, en

(31) 201600090093 (32) 06.09.2016 (33) IT

(54) FOLDING BANNER SUPPORT ASSEMBLY  
(71) Mosca, Domenico, Via dei Ligustri, 46, 63066 Grottammare (AP), IT  
(72) ACCIARRI, Gianluca, Via San Pietro Vecchio, 30, 63900 Fermo (FM), IT

(51) MKP  
**A61K 31/7088 2006 (97) EP 3312281**  
**C12N 15/113 2010**

(96) EP 17187047.0 3/13/2014  
(97) EP 3312281, 12/5/2018 201849, en

(31) 201361782531 P (32) 14.03.2013 (33) US  
201361837399 P 20.06.2013 US  
201361904579 P 15.11.2013 US  
201361912777 P 06.12.2013 US  
201461942367 P 20.02.2014 US

(54) COMPLEMENT COMPONENT C5 IRNA COMPOSITIONS AND METHODS OF USE THEREOF  
(72) FITZGERALD, Kevin, 300 Third Street 3rd Floor, Cambridge, MA 02142, US  
BUTLER, James, 300 Third Street 3rd Floor, Cambridge, MA 02142, US  
BETTENCOURT, Brian, 300 Third Street 3rd Floor, Cambridge, MA 02142, US  
BORODOVSKY, Anna, 300 Third Street 3rd Floor, Cambridge, MA 02142, US  
KUCHIMANCHI, Satyanarayana, 300 Third Street 3rd Floor, Cambridge, MA 02142, US  
CHARISSE, Klaus, 300 Third Street 3rd Floor, Cambridge, MA 02142, US  
MANOHARAN, Muthiah, 300 Third Street 3rd Floor, Cambridge, MA 02142, US  
MAIER, Martin, 300 Third Street 3rd Floor, Cambridge, MA 02142, US  
RAJEEV, Kallanthottahil G., 300 Third Street 3rd Floor, Cambridge, MA 02142, US  
FOSTER, Donald, 300 Third Street 3rd Floor, Cambridge, MA 02142, US

(51) MKP  
**C07D 237/32 2006 (97) EP 3275870**

(96) EP 17187226.0 5/8/2012  
(97) EP 3275870, 8/29/2018 201835, en

(31) 201161484500 P (32) 10.05.2011 (33) US  
201161503543 P 30.06.2011 US

(54) FUSED HETEROCYCLIC COMPOUNDS AS ION CHANNEL MODULATORS  
(72) Corkey, Britton Kenneth, 243 Harrison Avenue, Redwood City, CA California 94062, US  
Elzein, Elfatih, 4644 Creekwood Drive, Fremont, CA California 94555, US  
Jiang, Robert H, 8057 Park Villa Circle, Cupertino, CA California 95014, US  
Kalla, Rao V, 125 Connemara Way, 9, Sunnyvale, CA California 94087, US  
Kobayashi, Tetsuya, 1362 Arleen Avenue, Sunnyvale, CA California 94087, US  
Koltun, Dmitry, 1075 Grebe Street, Foster City, CA California 94404, US  
Li, Xiaofen, 161 Montelena Court, Mountain View, CA California 94040, US  
Martinez, Ruben, 128 37th Avenue, San Mateo, CA California 94403, US  
Notte, Gregory, 21 Otay Avenue, San Mateo, CA California 94403, US  
Parkhill, Eric Q, 1392 Funston Avenue, Apt. 2, San Francisco, CA California 94122, US  
Perry, Thao, 5109 Adair Way, San Jose, CA California 95124, US  
Zablocki, Jeff, 490 Raquel Court, Los Altos, CA California 94022, US  
Venkataramani, Chandrasekar, 1 Chart Lane, Redwood City, CA California 94065, US  
Graupe, Michael, 1131 Banyan Way, Pacifica, CA California 94044, US  
Guerrero, Juan, 2380 Saint George Drive, Concord, CA California 94520, US

(51) MKP  
**A61K 31/00 2006 (97) EP 3305285**  
**A61K 31/4166 2006**  
**A61K 31/4439 2006**  
**A61P 35/00 2006**

(96) EP 17187458.9 9/23/2013  
(97) EP 3305285, 11/21/2018 201847, en  
(31) 201261705900 P (32) 26.09.2012 (33) US  
(54) ANTI-ANDROGENS FOR THE TREATMENT OF NON-METASTATIC CASTRATE-RESISTANT PROSTATE CANCER  
(72) CHEN, Isan, 2777 San Clemente Terrace, San Diego, CA California 92122, US

---

(51) MKP  
**A61K 9/00 2006 (97) EP 3383958**  
**C09C 1/02 2006**  
(96) EP 16808595.9 12/1/2016  
(97) EP 3383958, 10/10/2018 201841, en  
(31) 15197395 (32) 01.12.2015 (33) EP  
(54) METHOD FOR THE PRODUCTION OF GRANULES COMPRISING SURFACE-REACTED CALCIUM CARBONATE  
(72) DIAZ QUIJANO, Carolina, c/o Omya International AG Baslerstrasse 42, 4665 Oftringen, CH  
GERARD, Daniel E., Rheinfelderstrasse 12, 4058 Basel, CH  
SCHOELKOPF, Joachim, Dysshofweg 3, 5727 Oberkulm, CH  
GANE, Patrick A.C., Studenweg 8, 4852 Rothrist, CH

---

(51) MKP  
**A61K 31/437 2006 (97) EP 3386979**  
**A61P 11/00 2006**  
**C07D 471/04 2006**  
(96) EP 16808613.0 12/7/2016  
(97) EP 3386979, 10/17/2018 201842, de  
(31) 15199270 (32) 10.12.2015 (33) EP  
16196836 02.11.2016 EP  
(54) 2-PHENYL-3-(PIPERAZINOMETHYL)IMIDAZO[1,2-A]PYRIDINE DERIVATIVES AS BLOCKERS OF TASK-1 AND TASK-2 CHANNELS, FOR THE TREATMENT OF SLEEP-RELATED BREATHING DISORDERS  
(72) DELBECK, Martina, Müllerweg 10, 42579 Heiligenhaus, DE  
HAHN, Michael, Rietherbach 42D, 40764 Langenfeld, DE  
MÜLLER, Thomas, Parkstr. 24, 40764 Langenfeld, DE  
MEIER, Heinrich, Viktoriastr. 66, 42115 Wuppertal, DE  
LUSTIG, Klemens, Falkenberg 159, 42113 Wuppertal, DE  
MOSIG, Johanna, Vinckestr. 5, 44139 Dortmund, DE  
TOSCHI, Luisella, Sömmeringstr. 14, 10589 Berlin, DE  
ALBUS, Udo, Am Römerkastell 9, 61197 Florstadt, DE  
GEHRING, Doris, Frankfurter Str. 166, 65779 Kelkheim, DE  
ROSENSTEIN, Björn, Mühlenstr. 2, 63628 Bad Soden-Salmünster, DE

---

(51) MKP  
**A61K 9/14 2006 (97) EP 3386485**  
(96) EP 16808626.2 12/7/2016  
(97) EP 3386485, 10/17/2018 201842, en  
(31) 201562264792 P (32) 08.12.2015 (33) US  
(54) PHARMACEUTICAL COMPOSITION COMPRISING A POTENT INHIBITOR OF URAT1  
(71) Ardea Biosciences, Inc., 9390 Towne Centre Drive, San Diego, CA 92121, US  
(72) REILAND WAKEMAN, Joanne, 10952 Riesling Drive, San Diego California 92131, US  
ROWLINGS, Colin, 5484 Shannon Ridge Lane, San Diego California 92130, US  
LIU, Sha, 5827 Lopez Canyon Way, San Diego California 92126, US  
BURKE, Gerry, 4427 Corte Morea, San Diego California 92129, US  
VON CORSWANT, Christian, AstraZeneca R&D, 431 83 Mölndal, SE  
TANNERGREN, Christer, AstraZeneca R&D, 431 83 Mölndal, SE  
HJÄRTSTAM, Johan, AstraZeneca R&D, 431 83 Mölndal, SE

---

(51) MKP  
**A61K 31/404 2006 (97) EP 3383858**  
**A61P 31/04 2006**  
**C07D 209/42 2006**  
**C07D 401/04 2006**  
**C07D 403/04 2006**  
**C07D 413/10 2006**  
**C07D 471/04 2006**

(96) EP 16808753.4 11/30/2016  
(97) EP 3383858, 10/10/2018 201841, en  
(31) 201521059 (32) 30.11.2015 (33) GB  
(54) INHIBITORS OF METALLO-BETA-LACTAMASES  
(71) Oxford University Innovation Limited, Buxton Court 3 West Way, Botley Oxford OX2 0JB, GB  
(72) BREM, Jürgen, Chemistry Research Laboratory University of Oxford 12 Mansfield Road, Oxford OX1 3TA, GB  
RYDZIK, Anna M., Chemistry Research Laboratory University of Oxford 12 Mansfield Road, Oxford OX1 3TA, GB  
MCDONOUGH, Michael A., Chemistry Research Laboratory University of Oxford 12 Mansfield Road, Oxford OX1 3TA, GB  
SCHOFIELD, Christopher J., Chemistry Research Laboratory University of Oxford 12 Mansfield Road, Oxford OX1 3TA, GB  
MORRISON, Angus, European Screening Centre University of Dundee BioCity Scotland Bo'ness Road, Newhouse ML1 5UH, GB  
HEWITT, Joanne, European Screening Centre University of Dundee BioCity Scotland Bo'ness Road, Newhouse ML1 5UH, GB  
PANNIFER, Andrew, European Screening Centre University of Dundee BioCity Scotland Bo'ness Road, Newhouse ML1 5UH, GB  
JONES, Philip, European Screening Centre University of Dundee BioCity Scotland Bo'ness Road, Newhouse ML1 5UH, GB

---

(51) MKP  
**A61F 5/44 2006 (97) EP 3389575**  
**A61F 5/445 2006**  
**A61M 1/00 2006**  
(96) EP 16808817.7 12/5/2016  
(97) EP 3389575, 10/24/2018 201843, fr  
(31) 1562433 (32) 15.12.2015 (33) FR  
(54) DEVICE ALLOWING AN ALIMENTARY BOLUS FLOW BETWEEN TWO STOMAS  
(71) Centre Hospitalier Régional Universitaire de Lille, 2, avenue Oscar Lambret, 59037 Lille Cedex, FR  
(72) LOGIER, Régis, 4 rue Gambrinus, 59520 Marquette-les-Lille, FR  
SOZANSKI, Jean-Pierre, 2 rue du Houblon, 59650 Villeneuve d'Ascq, FR  
NZAMUSH ELEPAN MABLA, Jean-Robert, 16 boulevard Desnouettes, 1420 Braines l'Alleud, BE

---

(51) MKP  
**A61F 2/24 2006 (97) EP 3370648**  
(96) EP 16808847.4 11/4/2016  
(97) EP 3370648, 9/12/2018 201837, en  
(31) 201562252390 P (32) 06.11.2015 (33) US  
(54) MITRAL VALVE PROSTHESIS  
(71) Micor Limited, Offshore Incorporations (Cayman) Limited Floor 4 Willow House Cricket Square, Grand Cayman KY1-1112, KY  
(72) WALSH, Brandon G., 342 Crestwood Road, Kaysville, Utah 84037, US  
ZHANG, Ji, 9160 Mona Avenue, Burnaby, British Columbia V3N 5A7, CA  
YANG, Cheng Yong, 730 Tender Lane, Foster City, California 94404, US  
ZHU, Jinhua, 162 Brewster Street, San Francisco, California 94110, US

---

(51) MKP  
**A61K 31/7052 2006 (97) EP 3380486**  
**A61P 1/04 2006**  
**C07D 487/04 2006**  
**C07H 15/26 2006**  
(96) EP 16808876.3 11/22/2016  
(97) EP 3380486, 10/3/2018 201840, en  
(31) 201562259273 P (32) 24.11.2015 (33) US  
(54) PRODRUGS OF A JAK INHIBITOR COMPOUND FOR TREATMENT OF GASTROINTESTINAL INFLAMMATORY DISEASE  
(72) HUDSON, Ryan, 1454 Walbrook Drive, San Jose, California 95129, US  
LONG, Daniel D., 10 Sunview Drive, San Francisco, California 94131, US  
WILTON, Donna A.A., 181 Fair Oaks Street, San Francisco, California 94110, US  
LOO, Mandy, 2119 Imwalle Court, San Jose, California 95131, US  
BRASSIL, Patrick J., 1215 Chantal Way, Redwood City, California, CA 94061, US

---

(51) MKP  
**A61K 39/00 2006 (97) EP 3380196**  
**A61P 35/02 2006**  
**C07K 16/28 2006**  
**C07K 16/30 2006**  
**C07K 16/46 2006**  
(96) EP 16808889.6 11/23/2016  
(97) EP 3380196, 10/3/2018 201840, en

(31)	201514952786	(32)	25.11.2015	(33)	US
	PCT/US2015/062786		25.11.2015		WO

(54) HETERODIMERIC ANTIBODIES THAT BIND CD3 AND CD38  
(72) STEVENS, Jennitte, Leann, 126 Siesta Avenue, Thousand Oaks, CA 91360, US  
BALAZS, Mercedesz, c/o Amgen Inc. One Amgen Center Drive, Thousand Oaks, CA 91320-1799, US  
NOLAN-STEVAUX, Olivier, 340 Hazel Avenue, Millbrac, CA 94030, US  
MOORE, Gregory, c/o Xencor Inc. 111 West Lemon Avenue, Monrovia, CA 91016, US  
DESJARLAIS, John, c/o Xencor Inc. 111 West Lemon Avenue, Monrovia, CA 91016, US  
BERNETT, Matthew, J., c/o Xencor Inc. 111 West Lemon Avenue, Monrovia, CA 91016, US  
CHU, Seung, Y., c/o Xencor Inc. 111 West Lemon Avenue, Monrovia, CA 91016, US  
RASHID, Rumana, c/o Xencor Inc. 111 West Lemon Avenue, Monrovia, CA 91016, GB  
MUCHHAL, Umesh, c/o Xencor Inc. 111 West Lemon Avenue, Monrovia, CA 91016, US

---

(51) MKP  
**C12M 1/00 2006 (97) EP 3374511**  
**C12M 1/107 2006**  
**C12P 5/02 2006**

(96) EP 16808900.1 11/15/2016  
(97) EP 3374511, 9/19/2018 201838, en

(31)	201500719	(32)	15.11.2015	(33)	DK
------	-----------	------	------------	------	----

(54) METHOD FOR POULTRY LITTER FERMENTATION AND BIOGAS PRODUCTION  
(72) JENSEN, Anders Peter, Søtoften 7 Blegind, 8362 Hørning, DK  
ØSTERGAARD, Ole, Højbakkevej 38 e Biersted, 9440 Aabybro, DK

---

(51) MKP  
**B65D 6/18 2006 (97) EP 3377416**  
**B65D 6/34 2006**  
**B65D 21/02 2006**  
**B65D 85/34 2006**

(96) EP 16808925.8 11/17/2016  
(97) EP 3377416, 9/26/2018 201839, de

(31)	202015106211 U	(32)	17.11.2015	(33)	DE
------	----------------	------	------------	------	----

(54) CONTAINER MADE OF PLASTIC  
(71) Euro Pool System International B.v., Laan van Vredenoord 8, 2289 DJ Rijswijk, NL  
(72) ROELOFS, Christian, Schulweg 9, 49824 Ringe, DE  
VAN DER KNAAP, Arthur F., Anthony Fokkersingel 14, 2497 BG Den Haag, NL

---

(51) MKP  
**A61K 39/00 2006 (97) EP 3383425**  
**A61P 35/00 2006**  
**C07K 16/18 2006**  
**C07K 16/28 2006**  
**C07K 16/46 2006**

(96) EP 16808971.2 12/2/2016  
(97) EP 3383425, 10/10/2018 201841, en

(31)	15197999	(32)	04.12.2015	(33)	EP
------	----------	------	------------	------	----

(54) BIPARATOPIC POLYPEPTIDES ANTAGONIZING WNT SIGNALING IN TUMOR CELLS  
(71) Boehringer Ingelheim International GmbH & Co. KG, Binger Strasse 173, 55216 Ingelheim am Rhein, DE  
(72) ZINZALLA, Vittoria, Boehringer Ingelheim GmbH/ Corporate Patents Binger Strasse 173, 55216 Ingelheim am Rhein, DE  
KUENKELE, Klaus-Peter, Boehringer Ingelheim GmbH/ Corporate Patents Binger Strasse 173, 55216 Ingelheim am Rhein, DE  
BUYSE, Marie-Ange, Ablynx N.V. Technologiepark 21, 9052 Zwijnaarde, BE  
CROMIE, Karen, ABLYNX N.V. Technologiepark 21, 9052 Zwijnaarde, BE  
STAELENS, Stephanie, Ablynx N.V. Technologiepark 21, 9052 Zwijnaarde, BE  
STRUBBE, Beatrijs, Ablynx N.V. Technologiepark 21, 9052 Zwijnaarde, BE

---

(51) MKP  
**A61K 9/00 2006 (97) EP 3413868**  
**A61K 31/7032 2006**  
**A61K 31/728 2006**  
**A61P 27/02 2006**

(96) EP 16809172.6 11/8/2016  
(97) EP 3413868, 12/19/2018 201851, en

(31)	UB20160543	(32)	08.02.2016	(33)	IT
------	------------	------	------------	------	----

- (54) OPHTHALMIC COMPOSITION FOR THE USE IN THE TREATMENT OF EYE DISORDERS RELATED TO ALTERATIONS OF THE CORNEAL CONJUNCTIVAL SURFACE  
(71) Sooft Italia S.p.A., Contrada Molino, 17, 63833 Montegiorgio (FM), IT  
(72) BIONDI, Marco, Via A. Gramsci 19, I-63822 Porto San Giorgio (FM), IT  
BIONDI, Piero, Via A. Gramsci 19, I-63822 Porto San Giorgio (FM), IT  
STAGNI, Edoardo, Via Gregorio VIII n. 58, 00165 Roma, IT  
STAGNI, Marcello, Via Mazzini n. 165, 63822 Porto San Giorgio (FM), IT
- 

- (51) MKP  
**A61K 31/4709 2006 (97) EP 3383867**  
**C07D 401/12 2006**  
**C07D 409/14 2006**  
**C07D 471/08 2006**  
(96) EP 16809306.0 11/29/2016  
(97) EP 3383867, 10/10/2018 201841, en  
(31) 15197730 (32) 03.12.2015 (33) EP  
(54) COMPOUNDS HAVING MUSCARINIC RECEPTOR ANTAGONIST AND BETA2 ADRENERGIC RECEPTOR AGONIST ACTIVITY  
(71) Chiesi Farmaceutici S.p.A., Via Palermo, 26/A, 43122 Parma, IT  
(72) RANCATI, Fabio, c/o Chiesi Farmaceutici S.p.a. Via Palermo 26/A, 43122 Parma, IT  
RIZZI, Andrea, c/o Chiesi Farmaceutici S.p.a. Via Palermo 26/A, 43122 Parma, IT  
CARZANIGA, Laura, c/o Chiesi Farmaceutici S.p.a. Via Palermo 26/A, 43122 Parma, IT  
LINNEY, Ian, c/o Chiesi Farmaceutici S.p.a. Via Palermo 26/A, 43122 Parma, IT
- 

- (51) MKP  
**C12Q 1/68 2018 (97) EP 3384045**  
(96) EP 16809319.3 12/1/2016  
(97) EP 3384045, 10/10/2018 201841, en  
(31) 15197894 (32) 03.12.2015 (33) EP  
(54) METHOD FOR DETERMINING CELL CLONALITY  
(72) LA NEVE, Fabio, Corso Peschiera 258, 10138 Torino, IT  
FEGER, Georg, 108A Rue de Carouge, 1205 Geneva, CH  
TOSO, Emiliano, Via Almasso 26, 13888 Mongrando (BI), IT
- 

- (51) MKP  
**A61B 1/307 2006 (97) EP 3349641**  
**A61M 3/02 2006**  
(96) EP 16809517.2 9/15/2016  
(97) EP 3349641, 7/25/2018 201830, en  
(31) 1500419 (32) 16.09.2015 (33) HU  
1500648 23.12.2015 HU  
(54) ADAPTER, PROCESS AND USE FOR INSTILLATION OF AGENTS INTO THE BLADDER THROUGH THE URETHRA WITHOUT CATHETER  
(71) Lovász, Sándor, Hegedűs Gyula u. 8, 1136 Budapest, HU  
Rényi, Gábor, Svent István park 26, 1137 Budapest, HU  
Giber, János, Városmajor u. 39/b, 1122 Budapest, HU  
(72) Lovász, Sándor, Hegedűs Gyula u. 8, 1136 Budapest, HU  
Rényi, Gábor, Svent István park 26, 1137 Budapest, HU  
Giber, János, Városmajor u. 39/b, 1122 Budapest, HU
- 

- (51) MKP  
**G01N 33/68 2006 (97) EP 3377908**  
(96) EP 16809582.6 11/15/2016  
(97) EP 3377908, 9/26/2018 201839, en  
(31) 201562257089 P (32) 18.11.2015 (33) US  
(54) BIOMARKER OF POLYCYSTIC KIDNEY DISEASE AND USES THEREOF  
(71) Genzyme Corporation, 50 Binney Street, Cambridge, MA 02142, US  
(72) BUKANOV, Nikolai, c/o Sanofi 55 Corporate Drive Mail Code: 55A-505A, Bridgewater, New Jersey 08807, US  
MORENO, Sarah, c/o Sanofi 55 Corporate Drive Mail Code: 55A-505A, Bridgewater, New Jersey 08807, US  
WEEDEN, Timothy E., c/o Sanofi 55 Corporate Drive Mail Code: 55A-505A, Bridgewater, New Jersey 08807, US
- 

- (51) MKP

**G01N 33/68 2006 (97) EP 3377909**  
(96) EP 16809652.7 11/17/2016  
(97) EP 3377909, 9/26/2018 201839, en  
(31) 15195662 (32) 20.11.2015 (33) EP  
(54) LACTOFERRIN FOR USE IN THE DIAGNOSIS OR PROGNOSIS OF ALZHEIMER'S DISEASE, OR IN THE DIAGNOSIS OF PARKINSON'S DISEASE  
(71) Geroa Diagnostics, S.L, Edificio CEIA C/ Albert Einstein 15, 01510 Miñano Mayor, ES  
(72) CARRO DIAZ, Eva Maria, C/ Duque De Sesto, 37, 28009 Madrid, ES

---

(51) MKP  
**C12N 5/00 2006 (97) EP 3365678**  
**C12N 5/0775 2010**  
**G01N 33/569 2006**  
(96) EP 16810017.0 10/20/2016  
(97) EP 3365678, 8/29/2018 201835, en  
(31) 201562245249 P (32) 22.10.2015 (33) US  
(54) METHODS FOR CULTURING CELLS AND KITS AND APPARATUS FOR SAME  
(72) GERMERTH, Lothar, Rudolf Wissellstrasse 28, 37079 Göttingen, DE  
STEMBERGER, Christian, Rudolf Wissellstrasse 28, 37079 Göttingen, DE  
GRÄF, Patricia, Rudolf Wissellstrasse 28, 37079 Göttingen, DE

---

(51) MKP  
**A61K 9/00 2006 (97) EP 3383364**  
**A61K 9/19 2006**  
**A61K 47/26 2006**  
**A61K 47/40 2006**  
(96) EP 16810066.7 11/30/2016  
(97) EP 3383364, 10/10/2018 201841, en  
(31) 201562260727 P (32) 30.11.2015 (33) US  
(54) FORMULATIONS FOR INTRAVENOUS INJECTION OF DANIRIXIN  
(72) APFELBAUM, Rachel, 1250 South Collegeville Road, Collegeville, Pennsylvania 19426, US  
OH, Yoon, 1250 South Collegeville Road, Collegeville, Pennsylvania 19426, US  
PEAT, Andrew James, 1250 South Collegeville Road, Collegeville, Pennsylvania 19426, US

---

(51) MKP  
**C07K 16/28 2006 (97) EP 3383907**  
(96) EP 16810068.3 12/1/2016  
(97) EP 3383907, 10/10/2018 201841, en  
(31) 201562261481 P (32) 01.12.2015 (33) US  
(54) COMBINATION TREATMENTS AND USES AND METHODS THEREOF  
(72) MAYES, Patrick A., 1250 South Collegeville Road, Collegeville, PA 19426, US  
SEESTALLER-WEHR, Laura M., 1250 South Collegeville Road, Collegeville, PA 19426, US  
TSVETKOV, Lyuben, 1250 South Collegeville Road, Collegeville, PA 19426, US  
YANAMANDRA, Niranjan, 1250 South Collegeville Road, Collegeville, PA 19426, US  
YANG, Jingsong, 1250 South Collegeville Road, Collegeville, PA 19426, US

---

(51) MKP  
**C07K 14/54 2006 (97) EP 3383891**  
(96) EP 16810069.1 12/1/2016  
(97) EP 3383891, 10/10/2018 201841, en  
(31) 201562263008 P (32) 04.12.2015 (33) US  
(54) ANTIBODY CYTOKINE ENGRAFTED COMPOSITIONS AND METHODS OF USE FOR IMMUNOREGULATION  
(72) DIDONATO, Michael, Novartis Institute for Functional Genomics Inc. Db a Genomics Institute of the Novartis Research Foundation 10675 John Jay Hopkins Drive, San Diego, CA 92121, US  
KNUTH, Mark, Novartis Institute for Functional Genomics Inc. Db a Genomics Institute of the Novartis Research Foundation 10675 John Jay Hopkins Drive, San Diego, CA 92121, US  
MEEUSEN, Shelly, Novartis Institute for Functional Genomics Inc. Db a Genomics Institute of the Novartis Research Foundation 10675 John Jay Hopkins Drive, San Diego, CA 92121, US  
SPRAGGON, Glen, Novartis Institute for Functional Genomics Inc. Db a Genomics Institute of the Novartis Research Foundation 10675 John Jay Hopkins Drive, San Diego, CA 92121, US  
TRAUGER, John, Novartis Institute for Biomedical Research, Inc. 250 Massachusetts Avenue, Cambridge, MA 02139, US



GEIERSTANGER, Bernhard Hubert, Novartis Institute for Functional Genomics Inc. DbA Genomics Institute of the Novartis Research Foundation  
10675 John Jay Hopkins Drive, San Diego, CA 92121, US  
SIMPSON, Carolina Nicole, Novartis Institute for Functional Genomics Inc. DbA Genomics Institute of the Novartis Research Foundation 10675  
John Jay Hopkins Drive, San Diego, CA 92121, US  
JUNT, Tobias, c/o Novartis Pharma AG Novartis Institutes for Biomedical Research Postfach, 4002 Basel, CH

---

(51) MKP  
**A61K 35/17 2015 (97) EP 3370762**  
**A61K 39/00 2006**  
**C07K 14/00 2006**  
**C07K 14/705 2006**  
(96) EP 16810123.6 11/4/2016  
(97) EP 3370762, 9/12/2018 201837, en  
(31) 201562251590 P (32) 05.11.2015 (33) US  
(54) CHIMERIC RECEPTORS CONTAINING TRAF-INDUCING DOMAINS AND RELATED COMPOSITIONS AND METHODS  
(72) THOMPSON, Lucas, James, 400 Dexter Avenue North Suite 1200, Seattle, WA 98109, US  
ODEGARD, Valerie, 400 Dexter Avenue North Suite 1200, Seattle, WA 98109, US  
SATHER, Blythe, 400 Dexter Avenue North Suite 1200, Seattle, WA 98109, US  
BRAHMAMDAM, Archana, 400 Dexter Avenue North Suite 1200, Seattle, WA 98109, US

---

(51) MKP  
**G01N 33/574 2006 (97) EP 3371601**  
(96) EP 16810124.4 11/7/2016  
(97) EP 3371601, 9/12/2018 201837, en  
(31) 201562251322 P (32) 05.11.2015 (33) US  
201662351877 P 17.06.2016 US  
(54) FLOW CYTOMETRY FOR MONITORING HISTONE H3 METHYLATION STATUS  
(72) PLESCIA, Christopher, 400 Technology Square 4th Floor, Cambridge, Massachusetts 02139, US

---

(51) MKP  
**A61K 38/16 2006 (97) EP 3387010**  
**A61K 48/00 2006**  
**C07K 14/52 2006**  
**C12N 15/62 2006**  
(96) EP 16810130.1 11/11/2016  
(97) EP 3387010, 10/17/2018 201842, en  
(31) 201562254139 P (32) 11.11.2015 (33) US  
(54) COMPOSITIONS AND METHODS FOR EXPRESSION OF MULTIPLE BIOLOGICALLY ACTIVE POLYPEPTIDES FROM A SINGLE VECTOR  
FOR TREATMENT OF CARDIAC CONDITIONS AND OTHER PATHOLOGIES  
(72) PATEL, Dimki S., 20358 Seneca Meadows Pkwy, Germantown, Maryland 20876, US  
PATEL, Amit N., 1040 Chartwell Ct., Salt Lake City, Utah 84103, US

---

(51) MKP  
**A61K 38/57 2006 (97) EP 3377093**  
**C07K 14/81 2006**  
(96) EP 16810158.2 11/18/2016  
(97) EP 3377093, 9/26/2018 201839, en  
(31) 201562257711 P (32) 19.11.2015 (33) US  
(54) RECOMBINANT HUMAN C1 ESTERASE INHIBITOR AND USES THEREOF  
(72) NORTON, Angela, W., 300 Shire Way, Lexington, MA 02421, US  
COPPOLA, Germano, 300 Shire Way, Lexington, MA 02421, US

---

(51) MKP  
**A61K 39/00 2006 (97) EP 3380522**  
**A61K 39/395 2006**  
**C07K 16/28 2006**  
(96) EP 16810195.4 11/23/2016  
(97) EP 3380522, 10/3/2018 201840, en  
(31) 201562259897 P (32) 25.11.2015 (33) US  
201662313684 P 25.03.2016 US  
201662399087 P 23.09.2016 US

---

- (54) ANTIBODY MOLECULES TO APRIL AND USES THEREOF  
 (71) Visterra, Inc., 275 2nd Avenue, 4th Floor, Waltham, MA 02451, US  
 (72) MYETTE, James, R., 33 Winthrop Street, Waltham, MA 02453, US  
 SHRIVER, Zachary, Holmes, 21 Mount Pleasant Street, Winchester, MA 01890, US  
 VISWANATHAN, Karthik, 1 John Swift Road, Acton, MA 01720, US  
 WOLLACOTT, Andrew, M., 16 Woodchester Drive, Milton, MA 02186, US  
 ADARI-HALL, Hedy, 17 Emerson Way, Sudbury, MA 01776, US  
 RAMAKRISHNAN, Boopathy, 605 Middle Street Unit 19, Braintree, MA 02184, US  
 BABCOCK, Gregory, 38 Muir Way, Marlborough, MA 01752, US
- 

- (51) MKP  
**A61K 39/00 2006 (97) EP 3371224**  
**A61K 39/395 2006**  
**A61P 27/02 2006**  
**C07K 16/28 2006**
- (96) EP 16810513.8 11/3/2016  
 (97) EP 3371224, 9/12/2018 201837, en
- (31) 201562250269 P (32) 03.11.2015 (33) US  
 16306166 14.09.2016 EP  
 201662408391 P 14.10.2016 US
- (54) COMPOSITIONS COMPRISING IL6R ANTIBODIES FOR THE TREATMENT OF UVEITIS AND MACULAR EDEMA AND METHODS OF USING SAME  
 (72) SRIDHARA SUNDARAM, Preethi, Aavali, c/o Sanofi Department Brevets 54 Rue La Boetie, 75008 Paris, FR  
 BUGGAGE, Ronald, c/o Sanofi Department Brevets 54 Rue La Boetie, 75008 Paris, FR  
 VITTI, Robert, L., c/o Regeneron Pharmaceuticals Inc. 777 Old Saw Mill River Road, Tarrytown, NY 10591-6707, US  
 CORP DIT GENTI, Valérie, c/o Sanofi Department Brevets 54 Rue La Boetie, 75008 Paris, FR  
 VARONA, Rafael, c/o Sanofi Department Brevets 54 Rue La Boetie, 75008 Paris, FR  
 ERICKSON, Kristine, A., c/o Regeneron Pharmaceuticals Inc. 777 Old Saw Mill River Road, Tarrytown, NY 10591-6707, US  
 CHU, Karen, W., c/o Regeneron Pharmaceuticals Inc. 777 Old Saw Mill River Road, Tarrytown, NY 10591-9707, US  
 MERY-MIGNARD, Dominique, c/o Sanofi Dpartment Brevets 54 Rue La Boetie, 75008 Paris, FR
- 

- (51) MKP  
**A61K 31/00 2006 (97) EP 3380091**  
**A61K 31/4152 2006**  
**A61P 9/00 2006**  
**A61P 9/10 2006**
- (96) EP 16810536.9 11/21/2016  
 (97) EP 3380091, 10/3/2018 201840, en
- (31) 201562259498 P (32) 24.11.2015 (33) US
- (54) TARGETING OF THE FORMYL-PEPTIDE RECEPTOR 2/LIPOXIN A4 RECEPTOR (FPR2/ALX) FOR TREATMENT OF HEART DISEASE  
 (72) OSTROWSKI, Jacek, 2445 Primrose Court, Jamison, PA 18929, US  
 GARCIA, Ricardo, c/o Bristol-Myers Squibb Company 311 Pennington-Rocky Hill Road, Pennington, New Jersey 08534, US  
 WURTZ, Nicholas R., c/o Bristol-Myers Squibb Company 311 Pennington-Rocky Hill Road, Pennington, New Jersey 08534, US
- 

- (51) MKP  
**A01N 31/08 2006 (97) EP 3380413**  
**A23B 7/154 2006**  
**B65D 85/34 2006**
- (96) EP 16812680.3 11/21/2016  
 (97) EP 3380413, 10/3/2018 201840, en
- (31) UB20155878 (32) 25.11.2015 (33) IT
- (54) PACKAGING FOR FRUIT AND VEGETABLE PRODUCTS TREATED WITH AN ANTIMICROBIAL SOLUTION  
 (71) Consorzio Bestack, Via Miller, 32, 47121 Forlì, IT  
 (72) LANCIOTTI, Rosalba, c/o ALMA MATER STUDIORUM Università di Bologna Via Zamboni 33, 40126 Bologna, IT  
 PATRIGNANI, Francesca, c/o ALMA MATER STUDIORUM Università di Bologna Via Zamboni 33, 40126 Bologna, IT  
 GARDINI, Fausto, c/o ALMA MATER STUDIORUM Università di Bologna Via Zamboni 33, 40126 Bologna, IT  
 SIROLI, Lorenzo, c/o ALMA MATER STUDIORUM Università di Bologna Via Zamboni 33, 40126 Bologna, IT
- 

- (51) MKP  
**A23L 3/18 2006 (97) EP 3389398**  
**A23L 3/30 2006**  
**A23L 3/3418 2006**

	<b>A23L 3/358 2006</b>						
	<b>A23L 3/3589 2006</b>						
	<b>A61L 2/07 2006</b>						
	<b>A61L 2/18 2006</b>						
	<b>A61L 2/22 2006</b>						
(96)	EP 16812753.8	12/19/2016					
(97)	EP 3389398,	10/24/2018	201843,	en			
(31)	201570836		(32)	18.12.2015		(33)	DK
	201562269690 P			18.12.2015			US
(54)	INSTALLATION AND METHOD FOR SANITIZING FOOD PRODUCTS						
(71)	FORCE Technology, Park Allé 345, 2605 Brøndby, DK						
(72)	KREBS, Niels, Bøgehøj 45, 2900 Hellerup, DK						
	MEEKS, Keith D., 57 W. Goshen Avenue, Clovis California 93611, US						
	ORMOND, Aaron, 57 W. Goshen Avenue, Clovis California 93611, US						
<hr/>							
(51)	MKP						
	<b>C07H 1/00 2006</b>		<b>(97) EP 3386998</b>				
	<b>C07H 19/06 2006</b>						
(96)	EP 16812797.5	12/9/2016					
(97)	EP 3386998,	10/17/2018	201842,	en			
(31)	6635CH2015		(32)	11.12.2015		(33)	IN
	201602185			08.02.2016			GB
(54)	DIASTEREOSELECTIVE SYNTHESIS OF PHOSPHATE DERIVATIVES AND OF THE GEMCITABINE PRODRUG NUC-1031						
(71)	Laurus Labs Private Limited, IKP Knowledge Park Plot No. DS1 Genome Valley Turkapally Shameerpet Mandal, Ranga District, Hyderabad 500078, IN						
(72)	KOTALA, Mani Bushan, c/o Laurus Labs Private Ltd IKP Knowledge Park Genome Valley Turkapally Shameerpet Mandal, Hyderabad Telangana 500 078, IN						
	DAMMALAPATI, Venkata Lakshmi Narasimha Rao, c/o Laurus Labs Private Ltd IKP Knowledge Park Genome Valley Turkapally Shameerpet Mandal, Hyderabad Telangana 500 078, IN						
<hr/>							
(51)	MKP						
	<b>A47J 31/54 2006</b>		<b>(97) EP 3364835</b>				
	<b>F24H 1/10 2006</b>						
(96)	EP 16812827.0	10/24/2016					
(97)	EP 3364835,	8/29/2018	201835,	en			
(31)	UB20155255		(32)	23.10.2015		(33)	IT
	UB20161423			07.03.2016			IT
(54)	METHOD, MACHINE AND BOILER FOR THE PREPARATION OF BEVERAGES						
(72)	GAMBERINI, Paolo, c/o EUREK S.r.l. Via Celletta 8/B, 40026 Imola, IT						
	PASQUI, Daniele, c/o EUREK S.r.l. Via Celletta 8/B, 40026 Imola, IT						
	ZACCHERINI, Maurizio, c/o EUREK S.r.l. Via Celletta 8/B, 40026 Imola, IT						
<hr/>							
(51)	MKP						
	<b>A47J 31/54 2006</b>		<b>(97) EP 3364836</b>				
	<b>F24H 1/10 2006</b>						
(96)	EP 16812828.8	10/24/2016					
(97)	EP 3364836,	8/29/2018	201835,	en			
(31)	UB20155255		(32)	23.10.2015		(33)	IT
	UB20161425			07.03.2016			IT
	UB20161428			07.03.2016			IT
(54)	METHOD AND MACHINE FOR PREPARING BEVERAGES						
(71)	Eurek S.r.l., Via Celletta 8/B, 40026 Imola, IT						
(72)	GAMBERINI, Paolo, c/o EUREK S.r.l. Via Celletta 8/B, 40026 Imola, IT						
	PASQUI, Daniele, c/o EUREK S.r.l. Via Celletta 8/B, 40026 Imola, IT						
	ZACCHERINI, Maurizio, c/o EUREK S.r.l. Via Celletta 8/B, 40026 Imola, IT						
<hr/>							
(51)	MKP						
	<b>A21B 1/48 2006</b>		<b>(97) EP 3364765</b>				
	<b>A21B 5/02 2006</b>						
(96)	EP 16812830.4	10/24/2016					
(97)	EP 3364765,	8/29/2018	201835,	en			
(31)	UB20155257		(32)	23.10.2015		(33)	IT

- (54) METHOD AND APPARATUS FOR MAKING PANIGACCI  
(71) F.Ili Venturini S.r.l., Via Provinciale 86, 54010 Podenzana (MS), IT  
(72) VENTURINI, Andrea, Via Triola 1, I - 54026 Mulazzo (MS), IT  
VENTURINI, Luca, Via Canaletto 16, I - 19038 Sarzana (SP), IT  
VENTURINI, Nicola, Via Triola 1, I - 54026 Mulazzo (MS), IT
- 

- (51) MKP  
**A61K 51/04 2006 (97) EP 3389727**  
**A61K 101/02 2006**  
**C07B 59/00 2006**  
**C07D 487/04 2006**  
(96) EP 16812961.7 12/16/2016  
(97) EP 3389727, 10/24/2018 201843, en  
(31) 15201240 (32) 18.12.2015 (33) EP  
(54) RADIOLABELLED MGLUR2/3 PET LIGANDS  
(72) ANDRÉS-GIL, José, Ignacio, c/o Janssen-Cilag S.A. Edificio Johnson&Johnson Paseo de las Doce Estrellas 5-7 5° planta Campo de las Naciones, 28042 Madrid, ES  
VAN GOOL, Michiel, Luc, Maria, c/o Janssen-Cilag S.A. Edificio Johnson&Johnson Paseo de las Doce Estrellas 5-7 5° planta Campo de las Naciones, 28042 Madrid, ES  
BORMANS, Guy, Maurits, R, c/o Katholieke Universiteit Leuven K.U.Leuven Research&Development Minderbroedersstraat 8a - bus 5105, 3000 Leuven, BE  
VERBEEK, Joost, c/o Katholieke Universiteit Leuven K.U.Leuven Research&Development Minderbroedersstraat 8a - bus 5105, 3000 Leuven, BE
- 

- (51) MKP  
**A61K 31/513 2006 (97) EP 3383860**  
**A61P 9/04 2006**  
**A61P 9/10 2006**  
**A61P 9/12 2006**  
**C07D 239/54 2006**  
**C07D 401/10 2006**  
**C07D 401/14 2006**  
**C07D 403/06 2006**  
**C07D 403/10 2006**  
**C07D 413/06 2006**  
**C07D 413/10 2006**  
**C07D 417/06 2006**  
**C07D 417/14 2006**  
(96) EP 16813199.3 12/2/2016  
(97) EP 3383860, 10/10/2018 201841, en  
(31) 201562263106 P (32) 04.12.2015 (33) US  
(54) APELIN RECEPTOR AGONISTS AND METHODS OF USE  
(72) MENG, Wei, c/o Bristol-Myers Squibb Company 311 Pennington-Rocky Hill Road, Pennington, New Jersey 08534, US  
CHAO, Hannanguang J., 4 Myopia Lane, Nashua, New Hampshire 03063, US  
FINLAY, Heather, c/o Bristol-Myers Squibb Company 311 Pennington-Rocky Hill Road, Pennington, New Jersey 08534, US  
LAWRENCE, R., Michael, c/o Bristol-Myers Squibb Company 311 Pennington-Rocky Hill Road, Pennington, New Jersey 08534, US  
MYERS, Michael C., c/o Bristol-Myers Squibb Company 311 Pennington-Rocky Hill Road, Pennington, New Jersey 08534, US
- 

- (51) MKP  
**A61K 39/00 2006 (97) EP 3380119**  
**A61K 39/135 2006**  
**C07K 14/32 2006**  
(96) EP 16813258.7 11/16/2016  
(97) EP 3380119, 10/3/2018 201840, en  
(31) 201562259043 P (32) 23.11.2015 (33) US  
(54) FMDV AND E2 FUSION PROTEINS AND USES THEREOF  
(72) AUDONNET, Jean-christophe, 119 Rue De Crequi, 69006 Lyon, FR  
REYNARD, Frederic, 35 Impasse Des Magnanarelles, 69720 St Bonnet-de Mure, FR  
BOMCHIL, Natalia, 9 Rue Des Alouettes, 69008 Lyon, FR  
SIGOILLOT-CLAUDE, Cecile, 27 Rue De Merlo, 69600 Oullins, FR
- 

- (51) MKP

**A61K 31/497 2006 (97) EP 3386975**  
**A61P 35/00 2006**  
**C07D 403/12 2006**  
(96) EP 16813274.4 12/1/2016  
(97) EP 3386975, 10/17/2018 201842, en  
(31) 201562263908 P (32) 07.12.2015 (33) US  
(54) 5-(5-(2-(3-AMINOPROPOXY)-6-METHOXYPHENYL)-1H-PYRAZOL-3-YLAMINO)PYRAZINE-2-CARBONITRILE (S)-LACTATE MONOHYDRATE  
(72) ENNETT-SHEPARD, Alessandra B., c/o Eli Lilly and Company P.o. Box 6288, Indianapolis Indiana 46206-6288, US

---

(51) MKP  
**A61C 5/55 2017 (97) EP 3383306**  
(96) EP 16813318.9 12/5/2016  
(97) EP 3383306, 10/10/2018 201841, en  
(31) 201562262904 P (32) 03.12.2015 (33) US  
(54) SELF-HEATING ELECTRIC PLUGGER/SYRINGE NEEDLE FOR USE IN FILLING A ROOT CANAL  
(71) Buchanan, L. Stephen, 1515 State Street Suite 16, Santa Barbara CA 93101, US  
(72) Buchanan, L. Stephen, 1515 State Street Suite 16, Santa Barbara CA 93101, US

---

(51) MKP  
**A61C 5/40 2017 (97) EP 3383313**  
**A61C 17/02 2006**  
(96) EP 16813319.7 12/5/2016  
(97) EP 3383313, 10/10/2018 201841, en  
(31) 201562262897 P (32) 03.12.2015 (33) US  
(54) MULTI-CANNULA NEGATIVE PRESSURE IRRIGATION SYSTEM  
(71) Buchanan, Stephen L., 1515 State Street Suite 16, Santa Barbara, CA 93101, US  
(72) Buchanan, Stephen L., 1515 State Street Suite 16, Santa Barbara, CA 93101, US

---

(51) MKP  
**C09K 17/32 2006 (97) EP 3394205**  
**E21D 9/06 2006**  
(96) EP 16815565.3 12/6/2016  
(97) EP 3394205, 10/31/2018 201844, en  
(31) UB20159216 (32) 21.12.2015 (33) IT  
(54) FOAMING ADDITIVE FOR SOIL CONDITIONING IN THE PRESENCE OF MECHANISED EXCAVATION FOR TUNNEL CONSTRUCTION  
(72) STEFANONI, Massimo, c/o MAPEI S.p.A. Via Cafiero 22, 20158 Milano (MI), IT  
PISTOLESI, Carlo, c/o MAPEI S.p.A. Via Cafiero 22, 20158 Milano (MI), IT  
SQUINZI, Marco, c/o MAPEI S.p.A. Via Cafiero 22, 20158 Milano (MI), IT  
DAL NEGRO, Enrico, c/o MAPEI S.p.A. Via Cafiero 22, 20158 Milano (MI), IT  
MALTESE, Cristiano, c/o MAPEI S.p.A. Via Cafiero 22, 20158 Milano (MI), IT  
PEILA, Daniele, Politecnico di Torino Dipartimento "DIATI-Dipartimento di Ingegneria dell'Ambiente del Territorio e delle Infrastrutture" C.so Duca degli Abruzzi 24, 10100 Torino (TO), IT

---

(51) MKP  
**C01B 32/10 2017 (97) EP 3362407**  
**C01B 32/336 2017**  
(96) EP 16762743.9 8/24/2016  
(97) EP 3362407, 8/22/2018 201834, de  
(31) 102015015860 (32) 10.12.2015 (33) DE  
102016101215 25.01.2016 DE  
(54) METHOD FOR PRODUCING ACTIVATED CARBON AND ACTIVATED CARBON OBTAINED IN THIS WAY, AND USE THEREOF  
(72) MODROW, Antje, Dr., c/o Blücher GmbH Mettmanner Strasse 25, 40699 Erkrath, DE  
BÖHRINGER, Bertram, Dr., c/o Blücher GmbH Mettmanner Strasse 25, 40699 Erkrath, DE  
GIEBELHAUSEN, Jann-Michael, c/o Blücher GmbH Mettmanner Strasse 25, 40699 Erkrath, DE

---

(51) MKP  
**B01D 53/18 2006 (97) EP 3359281**  
**B01D 53/62 2006**  
**B01D 53/78 2006**  
**B01D 53/96 2006**  
**F23J 15/04 2006**

(96) EP 16762779.3 9/6/2016  
 (97) EP 3359281, 8/15/2018 201833, en  
 (31) 20151155 (32) 08.09.2015 (33) NO  
 (54) METHOD AND PLANT FOR CO2 CAPTURE  
 (71) Capsol-Eop AS, Nobels gate 10, 0273 Oslo, NO  
 (72) HAMRIN, Stellan, Jägaråsvägen 82, 736 93 Kungsör, SE

---

(51) MKP  
**A61K 39/12 2006 (97) EP 3344289**  
**A61P 31/00 2006**  
 (96) EP 16763176.1 8/31/2016  
 (97) EP 3344289, 7/11/2018 201828, en  
 (31) 201562212124 P (32) 31.08.2015 (33) US  
 (54) PESTIVIRUS VACCINES FOR CONGENITAL TREMORS  
 (71) Iowa State University Research Foundation, Inc., 1805 Collaboration Place, Suite 2100, Ames, IA 50010, US  
 (72) VICTORIA, Joseph Gilbert, c/o VP IP Legal Boehringer Ingelheim USA Corp. 900 Ridgebury Road P.O. Box 368, Ridgefield, Connecticut 06877-0368, US  
 PATTERSON, Abby Rae, c/o VP IP Legal Boehringer Ingelheim USA Corp. 900 Ridgebury Road P.O. Box 368, Ridgefield, Connecticut 06877-0368, US  
 VISEK, Callie Ann, c/o VP IP Legal Boehringer Ingelheim USA Corp. 900 Ridgebury Road P.O. Box 368, Ridgefield, Connecticut 06877-0368, US  
 IYER, Arun V., c/o VP IP Legal Boehringer Ingelheim USA Corp. 900 Ridgebury Road P.O. Box 368, Ridgefield, Connecticut 06877-0368, US  
 HOBBS, Lea Ann, c/o VP IP Legal Boehringer Ingelheim USA Corp. 900 Ridgebury Road P.O. Box 368, Ridgefield, Connecticut 06877-0368, US  
 ARRUDA, Bailey Lauren, Iowa State University Veterinary Diagnostic Laboratory College of Veterinary Medicine 1800 Christensen Dr., Ames, Iowa 50011-1134, US  
 ARRUDA, Paulo Henrique Elias, Iowa State University Veterinary Diagnostic Laboratory College of Veterinary Medicine 1800 Christensen Dr., Ames, Iowa 50011-1134, US  
 MAGSTADT, Drew Robert, Iowa State University Veterinary Diagnostic Laboratory College of Veterinary Medicine 1800 Christensen Dr., Ames, Iowa 50011-1134, US  
 SCHWARTZ, Kent Jay, Iowa State University Veterinary Diagnostic Laboratory College of Veterinary Medicine 1800 Christensen Dr., Ames, Iowa 50011-1134, US

---

(51) MKP  
**B60F 3/00 2006 (97) EP 3347215**  
**B62D 37/00 2006**  
**B62D 61/00 2006**  
 (96) EP 16763250.4 9/7/2016  
 (97) EP 3347215, 7/18/2018 201829, en  
 (31) UB20153451 (32) 07.09.2015 (33) IT  
 (54) SELF-STABILISING TWO-WHEELED VEHICLE, IN PARTICULAR AN AMPHIBIOUS VEHICLE  
 (71) Def-Tech SAS. Di Ettore De Francesco&C., Largo Strindberg 43, 00142 Roma (RM), IT  
 (72) DE FRANCESCO, Eduardo, c/o DEF-TECH SAS. DI ETTORE DE FRANCESCO&C. Largo Strindberg 43, 00142 Roma (RM), IT  
 DE FRANCESCO, Ettore, c/o DEF-TECH SAS. DI ETTORE DE FRANCESCO&C. Largo Strindberg 43, 00142 Roma (RM), IT  
 DE FRANCESCO, Ruggero, c/o DEF-TECH SAS. DI ETTORE DE FRANCESCO&C. Largo Strindberg 43, 00142 Roma (RM), IT

---

(51) MKP  
**A61K 31/454 2006 (97) EP 3344254**  
**A61K 31/519 2006**  
**A61K 31/573 2006**  
**A61K 35/00 2006**  
 (96) EP 16763673.7 8/31/2016  
 (97) EP 3344254, 7/11/2018 201828, en  
 (31) 201562212518 P (32) 31.08.2015 (33) US  
 (54) BTK INHIBITOR COMBINATIONS FOR TREATING MULTIPLE MYELOMA  
 (72) BILOTTI, Elizabeth, 995 East Arques Avenue, Sunnyvale, CA 94085, US  
 GRAEF, Thorsten, 26209 Dori Lane, Los Altos Hills, CA 94022, US

---

(51) MKP  
**A61K 39/00 2006 (97) EP 3344656**  
**C07K 16/28 2006**  
 (96) EP 16763697.6 9/1/2016  
 (97) EP 3344656, 7/11/2018 201828, en  
 (31) 201562212851 P (32) 01.09.2015 (33) US

201562216043 P 09.09.2015 US  
 201562257195 P 18.11.2015 US

(54) ANTI-PD-1 ANTIBODIES AND METHODS OF USE THEREOF  
 (72) VAN DIJK, Marc, Gaailaan 16, 3722 ZH Bilthoven, NL  
 MUNDT, Cornelia, Anne, Hangstrasse 34, 79539 Lorrach, DE  
 RITTER, Gert, Ludwig Institute for Cancer Research 666 Third Avenue 28th Floor, New York, NY 10017, US  
 WOLCHOK, Jedd, David, 333 East 30th Street Apt. 17C, New York, NY 10016, US  
 MERGHOU, Taha, 10 Huron Avenue Apt. 14K, Jersey City, NJ 07306, US  
 ZAPPASODI, Roberta, 475 Main Street Apt. 2U, New York, NY 10044, US  
 HOLMGAARD, Rikke, Bæk, 200 West 60th Street Apt. 14F, New York, NY 10023, US  
 SCHAER, David, 715 Shore Acres Drive, Mamaroneck, NY 10543, US  
 SAVITSKY, David, Adam, 28 Sunrise Road, Boxford, MA 01921, US  
 WILSON, Nicholas, Stuart, 68 Electric Avenue Apt. 1, Somerville, MA 02144, US

---

(51) MKP  
**A61K 31/4178 2006 (97) EP 3344245**  
**A61K 31/496 2006**  
**A61K 31/513 2006**  
**A61K 31/565 2006**  
**A61P 15/00 2006**

(96) EP 16763701.6 9/1/2016  
 (97) EP 3344245, 7/11/2018 201828, en

(31) 201562213000 P (32) 01.09.2015 (33) US

(54) METHODS OF ADMINISTERING ELAGOLIX  
 (72) GOSS, Sandra L., 2916 Southern Hills Drive, Wadsworth, Illinois 60083, US  
 KLEIN, Cheri E., 1933 Barberry Road, Northbrook, Illinois 60062, US  
 NG, Juki Wing-Keung, 1661 Cavell Avenue, Highland Park, Illinois 60035, US  
 SALEM, Ahmed, 1501 North Milwaukee Avenue, Libertyville, Illinois 60048, US

---

(51) MKP  
**F01K 23/10 2006 (97) EP 3344856**  
**F01K 25/10 2006**  
**F02C 1/00 2006**  
**F02C 3/34 2006**  
**F02C 6/02 2006**

(96) EP 16764027.5 8/31/2016  
 (97) EP 3344856, 7/11/2018 201828, en

(31) 201562212749 P (32) 01.09.2015 (33) US

(54) SYSTEMS AND METHODS FOR POWER PRODUCTION USING NESTED CO2 CYCLES  
 (72) ALLAM, Rodney John, Lanhill House, Lanhill Chippenham Wiltshire SN14 6LY, GB  
 FORREST, Brock Alan, 2113 Englewood Avenue DN, Durham, North Carolina 27705, US

---

(51) MKP  
**A61K 47/68 2017 (97) EP 3347054**  
**A61P 35/00 2006**

(96) EP 16765958.0 9/9/2016  
 (97) EP 3347054, 7/18/2018 201829, en

(31) 201562217320 P (32) 11.09.2015 (33) US

(54) DOSING REGIMENS FOR ANTI-TF-ANTIBODY DRUG-CONJUGATES  
 (72) LISBY, Steen, Uranusvej 16D, 3100 Hornbaek, DK  
 WHITING, Nancy Cherry, 8920 Sand Point Way NE, Seattle, Washington 98115, US

---

(51) MKP  
**B60W 30/18 2012 (97) EP 3350059**  
**B62D 15/02 2006**

(96) EP 16765970.5 9/13/2016  
 (97) EP 3350059, 7/25/2018 201830, de

(31) 102015217498 (32) 14.09.2015 (33) DE

(54) METHOD AND DEVICE IN A MOTOR VEHICLE FOR AN AUTOMATIC DRIVE  
 (72) ULBRICH, Simon, Juliusstrasse 34a, 38118 Braunschweig, DE  
 GROSSJOHANN, Simon, Hühnerwinkel 46, 38442 Wolfsburg, DE

- (51) MKP  
**A61K 31/404 2006 (97) EP 3350162**  
**A61P 31/12 2006**  
**C07D 209/12 2006**
- (96) EP 16766010.9 9/15/2016  
(97) EP 3350162, 7/25/2018 201830, en
- (31) 15185523 (32) 16.09.2015 (33) EP  
16163472 01.04.2016 EP
- (54) MONO- OR DI-SUBSTITUTED INDOLE DERIVATIVES AS DENGUE VIRAL REPLICATION INHIBITORS  
(72) KESTELEYN, Bart Rudolf Romanie, c/o Janssen Pharmaceutica NV Turnhoutseweg 30, 2340 Beerse, BE  
RABOISSON, Pierre Jean-Marie Bernard, c/o Janssen Pharmaceutica NV Turnhoutseweg 30, 2340 Beerse, BE  
BONFANTI, Jean-François, c/o Janssen-Cilag 1 rue Camille Desmoulins TSA 91003, 92787 Issy-les-Moulineaux Cedex 9, FR  
JONCKERS, Tim Hugo Maria, c/o Janssen Pharmaceutica NV Turnhoutseweg 30, 2340 Beerse, BE  
BARDIOT, Dorothée Alice Marie-Eve, c/o Cistim Leuven vzw Gaston Geenslaan 2, 3001 Leuven (Heverlee), BE  
MARCHAND, Arnaud Didier M, c/o Cistim Leuven vzw Gaston Geenslaan 2, 3001 Leuven (Heverlee), BE
- 

- (51) MKP  
**A01K 67/027 2006 (97) EP 3344034**  
**C12N 15/85 2006**
- (96) EP 16766164.4 9/1/2016  
(97) EP 3344034, 7/11/2018 201828, en
- (31) 201562213389 P (32) 02.09.2015 (33) US
- (54) RODENT MODEL OF PROSTATE CANCER  
(72) SIAO, Chia-Jen, c/o Regeneron Pharmaceuticals Inc. 777 Old Saw Mill River Road, Tarrytown, New York 10591, US  
LEE, Hoi-Ching, c/o Regeneron Pharmaceuticals Inc. 777 Old Saw Mill River Road, Tarrytown, New York 10591, US  
LI, Zhe, c/o Regeneron Pharmaceuticals Inc. 777 Old Saw Mill River Road, Tarrytown, New York 10591, US  
LAI, Ka-Man Venus, 127 West Main Street Unit 201, Tarrytown, New York 10591, US  
THURSTON, Gavin, c/o Regeneron Pharmaceuticals Inc. 777 Old Saw Mill River Road, Tarrytown, New York 10591, US
- 

- (51) MKP  
**A61K 31/7072 2006 (97) EP 3344642**  
**A61P 31/14 2006**  
**C07H 19/06 2006**
- (96) EP 16766172.7 9/1/2016  
(97) EP 3344642, 7/11/2018 201828, en
- (31) 201562213378 P (32) 02.09.2015 (33) US  
201562242136 P 15.10.2015 US  
201562253426 P 10.11.2015 US  
201662294449 P 12.02.2016 US  
201662296801 P 18.02.2016 US  
201662321538 P 12.04.2016 US  
201662327087 P 25.04.2016 US  
201662351038 P 16.06.2016 US  
201662363640 P 18.07.2016 US  
201662375029 P 15.08.2016 US
- (54) ANTI-VIRAL TETRAHYDROFURANE DERIVATIVES  
(72) CHAU, Jaclyn, 2581 E. 40th Avenue, Vancouver, British Columbia V5R 2V8, CA  
CHEN, Hui-Ju J., 4 Crow's Nest Court, Grayslake, Illinois 60030, US  
DEGOEY, David A., 8649 226th Avenue, Salem, Wisconsin 53168, US  
HARTUNG, John, 733 Chicago Avenue Apt. 208, Evanston, Illinois 60202, US  
IDE, Nathan, 345 Tanager Lane, Lindenhurst, Illinois 60046, US  
KALTHOD, Vikram, 1401 Sheridan Road, North Chicago, Illinois 60064, US  
KRUEGER, Allan C., 7260 Presidential Drive, Gurnee, Illinois 60031, US  
KU, Yi-Yin, 23 River Oaks, Buffalo Grove, Illinois 60089, US  
LI, Tongmei, 12877 Sanctuary Lane, Lake Bluff, Illinois 60044, US  
RANDOLPH, John T., 304 Broadway, Libertyville, Illinois 60048, US  
WAGNER, Rolf, 42530 Sheridan Oaks, Antioch, Illinois 60002, US  
VOIGHT, Eric, 10615 48th Avenue, Pleasant Prairie, WI 53158, US  
HALVORSEN, Geoff T., 29625 N. Waukegan Road Apt. 206, Lake Bluff, IL 60044, US  
MARVIN, Christopher C., 242 Braxton Way, Grayslake, IL 60030, US  
MARTINEZ, Steven, R., 4713 N. Hermitage Ave., 2, Chicago, IL 60640, US



BROWN, Brian, S., 812 Washington., Evanston IL 60202, US  
HEYMAN, Howard, R., 827 Woodward Ave., Deerfield, Illinois 60015, US  
SHRESTHA, Anurupa, 2011 Greystem Circle, Apt. 2, Gurnee, IL 60031, US

---

- (51) MKP  
**B65B 19/34 2006 (97) EP 3344551**  
**B65B 35/08 2006**  
**B65B 35/24 2006**  
**B65G 15/14 2006**  
**B65G 47/31 2006**
- (96) EP 16766187.5 9/2/2016  
(97) EP 3344551, 7/11/2018 201828, en
- (31) 201562213928 P (32) 03.09.2015 (33) US  
201662332745 P 06.05.2016 US
- (54) LAUNCHING SYSTEM FOR ROBOTIC SAUSAGE LOADING MACHINE  
(71) F.R. Drake Company, 1410 Genicom Drive, Waynesboro, Virginia 22980, US  
(72) MILO, Nicholas J., 27 Lodge Trail, Vesuvius, Virginia 24483, US  
HOPKINS, Keith W., 19 Heatwole Drive, Waynesboro, Virginia 22980, US  
REED, George E., 1320 Chatham Road, Waynesboro, Virginia 22980, US
- 

- (51) MKP  
**A61K 31/713 2006 (97) EP 3347470**  
**A61P 9/10 2006**  
**A61P 27/02 2006**  
**C07H 21/02 2006**  
**C12N 15/113 2010**
- (96) EP 16766270.9 9/7/2016  
(97) EP 3347470, 7/18/2018 201829, en
- (31) 15382440 (32) 08.09.2015 (33) EP
- (54) SIRNA AND THEIR USE IN METHODS AND COMPOSITIONS FOR INHIBITING THE EXPRESSION OF THE NRARP GENE  
(71) Sylentis SAU, Parque Tecnológico de Madrid, PCM C/Santiago Grisolia No 2 Tres Cantos, Madrid 28760, ES  
(72) JIMENEZ, Ana Isabel, c/o Sylentis SAU Parque Tecnológico de Madrid PCM C/Santiago Grisolia nº 2 Tres Cantos, 28760 Madrid, ES  
PAÑEDA, Covadonga, c/o Sylentis SAU Parque Tecnológico de Madrid PCM C/Santiago Grisolia nº 2 Tres Cantos, 28760 Madrid, ES  
MARTINEZ, Tamara, c/o Sylentis SAU Parque Tecnológico de Madrid PCM C/Santiago Grisolia nº 2 Tres Cantos, 28760 Madrid, ES
- 

- (51) MKP  
**A61K 9/00 2006 (97) EP 3347377**  
**A61P 11/06 2006**  
**A61P 37/08 2006**  
**C07K 16/24 2006**
- (96) EP 16766396.2 9/7/2016  
(97) EP 3347377, 7/18/2018 201829, en
- (31) 201562216050 P (32) 09.09.2015 (33) US  
201662342511 P 27.05.2016 US
- (54) THYMIC STROMAL LYMPHOPOIETIN (TSLP)-BINDING ANTIBODIES AND METHODS OF USING THE ANTIBODIES  
(72) RONDEAU, Jean-Michel Rene, Novartis Pharma AG Postfach, 4002 Basel, CH  
EDWARDS, Matthew John, 19 Millais, Horsham Sussex RH13 6BS, GB  
MILLER, Danforth, Novartis Pharmaceuticals Corporation 150 Industrial Road, San Carlos, California 94070, US  
HUANG, Daniel, Novartis Pharmaceuticals Corporation 150 Industrial Road, San Carlos, California 94070, US  
HEMMIG, Rene, Novartis Pharma AG Postfach, 4002 Basel, CH  
KNOPF, Hans-Peter, Novartis Pharma AG Postfach, 4002 Basel, CH  
GUPTA, Kapil, 92 Border Road, Concord, Massachusetts 01742, US  
VAN HEEKE, Gino Anselmus, 1 Tudor Drive, Upper Beeding BN44 3HP, GB  
HAUBST, Nicole, MorphoSys AG Semmelweisstr. 7, 82152 Planegg, DE  
ANDLAUER, Barbara, MorphoSys AG Semmelweisstr. 7, 82152 Planegg, DE
- 

- (51) MKP  
**A61K 31/438 2006 (97) EP 3347360**  
**A61P 17/06 2006**  
**A61P 37/00 2006**  
**C07D 495/20 2006**
- (96) EP 16766765.8 9/6/2016  
(97) EP 3347360, 7/18/2018 201829, en

(31) 201562215929 P (32) 09.09.2015 (33) US  
(54) COMPOUNDS USEFUL FOR INHIBITING ROR-GAMMA-T  
(72) MORPHY, John Richard, c/o Eli Lilly and Company P.O. Box 6288, Indianapolis, Indiana 46206-6288, US

---

(51) MKP  
B65B 7/16 2006 (97) EP 3347277  
B65B 7/28 2006  
(96) EP 16766847.4 9/9/2016  
(97) EP 3347277, 7/18/2018 201829, en  
(31) 201570587 (32) 11.09.2015 (33) DK  
(54) DEVICE FOR FORWARDING CLOSURE BLANKS FROM A WEB  
(71) Primoreels A/S, Skimmedevej 10 Ågerup, 4390 Vipperød, DK  
(72) MADSEN, Valdemar Hougaard, Langebrogade 19 1.th., 1411 Copenhagen K, DK

---

(51) MKP  
A61K 31/501 2006 (97) EP 3344615  
C07D 401/12 2006  
(96) EP 16766865.6 8/31/2016  
(97) EP 3344615, 7/11/2018 201828, en  
(31) 201562213137 P (32) 02.09.2015 (33) US  
(54) PYRIDINONE DICARBOXAMIDE FOR USE AS BROMODOMAIN INHIBITORS  
(72) ATKINSON, Stephen John, GlaxoSmithKline Gunnels Wood Road, Stevenage Hertfordshire SG1 2NY, GB  
AYLOTT, Helen Elizabeth, GlaxoSmithKline Gunnels Wood Road, Stevenage Hertfordshire SG1 2NY, GB  
COOPER, Anthony William James, GlaxoSmithKline Gunnels Wood Road, Stevenage Hertfordshire SG1 2NY, GB  
DEMONT, Emmanuel Hubert, GlaxoSmithKline Gunnels Wood Road, Stevenage Hertfordshire SG1 2NY, GB  
HARRISON, Lee Andrew, GlaxoSmithKline Gunnels Wood Road, Stevenage Hertfordshire SG1 2NY, GB  
HAYHOW, Thomas George Christopher, GlaxoSmithKline Gunnels Wood Road, Stevenage Hertfordshire SG1 2NY, GB  
LINDON, Matthew J, GlaxoSmithKline Gunnels Wood Road, Stevenage Hertfordshire SG1 2NY, GB  
PRESTON, Alexander G, GlaxoSmithKline Gunnels Wood Road, Stevenage Hertfordshire SG1 2NY, GB  
SEAL, Jonathan Thomas, GlaxoSmithKline Gunnels Wood Road, Stevenage Hertfordshire SG1 2NY, GB  
WALL, Ian David, GlaxoSmithKline Gunnels Wood Road, Stevenage Hertfordshire SG1 2NY, GB  
WATSON, Robert J, GlaxoSmithKline Gunnels Wood Road, Stevenage Hertfordshire SG1 2NY, GB  
WOOLVEN, James Michael, GlaxoSmithKline Gunnels Wood Road, Stevenage Hertfordshire SG1 2NY, GB

---

(51) MKP  
B65D 75/32 2006 (97) EP 3353086  
(96) EP 16766968.8 9/19/2016  
(97) EP 3353086, 8/1/2018 201831, de  
(31) 15186159 (32) 22.09.2015 (33) EP  
(54) INDIVIDUAL BLISTER PACK FOR OPTIMIZED STACKING  
(72) BRACHT, Stefan, Staerkstr. 29, 16548 Glienicke Nordbahn, DE

---

(51) MKP  
B63B 1/12 2006 (97) EP 3353045  
B63B 7/00 2006  
B63B 35/73 2006  
B63H 21/17 2006  
G05B 11/38 2006  
(96) EP 16766977.9 9/19/2016  
(97) EP 3353045, 8/1/2018 201831, de  
(31) 102015115895 (32) 21.09.2015 (33) DE  
(54) FLOATING VESSEL  
(72) WALPURGIS, Hans-Peter, Austrasse 12, 6352 Ellmau, AT  
SCHNAUFFER, Peter, Franz von Sickingenstraße 61, 75038 Oberdingen, DE

---

(51) MKP  
A61K 31/501 2006 (97) EP 3353162  
C07D 401/12 2006  
(96) EP 16766979.5 9/20/2016  
(97) EP 3353162, 8/1/2018 201831, en  
(31) 201562221649 P (32) 22.09.2015 (33) US

(54) PYRIDINONE DICARBOXAMIDE FOR USE AS BROMODOMAIN INHIBITORS  
(72) ATKINSON, Stephen John, GlaxoSmithKline Gunnels Wood Road, Stevenage Hertfordshire SG1 2NY, GB  
DEMONT, Emmanuel Hubert, GlaxoSmithKline Gunnels Wood Road, Stevenage Hertfordshire SG1 2NY, GB  
HARRISON, Lee Andrew, GlaxoSmithKline Gunnels Wood Road, Stevenage Hertfordshire SG1 2NY, GB  
HAYHOW, Thomas George Christopher, GlaxoSmithKline Gunnels Wood Road, Stevenage Hertfordshire SG1 2NY, GB  
HOUSE, David, GlaxoSmithKline Gunnels Wood Road, Stevenage Hertfordshire SG1 2NY, GB  
LINDON, Matthew J, GlaxoSmithKline Gunnels Wood Road, Stevenage Hertfordshire SG1 2NY, GB  
PRESTON, Alexander G, GlaxoSmithKline Gunnels Wood Road, Stevenage Hertfordshire SG1 2NY, GB  
SEAL, Jonathan Thomas, GlaxoSmithKline Gunnels Wood Road, Stevenage Hertfordshire SG1 2NY, GB  
WALL, Ian David, GlaxoSmithKline Gunnels Wood Road, Stevenage Hertfordshire SG1 2NY, GB  
WATSON, Robert J, GlaxoSmithKline Gunnels Wood Road, Stevenage Hertfordshire SG1 2NY, GB  
WOOLVEN, James Michael, GlaxoSmithKline Gunnels Wood Road, Stevenage Hertfordshire SG1 2NY, GB

---

(51) MKP  
**B31B 50/59 2017 (97) EP 3347196**  
**B31D 5/02 2017**  
**B31F 1/00 2006**  
**B31F 1/36 2006**  
**B65B 47/06 2006**  
(96) EP 16767162.7 9/4/2016  
(97) EP 3347196, 7/18/2018 201829, de  
(31) 102015115251 (32) 10.09.2015 (33) DE  
(54) METHOD FOR THREE-DIMENSIONAL SHAPING OF MATERIAL  
(72) HAUG, Hans, Am Meierhof 12, 87730 Bad Grönenbach, DE

---

(51) MKP  
**A61K 31/454 2006 (97) EP 3350163**  
**A61P 31/14 2006**  
**C07D 209/12 2006**  
(96) EP 16767235.1 9/15/2016  
(97) EP 3350163, 7/25/2018 201830, en  
(31) 15185522 (32) 16.09.2015 (33) EP  
16163465 01.04.2016 EP  
(54) MONO- OR DI-SUBSTITUTED INDOLE DERIVATIVES AS DENGUE VIRAL REPLICATION INHIBITORS  
(72) KESTELEYN, Bart Rudolf Romanie, c/o Janssen Pharmaceutica NV Turnhoutseweg 30, 2340 Beerse, BE  
RABOISSON, Pierre Jean-Marie Bernard, c/o Janssen Pharmaceutica NV Turnhoutseweg 30, 2340 Beerse, BE  
BONFANTI, Jean-François, c/o Janssen-Cilag 1 rue Camille Desmoulins TSA 91003, 92787 Issy-les-Moulineaux Cedex 9, FR  
JONCKERS, Tim Hugo Maria, c/o Janssen Pharmaceutica NV Turnhoutseweg 30, 2340 Beerse, BE  
BARDIOT, Dorothee Alice Marie-Eve, c/o Cistim Leuven vzw Gaston Geenslaan 2, 3001 Leuven (Heverlee), BE  
MARCHAND, Arnaud Didier M, c/o Cistim Leuven vzw Gaston Geenslaan 2, 3001 Leuven (Heverlee), BE

---

(51) MKP  
**A61K 31/4523 2006 (97) EP 3344616**  
**A61P 17/00 2006**  
**A61P 25/00 2006**  
**A61P 35/00 2006**  
**A61P 37/08 2006**  
**C07D 401/14 2006**  
**C07D 413/14 2006**  
**C07D 417/14 2006**  
**C07D 487/04 2006**  
**C07D 498/04 2006**  
(96) EP 16767368.0 9/2/2016  
(97) EP 3344616, 7/11/2018 201828, en  
(31) 201562214299 P (32) 04.09.2015 (33) US  
41507815 04.12.2015 PL  
(54) SUBSTITUTED AMINO TRIAZOLES USEFUL AS HUMAN CHITINASE INHIBITORS  
(71) ONCOARENDI THERAPEUTICS S.A., Zwirki i Wigury 101, 02-089 Warszawa, PL  
(72) MAZUR, Marzena, Szpitalna 4A/8, 92-207 Lodz, PL  
KORALEWSKI, Robert, Ks. Brzoski 32/93, 91-321 Lodz, PL  
BOREK, Bartłomiej, Mysliwska 17/20, 93-519 Lodz, PL  
OLEJNICZAK, Sylwia, Obywatelska 106B/63, 94-104 Lodz, PL  
CZESTKOWSKI, Wojciech J., Gorka Pabianicka 64, 95-200 Pabianice, PL  
PIOTROWICZ, Michal C., Marszałka Edwarda Smiglego-Rydzka 30/85, 93-281 Lodz, PL

OLCZAK, Jacek P., Golebia 1/3 m 66, 90-340 Lodz, PL  
GOLEBIEWSKI, Adam A., Lirowa 24/23, 02-387 Warszawa, PL  
BARTOSZEWICZ, Agnieszka, Wlodarzewska 67E/21, 02-384 Warsaw, PL  
PLUTA, Elzbieta, Romanowka 19/14, 08-110 Siedlce, PL  
KOWALSKI, Michal L., Polna 470, 43-376 Godziszka, PL

---

- (51) MKP  
**A61B 17/04 2006 (97) EP 3344159**  
**A61B 17/06 2006**
- (96) EP 16767410.0 8/30/2016  
(97) EP 3344159, 7/11/2018 201828, en
- (31) 201514844210 (32) 03.09.2015 (33) US
- (54) END EFFECTORS FOR WOUND CLOSURE DEVICES
- (72) LINDH, SR., David C., P.O. Box 151 US. Route 22, Somerville, New Jersey 08876, US  
HUFF, Jason, P.O. Box 151 U.S Route 22, Somerville, New Jersey 08876, US  
NAWROCKI, Jesse G., P.O. Box 151 U.S. Route 22, Somerville, New Jersey 08876, US  
PERKINS, Jason T., P.O. Box 151 U.S Route 22, Somerville, New Jersey 08876, US  
SCOGNA, Robert, P.O. Box 151 U.S. Route 22, Somerville, New Jersey 08876, US  
SZABO, Dave, P.O. Box 151 U.S. Route 22, Somerville, New Jersey 08876, US  
BEAKE, Thomas G., P.O. Box 151 U.S. Route 22, Somerville, New Jersey 08876, US  
WISNIEWSKI, Jonathan, P.O. Box 151 U.S. Route 22, Somerville, New Jersey 08876, US
- 

- (51) MKP  
**H02K 3/04 2006 (97) EP 3258575**  
**H02K 21/14 2006**  
**H02K 53/00 2006**
- (96) EP 16767789.7 2/16/2016  
(97) EP 3258575, 9/5/2018 201836, en
- (31) 201530398 (32) 26.03.2015 (33) ES
- (54) GENERATOR OF ELECTRICAL CURRENT BY MOVEMENT AND INDUCTION BY MEANS OF PERMANENT MAGNETS AND RESONANT COILS
- (71) Energy Resonance Magnetic, S.L., C/ Vicente de los Ríos 13, 14011 Córdoba, ES  
(72) MORENO MAGDALENO, Ana Maria, Vicente De Los Rios 13, 14011 Cordoba, ES
- 

- (51) MKP  
**A61K 9/00 2006 (97) EP 3349726**  
**A61K 9/14 2006**  
**A61K 9/16 2006**  
**A61K 31/00 2006**
- (96) EP 16770213.3 9/6/2016  
(97) EP 3349726, 7/25/2018 201830, en
- (31) UB20153652 (32) 16.09.2015 (33) IT
- (54) MICROSPHERES CONTAINING ANTHELMINTIC MACROCYCLIC LACTONES
- (71) FATRO S.p.A., Via Emilia, 285, I-40064 Ozzano Emilia, IT  
(72) CORACE, Giuseppe, c/o FATRO S.p.A. Via Emilia 285, 40064 Ozzano Dell'emilia (bo), IT  
MORBIDELLI, Eva, c/o FATRO S.p.A. Via Emilia 285, 40064 Ozzano Dell'emilia (bo), IT  
BERTOCCHI, Laura, c/o FATRO S.p.A. Via Emilia 285, 40064 Ozzano Dell'emilia (bo), IT  
MONTECCHI, Lauretta, c/o FATRO S.p.A. Via Emilia 285, 40064 Ozzano Dell'emilia (bo), IT
- 

- (51) MKP  
**A24B 15/10 2006 (97) EP 3349604**  
**A24F 47/00 2006**  
**A61M 15/06 2006**  
**A61Q 19/08 2006**
- (96) EP 16770249.7 9/16/2016  
(97) EP 3349604, 7/25/2018 201830, en
- (31) 15185555 (32) 16.09.2015 (33) EP  
15185550 16.09.2015 EP
- (54) A METHOD AND A DISPENSING ARRANGEMENT FOR TREATING A FLOW OF VAPORIZED LIQUID PROVIDED BY AN E-CIGARETTE AND AN E-CIGARETTE FOR THE ORAL INTAKE OF VAPORIZED LIQUID CONTAINING AN ADDITIONAL COMPOSITION
- (71) DILLMANN,, Alexandra, Brochenzellerstrasse 31/1, 88074 Meckenbeuren, DE  
(72) BIZU, Katharina, Rohrachstrasse 47, 87487 Wiggensbach, DE  
DILLMANN, Alexandra, Brochenzellerstrasse 31/1, 88074 Meckenbeuren, DE

---

(51) MKP  
**A61P 37/00 2006 (97) EP 3353207**  
**C07K 16/28 2006**

(96) EP 16770261.2 9/21/2016  
(97) EP 3353207, 8/1/2018 201831, en

(31) 201516836 (32) 23.09.2015 (33) GB

(54) DOSING REGIMEN OF COMBINATION OF ANTI-CD20 AND ANTI-BLYS ANTIBODIES  
(72) HENDERSON, Robert B., GlaxoSmithKline Gunnels Wood Road, Stevenage Hertfordshire SG1 2NY, GB

---

(51) MKP  
**A61K 31/4418 2006 (97) EP 3353163**  
**A61P 25/16 2006**  
**A61P 25/28 2006**  
**C07D 401/12 2006**

(96) EP 16770283.6 9/23/2016  
(97) EP 3353163, 8/1/2018 201831, en

(31) 15186394 (32) 23.09.2015 (33) EP  
16172005 30.05.2016 EP

(54) 2,3,4,5-TETRAHYDROPYRIDIN-6-AMINE DERIVATIVES  
(72) ROMBOUTS, Frederik, Jan, Rita, c/o Janssen Pharmaceutica NV Turnhoutseweg 30, 2340 Beerse, BE  
GIJSEN, Henricus, Jacobus, Maria, c/o Janssen Pharmaceutica NV Turnhoutseweg 30, 2340 Beerse, BE  
VAN BRANDT, Sven, Franciscus, Anna, c/o Janssen Pharmaceutica NV Turnhoutseweg 30, 2340 Beerse, BE  
TRABANCO-SUÁREZ, Andrés, Avelino, c/o Janssen-Cilag S.A. Edificio Johnson&Johnson Paseo de las Doce Estrellas 5-7 5° planta Campo de las Naciones, 28042 Madrid, ES

---

(51) MKP  
**A61K 35/12 2015 (97) EP 3347453**  
**C12N 5/0783 2010**

(96) EP 16770406.3 9/9/2016  
(97) EP 3347453, 7/18/2018 201829, en

(31) 201562217677 P (32) 11.09.2015 (33) US

(54) ENGINEERED HOST CELLS AND METHODS OF USE THEREOF  
(72) DIJK, Marc, Van, Gaailaan 16, 3722 ZH Bilthoven, NL  
VOLKER, Seibert, Tumringer Str. 261c, 79539 Lörrach, DE  
STEIN, Robert, Benjamin, 155 Oceana Drive East Apartment 4i, Brooklyn, NY 11235, US

---

(51) MKP  
**A61K 31/4709 2006 (97) EP 3347351**  
**A61P 35/00 2006**  
**C07D 215/60 2006**  
**C07D 221/18 2006**  
**C07D 401/12 2006**  
**C07D 401/14 2006**  
**C07F 7/18 2006**

(96) EP 16770411.3 9/9/2016  
(97) EP 3347351, 7/18/2018 201829, en

(31) 201562216045 P (32) 09.09.2015 (33) US  
201562244933 P 22.10.2015 US

(54) SALTS OF A PIM KINASE INHIBITOR  
(72) JIA, Zhongjiang, Incyte Corporation 1801 Augustine Cut-Off, Wilmington, Delaware 19803, US  
CAO, Ganfeng, Incyte Corporation 1801 Augustine Cut-Off, Wilmington, Delaware 19803, US  
LIN, Qiyang, Incyte Corporation 1801 Augustine Cut-Off, Wilmington, Delaware 19803, US  
PAN, Yongchun, Incyte Corporation 1801 Augustine Cut-Off, Wilmington, Delaware 19803, US  
QIAO, Lei, Incyte Corporation 1801 Augustine Cut-Off, Wilmington, Delaware 19803, US  
SHARIEF, Vaqar, Incyte Corporation 1801 Augustine Cut-Off, Wilmington, Delaware 19803, US  
SHI, ChongSheng Eric, Incyte Corporation 1801 Augustine Cut-Off, Wilmington, Delaware 19803, US  
XIA, Michael, Incyte Corporation 1801 Augustine Cut-Off, Wilmington, Delaware 19803, US  
ZHENG, Changsheng, Incyte Corporation 1801 Augustine Cut-Off, Wilmington, Delaware 19803, US  
ZHOU, Jiacheng, Incyte Corporation 1801 Augustine Cut-Off, Wilmington, Delaware 19803, US  
LI, Qun, Incyte Corporation 1801 Augustine Cut-Off, Wilmington, Delaware 19803, US

---

(51) MKP  
**B65D 1/26 2006 (97) EP 3347287**  
**B65D 85/804 2006**  
(96) EP 16770448.5 9/4/2016  
(97) EP 3347287, 7/18/2018 201829, de  
(31) 102015115249 (32) 10.09.2015 (33) DE  
(54) PACKAGING  
(72) HAUG, Hans, Am Meierhof 12, 87730 Bad Grönenbach, DE

---

(51) MKP  
**A61K 31/437 2006 (97) EP 3350180**  
**A61P 35/00 2006**  
**C07D 471/04 2006**  
(96) EP 16770461.8 9/15/2016  
(97) EP 3350180, 7/25/2018 201830, en  
(31) 201516504 (32) 17.09.2015 (33) GB  
(54) 8-[6-[3-(AMINO)PROPOXY]-3-PYRIDYL]-1-ISOPROPYL-IMIDAZO[4,5-C]QUINOLIN-2-ONE DERIVATIVES AS SELECTIVE MODULATORS OF ATAXIA TELANGIECTASIA MUTATED (ATM) KINASE FOR THE TREATMENT OF CANCER  
(72) PIKE, Kurt, Gordon, AstraZeneca Darwin Building Cambridge Science Park Milton Road, Cambridge CB4 0WG, GB  
BARLAAM, Bernard, Christophe, AstraZeneca Darwin Building Cambridge Science Park Milton Road, Cambridge CB4 0WG, GB  
HUNT, Thomas, Anthony, AstraZeneca Darwin Building Cambridge Science Park Milton Road, Cambridge CB4 0WG, GB  
EATHERTON, Andrew, John, AstraZeneca Hodgkin Building Chesterford Research Park Little Chesterford, Essex CB10 1XL, GB

---

(51) MKP  
**A61K 31/55 2006 (97) EP 3350174**  
**A61P 31/18 2006**  
**C07D 223/16 2006**  
**C07D 405/10 2006**  
**C07D 405/14 2006**  
(96) EP 16770562.3 9/14/2016  
(97) EP 3350174, 7/25/2018 201830, en  
(31) 201562219687 P (32) 17.09.2015 (33) US  
(54) BENZAZEPINE DERIVATIVES  
(71) ViiV Healthcare UK Limited, 980 Great West Road, Brentford, Middlesex TW8 9GS, GB  
(72) JOHNS, Brian Alvin, Five Moore Drive Research Triangle Park, NC 27709, US  
SUWANDI, Lita S., Five Moore Drive Research Triangle Park, NC 27709, US  
VELTHUISEN, Emile Johann, Five Moore Drive Research Triangle Park, NC 27709, US  
WEATHERHEAD, Jason Gordon, Five Moore Drive Research Triangle Park, NC 27709, US

---

(51) MKP  
**A61K 31/454 2006 (97) EP 3349798**  
**A61K 31/4985 2006**  
**A61K 31/519 2006**  
**A61K 45/06 2006**  
**A61P 35/00 2006**  
**A61P 35/02 2006**  
**C07K 14/70 2006**  
**C07K 16/28 2006**  
**C12N 5/07 2010**  
(96) EP 16770565.6 9/15/2016  
(97) EP 3349798, 7/25/2018 201830, en  
(31) 201562218958 P (32) 15.09.2015 (33) US  
201562243646 P 19.10.2015 US  
201662277474 P 11.01.2016 US  
(54) THERAPEUTIC COMBINATIONS OF A CD19 INHIBITOR AND A BTK INHIBITOR  
(71) Acerta Pharma B.V., RK4210 Industrielaan 63, 5349 AE Oss, NL  
(72) ROTHBAUM, Wayne, 1171 S. Ocean Boulevard, Delray Beach, Florida 33483, US  
LANNUTTI, Brian, 627 Glencrest Place, Solana Beach, California 92075, US

---

(51) MKP  
**C07K 16/30 2006 (97) EP 3350226**  
(96) EP 16770571.4 9/16/2016

(97) EP 3350226, 7/25/2018 201830, en  
(31) 201562219599 P (32) 16.09.2015 (33) US  
(54) USE OF ANTI-MCAM ANTIBODIES FOR TREATMENT OR PROPHYLAXIS OF GIANT CELL ARTERITIS, POLYMYALGIA RHEUMATICA OR TAKAYASU'S ARTERITIS  
(71) Prothema Biosciences Limited, Adelphi Plaza Upper George's Street Dun Laoghaire, Co. Dublin A96 T927, IE  
(72) LIU, Yue, 815 Peary Lane, Foster City, California 94404, US  
GARIDEL, Patrick, Binger Strasse 173, 55216 Ingelheim Am Rhein, DE  
LANGER, Andreas, Bingerstrasse 173, 55216 Ingelheim am Rhein, DE  
FLANAGAN, Kenneth, 742 Palmera Ctourt, Alameda, CA 94501, US

---

(51) MKP  
**A61B 17/00 2006 (97) EP 3352679**  
**A61M 5/19 2006**  
(96) EP 16770615.9 9/12/2016  
(97) EP 3352679, 8/1/2018 201831, en  
(31) 201514863489 (32) 24.09.2015 (33) US  
(54) SPRAY OR DRIP TIPS HAVING MULTIPLE OUTLET CHANNELS  
(72) LAI, Gwan-Ywan, P.O.box151 U.S. Route 22, Somerville, New Jersey 08876, US  
JEFFCOAT, Keith L., P.O. Box 151 U.S. Route 22, Somerville, New Jersey 08876, US

---

(51) MKP  
**C04B 28/14 2006 (97) EP 3383822**  
**C04B 40/00 2006**  
(96) EP 16770680.3 9/9/2016  
(97) EP 3383822, 10/10/2018 201841, en  
(31) 102015015300 (32) 30.11.2015 (33) DE  
(54) ADDITIVE FOR GYPSUM BUILDING MATERIALS  
(72) KÖHLER, Juliane, Arndtstr. 33, 97072 Würzburg, DE  
KÖHLER, Verena, An der Talaue 29, 91433 Scheinfeld, DE

---

(51) MKP  
**B01D 1/18 2006 (97) EP 3353232**  
**C08J 3/12 2006**  
**D21C 9/00 2006**  
**F26B 3/12 2006**  
(96) EP 16770771.0 9/26/2016  
(97) EP 3353232, 8/1/2018 201831, en  
(31) 15186998 (32) 25.09.2015 (33) EP  
(54) SUPERCRITICAL CO2 CELLULOSE SPRAYDRYING  
(72) MENENDEZ GONZALEZ, Reyes, Albatrospad 83, 1021 TR Amsterdam, NL  
TRAMBITAS, Daniela Oana, Molenpolderstraat 44, 2493 VA Den Haag, NL  
CANTEKIN, Seda, Aventijnhof 12, 6215 ES Maastricht, NL  
GRAVESON, Ian, 75 Bettina Close, Nuneaton Warwickshire CV10 9EX, GB  
JENNEKENS, Math, Lerschenstraat 4, 6369 BZ Simpelveld, NL  
MOMIN, Saschi, 7 Warren Crescent Edmonton, London Greater London N9 9JF, GB

---

(51) MKP  
**A61K 31/519 2006 (97) EP 3350185**  
**A61P 3/00 2006**  
**A61P 25/00 2006**  
**A61P 35/00 2006**  
**C07D 487/04 2006**  
**C07D 495/04 2006**  
(96) EP 16770800.7 9/15/2016  
(97) EP 3350185, 7/25/2018 201830, en  
(31) 201562218740 P (32) 15.09.2015 (33) US  
201662318321 P 05.04.2016 US  
(54) 1-PHENYLPYRROLIDIN-2-ONE DERIVATIVES AS PERK INHIBITORS  
(72) AXTEN, Jeffrey Michael, 709 Swedeland Road, King of Prussia, Pennsylvania 19406, US  
FAUCHER, Nicolas Eric, 25-27 Avenue du Québec, 91951 Les Ulis Cedex, FR  
DAUGAN, Alain Claude-Marie, 25-27 Avenue du Québec, 91951 Les Ulis Cedex, FR  
KETHIRI, Raghava Reddy, H.No.227, Shri Nilaya Karishma Hills, Subramanyapura, Bangalore, IN

(51) MKP  
**A61K 31/519 2006 (97) EP 3349757**  
**A61P 31/18 2006**  
(96) EP 16770854.4 9/13/2016  
(97) EP 3349757, 7/25/2018 201830, en  
(31) 201562218858 P (32) 15.09.2015 (33) US  
201662382550 P 01.09.2016 US  
(54) MODULATORS OF TOLL-LIKE RECEPTORS FOR THE TREATMENT OF HIV  
(72) GELEZIUNAS, Romas, C/o Gilead Sciences Inc. 333 Lakeside Drive, Foster City, CA 94404, US  
HESSELGESSER, Joseph, E., C/o Gilead Sciences Inc. 333 Lakeside Drive, Foster City, CA 94404, US  
KAUR, Jasmine, C/o Gilead Sciences Inc. 333 Lakeside Drive, Foster City, CA 94404, US  
MURRY, Jeffrey, Patrick, C/o Gilead Sciences Inc. 333 Lakeside Drive, Foster City, CA 94404, US  
SLOAN, Derek, Dean, 2911 San Juan Blvd., Belmont, CA 94002, US

---

(51) MKP  
**A61K 31/53 2006 (97) EP 3349758**  
**A61K 31/664 2006**  
**A61K 31/675 2006**  
**A61K 31/683 2006**  
**A61K 31/685 2006**  
**A61P 31/12 2006**  
(96) EP 16770866.8 9/16/2016  
(97) EP 3349758, 7/25/2018 201830, en  
(31) 201562219302 P (32) 16.09.2015 (33) US  
201562239696 P 09.10.2015 US  
(54) METHODS FOR TREATING ARENAVIRIDAE AND CORONAVIRIDAE VIRUS INFECTIONS  
(72) CLARKE, Michael O' Neil Hanrahan, c/o Gilead Sciences Inc. 333 Lakeside Drive, Foster City, CA 94404, US  
FENG, Joy Yang, c/o Gilead Sciences Inc. 333 Lakeside Drive, Foster City, CA 94404, US  
JORDAN, Robert, c/o Gilead Sciences Inc. 333 Lakeside Drive, Foster City, CA 94404, US  
MACKMAN, Richard L., c/o Gilead Sciences Inc. 333 Lakeside Drive, Foster City, CA 94404, US  
RAY, Adrian S., c/o Gilead Sciences Inc. 333 Lakeside Drive, Foster City, CA 94404, US  
SIEGEL, Dustin, c/o Gilead Sciences Inc. 333 Lakeside Drive, Foster City, CA 94404, US

---

(51) MKP  
**A61K 31/56 2006 (97) EP 3353158**  
**A61P 31/18 2006**  
**C07D 211/96 2006**  
**C07D 279/12 2006**  
**C07J 63/00 2006**  
(96) EP 16771000.3 9/22/2016  
(97) EP 3353158, 8/1/2018 201831, en  
(31) 201562232068 P (32) 24.09.2015 (33) US  
(54) COMPOUNDS WITH HIV MATURATION INHIBITORY ACTIVITY  
(72) JOHNS, Brian Alvin, Five Moore Drive Research Triangle Park, NC 27709, US

---

(51) MKP  
**A23L 33/135 2016 (97) EP 3368696**  
**A61K 31/404 2006**  
**A61K 35/74 2015**  
**A61K 35/741 2015**  
**C12N 1/20 2006**  
**C12N 15/70 2006**  
**C12R 1/01 2006**  
**C12R 1/19 2006**  
(96) EP 16771037.5 9/8/2016  
(97) EP 3368696, 9/5/2018 201836, en  
(31) 201562248805 P (32) 30.10.2015 (33) US  
201562248825 P 30.10.2015 US  
201562248814 P 30.10.2015 US  
201562256042 P 16.11.2015 US



	201562256044 P		16.11.2015		US
	201562256048 P		16.11.2015		US
	201514998376		22.12.2015		US
	201662291470 P		04.02.2016		US
	201662291461 P		04.02.2016		US
	201662291468 P		04.02.2016		US
	PCT/US2016/020530		02.03.2016		WO

(54) BACTERIA ENGINEERED TO TREAT DISEASES THAT BENEFIT FROM REDUCED GUT INFLAMMATION AND/OR TIGHTENED GUT MUCOSAL BARRIER

(71) Synlogic Operating Company, Inc., 200 Sidney Street, Suite 320, Cambridge, MA 02139, US

(72) FALB, Dean, 180 Lake Street, Sherborn, MA 01770, US  
 ISABELLA, Vincent, M., 125 Grove Street, Watertown, MA 0247, US  
 KOTULA, Jonathan, W., 345 Washington Street, Somerville, MA 02143, US  
 MILLER, Paul, F., 39 Emerald Glen Lane, Salem, CT 06420, US  
 MILLET, Yves, 15 Frederick Street, Newton, MA 02460, US  
 FISHER, Adam, 240 Sidney Street, Apt. 306, Cambridge, MA 02139, US

---

(51) MKP  
**A61K 31/137 2006 (97) EP 3349740**  
**A61K 31/7042 2006**  
**A61P 1/16 2006**  
**A61P 3/00 2006**  
**A61P 3/04 2006**  
**A61P 9/00 2006**  
**A61P 9/12 2006**  
**A61P 13/00 2006**  
**A61P 43/00 2006**

(96) EP 16771043.3 9/13/2016  
 (97) EP 3349740, 7/25/2018 201830, en

(31)	201562218842 P	(32)	15.09.2015	(33)	US
	201662306110 P		10.03.2016		US
	201615262038		12.09.2016		US

(54) CO-THERAPY COMPRISING CANAGLIFLOZIN AND PHENTERMINE FOR THE TREATMENT OF OBESITY AND OBESITY RELATED DISORDERS

(72) ROSENTHAL, Norman R., 920 US Highway 202 S, Raritan, New Jersey 08869, US  
 ROTHENBERG, Paul, 920 US Highway 202 S, Raritan, New Jersey 08869, US  
 POLIDORI, David C., 3210 Merryfield Row, San Diego, California 92121, US  
 WAYS, Douglas K., 920 US Highway 202 S, Raritan, New Jersey 08869, US  
 STEIN, Peter P., 19 Birchwood Court, Princeton, New Jersey 08550, US

---

(51) MKP  
**A61K 39/00 2006 (97) EP 3355915**  
**A61K 39/12 2006**  
**A61K 39/135 2006**  
**A61K 39/23 2006**

(96) EP 16771050.8 9/14/2016  
 (97) EP 3355915, 8/8/2018 201832, en

(31)	201562234196 P	(32)	29.09.2015	(33)	US
------	----------------	------	------------	------	----

(54) CANINE PARVOVIRUS (CPV) VIRUS-LIKE PARTICLE (VLP) VACCINES AND USES THEREOF

(72) DAVID, Frederic, 1130 Christian Terrace, Watkinsville, GA 30677, US  
 HANNAS-DJEBBARA, Zahia, Les Bastides Du Vallon 4 Rue Des Chaux, 69340 Francheville, FR  
 POULET, Herve, 2 Place Des Quatre Vierges, 69110 Sainte Foy-Les Lyon, FR  
 MINKE, Jules, Maarten, 12 Avenue de la Californie, 06200 Nice, FR

---

(51) MKP  
**C07K 16/00 2006 (97) EP 3350216**  
**C07K 16/24 2006**  
**C07K 16/28 2006**  
**C07K 16/46 2006**

(96) EP 16771059.9 9/15/2016  
 (97) EP 3350216, 7/25/2018 201830, en

(31)	201562218977 P	(32)	15.09.2015	(33)	US
	PCT/US2015/050115		15.09.2015		WO

(54) TETRAVALENT BISPECIFIC AND TETRASPECIFIC ANTIGEN BINDING PROTEINS AND USES THEREOF

(72) KANNAN, Gunasekaran, 151 Crestview Circle, Daly City, California 94015, US  
HORTTER, Michelle, 455 Mariposa Drive, Camarillo, California 93012, US  
BELOUSKI, Edward J., 761 Camino Las Conchas, Thousand Oaks, California 91360, US

---

(51) MKP  
**A61L 27/36 2006 (97) EP 3349812**  
**A61L 27/56 2006**  
**A61L 27/60 2006**

(96) EP 16771073.0 9/16/2016

(97) EP 3349812, 7/25/2018 201830, en

(31) 201562220227 P (32) 17.09.2015 (33) US  
201662334437 P 10.05.2016 US

(54) COMPOSITIONS DERIVED FROM PLACENTA AND METHODS OF PRODUCING THE SAME

(72) DANIEL, John, 1225 Northmeadow Parkway Suite 104, Roswell, Georgia 30076, US  
GRIFFITHS, Sarah, 1225 Northmeadow Parkway Suite 104, Roswell, Georgia 30076, US  
BERG, Richard A., 1225 Northmeadow Parkway Suite 104, Roswell, Georgia 30076, US

---

(51) MKP  
**C10L 1/12 2006 (97) EP 3153565**  
**C10L 1/16 2006**  
**C10L 1/182 2006**  
**C10L 1/188 2006**  
**C10L 1/189 2006**  
**C10L 1/222 2006**  
**C10L 1/224 2006**  
**C10L 1/232 2006**  
**C10L 1/233 2006**  
**C10L 1/24 2006**  
**C10L 10/02 2006**

(96) EP 15002868.6 10/7/2015

(97) EP 3153565, 7/18/2018 201829, de

(31) 6482015 (32) 05.10.2015 (33) AT

(54) FUEL ADDITIVE

(71) Mauerhofer, Franz, Am Rosenhügel 74, 2401 Fischamend, AT  
Aksüz, Hasan, Dopschstrasse 29/7/72, 1210 Wien, AT  
Masca, Abdullah Ismail, Krieglergasse 14/16, 1030 Wien, AT  
(72) Mauerhofer, Franz, Am Rosenhügel 74, 2401 Fischamend, AT  
Aksüz, Hasan, Dopschstrasse 29/7/72, 1210 Wien, AT  
Masca, Abdullah Ismail, Krieglergasse 14/16, 1030 Wien, AT

---

(51) MKP  
**A61K 51/00 2006 (97) EP 3309796**  
**A61K 51/12 2006**  
**A61M 36/00 2006**  
**G21G 1/00 2006**

(96) EP 17200924.3 10/26/2012

(97) EP 3309796, 11/14/2018 201846, en

(31) 201261697244 P (32) 05.09.2012 (33) US

(54) RUBIDIUM ELUTION SYSTEM CONTROL

(72) LEFORT, Étienne, 132 Niagara, Kirkland, Québec H9J 3B6, CA  
TEOLI, Vincenzo, 10275 Tanguay, Montreal, Québec H3L 3G6, CA  
DEKEMP, Robert A., 92 Ross Avenue, Ottawa, Ontario K1Y 0N5, CA  
KLEIN, Ran, 247 Pleasant Park Road, Ottawa, Ontario K1H 5M4, CA

---

(51) MKP  
**A61K 31/4375 2006 (97) EP 3318565**  
**A61P 35/00 2006**  
**C07D 471/04 2006**  
**C07D 487/04 2006**

(96) EP 17200940.9 11/20/2014

(97) EP 3318565, 12/19/2018 201851, en

(31) 201361912074 P (32) 05.12.2013 (33) US

(54) PYRROLO[2,3-D]PYRIMIDINYL, PYRROLO[2,3-B]PYRAZINYL AND PYRROLO[2,3-D]PYRIDINYL ACRYLAMIDES

(72) BROWN, Matthew Frank, 443 Wheeler Road, Stonington, CT Connecticut 06378, US  
CASIMIRO-GARCIA, Agustin, 61 Woodland Road, Concord, MA Massachusetts 01742, US  
CHE, Ye, 166 Ledgewood Road Apartment 308, Groton, CT Connecticut 06340, US  
COE, Jotham Wadsworth, 8 Bush Hill Drive, Niantic, CT Connecticut 06357, US  
FLANAGAN, Mark Edward, 10 Queen Eleanor Drive, Gales Ferry, CT Connecticut 06335, US  
GILBERT, Adam Matthew, 178 Denison Drive, Guilford, CT Connecticut 06437, US  
HAYWARD, Matthew Merrill, 3 Pyrus Court, Old Lyme, CT Connecticut 06371, US  
LANGILLE, Jonathan David, 15 Clark Place, Quaker Hill, CT Connecticut 06375, US  
MONTGOMERY, Justin Ian, 61 Spicer Hill Road, Ledyard, CT Connecticut 06339, US  
TELLIEZ, Jean-Baptiste, 211 East Emerson Road, Lexington, MA Massachusetts 02420, US  
THORARENSEN, Atli, 581 Great Road, Stow, MA Massachusetts 01775, US  
UNWALLA, Rayomand Jal, 22 Fox Run Road, Bedford, MA Massachusetts 01730, US  
TRUJILLO, John I, 33 Saw Mill Drive, Ledyard, CT Connecticut 06339, US

---

(51) MKP  
**A61K 9/00 2006 (97) EP 3318247**  
**A61K 9/50 2006**  
**A61K 31/55 2006**  
**A61P 9/04 2006**

(96) EP 17201489.6 8/10/2012

(97) EP 3318247, 12/19/2018 201851, en

(31) 11177354 (32) 12.08.2011 (33) EP

(54) TASTE MASKED PHARMACEUTICAL COMPOSITION

(71) Boehringer Ingelheim Vetmedica GmbH, Binger Strasse 173, 55216 Ingelheim am Rhein, DE

(72) FOLGER, Martin Andreas, Boehringer Ingelheim GmbH Corporate Patents Binger Strasse 173, 55216 Ingelheim am Rhein, DE

GRAVE, Annette, Glatt GmbH Werner-Glatt-Str. 1, 79589 Binzen, DE

LEHNER, Stefan Johannes, Boehringer Ingelheim GmbH Corporate Patents Binger Strasse 173, 55216 Ingelheim am Rhein, DE

POELINGER, Norbert, Glatt GmbH Werner-Glatt-Str. 1, 79589 Binzen, DE

SEIDLER, Randolph, Boehringer Ingelheim GmbH Corporate Patents Binger Strasse 173, 55216 Ingelheim am Rhein, DE

---

(51) MKP  
**A61K 39/00 2006 (97) EP 3318272**  
**A61K 39/395 2006**  
**C07K 16/18 2006**  
**C07K 16/26 2006**

(96) EP 17201603.2 6/7/2011

(97) EP 3318272, 12/19/2018 201851, en

(31) 353323 P (32) 10.06.2010 (33) US

(54) CGRP ANTIBODIES

(72) ALLAN, Barrett, c/o Eli Lilly and Company PATENT DEPARTMENT PO BOX 6288, Indianapolis, IN 46206-6288, US

BENSCHOP, Robert Jan, c/o Eli Lilly and Company PATENT DEPARTMENT PO BOX 6288, Indianapolis, IN 46206-6288, US

CHAMBERS, Mark Geoffrey, c/o Eli Lilly and Company PATENT DEPARTMENT PO Box 6288, Indianapolis, IN 46206-6288, US

DARLING, Ryan James, c/o ELI LILLY AND COMPANY PATENT DEPARTMENT PO BOX 6288, Indianapolis, IN 46206-6288, US

---

(51) MKP  
**A61K 9/20 2006 (97) EP 3318249**  
**A61K 9/32 2006**  
**A61K 31/225 2006**  
**A61P 25/28 2006**

(96) EP 17202547.0 4/29/2010

(97) EP 3318249, 12/19/2018 201851, en

(31) 173797 P (32) 29.04.2009 (33) US  
175270 P 04.05.2009 US

(54) DIMETHYL FUMARATE DOSAGE REGIMENS FOR THE TREATMENT OF MULTIPLE SCLEROSIS

(72) Lukashov, Matvey, 3 Louis Rd., Tewksbury, MA Massachusetts 01876, US

---

(51) MKP  
**C07K 11/02 2006 (97) EP 3301109**

(96) EP 17202877.1 12/3/2013

(97) EP 3301109, 11/7/2018 201845, en

(31) 201261732894 P (32) 03.12.2012 (33) US

(54) NOVEL DEPSIPEPTIDE AND USES THEREOF

(72) PEOPLES, Aaron, J., 807 Somerville Avenue Apt. 3, Somerville, MA 02143, US  
HUGHES, Dallas, 22 Field Pond Road, Milford, MA 01757, US  
LING, Losee, Lucy, 131 Gloucester Street, Arlington, MA 02476, US  
MILLETT, William, 33 Alvarado Avenue Apt. 1F, Worcester, MA 01604, US  
NITTI, Anthony, 993 Massachusetts Avenue, Lexington, MA 02420, US  
SPOERING, Amy, 429 Main Street, Waltham, MA 02452, US  
STEADMAN, Victoria, Alexandra, Fyfield Business & Research Park Fyfield Road, Ongar, Essex CM5 0GS, GB  
CHIVA, Jean-Yves, Christophe, Fyfield Business & Research Park Fyfield Road, Ongar, Essex CM5 0GS, GB  
LAZARIDES, Linos, Fyfield Business & Research Park Fyfield Road, Ongar, Essex CM5 0GS, GB  
JONES, Michael, Kenyon, Fyfield Business & Research Park Fyfield Road, Ongar, Essex CM5 0GS, GB  
POULLENNEC, Karine, Gaele, Fyfield Business & Research Park Fyfield Road, Ongar, Essex CM5 0GS, GB  
LEWIS, Kim, 49 Glendale Road, Newton, MA 02459, US  
EPSTEIN, Slava, 135 Bonham Road, Dedham, MA 02026, US

---

(51) MKP  
**A61K 31/535 2006 (97) EP 3321270**  
**A61P 31/18 2006**  
**C07D 498/14 2006**  
(96) EP 17204116.2 6/19/2015  
(97) EP 3321270, 12/26/2018 201852, en  
(31) 201462015245 P (32) 20.06.2014 (33) US  
(54) SODIUM (2R, 5S, 13AR) -7, 9-DIOXO-10- ((2,4,6-TRIFLUOROBENZYL) CARBAMOYL) -2, 3, 4, 5, 7, 9, 13, 13A-OCTAHYDRO-2, 5-METHANOPYRIDO [1',2' : 4.5] PYRAZINO [2, 1-B] OXAZEPIN-8-OLATE  
(72) CARRA, Ernest, A., c/o Gilead Sciences, Inc. 333 Lakeside Drive, Foster City, CA California 94404, US  
CHEN, Irene, c/o Gilead Sciences, Inc. 333 Lakeside Drive, Foster City, CA California 94404, US  
ZIA, Vahid, c/o Gilead Sciences, Inc. 333 Lakeside Drive, Foster City, CA California 94404, US

---

(51) MKP  
**A23P 10/30 2016 (97) EP 3318268**  
**A61K 38/16 2006**  
**A61K 39/02 2006**  
**A61K 48/00 2006**  
**A61P 1/00 2006**  
**A61P 17/00 2006**  
**A61P 19/00 2006**  
**A61P 29/00 2006**  
**A61P 37/00 2006**  
**C07K 14/195 2006**  
(96) EP 17204215.2 4/10/2014  
(97) EP 3318268, 12/19/2018 201851, en  
(31) 201306536 (32) 10.04.2013 (33) GB  
(54) ROSEBURIA FLAGELLIN AND IMMUNE MODULATION  
(72) KELLY, Denise, c/o 4D Pharma Research Limited Life Sciences Innovation Building Cornhill Road Aberdeen, Aberdeenshire, AB25 2ZS, GB  
PATTERSON, Angela, c/o 4D Pharma Research Limited Life Sciences Innovation Building Cornhill Road Aberdeen, Aberdeenshire, AB25 2ZS, GB  
MONNAIS, Edouard, c/o 4D Pharma Research Limited Life Sciences Innovation Building Cornhill Road Aberdeen, Aberdeenshire, AB25 2ZS, GB  
MULDER, Imke, c/o 4D Pharma Research Limited Life Sciences Innovation Building Cornhill Road Aberdeen, Aberdeenshire, AB25 2ZS, GB

---

(51) MKP  
**A61K 31/485 2006 (97) EP 3345604**  
**A61P 25/32 2006**  
(96) EP 17206034.5 6/27/2013  
(97) EP 3345604, 7/11/2018 201828, en  
(31) 201261664804 P (32) 27.06.2012 (33) US  
201261721539 P 02.11.2012 US  
201261736740 P 13.12.2012 US  
201361788810 P 15.03.2013 US  
(54) NALMEFENE FOR REDUCTION OF ALCOHOL CONSUMPTION IN SPECIFIC TARGET POPULATIONS  
(72) Torup,, Lars, Inavej 41, DK-3500 Værløse, DK  
Abbariki, Afsaneh, Grønnersvej 1, DK-2840 Holte, DK  
Bladström, Anna, Qvantenborgsvägen 19, S-227 38 Lund, SE  
Persson, Christine, Skolrådsvägen 13, S-224 67 Lund, SE  
Meulien, Didier, 16 rue Heinrich, F-92100 Boulogne Billancourt, FR  
Sørensen, Per, Skovgaardsgade 23, DK-2100 København Ø, DK

(51) MKP  
**A61K 39/395 2006 (97) EP 3318273**

(96) EP 17206669.8 3/30/2012  
(97) EP 3318273, 12/19/2018 201851, en

(31) 201161471007 P (32) 01.04.2011 (33) US

(54) METHODS FOR INCREASING EFFICACY OF FOLR1 CANCER THERAPY  
(72) Carrigan, Christina, 4003 24th St., Apt. 3, San Francisco, CA 94114, US  
Whiteman, Kathleen R., 512 Shawshen Avenue, Wilmington, MA 01887, US  
Payne, Gillian, 21 Oakvale Road, Waban, MA 02468, US  
Ladd, Sharron, 9970 Joslin Lake Rd., Gregory, MI 48137, US

---

(51) MKP  
**B23K 26/00 2014 (97) EP 3363576**  
**B23K 26/0622 2014**  
**B23K 26/082 2014**  
**B23K 26/12 2014**  
**B23K 26/14 2014**  
**B23K 26/322 2014**  
**B23K 26/352 2014**  
**B23K 26/60 2014**

(96) EP 17207229.0 12/14/2017  
(97) EP 3363576, 9/5/2018 201836, de

(31) 102017000347 (32) 17.01.2017 (33) DE  
102017106672 28.03.2017 DE

(54) METHOD AND IDENTIFICATION AND/OR MARKING OF GALVANIZED, IN PARTICULAR HOT DIPPED COMPONENTS  
(72) PINGER, Thomas, Zum Imberg 24, 45721 Haltern am See, DE  
BAUMGÜRTEL, Lars, Hövel 2, 48301 Nottuln, DE

---

(51) MKP  
**A61K 39/00 2006 (97) EP 3348644**  
**C12N 15/63 2006**  
**C12N 15/67 2006**

(96) EP 17207479.1 2/15/2013  
(97) EP 3348644, 7/18/2018 201829, en

(31) PCT/EP2012/000674 (32) 15.02.2012 (33) WO

(54) NUCLEIC ACID COMPRISING OR CODING FOR A HISTONE STEM-LOOP AND A POLY(A) SEQUENCE OR A POLYADENYLATION SIGNAL FOR INCREASING THE EXPRESSION OF AN ENCODED TUMOUR ANTIGEN  
(72) Theß, Andreas, Hindenburgstr. 9, 72127 Kusterdingen, DE  
Schlake, Thomas, Gartenweg 1, 79194 Gundelfingen, DE  
Probst, Jochen, In den Kirchhöfländern 19, 72649 Wolfschlügen, DE

---

(51) MKP  
**A61B 17/06 2006 (97) EP 3323451**  
**A61L 31/02 2006**  
**A61L 31/10 2006**  
**A61M 5/32 2006**

(96) EP 17207802.4 10/21/2010  
(97) EP 3323451, 11/14/2018 201846, en

(31) 614665 (32) 09.11.2009 (33) US  
858485 18.08.2010 US

(54) SURGICAL NEEDLE COATINGS AND METHODS  
(71) Ethicon LLC, Road 183, KM 8.3 Hato Industrial Park, San Lorenzo, PR  
(72) MAURER, Robert, 3 McElroy Lane, Montgomery, NJ 08502, US  
BAR, S. Neil, 318 Thatcher Terrace, Hillsborough, NJ 08844, US  
HINRICHS, Eric, 366 Cafferty Road, Bucks, PA 18947, US  
HAMILTON, Michael, 6002 April Street, San Angelo, TX 76904, US  
WILKES, Thomas, 1 Richmond Street Apt 3106, New Brunswick, NJ 08901, US

---

(51) MKP  
**A61K 31/7125 2006 (97) EP 3366775**  
**C12N 15/113 2010**  
(96) EP 17209680.2 11/16/2012  
(97) EP 3366775, 8/29/2018 201835, en  
(31) 201161561710 P (32) 18.11.2011 (33) US  
(54) MODIFIED RNAI AGENTS  
(72) RAJEEV, Kallanthottathil, G., c/o Alnylam Pharmaceuticals, Inc. 300 Third Street, Cambridge, MA 02142, US  
ZIMMERMANN, Tracy, c/o Alnylam Pharmaceuticals, Inc. 300 Third Street, Cambridge, MA 02142, US  
MANOHARAN, Muthiah, c/o Alnylam Pharmaceuticals, Inc. 300 Third Street, Cambridge, MA 02142, US  
MAIER, Martin, c/o Alnylam Pharmaceuticals, Inc. 300 Third Street, Cambridge, MA 02142, US  
KUCHIMANCHI, Satyanarayana, c/o Alnylam Pharmaceuticals, Inc. 300 Third Street, Cambridge, MA 02142, US  
CHARISSE, Klaus, c/o Alnylam Pharmaceuticals, Inc. 300 Third Street, Cambridge, MA 02142, US

---

(51) MKP  
**E04F 15/024 2006 (97) EP 3369874**  
**F24D 3/12 2006**  
(96) EP 17425022.5 3/1/2017  
(97) EP 3369874, 9/5/2018 201836, en  
(54) A MODULAR FLOATING SCREED WITH INCORPORATED HEATING ELEMENTS  
(71) Casprini, Matteo, via S. Maria Novella 91 Loc. Fiano, 50052 Certaldo (FI), IT  
(72) Casprini, Matteo, via S. Maria Novella 91 Loc. Fiano, 50052 Certaldo (FI), IT

---

(51) MKP  
**B01D 17/00 2006 (97) EP 3238801**  
**B01D 17/04 2006**  
**E03F 5/16 2006**  
(96) EP 17460024.7 4/21/2017  
(97) EP 3238801, 7/11/2018 201828, en  
(31) 41706216 (32) 29.04.2016 (33) PL  
(54) COALESCING SEPARATOR  
(71) Delfin Sp. z o.o., ul. Chorzowska 22, 25-852 Kielce, PL  
(72) Skrzypczak, Dariusz, ul. Jurajska 10/15, 25-640 Kielce, PL

---

(51) MKP  
**A61K 9/00 2006 (97) EP 3388063**  
**A61K 9/20 2006**  
**A61K 31/4164 2006**  
**A61K 31/4178 2006**  
**A61K 31/7048 2006**  
**A61K 45/06 2006**  
**A61K 47/06 2006**  
**A61P 31/04 2006**  
(96) EP 17461524.5 4/14/2017  
(97) EP 3388063, 10/17/2018 201842, en  
(54) TREATMENT OF A BACTERIAL VAGINAL INFECTION  
(72) Berdzik-Kalarus, Sylwia, ul. Czajek 14, 40-534 Katowice, PL

---

(51) MKP  
**B27N 3/02 2006 (97) EP 3400120**  
**B27N 3/04 2006**  
**B27N 3/06 2006**  
**B27N 3/10 2006**  
**B27N 3/12 2006**  
(96) EP 17700006.4 1/2/2017  
(97) EP 3400120, 11/14/2018 201846, en  
(31) 16150612 (32) 08.01.2016 (33) EP  
201662302232 P 02.03.2016 US  
(54) IN-LINE COATED WOOD-BASED BOARDS  
(72) SCHRUL, Christopher, Stockenmatt 11, 6063 Stalden (Sarnen), CH  
HUNZIKER, Philipp, 1337 Harbor Cove, Loveland Ohio 45140, US

---

(51) MKP  
**C09C 1/02 2006 (97) EP 3402846**

(96) EP 17700074.2 1/5/2017  
(97) EP 3402846, 11/21/2018 201847, en

(31) 16151383 (32) 14.01.2016 (33) EP  
201662311043 P 21.03.2016 US

(54) TREATMENT OF SURFACE-REACTED CALCIUM CARBONATE  
(72) RENTSCH, Samuel, Gurtengartenstrasse 1, 3095 Spiegel bei Bern, CH  
WELKER, Matthias, 11 Rue des Rossignols, 68220 Héisingue, FR  
GANE, Patrick A.C., Studenweg 8, 4852 Rothrist, CH

---

(51) MKP  
**B25B 13/46 2006 (97) EP 3408063**  
**B26D 1/547 2006**

(96) EP 17700291.2 1/12/2017  
(97) EP 3408063, 12/5/2018 201849, en

(31) 201601500 (32) 27.01.2016 (33) GB

(54) WINDER UNIT FOR VEHICLE GLAZING PANEL CUT OUT  
(71) Belron International Limited, Milton Park Stroude Road, Egham, Surrey TW20 9EL, GB  
(72) FINCK, William, c/o Belron International Limited Milton Park, Stroude Road, Egham, Surrey TW20 9EL, GB

---

(51) MKP  
**A61K 31/426 2006 (97) EP 3397622**  
**A61K 45/06 2006**  
**A61P 15/00 2006**  
**A61P 15/06 2006**  
**C07D 277/06 2006**

(96) EP 17700391.0 1/4/2017  
(97) EP 3397622, 11/7/2018 201845, en

(31) 201614987586 (32) 04.01.2016 (33) US  
201662274674 P 04.01.2016 US  
201662395664 P 16.09.2016 US  
201662407918 P 13.10.2016 US

(54) ALPHA-AMINO ESTERS OF HYDROXYPROPYLTHIAZOLIDINE CARBOXAMIDE DERIVATIVE AND SALT FORM, CRYSTAL POLYMORPH THEREOF  
(72) NAXOS PAGE, Patrick, Les Cyclades Avenue de Genève, 74160 Saint-Julien-en-Genevois, CH  
SCHWARZ, Matthias, 43 Rue Philippe Plantamour, 1201 Genève, CH  
JORAND-LEBRUN, Catherine, Chef Lieu, 74270 Contamine-Sarzin, FR  
QUATTROPANI, Anna, Route de Chêne 2, 1207 Genève, CH  
POMEL, Vincent, 228 Chemin du Bois des Presses, 74570 Groisy, FR  
LOUMAYE, Ernest, 29 Chemin de la Planta, 1223 Cologny, CH  
POHL, Oliver, c/o ObsEva S.A. Chemin des Aulx 12, 1228 Plan-les-Ouates, CH  
GOTTELAND, Jean-Pierre, 9 Rue Charles Humbert, 1205 Geneva, CH

---

(51) MKP  
**A61K 31/426 2006 (97) EP 3400217**  
**A61K 45/06 2006**  
**A61P 15/00 2006**  
**A61P 15/06 2006**  
**C07D 277/06 2006**

(96) EP 17700392.8 1/4/2017  
(97) EP 3400217, 11/14/2018 201846, en

(31) 201614987586 (32) 04.01.2016 (33) US  
201662274674 P 04.01.2016 US  
201662395664 P 16.09.2016 US  
201662407918 P 13.10.2016 US

(54) L-VALINATE OF HYDROXYPROPYLTHIAZOLIDINE CARBOXAMIDE DERIVATIVE AND SALT FORM, CRYSTAL POLYMORPH THEREOF  
(72) NAXOS PAGE, Patrick, Les Cyclades Avenue de Genève, 74160 Saint-Julien-en-Genevois, CH  
SCHWARZ, Matthias, 43 Rue Philippe Plantamour, 1201 Genève, CH  
JORAND-LEBRUN, Catherine, Chef Lieu, 74270 Contamine-Sarzin, FR  
QUATTROPANI, Anna, Route de Chêne 2, 1207 Genève, CH  
POMEL, Vincent, 228 Chemin du Bois des Presses, 74570 Groisy, FR

(51) MKP  
**C07K 16/26 2006 (97) EP 3397965**  
**C07K 16/30 2006**  
**G01N 33/574 2006**  
**G01N 33/74 2006**

(96) EP 17700481.9 1/2/2017  
(97) EP 3397965, 11/7/2018 201845, en

(31) 15307190 (32) 31.12.2015 (33) EP  
16305133 05.02.2016 EP

(54) COMPOSITIONS AND METHODS FOR ASSESSING THE RISK OF CANCER OCCURRENCE  
(71) Syncerus S.à R.l., 11 Côte d'Eich, 1450 Luxembourg, LU  
(72) FLOCH, Jean-François, Château Bois de la Roche, 29610 Garlan, FR

(51) MKP  
**A61K 31/191 2006 (97) EP 3399969**  
**A61P 31/00 2006**  
**A61P 33/00 2006**  
**A61P 33/02 2006**

(96) EP 17700489.2 1/4/2017  
(97) EP 3399969, 11/14/2018 201846, en

(31) 201662274432 P (32) 04.01.2016 (33) US  
201662274446 P 04.01.2016 US

(54) METHOD FOR PREVENTION, TREATMENT AND ALLEVIATION OF INFECTIOUS DISEASES AND DISORDERS  
(71) Replicon Health OY, Tekniikantie 2, 02150 Espoo, FI  
(72) HIRVONEN, Petteri, Kellosaarenkatu 7 A 1, 00180 Helsinki, FI  
ERIKSSON, Peter, Linnankoskenkatu 15 A 4, 00250 Helsinki, FI  
KAKSONEN, Risto, Sammalkallionkuja 2 F 102, 02210 Espoo, FI

(51) MKP  
**A61K 39/00 2006 (97) EP 3400004**  
**A61P 35/00 2006**

(96) EP 17700495.9 1/5/2017  
(97) EP 3400004, 11/14/2018 201846, en

(31) 16150574 (32) 08.01.2016 (33) EP  
16178393 07.07.2016 EP

(54) THERAPEUTIC ANTICANCER NEOEPITOPE VACCINE  
(72) GRANUM, Stine, Østmarkveien 24, 0687 Oslo, NO  
STUBSRUD, Elisabeth, Skøyenveien 69, 0375 Oslo, NO  
FREDRIKSEN, Agnete Brunsvik, Strandveien 5, 2005 Rælingen, NO

(51) MKP  
**A61K 39/00 2006 (97) EP 3400005**  
**A61P 35/00 2006**

(96) EP 17700498.3 1/5/2017  
(97) EP 3400005, 11/14/2018 201846, en

(31) 16150574 (32) 08.01.2016 (33) EP  
16178393 07.07.2016 EP  
16178816 11.07.2016 EP

(54) NEOEPITOPE RNA CANCER VACCINE  
(72) FREDRIKSEN, Agnete Brunsvik, Strandveien 5, 2005 Rælingen, NO

(51) MKP  
**C23C 2/02 2006 (97) EP 3400317**  
**C23C 2/06 2006**  
**C23C 2/14 2006**  
**C23C 2/26 2006**  
**C23C 2/30 2006**

(96) EP 17700503.0 1/9/2017  
(97) EP 3400317, 11/14/2018 201846, de

(31) 102016002783 (32) 09.03.2016 (33) DE  
102016104855 16.03.2016 DE



- (54) HOT-DIP GALVANIZATION SYSTEM AND HOT-DIP GALVANIZATION METHOD, IN PARTICULAR FOR MASS PRODUCTION  
 (72) PINGER, Thomas, Zum Imberg 24, 45721 Haltern am See, DE  
 BAUMGÜRTEL, Lars, Hövel 2, 48301 Nottuln, DE
- 

- (51) MKP  
**A61K 31/437 2006 (97) EP 3405466**  
**A61P 31/16 2006**  
**C07D 403/04 2006**  
**C07D 403/12 2006**  
**C07D 471/04 2006**  
**C07D 487/04 2006**  
**C07D 495/04 2006**  
 (96) EP 17700580.8 1/19/2017  
 (97) EP 3405466, 11/28/2018 201848, en  
 (31) 16152095 (32) 20.01.2016 (33) EP  
 (54) ARYL SUBSTITUTED PYRIMIDINES FOR USE IN INFLUENZA VIRUS INFECTION  
 (72) JONCKERS, Tim Hugo Maria, c/o Janssen Pharmaceutica NV Turnhoutseweg 30, 2340 Beerse, BE  
 MC GOWAN, David Craig, c/o Janssen Pharmaceutica NV Turnhoutseweg 30, 2340 Beerse, BE  
 GUILLEMONT, Jérôme Emile Georges, c/o Janssen-Cilag 1 rue Camille Desmoulins TSA 91003, 92787 Issy-les-Moulineaux Cedex 9, FR  
 EMBRECHTS, Werner Constant J, c/o Janssen Pharmaceutica NV Turnhoutseweg 30, 2340 Beerse, BE  
 MERCEY, Guillaume Jean Maurice, c/o Janssen-Cilag 1 rue Camille Desmoulins TSA 91003, 92787 Issy-les-Moulineaux Cedex 9, FR  
 BUYCK, Christophe Francis Robert Nestor, c/o Janssen Pharmaceutica NV Turnhoutseweg 30, 2340 Beerse, BE  
 BALEMANS, Wendy Mia Albert, c/o Janssen Pharmaceutica NV Turnhoutseweg 30, 2340 Beerse, BE  
 RABOISSON, Pierre Jean-Marie Bernard, c/o Janssen Pharmaceutica NV Turnhoutseweg 30, 2340 Beerse, BE
- 

- (51) MKP  
**D06P 1/653 2006 (97) EP 3390711**  
**D06P 3/54 2006**  
**D06P 5/04 2006**  
 (96) EP 17700613.7 1/4/2017  
 (97) EP 3390711, 10/24/2018 201843, en  
 (31) 201600098 (32) 04.01.2016 (33) GB  
 (54) METHOD OF DYE CLEARING TEXTILES  
 (72) ELLIS, David John, 27 Orchard Road, Burgess Hill Sussex RH15 9PG, GB  
 BROWN, Nicholas, Warwick House Church Street, Ticehurst Sussex TN5 7AA, GB
- 

- (51) MKP  
**A61K 31/437 2006 (97) EP 3400225**  
**A61K 31/519 2006**  
**A61P 31/16 2006**  
**C07D 471/04 2006**  
**C07D 487/04 2006**  
 (96) EP 17700614.5 1/5/2017  
 (97) EP 3400225, 11/14/2018 201846, en  
 (31) 16150457 (32) 07.01.2016 (33) EP  
 (54) FUNCTIONALIZED PENTANOIC ACIDS FOR USE IN INFLUENZA VIRAL INFECTIONS  
 (72) GUILLEMONT, Jérôme, Émile, Georges, c/o Janssen-Cilag 1 Rue Camille Desmoulins TSA 91003, 92787 Issy-les-Moulineaux Cedex 9, FR  
 BALEMANS, Wendy, Mia, Albert, c/o Janssen Pharmaceutica NV Turnhoutseweg 30, 2340 Beerse, BE  
 MC GOWAN, David, Craig, c/o Janssen Pharmaceutica NV Turnhoutseweg 30, 2340 Beerse, BE  
 MOTTE, Magali, Madeleine, Simone, c/o Janssen-Cilag 1 Rue Camille Desmoulins TSA 91003, 92787 Issy-les-Moulineaux Cedex 9, FR  
 LANÇOIS, David, Francis, Alain, c/o Janssen-Cilag 1 Rue Camille Desmoulin TSA 91003, 92787 Issy-les-Moulineaux Cedex 9, FR  
 LAMBERT, Emilie, Marie, c/o Janssen-Cilag 1 Rue Camille desmoulins TSA 91003, 92787 Issy-les-Moulineaux Cedex 9, FR
- 

- (51) MKP  
**A61K 49/00 2006 (97) EP 3405216**  
 (96) EP 17700685.5 1/18/2017  
 (97) EP 3405216, 11/28/2018 201848, en  
 (31) 201601004 (32) 19.01.2016 (33) GB  
 (54) NANOPARTICLE CONJUGATES  
 (71) Chromition Limited, 11 Riverview The Embankment Business Park Heaton Mersey, Stockport, Cheshire SK4 3GN, GB

(72) MCCAIRN, Mark, Chromition Limited Greenheys Manchester Science Park Pencroft Way, Manchester M15 6JJ, GB  
TURNER, Michael, Chromition Limited Greenheys Manchester Science Park Pencroft Way, Manchester M15 6JJ, GB  
LIDSTER, Benjamin, Chromition Limited Greenheys Manchester Science Park Pencroft Way, Manchester M15 6JJ, GB

---

(51) MKP  
**E05C 19/00 2006 (97) EP 3405635**  
**E06B 7/18 2006**

(96) EP 17700702.8 1/20/2017

(97) EP 3405635, 11/28/2018 201848, en

(31) 16382024 (32) 21.01.2016 (33) EP

(54) DOOR DEVICE

(71) Puertas y Sistemas anti Inundaciones S.L., Etxesakan 5 Puerta 11, 31180 Zizur Mayor Navarra, ES

(72) ELIZALDE SALEGUI, Lucas Ma, Travesia Acella 5, 2° A, 31008 Pamplona, ES

---

(51) MKP  
**B22D 41/22 2006 (97) EP 3408043**  
**B22D 41/28 2006**  
**B22D 41/34 2006**

(96) EP 17700717.6 1/24/2017

(97) EP 3408043, 12/5/2018 201849, en

(31) 16152591 (32) 25.01.2016 (33) EP

(54) SLIDING GATE VALVE PLATE

(71) Vesuvius Group S.A, Rue de Douvrain, 17, 7011 Ghlin, BE

(72) COLLURA, Mariano, 63 rue Harmegnies, 7110 Strepv-Bracquognies, BE

SIBIET, Fabrice, 21 rue de la gare, 59680 Colletet, FR

---

(51) MKP  
**A61P 35/00 2006 (97) EP 3405490**  
**C07K 16/28 2006**  
**C07K 16/30 2006**

(96) EP 17700749.9 1/10/2017

(97) EP 3405490, 11/28/2018 201848, en

(31) 201662281543 P (32) 21.01.2016 (33) US  
201662431766 P 08.12.2016 US

(54) MONO AND BISPECIFIC ANTIBODIES FOR EPIDERMAL GROWTH FACTOR RECEPTOR VARIANT III AND CD3 AND THEIR USES

(72) CHOU, Joyce Ching, 767 Silkoak Way, Sunnyvale, CA 94086, US

WONG, Oi Kwan, 15 Arroyo View Circle, Belmont, CA 94002, US

---

(51) MKP  
**A61K 9/20 2006 (97) EP 3405177**  
**A61K 9/48 2006**  
**A61K 31/00 2006**

(96) EP 17700820.8 1/18/2017

(97) EP 3405177, 11/28/2018 201848, en

(31) 201621001986 (32) 19.01.2016 (33) IN

(54) FORMULATIONS/COMPOSITIONS COMPRISING A BTK INHIBITOR

(72) GUPTA, Manish, Kumar, c/o Janssen Pharmaceutica NV Turnhoutseweg 30, 2340 Beerse, BE

KULKARNI, Parikshit, Rameshram, Ratnadeep plot no. 3 Gita housing society Manisha nagar road, Pandharpur Maharashtra 413304, IN

KRISHNAN NAIR, Binuraj, Maxima D 901 Casa Bella Gold Palava Kalyan Shil Phata Road, Dombivali East Maharashtra 421204, IN

---

(51) MKP  
**A61K 9/20 2006 (97) EP 3405178**  
**A61K 31/00 2006**

(96) EP 17700821.6 1/18/2017

(97) EP 3405178, 11/28/2018 201848, en

(31) 201621001987 (32) 19.01.2016 (33) IN

(54) FORMULATIONS/COMPOSITIONS COMPRISING A BTK INHIBITOR

(72) GUPTA, Manish, Kumar, c/o Janssen Pharmaceutica NV Turnhoutseweg 30, 2340 Beerse, BE

KULKARNI, Parikshit, Rameshram, Ratnadeep plot no. 3 Gita housing society Manisha nagar road, Pandharpur Maharashtra 413304, IN

KRISHNAN NAIR, Binuraj, Maxima D 901 Casa Bella Gold Palava Kalyan Shil Phata Road, Dombivali East Maharashtra 421204, IN

---

(51) MKP  
**C07D 205/04 2006 (97) EP 3400211**

(96) EP 17700878.6 1/3/2017  
(97) EP 3400211, 11/14/2018 201846, en  
(31) 201662274558 P (32) 04.01.2016 (33) US

(54) AZETIDINE MODULATORS OF THE SPHINGOSINE 1-PHOSPHATE RECEPTOR  
(71) Auspex Pharmaceuticals, Inc., 1090 Horsham Road, North Wales, PA 19454, US  
(72) ZHANG, Chengzhi, 1090 Horsham Road, North Wales, PA 19454, US  
CHAKMA, Justin, 1090 Horsham Road, North Wales, PA 19454, US

---

(51) MKP  
**C23C 2/02 2006 (97) EP 3400318**  
**C23C 2/06 2006**  
**C23C 2/14 2006**  
**C23C 2/26 2006**  
**C23C 2/30 2006**

(96) EP 17701042.8 1/9/2017  
(97) EP 3400318, 11/14/2018 201846, de  
(31) 102016002782 (32) 09.03.2016 (33) DE  
102016104854 16.03.2016 DE  
102016106660 12.04.2016 DE

(54) HOT-DIP GALVANIZATION SYSTEM AND HOT-DIP GALVANIZATION METHOD  
(72) PINGER, Thomas, Zum Imberg 24, 45721 Haltern am See, DE  
BAUMGÜRTEL, Lars, Hövel 2, 48301 Nottuln, DE

---

(51) MKP  
**A61K 31/506 2006 (97) EP 3405196**  
**A61K 31/5377 2006**  
**A61K 31/55 2006**  
**A61P 3/00 2006**  
**A61P 29/00 2006**  
**A61P 35/00 2006**  
**A61P 37/00 2006**  
**C07D 401/14 2006**  
**C07D 403/14 2006**  
**C07D 405/14 2006**  
**C07D 413/14 2006**  
**C07D 471/10 2006**  
**C07D 487/04 2006**  
**C07D 487/10 2006**

(96) EP 17701110.3 1/20/2017  
(97) EP 3405196, 11/28/2018 201848, en  
(31) 16152416 (32) 22.01.2016 (33) EP  
16159651 10.03.2016 EP

(54) NEW SUBSTITUTED CYANOINDOLINE DERIVATIVES AS NIK INHIBITORS  
(72) STANSFIELD, Ian, c/o Janssen-Cilag 1 rue Camille Desmoulins TSA 91003, 92787 Issy-les Moulineaux Cedex 9, FR  
QUEROLLE, Olivier Alexis Georges, c/o Janssen-Cilag 1 rue Camille Desmoulins TSA 91003, 92787 Issy-les Moulineaux Cedex 9, FR  
PONCELET, Virginie Sophie, c/o Janssen-Cilag 1 rue Camille Desmoulins TSA 91003, 92787 Issy-les Moulineaux Cedex 9, FR  
GROSS, Gerhard Max, c/o Janssen Pharmaceutica NV Turnhoutseweg 30, 2340 Beerse, BE  
JACOBY, Edgar, c/o Janssen Pharmaceutica NV Turnhoutseweg 30, 2340 Beerse, BE  
MEERPOEL, Lieven, c/o Janssen Pharmaceutica NV Turnhoutseweg 30, 2340 Beerse, BE  
KULAGOWSKI, Janusz Jozef, c/o Argenta Discovery 2009 Limited 8/9 Spire Green Centre Flex Meadow, Harlow Essex CM19 5TR, GB  
MACLEOD, Calum, c/o Argenta Discovery 2009 Limited 8/9 Spire Green Centre Flex Meadow, Harlow Essex CM19 5TR, GB  
MANN, Samuel Edward, c/o Argenta Discovery 2009 Limited 8/9 Spire Green Centre Flex Meadow, Harlow Essex CM19 5TR, GB  
GREEN, Simon Richard, c/o Argenta Discovery 2009 Limited 8/9 Spire Green Centre Flex Meadow, Harlow Essex CM19 5TR, GB  
HYND, George, c/o Argenta Discovery 2009 Limited 8/9 Spire Green Centre Flex Meadow, Harlow Essex CM19 5TR, GB

---

(51) MKP  
**A61K 31/506 2006 (97) EP 3405464**  
**A61K 31/5377 2006**  
**A61K 31/553 2006**  
**A61P 3/00 2006**  
**A61P 29/00 2006**

**A61P 35/00 2006**  
**A61P 37/00 2006**  
**C07D 401/14 2006**  
**C07D 403/04 2006**  
**C07D 403/14 2006**  
**C07D 405/14 2006**  
**C07D 413/14 2006**

(96) EP 17701111.1 1/20/2017  
(97) EP 3405464, 11/28/2018 201848, en

(31)	16152415	(32)	22.01.2016	(33)	EP
	16152414		22.01.2016		EP
	16159658		10.03.2016		EP
	16159659		10.03.2016		EP

(54) NEW 6-MEMBERED HETEROAROMATIC SUBSTITUTED CYANOINDOLINE DERIVATIVES AS NIK INHIBITORS  
(72) STANSFIELD, Ian, c/o Janssen-Cilag 1 rue Camille Desmoulins TSA 91003, 92787 Issy-les Moulineaux Cedex 9, FR  
QUEROLLE, Olivier Alexis Georges, c/o Janssen-Cilag 1 rue Camille Desmoulins TSA 91003, 92787 Issy-les Moulineaux Cedex 9, FR  
GROSS, Gerhard Max, c/o Janssen Pharmaceutica NV Turnhoutseweg 30, 2340 Beerse, BE  
JACOBY, Edgar, c/o Janssen Pharmaceutica NV Turnhoutseweg 30, 2340 Beerse, BE  
MEERPOEL, Lieven, c/o Janssen Pharmaceutica NV Turnhoutseweg 30, 2340 Beerse, BE  
KULAGOWSKI, Janusz Jozef, c/o Argenta Discovery 2009 Limited 8/9 Spire Green Centre Flex Meadow, Harlow Essex CM19 5TR, GB  
MACLEOD, Calum, c/o Argenta Discovery 2009 Limited 8/9 Spire Green Centre Flex Meadow, Harlow Essex CM19 5TR, GB  
MANN, Samuel Edward, c/o Argenta Discovery 2009 Limited 8/9 Spire Green Centre Flex Meadow, Harlow Essex CM19 5TR, GB  
GREEN, Simon Richard, c/o Argenta Discovery 2009 Limited 8/9 Spire Green Centre Flex Meadow, Harlow Essex CM19 5TR, GB  
HYND, George, c/o Argenta Discovery 2009 Limited 8/9 Spire Green Centre Flex Meadow, Harlow Essex CM19 5TR, GB

---

(51) MKP  
**A61K 38/00 2006 (97) EP 3405481**  
**A61K 48/00 2006**  
**C07K 14/47 2006**  
**C07K 16/28 2006**  
**C07K 16/30 2006**

(96) EP 17701190.5 1/10/2017  
(97) EP 3405481, 11/28/2018 201848, en

(31)	201662281533 P	(32)	21.01.2016	(33)	US
	201662431758 P		08.12.2016		US

(54) CHIMERIC ANTIGEN RECEPTORS TARGETING EPIDERMAL GROWTH FACTOR RECEPTOR VARIANT III  
(72) WONG, Oi Kwan, 15 Arroyo View Circle, Belmont, CA 94002, US  
CHOU, Joyce Ching, 767 Silkoak Way, Sunnyvale, CA 94086, US  
DUSSEAUX, Mathilde Brunnhilde, 19 Domaine de Chateau Gaillard, 94700 Maisons-Alfort, FR  
SMITH, Julianne, 1675 York Avenue, New York, NY 10128, US

---

(51) MKP  
**A61K 31/506 2006 (97) EP 3400221**  
**A61P 35/00 2006**  
**C07D 401/14 2006**  
**C07D 403/14 2006**

(96) EP 17701205.1 1/4/2017  
(97) EP 3400221, 11/14/2018 201846, en

(31)	201662274942 P	(32)	05.01.2016	(33)	US
------	----------------	------	------------	------	----

(54) PYRIDINE AND PYRIDIMINE COMPOUNDS AS PI3K-GAMMA INHIBITORS  
(72) SPARKS, Richard B., Incyte Corporation 1801 Augustine Cut-Off, Wilmington, Delaware 19803, US  
SHEPARD, Stacey, Incyte Corporation 1801 Augustine Cut-Off, Wilmington, Delaware 19803, US  
COMBS, Andrew P., Incyte Corporation 1801 Augustine Cut-Off, Wilmington, Delaware 19803, US  
BUESKING, Andrew W., Incyte Corporation 1801 Augustine Cut-Off, Wilmington, Delaware 19803, US  
SHAO, Lixin, Incyte Corporation 1801 Augustine Cut-Off, Wilmington, Delaware 19803, US  
WANG, Haisheng, Incyte Corporation 1801 Augustine Cut-Off, Wilmington, Delaware 19803, US  
FALAHATPISHEH, Nikoo, Incyte Corporation 1801 Augustine Cut-Off, Wilmington, Delaware 19803, US

---

(51) MKP  
**A61K 31/403 2006 (97) EP 3400212**  
**A61P 25/00 2006**  
**C07D 209/56 2006**

(96) EP 17701225.9 1/6/2017  
(97) EP 3400212, 11/14/2018 201846, en

(31) 201662275444 P (32) 06.01.2016 (33) US  
(54) TETRAHYDROCARBAZOLE INHIBITORS OF SIRT1 RECEPTORS  
(72) ZHANG, Chengzhi, 1090 Horsham Road, North Wales, PA 19454, US  
LAUFER, Ralph, 1090 Horsham Road, North Wales, PA 19454, US

---

(51) MKP  
**A61K 38/20 2006 (97) EP 3402819**  
**C07K 16/24 2006**  
(96) EP 17701362.0 1/11/2017  
(97) EP 3402819, 11/21/2018 201847, en  
(31) 201662277113 P (32) 11.01.2016 (33) US  
(54) IMMUNE-STIMULATING HUMANIZED MONOCLONAL ANTIBODIES AGAINST HUMAN INTERLEUKIN-2, AND FUSION PROTEINS THEREOF  
(72) ARENAS-RAMIREZ, Natalia, Hopfenstrasse 19, 8045 Zürich, CH  
BEUVINK, Iwan, Novartis Pharma AG Postfach Novartis Institutes for Biomed Research, 4002 Basel, CH  
BOYMAN, Onur, Boglerenstrasse 44A, 8700 Küsnacht, CH  
BRANNETTI, Barbara, Novartis Pharma AG Postfach Novartis Institutes for Biomed Research, 4002 Basel, CH  
KATOPODIS, Andreas, Novartis Pharma AG Postfach Novartis Institutes for Biomed Research, 4002 Basel, CH  
POPP, Simone, Novartis Pharma AG Postfach Novartis Institutes for Biomed Research, 4002 Basel, CH  
REGNIER, Catherine, Novartis Pharma AG Postfach Novartis Institutes for Biomed Research, 4002 Basel, CH  
ZOU, Chao, Novartis Pharma AG Novartis Institutes for Biomed Research Postfach, 4002 Basel, CH

---

(51) MKP  
**C09K 11/06 2006 (97) EP 3405551**  
**H01L 51/00 2006**  
(96) EP 17701447.9 1/18/2017  
(97) EP 3405551, 11/28/2018 201848, en  
(31) 201601007 (32) 19.01.2016 (33) GB  
(54) NANOPARTICLES FOR USE IN LIGHT EMITTING APPLICATIONS  
(72) MCCAIRN, Mark, Chromition Limited Greenheys Manchester Science Park Pencroft Way, Manchester M15 6JJ, GB  
TURNER, Michael, Chromition Limited Greenheys Manchester Science Park Pencroft Way, Manchester M15 6JJ, GB  
ESQUIVEL GUZMAN, Jair, Chromition Limited Greenheys Manchester Science Park Pencroft Way, Manchester M15 6JJ, GB  
LIDSTER, Benjamin, Chromition Limited Greenheys Manchester Science Park Pencroft Way, Manchester M15 6JJ, GB

---

(51) MKP  
**E02D 27/34 2006 (97) EP 3411532**  
(96) EP 17701461.0 1/23/2017  
(97) EP 3411532, 12/12/2018 201850, en  
(31) UB20160366 (32) 04.02.2016 (33) IT  
(54) FOUNDATION  
(71) Teobaldelli, Ivan, 16 Via Lino Liviabella, 62100 Macerata, IT  
(72) Teobaldelli, Ivan, 16 Via Lino Liviabella, 62100 Macerata, IT

---

(51) MKP  
**C07C 251/72 2006 (97) EP 3411360**  
**C07D 231/14 2006**  
(96) EP 17701485.9 1/25/2017  
(97) EP 3411360, 12/12/2018 201850, en  
(31) 16153833 (32) 02.02.2016 (33) EP  
(54) CATALYTIC HYDROGENATION PROCESS FOR PREPARING PYRAZOLES  
(72) KLAUBER, Eric George, 9800 Kellner Road, Huntsville, AL 35824, US  
RACK, Michael, Carl-Bosch-Strasse 38, 67056 Ludwigshafen, DE  
SOERGEL, Sebastian, Speyerer Straße 2, 67117 Limburgerhof, DE  
GOCKEL, Birgit, Carl-Bosch-Strasse 38, 67056 Ludwigshafen, DE  
GOETZ, Roland, Carl-Bosch-Strasse 38, 67056 Ludwigshafen, DE

---

(51) MKP  
**A61K 9/20 2006 (97) EP 3407874**  
**A61K 31/506 2006**  
(96) EP 17701495.8 1/25/2017  
(97) EP 3407874, 12/5/2018 201849, en

(31) 201600024 (32) 25.01.2016 (33) SI  
(54) FAST DISPERSIBLE PHARMACEUTICAL COMPOSITION COMPRISING TYROSINE-KINASE INHIBITOR  
(72) KORASA, Klemen, Kandijaska cesta 73, 8000 Novo mesto, SI  
KUKEC, Simon, Trzisce 12d, 8295 Trzisce, SI  
KROSELJ, Vesna, Ragovska 15b, Novo mesto 8000, SI  
VRECER, Franc, Potok 5b, 8351 Straza pri Novem mestu, SI  
SKRABANJA, Vida, Zupnca 4b, 8000 Novo mesto, SI  
GERMAN ILIC, Tamara, Nusdorferjeva ulica 15, 1000 Ljubljana, SI

---

(51) MKP  
A61K 31/454 2006 (97) EP 3402503  
A61K 31/4985 2006  
A61K 31/517 2006  
A61K 31/519 2006  
A61K 31/52 2006  
A61K 31/522 2006  
A61K 38/00 2006  
A61K 39/00 2006  
A61K 45/06 2006  
A61P 35/00 2006  
A61P 35/02 2006

(96) EP 17701596.3 1/13/2017

(97) EP 3402503, 11/21/2018 201847, en

(31) 201662278374 P (32) 13.01.2016 (33) US  
201662371626 P 05.08.2016 US

(54) THERAPEUTIC COMBINATIONS OF AN ANTIFOLATE AND A BTK INHIBITOR

(72) KAPTEIN, Allard, Marten van Rossemsingel 51, 5301 HB Zaltbommel, NL  
ROTHBAUM, Wayne, 1171 S. Ocean Boulevard, Delray Beach, Florida 33483, US  
LANNUTTI, Brian, 627 Glencrest Place, Solana Beach, California 92075, US

---

(51) MKP  
F17C 1/16 2006 (97) EP 3397892  
F17C 13/08 2006

(96) EP 17701605.2 1/3/2017

(97) EP 3397892, 11/7/2018 201845, en

(31) 201562273591 P (32) 31.12.2015 (33) US

(54) INTEGRATED COMPOSITE MOUNTING STRUCTURE FOR USE IN PRESSURE VESSELS AND PRESSURE VESSEL SYSTEMS

(71) Cleanng LLC, 10738 East 55th Place, Tulsa, OK 74146, US

(72) VILLARREAL, R., Matt, 7894 East 126th Street South Apt. 1025, Bixby, OK 74008, US

---

(51) MKP  
A61K 31/165 2006 (97) EP 3402474  
A61K 31/19 2006  
A61P 25/02 2006

(96) EP 17701646.6 1/13/2017

(97) EP 3402474, 11/21/2018 201847, en

(31) 16151618 (32) 15.01.2016 (33) EP  
16190871 27.09.2016 EP

(54) IL-8 INHIBITORS FOR USE IN THE TREATMENT OF CHEMOTHERAPY-INDUCED PERIPHERAL NEUROPATHY

(72) BRANDOLINI, Laura, c/o Dompé farmaceutici S.p.A. Via Campo Di Pile s.n.c., I-67100 L'Aquila (AQ), IT  
RUFFINI, Pier Adelchi, c/o Dompé farmaceutici S.p.A. Via Campo Di Pile s.n.c., I-67100 L'Aquila (AQ), IT  
ALLEGRETTI, Marcello, c/o Dompé farmaceutici S.p.A. Via Campo Di Pile s.n.c., I-67100 L'Aquila (AQ), IT

---

(51) MKP  
A61K 31/437 2006 (97) EP 3402790  
A61K 31/4427 2006  
C07D 213/64 2006  
C07D 231/12 2006  
C07D 231/18 2006  
C07D 231/54 2006  
C07D 401/12 2006  
C07D 401/14 2006  
C07D 413/12 2006

**C07D 471/04 2006**  
**C07D 471/12 2006**  
**C07D 513/04 2006**  
 (96) EP 17701785.2 1/13/2017  
 (97) EP 3402790, 11/21/2018 201847, en  
 (31) 201662278122 P (32) 13.01.2016 (33) US  
 (54) SPIROHEPTANE SALICYLAMIDES AND RELATED COMPOUNDS AS INHIBITORS OF ROCK  
 (72) SMITH II, Leon M., c/o Bristol-Myers Squibb Company 311 Pennington-Rocky Hill Road, Pennington New Jersey 08534, US  
 LADZIATA, Vladimir, c/o Bristol-Myers Squibb Company 311 Pennington-Rocky Hill Road, Pennington New Jersey 08534, US  
 DELUCCA, Indawati, 9 Hunters Ridge Drive, Pennington, NJ 08534, US  
 PINTO, Donald, J., P., c/o Bristol-Myers Squibb Company 311 Pennington-Rocky Hill Road, Pennington New Jersey 08534, US  
 ORWAT, Michael J., c/o Bristol-Myers Squibb Company 311 Pennington-Rocky Hill Road, Pennington New Jersey 08534, US  
 DILGER, Andrew K., c/o Bristol-Myers Squibb Company 311 Pennington-Rocky Hill Road, Pennington New Jersey 08534, US  
 PABBISSETTY, Kumar Balashanmuga, c/o Bristol-Myers Squibb Company 311 Pennington-Rocky Hill Road, Pennington New Jersey 08534, US  
 YANG, Wu, c/o Bristol-Myers Squibb Company 311 Pennington-Rocky Hill Road, Pennington New Jersey 08534, US  
 SHAW, Scott A., c/o Bristol-Myers Squibb Company 311 Pennington-Rocky Hill Road, Pennington New Jersey 08534, US  
 GLUNZ, Peter W., c/o Bristol-Myers Squibb Company 311 Pennington-Rocky Hill Road, Pennington New Jersey 08534, US  
 PANDA, Manoranjan, c/o SYNGENE INTERNATIONAL LIMITED Biocon Special Economic Zone Biocon Park Plot No. 2&3 Bommasandra  
 Industrial Area IV Phase Jigani Line Road Bommasandra, Bangalore Karnataka 560 099, IN

---

(51) MKP  
**A61P 35/00 2006 (97) EP 3402822**  
**C07K 16/28 2006**  
 (96) EP 17701812.4 1/13/2017  
 (97) EP 3402822, 11/21/2018 201847, en  
 (31) 201662278283 P (32) 13.01.2016 (33) US  
 PCT/EP2016/066353 08.07.2016 WO  
 (54) AXL-SPECIFIC ANTIBODY-DRUG CONJUGATES FOR CANCER TREATMENT  
 (72) BOSHUIZEN, Julia, Legmeerstraat 83-2, 1058 NC Amsterdam, NL  
 BREIJ, Esther, C/O Genmab B.V. Yalelaan 60, 3584 CM Utrecht, NL  
 KOOPMAN, Louise, C/O Genmab B.V. Yalelaan 60, 3584 CM Utrecht, NL  
 SATIJN, David, C/O Genmab B.V. Yalelaan 60, 3584 CM Utrecht, NL  
 VAN DEN BRINK, Edward, C/O Genmab B.V. Yalelaan 60, 3584 CM Utrecht, NL  
 VERZIJL, Dennis, C/O Genmab B.V. Yalelaan 60, 3584 CM Utrecht, NL  
 DE JONG, Rob, C/O Genmab B.V. Yalelaan 60, 3584 CM Utrecht, NL  
 VAN DIJKHUIZEN RADERSMA, Riemke, C/O Genmab B.V. Yalelaan 60, 3584 CM Utrecht, NL  
 PEEPER, Daniel, Anton de Langelaan 2, 1183 DN Amstelveen, NL  
 PARREN, Paul, C/O Genmab B.V. Yalelaan 60, 3584 CM Utrecht, NL

---

(51) MKP  
**C23C 2/02 2006 (97) EP 3411510**  
**C23C 2/06 2006**  
**C23C 2/14 2006**  
**C23C 2/26 2006**  
**C23C 2/30 2006**  
 (96) EP 17702005.4 1/9/2017  
 (97) EP 3411510, 12/12/2018 201850, de  
 (31) 102016003323 (32) 21.03.2016 (33) DE  
 102016106617 11.04.2016 DE  
 (54) HOT-DIP GALVANIZATION SYSTEM AND HOT-DIP GALVANIZATION METHOD  
 (72) PINGER, Thomas, Zum Imberg 24, 45721 Haltern am See, DE  
 BAUMGÜRTEL, Lars, Hövel 2, 48301 Nottuln, DE

---

(51) MKP  
**A61K 31/41 2006 (97) EP 3411028**  
**A61K 31/4184 2006**  
**A61K 31/437 2006**  
**A61K 31/519 2006**  
**A61K 31/52 2006**  
**A61K 31/53 2006**  
**A61K 31/5377 2006**  
**A61K 31/55 2006**  
**A61K 31/5513 2006**  
**A61K 31/70 2006**

**A61K 31/7056 2006**  
**A61K 39/395 2006**  
**A61P 31/12 2006**  
(96) EP 17702125.0 2/2/2017  
(97) EP 3411028, 12/12/2018 201850, en  
(31) 16154035 (32) 03.02.2016 (33) EP  
(54) COMBINATION PRODUCTS FOR THE TREATMENT OF RSV  
(72) YSEBAERT, Nina, c/o Janssen Pharmaceutica NV Turnhoutseweg 30, 2340 Beerse, BE  
GOEYVAERTS, Nele Isa E., c/o Janssen Pharmaceutica NV Turnhoutseweg 30, 2340 Beerse, BE  
ROYMANS, Dirk André E., c/o Janssen Pharmaceutica NV Turnhoutseweg 30, 2340 Beerse, BE  
KOUL, Anil, c/o Janssen Pharmaceutica NV Turnhoutseweg 30, 2340 Beerse, BE

---

(51) MKP  
**C07K 16/28 2006 (97) EP 3405492**  
(96) EP 17702163.1 1/20/2017  
(97) EP 3405492, 11/28/2018 201848, en  
(31) PCT/CN2016/071599 (32) 21.01.2016 (33) WO  
(54) MULTISPECIFIC MOLECULES TARGETING CLL-1  
(72) EBERSBACH, Hilmar, c/o Novartis Pharma AG Postfach, 4002 Basel, CH  
DALEY, Michael, c/o Novartis Institutes for Biomedical Research Inc. 250 Massachusetts Avenue, Cambridge, Massachusetts 02139, US  
JASCUR, Julia, c/o Novartis Pharma AG Postfach, 4002 Basel, CH  
WU, Qilong, c/o China Novartis Institutes for Biomedical Research Co. Ltd. 4218 Jinke Road Zhang Jiang Hi-Tech Park Pudong New Area, Shanghai 201203, CN  
YANG, Qiumei, c/o China Novartis Institutes for Biomedical Research Co. Ltd. 4218 Jinke Road Zhang Jiang Hi-Tech Park Pudong New Area, Shanghai 201203, CN  
ZHANG, Jiquan, c/o China Novartis Institutes for Biomedical Research Co. Ltd. 4218 Jinke Road Zhang Jiang Hi-Tech Park Pudong New Area, Shanghai 201203, CN

---

(51) MKP  
**A61J 1/20 2006 (97) EP 3411005**  
**A61M 5/24 2006**  
**A61M 5/28 2006**  
**A61M 39/24 2006**  
(96) EP 17702247.2 1/18/2017  
(97) EP 3411005, 12/12/2018 201850, en  
(31) 201662280410 P (32) 19.01.2016 (33) US  
(54) MEDICAL METERING DEVICE  
(72) WU, Haiming, 30 Kendal Common Road, Weston MA 02493, US

---

(51) MKP  
**A61K 39/395 2006 (97) EP 3405493**  
**A61P 35/00 2006**  
**C07K 16/28 2006**  
(96) EP 17702264.7 1/19/2017  
(97) EP 3405493, 11/28/2018 201848, en  
(31) 201662286121 P (32) 22.01.2016 (33) US  
(54) ANTI-ROR1 ANTIBODIES, ROR1 X CD3 BISPECIFIC ANTIBODIES, AND METHODS OF USING THE SAME  
(72) ANDERSON, Glenn Mark, 1400 Welsh and McKean Roads, Spring House Pennsylvania 19477, US  
ATTAR, Ricardo, 1400 Welsh and McKean Roads, Spring House Pennsylvania 19477, US  
BALDWIN, Eric T., 1400 Welsh and McKean Roads, Spring House Pennsylvania 19477, US  
CARDOSO, Rosa M.F., 1400 Welsh and McKean Roads, Spring House Pennsylvania 19477, US  
GAUDET, Francois, 1400 Welsh and McKean Roads, Spring House Pennsylvania 19477, US  
HARMAN, Benjamin, 1400 Welsh and McKean Roads, Spring House Pennsylvania 19477, US  
LI, Yingzhe, 1400 Welsh and McKean Roads, Spring House Pennsylvania 19477, US  
LUO, Jinquan, 1400 Welsh and McKean Roads, Spring House Pennsylvania 19477, US  
MCDAID, Ronan, 1400 Welsh and McKean Roads, Spring House Pennsylvania 19477, US  
NEMETH-SEAY, Jennifer F., 1400 Welsh and McKean Roads, Spring House Pennsylvania 19477, US  
POMERANTZ, Steven C., 1400 Welsh and McKean Roads, Spring House Pennsylvania 19477, US  
TEPLYAKOV, Alexey, 1400 Welsh and McKean Roads, Spring House Pennsylvania 19477, US  
TAM, Susan H., 1400 Welsh and McKean Roads, Spring House Pennsylvania 19477, US  
WU, Sheng-Jiun, 1400 Welsh and McKean Roads, Spring House Pennsylvania 19477, US

---



(51) MKP  
**C07K 14/08 2006 (97) EP 3408280**  
**C12N 7/06 2006**  
(96) EP 17702277.9 1/20/2017  
(97) EP 3408280, 12/5/2018 201849, en  
(31) 201662287488 P (32) 27.01.2016 (33) US  
(54) INACTIVATION OF VIRUSES BY DELIPIDATION  
(72) DIAZ, Leyla, c/o Eli Lilly and Company P.O. Box 6288, Indianapolis IN 46206-6288, US  
WU, Stephen, c/o Eli Lilly and Company P.O. Box 6288, Indianapolis IN 46206-6288, US

---

(51) MKP  
**A61K 9/00 2006 (97) EP 3402465**  
**A61K 9/19 2006**  
**A61K 39/395 2006**  
**A61K 47/18 2017**  
**A61K 47/26 2006**  
**C07K 16/28 2006**  
(96) EP 17702300.9 1/13/2017  
(97) EP 3402465, 11/21/2018 201847, en  
(31) 201662278217 P (32) 13.01.2016 (33) US  
(54) FORMULATION FOR ANTIBODY AND DRUG CONJUGATE THEREOF  
(72) HARLOW, Lene, Schantz, C/O Genmab A/S Bredgade 34 E, 1260 Copenhagen K, DK  
PAUL, Timothy, Warren, 4102 W. Portage Trail, Bloomington IN 47404, US  
MAYHUGH, Brendan, M., 7108 W. Crown Circle, Bloomington IN 47404, US  
ROBY, Kelly, Ann, 4356 W. McHaffey Woods Dr., Bloomington IN 47403, US  
SACHA, Gregory, Allan, 4271 Whitetail Woods Dr., Bargsville IN 46106, US  
JING, Xiaona, Burgstrasse 123, 4125 Riehen, CH  
HAGARMAN, Andrew, 4517 Lazyriver Dr., Durham NC 27712, US  
HALBLEIB, Cale, 208 Kings Castle Dr., Apex NC 27502, US

---

(51) MKP  
**A61P 35/00 2006 (97) EP 3405495**  
**C07K 16/28 2006**  
(96) EP 17702315.7 1/20/2017  
(97) EP 3405495, 11/28/2018 201848, en  
(31) 201662281217 P (32) 21.01.2016 (33) US  
(54) NEUTRALIZATION OF INHIBITORY PATHWAYS IN LYMPHOCYTES  
(72) ANDRE, Pascale, 38 rue de la Loubière, 13006 Marseille, FR  
BLERY, Mathieu, 50 Bd du Vaisseau Les Hauts de Mazargues Bt D4, 13009 Marseille, FR  
DENIS, Caroline, 10 Rue André Audoli, 13010 Marseille, FR  
PATUREL, Carine, 411 allée du bois, 69280 Marcy l'Etoile, FR  
WAGTMANN, Nicolai, 16 Avenue Joseph Liautaud, 13260 Cassis, FR

---

(51) MKP  
**C10L 1/00 2006 (97) EP 3402862**  
**C10L 1/30 2006**  
**C10M 171/00 2006**  
(96) EP 17702428.8 1/12/2017  
(97) EP 3402862, 11/21/2018 201847, fr  
(31) 1650208 (32) 12.01.2016 (33) FR  
(54) USE OF RARE EARTH COMPLEXES AS MARKERS OF PETROLEUM PRODUCTS, CRUDE OILS, BIOFUELS OR LUBRICANTS  
(71) Inoventeam, 5 rue Saint Louis en L'île, 75004 Paris, FR  
Université Claude Bernard Lyon 1, 43 Boulevard du 11 Novembre 1918, 69922 Villeurbanne, FR  
Centre National de la Recherche Scientifique (CNRS), 3, rue Michel Ange, 75016 Paris, FR  
(72) MARAIS, Arthur, 9 rue Léon Blum, 56650 Lochrist, FR  
OULD-METIDJI, Mahmoud, 92 rue le chatelier, 13015 Marseille, FR  
LEPOIVRE, Florian, 6 rue Flandres-Dunkerque 1940, 53000 Laval, FR  
COLLET, Anatole, 11 route d'Ancône, 26200 Montelimar, FR  
MARTINI, Matteo, 36 rue de la Mantoliere, 01330 Villars Les Dombes, FR  
ROSSETTI, Fabien, 33 rue de la Filature, 69100 Villeurbanne, FR  
TILLEMENT, Olivier, 305 rue des Fours, 69270 Fontaines Saint-Martin, FR  
VANLAER, Antoine, 5 rue Saint-Louis en l'île, 75004 PARIS, FR  
GHILLEBAERT, François, 11 rue Principale, 62380 Affringues, FR

---

(51) MKP  
**A61K 31/575 2006 (97) EP 3405474**  
**A61P 31/18 2006**  
**C07J 63/00 2006**

(96) EP 17702433.8 1/19/2017  
(97) EP 3405474, 11/28/2018 201848, en

(31) 201662280809 P (32) 20.01.2016 (33) US

(54) AMINE DERIVATIVES OF LUPANES WITH HIV MATURATION INHIBITORY ACTIVITY  
(72) JOHNS, Brian Alvin, Five Moore Drive Research Triangle Park, North Carolina 27709, US

---

(51) MKP  
**A61K 39/00 2006 (97) EP 3405489**  
**C07K 16/00 2006**  
**C07K 16/18 2006**  
**G01N 33/15 2006**

(96) EP 17702743.0 1/20/2017  
(97) EP 3405489, 11/28/2018 201848, en

(31) 201662281140 P (32) 20.01.2016 (33) US  
201662350105 P 14.06.2016 US  
201662430852 P 06.12.2016 US

(54) HIGH DOSE TREATMENTS FOR ALZHEIMER'S DISEASE  
(72) SMITH, Jillian, Hexagon Place 6 Falcon Way Shire Park, Welwyn Garden City Hertfordshire AL7 1TW, GB  
SMITH, Janice, Hexagon Place 6 Falcon Way Shire Park, Welwyn Garden City Hertfordshire AL7 1TW, GB  
KERCHNER, Geoff, c/o Genentech Inc. 1 DNA Way, South San Francisco California 94080, US

---

(51) MKP  
**A21D 13/00 2017 (97) EP 3407725**  
**A21D 13/14 2017**  
**A21D 13/32 2017**  
**A23G 3/54 2006**

(96) EP 17702768.7 1/27/2017  
(97) EP 3407725, 12/5/2018 201849, de

(31) 16000222 (32) 29.01.2016 (33) EP  
202016000606 U 29.01.2016 DE

(54) BAKED PRODUCT WITH A LONG SHELF LIFE AND METHOD FOR PRODUCING SAME  
(71) Bahlsen GmbH & Co. KG, Podbielskistrasse 11, 30163 Hannover, DE  
(72) HABEL, Martin, Künnekestrasse 15, 33647 Bielefeld, DE  
PIETSCH, Christine, Werlhofstrasse 17, 30853 Langenhagen, DE

---

(51) MKP  
**A61K 39/395 2006 (97) EP 3408295**  
**A61K 47/00 2006**  
**C07K 16/28 2006**

(96) EP 17702801.6 1/25/2017  
(97) EP 3408295, 12/5/2018 201849, en

(31) 201662286552 P (32) 25.01.2016 (33) US

(54) PHARMACEUTICAL COMPOSITION COMPRISING BISPECIFIC ANTIBODY CONSTRUCTS  
(72) KANAPURAM, Sekhar, 5676 Via Bonita, Thousand Oaks, California 91320, US  
LATYPOV, Ramil, 55 Park Avenue, Wellesley, Massachusetts 02481, US  
THANGARAJ, Balakumar, 4 Milk Street, Lexington, Massachusetts 02421, US  
POMPE, Cornelius, c/o Amgen Research (Munich) GmbH Staffelseestrasse 2, 81477 Munich, DE

---

(51) MKP  
**A63F 1/12 2006 (97) EP 3407990**  
**A63F 1/18 2006**  
**G07F 17/32 2006**

(96) EP 17702806.5 1/25/2017  
(97) EP 3407990, 12/5/2018 201849, en

(31) 1650098 (32) 27.01.2016 (33) SE

(54) METHOD AND SYSTEM FOR CARD SHUFFLE INTEGRITY TRACKING

(72) KRASTIN , Janis, Liepu aleja 5, 5052 IKskile, LV  
JOHANNISONE-MELKVISTA, Tania, Torregiani Towers Block B P/H 17 Qui-Si-Sana, Sliema SLM 3112, MT  
LIPOVSKA, Sne ana, Gunara Astras 8/1 apt. 69, 1082 Riga, LV

---

(51) MKP  
**A61K 39/12 2006 (97) EP 3407910**  
**C07K 14/005 2006**  
**C12N 15/86 2006**

(96) EP 17702827.1 1/27/2017

(97) EP 3407910, 12/5/2018 201849, en

(31) 16153394 (32) 29.01.2016 (33) EP  
16157055 24.02.2016 EP  
16185012 19.08.2016 EP

(54) RECOMBINANT MODIFIED VACCINIA VIRUS ANKARA (MVA) EQUINE ENCEPHALITIS VIRUS VACCINE

(72) STEIGERWALD, Robin, Klenzstrasse 97, 80469 Munich, DE  
KALLA, Markus, Wöfl 6c, 82377 Penzberg, DE

---

(51) MKP  
**A61K 39/00 2006 (97) EP 3411394**  
**C07K 14/705 2006**  
**C07K 16/32 2006**

(96) EP 17702860.2 2/1/2017

(97) EP 3411394, 12/12/2018 201850, en

(31) 16153966 (32) 02.02.2016 (33) EP

(54) ENGINEERED ANTIGEN PRESENTING CELLS AND USES THEREOF

(72) DE PALMA, Michele, Rue du Petit St-Jean 5, 1003 Lausanne, CH  
SQUADRITO, Mario Leonardo, Via dei Boderi 26, 21100 Varese (VA), IT

---

(51) MKP  
**B05B 11/00 2006 (97) EP 3416747**  
**B65D 83/20 2006**  
**B65D 83/22 2006**  
**B65D 83/30 2006**

(96) EP 17702895.8 2/8/2017

(97) EP 3416747, 12/26/2018 201852, en

(31) 16155950 (32) 16.02.2016 (33) EP

(54) DISPENSER WITH ARTICULATED DISPENSING TUBE

(72) MASCIAMBRUNI, Roberto, Via Malagrida 38, 65124 Pescara, IT

---

(51) MKP  
**A61K 31/56 2006 (97) EP 3353190**  
**A61K 31/58 2006**  
**A61K 31/585 2006**  
**A61P 29/00 2006**  
**C07J 63/00 2006**  
**C07J 71/00 2006**

(96) EP 16781915.0 9/23/2016

(97) EP 3353190, 8/1/2018 201831, en

(31) 201562222632 P (32) 23.09.2015 (33) US

(54) C4-MODIFIED OLEANOLIC ACID DERIVATIVES FOR INHIBITION OF IL-17 AND OTHER USES

(72) VISNICK, Melean, c/o 2801 Gateway Drive Suite 150, Irving, TX 75063-2648, US  
JIANG, Xin, c/o 2801 Gateway Drive Suite 150, Irving, TX 75063-2648, US  
HOTEMA, Martha, R., c/o 2801 Gateway Drive Suite 150, Irving, TX 75063-2648, US  
LEE, Chitase, c/o 3985 Research Park Drive, Ann Arbor, MI 48108, US  
CAPRATHE, Bradley, William, c/o 3985 Research Park Drive, Ann Arbor, MI 48108, US  
ROARK, William, H., c/o 3985 Research Park Drive, Ann Arbor, MI 48108, US  
BOLTON, Gary, c/o 3985 Research Park Drive, Ann Arbor, MI 48108, US

---

(51) MKP  
**A61K 31/445 2006 (97) EP 3356360**  
**A61P 29/00 2006**

**C07D 417/12 2006**  
**C07D 417/14 2006**  
(96) EP 16781926.7 9/27/2016  
(97) EP 3356360, 8/8/2018 201832, en  
(31) 201562233863 P (32) 28.09.2015 (33) US  
201662298817 P 23.02.2016 US  
PCT/CN2016/096659 25.08.2016 WO  
(54) THERAPEUTIC COMPOUNDS AND METHODS OF USE THEREOF  
(72) BERGERON, Phillipe, 1 DNA Way, South San Francisco, California 94080-4990, US  
BURFORD, Kristen, 200-3650 Gilmore Way, Burnaby, British Columbia V5G 4W8, CA  
CHOWDHURY, Sultan, 200-3650 Gilmore Way, Burnaby, British Columbia V5G 4W8, CA  
DEHNHARDT, Christoph Martin, 200-3650 Gilmore Way, Burnaby, British Columbia V5G 4W8, CA  
FOCKEN, Thilo, 200-3650 Gilmore Way, Burnaby, British Columbia V5G 4W8, CA  
GRIMWOOD, Michael Edward, 200-3650 Gilmore Way, Burnaby, British Columbia V5G 4W8, CA  
HASAN, Abid, 200-3650 Gilmore Way, Burnaby, British Columbia V5G 4W8, CA  
LAI, Kwong Wah, 288 Fute Zhong Road WaiGaoQiao Free Trade Zone, Shanghai 200131, CN  
LIU, Zhiguo, 288 Fute Zhong Road WaiGaoQiao Free Trade Zone, Shanghai 200131, CN  
MCKERRALL, Steven, 1 DNA Way, South San Francisco, California 94080-4990, US  
NGUYEN, Teresa Phuongtram, 1 DNA Way, South San Francisco, California 94080-4990, US  
SAFINA, Brian, 1 DNA Way, South San Francisco, California 94080-4990, US  
SUTHERLIN, Daniel, 1 DNA Way, South San Francisco, California 94080-4990, US  
WANG, Tao, 288 Fute Zhong Road WaiGaoQiao Free Trade Zone, Shanghai 200131, CN

---

(51) MKP  
**A61K 31/437 2006 (97) EP 3355922**  
**A61K 31/495 2006**  
**A61K 31/519 2006**  
**A61K 31/551 2006**  
**A61K 45/00 2006**  
**A61K 45/06 2006**  
**A61P 35/00 2006**  
(96) EP 16781957.2 9/30/2016  
(97) EP 3355922, 8/8/2018 201832, en  
(31) 201562236280 P (32) 02.10.2015 (33) US  
(54) COMBINATION THERAPY OF BROMODOMAIN INHIBITORS AND CHECKPOINT BLOCKADE  
(71) Dana Farber Cancer Institute, Inc., 450 Brookline Avenue, Boston, Massachusetts 02215, US  
Peter MacCallum Cancer Institute, Smorgon Family Building St Andrews Place, East Melbourne VIC 3002, AU  
(72) BRADNER, James, E., 6 Buckskin Drive, Weston, MA 02493, US  
HOGG, Simon, John, 208 Drummond Street, Carlton 3053, AU  
JOHNSTON, Ricky, Wayne, 6 Ross Street, Alphington 3070, AU  
SHORTT, Jake, 1 Little Newmarket Street, Northcote 3070, AU

---

(51) MKP  
**C07K 14/47 2006 (97) EP 3359565**  
**C07K 16/18 2006**  
**G01N 33/53 2006**  
(96) EP 16782018.2 10/4/2016  
(97) EP 3359565, 8/15/2018 201833, en  
(31) 201517913 (32) 09.10.2015 (33) GB  
201562239438 P 09.10.2015 US  
15189753 14.10.2015 EP  
(54) ANTI-WT1/HLA-SPECIFIC ANTIBODIES  
(72) KRAUS, Alexandra, Burg-Eltz-Weg 5, 81375 München, DE  
HARTLEPP, Felix, Bäckerstrasse 3, 81241 München, DE  
MAHR, Andrea, Kirschenweg 22, 72076 Tübingen, DE  
WEINSCHENK, Toni, Im Morgenrain 15, 73773 Aichwald, DE  
WAGNER, Claudia, Nürtinger Strasse 32, 72074 Tübingen, DE  
MAURER, Dominik, Fleinerweg 7, 72116 Mössingen, DE

---

(51) MKP  
**H04M 11/00 2006 (97) EP 3350981**  
**H04M 19/00 2006**  
(96) EP 16782088.5 9/14/2016  
(97) EP 3350981, 7/25/2018 201830, en

(31) 20150100401 (32) 15.09.2015 (33) GR  
(54) LOW POWER MODEM AND CONTROLLER  
(71) TBSP Engineering Technical Company Societe Anonyme For Trading, Construction, Support of Systems and Projects of High Technology and Safety and, Services Provider 1st Km Koropious-Varis Avenue, 19400 Koropi Attikis, GR  
(72) TSIgiROGLOU, Kiriakos, 10 Agamemnonos Str., GR 16673 Voula Attikis, GR

---

(51) MKP  
**A61K 31/522 2006 (97) EP 3355933**  
**A61K 47/54 2017**  
**A61K 47/69 2017**  
**A61P 35/00 2006**  
**C07D 473/34 2006**

(96) EP 16782095.0 9/28/2016  
(97) EP 3355933, 8/8/2018 201832, en

(31) 201562234481 P (32) 29.09.2015 (33) US  
(54) ADENINE CONJUGATE COMPOUNDS AND THEIR USE AS VACCINE ADJUVANTS  
(71) AstraZeneca Aktiebolag, 15185 Södertälje, SE  
(72) BAN, Hitoshi, c/o Sumitomo Dainippon Pharma Co. Ltd. 1-98 Kasugadenaka 3-chome Konohana-ku, Osaka-shi Osaka 554-0022, JP  
NISHIO, Yukihiro, 9-1-820 Inari 1-chome, Fujisawa-shi Kanagawa 251-0862, JP  
MALYALA, Padma, c/o MedImmune LLC One MedImmune Way, Gaithersburg, Maryland 20878, US  
MURALIDHARA, Bilikallahalli K., c/o MedImmune LLC One MedImmune Way, Gaithersburg, Maryland 20878, US  
WONG, Marcus, c/o MedImmune LLC One MedImmune Way, Gaithersburg, Maryland 20878, US

---

(51) MKP  
**A61K 38/18 2006 (97) EP 3353546**  
**G01N 33/50 2006**  
**G01N 33/68 2006**

(96) EP 16782123.0 9/23/2016  
(97) EP 3353546, 8/1/2018 201831, en

(31) 201562233148 P (32) 25.09.2015 (33) US  
(54) METHODS FOR TREATING CARDIAC INJURY  
(71) Sawyer, Douglas, B., 81 Research Drive, Scarborough, ME 04074, US  
(72) Sawyer, Douglas, B., 81 Research Drive, Scarborough, ME 04074, US

---

(51) MKP  
**A61K 38/12 2006 (97) EP 3356386**  
**A61P 3/04 2006**  
**C07K 7/54 2006**

(96) EP 16782150.3 9/29/2016  
(97) EP 3356386, 8/8/2018 201832, en

(31) 201562235003 P (32) 30.09.2015 (33) US  
(54) METHOD OF TREATING MELANOCORTIN-4 RECEPTOR PATHWAY-ASSOCIATED DISORDERS  
(72) SHARMA, Shubh, 6 Petty Rd, Cranbury, NJ 08512, US  
VAN DER PLOEG, Leonardus H.T., 101 Hammond Street, Newton, MA 02467, US  
HENDERSON, Bart, 48 Prentiss Lane, Belmont, MA 02478, US

---

(51) MKP  
**A61K 8/19 2006 (97) EP 3355855**  
**A61K 8/73 2006**  
**A61K 9/16 2006**  
**A61Q 19/00 2006**

(96) EP 16782339.2 9/29/2016  
(97) EP 3355855, 8/8/2018 201832, en

(31) 201562234209 P (32) 29.09.2015 (33) US  
(54) COMPOSITION FOR DUST PARTICLE REDUCTION  
(72) BONNER, Patricia, 199 Grandview Road, Skillman, New Jersey 08558, US  
HERNANDEZ, Amanda, 755 Estates Boulevard Apt. 279, Mercerville, New Jersey 08619, US  
MAITRA, Prithwiraj, 199 Grandview Road, Skillman, New Jersey 08558, US  
PATEL, Jiger J., 199 Grandview Road, Skillman, New Jersey 08558, US  
PATEL, Meenskahi Lalit, 290 Echelon Road Apt. 8, Voorhees, New Jersey 08043, US

---

(51) MKP

**A61K 38/12 2006 (97) EP 3355905**  
**A61P 3/04 2006**  
(96) EP 16782343.4 9/29/2016  
(97) EP 3355905, 8/8/2018 201832, en  
(31) 201562235003 P (32) 30.09.2015 (33) US  
(54) METHOD OF TREATING MELANOCORTIN-4 RECEPTOR PATHWAY-ASSOCIATED DISORDERS  
(71) Rhythm Pharmaceuticals, Inc., 500 Boylston Street 11th Floor, Boston, MA 02116, US  
Charité - Universitätsmedizin Berlin, Charitéplatz 1, 10117 Berlin, DE  
(72) VAN DER PLOEG, Leonardus, H.T., 101 Hammond Street, Newton, MA 02457, US  
HENDERSON, Bart, 48 Prentiss Lane, Belmont, MA 02478, US  
KUHNE, Peter, Schoenfließer Strasse 3b, 13465 Berlin, DE

---

(51) MKP  
**A61K 38/18 2006 (97) EP 3355908**  
**A61P 1/16 2006**  
(96) EP 16782352.5 9/30/2016  
(97) EP 3355908, 8/8/2018 201832, en  
(31) 201562236050 P (32) 01.10.2015 (33) US  
(54) TREATMENT OF BILE ACID DISORDERS  
(72) XU, Jing, 982 Javelin Ct, Thousand Oaks, California 91320, US  
STANISLAUS, Shanaka, 4196 Minnetocota Drive, Thousand Oaks, California 91360, US  
CHEN, Mei-Hsiu M., 5526 Cedarhaven Drive, Agoura Hills, California 91301, US  
HALE, Clarence H., 4787 Aqua Verde Court, Camarillo, California 93012, US  
VENIANT-ELLISON, Murielle, 645 Camino Manzanitas, Thousand Oaks, California 91360, US

---

(51) MKP  
**A61K 31/337 2006 (97) EP 3359196**  
**A61K 31/52 2006**  
**A61K 31/704 2006**  
**A61K 45/06 2006**  
**A61P 35/00 2006**  
(96) EP 16782374.9 10/5/2016  
(97) EP 3359196, 8/15/2018 201833, en  
(31) 201562237470 P (32) 05.10.2015 (33) US  
(54) RATIONAL COMBINATION THERAPY FOR THE TREATMENT OF CANCER  
(72) CHIOSIS, Gabriela, c/o Memorial Sloan Kettering Cancer Center 1275 York Avenue, New York, New York 10065, US  
TALDONE, Tony, c/o Memorial Sloan Kettering Cancer Center 1275 York Avenue, New York, New York 10065, US  
SHRESTHA, Liza, c/o Memorial Sloan Kettering Cancer Center 1275 York Avenue, New York, New York 10065, US  
KOREN, John, c/o Memorial Sloan Kettering Cancer Center 1275 York Avenue, New York, New York 10065, US  
GOMES-DAGAMA, Erica M., c/o Memorial Sloan Kettering Cancer Center 1275 York Avenue, New York, New York 10065, US  
RODINA, Anna, c/o Memorial Sloan Kettering Cancer Center 1275 York Avenue, New York, New York 10065, US

---

(51) MKP  
**A61K 31/4709 2006 (97) EP 3359536**  
**A61P 11/00 2006**  
**C07D 401/04 2006**  
**C07D 405/04 2006**  
**C07D 405/14 2006**  
**C07D 409/04 2006**  
**C07D 409/14 2006**  
**C07D 413/04 2006**  
**C07D 413/14 2006**  
**C07D 417/04 2006**  
**C07D 471/04 2006**  
**C07D 487/04 2006**  
**C07D 493/08 2006**  
(96) EP 16782380.6 10/6/2016  
(97) EP 3359536, 8/15/2018 201833, en  
(31) 201562237887 P (32) 06.10.2015 (33) US  
201662277600 P 12.01.2016 US  
201662319433 P 07.04.2016 US  
(54) COMPOUNDS, COMPOSITIONS, AND METHODS FOR MODULATING CFTR

(72) MUNOZ, Benito, 377 Lowell Avenue, Newtonville, MA 02460, US  
BASTOS, Cecilia, M., 1 Bigelow Way, South Grafton, MA 01560, US  
PARKS, Daniel, 11A Orion Road, Pepperell, MA 01463, US  
KOMBO, David, 7 Cutler Farm Road, Lexington, MA 02421, US

---

(51) MKP  
**A61K 9/00 2006 (97) EP 3355887**  
**A61K 31/473 2006**  
**A61K 47/12 2006**  
**A61K 47/20 2006**  
**A61P 15/00 2006**  
**A61P 15/10 2006**  
**A61P 25/00 2006**  
**A61P 25/16 2006**  
**A61P 25/18 2006**  
**A61P 25/28 2006**

(96) EP 16784139.4 9/28/2016  
(97) EP 3355887, 8/8/2018 201832, en  
(31) 15187194 (32) 28.09.2015 (33) EP  
(54) AQUEOUS COMPOSITION OF APOMORPHINE FOR SUBCUTANEOUS ADMINISTRATION  
(71) EVER Neuro Pharma GmbH, Oberburgau 3, 4866 Unterach am Attersee, AT  
(72) SCHNAIT, Heinz, Pfarrer-Schuster-Platz 1, 4863 Seewalchen, AT  
TÖLGYESI, Zoltán, Untergaisberg 21/2, 5310 Mondsee, AT  
SCHMIDT, Sabine, Mauracherstrasse 3, 5020 Salzburg, AT  
HARTWIG, Kerstin, Kreuzbichlstraße 19/9, 5330 Fuschl am See, AT  
MEIER, Dieter Horst, Brandlbergstr. 33, 5310 Mondsee, AT  
SELIGER, Christian, Heimgartenstrasse 2, 82407 Wielenbach, DE

---

(51) MKP  
**H05F 3/02 2006 (97) EP 3354117**

(96) EP 16784301.0 9/23/2016  
(97) EP 3354117, 8/1/2018 201831, en  
(31) 201562233343 P (32) 26.09.2015 (33) US  
(54) STATIC ELIMINATOR  
(71) Alpha Innovation Inc., 86 Pleasant Street, Marblehead, MA 01945, US  
(72) LARKIN, William, J., Sr., 86 Pleasant Street, Marblehead, MA 01945, US  
LARKIN, William, J., Jr., 86 Pleasant Street, Marblehead, MA 01945, US

---

(51) MKP  
**A61K 39/39 2006 (97) EP 3365010**

(96) EP 16784487.7 10/20/2016  
(97) EP 3365010, 8/29/2018 201835, en  
(31) PCT/EP2015/074386 (32) 21.10.2015 (33) WO  
(54) CYTOTOXIC IMMUNOSTIMULATING PARTICLES AND USES THEREOF  
(72) PASCOLO, Steve, Kanzleistraße 231, 8004 Zürich, CH

---

(51) MKP  
**A61K 47/64 2017 (97) EP 3365024**  
**A61P 37/00 2006**  
**A61P 37/04 2006**

(96) EP 16784491.9 10/20/2016  
(97) EP 3365024, 8/29/2018 201835, en  
(31) PCT/EP2015/074389 (32) 21.10.2015 (33) WO  
(54) METHODS AND MEANS FOR INDUCING AN IMMUNE RESPONSE  
(72) PASCOLO, Steve, Kanzleistraße 231, 8004 Zürich, CH

---

(51) MKP  
**A61K 31/41 2006 (97) EP 3371167**  
**A61K 31/4196 2006**  
**A61K 31/445 2006**  
**C07D 401/04 2006**

**C07D 401/06 2006**  
**C07D 401/10 2006**  
**C07D 401/12 2006**  
**C07D 401/14 2006**  
(96) EP 16784575.9 10/6/2016  
(97) EP 3371167, 9/12/2018 201837, en  
(31) 201562237659 P (32) 06.10.2015 (33) US  
(54) ARYL CYCLOHEXYL PYRAZOLES AS NRF2 REGULATORS  
(72) CALLAHAN, James Francis, 709 Swedeland Road, King of Prussia, Pennsylvania 19406, US  
KERNS, Jeffrey K., 709 Swedeland Road, King of Prussia, Pennsylvania 19406, US  
LI, Tindy, 709 Swedeland Road, King of Prussia, Pennsylvania 19406, US  
MCCLELAND, Brent W., 709 Swedeland Road, King of Prussia, Pennsylvania 19406, US  
NIE, Hong, 709 Swedeland Road, King of Prussia, Pennsylvania 19406, US  
PERO, Joseph E., 709 Swedeland Road, King of Prussia, Pennsylvania 19406, US  
DAVIES, Thomas Glanmor, 436 Cambridge Science Park Milton Road, Cambridge Cambridgeshire, GB  
HEIGHTMAN, Thomas Daniel, 436 Cambridge Science Park Milton Road, Cambridge Cambridgeshire, GB  
GRIFFITHS-JONES, Charlotte Mary, 436 Cambridge Science Park Milton Road, Cambridge Cambridgeshire, GB  
HOWARD, Steven, 436 Cambridge Science Park Milton Road, Cambridge Cambridgeshire, GB  
NORTON, David, 436 Cambridge Science Park Milton Road, Cambridge Cambridgeshire, GB  
VERDONK, Marinus Leendert, 436 Cambridge Science Park Milton Road, Cambridge Cambridgeshire, GB  
WOOLFORD, Alison Jo-Anne, 436 Cambridge Science Park Milton Road, Cambridge Cambridgeshire, GB

---

(51) MKP  
**A61K 39/00 2006 (97) EP 3359571**  
**A61P 35/00 2006**  
**A61P 37/00 2006**  
**C07K 16/28 2006**  
(96) EP 16784684.9 10/7/2016  
(97) EP 3359571, 8/15/2018 201833, en  
(31) 201562239524 P (32) 09.10.2015 (33) US  
201562257791 P 20.11.2015 US  
201662315119 P 30.03.2016 US  
201662359921 P 08.07.2016 US  
201662365006 P 21.07.2016 US  
(54) ANTI-LAG3 ANTIBODIES AND USES THEREOF  
(72) ULLMAN, Erica, c/o Regeneron Pharmaceuticals Inc. 777 Old Saw Mill River Road, Tarrytown, New York 10591, US  
HERMANN, Aynur, c/o Regeneron Pharmaceuticals Inc. 777 Old Saw Mill River Road, Tarrytown, New York 10591, US  
IOFFE, Ella, c/o Regeneron Pharmaceuticals Inc. 777 Old Saw Mill River Road, Tarrytown, New York 10591, US  
BUROVA, Elena, c/o Regeneron Pharmaceuticals Inc. 777 Old Saw Mill River Road, Tarrytown, New York 10591, US  
THURSTON, Gavin, c/o Regeneron Pharmaceuticals Inc. 777 Old Saw Mill River Road Tarrytown, New York 10591, US

---

(51) MKP  
**A61K 31/424 2006 (97) EP 3365346**  
**C07D 498/10 2006**  
(96) EP 16784795.3 10/21/2016  
(97) EP 3365346, 8/29/2018 201835, en  
(31) 15382523 (32) 23.10.2015 (33) EP  
(54) OXA-DIAZASPIRO COMPOUNDS HAVING ACTIVITY AGAINST PAIN  
(72) VIRGILI-BERNADO, Marina, C/Baldiri Reixac 10, 08028 Baecelona, ES  
ALMANSA-ROSALES, Carmen, C/ Teodora Lamadrid No. 41 Ent. 4A, 08022 Barcelona, ES  
ALEGRET-MOLINA, Carlos, C/ Baldiri Reixac 10, 08028 Barcelona, ES

---

(51) MKP  
**A61K 31/41 2006 (97) EP 3359532**  
**A61K 31/4196 2006**  
**A61K 31/445 2006**  
**C07D 401/04 2006**  
**C07D 401/06 2006**  
**C07D 401/10 2006**  
**C07D 401/12 2006**  
**C07D 401/14 2006**  
(96) EP 16784966.0 10/6/2016  
(97) EP 3359532, 8/15/2018 201833, en  
(31) 201562237655 P (32) 06.10.2015 (33) US



(54) BIARYL PYRAZOLES AS NRF2 REGULATORS  
(72) CALLAHAN, James Francis, 709 Swedeland Road, King of Prussia, Pennsylvania 19406, US  
KERNS, Jeffrey K., 709 Swedeland Road, King of Prussia, Pennsylvania 19406, US  
LI, Peng, 709 Swedeland Road, King of Prussia, Pennsylvania 19406, US  
LI, Tindy, 709 Swedeland Road, King of Prussia, Pennsylvania 19406, US  
MCCLELAND, Brent W., 709 Swedeland Road, King of Prussia, Pennsylvania 19406, US  
NIE, Hong, 709 Swedeland Road, King of Prussia, Pennsylvania 19406, US  
PERO, Joseph E., 709 Swedeland Road, King of Prussia, Pennsylvania 19406, US  
DAVIES, Thomas Glanmor, 436 Cambridge Science Park Milton Road, Cambridge Cambridgeshire, GB  
GRAZIA CARR, Maria, 436 Cambridge Science Park Milton Road, Cambridge Cambridgeshire, GB  
GRIFFITHS-JONES, Charlotte Mary, 436 Cambridge Science Park Milton Road, Cambridge Cambridgeshire, GB  
HEIGHTMAN, Thomas Daniel, 436 Cambridge Science Park Milton Road, Cambridge Cambridgeshire, GB  
NORTON, David, 436 Cambridge Science Park Milton Road, Cambridge Cambridgeshire, GB  
VERDONK, Marinus Leendert, 436 Cambridge Science Park Milton Road, Cambridge Cambridgeshire, GB  
WOOLFORD, Alison Jo-Anne, 436 Cambridge Science Park Milton Road, Cambridge Cambridgeshire, GB  
WILLEMS, Hendrika Maria Gerarda, 436 Cambridge Science Park Milton Road, Cambridge Cambridgeshire, GB

---

(51) MKP  
**A61K 31/4196 2006 (97) EP 3356355**  
**A61P 31/18 2006**  
**C07D 249/10 2006**  
**C07D 405/12 2006**  
(96) EP 16785016.3 9/29/2016  
(97) EP 3356355, 8/8/2018 201832, en  
(31) 201562235302 P (32) 30.09.2015 (33) US  
(54) COMPOUNDS AND COMBINATIONS FOR THE TREATMENT OF HIV  
(72) YU, Helen, C/o Gilead Sciences Inc. 333 Lakeside Drive, Foster City, CA 94404, US  
CIHLAR, Tomas, C/o Gilead Sciences Inc. 333 Lakeside Drive, Foster City, CA 94404, US  
STEPAN, George, C/o Gilead Sciences Inc. 333 Lakeside Drive, Foster City, CA 94404, US  
SLOAN, Derek, Dean, 2911 San Juan Boulevard, Belmont, CA 94002, US  
MURRY, Jeffrey, Patrick, C/o Gilead Sciences Inc. 333 Lakeside Drive, Foster City, CA 94404, US  
HU, Yunfeng, Eric, C/o Gilead Sciences Inc. 333 Lakeside Drive, Foster City, CA 94404, US  
GRAUPE, Michael, C/o Gilead Sciences Inc. 333 Lakeside Drive, Foster City, CA 94404, US

---

(51) MKP  
**A61K 31/437 2006 (97) EP 3359539**  
**A61P 11/12 2006**  
**C07D 471/04 2006**  
**C07D 519/00 2006**  
(96) EP 16785567.5 10/7/2016  
(97) EP 3359539, 8/15/2018 201833, en  
(31) 201562239475 P (32) 09.10.2015 (33) US  
(54) SUBSTITUTED PYRAZOLO[3,4-B]PYRIDIN-6-CARBOXYLIC ACIDS AND THEIR USE  
(72) AKKARI, Rhalid, Galapagos SASU 102 Avenue Gaston Roussel, 93230 Romainville, FR  
ALVEY, Luke Jonathan, Galapagos SASU 102 Avenue Gaston Roussel, 93230 Romainville, FR  
BOCK, Xavier Marie, Galapagos SASU 102 Avenue Gaston Roussel, 93230 Romainville, FR  
CLAES, Pieter Isabelle Roger, Klokstraat 112, 9050 Gentbrugge, BE  
COWART, Marlon D., 43 Dahlia Lane, Round Lake Beach, Illinois 60073, US  
DE LEMOS, Elsa, Galapagos SASU 102 Avenue Gaston Roussel, 93230 Romainville, FR  
DESROY, Nicolas, Galapagos SASU 102 Avenue Gaston Roussel, 93230 Romainville, FR  
DUTHION, Béranger, Galapagos SASU 102 Avenue Gaston Roussel, 93230 Romainville, FR  
GFESSER, Gregory A., 110 Timber Lane, Lindenhurst, Illinois 60046, US  
GOSMINI, Romain Luc Marie, Galapagos SASU 102 Avenue Gaston Roussel, 93230 Romainville, FR  
HOUSSEMAN, Christopher Gaëtan, Galapagos SASU 102 Avenue Gaston Roussel, 93230 Romainville, FR  
JANSEN, Koen Karel, Sint Jorislaan 19, 2300 Turnhout, BE  
JI, Jianguo, 1973 Sparrow Court, Libertyville, Illinois 60048, US  
KYM, Philip R., 1002 Gracewood Avenue, Libertyville, Illinois 60048, US  
LEFRANCOIS, Jean-Michel, Galapagos SASU 102 Avenue Gaston Roussel, 93230 Romainville, FR  
MAMMOLITI, Oscar, Galapagos NV Generaal de Wittelaan L11/A3, 2800 Mechelen, BE  
MENET, Christel Jeanne Marie, Confo Therapeutics Pleinlaan 2 Building E 7th Floor E7.6, 1050 Brussels, BE  
NEWSOME, Gregory John Robert, Galapagos SASU 102 Avenue Gaston Roussel, 93230 Romainville, FR  
PALISSE, Adeline Marie Elise, Galapagos NV Generaal de Wittelaan L11/A3, 2800 Mechelen, BE  
PATEL, Sachin V., 1259 Wild Meadow Road, Round Lake Illinois 60073, US  
PIZZONERO, Mathieu Rafaël, Galapagos SASU 102 Avenue Gaston Roussel, 93230 Romainville, FR  
SHRESTHA, Anurupa, 378 Pine Lake Circle, Vernon Hills, Illinois 60061, US

SWIFT, Elizabeth C., 2514 Green Bay Road, Highland Park, Illinois 60035, US  
VAN DER PLAS, Steven Emiel, Galapagos NV Generaal de Wittelaan L11/A3, 2800 Mechelen, BE  
WANG, Xueqing, 1742 Larkdale Road, Northbrook, Illinois 60062, US

---

- (51) MKP  
**A61K 31/437 2006 (97) EP 3359540**  
**A61P 11/00 2006**  
**C07D 471/04 2006**  
**C07D 519/00 2006**  
**G01N 33/68 2006**
- (96) EP 16785568.3 10/7/2016  
(97) EP 3359540, 8/15/2018 201833, en
- (31) 201562239699 P (32) 09.10.2015 (33) US
- (54) NOVEL COMPOUNDS FOR TREATMENT OF CYSTIC FIBROSIS
- (71) AbbVie S.A.R.L., 26 Boulevard Royal, 2449 Luxembourg, LU
- (72) AKKARI, Rhalid, Galapagos SASU 102 Avenue Gaston Roussel, 93230 Romainville, FR  
ALVEY, Luke Jonathan, Galapagos SASU 102 Avenue Gaston Roussel, 93230 Romainville, FR  
BOCK, Xavier Marie, Galapagos SASU 102 Avenue Gaston Roussel, 93230 Romainville, FR  
BROWN, Brian S., 812 Washington, Evanston, Illinois 60202, US  
CLAES, Pieter Isabelle Roger, Galapagos NV Generaal de Wittelaan L11/A3, 2800 Mechelen, BE  
COWART, Marlon D., 43 Dahlia Lane, Round Lake Beach, Illinois 60073, US  
CONRATH, Katja E., Galapagos NV Generaal de Wittelaan L11/A3, 2800 Mechelen, BE  
CYR, Douglas, 109 Mason Farm Road, Chapel Hill, North Carolina 27599, US  
DE LEMOS, Elsa, Galapagos SASU 102 Avenue Gaston Roussel, 93230 Romainville, FR  
DE WILDE, Gert Jules Hector, Galapagos NV Generaal de Wittelaan L11/A3, 2800 Mechelen, BE  
DESROY, Nicolas, Galapagos SASU 102 Avenue Gaston Roussel, 93230 Romainville, FR  
DUTHION, Béranger, Galapagos SASU 102 Avenue Gaston Roussel, 93230 Romainville, FR  
GFESSER, Gregory A., 110 Timber Lane, Lindenhurst, Illinois 60046, US  
GOSMINI, Romain Luc Marie, Galapagos SASU 102 Avenue Gaston Roussel, 93230 Romainville, FR  
HOUSSEMAN, Christopher Gaëtan, Galapagos SASU 102 Avenue Gaston Roussel, 93230 Romainville, FR  
JANSEN, Koen Karel, Galapagos NV Generaal de Wittelaan L11/A3, 2800 Mechelen, BE  
JI, Jianguo, 1973 Sparrow Court, Libertyville, Illinois 60048, US  
KYM, Philip R., 1002 Gracewood Avenue, Libertyville, Illinois 60048, US  
LEFRANCOIS, Jean-Michel, Galapagos SASU 102 Avenue Gaston Roussel, 93230 Romainville, FR  
MAMMOLITI, Oscar, Galapagos NV Generaal de Wittelaan L11/A3, 2800 Mechelen, BE  
MENET, Christel Jeanne Marie, Confo Therapeutics Pleinlaan 2 Building E 7th Floor E7 6, 1050 Brussels, BE  
MERAYO, Nuria Merayo, Galapagos SASU 102 Avenue Gaston Roussel, 93230 Romainville, FR  
NEWSOME, Gregory John Robert, Galapagos SASU 102 Avenue Gaston Roussel, 93230 Romainville, FR  
PALISSE, Adeline Marie Elise, Galapagos NV Generaal de Wittelaan L11/A3, 2800 Mechelen, BE  
PATEL, Sachin V., 1259 Wild Meadow Road, Round Lake, Illinois 60073, US  
PIZZONERO, Mathieu Rafaël, Galapagos SASU 102 Avenue Gaston Roussel, 93230 Romainville, FR  
SHRESTHA, Anurupa, 378 Pine Lake Circle, Vernon Hills, Illinois 60061, US  
SWIFT, Elizabeth C., 2514 Green Bay Road, Highland Park, Illinois 60035, US  
TSE, Chris, 1321 St. William Drive, Libertyville, Illinois 60048, US  
VAN DER PLAS, Steven Emiel, Galapagos NV Generaal de Wittelaan L11/A3, 2800 Mechelen, BE  
WANG, Xueqing, 1742 Larkdale Road, Northbrook, Illinois 60062, US
- 

- (51) MKP  
**A23K 10/00 2016 (97) EP 3358967**  
**A23K 10/40 2016**
- (96) EP 16785599.8 10/3/2016  
(97) EP 3358967, 8/15/2018 201833, en
- (31) PCT/US2015/054040 (32) 05.10.2015 (33) WO
- (54) METHODS AND FORMULATIONS FOR REDUCING BOVINE EMISSIONS
- (72) HERR, Cory T., c/o Eli Lilly and Company P.O. Box 6288, Indianapolis, Indiana 46206-6288, US  
KUBE, John Charles, c/o Eli Lilly and Company P.O. Box 6288, Indianapolis, Indiana 46206-6288, US  
TEETER, Jerold Scott, c/o Eli Lilly and Company P.O. Box 6288, Indianapolis, Indiana 46206-6288, US
- 

- (51) MKP  
**A61K 31/4174 2006 (97) EP 3359528**  
**A61K 31/4439 2006**  
**A61P 21/00 2006**  
**C07D 233/64 2006**

**C07D 401/04 2006**  
**C07D 405/10 2006**  
(96) EP 16785611.1 10/5/2016  
(97) EP 3359528, 8/15/2018 201833, en  
(31) 201562238629 P (32) 07.10.2015 (33) US  
201562243263 P 19.10.2015 US  
201662352348 P 20.06.2016 US  
(54) PPAR AGONISTS, COMPOUNDS, PHARMACEUTICAL COMPOSITIONS, AND METHODS OF USE THEREOF  
(71) Mitobridge, Inc., 1030 Massachusetts Avenue Suite 200, Cambridge, MA 02138, US  
(72) DOWNES, Michael, The Salk Institute for Biological Studies 10010 N. Torrey Pines, La Jolla, CA 92037, US  
EVANS, Ronald, M., The Salk Institute for Biological Studies 10010 N. Torrey Pines Road, La Jolla, CA 92037, US  
KLUGE, Arthur, P.O. Box 6177, Lincoln MA 01773, US  
LAGU, Bharat, 21 Lexington Drive, Acton MA 01720, US  
MIURA, Masanori, Miyukigaoka 21 Tsukuba, Ibaraki, JP  
PANIGRAHI, Sunil, Kumar, Bollaram Road Miyapur, Hyderabad-500049, IN  
PATANE, Michael, 6 Westwind Road, Andover MA 01810, US  
SAMAJDAR, Susanta, Bollaram Road Miyapur, Hyderabad-500049, IN  
SENAIAR, Ramesh, Bollaram Road Miyapur, Hyderabad-500049, IN  
TAKAHASHI, Taisuke, Miyukigaoka 21 Tsukuba, Ibaraki, JP

---

(51) MKP  
**C07K 4/04 2006 (97) EP 3362466**  
**C07K 14/21 2006**  
**C12N 15/82 2006**  
(96) EP 16785666.5 10/13/2016  
(97) EP 3362466, 8/22/2018 201834, en  
(31) 201562241220 P (32) 14.10.2015 (33) US  
(54) AXMI554 DELTA-ENDOTOXIN GENE AND METHODS FOR ITS USE  
(71) Bayer CropScience AG, Alfred-Nobel-Straße 50, 40789 Monheim, DE  
(72) RODGERS-VIEIRA, Elyse, 7 Silverbush Court, Durham, NC 27707, US  
SAMPSON, Kimberly, 5505 Frenchman's Creek Drive, Durham, NC 27713, US  
LEHTINEN, Duane, 521 Stonecroft Lane, Cary, NC 27519, US  
LOESEL, Peter, Am Schokker 5, 51371 Leverkusen, DE  
PORTZ, Daniela, Oststr. 1, 52391 Vettweiss 6220 Monheim, DE  
CHOUGULE, Nanasaheb, 3500 Paramount Parkway, Morrisville, North Carolina 27560, US

---

(51) MKP  
**A61K 38/26 2006 (97) EP 3368061**  
**C07K 14/605 2006**  
(96) EP 16785669.9 10/14/2016  
(97) EP 3368061, 9/5/2018 201836, en  
(31) 201562246199 P (32) 26.10.2015 (33) US  
(54) GLUCAGON RECEPTOR AGONISTS  
(71) Elanco US Inc., 2500 Innovation Way, Greenfield, IN 46140, US  
(72) COSKUN, Tamer, c/o Eli Lilly and Company P.O. Box 6288, Indianapolis, Indiana 46206-6288, US  
ALSINA-FERNANDEZ, Jorge, c/o Eli Lilly and Company P.O. Box 6288, Indianapolis, Indiana 46206-6288, US

---

(51) MKP  
**A61K 31/437 2006 (97) EP 3365340**  
**A61K 31/5025 2006**  
**A61K 31/519 2006**  
**A61P 31/12 2006**  
**A61P 35/00 2006**  
**C07D 471/04 2006**  
**C07D 487/04 2006**  
(96) EP 16787687.9 10/18/2016  
(97) EP 3365340, 8/29/2018 201835, en  
(31) 201562243307 P (32) 19.10.2015 (33) US  
201662322949 P 15.04.2016 US  
201662385053 P 08.09.2016 US  
(54) HETEROCYCLIC COMPOUNDS AS IMMUNOMODULATORS  
(72) WU, Liangxing, Incyte Corporation 1801 Augustine Cut-Off, Wilmington, Delaware 19803, US  
SHEN, Bo, Incyte Corporation 1801 Augustine Cut-Off, Wilmington, Delaware 19803, US

LI, Jingwei, Incyte Corporation 1801 Augustine Cut-Off, Wilmington, Delaware 19803, US  
LI, Zhenwu, Incyte Corporation 1801 Augustine Cut-Off, Wilmington, Delaware 19803, US  
LIU, Kai, Incyte Corporation 1801 Augustine Cut-Off, Wilmington, Delaware 19803, US  
ZHANG, Fenglei, Incyte Corporation 1801 Augustine Cut-Off, Wilmington, Delaware 19803, US  
YAO, Wenqing, Incyte Corporation 1801 Augustine Cut-Off, Wilmington, Delaware 19803, US

---

(51) MKP  
**G10L 19/008 2013 (97) EP 3360135**  
**G10L 19/24 2013**  
(96) EP 16787751.3 10/7/2016  
(97) EP 3360135, 8/15/2018 201833, en  
(31) 15306590 (32) 08.10.2015 (33) EP  
201662361809 P 13.07.2016 US  
(54) LAYERED CODING FOR COMPRESSED SOUND OR SOUND FIELD REPRESENTATIONS  
(72) KORDON, Sven, Mühlenkampstrasse 50 A, 31515 Wunstorf, DE  
KRUEGER, Alexander, Feuerbachstrasse 16, 30655 Hannover, DE

---

(51) MKP  
**C08G 18/16 2006 (97) EP 3400251**  
**C08G 18/20 2006**  
**C08G 18/24 2006**  
**C08G 18/40 2006**  
**C08G 18/48 2006**  
**C08G 18/63 2006**  
**C08G 18/76 2006**  
**C08G 101/00 2006**  
(96) EP 16788006.1 9/15/2016  
(97) EP 3400251, 11/14/2018 201846, en  
(31) 320416 (32) 07.01.2016 (33) BG  
353216 22.06.2016 BG  
11237416 07.09.2016 BG  
(54) POLYURETHANE FOAM COMPOSITION  
(71) Ted-Bed JSC, bul. Shesti Septemvri 222A, Plovdiv 4000, BG  
(72) KOSTOV, Hristiyan, 8 Rodopi Str., 7058 Marten Ruse, BG  
RUPCHEV, Stephan, 20 Miziya Str., Veliko Tarnovo, BG

---

(51) MKP  
**A61K 31/519 2006 (97) EP 3362453**  
**C07D 487/04 2006**  
(96) EP 16788047.5 10/12/2016  
(97) EP 3362453, 8/22/2018 201834, en  
(31) 15189600 (32) 13.10.2015 (33) EP  
(54) CYCLIC ETHER DERIVATIVES OF PYRAZOLO[1,5-A]PYRIMIDINE-3-CARBOXYAMIDE  
(72) HOENKE, Christoph, Boehringer Ingelheim GmbH Corporate Patents Binger Strasse 173, 55216 Ingelheim am Rhein, DE  
BERTANI, Barbara, Boehringer Ingelheim GmbH Corporate Patents Binger Strasse 173, 55216 Ingelheim am Rhein, DE  
FERRARA, Marco, Boehringer Ingelheim GmbH Corporate Patents Binger Strasse 173, 55216 Ingelheim am Rhein, DE  
FOSSATI, Giacomo, Boehringer Ingelheim GmbH Corporate Patents Binger Strasse 173, 55216 Ingelheim am Rhein, DE  
FRATTINI, Sara, Boehringer Ingelheim GmbH Corporate Patents Binger Strasse 173, 55216 Ingelheim am Rhein, DE  
GIOVANNINI, Riccardo, Boehringer Ingelheim GmbH Corporate Patents Binger Strasse 173, 55216 Ingelheim am Rhein, DE  
HOBSON, Scott, Boehringer Ingelheim GmbH Corporate Patents Binger Strasse 173, 55216 Ingelheim am Rhein, DE

---

(51) MKP  
**A61M 5/142 2006 (97) EP 3368101**  
**A61M 5/145 2006**  
**A61M 5/20 2006**  
**A61M 5/315 2006**  
**A61M 5/32 2006**  
(96) EP 16788129.1 10/28/2016  
(97) EP 3368101, 9/5/2018 201836, en  
(31) 15191929 (32) 28.10.2015 (33) EP  
(54) SINGLE-USE AUTO-INJECTOR  
(72) KNUDSEN, Hans Stenberg, c/o NNE A/S Bredevej 2, 2830 Virum, DK  
PLAMBECH, Christian, c/o NNE A/S Bredevej 2, 2830 Virum, DK

- (51) MKP  
**A61K 31/195 2006 (97) EP 3359148**  
**A61K 31/198 2006**  
**A61K 31/454 2006**  
**A61P 25/16 2006**
- (96) EP 16788231.5 10/7/2016  
(97) EP 3359148, 8/15/2018 201833, en
- (31) 201562284800 P (32) 09.10.2015 (33) US
- (54) COMBINATION OF DEUTERATED LEVODOPA WITH CARBIDOPA AND OPICAPONE FOR THE TREATMENT OF PARKINSON'S DISEASE  
(72) RUSS, Hermann., Zurichstrasse 37C, 8852 Altendorf, CH  
MANDEL, Silvia Alicia., Moshav Aviel Habroshim St. POB 68, Arie Sharon, IL  
ORBACH, Aric., Levona 1, 76350 Rehovot, IL
- 

- (51) MKP  
**A61K 31/437 2006 (97) EP 3359541**  
**A61P 11/12 2006**  
**C07D 471/04 2006**  
**C07D 519/00 2006**
- (96) EP 16788232.3 10/7/2016  
(97) EP 3359541, 8/15/2018 201833, en
- (31) 201562239647 P (32) 09.10.2015 (33) US  
201662309794 P 17.03.2016 US
- (54) N-SULFONYLATED PYRAZOLO[3,4-B]PYRIDIN-6-CARBOXAMIDES AND METHOD OF USE  
(72) AKKARI, Rhalid, Galapagos SASU 102 Avenue Gaston Roussel, 932330 Romainville, FR  
ALVEY, Luke Jonathan, Galapagos SASU 102 Avenue Gaston Roussel, 932330 Romainville, FR  
BOCK, Xavier Marie, Galapagos SASU 102 Avenue Gaston Roussel, 93230 Romainville, FR  
BROWN, Brian S., 812 Washington, Evanston, Illinois 60202, US  
CLAES, Pieter Isabelle Roger, Klokstraat 112, 9050 Gentbrugge, BE  
COWART, Marlon D., 43 Dahlia Lane, Round Lake Beach, Illinois 60073, US  
DE LEMOS, Elsa, 102 Avenue Gaston Roussel, 93230 Romainville, FR  
DESROY, Nicolas, Galapagos SASU 102 Avenue Gaston Roussel, 93230 Romainville, FR  
DUTHION, Béranger, Galapagos SASU 102 Avenue Gaston Roussel, 93230 Romainville, FR  
GFESSER, Gregory A., 110 Timber Lane, Lindnhurst, Illinois 60046, US  
GOSMINI, Romain Luc Marie, Galapagos SASU 102 Avenue Gaston Roussel, 93230 Romainville, FR  
HOUSSEMAN, Christopher Gaëtan, Galapagos SASU 102 Avenue Gaston Roussel, 93230 Romainville, FR  
JANSEN, Koen Karel, Sint Jorislaan 19, 2300 Turnhout, BE  
JI, Jianguo, 1973 Sparrow Court, Libertyville, Illinois 60048, US  
KYM, Philip R., 1002 Gracewood Avenue, Libertyville, Illinois 60048, US  
LEFRANCOIS, Jean-Michel, Galapagos SASU 102 Avenue Gaston Roussel, 93230 Romainville, FR  
MAMMOLITI, Oscar, Galapagos NV Generaal de Wittelaan L11/A3, 2800 Mechelen, BE  
MENET, Christel Jeanne Marie, Confo Therapeutiques Pleinlaan 2 Building E 7th Floor E7.6, 1050 Brussels, BE  
MERAYO, Nuria Merayo, Galapagos SASU 102 Avenue Gaston Roussel, 93230 Romainville, FR  
NEWSOME, Gregory John Robert, Galapagos SASU 102 Avenue Gaston Roussel, 93230 Romainville, FR  
PALISSE, Adeline Marie Elise, Galapagos NV Generaal de Wittelaan L11/A3, 93230 Romainville, FR  
PATEL, Sachin V., 1259 Wild Meadow Road, Round Lake, Illinois 60073, US  
PIZZONERO, Mathieu Rafaël, Galapagos SASU 102 Avenue Gaston Roussel, 93230 Romainville, FR  
SHRESTHA, Anurupa, 378 Pine Lake Circle, Vernon Hills, Illinois 60061, US  
SWIFT, Elizabeth C., 2514 Green Bay Road, Highland Park, Illinois 60035, US  
VAN DER PLAS, Steven Emiel, Galapagos NV Generaal de Wittelaan L11/A3, 2800 Mechelen, BE  
WANG, Xueqing, 1742 Larkdale Road, Northbrook, Illinois 60062, US  
DE BLIECK, Ann, Vleeshouwersstraat 74, 9112 Sinaai, BE
- 

- (51) MKP  
**A61K 47/64 2017 (97) EP 3362100**  
**A61K 47/68 2017**  
**A61P 35/00 2006**
- (96) EP 16788243.0 10/14/2016  
(97) EP 3362100, 8/22/2018 201834, en
- (31) PCT/CN2015/092084 (32) 16.10.2015 (33) WO
- (54) HINDERED DISULFIDE DRUG CONJUGATES

(72) DRAGOVICH, Peter, Genentech Inc. 1 DNA Way, South San Francisco, California 94080, US  
PEI, Zhonghua, Genentech Inc. 1 DNA Way, South San Francisco, California 94080, US  
PILLOW, Thomas, Genentech Inc. 1 DNA Way, South San Francisco, California 94080, US  
SADOWSKY, Jack, Genentech Inc. 1 DNA Way MS49, South San Francisco, California 94080, US  
CHEN, Jinhua, WuXi AppTec Corporate Legal Office 8F Sanlian South Building 2 Huajing Road Waigaoqiao Free Trade Zone, Jiangsu Shanghai 200131, CN  
WAI, John, WuXi AppTec Corporate Legal Office 8F Sanlian South Building 2 Huajing Road Waigaoqiao Free Trade Zone, Jiangsu Shanghai 200131, CN

---

(51) MKP  
**A61P 35/00 2006 (97) EP 3362455**  
**C07D 487/14 2006**

(96) EP 16788358.6 10/17/2016  
(97) EP 3362455, 8/22/2018 201834, en

(31) 201562242797 P (32) 16.10.2015 (33) US  
201562267672 P 15.12.2015 US  
201662301537 P 29.02.2016 US  
201662352380 P 20.06.2016 US

(54) PROCESSES FOR THE PREPARATION OF (3S,4R)-3-ETHYL-4-(3H-IMIDAZO[1,2-a]PYRROLO[2,3-e]PYRAZIN-8-YL)-N-(2,2,2-TRIFLUOROETHYL)PYRROLIDINE-1-CARBOXAMIDE AND SOLID STATE FORMS THEREOF

(72) ALLIAN, Aymen D., 48 Secret Hollow Lane, Newbury Park, California 91320, US  
JAYANTH, Jayanthi, 915 Pine Tree Circle, Buffalo Grove, Illinois 60089, US  
MOHAMED, Mohamed-Eslam F., 1500 Almaden Lane, Gurnee, Illinois 60031, US  
MULHERN, Mathew M., 1009 Oaktree Terrace, Lake Villa, Illinois 60046, US  
NORDSTROEM, Lars F., 1401 Sheridan Road, North Chicago, Illinois 60064, US  
OTHMAN, Ahmed A., 14615 South Somerset Circle, Libertyville, Illinois 60048, US  
ROZEMA, Michael J., 52154 1st Street, Kenosha, Wisconsin 53144, US  
BHAGAVATULA, Lakshmi, 272 Noble Circle, Vernon Hills, Illinois 60061, US  
MARROUM, Patrick J., 9114 Blarney Stone Drive, Springfield, VA 22152, US  
MAYER, Peter T., 1117 Avalon Lane, Libertyville, Illinois 60048, US  
SHEIKH, Ahmad Y., 700 Pine Street, Deerfield, Illinois 60015, US  
BORCHARDT, Thomas B., 2433 55th Avenue, Kenosha, Wisconsin 53144, US

---

(51) MKP  
**C12N 5/0783 2010 (97) EP 3368658**

(96) EP 16788539.1 10/31/2016  
(97) EP 3368658, 9/5/2018 201836, en

(31) 201519198 (32) 30.10.2015 (33) GB  
201612731 22.07.2016 GB

(54) EXPANSION OF NON-HAEMATOPOIETIC TISSUE-RESIDENT GAMMA DELTA T CELLS AND USES OF THESE CELLS

(71) Cancer Research Technology Limited, Angel Building 407 St. John Street, London, Greater London EC1V 4AD, GB  
The Francis Crick Institute Limited, 1 Midland Road, London, Greater London NW1 1AT, GB

(72) HAYDAY, Adrian, King's College London School of Medicine 2nd Floor Borough Wing, London Greater London SE1 9RT, GB  
NUSSBAUMER, Oliver, King's College London School of Medicine 2nd Floor Borough Wing, London Greater London SE1 9RT, GB  
WOOLF, Richard, King's College London School of Medicine 2nd Floor Borough Wing, London Greater London SE1 9RT, GB

---

(51) MKP  
**H01L 33/00 2010 (97) EP 3353820**  
**H01L 33/16 2010**

(96) EP 16788577.1 9/23/2016  
(97) EP 3353820, 8/1/2018 201831, en

(31) 41407715 (32) 23.09.2015 (33) PL

(54) ALINGAN-BASED SUPERLUMINESCENT DIODE

(71) Topgan SP. Z O.O., Ul. Sokolowska 29/37, 01-142 Warszawa, PL  
Instytut Wysokich Cisnien Polskiej Akademii Nauk, Sokolowska 29/37, 01-142 Warszawa, PL

(72) KAFAR, Anna, Kruczkowskiego 6A 5, 81-597 Gdynia, PL  
STANCZYK, Szymon, Zelazna 18A 15, 81-150 Gdynia, PL  
NOWAKOWSKA-SIWINSKA, Anna, Mickiewicza 23 5, 01-517 Warszawa, PL  
SARZYNSKI, Marcin, Pirenejska 7 81, 01-493 Warszawa, PL  
SUSKI, Tadeusz, Akacja 102, 05-505 Nowy Przemów, PL  
PERLIN, Piotr, Okulickiego 6 12, 03-984 Warszawa, PL

---

(51) MKP  
**G06F 19/00 2018 (97) EP 3360066**

(96) EP 16788599.5 10/5/2016  
(97) EP 3360066, 8/15/2018 201833, en

(31) 201562238393 P (32) 07.10.2015 (33) US

(54) SYSTEMS AND METHODS FOR PREDICTING VITREAL HALF-LIFE OF THERAPEUTIC AGENT-POLYMER CONJUGATES  
(72) KELLEY, Robert, Genentech Inc. 1 DNA Way, South San Francisco, California 94080, US  
SCHEER, Justin, Genentech Inc. 1 DNA Way, South San Francisco, California 94080, US  
SHATZ, Whitney, Genentech Inc. 1 DNA Way, South San Francisco, California 94080, US

---

(51) MKP  
**A61K 31/444 2006 (97) EP 3370722**  
**A61K 31/4545 2006**  
**A61P 35/00 2006**  
**C07D 471/04 2006**

(96) EP 16788723.1 11/2/2016  
(97) EP 3370722, 9/12/2018 201837, en

(31) 201519568 (32) 05.11.2015 (33) GB

(54) IMIDAZO[4,5-C]QUINOLIN-2-ONE COMPOUNDS AND THEIR USE IN TREATING CANCER  
(72) PIKE, Kurt, Gordon, AstraZeneca Hodgkin Building Chesterford Research Park, Little Chesterford Essex CB10 1XL, GB  
BARLAAM, Bernard, Christophe, AstraZeneca Darwin Building Cambridge Science Park Milton Road, Cambridge CB4 0WG, GB  
HUNT, Thomas, Anthony, AstraZeneca Darwin Building Cambridge Science Park Milton Road, Cambridge CB4 0WG, GB  
EATHERTON, Andrew, John, AstraZeneca Hodgkin Building Chesterford Research Park, Little Chesterford Essex CB10 1XL, GB

---

(51) MKP  
**A61K 31/4035 2006 (97) EP 3365334**  
**A61P 35/00 2006**  
**C07D 401/14 2006**  
**C07D 403/14 2006**  
**C07D 405/14 2006**  
**C07D 409/14 2006**  
**C07D 413/14 2006**  
**C07D 417/14 2006**  
**C07D 471/04 2006**  
**C07D 471/08 2006**

(96) EP 16788794.2 10/20/2016  
(97) EP 3365334, 8/29/2018 201835, en

(31) 201518676 (32) 21.10.2015 (33) GB  
201611351 30.06.2016 GB

(54) BENZOLACTAM COMPOUNDS AS PROTEIN KINASE INHIBITORS  
(72) BERDINI, Valerio, Cambridge Science Park 436 Milton Road, Cambridge CB4 0QA, GB  
BUCK, Ildiko Maria, Cambridge Science Park 436 Milton Road, Cambridge CB4 0QA, GB  
DAY, James Edward Harvey, Cambridge Science Park 436 Milton Road, Cambridge CB4 0QA, GB  
GRIFFITHS-JONES, Charlotte Mary, Cambridge Science Park 436 Milton Road, Cambridge CB4 0QA, GB  
HEIGHTMAN, Thomas Daniel, Cambridge Science Park 436 Milton Road, Cambridge CB4 0QA, GB  
HOWARD, Steven, Cambridge Science Park 436 Milton Road, Cambridge CB4 0QA, GB  
MURRAY, Christopher William, Cambridge Science Park 436 Milton Road, Cambridge CB4 0QA, GB  
NORTON, David, Cambridge Science Park 436 Milton Road, Cambridge CB4 0QA, GB  
O'REILLY, Marc, Cambridge Science Park 436 Milton Road, Cambridge CB4 0QA, GB  
WOOLFORD, Alison Jo-Anne, Cambridge Science Park 436 Milton Road, Cambridge CB4 0QA, GB  
COOKE, Michael Liam, Sygnature Discovery Limited Biocity Pennyfoot Street, Nottingham NG1 1GF, GB  
COUSIN, David, Sygnature Discovery Limited Biocity Pennyfoot Street, Nottingham NG1 1GF, GB  
ONIONS, Stuart Thomas, Sygnature Discovery Limited Biocity Pennyfoot Street, Nottingham NG1 1GF, GB  
SHANNON, Jonathan Martin, Sygnature Discovery Limited Biocity Pennyfoot Street, Nottingham NG1 1GF, GB  
WATTS, John Paul, Sygnature Discovery Limited Biocity Pennyfoot Street, Nottingham NG1 1GF, GB

---

(51) MKP  
**A61K 47/68 2017 (97) EP 3365025**  
**A61P 35/00 2006**

(96) EP 16788813.0 10/19/2016  
(97) EP 3365025, 8/29/2018 201835, en

(31) 201562243967 P (32) 20.10.2015 (33) US

(54) CALICHEAMICIN-ANTIBODY-DRUG CONJUGATES AND METHODS OF USE

(72) PILLOW, Thomas, Genentech Inc. 1 DNA Way, South San Francisco, California 94080, US

---

(51) MKP

**A61K 31/4427 2006 (97) EP 3362443**  
**A61P 35/00 2006**  
**A61P 37/00 2006**  
**C07D 207/12 2006**  
**C07D 213/71 2006**  
**C07D 213/85 2006**  
**C07D 401/12 2006**  
**C07D 401/14 2006**  
**C07D 403/12 2006**  
**C07D 455/02 2006**

(96) EP 16788857.7 10/12/2016

(97) EP 3362443, 8/22/2018 201834, en

(31) 201562242072 P (32) 15.10.2015 (33) US  
201615290167 11.10.2016 US

(54) COMPOUNDS USEFUL AS IMMUNOMODULATORS

(72) YEUNG, Kap-Sun, c/o Bristol-Myers Squibb Company 5 Research Parkway, Wallingford, Connecticut 06492, US  
CONNOLLY, Timothy P., 7328 36th Avenue, Kenosha, Wisconsin 53142, US  
FRENNESSON, David B., c/o Bristol-Myers Squibb Company 5 Research Parkway, Wallingford, Connecticut 06492, US  
GRANT-YOUNG, Katharine A., 1343 Boston Post Road, unit 208, Madison, CT 06443, US  
HEWAWASAM, Piyasena, 31 Brookview Lane, Middletown, Connecticut 06457, US  
LANGLEY, David R., c/o Bristol-Myers Squibb Company 5 Research Parkway, Wallingford, Connecticut 06492, US  
MENG, Zhaoxing, c/o Bristol-Myers Squibb Company 5 Research Parkway, Wallingford, Connecticut 06492, US  
MULL, Eric, c/o Bristol-Myers Squibb Company 5 Research Parkway, Wallingford, Connecticut 06492, US  
PARCELLA, Kyle E., 20 Anna Drive, Wallingford, Connecticut 06492, US  
SAULNIER, Mark George, c/o Bristol-Myers Squibb Company 5 Research Parkway, Wallingford, Connecticut 06492, US  
SUN, Li-Qiang, c/o Bristol-Myers Squibb Company 5 Research Parkway, Wallingford, Connecticut 06492, US  
WANG, Alan Xiangdong, c/o Bristol-Myers Squibb Company 5 Research Parkway, Wallingford, Connecticut 06492, US  
XU, Ningning, 18 Twin Pines Drive, Wallingford, Connecticut 06492, US  
ZHU, Juliang, 22 Windsor Road East, North Haven, Connecticut 06473, US  
SCOLA, Paul Michael, c/o Bristol-Myers Squibb Company 5 Research Parkway, Wallingford, Connecticut 06492, US

---

(51) MKP

**A61K 9/127 2006 (97) EP 3362049**  
**A61K 31/4745 2006**

(96) EP 16788877.5 10/15/2016

(97) EP 3362049, 8/22/2018 201834, en

(31) 201562242873 P (32) 16.10.2015 (33) US  
201562242835 P 16.10.2015 US  
201562244082 P 20.10.2015 US  
201562244061 P 20.10.2015 US

(54) STABILIZING CAMPTOTHECIN PHARMACEUTICAL COMPOSITIONS

(72) DRUMMOND, Daryl, C., 1 Brooks Road, Lincoln, MA 01773, US  
KIRPOTIN, Dmitri, B., 382 Ocean Avenue Apt. 1509, Revere, MA 02151, US  
HAYES, Mark, Eamon, 49 Keats Drive, Mill Valley, CA 94941, US  
NOBLE, Charles, 990 Carolina Street, San Francisco, CA 94158, US  
KESPER, Kevin, 21 Brimmer Street, Watertown, MA 02472, US  
AWAD, Antoine, M., 352 Corey Street, West Roxbury, MA 02132, US  
MOORE, Douglas, J., 89 Fairway Drive, Newton, MA 02465, US  
O'BRIEN, Andrew, J., 22 Dover Circle, Franklin, MA 02038, US

---

(51) MKP

**A23L 7/161 2016 (97) EP 3351120**  
**A23P 20/10 2016**

(96) EP 16789357.7 5/4/2016

(97) EP 3351120, 7/25/2018 201830, en

(31) 201530621 (32) 07.05.2015 (33) ES

(54) IMPROVEMENTS TO PATENT P201231330 "METHOD FOR THE TREATMENT OF CORN KERNELS INTENDED FOR THE PRODUCTION OF POPCORN USING MICROWAVE APPLIANCES, AND RESULTING PRODUCT"

(71) Dode S.A., Avda. Alcalde Ramón Escayola 66 Valldoreix, 08197 Sant Cugat del Vallés, ES

(72) GALCERAN MARTORELL, Carlos, Alcalde Ramón Escayola, 66, 08197 Valldoreix, ES

---



---

(51) MKP  
**A23J 3/14 2006 (97) EP 3361880**  
**A23L 7/117 2016**  
**A23L 7/17 2016**  
**A23L 33/185 2016**  
**A23L 33/21 2016**

(96) EP 16790282.4 10/13/2016  
(97) EP 3361880, 8/22/2018 201834, en

(31) 15190251 (32) 16.10.2015 (33) EP  
201615229290 05.08.2016 US

(54) A METHOD OF MANUFACTURING A TEXTURED FOOD PRODUCT AND A TEXTURED FOOD PRODUCT  
(71) Gold&Green Foods Oy, Hämeentie 157, 00560 Helsinki, FI  
(72) KIVELÄ, Reetta, Stenbäckinkatu 18 B, 00250 Helsinki, FI  
HÄKÄMIES, Anna, Vattuniemenkatu 10 A 14, 00210 Helsinki, FI  
JIANG, Zhongqing, Oltermannintie 31 B 5, 00620 Helsinki, FI

---

(51) MKP  
**A61K 9/00 2006 (97) EP 3370693**  
**A61K 9/19 2006**  
**A61K 31/50 2006**

(96) EP 16790403.6 11/4/2016  
(97) EP 3370693, 9/12/2018 201837, en

(31) 15193521 (32) 06.11.2015 (33) EP

(54) IMPROVED FORMULATIONS OF LEVOSIMENDAN FOR INTRAVENOUS ADMINISTRATION AS INFUSION OR INJECTION AND OF INFUSION CONCENTRATE  
(71) CARINOPHARM GmbH, Bahnhofstraße 18, 31008 Elze, DE  
(72) WEILAND, Andrea, Georg-Knorr-Str. 4, Hohenbrunn 85662, DE

---

(51) MKP  
**A61B 5/00 2006 (97) EP 3352650**  
**A61B 5/01 2006**  
**A61B 5/021 2006**  
**A61B 5/024 2006**  
**A61B 5/07 2006**  
**A61B 5/145 2006**  
**A61B 5/1459 2006**  
**A61B 5/1486 2006**  
**A61B 5/16 2006**  
**A61K 9/00 2006**

(96) EP 16790454.9 9/13/2016  
(97) EP 3352650, 8/1/2018 201831, en

(31) 201562221786 P (32) 22.09.2015 (33) US

(54) VAGINAL RING SENSOR  
(72) FOUGERE, Richard J., 199 Grandview Road, Skillman, New Jersey 08558, US  
DONG, Ming, 199 Grandview Road, Skillman, New Jersey 08558, US

---

(51) MKP  
**C07K 14/715 2006 (97) EP 3359567**  
**C07K 16/24 2006**  
**G01N 33/50 2006**

(96) EP 16790463.0 10/5/2016  
(97) EP 3359567, 8/15/2018 201833, en

(31) 201562237624 P (32) 06.10.2015 (33) US

(54) BIOMARKERS RELATED TO INTERLEUKIN-33 (IL-33)-MEDIATED DISEASES AND USES THEREOF  
(72) ORENGO, Jamie M., c/o Regeneron Pharmaceuticals Inc. 777 Old Saw Mill River Road, Tarrytown, New York 10591, US  
ALLINNE, Jeanne, c/o Regeneron Pharmaceuticals Inc. 777 Old Saw Mill River Road, Tarrytown, New York 10591, US  
FURY, Wen, c/o Regeneron Pharmaceuticals Inc. 777 Old Saw Mill River Road, Tarrytown, New York 10591, US  
BAI, Yu, c/o Regeneron Pharmaceuticals Inc. 777 Old Saw Mill River Road, Tarrytown, New York 10591, US

---

(51) MKP

	<b>A61K 31/4188</b>	<b>2006</b>	<b>(97) EP 3362454</b>				
	<b>A61P 35/00</b>	<b>2006</b>					
	<b>C07D 487/04</b>	<b>2006</b>					
	<b>C07D 519/00</b>	<b>2006</b>					
(96)	EP 16790486.1 10/14/2016						
(97)	EP 3362454, 8/22/2018 201834, en						
(31)	201562242734 P		(32)	16.10.2015		(33)	US
	201562242748 P			16.10.2015			US
	2522016			13.10.2016			BD
(54)	EP4 ANTAGONISTS						
(72)	ZHENG, Wanjun, 14 Devonshire Lane, Londonderry, New Hampshire 03053, US						
	ZHU, Xiaojie, 12 Linda Road, Andover, Massachusetts 01810, US						
	DU, Hong, c/o Eisai Inc. 4 Corporate Drive, Andover, Massachusetts 01810, US						
	POSTEMA, Maarten, 5 Forbush Road, Dublin, New Hampshire 03444, US						
	JIANG, Yimin, 16 Devonshire Lane, Londonderry, New Hampshire 03053, US						
	LI, Jing, 40 Lincoln Circle East, Andover, Massachusetts 01810, US						
	YU, Robert, 1 Day Street, Arlington, Massachusetts 02476, US						
	CHOI, Hyeong-Wook, 39 Juniper Road, Andover, Massachusetts 01810, US						
	LEE, Jaemoon, 57 Argilla Road, Andover, Massachusetts 01810, US						
	FANG, Frank, 16 Greybitch Road, Andover, Massachusetts 01810, US						
	CUSTAR, Daniel, 105 Peachtree Lane, North Andover, Massachusetts 01845, US						

---

(51)	MKP						
	<b>A61J 1/03</b>	<b>2006</b>	<b>(97) EP 3364934</b>				
	<b>A61J 7/04</b>	<b>2006</b>					
	<b>B65D 75/32</b>	<b>2006</b>					
(96)	EP 16790489.5 10/17/2016						
(97)	EP 3364934, 8/29/2018 201835, en						
(31)	201562243436 P		(32)	19.10.2015		(33)	US
(54)	MEDICATION PACKAGING AND DISPENSING SYSTEM						
(72)	KIM, Lori, 1846 Haven Lane, Green Oaks, IL 60048, US						
	BREBAN-LOPEZ, Alexandra, 2550 Waterview Drive Unit 150, Northbrook, Illinois 60062, US						
	MEDHAL, Bhimaprasad, 317 Brampton Court, Lake Forest, Illinois 60045, US						
	BOJICIC, Dejan, 1226 N. Noble Street 1, Chicago, Illinois 60642, US						
	UPCHURCH, Guy, 943 W. 14th Place Unit 1B, Chicago, Illinois 60608, US						
	FINCH, John G., 120 South Deerpath Drive, Vernon Hills, Illinois 60061, US						
	SITA, Lewis, 21234 West Creekside Drive, Kildeer, Illinois 60047, US						

---

(51)	MKP						
	<b>A61K 31/437</b>	<b>2006</b>	<b>(97) EP 3371183</b>				
	<b>A61P 35/00</b>	<b>2006</b>					
	<b>C07D 471/04</b>	<b>2006</b>					
(96)	EP 16790601.5 11/2/2016						
(97)	EP 3371183, 9/12/2018 201837, en						
(31)	201519406		(32)	03.11.2015		(33)	GB
(54)	IMIDAZO[4,5-C]QUINOLIN-2-ONE COMPOUNDS AND THEIR USE IN TREATING CANCER						
(72)	PIKE, Kurt, Gordon, AstraZeneca Hodgkin Building Chesterford Research Park, Little Chesterford Essex CB10 1XL, GB						
	BARLAAM, Bernard, Christophe, AstraZeneca Darwin Building Cambridge Science Park Milton Road, Cambridge CB4 0WG, GB						
	HUNT, Thomas, Anthony, AstraZeneca Darwin Building Cambridge Science Park Milton Road, Cambridge CB4 0WG, GB						
	EATHERTON, Andrew, John, AstraZeneca Hodgkin Building Chesterford Research Park, Little Chesterford Essex CB10 1XL, GB						

---

(51)	MKP						
	<b>C12C 5/00</b>	<b>2006</b>	<b>(97) EP 3359636</b>				
	<b>C12C 12/02</b>	<b>2006</b>					
(96)	EP 16790698.1 10/6/2016						
(97)	EP 3359636, 8/15/2018 201833, fr						
(31)	1559520		(32)	07.10.2015		(33)	FR
(54)	METHOD FOR PRODUCING A BEER CONTAINING A REDUCED CARBOHYDRATE CONTENT AND ASSOCIATED BEER						
(71)	Di Pompeo, Christophe, 41 Rue Abélard, 59000 Lille, FR						
	Forest, Olivier, 246 Avenue de la Brasserie, 59620 Monceau Saint Waast, FR						
(72)	Di Pompeo, Christophe, 41 Rue Abélard, 59000 Lille, FR						
	Forest, Olivier, 246 Avenue de la Brasserie, 59620 Monceau Saint Waast, FR						

(51) MKP  
**A61K 31/52 2006 (97) EP 3368092**  
**A61K 47/68 2017**  
**A61P 35/00 2006**  
**C07D 473/34 2006**

(96) EP 16790722.9 10/25/2016  
(97) EP 3368092, 9/5/2018 201836, en

(31) 201562247896 P (32) 29.10.2015 (33) US

(54) ANTIBODY CONJUGATES COMPRISING TOLL-LIKE RECEPTOR AGONIST

(72) CORTEZ, Alex, Novartis Institute for Functional Genomics Inc. dba Genomics Institute of the Novartis Research Foundation 10675 John Jay Hopkins Drive, San Diego, California 92121, US  
GEIERSTANGER, Bernhard Hubert, Novartis Institute for Functional Genomics Inc. dba Genomics Institute of the Novartis Research Foundation 10675 John Jay Hopkins Drive, San Diego, California 92121, US  
HOFFMAN, Timothy Z., Novartis Institute for Functional Genomics Inc. dba Genomics Institute of the Novartis Research Foundation 10675 John Jay Hopkins Drive, San Diego, California 92121, US  
KASIBHATLA, Shailaja, Novartis Institute for Functional Genomics Inc. dba Genomics Institute of the Novartis Research Foundation 10675 John Jay Hopkins Drive, San Diego, California 92121, US  
UNO, Tetsuo, Novartis Institute for Functional Genomics Inc. dba Genomics Institute of the Novartis Research Foundation 10675 John Jay Hopkins Drive, San Diego, California 92121, US  
WANG, Xing, Novartis Institute for Functional Genomics Inc. dba Genomics Institute of the Novartis Research Foundation 10675 John Jay Hopkins Drive, San Diego, California 92121, US  
WU, Tom Yao-Hsiang, Novartis Institute for Functional Genomics Inc. dba Genomics Institute of the Novartis Research Foundation 10675 John Jay Hopkins Drive, San Diego, California 92121, US

---

(51) MKP  
**A61P 31/14 2006 (97) EP 3368562**  
**C07K 16/10 2006**

(96) EP 16790858.1 10/27/2016  
(97) EP 3368562, 9/5/2018 201836, en

(31) 201562247841 P (32) 29.10.2015 (33) US  
201662367359 P 27.07.2016 US

(54) ANTIBODY NEUTRALIZING HUMAN RESPIRATORY SYNCYTIAL VIRUS

(72) VORA, Kalpit, A., 770 Sumneytown Pike, West Point, Pennsylvania 19486, US  
COX, Kara, S., 770 Sumneytown Pike, West Point, Pennsylvania 19486, US  
TANG, Aimin, 770 Sumneytown Pike, West Point, Pennsylvania 19486, US  
CHEN, Zhifeng, 770 Sumneytown Pike, West Point, Pennsylvania 19486, US  
DISTEFANO, Daniel, 770 Sumneytown Pike, West Point, Pennsylvania 19486, US  
ZHANG, Lan, 770 Sumneytown Pike, West Point, Pennsylvania 19486, US  
SU, Hua-Poo, 770 Sumneytown Pike, West Point, Pennsylvania 19486, US

---

(51) MKP  
**C12N 5/09 2010 (97) EP 3365436**  
**C12Q 1/02 2006**

(96) EP 16791191.6 10/20/2016  
(97) EP 3365436, 8/29/2018 201835, en

(31) 201562243765 P (32) 20.10.2015 (33) US

(54) METHODS OF PREPARING A PRIMARY CELL SAMPLE

(72) LAING, Lance, Gavin, 994 Hunt Farm Road, Orono, MN 55356, US  
RICH, Ben, 16305 36th Ave N. Ste 450, Minneapolis, MN 55446, US  
DANDAPAT, Abhijit, 16305 36th Ave N. Ste 450, Minneapolis, MN 55446, US

---

(51) MKP  
**A01N 43/90 2006 (97) EP 3368540**  
**A61K 31/519 2006**  
**A61P 3/04 2006**  
**A61P 3/06 2006**  
**A61P 31/00 2006**  
**C07D 495/04 2006**

(96) EP 16791253.4 10/26/2016  
(97) EP 3368540, 9/5/2018 201836, en

(31) 201562246318 P (32) 26.10.2015 (33) US

(54) ACC INHIBITORS AND USES THEREOF

(72) GHOSH, Shomir, c/o Gilead Apollo LLC 333 Lakeside Drive, Foster City, California 94404, US  
HARRIMAN, Geraldine C., c/o Gilead Apollo LLC 333 Lakeside Drive, Foster City, California 94404, US  
LEIT DE MORADEI, Silvana Marcel, c/o Gilead Sciences, LLC 333 Lakeside Drive, Foster City, CA 94404, US  
GREENWOOD, Jeremy R., c/o Gilead Apollo, LLC 333 Lakeside Drive, Foster City, California 94404, US

---

(51) MKP  
**A61M 11/00 2006 (97) EP 3368110**  
**A61M 15/00 2006**  
(96) EP 16791268.2 10/28/2016  
(97) EP 3368110, 9/5/2018 201836, en  
(31) 201562248682 P (32) 30.10.2015 (33) US  
(54) ASEPTIC AEROSOL MISTING DEVICE  
(72) PAUNESCU, Alexandru, 199 Grandview Road, Skillman, New Jersey 08558, US  
RYTEL, John, 199 Grandview Road, Skillman, New Jersey 08558, US  
MENKE, James C., 199 Grandview Road, Skillman, New Jersey 08558, US

---

(51) MKP  
**A61K 39/00 2006 (97) EP 3371218**  
**C07K 16/24 2006**  
(96) EP 16791362.3 10/31/2016  
(97) EP 3371218, 9/12/2018 201837, en  
(31) 201519331 (32) 02.11.2015 (33) GB  
(54) TREATMENT PARADIGM  
(72) TAK, Paul-Peter, GlaxoSmithKline Gunnels Wood Road, Stevenage Hertfordshire SG1 2NY, GB

---

(51) MKP  
**A61K 31/4985 2006 (97) EP 3374359**  
**A61P 35/00 2006**  
**C07D 403/04 2006**  
**C07D 487/04 2006**  
(96) EP 16791420.9 11/8/2016  
(97) EP 3374359, 9/19/2018 201838, en  
(31) 201562252726 P (32) 09.11.2015 (33) US  
201662401351 P 29.09.2016 US  
(54) DIHYDROIMIDAZOPYRAZINONE DERIVATIVES USEFUL IN THE TREATMENT OF CANCER  
(72) WARD, Richard, Andrew, AstraZeneca Darwin Building Cambridge Science Park, Milton Road Cambridge CB4 0WG, GB  
JONES, Clifford, David, c/o AstraZeneca Intellectual Property AstraZeneca Alderley Park, Macclesfield Cheshire SK10 4TG, GB  
SWALLOW, Steven, AstraZeneca Charter Way, Macclesfield Cheshire SK10 2NA, GB  
GRAHAM, Mark, Andrew, AstraZeneca Charter Way, Macclesfield Cheshire SK10 2NA, GB  
DOBSON, Andrew, Hornby, AstraZeneca Charter Way, Macclesfield Cheshire SK10 2NA, GB  
MCCABE, James, Francis, AstraZeneca Charter Way, Macclesfield Cheshire SK10 2NA, GB

---

(51) MKP  
**A61K 9/19 2006 (97) EP 3373912**  
**A61K 35/16 2015**  
**C07K 14/755 2006**  
**F26B 3/12 2006**  
**F26B 5/06 2006**  
(96) EP 16791576.8 11/4/2016  
(97) EP 3373912, 9/19/2018 201838, en  
(31) 15194340 (32) 12.11.2015 (33) EP  
(54) METHOD FOR THE PRODUCTION OF FREEZE-DRIED PELLETS COMPRISING FACTOR VIII  
(72) OLBRICH, Carsten, Gneisenaustrasse 46, 10961 Berlin, DE  
PLITZKO, Matthias, René-Schickele-Strasse 8, 79395 Neuenburg, DE  
LUY, Bernhard, Landsknechtstrasse 13, 79102 Freiburg, DE  
SCHNEID, Stefan Christian, Kronenstrasse 39, 40217 Düsseldorf, DE

---

(51) MKP  
**A61K 39/395 2006 (97) EP 3368903**  
**G01N 33/574 2006**  
(96) EP 16791700.4 10/28/2016  
(97) EP 3368903, 9/5/2018 201836, en

(31) 201562248595 P (32) 30.10.2015 (33) US  
201562261957 P 02.12.2015 US  
(54) PROGNOSTIC METHOD  
(72) CRAIGEN, Jenny L., Gunnels Wood Road, Stevenage Hertfordshire SG1 2NY, GB  
GERMASCHIEWSKI, Fiona M., Gunnels Wood Road, Stevenage Hertfordshire SG1 2NY, GB  
FIELES, William E., 709 Swedeland Road, King of Prussia, Pennsylvania 19406, US  
MAYES, Patrick A., 1250 South Collegeville Road, Collegeville, Pennsylvania 19426, US  
MCCAHERON, Lee, Gunnels Wood Road, Stevenage Hertfordshire SG1 2NY, GB  
NEVIN (NEE SULLY), Katherine, Gunnels Wood Road, Stevenage Hertfordshire SG1 2NY, GB  
SEESTALLER-WEHR, Laura M., 1250 South Collegeville Road, Collegeville, Pennsylvania 19426, US  
TUNSTEAD, James, 709 Swedeland Road, King of Prussia, Pennsylvania 19406, US  
LEE, Lydia, 72 Huntley Street, London WC1E 6DD, GB  
PATERSON, Jennifer, 72 Huntley Street, London WC1E 6DD, GB  
RODRIGUEZ-JUSTO, Manuel, 72 Huntley Street, London WC1E 6DD, GB  
BOUNDS, Danton, 72 Huntley Street, London WC1E 6DD, GB  
YONG, Kwee L., 72 Huntley Street, London WC1E 6DD, GB  
HERLEDAN, Gaele, 72 Huntley Street, London WC1E 6DD, GB

---

(51) MKP  
**A61K 38/20 2006 (97) EP 3359182**  
**A61P 35/00 2006**  
(96) EP 16791713.7 10/7/2016  
(97) EP 3359182, 8/15/2018 201833, en  
(31) 201562239207 P (32) 08.10.2015 (33) US  
(54) COMBINATION OF AN IL-2RBETA-SELECTIVE AGONIST AND A LONG-ACTING IL-15 AGONIST  
(72) CHARYCH, Deborah, 909 Taylor Street, Albany, CA 94706, US  
KIRK, Peter, 413 Poinsettia Avenue, San Mateo, CA 94403, US

---

(51) MKP  
**A61M 11/00 2006 (97) EP 3368111**  
**A61M 15/00 2006**  
(96) EP 16791785.5 10/28/2016  
(97) EP 3368111, 9/5/2018 201836, en  
(31) 201562248682 P (32) 30.10.2015 (33) US  
201562248736 P 30.10.2015 US  
(54) ASEPTIC AEROSOL MISTING DEVICE  
(72) PAUNESCU, Alexandru, 199 Grandview Road, Skillman, New Jersey 08558, US  
BRENNAN, Robert A., 199 Grandview Road, Skillman, New Jersey 08558, US

---

(51) MKP  
**A61M 11/00 2006 (97) EP 3368112**  
**B05B 17/06 2006**  
(96) EP 16791786.3 10/28/2016  
(97) EP 3368112, 9/5/2018 201836, en  
(31) 201562248699 P (32) 30.10.2015 (33) US  
(54) ASEPTIC AEROSOL MISTING DEVICE  
(72) PAUNESCU, Alexandru, 199 Grandview Road, Skillman, New Jersey 08558, US

---

(51) MKP  
**A61M 11/00 2006 (97) EP 3368113**  
**A61M 15/00 2006**  
(96) EP 16791787.1 10/28/2016  
(97) EP 3368113, 9/5/2018 201836, en  
(31) 201562248736 P (32) 30.10.2015 (33) US  
(54) UNIT DOSE ASEPTIC AEROSOL MISTING DEVICE  
(72) PAUNESCU, Alexandru, 199 Grandview Road, Skillman, New Jersey 08558, US  
FOUGERE, Richard J., 7050 Camp Hill Road, Fort Washington, Pennsylvania 19304, US

---

(51) MKP  
**E04B 1/86 2006 (97) EP 3394360**  
**E04C 2/04 2006**  
**E04F 13/08 2006**

(96)	EP 16793743.2	10/12/2016					
(97)	EP 3394360, 10/31/2018 201844, en						
(31)	15003628		(32)	21.12.2015		(33)	EP
(54)	ACOUSTIC DRYWALL PANEL						
(72)	SEIDEL, Jochen, Am Henkelsee 27, D-97346 Iphofen, DE HERFURTH, Dominik, Pfaffensteig 8, 97346 Iphofen, DE VIEBAHN, Michael, Ludwigstraße 5, 97346 Iphofen, DE						
<hr/>							
(51)	MKP						
	<b>A61P 25/18</b>	<b>2006</b>					<b>(97) EP 3371188</b>
	<b>C07D 487/04</b>	<b>2006</b>					
(96)	EP 16793800.0	11/2/2016					
(97)	EP 3371188, 9/12/2018 201837, en						
(31)	15192661		(32)	02.11.2015		(33)	EP
	15192966			04.11.2015			EP
(54)	[1,2,4]TRIAZOLO[1,5-a]PYRIMIDIN-7-YL COMPOUND						
(72)	BUIJNSTERS, Petrus Jacobus Johannes Antonius, c/o Janssen Pharmaceutica NV Turnhoutseweg 30, 2340 Beerse, BE GIJSEN, Henricus Jacobus Maria, c/o Janssen Pharmaceutica NV Turnhoutseweg 30, 2340 Beerse, BE DRINKENBURG, Wilhelmus, Helena Ignatius Maria, c/o Janssen Pharmaceutica NV Turnhoutseweg 30, 2340 Beerse, BE AHNAOU, Abdallah, c/o Janssen Pharmaceutica NV Turnhoutseweg 30, 2340 Beerse, BE						
<hr/>							
(51)	MKP						
	<b>A42B 3/06</b>	<b>2006</b>					<b>(97) EP 3349607</b>
	<b>F16F 7/12</b>	<b>2006</b>					
(96)	EP 16794033.7	9/16/2016					
(97)	EP 3349607, 7/25/2018 201830, en						
(31)	UB20153738		(32)	18.09.2015		(33)	IT
(54)	A COMPOSITE GEOMETRY STRUCTURE FOR THE ABSORPTION AND DISSIPATION OF THE ENERGY GENERATED BY AN IMPACT AND A SAFETY HELMET COMPRISING SAID STRUCTURE.						
(71)	Pedevilla, Patrick, Via Firenze 6, 39100 Bolzano, IT Airhelmet S.r.l., Via Louis Braille, 10, 39100 Bolzano, IT						
(72)	ABDOLAHIAN, Alessio, Via del Passo 25, 31100 Treviso, IT CROSERA, Giovanni, Via Perin 3/2, 30027 San Dona'di Piave (VE), IT						
<hr/>							
(51)	MKP						
	<b>F16H 1/28</b>	<b>2006</b>					<b>(97) EP 3350477</b>
(96)	EP 16794035.2	9/16/2016					
(97)	EP 3350477, 7/25/2018 201830, en						
(31)	UB20153713		(32)	17.09.2015		(33)	IT
(54)	PRECISION PLANETARY GEAR						
(71)	Samp S.p.a. Con Unico Socio, Via Saliceto 15, 40010 Bentivoglio, IT						
(72)	FELISA, Giuseppe, c/o SAMP S.P.A. CON UNICO SOCIO Via Saliceto 15, 40010 Bentivoglio, IT FIORETTI, Daniele, c/o SAMP S.P.A. CON UNICO SOCIO Via Saliceto 15, 40010 Bentivoglio, IT						
<hr/>							
(51)	MKP						
	<b>A63H 15/06</b>	<b>2006</b>					<b>(97) EP 3365086</b>
(96)	EP 16794054.3	10/17/2016					
(97)	EP 3365086, 8/29/2018 201835, en						
(31)	UB20154990		(32)	21.10.2015		(33)	IT
(54)	TOY PUPPET						
(72)	GRANI, Enrico, c/o GRANI & PARTNERS S.r.l. Via Gioberti, 1, 20123 Milano, IT						
<hr/>							
(51)	MKP						
	<b>C07K 16/28</b>	<b>2006</b>					<b>(97) EP 3365373</b>
	<b>C07K 16/30</b>	<b>2006</b>					
	<b>C07K 16/40</b>	<b>2006</b>					
(96)	EP 16794080.8	10/21/2016					
(97)	EP 3365373, 8/29/2018 201835, en						
(31)	15191343		(32)	23.10.2015		(33)	EP
	16168647			06.05.2016			EP

- (54) BINDING MOLECULES THAT INHIBIT CANCER GROWTH  
 (71) Koninklijke Nederlandse Akademie van Wetenschappen, Kloveniersburgwal 29, 1011 JV Amsterdam, NL  
 Ocello B.V., J.H. Oortweg 21, 2333 CH Leiden, NL  
 Institute For Research In Biomedicine (IRB Barcelona), Baldiri Reixac 10, 08028 Barcelona, ES  
 Institució Catalana de Recerca I Estudis Avançats, Passeig Lluís Companys, 23, 08010 Barcelona, ES  
 (72) THROSBY, Mark, c/o Yalelaan 62, 3584 CM Utrecht, NL  
 LOGTENBERG, Ton, c/o Yalelaan 62, 3584 CM Utrecht, NL  
 CLEVERS, Johannes Carolus, c/o Hubrecht Instituut Uppsalalaan 8, 3584 CT Utrecht, NL  
 VRIES, Robert Gerhardus Jacob, c/o Hubrecht Instituut Uppsalalaan 8, 3684 CT Utrecht, NL  
 BATLLE, Eduard, c/o Baldiri Reixac 10, 08028 Barcelona, ES  
 HERPERS, Bram, c/o J.H. Oortweg 21, 2333 CH Leiden, NL
- 

- (51) MKP  
**H01M 4/133 2010 (97) EP 3375029**  
**H01M 4/136 2010**  
**H01M 4/1393 2010**  
**H01M 4/1397 2010**  
**H01M 4/36 2006**  
**H01M 4/38 2006**  
**H01M 4/587 2010**  
**H01M 4/62 2006**  
**H01M 4/66 2006**  
**H01M 10/052 2010**  
 (96) EP 16794337.2 11/10/2016  
 (97) EP 3375029, 9/19/2018 201838, en  
 (31) 15382557 (32) 10.11.2015 (33) EP  
 (54) CARBON COMPOSITES  
 (71) Grabat Energy, S.L., Zurbano, 80, 5° izq., 28010 Madrid, ES  
 (72) MORALES PALOMINO, Julián, Departamento de Química Inorgánica e Ingeniería Química Edificio Marie Curie Campus de Rabanales  
 Universidad de Córdoba, E-14071 Córdoba, ES  
 CABALLERO AMORES, Álvaro, Departamento de Química Inorgánica e Ingeniería Química Edificio Marie Curie Campus de Rabanales  
 Universidad de Córdoba, E-14071 Córdoba, ES
- 

- (51) MKP  
**A61K 8/02 2006 (97) EP 3383353**  
**A61K 8/19 2006**  
**A61K 8/25 2006**  
**A61Q 11/00 2006**  
 (96) EP 16794351.3 11/11/2016  
 (97) EP 3383353, 10/10/2018 201841, en  
 (31) 15198112 (32) 04.12.2015 (33) EP  
 201662286491 P 25.01.2016 US  
 (54) ORAL CARE COMPOSITION FOR REMINERALISATION AND WHITENING OF TEETH  
 (72) BUDDE, Tanja, Grubenring 3, 4805 Brittnau, CH  
 GERARD, Daniel, E., Rheinfelderstrasse 12, 4058 Basel, CH  
 GANE, Patrick, A., C., Studenweg 8, 4852 Rothrist, CH
- 

- (51) MKP  
**B01D 53/56 2006 (97) EP 3365094**  
**B01D 53/60 2006**  
**B01D 53/64 2006**  
**B01D 53/78 2006**  
**F23J 15/04 2006**  
 (96) EP 16794466.9 10/21/2016  
 (97) EP 3365094, 8/29/2018 201835, en  
 (31) 201562244411 P (32) 21.10.2015 (33) US  
 (54) SYSTEMS AND METHODS FOR REMOVING COMBUSTION PRODUCTS FROM A POWER GENERATION CYCLE  
 (72) ALLAM, Rodney John, Lanhill House, Lanhill Chippenham Wiltshire SN14 6LY, GB  
 LU, Xijia, 3708 Kilgo Drive, Durham, North Carolina 27705, US  
 MARTIN, Scott Thomas, 501 Willard Street Apt. 431, Durham, North Carolina 27701, US
- 

- (51) MKP

**A61K 39/42 2006 (97) EP 3365366**  
**C07K 16/10 2006**

(96) EP 16794472.7 10/24/2016  
(97) EP 3365366, 8/29/2018 201835, en

(31) 201562246113 P (32) 25.10.2015 (33) US  
PCT/EP2016/305211 24.02.2016 WO  
201662322029 P 13.04.2016 US  
201662331169 P 03.05.2016 US

(54) TRISPECIFIC AND/OR TRIVALENT BINDING PROTEINS FOR PREVENTION OR TREATMENT OF HIV INFECTION  
(71) THE USA, AS REPRESENTED BY THE SECRETARY, DEPARTMENT OF HEALTH AND HUMAN SERVICES, National Institutes of Health  
6011 Executive Boulevard, Suite 325, Rockville, MD 20852, US

(72) YANG, Zhi-Yong, c/o Sanofi 55 Corporate Drive Mail Code: 55A-505A, Bridgewater, NJ 08807, US  
NABEL, Gary, J., c/o Sanofi 55 Corporate Drive Mail Code: 55A-505A, Bridgewater, NJ 08807, US  
XU, Ling, c/o Sanofi 55 Corporate Drive Mail Code: 55A-505A, Bridgewater, NJ 08807, US  
WEI, Ronnie, c/o Sanofi 55 Corporate Drive Mail Code: 55A-505A, Bridgewater, NJ 08807, US  
QIU, Huawei, c/o Sanofi 55 Corporate Drive Mail Code: 55A-505A, Bridgewater, NJ 08807, US  
BENINGA, Jochen, c/o Sanofi-Aventis Deutschland GmbH, 65926 Frankfurt Am Main, DE  
KRUIP, Jochen, c/o Sanofi-Aventis Deutschland GmbH, 65926 Frankfurt Am Main, DE  
RAO, Ercole, c/o Sanofi-Aventis Deutschland GmbH, 65926 Frankfurt Am Main, DE  
LEUSCHNER, Wulf, Dirk, c/o Sanofi-Aventis Deutschland GmbH, 65926 Frankfurt Am Main, DE  
BEIL, Christian, c/o Sanofi-Aventis Deutschland GmbH, 65926 Frankfurt Am Main, DE  
LANGE, Christian, c/o Sanofi-Aventis Deutschland GmbH, 65926 Frankfurt Am Main, DE  
CONNORS, Mark, c/o National Institutes of Health 6011 Executive Boulevard Suite 325, Rockville, MD 20852, US  
MASCOLA, John, R., c/o National Institutes of Health 6011 Executive Boulevard Suite 325, Rockville, MD 20852, US  
KROUP, Richard, A., c/o National Institutes of Health 6011 Executive Boulevard Suite 325, Rockville, MD 20852, US  
HUANG, Jinghe, c/o National Institutes of Health 6011 Executive Boulevard Suite 325, Rockville, MD 20852, US  
DORIA-ROSE, Nicole, A., c/o National Institutes of Health 6011 Executive Boulevard Suite 325, Rockville, MD 20852, US  
ZHOU, Tongqing, c/o National Institutes of Health 6011 Executive Boulevard Suite 325, Rockville, MD 20852, US  
KWONG, Peter, D., c/o National Institutes of Health 6011 Executive Boulevard Suite 325, Rockville, MD 20852, US  
KWON, Young, Do, c/o National Institutes of Health 6011 Executive Boulevard Suite 325, Rockville, MD 20852, US  
PEGU, Amarendra, c/o National Institutes of Health 6011 Executive Boulevard Suite 325, Rockville, MD 20852, US  
ASOKAN, Mangaiarkarasi, c/o National Institutes of Health 6011 Executive Boulevard, Suite 325, Rockville, MD 20852, US

---

(51) MKP  
**A61K 31/4375 2006 (97) EP 3368534**  
**A61P 25/00 2006**  
**C07D 471/04 2006**

(96) EP 16794479.2 10/28/2016  
(97) EP 3368534, 9/5/2018 201836, en

(31) 201562249074 P (32) 30.10.2015 (33) US

(54) VALBENZAZINE SALTS AND POLYMORPHS THEREOF  
(72) MCGEE, Kevin, 7650 Norcanyon Way, San Diego, CA 92126, US  
ZOOK, Scott, 3716 Arizona Street, San Diego, CA 92104, US  
CARR, Andrew, 91 Lancaster Gate, Upper Cambourne Cambridge CB23 6AU, GB  
BONNAUD, Thierry, 17 Sunmead Walk, Cambridge CB19YB, GB

---

(51) MKP  
**C12Q 1/68 2018 (97) EP 3374519**

(96) EP 16794589.8 11/9/2016  
(97) EP 3374519, 9/19/2018 201838, en

(31) 15193966 (32) 10.11.2015 (33) EP

(54) DETECTION OF FOETAL CHROMOSOMAL ANEUPLOIDIES USING DNA REGIONS THAT ARE DIFFERENTIALLY METHYLATED BETWEEN  
THE FOETUS AND THE PREGNANT FEMALE  
(72) WERLER, Steffi, c/o LifeCodexx AG Jakob-Stadler-Platz 7, 78467 Konstanz, DE  
HOFMANN, Wera, c/o LifeCodexx AG Jakob-Stadler-Platz 7, 78467 Konstanz, DE  
SACHSE, Matthias, c/o LifeCodexx AG Jakob-Stadler-Platz 7, 78467 Konstanz, DE

---

(51) MKP  
**A61K 31/4985 2006 (97) EP 3371189**  
**A61P 35/00 2006**  
**C07D 487/04 2006**

(96) EP 16794751.4 11/4/2016  
(97) EP 3371189, 9/12/2018 201837, en



(31) 201562252420 P (32) 06.11.2015 (33) US  
201562261228 P 30.11.2015 US  
(54) IMIDAZOPYRAZINE INHIBITORS OF BRUTON'S TYROSINE KINASE  
(72) BARF, Tjeerd, St. Luciastraat 7, 5371 AS Ravenstein, NL  
DE ZWART, Edwin, Waaldijk 26, 6621 KH Dreumel, NL  
VERKAIK, Saskia, Caspar Boshartstraat 23, 5367 AC Macharen, NL  
HOOGENBOOM, Niels, Het Reut 605, 5351 TH Berghem, NL  
DEMONT, Dennis, Zevenblad 16, 5345 KX Oss, NL

---

(51) MKP  
**A61K 31/164 2006 (97) EP 3368026**  
**A61K 31/337 2006**  
**A61K 31/495 2006**  
**A61K 31/505 2006**  
**A61P 25/02 2006**  
(96) EP 16794838.9 10/27/2016  
(97) EP 3368026, 9/5/2018 201836, en  
(31) 201562246965 P (32) 27.10.2015 (33) US  
201662281990 P 22.01.2016 US  
(54) HDAC INHIBITORS FOR THE TREATMENT OF DIABETIC PERIPHERAL NEUROPATHY  
(72) GOLONZHKA, Olga, 9 Molloy Street, Watertown, MA 02472, US  
JARPE, Matthew, B., 46 Warwick Street, Quincy, MA 02170, US

---

(51) MKP  
**A61K 38/17 2006 (97) EP 3371208**  
**C07K 14/705 2006**  
(96) EP 16794878.5 11/1/2016  
(97) EP 3371208, 9/12/2018 201837, en  
(31) 201562249836 P (32) 02.11.2015 (33) US  
201662373654 P 11.08.2016 US  
(54) CD80 EXTRACELLULAR DOMAIN POLYPEPTIDES AND THEIR USE IN CANCER TREATMENT  
(72) BRENNAN, Thomas, Two Corporate Drive, South San Francisco, California 94080, US  
BELLOVIN, David, Two Corporate Drive, South San Francisco, California 94080, US  
BUSHA, David, Two Corporate Drive, South San Francisco, California 94080, US  
SENNINO, Barbara, Two Corporate Drive, South San Francisco, California 94080, US

---

(51) MKP  
**A61K 39/395 2006 (97) EP 3371220**  
**C07K 16/28 2006**  
(96) EP 16794880.1 11/1/2016  
(97) EP 3371220, 9/12/2018 201837, en  
(31) 201562249466 P (32) 02.11.2015 (33) US  
(54) ANTI-IL1RAP ANTIBODIES, BISPECIFIC ANTIGEN BINDING MOLECULES THAT BIND IL1RAP AND CD3, AND USES THEREOF  
(71) Janssen Pharmaceutica NV, Turnhoutseweg 30, 2340 Beerse, BE  
(72) HEIDRICH, Bradley J., 1400 McKean Road, Spring House, Pennsylvania 19477, US  
NEMETH, Jennifer F., Welsh and McKean Roads, Spring House, Pennsylvania 19477, US  
NISHIOKA, JR., Walter K., 3210 Merryfield Row, San Diego, California 92121, US  
DINH, Thai, 3210 Merryfield Road, San Diego, California 92121, US  
CARDOSO, Rosa Maria Fernandes, 1400 McKean Road, Spring House, Pennsylvania 19477, US  
PIZUTTI, Darlene, 1400 McKean Road, Spring House, Pennsylvania 19477, US  
STRAKE, Brandy, Welsh and McKean Roads, Spring House, Pennsylvania 19477, US  
FISHER, Jamie, Welsh and McKean Roads, Spring House, Pennsylvania 19477, US  
ATTAR, Ricardo Marcos, 1400 McKean Road, Spring House, Pennsylvania 19477, US  
GAUDET, Francois, 1400 McKean Road, Spring House, Pennsylvania 19477, US  
SALVATI, Mark E., 1400 Welsh Road, Spring House, Pennsylvania 19477, US

---

(51) MKP  
**C08J 5/18 2006 (97) EP 3383939**  
**C08K 3/26 2006**  
**C08K 9/02 2006**  
**C09C 1/02 2006**  
(96) EP 16795026.0 11/11/2016  
(97) EP 3383939, 10/10/2018 201841, en

(31) 15197670 (32) 02.12.2015 (33) EP  
201562264893 P 09.12.2015 US  
(54) SURFACE-TREATED FILLERS FOR ULTRATHIN BREATHABLE FILMS  
(72) BRUNNER, Martin, Rosenstrasse 5, 4323 Wallbach, CH  
FORNERA, Tazio, Innere Altachen 12, 4800 Zofingen, CH  
KNERR, Michael, Wolfbachring 20, 4665 Oftringen, CH  
TINKL, Michael, Kornbergweg 5, 5073 Gipf-Oberfrick, CH  
UNGER, Marcus, Breslauerstrasse 13, 91601 Dombühl, DE

---

(51) MKP  
**A61K 38/06 2006 (97) EP 3377515**  
**C07K 5/097 2006**  
(96) EP 16795077.3 11/15/2016  
(97) EP 3377515, 9/26/2018 201839, en  
(31) 15382567 (32) 16.11.2015 (33) EP  
(54) GELATINASE INHIBITORS AND USE THEREOF  
(71) Iproteos S.L, Baldiri Reixac 10 Edificio Cluster I, 08028 Barcelona, ES  
(72) PRADES COSANO, Roger, Iproteos S.L Baldiri Reixac 10 Edificio Cluster I, 08028 Barcelona, ES  
SECO MORAL, Jesús, Iproteos S.L Baldiri Reixac 10 Edificio Cluster I, 08028 Barcelona, ES  
TARRAGÓ CLUA, María, Teresa, Iproteos S.L Baldiri Reixac 10 Edificio Cluster I, 08028 Barcelona, ES

---

(51) MKP  
**B65D 19/34 2006 (97) EP 3344555**  
(96) EP 16795130.0 9/2/2016  
(97) EP 3344555, 7/11/2018 201828, en  
(31) 1500147 U (32) 04.09.2015 (33) HU  
(54) PALLET MADE OF CORRUGATED PAPERBOARD  
(71) Berkes, Mihály, Kaptárk utca 12. X. 29., 1118 Budapest, HU  
(72) Berkes, Mihály, Kaptárk utca 12. X. 29., 1118 Budapest, HU

---

(51) MKP  
**C12N 9/12 2006 (97) EP 3362555**  
**C12N 15/62 2006**  
(96) EP 16795177.1 10/14/2016  
(97) EP 3362555, 8/22/2018 201834, en  
(31) 201562241350 P (32) 14.10.2015 (33) US  
(54) MODIFICATION OF RNA-RELATED ENZYMES FOR ENHANCED PRODUCTION  
(72) STRACK-LOGUE, Bettina, 300 Shire Way, Lexington, MA 02421, US  
DEROSA, Frank, 300 Shire Way, Lexington, MA 02421, US  
HEARTLEIN, Michael, 300 Shire Way, Lexington, MA 02421, US

---

(51) MKP  
**B41M 3/14 2006 (97) EP 3380331**  
**B41M 7/00 2006**  
**D21H 21/30 2006**  
**D21H 21/48 2006**  
(96) EP 16795309.0 11/11/2016  
(97) EP 3380331, 10/3/2018 201840, en  
(31) 15196143 (32) 24.11.2015 (33) EP  
201562261352 P 01.12.2015 US  
(54) PRINTED WATERMARK  
(72) BOLLSTRÖM, Roger, Ackerstrasse 11, 4800 Zofingen, CH  
GANE, Patrick A.C., Studenweg 8, 4852 Rothrist, CH  
SCHOELEKOPF, Joachim, Dyshofweg 3, 5727 Oberkulm, CH

---

(51) MKP  
**A61K 39/00 2006 (97) EP 3377528**  
**A61K 39/395 2006**  
**A61P 25/00 2006**  
**C07K 16/28 2006**  
(96) EP 16795333.0 11/15/2016

(97) EP 3377528, 9/26/2018 201839, en  
(31) PCT/CN2015/094779 (32) 17.11.2015 (33) WO  
PCT/CN2016/095545 16.08.2016 WO  
201618814 08.11.2016 GB  
(54) BINDING AGONISTS FOR TREATMENT OF NEUROLOGICAL AND OTHER DISORDERS  
(72) BHINDER, Tejinder, Kaur, GlaxoSmithKline Gunnels Wood Road, Stevenage Hertfordshire SG1 2NY, GB  
DING, Chong, GlaxoSmithKline (China) R&D Co Ltd Building 3, 898 Halei Road Zhangjiang Hi-Tech Park Pudong New Area, Shanghai 201203, CN  
FENG, Xu, GlaxoSmithKline (China) R&D Co Ltd Building 3, 898 Halei Road Zhangjiang Hi-Tech Park Pudong New Area, Shanghai 201203, CN  
JIANG, Wenqing, GlaxoSmithKline (China) R&D Co Ltd Building 3, 898 Halei Road Zhangjiang Hi-Tech Park Pudong New Area, Shanghai 201203, CN  
LEWIS, Alan, Peter, GlaxoSmithKline Gunnels Wood Road, Stevenage Hertfordshire SG1 2NY, GB  
MA, Yingli, c/o GlaxoSmithKline (China) R&D Co Ltd Building 3, 898 Halei Road Zhangjiang Hi-Tech Park Pudong New Area, Shanghai 201203, CN  
NAGAPPAN, Guhan, GlaxoSmithKline (China) R&D Co Ltd Building 3, 898 Halei Road Zhangjiang Hi-Tech Park Pudong New Area, Shanghai 201203, CN  
PARMAR, Radha, Shah, GlaxoSmithKline Gunnels Wood Road, Stevenage Hertfordshire SG1 2NY, GB  
QIU, Yangsheng, c/o GlaxoSmithKline (China) R&D Co Ltd Building 3, 898 Halei Road Zhangjiang Hi-Tech Park Pudong New Area, Shanghai 201203, CN  
YANG, Liuqing, c/o GlaxoSmithKline (China) R&D Co Ltd Building 3, 898 Halei Road Zhangjiang Hi-Tech Park Pudong New Area, Shanghai 201203, CN  
ZHANG, Qing, c/o GlaxoSmithKline (China) R&D Co Ltd Building 3, 898 Halei Road Zhangjiang Hi-Tech Park Pudong New Area, Shanghai 201203, CN  
ZHOU, Yanjiao, GlaxoSmithKline (China) R&D Co Ltd Building 3, 898 Halei Road Zhangjiang Hi-Tech Park Pudong New Area, Shanghai 201203, CN

---

(51) MKP  
**G01N 33/50 2006 (97) EP 3371593**  
**G01N 33/573 2006**  
(96) EP 16795529.3 11/7/2016  
(97) EP 3371593, 9/12/2018 201837, en  
(31) 201562252181 P (32) 06.11.2015 (33) US  
(54) CELL-BASED ASSAYS FOR DETECTION OF ANTIBODIES OR OTHER FACTORS THAT NEUTRALIZE UPTAKE OF LYSOSOMAL ENZYMES  
(72) MELTON, Andrew, 105 Digital Drive, Novato, CA 94949, US  
ZOOG, Stephen, 105 Digital Drive, Novato, CA 94949, US  
JESAITIS, Lynne, 105 Digital Drive, Novato, CA 94949, US

---

(51) MKP  
**A61K 31/7072 2006 (97) EP 3253773**  
**A61K 31/7076 2006**  
**A61K 31/708 2006**  
**A61P 31/14 2006**  
**C07H 19/067 2006**  
**C07H 19/073 2006**  
**C07H 19/10 2006**  
**C07H 19/11 2006**  
**C07H 19/173 2006**  
**C07H 19/20 2006**  
**C07H 19/213 2006**  
(96) EP 15870943.6 12/16/2015  
(97) EP 3253773, 9/26/2018 201839, en  
(31) 201462094458 P (32) 19.12.2014 (33) US  
(54) SUBSTITUTED NUCLEOSIDES, NUCLEOTIDES AND ANALOGS THEREOF  
(72) BEIGELMAN, Leonid, 260 E. Grand Avenue 2nd Floor, South San Francisco, CA 94080, US  
SMITH, David, Bernard, 260 E. Grand Avenue 2nd Floor, South San Francisco, CA 94080, US  
WANG, Guangyi, 260 E. Grand Avenue 2nd Floor, South San Francisco, CA 94080, US  
DYATKINA, Natalia, 260 E. Grand Avenue 2nd Floor, South San Francisco, CA 94080, US

---

(51) MKP  
**A01C 15/04 2006 (97) EP 3247190**  
**B65G 53/16 2006**  
**B65G 53/52 2006**  
**G01F 11/00 2006**  
(96) EP 15879147.5 1/20/2015

(97) EP 3247190, 9/19/2018 201838, en  
(54) METERING SYSTEM FOR SOLID PARTICULATE  
(72) MONTAG, Roger A., 3816 461st Avenue, Emmetsburg, Iowa 50536, US  
MOGLER, Isaac, 3816 461st Avenue, Emmetsburg, Iowa 50536, US  
FEHR, Jason, 3816 461st Avenue, Emmetsburg, Iowa 50536, US

---

(51) MKP  
**A01C 7/08 2006 (97) EP 3247191**  
**A01C 7/10 2006**  
**A01C 7/16 2006**  
**A01C 15/00 2006**  
**A01C 15/04 2006**  
**A01C 15/16 2006**  
**A01C 19/02 2006**  
**G01F 13/00 2006**  
**G05D 7/06 2006**  
**G05D 11/12 2006**  
**G05D 11/13 2006**

(96) EP 15879150.9 1/20/2015  
(97) EP 3247191, 9/12/2018 201837, en  
(54) SINGLE PARTICULATE METERING SYSTEM WITH VARIABLE RATE CONTROLS  
(71) Montag Investments, LLC, 3816 461st Avenue, Emmetsburg, Iowa 50536, US  
(72) MONTAG, Roger A., 3816 461st Avenue, Emmetsburg, IA 50536, US  
MOGLER, Isaac, 3816 461st Avenue, Emmetsburg, IA 50536, US  
FEHR, Jason, 3816 461st Avenue, Emmetsburg, IA 50536, US

---

(51) MKP  
**A61K 31/519 2006 (97) EP 3381916**  
**A61K 31/55 2006**  
**A61P 35/00 2006**  
**A61P 43/00 2006**  
**C07D 471/04 2006**  
**C07D 519/00 2006**

(96) EP 16868662.4 11/25/2016  
(97) EP 3381916, 10/3/2018 201840, en  
(31) 2015232273 (32) 27.11.2015 (33) JP  
(54) CONDENSED PYRIMIDINE COMPOUND OR SALT THEREOF  
(71) Taiho Pharmaceutical Co., Ltd., 27, Kandanshiki-cho 1-chome Chiyoda-ku, Tokyo 101-8444, JP  
(72) MINAMIGUCHI, Kazuhisa, c/o Taiho Pharmaceutical Co., Ltd. Discovery and Preclinical Research Division 3, Okubo, Tsukuba-shi Ibaraki 300-2611, JP  
OKAJIMA, Shigeo, c/o Taiho Pharmaceutical Co., Ltd. Chemical Technology Division 200-22, Ooaza-motohara Kamikawa-machi Kodama-gun, Saitama 367-0241, JP  
ASAI, Takahiro, c/o Taiho Pharmaceutical Co., Ltd. Discovery and Preclinical Research Division 3, Okubo, Tsukuba-shi Ibaraki 300-2611, JP  
ASAI, Masanori, c/o Taiho Pharmaceutical Co. Ltd. Discovery and Preclinical Research Division 3 Okubo, Tsukuba-shi Ibaraki 300-2611, JP  
OGINO, Yoshio, c/o Taiho Pharmaceutical Co., Ltd. Discovery and Preclinical Research Division 3, Okubo, Tsukuba-shi Ibaraki 300-2611, JP

---

(51) MKP  
**A61K 31/40 2006 (97) EP 3381896**  
**A61K 31/404 2006**  
**A61K 31/407 2006**  
**A61K 31/416 2006**  
**A61K 31/4184 2006**  
**C07D 207/04 2006**

(96) EP 16868699.6 11/25/2016  
(97) EP 3381896, 10/3/2018 201840, en  
(31) 2015232009 (32) 27.11.2015 (33) JP  
2016117454 13.06.2016 JP  
(54) NOVEL BIPHENYL COMPOUND OR SALT THEREOF  
(72) YAMASHITA, Satoshi, c/o TAIHO PHARMACEUTICAL CO. LTD. 3 Okubo, Tsukuba-shi Ibaraki 300-2611, JP  
OGAWA, Takahiro, c/o TAIHO PHARMACEUTICAL CO. LTD. 3 Okubo, Tsukuba-shi Ibaraki 300-2611, JP  
KOMATANI, Hideya, c/o TAIHO PHARMACEUTICAL CO. LTD. 3 Okubo, Tsukuba-shi Ibaraki 300-2611, JP

---

(51) MKP

	<b>A41D 19/015</b>	<b>2006</b>	<b>(97) EP 3383602</b>			
	<b>A61B 42/10</b>	<b>2016</b>				
	<b>A61B 42/50</b>	<b>2016</b>				
	<b>A61J 3/00</b>	<b>2006</b>				
	<b>B25J 21/02</b>	<b>2006</b>				
	<b>G21F 7/053</b>	<b>2006</b>				
(96)	EP 16869435.4 11/25/2016					
(97)	EP 3383602, 10/10/2018 201841, en					
(31)	201562261411 P		(32)	01.12.2015	(33)	US
(54)	ISOLATOR SLEEVE SYSTEMS					
(71)	Clean Air Essentials 797 Inc., 1320 Graham Boulevard Suite 120, Montreal, Québec H3P 3C8, CA					
(72)	MOUSSA, Magdi, 1320 Graham Boulevard Suite 120, Montreal, Québec H3P 3C8, CA					
	ZINI, Daniel, 1320 Graham Boulevard Suite 120, Montreal, Québec H3P 3C8, CA					
<hr/>						
(51)	MKP					
	<b>B60P 1/36</b>	<b>2006</b>	<b>(97) EP 3383774</b>			
	<b>B65G 17/06</b>	<b>2006</b>				
	<b>B65G 17/12</b>	<b>2006</b>				
	<b>B65G 17/26</b>	<b>2006</b>				
	<b>B65G 67/20</b>	<b>2006</b>				
	<b>B65G 67/24</b>	<b>2006</b>				
	<b>B65G 67/46</b>	<b>2006</b>				
	<b>B66F 9/06</b>	<b>2006</b>				
(96)	EP 16870050.8 12/1/2016					
(97)	EP 3383774, 10/10/2018 201841, en					
(31)	20155902		(32)	01.12.2015	(33)	FI
(54)	EQUIPMENT FOR MOVING A PALLET					
(72)	KAUHANEN, Juho, Kalevalankatu 51-53 a 2, 76100 Pieksämäki, FI					
	AUVINEN, Janne, Välikatu 2 A 19, 76100 Pieksämäki, FI					
	MUSTONEN, Eetu, Reunakatu 1 F 55, 76100 Pieksämäki, FI					
<hr/>						
(51)	MKP					
	<b>A61K 35/13</b>	<b>2015</b>	<b>(97) EP 3383412</b>			
	<b>A61K 39/395</b>	<b>2006</b>				
	<b>A61K 49/16</b>	<b>2006</b>				
	<b>C07K 16/18</b>	<b>2006</b>				
	<b>C07K 16/28</b>	<b>2006</b>				
	<b>C12P 21/08</b>	<b>2006</b>				
(96)	EP 16871487.1 12/1/2016					
(97)	EP 3383412, 10/10/2018 201841, en					
(31)	201562262303 P		(32)	02.12.2015	(33)	US
(54)	ANTIBODIES SPECIFIC TO GLYCOSYLATED PD-1 AND METHODS OF USE THEREOF					
(71)	STCUBE, INC., 2201, Trade Center Trade Tower 511, Yeongdong-daero Gangnam-gu, Seoul 135-729, KR					
(72)	YOO, Stephen S., 5233 Jule Star Drive, Centreville, Virginia 20120, US					
	CHUNG, Ezra M., 14740 Chisholm Landing Way, North Potomac, Maryland 20878, US					
	KIM, Yong-Soo, 267 Rollins Avenue, Rockville, Maryland 20852, US					
	LIM, Seung-Oe, 2425 Underwood Street Apt. 256, Houston, Texas 77030, US					
	LI, Chia-Wei, 7901 Cambridge Street, Apt. 2, Houston, Texas 77030, US					
	HUNG, Mien-Chie, 5762 Birdwood Road, Houston, Texas 77096, US					
<hr/>						
(51)	MKP					
	<b>A61K 31/55</b>	<b>2006</b>	<b>(97) EP 3383917</b>			
	<b>A61K 45/06</b>	<b>2006</b>				
	<b>A61P 35/02</b>	<b>2006</b>				
	<b>C07D 519/00</b>	<b>2006</b>				
	<b>C07K 16/30</b>	<b>2006</b>				
(96)	EP 16871574.6 12/2/2016					
(97)	EP 3383917, 10/10/2018 201841, en					
(31)	201562263542 P		(32)	04.12.2015	(33)	US
	201662427027 P			28.11.2016		US
(54)	NOVEL ANTI-CLAUDIN ANTIBODIES AND METHODS OF USE					
(72)	FONG, Sarah, 4432 39th Avenue, Oakland, California 94619, US					
	SISODIYA, Vikram Natwarsinhji, 3615 22nd Street Apt. 23, San Francisco, California 94114, US					

- (51) MKP  
**A61K 39/395 2006 (97) EP 3383430**  
**A61K 47/68 2017**  
**C07K 16/28 2006**  
**C07K 16/30 2006**
- (96) EP 16871583.7 12/2/2016  
(97) EP 3383430, 10/10/2018 201841, en
- (31) 201562262369 P (32) 02.12.2015 (33) US  
201662419911 P 09.11.2016 US
- (54) ANTIBODIES AND METHODS OF USE THEREOF  
(72) WILSON, Nicholas S., 68 Electric Avenue Apt. 1, Somerville, Massachusetts 02144, US  
WAIGHT, Jeremy D., 25 Charlton Street Apt. 403, Everett, Massachusetts 02149, US  
RITTER, Gerd, Ludwig Institute for Cancer Research 666 Third Avenue 28th Fl., New York, New York 10017, US  
SCHAER, David, 715 Shore Acres Drive, Mamaroneck, New York 10543, US  
HIRSCHHORN-CYMERMAN, Daniel, 255 East 49th St. 27B, New York, New York 10017, US  
MERGHOUB, Taha, 10 Huron Avenue Apt. 14K, Jersey City, New Jersey 07306, US  
BREOUS-NYSTROM, Ekaterina V., Waldenburgerstrasse 15, 4052 Basel, CH  
SEIBERT, Volker, Tumringerstrasse 261C, 79539 Lorrach, DE  
TSUJI, Takemasa, 249 Palmdale Drive Apt. 5, Williamsville, New York 14221, US  
LEGER, Olivier, 603 Route des Luches, 74800 Saint-Sixt, FR  
UNDERWOOD, Dennis J., 28 John A. Andrew Street, Jamaica Plain, Massachusetts 02130, US  
VAN DIJK, Marc, Gaailaan 16, 3722 ZH Bilthoven, NL
- 

- (51) MKP  
**A61K 39/395 2006 (97) EP 3383431**  
**C07K 16/28 2006**  
**C07K 16/30 2006**
- (96) EP 16871589.4 12/2/2016  
(97) EP 3383431, 10/10/2018 201841, en
- (31) 201562262376 P (32) 02.12.2015 (33) US  
201662328542 P 27.04.2016 US
- (54) ANTI-GITR ANTIBODIES AND METHODS OF USE THEREOF  
(72) WILSON, Nicholas S., 68 Electric Avenue Apt. 1, Somerville, Massachusetts 02144, US  
WAIGHT, Jeremy D., 25 Charlton Street Apt. 403, Everett, Massachusetts 02149, US  
RITTER, Gerd, Ludwig Institute for Cancer Research 666 Third Avenue 28th Fl., New York, New York 10017, US  
TSUJI, Takemasa, 249 Palmdale Drive Apt. 5, Williamsville, New York 14221, US  
LEGER, Olivier, 603 Route des Luches, 74800 Saint-Sixt, FR  
SEIBERT, Volker, Tumringerstrasse 261C, 79539 Lorrach, DE  
SCHAER, David, 715 Shore Acres Drive, Mamaroneck, New York 10543, US  
MERGHOUB, Taha, 10 Huron Avenue Apt. 14K, Jersey City, New Jersey 07306, US  
UNDERWOOD, Dennis J., 28 John A. Andrew Street, Jamaica Plain, Massachusetts 02130, US  
GONZALEZ, Ana M., 2A Union Terrace, Cambridge, Massachusetts 02141, US  
VAN DIJK, Marc, Gaailaan 16, 3722 ZH Bilthoven, NL
- 

- (51) MKP  
**A01H 1/00 2006 (97) EP 3383170**  
**A01H 5/10 2018**  
**A24D 1/00 2006**  
**C12N 15/63 2006**
- (96) EP 16871634.8 12/2/2016  
(97) EP 3383170, 10/10/2018 201841, en
- (31) 201562263151 P (32) 04.12.2015 (33) US
- (54) TARGETED MUTAGENESIS OF TOBACCO BERBERINE BRIDGE ENZYME-LIKE NUCLEIC ACIDS  
(71) North Carolina State University, 1021 Main Campus Drive 2nd Floor, Raleigh, NC 27606, US  
(72) DEWEY, Ralph E., 2403 Colony Woods Drive, Apex, North Carolina 27523, US  
LEWIS, Ramsey S., 8640 Glade Hill Drive, Apex, North Carolina 27539, US
- 

- (51) MKP

**A61K 39/395 2006 (97) EP 3383914**  
**C07K 16/28 2006**  
**G01N 33/68 2006**  
(96) EP 16871651.2 12/2/2016  
(97) EP 3383914, 10/10/2018 201841, en  
(31) 201562262371 P (32) 02.12.2015 (33) US  
(54) ANTI-OX40 ANTIBODIES AND METHODS OF USE THEREOF  
(72) WILSON, Nicholas S., 68 Electric Avenue Apt. 1, Somerville, Massachusetts 02144, US  
WRIGHT, Jeremy D., 25 Charlton Street Apt. 403, Everett, Massachusetts 02149, US  
BREOUS-NYSTROM, Ekaterina V., Waldenburgerstrasse 15, 4052 Basel, CH  
RITTER, Gerd, c/o LUDWIG INSTITUTE FOR CANCER RESEARCH 666 Third Avenue 28th Floor, New York, New York 10017, US  
SCHAER, David, 715 Shore Acres Drive, Mamaroneck, New York 10543, US  
HIRSCHHORN-CYMERMAN, Daniel, 255 East 49th Street 27B, New York, New York 10017, US  
MERGHOU, Taha, 10 Huron Avenue Apt. 14K, Jersey City, New Jersey 07306, US  
SEIBERT, Volker, Tumringer Strasse 261C, 79539 Lörrach, DE  
VAN DIJK, Marc, Gaailaan 16, 3722 ZH Bilthoven, NL

---

(51) MKP  
**A61B 17/29 2006 (97) EP 3393380**  
**A61B 17/32 2006**  
(96) EP 16871767.6 12/14/2016  
(97) EP 3393380, 10/31/2018 201844, en  
(31) 201514976127 (32) 21.12.2015 (33) US  
(54) ULTRASONIC SURGICAL INSTRUMENT WITH BLADE REPLACEMENT FEATURES  
(72) HIBNER, John, A., 4545 Creek Road, Cincinnati, OH 45242, US  
SMITH, Richard, C., 4545 Creek Road, Cincinnati, OH 45242, US  
CORBETT, Catherine, A., 4545 Creek Road, Cincinnati, OH 45242, US  
FALLER, Craig, N., 4545 Creek Road, Cincinnati, OH 45242, US  
WITT, David, A., 4545 Creek Road, Cincinnati, OH 45242, US

---

(51) MKP  
**G01N 27/26 2006 (97) EP 3387425**  
**G01N 33/24 2006**  
(96) EP 16871814.6 12/12/2016  
(97) EP 3387425, 10/17/2018 201842, en  
(31) 2015905128 (32) 11.12.2015 (33) AU  
(54) SOIL ANALYSIS METHOD  
(71) Injekta Environmental Pty Ltd, 334/29 Milton Parade, Malvern VIC 3144, AU  
(72) SCOTT, Edward Dundas, 334/29 Milton Parade, Malvern VIC 3144, AU  
EYRES, Michael, 334/29 Milton Parade, Malvern VIC 3144, AU

---

(51) MKP  
**E03D 1/24 2006 (97) EP 3388587**  
(96) EP 16872462.3 10/19/2016  
(97) EP 3388587, 10/17/2018 201842, en  
(31) 201531371 U (32) 10.12.2015 (33) ES  
(54) DEVICE FOR REGULATING THE HEIGHT OF A CISTERN FLUSHING MECHANISM  
(71) Fominaya, S.A., Carretera del Pla, s/n, 46117 Betera, Valencia, ES  
(72) FOMINAYA GONZÁLEZ, Pablo, Carretera del Pla s/n, 46117 Bétera (Valencia), ES

---

(51) MKP  
**B29C 70/72 2006 (97) EP 3387690**  
**H01M 4/04 2006**  
**H01M 4/20 2006**  
**H01M 4/22 2006**  
**H01M 4/68 2006**  
(96) EP 16872525.7 12/9/2016  
(97) EP 3387690, 10/17/2018 201842, en  
(31) 15715083 (32) 11.12.2015 (33) NZ  
(54) LEAD-ACID BATTERY ELECTRODE MANUFACTURE  
(71) Arcactive Limited, 128B Waterloo Road, Hornby, Christchurch 8042, NZ

(72) ABRAHAMSON, John, 16A De Thier Lane, Richmond Hill Christchurch 8081, NZ  
CHRISTIE, Shane, 128b Waterloo Road, Hornby Christchurch 8042, NZ  
HEFFER, Euan Scott, 128b Waterloo Road, Hornby Christchurch 8042, NZ  
OUT, Hannu, 128b Waterloo Road, Hornby Christchurch 8042, NZ  
PAVITT, Aimee, 128b Waterloo Road, Hornby Christchurch 8042, NZ  
TITELMAN, Grigory Isaac, 128b Waterloo Road, Hornby Christchurch 8042, NZ  
WONG, Yoon San, 128b Waterloo Road, Hornby Christchurch 8042, NZ

---

(51) MKP  
**A61K 31/421 2006 (97) EP 3388425**  
**A61K 31/422 2006**  
**A61K 31/4245 2006**  
**A61K 31/426 2006**  
**A61K 31/427 2006**  
**A61K 31/428 2006**  
**A61K 31/433 2006**  
**A61K 31/4439 2006**  
**A61K 31/454 2006**  
**A61K 31/4709 2006**  
**A61K 31/4725 2006**  
**A61K 31/497 2006**  
**A61K 31/498 2006**  
**A61K 31/501 2006**  
**A61K 31/5377 2006**  
**A61P 21/00 2006**  
**A61P 21/04 2006**  
**A61P 43/00 2006**  
**C07C 335/12 2006**  
**C07D 263/48 2006**

(96) EP 16873130.5 12/9/2016

(97) EP 3388425, 10/17/2018 201842, en

(31) 2015242065 (32) 11.12.2015 (33) JP

(54) AMINOAZOLE DERIVATIVE

(72) HOSODA, Shinnosuke, c/o Teijin Pharma Limited 2-1 Kasumigaseki 3-chome Chiyoda-ku, Tokyo 100-0013, JP  
UNOKI, Gen, c/o Teijin Pharma Limited 2-1 Kasumigaseki 3-chome Chiyoda-ku, Tokyo 100-0013, JP  
WATANABE, Hidekazu, c/o Teijin Pharma Limited 2-1 Kasumigaseki 3-chome Chiyoda-ku, Tokyo 100-0013, JP  
SASAKI, Kosuke, c/o Teijin Pharma Limited 2-1 Kasumigaseki 3-chome Chiyoda-ku, Tokyo 100-0013, JP  
SHIBATA, Jun, c/o Teijin Pharma Limited 2-1 Kasumigaseki 3-chome Chiyoda-ku, Tokyo 100-0013, JP  
YOKOYAMA, Emi, c/o Teijin Pharma Limited 2-1 Kasumigaseki 3-chome Chiyoda-ku, Tokyo 100-0013, JP  
HORIE, Kyohei, c/o Teijin Pharma Limited 2-1 Kasumigaseki 3-chome Chiyoda-ku, Tokyo 100-0013, JP  
TAKAGI, Kenichiro, c/o Teijin Pharma Limited 2-1 Kasumigaseki 3-chome Chiyoda-ku, Tokyo 100-0013, JP

---

(51) MKP  
**C10M 103/00 2006 (97) EP 3388501**  
**C10M 103/02 2006**  
**C10M 103/06 2006**  
**C10M 107/04 2006**  
**C10M 107/06 2006**  
**C10M 107/38 2006**  
**C10M 107/44 2006**  
**C10M 107/50 2006**  
**C10M 171/00 2006**  
**C10N 50/08 2006**

(96) EP 16873138.8 12/9/2016

(97) EP 3388501, 10/17/2018 201842, en

(31) 2015242309 (32) 11.12.2015 (33) JP

(54) SLIDING MEMBER EXCLUDING THOSE USED FOR IMAGE FORMATION DEVICE, COMPONENT, AND METHOD FOR REDUCING NOISE  
IN MACHINE DEVICE

(71) Dow Corning Toray Co., Ltd., 5-1, Otemachi 1-chome Chiyoda-ku, Tokyo 100-0004, JP

Ricoh Company, Ltd., 3-6, Nakamagome 1-chome Ohta-ku, Tokyo 143-8555, JP

(72) SASAKI Takahiko, c/o Dow Corning Toray Co. Ltd. 507-1 Kishi Yamakita-machi, Ashigarakami-gun Kanagawa 258-0112, JP  
YAMAGUCHI Tetsuji, c/o Dow Corning Toray Co. Ltd. 507-1 Kishi Yamakita-machi, Ashigarakami-gun Kanagawa 258-0112, JP

---

(51) MKP



**A61K 9/127 2006 (97) EP 3386484**  
**A61K 9/133 2006**  
**A61K 31/7088 2006**  
**C12N 15/88 2006**  
(96) EP 16873489.5 12/10/2016  
(97) EP 3386484, 10/17/2018 201842, en  
(31) 201562265973 P (32) 10.12.2015 (33) US  
201562266581 P 12.12.2015 US  
201662311388 P 21.03.2016 US  
201662311386 P 21.03.2016 US  
201662311380 P 21.03.2016 US  
201662350172 P 14.06.2016 US  
201662350165 P 14.06.2016 US  
201662413027 P 26.10.2016 US  
201662413050 P 26.10.2016 US  
(54) COMPOSITIONS AND METHODS FOR DELIVERY OF THERAPEUTIC AGENTS  
(72) BESIN, Gilles, 6 Roberts Street 3, Brookline MA 02445, US  
HOGE, Stephen, 320 Bent Street, Cambridge MA 02141, US  
SENN, Joseph, 45 Sanborn Lane, Reading MA 01867, US  
BENENATO, Kerry, 415 Lincoln Road, Sudbury MA 01776, US  
SABNIS, Staci, 193 School Street, Somerville MA 02145, US

---

(51) MKP  
**C12Q 1/68 2018 (97) EP 3387155**  
**G01N 33/574 2006**  
(96) EP 16873900.1 12/9/2016  
(97) EP 3387155, 10/17/2018 201842, en  
(31) 201562265638 P (32) 10.12.2015 (33) US  
(54) METHODS FOR TREATMENT AND SELECTION OF PATIENTS RESPONSIVE TO IMMUNE MEDIATED CANCER THERAPY  
(71) Definiens AG, Bernhard-Wicki-Straße 5, 80636 München, DE  
(72) BINNIG, Gerd, c/o Definiens AG Bernhard-Wicki-Strasse 5, 80636 Munich, DE  
ALTHAMMER, Sonja, c/o Definiens AG Bernhard-Wicki-Strasse 5, 80636 Munich, DE  
SCHMIDT, Gunter, c/o Definiens AG Bernhard-Wicki-Strasse 5, 80636 Munich, DE  
HIGGS, Brandon, c/o MedImmune, LLC One MedImmune Way, Gaithersburg, MD 20878, US  
STEELE, Keith, c/o MedImmune, LLC One MedImmune Way, Gaithersburg, MD 20878, US

---

(51) MKP  
**G06F 15/16 2006 (97) EP 3387561**  
**G06F 17/30 2006**  
(96) EP 16873939.9 12/9/2016  
(97) EP 3387561, 10/17/2018 201842, en  
(31) 201562265205 P (32) 09.12.2015 (33) US  
201615204818 07.07.2016 US  
(54) DATABASE MANAGEMENT FOR A LOGICAL REGISTRY  
(71) Universal Research Solutions LLC, 800 Cherry Street, 2nd Floor, Columbia, Missouri 65201, US  
(72) HUSSAM, Ali Adel, 800 Cherry Street 2nd Floor, Columbia, Missouri 65201, US  
WOOD, Andrea, 800 Cherry Street 2nd Floor, Columbia, Missouri 65201, US

---

(51) MKP  
**A61K 9/12 2006 (97) EP 3391897**  
**A61K 38/00 2006**  
**A61L 26/00 2006**  
**A61P 7/04 2006**  
**A61P 17/02 2006**  
**A61P 43/00 2006**  
**C07K 7/00 2006**  
(96) EP 16875700.3 12/14/2016  
(97) EP 3391897, 10/24/2018 201843, en  
(31) 2015247334 (32) 18.12.2015 (33) JP  
(54) HEMOSTATIC COMPOSITION AND HEMOSTATIC METHOD USING HEMOSTATIC COMPOSITION  
(71) 3-D Matrix Ltd., 3-2-4 Kojimachi, Chiyoda-ku Tokyo 102-0083, JP  
(72) NAGANO, Keiji, c/o 3-D MATRIX LTD. 3-2-4 Kojimachi Chiyoda-ku, Tokyo 102-0083, JP  
KOBAYASHI, Satoru, c/o 3-D MATRIX LTD. 3-2-4 Kojimachi Chiyoda-ku, Tokyo 102-0083, JP

---

(51) MKP  
**A01N 43/50 2006 (97) EP 3395801**  
**A01N 43/56 2006**  
**A01N 43/647 2006**  
**A01N 43/653 2006**  
**A01N 55/00 2006**  
**A01P 7/02 2006**  
**A01P 7/04 2006**  
**A61K 31/415 2006**  
**A61K 31/4164 2006**  
**A61K 31/4178 2006**  
**A61K 31/4192 2006**  
**A61K 31/4196 2006**  
**A61K 31/4439 2006**  
**A61K 31/695 2006**  
**A61P 33/10 2006**  
**A61P 33/14 2006**  
**C07D 231/12 2006**  
**C07D 231/14 2006**  
**C07D 231/38 2006**  
**C07D 233/64 2006**  
**C07D 233/68 2006**

(96) EP 16875718.5 12/15/2016  
(97) EP 3395801, 10/31/2018 201844, en

(31) 2015245712 (32) 16.12.2015 (33) JP  
2016060605 24.03.2016 JP  
2016198677 07.10.2016 JP

(54) ARYLAZOLE COMPOUND AND PEST CONTROL AGENT  
(72) HAMAMOTO Isami, *c/o* Odawara Research Center Nippon Soda Co. Ltd. 345 Takada, Odawara-shi Kanagawa 250-0280, JP  
AOYAMA Hikaru, *c/o* Odawara Research Center Nippon Soda Co. Ltd. 345 Takada, Odawara-shi Kanagawa 250-0280, JP  
SAKANISHI Keita, *c/o* Odawara Research Center Nippon Soda Co. Ltd. 345 Takada, Odawara-shi Kanagawa 250-0280, JP  
IWASA Takao, *c/o* Odawara Research Center Nippon Soda Co. Ltd. 345 Takada, Odawara-shi Kanagawa 250-0280, JP  
KOBAYASHI Tomomi, *c/o* Odawara Research Center Nippon Soda Co. Ltd. 345 Takada, Odawara-shi Kanagawa 250-0280, JP

---

(51) MKP  
**C07C 231/10 2006 (97) EP 3392236**  
**C07C 237/42 2006**

(96) EP 16875812.6 12/16/2016  
(97) EP 3392236, 10/24/2018 201843, en

(31) 2015247774 (32) 18.12.2015 (33) JP

(54) METHOD FOR PRODUCING AROMATIC AMIDE DERIVATIVE  
(71) Mitsui Chemicals Agro, Inc., 1-19-1, Nihonbashi, Chuo-ku, Tokyo 103-0027, JP  
(72) TAKAHASHI, Yusuke, *c/o* Mitsui Chemicals Agro Inc. 30 Asamutacho, Omuta-shi Fukuoka 836-8610, JP  
IKISHIMA, Hideaki, *c/o* Mitsui Chemicals Agro Inc. 1144 Togo, Mobarashi Chiba 297-0017, JP  
OKURA, Hironari, *c/o* Mitsui Chemicals Agro Inc. 30 Asamutacho, Omuta-shi Fukuoka 836-8610, JP

---

(51) MKP  
**A61K 39/395 2006 (97) EP 3389714**  
**C07K 16/28 2006**  
**C07K 16/30 2006**  
**C07K 16/46 2006**

(96) EP 16876434.8 12/12/2016  
(97) EP 3389714, 10/24/2018 201843, en

(31) 201562266944 P (32) 14.12.2015 (33) US

(54) BISPECIFIC MOLECULES HAVING IMMUNOREACTIVITY WITH PD-1 AND CTLA-4, AND METHODS OF USE THEREOF  
(72) JOHNSON, Leslie, S., 14411 Poplar Hill Road, Darnestown, MD 20874, US  
CHICHILI, Gurunadh, Reddy, 13926 Lullaby Road, Germantown, MD 20874, US  
SHAH, Kalpana, 13013 Ethel Rose Way, Boyds, MD 20841, US  
LA MOTTE-MOHS, Ross, 16000 Schaeffer Road, Boyds, MD 20841, US  
MOORE, Paul, A., 10 Turley Court, North Potomac, MD 20878, US  
BONVINI, Ezio, 11136 Powder Horn Drive, Potomac, MD 20854, US  
KOENIG, Scott, 10901 Ralston Road, Rockville, MD 20852, US

---

(51) MKP  
**A61K 31/397 2006 (97) EP 3390357**  
**A61P 31/04 2006**  
**C07D 205/08 2006**

(96) EP 16876436.3 12/12/2016  
(97) EP 3390357, 10/24/2018 201843, en

(31) 201562267855 P (32) 15.12.2015 (33) US

(54) BIARYL MONOBACTAM COMPOUNDS AND METHODS OF USE THEREOF FOR THE TREATMENT OF BACTERIAL INFECTIONS  
(72) TANG, Haifeng, 2000 Galloping Hill Road, Kenilworth New Jersey 07033, US  
LIU, Weiguo, 2000 Galloping Hill Road, Kenilworth New Jersey 07033, US  
DING, Fa-Xiang, 2000 Galloping Hill Road, Kenilworth New Jersey 07033, US  
SUN, Wanying, 2000 Galloping Hill Road, Kenilworth New Jersey 07033, US  
ZANG, Yi, 126 East Lincoln Avenue, Rahway New Jersey 07065-0907, US  
PAN, Weidong, 20 Polhemus Drive, Hillsborough New Jersey 08844, US  
OGAWA, Anthony, 2000 Galloping Hill Road, Kenilworth New Jersey 07033, US  
BROCKUNIER, Linda, 389 Lawn Ridge Road, Orange New Jersey 07050, US  
HUANG, Xianhai, 2000 Galloping Hill Road, Kenilworth New Jersey 07033, US  
WANG, Hongwu, 2000 Galloping Hill Road, Kenilworth New Jersey 07033, US  
MAL, Rudrajit, 313 Hampshire Court, Piscataway New Jersey 08854, US  
BIFTU, Tesfaye, 3 Ocala Court, Freehold New Jersey 07728, US  
PARK, Min, 138 Sunrise Drive, Whippany New Jersey 07981, US  
GUO, Yan, 2000 Galloping Hill Road, Kenilworth New Jersey 07033, US  
JIANG, Jinlong, 2000 Galloping Hill Road, Kenilworth New Jersey 07033, US  
CHEN, Helen, 2000 Galloping Hill Road, Kenilworth New Jersey 07033, US  
PLUMMER, Christopher, W., 2000 Galloping Hill Road, Kenilworth New Jersey 07033, US

---

(51) MKP  
**A61K 38/00 2006 (97) EP 3399989**  
**A61K 39/00 2006**  
**A61K 39/395 2006**  
**C07K 16/28 2006**  
**C12P 21/08 2006**

(96) EP 16876461.1 12/13/2016  
(97) EP 3399989, 11/14/2018 201846, en

(31) 201562268070 P (32) 16.12.2015 (33) US

(54) ANTI-LAG3 ANTIBODIES AND ANTIGEN-BINDING FRAGMENTS  
(72) MALEFYT, Rene De Waal, 901 S. California Avenue, Palo Alto California 94304, US  
FAYADAT-DILMAN, Laurence, 901 S. California Avenue, Palo Alto California 94304, US  
LIANG, Linda, 128 Ada Avenue Apt., Mountain View California 94043, US

---

(51) MKP  
**A61K 47/50 2017 (97) EP 3389719**  
**A61P 21/00 2006**  
**A61P 31/16 2006**

(96) EP 16876554.3 12/14/2016  
(97) EP 3389719, 10/24/2018 201843, en

(31) 201562267723 P (32) 15.12.2015 (33) US

(54) PEPTIDE OLIGONUCLEOTIDE CONJUGATES  
(72) HANSON, Gunnar, J., c/o Sarepta Therapeutics Inc. 215 First Street, Cambridge, MA 02142, US  
ZHOU, Ming, c/o Sarepta Therapeutics Inc. 215 First Street, Cambridge, MD 02142, US

---

(51) MKP  
**A61K 31/4433 2006 (97) EP 3389657**  
**A61K 31/497 2006**  
**A61P 1/10 2006**  
**C07D 405/04 2006**

(96) EP 16876556.8 12/14/2016  
(97) EP 3389657, 10/24/2018 201843, en

(31) 201562267144 P (32) 14.12.2015 (33) US

(54) METHODS OF TREATING HYPERALGESIA  
(71) Trevena, Inc., 955 Chesterbrook Blvd, Suite 200, Chesterbrook, PA 19087, US

(72) COWAN, Conrad, 955 Chesterbrook Blvd Suite 200, Chesterbrook, PA 19087, US  
KOBlish, Michael, 955 Chesterbrook Blvd Suite 200, Chesterbrook, PA 19087, US  
LARK, Michael W., 955 Chesterbrook Blvd Suite 200, Chesterbrook, PA 19087, US

---

(51) MKP  
**A61K 39/00 2006 (97) EP 3389699**  
**A61K 39/395 2006**  
**C07K 16/00 2006**  
**C12P 21/08 2006**

(96) EP 16876612.9 12/14/2016

(97) EP 3389699, 10/24/2018 201843, en

(31)	201562267735 P	(32)	15.12.2015	(33)	US
	201662309169 P		16.03.2016		US
	201662359036 P		06.07.2016		US

(54) CHIMERIC AND HUMANIZED ANTI-HUMAN CTLA4 MONOCLONAL ANTIBODIES AND USES THEREOF

(71) Oncoimmune, Inc., 9430 Key West Avenue Suite 113, Rockville, Maryland 20850, US

(72) LIU, Yang, 502 E Street NE, Washington, District of Columbia 20002, US  
ZHENG, Pan, 502 E Street NE, Washington, District of Columbia 20002, US  
DEVENPORT, Martin, 614 Still Creek Lane, Gaithersburg, Maryland 20878, US

---

(51) MKP  
**A61K 31/425 2006 (97) EP 3389654**  
**A61P 43/00 2006**  
**C07C 311/15 2006**

(96) EP 16876635.0 12/15/2016

(97) EP 3389654, 10/24/2018 201843, en

(31)	201562269648 P	(32)	18.12.2015	(33)	US
	201662417040 P		03.11.2016		US
	201662422182 P		15.11.2016		US

(54) DIAMINO-ALKYLAMINO-LINKED ARYLSULFONAMIDE COMPOUNDS WITH SELECTIVE ACTIVITY IN VOLTAGE-GATED SODIUM CHANNELS

(72) GRESHOCK, Thomas, J., 770 Sumneytown Pike, West Point Pennsylvania 19486, US

MULHEARN, James, 770 Sumneytown Pike, West Point Pennsylvania 19486, US  
GUO, Liangqin, 2000 Galloping Hill Road, Kenilworth New Jersey 07033, US  
ZHANG, Ting, 126 East Lincoln Avenue, Rahway New Jersey 07065-0907, US  
WANG, Deping, 770 Sumneytown Pike, West Point Pennsylvania 19486, US  
KIM, Ronald, M., 2000 Galloping Hill Road, Kenilworth New Jersey 07033, US  
LAYTON, Mark, E., 770 Sumneytown Pike, West Point Pennsylvania 19486, US  
KELLY, Michael, J., III, 770 Sumneytown Pike, West Point Pennsylvania 19486, US  
ANAND, Rajan, 2000 Galloping Hill Road, Kenilworth New Jersey 07033, US  
JIAN, Tianying, 126 East Lincoln Avenue, Rahway New Jersey 07065-0907, US  
NANTERMET, Philippe, 770 Sumneytown Pike, West Point Pennsylvania 19486, US  
ROECKER, Anthony, J., 770 Sumneytown Pike, West Point Pennsylvania 19486, US  
WON, Walter, 950 Closter Dock Road, Alpine New Jersey 08820, US  
ZHOU, Gang, 111 Timothy Place, Bridgewater New Jersey 08807, US

---

(51) MKP  
**A61P 9/10 2006 (97) EP 3389781**  
**A61P 37/06 2006**  
**C12N 5/071 2010**

(96) EP 16876644.2 12/15/2016

(97) EP 3389781, 10/24/2018 201843, en

(31)	201562267712 P	(32)	15.12.2015	(33)	US
------	----------------	------	------------	------	----

(54) INHIBITORS OF TNF SUPERFAMILY COSTIMULATORY INTERACTIONS AND METHODS FOR USES OF THE SAME

(71) University of Miami, Office of Technology Transfer 1951 NW 7th Avenue 3rd Floor Suite 310, Miami, FL 33136, US

(72) BUCHWALD, Peter, C/o Diabetes Research Institute 1450 NW 10 Ave ( R-134) Room 5012, Miami FL 33136, US

---

(51) MKP  
**A61K 31/165 2006 (97) EP 3389656**  
**A61K 31/439 2006**  
**A61K 31/444 2006**

(96) EP 16876711.9 12/15/2016

(97) EP 3389656, 10/24/2018 201843, en

(31) 201562268874 P (32) 17.12.2015 (33) US  
(54) COMBINATIONS OF OPIOID RECEPTOR LIGANDS AND CYTOCHROME P450 INHIBITORS  
(72) VIOLIN, Jonathan D., 1018 West 8th Avenue Suite A, King of Prussia, Pennsylvania 19406, US  
SOERGEL, David G., 1018 West 8th Avenue Suite A, King of Prussia, Pennsylvania 19406, US

---

(51) MKP  
A61K 9/10 2006 (97) EP 3389630  
A61K 35/15 2015  
A61K 39/00 2006  
A61K 39/39 2006  
A61K 39/395 2006  
A61P 35/00 2006

(96) EP 16876766.3 12/16/2016

(97) EP 3389630, 10/24/2018 201843, en

(31) 201562268333 P (32) 16.12.2015 (33) US  
201662317823 P 04.04.2016 US  
201662379986 P 26.08.2016 US  
201662394074 P 13.09.2016 US  
201662425995 P 23.11.2016 US

(54) NEOANTIGEN IDENTIFICATION, MANUFACTURE, AND USE

(71) Gritstone Oncology, Inc., 5858 Horton Street, Suite 210, Emeryville, CA 94608, US

(72) YELENSKY, Roman, c/o Gritstone Oncology Inc. 5858 Horton Street Suite 210, Emeryville CA 94608, US

DERTI, Adnan, c/o Gritstone Oncology Inc. 5858 Horton Street Suite 210, Emeryville CA 94608, US

BULIK-SULLIVAN, Brendan, c/o Gritstone Oncology Inc. 5858 Horton Street Suite 210, Emeryville CA 94608, US

BUSBY, Jennifer, c/o Gritstone Oncology Inc. 5858 Horton Street Suite 210, Emeryville CA 94608, US

---

(51) MKP  
A61K 31/70 2006 (97) EP 3389705  
A61K 31/7036 2006  
A61K 39/00 2006  
A61K 39/02 2006

(96) EP 16876841.4 12/16/2016

(97) EP 3389705, 10/24/2018 201843, en

(31) 201562268255 P (32) 16.12.2015 (33) US

(54) LISTERIA-BASED IMMUNOTHERAPY AND METHODS OF USE THEREOF

(72) PETIT, Robert, 149 Parsons Lane, Newtown Pennsylvania 18940, US

CODER, Brandon, c/o Advaxis Inc. 305 College Road East, Princeton New Jersey 08540, US

---

(51) MKP  
A61K 31/282 2006 (97) EP 3395857  
A61K 31/555 2006  
A61K 47/50 2017  
A61P 35/00 2006  
C08G 65/334 2006  
C08G 69/08 2006  
C08G 69/48 2006  
C08G 81/00 2006

(96) EP 16878558.2 12/16/2016

(97) EP 3395857, 10/31/2018 201844, en

(31) 2015250255 (32) 22.12.2015 (33) JP

(54) POLYMER CONJUGATE OF SULFOXIDE DERIVATIVE-COORDINATED PLATINUM(II) COMPLEX

(72) NAKAMURA Masaharu, c/o NIPPON KAYAKU KABUSHIKI KAISHA Pharmaceuticals Research Laboratories 31-12 Shimo 3-chome Kita-ku, Tokyo 115-8588, JP

FUKUDA Tsuyoshi, c/o NIPPON KAYAKU KABUSHIKI KAISHA Pharmaceuticals Research Laboratories 31-12 Shimo 3-chome Kita-ku, Tokyo 115-8588, JP

YAMAKAWA Ken, c/o NIPPON KAYAKU KABUSHIKI KAISHA Pharmaceuticals Research Laboratories 31-12 Shimo 3-chome Kita-ku, Tokyo 115-8588, JP

KATO Takuya, c/o NIPPON KAYAKU KABUSHIKI KAISHA Pharmaceuticals Research Laboratories 31-12 Shimo 3-chome Kita-ku, Tokyo 115-8588, JP

---

(51) MKP

**A23L 29/206 2016 (97) EP 3395187**  
**A23L 33/135 2016**  
**A23L 33/175 2016**  
(96) EP 16878875.0 12/22/2016  
(97) EP 3395187, 10/31/2018 201844, en  
(31) 2015253929 (32) 25.12.2015 (33) JP  
(54) GEL-LIKE FOOD COMPOSITION  
(72) TOYOOKA, Keiko, c/o OTSUKA PHARMACEUTICAL CO. LTD. 3-2-27 Otedori Chuo-ku, Osaka-shi Osaka 540-0021, JP  
HAMADA, Koichiro, c/o OTSUKA PHARMACEUTICAL CO. LTD. 3-2-27 Otedori Chuo-ku, Osaka-shi Osaka 540-0021, JP  
SAITOH, Hiroshi, c/o OTSUKA PHARMACEUTICAL CO. LTD. 3-2-27 Otedori Chuo-ku, Osaka-shi Osaka 540-0021, JP

---

(51) MKP  
**A61K 31/167 2006 (97) EP 3395345**  
**A61K 31/282 2006**  
**A61K 31/337 2006**  
**A61K 31/357 2006**  
**A61K 31/4045 2006**  
**A61K 31/4164 2006**  
**A61K 31/436 2006**  
**A61K 31/44 2006**  
**A61K 31/454 2006**  
**A61K 31/4545 2006**  
**A61K 31/47 2006**  
**A61K 31/4709 2006**  
**A61K 31/473 2006**  
**A61K 31/4747 2006**  
**A61K 31/497 2006**  
**A61K 31/502 2006**  
**A61K 31/5025 2006**  
**A61K 31/513 2006**  
**A61K 31/519 2006**  
**A61K 31/52 2006**  
(96) EP 16878960.0 12/22/2016  
(97) EP 3395345, 10/31/2018 201844, en  
(31) 2015250705 (32) 22.12.2015 (33) JP  
2016194889 30.09.2016 JP  
(54) ANTITUMOR EFFECT POTENTIATOR COMPRISING PYRROLOPYRIMIDINE COMPOUND  
(72) ISHIDA, Keiji, c/o TAIHO PHARMACEUTICAL CO. LTD. 3 Okubo, Tsukuba-shi Ibaraki 300-2611, JP

---

(51) MKP  
**B01J 23/72 2006 (97) EP 3393655**  
**B01J 27/055 2006**  
**B01J 27/122 2006**  
**B01J 27/25 2006**  
**C07C 45/54 2006**  
**C07C 49/223 2006**  
(96) EP 16879990.6 12/20/2016  
(97) EP 3393655, 10/31/2018 201844, en  
(31) 201562271172 P (32) 22.12.2015 (33) US  
(54) FENFLURAMINE COMPOSITIONS AND METHODS OF PREPARING THE SAME  
(71) Zogenix International Limited, Siena Court Broadway, Maidenhead, Berkshire SL6 1NJ, GB  
(72) LONDESBROUGH, Derek, c/o Zogenix International Limited Siena Court Broadway, Maidenhead, Berkshire SL6 1NJ, GB  
ANDERSEN, Marc W., 4500 Touchstone Forest Road, Raleigh North Carolina 27612, US

---

(51) MKP  
**A61K 31/551 2006 (97) EP 3394106**  
**A61K 47/68 2017**  
**C07K 16/40 2006**  
(96) EP 16880046.4 12/21/2016  
(97) EP 3394106, 10/31/2018 201844, en  
(31) 201562270846 P (32) 22.12.2015 (33) US  
201662433759 P 13.12.2016 US  
(54) NOVEL ANTI-MMP16 ANTIBODIES AND METHODS OF USE

(72) ROY, Somdutta, 3545 Fleetwood Drive, San Bruno California 94066, US  
WILLIAMS, Samuel A., 3000 Monterey Street, San Mateo California 94403, US  
DYLLA, Scott J., 25 Danford Court, Emerald Hills California 94062, US  
HUANG, Zhao, 117 Park Road Apt. 101, Burlingame California 94010, US  
SAUNDERS, Laura, 170 King Street Unit 809, San Francisco California 94107, US  
LIU, David, 300 Santa Rosa Avenue Apt. 1, San Francisco California 94112, US  
FRANKLIN, Casey, 380 Talbot Avenue Apt. 110, Pacifica California 94044, US  
COELHO, David, 335 Euclid Ave. 105, San Francisco California 94118, US

---

(51) MKP  
**A61K 31/551 2006 (97) EP 3394107**  
**A61K 47/68 2017**  
**C07K 16/40 2006**

(96) EP 16880052.2 12/21/2016

(97) EP 3394107, 10/31/2018 201844, en

(31)	201562270985 P	(32)	22.12.2015	(33)	US
	201662330672 P		02.05.2016		US
	201662434782 P		15.12.2016		US

(54) NOVEL ANTI-TNFSF9 ANTIBODIES AND METHODS OF USE

(72) BERNSTEIN, Jeffrey, 70 Clipper Street, San Francisco California 94114, US  
COELHO, David, 335 Euclid Avenue 105, San Francisco California 94118, US  
SAUNDERS, Laura, 170 King Street Unit 809, San Francisco California 94017, US  
LAYSANG, Amy, 2237 East 23rd Street B, Oakland California 94606, US  
WILLIAMS, Samuel A., 3000 Monterey Street, San Mateo California 94403, US  
LIU, David, 300 Santa Rosa Avenue Apt. 1, San Francisco California 94112, US  
KIM, Earl, 828 El Camino Real 4, Burlingame California 94010, US  
STULL, Robert A., 1519 Fifth Street, Alameda California 94501, US

---

(51) MKP  
**A61K 39/395 2006 (97) EP 3393516**  
**A61P 35/00 2006**

(96) EP 16880066.2 12/21/2016

(97) EP 3393516, 10/31/2018 201844, en

(31)	201562270993 P	(32)	22.12.2015	(33)	US
	201662430191 P		05.12.2016		US

(54) NOVEL ANTI-UPK1B ANTIBODIES AND METHODS OF USE

(72) MCKNIGHT, Kristen, 403 Carl Street, San Francisco, California 94117, US  
FONG, Sarah, 4432 39th Avenue, Oakland California 94619, US  
ANDERSON, Wade, 1420 Northwood Drive, Fairfield California 94534, US  
SANTAGUIDA, Marianne, 1706 Pine Knoll Drive, Belmont California 94002, US  
WILLIAMS, Samuel A., 3000 Monterey Street, San Mateo California 94403, US  
HUANG, Zhao, 117 Park Road Apt. 101, Burlingame California 94010, US  
KIM, Earl, 828 El Camino Real 4, Burlingame California 94010, US  
COELHO, David, 335 Euclid Avenue 105, San Francisco California 94118, US  
STULL, Robert A., 1519 Fifth Street, Alameda California 94501, US

---

(51) MKP  
**A61K 31/00 2006 (97) EP 3393458**  
**A61K 31/33 2006**  
**A61K 31/395 2006**  
**A61K 31/495 2006**  
**A61K 31/505 2006**

(96) EP 16880073.8 12/22/2016

(97) EP 3393458, 10/31/2018 201844, en

(31)	201562270835 P	(32)	22.12.2015	(33)	US
	201662350224 P		15.06.2016		US
	201662399149 P		23.09.2016		US

(54) METHODS OF USE OF A CLASS IIA HDAC INHIBITOR

(71) Dana Farber Cancer Institute, Inc., 450 Brookline Avenue, Boston, Massachusetts 02215, US  
(72) GHOSH, Shomir, 134 Sewall Ave Unit C, Brookline MA 02446, US  
GUERRIERO, Jennifer, 450 Brookline Avenue, Boston MA 02215, US  
KRUIDENIER, Laurens, Gunnels Wood Road, Stevenage Hertfordshire SG1 2NY, GB  
LETAI, Anthony, 450 Bookline Avenue, Boston MA 02215, US  
LOBERA, Mercedes, 200 Technology Square, Cambridge MA 02139, US

- (51) MKP  
**G01N 1/00 2006 (97) EP 3394589**
- (96) EP 16880078.7 12/22/2016  
(97) EP 3394589, 10/31/2018 201844, en
- (31) 201562387348 P (32) 23.12.2015 (33) US  
201662279315 P 15.01.2016 US  
201662328876 P 28.04.2016 US  
201662328885 P 28.04.2016 US  
201662422279 P 15.11.2016 US
- (54) A METHOD TO IDENTIFY AN APPROACH FOR ACHIEVING MAMMALIAN FERTILIZATION AND TIME PERIOD FOR INSEMINATION  
(71) Androvia Life Sciences LLC, 187 Mill Lane, Mountainside, NJ 07092, US  
(72) TRAVIS, Alexander, J., 1044 Cayuga Heights Road, Ithaca NY 14850, US  
CARDONA, Cristina, 179 Walnut Court, Highland Park NJ 08904, US  
MOODY, Melissa, A., 107 Brandywine Court, Brick NJ 08724, US  
SIMPSON, Alana, J., 147 Summit Avenue Apartment 36, Summit NJ 07901, US  
OSTERMEIER, G., Charles, 189 Longview Terrace, Gillette NJ 07933, US
- 

- (51) MKP  
**C08G 18/00 2006 (97) EP 3398980**  
**C08G 18/10 2006**  
**C08G 18/44 2006**  
**C08G 18/48 2006**  
**C08G 18/65 2006**  
**C08L 75/04 2006**  
**D06M 15/564 2006**
- (96) EP 16881529.8 10/27/2016  
(97) EP 3398980, 11/7/2018 201845, en
- (31) 2015256325 (32) 28.12.2015 (33) JP
- (54) AQUEOUS-DISPERSION TYPE POLYCARBONATE-BASED POLYURETHANE RESIN COMPOSITION, TEXTILE PRODUCT TREATED WITH SAME, AND PROCESS FOR PRODUCING AQUEOUS-DISPERSION TYPE POLYCARBONATE-BASED POLYURETHANE RESIN COMPOSITION  
(71) Nicca Chemical Co., Ltd., 23-1 Bunkyo 4-chome, Fukui-shi, Fukui 910-8670, JP  
(72) NANBOKU Naoki, c/o NICCA CHEMICAL CO. LTD. 23-1 Bunkyo 4-chome, Fukui-shi Fukui 910-8670, JP  
KIBE Yoshinobu, c/o NICCA CHEMICAL CO. LTD. 23-1 Bunkyo 4-chome, Fukui-shi Fukui 910-8670, JP
- 

- (51) MKP  
**A61K 31/131 2006 (97) EP 3394047**  
**A61K 31/282 2006**  
**A61K 31/337 2006**  
**A61K 31/409 2006**  
**A61K 31/506 2006**  
**A61K 31/517 2006**  
**A61K 31/519 2006**  
**A61K 31/5377 2006**  
**A61K 31/7068 2006**  
**A61K 39/395 2006**  
**A61P 35/00 2006**  
**C07B 59/00 2006**  
**C07D 403/04 2006**
- (96) EP 16882478.7 12/23/2016  
(97) EP 3394047, 10/31/2018 201844, en
- (31) 201562271275 P (32) 27.12.2015 (33) US  
201662330810 P 02.05.2016 US
- (54) DEUTERATED COMPOUNDS FOR TREATING CANCER AND RELATED DISEASES AND CONDITIONS, AND COMPOSITIONS AND METHODS THEREOF  
(72) CHAORAN, Huang, 92 West Pine Street, Auburndale MA 02466, US  
CHANGFU, Cheng, 207 Howard Street, Northborough MA 01532, US
- 

- (51) MKP



**A61K 39/395 2006 (97) EP 3397282**  
**C12P 21/00 2006**  
**G01N 33/68 2006**  
 (96) EP 16882558.6 12/28/2016  
 (97) EP 3397282, 11/7/2018 201845, en  
 (31) 201562273337 P (32) 30.12.2015 (33) US  
 (54) METHODS RELATED TO BIOLOGICS  
 (72) ROBBLEE, John, 324 Sudbury Road, Concord Massachusetts 01742, US

---

(51) MKP  
**A61K 31/496 2006 (97) EP 3397625**  
**A61K 31/551 2006**  
**C07D 333/38 2006**  
 (96) EP 16882651.9 12/29/2016  
 (97) EP 3397625, 11/7/2018 201845, en  
 (31) 201562273135 P (32) 30.12.2015 (33) US  
 (54) TREATMENT OF TUMORS INCORPORATING MUTANT ISOCITRATE DEHYDROGENASE  
 (72) SI, Yaguang, 15 Hawthorne Avenue, Arlington, MA 02476, US  
 KEENAN, Marle C., 35 Sutcliffe Avenue, Canton, MA 02021, US

---

(51) MKP  
**B41J 2/045 2006 (97) EP 3400137**  
 (96) EP 16884177.3 12/16/2016  
 (97) EP 3400137, 11/14/2018 201846, en  
 (31) 201614990729 (32) 07.01.2016 (33) US  
 (54) MULTIPLEXED MULTILEVEL CONVERTER AMPLIFIER  
 (71) Apex Microtechnology, Inc., 5980 North Shannon Road, Tucson, Arizona 85741, US  
 (72) VASIC, Miroslav, Centro de Electronica/Industrial ETSI Industriales Calle Jose Gutierrez Abascal 2, 28006 Madrid, ES  
 GARCIA, Oscar, Centro de Electronica/Industrial ETSI Industriales Calle Jose Gutierrez Abascal 2, 28006 Madrid, ES  
 ALOU, Pedro, Centro de Electronica/Industrial ETSI Industriales Calle Jose Gutierrez Abascal 2, 28006 Madrid, ES  
 OLIVER, Jesus, Centro de Electronica/Industrial ETSI Industriales Calle Jose Gutierrez Abascal 2, 28006 Madrid, ES  
 COBOS, Jose A., Centro de Electronica/Industrial ETSI Industriales Calle Jose Gutierrez Abascal 2, 28006 Madrid, ES  
 BOERE, Eric J., Stepelerveld 51, 2151JM Nieuw-Vennep, NL

---

(51) MKP  
**A61K 31/352 2006 (97) EP 3418274**  
**A61K 36/41 2006**  
**C07D 311/30 2006**  
 (96) EP 16890195.7 2/19/2016  
 (97) EP 3418274, 12/26/2018 201852, en  
 (54) METHOD FOR EXTRACTING HERBACETIN FROM RHODIOLA ROSEA  
 (71) Taizhou Forever Biotechnology Co., Ltd., (Caojia Village and Yinjia Village of Luotang St.) Hi-tech Innovation Center Jiangyan District, Taizhou, Jiangsu 225312, CN  
 (72) GU, Zhengbing, (Caojia Village and Yinjia Village of Luotang St.) Hi-tech Innovation Center, Jianyan District, Taizhou Jiangsu 225312, CN  
 ZHANG, Jie, (Caojia Village and Yinjia Village of Luotang St.) Hi-tech Innovation Center, Jianyan District, Taizhou Jiangsu 225312, CN  
 TAO, Yuehong, (Caojia Village and Yinjia Village of Luotang St.) Hi-tech Innovation Center, Jianyan District, Taizhou Jiangsu 225312, CN  
 ZENG, Cheng, (Caojia Village and Yinjia Village of Luotang St.) Hi-tech Innovation Center, Jianyan District, Taizhou Jiangsu 225312, CN  
 XU, Lili, (Caojia Village and Yinjia Village of Luotang St.) Hi-tech Innovation Center, Jianyan District, Taizhou Jiangsu 225312, CN

---

(51) MKP  
**C12N 5/00 2006 (97) EP 3406714**  
**C12N 5/09 2010**  
**C12N 5/095 2010**  
**G01N 33/574 2006**  
 (96) EP 16892410.8 3/3/2016  
 (97) EP 3406714, 11/28/2018 201848, en  
 (54) METHOD FOR DETECTING OR SEPARATING/OBTAINING CIRCULATING TUMOR CELL EMPLOYING CELL PROLIFERATION METHOD  
 (71) Umezu, Yasuiki, 4-20-12 Nakayama Aoba-ku, Sendai-shi, Miyagi 981-0952, JP  
 (72) Umezu, Yasuiki, 4-20-12 Nakayama Aoba-ku, Sendai-shi, Miyagi 981-0952, JP

---

(51) MKP

**B41J 2/175 2006 (97) EP 3415326**

- (96) EP 16897636.3 5/17/2016  
(97) EP 3415326, 12/19/2018 201851, en  
(31) 201610211985 (32) 07.04.2016 (33) CN  
(54) INK BOX CHIP, INK BOX AND OPERATION METHOD FOR RESPONDING TO PRINTING WORK  
(71) Hangzhou Chipjet Technology Co., Ltd., Room 421, 4th Floor Building 1, Block 1 No. 1180 Bin'an Road Binjiang District, Hangzhou, Zhejiang 310012, CN  
(72) ZHANG, Zhengdong, Room 421 4th Fl. Building 1 Block 1 No. 1180 Bin'an Rd. Binjiang, Hangzhou Zhejiang 310012, CN  
SUN, Yun, Room 421 4th Fl. Building 1 Block 1 No. 1180 Bin'an Rd. Binjiang, Hangzhou Zhejiang 310012, CN  
LUO, Shan, Room 421 4th Fl. Building 1 Block 1 No. 1180 Bin'an Rd. Binjiang, Hangzhou Zhejiang 310012, CN
- 

(51) MKP  
**E01F 15/00 2006 (97) EP 3366841**  
**E01F 15/14 2006**

- (96) EP 16906418.5 11/14/2016  
(97) EP 3366841, 8/29/2018 201835, en  
(31) 2016124324 (32) 20.06.2016 (33) RU  
2016124955 22.06.2016 RU  
(54) DAMPING DEVICE  
(71) Makarov, Georgy Vladimirovich, Ul. Travyanaya 20 kv. 15 Oktyabrsky r-n, Samarskaya obl., g. Samara 443011, RU  
(72) NEMOV, Ivan Petrovich, Yaroslavskoe sh. 174 kv. 39, Moskovskaya obl. g. Pushkino 141202, RU  
KURBATOV, Vitaly Viktorovich, d. 28s kv. 4, Zabaikalsky krai g. Krasnokamensk 674670, RU  
MAKAROV, Georgy Vladimirovich, d. 28s kv. 4, Zabaikalsky krai g. Krasnokamensk 674670, RU
- 

(51) MKP  
**A41D 19/00 2006 (97) EP 3372107**  
**A45D 33/00 2006**  
**A45D 34/04 2006**  
**A45D 44/00 2006**  
**A47K 7/02 2006**

- (96) EP 17000354.5 3/7/2017  
(97) EP 3372107, 9/12/2018 201837, en  
(54) COSMETIC GLOVE  
(71) Sav, Monica Olimpia, Bdul Traian nr.24, ap.23 Jud. Maramures, 430262 Baia Mare, RO  
(72) Sav, Monica Olimpia, Bdul Traian nr.24, ap.23 Jud. Maramures, 430262 Baia Mare, RO
- 

(51) MKP  
**G01S 7/481 2006 (97) EP 3258314**  
**G02B 27/00 2006**  
**G03B 11/04 2006**  
**G03B 15/04 2006**  
**G03B 17/02 2006**

- (96) EP 17001008.6 6/14/2017  
(97) EP 3258314, 8/1/2018 201831, en  
(31) 201615183630 (32) 15.06.2016 (33) US  
201715455661 10.03.2017 US  
(54) ENCLOSURE DEVICE  
(71) Lincoln Global, Inc., 9160 Norwalk Boulevard, Santa Fe Springs, CA 90670, US  
(72) Goddard, Brad J., 3532 25th Ave., Rock Island, IL 61201, US  
Hann, Mark A., 54 Country Club Ct., LeClaire, IA 52748, US
- 

(51) MKP  
**B65C 9/18 2006 (97) EP 3381823**

- (96) EP 17001116.7 6/29/2017  
(97) EP 3381823, 10/3/2018 201840, en  
(31) 201700366 (32) 31.03.2017 (33) ES  
(54) DEVICE FOR FORMING AND TRANSFERRING DECORATIVE BANNERS FOR THERMOFORMING PACKAGING MACHINES  
(72) Hernández Socastro, José Manuel, C/ Emilio Vargas n° 20, 4° E, 28043 Madrid, ES
- 

(51) MKP

	<b>B32B 5/26</b>	<b>2006</b>	<b>(97) EP 3269901</b>				
	<b>B32B 27/12</b>	<b>2006</b>					
	<b>D04H 1/4218</b>	<b>2012</b>					
	<b>E04H 15/54</b>	<b>2006</b>					
(96)	EP 17001209.0 7/17/2017						
(97)	EP 3269901, 8/22/2018 201834, de						
(31)	202016004338 U		(32)	15.07.2016		(33)	DE
(54)	IMPROVED INDUSTRIAL TENT AND PLANNING COMPOSITE						
(71)	Herchenbach Industrie-Zeltebau GmbH, Löhestraße 6, 53773 Hennef, DE						
(72)	PUCK, Karsten, Im Tönnefeld 52, 50859 Köln, DE						
<hr/>							
(51)	MKP						
	<b>B23B 49/00</b>	<b>2006</b>	<b>(97) EP 3299529</b>				
	<b>B23B 51/04</b>	<b>2006</b>					
	<b>E04B 1/76</b>	<b>2006</b>					
(96)	EP 17001556.4 9/19/2017						
(97)	EP 3299529, 9/26/2018 201839, en						
(31)	201600238		(32)	23.09.2016		(33)	SI
(54)	A CUTTER AND METHOD FOR MAKING DENTS AND FIXING INSULATION						
(71)	F. Leskovec, d.o.o., Sentjost nad Horjulom 16, 1354 Horjul, SI						
(72)	BUH, Gregor, Goli Vrh 4, 4224 Gorenja Vas, SI						
<hr/>							
(51)	MKP						
	<b>C11C 3/00</b>	<b>2006</b>	<b>(97) EP 3299444</b>				
(96)	EP 17001568.9 9/21/2017						
(97)	EP 3299444, 12/19/2018 201851, en						
(31)	201600775		(32)	21.09.2016		(33)	ES
(54)	HIGH EFFICIENCY METHOD AND CATALYST FOR THE PRODUCTION OF ALKYL ESTERS FROM FATTY ACIDS WITH ACID CATALYSIS						
(71)	Bio-Oils Huelva, S.L., Poligono Nuevo Puerto calle Transversal A, 21810 Palos de la Frontera, Huelva, ES Universidad De Malaga, Avenida Cervantes N° 2, E-29016 Málaga, ES						
(72)	CONDE LIMÓN, María, c/Monte Esquinza, 30 3° dcha, 28010 Madrid, ES SÁNCHEZ OBREGÓN, Virginia, Pol. Ind. Nuevo Puerto c/Gobernador Ángel de Horcajadas, s/n, 21810 Palos de la Frontera (Huelva), ES ALEMANY ARREBOLA, Luis J., Plaza de El Ejido, S/N, 29071 Malaga, ES						
<hr/>							
(51)	MKP						
	<b>H01Q 1/22</b>	<b>2006</b>	<b>(97) EP 3331094</b>				
	<b>H01Q 1/52</b>	<b>2006</b>					
	<b>H01Q 3/30</b>	<b>2006</b>					
	<b>H01Q 5/35</b>	<b>2015</b>					
	<b>H01Q 9/04</b>	<b>2006</b>					
	<b>H01Q 21/28</b>	<b>2006</b>					
(96)	EP 17001956.6 11/29/2017						
(97)	EP 3331094, 8/29/2018 201835, de						
(31)	102016014589		(32)	05.12.2016		(33)	DE
(54)	ANTENNA ASSEMBLY						
(71)	KATHREIN Sachsen GmbH, Lindenstrasse 3, 09241 Mühlau, DE						
(72)	Iliev, Stoyan, Götschweg 2, 83026 Rosenheim, DE Schönig, Volker, Sachsenkam 5 1/2, 83101 Rohrdorf, DE Brunner, Thomas, Wolferkam 8, 83083 Riedering, DE						
<hr/>							
(51)	MKP						
	<b>A61M 16/00</b>	<b>2006</b>	<b>(97) EP 3258999</b>				
	<b>A61M 16/12</b>	<b>2006</b>					
(96)	EP 15790644.7 9/10/2015						
(97)	EP 3258999, 11/21/2018 201847, en						
(31)	P1400421		(32)	10.09.2014		(33)	HU
(54)	DEVICE FOR ADJUSTMENT AND/OR CONDITIONING OF THE CO2 CONTENT OF THE INHALED AIR						
(71)	Pomoziné Gyarmathy, Ágnes, Présház u.8, 2040 Budaörs, HU						
(72)	POMOZI, István, Présház u.8, 2040 Budaörs, HU SZÁZ, Dénes, Toldi u.8., 5000 Szolnok, HU						

(51) MKP  
**A61K 39/00 2006 (97) EP 3368066**  
**A61K 39/395 2006**  
**C07K 16/18 2006**  
**C07K 16/24 2006**  
**C07K 16/26 2006**

(96) EP 15791212.2 10/30/2015  
(97) EP 3368066, 9/5/2018 201836, en  
(54) ANTI-CGRP/ANTI-IL-23 BISPECIFIC ANTIBODIES AND USES THEREOF  
(72) BENSCHOP, Robert Jan, c/o Eli Lilly and Company P.O. Box 6288, Indianapolis, Indiana 46206-6288, US  
ALLAN, Barrett, c/o Eli Lilly and Company P.O. Box 6288, Indianapolis, Indiana 46206-6288, US  
MILLICAN, Rohn Lee, Jr., c/o Eli Lilly and Company P.O. Box 6288, Indianapolis, Indiana 46206-6288, US  
BEIDLER, Catherine Brautigam, c/o Eli Lilly and Company P.O. Box 6288, Indianapolis, Indiana 46206-6288, US

---

(51) MKP  
**H04L 9/08 2006 (97) EP 3257192**  
**H04L 9/32 2006**  
**H04L 29/06 2006**  
**H04L 29/12 2006**

(96) EP 16749597.7 1/29/2016  
(97) EP 3257192, 8/29/2018 201835, en  
(31) 201562116414 P (32) 14.02.2015 (33) US  
(54) SECURE AND DELEGATED DISTRIBUTION OF PRIVATE KEYS VIA DOMAIN NAME SERVICE  
(71) Valimail Inc., 180 Montgomery Street, 18th Floor, San Francisco, CA 94104, US  
(72) GOLDSTEIN, Peter, Martin, C/o Valimail Inc. 180 Montgomery Street 18th Floor, San Francisco, CA 94104, US

---

(51) MKP  
**C07F 5/05 2006 (97) EP 3256481**

(96) EP 16749834.4 2/10/2016  
(97) EP 3256481, 8/22/2018 201834, en  
(31) 201562114838 P (32) 11.02.2015 (33) US  
201562265762 P 10.12.2015 US  
(54) NOVEL CRYSTALLINE FORM OF A PROTEASOME INHIBITOR  
(72) LANGSTON, Marianne, 164 Mill Road, North Andover, MA 01845, US  
MAZAIK, Debra, 125 Wilson Street, Holliston, MA 01746, US  
ELLIOTT, Eric, 95 Channing Road, Watertown, MA 02472, US  
PETERSON, Anton, 837 Winter Street, Holliston, MA 01746, US  
ANDRES, Patricia, 2307 Sycamore Lane, West Lafayette, IN 47906, US  
TENG, Jing, 3027 Sullivan Street, West Lafayette, IN 47906, US

---

(51) MKP  
**C12N 7/00 2006 (97) EP 3256571**

(96) EP 16749976.3 2/12/2016  
(97) EP 3256571, 7/25/2018 201830, en  
(31) 201562116361 P (32) 13.02.2015 (33) US  
(54) METHODS FOR PRODUCING VIRUS FOR VACCINE PRODUCTION  
(72) RAO, Raman, c/o Takeda Vaccines Inc. 2155 Analysis Drive, Bozeman, MT 59718, US

---

(51) MKP  
**C07C 51/09 2006 (97) EP 3257009**  
**C08F 122/02 2006**  
**G06Q 30/02 2012**

(96) EP 16749983.9 2/12/2016  
(97) EP 3257009, 10/24/2018 201843, en  
(31) 201562116238 P (32) 13.02.2015 (33) US  
(54) SYSTEMS AND PROCESSES FOR POLYMER PRODUCTION  
(72) FARMER, Jay, J., c/o Novomer, Inc. 1 Bowdoin Square, Suite 300, Boston, MA 02114, US  
GALEBACH, Peter, 1225 East Dayton Street, Apt.1, Madison, WI 53703, US  
SHERRY, Kyle, c/o Novomer, Inc. 1 Bowdoin Square, Suite 300, Boston, MA 02114, US  
SOOKRAJ, Sadesh H., c/o Novomer, Inc. 1 Bowdoin Square, Suite 300, Boston, MA 02114, US

---

(51) MKP  
**C07C 51/12 2006 (97) EP 3256442**  
**C07C 51/14 2006**  
**C07C 51/145 2006**  
**C07C 51/16 2006**  
**C07C 51/377 2006**  
**C07C 57/04 2006**  
**C07C 59/01 2006**  
**C08F 2/01 2006**  
**C08F 2/18 2006**  
**C08F 20/00 2006**  
**C08F 20/06 2006**  
(96) EP 16750004.0 2/12/2016  
(97) EP 3256442, 10/10/2018 201841, en  
(31) 201562116229 P (32) 13.02.2015 (33) US  
(54) SYSTEMS AND PROCESSES FOR POLYACRYLIC ACID PRODUCTION  
(72) SOOKRAJ, Sadesh H., c/o Novomer, Inc. 1 Bowdoin Square, Suite 300, Boston, MA 02114, US

---

(51) MKP  
**C07C 29/147 2006 (97) EP 3256443**  
**C07C 51/09 2006**  
**C07C 57/04 2006**  
**C07C 67/00 2006**  
**C07C 67/03 2006**  
**C07C 69/54 2006**  
**C07D 301/02 2006**  
**C07D 305/12 2006**  
**C07D 307/60 2006**  
**C08G 63/78 2006**  
(96) EP 16750012.3 2/12/2016  
(97) EP 3256443, 8/15/2018 201833, en  
(31) 201562116234 P (32) 13.02.2015 (33) US  
(54) FLEXIBLE CHEMICAL PRODUCTION PLATFORM  
(72) SOOKRAJ, Sadesh H., c/o Novomer, Inc. 1 Bowdoin Square, Suite 300, Boston, MA 02114, US

---

(51) MKP  
**C07C 51/09 2006 (97) EP 3256439**  
**C07C 57/04 2006**  
(96) EP 16750017.2 2/12/2016  
(97) EP 3256439, 10/10/2018 201841, en  
(31) 201562116325 P (32) 13.02.2015 (33) US  
(54) PROCESS FOR PRODUCTION OF ACRYLIC ACID  
(72) FARMER, Jay J., c/o Novomer, Inc. 1 Bowdoin Square, Suite 300, Boston, MA 02114, US  
SHERRY, Kyle, c/o Novomer, Inc. 1 Bowdoin Square, Suite 300, Boston, MA 02114, US  
SOOKRAJ, Sadesh H., c/o Novomer, Inc. 1 Bowdoin Square, Suite 300, Boston, MA 02114, US  
GALEBACH, Peter, 1225 East Dayton Street, Apt. 1, Madison, WI 53703, US

---

(51) MKP  
**B01J 19/24 2006 (97) EP 3256440**  
**C07C 51/09 2006**  
**C07C 57/04 2006**  
**C08G 63/08 2006**  
**C08G 63/82 2006**  
(96) EP 16750025.5 2/12/2016  
(97) EP 3256440, 10/10/2018 201841, en  
(31) 201562116328 P (32) 13.02.2015 (33) US  
(54) DISTILLATION PROCESS FOR PRODUCTION OF ACRYLIC ACID  
(72) SOOKRAJ, Sadesh H., c/o Novomer, Inc. 1 Bowdoin Square, Suite 300, Boston, MA 2114, US

---

(51) MKP  
**C07D 305/12 2006 (97) EP 3256454**  
**C07D 307/60 2006**  
(96) EP 16750026.3 2/12/2016

(97) EP 3256454, 8/15/2018 201833, en  
(31) 201562116109 P (32) 13.02.2015 (33) US  
(54) INTEGRATED METHODS FOR CHEMICAL SYNTHESIS  
(72) SOOKRAJ, Sadesh H., c/o Novomer, Inc. 1 Bowdoin Square, Suite 300, Boston, MA 02114, US  
SLOWIK, Michael A., c/o Novomer, Inc. 1 Bowdoin Square, Suite 300, Boston, MA 02114, US

---

(51) MKP  
**A61B 3/117 2006 (97) EP 3256084**  
**A61B 3/14 2006**  
**A61F 9/00 2006**  
**A61F 9/007 2006**  
(96) EP 16750071.9 2/16/2016  
(97) EP 3256084, 12/5/2018 201849, en  
(31) 201562115991 P (32) 13.02.2015 (33) US  
(54) DEVICE, SYSTEM, AND METHOD FOR FUNCTIONAL IMAGING OF EPISCLERAL VESSELS  
(72) MOSAED, Sameh, 25771 Nelie Gail Road, Laguna Hills, CA 92653, US  
LIN, Ken, 42 Donovan, Irvine, CA 92620, US

---

(51) MKP  
**A61K 31/4155 2006 (97) EP 3347349**  
**A61K 31/416 2006**  
**A61K 31/427 2006**  
**A61K 31/428 2006**  
**A61K 31/4439 2006**  
**A61K 31/4545 2006**  
**A61P 25/00 2006**  
**C07D 401/06 2006**  
**C07D 401/12 2006**  
**C07D 401/14 2006**  
**C07D 403/06 2006**  
**C07D 403/14 2006**  
**C07D 417/06 2006**  
**C07D 417/14 2006**  
(96) EP 16750259.0 7/19/2016  
(97) EP 3347349, 7/18/2018 201829, en  
(31) 4809CH2015 (32) 10.09.2015 (33) IN  
(54) FLUOROINDOLE DERIVATIVES AS MUSCARINIC M1 RECEPTOR POSITIVE ALLOSTERIC MODULATORS  
(72) NIROGI, Ramakrishna, Suven Life Sciences Limited Serene Chambers Road-5, Avenue 7 Banjara Hills, Hyderabad Telangana 500034, IN  
SHINDE, Anil Karbhari, Suven Life Sciences Limited Serene Chambers Road-5, Avenue 7 Banjara Hills, Hyderabad Telangana 500034, IN  
MOHAMMED, Abdul Rasheed, Suven Life Sciences Limited Serene Chambers Road-5, Avenue 7 Banjara Hills, Hyderabad Telangana 500034, IN  
SUBRAMANIAN, Ramkumar, Suven Life Sciences Limited Serene Chambers Road-5, Avenue 7 Banjara Hills, Hyderabad Telangana 500034, IN  
BENADE, Vijay Sidram, Suven Life Sciences Limited Serene Chambers Road-5, Avenue 7 Banjara Hills, Hyderabad Telangana 500034, IN  
BHYRAPUNENI, Gopinadh, Suven Life Sciences Limited Serene Chambers Road-5, Avenue 7 Banjara Hills, Hyderabad Telangana 500034, IN  
JASTI, Venkateswarlu, Suven Life Sciences Limited Serene Chambers Road-5, Avenue 7 Banjara Hills, Hyderabad Telangana 500034, IN

---

(51) MKP  
**F01N 1/16 2006 (97) EP 3347579**  
**F01N 3/00 2006**  
**F01N 9/00 2006**  
**F01N 13/04 2010**  
**F01N 13/08 2010**  
(96) EP 16750823.3 8/10/2016  
(97) EP 3347579, 7/18/2018 201829, en  
(31) 15002654 (32) 10.09.2015 (33) EP  
(54) EXHAUST SYSTEM FOR AN INTERNAL COMBUSTION AUTOMOTIVE ENGINE  
(71) Akrapovic d.d., Malo Hudo 8a, 1295 Ivancna Gorica, SI  
(72) AKRAPOVIC, Igor, Rozna dolina Cesta VIII 10/A, 1000 Ljubljana, SI  
KLEMENC, Jaka, Skrabceva 21, 1000 Ljubljana, SI  
SEDEJ, Gasper, Jelčni Vrh 7, 5280 Idrija, SI  
VIPAVEC, Simon, Gubceva 7, 8340 Crnomelj, SI

---

(51) MKP

**A61K 36/04 2006 (97) EP 3380109**  
**A61K 36/09 2006**  
**A61K 36/185 2006**  
**A61K 36/48 2006**  
**A61K 36/68 2006**  
**A61K 36/73 2006**  
**A61K 36/888 2006**  
**A61K 36/8988 2006**  
(96) EP 16751231.8 7/29/2016  
(97) EP 3380109, 10/3/2018 201840, de  
(31) 102015015145 (32) 25.11.2015 (33) DE  
102015121607 11.12.2015 DE  
(54) COMPOSITION FOR THE TREATMENT OF COLDS AND ALLERGIES  
(72) VESTWEBER, Anna-Maria, Maxhan 34, 51399 Burscheid, DE  
UNKAUF, Markus, Liebigstrasse 10A, 80538 München, DE

---

(51) MKP  
**C07C 311/54 2006 (97) EP 3259253**  
**C07C 311/56 2006**  
**C07D 213/71 2006**  
**C07D 217/22 2006**  
**C07D 231/18 2006**  
**C07D 249/04 2006**  
**C07D 249/12 2006**  
**C07D 271/12 2006**  
**C07D 277/36 2006**  
**C07D 307/18 2006**  
**C07D 307/64 2006**  
**C07D 307/82 2006**  
**C07D 309/08 2006**  
**C07D 311/60 2006**  
**C07D 333/34 2006**  
**C07D 333/62 2006**  
**C07D 403/12 2006**  
**C07D 405/12 2006**  
**C07D 407/12 2006**  
**C07D 417/12 2006**  
(96) EP 16751821.6 2/16/2016  
(97) EP 3259253, 7/25/2018 201830, en  
(31) 2015900507 (32) 16.02.2015 (33) AU  
(54) SULFONYLUREAS AND RELATED COMPOUNDS AND USE OF SAME  
(71) The Provost, Fellows, Foundation Scholars, and The Other Members of Board, of The College of The Holy and Undivided Trinity of Queen Elizabeth, College Green, Dublin 2, IE  
(72) O'NEILL, Luke, Trinity Biomedical Sciences Institute Trinity College Dublin 152-160 Pearse Street, Dublin 2, IE  
COLL, Rebecca, 18 Forbes Street, West End, Queensland 4101, AU  
COOPER, Matthew, 29 Camborne Place, Chapel Hill, Queensland 4049, AU  
ROBERTSON, Avril, 44 Maryland Street, Kenmore, Queensland 4069, AU  
SCHRODER, Kate, 7 Love Street, Fairfield, Queensland 4103, AU

---

(51) MKP  
**A01N 25/04 2006 (97) EP 3259992**  
**A01N 25/22 2006**  
**A01N 43/90 2006**  
**A01P 7/02 2006**  
(96) EP 16752397.6 2/12/2016  
(97) EP 3259992, 7/25/2018 201830, en  
(31) 2015028628 (32) 17.02.2015 (33) JP  
(54) AGROCHEMICAL COMPOSITION  
(72) KAI Tetsutarō, c/o Odawara Research Center Haibara Field Research Center Nippon Soda Co. Ltd. 62-1 Sakabe, Makinohara-shi Shizuoka 421-0412, JP  
OKADA Eriko, c/o Odawara Research Center Haibara Field Research Center Nippon Soda Co. Ltd. 62-1 Sakabe, Makinohara-shi Shizuoka 421-0412, JP  
MAEKAWA Takahiro, c/o Odawara Research Center Haibara Field Research Center Nippon Soda Co. Ltd. 62-1 Sakabe, Makinohara-shi Shizuoka 421-0412, JP

---

(51) MKP  
**A61K 31/69 2006 (97) EP 3258965**  
**A61K 39/395 2006**  
**A61K 45/06 2006**  
**A61P 35/00 2006**  
**C07K 16/00 2006**  
**C07K 16/18 2006**

(96) EP 16752904.9 2/16/2016  
(97) EP 3258965, 8/29/2018 201835, en

(31) 201562117283 P (32) 17.02.2015 (33) US

(54) COMBINATION THERAPY FOR CANCER TREATMENT  
(72) LABOTKA, Richard, 536 South Fourth Avenue, Des Plaines, IL 60016, US  
FERGUS, Andrew, 16 Balmoral St. ,101, Andover, MA 01810, US

---

(51) MKP  
**A61K 9/20 2006 (97) EP 3258962**  
**A61K 31/07 2006**  
**A61K 31/375 2006**  
**A61K 39/35 2006**  
**A61P 37/08 2006**

(96) EP 16753171.4 2/19/2016  
(97) EP 3258962, 7/11/2018 201828, en

(31) 201562119014 P (32) 20.02.2015 (33) US

(54) MIXED ALLERGEN COMPOSITIONS AND METHODS FOR USING THE SAME  
(71) The Board of Trustees of The Leland Stanford Junior University, Office of The General Counsel Building 170, 3rd Floor, Main Quad P.O. Box 20386, Stanford, CA 94305-2038, US  
(72) NADEAU, Kari C., 27957 Via Ventana Way, Los Altos Hills, California 94022, US

---

(51) MKP  
**A61K 38/37 2006 (97) EP 3260132**  
**A61P 7/04 2006**  
**C07K 14/755 2006**  
**G01N 33/50 2006**  
**G01N 33/569 2006**

(96) EP 17167928.5 10/27/2011  
(97) EP 3260132, 7/25/2018 201830, en

(31) 407402 P (32) 27.10.2010 (33) US  
201161467894 P 25.03.2011 US  
201161502476 P 29.06.2011 US

(54) FVIII PEPTIDES FOR IMMUNE TOLERANCE INDUCTION AND IMMUNODIAGNOSTICS  
(71) Baxalta GmbH, Zählerweg 4, 6300 Zug, CH  
(72) Steinitz, Katharina Nora, Querweg 14, 2500 Siegenfeld, AT  
Wilhelmina van Helden, Paula Maria, Eimeren 54, 5235 DV Den Bosch, NL  
Reipert, Birgit Maria, Heinegasse 2, 2232 Deutsch-Wagram, AT  
Schwarz, Hans-Peter, Weimarer Strasse 76, 1180 Vienna, AT  
Ehrlich, Hartmut, Bienenweg 1, 1170 Vienna, CH

---

(51) MKP  
**A61K 9/00 2006 (97) EP 3266456**  
**A61K 9/127 2006**  
**A61K 31/4745 2006**  
**A61K 31/513 2006**  
**A61K 31/519 2006**  
**A61K 45/06 2006**  
**A61P 35/00 2006**

(96) EP 17169098.5 6/12/2013  
(97) EP 3266456, 8/1/2018 201831, en

(31) 201261659211 P (32) 13.06.2012 (33) US  
201361784382 P 14.03.2013 US

(54) COMBINATIONS OF LIPOSOMAL IRINOTECAN, 5-FU AND LEUCOVORIN FOR THE TREATMENT OF PANCREATIC CANCER  
(71) Ipsen Biopharm Ltd., Ash Road, Wrexham Industrial Estate Wrexham LL13 9UF, GB



(72) BAYEVER, Eliel, 225 West 60th Street PH1D, New York, NY New York 10023, US  
DHINDSA, Navreet, 190 Bolton Street, Boston, MA Massachusetts 02127, US  
FITZGERALD, Jonathan, Basil, 32 Magnolia Street, Arlington, MA Massachusetts 02474, US  
LAIVINS, Peter, 22 Bridle Lane, Scituate, MA Massachusetts 02066, US  
MOYO, Victor, 2 Neshanic Dr., Ringoes, NJ New Jersey 08551, US  
NIYIKIZA, Clet, 326 Overlook Lane, Gulph Mills, PA Pennsylvania 19428, US  
KIM, Jaeyeon, 30 Donald Street, Lexington, MA Massachusetts 02420, US

---

(51) MKP  
**A61K 31/437 2006 (97) EP 3284744**  
**A61K 31/444 2006**  
**A61K 31/4545 2006**  
**A61K 31/496 2006**  
**A61K 31/5377 2006**  
**A61P 19/00 2006**  
**A61P 25/28 2006**  
**A61P 31/10 2006**  
**A61P 31/12 2006**  
**A61P 35/00 2006**  
**C07D 471/04 2006**

(96) EP 17169783.2 3/13/2013

(97) EP 3284744, 9/26/2018 201839, en

(31) 201261620107 P (32) 04.04.2012 (33) US

(54) INDAZOLE INHIBITORS OF THE WNT SIGNAL PATHWAY AND THERAPEUTIC USES THEREOF

(72) HOOD, John, 10831 Vereda Sol Del Dios, San Diego, CA California 92130, US

WALLACE, David, Mark, 6448 Peinado Way, San Diego, CA California 92121, US

KC, Sunil, Kumar, 10504 Clasico Court, San Diego, CA California 92127, US

---

(51) MKP  
**B65D 30/18 2006 (97) EP 3257776**  
**B65D 30/20 2006**  
**B65D 33/06 2006**  
**B65D 33/10 2006**

(96) EP 17170571.8 5/11/2017

(97) EP 3257776, 8/1/2018 201831, de

(31) 102016111030 (32) 16.06.2016 (33) DE  
102016119113 07.10.2016 DE

(54) BAG AND METHOD FOR MANUFACTURING THE SAME

(72) Bruns, Thomas, Kupferstr. 18, 48496 Hopsten, DE

Lüttmann, Peter, Kupferstr. 18, 48496 Hopsten, DE

---

(51) MKP  
**A23K 20/24 2016 (97) EP 3400810**  
**A23L 29/00 2016**  
**A23P 10/43 2016**  
**A61K 33/10 2006**  
**C09C 1/02 2006**

(96) EP 17170704.5 5/11/2017

(97) EP 3400810, 11/14/2018 201846, en

(54) SURFACE-REACTED CALCIUM CARBONATE IN FOOD

(72) BUDDE, Tanja, Grubenring 3, 4805 Brittnau, CH

HECKER, Anaïs, Neugasse 9, 4665 Oftringen, CH

SHARMA, Lalit, Gottfried Keller Strasse 6, 4800 Zofingen, CH

---

(51) MKP  
**A61K 39/395 2006 (97) EP 3254695**  
**A61K 45/06 2006**  
**C07K 16/30 2006**

(96) EP 17171169.0 5/21/2013

(97) EP 3254695, 7/18/2018 201829, en

(31) PCT/EP2012/002210 (32) 23.05.2012 (33) WO

(54) COMBINATION THERAPY INVOLVING ANTIBODIES AGAINST CLAUDIN 18.2 FOR TREATMENT OF CANCER

(72) SAHIN, Ugur, Philipp-von-Zabern-Platz 1, 55116 Mainz, DE  
TÜRECI, Özlem, Philipp-von-Zabern-Platz 1, 55116 Mainz, DE  
MITNACHT-KRAUS, Rita, Taunusstrasse 45, 61169 Friedberg, DE  
JACOBS, Stefan, Denis, Friedenstrasse 7, 55252 Mainz-Kastel, DE  
UTSCH, Magdalena, Jadwiga, Fingerkrautweg 30b, 55262 Heidesheim am Rhein, DE  
HEINZ, Cornelia, Adriana, Maria, Auf den Elfmorgen 22, 55278 Dalheim, DE  
STADLER, Christiane, Regina, Fritz-Bockius Strasse 13, 64625 Bensheim, DE

---

(51) MKP  
**A01N 59/00 2006 (97) EP 3403505**  
**A01N 59/16 2006**  
**A01P 3/00 2006**

(96) EP 17171322.5 5/16/2017  
(97) EP 3403505, 11/21/2018 201847, en  
(54) BIOCIDES FREE PRESERVATION  
(72) GLAUBITZ, Joachim, Parkweier 1, 6264 Pfaffnau, CH  
SÜTTERLIN, Klaus, Hauptstrasse 19, 79426 Buggingen, DE

---

(51) MKP  
**A61K 48/00 2006 (97) EP 3251700**  
**C07H 21/04 2006**

(96) EP 17171651.7 9/4/2012  
(97) EP 3251700, 7/18/2018 201829, en  
(31) 201161532667 P (32) 09.09.2011 (33) US  
(54) A CONDITIONAL REPLICATING CYTOMEGALOVIRUS AS A VACCINE FOR CMV  
(72) FU, Tong-Ming, 770, Sumneytown Pike, West Point, PA 19486, US  
WANG, Dai, 770, Sumneytown Pike, West Point, PA 19486, US  
MEDI, Muneeswara Babu, 770, Sumneytown Pike, West Point, PA 19486, US

---

(51) MKP  
**A61K 31/664 2006 (97) EP 3290428**  
**A61K 31/7072 2006**  
**A61K 31/716 2006**  
**A61P 31/14 2006**  
**C07F 9/22 2006**  
**C07F 9/24 2006**  
**C07F 9/6558 2006**  
**C07H 19/073 2006**  
**C07H 19/10 2006**

(96) EP 17172585.6 3/31/2011  
(97) EP 3290428, 10/10/2018 201841, en  
(31) 319513 P (32) 31.03.2010 (33) US  
319548 P 31.03.2010 US  
783680 20.05.2010 US  
(54) TABLET COMPRISING CRYSTALLINE (S)-ISOPROPYL 2-(((S)-((2R,3R,4R,5R)-5-(2,4-DIOXO-3,4-DIHYDROPYRIMIDIN-1 (2H)-YL)-4-FLUORO-3-HYDROXY-4-METHYLTETRAHYDROFURAN-2-YL)METHOXY)(PHENOXY)PHOSPHORYL)AMINO)PROPANOATE  
(72) Ross, Bruce S, 155 Del Monte Road, El Granada, CA California 94018, US  
Sofia, Michael Joseph, 3066 Antler Drive, Doylestown, PA Pennsylvania 18902, US  
Pamulapati, Ganapati Reddy, 1709 Blakesley Drive, San Ramon, CA California 94582, US  
Rachakonda, Suguna, 1272 Sharonbrook Drive, Twinsburg, OH Ohio 44087, US  
Zhang, Hai-Ren, 6767 Mason Way, San Jose, CA California 95129, US  
Chun, Byoung-Kwon, 135 Heritage Street, Robbinsville, NJ New Jersey 08691, US  
Wang, Peiyuan, 42 Continental Circle, Totowa, NJ New Jersey 07512, US

---

(51) MKP  
**B41M 3/00 2006 (97) EP 3406455**  
**B41M 3/14 2006**  
**C09D 11/54 2014**

(96) EP 17172598.9 5/23/2017  
(97) EP 3406455, 11/28/2018 201848, en  
(54) METHOD FOR PRODUCING WATER-INSOLUBLE QUANTUM DOT PATTERNS  
(72) BOLLSTRÖM, Roger, Ackerstrasse 11, 4800 Zofingen, CH  
FTOUNI, Jamal, Vordere Hauptgasse 86, 4800 Zofingen, CH

---

(51) MKP  
**C07K 16/00 2006 (97) EP 3275896**

(96) EP 17173501.2 2/2/2011  
(97) EP 3275896, 9/5/2018 201836, en

(31) 201001791 (32) 03.02.2010 (33) GB

(54) PROCESS FOR OBTAINING ANTIBODIES  
(72) Bilgischer, Jean-Pascal Pierre, c/o UCB Pharma, IP Department 60 Allée de la Recherche, 1070 Brussels, BE  
Bassett, Philip Jonathan, c/o UCB Celltech, IP department 208 Bath Road, Slough, Berkshire SL1 3WE, GB  
Pearce-Higgins, Mark Robert, c/o UCB Celltech, IP department 208 Bath Road, Slough, Berkshire SL1 3WE, GB  
Kenny, Andrew John, 21 Beechwood Road, Fishburn, Stockton-on-Tees TS21 4EP, GB

---

(51) MKP  
**A61K 9/08 2006 (97) EP 3400950**  
**A61K 31/728 2006**  
**A61K 31/737 2006**  
**A61P 13/10 2006**  
**A61P 29/00 2006**

(96) EP 17173817.2 5/31/2017  
(97) EP 3400950, 11/14/2018 201846, de

(31) 17000820 (32) 12.05.2017 (33) EP

(54) BLADDER INSTILLATION COMPOSITION CONTAINING CHONDOITIN SULFATE (20 MG/ML), HYALURONIC ACID (16 MG/ML) AND PHOSPHATE BUFFER (PH 6,1 TO 7,9) WITH AN IMPROVED STORAGE STABILITY FOR THE TREATMENT OF CYSTITIS  
(72) MEIER, Andreas, c/o Farco-Pharma GmbH Gereonsmühlengasse 1-11, D - 50670 Köln, DE

---

(51) MKP  
**A61K 9/08 2006 (97) EP 3400951**  
**A61K 31/728 2006**  
**A61K 31/737 2006**  
**A61P 13/10 2006**  
**A61P 29/00 2006**

(96) EP 17173823.0 5/31/2017  
(97) EP 3400951, 11/14/2018 201846, de

(31) 17000821 (32) 12.05.2017 (33) EP

(54) BLADDER INSTILLATION COMPOSITION CONTAINING CHONDOITIN SULFATE (4,5 MG/ML), HYALURONIC ACID (16 MG/ML) AND PHOSPHATE BUFFER (PH 6,1 TO 7,9) WITH AN IMPROVED STORAGE STABILITY FOR THE TREATMENT OF CYSTITIS  
(72) MEIER, Andreas, c/o Farco-Pharma GmbH Gereonsmühlengasse 1-11, D - 50670 Köln, DE

---

(51) MKP  
**A61K 31/728 2006 (97) EP 3400949**  
**A61K 31/737 2006**  
**A61P 13/10 2006**

(96) EP 17173824.8 5/31/2017  
(97) EP 3400949, 11/14/2018 201846, de

(31) 17000822 (32) 12.05.2017 (33) EP

(54) COMPOSITION FOR TOPICAL USE, IN PARTICULAR FOR BLADDER INSTILLATION  
(72) SODHA, Frank, c/o Farco-Pharma GmbH Gereonsmühlengasse 1-11, D - 50670 Köln, DE

---

(51) MKP  
**A61B 5/00 2006 (97) EP 3254612**  
**A61B 17/00 2006**  
**A61B 18/00 2006**

(96) EP 17174355.2 6/2/2017  
(97) EP 3254612, 7/25/2018 201830, en

(31) 201615172530 (32) 03.06.2016 (33) US

(54) SPINE CONSTRUCTION FOR BASKET CATHETER  
(72) GUTA, Alexandru, 15715 Arrow Highway, Irwindale, CA 91706, US  
PETRULIS, Marius, 15715 Arrow Highway, Irwindale, CA 91706, US  
LIN, Ronald, 15715 Arrow Highway, Irwindale, CA 91706, US  
DAVIS, Jon, 15715 Arrow Highway, Irwindale, CA 91706, US

---

(51) MKP  
C07K 16/00 2006 (97) EP 3263597  
C07K 16/10 2006  
C07K 16/28 2006  
C07K 16/30 2006  
C07K 16/46 2006  
(96) EP 17174827.0 9/26/2012  
(97) EP 3263597, 8/8/2018 201832, en  
(31) 201161539116 P (32) 26.09.2011 (33) US  
(54) GENERATION OF BINDING MOLECULES  
(71) Merus N.V., Yalelaan 62, 3584 CM Utrecht, NL  
(72) Throsby, Mark, c/o Yalelaan 62, 3584 CM Utrecht, NL  
Logtenberg, Ton, c/o Yalelaan 62, 3584 CM Utrecht, NL  
de Kruif, Cornelis Adriaan, c/o Yalelaan 62, 3584 CM Utrecht, NL

---

(51) MKP  
A61B 5/00 2006 (97) EP 3254614  
A61B 5/042 2006  
A61B 5/06 2006  
(96) EP 17175072.2 6/8/2017  
(97) EP 3254614, 7/25/2018 201830, en  
(31) 201615177775 (32) 09.06.2016 (33) US  
201615359838 23.11.2016 US  
(54) MULTI-FUNCTION CONDUCTING ELEMENTS FOR A CATHETER  
(72) BAR-TAL, Meir, c/o Biosense Webster (Israel), Ltd. P.O. Box 275 4 Hatnufa Street, 2066717 Yokneam, IL  
LEVIN, Michael, c/o Biosense Webster (Israel), Ltd. P.O. Box 275 4 Hatnufa Street, 2066717 Yokneam, IL  
REUVENI, Avi, c/o Biosense Webster (Israel), Ltd. P.O. Box 275 4 Hatnufa Street, 2066717 Yokneam, IL  
HIGHSMITH, Debby Esther, 15715 Arrow Highway, Irwindale, CA 91706, US  
GARCIA, Ariel, 15715 Arrow Highway, Irwindale, CA 91706, US  
OSADCHY, Daniel, c/o Biosense Webster (Israel), Ltd. P.O. Box 275 4 Hatnufa Street, 2066717 Yokneam, IL  
AUERBACH, Shmuel, c/o Biosense Webster (Israel), Ltd. P.O. Box 275 4 Hatnufa Street, 2066717 Yokneam, IL

---

(51) MKP  
A61B 5/00 2006 (97) EP 3254618  
A61B 5/04 2006  
A61B 5/042 2006  
A61B 5/044 2006  
A61B 5/0452 2006  
A61B 5/046 2006  
(96) EP 17175147.2 6/9/2017  
(97) EP 3254618, 7/25/2018 201830, en  
(31) 201615179002 (32) 10.06.2016 (33) US  
(54) IDENTIFICATION AND VISUALIZATION OF CARDIAC ACTIVATION SEQUENCE IN MULTI-CHANNEL RECORDINGS  
(72) ZEIDAN, Ziyad, c/o Biosense Webster (Israel) Ltd. P.O. Box 275 4 Hatnufa Street, 2066717 Yokneam, IL  
HAYAM, Gal, c/o Biosense Webster (Israel) Ltd. P.O. Box 275 4 Hatnufa Street, 2066717 Yokneam, IL

---

(51) MKP  
A61K 31/422 2006 (97) EP 3257847  
A61K 31/4439 2006  
A61P 1/16 2006  
A61P 3/04 2006  
A61P 3/10 2006  
A61P 29/00 2006  
A61P 35/00 2006  
C07D 401/14 2006  
C07D 413/12 2006  
C07D 413/14 2006  
(96) EP 17175336.1 6/9/2017  
(97) EP 3257847, 10/17/2018 201842, en  
(31) 201662349490 P (32) 13.06.2016 (33) US

(54) FXR (NR1H4) MODULATING COMPOUNDS  
(72) BLOMGREN, Peter A, c/o Gilead Sciences, Inc. 333 Lakeside Drive, Foster City, CA 94404, US  
CURRIE, Kevin S, c/o Gilead Sciences, Inc. 333 Lakeside Drive, Foster City, CA 94404, US  
GEGE, Christian, c/o Phenex Pharmaceuticals AG Donnersbergweg 1, 67059 Ludwigshafen, DE  
KROPF, Jeffrey E, c/o Gilead Sciences, Inc. 333 Lakeside Drive, Foster City, CA 94404, US  
XU, Jianjun, c/o Gilead Sciences, Inc. 333 Lakeside Drive, Foster City, CA 94404, US

---

(51) MKP  
**F23D 14/22 2006 (97) EP 3293456**  
**F23L 7/00 2006**  
**F23Q 1/02 2006**  
(96) EP 17175526.7 6/12/2017  
(97) EP 3293456, 10/24/2018 201843, de  
(31) 102016008579 (32) 14.07.2016 (33) DE  
(54) BURNER  
(72) Demuth, Martin, Hauptstraße 56/10, 2353 Guntramsdorf, AT

---

(51) MKP  
**B66F 3/06 2006 (97) EP 3260735**  
**F16G 13/20 2006**  
**F16H 19/06 2006**  
(96) EP 17175813.9 6/13/2017  
(97) EP 3260735, 8/1/2018 201831, de  
(31) 102016110949 (32) 15.06.2016 (33) DE  
(54) THRUST CHAIN  
(72) Rossaint, Jens, Harkortstraße 40, 58313 Herdecke, DE  
Raffenbeul, Thomas, Selbecker Straße 69, 58091 Hagen, DE

---

(51) MKP  
**B66F 3/06 2006 (97) EP 3258132**  
**F16G 13/20 2006**  
**F16H 19/06 2006**  
(96) EP 17175984.8 6/14/2017  
(97) EP 3258132, 7/25/2018 201830, de  
(31) 102016110950 (32) 15.06.2016 (33) DE  
(54) DEVICE FOR DEFLECTING PUSH CHAINS AND PUSH CHAIN  
(71) Wippermann jr. GmbH, Delsterner Straße 133, 58091 Hagen, DE  
(72) Rossaint, Jens, Harkortstraße 10, 58313 Herdecke, DE

---

(51) MKP  
**C08K 9/00 2006 (97) EP 3415570**  
**C09C 1/02 2006**  
(96) EP 17176142.2 6/14/2017  
(97) EP 3415570, 12/19/2018 201851, en  
(54) PROCESS FOR PREPARING A SURFACE TREATED FILLER MATERIAL PRODUCT WITH MONO-SUBSTITUTED SUCCINIC ANHYDRIDE(S) AND A MIXTURE OF ALIPHATIC LINEAR OR BRANCHED CARBOXYLIC ACIDS COMPRISING STEARIC ACID  
(72) PULLEGA, Francesco, Via dello Spiraglio, 5, 40138 Bologna, IT  
BLANCHARD, Pierre, 63 Chemin de Budron, 01 600 Reyrieux, FR  
FORNERA, Tazio, Innere Altachen 12, 4800 Zofingen, CH  
WELKER, Matthias, 11 Rue des Rossignols, 68220 Héisingue, FR

---

(51) MKP  
**A61K 31/567 2006 (97) EP 3252069**  
**A61K 31/573 2006**  
**A61P 5/36 2006**  
**C07J 31/00 2006**  
**C07J 41/00 2006**  
(96) EP 17176264.4 7/7/2010  
(97) EP 3252069, 7/18/2018 201829, de  
(31) 102009034362 (32) 20.07.2009 (33) DE  
(54) (11.BETA.,17.BETA.)-17-HYDROXY-11-[4-(METHYLSULFONYL)PHENYL]-17-(PENTALFUOROMETHYL)ESTRA-4,9-DIEN-3-ONE FOR USE IN THE TREATMENT OF DISEASES

(72) Schwede, Wolfgang, Bayer Pharma AG Magdeburger Str. 41a, 16548 Glienicke, DE  
Klar, Ulrich, Bayer Pharma AG Isegrimsteig 8a, 13503 Berlin, DE  
Möller, Carsten, Gaillardstr. 14B, 13187 Berlin, DE  
Rotgeri, Andrea, Bayer Pharma AG Damwildsteig 21, 13503 Berlin, DE  
Bone, Wilhelm, Bayer Pharma AG Drewitzer Str. 46, 13467 Berlin, DE

---

(51) MKP  
**A61K 31/497 2006 (97) EP 3309151**  
**C07D 215/227 2006**  
**C07D 263/58 2006**  
**C07D 401/12 2006**  
**C07D 417/12 2006**  
**C07D 471/04 2006**  
**C07F 9/6558 2006**

(96) EP 17176623.1 6/24/2010

(97) EP 3309151, 12/5/2018 201849, en

(31) 220480 P (32) 25.06.2009 (33) US  
293087 P 07.01.2010 US

(54) HETEROCYCLIC COMPOUNDS FOR THE TREATMENT OF NEUROLOGICAL AND PSYCHOLOGICAL DISORDERS

(72) REMENAR, Julius F., 9 Eaton Road, Framlingham, MA 01701, US

BLUMBERG, Laura Cook, 37 Mill Street, Lincoln, MA 01773, US

ZEIDAN, Tarek A., 296 Lexington Street, Watertown, MA 02472, US

---

(51) MKP  
**A61K 31/69 2006 (97) EP 3251678**  
**A61P 31/04 2006**  
**C07F 5/02 2006**

(96) EP 17176654.6 9/7/2011

(97) EP 3251678, 7/11/2018 201828, en

(31) 380596 P (32) 07.09.2010 (33) US

(54) BENZOXABOROLE DERIVATIVES FOR TREATING BACTERIAL INFECTIONS

(71) Anacor Pharmaceuticals, Inc., 235 East 42nd Street, New York, NY 10017, US

(72) HERNANDEZ, Vincent, S., 287 Gilchrist Lane, Watsonville, California 95076, US

DING, Charles, 23 Treetop Lane, San Mateo, California 94402, US

PLATTNER, Jacob, J., 119 Via Floreado, Orinda, California 94563, US

ALLEY, Michael, Richard, Kevin, 3751 Lillick Drive, Santa Clara, California 95051, US

ROCK, Fernando, 1183 Lisa Lane, Los Altos, California 94024, US

ZHANG, Suoming, 1011 Halei Lu Building No 9, Room 206 Pudong Hi-Tech Park, Shanghai 201203, CN

EASOM, Eric, 1558 Mercy Street, Mountain View, California 94041, US

LI, Xianfeng, 10059 Craft Drive, Cupertino, California 94014, US

ZHOU, Ding, 2nd Floor, Bldg. 1B 528 Rui Qing Road, Shanghai, Pudong 201201, CN

---

(51) MKP  
**E04D 3/363 2006 (97) EP 3266952**

(96) EP 17177054.8 6/21/2017

(97) EP 3266952, 8/15/2018 201833, en

(31) 201600069659 (32) 05.07.2016 (33) IT

(54) PANEL FOR CLADDING SURFACES

(71) Roof Planet S.r.l., Via Circonvallazione 11, 10043 Orbassano Torino, IT

(72) Del Puppo, Luca, via Martiri della Bettola, 24/1, 42123 Reggio Emilia (RE), IT

Grosso, Giuseppe, Via Circonvallazione Giolitti 37, 12030 Torre San Giorgio Cuneo (CN), IT

---

(51) MKP  
**C07K 16/36 2006 (97) EP 3275903**

(96) EP 17177235.3 12/14/2012

(97) EP 3275903, 8/29/2018 201835, en

(31) 201121513 (32) 14.12.2011 (33) GB

(54) THROMBIN-BINDING ANTIBODY MOLECULES AND USES THEREOF

(72) HUNTINGTON, James Andrew, Department of Haematology CIMR Hills Road, Cambridge, Cambridgeshire CB2 2XY, GB

BAGLIN, Trevor, School of Clinical Medicine P.O. Box 111 Addenbrookes Hospital Hills Road, Cambridge, Cambridgeshire CB2 0SP, GB

LANGDOWN, Jonathan, School of Clinical Medicine P.O. Box 111 Addenbrookes Hospital Hills Road, Cambridge, Cambridgeshire CB2 0SP, GB

(51) MKP  
**H01T 1/22 2006 (97) EP 3270474**  
**H01T 4/12 2006**  
(96) EP 17177353.4 6/22/2017  
(97) EP 3270474, 8/22/2018 201834, de  
(31) 102016112637 (32) 11.07.2016 (33) DE  
(54) SPARK GAP ARRESTER  
(71) OBO Bettermann GmbH & Co. KG, Hüingsser Ring 52, 58710 Menden, DE  
(72) Hoffmann, Marcel, Bosselbar 10, 58675 Hemer, DE  
Schurwanz, Jürgen, Eifelstr. 30, 58710 Menden, DE

(51) MKP  
**F01K 1/04 2006 (97) EP 3260803**  
**F28D 20/00 2006**  
**F28D 20/02 2006**  
(96) EP 17177356.7 6/22/2017  
(97) EP 3260803, 8/8/2018 201832, de  
(31) 505712016 (32) 23.06.2016 (33) AT  
505702016 23.06.2016 AT  
(54) STEAM STORAGE  
(72) HOFMANN, Rene, Josef-Schleussner-Straße 8-10/3/1, 2340 Mödling, AT  
ZAUNER, Christoph, Hartlgasse 1, 1200 Wien, AT  
DUSEK, Sabrina, Doktor-Max-Burckhard-Ring 16, 2100 Korneuburg, AT  
HENGSTBERGER, Florian, Birkengasse 593, 3034 Maria Anzbach, AT

(51) MKP  
**B41M 3/00 2006 (97) EP 3418064**  
**B41M 3/14 2006**  
**B41M 5/323 2006**  
(96) EP 17177495.3 6/22/2017  
(97) EP 3418064, 12/26/2018 201852, en  
(54) TAMPER-PROOF MEDIUM FOR THERMAL PRINTING  
(72) BOLLSTRÖM, Roger, Ackerstrasse 11, 4800 Zofingen, CH  
BOTTY, Gilbert, Gebroeders Ummelsstraat 10, 6226 Maastricht, NL  
HUNZIKER, Philipp, 1337 Harbor Cove, Loveland, OH Ohio 45140, US

(51) MKP  
**G06F 3/048 2013 (97) EP 3258446**  
**G06T 19/20 2011**  
(96) EP 17177516.6 6/13/2012  
(97) EP 3258446, 7/25/2018 201830, en  
(31) 201213470802 (32) 14.05.2012 (33) US  
(54) METHOD AND SYSTEM FOR PROVIDING INFORMATION FROM A PATIENT-SPECIFIC MODEL OF BLOOD FLOW  
(72) HART, Gregory Richard, 345 Iris Way, Palo Alto, CA 94303, US  
STEVENS, John Henry, 1107 Cowper Street, Palo Alto, CA 94303, US

(51) MKP  
**C10B 53/02 2006 (97) EP 3260521**  
**C10J 3/26 2006**  
(96) EP 17177536.4 6/22/2017  
(97) EP 3260521, 8/1/2018 201831, en  
(31) UA20165101 (32) 22.06.2016 (33) IT  
(54) GASIFIER WITH IMPROVED AIR INLET ASSEMBLY  
(71) FEDRA SOCIETA' COOPERATIVA, Via Alessandro della Seta, 20, 00178 Roma, IT  
(72) LONER, Roberto, c/o Fedra Societa' Cooperativa Via Alessandro della Seta, 20, 00178 Roma, IT

(51) MKP  
**B01D 21/00 2006 (97) EP 3263221**  
**B03C 1/28 2006**  
**F24D 19/00 2006**

(96) EP 17177670.1 6/23/2017  
(97) EP 3263221, 8/8/2018 201832, en  
(31) UA20164716 (32) 28.06.2016 (33) IT  
(54) DIRT MAGNETIC SEPARATOR FOR THERMAL PLANTS  
(72) ALLESINA, Guerrino, FAR RUBINETTERIE S.P.A. Via Morena 20, 28024 Gozzano, IT

---

(51) MKP  
B65H 51/10 2006 (97) EP 3165487  
B65H 51/32 2006  
H01R 43/052 2006  
(96) EP 15193568.1 11/8/2015  
(97) EP 3165487, 10/24/2018 201843, de  
(54) CONDUIT TRANSPORTATION DEVICE, IN PARTICULAR FOR CABLES TO BE PROCESSED IN CABLE PROCESSING MACHINES  
(72) MAZUR, Michael, Haselheckstrasse 5, 61209 Echzell, DE  
SCHÄFER, Benjamin, Ortsstrasse 7, 35649 Bischoffen, DE

---

(51) MKP  
B21D 7/024 2006 (97) EP 3377240  
B21D 7/12 2006  
(96) EP 16815645.3 11/17/2016  
(97) EP 3377240, 9/26/2018 201839, en  
(31) UB20155771 (32) 20.11.2015 (33) IT  
(54) MACHINE FOR BENDING PIPES OR SECTIONS IN PARTICULAR OF METAL, TO OBTAIN ANY SHAPE  
(72) Massaro, Libero Angelo, Via Cavallara 5, 03030 Piedimonte San Germano (FR), IT

---

(51) MKP  
F42B 5/02 2006 (97) EP 3390958  
F42B 5/03 2006  
F42B 8/14 2006  
F42B 12/06 2006  
F42B 12/36 2006  
(96) EP 16815946.5 12/8/2016  
(97) EP 3390958, 10/24/2018 201843, en  
(31) 201562267987 P (32) 16.12.2015 (33) US  
(54) IMPROVED FRAGMENTATION PROJECTILE AND METHOD FOR ITS MANUFACTURING  
(71) RUAG Ammotec AG, Uttigenstrasse 67, 3602 Thun, CH  
(72) MUSTER, Michael, Dählenweg 8, 3054 Schüpfen, CH  
WOLF, Juergen, Hohmadpark 5, 3604 Thun, CH  
MEYER, Donald, Les Thurlings 63, 1772 Grolley, CH  
SPATZ, Peter, Auroraweg 24, 3185 Schmitten, CH

---

(51) MKP  
A61K 31/4709 2006 (97) EP 3390384  
A61P 21/00 2006  
C07D 215/20 2006  
C07D 215/54 2006  
C07D 401/04 2006  
C07D 401/12 2006  
C07D 401/14 2006  
C07D 405/12 2006  
C07D 413/12 2006  
C07D 413/14 2006  
C07D 417/12 2006  
C07D 491/048 2006  
(96) EP 16815960.6 12/15/2016  
(97) EP 3390384, 10/24/2018 201843, en  
(31) 201562268630 P (32) 17.12.2015 (33) US  
(54) QUINOLINE-3-CARBOXAMIDES AS H-PGDS INHIBITORS  
(72) CADILLA, Rodolfo, Five Moore Drive, Research Triangle Park North Carolina 27709, US  
DEATON, Dave Norman, 709 Swedeland Road UW2220, King of Prussia Pennsylvania 19406, US  
HANCOCK, Ashley Paul, Gunnels Wood Road, Stevenage Hertfordshire SG1 2NY, GB  
HOBBS, Heather, Gunnels Wood Road, Stevenage Hertfordshire SG1 2NY, GB  
HODGSON, Simon Teanby, Gunnels Wood Road, Stevenage Hertfordshire SG1 2NY, GB



LARKIN, Andrew L., 709 Swedeland Road UW2220, King of Prussia Pennsylvania 19406, US  
 LE, Joelle, Gunnels Wood Road, Stevenage Hertfordshire SG1 2NY, GB  
 MORTENSON, Paul N., 436 Cambridge Science Park Milton Road, Cambridge Cambridgeshire CB4 0QA, GB  
 PRICE, Daniel J., 830 Winter Street 2W022, Waltham Massachusetts 02451, US  
 SAXTY, Gordon, 436 Cambridge Science Park Milton Road, Cambridge Cambridgeshire CB4 0QA, GB  
 SCHALLER, Lee T., Five Moore Drive, Research Triangle Park North Carolina 27709, US  
 SCHULTE, Christie, 709 Swedeland Road UW2220, King of Prussia Pennsylvania 19406, US  
 SMITH, Ian Edward David, Gunnels Wood Road, Stevenage Hertfordshire SG1 2NY, GB  
 THOMSON, Stephen Andrew, 12938 Caminito Del Pasaje, Del Mar California 92014, US  
 WILSON, Joseph Wendell, 410 Hadfield Street, Hillsborough North Carolina 27278, US

---

(51) MKP  
**C07D 217/04 2006 (97) EP 3377482**  
**C07D 217/16 2006**  
**C07D 217/24 2006**  
**C07D 231/56 2006**  
**C07D 239/88 2006**  
**C07D 401/04 2006**  
**C07D 401/06 2006**  
**C07D 401/12 2006**  
**C07D 401/14 2006**  
**C07D 405/12 2006**  
**C07D 471/04 2006**  
**C07D 495/04 2006**  
 (96) EP 16816023.2 11/17/2016  
 (97) EP 3377482, 9/26/2018 201839, en  
 (31) 201562257964 P (32) 20.11.2015 (33) US  
 201662320805 P 11.04.2016 US  
 (54) MODULATORS OF ROR-GAMMA  
 (71) Vitae Pharmaceuticals, Inc., 5 Giralda Farms, Madison, NJ 07940, US  
 (72) CLAREMON, David, A., 1508 Aidenn Lair Road, Maple Glen, PA 19002, US  
 DILLARD, Lawrence, Wayne, 496 Kings Road, Yardley, PA 19067, US  
 FAN, Yi, 40 Bittersweet Drive, Doylestown, PA 18901, US  
 JIA, Lanqi, 22 Beaver Hill Road, Horsham, PA 19044, US  
 SINGH, Suresh, B., 4 Adams Road, Kendall Park, NJ 08824, US  
 TICE, Colin, M., 1325 Pinebrook Court, Maple Glen, PA 19002, US  
 XU, Zhenrong, 3224 Riding Court, Chalfont, PA 18914, US  
 YUAN, Jing, 537 Candlemaker Way, Lansdale, PA 19446, US  
 ZHUANG, Linghang, 3135 Fox Drive, Chalfont, PA 18914, US

---

(51) MKP  
**A61K 31/335 2006 (97) EP 3386956**  
**A61P 35/00 2006**  
**A61P 37/00 2006**  
**C07D 303/46 2006**  
 (96) EP 16816157.8 12/9/2016  
 (97) EP 3386956, 10/17/2018 201842, en  
 (31) 201562265675 P (32) 10.12.2015 (33) US  
 (54) FUMAGILLOL DERIVATIVES AND POLYMORPHS THEREOF  
 (72) PETERSEN, John S., 6 Jackson Drive, Action, Massachusetts 01720, US

---

(51) MKP  
**H04L 29/06 2006 (97) EP 3398346**  
**H04N 21/218 2011**  
**H04N 21/2343 2011**  
**H04N 21/262 2011**  
**H04N 21/845 2011**  
**H04N 21/854 2011**  
 (96) EP 16816318.6 12/27/2016  
 (97) EP 3398346, 11/7/2018 201845, en  
 (31) 15202816 (32) 28.12.2015 (33) EP  
 (54) VIDEO STREAMS  
 (71) Koninklijke KPN N.V., Wilhelminakade 123, 3072 AP Rotterdam, NL

(72) THOMAS, Emmanuel, Noorderhof 78, 2611 WD Delft, NL  
VEENHUIZEN, Arjen, Croeselaan 369B, 3521BW Utrecht, NL  
VAN BRANDENBURG, Ray, Statenweg 80 A 02, 3039 JH Rotterdam, NL  
VAN DEVENTER, Mattijs Oskar, Hannie Schaftstraat 62, 2264 DL Leidschendam, NL

---

(51) MKP  
**C04B 11/00 2006 (97) EP 3393997**  
**C04B 28/14 2006**  
(96) EP 16816339.2 12/14/2016  
(97) EP 3393997, 10/31/2018 201844, en  
(31) 201522664 (32) 22.12.2015 (33) GB  
(54) METHOD FOR THE PRODUCTION OF GYPSUM-BASED BOARDS AND STUCCO SLURRY COMPRISING NON-PREGELATINIZED  
MIGRATORY STARCH FOR USE THEREWITH  
(72) MORLAT, Richard, Gyproc Process Innovation 306 à 348 Route de Meaux, 93410 Vaujours, FR  
FLETCHER, James, Technical Building, East Leake Loughborough LE12 6JS, GB  
KAMLER, Radomir, c/o Saint-Gobain Construction Products CZ A.S. Pocericka 272/96, 108 03 Prague 10, CZ

---

(51) MKP  
**A61K 31/415 2006 (97) EP 3390395**  
**A61K 31/4155 2006**  
**A61P 35/00 2006**  
**C07D 231/14 2006**  
**C07D 401/04 2006**  
**C07D 401/06 2006**  
**C07D 403/04 2006**  
**C07D 405/04 2006**  
**C07D 405/06 2006**  
**C07D 405/08 2006**  
**C07D 405/14 2006**  
**C07D 413/06 2006**  
(96) EP 16816363.2 12/16/2016  
(97) EP 3390395, 10/24/2018 201843, en  
(31) 201522245 (32) 16.12.2015 (33) GB  
201613945 15.08.2016 GB  
(54) COMPOUNDS USEFUL AS KINASE INHIBITORS  
(71) Loxo Oncology Inc., 281 Tresser Boulevard 9th Floor, Stamford, Connecticut 06901, US  
(72) GUISSOT, Nicolas, c/o Redx Pharma PLC Block 33F Mereside Alderley Park, Alderley Edge Cheshire SK10 4TG, GB

---

(51) MKP  
**A61K 31/4025 2006 (97) EP 3390391**  
**A61K 31/407 2006**  
**A61P 25/28 2006**  
**A61P 35/00 2006**  
**C07D 207/09 2006**  
**C07D 401/12 2006**  
**C07D 403/12 2006**  
**C07D 403/14 2006**  
**C07D 413/12 2006**  
**C07D 417/12 2006**  
**C07D 417/14 2006**  
**C07D 471/04 2006**  
**C07D 487/04 2006**  
(96) EP 16816365.7 12/16/2016  
(97) EP 3390391, 10/24/2018 201843, en  
(31) 201522267 (32) 17.12.2015 (33) GB  
(54) NOVEL COMPOUNDS  
(72) KEMP, Mark Ian, C/o Mission Therapeutics Limited Moneta (Building 280) Babraham Research Campus, Cambridge CB22 3AT, GB  
STOCKLEY, Martin Lee, C/o Mission Therapeutics Limited Moneta (Building 280) Babraham Research Campus, Cambridge CB22 3AT, GB  
MADIN, Andrew, C/o Mission Therapeutics Limited Moneta (Building 280) Babraham Research Campus, Cambridge CB22 3AT, GB

---

(51) MKP  
**A61K 9/16 2006 (97) EP 3383372**  
**A61K 9/20 2006**

	<b>A61K 31/506</b>	<b>2006</b>					
	<b>A61P 9/00</b>	<b>2006</b>					
(96)	EP 16816486.1 11/22/2016						
(97)	EP 3383372, 10/10/2018 201841, en						
(31)	201562260910 P		(32)	30.11.2015		(33)	US
	201662359440 P			07.07.2016			US
(54)	SOLID DISPERSIONS COMPRISING A SGC STIMULATOR						
(72)	DUNBAR, Craig Anthony, 24 Shirley Road, Needham Massachusetts 02494, US						
	SETHURAMAN, Vasu, 80 Milner Street, Waltham Massachusetts 02451, US						
	HASHASH, Ahmad, 5 Oland Lane, Southborough Massachusetts 01772, US						
<hr/>							
(51)	MKP						
	<b>A61K 31/4745</b>	<b>2006</b>	(97)	<b>EP 3389660</b>			
	<b>A61K 31/497</b>	<b>2006</b>					
	<b>A61P 35/00</b>	<b>2006</b>					
(96)	EP 16816563.7 12/8/2016						
(97)	EP 3389660, 10/24/2018 201843, en						
(31)	201562267462 P		(32)	15.12.2015		(33)	US
(54)	COMBINATION THERAPY FOR CANCER						
(72)	BECKMANN, Richard Paul, c/o Eli Lilly and Company P.O. Box 6288, Indianapolis Indiana 46206-6288, US						
	DONOHO, Gregory Paul, c/o Eli Lilly and Company P.O. Box 6288, Indianapolis Indiana 46206-6288, US						
	LIN, Aimee Karis, c/o Eli Lilly and Company P.O. Box 6288, Indianapolis Indiana 46206-6288, US						
	WACHECK, Volker, c/o Eli Lilly and Company P.O. Box 6288, Indianapolis Indiana 46206-6288, US						
<hr/>							
(51)	MKP						
	<b>A61K 31/519</b>	<b>2006</b>	(97)	<b>EP 3405471</b>			
	<b>A61K 31/661</b>	<b>2006</b>					
	<b>A61P 35/00</b>	<b>2006</b>					
	<b>C07D 495/04</b>	<b>2006</b>					
	<b>C07F 9/6561</b>	<b>2006</b>					
(96)	EP 16816667.6 12/19/2016						
(97)	EP 3405471, 11/28/2018 201848, en						
(31)	1650411		(32)	19.01.2016		(33)	FR
(54)	NEW AMMONIUM DERIVATIVES, A PROCESS FOR THEIR PREPARATION AND PHARMACEUTICAL COMPOSITIONS CONTAINING THEM						
(72)	PACZAL, Attila, Orjárat utca 95., 1158 Budapest, HU						
	SZLÁVIK, Zoltán, Költő utca 2-4 D/2, 1121 Budapest, HU						
	KOTSCHY, András, Álmos Vezér u.4, 2045 Törökbálint, HU						
	CHANRION, Maïa, 14 rue de la Galiote Apt D441, 92130 Issy Les Moulineaux, FR						
	MARAGNO, Ana Leticia, 4, Allée Anastasi, 78290 Croissy-sur-Seine, FR						
	GENESTE, Olivier, Bâtiment A 17, rue Crevel Duval, 92500 Rueil Malmaison, FR						
	DEMARLES, Didier, 21 rue du Lièvre, 45430 Checy, FR						
	BÁLINT, Balázs, Lehel utca 18, 2151 Fót, HU						
	SIPOS, Szabolcs, Rőppentyü utca 21-23. A épület 3/10, 1139 Budapest, HU						
<hr/>							
(51)	MKP						
	<b>A61K 38/17</b>	<b>2006</b>	(97)	<b>EP 3377087</b>			
	<b>A61P 35/00</b>	<b>2006</b>					
(96)	EP 16816786.4 11/21/2016						
(97)	EP 3377087, 9/26/2018 201839, en						
(31)	201562257945 P		(32)	20.11.2015		(33)	US
(54)	COMPOSITIONS AND METHODS OF TREATING CANCER						
(71)	Beth Israel Deaconess Medical Center, 330 Brookline Avenue, Boston, MA 02215, US						
(72)	AVIGAN, David, 11 Knife Shop Lane, Sharon, Massachusetts 02067, US						
	ROSENBLATT, Jacalyn, 16 Country Club Road, Newton, Massachusetts 02459, US						
	KUFFE, Donald, 179 Grove Street, Wellesley, Massachusetts 02482, US						
<hr/>							
(51)	MKP						
	<b>A61K 31/454</b>	<b>2006</b>	(97)	<b>EP 3383433</b>			
	<b>A61K 45/06</b>	<b>2006</b>					
	<b>A61P 35/00</b>	<b>2006</b>					
	<b>A61P 35/02</b>	<b>2006</b>					
(96)	EP 16816817.7 12/2/2016						
(97)	EP 3383433, 10/10/2018 201841, en						

(31) 201562263580 P (32) 04.12.2015 (33) US  
201662300721 P 26.02.2016 US  
(54) METHODS OF TREATMENT OF MALIGNANCIES  
(72) WU, Bin, 32 Albert Avenue, Belmont, MA 02478, US  
CHOE, Sung, Eun, 12 Kimball Road, Lexington, MA 02421, US

---

(51) MKP  
**C12N 15/867 2006 (97) EP 3394271**  
(96) EP 16819072.6 12/20/2016  
(97) EP 3394271, 10/31/2018 201844, en  
(31) 15201510 (32) 21.12.2015 (33) EP  
(54) STABLE INTEGRATION OF SIN TRANSFER VECTORS  
(72) STORNAIUOLO, Anna, MolMed SpA Via Olgettina 58, 20132 Milan, IT  
BOVOLENTA, Chiara, MolMed SpA Via Olgettina 58, 20132 Milan, IT  
MAVILIO, Fulvio, Genethon 1bis Rue de l'Internationale, 91002 Evry, FR  
RIZZARDI, Gian Paolo, MolMed SpA Via Olgettina 58, 20132 Milan, IT

---

(51) MKP  
**A61K 47/68 2017 (97) EP 3383909**  
**A61P 35/00 2006**  
**C07K 16/28 2006**  
**C07K 16/30 2006**  
(96) EP 16819220.1 11/29/2016  
(97) EP 3383909, 10/10/2018 201841, en  
(31) 201562261092 P (32) 30.11.2015 (33) US  
201662417480 P 04.11.2016 US  
(54) ANTI-huLRRC15 ANTIBODY DRUG CONJUGATES AND METHODS FOR THEIR USE  
(72) GISH, Kurt C., 37 Artuna Avenue, Piedmont California 94611, US  
HICKSON, Jonathan A., 725 Northwind Lane, Lake Villa Illinois 60046, US  
PURCELL, James W., 391 Haight Street Apt. 4, San Francisco California 94102, US  
MORGAN-LAPPE, Susan Elizabeth, 601 Eagle Court, Riverwoods Illinois 60015, US

---

(51) MKP  
**A61K 31/519 2006 (97) EP 3390405**  
**A61P 11/00 2006**  
**A61P 11/06 2006**  
**A61P 37/08 2006**  
**C07D 487/04 2006**  
(96) EP 16819478.5 12/13/2016  
(97) EP 3390405, 10/24/2018 201843, en  
(31) 15199816 (32) 14.12.2015 (33) EP  
(54) NOVEL TETRAHYDROTRIAZOLOPYRIMIDINE DERIVATIVES AS NHE INHIBITORS  
(72) ARMANI, Elisabetta, c/o CHIESI FARMACEUTICI S.P.A. Via Palermo 26/A, 43122 Parma, IT  
CAPALDI, Carmelida, c/o CHIESI FARMACEUTICI S.P.A. Via Palermo 26/A, 43122 Parma, IT

---

(51) MKP  
**A01N 25/04 2006 (97) EP 3393239**  
**A01N 43/90 2006**  
**A01N 59/06 2006**  
**A01N 65/20 2009**  
(96) EP 16819573.3 12/23/2016  
(97) EP 3393239, 10/31/2018 201844, en  
(31) 15202519 (32) 23.12.2015 (33) EP  
(54) COMPOSITION FOR AQUATIC PEST CONTROL  
(72) GANTENBEIN, Daniel, Metzgerstrasse 63, 4056 Basel, CH  
DIAZ QUIJANO, Carolina, c/o Omya International AG Baslerstrasse 42, 4665 Oftringen, CH  
SCHOELKOPF, Joachim, Dyshofweg 3, 5727 Oberkulm, CH  
GANE, Patrick A.C., Studenweg 8, 4852 Rothrist, CH

---

(51) MKP

**B41M 5/28 2006 (97) EP 3344674**  
**C08G 18/10 2006**  
**C08G 18/18 2006**  
**C08G 18/24 2006**  
**C08G 18/32 2006**  
**C08G 18/42 2006**  
**C08G 18/76 2006**  
(96) EP 16819580.8 12/27/2016  
(97) EP 3344674, 7/11/2018 201828, de  
(31) 102016000144 (32) 12.01.2016 (33) DE  
(54) THERMOCHROMIC POLYURETHANE FOAM  
(71) PCC Prodex GmbH, Hilgerstrasse 20, 45141 Essen, DE  
(72) FACH, Thomas, Dickebank 29, 45259 Essen, DE

---

(51) MKP  
**C07D 209/46 2006 (97) EP 3386950**  
**C07D 217/24 2006**  
**C07D 239/88 2006**  
**C07D 253/08 2006**  
**C07D 401/04 2006**  
**C07D 401/10 2006**  
**C07D 403/10 2006**  
**C07D 405/04 2006**  
**C07D 409/04 2006**  
**C07D 417/04 2006**  
(96) EP 16819668.1 12/8/2016  
(97) EP 3386950, 10/17/2018 201842, en  
(31) 201562264628 P (32) 08.12.2015 (33) US  
(54) SUBSTITUTED BENZAZINONES AS ANTIBACTERIAL COMPOUNDS  
(72) JIN, Qi, 1250 South Collegeville Road, Collegeville Pennsylvania 19426, US  
POHLHAUS, Denise Teotico, 184 Liberty Corner Road, Warren New Jersey 07059, US  
SPLETSTOSER, Jared, 1250 South Collegeville Road, Collegeville Pennsylvania 19426, US

---

(51) MKP  
**A61K 47/68 2017 (97) EP 3383910**  
**C07K 16/28 2006**  
**C07K 16/30 2006**  
(96) EP 16819742.4 11/29/2016  
(97) EP 3383910, 10/10/2018 201841, en  
(31) 201562261114 P (32) 30.11.2015 (33) US  
201662417489 P 04.11.2016 US  
(54) ANTI-huLRRc15 ANTIBODY DRUG CONJUGATES AND METHODS FOR THEIR USE  
(72) GISH, Kurt C., 37 Artuna Avenue, Piedmont California 94611, US  
HICKSON, Jonathan A., 725 Northwind Lane, Lake Villa Illinois 60046, US  
PURCELL, James W., 391 Haight Street Apt. 4, San Francisco California 94102, US  
MORGAN-LAPPE, Susan Elizabeth, 601 Eagle Court, Riverwoods Illinois 60015, US

---

(51) MKP  
**F01N 1/08 2006 (97) EP 3371424**  
(96) EP 16819792.9 11/6/2016  
(97) EP 3371424, 9/19/2018 201838, en  
(31) 20150781 (32) 05.11.2015 (33) CZ  
(54) COMBINED EXHAUST GAS SILENCER  
(71) Mach, Zdenek, Malecí 581, Nové Mesto nad Metuji 54901, CZ  
Machová, Zdenka, Malecí 581, Nové Mesto nad Metuji 54901, CZ  
(72) MACH, Zdenek, Maleci 581, Nove Mesto nad Metuji 54901, CZ  
EKART, Zdenek, Svárov 1080, Vsetín 75501, CZ

---

(51) MKP  
**A61K 31/381 2006 (97) EP 3394051**  
**A61P 5/00 2006**  
**C07D 409/10 2006**

(96) EP 16819899.2 12/20/2016  
(97) EP 3394051, 10/31/2018 201844, en  
(31) 15201459 (32) 21.12.2015 (33) EP  
16172070 31.05.2016 EP

(54) CRYSTALLIZATION PROCEDURE FOR OBTAINING CANAGLIFLOZIN HEMIHYDRATE CRYSTALS  
(72) DE KEYSER, Ruben, Janssen Pharmaceutica NV Turnhoutseweg 30, 2340 Beerse, BE  
LAPS, Stijn, Janssen Pharmaceutica NV Turnhoutseweg 30, 2340 Beerse, BE  
RAMMELOO, Thomas Joachim Landewald, Janssen Pharmaceutica NV Turnhoutseweg 30, 2340 Beerse, BE  
WEERTS, Koen Johan Herman, Janssen Pharmaceutica NV Turnhoutseweg 30, 2340 Beerse, BE

---

(51) MKP  
**A61K 31/7068 2006 (97) EP 3393478**  
**A61K 33/00 2006**  
**A61P 35/00 2006**

(96) EP 16820005.3 12/21/2016  
(97) EP 3393478, 10/31/2018 201844, en  
(31) PCT/GB2015/054158 (32) 23.12.2015 (33) WO  
201609770 03.06.2016 GB

(54) COMBINATION THERAPY  
(72) GRIFFITH, Hugh, c/o NuCana plc 3 Lochside Place, Edinburgh EH12 9DT, GB

---

(51) MKP  
**A61K 9/00 2006 (97) EP 3383365**  
**A61K 47/38 2006**  
**A61M 31/00 2006**

(96) EP 16820048.3 12/1/2016  
(97) EP 3383365, 10/10/2018 201841, en  
(31) 201562261752 P (32) 01.12.2015 (33) US

(54) GASTRIC RETENTIVE DEVICES  
(71) Clexio Biosciences Ltd., 21 Nahum Haftzadi Street, Jerusalem, IL  
(72) ZALIT, Ilan, Zayit 8, Rosh Ha'ayin, IL  
BEN MENACHEM, Avshalom, 8 Nahal Alexander Street, Zur Izhak, IL

---

(51) MKP  
**A01C 7/06 2006 (97) EP 3393240**  
**A01C 7/20 2006**  
**A01N 25/16 2006**  
**A01N 53/00 2006**  
**A01N 63/00 2006**

(96) EP 16820075.6 12/8/2016  
(97) EP 3393240, 10/31/2018 201844, en  
(31) 201562387263 P (32) 23.12.2015 (33) US

(54) IN SITU TREATMENT OF SEED IN FURROW  
(71) FMC Corporation, FMC Tower at Cira Centre South 2929 Walnut Street, Philadelphia, PA 19104, US  
(72) MARTIN, Timothy, M., 1 High Mowing Road, Ringoes, NJ 08551, US

---

(51) MKP  
**A61M 5/50 2006 (97) EP 3386573**  
**G06F 19/00 2018**

(96) EP 16820087.1 12/9/2016  
(97) EP 3386573, 10/17/2018 201842, en  
(31) 201562265142 P (32) 09.12.2015 (33) US

(54) AUTO-INJECTOR WITH SIGNALING CAP  
(72) YANG, Huaying, 878 Writer Court, Vernon Hills, IL 60061, US  
YIN, Desheng, 2377 Rutland Place, Thousand Oaks, CA 91362, US  
TAMTORO, Ferry, 1713 E. Shoreview Drive, San Ramon, CA 94582, US  
GIBSON, Scott R., 12141 Bellando Court, Granada Hills, CA 91344, US  
KOGLER, Keith P., 213 Fawn Valley Court, Simi Valley, CA 93065, US  
FRIEDMAN, Michael, 6 N Madrid Avenue, Newbury Park, CA 91320, GB  
JOHNSTON, Neal, 3309 Citation Drive, Dallas, TX 75229, US  
MCCULLOUGH, Adam B., 2792 Great Smokey Court, Westlake Village, CA 91362, US

---

(51) MKP  
**A61K 31/519 2006 (97) EP 3386991**  
**A61P 19/00 2006**  
**A61P 35/00 2006**  
**A61P 37/00 2006**  
**C07D 495/16 2006**  
**C07D 519/00 2006**  
(96) EP 16820106.9 12/9/2016  
(97) EP 3386991, 10/17/2018 201842, en  
(31) 201562265836 P (32) 10.12.2015 (33) US  
(54) POLYCYCLIC COMPOUNDS AS INHIBITORS OF BRUTON'S TYROSINE KINASE  
(72) ARORA, Nidhi, 3210 Merryfield Row, San Diego, California 92121, US  
BACANI, Genesis M., 3210 Merryfield Row, San Diego, California 92121, US  
BARBAY, Joseph Kent, Welsh&McKean Roads, Spring House, Pennsylvania 19477, US  
BEMBENEK, Scott D., 3210 Merryfield Row, San Diego, California 92121, US  
CAI, Min, c/o Hutchinson Medipharma Limited Building 4 720 Cailun Road Zhangjian Hi-Tech Park, Shanghai 201203, CN  
CHEN, Wei, c/o Hutchinson Medipharma Limited Building 4 720 Cailun Road Zhangjian Hi-Tech Park, Shanghai 201203, CN  
DECKHUT, Charlotte Pooley, 3210 Merryfield Row, San Diego, California 92121, US  
EDWARDS, James P., 3210 Merryfield Row, San Diego California 92121, US  
GHOSH, Brahmananda, 1400 McKean Road, Spring House, Pennsylvania 19477, US  
KREUTTER, Kevin, c/o Janssen Research&Development LLC 1400 McKean Road, Spring House, Pennsylvania 19477, US  
LI, Gang, c/o Hutchinson Medipharma Limited Building 4 720 Cailun Road Zhangjian Hi-Tech Park, Shanghai 201203, CN  
TICHENOR, Mark S., 3210 Merryfield Row, San Diego, California 92121, US  
VENABLE, Jennifer D., 3210 Merryfield Row, San Diego, California 92121, US  
WEI, Jianmei, 3210 Merryfield Row, San Diego, California 92121, US  
WIENER, John J. M., 3210 Merryfield Row, San Diego, California 92121, US  
WU, Yao, c/o Hutchinson Medipharma Limited Building 4 720 Cailun Road Zhangjian Hi-Tech Park, Shanghai 201203, CN  
XIAO, Kun, c/o Hutchinson Medipharma Limited Building 4 720 Cailun Road Zhangjian Hi-Tech Park, Shanghai 201203, CN  
ZHANG, Feihuang, c/o Hutchinson Medipharma Limited Building 4 720 Cailun Road Zhangjian Hi-Tech Park, Shanghai 201203, CN  
ZHU, Yaoping, c/o Hutchinson Medipharma Limited Building 4 720 Cailun Road Zhangjian Hi-Tech Park, Shanghai 201203, CN

---

(51) MKP  
**A61K 31/519 2006 (97) EP 3386992**  
**A61P 35/00 2006**  
**C07D 495/16 2006**  
(96) EP 16820107.7 12/9/2016  
(97) EP 3386992, 10/17/2018 201842, en  
(31) 201562265780 P (32) 10.12.2015 (33) US  
(54) INHIBITORS OF BRUTON'S TYROSINE KINASE AND METHODS OF THEIR USE  
(72) ARORA, Nidhi, 3210 Merryfield Row, San Diego, California 92121, US  
BACANI, Genesis M., 3210 Merryfield Row, San Diego, California 92121, US  
BARBAY, Joseph Kent, Welsh&McKean Roads, Spring House, Pennsylvania 19477, US  
BEMBENEK, Scott D., 3210 Merryfield Row, San Diego, California 92121, US  
CAI, Min, c/o Hutchinson Medipharma Limited Building 4 720 Cailun Road Zhangjian Hi-Tech Park, Shanghai 201203, CN  
CHEN, Wei, c/o Hutchinson Medipharma Limited Building 4 720 Cailun Road Zhangjian Hi-Tech Park, Shanghai 201203, CN  
DECKHUT, Charlotte Pooley, 3210 Merryfield Row, San Diego, California 92121, US  
EDWARDS, James P., 3210 Merryfield Row, San Diego, California 92121, US  
GHOSH, Brahmananda, 1400 McKean Road, Spring House, Pennsylvania 19477, US  
HAO, Baoyu, c/o Hutchinson Medipharma Limited Building 4 720 Cailun Road Zhangjian Hi-Tech Park, Shanghai 201203, CN  
KREUTTER, Kevin, c/o Janssen Research&Development LLC 1400 McKean Road, Spring House, Pennsylvania 19477, US  
LI, Gang, c/o Hutchinson Medipharma Limited Building 4 720 Cailun Road Zhangjian Hi-Tech Park, Shanghai 201203, CN  
TICHENOR, Mark S., 3210 Merryfield Row, San Diego, California 92121, US  
VENABLE, Jennifer D., 3210 Merryfield Row, San Diego, California 92121, US  
WEI, Jianmei, 3210 Merryfield Row, San Diego, California 92121, US  
WIENER, John J. M., 3210 Merryfield Row, San Diego, California 92121, US  
WU, Yao, c/o Hutchinson Medipharma Limited Building 4 720 Cailun Road Zhangjian Hi-Tech Park, Shanghai 201203, CN  
ZHU, Yaoping, c/o Hutchinson Medipharma Limited Building 4 720 Cailun Road Zhangjian Hi-Tech Park, Shanghai 201203, CN  
ZHANG, Feihuang, c/o Hutchinson Medipharma Limited Building 4 720 Cailun Road Zhangjian Hi-Tech Park, Shanghai 201203, CN  
ZHANG, Zheng, c/o Hutchinson Medipharma Limited Building 4 720 Cailun Road Zhangjian Hi-Tech Park, Shanghai 201203, CN  
XIAO, Kun, c/o Hutchinson Medipharma Limited Building 4 720 Cailun Road Zhangjian Hi-Tech Park, Shanghai 201203, CN

---

(51) MKP  
**A61K 39/02 2006 (97) EP 3397279**  
**A61K 39/12 2006**  
(96) EP 16820125.9 12/14/2016

(97) EP 3397279, 11/7/2018 201845, en  
(31) 201562272017 P (32) 28.12.2015 (33) US  
(54) M HYO MULTIVALENT VACCINE AND USES THEREOF  
(72) WILSON, Keith, 1302 Casa Marina Lane NW, Alexandria, MN 56308, US  
LAWRENCE, Paulraj, 4462 Snelling Avenue N, Arden Hills, MN 55112, US

---

(51) MKP  
A61K 38/17 2006 (97) EP 3389710  
A61K 39/395 2006  
C07K 16/28 2006  
(96) EP 16820131.7 12/15/2016  
(97) EP 3389710, 10/24/2018 201843, en  
(31) 201562269664 P (32) 18.12.2015 (33) US  
(54) BISPECIFIC ANTIBODY PLATFORM  
(72) PREYER, Martin, 43 Weston Avenue B, Somerville Massachusetts 02144, US

---

(51) MKP  
A61K 31/4433 2006 (97) EP 3394044  
A61P 35/00 2006  
A61P 37/00 2006  
C07D 239/42 2006  
C07D 401/10 2006  
C07D 401/12 2006  
C07D 401/14 2006  
C07D 405/12 2006  
C07D 413/12 2006  
C07D 413/14 2006  
(96) EP 16820135.8 12/15/2016  
(97) EP 3394044, 10/31/2018 201844, en  
(31) 201562268846 P (32) 17.12.2015 (33) US  
201662425396 P 22.11.2016 US  
(54) TANK-BINDING KINASE INHIBITOR COMPOUNDS  
(72) DU, Zhimin, c/o Gilead Sciences Inc. 333 Lakeside Drive, Foster City, CA 94404, US  
DORNAN, David, c/o Gilead Sciences Inc. 333 Lakeside Drive, Foster City, CA 94404, US  
GUERRERO, Juan A., c/o Gilead Sciences Inc. 333 Lakeside Drive, Foster City, CA 94404, US  
KAPLAN, Joshua A., c/o Gilead Sciences Inc. 333 Lakeside Drive, Foster City, CA 94404, US  
KNOX, John E., c/o Gilead Sciences Inc. 333 Lakeside Drive, Foster City, CA 94404, US  
NADUTHAMBI, Devan, c/o Gilead Sciences Inc. 333 Lakeside Drive, Foster City, CA 94404, US  
PHILLIPS, Barton W., c/o Gilead Sciences Inc. 333 Lakeside Drive, Foster City, CA 94404, US  
STINSON, Susanna Y., c/o Gilead Sciences Inc. 333 Lakeside Drive, Foster City, CA 94404, US  
VENKATARAMANI, Chandrasekar, c/o Gilead Sciences Inc. 333 Lakeside Drive, Foster City, CA 94404, US  
WANG, Peiyuan, c/o Gilead Sciences Inc. 333 Lakeside Drive, Foster City, CA 94404, US  
WATKINS, William J., c/o Gilead Sciences Inc. 333 Lakeside Drive, Foster City, CA 94404, US

---

(51) MKP  
A61K 31/4035 2006 (97) EP 3390396  
A61P 1/04 2006  
A61P 1/18 2006  
A61P 11/06 2006  
A61P 11/12 2006  
A61P 17/06 2006  
A61P 37/00 2006  
C07D 209/44 2006  
C07D 407/06 2006  
(96) EP 16820199.4 12/14/2016  
(97) EP 3390396, 10/24/2018 201843, en  
(31) 201562267391 P (32) 15.12.2015 (33) US  
(54) ISOINDOLE COMPOUNDS  
(72) LEVER, Sarah, AstraZeneca, SE-431 83 Mölndal, SE  
NARJES, Frank, AstraZeneca, SE-431 83 Mölndal, SE  
OLSSON, Roine, Ingemar, AstraZeneca, SE-431 83 Mölndal, SE  
VON BERG, Stefan, AstraZeneca, SE-431 83 Mölndal, SE

---



(51) MKP  
**C12Q 1/66 2006 (97) EP 3394285**

(96) EP 16820240.6 12/20/2016  
(97) EP 3394285, 10/31/2018 201844, en

(31) 15202170 (32) 22.12.2015 (33) EP  
201562272152 P 29.12.2015 US

(54) MICROBIAL CELL VIABILITY ASSAY FOR DETECTION OF OR DETERMINING SLURRY CONTAMINATION  
(72) GLAUBITZ, Joachim, Parkweier 1, 6264 Pfaffnau, CH  
RUPP, Katharina, Robertsenstrasse 10, 4310 Rheinfelden, CH  
BRÜLISAUER, Karin, Fidesstrasse 5, 9000 St. Gallen, CH

---

(51) MKP  
**B01F 3/04 2006 (97) EP 3374069**  
**B01F 5/06 2006**  
**B01F 15/00 2006**

(96) EP 16820326.3 11/8/2016  
(97) EP 3374069, 9/19/2018 201838, en

(31) UB20155366 (32) 09.11.2015 (33) IT

(54) DEVICE AND CORRESPONDING METHOD FOR THE DISPERSION OF GAS IN LIQUIDS  
(71) Societa'Italiana Acetilene & Derivati S.I.A.D. S.p.A. in breve S.I.A.D. S.p.A., Via S. Bernardino, 92, 24126 Bergamo, IT  
(72) FRATI, Maurizio, c/o SOCIETA' ITALIANA ACETILENE&DERIVATI S.I.A.D. S.P.A. IN BREVE S.I.A.D. S.P.A. Via S. Bernardino 92, 24126 Bergamo (BG), IT

---

(51) MKP  
**A61K 31/5377 2006 (97) EP 3386513**  
**A61P 35/02 2006**  
**C12Q 1/68 2018**

(96) EP 16820418.8 12/7/2016  
(97) EP 3386513, 10/17/2018 201842, en

(31) 201562264169 P (32) 07.12.2015 (33) US  
201662409320 P 17.10.2016 US

(54) INHIBITORS OF EZH2 AND METHODS OF USE THEREOF  
(72) BLAKEMORE, Stephen, 400 Technology Drive 4th Floor, Cambridge Massachusetts 02139, US  
DAIGLE, Scott Richard, 21B Cherry Street, Newburyport Massachusetts 01950, US

---

(51) MKP  
**A61K 31/4168 2006 (97) EP 3390374**  
**A61K 31/4178 2006**  
**A61K 31/4196 2006**  
**A61K 31/551 2006**  
**A61P 11/14 2006**  
**A61P 29/00 2006**  
**C07D 277/52 2006**  
**C07D 285/08 2006**  
**C07D 417/12 2006**

(96) EP 16820497.2 12/14/2016  
(97) EP 3390374, 10/24/2018 201843, en

(31) 201562269327 P (32) 18.12.2015 (33) US  
201662290235 P 02.02.2016 US  
201662420956 P 11.11.2016 US

(54) HYDROXYALKYLAMINE- AND HYDROXYCYCLOALKYLAMINE-SUBSTITUTED DIAMINE-ARYLSULFONAMIDE COMPOUNDS WITH SELECTIVE ACTIVITY IN VOLTAGE-GATED SODIUM CHANNELS  
(72) GRESHOCK, Thomas, J., 770 Sumneytown Pike, West Point Pennsylvania 19486, US  
MULHEARN, James, 770 Sumneytown Pike, West Point Pennsylvania 19486, US  
ZHENG, Junying, 31 Newcomb Drive, New Providence New Jersey 07074, US  
KIM, Ronald, M., 2000 Galloping Hill Road, Kenilworth New Jersey 07033, US  
ZHANG, Ting, 126 East Lincoln Avenue, Rahway New Jersey 07065-0907, US  
ROECKER, Anthony, J., 770 Sumneytown Pike, West Point Pennsylvania 19486, US  
WON, Walter, 950 Closter Rock Road, Alpine New Jersey 08820, US  
NANTERMET, Philippe, 770 Sumneytown Pike, West Point Pennsylvania 19486, US  
ANAND, Rajan, 22 Rainier Road, Fanwood New Jersey 07012, US  
ZHOU, Gang, 111 Timothy Place, Bridgewater New Jersey 08807, US

- (51) MKP  
**A61K 31/513 2006 (97) EP 3390400**  
**A61P 9/00 2006**  
**C07D 403/04 2006**  
**C07D 413/04 2006**  
**C07D 413/14 2006**  
**C07D 417/14 2006**
- (96) EP 16820507.8 12/15/2016  
(97) EP 3390400, 10/24/2018 201843, en
- (31) 201562267997 P (32) 16.12.2015 (33) US
- (54) HETEROARYLHYDROXYPYRIMIDINONES AS AGONISTS OF THE APJ RECEPTOR
- (72) MYERS, Michael C., c/o Bristol-Myers Squibb Company 311 Pennington Rocky Hill Road, Pennington New Jersey 08534, US  
LAWRENCE, R. Michael, c/o Bristol-Myers Squibb Company 311 Pennington Rocky Hill Road, Pennington New Jersey 08534, US  
BILDER, Donna M., c/o Bristol-Myers Squibb Company 311 Pennington Rocky Hill Road, Pennington New Jersey 08534, US  
MENG, Wei, c/o Bristol-Myers Squibb Company 311 Pennington Rocky Hill Road, Pennington New Jersey 08534, US  
PI, Zulan, c/o Bristol-Myers Squibb Company 311 Pennington Rocky Hill Road, Pennington New Jersey 08534, US  
BRIGANCE, Robert Paul, 28 Lakeside Drive, Levittown PA 19054, US  
FINLAY, Heather, c/o Bristol-Myers Squibb Company 311 Pennington Rocky Hill Road, Pennington New Jersey 08534, US
- 

- (51) MKP  
**C07K 16/00 2006 (97) EP 3390449**  
**C07K 16/28 2006**  
**C07K 16/44 2006**
- (96) EP 16820526.8 12/15/2016  
(97) EP 3390449, 10/24/2018 201843, en
- (31) 201562268898 P (32) 17.12.2015 (33) US
- (54) ANTIBODIES TO RISPERIDONE AND USE THEREOF
- (72) SANKARAN, Banumathi, 2 Bryant Road, Lexington, Massachusetts 02420, US  
DECORY, Thomas R., 24 Round Trail Drive, Pittsford, New York 14534, US  
TUBBS, Theresa, 140 Creighton Lane, Rochester, New York 14612, US  
COLT, Linda, 151 Saint Rita Drive, Rochester, New York 14606, US  
VLIEGEN, Maarten, Turnhoutseweg 30, 2340 Beerse, BE  
HASPELGH, Pieter Rik, Turnhoutseweg 30, 2340 Beerse, BE  
HRYHORENKO, Eric, 45 Fraser Drive, Hilton, New York 14468, US
- 

- (51) MKP  
**A61K 39/00 2006 (97) EP 3390447**  
**C07K 16/26 2006**
- (96) EP 16820534.2 12/15/2016  
(97) EP 3390447, 10/24/2018 201843, en
- (31) 201562267822 P (32) 15.12.2015 (33) US
- (54) PACAP ANTIBODIES AND USES THEREOF
- (72) HAMBURGER, Agnes, E., 3885 Calle Alta Vista, Newbury Park, CA 91320, US  
XU, Cen, 5221 Via Jacinto, Newbury Park, CA 91320, US  
SUN, Hong, 29 Longmeadow Road, Belmont, MA 02478, US  
SHIH, Yuan, D., 4113 Park Verdi, Calabasas, CA 91302, US  
WEERARATNE, Dohan, 10623 Petunia Street, Ventura, CA 93004, US
- 

- (51) MKP  
**A61K 31/47 2006 (97) EP 3389659**  
**A61K 31/4709 2006**  
**A61P 31/04 2006**  
**A61P 31/06 2006**
- (96) EP 16822230.5 12/16/2016  
(97) EP 3389659, 10/24/2018 201843, en
- (31) 201522232 (32) 16.12.2015 (33) GB
- (54) COMBINATION PRODUCT
- (72) BIAGINI, Giancarlo A., Liverpool School of Tropical Medicine Pembroke Place, Liverpool L3 5QA, GB  
WARD, Stephen A., Liverpool School of Tropical Medicine Pembroke Place, Liverpool L3 5QA, GB

(51) MKP  
**A61K 31/40 2006 (97) EP 3394049**  
**A61P 35/00 2006**  
**C07D 207/10 2006**  
**C07D 403/12 2006**  
**C07D 413/12 2006**  
**C07D 413/14 2006**  
**C07D 417/12 2006**  
**C07D 417/14 2006**  
(96) EP 16822240.4 12/21/2016  
(97) EP 3394049, 10/31/2018 201844, en  
(31) 201522768 (32) 23.12.2015 (33) GB  
(54) CYANOPYRROLIDINE DERIVATIVES AS INHIBITORS FOR DUBS  
(72) KEMP, Mark Ian, C/o Mission Therapeutics Limited Moneta (Building 280) Babraham Research Campus, Cambridge CB22 3AT, GB  
WOODROW, Michael David, C/o Mission Therapeutics Limited Moneta (Building 280) Babraham Research Campus, Cambridge CB22 3AT, GB

---

(51) MKP  
**A61K 9/00 2006 (97) EP 3393453**  
**A61K 9/08 2006**  
**A61K 31/7072 2006**  
**A61K 31/7076 2006**  
**A61P 35/00 2006**  
(96) EP 16822242.0 12/21/2016  
(97) EP 3393453, 10/31/2018 201844, en  
(31) 201522764 (32) 23.12.2015 (33) GB  
(54) FORMULATIONS OF PHOSPHORAMIDATE DERIVATIVES OF NUCLEOSIDE DRUGS  
(71) NuCana plc, 3 Lochside Way, Edinburgh EH12 9DT, GB  
(72) KENNOVIN, Gordon, c/o NuCana plc 3 Lochside Way, EH129DT, GB  
GRIFFITH, Hugh, c/o NuCana plc 3 Lochside Way, EH12 9DT, GB

---

(51) MKP  
**F23C 99/00 2006 (97) EP 3384207**  
(96) EP 16822371.7 11/30/2016  
(97) EP 3384207, 10/10/2018 201841, en  
(31) 102015300450 (32) 30.11.2015 (33) BR  
(54) SYSTEM, METHOD AND DEVICE TO OPTIMIZE THE EFFICIENCY OF THE COMBUSTION OF GASES FOR THE PRODUCTION OF CLEAN ENERGY  
(71) The Bluedot Alliance B.V., Hullenbergweg 278, 1101 BV Amsterdam, NL  
(72) PIMENTEL, Marcelo Fernando, Rua João Paulo 174 Jardim Mosteiro, 18135-490 São Roque - SP, BR

---

(51) MKP  
**C07K 14/16 2006 (97) EP 3390430**  
(96) EP 16822410.3 12/15/2016  
(97) EP 3390430, 10/24/2018 201843, en  
(31) 15200138 (32) 15.12.2015 (33) EP  
16194124 17.10.2016 EP  
(54) HUMAN IMMUNODEFICIENCY VIRUS ANTIGENS, VECTORS, COMPOSITIONS, AND METHODS OF USE THEREOF  
(72) LANGEDIJK, Johannes, Petrus, Maria, Archimedesweg 4-6, 2333 CN Leiden, NL

---

(51) MKP  
**B01D 46/32 2006 (97) EP 3383552**  
**B05B 15/12 2006**  
(96) EP 16822536.5 11/28/2016  
(97) EP 3383552, 10/10/2018 201841, en  
(31) UB20156098 (32) 02.12.2015 (33) IT  
(54) PAINTING BOOTH WITH OVERSPRAY REMOVAL SYSTEM, METHOD FOR REMOVING THE OVERSPRAY, AND PLANT  
(72) IGLIO, Valerio, Viale Vittorio Veneto 21, I-20900 Monza (MB), IT  
DI LUCREZIA, Alessandro, c/o GEICO SPA Via Pelizza da Volpedo 109/111, I-20092 Cinisello Balsamo (MI), IT

---

(51) MKP  
**G01N 33/68 2006 (97) EP 3384294**

(96) EP 16822558.9 12/2/2016  
(97) EP 3384294, 10/10/2018 201841, en

(31) 201562263612 P (32) 04.12.2015 (33) US  
201662417284 P 03.11.2016 US

(54) METHODS AND COMPOSITIONS RELATED TO TOXICITY ASSOCIATED WITH CELL THERAPY  
(72) LI, He, 307 Westlake Ave. North Suite 300, Seattle, WA 98109, US  
GILBERT, Mark J., 400 Dexter Avenue North Suite 1200, Seattle, WA 98109, US  
MALONEY, David, 1100 Fairview Ave. North, Seattle, WA 98109, US  
RIDDELL, Stanley R., 1100 Fairview Ave. North, Seattle, WA 98109, US  
TURTLE, Cameron J., 1100 Fairview Ave. North, Seattle, WA 98109, US

---

(51) MKP  
**A01K 67/027 2006 (97) EP 3390644**  
**A61K 48/00 2006**  
**C12N 9/12 2006**  
**C12N 15/86 2006**

(96) EP 16822578.7 12/14/2016  
(97) EP 3390644, 10/24/2018 201843, en

(31) 201562267502 P (32) 15.12.2015 (33) US

(54) ADENO-ASSOCIATED VIRAL VECTORS FOR TREATING MUCOLIPIDOSIS TYPE II  
(71) Samsung Life Public Welfare Foundation, 48 Itaewon-ro 55-gil Yongsan-gu, Seoul 04348, KR  
(72) YEW, Nelson, c/o Sanofi 55 Corporate Drive, Bridgewater, NJ 08807, US  
JIN, Dong-Kyu, c/o Samsung Life Public Welfare Foundation 48 Itaewon-ro 55-gil Yongsan-gu, Seoul, KR

---

(51) MKP  
**A61K 48/00 2006 (97) EP 3394270**  
**A61P 21/00 2006**  
**C12N 15/864 2006**

(96) EP 16822581.1 12/14/2016  
(97) EP 3394270, 10/31/2018 201844, en

(31) 201562267012 P (32) 14.12.2015 (33) US

(54) ADENO-ASSOCIATED VIRAL VECTORS USEFUL IN TREATMENT OF SPINAL MUSCULAR ATROPY  
(72) WILSON, James, M., 1831 Delancey Street, Philadelphia, PA 19103, US  
HINDERER, Christain, 212 Brown St. Apt. 8A, Philadelphia, PA 19123, US

---

(51) MKP  
**C07K 16/24 2006 (97) EP 3390444**

(96) EP 16822583.7 12/14/2016  
(97) EP 3390444, 10/24/2018 201843, en

(31) 201562268432 P (32) 16.12.2015 (33) US  
201662333063 P 06.05.2016 US  
PCT/US2016/052006 15.09.2016 WO

(54) ANTI-TL1A/ANTI-TNF-ALPHA BISPECIFIC ANTIGEN BINDING PROTEINS AND USES THEREOF  
(72) HSU, Hailing, 7264 Littler Court, Moorpark California 93021, US  
KANNAN, Gunasekaran, 151 Crestview Circle, Daly City California 94015, US  
WALKER, Kenneth W., 175 Mesa Avenue, Newbury Park California 91320, US  
HORTTER, Michelle, 455 Mariposa Drive, Camarillo California 93012, US  
BELOUSKI, Edward J., 761 Camino Las Conchas, Thousand Oaks California 91360, US

---

(51) MKP  
**A61K 9/127 2006 (97) EP 3390630**  
**A61K 31/7088 2006**  
**A61P 3/00 2006**  
**C12N 9/90 2006**  
**C12N 15/61 2006**

(96) EP 16822592.8 12/16/2016  
(97) EP 3390630, 10/24/2018 201843, en

(31) 201562269089 P (32) 17.12.2015 (33) US

201562269092 P	17.12.2015	US
201562273112 P	30.12.2015	US
201562273108 P	30.12.2015	US
201662274727 P	04.01.2016	US
201662274722 P	04.01.2016	US
201662274733 P	04.01.2016	US
201662274726 P	04.01.2016	US
201662338478 P	18.05.2016	US
201662338456 P	18.05.2016	US
201662409343 P	17.10.2016	US

- (54) POLYNUCLEOTIDES ENCODING METHYLMALONYL-CoA MUTASE  
(71) Modernatx, Inc., 200 Technology Square, Cambridge, MA 02139, US  
(72) MARTINI, Paolo, C/o MODERNATX INC. 200 Technology Square, Cambridge Massachusetts 02139, US  
PRESNYAK, Vladimir, 123 Webster Avenue 3, Cambridge MA 02141, US
- 

- (51) MKP  
**C07K 16/18 2006 (97) EP 3390445**  
**C07K 16/24 2006**
- (96) EP 16822624.9 12/14/2016  
(97) EP 3390445, 10/24/2018 201843, en
- (31) 201522391 (32) 18.12.2015 (33) GB
- (54) MULTI-SPECIFIC ANTIBODY MOLECULES HAVING SPECIFICITY FOR TNF-ALPHA, IL-17A AND IL-17F  
(72) ADAMS, Ralph, c/o IPD UCB Celltech 208 Bath Road, Slough Berkshire SL1 3WE, GB  
BHATTA, Pallavi, c/o IPD UCB Celltech 208 Bath Road, Slough Berkshire SL1 3WE, GB  
DAVE, Emma, c/o IPD UCB Celltech 208 Bath Road, Slough Berkshire SL1 3WE, GB  
HEYWOOD, Sam Philip, c/o IPD UCB Celltech 208 Bath Road, Slough Berkshire SL1 3WE, GB  
HUMPHREYS, David Paul, c/o IPD UCB Celltech 208 Bath Road, Slough Berkshire SL1 3WE, GB  
MARSHALL, Diane, c/o IPD UCB Celltech 208 Bath Road, Slough Berkshire SL1 3WE, GB  
SHAW, Stevan Graham, c/o IPD UCB Celltech 208 Bath Road, Slough Berkshire SL1 3WE, GB  
LIGHTWOOD, Daniel, John, c/o IPD UCB Celltech 208 Bath Road, Slough Berkshire SL1 3WE, GB
- 

- (51) MKP  
**A01H 1/04 2006 (97) EP 3370507**  
**A01H 5/10 2018**  
**C07K 14/415 2006**  
**C12N 15/82 2006**  
**C12Q 1/68 2018**
- (96) EP 16822634.8 12/15/2016  
(97) EP 3370507, 9/12/2018 201837, en
- (31) 201562267460 P (32) 15.12.2015 (33) US
- (54) BRASSICACEAE PLANTS RESISTANT TO PLASMIDIOPHORA BRASSICAE (CLUBROOT)  
(72) ENGELEN, Steven, Bastelare 62, 9080 Zeveneken - Lochristi, BE  
VAN THOURNOUT, Michel, Groene Poortdreef 32, 8200 Sint Michiels, BE  
RAE, Stephen, Koningin Astridlaan 16, 9840 De Pinte, BE  
CROMMAR, Kim, Halewijnstationstraat 113, 9031 Drongen, BE  
HOSTYN, Vanessa, Beekstraatdries 17, 9030 Mariakerke, BE  
CHONGO, Godfrey, 203 Wright Crescent, Saskatoon Saskatchewan, CA
- 

- (51) MKP  
**A61K 51/04 2006 (97) EP 3389728**  
**A61K 101/02 2006**  
**C07B 59/00 2006**  
**C07D 487/04 2006**
- (96) EP 16822655.3 12/16/2016  
(97) EP 3389728, 10/24/2018 201843, en
- (31) 15201239 (32) 18.12.2015 (33) EP
- (54) RADIOLABELLED MGLUR2/3 PET LIGANDS  
(72) ANDRÉS-GIL, José, Ignacio, c/o Janssen-Cilag S.A. Edificio Johnson&Johnson Paseo de las Doce Estrellas 5-7 5° planta Campo de las Naciones, 28042 Madrid, ES  
VAN GOOL, Michiel, Luc, Maria, c/o Janssen-Cilag S.A. Edificio Johnson&Johnson Paseo de las Doce Estrellas 5-7 5° planta Campo de las Naciones, 28042 Madrid, ES  
BORMANS, Guy, Maurits, R, c/o Katholieke Universiteit Leuven K.U.Leuven Research&Development Minderbroederstraat 8a - bus 5105, 3000 Leuven, BE  
VERBEEK, Joost, c/o Katholieke Universiteit Leuven K.U.Leuven Research&Development Minderbroederstraat 8a - bus 5105, 3000 Leuven, BE

---

(51) MKP  
**A61K 31/713 2006 (97) EP 3387129**  
**A61P 3/06 2006**  
**C12N 15/113 2010**

(96) EP 16822839.3 12/9/2016  
(97) EP 3387129, 10/17/2018 201842, en

(31) 201562265580 P (32) 10.12.2015 (33) US  
201662378964 P 24.08.2016 US

(54) STEROL REGULATORY ELEMENT BINDING PROTEIN (SREBP) CHAPERONE (SCAP) iRNA COMPOSITIONS AND METHODS OF USE THEREOF

(72) FITZGERALD, Kevin, 300 Third Street 3rd Floor, Cambridge, MA 02142, US  
XU, Huilei, 300 Third Street 3rd Floor, Cambridge, MA 02142, US  
HINKLE, Gregory, 300 Third Street 3rd Floor, Cambridge, MA 02142, US

---

(51) MKP  
**A23K 10/18 2016 (97) EP 3389399**  
**A23K 20/147 2016**  
**A23K 20/24 2016**  
**A23K 40/10 2016**  
**A23L 3/46 2006**  
**A23L 29/00 2016**  
**A23L 29/281 2016**  
**A23L 29/294 2016**  
**A23L 33/135 2016**  
**A23P 10/20 2016**  
**A23P 10/30 2016**  
**A61K 9/00 2006**  
**A61K 9/16 2006**  
**A61K 39/00 2006**  
**A61K 39/02 2006**  
**A61K 47/02 2006**  
**A61K 47/42 2017**

(96) EP 16822937.5 12/16/2016  
(97) EP 3389399, 10/24/2018 201843, en

(31) 15382634 (32) 17.12.2015 (33) EP

(54) MICROPARTICLES FOR ENCAPSULATING PROBIOTICS, OBTAINING SAID MICROPARTICLES AND USES THEREOF

(71) Centro Nacional de Tecnología y Seguridad alimentaria (CNTA), Ctra. Na - 134, Km 53, 31570 San Adrián, ES

(72) GONZÁLEZ FERRERO, Carolina, CNTA Carretera NA -134 Km 53, 31570 San Adrián-Navarra, ES  
GONZÁLEZ NAVARRO, Carlos Javier, S.G.I. (D.P.I.) Avda. Pío XII, 53, 31008 Pamplona, Navarra, ES  
IRACHE GARRETA, Juan Manuel, S.G.I (D.P.I) Avenida Pio XII, 53, 31008 Pamplona, Navarra, ES  
MARIN CALVO, Beatriz, CNTA Carretera NA -134 Km 53, 31570 San Adrián-Navarra, ES  
ROMO HUALDE, Ana, S.G.I (D.P.I) Avenida Pio XII, 53, 31008 Pamplona, Navarra, ES  
VIRTO RESANO, Raquel, CNTA Carretera. NA -134 Km 53, 31570 San Adrián-Navarra, ES

---

(51) MKP  
**A61K 31/506 2006 (97) EP 3397631**  
**A61P 3/06 2006**  
**A61P 3/10 2006**  
**A61P 7/02 2006**  
**A61P 9/00 2006**  
**A61P 25/02 2006**  
**A61P 25/30 2006**  
**A61P 35/00 2006**  
**A61P 37/00 2006**  
**C07D 401/14 2006**  
**C07D 403/04 2006**  
**C07D 403/14 2006**

(96) EP 16823054.8 12/16/2016  
(97) EP 3397631, 11/7/2018 201845, en

(31) 201562272598 P (32) 29.12.2015 (33) US  
201662423549 P 17.11.2016 US

(54) SUBSTITUTED 3-AZABICYCLO[3.1.0]HEXANES AS KETOHEXOKINASE INHIBITORS

(72) DOWLING, Matthew, 1 Pyrus Court, Old Lyme, Connecticut 06371, US  
FERNANDO, Dilinie, 15 Freedom Way Unit 46, Niantic, Connecticut 06357, US  
FUTATSUGI, Kentaro, 12 Lee Road, Sharon, MA 02067, US  
HUARD, Kim, 34 Thatcher Street, Medford, Massachusetts 02155, US  
MAGEE, Thomas Victor, 70 Fletcher Street, Winchester, Massachusetts 01890, US  
RAYMER, Brian, 3 Pilgrim Road, Holliston, Massachusetts 01746, US  
SHAVNYA, Andre, 48 Dean Road, East Lyme, Connecticut 06333, US  
SMITH, Aaron, 15 Allison Avenue, North Providence, Rhode Island 02911, US  
THUMA, Benjamin, 1 Smiths Neck Road, Old Lyme, Connecticut 06371, US  
TSAI, Andy, 132 Ledgeland Drive, Mystic, Connecticut 06355, US  
TU, Meihua, 6 Henley Road, Acton, Massachusetts 01720, US

---

(51) MKP  
**A61B 17/064 2006 (97) EP 3397176**  
**A61B 17/068 2006**  
**A61B 17/29 2006**  
**A61B 90/00 2016**  
**A61F 2/00 2006**

(96) EP 16823116.5 12/15/2016

(97) EP 3397176, 11/7/2018 201845, en

(31) 201514979909 (32) 28.12.2015 (33) US

(54) APPLICATOR INSTRUMENTS HAVING OFF-AXIS SURGICAL FASTENER DELIVERY

(72) CARDINALE, Michael, Route 22 West, Somerville New Jersey 08876, US  
SOULS, Doug, Route 22 West, Somerville New Jersey 08876, US  
MIKSZA, Anthony, U.S. Route 22, Somerville New Jersey 08876, US  
BRICKNER, Aaron J., Route 22 West, Somerville New Jersey 08876, US  
SCHNEIDER, Jared, Route 22 West, Somerville New Jersey 08876, US  
SACK, Todd, 2021 Poplar Street, Philadelphia Pennsylvania 19130, US  
SCHIFF, David R., 213 Valentine Street, Highland Park New Jersey 08904, US  
WENIG, Erin Elizabeth, 1817 Rivertrace Point, High Point North Carolina 27265, US

---

(51) MKP  
**A61K 31/4025 2006 (97) EP 3368532**  
**A61P 25/28 2006**  
**C07D 405/14 2006**

(96) EP 16823162.9 10/25/2016

(97) EP 3368532, 9/5/2018 201836, en

(31) 201518950 (32) 27.10.2015 (33) GB

(54) D-PROLINE DERIVATIVES AS SAP DEPLETING AGENT

(72) DENIS, Alexis, Laboratoire GlaxoSmithKline S.A.S. Centre de Recherches 25 Avenue du Quebec ZA de Courtaboeuf, 91951 Les Ulis, FR  
MIRGUET, Olivier, c/o Laboratoire GlaxoSmithKline S.A.S. Centre de Recherches 25 Avenue du Quebec ZA de Courtaboeuf, 91951 Les Ulis, FR  
TOUM, Jérôme, Laboratoire GlaxoSmithKline S.A.S. Centre de Recherches 25 Avenue du Quebec ZA de Courtaboeuf, 91951 Les Ulis, FR

---

(51) MKP  
**A61K 31/381 2006 (97) EP 3394053**  
**A61K 31/4025 2006**  
**A61K 31/4155 2006**  
**A61K 31/4436 2006**  
**A61K 31/4535 2006**  
**A61K 31/5355 2006**  
**A61K 31/5377 2006**  
**A61P 11/00 2006**  
**A61P 13/00 2006**  
**A61P 29/00 2006**  
**C07D 277/56 2006**  
**C07D 417/06 2006**

(96) EP 16823231.2 12/16/2016

(97) EP 3394053, 10/31/2018 201844, en

(31) 15201788 (32) 21.12.2015 (33) EP

(54) 4-HYDROXY-2-PHENYL-1,3-THIAZOL-5-YL METHANONE DERIVATIVES AS TRPM8 ANTAGONISTS

(72) ARAMINI, Andrea, c/o DOMPE' FARMACEUTICI S.P.A. Via Campo di Pile s.n.c., I-67100 L'Aquila (AQ), IT  
BIANCHINI, Gianluca, c/o DOMPE' FARMACEUTICI S.P.A. Via Campo di Pile s.n.c., I-67100 L'Aquila (AQ), IT  
LILLINI, Samuele, c/o DOMPE' FARMACEUTICI S.P.A. Via Campo di Pile s.n.c., I-67100 L'Aquila (AQ), IT

---

(51) MKP  
**A21D 13/06 2017 (97) EP 3389400**  
**A21D 13/066 2017**  
**A23L 5/20 2016**  
**A23L 5/30 2016**  
**A23L 7/10 2016**  
**A23L 7/196 2016**  
**C12C 1/02 2006**

(96) EP 16823236.1 12/16/2016  
(97) EP 3389400, 10/24/2018 201843, en

(31) UB20159442 (32) 17.12.2015 (33) IT

(54) METHOD FOR THE DETOXIFICATION OF GLUTEN PROTEINS FROM CEREAL GRAINS AND USES THEREOF IN MEDICAL FIELD  
(71) New Gluten World S.r.l., Viale Michelangelo 177, 71121 Foggia, IT  
(72) LAMACCHIA, Carmela, Via Paolo Telesforo 33, 71122 Foggia, IT

---

(51) MKP  
**C12N 15/113 2010 (97) EP 3394259**

(96) EP 16823350.0 12/19/2016  
(97) EP 3394259, 10/31/2018 201844, en

(31) 201562270165 P (32) 21.12.2015 (33) US

(54) COMPOSITIONS AND METHODS FOR DECREASING TAU EXPRESSION  
(72) POLYDORO OFENGEIM, Manuela, Novartis Institutes for BioMedical Research Inc. 250 Massachusetts Ave., Cambridge, MA 02139, US  
WEILER, Jan, Novartis Institutes for BioMedical Research Inc. 250 Massachusetts Ave., Cambridge, MA 02139, US

---

(51) MKP  
**A61F 13/20 2006 (97) EP 3397557**  
**B65B 11/32 2006**  
**B65B 19/00 2006**  
**B65B 47/06 2006**  
**B65B 49/12 2006**

(96) EP 16823353.4 12/30/2016  
(97) EP 3397557, 11/7/2018 201845, en

(31) 201562273775 P (32) 31.12.2015 (33) US

(54) METHOD OF FORMING PRIMARY PACKAGE TUBE FOR TAMPONS  
(72) CANKAR, Thomas, Heckinghauser Strasse 263, 42289 Wuppertal, DE  
KLAR, Markus, Heckinghauser Strasse 263, 42289 Wuppertal, DE  
BERGERMANN, Martin, Heckinghauser Strasse 263, 42289 Wuppertal, DE  
ARNESEN, Jens-Petter, Route de Retortat, 51120 Sezanne, FR  
ANGER, Markus, Heckinghauser Strasse 263, 42289 Wuppertal, DE

---

(51) MKP  
**A61K 31/7105 2006 (97) EP 3386533**  
**A61K 31/7115 2006**  
**A61K 38/45 2006**  
**A61P 3/00 2006**

(96) EP 16823387.2 12/9/2016  
(97) EP 3386533, 10/17/2018 201842, en

(31) 201562265174 P (32) 09.12.2015 (33) US

(54) MODIFIED MRNA ENCODING A URIDINE DIPHOSPHATE GLUCURONOSYL TRANSFERASE AND USES THEREOF  
(72) LASARO, Melissa, 95A Walnut Tree Hill Road., Sandy Hook, CT 06482, US  
OSTERMAN, David, 75 Church Hill Road., Glastonbury, CT 06033, US  
VASAVADA, Haren, 51 Farm Brook Court, Hamden, CT 06514, US  
COBAUGH, Christian, 33 Beverly Road., Newton Highlands, MA 02461, US

---

(51) MKP  
**A61B 17/00 2006 (97) EP 3397182**  
**A61B 17/29 2006**  
**A61B 17/32 2006**  
**A61B 18/14 2006**

(96) EP 16823399.7 12/14/2016



(97) EP 3397182, 11/7/2018 201845, en  
(31) 201514983634 (32) 30.12.2015 (33) US  
(54) SURGICAL INSTRUMENT WITH STAGED APPLICATION OF ELECTROSURGICAL AND ULTRASONIC ENERGY  
(72) HOUSER, Kevin L., 4545 Creek Road, Cincinnati Ohio 45242, US

---

(51) MKP  
**A46B 15/00 2006 (97) EP 3393377**

**A61B 17/28 2006**  
**A61B 17/32 2006**

(96) EP 16823400.3 12/14/2016

(97) EP 3393377, 10/31/2018 201844, en

(31) 201514976047 (32) 21.12.2015 (33) US

(54) ULTRASONIC SURGICAL INSTRUMENT WITH TUBULAR ACOUSTIC WAVEGUIDE SEGMENT

(72) HOUSER, Kevin L., 4545 Creek Road, Cincinnati, Ohio 45242, US

---

(51) MKP  
**A61K 31/4704 2006 (97) EP 3390392**

**A61P 29/00 2006**

**C07D 403/12 2006**

**C07D 413/12 2006**

(96) EP 16823447.4 12/19/2016

(97) EP 3390392, 10/24/2018 201843, en

(31) 201562269518 P (32) 18.12.2015 (33) US

(54) ALKYL DIHYDROQUINOLINE SULFONAMIDE COMPOUNDS

(72) WEISS, Matthew, 99 Revere Street, Boston, MA 02114, US

MILGRAM, Benjamin C, 84 Prescott Street, Apt. 3, Cambridge, MA 02138, US

MARX, Isaac E., 7 Michael Street, Arlington, MA 02474, US

DINEEN, Thomas, 135 Wright Street, Arlington, MA 02474, US

---

(51) MKP  
**A61K 31/4704 2006 (97) EP 3390393**

**C07D 215/36 2006**

**C07D 241/44 2006**

**C07D 403/12 2006**

**C07D 413/12 2006**

**C07D 413/14 2006**

**C07D 417/12 2006**

(96) EP 16823450.8 12/19/2016

(97) EP 3390393, 10/24/2018 201843, en

(31) 201562269533 P (32) 18.12.2015 (33) US

(54) ALKYNYL DIHYDROQUINOLINE SULFONAMIDE COMPOUNDS

(72) WEISS, Matthew, 99 Revere Street, Boston Massachusetts 02114, US

DINEEN, Thomas, 135 Wright Street, Arlington, MA 02474, US

VAIDA, Karina R., 24 Winn Valley Drive, Burlington Massachusetts 01803, US

---

(51) MKP  
**A61K 31/519 2006 (97) EP 3394067**

**A61P 9/00 2006**

**A61P 9/04 2006**

**A61P 9/10 2006**

**A61P 9/12 2006**

**C07D 487/04 2006**

(96) EP 16823455.7 12/20/2016

(97) EP 3394067, 10/31/2018 201844, en

(31) PCT/CN2015/098251 (32) 22.12.2015 (33) WO

(54) 4-AMINO-2-(1H-PYRAZOLO[3,4-B]PYRIDIN-3-YL)-6-OXO-6,7-DIHYDRO-5H-PYRROLO[2,3-D]PYRIMIDINE DERIVATIVES AND THE RESPECTIVE (1H-INDAZOL-3-YL) DERIVATIVES AS CGMP MODULATORS FOR TREATING CARDIOVASCULAR DISEASES

(72) BERGER, Raphelle, 126 East Lincoln Avenue, Rahway, New Jersey 07065-0907, US

CHEN, Yi-Heng, 126 East Lincoln Avenue, Rahway, New Jersey 07065-0907, US

LI, Guoqing, 2000 Galloping Hill Road, Kenilworth, New Jersey 07033, US

GARFUNKLE, Joie, 600 Coporate Drive, Lebanon, New Jersey 08833, US

LI, Hong, 126 East Lincoln Avenue, Rahway, New Jersey 07065-0907, US

MIAO, Shouwu, 295 Prestwick Way, Edison, New Jersey 08820, US  
 RAGHAVAN, Subharekha, 2000 Galloping Hill Road, Kenilworth, New Jersey 07033, US  
 SMITH, Cameron, J., 9004 Snowford Court, Montgomery Village, Maryland 20886-4017, US  
 STELMACH, John, 228 Seneca Place, Westfield, New Jersey 07090, US  
 WHITEHEAD, Alan, 126 East Lincoln Avenue, Rahway, New Jersey 07065-0907, US  
 ZHANG, Rui, 2000 Galloping Hill Road, Kenilworth, New Jersey 07033, US  
 ZHANG, Yong, 126 East Lincoln Avenue, Rahway, New Jersey 07065-0907, US  
 FU, Jianmin, 6 Tai-He Road BDA, Beijing 100176, CN  
 JI, Gang, 6 Tai-He Road BDA, Beijing 100176, CN  
 JIANG, Falong, 6 Tai-He Road BDA, Beijing 100176, CN

- (51) MKP  
**A61M 5/142 2006 (97) EP 3393555**  
**A61M 5/24 2006**  
 (96) EP 16823472.2 12/20/2016  
 (97) EP 3393555, 10/31/2018 201844, en  
 (31) 201562271283 P (32) 27.12.2015 (33) US  
 201662352362 P 20.06.2016 US  
 (54) WEARABLE AUTOMATIC INJECTION DEVICE AND RELATED METHODS OF ASSEMBLY AND USE  
 (72) GALITZ, Charles M., 7540 18th Avenue, Kenosha Wisconsin 53143, US  
 ABRAHAMSON, Kent, 1001 Ashley Lane, Libertyville Illinois 60048, US  
 MCLENNAN, Kevin P., 4651 N. Wolcott Avenue Apt. 2, Chicago Illinois 60640, US

- (51) MKP  
**A61K 31/519 2006 (97) EP 3394056**  
**A61P 29/00 2006**  
**A61P 35/00 2006**  
**C07D 221/04 2006**  
**C07D 239/94 2006**  
**C07D 401/04 2006**  
**C07D 401/12 2006**  
**C07D 401/14 2006**  
**C07D 407/14 2006**  
**C07D 409/14 2006**  
**C07D 413/14 2006**  
**C07D 471/04 2006**  
**C07D 473/30 2006**  
**C07D 495/04 2006**  
**C07D 495/14 2006**  
 (96) EP 16823505.9 12/21/2016  
 (97) EP 3394056, 10/31/2018 201844, en  
 (31) 201562271185 P (32) 22.12.2015 (33) US  
 (54) COMPOUNDS FOR THE TREATMENT OF CANCER AND INFLAMMATORY DISEASE  
 (71) Shy Therapeutics LLC, 34 Bates Road, Harrison, NY 10528, US  
 (72) HADARI, Yaron, R., 34 Bates Road, Harrison NY 10528, US  
 CARTA, Luca, 263 Pleasant Avenue 5C, New York NY 10029, US  
 SCHMERTZLER, Michael, 1300 Valley Road, New Canaan CT 06840, US  
 WILLIAMS, Theresa, M., 260 Shady Nook Road, Harleysville PA 19438, US  
 REYNOLDS, Charles, H., 171 Forest Trail Drive, Lansdale PA 19446, US

- (51) MKP  
**A61K 31/34 2006 (97) EP 3393465**  
**A61K 31/341 2006**  
**A61K 31/42 2006**  
**A61K 31/422 2006**  
**A61K 31/4245 2006**  
**A61K 31/5377 2006**  
**A61P 11/00 2006**  
 (96) EP 16823527.3 12/22/2016  
 (97) EP 3393465, 10/31/2018 201844, en  
 (31) 201562271191 P (32) 22.12.2015 (33) US  
 201562271804 P 28.12.2015 US  
 (54) METHODS OF TREATING PULMONARY DISEASES AND DISORDERS

(72) MILLER, John, 43 Allston Avenue, Worcester MA 01604, US  
BASTOS, Cecilia, M., 1 Bigelow Way, South Grafton MA 01560, US  
MUNOZ, Benito, 377 Lowell Avenue, Newtonview MA 02460, US

---

(51) MKP  
**C07D 471/04 2006 (97) EP 3394057**

(96) EP 16823529.9 12/22/2016

(97) EP 3394057, 10/31/2018 201844, en

(31) 201562387442 P

(32) 23.12.2015

(33) US

(54) SYNTHETIC METHODS FOR PREPARATION OF (S)-(2R,3R,11BR)-3-ISOBUTYL-9,10-DIMETHOXY-2,3,4,6,7,11B-HEXAHYDRO-1H-PYRIDO[2,1-A]ISOQUINOLIN-2-YL 2-AMINO-3-METHYLBUTANOATE DI(4-METHYLBENZENESULFONATE)

(71) Neurocrine Biosciences Inc., 12780 El Camino Real, San Diego, CA 92130, US

(72) MCGEE, Kevin, 82663 Marlow Road, Eugene, OR 97405, US

LI, Bin-Feng, A5-4F BioBay 218 Xinghu Street, Suzhou Industrial Park 215123, CN

---

(51) MKP  
**C07K 14/54 2006 (97) EP 3390433**  
**C07K 14/705 2006**  
**C12N 15/62 2006**

(96) EP 16825355.7 12/16/2016

(97) EP 3390433, 10/24/2018 201843, en

(31) PCT/EP2015/080299

(32) 17.12.2015

(33) WO

(54) NOVEL CYTOKINE FUSION PROTEINS

(72) SAHIN, Ugur, Philipp-von-Zabern-Platz 1, 55116 Mainz, DE

GIESEKE, Friederike, Am Römertor 5, 55116 Mainz, DE

KREITER, Sebastian, Niklas-Vogt-Strasse 3, 55131 Mainz, DE

DIKEN, Mustafa, Bert-Brecht-Strasse 5, 55128 Mainz, DE

---

(51) MKP  
**A61K 31/437 2006 (97) EP 3394058**  
**A61P 11/00 2006**  
**A61P 11/06 2006**  
**C07D 471/04 2006**

(96) EP 16825371.4 12/20/2016

(97) EP 3394058, 10/31/2018 201844, en

(31) 15202346

(32) 23.12.2015

(33) EP

(54) N-[3-(3-{4-[[1,2,4]TRIAZOLO[4,3-A]PYRIDIN-6-YLOXY]-1,2,3,4-TETRAHYDRO-NAPHTHALEN-1-YL}-UREIDO)-PHENYL]-METHANESULFONAMIDE DERIVATIVES AND THEIR USE AS P38 MAPK INHIBITORS

(72) CAPALDI, Carmelida, c/o Chiesi Farmaceutici S.p.A. Via Palermo 26/A, 43122 Parma, IT

ARMANI, Elisabetta, c/o Chiesi Farmaceutici S.p.A. Via Palermo 26/A, 43122 Parma, IT

JENNINGS, Andrew Stephen Robert, c/o Chiesi Farmaceutici S.p.A. Via Palermo 26/A, 43122 Parma, IT

HURLEY, Christopher, c/o Chiesi Farmaceutici S.p.A. Via Palermo 26/A, 43122 Parma, IT

---

(51) MKP  
**A61K 31/437 2006 (97) EP 3394059**  
**A61P 11/00 2006**  
**A61P 11/06 2006**  
**C07D 471/04 2006**

(96) EP 16825372.2 12/20/2016

(97) EP 3394059, 10/31/2018 201844, en

(31) 15202348

(32) 23.12.2015

(33) EP

(54) 1-(3-TERT-BUTYL-PHENYL)-3-(4-[[1,2,4]TRIAZOLO[4,3-A]PYRIDIN-6-YLOXY]-1,2,3,4-TETRAHYDRO-NAPHTHALEN-1-YL)-UREA DERIVATIVES AND THEIR USE AS P38 MAPK INHIBITORS

(72) CAPALDI, Carmelida, c/o Chiesi Farmaceutici S.p.A. Via Palermo 26/A, 43122 Parma, IT

ARMANI, Elisabetta, c/o Chiesi Farmaceutici S.p.A. Via Palermo 26/A, 43122 Parma, IT

JENNINGS, Andrew Stephen Robert, c/o Chiesi Farmaceutici S.p.A. Via Palermo 26/A, 43122 Parma, IT

HURLEY, Christopher, c/o Chiesi Farmaceutici S.p.A. Via Palermo 26/A, 43122 Parma, IT

---

(51) MKP  
**A61K 31/437 2006 (97) EP 3394060**  
**A61P 11/00 2006**

**A61P 11/06 2006**  
**C07D 471/04 2006**  
(96) EP 16825373.0 12/20/2016  
(97) EP 3394060, 10/31/2018 201844, en  
(31) 15202350 (32) 23.12.2015 (33) EP  
(54) 1-(3-TERT-BUTYL-2H-PYRAZOL-5-YL OR 5-TERT-BUTYL-ISOXAL-3-YL)-3-(4-([1,2,4]TRIAZOLO[4,3-A]PYRIDIN-6-YLOXY)-1,2,3,4-TETRAHYDRO-NAPHTHALENYL) UREA DERIVATIVES AND THEIR USE AS P38 MAPK INHIBITORS  
(72) CAPALDI, Carmelida, c/o Chiesi Farmaceutici S.p.A. Via Palermo 26/A, 43122 Parma, IT  
ARMANI, Elisabetta, c/o Chiesi Farmaceutici S.p.A. Via Palermo 26/A, 43122 Parma, IT  
JENNINGS, Andrew Stephen Robert, c/o Chiesi Farmaceutici S.p.A. Via Palermo 26/A, 43122 Parma, IT  
HURLEY, Christopher, c/o Chiesi Farmaceutici S.p.A. Via Palermo 26/A, 43122 Parma, IT

---

(51) MKP  
**D06P 1/52 2006 (97) EP 3397805**  
**D06P 5/00 2006**  
**D06P 5/30 2006**  
(96) EP 16825416.7 12/22/2016  
(97) EP 3397805, 11/7/2018 201845, en  
(31) UB20159759 (32) 30.12.2015 (33) IT  
(54) PROCESS FOR OBTAINING A CLOTH WITH HIGH PERFORMANCES FOR DIGITAL PRINTING AND RELATIVE CLOTH  
(71) Manifattura Del Seveso S.p.A., Via Monte Grappa 7, 24121 Bergamo, IT  
(72) BOLOGNA, Franco, Manifattura Del Seveso S.p.A. Via Monte Grappa 7, 24121 Bergamo, IT

---

(51) MKP  
**A45C 5/03 2006 (97) EP 3389430**  
**A45C 5/14 2006**  
**A45C 13/00 2006**  
**A45C 13/08 2006**  
(96) EP 16825551.1 9/13/2016  
(97) EP 3389430, 10/24/2018 201843, en  
(31) UB20159427 (32) 15.12.2015 (33) IT  
(54) A SUITCASE, PREFERABLY OF THE RIGID TYPE, WITH AN INTERCHANGEABLE EXTERNAL CASE  
(71) VF Agency Limited, 36 Quayside Mews, Lymm, Cheshire WA13 0HZ, GB  
(72) FABBRÌ, Valentina, Via San Marcellino 59, 50126 Firenze, IT

---

(51) MKP  
**A63B 9/00 2006 (97) EP 3377187**  
**A63B 17/04 2006**  
**A63C 19/02 2006**  
**A63G 31/00 2006**  
**H02S 30/20 2014**  
(96) EP 16825554.5 11/14/2016  
(97) EP 3377187, 9/26/2018 201839, en  
(31) UB20155611 (32) 16.11.2015 (33) IT  
(54) REVERSIBLY INSTALLABLE MODULAR FITNESS AREA  
(71) Metalco Active S.r.l., Via della Fornace 44, 31023 Castelminio di Resana, IT  
(72) INNOCENZI, Gian Luca, c/o METALCO ACTIVE S.R.L. Via Madonnina 5, I-20121 Milano, IT

---

(51) MKP  
**A63B 7/02 2006 (97) EP 3377186**  
**A63B 9/00 2006**  
**A63B 17/04 2006**  
**A63B 21/08 2006**  
**A63B 23/12 2006**  
**A63G 31/00 2006**  
(96) EP 16825555.2 11/14/2016  
(97) EP 3377186, 9/26/2018 201839, en  
(31) UB20155609 (32) 16.11.2015 (33) IT  
(54) PERSONALIZABLE MODULAR FITNESS AREA  
(71) Metalco Active S.r.l., Via della Fornace, 44, 31023 Castelminio di Resana (TV), IT  
(72) INNOCENZI, Gian Luca, c/o METALCO ACTIVE S.R.L. Via Madonnina 5, I-20121 Milano, IT

---

(51) MKP  
**C07K 14/195 2006 (97) EP 3377634**  
**C12N 1/21 2006**  
**C12N 15/62 2006**  
**C12N 15/70 2006**  
**C12N 15/74 2006**

(96) EP 16825704.6 11/17/2016  
(97) EP 3377634, 9/26/2018 201839, en  
(31) 15195493 (32) 19.11.2015 (33) EP  
(54) BACTERIA-BASED PROTEIN DELIVERY  
(72) ITTIG, Simon, Zehntenfreistrasse 32, 4103 Bottmingen, CH  
AMSTUTZ, Marlise, Wittlingerstr. 140, 4058 Basel, CH  
KASPER, Christoph, Ruttigerweg 4, 4600 Olten, CH

---

(51) MKP  
**C12N 1/19 2006 (97) EP 3394281**  
**C12N 15/63 2006**  
**C12P 21/02 2006**  
**C12R 1/84 2006**

(96) EP 16825759.0 12/22/2016  
(97) EP 3394281, 10/31/2018 201844, en  
(31) 15202233 (32) 22.12.2015 (33) EP  
(54) YEAST CELL  
(71) BISY E.U., Wetzawinkel 20A, 8200 Hofstätten an der Raab, AT  
(72) VOGL, Thomas, Thalerseestraße 7, 8052 Graz, AT  
GLIEDER, Anton, Wetzawinkel 20, 8200 Hofstätten an der Raab, AT

---

(51) MKP  
**A61K 38/04 2006 (97) EP 3383419**  
**A61K 38/17 2006**  
**C07K 7/04 2006**  
**C07K 16/28 2006**  
**C07K 16/30 2006**

(96) EP 16825929.9 12/2/2016  
(97) EP 3383419, 10/10/2018 201841, en  
(31) 201562262912 P (32) 03.12.2015 (33) US  
201662348126 P 09.06.2016 US  
(54) COMPOSITIONS AND METHODS FOR REDUCING IMMUNE RESPONSES AGAINST CHIMERIC ANTIGEN RECEPTORS  
(72) BONYHADI, Mark L., 400 Dexter Avenue North Suite 1200, Seattle, WA 98109, US

---

(51) MKP  
**A61K 31/00 2006 (97) EP 3387017**  
**A61P 35/00 2006**  
**C07K 16/28 2006**  
**C07K 16/32 2006**

(96) EP 16825935.6 12/9/2016  
(97) EP 3387017, 10/17/2018 201842, en  
(31) 201562266103 P (32) 11.12.2015 (33) US  
(54) METHODS FOR REDUCING OR PREVENTING GROWTH OF TUMORS RESISTANT TO EGFR AND/OR ERBB3 BLOCKADE  
(72) DALY, Christopher, c/o Regeneron Pharmaceuticals Inc. 777 Old Saw Mill River Road, Tarrytown, New York 10591-6707, US  
CASTANARO, Carla, c/o Regeneron Pharmaceuticals Inc. 777 Old Saw Mill River Road, Tarrytown, New York 10591-6707, US  
ZHANG, Wen, c/o Regeneron Pharmaceuticals Inc. 777 Old Saw Mill River Road, Tarrytown, New York 10591-6707, US  
THURSTON, Gavin, c/o Regeneron Pharmaceuticals Inc. 777 Old Saw Mill River Road, Tarrytown, New York 10591-6707, US

---

(51) MKP  
**A61K 48/00 2006 (97) EP 3400304**  
**C07K 14/705 2006**  
**C12N 15/86 2006**

(96) EP 16825936.4 12/9/2016  
(97) EP 3400304, 11/14/2018 201846, en  
(31) 201562266383 P (32) 11.12.2015 (33) US  
201562269440 P 18.12.2015 US

(54) GENE THERAPY FOR TREATING FAMILIAL HYPERCHOLESTEROLEMIA  
(72) WILSON, James M., 1831 Delancey Street, Philadelphia, PA 19103, US  
RADER, Daniel J., 333 S. Smedley St., Philadelphia, PA 19103, US

---

(51) MKP  
**C07K 14/765 2006 (97) EP 3394265**  
**C12N 15/62 2006**  
(96) EP 16825950.5 12/16/2016  
(97) EP 3394265, 10/31/2018 201844, en  
(31) 201562387116 P (32) 23.12.2015 (33) US  
(54) DKK2 CYSTEINE RICH DOMAIN 2 CONTAINING PROTEINS AND USES THEREOF  
(72) PEPINSKY, R. Blake, 30 Falmouth Road, Arlington, Massachusetts 02474, US  
SOPKO, Richelle, 8 Colbourne Crescent 3, Brookline, Massachusetts 02445, US  
MUGFORD, Joshua, 72 Warren Street, Waltham, Massachusetts 02453, US  
LEHMANN, Andreas, 35 Gilbert Road 2, Belmont, Massachusetts 02478, US  
ARNDT, Joseph W., 32 Ross Road, Swampscott, Massachusetts 01907, US  
PEDERSON, Nels E., 71 Patty's Road, Mansfield, Massachusetts 02048, US  
MINESINGER, Brenda K., 18 Pupkis Road, Tewksbury, Massachusetts 01876, US

---

(51) MKP  
**A61K 39/00 2006 (97) EP 3393504**  
(96) EP 16825970.3 12/21/2016  
(97) EP 3393504, 10/31/2018 201844, en  
(31) 201562270780 P (32) 22.12.2015 (33) US  
(54) MESOTHELIN CHIMERIC ANTIGEN RECEPTOR (CAR) AND ANTIBODY AGAINST PD-L1 INHIBITOR FOR COMBINED USE IN  
ANTICANCER THERAPY  
(71) President and Fellows of Harvard College, 17 Quincy Street, Cambridge, MA 02138, US  
(72) BROGDON, Jennifer, Novartis Institutes for Biomedical Research Inc. 250 Massachusetts Avenue, Cambridge, MA 02139, US  
CHANG, Hwai, Wen, 1318 Shadow Hills Drive, San Marcos, CA 92069, US  
ENGELS, Boris, Novartis Institutes for Biomedical Research Inc. 250 Massachusetts Ave, Cambridge, MA 02139, US  
FREEMAN, Gordon, James, 305 Walnut Street, Brookline, MA 02445, US  
FREY, Gerhard, Johann, 13768 Via Cima Bella, San Diego, CA 92129, US  
MATARAZA, Jennifer, Marie, Novartis Institutes for Biomedical Research Inc. 250 Massachusetts Ave., Cambridge, MA 02139, US  
SINGH, Reshma, Novartis Institutes for Biomedical Research Inc. 250 Massachusetts Avenue, Cambridge, MA 02139, US  
SHARPE, Arlene, Helen, 305 Walnut Street, Brookline, MA 02445, US

---

(51) MKP  
**B03B 9/00 2006 (97) EP 3386655**  
**B03B 9/06 2006**  
**B09B 3/00 2006**  
**B29B 17/00 2006**  
**B29B 17/02 2006**  
**C05F 9/00 2006**  
**C10L 5/48 2006**  
**D21B 1/02 2006**  
**D21C 5/02 2006**  
(96) EP 16826139.4 12/8/2016  
(97) EP 3386655, 10/17/2018 201842, en  
(31) 201521624 (32) 08.12.2015 (33) GB  
(54) WASTE PROCESSING  
(71) Fiberright Limited, 32 Monk Street, Abergavenny, Gwent NP7 5NW, GB  
(72) BANKS, Charles, University of Southampton University Road Highfield, Southampton Hampshire S017 1BJ, GB  
THOMPSON, Nicholas Mark, Sun Inn Cottage, Longtown HR2 0LD, GB  
PURI, Dhivya Jyoti, 5 Redhill Bassett, Southampton Hampshire SO16 7BN, GB  
SPELLER, Peter, Carreg Coch 5 Lisvane Road, Llanishen CF14 0SA, GB  
STUART-PAUL, Craig, 107 Forest Drive, Catonsville Maryland 21228, US

---

(51) MKP  
**A61F 13/20 2006 (97) EP 3397223**  
**A61F 13/34 2006**  
**B65H 65/00 2006**  
**B65H 69/04 2006**

(96) EP 16826183.2 12/30/2016  
(97) EP 3397223, 11/7/2018 201845, en  
(31) 201562273791 P (32) 31.12.2015 (33) US  
(54) METHOD OF WINDING UP TAMPON MATERIAL  
(72) CANKAR, Thomas, Heckinghauser Strasse 263, 42289 Wuppertal, DE  
KLAR, Markus, Heckinghauser Strasse 263, 42289 Wuppertal, DE  
ANGER, Markus, Heckinghauser Strasse 263, 42289 Wuppertal, DE  
BERGERMANN, Martin, Heckinghauser Strasse 263, 42289 Wuppertal, DE

---

(51) MKP  
**A61K 31/437 2006 (97) EP 3386980**  
**A61P 35/00 2006**  
**C07D 471/04 2006**  
(96) EP 16826214.5 12/6/2016  
(97) EP 3386980, 10/17/2018 201842, en  
(31) 201562264180 P (32) 07.12.2015 (33) US  
(54) COMPOUNDS AND METHODS FOR KINASE MODULATION, AND INDICATIONS THEREFOR  
(72) WU, Guoxian, c/o Plexxikon Inc. 91 Bolivar Drive Suite A, Berkeley California 94710, US  
WU, Jeffrey, c/o Plexxikon Inc. 91 Bolivar Drive Suite A, Berkeley California 94710, US  
CHAN, Katrina, c/o Plexxikon Inc. 91 Bolivar Drive Suite A, Berkeley California 94710, US  
DONG, Ken, c/o Plexxikon Inc. 91 Bolivar Drive Suite A, Berkeley California 94710, US  
EWING, Todd, c/o Plexxikon Inc. 91 Bolivar Drive Suite A, Berkeley California 94710, US  
IBRAHIM, Prabha N., c/o Plexxikon Inc. 91 Bolivar Drive Suite A, Berkeley California 94710, US  
LIN, Jack, c/o Plexxikon Inc. 91 Bolivar Drive Suite A, Berkeley California 94710, US  
SPEVAK, Wayne, c/o Plexxikon Inc. 91 Bolivar Drive Suite A, Berkeley California 94710, US  
ZHANG, Ying, c/o Plexxikon Inc. 91 Bolivar Drive Suite A, Berkeley California 94710, US

---

(51) MKP  
**C08B 3/08 2006 (97) EP 3394108**  
**C08B 3/10 2006**  
(96) EP 16826304.4 12/19/2016  
(97) EP 3394108, 10/31/2018 201844, en  
(31) 15202027 (32) 22.12.2015 (33) EP  
(54) ACYLATION OF BIOPOLYMER COMPRISING ANHYDROGLUCOSE UNITS  
(72) ENGLISH, Robert, 8a Borrisdale, Isle of Harris Eilean Siar HS5 3UE, GB  
GRAVESON, Ian, 75 Bettina Close, Nuneaton Warwickshire CV10 9EX, GB  
MOMIN, Saschi, 7 Warren Crescent, Edmonton London N9 9JF, GB  
FERLIN, Nadège, 907 avenue de Fes Appart A107, 34080 Montpellier, FR

---

(51) MKP  
**A61B 17/29 2006 (97) EP 3383286**  
**A61B 18/14 2006**  
(96) EP 16826492.7 11/29/2016  
(97) EP 3383286, 10/10/2018 201841, en  
(31) 201514959361 (32) 04.12.2015 (33) US  
(54) DEVICES AND METHODS FOR INCREASING ROTATIONAL TORQUE DURING END EFFECTOR ARTICULATION  
(72) WORRELL, Barry C., 4545 Creek Road, Cincinnati Ohio 45242, US  
LESKO, Jason R., 4545 Creek Road, Cincinnati Ohio 45242, US

---

(51) MKP  
**C07K 16/44 2006 (97) EP 3390455**  
**G01N 33/94 2006**  
(96) EP 16826522.1 12/15/2016  
(97) EP 3390455, 10/24/2018 201843, en  
(31) 201562268924 P (32) 17.12.2015 (33) US  
(54) ANTIBODIES TO QUETIAPINE AND USE THEREOF  
(72) HRYHORENKO, Eric, 45 Fraser Drive, Hilton, New York 14468, US  
SANKARAN, Banumathi, 12 Coddington Grove, Pittsford, New York 14534, US  
DECORY, Thomas R., 24 Round Trail Drive, Pittsford, New York 14534, US  
TUBBS, Theresa, 425 Hoes Lane, Piscataway, New Jersey 08855, US  
COLT, Linda, 151 Saint Rita Drive, Rochester, New York 14606, US  
REMMERIE, Bart M., Turnhoutseweg 30, 2340 Beerse, BE

SALTER, Rhys, Welsh & McKean Roads, Spring House, Pennsylvania 19477, US  
DONAHUE, Matthew G., 1700 Street Road Apt A10, Warrington, Pennsylvania 18976, US  
GONG, Yong, Welsh & McKean Roads, Spring House, Pennsylvania 19477, US

---

- (51) MKP  
**A61K 31/4375 2006 (97) EP 3394033**  
**A61K 31/47 2006**  
**A61K 31/4985 2006**  
**A61K 31/519 2006**  
**A61P 31/00 2006**  
**A61P 35/00 2006**  
**C07D 215/40 2006**  
**C07D 471/04 2006**
- (96) EP 16826549.4 12/21/2016  
(97) EP 3394033, 10/31/2018 201844, en
- (31) 201562270931 P (32) 22.12.2015 (33) US  
201662324502 P 19.04.2016 US  
201662385341 P 09.09.2016 US
- (54) HETEROCYCLIC COMPOUNDS AS IMMUNOMODULATORS  
(72) LAJKIEWICZ, Neil, Incyte Corporation 1801 Augustine Cut-Off, Wilmington Delaware 19803, US  
WU, Liangxing, Incyte Corporation 1801 Augustine Cut-Off, Wilmington Delaware 19803, US  
YAO, Wenqing, Incyte Corporation 1801 Augustine Cut-Off, Wilmington Delaware 19803, US
- 

- (51) MKP  
**A61K 31/5025 2006 (97) EP 3397639**  
**A61P 31/18 2006**  
**C07D 471/16 2006**
- (96) EP 16826561.9 12/22/2016  
(97) EP 3397639, 11/7/2018 201845, en
- (31) PCT/CN2015/100106 (32) 31.12.2015 (33) WO
- (54) FUSED TRICYCLIC HETEROCYCLIC COMPOUNDS AS HIV INTEGRASE INHIBITORS  
(72) YU, Tao, 2000 Galloping Hill Road, Kenilworth New Jersey 07033, US  
WADDELL, Sherman, T., 735 Coleman Place, Westfield New Jersey 07090, US  
GRAHAM, Thomas, H., 33 Avenue Louis Pasteur, Boston Massachusetts 02115-5727, US  
ZHANG, Yonglian, 2000 Galloping Hill Road, Kenilworth New Jersey 07033, US  
MCCAULEY, John, A., 770 Sumneytown Pike, West Point Pennsylvania 19486, US  
STAMFORD, Andrew, W., 27 Overlook Road, Chatham Township New Jersey 07928, US  
CAI, Jiaqiang, No. 1 Building 288 Fute Zhong Road Waigaoqiao Free Trade Zone, Shanghai 200131, CN  
QI, Zhiqi, No. 1 Building 288 Fute Zhong Road Waigaoqiao Free Trade Zone, Shanghai 200131, CN
- 

- (51) MKP  
**A61K 31/4196 2006 (97) EP 3397633**  
**A61P 11/00 2006**  
**A61P 25/28 2006**  
**A61P 27/02 2006**  
**A61P 31/12 2006**  
**A61P 35/00 2006**  
**A61P 37/00 2006**  
**C07D 249/08 2006**  
**C07D 401/12 2006**  
**C07D 403/12 2006**  
**C07D 413/12 2006**
- (96) EP 16826682.3 12/30/2016  
(97) EP 3397633, 11/7/2018 201845, en
- (31) 201562273857 P (32) 31.12.2015 (33) US
- (54) NUCLEAR TRANSPORT MODULATORS AND USES THEREOF  
(72) BALOGLU, Erkan, 8 Benjamin Terrace, Stoneham, MA 02180, US
- 

- (51) MKP  
**A61K 31/4965 2006 (97) EP 3397634**  
**A61P 35/00 2006**  
**C07D 239/26 2006**  
**C07D 241/12 2006**



**C07D 401/08 2006**  
**C07D 401/12 2006**  
**C07D 403/06 2006**  
**C07D 403/08 2006**  
**C07D 403/12 2006**  
**C07D 409/06 2006**  
**C07D 413/06 2006**  
(96) EP 16826684.9 12/30/2016  
(97) EP 3397634, 11/7/2018 201845, en  
(31) 201562273964 P (32) 31.12.2015 (33) US  
(54) NUCLEAR TRANSPORT MODULATORS AND USES THEREOF  
(72) BALOGLU, Erkan, 8 Benjamin Terrace, Stoneham, MA 02180, US

---

(51) MKP  
**A61K 31/445 2006 (97) EP 3397273**  
**A61K 38/47 2006**  
(96) EP 16826898.5 12/29/2016  
(97) EP 3397273, 11/7/2018 201845, en  
(31) 201562272890 P (32) 30.12.2015 (33) US  
201662300479 P 26.02.2016 US  
201662315412 P 30.03.2016 US  
201662402454 P 30.09.2016 US  
201662428867 P 01.12.2016 US  
201662431791 P 08.12.2016 US  
(54) AUGMENTED ACID ALPHA-GLUCOSIDASE FOR THE TREATMENT OF POMPE DISEASE  
(72) DO, Hung V., 1 Cedarbrook Drive, Cranbury, New Jersey 08512, US  
KHANNA, Richie, 1 Cedar Brook Drive, Cranbury, New Jersey 08512, US  
GOTSCHALL, Russell, 1 Cedar Brook Drive, Cranbury, New Jersey 08512, US

---

(51) MKP  
**A61K 35/17 2015 (97) EP 3344263**  
**A61K 39/00 2006**  
**A61P 35/02 2006**  
(96) EP 17837803.0 8/4/2017  
(97) EP 3344263, 7/11/2018 201828, en  
(31) 201662371199 P (32) 04.08.2016 (33) US  
(54) CANCER ANTIGEN TARGETS AND USES THEREOF  
(72) SADELAIN, Michel, 15 West 84th Street, New York, NY 10024, US  
PERNA, Fabiana, 216 East 77th Street, New York, NY 10075, US

---

(51) MKP  
**A61B 17/00 2006 (97) EP 3345552**  
(96) EP 17844969.0 6/9/2017  
(97) EP 3345552, 7/11/2018 201828, en  
(31) 201610751855 (32) 27.08.2016 (33) CN  
(54) NATURAL CHANNEL-BASED MICROSURGICAL DEVICE  
(71) Tianjin University, No.92 Weijin Road Nankai, Tianjin 300072, CN  
(72) WANG, Shuxin, No. 92 Weijin Road Nankai District, Tianjin 300072, CN  
ZHANG, Guokai, No. 92 Weijin Road Nankai District, Tianjin 300072, CN  
WEI, Junbo, No. 92 Weijin Road Nankai District, Tianjin 300072, CN

---

(51) MKP  
**A01K 67/027 2006 (97) EP 3407709**  
**C07K 16/00 2006**  
**C12N 15/85 2006**  
**C12N 15/90 2006**  
(96) EP 17863293.1 11/3/2017  
(97) EP 3407709, 12/5/2018 201849, en  
(31) 201662417845 P (32) 04.11.2016 (33) US  
201762567932 P 04.10.2017 US  
(54) NON-HUMAN ANIMALS HAVING AN ENGINEERED IMMUNOGLOBULIN LAMBDA LIGHT CHAIN LOCUS  
(71) Regeneron Pharmaceuticals, Inc., 777 Old Saw Mill River Road, Tarrytown, NY 10591-6706, US

(72) GUO, Chunguang, c/o Regeneron Pharmaceuticals Inc. 777 Old Saw Mill Rover Road, Tarrytown, NY 10591, US  
HARRIS, Faith, c/o Regeneron Pharmaceuticals Inc. 777 Old Saw Mill Rover Road, Tarrytown, NY 10591, US  
VORONINA, Vera, c/o Regeneron Pharmaceuticals Inc. 777 Old Saw Mill Rover Road, Tarrytown, NY 10591, US  
MCWHIRTER, John, c/o Regeneron Pharmaceuticals Inc. 777 Old Saw Mill Rover Road, Tarrytown, NY 10591, US  
LEVENKONA, Natasha, c/o Regeneron Pharmaceuticals Inc. 777 Old Saw Mill Rover Road, Tarrytown, NY 10591, US  
MACDONALD, Lynn, c/o Regeneron Pharmaceuticals Inc. 777 Old Saw Mill Rover Road, Tarrytown, NY 10591, US  
TU, Naxin, c/o Regeneron Pharmaceuticals Inc. 777 Old Saw Mill Rover Road, Tarrytown, NY 10591, US  
MURPHY, Andrew, J., c/o Regeneron Pharmaceuticals Inc. 777 Old Saw Mill Rover Road, Tarrytown, NY 10591, US

---

(51) MKP  
**A61K 35/14 2015 (97) EP 3403659**  
**A61K 35/16 2015**  
**A61K 38/48 2006**

(96) EP 18020251.7 3/11/2011

(97) EP 3403659, 11/21/2018 201847, en

(31) 201004072 (32) 11.03.2010 (33) GB

(54) PROCESS, TUBE AND DEVICE FOR THE PREPARATION OF WOUND HEALANT COMPOSITION

(71) Regen Lab SA, En Budron B2, 1052 Le Mont-sur-Lausanne, CH

(72) TURZI Antonie, 5 B rue de L'Englise, 1146 Mollens, CH

---

(51) MKP  
**A61K 31/55 2006 (97) EP 3375780**

**A61K 31/5513 2006**

**A61K 31/553 2006**

**A61K 31/554 2006**

**A61P 17/06 2006**

**A61P 25/28 2006**

**A61P 29/00 2006**

**A61P 37/00 2006**

**C07D 223/08 2006**

**C07D 267/14 2006**

**C07D 281/10 2006**

**C07D 403/12 2006**

**C07D 403/14 2006**

**C07D 409/12 2006**

**C07D 413/12 2006**

**C07D 413/14 2006**

**C07D 417/12 2006**

**C07D 487/04 2006**

**C07D 498/04 2006**

(96) EP 18152185.7 2/14/2014

(97) EP 3375780, 9/19/2018 201838, en

(31) 201361765664 P (32) 15.02.2013 (33) US

201361790044 P 15.03.2013 US

(54) HETEROCYCLIC AMIDES AS KINASE INHIBITORS

(72) BANDYOPADHYAY, Deepak, 1250 South Collegeville Road, Collegeville, PA 19426, US

EIDAM, Patrick M., 1250 South Collegeville Road, Collegeville, PA 19426, US

GOUGH, Peter J., 1250 South Collegeville Road, Collegeville, PA 19426, US

HARRIS, Philip Anthony, 1250 South Collegeville Road, Collegeville, PA 19426, US

JEONG, Jae U., 1250 South Collegeville Road, Collegeville, PA 19426, US

KANG, Jianxing, 1250 South Collegeville Road, Collegeville, PA 19426, US

KING, Bryan Wayne, 1250 South Collegeville Road, Collegeville, PA 19426, US

LAKDAWALA SHAH, Ami, 709 Swedeland Road, King of Prussia, PA 19406, US

MARQUIS, JR., Robert W., 1250 South Collegeville Road, Collegeville, PA 19426, US

LEISTER, Lara Kathryn, 1250 South Collegeville Road, Collegeville, PA 19426, US

RAHMAN, Attiq, 1250 South Collegeville Road, Collegeville, PA 19426, US

RAMANJULU, Joshi M., 1250 South Collegeville Road, Collegeville, PA 19426, US

SEHON, Clark A., 1250 South Collegeville Road, Collegeville, PA 19426, US

SINGHAUS, JR., Robert, 1250 South Collegeville Road, Collegeville, PA 19426, US

ZHANG, Daohua, 1250 South Collegeville Road, Collegeville, PA 19426, US

---

(51) MKP  
**A61K 38/46 2006 (97) EP 3401400**  
**A61K 48/00 2006**

**C07K 19/00 2006**  
**C12N 15/10 2006**  
**C12N 15/11 2006**  
**C12N 15/63 2006**  
**C12N 15/90 2006**

(96) EP 18152360.6 3/15/2013  
(97) EP 3401400, 12/26/2018 201852, en  
(31) 201261652086 P (32) 25.05.2012 (33) US  
201261716256 P 19.10.2012 US  
201361757640 P 28.01.2013 US  
201361765576 P 15.02.2013 US

(54) METHODS AND COMPOSITIONS FOR RNA-DIRECTED TARGET DNA MODIFICATION AND FOR RNA-DIRECTED MODULATION OF TRANSCRIPTION  
(72) CHARPENTIER, Emmanuelle, Department Of Regulation in Infection Biology Max Planck Institute for Infection Biology Charitéplatz 1, 10117 Berlin, DE  
JINEK, Martin, 1846 Spruce Street, Berkeley, CA 94709, US  
DOUDNA CATE, James Harrison, 164 Vicente Road, Berkeley, CA 94705, US  
LIM, Wendell, 149 Collins Street, San Francisco, CA 94118, US  
QI, Lei, 730 Kinkead Way, 302, Albany, CA 94706, US  
CHYLINSKI, Krzysztof, Simmeringer Hauptstrasse 45/8, 1110 Vienna, AT  
DOUDNA, Jennifer A., 164 Vicente Road, Berkeley, CA 94705, US

---

(51) MKP  
**B65D 1/34 2006 (97) EP 3357823**

(96) EP 18152760.7 1/22/2018  
(97) EP 3357823, 8/8/2018 201832, en  
(31) 201700010753 (32) 01.02.2017 (33) IT

(54) AN INNOVATIVE TRAY OF BIODEGRADABLE TYPE FOR CARRYING FINDINGS AND DELICATE OBJECTS  
(72) FALORNI, Federico, Via Mazzini 32, 50012 Bagno a Ripoli, IT  
FRASSINE, Roberto, Via Achille Papa 3/5, 25128 Brescia, IT  
MARCHESI, Maria Chiara, Via Giuseppe Garibaldi 21, 20090 Vimodrone, IT

---

(51) MKP  
**A44C 11/00 2006 (97) EP 3354153**

(96) EP 18153005.6 1/23/2018  
(97) EP 3354153, 10/24/2018 201843, de  
(31) 202017100392 U (32) 25.01.2017 (33) DE

(54) ORNAMENTAL CHAIN  
(71) Friedrich Binder GmbH & Co. KG, Leonberger Straße 34, 71297 Mönshheim, DE  
(72) Binder, Fritz, Wimsheimer Straße 7, 71297 Mönshheim, DE

---

(51) MKP  
**A61K 39/00 2006 (97) EP 3348645**  
**A61K 39/12 2006**  
**C12N 15/63 2006**  
**C12N 15/67 2006**

(96) EP 18153324.1 2/15/2013  
(97) EP 3348645, 7/18/2018 201829, en  
(31) PCT/EP2012/000673 (32) 15.02.2012 (33) WO

(54) NUCLEIC ACID COMPRISING OR CODING FOR A HISTONE STEM-LOOP AND A POLY(A) SEQUENCE OR A POLYADENYLATION SIGNAL FOR INCREASING THE EXPRESSION OF AN ENCODED PATHOGENIC ANTIGEN  
(72) Theß, Andreas, Hindenburgstr. 9, 72127 Kusterdingen, DE  
Schlake, Thomas, Gartenweg 1, 79194 Gundelfingen, DE  
Probst, Jochen, In den Kirchhofländern 19, 72649 Wolfschlügen, DE

---

(51) MKP  
**C07C 51/347 2006 (97) EP 3398931**  
**C07C 205/57 2006**  
**C07D 301/32 2006**  
**C07F 7/18 2006**

(96) EP 18154039.4 12/6/2013  
(97) EP 3398931, 11/7/2018 201845, en

(31) 201261734672 P (32) 07.12.2012 (33) US  
201361777882 P 12.03.2013 US  
(54) METHODS OF SYNTHESIZING A PROSTACYCLIN ANALOG  
(72) HERING, Kirk William, 1298 Hendrie, Canton, MI Michigan 48187, US  
CHAMBOURNIER, Gilles, 4055 Brookview Court, Ann Arbor, MI Michigan 48108, US  
ENDRES, Gregory William, 386 Dr. Huntington, Saline, MI Michigan 48176, US  
FEDIJ, Victor, 5702 Huntington Drive, Ypsilanti, MI Michigan 48197, US  
KRELL, Thomas James, II, 3500 Dr. Beech, Ypsilanti, MI Michigan 48197, US  
MAHMOUD, Hussein Mahmoud, 4429 Blossom Hill Trail, Ann Arbor, MI Michigan 48108, US

---

(51) MKP  
**A61K 39/00 2006 (97) EP 3338794**  
(96) EP 18154090.7 7/12/2013  
(97) EP 3338794, 8/15/2018 201833, en  
(31) 201261671482 P (32) 13.07.2012 (33) US  
201361782982 P 14.03.2013 US  
(54) TOXICITY MANAGEMENT FOR ANTI-TUMOR ACTIVITY OF CARS  
(72) JUNE, Carl, H., 409 Baird Road, Merion Station, PA 19066, US  
LEVINE, Bruce, L., 1258 Liberty Bell Drive, Cherry Hill, NJ 08003, US  
KALOS, Michael D., 716 Carpenter Lane, Philadelphia, PA 19119, US  
GRUPP, Stephan, 107 Llandaff Road, Havertown, PA 19083, US

---

(51) MKP  
**A61K 39/395 2006 (97) EP 3345923**  
**A61P 29/00 2006**  
**C07K 16/24 2006**  
(96) EP 18155371.0 9/19/2013  
(97) EP 3345923, 7/11/2018 201828, en  
(31) 12185235 (32) 20.09.2012 (33) EP  
201261703871 P 21.09.2012 US  
(54) TREATMENT FOR RHEUMATOID ARTHRITIS WITH ANTI-GM-CSF ANTIBODY  
(71) MorphoSys AG, Semmelweisstrasse 7, 82152 Planegg, DE  
(72) HAERTLE, Stefan, Biberfeldstrasse 3, 82291 Mammendorf, DE  
LECLAIR, Stephane, Schulstrasse 12 1/2, 82131 Gauting, DE  
SHEBL, Amgad, Kaiser-Ludwig-Platz 6, 80336 München, DE  
STEIDL, Stefan, Ebenböckstrasse 25, 81241 München, DE

---

(51) MKP  
**A61K 31/415 2006 (97) EP 3348545**  
**A61P 3/00 2006**  
**A61P 3/04 2006**  
**A61P 3/10 2006**  
**A61P 9/04 2006**  
**A61P 9/10 2006**  
**A61P 11/00 2006**  
**A61P 13/12 2006**  
**A61P 25/00 2006**  
**A61P 27/02 2006**  
**A61P 27/12 2006**  
**A61P 43/00 2006**  
**C07D 231/12 2006**  
(96) EP 18156002.0 3/14/2014  
(97) EP 3348545, 7/18/2018 201829, en  
(31) 201361791164 P (32) 15.03.2013 (33) US  
2013053195 15.03.2013 JP  
2013127318 18.06.2013 JP  
(54) PYRAZOLE-AMIDE COMPOUND AND MEDICINAL USES THEREFOR  
(72) MOTOMURA, Takahisa, c/o Central Pharmaceutical Research Institute, Japan Tobacco Inc. 1-1 Murasaki-cho Takatsuki-shi, Osaka 596-1125, JP  
SHOMI, Gakujun, c/o Central Pharmaceutical Research Institute, Japan Tobacco Inc. 1-1 Murasaki-cho Takatsuki-shi, Osaka 596-1125, JP

---

(51) MKP

**A61K 38/17 2006 (97) EP 3363456**  
**A61K 39/00 2006**  
**A61P 35/00 2006**  
**C07K 7/06 2006**  
**C07K 7/08 2006**  
**G01N 33/50 2006**  
(96) EP 18156634.0 3/15/2011  
(97) EP 3363456, 8/22/2018 201834, en  
(31) 315704 P (32) 19.03.2010 (33) US  
201004551 19.03.2010 GB  
(54) NOVEL IMMUNOTHERAPY AGAINST SEVERAL TUMORS INCLUDING GASTROINTESTINAL AND GASTRIC CANCER  
(71) immatics Biotechnologies GmbH, Paul-Ehrlich-Straße 15, 72076 Tübingen, DE  
(72) Weinschenk, Toni, Im Morgenrain 15, 73773 Aichwald, DE  
Fritsche, Jens, Lärchenweg 11, 72144 Dusslingen, DE  
Walter, Steffen, 2901 Wroxtton Road, Houston, TX Texas 77005, US  
Lewandrowski, Peter, Grabenstrasse 11, 72070 Tübingen-Hirschau, DE  
Singh, Harpreet, 5122 Morningside Dr, Apt. 525, Houston, TX Texas 77005, US

---

(51) MKP  
**E05B 3/06 2006 (97) EP 3363969**  
(96) EP 18156957.5 2/15/2018  
(97) EP 3363969, 8/22/2018 201834, de  
(31) 102017103102 (32) 15.02.2017 (33) DE  
(54) ACTUATION HANDLE  
(71) HOPPE AG, Industriezone 1/5 - Eurocenter, 39011 Lana (BZ), IT  
(72) Schuberth, Oliver, Schulweg 15, 39023 Laas, IT  
Karnutsch, Elias, Karl-Blaas-Gasse 464, 6543 Nauders, AT  
Nestler, André, Parksiedlung 32, 09481 Scheibenberg, DE

---

(51) MKP  
**A61P 11/00 2006 (97) EP 3360897**  
**A61P 19/02 2006**  
**A61P 29/00 2006**  
**C07K 16/24 2006**  
(96) EP 18157106.8 10/19/2012  
(97) EP 3360897, 8/15/2018 201833, en  
(31) 11185763 (32) 19.10.2011 (33) EP  
201161548744 P 19.10.2011 US  
(54) ANTAGONISTS OF IL17C FOR THE TREATMENT OF INFLAMMATORY DISORDERS  
(72) BÜLTMANN, Andreas, Josef-von-Hirsch-Str. 46, 82152 Planegg, DE  
MÜHLBACHER, Robert, Buchbergerstr. 1a, 82538 Geretsried/Gelting, DE  
GARCIA, Teresa, Galapagos SASU 102 Avenue Gaston Roussel, 93230 Romainville, FR  
BRYNS, Reginald, Galapagos SASU 102 Avenue Gaston Roussel, 93230 Romainville, FR  
NELLES, LUC, Galapagos NV Industriepark Mechelen Noord, Generaal De Wittelaan L11 A3, 2800 Mechelen, BE  
CONRATH, Katja, Galapagos NV Industriepark Mechelen Noord, Generaal De Wittelaan L11 A3, 2800 Mechelen, BE

---

(51) MKP  
**G01N 27/02 2006 (97) EP 3346272**  
**G01N 33/50 2006**  
**G01N 33/574 2006**  
(96) EP 18157442.7 6/12/2013  
(97) EP 3346272, 10/24/2018 201843, en  
(31) 201213494618 (32) 12.06.2012 (33) US  
(54) WHOLE CELL ASSAYS AND METHODS  
(72) LAING, Lance, Gavin, 12 Leslie Road, Belmont, MA Massachusetts 02478, US  
SULLIVAN, Brian, Francis, 2400 Bantle Farm Road, Belmont, MN Minnesota 55340, US

---

(51) MKP  
**B60P 1/26 2006 (97) EP 3392083**  
**B62D 33/037 2006**  
(96) EP 18158126.5 2/22/2018  
(97) EP 3392083, 10/24/2018 201843, en

(31) 202017042892 U (32) 19.04.2017 (33) IT  
(54) AN INNOVATIVE, PREFERABLY REAR PILLAR OF DISMOUNTABLE TYPE FOR LORRIES  
(71) Officine Cucini S.r.l., Via delle Città 15, 50052 Certaldo, IT  
(72) CUCINI, Fabio, Via delle Città 13, 50052 Certaldo, IT

---

(51) MKP  
**A61K 31/495 2006 (97) EP 3418281**  
**A61P 35/00 2006**  
**C07D 487/04 2006**

(96) EP 18159811.1 12/6/2013

(97) EP 3418281, 12/26/2018 201852, en

(31) 201261734726 P (32) 07.12.2012 (33) US  
201361787568 P 15.03.2013 US  
201361868132 P 21.08.2013 US

(54) COMPOUNDS USEFUL AS INHIBITORS OF ATR KINASE FOR THE TREATMENT OF CANCER DISEASES

(72) AHMAD, Nadia, 86-88 Jubilee Avenue Milton Park, Abingdon Oxfordshire OX14 4RW, GB  
BOYALL, Dean, 86-88 Jubilee Avenue Milton Park, Abingdon Oxfordshire OX14 4RW, GB  
CHARRIER, Jean-Damien, 86-88 Jubilee Avenue Milton Park, Abingdon Oxfordshire OX14 4RW, GB  
DAVIS, Chris, 86-88 Jubilee Avenue Milton Park, Abingdon Oxfordshire OX14 4RW, GB  
DAVIS, Rebecca, 86-88 Jubilee Avenue Milton Park, Abingdon Oxfordshire OX14 4RW, GB  
DURRANT, Steven, 86-88 Jubilee Avenue Milton Park, Abingdon Oxfordshire OX14 4RW, GB  
ETXEBARRIA I JARDI, Gorka, 86-88 Jubilee Avenue Milton Park, Abingdon Oxfordshire OX14 4RW, GB  
FRAYSSE, Damine, 86-88 Jubilee Avenue Milton Park, Abingdon Oxfordshire OX14 4RW, GB  
JIMENEZ, Juan-Miguel, 86-88 Jubilee Avenue Milton Park, Abingdon Oxfordshire OX14 4RW, GB  
KAY, David, 86-88 Jubilee Avenue Milton Park, Abingdon Oxfordshire OX14 4RW, GB  
KNEGTEL, Ronald, 86-88 Jubilee Avenue Milton Park, Abingdon Oxfordshire OX14 4RW, GB  
MIDDLETON, Donald, 86-88 Jubilee Avenue Milton Park, Abingdon Oxfordshire OX14 4RW, GB  
ODONNELL, Michael, 86-88 Jubilee Avenue Milton Park, Abingdon Oxfordshire OX14 4RW, GB  
PANESAR, Maninder, 86-88 Jubilee Avenue Milton Park, Abingdon Oxfordshire OX14 4RW, GB  
PIERARD, Francoise, 86-88 Jubilee Avenue Milton Park, Abingdon Oxfordshire OX14 4RW, GB  
PINDER, Joanne, 86-88 Jubilee Avenue Milton Park, Abingdon Oxfordshire OX14 4RW, GB  
SHAW, David, 86-88 Jubilee Avenue Milton Park, Abingdon Oxfordshire OX14 4RW, GB  
STORCK, Pierre-Henri, 86-88 Jubilee Avenue Milton Park, Abingdon Oxfordshire OX14 4RW, GB  
STUDLEY, John, 86-88 Jubilee Avenue Milton Park, Abingdon Oxfordshire OX14 4RW, GB  
TWIN, Heather, 86-88 Jubilee Avenue Milton Park, Abingdon Oxfordshire OX14 4RW, GB

---

(51) MKP  
**C01D 15/08 2006 (97) EP 3363930**  
**C22B 3/04 2006**  
**C22B 26/12 2006**  
**C25B 1/16 2006**

(96) EP 18160013.1 5/30/2013

(97) EP 3363930, 8/22/2018 201834, en

(31) 201261653035 P (32) 30.05.2012 (33) US  
201361767328 P 21.02.2013 US

(54) PROCESSES FOR PREPARING LITHIUM CARBONATE

(72) BOURASSA, Guy, 281 rue Sabourin, Québec, Québec G1C 7G2, CA  
PEARSE, Gary, 101-174 Stanley Avenue, Ottawa, Ontario Ottawa, CA  
MACKIE, Stephen Charles, 1463 Champlain Drive, Peterborough, Ontario K9L 1N3, CA  
GLADKOVAS, Mykolas, 2291 Lawrence Avenue W., Toronto, Ontario M9P 2A7, CA

---

(51) MKP  
**A61K 31/44 2006 (97) EP 3357921**  
**A61K 31/505 2006**  
**A61K 31/506 2006**  
**A61P 25/02 2006**  
**A61P 35/00 2006**  
**A61P 37/00 2006**  
**C07D 239/30 2006**  
**C07D 401/14 2006**  
**C07D 403/12 2006**  
**C07D 409/14 2006**  
**C07D 413/14 2006**  
**C07D 417/12 2006**

**C07D 417/14 2006**  
**C07D 495/04 2006**  
**C07D 513/04 2006**  
**C07F 5/02 2006**  
(96) EP 18160575.9 12/11/2014  
(97) EP 3357921, 8/8/2018 201832, en  
(31) 201361914886 P (32) 11.12.2013 (33) US  
(54) BIARYL COMPOUNDS USEFUL FOR THE TREATMENT OF HUMAN DISEASES IN ONCOLOGY, NEUROLOGY AND IMMUNOLOGY  
(72) HOPKINS, Brian T., c/o Biogen Idec Inc. 14 Cambridge Center, Cambridge, Massachusetts 02142, US  
MA, Bin, c/o Biogen Idec Inc. 14 Cambridge Center, Cambridge, Massachusetts 02142, US  
CHAN, Timothy, Raymond, c/o Biogen Idec Inc. 14 Cambridge Center, Cambridge, Massachusetts 02142, US  
SUN, Lihong, c/o Biogen Idec Inc. 14 Cambridge Center, Cambridge, Massachusetts 02142, US  
ZHANG, Lei, c/o Biogen Idec Inc. 14 Cambridge Center, Cambridge, Massachusetts 02142, US  
KUMARAVEL, Gnanasambandam, c/o Biogen Idec Inc. 14 Cambridge Center, Cambridge, Massachusetts 02142, US  
LYSSIKATOS, Joseph, P., c/o Biogen Idec Inc. 14 Cambridge Center, Cambridge, Massachusetts 02142, US  
KOCH, Kevin, c/o Biogen Idec Inc. 14 Cambridge Center, Cambridge, Massachusetts 02142, US  
MIAO, Hua, c/o Biogen Idec Inc. 14 Cambridge Center, Cambridge, Massachusetts 02142, US

---

(51) MKP  
**A61K 31/44 2006 (97) EP 3357921**  
**A61K 31/505 2006**  
**A61K 31/506 2006**  
**A61P 25/02 2006**  
**A61P 35/00 2006**  
**A61P 37/00 2006**  
**C07D 239/30 2006**  
**C07D 401/14 2006**  
**C07D 403/12 2006**  
**C07D 409/14 2006**  
**C07D 413/14 2006**  
**C07D 417/12 2006**  
**C07D 417/14 2006**  
**C07D 495/04 2006**  
**C07D 513/04 2006**  
**C07F 5/02 2006**  
(96) EP 18160575.9 12/11/2014  
(97) EP 3357921, 9/12/2018 201837, en  
(31) 201361914886 P (32) 11.12.2013 (33) US  
(54) BIARYL COMPOUNDS USEFUL FOR THE TREATMENT OF HUMAN DISEASES IN ONCOLOGY, NEUROLOGY AND IMMUNOLOGY  
(72) HOPKINS, Brian T., c/o Biogen Idec Inc. 14 Cambridge Center, Cambridge, Massachusetts 02142, US  
MA, Bin, c/o Biogen Idec Inc. 14 Cambridge Center, Cambridge, Massachusetts 02142, US  
CHAN, Timothy, Raymond, c/o Biogen Idec Inc. 14 Cambridge Center, Cambridge, Massachusetts 02142, US  
SUN, Lihong, c/o Biogen Idec Inc. 14 Cambridge Center, Cambridge, Massachusetts 02142, US  
ZHANG, Lei, c/o Biogen Idec Inc. 14 Cambridge Center, Cambridge, Massachusetts 02142, US  
KUMARAVEL, Gnanasambandam, c/o Biogen Idec Inc. 14 Cambridge Center, Cambridge, Massachusetts 02142, US  
LYSSIKATOS, Joseph, P., c/o Biogen Idec Inc. 14 Cambridge Center, Cambridge, Massachusetts 02142, US  
KOCH, Kevin, c/o Biogen Idec Inc. 14 Cambridge Center, Cambridge, Massachusetts 02142, US  
MIAO, Hua, c/o Biogen Idec Inc. 14 Cambridge Center, Cambridge, Massachusetts 02142, US

---

(51) MKP  
**G06F 3/01 2006 (97) EP 3352055**  
**G06F 3/16 2006**  
**G08B 6/00 2006**  
**G10L 15/26 2006**  
**G10L 21/16 2013**  
**G10L 25/03 2013**  
(96) EP 18161106.2 10/27/2010  
(97) EP 3352055, 7/25/2018 201830, en  
(31) 608707 (32) 29.10.2009 (33) US  
(54) SYSTEMS AND METHODS FOR HAPTIC AUGMENTATION OF VOICE-TO-TEXT CONVERSION  
(71) Immersion Corporation, 50 Rio Robles, San Jose, CA 95134, US  
(72) HEUBEL, Robert W, 652 Begier Avenue, San Leandro, CA California 94577, US  
RAMSAY, Erin, 106 Beechwood Street, Dollard-des-Ormeaux, Québec H9A 1K5, CA

---

(51) MKP  
**A61K 39/395 2006 (97) EP 3354280**  
**A61M 5/315 2006**  
**C07K 16/28 2006**  
(96) EP 18161288.8 10/5/2011  
(97) EP 3354280, 8/1/2018 201831, en  
(31) 390283 P (32) 06.10.2010 (33) US  
(54) STABILIZED FORMULATIONS CONTAINING ANTI-INTERLEUKIN-4 RECEPTOR (IL-4R) ANTIBODIES  
(72) DIX, Daniel B., 55 Memory Trail, Lagrangeville, New York 12540, US  
TANG, Xiaolin, 5 Eckerson Court, Old Tappan, New Jersey 07675, US

---

(51) MKP  
**A61K 31/4985 2006 (97) EP 3351249**  
**A61K 31/505 2006**  
**A61K 31/513 2006**  
**A61K 31/52 2006**  
**A61K 31/536 2006**  
**A61K 31/5365 2006**  
**A61P 31/18 2006**  
(96) EP 18161536.0 1/24/2011  
(97) EP 3351249, 7/25/2018 201830, en  
(31) 29858910 P (32) 27.01.2010 (33) US  
(54) ANTIVIRAL THERAPY  
(71) VIIV Healthcare Company, 251 Little Falls Drive, Wilmington, DE 19808, US  
(72) UNDERWOOD, Mark Richard, c/o GlaxoSmithKline, Global Patents Dept Five Moore Drive, Research Triangle Park, NC North Carolina 27709, US

---

(51) MKP  
**G09B 9/00 2006 (97) EP 3382674**  
(96) EP 18161550.1 3/13/2018  
(97) EP 3382674, 10/3/2018 201840, en  
(31) 201700035950 (32) 31.03.2017 (33) IT  
(54) SIMULATOR FOR TRAINING IN ENVIRONMENTS CONFINED AND / OR SUSPECTED OF POLLUTION  
(71) Istituto Nazionale per l'Assicurazione contro gli Infortuni sul lavoro - INAIL, Piazzale Giulio Pastore, 6, 00144 Roma, IT  
(72) Di Donato, Luciano, Via Rocca di Papa, 12/E, 00041 Cecchina (RM), IT

---

(51) MKP  
**A61K 31/138 2006 (97) EP 3351527**  
**A61P 3/06 2006**  
**C07C 217/18 2006**  
(96) EP 18161551.9 8/3/2012  
(97) EP 3351527, 7/25/2018 201830, en  
(31) 201161515278 P (32) 04.08.2011 (33) US  
(54) TRANS-CLOMIPHENE METABOLITES AND USES THEREOF  
(72) Podolski, Joseph S., 3 Pebble Hollow Court, The Woodlands, TX Texas 77381, US  
Wiehle, Ronald D., 13903 Viewfield Court, Houston, TX Texas 77059, US

---

(51) MKP  
**A61K 31/506 2006 (97) EP 3357919**  
**A61P 11/00 2006**  
**A61P 29/00 2006**  
**A61P 31/00 2006**  
**C07D 401/14 2006**  
**C07D 409/14 2006**  
(96) EP 18161869.5 2/13/2015  
(97) EP 3357919, 8/8/2018 201832, en  
(31) 201461940282 P (32) 14.02.2014 (33) US  
201461941064 P 18.02.2014 US  
(54) AROMATIC HETEROCYCLIC COMPOUNDS AS ANTIINFLAMMATORY COMPOUNDS  
(72) LONGSHAW, Alistair Ian, c/o Sygnature Discovery Ltd Biocity Nottingham Pennyfoot Street, Nottingham, Nottinghamshire NG1 1GF, GB  
FORDYCE, Euan Alexander Fraser, c/o Sygnature Discovery Ltd Biocity Nottingham Pennyfoot Street, Nottingham, NG1 1GF, GB  
ONIONS, Stuart Thomas, c/o Sygnature Discovery Ltd Biocity Nottingham Pennyfoot Street, Nottingham, NG1 1GF, GB



- (51) MKP  
**A61K 31/7084 2006 (97) EP 3366691**  
**A61K 39/00 2006**  
**A61K 39/39 2006**  
**A61P 31/12 2006**  
**A61P 35/00 2006**  
**C07F 9/6574 2006**  
**C07H 21/00 2006**  
**C07H 21/02 2006**  
**C07H 21/04 2006**
- (96) EP 18161946.1 12/1/2016  
(97) EP 3366691, 8/29/2018 201835, en
- (31) 201562262668 P (32) 03.12.2015 (33) US  
201662299253 P 24.02.2016 US  
201662299704 P 25.02.2016 US  
201662327579 P 26.04.2016 US  
201662332517 P 06.05.2016 US
- (54) CYCLIC PURINE DINUCLEOTIDES AS MODULATORS OF STING  
(72) ADAMS, Jerry Leroy, 1250 South Collegeville Road, Collegeville, PA Pennsylvania 19426, US  
DUFFY, Kevin J., 1250 South Collegeville Road, Collegeville, PA Pennsylvania 19426, US  
LIAN, Yiqian, 1250 South Collegeville Road, Collegeville, PA Pennsylvania 19426, US
- 

- (51) MKP  
**C07K 16/28 2006 (97) EP 3406633**
- (96) EP 18163581.4 7/25/2014  
(97) EP 3406633, 11/28/2018 201848, en
- (31) 201361858402 P (32) 25.07.2013 (33) US
- (54) MULTISPECIFIC ANTIBODIES, MULTISPECIFIC ACTIVATABLE ANTIBODIES AND METHODS OF USING THE SAME  
(72) IRVING, Bryan Allen, 108 Ware Road, Woodside, CA 94062, US  
HOSTETTER, Daniel Robert, 1554 Rochester Way, Rocklin, CA 95765, US  
WONG, Chihunt, 483 Anita Dr, Millbrae, CA 94030, US  
LOWMAN, Henry Bernard, P.O. Box 2556, El Granada, CA 94018-2556, US  
WEST, James William, 2886 NW Melville Drive, Bend, OR 97703, US  
LA PORTE, Sherry Lynn, P.O. Box 31894, San Francisco, CA 94131, US
- 

- (51) MKP  
**C07K 16/24 2006 (97) EP 3369744**
- (96) EP 18163940.2 11/21/2011  
(97) EP 3369744, 9/5/2018 201836, en
- (31) 416495 P (32) 23.11.2010 (33) US
- (54) ANTIGEN BINDING PROTEINS TO ONCOSTATIN M (OSM)  
(72) BEMBRIDGE, Gary Peter, GlaxoSmithKline Gunnels Wood Road, Stevenage, Hertfordshire SG1 2NY, GB  
CHUNG, Chun-wa, GlaxoSmithKline Gunnels Wood Road, Stevenage, Hertfordshire SG1 2NY, GB  
FEENEY, Maria, GlaxoSmithKline Gunnels Wood Road, Stevenage, Hertfordshire SG1 2NY, GB  
FORD, Susannah Karen, GlaxoSmithKline Gunnels Wood Road, Stevenage, Hertfordshire SG1 2NY, GB  
KIRBY, Ian, GlaxoSmithKline Gunnels Wood Road, Stevenage, Hertfordshire SG1 2NY, GB  
MCADAM, Ruth, GlaxoSmithKline Gunnels Wood Road, Stevenage, Hertfordshire SG1 2NY, GB
- 

- (51) MKP  
**A61K 39/00 2006 (97) EP 3415531**  
**A61K 47/68 2017**  
**C07K 16/28 2006**
- (96) EP 18163942.8 5/24/2012  
(97) EP 3415531, 12/19/2018 201851, en
- (31) 201161490732 P (32) 27.05.2011 (33) US  
201261647196 P 15.05.2012 US
- (54) BCMA (CD269/TNFRSF17) - BINDING PROTEINS  
(72) ALGATE, Paul, 580 Kalmia Place NW, Issaquah, WA, US  
CLEGG, Stephanie Jane, GlaxoSmithKline Gunnels Wood Road, Stevenage, Hertfordshire SG1 2NY, GB

CRAIGEN, Jennifer L., GlaxoSmithKline Gunnels Wood Road, Stevenage, Hertfordshire SG1 2NY, GB  
HAMBLIN, Paul Andrew, GlaxoSmithKline Gunnels Wood Road, Stevenage, Hertfordshire SG1 2NY, GB  
LEWIS, Alan Peter, GlaxoSmithKline Gunnels Wood Road, Stevenage, Hertfordshire SG1 2NY, GB  
PARMAR, Radha Shah, GlaxoSmithKline Gunnels Wood Road, Stevenage, Hertfordshire SG1 2NY, GB  
MAYES, Patrick, GlaxoSmithKline 1250 S Collegeville Road, Collegeville, PA 19426-0989, US  
WATTAM, Trevor Anthony Kenneth, GlaxoSmithKline Gunnels Wood Road, Stevenage, Hertfordshire SG1 2NY, GB

---

- (51) MKP  
**A61P 25/00 2006 (97) EP 3404027**  
**A61P 35/00 2006**  
**C07D 249/08 2006**  
**C07D 403/12 2006**  
**C07D 413/12 2006**
- (96) EP 18164757.9 5/9/2013  
(97) EP 3404027, 11/21/2018 201847, en
- (31) 201261644802 P (32) 09.05.2012 (33) US  
201361798188 P 15.03.2013 US
- (54) NUCLEAR TRANSPORT MODULATORS AND USES THEREOF  
(72) SANDANAYAKA, Vincent, P., 10 Laurel Avenue, Northboro, MA 01532, US  
SHECHTER, Sharon, 18 Ivy Lane, Andover, MA 01810, US  
SHACHAM, Sharon, 15 Bontempo Road, Newton, MA 02459, US  
MCCAULEY, Dilara, 85 Gore Street, Cambridge, MA 02141, US  
BALOGLU, Erkan, 8 Benjamin Terrace, Stoneham, MA 02180, US
- 

- (51) MKP  
**A61K 35/74 2015 (97) EP 3360559**  
**A61K 35/745 2015**  
**A61P 11/06 2006**  
**A61P 35/00 2006**
- (96) EP 18165143.1 6/15/2016  
(97) EP 3360559, 8/15/2018 201833, en
- (31) 201510467 (32) 15.06.2015 (33) GB  
201520501 20.11.2015 GB
- (54) COMPOSITIONS COMPRISING BACTERIAL STRAINS  
(72) GRANT, George, Life Sciences Innovation Building Cornhill Road, Aberdeen, Aberdeenshire AB25 2ZS, GB  
PATTERSON, Angela Margaret, Norwich Medical School Faculty of Medicine and Health Sciences University of East Anglia, Norwich, Norfolk NR4 7JT, GB  
MULDER, Imke, Life Sciences Innovation Building Cornhill Road, Aberdeen, Aberdeenshire AB25 2ZS, GB  
MCCLUSKEY, Seanin, c/o 4D PHARMA PLC 3rd Floor 9 Bond Court, Leeds, Yorkshire LS1 2JZ, GB  
RAFTIS, Emma, c/o 4D PHARMA PLC 3rd Floor 9 Bond Court, Leeds, Yorkshire LS1 2JZ, GB
- 

- (51) MKP  
**B22D 11/06 2006 (97) EP 3385012**  
**B22D 11/128 2006**
- (96) EP 18165451.8 4/3/2018  
(97) EP 3385012, 10/10/2018 201841, en
- (31) 201700036965 (32) 04.04.2017 (33) IT
- (54) JACKET FOR A ROLLER USED IN CONTINUOUS CASTING, PARTICULARLY FOR THE PRODUCTION OF ALUMINUM OR ALUMINUM ALLOY STRIPS AND OF ZINC-BASED ALLOY STRIPS  
(71) Bruno Presezzi S.p.A., Via Per Rossino Ornago 8, 20875 Burago di Molgora, IT  
(72) PRESEZZI, ALBERTO, BRUNO PRESEZZI S.P.A. VIA PER ROSSINO ORNAGO 8, 20875 BURAGO DI MOLGORA (MONZA BRIANZA), IT  
SARDARA, GIOVANNI, VIA PASCOLI 20, 20863 CONCOREZZO (MONZA BRIANZA), IT  
VERONESE, RAFFAELE, VIA PIONNIO 37, 27022 CASORATE PRIMO (PAVIA), IT
- 

- (51) MKP  
**A61K 31/712 2006 (97) EP 3412774**  
**A61K 31/713 2006**  
**A61P 1/16 2006**  
**A61P 11/00 2006**  
**A61P 35/00 2006**  
**C12N 15/113 2010**
- (96) EP 18165484.9 5/22/2014  
(97) EP 3412774, 12/12/2018 201850, en

(31)	201361826125 P 201361898695 P 201461979727 P 201461989028 P	(32)	22.05.2013 01.11.2013 15.04.2014 06.05.2014	(33)	US US US US
------	--	------	--	------	----------------------

(54) SERPINA1 IRNA COMPOSITIONS AND METHODS OF USE THEREOF  
(72) SEHGAL, Alfica, c/o Alnylam Pharmaceuticals, Inc. 300 Third Street, 3rd Floor, Cambridge, MA 02142, US  
CHARISSE, Klaus, c/o Alnylam Pharmaceuticals, Inc. 300 Third Street, 3rd Floor, Cambridge, MA 02142, US  
BETTENCOURT, Brian, c/o Alnylam Pharmaceuticals, Inc. 300 Third Street, 3rd Floor, Cambridge, MA 02142, US  
MAIER, Martin, c/o Alnylam Pharmaceuticals, Inc. 300 Third Street, 3rd Floor, Cambridge, MA 02142, US  
RAJEEV, Kallanthottathil G., c/o Alnylam Pharmaceuticals, Inc. 300 Third Street, 3rd Floor, Cambridge, MA 02142, US  
HINKLE, Gregory, c/o Alnylam Pharmaceuticals, Inc. 300 Third Street, 3rd Floor, Cambridge, MA 02142, US  
MANOHARAN, Muthiah, c/o Alnylam Pharmaceuticals, Inc. 300 Third Street, 3rd Floor, Cambridge, MA 02142, US

---

(51) MKP  
**A61K 31/221 2006 (97) EP 3366668**  
**C07C 219/08 2006**  
**C07C 229/12 2006**  
**C07C 229/16 2006**  
**C07C 309/18 2006**

(96) EP 18166993.8 3/14/2014  
(97) EP 3366668, 12/5/2018 201849, en

(31)	201361782445 P 201461934365 P	(32)	14.03.2013 31.01.2014	(33)	US US
------	----------------------------------	------	--------------------------	------	----------

(54) PRODRUGS OF FUMARATES AND THEIR USE IN TREATING VARIOUS DISEASES  
(72) ZEIDAN, Tarek, A., 296 Lexington Street, Watertown, MA Massachusetts 02472, US  
DUNCAN, Scott, 4 Wayte Road, Bedford, MA Massachusetts 01730, US  
HENCKEN, Christopher, P., 36 Dwinell Street, Boston, MA Massachusetts 02132, US  
WYNN, Thomas, Andrew, 94 North Street, Lexington,, MA Massachusetts 02420, US  
SANRAME, Carlos, N., 9 Rumford Road, Lexington,, MA Massachusetts 02420, US

---

(51) MKP  
**C07K 16/28 2006 (97) EP 3409689**  
**C07K 16/30 2006**  
**G01N 33/68 2006**

(96) EP 18167594.3 9/13/2012  
(97) EP 3409689, 12/5/2018 201849, en

(31)	201116092	(32)	16.09.2011	(33)	GB
------	-----------	------	------------	------	----

(54) ANTI-CD134 (OX40) ANTIBODIES AND USES THEREOF  
(72) Simons, Petrus Johannes, Leidsestraat 43, 2182 DH Hillegom, NL  
Boon, Louis, Orchideelaan 137, 1171 MG Badhoevedorp, NL

---

(51) MKP  
**C07D 471/04 2006 (97) EP 3395818**

(96) EP 18167649.5 8/3/2015  
(97) EP 3395818, 10/31/2018 201844, en

(31)	14179692 15159342	(32)	04.08.2014 17.03.2015	(33)	EP EP
------	----------------------	------	--------------------------	------	----------

(54) 2-(MORPHOLIN-4-YL)-1,7-NAPHTHYRIDINES  
(72) WORTMANN, Lars, Kastanienallee 103, 10435 Berlin, DE  
LÜCKING, Ulrich, Paula-Fürst-Str. 2, 10317 Berlin, DE  
LEFRANC, Julien, Wallstraße 26, 10179 Berlin, DE  
BRIEM, Hans, Emser Str. 3, 10719 Berlin, DE  
KOPPITZ, Marcus, Eisenbruchstr. 34A, 13467 Berlin, DE  
EIS, Knut, Fichtenweg 1, 13587 Berlin, DE  
VON NUSSBAUM, Franz, Kreuzritterstr. 3, 13465 Berlin, DE  
BADER, Benjamin, Hillmannstr. 14, 13467 Berlin, DE  
WENGENER, Antje-Margret, Borkumstr. 12 e, 13189 Berlin, DE  
SIEMEISTER, Gerhard, Reimerswalder Steig 26, 13503 Berlin, DE  
BONE, Wilhelm, Drewitzer Str. 46, 13467 Berlin, DE  
LIENAU, Philip, Jahnstr. 13, 10967 Berlin, DE  
GRUDZINSKA-GOEBEL, Joanna, An den Eldenaer Höfen 37, 10247 Berlin, DE  
MOOSMAYER, Dieter, Wöhlerstr. 11, 10115 Berlin, DE

- (51) MKP  
**A61K 9/127 2006 (97) EP 3403647**  
**A61K 31/7105 2006**  
**A61K 48/00 2006**  
**C07H 21/02 2006**
- (96) EP 18167995.2 11/30/2010  
(97) EP 3403647, 11/21/2018 201847, en
- (31) 26565309 P (32) 01.12.2009 (33) US
- (54) DELIVERY OF MRNA FOR THE AUGMENTATION OF PROTEINS AND ENZYMES IN HUMAN GENETIC DISEASES  
(72) GUILD, Braydon Charles, 109 Riverdale Road, Concord, MA Massachusetts 01742, US  
DEROSA, Frank, 26 Mount Auburn Street, Chelmsford, MA Massachusetts 01824, US  
HEARTLEIN, Michael, 167 Reed Farm Road, Boxborough, MA Massachusetts 01719, US  
CONCINO, Michael, 297 Long Hill Road, Bolton, MA Massachusetts 01740, US
- 

- (51) MKP  
**A61K 39/00 2006 (97) EP 3404103**  
**A61K 39/35 2006**  
**C12N 15/117 2010**  
**C12N 15/68 2006**
- (96) EP 18168859.9 2/15/2013  
(97) EP 3404103, 11/21/2018 201847, en
- (31) PCT/EP2012/000672 (32) 15.02.2012 (33) WO
- (54) NUCLEIC ACID COMPRISING OR CODING FOR A HISTONE STEM-LOOP AND A POLY(A) SEQUENCE OR A POLYADENYLATION SIGNAL FOR INCREASING THE EXPRESSION OF AN ENCODED ALLERGENIC ANTIGEN OR AN AUTOIMMUNE SELF-ANTIGEN  
(72) THEß, Andreas, Hindenburgstr. 9, 72127 Kusterdingen, DE  
SCHLAKE, Thomas, Gartenweg 1, 79194 Gundelfingen, DE  
PROBST, Jochen, In den Kirchhofländern 19, 72649 Wolfschlugen, DE
- 

- (51) MKP  
**A61B 5/06 2006 (97) EP 3396810**  
**A61B 34/20 2016**  
**H01F 38/14 2006**  
**H02J 7/00 2006**  
**H02J 50/10 2016**  
**H02J 50/40 2016**
- (96) EP 18169288.0 4/25/2018  
(97) EP 3396810, 10/31/2018 201844, en
- (31) 201715498038 (32) 26.04.2017 (33) US
- (54) USING LOCATION TRANSMISSION SIGNALS FOR CHARGING A WIRELESS TOOL OF AN ELECTROMAGNETIC NAVIGATION SYSTEM  
(71) Biosense Webster (Israel) Ltd., 4 Hatnufa Street, Yokneam 2066717, IL  
(72) GLINER, Vadim, c/o Biosense Webster (Israel) Ltd. P.O. Box 275 4 Hatnufa Street, 2066717 Yokneam, IL  
EPHRATH, Yaron, Tzafirim 30, 3707969 Karkur, IL
- 

- (51) MKP  
**A61L 27/00 2006 (97) EP 3384939**  
**A61L 31/08 2006**  
**A61L 31/16 2006**  
**C07K 14/00 2006**
- (96) EP 18171179.7 3/12/2012  
(97) EP 3384939, 10/10/2018 201841, en
- (31) 11157842 (32) 11.03.2011 (33) EP  
201161451855 P 11.03.2011 US  
201161487595 P 18.05.2011 US  
11176725 05.08.2011 EP
- (54) MOLECULES AND METHODS FOR INHIBITION AND DETECTION OF PROTEINS  
(71) Universiteit Gent, Sint-Pietersnieuwstraat 25, 9000 Gent, BE  
(72) SCHYMKOWITZ, Joost, Attenrodestraat 15, 3391 Meensel-Kiezegegem, BE  
ROUSSEAU, Frederic, Poverstraat 70, 1700 Sint-Martens-Bodegem, BE
-

(51) MKP  
**C07K 16/28 2006 (97) EP 3409690**

(96) EP 18173123.3 3/18/2014  
(97) EP 3409690, 12/5/2018 201849, en

(31) 13159794 (32) 18.03.2013 (33) EP

(54) HUMANIZED ANTI-CD134 (OX40) ANTIBODIES AND USES THEREOF  
(71) BiocerOX Products B.V., Wim Schuhmacherhof 29, 1328 GJ Almere, NL  
(72) Simons, Petrus Johannes, c/o Wim Schuhmacherhof 29, 1328 GJ Almere, NL  
Boon, Louis, c/o Wim Schuhmacherhof 29, 1328 GJ Almere, NL  
Luo, Jinqun, c/o 1400 McKean Road, Spring House, PA 19477, US  
Brezski, Randall, c/o 1400 McKean Road, Spring House, PA 19477, US  
Goldberg, Monica, c/o 1400 McKean Road, Spring House, PA 19477, US

---

(51) MKP  
**C07K 16/00 2006 (97) EP 3385279**  
**C07K 16/18 2006**  
**C07K 16/44 2006**  
**C07K 19/00 2006**  
**C12P 21/08 2006**

(96) EP 18173194.4 3/19/2010  
(97) EP 3385279, 10/10/2018 201841, en

(31) 210594 P (32) 20.03.2009 (33) US

(54) CARRIER IMMUNOGLOBULINS AND USES THEREOF  
(72) WALKER, Kenneth, W., 175 Mesa Avenue, Newbury Park, CA 91320, US  
LI, Yue-Sheng, 8 Museum Way, Unit 807, Cambridge, MA 02141, US  
BOONE, Thomas, C., 2715 Kelly Knoll Lane, Newbury Park, CA 91320, US  
MIN, HoSung, 105-904, Lotte Castle Galaxy 1-cha 50 Jamwon-dong, Seocho-gu, 137-795 Seoul, KR  
TALVENHEIMO, Jane, 12563 7th Avenue NW, Seattle, WA 98177, US  
ARORA, Taruna, 2317 St Francis Drive, Palo Alto, CA 94303, US  
JACOBSEN, Frederick, W., 1168 Homestake Place, Newbury Park, CA 91320, US  
DOELLGAST, George, -, deceased, US

---

(51) MKP  
**A61B 17/064 2006 (97) EP 3403593**  
**A61B 17/072 2006**  
**A61B 90/00 2016**

(96) EP 18173568.9 9/1/2015  
(97) EP 3403593, 11/21/2018 201847, en

(31) 201414474653 (32) 02.09.2014 (33) US

(54) DEVICES FOR STABILIZING FASTENERS POST-DEPLOYMENT  
(72) SCHELLIN, Emily A., 11919 Snider Road, Cincinnati, OH 45249, US  
SHELTON, Frederick E., 245 East Main Street, Hillsboro, OH 45133, US  
MORGAN, Jerome R., 3275 South Whitetree Circle, Cincinnati, OH 45236, US  
SWAYZE, Jeffrey S., 7047 Birchley Drive, Hamilton, OH 45011, US  
KNIGHT, Gary W., 8264 Meadowlark Drive, West Chester, OH 45069, US

---

(51) MKP  
**F24D 19/06 2006 (97) EP 3412977**

(96) EP 18173805.5 5/23/2018  
(97) EP 3412977, 12/12/2018 201850, en

(31) 201700061757 (32) 06.06.2017 (33) IT

(54) RADIANT MODULE FOR FORMING A RADIANT BODY  
(71) W-A Progettazioni S.r.l., Via Menarini 41, 40054 Loc. Cento - Budrio (Bologna), IT  
(72) LOLLI, Valter, Via Baracca, 5, 40033 CASALECCHIO DI RENO, IT

---

(51) MKP  
**A61K 39/00 2006 (97) EP 3388075**  
**C07K 14/47 2006**

(96) EP 18174251.1 3/24/2016  
(97) EP 3388075, 10/17/2018 201842, en

(31) 201562139189 P (32) 27.03.2015 (33) US  
201505305 (32) 27.03.2015 (33) GB

(54) NOVEL PEPTIDES AND COMBINATION OF PEPTIDES FOR USE IN IMMUNOTHERAPY AGAINST VARIOUS TUMORS (SEQ ID 25 - MRAX5-003)  
(72) Mahr, Andrea, Kirschenweg 22, 72076 Tübingen, DE  
Stevermann, Lea, Dennewartstrasse 15, 52068 Aachen, DE  
Weinschenk, Toni, Im Morgenrain 15, 73773 Aichwald, DE  
Schoor, Oliver, Eichhaldenstrasse 19, 72074 Tübingen, DE  
Fritsche, Jens, Lärchenweg 11, 72144 Dusslingen, DE  
Singh, Harpreet, 5122 Morningside Dr, Apt. 525, Houston, TX Texas 77005, US

---

(51) MKP  
**A61K 39/00 2006 (97) EP 3388076**  
**C07K 14/47 2006**  
(96) EP 18174292.5 3/24/2016  
(97) EP 3388076, 10/17/2018 201842, en  
(31) 201562139189 P (32) 27.03.2015 (33) US  
201505305 27.03.2015 GB  
(54) NOVEL PEPTIDES AND COMBINATION OF PEPTIDES FOR USE IN IMMUNOTHERAPY AGAINST VARIOUS TUMORS (SEQ ID 274 - IGF-004)  
(72) Mahr, Andrea, Kirschenweg 22, 72076 Tübingen, DE  
Stevermann, Lea, Dennewartstrasse 15, 52068 Aachen, DE  
Weinschenk, Toni, Im Morgenrain 15, 73773 Aichwald, DE  
Schoor, Oliver, Eichhaldenstrasse 19, 72074 Tübingen, DE  
Fritsche, Jens, Lärchenweg 11, 72144 Dusslingen, DE  
Singh, Harpreet, 5122 Morningside Dr, Apt. 525, Houston, TX Texas 77005, US

---

(51) MKP  
**A61K 39/00 2006 (97) EP 3388077**  
**C07K 14/47 2006**  
(96) EP 18174312.1 3/24/2016  
(97) EP 3388077, 10/17/2018 201842, en  
(31) 201562139189 P (32) 27.03.2015 (33) US  
201505305 27.03.2015 GB  
(54) NOVEL PEPTIDES AND COMBINATION OF PEPTIDES FOR USE IN IMMUNOTHERAPY AGAINST VARIOUS TUMORS (SEQ ID 245 - MAGEA4-003)  
(72) Mahr, Andrea, Kirschenweg 22, 72076 Tübingen, DE  
Stevermann, Lea, Dennewartstrasse 15, 52068 Aachen, DE  
Weinschenk, Toni, Im Morgenrain 15, 73773 Aichwald, DE  
Schoor, Oliver, Eichhaldenstrasse 19, 72074 Tübingen, DE  
Fritsche, Jens, Lärchenweg 11, 72144 Dusslingen, DE  
Singh, Harpreet, 5122 Morningside Dr, Apt. 525, Houston, TX Texas 77005, US

---

(51) MKP  
**A61K 39/00 2006 (97) EP 3388078**  
**C07K 14/47 2006**  
(96) EP 18174323.8 3/24/2016  
(97) EP 3388078, 10/17/2018 201842, en  
(31) 201562139189 P (32) 27.03.2015 (33) US  
201505305 27.03.2015 GB  
(54) NOVEL PEPTIDES AND COMBINATION OF PEPTIDES FOR USE IN IMMUNOTHERAPY AGAINST VARIOUS TUMORS (SEQ ID 23 - MMP-002)  
(72) Mahr, Andrea, Kirschenweg 22, 72076 Tübingen, DE  
Stevermann, Lea, Dennewartstrasse 15, 52068 Aachen, DE  
Weinschenk, Toni, Im Morgenrain 15, 73773 Aichwald, DE  
Schoor, Oliver, Eichhaldenstrasse 19, 72074 Tübingen, DE  
Fritsche, Jens, Lärchenweg 11, 72144 Dusslingen, DE  
Singh, Harpreet, 5122 Morningside Dr, Apt. 525, Houston, TX Texas 77005, US

---

(51) MKP  
**A61K 39/00 2006 (97) EP 3388079**  
**C07K 14/47 2006**  
(96) EP 18174337.8 3/24/2016  
(97) EP 3388079, 10/17/2018 201842, en  
(31) 201562139189 P (32) 27.03.2015 (33) US

201505305

27.03.2015

GB

- (54) NOVEL PEPTIDES AND COMBINATION OF PEPTIDES FOR USE IN IMMUNOTHERAPY AGAINST VARIOUS TUMORS (SEQ ID 253 - RAD54B)
- (72) Mahr, Andrea, Kirschenweg 22, 72076 Tübingen, DE  
 Stevermann, Lea, Dennewartstrasse 15, 52068 Aachen, DE  
 Weinschenk, Toni, Im Morgenrain 15, 73773 Aichwald, DE  
 Schoor, Oliver, Eichhaldenstrasse 19, 72074 Tübingen, DE  
 Fritsche, Jens, Lärchenweg 11, 72144 Dusslingen, DE  
 Singh, Harpreet, 5122 Morningside Dr, Apt. 525, Houston, TX Texas 77005, US
- 

- (51) MKP  
**A61K 39/00 2006 (97) EP 3388080**  
**C07K 14/47 2006**
- (96) EP 18174354.3 3/24/2016  
 (97) EP 3388080, 10/17/2018 201842, en
- (31) 201562139189 P (32) 27.03.2015 (33) US  
 201505305 27.03.2015 GB
- (54) NOVEL PEPTIDES AND COMBINATION OF PEPTIDES FOR USE IN IMMUNOTHERAPY AGAINST VARIOUS TUMORS (SEQ ID 243 - SPC25-001)
- (72) Mahr, Andrea, Kirschenweg 22, 72076 Tübingen, DE  
 Stevermann, Lea, Dennewartstrasse 15, 52068 Aachen, DE  
 Weinschenk, Toni, Im Morgenrain 15, 73773 Aichwald, DE  
 Schoor, Oliver, Eichhaldenstrasse 19, 72074 Tübingen, DE  
 Fritsche, Jens, Lärchenweg 11, 72144 Dusslingen, DE  
 Singh, Harpreet, 5122 Morningside Dr, Apt. 525, Houston, TX Texas 77005, US
- 

- (51) MKP  
**A61K 9/00 2006 (97) EP 3384899**  
**A61K 31/13 2006**
- (96) EP 18174428.5 4/12/2010  
 (97) EP 3384899, 10/10/2018 201841, en
- (31) 09290298 (32) 21.04.2009 (33) EP
- (54) PAEDIATRIC SOLUTIONS COMPRISING A BETA-BLOCKER
- (71) Pierre Fabre Dermatologie, 45, Place Abel Gance, 92100 Boulogne Billancourt, FR  
 (72) CHAUMONT, Christine, c/o Pierre Fabre Dermatologie 45 place Abel Gance, 92100 BOULOGNE-BILLANCOURT, FR  
 CORDOLIANI, Jean-François, c/o Pierre Fabre Dermatologie 45 place Abel Gance, 92100 BOULOGNE-BILLANCOURT, FR  
 LEVERD, Élie, c/o Pierre Fabre Dermatologie 45 place Abel Gance, 92100 BOULOGNE-BILLANCOURT, FR  
 MUGUET, Valérie, c/o Pierre Fabre Dermatologie 45 place Abel Gance, 92100 BOULOGNE-BILLANCOURT, FR
- 

- (51) MKP  
**C07H 15/26 2006 (97) EP 3388441**
- (96) EP 18174910.2 12/18/2013  
 (97) EP 3388441, 10/17/2018 201842, en
- (31) 201261738620 P (32) 18.12.2012 (33) US  
 201361788241 P 15.03.2013 US  
 201361874501 P 06.09.2013 US
- (54) MANNOSE DERIVATIVES FOR TREATING BACTERIAL INFECTIONS
- (72) RAMTOHUL, Yeeman, K., 12665 Boulevard Gouin Quest, PIERREFONDS, Québec H8Z 1W6, CA  
 DAS, Sanjoy, Kumar, 4451 King Street, PIERREFONDS, Québec H9H 2G2, CA  
 CADILHAC, Caroline, 4376 Oxford, MONTREAL, Québec H2A 2Y6, CA  
 REDDY, Thumkunta, Jagadeeswar, 12546 Bedford Street, PIERREFONDS, Québec H9A 3K5, CA  
 VAILLANCOURT, Louis, 2775 rue des Futaies, MASCOUCHE, Québec J7K 4B8, CA  
 GALLANT, Michel, 18533 Lagrange Pierrefonds, PIERREFONDS, Québec H9K 1R4, CA  
 LIU, Bingcan, 204 St. Aubin Street, MONTREAL, Québec H4M 2H9, CA  
 DIETRICH, Evelyne, 17 rue d'Orly, LAVAL, Québec H7N 4W8, CA  
 VALLEE, Frederic, 7272 Papineau, MONTREAL, Québec H2E 2G6, CA  
 MARTEL, Julien, 10129 Lajeunesse Street 3, MONTREAL, Québec H3L 2E3, CA  
 POISSON, Carl, 1170 de Louvain East Street, MONTREAL, Québec H2M 1B5, CA
- 

- (51) MKP  
**A61P 9/00 2006 (97) EP 3391941**  
**A61P 11/00 2006**

**A61P 21/00 2006**  
**A61P 35/00 2006**  
(96) EP 18175718.8 4/8/2015  
(97) EP 3391941, 10/24/2018 201843, en  
(31) PA201470190 (32) 08.04.2014 (33) DK  
(54) NOVEL CELL-PERMEABLE SUCCINATE COMPOUNDS  
(71) NeuroVive Pharmaceutical AB, Medicon Village Scheelevägen 2, 223 81 Lund, SE  
(72) Elmér, Eskil, Mercuriusgatan 20, 224 57 Lund, SE  
Hansson, Magnus Joakim, Artillerigatan 52, 261 33 Landskrona, SE  
Ehinger, Karl Henrik Johannes, Schlyters väg 14, 224 60 Lund, SE  
Moss, Steven, 30 The Rookery, Balsham, CB21 4EU, GB

---

(51) MKP  
**C07D 453/02 2006 (97) EP 3401316**  
(96) EP 18177114.8 8/14/2013  
(97) EP 3401316, 11/14/2018 201846, en  
(31) 201261683369 P (32) 15.08.2012 (33) US  
(54) CHEMICAL PROCESS  
(71) GLAXO GROUP LIMITED, 980 Great West Road Brentford, Middlesex TW8 9GS, GB  
(72) HOSSNER, Frank, c/o GlaxoSmithKline 980 Great West Road, Brentford, Middlesex TW8 9GS, GB  
STRACHAN, John Bryce, GlaxoSmithKline Gunnels Wood Road, Stevenage, Hertfordshire SG1 2NY, GB

---

(51) MKP  
**C07D 471/04 2006 (97) EP 3415515**  
(96) EP 18178602.1 11/22/2010  
(97) EP 3415515, 12/19/2018 201851, de  
(31) 09177371 (32) 27.11.2009 (33) EP  
(54) METHOD FOR THE PREPARATION OF METHYL-{4,6-DIAMINO-2-[1-(2-FLUOROBENZYL)-1H-PYRAZOLO[3,4-B]PYRIDIN-3-YL]PYRIMIDIN-5-YL}METHYLCARBAMATE  
(72) MAIS, Franz-Josef, Otto-Hahn-Str. 164, 40591 Düsseldorf, DE  
REHSE, Joachim, Am Kloster 12, 42799 Leichlingen, DE  
JOENTGEN, Winfried, Sprengelstrasse 1, 50735 Köln, DE  
SIEGEL, Konrad, Augsburg Strasse 11, 40597 Düsseldorf, DE

---

(51) MKP  
**A61K 31/554 2006 (97) EP 3400944**  
**A61P 1/16 2006**  
(96) EP 18179884.4 11/8/2011  
(97) EP 3400944, 11/14/2018 201846, en  
(31) 41095710 P (32) 08.11.2010 (33) US  
1051165 08.11.2010 SE  
(54) IBAT INHIBITORS FOR THE TREATMENT OF LIVER DISEASES  
(72) GILLBERG, Per-Göran, Södermalmsgatan 22, 431 69 Mölndal, SE  
GRAFFNER, Hans, Konsulns väg 16, 252 84 Helsingborg, SE  
STARKE, Ingemar, Frigångsgatan 8C, 413 01 Göteborg, SE

---

(51) MKP  
**C07K 16/00 2006 (97) EP 3415619**  
**C07K 16/12 2006**  
**C12N 5/10 2006**  
**G01N 33/68 2006**  
(96) EP 18180597.9 4/27/2012  
(97) EP 3415619, 12/19/2018 201851, en  
(31) 201161517976 P (32) 28.04.2011 (33) US  
201161575652 P 24.08.2011 US  
201261599870 P 16.02.2012 US  
201261608571 P 08.03.2012 US  
(54) IDENTIFICATION OF POLYNUCLEOTIDES ASSOCIATED WITH A SAMPLE  
(71) The Board of Trustees of the Leland Stanford Junior University, 1705 El Camino Real, Palo Alto, CA 94306-1106, US



(72) ROBINSON, William H., 3801 Miranda, Palo Alto, CA 94304-1207, US  
TAN, Yann Chong, 4250 El Camino Real Apt. A201, Palo Alto, CA 94306, US  
SOKOLOVE, Jeremy, 243 Sierra Vista Avenue, Mountain View, CA 94043, US

---

(51) MKP  
**C07D 401/04 2006 (97) EP 3409669**  
**C07D 401/14 2006**  
**C07D 403/04 2006**  
**C07D 403/14 2006**  
**C07D 405/12 2006**  
**C07D 405/14 2006**  
**C07D 471/04 2006**

(96) EP 18182201.6 5/13/2015

(97) EP 3409669, 12/5/2018 201849, en

(31) 201462014500 P (32) 19.06.2014 (33) US

(54) HETEROARYL COMPOUNDS FOR KINASE INHIBITION

(72) HUANG, Wei-sheng, 10a Henley Road, Acton, MA 01720, US

GONG, Yongjin, 14 Emerson Street, Belmont, MA 02478, US

LI, Feng, 7 New Meadows Road, Winchester, MA 01890, US

BENCIVENGA, Nicholas, E., c/o ARIAD Pharmaceuticals 40 Landsdowne Street, Cambridge, MA 02139, US

DALGARNÓ, David, C., 50 Crowninshield Road, Brookline, MA 02446, US

KOHLMANN, Anna, 58 Thornberry Road, Winchester, MA 01890, US

SHAKESPEARE, William, C., 2 Hubley Lane, Southborough, MA 01772, US

THOMAS, Ranny, M., 419 Massapoag Avenue, Sharon, MA 02067, US

ZHU, Xiaotian, 137 Temple Street, Newton, MA 02465, US

WEST, Angela, V., 18 Hunters Run, Franklin, MA 02038, US

YOUNGSAYE, Willmen, 195 Park Drive 42, Boston, MA 02215, US

ZHANG, Yun, 6 Sawmill Road, Acton, MA 01720, US

ZHOU, Tianjun, 55 Horne Road, Belmont, MA 02478, US

---

(51) MKP  
**A01N 43/54 2006 (97) EP 3406141**  
**A61K 31/425 2006**  
**A61K 31/505 2006**  
**A61P 35/00 2006**

(96) EP 18182899.7 3/8/2011

(97) EP 3406141, 11/28/2018 201848, en

(31) 313515 P (32) 12.03.2010 (33) US

(54) COMBINATION THERAPY FOR TREATING CANCER

(71) Genzyme Corporation, 500 Kendall Street, Cambridge, MA 02142, US

(72) Harper, Jay, 10 Lathrop Street, Salem, MA Massachusetts 01970, US

Lonning, Scott Michael, 337 Olivia Drive, Northbridge, MA Massachusetts 01534, US

Hsu, Frank James, 14 Fisher Avenue, Wellesley, MA Massachusetts 02482, US

---

(51) MKP  
**A61K 9/51 2006 (97) EP 3412282**

(96) EP 18185536.2 5/24/2012

(97) EP 3412282, 12/12/2018 201850, en

(31) 201161492626 P (32) 02.06.2011 (33) US

(54) MEMBRANE ENCAPSULATED NANOPARTICLES AND METHOD OF USE

(71) The Regents of the University of California, 1111 Franklin Street, 5th Floor, Oakland, CA 94607-5200, US

(72) ZHANG, Liangfang, 6191 Blue Dawn Trail, San Diego, CA California 92130, US

FANG, Ronnie, Hongbo, 27 Galena, Irvine, CA California 92602, US

HU, Che-ming (jack), 3961 Camino Calma, San Diego, CA California 92122, US

COPP, Jonathan, 9152 Regents Road, Apt. A, La Jolla, CA California 92037, US

---

(51) MKP  
**A61K 9/00 2006 (97) EP 3418279**  
**A61K 31/506 2006**  
**A61K 47/26 2006**  
**A61P 11/00 2006**  
**A61P 29/00 2006**

**A61P 31/00 2006**  
**C07D 401/12 2006**  
**C07D 401/14 2006**  
**C07D 409/14 2006**  
**C07D 413/14 2006**  
**C07D 487/04 2006**  
(96) EP 18186182.4 2/13/2015  
(97) EP 3418279, 12/26/2018 201852, en  
(31) 201461940282 P (32) 14.02.2014 (33) US  
201461941064 P 18.02.2014 US  
(54) AROMATIC HETEROCYCLIC COMPOUNDS AS ANTIINFLAMMATORY COMPOUNDS  
(72) LONGSHAW, Alistair Ian, c/o Sygnature Discovery Limited Biocity Nottingham Pennyfoot Street, Nottingham, Nottinghamshire NG1 1GF, GB  
FORDYCE, Euan Alexander Fraser, c/o Sygnature Discovery Limited Biocity Nottingham Pennyfoot Street, Nottingham, Nottinghamshire NG1 1GF, GB  
ONIONS, Stuart Thomas, c/o Sygnature Discovery Limited Biocity Nottingham Pennyfoot Street, Nottingham, Nottinghamshire NG1 1GF, GB  
KING-UNDERWOOD, John, Moorend Cottage, School Lane, Pendock, Worcestershire GL19 3PW, GB  
VENABLE, Jennifer Diane, 609 Glencrest Place, Solana Beach, CA 92075, US  
WALTERS, Iain, c/o Sygnature Discovery Limited Biocity Nottingham Pennyfoot Street, Nottingham, Nottinghamshire NG1 1GF, GB

---

(51) MKP  
**A61K 31/4995 2006 (97) EP 3395820**  
**A61P 35/00 2006**  
**C07D 515/22 2006**  
(96) EP 18382287.3 4/27/2018  
(97) EP 3395820, 12/19/2018 201851, en  
(31) 17382228 (32) 27.04.2017 (33) EP  
17382497 26.07.2017 EP  
(54) ANTITUMORAL COMPOUNDS  
(71) Pharma Mar S.A., Poligono Industrial La Mina Avda. de los Reyes 1 Colmenar Viejo, 28770 Madrid, ES  
(72) CUEVAS MARCHANTE, María del Carmen, PHARMA MAR, S.A. Avenida de los Reyes, 1 Polígono Industrial La Mina, E-28770 Colmenar Viejo, Madrid, ES  
FRANCESCH SOLLOSO, Andrés, PHARMA MAR, S.A. Avenida de los Reyes, 1 Polígono Industrial La Mina, E-28770 Colmenar Viejo, Madrid, ES  
MARTÍNEZ BARRASA, Valentín, PHARMA MAR, S.A. Avenida de los Reyes, 1 Polígono Industrial La Mina, E-28770 Colmenar Viejo, Madrid, ES

---

(51) MKP  
**A61K 31/4995 2006 (97) EP 3395821**  
**A61P 35/00 2006**  
**C07D 515/22 2006**  
(96) EP 18382288.1 4/27/2018  
(97) EP 3395821, 12/19/2018 201851, en  
(31) 17382228 (32) 27.04.2017 (33) EP  
17382497 26.07.2017 EP  
(54) ANTITUMORAL COMPOUNDS  
(72) CUEVAS MARCHANTE, María del Carmen, PHARMA MAR, S.A. Avenida de los Reyes, 1 Polígono Industrial La Mina, E-28770 Colmenar Viejo, Madrid, ES  
FRANCESCH SOLLOSO, Andrés, PHARMA MAR, S.A. Avenida de los Reyes, 1 Polígono Industrial La Mina, E-28770 Colmenar Viejo, Madrid, ES  
MARTÍNEZ BARRASA, Valentín, PHARMA MAR, S.A. Avenida de los Reyes, 1 Polígono Industrial La Mina, E-28770 Colmenar Viejo, Madrid, ES

---

(51) MKP  
**C07K 16/18 2006 (97) EP 3411400**  
(96) EP 18701250.5 1/3/2018  
(97) EP 3411400, 12/12/2018 201850, en  
(31) 17164573 (32) 03.04.2017 (33) EP  
17177657 23.06.2017 EP  
17189938 07.09.2017 EP  
(54) TREATMENT OF INFLAMMATORY DISEASES WITH INHIBITORS OF C5A ACTIVITY  
(71) InflaRx GmbH, Winzerlaer Strasse 2, 07745 Jena, DE  
(72) GUO, Renfeng, 821 Gallery Lane Ann Arbor, Miami, Florida 48103, US  
RIEDEMANN, Niels R., Über den Teufelslöchern 7, 07749 Jena, DE

(51) MKP  
**G05B 9/02 2006 (97) EP 3299909**  
**H01H 47/00 2006**  
(96) EP 17188164.2 8/28/2017  
(97) EP 3299909, 11/7/2018 201845, de  
(31) 102016117821 (32) 21.09.2016 (33) DE  
(54) SAFETY CIRCUIT FOR THE FAIL-SAFE SHUTDOWN OF A DANGEROUS TECHNICAL INSTALLATION  
(71) Pilz GmbH & Co. KG, Felix-Wankel-Strasse 2, 73760 Ostfildern, DE  
(72) Zinser, Christoph, Felix-Wankel-Straße 2, 73760 Ostfildern, DE

(51) MKP  
**C07K 16/28 2006 (97) EP 3309174**  
**G01N 33/53 2006**  
(96) EP 17188907.4 5/29/2015  
(97) EP 3309174, 11/21/2018 201847, en  
(31) 201462023741 P (32) 11.07.2014 (33) US  
(54) ANTI-PD-L1 ANTIBODIES AND DIAGNOSTIC USES THEREOF  
(72) BOYD, Zachary, 1 DNA Way, South San Francisco, CA 94080-4990, US  
KOWANETZ, Marcin, 1 DNA Way, South San Francisco, CA 94080-4990, US  
ROCHE, Patrick C., 931 E. Calle Mariposa, Tucson, AZ 85718, US  
VENNAPUSA, Bharathi, 10871 N. Guava Drive, Tucson, AZ 85737, US  
ZHU, Yifei, 1408 Maxwell Way, San Jose, CA 95131, US  
LIAO, Zhiming, 4300 Hacienda Drive, Pleasanton, CA 94588, US  
KOEPPEN, Hartmut, 1 DNA Way, South San Francisco, CA 94080-4990, US

(51) MKP  
**A23C 15/04 2006 (97) EP 3289884**  
**A23C 15/16 2006**  
**A23D 9/00 2006**  
**A23D 9/04 2006**  
**A23G 3/34 2006**  
(96) EP 17189148.4 9/4/2017  
(97) EP 3289884, 9/26/2018 201839, fr  
(31) 1658221 (32) 05.09.2016 (33) FR  
(54) FOOD COMPOSITION BASED ON DAIRY PRODUCTS AND METHOD FOR MANUFACTURING SAME  
(71) SAVENCIA SA, 42, rue Rieussec, 78220 Viroflay, FR  
(72) DA SILVA BOUCHER, Anne-Claire, 3 impasse de la Ferme, 78125 ORCEMONT, FR  
MESTDAGH-ROMAN, Olesea, 29 rue de la Biche, 28100 DREUX, FR

(51) MKP  
**A61K 39/00 2006 (97) EP 3305813**  
**A61K 39/395 2006**  
**A61P 35/00 2006**  
**C07K 14/705 2006**  
**C07K 16/28 2006**  
**C07K 16/30 2006**  
(96) EP 17189247.4 11/11/2010  
(97) EP 3305813, 11/14/2018 201846, en  
(31) 09014136 (32) 11.11.2009 (33) EP  
260202 P 11.11.2009 US  
10006956 06.07.2010 EP  
361618 P 06.07.2010 US  
(54) ANTIBODIES SPECIFIC FOR CLAUDIN 6 (CLDN6)  
(72) SAHIN, Ugur, Philipp-von-Zabern-Platz 1, 55116 Mainz, DE  
TÜRECI, Özlem, Philipp-von-Zabern-Platz 1, 55116 Mainz, DE  
KOSLOWSKI, Michael, Am Ried 23, 85764 Oberschleissheim, DE  
WALTER, Korden, Hüglerstrasse 3, 65203 Wiesbaden, DE  
WÖLL, Stefan, Pommardstrasse 22a, 55299 Nackenheim, DE  
KREUZBERG, Maria, Freiherr-vom-Stein-Strasse 1, 55131 Mainz, DE  
HUBNER, Bernd, Thelottstrasse 14, 80933 München, DE  
ERDELJAN, Michael, Freiherr-vom-Stein-Strasse 11, 55131 Mainz, DE

(51) MKP  
**C12N 5/00 2006 (97) EP 3318627**  
**C12N 5/071 2010**  
**C12N 5/09 2010**  
**G01N 33/50 2006**

(96) EP 17189470.2 6/11/2012  
(97) EP 3318627, 12/12/2018 201850, en

(31) 201161520569 P (32) 10.06.2011 (33) US  
201111244 30.06.2011 GB  
201161571663 P 30.06.2011 US  
201161513461 P 29.07.2011 US  
201113194866 29.07.2011 US  
201261594295 P 02.02.2012 US

(54) CULTURE MEDIA FOR STEM CELLS  
(72) CLEVERS, Johannes Carolus, c/o Hubrecht Institute Uppsalaalaan 8, 3584 CT Utrecht, NL  
SATO, Toshiro, c/o Hubrecht Institute Uppsalaalaan 8, 3584 CT Utrecht, NL  
HUCH ORTEGA, Meritxell, c/o Hubrecht Institute Uppsalaalaan 8, 3584 CT Utrecht, NL  
KARTHAUS, Wouter Richard, c/o Hubrecht Institute Uppsalaalaan 8, 3584 CT Utrecht, NL

(51) MKP  
**A61B 17/072 2006 (97) EP 3275378**  
**A61L 31/04 2006**  
**A61L 31/12 2006**  
**A61L 31/14 2006**

(96) EP 17189491.8 3/27/2013  
(97) EP 3275378, 7/18/2018 201829, en

(31) 201213433096 (32) 28.03.2012 (33) US

(54) TISSUE THICKNESS COMPENSATOR COMPRISING A PLURALITY OF CAPSULES  
(71) Ethicon LLC, 475 Street C, Suite 401 Los Frailes Industrial Park, 00969 Guaynabo, PR  
(72) VASUDEVAN, Venkataramanan Mandakolathur, Johnson House 64-66 Senapati Bapat Marg Mahim (W), 400016 Mumbai, IN  
ARONHALT, Taylor W, 306 Beech Road, Loveland, Ohio 45140, US  
ALDRIDGE, Jeffrey L, 106 W. Concord Drive, Lebanon, Ohio 45036, US  
SCHEIB, Charles J, 11329 Donwiddle Drive, Loveland, Ohio 45140, US  
YANG, Chunlin, 93 Matthews Farm Road, Belle Mead, New Jersey 08502, US  
SCHALL, Christopher J, 688 Whippoorwill Drive, Cincinnati, Ohio 45244, US  
BAXTER, III, Chester O, 6375 Pawnee Ridge, Loveland, Ohio 45140, US  
CHUN, Iksoo, 269 Shadybrook Lane, Princeton, New Jersey 08540, US  
BEZWADA, Rao S, 1 Nevius Road, Whitehouse Station, New Jersey 08889, US  
CONLON, Sean P, 6234 C. North Shadow Hill Way, Loveland, Ohio 45140, US  
CROPPER, Michael S, 3232 Charter Oak, Edgewood, Kentucky 41017, US  
UTH, Joshua R., 7752 Hunters Trail, Mason, Ohio 45040, US  
LEIMBACH, Richard L, -, deceased, US  
KORVICK, Donna L., 8158 Worcester Drive, Maineville, Ohio 45039, US

(51) MKP  
**C07H 5/10 2006 (97) EP 3301102**  
**C12N 15/11 2006**  
**C12N 15/67 2006**

(96) EP 17189627.7 3/14/2014  
(97) EP 3301102, 10/24/2018 201843, en

(31) 201361785098 P (32) 14.03.2013 (33) US

(54) RIBONUCLEIC ACIDS WITH 4'-THIO-MODIFIED NUCLEOTIDES AND RELATED METHODS  
(72) DEROSA, Frank, c/o Shire Human Genetic Therapies Inc. 300 Shire Way, Lexington, MA 02421, US  
HEARTLEIN, Michael, c/o Shire Human Genetic Therapies Inc. 300 Shire Way, Lexington, MA 02421, US

(51) MKP  
**A47J 43/28 2006 (97) EP 3305717**  
**B67B 7/46 2006**

(96) EP 17189698.8 9/6/2017  
(97) EP 3305717, 11/21/2018 201847, en

(31) 201615289326 (32) 10.10.2016 (33) US

(54) FOOD BAG WORKING TOOL

- (71) San Jamar, Inc., 555 Koopman Lane, Elkhorn, WI 53121, US  
(72) LEE, Jeffrey, 2859 Honey Creek Court, Apt. 524, East Troy, WI Wisconsin 53120, US  
YOUNG, Michael, 1103 Rainbow Court, Mukwonago, WI Wisconsin, US
- 

- (51) MKP  
**A61P 35/02 2006 (97) EP 3284754**  
**C07K 16/28 2006**

(96) EP 17189925.5 12/30/2011

(97) EP 3284754, 9/26/2018 201839, en

(31)	201061428699 P	(32)	30.12.2010	(33)	US
	201161470406 P		31.03.2011		US
	201161470382 P		31.03.2011		US
	201161485104 P		11.05.2011		US

(54) ANTI-CD38 ANTIBODIES

- (72) ELIAS, Kathleen Ann, c/o Takeda California, Inc. 10410 Science Center Drive, San Diego, CA 92121, US  
LANDES, Gregory, c/o Takeda California, Inc. 10410 Science Center Drive, San Diego, CA 92121, US  
SINGH, Shweta, c/o Takeda California, Inc. 10410 Science Center Drive, San Diego, CA 92121, US  
KORVER, Wouter, c/o Takeda California, Inc. 10410 Science Center Drive, San Diego, CA 92121, US  
DRAKE, Andrew Walling, c/o Takeda California, Inc. 10410 Science Center Drive, San Diego, CA 92121, US  
HAAK-FRENDSCHO, Mary, c/o Takeda California, Inc. 10410 Science Center Drive, San Diego, CA 92121, US  
SNELL, Gyorgy Pal, c/o Takeda California, Inc. 10410 Science Center Drive, San Diego, CA 92121, US  
BHASKAR, Vinay, c/o Takeda California, Inc. 10410 Science Center Drive, San Diego, CA 92121, US
- 

- (51) MKP  
**G06F 17/50 2006 (97) EP 3293650**

(96) EP 17189975.0 9/7/2017

(97) EP 3293650, 9/5/2018 201836, fr

(31)	1658374	(32)	08.09.2016	(33)	FR
------	---------	------	------------	------	----

(54) METHOD, DEVICE AND COMPUTER PROGRAM TO ASSIST WITH THE SELECTION AND INSTALLATION OF CONSTRUCTION MATERIAL ELEMENTS

(71) Applications Logiciels Pour Ingénierie ALPI, Immeuble le Noblet 1 bd Charles de Gaulle, 92700 Colombes, FR

(72) Fanet, Michel, 7 BIS avenue Augier, 78290 Croissy S/Seine, FR

---

- (51) MKP  
**C12Q 1/68 2018 (97) EP 3293273**

(96) EP 17190019.4 9/8/2017

(97) EP 3293273, 10/17/2018 201842, en

(31)	2016176302	(32)	09.09.2016	(33)	JP
------	------------	------	------------	------	----

(54) METHOD FOR ASSISTING JUDGMENT OF PROGNOSIS OF BREAST CANCER, AND APPARATUS FOR ASSISTING JUDGMENT OF PROGNOSIS OF BREAST CANCER

(71) SYSMEX CORPORATION, 5-1 Wakinohama-Kaigandori 1-chome Chuo-ku, Kobe-shi Hyogo 651-0073, JP

- (72) Yamada, Tesshi, c/o National Cancer Center 5-1-1, Tsukiji, Chuo-ku, Tokyo, 1040045, JP  
Yoshida, Masayuki, c/o National Cancer Center 5-1-1 Tsukiji, Chuo-ku, Tokyo, 1040045, JP  
Masuda, Mari, c/o National Cancer Center 5-1-1 Tsukiji, Chuo-ku, Tokyo, 1040045, JP  
Sugano, Teppel, c/o National Cancer Center 5-1-1 Tsukiji, Chuo-ku, Tokyo, 1040045, JP  
Honda, Kazufumi, c/o National Cancer Center 5-1-1 Tsukiji, Chuo-ku, Tokyo, 1040045, JP
- 

- (51) MKP  
**C07D 403/12 2006 (97) EP 3299367**

(96) EP 17190132.5 3/13/2014

(97) EP 3299367, 11/7/2018 201845, en

(31)	201361783558 P	(32)	14.03.2013	(33)	US
------	----------------	------	------------	------	----

(54) BIARYL AMIDE COMPOUNDS AS KINASE INHIBITORS

- (72) AVERSA, Robert John, Novartis Institutes for BioMedical Research, Inc. 4560 Horton Street, Emeryville, California 94608, US  
BARSANTI, Paul Andrew, Novartis Institutes for BioMedical Research, Inc. 4560 Horton Street, Emeryville, California 94608, US  
BURGER, Matthew, Novartis Institutes for BioMedical Research, Inc. 4560 Horton Street, Emeryville, California 94608, US  
DILLON, Michael Patrick, Novartis Institutes for BioMedical Research, Inc. 4560 Horton Street, Emeryville, California 94608, US  
DIPESA, Alan, 3300 Netherland Avenue Apt 2C, Bronx, New York 10463, US  
HU, Cheng, Novartis Institutes for BioMedical Research, Inc. 4560 Horton Street, Emeryville, California 94608, US  
LOU, Yan, Novartis Institutes for BioMedical Research, Inc. 4560 Horton Street, Emeryville, California 94608, US  
NISHIGUCHI, Gisele, Novartis Institutes for BioMedical Research, Inc. 4560 Horton Street, Emeryville, California 94608, US

PAN, Yue, Novartis Institutes for BioMedical Research, Inc. 4560 Horton Street, Emeryville, California 94608, US  
POLYAKOV, Valery, Novartis Institutes for BioMedical Research, Inc. 4560 Horton Street, Emeryville, California 94608, US  
RAMURTHY, Savithri, Novartis Institutes for BioMedical Research, Inc. 4560 Horton Street, Emeryville, California 94608, US  
RICO, Alice, Novartis Institutes for BioMedical Research, Inc. 4560 Horton Street, Emeryville, California 94608, US  
SETTI, Lina, Novartis Institutes for BioMedical Research, Inc. 4560 Horton Street, Emeryville, California 94608, US  
SMITH, Aaron, Novartis Institutes for BioMedical Research, Inc. 4560 Horton Street, Emeryville, California 94608, US  
SUBRAMANIAN, Sharadha, Novartis Institutes for BioMedical Research, Inc. 4560 Horton Street, Emeryville, California 94608, US  
TAFT, Benjamin, Novartis Institutes for BioMedical Research, Inc. 4560 Horton Street, Emeryville, California 94608, US  
TANNER, Huw, Novartis Institutes for BioMedical Research, Inc. 4560 Horton Street, Emeryville, California 94608, US  
WAN, Lifeng, Novartis Institutes for BioMedical Research, Inc. 4560 Horton Street, Emeryville, California 94608, US  
YUSUFF, Naem, 8 Watson Street, Cambridge, Massachusetts 02139, US

---

- (51) MKP  
**A61K 38/00 2006 (97) EP 3308796**  
**A61K 38/17 2006**  
**A61K 38/22 2006**  
**A61K 38/27 2006**  
**A61K 38/29 2006**  
**A61P 19/08 2006**  
**A61P 19/10 2006**
- (96) EP 17190589.6 11/1/2013  
(97) EP 3308796, 11/21/2018 201847, en
- (31) 201261721898 P (32) 02.11.2012 (33) US  
201261740665 P 21.12.2012 US
- (54) ACTIVIN-ACTRII ANTAGONISTS AND USES FOR TREATING BONE AND OTHER DISORDERS  
(72) Schorr Sloan, Victor, 34 Stirrup Lane, Flemington, NJ New Jersey 08822, US  
Hruska, Keith, One Brookings Drive, St. Louis, MO Missouri 63130, US  
Fang, Yifu, One Brookings Drive, St. Louis, MO Missouri 63130, US  
Sung, Victoria, 1529 Oak St., San Francisco, CA California 94117, US  
Stevens, Randall, 2 Straitsmouth Way, Rockport, MA Massachusetts 01966, US  
Smith, William, 1521 Glasco Turnpike, Woodstock, NY New York 12498, US
- 

- (51) MKP  
**C12N 5/00 2006 (97) EP 3305890**
- (96) EP 17190649.8 4/5/2012  
(97) EP 3305890, 11/14/2018 201846, en
- (31) 201161473457 P (32) 08.04.2011 (33) US
- (54) REVERSING THE EFFECTS OF THE TUMOR MICROENVIRONMENT USING CHIMERIC CYTOKINE RECEPTORS  
(72) LEEN, Ann Marie, 5227 Maple Street, Bellaire, Texas 77401, US  
VERA, Juan F, 5227 Maple Street, Bellaire, Texas 77401, US
- 

- (51) MKP  
**A61K 9/00 2006 (97) EP 3351546**  
**A61K 31/365 2006**  
**A61K 47/34 2017**  
**A61P 33/00 2006**  
**C07D 493/22 2006**
- (96) EP 17190708.2 11/30/2012  
(97) EP 3351546, 7/25/2018 201830, en
- (31) 201161566336 P (32) 02.12.2011 (33) US
- (54) LONG-ACTING INJECTABLE MOXIDECTIN FORMULATIONS  
(72) CADY, Susan, Mancini, 1501 Revere Road, Yardley, PA Pennsylvania 19067, US  
MA, Baoqing, 10 Jared Blvd., Kendall Park, NJ New Jersey 08824, US  
CHAPMAN, Robert, Clark, 4 Jefferson Court, Downingtown, PA Pennsylvania 19335, US  
YANG, Chunhua, 20 Canady Ct., Belle Mead, NJ New Jersey 08502, US  
JAIN, Uday, 3 Jay Court, Plainsboro, NJ New Jersey 08536, US
- 

- (51) MKP  
**A61K 31/4439 2006 (97) EP 3284742**  
**A61P 3/00 2006**  
**A61P 11/00 2006**  
**A61P 25/00 2006**

**A61P 29/00 2006**  
**A61P 31/00 2006**  
**A61P 35/00 2006**  
**C07D 405/14 2006**  
(96) EP 17190920.3 3/13/2014  
(97) EP 3284742, 9/26/2018 201839, en  
(31) 201361791007 P (32) 15.03.2013 (33) US  
(54) SUBSTITUTED PYRIDINE DERIVATIVES USEFUL AS C-FMS KINASE INHIBITORS  
(72) CHEN, Jie, 4 Worthington Terrace, Flemington, NJ New Jersey 08822, US  
DONAHUE, Matthew, 200 Foxgate Avenue Apt. 5H, Hattiesburg, MS Mississippi 39402, US  
LIM, Heng-Keang, 9 Dustin Drive, Lawrenceville, NJ New Jersey 08648, US  
LIN, Ronghui, 3003 Shawnee Green, Ambler, PA Pennsylvania 19002, US  
SALTER, Rhys, 204 Windsor Way, Doylestown, PA Pennsylvania 18901, US  
WU, Jiejun, 11383 Pacific Shores Way, San Diego, CA California 92130, US

---

(51) MKP  
**F16B 7/18 2006 (97) EP 3301311**  
(96) EP 17191005.2 9/14/2017  
(97) EP 3301311, 10/10/2018 201841, de  
(31) 102016217622 (32) 15.09.2016 (33) DE  
(54) COUPLING  
(71) PERI GMBH, Rudolf-Diesel-Strasse 19, 89264 Weissenhorn, DE  
(72) Sturm, Florian, Höhlgasse 10, 89299 Unterroth, DE

---

(51) MKP  
**A61K 31/519 2006 (97) EP 3290421**  
**A61P 37/00 2006**  
**C07D 487/04 2006**  
**C07D 519/00 2006**  
(96) EP 17191163.9 2/11/2014  
(97) EP 3290421, 10/17/2018 201842, en  
(31) 201361767947 P (32) 22.02.2013 (33) US  
(54) COMBINATION OF PYRROLO [2, 3 -D]PYRIMIDINE DERIVATIVES WITH ONE OR MORE ADDITIONAL AGENTS AS INHIBITORS OF JANUS- RELATED KINASES (JAK)  
(72) BROWN, Matthew Frank, 443 Wheeler Road, Stonington, CT Connecticut 06378, US  
FENWICK, Ashley Edward, 6551 Hidden Lake Circle, Richland, MI Michigan 49083, US  
FLANAGAN, Mark Edward, 10 Queen Eleanor Drive, Gales Ferry, CT Connecticut 06334, US  
GONZALES, Andrea, 5403 Telluride Road, Kalamazoo, MI Michigan 49009, US  
JOHNSON, Timothy Allan, 6178 Hidden Lake Circle, Richland, MI Michigan 49083, US  
KAILA, Neelu, 17 Augustus Road, Lexington, MA Massachusetts 02421, US  
MITTON-FRY, Mark J., 120 Denison Drive, Granville, OH Ohio 43023, US  
STROHBACH, Joseph Walter, 114 Crockett Creek Drive, Wentzville, MO Missouri 63385, US  
TENBRINK, Ruth E., 125 Skyview Lane, Labadie, MO Missouri 63055, US  
TRZUPEK, John David, 55 Station Landing 515, Medford, MA Massachusetts 02155, US  
UNWALLA, Rayomand Jal, 22 Fox Run Road, Bedford, MA Massachusetts 01730, US  
VAZQUEZ, Michael L., 23 Timbercreek Road, Billerica, MA Massachusetts 01821, US  
PARIKH, Mihir, D., 600 Meridian Street Ext. Apt. 305, Groton, MA Massachusetts 06340, US

---

(51) MKP  
**A61K 39/395 2006 (97) EP 3287142**  
**C07K 16/40 2006**  
**C12N 15/11 2006**  
(96) EP 17191208.2 4/6/2012  
(97) EP 3287142, 10/3/2018 201840, en  
(31) 201161473698 P (32) 08.04.2011 (33) US  
(54) METHODS FOR TREATING CONDITIONS ASSOCIATED WITH MASP-2 DEPENDENT COMPLEMENT ACTIVATION  
(72) DEMOPULOS, Gregory A., 4845 Forest Avenue SE, Mercer Island, WA 98040, US  
DUDLER, Tom, 13410 NE 36th Street, Bellevue, WA 98005, US  
SCHWAEBLE, Hans-Wilhelm, 36 The Green, Mountsorrel, Leicestershire LE12 7AF, GB

---

(51) MKP

**A61K 31/513 2006 (97) EP 3295942**  
**A61P 31/18 2006**  
(96) EP 17191307.2 10/7/2013  
(97) EP 3295942, 10/31/2018 201844, en  
(31) PCT/CN2012/001358 (32) 08.10.2012 (33) WO  
(54) COMBINATIONS COMPRISING 5-PHENOXY-3H-PYRIMIDIN-4-ONE DERIVATIVES AND THEIR USE FOR THE PROPHYLAXIS OR TREATMENT OF INFECTION BY HIV  
(71) MERCK SHARP & DOHME CORP., 126 East Lincoln Avenue, Rahway, NJ 07065-0907, US  
(72) Arrington, Kenneth L., 770 Sumneytown Pike, West Point, Pennsylvania 19486, US  
Burgey, Christopher, 770 Sumneytown Pike, West Point, Pennsylvania 19486, US  
Gillfillan, Robert, 770 Sumneytown Pike, Westpoint, Pennsylvania 19486, US  
Han, Yongxin, 2F No. 10 Building, Landscape No.88 Darwin Road, Zhangjiang High-tech Park,, Pudong, New District, Shanghai 201203, CN  
Patel, Mehul, 770 Sumneytown Pike, West Point, Pennsylvania 19486, US  
Li, Chun Sing, 288 Fute Zhong Road, Waigaoqiao Free Trade Zone, Shanghai 200131, CN  
Li, Yaozong, 288 Fute Zhong Road, Waigaoqiao Free Trade Zone, Shanghai 200131, CN  
Luo, Yunfu, 288 Fute Zhong Road, Waigaoqiao Free Trade Zone, Shanghai 200131, CN  
Xu, Jiayi, 126 East Lincoln Avenue, Rahway, New Jersey 07065-0907, US

---

(51) MKP  
**A61K 39/00 2006 (97) EP 3305798**  
**C07H 21/04 2006**  
(96) EP 17191702.4 12/9/2011  
(97) EP 3305798, 11/14/2018 201846, en  
(31) 421470 P (32) 09.12.2010 (33) US  
201161502649 P 29.06.2011 US  
(54) USE OF CHIMERIC ANTIGEN RECEPTOR-MODIFIED T CELLS TO TREAT CANCER  
(72) JUNE, Carl H., 409 Baird Road, Merion Station, PA 19066, US  
LEVINE, Bruce L., 1258 Liberty Bell Drive, Cherry Hill, NJ 08003, US  
PORTER, David L., 821 Crum Creek Road, Springfield, PA 19064, US  
KALOS, Michael D., 716 Carpenter Lane, Philadelphia, PA 19119, US  
MILONE, Michael C., 314 Surrey Road, Cherry Hill, NJ 08002, US

---

(51) MKP  
**B60R 25/021 2013 (97) EP 3296163**  
**B60R 25/023 2013**  
(96) EP 17191764.4 9/19/2017  
(97) EP 3296163, 10/31/2018 201844, de  
(31) 102016117641 (32) 19.09.2016 (33) DE  
(54) SECURED DEVICE FOR BLOCKING AN ESSENTIAL COMPONENT OF A MOTOR VEHICLE  
(71) HUF HÜLSBECK & FÜRST GmbH & Co. KG, Steeger Str. 17, 42551 Velbert, DE  
(72) Trischberger, Werner, HUF HÜLSBECK & FÜRST GmbH & Co. KG Altomünsterstr. 20a, 85229 Langenpettenbach / Markt Indersdorf, DE

---

(51) MKP  
**C07K 16/00 2006 (97) EP 3339322**  
**C07K 16/22 2006**  
**C07K 16/28 2006**  
**C07K 16/42 2006**  
(96) EP 17191815.4 8/13/2012  
(97) EP 3339322, 10/31/2018 201844, en  
(31) 201161524488 P (32) 17.08.2011 (33) US  
201121226 12.12.2011 GB  
201121233 12.12.2011 GB  
201121236 12.12.2011 GB  
PCT/EP2012/064632 25.07.2012 WO  
(54) IMMUNOGLOBULIN SINGLE VARIABLE DOMAIN ANTIBODIES WITH A C-TERMINAL EXTENSION FOR REDUCED IMMUNOGENICITY  
(72) ASHMAN, Claire, GlaxoSmithKline Gunnels Wood Road, Stevenage, Hertfordshire SG1 2NY, GB  
BIRCHLER, Mary, GlaxoSmithKline 709 Swedeland Road, King of Prussia, PA Pennsylvania 19406, US  
DE WILDT, Rudolf M T, GlaxoSmithKline Gunnels Wood Road, Stevenage, Hertfordshire SG1 2NY, GB  
HOLLAND, Claire, GlaxoSmithKline 709 Swedeland Road, King of Prussia, PA Pennsylvania 19406, US  
LEWIS, Alan Peter, GlaxoSmithKline Gunnels Wood Road, Stevenage, Hertfordshire SG1 2NY, GB  
MORLEY, Peter, GlaxoSmithKline Gunnels Wood Road, Stevenage, Hertfordshire SG1 2NY, GB  
SANDAL, Thomas, c/o GlaxoSmithKline Gunnels Wood Road, Stevenage, Hertfordshire SG1 2NY, GB  
STEWART, Michael, GlaxoSmithKline Gunnels Wood Road, Stevenage, Hertfordshire SG1 2NY, GB



---

(51) MKP  
**B05C 1/04 2006 (97) EP 3273134**  
**B62J 31/00 2006**  
**F16H 57/05 2006**  
**F16N 3/04 2006**  
**F16N 9/00 2006**

(96) EP 17192186.9 9/20/2017  
(97) EP 3273134, 8/29/2018 201835, de

(31) 202016103943 U (32) 20.07.2016 (33) DE  
202016107296 U 22.12.2016 DE

(54) DEVICE FOR APPLYING OIL TO A CHAIN OF A TWO-WHEELED VEHICLE, IN PARTICULAR A BICYCLE  
(72) Kordes, Sven, Grüner Weg 1, 59846 Sundern, DE  
Grabski, Karsten, Fasanenweg 19, 59469 Ense, DE  
Schweineberg, Rolf, Friedrich-Naumann-Straße 39, 59759 Arnsberg, DE

---

(51) MKP  
**A61M 5/142 2006 (97) EP 3287161**  
**A61M 5/158 2006**  
**F15C 5/00 2006**  
**F16K 99/00 2006**  
**G01L 9/00 2006**

(96) EP 17192248.7 5/5/2010  
(97) EP 3287161, 10/3/2018 201840, en

(31) 436365 (32) 06.05.2009 (33) US  
436360 06.05.2009 US

(54) LOW-DEAD VOLUME MICROFLUIDIC CIRCUIT AND METHODS  
(71) CeQur SA, Altsagenstrasse 5, 6048 Horw, CH  
(72) Gravesen, Peter, Hyldebaervej 6, DK-6430 Nordborg, DK  
Arndt, Heiko, Hafendamm 31, 24937 Flensburg, DE

---

(51) MKP  
**C11D 1/83 2006 (97) EP 3299445**  
**C11D 3/00 2006**  
**C11D 3/22 2006**  
**C11D 3/37 2006**  
**C11D 3/50 2006**  
**C11D 11/00 2006**  
**C11D 17/00 2006**

(96) EP 17192249.5 9/20/2017  
(97) EP 3299445, 11/7/2018 201845, en

(31) 201600094646 (32) 21.09.2016 (33) IT

(54) ADDITIVE COMPOSITION WITH INTEGRATED ACTION  
(72) BRIGNOLI, Cinzia, Piazza Trento, 1, I-20135 Milano (MI), IT  
CECERE, Giulia, Via Pascoli, 16, I-20070 Cerro al Lambro (MI), IT  
FONTANA, Daniela, Via Vittorio Emanuele II, 27, I-20900 Monza (MB), IT  
VILLA, Ilaria, Via San Giacomo, 26, I-20142 Milano (MI), IT

---

(51) MKP  
**D06F 35/00 2006 (97) EP 3299505**  
**D06F 39/02 2006**

(96) EP 17192255.2 9/20/2017  
(97) EP 3299505, 11/7/2018 201845, en

(31) 201600094671 (32) 21.09.2016 (33) IT

(54) OPTIMIZED METHOD FOR WASHING IN WASHING MACHINES  
(72) NOVITA', Luciano, Via Pertini, 1, 20090 Segrate (MI), IT  
PIMAZZONI, Massimiliano, Via Bach, 44, 21042 Caronno Pertusella (VA), IT  
BRIGNOLI, Cinzia, Piazza Trento, 1, 20135 Milano (MI), IT

---

(51) MKP

**A61K 31/44 2006 (97) EP 3293176**  
**A61P 11/00 2006**  
**C07D 213/89 2006**  
(96) EP 17192278.4 10/17/2014  
(97) EP 3293176, 9/5/2018 201836, en  
(31) 13189784 (32) 22.10.2013 (33) EP  
(54) CRYSTAL FORM OF A PDE4 INHIBITOR  
(72) FALCHI, Alessandro, c/o CHIESI FARMACEUTICI S.p.A. Via Palermo, 26/A, 43122 PARMA, IT  
LUTERO, Emilio, c/o CHIESI FARMACEUTICI S.p.A. Via Palermo, 26/A, 43122 PARMA, IT  
FERRARI, Emanuele, c/o CHIESI FARMACEUTICI S.p.A. Via Palermo, 26/A, 43122 PARMA, IT  
PIVETTI, Fausto, c/o CHIESI FARMACEUTICI S.p.A. Via Palermo, 26/A, 43122 PARMA, IT  
BUSSOLATI, Rocco, c/o CHIESI FARMACEUTICI S.p.A. Via Palermo, 26/A, 43122 PARMA, IT  
MARIANI, Edoardo, c/o CHIESI FARMACEUTICI S.p.A. Via Palermo, 26/A, 43122 PARMA, IT  
VECCHI, Orsola, c/o CHIESI FARMACEUTICI S.p.A. Via Palermo, 26/A, 43122 PARMA, IT  
BAPPERT, Erhard, c/o CHIESI FARMACEUTICI S.p.A. Via Palermo, 26/A, 43122 PARMA, IT  
VENTRICI, Caterina, c/o CHIESI FARMACEUTICI S.p.A. Via Palermo, 26/A, 43122 PARMA, IT

---

(51) MKP  
**B65D 90/00 2006 (97) EP 3305709**  
**B66C 1/10 2006**  
**B66C 1/66 2006**  
**B66F 9/065 2006**  
**E05B 83/08 2014**  
(96) EP 17194275.8 10/2/2017  
(97) EP 3305709, 10/31/2018 201844, en  
(31) 41900216 (32) 05.10.2016 (33) PL  
(54) A SYSTEM FOR TRANSPORTING AND UNLOADING CONTAINERS FOR GOODS, IN PARTICULAR FOR BULK MATERIAL, A CONTAINER AND A CONTAINER SPREADER  
(71) ECCO WOOD Spolka z ograniczona odpowiedzialnoscia, ul. Chorzowska 6, 40-101 Katowice, PL  
(72) Pilarczyk, Jerzy, ul. Szklarskiego 4, 40-668 Katowice, PL

---

(51) MKP  
**A21D 6/00 2006 (97) EP 3305078**  
**A21D 8/02 2006**  
**A21D 8/04 2006**  
(96) EP 17194677.5 10/4/2017  
(97) EP 3305078, 10/10/2018 201841, en  
(31) 201600101204 (32) 10.10.2016 (33) IT  
(54) NEW METHOD FOR MAKING (FERMENTED) BAKERY PRODUCTS  
(71) Sangiorgio, Luciano, Largo Boccea n. 19, 00167 Roma (RM), IT  
(72) Sangiorgio, Luciano, Largo Boccea n. 19, 00167 Roma (RM), IT

---

(51) MKP  
**A61K 31/506 2006 (97) EP 3323818**  
**A61P 3/00 2006**  
**C07D 413/14 2006**  
(96) EP 17195060.3 9/21/2011  
(97) EP 3323818, 12/26/2018 201852, en  
(31) 385410 P (32) 22.09.2010 (33) US  
201161478262 P 22.04.2011 US  
(54) MODULATORS OF THE GPR119 RECEPTOR AND THE TREATMENT OF DISORDERS RELATED THERETO  
(72) JONES, Robert M., 10937 Corte luz del Sol, San Diego, CA California 92130, US  
LEHMANN, Juerg, 9840 La Tortola Court, San Diego, CA California 92129, US  
CHEN, Weichao, 10617 Senda Acuario, San Diego, CA California 92130, US  
EDWARDS, Jeffrey, 4564 Vereda Mar del Sol, San Diego, CA 92130, US  
MARQUEZ, Glen, 578 Breezyglen Court, San Jose, CA California 95133, US  
MORGAN, Michael E., 11746 Candy Rose Way, San Diego, CA California 92131, US  
SADEQUE, Abu J.M., 11828 Pickford Road, San Diego, CA California 92131, US  
KIM, Sun Hee, 13640 Via Cima Bella, San Diego, CA 92129, US

---

(51) MKP  
**A61K 39/395 2006 (97) EP 3299390**  
**C07K 16/24 2006**

(96) EP 17195148.6 10/7/2011  
(97) EP 3299390, 11/7/2018 201845, en  
(31) 391388 P (32) 08.10.2010 (33) US  
(54) METHODS OF TREATING PSORIASIS USING IL-17 ANTAGONISTS  
(72) Guettner, Achim, Novartis Pharma AG Postfach, 4002 Basel, CH  
Machacek, Matthias, Novartis Pharma AG Postfach, 4002 Basel, CH  
Papavassilis, Charis, Novartis Pharma AG Postfach, 4002 Basel, CH  
Sander, Oliver, Novartis Pharma AG Postfach, 4002 Basel, CH

---

(51) MKP  
**A61K 39/395 2006 (97) EP 3295957**  
**A61P 17/06 2006**  
**C07K 16/28 2006**  
(96) EP 17195530.5 1/12/2011  
(97) EP 3295957, 10/31/2018 201844, en  
(31) 295387 P (32) 15.01.2010 (33) US  
422059 P 10.12.2010 US  
(54) ANTIBODY FORMULATION AND THERAPEUTIC REGIMENS  
(72) LIU, Dingjiang, 766 Bellagio Court, Oak Park, CA 91377, US  
HUANG, Holly Zhuohong, 1792 Amarelle Street, Thousand Oaks, CA 91320, US  
MARTIN, David Andrew, 6515 20th Avenue NE, Seattle, WA 98115, US  
RUSSELL, Christopher Boyd, 3570 Crystal Springs Dr. NE, Bainbridge Island, WA 98110, US  
SALINGER, David H., 6234 29th Avenue NE, Seattle, WA 98115, US  
BAUMGARTNER, Scott Walter, 3020 Hollycrest Avenue, Thousand Oaks, CA 91362, US  
ENDRES, Christopher J., 3258 NW Market Street, Seattle, WA 98107, US

---

(51) MKP  
**E04H 4/08 2006 (97) EP 3312364**  
**E04H 4/10 2006**  
(96) EP 17195786.3 10/10/2017  
(97) EP 3312364, 7/25/2018 201830, fr  
(31) 1660167 (32) 20.10.2016 (33) FR  
(54) MOTOR ASSEMBLY INCLUDING AT LEAST ONE GEAR MOTOR UNIT  
(71) Unicum Transmission de Puissance, Zac de Montrambert-Pigeot, 42150 La Ricamarie, FR  
(72) FAURIAUX, Samuel, 13 Rue des Gabelles, 94370 SUCY EN BRIE, FR

---

(51) MKP  
**G01B 7/16 2006 (97) EP 3312550**  
**G01L 1/22 2006**  
**H01C 17/24 2006**  
(96) EP 17195897.8 10/11/2017  
(97) EP 3312550, 9/5/2018 201836, en  
(31) 2016206958 (32) 21.10.2016 (33) JP  
(54) STRAIN GAUGE  
(71) Minebea Mitsumi Inc., 4106-73, Oaza Miyota, Miyota-machi,, Kitasaku-gun, Nagano 3890293, JP  
(72) Inamori, Dohaku, c/o Minebea Mitsumi Inc. 4106-73 Oaza Miyota, Miyota-machi, Kitasaku-gun, Nagano, 389-0293, JP

---

(51) MKP  
**A47C 7/38 2006 (97) EP 3308675**  
**B60N 2/838 2018**  
(96) EP 17196108.9 10/12/2017  
(97) EP 3308675, 11/21/2018 201847, en  
(31) 201621115827 U (32) 12.10.2016 (33) CN  
(54) ANGLE-ADJUSTER FOR A HEADREST  
(71) Nisi, Cristian, Via Ossi 45/R, 47121 Florli' (FC), IT  
(72) Jiang Tian Liang, c/o DONGGUAN ZHENXIN FURNITURE FITTINGS CO.,LTD. Tangxia town shitanbu New River Road No.9, Dongguan city, CN  
Wang Yong, c/o DONGGUAN ZHENXIN FURNITURE FITTINGS CO.,LTD. Tangxia town shitanbu New River Road No.9, Dongguan city, CN

---

(51) MKP

	<b>B60B 17/00</b>	<b>2006</b>	<b>(97) EP 3309358</b>				
	<b>B61F 9/00</b>	<b>2006</b>					
	<b>E21D 11/10</b>	<b>2006</b>					
(96)	EP 17196261.6 10/13/2017						
(97)	EP 3309358, 10/10/2018 201841, de						
(31)	102016220046		(32)	14.10.2016		(33)	DE
(54)	CARRYING WHEEL ASSEMBLY						
(72)	Sturm, Florian, Höhlgasse 10, 89299 Unterroth, DE Schnepf, Manfred, Jägerweg 2, 89297 Roggenburg, DE						
<hr/>							
(51)	MKP						
	<b>A61B 18/14</b>	<b>2006</b>	<b>(97) EP 3308730</b>				
(96)	EP 17196531.2 10/16/2017						
(97)	EP 3308730, 11/21/2018 201847, en						
(31)	201615295296		(32)	17.10.2016		(33)	US
(54)	CATHETER WITH ANGLED IRRIGATION HOLES						
(72)	BEECKLER, Christopher Thomas, 15815 Arrow Highway, Irwindale, CA California 91706, US KEYES, Joseph Thomas, 15815 Arrow Highway, Irwindale, CA California 91706, US						
<hr/>							
(51)	MKP						
	<b>A61K 39/395</b>	<b>2006</b>	<b>(97) EP 3299391</b>				
	<b>A61P 35/00</b>	<b>2006</b>					
	<b>C07K 16/28</b>	<b>2006</b>					
(96)	EP 17197596.4 3/13/2014						
(97)	EP 3299391, 10/31/2018 201844, en						
(31)	201361784877 P		(32)	14.03.2013		(33)	US
	201361785811 P			14.03.2013			US
	201361874175 P			05.09.2013			US
(54)	ANTI-B7-H4 ANTIBODIES AND IMMUNOCONJUGATES						
(72)	LEONG, Steven R., Genentech, Inc. 1 DNA Way, South San Francisco, CA 94080, US POLSON, Andrew, Genentech, Inc. 1 DNA Way, South San Francisco, CA 94080, US POLAKIS, Paul, Genentech, Inc. 1 DNA Way, South San Francisco, CA 94080, US WU, Yan, Genentech, Inc. 1 DNA Way, South San Francisco, CA 94080, US LIANG, Wei-Chang, Genentech, Inc. 1 DNA Way, South San Francisco, CA 94080, US FIRESTEIN, Ron, Genentech, Inc. 1 DNA Way, South San Francisco, CA 94080, US						
<hr/>							
(51)	MKP						
	<b>A61K 8/02</b>	<b>2006</b>	<b>(97) EP 3315116</b>				
	<b>A61K 8/19</b>	<b>2006</b>					
	<b>A61K 8/27</b>	<b>2006</b>					
	<b>A61K 8/29</b>	<b>2006</b>					
	<b>A61K 8/85</b>	<b>2006</b>					
	<b>A61Q 17/04</b>	<b>2006</b>					
(96)	EP 17197688.9 10/23/2017						
(97)	EP 3315116, 12/5/2018 201849, en						
(31)	201662414205 P		(32)	28.10.2016		(33)	US
(54)	TOPICAL SUNSCREEN COMPOSITION, METHOD OF PREPARATION, AND USE THEREOF						
(71)	Cyberderm Laboratories Inc., 1600 Carling Avenue, Suite 650, Ottawa, Ontario K1Z 1G3, CA						
(72)	Dudley, Denis, 94 Dufferin Road, Ottawa, Ontario K1M 2A6, CA Heinar, Thomas, 11 Garrick Road, Toronto, Ontario M1M 1S6, CA Dudley, Sara, 124-500 Richmond Street West, Toronto, Ontario M5V 3N4, CA						
<hr/>							
(51)	MKP						
	<b>A61K 9/00</b>	<b>2006</b>	<b>(97) EP 3311800</b>				
	<b>A61K 9/107</b>	<b>2006</b>					
	<b>A61K 9/50</b>	<b>2006</b>					
	<b>A61K 36/28</b>	<b>2006</b>					
(96)	EP 17197861.2 10/23/2017						
(97)	EP 3311800, 12/5/2018 201849, en						
(31)	201600106992		(32)	24.10.2016		(33)	IT
(54)	COMPOSITION COMPRISING MICROSTRUCTURES FOR THE CONTROLLED RELEASE OF OZONIZED OIL						
(71)	General Services Spain Italy S.L., Calle Parsi 14, Naves 30-31, 41016 Sevilla, ES						

(72) CAROCCI, Giancarlo, Calle Cies 26, 41016 Sevilla, ES

---

(51) MKP

**A61K 31/19 2006 (97) EP 3312169**  
**A61K 31/5386 2006**  
**C07C 53/18 2006**  
**C07C 53/40 2006**  
**C07D 221/22 2006**  
**C07D 401/04 2006**  
**C07D 401/12 2006**  
**C07D 401/14 2006**  
**C07D 403/04 2006**  
**C07D 451/12 2006**  
**C07D 453/02 2006**  
**C07D 471/02 2006**  
**C07D 471/04 2006**  
**C07D 471/08 2006**  
**C07D 487/14 2006**  
**C07D 498/08 2006**  
**C07D 519/00 2006**

(96) EP 17198245.7 7/16/2013

(97) EP 3312169, 12/5/2018 201849, en

(31) 201261672709 P (32) 17.07.2012 (33) US  
201261708521 P 01.10.2012 US

(54) 5-HT3 RECEPTOR ANTAGONISTS

(72) HITCHCOCK, Stephen, 10410 Science Center Drive, San Diego, CA California 92121, US  
MONENSCHIN, Holger, 10410 Science Center Drive, San Diego, CA California 92121, US  
REICHARD, Holly, 10410 Science Center Drive, San Diego, CA California 92121, US  
SUN, Huikai, 10410 Science Center Drive, San Diego, CA California 92121, US  
KIKUCHI, Shota, 10410 Science Center Drive, San Diego, CA California 92121, US  
MACKLIN, Todd, 10410 Science Center Drive, San Diego, CA California 92121, US  
HOPKINS, Maria, 10410 Science Center Drive, San Diego, CA California 92121, US

---

(51) MKP

**E04B 5/38 2006 (97) EP 3315682**  
**E04B 5/48 2006**  
**E04B 9/00 2006**

(96) EP 17198993.2 10/27/2017

(97) EP 3315682, 12/12/2018 201850, de

(31) 102016012948 (32) 28.10.2016 (33) DE

(54) FORMWORK ELEMENT AND METHOD FOR MANUFACTURING A CEILING

(71) Meier Betonwerke GmbH, Zur Schanze 2, 92283 Lauterhofen, DE

(72)

---

(51) MKP

**H04L 29/08 2006 (97) EP 3319301**

(96) EP 17199302.5 10/31/2017

(97) EP 3319301, 12/12/2018 201850, en

(31) 14732016 (32) 07.11.2016 (33) CH

(54) COMPUTER-IMPLEMENTED METHOD AND COMPUTER SYSTEM FOR DISTRIBUTING PUSH NOTIFICATIONS

(71) GMC Software AG, Oberer Gansbach 1, 9050 Appenzell, CH

(72) Knoulich, Jan, U Strelnice 884, 50009 Hradec Kralove 9, CZ  
Novotny, Petr, Strelcova 1561, 53501 Prelouc, CZ  
Jirak, Vladimir, Starechovice 35, 798 41 Kostelec na Hane, CZ  
Hemon-Laurens, Antoine, 27 rue de la Contrie, 44100 Nantes, FR

---

(51) MKP

**A01N 31/16 2006 (97) EP 3318125**  
**A01N 45/00 2006**  
**A01P 3/00 2006**

(96) EP 17199826.3 11/3/2017

(97) EP 3318125, 12/19/2018 201851, en

(31) 201600111393 (32) 04.11.2016 (33) IT  
(54) ANTIFUNGAL COMPOSITION  
(71) Chemia S.p.A., Via Statale, 327 Frazione Dosso, 44047 Sant'Agostino (FE), IT  
(72) GIBERTI, Andrea, Via Cavalieri A., 3, I-44042 CENTO (FE), IT  
FERRARESI, Angelo, Via Giovanni XXIII, 7, I-45046 LENDINARA (RO), IT  
PERINI, Luca, Via Tito Strozzi, 29, I-44121 FERRARA (FE), IT

---

(51) MKP  
**A41B 9/02 2006 (97) EP 3320793**  
(96) EP 17200190.1 11/6/2017  
(97) EP 3320793, 12/26/2018 201852, fr  
(31) 201605846 (32) 10.11.2016 (33) BE  
(54) MEN'S UNDERGARMENT  
(71) L&J Underwear, 8 Rue de la Foret, 7522 Blandain, BE  
(72) CRUCKE, Jacques, 12 rue des Sablières, 7522 BLANDAIN, BE  
HENRY, Loïc, 12 rue des Sablières, 7522 BLANDAIN, BE

---

(51) MKP  
**A61K 35/744 2015 (97) EP 3402499**  
**A61K 38/20 2006**  
**A61K 39/00 2006**  
**A61P 3/10 2006**  
**A61P 37/06 2006**  
**C12N 1/00 2006**  
**C12N 1/20 2006**  
**C12N 15/09 2006**  
**C12R 1/01 2006**  
(96) EP 17702950.1 1/13/2017  
(97) EP 3402499, 11/21/2018 201847, en  
(31) 201662278493 P (32) 14.01.2016 (33) US  
201662350472 P 15.06.2016 US  
(54) COMPOSITIONS AND METHODS FOR THE TREATMENT OF TYPE 1 DIABETES  
(71) Intrexon Actobiotics NV, Industriepark Zwijnaarde 7 C building D, 9052 Zwijnaarde, BE  
(72) ROTTIERS, Pieter, Twee Dreven 37, B-9840 De Pinte, BE  
STEIDLER, Lothar, Bokslaarstraat 41, B-9160 Lokeren, BE

---

(51) MKP  
**A61K 51/04 2006 (97) EP 3411083**  
**A61K 101/02 2006**  
**C07B 59/00 2006**  
**C07D 401/14 2006**  
(96) EP 17703109.3 2/1/2017  
(97) EP 3411083, 12/12/2018 201850, en  
(31) 16154123 (32) 03.02.2016 (33) EP  
16161466 21.03.2016 EP  
16183009 05.08.2016 EP  
16186603 31.08.2016 EP  
(54) TAU PET IMAGING LIGANDS  
(72) MOECHARS, Diederik Willem Elisabeth, c/o Janssen Pharmaceutica NV Turnhoutseweg 30, 2340 Beerse, BE  
ROMBOUITS, Frederik Jan Rita, c/o Janssen Pharmaceutica NV Turnhoutseweg 30, 2340 Beerse, BE  
LEENAERTS, Joseph Elisabeth, c/o Janssen Pharmaceutica NV Turnhoutseweg 30, 2340 Beerse, BE  
ANDRÉS-GIL, José Ignacio, c/o Janssen-Cilag S.A. Edificio Johnson&Johnson Paseo de las Doce Estrellas 5-7 5° planta Campo de las Naciones, 28042 Madrid, ES  
FIERENS, Katleen, c/o Janssen Pharmaceutica NV Turnhoutseweg 30, 2340 Beerse, BE  
CHUPAKHIN, Vladimir, c/o Janssen Pharmaceutica NV Turnhoutseweg 30, 2340 Beerse, BE  
BORMANS, Guy Maurits R., c/o Katholieke Universiteit Leuven K.U.Leuven Research&Development Waaistraat 6 bus 5105, 3000 Leuven, BE  
DECLERCQ, Lieven Denis Herwig, c/o Katholieke Universiteit Leuven K.U.Leuven Research&Development Waaistraat 6 - bus 5105, 3000 Leuven, BE  
KOLB, Hartmuth, c/o Janssen Research&Development LLC 920 US Route 202 PO Box 300, Raritan New Jersey 08869, US  
ZHANG, Wei, c/o Janssen Research&Development LLC 920 US Route 202 PO Box 300, Raritan New Jersey 08869, US

---

(51) MKP

**A61K 31/4439 2006 (97) EP 3402791**  
**A61P 35/00 2006**  
**C07D 401/04 2006**  
**C07D 401/14 2006**  
**C07D 405/14 2006**  
**C07D 409/14 2006**  
**C07D 413/14 2006**  
**C07D 451/02 2006**  
**C07D 451/06 2006**  
**C07D 487/04 2006**  
**C07D 491/044 2006**  
**C07D 491/048 2006**  
(96) EP 17703249.7 1/10/2017  
(97) EP 3402791, 11/21/2018 201847, en  
(31) 201662277009 P (32) 11.01.2016 (33) US  
201662363534 P 18.07.2016 US  
(54) SUBSTITUTED THIOHYDANTOIN DERIVATIVES AS ANDROGEN RECEPTOR ANTAGONISTS  
(72) BIGNAN, Gilles, 1400 McKean Road, Spring House Pennsylvania 19477, US  
CONNOLLY, Peter J., 1400 McKean Road, Spring House Pennsylvania 19477, US  
HICKSON, Ian, 66 John Dyer Way, Doylestown Pennsylvania 18902-9607, US  
MEERPOEL, Lieven, Turnhoutseweg 30, 2340 Beerse, BE  
PANDE, Vineet, Turnhoutseweg 30, 2340 Beerse, BE  
ZHANG, Zhuming, 1400 McKean Road, Spring House Pennsylvania 19477, US  
BRANCH, Jonathan, 1400 McKean Road, Spring House Pennsylvania 19477, US  
ROCABOY, Christian, Parque Tecnologico de Fuente Alamo. Ctra. El Estrecho-Lobosillo Km. 2 5 Av., E-30320 El Estrecho-Lobosillo Murcia, ES  
TRABALON ESCOLAR, Luis B., Parque Tecnologico de Fuente Alamo. Ctra. El Estrecho-Lobosillo Km. 2 5 Av., E-30320 El Estrecho-Lobosillo Murcia, ES

---

(51) MKP  
**A61K 48/00 2006 (97) EP 3400023**  
**C07K 16/28 2006**  
(96) EP 17703251.3 1/10/2017  
(97) EP 3400023, 11/14/2018 201846, en  
(31) 201662276958 P (32) 10.01.2016 (33) US  
201662276959 P 10.01.2016 US  
201662290436 P 02.02.2016 US  
201662290435 P 02.02.2016 US  
(54) THERAPEUTIC MRNAS ENCODING ANTI CTLA-4 ANTIBODIES  
(72) FREDERICK, Joshua, 41 Garden Street Apt. 5, Boston Massachusetts 02114, US

---

(51) MKP  
**A61P 7/02 2006 (97) EP 3405498**  
**C07K 16/36 2006**  
(96) EP 17703278.6 1/19/2017  
(97) EP 3405498, 11/28/2018 201848, en  
(31) 201662281842 P (32) 22.01.2016 (33) US  
(54) ANTI-COAGULATION FACTOR XI ANTIBODIES  
(72) CHEN, Zhu, 5 Normandy Ct., Warren, New Jersey 07059, US  
ELLSWORTH, Kenneth, P., 2000 Galloping Hill Road, Kenilworth, New Jersey 07033, US  
MILLIGAN, James, A., 30 Lauren Lane, New Egypt, New Jersey 08533, US  
OLDHAM, Elizabeth, 901 S. California Avenue, Palo Alto, California 94304, US  
SEIFFERT, Dietmar, 12 Village Court, Lawrenceville, New Jersey 08648, US  
GANTI, Vaishnavi, 901 S. California Avenue, Palo Alto, California 94304, US  
TABRIZIFARD, Mohammad, 901 S. California Avenue, Palo Alto, California 94304, US  
PRINZ, Blanka, 7 Lucent Drive, Lebanon, NH 03766, US

---

(51) MKP  
**C07K 16/28 2006 (97) EP 3411402**  
(96) EP 17703376.8 2/2/2017  
(97) EP 3411402, 12/12/2018 201850, en  
(31) 201662290831 P (32) 03.02.2016 (33) US  
(54) BCMA AND CD3 BISPECIFIC T CELL ENGAGING ANTIBODY CONSTRUCTS

(72) RAUM, Tobias, c/o Amgen Research (Munich) GmbH Staffelseestrasse 2, 81477 Munich, DE  
MUENZ, Markus, c/o Amgen Research (Munich) GmbH Staffelseestrasse 2, 81477 Munich, DE  
BROZY, Johannes, c/o Amgen Research (Munich) GmbH Staffelseestrasse 2, 81477 Munich, DE  
KUFER, Peter, c/o Amgen Research (Munich) GmbH Staffelseestrasse 2, 81477 Munich, DE  
HOFFMANN, Patrick, c/o Amgen Research (Munich) GmbH Staffelseestrasse 2, 81477 Munich, DE  
FRIEDRICH, Matthias, c/o Amgen Research (Munich) GmbH Staffelseestrasse 2, 81477 Munich, DE  
RATTEL, Benno, c/o Amgen Research (Munich) GmbH Staffelseestrasse 2, 81477 Munich, DE  
BOGNER, Pamela, c/o Amgen Research (Munich) GmbH Staffelseestrasse 2, 81477 Munich, DE  
WOLF, Andreas, c/o Amgen Research (Munich) GmbH Staffelseestrasse 2, 81477 Munich, DE  
POMPE, Cornelius, c/o Amgen Research (Munich) GmbH Staffelseestrasse 2, 81477 Munich, DE

---

(51) MKP  
**C07K 16/28 2006 (97) EP 3411403**  
**C07K 16/30 2006**  
(96) EP 17703379.2 2/2/2017  
(97) EP 3411403, 12/12/2018 201850, en  
(31) 201662290861 P (32) 03.02.2016 (33) US  
(54) BISPECIFIC T CELL ENGAGING ANTIBODY CONSTRUCTS  
(72) RAUM, Tobias, c/o Amgen Research (Munich) GmbH Staffelseestrasse 2, 81477 Munich, DE  
MUENZ, Markus, c/o Amgen Research (Munich) GmbH Staffelseestrasse 2, 81477 Munich, DE  
BROZY, Johannes, c/o Amgen Research (Munich) GmbH Staffelseestrasse 2, 81477 Munich, DE  
KUFER, Peter, c/o Amgen Research (Munich) GmbH Staffelseestrasse 2, 81477 Munich, DE  
HOFFMANN, Patrick, c/o Amgen Research (Munich) GmbH Staffelseestrasse 2, 81477 Munich, DE  
FRIEDRICH, Matthias, c/o Amgen Research (Munich) GmbH Staffelseestrasse 2, 81477 Munich, DE  
RATTEL, Benno, c/o Amgen Research (Munich) GmbH Staffelseestrasse 2, 81477 Munich, DE  
BOGNER, Pamela, c/o Amgen Research (Munich) GmbH Staffelseestrasse 2, 81477 Munich, DE  
WOLF, Andreas, c/o Amgen Research (Munich) GmbH Staffelseestrasse 2, 81477 Munich, DE  
POMPE, Cornelius, c/o Amgen Research (Munich) GmbH Staffelseestrasse 2, 81477 Munich, DE

---

(51) MKP  
**A23L 2/54 2006 (97) EP 3411336**  
**C02F 1/44 2006**  
**C02F 1/66 2006**  
**C02F 1/68 2006**  
(96) EP 17703409.7 2/3/2017  
(97) EP 3411336, 12/12/2018 201850, en  
(31) 16154570 (32) 05.02.2016 (33) EP  
201662294572 P 12.02.2016 US  
(54) INSTALLATION FOR THE PREPARATION OF AN AQUEOUS SOLUTION COMPRISING AT LEAST ONE EARTH ALKALI HYDROGEN  
CARBONATE  
(72) NELSON, Nicholas Charles, Stationsstrasse 50, 8003 Zürich, CH  
RIEPL, Herbert, Finkensteinerstrasse 15, 9585 Gödersdorf, AT  
KREUGER, Wolfgang, Ladinach 232, 9181 Feistritz/Rosental, AT

---

(51) MKP  
**A61K 31/5377 2006 (97) EP 3408261**  
**A61K 45/06 2006**  
**C07D 277/28 2006**  
(96) EP 17703588.8 1/24/2017  
(97) EP 3408261, 12/5/2018 201849, en  
(31) 201662288029 P (32) 28.01.2016 (33) US  
(54) CRYSTALLINE FORM OF 1,3-THIAZOL-5-YLMETHYL [(2R,5R)-5-[[[(2S)-2-[(METHYL[[2-(PROPAN-2-YL)-1,3-THIAZOL-4-  
YL]METHYL)CARBAMOYL]AMINO]-4-(MORPHOLIN-4-YL)BUTANOYL 9AMINO]-1,6-DIPHENYLHEXAN-2-YL]CARBAMATE OR COBICISTAT  
(72) LAI, Chiajen, c/o Gilead Sciences Inc. 333 Lakeside Drive, Foster City CA 94404, US  
YU, Lok Him Lawrence, c/o Gilead Sciences Inc. 333 Lakeside Drive, Foster City CA 94404, US  
YU, Richard Hung Chiu, c/o Gilead Sciences Inc. 333 Lakeside Drive, Foster City CA 94404, US  
DE ARMAS, Hector Novoa, c/o Janssen Pharmaceutica NV Turnhoutseweg 30, 23450 Beerse, BE

---

(51) MKP  
**C07K 16/18 2006 (97) EP 3408291**  
**C07K 16/40 2006**  
(96) EP 17703599.5 1/25/2017  
(97) EP 3408291, 12/5/2018 201849, en



(31) 201662286933 P (32) 25.01.2016 (33) US  
201662385059 P 08.09.2016 US  
(54) ANTI-C5 ANTIBODIES WITH ENHANCED PH SWITCH  
(72) NATARAJAN, Madhusudan, C/o Shire Human Genetic Therapies Inc. 300 Shire Way, Lexington MA 02421, US  
STRACK-LOGUE, Bettina, C/o Shire Human Genetic Therapies Inc. 300 Shire Way, Lexington MA 02421, US  
ISLAM, Rizwana, C/o Shire Human Genetic Therapies Inc. 300 Shire Way, Lexington MA 02421, US

---

(51) MKP  
**A61K 31/4184 2006 (97) EP 3408268**  
**A61K 31/4433 2006**  
**A61P 17/06 2006**  
**A61P 25/00 2006**  
**A61P 29/00 2006**  
**A61P 35/00 2006**  
**C07D 233/88 2006**  
**C07D 233/90 2006**  
**C07D 405/06 2006**  
**C07D 405/14 2006**  
**C07D 471/04 2006**  
(96) EP 17703628.2 1/27/2017  
(97) EP 3408268, 12/5/2018 201849, en  
(31) 201662288487 P (32) 29.01.2016 (33) US  
201662320893 P 11.04.2016 US  
(54) BENZIMIDAZOLE DERIVATIVES AS MODULATORS OF ROR-GAMMA  
(72) CLAREMON, David, A., 1508 Aidenn Lair Road, Maple Glen PA 19002, US  
DILLARD, Lawrence, Wayne, 496 Kings Road, Yardley PA 19067, US  
FAN, Yi, 40 Bittersweet Drive, Doylestown PA 18901, US  
LOTESTA, Stephen, D., 99 Jennifer Lane, Burlington NJ 08016, US  
SINGH, Suresh, B., 4 Adams Road, Kendall Park NJ 08824, US  
TICE, Colin, M., 1325 Pinebrook Court, Maple Glen PA 19002, US  
ZHAO, Wei, 11306 Royal Manor Way, North Potomac MD 20878, US  
ZHUNG, Linghang, 3135 Fox Drive, Chalfont PA 18914, US

---

(51) MKP  
**A61K 31/519 2006 (97) EP 3411497**  
**C12Q 1/68 2018**  
(96) EP 17703683.7 1/30/2017  
(97) EP 3411497, 12/12/2018 201850, en  
(31) 201662289713 P (32) 01.02.2016 (33) US  
201662376017 P 17.08.2016 US  
(54) COPANLISIB BIOMARKERS  
(72) LIU, Li, 11 Hillside Drive, East Hanover, NJ 07936, US  
PENA, Carol, 341 Mount Airy Rd, Basking Ridge, NJ 07920, US  
CHENG, Jie, 18 Dixon Ln, Belle Mead, NJ 08502, US  
KÖCHERT, Karl, Kirschallee 174, 14469 Potsdam, DE

---

(51) MKP  
**A61K 31/519 2006 (97) EP 3411498**  
**C12Q 1/68 2018**  
(96) EP 17703689.4 1/31/2017  
(97) EP 3411498, 12/12/2018 201850, en  
(31) 201662289715 P (32) 01.02.2016 (33) US  
(54) COPANLISIB BIOMARKERS  
(72) PENA, Carol, 341 Mount Airy Rd., Basking Ridge, NJ 07920, US  
LIU, Li, 11 Hillside Drive, East Hanover, NJ 07936, US  
CHENG, Jie, 18 Dixon Ln, Belle Mead, NJ 08502, US  
KÖCHERT, Karl, Kirschallee 174, 14469 Potsdam, DE

---

(51) MKP  
**C07K 16/28 2006 (97) EP 3411404**  
**C07K 16/30 2006**  
(96) EP 17703714.0 2/2/2017  
(97) EP 3411404, 12/12/2018 201850, en

(31) 201662290875 P (32) 03.02.2016 (33) US  
(54) PSMA AND CD3 BISPECIFIC T CELL ENGAGING ANTIBODY CONSTRUCTS  
(72) RAUM, Tobias, c/o Amgen Research (Munich) GmbH Staffelseestrasse 2, 81477 Munich, DE  
MUENZ, Markus, c/o Amgen Research (Munich) GmbH Staffelseestrasse 2, 81477 Munich, DE  
BROZY, Johannes, c/o Amgen Research (Munich) GmbH Staffelseestrasse 2, 81477 Munich, DE  
KUFER, Peter, c/o Amgen Research (Munich) GmbH Staffelseestrasse 2, 81477 Munich, DE  
HOFFMANN, Patrick, c/o Amgen Research (Munich) GmbH Staffelseestrasse 2, 81477 Munich, DE  
FRIEDRICH, Matthias, c/o Amgen Research (Munich) GmbH Staffelseestrasse 2, 81477 Munich, DE  
RATTEL, Benno, c/o Amgen Research (Munich) GmbH Staffelseestrasse 2, 81477 Munich, DE  
BOGNER, Pamela, c/o Amgen Research (Munich) GmbH Staffelseestrasse 2, 81477 Munich, DE  
WOLF, Andreas, c/o Amgen Research (Munich) GmbH Staffelseestrasse 2, 81477 Munich, DE  
POMPE, Cornelius, c/o Amgen Research (Munich) GmbH Staffelseestrasse 2, 81477 Munich, DE

---

(51) MKP  
C09C 1/02 2006 (97) EP 3417013  
C09C 1/40 2006  
C09C 1/42 2006  
D21H 17/00 2006

(96) EP 17703784.3 2/13/2017

(97) EP 3417013, 12/26/2018 201852, en

(31) 16156003 (32) 16.02.2016 (33) EP  
201662298485 P 23.02.2016 US

(54) PROCESS FOR MANUFACTURING WHITE PIGMENT CONTAINING PRODUCTS

(72) SÖTEMANN, Jörg, Fritz-Rössler-Strasse 14a, 79618 Rheinfelden, DE

MAIER, Jörg Andreas, Heugasse 6, 9524 Villach, AT

---

(51) MKP  
A61K 9/00 2006 (97) EP 3405173  
A61K 9/14 2006  
A61K 9/50 2006  
A61K 31/40 2006

(96) EP 17703932.8 1/24/2017

(97) EP 3405173, 11/28/2018 201848, en

(31) 16152461 (32) 22.01.2016 (33) EP

(54) PREPARATION OF MICRONIZED PARTICLES OF AN ANTIMUSCARINIC COMPOUND BY HYDRODYNAMIC CAVITATION

(72) DAVANZO, Stephen P, c/o Chiesi Farmaceutici S.p.A Via Palermo 26/A, 43122 Parma, IT

NALL, Barry E, c/o Chiesi Farmaceutici S.p.A Via Palermo 26/A, 43122 Parma, IT

ROUSE, Timothy J, c/o Chiesi Farmaceutici S.p.A Via Palermo 26/A, 43122 Parma, IT

MIOZZI, Michele, c/o Chiesi Farmaceutici S.p.A Via Palermo 26/A, 43122 Parma, IT

---

(51) MKP  
A61J 1/00 2006 (97) EP 3414170  
B65D 5/00 2006  
B65D 5/42 2006  
G09F 3/00 2006

(96) EP 17704015.1 2/9/2017

(97) EP 3414170, 12/19/2018 201851, en

(31) 201662293911 P (32) 11.02.2016 (33) US  
201602470 11.02.2016 GB

(54) HEALTHCARE PRODUCT PACKAGE

(72) BLUNDELL, Jonathan, GlaxoSmithKline Harmire Road, Barnard Castle Durham DL12 8DT, GB

---

(51) MKP  
C09C 1/02 2006 (97) EP 3417014  
C09C 1/40 2006  
C09C 1/42 2006

(96) EP 17704022.7 2/13/2017

(97) EP 3417014, 12/26/2018 201852, en

(31) 16155963 (32) 16.02.2016 (33) EP  
201662298486 P 23.02.2016 US

(54) PROCESS FOR MANUFACTURING WHITE PIGMENT CONTAINING PRODUCTS

(72) SÖTEMANN, Jörg, Fritz-Rössler-Strasse 14a, 79618 Rheinfelden, DE  
MAIER, Jörg Andreas, Heugasse 6, 9524 Villah, AT

---

(51) MKP  
**A61K 31/56 2006 (97) EP 3411381**  
**A61K 31/575 2006**  
**A61K 31/58 2006**  
**A61P 31/18 2006**  
**C07J 63/00 2006**  
**C12N 9/50 2006**

(96) EP 17704093.8 2/2/2017

(97) EP 3411381, 12/12/2018 201850, en

(31) 201662291298 P (32) 04.02.2016 (33) US

(54) C-3 AND C-17 MODIFIED TRITERPENOIDS AS HIV-1 INHIBITORS  
(72) CHEN, Jie, 5 Research Parkway, Wallingford, Connecticut 06492, US  
CHEN, Yan, 5 Research Parkway, Wallingford, Connecticut 06492, US  
DICKER, Ira B., 5 Research Parkway, Wallingford, Connecticut 06492, US  
HARTZ, Richard A, 5 Research Parkway, Wallingford, Connecticut 06492, US  
MEANWELL, Nicholas A, 5 Research Parkway, Wallingford, Connecticut 06492, US  
REGUEIRO-REN, Alicia, 5 Research Parkway, Wallingford, Connecticut 06492, US  
SIT, Sing-Yuen, 5 Research Parkway, Wallingford, Connecticut 06492, US  
SIN, Ny, 5 Research Parkway, Wallingford, Connecticut 06492, US  
SWIDORSKI, Jacob, 5 Research Parkway, Wallingford, Connecticut 06492, US  
VENABLES, Brian Lee, 5 Research Parkway, Wallingford, Connecticut 06492, US

---

(51) MKP  
**A61K 31/535 2006 (97) EP 3408271**  
**A61P 35/00 2006**  
**C07D 498/18 2006**

(96) EP 17704134.0 1/24/2017

(97) EP 3408271, 12/5/2018 201849, en

(31) 201662286858 P (32) 25.01.2016 (33) US

(54) MAYTANSINOID DERIVATIVES, CONJUGATES THEREOF, AND METHODS OF USE  
(72) NITTOLI, Thomas, c/o Regeneron Pharmaceuticals Inc. 777 Old Saw Mill River Road, Tarrytown New York 10591, US  
MARKOTAN, Thomas P., 518 Washington Crossing Road, Newtown Pennsylvania 19840, US

---

(51) MKP  
**A61K 47/68 2017 (97) EP 3411406**  
**A61P 35/00 2006**  
**C07K 16/28 2006**  
**C07K 16/32 2006**

(96) EP 17704190.2 2/3/2017

(97) EP 3411406, 12/12/2018 201850, en

(31) 201600074 (32) 05.02.2016 (33) DK

(54) MULTISPECIFIC ANTIGEN-BINDING MOLECULE WITH IMPROVED INTERNALIZATION CHARACTERISTICS  
(72) DE GOEIJ, Bart, c/o Genmab B.V. Yalelaan 60, 3584 CM Utrecht, NL  
MELIS, Joost, c/o Genmab B.V. Yalelaan 60, 3584-CM Utrecht, NL  
VINK, Tom, c/o Genmab B.V. Yalelaan 60, 3584-CM Utrecht, NL  
TEN NAPEL, Hendrik, c/o Genmab B.V. Yalelaan 60, 3584-CM Utrecht, NL  
BREIJ, Esther, c/o Genmab B.V. Yalelaan 60, 3584-CM Utrecht, NL  
SATIJN, David, c/o Genmab B.V. Yalelaan 60, 3584-CM Utrecht, NL  
PARREN, Paul, c/o Genmab B.V. Yalelaan 60, 3584 CM Utrecht, NL

---

(51) MKP  
**A23L 2/54 2006 (97) EP 3411337**  
**B01D 61/14 2006**  
**C02F 1/44 2006**  
**C02F 1/66 2006**  
**C02F 1/68 2006**

(96) EP 17704193.6 2/3/2017

(97) EP 3411337, 12/12/2018 201850, en

(31) 16154567 (32) 05.02.2016 (33) EP  
201662294568 P 12.02.2016 US

- (54) PROCESS FOR THE PREPARATION OF AN AQUEOUS SOLUTION COMPRISING AT LEAST ONE EARTH ALKALI HYDROGEN CARBONATE  
(72) NELSON, Nicholas Charles, Stationsstrasse 50, 8003 Zürich, CH  
RIEPL, Herbert, Finkensteinerstrasse 15, 9585 Gödersdorf, AT  
KREUGER, Wolfgang, Ladinach 232, 9181 Feistritz / Rosental, AT
- 

- (51) MKP  
**A61K 31/496 2006 (97) EP 3414228**  
**A61P 9/00 2006**  
**A61P 11/00 2006**  
**A61P 15/08 2006**  
**A61P 25/24 2006**  
**A61P 25/28 2006**  
**A61P 37/08 2006**  
**C07D 213/76 2006**  
(96) EP 17704257.9 2/10/2017  
(97) EP 3414228, 12/19/2018 201851, en  
(31) 201602527 (32) 12.02.2016 (33) GB  
(54) CHEMICAL COMPOUNDS AS INHIBITORS OF KINASE ACTIVITY  
(72) ANDERSON, Niall Andrew, GlaxoSmithKline Gunnels Wood Road, Stevenage Hertfordshire SG1 2NY, GB  
BARTON, Nicholas Paul, c/o GlaxoSmithKline Gunnels Wood Road, Stevenage Hertfordshire SG1 2NY, GB  
CAMPOS, Sebastien Andre, GlaxoSmithKline Gunnels Wood Road, Stevenage Hertfordshire SG1 2NY, GB  
CANNONS, Edward Paul, GlaxoSmithKline Gunnels Wood Road, Stevenage Hertfordshire SG1 2NY, GB  
COOPER, Anthony William James, GlaxoSmithKline Gunnels Wood Road, Stevenage Hertfordshire SG1 2NY, GB  
DOWN, Kenneth David, GlaxoSmithKline Gunnels Wood Road, Stevenage Hertfordshire SG1 2NY, GB  
DOYLE, Kevin James, Charles River Chesterford Research Park, Saffron Walden Essex CB10 1XL, GB  
HAMPLIN, Julie Nicole, GlaxoSmithKline Gunnels Wood Road, Stevenage Hertfordshire SG1 2NY, GB  
INGLIS, Graham George Adam, GlaxoSmithKline Gunnels Wood Road, Stevenage Hertfordshire SG1 2NY, GB  
LE GALL, Armelle, GlaxoSmithKline Gunnels Wood Road, Stevenage Hertfordshire SG1 2NY, GB  
PATEL, Vipulkumar Kantibhai, GlaxoSmithKline Gunnels Wood Road, Stevenage Hertfordshire SG1 2NY, GB  
PEACE, Simon, GlaxoSmithKline Gunnels Wood Road, Stevenage Hertfordshire SG1 2NY, GB  
SHARPE, Andrew, Charles River Chesterford Research Park, Saffron Walden Essex CB10 1XL, GB  
WHITE, Gemma Victoria, GlaxoSmithKline Gunnels Wood Road, Stevenage Hertfordshire SG1 2NY, GB
- 

- (51) MKP  
**A61K 47/68 2017 (97) EP 3413923**  
(96) EP 17704263.7 2/10/2017  
(97) EP 3413923, 12/19/2018 201851, en  
(31) 201602356 (32) 10.02.2016 (33) GB  
(54) PYRROLOBENZODIAZEPINE CONJUGATES  
(72) HOWARD, Philip Wilson, MedImmune Limited Milstein Building Granta Park, Cambridge Cambridgeshire CB21 6GH, GB  
DUNNY, Elizabeth, MedImmune Limited Milstein Building Granta Park, Cambridge Cambridgeshire CB21 6GH, GB  
MASTERSON, Luke, MedImmune Limited Milstein Building Granta Park, Cambridge Cambridgeshire CB21 6GH, GB
- 

- (51) MKP  
**A61K 31/7084 2006 (97) EP 3402801**  
**A61P 35/00 2006**  
**C07H 21/00 2006**  
(96) EP 17704338.7 1/11/2017  
(97) EP 3402801, 11/21/2018 201847, en  
(31) 201662277273 P (32) 11.01.2016 (33) US  
201662436759 P 20.12.2016 US  
(54) CYCLIC DINUCLEOTIDES FOR TREATING CONDITIONS ASSOCIATED WITH STING ACTIVITY SUCH AS CANCER  
(71) Innate Tumor Immunity, Inc., Route 206 and Province Line Road, Princeton, New Jersey 08543, US  
(72) GLICK, Gary, 1663 Snowberry Ridge Rd., Ann Arbor, MI 48103, US  
GHOSH, Shomir, 134 Sewall Avenue Unit C, Brookline, MA 02446, US  
OLHAVA, Edward, James, 11 Scarsdale Rd, Newton, MA 02460, US  
ROUSH, William, R., 1013 Town Hall Avenue, Jupiter, FL 33458, US  
JONES, Roger, 65 Hillcrest Rd., Martinsville, NJ 08836, US
- 

- (51) MKP

**A61K 31/197 2006 (97) EP 3411026**  
**A61K 31/198 2006**  
**A61K 31/506 2006**  
**A61K 31/5377 2006**  
**A61P 1/16 2006**  
(96) EP 17704916.0 1/31/2017  
(97) EP 3411026, 12/12/2018 201850, en  
(31) 201662289463 P (32) 01.02.2016 (33) US  
201662398872 P 23.09.2016 US  
(54) USE OF sGC STIMULATORS FOR THE TREATMENT OF NONALCOHOLIC STEATOHEPATITIS (NASH)  
(72) IM, G-Yoon, Jamie, 931 Massachusetts Avenue Apartment 604, Cambridge, MA 02139, US  
CURRIE, Mark, G., 197 8th Street, Boston, MA 02129, US  
SHEPPECK, James, Edward, 356 Crittenden Drive, Newtown, PA 18940, US  
RENHOWE, Paul, Allan, 19 Sky View Road, Sudbury, MA 01776, US  
GE, Pei, 1261 Massachusetts Avenue Unit 1, Arlington, MA 02476, US  
MASFERRER, Jaime, L., 176 Raymond Street, Cambridge, MA 02140, US

---

(51) MKP  
**A61K 47/68 2017 (97) EP 3411075**  
**A61P 35/00 2006**  
**C07K 16/30 2006**  
**C07K 16/40 2006**  
(96) EP 17704968.1 2/3/2017  
(97) EP 3411075, 12/12/2018 201850, en  
(31) 201662292087 P (32) 05.02.2016 (33) US  
(54) GCC-TARGETED ANTIBODY-DRUG CONJUGATES  
(72) VEIBY, Ole Peter, 16 Nipmuck Drive, Westborough MA 01581, US  
CHARI, Ravi, V. J., 174 Winchester Street, Newton MA 02461, US  
LAMBERT, John M., 19 Chalk Street, Cambridge MA 02139, US  
LAI, Katharine C., 6 Wychwood Drive, Littleton MA 01460, US  
HERBST, Robert W., 31 Hollis Avenue, Braintree MA 02184, US  
HILDERBRAND, Scott A., 19 Lawrence Terrace, Swampscott MA 01907, US

---

(51) MKP  
**G07F 17/32 2006 (97) EP 3403249**  
(96) EP 17705014.3 1/12/2017  
(97) EP 3403249, 11/21/2018 201847, en  
(31) 1650026 (32) 12.01.2016 (33) SE  
(54) ROULETTE WHEEL BIAS TRACKING  
(71) Evolution Malta Ltd, Level 1 The Centre Tigne Point, Sliema, TPO 0001, MT  
(72) KRASTINS, Janis, Liepu aleja 5, 5052 Ikskile, LV  
JOHANNISONE-MELKVISTA, Tania, Torregiani Towers Block B P/H 17 Qui-Si-Sana, Sliema SLM 3112, MT  
LIPOVSKA, Snezana, Gunara Astras 8/1 apt. 69, 1082 Riga, LV

---

(51) MKP  
**A41G 3/00 2006 (97) EP 3407746**  
**A41G 5/00 2006**  
**A45D 8/36 2006**  
(96) EP 17705029.1 1/25/2017  
(97) EP 3407746, 12/5/2018 201849, en  
(31) 201615006218 (32) 26.01.2016 (33) US  
201615132756 19.04.2016 US  
(54) HAIR BAND WITH HAIR CARRYING STRIPS  
(71) hairtalk GmbH, Am Wolfsmantel 8, 91058 Erlangen, DE  
(72) ALEX, Günter, Schleifweg 13, 91058 Erlangen, DE

---

(51) MKP  
**F41H 5/04 2006 (97) EP 3362761**  
(96) EP 17705132.3 2/15/2017  
(97) EP 3362761, 8/22/2018 201834, de  
(31) 102016001799 (32) 17.02.2016 (33) DE  
102016110896 14.06.2016 DE

(54) BALLISTIC PROTECTION MATERIAL AND USE THEREOF  
(72) VON BLÜCHER, Hasso, Parkstrasse 10, 40699 Erkrath, DE

---

(51) MKP  
**A01N 37/06 2006 (97) EP 3405032**  
**A01N 65/12 2009**  
**A01P 3/00 2006**  
(96) EP 17705162.0 1/20/2017  
(97) EP 3405032, 11/28/2018 201848, fr  
(31) 1600099 (32) 21.01.2016 (33) FR  
(54) PLANT EXTRACT ACTING AS ANTIFUNGAL AGENT, AND PREPARATION METHOD  
(71) Greentech, Biopôle, 63360 Saint Beauzire, FR  
(72) TAMM, Lucius, Schulweg 170, 5077 Elffingen, CH  
SCHAERER, Hans-Jakob, Haldengasse 9, 4314 Zeiningen, CH  
LEVERT, Annabel, 6 rue d'Aldeguier App 615, 31500 Toulouse, FR  
ANDREU, Vanessa, 6 Bis rue des Trois Moulins, 11540 Roquefort des Corbières, FR  
BERTRAND, Cédric, 26 rue Marcel Ducassy, 66000 Perpignan, FR

---

(51) MKP  
**A61K 31/4985 2006 (97) EP 3414249**  
**A61P 7/12 2006**  
**A61P 9/12 2006**  
**A61P 13/12 2006**  
**C07D 487/04 2006**  
(96) EP 17705269.3 2/3/2017  
(97) EP 3414249, 12/19/2018 201851, en  
(31) 201662294329 P (32) 12.02.2016 (33) US  
(54) PDE1 INHIBITOR  
(72) JESUDASON, Cynthia Darshini, c/o Eli Lilly and Company P.O. Box 6288, Indianapolis, Indiana 46206-6288, US  
REKHTER, Mark David, c/o Eli Lilly and Company P.O. Box 6288, Indianapolis, Indiana 46206-6288, US

---

(51) MKP  
**A01K 67/027 2006 (97) EP 3411392**  
**A61K 39/00 2006**  
**A61K 49/00 2006**  
**C07K 14/515 2006**  
**C07K 16/22 2006**  
(96) EP 17705276.8 2/3/2017  
(97) EP 3411392, 12/12/2018 201850, en  
(31) 201662291446 P (32) 04.02.2016 (33) US  
(54) NON-HUMAN ANIMALS HAVING AN ENGINEERED ANGPLT8 GENE  
(72) GUSAROVA, Viktoria, c/o Regeneron Pharmaceuticals Inc. 777 Old Saw Mill River Road, Tarrytown New York 10591-6707, US  
MURPHY, Andrew J., c/o Regeneron Pharmaceuticals Inc. 777 Old Saw Mill River Road, Tarrytown New York 10591-6707, US  
GROMADA, Jesper, c/o Regeneron Pharmaceuticals Inc. 777 Old Saw Mill River Road, Tarrytown New York 10591-6707, US  
GUO, Dayong, 9612 W 116th Terrace, Overland Park Kansas 66210, US

---

(51) MKP  
**A61P 29/00 2006 (97) EP 3416948**  
**C07C 307/06 2006**  
**C07C 307/08 2006**  
**C07C 307/10 2006**  
**C07D 231/18 2006**  
**C07D 295/26 2006**  
(96) EP 17705416.0 2/16/2017  
(97) EP 3416948, 12/26/2018 201852, en  
(31) 2016900535 (32) 16.02.2016 (33) AU  
(54) SULFONYLUREAS AND RELATED COMPOUNDS AND USE OF SAME  
(71) The University Of Queensland, St. Lucia, QLD 4072, AU  
The Provost, Fellows, Foundation Scholars, and the other members of Board, of the College of the Holy & Undiv. Trinity of Queen Elizabeth near  
Dublin, College Green, Dublin 2, IE  
(72) O'NEILL, Luke, Trinity Biomedical Sciences Institute Trinity College Dublin 152-160 Pearse Street, Dublin 2, IE  
COLL, Rebecca, 18 Forbes Street, West End, Queensland 4101, AU

COOPER, Matthew, 29 Camborne Place, Chapel Hill Queensland 4049, AU  
ROBERTSON, Avril, 44 Marland Street, Kenmore, Queensland 4069, AU  
SCHRODER, Kate, 7 Love Street, Fairfield Queensland 4103, AU  
MACLEOD, Angus Murray, D6 Grain House Mill Court Great Shelford, Cambridge Cambridgeshire CB22 5LD, GB  
MILLER, David John, D6 Grain House Mill Court Great Shelford, Cambridge Cambridgeshire CB22 5LD, GB

---

- (51) MKP  
**A61K 31/4745 2006 (97) EP 3416946**  
**A61P 31/12 2006**  
**C07D 217/08 2006**  
**C07D 491/14 2006**
- (96) EP 17705425.1 2/16/2017  
(97) EP 3416946, 12/26/2018 201852, en
- (31) 201662297590 P (32) 19.02.2016 (33) US  
201662434658 P 15.12.2016 US
- (54) TETRACYCLIC PYRIDONE COMPOUNDS AS ANTIVIRALS  
(72) FU, Jiping, c/o Novartis Institutes for BioMedical Research Inc. 5300 Chiron Way, Emeryville California 94608, US  
JIN, Xianming, c/o Novartis Institutes for BioMedical Research Inc. 5300 Chiron Way, Emeryville California 94608, US  
LEE, Patrick, c/o Novartis Institutes for BioMedical Research Inc. 5300 Chiron Way, Emeryville California 94608, US  
LU, Peichao, c/o Novartis Institutes for BioMedical Research Inc. 5300 Chiron Way, Emeryville California 94608, US  
YOUNG, Joseph Michael, c/o Novartis Institutes for BioMedical Research Inc. 5300 Chiron Way, Emeryville California 94608, US
- 

- (51) MKP  
**A61K 31/435 2006 (97) EP 3411358**  
**A61P 3/04 2006**  
**C07D 211/36 2006**
- (96) EP 17705706.4 2/1/2017  
(97) EP 3411358, 12/12/2018 201850, en
- (31) 2016019834 (32) 04.02.2016 (33) JP
- (54) SUBSTITUTED PIPERIDINE COMPOUND AND USE THEREOF  
(72) FUJIMOTO, Tatsuhiro, c/o TAKEDA PHARMACEUTICAL COMPANY LIMITED 26-1 Muraoka-Higashi 2-chome, Fujisawa-shi Kanagawa 251-0012, JP  
RIKIMARU, Kentaro, c/o TAKEDA PHARMACEUTICAL COMPANY LIMITED 26-1 Muraoka-Higashi 2-chome, Fujisawa-shi Kanagawa 251-0012, JP  
FUKUDA, Koichiro, c/o TAKEDA PHARMACEUTICAL COMPANY LIMITED 26-1 Muraoka-Higashi 2-chome, Fujisawa-shi Kanagawa 251-0012, JP  
SUGIMOTO, Hiromichi, c/o TAKEDA PHARMACEUTICAL COMPANY LIMITED 8-2 Marunouchi 1-chome Chiyoda-ku, Tokyo 100-0005, JP  
MATSUMOTO, Takahiro, 19-17 Shonandai 5-chome, Fujisawa-shi Kanagawa 252-0804, JP  
TOKUNAGA, Norihito, c/o TAKEDA PHARMACEUTICAL COMPANY LIMITED 26-1 Muraoka-Higashi 2-chome, Fujisawa-shi Kanagawa 251-0012, JP  
HIROZANE, Mariko, c/o TAKEDA PHARMACEUTICAL COMPANY LIMITED 26-1 Muraoka-Higashi 2-chome, Fujisawa-shi Kanagawa 251-0012, JP
- 

- (51) MKP  
**C07D 403/12 2006 (97) EP 3414239**
- (96) EP 17705751.0 2/3/2017  
(97) EP 3414239, 12/19/2018 201851, en
- (31) 201662292202 P (32) 05.02.2016 (33) US  
201662341019 P 24.05.2016 US  
201662363775 P 18.07.2016 US  
201662385217 P 08.09.2016 US  
201662417219 P 03.11.2016 US
- (54) INHIBITORS OF RECEPTOR-INTERACTING PROTEIN KINASE 1  
(71) Denali Therapeutics Inc., 151 Oyster Point Boulevard 2nd Floor, South San Francisco, California 94080, US  
(72) ESTRADA, Anthony A., c/o Denali Therapeutics Inc. 151 Oyster Point Blvd. 2nd Floor, South San Francisco California 94080, US  
FENG, Jianwen A., c/o Denali Therapeutics Inc. 151 Oyster Point Blvd. 2nd Floor, South San Francisco California 94080, US  
FOX, Brian, c/o Denali Therapeutics Inc. 151 Oyster Point Blvd. 2nd Floor, South San Francisco California 94080, US  
LESLIE, Colin Philip, c/o Denali Therapeutics Inc. 151 Oyster Point Blvd. 2nd Floor, South San Francisco California 94080, US  
LYSSIKATOS, Joseph P., c/o Denali Therapeutics Inc. 151 Oyster Point Blvd. 2nd Floor, South San Francisco California 94080, US  
POZZAN, Alfonso, c/o Denali Therapeutics Inc. 151 Oyster Point Blvd. 2nd Floor, South San Francisco California 94080, US  
SWEENEY, Zachary K., c/o Denali Therapeutics Inc. 151 Oyster Point Blvd. 2nd Floor, South San Francisco California 94080, US  
DE VICENTE FIDALGO, Javier, c/o Denali Therapeutics Inc. 151 Oyster Point Blvd. 2nd Floor, South San Francisco California 94080, US
-

(51) MKP  
**A61K 31/4192 2006 (97) EP 3414233**  
**A61P 9/10 2006**  
**A61P 25/02 2006**  
**A61P 25/04 2006**  
**A61P 25/06 2006**  
**A61P 25/16 2006**  
**A61P 25/24 2006**  
**A61P 25/28 2006**  
**A61P 25/30 2006**  
**C07D 401/12 2006**  
**C07D 401/14 2006**  
**C07D 403/12 2006**  
**C07D 403/14 2006**  
**C07D 405/14 2006**  
**C07D 409/14 2006**

(96) EP 17705768.4 2/9/2017  
(97) EP 3414233, 12/19/2018 201851, en

(31) 201662293680 P (32) 10.02.2016 (33) US

(54) SUBSTITUTED 1,2,3-TRIAZOLES AS NR2B-SELECTIVE NMDA MODULATORS  
(72) CHEN, Gang, 3210 Merryfield Row, San Diego, California 92121, US  
CHROVIAN, Christa C., 3210 Merryfield Row, San Diego, California 92121, US  
COATE, Heather R., 3210 Merryfield Row, San Diego, California 92121, US  
DVORAK, Curt A., 3210 Merryfield Row, San Diego, California 92121, US  
GELIN, Christine F., 3210 Merryfield Row, San Diego, California 92121, US  
HISCOX, Afton, 3210 Merryfield Row, San Diego, California 92121, US  
LETAVIC, Michael A., 3210 Merryfield Row, San Diego, California 92121, US  
RECH, Jason C., 3210 Merryfield Row, San Diego, California 92121, US  
SOYODE-JOHNSON, Akinola, 3210 Merryfield Row, San Diego, California 92121, US  
STENNE, Brice, 3210 Merryfield Row, San Diego, California 92121, US  
WALL, Jessica L., 3210 Merryfield Row, San Diego, California 92121, US  
ZHANG, Wei, 3210 Merryfield Row, San Diego, California 92121, US

---

(51) MKP  
**A61K 31/519 2006 (97) EP 3411375**  
**A61P 11/00 2006**  
**C07D 487/04 2006**

(96) EP 17705804.7 1/31/2017  
(97) EP 3411375, 12/12/2018 201850, en

(31) 16154299 (32) 04.02.2016 (33) EP

(54) PYRAZOLE DERIVATIVES AS PHOSPHOINOSITIDE 3-KINASES INHIBITORS  
(72) BIAGETTI, Matteo, c/o CHIESI FARMACEUTICI S.p.A. Via Palermo 26/A, 43122 PARMA, IT  
CAPELLI, Anna Maria, c/o CHIESI FARMACEUTICI S.p.A. Via Palermo 26/A, 43122 PARMA, IT  
RETINI, Michele, c/o CHIESI FARMACEUTICI S.p.A. Via Palermo 26/A, 43122 PARMA, IT

---

(51) MKP  
**A61K 39/00 2006 (97) EP 3416983**  
**C07K 16/24 2006**

(96) EP 17705873.2 2/17/2017  
(97) EP 3416983, 12/26/2018 201852, en

(31) 16156582 (32) 19.02.2016 (33) EP  
16156651 22.02.2016 EP

(54) ANTIBODIES FOR IL-17C  
(72) HAAS, Jan Dominik, Riedener Str. 12, 81475 München, DE  
KLATTIG, Jürgen, Weinhartstrasse 13c, 82380 Peißenberg, DE  
VANDEGHINSTE, Nick Ernest René, Galapagos NV Generaal De Wittelaan L11/A3, 2800 Mechelen, BE

---

(51) MKP  
**C07K 14/47 2006 (97) EP 3416980**

(96) EP 17705891.4 2/17/2017  
(97) EP 3416980, 12/26/2018 201852, en

(31) 201602918 (32) 19.02.2016 (33) GB  
201662297495 P 19.02.2016 US



(54) NOVEL PEPTIDES AND COMBINATION OF PEPTIDES FOR USE IN IMMUNOTHERAPY AGAINST NHL AND OTHER CANCERS  
(72) SCHOOR, Oliver, Eichhaldenstrasse 19, 72074 Tübingen, DE  
MAHR, Andrea, Kirschenweg 22, 72076 Tübingen, DE  
WEINSCHENK, Toni, Im Morgenrain 15, 73773 Aichwald, DE  
WIEBE, Anita, Quellenstrasse 49, 72124 Ruebgarten, DE  
FRITSCHKE, Jens, Lärchenweg 11, 72144 Dusslingen, DE  
SINGH, Harpreet, Heckscherstrasse 25a, 80804 München, DE

---

(51) MKP  
**C08B 1/00 2006 (97) EP 3411415**  
**C08B 16/00 2006**  
**C08J 11/08 2006**  
**D01F 2/00 2006**  
**D04H 1/425 2012**  
**D21H 11/20 2006**

(96) EP 17705965.6 2/1/2017

(97) EP 3411415, 12/12/2018 201850, en

(31) 2016190 (32) 01.02.2016 (33) NL

(54) METHOD FOR PRODUCING REGENERATED CELLULOSE FIBERS FROM COTTON CONTAINING TEXTILE WASTE

(71) Stichting Saxion, M.H. Tromplaan 30, 7513 AB Enschede, NL

(72) BRINKS, Gerrit Johannes, c/o Brinks Management Advice/Techne B.V. Wagnerstraat 4, 7604 CG Almelo, NL

BOUWHUIS, Gerhard Herman, c/o Gerrit Bouwhuis B.V. Sportlaan 62, 7581 BZ Losser, NL

AGRAWAL, Pramodkumar Bhagwandas, c/o Agrawal Ecolabs Voermanstraat 23, 7521 HW Enschede, NL

GOOIJER, Hendrik, c/o Filo Engineering Adolf van Nieuwenaarlaan 5, 6824 AM Arnhem, NL

OELERICH, Jens Josef, Weiner 296, 48607 Ochtrup, DE

---

(51) MKP  
**A61K 9/50 2006 (97) EP 3413879**  
**A61K 31/225 2006**  
**A61P 25/00 2006**

(96) EP 17706072.0 2/8/2017

(97) EP 3413879, 12/19/2018 201851, en

(31) 201662294054 P (32) 11.02.2016 (33) US

(54) PHARMACEUTICAL BEAD FORMULATIONS COMPRISING DIMETHYL FUMARATE

(72) KARKI, Shyam, B., 9 Todd Street, Hillsborough NJ 08844, US

ZAWANEH, Peter, 14 Roberts Street Unit 1, Brookline MA 02445, US

LEUNG, Cheuk-Yui, 16 Prescott Road, Acton MA 01720, US

VASUDEVAN, Kalyan, 28 Fayette Street, G-Unit, Cambridge MA 02139, US

LIN, Yiqing, 60 Baskin Road, Lexington MA 02421, US

XU, Jin, 107 Ridge Lane 5, Waltham MA 20452, US

TREMENTOZZI, Andrea, 58 Oldfield Drive, Sherborn MA 01770, US

NESTOROV, Ivan, 3 Willis Holden Drive, Acton MA 01720, US

---

(51) MKP  
**A61K 31/7076 2006 (97) EP 3413897**  
**A61P 31/18 2006**

(96) EP 17706102.5 2/10/2017

(97) EP 3413897, 12/19/2018 201851, en

(31) 201662294576 P (32) 12.02.2016 (33) US

201662297657 P 19.02.2016 US

(54) METHODS FOR TREATMENT AND PROPHYLAXIS OF HIV AND AIDS

(72) HAZUDA, Daria, 770 Sumneytown Pike, West Point Pennsylvania 19486, US

MILLER, Michael D., 351 North Sumneytown Pike, North Wales Pennsylvania 19454, US

GROBLER, Jay A., 770 Sumneytown Pike, West Point Pennsylvania 19486, US

NICOLL-GRIFFITH, Deborah Anne, 261 rue Principale, St-Basile-le-Grand Québec J3N 1H3, CA

---

(51) MKP  
**A61K 39/12 2006 (97) EP 3416682**  
**C12N 7/00 2006**

(96) EP 17706103.3 2/10/2017

(97) EP 3416682, 12/26/2018 201852, en

(31) 201662296658 P (32) 18.02.2016 (33) US

(54) PORCINE REPRODUCTIVE AND RESPIRATORY SYNDROME VACCINE VIRUS

(71) ELANCO US INC., 2500 Innovation Way, Greenfield, IN 46140, US  
(72) FANG, Ying, c/o Eli Lilly and Company P.O. Box 6288, Indianapolis, Indiana 46206-6288, US  
WU, Stephen, c/o Eli Lilly and Company P.O. Box 6288, Indianapolis, Indiana 46206-6288, US

---

(51) MKP  
**A61K 31/4985 2006 (97) EP 3414251**  
**A61P 35/00 2006**  
**A61P 37/00 2006**  
**C07D 495/04 2006**  
(96) EP 17706132.2 2/13/2017  
(97) EP 3414251, 12/19/2018 201851, en  
(31) 201662294583 P (32) 12.02.2016 (33) US  
(54) THIENOPYRAZINE CARBOXAMIDES AS UBIQUITIN-SPECIFIC PROTEASE INHIBITORS  
(72) GUERIN, David Joseph, 16 Huntington Street, Natick, Massachusetts 01760, US  
BAIR, Kenneth W., 41 Cartwright Road, Wellesley, Massachusetts 02482, US  
CARAVELLA, Justin A., 121 Sciarappa Street 3, Cambridge, Massachusetts 02141, US  
IOANNIDIS, Stephanos, 8 Penobscot Road, Natick, Massachusetts 01760, US  
LANCIA, JR., David R., 862 E 2nd Street Unit 4, Boston, Massachusetts 02127, US  
LI, Hongbin, 52 Whitman Road, Madison, Connecticut 06443, US  
MISCHKE, Steven, 646 South Street Apt B, Waltham, Massachusetts 02453, US  
NG, Pui Yee, 220 Grove Street 1, Waltham, Massachusetts 02453, US  
RICHARD, David, 44 Spectacle Pond Road, Littleton, Massachusetts 01460, US  
SCHILLER, Shawn E.R., 614 Hilldale Avenue, Haverhill, Massachusetts 01832, US  
SHELEKHIN, Tatiana, 4 High Valley Road, Ridgefield, Connecticut 06877, US  
WANG, Zhongguo, 19 Earl Street, Lexington, Massachusetts 02421, US

---

(51) MKP  
**A23L 2/52 2006 (97) EP 3405207**  
**A23L 33/105 2016**  
**A61K 9/20 2006**  
**A61K 9/48 2006**  
**A61K 36/67 2006**  
**A61P 1/16 2006**  
(96) EP 17706271.8 1/16/2017  
(97) EP 3405207, 11/28/2018 201848, fr  
(31) 1650470 (32) 21.01.2016 (33) FR  
(54) DETOXIFYING COMPOSITION FOR ORAL ADMINISTRATION AND METHOD FOR PREPARING SAME  
(71) Hay, Ly Eang, 34A rue 240, Phnom Penh, KH  
(72) Hay, Ly Eang, 34A rue 240, Phnom Penh, KH

---

(51) MKP  
**B21D 5/04 2006 (97) EP 3416765**  
(96) EP 17706308.8 1/26/2017  
(97) EP 3416765, 12/26/2018 201852, en  
(31) UB20160836 (32) 18.02.2016 (33) IT  
(54) A BENDING GROUP OF A PANELLING MACHINE TOOL  
(71) OLMA S.r.l., 55 Via Dante Alighieri, 20081 Abbiategrasso (MI), IT  
(72) LAZZATI, Alberto, 30 Via Trieste, I-20081 Abbiategrasso (MI), IT

---

(51) MKP  
**H04L 29/06 2006 (97) EP 3412017**  
**H04W 12/06 2009**  
**H04W 12/08 2009**  
(96) EP 17706313.8 2/3/2017  
(97) EP 3412017, 12/12/2018 201850, en  
(31) 201662290491 P (32) 03.02.2016 (33) US  
201662313845 P 28.03.2016 US  
201662325478 P 21.04.2016 US  
201662416210 P 02.11.2016 US  
(54) METHOD AND APPARATUS FOR FACILITATING FRICTIONLESS TWO-FACTOR AUTHENTICATION  
(71) Avera US, Inc., 2654 W. Horizon Ridge Pkwy. B5-229, Henderson, NV 89052, US  
(72) BROWN, Wendell, 2654 W. Horizon Ridge Pkwy. B5-229, Henderson, Nevada 89052, US

---

(51) MKP  
**C21D 8/02 2006 (97) EP 3402906**  
**C21D 8/04 2006**  
**C21D 9/46 2006**  
**C21D 9/48 2006**

(96) EP 17706330.2 1/17/2017  
(97) EP 3402906, 11/21/2018 201847, en

(31) 201662278567 P (32) 14.01.2016 (33) US  
201662407001 P 12.10.2016 US

(54) WARM ROLLING OF STEELS CONTAINING METASTABLE AUSTENITE  
(72) GILL, Amrinder, Sigh, 7880 Christine Avenue, West Chester OH 45241, US

---

(51) MKP  
**A47K 10/32 2006 (97) EP 3410910**  
**A47K 10/38 2006**

(96) EP 17706595.0 2/1/2017  
(97) EP 3410910, 12/12/2018 201850, en

(31) 2016196 (32) 01.02.2016 (33) NL

(54) SYSTEM FOR STORING AND DISPENSING WIPES  
(71) Save-Insight B.V., Witte klaverlaan 2, 1562 AM Krommenie, NL  
(72) RAMAKER, Ron, Witte Klaverlaan 2, 1562 AM Krommenie, NL

---

(51) MKP  
**A61K 39/00 2006 (97) EP 3416984**  
**C07K 16/28 2006**

(96) EP 17706644.6 2/10/2017  
(97) EP 3416984, 12/26/2018 201852, en

(31) 201662296729 P (32) 18.02.2016 (33) US

(54) CHIMERIC CANINE ANTI-CD20 ANTIBODY  
(72) PANCOOK, James David, c/o Eli Lilly and Company P.O. Box 6288, Indianapolis, Indiana 46206-6288, US

---

(51) MKP  
**C07D 295/096 2006 (97) EP 3414231**

(96) EP 17706675.0 2/6/2017  
(97) EP 3414231, 12/19/2018 201851, en

(31) 201670066 (32) 08.02.2016 (33) DK

(54) SYNTHESIS OF 1-[2-(2,4-DIMETHYL-PHENYLSULFANYL)-PHENYL]PIPERAZINE  
(72) DINESS, Frederik, Margeritvej 2, 3650 Ølstykke, DK  
MELDAL, Morten, Mosesvinget 78, 2400 Copenhagen NV, DK  
JACOBSEN, Christian Borch, Kongens Vænge 175, 3400 Hillerød, DK

---

(51) MKP  
**A61M 16/00 2006 (97) EP 3416712**

(96) EP 17706681.8 2/16/2017  
(97) EP 3416712, 12/26/2018 201852, en

(31) 201670086 (32) 16.02.2016 (33) DK  
201670900 11.11.2016 DK

(54) A BREATHING DEVICE  
(71) Balancair APS, c/o Scion DTU Diplomvej 381, 2800 Kgs. Lyngby, DK  
(72) OTHEL-JACOBSEN, Erik, Turbinevej 7, 2900 Hellerup, DK  
JOHANSEN, Asger, Islands Brygge 24A 4. tv., 2300 Copenhagen S, DK  
JOHANSEN, Troels, Absalonsgade 26, 8000 Aarhus C, DK

---

(51) MKP  
**A61K 31/4025 2006 (97) EP 3416960**  
**A61K 31/407 2006**  
**A61P 35/00 2006**  
**C07D 401/06 2006**  
**C07D 401/12 2006**

**C07D 401/14 2006**  
**C07D 403/06 2006**  
**C07D 403/14 2006**  
**C07D 413/06 2006**  
**C07D 413/12 2006**  
**C07D 417/12 2006**  
**C07D 417/14 2006**  
**C07D 471/04 2006**  
**C07D 487/04 2006**  
**C07D 487/10 2006**  
(96) EP 17706864.0 2/16/2017  
(97) EP 3416960, 12/26/2018 201852, en  
(31) 201602854 (32) 18.02.2016 (33) GB  
(54) NOVEL COMPOUNDS  
(71) Mission Therapeutics Limited, Babraham Research Campus Moneta, Cambridge, Cambridgeshire CB22 3AT, GB  
(72) GIBSON, Karl Richard, C/o Sandexis Medicinal Chemistry Ltd Innovation House Discovery Park Ramsgate Road, Sandwich Kent CT13 9ND, GB  
JONES, Alison, C/o Mission Therapeutics Limited Moneta Building Babraham Research Campus, Cambridge CB22 3AT, GB  
KEMP, Mark Ian, C/o Mission Therapeutics Limited Moneta Building Babraham Research Campus, Cambridge CB22 3AT, GB  
MADIN, Andrew, C/o Mission Therapeutics Limited Moneta Building Babraham Research Campus, Cambridge CB22 3AT, GB  
STOCKLEY, Martin Lee, C/o Mission Therapeutics Limited Moneta Building Babraham Research Campus, Cambridge CB22 3AT, GB  
WHITLOCK, Gavin Alistair, C/o Sandexis Medicinal Chemistry Ltd Innovation House Discovery Park Ramsgate Road, Sandwich Kent CT13 9ND, GB  
WOODROW, Michael D., C/o Mission Therapeutics Limited Moneta Building Babraham Research Campus, Cambridge CB22 3AT, GB

---

(51) MKP  
**A61K 39/00 2006 (97) EP 3411488**  
**A61K 48/00 2006**  
**C12N 9/24 2006**  
**C12N 15/86 2006**  
(96) EP 17706915.0 2/2/2017  
(97) EP 3411488, 12/12/2018 201850, en  
(31) 201662290547 P (32) 03.02.2016 (33) US  
201662323271 P 15.04.2016 US  
201662337178 P 16.05.2016 US  
201662367798 P 28.07.2016 US  
201762452560 P 31.01.2017 US  
(54) GENE THERAPY FOR TREATING MUCOPOLYSACCHARIDOSIS TYPE I  
(72) HINDERER, Christian, 212 Brown Street, Apt. 8A, Philadelphia Pennsylvania 19123, US  
WILSON, James, M., 1831 Delancey Street, Philadelphia Pennsylvania 19103, US

---

(51) MKP  
**A61K 39/395 2006 (97) EP 3416684**  
**A61P 3/06 2006**  
**C07K 16/22 2006**  
(96) EP 17706945.7 2/13/2017  
(97) EP 3416684, 12/26/2018 201852, en  
(31) 201662296110 P (32) 17.02.2016 (33) US  
(54) METHODS FOR TREATING OR PREVENTING ATHEROSCLEROSIS BY ADMINISTERING AN INHIBITOR OF ANGPTL3  
(72) GROMADA, Jesper, c/o Regeneron Pharmaceuticals Inc. 777 Old Saw Mill River Road, Tarrytown, New York 10591, US  
GUSAROVA, Viktoria, c/o Regeneron Pharmaceuticals Inc. 777 Old Saw Mill River Road, Tarrytown, New York 10591, US  
MURPHY, Andrew J., c/o Regeneron Pharmaceuticals Inc. 777 Old Saw Mill River Road, Tarrytown, New York 10591, US

---

(51) MKP  
**A61K 47/69 2017 (97) EP 3411077**  
**C07K 1/13 2006**  
(96) EP 17707135.4 2/3/2017  
(97) EP 3411077, 12/12/2018 201850, en  
(31) 201662292018 P (32) 05.02.2016 (33) US  
(54) EFFICIENT PROCESS FOR PREPARING CELL-BINDING AGENT-CYTOTOXIC AGENT CONJUGATES  
(72) LAI, Katharine, C., 6 Wychwood Drive, Littleton MA 01460, US  
HERBST, Robert, W., 31 Hollis Avenue, Braintree MA 02184, US  
HILDERBRAND, Scott, Alan, 19 Lawrence Terrace, Swampscott MA 01907, US

---

(51) MKP  
**A61K 39/395 2006 (97) EP 3416982**  
**C07K 16/22 2006**

(96) EP 17707960.5 2/17/2017  
(97) EP 3416982, 12/26/2018 201852, en

(31) 201662296282 P (32) 17.02.2016 (33) US

(54) TGFΒETA 2 ANTIBODIES

(72) IBEBUNJO, Chikwendu, Novartis Institutes for BioMedical Research Inc. 250 Massachusetts Avenue, Cambridge Massachusetts 02139, US  
JACOBI, Carsten, Novartis Pharma AG Postfach Novartis Institutes for Biomed. Research, 4002 Basel, CH  
MEYER, Angelika, Novartis Pharma AG Postfach Novartis Institutes for Biomed. Research, 4002 Basel, CH  
SCHAADT, Eveline, MORPHOSYS AG Lena-Christ-Strasse 48, 82152 Planegg, DE  
TRENDELENBURG, Anne-Ulrike, Novartis Institutes for BioMedical Research Inc. 250 Massachusetts Avenue, Cambridge Massachusetts 02139, US  
VLADIMIROVNA MITINA, Olga, Morphosys AG Lena-Christ-Strasse 48, 82152 Planegg, DE

---

(51) MKP  
**C07C 233/23 2006 (97) EP 3408256**  
**C07C 233/41 2006**  
**C07C 235/36 2006**  
**C07C 271/24 2006**  
**C07C 311/06 2006**  
**C07C 317/30 2006**  
**C07D 205/04 2006**  
**C07D 231/12 2006**  
**C07D 231/14 2006**  
**C07D 237/14 2006**  
**C07D 239/42 2006**  
**C07D 261/10 2006**  
**C07D 309/08 2006**  
**C07D 309/14 2006**  
**C07D 413/12 2006**

(96) EP 17707970.4 1/24/2017  
(97) EP 3408256, 12/5/2018 201849, en

(31) 201601301 (32) 25.01.2016 (33) GB

(54) INDANE DERIVATIVES AS MGLUR7 MODULATORS

(72) GOLDBY, Anne, c/o Takeda Cambridge Limited 418 Cambridge Science Park Milton Road, Cambridge CB4 0PA, GB  
LIWICKI, Gemma, c/o Takeda Cambridge Limited 418 Cambridge Science Park Milton Road, Cambridge CB4 0PA, GB  
MACK, Stephen, c/o Takeda Cambridge Limited 418 Cambridge Science Park Milton Road, Cambridge CB4 0PA, GB  
TEALL, Martin, c/o Takeda Cambridge Limited 418 Cambridge Science Park Milton Road, Cambridge CB4 0PA, GB  
WHITE, Katy, c/o Takeda Cambridge Limited 418 Cambridge Science Park Milton Road, Cambridge CB4 0PA, GB

---

(51) MKP  
**A61M 5/142 2006 (97) EP 3413953**  
**A61M 5/145 2006**  
**A61M 5/315 2006**

(96) EP 17708028.0 2/13/2017  
(97) EP 3413953, 12/19/2018 201851, en

(31) 201662294842 P (32) 12.02.2016 (33) US  
201662297718 P 19.02.2016 US  
201662320438 P 08.04.2016 US

(54) DRUG DELIVERY DEVICE AND METHOD OF MANUFACTURE

(72) GIBSON, Scott, R., 12141 Bellando Court, Granada Hills, CA 91344, US  
MOBERG, Sheldon, B., 1030 Chalet Circle, Thousand Oaks, CA 91362, US  
TAHA, Basel, Hasan, 1625 Berwick Place, Westlake Village, CA 91361, US  
BOYAVAL, Margaux, Frances, 684 Via Vista, Newbury Park, CA 91320, US  
DESTEFANO, Mark, A, 255 Zvarick Road, Collegeville, PA 19426, US  
LOVE, John, C., 5173 Terraza Quintana, San Diego, CA 92124, US  
HANSON, IAN, B., 690 Davis Lane, Wayne, PA 19087, US  
BENTE, Paul, F., 87 Bunker Hill Court, Wayne, PA 19087, US  
CLEMENTE, Matthew, J., 13939 Danube Drive, Carmel, IL 46032, US  
RAMASWAMY, Rajan, 18245 Moon Song Court, San Diego, CA 92127, US  
CODD, Daniel, S., 330 Eldorado Drive, Escondido, CA 92025, US  
BEAVER, Scott, 969 Fortune Rd., San Marcos California 92078, US  
BOKELMAN, Kevin, L., 16069 Bedford Hill, San Diego, CA 92127, US  
O'CONNOR, Sean, M., 201 Ford Circle, West Chester, PA 19380, US

DECKER, Robert, 104 Old York Road, Dillsburg Pennsylvania 17019, US  
SHETTY, Gautam, N., 41 Hemison Court, Pikesville, MD 21208, US  
AGARD, Ryan, M., 320 Autumn Lane, Royersford, PA 19468, US  
CICCARELLI, Nicholas, J., 1906 Mount Vernon Street, Philadelphia Pennsylvania 19130, US  
DAVENPORT, Daniel, 73 College Avenue, Collegeville, PA 19426, US

---

- (51) MKP  
**A61K 31/4365 2006 (97) EP 3414252**  
**A61K 31/437 2006**  
**A61K 31/438 2006**  
**A61K 31/496 2006**  
**A61K 31/4985 2006**  
**A61K 31/506 2006**  
**A61K 31/5386 2006**  
**A61K 31/551 2006**  
**A61P 29/00 2006**  
**A61P 31/04 2006**  
**A61P 31/12 2006**  
**A61P 35/00 2006**  
**A61P 37/00 2006**  
**C07D 495/04 2006**
- (96) EP 17708031.4 2/13/2017  
(97) EP 3414252, 12/19/2018 201851, en
- (31) 201662294625 P (32) 12.02.2016 (33) US
- (54) THIENOPYRIDINE CARBOXAMIDES AS UBIQUITIN-SPECIFIC PROTEASE INHIBITORS
- (72) GUERIN, David Joseph, 16 Huntington Street, Natick, Massachusetts 01760, US  
BAIR, Kenneth W., 41 Cartwright Road, Wellesley, Massachusetts 02482, US  
CARAVELLA, Justin A., 121 Sciarappa Street 3, Cambridge, Massachusetts 02141, US  
IOANNIDIS, Stephanos, 8 Penobscot Road, Natick, Massachusetts 01760, US  
LANCIA JR., David R., 862 E 2nd Street Unit 4, Boston, Massachusetts 02127, US  
LI, Hongbin, 52 Whitman Road, Madison, Connecticut 06443, US  
MISCHKE, Steven, 646 South Street Apt B, Waltham, Massachusetts 02453, US  
NG, Pui Yee, 220 Grove Street 1, Waltham, Massachusetts 02453, US  
RICHARD, David, 44 Spectacle Pond Road, Littleton, Massachusetts 01460, US  
SCHILLER, Shawn E. R., 614 Hilldale Avenue, Haverhill, Massachusetts 01832, US  
SHELEKHIN, Tatiana, 4 High Valley Road, Ridgefield, Connecticut 06877, US  
WANG, Zhongguo, 19 Earl Street, Lexington, Massachusetts 02421, US
- 

- (51) MKP  
**A61K 38/46 2006 (97) EP 3416678**  
**A61P 3/00 2006**
- (96) EP 17708395.3 2/17/2017  
(97) EP 3416678, 12/26/2018 201852, en
- (31) 201662296563 P (32) 17.02.2016 (33) US  
201762453864 P 02.02.2017 US
- (54) METHODS AND COMPOSITIONS FOR CNS DELIVERY OF ARYLSULFATASE A
- (72) WASILEWSKI, Margaret, c/o Shire Human Genetic Therapies Inc. 300 Shire Way, Lexington MA 02421, US  
WIJATYK, Anna, c/o Shire Human Genetic Therapies Inc. 300 Shire Way, Lexington MA 02421, US
- 

- (51) MKP  
**A61K 9/00 2006 (97) EP 3399971**  
**A61K 31/202 2006**  
**A61P 17/00 2006**
- (96) EP 17708574.3 1/6/2017  
(97) EP 3399971, 11/14/2018 201846, en
- (31) 201662276019 P (32) 07.01.2016 (33) US  
201662357000 P 30.06.2016 US
- (54) PHARMACEUTICAL COMPOSITIONS COMPRISING DGLA AND USE OF SAME
- (72) DUNNE, James, C/o Trintech Building South County Business Park Leopardstown, Dublin 18, IE  
MANKU, Mehar, 21 Hollywood Drive, Birmingham B47 5PS, GB  
CLIMAX, John, c/o Trintech Building South County Business Park Leopardstown, Dublin 18, IE  
COUGHLAN, David, c/o Trintech Building South County Business Park Leopardstown, Dublin 18, IE
-

(51) MKP  
**A61K 9/00 2006 (97) EP 3414320**  
**A61K 35/28 2015**  
**C12N 5/00 2006**  
**C12N 5/0775 2010**  
(96) EP 17709507.2 2/13/2017  
(97) EP 3414320, 12/19/2018 201851, en  
(31) 201662294489 P (32) 12.02.2016 (33) US  
201662414285 P 28.10.2016 US  
(54) ADIPOSE TISSUE DERIVED MESENCHYMAL STROMAL CELL CONDITIONED MEDIA AND METHODS OF MAKING AND USING THE SAME  
(71) Cell Care Therapeutics, 805 S. Shamrock Avenue, Monrovia, California 91016-6353, US  
(72) GANGARAJU, Raja Shekhar, 3432 Village Cross Ln, Collierville, Tennessee 38017, US  
SOHL, Nicolas Miroslav Jotterand, 362 Havana Ave., Long Beach, California 90814, US  
JOTTERAND, Veronique Hedwige, 362 Havana Ave., Long Beach, California 90814, US  
PENTECOST, Mickey, 7911 Norton Avenue 3/8, West Hollywood, California 90046, US

---

(51) MKP  
**F03G 3/08 2006 (97) EP 3417170**  
**H02K 7/02 2006**  
(96) EP 17709804.3 2/13/2017  
(97) EP 3417170, 12/26/2018 201852, en  
(31) 16155740 (32) 15.02.2016 (33) EP  
(54) FLYWHEEL ENERGY STORAGE DEVICE AND METHOD OF ITS USE  
(72) NOVÁK, Miroslav, Oponice 111, 956 14 Oponice, SK

---

(51) MKP  
**A01K 67/027 2006 (97) EP 3416479**  
**C07K 16/10 2006**  
**C12N 9/14 2006**  
(96) EP 17709838.1 2/16/2017  
(97) EP 3416479, 12/26/2018 201852, en  
(31) 201662295524 P (32) 16.02.2016 (33) US  
(54) NON-HUMAN ANIMALS HAVING A MUTANT KYNURENINASE GENE  
(72) KYRATSOUS, Christos, 777 Old Saw Mill River Road, Tarrytown NY 10591, US  
MUJICA, Alexander, O., 777 Old Saw Mill River Road, Tarrytown NY 10591, US

---

(51) MKP  
**G06F 21/32 2013 (97) EP 3417392**  
**H04L 29/06 2006**  
(96) EP 17710067.4 2/16/2017  
(97) EP 3417392, 12/26/2018 201852, en  
(31) 2016272 (32) 16.02.2016 (33) NL  
(54) METHOD, SYSTEM, DEVICE AND SOFTWARE PROGRAMME PRODUCT FOR THE REMOTE AUTHORIZATION OF A USER OF DIGITAL SERVICES  
(71) Morpho B.V., Oudeweg 32, 2031 CC Haarlem, NL  
(72) VAN PROOIJEN, Joost, Oudeweg 32, 2031 CC Haarlem, NL  
DURAND, Claire, Oudeweg 32, 2031 CC Haarlem, NL  
HUGEL, Rodolphe, Oudeweg 32, 2031 CC Haarlem, NL  
DE VOS, Jouri, Oudeweg 32, 2031 CC Haarlem, NL

---

(51) MKP  
**A61K 31/365 2006 (97) EP 3407883**  
**A61K 31/405 2006**  
**A61K 33/06 2006**  
**A61K 33/08 2006**  
**A61K 36/28 2006**  
**A61K 36/48 2006**  
**A61P 25/06 2006**  
(96) EP 17711314.9 1/25/2017  
(97) EP 3407883, 12/5/2018 201849, en  
(31) UB20160516 (32) 29.01.2016 (33) IT  
(54) FORMULATION FOR TREATING MIGRAINE

(71) GOTHAM S.r.l., Via Leonardo Da Vinci, 20, 25122 Brescia, IT  
(72) DALLA VOLTA, Giorgio, Via Bassiche, 45/B, 25122 Brescia, IT

---

(51) MKP  
**C10J 3/84 2006 (97) EP 3417037**

(96) EP 17711757.9 2/16/2017  
(97) EP 3417037, 12/26/2018 201852, en  
(31) 201662296730 P (32) 18.02.2016 (33) US  
(54) SYSTEM AND METHOD FOR POWER PRODUCTION INCLUDING METHANATION  
(72) FORREST, Brock Alan, 2113 Englewood Avenue DN, Durham, North Carolina 27705, US  
LU, Xijia, 3708 Kilgo Drive, Durham, North Carolina 27705, US

---

(51) MKP  
**B09C 1/10 2006 (97) EP 3416759**  
**C12P 1/04 2006**  
**C12P 5/02 2006**  
**C22B 3/00 2006**  
**C22B 3/18 2006**  
**E21B 43/00 2006**

(96) EP 17712017.7 2/16/2017  
(97) EP 3416759, 12/26/2018 201852, en  
(31) 201600003 (32) 16.02.2016 (33) EE  
(54) METHOD FOR DECOMPOSITION OF THE METALLOORGANIC MATTER OF GRAPTOLITE-ARGILLITE BY MICROBIAL CONSORTIUM  
(71) BiotaTec OÜ, Pirmi 7, 10617 Tallinn, Kristiine linnaosa, EE  
(72) MENERT, Anne, Vaksali 3-24, 50410 Tartu, EE  
KIVISAAR, Maia, Mõisavahe 42-47, 50708 Tartu, EE  
SIPP KULLI, Sirli, Hämariku tee 15, 76901 Tabasalu Harku vald, EE  
HEINARU, Ain, Riia 5-8, 51010 Tartu, EE  
MAIDRE, Tiit, Linnamäe tee 5-18, 13912 Tallinn, EE

---

(51) MKP  
**A61B 50/30 2016 (97) EP 3413828**  
**A61B 90/90 2016**  
**A61B 90/98 2016**  
**A61L 2/24 2006**

(96) EP 17712225.6 2/7/2017  
(97) EP 3413828, 12/19/2018 201851, en  
(31) UB20160638 (32) 10.02.2016 (33) IT  
(54) METHOD FOR THE PREPARATION AND PACKAGING OF A STERILE PROCEDURE PACK OR KIT FOR OPERATING ROOM USE  
(71) Servizi Ospedaliari S.p.A., Via G. Calvino 33, 44122 Ferrara, IT  
(72) FRANCESCHINI, Alberto, Servizi Ospedaliari S.p.A. Via G. Calvino 33, 44122 Ferrara, IT

---

(51) MKP  
**A61K 31/42 2006 (97) EP 3408260**  
**A61P 9/00 2006**  
**C07D 261/18 2006**

(96) EP 17712605.9 3/7/2017  
(97) EP 3408260, 12/5/2018 201849, en  
(31) 201662305393 P (32) 08.03.2016 (33) US  
201662346336 P 06.06.2016 US  
(54) CRYSTALLINE(2S,4R)-5-(5'-CHLORO-2'-FLUORO-[1,1'-BIPHENYL]-4-YL)-2-(ETHOXYMETHYL)-4-(3-HYDROXYISOXAZOLE-5-CARBOXAMIDO)-2-METHYLPENTANOIC ACID AND USES THEREOF  
(72) HUGHES, Adam D., 2029 Touraine Lane, Half Moon Bay, California 94019, US  
FLEURY, Melissa, 47D Joy Avenue, Brisbane, California 94005, US  
RAPTA, Miroslav, 1240 Highland Court, San Carlos, California 94070, US  
THALLADI, Venkat R., 888 Foster City Boulevard Apt. E3, Foster City, California 94404, US  
FASS, Gene Timothy, 998 Burnett Avenue, San Francisco, California 94131, US  
SIMEONE, Michael, 75 Heather Avenue 6, San Francisco, California 94118, US  
BALDWIN, R. Michael, 1720 2nd Avenue, San Mateo, California 94401, US  
BOURDET, David L., 614 Bayview Avenue, Millbrae, California 94030, US

---



(51) MKP  
**A63B 21/28 2006 (97) EP 3407985**  
**A63B 22/16 2006**  
**A63B 22/18 2006**  
**A63B 26/00 2006**  
**A63B 69/00 2006**  
(96) EP 17713429.3 1/27/2017  
(97) EP 3407985, 12/5/2018 201849, en  
(31) UB20160369 (32) 29.01.2016 (33) IT  
(54) MOBILE SUPPORT FOR PHYSICAL EXERCISE  
(71) Reaxing S.r.l., Via Torino 2, 20123 Milano, IT  
(72) D'ALESIO, Gionata, c/o TTR S.r.l. Via Mutilati e Invalidi del Lavoro n. 108, 63100 Ascoli Piceno (AP), IT

---

(51) MKP  
**A61B 5/103 2006 (97) EP 3407987**  
**A61H 1/02 2006**  
**A63B 21/00 2006**  
**A63B 21/005 2006**  
**A63B 22/18 2006**  
**A63B 23/08 2006**  
**A63B 24/00 2006**  
**A63B 26/00 2006**  
**A63B 69/00 2006**  
(96) EP 17714006.8 1/25/2017  
(97) EP 3407987, 12/5/2018 201849, en  
(31) UB20160357 (32) 26.01.2016 (33) IT  
(54) MOVABLE PLATFORM FOR PHYSICAL EXERCISE  
(72) D'ALESIO, Gionata, c/o TTR S.r.l. Via Mutilati e Invalidi del Lavoro n. 108, 63100 Ascoli Piceno (AP), IT

---

(51) MKP  
**A43B 1/12 2006 (97) EP 3416819**  
**B29C 43/00 2006**  
**B29C 44/02 2006**  
**B29D 35/00 2010**  
**B29D 35/12 2010**  
**B29D 35/14 2010**  
**C08J 9/33 2006**  
(96) EP 17714015.9 2/14/2017  
(97) EP 3416819, 12/26/2018 201852, en  
(31) UB20160726 (32) 15.02.2016 (33) IT  
(54) A METHOD OF MOULDING AN OBJECT IN POLYURETHANE, IN PARTICULAR A SOLE FOR FOOTWEAR, OBTAINED FROM POLYURETHANE SCRAPS, AND MOULDED OBJECT IN POLYURETHANE THEREOF  
(72) PAGLIALUNGA, Daniele, c/o Eurosuole S.p.A. Zona Industriale "A" Via Sandro Pertini 8, I-62012 Civitanova Marche (Macerata), IT  
RUFFINI, Giorgio, c/o Eurosuole S.p.A. Zona Industriale "A" Via Sandro Pertini 8, I-62012 Civitanova Marche (Macerata), IT  
ERCOLI, Rosaria, c/o Eurosuole S.p.A. Zona Industriale "A" Via Sandro Pertini 8, I-62012 Civitanova Marche (Macerata), IT  
ERCOLI, Germano, c/o Eurosuole S.p.A. Zona Industriale "A" Via Sandro Pertini 8, I-62012 Civitanova Marche (Macerata), IT

---

(51) MKP  
**B21D 53/26 2006 (97) EP 3365185**  
**B21H 1/10 2006**  
**B60B 3/00 2006**  
**B60B 3/02 2006**  
**B60B 3/06 2006**  
(96) EP 17724719.4 5/5/2017  
(97) EP 3365185, 8/29/2018 201835, de  
(31) 5007516 U (32) 06.05.2016 (33) AT  
(54) METHOD FOR PRODUCING A WHEEL  
(71) Borbet Austria GmbH, Lamprechtshausener Strasse 77, 5282 Ranshofen, AT  
(72) EBETSHUBER, Manfred, Rombergerstrasse 9, 4942 Gurten, AT  
HOFMANN, Josef, Nr. 42, 5242 St. Johann am Walde, AT

---

(51) MKP

**A61K 35/14 2015 (97) EP 3352769**  
**A61K 35/16 2015**  
**A61P 17/00 2006**  
**A61P 17/18 2006**  
**A61P 29/00 2006**  
**A61P 39/00 2006**  
(96) EP 17728051.8 5/11/2017  
(97) EP 3352769, 8/1/2018 201831, en  
(31) 16001807 (32) 17.08.2016 (33) EP  
PCT/EP2016/001887 14.11.2016 WO  
PCT/EP2016/001888 14.11.2016 WO  
(54) ANTI-AGEING PHARMACEUTICAL PREPARATION  
(71) Orthogen AG, Ernst-Schneider-Platz 1, 40212 Düsseldorf, DE  
(72) WEHLING, Peter, Pigageallee 2A, D-40597 Düsseldorf, DE  
REINECKE, Julio, Kamerunstrasse 20, 50733 Köln, DE

---

(51) MKP  
**A61K 35/14 2015 (97) EP 3352770**  
**A61K 35/16 2015**  
**A61P 17/00 2006**  
**A61P 17/18 2006**  
**A61P 29/00 2006**  
**A61P 39/00 2006**  
(96) EP 17728052.6 5/12/2017  
(97) EP 3352770, 8/1/2018 201831, en  
(31) 16001807 (32) 17.08.2016 (33) EP  
PCT/EP2016/001887 14.11.2016 WO  
PCT/EP2016/001888 14.11.2016 WO  
(54) ANTI-AGEING PHARMACEUTICAL PREPARATION  
(72) WEHLING, Peter, Pigageallee 2A, 40597 Düsseldorf, DE  
REINECKE, Julio, Kamerunstrafte 20, 50733 Köln, DE

---

(51) MKP  
**A61K 31/506 2006 (97) EP 3400963**  
**A61K 31/7072 2006**  
**A61K 39/395 2006**  
**A61K 45/06 2006**  
**A61P 35/00 2006**  
**A61P 37/02 2006**  
(96) EP 17736021.1 1/6/2017  
(97) EP 3400963, 11/14/2018 201846, en  
(31) 2016002463 (32) 08.01.2016 (33) JP  
2016119117 15.06.2016 JP  
(54) ANTI-TUMOR AGENT CONTAINING IMMUNOMODULATOR, AND ANTI-TUMOR EFFECT ENHANCER  
(72) SUZUKI, Norihiko, c/o Taiho Pharmaceutical Co. Ltd. 224-2 Hiraishiebisuno Kawauchi-cho, Tokushima-shi Tokushima 771-0194, JP

---

(51) MKP  
**A61K 39/395 2006 (97) EP 3400012**  
**A61K 45/06 2006**  
**C07K 16/40 2006**  
(96) EP 17736341.3 1/5/2017  
(97) EP 3400012, 11/14/2018 201846, en  
(31) 201662275025 P (32) 05.01.2016 (33) US  
201662407979 P 13.10.2016 US  
(54) METHODS FOR INHIBITING FIBROSIS IN A SUBJECT IN NEED THEREOF  
(71) University Of Leicester, University Road, Leicester Leicestershire LE1 7RH, GB  
(72) BRUNSKILL, Nigel, John, 36 The Green, Mountsorrel Leicestershire LE1 7AF, GB  
DEMOPULOS, Gregory, A., 36 The Green, Mountsorrel Leicestershire LE1 7AF, US  
DUDLER, Thomas, 36 The Green, Mountsorrel Leicestershire LE1 7AF, US  
SCHWAEBLE, Hans-Wilhelm, 36 The Green, Mountsorrel Leicestershire LE1 7AF, GB

---

(51) MKP

	<b>A61B 5/00</b>	<b>2006</b>	<b>(97) EP 3400549</b>			
	<b>G06F 19/26</b>	<b>2011</b>				
	<b>G06Q 50/24</b>	<b>2018</b>				
	<b>G08B 21/04</b>	<b>2006</b>				
(96)	EP 17736524.4 1/9/2017					
(97)	EP 3400549, 11/14/2018 201846, en					
(31)	201614991379		(32)	08.01.2016	(33)	US
	201615008296			27.01.2016		US
(54)	PROCESSING OF PORTABLE DEVICE DATA					
(72)	HUSSAM, Ali Adel, 800 Cherry Street 2nd Floor, Columbia Missouri 65201, US					
	BLEIGH, Nathan, 800 Cherry Street 2nd Floor, Columbia Missouri 65201, US					

---

(51)	MKP					
	<b>B61D 5/00</b>	<b>2006</b>	<b>(97) EP 3403060</b>			
	<b>G01F 23/284</b>	<b>2006</b>				
(96)	EP 17738063.1 1/12/2017					
(97)	EP 3403060, 11/21/2018 201847, en					
(31)	201662278223 P		(32)	13.01.2016	(33)	US
(54)	DEVICE AND METHOD FOR MEASURING COMMODITY VOLUME IN A RAIL TANK CAR					
(71)	Transrail Innovation Inc., Suite 100 999 - 8th Street NW, Calgary, Alberta T2R 1J5, CA					
(72)	STOBART, Christopher William, Suite 100 999 - 8th Street NW, Calgary Alberta T2R 1J5, CA					
	FORBES, Nicholas Andrew, Suite 100 999 - 8th Street NW, Calgary Alberta T2R 1J5, CA					

---

(51)	MKP					
	<b>A61K 39/395</b>	<b>2006</b>	<b>(97) EP 3404040</b>			
	<b>A61P 1/04</b>	<b>2006</b>				
	<b>A61P 11/00</b>	<b>2006</b>				
	<b>A61P 35/00</b>	<b>2006</b>				
	<b>A61P 37/08</b>	<b>2006</b>				
	<b>C07K 16/18</b>	<b>2006</b>				
	<b>C07K 16/46</b>	<b>2006</b>				
	<b>C12N 15/09</b>	<b>2006</b>				
(96)	EP 17738420.3 1/11/2017					
(97)	EP 3404040, 11/21/2018 201847, en					
(31)	2016003429		(32)	12.01.2016	(33)	JP
(54)	ANTI-MYL9 ANTIBODY					
(71)	National University Corporation Chiba University, 1-33, Yayoi-cho Inage-ku, Chiba-shi, Chiba 263-8522, JP					
(72)	NAKAYAMA, Toshinori, c/o Graduate School of Medicine National University Corporation Chiba University 1-8-1 Inohana Chuo-ku, Chiba-shi Chiba 260-8670, JP					
	KIMURA, Motoko, c/o Graduate School of Medicine National University Corporation Chiba University 1-8-1 Inohana Chuo-ku, Chiba-shi Chiba 260-8670, JP					
	HAYASHIZAKI, Koji, c/o Graduate School of Medicine National University Corporation Chiba University 1-8-1 Inohana Chuo-ku, Chiba-shi Chiba 260-8670, JP					
	HIRAYAMA, Toshifumi, C/O KAN Research Institute Inc. 6-8-2 Minatojima-minamimachi Chuo-ku, Kobe-shi Hyogo 650-0047, JP					
	KAKUTA, Jungo, C/O KAN Research Institute Inc. 6-8-2 Minatojima-minamimachi Chuo-ku, Kobe-shi Hyogo 650-0047, JP					
	SAKAMOTO, Yoshimasa, C/O KAN Research Institute Inc. 6-8-2 Minatojima-minamimachi Chuo-ku, Kobe-shi Hyogo 650-0047, JP					
	GEJIMA, Ryu, C/O KAN Research Institute Inc. 6-8-2 Minatojima-minamimachi Chuo-ku, Kobe-shi Hyogo 650-0047, JP					
	TOKITA, Daisuke, C/O KAN Research Institute Inc. 6-8-2 Minatojima-minamimachi Chuo-ku, Kobe-shi Hyogo 650-0047, JP					
	MURAMOTO, Kenzo, C/O KAN Research Institute Inc. 6-8-2 Minatojima-minamimachi Chuo-ku, Kobe-shi Hyogo 650-0047, JP					
	IMAI, Toshio, C/O KAN Research Institute Inc. 6-8-2 Minatojima-minamimachi Chuo-ku, Kobe-shi Hyogo 650-0047, JP					

---

(51)	MKP					
	<b>B21D 51/38</b>	<b>2006</b>	<b>(97) EP 3402618</b>			
	<b>B21D 51/44</b>	<b>2006</b>				
	<b>B65B 35/58</b>	<b>2006</b>				
	<b>B65G 47/24</b>	<b>2006</b>				
	<b>B65G 47/244</b>	<b>2006</b>				
	<b>B65G 47/252</b>	<b>2006</b>				
(96)	EP 17738774.3 1/9/2017					
(97)	EP 3402618, 11/21/2018 201847, en					
(31)	201662278049 P		(32)	13.01.2016	(33)	US
(54)	SYSTEM AND METHOD FOR ORIENTING THE ROLLING DIRECTION OF AN END SHELL IN A METAL CONTAINER MANUFACTURING PROCESS					

(72) ELLEFSON, Dean, C., 8564 West Iliff Avenue, Lakewood CO 80227, US

---

(51) MKP

**A61K 48/00 2006 (97) EP 3402532**

(96) EP 17738831.1 1/11/2017

(97) EP 3402532, 11/21/2018 201847, en

(31) 201662277262 P (32) 11.01.2016 (33) US  
201662420258 P 10.11.2016 US  
201762444172 P 09.01.2017 US

(54) INHIBITING ATAXIA TELANGIECTASIA AND RAD3-RELATED PROTEIN (ATR)

(72) DRUMMOND, Daryl C., 1 Brooks Road, Lincoln, MA 01773, US

GENG, Bolin, 7 Odyssey Way, Andover, MA 01810, US

KIRPOTIN, Dmitri B., 382 Ocean Avenue Apartment 1509, Revere, MA 02151, US

TIPPARAJU, Suresh, K., 48 Epping Street, Arlington, MA 02474, US

KOSHKARYEV, Alexander, 15 Clark Street, Newton, MA 02459, US

ALKAN, Ozan, 6 Salem Street, Cambridge, MA 02139, US

---

(51) MKP

**A61K 31/4468 2006 (97) EP 3402485**

**A61K 31/496 2006**

(96) EP 17738848.5 1/11/2017

(97) EP 3402485, 11/21/2018 201847, en

(31) 201662277248 P (32) 11.01.2016 (33) US  
201762444168 P 09.01.2017 US

(54) INHIBITING B-CELL LYMPHOMA 2 (BCL-2) AND RELATED PROTEINS

(72) DRUMMOND, Daryl, C., 1 Brooks Road, Lincoln MA 01773, US

GENG, Bolin, 7 Odyssey Way, Andover MA 01810, US

KIRPOTIN, Dmitri, B., 382 Ocean Avenue Apartment 1509, Revere MA 02151, US

TIPPARAJU, Suresh, K., 48 Epping Street, Arlington MA 02474, US

KOSHKARYEV, Alexander, 15 Clark Street, Newton MA 02459, US

---

(51) MKP

**A61K 39/145 2006 (97) EP 3402513**

**A61P 31/16 2006**

**C07K 14/11 2006**

**C07K 16/08 2006**

**C07K 16/10 2006**

**C12N 15/44 2006**

(96) EP 17738889.9 1/12/2017

(97) EP 3402513, 11/21/2018 201847, en

(31) 201662278068 P (32) 13.01.2016 (33) US

(54) METHOD OF TREATING INFLUENZA A

(72) KALLEWAARD-LELAY, Nicole, c/o MedImmune, LLC One MedImmune Way, Gaithersburg, MD 20878, US

MALLORY, Raburn, c/o MedImmune, LLC One MedImmune Way, Gaithersburg, MD 20878, US

ROBBIE, Gabriel, c/o MedImmune, LLC One MedImmune Way, Gaithersburg, MD 20878, US

REN, Song, c/o MedImmune, LLC One MedImmune Way, Gaithersburg, MD 20878, US

---

(51) MKP

**A61K 31/517 2006 (97) EP 3402486**

**A61K 31/551 2006**

(96) EP 17738902.0 1/12/2017

(97) EP 3402486, 11/21/2018 201847, en

(31) 201662278788 P (32) 14.01.2016 (33) US  
201662280346 P 19.01.2016 US  
201662347450 P 08.06.2016 US  
201662397527 P 21.09.2016 US

(54) METHOD OF TREATING C3 GLOMERULOPATHY

(72) BEKKER, Petrus, 24 Coronado Avenue, Los Altos CA 94022, US

---

(51) MKP

**A61M 5/178 2006 (97) EP 3402556**  
**A61M 5/20 2006**  
**A61M 5/24 2006**  
**A61M 5/31 2006**  
**A61M 5/315 2006**  
**A61M 5/32 2006**  
(96) EP 17738952.5 1/12/2017  
(97) EP 3402556, 11/21/2018 201847, en  
(31) 201662277939 P (32) 12.01.2016 (33) US  
(54) INJECTION DEVICE  
(71) Pharma Consult Ges.m.b.H., Divischgasse 4, 1210 Wien, AT  
(72) CHAKRABARTI, Ajoy, 2429 1st Ave. N., Seattle Washington 98109, US  
BALSLEY, Eric, 14517 Brookmead Drive, Darnestown Maryland 20874, US  
APPY, Jacques, 135 A r Violette, 38140 Rives, FR  
STAMPER, Sylvain, 6 rue Michel Petrucciani, 69800 Saint Priest, FR  
ALFONSI, Frederic, c/o Namera Buffalo Grove LLC 600 Deerfield Parkway, Buffalo Grove Illinois 60089, US  
PAINCHAUD, Gaetan, c/o Namera Buffalo Grove LLC 600 Deerfield Parkway, Buffalo Grove Illinois 60089, US  
KUNTZER, Nicolas, 1 montee des Coteaux du Golf, 38080 L'Isle d'Abeau, FR

---

(51) MKP  
**A61K 48/00 2006 (97) EP 3402534**  
(96) EP 17739050.7 1/13/2017  
(97) EP 3402534, 11/21/2018 201847, en  
(31) 201662278635 P (32) 14.01.2016 (33) US  
201662413587 P 27.10.2016 US  
(54) CELLULAR BLEND FOR THE REGENERATION OF CHONDROCYTES OR CARTILAGE TYPE CELLS  
(71) Spinalcyte, LLC, 17006 Evergreen Elm Way, Houston, TX 77059, US  
(72) O'HEERON, Pete, 17300 Ei Camino Real Suite 110, Houston, TX 77058, US

---

(51) MKP  
**A61K 39/395 2006 (97) EP 3402519**  
**A61P 35/00 2006**  
**C07K 16/00 2006**  
**C07K 16/18 2006**  
**C07K 16/46 2006**  
**C12N 1/15 2006**  
(96) EP 17739081.2 1/13/2017  
(97) EP 3402519, 11/21/2018 201847, en  
(31) 201662278359 P (32) 13.01.2016 (33) US  
201662361842 P 13.07.2016 US  
(54) MULTISPECIFIC IMMUNOMODULATORY ANTIGEN-BINDING CONSTRUCTS  
(71) Compass Therapeutics LLC, 245 First Street, Cambridge, MA 02142, US  
(72) SABZEVARI, Helen, c/o Compass Therapeutics LLC 245 First Street, Cambridge, MA 02142, US  
SCHUETZ, Thomas, Joseph, C/o Compass Therapeutics Llc 245 First Street, Cambridge, MA 02142, US  
BOBROWICZ, Piotr, c/o Compass Therapeutics LLC 245 First Street, Cambridge, MA 02142, US  
SCHMIDT, Michael, March, c/o Compass Therapeutics LLC 245 First Street, Cambridge, MA 02142, US  
TIGHE, Robert, V. III, c/o Compass Therapeutics LLC 245 First Street, Cambridge, MA 02142, US  
METENOU, Simon, c/o Compass Therapeutics LLC 245 First Street, Cambridge, MA 02142, US

---

(51) MKP  
**C07C 49/753 2006 (97) EP 3406586**  
(96) EP 17741118.8 1/22/2017  
(97) EP 3406586, 11/28/2018 201848, en  
(31) 201610044990 (32) 22.01.2016 (33) CN  
(54) MANUFACTURING METHOD FOR HIGH-PURITY CYCLOHEXENONE LONG-CHAIN ALCOHOL  
(72) ZHANG, Jian, 1088 Chuansha Road Pudong, Shanghai 201209, CN  
JIANG, Dehui, 1088 Chuansha Road Pudong, Shanghai 201209, CN  
SHEN, Xiaojun, 1088 Chuansha Road Pudong, Shanghai 201209, CN

---

(51) MKP  
**G06Q 10/04 2012 (97) EP 3405914**  
**G06Q 50/06 2012**

(96) EP 17741162.6 1/18/2017  
(97) EP 3405914, 11/28/2018 201848, en  
(31) 201662279943 P (32) 18.01.2016 (33) US  
201662331648 P 04.05.2016 US  
(54) METHOD FOR OPERATION OF HYDROPOWER RESERVOIR WITH A 2-PARAMETER ELEVATION RULE CURVE  
(71) Velasco, Horacio, 1000 Ponce de Leon Blvd. Suite 1000 Box 7, Coral Gables, Florida 33134, US  
Caltec Overseas, Inc., 1000 Ponce de Leon Blvd. Suite 120, Coral Gables, Florida 33134, US  
(72) VELASCO, Horacio, 1000 Ponce de Leon Blvd. Suite 120, Coral Gables, Florida 33134, US

---

(51) MKP  
**C10M 107/02 2006 (97) EP 3406694**  
**C10M 135/08 2006**  
**C10M 139/00 2006**  
**C10M 145/14 2006**  
**C10M 169/04 2006**  
**C10N 20/02 2006**  
**C10N 20/04 2006**  
**C10N 30/00 2006**  
**C10N 30/04 2006**  
**C10N 30/06 2006**  
**C10N 40/04 2006**  
(96) EP 17741583.3 1/23/2017  
(97) EP 3406694, 11/28/2018 201848, en  
(31) 2016009467 (32) 21.01.2016 (33) JP  
2016246203 20.12.2016 JP  
(54) LUBRICATING OIL COMPOSITION  
(71) ExxonMobil Research and Engineering Company, 1545 Route 22 East, Annandale, NJ 08801, US  
(72) MORI, Takafumi, c/o TonenGeneral Sekiyu K.K. Research Center 6-1 Ukishima-cho Kawasaki-ku, Kawasaki-shi Kanagawa 210-9526, JP  
SATO, Takehisa, c/o TonenGeneral Sekiyu K.K. Research Center 6-1 Ukishima-cho Kawasaki-ku, Kawasaki-shi Aichi 210-9526, JP  
Fukumizu, Takahiro, c/o TOYOTA JIDOSHA KABUSHIKI KAISHA 1 Toyotacho, Toyota-shi Aichi 471-8571, JP  
OGAWA, Masashi, c/o TOYOTA JIDOSHA KABUSHIKI KAISHA 1 Toyotacho, Toyota-shi Aichi 471-8571, JP  
NISHINOSONO, Junichi, c/o TOYOTA JIDOSHA KABUSHIKI KAISHA 1 Toyotacho, Toyota-shi Aichi 471-8571, JP

---

(51) MKP  
**C07D 209/00 2006 (97) EP 3405455**  
**C07D 209/34 2006**  
(96) EP 17741838.1 1/18/2017  
(97) EP 3405455, 11/28/2018 201848, en  
(31) 201662280969 P (32) 20.01.2016 (33) US  
(54) 2-OXINDOLE COMPOUNDS  
(72) CHEN, Xi, 1198 Beech Street, E. Palo Alto CA 94303, US  
DRAGOLI, Dean, R., 24645 Summerhill Avenue, Los Altos CA 94024, US  
FAN, Pingchen, 2157 Kalenda Commons, Fremont CA 94539, US  
LELETI, Manmohan, Reddy, 7269 Ventana Drive, San Jose CA 95129, US  
LUI, Rebecca, M., 3901 Lick Mill Boulevard 3, Santa Clara CA 95054, US  
MALATHONG, Viengkham, 1988 San Luis Avenue 3, Mountain View CA 94043, US  
POWERS, Jay, P., 745 Rockaway Beach Avenue, Pacifica CA 94044, US  
SINGH, Rajinder, 1832 Hillman Avenue, Belmont CA 94002, US  
TANAKA, Hiroko, 600 Rainbow Drive 148, Mountain View CA 94041, US  
YANG, Ju, 966 Clara Drive, Palo Alto CA 94303, US  
YU, Chao, 555 E. Washington Avenue Apt. 1105, Sunnyvale CA 94086, US  
ZHANG, Penglie, 1036 Jamaica Street, Foster City CA 94404, US

---

(51) MKP  
**A61K 31/436 2006 (97) EP 3405211**  
**A61K 31/55 2006**  
**A61K 38/31 2006**  
(96) EP 17742029.6 1/20/2017  
(97) EP 3405211, 11/28/2018 201848, en  
(31) 201662281320 P (32) 21.01.2016 (33) US  
201662299607 P 25.02.2016 US  
201662303072 P 03.03.2016 US  
(54) ORAL OCTREOTIDE FOR THE TREATMENT OF DISEASE

(72) MAMLUK, Roni, Hagefen 3, Mazkeret Batya, IL  
PATOY, Gary, 26353 Esperanza Drive, Los Altos Hills CA 94022, US  
GELBAUM, Dana, 13 Mishmar Hagvul Street, 6969783 Tel Aviv, IL  
HAVIV, Asi, Gan-Shlomo, 76802, IL

---

(51) MKP  
**A61B 3/10 2006 (97) EP 3410397**  
**A61B 3/18 2006**  
**G02C 5/00 2006**  
**G02C 7/00 2006**  
**G06T 7/60 2017**

(96) EP 17743770.4 1/9/2017

(97) EP 3410397, 12/5/2018 201849, en

(31) 201630086 (32) 25.01.2016 (33) ES  
201631703 28.12.2016 ES

(54) METHOD FOR PRODUCING LENSES AND FRAMES WITH PERSONALISED DESIGN AND REMOTE BEVELLING OF CORRECTIVE LENSES, AND OPTICAL DEVICE FOR MORPHOLOGICAL MEASUREMENT FOR PERFORMING SAID METHOD

(71) Ópticas Claravisión, S.L., C/ Manuel de Falla 10, 18005 Granada, ES

(72) PÉREZ ORTEGA, Antonio Javier, C/ Manuel de Falla 10, 18005 Granada, ES

CANTÓ VAÑO, Javier, C/ Manuel de Falla 10, 18005 Granada, ES

GONZÁLEZ MERINO, Ramón, C/ Manuel de Falla 10, 18005 Granada, ES

---

(51) MKP  
**C10M 105/04 2006 (97) EP 3409751**  
**C10M 107/02 2006**  
**C10M 135/04 2006**  
**C10M 169/04 2006**  
**C10N 20/02 2006**  
**C10N 30/00 2006**  
**C10N 30/06 2006**  
**C10N 40/04 2006**

(96) EP 17744351.2 1/26/2017

(97) EP 3409751, 12/5/2018 201849, en

(31) 2016013271 (32) 27.01.2016 (33) JP

(54) LUBRICANT COMPOSITION

(71) ExxonMobil Research and Engineering Company, 1545 Route 22 East, Annandale, New Jersey 08801, US

(72) UMAMORI, Nobuharu, c/o TonenGeneral Sekiyu K.K. Research Center 6-1 Ukishima-cho Kawasaki-ku, Kawasaki-shi Kanagawa 210-9526, JP

UENO, Kenji, c/o TOYOTA JIDOSHA KABUSHIKI KAISHA 1 Toyotacho, Toyota-shi Aichi 471-8571, JP

HIRAGA, Kotaro, c/o TOYOTA JIDOSHA KABUSHIKI KAISHA 1 Toyotacho, Toyota-shi Aichi 471-8571, JP

---

(51) MKP  
**A61K 39/395 2006 (97) EP 3407914**  
**C07K 16/00 2006**  
**C12P 21/00 2006**

(96) EP 17744858.6 1/26/2017

(97) EP 3407914, 12/5/2018 201849, en

(31) 201662287472 P (32) 27.01.2016 (33) US

(54) METHODS FOR PREPARING ANTIBODIES WITH A DEFINED GLYCOSYLATION PATTERN

(72) GAO, Changshou, c/o MedImmune, LLC One MedImmune Way, Gaithersburg, MD 20878, US

THOMPSON, Pamela, c/o MedImmune, LLC One MedImmune Way, Gaithersburg, MD 20878, US

TOADER, Dorin, c/o MedImmune, LLC One MedImmune Way, Gaithersburg, MD 20878, US

DIMASI, Nazzareno, c/o MedImmune, LLC One MedImmune Way, Gaithersburg, MD 20878, US

---

(51) MKP  
**C07K 16/24 2006 (97) EP 3408293**  
**C07K 16/46 2006**

(96) EP 17744941.0 1/27/2017

(97) EP 3408293, 12/5/2018 201849, en

(31) 201662288124 P (32) 28.01.2016 (33) US

(54) BISPECIFIC ANTI-TNF-ALPHA/IL-17A ANTIBODIES AND ANTI-TNF-ALPHA ANTIBODIES AND METHODS OF THEIR USE

(72) CHIU, Mark, 1400 McKean Road, Spring House Pennsylvania 19477, US

NEMETH-SEAY, Jennifer, 1400 McKean Road, Spring House Pennsylvania 19477, US

ORT, Tatiana, 1400 McKean Road, Spring House Pennsylvania 19477, US  
SHEN, Fang, 1400 McKean Road, Spring House Pennsylvania 19477, US

---

(51) MKP  
**A61K 31/444 2006 (97) EP 3407978**  
**A61K 31/5377 2006**  
**A61P 35/00 2006**  
(96) EP 17744977.4 1/27/2017  
(97) EP 3407978, 12/5/2018 201849, en  
(31) 201662289050 P (32) 29.01.2016 (33) US  
(54) COMBINATION THERAPY FOR TREATING CANCER  
(72) RAIMONDI, Maria, Alejandra, 22 McBride Street, Jamaica Plain MA 02130, US

---

(51) MKP  
**A61K 35/74 2015 (97) EP 3408395**  
**A61K 39/00 2006**  
**A61K 48/00 2006**  
**C07K 5/10 2006**  
**C07K 14/705 2006**  
**C12N 15/66 2006**  
**C12N 15/74 2006**  
(96) EP 17744997.2 1/27/2017  
(97) EP 3408395, 12/5/2018 201849, en  
(31) 201662287871 P (32) 27.01.2016 (33) US  
(54) PERSONALIZED DELIVERY VECTOR-BASED IMMUNOTHERAPY AND USES THEREOF  
(72) PETIT, Robert, 149 Parsons Lane, Newtown Pennsylvania 18940, US  
PERRY, Kyle, 2233 Town Court North, Lawrenceville New Jersey 08648, US  
PRINCIOTTA, Michael F., 222 Mercer Street, Hightstown New Jersey 08520, US

---

(51) MKP  
**C07D 257/04 2006 (97) EP 3408298**  
**C07D 401/04 2006**  
**C07K 14/705 2006**  
**C07K 14/72 2006**  
**C07K 16/28 2006**  
**G01N 33/566 2006**  
(96) EP 17745078.0 1/30/2017  
(97) EP 3408298, 12/5/2018 201849, en  
(31) PCT/US2016/015817 (32) 29.01.2016 (33) WO  
201662308325 P 15.03.2016 US  
201662425403 P 22.11.2016 US  
(54) G PROTEIN-COUPLED RECEPTOR (GPCR) MODULATION BY IMIPRIDONES  
(72) ALLEN, Joshua E., 43 Chestnut Street Unit 311, New Haven, CT 06511, US  
STOGNIEW, Martin, 1870 Ferguson Lane, Blue Bell Pennsylvania 19422, US  
PRABHU, Varun Vijay, 2375 Woodward St, Philadelphia Pennsylvania 19115, US

---

(51) MKP  
**C12N 15/113 2010 (97) EP 3408391**  
(96) EP 17745083.0 1/30/2017  
(97) EP 3408391, 12/5/2018 201849, en  
(31) 201662289268 P (32) 31.01.2016 (33) US  
201662317113 P 01.04.2016 US  
(54) BRANCHED OLIGONUCLEOTIDES  
(72) KHVOROVA, Anastasia, 10 Rocklawn Road, Westborough Massachusetts 01581, US  
HASSLER, Matthew, 55 Lake Avenue North Suite S4-110, Worcester Massachusetts 01655, US  
ALTERMAN, Julia, 123 Hamilton Street Apartment 3, Worcester Massachusetts 01604, US  
GODINHO, Bruno Miguel da Cruz, 1 Normal Street Apt. 3, Worcester Massachusetts 01605, US

---

(51) MKP



**A47G 1/02 2006 (97) EP 3410897**  
**A61F 5/455 2006**  
**A61M 25/01 2006**  
(96) EP 17746172.0 2/1/2017  
(97) EP 3410897, 12/12/2018 201850, en  
(31) 1600050 (32) 01.02.2016 (33) HU  
(54) MODULAR BUILT MEDICAL DEVICE FOR HELPING SELF-CATHETERIZATION AND/OR INSTILLATION OF DRUG-SOLUTIONS INTO THE  
BLADDER IN FEMALE PATIENTS  
(72) Lovász, Sándor, Hegedüs Gyula u. 8, 1136 Budapest, HU  
Rényi, Gábor, Svent István park 26, 1137 Budapest, HU  
Giber, János, Városmajor u. 39/b, 1122 Budapest, HU

---

(51) MKP  
**A61K 31/519 2006 (97) EP 3412671**  
**A61P 31/12 2006**  
**C07D 487/04 2006**  
(96) EP 17747003.6 2/4/2017  
(97) EP 3412671, 12/12/2018 201850, en  
(31) 201610082030 (32) 05.02.2016 (33) CN  
(54) TLR7 AGONIST MALEATE SALT, CRYSTALLINE FORMS C, D AND E THEREOF, PREPARATION METHODS AND USES OF MALEATE  
SALT AND CRYSTALLINE FORMS  
(71) Chia Tai Tianqing Pharmaceutical Group Co.,Ltd, No. 369 Yuzhou South Road Haizhou District, Lianyungang, Jiangsu 222062, CN  
(72) DING, Zhaozhong, 288 Futezhong Road Pudong New Area, Shanghai 200131, CN  
SUN, Fei, 288 Futezhong Road Pudong New Area, Shanghai 200131, CN  
HU, Yinghu, 288 Futezhong Road Pudong New Area, Shanghai 200131, CN  
ZHOU, Yilong, 288 Futezhong Road Pudong New Area, Shanghai 200131, CN  
WANG, Zheng, 288 Futezhong Road Pudong New Area, Shanghai 200131, CN  
YANG, Ling, No.369 Yuzhou South Rd. Haizhou District, Lianyungang Jiangsu 222062, CN

---

(51) MKP  
**A61K 31/519 2006 (97) EP 3412672**  
**A61P 31/12 2006**  
**C07D 487/04 2006**  
(96) EP 17747004.4 2/4/2017  
(97) EP 3412672, 12/12/2018 201850, en  
(31) 201610082029 (32) 05.02.2016 (33) CN  
(54) TLR7 AGONIST CRYSTALLINE FORM A, PREPARATION METHOD AND USE THEREOF  
(72) DING, Zhaozhong, 288 Futezhong Road Pudong New Area, Shanghai 200131, CN  
SUN, Fei, 288 Futezhong Road Pudong New Area, Shanghai 200131, CN  
HU, Yinghu, 288 Futezhong Road Pudong New Area, Shanghai 200131, CN  
ZHOU, Yilong, 288 Futezhong Road Pudong New Area, Shanghai 200131, CN  
WANG, Zheng, 288 Futezhong Road Pudong New Area, Shanghai 200131, CN  
ZHAO, Rui, No.369 Yuzhou South Rd. Haizhou District, Lianyungang Jiangsu 222062, CN  
YANG, Ling, No.369 Yuzhou South Rd. Haizhou District, Lianyungang Jiangsu 222062, CN

---

(51) MKP  
**C07D 487/04 2006 (97) EP 3412673**  
(96) EP 17747006.9 2/4/2017  
(97) EP 3412673, 12/12/2018 201850, en  
(31) 201610082028 (32) 05.02.2016 (33) CN  
(54) METHOD FOR PREPARING PYRROLO[3,2-D]PYRIMIDINE COMPOUND, AND INTERMEDIATES THEREOF  
(72) DING, Zhaozhong, 288 Futezhong Road Pudong New Area, Shanghai 200131, CN  
SUN, Fei, 288 Futezhong Road Pudong New Area, Shanghai 200131, CN  
HU, Yinghu, 288 Futezhong Road Pudong New Area, Shanghai 200131, CN  
ZHOU, Yilong, 288 Futezhong Road Pudong New Area, Shanghai 200131, CN  
ZHAO, Rui, No.369 Yuzhou South Rd. Haizhou District, Lianyungang Jiangsu 222062, CN  
YANG, Ling, No.369 Yuzhou South Rd. Haizhou District, Lianyungang Jiangsu 222062, CN

---

(51) MKP  
**A61K 31/519 2006 (97) EP 3412674**  
**A61P 31/12 2006**  
**C07D 487/04 2006**

(96) EP 17747007.7 2/4/2017  
(97) EP 3412674, 12/12/2018 201850, en  
(31) 201610081899 (32) 05.02.2016 (33) CN  
(54) TLR7 AGONIST TRIFLUOROACETATE SALT AND CRYSTALLINE FORM B THEREOF, PREPARATION METHODS AND USES  
(72) DING, Zhaozhong, 288 Futezhong Road Pudong New Area, Shanghai 200131, CN  
SUN, Fei, 288 Futezhong Road Pudong New Area, Shanghai 200131, CN  
HU, Yinghu, 288 Futezhong Road Pudong New Area, Shanghai 200131, CN  
ZHOU, Yilong, 288 Futezhong Road Pudong New Area, Shanghai 200131, CN  
WANG, Zheng, 288 Futezhong Road Pudong New Area, Shanghai 200131, CN  
ZHAO, Rui, No.369 Yuzhou South Rd. Haizhou District, Lianyungang Jiangsu 222062, CN  
YANG, Ling, No.369 Yuzhou South Rd. Haizhou District, Lianyungang Jiangsu 222062, CN

---

(51) MKP  
**A61K 31/506 2006 (97) EP 3412295**  
**A61K 31/7072 2006**  
**A61P 1/00 2006**  
**A61P 35/00 2006**  
(96) EP 17747563.9 2/3/2017  
(97) EP 3412295, 12/12/2018 201850, en  
(31) 201662291799 P (32) 05.02.2016 (33) US  
(54) METHOD FOR TREATING CANCER PATIENTS WITH SEVERE RENAL DYSFUNCTION  
(72) YOSHIDA, Kenichiro, c/o Taiho Pharmaceutical Co., Ltd. 3 Okubo, Tsukuba-shi Ibaraki 300-2611, JP

---

(51) MKP  
**A61K 31/4439 2006 (97) EP 3412664**  
**A61K 31/506 2006**  
**A61P 1/04 2006**  
**A61P 1/18 2006**  
**A61P 3/10 2006**  
**A61P 11/06 2006**  
**A61P 11/08 2006**  
**A61P 11/14 2006**  
**A61P 17/04 2006**  
**A61P 19/02 2006**  
**A61P 25/00 2006**  
**A61P 25/04 2006**  
**A61P 29/00 2006**  
**A61P 37/08 2006**  
**A61P 43/00 2006**  
**C07D 403/12 2006**  
**C07D 405/14 2006**  
**C07D 409/14 2006**  
**C07D 491/048 2006**  
**C07K 14/705 2006**  
(96) EP 17747613.2 2/3/2017  
(97) EP 3412664, 12/12/2018 201850, en  
(31) 2016021358 (32) 05.02.2016 (33) JP  
(54) HETEROCYCLIC SULFONAMIDE DERIVATIVE AND MEDICINE CONTAINING SAME  
(71) EA Pharma Co., Ltd., 2-1-1, Irifune Chuo-ku, Tokyo 104-0042, JP  
(72) KOBAYASHI, Kaori, c/o EA Pharma Co. Ltd. 1-1 Suzuki-cho Kawasaki-ku, Kawasaki-shi Kanagawa 210-8681, JP  
SUZUKI, Tamotsu, c/o EA Pharma Co. Ltd. 1-1 Suzuki-cho Kawasaki-ku, Kawasaki-shi Kanagawa 210-8681, JP  
OKUZUMI, Tatsuya, c/o EA Pharma Co. Ltd. 1-1 Suzuki-cho Kawasaki-ku, Kawasaki-shi Kanagawa 210-8681, JP

---

(51) MKP  
**A61K 48/00 2006 (97) EP 3411484**  
**C12N 15/63 2006**  
**C12N 15/861 2006**  
(96) EP 17747935.9 1/25/2017  
(97) EP 3411484, 12/12/2018 201850, en  
(31) 201662292157 P (32) 05.02.2016 (33) US  
(54) INJECTION OF SINGLE-STRANDED OR SELF-COMPLEMENTARY ADENO-ASSOCIATED VIRUS 9 INTO THE CEREBROSPINAL FLUID  
(71) Emory University, 1599 Clifton Road NE 4th Floor, Atlanta, GA 30322, US  
REGENXBIO Inc., 9600 Blackwell Road Suite 210, Rockville, MD 20850, US

(72) DONSANTE, Anthony, 1021 N Jamestown Rd, Decatur, GA 30033, US  
KOZARSKY, Karen, 56 E Levering Mill Rd., Bala Cynwyd, PA 19004, US

---

(51) MKP  
**A61K 39/00 2006 (97) EP 3411411**  
**A61P 9/00 2006**  
**A61P 37/06 2006**  
**C07K 16/28 2006**

(96) EP 17748044.9 2/1/2017

(97) EP 3411411, 12/12/2018 201850, en

(31) 201662289653 P (32) 01.02.2016 (33) US

(54) BENZOPYRAZOLE COMPOUNDS AND ANALOGUES THEREOF

(72) KOTIAN, Pravin, L., 1139 Magnolia Run, Hoover, Alabama 35226, US

BABU, Yarlagadda, S., 4836 Southlake Parkway, Birmingham AL 35244, US

ZHANG, Weihe, 2645 Manchester Court, Vestavia AL 35226, US

VOGETI, Lakshminarayana, 905 Congressional Drive, Lawrence, Kansas 66049, US

WU, Minwan, 2709 Paden Trail, Vestavia Hills AL 35226, US

CHINTAREDDY, Venkat, R., 3134 Renfro Road, Vestavia Hills, Alabama 35216, US

RAMAN, Krishnan, 3739 Spearman Drive, Birmingham AL 35244, US

---

(51) MKP  
**A61K 38/17 2006 (97) EP 3411062**  
**C07K 14/00 2006**  
**C07K 14/435 2006**  
**C07K 14/705 2006**

(96) EP 17748111.6 2/2/2017

(97) EP 3411062, 12/12/2018 201850, en

(31) 201662290202 P (32) 02.02.2016 (33) US

(54) USE OF CD24 PROTEINS FOR TREATING LEPTIN-DEFICIENT CONDITIONS

(71) Oncoimmune Inc., 9430 Key West Avenue Suite 113, Rockville, Maryland 20850, US

(72) LIU, Yang, 502 E Street NE, Washington District of Columbia 20002, US

ZHENG, Pan, 502 E Street NE, Washington District of Columbia 20002, US

DEVENPORT, Martin, 614 Still Creek Lane, Gaithersburg Maryland 20878, US

---

(51) MKP  
**A61K 31/496 2006 (97) EP 3411503**  
**C12Q 1/68 2018**

(96) EP 17748127.2 2/2/2017

(97) EP 3411503, 12/12/2018 201850, en

(31) 201662292065 P (32) 05.02.2016 (33) US

201662293554 P 10.02.2016 US

201662348439 P 10.06.2016 US

(54) FLUOROQUINOLONE FORMULATIONS FOR CYSTIC FIBROSIS

(71) Horizon Orphan LLC, 150 South Saunders Road, Lake Forest, IL 60045, US

(72) VANDERVANTER, Donald, 12520 33 Street, Puyallup, WA 98372, US

---

(51) MKP  
**C12Q 1/68 2018 (97) EP 3411504**

(96) EP 17748134.8 2/2/2017

(97) EP 3411504, 12/12/2018 201850, en

(31) 201662291673 P (32) 05.02.2016 (33) US

(54) ANTI-TNF ANTIBODIES, COMPOSITIONS, METHODS AND USE FOR THE TREATMENT OR PREVENTION OF TYPE 1 DIABETES

(72) HEDRICK, Joseph, 920 US Highway 202 S, Raritan, New Jersey 08869, US

HSIA, Elizabeth, 1400 McKean Road P.O. Box 776, Spring House, Pennsylvania 19477, US

IMM, Paul, 1400 McKean Road P.O. Box 776, Spring House, Pennsylvania 19477, US

LEU, Jocelyn, 1400 McKean Road P.O. Box 776, Spring House, Pennsylvania 19477, US

PAXSON, Bethany, 1400 McKean Road P.O. Box 776, Spring House, Pennsylvania 19477, US

RIGBY, Mark, 1400 McKean Road P.O. Box 776, Spring House, Pennsylvania 19477, US

ZHENG, Songmao, 1400 McKean Road P.O. Box 776, Spring House, Pennsylvania 19477, US

ZOKA, Ramineh, 1400 McKean Road P.O. Box 776, Spring House, Pennsylvania 19477, US

---

(51) MKP  
**C07K 7/08 2006 (97) EP 3411387**

(96) EP 17748141.3 2/2/2017  
(97) EP 3411387, 12/12/2018 201850, en

(31) 201662290629 P (32) 03.02.2016 (33) US

(54) SIGNAL MOLECULES AS CELL PENETRATION AGENTS  
(71) Kennesaw State University Research And Services Foundation Inc., 1000 Chastain Road, Kennesaw, GA 30144, US  
Mcmurry, Jonathan L., 329 Nelson Street, Marietta, GA 30064, US  
Salerno, John C., 5408 Anemone Court, Acworth, GA 30102, US  
Nowak, Scott J., 588 Braidwood Circle NW, Acworth, GA 30101, US  
Davis, Marcus C., 814 Milwood Street 103, Woodstock, GA 30188, US  
Bartlow, Kathleen, 132 Souty 6th Street, Richmond, IN 47374, US

(72) MCMURRY, Jonathan L., 132 Souty 6th Street, Richmond, IN 47374, US  
SALERNO, John C., 132 Souty 6th Street, Richmond, IN 47374, US  
NOWAK, Scott J., 132 Souty 6th Street, Richmond, IN 47374, US  
DAVIS, Marcus C., 132 Souty 6th Street, Richmond, IN 47374, US  
BARTLOW, Kathleen, 132 Souty 6th Street, Richmond, IN 47374, US

---

(51) MKP  
**A61K 31/454 2006 (97) EP 3411031**  
**A61P 1/08 2006**  
**C07D 401/14 2006**

(96) EP 17748198.3 2/3/2017  
(97) EP 3411031, 12/12/2018 201850, en

(31) 201662291198 P (32) 04.02.2016 (33) US

(54) DEUTERATED DOMPERIDONE COMPOSITIONS AND METHODS FOR THERAPY OF DISORDERS  
(71) Cinrx Pharma, LLC, 5375 Medpace Way, Cincinnati, OH 45227, US  
(72) PEARCE, Catherine, 8781 Harper's Point Drive, Cincinnati, OH 45249, US  
ISAACSOHN, Jon, 3130 Laughead Lane, Garnet Valley, PA 19060, US  
PATEL, Piyush, 3130 Laughead Lane, Garnet Valley, PA 19060, US

---

(51) MKP  
**A41G 5/00 2006 (97) EP 3416513**

(96) EP 17748277.5 2/3/2017  
(97) EP 3416513, 12/26/2018 201852, en

(31) 201662291814 P (32) 05.02.2016 (33) US  
201662407212 P 12.10.2016

(54) HAIR BUNDLE APPARATUS AND METHOD OF MANUFACTURING SAME  
(71) Shake-n-Go Fashion, Inc., 85 Harbor Road, Port Washington, NY 11050, US  
(72) KIM, James, K., c/o Shake -N-Go Fashion Inc. 85 Harbor Road, Port Washington NY 11040, US  
OUGH, Peter, c/o Shake-N-Go Fashion Inc. 85 Harbor Road, Port Washington NY 11040, US

---

(51) MKP  
**A61K 31/33 2006 (97) EP 3414244**  
**A61K 31/404 2006**  
**A61P 1/16 2006**  
**A61P 9/00 2006**  
**A61P 13/12 2006**  
**A61P 29/00 2006**  
**A61P 35/00 2006**  
**C07D 209/10 2006**  
**C07D 401/04 2006**  
**C07D 403/04 2006**  
**C07D 405/04 2006**  
**C07D 413/04 2006**  
**C07D 471/04 2006**

(96) EP 17749812.8 2/10/2017  
(97) EP 3414244, 12/19/2018 201851, en

(31) 2016900478 (32) 12.02.2016 (33) AU  
2016902593 01.07.2016 AU

(54) HALOALLYLAMINE INDOLE AND AZAINDOLE DERIVATIVE INHIBITORS OF LYSYL OXIDASES AND USES THEREOF  
(71) Pharmaxis Ltd., 20 Rodborough Road Frenchs Forest, New South Wales 2086, AU

(72) FINDLAY, Alison Dorothy, 20 Rodborough Road, Frenchs Forest, NSW 2086, AU  
TURNER, Craig Ivan, 20 Rodborough Road, Frenchs Forest, NSW 2086, AU  
DEODHAR, Mandar, 20 Rodborough Road, Frenchs Forest, NSW 2086, AU  
FOOT, Jonathan Stuart, 20 Rodborough Road, Frenchs Forest, NSW 2086, AU  
JAROLIMEK, Wolfgang, 20 Rodborough Road, Frenchs Forest, NSW 2086, AU  
ZHOU, Wenbin, 20 Rodborough Road, Frenchs Forest, NSW 2086, AU  
ROBERTSON, Alan Duncan, 12 Cherry Street, Warrawee, NSW 2074, AU

---

(51) MKP  
**A61K 31/00 2006 (97) EP 3414226**  
**A61K 31/404 2006**  
**A61P 35/00 2006**  
**C07D 209/24 2006**  
**C07D 471/04 2006**  
**C07D 487/04 2006**

(96) EP 17749813.6 2/10/2017

(97) EP 3414226, 12/19/2018 201851, en

(31) 2016900478 (32) 12.02.2016 (33) AU  
2016902593 01.07.2016 AU

(54) INDOLE AND AZAINDOLE HALOALLYLAMINE DERIVATIVE INHIBITORS OF LYSYL OXIDASES AND USES THEREOF

(72) FINDLAY, Alison Dorothy, 20 Rodborough Road, Frenchs Forest, NSW 2086, AU  
TURNER, Craig Ivan, 20 Rodborough Road, Frenchs Forest, NSW 2086, AU  
DEODHAR, Mandar, 20 Rodborough Road, Frenchs Forest, NSW 2086, AU  
FOOT, Jonathan Stuart, 20 Rodborough Road, Frenchs Forest, NSW 2086, AU  
JAROLIMEK, Wolfgang, 20 Rodborough Road, Frenchs Forest, NSW 2086, AU  
ZHOU, Wenbin, 20 Rodborough Road, Frenchs Forest, NSW 2086, AU  
ROBERTSON, Alan Duncan, 12 Cherry Street, Warrawee, NSW 2074, AU

---

(51) MKP  
**H04L 9/28 2006 (97) EP 3414867**

(96) EP 17749821.9 2/7/2017

(97) EP 3414867, 12/19/2018 201851, en

(31) 2016900405 (32) 08.02.2016 (33) AU

(54) A SYSTEM AND METHOD FOR DOCUMENT INFORMATION AUTHENTICITY VERIFICATION

(71) Moloney, Lindsay, L11 65 York Street, Sydney, New South Wales 2000, AU  
Scott, Guy, L11 65 York Street, Sydney, New South Wales 2000, AU  
(72) Moloney, Lindsay, L11 65 York Street, Sydney, New South Wales 2000, AU  
Scott, Guy, L11 65 York Street, Sydney, New South Wales 2000, AU

---

(51) MKP  
**A61K 47/66 2017 (97) EP 3413921**  
**A61K 47/68 2017**  
**A61P 35/00 2006**

(96) EP 17750665.6 2/8/2017

(97) EP 3413921, 12/19/2018 201851, en

(31) 201662388862 P (32) 09.02.2016 (33) US  
201662389137 P 18.02.2016 US  
201662390624 P 04.04.2016 US  
201662494420 P 08.08.2016 US

(54) SITE-SELECTIVE FUNCTIONALIZATION OF PROTEINS USING TRACELESS AFFINITY LABELS

(71) Krantz, Alexander, 280 Commonwealth Avenue 301, Boston, MA 02116, US  
Wilczynski, Andrzej, 66 Beach Point Place Apt 703, Boston, MA 02125, US  
(72) Krantz, Alexander, 280 Commonwealth Avenue 301, Boston, MA 02116, US  
Wilczynski, Andrzej, 66 Beach Point Place Apt 703, Boston, MA 02125, US

---

(51) MKP  
**A61B 6/00 2006 (97) EP 3399916**  
**G06K 9/00 2006**  
**G06K 9/36 2006**

(96) EP 17750690.4 2/8/2017

(97) EP 3399916, 11/14/2018 201846, en

(31) 201662292413 P (32) 08.02.2016 (33) US

(54) SYSTEM AND METHOD FOR THE VISUALIZATION AND CHARACTERIZATION OF OBJECTS IN IMAGES  
(71) Imago Systems, Inc., 35 Union Place Suite 272, Summit, NJ 07901, US  
(72) RAMSAY, Thomas E., 221 Newhall Place S.W., Leesburg VA 20175, US  
RAMSAY, Eugene B., 7225 E. 18th Street, Tucson AZ 85710, US

---

(51) MKP  
**G01J 3/447 2006 (97) EP 3414620**  
**G01N 21/19 2006**  
**G02F 1/11 2006**  
(96) EP 17750735.7 2/9/2017  
(97) EP 3414620, 12/19/2018 201851, en  
(31) 201662293514 P (32) 10.02.2016 (33) US  
(54) METHODS OF IMPROVING THE RETARDATION ACCURACY AND STABILITY OF PHOTOELASTIC MODULATOR DEVICES  
(72) WHITE, Nigel, Thornton, Hopley, 10 Leith View North Holmwood, Dorking Surrey RH5 4TG, GB  
COLE, Lindsay, John, 34 White Way, Bookham Surrey KT23 4LT, GB

---

(51) MKP  
**A61K 31/47 2006 (97) EP 3413892**  
**C07D 217/08 2006**  
(96) EP 17750801.7 2/10/2017  
(97) EP 3413892, 12/19/2018 201851, en  
(31) 201662285039 P (32) 12.02.2016 (33) US  
(54) TETRAHYDROISOQUINOLINE DERIVATIVES  
(72) SATO, Ippei, C/o Astellas Pharma Inc. 5-1 Nihonbashi-honcho 2-chome Chuo-ku, Tokyo 103-8411, JP  
KAMIKUBO, Takashi, C/o Astellas Pharma Inc. 5-1 Nihonbashi-honcho 2-chome Chuo-ku, Tokyo 103-8411, JP  
MIURA, Masanori, C/o Astellas Pharma Inc. 5-1 Nihonbashi-honcho 2-chome Chuo-ku, Tokyo 103-8411, JP  
MATSUSHIMA, Yuji, C/o Astellas Pharma Inc. 5-1 Nihonbashi-honcho 2-chome Chuo-ku, Tokyo 103-8411, JP  
TANAKA, Hiroaki, C/o Astellas Pharma Inc. 5-1 Nihonbashi-honcho 2-chome Chuo-ku, Tokyo 103-8411, JP  
SHIINA, Yasuhiro, C/o Astellas Pharma Inc. 5-1 Nihonbashi-honcho 2-chome Chuo-ku, Tokyo 103-8411, JP  
YAMAKI, Susumu, C/o Astellas Pharma Inc. 5-1 Nihonbashi-honcho 2-chome Chuo-ku, Tokyo 103-8411, JP  
SAITO, Tomoyuki, C/o Astellas Pharma Inc. 5-1 Nihonbashi-honcho 2-chome Chuo-ku, Tokyo 103-8411, JP  
KIYOHARA, Hiroshi, C/o Astellas Pharma Inc. 5-1 Nihonbashi-honcho 2-chome Chuo-ku, Tokyo 103-8411, JP  
OHE, Munemichi, C/o Astellas Pharma Inc. 5-1 Nihonbashi-honcho 2-chome Chuo-ku, Tokyo 103-8411, JP  
MIHARA, Kayoko, C/o Astellas Pharma Inc. 5-1 Nihonbashi-honcho 2-chome Chuo-ku, Tokyo 103-8411, JP  
MORGAN, Bradley, Paul, 1206 Rimer Drive, Moraga CA 94556, US  
MALIK, Fady, 2884 Hillside Drive, Burlingame CA 94010, US  
COLLIBEE, Scott, Emile, 2065 Brittan Avenue, San Carlos CA 94070, US  
ASHCRAFT, Luke, 668 Carolina Street, San Francisco CA 94107, US  
LU, Pu-Ping, 1017 Flying Fish Street, Foster City CA 94404, US  
WARRINGTON, Jeffrey, Michael, 1936 Playa Street, San Mateo CA 94403, US  
GARARD, Marc, 16745 Kildare Road, San Leandro CA 94578, US

---

(51) MKP  
**C07D 403/02 2006 (97) EP 3414235**  
**C07D 411/02 2006**  
**C07D 495/04 2006**  
(96) EP 17750825.6 2/10/2017  
(97) EP 3414235, 12/19/2018 201851, en  
(31) 201662294543 P (32) 12.02.2016 (33) US  
(54) DEUTERIUM-MODIFIED CFTR MODULATORS  
(72) SILVERMAN, I., Robert, 36 Orvis Road, Arlington MA 02474, US

---

(51) MKP  
**B65D 19/00 2006 (97) EP 3416896**  
**B65D 19/38 2006**  
**B65G 65/02 2006**  
**B65G 67/04 2006**  
**B65G 69/22 2006**  
(96) EP 17752733.0 2/16/2017  
(97) EP 3416896, 12/26/2018 201852, en  
(31) 20165111 (32) 16.02.2016 (33) FI  
(54) TRANSFER EQUIPMENT AND LOAD TRANSFER APPLIANCE  
(72) VIINONEN, Reijo, Kirkkotie 4-6 B 18, 76150 Pieksämäki, FI

---

(51) MKP  
A61K 31/4155 2006 (97) EP 3416964  
A61K 31/4525 2006  
A61K 31/454 2006  
A61K 31/4985 2006  
A61P 35/00 2006  
C07D 403/12 2006  
C07D 405/12 2006  
C07D 409/12 2006  
C07D 471/04 2006  
C07D 471/14 2006  
C07D 487/04 2006  
C07D 491/048 2006  
(96) EP 17752742.1 2/17/2017  
(97) EP 3416964, 12/26/2018 201852, en  
(31) 201662297522 P (32) 19.02.2016 (33) US  
(54) CARBOXAMIDE DERIVATIVES USEFUL AS RSK INHIBITORS  
(71) Phoenix Molecular Designs, 110-13120 Vanier Place, Richmond, British Columbia V6V 2J2, CA  
(72) DUNN, Sandra, E., 110-13120 Vanier Place, Richmond, British Columbia V6V 2J2, CA  
JAYANTHAN, Aarthi, 110-13120 Vanier Place, Richmond, British Columbia V6V 2J2, CA  
NAGIREDDY, Jaipal, Reddy, 110-13120 Vanier Place, Richmond, British Columbia V6V 2J2, CA  
ANNEDI, Subhash, 110-13120 Vanier Place, Richmond, British Columbia V6V 2J2, CA  
VAN DRIE, John, H., 110-13120 Vanier Place, Richmond, British Columbia V6V 2J2, CA  
DAYNARD, Timothy, S., 110-13120 Vanier Place, Richmond, British Columbia V6V 2J2, CA  
HUYNH, My-my, 110-13120 Vanier Place, Richmond, British Columbia V6V 2J2, CA

---

(51) MKP  
A61K 31/4439 2006 (97) EP 3418276  
A61K 31/444 2006  
A61K 31/4545 2006  
A61K 31/46 2006  
A61K 31/4709 2006  
A61K 31/498 2006  
A61K 31/5355 2006  
A61K 31/5377 2006  
A61P 13/12 2006  
A61P 43/00 2006  
C07D 401/04 2006  
C07D 401/14 2006  
C07D 405/14 2006  
C07D 409/14 2006  
C07D 413/14 2006  
C07D 417/14 2006  
C07D 451/02 2006  
(96) EP 17753183.7 2/14/2017  
(97) EP 3418276, 12/26/2018 201852, en  
(31) 2016025878 (32) 15.02.2016 (33) JP  
(54) AZOLE-SUBSTITUTED PYRIDINE COMPOUND  
(72) TANAKA, Hiroaki, c/o Taisho Pharmaceutical Co. Ltd. 24-1 Takada 3-chome Toshima-ku, Tokyo 170-8633, JP  
BOHNO, Ayako, c/o Taisho Pharmaceutical Co. Ltd. 24-1 Takada 3-chome Toshima-ku, Tokyo 170-8633, JP  
HAMADA, Makoto, c/o Taisho Pharmaceutical Co. Ltd. 24-1 Takada 3-chome Toshima-ku, Tokyo 170-8633, JP  
ITO, Yuji, c/o Taisho Pharmaceutical Co. Ltd. 24-1 Takada 3-chome Toshima-ku, Tokyo 170-8633, JP  
KOBASHI, Yohei, c/o Taisho Pharmaceutical Co. Ltd. 24-1 Takada 3-chome Toshima-ku, Tokyo 170-8633, JP  
KAWAMURA, Madoka, c/o Taisho Pharmaceutical Co. Ltd. 24-1 Takada 3-chome Toshima-ku, Tokyo 170-8633, JP

---

(51) MKP  
A61K 38/00 2006 (97) EP 3417294  
A61K 39/395 2006  
A61K 48/00 2006  
A61P 35/00 2006  
G01N 33/574 2006  
(96) EP 17753704.0 2/14/2017  
(97) EP 3417294, 12/26/2018 201852, en

(31) 201662295421 P (32) 15.02.2016 (33) US  
 (54) METHODS COMPRISING FIXED INTERMITTENT DOSING OF CEDIRANIB  
 (71) The United States of America, as Represented By the Secretary, Department of Health and Human Services, Office of Technology Transfer  
 National Institutes of Health 6011 Executive Boulevard Suite 325 MSC 7660, Bethesda, MD 20892-7660, US  
 (72) BARRY, Simon, AstraZeneca Darwin Building Cambridge Science Park Milton Road, Cambridge CB4 0WG, GB  
 KENDREW, Jane, AstraZeneca Alderley Park, Macclesfield Cheshire SK10 4TG, GB  
 HO, Tony, AstraZeneca Pharmaceuticals LP One MedImmune Way, Gaithersburg, MD 20878, US  
 WEDGE, Stephen, Robert, AstraZeneca Riverside Buildnig 2, Granta Park Cambridge CB21 6GH, GB  
 IVY,Susan Percy, National Institutes of Health 6011 Executive Boulevard Suite 325 MSC 7660, Bethesda, MD 20892-7660, US  
 KOHN, Elise, National Institutes of Health 6011 Executive Boulevard Suite 325 MSC 7660, Bethesda, MD 20892-7660, US  
 LEE, Jung-Min, National Institutes of Health 6011 Executive Boulevard Suite 325 MSC 7660, Bethesda, MD 20892-7660, US

---

(51) MKP  
**C01B 32/10 2017 (97) EP 3417502**  
**H01M 2/14 2006**  
**H01M 4/134 2010**  
**H01M 4/36 2006**  
**H01M 4/38 2006**  
**H01M 10/052 2010**  
**H01M 10/058 2010**

(96) EP 17753807.1 2/16/2017  
 (97) EP 3417502, 12/26/2018 201852, en

(31) 201662296286 P (32) 17.02.2016 (33) US  
 201662364113 P 19.07.2016 US  
 201662367314 P 27.07.2016 US

(54) IMMOBILIZED SELENIUM, A METHOD OF MAKING, AND USES OF IMMOBILIZED SELENIUM IN A RECHARGEABLE BATTERY

(71) II-VI INCORPORATED, 375 Saxonburg Boulevard, Saxonburg, PA 16056, US  
 (72) EISSLER, Elgin E., 205 Beacon Light Road, Renfrew Pennsylvania 16053, US  
 XU, Wen-Qing, 20 Hearthstone Drive, Medfield Massachusetts 02052, US  
 LI, Xiaoming, 3106 Westwind Drive, Allison Park Pennsylvania 15101, US  
 ZHANG, Yancheng, 2286 Gwenedd Lane, State College Pennsylvania 16801, US  
 PATKAR, Shailesh, 114 Dolores Drive, Irwin Pennsylvania 15642, US  
 BARBAROSSA, Giovanni, 12430 Curry Court, Saratoga California 95070, US  
 GUO, Yu-Guo, No. 4-701, Building 956, Zhongguancun Third South Street, Haidian District,, Beijing 100190, CN  
 ZHANG, Shuaifeng, No. 4-701, Building 956, Zhongguancun Third South Street, Haidian District, Beijing 100190, CN  
 YIN, Yaxia, No. 4-701, Building 956, Zhongguancun Third South Street, Haidian District, Beijing 100190, CN

---

(51) MKP  
**A61K 8/00 2006 (97) EP 3416679**  
**A61K 39/00 2006**  
**A61K 48/00 2006**  
**C07K 14/435 2006**  
**C07K 14/47 2006**  
**C12N 9/00 2006**

(96) EP 17753810.5 2/16/2017  
 (97) EP 3416679, 12/26/2018 201852, en

(31) 201662295711 P (32) 16.02.2016 (33) US  
 201662343448 P 31.05.2016 US

(54) PATHOGEN VACCINES AND METHODS OF PRODUCING AND USING THE SAME

(72) ALI, Omar, Abdel-Rahman, 700 Huron Avenue Apt. 15, Cambridge, MA 02138, US  
 CARTWRIGHT, Mark, Joseph, 37 Princess Road, West Newton, MA 02465, US  
 DOHERTY, Edward, 10 Nathan Road, Mansfield, MA 02048, US  
 GRAVELINE, Amanda, 3 Blackfan Circle, Boston, MA 02115, US  
 INGBER, Donald, E., 3 Blackfan Circle, Boston, MA 02115, US  
 MOONEY, David, J., 27 Powers Road, Sudbury, MA 01776, US  
 SEILER, Benjamin, 3 Blackfan Circle, Boston, MA 02115, US  
 STAFFORD, Alexander, 150 Procter Avenue, Revere, MA 02151, US  
 SUPER, Michael, 354 Concord Avenue, Lexington, MA 02421, US  
 WHITE, Des, 3 Blackfan Circle, Boston, MA 02115, US

---

(51) MKP  
**A61K 31/4365 2006 (97) EP 3416639**  
**C07D 495/04 2006**

(96) EP 17753822.0 2/16/2017



(97) EP 3416639, 12/26/2018 201852, en  
(31) 201662296012 P (32) 16.02.2016 (33) US  
201662402438 P 30.09.2016 US  
(54) POSITIVE ALLOSTERIC MODULATORS OF THE MUSCARINIC ACETYLCHOLINE RECEPTOR M1  
(72) LINDSLEY, Craig, W., 9281 Wardley Park Lane, Brentwood TN 37027, US  
CONN, P., Jeffrey, 2806 Acklen Avenue, Nashville TN 37212, US  
ENGERS, Darren, W., 1744 Stillwater Circle, Brentwood TN 37027, US  
BOLLINGER, Katrina, A., 140 Melstone Court, Murfreesboro TN 37127, US  
ENGERS, Julie, L., 1744 Stillwater Circle, Brentwood TN 37027, US

---

(51) MKP  
**C12N 5/00 2006 (97) EP 3417051**  
**G01N 1/30 2006**  
**G01N 33/50 2006**  
**G01N 33/68 2006**  
(96) EP 17753900.4 2/17/2017  
(97) EP 3417051, 12/26/2018 201852, en  
(31) 201662296420 P (32) 17.02.2016 (33) US  
201662322252 P 14.04.2016 US  
201662328890 P 28.04.2016 US  
(54) METHODS AND TEST KITS FOR DETERMINING MALE FERTILITY STATUS  
(72) TRAVIS, Alexander, J., 1044 Cayuga Heights Road, Ithaca New Jersey 14850, US  
CARDONA, Cristina, 71 Mitchell Avenue, Piscataway, NJ 08854, US  
MOODY, Melissa, A., 107 Brandywine Court, Brick New Jersey 08724, US  
SIMPSON, Alana, J., 147 Summit Avenue Apartment 36, Summit New Jersey 07901, US  
OSTERMERIER, G., Charles, 189 Longview Terrace, Gillette New Jersey 07933, US

---

(51) MKP  
**A61K 31/4439 2006 (97) EP 3347352**  
**A61P 31/18 2006**  
**C07D 401/14 2006**  
(96) EP 17758388.7 8/17/2017  
(97) EP 3347352, 7/18/2018 201829, en  
(31) 201662377312 P (32) 19.08.2016 (33) US  
201762457555 P 10.02.2017 US  
(54) THERAPEUTIC COMPOUNDS USEFUL FOR THE PROPHYLACTIC OR THERAPEUTIC TREATMENT OF AN HIV VIRUS INFECTION  
(72) GRAUPE, Michael, c/o Gilead Sciences Inc. 333 Lakeside Drive, Foster City, CA 94404, US  
HENRY, Steven J., c/o Gilead Sciences Inc. 333 Lakeside Drive, Foster City, CA 94404, US  
LINK, John O., c/o Gilead Sciences Inc. 333 Lakeside Drive, Foster City, CA 94404, US  
ROWE, Charles William, c/o Gilead Sciences Inc. 333 Lakeside Drive, Foster City, CA 94404, US  
SAITO, Roland D., c/o Gilead Sciences Inc. 333 Lakeside Drive, Foster City, CA 94404, US  
SCHROEDER, Scott D., c/o Gilead Sciences Inc. 333 Lakeside Drive, Foster City, CA 94404, US  
STEFANIDIS, Dimitrios, c/o Gilead Sciences Inc. 333 Lakeside Drive, Foster City, CA 94404, US  
TSE, Winston C., c/o Gilead Sciences Inc. 333 Lakeside Drive, Foster City, CA 94404, US  
ZHANG, Jennifer R., c/o Gilead Sciences Inc. 333 Lakeside Drive, Foster City, CA 94404, US

---

(51) MKP  
**B64C 39/02 2006 (97) EP 3400676**  
**G05B 19/418 2006**  
**H04L 9/32 2006**  
(96) EP 17763681.8 1/5/2017  
(97) EP 3400676, 11/14/2018 201846, en  
(31) 201662387804 P (32) 05.01.2016 (33) US  
(54) A SAFETY ARCHITECTURE FOR AUTONOMOUS VEHICLES  
(71) Carnegie Mellon University, 5000 Forbes Avenue, Pittsburgh, PA 15213, US  
(72) WAGNER, Michael D., 142 Crescent Drive, Pittsburgh, Pennsylvania 15228, US  
RAY, Justin, c/o Carnegie Mellon University 5000 Forbes Avenue, Pittsburgh, PA 15213, US  
KANE, Aaron, 5823 Holden Street, Apt. 1, Pittsburgh, PA 15232, US  
KOOPMAN, Philip, 5463 Fair Oaks St, Pittsburgh, PA 15217, US

---

(51) MKP  
**A61K 31/13 2006 (97) EP 3359146**  
**A61P 25/00 2006**

(96) EP 17767933.9 8/11/2017  
(97) EP 3359146, 11/21/2018 201847, en  
(31) 201613828 (32) 11.08.2016 (33) GB  
201702552 16.02.2017 GB  
201705762 10.04.2017 GB  
201706854 28.04.2017 GB  
(54) PHARMACEUTICAL COMPOSITIONS AND USES DIRECTED TO LYSOSOMAL STORAGE DISORDERS  
(71) Intrabio Ltd, Begbroke Science Park Begbroke Hill Woodstock Road, Begbroke, Oxfordshire OX5 1PF, GB  
(72) STRUPP, Michael, c/o The Department of Neurology and German Center for Vertigo and Balance Disorders Ludwig-Maximilians-University Hospital Munich Campus Grosshadern Marchioninstr. 15, 81377 Munich, DE

---

(51) MKP  
**A61K 31/13 2006 (97) EP 3416631**  
**A61P 25/00 2006**  
(96) EP 17767934.7 8/11/2017  
(97) EP 3416631, 12/26/2018 201852, en  
(31) 201613829 (32) 11.08.2016 (33) GB  
201702551 16.02.2017 GB  
201705766 10.04.2017 GB  
201706867 28.04.2017 GB  
(54) THERAPEUTIC AGENTS FOR NEURODEGENERATIVE DISEASES  
(72) STRUPP, Michael, c/o The Department of Neurology and German Center for Vertigo and Balance Disorders Ludwig-Maximilians-University Hospital Munich Campus Grosshadern Marchioninstr. 15, 81377 Munich, DE

---

(51) MKP  
**G06F 17/50 2006 (97) EP 3347879**  
**G06T 17/10 2006**  
**G06T 19/00 2011**  
(96) EP 17811820.4 2/3/2017  
(97) EP 3347879, 7/18/2018 201829, en  
(31) 201615207927 (32) 12.07.2016 (33) US  
(54) METHOD FOR IMMEDIATE BOOLEAN OPERATIONS USING GEOMETRIC FACETS  
(71) CAO, Shangwen, 361 St-Joseph O., Montreal QC H2V 2P1, CA  
(72) CAO, Shangwen, 361 St-Joseph O., Montreal QC H2V 2P1, CA

---

(51) MKP  
**A61K 35/74 2015 (97) EP 3359172**  
**A61P 1/14 2006**  
**A61P 29/00 2006**  
(96) EP 17818220.0 12/12/2017  
(97) EP 3359172, 8/15/2018 201833, en  
(31) 201621123 (32) 12.12.2016 (33) GB  
(54) COMPOSITIONS COMPRISING BACTERIAL STRAINS  
(72) JEFFERY, Ian, c/o 4D Pharma Cork Limited Room 447 Food Science Building University College Co Cork Western Road, Cork, IE  
SHANAHAN, Fergus, Seafort Fort Hill, Kinsale County Cork, IE  
O'TOOLE, Paul, c/o 4D Pharma Cork Limited Room 447 Food Science Building University College Co Cork Western Road, Cork, IE  
STEVENSON, Alex, c/o 4D Pharma PLC 3rd Floor 9 Bond Court, Leeds Yorkshire LS1 2JZ, GB  
MULDER, Imke, c/o 4D Pharma Research Limited Life Sciences Innovation Building Cornhill Road, Aberdeen Aberdeenshire AB25 2ZS, GB  
SAVIGNAC, Helene, c/o 4D Pharma PLC 3rd Floor 9 Bond Court, Leeds Yorkshire LS1 2JZ, GB

---

(51) MKP  
**B65G 39/04 2006 (97) EP 3408197**  
**B65G 39/07 2006**  
(96) EP 17825182.3 12/15/2017  
(97) EP 3408197, 12/5/2018 201849, de  
(31) 102016125136 (32) 21.12.2016 (33) DE  
(54) CONVEYOR ROLLER WITH CONICAL TAPERED ELEMENT  
(71) Interroll Holding AG, Zona Industriale, 6592 Sant' Antonino, CH  
(72) LANGENSIEPEN, Dominik, c/o INTERROLL Holding GmbH Höferhof 16, 42929 Wermelskirchen, DE  
LINDHOLM, Armin, c/o INTERROLL Holding GmbH Höferhof 16, 42929 Wermelskirchen, DE

---

- (51) MKP  
**A61K 9/00 2006 (97) EP 3368011**  
**A61K 31/137 2006**  
**A61K 45/06 2006**
- (96) EP 17828300.8 7/11/2017
- (97) EP 3368011, 9/5/2018 201836, en
- (31) 201662361263 P (32) 12.07.2016 (33) US
- (54) NOVEL COMPOUNDS AND USES THEREOF
- (71) Accutar Biotechnology Inc., 760 Parkside Avenue Room 213, Brooklyn, NY 11226, US
- (72) FAN, Jie, 400 East 66th Street Apt. 16b, New York, NY 10065, US  
LIU, Ke, 1189 Wuzhong Road Minghang District Debiyiyuan Room 846, Shanghai 201103, CN

## Indeks brojeva zahtjeva za proširenje evropskih prijave patenta

Broj objave evropske prijave patenta (97)	MKP (51)
3022022	<b>B26B 21/22</b> (2006.01) <b>B26B 21/52</b> (2006.01)
2929976	<b>B23K 26/12</b> (2014.01) <b>B23K 26/14</b> (2014.01) <b>B23K 26/34</b> (2014.01) <b>B23K 35/38</b> (2006.01) <b>B23K 103/04</b> (2006.01)
2929977	<b>B23K 26/12</b> (2014.01) <b>B23K 35/38</b> (2006.01)
2476919	<b>F16B 23/00</b> (2006.01) <b>F16B 25/00</b> (2006.01) <b>F16B 37/12</b> (2006.01)
2708403	<b>B60L 11/18</b> (2006.01) <b>H02J 3/14</b> (2006.01)
2375154	<b>F23J 1/02</b> (2006.01)
2657631	<b>A23L 3/375</b> (2006.01) <b>F25D 3/10</b> (2006.01) <b>F25D 3/12</b> (2006.01)
2657630	<b>F25D 3/10</b> (2006.01) <b>F25D 3/12</b> (2006.01)
2741002	<b>F23N 1/02</b> (2006.01)
2730769	<b>F02D 41/00</b> (2006.01) <b>F02D 41/02</b> (2006.01)
3349594	<b>A23L 27/40</b> (2016.01) <b>A23L 33/165</b> (2016.01) <b>A61P 9/12</b> (2006.01)
3359163	<b>A61K 31/7068</b> (2006.01) <b>A61P 35/00</b> (2006.01)
3349765	<b>A61K 33/06</b> (2006.01) <b>A61K 36/185</b> (2006.01) <b>A61K 36/28</b> (2006.01) <b>A61K 36/53</b> (2006.01)
3247650	<b>B65D 51/24</b> (2006.01) <b>C12G 1/08</b> (2006.01)
3170887	<b>C12G 1/032</b> (2006.01)
3358965	<b>A23K 10/00</b> (2016.01)
3359038	<b>A61B 5/145</b> (2006.01) <b>A61B 5/1455</b> (2006.01)
3109168	<b>B64C 13/50</b> (2006.01) <b>B64D 45/00</b> (2006.01)

Broj objave evropske prijava patenta (97)	MKP (51)
	<b>G05D 1/00</b> (2006.01) <b>H04B 7/185</b> (2006.01)
3254861	<b>B42D 1/00</b> (2006.01)
3260776	<b>F23J 7/00</b> (2006.01) <b>F23J 15/00</b> (2006.01) <b>F23J 15/04</b> (2006.01)
3260231	<b>B21F 15/08</b> (2006.01) <b>B23K 37/04</b> (2006.01) <b>B23K 101/32</b> (2006.01) <b>B25J 15/00</b> (2006.01) <b>B25J 15/02</b> (2006.01)
3260114	<b>A23L 29/00</b> (2016.01) <b>A61K 8/00</b> (2006.01) <b>A61K 9/16</b> (2006.01)
3260115	<b>A23L 29/00</b> (2016.01) <b>A61K 8/00</b> (2006.01) <b>A61K 9/16</b> (2006.01)
3405704	<b>F04B 53/14</b> (2006.01) <b>F15B 15/14</b> (2006.01) <b>F16F 9/48</b> (2006.01) <b>F16J 3/06</b> (2006.01) <b>F16J 10/00</b> (2006.01)
2534989	<b>A47L 5/38</b> (2006.01) <b>A47L 9/00</b> (2006.01) <b>A47L 9/24</b> (2006.01)
3287682	<b>F16L 21/06</b> (2006.01) <b>F16L 31/00</b> (2006.01)
3287710	<b>B29C 65/68</b> (2006.01) <b>B60H 1/00</b> (2006.01) <b>F24H 3/04</b> (2006.01) <b>H01R 4/72</b> (2006.01) <b>H05B 3/40</b> (2006.01)
3290315	<b>B62K 5/00</b> (2013.01) <b>B62K 5/10</b> (2013.01) <b>B62K 7/04</b> (2006.01)
3290436	<b>A23L 33/195</b> (2016.01) <b>A61K 38/00</b> (2006.01) <b>C07K 14/195</b> (2006.01)
3290819	<b>F24H 1/00</b> (2006.01) <b>F24H 9/00</b> (2006.01) <b>F24H 9/18</b> (2006.01) <b>H05B 1/02</b> (2006.01) <b>H05B 3/48</b> (2006.01)
3150136	<b>A61B 17/072</b> (2006.01)
3376880	<b>A23L 29/231</b> (2016.01)

Broj objave evropske prijava patenta (97)	MKP (51)
3254559	<b>A01M 1/02</b> (2006.01) <b>A01M 1/10</b> (2006.01) <b>A01M 1/20</b> (2006.01)
3278798	<b>A23L 21/20</b> (2016.01) <b>A23L 33/10</b> (2016.01) <b>A61K 31/192</b> (2006.01) <b>A61K 35/644</b> (2015.01) <b>A61P 31/10</b> (2006.01)
3301170	<b>B27H 5/04</b> (2006.01) <b>B27M 1/06</b> (2006.01) <b>C12G 3/07</b> (2006.01) <b>C12J 1/00</b> (2006.01)
3318716	<b>F01D 5/00</b> (2006.01) <b>F01D 5/30</b> (2006.01) <b>F01D 25/28</b> (2006.01)
3245224	<b>A61K 38/00</b> (2006.01) <b>A61K 38/20</b> (2006.01) <b>C07K 14/54</b> (2006.01)
3242892	<b>A61K 39/00</b> (2006.01) <b>A61K 39/395</b> (2006.01) <b>A61P 37/00</b> (2006.01) <b>C07K 16/28</b> (2006.01)
3250050	<b>A23L 2/52</b> (2006.01) <b>A23L 2/60</b> (2006.01) <b>A23L 27/12</b> (2016.01)
3250051	<b>A23L 2/52</b> (2006.01) <b>A23L 2/60</b> (2006.01) <b>A23L 27/12</b> (2016.01)
3242684	<b>A61K 39/00</b> (2006.01) <b>A61K 39/395</b> (2006.01) <b>A61P 1/00</b> (2006.01) <b>C07K 16/28</b> (2006.01)
3402577	<b>A62B 35/00</b> (2006.01) <b>A62B 35/04</b> (2006.01)
3256127	<b>A61K 31/4439</b> (2006.01) <b>A61P 27/00</b> (2006.01)
3247393	<b>A61K 39/395</b> (2006.01) <b>C07K 16/28</b> (2006.01)
3259250	<b>A61K 31/18</b> (2006.01) <b>A61K 31/4402</b> (2006.01) <b>A61K 31/47</b> (2006.01) <b>A61K 31/505</b> (2006.01) <b>A61P 31/00</b> (2006.01) <b>C07C 311/00</b> (2006.01) <b>C07D 213/71</b> (2006.01) <b>C07D 215/36</b> (2006.01) <b>C07D 217/22</b> (2006.01) <b>C07D 239/42</b> (2006.01) <b>C07D 239/47</b> (2006.01) <b>C07D 239/48</b> (2006.01)

Broj objave evropske prijave patenta (97)	MKP (51)
	<b>C07D 251/22</b> (2006.01) <b>C07D 311/20</b> (2006.01) <b>C07D 487/04</b> (2006.01)
3253747	<b>A61K 31/551</b> (2006.01) <b>A61K 31/553</b> (2006.01) <b>A61P 35/00</b> (2006.01) <b>C07D 243/14</b> (2006.01) <b>C07D 267/12</b> (2006.01) <b>C07D 403/06</b> (2006.01) <b>C07D 413/06</b> (2006.01)
3256107	<b>A61K 9/16</b> (2006.01) <b>A61K 31/265</b> (2006.01)
3384100	<b>E04C 1/00</b> (2006.01) <b>E04C 2/04</b> (2006.01)
3374577	<b>E04C 2/04</b> (2006.01)
3397568	<b>B65D 51/28</b> (2006.01)
3402570	<b>A61N 5/06</b> (2006.01)
3253870	<b>C12N 9/74</b> (2006.01) <b>G01N 33/48</b> (2006.01)
3395716	<b>B65D 81/34</b> (2006.01)
3344620	<b>A61K 31/496</b> (2006.01) <b>A61P 25/34</b> (2006.01) <b>C07D 403/12</b> (2006.01)
3344769	<b>A61K 31/713</b> (2006.01) <b>C12N 15/113</b> (2010.01)
3394081	<b>A61K 31/575</b> (2006.01) <b>A61P 1/16</b> (2006.01) <b>C07J 9/00</b> (2006.01) <b>C07J 17/00</b> (2006.01) <b>C07J 51/00</b> (2006.01)
3250039	<b>A22C 21/00</b> (2006.01)
3373769	<b>A47C 7/02</b> (2006.01) <b>A47C 7/28</b> (2006.01) <b>A47C 31/02</b> (2006.01) <b>B68G 7/00</b> (2006.01) <b>D03D 15/04</b> (2006.01)
3165540	<b>A01K 67/027</b> (2006.01) <b>A61K 39/395</b> (2006.01) <b>A61P 35/00</b> (2006.01) <b>A61P 37/02</b> (2006.01) <b>C07K 14/705</b> (2006.01) <b>C07K 16/28</b> (2006.01)
3156975	<b>G06T 15/08</b> (2011.01) <b>G06T 17/20</b> (2006.01)

Broj objave evropske prijava patenta (97)	MKP (51)
	<b>G06T 19/00</b> (2011.01)
3159314	<b>B01D 24/36</b> (2006.01) <b>B01D 24/46</b> (2006.01) <b>C02F 3/08</b> (2006.01) <b>C02F 3/12</b> (2006.01)
3156073	<b>A61K 39/395</b> (2006.01) <b>C07K 16/24</b> (2006.01)
3321020	<b>B23D 65/00</b> (2006.01) <b>B24B 7/17</b> (2006.01) <b>B24B 21/04</b> (2006.01)
3321990	<b>H01M 2/02</b> (2006.01) <b>H01M 4/86</b> (2006.01) <b>H01M 4/88</b> (2006.01) <b>H01M 12/06</b> (2006.01) <b>H01M 12/08</b> (2006.01)
3153474	<b>C02F 1/00</b> (2006.01) <b>C02F 1/44</b> (2006.01) <b>C02F 1/50</b> (2006.01) <b>C02F 1/66</b> (2006.01) <b>C02F 1/76</b> (2006.01) <b>C02F 1/78</b> (2006.01) <b>C02F 5/14</b> (2006.01) <b>C02F 103/42</b> (2006.01) <b>E04H 4/12</b> (2006.01)
3156111	<b>B01D 21/30</b> (2006.01) <b>B01D 61/04</b> (2006.01) <b>C02F 1/00</b> (2006.01) <b>C02F 1/24</b> (2006.01) <b>C02F 1/44</b> (2006.01) <b>C02F 1/50</b> (2006.01) <b>C02F 1/52</b> (2006.01) <b>C02F 1/56</b> (2006.01) <b>C02F 1/72</b> (2006.01) <b>C02F 1/76</b> (2006.01) <b>C02F 1/78</b> (2006.01) <b>C02F 5/08</b> (2006.01) <b>C02F 9/02</b> (2006.01) <b>C02F 101/20</b> (2006.01) <b>C02F 103/02</b> (2006.01) <b>C02F 103/08</b> (2006.01) <b>C02F 103/10</b> (2006.01)
3173825	<b>G01N 27/72</b> (2006.01) <b>G01V 3/10</b> (2006.01)
3332672	<b>A47F 1/12</b> (2006.01) <b>G07F 9/10</b> (2006.01) <b>G07F 11/04</b> (2006.01) <b>G07F 11/16</b> (2006.01) <b>G07F 11/22</b> (2006.01) <b>G07F 11/42</b> (2006.01)
3165086	<b>A01K 67/027</b> (2006.01) <b>C07K 16/00</b> (2006.01) <b>C07K 16/28</b> (2006.01) <b>C12N 15/85</b> (2006.01)



Broj objave evropske prijava patenta (97)	MKP (51)
3348346	<b>B23P 19/02</b> (2006.01) <b>B23P 21/00</b> (2006.01)
3214477	<b>G02B 19/00</b> (2006.01) <b>G02B 27/09</b> (2006.01) <b>G02B 27/14</b> (2006.01) <b>H01S 5/40</b> (2006.01)
3354622	<b>C01F 11/18</b> (2006.01) <b>C09C 1/02</b> (2006.01)
3360601	<b>A61K 8/02</b> (2006.01) <b>A61K 8/19</b> (2006.01) <b>A61K 8/29</b> (2006.01) <b>A61Q 17/04</b> (2006.01)
3366740	<b>C08J 7/04</b> (2006.01) <b>C09D 151/02</b> (2006.01)
3366671	<b>C07C 303/04</b> (2006.01) <b>C07C 309/22</b> (2006.01)
3410936	<b>A61B 5/145</b> (2006.01) <b>A61B 5/1486</b> (2006.01)
3411654	<b>F41C 33/02</b> (2006.01)
3411356	<b>C07C 273/10</b> (2006.01)
3377500	<b>A61K 31/5386</b> (2006.01) <b>A61P 25/32</b> (2006.01) <b>A61P 25/34</b> (2006.01) <b>A61P 25/36</b> (2006.01) <b>C07D 498/10</b> (2006.01)
3347416	<b>A43B 13/04</b> (2006.01) <b>C08J 9/00</b> (2006.01) <b>C08J 9/04</b> (2006.01) <b>C08K 5/10</b> (2006.01) <b>C08L 67/02</b> (2006.01)
3347535	<b>E04B 1/16</b> (2006.01) <b>E04B 1/20</b> (2006.01) <b>E04B 1/24</b> (2006.01) <b>E04B 2/56</b> (2006.01) <b>E04B 2/74</b> (2006.01) <b>E04G 23/02</b> (2006.01) <b>E04H 9/02</b> (2006.01)
3377094	<b>A61K 39/00</b> (2006.01) <b>A61K 39/02</b> (2006.01)
3377478	<b>A61K 31/445</b> (2006.01) <b>A61P 37/08</b> (2006.01) <b>C07D 401/04</b> (2006.01)
3346995	<b>A61K 9/20</b> (2006.01) <b>A61K 9/24</b> (2006.01) <b>A61K 9/28</b> (2006.01) <b>A61K 31/513</b> (2006.01) <b>A61K 31/5365</b> (2006.01)

Broj objave evropske prijava patenta (97)	MKP (51)
	<b>A61K 31/553</b> (2006.01) <b>A61K 31/675</b> (2006.01) <b>A61P 31/18</b> (2006.01)
3380605	<b>C12N 7/00</b> (2006.01) <b>C12N 15/85</b> (2006.01) <b>C12N 15/86</b> (2006.01)
3365957	<b>H02J 9/00</b> (2006.01) <b>H02J 9/06</b> (2006.01)
3371164	<b>A61K 31/445</b> (2006.01) <b>A61K 31/4545</b> (2006.01) <b>A61P 25/16</b> (2006.01) <b>A61P 25/18</b> (2006.01) <b>A61P 25/28</b> (2006.01) <b>C07D 211/26</b> (2006.01) <b>C07D 211/40</b> (2006.01) <b>C07D 401/12</b> (2006.01)
3373896	<b>A01N 25/30</b> (2006.01) <b>A61K 8/34</b> (2006.01) <b>A61K 8/892</b> (2006.01) <b>A61K 8/97</b> (2017.01) <b>A61Q 5/02</b> (2006.01) <b>A61Q 5/12</b> (2006.01) <b>A61Q 19/10</b> (2006.01)
3376968	<b>A61B 17/00</b> (2006.01) <b>A61B 17/068</b> (2006.01) <b>A61F 2/00</b> (2006.01)
3414514	<b>F42B 12/32</b> (2006.01)
3380604	<b>C12N 5/10</b> (2006.01) <b>C12N 7/02</b> (2006.01) <b>C12N 7/04</b> (2006.01) <b>C12N 15/85</b> (2006.01)
3371147	<b>C07C 231/12</b> (2006.01) <b>C07C 237/46</b> (2006.01)
3379963	<b>A43B 13/12</b> (2006.01) <b>A43B 13/18</b> (2006.01)
3383762	<b>B65D 77/20</b> (2006.01)
3374397	<b>A61K 39/00</b> (2006.01) <b>A61K 39/395</b> (2006.01) <b>C07K 16/28</b> (2006.01) <b>G01N 33/53</b> (2006.01)
3390372	<b>A01N 43/653</b> (2006.01) <b>A01N 43/713</b> (2006.01) <b>A01N 43/82</b> (2006.01) <b>C07D 249/14</b> (2006.01) <b>C07D 257/06</b> (2006.01) <b>C07D 271/04</b> (2006.01) <b>C07D 271/07</b> (2006.01)
3377494	<b>A61K 31/519</b> (2006.01) <b>A61P 25/28</b> (2006.01)

Broj objave evropske prijava patenta (97)	MKP (51)
	<b>A61P 35/00</b> (2006.01) <b>C07D 487/04</b> (2006.01)
3377501	<b>A61K 31/429</b> (2006.01) <b>A61K 31/519</b> (2006.01) <b>A61P 25/28</b> (2006.01) <b>A61P 35/00</b> (2006.01) <b>C07D 513/04</b> (2006.01) <b>C07D 519/00</b> (2006.01)
3377048	<b>A61K 9/70</b> (2006.01) <b>A61K 31/485</b> (2006.01) <b>A61P 25/04</b> (2006.01)
3377082	<b>A61K 35/744</b> (2015.01) <b>A61P 29/00</b> (2006.01) <b>A61P 35/00</b> (2006.01) <b>A61P 37/00</b> (2006.01)
3374327	<b>C04B 28/02</b> (2006.01) <b>C04B 28/04</b> (2006.01) <b>C04B 38/00</b> (2006.01) <b>C04B 111/00</b> (2006.01) <b>C04B 111/22</b> (2006.01) <b>C04B 111/26</b> (2006.01)
3380669	<b>B41M 3/14</b> (2006.01) <b>B42D 25/29</b> (2014.01) <b>B42D 25/30</b> (2014.01) <b>D21H 19/82</b> (2006.01) <b>D21H 21/40</b> (2006.01) <b>D21H 21/42</b> (2006.01) <b>D21H 21/44</b> (2006.01) <b>D21H 21/48</b> (2006.01)
3383604	<b>B27N 3/02</b> (2006.01)
3380467	<b>A61K 31/506</b> (2006.01) <b>A61K 31/53</b> (2006.01) <b>A61P 31/14</b> (2006.01) <b>C07D 403/04</b> (2006.01) <b>C07D 487/04</b> (2006.01)
3365434	<b>C12N 5/0783</b> (2010.01) <b>G01N 1/30</b> (2006.01)
3374555	<b>D04B 15/88</b> (2006.01) <b>D04B 35/34</b> (2006.01)
3368422	<b>A23L 3/04</b> (2006.01) <b>B65B 55/02</b> (2006.01) <b>B65B 55/04</b> (2006.01) <b>B65B 55/10</b> (2006.01)
3394176	<b>A61K 8/891</b> (2006.01) <b>C08L 83/04</b> (2006.01)
3380468	<b>A61K 31/501</b> (2006.01) <b>A61P 35/00</b> (2006.01) <b>C07D 403/14</b> (2006.01)

Broj objave evropske prijava patenta (97)	MKP (51)
3377108	<b>A61K 9/00</b> (2006.01) <b>A61K 9/14</b> (2006.01) <b>A61K 31/00</b> (2006.01) <b>A61K 47/12</b> (2006.01) <b>A61K 47/26</b> (2006.01)
3377109	<b>A61K 9/00</b> (2006.01) <b>A61K 9/14</b> (2006.01) <b>A61K 31/00</b> (2006.01) <b>A61K 47/12</b> (2006.01) <b>A61K 47/26</b> (2006.01)
3379962	<b>A43B 7/14</b> (2006.01)
3394084	<b>A61K 38/17</b> (2006.01) <b>A61K 39/00</b> (2006.01) <b>C07K 7/06</b> (2006.01) <b>C07K 7/08</b> (2006.01) <b>C07K 14/47</b> (2006.01) <b>C07K 16/28</b> (2006.01)
3383871	<b>A61K 31/501</b> (2006.01) <b>A61K 31/53</b> (2006.01) <b>A61P 35/00</b> (2006.01) <b>C07D 417/14</b> (2006.01)
3370756	<b>A61K 38/13</b> (2006.01) <b>A61K 38/26</b> (2006.01) <b>A61P 9/10</b> (2006.01)
3374374	<b>C07K 14/005</b> (2006.01) <b>C07K 14/54</b> (2006.01) <b>C12N 7/00</b> (2006.01)
3374398	<b>A61K 39/395</b> (2006.01) <b>C07K 16/28</b> (2006.01) <b>G01N 33/574</b> (2006.01)
3379977	<b>A47F 3/04</b> (2006.01)
3377045	<b>A61K 9/14</b> (2006.01) <b>A61K 9/50</b> (2006.01) <b>A61K 31/7056</b> (2006.01)
3371186	<b>A61K 31/437</b> (2006.01) <b>A61P 11/00</b> (2006.01) <b>C07D 471/04</b> (2006.01)
3383872	<b>A61K 31/433</b> (2006.01) <b>A61P 35/00</b> (2006.01) <b>C07D 417/14</b> (2006.01)
3371190	<b>A61K 31/519</b> (2006.01) <b>A61P 25/00</b> (2006.01) <b>A61P 35/00</b> (2006.01) <b>A61P 37/00</b> (2006.01) <b>C07D 487/04</b> (2006.01) <b>C07D 519/00</b> (2006.01)
3387008	<b>C07K 14/47</b> (2006.01)

Broj objave evropske prijava patenta (97)	MKP (51)
3380615	<b>A61K 31/7088</b> (2006.01) <b>A61P 29/00</b> (2006.01) <b>C12N 15/113</b> (2010.01)
3380517	<b>C07K 16/18</b> (2006.01) <b>C07K 16/28</b> (2006.01) <b>C07K 16/46</b> (2006.01)
3383905	<b>A61K 39/395</b> (2006.01) <b>C07K 16/28</b> (2006.01) <b>C07K 16/30</b> (2006.01) <b>C07K 16/46</b> (2006.01)
3383906	<b>A61K 39/395</b> (2006.01) <b>C07K 16/28</b> (2006.01) <b>C07K 16/30</b> (2006.01) <b>C07K 16/46</b> (2006.01) <b>C12N 15/13</b> (2006.01)
3365453	<b>C12N 15/86</b> (2006.01)
3370775	<b>A61K 31/4523</b> (2006.01) <b>A61K 31/496</b> (2006.01) <b>A61K 45/06</b> (2006.01) <b>A61P 35/00</b> (2006.01)
3377526	<b>A61K 39/395</b> (2006.01) <b>C07K 16/18</b> (2006.01) <b>C07K 16/28</b> (2006.01)
3377527	<b>A61K 39/395</b> (2006.01) <b>C07K 16/18</b> (2006.01) <b>C07K 16/28</b> (2006.01)
3377531	<b>C07K 16/18</b> (2006.01) <b>C07K 16/28</b> (2006.01)
3377488	<b>A61K 31/423</b> (2006.01) <b>A61K 31/428</b> (2006.01) <b>A61K 31/4355</b> (2006.01) <b>A61K 31/4985</b> (2006.01) <b>A61P 31/12</b> (2006.01) <b>A61P 35/00</b> (2006.01) <b>C07D 263/57</b> (2006.01) <b>C07D 413/10</b> (2006.01) <b>C07D 413/12</b> (2006.01) <b>C07D 413/14</b> (2006.01) <b>C07D 417/10</b> (2006.01) <b>C07D 491/04</b> (2006.01) <b>C07D 498/04</b> (2006.01)
3380466	<b>A61K 31/416</b> (2006.01) <b>A61P 9/00</b> (2006.01) <b>A61P 11/00</b> (2006.01) <b>A61P 17/04</b> (2006.01) <b>A61P 25/00</b> (2006.01) <b>C07D 231/56</b> (2006.01) <b>C07D 401/04</b> (2006.01) <b>C07D 401/14</b> (2006.01) <b>C07D 403/04</b> (2006.01) <b>C07D 403/06</b> (2006.01) <b>C07D 403/12</b> (2006.01) <b>C07D 405/04</b> (2006.01)

Broj objave evropske prijava patenta (97)	MKP (51)
	<b>C07D 405/14</b> (2006.01)
3377127	<b>A61L 29/06</b> (2006.01) <b>A61L 29/08</b> (2006.01)
3383385	<b>A61K 31/223</b> (2006.01) <b>A61K 31/573</b> (2006.01)
3383873	<b>A61K 31/501</b> (2006.01) <b>A61K 31/53</b> (2006.01) <b>A61P 35/00</b> (2006.01) <b>C07D 417/14</b> (2006.01)
3384080	<b>D21D 1/02</b> (2006.01) <b>D21D 1/20</b> (2006.01)
3386703	<b>B29B 7/00</b> (2006.01) <b>B29B 7/16</b> (2006.01) <b>B29B 7/28</b> (2006.01) <b>B29B 7/90</b> (2006.01) <b>B29B 9/14</b> (2006.01)
3370699	<b>A61K 9/00</b> (2006.01) <b>A61K 31/4245</b> (2006.01) <b>A61K 39/395</b> (2006.01) <b>A61K 45/06</b> (2006.01) <b>A61P 35/00</b> (2006.01)
3379928	<b>A01N 25/02</b> (2006.01) <b>A01N 25/30</b> (2006.01) <b>A01N 43/40</b> (2006.01) <b>A01N 47/02</b> (2006.01) <b>A01N 49/00</b> (2006.01) <b>A01P 7/00</b> (2006.01) <b>A01P 7/02</b> (2006.01) <b>A61K 31/415</b> (2006.01)
3216594	<b>B29C 51/26</b> (2006.01) <b>B31B 50/59</b> (2017.01) <b>B31F 1/00</b> (2006.01)
3246027	<b>A01N 43/38</b> (2006.01) <b>A61K 31/405</b> (2006.01) <b>A61K 31/444</b> (2006.01) <b>A61K 31/496</b> (2006.01) <b>A61K 31/501</b> (2006.01) <b>A61K 31/506</b> (2006.01) <b>A61K 31/5377</b> (2006.01) <b>A61K 31/5383</b> (2006.01) <b>A61K 31/541</b> (2006.01) <b>A61K 31/551</b> (2006.01) <b>A61P 35/00</b> (2006.01) <b>C07D 401/14</b> (2006.01) <b>C07D 405/14</b> (2006.01)
3378502	<b>A61L 15/18</b> (2006.01) <b>A61L 15/46</b> (2006.01)
3385335	<b>C09C 1/02</b> (2006.01) <b>D21H 17/67</b> (2006.01)

Broj objave evropske prijava patenta (97)	MKP (51)
3385046	<b>B27N 3/02</b> (2006.01) <b>B27N 3/04</b> (2006.01) <b>B27N 3/06</b> (2006.01) <b>B27N 3/10</b> (2006.01) <b>B27N 3/12</b> (2006.01) <b>B27N 7/00</b> (2006.01) <b>B44C 5/04</b> (2006.01)
3290439	<b>A61K 38/17</b> (2006.01) <b>A61P 3/00</b> (2006.01) <b>C07K 14/475</b> (2006.01) <b>C07K 14/705</b> (2006.01)
3252044	<b>A61K 31/343</b> (2006.01) <b>A61P 29/00</b> (2006.01) <b>A61P 35/00</b> (2006.01) <b>C07D 307/85</b> (2006.01)
3263444	<b>B64C 1/10</b> (2006.01) <b>B64D 11/00</b> (2006.01) <b>B64D 11/06</b> (2006.01)
3244932	<b>A61K 38/00</b> (2006.01) <b>A61K 48/00</b> (2006.01) <b>C07H 21/04</b> (2006.01) <b>C12N 15/00</b> (2006.01)
3245601	<b>G06F 17/30</b> (2006.01) <b>G06F 19/10</b> (2011.01) <b>G06Q 50/22</b> (2012.01) <b>G16H 10/60</b> (2018.01)
3370692	<b>A61K 9/00</b> (2006.01) <b>A61K 31/047</b> (2006.01) <b>A61K 31/731</b> (2006.01) <b>A61K 33/14</b> (2006.01) <b>A61K 45/06</b> (2006.01) <b>A61P 11/02</b> (2006.01) <b>A61P 31/16</b> (2006.01)
3393994	<b>C04B 20/10</b> (2006.01) <b>C04B 26/06</b> (2006.01)
3225733	<b>D06M 15/248</b> (2006.01) <b>D06M 15/263</b> (2006.01) <b>D06M 15/564</b> (2006.01) <b>D06M 23/16</b> (2006.01) <b>E06B 9/24</b> (2006.01)
3259269	<b>A61K 31/4375</b> (2006.01) <b>A61K 31/444</b> (2006.01) <b>A61K 31/519</b> (2006.01) <b>A61K 31/5377</b> (2006.01) <b>A61K 31/541</b> (2006.01) <b>A61P 19/00</b> (2006.01) <b>A61P 35/00</b> (2006.01) <b>C07D 471/04</b> (2006.01)
3247331	<b>A61K 9/00</b> (2006.01) <b>A61K 31/137</b> (2006.01) <b>A61K 31/56</b> (2006.01) <b>A61P 11/00</b> (2006.01)

Broj objave evropske prijava patenta (97)	MKP (51)
3413769	<b>A47K 5/12</b> (2006.01) <b>B01F 3/08</b> (2006.01) <b>B01F 13/00</b> (2006.01) <b>B01F 15/00</b> (2006.01) <b>B01F 15/02</b> (2006.01)
3406086	<b>H04R 7/04</b> (2006.01)
3250640	<b>B65D 81/26</b> (2006.01) <b>C08K 3/24</b> (2006.01) <b>C08K 5/00</b> (2006.01) <b>C08K 5/09</b> (2006.01) <b>C08L 67/02</b> (2006.01) <b>C08L 71/02</b> (2006.01)
3411013	<b>A61K 9/00</b> (2006.01) <b>A61K 9/107</b> (2006.01) <b>A61K 31/454</b> (2006.01) <b>A61K 31/496</b> (2006.01) <b>A61K 31/5377</b> (2006.01) <b>A61K 47/24</b> (2006.01)
3250695	<b>A61K 35/00</b> (2006.01) <b>A61K 35/12</b> (2015.01) <b>A61K 35/14</b> (2015.01) <b>A61K 35/17</b> (2015.01) <b>A61K 45/06</b> (2006.01) <b>A61K 48/00</b> (2006.01) <b>C07K 14/705</b> (2006.01) <b>C07K 14/725</b> (2006.01) <b>C07K 16/28</b> (2006.01) <b>C07K 16/32</b> (2006.01) <b>C12N 15/85</b> (2006.01)
3255508	<b>G03G 15/00</b> (2006.01) <b>G03G 21/16</b> (2006.01) <b>G03G 21/18</b> (2006.01)
3253412	<b>A61K 39/395</b> (2006.01) <b>C07K 16/28</b> (2006.01)
3253401	<b>A61K 9/48</b> (2006.01) <b>A61K 38/08</b> (2006.01) <b>A61P 5/06</b> (2006.01)
3352606	<b>A43B 1/00</b> (2006.01) <b>A43B 7/00</b> (2006.01) <b>A43B 7/12</b> (2006.01) <b>A43B 23/07</b> (2006.01) <b>A62B 17/00</b> (2006.01)
3257017	<b>G16H 10/60</b> (2018.01) <b>G16H 20/10</b> (2018.01) <b>G16H 40/63</b> (2018.01)
3256954	<b>G06F 15/16</b> (2006.01) <b>H04L 12/58</b> (2006.01) <b>H04L 29/12</b> (2006.01)
3347002	<b>A61K 31/185</b> (2006.01) <b>A61K 31/205</b> (2006.01)



Broj objave evropske prijava patenta (97)	MKP (51)
	<b>C07C 309/02</b> (2006.01)
3362098	<b>A61K 47/50</b> (2017.01)
3350442	<b>B64G 1/40</b> (2006.01) <b>F03H 1/00</b> (2006.01)
3349831	<b>A61B 5/08</b> (2006.01) <b>A61K 9/72</b> (2006.01) <b>A61K 49/00</b> (2006.01) <b>A61M 15/00</b> (2006.01)
3351595	<b>C08K 3/34</b> (2006.01) <b>C08K 9/04</b> (2006.01) <b>C08L 23/02</b> (2006.01) <b>C08L 53/00</b> (2006.01) <b>C08L 91/00</b> (2006.01) <b>C08L 101/02</b> (2006.01) <b>C08L 101/12</b> (2006.01)
3351580	<b>A61K 33/24</b> (2006.01) <b>A61P 35/00</b> (2006.01) <b>C07F 15/00</b> (2006.01) <b>C08G 65/333</b> (2006.01) <b>C08G 65/337</b> (2006.01) <b>C08G 69/10</b> (2006.01) <b>C08G 69/40</b> (2006.01) <b>C08G 69/48</b> (2006.01)
3351542	<b>A61K 31/5377</b> (2006.01) <b>A61P 29/00</b> (2006.01) <b>A61P 37/08</b> (2006.01) <b>A61P 43/00</b> (2006.01) <b>C07D 401/12</b> (2006.01)
3349750	<b>A61K 31/404</b> (2006.01) <b>C07D 209/30</b> (2006.01)
3350337	<b>A61K 38/16</b> (2006.01) <b>C07K 14/005</b> (2006.01) <b>C07K 14/195</b> (2006.01) <b>C12N 15/74</b> (2006.01) <b>C12P 21/00</b> (2006.01)
3349794	<b>A61K 39/395</b> (2006.01) <b>C07K 16/28</b> (2006.01)
3349796	<b>A61K 39/395</b> (2006.01) <b>C07K 16/28</b> (2006.01) <b>C07K 16/30</b> (2006.01) <b>C07K 16/46</b> (2006.01)
3350158	<b>A61K 31/16</b> (2006.01) <b>C07C 233/55</b> (2006.01) <b>C07C 233/63</b> (2006.01) <b>C07C 255/60</b> (2006.01) <b>C07D 305/06</b> (2006.01) <b>C07D 309/06</b> (2006.01)
3350165	<b>A61K 31/16</b> (2006.01) <b>A61K 31/4412</b> (2006.01) <b>A61K 31/4418</b> (2006.01)

Broj objave evropske prijave patenta (97)	MKP (51)
	<b>C07D 207/12</b> (2006.01) <b>C07D 213/63</b> (2006.01)
3350164	<b>A61K 31/4418</b> (2006.01) <b>A61K 31/4465</b> (2006.01) <b>C07C 233/55</b> (2006.01) <b>C07C 233/63</b> (2006.01) <b>C07D 211/10</b> (2006.01) <b>C07D 213/04</b> (2006.01) <b>C07D 213/06</b> (2006.01)
3350166	<b>A61K 31/404</b> (2006.01) <b>A61K 31/44</b> (2006.01) <b>A61K 31/444</b> (2006.01) <b>A61K 31/47</b> (2006.01) <b>C07D 213/72</b> (2006.01) <b>C07D 213/75</b> (2006.01) <b>C07D 217/12</b> (2006.01) <b>C07D 401/12</b> (2006.01)
3349789	<b>A61K 39/00</b> (2006.01) <b>A61K 39/02</b> (2006.01) <b>A61K 48/00</b> (2006.01)
3350196	<b>A61K 31/282</b> (2006.01) <b>A61K 33/24</b> (2006.01) <b>C07J 9/00</b> (2006.01)
3398400	<b>C02F 1/32</b> (2006.01) <b>H05B 3/00</b> (2006.01)
3353175	<b>A61K 31/427</b> (2006.01) <b>A61P 31/04</b> (2006.01) <b>C07D 417/14</b> (2006.01)
3353841	<b>C04B 35/528</b> (2006.01) <b>C04B 35/63</b> (2006.01) <b>C04B 35/632</b> (2006.01) <b>H01M 4/36</b> (2006.01) <b>H01M 4/587</b> (2010.01) <b>H01M 10/052</b> (2010.01) <b>H01M 10/0568</b> (2010.01) <b>H01M 10/0569</b> (2010.01)
3352781	<b>A61K 38/44</b> (2006.01) <b>C12N 1/20</b> (2006.01)
3353192	<b>A61K 39/145</b> (2006.01) <b>A61K 39/39</b> (2006.01) <b>C07K 14/005</b> (2006.01) <b>C12N 9/24</b> (2006.01) <b>C12N 15/63</b> (2006.01)
3352768	<b>A61K 31/56</b> (2006.01) <b>A61K 31/58</b> (2006.01) <b>A61K 31/79</b> (2006.01)
3352757	<b>A61K 31/47</b> (2006.01) <b>C07D 215/56</b> (2006.01)
3353197	<b>C07K 14/705</b> (2006.01) <b>C07K 14/725</b> (2006.01)

Broj objave evropske prijava patenta (97)	MKP (51)
	<b>C07K 19/00</b> (2006.01)
3352749	<b>A61K 31/20</b> (2006.01) <b>A61K 47/34</b> (2017.01)
3352758	<b>A61K 31/435</b> (2006.01) <b>A61K 31/47</b> (2006.01) <b>A61K 31/4704</b> (2006.01) <b>A61K 31/472</b> (2006.01) <b>A61P 11/12</b> (2006.01) <b>C07D 215/00</b> (2006.01) <b>C07D 215/16</b> (2006.01) <b>C07D 215/56</b> (2006.01) <b>C07D 471/04</b> (2006.01)
3353328	<b>A61K 31/7088</b> (2006.01) <b>C07H 21/04</b> (2006.01) <b>C12N 15/113</b> (2010.01) <b>C12Q 1/68</b> (2018.01)
3353153	<b>C07C 281/16</b> (2006.01) <b>C07D 223/14</b> (2006.01)
3353189	<b>A61K 31/575</b> (2006.01) <b>A61P 1/16</b> (2006.01) <b>A61P 9/10</b> (2006.01) <b>A61P 13/12</b> (2006.01) <b>C07J 9/00</b> (2006.01) <b>C07J 31/00</b> (2006.01)
3352761	<b>A61K 31/496</b> (2006.01) <b>A61K 31/5377</b> (2006.01)
3357901	<b>C07B 53/00</b> (2006.01) <b>C07B 61/00</b> (2006.01) <b>C07C 51/09</b> (2006.01) <b>C07C 57/58</b> (2006.01)
3357837	<b>B65D 85/00</b> (2006.01) <b>B65D 88/00</b> (2006.01) <b>F17C 13/00</b> (2006.01)
3356833	<b>G01N 33/543</b> (2006.01) <b>G01N 33/94</b> (2006.01)
3355954	<b>A61K 9/00</b> (2006.01) <b>A61M 5/00</b> (2006.01)
3356528	<b>C12N 9/14</b> (2006.01) <b>C12N 9/22</b> (2006.01) <b>C12N 15/11</b> (2006.01) <b>C12N 15/63</b> (2006.01)
3355991	<b>A61K 31/495</b> (2006.01) <b>A61K 31/522</b> (2006.01) <b>A61P 31/14</b> (2006.01)
3355890	<b>A61K 31/4439</b> (2006.01) <b>A61K 31/519</b> (2006.01) <b>C07D 405/12</b> (2006.01)

Broj objave evropske prijava patenta (97)	MKP (51)
3355921	<b>A61K 39/395</b> (2006.01) <b>A61P 1/00</b> (2006.01) <b>A61P 37/00</b> (2006.01)
3356529	<b>C12N 15/113</b> (2010.01)
3356532	<b>A61K 39/395</b> (2006.01) <b>A61P 35/00</b> (2006.01) <b>A61P 35/02</b> (2006.01) <b>C12N 15/13</b> (2006.01)
3356561	<b>C07K 14/525</b> (2006.01) <b>C07K 14/54</b> (2006.01) <b>C07K 16/28</b> (2006.01) <b>C12Q 1/68</b> (2018.01) <b>G01N 33/50</b> (2006.01)
3356525	<b>C12N 15/09</b> (2006.01) <b>C12N 15/11</b> (2006.01) <b>C12N 15/63</b> (2006.01) <b>C12N 15/67</b> (2006.01) <b>C12Q 1/68</b> (2018.01)
3389724	<b>A61K 48/00</b> (2006.01) <b>C07K 14/47</b> (2006.01)
3360415	<b>A01N 37/46</b> (2006.01) <b>A01N 43/10</b> (2006.01) <b>A01N 43/24</b> (2006.01) <b>A01N 43/40</b> (2006.01) <b>A01N 43/42</b> (2006.01) <b>A01N 43/56</b> (2006.01) <b>A01N 43/60</b> (2006.01) <b>A01N 43/653</b> (2006.01) <b>A01N 43/72</b> (2006.01) <b>A01N 43/80</b> (2006.01) <b>A01N 43/90</b> (2006.01) <b>A01N 47/12</b> (2006.01) <b>A01P 3/00</b> (2006.01)
3371175	<b>C07D 211/86</b> (2006.01) <b>C07D 405/12</b> (2006.01) <b>C07D 405/14</b> (2006.01)
3359192	<b>A61K 35/04</b> (2006.01) <b>A61K 39/395</b> (2006.01) <b>C07K 16/18</b> (2006.01) <b>C07K 16/28</b> (2006.01)
3359745	<b>E02D 17/20</b> (2006.01) <b>E02D 29/02</b> (2006.01)
3359160	<b>A61K 31/56</b> (2006.01) <b>A61K 31/57</b> (2006.01) <b>A61K 31/575</b> (2006.01) <b>C07J 9/00</b> (2006.01) <b>C07J 43/00</b> (2006.01)
3359162	<b>A61K 31/64</b> (2006.01)
3359668	<b>A61K 31/7125</b> (2006.01) <b>C07H 21/04</b> (2006.01)

Broj objave evropske prijava patenta (97)	MKP (51)
	<b>C12N 15/113</b> (2010.01)
3359648	<b>C12N 5/0789</b> (2010.01) <b>C12N 5/0793</b> (2010.01)
3362456	<b>C07F 7/02</b> (2006.01)
3362389	<b>B65H 43/02</b> (2006.01) <b>B65H 51/30</b> (2006.01) <b>G05B 11/01</b> (2006.01) <b>G05B 11/32</b> (2006.01) <b>G05B 21/02</b> (2006.01) <b>G06Q 30/06</b> (2012.01) <b>G06Q 50/04</b> (2012.01)
3373951	<b>A61K 31/415</b> (2006.01) <b>A61K 38/08</b> (2006.01) <b>A61K 38/12</b> (2006.01) <b>A61P 17/02</b> (2006.01)
3362065	<b>A61K 31/4439</b> (2006.01) <b>C07H 19/06</b> (2006.01)
3362066	<b>A61K 31/4439</b> (2006.01) <b>A61P 35/00</b> (2006.01) <b>C07H 19/12</b> (2006.01)
3371176	<b>A61K 31/425</b> (2006.01) <b>C07D 405/06</b> (2006.01) <b>C07D 407/06</b> (2006.01)
3362053	<b>A61K 9/16</b> (2006.01) <b>A61K 9/22</b> (2006.01) <b>A61K 31/52</b> (2006.01) <b>A61K 31/522</b> (2006.01)
3368675	<b>A61K 39/00</b> (2006.01) <b>A61K 39/02</b> (2006.01) <b>A61K 39/12</b> (2006.01) <b>A61K 39/39</b> (2006.01) <b>C07K 14/005</b> (2006.01) <b>C07K 14/195</b> (2006.01) <b>C12N 15/74</b> (2006.01)
3362067	<b>A61K 31/453</b> (2006.01) <b>A61P 43/00</b> (2006.01) <b>C07D 311/02</b> (2006.01)
3373014	<b>G01N 33/92</b> (2006.01)
3366243	<b>A61B 17/70</b> (2006.01) <b>A61B 17/72</b> (2006.01) <b>A61B 17/86</b> (2006.01) <b>A61F 2/44</b> (2006.01)
3366244	<b>A61B 17/70</b> (2006.01) <b>A61B 17/72</b> (2006.01) <b>A61B 17/86</b> (2006.01) <b>A61F 2/44</b> (2006.01)

Broj objave evropske prijave patenta (97)	MKP (51)
3354271	<b>A61K 9/08</b> (2006.01) <b>A61K 31/737</b> (2006.01) <b>A61K 35/32</b> (2015.01) <b>A61K 35/60</b> (2006.01) <b>A61K 47/10</b> (2017.01) <b>A61P 19/02</b> (2006.01)
3366288	<b>A61K 31/375</b> (2006.01) <b>A61K 31/4415</b> (2006.01) <b>A61K 31/51</b> (2006.01) <b>A61P 25/24</b> (2006.01)
3365505	<b>E04B 1/21</b> (2006.01) <b>E04B 1/24</b> (2006.01) <b>E04B 1/41</b> (2006.01) <b>E04B 1/58</b> (2006.01) <b>F16B 13/04</b> (2006.01) <b>F16S 3/00</b> (2006.01)
3365336	<b>A61K 31/53</b> (2006.01) <b>A61P 35/00</b> (2006.01) <b>C07D 401/14</b> (2006.01)
3370515	<b>A01M 1/00</b> (2006.01) <b>C12Q 1/68</b> (2018.01) <b>G01N 33/50</b> (2006.01) <b>G01N 33/563</b> (2006.01) <b>G01N 33/566</b> (2006.01) <b>G06F 7/00</b> (2006.01)
3364980	<b>A61K 31/7105</b> (2006.01) <b>A61P 31/22</b> (2006.01) <b>C12N 15/38</b> (2006.01)
3365367	<b>C07K 16/18</b> (2006.01) <b>C12N 5/12</b> (2006.01) <b>C12N 5/20</b> (2006.01) <b>G01N 33/563</b> (2006.01) <b>G01N 33/569</b> (2006.01) <b>G01N 33/577</b> (2006.01)
3364981	<b>A61K 31/7105</b> (2006.01) <b>A61K 31/7115</b> (2006.01) <b>A61K 39/245</b> (2006.01) <b>A61P 31/22</b> (2006.01)
3364956	<b>A61K 31/015</b> (2006.01) <b>A61K 31/56</b> (2006.01) <b>A61K 45/06</b> (2006.01) <b>C07J 63/00</b> (2006.01)
3364982	<b>A61K 31/7105</b> (2006.01) <b>A61K 31/7115</b> (2006.01) <b>A61K 39/12</b> (2006.01) <b>A61P 31/14</b> (2006.01)
3364949	<b>A61K 9/10</b> (2006.01) <b>A61K 39/00</b> (2006.01) <b>A61K 48/00</b> (2006.01)
3365007	<b>A61K 9/51</b> (2006.01) <b>A61K 39/145</b> (2006.01)

Broj objave evropske prijava patenta (97)	MKP (51)
	<b>A61P 31/16</b> (2006.01)
3365008	<b>A61K 31/7105</b> (2006.01) <b>A61K 31/7115</b> (2006.01) <b>A61K 39/155</b> (2006.01) <b>A61P 31/14</b> (2006.01)
3365009	<b>A61K 31/7105</b> (2006.01) <b>A61K 31/7115</b> (2006.01) <b>A61K 39/245</b> (2006.01) <b>A61P 31/22</b> (2006.01)
3364950	<b>A61K 9/10</b> (2006.01) <b>A61K 39/00</b> (2006.01) <b>A61K 39/12</b> (2006.01) <b>A61K 48/00</b> (2006.01)
3364983	<b>A61K 31/7105</b> (2006.01) <b>A61K 31/7115</b> (2006.01) <b>A61K 39/12</b> (2006.01) <b>A61P 11/00</b> (2006.01)
3368030	<b>A61K 9/16</b> (2006.01) <b>A61K 31/225</b> (2006.01) <b>A61K 31/616</b> (2006.01)
3396573	<b>G06F 19/18</b> (2011.01) <b>G06F 19/22</b> (2011.01) <b>G06F 19/28</b> (2011.01)
3368036	<b>A61K 31/44</b> (2006.01) <b>A61K 31/4418</b> (2006.01) <b>A61K 31/4427</b> (2006.01) <b>C07D 213/02</b> (2006.01) <b>C07D 213/04</b> (2006.01) <b>C07D 401/06</b> (2006.01)
3368027	<b>A61K 9/00</b> (2006.01) <b>A61K 9/20</b> (2006.01) <b>A61K 31/167</b> (2006.01) <b>A61K 45/06</b> (2006.01)
3368038	<b>A61K 9/10</b> (2006.01) <b>A61K 31/439</b> (2006.01) <b>A61K 31/485</b> (2006.01)
3369097	<b>B01J 49/00</b> (2017.01) <b>G21G 4/08</b> (2006.01)
3368157	<b>A61K 8/44</b> (2006.01) <b>A61K 31/16</b> (2006.01) <b>A61K 38/46</b> (2006.01) <b>A61P 3/10</b> (2006.01) <b>C12N 9/14</b> (2006.01) <b>C12N 15/113</b> (2010.01) <b>C12Q 1/68</b> (2018.01) <b>G01N 33/50</b> (2006.01)
3368541	<b>A61K 31/69</b> (2006.01) <b>A61P 35/00</b> (2006.01) <b>C07D 207/16</b> (2006.01) <b>C07F 5/02</b> (2006.01)

Broj objave evropske prijava patenta (97)	MKP (51)
	<b>C07F 5/04</b> (2006.01)
3368097	<b>A61M 1/02</b> (2006.01) <b>A61M 1/14</b> (2006.01) <b>A61M 1/16</b> (2006.01) <b>A61M 1/18</b> (2006.01) <b>A61M 5/307</b> (2006.01) <b>A61M 5/315</b> (2006.01)
3368077	<b>A61K 39/395</b> (2006.01) <b>A61K 45/00</b> (2006.01) <b>A61P 35/00</b> (2006.01) <b>C07K 16/18</b> (2006.01) <b>C07K 16/28</b> (2006.01) <b>C12P 21/08</b> (2006.01)
3368559	<b>C07K 14/705</b> (2006.01) <b>C07K 16/28</b> (2006.01) <b>C07K 19/00</b> (2006.01)
3382010	<b>A61K 35/76</b> (2015.01) <b>A61K 39/145</b> (2006.01) <b>A61P 31/16</b> (2006.01) <b>A61P 35/00</b> (2006.01) <b>C12N 7/01</b> (2006.01) <b>C12N 15/86</b> (2006.01)
3370728	<b>A61K 31/575</b> (2006.01) <b>C07J 9/00</b> (2006.01) <b>C07J 31/00</b> (2006.01)
3370768	<b>A61K 39/00</b> (2006.01) <b>A61K 39/395</b> (2006.01)
3370770	<b>A61K 31/198</b> (2006.01) <b>A61K 31/4439</b> (2006.01) <b>A61K 31/573</b> (2006.01) <b>A61K 31/69</b> (2006.01) <b>A61K 39/395</b> (2006.01) <b>C07K 16/28</b> (2006.01)
3370738	<b>A61K 33/20</b> (2006.01) <b>A61P 25/28</b> (2006.01) <b>C01B 11/10</b> (2006.01)
3370763	<b>A61K 39/00</b> (2006.01) <b>A61K 39/39</b> (2006.01) <b>C07K 7/06</b> (2006.01) <b>C07K 7/08</b> (2006.01)
3370741	<b>A61K 35/15</b> (2015.01) <b>A61K 35/17</b> (2015.01) <b>A61K 45/06</b> (2006.01) <b>A61K 48/00</b> (2006.01) <b>A61P 35/00</b> (2006.01) <b>A61P 35/02</b> (2006.01)
3371100	<b>C01B 17/02</b> (2006.01) <b>C01B 17/04</b> (2006.01) <b>C01B 17/50</b> (2006.01)



Broj objave evropske prijave patenta (97)	MKP (51)
3370713	<b>A61K 31/194</b> (2006.01) <b>A61P 1/18</b> (2006.01)
3370725	<b>A61K 31/4433</b> (2006.01) <b>A61K 31/4436</b> (2006.01) <b>A61K 31/497</b> (2006.01) <b>A61K 31/5355</b> (2006.01) <b>A61P 35/00</b> (2006.01)
3374592	<b>E21B 23/01</b> (2006.01) <b>E21B 23/10</b> (2006.01)
3378863	<b>A61K 31/4375</b> (2006.01) <b>A61K 31/444</b> (2006.01) <b>A61K 31/497</b> (2006.01) <b>A61K 31/506</b> (2006.01) <b>A61P 9/10</b> (2006.01) <b>A61P 21/02</b> (2006.01) <b>A61P 25/00</b> (2006.01) <b>A61P 25/04</b> (2006.01) <b>A61P 25/08</b> (2006.01) <b>A61P 25/14</b> (2006.01) <b>A61P 25/16</b> (2006.01) <b>A61P 25/18</b> (2006.01) <b>A61P 25/22</b> (2006.01) <b>A61P 25/24</b> (2006.01) <b>A61P 25/28</b> (2006.01) <b>A61P 25/30</b> (2006.01) <b>C07D 491/147</b> (2006.01)
3375782	<b>A61K 31/427</b> (2006.01) <b>A61K 31/497</b> (2006.01) <b>C07D 417/12</b> (2006.01) <b>C07D 417/14</b> (2006.01)
3373963	<b>A61K 39/00</b> (2006.01) <b>A61K 39/395</b> (2006.01) <b>A61P 7/02</b> (2006.01) <b>A61P 37/02</b> (2006.01) <b>C07K 16/40</b> (2006.01)
3373978	<b>A61K 9/14</b> (2006.01) <b>A61K 9/50</b> (2006.01) <b>A61K 47/50</b> (2017.01)
3377069	<b>A61K 9/00</b> (2006.01) <b>A61K 31/47</b> (2006.01) <b>A61K 31/568</b> (2006.01) <b>A61P 43/00</b> (2006.01)
3377078	<b>A61K 35/30</b> (2015.01) <b>A61K 35/545</b> (2015.01) <b>A61P 25/00</b> (2006.01)
3383386	<b>A61K 31/341</b> (2006.01) <b>C07C 225/20</b> (2006.01)
3377059	<b>A61K 31/404</b> (2006.01) <b>A61K 31/407</b> (2006.01) <b>A61K 31/5377</b> (2006.01)

Broj objave evropske prijava patenta (97)	MKP (51)
3377079	<b>A61K 35/44</b> (2015.01) <b>C07K 16/28</b> (2006.01)
3377516	<b>A61K 39/00</b> (2006.01) <b>C07K 7/08</b> (2006.01) <b>C07K 14/47</b> (2006.01)
3377070	<b>A61K 31/56</b> (2006.01) <b>A61K 31/57</b> (2006.01) <b>A61K 31/573</b> (2006.01)
3377636	<b>A61K 39/00</b> (2006.01) <b>A61K 39/015</b> (2006.01) <b>A61K 39/04</b> (2006.01) <b>A61K 39/12</b> (2006.01) <b>A61K 48/00</b> (2006.01) <b>C12N 15/86</b> (2006.01)
3389655	<b>A61K 31/197</b> (2006.01) <b>A61K 31/437</b> (2006.01) <b>A61K 31/4422</b> (2006.01) <b>A61K 31/506</b> (2006.01) <b>A61K 31/519</b> (2006.01) <b>A61K 31/5377</b> (2006.01) <b>A61K 45/06</b> (2006.01) <b>A61P 1/00</b> (2006.01)
3390441	<b>A61K 39/395</b> (2006.01) <b>C07K 16/10</b> (2006.01)
3386746	<b>B32B 7/00</b> (2006.01) <b>B32B 7/12</b> (2006.01) <b>B32B 15/00</b> (2006.01) <b>B32B 15/01</b> (2006.01) <b>B32B 15/08</b> (2006.01) <b>B32B 15/20</b> (2006.01) <b>B62D 29/00</b> (2006.01) <b>C22C 1/00</b> (2006.01) <b>C22C 23/00</b> (2006.01)
3389515	<b>A61B 17/32</b> (2006.01) <b>A61B 18/14</b> (2006.01)
3389516	<b>A61B 17/32</b> (2006.01) <b>A61B 18/14</b> (2006.01)
3389517	<b>A61B 17/32</b> (2006.01) <b>A61B 18/14</b> (2006.01)
3393378	<b>A61B 17/32</b> (2006.01) <b>A61B 18/14</b> (2006.01)
3397253	<b>A61K 31/19</b> (2006.01) <b>A61K 31/192</b> (2006.01) <b>A61K 31/395</b> (2006.01) <b>A61K 31/55</b> (2006.01) <b>A61P 25/08</b> (2006.01)
3397619	<b>A61K 31/421</b> (2006.01) <b>A61P 17/00</b> (2006.01) <b>C07D 263/32</b> (2006.01)

Broj objave evropske prijava patenta (97)	MKP (51)
3383892	<b>C07K 14/705</b> (2006.01)
3393247	<b>A01N 31/08</b> (2006.01) <b>A01N 35/08</b> (2006.01) <b>A01N 43/40</b> (2006.01) <b>A01N 43/80</b> (2006.01) <b>A01N 59/00</b> (2006.01) <b>A01N 59/06</b> (2006.01) <b>A01N 59/16</b> (2006.01) <b>A01P 1/00</b> (2006.01) <b>D21H 21/36</b> (2006.01)
3393801	<b>B32B 33/00</b> (2006.01) <b>B32B 37/18</b> (2006.01) <b>B32B 37/20</b> (2006.01) <b>B42D 25/328</b> (2014.01) <b>G03H 1/18</b> (2006.01)
3405463	<b>C07D 307/20</b> (2006.01) <b>C07D 319/12</b> (2006.01) <b>C07H 19/10</b> (2006.01)
3389518	<b>A61B 17/32</b> (2006.01)
3386534	<b>A61K 38/46</b> (2006.01) <b>A61K 38/47</b> (2006.01) <b>A61P 43/00</b> (2006.01) <b>C12N 9/40</b> (2006.01) <b>C12N 9/42</b> (2006.01)
3397638	<b>A01N 43/72</b> (2006.01) <b>C07D 273/00</b> (2006.01) <b>C07D 413/14</b> (2006.01) <b>C07K 11/02</b> (2006.01)
3390453	<b>C07K 16/28</b> (2006.01)
3394358	<b>E04B 1/21</b> (2006.01) <b>E04H 9/02</b> (2006.01)
3394045	<b>A61K 31/4725</b> (2006.01) <b>A61P 35/00</b> (2006.01) <b>C07C 55/08</b> (2006.01) <b>C07C 57/145</b> (2006.01) <b>C07C 59/245</b> (2006.01) <b>C07C 59/265</b> (2006.01) <b>C07C 59/54</b> (2006.01) <b>C07C 65/05</b> (2006.01) <b>C07C 65/10</b> (2006.01) <b>C07D 401/14</b> (2006.01)
3390747	<b>E04H 9/02</b> (2006.01) <b>F16F 1/38</b> (2006.01) <b>F16F 7/00</b> (2006.01) <b>F16F 7/04</b> (2006.01)
3373946	<b>A23L 3/3472</b> (2006.01) <b>A61K 8/97</b> (2017.01) <b>A61K 36/48</b> (2006.01) <b>A61K 36/575</b> (2006.01) <b>A61Q 17/00</b> (2006.01)

Broj objave evropske prijave patenta (97)	MKP (51)
3394104	<b>A61K 38/26</b> (2006.01) <b>A61K 39/395</b> (2006.01) <b>A61P 3/10</b> (2006.01) <b>C07K 16/28</b> (2006.01)
3386299	<b>A01N 25/04</b> (2006.01) <b>A01N 25/12</b> (2006.01) <b>A01N 25/30</b> (2006.01) <b>A01N 43/707</b> (2006.01) <b>A01N 43/78</b> (2006.01) <b>A01N 47/04</b> (2006.01) <b>A01N 51/00</b> (2006.01) <b>C09D 5/00</b> (2006.01) <b>C09D 11/00</b> (2014.01)
3393889	<b>B62D 21/16</b> (2006.01) <b>B62D 29/04</b> (2006.01) <b>B62D 31/00</b> (2006.01) <b>B62D 63/02</b> (2006.01)
3390440	<b>C07K 16/00</b> (2006.01)
3397620	<b>C07D 275/06</b> (2006.01)
3397600	<b>C04B 28/14</b> (2006.01)
3389647	<b>A61K 31/202</b> (2006.01) <b>A61P 3/08</b> (2006.01) <b>A61P 17/06</b> (2006.01) <b>A61P 25/00</b> (2006.01) <b>A61P 29/00</b> (2006.01) <b>A61P 35/00</b> (2006.01)
3380610	<b>C12N 9/64</b> (2006.01) <b>C12N 9/72</b> (2006.01) <b>C12N 9/74</b> (2006.01)
3393379	<b>A61B 17/32</b> (2006.01) <b>A61B 90/70</b> (2016.01)
3389526	<b>A61B 18/02</b> (2006.01) <b>A61B 34/10</b> (2016.01)
3393967	<b>B82Y 30/00</b> (2011.01) <b>C08J 5/18</b> (2006.01) <b>C08L 23/08</b> (2006.01) <b>C09D 123/08</b> (2006.01)
3411363	<b>A61K 31/336</b> (2006.01) <b>A61K 31/5375</b> (2006.01) <b>A61K 38/07</b> (2006.01) <b>C07D 303/36</b> (2006.01) <b>C07K 5/10</b> (2006.01)
3397621	<b>C07D 275/06</b> (2006.01)
3397179	<b>A61B 17/28</b> (2006.01) <b>A61B 17/29</b> (2006.01) <b>A61B 17/32</b> (2006.01)

Broj objave evropske prijave patenta (97)	MKP (51)
3345909	<b>A61K 31/501</b> (2006.01) <b>A61K 31/5377</b> (2006.01) <b>A61P 25/04</b> (2006.01) <b>A61P 25/18</b> (2006.01) <b>A61P 25/28</b> (2006.01) <b>A61P 29/00</b> (2006.01) <b>C07D 491/044</b> (2006.01)
3397054	<b>A01G 1/00</b> (2006.01) <b>A01G 3/06</b> (2006.01) <b>A01G 29/00</b> (2006.01) <b>A01N 25/04</b> (2006.01) <b>A01N 25/26</b> (2006.01) <b>A01P 21/00</b> (2006.01) <b>C05G 3/00</b> (2006.01) <b>C05G 3/04</b> (2006.01) <b>C05G 3/06</b> (2006.01)
3397804	<b>D06N 3/00</b> (2006.01) <b>D06N 3/18</b> (2006.01)
3390361	<b>A61K 31/44</b> (2006.01) <b>A61K 31/4545</b> (2006.01) <b>A61P 31/00</b> (2006.01) <b>A61P 35/00</b> (2006.01) <b>A61P 37/04</b> (2006.01) <b>C07D 213/81</b> (2006.01) <b>C07D 213/84</b> (2006.01) <b>C07D 237/24</b> (2006.01) <b>C07D 239/28</b> (2006.01) <b>C07D 241/24</b> (2006.01) <b>C07D 401/06</b> (2006.01) <b>C07D 401/12</b> (2006.01) <b>C07D 401/14</b> (2006.01) <b>C07D 405/12</b> (2006.01) <b>C07D 405/14</b> (2006.01)
3346209	<b>F25B 21/02</b> (2006.01) <b>H05K 7/14</b> (2006.01) <b>H05K 7/20</b> (2006.01)
3345907	<b>A61K 31/519</b> (2006.01) <b>A61P 35/00</b> (2006.01) <b>C07D 487/04</b> (2006.01)
3344613	<b>A61K 31/4439</b> (2006.01) <b>A61K 31/497</b> (2006.01) <b>C07D 401/04</b> (2006.01) <b>C07D 403/04</b> (2006.01)
3344564	<b>B21D 51/04</b> (2006.01) <b>B21D 51/44</b> (2006.01) <b>B41F 17/28</b> (2006.01) <b>B65G 47/24</b> (2006.01) <b>B65G 47/244</b> (2006.01) <b>B65G 47/248</b> (2006.01)
3344248	<b>A61K 31/445</b> (2006.01) <b>A61P 25/00</b> (2006.01) <b>C07D 211/00</b> (2006.01)

Broj objave evropske prijava patenta (97)	MKP (51)
3344337	<b>A61K 38/47</b> (2006.01) <b>A61P 3/00</b> (2006.01)
3344271	<b>A61K 31/05</b> (2006.01) <b>A61K 36/55</b> (2006.01)
3344614	<b>A61K 31/437</b> (2006.01) <b>A61K 31/4439</b> (2006.01) <b>A61K 31/444</b> (2006.01) <b>C07D 401/06</b> (2006.01) <b>C07D 471/12</b> (2006.01) <b>C07D 471/18</b> (2006.01)
3344626	<b>A61K 31/336</b> (2006.01) <b>A61K 31/437</b> (2006.01) <b>A61K 31/46</b> (2006.01) <b>C07D 471/12</b> (2006.01) <b>C07D 471/18</b> (2006.01) <b>C07D 491/147</b> (2006.01)
3344627	<b>A61K 31/437</b> (2006.01) <b>A61K 31/4375</b> (2006.01) <b>C07D 471/12</b> (2006.01) <b>C07D 471/18</b> (2006.01)
3344628	<b>A61K 31/336</b> (2006.01) <b>A61K 31/437</b> (2006.01) <b>A61K 31/46</b> (2006.01) <b>C07D 471/12</b> (2006.01) <b>C07D 471/18</b> (2006.01) <b>C07D 491/147</b> (2006.01)
3344212	<b>A61J 1/03</b> (2006.01) <b>A61J 7/02</b> (2006.01) <b>A61J 7/04</b> (2006.01)
3344629	<b>A61K 31/336</b> (2006.01) <b>A61K 31/36</b> (2006.01) <b>A61K 31/437</b> (2006.01) <b>C07D 317/46</b> (2006.01) <b>C07D 471/12</b> (2006.01) <b>C07D 471/18</b> (2006.01) <b>C07D 491/147</b> (2006.01)
3344265	<b>A61K 35/52</b> (2015.01) <b>A61P 31/12</b> (2006.01)
3394269	<b>A01H 5/00</b> (2018.01) <b>A01N 63/00</b> (2006.01) <b>A01N 63/02</b> (2006.01) <b>C07K 14/195</b> (2006.01) <b>C12N 15/82</b> (2006.01)
3348572	<b>A61K 39/395</b> (2006.01) <b>A61P 21/02</b> (2006.01) <b>A61P 43/00</b> (2006.01) <b>C07K 16/28</b> (2006.01) <b>C12N 15/09</b> (2006.01)
2687403	<b>B60P 3/40</b> (2006.01) <b>B62D 53/02</b> (2006.01)

Broj objave evropske prijava patenta (97)	MKP (51)
3356363	<b>A61K 31/437</b> (2006.01) <b>A61P 25/16</b> (2006.01) <b>A61P 25/28</b> (2006.01) <b>A61P 35/00</b> (2006.01) <b>C07D 471/04</b> (2006.01)
3356364	<b>A61K 31/437</b> (2006.01) <b>A61K 31/519</b> (2006.01) <b>A61P 25/16</b> (2006.01) <b>A61P 25/28</b> (2006.01) <b>A61P 35/00</b> (2006.01) <b>C07D 471/04</b> (2006.01) <b>C07D 487/04</b> (2006.01)
3359560	<b>A61K 38/17</b> (2006.01) <b>A61K 39/00</b> (2006.01) <b>C07K 7/06</b> (2006.01) <b>C07K 14/47</b> (2006.01) <b>G01N 33/574</b> (2006.01)
3350223	<b>A61P 37/06</b> (2006.01) <b>C07K 16/28</b> (2006.01)
3353167	<b>A61K 31/41</b> (2006.01) <b>A61K 31/433</b> (2006.01) <b>C07D 235/30</b> (2006.01) <b>C07D 263/48</b> (2006.01) <b>C07D 263/58</b> (2006.01) <b>C07D 277/80</b> (2006.01) <b>C07D 285/08</b> (2006.01) <b>C07D 403/12</b> (2006.01) <b>C07D 413/12</b> (2006.01) <b>C07D 417/12</b> (2006.01)
3353151	<b>A61K 31/421</b> (2006.01) <b>A61K 31/426</b> (2006.01) <b>A61K 31/433</b> (2006.01) <b>A61K 31/44</b> (2006.01) <b>A61P 31/18</b> (2006.01) <b>C07D 213/74</b> (2006.01) <b>C07D 235/30</b> (2006.01) <b>C07D 239/42</b> (2006.01) <b>C07D 241/20</b> (2006.01) <b>C07D 253/06</b> (2006.01) <b>C07D 263/48</b> (2006.01) <b>C07D 263/58</b> (2006.01) <b>C07D 277/82</b> (2006.01) <b>C07D 285/00</b> (2006.01) <b>C07D 307/66</b> (2006.01) <b>C07D 309/14</b> (2006.01) <b>C07D 333/20</b> (2006.01)
3383606	<b>B28B 1/52</b> (2006.01) <b>C04B 28/14</b> (2006.01) <b>C04B 111/52</b> (2006.01)
3352734	<b>A61K 9/00</b> (2006.01) <b>A61K 31/519</b> (2006.01) <b>A61P 17/14</b> (2006.01)
3350175	<b>A61K 31/443</b> (2006.01) <b>A61P 29/00</b> (2006.01) <b>A61P 37/00</b> (2006.01) <b>C07D 405/06</b> (2006.01)

Broj objave evropske prijava patenta (97)	MKP (51)
	<b>C07D 405/14</b> (2006.01) <b>C07D 413/14</b> (2006.01) <b>C07D 417/14</b> (2006.01)
3350346	<b>C12Q 1/68</b> (2018.01)
3356542	<b>A61K 38/43</b> (2006.01) <b>A61K 38/47</b> (2006.01) <b>C12P 21/00</b> (2006.01) <b>C12P 21/02</b> (2006.01)
3352759	<b>A61K 31/473</b> (2006.01) <b>A61K 31/49</b> (2006.01) <b>A61K 31/517</b> (2006.01) <b>A61K 31/5377</b> (2006.01) <b>A61K 39/395</b> (2006.01) <b>A61K 45/00</b> (2006.01) <b>A61P 25/28</b> (2006.01)
3349813	<b>A61L 27/36</b> (2006.01) <b>A61L 27/56</b> (2006.01) <b>A61L 27/60</b> (2006.01)
3353722	<b>G01C 21/34</b> (2006.01) <b>G01C 21/36</b> (2006.01) <b>G06Q 10/04</b> (2012.01) <b>G06Q 10/06</b> (2012.01) <b>G06Q 50/30</b> (2012.01) <b>H04W 4/02</b> (2009.01) <b>H04W 4/04</b> (2009.01)
3359563	<b>C07K 14/725</b> (2006.01) <b>C07K 16/28</b> (2006.01)
3356344	<b>A61K 31/454</b> (2006.01) <b>A61K 31/506</b> (2006.01) <b>A61K 35/00</b> (2006.01) <b>C07B 59/00</b> (2006.01) <b>C07D 401/06</b> (2006.01) <b>C07D 401/14</b> (2006.01) <b>C07D 403/06</b> (2006.01) <b>C07D 403/14</b> (2006.01) <b>C07D 405/14</b> (2006.01) <b>C07D 407/14</b> (2006.01) <b>C07D 409/14</b> (2006.01) <b>C07D 413/14</b> (2006.01) <b>C07D 417/14</b> (2006.01) <b>C07D 487/04</b> (2006.01) <b>C07D 487/08</b> (2006.01)
3356350	<b>A61K 31/4035</b> (2006.01) <b>A61P 35/00</b> (2006.01) <b>C07B 59/00</b> (2006.01) <b>C07D 209/48</b> (2006.01) <b>C07D 403/06</b> (2006.01) <b>C07D 403/12</b> (2006.01) <b>C07D 405/12</b> (2006.01) <b>C07D 405/14</b> (2006.01) <b>C07D 413/06</b> (2006.01) <b>C07D 413/12</b> (2006.01) <b>C07F 9/572</b> (2006.01)



Broj objave evropske prijava patenta (97)	MKP (51)
3411638	<b>F24J 2/52</b> (2018.01) <b>H02S 20/10</b> (2014.01)
3359533	<b>A61K 31/397</b> (2006.01) <b>A61K 31/4025</b> (2006.01) <b>A61K 31/498</b> (2006.01) <b>A61K 31/4985</b> (2006.01) <b>C07D 241/14</b> (2006.01) <b>C07D 401/04</b> (2006.01) <b>C07D 401/06</b> (2006.01) <b>C07D 403/04</b> (2006.01) <b>C07D 403/06</b> (2006.01) <b>C07D 403/12</b> (2006.01) <b>C07D 403/14</b> (2006.01) <b>C07D 413/04</b> (2006.01) <b>C07D 413/06</b> (2006.01) <b>C07D 417/06</b> (2006.01) <b>C07D 471/04</b> (2006.01) <b>C07D 487/02</b> (2006.01) <b>C07D 491/10</b> (2006.01) <b>C07D 498/10</b> (2006.01) <b>C07D 513/10</b> (2006.01)
3359137	<b>A61K 9/20</b> (2006.01) <b>A61K 31/426</b> (2006.01)
3359542	<b>A61K 31/438</b> (2006.01) <b>A61P 35/00</b> (2006.01) <b>C07D 471/22</b> (2006.01) <b>C07D 487/22</b> (2006.01)
3386496	<b>A61K 31/19</b> (2006.01) <b>A61K 31/728</b> (2006.01) <b>A61P 19/02</b> (2006.01)
3359531	<b>A61K 31/4412</b> (2006.01) <b>A61K 31/4439</b> (2006.01) <b>A61P 35/00</b> (2006.01) <b>C07D 213/82</b> (2006.01) <b>C07D 401/12</b> (2006.01) <b>C07D 401/14</b> (2006.01)
3360133	<b>G10L 19/008</b> (2013.01)
3360134	<b>G10L 19/008</b> (2013.01)
3353179	<b>A61K 31/506</b> (2006.01) <b>A61P 35/00</b> (2006.01) <b>C07D 471/04</b> (2006.01)
3352836	<b>A61M 37/00</b> (2006.01) <b>A61N 7/00</b> (2006.01)
3352853	<b>A61M 37/00</b> (2006.01) <b>A61N 7/00</b> (2006.01)
3355865	<b>A61K 9/28</b> (2006.01) <b>A61K 31/4409</b> (2006.01)
3356413	<b>A61K 39/00</b> (2006.01) <b>C07K 16/28</b> (2006.01)

Broj objave evropske prijava patenta (97)	MKP (51)
3356414	<b>A61K 31/7068</b> (2006.01) <b>A61P 35/00</b> (2006.01) <b>C07K 16/28</b> (2006.01) <b>C07K 16/30</b> (2006.01) <b>C12N 5/095</b> (2010.01) <b>G01N 33/574</b> (2006.01)
3355919	<b>A61K 31/00</b> (2006.01) <b>A61K 39/395</b> (2006.01) <b>C07K 16/22</b> (2006.01) <b>C07K 16/28</b> (2006.01) <b>G01N 33/50</b> (2006.01) <b>G01N 33/574</b> (2006.01)
3359210	<b>A61L 27/22</b> (2006.01)
3359173	<b>A23L 29/30</b> (2016.01) <b>A23L 33/135</b> (2016.01) <b>A23P 10/43</b> (2016.01) <b>A61K 35/741</b> (2015.01) <b>A61K 35/745</b> (2015.01) <b>A61K 35/747</b> (2015.01)
3359564	<b>A61K 39/00</b> (2006.01) <b>A61K 39/42</b> (2006.01) <b>C07K 14/005</b> (2006.01) <b>C07K 16/08</b> (2006.01) <b>C07K 16/10</b> (2006.01)
3361858	<b>A01H 5/10</b> (2018.01) <b>C12N 9/06</b> (2006.01) <b>C12N 15/82</b> (2006.01)
3353212	<b>C07K 16/28</b> (2006.01) <b>C07K 16/30</b> (2006.01)
3344350	<b>A63B 43/00</b> (2006.01) <b>A63B 43/02</b> (2006.01) <b>A63B 69/00</b> (2006.01)
3393646	<b>B01F 7/00</b> (2006.01) <b>B01F 7/18</b> (2006.01) <b>B01F 15/00</b> (2006.01) <b>B01F 15/06</b> (2006.01) <b>B01J 8/08</b> (2006.01) <b>B01J 8/10</b> (2006.01) <b>B01J 20/20</b> (2006.01) <b>B01J 20/30</b> (2006.01) <b>B01J 20/32</b> (2006.01) <b>F26B 11/16</b> (2006.01) <b>F26B 25/04</b> (2006.01)
3362600	<b>D21C 5/02</b> (2006.01) <b>D21H 19/40</b> (2006.01) <b>D21H 19/44</b> (2006.01) <b>D21H 19/52</b> (2006.01) <b>D21H 19/54</b> (2006.01)
3362161	<b>A63H 33/04</b> (2006.01) <b>A63H 33/06</b> (2006.01) <b>A63H 33/10</b> (2006.01) <b>E04B 1/343</b> (2006.01)

Broj objave evropske prijava patenta (97)	MKP (51)
3364975	<b>A61K 31/195</b> (2006.01) <b>A61K 31/496</b> (2006.01) <b>A61K 45/06</b> (2006.01) <b>A61P 25/02</b> (2006.01) <b>A61P 25/04</b> (2006.01)
3352837	<b>A61M 37/00</b> (2006.01) <b>A61N 7/00</b> (2006.01)
3269984	<b>F04D 29/42</b> (2006.01) <b>F04D 29/60</b> (2006.01)
3252037	<b>A61K 31/4025</b> (2006.01) <b>A61P 5/10</b> (2006.01) <b>C07D 207/22</b> (2006.01)
3263566	<b>C07D 401/12</b> (2006.01)
3272356	<b>A61K 38/46</b> (2006.01) <b>C12N 9/22</b> (2006.01)
3264033	<b>G01B 11/06</b> (2006.01) <b>G02B 1/04</b> (2006.01)
3255041	<b>A61K 31/4418</b> (2006.01) <b>A61P 25/08</b> (2006.01) <b>C07D 233/90</b> (2006.01) <b>C07D 401/12</b> (2006.01) <b>C07D 401/14</b> (2006.01) <b>C07D 403/04</b> (2006.01) <b>C07D 403/12</b> (2006.01) <b>C07D 405/12</b> (2006.01) <b>C07D 405/14</b> (2006.01)
3399050	<b>C12Q 1/18</b> (2006.01) <b>G01N 33/487</b> (2006.01)
3263054	<b>A61B 17/28</b> (2006.01) <b>A61B 17/32</b> (2006.01) <b>A61B 18/14</b> (2006.01)
3263178	<b>A61K 9/00</b> (2006.01) <b>A61K 9/19</b> (2006.01) <b>A61K 39/00</b> (2006.01) <b>A61K 39/395</b> (2006.01) <b>A61K 47/18</b> (2017.01) <b>A61K 47/26</b> (2006.01) <b>A61P 1/00</b> (2006.01) <b>C07K 16/28</b> (2006.01)
3311834	<b>A61K 9/00</b> (2006.01) <b>A61K 39/395</b> (2006.01) <b>A61K 47/12</b> (2006.01) <b>A61K 47/14</b> (2017.01) <b>A61K 47/18</b> (2017.01) <b>A61K 47/26</b> (2006.01)
3269950	<b>F01M 1/18</b> (2006.01) <b>F01M 5/00</b> (2006.01) <b>F01P 3/06</b> (2006.01) <b>F01P 7/14</b> (2006.01)

Broj objave evropske prijava patenta (97)	MKP (51)
	<b>F16K 31/06</b> (2006.01)
3409259	<b>A61J 1/10</b> (2006.01) <b>A61J 1/20</b> (2006.01) <b>F26B 5/06</b> (2006.01)
3311845	<b>A61K 9/00</b> (2006.01) <b>A61K 9/51</b> (2006.01) <b>A61K 31/00</b> (2006.01) <b>A61K 47/12</b> (2006.01)
3257498	<b>A61K 9/08</b> (2006.01) <b>A61K 47/34</b> (2017.01)
3296313	<b>A61K 31/585</b> (2006.01) <b>A61P 35/00</b> (2006.01) <b>C07J 19/00</b> (2006.01)
3273293	<b>B29D 11/00</b> (2006.01) <b>G02C 7/04</b> (2006.01)
3272937	<b>E01C 5/00</b> (2006.01) <b>E01C 11/22</b> (2006.01) <b>E01F 9/529</b> (2016.01)
3290922	<b>G01N 33/68</b> (2006.01)
3272754	<b>A61K 31/4188</b> (2006.01) <b>A61P 35/00</b> (2006.01) <b>C07D 487/04</b> (2006.01)
3282015	<b>C12N 5/074</b> (2010.01) <b>C12N 5/16</b> (2006.01) <b>C12N 9/12</b> (2006.01) <b>C12N 15/63</b> (2006.01) <b>C12N 15/67</b> (2006.01)
3287208	<b>B21D 13/04</b> (2006.01) <b>B21D 22/10</b> (2006.01) <b>B21H 8/00</b> (2006.01) <b>B44B 5/00</b> (2006.01)
3312160	<b>C07D 211/96</b> (2006.01)
3263717	<b>C12Q 1/68</b> (2018.01) <b>G01N 33/50</b> (2006.01)
3275761	<b>B61G 9/02</b> (2006.01) <b>B61G 9/04</b> (2006.01)
3275760	<b>B61F 1/08</b> (2006.01)
3290627	<b>E06B 7/215</b> (2006.01)
3279054	<b>B61C 9/38</b> (2006.01)
3415163	<b>A61K 9/00</b> (2006.01) <b>A61K 9/08</b> (2006.01) <b>A61K 31/167</b> (2006.01) <b>A61K 31/728</b> (2006.01)

Broj objave evropske prijava patenta (97)	MKP (51)
	<b>A61K 31/737</b> (2006.01) <b>A61K 45/06</b> (2006.01) <b>A61K 47/02</b> (2006.01) <b>A61K 47/36</b> (2006.01) <b>A61P 13/02</b> (2006.01) <b>A61P 13/10</b> (2006.01)
3266782	<b>A61K 31/4375</b> (2006.01) <b>A61K 31/444</b> (2006.01) <b>A61K 31/506</b> (2006.01) <b>A61K 45/06</b> (2006.01) <b>A61P 3/10</b> (2006.01) <b>A61P 27/00</b> (2006.01) <b>C07D 471/04</b> (2006.01)
3312189	<b>C07H 21/02</b> (2006.01)
3298933	<b>A47J 31/40</b> (2006.01) <b>A47J 31/56</b> (2006.01)
3291211	<b>G09F 17/00</b> (2006.01)
3312281	<b>A61K 31/7088</b> (2006.01) <b>C12N 15/113</b> (2010.01)
3275870	<b>C07D 237/32</b> (2006.01)
3305285	<b>A61K 31/00</b> (2006.01) <b>A61K 31/4166</b> (2006.01) <b>A61K 31/4439</b> (2006.01) <b>A61P 35/00</b> (2006.01)
3383958	<b>A61K 9/00</b> (2006.01) <b>C09C 1/02</b> (2006.01)
3386979	<b>A61K 31/437</b> (2006.01) <b>A61P 11/00</b> (2006.01) <b>C07D 471/04</b> (2006.01)
3386485	<b>A61K 9/14</b> (2006.01)
3383858	<b>A61K 31/404</b> (2006.01) <b>A61P 31/04</b> (2006.01) <b>C07D 209/42</b> (2006.01) <b>C07D 401/04</b> (2006.01) <b>C07D 403/04</b> (2006.01) <b>C07D 413/10</b> (2006.01) <b>C07D 471/04</b> (2006.01)
3389575	<b>A61F 5/44</b> (2006.01) <b>A61F 5/445</b> (2006.01) <b>A61M 1/00</b> (2006.01)
3370648	<b>A61F 2/24</b> (2006.01)
3380486	<b>A61K 31/7052</b> (2006.01) <b>A61P 1/04</b> (2006.01) <b>C07D 487/04</b> (2006.01) <b>C07H 15/26</b> (2006.01)

Broj objave evropske prijava patenta (97)	MKP (51)
3380196	<b>A61K 39/00</b> (2006.01) <b>A61P 35/02</b> (2006.01) <b>C07K 16/28</b> (2006.01) <b>C07K 16/30</b> (2006.01) <b>C07K 16/46</b> (2006.01)
3374511	<b>C12M 1/00</b> (2006.01) <b>C12M 1/107</b> (2006.01) <b>C12P 5/02</b> (2006.01)
3377416	<b>B65D 6/18</b> (2006.01) <b>B65D 6/34</b> (2006.01) <b>B65D 21/02</b> (2006.01) <b>B65D 85/34</b> (2006.01)
3383425	<b>A61K 39/00</b> (2006.01) <b>A61P 35/00</b> (2006.01) <b>C07K 16/18</b> (2006.01) <b>C07K 16/28</b> (2006.01) <b>C07K 16/46</b> (2006.01)
3413868	<b>A61K 9/00</b> (2006.01) <b>A61K 31/7032</b> (2006.01) <b>A61K 31/728</b> (2006.01) <b>A61P 27/02</b> (2006.01)
3383867	<b>A61K 31/4709</b> (2006.01) <b>C07D 401/12</b> (2006.01) <b>C07D 409/14</b> (2006.01) <b>C07D 471/08</b> (2006.01)
3384045	<b>C12Q 1/68</b> (2018.01)
3349641	<b>A61B 1/307</b> (2006.01) <b>A61M 3/02</b> (2006.01)
3377908	<b>G01N 33/68</b> (2006.01)
3377909	<b>G01N 33/68</b> (2006.01)
3365678	<b>C12N 5/00</b> (2006.01) <b>C12N 5/0775</b> (2010.01) <b>G01N 33/569</b> (2006.01)
3383364	<b>A61K 9/00</b> (2006.01) <b>A61K 9/19</b> (2006.01) <b>A61K 47/26</b> (2006.01) <b>A61K 47/40</b> (2006.01)
3383907	<b>C07K 16/28</b> (2006.01)
3383891	<b>C07K 14/54</b> (2006.01)
3370762	<b>A61K 35/17</b> (2015.01) <b>A61K 39/00</b> (2006.01) <b>C07K 14/00</b> (2006.01) <b>C07K 14/705</b> (2006.01)
3371601	<b>G01N 33/574</b> (2006.01)

Broj objave evropske prijava patenta (97)	MKP (51)
3387010	<b>A61K 38/16</b> (2006.01) <b>A61K 48/00</b> (2006.01) <b>C07K 14/52</b> (2006.01) <b>C12N 15/62</b> (2006.01)
3377093	<b>A61K 38/57</b> (2006.01) <b>C07K 14/81</b> (2006.01)
3380522	<b>A61K 39/00</b> (2006.01) <b>A61K 39/395</b> (2006.01) <b>C07K 16/28</b> (2006.01)
3371224	<b>A61K 39/00</b> (2006.01) <b>A61K 39/395</b> (2006.01) <b>A61P 27/02</b> (2006.01) <b>C07K 16/28</b> (2006.01)
3380091	<b>A61K 31/00</b> (2006.01) <b>A61K 31/4152</b> (2006.01) <b>A61P 9/00</b> (2006.01) <b>A61P 9/10</b> (2006.01)
3380413	<b>A01N 31/08</b> (2006.01) <b>A23B 7/154</b> (2006.01) <b>B65D 85/34</b> (2006.01)
3389398	<b>A23L 3/18</b> (2006.01) <b>A23L 3/30</b> (2006.01) <b>A23L 3/3418</b> (2006.01) <b>A23L 3/358</b> (2006.01) <b>A23L 3/3589</b> (2006.01) <b>A61L 2/07</b> (2006.01) <b>A61L 2/18</b> (2006.01) <b>A61L 2/22</b> (2006.01)
3386998	<b>C07H 1/00</b> (2006.01) <b>C07H 19/06</b> (2006.01)
3364835	<b>A47J 31/54</b> (2006.01) <b>F24H 1/10</b> (2006.01)
3364836	<b>A47J 31/54</b> (2006.01) <b>F24H 1/10</b> (2006.01)
3364765	<b>A21B 1/48</b> (2006.01) <b>A21B 5/02</b> (2006.01)
3389727	<b>A61K 51/04</b> (2006.01) <b>A61K 101/02</b> (2006.01) <b>C07B 59/00</b> (2006.01) <b>C07D 487/04</b> (2006.01)
3383860	<b>A61K 31/513</b> (2006.01) <b>A61P 9/04</b> (2006.01) <b>A61P 9/10</b> (2006.01) <b>A61P 9/12</b> (2006.01) <b>C07D 239/54</b> (2006.01) <b>C07D 401/10</b> (2006.01) <b>C07D 401/14</b> (2006.01) <b>C07D 403/06</b> (2006.01) <b>C07D 403/10</b> (2006.01) <b>C07D 413/06</b> (2006.01)

Broj objave evropske prijava patenta (97)	MKP (51)
	<b>C07D 413/10</b> (2006.01) <b>C07D 417/06</b> (2006.01) <b>C07D 417/14</b> (2006.01)
3380119	<b>A61K 39/00</b> (2006.01) <b>A61K 39/135</b> (2006.01) <b>C07K 14/32</b> (2006.01)
3386975	<b>A61K 31/497</b> (2006.01) <b>A61P 35/00</b> (2006.01) <b>C07D 403/12</b> (2006.01)
3383306	<b>A61C 5/55</b> (2017.01)
3383313	<b>A61C 5/40</b> (2017.01) <b>A61C 17/02</b> (2006.01)
3394205	<b>C09K 17/32</b> (2006.01) <b>E21D 9/06</b> (2006.01)
3362407	<b>C01B 32/10</b> (2017.01) <b>C01B 32/336</b> (2017.01)
3359281	<b>B01D 53/18</b> (2006.01) <b>B01D 53/62</b> (2006.01) <b>B01D 53/78</b> (2006.01) <b>B01D 53/96</b> (2006.01) <b>F23J 15/04</b> (2006.01)
3344289	<b>A61K 39/12</b> (2006.01) <b>A61P 31/00</b> (2006.01)
3347215	<b>B60F 3/00</b> (2006.01) <b>B62D 37/00</b> (2006.01) <b>B62D 61/00</b> (2006.01)
3344254	<b>A61K 31/454</b> (2006.01) <b>A61K 31/519</b> (2006.01) <b>A61K 31/573</b> (2006.01) <b>A61K 35/00</b> (2006.01)
3344656	<b>A61K 39/00</b> (2006.01) <b>C07K 16/28</b> (2006.01)
3344245	<b>A61K 31/4178</b> (2006.01) <b>A61K 31/496</b> (2006.01) <b>A61K 31/513</b> (2006.01) <b>A61K 31/565</b> (2006.01) <b>A61P 15/00</b> (2006.01)
3344856	<b>F01K 23/10</b> (2006.01) <b>F01K 25/10</b> (2006.01) <b>F02C 1/00</b> (2006.01) <b>F02C 3/34</b> (2006.01) <b>F02C 6/02</b> (2006.01)
3347054	<b>A61K 47/68</b> (2017.01) <b>A61P 35/00</b> (2006.01)



Broj objave evropske prijava patenta (97)	MKP (51)
3350059	<b>B60W 30/18</b> (2012.01) <b>B62D 15/02</b> (2006.01)
3350162	<b>A61K 31/404</b> (2006.01) <b>A61P 31/12</b> (2006.01) <b>C07D 209/12</b> (2006.01)
3344034	<b>A01K 67/027</b> (2006.01) <b>C12N 15/85</b> (2006.01)
3344642	<b>A61K 31/7072</b> (2006.01) <b>A61P 31/14</b> (2006.01) <b>C07H 19/06</b> (2006.01)
3344551	<b>B65B 19/34</b> (2006.01) <b>B65B 35/08</b> (2006.01) <b>B65B 35/24</b> (2006.01) <b>B65G 15/14</b> (2006.01) <b>B65G 47/31</b> (2006.01)
3347470	<b>A61K 31/713</b> (2006.01) <b>A61P 9/10</b> (2006.01) <b>A61P 27/02</b> (2006.01) <b>C07H 21/02</b> (2006.01) <b>C12N 15/113</b> (2010.01)
3347377	<b>A61K 9/00</b> (2006.01) <b>A61P 11/06</b> (2006.01) <b>A61P 37/08</b> (2006.01) <b>C07K 16/24</b> (2006.01)
3347360	<b>A61K 31/438</b> (2006.01) <b>A61P 17/06</b> (2006.01) <b>A61P 37/00</b> (2006.01) <b>C07D 495/20</b> (2006.01)
3347277	<b>B65B 7/16</b> (2006.01) <b>B65B 7/28</b> (2006.01)
3344615	<b>A61K 31/501</b> (2006.01) <b>C07D 401/12</b> (2006.01)
3353086	<b>B65D 75/32</b> (2006.01)
3353045	<b>B63B 1/12</b> (2006.01) <b>B63B 7/00</b> (2006.01) <b>B63B 35/73</b> (2006.01) <b>B63H 21/17</b> (2006.01) <b>G05B 11/38</b> (2006.01)
3353162	<b>A61K 31/501</b> (2006.01) <b>C07D 401/12</b> (2006.01)
3347196	<b>B31B 50/59</b> (2017.01) <b>B31D 5/02</b> (2017.01) <b>B31F 1/00</b> (2006.01) <b>B31F 1/36</b> (2006.01) <b>B65B 47/06</b> (2006.01)
3350163	<b>A61K 31/454</b> (2006.01) <b>A61P 31/14</b> (2006.01)

Broj objave evropske prijave patenta (97)	MKP (51)
	<b>C07D 209/12</b> (2006.01)
3344616	<b>A61K 31/4523</b> (2006.01) <b>A61P 17/00</b> (2006.01) <b>A61P 25/00</b> (2006.01) <b>A61P 35/00</b> (2006.01) <b>A61P 37/08</b> (2006.01) <b>C07D 401/14</b> (2006.01) <b>C07D 413/14</b> (2006.01) <b>C07D 417/14</b> (2006.01) <b>C07D 487/04</b> (2006.01) <b>C07D 498/04</b> (2006.01)
3344159	<b>A61B 17/04</b> (2006.01) <b>A61B 17/06</b> (2006.01)
3258575	<b>H02K 3/04</b> (2006.01) <b>H02K 21/14</b> (2006.01) <b>H02K 53/00</b> (2006.01)
3349726	<b>A61K 9/00</b> (2006.01) <b>A61K 9/14</b> (2006.01) <b>A61K 9/16</b> (2006.01) <b>A61K 31/00</b> (2006.01)
3349604	<b>A24B 15/10</b> (2006.01) <b>A24F 47/00</b> (2006.01) <b>A61M 15/06</b> (2006.01) <b>A61Q 19/08</b> (2006.01)
3353207	<b>A61P 37/00</b> (2006.01) <b>C07K 16/28</b> (2006.01)
3353163	<b>A61K 31/4418</b> (2006.01) <b>A61P 25/16</b> (2006.01) <b>A61P 25/28</b> (2006.01) <b>C07D 401/12</b> (2006.01)
3347453	<b>A61K 35/12</b> (2015.01) <b>C12N 5/0783</b> (2010.01)
3347351	<b>A61K 31/4709</b> (2006.01) <b>A61P 35/00</b> (2006.01) <b>C07D 215/60</b> (2006.01) <b>C07D 221/18</b> (2006.01) <b>C07D 401/12</b> (2006.01) <b>C07D 401/14</b> (2006.01) <b>C07F 7/18</b> (2006.01)
3347287	<b>B65D 1/26</b> (2006.01) <b>B65D 85/804</b> (2006.01)
3350180	<b>A61K 31/437</b> (2006.01) <b>A61P 35/00</b> (2006.01) <b>C07D 471/04</b> (2006.01)
3350174	<b>A61K 31/55</b> (2006.01) <b>A61P 31/18</b> (2006.01) <b>C07D 223/16</b> (2006.01) <b>C07D 405/10</b> (2006.01) <b>C07D 405/14</b> (2006.01)

Broj objave evropske prijava patenta (97)	MKP (51)
3349798	<b>A61K 31/454</b> (2006.01) <b>A61K 31/4985</b> (2006.01) <b>A61K 31/519</b> (2006.01) <b>A61K 45/06</b> (2006.01) <b>A61P 35/00</b> (2006.01) <b>A61P 35/02</b> (2006.01) <b>C07K 14/70</b> (2006.01) <b>C07K 16/28</b> (2006.01) <b>C12N 5/07</b> (2010.01)
3350226	<b>C07K 16/30</b> (2006.01)
3352679	<b>A61B 17/00</b> (2006.01) <b>A61M 5/19</b> (2006.01)
3383822	<b>C04B 28/14</b> (2006.01) <b>C04B 40/00</b> (2006.01)
3353232	<b>B01D 1/18</b> (2006.01) <b>C08J 3/12</b> (2006.01) <b>D21C 9/00</b> (2006.01) <b>F26B 3/12</b> (2006.01)
3350185	<b>A61K 31/519</b> (2006.01) <b>A61P 3/00</b> (2006.01) <b>A61P 25/00</b> (2006.01) <b>A61P 35/00</b> (2006.01) <b>C07D 487/04</b> (2006.01) <b>C07D 495/04</b> (2006.01)
3349757	<b>A61K 31/519</b> (2006.01) <b>A61P 31/18</b> (2006.01)
3349758	<b>A61K 31/53</b> (2006.01) <b>A61K 31/664</b> (2006.01) <b>A61K 31/675</b> (2006.01) <b>A61K 31/683</b> (2006.01) <b>A61K 31/685</b> (2006.01) <b>A61P 31/12</b> (2006.01)
3353158	<b>A61K 31/56</b> (2006.01) <b>A61P 31/18</b> (2006.01) <b>C07D 211/96</b> (2006.01) <b>C07D 279/12</b> (2006.01) <b>C07J 63/00</b> (2006.01)
3368696	<b>A23L 33/135</b> (2016.01) <b>A61K 31/404</b> (2006.01) <b>A61K 35/74</b> (2015.01) <b>A61K 35/741</b> (2015.01) <b>C12N 1/20</b> (2006.01) <b>C12N 15/70</b> (2006.01) <b>C12R 1/01</b> (2006.01) <b>C12R 1/19</b> (2006.01)
3349740	<b>A61K 31/137</b> (2006.01) <b>A61K 31/7042</b> (2006.01) <b>A61P 1/16</b> (2006.01) <b>A61P 3/00</b> (2006.01) <b>A61P 3/04</b> (2006.01) <b>A61P 9/00</b> (2006.01) <b>A61P 9/12</b> (2006.01) <b>A61P 13/00</b> (2006.01)

Broj objave evropske prijava patenta (97)	MKP (51)
	<b>A61P 43/00</b> (2006.01)
3355915	<b>A61K 39/00</b> (2006.01) <b>A61K 39/12</b> (2006.01) <b>A61K 39/135</b> (2006.01) <b>A61K 39/23</b> (2006.01)
3350216	<b>C07K 16/00</b> (2006.01) <b>C07K 16/24</b> (2006.01) <b>C07K 16/28</b> (2006.01) <b>C07K 16/46</b> (2006.01)
3349812	<b>A61L 27/36</b> (2006.01) <b>A61L 27/56</b> (2006.01) <b>A61L 27/60</b> (2006.01)
3153565	<b>C10L 1/12</b> (2006.01) <b>C10L 1/16</b> (2006.01) <b>C10L 1/182</b> (2006.01) <b>C10L 1/188</b> (2006.01) <b>C10L 1/189</b> (2006.01) <b>C10L 1/222</b> (2006.01) <b>C10L 1/224</b> (2006.01) <b>C10L 1/232</b> (2006.01) <b>C10L 1/233</b> (2006.01) <b>C10L 1/24</b> (2006.01) <b>C10L 10/02</b> (2006.01)
3309796	<b>A61K 51/00</b> (2006.01) <b>A61K 51/12</b> (2006.01) <b>A61M 36/00</b> (2006.01) <b>G21G 1/00</b> (2006.01)
3318565	<b>A61K 31/4375</b> (2006.01) <b>A61P 35/00</b> (2006.01) <b>C07D 471/04</b> (2006.01) <b>C07D 487/04</b> (2006.01)
3318247	<b>A61K 9/00</b> (2006.01) <b>A61K 9/50</b> (2006.01) <b>A61K 31/55</b> (2006.01) <b>A61P 9/04</b> (2006.01)
3318272	<b>A61K 39/00</b> (2006.01) <b>A61K 39/395</b> (2006.01) <b>C07K 16/18</b> (2006.01) <b>C07K 16/26</b> (2006.01)
3318249	<b>A61K 9/20</b> (2006.01) <b>A61K 9/32</b> (2006.01) <b>A61K 31/225</b> (2006.01) <b>A61P 25/28</b> (2006.01)
3301109	<b>C07K 11/02</b> (2006.01)
3321270	<b>A61K 31/535</b> (2006.01) <b>A61P 31/18</b> (2006.01) <b>C07D 498/14</b> (2006.01)
3318268	<b>A23P 10/30</b> (2016.01) <b>A61K 38/16</b> (2006.01) <b>A61K 39/02</b> (2006.01)

Broj objave evropske prijave patenta (97)	MKP (51)
	<b>A61K 48/00</b> (2006.01) <b>A61P 1/00</b> (2006.01) <b>A61P 17/00</b> (2006.01) <b>A61P 19/00</b> (2006.01) <b>A61P 29/00</b> (2006.01) <b>A61P 37/00</b> (2006.01) <b>C07K 14/195</b> (2006.01)
3345604	<b>A61K 31/485</b> (2006.01) <b>A61P 25/32</b> (2006.01)
3318273	<b>A61K 39/395</b> (2006.01)
3363576	<b>B23K 26/00</b> (2014.01) <b>B23K 26/0622</b> (2014.01) <b>B23K 26/082</b> (2014.01) <b>B23K 26/12</b> (2014.01) <b>B23K 26/14</b> (2014.01) <b>B23K 26/322</b> (2014.01) <b>B23K 26/352</b> (2014.01) <b>B23K 26/60</b> (2014.01)
3348644	<b>A61K 39/00</b> (2006.01) <b>C12N 15/63</b> (2006.01) <b>C12N 15/67</b> (2006.01)
3323451	<b>A61B 17/06</b> (2006.01) <b>A61L 31/02</b> (2006.01) <b>A61L 31/10</b> (2006.01) <b>A61M 5/32</b> (2006.01)
3366775	<b>A61K 31/7125</b> (2006.01) <b>C12N 15/113</b> (2010.01)
3369874	<b>E04F 15/024</b> (2006.01) <b>F24D 3/12</b> (2006.01)
3238801	<b>B01D 17/00</b> (2006.01) <b>B01D 17/04</b> (2006.01) <b>E03F 5/16</b> (2006.01)
3388063	<b>A61K 9/00</b> (2006.01) <b>A61K 9/20</b> (2006.01) <b>A61K 31/4164</b> (2006.01) <b>A61K 31/4178</b> (2006.01) <b>A61K 31/7048</b> (2006.01) <b>A61K 45/06</b> (2006.01) <b>A61K 47/06</b> (2006.01) <b>A61P 31/04</b> (2006.01)
3400120	<b>B27N 3/02</b> (2006.01) <b>B27N 3/04</b> (2006.01) <b>B27N 3/06</b> (2006.01) <b>B27N 3/10</b> (2006.01) <b>B27N 3/12</b> (2006.01)
3402846	<b>C09C 1/02</b> (2006.01)
3408063	<b>B25B 13/46</b> (2006.01) <b>B26D 1/547</b> (2006.01)

Broj objave evropske prijava patenta (97)	MKP (51)
3397622	<b>A61K 31/426</b> (2006.01) <b>A61K 45/06</b> (2006.01) <b>A61P 15/00</b> (2006.01) <b>A61P 15/06</b> (2006.01) <b>C07D 277/06</b> (2006.01)
3400217	<b>A61K 31/426</b> (2006.01) <b>A61K 45/06</b> (2006.01) <b>A61P 15/00</b> (2006.01) <b>A61P 15/06</b> (2006.01) <b>C07D 277/06</b> (2006.01)
3397965	<b>C07K 16/26</b> (2006.01) <b>C07K 16/30</b> (2006.01) <b>G01N 33/574</b> (2006.01) <b>G01N 33/74</b> (2006.01)
3399969	<b>A61K 31/191</b> (2006.01) <b>A61P 31/00</b> (2006.01) <b>A61P 33/00</b> (2006.01) <b>A61P 33/02</b> (2006.01)
3400004	<b>A61K 39/00</b> (2006.01) <b>A61P 35/00</b> (2006.01)
3400005	<b>A61K 39/00</b> (2006.01) <b>A61P 35/00</b> (2006.01)
3400317	<b>C23C 2/02</b> (2006.01) <b>C23C 2/06</b> (2006.01) <b>C23C 2/14</b> (2006.01) <b>C23C 2/26</b> (2006.01) <b>C23C 2/30</b> (2006.01)
3405466	<b>A61K 31/437</b> (2006.01) <b>A61P 31/16</b> (2006.01) <b>C07D 403/04</b> (2006.01) <b>C07D 403/12</b> (2006.01) <b>C07D 471/04</b> (2006.01) <b>C07D 487/04</b> (2006.01) <b>C07D 495/04</b> (2006.01)
3390711	<b>D06P 1/653</b> (2006.01) <b>D06P 3/54</b> (2006.01) <b>D06P 5/04</b> (2006.01)
3400225	<b>A61K 31/437</b> (2006.01) <b>A61K 31/519</b> (2006.01) <b>A61P 31/16</b> (2006.01) <b>C07D 471/04</b> (2006.01) <b>C07D 487/04</b> (2006.01)
3405216	<b>A61K 49/00</b> (2006.01)
3405635	<b>E05C 19/00</b> (2006.01) <b>E06B 7/18</b> (2006.01)
3408043	<b>B22D 41/22</b> (2006.01) <b>B22D 41/28</b> (2006.01) <b>B22D 41/34</b> (2006.01)

Broj objave evropske prijave patenta (97)	MKP (51)
3405490	<b>A61P 35/00</b> (2006.01) <b>C07K 16/28</b> (2006.01) <b>C07K 16/30</b> (2006.01)
3405177	<b>A61K 9/20</b> (2006.01) <b>A61K 9/48</b> (2006.01) <b>A61K 31/00</b> (2006.01)
3405178	<b>A61K 9/20</b> (2006.01) <b>A61K 31/00</b> (2006.01)
3400211	<b>C07D 205/04</b> (2006.01)
3400318	<b>C23C 2/02</b> (2006.01) <b>C23C 2/06</b> (2006.01) <b>C23C 2/14</b> (2006.01) <b>C23C 2/26</b> (2006.01) <b>C23C 2/30</b> (2006.01)
3405196	<b>A61K 31/506</b> (2006.01) <b>A61K 31/5377</b> (2006.01) <b>A61K 31/55</b> (2006.01) <b>A61P 3/00</b> (2006.01) <b>A61P 29/00</b> (2006.01) <b>A61P 35/00</b> (2006.01) <b>A61P 37/00</b> (2006.01) <b>C07D 401/14</b> (2006.01) <b>C07D 403/14</b> (2006.01) <b>C07D 405/14</b> (2006.01) <b>C07D 413/14</b> (2006.01) <b>C07D 471/10</b> (2006.01) <b>C07D 487/04</b> (2006.01) <b>C07D 487/10</b> (2006.01)
3405464	<b>A61K 31/506</b> (2006.01) <b>A61K 31/5377</b> (2006.01) <b>A61K 31/553</b> (2006.01) <b>A61P 3/00</b> (2006.01) <b>A61P 29/00</b> (2006.01) <b>A61P 35/00</b> (2006.01) <b>A61P 37/00</b> (2006.01) <b>C07D 401/14</b> (2006.01) <b>C07D 403/04</b> (2006.01) <b>C07D 403/14</b> (2006.01) <b>C07D 405/14</b> (2006.01) <b>C07D 413/14</b> (2006.01)
3405481	<b>A61K 38/00</b> (2006.01) <b>A61K 48/00</b> (2006.01) <b>C07K 14/47</b> (2006.01) <b>C07K 16/28</b> (2006.01) <b>C07K 16/30</b> (2006.01)
3400221	<b>A61K 31/506</b> (2006.01) <b>A61P 35/00</b> (2006.01) <b>C07D 401/14</b> (2006.01) <b>C07D 403/14</b> (2006.01)
3400212	<b>A61K 31/403</b> (2006.01) <b>A61P 25/00</b> (2006.01) <b>C07D 209/56</b> (2006.01)

Broj objave evropske prijava patenta (97)	MKP (51)
3402819	<b>A61K 38/20</b> (2006.01) <b>C07K 16/24</b> (2006.01)
3405551	<b>C09K 11/06</b> (2006.01) <b>H01L 51/00</b> (2006.01)
3411532	<b>E02D 27/34</b> (2006.01)
3411360	<b>C07C 251/72</b> (2006.01) <b>C07D 231/14</b> (2006.01)
3407874	<b>A61K 9/20</b> (2006.01) <b>A61K 31/506</b> (2006.01)
3402503	<b>A61K 31/454</b> (2006.01) <b>A61K 31/4985</b> (2006.01) <b>A61K 31/517</b> (2006.01) <b>A61K 31/519</b> (2006.01) <b>A61K 31/52</b> (2006.01) <b>A61K 31/522</b> (2006.01) <b>A61K 38/00</b> (2006.01) <b>A61K 39/00</b> (2006.01) <b>A61K 45/06</b> (2006.01) <b>A61P 35/00</b> (2006.01) <b>A61P 35/02</b> (2006.01)
3397892	<b>F17C 1/16</b> (2006.01) <b>F17C 13/08</b> (2006.01)
3402474	<b>A61K 31/165</b> (2006.01) <b>A61K 31/19</b> (2006.01) <b>A61P 25/02</b> (2006.01)
3402790	<b>A61K 31/437</b> (2006.01) <b>A61K 31/4427</b> (2006.01) <b>C07D 213/64</b> (2006.01) <b>C07D 231/12</b> (2006.01) <b>C07D 231/18</b> (2006.01) <b>C07D 231/54</b> (2006.01) <b>C07D 401/12</b> (2006.01) <b>C07D 401/14</b> (2006.01) <b>C07D 413/12</b> (2006.01) <b>C07D 471/04</b> (2006.01) <b>C07D 471/12</b> (2006.01) <b>C07D 513/04</b> (2006.01)
3402822	<b>A61P 35/00</b> (2006.01) <b>C07K 16/28</b> (2006.01)
3411510	<b>C23C 2/02</b> (2006.01) <b>C23C 2/06</b> (2006.01) <b>C23C 2/14</b> (2006.01) <b>C23C 2/26</b> (2006.01) <b>C23C 2/30</b> (2006.01)
3411028	<b>A61K 31/41</b> (2006.01) <b>A61K 31/4184</b> (2006.01) <b>A61K 31/437</b> (2006.01) <b>A61K 31/519</b> (2006.01) <b>A61K 31/52</b> (2006.01) <b>A61K 31/53</b> (2006.01) <b>A61K 31/5377</b> (2006.01) <b>A61K 31/55</b> (2006.01)



Broj objave evropske prijava patenta (97)	MKP (51)
	<b>A61K 31/5513</b> (2006.01) <b>A61K 31/70</b> (2006.01) <b>A61K 31/7056</b> (2006.01) <b>A61K 39/395</b> (2006.01) <b>A61P 31/12</b> (2006.01)
3405492	<b>C07K 16/28</b> (2006.01)
3411005	<b>A61J 1/20</b> (2006.01) <b>A61M 5/24</b> (2006.01) <b>A61M 5/28</b> (2006.01) <b>A61M 39/24</b> (2006.01)
3405493	<b>A61K 39/395</b> (2006.01) <b>A61P 35/00</b> (2006.01) <b>C07K 16/28</b> (2006.01)
3408280	<b>C07K 14/08</b> (2006.01) <b>C12N 7/06</b> (2006.01)
3402465	<b>A61K 9/00</b> (2006.01) <b>A61K 9/19</b> (2006.01) <b>A61K 39/395</b> (2006.01) <b>A61K 47/18</b> (2017.01) <b>A61K 47/26</b> (2006.01) <b>C07K 16/28</b> (2006.01)
3405495	<b>A61P 35/00</b> (2006.01) <b>C07K 16/28</b> (2006.01)
3402862	<b>C10L 1/00</b> (2006.01) <b>C10L 1/30</b> (2006.01) <b>C10M 17/100</b> (2006.01)
3405474	<b>A61K 31/575</b> (2006.01) <b>A61P 31/18</b> (2006.01) <b>C07J 63/00</b> (2006.01)
3405489	<b>A61K 39/00</b> (2006.01) <b>C07K 16/00</b> (2006.01) <b>C07K 16/18</b> (2006.01) <b>G01N 33/15</b> (2006.01)
3407725	<b>A21D 13/00</b> (2017.01) <b>A21D 13/14</b> (2017.01) <b>A21D 13/32</b> (2017.01) <b>A23G 3/54</b> (2006.01)
3408295	<b>A61K 39/395</b> (2006.01) <b>A61K 47/00</b> (2006.01) <b>C07K 16/28</b> (2006.01)
3407990	<b>A63F 1/12</b> (2006.01) <b>A63F 1/18</b> (2006.01) <b>G07F 17/32</b> (2006.01)
3407910	<b>A61K 39/12</b> (2006.01) <b>C07K 14/005</b> (2006.01) <b>C12N 15/86</b> (2006.01)

Broj objave evropske prijava patenta (97)	MKP (51)
3411394	<b>A61K 39/00</b> (2006.01) <b>C07K 14/705</b> (2006.01) <b>C07K 16/32</b> (2006.01)
3416747	<b>B05B 11/00</b> (2006.01) <b>B65D 83/20</b> (2006.01) <b>B65D 83/22</b> (2006.01) <b>B65D 83/30</b> (2006.01)
3353190	<b>A61K 31/56</b> (2006.01) <b>A61K 31/58</b> (2006.01) <b>A61K 31/585</b> (2006.01) <b>A61P 29/00</b> (2006.01) <b>C07J 63/00</b> (2006.01) <b>C07J 71/00</b> (2006.01)
3356360	<b>A61K 31/445</b> (2006.01) <b>A61P 29/00</b> (2006.01) <b>C07D 417/12</b> (2006.01) <b>C07D 417/14</b> (2006.01)
3355922	<b>A61K 31/437</b> (2006.01) <b>A61K 31/495</b> (2006.01) <b>A61K 31/519</b> (2006.01) <b>A61K 31/551</b> (2006.01) <b>A61K 45/00</b> (2006.01) <b>A61K 45/06</b> (2006.01) <b>A61P 35/00</b> (2006.01)
3359565	<b>C07K 14/47</b> (2006.01) <b>C07K 16/18</b> (2006.01) <b>G01N 33/53</b> (2006.01)
3350981	<b>H04M 11/00</b> (2006.01) <b>H04M 19/00</b> (2006.01)
3355933	<b>A61K 31/522</b> (2006.01) <b>A61K 47/54</b> (2017.01) <b>A61K 47/69</b> (2017.01) <b>A61P 35/00</b> (2006.01) <b>C07D 473/34</b> (2006.01)
3353546	<b>A61K 38/18</b> (2006.01) <b>G01N 33/50</b> (2006.01) <b>G01N 33/68</b> (2006.01)
3356386	<b>A61K 38/12</b> (2006.01) <b>A61P 3/04</b> (2006.01) <b>C07K 7/54</b> (2006.01)
3355855	<b>A61K 8/19</b> (2006.01) <b>A61K 8/73</b> (2006.01) <b>A61K 9/16</b> (2006.01) <b>A61Q 19/00</b> (2006.01)
3355905	<b>A61K 38/12</b> (2006.01) <b>A61P 3/04</b> (2006.01)
3355908	<b>A61K 38/18</b> (2006.01) <b>A61P 1/16</b> (2006.01)

Broj objave evropske prijava patenta (97)	MKP (51)
3359196	<b>A61K 31/337</b> (2006.01) <b>A61K 31/52</b> (2006.01) <b>A61K 31/704</b> (2006.01) <b>A61K 45/06</b> (2006.01) <b>A61P 35/00</b> (2006.01)
3359536	<b>A61K 31/4709</b> (2006.01) <b>A61P 11/00</b> (2006.01) <b>C07D 401/04</b> (2006.01) <b>C07D 405/04</b> (2006.01) <b>C07D 405/14</b> (2006.01) <b>C07D 409/04</b> (2006.01) <b>C07D 409/14</b> (2006.01) <b>C07D 413/04</b> (2006.01) <b>C07D 413/14</b> (2006.01) <b>C07D 417/04</b> (2006.01) <b>C07D 471/04</b> (2006.01) <b>C07D 487/04</b> (2006.01) <b>C07D 493/08</b> (2006.01)
3355887	<b>A61K 9/00</b> (2006.01) <b>A61K 31/473</b> (2006.01) <b>A61K 47/12</b> (2006.01) <b>A61K 47/20</b> (2006.01) <b>A61P 15/00</b> (2006.01) <b>A61P 15/10</b> (2006.01) <b>A61P 25/00</b> (2006.01) <b>A61P 25/16</b> (2006.01) <b>A61P 25/18</b> (2006.01) <b>A61P 25/28</b> (2006.01)
3354117	<b>H05F 3/02</b> (2006.01)
3365010	<b>A61K 39/39</b> (2006.01)
3365024	<b>A61K 47/64</b> (2017.01) <b>A61P 37/00</b> (2006.01) <b>A61P 37/04</b> (2006.01)
3371167	<b>A61K 31/41</b> (2006.01) <b>A61K 31/4196</b> (2006.01) <b>A61K 31/445</b> (2006.01) <b>C07D 401/04</b> (2006.01) <b>C07D 401/06</b> (2006.01) <b>C07D 401/10</b> (2006.01) <b>C07D 401/12</b> (2006.01) <b>C07D 401/14</b> (2006.01)
3359571	<b>A61K 39/00</b> (2006.01) <b>A61P 35/00</b> (2006.01) <b>A61P 37/00</b> (2006.01) <b>C07K 16/28</b> (2006.01)
3365346	<b>A61K 31/424</b> (2006.01) <b>C07D 498/10</b> (2006.01)
3359532	<b>A61K 31/41</b> (2006.01) <b>A61K 31/4196</b> (2006.01) <b>A61K 31/445</b> (2006.01) <b>C07D 401/04</b> (2006.01) <b>C07D 401/06</b> (2006.01) <b>C07D 401/10</b> (2006.01) <b>C07D 401/12</b> (2006.01)

Broj objave evropske prijava patenta (97)	MKP (51)
	<b>C07D 401/14</b> (2006.01)
3356355	<b>A61K 31/4196</b> (2006.01) <b>A61P 31/18</b> (2006.01) <b>C07D 249/10</b> (2006.01) <b>C07D 405/12</b> (2006.01)
3359539	<b>A61K 31/437</b> (2006.01) <b>A61P 11/12</b> (2006.01) <b>C07D 471/04</b> (2006.01) <b>C07D 519/00</b> (2006.01)
3359540	<b>A61K 31/437</b> (2006.01) <b>A61P 11/00</b> (2006.01) <b>C07D 471/04</b> (2006.01) <b>C07D 519/00</b> (2006.01) <b>G01N 33/68</b> (2006.01)
3358967	<b>A23K 10/00</b> (2016.01) <b>A23K 10/40</b> (2016.01)
3359528	<b>A61K 31/4174</b> (2006.01) <b>A61K 31/4439</b> (2006.01) <b>A61P 21/00</b> (2006.01) <b>C07D 233/64</b> (2006.01) <b>C07D 401/04</b> (2006.01) <b>C07D 405/10</b> (2006.01)
3362466	<b>C07K 4/04</b> (2006.01) <b>C07K 14/21</b> (2006.01) <b>C12N 15/82</b> (2006.01)
3368061	<b>A61K 38/26</b> (2006.01) <b>C07K 14/605</b> (2006.01)
3365340	<b>A61K 31/437</b> (2006.01) <b>A61K 31/5025</b> (2006.01) <b>A61K 31/519</b> (2006.01) <b>A61P 31/12</b> (2006.01) <b>A61P 35/00</b> (2006.01) <b>C07D 471/04</b> (2006.01) <b>C07D 487/04</b> (2006.01)
3360135	<b>G10L 19/008</b> (2013.01) <b>G10L 19/24</b> (2013.01)
3400251	<b>C08G 18/16</b> (2006.01) <b>C08G 18/20</b> (2006.01) <b>C08G 18/24</b> (2006.01) <b>C08G 18/40</b> (2006.01) <b>C08G 18/48</b> (2006.01) <b>C08G 18/63</b> (2006.01) <b>C08G 18/76</b> (2006.01) <b>C08G 101/00</b> (2006.01)
3362453	<b>A61K 31/519</b> (2006.01) <b>C07D 487/04</b> (2006.01)
3368101	<b>A61M 5/142</b> (2006.01) <b>A61M 5/145</b> (2006.01) <b>A61M 5/20</b> (2006.01) <b>A61M 5/315</b> (2006.01)

Broj objave evropske prijava patenta (97)	MKP (51)
	<b>A61M 5/32</b> (2006.01)
3359148	<b>A61K 31/195</b> (2006.01) <b>A61K 31/198</b> (2006.01) <b>A61K 31/454</b> (2006.01) <b>A61P 25/16</b> (2006.01)
3359541	<b>A61K 31/437</b> (2006.01) <b>A61P 11/12</b> (2006.01) <b>C07D 471/04</b> (2006.01) <b>C07D 519/00</b> (2006.01)
3362100	<b>A61K 47/64</b> (2017.01) <b>A61K 47/68</b> (2017.01) <b>A61P 35/00</b> (2006.01)
3362455	<b>A61P 35/00</b> (2006.01) <b>C07D 487/14</b> (2006.01)
3368658	<b>C12N 5/0783</b> (2010.01)
3353820	<b>H01L 33/00</b> (2010.01) <b>H01L 33/16</b> (2010.01)
3360066	<b>G06F 19/00</b> (2018.01)
3370722	<b>A61K 31/444</b> (2006.01) <b>A61K 31/4545</b> (2006.01) <b>A61P 35/00</b> (2006.01) <b>C07D 471/04</b> (2006.01)
3365334	<b>A61K 31/4035</b> (2006.01) <b>A61P 35/00</b> (2006.01) <b>C07D 401/14</b> (2006.01) <b>C07D 403/14</b> (2006.01) <b>C07D 405/14</b> (2006.01) <b>C07D 409/14</b> (2006.01) <b>C07D 413/14</b> (2006.01) <b>C07D 417/14</b> (2006.01) <b>C07D 471/04</b> (2006.01) <b>C07D 471/08</b> (2006.01)
3365025	<b>A61K 47/68</b> (2017.01) <b>A61P 35/00</b> (2006.01)
3362443	<b>A61K 31/4427</b> (2006.01) <b>A61P 35/00</b> (2006.01) <b>A61P 37/00</b> (2006.01) <b>C07D 207/12</b> (2006.01) <b>C07D 213/71</b> (2006.01) <b>C07D 213/85</b> (2006.01) <b>C07D 401/12</b> (2006.01) <b>C07D 401/14</b> (2006.01) <b>C07D 403/12</b> (2006.01) <b>C07D 455/02</b> (2006.01)
3362049	<b>A61K 9/127</b> (2006.01) <b>A61K 31/4745</b> (2006.01)

Broj objave evropske prijava patenta (97)	MKP (51)
3351120	<b>A23L 7/161</b> (2016.01) <b>A23P 20/10</b> (2016.01)
3361880	<b>A23J 3/14</b> (2006.01) <b>A23L 7/117</b> (2016.01) <b>A23L 7/17</b> (2016.01) <b>A23L 33/185</b> (2016.01) <b>A23L 33/21</b> (2016.01)
3370693	<b>A61K 9/00</b> (2006.01) <b>A61K 9/19</b> (2006.01) <b>A61K 31/50</b> (2006.01)
3352650	<b>A61B 5/00</b> (2006.01) <b>A61B 5/01</b> (2006.01) <b>A61B 5/021</b> (2006.01) <b>A61B 5/024</b> (2006.01) <b>A61B 5/07</b> (2006.01) <b>A61B 5/145</b> (2006.01) <b>A61B 5/1459</b> (2006.01) <b>A61B 5/1486</b> (2006.01) <b>A61B 5/16</b> (2006.01) <b>A61K 9/00</b> (2006.01)
3359567	<b>C07K 14/715</b> (2006.01) <b>C07K 16/24</b> (2006.01) <b>G01N 33/50</b> (2006.01)
3362454	<b>A61K 31/4188</b> (2006.01) <b>A61P 35/00</b> (2006.01) <b>C07D 487/04</b> (2006.01) <b>C07D 519/00</b> (2006.01)
3364934	<b>A61J 1/03</b> (2006.01) <b>A61J 7/04</b> (2006.01) <b>B65D 75/32</b> (2006.01)
3371183	<b>A61K 31/437</b> (2006.01) <b>A61P 35/00</b> (2006.01) <b>C07D 471/04</b> (2006.01)
3359636	<b>C12C 5/00</b> (2006.01) <b>C12C 12/02</b> (2006.01)
3368092	<b>A61K 31/52</b> (2006.01) <b>A61K 47/68</b> (2017.01) <b>A61P 35/00</b> (2006.01) <b>C07D 473/34</b> (2006.01)
3368562	<b>A61P 31/14</b> (2006.01) <b>C07K 16/10</b> (2006.01)
3365436	<b>C12N 5/09</b> (2010.01) <b>C12Q 1/02</b> (2006.01)
3368540	<b>A01N 43/90</b> (2006.01) <b>A61K 31/519</b> (2006.01) <b>A61P 3/04</b> (2006.01) <b>A61P 3/06</b> (2006.01) <b>A61P 31/00</b> (2006.01) <b>C07D 495/04</b> (2006.01)

Broj objave evropske prijava patenta (97)	MKP (51)
3368110	<b>A61M 11/00</b> (2006.01) <b>A61M 15/00</b> (2006.01)
3371218	<b>A61K 39/00</b> (2006.01) <b>C07K 16/24</b> (2006.01)
3374359	<b>A61K 31/4985</b> (2006.01) <b>A61P 35/00</b> (2006.01) <b>C07D 403/04</b> (2006.01) <b>C07D 487/04</b> (2006.01)
3373912	<b>A61K 9/19</b> (2006.01) <b>A61K 35/16</b> (2015.01) <b>C07K 14/755</b> (2006.01) <b>F26B 3/12</b> (2006.01) <b>F26B 5/06</b> (2006.01)
3368903	<b>A61K 39/395</b> (2006.01) <b>G01N 33/574</b> (2006.01)
3359182	<b>A61K 38/20</b> (2006.01) <b>A61P 35/00</b> (2006.01)
3368111	<b>A61M 11/00</b> (2006.01) <b>A61M 15/00</b> (2006.01)
3368112	<b>A61M 11/00</b> (2006.01) <b>B05B 17/06</b> (2006.01)
3368113	<b>A61M 11/00</b> (2006.01) <b>A61M 15/00</b> (2006.01)
3394360	<b>E04B 1/86</b> (2006.01) <b>E04C 2/04</b> (2006.01) <b>E04F 13/08</b> (2006.01)
3371188	<b>A61P 25/18</b> (2006.01) <b>C07D 487/04</b> (2006.01)
3349607	<b>A42B 3/06</b> (2006.01) <b>F16F 7/12</b> (2006.01)
3350477	<b>F16H 1/28</b> (2006.01)
3365086	<b>A63H 15/06</b> (2006.01)
3365373	<b>C07K 16/28</b> (2006.01) <b>C07K 16/30</b> (2006.01) <b>C07K 16/40</b> (2006.01)
3375029	<b>H01M 4/133</b> (2010.01) <b>H01M 4/136</b> (2010.01) <b>H01M 4/1393</b> (2010.01) <b>H01M 4/1397</b> (2010.01) <b>H01M 4/36</b> (2006.01) <b>H01M 4/38</b> (2006.01) <b>H01M 4/587</b> (2010.01) <b>H01M 4/62</b> (2006.01) <b>H01M 4/66</b> (2006.01)

Broj objave evropske prijava patenta (97)	MKP (51)
	<b>H01M 10/052</b> (2010.01)
3383353	<b>A61K 8/02</b> (2006.01) <b>A61K 8/19</b> (2006.01) <b>A61K 8/25</b> (2006.01) <b>A61Q 11/00</b> (2006.01)
3365094	<b>B01D 53/56</b> (2006.01) <b>B01D 53/60</b> (2006.01) <b>B01D 53/64</b> (2006.01) <b>B01D 53/78</b> (2006.01) <b>F23J 15/04</b> (2006.01)
3365366	<b>A61K 39/42</b> (2006.01) <b>C07K 16/10</b> (2006.01)
3368534	<b>A61K 31/4375</b> (2006.01) <b>A61P 25/00</b> (2006.01) <b>C07D 471/04</b> (2006.01)
3374519	<b>C12Q 1/68</b> (2018.01)
3371189	<b>A61K 31/4985</b> (2006.01) <b>A61P 35/00</b> (2006.01) <b>C07D 487/04</b> (2006.01)
3368026	<b>A61K 31/164</b> (2006.01) <b>A61K 31/337</b> (2006.01) <b>A61K 31/495</b> (2006.01) <b>A61K 31/505</b> (2006.01) <b>A61P 25/02</b> (2006.01)
3371208	<b>A61K 38/17</b> (2006.01) <b>C07K 14/705</b> (2006.01)
3371220	<b>A61K 39/395</b> (2006.01) <b>C07K 16/28</b> (2006.01)
3383939	<b>C08J 5/18</b> (2006.01) <b>C08K 3/26</b> (2006.01) <b>C08K 9/02</b> (2006.01) <b>C09C 1/02</b> (2006.01)
3377515	<b>A61K 38/06</b> (2006.01) <b>C07K 5/097</b> (2006.01)
3344555	<b>B65D 19/34</b> (2006.01)
3362555	<b>C12N 9/12</b> (2006.01) <b>C12N 15/62</b> (2006.01)
3380331	<b>B41M 3/14</b> (2006.01) <b>B41M 7/00</b> (2006.01) <b>D21H 21/30</b> (2006.01) <b>D21H 21/48</b> (2006.01)
3377528	<b>A61K 39/00</b> (2006.01) <b>A61K 39/395</b> (2006.01) <b>A61P 25/00</b> (2006.01)



Broj objave evropske prijava patenta (97)	MKP (51)
	<b>C07K 16/28</b> (2006.01)
3371593	<b>G01N 33/50</b> (2006.01) <b>G01N 33/573</b> (2006.01)
3253773	<b>A61K 31/7072</b> (2006.01) <b>A61K 31/7076</b> (2006.01) <b>A61K 31/708</b> (2006.01) <b>A61P 31/14</b> (2006.01) <b>C07H 19/067</b> (2006.01) <b>C07H 19/073</b> (2006.01) <b>C07H 19/10</b> (2006.01) <b>C07H 19/11</b> (2006.01) <b>C07H 19/173</b> (2006.01) <b>C07H 19/20</b> (2006.01) <b>C07H 19/213</b> (2006.01)
3247190	<b>A01C 15/04</b> (2006.01) <b>B65G 53/16</b> (2006.01) <b>B65G 53/52</b> (2006.01) <b>G01F 11/00</b> (2006.01)
3247191	<b>A01C 7/08</b> (2006.01) <b>A01C 7/10</b> (2006.01) <b>A01C 7/16</b> (2006.01) <b>A01C 15/00</b> (2006.01) <b>A01C 15/04</b> (2006.01) <b>A01C 15/16</b> (2006.01) <b>A01C 19/02</b> (2006.01) <b>G01F 13/00</b> (2006.01) <b>G05D 7/06</b> (2006.01) <b>G05D 11/12</b> (2006.01) <b>G05D 11/13</b> (2006.01)
3381916	<b>A61K 31/519</b> (2006.01) <b>A61K 31/55</b> (2006.01) <b>A61P 35/00</b> (2006.01) <b>A61P 43/00</b> (2006.01) <b>C07D 471/04</b> (2006.01) <b>C07D 519/00</b> (2006.01)
3381896	<b>A61K 31/40</b> (2006.01) <b>A61K 31/404</b> (2006.01) <b>A61K 31/407</b> (2006.01) <b>A61K 31/416</b> (2006.01) <b>A61K 31/4184</b> (2006.01) <b>C07D 207/04</b> (2006.01)
3383602	<b>A41D 19/015</b> (2006.01) <b>A61B 42/10</b> (2016.01) <b>A61B 42/50</b> (2016.01) <b>A61J 3/00</b> (2006.01) <b>B25J 21/02</b> (2006.01) <b>G21F 7/053</b> (2006.01)
3383774	<b>B60P 1/36</b> (2006.01) <b>B65G 17/06</b> (2006.01) <b>B65G 17/12</b> (2006.01) <b>B65G 17/26</b> (2006.01) <b>B65G 67/20</b> (2006.01) <b>B65G 67/24</b> (2006.01) <b>B65G 67/46</b> (2006.01)

Broj objave evropske prijava patenta (97)	MKP (51)
	<b>B66F 9/06</b> (2006.01)
3383412	<b>A61K 35/13</b> (2015.01) <b>A61K 39/395</b> (2006.01) <b>A61K 49/16</b> (2006.01) <b>C07K 16/18</b> (2006.01) <b>C07K 16/28</b> (2006.01) <b>C12P 21/08</b> (2006.01)
3383917	<b>A61K 31/55</b> (2006.01) <b>A61K 45/06</b> (2006.01) <b>A61P 35/02</b> (2006.01) <b>C07D 519/00</b> (2006.01) <b>C07K 16/30</b> (2006.01)
3383430	<b>A61K 39/395</b> (2006.01) <b>A61K 47/68</b> (2017.01) <b>C07K 16/28</b> (2006.01) <b>C07K 16/30</b> (2006.01)
3383431	<b>A61K 39/395</b> (2006.01) <b>C07K 16/28</b> (2006.01) <b>C07K 16/30</b> (2006.01)
3383170	<b>A01H 1/00</b> (2006.01) <b>A01H 5/10</b> (2018.01) <b>A24D 1/00</b> (2006.01) <b>C12N 15/63</b> (2006.01)
3383914	<b>A61K 39/395</b> (2006.01) <b>C07K 16/28</b> (2006.01) <b>G01N 33/68</b> (2006.01)
3393380	<b>A61B 17/29</b> (2006.01) <b>A61B 17/32</b> (2006.01)
3387425	<b>G01N 27/26</b> (2006.01) <b>G01N 33/24</b> (2006.01)
3388587	<b>E03D 1/24</b> (2006.01)
3387690	<b>B29C 70/72</b> (2006.01) <b>H01M 4/04</b> (2006.01) <b>H01M 4/20</b> (2006.01) <b>H01M 4/22</b> (2006.01) <b>H01M 4/68</b> (2006.01)
3388425	<b>A61K 31/421</b> (2006.01) <b>A61K 31/422</b> (2006.01) <b>A61K 31/4245</b> (2006.01) <b>A61K 31/426</b> (2006.01) <b>A61K 31/427</b> (2006.01) <b>A61K 31/428</b> (2006.01) <b>A61K 31/433</b> (2006.01) <b>A61K 31/4439</b> (2006.01) <b>A61K 31/454</b> (2006.01) <b>A61K 31/4709</b> (2006.01) <b>A61K 31/4725</b> (2006.01) <b>A61K 31/497</b> (2006.01) <b>A61K 31/498</b> (2006.01) <b>A61K 31/501</b> (2006.01) <b>A61K 31/5377</b> (2006.01)

Broj objave evropske prijava patenta (97)	MKP (51)
	<b>A61P 21/00</b> (2006.01) <b>A61P 21/04</b> (2006.01) <b>A61P 43/00</b> (2006.01) <b>C07C 335/12</b> (2006.01) <b>C07D 263/48</b> (2006.01)
3388501	<b>C10M 103/00</b> (2006.01) <b>C10M 103/02</b> (2006.01) <b>C10M 103/06</b> (2006.01) <b>C10M 107/04</b> (2006.01) <b>C10M 107/06</b> (2006.01) <b>C10M 107/38</b> (2006.01) <b>C10M 107/44</b> (2006.01) <b>C10M 107/50</b> (2006.01) <b>C10M 171/00</b> (2006.01) <b>C10N 50/08</b> (2006.01)
3386484	<b>A61K 9/127</b> (2006.01) <b>A61K 9/133</b> (2006.01) <b>A61K 31/7088</b> (2006.01) <b>C12N 15/88</b> (2006.01)
3387155	<b>C12Q 1/68</b> (2018.01) <b>G01N 33/574</b> (2006.01)
3387561	<b>G06F 15/16</b> (2006.01) <b>G06F 17/30</b> (2006.01)
3391897	<b>A61K 9/12</b> (2006.01) <b>A61K 38/00</b> (2006.01) <b>A61L 26/00</b> (2006.01) <b>A61P 7/04</b> (2006.01) <b>A61P 17/02</b> (2006.01) <b>A61P 43/00</b> (2006.01) <b>C07K 7/00</b> (2006.01)
3395801	<b>A01N 43/50</b> (2006.01) <b>A01N 43/56</b> (2006.01) <b>A01N 43/647</b> (2006.01) <b>A01N 43/653</b> (2006.01) <b>A01N 55/00</b> (2006.01) <b>A01P 7/02</b> (2006.01) <b>A01P 7/04</b> (2006.01) <b>A61K 31/415</b> (2006.01) <b>A61K 31/4164</b> (2006.01) <b>A61K 31/4178</b> (2006.01) <b>A61K 31/4192</b> (2006.01) <b>A61K 31/4196</b> (2006.01) <b>A61K 31/4439</b> (2006.01) <b>A61K 31/695</b> (2006.01) <b>A61P 33/10</b> (2006.01) <b>A61P 33/14</b> (2006.01) <b>C07D 231/12</b> (2006.01) <b>C07D 231/14</b> (2006.01) <b>C07D 231/38</b> (2006.01) <b>C07D 233/64</b> (2006.01) <b>C07D 233/68</b> (2006.01)
3392236	<b>C07C 231/10</b> (2006.01) <b>C07C 237/42</b> (2006.01)
3389714	<b>A61K 39/395</b> (2006.01) <b>C07K 16/28</b> (2006.01) <b>C07K 16/30</b> (2006.01)

Broj objave evropske prijava patenta (97)	MKP (51)
	<b>C07K 16/46</b> (2006.01)
3390357	<b>A61K 31/397</b> (2006.01) <b>A61P 31/04</b> (2006.01) <b>C07D 205/08</b> (2006.01)
3399989	<b>A61K 38/00</b> (2006.01) <b>A61K 39/00</b> (2006.01) <b>A61K 39/395</b> (2006.01) <b>C07K 16/28</b> (2006.01) <b>C12P 21/08</b> (2006.01)
3389719	<b>A61K 47/50</b> (2017.01) <b>A61P 21/00</b> (2006.01) <b>A61P 31/16</b> (2006.01)
3389657	<b>A61K 31/4433</b> (2006.01) <b>A61K 31/497</b> (2006.01) <b>A61P 1/10</b> (2006.01) <b>C07D 405/04</b> (2006.01)
3389699	<b>A61K 39/00</b> (2006.01) <b>A61K 39/395</b> (2006.01) <b>C07K 16/00</b> (2006.01) <b>C12P 21/08</b> (2006.01)
3389654	<b>A61K 31/425</b> (2006.01) <b>A61P 43/00</b> (2006.01) <b>C07C 311/15</b> (2006.01)
3389781	<b>A61P 9/10</b> (2006.01) <b>A61P 37/06</b> (2006.01) <b>C12N 5/071</b> (2010.01)
3389656	<b>A61K 31/165</b> (2006.01) <b>A61K 31/439</b> (2006.01) <b>A61K 31/444</b> (2006.01)
3389630	<b>A61K 9/10</b> (2006.01) <b>A61K 35/15</b> (2015.01) <b>A61K 39/00</b> (2006.01) <b>A61K 39/39</b> (2006.01) <b>A61K 39/395</b> (2006.01) <b>A61P 35/00</b> (2006.01)
3389705	<b>A61K 31/70</b> (2006.01) <b>A61K 31/7036</b> (2006.01) <b>A61K 39/00</b> (2006.01) <b>A61K 39/02</b> (2006.01)
3395857	<b>A61K 31/282</b> (2006.01) <b>A61K 31/555</b> (2006.01) <b>A61K 47/50</b> (2017.01) <b>A61P 35/00</b> (2006.01) <b>C08G 65/334</b> (2006.01) <b>C08G 69/08</b> (2006.01) <b>C08G 69/48</b> (2006.01) <b>C08G 81/00</b> (2006.01)
3395187	<b>A23L 29/206</b> (2016.01) <b>A23L 33/135</b> (2016.01)

Broj objave evropske prijava patenta (97)	MKP (51)
	<b>A23L 33/175</b> (2016.01)
3395345	<b>A61K 31/167</b> (2006.01) <b>A61K 31/282</b> (2006.01) <b>A61K 31/337</b> (2006.01) <b>A61K 31/357</b> (2006.01) <b>A61K 31/4045</b> (2006.01) <b>A61K 31/4164</b> (2006.01) <b>A61K 31/436</b> (2006.01) <b>A61K 31/44</b> (2006.01) <b>A61K 31/454</b> (2006.01) <b>A61K 31/4545</b> (2006.01) <b>A61K 31/47</b> (2006.01) <b>A61K 31/4709</b> (2006.01) <b>A61K 31/473</b> (2006.01) <b>A61K 31/4747</b> (2006.01) <b>A61K 31/497</b> (2006.01) <b>A61K 31/502</b> (2006.01) <b>A61K 31/5025</b> (2006.01) <b>A61K 31/513</b> (2006.01) <b>A61K 31/519</b> (2006.01) <b>A61K 31/52</b> (2006.01)
3393655	<b>B01J 23/72</b> (2006.01) <b>B01J 27/055</b> (2006.01) <b>B01J 27/122</b> (2006.01) <b>B01J 27/25</b> (2006.01) <b>C07C 45/54</b> (2006.01) <b>C07C 49/223</b> (2006.01)
3394106	<b>A61K 31/551</b> (2006.01) <b>A61K 47/68</b> (2017.01) <b>C07K 16/40</b> (2006.01)
3394107	<b>A61K 31/551</b> (2006.01) <b>A61K 47/68</b> (2017.01) <b>C07K 16/40</b> (2006.01)
3393516	<b>A61K 39/395</b> (2006.01) <b>A61P 35/00</b> (2006.01)
3393458	<b>A61K 31/00</b> (2006.01) <b>A61K 31/33</b> (2006.01) <b>A61K 31/395</b> (2006.01) <b>A61K 31/495</b> (2006.01) <b>A61K 31/505</b> (2006.01)
3394589	<b>G01N 1/00</b> (2006.01)
3398980	<b>C08G 18/00</b> (2006.01) <b>C08G 18/10</b> (2006.01) <b>C08G 18/44</b> (2006.01) <b>C08G 18/48</b> (2006.01) <b>C08G 18/65</b> (2006.01) <b>C08L 75/04</b> (2006.01) <b>D06M 15/564</b> (2006.01)
3394047	<b>A61K 31/131</b> (2006.01) <b>A61K 31/282</b> (2006.01) <b>A61K 31/337</b> (2006.01) <b>A61K 31/409</b> (2006.01) <b>A61K 31/506</b> (2006.01) <b>A61K 31/517</b> (2006.01)

Broj objave evropske prijave patenta (97)	MKP (51)
	<b>A61K 31/519</b> (2006.01) <b>A61K 31/5377</b> (2006.01) <b>A61K 31/7068</b> (2006.01) <b>A61K 39/395</b> (2006.01) <b>A61P 35/00</b> (2006.01) <b>C07B 59/00</b> (2006.01) <b>C07D 403/04</b> (2006.01)
3397282	<b>A61K 39/395</b> (2006.01) <b>C12P 21/00</b> (2006.01) <b>G01N 33/68</b> (2006.01)
3397625	<b>A61K 31/496</b> (2006.01) <b>A61K 31/551</b> (2006.01) <b>C07D 333/38</b> (2006.01)
3400137	<b>B41J 2/045</b> (2006.01)
3418274	<b>A61K 31/352</b> (2006.01) <b>A61K 36/41</b> (2006.01) <b>C07D 311/30</b> (2006.01)
3406714	<b>C12N 5/00</b> (2006.01) <b>C12N 5/09</b> (2010.01) <b>C12N 5/095</b> (2010.01) <b>G01N 33/574</b> (2006.01)
3415326	<b>B41J 2/175</b> (2006.01)
3366841	<b>E01F 15/00</b> (2006.01) <b>E01F 15/14</b> (2006.01)
3372107	<b>A41D 19/00</b> (2006.01) <b>A45D 33/00</b> (2006.01) <b>A45D 34/04</b> (2006.01) <b>A45D 44/00</b> (2006.01) <b>A47K 7/02</b> (2006.01)
3258314	<b>G01S 7/481</b> (2006.01) <b>G02B 27/00</b> (2006.01) <b>G03B 11/04</b> (2006.01) <b>G03B 15/04</b> (2006.01) <b>G03B 17/02</b> (2006.01)
3381823	<b>B65C 9/18</b> (2006.01)
3269901	<b>B32B 5/26</b> (2006.01) <b>B32B 27/12</b> (2006.01) <b>D04H 1/4218</b> (2012.01) <b>E04H 15/54</b> (2006.01)
3299529	<b>B23B 49/00</b> (2006.01) <b>B23B 51/04</b> (2006.01) <b>E04B 1/76</b> (2006.01)
3299444	<b>C11C 3/00</b> (2006.01)
3331094	<b>H01Q 1/22</b> (2006.01) <b>H01Q 1/52</b> (2006.01) <b>H01Q 3/30</b> (2006.01) <b>H01Q 5/35</b> (2015.01)

Broj objave evropske prijava patenta (97)	MKP (51)
	<b>H01Q 9/04</b> (2006.01) <b>H01Q 21/28</b> (2006.01)
3258999	<b>A61M 16/00</b> (2006.01) <b>A61M 16/12</b> (2006.01)
3368066	<b>A61K 39/00</b> (2006.01) <b>A61K 39/395</b> (2006.01) <b>C07K 16/18</b> (2006.01) <b>C07K 16/24</b> (2006.01) <b>C07K 16/26</b> (2006.01)
3257192	<b>H04L 9/08</b> (2006.01) <b>H04L 9/32</b> (2006.01) <b>H04L 29/06</b> (2006.01) <b>H04L 29/12</b> (2006.01)
3256481	<b>C07F 5/05</b> (2006.01)
3256571	<b>C12N 7/00</b> (2006.01)
3257009	<b>C07C 51/09</b> (2006.01) <b>C08F 122/02</b> (2006.01) <b>G06Q 30/02</b> (2012.01)
3256442	<b>C07C 51/12</b> (2006.01) <b>C07C 51/14</b> (2006.01) <b>C07C 51/145</b> (2006.01) <b>C07C 51/16</b> (2006.01) <b>C07C 51/377</b> (2006.01) <b>C07C 57/04</b> (2006.01) <b>C07C 59/01</b> (2006.01) <b>C08F 2/01</b> (2006.01) <b>C08F 2/18</b> (2006.01) <b>C08F 20/00</b> (2006.01) <b>C08F 20/06</b> (2006.01)
3256443	<b>C07C 29/147</b> (2006.01) <b>C07C 51/09</b> (2006.01) <b>C07C 57/04</b> (2006.01) <b>C07C 67/00</b> (2006.01) <b>C07C 67/03</b> (2006.01) <b>C07C 69/54</b> (2006.01) <b>C07D 301/02</b> (2006.01) <b>C07D 305/12</b> (2006.01) <b>C07D 307/60</b> (2006.01) <b>C08G 63/78</b> (2006.01)
3256439	<b>C07C 51/09</b> (2006.01) <b>C07C 57/04</b> (2006.01)
3256440	<b>B01J 19/24</b> (2006.01) <b>C07C 51/09</b> (2006.01) <b>C07C 57/04</b> (2006.01) <b>C08G 63/08</b> (2006.01) <b>C08G 63/82</b> (2006.01)
3256454	<b>C07D 305/12</b> (2006.01) <b>C07D 307/60</b> (2006.01)
3256084	<b>A61B 3/117</b> (2006.01) <b>A61B 3/14</b> (2006.01)

Broj objave evropske prijava patenta (97)	MKP (51)
	<b>A61F 9/00</b> (2006.01) <b>A61F 9/007</b> (2006.01)
3347349	<b>A61K 31/4155</b> (2006.01) <b>A61K 31/416</b> (2006.01) <b>A61K 31/427</b> (2006.01) <b>A61K 31/428</b> (2006.01) <b>A61K 31/4439</b> (2006.01) <b>A61K 31/4545</b> (2006.01) <b>A61P 25/00</b> (2006.01) <b>C07D 401/06</b> (2006.01) <b>C07D 401/12</b> (2006.01) <b>C07D 401/14</b> (2006.01) <b>C07D 403/06</b> (2006.01) <b>C07D 403/14</b> (2006.01) <b>C07D 417/06</b> (2006.01) <b>C07D 417/14</b> (2006.01)
3347579	<b>F01N 1/16</b> (2006.01) <b>F01N 3/00</b> (2006.01) <b>F01N 9/00</b> (2006.01) <b>F01N 13/04</b> (2010.01) <b>F01N 13/08</b> (2010.01)
3380109	<b>A61K 36/04</b> (2006.01) <b>A61K 36/09</b> (2006.01) <b>A61K 36/185</b> (2006.01) <b>A61K 36/48</b> (2006.01) <b>A61K 36/68</b> (2006.01) <b>A61K 36/73</b> (2006.01) <b>A61K 36/888</b> (2006.01) <b>A61K 36/8988</b> (2006.01)
3259253	<b>C07C 311/54</b> (2006.01) <b>C07C 311/56</b> (2006.01) <b>C07D 213/71</b> (2006.01) <b>C07D 217/22</b> (2006.01) <b>C07D 231/18</b> (2006.01) <b>C07D 249/04</b> (2006.01) <b>C07D 249/12</b> (2006.01) <b>C07D 271/12</b> (2006.01) <b>C07D 277/36</b> (2006.01) <b>C07D 307/18</b> (2006.01) <b>C07D 307/64</b> (2006.01) <b>C07D 307/82</b> (2006.01) <b>C07D 309/08</b> (2006.01) <b>C07D 311/60</b> (2006.01) <b>C07D 333/34</b> (2006.01) <b>C07D 333/62</b> (2006.01) <b>C07D 403/12</b> (2006.01) <b>C07D 405/12</b> (2006.01) <b>C07D 407/12</b> (2006.01) <b>C07D 417/12</b> (2006.01)
3259992	<b>A01N 25/04</b> (2006.01) <b>A01N 25/22</b> (2006.01) <b>A01N 43/90</b> (2006.01) <b>A01P 7/02</b> (2006.01)
3258965	<b>A61K 31/69</b> (2006.01) <b>A61K 39/395</b> (2006.01) <b>A61K 45/06</b> (2006.01) <b>A61P 35/00</b> (2006.01) <b>C07K 16/00</b> (2006.01)



Broj objave evropske prijava patenta (97)	MKP (51)
	<b>C07K 16/18</b> (2006.01)
3258962	<b>A61K 9/20</b> (2006.01) <b>A61K 31/07</b> (2006.01) <b>A61K 31/375</b> (2006.01) <b>A61K 39/35</b> (2006.01) <b>A61P 37/08</b> (2006.01)
3260132	<b>A61K 38/37</b> (2006.01) <b>A61P 7/04</b> (2006.01) <b>C07K 14/755</b> (2006.01) <b>G01N 33/50</b> (2006.01) <b>G01N 33/569</b> (2006.01)
3266456	<b>A61K 9/00</b> (2006.01) <b>A61K 9/127</b> (2006.01) <b>A61K 31/4745</b> (2006.01) <b>A61K 31/513</b> (2006.01) <b>A61K 31/519</b> (2006.01) <b>A61K 45/06</b> (2006.01) <b>A61P 35/00</b> (2006.01)
3284744	<b>A61K 31/437</b> (2006.01) <b>A61K 31/444</b> (2006.01) <b>A61K 31/4545</b> (2006.01) <b>A61K 31/496</b> (2006.01) <b>A61K 31/5377</b> (2006.01) <b>A61P 19/00</b> (2006.01) <b>A61P 25/28</b> (2006.01) <b>A61P 31/10</b> (2006.01) <b>A61P 31/12</b> (2006.01) <b>A61P 35/00</b> (2006.01) <b>C07D 471/04</b> (2006.01)
3257776	<b>B65D 30/18</b> (2006.01) <b>B65D 30/20</b> (2006.01) <b>B65D 33/06</b> (2006.01) <b>B65D 33/10</b> (2006.01)
3400810	<b>A23K 20/24</b> (2016.01) <b>A23L 29/00</b> (2016.01) <b>A23P 10/43</b> (2016.01) <b>A61K 33/10</b> (2006.01) <b>C09C 1/02</b> (2006.01)
3254695	<b>A61K 39/395</b> (2006.01) <b>A61K 45/06</b> (2006.01) <b>C07K 16/30</b> (2006.01)
3403505	<b>A01N 59/00</b> (2006.01) <b>A01N 59/16</b> (2006.01) <b>A01P 3/00</b> (2006.01)
3251700	<b>A61K 48/00</b> (2006.01) <b>C07H 21/04</b> (2006.01)
3290428	<b>A61K 31/664</b> (2006.01) <b>A61K 31/7072</b> (2006.01) <b>A61K 31/716</b> (2006.01) <b>A61P 31/14</b> (2006.01) <b>C07F 9/22</b> (2006.01) <b>C07F 9/24</b> (2006.01) <b>C07F 9/6558</b> (2006.01)

Broj objave evropske prijava patenta (97)	MKP (51)
	<b>C07H 19/073</b> (2006.01) <b>C07H 19/10</b> (2006.01)
3406455	<b>B41M 3/00</b> (2006.01) <b>B41M 3/14</b> (2006.01) <b>C09D 11/54</b> (2014.01)
3275896	<b>C07K 16/00</b> (2006.01)
3400950	<b>A61K 9/08</b> (2006.01) <b>A61K 31/728</b> (2006.01) <b>A61K 31/737</b> (2006.01) <b>A61P 13/10</b> (2006.01) <b>A61P 29/00</b> (2006.01)
3400951	<b>A61K 9/08</b> (2006.01) <b>A61K 31/728</b> (2006.01) <b>A61K 31/737</b> (2006.01) <b>A61P 13/10</b> (2006.01) <b>A61P 29/00</b> (2006.01)
3400949	<b>A61K 31/728</b> (2006.01) <b>A61K 31/737</b> (2006.01) <b>A61P 13/10</b> (2006.01)
3254612	<b>A61B 5/00</b> (2006.01) <b>A61B 17/00</b> (2006.01) <b>A61B 18/00</b> (2006.01)
3263597	<b>C07K 16/00</b> (2006.01) <b>C07K 16/10</b> (2006.01) <b>C07K 16/28</b> (2006.01) <b>C07K 16/30</b> (2006.01) <b>C07K 16/46</b> (2006.01)
3254614	<b>A61B 5/00</b> (2006.01) <b>A61B 5/042</b> (2006.01) <b>A61B 5/06</b> (2006.01)
3254618	<b>A61B 5/00</b> (2006.01) <b>A61B 5/04</b> (2006.01) <b>A61B 5/042</b> (2006.01) <b>A61B 5/044</b> (2006.01) <b>A61B 5/0452</b> (2006.01) <b>A61B 5/046</b> (2006.01)
3257847	<b>A61K 31/422</b> (2006.01) <b>A61K 31/4439</b> (2006.01) <b>A61P 1/16</b> (2006.01) <b>A61P 3/04</b> (2006.01) <b>A61P 3/10</b> (2006.01) <b>A61P 29/00</b> (2006.01) <b>A61P 35/00</b> (2006.01) <b>C07D 401/14</b> (2006.01) <b>C07D 413/12</b> (2006.01) <b>C07D 413/14</b> (2006.01)
3293456	<b>F23D 14/22</b> (2006.01) <b>F23L 7/00</b> (2006.01) <b>F23Q 1/02</b> (2006.01)

Broj objave evropske prijave patenta (97)	MKP (51)
3260735	<b>B66F 3/06</b> (2006.01) <b>F16G 13/20</b> (2006.01) <b>F16H 19/06</b> (2006.01)
3258132	<b>B66F 3/06</b> (2006.01) <b>F16G 13/20</b> (2006.01) <b>F16H 19/06</b> (2006.01)
3415570	<b>C08K 9/00</b> (2006.01) <b>C09C 1/02</b> (2006.01)
3252069	<b>A61K 31/567</b> (2006.01) <b>A61K 31/573</b> (2006.01) <b>A61P 5/36</b> (2006.01) <b>C07J 31/00</b> (2006.01) <b>C07J 41/00</b> (2006.01)
3309151	<b>A61K 31/497</b> (2006.01) <b>C07D 215/227</b> (2006.01) <b>C07D 263/58</b> (2006.01) <b>C07D 401/12</b> (2006.01) <b>C07D 417/12</b> (2006.01) <b>C07D 471/04</b> (2006.01) <b>C07F 9/6558</b> (2006.01)
3251678	<b>A61K 31/69</b> (2006.01) <b>A61P 31/04</b> (2006.01) <b>C07F 5/02</b> (2006.01)
3266952	<b>E04D 3/363</b> (2006.01)
3275903	<b>C07K 16/36</b> (2006.01)
3270474	<b>H01T 1/22</b> (2006.01) <b>H01T 4/12</b> (2006.01)
3260803	<b>F01K 1/04</b> (2006.01) <b>F28D 20/00</b> (2006.01) <b>F28D 20/02</b> (2006.01)
3418064	<b>B41M 3/00</b> (2006.01) <b>B41M 3/14</b> (2006.01) <b>B41M 5/323</b> (2006.01)
3258446	<b>G06F 3/048</b> (2013.01) <b>G06T 19/20</b> (2011.01)
3260521	<b>C10B 53/02</b> (2006.01) <b>C10J 3/26</b> (2006.01)
3263221	<b>B01D 21/00</b> (2006.01) <b>B03C 1/28</b> (2006.01) <b>F24D 19/00</b> (2006.01)
3165487	<b>B65H 51/10</b> (2006.01) <b>B65H 51/32</b> (2006.01) <b>H01R 43/052</b> (2006.01)

Broj objave evropske prijava patenta (97)	MKP (51)
3377240	<b>B21D 7/024</b> (2006.01) <b>B21D 7/12</b> (2006.01)
3390958	<b>F42B 5/02</b> (2006.01) <b>F42B 5/03</b> (2006.01) <b>F42B 8/14</b> (2006.01) <b>F42B 12/06</b> (2006.01) <b>F42B 12/36</b> (2006.01)
3390384	<b>A61K 31/4709</b> (2006.01) <b>A61P 21/00</b> (2006.01) <b>C07D 215/20</b> (2006.01) <b>C07D 215/54</b> (2006.01) <b>C07D 401/04</b> (2006.01) <b>C07D 401/12</b> (2006.01) <b>C07D 401/14</b> (2006.01) <b>C07D 405/12</b> (2006.01) <b>C07D 413/12</b> (2006.01) <b>C07D 413/14</b> (2006.01) <b>C07D 417/12</b> (2006.01) <b>C07D 491/048</b> (2006.01)
3377482	<b>C07D 217/04</b> (2006.01) <b>C07D 217/16</b> (2006.01) <b>C07D 217/24</b> (2006.01) <b>C07D 231/56</b> (2006.01) <b>C07D 239/88</b> (2006.01) <b>C07D 401/04</b> (2006.01) <b>C07D 401/06</b> (2006.01) <b>C07D 401/12</b> (2006.01) <b>C07D 401/14</b> (2006.01) <b>C07D 405/12</b> (2006.01) <b>C07D 471/04</b> (2006.01) <b>C07D 495/04</b> (2006.01)
3386956	<b>A61K 31/335</b> (2006.01) <b>A61P 35/00</b> (2006.01) <b>A61P 37/00</b> (2006.01) <b>C07D 303/46</b> (2006.01)
3398346	<b>H04L 29/06</b> (2006.01) <b>H04N 21/218</b> (2011.01) <b>H04N 21/2343</b> (2011.01) <b>H04N 21/262</b> (2011.01) <b>H04N 21/845</b> (2011.01) <b>H04N 21/854</b> (2011.01)
3393997	<b>C04B 11/00</b> (2006.01) <b>C04B 28/14</b> (2006.01)
3390395	<b>A61K 31/415</b> (2006.01) <b>A61K 31/4155</b> (2006.01) <b>A61P 35/00</b> (2006.01) <b>C07D 231/14</b> (2006.01) <b>C07D 401/04</b> (2006.01) <b>C07D 401/06</b> (2006.01) <b>C07D 403/04</b> (2006.01) <b>C07D 405/04</b> (2006.01) <b>C07D 405/06</b> (2006.01) <b>C07D 405/08</b> (2006.01) <b>C07D 405/14</b> (2006.01) <b>C07D 413/06</b> (2006.01)

Broj objave evropske prijava patenta (97)	MKP (51)
3390391	<b>A61K 31/4025</b> (2006.01) <b>A61K 31/407</b> (2006.01) <b>A61P 25/28</b> (2006.01) <b>A61P 35/00</b> (2006.01) <b>C07D 207/09</b> (2006.01) <b>C07D 401/12</b> (2006.01) <b>C07D 403/12</b> (2006.01) <b>C07D 403/14</b> (2006.01) <b>C07D 413/12</b> (2006.01) <b>C07D 417/12</b> (2006.01) <b>C07D 417/14</b> (2006.01) <b>C07D 471/04</b> (2006.01) <b>C07D 487/04</b> (2006.01)
3383372	<b>A61K 9/16</b> (2006.01) <b>A61K 9/20</b> (2006.01) <b>A61K 31/506</b> (2006.01) <b>A61P 9/00</b> (2006.01)
3389660	<b>A61K 31/4745</b> (2006.01) <b>A61K 31/497</b> (2006.01) <b>A61P 35/00</b> (2006.01)
3405471	<b>A61K 31/519</b> (2006.01) <b>A61K 31/661</b> (2006.01) <b>A61P 35/00</b> (2006.01) <b>C07D 495/04</b> (2006.01) <b>C07F 9/6561</b> (2006.01)
3377087	<b>A61K 38/17</b> (2006.01) <b>A61P 35/00</b> (2006.01)
3383433	<b>A61K 31/454</b> (2006.01) <b>A61K 45/06</b> (2006.01) <b>A61P 35/00</b> (2006.01) <b>A61P 35/02</b> (2006.01)
3394271	<b>C12N 15/867</b> (2006.01)
3383909	<b>A61K 47/68</b> (2017.01) <b>A61P 35/00</b> (2006.01) <b>C07K 16/28</b> (2006.01) <b>C07K 16/30</b> (2006.01)
3390405	<b>A61K 31/519</b> (2006.01) <b>A61P 11/00</b> (2006.01) <b>A61P 11/06</b> (2006.01) <b>A61P 37/08</b> (2006.01) <b>C07D 487/04</b> (2006.01)
3393239	<b>A01N 25/04</b> (2006.01) <b>A01N 43/90</b> (2006.01) <b>A01N 59/06</b> (2006.01) <b>A01N 65/20</b> (2009.01)
3344674	<b>B41M 5/28</b> (2006.01) <b>C08G 18/10</b> (2006.01) <b>C08G 18/18</b> (2006.01) <b>C08G 18/24</b> (2006.01) <b>C08G 18/32</b> (2006.01) <b>C08G 18/42</b> (2006.01) <b>C08G 18/76</b> (2006.01)

Broj objave evropske prijava patenta (97)	MKP (51)
3386950	<b>C07D 209/46</b> (2006.01) <b>C07D 217/24</b> (2006.01) <b>C07D 239/88</b> (2006.01) <b>C07D 253/08</b> (2006.01) <b>C07D 401/04</b> (2006.01) <b>C07D 401/10</b> (2006.01) <b>C07D 403/10</b> (2006.01) <b>C07D 405/04</b> (2006.01) <b>C07D 409/04</b> (2006.01) <b>C07D 417/04</b> (2006.01)
3383910	<b>A61K 47/68</b> (2017.01) <b>C07K 16/28</b> (2006.01) <b>C07K 16/30</b> (2006.01)
3371424	<b>F01N 1/08</b> (2006.01)
3394051	<b>A61K 31/381</b> (2006.01) <b>A61P 5/00</b> (2006.01) <b>C07D 409/10</b> (2006.01)
3393478	<b>A61K 31/7068</b> (2006.01) <b>A61K 33/00</b> (2006.01) <b>A61P 35/00</b> (2006.01)
3383365	<b>A61K 9/00</b> (2006.01) <b>A61K 47/38</b> (2006.01) <b>A61M 31/00</b> (2006.01)
3393240	<b>A01C 7/06</b> (2006.01) <b>A01C 7/20</b> (2006.01) <b>A01N 25/16</b> (2006.01) <b>A01N 53/00</b> (2006.01) <b>A01N 63/00</b> (2006.01)
3386573	<b>A61M 5/50</b> (2006.01) <b>G06F 19/00</b> (2018.01)
3386991	<b>A61K 31/519</b> (2006.01) <b>A61P 19/00</b> (2006.01) <b>A61P 35/00</b> (2006.01) <b>A61P 37/00</b> (2006.01) <b>C07D 495/16</b> (2006.01) <b>C07D 519/00</b> (2006.01)
3386992	<b>A61K 31/519</b> (2006.01) <b>A61P 35/00</b> (2006.01) <b>C07D 495/16</b> (2006.01)
3397279	<b>A61K 39/02</b> (2006.01) <b>A61K 39/12</b> (2006.01)
3389710	<b>A61K 38/17</b> (2006.01) <b>A61K 39/395</b> (2006.01) <b>C07K 16/28</b> (2006.01)
3394044	<b>A61K 31/4433</b> (2006.01) <b>A61P 35/00</b> (2006.01) <b>A61P 37/00</b> (2006.01) <b>C07D 239/42</b> (2006.01) <b>C07D 401/10</b> (2006.01) <b>C07D 401/12</b> (2006.01)

Broj objave evropske prijava patenta (97)	MKP (51)
	<b>C07D 401/14</b> (2006.01) <b>C07D 405/12</b> (2006.01) <b>C07D 413/12</b> (2006.01) <b>C07D 413/14</b> (2006.01)
3390396	<b>A61K 31/4035</b> (2006.01) <b>A61P 1/04</b> (2006.01) <b>A61P 1/18</b> (2006.01) <b>A61P 11/06</b> (2006.01) <b>A61P 11/12</b> (2006.01) <b>A61P 17/06</b> (2006.01) <b>A61P 37/00</b> (2006.01) <b>C07D 209/44</b> (2006.01) <b>C07D 407/06</b> (2006.01)
3394285	<b>C12Q 1/66</b> (2006.01)
3374069	<b>B01F 3/04</b> (2006.01) <b>B01F 5/06</b> (2006.01) <b>B01F 15/00</b> (2006.01)
3386513	<b>A61K 31/5377</b> (2006.01) <b>A61P 35/02</b> (2006.01) <b>C12Q 1/68</b> (2018.01)
3390374	<b>A61K 31/4168</b> (2006.01) <b>A61K 31/4178</b> (2006.01) <b>A61K 31/4196</b> (2006.01) <b>A61K 31/551</b> (2006.01) <b>A61P 11/14</b> (2006.01) <b>A61P 29/00</b> (2006.01) <b>C07D 277/52</b> (2006.01) <b>C07D 285/08</b> (2006.01) <b>C07D 417/12</b> (2006.01)
3390400	<b>A61K 31/513</b> (2006.01) <b>A61P 9/00</b> (2006.01) <b>C07D 403/04</b> (2006.01) <b>C07D 413/04</b> (2006.01) <b>C07D 413/14</b> (2006.01) <b>C07D 417/14</b> (2006.01)
3390449	<b>C07K 16/00</b> (2006.01) <b>C07K 16/28</b> (2006.01) <b>C07K 16/44</b> (2006.01)
3390447	<b>A61K 39/00</b> (2006.01) <b>C07K 16/26</b> (2006.01)
3389659	<b>A61K 31/47</b> (2006.01) <b>A61K 31/4709</b> (2006.01) <b>A61P 31/04</b> (2006.01) <b>A61P 31/06</b> (2006.01)
3394049	<b>A61K 31/40</b> (2006.01) <b>A61P 35/00</b> (2006.01) <b>C07D 207/10</b> (2006.01) <b>C07D 403/12</b> (2006.01) <b>C07D 413/12</b> (2006.01) <b>C07D 413/14</b> (2006.01) <b>C07D 417/12</b> (2006.01)

Broj objave evropske prijave patenta (97)	MKP (51)
	<b>C07D 417/14</b> (2006.01)
3393453	<b>A61K 9/00</b> (2006.01) <b>A61K 9/08</b> (2006.01) <b>A61K 31/7072</b> (2006.01) <b>A61K 31/7076</b> (2006.01) <b>A61P 35/00</b> (2006.01)
3384207	<b>F23C 99/00</b> (2006.01)
3390430	<b>C07K 14/16</b> (2006.01)
3383552	<b>B01D 46/32</b> (2006.01) <b>B05B 15/12</b> (2006.01)
3384294	<b>G01N 33/68</b> (2006.01)
3390644	<b>A01K 67/027</b> (2006.01) <b>A61K 48/00</b> (2006.01) <b>C12N 9/12</b> (2006.01) <b>C12N 15/86</b> (2006.01)
3394270	<b>A61K 48/00</b> (2006.01) <b>A61P 21/00</b> (2006.01) <b>C12N 15/864</b> (2006.01)
3390444	<b>C07K 16/24</b> (2006.01)
3390630	<b>A61K 9/127</b> (2006.01) <b>A61K 31/7088</b> (2006.01) <b>A61P 3/00</b> (2006.01) <b>C12N 9/90</b> (2006.01) <b>C12N 15/61</b> (2006.01)
3390445	<b>C07K 16/18</b> (2006.01) <b>C07K 16/24</b> (2006.01)
3370507	<b>A01H 1/04</b> (2006.01) <b>A01H 5/10</b> (2018.01) <b>C07K 14/415</b> (2006.01) <b>C12N 15/82</b> (2006.01) <b>C12Q 1/68</b> (2018.01)
3389728	<b>A61K 51/04</b> (2006.01) <b>A61K 101/02</b> (2006.01) <b>C07B 59/00</b> (2006.01) <b>C07D 487/04</b> (2006.01)
3387129	<b>A61K 31/713</b> (2006.01) <b>A61P 3/06</b> (2006.01) <b>C12N 15/113</b> (2010.01)
3389399	<b>A23K 10/18</b> (2016.01) <b>A23K 20/147</b> (2016.01) <b>A23K 20/24</b> (2016.01) <b>A23K 40/10</b> (2016.01) <b>A23L 3/46</b> (2006.01) <b>A23L 29/00</b> (2016.01) <b>A23L 29/281</b> (2016.01) <b>A23L 29/294</b> (2016.01) <b>A23L 33/135</b> (2016.01)



Broj objave evropske prijava patenta (97)	MKP (51)
	<b>A23P 10/20</b> (2016.01) <b>A23P 10/30</b> (2016.01) <b>A61K 9/00</b> (2006.01) <b>A61K 9/16</b> (2006.01) <b>A61K 39/00</b> (2006.01) <b>A61K 39/02</b> (2006.01) <b>A61K 47/02</b> (2006.01) <b>A61K 47/42</b> (2017.01)
3397631	<b>A61K 31/506</b> (2006.01) <b>A61P 3/06</b> (2006.01) <b>A61P 3/10</b> (2006.01) <b>A61P 7/02</b> (2006.01) <b>A61P 9/00</b> (2006.01) <b>A61P 25/02</b> (2006.01) <b>A61P 25/30</b> (2006.01) <b>A61P 35/00</b> (2006.01) <b>A61P 37/00</b> (2006.01) <b>C07D 401/14</b> (2006.01) <b>C07D 403/04</b> (2006.01) <b>C07D 403/14</b> (2006.01)
3397176	<b>A61B 17/064</b> (2006.01) <b>A61B 17/068</b> (2006.01) <b>A61B 17/29</b> (2006.01) <b>A61B 90/00</b> (2016.01) <b>A61F 2/00</b> (2006.01)
3368532	<b>A61K 31/4025</b> (2006.01) <b>A61P 25/28</b> (2006.01) <b>C07D 405/14</b> (2006.01)
3394053	<b>A61K 31/381</b> (2006.01) <b>A61K 31/4025</b> (2006.01) <b>A61K 31/4155</b> (2006.01) <b>A61K 31/4436</b> (2006.01) <b>A61K 31/4535</b> (2006.01) <b>A61K 31/5355</b> (2006.01) <b>A61K 31/5377</b> (2006.01) <b>A61P 11/00</b> (2006.01) <b>A61P 13/00</b> (2006.01) <b>A61P 29/00</b> (2006.01) <b>C07D 277/56</b> (2006.01) <b>C07D 417/06</b> (2006.01)
3389400	<b>A21D 13/06</b> (2017.01) <b>A21D 13/066</b> (2017.01) <b>A23L 5/20</b> (2016.01) <b>A23L 5/30</b> (2016.01) <b>A23L 7/10</b> (2016.01) <b>A23L 7/196</b> (2016.01) <b>C12C 1/02</b> (2006.01)
3394259	<b>C12N 15/113</b> (2010.01)
3397557	<b>A61F 13/20</b> (2006.01) <b>B65B 11/32</b> (2006.01) <b>B65B 19/00</b> (2006.01) <b>B65B 47/06</b> (2006.01) <b>B65B 49/12</b> (2006.01)
3386533	<b>A61K 31/7105</b> (2006.01) <b>A61K 31/7115</b> (2006.01) <b>A61K 38/45</b> (2006.01)

Broj objave evropske prijava patenta (97)	MKP (51)
	<b>A61P 3/00</b> (2006.01)
3397182	<b>A61B 17/00</b> (2006.01) <b>A61B 17/29</b> (2006.01) <b>A61B 17/32</b> (2006.01) <b>A61B 18/14</b> (2006.01)
3393377	<b>A46B 15/00</b> (2006.01) <b>A61B 17/28</b> (2006.01) <b>A61B 17/32</b> (2006.01)
3390392	<b>A61K 31/4704</b> (2006.01) <b>A61P 29/00</b> (2006.01) <b>C07D 403/12</b> (2006.01) <b>C07D 413/12</b> (2006.01)
3390393	<b>A61K 31/4704</b> (2006.01) <b>C07D 215/36</b> (2006.01) <b>C07D 241/44</b> (2006.01) <b>C07D 403/12</b> (2006.01) <b>C07D 413/12</b> (2006.01) <b>C07D 413/14</b> (2006.01) <b>C07D 417/12</b> (2006.01)
3394067	<b>A61K 31/519</b> (2006.01) <b>A61P 9/00</b> (2006.01) <b>A61P 9/04</b> (2006.01) <b>A61P 9/10</b> (2006.01) <b>A61P 9/12</b> (2006.01) <b>C07D 487/04</b> (2006.01)
3393555	<b>A61M 5/142</b> (2006.01) <b>A61M 5/24</b> (2006.01)
3394056	<b>A61K 31/519</b> (2006.01) <b>A61P 29/00</b> (2006.01) <b>A61P 35/00</b> (2006.01) <b>C07D 221/04</b> (2006.01) <b>C07D 239/94</b> (2006.01) <b>C07D 401/04</b> (2006.01) <b>C07D 401/12</b> (2006.01) <b>C07D 401/14</b> (2006.01) <b>C07D 407/14</b> (2006.01) <b>C07D 409/14</b> (2006.01) <b>C07D 413/14</b> (2006.01) <b>C07D 471/04</b> (2006.01) <b>C07D 473/30</b> (2006.01) <b>C07D 495/04</b> (2006.01) <b>C07D 495/14</b> (2006.01)
3393465	<b>A61K 31/34</b> (2006.01) <b>A61K 31/341</b> (2006.01) <b>A61K 31/42</b> (2006.01) <b>A61K 31/422</b> (2006.01) <b>A61K 31/4245</b> (2006.01) <b>A61K 31/5377</b> (2006.01) <b>A61P 11/00</b> (2006.01)
3394057	<b>C07D 471/04</b> (2006.01)
3390433	<b>C07K 14/54</b> (2006.01) <b>C07K 14/705</b> (2006.01)

Broj objave evropske prijava patenta (97)	MKP (51)
	<b>C12N 15/62</b> (2006.01)
3394058	<b>A61K 31/437</b> (2006.01) <b>A61P 11/00</b> (2006.01) <b>A61P 11/06</b> (2006.01) <b>C07D 471/04</b> (2006.01)
3394059	<b>A61K 31/437</b> (2006.01) <b>A61P 11/00</b> (2006.01) <b>A61P 11/06</b> (2006.01) <b>C07D 471/04</b> (2006.01)
3394060	<b>A61K 31/437</b> (2006.01) <b>A61P 11/00</b> (2006.01) <b>A61P 11/06</b> (2006.01) <b>C07D 471/04</b> (2006.01)
3397805	<b>D06P 1/52</b> (2006.01) <b>D06P 5/00</b> (2006.01) <b>D06P 5/30</b> (2006.01)
3389430	<b>A45C 5/03</b> (2006.01) <b>A45C 5/14</b> (2006.01) <b>A45C 13/00</b> (2006.01) <b>A45C 13/08</b> (2006.01)
3377187	<b>A63B 9/00</b> (2006.01) <b>A63B 17/04</b> (2006.01) <b>A63C 19/02</b> (2006.01) <b>A63G 31/00</b> (2006.01) <b>H02S 30/20</b> (2014.01)
3377186	<b>A63B 7/02</b> (2006.01) <b>A63B 9/00</b> (2006.01) <b>A63B 17/04</b> (2006.01) <b>A63B 21/08</b> (2006.01) <b>A63B 23/12</b> (2006.01) <b>A63G 31/00</b> (2006.01)
3377634	<b>C07K 14/195</b> (2006.01) <b>C12N 1/21</b> (2006.01) <b>C12N 15/62</b> (2006.01) <b>C12N 15/70</b> (2006.01) <b>C12N 15/74</b> (2006.01)
3394281	<b>C12N 1/19</b> (2006.01) <b>C12N 15/63</b> (2006.01) <b>C12P 21/02</b> (2006.01) <b>C12R 1/84</b> (2006.01)
3383419	<b>A61K 38/04</b> (2006.01) <b>A61K 38/17</b> (2006.01) <b>C07K 7/04</b> (2006.01) <b>C07K 16/28</b> (2006.01) <b>C07K 16/30</b> (2006.01)
3387017	<b>A61K 31/00</b> (2006.01) <b>A61P 35/00</b> (2006.01) <b>C07K 16/28</b> (2006.01) <b>C07K 16/32</b> (2006.01)

Broj objave evropske prijava patenta (97)	MKP (51)
3400304	<b>A61K 48/00</b> (2006.01) <b>C07K 14/705</b> (2006.01) <b>C12N 15/86</b> (2006.01)
3394265	<b>C07K 14/765</b> (2006.01) <b>C12N 15/62</b> (2006.01)
3393504	<b>A61K 39/00</b> (2006.01)
3386655	<b>B03B 9/00</b> (2006.01) <b>B03B 9/06</b> (2006.01) <b>B09B 3/00</b> (2006.01) <b>B29B 17/00</b> (2006.01) <b>B29B 17/02</b> (2006.01) <b>C05F 9/00</b> (2006.01) <b>C10L 5/48</b> (2006.01) <b>D21B 1/02</b> (2006.01) <b>D21C 5/02</b> (2006.01)
3397223	<b>A61F 13/20</b> (2006.01) <b>A61F 13/34</b> (2006.01) <b>B65H 65/00</b> (2006.01) <b>B65H 69/04</b> (2006.01)
3386980	<b>A61K 31/437</b> (2006.01) <b>A61P 35/00</b> (2006.01) <b>C07D 471/04</b> (2006.01)
3394108	<b>C08B 3/08</b> (2006.01) <b>C08B 3/10</b> (2006.01)
3383286	<b>A61B 17/29</b> (2006.01) <b>A61B 18/14</b> (2006.01)
3390455	<b>C07K 16/44</b> (2006.01) <b>G01N 33/94</b> (2006.01)
3394033	<b>A61K 31/4375</b> (2006.01) <b>A61K 31/47</b> (2006.01) <b>A61K 31/4985</b> (2006.01) <b>A61K 31/519</b> (2006.01) <b>A61P 31/00</b> (2006.01) <b>A61P 35/00</b> (2006.01) <b>C07D 215/40</b> (2006.01) <b>C07D 471/04</b> (2006.01)
3397639	<b>A61K 31/5025</b> (2006.01) <b>A61P 31/18</b> (2006.01) <b>C07D 471/16</b> (2006.01)
3397633	<b>A61K 31/4196</b> (2006.01) <b>A61P 11/00</b> (2006.01) <b>A61P 25/28</b> (2006.01) <b>A61P 27/02</b> (2006.01) <b>A61P 31/12</b> (2006.01) <b>A61P 35/00</b> (2006.01) <b>A61P 37/00</b> (2006.01) <b>C07D 249/08</b> (2006.01) <b>C07D 401/12</b> (2006.01) <b>C07D 403/12</b> (2006.01) <b>C07D 413/12</b> (2006.01)

Broj objave evropske prijave patenta (97)	MKP (51)
3397634	<b>A61K 31/4965</b> (2006.01) <b>A61P 35/00</b> (2006.01) <b>C07D 239/26</b> (2006.01) <b>C07D 241/12</b> (2006.01) <b>C07D 401/08</b> (2006.01) <b>C07D 401/12</b> (2006.01) <b>C07D 403/06</b> (2006.01) <b>C07D 403/08</b> (2006.01) <b>C07D 403/12</b> (2006.01) <b>C07D 409/06</b> (2006.01) <b>C07D 413/06</b> (2006.01)
3397273	<b>A61K 31/445</b> (2006.01) <b>A61K 38/47</b> (2006.01)
3344263	<b>A61K 35/17</b> (2015.01) <b>A61K 39/00</b> (2006.01) <b>A61P 35/02</b> (2006.01)
3345552	<b>A61B 17/00</b> (2006.01)
3407709	<b>A01K 67/027</b> (2006.01) <b>C07K 16/00</b> (2006.01) <b>C12N 15/85</b> (2006.01) <b>C12N 15/90</b> (2006.01)
3403659	<b>A61K 35/14</b> (2015.01) <b>A61K 35/16</b> (2015.01) <b>A61K 38/48</b> (2006.01)
3375780	<b>A61K 31/55</b> (2006.01) <b>A61K 31/5513</b> (2006.01) <b>A61K 31/553</b> (2006.01) <b>A61K 31/554</b> (2006.01) <b>A61P 17/06</b> (2006.01) <b>A61P 25/28</b> (2006.01) <b>A61P 29/00</b> (2006.01) <b>A61P 37/00</b> (2006.01) <b>C07D 223/08</b> (2006.01) <b>C07D 267/14</b> (2006.01) <b>C07D 281/10</b> (2006.01) <b>C07D 403/12</b> (2006.01) <b>C07D 403/14</b> (2006.01) <b>C07D 409/12</b> (2006.01) <b>C07D 413/12</b> (2006.01) <b>C07D 413/14</b> (2006.01) <b>C07D 417/12</b> (2006.01) <b>C07D 487/04</b> (2006.01) <b>C07D 498/04</b> (2006.01)
3401400	<b>A61K 38/46</b> (2006.01) <b>A61K 48/00</b> (2006.01) <b>C07K 19/00</b> (2006.01) <b>C12N 15/10</b> (2006.01) <b>C12N 15/11</b> (2006.01) <b>C12N 15/63</b> (2006.01) <b>C12N 15/90</b> (2006.01)
3357823	<b>B65D 1/34</b> (2006.01)
3354153	<b>A44C 11/00</b> (2006.01)

Broj objave evropske prijava patenta (97)	MKP (51)
3348645	<b>A61K 39/00</b> (2006.01) <b>A61K 39/12</b> (2006.01) <b>C12N 15/63</b> (2006.01) <b>C12N 15/67</b> (2006.01)
3398931	<b>C07C 51/347</b> (2006.01) <b>C07C 205/57</b> (2006.01) <b>C07D 301/32</b> (2006.01) <b>C07F 7/18</b> (2006.01)
3338794	<b>A61K 39/00</b> (2006.01)
3345923	<b>A61K 39/395</b> (2006.01) <b>A61P 29/00</b> (2006.01) <b>C07K 16/24</b> (2006.01)
3348545	<b>A61K 31/415</b> (2006.01) <b>A61P 3/00</b> (2006.01) <b>A61P 3/04</b> (2006.01) <b>A61P 3/10</b> (2006.01) <b>A61P 9/04</b> (2006.01) <b>A61P 9/10</b> (2006.01) <b>A61P 11/00</b> (2006.01) <b>A61P 13/12</b> (2006.01) <b>A61P 25/00</b> (2006.01) <b>A61P 27/02</b> (2006.01) <b>A61P 27/12</b> (2006.01) <b>A61P 43/00</b> (2006.01) <b>C07D 231/12</b> (2006.01)
3363456	<b>A61K 38/17</b> (2006.01) <b>A61K 39/00</b> (2006.01) <b>A61P 35/00</b> (2006.01) <b>C07K 7/06</b> (2006.01) <b>C07K 7/08</b> (2006.01) <b>G01N 33/50</b> (2006.01)
3363969	<b>E05B 3/06</b> (2006.01)
3360897	<b>A61P 11/00</b> (2006.01) <b>A61P 19/02</b> (2006.01) <b>A61P 29/00</b> (2006.01) <b>C07K 16/24</b> (2006.01)
3346272	<b>G01N 27/02</b> (2006.01) <b>G01N 33/50</b> (2006.01) <b>G01N 33/574</b> (2006.01)
3392083	<b>B60P 1/26</b> (2006.01) <b>B62D 33/037</b> (2006.01)
3418281	<b>A61K 31/495</b> (2006.01) <b>A61P 35/00</b> (2006.01) <b>C07D 487/04</b> (2006.01)
3363930	<b>C01D 15/08</b> (2006.01) <b>C22B 3/04</b> (2006.01) <b>C22B 26/12</b> (2006.01) <b>C25B 1/16</b> (2006.01)
3357921	<b>A61K 31/44</b> (2006.01) <b>A61K 31/505</b> (2006.01)

Broj objave evropske prijave patenta (97)	MKP (51)
	<b>A61K 31/506</b> (2006.01) <b>A61P 25/02</b> (2006.01) <b>A61P 35/00</b> (2006.01) <b>A61P 37/00</b> (2006.01) <b>C07D 239/30</b> (2006.01) <b>C07D 401/14</b> (2006.01) <b>C07D 403/12</b> (2006.01) <b>C07D 409/14</b> (2006.01) <b>C07D 413/14</b> (2006.01) <b>C07D 417/12</b> (2006.01) <b>C07D 417/14</b> (2006.01) <b>C07D 495/04</b> (2006.01) <b>C07D 513/04</b> (2006.01) <b>C07F 5/02</b> (2006.01)
3357921	<b>A61K 31/44</b> (2006.01) <b>A61K 31/505</b> (2006.01) <b>A61K 31/506</b> (2006.01) <b>A61P 25/02</b> (2006.01) <b>A61P 35/00</b> (2006.01) <b>A61P 37/00</b> (2006.01) <b>C07D 239/30</b> (2006.01) <b>C07D 401/14</b> (2006.01) <b>C07D 403/12</b> (2006.01) <b>C07D 409/14</b> (2006.01) <b>C07D 413/14</b> (2006.01) <b>C07D 417/12</b> (2006.01) <b>C07D 417/14</b> (2006.01) <b>C07D 495/04</b> (2006.01) <b>C07D 513/04</b> (2006.01) <b>C07F 5/02</b> (2006.01)
3352055	<b>G06F 3/01</b> (2006.01) <b>G06F 3/16</b> (2006.01) <b>G08B 6/00</b> (2006.01) <b>G10L 15/26</b> (2006.01) <b>G10L 21/16</b> (2013.01) <b>G10L 25/03</b> (2013.01)
3354280	<b>A61K 39/395</b> (2006.01) <b>A61M 5/315</b> (2006.01) <b>C07K 16/28</b> (2006.01)
3351249	<b>A61K 31/4985</b> (2006.01) <b>A61K 31/505</b> (2006.01) <b>A61K 31/513</b> (2006.01) <b>A61K 31/52</b> (2006.01) <b>A61K 31/536</b> (2006.01) <b>A61K 31/5365</b> (2006.01) <b>A61P 31/18</b> (2006.01)
3382674	<b>G09B 9/00</b> (2006.01)
3351527	<b>A61K 31/138</b> (2006.01) <b>A61P 3/06</b> (2006.01) <b>C07C 217/18</b> (2006.01)
3357919	<b>A61K 31/506</b> (2006.01) <b>A61P 11/00</b> (2006.01) <b>A61P 29/00</b> (2006.01) <b>A61P 31/00</b> (2006.01) <b>C07D 401/14</b> (2006.01) <b>C07D 409/14</b> (2006.01)

Broj objave evropske prijava patenta (97)	MKP (51)
3366691	<b>A61K 31/7084</b> (2006.01) <b>A61K 39/00</b> (2006.01) <b>A61K 39/39</b> (2006.01) <b>A61P 31/12</b> (2006.01) <b>A61P 35/00</b> (2006.01) <b>C07F 9/6574</b> (2006.01) <b>C07H 21/00</b> (2006.01) <b>C07H 21/02</b> (2006.01) <b>C07H 21/04</b> (2006.01)
3406633	<b>C07K 16/28</b> (2006.01)
3369744	<b>C07K 16/24</b> (2006.01)
3415531	<b>A61K 39/00</b> (2006.01) <b>A61K 47/68</b> (2017.01) <b>C07K 16/28</b> (2006.01)
3404027	<b>A61P 25/00</b> (2006.01) <b>A61P 35/00</b> (2006.01) <b>C07D 249/08</b> (2006.01) <b>C07D 403/12</b> (2006.01) <b>C07D 413/12</b> (2006.01)
3360559	<b>A61K 35/74</b> (2015.01) <b>A61K 35/745</b> (2015.01) <b>A61P 11/06</b> (2006.01) <b>A61P 35/00</b> (2006.01)
3385012	<b>B22D 11/06</b> (2006.01) <b>B22D 11/128</b> (2006.01)
3412774	<b>A61K 31/712</b> (2006.01) <b>A61K 31/713</b> (2006.01) <b>A61P 1/16</b> (2006.01) <b>A61P 11/00</b> (2006.01) <b>A61P 35/00</b> (2006.01) <b>C12N 15/113</b> (2010.01)
3366668	<b>A61K 31/221</b> (2006.01) <b>C07C 219/08</b> (2006.01) <b>C07C 229/12</b> (2006.01) <b>C07C 229/16</b> (2006.01) <b>C07C 309/18</b> (2006.01)
3409689	<b>C07K 16/28</b> (2006.01) <b>C07K 16/30</b> (2006.01) <b>G01N 33/68</b> (2006.01)
3395818	<b>C07D 471/04</b> (2006.01)
3403647	<b>A61K 9/127</b> (2006.01) <b>A61K 31/7105</b> (2006.01) <b>A61K 48/00</b> (2006.01) <b>C07H 21/02</b> (2006.01)
3404103	<b>A61K 39/00</b> (2006.01) <b>A61K 39/35</b> (2006.01) <b>C12N 15/117</b> (2010.01) <b>C12N 15/68</b> (2006.01)



Broj objave evropske prijava patenta (97)	MKP (51)
3396810	<b>A61B 5/06</b> (2006.01) <b>A61B 34/20</b> (2016.01) <b>H01F 38/14</b> (2006.01) <b>H02J 7/00</b> (2006.01) <b>H02J 50/10</b> (2016.01) <b>H02J 50/40</b> (2016.01)
3384939	<b>A61L 27/00</b> (2006.01) <b>A61L 31/08</b> (2006.01) <b>A61L 31/16</b> (2006.01) <b>C07K 14/00</b> (2006.01)
3409690	<b>C07K 16/28</b> (2006.01)
3385279	<b>C07K 16/00</b> (2006.01) <b>C07K 16/18</b> (2006.01) <b>C07K 16/44</b> (2006.01) <b>C07K 19/00</b> (2006.01) <b>C12P 21/08</b> (2006.01)
3403593	<b>A61B 17/064</b> (2006.01) <b>A61B 17/072</b> (2006.01) <b>A61B 90/00</b> (2016.01)
3412977	<b>F24D 19/06</b> (2006.01)
3388075	<b>A61K 39/00</b> (2006.01) <b>C07K 14/47</b> (2006.01)
3388076	<b>A61K 39/00</b> (2006.01) <b>C07K 14/47</b> (2006.01)
3388077	<b>A61K 39/00</b> (2006.01) <b>C07K 14/47</b> (2006.01)
3388078	<b>A61K 39/00</b> (2006.01) <b>C07K 14/47</b> (2006.01)
3388079	<b>A61K 39/00</b> (2006.01) <b>C07K 14/47</b> (2006.01)
3388080	<b>A61K 39/00</b> (2006.01) <b>C07K 14/47</b> (2006.01)
3384899	<b>A61K 9/00</b> (2006.01) <b>A61K 31/13</b> (2006.01)
3388441	<b>C07H 15/26</b> (2006.01)
3391941	<b>A61P 9/00</b> (2006.01) <b>A61P 11/00</b> (2006.01) <b>A61P 21/00</b> (2006.01) <b>A61P 35/00</b> (2006.01)
3401316	<b>C07D 453/02</b> (2006.01)
3415515	<b>C07D 471/04</b> (2006.01)

Broj objave evropske prijava patenta (97)	MKP (51)
3400944	<b>A61K 31/554</b> (2006.01) <b>A61P 1/16</b> (2006.01)
3415619	<b>C07K 16/00</b> (2006.01) <b>C07K 16/12</b> (2006.01) <b>C12N 5/10</b> (2006.01) <b>G01N 33/68</b> (2006.01)
3409669	<b>C07D 401/04</b> (2006.01) <b>C07D 401/14</b> (2006.01) <b>C07D 403/04</b> (2006.01) <b>C07D 403/14</b> (2006.01) <b>C07D 405/12</b> (2006.01) <b>C07D 405/14</b> (2006.01) <b>C07D 471/04</b> (2006.01)
3406141	<b>A01N 43/54</b> (2006.01) <b>A61K 31/425</b> (2006.01) <b>A61K 31/505</b> (2006.01) <b>A61P 35/00</b> (2006.01)
3412282	<b>A61K 9/51</b> (2006.01)
3418279	<b>A61K 9/00</b> (2006.01) <b>A61K 31/506</b> (2006.01) <b>A61K 47/26</b> (2006.01) <b>A61P 11/00</b> (2006.01) <b>A61P 29/00</b> (2006.01) <b>A61P 31/00</b> (2006.01) <b>C07D 401/12</b> (2006.01) <b>C07D 401/14</b> (2006.01) <b>C07D 409/14</b> (2006.01) <b>C07D 413/14</b> (2006.01) <b>C07D 487/04</b> (2006.01)
3395820	<b>A61K 31/4995</b> (2006.01) <b>A61P 35/00</b> (2006.01) <b>C07D 515/22</b> (2006.01)
3395821	<b>A61K 31/4995</b> (2006.01) <b>A61P 35/00</b> (2006.01) <b>C07D 515/22</b> (2006.01)
3411400	<b>C07K 16/18</b> (2006.01)
3299909	<b>G05B 9/02</b> (2006.01) <b>H01H 47/00</b> (2006.01)
3309174	<b>C07K 16/28</b> (2006.01) <b>G01N 33/53</b> (2006.01)
3289884	<b>A23C 15/04</b> (2006.01) <b>A23C 15/16</b> (2006.01) <b>A23D 9/00</b> (2006.01) <b>A23D 9/04</b> (2006.01) <b>A23G 3/34</b> (2006.01)
3305813	<b>A61K 39/00</b> (2006.01) <b>A61K 39/395</b> (2006.01) <b>A61P 35/00</b> (2006.01) <b>C07K 14/705</b> (2006.01) <b>C07K 16/28</b> (2006.01)

Broj objave evropske prijava patenta (97)	MKP (51)
	<b>C07K 16/30</b> (2006.01)
3318627	<b>C12N 5/00</b> (2006.01) <b>C12N 5/071</b> (2010.01) <b>C12N 5/09</b> (2010.01) <b>G01N 33/50</b> (2006.01)
3275378	<b>A61B 17/072</b> (2006.01) <b>A61L 31/04</b> (2006.01) <b>A61L 31/12</b> (2006.01) <b>A61L 31/14</b> (2006.01)
3301102	<b>C07H 5/10</b> (2006.01) <b>C12N 15/11</b> (2006.01) <b>C12N 15/67</b> (2006.01)
3305717	<b>A47J 43/28</b> (2006.01) <b>B67B 7/46</b> (2006.01)
3284754	<b>A61P 35/02</b> (2006.01) <b>C07K 16/28</b> (2006.01)
3293650	<b>G06F 17/50</b> (2006.01)
3293273	<b>C12Q 1/68</b> (2018.01)
3299367	<b>C07D 403/12</b> (2006.01)
3308796	<b>A61K 38/00</b> (2006.01) <b>A61K 38/17</b> (2006.01) <b>A61K 38/22</b> (2006.01) <b>A61K 38/27</b> (2006.01) <b>A61K 38/29</b> (2006.01) <b>A61P 19/08</b> (2006.01) <b>A61P 19/10</b> (2006.01)
3305890	<b>C12N 5/00</b> (2006.01)
3351546	<b>A61K 9/00</b> (2006.01) <b>A61K 31/365</b> (2006.01) <b>A61K 47/34</b> (2017.01) <b>A61P 33/00</b> (2006.01) <b>C07D 493/22</b> (2006.01)
3284742	<b>A61K 31/4439</b> (2006.01) <b>A61P 3/00</b> (2006.01) <b>A61P 11/00</b> (2006.01) <b>A61P 25/00</b> (2006.01) <b>A61P 29/00</b> (2006.01) <b>A61P 31/00</b> (2006.01) <b>A61P 35/00</b> (2006.01) <b>C07D 405/14</b> (2006.01)
3301311	<b>F16B 7/18</b> (2006.01)
3290421	<b>A61K 31/519</b> (2006.01) <b>A61P 37/00</b> (2006.01) <b>C07D 487/04</b> (2006.01) <b>C07D 519/00</b> (2006.01)

Broj objave evropske prijava patenta (97)	MKP (51)
3287142	<b>A61K 39/395</b> (2006.01) <b>C07K 16/40</b> (2006.01) <b>C12N 15/11</b> (2006.01)
3295942	<b>A61K 31/513</b> (2006.01) <b>A61P 31/18</b> (2006.01)
3305798	<b>A61K 39/00</b> (2006.01) <b>C07H 21/04</b> (2006.01)
3296163	<b>B60R 25/021</b> (2013.01) <b>B60R 25/023</b> (2013.01)
3339322	<b>C07K 16/00</b> (2006.01) <b>C07K 16/22</b> (2006.01) <b>C07K 16/28</b> (2006.01) <b>C07K 16/42</b> (2006.01)
3273134	<b>B05C 1/04</b> (2006.01) <b>B62J 31/00</b> (2006.01) <b>F16H 57/05</b> (2006.01) <b>F16N 3/04</b> (2006.01) <b>F16N 9/00</b> (2006.01)
3287161	<b>A61M 5/142</b> (2006.01) <b>A61M 5/158</b> (2006.01) <b>F15C 5/00</b> (2006.01) <b>F16K 99/00</b> (2006.01) <b>G01L 9/00</b> (2006.01)
3299445	<b>C11D 1/83</b> (2006.01) <b>C11D 3/00</b> (2006.01) <b>C11D 3/22</b> (2006.01) <b>C11D 3/37</b> (2006.01) <b>C11D 3/50</b> (2006.01) <b>C11D 11/00</b> (2006.01) <b>C11D 17/00</b> (2006.01)
3299505	<b>D06F 35/00</b> (2006.01) <b>D06F 39/02</b> (2006.01)
3293176	<b>A61K 31/44</b> (2006.01) <b>A61P 11/00</b> (2006.01) <b>C07D 213/89</b> (2006.01)
3305709	<b>B65D 90/00</b> (2006.01) <b>B66C 1/10</b> (2006.01) <b>B66C 1/66</b> (2006.01) <b>B66F 9/065</b> (2006.01) <b>E05B 83/08</b> (2014.01)
3305078	<b>A21D 6/00</b> (2006.01) <b>A21D 8/02</b> (2006.01) <b>A21D 8/04</b> (2006.01)
3323818	<b>A61K 31/506</b> (2006.01) <b>A61P 3/00</b> (2006.01) <b>C07D 413/14</b> (2006.01)

Broj objave evropske prijava patenta (97)	MKP (51)
3299390	<b>A61K 39/395</b> (2006.01) <b>C07K 16/24</b> (2006.01)
3295957	<b>A61K 39/395</b> (2006.01) <b>A61P 17/06</b> (2006.01) <b>C07K 16/28</b> (2006.01)
3312364	<b>E04H 4/08</b> (2006.01) <b>E04H 4/10</b> (2006.01)
3312550	<b>G01B 7/16</b> (2006.01) <b>G01L 1/22</b> (2006.01) <b>H01C 17/24</b> (2006.01)
3308675	<b>A47C 7/38</b> (2006.01) <b>B60N 2/838</b> (2018.01)
3309358	<b>B60B 17/00</b> (2006.01) <b>B61F 9/00</b> (2006.01) <b>E21D 11/10</b> (2006.01)
3308730	<b>A61B 18/14</b> (2006.01)
3299391	<b>A61K 39/395</b> (2006.01) <b>A61P 35/00</b> (2006.01) <b>C07K 16/28</b> (2006.01)
3315116	<b>A61K 8/02</b> (2006.01) <b>A61K 8/19</b> (2006.01) <b>A61K 8/27</b> (2006.01) <b>A61K 8/29</b> (2006.01) <b>A61K 8/85</b> (2006.01) <b>A61Q 17/04</b> (2006.01)
3311800	<b>A61K 9/00</b> (2006.01) <b>A61K 9/107</b> (2006.01) <b>A61K 9/50</b> (2006.01) <b>A61K 36/28</b> (2006.01)
3312169	<b>A61K 31/19</b> (2006.01) <b>A61K 31/5386</b> (2006.01) <b>C07C 53/18</b> (2006.01) <b>C07C 53/40</b> (2006.01) <b>C07D 221/22</b> (2006.01) <b>C07D 401/04</b> (2006.01) <b>C07D 401/12</b> (2006.01) <b>C07D 401/14</b> (2006.01) <b>C07D 403/04</b> (2006.01) <b>C07D 451/12</b> (2006.01) <b>C07D 453/02</b> (2006.01) <b>C07D 471/02</b> (2006.01) <b>C07D 471/04</b> (2006.01) <b>C07D 471/08</b> (2006.01) <b>C07D 487/14</b> (2006.01) <b>C07D 498/08</b> (2006.01) <b>C07D 519/00</b> (2006.01)
3315682	<b>E04B 5/38</b> (2006.01) <b>E04B 5/48</b> (2006.01) <b>E04B 9/00</b> (2006.01)

Broj objave evropske prijava patenta (97)	MKP (51)
3319301	<b>H04L 29/08</b> (2006.01)
3318125	<b>A01N 31/16</b> (2006.01) <b>A01N 45/00</b> (2006.01) <b>A01P 3/00</b> (2006.01)
3320793	<b>A41B 9/02</b> (2006.01)
3402499	<b>A61K 35/744</b> (2015.01) <b>A61K 38/20</b> (2006.01) <b>A61K 39/00</b> (2006.01) <b>A61P 3/10</b> (2006.01) <b>A61P 37/06</b> (2006.01) <b>C12N 1/00</b> (2006.01) <b>C12N 1/20</b> (2006.01) <b>C12N 15/09</b> (2006.01) <b>C12R 1/01</b> (2006.01)
3411083	<b>A61K 51/04</b> (2006.01) <b>A61K 101/02</b> (2006.01) <b>C07B 59/00</b> (2006.01) <b>C07D 401/14</b> (2006.01)
3402791	<b>A61K 31/4439</b> (2006.01) <b>A61P 35/00</b> (2006.01) <b>C07D 401/04</b> (2006.01) <b>C07D 401/14</b> (2006.01) <b>C07D 405/14</b> (2006.01) <b>C07D 409/14</b> (2006.01) <b>C07D 413/14</b> (2006.01) <b>C07D 451/02</b> (2006.01) <b>C07D 451/06</b> (2006.01) <b>C07D 487/04</b> (2006.01) <b>C07D 491/044</b> (2006.01) <b>C07D 491/048</b> (2006.01)
3400023	<b>A61K 48/00</b> (2006.01) <b>C07K 16/28</b> (2006.01)
3405498	<b>A61P 7/02</b> (2006.01) <b>C07K 16/36</b> (2006.01)
3411402	<b>C07K 16/28</b> (2006.01)
3411403	<b>C07K 16/28</b> (2006.01) <b>C07K 16/30</b> (2006.01)
3411336	<b>A23L 2/54</b> (2006.01) <b>C02F 1/44</b> (2006.01) <b>C02F 1/66</b> (2006.01) <b>C02F 1/68</b> (2006.01)
3408261	<b>A61K 31/5377</b> (2006.01) <b>A61K 45/06</b> (2006.01) <b>C07D 277/28</b> (2006.01)
3408291	<b>C07K 16/18</b> (2006.01) <b>C07K 16/40</b> (2006.01)
3408268	<b>A61K 31/4184</b> (2006.01) <b>A61K 31/4433</b> (2006.01) <b>A61P 17/06</b> (2006.01)

Broj objave evropske prijava patenta (97)	MKP (51)
	<b>A61P 25/00</b> (2006.01) <b>A61P 29/00</b> (2006.01) <b>A61P 35/00</b> (2006.01) <b>C07D 233/88</b> (2006.01) <b>C07D 233/90</b> (2006.01) <b>C07D 405/06</b> (2006.01) <b>C07D 405/14</b> (2006.01) <b>C07D 471/04</b> (2006.01)
3411497	<b>A61K 31/519</b> (2006.01) <b>C12Q 1/68</b> (2018.01)
3411498	<b>A61K 31/519</b> (2006.01) <b>C12Q 1/68</b> (2018.01)
3411404	<b>C07K 16/28</b> (2006.01) <b>C07K 16/30</b> (2006.01)
3417013	<b>C09C 1/02</b> (2006.01) <b>C09C 1/40</b> (2006.01) <b>C09C 1/42</b> (2006.01) <b>D21H 17/00</b> (2006.01)
3405173	<b>A61K 9/00</b> (2006.01) <b>A61K 9/14</b> (2006.01) <b>A61K 9/50</b> (2006.01) <b>A61K 31/40</b> (2006.01)
3414170	<b>A61J 1/00</b> (2006.01) <b>B65D 5/00</b> (2006.01) <b>B65D 5/42</b> (2006.01) <b>G09F 3/00</b> (2006.01)
3417014	<b>C09C 1/02</b> (2006.01) <b>C09C 1/40</b> (2006.01) <b>C09C 1/42</b> (2006.01)
3411381	<b>A61K 31/56</b> (2006.01) <b>A61K 31/575</b> (2006.01) <b>A61K 31/58</b> (2006.01) <b>A61P 31/18</b> (2006.01) <b>C07J 63/00</b> (2006.01) <b>C12N 9/50</b> (2006.01)
3408271	<b>A61K 31/535</b> (2006.01) <b>A61P 35/00</b> (2006.01) <b>C07D 498/18</b> (2006.01)
3411406	<b>A61K 47/68</b> (2017.01) <b>A61P 35/00</b> (2006.01) <b>C07K 16/28</b> (2006.01) <b>C07K 16/32</b> (2006.01)
3411337	<b>A23L 2/54</b> (2006.01) <b>B01D 61/14</b> (2006.01) <b>C02F 1/44</b> (2006.01) <b>C02F 1/66</b> (2006.01) <b>C02F 1/68</b> (2006.01)
3414228	<b>A61K 31/496</b> (2006.01) <b>A61P 9/00</b> (2006.01) <b>A61P 11/00</b> (2006.01)

Broj objave evropske prijava patenta (97)	MKP (51)
	<b>A61P 15/08</b> (2006.01) <b>A61P 25/24</b> (2006.01) <b>A61P 25/28</b> (2006.01) <b>A61P 37/08</b> (2006.01) <b>C07D 213/76</b> (2006.01)
3413923	<b>A61K 47/68</b> (2017.01)
3402801	<b>A61K 31/7084</b> (2006.01) <b>A61P 35/00</b> (2006.01) <b>C07H 21/00</b> (2006.01)
3411026	<b>A61K 31/197</b> (2006.01) <b>A61K 31/198</b> (2006.01) <b>A61K 31/506</b> (2006.01) <b>A61K 31/5377</b> (2006.01) <b>A61P 1/16</b> (2006.01)
3411075	<b>A61K 47/68</b> (2017.01) <b>A61P 35/00</b> (2006.01) <b>C07K 16/30</b> (2006.01) <b>C07K 16/40</b> (2006.01)
3403249	<b>G07F 17/32</b> (2006.01)
3407746	<b>A41G 3/00</b> (2006.01) <b>A41G 5/00</b> (2006.01) <b>A45D 8/36</b> (2006.01)
3362761	<b>F41H 5/04</b> (2006.01)
3405032	<b>A01N 37/06</b> (2006.01) <b>A01N 65/12</b> (2009.01) <b>A01P 3/00</b> (2006.01)
3414249	<b>A61K 31/4985</b> (2006.01) <b>A61P 7/12</b> (2006.01) <b>A61P 9/12</b> (2006.01) <b>A61P 13/12</b> (2006.01) <b>C07D 487/04</b> (2006.01)
3411392	<b>A01K 67/027</b> (2006.01) <b>A61K 39/00</b> (2006.01) <b>A61K 49/00</b> (2006.01) <b>C07K 14/515</b> (2006.01) <b>C07K 16/22</b> (2006.01)
3416948	<b>A61P 29/00</b> (2006.01) <b>C07C 307/06</b> (2006.01) <b>C07C 307/08</b> (2006.01) <b>C07C 307/10</b> (2006.01) <b>C07D 231/18</b> (2006.01) <b>C07D 295/26</b> (2006.01)
3416946	<b>A61K 31/4745</b> (2006.01) <b>A61P 31/12</b> (2006.01) <b>C07D 217/08</b> (2006.01) <b>C07D 491/14</b> (2006.01)
3411358	<b>A61K 31/435</b> (2006.01) <b>A61P 3/04</b> (2006.01)



Broj objave evropske prijava patenta (97)	MKP (51)
	<b>C07D 211/36</b> (2006.01)
3414239	<b>C07D 403/12</b> (2006.01)
3414233	<b>A61K 31/4192</b> (2006.01) <b>A61P 9/10</b> (2006.01) <b>A61P 25/02</b> (2006.01) <b>A61P 25/04</b> (2006.01) <b>A61P 25/06</b> (2006.01) <b>A61P 25/16</b> (2006.01) <b>A61P 25/24</b> (2006.01) <b>A61P 25/28</b> (2006.01) <b>A61P 25/30</b> (2006.01) <b>C07D 401/12</b> (2006.01) <b>C07D 401/14</b> (2006.01) <b>C07D 403/12</b> (2006.01) <b>C07D 403/14</b> (2006.01) <b>C07D 405/14</b> (2006.01) <b>C07D 409/14</b> (2006.01)
3411375	<b>A61K 31/519</b> (2006.01) <b>A61P 11/00</b> (2006.01) <b>C07D 487/04</b> (2006.01)
3416983	<b>A61K 39/00</b> (2006.01) <b>C07K 16/24</b> (2006.01)
3416980	<b>C07K 14/47</b> (2006.01)
3411415	<b>C08B 1/00</b> (2006.01) <b>C08B 16/00</b> (2006.01) <b>C08J 11/08</b> (2006.01) <b>D01F 2/00</b> (2006.01) <b>D04H 1/425</b> (2012.01) <b>D21H 11/20</b> (2006.01)
3413879	<b>A61K 9/50</b> (2006.01) <b>A61K 31/225</b> (2006.01) <b>A61P 25/00</b> (2006.01)
3413897	<b>A61K 31/7076</b> (2006.01) <b>A61P 31/18</b> (2006.01)
3416682	<b>A61K 39/12</b> (2006.01) <b>C12N 7/00</b> (2006.01)
3414251	<b>A61K 31/4985</b> (2006.01) <b>A61P 35/00</b> (2006.01) <b>A61P 37/00</b> (2006.01) <b>C07D 495/04</b> (2006.01)
3405207	<b>A23L 2/52</b> (2006.01) <b>A23L 33/105</b> (2016.01) <b>A61K 9/20</b> (2006.01) <b>A61K 9/48</b> (2006.01) <b>A61K 36/67</b> (2006.01) <b>A61P 1/16</b> (2006.01)
3416765	<b>B21D 5/04</b> (2006.01)
3412017	<b>H04L 29/06</b> (2006.01) <b>H04W 12/06</b> (2009.01)

Broj objave evropske prijava patenta (97)	MKP (51)
	<b>H04W 12/08</b> (2009.01)
3402906	<b>C21D 8/02</b> (2006.01) <b>C21D 8/04</b> (2006.01) <b>C21D 9/46</b> (2006.01) <b>C21D 9/48</b> (2006.01)
3410910	<b>A47K 10/32</b> (2006.01) <b>A47K 10/38</b> (2006.01)
3416984	<b>A61K 39/00</b> (2006.01) <b>C07K 16/28</b> (2006.01)
3414231	<b>C07D 295/096</b> (2006.01)
3416712	<b>A61M 16/00</b> (2006.01)
3416960	<b>A61K 31/4025</b> (2006.01) <b>A61K 31/407</b> (2006.01) <b>A61P 35/00</b> (2006.01) <b>C07D 401/06</b> (2006.01) <b>C07D 401/12</b> (2006.01) <b>C07D 401/14</b> (2006.01) <b>C07D 403/06</b> (2006.01) <b>C07D 403/14</b> (2006.01) <b>C07D 413/06</b> (2006.01) <b>C07D 413/12</b> (2006.01) <b>C07D 417/12</b> (2006.01) <b>C07D 417/14</b> (2006.01) <b>C07D 471/04</b> (2006.01) <b>C07D 487/04</b> (2006.01) <b>C07D 487/10</b> (2006.01)
3411488	<b>A61K 39/00</b> (2006.01) <b>A61K 48/00</b> (2006.01) <b>C12N 9/24</b> (2006.01) <b>C12N 15/86</b> (2006.01)
3416684	<b>A61K 39/395</b> (2006.01) <b>A61P 3/06</b> (2006.01) <b>C07K 16/22</b> (2006.01)
3411077	<b>A61K 47/69</b> (2017.01) <b>C07K 1/13</b> (2006.01)
3416982	<b>A61K 39/395</b> (2006.01) <b>C07K 16/22</b> (2006.01)
3408256	<b>C07C 233/23</b> (2006.01) <b>C07C 233/41</b> (2006.01) <b>C07C 235/36</b> (2006.01) <b>C07C 271/24</b> (2006.01) <b>C07C 311/06</b> (2006.01) <b>C07C 317/30</b> (2006.01) <b>C07D 205/04</b> (2006.01) <b>C07D 231/12</b> (2006.01) <b>C07D 231/14</b> (2006.01) <b>C07D 237/14</b> (2006.01) <b>C07D 239/42</b> (2006.01) <b>C07D 261/10</b> (2006.01) <b>C07D 309/08</b> (2006.01) <b>C07D 309/14</b> (2006.01)

Broj objave evropske prijava patenta (97)	MKP (51)
	<b>C07D 413/12</b> (2006.01)
3413953	<b>A61M 5/142</b> (2006.01) <b>A61M 5/145</b> (2006.01) <b>A61M 5/315</b> (2006.01)
3414252	<b>A61K 31/4365</b> (2006.01) <b>A61K 31/437</b> (2006.01) <b>A61K 31/438</b> (2006.01) <b>A61K 31/496</b> (2006.01) <b>A61K 31/4985</b> (2006.01) <b>A61K 31/506</b> (2006.01) <b>A61K 31/5386</b> (2006.01) <b>A61K 31/551</b> (2006.01) <b>A61P 29/00</b> (2006.01) <b>A61P 31/04</b> (2006.01) <b>A61P 31/12</b> (2006.01) <b>A61P 35/00</b> (2006.01) <b>A61P 37/00</b> (2006.01) <b>C07D 495/04</b> (2006.01)
3416678	<b>A61K 38/46</b> (2006.01) <b>A61P 3/00</b> (2006.01)
3399971	<b>A61K 9/00</b> (2006.01) <b>A61K 31/202</b> (2006.01) <b>A61P 17/00</b> (2006.01)
3414320	<b>A61K 9/00</b> (2006.01) <b>A61K 35/28</b> (2015.01) <b>C12N 5/00</b> (2006.01) <b>C12N 5/0775</b> (2010.01)
3417170	<b>F03G 3/08</b> (2006.01) <b>H02K 7/02</b> (2006.01)
3416479	<b>A01K 67/027</b> (2006.01) <b>C07K 16/10</b> (2006.01) <b>C12N 9/14</b> (2006.01)
3417392	<b>G06F 21/32</b> (2013.01) <b>H04L 29/06</b> (2006.01)
3407883	<b>A61K 31/365</b> (2006.01) <b>A61K 31/405</b> (2006.01) <b>A61K 33/06</b> (2006.01) <b>A61K 33/08</b> (2006.01) <b>A61K 36/28</b> (2006.01) <b>A61K 36/48</b> (2006.01) <b>A61P 25/06</b> (2006.01)
3417037	<b>C10J 3/84</b> (2006.01)
3416759	<b>B09C 1/10</b> (2006.01) <b>C12P 1/04</b> (2006.01) <b>C12P 5/02</b> (2006.01) <b>C22B 3/00</b> (2006.01) <b>C22B 3/18</b> (2006.01) <b>E21B 43/00</b> (2006.01)
3413828	<b>A61B 50/30</b> (2016.01) <b>A61B 90/90</b> (2016.01)

Broj objave evropske prijava patenta (97)	MKP (51)
	<b>A61B 90/98</b> (2016.01) <b>A61L 2/24</b> (2006.01)
3408260	<b>A61K 31/42</b> (2006.01) <b>A61P 9/00</b> (2006.01) <b>C07D 261/18</b> (2006.01)
3407985	<b>A63B 21/28</b> (2006.01) <b>A63B 22/16</b> (2006.01) <b>A63B 22/18</b> (2006.01) <b>A63B 26/00</b> (2006.01) <b>A63B 69/00</b> (2006.01)
3407987	<b>A61B 5/103</b> (2006.01) <b>A61H 1/02</b> (2006.01) <b>A63B 21/00</b> (2006.01) <b>A63B 21/005</b> (2006.01) <b>A63B 22/18</b> (2006.01) <b>A63B 23/08</b> (2006.01) <b>A63B 24/00</b> (2006.01) <b>A63B 26/00</b> (2006.01) <b>A63B 69/00</b> (2006.01)
3416819	<b>A43B 1/12</b> (2006.01) <b>B29C 43/00</b> (2006.01) <b>B29C 44/02</b> (2006.01) <b>B29D 35/00</b> (2010.01) <b>B29D 35/12</b> (2010.01) <b>B29D 35/14</b> (2010.01) <b>C08J 9/33</b> (2006.01)
3365185	<b>B21D 53/26</b> (2006.01) <b>B21H 1/10</b> (2006.01) <b>B60B 3/00</b> (2006.01) <b>B60B 3/02</b> (2006.01) <b>B60B 3/06</b> (2006.01)
3352769	<b>A61K 35/14</b> (2015.01) <b>A61K 35/16</b> (2015.01) <b>A61P 17/00</b> (2006.01) <b>A61P 17/18</b> (2006.01) <b>A61P 29/00</b> (2006.01) <b>A61P 39/00</b> (2006.01)
3352770	<b>A61K 35/14</b> (2015.01) <b>A61K 35/16</b> (2015.01) <b>A61P 17/00</b> (2006.01) <b>A61P 17/18</b> (2006.01) <b>A61P 29/00</b> (2006.01) <b>A61P 39/00</b> (2006.01)
3400963	<b>A61K 31/506</b> (2006.01) <b>A61K 31/7072</b> (2006.01) <b>A61K 39/395</b> (2006.01) <b>A61K 45/06</b> (2006.01) <b>A61P 35/00</b> (2006.01) <b>A61P 37/02</b> (2006.01)
3400012	<b>A61K 39/395</b> (2006.01) <b>A61K 45/06</b> (2006.01) <b>C07K 16/40</b> (2006.01)

Broj objave evropske prijave patenta (97)	MKP (51)
3400549	<b>A61B 5/00</b> (2006.01) <b>G06F 19/26</b> (2011.01) <b>G06Q 50/24</b> (2018.01) <b>G08B 21/04</b> (2006.01)
3403060	<b>B61D 5/00</b> (2006.01) <b>G01F 23/284</b> (2006.01)
3404040	<b>A61K 39/395</b> (2006.01) <b>A61P 1/04</b> (2006.01) <b>A61P 11/00</b> (2006.01) <b>A61P 35/00</b> (2006.01) <b>A61P 37/08</b> (2006.01) <b>C07K 16/18</b> (2006.01) <b>C07K 16/46</b> (2006.01) <b>C12N 15/09</b> (2006.01)
3402618	<b>B21D 51/38</b> (2006.01) <b>B21D 51/44</b> (2006.01) <b>B65B 35/58</b> (2006.01) <b>B65G 47/24</b> (2006.01) <b>B65G 47/244</b> (2006.01) <b>B65G 47/252</b> (2006.01)
3402532	<b>A61K 48/00</b> (2006.01)
3402485	<b>A61K 31/4468</b> (2006.01) <b>A61K 31/496</b> (2006.01)
3402513	<b>A61K 39/145</b> (2006.01) <b>A61P 31/16</b> (2006.01) <b>C07K 14/11</b> (2006.01) <b>C07K 16/08</b> (2006.01) <b>C07K 16/10</b> (2006.01) <b>C12N 15/44</b> (2006.01)
3402486	<b>A61K 31/517</b> (2006.01) <b>A61K 31/551</b> (2006.01)
3402556	<b>A61M 5/178</b> (2006.01) <b>A61M 5/20</b> (2006.01) <b>A61M 5/24</b> (2006.01) <b>A61M 5/31</b> (2006.01) <b>A61M 5/315</b> (2006.01) <b>A61M 5/32</b> (2006.01)
3402534	<b>A61K 48/00</b> (2006.01)
3402519	<b>A61K 39/395</b> (2006.01) <b>A61P 35/00</b> (2006.01) <b>C07K 16/00</b> (2006.01) <b>C07K 16/18</b> (2006.01) <b>C07K 16/46</b> (2006.01) <b>C12N 1/15</b> (2006.01)
3406586	<b>C07C 49/753</b> (2006.01)
3405914	<b>G06Q 10/04</b> (2012.01) <b>G06Q 50/06</b> (2012.01)
3406694	<b>C10M 107/02</b> (2006.01) <b>C10M 135/08</b> (2006.01)

Broj objave evropske prijava patenta (97)	MKP (51)
	<b>C10M 139/00</b> (2006.01) <b>C10M 145/14</b> (2006.01) <b>C10M 169/04</b> (2006.01) <b>C10N 20/02</b> (2006.01) <b>C10N 20/04</b> (2006.01) <b>C10N 30/00</b> (2006.01) <b>C10N 30/04</b> (2006.01) <b>C10N 30/06</b> (2006.01) <b>C10N 40/04</b> (2006.01)
3405455	<b>C07D 209/00</b> (2006.01) <b>C07D 209/34</b> (2006.01)
3405211	<b>A61K 31/436</b> (2006.01) <b>A61K 31/55</b> (2006.01) <b>A61K 38/31</b> (2006.01)
3410397	<b>A61B 3/10</b> (2006.01) <b>A61B 3/18</b> (2006.01) <b>G02C 5/00</b> (2006.01) <b>G02C 7/00</b> (2006.01) <b>G06T 7/60</b> (2017.01)
3409751	<b>C10M 105/04</b> (2006.01) <b>C10M 107/02</b> (2006.01) <b>C10M 135/04</b> (2006.01) <b>C10M 169/04</b> (2006.01) <b>C10N 20/02</b> (2006.01) <b>C10N 30/00</b> (2006.01) <b>C10N 30/06</b> (2006.01) <b>C10N 40/04</b> (2006.01)
3407914	<b>A61K 39/395</b> (2006.01) <b>C07K 16/00</b> (2006.01) <b>C12P 21/00</b> (2006.01)
3408293	<b>C07K 16/24</b> (2006.01) <b>C07K 16/46</b> (2006.01)
3407978	<b>A61K 31/444</b> (2006.01) <b>A61K 31/5377</b> (2006.01) <b>A61P 35/00</b> (2006.01)
3408395	<b>A61K 35/74</b> (2015.01) <b>A61K 39/00</b> (2006.01) <b>A61K 48/00</b> (2006.01) <b>C07K 5/10</b> (2006.01) <b>C07K 14/705</b> (2006.01) <b>C12N 15/66</b> (2006.01) <b>C12N 15/74</b> (2006.01)
3408298	<b>C07D 257/04</b> (2006.01) <b>C07D 401/04</b> (2006.01) <b>C07K 14/705</b> (2006.01) <b>C07K 14/72</b> (2006.01) <b>C07K 16/28</b> (2006.01) <b>G01N 33/566</b> (2006.01)
3408391	<b>C12N 15/113</b> (2010.01)
3410897	<b>A47G 1/02</b> (2006.01) <b>A61F 5/455</b> (2006.01)

Broj objave evropske prijava patenta (97)	MKP (51)
	<b>A61M 25/01</b> (2006.01)
3412671	<b>A61K 31/519</b> (2006.01) <b>A61P 31/12</b> (2006.01) <b>C07D 487/04</b> (2006.01)
3412672	<b>A61K 31/519</b> (2006.01) <b>A61P 31/12</b> (2006.01) <b>C07D 487/04</b> (2006.01)
3412673	<b>C07D 487/04</b> (2006.01)
3412674	<b>A61K 31/519</b> (2006.01) <b>A61P 31/12</b> (2006.01) <b>C07D 487/04</b> (2006.01)
3412295	<b>A61K 31/506</b> (2006.01) <b>A61K 31/7072</b> (2006.01) <b>A61P 1/00</b> (2006.01) <b>A61P 35/00</b> (2006.01)
3412664	<b>A61K 31/4439</b> (2006.01) <b>A61K 31/506</b> (2006.01) <b>A61P 1/04</b> (2006.01) <b>A61P 1/18</b> (2006.01) <b>A61P 3/10</b> (2006.01) <b>A61P 11/06</b> (2006.01) <b>A61P 11/08</b> (2006.01) <b>A61P 11/14</b> (2006.01) <b>A61P 17/04</b> (2006.01) <b>A61P 19/02</b> (2006.01) <b>A61P 25/00</b> (2006.01) <b>A61P 25/04</b> (2006.01) <b>A61P 29/00</b> (2006.01) <b>A61P 37/08</b> (2006.01) <b>A61P 43/00</b> (2006.01) <b>C07D 403/12</b> (2006.01) <b>C07D 405/14</b> (2006.01) <b>C07D 409/14</b> (2006.01) <b>C07D 491/048</b> (2006.01) <b>C07K 14/705</b> (2006.01)
3411484	<b>A61K 48/00</b> (2006.01) <b>C12N 15/63</b> (2006.01) <b>C12N 15/861</b> (2006.01)
3411411	<b>A61K 39/00</b> (2006.01) <b>A61P 9/00</b> (2006.01) <b>A61P 37/06</b> (2006.01) <b>C07K 16/28</b> (2006.01)
3411062	<b>A61K 38/17</b> (2006.01) <b>C07K 14/00</b> (2006.01) <b>C07K 14/435</b> (2006.01) <b>C07K 14/705</b> (2006.01)
3411503	<b>A61K 31/496</b> (2006.01) <b>C12Q 1/68</b> (2018.01)
3411504	<b>C12Q 1/68</b> (2018.01)

Broj objave evropske prijava patenta (97)	MKP (51)
3411387	<b>C07K 7/08</b> (2006.01)
3411031	<b>A61K 31/454</b> (2006.01) <b>A61P 1/08</b> (2006.01) <b>C07D 401/14</b> (2006.01)
3416513	<b>A41G 5/00</b> (2006.01)
3414244	<b>A61K 31/33</b> (2006.01) <b>A61K 31/404</b> (2006.01) <b>A61P 1/16</b> (2006.01) <b>A61P 9/00</b> (2006.01) <b>A61P 13/12</b> (2006.01) <b>A61P 29/00</b> (2006.01) <b>A61P 35/00</b> (2006.01) <b>C07D 209/10</b> (2006.01) <b>C07D 401/04</b> (2006.01) <b>C07D 403/04</b> (2006.01) <b>C07D 405/04</b> (2006.01) <b>C07D 413/04</b> (2006.01) <b>C07D 471/04</b> (2006.01)
3414226	<b>A61K 31/00</b> (2006.01) <b>A61K 31/404</b> (2006.01) <b>A61P 35/00</b> (2006.01) <b>C07D 209/24</b> (2006.01) <b>C07D 471/04</b> (2006.01) <b>C07D 487/04</b> (2006.01)
3414867	<b>H04L 9/28</b> (2006.01)
3413921	<b>A61K 47/66</b> (2017.01) <b>A61K 47/68</b> (2017.01) <b>A61P 35/00</b> (2006.01)
3399916	<b>A61B 6/00</b> (2006.01) <b>G06K 9/00</b> (2006.01) <b>G06K 9/36</b> (2006.01)
3414620	<b>G01J 3/447</b> (2006.01) <b>G01N 21/19</b> (2006.01) <b>G02F 1/11</b> (2006.01)
3413892	<b>A61K 31/47</b> (2006.01) <b>C07D 217/08</b> (2006.01)
3414235	<b>C07D 403/02</b> (2006.01) <b>C07D 411/02</b> (2006.01) <b>C07D 495/04</b> (2006.01)
3416896	<b>B65D 19/00</b> (2006.01) <b>B65D 19/38</b> (2006.01) <b>B65G 65/02</b> (2006.01) <b>B65G 67/04</b> (2006.01) <b>B65G 69/22</b> (2006.01)
3416964	<b>A61K 31/4155</b> (2006.01) <b>A61K 31/4525</b> (2006.01) <b>A61K 31/454</b> (2006.01) <b>A61K 31/4985</b> (2006.01) <b>A61P 35/00</b> (2006.01) <b>C07D 403/12</b> (2006.01)



Broj objave evropske prijave patenta (97)	MKP (51)
	<b>C07D 405/12</b> (2006.01) <b>C07D 409/12</b> (2006.01) <b>C07D 471/04</b> (2006.01) <b>C07D 471/14</b> (2006.01) <b>C07D 487/04</b> (2006.01) <b>C07D 491/048</b> (2006.01)
3418276	<b>A61K 31/4439</b> (2006.01) <b>A61K 31/444</b> (2006.01) <b>A61K 31/4545</b> (2006.01) <b>A61K 31/46</b> (2006.01) <b>A61K 31/4709</b> (2006.01) <b>A61K 31/498</b> (2006.01) <b>A61K 31/5355</b> (2006.01) <b>A61K 31/5377</b> (2006.01) <b>A61P 13/12</b> (2006.01) <b>A61P 43/00</b> (2006.01) <b>C07D 401/04</b> (2006.01) <b>C07D 401/14</b> (2006.01) <b>C07D 405/14</b> (2006.01) <b>C07D 409/14</b> (2006.01) <b>C07D 413/14</b> (2006.01) <b>C07D 417/14</b> (2006.01) <b>C07D 451/02</b> (2006.01)
3417294	<b>A61K 38/00</b> (2006.01) <b>A61K 39/395</b> (2006.01) <b>A61K 48/00</b> (2006.01) <b>A61P 35/00</b> (2006.01) <b>G01N 33/574</b> (2006.01)
3417502	<b>C01B 32/10</b> (2017.01) <b>H01M 2/14</b> (2006.01) <b>H01M 4/134</b> (2010.01) <b>H01M 4/36</b> (2006.01) <b>H01M 4/38</b> (2006.01) <b>H01M 10/052</b> (2010.01) <b>H01M 10/058</b> (2010.01)
3416679	<b>A61K 8/00</b> (2006.01) <b>A61K 39/00</b> (2006.01) <b>A61K 48/00</b> (2006.01) <b>C07K 14/435</b> (2006.01) <b>C07K 14/47</b> (2006.01) <b>C12N 9/00</b> (2006.01)
3416639	<b>A61K 31/4365</b> (2006.01) <b>C07D 495/04</b> (2006.01)
3417051	<b>C12N 5/00</b> (2006.01) <b>G01N 1/30</b> (2006.01) <b>G01N 33/50</b> (2006.01) <b>G01N 33/68</b> (2006.01)
3347352	<b>A61K 31/4439</b> (2006.01) <b>A61P 31/18</b> (2006.01) <b>C07D 401/14</b> (2006.01)
3400676	<b>B64C 39/02</b> (2006.01) <b>G05B 19/418</b> (2006.01) <b>H04L 9/32</b> (2006.01)

---

Broj objave evropske prijava patenta (97)	MKP (51)
3359146	<b>A61K 31/13</b> (2006.01) <b>A61P 25/00</b> (2006.01)
3416631	<b>A61K 31/13</b> (2006.01) <b>A61P 25/00</b> (2006.01)
3347879	<b>G06F 17/50</b> (2006.01) <b>G06T 17/10</b> (2006.01) <b>G06T 19/00</b> (2011.01)
3359172	<b>A61K 35/74</b> (2015.01) <b>A61P 1/14</b> (2006.01) <b>A61P 29/00</b> (2006.01)
3408197	<b>B65G 39/04</b> (2006.01) <b>B65G 39/07</b> (2006.01)
3368011	<b>A61K 9/00</b> (2006.01) <b>A61K 31/137</b> (2006.01) <b>A61K 45/06</b> (2006.01)

---

## Indeks klasifikacijskih oznaka zahtjeva za proširenje evropskih prijava patenta prema Međunarodnoj klasifikaciji patenata

MKP (51)	Broj objave evropske prijava patenta (97)	Naziv pronalaska (54)
<b>B26B 21/22</b> (2006.01)	3022022	RAZOR HAVING FREE MOVABILITY OF THE RAZOR HEAD
<b>B26B 21/52</b> (2006.01)	3022022	RAZOR HAVING FREE MOVABILITY OF THE RAZOR HEAD
<b>B23K 26/12</b> (2014.01)	2929976	METHOD FOR CO2 LASER WELDING OF HIGH ALLOY STEELS
<b>B23K 26/14</b> (2014.01)	2929976	METHOD FOR CO2 LASER WELDING OF HIGH ALLOY STEELS
<b>B23K 26/34</b> (2014.01)	2929976	METHOD FOR CO2 LASER WELDING OF HIGH ALLOY STEELS
<b>B23K 35/38</b> (2006.01)	2929976	METHOD FOR CO2 LASER WELDING OF HIGH ALLOY STEELS
<b>B23K 103/04</b> (2006.01)	2929976	METHOD FOR CO2 LASER WELDING OF HIGH ALLOY STEELS
<b>B23K 26/12</b> (2014.01)	2929977	METHOD FOR CO2 LASER WELDING OF LOW ALLOY STEELS
<b>B23K 35/38</b> (2006.01)	2929977	METHOD FOR CO2 LASER WELDING OF LOW ALLOY STEELS
<b>F16B 23/00</b> (2006.01)	2476919	Screw anchor and method for manufacturing a screw anchor
<b>F16B 25/00</b> (2006.01)	2476919	Screw anchor and method for manufacturing a screw anchor
<b>F16B 37/12</b> (2006.01)	2476919	Screw anchor and method for manufacturing a screw anchor
<b>B60L 11/18</b> (2006.01)	2708403	System and method for managing load on a power grid
<b>H02J 3/14</b> (2006.01)	2708403	System and method for managing load on a power grid
<b>F23J 1/02</b> (2006.01)	2375154	Heating device
<b>A23L 3/375</b> (2006.01)	2657631	Method and device for cooling products
<b>F25D 3/10</b> (2006.01)	2657631	Method and device for cooling products
<b>F25D 3/12</b> (2006.01)	2657631	Method and device for cooling products
<b>F25D 3/10</b> (2006.01)	2657630	Method and device for producing cooled products
<b>F25D 3/12</b> (2006.01)	2657630	Method and device for producing cooled products
<b>F23N 1/02</b> (2006.01)	2741002	Device and method for detecting and controlling the flow of a fluid medium in a controlled system
<b>F02D 41/00</b> (2006.01)	2730769	Method for operating a combustion engine with high pressure and low pressure exhaust gas recovery
<b>F02D 41/02</b> (2006.01)	2730769	Method for operating a combustion engine with high pressure and low pressure exhaust gas recovery
<b>A23L 27/40</b> (2016.01)	3349594	SALT SUBSTITUTE COMPOSITION, PREPARATION AND USE THEREOF
<b>A23L 33/165</b> (2016.01)	3349594	SALT SUBSTITUTE COMPOSITION, PREPARATION AND USE THEREOF
<b>A61P 9/12</b> (2006.01)	3349594	SALT SUBSTITUTE COMPOSITION, PREPARATION AND USE THEREOF
<b>A61K 31/7068</b> (2006.01)	3359163	COMBINATION THERAPY
<b>A61P 35/00</b> (2006.01)	3359163	COMBINATION THERAPY
<b>A61K 33/06</b> (2006.01)	3349765	COMBINATION PRODUCT FOR ASSISTING WITH RELAXATION AND SLEEP
<b>A61K 36/185</b> (2006.01)	3349765	COMBINATION PRODUCT FOR ASSISTING WITH RELAXATION AND SLEEP
<b>A61K 36/28</b> (2006.01)	3349765	COMBINATION PRODUCT FOR ASSISTING WITH RELAXATION AND SLEEP
<b>A61K 36/53</b> (2006.01)	3349765	COMBINATION PRODUCT FOR ASSISTING WITH RELAXATION AND SLEEP
<b>B65D 51/24</b> (2006.01)	3247650	A DEVICE FOR ELIMINATING FERMENTATION RESIDUES IN AN ALCOHOLIC BEVERAGE
<b>C12G 1/08</b> (2006.01)	3247650	A DEVICE FOR ELIMINATING FERMENTATION RESIDUES IN AN ALCOHOLIC BEVERAGE
<b>C12G 1/032</b> (2006.01)	3170887	IMPROVED FERMENTER
<b>A23K 10/00</b> (2016.01)	3358965	BIRD FEED AND IN PARTICULAR POULTRY FEED, COMPRISING SYNTHETIC CAPSAICINOID DERIVATIVES AND SUCH FEED FOR PROHYLACTIC USE OR TREATMENT OF SALMONELLA INFECTION
<b>A61B 5/145</b> (2006.01)	3359038	DEVICE FOR NON-INVASIVE MEASUREMENT OF BLOOD SUGAR LEVEL
<b>A61B 5/1455</b> (2006.01)	3359038	DEVICE FOR NON-INVASIVE MEASUREMENT OF BLOOD SUGAR LEVEL
<b>B64C 13/50</b> (2006.01)	3109168	METHOD AND APPARATUS FOR AUGMENTED PILOT OPERATIONS OF FLY-BY-WIRE VEHICLES
<b>B64D 45/00</b> (2006.01)	3109168	METHOD AND APPARATUS FOR AUGMENTED PILOT OPERATIONS OF FLY-BY-WIRE VEHICLES
<b>G05D 1/00</b> (2006.01)	3109168	METHOD AND APPARATUS FOR AUGMENTED PILOT OPERATIONS OF FLY-BY-WIRE VEHICLES

MKP (51)	Broj objave evropske prijava patenta (97)	Naziv pronalaska (54)
<b>H04B 7/185</b> (2006.01)	3109168	METHOD AND APPARATUS FOR AUGMENTED PILOT OPERATIONS OF FLY-BY-WIRE VEHICLES
<b>B42D 1/00</b> (2006.01)	3254861	PRINTING BOOK INCLUDING A FIRST ATTACHMENT DEVICE
<b>F23J 7/00</b> (2006.01)	3260776	LANCE SYSTEM, BOILER- CONTAINING LANCE SYSTEM AND METHOD FOR REDUCING NOX
<b>F23J 15/00</b> (2006.01)	3260776	LANCE SYSTEM, BOILER- CONTAINING LANCE SYSTEM AND METHOD FOR REDUCING NOX
<b>F23J 15/04</b> (2006.01)	3260776	LANCE SYSTEM, BOILER- CONTAINING LANCE SYSTEM AND METHOD FOR REDUCING NOX
<b>B21F 15/08</b> (2006.01)	3260231	GRIPPER AND METHOD FOR GRIPPING ENDS OF WIRES AND WIRE WELDING MACHINE AND ROBOT WITH SUCH GRIPPERS
<b>B23K 37/04</b> (2006.01)	3260231	GRIPPER AND METHOD FOR GRIPPING ENDS OF WIRES AND WIRE WELDING MACHINE AND ROBOT WITH SUCH GRIPPERS
<b>B23K 101/32</b> (2006.01)	3260231	GRIPPER AND METHOD FOR GRIPPING ENDS OF WIRES AND WIRE WELDING MACHINE AND ROBOT WITH SUCH GRIPPERS
<b>B25J 15/00</b> (2006.01)	3260231	GRIPPER AND METHOD FOR GRIPPING ENDS OF WIRES AND WIRE WELDING MACHINE AND ROBOT WITH SUCH GRIPPERS
<b>B25J 15/02</b> (2006.01)	3260231	GRIPPER AND METHOD FOR GRIPPING ENDS OF WIRES AND WIRE WELDING MACHINE AND ROBOT WITH SUCH GRIPPERS
<b>A23L 29/00</b> (2016.01)	3260114	METHOD FOR THE PRODUCTION OF A DOSAGE FORM
<b>A61K 8/00</b> (2006.01)	3260114	METHOD FOR THE PRODUCTION OF A DOSAGE FORM
<b>A61K 9/16</b> (2006.01)	3260114	METHOD FOR THE PRODUCTION OF A DOSAGE FORM
<b>A23L 29/00</b> (2016.01)	3260115	METHOD FOR THE PRODUCTION OF A DOSAGE FORM
<b>A61K 8/00</b> (2006.01)	3260115	METHOD FOR THE PRODUCTION OF A DOSAGE FORM
<b>A61K 9/16</b> (2006.01)	3260115	METHOD FOR THE PRODUCTION OF A DOSAGE FORM
<b>F04B 53/14</b> (2006.01)	3405704	PISTON-CHAMBER COMBINATION
<b>F15B 15/14</b> (2006.01)	3405704	PISTON-CHAMBER COMBINATION
<b>F16F 9/48</b> (2006.01)	3405704	PISTON-CHAMBER COMBINATION
<b>F16J 3/06</b> (2006.01)	3405704	PISTON-CHAMBER COMBINATION
<b>F16J 10/00</b> (2006.01)	3405704	PISTON-CHAMBER COMBINATION
<b>A47L 5/38</b> (2006.01)	2534989	Central vacuum cleaner assembly
<b>A47L 9/00</b> (2006.01)	2534989	Central vacuum cleaner assembly
<b>A47L 9/24</b> (2006.01)	2534989	Central vacuum cleaner assembly
<b>F16L 21/06</b> (2006.01)	3287682	HOLDING DEVICE FOR THE DETACHABLE, COAXIAL JOINING OF FLEXIBLE TUBING
<b>F16L 31/00</b> (2006.01)	3287682	HOLDING DEVICE FOR THE DETACHABLE, COAXIAL JOINING OF FLEXIBLE TUBING
<b>B29C 65/68</b> (2006.01)	3287710	ELECTRIC HEATER
<b>B60H 1/00</b> (2006.01)	3287710	ELECTRIC HEATER
<b>F24H 3/04</b> (2006.01)	3287710	ELECTRIC HEATER
<b>H01R 4/72</b> (2006.01)	3287710	ELECTRIC HEATER
<b>H05B 3/40</b> (2006.01)	3287710	ELECTRIC HEATER
<b>B62K 5/00</b> (2013.01)	3290315	LEANING CARGO MULTI-WHEELER
<b>B62K 5/10</b> (2013.01)	3290315	LEANING CARGO MULTI-WHEELER
<b>B62K 7/04</b> (2006.01)	3290315	LEANING CARGO MULTI-WHEELER
<b>A23L 33/195</b> (2016.01)	3290436	PHENYLALANINE-FREE PROTEIN FOR THE TREATMENT OF PKU
<b>A61K 38/00</b> (2006.01)	3290436	PHENYLALANINE-FREE PROTEIN FOR THE TREATMENT OF PKU
<b>C07K 14/195</b> (2006.01)	3290436	PHENYLALANINE-FREE PROTEIN FOR THE TREATMENT OF PKU
<b>F24H 1/00</b> (2006.01)	3290819	ELECTRIC HEATING DEVICE
<b>F24H 9/00</b> (2006.01)	3290819	ELECTRIC HEATING DEVICE
<b>F24H 9/18</b> (2006.01)	3290819	ELECTRIC HEATING DEVICE
<b>H05B 1/02</b> (2006.01)	3290819	ELECTRIC HEATING DEVICE
<b>H05B 3/48</b> (2006.01)	3290819	ELECTRIC HEATING DEVICE
<b>A61B 17/072</b> (2006.01)	3150136	PROGRESSIVELY RELEASABLE IMPLANTABLE ADJUNCT FOR USE WITH A SURGICAL STAPLING INSTRUMENT
<b>A23L 29/231</b> (2016.01)	3376880	ALCOHOLIC FOAM
<b>A01M 1/02</b> (2006.01)	3254559	INSECT TRAP
<b>A01M 1/10</b> (2006.01)	3254559	INSECT TRAP
<b>A01M 1/20</b> (2006.01)	3254559	INSECT TRAP
<b>A23L 21/20</b> (2016.01)	3278798	SYNERGISTIC COMPOSITION COMPRISING PROPOLIS AND CARNOSIC ACID FOR USE THEREOF IN TREATING AND PREVENTING INFECTIONS CAUSED BY SPECIES OF THE CRYPTOCOCCUS NEOFORMANS FUNGUS
<b>A23L 33/10</b> (2016.01)	3278798	SYNERGISTIC COMPOSITION COMPRISING PROPOLIS AND CARNOSIC ACID FOR USE THEREOF IN TREATING AND PREVENTING INFECTIONS CAUSED BY SPECIES OF THE CRYPTOCOCCUS NEOFORMANS FUNGUS

MKP (51)	Broj objave evropske prijava patenta (97)	Naziv pronalaska (54)
<b>A61K 31/192</b> (2006.01)	3278798	SYNERGISTIC COMPOSITION COMPRISING PROPOLIS AND CARNOSIC ACID FOR USE THEREOF IN TREATING AND PREVENTING INFECTIONS CAUSED BY SPECIES OF THE CRYPTOCOCCUS NEOFORMANS FUNGUS
<b>A61K 35/644</b> (2015.01)	3278798	SYNERGISTIC COMPOSITION COMPRISING PROPOLIS AND CARNOSIC ACID FOR USE THEREOF IN TREATING AND PREVENTING INFECTIONS CAUSED BY SPECIES OF THE CRYPTOCOCCUS NEOFORMANS FUNGUS
<b>A61P 31/10</b> (2006.01)	3278798	SYNERGISTIC COMPOSITION COMPRISING PROPOLIS AND CARNOSIC ACID FOR USE THEREOF IN TREATING AND PREVENTING INFECTIONS CAUSED BY SPECIES OF THE CRYPTOCOCCUS NEOFORMANS FUNGUS
<b>B27H 5/04</b> (2006.01)	3301170	DEVICE AND METHOD OF HEATING/BENDING/FORMING AND HEATING/TOASTING BARRELS, CASKS, VATS AND THE LIKE FOR REFINING, CONDITIONING AND AGEING ALCOHOLIC BEVERAGES AND OTHER FOODS
<b>B27M 1/06</b> (2006.01)	3301170	DEVICE AND METHOD OF HEATING/BENDING/FORMING AND HEATING/TOASTING BARRELS, CASKS, VATS AND THE LIKE FOR REFINING, CONDITIONING AND AGEING ALCOHOLIC BEVERAGES AND OTHER FOODS
<b>C12G 3/07</b> (2006.01)	3301170	DEVICE AND METHOD OF HEATING/BENDING/FORMING AND HEATING/TOASTING BARRELS, CASKS, VATS AND THE LIKE FOR REFINING, CONDITIONING AND AGEING ALCOHOLIC BEVERAGES AND OTHER FOODS
<b>C12J 1/00</b> (2006.01)	3301170	DEVICE AND METHOD OF HEATING/BENDING/FORMING AND HEATING/TOASTING BARRELS, CASKS, VATS AND THE LIKE FOR REFINING, CONDITIONING AND AGEING ALCOHOLIC BEVERAGES AND OTHER FOODS
<b>F01D 5/00</b> (2006.01)	3318716	INSTALLATION OR REMOVAL OF TURBINE BLADE AT TURBINE BLADE BASE
<b>F01D 5/30</b> (2006.01)	3318716	INSTALLATION OR REMOVAL OF TURBINE BLADE AT TURBINE BLADE BASE
<b>F01D 25/28</b> (2006.01)	3318716	INSTALLATION OR REMOVAL OF TURBINE BLADE AT TURBINE BLADE BASE
<b>A61K 38/00</b> (2006.01)	3245224	IL-17A-BINDING POLYPEPTIDES
<b>A61K 38/20</b> (2006.01)	3245224	IL-17A-BINDING POLYPEPTIDES
<b>C07K 14/54</b> (2006.01)	3245224	IL-17A-BINDING POLYPEPTIDES
<b>A61K 39/00</b> (2006.01)	3242892	ALTERED APRIL BINDING ANTIBODIES
<b>A61K 39/395</b> (2006.01)	3242892	ALTERED APRIL BINDING ANTIBODIES
<b>A61P 37/00</b> (2006.01)	3242892	ALTERED APRIL BINDING ANTIBODIES
<b>C07K 16/28</b> (2006.01)	3242892	ALTERED APRIL BINDING ANTIBODIES
<b>A23L 2/52</b> (2006.01)	3250050	A NATURAL SWEETENING COMPOSITION
<b>A23L 2/60</b> (2006.01)	3250050	A NATURAL SWEETENING COMPOSITION
<b>A23L 27/12</b> (2016.01)	3250050	A NATURAL SWEETENING COMPOSITION
<b>A23L 2/52</b> (2006.01)	3250051	A NATURAL SWEETENING COMPOSITION OF LUO HAN GUO AND APPLE
<b>A23L 2/60</b> (2006.01)	3250051	A NATURAL SWEETENING COMPOSITION OF LUO HAN GUO AND APPLE
<b>A23L 27/12</b> (2016.01)	3250051	A NATURAL SWEETENING COMPOSITION OF LUO HAN GUO AND APPLE
<b>A61K 39/00</b> (2006.01)	3242684	DOSAGE REGIMEN FOR MADCAM ANTAGONISTS
<b>A61K 39/395</b> (2006.01)	3242684	DOSAGE REGIMEN FOR MADCAM ANTAGONISTS
<b>A61P 1/00</b> (2006.01)	3242684	DOSAGE REGIMEN FOR MADCAM ANTAGONISTS
<b>C07K 16/28</b> (2006.01)	3242684	DOSAGE REGIMEN FOR MADCAM ANTAGONISTS
<b>A62B 35/00</b> (2006.01)	3402577	FALL ARRESTER WITH TORSIONAL ENERGY ABSORBING MEANS
<b>A62B 35/04</b> (2006.01)	3402577	FALL ARRESTER WITH TORSIONAL ENERGY ABSORBING MEANS
<b>A61K 31/4439</b> (2006.01)	3256127	METHOD OF PREVENTING OR TREATING HEARING LOSS
<b>A61P 27/00</b> (2006.01)	3256127	METHOD OF PREVENTING OR TREATING HEARING LOSS
<b>A61K 39/395</b> (2006.01)	3247393	MATRIX METALLOPROTEASE-CLEAVABLE AND SERINE PROTEASE CLEAVABLE SUBSTRATES AND METHODS OF USE THEREOF
<b>C07K 16/28</b> (2006.01)	3247393	MATRIX METALLOPROTEASE-CLEAVABLE AND SERINE PROTEASE CLEAVABLE SUBSTRATES AND METHODS OF USE THEREOF
<b>A61K 31/18</b> (2006.01)	3259250	NOVEL N-ACYL-ARYLSULFONAMIDE DERIVATIVES AS AMINOACYL-TRNA SYNTHETASE INHIBITORS
<b>A61K 31/4402</b> (2006.01)	3259250	NOVEL N-ACYL-ARYLSULFONAMIDE DERIVATIVES AS AMINOACYL-TRNA SYNTHETASE INHIBITORS
<b>A61K 31/47</b> (2006.01)	3259250	NOVEL N-ACYL-ARYLSULFONAMIDE DERIVATIVES AS AMINOACYL-TRNA SYNTHETASE INHIBITORS

MKP (51)	Broj objave evropske prijava patenta (97)	Naziv pronalaska (54)
<b>A61K 31/505</b> (2006.01)	3259250	NOVEL N-ACYL-ARYLSULFONAMIDE DERIVATIVES AS AMINOACYL-TRNA SYNTHETASE INHIBITORS
<b>A61P 31/00</b> (2006.01)	3259250	NOVEL N-ACYL-ARYLSULFONAMIDE DERIVATIVES AS AMINOACYL-TRNA SYNTHETASE INHIBITORS
<b>C07C 311/00</b> (2006.01)	3259250	NOVEL N-ACYL-ARYLSULFONAMIDE DERIVATIVES AS AMINOACYL-TRNA SYNTHETASE INHIBITORS
<b>C07D 213/71</b> (2006.01)	3259250	NOVEL N-ACYL-ARYLSULFONAMIDE DERIVATIVES AS AMINOACYL-TRNA SYNTHETASE INHIBITORS
<b>C07D 215/36</b> (2006.01)	3259250	NOVEL N-ACYL-ARYLSULFONAMIDE DERIVATIVES AS AMINOACYL-TRNA SYNTHETASE INHIBITORS
<b>C07D 217/22</b> (2006.01)	3259250	NOVEL N-ACYL-ARYLSULFONAMIDE DERIVATIVES AS AMINOACYL-TRNA SYNTHETASE INHIBITORS
<b>C07D 239/42</b> (2006.01)	3259250	NOVEL N-ACYL-ARYLSULFONAMIDE DERIVATIVES AS AMINOACYL-TRNA SYNTHETASE INHIBITORS
<b>C07D 239/47</b> (2006.01)	3259250	NOVEL N-ACYL-ARYLSULFONAMIDE DERIVATIVES AS AMINOACYL-TRNA SYNTHETASE INHIBITORS
<b>C07D 239/48</b> (2006.01)	3259250	NOVEL N-ACYL-ARYLSULFONAMIDE DERIVATIVES AS AMINOACYL-TRNA SYNTHETASE INHIBITORS
<b>C07D 251/22</b> (2006.01)	3259250	NOVEL N-ACYL-ARYLSULFONAMIDE DERIVATIVES AS AMINOACYL-TRNA SYNTHETASE INHIBITORS
<b>C07D 311/20</b> (2006.01)	3259250	NOVEL N-ACYL-ARYLSULFONAMIDE DERIVATIVES AS AMINOACYL-TRNA SYNTHETASE INHIBITORS
<b>C07D 487/04</b> (2006.01)	3259250	NOVEL N-ACYL-ARYLSULFONAMIDE DERIVATIVES AS AMINOACYL-TRNA SYNTHETASE INHIBITORS
<b>A61K 31/551</b> (2006.01)	3253747	3-ALKYL-4-AMIDO-BICYCLIC [4,5,0]HYDROXAMIC ACIDS AS HDAC INHIBITORS
<b>A61K 31/553</b> (2006.01)	3253747	3-ALKYL-4-AMIDO-BICYCLIC [4,5,0]HYDROXAMIC ACIDS AS HDAC INHIBITORS
<b>A61P 35/00</b> (2006.01)	3253747	3-ALKYL-4-AMIDO-BICYCLIC [4,5,0]HYDROXAMIC ACIDS AS HDAC INHIBITORS
<b>C07D 243/14</b> (2006.01)	3253747	3-ALKYL-4-AMIDO-BICYCLIC [4,5,0]HYDROXAMIC ACIDS AS HDAC INHIBITORS
<b>C07D 267/12</b> (2006.01)	3253747	3-ALKYL-4-AMIDO-BICYCLIC [4,5,0]HYDROXAMIC ACIDS AS HDAC INHIBITORS
<b>C07D 403/06</b> (2006.01)	3253747	3-ALKYL-4-AMIDO-BICYCLIC [4,5,0]HYDROXAMIC ACIDS AS HDAC INHIBITORS
<b>C07D 413/06</b> (2006.01)	3253747	3-ALKYL-4-AMIDO-BICYCLIC [4,5,0]HYDROXAMIC ACIDS AS HDAC INHIBITORS
<b>A61K 9/16</b> (2006.01)	3256107	PHARMACEUTICAL FORMULATION OF RACECADOTRIL
<b>A61K 31/265</b> (2006.01)	3256107	PHARMACEUTICAL FORMULATION OF RACECADOTRIL
<b>E04C 1/00</b> (2006.01)	3384100	BUILDING PRODUCTS COMPRISING GRAPHENE OR GRAPHENE OXIDE IN THE BULK MATERIAL AND METHOD FOR PRODUCING SUCH BUILDING PRODUCTS
<b>E04C 2/04</b> (2006.01)	3384100	BUILDING PRODUCTS COMPRISING GRAPHENE OR GRAPHENE OXIDE IN THE BULK MATERIAL AND METHOD FOR PRODUCING SUCH BUILDING PRODUCTS
<b>E04C 2/04</b> (2006.01)	3374577	BUILDING PRODUCTS WITH GRAPHENE OR GRAPHENE OXIDE
<b>B65D 51/28</b> (2006.01)	3397568	CONTAINER WITH MULTI DEPRESSIBLE CAP PRESS TOP
<b>A61N 5/06</b> (2006.01)	3402570	COMPACT UVB LIGHT THERAPY DEVICE FOR TREATING DERMAL CONDITIONS
<b>C12N 9/74</b> (2006.01)	3253870	METHOD FOR PREPARATION OF THROMBIN
<b>G01N 33/48</b> (2006.01)	3253870	METHOD FOR PREPARATION OF THROMBIN
<b>B65D 81/34</b> (2006.01)	3395716	BAG FOR COOKING CORN GRAINS IN A MICROWAVE
<b>A61K 31/496</b> (2006.01)	3344620	1-(4-(2-((1-(3,4-DIFLUOROPHENYL)-1H-PYRAZOL-3-YL)METHOXY)ETHYL) PIPERAZIN-1-YL)ETHANONE SALTS
<b>A61P 25/34</b> (2006.01)	3344620	1-(4-(2-((1-(3,4-DIFLUOROPHENYL)-1H-PYRAZOL-3-YL)METHOXY)ETHYL) PIPERAZIN-1-YL)ETHANONE SALTS
<b>C07D 403/12</b> (2006.01)	3344620	1-(4-(2-((1-(3,4-DIFLUOROPHENYL)-1H-PYRAZOL-3-YL)METHOXY)ETHYL) PIPERAZIN-1-YL)ETHANONE SALTS
<b>A61K 31/713</b> (2006.01)	3344769	PROGRAMMED CELL DEATH 1 LIGAND 1 (PD-L1) iRNA COMPOSITIONS AND METHODS OF USE THEREOF
<b>C12N 15/113</b> (2010.01)	3344769	PROGRAMMED CELL DEATH 1 LIGAND 1 (PD-L1) iRNA COMPOSITIONS AND METHODS OF USE THEREOF
<b>A61K 31/575</b> (2006.01)	3394081	POLYMORPHIC CRYSTALLINE FORMS OF OBETICHOLIC ACID
<b>A61P 1/16</b> (2006.01)	3394081	POLYMORPHIC CRYSTALLINE FORMS OF OBETICHOLIC ACID
<b>C07J 9/00</b> (2006.01)	3394081	POLYMORPHIC CRYSTALLINE FORMS OF OBETICHOLIC ACID
<b>C07J 17/00</b> (2006.01)	3394081	POLYMORPHIC CRYSTALLINE FORMS OF OBETICHOLIC ACID
<b>C07J 51/00</b> (2006.01)	3394081	POLYMORPHIC CRYSTALLINE FORMS OF OBETICHOLIC ACID

MKP (51)	Broj objave evropske prijava patenta (97)	Naziv pronalaska (54)
<b>A22C 21/00</b> (2006.01)	3250039	DEVICE FOR MAKING A PREPARATORY INCISION LONGITUDINALLY OF AN ANIMAL EXTREMITY PART WITH FIRST AND SECOND BONES ARTICULATED BY A JOINT
<b>A47C 7/02</b> (2006.01)	3373769	METHOD FOR PRODUCING A TEXTILE COMPOSITE MATERIAL AND TEXTILE COMPOSITE MATERIAL PRODUCED ACCORDING TO SAID METHOD
<b>A47C 7/28</b> (2006.01)	3373769	METHOD FOR PRODUCING A TEXTILE COMPOSITE MATERIAL AND TEXTILE COMPOSITE MATERIAL PRODUCED ACCORDING TO SAID METHOD
<b>A47C 31/02</b> (2006.01)	3373769	METHOD FOR PRODUCING A TEXTILE COMPOSITE MATERIAL AND TEXTILE COMPOSITE MATERIAL PRODUCED ACCORDING TO SAID METHOD
<b>B68G 7/00</b> (2006.01)	3373769	METHOD FOR PRODUCING A TEXTILE COMPOSITE MATERIAL AND TEXTILE COMPOSITE MATERIAL PRODUCED ACCORDING TO SAID METHOD
<b>D03D 15/04</b> (2006.01)	3373769	METHOD FOR PRODUCING A TEXTILE COMPOSITE MATERIAL AND TEXTILE COMPOSITE MATERIAL PRODUCED ACCORDING TO SAID METHOD
<b>A01K 67/027</b> (2006.01)	3165540	ANTIBODIES THAT BIND HUMAN CD27 AND USES THEREOF
<b>A61K 39/395</b> (2006.01)	3165540	ANTIBODIES THAT BIND HUMAN CD27 AND USES THEREOF
<b>A61P 35/00</b> (2006.01)	3165540	ANTIBODIES THAT BIND HUMAN CD27 AND USES THEREOF
<b>A61P 37/02</b> (2006.01)	3165540	ANTIBODIES THAT BIND HUMAN CD27 AND USES THEREOF
<b>C07K 14/705</b> (2006.01)	3165540	ANTIBODIES THAT BIND HUMAN CD27 AND USES THEREOF
<b>C07K 16/28</b> (2006.01)	3165540	ANTIBODIES THAT BIND HUMAN CD27 AND USES THEREOF
<b>G06T 15/08</b> (2011.01)	3156975	VOXELIZATION OF A TRIDIMENSIONAL MESH
<b>G06T 17/20</b> (2006.01)	3156975	VOXELIZATION OF A TRIDIMENSIONAL MESH
<b>G06T 19/00</b> (2011.01)	3156975	VOXELIZATION OF A TRIDIMENSIONAL MESH
<b>B01D 24/36</b> (2006.01)	3159314	CLARIFICATION UNIT, METHOD AND USE
<b>B01D 24/46</b> (2006.01)	3159314	CLARIFICATION UNIT, METHOD AND USE
<b>C02F 3/08</b> (2006.01)	3159314	CLARIFICATION UNIT, METHOD AND USE
<b>C02F 3/12</b> (2006.01)	3159314	CLARIFICATION UNIT, METHOD AND USE
<b>A61K 39/395</b> (2006.01)	3156073	IL-17 ANTIBODY FORMULATION
<b>C07K 16/24</b> (2006.01)	3156073	IL-17 ANTIBODY FORMULATION
<b>B23D 65/00</b> (2006.01)	3321020	DEVICE FOR THE POST-TREATMENT OF BUTT-WELDED WORKPIECES, IN PARTICULAR SAW BANDS OR BAND KNIVES
<b>B24B 7/17</b> (2006.01)	3321020	DEVICE FOR THE POST-TREATMENT OF BUTT-WELDED WORKPIECES, IN PARTICULAR SAW BANDS OR BAND KNIVES
<b>B24B 21/04</b> (2006.01)	3321020	DEVICE FOR THE POST-TREATMENT OF BUTT-WELDED WORKPIECES, IN PARTICULAR SAW BANDS OR BAND KNIVES
<b>H01M 2/02</b> (2006.01)	3321990	FLOW BATTERY, PROCESS FOR THE MANUFACTURE, AND USE THEREOF
<b>H01M 4/86</b> (2006.01)	3321990	FLOW BATTERY, PROCESS FOR THE MANUFACTURE, AND USE THEREOF
<b>H01M 4/88</b> (2006.01)	3321990	FLOW BATTERY, PROCESS FOR THE MANUFACTURE, AND USE THEREOF
<b>H01M 12/06</b> (2006.01)	3321990	FLOW BATTERY, PROCESS FOR THE MANUFACTURE, AND USE THEREOF
<b>H01M 12/08</b> (2006.01)	3321990	FLOW BATTERY, PROCESS FOR THE MANUFACTURE, AND USE THEREOF
<b>C02F 1/00</b> (2006.01)	3153474	SUSTAINABLE SYSTEM FOR TREATING WATER BODIES AFFECTED BY BACTERIA AND MICROALGAE AT LOW COST
<b>C02F 1/44</b> (2006.01)	3153474	SUSTAINABLE SYSTEM FOR TREATING WATER BODIES AFFECTED BY BACTERIA AND MICROALGAE AT LOW COST
<b>C02F 1/50</b> (2006.01)	3153474	SUSTAINABLE SYSTEM FOR TREATING WATER BODIES AFFECTED BY BACTERIA AND MICROALGAE AT LOW COST
<b>C02F 1/66</b> (2006.01)	3153474	SUSTAINABLE SYSTEM FOR TREATING WATER BODIES AFFECTED BY BACTERIA AND MICROALGAE AT LOW COST
<b>C02F 1/76</b> (2006.01)	3153474	SUSTAINABLE SYSTEM FOR TREATING WATER BODIES AFFECTED BY BACTERIA AND MICROALGAE AT LOW COST
<b>C02F 1/78</b> (2006.01)	3153474	SUSTAINABLE SYSTEM FOR TREATING WATER BODIES AFFECTED BY BACTERIA AND MICROALGAE AT LOW COST
<b>C02F 5/14</b> (2006.01)	3153474	SUSTAINABLE SYSTEM FOR TREATING WATER BODIES AFFECTED BY BACTERIA AND MICROALGAE AT LOW COST
<b>C02F 103/42</b> (2006.01)	3153474	SUSTAINABLE SYSTEM FOR TREATING WATER BODIES AFFECTED BY BACTERIA AND MICROALGAE AT LOW COST
<b>E04H 4/12</b> (2006.01)	3153474	SUSTAINABLE SYSTEM FOR TREATING WATER BODIES AFFECTED BY BACTERIA AND MICROALGAE AT LOW COST

MKP (51)	Broj objave evropske prijava patenta (97)	Naziv pronalaska (54)
<b>B01D 21/30</b> (2006.01)	3156111	METHOD FOR TREATING WATER USED FOR INDUSTRIAL PURPOSES
<b>B01D 61/04</b> (2006.01)	3156111	METHOD FOR TREATING WATER USED FOR INDUSTRIAL PURPOSES
<b>C02F 1/00</b> (2006.01)	3156111	METHOD FOR TREATING WATER USED FOR INDUSTRIAL PURPOSES
<b>C02F 1/24</b> (2006.01)	3156111	METHOD FOR TREATING WATER USED FOR INDUSTRIAL PURPOSES
<b>C02F 1/44</b> (2006.01)	3156111	METHOD FOR TREATING WATER USED FOR INDUSTRIAL PURPOSES
<b>C02F 1/50</b> (2006.01)	3156111	METHOD FOR TREATING WATER USED FOR INDUSTRIAL PURPOSES
<b>C02F 1/52</b> (2006.01)	3156111	METHOD FOR TREATING WATER USED FOR INDUSTRIAL PURPOSES
<b>C02F 1/56</b> (2006.01)	3156111	METHOD FOR TREATING WATER USED FOR INDUSTRIAL PURPOSES
<b>C02F 1/72</b> (2006.01)	3156111	METHOD FOR TREATING WATER USED FOR INDUSTRIAL PURPOSES
<b>C02F 1/76</b> (2006.01)	3156111	METHOD FOR TREATING WATER USED FOR INDUSTRIAL PURPOSES
<b>C02F 1/78</b> (2006.01)	3156111	METHOD FOR TREATING WATER USED FOR INDUSTRIAL PURPOSES
<b>C02F 5/08</b> (2006.01)	3156111	METHOD FOR TREATING WATER USED FOR INDUSTRIAL PURPOSES
<b>C02F 9/02</b> (2006.01)	3156111	METHOD FOR TREATING WATER USED FOR INDUSTRIAL PURPOSES
<b>C02F 101/20</b> (2006.01)	3156111	METHOD FOR TREATING WATER USED FOR INDUSTRIAL PURPOSES
<b>C02F 103/02</b> (2006.01)	3156111	METHOD FOR TREATING WATER USED FOR INDUSTRIAL PURPOSES
<b>C02F 103/08</b> (2006.01)	3156111	METHOD FOR TREATING WATER USED FOR INDUSTRIAL PURPOSES
<b>C02F 103/10</b> (2006.01)	3156111	METHOD FOR TREATING WATER USED FOR INDUSTRIAL PURPOSES
<b>G01N 27/72</b> (2006.01)	3173825	METHODS AND APPARATUS FOR COLLOCATING ELECTROMAGNETIC COILS AND ELECTRONIC CIRCUITS
<b>G01V 3/10</b> (2006.01)	3173825	METHODS AND APPARATUS FOR COLLOCATING ELECTROMAGNETIC COILS AND ELECTRONIC CIRCUITS
<b>A47F 1/12</b> (2006.01)	3332672	MOBILE MAGAZINE
<b>G07F 9/10</b> (2006.01)	3332672	MOBILE MAGAZINE
<b>G07F 11/04</b> (2006.01)	3332672	MOBILE MAGAZINE
<b>G07F 11/16</b> (2006.01)	3332672	MOBILE MAGAZINE
<b>G07F 11/22</b> (2006.01)	3332672	MOBILE MAGAZINE
<b>G07F 11/42</b> (2006.01)	3332672	MOBILE MAGAZINE
<b>A01K 67/027</b> (2006.01)	3165086	COMMON LIGHT CHAIN MOUSE
<b>C07K 16/00</b> (2006.01)	3165086	COMMON LIGHT CHAIN MOUSE
<b>C07K 16/28</b> (2006.01)	3165086	COMMON LIGHT CHAIN MOUSE
<b>C12N 15/85</b> (2006.01)	3165086	COMMON LIGHT CHAIN MOUSE
<b>B23P 19/02</b> (2006.01)	3348346	METHOD AND DEVICE FOR PRODUCING CONNECTION HOSES
<b>B23P 21/00</b> (2006.01)	3348346	METHOD AND DEVICE FOR PRODUCING CONNECTION HOSES
<b>G02B 19/00</b> (2006.01)	3214477	DEVICE FOR SHAPING LASER RADIATION
<b>G02B 27/09</b> (2006.01)	3214477	DEVICE FOR SHAPING LASER RADIATION
<b>G02B 27/14</b> (2006.01)	3214477	DEVICE FOR SHAPING LASER RADIATION
<b>H01S 5/40</b> (2006.01)	3214477	DEVICE FOR SHAPING LASER RADIATION
<b>C01F 11/18</b> (2006.01)	3354622	PROCESS FOR THE PREPARATION OF FRAGMENTED NATURAL CALCIUM CARBONATE WITH A REDUCED CONTENT OF IMPURITIES AND PRODUCTS OBTAINED THEREOF
<b>C09C 1/02</b> (2006.01)	3354622	PROCESS FOR THE PREPARATION OF FRAGMENTED NATURAL CALCIUM CARBONATE WITH A REDUCED CONTENT OF IMPURITIES AND PRODUCTS OBTAINED THEREOF
<b>A61K 8/02</b> (2006.01)	3360601	FUNCTIONALIZED CALCIUM CARBONATE FOR SUN PROTECTION BOOSTING
<b>A61K 8/19</b> (2006.01)	3360601	FUNCTIONALIZED CALCIUM CARBONATE FOR SUN PROTECTION BOOSTING
<b>A61K 8/29</b> (2006.01)	3360601	FUNCTIONALIZED CALCIUM CARBONATE FOR SUN PROTECTION BOOSTING
<b>A61Q 17/04</b> (2006.01)	3360601	FUNCTIONALIZED CALCIUM CARBONATE FOR SUN PROTECTION BOOSTING



MKP (51)	Broj objave evropske prijava patenta (97)	Naziv pronalaska (54)
<b>C08J 7/04</b> (2006.01)	3366740	MINERAL OIL BARRIER
<b>C09D 151/02</b> (2006.01)	3366740	MINERAL OIL BARRIER
<b>C07C 303/04</b> (2006.01)	3366671	PROCESS FOR THE PREPARATION OF SULFO-SUCCINIC ACID AND USE THEREOF
<b>C07C 309/22</b> (2006.01)	3366671	PROCESS FOR THE PREPARATION OF SULFO-SUCCINIC ACID AND USE THEREOF
<b>A61B 5/145</b> (2006.01)	3410936	MEASURING DEVICE FOR BLOOD AND/OR LIQUID INTERSTITIAL ANALYTES
<b>A61B 5/1486</b> (2006.01)	3410936	MEASURING DEVICE FOR BLOOD AND/OR LIQUID INTERSTITIAL ANALYTES
<b>F41C 33/02</b> (2006.01)	3411654	A HOLSTER FOR A FIREARM WITH AN ELECTRONIC DEVICE FOR DETECTING AND SENDING DATA
<b>C07C 273/10</b> (2006.01)	3411356	A CARBON NEUTRAL PROCESS AND RELATING APPARATUS TO PRODUCE UREA FROM MUNICIPAL OR INDUSTRIAL WASTES WITH ZERO EMISSIONS
<b>A61K 31/5386</b> (2006.01)	3377500	OXADIAZASPIRO COMPOUNDS FOR THE TREATMENT OF DRUG ABUSE AND ADDICTION
<b>A61P 25/32</b> (2006.01)	3377500	OXADIAZASPIRO COMPOUNDS FOR THE TREATMENT OF DRUG ABUSE AND ADDICTION
<b>A61P 25/34</b> (2006.01)	3377500	OXADIAZASPIRO COMPOUNDS FOR THE TREATMENT OF DRUG ABUSE AND ADDICTION
<b>A61P 25/36</b> (2006.01)	3377500	OXADIAZASPIRO COMPOUNDS FOR THE TREATMENT OF DRUG ABUSE AND ADDICTION
<b>C07D 498/10</b> (2006.01)	3377500	OXADIAZASPIRO COMPOUNDS FOR THE TREATMENT OF DRUG ABUSE AND ADDICTION
<b>A43B 13/04</b> (2006.01)	3347416	POLYMER COMPOSITION BASED ON THERMOPLASTIC COPOLYESTER ELASTOMER, MANUFACTURED ARTICLE MADE WITH SUCH POLYMER COMPOSITION AND PRODUCTION PROCESS OF SUCH POLYMER COMPOSITION
<b>C08J 9/00</b> (2006.01)	3347416	POLYMER COMPOSITION BASED ON THERMOPLASTIC COPOLYESTER ELASTOMER, MANUFACTURED ARTICLE MADE WITH SUCH POLYMER COMPOSITION AND PRODUCTION PROCESS OF SUCH POLYMER COMPOSITION
<b>C08J 9/04</b> (2006.01)	3347416	POLYMER COMPOSITION BASED ON THERMOPLASTIC COPOLYESTER ELASTOMER, MANUFACTURED ARTICLE MADE WITH SUCH POLYMER COMPOSITION AND PRODUCTION PROCESS OF SUCH POLYMER COMPOSITION
<b>C08K 5/10</b> (2006.01)	3347416	POLYMER COMPOSITION BASED ON THERMOPLASTIC COPOLYESTER ELASTOMER, MANUFACTURED ARTICLE MADE WITH SUCH POLYMER COMPOSITION AND PRODUCTION PROCESS OF SUCH POLYMER COMPOSITION
<b>C08L 67/02</b> (2006.01)	3347416	POLYMER COMPOSITION BASED ON THERMOPLASTIC COPOLYESTER ELASTOMER, MANUFACTURED ARTICLE MADE WITH SUCH POLYMER COMPOSITION AND PRODUCTION PROCESS OF SUCH POLYMER COMPOSITION
<b>E04B 1/16</b> (2006.01)	3347535	BUILDING SYSTEM WITH A LOAD-RESISTING FRAME MADE OF REINFORCED CONCRETE OR STEEL INTEGRATED WITH WOODEN INFILL PANELS
<b>E04B 1/20</b> (2006.01)	3347535	BUILDING SYSTEM WITH A LOAD-RESISTING FRAME MADE OF REINFORCED CONCRETE OR STEEL INTEGRATED WITH WOODEN INFILL PANELS
<b>E04B 1/24</b> (2006.01)	3347535	BUILDING SYSTEM WITH A LOAD-RESISTING FRAME MADE OF REINFORCED CONCRETE OR STEEL INTEGRATED WITH WOODEN INFILL PANELS
<b>E04B 2/56</b> (2006.01)	3347535	BUILDING SYSTEM WITH A LOAD-RESISTING FRAME MADE OF REINFORCED CONCRETE OR STEEL INTEGRATED WITH WOODEN INFILL PANELS
<b>E04B 2/74</b> (2006.01)	3347535	BUILDING SYSTEM WITH A LOAD-RESISTING FRAME MADE OF REINFORCED CONCRETE OR STEEL INTEGRATED WITH WOODEN INFILL PANELS
<b>E04G 23/02</b> (2006.01)	3347535	BUILDING SYSTEM WITH A LOAD-RESISTING FRAME MADE OF REINFORCED CONCRETE OR STEEL INTEGRATED WITH WOODEN INFILL PANELS
<b>E04H 9/02</b> (2006.01)	3347535	BUILDING SYSTEM WITH A LOAD-RESISTING FRAME MADE OF REINFORCED CONCRETE OR STEEL INTEGRATED WITH WOODEN INFILL PANELS
<b>A61K 39/00</b> (2006.01)	3377094	VIRULENCE ATTENUATED BACTERIA FOR TREATMENT OF MALIGNANT SOLID TUMORS

MKP (51)	Broj objave evropske prijava patenta (97)	Naziv pronalaska (54)
<b>A61K 39/02</b> (2006.01)	3377094	VIRULENCE ATTENUATED BACTERIA FOR TREATMENT OF MALIGNANT SOLID TUMORS
<b>A61K 31/445</b> (2006.01)	3377478	CO-CRYSTALS OF BENZIMIDAZOLE COMPOUNDS
<b>A61P 37/08</b> (2006.01)	3377478	CO-CRYSTALS OF BENZIMIDAZOLE COMPOUNDS
<b>C07D 401/04</b> (2006.01)	3377478	CO-CRYSTALS OF BENZIMIDAZOLE COMPOUNDS
<b>A61K 9/20</b> (2006.01)	3346995	THERAPEUTIC COMPOSITIONS FOR TREATMENT OF HUMAN IMMUNODEFICIENCY VIRUS
<b>A61K 9/24</b> (2006.01)	3346995	THERAPEUTIC COMPOSITIONS FOR TREATMENT OF HUMAN IMMUNODEFICIENCY VIRUS
<b>A61K 9/28</b> (2006.01)	3346995	THERAPEUTIC COMPOSITIONS FOR TREATMENT OF HUMAN IMMUNODEFICIENCY VIRUS
<b>A61K 31/513</b> (2006.01)	3346995	THERAPEUTIC COMPOSITIONS FOR TREATMENT OF HUMAN IMMUNODEFICIENCY VIRUS
<b>A61K 31/5365</b> (2006.01)	3346995	THERAPEUTIC COMPOSITIONS FOR TREATMENT OF HUMAN IMMUNODEFICIENCY VIRUS
<b>A61K 31/553</b> (2006.01)	3346995	THERAPEUTIC COMPOSITIONS FOR TREATMENT OF HUMAN IMMUNODEFICIENCY VIRUS
<b>A61K 31/675</b> (2006.01)	3346995	THERAPEUTIC COMPOSITIONS FOR TREATMENT OF HUMAN IMMUNODEFICIENCY VIRUS
<b>A61P 31/18</b> (2006.01)	3346995	THERAPEUTIC COMPOSITIONS FOR TREATMENT OF HUMAN IMMUNODEFICIENCY VIRUS
<b>C12N 7/00</b> (2006.01)	3380605	TRANSIENT TRANSFECTION METHOD FOR RETROVIRAL PRODUCTION
<b>C12N 15/85</b> (2006.01)	3380605	TRANSIENT TRANSFECTION METHOD FOR RETROVIRAL PRODUCTION
<b>C12N 15/86</b> (2006.01)	3380605	TRANSIENT TRANSFECTION METHOD FOR RETROVIRAL PRODUCTION
<b>H02J 9/00</b> (2006.01)	3365957	METHOD OF SUPPLYING AN EMERGENCY SUPPLY MODULE AND EMERGENCY SUPPLY MODULE WITH REDUCED POWER CONSUMPTION
<b>H02J 9/06</b> (2006.01)	3365957	METHOD OF SUPPLYING AN EMERGENCY SUPPLY MODULE AND EMERGENCY SUPPLY MODULE WITH REDUCED POWER CONSUMPTION
<b>A61K 31/445</b> (2006.01)	3371164	N-[2-(1 -BENZYLPIPERIDIN-4-YL)ETHYL]-4-(PYRAZIN-2-YL)-PIPERAZINE-1 -CARBOXAMIDE DERIVATIVES AND RELATED COMPOUNDS AS MUSCARINIC RECEPTOR 4 (M4) ANTAGONISTS FOR TREATING NEUROLOGICAL DISEASES
<b>A61K 31/4545</b> (2006.01)	3371164	N-[2-(1 -BENZYLPIPERIDIN-4-YL)ETHYL]-4-(PYRAZIN-2-YL)-PIPERAZINE-1 -CARBOXAMIDE DERIVATIVES AND RELATED COMPOUNDS AS MUSCARINIC RECEPTOR 4 (M4) ANTAGONISTS FOR TREATING NEUROLOGICAL DISEASES
<b>A61P 25/16</b> (2006.01)	3371164	N-[2-(1 -BENZYLPIPERIDIN-4-YL)ETHYL]-4-(PYRAZIN-2-YL)-PIPERAZINE-1 -CARBOXAMIDE DERIVATIVES AND RELATED COMPOUNDS AS MUSCARINIC RECEPTOR 4 (M4) ANTAGONISTS FOR TREATING NEUROLOGICAL DISEASES
<b>A61P 25/18</b> (2006.01)	3371164	N-[2-(1 -BENZYLPIPERIDIN-4-YL)ETHYL]-4-(PYRAZIN-2-YL)-PIPERAZINE-1 -CARBOXAMIDE DERIVATIVES AND RELATED COMPOUNDS AS MUSCARINIC RECEPTOR 4 (M4) ANTAGONISTS FOR TREATING NEUROLOGICAL DISEASES
<b>A61P 25/28</b> (2006.01)	3371164	N-[2-(1 -BENZYLPIPERIDIN-4-YL)ETHYL]-4-(PYRAZIN-2-YL)-PIPERAZINE-1 -CARBOXAMIDE DERIVATIVES AND RELATED COMPOUNDS AS MUSCARINIC RECEPTOR 4 (M4) ANTAGONISTS FOR TREATING NEUROLOGICAL DISEASES
<b>C07D 211/26</b> (2006.01)	3371164	N-[2-(1 -BENZYLPIPERIDIN-4-YL)ETHYL]-4-(PYRAZIN-2-YL)-PIPERAZINE-1 -CARBOXAMIDE DERIVATIVES AND RELATED COMPOUNDS AS MUSCARINIC RECEPTOR 4 (M4) ANTAGONISTS FOR TREATING NEUROLOGICAL DISEASES
<b>C07D 211/40</b> (2006.01)	3371164	N-[2-(1 -BENZYLPIPERIDIN-4-YL)ETHYL]-4-(PYRAZIN-2-YL)-PIPERAZINE-1 -CARBOXAMIDE DERIVATIVES AND RELATED COMPOUNDS AS MUSCARINIC RECEPTOR 4 (M4) ANTAGONISTS FOR TREATING NEUROLOGICAL DISEASES
<b>C07D 401/12</b> (2006.01)	3371164	N-[2-(1 -BENZYLPIPERIDIN-4-YL)ETHYL]-4-(PYRAZIN-2-YL)-PIPERAZINE-1 -CARBOXAMIDE DERIVATIVES AND RELATED COMPOUNDS AS MUSCARINIC RECEPTOR 4 (M4) ANTAGONISTS FOR TREATING NEUROLOGICAL DISEASES
<b>A01N 25/30</b> (2006.01)	3373896	PET CARE CLEANSING COMPOSITION
<b>A61K 8/34</b> (2006.01)	3373896	PET CARE CLEANSING COMPOSITION
<b>A61K 8/892</b> (2006.01)	3373896	PET CARE CLEANSING COMPOSITION

MKP	Broj objave evropske prijave patenta	Naziv pronalaska
(51)	(97)	(54)
<b>A61K 8/97</b> (2017.01)	3373896	PET CARE CLEANSING COMPOSITION
<b>A61Q 5/02</b> (2006.01)	3373896	PET CARE CLEANSING COMPOSITION
<b>A61Q 5/12</b> (2006.01)	3373896	PET CARE CLEANSING COMPOSITION
<b>A61Q 19/10</b> (2006.01)	3373896	PET CARE CLEANSING COMPOSITION
<b>A61B 17/00</b> (2006.01)	3376968	APPLICATOR INSTRUMENTS FOR DISPENSING SURGICAL FASTENERS HAVING ARTICULATING SHAFTS AND ARTICULATION CONTROL ELEMENTS
<b>A61B 17/068</b> (2006.01)	3376968	APPLICATOR INSTRUMENTS FOR DISPENSING SURGICAL FASTENERS HAVING ARTICULATING SHAFTS AND ARTICULATION CONTROL ELEMENTS
<b>A61F 2/00</b> (2006.01)	3376968	APPLICATOR INSTRUMENTS FOR DISPENSING SURGICAL FASTENERS HAVING ARTICULATING SHAFTS AND ARTICULATION CONTROL ELEMENTS
<b>F42B 12/32</b> (2006.01)	3414514	A FRAGMENTATION SHOT WITH READY DESTRUCTIVE ELEMENTS
<b>C12N 5/10</b> (2006.01)	3380604	STABLE CELL LINES FOR RETROVIRAL PRODUCTION
<b>C12N 7/02</b> (2006.01)	3380604	STABLE CELL LINES FOR RETROVIRAL PRODUCTION
<b>C12N 7/04</b> (2006.01)	3380604	STABLE CELL LINES FOR RETROVIRAL PRODUCTION
<b>C12N 15/85</b> (2006.01)	3380604	STABLE CELL LINES FOR RETROVIRAL PRODUCTION
<b>C07C 231/12</b> (2006.01)	3371147	INNOVATIVE PREPARATION AND CRYSTALLIZATION OF IOSIMENOL
<b>C07C 237/46</b> (2006.01)	3371147	INNOVATIVE PREPARATION AND CRYSTALLIZATION OF IOSIMENOL
<b>A43B 13/12</b> (2006.01)	3379963	SOLE, PARTICULARLY FOR SHOES
<b>A43B 13/18</b> (2006.01)	3379963	SOLE, PARTICULARLY FOR SHOES
<b>B65D 77/20</b> (2006.01)	3383762	TWO-LAYER CIRCUIT BOARD
<b>A61K 39/00</b> (2006.01)	3374397	ANTIGEN-BINDING POLYPEPTIDES DIRECTED AGAINST CD38
<b>A61K 39/395</b> (2006.01)	3374397	ANTIGEN-BINDING POLYPEPTIDES DIRECTED AGAINST CD38
<b>C07K 16/28</b> (2006.01)	3374397	ANTIGEN-BINDING POLYPEPTIDES DIRECTED AGAINST CD38
<b>G01N 33/53</b> (2006.01)	3374397	ANTIGEN-BINDING POLYPEPTIDES DIRECTED AGAINST CD38
<b>A01N 43/653</b> (2006.01)	3390372	BENZAMIDE COMPOUNDS AND THEIR USE AS HERBICIDES
<b>A01N 43/713</b> (2006.01)	3390372	BENZAMIDE COMPOUNDS AND THEIR USE AS HERBICIDES
<b>A01N 43/82</b> (2006.01)	3390372	BENZAMIDE COMPOUNDS AND THEIR USE AS HERBICIDES
<b>C07D 249/14</b> (2006.01)	3390372	BENZAMIDE COMPOUNDS AND THEIR USE AS HERBICIDES
<b>C07D 257/06</b> (2006.01)	3390372	BENZAMIDE COMPOUNDS AND THEIR USE AS HERBICIDES
<b>C07D 271/04</b> (2006.01)	3390372	BENZAMIDE COMPOUNDS AND THEIR USE AS HERBICIDES
<b>C07D 271/07</b> (2006.01)	3390372	BENZAMIDE COMPOUNDS AND THEIR USE AS HERBICIDES
<b>A61K 31/519</b> (2006.01)	3377494	PYRROPYRIMIDINE COMPOUNDS AS MNKS INHIBITORS
<b>A61P 25/28</b> (2006.01)	3377494	PYRROPYRIMIDINE COMPOUNDS AS MNKS INHIBITORS
<b>A61P 35/00</b> (2006.01)	3377494	PYRROPYRIMIDINE COMPOUNDS AS MNKS INHIBITORS
<b>C07D 487/04</b> (2006.01)	3377494	PYRROPYRIMIDINE COMPOUNDS AS MNKS INHIBITORS
<b>A61K 31/429</b> (2006.01)	3377501	FUSED THIAZOLOPYRIMIDINE DERIVATIVES AS MNKS INHIBITORS
<b>A61K 31/519</b> (2006.01)	3377501	FUSED THIAZOLOPYRIMIDINE DERIVATIVES AS MNKS INHIBITORS
<b>A61P 25/28</b> (2006.01)	3377501	FUSED THIAZOLOPYRIMIDINE DERIVATIVES AS MNKS INHIBITORS
<b>A61P 35/00</b> (2006.01)	3377501	FUSED THIAZOLOPYRIMIDINE DERIVATIVES AS MNKS INHIBITORS
<b>C07D 513/04</b> (2006.01)	3377501	FUSED THIAZOLOPYRIMIDINE DERIVATIVES AS MNKS INHIBITORS
<b>C07D 519/00</b> (2006.01)	3377501	FUSED THIAZOLOPYRIMIDINE DERIVATIVES AS MNKS INHIBITORS
<b>A61K 9/70</b> (2006.01)	3377048	ABUSE RESISTANT TRANSDERMAL DELIVERY DEVICES AND COMPOSITIONS COMPRISING AN OPIOID AGONIST AND A NON-TRANSDERMALLY DELIVERED N-OXIDE DERIVATIVE OF AN OPIOID ANTAGONIST FOR THE TREATMENT OF PAIN
<b>A61K 31/485</b> (2006.01)	3377048	ABUSE RESISTANT TRANSDERMAL DELIVERY DEVICES AND COMPOSITIONS COMPRISING AN OPIOID AGONIST AND A NON-TRANSDERMALLY DELIVERED N-OXIDE DERIVATIVE OF AN OPIOID ANTAGONIST FOR THE TREATMENT OF PAIN
<b>A61P 25/04</b> (2006.01)	3377048	ABUSE RESISTANT TRANSDERMAL DELIVERY DEVICES AND COMPOSITIONS COMPRISING AN OPIOID AGONIST AND A NON-TRANSDERMALLY DELIVERED N-OXIDE DERIVATIVE OF AN OPIOID ANTAGONIST FOR THE TREATMENT OF PAIN
<b>A61K 35/744</b> (2015.01)	3377082	COMPOSITIONS COMPRISING BACTERIAL STRAINS
<b>A61P 29/00</b> (2006.01)	3377082	COMPOSITIONS COMPRISING BACTERIAL STRAINS
<b>A61P 35/00</b> (2006.01)	3377082	COMPOSITIONS COMPRISING BACTERIAL STRAINS
<b>A61P 37/00</b> (2006.01)	3377082	COMPOSITIONS COMPRISING BACTERIAL STRAINS
<b>C04B 28/02</b> (2006.01)	3374327	CALCIUM NITRATE FOR REDUCING THE PORE SIZE DISTRIBUTION OF A HARDENED CEMENTITIOUS COMPOSITION AND STEEL REINFORCED CONCRETE HAVING AN ELEVATED RESISTANCE TOWARDS CARBONATION
<b>C04B 28/04</b> (2006.01)	3374327	CALCIUM NITRATE FOR REDUCING THE PORE SIZE DISTRIBUTION OF A HARDENED CEMENTITIOUS COMPOSITION AND STEEL REINFORCED CONCRETE HAVING AN ELEVATED RESISTANCE TOWARDS CARBONATION

MKP (51)	Broj objave evropske prijava patenta (97)	Naziv pronalaska (54)
<b>C04B 38/00</b> (2006.01)	3374327	CALCIUM NITRATE FOR REDUCING THE PORE SIZE DISTRIBUTION OF A HARDENED CEMENTITIOUS COMPOSITION AND STEEL REINFORCED CONCRETE HAVING AN ELEVATED RESISTANCE TOWARDS CARBONATION
<b>C04B 111/00</b> (2006.01)	3374327	CALCIUM NITRATE FOR REDUCING THE PORE SIZE DISTRIBUTION OF A HARDENED CEMENTITIOUS COMPOSITION AND STEEL REINFORCED CONCRETE HAVING AN ELEVATED RESISTANCE TOWARDS CARBONATION
<b>C04B 111/22</b> (2006.01)	3374327	CALCIUM NITRATE FOR REDUCING THE PORE SIZE DISTRIBUTION OF A HARDENED CEMENTITIOUS COMPOSITION AND STEEL REINFORCED CONCRETE HAVING AN ELEVATED RESISTANCE TOWARDS CARBONATION
<b>C04B 111/26</b> (2006.01)	3374327	CALCIUM NITRATE FOR REDUCING THE PORE SIZE DISTRIBUTION OF A HARDENED CEMENTITIOUS COMPOSITION AND STEEL REINFORCED CONCRETE HAVING AN ELEVATED RESISTANCE TOWARDS CARBONATION
<b>B41M 3/14</b> (2006.01)	3380669	METHOD OF TAGGING A SUBSTRATE
<b>B42D 25/29</b> (2014.01)	3380669	METHOD OF TAGGING A SUBSTRATE
<b>B42D 25/30</b> (2014.01)	3380669	METHOD OF TAGGING A SUBSTRATE
<b>D21H 19/82</b> (2006.01)	3380669	METHOD OF TAGGING A SUBSTRATE
<b>D21H 21/40</b> (2006.01)	3380669	METHOD OF TAGGING A SUBSTRATE
<b>D21H 21/42</b> (2006.01)	3380669	METHOD OF TAGGING A SUBSTRATE
<b>D21H 21/44</b> (2006.01)	3380669	METHOD OF TAGGING A SUBSTRATE
<b>D21H 21/48</b> (2006.01)	3380669	METHOD OF TAGGING A SUBSTRATE
<b>B27N 3/02</b> (2006.01)	3383604	CALCIUM CARBONATE FOR PARTICLE BOARDS
<b>A61K 31/506</b> (2006.01)	3380467	HETEROCYCLIC INDOLES FOR USE IN INFLUENZA VIRUS INFECTION
<b>A61K 31/53</b> (2006.01)	3380467	HETEROCYCLIC INDOLES FOR USE IN INFLUENZA VIRUS INFECTION
<b>A61P 31/14</b> (2006.01)	3380467	HETEROCYCLIC INDOLES FOR USE IN INFLUENZA VIRUS INFECTION
<b>C07D 403/04</b> (2006.01)	3380467	HETEROCYCLIC INDOLES FOR USE IN INFLUENZA VIRUS INFECTION
<b>C07D 487/04</b> (2006.01)	3380467	HETEROCYCLIC INDOLES FOR USE IN INFLUENZA VIRUS INFECTION
<b>C12N 5/0783</b> (2010.01)	3365434	METHODS FOR CULTURING CELLS AND KITS AND APPARATUS FOR SAME
<b>G01N 1/30</b> (2006.01)	3365434	METHODS FOR CULTURING CELLS AND KITS AND APPARATUS FOR SAME
<b>D04B 15/88</b> (2006.01)	3374555	OPEN-TYPE CIRCULAR KNITTING MACHINE FOR THE OPEN AND WIDTH-VARIABLE WEB PRODUCTION
<b>D04B 35/34</b> (2006.01)	3374555	OPEN-TYPE CIRCULAR KNITTING MACHINE FOR THE OPEN AND WIDTH-VARIABLE WEB PRODUCTION
<b>A23L 3/04</b> (2006.01)	3368422	FOOD-PROCESSING PLANT HAVING A PLURALITY OF SURROUNDED CHAMBERS, BETWEEN WHICH A CONTAINER CONVEYOR IS ARRANGED
<b>B65B 55/02</b> (2006.01)	3368422	FOOD-PROCESSING PLANT HAVING A PLURALITY OF SURROUNDED CHAMBERS, BETWEEN WHICH A CONTAINER CONVEYOR IS ARRANGED
<b>B65B 55/04</b> (2006.01)	3368422	FOOD-PROCESSING PLANT HAVING A PLURALITY OF SURROUNDED CHAMBERS, BETWEEN WHICH A CONTAINER CONVEYOR IS ARRANGED
<b>B65B 55/10</b> (2006.01)	3368422	FOOD-PROCESSING PLANT HAVING A PLURALITY OF SURROUNDED CHAMBERS, BETWEEN WHICH A CONTAINER CONVEYOR IS ARRANGED
<b>A61K 8/891</b> (2006.01)	3394176	SILOXANE ELASTOMERS HAVING AN IMMEDIATE OPTICAL AND SENSORIAL SMOOTHING EFFECT AND TOPICAL SKIN-CARE COMPOSITIONS CONTAINING SUCH SILICONE ELASTOMERS
<b>C08L 83/04</b> (2006.01)	3394176	SILOXANE ELASTOMERS HAVING AN IMMEDIATE OPTICAL AND SENSORIAL SMOOTHING EFFECT AND TOPICAL SKIN-CARE COMPOSITIONS CONTAINING SUCH SILICONE ELASTOMERS
<b>A61K 31/501</b> (2006.01)	3380468	BIS-PYRIDAZINE COMPOUNDS AND THEIR USE IN TREATING CANCER
<b>A61P 35/00</b> (2006.01)	3380468	BIS-PYRIDAZINE COMPOUNDS AND THEIR USE IN TREATING CANCER
<b>C07D 403/14</b> (2006.01)	3380468	BIS-PYRIDAZINE COMPOUNDS AND THEIR USE IN TREATING CANCER

MKP (51)	Broj objave evropske prijava patenta (97)	Naziv pronalaska (54)
<b>A61K 9/00</b> (2006.01)	3377108	A PROCESS FOR PREPARING A DRY POWDER FORMULATION COMPRISING AN ANTICHOLINERGIC, A CORTICOSTEROID AND A BETA-ADRENERGIC
<b>A61K 9/14</b> (2006.01)	3377108	A PROCESS FOR PREPARING A DRY POWDER FORMULATION COMPRISING AN ANTICHOLINERGIC, A CORTICOSTEROID AND A BETA-ADRENERGIC
<b>A61K 31/00</b> (2006.01)	3377108	A PROCESS FOR PREPARING A DRY POWDER FORMULATION COMPRISING AN ANTICHOLINERGIC, A CORTICOSTEROID AND A BETA-ADRENERGIC
<b>A61K 47/12</b> (2006.01)	3377108	A PROCESS FOR PREPARING A DRY POWDER FORMULATION COMPRISING AN ANTICHOLINERGIC, A CORTICOSTEROID AND A BETA-ADRENERGIC
<b>A61K 47/26</b> (2006.01)	3377108	A PROCESS FOR PREPARING A DRY POWDER FORMULATION COMPRISING AN ANTICHOLINERGIC, A CORTICOSTEROID AND A BETA-ADRENERGIC
<b>A61K 9/00</b> (2006.01)	3377109	A PROCESS FOR PREPARING A DRY POWDER FORMULATION COMPRISING AN ANTICHOLINERGIC, A CORTICOSTEROID AND A BETA-ADRENERGIC
<b>A61K 9/14</b> (2006.01)	3377109	A PROCESS FOR PREPARING A DRY POWDER FORMULATION COMPRISING AN ANTICHOLINERGIC, A CORTICOSTEROID AND A BETA-ADRENERGIC
<b>A61K 31/00</b> (2006.01)	3377109	A PROCESS FOR PREPARING A DRY POWDER FORMULATION COMPRISING AN ANTICHOLINERGIC, A CORTICOSTEROID AND A BETA-ADRENERGIC
<b>A61K 47/12</b> (2006.01)	3377109	A PROCESS FOR PREPARING A DRY POWDER FORMULATION COMPRISING AN ANTICHOLINERGIC, A CORTICOSTEROID AND A BETA-ADRENERGIC
<b>A61K 47/26</b> (2006.01)	3377109	A PROCESS FOR PREPARING A DRY POWDER FORMULATION COMPRISING AN ANTICHOLINERGIC, A CORTICOSTEROID AND A BETA-ADRENERGIC
<b>A43B 7/14</b> (2006.01)	3379962	MID-SOLE, OR INSOLE, PARTICULARLY FOR SHOES
<b>A61K 38/17</b> (2006.01)	3394084	PEPTIDES AND COMBINATION OF PEPTIDES FOR USE IN IMMUNOTHERAPY AGAINST BREAST CANCER AND OTHER CANCERS
<b>A61K 39/00</b> (2006.01)	3394084	PEPTIDES AND COMBINATION OF PEPTIDES FOR USE IN IMMUNOTHERAPY AGAINST BREAST CANCER AND OTHER CANCERS
<b>C07K 7/06</b> (2006.01)	3394084	PEPTIDES AND COMBINATION OF PEPTIDES FOR USE IN IMMUNOTHERAPY AGAINST BREAST CANCER AND OTHER CANCERS
<b>C07K 7/08</b> (2006.01)	3394084	PEPTIDES AND COMBINATION OF PEPTIDES FOR USE IN IMMUNOTHERAPY AGAINST BREAST CANCER AND OTHER CANCERS
<b>C07K 14/47</b> (2006.01)	3394084	PEPTIDES AND COMBINATION OF PEPTIDES FOR USE IN IMMUNOTHERAPY AGAINST BREAST CANCER AND OTHER CANCERS
<b>C07K 16/28</b> (2006.01)	3394084	PEPTIDES AND COMBINATION OF PEPTIDES FOR USE IN IMMUNOTHERAPY AGAINST BREAST CANCER AND OTHER CANCERS
<b>A61K 31/501</b> (2006.01)	3383871	1,3,4-THIADIAZOLE COMPOUNDS AND THEIR USE IN TREATING CANCER
<b>A61K 31/53</b> (2006.01)	3383871	1,3,4-THIADIAZOLE COMPOUNDS AND THEIR USE IN TREATING CANCER
<b>A61P 35/00</b> (2006.01)	3383871	1,3,4-THIADIAZOLE COMPOUNDS AND THEIR USE IN TREATING CANCER
<b>C07D 417/14</b> (2006.01)	3383871	1,3,4-THIADIAZOLE COMPOUNDS AND THEIR USE IN TREATING CANCER
<b>A61K 38/13</b> (2006.01)	3370756	COMBINATION
<b>A61K 38/26</b> (2006.01)	3370756	COMBINATION
<b>A61P 9/10</b> (2006.01)	3370756	COMBINATION
<b>C07K 14/005</b> (2006.01)	3374374	COMPOSITIONS COMPRISING LENTIVIRAL VECTORS EXPRESSING IL-12 AND METHODS OF USE THEREOF
<b>C07K 14/54</b> (2006.01)	3374374	COMPOSITIONS COMPRISING LENTIVIRAL VECTORS EXPRESSING IL-12 AND METHODS OF USE THEREOF
<b>C12N 7/00</b> (2006.01)	3374374	COMPOSITIONS COMPRISING LENTIVIRAL VECTORS EXPRESSING IL-12 AND METHODS OF USE THEREOF
<b>A61K 39/395</b> (2006.01)	3374398	BINDING MOLECULES SPECIFIC FOR ASCT2 AND USES THEREOF
<b>C07K 16/28</b> (2006.01)	3374398	BINDING MOLECULES SPECIFIC FOR ASCT2 AND USES THEREOF

MKP (51)	Broj objave evropske prijava patenta (97)	Naziv pronalaska (54)
<b>G01N 33/574</b> (2006.01)	3374398	BINDING MOLECULES SPECIFIC FOR ASCT2 AND USES THEREOF
<b>A47F 3/04</b> (2006.01)	3379977	IMPROVEMENTS IN REFRIGERATORS
<b>A61K 9/14</b> (2006.01)	3377045	PHARMACEUTICAL COMPOSITIONS OF RIBAVIRIN
<b>A61K 9/50</b> (2006.01)	3377045	PHARMACEUTICAL COMPOSITIONS OF RIBAVIRIN
<b>A61K 31/7056</b> (2006.01)	3377045	PHARMACEUTICAL COMPOSITIONS OF RIBAVIRIN
<b>A61K 31/437</b> (2006.01)	3371186	JAK KINASE INHIBITOR COMPOUNDS FOR TREATMENT OF RESPIRATORY DISEASE
<b>A61P 11/00</b> (2006.01)	3371186	JAK KINASE INHIBITOR COMPOUNDS FOR TREATMENT OF RESPIRATORY DISEASE
<b>C07D 471/04</b> (2006.01)	3371186	JAK KINASE INHIBITOR COMPOUNDS FOR TREATMENT OF RESPIRATORY DISEASE
<b>A61K 31/433</b> (2006.01)	3383872	1,3,4-THIADIAZOLE COMPOUNDS AND THEIR USE IN TREATING CANCER
<b>A61P 35/00</b> (2006.01)	3383872	1,3,4-THIADIAZOLE COMPOUNDS AND THEIR USE IN TREATING CANCER
<b>C07D 417/14</b> (2006.01)	3383872	1,3,4-THIADIAZOLE COMPOUNDS AND THEIR USE IN TREATING CANCER
<b>A61K 31/519</b> (2006.01)	3371190	HETEROCYCLIC COMPOUNDS AS PI3K-GAMMA INHIBITORS
<b>A61P 25/00</b> (2006.01)	3371190	HETEROCYCLIC COMPOUNDS AS PI3K-GAMMA INHIBITORS
<b>A61P 35/00</b> (2006.01)	3371190	HETEROCYCLIC COMPOUNDS AS PI3K-GAMMA INHIBITORS
<b>A61P 37/00</b> (2006.01)	3371190	HETEROCYCLIC COMPOUNDS AS PI3K-GAMMA INHIBITORS
<b>C07D 487/04</b> (2006.01)	3371190	HETEROCYCLIC COMPOUNDS AS PI3K-GAMMA INHIBITORS
<b>C07D 519/00</b> (2006.01)	3371190	HETEROCYCLIC COMPOUNDS AS PI3K-GAMMA INHIBITORS
<b>C07K 14/47</b> (2006.01)	3387008	NOVEL PEPTIDES AND COMBINATION OF PEPTIDES FOR USE IN IMMUNOTHERAPY AGAINST CLL AND OTHER CANCERS
<b>A61K 31/7088</b> (2006.01)	3380615	IL-34 ANTISENSE OLIGONUCLEOTIDES AND METHODS OF USING SAME
<b>A61P 29/00</b> (2006.01)	3380615	IL-34 ANTISENSE OLIGONUCLEOTIDES AND METHODS OF USING SAME
<b>C12N 15/113</b> (2010.01)	3380615	IL-34 ANTISENSE OLIGONUCLEOTIDES AND METHODS OF USING SAME
<b>C07K 16/18</b> (2006.01)	3380517	POLYPEPTIDES INHIBITING CD40L
<b>C07K 16/28</b> (2006.01)	3380517	POLYPEPTIDES INHIBITING CD40L
<b>C07K 16/46</b> (2006.01)	3380517	POLYPEPTIDES INHIBITING CD40L
<b>A61K 39/395</b> (2006.01)	3383905	ANTI-DEATH RECEPTOR ANTIBODIES AND METHODS OF USE THEREOF
<b>C07K 16/28</b> (2006.01)	3383905	ANTI-DEATH RECEPTOR ANTIBODIES AND METHODS OF USE THEREOF
<b>C07K 16/30</b> (2006.01)	3383905	ANTI-DEATH RECEPTOR ANTIBODIES AND METHODS OF USE THEREOF
<b>C07K 16/46</b> (2006.01)	3383905	ANTI-DEATH RECEPTOR ANTIBODIES AND METHODS OF USE THEREOF
<b>A61K 39/395</b> (2006.01)	3383906	ANTI-DR5 ANTIBODIES AND METHODS OF USE THEREOF
<b>C07K 16/28</b> (2006.01)	3383906	ANTI-DR5 ANTIBODIES AND METHODS OF USE THEREOF
<b>C07K 16/30</b> (2006.01)	3383906	ANTI-DR5 ANTIBODIES AND METHODS OF USE THEREOF
<b>C07K 16/46</b> (2006.01)	3383906	ANTI-DR5 ANTIBODIES AND METHODS OF USE THEREOF
<b>C12N 15/13</b> (2006.01)	3383906	ANTI-DR5 ANTIBODIES AND METHODS OF USE THEREOF
<b>C12N 15/86</b> (2006.01)	3365453	METHODS, KITS, AGENTS AND APPARATUSES FOR TRANSDUCTION
<b>A61K 31/4523</b> (2006.01)	3370775	COMBINATION OF BCL-2 INHIBITOR AND MEK INHIBITOR FOR THE TREATMENT OF CANCER
<b>A61K 31/496</b> (2006.01)	3370775	COMBINATION OF BCL-2 INHIBITOR AND MEK INHIBITOR FOR THE TREATMENT OF CANCER
<b>A61K 45/06</b> (2006.01)	3370775	COMBINATION OF BCL-2 INHIBITOR AND MEK INHIBITOR FOR THE TREATMENT OF CANCER
<b>A61P 35/00</b> (2006.01)	3370775	COMBINATION OF BCL-2 INHIBITOR AND MEK INHIBITOR FOR THE TREATMENT OF CANCER
<b>A61K 39/395</b> (2006.01)	3377526	PD1/CTLA4 Binders
<b>C07K 16/18</b> (2006.01)	3377526	PD1/CTLA4 Binders
<b>C07K 16/28</b> (2006.01)	3377526	PD1/CTLA4 Binders
<b>A61K 39/395</b> (2006.01)	3377527	CTLA4 BINDERS
<b>C07K 16/18</b> (2006.01)	3377527	CTLA4 BINDERS
<b>C07K 16/28</b> (2006.01)	3377527	CTLA4 BINDERS
<b>C07K 16/18</b> (2006.01)	3377531	PD1 AND/OR LAG3 BINDERS
<b>C07K 16/28</b> (2006.01)	3377531	PD1 AND/OR LAG3 BINDERS
<b>A61K 31/423</b> (2006.01)	3377488	HETEROCYCLIC COMPOUNDS AS IMMUNOMODULATORS
<b>A61K 31/428</b> (2006.01)	3377488	HETEROCYCLIC COMPOUNDS AS IMMUNOMODULATORS
<b>A61K 31/4355</b> (2006.01)	3377488	HETEROCYCLIC COMPOUNDS AS IMMUNOMODULATORS
<b>A61K 31/4985</b> (2006.01)	3377488	HETEROCYCLIC COMPOUNDS AS IMMUNOMODULATORS

MKP (51)	Broj objave evropske prijava patenta (97)	Naziv pronalaska (54)
<b>A61P 31/12</b> (2006.01)	3377488	HETEROCYCLIC COMPOUNDS AS IMMUNOMODULATORS
<b>A61P 35/00</b> (2006.01)	3377488	HETEROCYCLIC COMPOUNDS AS IMMUNOMODULATORS
<b>C07D 263/57</b> (2006.01)	3377488	HETEROCYCLIC COMPOUNDS AS IMMUNOMODULATORS
<b>C07D 413/10</b> (2006.01)	3377488	HETEROCYCLIC COMPOUNDS AS IMMUNOMODULATORS
<b>C07D 413/12</b> (2006.01)	3377488	HETEROCYCLIC COMPOUNDS AS IMMUNOMODULATORS
<b>C07D 413/14</b> (2006.01)	3377488	HETEROCYCLIC COMPOUNDS AS IMMUNOMODULATORS
<b>C07D 417/10</b> (2006.01)	3377488	HETEROCYCLIC COMPOUNDS AS IMMUNOMODULATORS
<b>C07D 491/04</b> (2006.01)	3377488	HETEROCYCLIC COMPOUNDS AS IMMUNOMODULATORS
<b>C07D 498/04</b> (2006.01)	3377488	HETEROCYCLIC COMPOUNDS AS IMMUNOMODULATORS
<b>A61K 31/416</b> (2006.01)	3380466	SUBSTITUTED BENZAMIDES USEFUL AS SODIUM CHANNEL BLOCKERS
<b>A61P 9/00</b> (2006.01)	3380466	SUBSTITUTED BENZAMIDES USEFUL AS SODIUM CHANNEL BLOCKERS
<b>A61P 11/00</b> (2006.01)	3380466	SUBSTITUTED BENZAMIDES USEFUL AS SODIUM CHANNEL BLOCKERS
<b>A61P 17/04</b> (2006.01)	3380466	SUBSTITUTED BENZAMIDES USEFUL AS SODIUM CHANNEL BLOCKERS
<b>A61P 25/00</b> (2006.01)	3380466	SUBSTITUTED BENZAMIDES USEFUL AS SODIUM CHANNEL BLOCKERS
<b>C07D 231/56</b> (2006.01)	3380466	SUBSTITUTED BENZAMIDES USEFUL AS SODIUM CHANNEL BLOCKERS
<b>C07D 401/04</b> (2006.01)	3380466	SUBSTITUTED BENZAMIDES USEFUL AS SODIUM CHANNEL BLOCKERS
<b>C07D 401/14</b> (2006.01)	3380466	SUBSTITUTED BENZAMIDES USEFUL AS SODIUM CHANNEL BLOCKERS
<b>C07D 403/04</b> (2006.01)	3380466	SUBSTITUTED BENZAMIDES USEFUL AS SODIUM CHANNEL BLOCKERS
<b>C07D 403/06</b> (2006.01)	3380466	SUBSTITUTED BENZAMIDES USEFUL AS SODIUM CHANNEL BLOCKERS
<b>C07D 403/12</b> (2006.01)	3380466	SUBSTITUTED BENZAMIDES USEFUL AS SODIUM CHANNEL BLOCKERS
<b>C07D 405/04</b> (2006.01)	3380466	SUBSTITUTED BENZAMIDES USEFUL AS SODIUM CHANNEL BLOCKERS
<b>C07D 405/14</b> (2006.01)	3380466	SUBSTITUTED BENZAMIDES USEFUL AS SODIUM CHANNEL BLOCKERS
<b>A61L 29/06</b> (2006.01)	3377127	COATING FOR A MEDICAL INSTRUMENT, METHOD FOR THE COATING THEREOF, AND MEDICAL INSTRUMENT COATED USING SAID METHOD
<b>A61L 29/08</b> (2006.01)	3377127	COATING FOR A MEDICAL INSTRUMENT, METHOD FOR THE COATING THEREOF, AND MEDICAL INSTRUMENT COATED USING SAID METHOD
<b>A61K 31/223</b> (2006.01)	3383385	MELFLUFEN DOSAGE REGIMENS FOR CANCER
<b>A61K 31/573</b> (2006.01)	3383385	MELFLUFEN DOSAGE REGIMENS FOR CANCER
<b>A61K 31/501</b> (2006.01)	3383873	1,3,4-THIADIAZOLE COMPOUNDS AND THEIR USE IN TREATING CANCER
<b>A61K 31/53</b> (2006.01)	3383873	1,3,4-THIADIAZOLE COMPOUNDS AND THEIR USE IN TREATING CANCER
<b>A61P 35/00</b> (2006.01)	3383873	1,3,4-THIADIAZOLE COMPOUNDS AND THEIR USE IN TREATING CANCER
<b>C07D 417/14</b> (2006.01)	3383873	1,3,4-THIADIAZOLE COMPOUNDS AND THEIR USE IN TREATING CANCER
<b>D21D 1/02</b> (2006.01)	3384080	PROCESS TO REDUCE THE OVERALL ENERGY CONSUMPTION IN THE PRODUCTION OF NANOCELLULOSE
<b>D21D 1/20</b> (2006.01)	3384080	PROCESS TO REDUCE THE OVERALL ENERGY CONSUMPTION IN THE PRODUCTION OF NANOCELLULOSE
<b>B29B 7/00</b> (2006.01)	3386703	PROCESS FOR MANUFACTURING A PRECURSOR MATERIAL
<b>B29B 7/16</b> (2006.01)	3386703	PROCESS FOR MANUFACTURING A PRECURSOR MATERIAL
<b>B29B 7/28</b> (2006.01)	3386703	PROCESS FOR MANUFACTURING A PRECURSOR MATERIAL
<b>B29B 7/90</b> (2006.01)	3386703	PROCESS FOR MANUFACTURING A PRECURSOR MATERIAL
<b>B29B 9/14</b> (2006.01)	3386703	PROCESS FOR MANUFACTURING A PRECURSOR MATERIAL
<b>A61K 9/00</b> (2006.01)	3370699	PHARMACEUTICAL COMPOSITIONS AND METHODS FOR INDOLEAMINE 2,3-DIOXYGENASE INHIBITION AND INDICATIONS THEREFOR
<b>A61K 31/4245</b> (2006.01)	3370699	PHARMACEUTICAL COMPOSITIONS AND METHODS FOR INDOLEAMINE 2,3-DIOXYGENASE INHIBITION AND INDICATIONS THEREFOR

MKP (51)	Broj objave evropske prijava patenta (97)	Naziv pronalaska (54)
<b>A61K 39/395</b> (2006.01)	3370699	PHARMACEUTICAL COMPOSITIONS AND METHODS FOR INDOLEAMINE 2,3-DIOXYGENASE INHIBITION AND INDICATIONS THEREFOR
<b>A61K 45/06</b> (2006.01)	3370699	PHARMACEUTICAL COMPOSITIONS AND METHODS FOR INDOLEAMINE 2,3-DIOXYGENASE INHIBITION AND INDICATIONS THEREFOR
<b>A61P 35/00</b> (2006.01)	3370699	PHARMACEUTICAL COMPOSITIONS AND METHODS FOR INDOLEAMINE 2,3-DIOXYGENASE INHIBITION AND INDICATIONS THEREFOR
<b>A01N 25/02</b> (2006.01)	3379928	VETERINARY FORMULATIONS
<b>A01N 25/30</b> (2006.01)	3379928	VETERINARY FORMULATIONS
<b>A01N 43/40</b> (2006.01)	3379928	VETERINARY FORMULATIONS
<b>A01N 47/02</b> (2006.01)	3379928	VETERINARY FORMULATIONS
<b>A01N 49/00</b> (2006.01)	3379928	VETERINARY FORMULATIONS
<b>A01P 7/00</b> (2006.01)	3379928	VETERINARY FORMULATIONS
<b>A01P 7/02</b> (2006.01)	3379928	VETERINARY FORMULATIONS
<b>A61K 31/415</b> (2006.01)	3379928	VETERINARY FORMULATIONS
<b>B29C 51/26</b> (2006.01)	3216594	APPARATUS FOR CLAMPING, HOLDING AND GUIDING FLAT MATERIAL AND PROCESS FOR OPERATING THE APPARATUS
<b>B31B 50/59</b> (2017.01)	3216594	APPARATUS FOR CLAMPING, HOLDING AND GUIDING FLAT MATERIAL AND PROCESS FOR OPERATING THE APPARATUS
<b>B31F 1/00</b> (2006.01)	3216594	APPARATUS FOR CLAMPING, HOLDING AND GUIDING FLAT MATERIAL AND PROCESS FOR OPERATING THE APPARATUS
<b>A01N 43/38</b> (2006.01)	3246027	INDOLE DERIVATIVES FOR THE TREATMENT OF CANCER
<b>A61K 31/405</b> (2006.01)	3246027	INDOLE DERIVATIVES FOR THE TREATMENT OF CANCER
<b>A61K 31/444</b> (2006.01)	3246027	INDOLE DERIVATIVES FOR THE TREATMENT OF CANCER
<b>A61K 31/496</b> (2006.01)	3246027	INDOLE DERIVATIVES FOR THE TREATMENT OF CANCER
<b>A61K 31/501</b> (2006.01)	3246027	INDOLE DERIVATIVES FOR THE TREATMENT OF CANCER
<b>A61K 31/506</b> (2006.01)	3246027	INDOLE DERIVATIVES FOR THE TREATMENT OF CANCER
<b>A61K 31/5377</b> (2006.01)	3246027	INDOLE DERIVATIVES FOR THE TREATMENT OF CANCER
<b>A61K 31/5383</b> (2006.01)	3246027	INDOLE DERIVATIVES FOR THE TREATMENT OF CANCER
<b>A61K 31/541</b> (2006.01)	3246027	INDOLE DERIVATIVES FOR THE TREATMENT OF CANCER
<b>A61K 31/551</b> (2006.01)	3246027	INDOLE DERIVATIVES FOR THE TREATMENT OF CANCER
<b>A61P 35/00</b> (2006.01)	3246027	INDOLE DERIVATIVES FOR THE TREATMENT OF CANCER
<b>C07D 401/14</b> (2006.01)	3246027	INDOLE DERIVATIVES FOR THE TREATMENT OF CANCER
<b>C07D 405/14</b> (2006.01)	3246027	INDOLE DERIVATIVES FOR THE TREATMENT OF CANCER
<b>A61L 15/18</b> (2006.01)	3378502	USE OF ZINC TREATED PRECIPITATED CALCIUM CARBONATE IN HYGIENIC PRODUCTS
<b>A61L 15/46</b> (2006.01)	3378502	USE OF ZINC TREATED PRECIPITATED CALCIUM CARBONATE IN HYGIENIC PRODUCTS
<b>C09C 1/02</b> (2006.01)	3385335	PIGMENT COMPOSITION COMPRISING SURFACE MODIFIED CALCIUM CARBONATE AND GROUND NATURAL CALCIUM CARBONATE
<b>D21H 17/67</b> (2006.01)	3385335	PIGMENT COMPOSITION COMPRISING SURFACE MODIFIED CALCIUM CARBONATE AND GROUND NATURAL CALCIUM CARBONATE
<b>B27N 3/02</b> (2006.01)	3385046	IN-LINE COATED DECORATIVE WOOD-BASED BOARDS
<b>B27N 3/04</b> (2006.01)	3385046	IN-LINE COATED DECORATIVE WOOD-BASED BOARDS
<b>B27N 3/06</b> (2006.01)	3385046	IN-LINE COATED DECORATIVE WOOD-BASED BOARDS
<b>B27N 3/10</b> (2006.01)	3385046	IN-LINE COATED DECORATIVE WOOD-BASED BOARDS
<b>B27N 3/12</b> (2006.01)	3385046	IN-LINE COATED DECORATIVE WOOD-BASED BOARDS
<b>B27N 7/00</b> (2006.01)	3385046	IN-LINE COATED DECORATIVE WOOD-BASED BOARDS
<b>B44C 5/04</b> (2006.01)	3385046	IN-LINE COATED DECORATIVE WOOD-BASED BOARDS
<b>A61K 38/17</b> (2006.01)	3290439	TRUNCATED ACTRIIB-FC FUSION PROTEINS
<b>A61P 3/00</b> (2006.01)	3290439	TRUNCATED ACTRIIB-FC FUSION PROTEINS
<b>C07K 14/475</b> (2006.01)	3290439	TRUNCATED ACTRIIB-FC FUSION PROTEINS
<b>C07K 14/705</b> (2006.01)	3290439	TRUNCATED ACTRIIB-FC FUSION PROTEINS
<b>A61K 31/343</b> (2006.01)	3252044	PREPARATION METHOD OF ABEXINOSTAT TOSYLATE SALT AND ASSOCIATED CRYSTALLINE FORM
<b>A61P 29/00</b> (2006.01)	3252044	PREPARATION METHOD OF ABEXINOSTAT TOSYLATE SALT AND ASSOCIATED CRYSTALLINE FORM
<b>A61P 35/00</b> (2006.01)	3252044	PREPARATION METHOD OF ABEXINOSTAT TOSYLATE SALT AND ASSOCIATED CRYSTALLINE FORM
<b>C07D 307/85</b> (2006.01)	3252044	PREPARATION METHOD OF ABEXINOSTAT TOSYLATE SALT AND ASSOCIATED CRYSTALLINE FORM
<b>B64C 1/10</b> (2006.01)	3263444	CABIN MODULE AND LAYOUT FOR A PASSENGER AIRCRAFT
<b>B64D 11/00</b> (2006.01)	3263444	CABIN MODULE AND LAYOUT FOR A PASSENGER AIRCRAFT
<b>B64D 11/06</b> (2006.01)	3263444	CABIN MODULE AND LAYOUT FOR A PASSENGER AIRCRAFT



MKP (51)	Broj objave evropske prijava patenta (97)	Naziv pronalaska (54)
<b>A61K 38/00</b> (2006.01)	3244932	RNA GUIDED ERADICATION OF HERPES SIMPLEX TYPE I AND OTHER RELATED HERPESVIRUSES
<b>A61K 48/00</b> (2006.01)	3244932	RNA GUIDED ERADICATION OF HERPES SIMPLEX TYPE I AND OTHER RELATED HERPESVIRUSES
<b>C07H 21/04</b> (2006.01)	3244932	RNA GUIDED ERADICATION OF HERPES SIMPLEX TYPE I AND OTHER RELATED HERPESVIRUSES
<b>C12N 15/00</b> (2006.01)	3244932	RNA GUIDED ERADICATION OF HERPES SIMPLEX TYPE I AND OTHER RELATED HERPESVIRUSES
<b>G06F 17/30</b> (2006.01)	3245601	HEALTHCARE DATA INTERCHANGE SYSTEM AND METHOD
<b>G06F 19/10</b> (2011.01)	3245601	HEALTHCARE DATA INTERCHANGE SYSTEM AND METHOD
<b>G06Q 50/22</b> (2012.01)	3245601	HEALTHCARE DATA INTERCHANGE SYSTEM AND METHOD
<b>G16H 10/60</b> (2018.01)	3245601	HEALTHCARE DATA INTERCHANGE SYSTEM AND METHOD
<b>A61K 9/00</b> (2006.01)	3370692	STUFFY NOSE DEBLOCKING COMPOSITION HAVING ANTIVIRAL ACTIVITY
<b>A61K 31/047</b> (2006.01)	3370692	STUFFY NOSE DEBLOCKING COMPOSITION HAVING ANTIVIRAL ACTIVITY
<b>A61K 31/731</b> (2006.01)	3370692	STUFFY NOSE DEBLOCKING COMPOSITION HAVING ANTIVIRAL ACTIVITY
<b>A61K 33/14</b> (2006.01)	3370692	STUFFY NOSE DEBLOCKING COMPOSITION HAVING ANTIVIRAL ACTIVITY
<b>A61K 45/06</b> (2006.01)	3370692	STUFFY NOSE DEBLOCKING COMPOSITION HAVING ANTIVIRAL ACTIVITY
<b>A61P 11/02</b> (2006.01)	3370692	STUFFY NOSE DEBLOCKING COMPOSITION HAVING ANTIVIRAL ACTIVITY
<b>A61P 31/16</b> (2006.01)	3370692	STUFFY NOSE DEBLOCKING COMPOSITION HAVING ANTIVIRAL ACTIVITY
<b>C04B 20/10</b> (2006.01)	3393994	COMPOSITION FOR A PASTY FILLER MATERIAL, PASTY FILLER, AND METHOD FOR PRODUCING A PASTY FILLER MATERIAL
<b>C04B 26/06</b> (2006.01)	3393994	COMPOSITION FOR A PASTY FILLER MATERIAL, PASTY FILLER, AND METHOD FOR PRODUCING A PASTY FILLER MATERIAL
<b>D06M 15/248</b> (2006.01)	3225733	TRANSPARENT TEXTILE WITH SELF-ADHESIVE PROPERTIES FOR DAMP ENVIRONMNTS
<b>D06M 15/263</b> (2006.01)	3225733	TRANSPARENT TEXTILE WITH SELF-ADHESIVE PROPERTIES FOR DAMP ENVIRONMNTS
<b>D06M 15/564</b> (2006.01)	3225733	TRANSPARENT TEXTILE WITH SELF-ADHESIVE PROPERTIES FOR DAMP ENVIRONMNTS
<b>D06M 23/16</b> (2006.01)	3225733	TRANSPARENT TEXTILE WITH SELF-ADHESIVE PROPERTIES FOR DAMP ENVIRONMNTS
<b>E06B 9/24</b> (2006.01)	3225733	TRANSPARENT TEXTILE WITH SELF-ADHESIVE PROPERTIES FOR DAMP ENVIRONMNTS
<b>A61K 31/4375</b> (2006.01)	3259269	BICYCLIC HETEROCYCLES AS FGFR INHIBITORS
<b>A61K 31/444</b> (2006.01)	3259269	BICYCLIC HETEROCYCLES AS FGFR INHIBITORS
<b>A61K 31/519</b> (2006.01)	3259269	BICYCLIC HETEROCYCLES AS FGFR INHIBITORS
<b>A61K 31/5377</b> (2006.01)	3259269	BICYCLIC HETEROCYCLES AS FGFR INHIBITORS
<b>A61K 31/541</b> (2006.01)	3259269	BICYCLIC HETEROCYCLES AS FGFR INHIBITORS
<b>A61P 19/00</b> (2006.01)	3259269	BICYCLIC HETEROCYCLES AS FGFR INHIBITORS
<b>A61P 35/00</b> (2006.01)	3259269	BICYCLIC HETEROCYCLES AS FGFR INHIBITORS
<b>C07D 471/04</b> (2006.01)	3259269	BICYCLIC HETEROCYCLES AS FGFR INHIBITORS
<b>A61K 9/00</b> (2006.01)	3247331	DRY POWDER INHALER COMPRISING FLUTICASONE PROPIONATE AND SALMETEROL XINAFOAT
<b>A61K 31/137</b> (2006.01)	3247331	DRY POWDER INHALER COMPRISING FLUTICASONE PROPIONATE AND SALMETEROL XINAFOAT
<b>A61K 31/56</b> (2006.01)	3247331	DRY POWDER INHALER COMPRISING FLUTICASONE PROPIONATE AND SALMETEROL XINAFOAT
<b>A61P 11/00</b> (2006.01)	3247331	DRY POWDER INHALER COMPRISING FLUTICASONE PROPIONATE AND SALMETEROL XINAFOAT
<b>A47K 5/12</b> (2006.01)	3413769	METHOD AND SHAKER FOR MIXING LIQUIDS
<b>B01F 3/08</b> (2006.01)	3413769	METHOD AND SHAKER FOR MIXING LIQUIDS
<b>B01F 13/00</b> (2006.01)	3413769	METHOD AND SHAKER FOR MIXING LIQUIDS
<b>B01F 15/00</b> (2006.01)	3413769	METHOD AND SHAKER FOR MIXING LIQUIDS
<b>B01F 15/02</b> (2006.01)	3413769	METHOD AND SHAKER FOR MIXING LIQUIDS
<b>H04R 7/04</b> (2006.01)	3406086	METHOD AND APPARATUS FOR PLAYING AUDIO BY MEANS OF PLANAR ACOUSTIC TRANSDUCERS
<b>B65D 81/26</b> (2006.01)	3250640	DURABLE OXYGEN SCAVENGING PLASTIC CONTAINERS
<b>C08K 3/24</b> (2006.01)	3250640	DURABLE OXYGEN SCAVENGING PLASTIC CONTAINERS
<b>C08K 5/00</b> (2006.01)	3250640	DURABLE OXYGEN SCAVENGING PLASTIC CONTAINERS
<b>C08K 5/09</b> (2006.01)	3250640	DURABLE OXYGEN SCAVENGING PLASTIC CONTAINERS
<b>C08L 67/02</b> (2006.01)	3250640	DURABLE OXYGEN SCAVENGING PLASTIC CONTAINERS

MKP (51)	Broj objave evropske prijava patenta (97)	Naziv pronalaska (54)
<b>C08L 71/02</b> (2006.01)	3250640	DURABLE OXYGEN SCAVENGING PLASTIC CONTAINERS
<b>A61K 9/00</b> (2006.01)	3411013	EMULSION COMPRISING AN NK-1 RECEPTOR ANTAGONIST
<b>A61K 9/107</b> (2006.01)	3411013	EMULSION COMPRISING AN NK-1 RECEPTOR ANTAGONIST
<b>A61K 31/454</b> (2006.01)	3411013	EMULSION COMPRISING AN NK-1 RECEPTOR ANTAGONIST
<b>A61K 31/496</b> (2006.01)	3411013	EMULSION COMPRISING AN NK-1 RECEPTOR ANTAGONIST
<b>A61K 31/5377</b> (2006.01)	3411013	EMULSION COMPRISING AN NK-1 RECEPTOR ANTAGONIST
<b>A61K 47/24</b> (2006.01)	3411013	EMULSION COMPRISING AN NK-1 RECEPTOR ANTAGONIST
<b>A61K 35/00</b> (2006.01)	3250695	UNIVERSAL IMMUNE CELLS FOR CANCER IMMUNOTHERAPY
<b>A61K 35/12</b> (2015.01)	3250695	UNIVERSAL IMMUNE CELLS FOR CANCER IMMUNOTHERAPY
<b>A61K 35/14</b> (2015.01)	3250695	UNIVERSAL IMMUNE CELLS FOR CANCER IMMUNOTHERAPY
<b>A61K 35/17</b> (2015.01)	3250695	UNIVERSAL IMMUNE CELLS FOR CANCER IMMUNOTHERAPY
<b>A61K 45/06</b> (2006.01)	3250695	UNIVERSAL IMMUNE CELLS FOR CANCER IMMUNOTHERAPY
<b>A61K 48/00</b> (2006.01)	3250695	UNIVERSAL IMMUNE CELLS FOR CANCER IMMUNOTHERAPY
<b>C07K 14/705</b> (2006.01)	3250695	UNIVERSAL IMMUNE CELLS FOR CANCER IMMUNOTHERAPY
<b>C07K 14/725</b> (2006.01)	3250695	UNIVERSAL IMMUNE CELLS FOR CANCER IMMUNOTHERAPY
<b>C07K 16/28</b> (2006.01)	3250695	UNIVERSAL IMMUNE CELLS FOR CANCER IMMUNOTHERAPY
<b>C07K 16/32</b> (2006.01)	3250695	UNIVERSAL IMMUNE CELLS FOR CANCER IMMUNOTHERAPY
<b>C12N 15/85</b> (2006.01)	3250695	UNIVERSAL IMMUNE CELLS FOR CANCER IMMUNOTHERAPY
<b>G03G 15/00</b> (2006.01)	3255508	CARTRIDGE, PHOTORECEPTOR UNIT, ELECTROPHOTOGRAPHIC IMAGE FORMING DEVICE
<b>G03G 21/16</b> (2006.01)	3255508	CARTRIDGE, PHOTORECEPTOR UNIT, ELECTROPHOTOGRAPHIC IMAGE FORMING DEVICE
<b>G03G 21/18</b> (2006.01)	3255508	CARTRIDGE, PHOTORECEPTOR UNIT, ELECTROPHOTOGRAPHIC IMAGE FORMING DEVICE
<b>A61K 39/395</b> (2006.01)	3253412	ANTI-CD40L ANTIBODIES AND METHODS FOR TREATING CD40L- RELATED DISEASES OR DISORDERS
<b>C07K 16/28</b> (2006.01)	3253412	ANTI-CD40L ANTIBODIES AND METHODS FOR TREATING CD40L- RELATED DISEASES OR DISORDERS
<b>A61K 9/48</b> (2006.01)	3253401	METHOD OF TREATING DISEASES
<b>A61K 38/08</b> (2006.01)	3253401	METHOD OF TREATING DISEASES
<b>A61P 5/06</b> (2006.01)	3253401	METHOD OF TREATING DISEASES
<b>A43B 1/00</b> (2006.01)	3352606	FUNCTIONAL FOOTWEAR UNIT
<b>A43B 7/00</b> (2006.01)	3352606	FUNCTIONAL FOOTWEAR UNIT
<b>A43B 7/12</b> (2006.01)	3352606	FUNCTIONAL FOOTWEAR UNIT
<b>A43B 23/07</b> (2006.01)	3352606	FUNCTIONAL FOOTWEAR UNIT
<b>A62B 17/00</b> (2006.01)	3352606	FUNCTIONAL FOOTWEAR UNIT
<b>G16H 10/60</b> (2018.01)	3257017	SYSTEMS, DEVICES, AND METHODS FOR INGESTIBLE EVENT SENSING AND ANALYSIS
<b>G16H 20/10</b> (2018.01)	3257017	SYSTEMS, DEVICES, AND METHODS FOR INGESTIBLE EVENT SENSING AND ANALYSIS
<b>G16H 40/63</b> (2018.01)	3257017	SYSTEMS, DEVICES, AND METHODS FOR INGESTIBLE EVENT SENSING AND ANALYSIS
<b>G06F 15/16</b> (2006.01)	3256954	CENTRALIZED VALIDATION OF EMAIL SENDERS VIA EHLO NAME AND IP ADDRESS TARGETING
<b>H04L 12/58</b> (2006.01)	3256954	CENTRALIZED VALIDATION OF EMAIL SENDERS VIA EHLO NAME AND IP ADDRESS TARGETING
<b>H04L 29/12</b> (2006.01)	3256954	CENTRALIZED VALIDATION OF EMAIL SENDERS VIA EHLO NAME AND IP ADDRESS TARGETING
<b>A61K 31/185</b> (2006.01)	3347002	METHODS OF TREATING NEURODEGENERATIVE DISORDERS IN A PARTICULAR PATIENT POPULATION
<b>A61K 31/205</b> (2006.01)	3347002	METHODS OF TREATING NEURODEGENERATIVE DISORDERS IN A PARTICULAR PATIENT POPULATION
<b>C07C 309/02</b> (2006.01)	3347002	METHODS OF TREATING NEURODEGENERATIVE DISORDERS IN A PARTICULAR PATIENT POPULATION
<b>A61K 47/50</b> (2017.01)	3362098	A METHOD FOR ALTERING THE FUNCTIONAL STATE OF MRNA ALLOWING ITS SELECTIVE AND SPECIFIC RECOGNITION
<b>B64G 1/40</b> (2006.01)	3350442	INTERNAL WIRE-TRIGGERED PULSED CATHODIC ARC PROPULSION SYSTEM
<b>F03H 1/00</b> (2006.01)	3350442	INTERNAL WIRE-TRIGGERED PULSED CATHODIC ARC PROPULSION SYSTEM
<b>A61B 5/08</b> (2006.01)	3349831	DRY POWDER DELIVERY SYSTEM AND METHOD
<b>A61K 9/72</b> (2006.01)	3349831	DRY POWDER DELIVERY SYSTEM AND METHOD
<b>A61K 49/00</b> (2006.01)	3349831	DRY POWDER DELIVERY SYSTEM AND METHOD
<b>A61M 15/00</b> (2006.01)	3349831	DRY POWDER DELIVERY SYSTEM AND METHOD
<b>C08K 3/34</b> (2006.01)	3351595	THERMOPLASTIC ELASTOMER COMPOSITION AND METHOD FOR PREPARING SAME
<b>C08K 9/04</b> (2006.01)	3351595	THERMOPLASTIC ELASTOMER COMPOSITION AND METHOD FOR PREPARING SAME

MKP (51)	Broj objave evropske prijava patenta (97)	Naziv pronalaska (54)
<b>C08L 23/02</b> (2006.01)	3351595	THERMOPLASTIC ELASTOMER COMPOSITION AND METHOD FOR PREPARING SAME
<b>C08L 53/00</b> (2006.01)	3351595	THERMOPLASTIC ELASTOMER COMPOSITION AND METHOD FOR PREPARING SAME
<b>C08L 91/00</b> (2006.01)	3351595	THERMOPLASTIC ELASTOMER COMPOSITION AND METHOD FOR PREPARING SAME
<b>C08L 101/02</b> (2006.01)	3351595	THERMOPLASTIC ELASTOMER COMPOSITION AND METHOD FOR PREPARING SAME
<b>C08L 101/12</b> (2006.01)	3351595	THERMOPLASTIC ELASTOMER COMPOSITION AND METHOD FOR PREPARING SAME
<b>A61K 33/24</b> (2006.01)	3351580	POLYMER CONJUGATE OF HEXA-COORDINATED PLATINUM COMPLEX
<b>A61P 35/00</b> (2006.01)	3351580	POLYMER CONJUGATE OF HEXA-COORDINATED PLATINUM COMPLEX
<b>C07F 15/00</b> (2006.01)	3351580	POLYMER CONJUGATE OF HEXA-COORDINATED PLATINUM COMPLEX
<b>C08G 65/333</b> (2006.01)	3351580	POLYMER CONJUGATE OF HEXA-COORDINATED PLATINUM COMPLEX
<b>C08G 65/337</b> (2006.01)	3351580	POLYMER CONJUGATE OF HEXA-COORDINATED PLATINUM COMPLEX
<b>C08G 69/10</b> (2006.01)	3351580	POLYMER CONJUGATE OF HEXA-COORDINATED PLATINUM COMPLEX
<b>C08G 69/40</b> (2006.01)	3351580	POLYMER CONJUGATE OF HEXA-COORDINATED PLATINUM COMPLEX
<b>C08G 69/48</b> (2006.01)	3351580	POLYMER CONJUGATE OF HEXA-COORDINATED PLATINUM COMPLEX
<b>A61K 31/5377</b> (2006.01)	3351542	NEW CRYSTAL OF PIPERAZINE COMPOUND
<b>A61P 29/00</b> (2006.01)	3351542	NEW CRYSTAL OF PIPERAZINE COMPOUND
<b>A61P 37/08</b> (2006.01)	3351542	NEW CRYSTAL OF PIPERAZINE COMPOUND
<b>A61P 43/00</b> (2006.01)	3351542	NEW CRYSTAL OF PIPERAZINE COMPOUND
<b>C07D 401/12</b> (2006.01)	3351542	NEW CRYSTAL OF PIPERAZINE COMPOUND
<b>A61K 31/404</b> (2006.01)	3349750	PHARMACEUTICAL COMPOUND
<b>C07D 209/30</b> (2006.01)	3349750	PHARMACEUTICAL COMPOUND
<b>A61K 38/16</b> (2006.01)	3350337	MANUFACTURING METHOD OF AN IMMUNOTHERAPEUTIC FORMULATION COMPRISING A RECOMBINANT LISTERIA STRAIN
<b>C07K 14/005</b> (2006.01)	3350337	MANUFACTURING METHOD OF AN IMMUNOTHERAPEUTIC FORMULATION COMPRISING A RECOMBINANT LISTERIA STRAIN
<b>C07K 14/195</b> (2006.01)	3350337	MANUFACTURING METHOD OF AN IMMUNOTHERAPEUTIC FORMULATION COMPRISING A RECOMBINANT LISTERIA STRAIN
<b>C12N 15/74</b> (2006.01)	3350337	MANUFACTURING METHOD OF AN IMMUNOTHERAPEUTIC FORMULATION COMPRISING A RECOMBINANT LISTERIA STRAIN
<b>C12P 21/00</b> (2006.01)	3350337	MANUFACTURING METHOD OF AN IMMUNOTHERAPEUTIC FORMULATION COMPRISING A RECOMBINANT LISTERIA STRAIN
<b>A61K 39/395</b> (2006.01)	3349794	ANTI-CD115 ANTIBODIES
<b>C07K 16/28</b> (2006.01)	3349794	ANTI-CD115 ANTIBODIES
<b>A61K 39/395</b> (2006.01)	3349796	THERAPEUTIC COMBINATIONS COMPRISING ANTI-FOLR1 IMMUNOCONJUGATES
<b>C07K 16/28</b> (2006.01)	3349796	THERAPEUTIC COMBINATIONS COMPRISING ANTI-FOLR1 IMMUNOCONJUGATES
<b>C07K 16/30</b> (2006.01)	3349796	THERAPEUTIC COMBINATIONS COMPRISING ANTI-FOLR1 IMMUNOCONJUGATES
<b>C07K 16/46</b> (2006.01)	3349796	THERAPEUTIC COMBINATIONS COMPRISING ANTI-FOLR1 IMMUNOCONJUGATES
<b>A61K 31/16</b> (2006.01)	3350158	FARNESOID X RECEPTOR AGONISTS AND USES THEREOF
<b>C07C 233/55</b> (2006.01)	3350158	FARNESOID X RECEPTOR AGONISTS AND USES THEREOF
<b>C07C 233/63</b> (2006.01)	3350158	FARNESOID X RECEPTOR AGONISTS AND USES THEREOF
<b>C07C 255/60</b> (2006.01)	3350158	FARNESOID X RECEPTOR AGONISTS AND USES THEREOF
<b>C07D 305/06</b> (2006.01)	3350158	FARNESOID X RECEPTOR AGONISTS AND USES THEREOF
<b>C07D 309/06</b> (2006.01)	3350158	FARNESOID X RECEPTOR AGONISTS AND USES THEREOF
<b>A61K 31/16</b> (2006.01)	3350165	FARNESOID X RECEPTOR AGONISTS AND USES THEREOF
<b>A61K 31/4412</b> (2006.01)	3350165	FARNESOID X RECEPTOR AGONISTS AND USES THEREOF
<b>A61K 31/4418</b> (2006.01)	3350165	FARNESOID X RECEPTOR AGONISTS AND USES THEREOF
<b>C07D 207/12</b> (2006.01)	3350165	FARNESOID X RECEPTOR AGONISTS AND USES THEREOF
<b>C07D 213/63</b> (2006.01)	3350165	FARNESOID X RECEPTOR AGONISTS AND USES THEREOF
<b>A61K 31/4418</b> (2006.01)	3350164	FARNESOID X RECEPTOR AGONISTS AND USES THEREOF
<b>A61K 31/4465</b> (2006.01)	3350164	FARNESOID X RECEPTOR AGONISTS AND USES THEREOF
<b>C07C 233/55</b> (2006.01)	3350164	FARNESOID X RECEPTOR AGONISTS AND USES THEREOF
<b>C07C 233/63</b> (2006.01)	3350164	FARNESOID X RECEPTOR AGONISTS AND USES THEREOF

MKP (51)	Broj objave evropske prijava patenta (97)	Naziv pronalaska (54)
<b>C07D 211/10</b> (2006.01)	3350164	FARNESOID X RECEPTOR AGONISTS AND USES THEREOF
<b>C07D 213/04</b> (2006.01)	3350164	FARNESOID X RECEPTOR AGONISTS AND USES THEREOF
<b>C07D 213/06</b> (2006.01)	3350164	FARNESOID X RECEPTOR AGONISTS AND USES THEREOF
<b>A61K 31/404</b> (2006.01)	3350166	FARNESOID X RECEPTOR AGONISTS AND USES THEREOF
<b>A61K 31/44</b> (2006.01)	3350166	FARNESOID X RECEPTOR AGONISTS AND USES THEREOF
<b>A61K 31/444</b> (2006.01)	3350166	FARNESOID X RECEPTOR AGONISTS AND USES THEREOF
<b>A61K 31/47</b> (2006.01)	3350166	FARNESOID X RECEPTOR AGONISTS AND USES THEREOF
<b>C07D 213/72</b> (2006.01)	3350166	FARNESOID X RECEPTOR AGONISTS AND USES THEREOF
<b>C07D 213/75</b> (2006.01)	3350166	FARNESOID X RECEPTOR AGONISTS AND USES THEREOF
<b>C07D 217/12</b> (2006.01)	3350166	FARNESOID X RECEPTOR AGONISTS AND USES THEREOF
<b>C07D 401/12</b> (2006.01)	3350166	FARNESOID X RECEPTOR AGONISTS AND USES THEREOF
<b>A61K 39/00</b> (2006.01)	3349789	RECOMBINANT LISTERIA VACCINE STRAINS AND METHODS OF USING THE SAME IN CANCER IMMUNOTHERAPY
<b>A61K 39/02</b> (2006.01)	3349789	RECOMBINANT LISTERIA VACCINE STRAINS AND METHODS OF USING THE SAME IN CANCER IMMUNOTHERAPY
<b>A61K 48/00</b> (2006.01)	3349789	RECOMBINANT LISTERIA VACCINE STRAINS AND METHODS OF USING THE SAME IN CANCER IMMUNOTHERAPY
<b>A61K 31/282</b> (2006.01)	3350196	CARBORANE COMPOUNDS AND METHODS OF USE THEREOF
<b>A61K 33/24</b> (2006.01)	3350196	CARBORANE COMPOUNDS AND METHODS OF USE THEREOF
<b>C07J 9/00</b> (2006.01)	3350196	CARBORANE COMPOUNDS AND METHODS OF USE THEREOF
<b>C02F 1/32</b> (2006.01)	3398400	TUBULAR CONCENTRATOR FOR CONCENTRIC RADIATION OF ELECTROMAGNETIC WAVES
<b>H05B 3/00</b> (2006.01)	3398400	TUBULAR CONCENTRATOR FOR CONCENTRIC RADIATION OF ELECTROMAGNETIC WAVES
<b>A61K 31/427</b> (2006.01)	3353175	SALTS AND SOLID FORMS OF MONOBACTAM ANTIBIOTIC
<b>A61P 31/04</b> (2006.01)	3353175	SALTS AND SOLID FORMS OF MONOBACTAM ANTIBIOTIC
<b>C07D 417/14</b> (2006.01)	3353175	SALTS AND SOLID FORMS OF MONOBACTAM ANTIBIOTIC
<b>C04B 35/528</b> (2006.01)	3353841	METHOD OF PREPARING AND APPLICATION OF CARBON-SELENIUM COMPOSITES
<b>C04B 35/63</b> (2006.01)	3353841	METHOD OF PREPARING AND APPLICATION OF CARBON-SELENIUM COMPOSITES
<b>C04B 35/632</b> (2006.01)	3353841	METHOD OF PREPARING AND APPLICATION OF CARBON-SELENIUM COMPOSITES
<b>H01M 4/36</b> (2006.01)	3353841	METHOD OF PREPARING AND APPLICATION OF CARBON-SELENIUM COMPOSITES
<b>H01M 4/587</b> (2010.01)	3353841	METHOD OF PREPARING AND APPLICATION OF CARBON-SELENIUM COMPOSITES
<b>H01M 10/052</b> (2010.01)	3353841	METHOD OF PREPARING AND APPLICATION OF CARBON-SELENIUM COMPOSITES
<b>H01M 10/0568</b> (2010.01)	3353841	METHOD OF PREPARING AND APPLICATION OF CARBON-SELENIUM COMPOSITES
<b>H01M 10/0569</b> (2010.01)	3353841	METHOD OF PREPARING AND APPLICATION OF CARBON-SELENIUM COMPOSITES
<b>A61K 38/44</b> (2006.01)	3352781	4'-SUBSTITUTED NUCLEOSIDE REVERSE TRANSCRIPTASE INHIBITORS AND PREPARATIONS THEREOF
<b>C12N 1/20</b> (2006.01)	3352781	4'-SUBSTITUTED NUCLEOSIDE REVERSE TRANSCRIPTASE INHIBITORS AND PREPARATIONS THEREOF
<b>A61K 39/145</b> (2006.01)	3353192	DESIGN AND CHARACTERIZATION OF INFLUENZA VACCINES
<b>A61K 39/39</b> (2006.01)	3353192	DESIGN AND CHARACTERIZATION OF INFLUENZA VACCINES
<b>C07K 14/005</b> (2006.01)	3353192	DESIGN AND CHARACTERIZATION OF INFLUENZA VACCINES
<b>C12N 9/24</b> (2006.01)	3353192	DESIGN AND CHARACTERIZATION OF INFLUENZA VACCINES
<b>C12N 15/63</b> (2006.01)	3353192	DESIGN AND CHARACTERIZATION OF INFLUENZA VACCINES
<b>A61K 31/56</b> (2006.01)	3352768	METHODS OF PROMOTING HEPATIC REGENERATION
<b>A61K 31/58</b> (2006.01)	3352768	METHODS OF PROMOTING HEPATIC REGENERATION
<b>A61K 31/79</b> (2006.01)	3352768	METHODS OF PROMOTING HEPATIC REGENERATION
<b>A61K 31/47</b> (2006.01)	3352757	ADMINISTRATION OF DEUTERATED CFTR POTENTIATORS
<b>C07D 215/56</b> (2006.01)	3352757	ADMINISTRATION OF DEUTERATED CFTR POTENTIATORS
<b>C07K 14/705</b> (2006.01)	3353197	METHOD OF REDIRECTING T CELLS TO TREAT HIV INFECTION
<b>C07K 14/725</b> (2006.01)	3353197	METHOD OF REDIRECTING T CELLS TO TREAT HIV INFECTION
<b>C07K 19/00</b> (2006.01)	3353197	METHOD OF REDIRECTING T CELLS TO TREAT HIV INFECTION
<b>A61K 31/20</b> (2006.01)	3352749	COMPOUNDS AND COMPOSITIONS FOR THE TREATMENT OF OCULAR DISORDERS
<b>A61K 47/34</b> (2017.01)	3352749	COMPOUNDS AND COMPOSITIONS FOR THE TREATMENT OF OCULAR DISORDERS
<b>A61K 31/435</b> (2006.01)	3352758	DEUTERATED CFTR POTENTIATORS
<b>A61K 31/47</b> (2006.01)	3352758	DEUTERATED CFTR POTENTIATORS
<b>A61K 31/4704</b> (2006.01)	3352758	DEUTERATED CFTR POTENTIATORS
<b>A61K 31/472</b> (2006.01)	3352758	DEUTERATED CFTR POTENTIATORS

MKP (51)	Broj objave evropske prijava patenta (97)	Naziv pronalaska (54)
<b>A61P 11/12</b> (2006.01)	3352758	DEUTERATED CFTR POTENTIATORS
<b>C07D 215/00</b> (2006.01)	3352758	DEUTERATED CFTR POTENTIATORS
<b>C07D 215/16</b> (2006.01)	3352758	DEUTERATED CFTR POTENTIATORS
<b>C07D 215/56</b> (2006.01)	3352758	DEUTERATED CFTR POTENTIATORS
<b>C07D 471/04</b> (2006.01)	3352758	DEUTERATED CFTR POTENTIATORS
<b>A61K 31/7088</b> (2006.01)	3353328	MODULATORS OF KRAS EXPRESSION
<b>C07H 21/04</b> (2006.01)	3353328	MODULATORS OF KRAS EXPRESSION
<b>C12N 15/113</b> (2010.01)	3353328	MODULATORS OF KRAS EXPRESSION
<b>C12Q 1/68</b> (2018.01)	3353328	MODULATORS OF KRAS EXPRESSION
<b>C07C 281/16</b> (2006.01)	3353153	THE TOTAL SYNTHESIS OF GLUCOSEPANE AND COMPOUNDS OBTAINED THEREFROM
<b>C07D 223/14</b> (2006.01)	3353153	THE TOTAL SYNTHESIS OF GLUCOSEPANE AND COMPOUNDS OBTAINED THEREFROM
<b>A61K 31/575</b> (2006.01)	3353189	METHODS AND INTERMEDIATES FOR THE PREPARATION BILE ACID DERIVATIVES
<b>A61P 1/16</b> (2006.01)	3353189	METHODS AND INTERMEDIATES FOR THE PREPARATION BILE ACID DERIVATIVES
<b>A61P 9/10</b> (2006.01)	3353189	METHODS AND INTERMEDIATES FOR THE PREPARATION BILE ACID DERIVATIVES
<b>A61P 13/12</b> (2006.01)	3353189	METHODS AND INTERMEDIATES FOR THE PREPARATION BILE ACID DERIVATIVES
<b>C07J 9/00</b> (2006.01)	3353189	METHODS AND INTERMEDIATES FOR THE PREPARATION BILE ACID DERIVATIVES
<b>C07J 31/00</b> (2006.01)	3353189	METHODS AND INTERMEDIATES FOR THE PREPARATION BILE ACID DERIVATIVES
<b>A61K 31/496</b> (2006.01)	3352761	METHOD OF TREATING MALIGNANT RHABDOID TUMOR OF THE OVARY (MRTO)/SMALL CELL CANCER OF THE OVARY OF THE HYPERCALCEMIC TYPE (SCCOHT) WITH AN EZH2 INHIBITOR
<b>A61K 31/5377</b> (2006.01)	3352761	METHOD OF TREATING MALIGNANT RHABDOID TUMOR OF THE OVARY (MRTO)/SMALL CELL CANCER OF THE OVARY OF THE HYPERCALCEMIC TYPE (SCCOHT) WITH AN EZH2 INHIBITOR
<b>C07B 53/00</b> (2006.01)	3357901	METHOD FOR PRODUCING OPTICALLY ACTIVE 2-(2- FLUOROBIPHENYL-4-YL) PROPANOIC ACID
<b>C07B 61/00</b> (2006.01)	3357901	METHOD FOR PRODUCING OPTICALLY ACTIVE 2-(2- FLUOROBIPHENYL-4-YL) PROPANOIC ACID
<b>C07C 51/09</b> (2006.01)	3357901	METHOD FOR PRODUCING OPTICALLY ACTIVE 2-(2- FLUOROBIPHENYL-4-YL) PROPANOIC ACID
<b>C07C 57/58</b> (2006.01)	3357901	METHOD FOR PRODUCING OPTICALLY ACTIVE 2-(2- FLUOROBIPHENYL-4-YL) PROPANOIC ACID
<b>B65D 85/00</b> (2006.01)	3357837	PALLET FOR CYLINDERS, METHOD FOR ARRANGING CYLINDERS IN A PALLET, AND PALLET WITH CYLINDERS
<b>B65D 88/00</b> (2006.01)	3357837	PALLET FOR CYLINDERS, METHOD FOR ARRANGING CYLINDERS IN A PALLET, AND PALLET WITH CYLINDERS
<b>F17C 13/00</b> (2006.01)	3357837	PALLET FOR CYLINDERS, METHOD FOR ARRANGING CYLINDERS IN A PALLET, AND PALLET WITH CYLINDERS
<b>G01N 33/543</b> (2006.01)	3356833	ANTIBODIES THAT BIND HUMAN CANNABINOID 1 (CB1) RECEPTOR
<b>G01N 33/94</b> (2006.01)	3356833	ANTIBODIES THAT BIND HUMAN CANNABINOID 1 (CB1) RECEPTOR
<b>A61K 9/00</b> (2006.01)	3355954	DELIVERY METHODS AND COMPOSITIONS
<b>A61M 5/00</b> (2006.01)	3355954	DELIVERY METHODS AND COMPOSITIONS
<b>C12N 9/14</b> (2006.01)	3356528	COMPOSITIONS AND METHODS FOR LATENT VIRAL TRANSCRIPTION REGULATION
<b>C12N 9/22</b> (2006.01)	3356528	COMPOSITIONS AND METHODS FOR LATENT VIRAL TRANSCRIPTION REGULATION
<b>C12N 15/11</b> (2006.01)	3356528	COMPOSITIONS AND METHODS FOR LATENT VIRAL TRANSCRIPTION REGULATION
<b>C12N 15/63</b> (2006.01)	3356528	COMPOSITIONS AND METHODS FOR LATENT VIRAL TRANSCRIPTION REGULATION
<b>A61K 31/495</b> (2006.01)	3355991	COMBINATION THERAPY REGIMEN FOR TREATMENT OF HCV
<b>A61K 31/522</b> (2006.01)	3355991	COMBINATION THERAPY REGIMEN FOR TREATMENT OF HCV
<b>A61P 31/14</b> (2006.01)	3355991	COMBINATION THERAPY REGIMEN FOR TREATMENT OF HCV
<b>A61K 31/4439</b> (2006.01)	3355890	HUMAN PLASMA KALLIKREIN INHIBITORS
<b>A61K 31/519</b> (2006.01)	3355890	HUMAN PLASMA KALLIKREIN INHIBITORS
<b>C07D 405/12</b> (2006.01)	3355890	HUMAN PLASMA KALLIKREIN INHIBITORS
<b>A61K 39/395</b> (2006.01)	3355921	ANTAGONISTIC ANTIBODIES SPECIFICALLY BINDING HUMAN CD40 AND METHODS OF USE
<b>A61P 1/00</b> (2006.01)	3355921	ANTAGONISTIC ANTIBODIES SPECIFICALLY BINDING HUMAN CD40 AND METHODS OF USE

MKP (51)	Broj objave evropske prijava patenta (97)	Naziv pronalaska (54)
<b>A61P 37/00</b> (2006.01)	3355921	ANTAGONISTIC ANTIBODIES SPECIFICALLY BINDING HUMAN CD40 AND METHODS OF USE
<b>C12N 15/113</b> (2010.01)	3356529	COMPOSITIONS AND METHODS FOR INHIBITING GENE EXPRESSION OF LPA
<b>A61K 39/395</b> (2006.01)	3356532	AGONISTIC ANTIBODIES SPECIFICALLY BINDING HUMAN CD40 AND METHODS OF USE
<b>A61P 35/00</b> (2006.01)	3356532	AGONISTIC ANTIBODIES SPECIFICALLY BINDING HUMAN CD40 AND METHODS OF USE
<b>A61P 35/02</b> (2006.01)	3356532	AGONISTIC ANTIBODIES SPECIFICALLY BINDING HUMAN CD40 AND METHODS OF USE
<b>C12N 15/13</b> (2006.01)	3356532	AGONISTIC ANTIBODIES SPECIFICALLY BINDING HUMAN CD40 AND METHODS OF USE
<b>C07K 14/525</b> (2006.01)	3356561	THERAPEUTIC AND DIAGNOSTIC METHODS FOR AUTOIMMUNE DISEASES AND/OR INFLAMMATION
<b>C07K 14/54</b> (2006.01)	3356561	THERAPEUTIC AND DIAGNOSTIC METHODS FOR AUTOIMMUNE DISEASES AND/OR INFLAMMATION
<b>C07K 16/28</b> (2006.01)	3356561	THERAPEUTIC AND DIAGNOSTIC METHODS FOR AUTOIMMUNE DISEASES AND/OR INFLAMMATION
<b>C12Q 1/68</b> (2018.01)	3356561	THERAPEUTIC AND DIAGNOSTIC METHODS FOR AUTOIMMUNE DISEASES AND/OR INFLAMMATION
<b>G01N 33/50</b> (2006.01)	3356561	THERAPEUTIC AND DIAGNOSTIC METHODS FOR AUTOIMMUNE DISEASES AND/OR INFLAMMATION
<b>C12N 15/09</b> (2006.01)	3356525	COMPOSITIONS FOR ADJUSTABLE RIBOSOME TRANSLATION SPEED AND METHODS OF USE
<b>C12N 15/11</b> (2006.01)	3356525	COMPOSITIONS FOR ADJUSTABLE RIBOSOME TRANSLATION SPEED AND METHODS OF USE
<b>C12N 15/63</b> (2006.01)	3356525	COMPOSITIONS FOR ADJUSTABLE RIBOSOME TRANSLATION SPEED AND METHODS OF USE
<b>C12N 15/67</b> (2006.01)	3356525	COMPOSITIONS FOR ADJUSTABLE RIBOSOME TRANSLATION SPEED AND METHODS OF USE
<b>C12Q 1/68</b> (2018.01)	3356525	COMPOSITIONS FOR ADJUSTABLE RIBOSOME TRANSLATION SPEED AND METHODS OF USE
<b>A61K 48/00</b> (2006.01)	3389724	GENE THERAPY FOR OCULAR DISORDERS
<b>C07K 14/47</b> (2006.01)	3389724	GENE THERAPY FOR OCULAR DISORDERS
<b>A01N 37/46</b> (2006.01)	3360415	AGRICULTURAL AND HORTICULTURAL FUNGICIDAL COMPOSITION
<b>A01N 43/10</b> (2006.01)	3360415	AGRICULTURAL AND HORTICULTURAL FUNGICIDAL COMPOSITION
<b>A01N 43/24</b> (2006.01)	3360415	AGRICULTURAL AND HORTICULTURAL FUNGICIDAL COMPOSITION
<b>A01N 43/40</b> (2006.01)	3360415	AGRICULTURAL AND HORTICULTURAL FUNGICIDAL COMPOSITION
<b>A01N 43/42</b> (2006.01)	3360415	AGRICULTURAL AND HORTICULTURAL FUNGICIDAL COMPOSITION
<b>A01N 43/56</b> (2006.01)	3360415	AGRICULTURAL AND HORTICULTURAL FUNGICIDAL COMPOSITION
<b>A01N 43/60</b> (2006.01)	3360415	AGRICULTURAL AND HORTICULTURAL FUNGICIDAL COMPOSITION
<b>A01N 43/653</b> (2006.01)	3360415	AGRICULTURAL AND HORTICULTURAL FUNGICIDAL COMPOSITION
<b>A01N 43/72</b> (2006.01)	3360415	AGRICULTURAL AND HORTICULTURAL FUNGICIDAL COMPOSITION
<b>A01N 43/80</b> (2006.01)	3360415	AGRICULTURAL AND HORTICULTURAL FUNGICIDAL COMPOSITION
<b>A01N 43/90</b> (2006.01)	3360415	AGRICULTURAL AND HORTICULTURAL FUNGICIDAL COMPOSITION
<b>A01N 47/12</b> (2006.01)	3360415	AGRICULTURAL AND HORTICULTURAL FUNGICIDAL COMPOSITION
<b>A01P 3/00</b> (2006.01)	3360415	AGRICULTURAL AND HORTICULTURAL FUNGICIDAL COMPOSITION
<b>C07D 211/86</b> (2006.01)	3371175	METHOD OF TREATING MEDULLOBLASTOMA WITH AN EZH2 INHIBITOR
<b>C07D 405/12</b> (2006.01)	3371175	METHOD OF TREATING MEDULLOBLASTOMA WITH AN EZH2 INHIBITOR
<b>C07D 405/14</b> (2006.01)	3371175	METHOD OF TREATING MEDULLOBLASTOMA WITH AN EZH2 INHIBITOR
<b>A61K 35/04</b> (2006.01)	3359192	COMBINATION THERAPY FOR THE TREATMENT OF CANCER
<b>A61K 39/395</b> (2006.01)	3359192	COMBINATION THERAPY FOR THE TREATMENT OF CANCER
<b>C07K 16/18</b> (2006.01)	3359192	COMBINATION THERAPY FOR THE TREATMENT OF CANCER
<b>C07K 16/28</b> (2006.01)	3359192	COMBINATION THERAPY FOR THE TREATMENT OF CANCER
<b>E02D 17/20</b> (2006.01)	3359745	GEOGRID MADE FROM A COEXTRUDED MULTILAYERED POLYMER
<b>E02D 29/02</b> (2006.01)	3359745	GEOGRID MADE FROM A COEXTRUDED MULTILAYERED POLYMER
<b>A61K 31/56</b> (2006.01)	3359160	FARNESOID X RECEPTOR MODULATORS
<b>A61K 31/57</b> (2006.01)	3359160	FARNESOID X RECEPTOR MODULATORS
<b>A61K 31/575</b> (2006.01)	3359160	FARNESOID X RECEPTOR MODULATORS
<b>C07J 9/00</b> (2006.01)	3359160	FARNESOID X RECEPTOR MODULATORS
<b>C07J 43/00</b> (2006.01)	3359160	FARNESOID X RECEPTOR MODULATORS
<b>A61K 31/64</b> (2006.01)	3359162	METHODS OF TREATING INJURIES OR CONDITIONS RELATED TO CNS EDEMA
<b>A61K 31/7125</b> (2006.01)	3359668	COMPOSITIONS AND METHODS FOR TREATING DUCHENNE MUSCULAR DYSTROPHY AND RELATED DISORDERS

MKP (51)	Broj objave evropske prijava patenta (97)	Naziv pronalaska (54)
<b>C07H 21/04</b> (2006.01)	3359668	COMPOSITIONS AND METHODS FOR TREATING DUCHENNE MUSCULAR DYSTROPHY AND RELATED DISORDERS
<b>C12N 15/113</b> (2010.01)	3359668	COMPOSITIONS AND METHODS FOR TREATING DUCHENNE MUSCULAR DYSTROPHY AND RELATED DISORDERS
<b>C12N 5/0789</b> (2010.01)	3359648	IN VITRO METHODS OF IDENTIFYING MODULATORS OF NEUROMUSCULAR JUNCTION ACTIVITY
<b>C12N 5/0793</b> (2010.01)	3359648	IN VITRO METHODS OF IDENTIFYING MODULATORS OF NEUROMUSCULAR JUNCTION ACTIVITY
<b>C07F 7/02</b> (2006.01)	3362456	EXTENDED USE ZIRCONIUM SILICATE COMPOSITIONS AND METHODS OF USE THEREOF
<b>B65H 43/02</b> (2006.01)	3362389	DISPOSABLE PRODUCT ASSEMBLY SYSTEMS AND METHODS
<b>B65H 51/30</b> (2006.01)	3362389	DISPOSABLE PRODUCT ASSEMBLY SYSTEMS AND METHODS
<b>G05B 11/01</b> (2006.01)	3362389	DISPOSABLE PRODUCT ASSEMBLY SYSTEMS AND METHODS
<b>G05B 11/32</b> (2006.01)	3362389	DISPOSABLE PRODUCT ASSEMBLY SYSTEMS AND METHODS
<b>G05B 21/02</b> (2006.01)	3362389	DISPOSABLE PRODUCT ASSEMBLY SYSTEMS AND METHODS
<b>G06Q 30/06</b> (2012.01)	3362389	DISPOSABLE PRODUCT ASSEMBLY SYSTEMS AND METHODS
<b>G06Q 50/04</b> (2012.01)	3362389	DISPOSABLE PRODUCT ASSEMBLY SYSTEMS AND METHODS
<b>A61K 31/415</b> (2006.01)	3373951	METHODS AND COMPOSITIONS FOR THE TREATMENT OF EPIDERMOLYSIS BULLOSA
<b>A61K 38/08</b> (2006.01)	3373951	METHODS AND COMPOSITIONS FOR THE TREATMENT OF EPIDERMOLYSIS BULLOSA
<b>A61K 38/12</b> (2006.01)	3373951	METHODS AND COMPOSITIONS FOR THE TREATMENT OF EPIDERMOLYSIS BULLOSA
<b>A61P 17/02</b> (2006.01)	3373951	METHODS AND COMPOSITIONS FOR THE TREATMENT OF EPIDERMOLYSIS BULLOSA
<b>A61K 31/4439</b> (2006.01)	3362065	COMBINATION THERAPY FOR TREATING MALIGNANCIES
<b>C07H 19/06</b> (2006.01)	3362065	COMBINATION THERAPY FOR TREATING MALIGNANCIES
<b>A61K 31/4439</b> (2006.01)	3362066	COMBINATION THERAPY FOR TREATING MALIGNANCIES
<b>A61P 35/00</b> (2006.01)	3362066	COMBINATION THERAPY FOR TREATING MALIGNANCIES
<b>C07H 19/12</b> (2006.01)	3362066	COMBINATION THERAPY FOR TREATING MALIGNANCIES
<b>A61K 31/425</b> (2006.01)	3371176	EPOTHILONE ANALOGS, METHODS OF SYNTHESIS, METHODS OF TREATMENT, AND DRUG CONJUGATES THEREOF
<b>C07D 405/06</b> (2006.01)	3371176	EPOTHILONE ANALOGS, METHODS OF SYNTHESIS, METHODS OF TREATMENT, AND DRUG CONJUGATES THEREOF
<b>C07D 407/06</b> (2006.01)	3371176	EPOTHILONE ANALOGS, METHODS OF SYNTHESIS, METHODS OF TREATMENT, AND DRUG CONJUGATES THEREOF
<b>A61K 9/16</b> (2006.01)	3362053	TREATMENT OF NON-ALCOHOLIC FATTY LIVER DISEASE OR NON-ALCOHOLIC STEATOHEPATITIS WITH DELAYED-RELEASE 6-MERCAPTOPYRINE
<b>A61K 9/22</b> (2006.01)	3362053	TREATMENT OF NON-ALCOHOLIC FATTY LIVER DISEASE OR NON-ALCOHOLIC STEATOHEPATITIS WITH DELAYED-RELEASE 6-MERCAPTOPYRINE
<b>A61K 31/52</b> (2006.01)	3362053	TREATMENT OF NON-ALCOHOLIC FATTY LIVER DISEASE OR NON-ALCOHOLIC STEATOHEPATITIS WITH DELAYED-RELEASE 6-MERCAPTOPYRINE
<b>A61K 31/522</b> (2006.01)	3362053	TREATMENT OF NON-ALCOHOLIC FATTY LIVER DISEASE OR NON-ALCOHOLIC STEATOHEPATITIS WITH DELAYED-RELEASE 6-MERCAPTOPYRINE
<b>A61K 39/00</b> (2006.01)	3368675	RECOMBINANT LISTERIA VACCINE STRAINS AND METHODS OF USING THE SAME IN CANCER IMMUNOTHERAPY
<b>A61K 39/02</b> (2006.01)	3368675	RECOMBINANT LISTERIA VACCINE STRAINS AND METHODS OF USING THE SAME IN CANCER IMMUNOTHERAPY
<b>A61K 39/12</b> (2006.01)	3368675	RECOMBINANT LISTERIA VACCINE STRAINS AND METHODS OF USING THE SAME IN CANCER IMMUNOTHERAPY
<b>A61K 39/39</b> (2006.01)	3368675	RECOMBINANT LISTERIA VACCINE STRAINS AND METHODS OF USING THE SAME IN CANCER IMMUNOTHERAPY
<b>C07K 14/005</b> (2006.01)	3368675	RECOMBINANT LISTERIA VACCINE STRAINS AND METHODS OF USING THE SAME IN CANCER IMMUNOTHERAPY
<b>C07K 14/195</b> (2006.01)	3368675	RECOMBINANT LISTERIA VACCINE STRAINS AND METHODS OF USING THE SAME IN CANCER IMMUNOTHERAPY
<b>C12N 15/74</b> (2006.01)	3368675	RECOMBINANT LISTERIA VACCINE STRAINS AND METHODS OF USING THE SAME IN CANCER IMMUNOTHERAPY
<b>A61K 31/453</b> (2006.01)	3362067	METHODS AND COMPOSITIONS FOR TREATING TRAUMATIC BRAIN INJURY
<b>A61P 43/00</b> (2006.01)	3362067	METHODS AND COMPOSITIONS FOR TREATING TRAUMATIC BRAIN INJURY
<b>C07D 311/02</b> (2006.01)	3362067	METHODS AND COMPOSITIONS FOR TREATING TRAUMATIC BRAIN INJURY

MKP (51)	Broj objave evropske prijava patenta (97)	Naziv pronalaska (54)
<b>G01N 33/92</b> (2006.01)	3373014	DIAGNOSTIC MARKER FOR CORONARY ARTERY DISEASE
<b>A61B 17/70</b> (2006.01)	3366243	SURGICAL SCREW AND FUSION DEVICE USING SAME
<b>A61B 17/72</b> (2006.01)	3366243	SURGICAL SCREW AND FUSION DEVICE USING SAME
<b>A61B 17/86</b> (2006.01)	3366243	SURGICAL SCREW AND FUSION DEVICE USING SAME
<b>A61F 2/44</b> (2006.01)	3366243	SURGICAL SCREW AND FUSION DEVICE USING SAME
<b>A61B 17/70</b> (2006.01)	3366244	SURGICAL SCREW AND FUSION DEVICE USING SAME
<b>A61B 17/72</b> (2006.01)	3366244	SURGICAL SCREW AND FUSION DEVICE USING SAME
<b>A61B 17/86</b> (2006.01)	3366244	SURGICAL SCREW AND FUSION DEVICE USING SAME
<b>A61F 2/44</b> (2006.01)	3366244	SURGICAL SCREW AND FUSION DEVICE USING SAME
<b>A61K 9/08</b> (2006.01)	3354271	AGENT FOR TREATING ARTHROLOGICAL DISEASES
<b>A61K 31/737</b> (2006.01)	3354271	AGENT FOR TREATING ARTHROLOGICAL DISEASES
<b>A61K 35/32</b> (2015.01)	3354271	AGENT FOR TREATING ARTHROLOGICAL DISEASES
<b>A61K 35/60</b> (2006.01)	3354271	AGENT FOR TREATING ARTHROLOGICAL DISEASES
<b>A61K 47/10</b> (2017.01)	3354271	AGENT FOR TREATING ARTHROLOGICAL DISEASES
<b>A61P 19/02</b> (2006.01)	3354271	AGENT FOR TREATING ARTHROLOGICAL DISEASES
<b>A61K 31/375</b> (2006.01)	3366288	AGENT EXHIBITING ANTI-STRESS, ANXIOLYTIC AND ANTI-DEPRESSION ACTIVITY, AND COMPOSITION BASED THEREON
<b>A61K 31/4415</b> (2006.01)	3366288	AGENT EXHIBITING ANTI-STRESS, ANXIOLYTIC AND ANTI-DEPRESSION ACTIVITY, AND COMPOSITION BASED THEREON
<b>A61K 31/51</b> (2006.01)	3366288	AGENT EXHIBITING ANTI-STRESS, ANXIOLYTIC AND ANTI-DEPRESSION ACTIVITY, AND COMPOSITION BASED THEREON
<b>A61P 25/24</b> (2006.01)	3366288	AGENT EXHIBITING ANTI-STRESS, ANXIOLYTIC AND ANTI-DEPRESSION ACTIVITY, AND COMPOSITION BASED THEREON
<b>E04B 1/21</b> (2006.01)	3365505	SUPPORT APPARATUS AND ITS COMPONENTS
<b>E04B 1/24</b> (2006.01)	3365505	SUPPORT APPARATUS AND ITS COMPONENTS
<b>E04B 1/41</b> (2006.01)	3365505	SUPPORT APPARATUS AND ITS COMPONENTS
<b>E04B 1/58</b> (2006.01)	3365505	SUPPORT APPARATUS AND ITS COMPONENTS
<b>F16B 13/04</b> (2006.01)	3365505	SUPPORT APPARATUS AND ITS COMPONENTS
<b>F16S 3/00</b> (2006.01)	3365505	SUPPORT APPARATUS AND ITS COMPONENTS
<b>A61K 31/53</b> (2006.01)	3365336	DEUTERATED COMPOUNDS FOR TREATING HEMATOLOGIC MALIGNANCIES, AND COMPOSITIONS AND METHODS THEREOF
<b>A61P 35/00</b> (2006.01)	3365336	DEUTERATED COMPOUNDS FOR TREATING HEMATOLOGIC MALIGNANCIES, AND COMPOSITIONS AND METHODS THEREOF
<b>C07D 401/14</b> (2006.01)	3365336	DEUTERATED COMPOUNDS FOR TREATING HEMATOLOGIC MALIGNANCIES, AND COMPOSITIONS AND METHODS THEREOF
<b>A01M 1/00</b> (2006.01)	3370515	BED BUGS DETECTION DEVICE
<b>C12Q 1/68</b> (2018.01)	3370515	BED BUGS DETECTION DEVICE
<b>G01N 33/50</b> (2006.01)	3370515	BED BUGS DETECTION DEVICE
<b>G01N 33/563</b> (2006.01)	3370515	BED BUGS DETECTION DEVICE
<b>G01N 33/566</b> (2006.01)	3370515	BED BUGS DETECTION DEVICE
<b>G06F 7/00</b> (2006.01)	3370515	BED BUGS DETECTION DEVICE
<b>A61K 31/7105</b> (2006.01)	3364980	NUCLEIC ACID VACCINES FOR VARICELLA ZOSTER VIRUS (VZV)
<b>A61P 31/22</b> (2006.01)	3364980	NUCLEIC ACID VACCINES FOR VARICELLA ZOSTER VIRUS (VZV)
<b>C12N 15/38</b> (2006.01)	3364980	NUCLEIC ACID VACCINES FOR VARICELLA ZOSTER VIRUS (VZV)
<b>C07K 16/18</b> (2006.01)	3365367	ANTI-BED BUG MONOCLONAL ANTIBODIES AND METHODS OF MAKING AND USES THEREOF
<b>C12N 5/12</b> (2006.01)	3365367	ANTI-BED BUG MONOCLONAL ANTIBODIES AND METHODS OF MAKING AND USES THEREOF
<b>C12N 5/20</b> (2006.01)	3365367	ANTI-BED BUG MONOCLONAL ANTIBODIES AND METHODS OF MAKING AND USES THEREOF
<b>G01N 33/563</b> (2006.01)	3365367	ANTI-BED BUG MONOCLONAL ANTIBODIES AND METHODS OF MAKING AND USES THEREOF
<b>G01N 33/569</b> (2006.01)	3365367	ANTI-BED BUG MONOCLONAL ANTIBODIES AND METHODS OF MAKING AND USES THEREOF
<b>G01N 33/577</b> (2006.01)	3365367	ANTI-BED BUG MONOCLONAL ANTIBODIES AND METHODS OF MAKING AND USES THEREOF
<b>A61K 31/7105</b> (2006.01)	3364981	HUMAN CYTOMEGALOVIRUS VACCINE
<b>A61K 31/7115</b> (2006.01)	3364981	HUMAN CYTOMEGALOVIRUS VACCINE
<b>A61K 39/245</b> (2006.01)	3364981	HUMAN CYTOMEGALOVIRUS VACCINE
<b>A61P 31/22</b> (2006.01)	3364981	HUMAN CYTOMEGALOVIRUS VACCINE
<b>A61K 31/015</b> (2006.01)	3364956	ANALOGS OF CELASTROL
<b>A61K 31/56</b> (2006.01)	3364956	ANALOGS OF CELASTROL
<b>A61K 45/06</b> (2006.01)	3364956	ANALOGS OF CELASTROL
<b>C07J 63/00</b> (2006.01)	3364956	ANALOGS OF CELASTROL
<b>A61K 31/7105</b> (2006.01)	3364982	SEXUALLY TRANSMITTED DISEASE VACCINES
<b>A61K 31/7115</b> (2006.01)	3364982	SEXUALLY TRANSMITTED DISEASE VACCINES
<b>A61K 39/12</b> (2006.01)	3364982	SEXUALLY TRANSMITTED DISEASE VACCINES
<b>A61P 31/14</b> (2006.01)	3364982	SEXUALLY TRANSMITTED DISEASE VACCINES



MKP (51)	Broj objave evropske prijava patenta (97)	Naziv pronalaska (54)
<b>A61K 9/10</b> (2006.01)	3364949	CANCER VACCINES
<b>A61K 39/00</b> (2006.01)	3364949	CANCER VACCINES
<b>A61K 48/00</b> (2006.01)	3364949	CANCER VACCINES
<b>A61K 9/51</b> (2006.01)	3365007	BROAD SPECTRUM INFLUENZA VIRUS VACCINE
<b>A61K 39/145</b> (2006.01)	3365007	BROAD SPECTRUM INFLUENZA VIRUS VACCINE
<b>A61P 31/16</b> (2006.01)	3365007	BROAD SPECTRUM INFLUENZA VIRUS VACCINE
<b>A61K 31/7105</b> (2006.01)	3365008	RESPIRATORY SYNCYTIAL VIRUS VACCINE
<b>A61K 31/7115</b> (2006.01)	3365008	RESPIRATORY SYNCYTIAL VIRUS VACCINE
<b>A61K 39/155</b> (2006.01)	3365008	RESPIRATORY SYNCYTIAL VIRUS VACCINE
<b>A61P 31/14</b> (2006.01)	3365008	RESPIRATORY SYNCYTIAL VIRUS VACCINE
<b>A61K 31/7105</b> (2006.01)	3365009	HERPES SIMPLEX VIRUS VACCINE
<b>A61K 31/7115</b> (2006.01)	3365009	HERPES SIMPLEX VIRUS VACCINE
<b>A61K 39/245</b> (2006.01)	3365009	HERPES SIMPLEX VIRUS VACCINE
<b>A61P 31/22</b> (2006.01)	3365009	HERPES SIMPLEX VIRUS VACCINE
<b>A61K 9/10</b> (2006.01)	3364950	TROPICAL DISEASE VACCINES
<b>A61K 39/00</b> (2006.01)	3364950	TROPICAL DISEASE VACCINES
<b>A61K 39/12</b> (2006.01)	3364950	TROPICAL DISEASE VACCINES
<b>A61K 48/00</b> (2006.01)	3364950	TROPICAL DISEASE VACCINES
<b>A61K 31/7105</b> (2006.01)	3364983	RESPIRATORY VIRUS VACCINES
<b>A61K 31/7115</b> (2006.01)	3364983	RESPIRATORY VIRUS VACCINES
<b>A61K 39/12</b> (2006.01)	3364983	RESPIRATORY VIRUS VACCINES
<b>A61P 11/00</b> (2006.01)	3364983	RESPIRATORY VIRUS VACCINES
<b>A61K 9/16</b> (2006.01)	3368030	PHARMACEUTICAL COMPOSITIONS OF DIMETHYL FUMARATE
<b>A61K 31/225</b> (2006.01)	3368030	PHARMACEUTICAL COMPOSITIONS OF DIMETHYL FUMARATE
<b>A61K 31/616</b> (2006.01)	3368030	PHARMACEUTICAL COMPOSITIONS OF DIMETHYL FUMARATE
<b>G06F 19/18</b> (2011.01)	3396573	METHOD AND SYSTEM FOR SELECTING CUSTOMIZED DRUG USING GENOMIC NUCLEOTIDE SEQUENCE VARIATION INFORMATION AND SURVIVAL INFORMATION OF CANCER PATIENT
<b>G06F 19/22</b> (2011.01)	3396573	METHOD AND SYSTEM FOR SELECTING CUSTOMIZED DRUG USING GENOMIC NUCLEOTIDE SEQUENCE VARIATION INFORMATION AND SURVIVAL INFORMATION OF CANCER PATIENT
<b>G06F 19/28</b> (2011.01)	3396573	METHOD AND SYSTEM FOR SELECTING CUSTOMIZED DRUG USING GENOMIC NUCLEOTIDE SEQUENCE VARIATION INFORMATION AND SURVIVAL INFORMATION OF CANCER PATIENT
<b>A61K 31/44</b> (2006.01)	3368036	FACTOR XIA INHIBITORS
<b>A61K 31/4418</b> (2006.01)	3368036	FACTOR XIA INHIBITORS
<b>A61K 31/4427</b> (2006.01)	3368036	FACTOR XIA INHIBITORS
<b>C07D 213/02</b> (2006.01)	3368036	FACTOR XIA INHIBITORS
<b>C07D 213/04</b> (2006.01)	3368036	FACTOR XIA INHIBITORS
<b>C07D 401/06</b> (2006.01)	3368036	FACTOR XIA INHIBITORS
<b>A61K 9/00</b> (2006.01)	3368027	METHODS OF TREATING PAIN OR FEVER USING PHARMACEUTICALLY ACTIVE ACETAMINOPHEN DIMERS LINKED THROUGH PHENOLIC HYDROXYL GROUPS
<b>A61K 9/20</b> (2006.01)	3368027	METHODS OF TREATING PAIN OR FEVER USING PHARMACEUTICALLY ACTIVE ACETAMINOPHEN DIMERS LINKED THROUGH PHENOLIC HYDROXYL GROUPS
<b>A61K 31/167</b> (2006.01)	3368027	METHODS OF TREATING PAIN OR FEVER USING PHARMACEUTICALLY ACTIVE ACETAMINOPHEN DIMERS LINKED THROUGH PHENOLIC HYDROXYL GROUPS
<b>A61K 45/06</b> (2006.01)	3368027	METHODS OF TREATING PAIN OR FEVER USING PHARMACEUTICALLY ACTIVE ACETAMINOPHEN DIMERS LINKED THROUGH PHENOLIC HYDROXYL GROUPS
<b>A61K 9/10</b> (2006.01)	3368038	ETHYLENE GLYCOL ETHER OF BUPRENORPHINE
<b>A61K 31/439</b> (2006.01)	3368038	ETHYLENE GLYCOL ETHER OF BUPRENORPHINE
<b>A61K 31/485</b> (2006.01)	3368038	ETHYLENE GLYCOL ETHER OF BUPRENORPHINE
<b>B01J 49/00</b> (2017.01)	3369097	COMPOSITE EXTRACTANT-ENHANCED POLYMER RESIN, METHOD OF MAKING THE SAME, AND ITS USAGE FOR EXTRACTION OF VALUABLE METAL(S)
<b>G21G 4/08</b> (2006.01)	3369097	COMPOSITE EXTRACTANT-ENHANCED POLYMER RESIN, METHOD OF MAKING THE SAME, AND ITS USAGE FOR EXTRACTION OF VALUABLE METAL(S)
<b>A61K 8/44</b> (2006.01)	3368157	METHODS FOR IDENTIFICATION, ASSESSMENT, PREVENTION, AND TREATMENT OF METABOLIC DISORDERS USING PM20D1 AND N-LIPIDATED AMINO ACIDS
<b>A61K 31/16</b> (2006.01)	3368157	METHODS FOR IDENTIFICATION, ASSESSMENT, PREVENTION, AND TREATMENT OF METABOLIC DISORDERS USING PM20D1 AND N-LIPIDATED AMINO ACIDS

MKP (51)	Broj objave evropske prijava patenta (97)	Naziv pronalaska (54)
<b>A61K 38/46</b> (2006.01)	3368157	METHODS FOR IDENTIFICATION, ASSESSMENT, PREVENTION, AND TREATMENT OF METABOLIC DISORDERS USING PM20D1 AND N-LIPIDATED AMINO ACIDS
<b>A61P 3/10</b> (2006.01)	3368157	METHODS FOR IDENTIFICATION, ASSESSMENT, PREVENTION, AND TREATMENT OF METABOLIC DISORDERS USING PM20D1 AND N-LIPIDATED AMINO ACIDS
<b>C12N 9/14</b> (2006.01)	3368157	METHODS FOR IDENTIFICATION, ASSESSMENT, PREVENTION, AND TREATMENT OF METABOLIC DISORDERS USING PM20D1 AND N-LIPIDATED AMINO ACIDS
<b>C12N 15/113</b> (2010.01)	3368157	METHODS FOR IDENTIFICATION, ASSESSMENT, PREVENTION, AND TREATMENT OF METABOLIC DISORDERS USING PM20D1 AND N-LIPIDATED AMINO ACIDS
<b>C12Q 1/68</b> (2018.01)	3368157	METHODS FOR IDENTIFICATION, ASSESSMENT, PREVENTION, AND TREATMENT OF METABOLIC DISORDERS USING PM20D1 AND N-LIPIDATED AMINO ACIDS
<b>G01N 33/50</b> (2006.01)	3368157	METHODS FOR IDENTIFICATION, ASSESSMENT, PREVENTION, AND TREATMENT OF METABOLIC DISORDERS USING PM20D1 AND N-LIPIDATED AMINO ACIDS
<b>A61K 31/69</b> (2006.01)	3368541	COMPOSITIONS AND METHODS FOR INHIBITING ARGINASE ACTIVITY
<b>A61P 35/00</b> (2006.01)	3368541	COMPOSITIONS AND METHODS FOR INHIBITING ARGINASE ACTIVITY
<b>C07D 207/16</b> (2006.01)	3368541	COMPOSITIONS AND METHODS FOR INHIBITING ARGINASE ACTIVITY
<b>C07F 5/02</b> (2006.01)	3368541	COMPOSITIONS AND METHODS FOR INHIBITING ARGINASE ACTIVITY
<b>C07F 5/04</b> (2006.01)	3368541	COMPOSITIONS AND METHODS FOR INHIBITING ARGINASE ACTIVITY
<b>A61M 1/02</b> (2006.01)	3368097	APPARATUS AND METHODS FOR DISPENSING ORAL TRANSMUCOSAL DOSAGE FORMS
<b>A61M 1/14</b> (2006.01)	3368097	APPARATUS AND METHODS FOR DISPENSING ORAL TRANSMUCOSAL DOSAGE FORMS
<b>A61M 1/16</b> (2006.01)	3368097	APPARATUS AND METHODS FOR DISPENSING ORAL TRANSMUCOSAL DOSAGE FORMS
<b>A61M 1/18</b> (2006.01)	3368097	APPARATUS AND METHODS FOR DISPENSING ORAL TRANSMUCOSAL DOSAGE FORMS
<b>A61M 5/307</b> (2006.01)	3368097	APPARATUS AND METHODS FOR DISPENSING ORAL TRANSMUCOSAL DOSAGE FORMS
<b>A61M 5/315</b> (2006.01)	3368097	APPARATUS AND METHODS FOR DISPENSING ORAL TRANSMUCOSAL DOSAGE FORMS
<b>A61K 39/395</b> (2006.01)	3368077	COMPOSITIONS AND METHODS FOR TUMOR TRANSDUCTION
<b>A61K 45/00</b> (2006.01)	3368077	COMPOSITIONS AND METHODS FOR TUMOR TRANSDUCTION
<b>A61P 35/00</b> (2006.01)	3368077	COMPOSITIONS AND METHODS FOR TUMOR TRANSDUCTION
<b>C07K 16/18</b> (2006.01)	3368077	COMPOSITIONS AND METHODS FOR TUMOR TRANSDUCTION
<b>C07K 16/28</b> (2006.01)	3368077	COMPOSITIONS AND METHODS FOR TUMOR TRANSDUCTION
<b>C12P 21/08</b> (2006.01)	3368077	COMPOSITIONS AND METHODS FOR TUMOR TRANSDUCTION
<b>C07K 14/705</b> (2006.01)	3368559	COMPOSITIONS AND METHODS FOR TREATMENT OF CANCER
<b>C07K 16/28</b> (2006.01)	3368559	COMPOSITIONS AND METHODS FOR TREATMENT OF CANCER
<b>C07K 19/00</b> (2006.01)	3368559	COMPOSITIONS AND METHODS FOR TREATMENT OF CANCER
<b>A61K 35/76</b> (2015.01)	3382010	ATTENUATED INFLUENZA VECTORS FOR THE PREVENTION AND/OR TREATMENT OF INFECTIOUS DISEASES AND FOR THE TREATMENT OF ONCOLOGICAL DISEASES
<b>A61K 39/145</b> (2006.01)	3382010	ATTENUATED INFLUENZA VECTORS FOR THE PREVENTION AND/OR TREATMENT OF INFECTIOUS DISEASES AND FOR THE TREATMENT OF ONCOLOGICAL DISEASES
<b>A61P 31/16</b> (2006.01)	3382010	ATTENUATED INFLUENZA VECTORS FOR THE PREVENTION AND/OR TREATMENT OF INFECTIOUS DISEASES AND FOR THE TREATMENT OF ONCOLOGICAL DISEASES
<b>A61P 35/00</b> (2006.01)	3382010	ATTENUATED INFLUENZA VECTORS FOR THE PREVENTION AND/OR TREATMENT OF INFECTIOUS DISEASES AND FOR THE TREATMENT OF ONCOLOGICAL DISEASES
<b>C12N 7/01</b> (2006.01)	3382010	ATTENUATED INFLUENZA VECTORS FOR THE PREVENTION AND/OR TREATMENT OF INFECTIOUS DISEASES AND FOR THE TREATMENT OF ONCOLOGICAL DISEASES
<b>C12N 15/86</b> (2006.01)	3382010	ATTENUATED INFLUENZA VECTORS FOR THE PREVENTION AND/OR TREATMENT OF INFECTIOUS DISEASES AND FOR THE TREATMENT OF ONCOLOGICAL DISEASES

MKP (51)	Broj objave evropske prijava patenta (97)	Naziv pronalaska (54)
<b>A61K 31/575</b> (2006.01)	3370728	METHODS FOR THE PREPARATION OF OBETICHOLIC ACID AND DERIVATIVES THEREOF
<b>C07J 9/00</b> (2006.01)	3370728	METHODS FOR THE PREPARATION OF OBETICHOLIC ACID AND DERIVATIVES THEREOF
<b>C07J 31/00</b> (2006.01)	3370728	METHODS FOR THE PREPARATION OF OBETICHOLIC ACID AND DERIVATIVES THEREOF
<b>A61K 39/00</b> (2006.01)	3370768	ANTIBODIES SPECIFICALLY BINDING PD-1 AND THEIR USES
<b>A61K 39/395</b> (2006.01)	3370768	ANTIBODIES SPECIFICALLY BINDING PD-1 AND THEIR USES
<b>A61K 31/198</b> (2006.01)	3370770	SUBCUTANEOUS FORMULATIONS OF ANTI-CD38 ANTIBODIES AND THEIR USES
<b>A61K 31/4439</b> (2006.01)	3370770	SUBCUTANEOUS FORMULATIONS OF ANTI-CD38 ANTIBODIES AND THEIR USES
<b>A61K 31/573</b> (2006.01)	3370770	SUBCUTANEOUS FORMULATIONS OF ANTI-CD38 ANTIBODIES AND THEIR USES
<b>A61K 31/69</b> (2006.01)	3370770	SUBCUTANEOUS FORMULATIONS OF ANTI-CD38 ANTIBODIES AND THEIR USES
<b>A61K 39/395</b> (2006.01)	3370770	SUBCUTANEOUS FORMULATIONS OF ANTI-CD38 ANTIBODIES AND THEIR USES
<b>C07K 16/28</b> (2006.01)	3370770	SUBCUTANEOUS FORMULATIONS OF ANTI-CD38 ANTIBODIES AND THEIR USES
<b>A61K 33/20</b> (2006.01)	3370738	TREATMENT OF NEURODEGENERATIVE DISEASE WITH SODIUM CHLORITE
<b>A61P 25/28</b> (2006.01)	3370738	TREATMENT OF NEURODEGENERATIVE DISEASE WITH SODIUM CHLORITE
<b>C01B 11/10</b> (2006.01)	3370738	TREATMENT OF NEURODEGENERATIVE DISEASE WITH SODIUM CHLORITE
<b>A61K 39/00</b> (2006.01)	3370763	CD200 INHIBITORS AND METHODS OF USE THEREOF
<b>A61K 39/39</b> (2006.01)	3370763	CD200 INHIBITORS AND METHODS OF USE THEREOF
<b>C07K 7/06</b> (2006.01)	3370763	CD200 INHIBITORS AND METHODS OF USE THEREOF
<b>C07K 7/08</b> (2006.01)	3370763	CD200 INHIBITORS AND METHODS OF USE THEREOF
<b>A61K 35/15</b> (2015.01)	3370741	METHODS AND COMPOSITIONS FOR GENE EDITING IN HEMATOPOIETIC STEM CELLS
<b>A61K 35/17</b> (2015.01)	3370741	METHODS AND COMPOSITIONS FOR GENE EDITING IN HEMATOPOIETIC STEM CELLS
<b>A61K 45/06</b> (2006.01)	3370741	METHODS AND COMPOSITIONS FOR GENE EDITING IN HEMATOPOIETIC STEM CELLS
<b>A61K 48/00</b> (2006.01)	3370741	METHODS AND COMPOSITIONS FOR GENE EDITING IN HEMATOPOIETIC STEM CELLS
<b>A61P 35/00</b> (2006.01)	3370741	METHODS AND COMPOSITIONS FOR GENE EDITING IN HEMATOPOIETIC STEM CELLS
<b>A61P 35/02</b> (2006.01)	3370741	METHODS AND COMPOSITIONS FOR GENE EDITING IN HEMATOPOIETIC STEM CELLS
<b>C01B 17/02</b> (2006.01)	3371100	METHOD FOR REDUCING ELEMENTAL SULFUR IN GYPSUM PRODUCTS
<b>C01B 17/04</b> (2006.01)	3371100	METHOD FOR REDUCING ELEMENTAL SULFUR IN GYPSUM PRODUCTS
<b>C01B 17/50</b> (2006.01)	3371100	METHOD FOR REDUCING ELEMENTAL SULFUR IN GYPSUM PRODUCTS
<b>A61K 31/194</b> (2006.01)	3370713	TREATMENT OF MIXED DYSLIPIDEMIA
<b>A61P 1/18</b> (2006.01)	3370713	TREATMENT OF MIXED DYSLIPIDEMIA
<b>A61K 31/4433</b> (2006.01)	3370725	PEDIATRIC DOSING FOR TREATMENT OF CANCER WITH AN EZH2 INHIBITOR
<b>A61K 31/4436</b> (2006.01)	3370725	PEDIATRIC DOSING FOR TREATMENT OF CANCER WITH AN EZH2 INHIBITOR
<b>A61K 31/497</b> (2006.01)	3370725	PEDIATRIC DOSING FOR TREATMENT OF CANCER WITH AN EZH2 INHIBITOR
<b>A61K 31/5355</b> (2006.01)	3370725	PEDIATRIC DOSING FOR TREATMENT OF CANCER WITH AN EZH2 INHIBITOR
<b>A61P 35/00</b> (2006.01)	3370725	PEDIATRIC DOSING FOR TREATMENT OF CANCER WITH AN EZH2 INHIBITOR
<b>E21B 23/01</b> (2006.01)	3374592	APPARATUSES AND METHODS FOR LOCATING WITHIN A WELLBORE
<b>E21B 23/10</b> (2006.01)	3374592	APPARATUSES AND METHODS FOR LOCATING WITHIN A WELLBORE
<b>A61K 31/4375</b> (2006.01)	3378863	PYRANODIPYRIDINE COMPOUND
<b>A61K 31/444</b> (2006.01)	3378863	PYRANODIPYRIDINE COMPOUND
<b>A61K 31/497</b> (2006.01)	3378863	PYRANODIPYRIDINE COMPOUND
<b>A61K 31/506</b> (2006.01)	3378863	PYRANODIPYRIDINE COMPOUND

MKP	Broj objave evropske prijave patenta	Naziv pronalaska
(51)	(97)	(54)
<b>A61P 9/10</b> (2006.01)	3378863	PYRANODIPYRIDINE COMPOUND
<b>A61P 21/02</b> (2006.01)	3378863	PYRANODIPYRIDINE COMPOUND
<b>A61P 25/00</b> (2006.01)	3378863	PYRANODIPYRIDINE COMPOUND
<b>A61P 25/04</b> (2006.01)	3378863	PYRANODIPYRIDINE COMPOUND
<b>A61P 25/08</b> (2006.01)	3378863	PYRANODIPYRIDINE COMPOUND
<b>A61P 25/14</b> (2006.01)	3378863	PYRANODIPYRIDINE COMPOUND
<b>A61P 25/16</b> (2006.01)	3378863	PYRANODIPYRIDINE COMPOUND
<b>A61P 25/18</b> (2006.01)	3378863	PYRANODIPYRIDINE COMPOUND
<b>A61P 25/22</b> (2006.01)	3378863	PYRANODIPYRIDINE COMPOUND
<b>A61P 25/24</b> (2006.01)	3378863	PYRANODIPYRIDINE COMPOUND
<b>A61P 25/28</b> (2006.01)	3378863	PYRANODIPYRIDINE COMPOUND
<b>A61P 25/30</b> (2006.01)	3378863	PYRANODIPYRIDINE COMPOUND
<b>C07D 491/147</b> (2006.01)	3378863	PYRANODIPYRIDINE COMPOUND
<b>A61K 31/427</b> (2006.01)	3375782	SODIUM CHANNEL BLOCKER
<b>A61K 31/497</b> (2006.01)	3375782	SODIUM CHANNEL BLOCKER
<b>C07D 417/12</b> (2006.01)	3375782	SODIUM CHANNEL BLOCKER
<b>C07D 417/14</b> (2006.01)	3375782	SODIUM CHANNEL BLOCKER
<b>A61K 39/00</b> (2006.01)	3373963	METHODS FOR TREATING CONDITIONS ASSOCIATED WITH MASP-2 DEPENDENT COMPLEMENT ACTIVATION
<b>A61K 39/395</b> (2006.01)	3373963	METHODS FOR TREATING CONDITIONS ASSOCIATED WITH MASP-2 DEPENDENT COMPLEMENT ACTIVATION
<b>A61P 7/02</b> (2006.01)	3373963	METHODS FOR TREATING CONDITIONS ASSOCIATED WITH MASP-2 DEPENDENT COMPLEMENT ACTIVATION
<b>A61P 37/02</b> (2006.01)	3373963	METHODS FOR TREATING CONDITIONS ASSOCIATED WITH MASP-2 DEPENDENT COMPLEMENT ACTIVATION
<b>C07K 16/40</b> (2006.01)	3373963	METHODS FOR TREATING CONDITIONS ASSOCIATED WITH MASP-2 DEPENDENT COMPLEMENT ACTIVATION
<b>A61K 9/14</b> (2006.01)	3373978	AGGREGATING MICROPARTICLES FOR THERAPY
<b>A61K 9/50</b> (2006.01)	3373978	AGGREGATING MICROPARTICLES FOR THERAPY
<b>A61K 47/50</b> (2017.01)	3373978	AGGREGATING MICROPARTICLES FOR THERAPY
<b>A61K 9/00</b> (2006.01)	3377069	PHEROMONE COMPOSITION TO STIMULATE REPRODUCTION IN FEMALE SUIDS AND METHODS OF USE
<b>A61K 31/47</b> (2006.01)	3377069	PHEROMONE COMPOSITION TO STIMULATE REPRODUCTION IN FEMALE SUIDS AND METHODS OF USE
<b>A61K 31/568</b> (2006.01)	3377069	PHEROMONE COMPOSITION TO STIMULATE REPRODUCTION IN FEMALE SUIDS AND METHODS OF USE
<b>A61P 43/00</b> (2006.01)	3377069	PHEROMONE COMPOSITION TO STIMULATE REPRODUCTION IN FEMALE SUIDS AND METHODS OF USE
<b>A61K 35/30</b> (2015.01)	3377078	NEURAL CELL EXTRACELLULAR VESSICLES
<b>A61K 35/545</b> (2015.01)	3377078	NEURAL CELL EXTRACELLULAR VESSICLES
<b>A61P 25/00</b> (2006.01)	3377078	NEURAL CELL EXTRACELLULAR VESSICLES
<b>A61K 31/341</b> (2006.01)	3383386	MODULATORS OF CHEMOKINE RECEPTORS
<b>C07C 225/20</b> (2006.01)	3383386	MODULATORS OF CHEMOKINE RECEPTORS
<b>A61K 31/404</b> (2006.01)	3377059	INHIBITORS OF CXCR2
<b>A61K 31/407</b> (2006.01)	3377059	INHIBITORS OF CXCR2
<b>A61K 31/5377</b> (2006.01)	3377059	INHIBITORS OF CXCR2
<b>A61K 35/44</b> (2015.01)	3377079	NOVEL ANTI-EMR2 ANTIBODIES AND METHODS OF USE
<b>C07K 16/28</b> (2006.01)	3377079	NOVEL ANTI-EMR2 ANTIBODIES AND METHODS OF USE
<b>A61K 39/00</b> (2006.01)	3377516	METHODS AND COMPOSITIONS FOR TREATING CANCER
<b>C07K 7/08</b> (2006.01)	3377516	METHODS AND COMPOSITIONS FOR TREATING CANCER
<b>C07K 14/47</b> (2006.01)	3377516	METHODS AND COMPOSITIONS FOR TREATING CANCER
<b>A61K 31/56</b> (2006.01)	3377070	COMPOUNDS AND METHODS OF THEIR USE
<b>A61K 31/57</b> (2006.01)	3377070	COMPOUNDS AND METHODS OF THEIR USE
<b>A61K 31/573</b> (2006.01)	3377070	COMPOUNDS AND METHODS OF THEIR USE
<b>A61K 39/00</b> (2006.01)	3377636	CMV VECTORS COMPRISING MICRORNA RECOGNITION ELEMENTS
<b>A61K 39/015</b> (2006.01)	3377636	CMV VECTORS COMPRISING MICRORNA RECOGNITION ELEMENTS
<b>A61K 39/04</b> (2006.01)	3377636	CMV VECTORS COMPRISING MICRORNA RECOGNITION ELEMENTS
<b>A61K 39/12</b> (2006.01)	3377636	CMV VECTORS COMPRISING MICRORNA RECOGNITION ELEMENTS
<b>A61K 48/00</b> (2006.01)	3377636	CMV VECTORS COMPRISING MICRORNA RECOGNITION ELEMENTS
<b>C12N 15/86</b> (2006.01)	3377636	CMV VECTORS COMPRISING MICRORNA RECOGNITION ELEMENTS
<b>A61K 31/197</b> (2006.01)	3389655	USE OF sGC STIMULATORS FOR THE TREATMENT OF GASTROINTESTINAL SPHINCTER DYSFUNCTION
<b>A61K 31/437</b> (2006.01)	3389655	USE OF sGC STIMULATORS FOR THE TREATMENT OF GASTROINTESTINAL SPHINCTER DYSFUNCTION
<b>A61K 31/4422</b> (2006.01)	3389655	USE OF sGC STIMULATORS FOR THE TREATMENT OF GASTROINTESTINAL SPHINCTER DYSFUNCTION
<b>A61K 31/506</b> (2006.01)	3389655	USE OF sGC STIMULATORS FOR THE TREATMENT OF GASTROINTESTINAL SPHINCTER DYSFUNCTION

MKP (51)	Broj objave evropske prijava patenta (97)	Naziv pronalaska (54)
<b>A61K 31/519</b> (2006.01)	3389655	USE OF sGC STIMULATORS FOR THE TREATMENT OF GASTROINTESTINAL SPHINCTER DYSFUNCTION
<b>A61K 31/5377</b> (2006.01)	3389655	USE OF sGC STIMULATORS FOR THE TREATMENT OF GASTROINTESTINAL SPHINCTER DYSFUNCTION
<b>A61K 45/06</b> (2006.01)	3389655	USE OF sGC STIMULATORS FOR THE TREATMENT OF GASTROINTESTINAL SPHINCTER DYSFUNCTION
<b>A61P 1/00</b> (2006.01)	3389655	USE OF sGC STIMULATORS FOR THE TREATMENT OF GASTROINTESTINAL SPHINCTER DYSFUNCTION
<b>A61K 39/395</b> (2006.01)	3390441	HUMAN IMMUNODEFICIENCY VIRUS NEUTRALIZING ANTIBODIES
<b>C07K 16/10</b> (2006.01)	3390441	HUMAN IMMUNODEFICIENCY VIRUS NEUTRALIZING ANTIBODIES
<b>B32B 7/00</b> (2006.01)	3386746	COMPOSITE STEEL
<b>B32B 7/12</b> (2006.01)	3386746	COMPOSITE STEEL
<b>B32B 15/00</b> (2006.01)	3386746	COMPOSITE STEEL
<b>B32B 15/01</b> (2006.01)	3386746	COMPOSITE STEEL
<b>B32B 15/08</b> (2006.01)	3386746	COMPOSITE STEEL
<b>B32B 15/20</b> (2006.01)	3386746	COMPOSITE STEEL
<b>B62D 29/00</b> (2006.01)	3386746	COMPOSITE STEEL
<b>C22C 1/00</b> (2006.01)	3386746	COMPOSITE STEEL
<b>C22C 23/00</b> (2006.01)	3386746	COMPOSITE STEEL
<b>A61B 17/32</b> (2006.01)	3389515	ULTRASONIC SURGICAL INSTRUMENT WITH CLEANING PORT
<b>A61B 18/14</b> (2006.01)	3389515	ULTRASONIC SURGICAL INSTRUMENT WITH CLEANING PORT
<b>A61B 17/32</b> (2006.01)	3389516	SURGICAL INSTRUMENT WITH MULTI-FUNCTION BUTTON
<b>A61B 18/14</b> (2006.01)	3389516	SURGICAL INSTRUMENT WITH MULTI-FUNCTION BUTTON
<b>A61B 17/32</b> (2006.01)	3389517	SURGICAL INSTRUMENT WITH FUNCTION SELECTOR
<b>A61B 18/14</b> (2006.01)	3389517	SURGICAL INSTRUMENT WITH FUNCTION SELECTOR
<b>A61B 17/32</b> (2006.01)	3393378	SURGICAL INSTRUMENT WITH VARIABLE CLAMPING FORCE
<b>A61B 18/14</b> (2006.01)	3393378	SURGICAL INSTRUMENT WITH VARIABLE CLAMPING FORCE
<b>A61K 31/19</b> (2006.01)	3397253	METHODS AND COMPOSITIONS FOR THE TREATMENT OF SEIZURE-RELATED DISORDERS
<b>A61K 31/192</b> (2006.01)	3397253	METHODS AND COMPOSITIONS FOR THE TREATMENT OF SEIZURE-RELATED DISORDERS
<b>A61K 31/395</b> (2006.01)	3397253	METHODS AND COMPOSITIONS FOR THE TREATMENT OF SEIZURE-RELATED DISORDERS
<b>A61K 31/55</b> (2006.01)	3397253	METHODS AND COMPOSITIONS FOR THE TREATMENT OF SEIZURE-RELATED DISORDERS
<b>A61P 25/08</b> (2006.01)	3397253	METHODS AND COMPOSITIONS FOR THE TREATMENT OF SEIZURE-RELATED DISORDERS
<b>A61K 31/421</b> (2006.01)	3397619	OINTMENT
<b>A61P 17/00</b> (2006.01)	3397619	OINTMENT
<b>C07D 263/32</b> (2006.01)	3397619	OINTMENT
<b>C07K 14/705</b> (2006.01)	3383892	MODIFIED CHIMERIC RECEPTORS AND RELATED COMPOSITIONS AND METHODS
<b>A01N 31/08</b> (2006.01)	3393247	METAL OXIDES AND/OR HYDRATES THEREOF FOR STABILISING AN AQUEOUS PREPARATION AGAINST MICROBIAL GROWTH
<b>A01N 35/08</b> (2006.01)	3393247	METAL OXIDES AND/OR HYDRATES THEREOF FOR STABILISING AN AQUEOUS PREPARATION AGAINST MICROBIAL GROWTH
<b>A01N 43/40</b> (2006.01)	3393247	METAL OXIDES AND/OR HYDRATES THEREOF FOR STABILISING AN AQUEOUS PREPARATION AGAINST MICROBIAL GROWTH
<b>A01N 43/80</b> (2006.01)	3393247	METAL OXIDES AND/OR HYDRATES THEREOF FOR STABILISING AN AQUEOUS PREPARATION AGAINST MICROBIAL GROWTH
<b>A01N 59/00</b> (2006.01)	3393247	METAL OXIDES AND/OR HYDRATES THEREOF FOR STABILISING AN AQUEOUS PREPARATION AGAINST MICROBIAL GROWTH
<b>A01N 59/06</b> (2006.01)	3393247	METAL OXIDES AND/OR HYDRATES THEREOF FOR STABILISING AN AQUEOUS PREPARATION AGAINST MICROBIAL GROWTH
<b>A01N 59/16</b> (2006.01)	3393247	METAL OXIDES AND/OR HYDRATES THEREOF FOR STABILISING AN AQUEOUS PREPARATION AGAINST MICROBIAL GROWTH
<b>A01P 1/00</b> (2006.01)	3393247	METAL OXIDES AND/OR HYDRATES THEREOF FOR STABILISING AN AQUEOUS PREPARATION AGAINST MICROBIAL GROWTH
<b>D21H 21/36</b> (2006.01)	3393247	METAL OXIDES AND/OR HYDRATES THEREOF FOR STABILISING AN AQUEOUS PREPARATION AGAINST MICROBIAL GROWTH
<b>B32B 33/00</b> (2006.01)	3393801	METHOD FOR INTEGRATING A HOLOGRAM INTO THE BODY OF A SECURITY DOCUMENT AND SECURITY DOCUMENT BODY
<b>B32B 37/18</b> (2006.01)	3393801	METHOD FOR INTEGRATING A HOLOGRAM INTO THE BODY OF A SECURITY DOCUMENT AND SECURITY DOCUMENT BODY
<b>B32B 37/20</b> (2006.01)	3393801	METHOD FOR INTEGRATING A HOLOGRAM INTO THE BODY OF A SECURITY DOCUMENT AND SECURITY DOCUMENT BODY
<b>B42D 25/328</b> (2014.01)	3393801	METHOD FOR INTEGRATING A HOLOGRAM INTO THE BODY OF A SECURITY DOCUMENT AND SECURITY DOCUMENT BODY

MKP (51)	Broj objave evropske prijava patenta (97)	Naziv pronalaska (54)
<b>G03H 1/18</b> (2006.01)	3393801	METHOD FOR INTEGRATING A HOLOGRAM INTO THE BODY OF A SECURITY DOCUMENT AND SECURITY DOCUMENT BODY
<b>C07D 307/20</b> (2006.01)	3405463	PROCESS FOR THE PREPARATION OF SOFOSBUVIR
<b>C07D 319/12</b> (2006.01)	3405463	PROCESS FOR THE PREPARATION OF SOFOSBUVIR
<b>C07H 19/10</b> (2006.01)	3405463	PROCESS FOR THE PREPARATION OF SOFOSBUVIR
<b>A61B 17/32</b> (2006.01)	3389518	SURGICAL INSTRUMENT WITH MULTI-FUNCTIONING TRIGGER
<b>A61K 38/46</b> (2006.01)	3386534	COMPOSITIONS AND METHODS FOR INTERNALIZING ENZYMES
<b>A61K 38/47</b> (2006.01)	3386534	COMPOSITIONS AND METHODS FOR INTERNALIZING ENZYMES
<b>A61P 43/00</b> (2006.01)	3386534	COMPOSITIONS AND METHODS FOR INTERNALIZING ENZYMES
<b>C12N 9/40</b> (2006.01)	3386534	COMPOSITIONS AND METHODS FOR INTERNALIZING ENZYMES
<b>C12N 9/42</b> (2006.01)	3386534	COMPOSITIONS AND METHODS FOR INTERNALIZING ENZYMES
<b>A01N 43/72</b> (2006.01)	3397638	ANTHELMINTIC DEPSIPEPTIDE COMPOUNDS
<b>C07D 273/00</b> (2006.01)	3397638	ANTHELMINTIC DEPSIPEPTIDE COMPOUNDS
<b>C07D 413/14</b> (2006.01)	3397638	ANTHELMINTIC DEPSIPEPTIDE COMPOUNDS
<b>C07K 11/02</b> (2006.01)	3397638	ANTHELMINTIC DEPSIPEPTIDE COMPOUNDS
<b>C07K 16/28</b> (2006.01)	3390453	ANTIBODIES SPECIFICALLY BINDING HLA-DR AND THEIR USES
<b>E04B 1/21</b> (2006.01)	3394358	ANTI-SEISMIC CONNECTION JOINT HAVING A SLOTTED HOLE
<b>E04H 9/02</b> (2006.01)	3394358	ANTI-SEISMIC CONNECTION JOINT HAVING A SLOTTED HOLE
<b>A61K 31/4725</b> (2006.01)	3394045	COCRYSTAL, PRODUCTION METHOD THEREOF, AND MEDICAMENT CONTAINING COCRYSTAL
<b>A61P 35/00</b> (2006.01)	3394045	COCRYSTAL, PRODUCTION METHOD THEREOF, AND MEDICAMENT CONTAINING COCRYSTAL
<b>C07C 55/08</b> (2006.01)	3394045	COCRYSTAL, PRODUCTION METHOD THEREOF, AND MEDICAMENT CONTAINING COCRYSTAL
<b>C07C 57/145</b> (2006.01)	3394045	COCRYSTAL, PRODUCTION METHOD THEREOF, AND MEDICAMENT CONTAINING COCRYSTAL
<b>C07C 59/245</b> (2006.01)	3394045	COCRYSTAL, PRODUCTION METHOD THEREOF, AND MEDICAMENT CONTAINING COCRYSTAL
<b>C07C 59/265</b> (2006.01)	3394045	COCRYSTAL, PRODUCTION METHOD THEREOF, AND MEDICAMENT CONTAINING COCRYSTAL
<b>C07C 59/54</b> (2006.01)	3394045	COCRYSTAL, PRODUCTION METHOD THEREOF, AND MEDICAMENT CONTAINING COCRYSTAL
<b>C07C 65/05</b> (2006.01)	3394045	COCRYSTAL, PRODUCTION METHOD THEREOF, AND MEDICAMENT CONTAINING COCRYSTAL
<b>C07C 65/10</b> (2006.01)	3394045	COCRYSTAL, PRODUCTION METHOD THEREOF, AND MEDICAMENT CONTAINING COCRYSTAL
<b>C07D 401/14</b> (2006.01)	3394045	COCRYSTAL, PRODUCTION METHOD THEREOF, AND MEDICAMENT CONTAINING COCRYSTAL
<b>E04H 9/02</b> (2006.01)	3390747	ANTI-SEISMIC CONNECTION JOINT
<b>F16F 1/38</b> (2006.01)	3390747	ANTI-SEISMIC CONNECTION JOINT
<b>F16F 7/00</b> (2006.01)	3390747	ANTI-SEISMIC CONNECTION JOINT
<b>F16F 7/04</b> (2006.01)	3390747	ANTI-SEISMIC CONNECTION JOINT
<b>A23L 3/3472</b> (2006.01)	3373946	NATURAL PRESERVATIVES AND ANTIMICROBIAL AGENTS, INCLUDING COMPOSITIONS THEREOF
<b>A61K 8/97</b> (2017.01)	3373946	NATURAL PRESERVATIVES AND ANTIMICROBIAL AGENTS, INCLUDING COMPOSITIONS THEREOF
<b>A61K 36/48</b> (2006.01)	3373946	NATURAL PRESERVATIVES AND ANTIMICROBIAL AGENTS, INCLUDING COMPOSITIONS THEREOF
<b>A61K 36/575</b> (2006.01)	3373946	NATURAL PRESERVATIVES AND ANTIMICROBIAL AGENTS, INCLUDING COMPOSITIONS THEREOF
<b>A61Q 17/00</b> (2006.01)	3373946	NATURAL PRESERVATIVES AND ANTIMICROBIAL AGENTS, INCLUDING COMPOSITIONS THEREOF
<b>A61K 38/26</b> (2006.01)	3394104	METHOD OF TREATING OR AMELIORATING METABOLIC DISORDERS USING BINDING PROTEINS FOR GASTRIC INHIBITORY PEPTIDE RECEPTOR (GIPR) IN COMBINATION WITH GLP-1 AGONISTS
<b>A61K 39/395</b> (2006.01)	3394104	METHOD OF TREATING OR AMELIORATING METABOLIC DISORDERS USING BINDING PROTEINS FOR GASTRIC INHIBITORY PEPTIDE RECEPTOR (GIPR) IN COMBINATION WITH GLP-1 AGONISTS
<b>A61P 3/10</b> (2006.01)	3394104	METHOD OF TREATING OR AMELIORATING METABOLIC DISORDERS USING BINDING PROTEINS FOR GASTRIC INHIBITORY PEPTIDE RECEPTOR (GIPR) IN COMBINATION WITH GLP-1 AGONISTS
<b>C07K 16/28</b> (2006.01)	3394104	METHOD OF TREATING OR AMELIORATING METABOLIC DISORDERS USING BINDING PROTEINS FOR GASTRIC INHIBITORY PEPTIDE RECEPTOR (GIPR) IN COMBINATION WITH GLP-1 AGONISTS

MKP (51)	Broj objave evropske prijava patenta (97)	Naziv pronalaska (54)
<b>A01N 25/04</b> (2006.01)	3386299	POLYELECTROLYTE-LAYER FORMING BLOCK COPOLYMERS AND COMPOSITIONS AND USED THEREOF
<b>A01N 25/12</b> (2006.01)	3386299	POLYELECTROLYTE-LAYER FORMING BLOCK COPOLYMERS AND COMPOSITIONS AND USED THEREOF
<b>A01N 25/30</b> (2006.01)	3386299	POLYELECTROLYTE-LAYER FORMING BLOCK COPOLYMERS AND COMPOSITIONS AND USED THEREOF
<b>A01N 43/707</b> (2006.01)	3386299	POLYELECTROLYTE-LAYER FORMING BLOCK COPOLYMERS AND COMPOSITIONS AND USED THEREOF
<b>A01N 43/78</b> (2006.01)	3386299	POLYELECTROLYTE-LAYER FORMING BLOCK COPOLYMERS AND COMPOSITIONS AND USED THEREOF
<b>A01N 47/04</b> (2006.01)	3386299	POLYELECTROLYTE-LAYER FORMING BLOCK COPOLYMERS AND COMPOSITIONS AND USED THEREOF
<b>A01N 51/00</b> (2006.01)	3386299	POLYELECTROLYTE-LAYER FORMING BLOCK COPOLYMERS AND COMPOSITIONS AND USED THEREOF
<b>C09D 5/00</b> (2006.01)	3386299	POLYELECTROLYTE-LAYER FORMING BLOCK COPOLYMERS AND COMPOSITIONS AND USED THEREOF
<b>C09D 11/00</b> (2014.01)	3386299	POLYELECTROLYTE-LAYER FORMING BLOCK COPOLYMERS AND COMPOSITIONS AND USED THEREOF
<b>B62D 21/16</b> (2006.01)	3393889	VEHICLE ARCHITECTURE
<b>B62D 29/04</b> (2006.01)	3393889	VEHICLE ARCHITECTURE
<b>B62D 31/00</b> (2006.01)	3393889	VEHICLE ARCHITECTURE
<b>B62D 63/02</b> (2006.01)	3393889	VEHICLE ARCHITECTURE
<b>C07K 16/00</b> (2006.01)	3390440	C-TERMINAL LYSINE CONJUGATED IMMUNOGLOBULINS
<b>C07D 275/06</b> (2006.01)	3397620	PROCESS FOR PREPARING 1.1.3-TRIOXO-1.2-BENZOTHAZOLE-6-CARBOXAMIDE
<b>C04B 28/14</b> (2006.01)	3397600	FIRE RESISTANT BUILDING BOARDS WITH INCREASED AMOUNTS OF ANTI-SHRINKAGE ADDITIVES AND DECREASED DENSITIES
<b>A61K 31/202</b> (2006.01)	3389647	COMPOSITIONS COMPRISING 15-HEPE AND METHODS OF USING THE SAME
<b>A61P 3/08</b> (2006.01)	3389647	COMPOSITIONS COMPRISING 15-HEPE AND METHODS OF USING THE SAME
<b>A61P 17/06</b> (2006.01)	3389647	COMPOSITIONS COMPRISING 15-HEPE AND METHODS OF USING THE SAME
<b>A61P 25/00</b> (2006.01)	3389647	COMPOSITIONS COMPRISING 15-HEPE AND METHODS OF USING THE SAME
<b>A61P 29/00</b> (2006.01)	3389647	COMPOSITIONS COMPRISING 15-HEPE AND METHODS OF USING THE SAME
<b>A61P 35/00</b> (2006.01)	3389647	COMPOSITIONS COMPRISING 15-HEPE AND METHODS OF USING THE SAME
<b>C12N 9/64</b> (2006.01)	3380610	RECOMBINANT SERINE PROTEASES
<b>C12N 9/72</b> (2006.01)	3380610	RECOMBINANT SERINE PROTEASES
<b>C12N 9/74</b> (2006.01)	3380610	RECOMBINANT SERINE PROTEASES
<b>A61B 17/32</b> (2006.01)	3393379	ULTRASONIC SURGICAL INSTRUMENT WITH BLADE CLEANING FEATURE
<b>A61B 90/70</b> (2016.01)	3393379	ULTRASONIC SURGICAL INSTRUMENT WITH BLADE CLEANING FEATURE
<b>A61B 18/02</b> (2006.01)	3389526	A MACHINERY FOR SURGICAL INTERVENTIONS OF CRYOABLATION WITH CLOSED CYCLE AND MULTIPURPOSE
<b>A61B 34/10</b> (2016.01)	3389526	A MACHINERY FOR SURGICAL INTERVENTIONS OF CRYOABLATION WITH CLOSED CYCLE AND MULTIPURPOSE
<b>B82Y 30/00</b> (2011.01)	3393967	ANTIMICROBIAL POLYMER COMPOSITION
<b>C08J 5/18</b> (2006.01)	3393967	ANTIMICROBIAL POLYMER COMPOSITION
<b>C08L 23/08</b> (2006.01)	3393967	ANTIMICROBIAL POLYMER COMPOSITION
<b>C09D 123/08</b> (2006.01)	3393967	ANTIMICROBIAL POLYMER COMPOSITION
<b>A61K 31/336</b> (2006.01)	3411363	CRYSTALLINE AND AMORPHOUS FORMS OF CARFILZOMIB
<b>A61K 31/5375</b> (2006.01)	3411363	CRYSTALLINE AND AMORPHOUS FORMS OF CARFILZOMIB
<b>A61K 38/07</b> (2006.01)	3411363	CRYSTALLINE AND AMORPHOUS FORMS OF CARFILZOMIB
<b>C07D 303/36</b> (2006.01)	3411363	CRYSTALLINE AND AMORPHOUS FORMS OF CARFILZOMIB
<b>C07K 5/10</b> (2006.01)	3411363	CRYSTALLINE AND AMORPHOUS FORMS OF CARFILZOMIB
<b>C07D 275/06</b> (2006.01)	3397621	PROCESS FOR PREPARING 1.1.3-TRIOXO-1.2-BENZOTHAZOLE-6-CARBOXAMIDE
<b>A61B 17/28</b> (2006.01)	3397179	SNAP FIT CLAMP PAD FOR ULTRASONIC SURGICAL INSTRUMENT
<b>A61B 17/29</b> (2006.01)	3397179	SNAP FIT CLAMP PAD FOR ULTRASONIC SURGICAL INSTRUMENT
<b>A61B 17/32</b> (2006.01)	3397179	SNAP FIT CLAMP PAD FOR ULTRASONIC SURGICAL INSTRUMENT
<b>A61K 31/501</b> (2006.01)	3345909	TETRAHYDROOXEPINOPYRIDINE COMPOUND
<b>A61K 31/5377</b> (2006.01)	3345909	TETRAHYDROOXEPINOPYRIDINE COMPOUND
<b>A61P 25/04</b> (2006.01)	3345909	TETRAHYDROOXEPINOPYRIDINE COMPOUND
<b>A61P 25/18</b> (2006.01)	3345909	TETRAHYDROOXEPINOPYRIDINE COMPOUND

MKP (51)	Broj objave evropske prijava patenta (97)	Naziv pronalaska (54)
<b>A61P 25/28</b> (2006.01)	3345909	TETRAHYDROOXEPINOPYRIDINE COMPOUND
<b>A61P 29/00</b> (2006.01)	3345909	TETRAHYDROOXEPINOPYRIDINE COMPOUND
<b>C07D 491/044</b> (2006.01)	3345909	TETRAHYDROOXEPINOPYRIDINE COMPOUND
<b>A01G 1/00</b> (2006.01)	3397054	CONTROLLED RELEASE AGROCHEMICAL DELIVERY UNITS, THEIR MANUFACTURE AND USE
<b>A01G 3/06</b> (2006.01)	3397054	CONTROLLED RELEASE AGROCHEMICAL DELIVERY UNITS, THEIR MANUFACTURE AND USE
<b>A01G 29/00</b> (2006.01)	3397054	CONTROLLED RELEASE AGROCHEMICAL DELIVERY UNITS, THEIR MANUFACTURE AND USE
<b>A01N 25/04</b> (2006.01)	3397054	CONTROLLED RELEASE AGROCHEMICAL DELIVERY UNITS, THEIR MANUFACTURE AND USE
<b>A01N 25/26</b> (2006.01)	3397054	CONTROLLED RELEASE AGROCHEMICAL DELIVERY UNITS, THEIR MANUFACTURE AND USE
<b>A01P 21/00</b> (2006.01)	3397054	CONTROLLED RELEASE AGROCHEMICAL DELIVERY UNITS, THEIR MANUFACTURE AND USE
<b>C05G 3/00</b> (2006.01)	3397054	CONTROLLED RELEASE AGROCHEMICAL DELIVERY UNITS, THEIR MANUFACTURE AND USE
<b>C05G 3/04</b> (2006.01)	3397054	CONTROLLED RELEASE AGROCHEMICAL DELIVERY UNITS, THEIR MANUFACTURE AND USE
<b>C05G 3/06</b> (2006.01)	3397054	CONTROLLED RELEASE AGROCHEMICAL DELIVERY UNITS, THEIR MANUFACTURE AND USE
<b>D06N 3/00</b> (2006.01)	3397804	PROCESS OF TREATING A NON-WOVEN MICROFIBROUS MATRIX MATERIAL WITH RESIN
<b>D06N 3/18</b> (2006.01)	3397804	PROCESS OF TREATING A NON-WOVEN MICROFIBROUS MATRIX MATERIAL WITH RESIN
<b>A61K 31/44</b> (2006.01)	3390361	N-PHENYL-PYRIDINE-2-CARBOXAMIDE DERIVATIVES AND THEIR USE AS PD-1/PD-L1 PROTEIN/PROTEIN INTERACTION MODULATORS
<b>A61K 31/4545</b> (2006.01)	3390361	N-PHENYL-PYRIDINE-2-CARBOXAMIDE DERIVATIVES AND THEIR USE AS PD-1/PD-L1 PROTEIN/PROTEIN INTERACTION MODULATORS
<b>A61P 31/00</b> (2006.01)	3390361	N-PHENYL-PYRIDINE-2-CARBOXAMIDE DERIVATIVES AND THEIR USE AS PD-1/PD-L1 PROTEIN/PROTEIN INTERACTION MODULATORS
<b>A61P 35/00</b> (2006.01)	3390361	N-PHENYL-PYRIDINE-2-CARBOXAMIDE DERIVATIVES AND THEIR USE AS PD-1/PD-L1 PROTEIN/PROTEIN INTERACTION MODULATORS
<b>A61P 37/04</b> (2006.01)	3390361	N-PHENYL-PYRIDINE-2-CARBOXAMIDE DERIVATIVES AND THEIR USE AS PD-1/PD-L1 PROTEIN/PROTEIN INTERACTION MODULATORS
<b>C07D 213/81</b> (2006.01)	3390361	N-PHENYL-PYRIDINE-2-CARBOXAMIDE DERIVATIVES AND THEIR USE AS PD-1/PD-L1 PROTEIN/PROTEIN INTERACTION MODULATORS
<b>C07D 213/84</b> (2006.01)	3390361	N-PHENYL-PYRIDINE-2-CARBOXAMIDE DERIVATIVES AND THEIR USE AS PD-1/PD-L1 PROTEIN/PROTEIN INTERACTION MODULATORS
<b>C07D 237/24</b> (2006.01)	3390361	N-PHENYL-PYRIDINE-2-CARBOXAMIDE DERIVATIVES AND THEIR USE AS PD-1/PD-L1 PROTEIN/PROTEIN INTERACTION MODULATORS
<b>C07D 239/28</b> (2006.01)	3390361	N-PHENYL-PYRIDINE-2-CARBOXAMIDE DERIVATIVES AND THEIR USE AS PD-1/PD-L1 PROTEIN/PROTEIN INTERACTION MODULATORS
<b>C07D 241/24</b> (2006.01)	3390361	N-PHENYL-PYRIDINE-2-CARBOXAMIDE DERIVATIVES AND THEIR USE AS PD-1/PD-L1 PROTEIN/PROTEIN INTERACTION MODULATORS
<b>C07D 401/06</b> (2006.01)	3390361	N-PHENYL-PYRIDINE-2-CARBOXAMIDE DERIVATIVES AND THEIR USE AS PD-1/PD-L1 PROTEIN/PROTEIN INTERACTION MODULATORS
<b>C07D 401/12</b> (2006.01)	3390361	N-PHENYL-PYRIDINE-2-CARBOXAMIDE DERIVATIVES AND THEIR USE AS PD-1/PD-L1 PROTEIN/PROTEIN INTERACTION MODULATORS
<b>C07D 401/14</b> (2006.01)	3390361	N-PHENYL-PYRIDINE-2-CARBOXAMIDE DERIVATIVES AND THEIR USE AS PD-1/PD-L1 PROTEIN/PROTEIN INTERACTION MODULATORS
<b>C07D 405/12</b> (2006.01)	3390361	N-PHENYL-PYRIDINE-2-CARBOXAMIDE DERIVATIVES AND THEIR USE AS PD-1/PD-L1 PROTEIN/PROTEIN INTERACTION MODULATORS



MKP (51)	Broj objave evropske prijava patenta (97)	Naziv pronalaska (54)
<b>C07D 405/14</b> (2006.01)	3390361	N-PHENYL-PYRIDINE-2-CARBOXAMIDE DERIVATIVES AND THEIR USE AS PD-1/PD-L1 PROTEIN/PROTEIN INTERACTION MODULATORS
<b>F25B 21/02</b> (2006.01)	3346209	COMPUTER WITH SPECIAL OUTER CASING ALLOWING THE SITUATION THEREOF IN EXPLOSIVE ATMOSPHERES
<b>H05K 7/14</b> (2006.01)	3346209	COMPUTER WITH SPECIAL OUTER CASING ALLOWING THE SITUATION THEREOF IN EXPLOSIVE ATMOSPHERES
<b>H05K 7/20</b> (2006.01)	3346209	COMPUTER WITH SPECIAL OUTER CASING ALLOWING THE SITUATION THEREOF IN EXPLOSIVE ATMOSPHERES
<b>A61K 31/519</b> (2006.01)	3345907	NOVEL PYRAZOLO[3,4-d]PYRIMIDINE COMPOUND OR SALT THEREOF
<b>A61P 35/00</b> (2006.01)	3345907	NOVEL PYRAZOLO[3,4-d]PYRIMIDINE COMPOUND OR SALT THEREOF
<b>C07D 487/04</b> (2006.01)	3345907	NOVEL PYRAZOLO[3,4-d]PYRIMIDINE COMPOUND OR SALT THEREOF
<b>A61K 31/4439</b> (2006.01)	3344613	HETEROARYL COMPOUNDS AND THEIR USE AS THERAPEUTIC DRUGS
<b>A61K 31/497</b> (2006.01)	3344613	HETEROARYL COMPOUNDS AND THEIR USE AS THERAPEUTIC DRUGS
<b>C07D 401/04</b> (2006.01)	3344613	HETEROARYL COMPOUNDS AND THEIR USE AS THERAPEUTIC DRUGS
<b>C07D 403/04</b> (2006.01)	3344613	HETEROARYL COMPOUNDS AND THEIR USE AS THERAPEUTIC DRUGS
<b>B21D 51/04</b> (2006.01)	3344564	APPARATUS AND METHOD FOR ORIENTING A BEVERAGE CONTAINER END CLOSURE AND APPLYING INDICIA IN A PREDETERMINED LOCATION
<b>B21D 51/44</b> (2006.01)	3344564	APPARATUS AND METHOD FOR ORIENTING A BEVERAGE CONTAINER END CLOSURE AND APPLYING INDICIA IN A PREDETERMINED LOCATION
<b>B41F 17/28</b> (2006.01)	3344564	APPARATUS AND METHOD FOR ORIENTING A BEVERAGE CONTAINER END CLOSURE AND APPLYING INDICIA IN A PREDETERMINED LOCATION
<b>B65G 47/24</b> (2006.01)	3344564	APPARATUS AND METHOD FOR ORIENTING A BEVERAGE CONTAINER END CLOSURE AND APPLYING INDICIA IN A PREDETERMINED LOCATION
<b>B65G 47/244</b> (2006.01)	3344564	APPARATUS AND METHOD FOR ORIENTING A BEVERAGE CONTAINER END CLOSURE AND APPLYING INDICIA IN A PREDETERMINED LOCATION
<b>B65G 47/248</b> (2006.01)	3344564	APPARATUS AND METHOD FOR ORIENTING A BEVERAGE CONTAINER END CLOSURE AND APPLYING INDICIA IN A PREDETERMINED LOCATION
<b>A61K 31/445</b> (2006.01)	3344248	6-MEMBERED AZA-HETEROCYCLIC CONTAINING DELTA-OPIOID RECEPTOR MODULATING COMPOUNDS, METHODS OF USING AND MAKING THE SAME
<b>A61P 25/00</b> (2006.01)	3344248	6-MEMBERED AZA-HETEROCYCLIC CONTAINING DELTA-OPIOID RECEPTOR MODULATING COMPOUNDS, METHODS OF USING AND MAKING THE SAME
<b>C07D 211/00</b> (2006.01)	3344248	6-MEMBERED AZA-HETEROCYCLIC CONTAINING DELTA-OPIOID RECEPTOR MODULATING COMPOUNDS, METHODS OF USING AND MAKING THE SAME
<b>A61K 38/47</b> (2006.01)	3344337	METHODS AND COMPOSITIONS FOR THE TREATMENT OF CYTOPPLASMIC GLYCOGEN STORAGE DISORDERS
<b>A61P 3/00</b> (2006.01)	3344337	METHODS AND COMPOSITIONS FOR THE TREATMENT OF CYTOPPLASMIC GLYCOGEN STORAGE DISORDERS
<b>A61K 31/05</b> (2006.01)	3344271	USE OF SECOISOLARICIREBINOL DIGLUCOSIDES (SDGs) AND RELATED COMPOUNDS FOR PROTECTION AGAINST RADIATION DAMAGE
<b>A61K 36/55</b> (2006.01)	3344271	USE OF SECOISOLARICIREBINOL DIGLUCOSIDES (SDGs) AND RELATED COMPOUNDS FOR PROTECTION AGAINST RADIATION DAMAGE
<b>A61K 31/437</b> (2006.01)	3344614	THERAPEUTIC COMPOUNDS FOR PAIN AND SYNTHESIS THEREOF
<b>A61K 31/4439</b> (2006.01)	3344614	THERAPEUTIC COMPOUNDS FOR PAIN AND SYNTHESIS THEREOF
<b>A61K 31/444</b> (2006.01)	3344614	THERAPEUTIC COMPOUNDS FOR PAIN AND SYNTHESIS THEREOF
<b>C07D 401/06</b> (2006.01)	3344614	THERAPEUTIC COMPOUNDS FOR PAIN AND SYNTHESIS THEREOF
<b>C07D 471/12</b> (2006.01)	3344614	THERAPEUTIC COMPOUNDS FOR PAIN AND SYNTHESIS THEREOF
<b>C07D 471/18</b> (2006.01)	3344614	THERAPEUTIC COMPOUNDS FOR PAIN AND SYNTHESIS THEREOF
<b>A61K 31/336</b> (2006.01)	3344626	THERAPEUTIC COMPOUNDS FOR PAIN AND SYNTHESIS THEREOF
<b>A61K 31/437</b> (2006.01)	3344626	THERAPEUTIC COMPOUNDS FOR PAIN AND SYNTHESIS THEREOF

MKP	Broj objave evropske prijave patenta	Naziv pronalaska
(51)	(97)	(54)
<b>A61K 31/46</b> (2006.01)	3344626	THERAPEUTIC COMPOUNDS FOR PAIN AND SYNTHESIS THEREOF
<b>C07D 471/12</b> (2006.01)	3344626	THERAPEUTIC COMPOUNDS FOR PAIN AND SYNTHESIS THEREOF
<b>C07D 471/18</b> (2006.01)	3344626	THERAPEUTIC COMPOUNDS FOR PAIN AND SYNTHESIS THEREOF
<b>C07D 491/147</b> (2006.01)	3344626	THERAPEUTIC COMPOUNDS FOR PAIN AND SYNTHESIS THEREOF
<b>A61K 31/437</b> (2006.01)	3344627	THERAPEUTIC COMPOUNDS FOR PAIN AND SYNTHESIS THEREOF
<b>A61K 31/4375</b> (2006.01)	3344627	THERAPEUTIC COMPOUNDS FOR PAIN AND SYNTHESIS THEREOF
<b>C07D 471/12</b> (2006.01)	3344627	THERAPEUTIC COMPOUNDS FOR PAIN AND SYNTHESIS THEREOF
<b>C07D 471/18</b> (2006.01)	3344627	THERAPEUTIC COMPOUNDS FOR PAIN AND SYNTHESIS THEREOF
<b>A61K 31/336</b> (2006.01)	3344628	THERAPEUTIC COMPOUNDS AND SYNTHESIS
<b>A61K 31/437</b> (2006.01)	3344628	THERAPEUTIC COMPOUNDS AND SYNTHESIS
<b>A61K 31/46</b> (2006.01)	3344628	THERAPEUTIC COMPOUNDS AND SYNTHESIS
<b>C07D 471/12</b> (2006.01)	3344628	THERAPEUTIC COMPOUNDS AND SYNTHESIS
<b>C07D 471/18</b> (2006.01)	3344628	THERAPEUTIC COMPOUNDS AND SYNTHESIS
<b>C07D 491/147</b> (2006.01)	3344628	THERAPEUTIC COMPOUNDS AND SYNTHESIS
<b>A61J 1/03</b> (2006.01)	3344212	MEDICATION PACKAGING AND DOSE REGIMEN SYSTEM
<b>A61J 7/02</b> (2006.01)	3344212	MEDICATION PACKAGING AND DOSE REGIMEN SYSTEM
<b>A61J 7/04</b> (2006.01)	3344212	MEDICATION PACKAGING AND DOSE REGIMEN SYSTEM
<b>A61K 31/336</b> (2006.01)	3344629	THERAPEUTIC COMPOUND FOR PAIN AND SYNTHESIS THEREOF
<b>A61K 31/36</b> (2006.01)	3344629	THERAPEUTIC COMPOUND FOR PAIN AND SYNTHESIS THEREOF
<b>A61K 31/437</b> (2006.01)	3344629	THERAPEUTIC COMPOUND FOR PAIN AND SYNTHESIS THEREOF
<b>C07D 317/46</b> (2006.01)	3344629	THERAPEUTIC COMPOUND FOR PAIN AND SYNTHESIS THEREOF
<b>C07D 471/12</b> (2006.01)	3344629	THERAPEUTIC COMPOUND FOR PAIN AND SYNTHESIS THEREOF
<b>C07D 471/18</b> (2006.01)	3344629	THERAPEUTIC COMPOUND FOR PAIN AND SYNTHESIS THEREOF
<b>C07D 491/147</b> (2006.01)	3344629	THERAPEUTIC COMPOUND FOR PAIN AND SYNTHESIS THEREOF
<b>A61K 35/52</b> (2015.01)	3344265	TOPICAL ANTIVIRAL COMPOSITIONS
<b>A61P 31/12</b> (2006.01)	3344265	TOPICAL ANTIVIRAL COMPOSITIONS
<b>A01H 5/00</b> (2018.01)	3394269	PESTICIDAL GENES AND METHODS OF USE
<b>A01N 63/00</b> (2006.01)	3394269	PESTICIDAL GENES AND METHODS OF USE
<b>A01N 63/02</b> (2006.01)	3394269	PESTICIDAL GENES AND METHODS OF USE
<b>C07K 14/195</b> (2006.01)	3394269	PESTICIDAL GENES AND METHODS OF USE
<b>C12N 15/82</b> (2006.01)	3394269	PESTICIDAL GENES AND METHODS OF USE
<b>A61K 39/395</b> (2006.01)	3348572	ANTI-EPHA4 ANTIBODY
<b>A61P 21/02</b> (2006.01)	3348572	ANTI-EPHA4 ANTIBODY
<b>A61P 43/00</b> (2006.01)	3348572	ANTI-EPHA4 ANTIBODY
<b>C07K 16/28</b> (2006.01)	3348572	ANTI-EPHA4 ANTIBODY
<b>C12N 15/09</b> (2006.01)	3348572	ANTI-EPHA4 ANTIBODY
<b>B60P 3/40</b> (2006.01)	2687403	Transport system for long loads
<b>B62D 53/02</b> (2006.01)	2687403	Transport system for long loads
<b>A61K 31/437</b> (2006.01)	3356363	NEW IMIDAZO[4,5-B]PYRIDINE DERIVATIVES AS DUAL DYRK1/CLK1 INHIBITORS
<b>A61P 25/16</b> (2006.01)	3356363	NEW IMIDAZO[4,5-B]PYRIDINE DERIVATIVES AS DUAL DYRK1/CLK1 INHIBITORS
<b>A61P 25/28</b> (2006.01)	3356363	NEW IMIDAZO[4,5-B]PYRIDINE DERIVATIVES AS DUAL DYRK1/CLK1 INHIBITORS
<b>A61P 35/00</b> (2006.01)	3356363	NEW IMIDAZO[4,5-B]PYRIDINE DERIVATIVES AS DUAL DYRK1/CLK1 INHIBITORS
<b>C07D 471/04</b> (2006.01)	3356363	NEW IMIDAZO[4,5-B]PYRIDINE DERIVATIVES AS DUAL DYRK1/CLK1 INHIBITORS
<b>A61K 31/437</b> (2006.01)	3356364	NEW PYRROLO[2,3-D]PYRIMIDINE DERIVATIVES AS DUAL DYRK1/CLK1 INHIBITORS
<b>A61K 31/519</b> (2006.01)	3356364	NEW PYRROLO[2,3-D]PYRIMIDINE DERIVATIVES AS DUAL DYRK1/CLK1 INHIBITORS
<b>A61P 25/16</b> (2006.01)	3356364	NEW PYRROLO[2,3-D]PYRIMIDINE DERIVATIVES AS DUAL DYRK1/CLK1 INHIBITORS
<b>A61P 25/28</b> (2006.01)	3356364	NEW PYRROLO[2,3-D]PYRIMIDINE DERIVATIVES AS DUAL DYRK1/CLK1 INHIBITORS
<b>A61P 35/00</b> (2006.01)	3356364	NEW PYRROLO[2,3-D]PYRIMIDINE DERIVATIVES AS DUAL DYRK1/CLK1 INHIBITORS
<b>C07D 471/04</b> (2006.01)	3356364	NEW PYRROLO[2,3-D]PYRIMIDINE DERIVATIVES AS DUAL DYRK1/CLK1 INHIBITORS
<b>C07D 487/04</b> (2006.01)	3356364	NEW PYRROLO[2,3-D]PYRIMIDINE DERIVATIVES AS DUAL DYRK1/CLK1 INHIBITORS
<b>A61K 38/17</b> (2006.01)	3359560	PEPTIDES AND COMBINATION OF PEPTIDES FOR USE IN IMMUNOTHERAPY AGAINST SMALL CELL LUNG CANCER AND OTHER CANCERS
<b>A61K 39/00</b> (2006.01)	3359560	PEPTIDES AND COMBINATION OF PEPTIDES FOR USE IN IMMUNOTHERAPY AGAINST SMALL CELL LUNG CANCER AND OTHER CANCERS

MKP (51)	Broj objave evropske prijava patenta (97)	Naziv pronalaska (54)
<b>C07K 7/06</b> (2006.01)	3359560	PEPTIDES AND COMBINATION OF PEPTIDES FOR USE IN IMMUNOTHERAPY AGAINST SMALL CELL LUNG CANCER AND OTHER CANCERS
<b>C07K 14/47</b> (2006.01)	3359560	PEPTIDES AND COMBINATION OF PEPTIDES FOR USE IN IMMUNOTHERAPY AGAINST SMALL CELL LUNG CANCER AND OTHER CANCERS
<b>G01N 33/574</b> (2006.01)	3359560	PEPTIDES AND COMBINATION OF PEPTIDES FOR USE IN IMMUNOTHERAPY AGAINST SMALL CELL LUNG CANCER AND OTHER CANCERS
<b>A61P 37/06</b> (2006.01)	3350223	ANTIBODIES THAT SPECIFICALLY BIND TO TL1A
<b>C07K 16/28</b> (2006.01)	3350223	ANTIBODIES THAT SPECIFICALLY BIND TO TL1A
<b>A61K 31/41</b> (2006.01)	3353167	MODULATORS OF INDOLEAMINE 2,3-DIOXYGENASE
<b>A61K 31/433</b> (2006.01)	3353167	MODULATORS OF INDOLEAMINE 2,3-DIOXYGENASE
<b>C07D 235/30</b> (2006.01)	3353167	MODULATORS OF INDOLEAMINE 2,3-DIOXYGENASE
<b>C07D 263/48</b> (2006.01)	3353167	MODULATORS OF INDOLEAMINE 2,3-DIOXYGENASE
<b>C07D 263/58</b> (2006.01)	3353167	MODULATORS OF INDOLEAMINE 2,3-DIOXYGENASE
<b>C07D 277/80</b> (2006.01)	3353167	MODULATORS OF INDOLEAMINE 2,3-DIOXYGENASE
<b>C07D 285/08</b> (2006.01)	3353167	MODULATORS OF INDOLEAMINE 2,3-DIOXYGENASE
<b>C07D 403/12</b> (2006.01)	3353167	MODULATORS OF INDOLEAMINE 2,3-DIOXYGENASE
<b>C07D 413/12</b> (2006.01)	3353167	MODULATORS OF INDOLEAMINE 2,3-DIOXYGENASE
<b>C07D 417/12</b> (2006.01)	3353167	MODULATORS OF INDOLEAMINE 2,3-DIOXYGENASE
<b>A61K 31/421</b> (2006.01)	3353151	MODULATORS OF INDOLEAMINE 2,3-DIOXYGENASE
<b>A61K 31/426</b> (2006.01)	3353151	MODULATORS OF INDOLEAMINE 2,3-DIOXYGENASE
<b>A61K 31/433</b> (2006.01)	3353151	MODULATORS OF INDOLEAMINE 2,3-DIOXYGENASE
<b>A61K 31/44</b> (2006.01)	3353151	MODULATORS OF INDOLEAMINE 2,3-DIOXYGENASE
<b>A61P 31/18</b> (2006.01)	3353151	MODULATORS OF INDOLEAMINE 2,3-DIOXYGENASE
<b>C07D 213/74</b> (2006.01)	3353151	MODULATORS OF INDOLEAMINE 2,3-DIOXYGENASE
<b>C07D 235/30</b> (2006.01)	3353151	MODULATORS OF INDOLEAMINE 2,3-DIOXYGENASE
<b>C07D 239/42</b> (2006.01)	3353151	MODULATORS OF INDOLEAMINE 2,3-DIOXYGENASE
<b>C07D 241/20</b> (2006.01)	3353151	MODULATORS OF INDOLEAMINE 2,3-DIOXYGENASE
<b>C07D 253/06</b> (2006.01)	3353151	MODULATORS OF INDOLEAMINE 2,3-DIOXYGENASE
<b>C07D 263/48</b> (2006.01)	3353151	MODULATORS OF INDOLEAMINE 2,3-DIOXYGENASE
<b>C07D 263/58</b> (2006.01)	3353151	MODULATORS OF INDOLEAMINE 2,3-DIOXYGENASE
<b>C07D 277/82</b> (2006.01)	3353151	MODULATORS OF INDOLEAMINE 2,3-DIOXYGENASE
<b>C07D 285/00</b> (2006.01)	3353151	MODULATORS OF INDOLEAMINE 2,3-DIOXYGENASE
<b>C07D 307/66</b> (2006.01)	3353151	MODULATORS OF INDOLEAMINE 2,3-DIOXYGENASE
<b>C07D 309/14</b> (2006.01)	3353151	MODULATORS OF INDOLEAMINE 2,3-DIOXYGENASE
<b>C07D 333/20</b> (2006.01)	3353151	MODULATORS OF INDOLEAMINE 2,3-DIOXYGENASE
<b>B28B 1/52</b> (2006.01)	3383606	SOUND-ABSORBING GYPSUM FIBRE BOARD AND METHOD FOR MANUFACTURING SUCH A GYPSUM FIBRE BOARD
<b>C04B 28/14</b> (2006.01)	3383606	SOUND-ABSORBING GYPSUM FIBRE BOARD AND METHOD FOR MANUFACTURING SUCH A GYPSUM FIBRE BOARD
<b>C04B 111/52</b> (2006.01)	3383606	SOUND-ABSORBING GYPSUM FIBRE BOARD AND METHOD FOR MANUFACTURING SUCH A GYPSUM FIBRE BOARD
<b>A61K 9/00</b> (2006.01)	3352734	TREATMENT OF ALOPECIA AREATA
<b>A61K 31/519</b> (2006.01)	3352734	TREATMENT OF ALOPECIA AREATA
<b>A61P 17/14</b> (2006.01)	3352734	TREATMENT OF ALOPECIA AREATA
<b>A61K 31/443</b> (2006.01)	3350175	NON-STEROIDAL GLUCOCORTICOID RECEPTOR MODULATORS FOR LOCAL DRUG DELIVERY
<b>A61P 29/00</b> (2006.01)	3350175	NON-STEROIDAL GLUCOCORTICOID RECEPTOR MODULATORS FOR LOCAL DRUG DELIVERY
<b>A61P 37/00</b> (2006.01)	3350175	NON-STEROIDAL GLUCOCORTICOID RECEPTOR MODULATORS FOR LOCAL DRUG DELIVERY
<b>C07D 405/06</b> (2006.01)	3350175	NON-STEROIDAL GLUCOCORTICOID RECEPTOR MODULATORS FOR LOCAL DRUG DELIVERY
<b>C07D 405/14</b> (2006.01)	3350175	NON-STEROIDAL GLUCOCORTICOID RECEPTOR MODULATORS FOR LOCAL DRUG DELIVERY
<b>C07D 413/14</b> (2006.01)	3350175	NON-STEROIDAL GLUCOCORTICOID RECEPTOR MODULATORS FOR LOCAL DRUG DELIVERY
<b>C07D 417/14</b> (2006.01)	3350175	NON-STEROIDAL GLUCOCORTICOID RECEPTOR MODULATORS FOR LOCAL DRUG DELIVERY
<b>C12Q 1/68</b> (2018.01)	3350346	NOVEL BIOMARKERS AND METHODS OF TREATING CANCER
<b>A61K 38/43</b> (2006.01)	3356542	MODIFIED LYSOSOMAL PROTEIN AND PRODUCTION THEREOF
<b>A61K 38/47</b> (2006.01)	3356542	MODIFIED LYSOSOMAL PROTEIN AND PRODUCTION THEREOF
<b>C12P 21/00</b> (2006.01)	3356542	MODIFIED LYSOSOMAL PROTEIN AND PRODUCTION THEREOF
<b>C12P 21/02</b> (2006.01)	3356542	MODIFIED LYSOSOMAL PROTEIN AND PRODUCTION THEREOF
<b>A61K 31/473</b> (2006.01)	3352759	TREATMENT OF NEURODEGENERATIVE DISEASES
<b>A61K 31/49</b> (2006.01)	3352759	TREATMENT OF NEURODEGENERATIVE DISEASES

MKP (51)	Broj objave evropske prijava patenta (97)	Naziv pronalaska (54)
<b>A61K 31/517</b> (2006.01)	3352759	TREATMENT OF NEURODEGENERATIVE DISEASES
<b>A61K 31/5377</b> (2006.01)	3352759	TREATMENT OF NEURODEGENERATIVE DISEASES
<b>A61K 39/395</b> (2006.01)	3352759	TREATMENT OF NEURODEGENERATIVE DISEASES
<b>A61K 45/00</b> (2006.01)	3352759	TREATMENT OF NEURODEGENERATIVE DISEASES
<b>A61P 25/28</b> (2006.01)	3352759	TREATMENT OF NEURODEGENERATIVE DISEASES
<b>A61L 27/36</b> (2006.01)	3349813	COMPOSITIONS DERIVED FROM PLACENTA AND METHODS OF PRODUCING THE SAME
<b>A61L 27/56</b> (2006.01)	3349813	COMPOSITIONS DERIVED FROM PLACENTA AND METHODS OF PRODUCING THE SAME
<b>A61L 27/60</b> (2006.01)	3349813	COMPOSITIONS DERIVED FROM PLACENTA AND METHODS OF PRODUCING THE SAME
<b>G01C 21/34</b> (2006.01)	3353722	METHOD, APPARATUS AND SYSTEM FOR DESTINATION RECOMMENDATION AND SELECTION
<b>G01C 21/36</b> (2006.01)	3353722	METHOD, APPARATUS AND SYSTEM FOR DESTINATION RECOMMENDATION AND SELECTION
<b>G06Q 10/04</b> (2012.01)	3353722	METHOD, APPARATUS AND SYSTEM FOR DESTINATION RECOMMENDATION AND SELECTION
<b>G06Q 10/06</b> (2012.01)	3353722	METHOD, APPARATUS AND SYSTEM FOR DESTINATION RECOMMENDATION AND SELECTION
<b>G06Q 50/30</b> (2012.01)	3353722	METHOD, APPARATUS AND SYSTEM FOR DESTINATION RECOMMENDATION AND SELECTION
<b>H04W 4/02</b> (2009.01)	3353722	METHOD, APPARATUS AND SYSTEM FOR DESTINATION RECOMMENDATION AND SELECTION
<b>H04W 4/04</b> (2009.01)	3353722	METHOD, APPARATUS AND SYSTEM FOR DESTINATION RECOMMENDATION AND SELECTION
<b>C07K 14/725</b> (2006.01)	3359563	ANTIGEN RECEPTORS AND USES THEREOF
<b>C07K 16/28</b> (2006.01)	3359563	ANTIGEN RECEPTORS AND USES THEREOF
<b>A61K 31/454</b> (2006.01)	3356344	ISOINDOLINONE INHIBITORS OF THE MDM2-P53 INTERACTION HAVING ANTICANCER ACTIVITY
<b>A61K 31/506</b> (2006.01)	3356344	ISOINDOLINONE INHIBITORS OF THE MDM2-P53 INTERACTION HAVING ANTICANCER ACTIVITY
<b>A61K 35/00</b> (2006.01)	3356344	ISOINDOLINONE INHIBITORS OF THE MDM2-P53 INTERACTION HAVING ANTICANCER ACTIVITY
<b>C07B 59/00</b> (2006.01)	3356344	ISOINDOLINONE INHIBITORS OF THE MDM2-P53 INTERACTION HAVING ANTICANCER ACTIVITY
<b>C07D 401/06</b> (2006.01)	3356344	ISOINDOLINONE INHIBITORS OF THE MDM2-P53 INTERACTION HAVING ANTICANCER ACTIVITY
<b>C07D 401/14</b> (2006.01)	3356344	ISOINDOLINONE INHIBITORS OF THE MDM2-P53 INTERACTION HAVING ANTICANCER ACTIVITY
<b>C07D 403/06</b> (2006.01)	3356344	ISOINDOLINONE INHIBITORS OF THE MDM2-P53 INTERACTION HAVING ANTICANCER ACTIVITY
<b>C07D 403/14</b> (2006.01)	3356344	ISOINDOLINONE INHIBITORS OF THE MDM2-P53 INTERACTION HAVING ANTICANCER ACTIVITY
<b>C07D 405/14</b> (2006.01)	3356344	ISOINDOLINONE INHIBITORS OF THE MDM2-P53 INTERACTION HAVING ANTICANCER ACTIVITY
<b>C07D 407/14</b> (2006.01)	3356344	ISOINDOLINONE INHIBITORS OF THE MDM2-P53 INTERACTION HAVING ANTICANCER ACTIVITY
<b>C07D 409/14</b> (2006.01)	3356344	ISOINDOLINONE INHIBITORS OF THE MDM2-P53 INTERACTION HAVING ANTICANCER ACTIVITY
<b>C07D 413/14</b> (2006.01)	3356344	ISOINDOLINONE INHIBITORS OF THE MDM2-P53 INTERACTION HAVING ANTICANCER ACTIVITY
<b>C07D 417/14</b> (2006.01)	3356344	ISOINDOLINONE INHIBITORS OF THE MDM2-P53 INTERACTION HAVING ANTICANCER ACTIVITY
<b>C07D 487/04</b> (2006.01)	3356344	ISOINDOLINONE INHIBITORS OF THE MDM2-P53 INTERACTION HAVING ANTICANCER ACTIVITY
<b>C07D 487/08</b> (2006.01)	3356344	ISOINDOLINONE INHIBITORS OF THE MDM2-P53 INTERACTION HAVING ANTICANCER ACTIVITY
<b>A61K 31/4035</b> (2006.01)	3356350	ISOINDOLINONE INHIBITORS OF THE MDM2-P53 INTERACTION HAVING ANTICANCER ACTIVITY
<b>A61P 35/00</b> (2006.01)	3356350	ISOINDOLINONE INHIBITORS OF THE MDM2-P53 INTERACTION HAVING ANTICANCER ACTIVITY
<b>C07B 59/00</b> (2006.01)	3356350	ISOINDOLINONE INHIBITORS OF THE MDM2-P53 INTERACTION HAVING ANTICANCER ACTIVITY
<b>C07D 209/48</b> (2006.01)	3356350	ISOINDOLINONE INHIBITORS OF THE MDM2-P53 INTERACTION HAVING ANTICANCER ACTIVITY
<b>C07D 403/06</b> (2006.01)	3356350	ISOINDOLINONE INHIBITORS OF THE MDM2-P53 INTERACTION HAVING ANTICANCER ACTIVITY

MKP (51)	Broj objave evropske prijava patenta (97)	Naziv pronalaska (54)
<b>C07D 403/12</b> (2006.01)	3356350	ISOINDOLINONE INHIBITORS OF THE MDM2-P53 INTERACTION HAVING ANTICANCER ACTIVITY
<b>C07D 405/12</b> (2006.01)	3356350	ISOINDOLINONE INHIBITORS OF THE MDM2-P53 INTERACTION HAVING ANTICANCER ACTIVITY
<b>C07D 405/14</b> (2006.01)	3356350	ISOINDOLINONE INHIBITORS OF THE MDM2-P53 INTERACTION HAVING ANTICANCER ACTIVITY
<b>C07D 413/06</b> (2006.01)	3356350	ISOINDOLINONE INHIBITORS OF THE MDM2-P53 INTERACTION HAVING ANTICANCER ACTIVITY
<b>C07D 413/12</b> (2006.01)	3356350	ISOINDOLINONE INHIBITORS OF THE MDM2-P53 INTERACTION HAVING ANTICANCER ACTIVITY
<b>C07F 9/572</b> (2006.01)	3356350	ISOINDOLINONE INHIBITORS OF THE MDM2-P53 INTERACTION HAVING ANTICANCER ACTIVITY
<b>F24J 2/52</b> (2018.01)	3411638	PHOTOVOLTAIC MODULE
<b>H02S 20/10</b> (2014.01)	3411638	PHOTOVOLTAIC MODULE
<b>A61K 31/397</b> (2006.01)	3359533	QUINOXALINE AND PYRIDOPYRAZINE DERIVATIVES AS PI3KBETA INHIBITORS
<b>A61K 31/4025</b> (2006.01)	3359533	QUINOXALINE AND PYRIDOPYRAZINE DERIVATIVES AS PI3KBETA INHIBITORS
<b>A61K 31/498</b> (2006.01)	3359533	QUINOXALINE AND PYRIDOPYRAZINE DERIVATIVES AS PI3KBETA INHIBITORS
<b>A61K 31/4985</b> (2006.01)	3359533	QUINOXALINE AND PYRIDOPYRAZINE DERIVATIVES AS PI3KBETA INHIBITORS
<b>C07D 241/14</b> (2006.01)	3359533	QUINOXALINE AND PYRIDOPYRAZINE DERIVATIVES AS PI3KBETA INHIBITORS
<b>C07D 401/04</b> (2006.01)	3359533	QUINOXALINE AND PYRIDOPYRAZINE DERIVATIVES AS PI3KBETA INHIBITORS
<b>C07D 401/06</b> (2006.01)	3359533	QUINOXALINE AND PYRIDOPYRAZINE DERIVATIVES AS PI3KBETA INHIBITORS
<b>C07D 403/04</b> (2006.01)	3359533	QUINOXALINE AND PYRIDOPYRAZINE DERIVATIVES AS PI3KBETA INHIBITORS
<b>C07D 403/06</b> (2006.01)	3359533	QUINOXALINE AND PYRIDOPYRAZINE DERIVATIVES AS PI3KBETA INHIBITORS
<b>C07D 403/12</b> (2006.01)	3359533	QUINOXALINE AND PYRIDOPYRAZINE DERIVATIVES AS PI3KBETA INHIBITORS
<b>C07D 403/14</b> (2006.01)	3359533	QUINOXALINE AND PYRIDOPYRAZINE DERIVATIVES AS PI3KBETA INHIBITORS
<b>C07D 413/04</b> (2006.01)	3359533	QUINOXALINE AND PYRIDOPYRAZINE DERIVATIVES AS PI3KBETA INHIBITORS
<b>C07D 413/06</b> (2006.01)	3359533	QUINOXALINE AND PYRIDOPYRAZINE DERIVATIVES AS PI3KBETA INHIBITORS
<b>C07D 417/06</b> (2006.01)	3359533	QUINOXALINE AND PYRIDOPYRAZINE DERIVATIVES AS PI3KBETA INHIBITORS
<b>C07D 471/04</b> (2006.01)	3359533	QUINOXALINE AND PYRIDOPYRAZINE DERIVATIVES AS PI3KBETA INHIBITORS
<b>C07D 487/02</b> (2006.01)	3359533	QUINOXALINE AND PYRIDOPYRAZINE DERIVATIVES AS PI3KBETA INHIBITORS
<b>C07D 491/10</b> (2006.01)	3359533	QUINOXALINE AND PYRIDOPYRAZINE DERIVATIVES AS PI3KBETA INHIBITORS
<b>C07D 498/10</b> (2006.01)	3359533	QUINOXALINE AND PYRIDOPYRAZINE DERIVATIVES AS PI3KBETA INHIBITORS
<b>C07D 513/10</b> (2006.01)	3359533	QUINOXALINE AND PYRIDOPYRAZINE DERIVATIVES AS PI3KBETA INHIBITORS
<b>A61K 9/20</b> (2006.01)	3359137	ORAL FEBUXOSTAT TABLET
<b>A61K 31/426</b> (2006.01)	3359137	ORAL FEBUXOSTAT TABLET
<b>A61K 31/438</b> (2006.01)	3359542	SPIRO[3H-INDOLE-3,2'-PYRROLIDIN]-2(1H)-ONE COMPOUNDS AND DERIVATIVES AS MDM2-P53 INHIBITORS
<b>A61P 35/00</b> (2006.01)	3359542	SPIRO[3H-INDOLE-3,2'-PYRROLIDIN]-2(1H)-ONE COMPOUNDS AND DERIVATIVES AS MDM2-P53 INHIBITORS
<b>C07D 471/22</b> (2006.01)	3359542	SPIRO[3H-INDOLE-3,2'-PYRROLIDIN]-2(1H)-ONE COMPOUNDS AND DERIVATIVES AS MDM2-P53 INHIBITORS
<b>C07D 487/22</b> (2006.01)	3359542	SPIRO[3H-INDOLE-3,2'-PYRROLIDIN]-2(1H)-ONE COMPOUNDS AND DERIVATIVES AS MDM2-P53 INHIBITORS
<b>A61K 31/19</b> (2006.01)	3386496	NOVEL INJECTABLE COMPOSITION; METHOD FOR PREPARING SAID COMPOSITION; USE OF SAID COMPOSITION
<b>A61K 31/728</b> (2006.01)	3386496	NOVEL INJECTABLE COMPOSITION; METHOD FOR PREPARING SAID COMPOSITION; USE OF SAID COMPOSITION
<b>A61P 19/02</b> (2006.01)	3386496	NOVEL INJECTABLE COMPOSITION; METHOD FOR PREPARING SAID COMPOSITION; USE OF SAID COMPOSITION

MKP (51)	Broj objave evropske prijava patenta (97)	Naziv pronalaska (54)
<b>A61K 31/4412</b> (2006.01)	3359531	2-OXO-1,2-DIHYDROPYRIDINE-3,5-DICARBOXAMIDE COMPOUNDS AS BROMODOMAIN INHIBITORS
<b>A61K 31/4439</b> (2006.01)	3359531	2-OXO-1,2-DIHYDROPYRIDINE-3,5-DICARBOXAMIDE COMPOUNDS AS BROMODOMAIN INHIBITORS
<b>A61P 35/00</b> (2006.01)	3359531	2-OXO-1,2-DIHYDROPYRIDINE-3,5-DICARBOXAMIDE COMPOUNDS AS BROMODOMAIN INHIBITORS
<b>C07D 213/82</b> (2006.01)	3359531	2-OXO-1,2-DIHYDROPYRIDINE-3,5-DICARBOXAMIDE COMPOUNDS AS BROMODOMAIN INHIBITORS
<b>C07D 401/12</b> (2006.01)	3359531	2-OXO-1,2-DIHYDROPYRIDINE-3,5-DICARBOXAMIDE COMPOUNDS AS BROMODOMAIN INHIBITORS
<b>C07D 401/14</b> (2006.01)	3359531	2-OXO-1,2-DIHYDROPYRIDINE-3,5-DICARBOXAMIDE COMPOUNDS AS BROMODOMAIN INHIBITORS
<b>G10L 19/008</b> (2013.01)	3360133	LAYERED CODING FOR COMPRESSED SOUND OR SOUND FIELD REPRESENTATIONS
<b>G10L 19/008</b> (2013.01)	3360134	LAYERED CODING AND DATA STRUCTURE FOR COMPRESSED HIGHER-ORDER AMBISONICS SOUND OR SOUND FIELD REPRESENTATIONS
<b>A61K 31/506</b> (2006.01)	3353179	HETEROCYCLIC COMPOUNDS AND USES THEREOF
<b>A61P 35/00</b> (2006.01)	3353179	HETEROCYCLIC COMPOUNDS AND USES THEREOF
<b>C07D 471/04</b> (2006.01)	3353179	HETEROCYCLIC COMPOUNDS AND USES THEREOF
<b>A61M 37/00</b> (2006.01)	3352836	DEVICES AND METHODS FOR ENHANCING THE TOPICAL APPLICATION OF A BENEFIT AGENT
<b>A61N 7/00</b> (2006.01)	3352836	DEVICES AND METHODS FOR ENHANCING THE TOPICAL APPLICATION OF A BENEFIT AGENT
<b>A61M 37/00</b> (2006.01)	3352853	METHODS FOR ENHANCING TOPICAL APPLICATION OF A BENEFIT AGENT
<b>A61N 7/00</b> (2006.01)	3352853	METHODS FOR ENHANCING TOPICAL APPLICATION OF A BENEFIT AGENT
<b>A61K 9/28</b> (2006.01)	3355865	SUSTAINED RELEASE COMPOSITIONS OF 4-AMINOPYRIDINE
<b>A61K 31/4409</b> (2006.01)	3355865	SUSTAINED RELEASE COMPOSITIONS OF 4-AMINOPYRIDINE
<b>A61K 39/00</b> (2006.01)	3356413	ANTI-TIGIT ANTIGEN-BINDING PROTEINS AND METHODS OF USE THEREOF
<b>C07K 16/28</b> (2006.01)	3356413	ANTI-TIGIT ANTIGEN-BINDING PROTEINS AND METHODS OF USE THEREOF
<b>A61K 31/7068</b> (2006.01)	3356414	COMPOSITIONS AND METHODS FOR INHIBITING CANCER STEM CELLS
<b>A61P 35/00</b> (2006.01)	3356414	COMPOSITIONS AND METHODS FOR INHIBITING CANCER STEM CELLS
<b>C07K 16/28</b> (2006.01)	3356414	COMPOSITIONS AND METHODS FOR INHIBITING CANCER STEM CELLS
<b>C07K 16/30</b> (2006.01)	3356414	COMPOSITIONS AND METHODS FOR INHIBITING CANCER STEM CELLS
<b>C12N 5/095</b> (2010.01)	3356414	COMPOSITIONS AND METHODS FOR INHIBITING CANCER STEM CELLS
<b>G01N 33/574</b> (2006.01)	3356414	COMPOSITIONS AND METHODS FOR INHIBITING CANCER STEM CELLS
<b>A61K 31/00</b> (2006.01)	3355919	COMBINATION THERAPY USING INHIBITORS OF HUMAN GROWTH AND DIFFERENTIATION FACTOR 15 (GDF-15) AND IMMUNE CHECKPOINT BLOCKERS
<b>A61K 39/395</b> (2006.01)	3355919	COMBINATION THERAPY USING INHIBITORS OF HUMAN GROWTH AND DIFFERENTIATION FACTOR 15 (GDF-15) AND IMMUNE CHECKPOINT BLOCKERS
<b>C07K 16/22</b> (2006.01)	3355919	COMBINATION THERAPY USING INHIBITORS OF HUMAN GROWTH AND DIFFERENTIATION FACTOR 15 (GDF-15) AND IMMUNE CHECKPOINT BLOCKERS
<b>C07K 16/28</b> (2006.01)	3355919	COMBINATION THERAPY USING INHIBITORS OF HUMAN GROWTH AND DIFFERENTIATION FACTOR 15 (GDF-15) AND IMMUNE CHECKPOINT BLOCKERS
<b>G01N 33/50</b> (2006.01)	3355919	COMBINATION THERAPY USING INHIBITORS OF HUMAN GROWTH AND DIFFERENTIATION FACTOR 15 (GDF-15) AND IMMUNE CHECKPOINT BLOCKERS
<b>G01N 33/574</b> (2006.01)	3355919	COMBINATION THERAPY USING INHIBITORS OF HUMAN GROWTH AND DIFFERENTIATION FACTOR 15 (GDF-15) AND IMMUNE CHECKPOINT BLOCKERS
<b>A61L 27/22</b> (2006.01)	3359210	PERIOSTIN FRAGMENTS AND USE THEREOF
<b>A23L 29/30</b> (2016.01)	3359173	PROBIOTIC FORMULATION
<b>A23L 33/135</b> (2016.01)	3359173	PROBIOTIC FORMULATION
<b>A23P 10/43</b> (2016.01)	3359173	PROBIOTIC FORMULATION

MKP (51)	Broj objave evropske prijava patenta (97)	Naziv pronalaska (54)
<b>A61K 35/741</b> (2015.01)	3359173	PROBIOTIC FORMULATION
<b>A61K 35/745</b> (2015.01)	3359173	PROBIOTIC FORMULATION
<b>A61K 35/747</b> (2015.01)	3359173	PROBIOTIC FORMULATION
<b>A61K 39/00</b> (2006.01)	3359564	ANTIBODIES THAT POTENTLY NEUTRALIZE HEPATITIS B VIRUS AND USES THEREOF
<b>A61K 39/42</b> (2006.01)	3359564	ANTIBODIES THAT POTENTLY NEUTRALIZE HEPATITIS B VIRUS AND USES THEREOF
<b>C07K 14/005</b> (2006.01)	3359564	ANTIBODIES THAT POTENTLY NEUTRALIZE HEPATITIS B VIRUS AND USES THEREOF
<b>C07K 16/08</b> (2006.01)	3359564	ANTIBODIES THAT POTENTLY NEUTRALIZE HEPATITIS B VIRUS AND USES THEREOF
<b>C07K 16/10</b> (2006.01)	3359564	ANTIBODIES THAT POTENTLY NEUTRALIZE HEPATITIS B VIRUS AND USES THEREOF
<b>A01H 5/10</b> (2018.01)	3361858	BRASSICA PLANTS WITH ALTERED PROPERTIES IN SEED PRODUCTION
<b>C12N 9/06</b> (2006.01)	3361858	BRASSICA PLANTS WITH ALTERED PROPERTIES IN SEED PRODUCTION
<b>C12N 15/82</b> (2006.01)	3361858	BRASSICA PLANTS WITH ALTERED PROPERTIES IN SEED PRODUCTION
<b>C07K 16/28</b> (2006.01)	3353212	OPTIMIZED ANTI-CD3 BISPECIFIC ANTIBODIES AND USES THEREOF
<b>C07K 16/30</b> (2006.01)	3353212	OPTIMIZED ANTI-CD3 BISPECIFIC ANTIBODIES AND USES THEREOF
<b>A63B 43/00</b> (2006.01)	3344350	A DEVICE FOR TRAINING AND REHABILITATION
<b>A63B 43/02</b> (2006.01)	3344350	A DEVICE FOR TRAINING AND REHABILITATION
<b>A63B 69/00</b> (2006.01)	3344350	A DEVICE FOR TRAINING AND REHABILITATION
<b>B01F 7/00</b> (2006.01)	3393646	DEVICE AND METHOD FOR MODIFYING POROUS SOLID SUBSTANCES
<b>B01F 7/18</b> (2006.01)	3393646	DEVICE AND METHOD FOR MODIFYING POROUS SOLID SUBSTANCES
<b>B01F 15/00</b> (2006.01)	3393646	DEVICE AND METHOD FOR MODIFYING POROUS SOLID SUBSTANCES
<b>B01F 15/06</b> (2006.01)	3393646	DEVICE AND METHOD FOR MODIFYING POROUS SOLID SUBSTANCES
<b>B01J 8/08</b> (2006.01)	3393646	DEVICE AND METHOD FOR MODIFYING POROUS SOLID SUBSTANCES
<b>B01J 8/10</b> (2006.01)	3393646	DEVICE AND METHOD FOR MODIFYING POROUS SOLID SUBSTANCES
<b>B01J 20/20</b> (2006.01)	3393646	DEVICE AND METHOD FOR MODIFYING POROUS SOLID SUBSTANCES
<b>B01J 20/30</b> (2006.01)	3393646	DEVICE AND METHOD FOR MODIFYING POROUS SOLID SUBSTANCES
<b>B01J 20/32</b> (2006.01)	3393646	DEVICE AND METHOD FOR MODIFYING POROUS SOLID SUBSTANCES
<b>F26B 11/16</b> (2006.01)	3393646	DEVICE AND METHOD FOR MODIFYING POROUS SOLID SUBSTANCES
<b>F26B 25/04</b> (2006.01)	3393646	DEVICE AND METHOD FOR MODIFYING POROUS SOLID SUBSTANCES
<b>D21C 5/02</b> (2006.01)	3362600	PROCESS FOR THE DEINKING OF COATED PAPER OR PAPERBOARD
<b>D21H 19/40</b> (2006.01)	3362600	PROCESS FOR THE DEINKING OF COATED PAPER OR PAPERBOARD
<b>D21H 19/44</b> (2006.01)	3362600	PROCESS FOR THE DEINKING OF COATED PAPER OR PAPERBOARD
<b>D21H 19/52</b> (2006.01)	3362600	PROCESS FOR THE DEINKING OF COATED PAPER OR PAPERBOARD
<b>D21H 19/54</b> (2006.01)	3362600	PROCESS FOR THE DEINKING OF COATED PAPER OR PAPERBOARD
<b>A63H 33/04</b> (2006.01)	3362161	HOLDING DEVICE
<b>A63H 33/06</b> (2006.01)	3362161	HOLDING DEVICE
<b>A63H 33/10</b> (2006.01)	3362161	HOLDING DEVICE
<b>E04B 1/343</b> (2006.01)	3362161	HOLDING DEVICE
<b>A61K 31/195</b> (2006.01)	3364975	COMBINATION OF TRAZODONE AND GABAPENTIN FOR THE TREATMENT OF PAIN
<b>A61K 31/496</b> (2006.01)	3364975	COMBINATION OF TRAZODONE AND GABAPENTIN FOR THE TREATMENT OF PAIN
<b>A61K 45/06</b> (2006.01)	3364975	COMBINATION OF TRAZODONE AND GABAPENTIN FOR THE TREATMENT OF PAIN
<b>A61P 25/02</b> (2006.01)	3364975	COMBINATION OF TRAZODONE AND GABAPENTIN FOR THE TREATMENT OF PAIN

MKP (51)	Broj objave evropske prijava patenta (97)	Naziv pronalaska (54)
<b>A61P 25/04</b> (2006.01)	3364975	COMBINATION OF TRAZODONE AND GABAPENTIN FOR THE TREATMENT OF PAIN
<b>A61M 37/00</b> (2006.01)	3352837	METHODS FOR ENHANCING TOPICAL APPLICATION OF A BENEFIT AGENT
<b>A61N 7/00</b> (2006.01)	3352837	METHODS FOR ENHANCING TOPICAL APPLICATION OF A BENEFIT AGENT
<b>F04D 29/42</b> (2006.01)	3269984	PUMP EQUIPPED WITH IMPROVED FLANGES
<b>F04D 29/60</b> (2006.01)	3269984	PUMP EQUIPPED WITH IMPROVED FLANGES
<b>A61K 31/4025</b> (2006.01)	3252037	PYRROLIDINE DERIVATIVES AS OXYTOCIN / VASOPRESSIN V1A RECEPTORS ANTAGONISTS
<b>A61P 5/10</b> (2006.01)	3252037	PYRROLIDINE DERIVATIVES AS OXYTOCIN / VASOPRESSIN V1A RECEPTORS ANTAGONISTS
<b>C07D 207/22</b> (2006.01)	3252037	PYRROLIDINE DERIVATIVES AS OXYTOCIN / VASOPRESSIN V1A RECEPTORS ANTAGONISTS
<b>C07D 401/12</b> (2006.01)	3263566	BICYCLO[3.2.1]OCTYL AMIDE DERIVATIVES AS ALLOSTERIC MODULATORS OF THE METABOTROPIC GLUTAMATE RECEPTOR 5 (MGLU5 OR MGLUR5) FOR THE TREATMENT OF CENTRAL NERVOUS SYSTEM (CNS) DISORDERS
<b>A61K 38/46</b> (2006.01)	3272356	COMPOSITIONS AND METHODS FOR THE TREATMENT OF HEMOGLOBINOPATHIES
<b>C12N 9/22</b> (2006.01)	3272356	COMPOSITIONS AND METHODS FOR THE TREATMENT OF HEMOGLOBINOPATHIES
<b>G01B 11/06</b> (2006.01)	3264033	SYSTEMS AND METHODS OF USING ABSORPTIVE AND NON ABSORPTIVE IMAGING METROLOGY TO MEASURE THE THICKNESS OF OPHTHALMIC LENSES
<b>G02B 1/04</b> (2006.01)	3264033	SYSTEMS AND METHODS OF USING ABSORPTIVE AND NON ABSORPTIVE IMAGING METROLOGY TO MEASURE THE THICKNESS OF OPHTHALMIC LENSES
<b>A61K 31/4418</b> (2006.01)	3255041	PYRIMIDINES AS SODIUM CHANNEL BLOCKERS
<b>A61P 25/08</b> (2006.01)	3255041	PYRIMIDINES AS SODIUM CHANNEL BLOCKERS
<b>C07D 233/90</b> (2006.01)	3255041	PYRIMIDINES AS SODIUM CHANNEL BLOCKERS
<b>C07D 401/12</b> (2006.01)	3255041	PYRIMIDINES AS SODIUM CHANNEL BLOCKERS
<b>C07D 401/14</b> (2006.01)	3255041	PYRIMIDINES AS SODIUM CHANNEL BLOCKERS
<b>C07D 403/04</b> (2006.01)	3255041	PYRIMIDINES AS SODIUM CHANNEL BLOCKERS
<b>C07D 403/12</b> (2006.01)	3255041	PYRIMIDINES AS SODIUM CHANNEL BLOCKERS
<b>C07D 405/12</b> (2006.01)	3255041	PYRIMIDINES AS SODIUM CHANNEL BLOCKERS
<b>C07D 405/14</b> (2006.01)	3255041	PYRIMIDINES AS SODIUM CHANNEL BLOCKERS
<b>C12Q 1/18</b> (2006.01)	3399050	A TEST STRIP FOR MINIMAL INHIBITION CONCENTRATION (MIC) DETECTION
<b>G01N 33/487</b> (2006.01)	3399050	A TEST STRIP FOR MINIMAL INHIBITION CONCENTRATION (MIC) DETECTION
<b>A61B 17/28</b> (2006.01)	3263054	ULTRASONIC SURGICAL INSTRUMENTS HAVING CLAMP
<b>A61B 17/32</b> (2006.01)	3263054	ULTRASONIC SURGICAL INSTRUMENTS HAVING CLAMP
<b>A61B 18/14</b> (2006.01)	3263054	ULTRASONIC SURGICAL INSTRUMENTS HAVING CLAMP
<b>A61K 9/00</b> (2006.01)	3263178	FORMULATION FOR ANTI-ALPHA4BETA7 ANTIBODY
<b>A61K 9/19</b> (2006.01)	3263178	FORMULATION FOR ANTI-ALPHA4BETA7 ANTIBODY
<b>A61K 39/00</b> (2006.01)	3263178	FORMULATION FOR ANTI-ALPHA4BETA7 ANTIBODY
<b>A61K 39/395</b> (2006.01)	3263178	FORMULATION FOR ANTI-ALPHA4BETA7 ANTIBODY
<b>A61K 47/18</b> (2017.01)	3263178	FORMULATION FOR ANTI-ALPHA4BETA7 ANTIBODY
<b>A61K 47/26</b> (2006.01)	3263178	FORMULATION FOR ANTI-ALPHA4BETA7 ANTIBODY
<b>A61P 1/00</b> (2006.01)	3263178	FORMULATION FOR ANTI-ALPHA4BETA7 ANTIBODY
<b>C07K 16/28</b> (2006.01)	3263178	FORMULATION FOR ANTI-ALPHA4BETA7 ANTIBODY
<b>A61K 9/00</b> (2006.01)	3311834	FORMULATION FOR ANTI-ALPHA4BETA7 ANTIBODY
<b>A61K 39/395</b> (2006.01)	3311834	FORMULATION FOR ANTI-ALPHA4BETA7 ANTIBODY
<b>A61K 47/12</b> (2006.01)	3311834	FORMULATION FOR ANTI-ALPHA4BETA7 ANTIBODY
<b>A61K 47/14</b> (2017.01)	3311834	FORMULATION FOR ANTI-ALPHA4BETA7 ANTIBODY
<b>A61K 47/18</b> (2017.01)	3311834	FORMULATION FOR ANTI-ALPHA4BETA7 ANTIBODY
<b>A61K 47/26</b> (2006.01)	3311834	FORMULATION FOR ANTI-ALPHA4BETA7 ANTIBODY
<b>F01M 1/18</b> (2006.01)	3269950	CONTROL VALVE FOR SUPPLYING ONE OR MORE NOZZLES WITH A PRESSURIZED FLUID
<b>F01M 5/00</b> (2006.01)	3269950	CONTROL VALVE FOR SUPPLYING ONE OR MORE NOZZLES WITH A PRESSURIZED FLUID
<b>F01P 3/06</b> (2006.01)	3269950	CONTROL VALVE FOR SUPPLYING ONE OR MORE NOZZLES WITH A PRESSURIZED FLUID
<b>F01P 7/14</b> (2006.01)	3269950	CONTROL VALVE FOR SUPPLYING ONE OR MORE NOZZLES WITH A PRESSURIZED FLUID
<b>F16K 31/06</b> (2006.01)	3269950	CONTROL VALVE FOR SUPPLYING ONE OR MORE NOZZLES WITH A PRESSURIZED FLUID



MKP (51)	Broj objave evropske prijava patenta (97)	Naziv pronalaska (54)
<b>A61J 1/10</b> (2006.01)	3409259	MULTI CHAMBER FLEXIBLE BAG AND METHODS OF USING SAME
<b>A61J 1/20</b> (2006.01)	3409259	MULTI CHAMBER FLEXIBLE BAG AND METHODS OF USING SAME
<b>F26B 5/06</b> (2006.01)	3409259	MULTI CHAMBER FLEXIBLE BAG AND METHODS OF USING SAME
<b>A61K 9/00</b> (2006.01)	3311845	THERAPEUTIC POLYMERIC NANOPARTICLES AND METHODS OF MAKING AND USING SAME
<b>A61K 9/51</b> (2006.01)	3311845	THERAPEUTIC POLYMERIC NANOPARTICLES AND METHODS OF MAKING AND USING SAME
<b>A61K 31/00</b> (2006.01)	3311845	THERAPEUTIC POLYMERIC NANOPARTICLES AND METHODS OF MAKING AND USING SAME
<b>A61K 47/12</b> (2006.01)	3311845	THERAPEUTIC POLYMERIC NANOPARTICLES AND METHODS OF MAKING AND USING SAME
<b>A61K 9/08</b> (2006.01)	3257498	BIODEGRADABLE DRUG DELIVERY COMPOSITIONS
<b>A61K 47/34</b> (2017.01)	3257498	BIODEGRADABLE DRUG DELIVERY COMPOSITIONS
<b>A61K 31/585</b> (2006.01)	3296313	CERTAIN CHEMICAL ENTITIES, COMPOSITIONS, AND METHODS
<b>A61P 35/00</b> (2006.01)	3296313	CERTAIN CHEMICAL ENTITIES, COMPOSITIONS, AND METHODS
<b>C07J 19/00</b> (2006.01)	3296313	CERTAIN CHEMICAL ENTITIES, COMPOSITIONS, AND METHODS
<b>B29D 11/00</b> (2006.01)	3273293	MOLD FOR CONTACT LENS WITH NON-ROTATIONALLY SYMMETRIC RIM OR EDGE
<b>G02C 7/04</b> (2006.01)	3273293	MOLD FOR CONTACT LENS WITH NON-ROTATIONALLY SYMMETRIC RIM OR EDGE
<b>E01C 5/00</b> (2006.01)	3272937	STREET SHOULDER SLAB
<b>E01C 11/22</b> (2006.01)	3272937	STREET SHOULDER SLAB
<b>E01F 9/529</b> (2016.01)	3272937	STREET SHOULDER SLAB
<b>G01N 33/68</b> (2006.01)	3290922	ATYPICAL HEMOLYTIC UREMIC SYNDROME (AHUS) BIOMARKER PROTEINS
<b>A61K 31/4188</b> (2006.01)	3272754	IMIDAZOPYRROLIDINONE COMPOUNDS
<b>A61P 35/00</b> (2006.01)	3272754	IMIDAZOPYRROLIDINONE COMPOUNDS
<b>C07D 487/04</b> (2006.01)	3272754	IMIDAZOPYRROLIDINONE COMPOUNDS
<b>C12N 5/074</b> (2010.01)	3282015	METHOD FOR CELLULAR RNA EXPRESSION
<b>C12N 5/16</b> (2006.01)	3282015	METHOD FOR CELLULAR RNA EXPRESSION
<b>C12N 9/12</b> (2006.01)	3282015	METHOD FOR CELLULAR RNA EXPRESSION
<b>C12N 15/63</b> (2006.01)	3282015	METHOD FOR CELLULAR RNA EXPRESSION
<b>C12N 15/67</b> (2006.01)	3282015	METHOD FOR CELLULAR RNA EXPRESSION
<b>B21D 13/04</b> (2006.01)	3287208	A MACHINE FOR SHAPING A METAL SHEET AND SHEET SO OBTAINED
<b>B21D 22/10</b> (2006.01)	3287208	A MACHINE FOR SHAPING A METAL SHEET AND SHEET SO OBTAINED
<b>B21H 8/00</b> (2006.01)	3287208	A MACHINE FOR SHAPING A METAL SHEET AND SHEET SO OBTAINED
<b>B44B 5/00</b> (2006.01)	3287208	A MACHINE FOR SHAPING A METAL SHEET AND SHEET SO OBTAINED
<b>C07D 211/96</b> (2006.01)	3312160	HEPATITIS B ANTIVIRAL AGENTS
<b>C12Q 1/68</b> (2018.01)	3263717	NOVEL TISSUE PROTECTIVE ERYTHROPOIETIN RECEPTOR (NEPOR) AND METHODS OF USE
<b>G01N 33/50</b> (2006.01)	3263717	NOVEL TISSUE PROTECTIVE ERYTHROPOIETIN RECEPTOR (NEPOR) AND METHODS OF USE
<b>B61G 9/02</b> (2006.01)	3275761	TRACTION ASSEMBLY FOR RAILWAY COUPLING AND RAILWAY VEHICLE INCLUDING SUCH AN ASSEMBLY
<b>B61G 9/04</b> (2006.01)	3275761	TRACTION ASSEMBLY FOR RAILWAY COUPLING AND RAILWAY VEHICLE INCLUDING SUCH AN ASSEMBLY
<b>B61F 1/08</b> (2006.01)	3275760	UNDERFRAME SIDE SILL AND RAILWAY VEHICLE COMPRISING SUCH A SIDE SILL
<b>E06B 7/215</b> (2006.01)	3290627	SEAL WITH A LIMIT ON THE MOVEMENT OF THE SEALING STRIP
<b>B61C 9/38</b> (2006.01)	3279054	MOTOR ASSEMBLY FOR A RAILWAY AXLE HAVING A CONTINUOUS VARIATION WITH AN ENERGY RECOVERY, AND RAILWAY WAGON COMPOSITION WITH TOPICAL ANAESTHETIC EFFECT AND THE USE THEREOF
<b>A61K 9/00</b> (2006.01)	3415163	COMPOSITION WITH TOPICAL ANAESTHETIC EFFECT AND THE USE THEREOF
<b>A61K 9/08</b> (2006.01)	3415163	COMPOSITION WITH TOPICAL ANAESTHETIC EFFECT AND THE USE THEREOF
<b>A61K 31/167</b> (2006.01)	3415163	COMPOSITION WITH TOPICAL ANAESTHETIC EFFECT AND THE USE THEREOF
<b>A61K 31/728</b> (2006.01)	3415163	COMPOSITION WITH TOPICAL ANAESTHETIC EFFECT AND THE USE THEREOF
<b>A61K 31/737</b> (2006.01)	3415163	COMPOSITION WITH TOPICAL ANAESTHETIC EFFECT AND THE USE THEREOF
<b>A61K 45/06</b> (2006.01)	3415163	COMPOSITION WITH TOPICAL ANAESTHETIC EFFECT AND THE USE THEREOF

MKP (51)	Broj objave evropske prijava patenta (97)	Naziv pronalaska (54)
<b>A61K 47/02</b> (2006.01)	3415163	COMPOSITION WITH TOPICAL ANAESTHETIC EFFECT AND THE USE THEREOF
<b>A61K 47/36</b> (2006.01)	3415163	COMPOSITION WITH TOPICAL ANAESTHETIC EFFECT AND THE USE THEREOF
<b>A61P 13/02</b> (2006.01)	3415163	COMPOSITION WITH TOPICAL ANAESTHETIC EFFECT AND THE USE THEREOF
<b>A61P 13/10</b> (2006.01)	3415163	COMPOSITION WITH TOPICAL ANAESTHETIC EFFECT AND THE USE THEREOF
<b>A61K 31/4375</b> (2006.01)	3266782	FLUORINATED INTEGRIN ANTAGONISTS
<b>A61K 31/444</b> (2006.01)	3266782	FLUORINATED INTEGRIN ANTAGONISTS
<b>A61K 31/506</b> (2006.01)	3266782	FLUORINATED INTEGRIN ANTAGONISTS
<b>A61K 45/06</b> (2006.01)	3266782	FLUORINATED INTEGRIN ANTAGONISTS
<b>A61P 3/10</b> (2006.01)	3266782	FLUORINATED INTEGRIN ANTAGONISTS
<b>A61P 27/00</b> (2006.01)	3266782	FLUORINATED INTEGRIN ANTAGONISTS
<b>C07D 471/04</b> (2006.01)	3266782	FLUORINATED INTEGRIN ANTAGONISTS
<b>C07H 21/02</b> (2006.01)	3312189	MODULATION OF HEPATITIS B VIRUS (HBV) EXPRESSION
<b>A47J 31/40</b> (2006.01)	3298933	METHOD AND DEVICE FOR PROVIDING A HOT DRINK
<b>A47J 31/56</b> (2006.01)	3298933	METHOD AND DEVICE FOR PROVIDING A HOT DRINK
<b>G09F 17/00</b> (2006.01)	3291211	FOLDING BANNER SUPPORT ASSEMBLY
<b>A61K 31/7088</b> (2006.01)	3312281	COMPLEMENT COMPONENT C5 IRNA COMPOSITIONS AND METHODS OF USE THEREOF
<b>C12N 15/113</b> (2010.01)	3312281	COMPLEMENT COMPONENT C5 IRNA COMPOSITIONS AND METHODS OF USE THEREOF
<b>C07D 237/32</b> (2006.01)	3275870	FUSED HETEROCYCLIC COMPOUNDS AS ION CHANNEL MODULATORS
<b>A61K 31/00</b> (2006.01)	3305285	ANTI-ANDROGENS FOR THE TREATMENT OF NON-METASTATIC CASTRATE-RESISTANT PROSTATE CANCER
<b>A61K 31/4166</b> (2006.01)	3305285	ANTI-ANDROGENS FOR THE TREATMENT OF NON-METASTATIC CASTRATE-RESISTANT PROSTATE CANCER
<b>A61K 31/4439</b> (2006.01)	3305285	ANTI-ANDROGENS FOR THE TREATMENT OF NON-METASTATIC CASTRATE-RESISTANT PROSTATE CANCER
<b>A61P 35/00</b> (2006.01)	3305285	ANTI-ANDROGENS FOR THE TREATMENT OF NON-METASTATIC CASTRATE-RESISTANT PROSTATE CANCER
<b>A61K 9/00</b> (2006.01)	3383958	METHOD FOR THE PRODUCTION OF GRANULES COMPRISING SURFACE-REACTED CALCIUM CARBONATE
<b>C09C 1/02</b> (2006.01)	3383958	METHOD FOR THE PRODUCTION OF GRANULES COMPRISING SURFACE-REACTED CALCIUM CARBONATE
<b>A61K 31/437</b> (2006.01)	3386979	2-PHENYL-3-(PIPERAZINOMETHYL)IMIDAZO[1,2-A]PYRIDINE DERIVATIVES AS BLOCKERS OF TASK-1 AND TASK-2 CHANNELS, FOR THE TREATMENT OF SLEEP-RELATED BREATHING DISORDERS
<b>A61P 11/00</b> (2006.01)	3386979	2-PHENYL-3-(PIPERAZINOMETHYL)IMIDAZO[1,2-A]PYRIDINE DERIVATIVES AS BLOCKERS OF TASK-1 AND TASK-2 CHANNELS, FOR THE TREATMENT OF SLEEP-RELATED BREATHING DISORDERS
<b>C07D 471/04</b> (2006.01)	3386979	2-PHENYL-3-(PIPERAZINOMETHYL)IMIDAZO[1,2-A]PYRIDINE DERIVATIVES AS BLOCKERS OF TASK-1 AND TASK-2 CHANNELS, FOR THE TREATMENT OF SLEEP-RELATED BREATHING DISORDERS
<b>A61K 9/14</b> (2006.01)	3386485	PHARMACEUTICAL COMPOSITION COMPRISING A POTENT INHIBITOR OF URAT1
<b>A61K 31/404</b> (2006.01)	3383858	INHIBITORS OF METALLO-BETA-LACTAMASES
<b>A61P 31/04</b> (2006.01)	3383858	INHIBITORS OF METALLO-BETA-LACTAMASES
<b>C07D 209/42</b> (2006.01)	3383858	INHIBITORS OF METALLO-BETA-LACTAMASES
<b>C07D 401/04</b> (2006.01)	3383858	INHIBITORS OF METALLO-BETA-LACTAMASES
<b>C07D 403/04</b> (2006.01)	3383858	INHIBITORS OF METALLO-BETA-LACTAMASES
<b>C07D 413/10</b> (2006.01)	3383858	INHIBITORS OF METALLO-BETA-LACTAMASES
<b>C07D 471/04</b> (2006.01)	3383858	INHIBITORS OF METALLO-BETA-LACTAMASES
<b>A61F 5/44</b> (2006.01)	3389575	DEVICE ALLOWING AN ALIMENTARY BOLUS FLOW BETWEEN TWO STOMAS
<b>A61F 5/445</b> (2006.01)	3389575	DEVICE ALLOWING AN ALIMENTARY BOLUS FLOW BETWEEN TWO STOMAS
<b>A61M 1/00</b> (2006.01)	3389575	DEVICE ALLOWING AN ALIMENTARY BOLUS FLOW BETWEEN TWO STOMAS
<b>A61F 2/24</b> (2006.01)	3370648	MITRAL VALVE PROSTHESIS
<b>A61K 31/7052</b> (2006.01)	3380486	PRODRUGS OF A JAK INHIBITOR COMPOUND FOR TREATMENT OF GASTROINTESTINAL INFLAMMATORY DISEASE

MKP (51)	Broj objave evropske prijava patenta (97)	Naziv pronalaska (54)
<b>A61P 1/04</b> (2006.01)	3380486	PRODRUGS OF A JAK INHIBITOR COMPOUND FOR TREATMENT OF GASTROINTESTINAL INFLAMMATORY DISEASE
<b>C07D 487/04</b> (2006.01)	3380486	PRODRUGS OF A JAK INHIBITOR COMPOUND FOR TREATMENT OF GASTROINTESTINAL INFLAMMATORY DISEASE
<b>C07H 15/26</b> (2006.01)	3380486	PRODRUGS OF A JAK INHIBITOR COMPOUND FOR TREATMENT OF GASTROINTESTINAL INFLAMMATORY DISEASE
<b>A61K 39/00</b> (2006.01)	3380196	HETERODIMERIC ANTIBODIES THAT BIND CD3 AND CD38
<b>A61P 35/02</b> (2006.01)	3380196	HETERODIMERIC ANTIBODIES THAT BIND CD3 AND CD38
<b>C07K 16/28</b> (2006.01)	3380196	HETERODIMERIC ANTIBODIES THAT BIND CD3 AND CD38
<b>C07K 16/30</b> (2006.01)	3380196	HETERODIMERIC ANTIBODIES THAT BIND CD3 AND CD38
<b>C07K 16/46</b> (2006.01)	3380196	HETERODIMERIC ANTIBODIES THAT BIND CD3 AND CD38
<b>C12M 1/00</b> (2006.01)	3374511	METHOD FOR POULTRY LITTER FERMENTATION AND BIOGAS PRODUCTION
<b>C12M 1/107</b> (2006.01)	3374511	METHOD FOR POULTRY LITTER FERMENTATION AND BIOGAS PRODUCTION
<b>C12P 5/02</b> (2006.01)	3374511	METHOD FOR POULTRY LITTER FERMENTATION AND BIOGAS PRODUCTION
<b>B65D 6/18</b> (2006.01)	3377416	CONTAINER MADE OF PLASTIC
<b>B65D 6/34</b> (2006.01)	3377416	CONTAINER MADE OF PLASTIC
<b>B65D 21/02</b> (2006.01)	3377416	CONTAINER MADE OF PLASTIC
<b>B65D 85/34</b> (2006.01)	3377416	CONTAINER MADE OF PLASTIC
<b>A61K 39/00</b> (2006.01)	3383425	BIPARATOPIC POLYPEPTIDES ANTAGONIZING WNT SIGNALING IN TUMOR CELLS
<b>A61P 35/00</b> (2006.01)	3383425	BIPARATOPIC POLYPEPTIDES ANTAGONIZING WNT SIGNALING IN TUMOR CELLS
<b>C07K 16/18</b> (2006.01)	3383425	BIPARATOPIC POLYPEPTIDES ANTAGONIZING WNT SIGNALING IN TUMOR CELLS
<b>C07K 16/28</b> (2006.01)	3383425	BIPARATOPIC POLYPEPTIDES ANTAGONIZING WNT SIGNALING IN TUMOR CELLS
<b>C07K 16/46</b> (2006.01)	3383425	BIPARATOPIC POLYPEPTIDES ANTAGONIZING WNT SIGNALING IN TUMOR CELLS
<b>A61K 9/00</b> (2006.01)	3413868	OPHTHALMIC COMPOSITION FOR THE USE IN THE TREATMENT OF EYE DISORDERS RELATED TO ALTERATIONS OF THE CORNEAL CONJUNCTIVAL SURFACE
<b>A61K 31/7032</b> (2006.01)	3413868	OPHTHALMIC COMPOSITION FOR THE USE IN THE TREATMENT OF EYE DISORDERS RELATED TO ALTERATIONS OF THE CORNEAL CONJUNCTIVAL SURFACE
<b>A61K 31/728</b> (2006.01)	3413868	OPHTHALMIC COMPOSITION FOR THE USE IN THE TREATMENT OF EYE DISORDERS RELATED TO ALTERATIONS OF THE CORNEAL CONJUNCTIVAL SURFACE
<b>A61P 27/02</b> (2006.01)	3413868	OPHTHALMIC COMPOSITION FOR THE USE IN THE TREATMENT OF EYE DISORDERS RELATED TO ALTERATIONS OF THE CORNEAL CONJUNCTIVAL SURFACE
<b>A61K 31/4709</b> (2006.01)	3383867	COMPOUNDS HAVING MUSCARINIC RECEPTOR ANTAGONIST AND BETA2 ADRENERGIC RECEPTOR AGONIST ACTIVITY
<b>C07D 401/12</b> (2006.01)	3383867	COMPOUNDS HAVING MUSCARINIC RECEPTOR ANTAGONIST AND BETA2 ADRENERGIC RECEPTOR AGONIST ACTIVITY
<b>C07D 409/14</b> (2006.01)	3383867	COMPOUNDS HAVING MUSCARINIC RECEPTOR ANTAGONIST AND BETA2 ADRENERGIC RECEPTOR AGONIST ACTIVITY
<b>C07D 471/08</b> (2006.01)	3383867	COMPOUNDS HAVING MUSCARINIC RECEPTOR ANTAGONIST AND BETA2 ADRENERGIC RECEPTOR AGONIST ACTIVITY
<b>C12Q 1/68</b> (2018.01)	3384045	METHOD FOR DETERMINING CELL CLONALITY
<b>A61B 1/307</b> (2006.01)	3349641	ADAPTER, PROCESS AND USE FOR INSTILLATION OF AGENTS INTO THE BLADDER THROUGH THE URETHRA WITHOUT CATHETER
<b>A61M 3/02</b> (2006.01)	3349641	ADAPTER, PROCESS AND USE FOR INSTILLATION OF AGENTS INTO THE BLADDER THROUGH THE URETHRA WITHOUT CATHETER
<b>G01N 33/68</b> (2006.01)	3377908	BIOMARKER OF POLYCYSTIC KIDNEY DISEASE AND USES THEREOF
<b>G01N 33/68</b> (2006.01)	3377909	LACTOFERRIN FOR USE IN THE DIAGNOSIS OR PROGNOSIS OF ALZHEIMER'S DISEASE, OR IN THE DIAGNOSIS OF PARKINSON'S DISEASE
<b>C12N 5/00</b> (2006.01)	3365678	METHODS FOR CULTURING CELLS AND KITS AND APPARATUS FOR SAME
<b>C12N 5/0775</b> (2010.01)	3365678	METHODS FOR CULTURING CELLS AND KITS AND APPARATUS FOR SAME
<b>G01N 33/569</b> (2006.01)	3365678	METHODS FOR CULTURING CELLS AND KITS AND APPARATUS FOR SAME
<b>A61K 9/00</b> (2006.01)	3383364	FORMULATIONS FOR INTRAVENOUS INJECTION OF DANIRIXIN

MKP (51)	Broj objave evropske prijava patenta (97)	Naziv pronalaska (54)
<b>A61K 9/19</b> (2006.01)	3383364	FORMULATIONS FOR INTRAVENOUS INJECTION OF DANIRIXIN
<b>A61K 47/26</b> (2006.01)	3383364	FORMULATIONS FOR INTRAVENOUS INJECTION OF DANIRIXIN
<b>A61K 47/40</b> (2006.01)	3383364	FORMULATIONS FOR INTRAVENOUS INJECTION OF DANIRIXIN
<b>C07K 16/28</b> (2006.01)	3383907	COMBINATION TREATMENTS AND USES AND METHODS THEREOF
<b>C07K 14/54</b> (2006.01)	3383891	ANTIBODY CYTOKINE ENGRAFTED COMPOSITIONS AND METHODS OF USE FOR IMMUNOREGULATION
<b>A61K 35/17</b> (2015.01)	3370762	CHIMERIC RECEPTORS CONTAINING TRAF-INDUCING DOMAINS AND RELATED COMPOSITIONS AND METHODS
<b>A61K 39/00</b> (2006.01)	3370762	CHIMERIC RECEPTORS CONTAINING TRAF-INDUCING DOMAINS AND RELATED COMPOSITIONS AND METHODS
<b>C07K 14/00</b> (2006.01)	3370762	CHIMERIC RECEPTORS CONTAINING TRAF-INDUCING DOMAINS AND RELATED COMPOSITIONS AND METHODS
<b>C07K 14/705</b> (2006.01)	3370762	CHIMERIC RECEPTORS CONTAINING TRAF-INDUCING DOMAINS AND RELATED COMPOSITIONS AND METHODS
<b>G01N 33/574</b> (2006.01)	3371601	FLOW CYTOMETRY FOR MONITORING HISTONE H3 METHYLATION STATUS
<b>A61K 38/16</b> (2006.01)	3387010	COMPOSITIONS AND METHODS FOR EXPRESSION OF MULTIPLE BIOLOGICALLY ACTIVE POLYPEPTIDES FROM A SINGLE VECTOR FOR TREATMENT OF CARDIAC CONDITIONS AND OTHER PATHOLOGIES
<b>A61K 48/00</b> (2006.01)	3387010	COMPOSITIONS AND METHODS FOR EXPRESSION OF MULTIPLE BIOLOGICALLY ACTIVE POLYPEPTIDES FROM A SINGLE VECTOR FOR TREATMENT OF CARDIAC CONDITIONS AND OTHER PATHOLOGIES
<b>C07K 14/52</b> (2006.01)	3387010	COMPOSITIONS AND METHODS FOR EXPRESSION OF MULTIPLE BIOLOGICALLY ACTIVE POLYPEPTIDES FROM A SINGLE VECTOR FOR TREATMENT OF CARDIAC CONDITIONS AND OTHER PATHOLOGIES
<b>C12N 15/62</b> (2006.01)	3387010	COMPOSITIONS AND METHODS FOR EXPRESSION OF MULTIPLE BIOLOGICALLY ACTIVE POLYPEPTIDES FROM A SINGLE VECTOR FOR TREATMENT OF CARDIAC CONDITIONS AND OTHER PATHOLOGIES
<b>A61K 38/57</b> (2006.01)	3377093	RECOMBINANT HUMAN C1 ESTERASE INHIBITOR AND USES THEREOF
<b>C07K 14/81</b> (2006.01)	3377093	RECOMBINANT HUMAN C1 ESTERASE INHIBITOR AND USES THEREOF
<b>A61K 39/00</b> (2006.01)	3380522	ANTIBODY MOLECULES TO APRIL AND USES THEREOF
<b>A61K 39/395</b> (2006.01)	3380522	ANTIBODY MOLECULES TO APRIL AND USES THEREOF
<b>C07K 16/28</b> (2006.01)	3380522	ANTIBODY MOLECULES TO APRIL AND USES THEREOF
<b>A61K 39/00</b> (2006.01)	3371224	COMPOSITIONS COMPRISING IL6R ANTIBODIES FOR THE TREATMENT OF UVEITIS AND MACULAR EDEMA AND METHODS OF USING SAME
<b>A61K 39/395</b> (2006.01)	3371224	COMPOSITIONS COMPRISING IL6R ANTIBODIES FOR THE TREATMENT OF UVEITIS AND MACULAR EDEMA AND METHODS OF USING SAME
<b>A61P 27/02</b> (2006.01)	3371224	COMPOSITIONS COMPRISING IL6R ANTIBODIES FOR THE TREATMENT OF UVEITIS AND MACULAR EDEMA AND METHODS OF USING SAME
<b>C07K 16/28</b> (2006.01)	3371224	COMPOSITIONS COMPRISING IL6R ANTIBODIES FOR THE TREATMENT OF UVEITIS AND MACULAR EDEMA AND METHODS OF USING SAME
<b>A61K 31/00</b> (2006.01)	3380091	TARGETING OF THE FORMYL-PEPTIDE RECEPTOR 2/LIPOXIN A4 RECEPTOR (FPR2/ALX) FOR TREATMENT OF HEART DISEASE
<b>A61K 31/4152</b> (2006.01)	3380091	TARGETING OF THE FORMYL-PEPTIDE RECEPTOR 2/LIPOXIN A4 RECEPTOR (FPR2/ALX) FOR TREATMENT OF HEART DISEASE
<b>A61P 9/00</b> (2006.01)	3380091	TARGETING OF THE FORMYL-PEPTIDE RECEPTOR 2/LIPOXIN A4 RECEPTOR (FPR2/ALX) FOR TREATMENT OF HEART DISEASE
<b>A61P 9/10</b> (2006.01)	3380091	TARGETING OF THE FORMYL-PEPTIDE RECEPTOR 2/LIPOXIN A4 RECEPTOR (FPR2/ALX) FOR TREATMENT OF HEART DISEASE
<b>A01N 31/08</b> (2006.01)	3380413	PACKAGING FOR FRUIT AND VEGETABLE PRODUCTS TREATED WITH AN ANTIMICROBIAL SOLUTION
<b>A23B 7/154</b> (2006.01)	3380413	PACKAGING FOR FRUIT AND VEGETABLE PRODUCTS TREATED WITH AN ANTIMICROBIAL SOLUTION
<b>B65D 85/34</b> (2006.01)	3380413	PACKAGING FOR FRUIT AND VEGETABLE PRODUCTS TREATED WITH AN ANTIMICROBIAL SOLUTION
<b>A23L 3/18</b> (2006.01)	3389398	INSTALLATION AND METHOD FOR SANITIZING FOOD PRODUCTS
<b>A23L 3/30</b> (2006.01)	3389398	INSTALLATION AND METHOD FOR SANITIZING FOOD PRODUCTS
<b>A23L 3/3418</b> (2006.01)	3389398	INSTALLATION AND METHOD FOR SANITIZING FOOD PRODUCTS

MKP	Broj objave evropske prijave patenta	Naziv pronalaska
(51)	(97)	(54)
<b>A23L 3/358</b> (2006.01)	3389398	INSTALLATION AND METHOD FOR SANITIZING FOOD PRODUCTS
<b>A23L 3/3589</b> (2006.01)	3389398	INSTALLATION AND METHOD FOR SANITIZING FOOD PRODUCTS
<b>A61L 2/07</b> (2006.01)	3389398	INSTALLATION AND METHOD FOR SANITIZING FOOD PRODUCTS
<b>A61L 2/18</b> (2006.01)	3389398	INSTALLATION AND METHOD FOR SANITIZING FOOD PRODUCTS
<b>A61L 2/22</b> (2006.01)	3389398	INSTALLATION AND METHOD FOR SANITIZING FOOD PRODUCTS
<b>C07H 1/00</b> (2006.01)	3386998	DIASTEREOSELECTIVE SYNTHESIS OF PHOSPHATE DERIVATIVES AND OF THE GEMCITABINE PRODRUG NUC-1031
<b>C07H 19/06</b> (2006.01)	3386998	DIASTEREOSELECTIVE SYNTHESIS OF PHOSPHATE DERIVATIVES AND OF THE GEMCITABINE PRODRUG NUC-1031
<b>A47J 31/54</b> (2006.01)	3364835	METHOD, MACHINE AND BOILER FOR THE PREPARATION OF BEVERAGES
<b>F24H 1/10</b> (2006.01)	3364835	METHOD, MACHINE AND BOILER FOR THE PREPARATION OF BEVERAGES
<b>A47J 31/54</b> (2006.01)	3364836	METHOD AND MACHINE FOR PREPARING BEVERAGES
<b>F24H 1/10</b> (2006.01)	3364836	METHOD AND MACHINE FOR PREPARING BEVERAGES
<b>A21B 1/48</b> (2006.01)	3364765	METHOD AND APPARATUS FOR MAKING PANIGACCI
<b>A21B 5/02</b> (2006.01)	3364765	METHOD AND APPARATUS FOR MAKING PANIGACCI
<b>A61K 51/04</b> (2006.01)	3389727	RADIOLABELLED MGLUR2/3 PET LIGANDS
<b>A61K 101/02</b> (2006.01)	3389727	RADIOLABELLED MGLUR2/3 PET LIGANDS
<b>C07B 59/00</b> (2006.01)	3389727	RADIOLABELLED MGLUR2/3 PET LIGANDS
<b>C07D 487/04</b> (2006.01)	3389727	RADIOLABELLED MGLUR2/3 PET LIGANDS
<b>A61K 31/513</b> (2006.01)	3383860	APELIN RECEPTOR AGONISTS AND METHODS OF USE
<b>A61P 9/04</b> (2006.01)	3383860	APELIN RECEPTOR AGONISTS AND METHODS OF USE
<b>A61P 9/10</b> (2006.01)	3383860	APELIN RECEPTOR AGONISTS AND METHODS OF USE
<b>A61P 9/12</b> (2006.01)	3383860	APELIN RECEPTOR AGONISTS AND METHODS OF USE
<b>C07D 239/54</b> (2006.01)	3383860	APELIN RECEPTOR AGONISTS AND METHODS OF USE
<b>C07D 401/10</b> (2006.01)	3383860	APELIN RECEPTOR AGONISTS AND METHODS OF USE
<b>C07D 401/14</b> (2006.01)	3383860	APELIN RECEPTOR AGONISTS AND METHODS OF USE
<b>C07D 403/06</b> (2006.01)	3383860	APELIN RECEPTOR AGONISTS AND METHODS OF USE
<b>C07D 403/10</b> (2006.01)	3383860	APELIN RECEPTOR AGONISTS AND METHODS OF USE
<b>C07D 413/06</b> (2006.01)	3383860	APELIN RECEPTOR AGONISTS AND METHODS OF USE
<b>C07D 413/10</b> (2006.01)	3383860	APELIN RECEPTOR AGONISTS AND METHODS OF USE
<b>C07D 417/06</b> (2006.01)	3383860	APELIN RECEPTOR AGONISTS AND METHODS OF USE
<b>C07D 417/14</b> (2006.01)	3383860	APELIN RECEPTOR AGONISTS AND METHODS OF USE
<b>A61K 39/00</b> (2006.01)	3380119	FMDV AND E2 FUSION PROTEINS AND USES THEREOF
<b>A61K 39/135</b> (2006.01)	3380119	FMDV AND E2 FUSION PROTEINS AND USES THEREOF
<b>C07K 14/32</b> (2006.01)	3380119	FMDV AND E2 FUSION PROTEINS AND USES THEREOF
<b>A61K 31/497</b> (2006.01)	3386975	5-(5-(2-(3-AMINOPROPOXY)-6-METHOXYPHENYL)-1H-PYRAZOL-3-YLAMINO)PYRAZINE-2-CARBONITRILE (S)-LACTATE MONOHYDRATE
<b>A61P 35/00</b> (2006.01)	3386975	5-(5-(2-(3-AMINOPROPOXY)-6-METHOXYPHENYL)-1H-PYRAZOL-3-YLAMINO)PYRAZINE-2-CARBONITRILE (S)-LACTATE MONOHYDRATE
<b>C07D 403/12</b> (2006.01)	3386975	5-(5-(2-(3-AMINOPROPOXY)-6-METHOXYPHENYL)-1H-PYRAZOL-3-YLAMINO)PYRAZINE-2-CARBONITRILE (S)-LACTATE MONOHYDRATE
<b>A61C 5/55</b> (2017.01)	3383306	SELF-HEATING ELECTRIC PLUGGER/SYRINGE NEEDLE FOR USE IN FILLING A ROOT CANAL
<b>A61C 5/40</b> (2017.01)	3383313	MULTI-CANNULA NEGATIVE PRESSURE IRRIGATION SYSTEM
<b>A61C 17/02</b> (2006.01)	3383313	MULTI-CANNULA NEGATIVE PRESSURE IRRIGATION SYSTEM
<b>C09K 17/32</b> (2006.01)	3394205	FOAMING ADDITIVE FOR SOIL CONDITIONING IN THE PRESENCE OF MECHANISED EXCAVATION FOR TUNNEL CONSTRUCTION
<b>E21D 9/06</b> (2006.01)	3394205	FOAMING ADDITIVE FOR SOIL CONDITIONING IN THE PRESENCE OF MECHANISED EXCAVATION FOR TUNNEL CONSTRUCTION
<b>C01B 32/10</b> (2017.01)	3362407	METHOD FOR PRODUCING ACTIVATED CARBON AND ACTIVATED CARBON OBTAINED IN THIS WAY, AND USE THEREOF
<b>C01B 32/336</b> (2017.01)	3362407	METHOD FOR PRODUCING ACTIVATED CARBON AND ACTIVATED CARBON OBTAINED IN THIS WAY, AND USE THEREOF
<b>B01D 53/18</b> (2006.01)	3359281	METHOD AND PLANT FOR CO2 CAPTURE
<b>B01D 53/62</b> (2006.01)	3359281	METHOD AND PLANT FOR CO2 CAPTURE
<b>B01D 53/78</b> (2006.01)	3359281	METHOD AND PLANT FOR CO2 CAPTURE
<b>B01D 53/96</b> (2006.01)	3359281	METHOD AND PLANT FOR CO2 CAPTURE
<b>F23J 15/04</b> (2006.01)	3359281	METHOD AND PLANT FOR CO2 CAPTURE
<b>A61K 39/12</b> (2006.01)	3344289	PESTIVIRUS VACCINES FOR CONGENITAL TREMORS
<b>A61P 31/00</b> (2006.01)	3344289	PESTIVIRUS VACCINES FOR CONGENITAL TREMORS
<b>B60F 3/00</b> (2006.01)	3347215	SELF-STABILISING TWO-WHEELED VEHICLE, IN PARTICULAR AN AMPHIBIOUS VEHICLE
<b>B62D 37/00</b> (2006.01)	3347215	SELF-STABILISING TWO-WHEELED VEHICLE, IN PARTICULAR AN AMPHIBIOUS VEHICLE
<b>B62D 61/00</b> (2006.01)	3347215	SELF-STABILISING TWO-WHEELED VEHICLE, IN PARTICULAR AN AMPHIBIOUS VEHICLE

MKP (51)	Broj objave evropske prijava patenta (97)	Naziv pronalaska (54)
<b>A61K 31/454</b> (2006.01)	3344254	BTK INHIBITOR COMBINATIONS FOR TREATING MULTIPLE MYELOMA
<b>A61K 31/519</b> (2006.01)	3344254	BTK INHIBITOR COMBINATIONS FOR TREATING MULTIPLE MYELOMA
<b>A61K 31/573</b> (2006.01)	3344254	BTK INHIBITOR COMBINATIONS FOR TREATING MULTIPLE MYELOMA
<b>A61K 35/00</b> (2006.01)	3344254	BTK INHIBITOR COMBINATIONS FOR TREATING MULTIPLE MYELOMA
<b>A61K 39/00</b> (2006.01)	3344656	ANTI-PD-1 ANTIBODIES AND METHODS OF USE THEREOF
<b>C07K 16/28</b> (2006.01)	3344656	ANTI-PD-1 ANTIBODIES AND METHODS OF USE THEREOF
<b>A61K 31/4178</b> (2006.01)	3344245	METHODS OF ADMINISTERING ELAGOLIX
<b>A61K 31/496</b> (2006.01)	3344245	METHODS OF ADMINISTERING ELAGOLIX
<b>A61K 31/513</b> (2006.01)	3344245	METHODS OF ADMINISTERING ELAGOLIX
<b>A61K 31/565</b> (2006.01)	3344245	METHODS OF ADMINISTERING ELAGOLIX
<b>A61P 15/00</b> (2006.01)	3344245	METHODS OF ADMINISTERING ELAGOLIX
<b>F01K 23/10</b> (2006.01)	3344856	SYSTEMS AND METHODS FOR POWER PRODUCTION USING NESTED CO2 CYCLES
<b>F01K 25/10</b> (2006.01)	3344856	SYSTEMS AND METHODS FOR POWER PRODUCTION USING NESTED CO2 CYCLES
<b>F02C 1/00</b> (2006.01)	3344856	SYSTEMS AND METHODS FOR POWER PRODUCTION USING NESTED CO2 CYCLES
<b>F02C 3/34</b> (2006.01)	3344856	SYSTEMS AND METHODS FOR POWER PRODUCTION USING NESTED CO2 CYCLES
<b>F02C 6/02</b> (2006.01)	3344856	SYSTEMS AND METHODS FOR POWER PRODUCTION USING NESTED CO2 CYCLES
<b>A61K 47/68</b> (2017.01)	3347054	DOSING REGIMENS FOR ANTI-TF-ANTIBODY DRUG-CONJUGATES
<b>A61P 35/00</b> (2006.01)	3347054	DOSING REGIMENS FOR ANTI-TF-ANTIBODY DRUG-CONJUGATES
<b>B60W 30/18</b> (2012.01)	3350059	METHOD AND DEVICE IN A MOTOR VEHICLE FOR AN AUTOMATIC DRIVE
<b>B62D 15/02</b> (2006.01)	3350059	METHOD AND DEVICE IN A MOTOR VEHICLE FOR AN AUTOMATIC DRIVE
<b>A61K 31/404</b> (2006.01)	3350162	MONO- OR DI-SUBSTITUTED INDOLE DERIVATIVES AS DENGUE VIRAL REPLICATION INHIBITORS
<b>A61P 31/12</b> (2006.01)	3350162	MONO- OR DI-SUBSTITUTED INDOLE DERIVATIVES AS DENGUE VIRAL REPLICATION INHIBITORS
<b>C07D 209/12</b> (2006.01)	3350162	MONO- OR DI-SUBSTITUTED INDOLE DERIVATIVES AS DENGUE VIRAL REPLICATION INHIBITORS
<b>A01K 67/027</b> (2006.01)	3344034	RODENT MODEL OF PROSTATE CANCER
<b>C12N 15/85</b> (2006.01)	3344034	RODENT MODEL OF PROSTATE CANCER
<b>A61K 31/7072</b> (2006.01)	3344642	ANTI-VIRAL TETRAHYDROFURANE DERIVATIVES
<b>A61P 31/14</b> (2006.01)	3344642	ANTI-VIRAL TETRAHYDROFURANE DERIVATIVES
<b>C07H 19/06</b> (2006.01)	3344642	ANTI-VIRAL TETRAHYDROFURANE DERIVATIVES
<b>B65B 19/34</b> (2006.01)	3344551	LAUNCHING SYSTEM FOR ROBOTIC SAUSAGE LOADING MACHINE
<b>B65B 35/08</b> (2006.01)	3344551	LAUNCHING SYSTEM FOR ROBOTIC SAUSAGE LOADING MACHINE
<b>B65B 35/24</b> (2006.01)	3344551	LAUNCHING SYSTEM FOR ROBOTIC SAUSAGE LOADING MACHINE
<b>B65G 15/14</b> (2006.01)	3344551	LAUNCHING SYSTEM FOR ROBOTIC SAUSAGE LOADING MACHINE
<b>B65G 47/31</b> (2006.01)	3344551	LAUNCHING SYSTEM FOR ROBOTIC SAUSAGE LOADING MACHINE
<b>A61K 31/713</b> (2006.01)	3347470	SIRNA AND THEIR USE IN METHODS AND COMPOSITIONS FOR INHIBITING THE EXPRESSION OF THE NRARP GENE
<b>A61P 9/10</b> (2006.01)	3347470	SIRNA AND THEIR USE IN METHODS AND COMPOSITIONS FOR INHIBITING THE EXPRESSION OF THE NRARP GENE
<b>A61P 27/02</b> (2006.01)	3347470	SIRNA AND THEIR USE IN METHODS AND COMPOSITIONS FOR INHIBITING THE EXPRESSION OF THE NRARP GENE
<b>C07H 21/02</b> (2006.01)	3347470	SIRNA AND THEIR USE IN METHODS AND COMPOSITIONS FOR INHIBITING THE EXPRESSION OF THE NRARP GENE
<b>C12N 15/113</b> (2010.01)	3347470	SIRNA AND THEIR USE IN METHODS AND COMPOSITIONS FOR INHIBITING THE EXPRESSION OF THE NRARP GENE
<b>A61K 9/00</b> (2006.01)	3347377	THYMIC STROMAL LYMPHOPOIETIN (TSLP)-BINDING ANTIBODIES AND METHODS OF USING THE ANTIBODIES
<b>A61P 11/06</b> (2006.01)	3347377	THYMIC STROMAL LYMPHOPOIETIN (TSLP)-BINDING ANTIBODIES AND METHODS OF USING THE ANTIBODIES
<b>A61P 37/08</b> (2006.01)	3347377	THYMIC STROMAL LYMPHOPOIETIN (TSLP)-BINDING ANTIBODIES AND METHODS OF USING THE ANTIBODIES
<b>C07K 16/24</b> (2006.01)	3347377	THYMIC STROMAL LYMPHOPOIETIN (TSLP)-BINDING ANTIBODIES AND METHODS OF USING THE ANTIBODIES
<b>A61K 31/438</b> (2006.01)	3347360	COMPOUNDS USEFUL FOR INHIBITING ROR-GAMMA-T
<b>A61P 17/06</b> (2006.01)	3347360	COMPOUNDS USEFUL FOR INHIBITING ROR-GAMMA-T
<b>A61P 37/00</b> (2006.01)	3347360	COMPOUNDS USEFUL FOR INHIBITING ROR-GAMMA-T

MKP (51)	Broj objave evropske prijava patenta (97)	Naziv pronalaska (54)
<b>C07D 495/20</b> (2006.01)	3347360	COMPOUNDS USEFUL FOR INHIBITING ROR-GAMMA-T
<b>B65B 7/16</b> (2006.01)	3347277	DEVICE FOR FORWARDING CLOSURE BLANKS FROM A WEB
<b>B65B 7/28</b> (2006.01)	3347277	DEVICE FOR FORWARDING CLOSURE BLANKS FROM A WEB
<b>A61K 31/501</b> (2006.01)	3344615	PYRIDINONE DICARBOXAMIDE FOR USE AS BROMODOMAIN INHIBITORS
<b>C07D 401/12</b> (2006.01)	3344615	PYRIDINONE DICARBOXAMIDE FOR USE AS BROMODOMAIN INHIBITORS
<b>B65D 75/32</b> (2006.01)	3353086	INDIVIDUAL BLISTER PACK FOR OPTIMIZED STACKING
<b>B63B 1/12</b> (2006.01)	3353045	FLOATING VESSEL
<b>B63B 7/00</b> (2006.01)	3353045	FLOATING VESSEL
<b>B63B 35/73</b> (2006.01)	3353045	FLOATING VESSEL
<b>B63H 21/17</b> (2006.01)	3353045	FLOATING VESSEL
<b>G05B 11/38</b> (2006.01)	3353045	FLOATING VESSEL
<b>A61K 31/501</b> (2006.01)	3353162	PYRIDINONE DICARBOXAMIDE FOR USE AS BROMODOMAIN INHIBITORS
<b>C07D 401/12</b> (2006.01)	3353162	PYRIDINONE DICARBOXAMIDE FOR USE AS BROMODOMAIN INHIBITORS
<b>B31B 50/59</b> (2017.01)	3347196	METHOD FOR THREE-DIMENSIONAL SHAPING OF MATERIAL
<b>B31D 5/02</b> (2017.01)	3347196	METHOD FOR THREE-DIMENSIONAL SHAPING OF MATERIAL
<b>B31F 1/00</b> (2006.01)	3347196	METHOD FOR THREE-DIMENSIONAL SHAPING OF MATERIAL
<b>B31F 1/36</b> (2006.01)	3347196	METHOD FOR THREE-DIMENSIONAL SHAPING OF MATERIAL
<b>B65B 47/06</b> (2006.01)	3347196	METHOD FOR THREE-DIMENSIONAL SHAPING OF MATERIAL
<b>A61K 31/454</b> (2006.01)	3350163	MONO- OR DI-SUBSTITUTED INDOLE DERIVATIVES AS DENGUE VIRAL REPLICATION INHIBITORS
<b>A61P 31/14</b> (2006.01)	3350163	MONO- OR DI-SUBSTITUTED INDOLE DERIVATIVES AS DENGUE VIRAL REPLICATION INHIBITORS
<b>C07D 209/12</b> (2006.01)	3350163	MONO- OR DI-SUBSTITUTED INDOLE DERIVATIVES AS DENGUE VIRAL REPLICATION INHIBITORS
<b>A61K 31/4523</b> (2006.01)	3344616	SUBSTITUTED AMINO TRIAZOLES USEFUL AS HUMAN CHITINASE INHIBITORS
<b>A61P 17/00</b> (2006.01)	3344616	SUBSTITUTED AMINO TRIAZOLES USEFUL AS HUMAN CHITINASE INHIBITORS
<b>A61P 25/00</b> (2006.01)	3344616	SUBSTITUTED AMINO TRIAZOLES USEFUL AS HUMAN CHITINASE INHIBITORS
<b>A61P 35/00</b> (2006.01)	3344616	SUBSTITUTED AMINO TRIAZOLES USEFUL AS HUMAN CHITINASE INHIBITORS
<b>A61P 37/08</b> (2006.01)	3344616	SUBSTITUTED AMINO TRIAZOLES USEFUL AS HUMAN CHITINASE INHIBITORS
<b>C07D 401/14</b> (2006.01)	3344616	SUBSTITUTED AMINO TRIAZOLES USEFUL AS HUMAN CHITINASE INHIBITORS
<b>C07D 413/14</b> (2006.01)	3344616	SUBSTITUTED AMINO TRIAZOLES USEFUL AS HUMAN CHITINASE INHIBITORS
<b>C07D 417/14</b> (2006.01)	3344616	SUBSTITUTED AMINO TRIAZOLES USEFUL AS HUMAN CHITINASE INHIBITORS
<b>C07D 487/04</b> (2006.01)	3344616	SUBSTITUTED AMINO TRIAZOLES USEFUL AS HUMAN CHITINASE INHIBITORS
<b>C07D 498/04</b> (2006.01)	3344616	SUBSTITUTED AMINO TRIAZOLES USEFUL AS HUMAN CHITINASE INHIBITORS
<b>A61B 17/04</b> (2006.01)	3344159	END EFFECTORS FOR WOUND CLOSURE DEVICES
<b>A61B 17/06</b> (2006.01)	3344159	END EFFECTORS FOR WOUND CLOSURE DEVICES
<b>H02K 3/04</b> (2006.01)	3258575	GENERATOR OF ELECTRICAL CURRENT BY MOVEMENT AND INDUCTION BY MEANS OF PERMANENT MAGNETS AND RESONANT COILS
<b>H02K 21/14</b> (2006.01)	3258575	GENERATOR OF ELECTRICAL CURRENT BY MOVEMENT AND INDUCTION BY MEANS OF PERMANENT MAGNETS AND RESONANT COILS
<b>H02K 53/00</b> (2006.01)	3258575	GENERATOR OF ELECTRICAL CURRENT BY MOVEMENT AND INDUCTION BY MEANS OF PERMANENT MAGNETS AND RESONANT COILS
<b>A61K 9/00</b> (2006.01)	3349726	MICROSPHERES CONTAINING ANTHELMINTIC MACROCYCLIC LACTONES
<b>A61K 9/14</b> (2006.01)	3349726	MICROSPHERES CONTAINING ANTHELMINTIC MACROCYCLIC LACTONES
<b>A61K 9/16</b> (2006.01)	3349726	MICROSPHERES CONTAINING ANTHELMINTIC MACROCYCLIC LACTONES
<b>A61K 31/00</b> (2006.01)	3349726	MICROSPHERES CONTAINING ANTHELMINTIC MACROCYCLIC LACTONES

MKP (51)	Broj objave evropske prijava patenta (97)	Naziv pronalaska (54)
<b>A24B 15/10</b> (2006.01)	3349604	A METHOD AND A DISPENSING ARRANGEMENT FOR TREATING A FLOW OF VAPORIZED LIQUID PROVIDED BY AN E-CIGARETTE AND AN E-CIGARETTE FOR THE ORAL INTAKE OF VAPORIZED LIQUID CONTAINING AN ADDITIONAL COMPOSITION
<b>A24F 47/00</b> (2006.01)	3349604	A METHOD AND A DISPENSING ARRANGEMENT FOR TREATING A FLOW OF VAPORIZED LIQUID PROVIDED BY AN E-CIGARETTE AND AN E-CIGARETTE FOR THE ORAL INTAKE OF VAPORIZED LIQUID CONTAINING AN ADDITIONAL COMPOSITION
<b>A61M 15/06</b> (2006.01)	3349604	A METHOD AND A DISPENSING ARRANGEMENT FOR TREATING A FLOW OF VAPORIZED LIQUID PROVIDED BY AN E-CIGARETTE AND AN E-CIGARETTE FOR THE ORAL INTAKE OF VAPORIZED LIQUID CONTAINING AN ADDITIONAL COMPOSITION
<b>A61Q 19/08</b> (2006.01)	3349604	A METHOD AND A DISPENSING ARRANGEMENT FOR TREATING A FLOW OF VAPORIZED LIQUID PROVIDED BY AN E-CIGARETTE AND AN E-CIGARETTE FOR THE ORAL INTAKE OF VAPORIZED LIQUID CONTAINING AN ADDITIONAL COMPOSITION
<b>A61P 37/00</b> (2006.01)	3353207	DOSING REGIMEN OF COMBINATION OF ANTI-CD20 AND ANTI-BLYS ANTIBODIES
<b>C07K 16/28</b> (2006.01)	3353207	DOSING REGIMEN OF COMBINATION OF ANTI-CD20 AND ANTI-BLYS ANTIBODIES
<b>A61K 31/4418</b> (2006.01)	3353163	2,3,4,5-TETRAHYDROPYRIDIN-6-AMINE DERIVATIVES
<b>A61P 25/16</b> (2006.01)	3353163	2,3,4,5-TETRAHYDROPYRIDIN-6-AMINE DERIVATIVES
<b>A61P 25/28</b> (2006.01)	3353163	2,3,4,5-TETRAHYDROPYRIDIN-6-AMINE DERIVATIVES
<b>C07D 401/12</b> (2006.01)	3353163	2,3,4,5-TETRAHYDROPYRIDIN-6-AMINE DERIVATIVES
<b>A61K 35/12</b> (2015.01)	3347453	ENGINEERED HOST CELLS AND METHODS OF USE THEREOF
<b>C12N 5/0783</b> (2010.01)	3347453	ENGINEERED HOST CELLS AND METHODS OF USE THEREOF
<b>A61K 31/4709</b> (2006.01)	3347351	SALTS OF A PIM KINASE INHIBITOR
<b>A61P 35/00</b> (2006.01)	3347351	SALTS OF A PIM KINASE INHIBITOR
<b>C07D 215/60</b> (2006.01)	3347351	SALTS OF A PIM KINASE INHIBITOR
<b>C07D 221/18</b> (2006.01)	3347351	SALTS OF A PIM KINASE INHIBITOR
<b>C07D 401/12</b> (2006.01)	3347351	SALTS OF A PIM KINASE INHIBITOR
<b>C07D 401/14</b> (2006.01)	3347351	SALTS OF A PIM KINASE INHIBITOR
<b>C07F 7/18</b> (2006.01)	3347351	SALTS OF A PIM KINASE INHIBITOR
<b>B65D 1/26</b> (2006.01)	3347287	PACKAGING
<b>B65D 85/804</b> (2006.01)	3347287	PACKAGING
<b>A61K 31/437</b> (2006.01)	3350180	8-[6-[3-(AMINO)PROPOXY]-3-PYRIDYL]-1 -ISOPROPYL-IMIDAZO[4,5-C]QUINOLIN-2-ONE DERIVATIVES AS SELECTIVE MODULATORS OF ATAXIA TELANGIECTASIA MUTATED (ATM) KINASE FOR THE TREATMENT OF CANCER
<b>A61P 35/00</b> (2006.01)	3350180	8-[6-[3-(AMINO)PROPOXY]-3-PYRIDYL]-1 -ISOPROPYL-IMIDAZO[4,5-C]QUINOLIN-2-ONE DERIVATIVES AS SELECTIVE MODULATORS OF ATAXIA TELANGIECTASIA MUTATED (ATM) KINASE FOR THE TREATMENT OF CANCER
<b>C07D 471/04</b> (2006.01)	3350180	8-[6-[3-(AMINO)PROPOXY]-3-PYRIDYL]-1 -ISOPROPYL-IMIDAZO[4,5-C]QUINOLIN-2-ONE DERIVATIVES AS SELECTIVE MODULATORS OF ATAXIA TELANGIECTASIA MUTATED (ATM) KINASE FOR THE TREATMENT OF CANCER
<b>A61K 31/55</b> (2006.01)	3350174	BENZOAZEPINE DERIVATIVES
<b>A61P 31/18</b> (2006.01)	3350174	BENZOAZEPINE DERIVATIVES
<b>C07D 223/16</b> (2006.01)	3350174	BENZOAZEPINE DERIVATIVES
<b>C07D 405/10</b> (2006.01)	3350174	BENZOAZEPINE DERIVATIVES
<b>C07D 405/14</b> (2006.01)	3350174	BENZOAZEPINE DERIVATIVES
<b>A61K 31/454</b> (2006.01)	3349798	THERAPEUTIC COMBINATIONS OF A CD19 INHIBITOR AND A BTK INHIBITOR
<b>A61K 31/4985</b> (2006.01)	3349798	THERAPEUTIC COMBINATIONS OF A CD19 INHIBITOR AND A BTK INHIBITOR
<b>A61K 31/519</b> (2006.01)	3349798	THERAPEUTIC COMBINATIONS OF A CD19 INHIBITOR AND A BTK INHIBITOR
<b>A61K 45/06</b> (2006.01)	3349798	THERAPEUTIC COMBINATIONS OF A CD19 INHIBITOR AND A BTK INHIBITOR
<b>A61P 35/00</b> (2006.01)	3349798	THERAPEUTIC COMBINATIONS OF A CD19 INHIBITOR AND A BTK INHIBITOR
<b>A61P 35/02</b> (2006.01)	3349798	THERAPEUTIC COMBINATIONS OF A CD19 INHIBITOR AND A BTK INHIBITOR
<b>C07K 14/70</b> (2006.01)	3349798	THERAPEUTIC COMBINATIONS OF A CD19 INHIBITOR AND A BTK INHIBITOR
<b>C07K 16/28</b> (2006.01)	3349798	THERAPEUTIC COMBINATIONS OF A CD19 INHIBITOR AND A BTK INHIBITOR



MKP (51)	Broj objave evropske prijava patenta (97)	Naziv pronalaska (54)
<b>C12N 5/07</b> (2010.01)	3349798	THERAPEUTIC COMBINATIONS OF A CD19 INHIBITOR AND A BTK INHIBITOR
<b>C07K 16/30</b> (2006.01)	3350226	USE OF ANTI-MCAM ANTIBODIES FOR TREATMENT OR PROPHYLAXIS OF GIANT CELL ARTERITIS, POLYMYALGIA RHEUMATICA OR TAKAYASU'S ARTERITIS
<b>A61B 17/00</b> (2006.01)	3352679	SPRAY OR DRIP TIPS HAVING MULTIPLE OUTLET CHANNELS
<b>A61M 5/19</b> (2006.01)	3352679	SPRAY OR DRIP TIPS HAVING MULTIPLE OUTLET CHANNELS
<b>C04B 28/14</b> (2006.01)	3383822	ADDITIVE FOR GYPSUM BUILDING MATERIALS
<b>C04B 40/00</b> (2006.01)	3383822	ADDITIVE FOR GYPSUM BUILDING MATERIALS
<b>B01D 1/18</b> (2006.01)	3353232	SUPERCritical CO2 CELLULOSE SPRAYDRYING
<b>C08J 3/12</b> (2006.01)	3353232	SUPERCritical CO2 CELLULOSE SPRAYDRYING
<b>D21C 9/00</b> (2006.01)	3353232	SUPERCritical CO2 CELLULOSE SPRAYDRYING
<b>F26B 3/12</b> (2006.01)	3353232	SUPERCritical CO2 CELLULOSE SPRAYDRYING
<b>A61K 31/519</b> (2006.01)	3350185	1-PHENYLPYRROLIDIN-2-ONE DERIVATIVES AS PERK INHIBITORS
<b>A61P 3/00</b> (2006.01)	3350185	1-PHENYLPYRROLIDIN-2-ONE DERIVATIVES AS PERK INHIBITORS
<b>A61P 25/00</b> (2006.01)	3350185	1-PHENYLPYRROLIDIN-2-ONE DERIVATIVES AS PERK INHIBITORS
<b>A61P 35/00</b> (2006.01)	3350185	1-PHENYLPYRROLIDIN-2-ONE DERIVATIVES AS PERK INHIBITORS
<b>C07D 487/04</b> (2006.01)	3350185	1-PHENYLPYRROLIDIN-2-ONE DERIVATIVES AS PERK INHIBITORS
<b>C07D 495/04</b> (2006.01)	3350185	1-PHENYLPYRROLIDIN-2-ONE DERIVATIVES AS PERK INHIBITORS
<b>A61K 31/519</b> (2006.01)	3349757	MODULATORS OF TOLL-LIKE RECPATORS FOR THE TREATMENT OF HIV
<b>A61P 31/18</b> (2006.01)	3349757	MODULATORS OF TOLL-LIKE RECPATORS FOR THE TREATMENT OF HIV
<b>A61K 31/53</b> (2006.01)	3349758	METHODS FOR TREATING ARENAVIRIDAE AND CORONAVIRIDAE VIRUS INFECTIONS
<b>A61K 31/664</b> (2006.01)	3349758	METHODS FOR TREATING ARENAVIRIDAE AND CORONAVIRIDAE VIRUS INFECTIONS
<b>A61K 31/675</b> (2006.01)	3349758	METHODS FOR TREATING ARENAVIRIDAE AND CORONAVIRIDAE VIRUS INFECTIONS
<b>A61K 31/683</b> (2006.01)	3349758	METHODS FOR TREATING ARENAVIRIDAE AND CORONAVIRIDAE VIRUS INFECTIONS
<b>A61K 31/685</b> (2006.01)	3349758	METHODS FOR TREATING ARENAVIRIDAE AND CORONAVIRIDAE VIRUS INFECTIONS
<b>A61P 31/12</b> (2006.01)	3349758	METHODS FOR TREATING ARENAVIRIDAE AND CORONAVIRIDAE VIRUS INFECTIONS
<b>A61K 31/56</b> (2006.01)	3353158	COMPOUNDS WITH HIV MATURATION INHIBITORY ACTIVITY
<b>A61P 31/18</b> (2006.01)	3353158	COMPOUNDS WITH HIV MATURATION INHIBITORY ACTIVITY
<b>C07D 211/96</b> (2006.01)	3353158	COMPOUNDS WITH HIV MATURATION INHIBITORY ACTIVITY
<b>C07D 279/12</b> (2006.01)	3353158	COMPOUNDS WITH HIV MATURATION INHIBITORY ACTIVITY
<b>C07J 63/00</b> (2006.01)	3353158	COMPOUNDS WITH HIV MATURATION INHIBITORY ACTIVITY
<b>A23L 33/135</b> (2016.01)	3368696	BACTERIA ENGINEERED TO TREAT DISEASES THAT BENEFIT FROM REDUCED GUT INFLAMMATION AND/OR TIGHTENED GUT MUCOSAL BARRIER
<b>A61K 31/404</b> (2006.01)	3368696	BACTERIA ENGINEERED TO TREAT DISEASES THAT BENEFIT FROM REDUCED GUT INFLAMMATION AND/OR TIGHTENED GUT MUCOSAL BARRIER
<b>A61K 35/74</b> (2015.01)	3368696	BACTERIA ENGINEERED TO TREAT DISEASES THAT BENEFIT FROM REDUCED GUT INFLAMMATION AND/OR TIGHTENED GUT MUCOSAL BARRIER
<b>A61K 35/741</b> (2015.01)	3368696	BACTERIA ENGINEERED TO TREAT DISEASES THAT BENEFIT FROM REDUCED GUT INFLAMMATION AND/OR TIGHTENED GUT MUCOSAL BARRIER
<b>C12N 1/20</b> (2006.01)	3368696	BACTERIA ENGINEERED TO TREAT DISEASES THAT BENEFIT FROM REDUCED GUT INFLAMMATION AND/OR TIGHTENED GUT MUCOSAL BARRIER
<b>C12N 15/70</b> (2006.01)	3368696	BACTERIA ENGINEERED TO TREAT DISEASES THAT BENEFIT FROM REDUCED GUT INFLAMMATION AND/OR TIGHTENED GUT MUCOSAL BARRIER
<b>C12R 1/01</b> (2006.01)	3368696	BACTERIA ENGINEERED TO TREAT DISEASES THAT BENEFIT FROM REDUCED GUT INFLAMMATION AND/OR TIGHTENED GUT MUCOSAL BARRIER
<b>C12R 1/19</b> (2006.01)	3368696	BACTERIA ENGINEERED TO TREAT DISEASES THAT BENEFIT FROM REDUCED GUT INFLAMMATION AND/OR TIGHTENED GUT MUCOSAL BARRIER
<b>A61K 31/137</b> (2006.01)	3349740	CO-THERAPY COMPRISING CANAGLIFLOZIN AND PHENTERMINE FOR THE TREATMENT OF OBESITY AND OBESITY RELATED DISORDERS

MKP (51)	Broj objave evropske prijava patenta (97)	Naziv pronalaska (54)
<b>A61K 31/7042</b> (2006.01)	3349740	CO-THERAPY COMPRISING CANAGLIFLOZIN AND PHENTERMINE FOR THE TREATMENT OF OBESITY AND OBESITY RELATED DISORDERS
<b>A61P 1/16</b> (2006.01)	3349740	CO-THERAPY COMPRISING CANAGLIFLOZIN AND PHENTERMINE FOR THE TREATMENT OF OBESITY AND OBESITY RELATED DISORDERS
<b>A61P 3/00</b> (2006.01)	3349740	CO-THERAPY COMPRISING CANAGLIFLOZIN AND PHENTERMINE FOR THE TREATMENT OF OBESITY AND OBESITY RELATED DISORDERS
<b>A61P 3/04</b> (2006.01)	3349740	CO-THERAPY COMPRISING CANAGLIFLOZIN AND PHENTERMINE FOR THE TREATMENT OF OBESITY AND OBESITY RELATED DISORDERS
<b>A61P 9/00</b> (2006.01)	3349740	CO-THERAPY COMPRISING CANAGLIFLOZIN AND PHENTERMINE FOR THE TREATMENT OF OBESITY AND OBESITY RELATED DISORDERS
<b>A61P 9/12</b> (2006.01)	3349740	CO-THERAPY COMPRISING CANAGLIFLOZIN AND PHENTERMINE FOR THE TREATMENT OF OBESITY AND OBESITY RELATED DISORDERS
<b>A61P 13/00</b> (2006.01)	3349740	CO-THERAPY COMPRISING CANAGLIFLOZIN AND PHENTERMINE FOR THE TREATMENT OF OBESITY AND OBESITY RELATED DISORDERS
<b>A61P 43/00</b> (2006.01)	3349740	CO-THERAPY COMPRISING CANAGLIFLOZIN AND PHENTERMINE FOR THE TREATMENT OF OBESITY AND OBESITY RELATED DISORDERS
<b>A61K 39/00</b> (2006.01)	3355915	CANINE PARVOVIRUS (CPV) VIRUS-LIKE PARTICLE (VLP) VACCINES AND USES THEREOF
<b>A61K 39/12</b> (2006.01)	3355915	CANINE PARVOVIRUS (CPV) VIRUS-LIKE PARTICLE (VLP) VACCINES AND USES THEREOF
<b>A61K 39/135</b> (2006.01)	3355915	CANINE PARVOVIRUS (CPV) VIRUS-LIKE PARTICLE (VLP) VACCINES AND USES THEREOF
<b>A61K 39/23</b> (2006.01)	3355915	CANINE PARVOVIRUS (CPV) VIRUS-LIKE PARTICLE (VLP) VACCINES AND USES THEREOF
<b>C07K 16/00</b> (2006.01)	3350216	TETRAVALENT BISPECIFIC AND TETRASPECIFIC ANTIGEN BINDING PROTEINS AND USES THEREOF
<b>C07K 16/24</b> (2006.01)	3350216	TETRAVALENT BISPECIFIC AND TETRASPECIFIC ANTIGEN BINDING PROTEINS AND USES THEREOF
<b>C07K 16/28</b> (2006.01)	3350216	TETRAVALENT BISPECIFIC AND TETRASPECIFIC ANTIGEN BINDING PROTEINS AND USES THEREOF
<b>C07K 16/46</b> (2006.01)	3350216	TETRAVALENT BISPECIFIC AND TETRASPECIFIC ANTIGEN BINDING PROTEINS AND USES THEREOF
<b>A61L 27/36</b> (2006.01)	3349812	COMPOSITIONS DERIVED FROM PLACENTA AND METHODS OF PRODUCING THE SAME
<b>A61L 27/56</b> (2006.01)	3349812	COMPOSITIONS DERIVED FROM PLACENTA AND METHODS OF PRODUCING THE SAME
<b>A61L 27/60</b> (2006.01)	3349812	COMPOSITIONS DERIVED FROM PLACENTA AND METHODS OF PRODUCING THE SAME
<b>C10L 1/12</b> (2006.01)	3153565	FUEL ADDITIVE
<b>C10L 1/16</b> (2006.01)	3153565	FUEL ADDITIVE
<b>C10L 1/182</b> (2006.01)	3153565	FUEL ADDITIVE
<b>C10L 1/188</b> (2006.01)	3153565	FUEL ADDITIVE
<b>C10L 1/189</b> (2006.01)	3153565	FUEL ADDITIVE
<b>C10L 1/222</b> (2006.01)	3153565	FUEL ADDITIVE
<b>C10L 1/224</b> (2006.01)	3153565	FUEL ADDITIVE
<b>C10L 1/232</b> (2006.01)	3153565	FUEL ADDITIVE
<b>C10L 1/233</b> (2006.01)	3153565	FUEL ADDITIVE
<b>C10L 1/24</b> (2006.01)	3153565	FUEL ADDITIVE
<b>C10L 10/02</b> (2006.01)	3153565	FUEL ADDITIVE
<b>A61K 51/00</b> (2006.01)	3309796	RUBIDIUM ELUTION SYSTEM CONTROL
<b>A61K 51/12</b> (2006.01)	3309796	RUBIDIUM ELUTION SYSTEM CONTROL
<b>A61M 36/00</b> (2006.01)	3309796	RUBIDIUM ELUTION SYSTEM CONTROL
<b>G21G 1/00</b> (2006.01)	3309796	RUBIDIUM ELUTION SYSTEM CONTROL
<b>A61K 31/4375</b> (2006.01)	3318565	PYRROLO[2,3-D]PYRIMIDINYL, PYRROLO[2,3-B]PYRAZINYL AND PYRROLO[2,3-D]PYRIDINYL ACRYLAMIDES
<b>A61P 35/00</b> (2006.01)	3318565	PYRROLO[2,3-D]PYRIMIDINYL, PYRROLO[2,3-B]PYRAZINYL AND PYRROLO[2,3-D]PYRIDINYL ACRYLAMIDES
<b>C07D 471/04</b> (2006.01)	3318565	PYRROLO[2,3-D]PYRIMIDINYL, PYRROLO[2,3-B]PYRAZINYL AND PYRROLO[2,3-D]PYRIDINYL ACRYLAMIDES

MKP (51)	Broj objave evropske prijava patenta (97)	Naziv pronalaska (54)
<b>C07D 487/04</b> (2006.01)	3318565	PYRROLO[2,3-D]PYRIMIDINYL, PYRROLO[2,3-B]PYRAZINYL AND PYRROLO[2,3-D]PYRIDINYL ACRYLAMIDES
<b>A61K 9/00</b> (2006.01)	3318247	TASTE MASKED PHARMACEUTICAL COMPOSITION
<b>A61K 9/50</b> (2006.01)	3318247	TASTE MASKED PHARMACEUTICAL COMPOSITION
<b>A61K 31/55</b> (2006.01)	3318247	TASTE MASKED PHARMACEUTICAL COMPOSITION
<b>A61P 9/04</b> (2006.01)	3318247	TASTE MASKED PHARMACEUTICAL COMPOSITION
<b>A61K 39/00</b> (2006.01)	3318272	CGRP ANTIBODIES
<b>A61K 39/395</b> (2006.01)	3318272	CGRP ANTIBODIES
<b>C07K 16/18</b> (2006.01)	3318272	CGRP ANTIBODIES
<b>C07K 16/26</b> (2006.01)	3318272	CGRP ANTIBODIES
<b>A61K 9/20</b> (2006.01)	3318249	DIMETHYL FUMARATE DOSAGE REGIMENS FOR THE TREATMENT OF MULTIPLE SCLEROSIS
<b>A61K 9/32</b> (2006.01)	3318249	DIMETHYL FUMARATE DOSAGE REGIMENS FOR THE TREATMENT OF MULTIPLE SCLEROSIS
<b>A61K 31/225</b> (2006.01)	3318249	DIMETHYL FUMARATE DOSAGE REGIMENS FOR THE TREATMENT OF MULTIPLE SCLEROSIS
<b>A61P 25/28</b> (2006.01)	3318249	DIMETHYL FUMARATE DOSAGE REGIMENS FOR THE TREATMENT OF MULTIPLE SCLEROSIS
<b>C07K 11/02</b> (2006.01)	3301109	NOVEL DEPSIPEPTIDE AND USES THEREOF
<b>A61K 31/535</b> (2006.01)	3321270	SODIUM (2R, 5S, 13AR) -7, 9-DIOXO-10- ( (2,4,6-TRIFLUOROBENZYL) CARBAMOYL) -2, 3, 4, 5, 7, 9, 13, 13A-OCTAHYDRO-2, 5-METHANOPYRIDO [1',2' : 4.5] PYRAZINO [2, 1-B] OXAZEPIN-8-OLATE
<b>A61P 31/18</b> (2006.01)	3321270	SODIUM (2R, 5S, 13AR) -7, 9-DIOXO-10- ( (2,4,6-TRIFLUOROBENZYL) CARBAMOYL) -2, 3, 4, 5, 7, 9, 13, 13A-OCTAHYDRO-2, 5-METHANOPYRIDO [1',2' : 4.5] PYRAZINO [2, 1-B] OXAZEPIN-8-OLATE
<b>C07D 498/14</b> (2006.01)	3321270	SODIUM (2R, 5S, 13AR) -7, 9-DIOXO-10- ( (2,4,6-TRIFLUOROBENZYL) CARBAMOYL) -2, 3, 4, 5, 7, 9, 13, 13A-OCTAHYDRO-2, 5-METHANOPYRIDO [1',2' : 4.5] PYRAZINO [2, 1-B] OXAZEPIN-8-OLATE
<b>A23P 10/30</b> (2016.01)	3318268	ROSEBURIA FLAGELLIN AND IMMUNE MODULATION
<b>A61K 38/16</b> (2006.01)	3318268	ROSEBURIA FLAGELLIN AND IMMUNE MODULATION
<b>A61K 39/02</b> (2006.01)	3318268	ROSEBURIA FLAGELLIN AND IMMUNE MODULATION
<b>A61K 48/00</b> (2006.01)	3318268	ROSEBURIA FLAGELLIN AND IMMUNE MODULATION
<b>A61P 1/00</b> (2006.01)	3318268	ROSEBURIA FLAGELLIN AND IMMUNE MODULATION
<b>A61P 17/00</b> (2006.01)	3318268	ROSEBURIA FLAGELLIN AND IMMUNE MODULATION
<b>A61P 19/00</b> (2006.01)	3318268	ROSEBURIA FLAGELLIN AND IMMUNE MODULATION
<b>A61P 29/00</b> (2006.01)	3318268	ROSEBURIA FLAGELLIN AND IMMUNE MODULATION
<b>A61P 37/00</b> (2006.01)	3318268	ROSEBURIA FLAGELLIN AND IMMUNE MODULATION
<b>C07K 14/195</b> (2006.01)	3318268	ROSEBURIA FLAGELLIN AND IMMUNE MODULATION
<b>A61K 31/485</b> (2006.01)	3345604	NALMEFENE FOR REDUCTION OF ALCOHOL CONSUMPTION IN SPECIFIC TARGET POPULATIONS
<b>A61P 25/32</b> (2006.01)	3345604	NALMEFENE FOR REDUCTION OF ALCOHOL CONSUMPTION IN SPECIFIC TARGET POPULATIONS
<b>A61K 39/395</b> (2006.01)	3318273	METHODS FOR INCREASING EFFICACY OF FOLR1 CANCER THERAPY
<b>B23K 26/00</b> (2014.01)	3363576	METHOD AND IDENTIFICATION AND/OR MARKING OF GALVANIZED, IN PARTICULAR HOT DIPPED COMPONENTS
<b>B23K 26/0622</b> (2014.01)	3363576	METHOD AND IDENTIFICATION AND/OR MARKING OF GALVANIZED, IN PARTICULAR HOT DIPPED COMPONENTS
<b>B23K 26/082</b> (2014.01)	3363576	METHOD AND IDENTIFICATION AND/OR MARKING OF GALVANIZED, IN PARTICULAR HOT DIPPED COMPONENTS
<b>B23K 26/12</b> (2014.01)	3363576	METHOD AND IDENTIFICATION AND/OR MARKING OF GALVANIZED, IN PARTICULAR HOT DIPPED COMPONENTS
<b>B23K 26/14</b> (2014.01)	3363576	METHOD AND IDENTIFICATION AND/OR MARKING OF GALVANIZED, IN PARTICULAR HOT DIPPED COMPONENTS
<b>B23K 26/322</b> (2014.01)	3363576	METHOD AND IDENTIFICATION AND/OR MARKING OF GALVANIZED, IN PARTICULAR HOT DIPPED COMPONENTS
<b>B23K 26/352</b> (2014.01)	3363576	METHOD AND IDENTIFICATION AND/OR MARKING OF GALVANIZED, IN PARTICULAR HOT DIPPED COMPONENTS
<b>B23K 26/60</b> (2014.01)	3363576	METHOD AND IDENTIFICATION AND/OR MARKING OF GALVANIZED, IN PARTICULAR HOT DIPPED COMPONENTS
<b>A61K 39/00</b> (2006.01)	3348644	NUCLEIC ACID COMPRISING OR CODING FOR A HISTONE STEM-LOOP AND A POLY(A) SEQUENCE OR A POLYADENYLATION SIGNAL FOR INCREASING THE EXPRESSION OF AN ENCODED TUMOUR ANTIGEN
<b>C12N 15/63</b> (2006.01)	3348644	NUCLEIC ACID COMPRISING OR CODING FOR A HISTONE STEM-LOOP AND A POLY(A) SEQUENCE OR A POLYADENYLATION SIGNAL FOR INCREASING THE EXPRESSION OF AN ENCODED TUMOUR ANTIGEN

MKP (51)	Broj objave evropske prijava patenta (97)	Naziv pronalaska (54)
<b>C12N 15/67</b> (2006.01)	3348644	NUCLEIC ACID COMPRISING OR CODING FOR A HISTONE STEM-LOOP AND A POLY(A) SEQUENCE OR A POLYADENYLATION SIGNAL FOR INCREASING THE EXPRESSION OF AN ENCODED TUMOUR ANTIGEN
<b>A61B 17/06</b> (2006.01)	3323451	SURGICAL NEEDLE COATINGS AND METHODS
<b>A61L 31/02</b> (2006.01)	3323451	SURGICAL NEEDLE COATINGS AND METHODS
<b>A61L 31/10</b> (2006.01)	3323451	SURGICAL NEEDLE COATINGS AND METHODS
<b>A61M 5/32</b> (2006.01)	3323451	SURGICAL NEEDLE COATINGS AND METHODS
<b>A61K 31/7125</b> (2006.01)	3366775	MODIFIED RNAI AGENTS
<b>C12N 15/113</b> (2010.01)	3366775	MODIFIED RNAI AGENTS
<b>E04F 15/024</b> (2006.01)	3369874	A MODULAR FLOATING SCREED WITH INCORPORATED HEATING ELEMENTS
<b>F24D 3/12</b> (2006.01)	3369874	A MODULAR FLOATING SCREED WITH INCORPORATED HEATING ELEMENTS
<b>B01D 17/00</b> (2006.01)	3238801	COALESCING SEPARATOR
<b>B01D 17/04</b> (2006.01)	3238801	COALESCING SEPARATOR
<b>E03F 5/16</b> (2006.01)	3238801	COALESCING SEPARATOR
<b>A61K 9/00</b> (2006.01)	3388063	TREATMENT OF A BACTERIAL VAGINAL INFECTION
<b>A61K 9/20</b> (2006.01)	3388063	TREATMENT OF A BACTERIAL VAGINAL INFECTION
<b>A61K 31/4164</b> (2006.01)	3388063	TREATMENT OF A BACTERIAL VAGINAL INFECTION
<b>A61K 31/4178</b> (2006.01)	3388063	TREATMENT OF A BACTERIAL VAGINAL INFECTION
<b>A61K 31/7048</b> (2006.01)	3388063	TREATMENT OF A BACTERIAL VAGINAL INFECTION
<b>A61K 45/06</b> (2006.01)	3388063	TREATMENT OF A BACTERIAL VAGINAL INFECTION
<b>A61K 47/06</b> (2006.01)	3388063	TREATMENT OF A BACTERIAL VAGINAL INFECTION
<b>A61P 31/04</b> (2006.01)	3388063	TREATMENT OF A BACTERIAL VAGINAL INFECTION
<b>B27N 3/02</b> (2006.01)	3400120	IN-LINE COATED WOOD-BASED BOARDS
<b>B27N 3/04</b> (2006.01)	3400120	IN-LINE COATED WOOD-BASED BOARDS
<b>B27N 3/06</b> (2006.01)	3400120	IN-LINE COATED WOOD-BASED BOARDS
<b>B27N 3/10</b> (2006.01)	3400120	IN-LINE COATED WOOD-BASED BOARDS
<b>B27N 3/12</b> (2006.01)	3400120	IN-LINE COATED WOOD-BASED BOARDS
<b>C09C 1/02</b> (2006.01)	3402846	TREATMENT OF SURFACE-REACTED CALCIUM CARBONATE
<b>B25B 13/46</b> (2006.01)	3408063	WINDER UNIT FOR VEHICLE GLAZING PANEL CUT OUT
<b>B26D 1/547</b> (2006.01)	3408063	WINDER UNIT FOR VEHICLE GLAZING PANEL CUT OUT
<b>A61K 31/426</b> (2006.01)	3397622	ALPHA-AMINO ESTERS OF HYDROXYPROPYLTHIAZOLIDINE CARBOXAMIDE DERIVATIVE AND SALT FORM, CRYSTAL POLYMORPH THEREOF
<b>A61K 45/06</b> (2006.01)	3397622	ALPHA-AMINO ESTERS OF HYDROXYPROPYLTHIAZOLIDINE CARBOXAMIDE DERIVATIVE AND SALT FORM, CRYSTAL POLYMORPH THEREOF
<b>A61P 15/00</b> (2006.01)	3397622	ALPHA-AMINO ESTERS OF HYDROXYPROPYLTHIAZOLIDINE CARBOXAMIDE DERIVATIVE AND SALT FORM, CRYSTAL POLYMORPH THEREOF
<b>A61P 15/06</b> (2006.01)	3397622	ALPHA-AMINO ESTERS OF HYDROXYPROPYLTHIAZOLIDINE CARBOXAMIDE DERIVATIVE AND SALT FORM, CRYSTAL POLYMORPH THEREOF
<b>C07D 277/06</b> (2006.01)	3397622	ALPHA-AMINO ESTERS OF HYDROXYPROPYLTHIAZOLIDINE CARBOXAMIDE DERIVATIVE AND SALT FORM, CRYSTAL POLYMORPH THEREOF
<b>A61K 31/426</b> (2006.01)	3400217	L-VALINATE OF HYDROXYPROPYLTHIAZOLIDINE CARBOXAMIDE DERIVATIVE AND SALT FORM, CRYSTAL POLYMORPH THEREOF
<b>A61K 45/06</b> (2006.01)	3400217	L-VALINATE OF HYDROXYPROPYLTHIAZOLIDINE CARBOXAMIDE DERIVATIVE AND SALT FORM, CRYSTAL POLYMORPH THEREOF
<b>A61P 15/00</b> (2006.01)	3400217	L-VALINATE OF HYDROXYPROPYLTHIAZOLIDINE CARBOXAMIDE DERIVATIVE AND SALT FORM, CRYSTAL POLYMORPH THEREOF
<b>A61P 15/06</b> (2006.01)	3400217	L-VALINATE OF HYDROXYPROPYLTHIAZOLIDINE CARBOXAMIDE DERIVATIVE AND SALT FORM, CRYSTAL POLYMORPH THEREOF
<b>C07D 277/06</b> (2006.01)	3400217	L-VALINATE OF HYDROXYPROPYLTHIAZOLIDINE CARBOXAMIDE DERIVATIVE AND SALT FORM, CRYSTAL POLYMORPH THEREOF
<b>C07K 16/26</b> (2006.01)	3397965	COMPOSITIONS AND METHODS FOR ASSESSING THE RISK OF CANCER OCCURRENCE
<b>C07K 16/30</b> (2006.01)	3397965	COMPOSITIONS AND METHODS FOR ASSESSING THE RISK OF CANCER OCCURRENCE
<b>G01N 33/574</b> (2006.01)	3397965	COMPOSITIONS AND METHODS FOR ASSESSING THE RISK OF CANCER OCCURRENCE
<b>G01N 33/74</b> (2006.01)	3397965	COMPOSITIONS AND METHODS FOR ASSESSING THE RISK OF CANCER OCCURRENCE
<b>A61K 31/191</b> (2006.01)	3399969	METHOD FOR PREVENTION, TREATMENT AND ALLEVIATION OF INFECTIOUS DISEASES AND DISORDERS

MKP (51)	Broj objave evropske prijava patenta (97)	Naziv pronalaska (54)
<b>A61P 31/00</b> (2006.01)	3399969	METHOD FOR PREVENTION, TREATMENT AND ALLEVIATION OF INFECTIOUS DISEASES AND DISORDERS
<b>A61P 33/00</b> (2006.01)	3399969	METHOD FOR PREVENTION, TREATMENT AND ALLEVIATION OF INFECTIOUS DISEASES AND DISORDERS
<b>A61P 33/02</b> (2006.01)	3399969	METHOD FOR PREVENTION, TREATMENT AND ALLEVIATION OF INFECTIOUS DISEASES AND DISORDERS
<b>A61K 39/00</b> (2006.01)	3400004	THERAPEUTIC ANTICANCER NEOEPITOPE VACCINE
<b>A61P 35/00</b> (2006.01)	3400004	THERAPEUTIC ANTICANCER NEOEPITOPE VACCINE
<b>A61K 39/00</b> (2006.01)	3400005	NEOEPITOPE RNA CANCER VACCINE
<b>A61P 35/00</b> (2006.01)	3400005	NEOEPITOPE RNA CANCER VACCINE
<b>C23C 2/02</b> (2006.01)	3400317	HOT-DIP GALVANIZATION SYSTEM AND HOT-DIP GALVANIZATION METHOD, IN PARTICULAR FOR MASS PRODUCTION
<b>C23C 2/06</b> (2006.01)	3400317	HOT-DIP GALVANIZATION SYSTEM AND HOT-DIP GALVANIZATION METHOD, IN PARTICULAR FOR MASS PRODUCTION
<b>C23C 2/14</b> (2006.01)	3400317	HOT-DIP GALVANIZATION SYSTEM AND HOT-DIP GALVANIZATION METHOD, IN PARTICULAR FOR MASS PRODUCTION
<b>C23C 2/26</b> (2006.01)	3400317	HOT-DIP GALVANIZATION SYSTEM AND HOT-DIP GALVANIZATION METHOD, IN PARTICULAR FOR MASS PRODUCTION
<b>C23C 2/30</b> (2006.01)	3400317	HOT-DIP GALVANIZATION SYSTEM AND HOT-DIP GALVANIZATION METHOD, IN PARTICULAR FOR MASS PRODUCTION
<b>A61K 31/437</b> (2006.01)	3405466	ARYL SUBSTITUTED PYRIMIDINES FOR USE IN INFLUENZA VIRUS INFECTION
<b>A61P 31/16</b> (2006.01)	3405466	ARYL SUBSTITUTED PYRIMIDINES FOR USE IN INFLUENZA VIRUS INFECTION
<b>C07D 403/04</b> (2006.01)	3405466	ARYL SUBSTITUTED PYRIMIDINES FOR USE IN INFLUENZA VIRUS INFECTION
<b>C07D 403/12</b> (2006.01)	3405466	ARYL SUBSTITUTED PYRIMIDINES FOR USE IN INFLUENZA VIRUS INFECTION
<b>C07D 471/04</b> (2006.01)	3405466	ARYL SUBSTITUTED PYRIMIDINES FOR USE IN INFLUENZA VIRUS INFECTION
<b>C07D 487/04</b> (2006.01)	3405466	ARYL SUBSTITUTED PYRIMIDINES FOR USE IN INFLUENZA VIRUS INFECTION
<b>C07D 495/04</b> (2006.01)	3405466	ARYL SUBSTITUTED PYRIMIDINES FOR USE IN INFLUENZA VIRUS INFECTION
<b>D06P 1/653</b> (2006.01)	3390711	METHOD OF DYE CLEARING TEXTILES
<b>D06P 3/54</b> (2006.01)	3390711	METHOD OF DYE CLEARING TEXTILES
<b>D06P 5/04</b> (2006.01)	3390711	METHOD OF DYE CLEARING TEXTILES
<b>A61K 31/437</b> (2006.01)	3400225	FUNCTIONALIZED PENTANOIC ACIDS FOR USE IN INFLUENZA VIRAL INFECTIONS
<b>A61K 31/519</b> (2006.01)	3400225	FUNCTIONALIZED PENTANOIC ACIDS FOR USE IN INFLUENZA VIRAL INFECTIONS
<b>A61P 31/16</b> (2006.01)	3400225	FUNCTIONALIZED PENTANOIC ACIDS FOR USE IN INFLUENZA VIRAL INFECTIONS
<b>C07D 471/04</b> (2006.01)	3400225	FUNCTIONALIZED PENTANOIC ACIDS FOR USE IN INFLUENZA VIRAL INFECTIONS
<b>C07D 487/04</b> (2006.01)	3400225	FUNCTIONALIZED PENTANOIC ACIDS FOR USE IN INFLUENZA VIRAL INFECTIONS
<b>A61K 49/00</b> (2006.01)	3405216	NANOPARTICLE CONJUGATES
<b>E05C 19/00</b> (2006.01)	3405635	DOOR DEVICE
<b>E06B 7/18</b> (2006.01)	3405635	DOOR DEVICE
<b>B22D 41/22</b> (2006.01)	3408043	SLIDING GATE VALVE PLATE
<b>B22D 41/28</b> (2006.01)	3408043	SLIDING GATE VALVE PLATE
<b>B22D 41/34</b> (2006.01)	3408043	SLIDING GATE VALVE PLATE
<b>A61P 35/00</b> (2006.01)	3405490	MONO AND BISPECIFIC ANTIBODIES FOR EPIDERMAL GROWTH FACTOR RECEPTOR VARIANT III AND CD3 AND THEIR USES
<b>C07K 16/28</b> (2006.01)	3405490	MONO AND BISPECIFIC ANTIBODIES FOR EPIDERMAL GROWTH FACTOR RECEPTOR VARIANT III AND CD3 AND THEIR USES
<b>C07K 16/30</b> (2006.01)	3405490	MONO AND BISPECIFIC ANTIBODIES FOR EPIDERMAL GROWTH FACTOR RECEPTOR VARIANT III AND CD3 AND THEIR USES
<b>A61K 9/20</b> (2006.01)	3405177	FORMULATIONS/COMPOSITIONS COMPRISING A BTK INHIBITOR
<b>A61K 9/48</b> (2006.01)	3405177	FORMULATIONS/COMPOSITIONS COMPRISING A BTK INHIBITOR
<b>A61K 31/00</b> (2006.01)	3405177	FORMULATIONS/COMPOSITIONS COMPRISING A BTK INHIBITOR
<b>A61K 9/20</b> (2006.01)	3405178	FORMULATIONS/COMPOSITIONS COMPRISING A BTK INHIBITOR
<b>A61K 31/00</b> (2006.01)	3405178	FORMULATIONS/COMPOSITIONS COMPRISING A BTK INHIBITOR
<b>C07D 205/04</b> (2006.01)	3400211	AZETIDINE MODULATORS OF THE SPHINGOSINE 1-PHOSPHATE RECEPTOR
<b>C23C 2/02</b> (2006.01)	3400318	HOT-DIP GALVANIZATION SYSTEM AND HOT-DIP GALVANIZATION METHOD

MKP (51)	Broj objave evropske prijava patenta (97)	Naziv pronalaska (54)
<b>C23C 2/06</b> (2006.01)	3400318	HOT-DIP GALVANIZATION SYSTEM AND HOT-DIP GALVANIZATION METHOD
<b>C23C 2/14</b> (2006.01)	3400318	HOT-DIP GALVANIZATION SYSTEM AND HOT-DIP GALVANIZATION METHOD
<b>C23C 2/26</b> (2006.01)	3400318	HOT-DIP GALVANIZATION SYSTEM AND HOT-DIP GALVANIZATION METHOD
<b>C23C 2/30</b> (2006.01)	3400318	HOT-DIP GALVANIZATION SYSTEM AND HOT-DIP GALVANIZATION METHOD
<b>A61K 31/506</b> (2006.01)	3405196	NEW SUBSTITUTED CYANOINDOLINE DERIVATIVES AS NIK INHIBITORS
<b>A61K 31/5377</b> (2006.01)	3405196	NEW SUBSTITUTED CYANOINDOLINE DERIVATIVES AS NIK INHIBITORS
<b>A61K 31/55</b> (2006.01)	3405196	NEW SUBSTITUTED CYANOINDOLINE DERIVATIVES AS NIK INHIBITORS
<b>A61P 3/00</b> (2006.01)	3405196	NEW SUBSTITUTED CYANOINDOLINE DERIVATIVES AS NIK INHIBITORS
<b>A61P 29/00</b> (2006.01)	3405196	NEW SUBSTITUTED CYANOINDOLINE DERIVATIVES AS NIK INHIBITORS
<b>A61P 35/00</b> (2006.01)	3405196	NEW SUBSTITUTED CYANOINDOLINE DERIVATIVES AS NIK INHIBITORS
<b>A61P 37/00</b> (2006.01)	3405196	NEW SUBSTITUTED CYANOINDOLINE DERIVATIVES AS NIK INHIBITORS
<b>C07D 401/14</b> (2006.01)	3405196	NEW SUBSTITUTED CYANOINDOLINE DERIVATIVES AS NIK INHIBITORS
<b>C07D 403/14</b> (2006.01)	3405196	NEW SUBSTITUTED CYANOINDOLINE DERIVATIVES AS NIK INHIBITORS
<b>C07D 405/14</b> (2006.01)	3405196	NEW SUBSTITUTED CYANOINDOLINE DERIVATIVES AS NIK INHIBITORS
<b>C07D 413/14</b> (2006.01)	3405196	NEW SUBSTITUTED CYANOINDOLINE DERIVATIVES AS NIK INHIBITORS
<b>C07D 471/10</b> (2006.01)	3405196	NEW SUBSTITUTED CYANOINDOLINE DERIVATIVES AS NIK INHIBITORS
<b>C07D 487/04</b> (2006.01)	3405196	NEW SUBSTITUTED CYANOINDOLINE DERIVATIVES AS NIK INHIBITORS
<b>C07D 487/10</b> (2006.01)	3405196	NEW SUBSTITUTED CYANOINDOLINE DERIVATIVES AS NIK INHIBITORS
<b>A61K 31/506</b> (2006.01)	3405464	NEW 6-MEMBERED HETEROAROMATIC SUBSTITUTED CYANOINDOLINE DERIVATIVES AS NIK INHIBITORS
<b>A61K 31/5377</b> (2006.01)	3405464	NEW 6-MEMBERED HETEROAROMATIC SUBSTITUTED CYANOINDOLINE DERIVATIVES AS NIK INHIBITORS
<b>A61K 31/553</b> (2006.01)	3405464	NEW 6-MEMBERED HETEROAROMATIC SUBSTITUTED CYANOINDOLINE DERIVATIVES AS NIK INHIBITORS
<b>A61P 3/00</b> (2006.01)	3405464	NEW 6-MEMBERED HETEROAROMATIC SUBSTITUTED CYANOINDOLINE DERIVATIVES AS NIK INHIBITORS
<b>A61P 29/00</b> (2006.01)	3405464	NEW 6-MEMBERED HETEROAROMATIC SUBSTITUTED CYANOINDOLINE DERIVATIVES AS NIK INHIBITORS
<b>A61P 35/00</b> (2006.01)	3405464	NEW 6-MEMBERED HETEROAROMATIC SUBSTITUTED CYANOINDOLINE DERIVATIVES AS NIK INHIBITORS
<b>A61P 37/00</b> (2006.01)	3405464	NEW 6-MEMBERED HETEROAROMATIC SUBSTITUTED CYANOINDOLINE DERIVATIVES AS NIK INHIBITORS
<b>C07D 401/14</b> (2006.01)	3405464	NEW 6-MEMBERED HETEROAROMATIC SUBSTITUTED CYANOINDOLINE DERIVATIVES AS NIK INHIBITORS
<b>C07D 403/04</b> (2006.01)	3405464	NEW 6-MEMBERED HETEROAROMATIC SUBSTITUTED CYANOINDOLINE DERIVATIVES AS NIK INHIBITORS
<b>C07D 403/14</b> (2006.01)	3405464	NEW 6-MEMBERED HETEROAROMATIC SUBSTITUTED CYANOINDOLINE DERIVATIVES AS NIK INHIBITORS
<b>C07D 405/14</b> (2006.01)	3405464	NEW 6-MEMBERED HETEROAROMATIC SUBSTITUTED CYANOINDOLINE DERIVATIVES AS NIK INHIBITORS
<b>C07D 413/14</b> (2006.01)	3405464	NEW 6-MEMBERED HETEROAROMATIC SUBSTITUTED CYANOINDOLINE DERIVATIVES AS NIK INHIBITORS
<b>A61K 38/00</b> (2006.01)	3405481	CHIMERIC ANTIGEN RECEPTORS TARGETING EPIDERMAL GROWTH FACTOR RECEPTOR VARIANT III
<b>A61K 48/00</b> (2006.01)	3405481	CHIMERIC ANTIGEN RECEPTORS TARGETING EPIDERMAL GROWTH FACTOR RECEPTOR VARIANT III
<b>C07K 14/47</b> (2006.01)	3405481	CHIMERIC ANTIGEN RECEPTORS TARGETING EPIDERMAL GROWTH FACTOR RECEPTOR VARIANT III
<b>C07K 16/28</b> (2006.01)	3405481	CHIMERIC ANTIGEN RECEPTORS TARGETING EPIDERMAL GROWTH FACTOR RECEPTOR VARIANT III

MKP (51)	Broj objave evropske prijava patenta (97)	Naziv pronalaska (54)
<b>C07K 16/30</b> (2006.01)	3405481	CHIMERIC ANTIGEN RECEPTORS TARGETING EPIDERMAL GROWTH FACTOR RECEPTOR VARIANT III
<b>A61K 31/506</b> (2006.01)	3400221	PYRIDINE AND PYRIDIMINE COMPOUNDS AS PI3K-GAMMA INHIBITORS
<b>A61P 35/00</b> (2006.01)	3400221	PYRIDINE AND PYRIDIMINE COMPOUNDS AS PI3K-GAMMA INHIBITORS
<b>C07D 401/14</b> (2006.01)	3400221	PYRIDINE AND PYRIDIMINE COMPOUNDS AS PI3K-GAMMA INHIBITORS
<b>C07D 403/14</b> (2006.01)	3400221	PYRIDINE AND PYRIDIMINE COMPOUNDS AS PI3K-GAMMA INHIBITORS
<b>A61K 31/403</b> (2006.01)	3400212	TETRAHYDROCARBAZOLE INHIBITORS OF SIRT1 RECEPTORS
<b>A61P 25/00</b> (2006.01)	3400212	TETRAHYDROCARBAZOLE INHIBITORS OF SIRT1 RECEPTORS
<b>C07D 209/56</b> (2006.01)	3400212	TETRAHYDROCARBAZOLE INHIBITORS OF SIRT1 RECEPTORS
<b>A61K 38/20</b> (2006.01)	3402819	IMMUNE-STIMULATING HUMANIZED MONOCLONAL ANTIBODIES AGAINST HUMAN INTERLEUKIN-2, AND FUSION PROTEINS THEREOF
<b>C07K 16/24</b> (2006.01)	3402819	IMMUNE-STIMULATING HUMANIZED MONOCLONAL ANTIBODIES AGAINST HUMAN INTERLEUKIN-2, AND FUSION PROTEINS THEREOF
<b>C09K 11/06</b> (2006.01)	3405551	NANOPARTICLES FOR USE IN LIGHT EMITTING APPLICATIONS
<b>H01L 51/00</b> (2006.01)	3405551	NANOPARTICLES FOR USE IN LIGHT EMITTING APPLICATIONS
<b>E02D 27/34</b> (2006.01)	3411532	FOUNDATION
<b>C07C 251/72</b> (2006.01)	3411360	CATALYTIC HYDROGENATION PROCESS FOR PREPARING PYRAZOLES
<b>C07D 231/14</b> (2006.01)	3411360	CATALYTIC HYDROGENATION PROCESS FOR PREPARING PYRAZOLES
<b>A61K 9/20</b> (2006.01)	3407874	FAST DISPERSIBLE PHARMACEUTICAL COMPOSITION COMPRISING TYROSINE-KINASE INHIBITOR
<b>A61K 31/506</b> (2006.01)	3407874	FAST DISPERSIBLE PHARMACEUTICAL COMPOSITION COMPRISING TYROSINE-KINASE INHIBITOR
<b>A61K 31/454</b> (2006.01)	3402503	THERAPEUTIC COMBINATIONS OF AN ANTIFOLATE AND A BTK INHIBITOR
<b>A61K 31/4985</b> (2006.01)	3402503	THERAPEUTIC COMBINATIONS OF AN ANTIFOLATE AND A BTK INHIBITOR
<b>A61K 31/517</b> (2006.01)	3402503	THERAPEUTIC COMBINATIONS OF AN ANTIFOLATE AND A BTK INHIBITOR
<b>A61K 31/519</b> (2006.01)	3402503	THERAPEUTIC COMBINATIONS OF AN ANTIFOLATE AND A BTK INHIBITOR
<b>A61K 31/52</b> (2006.01)	3402503	THERAPEUTIC COMBINATIONS OF AN ANTIFOLATE AND A BTK INHIBITOR
<b>A61K 31/522</b> (2006.01)	3402503	THERAPEUTIC COMBINATIONS OF AN ANTIFOLATE AND A BTK INHIBITOR
<b>A61K 38/00</b> (2006.01)	3402503	THERAPEUTIC COMBINATIONS OF AN ANTIFOLATE AND A BTK INHIBITOR
<b>A61K 39/00</b> (2006.01)	3402503	THERAPEUTIC COMBINATIONS OF AN ANTIFOLATE AND A BTK INHIBITOR
<b>A61K 45/06</b> (2006.01)	3402503	THERAPEUTIC COMBINATIONS OF AN ANTIFOLATE AND A BTK INHIBITOR
<b>A61P 35/00</b> (2006.01)	3402503	THERAPEUTIC COMBINATIONS OF AN ANTIFOLATE AND A BTK INHIBITOR
<b>A61P 35/02</b> (2006.01)	3402503	THERAPEUTIC COMBINATIONS OF AN ANTIFOLATE AND A BTK INHIBITOR
<b>F17C 1/16</b> (2006.01)	3397892	INTEGRATED COMPOSITE MOUNTING STRUCTURE FOR USE IN PRESSURE VESSELS AND PRESSURE VESSEL SYSTEMS
<b>F17C 13/08</b> (2006.01)	3397892	INTEGRATED COMPOSITE MOUNTING STRUCTURE FOR USE IN PRESSURE VESSELS AND PRESSURE VESSEL SYSTEMS
<b>A61K 31/165</b> (2006.01)	3402474	IL-8 INHIBITORS FOR USE IN THE TREATMENT OF CHEMOTHERAPY-INDUCED PERIPHERAL NEUROPATHY
<b>A61K 31/19</b> (2006.01)	3402474	IL-8 INHIBITORS FOR USE IN THE TREATMENT OF CHEMOTHERAPY-INDUCED PERIPHERAL NEUROPATHY
<b>A61P 25/02</b> (2006.01)	3402474	IL-8 INHIBITORS FOR USE IN THE TREATMENT OF CHEMOTHERAPY-INDUCED PERIPHERAL NEUROPATHY
<b>A61K 31/437</b> (2006.01)	3402790	SPIROHEPTANE SALICYLAMIDES AND RELATED COMPOUNDS AS INHIBITORS OF ROCK
<b>A61K 31/4427</b> (2006.01)	3402790	SPIROHEPTANE SALICYLAMIDES AND RELATED COMPOUNDS AS INHIBITORS OF ROCK
<b>C07D 213/64</b> (2006.01)	3402790	SPIROHEPTANE SALICYLAMIDES AND RELATED COMPOUNDS AS INHIBITORS OF ROCK

MKP (51)	Broj objave evropske prijava patenta (97)	Naziv pronalaska (54)
<b>C07D 231/12</b> (2006.01)	3402790	SPIROHEPTANE SALICYLAMIDES AND RELATED COMPOUNDS AS INHIBITORS OF ROCK
<b>C07D 231/18</b> (2006.01)	3402790	SPIROHEPTANE SALICYLAMIDES AND RELATED COMPOUNDS AS INHIBITORS OF ROCK
<b>C07D 231/54</b> (2006.01)	3402790	SPIROHEPTANE SALICYLAMIDES AND RELATED COMPOUNDS AS INHIBITORS OF ROCK
<b>C07D 401/12</b> (2006.01)	3402790	SPIROHEPTANE SALICYLAMIDES AND RELATED COMPOUNDS AS INHIBITORS OF ROCK
<b>C07D 401/14</b> (2006.01)	3402790	SPIROHEPTANE SALICYLAMIDES AND RELATED COMPOUNDS AS INHIBITORS OF ROCK
<b>C07D 413/12</b> (2006.01)	3402790	SPIROHEPTANE SALICYLAMIDES AND RELATED COMPOUNDS AS INHIBITORS OF ROCK
<b>C07D 471/04</b> (2006.01)	3402790	SPIROHEPTANE SALICYLAMIDES AND RELATED COMPOUNDS AS INHIBITORS OF ROCK
<b>C07D 471/12</b> (2006.01)	3402790	SPIROHEPTANE SALICYLAMIDES AND RELATED COMPOUNDS AS INHIBITORS OF ROCK
<b>C07D 513/04</b> (2006.01)	3402790	SPIROHEPTANE SALICYLAMIDES AND RELATED COMPOUNDS AS INHIBITORS OF ROCK
<b>A61P 35/00</b> (2006.01)	3402822	AXL-SPECIFIC ANTIBODY-DRUG CONJUGATES FOR CANCER TREATMENT
<b>C07K 16/28</b> (2006.01)	3402822	AXL-SPECIFIC ANTIBODY-DRUG CONJUGATES FOR CANCER TREATMENT
<b>C23C 2/02</b> (2006.01)	3411510	HOT-DIP GALVANIZATION SYSTEM AND HOT-DIP GALVANIZATION METHOD
<b>C23C 2/06</b> (2006.01)	3411510	HOT-DIP GALVANIZATION SYSTEM AND HOT-DIP GALVANIZATION METHOD
<b>C23C 2/14</b> (2006.01)	3411510	HOT-DIP GALVANIZATION SYSTEM AND HOT-DIP GALVANIZATION METHOD
<b>C23C 2/26</b> (2006.01)	3411510	HOT-DIP GALVANIZATION SYSTEM AND HOT-DIP GALVANIZATION METHOD
<b>C23C 2/30</b> (2006.01)	3411510	HOT-DIP GALVANIZATION SYSTEM AND HOT-DIP GALVANIZATION METHOD
<b>A61K 31/41</b> (2006.01)	3411028	COMBINATION PRODUCTS FOR THE TREATMENT OF RSV
<b>A61K 31/4184</b> (2006.01)	3411028	COMBINATION PRODUCTS FOR THE TREATMENT OF RSV
<b>A61K 31/437</b> (2006.01)	3411028	COMBINATION PRODUCTS FOR THE TREATMENT OF RSV
<b>A61K 31/519</b> (2006.01)	3411028	COMBINATION PRODUCTS FOR THE TREATMENT OF RSV
<b>A61K 31/52</b> (2006.01)	3411028	COMBINATION PRODUCTS FOR THE TREATMENT OF RSV
<b>A61K 31/53</b> (2006.01)	3411028	COMBINATION PRODUCTS FOR THE TREATMENT OF RSV
<b>A61K 31/5377</b> (2006.01)	3411028	COMBINATION PRODUCTS FOR THE TREATMENT OF RSV
<b>A61K 31/55</b> (2006.01)	3411028	COMBINATION PRODUCTS FOR THE TREATMENT OF RSV
<b>A61K 31/5513</b> (2006.01)	3411028	COMBINATION PRODUCTS FOR THE TREATMENT OF RSV
<b>A61K 31/70</b> (2006.01)	3411028	COMBINATION PRODUCTS FOR THE TREATMENT OF RSV
<b>A61K 31/7056</b> (2006.01)	3411028	COMBINATION PRODUCTS FOR THE TREATMENT OF RSV
<b>A61K 39/395</b> (2006.01)	3411028	COMBINATION PRODUCTS FOR THE TREATMENT OF RSV
<b>A61P 31/12</b> (2006.01)	3411028	COMBINATION PRODUCTS FOR THE TREATMENT OF RSV
<b>C07K 16/28</b> (2006.01)	3405492	MULTISPECIFIC MOLECULES TARGETING CLL-1
<b>A61J 1/20</b> (2006.01)	3411005	MEDICAL METERING DEVICE
<b>A61M 5/24</b> (2006.01)	3411005	MEDICAL METERING DEVICE
<b>A61M 5/28</b> (2006.01)	3411005	MEDICAL METERING DEVICE
<b>A61M 39/24</b> (2006.01)	3411005	MEDICAL METERING DEVICE
<b>A61K 39/395</b> (2006.01)	3405493	ANTI-ROR1 ANTIBODIES, ROR1 X CD3 BISPECIFIC ANTIBODIES, AND METHODS OF USING THE SAME
<b>A61P 35/00</b> (2006.01)	3405493	ANTI-ROR1 ANTIBODIES, ROR1 X CD3 BISPECIFIC ANTIBODIES, AND METHODS OF USING THE SAME
<b>C07K 16/28</b> (2006.01)	3405493	ANTI-ROR1 ANTIBODIES, ROR1 X CD3 BISPECIFIC ANTIBODIES, AND METHODS OF USING THE SAME
<b>C07K 14/08</b> (2006.01)	3408280	INACTIVATION OF VIRUSES BY DELIPIDATION
<b>C12N 7/06</b> (2006.01)	3408280	INACTIVATION OF VIRUSES BY DELIPIDATION
<b>A61K 9/00</b> (2006.01)	3402465	FORMULATION FOR ANTIBODY AND DRUG CONJUGATE THEREOF
<b>A61K 9/19</b> (2006.01)	3402465	FORMULATION FOR ANTIBODY AND DRUG CONJUGATE THEREOF
<b>A61K 39/395</b> (2006.01)	3402465	FORMULATION FOR ANTIBODY AND DRUG CONJUGATE THEREOF
<b>A61K 47/18</b> (2017.01)	3402465	FORMULATION FOR ANTIBODY AND DRUG CONJUGATE THEREOF
<b>A61K 47/26</b> (2006.01)	3402465	FORMULATION FOR ANTIBODY AND DRUG CONJUGATE THEREOF
<b>C07K 16/28</b> (2006.01)	3402465	FORMULATION FOR ANTIBODY AND DRUG CONJUGATE THEREOF
<b>A61P 35/00</b> (2006.01)	3405495	NEUTRALIZATION OF INHIBITORY PATHWAYS IN LYMPHOCYTES
<b>C07K 16/28</b> (2006.01)	3405495	NEUTRALIZATION OF INHIBITORY PATHWAYS IN LYMPHOCYTES
<b>C10L 1/00</b> (2006.01)	3402862	USE OF RARE EARTH COMPLEXES AS MARKERS OF PETROLEUM PRODUCTS, CRUDE OILS, BIOFUELS OR LUBRICANTS



MKP (51)	Broj objave evropske prijava patenta (97)	Naziv pronalaska (54)
<b>C10L 1/30</b> (2006.01)	3402862	USE OF RARE EARTH COMPLEXES AS MARKERS OF PETROLEUM PRODUCTS, CRUDE OILS, BIOFUELS OR LUBRICANTS
<b>C10M 171/00</b> (2006.01)	3402862	USE OF RARE EARTH COMPLEXES AS MARKERS OF PETROLEUM PRODUCTS, CRUDE OILS, BIOFUELS OR LUBRICANTS
<b>A61K 31/575</b> (2006.01)	3405474	AMINE DERIVATIVES OF LUPANES WITH HIV MATURATION INHIBITORY ACTIVITY
<b>A61P 31/18</b> (2006.01)	3405474	AMINE DERIVATIVES OF LUPANES WITH HIV MATURATION INHIBITORY ACTIVITY
<b>C07J 63/00</b> (2006.01)	3405474	AMINE DERIVATIVES OF LUPANES WITH HIV MATURATION INHIBITORY ACTIVITY
<b>A61K 39/00</b> (2006.01)	3405489	HIGH DOSE TREATMENTS FOR ALZHEIMER'S DISEASE
<b>C07K 16/00</b> (2006.01)	3405489	HIGH DOSE TREATMENTS FOR ALZHEIMER'S DISEASE
<b>C07K 16/18</b> (2006.01)	3405489	HIGH DOSE TREATMENTS FOR ALZHEIMER'S DISEASE
<b>G01N 33/15</b> (2006.01)	3405489	HIGH DOSE TREATMENTS FOR ALZHEIMER'S DISEASE
<b>A21D 13/00</b> (2017.01)	3407725	BAKED PRODUCT WITH A LONG SHELF LIFE AND METHOD FOR PRODUCING SAME
<b>A21D 13/14</b> (2017.01)	3407725	BAKED PRODUCT WITH A LONG SHELF LIFE AND METHOD FOR PRODUCING SAME
<b>A21D 13/32</b> (2017.01)	3407725	BAKED PRODUCT WITH A LONG SHELF LIFE AND METHOD FOR PRODUCING SAME
<b>A23G 3/54</b> (2006.01)	3407725	BAKED PRODUCT WITH A LONG SHELF LIFE AND METHOD FOR PRODUCING SAME
<b>A61K 39/395</b> (2006.01)	3408295	PHARMACEUTICAL COMPOSITION COMPRISING BISPECIFIC ANTIBODY CONSTRUCTS
<b>A61K 47/00</b> (2006.01)	3408295	PHARMACEUTICAL COMPOSITION COMPRISING BISPECIFIC ANTIBODY CONSTRUCTS
<b>C07K 16/28</b> (2006.01)	3408295	PHARMACEUTICAL COMPOSITION COMPRISING BISPECIFIC ANTIBODY CONSTRUCTS
<b>A63F 1/12</b> (2006.01)	3407990	METHOD AND SYSTEM FOR CARD SHUFFLE INTEGRITY TRACKING
<b>A63F 1/18</b> (2006.01)	3407990	METHOD AND SYSTEM FOR CARD SHUFFLE INTEGRITY TRACKING
<b>G07F 17/32</b> (2006.01)	3407990	METHOD AND SYSTEM FOR CARD SHUFFLE INTEGRITY TRACKING
<b>A61K 39/12</b> (2006.01)	3407910	RECOMBINANT MODIFIED VACCINIA VIRUS ANKARA (MVA) EQUINE ENCEPHALITIS VIRUS VACCINE
<b>C07K 14/005</b> (2006.01)	3407910	RECOMBINANT MODIFIED VACCINIA VIRUS ANKARA (MVA) EQUINE ENCEPHALITIS VIRUS VACCINE
<b>C12N 15/86</b> (2006.01)	3407910	RECOMBINANT MODIFIED VACCINIA VIRUS ANKARA (MVA) EQUINE ENCEPHALITIS VIRUS VACCINE
<b>A61K 39/00</b> (2006.01)	3411394	ENGINEERED ANTIGEN PRESENTING CELLS AND USES THEREOF
<b>C07K 14/705</b> (2006.01)	3411394	ENGINEERED ANTIGEN PRESENTING CELLS AND USES THEREOF
<b>C07K 16/32</b> (2006.01)	3411394	ENGINEERED ANTIGEN PRESENTING CELLS AND USES THEREOF
<b>B05B 11/00</b> (2006.01)	3416747	DISPENSER WITH ARTICULATED DISPENSING TUBE
<b>B65D 83/20</b> (2006.01)	3416747	DISPENSER WITH ARTICULATED DISPENSING TUBE
<b>B65D 83/22</b> (2006.01)	3416747	DISPENSER WITH ARTICULATED DISPENSING TUBE
<b>B65D 83/30</b> (2006.01)	3416747	DISPENSER WITH ARTICULATED DISPENSING TUBE
<b>A61K 31/56</b> (2006.01)	3353190	C4-MODIFIED OLEANOLIC ACID DERIVATIVES FOR INHIBITION OF IL-17 AND OTHER USES
<b>A61K 31/58</b> (2006.01)	3353190	C4-MODIFIED OLEANOLIC ACID DERIVATIVES FOR INHIBITION OF IL-17 AND OTHER USES
<b>A61K 31/585</b> (2006.01)	3353190	C4-MODIFIED OLEANOLIC ACID DERIVATIVES FOR INHIBITION OF IL-17 AND OTHER USES
<b>A61P 29/00</b> (2006.01)	3353190	C4-MODIFIED OLEANOLIC ACID DERIVATIVES FOR INHIBITION OF IL-17 AND OTHER USES
<b>C07J 63/00</b> (2006.01)	3353190	C4-MODIFIED OLEANOLIC ACID DERIVATIVES FOR INHIBITION OF IL-17 AND OTHER USES
<b>C07J 71/00</b> (2006.01)	3353190	C4-MODIFIED OLEANOLIC ACID DERIVATIVES FOR INHIBITION OF IL-17 AND OTHER USES
<b>A61K 31/445</b> (2006.01)	3356360	THERAPEUTIC COMPOUNDS AND METHODS OF USE THEREOF
<b>A61P 29/00</b> (2006.01)	3356360	THERAPEUTIC COMPOUNDS AND METHODS OF USE THEREOF
<b>C07D 417/12</b> (2006.01)	3356360	THERAPEUTIC COMPOUNDS AND METHODS OF USE THEREOF
<b>C07D 417/14</b> (2006.01)	3356360	THERAPEUTIC COMPOUNDS AND METHODS OF USE THEREOF
<b>A61K 31/437</b> (2006.01)	3355922	COMBINATION THERAPY OF BROMODOMAIN INHIBITORS AND CHECKPOINT BLOCKADE
<b>A61K 31/495</b> (2006.01)	3355922	COMBINATION THERAPY OF BROMODOMAIN INHIBITORS AND CHECKPOINT BLOCKADE
<b>A61K 31/519</b> (2006.01)	3355922	COMBINATION THERAPY OF BROMODOMAIN INHIBITORS AND CHECKPOINT BLOCKADE
<b>A61K 31/551</b> (2006.01)	3355922	COMBINATION THERAPY OF BROMODOMAIN INHIBITORS AND CHECKPOINT BLOCKADE

MKP (51)	Broj objave evropske prijava patenta (97)	Naziv pronalaska (54)
<b>A61K 45/00</b> (2006.01)	3355922	COMBINATION THERAPY OF BROMODOMAIN INHIBITORS AND CHECKPOINT BLOCKADE
<b>A61K 45/06</b> (2006.01)	3355922	COMBINATION THERAPY OF BROMODOMAIN INHIBITORS AND CHECKPOINT BLOCKADE
<b>A61P 35/00</b> (2006.01)	3355922	COMBINATION THERAPY OF BROMODOMAIN INHIBITORS AND CHECKPOINT BLOCKADE
<b>C07K 14/47</b> (2006.01)	3359565	ANTI-WT1/HLA-SPECIFIC ANTIBODIES
<b>C07K 16/18</b> (2006.01)	3359565	ANTI-WT1/HLA-SPECIFIC ANTIBODIES
<b>G01N 33/53</b> (2006.01)	3359565	ANTI-WT1/HLA-SPECIFIC ANTIBODIES
<b>H04M 11/00</b> (2006.01)	3350981	LOW POWER MODEM AND CONTROLLER
<b>H04M 19/00</b> (2006.01)	3350981	LOW POWER MODEM AND CONTROLLER
<b>A61K 31/522</b> (2006.01)	3355933	ADENINE CONJUGATE COMPOUNDS AND THEIR USE AS VACCINE ADJUVANTS
<b>A61K 47/54</b> (2017.01)	3355933	ADENINE CONJUGATE COMPOUNDS AND THEIR USE AS VACCINE ADJUVANTS
<b>A61K 47/69</b> (2017.01)	3355933	ADENINE CONJUGATE COMPOUNDS AND THEIR USE AS VACCINE ADJUVANTS
<b>A61P 35/00</b> (2006.01)	3355933	ADENINE CONJUGATE COMPOUNDS AND THEIR USE AS VACCINE ADJUVANTS
<b>C07D 473/34</b> (2006.01)	3355933	ADENINE CONJUGATE COMPOUNDS AND THEIR USE AS VACCINE ADJUVANTS
<b>A61K 38/18</b> (2006.01)	3353546	METHODS FOR TREATING CARDIAC INJURY
<b>G01N 33/50</b> (2006.01)	3353546	METHODS FOR TREATING CARDIAC INJURY
<b>G01N 33/68</b> (2006.01)	3353546	METHODS FOR TREATING CARDIAC INJURY
<b>A61K 38/12</b> (2006.01)	3356386	METHOD OF TREATING MELANOCORTIN-4 RECEPTOR PATHWAY-ASSOCIATED DISORDERS
<b>A61P 3/04</b> (2006.01)	3356386	METHOD OF TREATING MELANOCORTIN-4 RECEPTOR PATHWAY-ASSOCIATED DISORDERS
<b>C07K 7/54</b> (2006.01)	3356386	METHOD OF TREATING MELANOCORTIN-4 RECEPTOR PATHWAY-ASSOCIATED DISORDERS
<b>A61K 8/19</b> (2006.01)	3355855	COMPOSITION FOR DUST PARTICLE REDUCTION
<b>A61K 8/73</b> (2006.01)	3355855	COMPOSITION FOR DUST PARTICLE REDUCTION
<b>A61K 9/16</b> (2006.01)	3355855	COMPOSITION FOR DUST PARTICLE REDUCTION
<b>A61Q 19/00</b> (2006.01)	3355855	COMPOSITION FOR DUST PARTICLE REDUCTION
<b>A61K 38/12</b> (2006.01)	3355905	METHOD OF TREATING MELANOCORTIN-4 RECEPTOR PATHWAY-ASSOCIATED DISORDERS
<b>A61P 3/04</b> (2006.01)	3355905	METHOD OF TREATING MELANOCORTIN-4 RECEPTOR PATHWAY-ASSOCIATED DISORDERS
<b>A61K 38/18</b> (2006.01)	3355908	TREATMENT OF BILE ACID DISORDERS
<b>A61P 1/16</b> (2006.01)	3355908	TREATMENT OF BILE ACID DISORDERS
<b>A61K 31/337</b> (2006.01)	3359196	RATIONAL COMBINATION THERAPY FOR THE TREATMENT OF CANCER
<b>A61K 31/52</b> (2006.01)	3359196	RATIONAL COMBINATION THERAPY FOR THE TREATMENT OF CANCER
<b>A61K 31/704</b> (2006.01)	3359196	RATIONAL COMBINATION THERAPY FOR THE TREATMENT OF CANCER
<b>A61K 45/06</b> (2006.01)	3359196	RATIONAL COMBINATION THERAPY FOR THE TREATMENT OF CANCER
<b>A61P 35/00</b> (2006.01)	3359196	RATIONAL COMBINATION THERAPY FOR THE TREATMENT OF CANCER
<b>A61K 31/4709</b> (2006.01)	3359536	COMPOUNDS, COMPOSITIONS, AND METHODS FOR MODULATING CFTR
<b>A61P 11/00</b> (2006.01)	3359536	COMPOUNDS, COMPOSITIONS, AND METHODS FOR MODULATING CFTR
<b>C07D 401/04</b> (2006.01)	3359536	COMPOUNDS, COMPOSITIONS, AND METHODS FOR MODULATING CFTR
<b>C07D 405/04</b> (2006.01)	3359536	COMPOUNDS, COMPOSITIONS, AND METHODS FOR MODULATING CFTR
<b>C07D 405/14</b> (2006.01)	3359536	COMPOUNDS, COMPOSITIONS, AND METHODS FOR MODULATING CFTR
<b>C07D 409/04</b> (2006.01)	3359536	COMPOUNDS, COMPOSITIONS, AND METHODS FOR MODULATING CFTR
<b>C07D 409/14</b> (2006.01)	3359536	COMPOUNDS, COMPOSITIONS, AND METHODS FOR MODULATING CFTR
<b>C07D 413/04</b> (2006.01)	3359536	COMPOUNDS, COMPOSITIONS, AND METHODS FOR MODULATING CFTR
<b>C07D 413/14</b> (2006.01)	3359536	COMPOUNDS, COMPOSITIONS, AND METHODS FOR MODULATING CFTR

MKP (51)	Broj objave evropske prijava patenta (97)	Naziv pronalaska (54)
<b>C07D 417/04</b> (2006.01)	3359536	COMPOUNDS, COMPOSITIONS, AND METHODS FOR MODULATING CFTR
<b>C07D 471/04</b> (2006.01)	3359536	COMPOUNDS, COMPOSITIONS, AND METHODS FOR MODULATING CFTR
<b>C07D 487/04</b> (2006.01)	3359536	COMPOUNDS, COMPOSITIONS, AND METHODS FOR MODULATING CFTR
<b>C07D 493/08</b> (2006.01)	3359536	COMPOUNDS, COMPOSITIONS, AND METHODS FOR MODULATING CFTR
<b>A61K 9/00</b> (2006.01)	3355887	AQUEOUS COMPOSITION OF APOMORPHINE FOR SUBCUTANEOUS ADMINISTRATION
<b>A61K 31/473</b> (2006.01)	3355887	AQUEOUS COMPOSITION OF APOMORPHINE FOR SUBCUTANEOUS ADMINISTRATION
<b>A61K 47/12</b> (2006.01)	3355887	AQUEOUS COMPOSITION OF APOMORPHINE FOR SUBCUTANEOUS ADMINISTRATION
<b>A61K 47/20</b> (2006.01)	3355887	AQUEOUS COMPOSITION OF APOMORPHINE FOR SUBCUTANEOUS ADMINISTRATION
<b>A61P 15/00</b> (2006.01)	3355887	AQUEOUS COMPOSITION OF APOMORPHINE FOR SUBCUTANEOUS ADMINISTRATION
<b>A61P 15/10</b> (2006.01)	3355887	AQUEOUS COMPOSITION OF APOMORPHINE FOR SUBCUTANEOUS ADMINISTRATION
<b>A61P 25/00</b> (2006.01)	3355887	AQUEOUS COMPOSITION OF APOMORPHINE FOR SUBCUTANEOUS ADMINISTRATION
<b>A61P 25/16</b> (2006.01)	3355887	AQUEOUS COMPOSITION OF APOMORPHINE FOR SUBCUTANEOUS ADMINISTRATION
<b>A61P 25/18</b> (2006.01)	3355887	AQUEOUS COMPOSITION OF APOMORPHINE FOR SUBCUTANEOUS ADMINISTRATION
<b>A61P 25/28</b> (2006.01)	3355887	AQUEOUS COMPOSITION OF APOMORPHINE FOR SUBCUTANEOUS ADMINISTRATION
<b>H05F 3/02</b> (2006.01)	3354117	STATIC ELIMINATOR
<b>A61K 39/39</b> (2006.01)	3365010	CYTOTOXIC IMMUNOSTIMULATING PARTICLES AND USES THEREOF
<b>A61K 47/64</b> (2017.01)	3365024	METHODS AND MEANS FOR INDUCING AN IMMUNE RESPONSE
<b>A61P 37/00</b> (2006.01)	3365024	METHODS AND MEANS FOR INDUCING AN IMMUNE RESPONSE
<b>A61P 37/04</b> (2006.01)	3365024	METHODS AND MEANS FOR INDUCING AN IMMUNE RESPONSE
<b>A61K 31/41</b> (2006.01)	3371167	ARYLCYCLOHEXYL PYRAZOLES AS NRF2 REGULATORS
<b>A61K 31/4196</b> (2006.01)	3371167	ARYLCYCLOHEXYL PYRAZOLES AS NRF2 REGULATORS
<b>A61K 31/445</b> (2006.01)	3371167	ARYLCYCLOHEXYL PYRAZOLES AS NRF2 REGULATORS
<b>C07D 401/04</b> (2006.01)	3371167	ARYLCYCLOHEXYL PYRAZOLES AS NRF2 REGULATORS
<b>C07D 401/06</b> (2006.01)	3371167	ARYLCYCLOHEXYL PYRAZOLES AS NRF2 REGULATORS
<b>C07D 401/10</b> (2006.01)	3371167	ARYLCYCLOHEXYL PYRAZOLES AS NRF2 REGULATORS
<b>C07D 401/12</b> (2006.01)	3371167	ARYLCYCLOHEXYL PYRAZOLES AS NRF2 REGULATORS
<b>C07D 401/14</b> (2006.01)	3371167	ARYLCYCLOHEXYL PYRAZOLES AS NRF2 REGULATORS
<b>A61K 39/00</b> (2006.01)	3359571	ANTI-LAG3 ANTIBODIES AND USES THEREOF
<b>A61P 35/00</b> (2006.01)	3359571	ANTI-LAG3 ANTIBODIES AND USES THEREOF
<b>A61P 37/00</b> (2006.01)	3359571	ANTI-LAG3 ANTIBODIES AND USES THEREOF
<b>C07K 16/28</b> (2006.01)	3359571	ANTI-LAG3 ANTIBODIES AND USES THEREOF
<b>A61K 31/424</b> (2006.01)	3365346	OXA-DIAZASPIRO COMPOUNDS HAVING ACTIVITY AGAINST PAIN
<b>C07D 498/10</b> (2006.01)	3365346	OXA-DIAZASPIRO COMPOUNDS HAVING ACTIVITY AGAINST PAIN
<b>A61K 31/41</b> (2006.01)	3359532	BIARYL PYRAZOLES AS NRF2 REGULATORS
<b>A61K 31/4196</b> (2006.01)	3359532	BIARYL PYRAZOLES AS NRF2 REGULATORS
<b>A61K 31/445</b> (2006.01)	3359532	BIARYL PYRAZOLES AS NRF2 REGULATORS
<b>C07D 401/04</b> (2006.01)	3359532	BIARYL PYRAZOLES AS NRF2 REGULATORS
<b>C07D 401/06</b> (2006.01)	3359532	BIARYL PYRAZOLES AS NRF2 REGULATORS
<b>C07D 401/10</b> (2006.01)	3359532	BIARYL PYRAZOLES AS NRF2 REGULATORS
<b>C07D 401/12</b> (2006.01)	3359532	BIARYL PYRAZOLES AS NRF2 REGULATORS
<b>C07D 401/14</b> (2006.01)	3359532	BIARYL PYRAZOLES AS NRF2 REGULATORS
<b>A61K 31/4196</b> (2006.01)	3356355	COMPOUNDS AND COMBINATIONS FOR THE TREATMENT OF HIV
<b>A61P 31/18</b> (2006.01)	3356355	COMPOUNDS AND COMBINATIONS FOR THE TREATMENT OF HIV
<b>C07D 249/10</b> (2006.01)	3356355	COMPOUNDS AND COMBINATIONS FOR THE TREATMENT OF HIV
<b>C07D 405/12</b> (2006.01)	3356355	COMPOUNDS AND COMBINATIONS FOR THE TREATMENT OF HIV
<b>A61K 31/437</b> (2006.01)	3359539	SUBSTITUTED PYRAZOLO[3,4-B]PYRIDIN-6-CARBOXYLIC ACIDS AND THEIR USE
<b>A61P 11/12</b> (2006.01)	3359539	SUBSTITUTED PYRAZOLO[3,4-B]PYRIDIN-6-CARBOXYLIC ACIDS AND THEIR USE
<b>C07D 471/04</b> (2006.01)	3359539	SUBSTITUTED PYRAZOLO[3,4-B]PYRIDIN-6-CARBOXYLIC ACIDS AND THEIR USE
<b>C07D 519/00</b> (2006.01)	3359539	SUBSTITUTED PYRAZOLO[3,4-B]PYRIDIN-6-CARBOXYLIC ACIDS AND THEIR USE

MKP	Broj objave evropske prijave patenta	Naziv pronalaska
(51)	(97)	(54)
<b>A61K 31/437</b> (2006.01)	3359540	NOVEL COMPOUNDS FOR TREATMENT OF CYSTIC FIBROSIS
<b>A61P 11/00</b> (2006.01)	3359540	NOVEL COMPOUNDS FOR TREATMENT OF CYSTIC FIBROSIS
<b>C07D 471/04</b> (2006.01)	3359540	NOVEL COMPOUNDS FOR TREATMENT OF CYSTIC FIBROSIS
<b>C07D 519/00</b> (2006.01)	3359540	NOVEL COMPOUNDS FOR TREATMENT OF CYSTIC FIBROSIS
<b>G01N 33/68</b> (2006.01)	3359540	NOVEL COMPOUNDS FOR TREATMENT OF CYSTIC FIBROSIS
<b>A23K 10/00</b> (2016.01)	3358967	METHODS AND FORMULATIONS FOR REDUCING BOVINE EMISSIONS
<b>A23K 10/40</b> (2016.01)	3358967	METHODS AND FORMULATIONS FOR REDUCING BOVINE EMISSIONS
<b>A61K 31/4174</b> (2006.01)	3359528	PPAR AGONISTS, COMPOUNDS, PHARMACEUTICAL COMPOSITIONS, AND METHODS OF USE THEREOF
<b>A61K 31/4439</b> (2006.01)	3359528	PPAR AGONISTS, COMPOUNDS, PHARMACEUTICAL COMPOSITIONS, AND METHODS OF USE THEREOF
<b>A61P 21/00</b> (2006.01)	3359528	PPAR AGONISTS, COMPOUNDS, PHARMACEUTICAL COMPOSITIONS, AND METHODS OF USE THEREOF
<b>C07D 233/64</b> (2006.01)	3359528	PPAR AGONISTS, COMPOUNDS, PHARMACEUTICAL COMPOSITIONS, AND METHODS OF USE THEREOF
<b>C07D 401/04</b> (2006.01)	3359528	PPAR AGONISTS, COMPOUNDS, PHARMACEUTICAL COMPOSITIONS, AND METHODS OF USE THEREOF
<b>C07D 405/10</b> (2006.01)	3359528	PPAR AGONISTS, COMPOUNDS, PHARMACEUTICAL COMPOSITIONS, AND METHODS OF USE THEREOF
<b>C07K 4/04</b> (2006.01)	3362466	AXMI554 DELTA-ENDOTOXIN GENE AND METHODS FOR ITS USE
<b>C07K 14/21</b> (2006.01)	3362466	AXMI554 DELTA-ENDOTOXIN GENE AND METHODS FOR ITS USE
<b>C12N 15/82</b> (2006.01)	3362466	AXMI554 DELTA-ENDOTOXIN GENE AND METHODS FOR ITS USE
<b>A61K 38/26</b> (2006.01)	3368061	GLUCAGON RECEPTOR AGONISTS
<b>C07K 14/605</b> (2006.01)	3368061	GLUCAGON RECEPTOR AGONISTS
<b>A61K 31/437</b> (2006.01)	3365340	HETEROCYCLIC COMPOUNDS AS IMMUNOMODULATORS
<b>A61K 31/5025</b> (2006.01)	3365340	HETEROCYCLIC COMPOUNDS AS IMMUNOMODULATORS
<b>A61K 31/519</b> (2006.01)	3365340	HETEROCYCLIC COMPOUNDS AS IMMUNOMODULATORS
<b>A61P 31/12</b> (2006.01)	3365340	HETEROCYCLIC COMPOUNDS AS IMMUNOMODULATORS
<b>A61P 35/00</b> (2006.01)	3365340	HETEROCYCLIC COMPOUNDS AS IMMUNOMODULATORS
<b>C07D 471/04</b> (2006.01)	3365340	HETEROCYCLIC COMPOUNDS AS IMMUNOMODULATORS
<b>C07D 487/04</b> (2006.01)	3365340	HETEROCYCLIC COMPOUNDS AS IMMUNOMODULATORS
<b>G10L 19/008</b> (2013.01)	3360135	LAYERED CODING FOR COMPRESSED SOUND OR SOUND FIELD REPRESENTATIONS
<b>G10L 19/24</b> (2013.01)	3360135	LAYERED CODING FOR COMPRESSED SOUND OR SOUND FIELD REPRESENTATIONS
<b>C08G 18/16</b> (2006.01)	3400251	POLYURETHANE FOAM COMPOSITION
<b>C08G 18/20</b> (2006.01)	3400251	POLYURETHANE FOAM COMPOSITION
<b>C08G 18/24</b> (2006.01)	3400251	POLYURETHANE FOAM COMPOSITION
<b>C08G 18/40</b> (2006.01)	3400251	POLYURETHANE FOAM COMPOSITION
<b>C08G 18/48</b> (2006.01)	3400251	POLYURETHANE FOAM COMPOSITION
<b>C08G 18/63</b> (2006.01)	3400251	POLYURETHANE FOAM COMPOSITION
<b>C08G 18/76</b> (2006.01)	3400251	POLYURETHANE FOAM COMPOSITION
<b>C08G 101/00</b> (2006.01)	3400251	POLYURETHANE FOAM COMPOSITION
<b>A61K 31/519</b> (2006.01)	3362453	CYCLIC ETHER DERIVATIVES OF PYRAZOLO[1,5-A]PYRIMIDINE-3-CARBOXYAMIDE
<b>C07D 487/04</b> (2006.01)	3362453	CYCLIC ETHER DERIVATIVES OF PYRAZOLO[1,5-A]PYRIMIDINE-3-CARBOXYAMIDE
<b>A61M 5/142</b> (2006.01)	3368101	SINGLE-USE AUTO-INJECTOR
<b>A61M 5/145</b> (2006.01)	3368101	SINGLE-USE AUTO-INJECTOR
<b>A61M 5/20</b> (2006.01)	3368101	SINGLE-USE AUTO-INJECTOR
<b>A61M 5/315</b> (2006.01)	3368101	SINGLE-USE AUTO-INJECTOR
<b>A61M 5/32</b> (2006.01)	3368101	SINGLE-USE AUTO-INJECTOR
<b>A61K 31/195</b> (2006.01)	3359148	COMBINATION OF DEUTERATED LEVODOPA WITH CARBIDOPA AND OPICAPONE FOR THE TREATMENT OF PARKINSON'S DISEASE
<b>A61K 31/198</b> (2006.01)	3359148	COMBINATION OF DEUTERATED LEVODOPA WITH CARBIDOPA AND OPICAPONE FOR THE TREATMENT OF PARKINSON'S DISEASE
<b>A61K 31/454</b> (2006.01)	3359148	COMBINATION OF DEUTERATED LEVODOPA WITH CARBIDOPA AND OPICAPONE FOR THE TREATMENT OF PARKINSON'S DISEASE
<b>A61P 25/16</b> (2006.01)	3359148	COMBINATION OF DEUTERATED LEVODOPA WITH CARBIDOPA AND OPICAPONE FOR THE TREATMENT OF PARKINSON'S DISEASE
<b>A61K 31/437</b> (2006.01)	3359541	N-SULFONYLATED PYRAZOLO[3,4-B]PYRIDIN-6-CARBOXAMIDES AND METHOD OF USE
<b>A61P 11/12</b> (2006.01)	3359541	N-SULFONYLATED PYRAZOLO[3,4-B]PYRIDIN-6-CARBOXAMIDES AND METHOD OF USE
<b>C07D 471/04</b> (2006.01)	3359541	N-SULFONYLATED PYRAZOLO[3,4-B]PYRIDIN-6-CARBOXAMIDES AND METHOD OF USE

MKP (51)	Broj objave evropske prijava patenta (97)	Naziv pronalaska (54)
<b>C07D 519/00</b> (2006.01)	3359541	N-SULFONYLATED PYRAZOLO[3,4-B]PYRIDIN-6-CARBOXAMIDES AND METHOD OF USE
<b>A61K 47/64</b> (2017.01)	3362100	HINDERED DISULFIDE DRUG CONJUGATES
<b>A61K 47/68</b> (2017.01)	3362100	HINDERED DISULFIDE DRUG CONJUGATES
<b>A61P 35/00</b> (2006.01)	3362100	HINDERED DISULFIDE DRUG CONJUGATES
<b>A61P 35/00</b> (2006.01)	3362455	PROCESSES FOR THE PREPARATION OF (3S,4R)-3-ETHYL-4-(3H-IMIDAZO[1,2-a]PYRROLO[2,3-e]-PYRAZIN-8-YL)-N-(2,2,2-TRIFLUOROETHYL)PYRROLIDINE-1-CARBOXAMIDE AND SOLID STATE FORMS THEREOF
<b>C07D 487/14</b> (2006.01)	3362455	PROCESSES FOR THE PREPARATION OF (3S,4R)-3-ETHYL-4-(3H-IMIDAZO[1,2-a]PYRROLO[2,3-e]-PYRAZIN-8-YL)-N-(2,2,2-TRIFLUOROETHYL)PYRROLIDINE-1-CARBOXAMIDE AND SOLID STATE FORMS THEREOF
<b>C12N 5/0783</b> (2010.01)	3368658	EXPANSION OF NON-HAEMATOPOIETIC TISSUE-RESIDENT GAMMA DELTA T CELLS AND USES OF THESE CELLS
<b>H01L 33/00</b> (2010.01)	3353820	ALINGAN-BASED SUPERLUMINESCENT DIODE
<b>H01L 33/16</b> (2010.01)	3353820	ALINGAN-BASED SUPERLUMINESCENT DIODE
<b>G06F 19/00</b> (2018.01)	3360066	SYSTEMS AND METHODS FOR PREDICTING VITREAL HALF-LIFE OF THERAPEUTIC AGENT-POLYMER CONJUGATES
<b>A61K 31/444</b> (2006.01)	3370722	IMIDAZO[4,5-C]QUINOLIN-2-ONE COMPOUNDS AND THEIR USE IN TREATING CANCER
<b>A61K 31/4545</b> (2006.01)	3370722	IMIDAZO[4,5-C]QUINOLIN-2-ONE COMPOUNDS AND THEIR USE IN TREATING CANCER
<b>A61P 35/00</b> (2006.01)	3370722	IMIDAZO[4,5-C]QUINOLIN-2-ONE COMPOUNDS AND THEIR USE IN TREATING CANCER
<b>C07D 471/04</b> (2006.01)	3370722	IMIDAZO[4,5-C]QUINOLIN-2-ONE COMPOUNDS AND THEIR USE IN TREATING CANCER
<b>A61K 31/4035</b> (2006.01)	3365334	BENZOLACTAM COMPOUNDS AS PROTEIN KINASE INHIBITORS
<b>A61P 35/00</b> (2006.01)	3365334	BENZOLACTAM COMPOUNDS AS PROTEIN KINASE INHIBITORS
<b>C07D 401/14</b> (2006.01)	3365334	BENZOLACTAM COMPOUNDS AS PROTEIN KINASE INHIBITORS
<b>C07D 403/14</b> (2006.01)	3365334	BENZOLACTAM COMPOUNDS AS PROTEIN KINASE INHIBITORS
<b>C07D 405/14</b> (2006.01)	3365334	BENZOLACTAM COMPOUNDS AS PROTEIN KINASE INHIBITORS
<b>C07D 409/14</b> (2006.01)	3365334	BENZOLACTAM COMPOUNDS AS PROTEIN KINASE INHIBITORS
<b>C07D 413/14</b> (2006.01)	3365334	BENZOLACTAM COMPOUNDS AS PROTEIN KINASE INHIBITORS
<b>C07D 417/14</b> (2006.01)	3365334	BENZOLACTAM COMPOUNDS AS PROTEIN KINASE INHIBITORS
<b>C07D 471/04</b> (2006.01)	3365334	BENZOLACTAM COMPOUNDS AS PROTEIN KINASE INHIBITORS
<b>C07D 471/08</b> (2006.01)	3365334	BENZOLACTAM COMPOUNDS AS PROTEIN KINASE INHIBITORS
<b>A61K 47/68</b> (2017.01)	3365025	CALICHEAMICIN-ANTIBODY-DRUG CONJUGATES AND METHODS OF USE
<b>A61P 35/00</b> (2006.01)	3365025	CALICHEAMICIN-ANTIBODY-DRUG CONJUGATES AND METHODS OF USE
<b>A61K 31/4427</b> (2006.01)	3362443	COMPOUNDS USEFUL AS IMMUNOMODULATORS
<b>A61P 35/00</b> (2006.01)	3362443	COMPOUNDS USEFUL AS IMMUNOMODULATORS
<b>A61P 37/00</b> (2006.01)	3362443	COMPOUNDS USEFUL AS IMMUNOMODULATORS
<b>C07D 207/12</b> (2006.01)	3362443	COMPOUNDS USEFUL AS IMMUNOMODULATORS
<b>C07D 213/71</b> (2006.01)	3362443	COMPOUNDS USEFUL AS IMMUNOMODULATORS
<b>C07D 213/85</b> (2006.01)	3362443	COMPOUNDS USEFUL AS IMMUNOMODULATORS
<b>C07D 401/12</b> (2006.01)	3362443	COMPOUNDS USEFUL AS IMMUNOMODULATORS
<b>C07D 401/14</b> (2006.01)	3362443	COMPOUNDS USEFUL AS IMMUNOMODULATORS
<b>C07D 403/12</b> (2006.01)	3362443	COMPOUNDS USEFUL AS IMMUNOMODULATORS
<b>C07D 455/02</b> (2006.01)	3362443	COMPOUNDS USEFUL AS IMMUNOMODULATORS
<b>A61K 9/127</b> (2006.01)	3362049	STABILIZING CAMPTOTHECIN PHARMACEUTICAL COMPOSITIONS
<b>A61K 31/4745</b> (2006.01)	3362049	STABILIZING CAMPTOTHECIN PHARMACEUTICAL COMPOSITIONS
<b>A23L 7/161</b> (2016.01)	3351120	IMPROVEMENTS TO PATENT P201231330 "METHOD FOR THE TREATMENT OF CORN KERNELS INTENDED FOR THE PRODUCTION OF POPCORN USING MICROWAVE APPLIANCES, AND RESULTING PRODUCT"
<b>A23P 20/10</b> (2016.01)	3351120	IMPROVEMENTS TO PATENT P201231330 "METHOD FOR THE TREATMENT OF CORN KERNELS INTENDED FOR THE PRODUCTION OF POPCORN USING MICROWAVE APPLIANCES, AND RESULTING PRODUCT"
<b>A23J 3/14</b> (2006.01)	3361880	A METHOD OF MANUFACTURING A TEXTURED FOOD PRODUCT AND A TEXTURED FOOD PRODUCT
<b>A23L 7/117</b> (2016.01)	3361880	A METHOD OF MANUFACTURING A TEXTURED FOOD PRODUCT AND A TEXTURED FOOD PRODUCT
<b>A23L 7/17</b> (2016.01)	3361880	A METHOD OF MANUFACTURING A TEXTURED FOOD PRODUCT AND A TEXTURED FOOD PRODUCT

MKP (51)	Broj objave evropske prijava patenta (97)	Naziv pronalaska (54)
<b>A23L 33/185</b> (2016.01)	3361880	A METHOD OF MANUFACTURING A TEXTURED FOOD PRODUCT AND A TEXTURED FOOD PRODUCT
<b>A23L 33/21</b> (2016.01)	3361880	A METHOD OF MANUFACTURING A TEXTURED FOOD PRODUCT AND A TEXTURED FOOD PRODUCT
<b>A61K 9/00</b> (2006.01)	3370693	IMPROVED FORMULATIONS OF LEVOSIMENDAN FOR INTRAVENOUS ADMINISTRATION AS INFUSION OR INJECTION AND OF INFUSION CONCENTRATE
<b>A61K 9/19</b> (2006.01)	3370693	IMPROVED FORMULATIONS OF LEVOSIMENDAN FOR INTRAVENOUS ADMINISTRATION AS INFUSION OR INJECTION AND OF INFUSION CONCENTRATE
<b>A61K 31/50</b> (2006.01)	3370693	IMPROVED FORMULATIONS OF LEVOSIMENDAN FOR INTRAVENOUS ADMINISTRATION AS INFUSION OR INJECTION AND OF INFUSION CONCENTRATE
<b>A61B 5/00</b> (2006.01)	3352650	VAGINAL RING SENSOR
<b>A61B 5/01</b> (2006.01)	3352650	VAGINAL RING SENSOR
<b>A61B 5/021</b> (2006.01)	3352650	VAGINAL RING SENSOR
<b>A61B 5/024</b> (2006.01)	3352650	VAGINAL RING SENSOR
<b>A61B 5/07</b> (2006.01)	3352650	VAGINAL RING SENSOR
<b>A61B 5/145</b> (2006.01)	3352650	VAGINAL RING SENSOR
<b>A61B 5/1459</b> (2006.01)	3352650	VAGINAL RING SENSOR
<b>A61B 5/1486</b> (2006.01)	3352650	VAGINAL RING SENSOR
<b>A61B 5/16</b> (2006.01)	3352650	VAGINAL RING SENSOR
<b>A61K 9/00</b> (2006.01)	3352650	VAGINAL RING SENSOR
<b>C07K 14/715</b> (2006.01)	3359567	BIOMARKERS RELATED TO INTERLEUKIN-33 (IL-33)-MEDIATED DISEASES AND USES THEREOF
<b>C07K 16/24</b> (2006.01)	3359567	BIOMARKERS RELATED TO INTERLEUKIN-33 (IL-33)-MEDIATED DISEASES AND USES THEREOF
<b>G01N 33/50</b> (2006.01)	3359567	BIOMARKERS RELATED TO INTERLEUKIN-33 (IL-33)-MEDIATED DISEASES AND USES THEREOF
<b>A61K 31/4188</b> (2006.01)	3362454	EP4 ANTAGONISTS
<b>A61P 35/00</b> (2006.01)	3362454	EP4 ANTAGONISTS
<b>C07D 487/04</b> (2006.01)	3362454	EP4 ANTAGONISTS
<b>C07D 519/00</b> (2006.01)	3362454	EP4 ANTAGONISTS
<b>A61J 1/03</b> (2006.01)	3364934	MEDICATION PACKAGING AND DISPENSING SYSTEM
<b>A61J 7/04</b> (2006.01)	3364934	MEDICATION PACKAGING AND DISPENSING SYSTEM
<b>B65D 75/32</b> (2006.01)	3364934	MEDICATION PACKAGING AND DISPENSING SYSTEM
<b>A61K 31/437</b> (2006.01)	3371183	IMIDAZO[4,5-C]QUINOLIN-2-ONE COMPOUNDS AND THEIR USE IN TREATING CANCER
<b>A61P 35/00</b> (2006.01)	3371183	IMIDAZO[4,5-C]QUINOLIN-2-ONE COMPOUNDS AND THEIR USE IN TREATING CANCER
<b>C07D 471/04</b> (2006.01)	3371183	IMIDAZO[4,5-C]QUINOLIN-2-ONE COMPOUNDS AND THEIR USE IN TREATING CANCER
<b>C12C 5/00</b> (2006.01)	3359636	METHOD FOR PRODUCING A BEER CONTAINING A REDUCED CARBOHYDRATE CONTENT AND ASSOCIATED BEER
<b>C12C 12/02</b> (2006.01)	3359636	METHOD FOR PRODUCING A BEER CONTAINING A REDUCED CARBOHYDRATE CONTENT AND ASSOCIATED BEER
<b>A61K 31/52</b> (2006.01)	3368092	ANTIBODY CONJUGATES COMPRISING TOLL-LIKE RECEPTOR AGONIST
<b>A61K 47/68</b> (2017.01)	3368092	ANTIBODY CONJUGATES COMPRISING TOLL-LIKE RECEPTOR AGONIST
<b>A61P 35/00</b> (2006.01)	3368092	ANTIBODY CONJUGATES COMPRISING TOLL-LIKE RECEPTOR AGONIST
<b>C07D 473/34</b> (2006.01)	3368092	ANTIBODY CONJUGATES COMPRISING TOLL-LIKE RECEPTOR AGONIST
<b>A61P 31/14</b> (2006.01)	3368562	ANTIBODY NEUTRALIZING HUMAN RESPIRATORY SYNCYTIAL VIRUS
<b>C07K 16/10</b> (2006.01)	3368562	ANTIBODY NEUTRALIZING HUMAN RESPIRATORY SYNCYTIAL VIRUS
<b>C12N 5/09</b> (2010.01)	3365436	METHODS OF PREPARING A PRIMARY CELL SAMPLE
<b>C12Q 1/02</b> (2006.01)	3365436	METHODS OF PREPARING A PRIMARY CELL SAMPLE
<b>A01N 43/90</b> (2006.01)	3368540	ACC INHIBITORS AND USES THEREOF
<b>A61K 31/519</b> (2006.01)	3368540	ACC INHIBITORS AND USES THEREOF
<b>A61P 3/04</b> (2006.01)	3368540	ACC INHIBITORS AND USES THEREOF
<b>A61P 3/06</b> (2006.01)	3368540	ACC INHIBITORS AND USES THEREOF
<b>A61P 31/00</b> (2006.01)	3368540	ACC INHIBITORS AND USES THEREOF
<b>C07D 495/04</b> (2006.01)	3368540	ACC INHIBITORS AND USES THEREOF
<b>A61M 11/00</b> (2006.01)	3368110	ASEPTIC AEROSOL MISTING DEVICE
<b>A61M 15/00</b> (2006.01)	3368110	ASEPTIC AEROSOL MISTING DEVICE

MKP (51)	Broj objave evropske prijava patenta (97)	Naziv pronalaska (54)
<b>A61K 39/00</b> (2006.01)	3371218	TREATMENT PARADIGM
<b>C07K 16/24</b> (2006.01)	3371218	TREATMENT PARADIGM
<b>A61K 31/4985</b> (2006.01)	3374359	DIHYDROIMIDAZOPYRAZINONE DERIVATIVES USEFUL IN THE TREATMENT OF CANCER
<b>A61P 35/00</b> (2006.01)	3374359	DIHYDROIMIDAZOPYRAZINONE DERIVATIVES USEFUL IN THE TREATMENT OF CANCER
<b>C07D 403/04</b> (2006.01)	3374359	DIHYDROIMIDAZOPYRAZINONE DERIVATIVES USEFUL IN THE TREATMENT OF CANCER
<b>C07D 487/04</b> (2006.01)	3374359	DIHYDROIMIDAZOPYRAZINONE DERIVATIVES USEFUL IN THE TREATMENT OF CANCER
<b>A61K 9/19</b> (2006.01)	3373912	METHOD FOR THE PRODUCTION OF FREEZE-DRIED PELLETS COMPRISING FACTOR VIII
<b>A61K 35/16</b> (2015.01)	3373912	METHOD FOR THE PRODUCTION OF FREEZE-DRIED PELLETS COMPRISING FACTOR VIII
<b>C07K 14/755</b> (2006.01)	3373912	METHOD FOR THE PRODUCTION OF FREEZE-DRIED PELLETS COMPRISING FACTOR VIII
<b>F26B 3/12</b> (2006.01)	3373912	METHOD FOR THE PRODUCTION OF FREEZE-DRIED PELLETS COMPRISING FACTOR VIII
<b>F26B 5/06</b> (2006.01)	3373912	METHOD FOR THE PRODUCTION OF FREEZE-DRIED PELLETS COMPRISING FACTOR VIII
<b>A61K 39/395</b> (2006.01)	3368903	PROGNOSTIC METHOD
<b>G01N 33/574</b> (2006.01)	3368903	PROGNOSTIC METHOD
<b>A61K 38/20</b> (2006.01)	3359182	COMBINATION OF AN IL-2RBETA-SELECTIVE AGONIST AND A LONG-ACTING IL-15 AGONIST
<b>A61P 35/00</b> (2006.01)	3359182	COMBINATION OF AN IL-2RBETA-SELECTIVE AGONIST AND A LONG-ACTING IL-15 AGONIST
<b>A61M 11/00</b> (2006.01)	3368111	ASEPTIC AEROSOL MISTING DEVICE
<b>A61M 15/00</b> (2006.01)	3368111	ASEPTIC AEROSOL MISTING DEVICE
<b>A61M 11/00</b> (2006.01)	3368112	ASEPTIC AEROSOL MISTING DEVICE
<b>B05B 17/06</b> (2006.01)	3368112	ASEPTIC AEROSOL MISTING DEVICE
<b>A61M 11/00</b> (2006.01)	3368113	UNIT DOSE ASEPTIC AEROSOL MISTING DEVICE
<b>A61M 15/00</b> (2006.01)	3368113	UNIT DOSE ASEPTIC AEROSOL MISTING DEVICE
<b>E04B 1/86</b> (2006.01)	3394360	ACOUSTIC DRYWALL PANEL
<b>E04C 2/04</b> (2006.01)	3394360	ACOUSTIC DRYWALL PANEL
<b>E04F 13/08</b> (2006.01)	3394360	ACOUSTIC DRYWALL PANEL
<b>A61P 25/18</b> (2006.01)	3371188	[1,2,4]TRIAZOLO[1,5-a]PYRIMIDIN-7-YL COMPOUND
<b>C07D 487/04</b> (2006.01)	3371188	[1,2,4]TRIAZOLO[1,5-a]PYRIMIDIN-7-YL COMPOUND
<b>A42B 3/06</b> (2006.01)	3349607	A COMPOSITE GEOMETRY STRUCTURE FOR THE ABSORPTION AND DISSIPATION OF THE ENERGY GENERATED BY AN IMPACT AND A SAFETY HELMET COMPRISING SAID STRUCTURE.
<b>F16F 7/12</b> (2006.01)	3349607	A COMPOSITE GEOMETRY STRUCTURE FOR THE ABSORPTION AND DISSIPATION OF THE ENERGY GENERATED BY AN IMPACT AND A SAFETY HELMET COMPRISING SAID STRUCTURE.
<b>F16H 1/28</b> (2006.01)	3350477	PRECISION PLANETARY GEAR
<b>A63H 15/06</b> (2006.01)	3365086	TOY PUPPET
<b>C07K 16/28</b> (2006.01)	3365373	BINDING MOLECULES THAT INHIBIT CANCER GROWTH
<b>C07K 16/30</b> (2006.01)	3365373	BINDING MOLECULES THAT INHIBIT CANCER GROWTH
<b>C07K 16/40</b> (2006.01)	3365373	BINDING MOLECULES THAT INHIBIT CANCER GROWTH
<b>H01M 4/133</b> (2010.01)	3375029	CARBON COMPOSITES
<b>H01M 4/136</b> (2010.01)	3375029	CARBON COMPOSITES
<b>H01M 4/1393</b> (2010.01)	3375029	CARBON COMPOSITES
<b>H01M 4/1397</b> (2010.01)	3375029	CARBON COMPOSITES
<b>H01M 4/36</b> (2006.01)	3375029	CARBON COMPOSITES
<b>H01M 4/38</b> (2006.01)	3375029	CARBON COMPOSITES
<b>H01M 4/587</b> (2010.01)	3375029	CARBON COMPOSITES
<b>H01M 4/62</b> (2006.01)	3375029	CARBON COMPOSITES
<b>H01M 4/66</b> (2006.01)	3375029	CARBON COMPOSITES
<b>H01M 10/052</b> (2010.01)	3375029	CARBON COMPOSITES
<b>A61K 8/02</b> (2006.01)	3383353	ORAL CARE COMPOSITION FOR REMINERALISATION AND WHITENING OF TEETH
<b>A61K 8/19</b> (2006.01)	3383353	ORAL CARE COMPOSITION FOR REMINERALISATION AND WHITENING OF TEETH
<b>A61K 8/25</b> (2006.01)	3383353	ORAL CARE COMPOSITION FOR REMINERALISATION AND WHITENING OF TEETH
<b>A61Q 11/00</b> (2006.01)	3383353	ORAL CARE COMPOSITION FOR REMINERALISATION AND WHITENING OF TEETH
<b>B01D 53/56</b> (2006.01)	3365094	SYSTEMS AND METHODS FOR REMOVING COMBUSTION PRODUCTS FROM A POWER GENERATION CYCLE

MKP (51)	Broj objave evropske prijava patenta (97)	Naziv pronalaska (54)
<b>B01D 53/60</b> (2006.01)	3365094	SYSTEMS AND METHODS FOR REMOVING COMBUSTION PRODUCTS FROM A POWER GENERATION CYCLE
<b>B01D 53/64</b> (2006.01)	3365094	SYSTEMS AND METHODS FOR REMOVING COMBUSTION PRODUCTS FROM A POWER GENERATION CYCLE
<b>B01D 53/78</b> (2006.01)	3365094	SYSTEMS AND METHODS FOR REMOVING COMBUSTION PRODUCTS FROM A POWER GENERATION CYCLE
<b>F23J 15/04</b> (2006.01)	3365094	SYSTEMS AND METHODS FOR REMOVING COMBUSTION PRODUCTS FROM A POWER GENERATION CYCLE
<b>A61K 39/42</b> (2006.01)	3365366	TRISPECIFIC AND/OR TRIVALENT BINDING PROTEINS FOR PREVENTION OR TREATMENT OF HIV INFECTION
<b>C07K 16/10</b> (2006.01)	3365366	TRISPECIFIC AND/OR TRIVALENT BINDING PROTEINS FOR PREVENTION OR TREATMENT OF HIV INFECTION
<b>A61K 31/4375</b> (2006.01)	3368534	VALBENAZINE SALTS AND POLYMORPHS THEREOF
<b>A61P 25/00</b> (2006.01)	3368534	VALBENAZINE SALTS AND POLYMORPHS THEREOF
<b>C07D 471/04</b> (2006.01)	3368534	VALBENAZINE SALTS AND POLYMORPHS THEREOF
<b>C12Q 1/68</b> (2018.01)	3374519	DETECTION OF FOETAL CHROMOSOMAL ANEUPLOIDIES USING DNA REGIONS THAT ARE DIFFERENTIALLY METHYLATED BETWEEN THE FOETUS AND THE PREGNANT FEMALE
<b>A61K 31/4985</b> (2006.01)	3371189	IMIDAZOPYRAZINE INHIBITORS OF BRUTON'S TYROSINE KINASE
<b>A61P 35/00</b> (2006.01)	3371189	IMIDAZOPYRAZINE INHIBITORS OF BRUTON'S TYROSINE KINASE
<b>C07D 487/04</b> (2006.01)	3371189	IMIDAZOPYRAZINE INHIBITORS OF BRUTON'S TYROSINE KINASE
<b>A61K 31/164</b> (2006.01)	3368026	HDAC INHIBITORS FOR THE TREATMENT OF DIABETIC PERIPHERAL NEUROPATHY
<b>A61K 31/337</b> (2006.01)	3368026	HDAC INHIBITORS FOR THE TREATMENT OF DIABETIC PERIPHERAL NEUROPATHY
<b>A61K 31/495</b> (2006.01)	3368026	HDAC INHIBITORS FOR THE TREATMENT OF DIABETIC PERIPHERAL NEUROPATHY
<b>A61K 31/505</b> (2006.01)	3368026	HDAC INHIBITORS FOR THE TREATMENT OF DIABETIC PERIPHERAL NEUROPATHY
<b>A61P 25/02</b> (2006.01)	3368026	HDAC INHIBITORS FOR THE TREATMENT OF DIABETIC PERIPHERAL NEUROPATHY
<b>A61K 38/17</b> (2006.01)	3371208	CD80 EXTRACELLULAR DOMAIN POLYPEPTIDES AND THEIR USE IN CANCER TREATMENT
<b>C07K 14/705</b> (2006.01)	3371208	CD80 EXTRACELLULAR DOMAIN POLYPEPTIDES AND THEIR USE IN CANCER TREATMENT
<b>A61K 39/395</b> (2006.01)	3371220	ANTI-IL1RAP ANTIBODIES, BISPECIFIC ANTIGEN BINDING MOLECULES THAT BIND IL1RAP AND CD3, AND USES THEREOF
<b>C07K 16/28</b> (2006.01)	3371220	ANTI-IL1RAP ANTIBODIES, BISPECIFIC ANTIGEN BINDING MOLECULES THAT BIND IL1RAP AND CD3, AND USES THEREOF
<b>C08J 5/18</b> (2006.01)	3383939	SURFACE-TREATED FILLERS FOR ULTRATHIN BREATHABLE FILMS
<b>C08K 3/26</b> (2006.01)	3383939	SURFACE-TREATED FILLERS FOR ULTRATHIN BREATHABLE FILMS
<b>C08K 9/02</b> (2006.01)	3383939	SURFACE-TREATED FILLERS FOR ULTRATHIN BREATHABLE FILMS
<b>C09C 1/02</b> (2006.01)	3383939	SURFACE-TREATED FILLERS FOR ULTRATHIN BREATHABLE FILMS
<b>A61K 38/06</b> (2006.01)	3377515	GELATINASE INHIBITORS AND USE THEREOF
<b>C07K 5/097</b> (2006.01)	3377515	GELATINASE INHIBITORS AND USE THEREOF
<b>B65D 19/34</b> (2006.01)	3344555	PALLET MADE OF CORRUGATED PAPERBOARD
<b>C12N 9/12</b> (2006.01)	3362555	MODIFICATION OF RNA-RELATED ENZYMES FOR ENHANCED PRODUCTION
<b>C12N 15/62</b> (2006.01)	3362555	MODIFICATION OF RNA-RELATED ENZYMES FOR ENHANCED PRODUCTION
<b>B41M 3/14</b> (2006.01)	3380331	PRINTED WATERMARK
<b>B41M 7/00</b> (2006.01)	3380331	PRINTED WATERMARK
<b>D21H 21/30</b> (2006.01)	3380331	PRINTED WATERMARK
<b>D21H 21/48</b> (2006.01)	3380331	PRINTED WATERMARK
<b>A61K 39/00</b> (2006.01)	3377528	BINDING AGONISTS FOR TREATMENT OF NEUROLOGICAL AND OTHER DISORDERS
<b>A61K 39/395</b> (2006.01)	3377528	BINDING AGONISTS FOR TREATMENT OF NEUROLOGICAL AND OTHER DISORDERS
<b>A61P 25/00</b> (2006.01)	3377528	BINDING AGONISTS FOR TREATMENT OF NEUROLOGICAL AND OTHER DISORDERS
<b>C07K 16/28</b> (2006.01)	3377528	BINDING AGONISTS FOR TREATMENT OF NEUROLOGICAL AND OTHER DISORDERS
<b>G01N 33/50</b> (2006.01)	3371593	CELL-BASED ASSAYS FOR DETECTION OF ANTIBODIES OR OTHER FACTORS THAT NEUTRALIZE UPTAKE OF LYSOSOMAL ENZYMES
<b>G01N 33/573</b> (2006.01)	3371593	CELL-BASED ASSAYS FOR DETECTION OF ANTIBODIES OR OTHER FACTORS THAT NEUTRALIZE UPTAKE OF LYSOSOMAL ENZYMES
<b>A61K 31/7072</b> (2006.01)	3253773	SUBSTITUTED NUCLEOSIDES, NUCLEOTIDES AND ANALOGS THEREOF



MKP (51)	Broj objave evropske prijava patenta (97)	Naziv pronalaska (54)
<b>A61K 31/7076</b> (2006.01)	3253773	SUBSTITUTED NUCLEOSIDES, NUCLEOTIDES AND ANALOGS THEREOF
<b>A61K 31/708</b> (2006.01)	3253773	SUBSTITUTED NUCLEOSIDES, NUCLEOTIDES AND ANALOGS THEREOF
<b>A61P 31/14</b> (2006.01)	3253773	SUBSTITUTED NUCLEOSIDES, NUCLEOTIDES AND ANALOGS THEREOF
<b>C07H 19/067</b> (2006.01)	3253773	SUBSTITUTED NUCLEOSIDES, NUCLEOTIDES AND ANALOGS THEREOF
<b>C07H 19/073</b> (2006.01)	3253773	SUBSTITUTED NUCLEOSIDES, NUCLEOTIDES AND ANALOGS THEREOF
<b>C07H 19/10</b> (2006.01)	3253773	SUBSTITUTED NUCLEOSIDES, NUCLEOTIDES AND ANALOGS THEREOF
<b>C07H 19/11</b> (2006.01)	3253773	SUBSTITUTED NUCLEOSIDES, NUCLEOTIDES AND ANALOGS THEREOF
<b>C07H 19/173</b> (2006.01)	3253773	SUBSTITUTED NUCLEOSIDES, NUCLEOTIDES AND ANALOGS THEREOF
<b>C07H 19/20</b> (2006.01)	3253773	SUBSTITUTED NUCLEOSIDES, NUCLEOTIDES AND ANALOGS THEREOF
<b>C07H 19/213</b> (2006.01)	3253773	SUBSTITUTED NUCLEOSIDES, NUCLEOTIDES AND ANALOGS THEREOF
<b>A01C 15/04</b> (2006.01)	3247190	METERING SYSTEM FOR SOLID PARTICULATE
<b>B65G 53/16</b> (2006.01)	3247190	METERING SYSTEM FOR SOLID PARTICULATE
<b>B65G 53/52</b> (2006.01)	3247190	METERING SYSTEM FOR SOLID PARTICULATE
<b>G01F 11/00</b> (2006.01)	3247190	METERING SYSTEM FOR SOLID PARTICULATE
<b>A01C 7/08</b> (2006.01)	3247191	SINGLE PARTICULATE METERING SYSTEM WITH VARIABLE RATE CONTROLS
<b>A01C 7/10</b> (2006.01)	3247191	SINGLE PARTICULATE METERING SYSTEM WITH VARIABLE RATE CONTROLS
<b>A01C 7/16</b> (2006.01)	3247191	SINGLE PARTICULATE METERING SYSTEM WITH VARIABLE RATE CONTROLS
<b>A01C 15/00</b> (2006.01)	3247191	SINGLE PARTICULATE METERING SYSTEM WITH VARIABLE RATE CONTROLS
<b>A01C 15/04</b> (2006.01)	3247191	SINGLE PARTICULATE METERING SYSTEM WITH VARIABLE RATE CONTROLS
<b>A01C 15/16</b> (2006.01)	3247191	SINGLE PARTICULATE METERING SYSTEM WITH VARIABLE RATE CONTROLS
<b>A01C 19/02</b> (2006.01)	3247191	SINGLE PARTICULATE METERING SYSTEM WITH VARIABLE RATE CONTROLS
<b>G01F 13/00</b> (2006.01)	3247191	SINGLE PARTICULATE METERING SYSTEM WITH VARIABLE RATE CONTROLS
<b>G05D 7/06</b> (2006.01)	3247191	SINGLE PARTICULATE METERING SYSTEM WITH VARIABLE RATE CONTROLS
<b>G05D 11/12</b> (2006.01)	3247191	SINGLE PARTICULATE METERING SYSTEM WITH VARIABLE RATE CONTROLS
<b>G05D 11/13</b> (2006.01)	3247191	SINGLE PARTICULATE METERING SYSTEM WITH VARIABLE RATE CONTROLS
<b>A61K 31/519</b> (2006.01)	3381916	CONDENSED PYRIMIDINE COMPOUND OR SALT THEREOF
<b>A61K 31/55</b> (2006.01)	3381916	CONDENSED PYRIMIDINE COMPOUND OR SALT THEREOF
<b>A61P 35/00</b> (2006.01)	3381916	CONDENSED PYRIMIDINE COMPOUND OR SALT THEREOF
<b>A61P 43/00</b> (2006.01)	3381916	CONDENSED PYRIMIDINE COMPOUND OR SALT THEREOF
<b>C07D 471/04</b> (2006.01)	3381916	CONDENSED PYRIMIDINE COMPOUND OR SALT THEREOF
<b>C07D 519/00</b> (2006.01)	3381916	CONDENSED PYRIMIDINE COMPOUND OR SALT THEREOF
<b>A61K 31/40</b> (2006.01)	3381896	NOVEL BIPHENYL COMPOUND OR SALT THEREOF
<b>A61K 31/404</b> (2006.01)	3381896	NOVEL BIPHENYL COMPOUND OR SALT THEREOF
<b>A61K 31/407</b> (2006.01)	3381896	NOVEL BIPHENYL COMPOUND OR SALT THEREOF
<b>A61K 31/416</b> (2006.01)	3381896	NOVEL BIPHENYL COMPOUND OR SALT THEREOF
<b>A61K 31/4184</b> (2006.01)	3381896	NOVEL BIPHENYL COMPOUND OR SALT THEREOF
<b>C07D 207/04</b> (2006.01)	3381896	NOVEL BIPHENYL COMPOUND OR SALT THEREOF
<b>A41D 19/015</b> (2006.01)	3383602	ISOLATOR SLEEVE SYSTEMS
<b>A61B 42/10</b> (2016.01)	3383602	ISOLATOR SLEEVE SYSTEMS
<b>A61B 42/50</b> (2016.01)	3383602	ISOLATOR SLEEVE SYSTEMS
<b>A61J 3/00</b> (2006.01)	3383602	ISOLATOR SLEEVE SYSTEMS
<b>B25J 21/02</b> (2006.01)	3383602	ISOLATOR SLEEVE SYSTEMS
<b>G21F 7/053</b> (2006.01)	3383602	ISOLATOR SLEEVE SYSTEMS
<b>B60P 1/36</b> (2006.01)	3383774	EQUIPMENT FOR MOVING A PALLET
<b>B65G 17/06</b> (2006.01)	3383774	EQUIPMENT FOR MOVING A PALLET
<b>B65G 17/12</b> (2006.01)	3383774	EQUIPMENT FOR MOVING A PALLET
<b>B65G 17/26</b> (2006.01)	3383774	EQUIPMENT FOR MOVING A PALLET

MKP (51)	Broj objave evropske prijava patenta (97)	Naziv pronalaska (54)
<b>B65G 67/20</b> (2006.01)	3383774	EQUIPMENT FOR MOVING A PALLET
<b>B65G 67/24</b> (2006.01)	3383774	EQUIPMENT FOR MOVING A PALLET
<b>B65G 67/46</b> (2006.01)	3383774	EQUIPMENT FOR MOVING A PALLET
<b>B66F 9/06</b> (2006.01)	3383774	EQUIPMENT FOR MOVING A PALLET
<b>A61K 35/13</b> (2015.01)	3383412	ANTIBODIES SPECIFIC TO GLYCOSYLATED PD-1 AND METHODS OF USE THEREOF
<b>A61K 39/395</b> (2006.01)	3383412	ANTIBODIES SPECIFIC TO GLYCOSYLATED PD-1 AND METHODS OF USE THEREOF
<b>A61K 49/16</b> (2006.01)	3383412	ANTIBODIES SPECIFIC TO GLYCOSYLATED PD-1 AND METHODS OF USE THEREOF
<b>C07K 16/18</b> (2006.01)	3383412	ANTIBODIES SPECIFIC TO GLYCOSYLATED PD-1 AND METHODS OF USE THEREOF
<b>C07K 16/28</b> (2006.01)	3383412	ANTIBODIES SPECIFIC TO GLYCOSYLATED PD-1 AND METHODS OF USE THEREOF
<b>C12P 21/08</b> (2006.01)	3383412	ANTIBODIES SPECIFIC TO GLYCOSYLATED PD-1 AND METHODS OF USE THEREOF
<b>A61K 31/55</b> (2006.01)	3383917	NOVEL ANTI-CLAUDIN ANTIBODIES AND METHODS OF USE
<b>A61K 45/06</b> (2006.01)	3383917	NOVEL ANTI-CLAUDIN ANTIBODIES AND METHODS OF USE
<b>A61P 35/02</b> (2006.01)	3383917	NOVEL ANTI-CLAUDIN ANTIBODIES AND METHODS OF USE
<b>C07D 519/00</b> (2006.01)	3383917	NOVEL ANTI-CLAUDIN ANTIBODIES AND METHODS OF USE
<b>C07K 16/30</b> (2006.01)	3383917	NOVEL ANTI-CLAUDIN ANTIBODIES AND METHODS OF USE
<b>A61K 39/395</b> (2006.01)	3383430	ANTIBODIES AND METHODS OF USE THEREOF
<b>A61K 47/68</b> (2017.01)	3383430	ANTIBODIES AND METHODS OF USE THEREOF
<b>C07K 16/28</b> (2006.01)	3383430	ANTIBODIES AND METHODS OF USE THEREOF
<b>C07K 16/30</b> (2006.01)	3383430	ANTIBODIES AND METHODS OF USE THEREOF
<b>A61K 39/395</b> (2006.01)	3383431	ANTI-GITR ANTIBODIES AND METHODS OF USE THEREOF
<b>C07K 16/28</b> (2006.01)	3383431	ANTI-GITR ANTIBODIES AND METHODS OF USE THEREOF
<b>C07K 16/30</b> (2006.01)	3383431	ANTI-GITR ANTIBODIES AND METHODS OF USE THEREOF
<b>A01H 1/00</b> (2006.01)	3383170	TARGETED MUTAGENESIS OF TOBACCO BERBERINE BRIDGE ENZYME-LIKE NUCLEIC ACIDS
<b>A01H 5/10</b> (2018.01)	3383170	TARGETED MUTAGENESIS OF TOBACCO BERBERINE BRIDGE ENZYME-LIKE NUCLEIC ACIDS
<b>A24D 1/00</b> (2006.01)	3383170	TARGETED MUTAGENESIS OF TOBACCO BERBERINE BRIDGE ENZYME-LIKE NUCLEIC ACIDS
<b>C12N 15/63</b> (2006.01)	3383170	TARGETED MUTAGENESIS OF TOBACCO BERBERINE BRIDGE ENZYME-LIKE NUCLEIC ACIDS
<b>A61K 39/395</b> (2006.01)	3383914	ANTI-OX40 ANTIBODIES AND METHODS OF USE THEREOF
<b>C07K 16/28</b> (2006.01)	3383914	ANTI-OX40 ANTIBODIES AND METHODS OF USE THEREOF
<b>G01N 33/68</b> (2006.01)	3383914	ANTI-OX40 ANTIBODIES AND METHODS OF USE THEREOF
<b>A61B 17/29</b> (2006.01)	3393380	ULTRASONIC SURGICAL INSTRUMENT WITH BLADE REPLACEMENT FEATURES
<b>A61B 17/32</b> (2006.01)	3393380	ULTRASONIC SURGICAL INSTRUMENT WITH BLADE REPLACEMENT FEATURES
<b>G01N 27/26</b> (2006.01)	3387425	SOIL ANALYSIS METHOD
<b>G01N 33/24</b> (2006.01)	3387425	SOIL ANALYSIS METHOD
<b>E03D 1/24</b> (2006.01)	3388587	DEVICE FOR REGULATING THE HEIGHT OF A CISTERN FLUSHING MECHANISM
<b>B29C 70/72</b> (2006.01)	3387690	LEAD-ACID BATTERY ELECTRODE MANUFACTURE
<b>H01M 4/04</b> (2006.01)	3387690	LEAD-ACID BATTERY ELECTRODE MANUFACTURE
<b>H01M 4/20</b> (2006.01)	3387690	LEAD-ACID BATTERY ELECTRODE MANUFACTURE
<b>H01M 4/22</b> (2006.01)	3387690	LEAD-ACID BATTERY ELECTRODE MANUFACTURE
<b>H01M 4/68</b> (2006.01)	3387690	LEAD-ACID BATTERY ELECTRODE MANUFACTURE
<b>A61K 31/421</b> (2006.01)	3388425	AMINOAZOLE DERIVATIVE
<b>A61K 31/422</b> (2006.01)	3388425	AMINOAZOLE DERIVATIVE
<b>A61K 31/4245</b> (2006.01)	3388425	AMINOAZOLE DERIVATIVE
<b>A61K 31/426</b> (2006.01)	3388425	AMINOAZOLE DERIVATIVE
<b>A61K 31/427</b> (2006.01)	3388425	AMINOAZOLE DERIVATIVE
<b>A61K 31/428</b> (2006.01)	3388425	AMINOAZOLE DERIVATIVE
<b>A61K 31/433</b> (2006.01)	3388425	AMINOAZOLE DERIVATIVE
<b>A61K 31/4439</b> (2006.01)	3388425	AMINOAZOLE DERIVATIVE
<b>A61K 31/454</b> (2006.01)	3388425	AMINOAZOLE DERIVATIVE
<b>A61K 31/4709</b> (2006.01)	3388425	AMINOAZOLE DERIVATIVE
<b>A61K 31/4725</b> (2006.01)	3388425	AMINOAZOLE DERIVATIVE
<b>A61K 31/497</b> (2006.01)	3388425	AMINOAZOLE DERIVATIVE
<b>A61K 31/498</b> (2006.01)	3388425	AMINOAZOLE DERIVATIVE
<b>A61K 31/501</b> (2006.01)	3388425	AMINOAZOLE DERIVATIVE
<b>A61K 31/5377</b> (2006.01)	3388425	AMINOAZOLE DERIVATIVE
<b>A61P 21/00</b> (2006.01)	3388425	AMINOAZOLE DERIVATIVE

MKP (51)	Broj objave evropske prijava patenta (97)	Naziv pronalaska (54)
<b>A61P 21/04</b> (2006.01)	3388425	AMINOAZOLE DERIVATIVE
<b>A61P 43/00</b> (2006.01)	3388425	AMINOAZOLE DERIVATIVE
<b>C07C 335/12</b> (2006.01)	3388425	AMINOAZOLE DERIVATIVE
<b>C07D 263/48</b> (2006.01)	3388425	AMINOAZOLE DERIVATIVE
<b>C10M 103/00</b> (2006.01)	3388501	SLIDING MEMBER EXCLUDING THOSE USED FOR IMAGE FORMATION DEVICE, COMPONENT, AND METHOD FOR REDUCING NOISE IN MACHINE DEVICE
<b>C10M 103/02</b> (2006.01)	3388501	SLIDING MEMBER EXCLUDING THOSE USED FOR IMAGE FORMATION DEVICE, COMPONENT, AND METHOD FOR REDUCING NOISE IN MACHINE DEVICE
<b>C10M 103/06</b> (2006.01)	3388501	SLIDING MEMBER EXCLUDING THOSE USED FOR IMAGE FORMATION DEVICE, COMPONENT, AND METHOD FOR REDUCING NOISE IN MACHINE DEVICE
<b>C10M 107/04</b> (2006.01)	3388501	SLIDING MEMBER EXCLUDING THOSE USED FOR IMAGE FORMATION DEVICE, COMPONENT, AND METHOD FOR REDUCING NOISE IN MACHINE DEVICE
<b>C10M 107/06</b> (2006.01)	3388501	SLIDING MEMBER EXCLUDING THOSE USED FOR IMAGE FORMATION DEVICE, COMPONENT, AND METHOD FOR REDUCING NOISE IN MACHINE DEVICE
<b>C10M 107/38</b> (2006.01)	3388501	SLIDING MEMBER EXCLUDING THOSE USED FOR IMAGE FORMATION DEVICE, COMPONENT, AND METHOD FOR REDUCING NOISE IN MACHINE DEVICE
<b>C10M 107/44</b> (2006.01)	3388501	SLIDING MEMBER EXCLUDING THOSE USED FOR IMAGE FORMATION DEVICE, COMPONENT, AND METHOD FOR REDUCING NOISE IN MACHINE DEVICE
<b>C10M 107/50</b> (2006.01)	3388501	SLIDING MEMBER EXCLUDING THOSE USED FOR IMAGE FORMATION DEVICE, COMPONENT, AND METHOD FOR REDUCING NOISE IN MACHINE DEVICE
<b>C10M 171/00</b> (2006.01)	3388501	SLIDING MEMBER EXCLUDING THOSE USED FOR IMAGE FORMATION DEVICE, COMPONENT, AND METHOD FOR REDUCING NOISE IN MACHINE DEVICE
<b>C10N 50/08</b> (2006.01)	3388501	SLIDING MEMBER EXCLUDING THOSE USED FOR IMAGE FORMATION DEVICE, COMPONENT, AND METHOD FOR REDUCING NOISE IN MACHINE DEVICE
<b>A61K 9/127</b> (2006.01)	3386484	COMPOSITIONS AND METHODS FOR DELIVERY OF THERAPEUTIC AGENTS
<b>A61K 9/133</b> (2006.01)	3386484	COMPOSITIONS AND METHODS FOR DELIVERY OF THERAPEUTIC AGENTS
<b>A61K 31/7088</b> (2006.01)	3386484	COMPOSITIONS AND METHODS FOR DELIVERY OF THERAPEUTIC AGENTS
<b>C12N 15/88</b> (2006.01)	3386484	COMPOSITIONS AND METHODS FOR DELIVERY OF THERAPEUTIC AGENTS
<b>C12Q 1/68</b> (2018.01)	3387155	METHODS FOR TREATMENT AND SELECTION OF PATIENTS RESPONSIVE TO IMMUNE MEDIATED CANCER THERAPY
<b>G01N 33/574</b> (2006.01)	3387155	METHODS FOR TREATMENT AND SELECTION OF PATIENTS RESPONSIVE TO IMMUNE MEDIATED CANCER THERAPY
<b>G06F 15/16</b> (2006.01)	3387561	DATABASE MANAGEMENT FOR A LOGICAL REGISTRY
<b>G06F 17/30</b> (2006.01)	3387561	DATABASE MANAGEMENT FOR A LOGICAL REGISTRY
<b>A61K 9/12</b> (2006.01)	3391897	HEMOSTATIC COMPOSITION AND HEMOSTATIC METHOD USING HEMOSTATIC COMPOSITION
<b>A61K 38/00</b> (2006.01)	3391897	HEMOSTATIC COMPOSITION AND HEMOSTATIC METHOD USING HEMOSTATIC COMPOSITION
<b>A61L 26/00</b> (2006.01)	3391897	HEMOSTATIC COMPOSITION AND HEMOSTATIC METHOD USING HEMOSTATIC COMPOSITION
<b>A61P 7/04</b> (2006.01)	3391897	HEMOSTATIC COMPOSITION AND HEMOSTATIC METHOD USING HEMOSTATIC COMPOSITION
<b>A61P 17/02</b> (2006.01)	3391897	HEMOSTATIC COMPOSITION AND HEMOSTATIC METHOD USING HEMOSTATIC COMPOSITION
<b>A61P 43/00</b> (2006.01)	3391897	HEMOSTATIC COMPOSITION AND HEMOSTATIC METHOD USING HEMOSTATIC COMPOSITION
<b>C07K 7/00</b> (2006.01)	3391897	HEMOSTATIC COMPOSITION AND HEMOSTATIC METHOD USING HEMOSTATIC COMPOSITION
<b>A01N 43/50</b> (2006.01)	3395801	ARYLAZOLE COMPOUND AND PEST CONTROL AGENT
<b>A01N 43/56</b> (2006.01)	3395801	ARYLAZOLE COMPOUND AND PEST CONTROL AGENT
<b>A01N 43/647</b> (2006.01)	3395801	ARYLAZOLE COMPOUND AND PEST CONTROL AGENT
<b>A01N 43/653</b> (2006.01)	3395801	ARYLAZOLE COMPOUND AND PEST CONTROL AGENT
<b>A01N 55/00</b> (2006.01)	3395801	ARYLAZOLE COMPOUND AND PEST CONTROL AGENT
<b>A01P 7/02</b> (2006.01)	3395801	ARYLAZOLE COMPOUND AND PEST CONTROL AGENT

MKP (51)	Broj objave evropske prijava patenta (97)	Naziv pronalaska (54)
<b>A01P 7/04</b> (2006.01)	3395801	ARYLAZOLE COMPOUND AND PEST CONTROL AGENT
<b>A61K 31/415</b> (2006.01)	3395801	ARYLAZOLE COMPOUND AND PEST CONTROL AGENT
<b>A61K 31/4164</b> (2006.01)	3395801	ARYLAZOLE COMPOUND AND PEST CONTROL AGENT
<b>A61K 31/4178</b> (2006.01)	3395801	ARYLAZOLE COMPOUND AND PEST CONTROL AGENT
<b>A61K 31/4192</b> (2006.01)	3395801	ARYLAZOLE COMPOUND AND PEST CONTROL AGENT
<b>A61K 31/4196</b> (2006.01)	3395801	ARYLAZOLE COMPOUND AND PEST CONTROL AGENT
<b>A61K 31/4439</b> (2006.01)	3395801	ARYLAZOLE COMPOUND AND PEST CONTROL AGENT
<b>A61K 31/695</b> (2006.01)	3395801	ARYLAZOLE COMPOUND AND PEST CONTROL AGENT
<b>A61P 33/10</b> (2006.01)	3395801	ARYLAZOLE COMPOUND AND PEST CONTROL AGENT
<b>A61P 33/14</b> (2006.01)	3395801	ARYLAZOLE COMPOUND AND PEST CONTROL AGENT
<b>C07D 231/12</b> (2006.01)	3395801	ARYLAZOLE COMPOUND AND PEST CONTROL AGENT
<b>C07D 231/14</b> (2006.01)	3395801	ARYLAZOLE COMPOUND AND PEST CONTROL AGENT
<b>C07D 231/38</b> (2006.01)	3395801	ARYLAZOLE COMPOUND AND PEST CONTROL AGENT
<b>C07D 233/64</b> (2006.01)	3395801	ARYLAZOLE COMPOUND AND PEST CONTROL AGENT
<b>C07D 233/68</b> (2006.01)	3395801	ARYLAZOLE COMPOUND AND PEST CONTROL AGENT
<b>C07C 231/10</b> (2006.01)	3392236	METHOD FOR PRODUCING AROMATIC AMIDE DERIVATIVE
<b>C07C 237/42</b> (2006.01)	3392236	METHOD FOR PRODUCING AROMATIC AMIDE DERIVATIVE
<b>A61K 39/395</b> (2006.01)	3389714	BISPECIFIC MOLECULES HAVING IMMUNOREACTIVITY WITH PD-1 AND CTLA-4, AND METHODS OF USE THEREOF
<b>C07K 16/28</b> (2006.01)	3389714	BISPECIFIC MOLECULES HAVING IMMUNOREACTIVITY WITH PD-1 AND CTLA-4, AND METHODS OF USE THEREOF
<b>C07K 16/30</b> (2006.01)	3389714	BISPECIFIC MOLECULES HAVING IMMUNOREACTIVITY WITH PD-1 AND CTLA-4, AND METHODS OF USE THEREOF
<b>C07K 16/46</b> (2006.01)	3389714	BISPECIFIC MOLECULES HAVING IMMUNOREACTIVITY WITH PD-1 AND CTLA-4, AND METHODS OF USE THEREOF
<b>A61K 31/397</b> (2006.01)	3390357	BIARYL MONOBACTAM COMPOUNDS AND METHODS OF USE THEREOF FOR THE TREATMENT OF BACTERIAL INFECTIONS
<b>A61P 31/04</b> (2006.01)	3390357	BIARYL MONOBACTAM COMPOUNDS AND METHODS OF USE THEREOF FOR THE TREATMENT OF BACTERIAL INFECTIONS
<b>C07D 205/08</b> (2006.01)	3390357	BIARYL MONOBACTAM COMPOUNDS AND METHODS OF USE THEREOF FOR THE TREATMENT OF BACTERIAL INFECTIONS
<b>A61K 38/00</b> (2006.01)	3399989	ANTI-LAG3 ANTIBODIES AND ANTIGEN-BINDING FRAGMENTS
<b>A61K 39/00</b> (2006.01)	3399989	ANTI-LAG3 ANTIBODIES AND ANTIGEN-BINDING FRAGMENTS
<b>A61K 39/395</b> (2006.01)	3399989	ANTI-LAG3 ANTIBODIES AND ANTIGEN-BINDING FRAGMENTS
<b>C07K 16/28</b> (2006.01)	3399989	ANTI-LAG3 ANTIBODIES AND ANTIGEN-BINDING FRAGMENTS
<b>C12P 21/08</b> (2006.01)	3399989	ANTI-LAG3 ANTIBODIES AND ANTIGEN-BINDING FRAGMENTS
<b>A61K 47/50</b> (2017.01)	3389719	PEPTIDE OLIGONUCLEOTIDE CONJUGATES
<b>A61P 21/00</b> (2006.01)	3389719	PEPTIDE OLIGONUCLEOTIDE CONJUGATES
<b>A61P 31/16</b> (2006.01)	3389719	PEPTIDE OLIGONUCLEOTIDE CONJUGATES
<b>A61K 31/4433</b> (2006.01)	3389657	METHODS OF TREATING HYPERALGESIA
<b>A61K 31/497</b> (2006.01)	3389657	METHODS OF TREATING HYPERALGESIA
<b>A61P 1/10</b> (2006.01)	3389657	METHODS OF TREATING HYPERALGESIA
<b>C07D 405/04</b> (2006.01)	3389657	METHODS OF TREATING HYPERALGESIA
<b>A61K 39/00</b> (2006.01)	3389699	CHIMERIC AND HUMANIZED ANTI-HUMAN CTLA4 MONOCLONAL ANTIBODIES AND USES THEREOF
<b>A61K 39/395</b> (2006.01)	3389699	CHIMERIC AND HUMANIZED ANTI-HUMAN CTLA4 MONOCLONAL ANTIBODIES AND USES THEREOF
<b>C07K 16/00</b> (2006.01)	3389699	CHIMERIC AND HUMANIZED ANTI-HUMAN CTLA4 MONOCLONAL ANTIBODIES AND USES THEREOF
<b>C12P 21/08</b> (2006.01)	3389699	CHIMERIC AND HUMANIZED ANTI-HUMAN CTLA4 MONOCLONAL ANTIBODIES AND USES THEREOF
<b>A61K 31/425</b> (2006.01)	3389654	DIAMINO-ALKYLAMINO-LINKED ARYLSULFONAMIDE COMPOUNDS WITH SELECTIVE ACTIVITY IN VOLTAGE-GATED SODIUM CHANNELS
<b>A61P 43/00</b> (2006.01)	3389654	DIAMINO-ALKYLAMINO-LINKED ARYLSULFONAMIDE COMPOUNDS WITH SELECTIVE ACTIVITY IN VOLTAGE-GATED SODIUM CHANNELS
<b>C07C 311/15</b> (2006.01)	3389654	DIAMINO-ALKYLAMINO-LINKED ARYLSULFONAMIDE COMPOUNDS WITH SELECTIVE ACTIVITY IN VOLTAGE-GATED SODIUM CHANNELS
<b>A61P 9/10</b> (2006.01)	3389781	INHIBITORS OF TNF SUPERFAMILY COSTIMULATORY INTERACTIONS AND METHODS FOR USES OF THE SAME
<b>A61P 37/06</b> (2006.01)	3389781	INHIBITORS OF TNF SUPERFAMILY COSTIMULATORY INTERACTIONS AND METHODS FOR USES OF THE SAME
<b>C12N 5/071</b> (2010.01)	3389781	INHIBITORS OF TNF SUPERFAMILY COSTIMULATORY INTERACTIONS AND METHODS FOR USES OF THE SAME
<b>A61K 31/165</b> (2006.01)	3389656	COMBINATIONS OF OPIOID RECEPTOR LIGANDS AND CYTOCHROME P450 INHIBITORS

MKP (51)	Broj objave evropske prijava patenta (97)	Naziv pronalaska (54)
<b>A61K 31/439</b> (2006.01)	3389656	COMBINATIONS OF OPIOID RECEPTOR LIGANDS AND CYTOCHROME P450 INHIBITORS
<b>A61K 31/444</b> (2006.01)	3389656	COMBINATIONS OF OPIOID RECEPTOR LIGANDS AND CYTOCHROME P450 INHIBITORS
<b>A61K 9/10</b> (2006.01)	3389630	NEOANTIGEN IDENTIFICATION, MANUFACTURE, AND USE
<b>A61K 35/15</b> (2015.01)	3389630	NEOANTIGEN IDENTIFICATION, MANUFACTURE, AND USE
<b>A61K 39/00</b> (2006.01)	3389630	NEOANTIGEN IDENTIFICATION, MANUFACTURE, AND USE
<b>A61K 39/39</b> (2006.01)	3389630	NEOANTIGEN IDENTIFICATION, MANUFACTURE, AND USE
<b>A61K 39/395</b> (2006.01)	3389630	NEOANTIGEN IDENTIFICATION, MANUFACTURE, AND USE
<b>A61P 35/00</b> (2006.01)	3389630	NEOANTIGEN IDENTIFICATION, MANUFACTURE, AND USE
<b>A61K 31/70</b> (2006.01)	3389705	LISTERIA-BASED IMMUNOTHERAPY AND METHODS OF USE THEREOF
<b>A61K 31/7036</b> (2006.01)	3389705	LISTERIA-BASED IMMUNOTHERAPY AND METHODS OF USE THEREOF
<b>A61K 39/00</b> (2006.01)	3389705	LISTERIA-BASED IMMUNOTHERAPY AND METHODS OF USE THEREOF
<b>A61K 39/02</b> (2006.01)	3389705	LISTERIA-BASED IMMUNOTHERAPY AND METHODS OF USE THEREOF
<b>A61K 31/282</b> (2006.01)	3395857	POLYMER CONJUGATE OF SULFOXIDE DERIVATIVE-COORDINATED PLATINUM(II) COMPLEX
<b>A61K 31/555</b> (2006.01)	3395857	POLYMER CONJUGATE OF SULFOXIDE DERIVATIVE-COORDINATED PLATINUM(II) COMPLEX
<b>A61K 47/50</b> (2017.01)	3395857	POLYMER CONJUGATE OF SULFOXIDE DERIVATIVE-COORDINATED PLATINUM(II) COMPLEX
<b>A61P 35/00</b> (2006.01)	3395857	POLYMER CONJUGATE OF SULFOXIDE DERIVATIVE-COORDINATED PLATINUM(II) COMPLEX
<b>C08G 65/334</b> (2006.01)	3395857	POLYMER CONJUGATE OF SULFOXIDE DERIVATIVE-COORDINATED PLATINUM(II) COMPLEX
<b>C08G 69/08</b> (2006.01)	3395857	POLYMER CONJUGATE OF SULFOXIDE DERIVATIVE-COORDINATED PLATINUM(II) COMPLEX
<b>C08G 69/48</b> (2006.01)	3395857	POLYMER CONJUGATE OF SULFOXIDE DERIVATIVE-COORDINATED PLATINUM(II) COMPLEX
<b>C08G 81/00</b> (2006.01)	3395857	POLYMER CONJUGATE OF SULFOXIDE DERIVATIVE-COORDINATED PLATINUM(II) COMPLEX
<b>A23L 29/206</b> (2016.01)	3395187	GEL-LIKE FOOD COMPOSITION
<b>A23L 33/135</b> (2016.01)	3395187	GEL-LIKE FOOD COMPOSITION
<b>A23L 33/175</b> (2016.01)	3395187	GEL-LIKE FOOD COMPOSITION
<b>A61K 31/167</b> (2006.01)	3395345	ANTITUMOR EFFECT POTENTIATOR COMPRISING PYRROLOPYRIMIDINE COMPOUND
<b>A61K 31/282</b> (2006.01)	3395345	ANTITUMOR EFFECT POTENTIATOR COMPRISING PYRROLOPYRIMIDINE COMPOUND
<b>A61K 31/337</b> (2006.01)	3395345	ANTITUMOR EFFECT POTENTIATOR COMPRISING PYRROLOPYRIMIDINE COMPOUND
<b>A61K 31/357</b> (2006.01)	3395345	ANTITUMOR EFFECT POTENTIATOR COMPRISING PYRROLOPYRIMIDINE COMPOUND
<b>A61K 31/4045</b> (2006.01)	3395345	ANTITUMOR EFFECT POTENTIATOR COMPRISING PYRROLOPYRIMIDINE COMPOUND
<b>A61K 31/4164</b> (2006.01)	3395345	ANTITUMOR EFFECT POTENTIATOR COMPRISING PYRROLOPYRIMIDINE COMPOUND
<b>A61K 31/436</b> (2006.01)	3395345	ANTITUMOR EFFECT POTENTIATOR COMPRISING PYRROLOPYRIMIDINE COMPOUND
<b>A61K 31/44</b> (2006.01)	3395345	ANTITUMOR EFFECT POTENTIATOR COMPRISING PYRROLOPYRIMIDINE COMPOUND
<b>A61K 31/454</b> (2006.01)	3395345	ANTITUMOR EFFECT POTENTIATOR COMPRISING PYRROLOPYRIMIDINE COMPOUND
<b>A61K 31/4545</b> (2006.01)	3395345	ANTITUMOR EFFECT POTENTIATOR COMPRISING PYRROLOPYRIMIDINE COMPOUND
<b>A61K 31/47</b> (2006.01)	3395345	ANTITUMOR EFFECT POTENTIATOR COMPRISING PYRROLOPYRIMIDINE COMPOUND
<b>A61K 31/4709</b> (2006.01)	3395345	ANTITUMOR EFFECT POTENTIATOR COMPRISING PYRROLOPYRIMIDINE COMPOUND
<b>A61K 31/473</b> (2006.01)	3395345	ANTITUMOR EFFECT POTENTIATOR COMPRISING PYRROLOPYRIMIDINE COMPOUND
<b>A61K 31/4747</b> (2006.01)	3395345	ANTITUMOR EFFECT POTENTIATOR COMPRISING PYRROLOPYRIMIDINE COMPOUND
<b>A61K 31/497</b> (2006.01)	3395345	ANTITUMOR EFFECT POTENTIATOR COMPRISING PYRROLOPYRIMIDINE COMPOUND

MKP (51)	Broj objave evropske prijava patenta (97)	Naziv pronalaska (54)
<b>A61K 31/502</b> (2006.01)	3395345	ANTITUMOR EFFECT POTENTIATOR COMPRISING PYRROLOPYRIMIDINE COMPOUND
<b>A61K 31/5025</b> (2006.01)	3395345	ANTITUMOR EFFECT POTENTIATOR COMPRISING PYRROLOPYRIMIDINE COMPOUND
<b>A61K 31/513</b> (2006.01)	3395345	ANTITUMOR EFFECT POTENTIATOR COMPRISING PYRROLOPYRIMIDINE COMPOUND
<b>A61K 31/519</b> (2006.01)	3395345	ANTITUMOR EFFECT POTENTIATOR COMPRISING PYRROLOPYRIMIDINE COMPOUND
<b>A61K 31/52</b> (2006.01)	3395345	ANTITUMOR EFFECT POTENTIATOR COMPRISING PYRROLOPYRIMIDINE COMPOUND
<b>B01J 23/72</b> (2006.01)	3393655	FENFLURAMINE COMPOSITIONS AND METHODS OF PREPARING THE SAME
<b>B01J 27/055</b> (2006.01)	3393655	FENFLURAMINE COMPOSITIONS AND METHODS OF PREPARING THE SAME
<b>B01J 27/122</b> (2006.01)	3393655	FENFLURAMINE COMPOSITIONS AND METHODS OF PREPARING THE SAME
<b>B01J 27/25</b> (2006.01)	3393655	FENFLURAMINE COMPOSITIONS AND METHODS OF PREPARING THE SAME
<b>C07C 45/54</b> (2006.01)	3393655	FENFLURAMINE COMPOSITIONS AND METHODS OF PREPARING THE SAME
<b>C07C 49/223</b> (2006.01)	3393655	FENFLURAMINE COMPOSITIONS AND METHODS OF PREPARING THE SAME
<b>A61K 31/551</b> (2006.01)	3394106	NOVEL ANTI-MMP16 ANTIBODIES AND METHODS OF USE
<b>A61K 47/68</b> (2017.01)	3394106	NOVEL ANTI-MMP16 ANTIBODIES AND METHODS OF USE
<b>C07K 16/40</b> (2006.01)	3394106	NOVEL ANTI-MMP16 ANTIBODIES AND METHODS OF USE
<b>A61K 31/551</b> (2006.01)	3394107	NOVEL ANTI-TNFSF9 ANTIBODIES AND METHODS OF USE
<b>A61K 47/68</b> (2017.01)	3394107	NOVEL ANTI-TNFSF9 ANTIBODIES AND METHODS OF USE
<b>C07K 16/40</b> (2006.01)	3394107	NOVEL ANTI-TNFSF9 ANTIBODIES AND METHODS OF USE
<b>A61K 39/395</b> (2006.01)	3393516	NOVEL ANTI-UPK1B ANTIBODIES AND METHODS OF USE
<b>A61P 35/00</b> (2006.01)	3393516	NOVEL ANTI-UPK1B ANTIBODIES AND METHODS OF USE
<b>A61K 31/00</b> (2006.01)	3393458	METHODS OF USE OF A CLASS IIA HDAC INHIBITOR
<b>A61K 31/33</b> (2006.01)	3393458	METHODS OF USE OF A CLASS IIA HDAC INHIBITOR
<b>A61K 31/395</b> (2006.01)	3393458	METHODS OF USE OF A CLASS IIA HDAC INHIBITOR
<b>A61K 31/495</b> (2006.01)	3393458	METHODS OF USE OF A CLASS IIA HDAC INHIBITOR
<b>A61K 31/505</b> (2006.01)	3393458	METHODS OF USE OF A CLASS IIA HDAC INHIBITOR
<b>G01N 1/00</b> (2006.01)	3394589	A METHOD TO IDENTIFY AN APPROACH FOR ACHIEVING MAMMALIAN FERTILIZATION AND TIME PERIOD FOR INSEMINATION
<b>C08G 18/00</b> (2006.01)	3398980	AQUEOUS-DISPERSION TYPE POLYCARBONATE-BASED POLYURETHANE RESIN COMPOSITION, TEXTILE PRODUCT TREATED WITH SAME, AND PROCESS FOR PRODUCING AQUEOUS-DISPERSION TYPE POLYCARBONATE-BASED POLYURETHANE RESIN COMPOSITION
<b>C08G 18/10</b> (2006.01)	3398980	AQUEOUS-DISPERSION TYPE POLYCARBONATE-BASED POLYURETHANE RESIN COMPOSITION, TEXTILE PRODUCT TREATED WITH SAME, AND PROCESS FOR PRODUCING AQUEOUS-DISPERSION TYPE POLYCARBONATE-BASED POLYURETHANE RESIN COMPOSITION
<b>C08G 18/44</b> (2006.01)	3398980	AQUEOUS-DISPERSION TYPE POLYCARBONATE-BASED POLYURETHANE RESIN COMPOSITION, TEXTILE PRODUCT TREATED WITH SAME, AND PROCESS FOR PRODUCING AQUEOUS-DISPERSION TYPE POLYCARBONATE-BASED POLYURETHANE RESIN COMPOSITION
<b>C08G 18/48</b> (2006.01)	3398980	AQUEOUS-DISPERSION TYPE POLYCARBONATE-BASED POLYURETHANE RESIN COMPOSITION, TEXTILE PRODUCT TREATED WITH SAME, AND PROCESS FOR PRODUCING AQUEOUS-DISPERSION TYPE POLYCARBONATE-BASED POLYURETHANE RESIN COMPOSITION
<b>C08G 18/65</b> (2006.01)	3398980	AQUEOUS-DISPERSION TYPE POLYCARBONATE-BASED POLYURETHANE RESIN COMPOSITION, TEXTILE PRODUCT TREATED WITH SAME, AND PROCESS FOR PRODUCING AQUEOUS-DISPERSION TYPE POLYCARBONATE-BASED POLYURETHANE RESIN COMPOSITION
<b>C08L 75/04</b> (2006.01)	3398980	AQUEOUS-DISPERSION TYPE POLYCARBONATE-BASED POLYURETHANE RESIN COMPOSITION, TEXTILE PRODUCT TREATED WITH SAME, AND PROCESS FOR PRODUCING AQUEOUS-DISPERSION TYPE POLYCARBONATE-BASED POLYURETHANE RESIN COMPOSITION

MKP (51)	Broj objave evropske prijava patenta (97)	Naziv pronalaska (54)
<b>D06M 15/564</b> (2006.01)	3398980	AQUEOUS-DISPERSION TYPE POLYCARBONATE-BASED POLYURETHANE RESIN COMPOSITION, TEXTILE PRODUCT TREATED WITH SAME, AND PROCESS FOR PRODUCING AQUEOUS-DISPERSION TYPE POLYCARBONATE-BASED POLYURETHANE RESIN COMPOSITION
<b>A61K 31/131</b> (2006.01)	3394047	DEUTERATED COMPOUNDS FOR TREATING CANCER AND RELATED DISEASES AND CONDITIONS, AND COMPOSITIONS AND METHODS THEREOF
<b>A61K 31/282</b> (2006.01)	3394047	DEUTERATED COMPOUNDS FOR TREATING CANCER AND RELATED DISEASES AND CONDITIONS, AND COMPOSITIONS AND METHODS THEREOF
<b>A61K 31/337</b> (2006.01)	3394047	DEUTERATED COMPOUNDS FOR TREATING CANCER AND RELATED DISEASES AND CONDITIONS, AND COMPOSITIONS AND METHODS THEREOF
<b>A61K 31/409</b> (2006.01)	3394047	DEUTERATED COMPOUNDS FOR TREATING CANCER AND RELATED DISEASES AND CONDITIONS, AND COMPOSITIONS AND METHODS THEREOF
<b>A61K 31/506</b> (2006.01)	3394047	DEUTERATED COMPOUNDS FOR TREATING CANCER AND RELATED DISEASES AND CONDITIONS, AND COMPOSITIONS AND METHODS THEREOF
<b>A61K 31/517</b> (2006.01)	3394047	DEUTERATED COMPOUNDS FOR TREATING CANCER AND RELATED DISEASES AND CONDITIONS, AND COMPOSITIONS AND METHODS THEREOF
<b>A61K 31/519</b> (2006.01)	3394047	DEUTERATED COMPOUNDS FOR TREATING CANCER AND RELATED DISEASES AND CONDITIONS, AND COMPOSITIONS AND METHODS THEREOF
<b>A61K 31/5377</b> (2006.01)	3394047	DEUTERATED COMPOUNDS FOR TREATING CANCER AND RELATED DISEASES AND CONDITIONS, AND COMPOSITIONS AND METHODS THEREOF
<b>A61K 31/7068</b> (2006.01)	3394047	DEUTERATED COMPOUNDS FOR TREATING CANCER AND RELATED DISEASES AND CONDITIONS, AND COMPOSITIONS AND METHODS THEREOF
<b>A61K 39/395</b> (2006.01)	3394047	DEUTERATED COMPOUNDS FOR TREATING CANCER AND RELATED DISEASES AND CONDITIONS, AND COMPOSITIONS AND METHODS THEREOF
<b>A61P 35/00</b> (2006.01)	3394047	DEUTERATED COMPOUNDS FOR TREATING CANCER AND RELATED DISEASES AND CONDITIONS, AND COMPOSITIONS AND METHODS THEREOF
<b>C07B 59/00</b> (2006.01)	3394047	DEUTERATED COMPOUNDS FOR TREATING CANCER AND RELATED DISEASES AND CONDITIONS, AND COMPOSITIONS AND METHODS THEREOF
<b>C07D 403/04</b> (2006.01)	3394047	DEUTERATED COMPOUNDS FOR TREATING CANCER AND RELATED DISEASES AND CONDITIONS, AND COMPOSITIONS AND METHODS THEREOF
<b>A61K 39/395</b> (2006.01)	3397282	METHODS RELATED TO BIOLOGICS
<b>C12P 21/00</b> (2006.01)	3397282	METHODS RELATED TO BIOLOGICS
<b>G01N 33/68</b> (2006.01)	3397282	METHODS RELATED TO BIOLOGICS
<b>A61K 31/496</b> (2006.01)	3397625	TREATMENT OF TUMORS INCORPORATING MUTANT ISOCITRATE DEHYDROGENASE
<b>A61K 31/551</b> (2006.01)	3397625	TREATMENT OF TUMORS INCORPORATING MUTANT ISOCITRATE DEHYDROGENASE
<b>C07D 333/38</b> (2006.01)	3397625	TREATMENT OF TUMORS INCORPORATING MUTANT ISOCITRATE DEHYDROGENASE
<b>B41J 2/045</b> (2006.01)	3400137	MULTIPLICED MULTILEVEL CONVERTER AMPLIFIER
<b>A61K 31/352</b> (2006.01)	3418274	METHOD FOR EXTRACTING HERBACETIN FROM RHODIOLA ROSEA
<b>A61K 36/41</b> (2006.01)	3418274	METHOD FOR EXTRACTING HERBACETIN FROM RHODIOLA ROSEA
<b>C07D 311/30</b> (2006.01)	3418274	METHOD FOR EXTRACTING HERBACETIN FROM RHODIOLA ROSEA
<b>C12N 5/00</b> (2006.01)	3406714	METHOD FOR DETECTING OR SEPARATING/OBTAINING CIRCULATING TUMOR CELL EMPLOYING CELL PROLIFERATION METHOD
<b>C12N 5/09</b> (2010.01)	3406714	METHOD FOR DETECTING OR SEPARATING/OBTAINING CIRCULATING TUMOR CELL EMPLOYING CELL PROLIFERATION METHOD
<b>C12N 5/095</b> (2010.01)	3406714	METHOD FOR DETECTING OR SEPARATING/OBTAINING CIRCULATING TUMOR CELL EMPLOYING CELL PROLIFERATION METHOD

MKP (51)	Broj objave evropske prijava patenta (97)	Naziv pronalaska (54)
<b>G01N 33/574</b> (2006.01)	3406714	METHOD FOR DETECTING OR SEPARATING/OBTAINING CIRCULATING TUMOR CELL EMPLOYING CELL PROLIFERATION METHOD
<b>B41J 2/175</b> (2006.01)	3415326	INK BOX CHIP, INK BOX AND OPERATION METHOD FOR RESPONDING TO PRINTING WORK
<b>E01F 15/00</b> (2006.01)	3366841	DAMPING DEVICE
<b>E01F 15/14</b> (2006.01)	3366841	DAMPING DEVICE
<b>A41D 19/00</b> (2006.01)	3372107	COSMETIC GLOVE
<b>A45D 33/00</b> (2006.01)	3372107	COSMETIC GLOVE
<b>A45D 34/04</b> (2006.01)	3372107	COSMETIC GLOVE
<b>A45D 44/00</b> (2006.01)	3372107	COSMETIC GLOVE
<b>A47K 7/02</b> (2006.01)	3372107	COSMETIC GLOVE
<b>G01S 7/481</b> (2006.01)	3258314	ENCLOSURE DEVICE
<b>G02B 27/00</b> (2006.01)	3258314	ENCLOSURE DEVICE
<b>G03B 11/04</b> (2006.01)	3258314	ENCLOSURE DEVICE
<b>G03B 15/04</b> (2006.01)	3258314	ENCLOSURE DEVICE
<b>G03B 17/02</b> (2006.01)	3258314	ENCLOSURE DEVICE
<b>B65C 9/18</b> (2006.01)	3381823	DEVICE FOR FORMING AND TRANSFERRING DECORATIVE BANNERS FOR THERMOFORMING PACKAGING MACHINES
<b>B32B 5/26</b> (2006.01)	3269901	IMPROVED INDUSTRIAL TENT AND PLANNING COMPOSITE
<b>B32B 27/12</b> (2006.01)	3269901	IMPROVED INDUSTRIAL TENT AND PLANNING COMPOSITE
<b>D04H 1/4218</b> (2012.01)	3269901	IMPROVED INDUSTRIAL TENT AND PLANNING COMPOSITE
<b>E04H 15/54</b> (2006.01)	3269901	IMPROVED INDUSTRIAL TENT AND PLANNING COMPOSITE
<b>B23B 49/00</b> (2006.01)	3299529	A CUTTER AND METHOD FOR MAKING DENTS AND FIXING INSULATION
<b>B23B 51/04</b> (2006.01)	3299529	A CUTTER AND METHOD FOR MAKING DENTS AND FIXING INSULATION
<b>E04B 1/76</b> (2006.01)	3299529	A CUTTER AND METHOD FOR MAKING DENTS AND FIXING INSULATION
<b>C11C 3/00</b> (2006.01)	3299444	HIGH EFFICIENCY METHOD AND CATALYST FOR THE PRODUCTION OF ALKYL ESTERS FROM FATTY ACIDS WITH ACID CATALYSIS
<b>H01Q 1/22</b> (2006.01)	3331094	ANTENNA ASSEMBLY
<b>H01Q 1/52</b> (2006.01)	3331094	ANTENNA ASSEMBLY
<b>H01Q 3/30</b> (2006.01)	3331094	ANTENNA ASSEMBLY
<b>H01Q 5/35</b> (2015.01)	3331094	ANTENNA ASSEMBLY
<b>H01Q 9/04</b> (2006.01)	3331094	ANTENNA ASSEMBLY
<b>H01Q 21/28</b> (2006.01)	3331094	ANTENNA ASSEMBLY
<b>A61M 16/00</b> (2006.01)	3258999	DEVICE FOR ADJUSTMENT AND/OR CONDITIONING OF THE CO2 CONTENT OF THE INHALED AIR
<b>A61M 16/12</b> (2006.01)	3258999	DEVICE FOR ADJUSTMENT AND/OR CONDITIONING OF THE CO2 CONTENT OF THE INHALED AIR
<b>A61K 39/00</b> (2006.01)	3368066	ANTI-CGRP/ANTI-IL-23 BISPECIFIC ANTIBODIES AND USES THEREOF
<b>A61K 39/395</b> (2006.01)	3368066	ANTI-CGRP/ANTI-IL-23 BISPECIFIC ANTIBODIES AND USES THEREOF
<b>C07K 16/18</b> (2006.01)	3368066	ANTI-CGRP/ANTI-IL-23 BISPECIFIC ANTIBODIES AND USES THEREOF
<b>C07K 16/24</b> (2006.01)	3368066	ANTI-CGRP/ANTI-IL-23 BISPECIFIC ANTIBODIES AND USES THEREOF
<b>C07K 16/26</b> (2006.01)	3368066	ANTI-CGRP/ANTI-IL-23 BISPECIFIC ANTIBODIES AND USES THEREOF
<b>H04L 9/08</b> (2006.01)	3257192	SECURE AND DELEGATED DISTRIBUTION OF PRIVATE KEYS VIA DOMAIN NAME SERVICE
<b>H04L 9/32</b> (2006.01)	3257192	SECURE AND DELEGATED DISTRIBUTION OF PRIVATE KEYS VIA DOMAIN NAME SERVICE
<b>H04L 29/06</b> (2006.01)	3257192	SECURE AND DELEGATED DISTRIBUTION OF PRIVATE KEYS VIA DOMAIN NAME SERVICE
<b>H04L 29/12</b> (2006.01)	3257192	SECURE AND DELEGATED DISTRIBUTION OF PRIVATE KEYS VIA DOMAIN NAME SERVICE
<b>C07F 5/05</b> (2006.01)	3256481	NOVEL CRYSTALLINE FORM OF A PROTEASOME INHIBITOR
<b>C12N 7/00</b> (2006.01)	3256571	METHODS FOR PRODUCING VIRUS FOR VACCINE PRODUCTION
<b>C07C 51/09</b> (2006.01)	3257009	SYSTEMS AND PROCESSES FOR POLYMER PRODUCTION
<b>C08F 122/02</b> (2006.01)	3257009	SYSTEMS AND PROCESSES FOR POLYMER PRODUCTION
<b>G06Q 30/02</b> (2012.01)	3257009	SYSTEMS AND PROCESSES FOR POLYMER PRODUCTION
<b>C07C 51/12</b> (2006.01)	3256442	SYSTEMS AND PROCESSES FOR POLYACRYLIC ACID PRODUCTION
<b>C07C 51/14</b> (2006.01)	3256442	SYSTEMS AND PROCESSES FOR POLYACRYLIC ACID PRODUCTION
<b>C07C 51/145</b> (2006.01)	3256442	SYSTEMS AND PROCESSES FOR POLYACRYLIC ACID PRODUCTION
<b>C07C 51/16</b> (2006.01)	3256442	SYSTEMS AND PROCESSES FOR POLYACRYLIC ACID PRODUCTION



MKP	Broj objave evropske prijave patenta	Naziv pronalaska
(51)	(97)	(54)
<b>C07C 51/377</b> (2006.01)	3256442	SYSTEMS AND PROCESSES FOR POLYACRYLIC ACID PRODUCTION
<b>C07C 57/04</b> (2006.01)	3256442	SYSTEMS AND PROCESSES FOR POLYACRYLIC ACID PRODUCTION
<b>C07C 59/01</b> (2006.01)	3256442	SYSTEMS AND PROCESSES FOR POLYACRYLIC ACID PRODUCTION
<b>C08F 2/01</b> (2006.01)	3256442	SYSTEMS AND PROCESSES FOR POLYACRYLIC ACID PRODUCTION
<b>C08F 2/18</b> (2006.01)	3256442	SYSTEMS AND PROCESSES FOR POLYACRYLIC ACID PRODUCTION
<b>C08F 20/00</b> (2006.01)	3256442	SYSTEMS AND PROCESSES FOR POLYACRYLIC ACID PRODUCTION
<b>C08F 20/06</b> (2006.01)	3256442	SYSTEMS AND PROCESSES FOR POLYACRYLIC ACID PRODUCTION
<b>C07C 29/147</b> (2006.01)	3256443	FLEXIBLE CHEMICAL PRODUCTION PLATFORM
<b>C07C 51/09</b> (2006.01)	3256443	FLEXIBLE CHEMICAL PRODUCTION PLATFORM
<b>C07C 57/04</b> (2006.01)	3256443	FLEXIBLE CHEMICAL PRODUCTION PLATFORM
<b>C07C 67/00</b> (2006.01)	3256443	FLEXIBLE CHEMICAL PRODUCTION PLATFORM
<b>C07C 67/03</b> (2006.01)	3256443	FLEXIBLE CHEMICAL PRODUCTION PLATFORM
<b>C07C 69/54</b> (2006.01)	3256443	FLEXIBLE CHEMICAL PRODUCTION PLATFORM
<b>C07D 301/02</b> (2006.01)	3256443	FLEXIBLE CHEMICAL PRODUCTION PLATFORM
<b>C07D 305/12</b> (2006.01)	3256443	FLEXIBLE CHEMICAL PRODUCTION PLATFORM
<b>C07D 307/60</b> (2006.01)	3256443	FLEXIBLE CHEMICAL PRODUCTION PLATFORM
<b>C08G 63/78</b> (2006.01)	3256443	FLEXIBLE CHEMICAL PRODUCTION PLATFORM
<b>C07C 51/09</b> (2006.01)	3256439	PROCESS FOR PRODUCTION OF ACRYLIC ACID
<b>C07C 57/04</b> (2006.01)	3256439	PROCESS FOR PRODUCTION OF ACRYLIC ACID
<b>B01J 19/24</b> (2006.01)	3256440	DISTILLATION PROCESS FOR PRODUCTION OF ACRYLIC ACID
<b>C07C 51/09</b> (2006.01)	3256440	DISTILLATION PROCESS FOR PRODUCTION OF ACRYLIC ACID
<b>C07C 57/04</b> (2006.01)	3256440	DISTILLATION PROCESS FOR PRODUCTION OF ACRYLIC ACID
<b>C08G 63/08</b> (2006.01)	3256440	DISTILLATION PROCESS FOR PRODUCTION OF ACRYLIC ACID
<b>C08G 63/82</b> (2006.01)	3256440	DISTILLATION PROCESS FOR PRODUCTION OF ACRYLIC ACID
<b>C07D 305/12</b> (2006.01)	3256454	INTEGRATED METHODS FOR CHEMICAL SYNTHESIS
<b>C07D 307/60</b> (2006.01)	3256454	INTEGRATED METHODS FOR CHEMICAL SYNTHESIS
<b>A61B 3/117</b> (2006.01)	3256084	DEVICE, SYSTEM, AND METHOD FOR FUNCTIONAL IMAGING OF EPISCLERAL VESSELS
<b>A61B 3/14</b> (2006.01)	3256084	DEVICE, SYSTEM, AND METHOD FOR FUNCTIONAL IMAGING OF EPISCLERAL VESSELS
<b>A61F 9/00</b> (2006.01)	3256084	DEVICE, SYSTEM, AND METHOD FOR FUNCTIONAL IMAGING OF EPISCLERAL VESSELS
<b>A61F 9/007</b> (2006.01)	3256084	DEVICE, SYSTEM, AND METHOD FOR FUNCTIONAL IMAGING OF EPISCLERAL VESSELS
<b>A61K 31/4155</b> (2006.01)	3347349	FLUOROINDOLE DERIVATIVES AS MUSCARINIC M1 RECEPTOR POSITIVE ALLOSTERIC MODULATORS
<b>A61K 31/416</b> (2006.01)	3347349	FLUOROINDOLE DERIVATIVES AS MUSCARINIC M1 RECEPTOR POSITIVE ALLOSTERIC MODULATORS
<b>A61K 31/427</b> (2006.01)	3347349	FLUOROINDOLE DERIVATIVES AS MUSCARINIC M1 RECEPTOR POSITIVE ALLOSTERIC MODULATORS
<b>A61K 31/428</b> (2006.01)	3347349	FLUOROINDOLE DERIVATIVES AS MUSCARINIC M1 RECEPTOR POSITIVE ALLOSTERIC MODULATORS
<b>A61K 31/4439</b> (2006.01)	3347349	FLUOROINDOLE DERIVATIVES AS MUSCARINIC M1 RECEPTOR POSITIVE ALLOSTERIC MODULATORS
<b>A61K 31/4545</b> (2006.01)	3347349	FLUOROINDOLE DERIVATIVES AS MUSCARINIC M1 RECEPTOR POSITIVE ALLOSTERIC MODULATORS
<b>A61P 25/00</b> (2006.01)	3347349	FLUOROINDOLE DERIVATIVES AS MUSCARINIC M1 RECEPTOR POSITIVE ALLOSTERIC MODULATORS
<b>C07D 401/06</b> (2006.01)	3347349	FLUOROINDOLE DERIVATIVES AS MUSCARINIC M1 RECEPTOR POSITIVE ALLOSTERIC MODULATORS
<b>C07D 401/12</b> (2006.01)	3347349	FLUOROINDOLE DERIVATIVES AS MUSCARINIC M1 RECEPTOR POSITIVE ALLOSTERIC MODULATORS
<b>C07D 401/14</b> (2006.01)	3347349	FLUOROINDOLE DERIVATIVES AS MUSCARINIC M1 RECEPTOR POSITIVE ALLOSTERIC MODULATORS
<b>C07D 403/06</b> (2006.01)	3347349	FLUOROINDOLE DERIVATIVES AS MUSCARINIC M1 RECEPTOR POSITIVE ALLOSTERIC MODULATORS
<b>C07D 403/14</b> (2006.01)	3347349	FLUOROINDOLE DERIVATIVES AS MUSCARINIC M1 RECEPTOR POSITIVE ALLOSTERIC MODULATORS
<b>C07D 417/06</b> (2006.01)	3347349	FLUOROINDOLE DERIVATIVES AS MUSCARINIC M1 RECEPTOR POSITIVE ALLOSTERIC MODULATORS
<b>C07D 417/14</b> (2006.01)	3347349	FLUOROINDOLE DERIVATIVES AS MUSCARINIC M1 RECEPTOR POSITIVE ALLOSTERIC MODULATORS
<b>F01N 1/16</b> (2006.01)	3347579	EXHAUST SYSTEM FOR AN INTERNAL COMBUSTION AUTOMOTIVE ENGINE
<b>F01N 3/00</b> (2006.01)	3347579	EXHAUST SYSTEM FOR AN INTERNAL COMBUSTION AUTOMOTIVE ENGINE
<b>F01N 9/00</b> (2006.01)	3347579	EXHAUST SYSTEM FOR AN INTERNAL COMBUSTION AUTOMOTIVE ENGINE

MKP (51)	Broj objave evropske prijava patenta (97)	Naziv pronalaska (54)
<b>F01N 13/04</b> (2010.01)	3347579	EXHAUST SYSTEM FOR AN INTERNAL COMBUSTION AUTOMOTIVE ENGINE
<b>F01N 13/08</b> (2010.01)	3347579	EXHAUST SYSTEM FOR AN INTERNAL COMBUSTION AUTOMOTIVE ENGINE
<b>A61K 36/04</b> (2006.01)	3380109	COMPOSITION FOR THE TREATMENT OF COLDS AND ALLERGIES
<b>A61K 36/09</b> (2006.01)	3380109	COMPOSITION FOR THE TREATMENT OF COLDS AND ALLERGIES
<b>A61K 36/185</b> (2006.01)	3380109	COMPOSITION FOR THE TREATMENT OF COLDS AND ALLERGIES
<b>A61K 36/48</b> (2006.01)	3380109	COMPOSITION FOR THE TREATMENT OF COLDS AND ALLERGIES
<b>A61K 36/68</b> (2006.01)	3380109	COMPOSITION FOR THE TREATMENT OF COLDS AND ALLERGIES
<b>A61K 36/73</b> (2006.01)	3380109	COMPOSITION FOR THE TREATMENT OF COLDS AND ALLERGIES
<b>A61K 36/888</b> (2006.01)	3380109	COMPOSITION FOR THE TREATMENT OF COLDS AND ALLERGIES
<b>A61K 36/8988</b> (2006.01)	3380109	COMPOSITION FOR THE TREATMENT OF COLDS AND ALLERGIES
<b>C07C 311/54</b> (2006.01)	3259253	SULFONYLUREAS AND RELATED COMPOUNDS AND USE OF SAME
<b>C07C 311/56</b> (2006.01)	3259253	SULFONYLUREAS AND RELATED COMPOUNDS AND USE OF SAME
<b>C07D 213/71</b> (2006.01)	3259253	SULFONYLUREAS AND RELATED COMPOUNDS AND USE OF SAME
<b>C07D 217/22</b> (2006.01)	3259253	SULFONYLUREAS AND RELATED COMPOUNDS AND USE OF SAME
<b>C07D 231/18</b> (2006.01)	3259253	SULFONYLUREAS AND RELATED COMPOUNDS AND USE OF SAME
<b>C07D 249/04</b> (2006.01)	3259253	SULFONYLUREAS AND RELATED COMPOUNDS AND USE OF SAME
<b>C07D 249/12</b> (2006.01)	3259253	SULFONYLUREAS AND RELATED COMPOUNDS AND USE OF SAME
<b>C07D 271/12</b> (2006.01)	3259253	SULFONYLUREAS AND RELATED COMPOUNDS AND USE OF SAME
<b>C07D 277/36</b> (2006.01)	3259253	SULFONYLUREAS AND RELATED COMPOUNDS AND USE OF SAME
<b>C07D 307/18</b> (2006.01)	3259253	SULFONYLUREAS AND RELATED COMPOUNDS AND USE OF SAME
<b>C07D 307/64</b> (2006.01)	3259253	SULFONYLUREAS AND RELATED COMPOUNDS AND USE OF SAME
<b>C07D 307/82</b> (2006.01)	3259253	SULFONYLUREAS AND RELATED COMPOUNDS AND USE OF SAME
<b>C07D 309/08</b> (2006.01)	3259253	SULFONYLUREAS AND RELATED COMPOUNDS AND USE OF SAME
<b>C07D 311/60</b> (2006.01)	3259253	SULFONYLUREAS AND RELATED COMPOUNDS AND USE OF SAME
<b>C07D 333/34</b> (2006.01)	3259253	SULFONYLUREAS AND RELATED COMPOUNDS AND USE OF SAME
<b>C07D 333/62</b> (2006.01)	3259253	SULFONYLUREAS AND RELATED COMPOUNDS AND USE OF SAME
<b>C07D 403/12</b> (2006.01)	3259253	SULFONYLUREAS AND RELATED COMPOUNDS AND USE OF SAME
<b>C07D 405/12</b> (2006.01)	3259253	SULFONYLUREAS AND RELATED COMPOUNDS AND USE OF SAME
<b>C07D 407/12</b> (2006.01)	3259253	SULFONYLUREAS AND RELATED COMPOUNDS AND USE OF SAME
<b>C07D 417/12</b> (2006.01)	3259253	SULFONYLUREAS AND RELATED COMPOUNDS AND USE OF SAME
<b>A01N 25/04</b> (2006.01)	3259992	AGROCHEMICAL COMPOSITION
<b>A01N 25/22</b> (2006.01)	3259992	AGROCHEMICAL COMPOSITION
<b>A01N 43/90</b> (2006.01)	3259992	AGROCHEMICAL COMPOSITION
<b>A01P 7/02</b> (2006.01)	3259992	AGROCHEMICAL COMPOSITION
<b>A61K 31/69</b> (2006.01)	3258965	COMBINATION THERAPY FOR CANCER TREATMENT
<b>A61K 39/395</b> (2006.01)	3258965	COMBINATION THERAPY FOR CANCER TREATMENT
<b>A61K 45/06</b> (2006.01)	3258965	COMBINATION THERAPY FOR CANCER TREATMENT
<b>A61P 35/00</b> (2006.01)	3258965	COMBINATION THERAPY FOR CANCER TREATMENT
<b>C07K 16/00</b> (2006.01)	3258965	COMBINATION THERAPY FOR CANCER TREATMENT
<b>C07K 16/18</b> (2006.01)	3258965	COMBINATION THERAPY FOR CANCER TREATMENT
<b>A61K 9/20</b> (2006.01)	3258962	MIXED ALLERGEN COMPOSITIONS AND METHODS FOR USING THE SAME
<b>A61K 31/07</b> (2006.01)	3258962	MIXED ALLERGEN COMPOSITIONS AND METHODS FOR USING THE SAME
<b>A61K 31/375</b> (2006.01)	3258962	MIXED ALLERGEN COMPOSITIONS AND METHODS FOR USING THE SAME
<b>A61K 39/35</b> (2006.01)	3258962	MIXED ALLERGEN COMPOSITIONS AND METHODS FOR USING THE SAME
<b>A61P 37/08</b> (2006.01)	3258962	MIXED ALLERGEN COMPOSITIONS AND METHODS FOR USING THE SAME
<b>A61K 38/37</b> (2006.01)	3260132	FVIII PEPTIDES FOR IMMUNE TOLERANCE INDUCTION AND IMMUNODIAGNOSTICS
<b>A61P 7/04</b> (2006.01)	3260132	FVIII PEPTIDES FOR IMMUNE TOLERANCE INDUCTION AND IMMUNODIAGNOSTICS
<b>C07K 14/755</b> (2006.01)	3260132	FVIII PEPTIDES FOR IMMUNE TOLERANCE INDUCTION AND IMMUNODIAGNOSTICS
<b>G01N 33/50</b> (2006.01)	3260132	FVIII PEPTIDES FOR IMMUNE TOLERANCE INDUCTION AND IMMUNODIAGNOSTICS
<b>G01N 33/569</b> (2006.01)	3260132	FVIII PEPTIDES FOR IMMUNE TOLERANCE INDUCTION AND IMMUNODIAGNOSTICS
<b>A61K 9/00</b> (2006.01)	3266456	COMBINATIONS OF LIPOSOMAL IRINOTECAN, 5-FU AND LEUCOVORIN FOR THE TREATMENT OF PANCREATIC CANCER
<b>A61K 9/127</b> (2006.01)	3266456	COMBINATIONS OF LIPOSOMAL IRINOTECAN, 5-FU AND LEUCOVORIN FOR THE TREATMENT OF PANCREATIC CANCER
<b>A61K 31/4745</b> (2006.01)	3266456	COMBINATIONS OF LIPOSOMAL IRINOTECAN, 5-FU AND LEUCOVORIN FOR THE TREATMENT OF PANCREATIC CANCER

MKP (51)	Broj objave evropske prijava patenta (97)	Naziv pronalaska (54)
<b>A61K 31/513</b> (2006.01)	3266456	COMBINATIONS OF LIPOSOMAL IRINOTECAN, 5-FU AND LEUCOVORIN FOR THE TREATMENT OF PANCREATIC CANCER
<b>A61K 31/519</b> (2006.01)	3266456	COMBINATIONS OF LIPOSOMAL IRINOTECAN, 5-FU AND LEUCOVORIN FOR THE TREATMENT OF PANCREATIC CANCER
<b>A61K 45/06</b> (2006.01)	3266456	COMBINATIONS OF LIPOSOMAL IRINOTECAN, 5-FU AND LEUCOVORIN FOR THE TREATMENT OF PANCREATIC CANCER
<b>A61P 35/00</b> (2006.01)	3266456	COMBINATIONS OF LIPOSOMAL IRINOTECAN, 5-FU AND LEUCOVORIN FOR THE TREATMENT OF PANCREATIC CANCER
<b>A61K 31/437</b> (2006.01)	3284744	INDAZOLE INHIBITORS OF THE WNT SIGNAL PATHWAY AND THERAPEUTIC USES THEREOF
<b>A61K 31/444</b> (2006.01)	3284744	INDAZOLE INHIBITORS OF THE WNT SIGNAL PATHWAY AND THERAPEUTIC USES THEREOF
<b>A61K 31/4545</b> (2006.01)	3284744	INDAZOLE INHIBITORS OF THE WNT SIGNAL PATHWAY AND THERAPEUTIC USES THEREOF
<b>A61K 31/496</b> (2006.01)	3284744	INDAZOLE INHIBITORS OF THE WNT SIGNAL PATHWAY AND THERAPEUTIC USES THEREOF
<b>A61K 31/5377</b> (2006.01)	3284744	INDAZOLE INHIBITORS OF THE WNT SIGNAL PATHWAY AND THERAPEUTIC USES THEREOF
<b>A61P 19/00</b> (2006.01)	3284744	INDAZOLE INHIBITORS OF THE WNT SIGNAL PATHWAY AND THERAPEUTIC USES THEREOF
<b>A61P 25/28</b> (2006.01)	3284744	INDAZOLE INHIBITORS OF THE WNT SIGNAL PATHWAY AND THERAPEUTIC USES THEREOF
<b>A61P 31/10</b> (2006.01)	3284744	INDAZOLE INHIBITORS OF THE WNT SIGNAL PATHWAY AND THERAPEUTIC USES THEREOF
<b>A61P 31/12</b> (2006.01)	3284744	INDAZOLE INHIBITORS OF THE WNT SIGNAL PATHWAY AND THERAPEUTIC USES THEREOF
<b>A61P 35/00</b> (2006.01)	3284744	INDAZOLE INHIBITORS OF THE WNT SIGNAL PATHWAY AND THERAPEUTIC USES THEREOF
<b>C07D 471/04</b> (2006.01)	3284744	INDAZOLE INHIBITORS OF THE WNT SIGNAL PATHWAY AND THERAPEUTIC USES THEREOF
<b>B65D 30/18</b> (2006.01)	3257776	BAG AND METHOD FOR MANUFACTURING THE SAME
<b>B65D 30/20</b> (2006.01)	3257776	BAG AND METHOD FOR MANUFACTURING THE SAME
<b>B65D 33/06</b> (2006.01)	3257776	BAG AND METHOD FOR MANUFACTURING THE SAME
<b>B65D 33/10</b> (2006.01)	3257776	BAG AND METHOD FOR MANUFACTURING THE SAME
<b>A23K 20/24</b> (2016.01)	3400810	SURFACE-REACTED CALCIUM CARBONATE IN FOOD
<b>A23L 29/00</b> (2016.01)	3400810	SURFACE-REACTED CALCIUM CARBONATE IN FOOD
<b>A23P 10/43</b> (2016.01)	3400810	SURFACE-REACTED CALCIUM CARBONATE IN FOOD
<b>A61K 33/10</b> (2006.01)	3400810	SURFACE-REACTED CALCIUM CARBONATE IN FOOD
<b>C09C 1/02</b> (2006.01)	3400810	SURFACE-REACTED CALCIUM CARBONATE IN FOOD
<b>A61K 39/395</b> (2006.01)	3254695	COMBINATION THERAPY INVOLVING ANTIBODIES AGAINST CLAUDIN 18.2 FOR TREATMENT OF CANCER
<b>A61K 45/06</b> (2006.01)	3254695	COMBINATION THERAPY INVOLVING ANTIBODIES AGAINST CLAUDIN 18.2 FOR TREATMENT OF CANCER
<b>C07K 16/30</b> (2006.01)	3254695	COMBINATION THERAPY INVOLVING ANTIBODIES AGAINST CLAUDIN 18.2 FOR TREATMENT OF CANCER
<b>A01N 59/00</b> (2006.01)	3403505	BIOCIDE FREE PRESERVATION
<b>A01N 59/16</b> (2006.01)	3403505	BIOCIDE FREE PRESERVATION
<b>A01P 3/00</b> (2006.01)	3403505	BIOCIDE FREE PRESERVATION
<b>A61K 48/00</b> (2006.01)	3251700	A CONDITIONAL REPLICATING CYTOMEGALOVIRUS AS A VACCINE FOR CMV
<b>C07H 21/04</b> (2006.01)	3251700	A CONDITIONAL REPLICATING CYTOMEGALOVIRUS AS A VACCINE FOR CMV
<b>A61K 31/664</b> (2006.01)	3290428	TABLET COMPRISING CRYSTALLINE (S)-ISOPROPYL 2-(((S)-(((2R,3R,4R,5R)-5-(2,4-DIOXO-3,4-DIHYDROPYRIMIDIN-1 (2H)-YL)-4-FLUORO-3-HYDROXY-4-METHYLTETRAHYDROFURAN-2-YL)METHOXY)(PHENOXY)PHOSPHORYL)AMINO)PROPANOATE
<b>A61K 31/7072</b> (2006.01)	3290428	TABLET COMPRISING CRYSTALLINE (S)-ISOPROPYL 2-(((S)-(((2R,3R,4R,5R)-5-(2,4-DIOXO-3,4-DIHYDROPYRIMIDIN-1 (2H)-YL)-4-FLUORO-3-HYDROXY-4-METHYLTETRAHYDROFURAN-2-YL)METHOXY)(PHENOXY)PHOSPHORYL)AMINO)PROPANOATE
<b>A61K 31/716</b> (2006.01)	3290428	TABLET COMPRISING CRYSTALLINE (S)-ISOPROPYL 2-(((S)-(((2R,3R,4R,5R)-5-(2,4-DIOXO-3,4-DIHYDROPYRIMIDIN-1 (2H)-YL)-4-FLUORO-3-HYDROXY-4-METHYLTETRAHYDROFURAN-2-YL)METHOXY)(PHENOXY)PHOSPHORYL)AMINO)PROPANOATE
<b>A61P 31/14</b> (2006.01)	3290428	TABLET COMPRISING CRYSTALLINE (S)-ISOPROPYL 2-(((S)-(((2R,3R,4R,5R)-5-(2,4-DIOXO-3,4-DIHYDROPYRIMIDIN-1 (2H)-YL)-4-FLUORO-3-HYDROXY-4-METHYLTETRAHYDROFURAN-2-YL)METHOXY)(PHENOXY)PHOSPHORYL)AMINO)PROPANOATE

MKP (51)	Broj objave evropske prijava patenta (97)	Naziv pronalaska (54)
<b>C07F 9/22</b> (2006.01)	3290428	TABLET COMPRISING CRYSTALLINE (S)-ISOPROPYL 2-(((S)-(((2R,3R,4R,5R)-5-(2,4-DIOXO-3,4-DIHYDROPYRIMIDIN-1 (2H)-YL)-4-FLUORO-3-HYDROXY-4-METHYLTETRAHYDROFURAN-2-YL)METHOXY)(PHENOXY)PHOSPHORYLAMINO)PROPANOATE
<b>C07F 9/24</b> (2006.01)	3290428	TABLET COMPRISING CRYSTALLINE (S)-ISOPROPYL 2-(((S)-(((2R,3R,4R,5R)-5-(2,4-DIOXO-3,4-DIHYDROPYRIMIDIN-1 (2H)-YL)-4-FLUORO-3-HYDROXY-4-METHYLTETRAHYDROFURAN-2-YL)METHOXY)(PHENOXY)PHOSPHORYLAMINO)PROPANOATE
<b>C07F 9/6558</b> (2006.01)	3290428	TABLET COMPRISING CRYSTALLINE (S)-ISOPROPYL 2-(((S)-(((2R,3R,4R,5R)-5-(2,4-DIOXO-3,4-DIHYDROPYRIMIDIN-1 (2H)-YL)-4-FLUORO-3-HYDROXY-4-METHYLTETRAHYDROFURAN-2-YL)METHOXY)(PHENOXY)PHOSPHORYLAMINO)PROPANOATE
<b>C07H 19/073</b> (2006.01)	3290428	TABLET COMPRISING CRYSTALLINE (S)-ISOPROPYL 2-(((S)-(((2R,3R,4R,5R)-5-(2,4-DIOXO-3,4-DIHYDROPYRIMIDIN-1 (2H)-YL)-4-FLUORO-3-HYDROXY-4-METHYLTETRAHYDROFURAN-2-YL)METHOXY)(PHENOXY)PHOSPHORYLAMINO)PROPANOATE
<b>C07H 19/10</b> (2006.01)	3290428	TABLET COMPRISING CRYSTALLINE (S)-ISOPROPYL 2-(((S)-(((2R,3R,4R,5R)-5-(2,4-DIOXO-3,4-DIHYDROPYRIMIDIN-1 (2H)-YL)-4-FLUORO-3-HYDROXY-4-METHYLTETRAHYDROFURAN-2-YL)METHOXY)(PHENOXY)PHOSPHORYLAMINO)PROPANOATE
<b>B41M 3/00</b> (2006.01)	3406455	METHOD FOR PRODUCING WATER-INSOLUBLE QUANTUM DOT PATTERNS
<b>B41M 3/14</b> (2006.01)	3406455	METHOD FOR PRODUCING WATER-INSOLUBLE QUANTUM DOT PATTERNS
<b>C09D 11/54</b> (2014.01)	3406455	METHOD FOR PRODUCING WATER-INSOLUBLE QUANTUM DOT PATTERNS
<b>C07K 16/00</b> (2006.01)	3275896	PROCESS FOR OBTAINING ANTIBODIES
<b>A61K 9/08</b> (2006.01)	3400950	BLADDER INSTILLATION COMPOSITION CONTAINING CHONDOITIN SULFATE (20 MG/ML), HYALURONIC ACID (16 MG/ML) AND PHOSPHATE BUFFER (PH 6,1 TO 7,9) WITH AN IMPROVED STORAGE STABILITY FOR THE TREATMENT OF CYSTITIS
<b>A61K 31/728</b> (2006.01)	3400950	BLADDER INSTILLATION COMPOSITION CONTAINING CHONDOITIN SULFATE (20 MG/ML), HYALURONIC ACID (16 MG/ML) AND PHOSPHATE BUFFER (PH 6,1 TO 7,9) WITH AN IMPROVED STORAGE STABILITY FOR THE TREATMENT OF CYSTITIS
<b>A61K 31/737</b> (2006.01)	3400950	BLADDER INSTILLATION COMPOSITION CONTAINING CHONDOITIN SULFATE (20 MG/ML), HYALURONIC ACID (16 MG/ML) AND PHOSPHATE BUFFER (PH 6,1 TO 7,9) WITH AN IMPROVED STORAGE STABILITY FOR THE TREATMENT OF CYSTITIS
<b>A61P 13/10</b> (2006.01)	3400950	BLADDER INSTILLATION COMPOSITION CONTAINING CHONDOITIN SULFATE (20 MG/ML), HYALURONIC ACID (16 MG/ML) AND PHOSPHATE BUFFER (PH 6,1 TO 7,9) WITH AN IMPROVED STORAGE STABILITY FOR THE TREATMENT OF CYSTITIS
<b>A61P 29/00</b> (2006.01)	3400950	BLADDER INSTILLATION COMPOSITION CONTAINING CHONDOITIN SULFATE (20 MG/ML), HYALURONIC ACID (16 MG/ML) AND PHOSPHATE BUFFER (PH 6,1 TO 7,9) WITH AN IMPROVED STORAGE STABILITY FOR THE TREATMENT OF CYSTITIS
<b>A61K 9/08</b> (2006.01)	3400951	BLADDER INSTILLATION COMPOSITION CONTAINING CHONDOITIN SULFATE (4,5 MG/ML), HYALURONIC ACID (16 MG/ML) AND PHOSPHATE BUFFER (PH 6,1 TO 7,9) WITH AN IMPROVED STORAGE STABILITY FOR THE TREATMENT OF CYSTITIS
<b>A61K 31/728</b> (2006.01)	3400951	BLADDER INSTILLATION COMPOSITION CONTAINING CHONDOITIN SULFATE (4,5 MG/ML), HYALURONIC ACID (16 MG/ML) AND PHOSPHATE BUFFER (PH 6,1 TO 7,9) WITH AN IMPROVED STORAGE STABILITY FOR THE TREATMENT OF CYSTITIS
<b>A61K 31/737</b> (2006.01)	3400951	BLADDER INSTILLATION COMPOSITION CONTAINING CHONDOITIN SULFATE (4,5 MG/ML), HYALURONIC ACID (16 MG/ML) AND PHOSPHATE BUFFER (PH 6,1 TO 7,9) WITH AN IMPROVED STORAGE STABILITY FOR THE TREATMENT OF CYSTITIS
<b>A61P 13/10</b> (2006.01)	3400951	BLADDER INSTILLATION COMPOSITION CONTAINING CHONDOITIN SULFATE (4,5 MG/ML), HYALURONIC ACID (16 MG/ML) AND PHOSPHATE BUFFER (PH 6,1 TO 7,9) WITH AN IMPROVED STORAGE STABILITY FOR THE TREATMENT OF CYSTITIS
<b>A61P 29/00</b> (2006.01)	3400951	BLADDER INSTILLATION COMPOSITION CONTAINING CHONDOITIN SULFATE (4,5 MG/ML), HYALURONIC ACID (16 MG/ML) AND PHOSPHATE BUFFER (PH 6,1 TO 7,9) WITH AN IMPROVED STORAGE STABILITY FOR THE TREATMENT OF CYSTITIS

MKP (51)	Broj objave evropske prijava patenta (97)	Naziv pronalaska (54)
<b>A61K 31/728</b> (2006.01)	3400949	COMPOSITION FOR TOPICAL USE, IN PARTICULAR FOR BLADDER INSTILLATION
<b>A61K 31/737</b> (2006.01)	3400949	COMPOSITION FOR TOPICAL USE, IN PARTICULAR FOR BLADDER INSTILLATION
<b>A61P 13/10</b> (2006.01)	3400949	COMPOSITION FOR TOPICAL USE, IN PARTICULAR FOR BLADDER INSTILLATION
<b>A61B 5/00</b> (2006.01)	3254612	SPINE CONSTRUCTION FOR BASKET CATHETER
<b>A61B 17/00</b> (2006.01)	3254612	SPINE CONSTRUCTION FOR BASKET CATHETER
<b>A61B 18/00</b> (2006.01)	3254612	SPINE CONSTRUCTION FOR BASKET CATHETER
<b>C07K 16/00</b> (2006.01)	3263597	GENERATION OF BINDING MOLECULES
<b>C07K 16/10</b> (2006.01)	3263597	GENERATION OF BINDING MOLECULES
<b>C07K 16/28</b> (2006.01)	3263597	GENERATION OF BINDING MOLECULES
<b>C07K 16/30</b> (2006.01)	3263597	GENERATION OF BINDING MOLECULES
<b>C07K 16/46</b> (2006.01)	3263597	GENERATION OF BINDING MOLECULES
<b>A61B 5/00</b> (2006.01)	3254614	MULTI-FUNCTION CONDUCTING ELEMENTS FOR A CATHETER
<b>A61B 5/042</b> (2006.01)	3254614	MULTI-FUNCTION CONDUCTING ELEMENTS FOR A CATHETER
<b>A61B 5/06</b> (2006.01)	3254614	MULTI-FUNCTION CONDUCTING ELEMENTS FOR A CATHETER
<b>A61B 5/00</b> (2006.01)	3254618	IDENTIFICATION AND VISUALIZATION OF CARDIAC ACTIVATION SEQUENCE IN MULTI-CHANNEL RECORDINGS
<b>A61B 5/04</b> (2006.01)	3254618	IDENTIFICATION AND VISUALIZATION OF CARDIAC ACTIVATION SEQUENCE IN MULTI-CHANNEL RECORDINGS
<b>A61B 5/042</b> (2006.01)	3254618	IDENTIFICATION AND VISUALIZATION OF CARDIAC ACTIVATION SEQUENCE IN MULTI-CHANNEL RECORDINGS
<b>A61B 5/044</b> (2006.01)	3254618	IDENTIFICATION AND VISUALIZATION OF CARDIAC ACTIVATION SEQUENCE IN MULTI-CHANNEL RECORDINGS
<b>A61B 5/0452</b> (2006.01)	3254618	IDENTIFICATION AND VISUALIZATION OF CARDIAC ACTIVATION SEQUENCE IN MULTI-CHANNEL RECORDINGS
<b>A61B 5/046</b> (2006.01)	3254618	IDENTIFICATION AND VISUALIZATION OF CARDIAC ACTIVATION SEQUENCE IN MULTI-CHANNEL RECORDINGS
<b>A61K 31/422</b> (2006.01)	3257847	FXR (NR1H4) MODULATING COMPOUNDS
<b>A61K 31/4439</b> (2006.01)	3257847	FXR (NR1H4) MODULATING COMPOUNDS
<b>A61P 1/16</b> (2006.01)	3257847	FXR (NR1H4) MODULATING COMPOUNDS
<b>A61P 3/04</b> (2006.01)	3257847	FXR (NR1H4) MODULATING COMPOUNDS
<b>A61P 3/10</b> (2006.01)	3257847	FXR (NR1H4) MODULATING COMPOUNDS
<b>A61P 29/00</b> (2006.01)	3257847	FXR (NR1H4) MODULATING COMPOUNDS
<b>A61P 35/00</b> (2006.01)	3257847	FXR (NR1H4) MODULATING COMPOUNDS
<b>C07D 401/14</b> (2006.01)	3257847	FXR (NR1H4) MODULATING COMPOUNDS
<b>C07D 413/12</b> (2006.01)	3257847	FXR (NR1H4) MODULATING COMPOUNDS
<b>C07D 413/14</b> (2006.01)	3257847	FXR (NR1H4) MODULATING COMPOUNDS
<b>F23D 14/22</b> (2006.01)	3293456	BURNER
<b>F23L 7/00</b> (2006.01)	3293456	BURNER
<b>F23Q 1/02</b> (2006.01)	3293456	BURNER
<b>B66F 3/06</b> (2006.01)	3260735	THRUST CHAIN
<b>F16G 13/20</b> (2006.01)	3260735	THRUST CHAIN
<b>F16H 19/06</b> (2006.01)	3260735	THRUST CHAIN
<b>B66F 3/06</b> (2006.01)	3258132	DEVICE FOR DEFLECTING PUSH CHAINS AND PUSH CHAIN
<b>F16G 13/20</b> (2006.01)	3258132	DEVICE FOR DEFLECTING PUSH CHAINS AND PUSH CHAIN
<b>F16H 19/06</b> (2006.01)	3258132	DEVICE FOR DEFLECTING PUSH CHAINS AND PUSH CHAIN
<b>C08K 9/00</b> (2006.01)	3415570	PROCESS FOR PREPARING A SURFACE TREATED FILLER MATERIAL PRODUCT WITH MONO-SUBSTITUTED SUCCINIC ANHYDRIDE(S) AND A MIXTURE OF ALIPHATIC LINEAR OR BRANCHED CARBOXYLIC ACIDS COMPRISING STEARIC ACID
<b>C09C 1/02</b> (2006.01)	3415570	PROCESS FOR PREPARING A SURFACE TREATED FILLER MATERIAL PRODUCT WITH MONO-SUBSTITUTED SUCCINIC ANHYDRIDE(S) AND A MIXTURE OF ALIPHATIC LINEAR OR BRANCHED CARBOXYLIC ACIDS COMPRISING STEARIC ACID
<b>A61K 31/567</b> (2006.01)	3252069	(11.BETA.,17.BETA.)-17-HYDROXY-11-[4-(METHYLSULFONYL)PHENYL]-17-(PENTALFUOROMETHYL)ESTRA-4,9-DIEN-3-ONE FOR USE IN THE TREATMENT OF DISEASES
<b>A61K 31/573</b> (2006.01)	3252069	(11.BETA.,17.BETA.)-17-HYDROXY-11-[4-(METHYLSULFONYL)PHENYL]-17-(PENTALFUOROMETHYL)ESTRA-4,9-DIEN-3-ONE FOR USE IN THE TREATMENT OF DISEASES
<b>A61P 5/36</b> (2006.01)	3252069	(11.BETA.,17.BETA.)-17-HYDROXY-11-[4-(METHYLSULFONYL)PHENYL]-17-(PENTALFUOROMETHYL)ESTRA-4,9-DIEN-3-ONE FOR USE IN THE TREATMENT OF DISEASES
<b>C07J 31/00</b> (2006.01)	3252069	(11.BETA.,17.BETA.)-17-HYDROXY-11-[4-(METHYLSULFONYL)PHENYL]-17-(PENTALFUOROMETHYL)ESTRA-4,9-DIEN-3-ONE FOR USE IN THE TREATMENT OF DISEASES

MKP (51)	Broj objave evropske prijava patenta (97)	Naziv pronalaska (54)
<b>C07J 41/00</b> (2006.01)	3252069	(11.BETA.,17.BETA.)-17-HYDROXY-11-[4-(METHYLSULFONYL)PHENYL]-17-(PENTALFUOROMETHYL)ESTRA-4,9-DIEN-3-ONE FOR USE IN THE TREATMENT OF DISEASES
<b>A61K 31/497</b> (2006.01)	3309151	HETEROCYCLIC COMPOUNDS FOR THE TREATMENT OF NEUROLOGICAL AND PSYCHOLOGICAL DISORDERS
<b>C07D 215/227</b> (2006.01)	3309151	HETEROCYCLIC COMPOUNDS FOR THE TREATMENT OF NEUROLOGICAL AND PSYCHOLOGICAL DISORDERS
<b>C07D 263/58</b> (2006.01)	3309151	HETEROCYCLIC COMPOUNDS FOR THE TREATMENT OF NEUROLOGICAL AND PSYCHOLOGICAL DISORDERS
<b>C07D 401/12</b> (2006.01)	3309151	HETEROCYCLIC COMPOUNDS FOR THE TREATMENT OF NEUROLOGICAL AND PSYCHOLOGICAL DISORDERS
<b>C07D 417/12</b> (2006.01)	3309151	HETEROCYCLIC COMPOUNDS FOR THE TREATMENT OF NEUROLOGICAL AND PSYCHOLOGICAL DISORDERS
<b>C07D 471/04</b> (2006.01)	3309151	HETEROCYCLIC COMPOUNDS FOR THE TREATMENT OF NEUROLOGICAL AND PSYCHOLOGICAL DISORDERS
<b>C07F 9/6558</b> (2006.01)	3309151	HETEROCYCLIC COMPOUNDS FOR THE TREATMENT OF NEUROLOGICAL AND PSYCHOLOGICAL DISORDERS
<b>A61K 31/69</b> (2006.01)	3251678	BENZOXABOROLE DERIVATIVES FOR TREATING BACTERIAL INFECTIONS
<b>A61P 31/04</b> (2006.01)	3251678	BENZOXABOROLE DERIVATIVES FOR TREATING BACTERIAL INFECTIONS
<b>C07F 5/02</b> (2006.01)	3251678	BENZOXABOROLE DERIVATIVES FOR TREATING BACTERIAL INFECTIONS
<b>E04D 3/363</b> (2006.01)	3266952	PANEL FOR CLADDING SURFACES
<b>C07K 16/36</b> (2006.01)	3275903	THROMBIN-BINDING ANTIBODY MOLECULES AND USES THEREOF
<b>H01T 1/22</b> (2006.01)	3270474	SPARK GAP ARRESTER
<b>H01T 4/12</b> (2006.01)	3270474	SPARK GAP ARRESTER
<b>F01K 1/04</b> (2006.01)	3260803	STEAM STORAGE
<b>F28D 20/00</b> (2006.01)	3260803	STEAM STORAGE
<b>F28D 20/02</b> (2006.01)	3260803	STEAM STORAGE
<b>B41M 3/00</b> (2006.01)	3418064	TAMPER-PROOF MEDIUM FOR THERMAL PRINTING
<b>B41M 3/14</b> (2006.01)	3418064	TAMPER-PROOF MEDIUM FOR THERMAL PRINTING
<b>B41M 5/323</b> (2006.01)	3418064	TAMPER-PROOF MEDIUM FOR THERMAL PRINTING
<b>G06F 3/048</b> (2013.01)	3258446	METHOD AND SYSTEM FOR PROVIDING INFORMATION FROM A PATIENT-SPECIFIC MODEL OF BLOOD FLOW
<b>G06T 19/20</b> (2011.01)	3258446	METHOD AND SYSTEM FOR PROVIDING INFORMATION FROM A PATIENT-SPECIFIC MODEL OF BLOOD FLOW
<b>C10B 53/02</b> (2006.01)	3260521	GASIFIER WITH IMPROVED AIR INLET ASSEMBLY
<b>C10J 3/26</b> (2006.01)	3260521	GASIFIER WITH IMPROVED AIR INLET ASSEMBLY
<b>B01D 21/00</b> (2006.01)	3263221	DIRT MAGNETIC SEPARATOR FOR THERMAL PLANTS
<b>B03C 1/28</b> (2006.01)	3263221	DIRT MAGNETIC SEPARATOR FOR THERMAL PLANTS
<b>F24D 19/00</b> (2006.01)	3263221	DIRT MAGNETIC SEPARATOR FOR THERMAL PLANTS
<b>B65H 51/10</b> (2006.01)	3165487	CONDUIT TRANSPORTATION DEVICE, IN PARTICULAR FOR CABLES TO BE PROCESSED IN CABLE PROCESSING MACHINES
<b>B65H 51/32</b> (2006.01)	3165487	CONDUIT TRANSPORTATION DEVICE, IN PARTICULAR FOR CABLES TO BE PROCESSED IN CABLE PROCESSING MACHINES
<b>H01R 43/052</b> (2006.01)	3165487	CONDUIT TRANSPORTATION DEVICE, IN PARTICULAR FOR CABLES TO BE PROCESSED IN CABLE PROCESSING MACHINES
<b>B21D 7/024</b> (2006.01)	3377240	MACHINE FOR BENDING PIPES OR SECTIONS IN PARTICULAR OF METAL, TO OBTAIN ANY SHAPE
<b>B21D 7/12</b> (2006.01)	3377240	MACHINE FOR BENDING PIPES OR SECTIONS IN PARTICULAR OF METAL, TO OBTAIN ANY SHAPE
<b>F42B 5/02</b> (2006.01)	3390958	IMPROVED FRAGMENTATION PROJECTILE AND METHOD FOR ITS MANUFACTURING
<b>F42B 5/03</b> (2006.01)	3390958	IMPROVED FRAGMENTATION PROJECTILE AND METHOD FOR ITS MANUFACTURING
<b>F42B 8/14</b> (2006.01)	3390958	IMPROVED FRAGMENTATION PROJECTILE AND METHOD FOR ITS MANUFACTURING
<b>F42B 12/06</b> (2006.01)	3390958	IMPROVED FRAGMENTATION PROJECTILE AND METHOD FOR ITS MANUFACTURING
<b>F42B 12/36</b> (2006.01)	3390958	IMPROVED FRAGMENTATION PROJECTILE AND METHOD FOR ITS MANUFACTURING
<b>A61K 31/4709</b> (2006.01)	3390384	QUINOLINE-3-CARBOXAMIDES AS H-PGDS INHIBITORS
<b>A61P 21/00</b> (2006.01)	3390384	QUINOLINE-3-CARBOXAMIDES AS H-PGDS INHIBITORS
<b>C07D 215/20</b> (2006.01)	3390384	QUINOLINE-3-CARBOXAMIDES AS H-PGDS INHIBITORS
<b>C07D 215/54</b> (2006.01)	3390384	QUINOLINE-3-CARBOXAMIDES AS H-PGDS INHIBITORS
<b>C07D 401/04</b> (2006.01)	3390384	QUINOLINE-3-CARBOXAMIDES AS H-PGDS INHIBITORS
<b>C07D 401/12</b> (2006.01)	3390384	QUINOLINE-3-CARBOXAMIDES AS H-PGDS INHIBITORS

MKP (51)	Broj objave evropske prijava patenta (97)	Naziv pronalaska (54)
<b>C07D 401/14</b> (2006.01)	3390384	QUINOLINE-3-CARBOXAMIDES AS H-PGDS INHIBITORS
<b>C07D 405/12</b> (2006.01)	3390384	QUINOLINE-3-CARBOXAMIDES AS H-PGDS INHIBITORS
<b>C07D 413/12</b> (2006.01)	3390384	QUINOLINE-3-CARBOXAMIDES AS H-PGDS INHIBITORS
<b>C07D 413/14</b> (2006.01)	3390384	QUINOLINE-3-CARBOXAMIDES AS H-PGDS INHIBITORS
<b>C07D 417/12</b> (2006.01)	3390384	QUINOLINE-3-CARBOXAMIDES AS H-PGDS INHIBITORS
<b>C07D 491/048</b> (2006.01)	3390384	QUINOLINE-3-CARBOXAMIDES AS H-PGDS INHIBITORS
<b>C07D 217/04</b> (2006.01)	3377482	MODULATORS OF ROR-GAMMA
<b>C07D 217/16</b> (2006.01)	3377482	MODULATORS OF ROR-GAMMA
<b>C07D 217/24</b> (2006.01)	3377482	MODULATORS OF ROR-GAMMA
<b>C07D 231/56</b> (2006.01)	3377482	MODULATORS OF ROR-GAMMA
<b>C07D 239/88</b> (2006.01)	3377482	MODULATORS OF ROR-GAMMA
<b>C07D 401/04</b> (2006.01)	3377482	MODULATORS OF ROR-GAMMA
<b>C07D 401/06</b> (2006.01)	3377482	MODULATORS OF ROR-GAMMA
<b>C07D 401/12</b> (2006.01)	3377482	MODULATORS OF ROR-GAMMA
<b>C07D 401/14</b> (2006.01)	3377482	MODULATORS OF ROR-GAMMA
<b>C07D 405/12</b> (2006.01)	3377482	MODULATORS OF ROR-GAMMA
<b>C07D 471/04</b> (2006.01)	3377482	MODULATORS OF ROR-GAMMA
<b>C07D 495/04</b> (2006.01)	3377482	MODULATORS OF ROR-GAMMA
<b>A61K 31/335</b> (2006.01)	3386956	FUMAGILLOL DERIVATIVES AND POLYMORPHS THEREOF
<b>A61P 35/00</b> (2006.01)	3386956	FUMAGILLOL DERIVATIVES AND POLYMORPHS THEREOF
<b>A61P 37/00</b> (2006.01)	3386956	FUMAGILLOL DERIVATIVES AND POLYMORPHS THEREOF
<b>C07D 303/46</b> (2006.01)	3386956	FUMAGILLOL DERIVATIVES AND POLYMORPHS THEREOF
<b>H04L 29/06</b> (2006.01)	3398346	VIDEO STREAMS
<b>H04N 21/218</b> (2011.01)	3398346	VIDEO STREAMS
<b>H04N 21/2343</b> (2011.01)	3398346	VIDEO STREAMS
<b>H04N 21/262</b> (2011.01)	3398346	VIDEO STREAMS
<b>H04N 21/845</b> (2011.01)	3398346	VIDEO STREAMS
<b>H04N 21/854</b> (2011.01)	3398346	VIDEO STREAMS
<b>C04B 11/00</b> (2006.01)	3393997	METHOD FOR THE PRODUCTION OF GYPSUM-BASED BOARDS AND STUCCO SLURRY COMPRISING NON-PREGELATINIZED MIGRATORY STARCH FOR USE THEREWITH
<b>C04B 28/14</b> (2006.01)	3393997	METHOD FOR THE PRODUCTION OF GYPSUM-BASED BOARDS AND STUCCO SLURRY COMPRISING NON-PREGELATINIZED MIGRATORY STARCH FOR USE THEREWITH
<b>A61K 31/415</b> (2006.01)	3390395	COMPOUNDS USEFUL AS KINASE INHIBITORS
<b>A61K 31/4155</b> (2006.01)	3390395	COMPOUNDS USEFUL AS KINASE INHIBITORS
<b>A61P 35/00</b> (2006.01)	3390395	COMPOUNDS USEFUL AS KINASE INHIBITORS
<b>C07D 231/14</b> (2006.01)	3390395	COMPOUNDS USEFUL AS KINASE INHIBITORS
<b>C07D 401/04</b> (2006.01)	3390395	COMPOUNDS USEFUL AS KINASE INHIBITORS
<b>C07D 401/06</b> (2006.01)	3390395	COMPOUNDS USEFUL AS KINASE INHIBITORS
<b>C07D 403/04</b> (2006.01)	3390395	COMPOUNDS USEFUL AS KINASE INHIBITORS
<b>C07D 405/04</b> (2006.01)	3390395	COMPOUNDS USEFUL AS KINASE INHIBITORS
<b>C07D 405/06</b> (2006.01)	3390395	COMPOUNDS USEFUL AS KINASE INHIBITORS
<b>C07D 405/08</b> (2006.01)	3390395	COMPOUNDS USEFUL AS KINASE INHIBITORS
<b>C07D 405/14</b> (2006.01)	3390395	COMPOUNDS USEFUL AS KINASE INHIBITORS
<b>C07D 413/06</b> (2006.01)	3390395	COMPOUNDS USEFUL AS KINASE INHIBITORS
<b>A61K 31/4025</b> (2006.01)	3390391	NOVEL COMPOUNDS
<b>A61K 31/407</b> (2006.01)	3390391	NOVEL COMPOUNDS
<b>A61P 25/28</b> (2006.01)	3390391	NOVEL COMPOUNDS
<b>A61P 35/00</b> (2006.01)	3390391	NOVEL COMPOUNDS
<b>C07D 207/09</b> (2006.01)	3390391	NOVEL COMPOUNDS
<b>C07D 401/12</b> (2006.01)	3390391	NOVEL COMPOUNDS
<b>C07D 403/12</b> (2006.01)	3390391	NOVEL COMPOUNDS
<b>C07D 403/14</b> (2006.01)	3390391	NOVEL COMPOUNDS
<b>C07D 413/12</b> (2006.01)	3390391	NOVEL COMPOUNDS
<b>C07D 417/12</b> (2006.01)	3390391	NOVEL COMPOUNDS
<b>C07D 417/14</b> (2006.01)	3390391	NOVEL COMPOUNDS
<b>C07D 471/04</b> (2006.01)	3390391	NOVEL COMPOUNDS
<b>C07D 487/04</b> (2006.01)	3390391	NOVEL COMPOUNDS
<b>A61K 9/16</b> (2006.01)	3383372	SOLID DISPERSIONS COMPRISING A SGC STIMULATOR
<b>A61K 9/20</b> (2006.01)	3383372	SOLID DISPERSIONS COMPRISING A SGC STIMULATOR
<b>A61K 31/506</b> (2006.01)	3383372	SOLID DISPERSIONS COMPRISING A SGC STIMULATOR
<b>A61P 9/00</b> (2006.01)	3383372	SOLID DISPERSIONS COMPRISING A SGC STIMULATOR
<b>A61K 31/4745</b> (2006.01)	3389660	COMBINATION THERAPY FOR CANCER
<b>A61K 31/497</b> (2006.01)	3389660	COMBINATION THERAPY FOR CANCER
<b>A61P 35/00</b> (2006.01)	3389660	COMBINATION THERAPY FOR CANCER

MKP (51)	Broj objave evropske prijava patenta (97)	Naziv pronalaska (54)
<b>A61K 31/519</b> (2006.01)	3405471	NEW AMMONIUM DERIVATIVES, A PROCESS FOR THEIR PREPARATION AND PHARMACEUTICAL COMPOSITIONS CONTAINING THEM
<b>A61K 31/661</b> (2006.01)	3405471	NEW AMMONIUM DERIVATIVES, A PROCESS FOR THEIR PREPARATION AND PHARMACEUTICAL COMPOSITIONS CONTAINING THEM
<b>A61P 35/00</b> (2006.01)	3405471	NEW AMMONIUM DERIVATIVES, A PROCESS FOR THEIR PREPARATION AND PHARMACEUTICAL COMPOSITIONS CONTAINING THEM
<b>C07D 495/04</b> (2006.01)	3405471	NEW AMMONIUM DERIVATIVES, A PROCESS FOR THEIR PREPARATION AND PHARMACEUTICAL COMPOSITIONS CONTAINING THEM
<b>C07F 9/6561</b> (2006.01)	3405471	NEW AMMONIUM DERIVATIVES, A PROCESS FOR THEIR PREPARATION AND PHARMACEUTICAL COMPOSITIONS CONTAINING THEM
<b>A61K 38/17</b> (2006.01)	3377087	COMPOSITIONS AND METHODS OF TREATING CANCER
<b>A61P 35/00</b> (2006.01)	3377087	COMPOSITIONS AND METHODS OF TREATING CANCER
<b>A61K 31/454</b> (2006.01)	3383433	METHODS OF TREATMENT OF MALIGNANCIES
<b>A61K 45/06</b> (2006.01)	3383433	METHODS OF TREATMENT OF MALIGNANCIES
<b>A61P 35/00</b> (2006.01)	3383433	METHODS OF TREATMENT OF MALIGNANCIES
<b>A61P 35/02</b> (2006.01)	3383433	METHODS OF TREATMENT OF MALIGNANCIES
<b>C12N 15/867</b> (2006.01)	3394271	STABLE INTEGRATION OF SIN TRANSFER VECTORS
<b>A61K 47/68</b> (2017.01)	3383909	ANTI-huLRRC15 ANTIBODY DRUG CONJUGATES AND METHODS FOR THEIR USE
<b>A61P 35/00</b> (2006.01)	3383909	ANTI-huLRRC15 ANTIBODY DRUG CONJUGATES AND METHODS FOR THEIR USE
<b>C07K 16/28</b> (2006.01)	3383909	ANTI-huLRRC15 ANTIBODY DRUG CONJUGATES AND METHODS FOR THEIR USE
<b>C07K 16/30</b> (2006.01)	3383909	ANTI-huLRRC15 ANTIBODY DRUG CONJUGATES AND METHODS FOR THEIR USE
<b>A61K 31/519</b> (2006.01)	3390405	NOVEL TETRAHYDROTRIAZOLOPYRIMIDINE DERIVATIVES AS NHE INHIBITORS
<b>A61P 11/00</b> (2006.01)	3390405	NOVEL TETRAHYDROTRIAZOLOPYRIMIDINE DERIVATIVES AS NHE INHIBITORS
<b>A61P 11/06</b> (2006.01)	3390405	NOVEL TETRAHYDROTRIAZOLOPYRIMIDINE DERIVATIVES AS NHE INHIBITORS
<b>A61P 37/08</b> (2006.01)	3390405	NOVEL TETRAHYDROTRIAZOLOPYRIMIDINE DERIVATIVES AS NHE INHIBITORS
<b>C07D 487/04</b> (2006.01)	3390405	NOVEL TETRAHYDROTRIAZOLOPYRIMIDINE DERIVATIVES AS NHE INHIBITORS
<b>A01N 25/04</b> (2006.01)	3393239	COMPOSITION FOR AQUATIC PEST CONTROL
<b>A01N 43/90</b> (2006.01)	3393239	COMPOSITION FOR AQUATIC PEST CONTROL
<b>A01N 59/06</b> (2006.01)	3393239	COMPOSITION FOR AQUATIC PEST CONTROL
<b>A01N 65/20</b> (2009.01)	3393239	COMPOSITION FOR AQUATIC PEST CONTROL
<b>B41M 5/28</b> (2006.01)	3344674	THERMOCHROMIC POLYURETHANE FOAM
<b>C08G 18/10</b> (2006.01)	3344674	THERMOCHROMIC POLYURETHANE FOAM
<b>C08G 18/18</b> (2006.01)	3344674	THERMOCHROMIC POLYURETHANE FOAM
<b>C08G 18/24</b> (2006.01)	3344674	THERMOCHROMIC POLYURETHANE FOAM
<b>C08G 18/32</b> (2006.01)	3344674	THERMOCHROMIC POLYURETHANE FOAM
<b>C08G 18/42</b> (2006.01)	3344674	THERMOCHROMIC POLYURETHANE FOAM
<b>C08G 18/76</b> (2006.01)	3344674	THERMOCHROMIC POLYURETHANE FOAM
<b>C07D 209/46</b> (2006.01)	3386950	SUBSTITUTED BENZAZINONES AS ANTIBACTERIAL COMPOUNDS
<b>C07D 217/24</b> (2006.01)	3386950	SUBSTITUTED BENZAZINONES AS ANTIBACTERIAL COMPOUNDS
<b>C07D 239/88</b> (2006.01)	3386950	SUBSTITUTED BENZAZINONES AS ANTIBACTERIAL COMPOUNDS
<b>C07D 253/08</b> (2006.01)	3386950	SUBSTITUTED BENZAZINONES AS ANTIBACTERIAL COMPOUNDS
<b>C07D 401/04</b> (2006.01)	3386950	SUBSTITUTED BENZAZINONES AS ANTIBACTERIAL COMPOUNDS
<b>C07D 401/10</b> (2006.01)	3386950	SUBSTITUTED BENZAZINONES AS ANTIBACTERIAL COMPOUNDS
<b>C07D 403/10</b> (2006.01)	3386950	SUBSTITUTED BENZAZINONES AS ANTIBACTERIAL COMPOUNDS
<b>C07D 405/04</b> (2006.01)	3386950	SUBSTITUTED BENZAZINONES AS ANTIBACTERIAL COMPOUNDS
<b>C07D 409/04</b> (2006.01)	3386950	SUBSTITUTED BENZAZINONES AS ANTIBACTERIAL COMPOUNDS
<b>C07D 417/04</b> (2006.01)	3386950	SUBSTITUTED BENZAZINONES AS ANTIBACTERIAL COMPOUNDS
<b>A61K 47/68</b> (2017.01)	3383910	ANTI-huLRRC15 ANTIBODY DRUG CONJUGATES AND METHODS FOR THEIR USE
<b>C07K 16/28</b> (2006.01)	3383910	ANTI-huLRRC15 ANTIBODY DRUG CONJUGATES AND METHODS FOR THEIR USE
<b>C07K 16/30</b> (2006.01)	3383910	ANTI-huLRRC15 ANTIBODY DRUG CONJUGATES AND METHODS FOR THEIR USE
<b>F01N 1/08</b> (2006.01)	3371424	COMBINED EXHAUST GAS SILENCER



MKP (51)	Broj objave evropske prijava patenta (97)	Naziv pronalaska (54)
<b>A61K 31/381</b> (2006.01)	3394051	CRYSTALLIZATION PROCEDURE FOR OBTAINING CANAGLIFLOZIN HEMIHYDRATE CRYSTALS
<b>A61P 5/00</b> (2006.01)	3394051	CRYSTALLIZATION PROCEDURE FOR OBTAINING CANAGLIFLOZIN HEMIHYDRATE CRYSTALS
<b>C07D 409/10</b> (2006.01)	3394051	CRYSTALLIZATION PROCEDURE FOR OBTAINING CANAGLIFLOZIN HEMIHYDRATE CRYSTALS
<b>A61K 31/7068</b> (2006.01)	3393478	COMBINATION THERAPY
<b>A61K 33/00</b> (2006.01)	3393478	COMBINATION THERAPY
<b>A61P 35/00</b> (2006.01)	3393478	COMBINATION THERAPY
<b>A61K 9/00</b> (2006.01)	3383365	GASTRIC RETENTIVE DEVICES
<b>A61K 47/38</b> (2006.01)	3383365	GASTRIC RETENTIVE DEVICES
<b>A61M 31/00</b> (2006.01)	3383365	GASTRIC RETENTIVE DEVICES
<b>A01C 7/06</b> (2006.01)	3393240	IN SITU TREATMENT OF SEED IN FURROW
<b>A01C 7/20</b> (2006.01)	3393240	IN SITU TREATMENT OF SEED IN FURROW
<b>A01N 25/16</b> (2006.01)	3393240	IN SITU TREATMENT OF SEED IN FURROW
<b>A01N 53/00</b> (2006.01)	3393240	IN SITU TREATMENT OF SEED IN FURROW
<b>A01N 63/00</b> (2006.01)	3393240	IN SITU TREATMENT OF SEED IN FURROW
<b>A61M 5/50</b> (2006.01)	3386573	AUTO-INJECTOR WITH SIGNALING CAP
<b>G06F 19/00</b> (2018.01)	3386573	AUTO-INJECTOR WITH SIGNALING CAP
<b>A61K 31/519</b> (2006.01)	3386991	POLYCYCLIC COMPOUNDS AS INHIBITORS OF BRUTON'S TYROSINE KINASE
<b>A61P 19/00</b> (2006.01)	3386991	POLYCYCLIC COMPOUNDS AS INHIBITORS OF BRUTON'S TYROSINE KINASE
<b>A61P 35/00</b> (2006.01)	3386991	POLYCYCLIC COMPOUNDS AS INHIBITORS OF BRUTON'S TYROSINE KINASE
<b>A61P 37/00</b> (2006.01)	3386991	POLYCYCLIC COMPOUNDS AS INHIBITORS OF BRUTON'S TYROSINE KINASE
<b>C07D 495/16</b> (2006.01)	3386991	POLYCYCLIC COMPOUNDS AS INHIBITORS OF BRUTON'S TYROSINE KINASE
<b>C07D 519/00</b> (2006.01)	3386991	POLYCYCLIC COMPOUNDS AS INHIBITORS OF BRUTON'S TYROSINE KINASE
<b>A61K 31/519</b> (2006.01)	3386992	INHIBITORS OF BRUTON'S TYROSINE KINASE AND METHODS OF THEIR USE
<b>A61P 35/00</b> (2006.01)	3386992	INHIBITORS OF BRUTON'S TYROSINE KINASE AND METHODS OF THEIR USE
<b>C07D 495/16</b> (2006.01)	3386992	INHIBITORS OF BRUTON'S TYROSINE KINASE AND METHODS OF THEIR USE
<b>A61K 39/02</b> (2006.01)	3397279	M HYO MULTIVALENT VACCINE AND USES THEREOF
<b>A61K 39/12</b> (2006.01)	3397279	M HYO MULTIVALENT VACCINE AND USES THEREOF
<b>A61K 38/17</b> (2006.01)	3389710	BISPECIFIC ANTIBODY PLATFORM
<b>A61K 39/395</b> (2006.01)	3389710	BISPECIFIC ANTIBODY PLATFORM
<b>C07K 16/28</b> (2006.01)	3389710	BISPECIFIC ANTIBODY PLATFORM
<b>A61K 31/4433</b> (2006.01)	3394044	TANK-BINDING KINASE INHIBITOR COMPOUNDS
<b>A61P 35/00</b> (2006.01)	3394044	TANK-BINDING KINASE INHIBITOR COMPOUNDS
<b>A61P 37/00</b> (2006.01)	3394044	TANK-BINDING KINASE INHIBITOR COMPOUNDS
<b>C07D 239/42</b> (2006.01)	3394044	TANK-BINDING KINASE INHIBITOR COMPOUNDS
<b>C07D 401/10</b> (2006.01)	3394044	TANK-BINDING KINASE INHIBITOR COMPOUNDS
<b>C07D 401/12</b> (2006.01)	3394044	TANK-BINDING KINASE INHIBITOR COMPOUNDS
<b>C07D 401/14</b> (2006.01)	3394044	TANK-BINDING KINASE INHIBITOR COMPOUNDS
<b>C07D 405/12</b> (2006.01)	3394044	TANK-BINDING KINASE INHIBITOR COMPOUNDS
<b>C07D 413/12</b> (2006.01)	3394044	TANK-BINDING KINASE INHIBITOR COMPOUNDS
<b>C07D 413/14</b> (2006.01)	3394044	TANK-BINDING KINASE INHIBITOR COMPOUNDS
<b>A61K 31/4035</b> (2006.01)	3390396	ISOINDOLE COMPOUNDS
<b>A61P 1/04</b> (2006.01)	3390396	ISOINDOLE COMPOUNDS
<b>A61P 1/18</b> (2006.01)	3390396	ISOINDOLE COMPOUNDS
<b>A61P 11/06</b> (2006.01)	3390396	ISOINDOLE COMPOUNDS
<b>A61P 11/12</b> (2006.01)	3390396	ISOINDOLE COMPOUNDS
<b>A61P 17/06</b> (2006.01)	3390396	ISOINDOLE COMPOUNDS
<b>A61P 37/00</b> (2006.01)	3390396	ISOINDOLE COMPOUNDS
<b>C07D 209/44</b> (2006.01)	3390396	ISOINDOLE COMPOUNDS
<b>C07D 407/06</b> (2006.01)	3390396	ISOINDOLE COMPOUNDS
<b>C12Q 1/66</b> (2006.01)	3394285	MICROBIAL CELL VIABILITY ASSAY FOR DETECTION OF OR DETERMINING SLURRY CONTAMINATION
<b>B01F 3/04</b> (2006.01)	3374069	DEVICE AND CORRESPONDING METHOD FOR THE DISPERSION OF GAS IN LIQUIDS
<b>B01F 5/06</b> (2006.01)	3374069	DEVICE AND CORRESPONDING METHOD FOR THE DISPERSION OF GAS IN LIQUIDS

MKP (51)	Broj objave evropske prijava patenta (97)	Naziv pronalaska (54)
<b>B01F 15/00</b> (2006.01)	3374069	DEVICE AND CORRESPONDING METHOD FOR THE DISPERSION OF GAS IN LIQUIDS
<b>A61K 31/5377</b> (2006.01)	3386513	INHIBITORS OF EZH2 AND METHODS OF USE THEREOF
<b>A61P 35/02</b> (2006.01)	3386513	INHIBITORS OF EZH2 AND METHODS OF USE THEREOF
<b>C12Q 1/68</b> (2018.01)	3386513	INHIBITORS OF EZH2 AND METHODS OF USE THEREOF
<b>A61K 31/4168</b> (2006.01)	3390374	HYDROXYALKYLAMINE- AND HYDROXYCYCLOALKYLAMINE-SUBSTITUTED DIAMINE-ARYLSULFONAMIDE COMPOUNDS WITH SELECTIVE ACTIVITY IN VOLTAGE-GATED SODIUM CHANNELS
<b>A61K 31/4178</b> (2006.01)	3390374	HYDROXYALKYLAMINE- AND HYDROXYCYCLOALKYLAMINE-SUBSTITUTED DIAMINE-ARYLSULFONAMIDE COMPOUNDS WITH SELECTIVE ACTIVITY IN VOLTAGE-GATED SODIUM CHANNELS
<b>A61K 31/4196</b> (2006.01)	3390374	HYDROXYALKYLAMINE- AND HYDROXYCYCLOALKYLAMINE-SUBSTITUTED DIAMINE-ARYLSULFONAMIDE COMPOUNDS WITH SELECTIVE ACTIVITY IN VOLTAGE-GATED SODIUM CHANNELS
<b>A61K 31/551</b> (2006.01)	3390374	HYDROXYALKYLAMINE- AND HYDROXYCYCLOALKYLAMINE-SUBSTITUTED DIAMINE-ARYLSULFONAMIDE COMPOUNDS WITH SELECTIVE ACTIVITY IN VOLTAGE-GATED SODIUM CHANNELS
<b>A61P 11/14</b> (2006.01)	3390374	HYDROXYALKYLAMINE- AND HYDROXYCYCLOALKYLAMINE-SUBSTITUTED DIAMINE-ARYLSULFONAMIDE COMPOUNDS WITH SELECTIVE ACTIVITY IN VOLTAGE-GATED SODIUM CHANNELS
<b>A61P 29/00</b> (2006.01)	3390374	HYDROXYALKYLAMINE- AND HYDROXYCYCLOALKYLAMINE-SUBSTITUTED DIAMINE-ARYLSULFONAMIDE COMPOUNDS WITH SELECTIVE ACTIVITY IN VOLTAGE-GATED SODIUM CHANNELS
<b>C07D 277/52</b> (2006.01)	3390374	HYDROXYALKYLAMINE- AND HYDROXYCYCLOALKYLAMINE-SUBSTITUTED DIAMINE-ARYLSULFONAMIDE COMPOUNDS WITH SELECTIVE ACTIVITY IN VOLTAGE-GATED SODIUM CHANNELS
<b>C07D 285/08</b> (2006.01)	3390374	HYDROXYALKYLAMINE- AND HYDROXYCYCLOALKYLAMINE-SUBSTITUTED DIAMINE-ARYLSULFONAMIDE COMPOUNDS WITH SELECTIVE ACTIVITY IN VOLTAGE-GATED SODIUM CHANNELS
<b>C07D 417/12</b> (2006.01)	3390374	HYDROXYALKYLAMINE- AND HYDROXYCYCLOALKYLAMINE-SUBSTITUTED DIAMINE-ARYLSULFONAMIDE COMPOUNDS WITH SELECTIVE ACTIVITY IN VOLTAGE-GATED SODIUM CHANNELS
<b>A61K 31/513</b> (2006.01)	3390400	HETEROARYLHYDROXYPYRIMIDINONES AS AGONISTS OF THE APJ RECEPTOR
<b>A61P 9/00</b> (2006.01)	3390400	HETEROARYLHYDROXYPYRIMIDINONES AS AGONISTS OF THE APJ RECEPTOR
<b>C07D 403/04</b> (2006.01)	3390400	HETEROARYLHYDROXYPYRIMIDINONES AS AGONISTS OF THE APJ RECEPTOR
<b>C07D 413/04</b> (2006.01)	3390400	HETEROARYLHYDROXYPYRIMIDINONES AS AGONISTS OF THE APJ RECEPTOR
<b>C07D 413/14</b> (2006.01)	3390400	HETEROARYLHYDROXYPYRIMIDINONES AS AGONISTS OF THE APJ RECEPTOR
<b>C07D 417/14</b> (2006.01)	3390400	HETEROARYLHYDROXYPYRIMIDINONES AS AGONISTS OF THE APJ RECEPTOR
<b>C07K 16/00</b> (2006.01)	3390449	ANTIBODIES TO RISPERIDONE AND USE THEREOF
<b>C07K 16/28</b> (2006.01)	3390449	ANTIBODIES TO RISPERIDONE AND USE THEREOF
<b>C07K 16/44</b> (2006.01)	3390449	ANTIBODIES TO RISPERIDONE AND USE THEREOF
<b>A61K 39/00</b> (2006.01)	3390447	PACAP ANTIBODIES AND USES THEREOF
<b>C07K 16/26</b> (2006.01)	3390447	PACAP ANTIBODIES AND USES THEREOF
<b>A61K 31/47</b> (2006.01)	3389659	COMBINATION PRODUCT
<b>A61K 31/4709</b> (2006.01)	3389659	COMBINATION PRODUCT
<b>A61P 31/04</b> (2006.01)	3389659	COMBINATION PRODUCT
<b>A61P 31/06</b> (2006.01)	3389659	COMBINATION PRODUCT
<b>A61K 31/40</b> (2006.01)	3394049	CYANOPYRROLIDINE DERIVATIVES AS INHIBITORS FOR DUBS
<b>A61P 35/00</b> (2006.01)	3394049	CYANOPYRROLIDINE DERIVATIVES AS INHIBITORS FOR DUBS
<b>C07D 207/10</b> (2006.01)	3394049	CYANOPYRROLIDINE DERIVATIVES AS INHIBITORS FOR DUBS
<b>C07D 403/12</b> (2006.01)	3394049	CYANOPYRROLIDINE DERIVATIVES AS INHIBITORS FOR DUBS
<b>C07D 413/12</b> (2006.01)	3394049	CYANOPYRROLIDINE DERIVATIVES AS INHIBITORS FOR DUBS
<b>C07D 413/14</b> (2006.01)	3394049	CYANOPYRROLIDINE DERIVATIVES AS INHIBITORS FOR DUBS
<b>C07D 417/12</b> (2006.01)	3394049	CYANOPYRROLIDINE DERIVATIVES AS INHIBITORS FOR DUBS
<b>C07D 417/14</b> (2006.01)	3394049	CYANOPYRROLIDINE DERIVATIVES AS INHIBITORS FOR DUBS
<b>A61K 9/00</b> (2006.01)	3393453	FORMULATIONS OF PHOSPHORAMIDATE DERIVATIVES OF NUCLEOSIDE DRUGS
<b>A61K 9/08</b> (2006.01)	3393453	FORMULATIONS OF PHOSPHORAMIDATE DERIVATIVES OF NUCLEOSIDE DRUGS
<b>A61K 31/7072</b> (2006.01)	3393453	FORMULATIONS OF PHOSPHORAMIDATE DERIVATIVES OF NUCLEOSIDE DRUGS

MKP (51)	Broj objave evropske prijava patenta (97)	Naziv pronalaska (54)
<b>A61K 31/7076</b> (2006.01)	3393453	FORMULATIONS OF PHOSPHORAMIDATE DERIVATIVES OF NUCLEOSIDE DRUGS
<b>A61P 35/00</b> (2006.01)	3393453	FORMULATIONS OF PHOSPHORAMIDATE DERIVATIVES OF NUCLEOSIDE DRUGS
<b>F23C 99/00</b> (2006.01)	3384207	SYSTEM, METHOD AND DEVICE TO OPTIMIZE THE EFFICIENCY OF THE COMBUSTION OF GASES FOR THE PRODUCTION OF CLEAN ENERGY
<b>C07K 14/16</b> (2006.01)	3390430	HUMAN IMMUNODEFICIENCY VIRUS ANTIGENS, VECTORS, COMPOSITIONS, AND METHODS OF USE THEREOF
<b>B01D 46/32</b> (2006.01)	3383552	PAINTING BOOTH WITH OVERSPRAY REMOVAL SYSTEM, METHOD FOR REMOVING THE OVERSPRAY, AND PLANT
<b>B05B 15/12</b> (2006.01)	3383552	PAINTING BOOTH WITH OVERSPRAY REMOVAL SYSTEM, METHOD FOR REMOVING THE OVERSPRAY, AND PLANT
<b>G01N 33/68</b> (2006.01)	3384294	METHODS AND COMPOSITIONS RELATED TO TOXICITY ASSOCIATED WITH CELL THERAPY
<b>A01K 67/027</b> (2006.01)	3390644	ADENO-ASSOCIATED VIRAL VECTORS FOR TREATING MUCOLIPIDOSIS TYPE II
<b>A61K 48/00</b> (2006.01)	3390644	ADENO-ASSOCIATED VIRAL VECTORS FOR TREATING MUCOLIPIDOSIS TYPE II
<b>C12N 9/12</b> (2006.01)	3390644	ADENO-ASSOCIATED VIRAL VECTORS FOR TREATING MUCOLIPIDOSIS TYPE II
<b>C12N 15/86</b> (2006.01)	3390644	ADENO-ASSOCIATED VIRAL VECTORS FOR TREATING MUCOLIPIDOSIS TYPE II
<b>A61K 48/00</b> (2006.01)	3394270	ADENO-ASSOCIATED VIRAL VECTORS USEFUL IN TREATMENT OF SPINAL MUSCULAR ATROPY
<b>A61P 21/00</b> (2006.01)	3394270	ADENO-ASSOCIATED VIRAL VECTORS USEFUL IN TREATMENT OF SPINAL MUSCULAR ATROPY
<b>C12N 15/864</b> (2006.01)	3394270	ADENO-ASSOCIATED VIRAL VECTORS USEFUL IN TREATMENT OF SPINAL MUSCULAR ATROPY
<b>C07K 16/24</b> (2006.01)	3390444	ANTI-TL1A/ANTI-TNF-ALPHA BISPECIFIC ANTIGEN BINDING PROTEINS AND USES THEREOF
<b>A61K 9/127</b> (2006.01)	3390630	POLYNUCLEOTIDES ENCODING METHYLMALONYL-CoA MUTASE
<b>A61K 31/7088</b> (2006.01)	3390630	POLYNUCLEOTIDES ENCODING METHYLMALONYL-CoA MUTASE
<b>A61P 3/00</b> (2006.01)	3390630	POLYNUCLEOTIDES ENCODING METHYLMALONYL-CoA MUTASE
<b>C12N 9/90</b> (2006.01)	3390630	POLYNUCLEOTIDES ENCODING METHYLMALONYL-CoA MUTASE
<b>C12N 15/61</b> (2006.01)	3390630	POLYNUCLEOTIDES ENCODING METHYLMALONYL-CoA MUTASE
<b>C07K 16/18</b> (2006.01)	3390445	MULTI-SPECIFIC ANTIBODY MOLECULES HAVING SPECIFICITY FOR TNF-ALPHA, IL-17A AND IL-17F
<b>C07K 16/24</b> (2006.01)	3390445	MULTI-SPECIFIC ANTIBODY MOLECULES HAVING SPECIFICITY FOR TNF-ALPHA, IL-17A AND IL-17F
<b>A01H 1/04</b> (2006.01)	3370507	BRASSICACEAE PLANTS RESISTANT TO PLASMIDIOPHORA BRASSICAE (CLUBROOT)
<b>A01H 5/10</b> (2018.01)	3370507	BRASSICACEAE PLANTS RESISTANT TO PLASMIDIOPHORA BRASSICAE (CLUBROOT)
<b>C07K 14/415</b> (2006.01)	3370507	BRASSICACEAE PLANTS RESISTANT TO PLASMIDIOPHORA BRASSICAE (CLUBROOT)
<b>C12N 15/82</b> (2006.01)	3370507	BRASSICACEAE PLANTS RESISTANT TO PLASMIDIOPHORA BRASSICAE (CLUBROOT)
<b>C12Q 1/68</b> (2018.01)	3370507	BRASSICACEAE PLANTS RESISTANT TO PLASMIDIOPHORA BRASSICAE (CLUBROOT)
<b>A61K 51/04</b> (2006.01)	3389728	RADIOLABELLED MGLUR2/3 PET LIGANDS
<b>A61K 101/02</b> (2006.01)	3389728	RADIOLABELLED MGLUR2/3 PET LIGANDS
<b>C07B 59/00</b> (2006.01)	3389728	RADIOLABELLED MGLUR2/3 PET LIGANDS
<b>C07D 487/04</b> (2006.01)	3389728	RADIOLABELLED MGLUR2/3 PET LIGANDS
<b>A61K 31/713</b> (2006.01)	3387129	STEROL REGULATORY ELEMENT BINDING PROTEIN (SREBP) CHAPERONE (SCAP) iRNA COMPOSITIONS AND METHODS OF USE THEREOF
<b>A61P 3/06</b> (2006.01)	3387129	STEROL REGULATORY ELEMENT BINDING PROTEIN (SREBP) CHAPERONE (SCAP) iRNA COMPOSITIONS AND METHODS OF USE THEREOF
<b>C12N 15/113</b> (2010.01)	3387129	STEROL REGULATORY ELEMENT BINDING PROTEIN (SREBP) CHAPERONE (SCAP) iRNA COMPOSITIONS AND METHODS OF USE THEREOF
<b>A23K 10/18</b> (2016.01)	3389399	MICROPARTICLES FOR ENCAPSULATING PROBIOTICS, OBTAINING SAID MICROPARTICLES AND USES THEREOF
<b>A23K 20/147</b> (2016.01)	3389399	MICROPARTICLES FOR ENCAPSULATING PROBIOTICS, OBTAINING SAID MICROPARTICLES AND USES THEREOF

MKP (51)	Broj objave evropske prijava patenta (97)	Naziv pronalaska (54)
<b>A23K 20/24</b> (2016.01)	3389399	MICROPARTICLES FOR ENCAPSULATING PROBIOTICS, OBTAINING SAID MICROPARTICLES AND USES THEREOF
<b>A23K 40/10</b> (2016.01)	3389399	MICROPARTICLES FOR ENCAPSULATING PROBIOTICS, OBTAINING SAID MICROPARTICLES AND USES THEREOF
<b>A23L 3/46</b> (2006.01)	3389399	MICROPARTICLES FOR ENCAPSULATING PROBIOTICS, OBTAINING SAID MICROPARTICLES AND USES THEREOF
<b>A23L 29/00</b> (2016.01)	3389399	MICROPARTICLES FOR ENCAPSULATING PROBIOTICS, OBTAINING SAID MICROPARTICLES AND USES THEREOF
<b>A23L 29/281</b> (2016.01)	3389399	MICROPARTICLES FOR ENCAPSULATING PROBIOTICS, OBTAINING SAID MICROPARTICLES AND USES THEREOF
<b>A23L 29/294</b> (2016.01)	3389399	MICROPARTICLES FOR ENCAPSULATING PROBIOTICS, OBTAINING SAID MICROPARTICLES AND USES THEREOF
<b>A23L 33/135</b> (2016.01)	3389399	MICROPARTICLES FOR ENCAPSULATING PROBIOTICS, OBTAINING SAID MICROPARTICLES AND USES THEREOF
<b>A23P 10/20</b> (2016.01)	3389399	MICROPARTICLES FOR ENCAPSULATING PROBIOTICS, OBTAINING SAID MICROPARTICLES AND USES THEREOF
<b>A23P 10/30</b> (2016.01)	3389399	MICROPARTICLES FOR ENCAPSULATING PROBIOTICS, OBTAINING SAID MICROPARTICLES AND USES THEREOF
<b>A61K 9/00</b> (2006.01)	3389399	MICROPARTICLES FOR ENCAPSULATING PROBIOTICS, OBTAINING SAID MICROPARTICLES AND USES THEREOF
<b>A61K 9/16</b> (2006.01)	3389399	MICROPARTICLES FOR ENCAPSULATING PROBIOTICS, OBTAINING SAID MICROPARTICLES AND USES THEREOF
<b>A61K 39/00</b> (2006.01)	3389399	MICROPARTICLES FOR ENCAPSULATING PROBIOTICS, OBTAINING SAID MICROPARTICLES AND USES THEREOF
<b>A61K 39/02</b> (2006.01)	3389399	MICROPARTICLES FOR ENCAPSULATING PROBIOTICS, OBTAINING SAID MICROPARTICLES AND USES THEREOF
<b>A61K 47/02</b> (2006.01)	3389399	MICROPARTICLES FOR ENCAPSULATING PROBIOTICS, OBTAINING SAID MICROPARTICLES AND USES THEREOF
<b>A61K 47/42</b> (2017.01)	3389399	MICROPARTICLES FOR ENCAPSULATING PROBIOTICS, OBTAINING SAID MICROPARTICLES AND USES THEREOF
<b>A61K 31/506</b> (2006.01)	3397631	SUBSTITUTED 3-AZABICYCLO[3.1.0]HEXANES AS KETOHEXOKINASE INHIBITORS
<b>A61P 3/06</b> (2006.01)	3397631	SUBSTITUTED 3-AZABICYCLO[3.1.0]HEXANES AS KETOHEXOKINASE INHIBITORS
<b>A61P 3/10</b> (2006.01)	3397631	SUBSTITUTED 3-AZABICYCLO[3.1.0]HEXANES AS KETOHEXOKINASE INHIBITORS
<b>A61P 7/02</b> (2006.01)	3397631	SUBSTITUTED 3-AZABICYCLO[3.1.0]HEXANES AS KETOHEXOKINASE INHIBITORS
<b>A61P 9/00</b> (2006.01)	3397631	SUBSTITUTED 3-AZABICYCLO[3.1.0]HEXANES AS KETOHEXOKINASE INHIBITORS
<b>A61P 25/02</b> (2006.01)	3397631	SUBSTITUTED 3-AZABICYCLO[3.1.0]HEXANES AS KETOHEXOKINASE INHIBITORS
<b>A61P 25/30</b> (2006.01)	3397631	SUBSTITUTED 3-AZABICYCLO[3.1.0]HEXANES AS KETOHEXOKINASE INHIBITORS
<b>A61P 35/00</b> (2006.01)	3397631	SUBSTITUTED 3-AZABICYCLO[3.1.0]HEXANES AS KETOHEXOKINASE INHIBITORS
<b>A61P 37/00</b> (2006.01)	3397631	SUBSTITUTED 3-AZABICYCLO[3.1.0]HEXANES AS KETOHEXOKINASE INHIBITORS
<b>C07D 401/14</b> (2006.01)	3397631	SUBSTITUTED 3-AZABICYCLO[3.1.0]HEXANES AS KETOHEXOKINASE INHIBITORS
<b>C07D 403/04</b> (2006.01)	3397631	SUBSTITUTED 3-AZABICYCLO[3.1.0]HEXANES AS KETOHEXOKINASE INHIBITORS
<b>C07D 403/14</b> (2006.01)	3397631	SUBSTITUTED 3-AZABICYCLO[3.1.0]HEXANES AS KETOHEXOKINASE INHIBITORS
<b>A61B 17/064</b> (2006.01)	3397176	APPLICATOR INSTRUMENTS HAVING OFF-AXIS SURGICAL FASTENER DELIVERY
<b>A61B 17/068</b> (2006.01)	3397176	APPLICATOR INSTRUMENTS HAVING OFF-AXIS SURGICAL FASTENER DELIVERY
<b>A61B 17/29</b> (2006.01)	3397176	APPLICATOR INSTRUMENTS HAVING OFF-AXIS SURGICAL FASTENER DELIVERY
<b>A61B 90/00</b> (2016.01)	3397176	APPLICATOR INSTRUMENTS HAVING OFF-AXIS SURGICAL FASTENER DELIVERY
<b>A61F 2/00</b> (2006.01)	3397176	APPLICATOR INSTRUMENTS HAVING OFF-AXIS SURGICAL FASTENER DELIVERY
<b>A61K 31/4025</b> (2006.01)	3368532	D-PROLINE DERIVATIVES AS SAP DEPLETING AGENT
<b>A61P 25/28</b> (2006.01)	3368532	D-PROLINE DERIVATIVES AS SAP DEPLETING AGENT
<b>C07D 405/14</b> (2006.01)	3368532	D-PROLINE DERIVATIVES AS SAP DEPLETING AGENT

MKP (51)	Broj objave evropske prijava patenta (97)	Naziv pronalaska (54)
<b>A61K 31/381</b> (2006.01)	3394053	4-HYDROXY-2-PHENYL-1,3-THIAZOL-5-YL METHANONE DERIVATIVES AS TRPM8 ANTAGONISTS
<b>A61K 31/4025</b> (2006.01)	3394053	4-HYDROXY-2-PHENYL-1,3-THIAZOL-5-YL METHANONE DERIVATIVES AS TRPM8 ANTAGONISTS
<b>A61K 31/4155</b> (2006.01)	3394053	4-HYDROXY-2-PHENYL-1,3-THIAZOL-5-YL METHANONE DERIVATIVES AS TRPM8 ANTAGONISTS
<b>A61K 31/4436</b> (2006.01)	3394053	4-HYDROXY-2-PHENYL-1,3-THIAZOL-5-YL METHANONE DERIVATIVES AS TRPM8 ANTAGONISTS
<b>A61K 31/4535</b> (2006.01)	3394053	4-HYDROXY-2-PHENYL-1,3-THIAZOL-5-YL METHANONE DERIVATIVES AS TRPM8 ANTAGONISTS
<b>A61K 31/5355</b> (2006.01)	3394053	4-HYDROXY-2-PHENYL-1,3-THIAZOL-5-YL METHANONE DERIVATIVES AS TRPM8 ANTAGONISTS
<b>A61K 31/5377</b> (2006.01)	3394053	4-HYDROXY-2-PHENYL-1,3-THIAZOL-5-YL METHANONE DERIVATIVES AS TRPM8 ANTAGONISTS
<b>A61P 11/00</b> (2006.01)	3394053	4-HYDROXY-2-PHENYL-1,3-THIAZOL-5-YL METHANONE DERIVATIVES AS TRPM8 ANTAGONISTS
<b>A61P 13/00</b> (2006.01)	3394053	4-HYDROXY-2-PHENYL-1,3-THIAZOL-5-YL METHANONE DERIVATIVES AS TRPM8 ANTAGONISTS
<b>A61P 29/00</b> (2006.01)	3394053	4-HYDROXY-2-PHENYL-1,3-THIAZOL-5-YL METHANONE DERIVATIVES AS TRPM8 ANTAGONISTS
<b>C07D 277/56</b> (2006.01)	3394053	4-HYDROXY-2-PHENYL-1,3-THIAZOL-5-YL METHANONE DERIVATIVES AS TRPM8 ANTAGONISTS
<b>C07D 417/06</b> (2006.01)	3394053	4-HYDROXY-2-PHENYL-1,3-THIAZOL-5-YL METHANONE DERIVATIVES AS TRPM8 ANTAGONISTS
<b>A21D 13/06</b> (2017.01)	3389400	METHOD FOR THE DETOXIFICATION OF GLUTEN PROTEINS FROM CEREAL GRAINS AND USES THEREOF IN MEDICAL FIELD
<b>A21D 13/066</b> (2017.01)	3389400	METHOD FOR THE DETOXIFICATION OF GLUTEN PROTEINS FROM CEREAL GRAINS AND USES THEREOF IN MEDICAL FIELD
<b>A23L 5/20</b> (2016.01)	3389400	METHOD FOR THE DETOXIFICATION OF GLUTEN PROTEINS FROM CEREAL GRAINS AND USES THEREOF IN MEDICAL FIELD
<b>A23L 5/30</b> (2016.01)	3389400	METHOD FOR THE DETOXIFICATION OF GLUTEN PROTEINS FROM CEREAL GRAINS AND USES THEREOF IN MEDICAL FIELD
<b>A23L 7/10</b> (2016.01)	3389400	METHOD FOR THE DETOXIFICATION OF GLUTEN PROTEINS FROM CEREAL GRAINS AND USES THEREOF IN MEDICAL FIELD
<b>A23L 7/196</b> (2016.01)	3389400	METHOD FOR THE DETOXIFICATION OF GLUTEN PROTEINS FROM CEREAL GRAINS AND USES THEREOF IN MEDICAL FIELD
<b>C12C 1/02</b> (2006.01)	3389400	METHOD FOR THE DETOXIFICATION OF GLUTEN PROTEINS FROM CEREAL GRAINS AND USES THEREOF IN MEDICAL FIELD
<b>C12N 15/113</b> (2010.01)	3394259	COMPOSITIONS AND METHODS FOR DECREASING TAU EXPRESSION
<b>A61F 13/20</b> (2006.01)	3397557	METHOD OF FORMING PRIMARY PACKAGE TUBE FOR TAMPONS
<b>B65B 11/32</b> (2006.01)	3397557	METHOD OF FORMING PRIMARY PACKAGE TUBE FOR TAMPONS
<b>B65B 19/00</b> (2006.01)	3397557	METHOD OF FORMING PRIMARY PACKAGE TUBE FOR TAMPONS
<b>B65B 47/06</b> (2006.01)	3397557	METHOD OF FORMING PRIMARY PACKAGE TUBE FOR TAMPONS
<b>B65B 49/12</b> (2006.01)	3397557	METHOD OF FORMING PRIMARY PACKAGE TUBE FOR TAMPONS
<b>A61K 31/7105</b> (2006.01)	3386533	MODIFIED MRNA ENCODING A URIDINE DIPHOSPHATE GLUCURONOSYL TRANSFERASE AND USES THEREOF
<b>A61K 31/7115</b> (2006.01)	3386533	MODIFIED MRNA ENCODING A URIDINE DIPHOSPHATE GLUCURONOSYL TRANSFERASE AND USES THEREOF
<b>A61K 38/45</b> (2006.01)	3386533	MODIFIED MRNA ENCODING A URIDINE DIPHOSPHATE GLUCURONOSYL TRANSFERASE AND USES THEREOF
<b>A61P 3/00</b> (2006.01)	3386533	MODIFIED MRNA ENCODING A URIDINE DIPHOSPHATE GLUCURONOSYL TRANSFERASE AND USES THEREOF
<b>A61B 17/00</b> (2006.01)	3397182	SURGICAL INSTRUMENT WITH STAGED APPLICATION OF ELECTROSURGICAL AND ULTRASONIC ENERGY
<b>A61B 17/29</b> (2006.01)	3397182	SURGICAL INSTRUMENT WITH STAGED APPLICATION OF ELECTROSURGICAL AND ULTRASONIC ENERGY
<b>A61B 17/32</b> (2006.01)	3397182	SURGICAL INSTRUMENT WITH STAGED APPLICATION OF ELECTROSURGICAL AND ULTRASONIC ENERGY
<b>A61B 18/14</b> (2006.01)	3397182	SURGICAL INSTRUMENT WITH STAGED APPLICATION OF ELECTROSURGICAL AND ULTRASONIC ENERGY
<b>A46B 15/00</b> (2006.01)	3393377	ULTRASONIC SURGICAL INSTRUMENT WITH TUBULAR ACOUSTIC WAVEGUIDE SEGMENT
<b>A61B 17/28</b> (2006.01)	3393377	ULTRASONIC SURGICAL INSTRUMENT WITH TUBULAR ACOUSTIC WAVEGUIDE SEGMENT
<b>A61B 17/32</b> (2006.01)	3393377	ULTRASONIC SURGICAL INSTRUMENT WITH TUBULAR ACOUSTIC WAVEGUIDE SEGMENT
<b>A61K 31/4704</b> (2006.01)	3390392	ALKYL DIHYDROQUINOLINE SULFONAMIDE COMPOUNDS

MKP	Broj objave evropske prijave patenta	Naziv pronalaska
(51)	(97)	(54)
<b>A61P 29/00</b> (2006.01)	3390392	ALKYL DIHYDROQUINOLINE SULFONAMIDE COMPOUNDS
<b>C07D 403/12</b> (2006.01)	3390392	ALKYL DIHYDROQUINOLINE SULFONAMIDE COMPOUNDS
<b>C07D 413/12</b> (2006.01)	3390392	ALKYL DIHYDROQUINOLINE SULFONAMIDE COMPOUNDS
<b>A61K 31/4704</b> (2006.01)	3390393	ALKYNYL DIHYDROQUINOLINE SULFONAMIDE COMPOUNDS
<b>C07D 215/36</b> (2006.01)	3390393	ALKYNYL DIHYDROQUINOLINE SULFONAMIDE COMPOUNDS
<b>C07D 241/44</b> (2006.01)	3390393	ALKYNYL DIHYDROQUINOLINE SULFONAMIDE COMPOUNDS
<b>C07D 403/12</b> (2006.01)	3390393	ALKYNYL DIHYDROQUINOLINE SULFONAMIDE COMPOUNDS
<b>C07D 413/12</b> (2006.01)	3390393	ALKYNYL DIHYDROQUINOLINE SULFONAMIDE COMPOUNDS
<b>C07D 413/14</b> (2006.01)	3390393	ALKYNYL DIHYDROQUINOLINE SULFONAMIDE COMPOUNDS
<b>C07D 417/12</b> (2006.01)	3390393	ALKYNYL DIHYDROQUINOLINE SULFONAMIDE COMPOUNDS
<b>A61K 31/519</b> (2006.01)	3394067	4-AMINO-2-(1H-PYRAZOLO[3,4-B]PYRIDIN-3-YL)-6-OXO-6,7-DIHYDRO-5H-PYRROLO[2,3-D]PYRIMIDINE DERIVATIVES AND THE RESPECTIVE (1H-INDAZOL-3-YL) DERIVATIVES AS CGMP MODULATORS FOR TREATING CARDIOVASCULAR DISEASES
<b>A61P 9/00</b> (2006.01)	3394067	4-AMINO-2-(1H-PYRAZOLO[3,4-B]PYRIDIN-3-YL)-6-OXO-6,7-DIHYDRO-5H-PYRROLO[2,3-D]PYRIMIDINE DERIVATIVES AND THE RESPECTIVE (1H-INDAZOL-3-YL) DERIVATIVES AS CGMP MODULATORS FOR TREATING CARDIOVASCULAR DISEASES
<b>A61P 9/04</b> (2006.01)	3394067	4-AMINO-2-(1H-PYRAZOLO[3,4-B]PYRIDIN-3-YL)-6-OXO-6,7-DIHYDRO-5H-PYRROLO[2,3-D]PYRIMIDINE DERIVATIVES AND THE RESPECTIVE (1H-INDAZOL-3-YL) DERIVATIVES AS CGMP MODULATORS FOR TREATING CARDIOVASCULAR DISEASES
<b>A61P 9/10</b> (2006.01)	3394067	4-AMINO-2-(1H-PYRAZOLO[3,4-B]PYRIDIN-3-YL)-6-OXO-6,7-DIHYDRO-5H-PYRROLO[2,3-D]PYRIMIDINE DERIVATIVES AND THE RESPECTIVE (1H-INDAZOL-3-YL) DERIVATIVES AS CGMP MODULATORS FOR TREATING CARDIOVASCULAR DISEASES
<b>A61P 9/12</b> (2006.01)	3394067	4-AMINO-2-(1H-PYRAZOLO[3,4-B]PYRIDIN-3-YL)-6-OXO-6,7-DIHYDRO-5H-PYRROLO[2,3-D]PYRIMIDINE DERIVATIVES AND THE RESPECTIVE (1H-INDAZOL-3-YL) DERIVATIVES AS CGMP MODULATORS FOR TREATING CARDIOVASCULAR DISEASES
<b>C07D 487/04</b> (2006.01)	3394067	4-AMINO-2-(1H-PYRAZOLO[3,4-B]PYRIDIN-3-YL)-6-OXO-6,7-DIHYDRO-5H-PYRROLO[2,3-D]PYRIMIDINE DERIVATIVES AND THE RESPECTIVE (1H-INDAZOL-3-YL) DERIVATIVES AS CGMP MODULATORS FOR TREATING CARDIOVASCULAR DISEASES
<b>A61M 5/142</b> (2006.01)	3393555	WEARABLE AUTOMATIC INJECTION DEVICE AND RELATED METHODS OF ASSEMBLY AND USE
<b>A61M 5/24</b> (2006.01)	3393555	WEARABLE AUTOMATIC INJECTION DEVICE AND RELATED METHODS OF ASSEMBLY AND USE
<b>A61K 31/519</b> (2006.01)	3394056	COMPOUNDS FOR THE TREATMENT OF CANCER AND INFLAMMATORY DISEASE
<b>A61P 29/00</b> (2006.01)	3394056	COMPOUNDS FOR THE TREATMENT OF CANCER AND INFLAMMATORY DISEASE
<b>A61P 35/00</b> (2006.01)	3394056	COMPOUNDS FOR THE TREATMENT OF CANCER AND INFLAMMATORY DISEASE
<b>C07D 221/04</b> (2006.01)	3394056	COMPOUNDS FOR THE TREATMENT OF CANCER AND INFLAMMATORY DISEASE
<b>C07D 239/94</b> (2006.01)	3394056	COMPOUNDS FOR THE TREATMENT OF CANCER AND INFLAMMATORY DISEASE
<b>C07D 401/04</b> (2006.01)	3394056	COMPOUNDS FOR THE TREATMENT OF CANCER AND INFLAMMATORY DISEASE
<b>C07D 401/12</b> (2006.01)	3394056	COMPOUNDS FOR THE TREATMENT OF CANCER AND INFLAMMATORY DISEASE
<b>C07D 401/14</b> (2006.01)	3394056	COMPOUNDS FOR THE TREATMENT OF CANCER AND INFLAMMATORY DISEASE
<b>C07D 407/14</b> (2006.01)	3394056	COMPOUNDS FOR THE TREATMENT OF CANCER AND INFLAMMATORY DISEASE
<b>C07D 409/14</b> (2006.01)	3394056	COMPOUNDS FOR THE TREATMENT OF CANCER AND INFLAMMATORY DISEASE
<b>C07D 413/14</b> (2006.01)	3394056	COMPOUNDS FOR THE TREATMENT OF CANCER AND INFLAMMATORY DISEASE
<b>C07D 471/04</b> (2006.01)	3394056	COMPOUNDS FOR THE TREATMENT OF CANCER AND INFLAMMATORY DISEASE
<b>C07D 473/30</b> (2006.01)	3394056	COMPOUNDS FOR THE TREATMENT OF CANCER AND INFLAMMATORY DISEASE
<b>C07D 495/04</b> (2006.01)	3394056	COMPOUNDS FOR THE TREATMENT OF CANCER AND INFLAMMATORY DISEASE
<b>C07D 495/14</b> (2006.01)	3394056	COMPOUNDS FOR THE TREATMENT OF CANCER AND INFLAMMATORY DISEASE

MKP (51)	Broj objave evropske prijava patenta (97)	Naziv pronalaska (54)
<b>A61K 31/34</b> (2006.01)	3393465	METHODS OF TREATING PULMONARY DISEASES AND DISORDERS
<b>A61K 31/341</b> (2006.01)	3393465	METHODS OF TREATING PULMONARY DISEASES AND DISORDERS
<b>A61K 31/42</b> (2006.01)	3393465	METHODS OF TREATING PULMONARY DISEASES AND DISORDERS
<b>A61K 31/422</b> (2006.01)	3393465	METHODS OF TREATING PULMONARY DISEASES AND DISORDERS
<b>A61K 31/4245</b> (2006.01)	3393465	METHODS OF TREATING PULMONARY DISEASES AND DISORDERS
<b>A61K 31/5377</b> (2006.01)	3393465	METHODS OF TREATING PULMONARY DISEASES AND DISORDERS
<b>A61P 11/00</b> (2006.01)	3393465	METHODS OF TREATING PULMONARY DISEASES AND DISORDERS
<b>C07D 471/04</b> (2006.01)	3394057	SYNTHETIC METHODS FOR PREPARATION OF (S)-(2R,3R,11BR)-3-ISOBUTYL-9,10-DIMETHOXY-2,3,4,6,7,11B-HEXAHYDRO-1H-PYRIDO[2,1,-A]ISOQUINOLIN-2-YL 2-AMINO-3-METHYLBUTANOATE DI(4-METHYLBENZENESULFONATE)
<b>C07K 14/54</b> (2006.01)	3390433	NOVEL CYTOKINE FUSION PROTEINS
<b>C07K 14/705</b> (2006.01)	3390433	NOVEL CYTOKINE FUSION PROTEINS
<b>C12N 15/62</b> (2006.01)	3390433	NOVEL CYTOKINE FUSION PROTEINS
<b>A61K 31/437</b> (2006.01)	3394058	N-[3-(3-{4-[[1,2,4]TRIAZOLO[4,3-A]PYRIDIN-6-YLOXY]-1,2,3,4-TETRAHYDRO-NAPHTHALEN-1-YL}-UREIDO)-PHENYL]-METHANESULFONAMIDE DERIVATIVES AND THEIR USE AS P38 MAPK INHIBITORS
<b>A61P 11/00</b> (2006.01)	3394058	N-[3-(3-{4-[[1,2,4]TRIAZOLO[4,3-A]PYRIDIN-6-YLOXY]-1,2,3,4-TETRAHYDRO-NAPHTHALEN-1-YL}-UREIDO)-PHENYL]-METHANESULFONAMIDE DERIVATIVES AND THEIR USE AS P38 MAPK INHIBITORS
<b>A61P 11/06</b> (2006.01)	3394058	N-[3-(3-{4-[[1,2,4]TRIAZOLO[4,3-A]PYRIDIN-6-YLOXY]-1,2,3,4-TETRAHYDRO-NAPHTHALEN-1-YL}-UREIDO)-PHENYL]-METHANESULFONAMIDE DERIVATIVES AND THEIR USE AS P38 MAPK INHIBITORS
<b>C07D 471/04</b> (2006.01)	3394058	N-[3-(3-{4-[[1,2,4]TRIAZOLO[4,3-A]PYRIDIN-6-YLOXY]-1,2,3,4-TETRAHYDRO-NAPHTHALEN-1-YL}-UREIDO)-PHENYL]-METHANESULFONAMIDE DERIVATIVES AND THEIR USE AS P38 MAPK INHIBITORS
<b>A61K 31/437</b> (2006.01)	3394059	1-(3-TERT-BUTYL-PHENYL)-3-(4-([1,2,4]TRIAZOLO[4,3-A]PYRIDIN-6-YLOXY)-1,2,3,4-TETRAHYDRO-NAPHTHALEN-1-YL)-UREA DERIVATIVES AND THEIR USE AS P38 MAPK INHIBITORS
<b>A61P 11/00</b> (2006.01)	3394059	1-(3-TERT-BUTYL-PHENYL)-3-(4-([1,2,4]TRIAZOLO[4,3-A]PYRIDIN-6-YLOXY)-1,2,3,4-TETRAHYDRO-NAPHTHALEN-1-YL)-UREA DERIVATIVES AND THEIR USE AS P38 MAPK INHIBITORS
<b>A61P 11/06</b> (2006.01)	3394059	1-(3-TERT-BUTYL-PHENYL)-3-(4-([1,2,4]TRIAZOLO[4,3-A]PYRIDIN-6-YLOXY)-1,2,3,4-TETRAHYDRO-NAPHTHALEN-1-YL)-UREA DERIVATIVES AND THEIR USE AS P38 MAPK INHIBITORS
<b>C07D 471/04</b> (2006.01)	3394059	1-(3-TERT-BUTYL-PHENYL)-3-(4-([1,2,4]TRIAZOLO[4,3-A]PYRIDIN-6-YLOXY)-1,2,3,4-TETRAHYDRO-NAPHTHALEN-1-YL)-UREA DERIVATIVES AND THEIR USE AS P38 MAPK INHIBITORS
<b>A61K 31/437</b> (2006.01)	3394060	1-(3-TERT-BUTYL-2H-PYRAZOL-5-YL OR 5-TERT-BUTYL-ISOXAO-3-YL)-3-(4-([1,2,4]TRIAZOLO[4,3-A]PYRIDIN-6-YLOXY)-1,2,3,4-TETRAHYDRO-NAPHTHALENYL) UREA DERIVATIVES AND THEIR USE AS P38 MAPK INHIBITORS
<b>A61P 11/00</b> (2006.01)	3394060	1-(3-TERT-BUTYL-2H-PYRAZOL-5-YL OR 5-TERT-BUTYL-ISOXAO-3-YL)-3-(4-([1,2,4]TRIAZOLO[4,3-A]PYRIDIN-6-YLOXY)-1,2,3,4-TETRAHYDRO-NAPHTHALENYL) UREA DERIVATIVES AND THEIR USE AS P38 MAPK INHIBITORS
<b>A61P 11/06</b> (2006.01)	3394060	1-(3-TERT-BUTYL-2H-PYRAZOL-5-YL OR 5-TERT-BUTYL-ISOXAO-3-YL)-3-(4-([1,2,4]TRIAZOLO[4,3-A]PYRIDIN-6-YLOXY)-1,2,3,4-TETRAHYDRO-NAPHTHALENYL) UREA DERIVATIVES AND THEIR USE AS P38 MAPK INHIBITORS
<b>C07D 471/04</b> (2006.01)	3394060	1-(3-TERT-BUTYL-2H-PYRAZOL-5-YL OR 5-TERT-BUTYL-ISOXAO-3-YL)-3-(4-([1,2,4]TRIAZOLO[4,3-A]PYRIDIN-6-YLOXY)-1,2,3,4-TETRAHYDRO-NAPHTHALENYL) UREA DERIVATIVES AND THEIR USE AS P38 MAPK INHIBITORS
<b>D06P 1/52</b> (2006.01)	3397805	PROCESS FOR OBTAINING A CLOTH WITH HIGH PERFORMANCES FOR DIGITAL PRINTING AND RELATIVE CLOTH
<b>D06P 5/00</b> (2006.01)	3397805	PROCESS FOR OBTAINING A CLOTH WITH HIGH PERFORMANCES FOR DIGITAL PRINTING AND RELATIVE CLOTH
<b>D06P 5/30</b> (2006.01)	3397805	PROCESS FOR OBTAINING A CLOTH WITH HIGH PERFORMANCES FOR DIGITAL PRINTING AND RELATIVE CLOTH
<b>A45C 5/03</b> (2006.01)	3389430	A SUITCASE, PREFERABLY OF THE RIGID TYPE, WITH AN INTERCHANGEABLE EXTERNAL CASE
<b>A45C 5/14</b> (2006.01)	3389430	A SUITCASE, PREFERABLY OF THE RIGID TYPE, WITH AN INTERCHANGEABLE EXTERNAL CASE

MKP (51)	Broj objave evropske prijava patenta (97)	Naziv pronalaska (54)
<b>A45C 13/00</b> (2006.01)	3389430	A SUITCASE, PREFERABLY OF THE RIGID TYPE, WITH AN INTERCHANGEABLE EXTERNAL CASE
<b>A45C 13/08</b> (2006.01)	3389430	A SUITCASE, PREFERABLY OF THE RIGID TYPE, WITH AN INTERCHANGEABLE EXTERNAL CASE
<b>A63B 9/00</b> (2006.01)	3377187	REVERSIBLY INSTALLABLE MODULAR FITNESS AREA
<b>A63B 17/04</b> (2006.01)	3377187	REVERSIBLY INSTALLABLE MODULAR FITNESS AREA
<b>A63C 19/02</b> (2006.01)	3377187	REVERSIBLY INSTALLABLE MODULAR FITNESS AREA
<b>A63G 31/00</b> (2006.01)	3377187	REVERSIBLY INSTALLABLE MODULAR FITNESS AREA
<b>H02S 30/20</b> (2014.01)	3377187	REVERSIBLY INSTALLABLE MODULAR FITNESS AREA
<b>A63B 7/02</b> (2006.01)	3377186	PERSONALIZABLE MODULAR FITNESS AREA
<b>A63B 9/00</b> (2006.01)	3377186	PERSONALIZABLE MODULAR FITNESS AREA
<b>A63B 17/04</b> (2006.01)	3377186	PERSONALIZABLE MODULAR FITNESS AREA
<b>A63B 21/08</b> (2006.01)	3377186	PERSONALIZABLE MODULAR FITNESS AREA
<b>A63B 23/12</b> (2006.01)	3377186	PERSONALIZABLE MODULAR FITNESS AREA
<b>A63G 31/00</b> (2006.01)	3377186	PERSONALIZABLE MODULAR FITNESS AREA
<b>C07K 14/195</b> (2006.01)	3377634	BACTERIA-BASED PROTEIN DELIVERY
<b>C12N 1/21</b> (2006.01)	3377634	BACTERIA-BASED PROTEIN DELIVERY
<b>C12N 15/62</b> (2006.01)	3377634	BACTERIA-BASED PROTEIN DELIVERY
<b>C12N 15/70</b> (2006.01)	3377634	BACTERIA-BASED PROTEIN DELIVERY
<b>C12N 15/74</b> (2006.01)	3377634	BACTERIA-BASED PROTEIN DELIVERY
<b>C12N 1/19</b> (2006.01)	3394281	YEAST CELL
<b>C12N 15/63</b> (2006.01)	3394281	YEAST CELL
<b>C12P 21/02</b> (2006.01)	3394281	YEAST CELL
<b>C12R 1/84</b> (2006.01)	3394281	YEAST CELL
<b>A61K 38/04</b> (2006.01)	3383419	COMPOSITIONS AND METHODS FOR REDUCING IMMUNE RESPONSES AGAINST CHIMERIC ANTIGEN RECEPTORS
<b>A61K 38/17</b> (2006.01)	3383419	COMPOSITIONS AND METHODS FOR REDUCING IMMUNE RESPONSES AGAINST CHIMERIC ANTIGEN RECEPTORS
<b>C07K 7/04</b> (2006.01)	3383419	COMPOSITIONS AND METHODS FOR REDUCING IMMUNE RESPONSES AGAINST CHIMERIC ANTIGEN RECEPTORS
<b>C07K 16/28</b> (2006.01)	3383419	COMPOSITIONS AND METHODS FOR REDUCING IMMUNE RESPONSES AGAINST CHIMERIC ANTIGEN RECEPTORS
<b>C07K 16/30</b> (2006.01)	3383419	COMPOSITIONS AND METHODS FOR REDUCING IMMUNE RESPONSES AGAINST CHIMERIC ANTIGEN RECEPTORS
<b>A61K 31/00</b> (2006.01)	3387017	METHODS FOR REDUCING OR PREVENTING GROWTH OF TUMORS RESISTANT TO EGFR AND/OR ERBB3 BLOCKADE
<b>A61P 35/00</b> (2006.01)	3387017	METHODS FOR REDUCING OR PREVENTING GROWTH OF TUMORS RESISTANT TO EGFR AND/OR ERBB3 BLOCKADE
<b>C07K 16/28</b> (2006.01)	3387017	METHODS FOR REDUCING OR PREVENTING GROWTH OF TUMORS RESISTANT TO EGFR AND/OR ERBB3 BLOCKADE
<b>C07K 16/32</b> (2006.01)	3387017	METHODS FOR REDUCING OR PREVENTING GROWTH OF TUMORS RESISTANT TO EGFR AND/OR ERBB3 BLOCKADE
<b>A61K 48/00</b> (2006.01)	3400304	GENE THERAPY FOR TREATING FAMILIAL HYPERCHOLESTEROLEMIA
<b>C07K 14/705</b> (2006.01)	3400304	GENE THERAPY FOR TREATING FAMILIAL HYPERCHOLESTEROLEMIA
<b>C12N 15/86</b> (2006.01)	3400304	GENE THERAPY FOR TREATING FAMILIAL HYPERCHOLESTEROLEMIA
<b>C07K 14/765</b> (2006.01)	3394265	DKK2 CYSTEINE RICH DOMAIN 2 CONTAINING PROTEINS AND USES THEREOF
<b>C12N 15/62</b> (2006.01)	3394265	DKK2 CYSTEINE RICH DOMAIN 2 CONTAINING PROTEINS AND USES THEREOF
<b>A61K 39/00</b> (2006.01)	3393504	MESOTHELIN CHIMERIC ANTIGEN RECEPTOR (CAR) AND ANTIBODY AGAINST PD-L1 INHIBITOR FOR COMBINED USE IN ANTICANCER THERAPY
<b>B03B 9/00</b> (2006.01)	3386655	WASTE PROCESSING
<b>B03B 9/06</b> (2006.01)	3386655	WASTE PROCESSING
<b>B09B 3/00</b> (2006.01)	3386655	WASTE PROCESSING
<b>B29B 17/00</b> (2006.01)	3386655	WASTE PROCESSING
<b>B29B 17/02</b> (2006.01)	3386655	WASTE PROCESSING
<b>C05F 9/00</b> (2006.01)	3386655	WASTE PROCESSING
<b>C10L 5/48</b> (2006.01)	3386655	WASTE PROCESSING
<b>D21B 1/02</b> (2006.01)	3386655	WASTE PROCESSING
<b>D21C 5/02</b> (2006.01)	3386655	WASTE PROCESSING
<b>A61F 13/20</b> (2006.01)	3397223	METHOD OF WINDING UP TAMPON MATERIAL
<b>A61F 13/34</b> (2006.01)	3397223	METHOD OF WINDING UP TAMPON MATERIAL
<b>B65H 65/00</b> (2006.01)	3397223	METHOD OF WINDING UP TAMPON MATERIAL
<b>B65H 69/04</b> (2006.01)	3397223	METHOD OF WINDING UP TAMPON MATERIAL



MKP	Broj objave evropske prijave patenta	Naziv pronalaska
(51)	(97)	(54)
<b>A61K 31/437</b> (2006.01)	3386980	COMPOUNDS AND METHODS FOR KINASE MODULATION, AND INDICATIONS THEREFOR
<b>A61P 35/00</b> (2006.01)	3386980	COMPOUNDS AND METHODS FOR KINASE MODULATION, AND INDICATIONS THEREFOR
<b>C07D 471/04</b> (2006.01)	3386980	COMPOUNDS AND METHODS FOR KINASE MODULATION, AND INDICATIONS THEREFOR
<b>C08B 3/08</b> (2006.01)	3394108	ACYLATION OF BIOPOLYMER COMPRISING ANHYDROGLUCOSE UNITS
<b>C08B 3/10</b> (2006.01)	3394108	ACYLATION OF BIOPOLYMER COMPRISING ANHYDROGLUCOSE UNITS
<b>A61B 17/29</b> (2006.01)	3383286	DEVICES AND METHODS FOR INCREASING ROTATIONAL TORQUE DURING END EFFECTOR ARTICULATION
<b>A61B 18/14</b> (2006.01)	3383286	DEVICES AND METHODS FOR INCREASING ROTATIONAL TORQUE DURING END EFFECTOR ARTICULATION
<b>C07K 16/44</b> (2006.01)	3390455	ANTIBODIES TO QUETIAPINE AND USE THEREOF
<b>G01N 33/94</b> (2006.01)	3390455	ANTIBODIES TO QUETIAPINE AND USE THEREOF
<b>A61K 31/4375</b> (2006.01)	3394033	HETEROCYCLIC COMPOUNDS AS IMMUNOMODULATORS
<b>A61K 31/47</b> (2006.01)	3394033	HETEROCYCLIC COMPOUNDS AS IMMUNOMODULATORS
<b>A61K 31/4985</b> (2006.01)	3394033	HETEROCYCLIC COMPOUNDS AS IMMUNOMODULATORS
<b>A61K 31/519</b> (2006.01)	3394033	HETEROCYCLIC COMPOUNDS AS IMMUNOMODULATORS
<b>A61P 31/00</b> (2006.01)	3394033	HETEROCYCLIC COMPOUNDS AS IMMUNOMODULATORS
<b>A61P 35/00</b> (2006.01)	3394033	HETEROCYCLIC COMPOUNDS AS IMMUNOMODULATORS
<b>C07D 215/40</b> (2006.01)	3394033	HETEROCYCLIC COMPOUNDS AS IMMUNOMODULATORS
<b>C07D 471/04</b> (2006.01)	3394033	HETEROCYCLIC COMPOUNDS AS IMMUNOMODULATORS
<b>A61K 31/5025</b> (2006.01)	3397639	FUSED TRICYCLIC HETEROCYCLIC COMPOUNDS AS HIV INTEGRASE INHIBITORS
<b>A61P 31/18</b> (2006.01)	3397639	FUSED TRICYCLIC HETEROCYCLIC COMPOUNDS AS HIV INTEGRASE INHIBITORS
<b>C07D 471/16</b> (2006.01)	3397639	FUSED TRICYCLIC HETEROCYCLIC COMPOUNDS AS HIV INTEGRASE INHIBITORS
<b>A61K 31/4196</b> (2006.01)	3397633	NUCLEAR TRANSPORT MODULATORS AND USES THEREOF
<b>A61P 11/00</b> (2006.01)	3397633	NUCLEAR TRANSPORT MODULATORS AND USES THEREOF
<b>A61P 25/28</b> (2006.01)	3397633	NUCLEAR TRANSPORT MODULATORS AND USES THEREOF
<b>A61P 27/02</b> (2006.01)	3397633	NUCLEAR TRANSPORT MODULATORS AND USES THEREOF
<b>A61P 31/12</b> (2006.01)	3397633	NUCLEAR TRANSPORT MODULATORS AND USES THEREOF
<b>A61P 35/00</b> (2006.01)	3397633	NUCLEAR TRANSPORT MODULATORS AND USES THEREOF
<b>A61P 37/00</b> (2006.01)	3397633	NUCLEAR TRANSPORT MODULATORS AND USES THEREOF
<b>C07D 249/08</b> (2006.01)	3397633	NUCLEAR TRANSPORT MODULATORS AND USES THEREOF
<b>C07D 401/12</b> (2006.01)	3397633	NUCLEAR TRANSPORT MODULATORS AND USES THEREOF
<b>C07D 403/12</b> (2006.01)	3397633	NUCLEAR TRANSPORT MODULATORS AND USES THEREOF
<b>C07D 413/12</b> (2006.01)	3397633	NUCLEAR TRANSPORT MODULATORS AND USES THEREOF
<b>A61K 31/4965</b> (2006.01)	3397634	NUCLEAR TRANSPORT MODULATORS AND USES THEREOF
<b>A61P 35/00</b> (2006.01)	3397634	NUCLEAR TRANSPORT MODULATORS AND USES THEREOF
<b>C07D 239/26</b> (2006.01)	3397634	NUCLEAR TRANSPORT MODULATORS AND USES THEREOF
<b>C07D 241/12</b> (2006.01)	3397634	NUCLEAR TRANSPORT MODULATORS AND USES THEREOF
<b>C07D 401/08</b> (2006.01)	3397634	NUCLEAR TRANSPORT MODULATORS AND USES THEREOF
<b>C07D 401/12</b> (2006.01)	3397634	NUCLEAR TRANSPORT MODULATORS AND USES THEREOF
<b>C07D 403/06</b> (2006.01)	3397634	NUCLEAR TRANSPORT MODULATORS AND USES THEREOF
<b>C07D 403/08</b> (2006.01)	3397634	NUCLEAR TRANSPORT MODULATORS AND USES THEREOF
<b>C07D 403/12</b> (2006.01)	3397634	NUCLEAR TRANSPORT MODULATORS AND USES THEREOF
<b>C07D 409/06</b> (2006.01)	3397634	NUCLEAR TRANSPORT MODULATORS AND USES THEREOF
<b>C07D 413/06</b> (2006.01)	3397634	NUCLEAR TRANSPORT MODULATORS AND USES THEREOF
<b>A61K 31/445</b> (2006.01)	3397273	AUGMENTED ACID ALPHA-GLUCOSIDASE FOR THE TREATMENT OF POMPE DISEASE
<b>A61K 38/47</b> (2006.01)	3397273	AUGMENTED ACID ALPHA-GLUCOSIDASE FOR THE TREATMENT OF POMPE DISEASE
<b>A61K 35/17</b> (2015.01)	3344263	CANCER ANTIGEN TARGETS AND USES THEREOF
<b>A61K 39/00</b> (2006.01)	3344263	CANCER ANTIGEN TARGETS AND USES THEREOF
<b>A61P 35/02</b> (2006.01)	3344263	CANCER ANTIGEN TARGETS AND USES THEREOF
<b>A61B 17/00</b> (2006.01)	3345552	NATURAL CHANNEL-BASED MICROSURGICAL DEVICE
<b>A01K 67/027</b> (2006.01)	3407709	NON-HUMAN ANIMALS HAVING AN ENGINEERED IMMUNOGLOBULIN LAMBDA LIGHT CHAIN LOCUS
<b>C07K 16/00</b> (2006.01)	3407709	NON-HUMAN ANIMALS HAVING AN ENGINEERED IMMUNOGLOBULIN LAMBDA LIGHT CHAIN LOCUS
<b>C12N 15/85</b> (2006.01)	3407709	NON-HUMAN ANIMALS HAVING AN ENGINEERED IMMUNOGLOBULIN LAMBDA LIGHT CHAIN LOCUS
<b>C12N 15/90</b> (2006.01)	3407709	NON-HUMAN ANIMALS HAVING AN ENGINEERED IMMUNOGLOBULIN LAMBDA LIGHT CHAIN LOCUS

MKP (51)	Broj objave evropske prijava patenta (97)	Naziv pronalaska (54)
<b>A61K 35/14</b> (2015.01)	3403659	PROCESS, TUBE AND DEVICE FOR THE PREPARATION OF WOUND HEALANT COMPOSITION
<b>A61K 35/16</b> (2015.01)	3403659	PROCESS, TUBE AND DEVICE FOR THE PREPARATION OF WOUND HEALANT COMPOSITION
<b>A61K 38/48</b> (2006.01)	3403659	PROCESS, TUBE AND DEVICE FOR THE PREPARATION OF WOUND HEALANT COMPOSITION
<b>A61K 31/55</b> (2006.01)	3375780	HETEROCYCLIC AMIDES AS KINASE INHIBITORS
<b>A61K 31/5513</b> (2006.01)	3375780	HETEROCYCLIC AMIDES AS KINASE INHIBITORS
<b>A61K 31/553</b> (2006.01)	3375780	HETEROCYCLIC AMIDES AS KINASE INHIBITORS
<b>A61K 31/554</b> (2006.01)	3375780	HETEROCYCLIC AMIDES AS KINASE INHIBITORS
<b>A61P 17/06</b> (2006.01)	3375780	HETEROCYCLIC AMIDES AS KINASE INHIBITORS
<b>A61P 25/28</b> (2006.01)	3375780	HETEROCYCLIC AMIDES AS KINASE INHIBITORS
<b>A61P 29/00</b> (2006.01)	3375780	HETEROCYCLIC AMIDES AS KINASE INHIBITORS
<b>A61P 37/00</b> (2006.01)	3375780	HETEROCYCLIC AMIDES AS KINASE INHIBITORS
<b>C07D 223/08</b> (2006.01)	3375780	HETEROCYCLIC AMIDES AS KINASE INHIBITORS
<b>C07D 267/14</b> (2006.01)	3375780	HETEROCYCLIC AMIDES AS KINASE INHIBITORS
<b>C07D 281/10</b> (2006.01)	3375780	HETEROCYCLIC AMIDES AS KINASE INHIBITORS
<b>C07D 403/12</b> (2006.01)	3375780	HETEROCYCLIC AMIDES AS KINASE INHIBITORS
<b>C07D 403/14</b> (2006.01)	3375780	HETEROCYCLIC AMIDES AS KINASE INHIBITORS
<b>C07D 409/12</b> (2006.01)	3375780	HETEROCYCLIC AMIDES AS KINASE INHIBITORS
<b>C07D 413/12</b> (2006.01)	3375780	HETEROCYCLIC AMIDES AS KINASE INHIBITORS
<b>C07D 413/14</b> (2006.01)	3375780	HETEROCYCLIC AMIDES AS KINASE INHIBITORS
<b>C07D 417/12</b> (2006.01)	3375780	HETEROCYCLIC AMIDES AS KINASE INHIBITORS
<b>C07D 487/04</b> (2006.01)	3375780	HETEROCYCLIC AMIDES AS KINASE INHIBITORS
<b>C07D 498/04</b> (2006.01)	3375780	HETEROCYCLIC AMIDES AS KINASE INHIBITORS
<b>A61K 38/46</b> (2006.01)	3401400	METHODS AND COMPOSITIONS FOR RNA-DIRECTED TARGET DNA MODIFICATION AND FOR RNA-DIRECTED MODULATION OF TRANSCRIPTION
<b>A61K 48/00</b> (2006.01)	3401400	METHODS AND COMPOSITIONS FOR RNA-DIRECTED TARGET DNA MODIFICATION AND FOR RNA-DIRECTED MODULATION OF TRANSCRIPTION
<b>C07K 19/00</b> (2006.01)	3401400	METHODS AND COMPOSITIONS FOR RNA-DIRECTED TARGET DNA MODIFICATION AND FOR RNA-DIRECTED MODULATION OF TRANSCRIPTION
<b>C12N 15/10</b> (2006.01)	3401400	METHODS AND COMPOSITIONS FOR RNA-DIRECTED TARGET DNA MODIFICATION AND FOR RNA-DIRECTED MODULATION OF TRANSCRIPTION
<b>C12N 15/11</b> (2006.01)	3401400	METHODS AND COMPOSITIONS FOR RNA-DIRECTED TARGET DNA MODIFICATION AND FOR RNA-DIRECTED MODULATION OF TRANSCRIPTION
<b>C12N 15/63</b> (2006.01)	3401400	METHODS AND COMPOSITIONS FOR RNA-DIRECTED TARGET DNA MODIFICATION AND FOR RNA-DIRECTED MODULATION OF TRANSCRIPTION
<b>C12N 15/90</b> (2006.01)	3401400	METHODS AND COMPOSITIONS FOR RNA-DIRECTED TARGET DNA MODIFICATION AND FOR RNA-DIRECTED MODULATION OF TRANSCRIPTION
<b>B65D 1/34</b> (2006.01)	3357823	AN INNOVATIVE TRAY OF BIODEGRADABLE TYPE FOR CARRYING FINDINGS AND DELICATE OBJECTS
<b>A44C 11/00</b> (2006.01)	3354153	ORNAMENTAL CHAIN
<b>A61K 39/00</b> (2006.01)	3348645	NUCLEIC ACID COMPRISING OR CODING FOR A HISTONE STEM-LOOP AND A POLY(A) SEQUENCE OR A POLYADENYLATION SIGNAL FOR INCREASING THE EXPRESSION OF AN ENCODED PATHOGENIC ANTIGEN
<b>A61K 39/12</b> (2006.01)	3348645	NUCLEIC ACID COMPRISING OR CODING FOR A HISTONE STEM-LOOP AND A POLY(A) SEQUENCE OR A POLYADENYLATION SIGNAL FOR INCREASING THE EXPRESSION OF AN ENCODED PATHOGENIC ANTIGEN
<b>C12N 15/63</b> (2006.01)	3348645	NUCLEIC ACID COMPRISING OR CODING FOR A HISTONE STEM-LOOP AND A POLY(A) SEQUENCE OR A POLYADENYLATION SIGNAL FOR INCREASING THE EXPRESSION OF AN ENCODED PATHOGENIC ANTIGEN
<b>C12N 15/67</b> (2006.01)	3348645	NUCLEIC ACID COMPRISING OR CODING FOR A HISTONE STEM-LOOP AND A POLY(A) SEQUENCE OR A POLYADENYLATION SIGNAL FOR INCREASING THE EXPRESSION OF AN ENCODED PATHOGENIC ANTIGEN
<b>C07C 51/347</b> (2006.01)	3398931	METHODS OF SYNTHESIZING A PROSTACYCLIN ALALOG
<b>C07C 205/57</b> (2006.01)	3398931	METHODS OF SYNTHESIZING A PROSTACYCLIN ALALOG
<b>C07D 301/32</b> (2006.01)	3398931	METHODS OF SYNTHESIZING A PROSTACYCLIN ALALOG

MKP (51)	Broj objave evropske prijava patenta (97)	Naziv pronalaska (54)
<b>C07F 7/18</b> (2006.01)	3398931	METHODS OF SYNTHESIZING A PROSTACYCLIN ALALOG
<b>A61K 39/00</b> (2006.01)	3338794	TOXICITY MANAGEMENT FOR ANTI-TUMOR ACTIVITY OF CARS
<b>A61K 39/395</b> (2006.01)	3345923	TREATMENT FOR RHEUMATOID ARTHRITIS WITH ANTI-GM-CSF ANTIBODY
<b>A61P 29/00</b> (2006.01)	3345923	TREATMENT FOR RHEUMATOID ARTHRITIS WITH ANTI-GM-CSF ANTIBODY
<b>C07K 16/24</b> (2006.01)	3345923	TREATMENT FOR RHEUMATOID ARTHRITIS WITH ANTI-GM-CSF ANTIBODY
<b>A61K 31/415</b> (2006.01)	3348545	PYRAZOLE-AMIDE COMPOUND AND MEDICINAL USES THEREFOR
<b>A61P 3/00</b> (2006.01)	3348545	PYRAZOLE-AMIDE COMPOUND AND MEDICINAL USES THEREFOR
<b>A61P 3/04</b> (2006.01)	3348545	PYRAZOLE-AMIDE COMPOUND AND MEDICINAL USES THEREFOR
<b>A61P 3/10</b> (2006.01)	3348545	PYRAZOLE-AMIDE COMPOUND AND MEDICINAL USES THEREFOR
<b>A61P 9/04</b> (2006.01)	3348545	PYRAZOLE-AMIDE COMPOUND AND MEDICINAL USES THEREFOR
<b>A61P 9/10</b> (2006.01)	3348545	PYRAZOLE-AMIDE COMPOUND AND MEDICINAL USES THEREFOR
<b>A61P 11/00</b> (2006.01)	3348545	PYRAZOLE-AMIDE COMPOUND AND MEDICINAL USES THEREFOR
<b>A61P 13/12</b> (2006.01)	3348545	PYRAZOLE-AMIDE COMPOUND AND MEDICINAL USES THEREFOR
<b>A61P 25/00</b> (2006.01)	3348545	PYRAZOLE-AMIDE COMPOUND AND MEDICINAL USES THEREFOR
<b>A61P 27/02</b> (2006.01)	3348545	PYRAZOLE-AMIDE COMPOUND AND MEDICINAL USES THEREFOR
<b>A61P 27/12</b> (2006.01)	3348545	PYRAZOLE-AMIDE COMPOUND AND MEDICINAL USES THEREFOR
<b>A61P 43/00</b> (2006.01)	3348545	PYRAZOLE-AMIDE COMPOUND AND MEDICINAL USES THEREFOR
<b>C07D 231/12</b> (2006.01)	3348545	PYRAZOLE-AMIDE COMPOUND AND MEDICINAL USES THEREFOR
<b>A61K 38/17</b> (2006.01)	3363456	NOVEL IMMUNOTHERAPY AGAINST SEVERAL TUMORS INCLUDING GASTROINTESTINAL AND GASTRIC CANCER
<b>A61K 39/00</b> (2006.01)	3363456	NOVEL IMMUNOTHERAPY AGAINST SEVERAL TUMORS INCLUDING GASTROINTESTINAL AND GASTRIC CANCER
<b>A61P 35/00</b> (2006.01)	3363456	NOVEL IMMUNOTHERAPY AGAINST SEVERAL TUMORS INCLUDING GASTROINTESTINAL AND GASTRIC CANCER
<b>C07K 7/06</b> (2006.01)	3363456	NOVEL IMMUNOTHERAPY AGAINST SEVERAL TUMORS INCLUDING GASTROINTESTINAL AND GASTRIC CANCER
<b>C07K 7/08</b> (2006.01)	3363456	NOVEL IMMUNOTHERAPY AGAINST SEVERAL TUMORS INCLUDING GASTROINTESTINAL AND GASTRIC CANCER
<b>G01N 33/50</b> (2006.01)	3363456	NOVEL IMMUNOTHERAPY AGAINST SEVERAL TUMORS INCLUDING GASTROINTESTINAL AND GASTRIC CANCER
<b>E05B 3/06</b> (2006.01)	3363969	ACTUATION HANDLE
<b>A61P 11/00</b> (2006.01)	3360897	ANTAGONISTS OF IL17C FOR THE TREATMENT OF INFLAMMATORY DISORDERS
<b>A61P 19/02</b> (2006.01)	3360897	ANTAGONISTS OF IL17C FOR THE TREATMENT OF INFLAMMATORY DISORDERS
<b>A61P 29/00</b> (2006.01)	3360897	ANTAGONISTS OF IL17C FOR THE TREATMENT OF INFLAMMATORY DISORDERS
<b>C07K 16/24</b> (2006.01)	3360897	ANTAGONISTS OF IL17C FOR THE TREATMENT OF INFLAMMATORY DISORDERS
<b>G01N 27/02</b> (2006.01)	3346272	WHOLE CELL ASSAYS AND METHODS
<b>G01N 33/50</b> (2006.01)	3346272	WHOLE CELL ASSAYS AND METHODS
<b>G01N 33/574</b> (2006.01)	3346272	WHOLE CELL ASSAYS AND METHODS
<b>B60P 1/26</b> (2006.01)	3392083	AN INNOVATIVE, PREFERABLY REAR PILLAR OF DISMOUNTABLE TYPE FOR LORRIES
<b>B62D 33/037</b> (2006.01)	3392083	AN INNOVATIVE, PREFERABLY REAR PILLAR OF DISMOUNTABLE TYPE FOR LORRIES
<b>A61K 31/495</b> (2006.01)	3418281	COMPOUNDS USEFUL AS INHIBITORS OF ATR KINASE FOR THE TREATMENT OF CANCER DISEASES
<b>A61P 35/00</b> (2006.01)	3418281	COMPOUNDS USEFUL AS INHIBITORS OF ATR KINASE FOR THE TREATMENT OF CANCER DISEASES
<b>C07D 487/04</b> (2006.01)	3418281	COMPOUNDS USEFUL AS INHIBITORS OF ATR KINASE FOR THE TREATMENT OF CANCER DISEASES
<b>C01D 15/08</b> (2006.01)	3363930	PROCESSES FOR PREPARING LITHIUM CARBONATE
<b>C22B 3/04</b> (2006.01)	3363930	PROCESSES FOR PREPARING LITHIUM CARBONATE
<b>C22B 26/12</b> (2006.01)	3363930	PROCESSES FOR PREPARING LITHIUM CARBONATE
<b>C25B 1/16</b> (2006.01)	3363930	PROCESSES FOR PREPARING LITHIUM CARBONATE
<b>A61K 31/44</b> (2006.01)	3357921	BIARYL COMPOUNDS USEFUL FOR THE TREATMENT OF HUMAN DISEASES IN ONCOLOGY, NEUROLOGY AND IMMUNOLOGY
<b>A61K 31/505</b> (2006.01)	3357921	BIARYL COMPOUNDS USEFUL FOR THE TREATMENT OF HUMAN DISEASES IN ONCOLOGY, NEUROLOGY AND IMMUNOLOGY
<b>A61K 31/506</b> (2006.01)	3357921	BIARYL COMPOUNDS USEFUL FOR THE TREATMENT OF HUMAN DISEASES IN ONCOLOGY, NEUROLOGY AND IMMUNOLOGY
<b>A61P 25/02</b> (2006.01)	3357921	BIARYL COMPOUNDS USEFUL FOR THE TREATMENT OF HUMAN DISEASES IN ONCOLOGY, NEUROLOGY AND IMMUNOLOGY

MKP (51)	Broj objave evropske prijava patenta (97)	Naziv pronalaska (54)
<b>A61P 35/00</b> (2006.01)	3357921	BIARYL COMPOUNDS USEFUL FOR THE TREATMENT OF HUMAN DISEASES IN ONCOLOGY, NEUROLOGY AND IMMUNOLOGY
<b>A61P 37/00</b> (2006.01)	3357921	BIARYL COMPOUNDS USEFUL FOR THE TREATMENT OF HUMAN DISEASES IN ONCOLOGY, NEUROLOGY AND IMMUNOLOGY
<b>C07D 239/30</b> (2006.01)	3357921	BIARYL COMPOUNDS USEFUL FOR THE TREATMENT OF HUMAN DISEASES IN ONCOLOGY, NEUROLOGY AND IMMUNOLOGY
<b>C07D 401/14</b> (2006.01)	3357921	BIARYL COMPOUNDS USEFUL FOR THE TREATMENT OF HUMAN DISEASES IN ONCOLOGY, NEUROLOGY AND IMMUNOLOGY
<b>C07D 403/12</b> (2006.01)	3357921	BIARYL COMPOUNDS USEFUL FOR THE TREATMENT OF HUMAN DISEASES IN ONCOLOGY, NEUROLOGY AND IMMUNOLOGY
<b>C07D 409/14</b> (2006.01)	3357921	BIARYL COMPOUNDS USEFUL FOR THE TREATMENT OF HUMAN DISEASES IN ONCOLOGY, NEUROLOGY AND IMMUNOLOGY
<b>C07D 413/14</b> (2006.01)	3357921	BIARYL COMPOUNDS USEFUL FOR THE TREATMENT OF HUMAN DISEASES IN ONCOLOGY, NEUROLOGY AND IMMUNOLOGY
<b>C07D 417/12</b> (2006.01)	3357921	BIARYL COMPOUNDS USEFUL FOR THE TREATMENT OF HUMAN DISEASES IN ONCOLOGY, NEUROLOGY AND IMMUNOLOGY
<b>C07D 417/14</b> (2006.01)	3357921	BIARYL COMPOUNDS USEFUL FOR THE TREATMENT OF HUMAN DISEASES IN ONCOLOGY, NEUROLOGY AND IMMUNOLOGY
<b>C07D 495/04</b> (2006.01)	3357921	BIARYL COMPOUNDS USEFUL FOR THE TREATMENT OF HUMAN DISEASES IN ONCOLOGY, NEUROLOGY AND IMMUNOLOGY
<b>C07D 513/04</b> (2006.01)	3357921	BIARYL COMPOUNDS USEFUL FOR THE TREATMENT OF HUMAN DISEASES IN ONCOLOGY, NEUROLOGY AND IMMUNOLOGY
<b>C07F 5/02</b> (2006.01)	3357921	BIARYL COMPOUNDS USEFUL FOR THE TREATMENT OF HUMAN DISEASES IN ONCOLOGY, NEUROLOGY AND IMMUNOLOGY
<b>A61K 31/44</b> (2006.01)	3357921	BIARYL COMPOUNDS USEFUL FOR THE TREATMENT OF HUMAN DISEASES IN ONCOLOGY, NEUROLOGY AND IMMUNOLOGY
<b>A61K 31/505</b> (2006.01)	3357921	BIARYL COMPOUNDS USEFUL FOR THE TREATMENT OF HUMAN DISEASES IN ONCOLOGY, NEUROLOGY AND IMMUNOLOGY
<b>A61K 31/506</b> (2006.01)	3357921	BIARYL COMPOUNDS USEFUL FOR THE TREATMENT OF HUMAN DISEASES IN ONCOLOGY, NEUROLOGY AND IMMUNOLOGY
<b>A61P 25/02</b> (2006.01)	3357921	BIARYL COMPOUNDS USEFUL FOR THE TREATMENT OF HUMAN DISEASES IN ONCOLOGY, NEUROLOGY AND IMMUNOLOGY
<b>A61P 35/00</b> (2006.01)	3357921	BIARYL COMPOUNDS USEFUL FOR THE TREATMENT OF HUMAN DISEASES IN ONCOLOGY, NEUROLOGY AND IMMUNOLOGY
<b>A61P 37/00</b> (2006.01)	3357921	BIARYL COMPOUNDS USEFUL FOR THE TREATMENT OF HUMAN DISEASES IN ONCOLOGY, NEUROLOGY AND IMMUNOLOGY
<b>C07D 239/30</b> (2006.01)	3357921	BIARYL COMPOUNDS USEFUL FOR THE TREATMENT OF HUMAN DISEASES IN ONCOLOGY, NEUROLOGY AND IMMUNOLOGY
<b>C07D 401/14</b> (2006.01)	3357921	BIARYL COMPOUNDS USEFUL FOR THE TREATMENT OF HUMAN DISEASES IN ONCOLOGY, NEUROLOGY AND IMMUNOLOGY
<b>C07D 403/12</b> (2006.01)	3357921	BIARYL COMPOUNDS USEFUL FOR THE TREATMENT OF HUMAN DISEASES IN ONCOLOGY, NEUROLOGY AND IMMUNOLOGY
<b>C07D 409/14</b> (2006.01)	3357921	BIARYL COMPOUNDS USEFUL FOR THE TREATMENT OF HUMAN DISEASES IN ONCOLOGY, NEUROLOGY AND IMMUNOLOGY
<b>C07D 413/14</b> (2006.01)	3357921	BIARYL COMPOUNDS USEFUL FOR THE TREATMENT OF HUMAN DISEASES IN ONCOLOGY, NEUROLOGY AND IMMUNOLOGY
<b>C07D 417/12</b> (2006.01)	3357921	BIARYL COMPOUNDS USEFUL FOR THE TREATMENT OF HUMAN DISEASES IN ONCOLOGY, NEUROLOGY AND IMMUNOLOGY
<b>C07D 417/14</b> (2006.01)	3357921	BIARYL COMPOUNDS USEFUL FOR THE TREATMENT OF HUMAN DISEASES IN ONCOLOGY, NEUROLOGY AND IMMUNOLOGY
<b>C07D 495/04</b> (2006.01)	3357921	BIARYL COMPOUNDS USEFUL FOR THE TREATMENT OF HUMAN DISEASES IN ONCOLOGY, NEUROLOGY AND IMMUNOLOGY
<b>C07D 513/04</b> (2006.01)	3357921	BIARYL COMPOUNDS USEFUL FOR THE TREATMENT OF HUMAN DISEASES IN ONCOLOGY, NEUROLOGY AND IMMUNOLOGY
<b>C07F 5/02</b> (2006.01)	3357921	BIARYL COMPOUNDS USEFUL FOR THE TREATMENT OF HUMAN DISEASES IN ONCOLOGY, NEUROLOGY AND IMMUNOLOGY
<b>G06F 3/01</b> (2006.01)	3352055	SYSTEMS AND METHODS FOR HAPTIC AUGMENTATION OF VOICE-TO-TEXT CONVERSION
<b>G06F 3/16</b> (2006.01)	3352055	SYSTEMS AND METHODS FOR HAPTIC AUGMENTATION OF VOICE-TO-TEXT CONVERSION
<b>G08B 6/00</b> (2006.01)	3352055	SYSTEMS AND METHODS FOR HAPTIC AUGMENTATION OF VOICE-TO-TEXT CONVERSION
<b>G10L 15/26</b> (2006.01)	3352055	SYSTEMS AND METHODS FOR HAPTIC AUGMENTATION OF VOICE-TO-TEXT CONVERSION
<b>G10L 21/16</b> (2013.01)	3352055	SYSTEMS AND METHODS FOR HAPTIC AUGMENTATION OF VOICE-TO-TEXT CONVERSION
<b>G10L 25/03</b> (2013.01)	3352055	SYSTEMS AND METHODS FOR HAPTIC AUGMENTATION OF VOICE-TO-TEXT CONVERSION

MKP (51)	Broj objave evropske prijava patenta (97)	Naziv pronalaska (54)
<b>A61K 39/395</b> (2006.01)	3354280	STABILIZED FORMULATIONS CONTAINING ANTI-INTERLEUKIN-4 RECEPTOR (IL-4R) ANTIBODIES
<b>A61M 5/315</b> (2006.01)	3354280	STABILIZED FORMULATIONS CONTAINING ANTI-INTERLEUKIN-4 RECEPTOR (IL-4R) ANTIBODIES
<b>C07K 16/28</b> (2006.01)	3354280	STABILIZED FORMULATIONS CONTAINING ANTI-INTERLEUKIN-4 RECEPTOR (IL-4R) ANTIBODIES
<b>A61K 31/4985</b> (2006.01)	3351249	ANTIVIRAL THERAPY
<b>A61K 31/505</b> (2006.01)	3351249	ANTIVIRAL THERAPY
<b>A61K 31/513</b> (2006.01)	3351249	ANTIVIRAL THERAPY
<b>A61K 31/52</b> (2006.01)	3351249	ANTIVIRAL THERAPY
<b>A61K 31/536</b> (2006.01)	3351249	ANTIVIRAL THERAPY
<b>A61K 31/5365</b> (2006.01)	3351249	ANTIVIRAL THERAPY
<b>A61P 31/18</b> (2006.01)	3351249	ANTIVIRAL THERAPY
<b>G09B 9/00</b> (2006.01)	3382674	SIMULATOR FOR TRAINING IN ENVIRONMENTS CONFINED AND / OR SUSPECTED OF POLLUTION
<b>A61K 31/138</b> (2006.01)	3351527	TRANS-CLOMIPHENE METABOLITES AND USES THEREOF
<b>A61P 3/06</b> (2006.01)	3351527	TRANS-CLOMIPHENE METABOLITES AND USES THEREOF
<b>C07C 217/18</b> (2006.01)	3351527	TRANS-CLOMIPHENE METABOLITES AND USES THEREOF
<b>A61K 31/506</b> (2006.01)	3357919	AROMATIC HETEROCYCLIC COMPOUNDS AS ANTIINFLAMMATORY COMPOUNDS
<b>A61P 11/00</b> (2006.01)	3357919	AROMATIC HETEROCYCLIC COMPOUNDS AS ANTIINFLAMMATORY COMPOUNDS
<b>A61P 29/00</b> (2006.01)	3357919	AROMATIC HETEROCYCLIC COMPOUNDS AS ANTIINFLAMMATORY COMPOUNDS
<b>A61P 31/00</b> (2006.01)	3357919	AROMATIC HETEROCYCLIC COMPOUNDS AS ANTIINFLAMMATORY COMPOUNDS
<b>C07D 401/14</b> (2006.01)	3357919	AROMATIC HETEROCYCLIC COMPOUNDS AS ANTIINFLAMMATORY COMPOUNDS
<b>C07D 409/14</b> (2006.01)	3357919	AROMATIC HETEROCYCLIC COMPOUNDS AS ANTIINFLAMMATORY COMPOUNDS
<b>A61K 31/7084</b> (2006.01)	3366691	CYCLIC PURINE DINUCLEOTIDES AS MODULATORS OF STING
<b>A61K 39/00</b> (2006.01)	3366691	CYCLIC PURINE DINUCLEOTIDES AS MODULATORS OF STING
<b>A61K 39/39</b> (2006.01)	3366691	CYCLIC PURINE DINUCLEOTIDES AS MODULATORS OF STING
<b>A61P 31/12</b> (2006.01)	3366691	CYCLIC PURINE DINUCLEOTIDES AS MODULATORS OF STING
<b>A61P 35/00</b> (2006.01)	3366691	CYCLIC PURINE DINUCLEOTIDES AS MODULATORS OF STING
<b>C07F 9/6574</b> (2006.01)	3366691	CYCLIC PURINE DINUCLEOTIDES AS MODULATORS OF STING
<b>C07H 21/00</b> (2006.01)	3366691	CYCLIC PURINE DINUCLEOTIDES AS MODULATORS OF STING
<b>C07H 21/02</b> (2006.01)	3366691	CYCLIC PURINE DINUCLEOTIDES AS MODULATORS OF STING
<b>C07H 21/04</b> (2006.01)	3366691	CYCLIC PURINE DINUCLEOTIDES AS MODULATORS OF STING
<b>C07K 16/28</b> (2006.01)	3406633	MULTISPECIFIC ANTIBODIES, MULTISPECIFIC ACTIVATABLE ANTIBODIES AND METHODS OF USING THE SAME
<b>C07K 16/24</b> (2006.01)	3369744	ANTIGEN BINDING PROTEINS TO ONCOSTATIN M (OSM)
<b>A61K 39/00</b> (2006.01)	3415531	BCMA (CD269/TNFRSF17) - BINDING PROTEINS
<b>A61K 47/68</b> (2017.01)	3415531	BCMA (CD269/TNFRSF17) - BINDING PROTEINS
<b>C07K 16/28</b> (2006.01)	3415531	BCMA (CD269/TNFRSF17) - BINDING PROTEINS
<b>A61P 25/00</b> (2006.01)	3404027	NUCLEAR TRANSPORT MODULATORS AND USES THEREOF
<b>A61P 35/00</b> (2006.01)	3404027	NUCLEAR TRANSPORT MODULATORS AND USES THEREOF
<b>C07D 249/08</b> (2006.01)	3404027	NUCLEAR TRANSPORT MODULATORS AND USES THEREOF
<b>C07D 403/12</b> (2006.01)	3404027	NUCLEAR TRANSPORT MODULATORS AND USES THEREOF
<b>C07D 413/12</b> (2006.01)	3404027	NUCLEAR TRANSPORT MODULATORS AND USES THEREOF
<b>A61K 35/74</b> (2015.01)	3360559	COMPOSITIONS COMPRISING BACTERIAL STRAINS
<b>A61K 35/745</b> (2015.01)	3360559	COMPOSITIONS COMPRISING BACTERIAL STRAINS
<b>A61P 11/06</b> (2006.01)	3360559	COMPOSITIONS COMPRISING BACTERIAL STRAINS
<b>A61P 35/00</b> (2006.01)	3360559	COMPOSITIONS COMPRISING BACTERIAL STRAINS
<b>B22D 11/06</b> (2006.01)	3385012	JACKET FOR A ROLLER USED IN CONTINUOUS CASTING, PARTICULARLY FOR THE PRODUCTION OF ALUMINUM OR ALUMINUM ALLOY STRIPS AND OF ZINC-BASED ALLOY STRIPS
<b>B22D 11/128</b> (2006.01)	3385012	JACKET FOR A ROLLER USED IN CONTINUOUS CASTING, PARTICULARLY FOR THE PRODUCTION OF ALUMINUM OR ALUMINUM ALLOY STRIPS AND OF ZINC-BASED ALLOY STRIPS
<b>A61K 31/712</b> (2006.01)	3412774	SERPINA1 IRNA COMPOSITIONS AND METHODS OF USE THEREOF
<b>A61K 31/713</b> (2006.01)	3412774	SERPINA1 IRNA COMPOSITIONS AND METHODS OF USE THEREOF
<b>A61P 1/16</b> (2006.01)	3412774	SERPINA1 IRNA COMPOSITIONS AND METHODS OF USE THEREOF
<b>A61P 11/00</b> (2006.01)	3412774	SERPINA1 IRNA COMPOSITIONS AND METHODS OF USE THEREOF
<b>A61P 35/00</b> (2006.01)	3412774	SERPINA1 IRNA COMPOSITIONS AND METHODS OF USE THEREOF
<b>C12N 15/113</b> (2010.01)	3412774	SERPINA1 IRNA COMPOSITIONS AND METHODS OF USE THEREOF
<b>A61K 31/221</b> (2006.01)	3366668	PRODRUGS OF FUMARATES AND THEIR USE IN TREATING VARIOUS DISEASES

MKP (51)	Broj objave evropske prijava patenta (97)	Naziv pronalaska (54)
<b>C07C 219/08</b> (2006.01)	3366668	PRODRUGS OF FUMARATES AND THEIR USE IN TREATING VARIOUS DESEASES
<b>C07C 229/12</b> (2006.01)	3366668	PRODRUGS OF FUMARATES AND THEIR USE IN TREATING VARIOUS DESEASES
<b>C07C 229/16</b> (2006.01)	3366668	PRODRUGS OF FUMARATES AND THEIR USE IN TREATING VARIOUS DESEASES
<b>C07C 309/18</b> (2006.01)	3366668	PRODRUGS OF FUMARATES AND THEIR USE IN TREATING VARIOUS DESEASES
<b>C07K 16/28</b> (2006.01)	3409689	ANTI-CD134 (OX40) ANTIBODIES AND USES THEREOF
<b>C07K 16/30</b> (2006.01)	3409689	ANTI-CD134 (OX40) ANTIBODIES AND USES THEREOF
<b>G01N 33/68</b> (2006.01)	3409689	ANTI-CD134 (OX40) ANTIBODIES AND USES THEREOF
<b>C07D 471/04</b> (2006.01)	3395818	2-(MORPHOLIN-4-YL)-1,7-NAPHTHYRIDINES
<b>A61K 9/127</b> (2006.01)	3403647	DELIVERY OF MRNA FOR THE AUGMENTATION OF PROTEINS AND ENZYMES IN HUMAN GENETIC DISEASES
<b>A61K 31/7105</b> (2006.01)	3403647	DELIVERY OF MRNA FOR THE AUGMENTATION OF PROTEINS AND ENZYMES IN HUMAN GENETIC DISEASES
<b>A61K 48/00</b> (2006.01)	3403647	DELIVERY OF MRNA FOR THE AUGMENTATION OF PROTEINS AND ENZYMES IN HUMAN GENETIC DISEASES
<b>C07H 21/02</b> (2006.01)	3403647	DELIVERY OF MRNA FOR THE AUGMENTATION OF PROTEINS AND ENZYMES IN HUMAN GENETIC DISEASES
<b>A61K 39/00</b> (2006.01)	3404103	NUCLEIC ACID COMPRISING OR CODING FOR A HISTONE STEM-LOOP AND A POLY(A) SEQUENCE OR A POLYADENYLATION SIGNAL FOR INCREASING THE EXPRESSION OF AN ENCODED ALLERGENIC ANTIGEN OR AN AUTOIMMUNE SELF-ANTIGEN
<b>A61K 39/35</b> (2006.01)	3404103	NUCLEIC ACID COMPRISING OR CODING FOR A HISTONE STEM-LOOP AND A POLY(A) SEQUENCE OR A POLYADENYLATION SIGNAL FOR INCREASING THE EXPRESSION OF AN ENCODED ALLERGENIC ANTIGEN OR AN AUTOIMMUNE SELF-ANTIGEN
<b>C12N 15/117</b> (2010.01)	3404103	NUCLEIC ACID COMPRISING OR CODING FOR A HISTONE STEM-LOOP AND A POLY(A) SEQUENCE OR A POLYADENYLATION SIGNAL FOR INCREASING THE EXPRESSION OF AN ENCODED ALLERGENIC ANTIGEN OR AN AUTOIMMUNE SELF-ANTIGEN
<b>C12N 15/68</b> (2006.01)	3404103	NUCLEIC ACID COMPRISING OR CODING FOR A HISTONE STEM-LOOP AND A POLY(A) SEQUENCE OR A POLYADENYLATION SIGNAL FOR INCREASING THE EXPRESSION OF AN ENCODED ALLERGENIC ANTIGEN OR AN AUTOIMMUNE SELF-ANTIGEN
<b>A61B 5/06</b> (2006.01)	3396810	USING LOCATION TRANSMISSION SIGNALS FOR CHARGING A WIRELESS TOOL OF AN ELECTROMAGNETIC NAVIGATION SYSTEM
<b>A61B 34/20</b> (2016.01)	3396810	USING LOCATION TRANSMISSION SIGNALS FOR CHARGING A WIRELESS TOOL OF AN ELECTROMAGNETIC NAVIGATION SYSTEM
<b>H01F 38/14</b> (2006.01)	3396810	USING LOCATION TRANSMISSION SIGNALS FOR CHARGING A WIRELESS TOOL OF AN ELECTROMAGNETIC NAVIGATION SYSTEM
<b>H02J 7/00</b> (2006.01)	3396810	USING LOCATION TRANSMISSION SIGNALS FOR CHARGING A WIRELESS TOOL OF AN ELECTROMAGNETIC NAVIGATION SYSTEM
<b>H02J 50/10</b> (2016.01)	3396810	USING LOCATION TRANSMISSION SIGNALS FOR CHARGING A WIRELESS TOOL OF AN ELECTROMAGNETIC NAVIGATION SYSTEM
<b>H02J 50/40</b> (2016.01)	3396810	USING LOCATION TRANSMISSION SIGNALS FOR CHARGING A WIRELESS TOOL OF AN ELECTROMAGNETIC NAVIGATION SYSTEM
<b>A61L 27/00</b> (2006.01)	3384939	MOLECULES AND METHODS FOR INHIBITION AND DETECTION OF PROTEINS
<b>A61L 31/08</b> (2006.01)	3384939	MOLECULES AND METHODS FOR INHIBITION AND DETECTION OF PROTEINS
<b>A61L 31/16</b> (2006.01)	3384939	MOLECULES AND METHODS FOR INHIBITION AND DETECTION OF PROTEINS
<b>C07K 14/00</b> (2006.01)	3384939	MOLECULES AND METHODS FOR INHIBITION AND DETECTION OF PROTEINS
<b>C07K 16/28</b> (2006.01)	3409690	HUMANIZED ANTI-CD134 (OX40) ANTIBODIES AND USES THEREOF
<b>C07K 16/00</b> (2006.01)	3385279	CARRIER IMMUNOGLOBULINS AND USES THEREOF
<b>C07K 16/18</b> (2006.01)	3385279	CARRIER IMMUNOGLOBULINS AND USES THEREOF
<b>C07K 16/44</b> (2006.01)	3385279	CARRIER IMMUNOGLOBULINS AND USES THEREOF
<b>C07K 19/00</b> (2006.01)	3385279	CARRIER IMMUNOGLOBULINS AND USES THEREOF
<b>C12P 21/08</b> (2006.01)	3385279	CARRIER IMMUNOGLOBULINS AND USES THEREOF
<b>A61B 17/064</b> (2006.01)	3403593	DEVICES FOR STABILIZING FASTENERS POST-DEPLOYMENT
<b>A61B 17/072</b> (2006.01)	3403593	DEVICES FOR STABILIZING FASTENERS POST-DEPLOYMENT
<b>A61B 90/00</b> (2016.01)	3403593	DEVICES FOR STABILIZING FASTENERS POST-DEPLOYMENT
<b>F24D 19/06</b> (2006.01)	3412977	RADIANT MODULE FOR FORMING A RADIANT BODY

MKP (51)	Broj objave evropske prijava patenta (97)	Naziv pronalaska (54)
<b>A61K 39/00</b> (2006.01)	3388075	NOVEL PEPTIDES AND COMBINATION OF PEPTIDES FOR USE IN IMMUNOTHERAPY AGAINST VARIOUS TUMORS (SEQ ID 25 - MRAX5-003)
<b>C07K 14/47</b> (2006.01)	3388075	NOVEL PEPTIDES AND COMBINATION OF PEPTIDES FOR USE IN IMMUNOTHERAPY AGAINST VARIOUS TUMORS (SEQ ID 25 - MRAX5-003)
<b>A61K 39/00</b> (2006.01)	3388076	NOVEL PEPTIDES AND COMBINATION OF PEPTIDES FOR USE IN IMMUNOTHERAPY AGAINST VARIOUS TUMORS (SEQ ID 274 - IGF-004)
<b>C07K 14/47</b> (2006.01)	3388076	NOVEL PEPTIDES AND COMBINATION OF PEPTIDES FOR USE IN IMMUNOTHERAPY AGAINST VARIOUS TUMORS (SEQ ID 274 - IGF-004)
<b>A61K 39/00</b> (2006.01)	3388077	NOVEL PEPTIDES AND COMBINATION OF PEPTIDES FOR USE IN IMMUNOTHERAPY AGAINST VARIOUS TUMORS (SEQ ID 245 - MAGEA4-003)
<b>C07K 14/47</b> (2006.01)	3388077	NOVEL PEPTIDES AND COMBINATION OF PEPTIDES FOR USE IN IMMUNOTHERAPY AGAINST VARIOUS TUMORS (SEQ ID 245 - MAGEA4-003)
<b>A61K 39/00</b> (2006.01)	3388078	NOVEL PEPTIDES AND COMBINATION OF PEPTIDES FOR USE IN IMMUNOTHERAPY AGAINST VARIOUS TUMORS (SEQ ID 23 - MMP-002)
<b>C07K 14/47</b> (2006.01)	3388078	NOVEL PEPTIDES AND COMBINATION OF PEPTIDES FOR USE IN IMMUNOTHERAPY AGAINST VARIOUS TUMORS (SEQ ID 23 - MMP-002)
<b>A61K 39/00</b> (2006.01)	3388079	NOVEL PEPTIDES AND COMBINATION OF PEPTIDES FOR USE IN IMMUNOTHERAPY AGAINST VARIOUS TUMORS (SEQ ID 253 - RAD54B)
<b>C07K 14/47</b> (2006.01)	3388079	NOVEL PEPTIDES AND COMBINATION OF PEPTIDES FOR USE IN IMMUNOTHERAPY AGAINST VARIOUS TUMORS (SEQ ID 253 - RAD54B)
<b>A61K 39/00</b> (2006.01)	3388080	NOVEL PEPTIDES AND COMBINATION OF PEPTIDES FOR USE IN IMMUNOTHERAPY AGAINST VARIOUS TUMORS (SEQ ID 243 - SPC25-001)
<b>C07K 14/47</b> (2006.01)	3388080	NOVEL PEPTIDES AND COMBINATION OF PEPTIDES FOR USE IN IMMUNOTHERAPY AGAINST VARIOUS TUMORS (SEQ ID 243 - SPC25-001)
<b>A61K 9/00</b> (2006.01)	3384899	PAEDIATRIC SOLUTIONS COMPRISING A BETA-BLOCKER
<b>A61K 31/13</b> (2006.01)	3384899	PAEDIATRIC SOLUTIONS COMPRISING A BETA-BLOCKER
<b>C07H 15/26</b> (2006.01)	3388441	MANNOSE DERIVATIVES FOR TREATING BACTERIAL INFECTIONS
<b>A61P 9/00</b> (2006.01)	3391941	NOVEL CELL-PERMEABLE SUCCINATE COMPOUNDS
<b>A61P 11/00</b> (2006.01)	3391941	NOVEL CELL-PERMEABLE SUCCINATE COMPOUNDS
<b>A61P 21/00</b> (2006.01)	3391941	NOVEL CELL-PERMEABLE SUCCINATE COMPOUNDS
<b>A61P 35/00</b> (2006.01)	3391941	NOVEL CELL-PERMEABLE SUCCINATE COMPOUNDS
<b>C07D 453/02</b> (2006.01)	3401316	CHEMICAL PROCESS
<b>C07D 471/04</b> (2006.01)	3415515	METHOD FOR THE PREPARATION OF METHYL- $\{4,6\}$ -DIAMINO-2- $\{1-(2\text{-FLUOROBENZYL})-1\text{H-PYRAZOLO}[3,4\text{-}B\text{]PYRIDIN-3-YL}\}$ PYRIMIDIN-5-YL}METHYLCARBAMATE
<b>A61K 31/554</b> (2006.01)	3400944	IBAT INHIBITORS FOR THE TREATMENT OF LIVER DISEASES
<b>A61P 1/16</b> (2006.01)	3400944	IBAT INHIBITORS FOR THE TREATMENT OF LIVER DISEASES
<b>C07K 16/00</b> (2006.01)	3415619	IDENTIFICATION OF POLYNUCLEOTIDES ASSOCIATED WITH A SAMPLE
<b>C07K 16/12</b> (2006.01)	3415619	IDENTIFICATION OF POLYNUCLEOTIDES ASSOCIATED WITH A SAMPLE
<b>C12N 5/10</b> (2006.01)	3415619	IDENTIFICATION OF POLYNUCLEOTIDES ASSOCIATED WITH A SAMPLE
<b>G01N 33/68</b> (2006.01)	3415619	IDENTIFICATION OF POLYNUCLEOTIDES ASSOCIATED WITH A SAMPLE
<b>C07D 401/04</b> (2006.01)	3409669	HETEROARYL COMPOUNDS FOR KINASE INHIBITION
<b>C07D 401/14</b> (2006.01)	3409669	HETEROARYL COMPOUNDS FOR KINASE INHIBITION
<b>C07D 403/04</b> (2006.01)	3409669	HETEROARYL COMPOUNDS FOR KINASE INHIBITION
<b>C07D 403/14</b> (2006.01)	3409669	HETEROARYL COMPOUNDS FOR KINASE INHIBITION
<b>C07D 405/12</b> (2006.01)	3409669	HETEROARYL COMPOUNDS FOR KINASE INHIBITION
<b>C07D 405/14</b> (2006.01)	3409669	HETEROARYL COMPOUNDS FOR KINASE INHIBITION
<b>C07D 471/04</b> (2006.01)	3409669	HETEROARYL COMPOUNDS FOR KINASE INHIBITION
<b>A01N 43/54</b> (2006.01)	3406141	COMBINATION THERAPY FOR TREATING CANCER
<b>A61K 31/425</b> (2006.01)	3406141	COMBINATION THERAPY FOR TREATING CANCER
<b>A61K 31/505</b> (2006.01)	3406141	COMBINATION THERAPY FOR TREATING CANCER
<b>A61P 35/00</b> (2006.01)	3406141	COMBINATION THERAPY FOR TREATING CANCER

MKP (51)	Broj objave evropske prijava patenta (97)	Naziv pronalaska (54)
<b>A61K 9/51</b> (2006.01)	3412282	MEMBRANE ENCAPSULATED NANOPARTICLES AND METHOD OF USE
<b>A61K 9/00</b> (2006.01)	3418279	AROMATIC HETEROCYCLIC COMPOUNDS AS ANTIINFLAMMATORY COMPOUNDS
<b>A61K 31/506</b> (2006.01)	3418279	AROMATIC HETEROCYCLIC COMPOUNDS AS ANTIINFLAMMATORY COMPOUNDS
<b>A61K 47/26</b> (2006.01)	3418279	AROMATIC HETEROCYCLIC COMPOUNDS AS ANTIINFLAMMATORY COMPOUNDS
<b>A61P 11/00</b> (2006.01)	3418279	AROMATIC HETEROCYCLIC COMPOUNDS AS ANTIINFLAMMATORY COMPOUNDS
<b>A61P 29/00</b> (2006.01)	3418279	AROMATIC HETEROCYCLIC COMPOUNDS AS ANTIINFLAMMATORY COMPOUNDS
<b>A61P 31/00</b> (2006.01)	3418279	AROMATIC HETEROCYCLIC COMPOUNDS AS ANTIINFLAMMATORY COMPOUNDS
<b>C07D 401/12</b> (2006.01)	3418279	AROMATIC HETEROCYCLIC COMPOUNDS AS ANTIINFLAMMATORY COMPOUNDS
<b>C07D 401/14</b> (2006.01)	3418279	AROMATIC HETEROCYCLIC COMPOUNDS AS ANTIINFLAMMATORY COMPOUNDS
<b>C07D 409/14</b> (2006.01)	3418279	AROMATIC HETEROCYCLIC COMPOUNDS AS ANTIINFLAMMATORY COMPOUNDS
<b>C07D 413/14</b> (2006.01)	3418279	AROMATIC HETEROCYCLIC COMPOUNDS AS ANTIINFLAMMATORY COMPOUNDS
<b>C07D 487/04</b> (2006.01)	3418279	AROMATIC HETEROCYCLIC COMPOUNDS AS ANTIINFLAMMATORY COMPOUNDS
<b>A61K 31/4995</b> (2006.01)	3395820	ANTITUMORAL COMPOUNDS
<b>A61P 35/00</b> (2006.01)	3395820	ANTITUMORAL COMPOUNDS
<b>C07D 515/22</b> (2006.01)	3395820	ANTITUMORAL COMPOUNDS
<b>A61K 31/4995</b> (2006.01)	3395821	ANTITUMORAL COMPOUNDS
<b>A61P 35/00</b> (2006.01)	3395821	ANTITUMORAL COMPOUNDS
<b>C07D 515/22</b> (2006.01)	3395821	ANTITUMORAL COMPOUNDS
<b>C07K 16/18</b> (2006.01)	3411400	TREATMENT OF INFLAMMATORY DISEASES WITH INHIBITORS OF C5A ACTIVITY
<b>G05B 9/02</b> (2006.01)	3299909	SAFETY CIRCUIT FOR THE FAIL-SAFE SHUTDOWN OF A DANGEROUS TECHNICAL INSTALLATION
<b>H01H 47/00</b> (2006.01)	3299909	SAFETY CIRCUIT FOR THE FAIL-SAFE SHUTDOWN OF A DANGEROUS TECHNICAL INSTALLATION
<b>C07K 16/28</b> (2006.01)	3309174	ANTI-PD-L1 ANTIBODIES AND DIAGNOSTIC USES THEREOF
<b>G01N 33/53</b> (2006.01)	3309174	ANTI-PD-L1 ANTIBODIES AND DIAGNOSTIC USES THEREOF
<b>A23C 15/04</b> (2006.01)	3289884	FOOD COMPOSITION BASED ON DAIRY PRODUCTS AND METHOD FOR MANUFACTURING SAME
<b>A23C 15/16</b> (2006.01)	3289884	FOOD COMPOSITION BASED ON DAIRY PRODUCTS AND METHOD FOR MANUFACTURING SAME
<b>A23D 9/00</b> (2006.01)	3289884	FOOD COMPOSITION BASED ON DAIRY PRODUCTS AND METHOD FOR MANUFACTURING SAME
<b>A23D 9/04</b> (2006.01)	3289884	FOOD COMPOSITION BASED ON DAIRY PRODUCTS AND METHOD FOR MANUFACTURING SAME
<b>A23G 3/34</b> (2006.01)	3289884	FOOD COMPOSITION BASED ON DAIRY PRODUCTS AND METHOD FOR MANUFACTURING SAME
<b>A61K 39/00</b> (2006.01)	3305813	ANTIBODIES SPECIFIC FOR CLAUDIN 6 (CLDN6)
<b>A61K 39/395</b> (2006.01)	3305813	ANTIBODIES SPECIFIC FOR CLAUDIN 6 (CLDN6)
<b>A61P 35/00</b> (2006.01)	3305813	ANTIBODIES SPECIFIC FOR CLAUDIN 6 (CLDN6)
<b>C07K 14/705</b> (2006.01)	3305813	ANTIBODIES SPECIFIC FOR CLAUDIN 6 (CLDN6)
<b>C07K 16/28</b> (2006.01)	3305813	ANTIBODIES SPECIFIC FOR CLAUDIN 6 (CLDN6)
<b>C07K 16/30</b> (2006.01)	3305813	ANTIBODIES SPECIFIC FOR CLAUDIN 6 (CLDN6)
<b>C12N 5/00</b> (2006.01)	3318627	CULTURE MEDIA FOR STEM CELLS
<b>C12N 5/071</b> (2010.01)	3318627	CULTURE MEDIA FOR STEM CELLS
<b>C12N 5/09</b> (2010.01)	3318627	CULTURE MEDIA FOR STEM CELLS
<b>G01N 33/50</b> (2006.01)	3318627	CULTURE MEDIA FOR STEM CELLS
<b>A61B 17/072</b> (2006.01)	3275378	TISSUE THICKNESS COMPENSATOR COMPRISING A PLURALITY OF CAPSULES
<b>A61L 31/04</b> (2006.01)	3275378	TISSUE THICKNESS COMPENSATOR COMPRISING A PLURALITY OF CAPSULES
<b>A61L 31/12</b> (2006.01)	3275378	TISSUE THICKNESS COMPENSATOR COMPRISING A PLURALITY OF CAPSULES
<b>A61L 31/14</b> (2006.01)	3275378	TISSUE THICKNESS COMPENSATOR COMPRISING A PLURALITY OF CAPSULES
<b>C07H 5/10</b> (2006.01)	3301102	RIBONUCLEIC ACIDS WITH 4'-THIO-MODIFIED NUCLEOTIDES AND RELATED METHODS



MKP (51)	Broj objave evropske prijava patenta (97)	Naziv pronalaska (54)
<b>C12N 15/11</b> (2006.01)	3301102	RIBONUCLEIC ACIDS WITH 4'-THIO-MODIFIED NUCLEOTIDES AND RELATED METHODS
<b>C12N 15/67</b> (2006.01)	3301102	RIBONUCLEIC ACIDS WITH 4'-THIO-MODIFIED NUCLEOTIDES AND RELATED METHODS
<b>A47J 43/28</b> (2006.01)	3305717	FOOD BAG WORKING TOOL
<b>B67B 7/46</b> (2006.01)	3305717	FOOD BAG WORKING TOOL
<b>A61P 35/02</b> (2006.01)	3284754	ANTI-CD38 ANTIBODIES
<b>C07K 16/28</b> (2006.01)	3284754	ANTI-CD38 ANTIBODIES
<b>G06F 17/50</b> (2006.01)	3293650	METHOD, DEVICE AND COMPUTER PROGRAM TO ASSIST WITH THE SELECTION AND INSTALLATION OF CONSTRUCTION MATERIAL ELEMENTS
<b>C12Q 1/68</b> (2018.01)	3293273	METHOD FOR ASSISTING JUDGMENT OF PROGNOSIS OF BREAST CANCER, AND APPARATUS FOR ASSISTING JUDGMENT OF PROGNOSIS OF BREAST CANCER
<b>C07D 403/12</b> (2006.01)	3299367	BIARYL AMIDE COMPOUNDS AS KINASE INHIBITORS
<b>A61K 38/00</b> (2006.01)	3308796	ACTIVIN-ACTRII ANTAGONISTS AND USES FOR TREATING BONE AND OTHER DISORDERS
<b>A61K 38/17</b> (2006.01)	3308796	ACTIVIN-ACTRII ANTAGONISTS AND USES FOR TREATING BONE AND OTHER DISORDERS
<b>A61K 38/22</b> (2006.01)	3308796	ACTIVIN-ACTRII ANTAGONISTS AND USES FOR TREATING BONE AND OTHER DISORDERS
<b>A61K 38/27</b> (2006.01)	3308796	ACTIVIN-ACTRII ANTAGONISTS AND USES FOR TREATING BONE AND OTHER DISORDERS
<b>A61K 38/29</b> (2006.01)	3308796	ACTIVIN-ACTRII ANTAGONISTS AND USES FOR TREATING BONE AND OTHER DISORDERS
<b>A61P 19/08</b> (2006.01)	3308796	ACTIVIN-ACTRII ANTAGONISTS AND USES FOR TREATING BONE AND OTHER DISORDERS
<b>A61P 19/10</b> (2006.01)	3308796	ACTIVIN-ACTRII ANTAGONISTS AND USES FOR TREATING BONE AND OTHER DISORDERS
<b>C12N 5/00</b> (2006.01)	3305890	REVERSING THE EFFECTS OF THE TUMOR MICROENVIRONMENT USING CHIMERIC CYTOKINE RECEPTORS
<b>A61K 9/00</b> (2006.01)	3351546	LONG-ACTING INJECTABLE MOXIDECTIN FORMULATIONS
<b>A61K 31/365</b> (2006.01)	3351546	LONG-ACTING INJECTABLE MOXIDECTIN FORMULATIONS
<b>A61K 47/34</b> (2017.01)	3351546	LONG-ACTING INJECTABLE MOXIDECTIN FORMULATIONS
<b>A61P 33/00</b> (2006.01)	3351546	LONG-ACTING INJECTABLE MOXIDECTIN FORMULATIONS
<b>C07D 493/22</b> (2006.01)	3351546	LONG-ACTING INJECTABLE MOXIDECTIN FORMULATIONS
<b>A61K 31/4439</b> (2006.01)	3284742	SUBSTITUTED PYRIDINE DERIVATIVES USEFUL AS C-FMS KINASE INHIBITORS
<b>A61P 3/00</b> (2006.01)	3284742	SUBSTITUTED PYRIDINE DERIVATIVES USEFUL AS C-FMS KINASE INHIBITORS
<b>A61P 11/00</b> (2006.01)	3284742	SUBSTITUTED PYRIDINE DERIVATIVES USEFUL AS C-FMS KINASE INHIBITORS
<b>A61P 25/00</b> (2006.01)	3284742	SUBSTITUTED PYRIDINE DERIVATIVES USEFUL AS C-FMS KINASE INHIBITORS
<b>A61P 29/00</b> (2006.01)	3284742	SUBSTITUTED PYRIDINE DERIVATIVES USEFUL AS C-FMS KINASE INHIBITORS
<b>A61P 31/00</b> (2006.01)	3284742	SUBSTITUTED PYRIDINE DERIVATIVES USEFUL AS C-FMS KINASE INHIBITORS
<b>A61P 35/00</b> (2006.01)	3284742	SUBSTITUTED PYRIDINE DERIVATIVES USEFUL AS C-FMS KINASE INHIBITORS
<b>C07D 405/14</b> (2006.01)	3284742	SUBSTITUTED PYRIDINE DERIVATIVES USEFUL AS C-FMS KINASE INHIBITORS
<b>F16B 7/18</b> (2006.01)	3301311	COUPLING
<b>A61K 31/519</b> (2006.01)	3290421	COMBINATION OF PYRROLO [2, 3 -D]PYRIMIDINE DERIVATIVES WITH ONE OR MORE ADDITIONAL AGENTS AS INHIBITORS OF JANUS- RELATED KINASES (JAK)
<b>A61P 37/00</b> (2006.01)	3290421	COMBINATION OF PYRROLO [2, 3 -D]PYRIMIDINE DERIVATIVES WITH ONE OR MORE ADDITIONAL AGENTS AS INHIBITORS OF JANUS- RELATED KINASES (JAK)
<b>C07D 487/04</b> (2006.01)	3290421	COMBINATION OF PYRROLO [2, 3 -D]PYRIMIDINE DERIVATIVES WITH ONE OR MORE ADDITIONAL AGENTS AS INHIBITORS OF JANUS- RELATED KINASES (JAK)
<b>C07D 519/00</b> (2006.01)	3290421	COMBINATION OF PYRROLO [2, 3 -D]PYRIMIDINE DERIVATIVES WITH ONE OR MORE ADDITIONAL AGENTS AS INHIBITORS OF JANUS- RELATED KINASES (JAK)
<b>A61K 39/395</b> (2006.01)	3287142	METHODS FOR TREATING CONDITIONS ASSOCIATED WITH MASP-2 DEPENDENT COMPLEMENT ACTIVATION

MKP (51)	Broj objave evropske prijava patenta (97)	Naziv pronalaska (54)
<b>C07K 16/40</b> (2006.01)	3287142	METHODS FOR TREATING CONDITIONS ASSOCIATED WITH MASP-2 DEPENDENT COMPLEMENT ACTIVATION
<b>C12N 15/11</b> (2006.01)	3287142	METHODS FOR TREATING CONDITIONS ASSOCIATED WITH MASP-2 DEPENDENT COMPLEMENT ACTIVATION
<b>A61K 31/513</b> (2006.01)	3295942	COMBINATIONS COMPRISING 5-PHENOXY-3H-PYRIMIDIN-4-ONE DERIVATIVES AND THEIR USE FOR THE PROPHYLAXIS OR TREATMENT OF INFECTION BY HIV
<b>A61P 31/18</b> (2006.01)	3295942	COMBINATIONS COMPRISING 5-PHENOXY-3H-PYRIMIDIN-4-ONE DERIVATIVES AND THEIR USE FOR THE PROPHYLAXIS OR TREATMENT OF INFECTION BY HIV
<b>A61K 39/00</b> (2006.01)	3305798	USE OF CHIMERIC ANTIGEN RECEPTOR-MODIFIED T CELLS TO TREAT CANCER
<b>C07H 21/04</b> (2006.01)	3305798	USE OF CHIMERIC ANTIGEN RECEPTOR-MODIFIED T CELLS TO TREAT CANCER
<b>B60R 25/021</b> (2013.01)	3296163	SECURED DEVICE FOR BLOCKING AN ESSENTIAL COMPONENT OF A MOTOR VEHICLE
<b>B60R 25/023</b> (2013.01)	3296163	SECURED DEVICE FOR BLOCKING AN ESSENTIAL COMPONENT OF A MOTOR VEHICLE
<b>C07K 16/00</b> (2006.01)	3339322	IMMUNOGLOBULIN SINGLE VARIABLE DOMAIN ANTIBODIES WITH A C-TERMINAL EXTENSION FOR REDUCED IMMUNOGENICITY
<b>C07K 16/22</b> (2006.01)	3339322	IMMUNOGLOBULIN SINGLE VARIABLE DOMAIN ANTIBODIES WITH A C-TERMINAL EXTENSION FOR REDUCED IMMUNOGENICITY
<b>C07K 16/28</b> (2006.01)	3339322	IMMUNOGLOBULIN SINGLE VARIABLE DOMAIN ANTIBODIES WITH A C-TERMINAL EXTENSION FOR REDUCED IMMUNOGENICITY
<b>C07K 16/42</b> (2006.01)	3339322	IMMUNOGLOBULIN SINGLE VARIABLE DOMAIN ANTIBODIES WITH A C-TERMINAL EXTENSION FOR REDUCED IMMUNOGENICITY
<b>B05C 1/04</b> (2006.01)	3273134	DEVICE FOR APPLYING OIL TO A CHAIN OF A TWO-WHEELED VEHICLE, IN PARTICULAR A BICYCLE
<b>B62J 31/00</b> (2006.01)	3273134	DEVICE FOR APPLYING OIL TO A CHAIN OF A TWO-WHEELED VEHICLE, IN PARTICULAR A BICYCLE
<b>F16H 57/05</b> (2006.01)	3273134	DEVICE FOR APPLYING OIL TO A CHAIN OF A TWO-WHEELED VEHICLE, IN PARTICULAR A BICYCLE
<b>F16N 3/04</b> (2006.01)	3273134	DEVICE FOR APPLYING OIL TO A CHAIN OF A TWO-WHEELED VEHICLE, IN PARTICULAR A BICYCLE
<b>F16N 9/00</b> (2006.01)	3273134	DEVICE FOR APPLYING OIL TO A CHAIN OF A TWO-WHEELED VEHICLE, IN PARTICULAR A BICYCLE
<b>A61M 5/142</b> (2006.01)	3287161	LOW-DEAD VOLUME MICROFLUIDIC CIRCUIT AND METHODS
<b>A61M 5/158</b> (2006.01)	3287161	LOW-DEAD VOLUME MICROFLUIDIC CIRCUIT AND METHODS
<b>F15C 5/00</b> (2006.01)	3287161	LOW-DEAD VOLUME MICROFLUIDIC CIRCUIT AND METHODS
<b>F16K 99/00</b> (2006.01)	3287161	LOW-DEAD VOLUME MICROFLUIDIC CIRCUIT AND METHODS
<b>G01L 9/00</b> (2006.01)	3287161	LOW-DEAD VOLUME MICROFLUIDIC CIRCUIT AND METHODS
<b>C11D 1/83</b> (2006.01)	3299445	ADDITIVE COMPOSITION WITH INTEGRATED ACTION
<b>C11D 3/00</b> (2006.01)	3299445	ADDITIVE COMPOSITION WITH INTEGRATED ACTION
<b>C11D 3/22</b> (2006.01)	3299445	ADDITIVE COMPOSITION WITH INTEGRATED ACTION
<b>C11D 3/37</b> (2006.01)	3299445	ADDITIVE COMPOSITION WITH INTEGRATED ACTION
<b>C11D 3/50</b> (2006.01)	3299445	ADDITIVE COMPOSITION WITH INTEGRATED ACTION
<b>C11D 11/00</b> (2006.01)	3299445	ADDITIVE COMPOSITION WITH INTEGRATED ACTION
<b>C11D 17/00</b> (2006.01)	3299445	ADDITIVE COMPOSITION WITH INTEGRATED ACTION
<b>D06F 35/00</b> (2006.01)	3299505	OPTIMIZED METHOD FOR WASHING IN WASHING MACHINES
<b>D06F 39/02</b> (2006.01)	3299505	OPTIMIZED METHOD FOR WASHING IN WASHING MACHINES
<b>A61K 31/44</b> (2006.01)	3293176	CRYSTAL FORM OF A PDE4 INHIBITOR
<b>A61P 11/00</b> (2006.01)	3293176	CRYSTAL FORM OF A PDE4 INHIBITOR
<b>C07D 213/89</b> (2006.01)	3293176	CRYSTAL FORM OF A PDE4 INHIBITOR
<b>B65D 90/00</b> (2006.01)	3305709	A SYSTEM FOR TRANSPORTING AND UNLOADING CONTAINERS FOR GOODS, IN PARTICULAR FOR BULK MATERIAL, A CONTAINER AND A CONTAINER SPREADER
<b>B66C 1/10</b> (2006.01)	3305709	A SYSTEM FOR TRANSPORTING AND UNLOADING CONTAINERS FOR GOODS, IN PARTICULAR FOR BULK MATERIAL, A CONTAINER AND A CONTAINER SPREADER
<b>B66C 1/66</b> (2006.01)	3305709	A SYSTEM FOR TRANSPORTING AND UNLOADING CONTAINERS FOR GOODS, IN PARTICULAR FOR BULK MATERIAL, A CONTAINER AND A CONTAINER SPREADER
<b>B66F 9/065</b> (2006.01)	3305709	A SYSTEM FOR TRANSPORTING AND UNLOADING CONTAINERS FOR GOODS, IN PARTICULAR FOR BULK MATERIAL, A CONTAINER AND A CONTAINER SPREADER
<b>E05B 83/08</b> (2014.01)	3305709	A SYSTEM FOR TRANSPORTING AND UNLOADING CONTAINERS FOR GOODS, IN PARTICULAR FOR BULK MATERIAL, A CONTAINER AND A CONTAINER SPREADER

MKP (51)	Broj objave evropske prijava patenta (97)	Naziv pronalaska (54)
<b>A21D 6/00</b> (2006.01)	3305078	NEW METHOD FOR MAKING (FERMENTED) BAKERY PRODUCTS
<b>A21D 8/02</b> (2006.01)	3305078	NEW METHOD FOR MAKING (FERMENTED) BAKERY PRODUCTS
<b>A21D 8/04</b> (2006.01)	3305078	NEW METHOD FOR MAKING (FERMENTED) BAKERY PRODUCTS
<b>A61K 31/506</b> (2006.01)	3323818	MODULATORS OF THE GPR119 RECEPTOR AND THE TREATMENT OF DISORDERS RELATED THERETO
<b>A61P 3/00</b> (2006.01)	3323818	MODULATORS OF THE GPR119 RECEPTOR AND THE TREATMENT OF DISORDERS RELATED THERETO
<b>C07D 413/14</b> (2006.01)	3323818	MODULATORS OF THE GPR119 RECEPTOR AND THE TREATMENT OF DISORDERS RELATED THERETO
<b>A61K 39/395</b> (2006.01)	3299390	METHODS OF TREATING PSORIASIS USING IL-17 ANTAGONISTS
<b>C07K 16/24</b> (2006.01)	3299390	METHODS OF TREATING PSORIASIS USING IL-17 ANTAGONISTS
<b>A61K 39/395</b> (2006.01)	3295957	ANTIBODY FORMULATION AND THERAPEUTIC REGIMENS
<b>A61P 17/06</b> (2006.01)	3295957	ANTIBODY FORMULATION AND THERAPEUTIC REGIMENS
<b>C07K 16/28</b> (2006.01)	3295957	ANTIBODY FORMULATION AND THERAPEUTIC REGIMENS
<b>E04H 4/08</b> (2006.01)	3312364	MOTOR ASSEMBLY INCLUDING AT LEAST ONE GEAR MOTOR UNIT
<b>E04H 4/10</b> (2006.01)	3312364	MOTOR ASSEMBLY INCLUDING AT LEAST ONE GEAR MOTOR UNIT
<b>G01B 7/16</b> (2006.01)	3312550	STRAIN GAUGE
<b>G01L 1/22</b> (2006.01)	3312550	STRAIN GAUGE
<b>H01C 17/24</b> (2006.01)	3312550	STRAIN GAUGE
<b>A47C 7/38</b> (2006.01)	3308675	ANGLE-ADJUSTER FOR A HEADREST
<b>B60N 2/838</b> (2018.01)	3308675	ANGLE-ADJUSTER FOR A HEADREST
<b>B60B 17/00</b> (2006.01)	3309358	CARRYING WHEEL ASSEMBLY
<b>B61F 9/00</b> (2006.01)	3309358	CARRYING WHEEL ASSEMBLY
<b>E21D 11/10</b> (2006.01)	3309358	CARRYING WHEEL ASSEMBLY
<b>A61B 18/14</b> (2006.01)	3308730	CATHETER WITH ANGLED IRRIGATION HOLES
<b>A61K 39/395</b> (2006.01)	3299391	ANTI-B7-H4 ANTIBODIES AND IMMUNOCONJUGATES
<b>A61P 35/00</b> (2006.01)	3299391	ANTI-B7-H4 ANTIBODIES AND IMMUNOCONJUGATES
<b>C07K 16/28</b> (2006.01)	3299391	ANTI-B7-H4 ANTIBODIES AND IMMUNOCONJUGATES
<b>A61K 8/02</b> (2006.01)	3315116	TOPICAL SUNSCREEN COMPOSITION, METHOD OF PREPARATION, AND USE THEREOF
<b>A61K 8/19</b> (2006.01)	3315116	TOPICAL SUNSCREEN COMPOSITION, METHOD OF PREPARATION, AND USE THEREOF
<b>A61K 8/27</b> (2006.01)	3315116	TOPICAL SUNSCREEN COMPOSITION, METHOD OF PREPARATION, AND USE THEREOF
<b>A61K 8/29</b> (2006.01)	3315116	TOPICAL SUNSCREEN COMPOSITION, METHOD OF PREPARATION, AND USE THEREOF
<b>A61K 8/85</b> (2006.01)	3315116	TOPICAL SUNSCREEN COMPOSITION, METHOD OF PREPARATION, AND USE THEREOF
<b>A61Q 17/04</b> (2006.01)	3315116	TOPICAL SUNSCREEN COMPOSITION, METHOD OF PREPARATION, AND USE THEREOF
<b>A61K 9/00</b> (2006.01)	3311800	COMPOSITION COMPRISING MICROSTRUCTURES FOR THE CONTROLLED RELEASE OF OZONIZED OIL
<b>A61K 9/107</b> (2006.01)	3311800	COMPOSITION COMPRISING MICROSTRUCTURES FOR THE CONTROLLED RELEASE OF OZONIZED OIL
<b>A61K 9/50</b> (2006.01)	3311800	COMPOSITION COMPRISING MICROSTRUCTURES FOR THE CONTROLLED RELEASE OF OZONIZED OIL
<b>A61K 36/28</b> (2006.01)	3311800	COMPOSITION COMPRISING MICROSTRUCTURES FOR THE CONTROLLED RELEASE OF OZONIZED OIL
<b>A61K 31/19</b> (2006.01)	3312169	5-HT3 RECEPTOR ANTAGONISTS
<b>A61K 31/5386</b> (2006.01)	3312169	5-HT3 RECEPTOR ANTAGONISTS
<b>C07C 53/18</b> (2006.01)	3312169	5-HT3 RECEPTOR ANTAGONISTS
<b>C07C 53/40</b> (2006.01)	3312169	5-HT3 RECEPTOR ANTAGONISTS
<b>C07D 221/22</b> (2006.01)	3312169	5-HT3 RECEPTOR ANTAGONISTS
<b>C07D 401/04</b> (2006.01)	3312169	5-HT3 RECEPTOR ANTAGONISTS
<b>C07D 401/12</b> (2006.01)	3312169	5-HT3 RECEPTOR ANTAGONISTS
<b>C07D 401/14</b> (2006.01)	3312169	5-HT3 RECEPTOR ANTAGONISTS
<b>C07D 403/04</b> (2006.01)	3312169	5-HT3 RECEPTOR ANTAGONISTS
<b>C07D 451/12</b> (2006.01)	3312169	5-HT3 RECEPTOR ANTAGONISTS
<b>C07D 453/02</b> (2006.01)	3312169	5-HT3 RECEPTOR ANTAGONISTS
<b>C07D 471/02</b> (2006.01)	3312169	5-HT3 RECEPTOR ANTAGONISTS
<b>C07D 471/04</b> (2006.01)	3312169	5-HT3 RECEPTOR ANTAGONISTS
<b>C07D 471/08</b> (2006.01)	3312169	5-HT3 RECEPTOR ANTAGONISTS
<b>C07D 487/14</b> (2006.01)	3312169	5-HT3 RECEPTOR ANTAGONISTS
<b>C07D 498/08</b> (2006.01)	3312169	5-HT3 RECEPTOR ANTAGONISTS
<b>C07D 519/00</b> (2006.01)	3312169	5-HT3 RECEPTOR ANTAGONISTS
<b>E04B 5/38</b> (2006.01)	3315682	FORMWORK ELEMENT AND METHOD FOR MANUFACTURING A CEILING

MKP (51)	Broj objave evropske prijava patenta (97)	Naziv pronalaska (54)
<b>E04B 5/48</b> (2006.01)	3315682	FORMWORK ELEMENT AND METHOD FOR MANUFACTURING A CEILING
<b>E04B 9/00</b> (2006.01)	3315682	FORMWORK ELEMENT AND METHOD FOR MANUFACTURING A CEILING
<b>H04L 29/08</b> (2006.01)	3319301	COMPUTER-IMPLEMENTED METHOD AND COMPUTER SYSTEM FOR DISTRIBUTING PUSH NOTIFICATIONS
<b>A01N 31/16</b> (2006.01)	3318125	ANTIFUNGAL COMPOSITION
<b>A01N 45/00</b> (2006.01)	3318125	ANTIFUNGAL COMPOSITION
<b>A01P 3/00</b> (2006.01)	3318125	ANTIFUNGAL COMPOSITION
<b>A41B 9/02</b> (2006.01)	3320793	MEN'S UNDERGARMENT
<b>A61K 35/744</b> (2015.01)	3402499	COMPOSITIONS AND METHODS FOR THE TREATMENT OF TYPE 1 DIABETES
<b>A61K 38/20</b> (2006.01)	3402499	COMPOSITIONS AND METHODS FOR THE TREATMENT OF TYPE 1 DIABETES
<b>A61K 39/00</b> (2006.01)	3402499	COMPOSITIONS AND METHODS FOR THE TREATMENT OF TYPE 1 DIABETES
<b>A61P 3/10</b> (2006.01)	3402499	COMPOSITIONS AND METHODS FOR THE TREATMENT OF TYPE 1 DIABETES
<b>A61P 37/06</b> (2006.01)	3402499	COMPOSITIONS AND METHODS FOR THE TREATMENT OF TYPE 1 DIABETES
<b>C12N 1/00</b> (2006.01)	3402499	COMPOSITIONS AND METHODS FOR THE TREATMENT OF TYPE 1 DIABETES
<b>C12N 1/20</b> (2006.01)	3402499	COMPOSITIONS AND METHODS FOR THE TREATMENT OF TYPE 1 DIABETES
<b>C12N 15/09</b> (2006.01)	3402499	COMPOSITIONS AND METHODS FOR THE TREATMENT OF TYPE 1 DIABETES
<b>C12R 1/01</b> (2006.01)	3402499	COMPOSITIONS AND METHODS FOR THE TREATMENT OF TYPE 1 DIABETES
<b>A61K 51/04</b> (2006.01)	3411083	TAU PET IMAGING LIGANDS
<b>A61K 101/02</b> (2006.01)	3411083	TAU PET IMAGING LIGANDS
<b>C07B 59/00</b> (2006.01)	3411083	TAU PET IMAGING LIGANDS
<b>C07D 401/14</b> (2006.01)	3411083	TAU PET IMAGING LIGANDS
<b>A61K 31/4439</b> (2006.01)	3402791	SUBSTITUTED THIOHYDANTOIN DERIVATIVES AS ANDROGEN RECEPTOR ANTAGONISTS
<b>A61P 35/00</b> (2006.01)	3402791	SUBSTITUTED THIOHYDANTOIN DERIVATIVES AS ANDROGEN RECEPTOR ANTAGONISTS
<b>C07D 401/04</b> (2006.01)	3402791	SUBSTITUTED THIOHYDANTOIN DERIVATIVES AS ANDROGEN RECEPTOR ANTAGONISTS
<b>C07D 401/14</b> (2006.01)	3402791	SUBSTITUTED THIOHYDANTOIN DERIVATIVES AS ANDROGEN RECEPTOR ANTAGONISTS
<b>C07D 405/14</b> (2006.01)	3402791	SUBSTITUTED THIOHYDANTOIN DERIVATIVES AS ANDROGEN RECEPTOR ANTAGONISTS
<b>C07D 409/14</b> (2006.01)	3402791	SUBSTITUTED THIOHYDANTOIN DERIVATIVES AS ANDROGEN RECEPTOR ANTAGONISTS
<b>C07D 413/14</b> (2006.01)	3402791	SUBSTITUTED THIOHYDANTOIN DERIVATIVES AS ANDROGEN RECEPTOR ANTAGONISTS
<b>C07D 451/02</b> (2006.01)	3402791	SUBSTITUTED THIOHYDANTOIN DERIVATIVES AS ANDROGEN RECEPTOR ANTAGONISTS
<b>C07D 451/06</b> (2006.01)	3402791	SUBSTITUTED THIOHYDANTOIN DERIVATIVES AS ANDROGEN RECEPTOR ANTAGONISTS
<b>C07D 487/04</b> (2006.01)	3402791	SUBSTITUTED THIOHYDANTOIN DERIVATIVES AS ANDROGEN RECEPTOR ANTAGONISTS
<b>C07D 491/044</b> (2006.01)	3402791	SUBSTITUTED THIOHYDANTOIN DERIVATIVES AS ANDROGEN RECEPTOR ANTAGONISTS
<b>C07D 491/048</b> (2006.01)	3402791	SUBSTITUTED THIOHYDANTOIN DERIVATIVES AS ANDROGEN RECEPTOR ANTAGONISTS
<b>A61K 48/00</b> (2006.01)	3400023	THERAPEUTIC MRNAS ENCODING ANTI CTLA-4 ANTIBODIES
<b>C07K 16/28</b> (2006.01)	3400023	THERAPEUTIC MRNAS ENCODING ANTI CTLA-4 ANTIBODIES
<b>A61P 7/02</b> (2006.01)	3405498	ANTI-COAGULATION FACTOR XI ANTIBODIES
<b>C07K 16/36</b> (2006.01)	3405498	ANTI-COAGULATION FACTOR XI ANTIBODIES
<b>C07K 16/28</b> (2006.01)	3411402	BCMA AND CD3 BISPECIFIC T CELL ENGAGING ANTIBODY CONSTRUCTS
<b>C07K 16/28</b> (2006.01)	3411403	BISPECIFIC T CELL ENGAGING ANTIBODY CONSTRUCTS
<b>C07K 16/30</b> (2006.01)	3411403	BISPECIFIC T CELL ENGAGING ANTIBODY CONSTRUCTS
<b>A23L 2/54</b> (2006.01)	3411336	INSTALLATION FOR THE PREPARATION OF AN AQUEOUS SOLUTION COMPRISING AT LEAST ONE EARTH ALKALI HYDROGEN CARBONATE

MKP (51)	Broj objave evropske prijava patenta (97)	Naziv pronalaska (54)
<b>C02F 1/44</b> (2006.01)	3411336	INSTALLATION FOR THE PREPARATION OF AN AQUEOUS SOLUTION COMPRISING AT LEAST ONE EARTH ALKALI HYDROGEN CARBONATE
<b>C02F 1/66</b> (2006.01)	3411336	INSTALLATION FOR THE PREPARATION OF AN AQUEOUS SOLUTION COMPRISING AT LEAST ONE EARTH ALKALI HYDROGEN CARBONATE
<b>C02F 1/68</b> (2006.01)	3411336	INSTALLATION FOR THE PREPARATION OF AN AQUEOUS SOLUTION COMPRISING AT LEAST ONE EARTH ALKALI HYDROGEN CARBONATE
<b>A61K 31/5377</b> (2006.01)	3408261	CRYSTALLINE FORM OF 1,3-THIAZOL-5-YLMETHYL [(2R,5R)-5-[(2S)-2-[(METHYL[[2-(PROPAN-2-YL)-1,3-THIAZOL-4-YL]METHYL]CARBAMOYL)AMINO]-4-(MORPHOLIN-4-YL)BUTANOYL 9AMINO]-1,6-DIPHENYLHEXAN-2-YL]CARBAMATE OR COBICISTAT
<b>A61K 45/06</b> (2006.01)	3408261	CRYSTALLINE FORM OF 1,3-THIAZOL-5-YLMETHYL [(2R,5R)-5-[(2S)-2-[(METHYL[[2-(PROPAN-2-YL)-1,3-THIAZOL-4-YL]METHYL]CARBAMOYL)AMINO]-4-(MORPHOLIN-4-YL)BUTANOYL 9AMINO]-1,6-DIPHENYLHEXAN-2-YL]CARBAMATE OR COBICISTAT
<b>C07D 277/28</b> (2006.01)	3408261	CRYSTALLINE FORM OF 1,3-THIAZOL-5-YLMETHYL [(2R,5R)-5-[(2S)-2-[(METHYL[[2-(PROPAN-2-YL)-1,3-THIAZOL-4-YL]METHYL]CARBAMOYL)AMINO]-4-(MORPHOLIN-4-YL)BUTANOYL 9AMINO]-1,6-DIPHENYLHEXAN-2-YL]CARBAMATE OR COBICISTAT
<b>C07K 16/18</b> (2006.01)	3408291	ANTI-C5 ANTIBODIES WITH ENHANCED PH SWITCH
<b>C07K 16/40</b> (2006.01)	3408291	ANTI-C5 ANTIBODIES WITH ENHANCED PH SWITCH
<b>A61K 31/4184</b> (2006.01)	3408268	BENZIMIDAZOLE DERIVATIVES AS MODULATORS OF ROR-GAMMA
<b>A61K 31/4433</b> (2006.01)	3408268	BENZIMIDAZOLE DERIVATIVES AS MODULATORS OF ROR-GAMMA
<b>A61P 17/06</b> (2006.01)	3408268	BENZIMIDAZOLE DERIVATIVES AS MODULATORS OF ROR-GAMMA
<b>A61P 25/00</b> (2006.01)	3408268	BENZIMIDAZOLE DERIVATIVES AS MODULATORS OF ROR-GAMMA
<b>A61P 29/00</b> (2006.01)	3408268	BENZIMIDAZOLE DERIVATIVES AS MODULATORS OF ROR-GAMMA
<b>A61P 35/00</b> (2006.01)	3408268	BENZIMIDAZOLE DERIVATIVES AS MODULATORS OF ROR-GAMMA
<b>C07D 233/88</b> (2006.01)	3408268	BENZIMIDAZOLE DERIVATIVES AS MODULATORS OF ROR-GAMMA
<b>C07D 233/90</b> (2006.01)	3408268	BENZIMIDAZOLE DERIVATIVES AS MODULATORS OF ROR-GAMMA
<b>C07D 405/06</b> (2006.01)	3408268	BENZIMIDAZOLE DERIVATIVES AS MODULATORS OF ROR-GAMMA
<b>C07D 405/14</b> (2006.01)	3408268	BENZIMIDAZOLE DERIVATIVES AS MODULATORS OF ROR-GAMMA
<b>C07D 471/04</b> (2006.01)	3408268	BENZIMIDAZOLE DERIVATIVES AS MODULATORS OF ROR-GAMMA
<b>A61K 31/519</b> (2006.01)	3411497	COPANLISIB BIOMARKERS
<b>C12Q 1/68</b> (2018.01)	3411497	COPANLISIB BIOMARKERS
<b>A61K 31/519</b> (2006.01)	3411498	COPANLISIB BIOMARKERS
<b>C12Q 1/68</b> (2018.01)	3411498	COPANLISIB BIOMARKERS
<b>C07K 16/28</b> (2006.01)	3411404	PSMA AND CD3 BISPECIFIC T CELL ENGAGING ANTIBODY CONSTRUCTS
<b>C07K 16/30</b> (2006.01)	3411404	PSMA AND CD3 BISPECIFIC T CELL ENGAGING ANTIBODY CONSTRUCTS
<b>C09C 1/02</b> (2006.01)	3417013	PROCESS FOR MANUFACTURING WHITE PIGMENT CONTAINING PRODUCTS
<b>C09C 1/40</b> (2006.01)	3417013	PROCESS FOR MANUFACTURING WHITE PIGMENT CONTAINING PRODUCTS
<b>C09C 1/42</b> (2006.01)	3417013	PROCESS FOR MANUFACTURING WHITE PIGMENT CONTAINING PRODUCTS
<b>D21H 17/00</b> (2006.01)	3417013	PROCESS FOR MANUFACTURING WHITE PIGMENT CONTAINING PRODUCTS
<b>A61K 9/00</b> (2006.01)	3405173	PREPARATION OF MICRONIZED PARTICLES OF AN ANTIMUSCARINIC COMPOUND BY HYDRODYNAMIC CAVITATION
<b>A61K 9/14</b> (2006.01)	3405173	PREPARATION OF MICRONIZED PARTICLES OF AN ANTIMUSCARINIC COMPOUND BY HYDRODYNAMIC CAVITATION
<b>A61K 9/50</b> (2006.01)	3405173	PREPARATION OF MICRONIZED PARTICLES OF AN ANTIMUSCARINIC COMPOUND BY HYDRODYNAMIC CAVITATION
<b>A61K 31/40</b> (2006.01)	3405173	PREPARATION OF MICRONIZED PARTICLES OF AN ANTIMUSCARINIC COMPOUND BY HYDRODYNAMIC CAVITATION
<b>A61J 1/00</b> (2006.01)	3414170	HEALTHCARE PRODUCT PACKAGE
<b>B65D 5/00</b> (2006.01)	3414170	HEALTHCARE PRODUCT PACKAGE
<b>B65D 5/42</b> (2006.01)	3414170	HEALTHCARE PRODUCT PACKAGE
<b>G09F 3/00</b> (2006.01)	3414170	HEALTHCARE PRODUCT PACKAGE
<b>C09C 1/02</b> (2006.01)	3417014	PROCESS FOR MANUFACTURING WHITE PIGMENT CONTAINING PRODUCTS
<b>C09C 1/40</b> (2006.01)	3417014	PROCESS FOR MANUFACTURING WHITE PIGMENT CONTAINING PRODUCTS
<b>C09C 1/42</b> (2006.01)	3417014	PROCESS FOR MANUFACTURING WHITE PIGMENT CONTAINING PRODUCTS

MKP (51)	Broj objave evropske prijava patenta (97)	Naziv pronalaska (54)
<b>A61K 31/56</b> (2006.01)	3411381	C-3 AND C-17 MODIFIED TRITERPENOIDS AS HIV-1 INHIBITORS
<b>A61K 31/575</b> (2006.01)	3411381	C-3 AND C-17 MODIFIED TRITERPENOIDS AS HIV-1 INHIBITORS
<b>A61K 31/58</b> (2006.01)	3411381	C-3 AND C-17 MODIFIED TRITERPENOIDS AS HIV-1 INHIBITORS
<b>A61P 31/18</b> (2006.01)	3411381	C-3 AND C-17 MODIFIED TRITERPENOIDS AS HIV-1 INHIBITORS
<b>C07J 63/00</b> (2006.01)	3411381	C-3 AND C-17 MODIFIED TRITERPENOIDS AS HIV-1 INHIBITORS
<b>C12N 9/50</b> (2006.01)	3411381	C-3 AND C-17 MODIFIED TRITERPENOIDS AS HIV-1 INHIBITORS
<b>A61K 31/535</b> (2006.01)	3408271	MAYTANSINOID DERIVATIVES, CONJUGATES THEREOF, AND METHODS OF USE
<b>A61P 35/00</b> (2006.01)	3408271	MAYTANSINOID DERIVATIVES, CONJUGATES THEREOF, AND METHODS OF USE
<b>C07D 498/18</b> (2006.01)	3408271	MAYTANSINOID DERIVATIVES, CONJUGATES THEREOF, AND METHODS OF USE
<b>A61K 47/68</b> (2017.01)	3411406	MULTISPECIFIC ANTIGEN-BINDING MOLECULE WITH IMPROVED INTERNALIZATION CHARACTERISTICS
<b>A61P 35/00</b> (2006.01)	3411406	MULTISPECIFIC ANTIGEN-BINDING MOLECULE WITH IMPROVED INTERNALIZATION CHARACTERISTICS
<b>C07K 16/28</b> (2006.01)	3411406	MULTISPECIFIC ANTIGEN-BINDING MOLECULE WITH IMPROVED INTERNALIZATION CHARACTERISTICS
<b>C07K 16/32</b> (2006.01)	3411406	MULTISPECIFIC ANTIGEN-BINDING MOLECULE WITH IMPROVED INTERNALIZATION CHARACTERISTICS
<b>A23L 2/54</b> (2006.01)	3411337	PROCESS FOR THE PREPARATION OF AN AQUEOUS SOLUTION COMPRISING AT LEAST ONE EARTH ALKALI HYDROGEN CARBONATE
<b>B01D 61/14</b> (2006.01)	3411337	PROCESS FOR THE PREPARATION OF AN AQUEOUS SOLUTION COMPRISING AT LEAST ONE EARTH ALKALI HYDROGEN CARBONATE
<b>C02F 1/44</b> (2006.01)	3411337	PROCESS FOR THE PREPARATION OF AN AQUEOUS SOLUTION COMPRISING AT LEAST ONE EARTH ALKALI HYDROGEN CARBONATE
<b>C02F 1/66</b> (2006.01)	3411337	PROCESS FOR THE PREPARATION OF AN AQUEOUS SOLUTION COMPRISING AT LEAST ONE EARTH ALKALI HYDROGEN CARBONATE
<b>C02F 1/68</b> (2006.01)	3411337	PROCESS FOR THE PREPARATION OF AN AQUEOUS SOLUTION COMPRISING AT LEAST ONE EARTH ALKALI HYDROGEN CARBONATE
<b>A61K 31/496</b> (2006.01)	3414228	CHEMICAL COMPOUNDS AS INHIBITORS OF KINASE ACTIVITY
<b>A61P 9/00</b> (2006.01)	3414228	CHEMICAL COMPOUNDS AS INHIBITORS OF KINASE ACTIVITY
<b>A61P 11/00</b> (2006.01)	3414228	CHEMICAL COMPOUNDS AS INHIBITORS OF KINASE ACTIVITY
<b>A61P 15/08</b> (2006.01)	3414228	CHEMICAL COMPOUNDS AS INHIBITORS OF KINASE ACTIVITY
<b>A61P 25/24</b> (2006.01)	3414228	CHEMICAL COMPOUNDS AS INHIBITORS OF KINASE ACTIVITY
<b>A61P 25/28</b> (2006.01)	3414228	CHEMICAL COMPOUNDS AS INHIBITORS OF KINASE ACTIVITY
<b>A61P 37/08</b> (2006.01)	3414228	CHEMICAL COMPOUNDS AS INHIBITORS OF KINASE ACTIVITY
<b>C07D 213/76</b> (2006.01)	3414228	CHEMICAL COMPOUNDS AS INHIBITORS OF KINASE ACTIVITY
<b>A61K 47/68</b> (2017.01)	3413923	PYRROLOBENZODIAZEPINE CONJUGATES
<b>A61K 31/7084</b> (2006.01)	3402801	CYCLIC DINUCLEOTIDES FOR TREATING CONDITIONS ASSOCIATED WITH STING ACTIVITY SUCH AS CANCER
<b>A61P 35/00</b> (2006.01)	3402801	CYCLIC DINUCLEOTIDES FOR TREATING CONDITIONS ASSOCIATED WITH STING ACTIVITY SUCH AS CANCER
<b>C07H 21/00</b> (2006.01)	3402801	CYCLIC DINUCLEOTIDES FOR TREATING CONDITIONS ASSOCIATED WITH STING ACTIVITY SUCH AS CANCER
<b>A61K 31/197</b> (2006.01)	3411026	USE OF sGC STIMULATORS FOR THE TREATMENT OF NONALCOHOLIC STEATOHEPATITIS (NASH)
<b>A61K 31/198</b> (2006.01)	3411026	USE OF sGC STIMULATORS FOR THE TREATMENT OF NONALCOHOLIC STEATOHEPATITIS (NASH)
<b>A61K 31/506</b> (2006.01)	3411026	USE OF sGC STIMULATORS FOR THE TREATMENT OF NONALCOHOLIC STEATOHEPATITIS (NASH)
<b>A61K 31/5377</b> (2006.01)	3411026	USE OF sGC STIMULATORS FOR THE TREATMENT OF NONALCOHOLIC STEATOHEPATITIS (NASH)
<b>A61P 1/16</b> (2006.01)	3411026	USE OF sGC STIMULATORS FOR THE TREATMENT OF NONALCOHOLIC STEATOHEPATITIS (NASH)
<b>A61K 47/68</b> (2017.01)	3411075	GCC-TARGETED ANTIBODY-DRUG CONJUGATES
<b>A61P 35/00</b> (2006.01)	3411075	GCC-TARGETED ANTIBODY-DRUG CONJUGATES
<b>C07K 16/30</b> (2006.01)	3411075	GCC-TARGETED ANTIBODY-DRUG CONJUGATES
<b>C07K 16/40</b> (2006.01)	3411075	GCC-TARGETED ANTIBODY-DRUG CONJUGATES
<b>G07F 17/32</b> (2006.01)	3403249	ROULETTE WHEEL BIAS TRACKING
<b>A41G 3/00</b> (2006.01)	3407746	HAIR BAND WITH HAIR CARRYING STRIPS
<b>A41G 5/00</b> (2006.01)	3407746	HAIR BAND WITH HAIR CARRYING STRIPS
<b>A45D 8/36</b> (2006.01)	3407746	HAIR BAND WITH HAIR CARRYING STRIPS

MKP (51)	Broj objave evropske prijava patenta (97)	Naziv pronalaska (54)
<b>F41H 5/04</b> (2006.01)	3362761	BALLISTIC PROTECTION MATERIAL AND USE THEREOF
<b>A01N 37/06</b> (2006.01)	3405032	PLANT EXTRACT ACTING AS ANTIFUNGAL AGENT, AND PREPARATION METHOD
<b>A01N 65/12</b> (2009.01)	3405032	PLANT EXTRACT ACTING AS ANTIFUNGAL AGENT, AND PREPARATION METHOD
<b>A01P 3/00</b> (2006.01)	3405032	PLANT EXTRACT ACTING AS ANTIFUNGAL AGENT, AND PREPARATION METHOD
<b>A61K 31/4985</b> (2006.01)	3414249	PDE1 INHIBITOR
<b>A61P 7/12</b> (2006.01)	3414249	PDE1 INHIBITOR
<b>A61P 9/12</b> (2006.01)	3414249	PDE1 INHIBITOR
<b>A61K 13/12</b> (2006.01)	3414249	PDE1 INHIBITOR
<b>C07D 487/04</b> (2006.01)	3414249	PDE1 INHIBITOR
<b>A01K 67/027</b> (2006.01)	3411392	NON-HUMAN ANIMALS HAVING AN ENGINEERED ANGPTL8 GENE
<b>A61K 39/00</b> (2006.01)	3411392	NON-HUMAN ANIMALS HAVING AN ENGINEERED ANGPTL8 GENE
<b>A61K 49/00</b> (2006.01)	3411392	NON-HUMAN ANIMALS HAVING AN ENGINEERED ANGPTL8 GENE
<b>C07K 14/515</b> (2006.01)	3411392	NON-HUMAN ANIMALS HAVING AN ENGINEERED ANGPTL8 GENE
<b>C07K 16/22</b> (2006.01)	3411392	NON-HUMAN ANIMALS HAVING AN ENGINEERED ANGPTL8 GENE
<b>A61P 29/00</b> (2006.01)	3416948	SULFONYLUREAS AND RELATED COMPOUNDS AND USE OF SAME
<b>C07C 307/06</b> (2006.01)	3416948	SULFONYLUREAS AND RELATED COMPOUNDS AND USE OF SAME
<b>C07C 307/08</b> (2006.01)	3416948	SULFONYLUREAS AND RELATED COMPOUNDS AND USE OF SAME
<b>C07C 307/10</b> (2006.01)	3416948	SULFONYLUREAS AND RELATED COMPOUNDS AND USE OF SAME
<b>C07D 231/18</b> (2006.01)	3416948	SULFONYLUREAS AND RELATED COMPOUNDS AND USE OF SAME
<b>C07D 295/26</b> (2006.01)	3416948	SULFONYLUREAS AND RELATED COMPOUNDS AND USE OF SAME
<b>A61K 31/4745</b> (2006.01)	3416946	TETRACYCLIC PYRIDONE COMPOUNDS AS ANTIVIRALS
<b>A61P 31/12</b> (2006.01)	3416946	TETRACYCLIC PYRIDONE COMPOUNDS AS ANTIVIRALS
<b>C07D 217/08</b> (2006.01)	3416946	TETRACYCLIC PYRIDONE COMPOUNDS AS ANTIVIRALS
<b>C07D 491/14</b> (2006.01)	3416946	TETRACYCLIC PYRIDONE COMPOUNDS AS ANTIVIRALS
<b>A61K 31/435</b> (2006.01)	3411358	SUBSTITUTED PIPERIDINE COMPOUND AND USE THEREOF
<b>A61P 3/04</b> (2006.01)	3411358	SUBSTITUTED PIPERIDINE COMPOUND AND USE THEREOF
<b>C07D 211/36</b> (2006.01)	3411358	SUBSTITUTED PIPERIDINE COMPOUND AND USE THEREOF
<b>C07D 403/12</b> (2006.01)	3414239	INHIBITORS OF RECEPTOR-INTERACTING PROTEIN KINASE 1
<b>A61K 31/4192</b> (2006.01)	3414233	SUBSTITUTED 1,2,3-TRIAZOLES AS NR2B-SELECTIVE NMDA MODULATORS
<b>A61P 9/10</b> (2006.01)	3414233	SUBSTITUTED 1,2,3-TRIAZOLES AS NR2B-SELECTIVE NMDA MODULATORS
<b>A61P 25/02</b> (2006.01)	3414233	SUBSTITUTED 1,2,3-TRIAZOLES AS NR2B-SELECTIVE NMDA MODULATORS
<b>A61P 25/04</b> (2006.01)	3414233	SUBSTITUTED 1,2,3-TRIAZOLES AS NR2B-SELECTIVE NMDA MODULATORS
<b>A61P 25/06</b> (2006.01)	3414233	SUBSTITUTED 1,2,3-TRIAZOLES AS NR2B-SELECTIVE NMDA MODULATORS
<b>A61P 25/16</b> (2006.01)	3414233	SUBSTITUTED 1,2,3-TRIAZOLES AS NR2B-SELECTIVE NMDA MODULATORS
<b>A61P 25/24</b> (2006.01)	3414233	SUBSTITUTED 1,2,3-TRIAZOLES AS NR2B-SELECTIVE NMDA MODULATORS
<b>A61P 25/28</b> (2006.01)	3414233	SUBSTITUTED 1,2,3-TRIAZOLES AS NR2B-SELECTIVE NMDA MODULATORS
<b>A61P 25/30</b> (2006.01)	3414233	SUBSTITUTED 1,2,3-TRIAZOLES AS NR2B-SELECTIVE NMDA MODULATORS
<b>C07D 401/12</b> (2006.01)	3414233	SUBSTITUTED 1,2,3-TRIAZOLES AS NR2B-SELECTIVE NMDA MODULATORS
<b>C07D 401/14</b> (2006.01)	3414233	SUBSTITUTED 1,2,3-TRIAZOLES AS NR2B-SELECTIVE NMDA MODULATORS
<b>C07D 403/12</b> (2006.01)	3414233	SUBSTITUTED 1,2,3-TRIAZOLES AS NR2B-SELECTIVE NMDA MODULATORS
<b>C07D 403/14</b> (2006.01)	3414233	SUBSTITUTED 1,2,3-TRIAZOLES AS NR2B-SELECTIVE NMDA MODULATORS
<b>C07D 405/14</b> (2006.01)	3414233	SUBSTITUTED 1,2,3-TRIAZOLES AS NR2B-SELECTIVE NMDA MODULATORS
<b>C07D 409/14</b> (2006.01)	3414233	SUBSTITUTED 1,2,3-TRIAZOLES AS NR2B-SELECTIVE NMDA MODULATORS
<b>A61K 31/519</b> (2006.01)	3411375	PYRAZOLE DERIVATIVES AS PHOSPHOINOSITIDE 3-KINASES INHIBITORS
<b>A61P 11/00</b> (2006.01)	3411375	PYRAZOLE DERIVATIVES AS PHOSPHOINOSITIDE 3-KINASES INHIBITORS
<b>C07D 487/04</b> (2006.01)	3411375	PYRAZOLE DERIVATIVES AS PHOSPHOINOSITIDE 3-KINASES INHIBITORS
<b>A61K 39/00</b> (2006.01)	3416983	ANTIBODIES FOR IL-17C

MKP (51)	Broj objave evropske prijava patenta (97)	Naziv pronalaska (54)
<b>C07K 16/24</b> (2006.01)	3416983	ANTIBODIES FOR IL-17C
<b>C07K 14/47</b> (2006.01)	3416980	NOVEL PEPTIDES AND COMBINATION OF PEPTIDES FOR USE IN IMMUNOTHERAPY AGAINST NHL AND OTHER CANCERS
<b>C08B 1/00</b> (2006.01)	3411415	METHOD FOR PRODUCING REGENERATED CELLULOSE FIBERS FROM COTTON CONTAINING TEXTILE WASTE
<b>C08B 16/00</b> (2006.01)	3411415	METHOD FOR PRODUCING REGENERATED CELLULOSE FIBERS FROM COTTON CONTAINING TEXTILE WASTE
<b>C08J 11/08</b> (2006.01)	3411415	METHOD FOR PRODUCING REGENERATED CELLULOSE FIBERS FROM COTTON CONTAINING TEXTILE WASTE
<b>D01F 2/00</b> (2006.01)	3411415	METHOD FOR PRODUCING REGENERATED CELLULOSE FIBERS FROM COTTON CONTAINING TEXTILE WASTE
<b>D04H 1/425</b> (2012.01)	3411415	METHOD FOR PRODUCING REGENERATED CELLULOSE FIBERS FROM COTTON CONTAINING TEXTILE WASTE
<b>D21H 11/20</b> (2006.01)	3411415	METHOD FOR PRODUCING REGENERATED CELLULOSE FIBERS FROM COTTON CONTAINING TEXTILE WASTE
<b>A61K 9/50</b> (2006.01)	3413879	PHARMACEUTICAL BEAD FORMULATIONS COMPRISING DIMETHYL FUMARATE
<b>A61K 31/225</b> (2006.01)	3413879	PHARMACEUTICAL BEAD FORMULATIONS COMPRISING DIMETHYL FUMARATE
<b>A61P 25/00</b> (2006.01)	3413879	PHARMACEUTICAL BEAD FORMULATIONS COMPRISING DIMETHYL FUMARATE
<b>A61K 31/7076</b> (2006.01)	3413897	METHODS FOR TREATMENT AND PROPHYLAXIS OF HIV AND AIDS
<b>A61P 31/18</b> (2006.01)	3413897	METHODS FOR TREATMENT AND PROPHYLAXIS OF HIV AND AIDS
<b>A61K 39/12</b> (2006.01)	3416682	PORCINE REPRODUCTIVE AND RESPIRATORY SYNDROME VACCINE VIRUS
<b>C12N 7/00</b> (2006.01)	3416682	PORCINE REPRODUCTIVE AND RESPIRATORY SYNDROME VACCINE VIRUS
<b>A61K 31/4985</b> (2006.01)	3414251	THIENOPYRAZINE CARBOXAMIDES AS UBIQUITIN-SPECIFIC PROTEASE INHIBITORS
<b>A61P 35/00</b> (2006.01)	3414251	THIENOPYRAZINE CARBOXAMIDES AS UBIQUITIN-SPECIFIC PROTEASE INHIBITORS
<b>A61P 37/00</b> (2006.01)	3414251	THIENOPYRAZINE CARBOXAMIDES AS UBIQUITIN-SPECIFIC PROTEASE INHIBITORS
<b>C07D 495/04</b> (2006.01)	3414251	THIENOPYRAZINE CARBOXAMIDES AS UBIQUITIN-SPECIFIC PROTEASE INHIBITORS
<b>A23L 2/52</b> (2006.01)	3405207	DETOXIFYING COMPOSITION FOR ORAL ADMINISTRATION AND METHOD FOR PREPARING SAME
<b>A23L 33/105</b> (2016.01)	3405207	DETOXIFYING COMPOSITION FOR ORAL ADMINISTRATION AND METHOD FOR PREPARING SAME
<b>A61K 9/20</b> (2006.01)	3405207	DETOXIFYING COMPOSITION FOR ORAL ADMINISTRATION AND METHOD FOR PREPARING SAME
<b>A61K 9/48</b> (2006.01)	3405207	DETOXIFYING COMPOSITION FOR ORAL ADMINISTRATION AND METHOD FOR PREPARING SAME
<b>A61K 36/67</b> (2006.01)	3405207	DETOXIFYING COMPOSITION FOR ORAL ADMINISTRATION AND METHOD FOR PREPARING SAME
<b>A61P 1/16</b> (2006.01)	3405207	DETOXIFYING COMPOSITION FOR ORAL ADMINISTRATION AND METHOD FOR PREPARING SAME
<b>B21D 5/04</b> (2006.01)	3416765	A BENDING GROUP OF A PANELLING MACHINE TOOL
<b>H04L 29/06</b> (2006.01)	3412017	METHOD AND APPARATUS FOR FACILITATING FRICTIONLESS TWO-FACTOR AUTHENTICATION
<b>H04W 12/06</b> (2009.01)	3412017	METHOD AND APPARATUS FOR FACILITATING FRICTIONLESS TWO-FACTOR AUTHENTICATION
<b>H04W 12/08</b> (2009.01)	3412017	METHOD AND APPARATUS FOR FACILITATING FRICTIONLESS TWO-FACTOR AUTHENTICATION
<b>C21D 8/02</b> (2006.01)	3402906	WARM ROLLING OF STEELS CONTAINING METASTABLE AUSTENITE
<b>C21D 8/04</b> (2006.01)	3402906	WARM ROLLING OF STEELS CONTAINING METASTABLE AUSTENITE
<b>C21D 9/46</b> (2006.01)	3402906	WARM ROLLING OF STEELS CONTAINING METASTABLE AUSTENITE
<b>C21D 9/48</b> (2006.01)	3402906	WARM ROLLING OF STEELS CONTAINING METASTABLE AUSTENITE
<b>A47K 10/32</b> (2006.01)	3410910	SYSTEM FOR STORING AND DISPENSING WIPES
<b>A47K 10/38</b> (2006.01)	3410910	SYSTEM FOR STORING AND DISPENSING WIPES
<b>A61K 39/00</b> (2006.01)	3416984	CHIMERIC CANINE ANTI-CD20 ANTIBODY
<b>C07K 16/28</b> (2006.01)	3416984	CHIMERIC CANINE ANTI-CD20 ANTIBODY
<b>C07D 295/096</b> (2006.01)	3414231	SYNTHESIS OF 1-[2-(2,4-DIMETHYL-PHENYLSULFANYL)-PHENYL]PIPERAZINE
<b>A61M 16/00</b> (2006.01)	3416712	A BREATHING DEVICE
<b>A61K 31/4025</b> (2006.01)	3416960	NOVEL COMPOUNDS
<b>A61K 31/407</b> (2006.01)	3416960	NOVEL COMPOUNDS
<b>A61P 35/00</b> (2006.01)	3416960	NOVEL COMPOUNDS



MKP (51)	Broj objave evropske prijava patenta (97)	Naziv pronalaska (54)
<b>C07D 401/06</b> (2006.01)	3416960	NOVEL COMPOUNDS
<b>C07D 401/12</b> (2006.01)	3416960	NOVEL COMPOUNDS
<b>C07D 401/14</b> (2006.01)	3416960	NOVEL COMPOUNDS
<b>C07D 403/06</b> (2006.01)	3416960	NOVEL COMPOUNDS
<b>C07D 403/14</b> (2006.01)	3416960	NOVEL COMPOUNDS
<b>C07D 413/06</b> (2006.01)	3416960	NOVEL COMPOUNDS
<b>C07D 413/12</b> (2006.01)	3416960	NOVEL COMPOUNDS
<b>C07D 417/12</b> (2006.01)	3416960	NOVEL COMPOUNDS
<b>C07D 417/14</b> (2006.01)	3416960	NOVEL COMPOUNDS
<b>C07D 471/04</b> (2006.01)	3416960	NOVEL COMPOUNDS
<b>C07D 487/04</b> (2006.01)	3416960	NOVEL COMPOUNDS
<b>C07D 487/10</b> (2006.01)	3416960	NOVEL COMPOUNDS
<b>A61K 39/00</b> (2006.01)	3411488	GENE THERAPY FOR TREATING MUCOPOLYSACCHARIDOSIS TYPE I
<b>A61K 48/00</b> (2006.01)	3411488	GENE THERAPY FOR TREATING MUCOPOLYSACCHARIDOSIS TYPE I
<b>C12N 9/24</b> (2006.01)	3411488	GENE THERAPY FOR TREATING MUCOPOLYSACCHARIDOSIS TYPE I
<b>C12N 15/86</b> (2006.01)	3411488	GENE THERAPY FOR TREATING MUCOPOLYSACCHARIDOSIS TYPE I
<b>A61K 39/395</b> (2006.01)	3416684	METHODS FOR TREATING OR PREVENTING ATHEROSCLEROSIS BY ADMINISTERING AN INHIBITOR OF ANGPTL3
<b>A61P 3/06</b> (2006.01)	3416684	METHODS FOR TREATING OR PREVENTING ATHEROSCLEROSIS BY ADMINISTERING AN INHIBITOR OF ANGPTL3
<b>C07K 16/22</b> (2006.01)	3416684	METHODS FOR TREATING OR PREVENTING ATHEROSCLEROSIS BY ADMINISTERING AN INHIBITOR OF ANGPTL3
<b>A61K 47/69</b> (2017.01)	3411077	EFFICIENT PROCESS FOR PREPARING CELL-BINDING AGENT- CYTOTOXIC AGENT CONJUGATES
<b>C07K 1/13</b> (2006.01)	3411077	EFFICIENT PROCESS FOR PREPARING CELL-BINDING AGENT- CYTOTOXIC AGENT CONJUGATES
<b>A61K 39/395</b> (2006.01)	3416982	TGFBETA 2 ANTIBODIES
<b>C07K 16/22</b> (2006.01)	3416982	TGFBETA 2 ANTIBODIES
<b>C07C 233/23</b> (2006.01)	3408256	INDANE DERIVATIVES AS MGLUR7 MODULATORS
<b>C07C 233/41</b> (2006.01)	3408256	INDANE DERIVATIVES AS MGLUR7 MODULATORS
<b>C07C 235/36</b> (2006.01)	3408256	INDANE DERIVATIVES AS MGLUR7 MODULATORS
<b>C07C 271/24</b> (2006.01)	3408256	INDANE DERIVATIVES AS MGLUR7 MODULATORS
<b>C07C 311/06</b> (2006.01)	3408256	INDANE DERIVATIVES AS MGLUR7 MODULATORS
<b>C07C 317/30</b> (2006.01)	3408256	INDANE DERIVATIVES AS MGLUR7 MODULATORS
<b>C07D 205/04</b> (2006.01)	3408256	INDANE DERIVATIVES AS MGLUR7 MODULATORS
<b>C07D 231/12</b> (2006.01)	3408256	INDANE DERIVATIVES AS MGLUR7 MODULATORS
<b>C07D 231/14</b> (2006.01)	3408256	INDANE DERIVATIVES AS MGLUR7 MODULATORS
<b>C07D 237/14</b> (2006.01)	3408256	INDANE DERIVATIVES AS MGLUR7 MODULATORS
<b>C07D 239/42</b> (2006.01)	3408256	INDANE DERIVATIVES AS MGLUR7 MODULATORS
<b>C07D 261/10</b> (2006.01)	3408256	INDANE DERIVATIVES AS MGLUR7 MODULATORS
<b>C07D 309/08</b> (2006.01)	3408256	INDANE DERIVATIVES AS MGLUR7 MODULATORS
<b>C07D 309/14</b> (2006.01)	3408256	INDANE DERIVATIVES AS MGLUR7 MODULATORS
<b>C07D 413/12</b> (2006.01)	3408256	INDANE DERIVATIVES AS MGLUR7 MODULATORS
<b>A61M 5/142</b> (2006.01)	3413953	DRUG DELIVERY DEVICE AND METHOD OF MANUFACTURE
<b>A61M 5/145</b> (2006.01)	3413953	DRUG DELIVERY DEVICE AND METHOD OF MANUFACTURE
<b>A61M 5/315</b> (2006.01)	3413953	DRUG DELIVERY DEVICE AND METHOD OF MANUFACTURE
<b>A61K 31/4365</b> (2006.01)	3414252	THIENOPYRIDINE CARBOXAMIDES AS UBIQUITIN-SPECIFIC PROTEASE INHIBITORS
<b>A61K 31/437</b> (2006.01)	3414252	THIENOPYRIDINE CARBOXAMIDES AS UBIQUITIN-SPECIFIC PROTEASE INHIBITORS
<b>A61K 31/438</b> (2006.01)	3414252	THIENOPYRIDINE CARBOXAMIDES AS UBIQUITIN-SPECIFIC PROTEASE INHIBITORS
<b>A61K 31/496</b> (2006.01)	3414252	THIENOPYRIDINE CARBOXAMIDES AS UBIQUITIN-SPECIFIC PROTEASE INHIBITORS
<b>A61K 31/4985</b> (2006.01)	3414252	THIENOPYRIDINE CARBOXAMIDES AS UBIQUITIN-SPECIFIC PROTEASE INHIBITORS
<b>A61K 31/506</b> (2006.01)	3414252	THIENOPYRIDINE CARBOXAMIDES AS UBIQUITIN-SPECIFIC PROTEASE INHIBITORS
<b>A61K 31/5386</b> (2006.01)	3414252	THIENOPYRIDINE CARBOXAMIDES AS UBIQUITIN-SPECIFIC PROTEASE INHIBITORS
<b>A61K 31/551</b> (2006.01)	3414252	THIENOPYRIDINE CARBOXAMIDES AS UBIQUITIN-SPECIFIC PROTEASE INHIBITORS
<b>A61P 29/00</b> (2006.01)	3414252	THIENOPYRIDINE CARBOXAMIDES AS UBIQUITIN-SPECIFIC PROTEASE INHIBITORS

MKP (51)	Broj objave evropske prijava patenta (97)	Naziv pronalaska (54)
<b>A61P 31/04</b> (2006.01)	3414252	THIENOPYRIDINE CARBOXAMIDES AS UBIQUITIN-SPECIFIC PROTEASE INHIBITORS
<b>A61P 31/12</b> (2006.01)	3414252	THIENOPYRIDINE CARBOXAMIDES AS UBIQUITIN-SPECIFIC PROTEASE INHIBITORS
<b>A61P 35/00</b> (2006.01)	3414252	THIENOPYRIDINE CARBOXAMIDES AS UBIQUITIN-SPECIFIC PROTEASE INHIBITORS
<b>A61P 37/00</b> (2006.01)	3414252	THIENOPYRIDINE CARBOXAMIDES AS UBIQUITIN-SPECIFIC PROTEASE INHIBITORS
<b>C07D 495/04</b> (2006.01)	3414252	THIENOPYRIDINE CARBOXAMIDES AS UBIQUITIN-SPECIFIC PROTEASE INHIBITORS
<b>A61K 38/46</b> (2006.01)	3416678	METHODS AND COMPOSITIONS FOR CNS DELIVERY OF ARYLSULFATASE A
<b>A61P 3/00</b> (2006.01)	3416678	METHODS AND COMPOSITIONS FOR CNS DELIVERY OF ARYLSULFATASE A
<b>A61K 9/00</b> (2006.01)	3399971	PHARMACEUTICAL COMPOSITIONS COMPRISING DGLA AND USE OF SAME
<b>A61K 31/202</b> (2006.01)	3399971	PHARMACEUTICAL COMPOSITIONS COMPRISING DGLA AND USE OF SAME
<b>A61P 17/00</b> (2006.01)	3399971	PHARMACEUTICAL COMPOSITIONS COMPRISING DGLA AND USE OF SAME
<b>A61K 9/00</b> (2006.01)	3414320	ADIPOSE TISSUE DERIVED MESENCHYMAL STROMAL CELL CONDITIONED MEDIA AND METHODS OF MAKING AND USING THE SAME
<b>A61K 35/28</b> (2015.01)	3414320	ADIPOSE TISSUE DERIVED MESENCHYMAL STROMAL CELL CONDITIONED MEDIA AND METHODS OF MAKING AND USING THE SAME
<b>C12N 5/00</b> (2006.01)	3414320	ADIPOSE TISSUE DERIVED MESENCHYMAL STROMAL CELL CONDITIONED MEDIA AND METHODS OF MAKING AND USING THE SAME
<b>C12N 5/0775</b> (2010.01)	3414320	ADIPOSE TISSUE DERIVED MESENCHYMAL STROMAL CELL CONDITIONED MEDIA AND METHODS OF MAKING AND USING THE SAME
<b>F03G 3/08</b> (2006.01)	3417170	FLYWHEEL ENERGY STORAGE DEVICE AND METHOD OF ITS USE
<b>H02K 7/02</b> (2006.01)	3417170	FLYWHEEL ENERGY STORAGE DEVICE AND METHOD OF ITS USE
<b>A01K 67/027</b> (2006.01)	3416479	NON-HUMAN ANIMALS HAVING A MUTANT KYNURENINASE GENE
<b>C07K 16/10</b> (2006.01)	3416479	NON-HUMAN ANIMALS HAVING A MUTANT KYNURENINASE GENE
<b>C12N 9/14</b> (2006.01)	3416479	NON-HUMAN ANIMALS HAVING A MUTANT KYNURENINASE GENE
<b>G06F 21/32</b> (2013.01)	3417392	METHOD, SYSTEM, DEVICE AND SOFTWARE PROGRAMME PRODUCT FOR THE REMOTE AUTHORIZATION OF A USER OF DIGITAL SERVICES
<b>H04L 29/06</b> (2006.01)	3417392	METHOD, SYSTEM, DEVICE AND SOFTWARE PROGRAMME PRODUCT FOR THE REMOTE AUTHORIZATION OF A USER OF DIGITAL SERVICES
<b>A61K 31/365</b> (2006.01)	3407883	FORMULATION FOR TREATING MIGRAINE
<b>A61K 31/405</b> (2006.01)	3407883	FORMULATION FOR TREATING MIGRAINE
<b>A61K 33/06</b> (2006.01)	3407883	FORMULATION FOR TREATING MIGRAINE
<b>A61K 33/08</b> (2006.01)	3407883	FORMULATION FOR TREATING MIGRAINE
<b>A61K 36/28</b> (2006.01)	3407883	FORMULATION FOR TREATING MIGRAINE
<b>A61K 36/48</b> (2006.01)	3407883	FORMULATION FOR TREATING MIGRAINE
<b>A61P 25/06</b> (2006.01)	3407883	FORMULATION FOR TREATING MIGRAINE
<b>C10J 3/84</b> (2006.01)	3417037	SYSTEM AND METHOD FOR POWER PRODUCTION INCLUDING METHANATION
<b>B09C 1/10</b> (2006.01)	3416759	METHOD FOR DECOMPOSITION OF THE METALLOORGANIC MATTER OF GRAPTOLITE-ARGILLITE BY MICROBIAL CONSORTIUM
<b>C12P 1/04</b> (2006.01)	3416759	METHOD FOR DECOMPOSITION OF THE METALLOORGANIC MATTER OF GRAPTOLITE-ARGILLITE BY MICROBIAL CONSORTIUM
<b>C12P 5/02</b> (2006.01)	3416759	METHOD FOR DECOMPOSITION OF THE METALLOORGANIC MATTER OF GRAPTOLITE-ARGILLITE BY MICROBIAL CONSORTIUM
<b>C22B 3/00</b> (2006.01)	3416759	METHOD FOR DECOMPOSITION OF THE METALLOORGANIC MATTER OF GRAPTOLITE-ARGILLITE BY MICROBIAL CONSORTIUM
<b>C22B 3/18</b> (2006.01)	3416759	METHOD FOR DECOMPOSITION OF THE METALLOORGANIC MATTER OF GRAPTOLITE-ARGILLITE BY MICROBIAL CONSORTIUM
<b>E21B 43/00</b> (2006.01)	3416759	METHOD FOR DECOMPOSITION OF THE METALLOORGANIC MATTER OF GRAPTOLITE-ARGILLITE BY MICROBIAL CONSORTIUM
<b>A61B 50/30</b> (2016.01)	3413828	METHOD FOR THE PREPARATION AND PACKAGING OF A STERILE PROCEDURE PACK OR KIT FOR OPERATING ROOM USE
<b>A61B 90/90</b> (2016.01)	3413828	METHOD FOR THE PREPARATION AND PACKAGING OF A STERILE PROCEDURE PACK OR KIT FOR OPERATING ROOM USE

MKP (51)	Broj objave evropske prijava patenta (97)	Naziv pronalaska (54)
<b>A61B 90/98</b> (2016.01)	3413828	METHOD FOR THE PREPARATION AND PACKAGING OF A STERILE PROCEDURE PACK OR KIT FOR OPERATING ROOM USE
<b>A61L 2/24</b> (2006.01)	3413828	METHOD FOR THE PREPARATION AND PACKAGING OF A STERILE PROCEDURE PACK OR KIT FOR OPERATING ROOM USE
<b>A61K 31/42</b> (2006.01)	3408260	CRYSTALLINE(2S,4R)-5-(5'-CHLORO-2'-FLUORO-[1,1'-BIPHENYL]-4-YL)-2-(ETHOXYMETHYL)-4-(3-HYDROXYISOXAZOLE-5-CARBOXAMIDO)-2-METHYLPENTANOIC ACID AND USES THEREOF
<b>A61P 9/00</b> (2006.01)	3408260	CRYSTALLINE(2S,4R)-5-(5'-CHLORO-2'-FLUORO-[1,1'-BIPHENYL]-4-YL)-2-(ETHOXYMETHYL)-4-(3-HYDROXYISOXAZOLE-5-CARBOXAMIDO)-2-METHYLPENTANOIC ACID AND USES THEREOF
<b>C07D 261/18</b> (2006.01)	3408260	CRYSTALLINE(2S,4R)-5-(5'-CHLORO-2'-FLUORO-[1,1'-BIPHENYL]-4-YL)-2-(ETHOXYMETHYL)-4-(3-HYDROXYISOXAZOLE-5-CARBOXAMIDO)-2-METHYLPENTANOIC ACID AND USES THEREOF
<b>A63B 21/28</b> (2006.01)	3407985	MOBILE SUPPORT FOR PHYSICAL EXERCISE
<b>A63B 22/16</b> (2006.01)	3407985	MOBILE SUPPORT FOR PHYSICAL EXERCISE
<b>A63B 22/18</b> (2006.01)	3407985	MOBILE SUPPORT FOR PHYSICAL EXERCISE
<b>A63B 26/00</b> (2006.01)	3407985	MOBILE SUPPORT FOR PHYSICAL EXERCISE
<b>A63B 69/00</b> (2006.01)	3407985	MOBILE SUPPORT FOR PHYSICAL EXERCISE
<b>A61B 5/103</b> (2006.01)	3407987	MOVABLE PLATFORM FOR PHYSICAL EXERCISE
<b>A61H 1/02</b> (2006.01)	3407987	MOVABLE PLATFORM FOR PHYSICAL EXERCISE
<b>A63B 21/00</b> (2006.01)	3407987	MOVABLE PLATFORM FOR PHYSICAL EXERCISE
<b>A63B 21/005</b> (2006.01)	3407987	MOVABLE PLATFORM FOR PHYSICAL EXERCISE
<b>A63B 22/18</b> (2006.01)	3407987	MOVABLE PLATFORM FOR PHYSICAL EXERCISE
<b>A63B 23/08</b> (2006.01)	3407987	MOVABLE PLATFORM FOR PHYSICAL EXERCISE
<b>A63B 24/00</b> (2006.01)	3407987	MOVABLE PLATFORM FOR PHYSICAL EXERCISE
<b>A63B 26/00</b> (2006.01)	3407987	MOVABLE PLATFORM FOR PHYSICAL EXERCISE
<b>A63B 69/00</b> (2006.01)	3407987	MOVABLE PLATFORM FOR PHYSICAL EXERCISE
<b>A43B 1/12</b> (2006.01)	3416819	A METHOD OF MOULDING AN OBJECT IN POLYURETHANE, IN PARTICULAR A SOLE FOR FOOTWEAR, OBTAINED FROM POLYURETHANE SCRAPS, AND MOULDED OBJECT IN POLYURETHANE THEREOF
<b>B29C 43/00</b> (2006.01)	3416819	A METHOD OF MOULDING AN OBJECT IN POLYURETHANE, IN PARTICULAR A SOLE FOR FOOTWEAR, OBTAINED FROM POLYURETHANE SCRAPS, AND MOULDED OBJECT IN POLYURETHANE THEREOF
<b>B29C 44/02</b> (2006.01)	3416819	A METHOD OF MOULDING AN OBJECT IN POLYURETHANE, IN PARTICULAR A SOLE FOR FOOTWEAR, OBTAINED FROM POLYURETHANE SCRAPS, AND MOULDED OBJECT IN POLYURETHANE THEREOF
<b>B29D 35/00</b> (2010.01)	3416819	A METHOD OF MOULDING AN OBJECT IN POLYURETHANE, IN PARTICULAR A SOLE FOR FOOTWEAR, OBTAINED FROM POLYURETHANE SCRAPS, AND MOULDED OBJECT IN POLYURETHANE THEREOF
<b>B29D 35/12</b> (2010.01)	3416819	A METHOD OF MOULDING AN OBJECT IN POLYURETHANE, IN PARTICULAR A SOLE FOR FOOTWEAR, OBTAINED FROM POLYURETHANE SCRAPS, AND MOULDED OBJECT IN POLYURETHANE THEREOF
<b>B29D 35/14</b> (2010.01)	3416819	A METHOD OF MOULDING AN OBJECT IN POLYURETHANE, IN PARTICULAR A SOLE FOR FOOTWEAR, OBTAINED FROM POLYURETHANE SCRAPS, AND MOULDED OBJECT IN POLYURETHANE THEREOF
<b>C08J 9/33</b> (2006.01)	3416819	A METHOD OF MOULDING AN OBJECT IN POLYURETHANE, IN PARTICULAR A SOLE FOR FOOTWEAR, OBTAINED FROM POLYURETHANE SCRAPS, AND MOULDED OBJECT IN POLYURETHANE THEREOF
<b>B21D 53/26</b> (2006.01)	3365185	METHOD FOR PRODUCING A WHEEL
<b>B21H 1/10</b> (2006.01)	3365185	METHOD FOR PRODUCING A WHEEL
<b>B60B 3/00</b> (2006.01)	3365185	METHOD FOR PRODUCING A WHEEL
<b>B60B 3/02</b> (2006.01)	3365185	METHOD FOR PRODUCING A WHEEL
<b>B60B 3/06</b> (2006.01)	3365185	METHOD FOR PRODUCING A WHEEL
<b>A61K 35/14</b> (2015.01)	3352769	ANTI-AGEING PHARMACEUTICAL PREPARATION
<b>A61K 35/16</b> (2015.01)	3352769	ANTI-AGEING PHARMACEUTICAL PREPARATION
<b>A61P 17/00</b> (2006.01)	3352769	ANTI-AGEING PHARMACEUTICAL PREPARATION
<b>A61P 17/18</b> (2006.01)	3352769	ANTI-AGEING PHARMACEUTICAL PREPARATION
<b>A61P 29/00</b> (2006.01)	3352769	ANTI-AGEING PHARMACEUTICAL PREPARATION
<b>A61P 39/00</b> (2006.01)	3352769	ANTI-AGEING PHARMACEUTICAL PREPARATION
<b>A61K 35/14</b> (2015.01)	3352770	ANTI-AGEING PHARMACEUTICAL PREPARATION
<b>A61K 35/16</b> (2015.01)	3352770	ANTI-AGEING PHARMACEUTICAL PREPARATION

MKP (51)	Broj objave evropske prijava patenta (97)	Naziv pronalaska (54)
<b>A61P 17/00</b> (2006.01)	3352770	ANTI-AGEING PHARMACEUTICAL PREPARATION
<b>A61P 17/18</b> (2006.01)	3352770	ANTI-AGEING PHARMACEUTICAL PREPARATION
<b>A61P 29/00</b> (2006.01)	3352770	ANTI-AGEING PHARMACEUTICAL PREPARATION
<b>A61P 39/00</b> (2006.01)	3352770	ANTI-AGEING PHARMACEUTICAL PREPARATION
<b>A61K 31/506</b> (2006.01)	3400963	ANTI-TUMOR AGENT CONTAINING IMMUNOMODULATOR, AND ANTI-TUMOR EFFECT ENHANCER
<b>A61K 31/7072</b> (2006.01)	3400963	ANTI-TUMOR AGENT CONTAINING IMMUNOMODULATOR, AND ANTI-TUMOR EFFECT ENHANCER
<b>A61K 39/395</b> (2006.01)	3400963	ANTI-TUMOR AGENT CONTAINING IMMUNOMODULATOR, AND ANTI-TUMOR EFFECT ENHANCER
<b>A61K 45/06</b> (2006.01)	3400963	ANTI-TUMOR AGENT CONTAINING IMMUNOMODULATOR, AND ANTI-TUMOR EFFECT ENHANCER
<b>A61P 35/00</b> (2006.01)	3400963	ANTI-TUMOR AGENT CONTAINING IMMUNOMODULATOR, AND ANTI-TUMOR EFFECT ENHANCER
<b>A61P 37/02</b> (2006.01)	3400963	ANTI-TUMOR AGENT CONTAINING IMMUNOMODULATOR, AND ANTI-TUMOR EFFECT ENHANCER
<b>A61K 39/395</b> (2006.01)	3400012	METHODS FOR INHIBITING FIBROSIS IN A SUBJECT IN NEED THEREOF
<b>A61K 45/06</b> (2006.01)	3400012	METHODS FOR INHIBITING FIBROSIS IN A SUBJECT IN NEED THEREOF
<b>C07K 16/40</b> (2006.01)	3400012	METHODS FOR INHIBITING FIBROSIS IN A SUBJECT IN NEED THEREOF
<b>A61B 5/00</b> (2006.01)	3400549	PROCESSING OF PORTABLE DEVICE DATA
<b>G06F 19/26</b> (2011.01)	3400549	PROCESSING OF PORTABLE DEVICE DATA
<b>G06Q 50/24</b> (2018.01)	3400549	PROCESSING OF PORTABLE DEVICE DATA
<b>G08B 21/04</b> (2006.01)	3400549	PROCESSING OF PORTABLE DEVICE DATA
<b>B61D 5/00</b> (2006.01)	3403060	DEVICE AND METHOD FOR MEASURING COMMODITY VOLUME IN A RAIL TANK CAR
<b>G01F 23/284</b> (2006.01)	3403060	DEVICE AND METHOD FOR MEASURING COMMODITY VOLUME IN A RAIL TANK CAR
<b>A61K 39/395</b> (2006.01)	3404040	ANTI-MYL9 ANTIBODY
<b>A61P 1/04</b> (2006.01)	3404040	ANTI-MYL9 ANTIBODY
<b>A61P 11/00</b> (2006.01)	3404040	ANTI-MYL9 ANTIBODY
<b>A61P 35/00</b> (2006.01)	3404040	ANTI-MYL9 ANTIBODY
<b>A61P 37/08</b> (2006.01)	3404040	ANTI-MYL9 ANTIBODY
<b>C07K 16/18</b> (2006.01)	3404040	ANTI-MYL9 ANTIBODY
<b>C07K 16/46</b> (2006.01)	3404040	ANTI-MYL9 ANTIBODY
<b>C12N 15/09</b> (2006.01)	3404040	ANTI-MYL9 ANTIBODY
<b>B21D 51/38</b> (2006.01)	3402618	SYSTEM AND METHOD FOR ORIENTING THE ROLLING DIRECTION OF AN END SHELL IN A METAL CONTAINER MANUFACTURING PROCESS
<b>B21D 51/44</b> (2006.01)	3402618	SYSTEM AND METHOD FOR ORIENTING THE ROLLING DIRECTION OF AN END SHELL IN A METAL CONTAINER MANUFACTURING PROCESS
<b>B65B 35/58</b> (2006.01)	3402618	SYSTEM AND METHOD FOR ORIENTING THE ROLLING DIRECTION OF AN END SHELL IN A METAL CONTAINER MANUFACTURING PROCESS
<b>B65G 47/24</b> (2006.01)	3402618	SYSTEM AND METHOD FOR ORIENTING THE ROLLING DIRECTION OF AN END SHELL IN A METAL CONTAINER MANUFACTURING PROCESS
<b>B65G 47/244</b> (2006.01)	3402618	SYSTEM AND METHOD FOR ORIENTING THE ROLLING DIRECTION OF AN END SHELL IN A METAL CONTAINER MANUFACTURING PROCESS
<b>B65G 47/252</b> (2006.01)	3402618	SYSTEM AND METHOD FOR ORIENTING THE ROLLING DIRECTION OF AN END SHELL IN A METAL CONTAINER MANUFACTURING PROCESS
<b>A61K 48/00</b> (2006.01)	3402532	INHIBITING ATAXIA TELANGIECTASIA AND RAD3-RELATED PROTEIN (ATR)
<b>A61K 31/4468</b> (2006.01)	3402485	INHIBITING B-CELL LYMPHOMA 2 (BCL-2) AND RELATED PROTEINS
<b>A61K 31/496</b> (2006.01)	3402485	INHIBITING B-CELL LYMPHOMA 2 (BCL-2) AND RELATED PROTEINS
<b>A61K 39/145</b> (2006.01)	3402513	METHOD OF TREATING INFLUENZA A
<b>A61P 31/16</b> (2006.01)	3402513	METHOD OF TREATING INFLUENZA A
<b>C07K 14/11</b> (2006.01)	3402513	METHOD OF TREATING INFLUENZA A
<b>C07K 16/08</b> (2006.01)	3402513	METHOD OF TREATING INFLUENZA A
<b>C07K 16/10</b> (2006.01)	3402513	METHOD OF TREATING INFLUENZA A
<b>C12N 15/44</b> (2006.01)	3402513	METHOD OF TREATING INFLUENZA A
<b>A61K 31/517</b> (2006.01)	3402486	METHOD OF TREATING C3 GLOMERULOPATHY
<b>A61K 31/551</b> (2006.01)	3402486	METHOD OF TREATING C3 GLOMERULOPATHY

MKP (51)	Broj objave evropske prijava patenta (97)	Naziv pronalaska (54)
<b>A61M 5/178</b> (2006.01)	3402556	INJECTION DEVICE
<b>A61M 5/20</b> (2006.01)	3402556	INJECTION DEVICE
<b>A61M 5/24</b> (2006.01)	3402556	INJECTION DEVICE
<b>A61M 5/31</b> (2006.01)	3402556	INJECTION DEVICE
<b>A61M 5/315</b> (2006.01)	3402556	INJECTION DEVICE
<b>A61M 5/32</b> (2006.01)	3402556	INJECTION DEVICE
<b>A61K 48/00</b> (2006.01)	3402534	CELLULAR BLEND FOR THE REGENERATION OF CHONDROCYTES OR CARTILAGE TYPE CELLS
<b>A61K 39/395</b> (2006.01)	3402519	MULTISPECIFIC IMMUNOMODULATORY ANTIGEN-BINDING CONSTRUCTS
<b>A61P 35/00</b> (2006.01)	3402519	MULTISPECIFIC IMMUNOMODULATORY ANTIGEN-BINDING CONSTRUCTS
<b>C07K 16/00</b> (2006.01)	3402519	MULTISPECIFIC IMMUNOMODULATORY ANTIGEN-BINDING CONSTRUCTS
<b>C07K 16/18</b> (2006.01)	3402519	MULTISPECIFIC IMMUNOMODULATORY ANTIGEN-BINDING CONSTRUCTS
<b>C07K 16/46</b> (2006.01)	3402519	MULTISPECIFIC IMMUNOMODULATORY ANTIGEN-BINDING CONSTRUCTS
<b>C12N 1/15</b> (2006.01)	3402519	MULTISPECIFIC IMMUNOMODULATORY ANTIGEN-BINDING CONSTRUCTS
<b>C07C 49/753</b> (2006.01)	3406586	MANUFACTURING METHOD FOR HIGH-PURITY CYCLOHEXENONE LONG-CHAIN ALCOHOL
<b>G06Q 10/04</b> (2012.01)	3405914	METHOD FOR OPERATION OF HYDROPOWER RESERVOIR WITH A 2-PARAMETER ELEVATION RULE CURVE
<b>G06Q 50/06</b> (2012.01)	3405914	METHOD FOR OPERATION OF HYDROPOWER RESERVOIR WITH A 2-PARAMETER ELEVATION RULE CURVE
<b>C10M 107/02</b> (2006.01)	3406694	LUBRICATING OIL COMPOSITION
<b>C10M 135/08</b> (2006.01)	3406694	LUBRICATING OIL COMPOSITION
<b>C10M 139/00</b> (2006.01)	3406694	LUBRICATING OIL COMPOSITION
<b>C10M 145/14</b> (2006.01)	3406694	LUBRICATING OIL COMPOSITION
<b>C10M 169/04</b> (2006.01)	3406694	LUBRICATING OIL COMPOSITION
<b>C10N 20/02</b> (2006.01)	3406694	LUBRICATING OIL COMPOSITION
<b>C10N 20/04</b> (2006.01)	3406694	LUBRICATING OIL COMPOSITION
<b>C10N 30/00</b> (2006.01)	3406694	LUBRICATING OIL COMPOSITION
<b>C10N 30/04</b> (2006.01)	3406694	LUBRICATING OIL COMPOSITION
<b>C10N 30/06</b> (2006.01)	3406694	LUBRICATING OIL COMPOSITION
<b>C10N 40/04</b> (2006.01)	3406694	LUBRICATING OIL COMPOSITION
<b>C07D 209/00</b> (2006.01)	3405455	2-OXINDOLE COMPOUNDS
<b>C07D 209/34</b> (2006.01)	3405455	2-OXINDOLE COMPOUNDS
<b>A61K 31/436</b> (2006.01)	3405211	ORAL OCTREOTIDE FOR THE TREATMENT OF DISEASE
<b>A61K 31/55</b> (2006.01)	3405211	ORAL OCTREOTIDE FOR THE TREATMENT OF DISEASE
<b>A61K 38/31</b> (2006.01)	3405211	ORAL OCTREOTIDE FOR THE TREATMENT OF DISEASE
<b>A61B 3/10</b> (2006.01)	3410397	METHOD FOR PRODUCING LENSES AND FRAMES WITH PERSONALISED DESIGN AND REMOTE BEVELLING OF CORRECTIVE LENSES, AND OPTICAL DEVICE FOR MORPHOLOGICAL MEASUREMENT FOR PERFORMING SAID METHOD
<b>A61B 3/18</b> (2006.01)	3410397	METHOD FOR PRODUCING LENSES AND FRAMES WITH PERSONALISED DESIGN AND REMOTE BEVELLING OF CORRECTIVE LENSES, AND OPTICAL DEVICE FOR MORPHOLOGICAL MEASUREMENT FOR PERFORMING SAID METHOD
<b>G02C 5/00</b> (2006.01)	3410397	METHOD FOR PRODUCING LENSES AND FRAMES WITH PERSONALISED DESIGN AND REMOTE BEVELLING OF CORRECTIVE LENSES, AND OPTICAL DEVICE FOR MORPHOLOGICAL MEASUREMENT FOR PERFORMING SAID METHOD
<b>G02C 7/00</b> (2006.01)	3410397	METHOD FOR PRODUCING LENSES AND FRAMES WITH PERSONALISED DESIGN AND REMOTE BEVELLING OF CORRECTIVE LENSES, AND OPTICAL DEVICE FOR MORPHOLOGICAL MEASUREMENT FOR PERFORMING SAID METHOD
<b>G06T 7/60</b> (2017.01)	3410397	METHOD FOR PRODUCING LENSES AND FRAMES WITH PERSONALISED DESIGN AND REMOTE BEVELLING OF CORRECTIVE LENSES, AND OPTICAL DEVICE FOR MORPHOLOGICAL MEASUREMENT FOR PERFORMING SAID METHOD
<b>C10M 105/04</b> (2006.01)	3409751	LUBRICANT COMPOSITION

MKP (51)	Broj objave evropske prijava patenta (97)	Naziv pronalaska (54)
<b>C10M 107/02</b> (2006.01)	3409751	LUBRICANT COMPOSITION
<b>C10M 135/04</b> (2006.01)	3409751	LUBRICANT COMPOSITION
<b>C10M 169/04</b> (2006.01)	3409751	LUBRICANT COMPOSITION
<b>C10N 20/02</b> (2006.01)	3409751	LUBRICANT COMPOSITION
<b>C10N 30/00</b> (2006.01)	3409751	LUBRICANT COMPOSITION
<b>C10N 30/06</b> (2006.01)	3409751	LUBRICANT COMPOSITION
<b>C10N 40/04</b> (2006.01)	3409751	LUBRICANT COMPOSITION
<b>A61K 39/395</b> (2006.01)	3407914	METHODS FOR PREPARING ANTIBODIES WITH A DEFINED GLYCOSYLATION PATTERN
<b>C07K 16/00</b> (2006.01)	3407914	METHODS FOR PREPARING ANTIBODIES WITH A DEFINED GLYCOSYLATION PATTERN
<b>C12P 21/00</b> (2006.01)	3407914	METHODS FOR PREPARING ANTIBODIES WITH A DEFINED GLYCOSYLATION PATTERN
<b>C07K 16/24</b> (2006.01)	3408293	BISPECIFIC ANTI-TNF-ALPHA/IL-17A ANTIBODIES AND ANTI-TNF-ALPHA ANTIBODIES AND METHODS OF THEIR USE
<b>C07K 16/46</b> (2006.01)	3408293	BISPECIFIC ANTI-TNF-ALPHA/IL-17A ANTIBODIES AND ANTI-TNF-ALPHA ANTIBODIES AND METHODS OF THEIR USE
<b>A61K 31/444</b> (2006.01)	3407978	COMBINATION THERAPY FOR TREATING CANCER
<b>A61K 31/5377</b> (2006.01)	3407978	COMBINATION THERAPY FOR TREATING CANCER
<b>A61P 35/00</b> (2006.01)	3407978	COMBINATION THERAPY FOR TREATING CANCER
<b>A61K 35/74</b> (2015.01)	3408395	PERSONALIZED DELIVERY VECTOR-BASED IMMUNOTHERAPY AND USES THEREOF
<b>A61K 39/00</b> (2006.01)	3408395	PERSONALIZED DELIVERY VECTOR-BASED IMMUNOTHERAPY AND USES THEREOF
<b>A61K 48/00</b> (2006.01)	3408395	PERSONALIZED DELIVERY VECTOR-BASED IMMUNOTHERAPY AND USES THEREOF
<b>C07K 5/10</b> (2006.01)	3408395	PERSONALIZED DELIVERY VECTOR-BASED IMMUNOTHERAPY AND USES THEREOF
<b>C07K 14/705</b> (2006.01)	3408395	PERSONALIZED DELIVERY VECTOR-BASED IMMUNOTHERAPY AND USES THEREOF
<b>C12N 15/66</b> (2006.01)	3408395	PERSONALIZED DELIVERY VECTOR-BASED IMMUNOTHERAPY AND USES THEREOF
<b>C12N 15/74</b> (2006.01)	3408395	PERSONALIZED DELIVERY VECTOR-BASED IMMUNOTHERAPY AND USES THEREOF
<b>C07D 257/04</b> (2006.01)	3408298	G PROTEIN-COUPLED RECEPTOR (GPCR) MODULATION BY IMIPRIDONES
<b>C07D 401/04</b> (2006.01)	3408298	G PROTEIN-COUPLED RECEPTOR (GPCR) MODULATION BY IMIPRIDONES
<b>C07K 14/705</b> (2006.01)	3408298	G PROTEIN-COUPLED RECEPTOR (GPCR) MODULATION BY IMIPRIDONES
<b>C07K 14/72</b> (2006.01)	3408298	G PROTEIN-COUPLED RECEPTOR (GPCR) MODULATION BY IMIPRIDONES
<b>C07K 16/28</b> (2006.01)	3408298	G PROTEIN-COUPLED RECEPTOR (GPCR) MODULATION BY IMIPRIDONES
<b>G01N 33/566</b> (2006.01)	3408298	G PROTEIN-COUPLED RECEPTOR (GPCR) MODULATION BY IMIPRIDONES
<b>C12N 15/113</b> (2010.01)	3408391	BRANCHED OLIGONUCLEOTIDES
<b>A47G 1/02</b> (2006.01)	3410897	MODULAR BUILT MEDICAL DEVICE FOR HELPING SELF-CATHETERIZATION AND/OR INSTILLATION OF DRUG-SOLUTIONS INTO THE BLADDER IN FEMALE PATIENTS
<b>A61F 5/455</b> (2006.01)	3410897	MODULAR BUILT MEDICAL DEVICE FOR HELPING SELF-CATHETERIZATION AND/OR INSTILLATION OF DRUG-SOLUTIONS INTO THE BLADDER IN FEMALE PATIENTS
<b>A61M 25/01</b> (2006.01)	3410897	MODULAR BUILT MEDICAL DEVICE FOR HELPING SELF-CATHETERIZATION AND/OR INSTILLATION OF DRUG-SOLUTIONS INTO THE BLADDER IN FEMALE PATIENTS
<b>A61K 31/519</b> (2006.01)	3412671	TLR7 AGONIST MALEATE SALT, CRYSTALLINE FORMS C, D AND E THEREOF, PREPARATION METHODS AND USES OF MALEATE SALT AND CRYSTALLINE FORMS
<b>A61P 31/12</b> (2006.01)	3412671	TLR7 AGONIST MALEATE SALT, CRYSTALLINE FORMS C, D AND E THEREOF, PREPARATION METHODS AND USES OF MALEATE SALT AND CRYSTALLINE FORMS
<b>C07D 487/04</b> (2006.01)	3412671	TLR7 AGONIST MALEATE SALT, CRYSTALLINE FORMS C, D AND E THEREOF, PREPARATION METHODS AND USES OF MALEATE SALT AND CRYSTALLINE FORMS
<b>A61K 31/519</b> (2006.01)	3412672	TLR7 AGONIST CRYSTALLINE FORM A, PREPARATION METHOD AND USE THEREOF

MKP (51)	Broj objave evropske prijava patenta (97)	Naziv pronalaska (54)
<b>A61P 31/12</b> (2006.01)	3412672	TLR7 AGONIST CRYSTALLINE FORM A, PREPARATION METHOD AND USE THEREOF
<b>C07D 487/04</b> (2006.01)	3412672	TLR7 AGONIST CRYSTALLINE FORM A, PREPARATION METHOD AND USE THEREOF
<b>C07D 487/04</b> (2006.01)	3412673	METHOD FOR PREPARING PYRROLO[3,2-D]PYRIMIDINE COMPOUND, AND INTERMEDIATES THEREOF
<b>A61K 31/519</b> (2006.01)	3412674	TLR7 AGONIST TRIFLUOROACETATE SALT AND CRYSTALLINE FORM B THEREOF, PREPARATION METHODS AND USES
<b>A61P 31/12</b> (2006.01)	3412674	TLR7 AGONIST TRIFLUOROACETATE SALT AND CRYSTALLINE FORM B THEREOF, PREPARATION METHODS AND USES
<b>C07D 487/04</b> (2006.01)	3412674	TLR7 AGONIST TRIFLUOROACETATE SALT AND CRYSTALLINE FORM B THEREOF, PREPARATION METHODS AND USES
<b>A61K 31/506</b> (2006.01)	3412295	METHOD FOR TREATING CANCER PATIENTS WITH SEVERE RENAL DYSFUNCTION
<b>A61K 31/7072</b> (2006.01)	3412295	METHOD FOR TREATING CANCER PATIENTS WITH SEVERE RENAL DYSFUNCTION
<b>A61P 1/00</b> (2006.01)	3412295	METHOD FOR TREATING CANCER PATIENTS WITH SEVERE RENAL DYSFUNCTION
<b>A61P 35/00</b> (2006.01)	3412295	METHOD FOR TREATING CANCER PATIENTS WITH SEVERE RENAL DYSFUNCTION
<b>A61K 31/4439</b> (2006.01)	3412664	HETEROCYCLIC SULFONAMIDE DERIVATIVE AND MEDICINE CONTAINING SAME
<b>A61K 31/506</b> (2006.01)	3412664	HETEROCYCLIC SULFONAMIDE DERIVATIVE AND MEDICINE CONTAINING SAME
<b>A61P 1/04</b> (2006.01)	3412664	HETEROCYCLIC SULFONAMIDE DERIVATIVE AND MEDICINE CONTAINING SAME
<b>A61P 1/18</b> (2006.01)	3412664	HETEROCYCLIC SULFONAMIDE DERIVATIVE AND MEDICINE CONTAINING SAME
<b>A61P 3/10</b> (2006.01)	3412664	HETEROCYCLIC SULFONAMIDE DERIVATIVE AND MEDICINE CONTAINING SAME
<b>A61P 11/06</b> (2006.01)	3412664	HETEROCYCLIC SULFONAMIDE DERIVATIVE AND MEDICINE CONTAINING SAME
<b>A61P 11/08</b> (2006.01)	3412664	HETEROCYCLIC SULFONAMIDE DERIVATIVE AND MEDICINE CONTAINING SAME
<b>A61P 11/14</b> (2006.01)	3412664	HETEROCYCLIC SULFONAMIDE DERIVATIVE AND MEDICINE CONTAINING SAME
<b>A61P 17/04</b> (2006.01)	3412664	HETEROCYCLIC SULFONAMIDE DERIVATIVE AND MEDICINE CONTAINING SAME
<b>A61P 19/02</b> (2006.01)	3412664	HETEROCYCLIC SULFONAMIDE DERIVATIVE AND MEDICINE CONTAINING SAME
<b>A61P 25/00</b> (2006.01)	3412664	HETEROCYCLIC SULFONAMIDE DERIVATIVE AND MEDICINE CONTAINING SAME
<b>A61P 25/04</b> (2006.01)	3412664	HETEROCYCLIC SULFONAMIDE DERIVATIVE AND MEDICINE CONTAINING SAME
<b>A61P 29/00</b> (2006.01)	3412664	HETEROCYCLIC SULFONAMIDE DERIVATIVE AND MEDICINE CONTAINING SAME
<b>A61P 37/08</b> (2006.01)	3412664	HETEROCYCLIC SULFONAMIDE DERIVATIVE AND MEDICINE CONTAINING SAME
<b>A61P 43/00</b> (2006.01)	3412664	HETEROCYCLIC SULFONAMIDE DERIVATIVE AND MEDICINE CONTAINING SAME
<b>C07D 403/12</b> (2006.01)	3412664	HETEROCYCLIC SULFONAMIDE DERIVATIVE AND MEDICINE CONTAINING SAME
<b>C07D 405/14</b> (2006.01)	3412664	HETEROCYCLIC SULFONAMIDE DERIVATIVE AND MEDICINE CONTAINING SAME
<b>C07D 409/14</b> (2006.01)	3412664	HETEROCYCLIC SULFONAMIDE DERIVATIVE AND MEDICINE CONTAINING SAME
<b>C07D 491/048</b> (2006.01)	3412664	HETEROCYCLIC SULFONAMIDE DERIVATIVE AND MEDICINE CONTAINING SAME
<b>C07K 14/705</b> (2006.01)	3412664	HETEROCYCLIC SULFONAMIDE DERIVATIVE AND MEDICINE CONTAINING SAME
<b>A61K 48/00</b> (2006.01)	3411484	INJECTION OF SINGLE-STRANDED OR SELF-COMPLEMENTARY ADENO-ASSOCIATED VIRUS 9 INTO THE CEREBROSPINAL FLUID
<b>C12N 15/63</b> (2006.01)	3411484	INJECTION OF SINGLE-STRANDED OR SELF-COMPLEMENTARY ADENO-ASSOCIATED VIRUS 9 INTO THE CEREBROSPINAL FLUID
<b>C12N 15/861</b> (2006.01)	3411484	INJECTION OF SINGLE-STRANDED OR SELF-COMPLEMENTARY ADENO-ASSOCIATED VIRUS 9 INTO THE CEREBROSPINAL FLUID
<b>A61K 39/00</b> (2006.01)	3411411	BENZOPYRAZOLE COMPOUNDS AND ANALOGUES THEREOF
<b>A61P 9/00</b> (2006.01)	3411411	BENZOPYRAZOLE COMPOUNDS AND ANALOGUES THEREOF

MKP (51)	Broj objave evropske prijava patenta (97)	Naziv pronalaska (54)
<b>A61P 37/06</b> (2006.01)	3411411	BENZOPYRAZOLE COMPOUNDS AND ANALOGUES THEREOF
<b>C07K 16/28</b> (2006.01)	3411411	BENZOPYRAZOLE COMPOUNDS AND ANALOGUES THEREOF
<b>A61K 38/17</b> (2006.01)	3411062	USE OF CD24 PROTEINS FOR TREATING LEPTIN-DEFICIENT CONDITIONS
<b>C07K 14/00</b> (2006.01)	3411062	USE OF CD24 PROTEINS FOR TREATING LEPTIN-DEFICIENT CONDITIONS
<b>C07K 14/435</b> (2006.01)	3411062	USE OF CD24 PROTEINS FOR TREATING LEPTIN-DEFICIENT CONDITIONS
<b>C07K 14/705</b> (2006.01)	3411062	USE OF CD24 PROTEINS FOR TREATING LEPTIN-DEFICIENT CONDITIONS
<b>A61K 31/496</b> (2006.01)	3411503	FLUOROQUINOLONE FORMULATIONS FOR CYSTIC FIBROSIS
<b>C12Q 1/68</b> (2018.01)	3411503	FLUOROQUINOLONE FORMULATIONS FOR CYSTIC FIBROSIS
<b>C12Q 1/68</b> (2018.01)	3411504	ANTI-TNF ANTIBODIES, COMPOSITIONS, METHODS AND USE FOR THE TREATMENT OR PREVENTION OF TYPE 1 DIABETES
<b>C07K 7/08</b> (2006.01)	3411387	SIGNAL MOLECULES AS CELL PENETRATION AGENTS
<b>A61K 31/454</b> (2006.01)	3411031	DEUTERATED DOMPERIDONE COMPOSITIONS AND METHODS FOR THERAPY OF DISORDERS
<b>A61P 1/08</b> (2006.01)	3411031	DEUTERATED DOMPERIDONE COMPOSITIONS AND METHODS FOR THERAPY OF DISORDERS
<b>C07D 401/14</b> (2006.01)	3411031	DEUTERATED DOMPERIDONE COMPOSITIONS AND METHODS FOR THERAPY OF DISORDERS
<b>A41G 5/00</b> (2006.01)	3416513	HAIR BUNDLE APPARATUS AND METHOD OF MANUFACTURING SAME
<b>A61K 31/33</b> (2006.01)	3414244	HALOALLYLAMINE INDOLE AND AZAINDOLE DERIVATIVE INHIBITORS OF LYSYL OXIDASES AND USES THEREOF
<b>A61K 31/404</b> (2006.01)	3414244	HALOALLYLAMINE INDOLE AND AZAINDOLE DERIVATIVE INHIBITORS OF LYSYL OXIDASES AND USES THEREOF
<b>A61P 1/16</b> (2006.01)	3414244	HALOALLYLAMINE INDOLE AND AZAINDOLE DERIVATIVE INHIBITORS OF LYSYL OXIDASES AND USES THEREOF
<b>A61P 9/00</b> (2006.01)	3414244	HALOALLYLAMINE INDOLE AND AZAINDOLE DERIVATIVE INHIBITORS OF LYSYL OXIDASES AND USES THEREOF
<b>A61P 13/12</b> (2006.01)	3414244	HALOALLYLAMINE INDOLE AND AZAINDOLE DERIVATIVE INHIBITORS OF LYSYL OXIDASES AND USES THEREOF
<b>A61P 29/00</b> (2006.01)	3414244	HALOALLYLAMINE INDOLE AND AZAINDOLE DERIVATIVE INHIBITORS OF LYSYL OXIDASES AND USES THEREOF
<b>A61P 35/00</b> (2006.01)	3414244	HALOALLYLAMINE INDOLE AND AZAINDOLE DERIVATIVE INHIBITORS OF LYSYL OXIDASES AND USES THEREOF
<b>C07D 209/10</b> (2006.01)	3414244	HALOALLYLAMINE INDOLE AND AZAINDOLE DERIVATIVE INHIBITORS OF LYSYL OXIDASES AND USES THEREOF
<b>C07D 401/04</b> (2006.01)	3414244	HALOALLYLAMINE INDOLE AND AZAINDOLE DERIVATIVE INHIBITORS OF LYSYL OXIDASES AND USES THEREOF
<b>C07D 403/04</b> (2006.01)	3414244	HALOALLYLAMINE INDOLE AND AZAINDOLE DERIVATIVE INHIBITORS OF LYSYL OXIDASES AND USES THEREOF
<b>C07D 405/04</b> (2006.01)	3414244	HALOALLYLAMINE INDOLE AND AZAINDOLE DERIVATIVE INHIBITORS OF LYSYL OXIDASES AND USES THEREOF
<b>C07D 413/04</b> (2006.01)	3414244	HALOALLYLAMINE INDOLE AND AZAINDOLE DERIVATIVE INHIBITORS OF LYSYL OXIDASES AND USES THEREOF
<b>C07D 471/04</b> (2006.01)	3414244	HALOALLYLAMINE INDOLE AND AZAINDOLE DERIVATIVE INHIBITORS OF LYSYL OXIDASES AND USES THEREOF
<b>A61K 31/00</b> (2006.01)	3414226	INDOLE AND AZAINDOLE HALOALLYLAMINE DERIVATIVE INHIBITORS OF LYSYL OXIDASES AND USES THEREOF
<b>A61K 31/404</b> (2006.01)	3414226	INDOLE AND AZAINDOLE HALOALLYLAMINE DERIVATIVE INHIBITORS OF LYSYL OXIDASES AND USES THEREOF
<b>A61P 35/00</b> (2006.01)	3414226	INDOLE AND AZAINDOLE HALOALLYLAMINE DERIVATIVE INHIBITORS OF LYSYL OXIDASES AND USES THEREOF
<b>C07D 209/24</b> (2006.01)	3414226	INDOLE AND AZAINDOLE HALOALLYLAMINE DERIVATIVE INHIBITORS OF LYSYL OXIDASES AND USES THEREOF
<b>C07D 471/04</b> (2006.01)	3414226	INDOLE AND AZAINDOLE HALOALLYLAMINE DERIVATIVE INHIBITORS OF LYSYL OXIDASES AND USES THEREOF
<b>C07D 487/04</b> (2006.01)	3414226	INDOLE AND AZAINDOLE HALOALLYLAMINE DERIVATIVE INHIBITORS OF LYSYL OXIDASES AND USES THEREOF
<b>H04L 9/28</b> (2006.01)	3414867	A SYSTEM AND METHOD FOR DOCUMENT INFORMATION AUTHENTICITY VERIFICATION
<b>A61K 47/66</b> (2017.01)	3413921	SITE-SELECTIVE FUNCTIONALIZATION OF PROTEINS USING TRACELESS AFFINITY LABELS
<b>A61K 47/68</b> (2017.01)	3413921	SITE-SELECTIVE FUNCTIONALIZATION OF PROTEINS USING TRACELESS AFFINITY LABELS



MKP (51)	Broj objave evropske prijava patenta (97)	Naziv pronalaska (54)
<b>A61P 35/00</b> (2006.01)	3413921	SITE-SELECTIVE FUNCTIONALIZATION OF PROTEINS USING TRACELESS AFFINITY LABELS
<b>A61B 6/00</b> (2006.01)	3399916	SYSTEM AND METHOD FOR THE VISUALIZATION AND CHARACTERIZATION OF OBJECTS IN IMAGES
<b>G06K 9/00</b> (2006.01)	3399916	SYSTEM AND METHOD FOR THE VISUALIZATION AND CHARACTERIZATION OF OBJECTS IN IMAGES
<b>G06K 9/36</b> (2006.01)	3399916	SYSTEM AND METHOD FOR THE VISUALIZATION AND CHARACTERIZATION OF OBJECTS IN IMAGES
<b>G01J 3/447</b> (2006.01)	3414620	METHODS OF IMPROVING THE RETARDATION ACCURACY AND STABILITY OF PHOTOELASTIC MODULATOR DEVICES
<b>G01N 21/19</b> (2006.01)	3414620	METHODS OF IMPROVING THE RETARDATION ACCURACY AND STABILITY OF PHOTOELASTIC MODULATOR DEVICES
<b>G02F 1/11</b> (2006.01)	3414620	METHODS OF IMPROVING THE RETARDATION ACCURACY AND STABILITY OF PHOTOELASTIC MODULATOR DEVICES
<b>A61K 31/47</b> (2006.01)	3413892	TETRAHYDROISOQUINOLINE DERIVATIVES
<b>C07D 217/08</b> (2006.01)	3413892	TETRAHYDROISOQUINOLINE DERIVATIVES
<b>C07D 403/02</b> (2006.01)	3414235	DEUTERIUM-MODIFIED CFTR MODULATORS
<b>C07D 411/02</b> (2006.01)	3414235	DEUTERIUM-MODIFIED CFTR MODULATORS
<b>C07D 495/04</b> (2006.01)	3414235	DEUTERIUM-MODIFIED CFTR MODULATORS
<b>B65D 19/00</b> (2006.01)	3416896	TRANSFER EQUIPMENT AND LOAD TRANSFER APPLIANCE
<b>B65D 19/38</b> (2006.01)	3416896	TRANSFER EQUIPMENT AND LOAD TRANSFER APPLIANCE
<b>B65G 65/02</b> (2006.01)	3416896	TRANSFER EQUIPMENT AND LOAD TRANSFER APPLIANCE
<b>B65G 67/04</b> (2006.01)	3416896	TRANSFER EQUIPMENT AND LOAD TRANSFER APPLIANCE
<b>B65G 69/22</b> (2006.01)	3416896	TRANSFER EQUIPMENT AND LOAD TRANSFER APPLIANCE
<b>A61K 31/4155</b> (2006.01)	3416964	CARBOXAMIDE DERIVATIVES USEFUL AS RSK INHIBITORS
<b>A61K 31/4525</b> (2006.01)	3416964	CARBOXAMIDE DERIVATIVES USEFUL AS RSK INHIBITORS
<b>A61K 31/454</b> (2006.01)	3416964	CARBOXAMIDE DERIVATIVES USEFUL AS RSK INHIBITORS
<b>A61K 31/4985</b> (2006.01)	3416964	CARBOXAMIDE DERIVATIVES USEFUL AS RSK INHIBITORS
<b>A61P 35/00</b> (2006.01)	3416964	CARBOXAMIDE DERIVATIVES USEFUL AS RSK INHIBITORS
<b>C07D 403/12</b> (2006.01)	3416964	CARBOXAMIDE DERIVATIVES USEFUL AS RSK INHIBITORS
<b>C07D 405/12</b> (2006.01)	3416964	CARBOXAMIDE DERIVATIVES USEFUL AS RSK INHIBITORS
<b>C07D 409/12</b> (2006.01)	3416964	CARBOXAMIDE DERIVATIVES USEFUL AS RSK INHIBITORS
<b>C07D 471/04</b> (2006.01)	3416964	CARBOXAMIDE DERIVATIVES USEFUL AS RSK INHIBITORS
<b>C07D 471/14</b> (2006.01)	3416964	CARBOXAMIDE DERIVATIVES USEFUL AS RSK INHIBITORS
<b>C07D 487/04</b> (2006.01)	3416964	CARBOXAMIDE DERIVATIVES USEFUL AS RSK INHIBITORS
<b>C07D 491/048</b> (2006.01)	3416964	CARBOXAMIDE DERIVATIVES USEFUL AS RSK INHIBITORS
<b>A61K 31/4439</b> (2006.01)	3418276	AZOLE-SUBSTITUTED PYRIDINE COMPOUND
<b>A61K 31/444</b> (2006.01)	3418276	AZOLE-SUBSTITUTED PYRIDINE COMPOUND
<b>A61K 31/4545</b> (2006.01)	3418276	AZOLE-SUBSTITUTED PYRIDINE COMPOUND
<b>A61K 31/46</b> (2006.01)	3418276	AZOLE-SUBSTITUTED PYRIDINE COMPOUND
<b>A61K 31/4709</b> (2006.01)	3418276	AZOLE-SUBSTITUTED PYRIDINE COMPOUND
<b>A61K 31/498</b> (2006.01)	3418276	AZOLE-SUBSTITUTED PYRIDINE COMPOUND
<b>A61K 31/5355</b> (2006.01)	3418276	AZOLE-SUBSTITUTED PYRIDINE COMPOUND
<b>A61K 31/5377</b> (2006.01)	3418276	AZOLE-SUBSTITUTED PYRIDINE COMPOUND
<b>A61P 13/12</b> (2006.01)	3418276	AZOLE-SUBSTITUTED PYRIDINE COMPOUND
<b>A61P 43/00</b> (2006.01)	3418276	AZOLE-SUBSTITUTED PYRIDINE COMPOUND
<b>C07D 401/04</b> (2006.01)	3418276	AZOLE-SUBSTITUTED PYRIDINE COMPOUND
<b>C07D 401/14</b> (2006.01)	3418276	AZOLE-SUBSTITUTED PYRIDINE COMPOUND
<b>C07D 405/14</b> (2006.01)	3418276	AZOLE-SUBSTITUTED PYRIDINE COMPOUND
<b>C07D 409/14</b> (2006.01)	3418276	AZOLE-SUBSTITUTED PYRIDINE COMPOUND
<b>C07D 413/14</b> (2006.01)	3418276	AZOLE-SUBSTITUTED PYRIDINE COMPOUND
<b>C07D 417/14</b> (2006.01)	3418276	AZOLE-SUBSTITUTED PYRIDINE COMPOUND
<b>C07D 451/02</b> (2006.01)	3418276	AZOLE-SUBSTITUTED PYRIDINE COMPOUND
<b>A61K 38/00</b> (2006.01)	3417294	METHODS COMPRISING FIXED INTERMITTENT DOSING OF CEDIRANIB
<b>A61K 39/395</b> (2006.01)	3417294	METHODS COMPRISING FIXED INTERMITTENT DOSING OF CEDIRANIB
<b>A61K 48/00</b> (2006.01)	3417294	METHODS COMPRISING FIXED INTERMITTENT DOSING OF CEDIRANIB
<b>A61P 35/00</b> (2006.01)	3417294	METHODS COMPRISING FIXED INTERMITTENT DOSING OF CEDIRANIB
<b>G01N 33/574</b> (2006.01)	3417294	METHODS COMPRISING FIXED INTERMITTENT DOSING OF CEDIRANIB
<b>C01B 32/10</b> (2017.01)	3417502	IMMOBILIZED SELENIUM, A METHOD OF MAKING, AND USES OF IMMOBILIZED SELENIUM IN A RECHARGEABLE BATTERY
<b>H01M 2/14</b> (2006.01)	3417502	IMMOBILIZED SELENIUM, A METHOD OF MAKING, AND USES OF IMMOBILIZED SELENIUM IN A RECHARGEABLE BATTERY

MKP (51)	Broj objave evropske prijava patenta (97)	Naziv pronalaska (54)
<b>H01M 4/134</b> (2010.01)	3417502	IMMOBILIZED SELENIUM, A METHOD OF MAKING, AND USES OF IMMOBILIZED SELENIUM IN A RECHARGEABLE BATTERY
<b>H01M 4/36</b> (2006.01)	3417502	IMMOBILIZED SELENIUM, A METHOD OF MAKING, AND USES OF IMMOBILIZED SELENIUM IN A RECHARGEABLE BATTERY
<b>H01M 4/38</b> (2006.01)	3417502	IMMOBILIZED SELENIUM, A METHOD OF MAKING, AND USES OF IMMOBILIZED SELENIUM IN A RECHARGEABLE BATTERY
<b>H01M 10/052</b> (2010.01)	3417502	IMMOBILIZED SELENIUM, A METHOD OF MAKING, AND USES OF IMMOBILIZED SELENIUM IN A RECHARGEABLE BATTERY
<b>H01M 10/058</b> (2010.01)	3417502	IMMOBILIZED SELENIUM, A METHOD OF MAKING, AND USES OF IMMOBILIZED SELENIUM IN A RECHARGEABLE BATTERY
<b>A61K 8/00</b> (2006.01)	3416679	PATHOGEN VACCINES AND METHODS OF PRODUCING AND USING THE SAME
<b>A61K 39/00</b> (2006.01)	3416679	PATHOGEN VACCINES AND METHODS OF PRODUCING AND USING THE SAME
<b>A61K 48/00</b> (2006.01)	3416679	PATHOGEN VACCINES AND METHODS OF PRODUCING AND USING THE SAME
<b>C07K 14/435</b> (2006.01)	3416679	PATHOGEN VACCINES AND METHODS OF PRODUCING AND USING THE SAME
<b>C07K 14/47</b> (2006.01)	3416679	PATHOGEN VACCINES AND METHODS OF PRODUCING AND USING THE SAME
<b>C12N 9/00</b> (2006.01)	3416679	PATHOGEN VACCINES AND METHODS OF PRODUCING AND USING THE SAME
<b>A61K 31/4365</b> (2006.01)	3416639	POSITIVE ALLOSTERIC MODULATORS OF THE MUSCARINIC ACETYLCHOLINE RECEPTOR M1
<b>C07D 495/04</b> (2006.01)	3416639	POSITIVE ALLOSTERIC MODULATORS OF THE MUSCARINIC ACETYLCHOLINE RECEPTOR M1
<b>C12N 5/00</b> (2006.01)	3417051	METHODS AND TEST KITS FOR DETERMINING MALE FERTILITY STATUS
<b>G01N 1/30</b> (2006.01)	3417051	METHODS AND TEST KITS FOR DETERMINING MALE FERTILITY STATUS
<b>G01N 33/50</b> (2006.01)	3417051	METHODS AND TEST KITS FOR DETERMINING MALE FERTILITY STATUS
<b>G01N 33/68</b> (2006.01)	3417051	METHODS AND TEST KITS FOR DETERMINING MALE FERTILITY STATUS
<b>A61K 31/4439</b> (2006.01)	3347352	THERAPEUTIC COMPOUNDS USEFUL FOR THE PROPHYLACTIC OR THERAPEUTIC TREATMENT OF AN HIV VIRUS INFECTION
<b>A61P 31/18</b> (2006.01)	3347352	THERAPEUTIC COMPOUNDS USEFUL FOR THE PROPHYLACTIC OR THERAPEUTIC TREATMENT OF AN HIV VIRUS INFECTION
<b>C07D 401/14</b> (2006.01)	3347352	THERAPEUTIC COMPOUNDS USEFUL FOR THE PROPHYLACTIC OR THERAPEUTIC TREATMENT OF AN HIV VIRUS INFECTION
<b>B64C 39/02</b> (2006.01)	3400676	A SAFETY ARCHITECTURE FOR AUTONOMOUS VEHICLES
<b>G05B 19/418</b> (2006.01)	3400676	A SAFETY ARCHITECTURE FOR AUTONOMOUS VEHICLES
<b>H04L 9/32</b> (2006.01)	3400676	A SAFETY ARCHITECTURE FOR AUTONOMOUS VEHICLES
<b>A61K 31/13</b> (2006.01)	3359146	PHARMACEUTICAL COMPOSITIONS AND USES DIRECTED TO LYSOSOMAL STORAGE DISORDERS
<b>A61P 25/00</b> (2006.01)	3359146	PHARMACEUTICAL COMPOSITIONS AND USES DIRECTED TO LYSOSOMAL STORAGE DISORDERS
<b>A61K 31/13</b> (2006.01)	3416631	THERAPEUTIC AGENTS FOR NEURODEGENERATIVE DISEASES
<b>A61P 25/00</b> (2006.01)	3416631	THERAPEUTIC AGENTS FOR NEURODEGENERATIVE DISEASES
<b>G06F 17/50</b> (2006.01)	3347879	METHOD FOR IMMEDIATE BOOLEAN OPERATIONS USING GEOMETRIC FACETS
<b>G06T 17/10</b> (2006.01)	3347879	METHOD FOR IMMEDIATE BOOLEAN OPERATIONS USING GEOMETRIC FACETS
<b>G06T 19/00</b> (2011.01)	3347879	METHOD FOR IMMEDIATE BOOLEAN OPERATIONS USING GEOMETRIC FACETS
<b>A61K 35/74</b> (2015.01)	3359172	COMPOSITIONS COMPRISING BACTERIAL STRAINS
<b>A61P 1/14</b> (2006.01)	3359172	COMPOSITIONS COMPRISING BACTERIAL STRAINS
<b>A61P 29/00</b> (2006.01)	3359172	COMPOSITIONS COMPRISING BACTERIAL STRAINS
<b>B65G 39/04</b> (2006.01)	3408197	CONVEYOR ROLLER WITH CONICAL TAPERED ELEMENT
<b>B65G 39/07</b> (2006.01)	3408197	CONVEYOR ROLLER WITH CONICAL TAPERED ELEMENT
<b>A61K 9/00</b> (2006.01)	3368011	NOVEL COMPOUNDS AND USES THEREOF
<b>A61K 31/137</b> (2006.01)	3368011	NOVEL COMPOUNDS AND USES THEREOF
<b>A61K 45/06</b> (2006.01)	3368011	NOVEL COMPOUNDS AND USES THEREOF

## Indeks podnosilaca zahtjeva za proširenje evropskih prijave patenta

Podnosilac evropske prijave patenta (71)	MKP (51)	Broj objave evropske prijave patenta (97)	Naziv pronalaska (54)
	<b>B26B 21/22</b> (2006.01)	3022022	RAZOR HAVING FREE MOVABILITY OF THE RAZOR HEAD
	<b>B26B 21/52</b> (2006.01)		
	<b>B23K 26/12</b> (2014.01)	2929976	METHOD FOR CO2 LASER WELDING OF HIGH ALLOY STEELS
	<b>B23K 26/14</b> (2014.01)		
	<b>B23K 26/34</b> (2014.01)		
	<b>B23K 35/38</b> (2006.01)		
	<b>B23K 103/04</b> (2006.01)		
	<b>B23K 26/12</b> (2014.01)	2929977	METHOD FOR CO2 LASER WELDING OF LOW ALLOY STEELS
	<b>B23K 35/38</b> (2006.01)		
HILTI Aktiengesellschaft	<b>F16B 23/00</b> (2006.01)	2476919	Screw anchor and method for manufacturing a screw anchor
	<b>F16B 25/00</b> (2006.01)		
	<b>F16B 37/12</b> (2006.01)		
POD Point Holding Ltd	<b>B60L 11/18</b> (2006.01)	2708403	System and method for managing load on a power grid
	<b>H02J 3/14</b> (2006.01)		
KWB - Kraft und Wärme aus Biomasse Gesellschaft m.b.H.	<b>F23J 1/02</b> (2006.01)	2375154	Heating device
	<b>A23L 3/375</b> (2006.01)	2657631	Method and device for cooling products
	<b>F25D 3/10</b> (2006.01)		
	<b>F25D 3/12</b> (2006.01)		
	<b>F25D 3/10</b> (2006.01)	2657630	Method and device for producing cooled products
	<b>F25D 3/12</b> (2006.01)		
	<b>F23N 1/02</b> (2006.01)	2741002	Device and method for detecting and controlling the flow of a fluid medium in a controlled system
	<b>F02D 41/00</b> (2006.01)	2730769	Method for operating a combustion engine with high pressure and low pressure exhaust gas recovery
	<b>F02D 41/02</b> (2006.01)		
PODRAVKA d.d.	<b>A23L 27/40</b> (2016.01)	3349594	SALT SUBSTITUTE COMPOSITION, PREPARATION AND USE THEREOF
	<b>A23L 33/165</b> (2016.01)		
	<b>A61P 9/12</b> (2006.01)		
NuCana plc	<b>A61K 31/7068</b> (2006.01)	3359163	COMBINATION THERAPY
	<b>A61P 35/00</b> (2006.01)		
URGO RECHERCHE INNOVATION ET DEVELOPPEMENT	<b>A61K 33/06</b> (2006.01)	3349765	COMBINATION PRODUCT FOR ASSISTING WITH RELAXATION AND SLEEP
	<b>A61K</b>		

Podnosilac evropske prijave patenta (71)	MKP (51)	Broj objave evropske prijave patenta (97)	Naziv pronalaska (54)
Gins S.r.l.	<b>36/185</b> (2006.01) <b>A61K 36/28</b> (2006.01) <b>A61K 36/53</b> (2006.01) <b>B65D 51/24</b> (2006.01) <b>C12G 1/08</b> (2006.01)	3247650	A DEVICE FOR ELIMINATING FERMENTATION RESIDUES IN AN ALCOHOLIC BEVERAGE
Castle Commercial Enterprises Limited	<b>C12G 1/032</b> (2006.01)	3170887	IMPROVED FERMENTER
Axichem AB	<b>A23K 10/00</b> (2016.01)	3358965	BIRD FEED AND IN PARTICULAR POULTRY FEED, COMPRISING SYNTHETIC CAPSAICINOID DERIVATIVES AND SUCH FEED FOR PROHYLACTIC USE OR TREATMENT OF SALMONELLA INFECTION
Dia-Vit Ltd.	<b>A61B 5/145</b> (2006.01) <b>A61B 5/1455</b> (2006.01)	3359038	DEVICE FOR NON-INVASIVE MEASUREMENT OF BLOOD SUGAR LEVEL
Schultz, Douglas Allen	<b>B64C 13/50</b> (2006.01) <b>B64D 45/00</b> (2006.01) <b>G05D 1/00</b> (2006.01) <b>H04B 7/185</b> (2006.01)	3109168	METHOD AND APPARATUS FOR AUGMENTED PILOT OPERATIONS OF FLY-BY-WIRE VEHICLES
Rosomanov, Zoran	<b>B42D 1/00</b> (2006.01) <b>F23J 7/00</b> (2006.01) <b>F23J 15/00</b> (2006.01) <b>F23J 15/04</b> (2006.01)	3254861 3260776	PRINTING BOOK INCLUDING A FIRST ATTACHMENT DEVICE LANCE SYSTEM, BOILER- CONTAINING LANCE SYSTEM AND METHOD FOR REDUCING NOX
Ideal-Werk C. & E. Jungeblodt GmbH & Co.KG	<b>B21F 15/08</b> (2006.01) <b>B23K 37/04</b> (2006.01) <b>B23K 101/32</b> (2006.01) <b>B25J 15/00</b> (2006.01) <b>B25J 15/02</b> (2006.01) <b>A23L 29/00</b> (2016.01) <b>A61K 8/00</b> (2006.01) <b>A61K 9/16</b> (2006.01) <b>A23L 29/00</b> (2016.01) <b>A61K 8/00</b> (2006.01) <b>A61K 9/16</b> (2006.01)	3260231 3260114 3260115	GRIPPER AND METHOD FOR GRIPPING ENDS OF WIRES AND WIRE WELDING MACHINE AND ROBOT WITH SUCH GRIPPERS METHOD FOR THE PRODUCTION OF A DOSAGE FORM METHOD FOR THE PRODUCTION OF A DOSAGE FORM
NVB Propulsion International Ltd Van Der Blom, Nicolaas	<b>F04B 53/14</b> (2006.01) <b>F15B 15/14</b> (2006.01) <b>F16F 9/48</b> (2006.01) <b>F16J 3/06</b>	3405704	PISTON-CHAMBER COMBINATION

Podnosilac evropske prijave patenta (71)	MKP (51)	Broj objave evropske prijave patenta (97)	Naziv pronalaska (54)
	(2006.01) <b>F16J 10/00</b> (2006.01)		
ZentorgA Zentralstaubsauganlagen GmbH	<b>A47L 5/38</b> (2006.01) <b>A47L 9/00</b> (2006.01) <b>A47L 9/24</b> (2006.01)	2534989	Central vacuum cleaner assembly
Streitmaier, Horst	<b>F16L 21/06</b> (2006.01) <b>F16L 31/00</b> (2006.01)	3287682	HOLDING DEVICE FOR THE DETACHABLE, COAXIAL JOINING OF FLEXIBLE TUBING
	<b>B29C 65/68</b> (2006.01) <b>B60H 1/00</b> (2006.01) <b>F24H 3/04</b> (2006.01) <b>H01R 4/72</b> (2006.01) <b>H05B 3/40</b> (2006.01)	3287710	ELECTRIC HEATER
Babboe B.V.	<b>B62K 5/00</b> (2013.01) <b>B62K 5/10</b> (2013.01) <b>B62K 7/04</b> (2006.01)	3290315	LEANING CARGO MULTI-WHEELER
metaX Institut für Diätetik GmbH	<b>A23L 33/195</b> (2016.01) <b>A61K 38/00</b> (2006.01) <b>C07K 14/195</b> (2006.01)	3290436	PHENYLALANINE-FREE PROTEIN FOR THE TREATMENT OF PKU
	<b>F24H 1/00</b> (2006.01) <b>F24H 9/00</b> (2006.01) <b>F24H 9/18</b> (2006.01) <b>H05B 1/02</b> (2006.01) <b>H05B 3/48</b> (2006.01)	3290819	ELECTRIC HEATING DEVICE
Ethicon Endo-Surgery, LLC	<b>A61B 17/072</b> (2006.01)	3150136	PROGRESSIVELY RELEASABLE IMPLANTABLE ADJUNCT FOR USE WITH A SURGICAL STAPLING INSTRUMENT
IBEX SARL DURDEN CONCEPT SARL	<b>A23L 29/231</b> (2016.01)	3376880	ALCOHOLIC FOAM
Sociedad Española de Desarrollos Químicos, S.L. (SEDQ)	<b>A01M 1/02</b> (2006.01) <b>A01M 1/10</b> (2006.01) <b>A01M 1/20</b> (2006.01)	3254559	INSECT TRAP
VITALGAIA ESPAÑA, S.L.	<b>A23L 21/20</b> (2016.01) <b>A23L 33/10</b> (2016.01) <b>A61K 31/192</b> (2006.01) <b>A61K</b>	3278798	SYNERGISTIC COMPOSITION COMPRISING PROPOLIS AND CARNOSIC ACID FOR USE THEREOF IN TREATING AND PREVENTING INFECTIONS CAUSED BY SPECIES OF THE CRYPTOCOCCUS NEOFORMANS FUNGUS

Podnosilac evropske prijave patenta (71)	MKP (51)	Broj objave evropske prijave patenta (97)	Naziv pronalaska (54)
G. & P. Garbellotto S.p.A.	<b>35/644</b> (2015.01) <b>A61P 31/10</b> (2006.01) <b>B27H 5/04</b> (2006.01) <b>B27M 1/06</b> (2006.01) <b>C12G 3/07</b> (2006.01) <b>C12J 1/00</b> (2006.01)	3301170	DEVICE AND METHOD OF HEATING/BENDING/FORMING AND HEATING/TOASTING BARRELS, CASKS, VATS AND THE LIKE FOR REFINING, CONDITIONING AND AGEING ALCOHOLIC BEVERAGES AND OTHER FOODS
General Electric Company	<b>F01D 5/00</b> (2006.01) <b>F01D 5/30</b> (2006.01) <b>F01D 25/28</b> (2006.01)	3318716	INSTALLATION OR REMOVAL OF TURBINE BLADE AT TURBINE BLADE BASE
Affibody AB	<b>A61K 38/00</b> (2006.01) <b>A61K 38/20</b> (2006.01) <b>C07K 14/54</b> (2006.01) <b>A61K 39/00</b> (2006.01) <b>A61K 39/395</b> (2006.01) <b>A61P 37/00</b> (2006.01) <b>C07K 16/28</b> (2006.01)	3245224	IL-17A-BINDING POLYPEPTIDES
	<b>A61K 39/00</b> (2006.01) <b>A61K 39/395</b> (2006.01) <b>A61P 37/00</b> (2006.01) <b>C07K 16/28</b> (2006.01)	3242892	ALTERED APRIL BINDING ANTIBODIES
	<b>A23L 2/52</b> (2006.01) <b>A23L 2/60</b> (2006.01) <b>A23L 27/12</b> (2016.01)	3250050	A NATURAL SWEETENING COMPOSITION
Montero Gida Sanayi Ve Ticaret A.S.	<b>A23L 2/52</b> (2006.01) <b>A23L 2/60</b> (2006.01) <b>A23L 27/12</b> (2016.01)	3250051	A NATURAL SWEETENING COMPOSITION OF LUO HAN GUO AND APPLE
	<b>A61K 39/00</b> (2006.01) <b>A61K 39/395</b> (2006.01) <b>A61P 1/00</b> (2006.01) <b>C07K 16/28</b> (2006.01)	3242684	DOSAGE REGIMEN FOR MADCAM ANTAGONISTS
DALEKOVOD PROIZVODNJA d.o.o.	<b>A62B 35/00</b> (2006.01) <b>A62B 35/04</b> (2006.01)	3402577	FALL ARRESTER WITH TORSIONAL ENERGY ABSORBING MEANS
Support-Venture GmbH	<b>A61K 31/4439</b> (2006.01) <b>A61P 27/00</b> (2006.01) <b>A61K 39/395</b> (2006.01)	3256127	METHOD OF PREVENTING OR TREATING HEARING LOSS
	<b>A61K 39/395</b> (2006.01)	3247393	MATRIX METALLOPROTEASE-CLEAVABLE AND SERINE PROTEASE CLEAVABLE SUBSTRATES AND METHODS OF USE THEREOF

Podnosilac evropske prijave patenta (71)	MKP (51)	Broj objave evropske prijave patenta (97)	Naziv pronalaska (54)		
Oxford Drug Design Limited	<b>C07K 16/28</b> (2006.01)	3259250	NOVEL N-ACYL-ARYLSULFONAMIDE DERIVATIVES AS AMINOACYL-TRNA SYNTHETASE INHIBITORS		
	<b>A61K 31/18</b> (2006.01)				
	<b>A61K 31/4402</b> (2006.01)				
	<b>A61K 31/47</b> (2006.01)				
	<b>A61K 31/505</b> (2006.01)				
	<b>A61P 31/00</b> (2006.01)				
	<b>C07C 311/00</b> (2006.01)				
	<b>C07D 213/71</b> (2006.01)				
	<b>C07D 215/36</b> (2006.01)				
	<b>C07D 217/22</b> (2006.01)				
	<b>C07D 239/42</b> (2006.01)				
	<b>C07D 239/47</b> (2006.01)				
	<b>C07D 239/48</b> (2006.01)				
	<b>C07D 251/22</b> (2006.01)				
	<b>C07D 311/20</b> (2006.01)				
	<b>C07D 487/04</b> (2006.01)				
	<b>A61K 31/551</b> (2006.01)			3253747	3-ALKYL-4-AMIDO-BICYCLIC [4,5,0]HYDROXAMIC ACIDS AS HDAC INHIBITORS
	<b>A61K 31/553</b> (2006.01)			3256107	PHARMACEUTICAL FORMULATION OF RACECADOTRIL
	<b>A61P 35/00</b> (2006.01)				
	<b>C07D 243/14</b> (2006.01)				
<b>C07D 267/12</b> (2006.01)					
<b>C07D 403/06</b> (2006.01)					
<b>C07D 413/06</b> (2006.01)					
<b>A61K 9/16</b> (2006.01)					
<b>A61K 31/265</b> (2006.01)	3384100	BUILDING PRODUCTS COMPRISING GRAPHENE OR GRAPHENE OXIDE IN THE BULK MATERIAL AND METHOD FOR PRODUCING SUCH BUILDING PRODUCTS			
<b>E04C 1/00</b> (2006.01)					
<b>E04C 2/04</b> (2006.01)					
Teamplast B.V.	<b>E04C 2/04</b> (2006.01)	3374577	BUILDING PRODUCTS WITH GRAPHENE OR GRAPHENE OXIDE		
	<b>B65D 51/28</b> (2006.01)	3397568	CONTAINER WITH MULTI DEPRESSIBLE CAP PRESS TOP		
Comin SP. Z O.O.	<b>A61N 5/06</b> (2006.01)	3402570	COMPACT UVB LIGHT THERAPY DEVICE FOR TREATING DERMAL CONDITIONS		
Guangzhou Bioseal Biotech Co., Ltd.	<b>C12N 9/74</b> (2006.01)	3253870	METHOD FOR PREPARATION OF THROMBIN		

Podnosilac evropske prijave patenta (71)	MKP (51)	Broj objave evropske prijave patenta (97)	Naziv pronalaska (54)
DODE, S.A.	<b>G01N 33/48</b> (2006.01)		
	<b>B65D 81/34</b> (2006.01)	3395716	BAG FOR COOKING CORN GRAINS IN A MICROWAVE
	<b>A61K 31/496</b> (2006.01)	3344620	1-(4-(2-((1-(3,4-DIFLUOROPHENYL)-1H-PYRAZOL-3-YL)METHOXY)ETHYL) PIPERAZIN-1-YL)ETHANONE SALTS
	<b>A61P 25/34</b> (2006.01)		
	<b>C07D 403/12</b> (2006.01)		
	<b>A61K 31/713</b> (2006.01)	3344769	PROGRAMMED CELL DEATH 1 LIGAND 1 (PD-L1) iRNA COMPOSITIONS AND METHODS OF USE THEREOF
	<b>C12N 15/113</b> (2010.01)		
	<b>A61K 31/575</b> (2006.01)	3394081	POLYMORPHIC CRYSTALLINE FORMS OF OBETICHOLIC ACID
	<b>A61P 1/16</b> (2006.01)		
	<b>C07J 9/00</b> (2006.01)		
	<b>C07J 17/00</b> (2006.01)		
	<b>C07J 51/00</b> (2006.01)		
	Foodmate B.V.	<b>A22C 21/00</b> (2006.01)	3250039
<b>A47C 7/02</b> (2006.01)		3373769	METHOD FOR PRODUCING A TEXTILE COMPOSITE MATERIAL AND TEXTILE COMPOSITE MATERIAL PRODUCED ACCORDING TO SAID METHOD
<b>A47C 7/28</b> (2006.01)			
<b>A47C 31/02</b> (2006.01)			
<b>B68G 7/00</b> (2006.01)			
<b>D03D 15/04</b> (2006.01)			
<b>A01K 67/027</b> (2006.01)		3165540	ANTIBODIES THAT BIND HUMAN CD27 AND USES THEREOF
<b>A61K 39/395</b> (2006.01)			
<b>A61P 35/00</b> (2006.01)			
<b>A61P 37/02</b> (2006.01)			
<b>C07K 14/705</b> (2006.01)			
<b>C07K 16/28</b> (2006.01)			
<b>G06T 15/08</b> (2011.01)		3156975	VOXELIZATION OF A TRIDIMENSIONAL MESH
<b>G06T 17/20</b> (2006.01)			
<b>G06T 19/00</b> (2011.01)			
Lorch, Roland Schaible, Jürgen	<b>B01D 24/36</b> (2006.01)	3159314	CLARIFICATION UNIT, METHOD AND USE
	<b>B01D 24/46</b> (2006.01)		
	<b>C02F 3/08</b>		



Podnosilac evropske prijave patenta (71)	MKP (51)	Broj objave evropske prijave patenta (97)	Naziv pronalaska (54)
Haq, Manan	(2006.01) <b>C02F 3/12</b> (2006.01) <b>A61K 39/395</b> (2006.01) <b>C07K 16/24</b> (2006.01) <b>B23D 65/00</b> (2006.01) <b>B24B 7/17</b> (2006.01) <b>B24B 21/04</b> (2006.01) <b>H01M 2/02</b> (2006.01) <b>H01M 4/86</b> (2006.01) <b>H01M 4/88</b> (2006.01) <b>H01M 12/06</b> (2006.01) <b>H01M 12/08</b> (2006.01) <b>C02F 1/00</b> (2006.01) <b>C02F 1/44</b> (2006.01) <b>C02F 1/50</b> (2006.01) <b>C02F 1/66</b> (2006.01) <b>C02F 1/76</b> (2006.01) <b>C02F 1/78</b> (2006.01) <b>C02F 5/14</b> (2006.01) <b>C02F 103/42</b> (2006.01) <b>E04H 4/12</b> (2006.01) <b>B01D 21/30</b> (2006.01) <b>B01D 61/04</b> (2006.01) <b>C02F 1/00</b> (2006.01) <b>C02F 1/24</b> (2006.01) <b>C02F 1/44</b> (2006.01) <b>C02F 1/50</b> (2006.01) <b>C02F 1/52</b> (2006.01) <b>C02F 1/56</b> (2006.01) <b>C02F 1/72</b> (2006.01) <b>C02F 1/76</b> (2006.01) <b>C02F 1/78</b> (2006.01) <b>C02F 5/08</b> (2006.01) <b>C02F 9/02</b>	3156073	IL-17 ANTIBODY FORMULATION
	3321020	DEVICE FOR THE POST-TREATMENT OF BUTT-WELDED WORKPIECES, IN PARTICULAR SAW BANDS OR BAND KNIVES	
	3321990	FLOW BATTERY, PROCESS FOR THE MANUFACTURE, AND USE THEREOF	
	3153474	SUSTAINABLE SYSTEM FOR TREATING WATER BODIES AFFECTED BY BACTERIA AND MICROALGAE AT LOW COST	
	3156111	METHOD FOR TREATING WATER USED FOR INDUSTRIAL PURPOSES	

Podnosilac evropske prijave patenta (71)	MKP (51)	Broj objave evropske prijave patenta (97)	Naziv pronalaska (54)
	(2006.01) <b>C02F 101/20</b> (2006.01) <b>C02F 103/02</b> (2006.01) <b>C02F 103/08</b> (2006.01) <b>C02F 103/10</b> (2006.01)		
	<b>G01N 27/72</b> (2006.01)	3173825	METHODS AND APPARATUS FOR COLLOCATING ELECTROMAGNETIC COILS AND ELECTRONIC CIRCUITS
	<b>G01V 3/10</b> (2006.01)		
smark - Philipp Hoening & Maximilian Ittermann GbR	<b>A47F 1/12</b> (2006.01)	3332672	MOBILE MAGAZINE
	<b>G07F 9/10</b> (2006.01)		
	<b>G07F 11/04</b> (2006.01)		
	<b>G07F 11/16</b> (2006.01)		
	<b>G07F 11/22</b> (2006.01)		
	<b>G07F 11/42</b> (2006.01)		
REGENERON PHARMACEUTICALS, INC.	<b>A01K 67/027</b> (2006.01)	3165086	COMMON LIGHT CHAIN MOUSE
	<b>C07K 16/00</b> (2006.01)		
	<b>C07K 16/28</b> (2006.01)		
	<b>C12N 15/85</b> (2006.01)		
KNAPHEIDE GmbH Hydraulik-Systeme	<b>B23P 19/02</b> (2006.01)	3348346	METHOD AND DEVICE FOR PRODUCING CONNECTION HOSES
	<b>B23P 21/00</b> (2006.01)		
LIMO GmbH	<b>G02B 19/00</b> (2006.01)	3214477	DEVICE FOR SHAPING LASER RADIATION
	<b>G02B 27/09</b> (2006.01)		
	<b>G02B 27/14</b> (2006.01)		
	<b>H01S 5/40</b> (2006.01)		
	<b>C01F 11/18</b> (2006.01)	3354622	PROCESS FOR THE PREPARATION OF FRAGMENTED NATURAL CALCIUM CARBONATE WITH A REDUCED CONTENT OF IMPURITIES AND PRODUCTS OBTAINED THEREOF
	<b>C09C 1/02</b> (2006.01)		
	<b>A61K 8/02</b> (2006.01)	3360601	FUNCTIONALIZED CALCIUM CARBONATE FOR SUN PROTECTION BOOSTING
	<b>A61K 8/19</b> (2006.01)		
	<b>A61K 8/29</b> (2006.01)		
	<b>A61Q 17/04</b> (2006.01)		
	<b>C08J 7/04</b> (2006.01)	3366740	MINERAL OIL BARRIER
	<b>C09D 151/02</b> (2006.01)		
ESIM Chemicals GmbH	<b>C07C 303/04</b> (2006.01)	3366671	PROCESS FOR THE PREPARATION OF SULFO-SUCCINIC ACID AND USE THEREOF
	<b>C07C 309/22</b> (2006.01)		

Podnosilac evropske prijave patenta (71)	MKP (51)	Broj objave evropske prijave patenta (97)	Naziv pronalaska (54)
Sensor Health S.R.L.	<b>A61B 5/145</b> (2006.01)	3410936	MEASURING DEVICE FOR BLOOD AND/OR LIQUID INTERSTITIAL ANALYTES
	<b>A61B 5/1486</b> (2006.01)		
	<b>F41C 33/02</b> (2006.01)	3411654	A HOLSTER FOR A FIREARM WITH AN ELECTRONIC DEVICE FOR DETECTING AND SENDING DATA
Processi Innovativi Srl	<b>C07C 273/10</b> (2006.01)	3411356	A CARBON NEUTRAL PROCESS AND RELATING APPARATUS TO PRODUCE UREA FROM MUNICIPAL OR INDUSTRIAL WASTES WITH ZERO EMISSIONS
ESTEVE PHARMACEUTICALS, S.A.	<b>A61K 31/5386</b> (2006.01)	3377500	OXADIAZASPIRO COMPOUNDS FOR THE TREATMENT OF DRUG ABUSE AND ADDICTION
	<b>A61P 25/32</b> (2006.01)		
	<b>A61P 25/34</b> (2006.01)		
	<b>A61P 25/36</b> (2006.01)		
	<b>C07D 498/10</b> (2006.01)		
SO.F.TER. SPA	<b>A43B 13/04</b> (2006.01)	3347416	POLYMER COMPOSITION BASED ON THERMOPLASTIC COPOLYESTER ELASTOMER, MANUFACTURED ARTICLE MADE WITH SUCH POLYMER COMPOSITION AND PRODUCTION PROCESS OF SUCH POLYMER COMPOSITION
	<b>C08J 9/00</b> (2006.01)		
	<b>C08J 9/04</b> (2006.01)		
	<b>C08K 5/10</b> (2006.01)		
	<b>C08L 67/02</b> (2006.01)		
Università degli Studi "G. d'Annunzio" CHIETI-PESCARA	<b>E04B 1/16</b> (2006.01)	3347535	BUILDING SYSTEM WITH A LOAD-RESISTING FRAME MADE OF REINFORCED CONCRETE OR STEEL INTEGRATED WITH WOODEN INFILL PANELS
	<b>E04B 1/20</b> (2006.01)		
	<b>E04B 1/24</b> (2006.01)		
	<b>E04B 2/56</b> (2006.01)		
	<b>E04B 2/74</b> (2006.01)		
	<b>E04G 23/02</b> (2006.01)		
	<b>E04H 9/02</b> (2006.01)		
Universität Basel	<b>A61K 39/00</b> (2006.01)	3377094	VIRULENCE ATTENUATED BACTERIA FOR TREATMENT OF MALIGNANT SOLID TUMORS
	<b>A61K 39/02</b> (2006.01)		
	<b>A61K 31/445</b> (2006.01)	3377478	CO-CRYSTALS OF BENZIMIDAZOLE COMPOUNDS
	<b>A61P 37/08</b> (2006.01)		
	<b>C07D 401/04</b> (2006.01)		
	<b>A61K 9/20</b> (2006.01)	3346995	THERAPEUTIC COMPOSITIONS FOR TREATMENT OF HUMAN IMMUNODEFICIENCY VIRUS
	<b>A61K 9/24</b> (2006.01)		
	<b>A61K 9/28</b> (2006.01)		
	<b>A61K 31/513</b> (2006.01)		
	<b>A61K 31/5365</b>		

Podnosilac evropske prijave patenta (71)	MKP (51)	Broj objave evropske prijave patenta (97)	Naziv pronalaska (54)
	(2006.01) <b>A61K</b> <b>31/553</b>		
	(2006.01) <b>A61K</b> <b>31/675</b>		
	(2006.01) <b>A61P 31/18</b>		
	(2006.01) <b>C12N 7/00</b>	3380605	TRANSIENT TRANSFECTION METHOD FOR RETROVIRAL PRODUCTION
	(2006.01) <b>C12N 15/85</b>		
	(2006.01) <b>C12N 15/86</b>		
TM TECHNOLOGIE spolka z ograniczona odpowiedzialnoscia	(2006.01) <b>H02J 9/00</b>	3365957	METHOD OF SUPPLYING AN EMERGENCY SUPPLY MODULE AND EMERGENCY SUPPLY MODULE WITH REDUCED POWER CONSUMPTION
	(2006.01) <b>H02J 9/06</b>		
	(2006.01) <b>A61K</b> <b>31/445</b>	3371164	N-[2-(1 -BENZYLPIPERIDIN-4-YL)ETHYL]-4-(PYRAZIN-2-YL)-PIPERAZINE-1 -CARBOXAMIDE DERIVATIVES AND RELATED COMPOUNDS AS MUSCARINIC RECEPTOR 4 (M4) ANTAGONISTS FOR TREATING NEUROLOGICAL DISEASES
	(2006.01) <b>A61K</b> <b>31/4545</b>		
	(2006.01) <b>A61P 25/16</b>		
	(2006.01) <b>A61P 25/18</b>		
	(2006.01) <b>A61P 25/28</b>		
	(2006.01) <b>C07D 211/26</b>		
	(2006.01) <b>C07D 211/40</b>		
	(2006.01) <b>C07D 401/12</b>		
	(2006.01) <b>A01N 25/30</b>	3373896	PET CARE CLEANSING COMPOSITION
	(2006.01) <b>A61K 8/34</b>		
	(2006.01) <b>A61K 8/892</b>		
	(2006.01) <b>A61K 8/97</b>		
	(2017.01) <b>A61Q 5/02</b>		
	(2006.01) <b>A61Q 5/12</b>		
	(2006.01) <b>A61Q 19/10</b>		
	(2006.01) <b>A61B 17/00</b>	3376968	APPLICATOR INSTRUMENTS FOR DISPENSING SURGICAL FASTENERS HAVING ARTICULATING SHAFTS AND ARTICULATION CONTROL ELEMENTS
	(2006.01) <b>A61B</b> <b>17/068</b>		
	(2006.01) <b>A61F 2/00</b>		
Petkov, Stancho Petkov Transmobil Ltd	(2006.01) <b>F42B 12/32</b>	3414514	A FRAGMENTATION SHOT WITH READY DESTRUCTIVE ELEMENTS
	(2006.01) <b>C12N 5/10</b>	3380604	STABLE CELL LINES FOR RETROVIRAL PRODUCTION
	(2006.01) <b>C12N 7/02</b>		
	(2006.01) <b>C12N 7/04</b>		
	(2006.01)		

Podnosilac evropske prijave patenta (71)	MKP (51)	Broj objave evropske prijave patenta (97)	Naziv pronalaska (54)	
Constantia Teich GmbH	<b>C12N 15/85</b> (2006.01)	3371147	INNOVATIVE PREPARATION AND CRYSTALLIZATION OF IOSIMENOL	
	<b>C07C 231/12</b> (2006.01)			
	<b>C07C 237/46</b> (2006.01)	3379963	SOLE, PARTICULARLY FOR SHOES	
	<b>A43B 13/12</b> (2006.01)			
	<b>A43B 13/18</b> (2006.01)	3383762	TWO-LAYER CIRCUIT BOARD	
	<b>B65D 77/20</b> (2006.01)			
	University Medical Center Hamburg - Eppendorf	<b>A61K 39/00</b> (2006.01)	3374397	ANTIGEN-BINDING POLYPEPTIDES DIRECTED AGAINST CD38
		<b>A61K 39/395</b> (2006.01)		
		<b>C07K 16/28</b> (2006.01)	3390372	BENZAMIDE COMPOUNDS AND THEIR USE AS HERBICIDES
		<b>G01N 33/53</b> (2006.01)		
<b>A01N 43/653</b> (2006.01)		3377494	PYRROPYRIMIDINE COMPOUNDS AS MNKS INHIBITORS	
<b>A01N 43/713</b> (2006.01)				
<b>A01N 43/82</b> (2006.01)		3377501	FUSED THIAZOLOPYRIMIDINE DERIVATIVES AS MNKS INHIBITORS	
<b>C07D 249/14</b> (2006.01)				
LifeArc		<b>C07D 257/06</b> (2006.01)	3377048	ABUSE RESISTANT TRANSDERMAL DELIVERY DEVICES AND COMPOSITIONS COMPRISING AN OPIOID AGONIST AND A NON-TRANSDERMALLY DELIVERED N-OXIDE DERIVATIVE OF AN OPIOID ANTAGONIST FOR THE TREATMENT OF PAIN
		<b>C07D 271/04</b> (2006.01)		
	<b>C07D 271/07</b> (2006.01)	3377048	ABUSE RESISTANT TRANSDERMAL DELIVERY DEVICES AND COMPOSITIONS COMPRISING AN OPIOID AGONIST AND A NON-TRANSDERMALLY DELIVERED N-OXIDE DERIVATIVE OF AN OPIOID ANTAGONIST FOR THE TREATMENT OF PAIN	
	<b>A61K 31/519</b> (2006.01)			
	<b>A61P 25/28</b> (2006.01)	3377048	ABUSE RESISTANT TRANSDERMAL DELIVERY DEVICES AND COMPOSITIONS COMPRISING AN OPIOID AGONIST AND A NON-TRANSDERMALLY DELIVERED N-OXIDE DERIVATIVE OF AN OPIOID ANTAGONIST FOR THE TREATMENT OF PAIN	
	<b>A61P 35/00</b> (2006.01)			
	<b>C07D 487/04</b> (2006.01)	3377048	ABUSE RESISTANT TRANSDERMAL DELIVERY DEVICES AND COMPOSITIONS COMPRISING AN OPIOID AGONIST AND A NON-TRANSDERMALLY DELIVERED N-OXIDE DERIVATIVE OF AN OPIOID ANTAGONIST FOR THE TREATMENT OF PAIN	
	<b>A61K 31/429</b> (2006.01)			
	<b>A61K 31/519</b> (2006.01)	3377048	ABUSE RESISTANT TRANSDERMAL DELIVERY DEVICES AND COMPOSITIONS COMPRISING AN OPIOID AGONIST AND A NON-TRANSDERMALLY DELIVERED N-OXIDE DERIVATIVE OF AN OPIOID ANTAGONIST FOR THE TREATMENT OF PAIN	
	<b>A61P 25/28</b> (2006.01)			
<b>A61P 35/00</b> (2006.01)	3377048	ABUSE RESISTANT TRANSDERMAL DELIVERY DEVICES AND COMPOSITIONS COMPRISING AN OPIOID AGONIST AND A NON-TRANSDERMALLY DELIVERED N-OXIDE DERIVATIVE OF AN OPIOID ANTAGONIST FOR THE TREATMENT OF PAIN		
<b>C07D 513/04</b> (2006.01)				
<b>C07D 519/00</b> (2006.01)	3377048	ABUSE RESISTANT TRANSDERMAL DELIVERY DEVICES AND COMPOSITIONS COMPRISING AN OPIOID AGONIST AND A NON-TRANSDERMALLY DELIVERED N-OXIDE DERIVATIVE OF AN OPIOID ANTAGONIST FOR THE TREATMENT OF PAIN		
<b>A61K 9/70</b> (2006.01)				
<b>A61K 31/485</b> (2006.01)	3377048	ABUSE RESISTANT TRANSDERMAL DELIVERY DEVICES AND COMPOSITIONS COMPRISING AN OPIOID AGONIST AND A NON-TRANSDERMALLY DELIVERED N-OXIDE DERIVATIVE OF AN OPIOID ANTAGONIST FOR THE TREATMENT OF PAIN		
<b>A61P 25/04</b> (2006.01)				

Podnosilac evropske prijave patenta (71)	MKP (51)	Broj objave evropske prijave patenta (97)	Naziv pronalaska (54)
	<b>A61K 35/744</b> (2015.01)	3377082	COMPOSITIONS COMPRISING BACTERIAL STRAINS
	<b>A61P 29/00</b> (2006.01)		
	<b>A61P 35/00</b> (2006.01)		
	<b>A61P 37/00</b> (2006.01)		
	<b>C04B 28/02</b> (2006.01)	3374327	CALCIUM NITRATE FOR REDUCING THE PORE SIZE DISTRIBUTION OF A HARDENED CEMENTITIOUS COMPOSITION AND STEEL REINFORCED CONCRETE HAVING AN ELEVATED RESISTANCE TOWARDS CARBONATION
	<b>C04B 28/04</b> (2006.01)		
	<b>C04B 38/00</b> (2006.01)		
	<b>C04B 111/00</b> (2006.01)		
	<b>C04B 111/22</b> (2006.01)		
	<b>C04B 111/26</b> (2006.01)		
	<b>B41M 3/14</b> (2006.01)	3380669	METHOD OF TAGGING A SUBSTRATE
	<b>B42D 25/29</b> (2014.01)		
	<b>B42D 25/30</b> (2014.01)		
	<b>D21H 19/82</b> (2006.01)		
	<b>D21H 21/40</b> (2006.01)		
	<b>D21H 21/42</b> (2006.01)		
	<b>D21H 21/44</b> (2006.01)		
	<b>D21H 21/48</b> (2006.01)		
	<b>B27N 3/02</b> (2006.01)	3383604	CALCIUM CARBONATE FOR PARTICLE BOARDS
	<b>A61K 31/506</b> (2006.01)	3380467	HETEROCYCLIC INDOLES FOR USE IN INFLUENZA VIRUS INFECTION
	<b>A61K 31/53</b> (2006.01)		
	<b>A61P 31/14</b> (2006.01)		
	<b>C07D 403/04</b> (2006.01)		
	<b>C07D 487/04</b> (2006.01)		
	<b>C12N 5/0783</b> (2010.01)	3365434	METHODS FOR CULTURING CELLS AND KITS AND APPARATUS FOR SAME
	<b>G01N 1/30</b> (2006.01)		
	<b>D04B 15/88</b> (2006.01)	3374555	OPEN-TYPE CIRCULAR KNITTING MACHINE FOR THE OPEN AND WIDTH-VARIABLE WEB PRODUCTION
	<b>D04B 35/34</b> (2006.01)		
Hipp & Co	<b>A23L 3/04</b> (2006.01)	3368422	FOOD-PROCESSING PLANT HAVING A PLURALITY OF SURROUNDED CHAMBERS, BETWEEN WHICH A CONTAINER CONVEYOR IS ARRANGED
	<b>B65B 55/02</b> (2006.01)		
	<b>B65B 55/04</b> (2006.01)		
	<b>B65B 55/10</b> (2006.01)		

Podnosilac evropske prijave patenta (71)	MKP (51)	Broj objave evropske prijave patenta (97)	Naziv pronalaska (54)	
Cancer Research Technology Ltd.	<b>A61K 8/891</b> (2006.01)	3394176	SILOXANE ELASTOMERS HAVING AN IMMEDIATE OPTICAL AND SENSORIAL SMOOTHING EFFECT AND TOPICAL SKIN-CARE COMPOSITIONS CONTAINING SUCH SILICONE ELASTOMERS	
	<b>C08L 83/04</b> (2006.01)			
	<b>A61K 31/501</b> (2006.01)	3380468	BIS-PYRIDAZINE COMPOUNDS AND THEIR USE IN TREATING CANCER	
	<b>A61P 35/00</b> (2006.01)			
	<b>C07D 403/14</b> (2006.01)			
	<b>A61K 9/00</b> (2006.01)	3377108	A PROCESS FOR PREPARING A DRY POWDER FORMULATION COMPRISING AN ANTICHOLINERGIC, A CORTICOSTEROID AND A BETA-ADRENERGIC	
	<b>A61K 9/14</b> (2006.01)			
	<b>A61K 31/00</b> (2006.01)			
	<b>A61K 47/12</b> (2006.01)			
	<b>A61K 47/26</b> (2006.01)	3377109	A PROCESS FOR PREPARING A DRY POWDER FORMULATION COMPRISING AN ANTICHOLINERGIC, A CORTICOSTEROID AND A BETA-ADRENERGIC	
	<b>A61K 9/00</b> (2006.01)			
	<b>A61K 9/14</b> (2006.01)			
	<b>A61K 31/00</b> (2006.01)			
	<b>A61K 47/12</b> (2006.01)			
	<b>A61K 47/26</b> (2006.01)	3379962	MID-SOLE, OR INSOLE, PARTICULARLY FOR SHOES	
	<b>A43B 7/14</b> (2006.01)			
	Genesis Pharma SA	<b>A61K 38/17</b> (2006.01)	3394084	PEPTIDES AND COMBINATION OF PEPTIDES FOR USE IN IMMUNOTHERAPY AGAINST BREAST CANCER AND OTHER CANCERS
		<b>A61K 39/00</b> (2006.01)		
		<b>C07K 7/06</b> (2006.01)		
<b>C07K 7/08</b> (2006.01)		3383871	1,3,4-THIADIAZOLE COMPOUNDS AND THEIR USE IN TREATING CANCER	
<b>C07K 14/47</b> (2006.01)				
<b>C07K 16/28</b> (2006.01)				
<b>A61K 31/501</b> (2006.01)				
<b>A61K 31/53</b> (2006.01)				
<b>A61P 35/00</b> (2006.01)		3370756	COMBINATION	
<b>C07D 417/14</b> (2006.01)				
<b>A61K 38/13</b> (2006.01)				
<b>A61K 38/26</b> (2006.01)		3374374	COMPOSITIONS COMPRISING LENTIVIRAL VECTORS EXPRESSING IL-12 AND METHODS OF USE THEREOF	
<b>A61P 9/10</b> (2006.01)				
<b>C07K 14/005</b> (2006.01)				
<b>C07K 14/54</b> (2006.01)				
<b>C12N 7/00</b> (2006.01)				

Podnosilac evropske prijave patenta (71)	MKP (51)	Broj objave evropske prijave patenta (97)	Naziv pronalaska (54)
	<b>A61K 39/395</b> (2006.01) <b>C07K 16/28</b> (2006.01) <b>G01N 33/574</b> (2006.01)	3374398	BINDING MOLECULES SPECIFIC FOR ASCT2 AND USES THEREOF
Aerofoil Energy Limited	<b>A47F 3/04</b> (2006.01)	3379977	IMPROVEMENTS IN REFRIGERATORS
Liquidia Technologies, Inc.	<b>A61K 9/14</b> (2006.01) <b>A61K 9/50</b> (2006.01) <b>A61K 31/7056</b> (2006.01) <b>A61K 31/437</b> (2006.01) <b>A61P 11/00</b> (2006.01) <b>C07D 471/04</b> (2006.01) <b>A61K 31/433</b> (2006.01) <b>A61P 35/00</b> (2006.01) <b>C07D 417/14</b> (2006.01) <b>A61K 31/519</b> (2006.01) <b>A61P 25/00</b> (2006.01) <b>A61P 35/00</b> (2006.01) <b>A61P 37/00</b> (2006.01) <b>C07D 487/04</b> (2006.01) <b>C07D 519/00</b> (2006.01) <b>C07K 14/47</b> (2006.01) <b>A61K 31/7088</b> (2006.01) <b>A61P 29/00</b> (2006.01) <b>C12N 15/113</b> (2010.01) <b>C07K 16/18</b> (2006.01) <b>C07K 16/28</b> (2006.01) <b>C07K 16/46</b> (2006.01)	3377045	PHARMACEUTICAL COMPOSITIONS OF RIBAVIRIN
		3371186	JAK KINASE INHIBITOR COMPOUNDS FOR TREATMENT OF RESPIRATORY DISEASE
		3383872	1,3,4-THIADIAZOLE COMPOUNDS AND THEIR USE IN TREATING CANCER
		3371190	HETEROCYCLIC COMPOUNDS AS PI3K-GAMMA INHIBITORS
		3387008	NOVEL PEPTIDES AND COMBINATION OF PEPTIDES FOR USE IN IMMUNOTHERAPY AGAINST CLL AND OTHER CANCERS
		3380615	IL-34 ANTISENSE OLIGONUCLEOTIDES AND METHODS OF USING SAME
		3380517	POLYPEPTIDES INHIBITING CD40L
GENMAB B.V.	<b>A61K 39/395</b> (2006.01) <b>C07K 16/28</b> (2006.01) <b>C07K 16/30</b> (2006.01)	3383905	ANTI-DEATH RECEPTOR ANTIBODIES AND METHODS OF USE THEREOF



Podnosilac evropske prijave patenta (71)	MKP (51)	Broj objave evropske prijave patenta (97)	Naziv pronalaska (54)
Juno Therapeutics GmbH	<b>C07K 16/46</b> (2006.01)	3383906	ANTI-DR5 ANTIBODIES AND METHODS OF USE THEREOF
	<b>A61K 39/395</b> (2006.01)		
	<b>C07K 16/28</b> (2006.01)		
	<b>C07K 16/30</b> (2006.01)	3365453	METHODS, KITS, AGENTS AND APPARATUSES FOR TRANSDUCTION
	<b>C07K 16/46</b> (2006.01)		
	<b>C12N 15/13</b> (2006.01)		
	<b>C12N 15/86</b> (2006.01)	3370775	COMBINATION OF BCL-2 INHIBITOR AND MEK INHIBITOR FOR THE TREATMENT OF CANCER
	<b>A61K 31/4523</b> (2006.01)		
	<b>A61K 31/496</b> (2006.01)		
	<b>A61K 45/06</b> (2006.01)	3377526	PD1/CTLA4 Binders
	<b>A61P 35/00</b> (2006.01)		
	<b>A61K 39/395</b> (2006.01)		
	<b>C07K 16/18</b> (2006.01)	3377527	CTLA4 BINDERS
	<b>C07K 16/28</b> (2006.01)		
	<b>A61K 39/395</b> (2006.01)		
	<b>C07K 16/18</b> (2006.01)	3377531	PD1 AND/OR LAG3 BINDERS
	<b>C07K 16/28</b> (2006.01)		
	<b>C07K 16/18</b> (2006.01)		
	<b>C07K 16/28</b> (2006.01)	3377488	HETEROCYCLIC COMPOUNDS AS IMMUNOMODULATORS
	<b>A61K 31/423</b> (2006.01)		
	<b>A61K 31/428</b> (2006.01)		
	<b>A61K 31/4355</b> (2006.01)		
	<b>A61K 31/4985</b> (2006.01)		
	<b>A61P 31/12</b> (2006.01)		
	<b>A61P 35/00</b> (2006.01)		
	<b>C07D 263/57</b> (2006.01)		
	<b>C07D 413/10</b> (2006.01)		
	<b>C07D 413/12</b> (2006.01)		
	<b>C07D 413/14</b> (2006.01)		

Podnosilac evropske prijave patenta (71)	MKP (51)	Broj objave evropske prijave patenta (97)	Naziv pronalaska (54)
	<b>C07D 417/10</b> (2006.01)		
	<b>C07D 491/04</b> (2006.01)		
	<b>C07D 498/04</b> (2006.01)		
	<b>A61K 31/416</b> (2006.01)	3380466	SUBSTITUTED BENZAMIDES USEFUL AS SODIUM CHANNEL BLOCKERS
	<b>A61P 9/00</b> (2006.01)		
	<b>A61P 11/00</b> (2006.01)		
	<b>A61P 17/04</b> (2006.01)		
	<b>A61P 25/00</b> (2006.01)		
	<b>C07D 231/56</b> (2006.01)		
	<b>C07D 401/04</b> (2006.01)		
	<b>C07D 401/14</b> (2006.01)		
	<b>C07D 403/04</b> (2006.01)		
	<b>C07D 403/06</b> (2006.01)		
	<b>C07D 403/12</b> (2006.01)		
	<b>C07D 405/04</b> (2006.01)		
	<b>C07D 405/14</b> (2006.01)		
Urotech GmbH	<b>A61L 29/06</b> (2006.01)	3377127	COATING FOR A MEDICAL INSTRUMENT, METHOD FOR THE COATING THEREOF, AND MEDICAL INSTRUMENT COATED USING SAID METHOD
	<b>A61L 29/08</b> (2006.01)		
	<b>A61K 31/223</b> (2006.01)	3383385	MELFLUFEN DOSAGE REGIMENS FOR CANCER
	<b>A61K 31/573</b> (2006.01)		
	<b>A61K 31/501</b> (2006.01)	3383873	1,3,4-THIADIAZOLE COMPOUNDS AND THEIR USE IN TREATING CANCER
	<b>A61K 31/53</b> (2006.01)		
	<b>A61P 35/00</b> (2006.01)		
	<b>C07D 417/14</b> (2006.01)		
	<b>D21D 1/02</b> (2006.01)	3384080	PROCESS TO REDUCE THE OVERALL ENERGY CONSUMPTION IN THE PRODUCTION OF NANOCELLULOSE
	<b>D21D 1/20</b> (2006.01)		
	<b>B29B 7/00</b> (2006.01)	3386703	PROCESS FOR MANUFACTURING A PRECURSOR MATERIAL
	<b>B29B 7/16</b> (2006.01)		
	<b>B29B 7/28</b> (2006.01)		
	<b>B29B 7/90</b> (2006.01)		
	<b>B29B 9/14</b> (2006.01)		

Podnosilac evropske prijave patenta (71)	MKP (51)	Broj objave evropske prijave patenta (97)	Naziv pronalaska (54)
	<b>A61K 9/00</b> (2006.01) <b>A61K 31/4245</b> (2006.01) <b>A61K 39/395</b> (2006.01) <b>A61K 45/06</b> (2006.01) <b>A61P 35/00</b> (2006.01)	3370699	PHARMACEUTICAL COMPOSITIONS AND METHODS FOR INDOLEAMINE 2,3-DIOXYGENASE INHIBITION AND INDICATIONS THEREFOR
	<b>A01N 25/02</b> (2006.01) <b>A01N 25/30</b> (2006.01) <b>A01N 43/40</b> (2006.01) <b>A01N 47/02</b> (2006.01) <b>A01N 49/00</b> (2006.01) <b>A01P 7/00</b> (2006.01) <b>A01P 7/02</b> (2006.01) <b>A61K 31/415</b> (2006.01)	3379928	VETERINARY FORMULATIONS
	<b>B29C 51/26</b> (2006.01) <b>B31B 50/59</b> (2017.01) <b>B31F 1/00</b> (2006.01)	3216594	APPARATUS FOR CLAMPING, HOLDING AND GUIDING FLAT MATERIAL AND PROCESS FOR OPERATING THE APPARATUS
	<b>A01N 43/38</b> (2006.01) <b>A61K 31/405</b> (2006.01) <b>A61K 31/444</b> (2006.01) <b>A61K 31/496</b> (2006.01) <b>A61K 31/501</b> (2006.01) <b>A61K 31/506</b> (2006.01) <b>A61K 31/5377</b> (2006.01) <b>A61K 31/5383</b> (2006.01) <b>A61K 31/541</b> (2006.01) <b>A61K 31/551</b> (2006.01) <b>A61P 35/00</b> (2006.01) <b>C07D 401/14</b>	3246027	INDOLE DERIVATIVES FOR THE TREATMENT OF CANCER

Podnosilac evropske prijave patenta (71)	MKP (51)	Broj objave evropske prijave patenta (97)	Naziv pronalaska (54)
	(2006.01) <b>C07D 405/14</b> (2006.01)		
	<b>A61L 15/18</b> (2006.01)	3378502	USE OF ZINC TREATED PRECIPITATED CALCIUM CARBONATE IN HYGIENIC PRODUCTS
	<b>A61L 15/46</b> (2006.01)		
	<b>C09C 1/02</b> (2006.01)	3385335	PIGMENT COMPOSITION COMPRISING SURFACE MODIFIED CALCIUM CARBONATE AND GROUND NATURAL CALCIUM CARBONATE
	<b>D21H 17/67</b> (2006.01)		
	<b>B27N 3/02</b> (2006.01)	3385046	IN-LINE COATED DECORATIVE WOOD-BASED BOARDS
	<b>B27N 3/04</b> (2006.01)		
	<b>B27N 3/06</b> (2006.01)		
	<b>B27N 3/10</b> (2006.01)		
	<b>B27N 3/12</b> (2006.01)		
	<b>B27N 7/00</b> (2006.01)		
	<b>B44C 5/04</b> (2006.01)		
	<b>A61K 38/17</b> (2006.01)	3290439	TRUNCATED ACTRIIB-FC FUSION PROTEINS
	<b>A61P 3/00</b> (2006.01)		
	<b>C07K 14/475</b> (2006.01)		
	<b>C07K 14/705</b> (2006.01)		
	<b>A61K 31/343</b> (2006.01)	3252044	PREPARATION METHOD OF ABEXINOSTAT TOSYLATE SALT AND ASSOCIATED CRYSTALLINE FORM
	<b>A61P 29/00</b> (2006.01)		
	<b>A61P 35/00</b> (2006.01)		
	<b>C07D 307/85</b> (2006.01)		
Cathay Pacific Airways Limited	<b>B64C 1/10</b> (2006.01)	3263444	CABIN MODULE AND LAYOUT FOR A PASSENGER AIRCRAFT
	<b>B64D 11/00</b> (2006.01)		
	<b>B64D 11/06</b> (2006.01)		
	<b>A61K 38/00</b> (2006.01)	3244932	RNA GUIDED ERADICATION OF HERPES SIMPLEX TYPE I AND OTHER RELATED HERPESVIRUSES
	<b>A61K 48/00</b> (2006.01)		
	<b>C07H 21/04</b> (2006.01)		
	<b>C12N 15/00</b> (2006.01)		
PricewaterhouseCoopers LLP	<b>G06F 17/30</b> (2006.01)	3245601	HEALTHCARE DATA INTERCHANGE SYSTEM AND METHOD
	<b>G06F 19/10</b> (2011.01)		
	<b>G06Q 50/22</b> (2012.01)		
	<b>G16H 10/60</b> (2018.01)		

Podnosilac evropske prijave patenta (71)	MKP (51)	Broj objave evropske prijave patenta (97)	Naziv pronalaska (54)
	<b>A61K 9/00</b> (2006.01) <b>A61K 31/047</b> (2006.01) <b>A61K 31/731</b> (2006.01) <b>A61K 33/14</b> (2006.01) <b>A61K 45/06</b> (2006.01) <b>A61P 11/02</b> (2006.01) <b>A61P 31/16</b> (2006.01)	3370692	STUFFY NOSE DEBLOCKING COMPOSITION HAVING ANTIVIRAL ACTIVITY
	<b>C04B 20/10</b> (2006.01) <b>C04B 26/06</b> (2006.01)	3393994	COMPOSITION FOR A PASTY FILLER MATERIAL, PASTY FILLER, AND METHOD FOR PRODUCING A PASTY FILLER MATERIAL
Lampe Textiles	<b>D06M 15/248</b> (2006.01) <b>D06M 15/263</b> (2006.01) <b>D06M 15/564</b> (2006.01) <b>D06M 23/16</b> (2006.01) <b>E06B 9/24</b> (2006.01)	3225733	TRANSPARENT TEXTILE WITH SELF-ADHESIVE PROPERTIES FOR DAMP ENVIRONMENTS
	<b>A61K 31/4375</b> (2006.01) <b>A61K 31/444</b> (2006.01) <b>A61K 31/519</b> (2006.01) <b>A61K 31/5377</b> (2006.01) <b>A61K 31/541</b> (2006.01) <b>A61P 19/00</b> (2006.01) <b>A61P 35/00</b> (2006.01) <b>C07D 471/04</b> (2006.01)	3259269	BICYCLIC HETEROCYCLES AS FGFR INHIBITORS
Teva Branded Pharmaceutical Products R & D, Inc.	<b>A61K 9/00</b> (2006.01) <b>A61K 31/137</b> (2006.01) <b>A61K 31/56</b> (2006.01) <b>A61P 11/00</b> (2006.01)	3247331	DRY POWDER INHALER COMPRISING FLUTICASONE PROPIONATE AND SALMETEROL XINAFOAT
SUPAN, Carlota	<b>A47K 5/12</b> (2006.01) <b>B01F 3/08</b> (2006.01)	3413769	METHOD AND SHAKER FOR MIXING LIQUIDS

Podnosilac evropske prijave patenta (71)	MKP (51)	Broj objave evropske prijave patenta (97)	Naziv pronalaska (54)
Glauk S.r.l.	<b>B01F 13/00</b> (2006.01)		
	<b>B01F 15/00</b> (2006.01)		
	<b>B01F 15/02</b> (2006.01)		
	<b>H04R 7/04</b> (2006.01)	3406086	METHOD AND APPARATUS FOR PLAYING AUDIO BY MEANS OF PLANAR ACOUSTIC TRANSDUCERS
	<b>B65D 81/26</b> (2006.01)	3250640	DURABLE OXYGEN SCAVENGING PLASTIC CONTAINERS
	<b>C08K 3/24</b> (2006.01)		
	<b>C08K 5/00</b> (2006.01)		
	<b>C08K 5/09</b> (2006.01)		
	<b>C08L 67/02</b> (2006.01)		
	<b>C08L 71/02</b> (2006.01)		
Heron Therapeutics, Inc.	<b>A61K 9/00</b> (2006.01)	3411013	EMULSION COMPRISING AN NK-1 RECEPTOR ANTAGONIST
	<b>A61K 9/107</b> (2006.01)		
	<b>A61K 31/454</b> (2006.01)		
	<b>A61K 31/496</b> (2006.01)		
	<b>A61K 31/5377</b> (2006.01)		
	<b>A61K 47/24</b> (2006.01)		
	<b>A61K 35/00</b> (2006.01)	3250695	UNIVERSAL IMMUNE CELLS FOR CANCER IMMUNOTHERAPY
	<b>A61K 35/12</b> (2015.01)		
	<b>A61K 35/14</b> (2015.01)		
	<b>A61K 35/17</b> (2015.01)		
	<b>A61K 45/06</b> (2006.01)		
	<b>A61K 48/00</b> (2006.01)		
	<b>C07K 14/705</b> (2006.01)		
	<b>C07K 14/725</b> (2006.01)		
	<b>C07K 16/28</b> (2006.01)		
	<b>C07K 16/32</b> (2006.01)		
	<b>C12N 15/85</b> (2006.01)		
	<b>G03G 15/00</b> (2006.01)	3255508	CARTRIDGE, PHOTORECEPTOR UNIT, ELECTROPHOTOGRAPHIC IMAGE FORMING DEVICE
	<b>G03G 21/16</b> (2006.01)		
	<b>G03G 21/18</b> (2006.01)		
ALS Therapy Development Institute	<b>A61K 39/395</b>	3253412	ANTI-CD40L ANTIBODIES AND METHODS FOR TREATING CD40L-RELATED DISEASES OR DISORDERS

Podnosilac evropske prijave patenta (71)	MKP (51)	Broj objave evropske prijave patenta (97)	Naziv pronalaska (54)
	(2006.01)		
	<b>C07K 16/28</b>		
	(2006.01)		
Chiasma Inc.	<b>A61K 9/48</b>	3253401	METHOD OF TREATING DISEASES
	(2006.01)		
	<b>A61K 38/08</b>		
	(2006.01)		
	<b>A61P 5/06</b>		
	(2006.01)		
	<b>A43B 1/00</b>	3352606	FUNCTIONAL FOOTWEAR UNIT
	(2006.01)		
	<b>A43B 7/00</b>		
	(2006.01)		
	<b>A43B 7/12</b>		
	(2006.01)		
	<b>A43B 23/07</b>		
	(2006.01)		
	<b>A62B 17/00</b>		
	(2006.01)		
	<b>G16H 10/60</b>	3257017	SYSTEMS, DEVICES, AND METHODS FOR INGESTIBLE EVENT SENSING AND ANALYSIS
	(2018.01)		
	<b>G16H 20/10</b>		
	(2018.01)		
	<b>G16H 40/63</b>		
	(2018.01)		
	<b>G06F 15/16</b>	3256954	CENTRALIZED VALIDATION OF EMAIL SENDERS VIA EHLO NAME AND IP ADDRESS TARGETING
	(2006.01)		
	<b>H04L 12/58</b>		
	(2006.01)		
	<b>H04L 29/12</b>		
	(2006.01)		
Alzheon, Inc.	<b>A61K 31/185</b>	3347002	METHODS OF TREATING NEURODEGENERATIVE DISORDERS IN A PARTICULAR PATIENT POPULATION
	(2006.01)		
	<b>A61K 31/205</b>		
	(2006.01)		
	<b>C07C 309/02</b>		
	(2006.01)		
Ústav Polymérov Sav	<b>A61K 47/50</b>	3362098	A METHOD FOR ALTERING THE FUNCTIONAL STATE OF MRNA ALLOWING ITS SELECTIVE AND SPECIFIC RECOGNITION
	(2017.01)		
Neumann Space PTY Ltd	<b>B64G 1/40</b>	3350442	INTERNAL WIRE-TRIGGERED PULSED CATHODIC ARC PROPULSION SYSTEM
	(2006.01)		
	<b>F03H 1/00</b>		
	(2006.01)		
1355540 Ontario Inc.	<b>A61B 5/08</b>	3349831	DRY POWDER DELIVERY SYSTEM AND METHOD
	(2006.01)		
	<b>A61K 9/72</b>		
	(2006.01)		
	<b>A61K 49/00</b>		
	(2006.01)		
	<b>A61M 15/00</b>		
	(2006.01)		
	<b>C08K 3/34</b>	3351595	THERMOPLASTIC ELASTOMER COMPOSITION AND METHOD FOR PREPARING SAME
	(2006.01)		
	<b>C08K 9/04</b>		
	(2006.01)		
	<b>C08L 23/02</b>		
	(2006.01)		
	<b>C08L 53/00</b>		
	(2006.01)		
	<b>C08L 91/00</b>		
	(2006.01)		
	<b>C08L 101/02</b>		
	(2006.01)		

Podnosilac evropske prijave patenta (71)	MKP (51)	Broj objave evropske prijave patenta (97)	Naziv pronalaska (54)
	<b>C08L 101/12</b> (2006.01)		
	<b>A61K 33/24</b> (2006.01)	3351580	POLYMER CONJUGATE OF HEXA-COORDINATED PLATINUM COMPLEX
	<b>A61P 35/00</b> (2006.01)		
	<b>C07F 15/00</b> (2006.01)		
	<b>C08G 65/333</b> (2006.01)		
	<b>C08G 65/337</b> (2006.01)		
	<b>C08G 69/10</b> (2006.01)		
	<b>C08G 69/40</b> (2006.01)		
	<b>C08G 69/48</b> (2006.01)		
	<b>A61K 31/5377</b> (2006.01)	3351542	NEW CRYSTAL OF PIPERAZINE COMPOUND
	<b>A61P 29/00</b> (2006.01)		
	<b>A61P 37/08</b> (2006.01)		
	<b>A61P 43/00</b> (2006.01)		
	<b>C07D 401/12</b> (2006.01)		
Iomet Pharma Ltd.	<b>A61K 31/404</b> (2006.01)	3349750	PHARMACEUTICAL COMPOUND
	<b>C07D 209/30</b> (2006.01)		
	<b>A61K 38/16</b> (2006.01)	3350337	MANUFACTURING METHOD OF AN IMMUNOTHERAPEUTIC FORMULATION COMPRISING A RECOMBINANT LISTERIA STRAIN
	<b>C07K 14/005</b> (2006.01)		
	<b>C07K 14/195</b> (2006.01)		
	<b>C12N 15/74</b> (2006.01)		
	<b>C12P 21/00</b> (2006.01)		
Ablexis, LLC	<b>A61K 39/395</b> (2006.01)	3349794	ANTI-CD115 ANTIBODIES
	<b>C07K 16/28</b> (2006.01)		
	<b>A61K 39/395</b> (2006.01)	3349796	THERAPEUTIC COMBINATIONS COMPRISING ANTI-FOLR1 IMMUNOCONJUGATES
	<b>C07K 16/28</b> (2006.01)		
	<b>C07K 16/30</b> (2006.01)		
	<b>C07K 16/46</b> (2006.01)		
Metacrine, Inc.	<b>A61K 31/16</b> (2006.01)	3350158	FARNESOID X RECEPTOR AGONISTS AND USES THEREOF
	<b>C07C 233/55</b> (2006.01)		
	<b>C07C 233/63</b> (2006.01)		



Podnosilac evropske prijave patenta (71)	MKP (51)	Broj objave evropske prijave patenta (97)	Naziv pronalaska (54)
	(2006.01) <b>C07C 255/60</b> (2006.01) <b>C07D 305/06</b> (2006.01) <b>C07D 309/06</b> (2006.01) <b>A61K 31/16</b> (2006.01) <b>A61K</b> <b>31/4412</b> (2006.01) <b>A61K</b> <b>31/4418</b> (2006.01) <b>C07D 207/12</b> (2006.01) <b>C07D 213/63</b> (2006.01) <b>A61K</b> <b>31/4418</b> (2006.01) <b>A61K</b> <b>31/4465</b> (2006.01) <b>C07C 233/55</b> (2006.01) <b>C07C 233/63</b> (2006.01) <b>C07D 211/10</b> (2006.01) <b>C07D 213/04</b> (2006.01) <b>C07D 213/06</b> (2006.01) <b>A61K</b> <b>31/404</b> (2006.01) <b>A61K 31/44</b> (2006.01) <b>A61K</b> <b>31/444</b> (2006.01) <b>A61K 31/47</b> (2006.01) <b>C07D 213/72</b> (2006.01) <b>C07D 213/75</b> (2006.01) <b>C07D 217/12</b> (2006.01) <b>C07D 401/12</b> (2006.01) <b>A61K 39/00</b> (2006.01) <b>A61K 39/02</b> (2006.01) <b>A61K 48/00</b> (2006.01) <b>A61K</b> <b>31/282</b> (2006.01) <b>A61K 33/24</b> (2006.01) <b>C07J 9/00</b> (2006.01)	3350165	FARNESOID X RECEPTOR AGONISTS AND USES THEREOF
		3350164	FARNESOID X RECEPTOR AGONISTS AND USES THEREOF
		3350166	FARNESOID X RECEPTOR AGONISTS AND USES THEREOF
		3349789	RECOMBINANT LISTERIA VACCINE STRAINS AND METHODS OF USING THE SAME IN CANCER IMMUNOTHERAPY
Institute of Molecular Genetics of ASCR, v.v.i.		3350196	CARBORANE COMPOUNDS AND METHODS OF USE THEREOF

Podnosilac evropske prijave patenta (71)	MKP (51)	Broj objave evropske prijave patenta (97)	Naziv pronalaska (54)
Rupnik, Carlo	<b>C02F 1/32</b> (2006.01) <b>H05B 3/00</b> (2006.01) <b>A61K 31/427</b> (2006.01) <b>A61P 31/04</b> (2006.01) <b>C07D 417/14</b> (2006.01)	3398400  3353175	TUBULAR CONCENTRATOR FOR CONCENTRIC RADIATION OF ELECTROMAGNETIC WAVES  SALTS AND SOLID FORMS OF MONOBACTAM ANTIBIOTIC
Institute of Chemistry, Chinese Academy of Science	<b>C04B 35/528</b> (2006.01) <b>C04B 35/63</b> (2006.01) <b>C04B 35/632</b> (2006.01) <b>H01M 4/36</b> (2006.01) <b>H01M 4/587</b> (2010.01) <b>H01M 10/052</b> (2010.01) <b>H01M 10/0568</b> (2010.01) <b>H01M 10/0569</b> (2010.01) <b>A61K 38/44</b> (2006.01) <b>C12N 1/20</b> (2006.01)	3353841  3352781	METHOD OF PREPARING AND APPLICATION OF CARBON-SELENIUM COMPOSITES  4'-SUBSTITUTED NUCLEOSIDE REVERSE TRANSCRIPTASE INHIBITORS AND PREPARATIONS THEREOF
Oregon Health & Science University	<b>A61K 39/145</b> (2006.01) <b>A61K 39/39</b> (2006.01) <b>C07K 14/005</b> (2006.01) <b>C12N 9/24</b> (2006.01) <b>C12N 15/63</b> (2006.01) <b>A61K 31/56</b> (2006.01) <b>A61K 31/58</b> (2006.01) <b>A61K 31/79</b> (2006.01)	3353192  3352768	DESIGN AND CHARACTERIZATION OF INFLUENZA VACCINES  METHODS OF PROMOTING HEPATIC REGENERATION
Vertex Pharmaceuticals (Europe) Limited	<b>A61K 31/47</b> (2006.01) <b>C07D 215/56</b> (2006.01)	3352757	ADMINISTRATION OF DEUTERATED CFTR POTENTIATORS
The Trustees of The University of Pennsylvania	<b>C07K 14/705</b> (2006.01) <b>C07K 14/725</b> (2006.01) <b>C07K 19/00</b> (2006.01)	3353197	METHOD OF REDIRECTING T CELLS TO TREAT HIV INFECTION

Podnosilac evropske prijave patenta (71)	MKP (51)	Broj objave evropske prijave patenta (97)	Naziv pronalaska (54)		
Graybug Vision, Inc.	<b>A61K 31/20</b> (2006.01)	3352749	COMPOUNDS AND COMPOSITIONS FOR THE TREATMENT OF OCULAR DISORDERS		
	<b>A61K 47/34</b> (2017.01)				
	<b>A61K 31/435</b> (2006.01)	3352758	DEUTERATED CFTR POTENTIATORS		
	<b>A61K 31/47</b> (2006.01)				
	<b>A61K 31/4704</b> (2006.01)				
	<b>A61K 31/472</b> (2006.01)				
	<b>A61P 11/12</b> (2006.01)				
	<b>C07D 215/00</b> (2006.01)				
	<b>C07D 215/16</b> (2006.01)				
	<b>C07D 215/56</b> (2006.01)				
	<b>C07D 471/04</b> (2006.01)				
	<b>A61K 31/7088</b> (2006.01)			3353328	MODULATORS OF KRAS EXPRESSION
	<b>C07H 21/04</b> (2006.01)				
	<b>C12N 15/113</b> (2010.01)				
	<b>C12Q 1/68</b> (2018.01)				
	<b>C07C 281/16</b> (2006.01)	3353153	THE TOTAL SYNTHESIS OF GLUCOSEPANE AND COMPOUNDS OBTAINED THEREFROM		
	<b>C07D 223/14</b> (2006.01)				
	<b>A61K 31/575</b> (2006.01)	3353189	METHODS AND INTERMEDIATES FOR THE PREPARATION BILE ACID DERIVATIVES		
	<b>A61P 1/16</b> (2006.01)				
	<b>A61P 9/10</b> (2006.01)				
	<b>A61P 13/12</b> (2006.01)				
	<b>C07J 9/00</b> (2006.01)				
	<b>C07J 31/00</b> (2006.01)				
	<b>A61K 31/496</b> (2006.01)			3352761	METHOD OF TREATING MALIGNANT RHABDOID TUMOR OF THE OVARY (MRTO)/SMALL CELL CANCER OF THE OVARY OF THE HYPERCALCEMIC TYPE (SCCOHT) WITH AN EZH2 INHIBITOR
	<b>A61K 31/5377</b> (2006.01)				
	<b>C07B 53/00</b> (2006.01)			3357901	METHOD FOR PRODUCING OPTICALLY ACTIVE 2-(2-FLUOROBIPHENYL-4-YL) PROPANOIC ACID
	<b>C07B 61/00</b> (2006.01)				
	<b>C07C 51/09</b> (2006.01)				
	<b>C07C 57/58</b> (2006.01)				

Podnosilac evropske prijave patenta (71)	MKP (51)	Broj objave evropske prijave patenta (97)	Naziv pronalaska (54)
Sorokin, Konstantin Vladimirovich	<b>B65D 85/00</b> (2006.01) <b>B65D 88/00</b> (2006.01) <b>F17C 13/00</b> (2006.01)	3357837	PALLET FOR CYLINDERS, METHOD FOR ARRANGING CYLINDERS IN A PALLET, AND PALLET WITH CYLINDERS
BIRD ROCK BIO, INC.	<b>G01N 33/543</b> (2006.01) <b>G01N 33/94</b> (2006.01)	3356833	ANTIBODIES THAT BIND HUMAN CANNABINOID 1 (CB1) RECEPTOR
Agenovir Corporation	<b>A61K 9/00</b> (2006.01) <b>A61M 5/00</b> (2006.01) <b>C12N 9/14</b> (2006.01) <b>C12N 9/22</b> (2006.01) <b>C12N 15/11</b> (2006.01) <b>C12N 15/63</b> (2006.01)	3355954  3356528	DELIVERY METHODS AND COMPOSITIONS  COMPOSITIONS AND METHODS FOR LATENT VIRAL TRANSCRIPTION REGULATION
	<b>A61K 31/495</b> (2006.01) <b>A61K 31/522</b> (2006.01) <b>A61P 31/14</b> (2006.01) <b>A61K 31/4439</b> (2006.01) <b>A61K 31/519</b> (2006.01) <b>C07D 405/12</b> (2006.01)	3355991	COMBINATION THERAPY REGIMEN FOR TREATMENT OF HCV
	<b>A61K 39/395</b> (2006.01) <b>A61P 1/00</b> (2006.01) <b>A61P 37/00</b> (2006.01)	3355890	HUMAN PLASMA KALLIKREIN INHIBITORS
	<b>C12N 15/113</b> (2010.01)	3355921	ANTAGONISTIC ANTIBODIES SPECIFICALLY BINDING HUMAN CD40 AND METHODS OF USE
Arrowhead Pharmaceuticals, Inc.	<b>C12N 15/113</b> (2010.01)	3356529	COMPOSITIONS AND METHODS FOR INHIBITING GENE EXPRESSION OF LPA
	<b>A61K 39/395</b> (2006.01) <b>A61P 35/00</b> (2006.01) <b>A61P 35/02</b> (2006.01) <b>C12N 15/13</b> (2006.01)	3356532	AGONISTIC ANTIBODIES SPECIFICALLY BINDING HUMAN CD40 AND METHODS OF USE
Momenta Pharmaceuticals, Inc.	<b>C07K 14/525</b> (2006.01) <b>C07K 14/54</b> (2006.01) <b>C07K 16/28</b> (2006.01) <b>C12Q 1/68</b> (2018.01)	3356561	THERAPEUTIC AND DIAGNOSTIC METHODS FOR AUTOIMMUNE DISEASES AND/OR INFLAMMATION

Podnosilac evropske prijave patenta (71)	MKP (51)	Broj objave evropske prijave patenta (97)	Naziv pronalaska (54)			
University of Utah Research Foundation	<b>G01N 33/50</b> (2006.01)	3356525	COMPOSITIONS FOR ADJUSTABLE RIBOSOME TRANSLATION SPEED AND METHODS OF USE			
	<b>C12N 15/09</b> (2006.01)					
	<b>C12N 15/11</b> (2006.01)					
	<b>C12N 15/63</b> (2006.01)					
	<b>C12N 15/67</b> (2006.01)	3389724	GENE THERAPY FOR OCULAR DISORDERS			
	<b>C12Q 1/68</b> (2018.01)					
	<b>A61K 48/00</b> (2006.01)	3360415	AGRICULTURAL AND HORTICULTURAL FUNGICIDAL COMPOSITION			
	<b>C07K 14/47</b> (2006.01)					
	<b>A01N 37/46</b> (2006.01)					
	<b>A01N 43/10</b> (2006.01)					
	<b>A01N 43/24</b> (2006.01)					
	<b>A01N 43/40</b> (2006.01)					
	<b>A01N 43/42</b> (2006.01)					
	<b>A01N 43/56</b> (2006.01)					
<b>A01N 43/60</b> (2006.01)						
<b>A01N 43/653</b> (2006.01)						
<b>A01N 43/72</b> (2006.01)						
<b>A01N 43/80</b> (2006.01)						
<b>A01N 43/90</b> (2006.01)						
<b>A01N 47/12</b> (2006.01)						
<b>A01P 3/00</b> (2006.01)	3371175	METHOD OF TREATING MEDULLOBLASTOMA WITH AN EZH2 INHIBITOR				
<b>C07D 211/86</b> (2006.01)						
<b>C07D 405/12</b> (2006.01)						
<b>C07D 405/14</b> (2006.01)						
The Regents of the University of Colorado, a body corporate	<b>A61K 35/04</b> (2006.01)	3359192	COMBINATION THERAPY FOR THE TREATMENT OF CANCER			
	<b>A61K 39/395</b> (2006.01)					
	<b>C07K 16/18</b> (2006.01)					
	<b>C07K 16/28</b> (2006.01)					
	Tensor Corporation, LLC			<b>E02D 17/20</b> (2006.01)	3359745	GEOGRID MADE FROM A COEXTRUDED MULTILAYERED POLYMER
				<b>E02D 29/02</b> (2006.01)	3359160	FARNESOID X RECEPTOR MODULATORS
				<b>A61K 31/56</b> (2006.01)		
	<b>A61K 31/57</b> (2006.01)					
	<b>A61K</b>					

Podnosilac evropske prijave patenta (71)	MKP (51)	Broj objave evropske prijave patenta (97)	Naziv pronalaska (54)
	<b>31/575</b> (2006.01)		
	<b>C07J 9/00</b> (2006.01)		
	<b>C07J 43/00</b> (2006.01)		
	<b>A61K 31/64</b> (2006.01)	3359162	METHODS OF TREATING INJURIES OR CONDITIONS RELATED TO CNS EDEMA
	<b>A61K 31/7125</b> (2006.01)	3359668	COMPOSITIONS AND METHODS FOR TREATING DUCHENNE MUSCULAR DYSTROPHY AND RELATED DISORDERS
	<b>C07H 21/04</b> (2006.01)		
	<b>C12N 15/113</b> (2010.01)		
	<b>C12N 5/0789</b> (2010.01)	3359648	IN VITRO METHODS OF IDENTIFYING MODULATORS OF NEUROMUSCULAR JUNCTION ACTIVITY
	<b>C12N 5/0793</b> (2010.01)		
ZS Pharma, Inc.	<b>C07F 7/02</b> (2006.01)	3362456	EXTENDED USE ZIRCONIUM SILICATE COMPOSITIONS AND METHODS OF USE THEREOF
	<b>B65H 43/02</b> (2006.01)	3362389	DISPOSABLE PRODUCT ASSEMBLY SYSTEMS AND METHODS
	<b>B65H 51/30</b> (2006.01)		
	<b>G05B 11/01</b> (2006.01)		
	<b>G05B 11/32</b> (2006.01)		
	<b>G05B 21/02</b> (2006.01)		
	<b>G06Q 30/06</b> (2012.01)		
	<b>G06Q 50/04</b> (2012.01)		
Tarix Pharmaceuticals Ltd.	<b>A61K 31/415</b> (2006.01)	3373951	METHODS AND COMPOSITIONS FOR THE TREATMENT OF EPIDERMOLYSIS BULLOSA
	<b>A61K 38/08</b> (2006.01)		
	<b>A61K 38/12</b> (2006.01)		
	<b>A61P 17/02</b> (2006.01)		
	<b>A61K 31/4439</b> (2006.01)	3362065	COMBINATION THERAPY FOR TREATING MALIGNANCIES
	<b>C07H 19/06</b> (2006.01)		
	<b>A61K 31/4439</b> (2006.01)	3362066	COMBINATION THERAPY FOR TREATING MALIGNANCIES
	<b>A61P 35/00</b> (2006.01)		
	<b>C07H 19/12</b> (2006.01)		
William Marsh Rice University	<b>A61K 31/425</b> (2006.01)	3371176	EPOTHILONE ANALOGS, METHODS OF SYNTHESIS, METHODS OF TREATMENT, AND DRUG CONJUGATES THEREOF
	<b>C07D 405/06</b> (2006.01)		
	<b>C07D 407/06</b> (2006.01)		

Podnosilac evropske prijave patenta (71)	MKP (51)	Broj objave evropske prijave patenta (97)	Naziv pronalaska (54)
Hadasit Medical Research Services and Development Ltd.	<b>A61K 9/16</b> (2006.01)	3362053	TREATMENT OF NON-ALCOHOLIC FATTY LIVER DISEASE OR NON-ALCOHOLIC STEATOHEPATITIS WITH DELAYED-RELEASE 6-MERCAPTOPYRIMIDINE
	<b>A61K 9/22</b> (2006.01)		
	<b>A61K 31/52</b> (2006.01)		
	<b>A61K 31/522</b> (2006.01)		
	<b>A61K 39/00</b> (2006.01)		
	<b>A61K 39/02</b> (2006.01)		
	<b>A61K 39/12</b> (2006.01)		
	<b>A61K 39/39</b> (2006.01)		
	<b>C07K 14/005</b> (2006.01)		
	<b>C07K 14/195</b> (2006.01)		
Scythian Biosciences Inc.	<b>C12N 15/74</b> (2006.01)	3362067	METHODS AND COMPOSITIONS FOR TREATING TRAUMATIC BRAIN INJURY
	<b>A61K 31/453</b> (2006.01)		
	<b>A61P 43/00</b> (2006.01)		
	<b>C07D 311/02</b> (2006.01)		
	<b>G01N 33/92</b> (2006.01)		
L & K Biomed Co. Ltd.	<b>G01N 33/92</b> (2006.01)	3373014	DIAGNOSTIC MARKER FOR CORONARY ARTERY DISEASE
	<b>A61B 17/70</b> (2006.01)		
	<b>A61B 17/72</b> (2006.01)		
	<b>A61B 17/86</b> (2006.01)		
L&K Biomed Co., Ltd.	<b>A61F 2/44</b> (2006.01)	3366244	SURGICAL SCREW AND FUSION DEVICE USING SAME
	<b>A61B 17/70</b> (2006.01)		
	<b>A61B 17/72</b> (2006.01)		
	<b>A61B 17/86</b> (2006.01)		
Limited Liability Company "Diamed-Farma"	<b>A61F 2/44</b> (2006.01)	3354271	AGENT FOR TREATING ARTHROLOGICAL DISEASES
	<b>A61K 9/08</b> (2006.01)		
	<b>A61K 31/737</b> (2006.01)		
	<b>A61K 35/32</b> (2015.01)		
	<b>A61K 35/60</b> (2006.01)		
	<b>A61K 47/10</b> (2017.01)		
Obshchestvo S Ogranichennoy Otvetstvennostyu "Normfarm"	<b>A61P 19/02</b> (2006.01)	3366288	AGENT EXHIBITING ANTI-STRESS, ANXIOLYTIC AND ANTI-DEPRESSION ACTIVITY, AND COMPOSITION BASED THEREON
	<b>A61K 31/375</b> (2006.01)		
	<b>A61K 31/375</b> (2006.01)		
	<b>A61K 31/375</b> (2006.01)		

Podnosilac evropske prijave patenta (71)	MKP (51)	Broj objave evropske prijave patenta (97)	Naziv pronalaska (54)
2Elms Pte. Ltd.	<b>31/4415</b> (2006.01) <b>A61K 31/51</b> (2006.01) <b>A61P 25/24</b> (2006.01) <b>E04B 1/21</b> (2006.01) <b>E04B 1/24</b> (2006.01) <b>E04B 1/41</b> (2006.01) <b>E04B 1/58</b> (2006.01) <b>F16B 13/04</b> (2006.01) <b>F16S 3/00</b> (2006.01)	3365505	SUPPORT APPARATUS AND ITS COMPONENTS
Neuform Pharmaceuticals, Inc.	<b>A61K 31/53</b> (2006.01) <b>A61P 35/00</b> (2006.01) <b>C07D 401/14</b> (2006.01)	3365336	DEUTERATED COMPOUNDS FOR TREATING HEMATOLOGIC MALIGNANCIES, AND COMPOSITIONS AND METHODS THEREOF
Zin, Benedict Louis	<b>A01M 1/00</b> (2006.01) <b>C12Q 1/68</b> (2018.01) <b>G01N 33/50</b> (2006.01) <b>G01N 33/563</b> (2006.01) <b>G01N 33/566</b> (2006.01) <b>G06F 7/00</b> (2006.01)	3370515	BED BUGS DETECTION DEVICE
Redcoat Solutions, Inc.	<b>A61K 31/7105</b> (2006.01) <b>A61P 31/22</b> (2006.01) <b>C12N 15/38</b> (2006.01) <b>C07K 16/18</b> (2006.01) <b>C12N 5/12</b> (2006.01) <b>C12N 5/20</b> (2006.01) <b>G01N 33/563</b> (2006.01) <b>G01N 33/569</b> (2006.01) <b>G01N 33/577</b> (2006.01)	3364980	NUCLEIC ACID VACCINES FOR VARICELLA ZOSTER VIRUS (VZV)
Redcoat Solutions, Inc.	<b>A61K 31/7105</b> (2006.01) <b>A61K 31/7115</b> (2006.01) <b>A61K 31/7115</b> (2006.01) <b>A61K 31/7115</b> (2006.01)	3365367	ANTI-BED BUG MONOCLONAL ANTIBODIES AND METHODS OF MAKING AND USES THEREOF
	<b>A61K 31/7105</b> (2006.01)	3364981	HUMAN CYTOMEGALOVIRUS VACCINE



Podnosilac evropske prijave patenta (71)	MKP (51)	Broj objave evropske prijave patenta (97)	Naziv pronalaska (54)		
ERX Pharmaceuticals, Inc.	<b>39/245</b> (2006.01)	3364956	ANALOGS OF CELASTROL		
	<b>A61P 31/22</b> (2006.01)				
	<b>A61K 31/015</b> (2006.01)				
	<b>A61K 31/56</b> (2006.01)				
	<b>A61K 45/06</b> (2006.01)				
	<b>C07J 63/00</b> (2006.01)				
	<b>A61K 31/7105</b> (2006.01)	3364982	SEXUALLY TRANSMITTED DISEASE VACCINES		
	<b>A61K 31/7115</b> (2006.01)				
	<b>A61K 39/12</b> (2006.01)				
	<b>A61P 31/14</b> (2006.01)				
	<b>A61K 9/10</b> (2006.01)			3364949	CANCER VACCINES
	<b>A61K 39/00</b> (2006.01)				
	<b>A61K 48/00</b> (2006.01)	3365007	BROAD SPECTRUM INFLUENZA VIRUS VACCINE		
	<b>A61K 9/51</b> (2006.01)				
	<b>A61K 39/145</b> (2006.01)				
	<b>A61P 31/16</b> (2006.01)				
	<b>A61K 31/7105</b> (2006.01)			3365008	RESPIRATORY SYNCYTIAL VIRUS VACCINE
	<b>A61K 31/7115</b> (2006.01)				
	<b>A61K 39/155</b> (2006.01)				
	<b>A61P 31/14</b> (2006.01)				
	<b>A61K 31/7105</b> (2006.01)	3365009	HERPES SIMPLEX VIRUS VACCINE		
	<b>A61K 31/7115</b> (2006.01)				
	<b>A61K 39/245</b> (2006.01)				
	<b>A61P 31/22</b> (2006.01)				
	<b>A61K 9/10</b> (2006.01)			3364950	TROPICAL DISEASE VACCINES
	<b>A61K 39/00</b> (2006.01)				
	<b>A61K 39/12</b> (2006.01)				
	<b>A61K 48/00</b> (2006.01)				

Podnosilac evropske prijave patenta (71)	MKP (51)	Broj objave evropske prijave patenta (97)	Naziv pronalaska (54)
	<b>A61K 31/7105</b> (2006.01)	3364983	RESPIRATORY VIRUS VACCINES
	<b>A61K 31/7115</b> (2006.01)		
	<b>A61K 39/12</b> (2006.01)		
	<b>A61P 11/00</b> (2006.01)		
Sun Pharmaceutical Industries Limited	<b>A61K 9/16</b> (2006.01)	3368030	PHARMACEUTICAL COMPOSITIONS OF DIMETHYL FUMARATE
	<b>A61K 31/225</b> (2006.01)		
	<b>A61K 31/616</b> (2006.01)		
CIPHEROME	<b>G06F 19/18</b> (2011.01)	3396573	METHOD AND SYSTEM FOR SELECTING CUSTOMIZED DRUG USING GENOMIC NUCLEOTIDE SEQUENCE VARIATION INFORMATION AND SURVIVAL INFORMATION OF CANCER PATIENT
	<b>G06F 19/22</b> (2011.01)		
	<b>G06F 19/28</b> (2011.01)		
	<b>A61K 31/44</b> (2006.01)	3368036	FACTOR XIA INHIBITORS
	<b>A61K 31/4418</b> (2006.01)		
	<b>A61K 31/4427</b> (2006.01)		
	<b>C07D 213/02</b> (2006.01)		
	<b>C07D 213/04</b> (2006.01)		
	<b>C07D 401/06</b> (2006.01)		
	<b>A61K 9/00</b> (2006.01)	3368027	METHODS OF TREATING PAIN OR FEVER USING PHARMACEUTICALLY ACTIVE ACETAMINOPHEN DIMERS LINKED THROUGH PHENOLIC HYDROXYL GROUPS
	<b>A61K 9/20</b> (2006.01)		
	<b>A61K 31/167</b> (2006.01)		
	<b>A61K 45/06</b> (2006.01)		
	<b>A61K 9/10</b> (2006.01)	3368038	ETHYLENE GLYCOL ETHER OF BUPRENORPHINE
	<b>A61K 31/439</b> (2006.01)		
	<b>A61K 31/485</b> (2006.01)		
	<b>B01J 49/00</b> (2017.01)	3369097	COMPOSITE EXTRACTANT-ENHANCED POLYMER RESIN, METHOD OF MAKING THE SAME, AND ITS USAGE FOR EXTRACTION OF VALUABLE METAL(S)
	<b>G21G 4/08</b> (2006.01)		
Spiegelman, Bruce, M. Long, Jonathan, Z.	<b>A61K 8/44</b> (2006.01)	3368157	METHODS FOR IDENTIFICATION, ASSESSMENT, PREVENTION, AND TREATMENT OF METABOLIC DISORDERS USING PM20D1 AND N-LIPIDATED AMINO ACIDS
	<b>A61K 31/16</b> (2006.01)		
	<b>A61K 38/46</b> (2006.01)		
	<b>A61P 3/10</b> (2006.01)		

Podnosilac evropske prijave patenta (71)	MKP (51)	Broj objave evropske prijave patenta (97)	Naziv pronalaska (54)
	<b>C12N 9/14</b> (2006.01)		
	<b>C12N 15/113</b> (2010.01)		
	<b>C12Q 1/68</b> (2018.01)		
	<b>G01N 33/50</b> (2006.01)		
	<b>A61K 31/69</b> (2006.01)	3368541	COMPOSITIONS AND METHODS FOR INHIBITING ARGINASE ACTIVITY
	<b>A61P 35/00</b> (2006.01)		
	<b>C07D 207/16</b> (2006.01)		
	<b>C07F 5/02</b> (2006.01)		
	<b>C07F 5/04</b> (2006.01)		
AcelRx Pharmaceuticals, Inc.	<b>A61M 1/02</b> (2006.01)	3368097	APPARATUS AND METHODS FOR DISPENSING ORAL TRANSMUCOSAL DOSAGE FORMS
	<b>A61M 1/14</b> (2006.01)		
	<b>A61M 1/16</b> (2006.01)		
	<b>A61M 1/18</b> (2006.01)		
	<b>A61M 5/307</b> (2006.01)		
	<b>A61M 5/315</b> (2006.01)		
Aleta Biotherapeutics Inc.	<b>A61K 39/395</b> (2006.01)	3368077	COMPOSITIONS AND METHODS FOR TUMOR TRANSDUCTION
	<b>A61K 45/00</b> (2006.01)		
	<b>A61P 35/00</b> (2006.01)		
	<b>C07K 16/18</b> (2006.01)		
	<b>C07K 16/28</b> (2006.01)		
	<b>C12P 21/08</b> (2006.01)		
	<b>C07K 14/705</b> (2006.01)	3368559	COMPOSITIONS AND METHODS FOR TREATMENT OF CANCER
	<b>C07K 16/28</b> (2006.01)		
	<b>C07K 19/00</b> (2006.01)		
«PHARMENTERPRISES BIOTECH» LIMITED LIABILITY COMPANY	<b>A61K 35/76</b> (2015.01)	3382010	ATTENUATED INFLUENZA VECTORS FOR THE PREVENTION AND/OR TREATMENT OF INFECTIOUS DISEASES AND FOR THE TREATMENT OF ONCOLOGICAL DISEASES
	<b>A61K 39/145</b> (2006.01)		
	<b>A61P 31/16</b> (2006.01)		
	<b>A61P 35/00</b> (2006.01)		
	<b>C12N 7/01</b> (2006.01)		
	<b>C12N 15/86</b> (2006.01)		

Podnosilac evropske prijave patenta (71)	MKP (51)	Broj objave evropske prijave patenta (97)	Naziv pronalaska (54)
	<b>A61K 31/575</b> (2006.01)	3370728	METHODS FOR THE PREPARATION OF OBETICHOLIC ACID AND DERIVATIVES THEREOF
	<b>C07J 9/00</b> (2006.01)		
	<b>C07J 31/00</b> (2006.01)		
	<b>A61K 39/00</b> (2006.01)	3370768	ANTIBODIES SPECIFICALLY BINDING PD-1 AND THEIR USES
	<b>A61K 39/395</b> (2006.01)		
	<b>A61K 31/198</b> (2006.01)	3370770	SUBCUTANEOUS FORMULATIONS OF ANTI-CD38 ANTIBODIES AND THEIR USES
	<b>A61K 31/4439</b> (2006.01)		
	<b>A61K 31/573</b> (2006.01)		
	<b>A61K 31/69</b> (2006.01)		
	<b>A61K 39/395</b> (2006.01)		
	<b>C07K 16/28</b> (2006.01)		
Neuraltus Pharmaceuticals, Inc.	<b>A61K 33/20</b> (2006.01)	3370738	TREATMENT OF NEURODEGENERATIVE DISEASE WITH SODIUM CHLORITE
	<b>A61P 25/28</b> (2006.01)		
	<b>C01B 11/10</b> (2006.01)		
Regents of the University of Minnesota	<b>A61K 39/00</b> (2006.01)	3370763	CD200 INHIBITORS AND METHODS OF USE THEREOF
	<b>A61K 39/39</b> (2006.01)		
	<b>C07K 7/06</b> (2006.01)		
	<b>C07K 7/08</b> (2006.01)		
	<b>A61K 35/15</b> (2015.01)	3370741	METHODS AND COMPOSITIONS FOR GENE EDITING IN HEMATOPOIETIC STEM CELLS
	<b>A61K 35/17</b> (2015.01)		
	<b>A61K 45/06</b> (2006.01)		
	<b>A61K 48/00</b> (2006.01)		
	<b>A61P 35/00</b> (2006.01)		
	<b>A61P 35/02</b> (2006.01)		
	<b>C01B 17/02</b> (2006.01)	3371100	METHOD FOR REDUCING ELEMENTAL SULFUR IN GYPSUM PRODUCTS
	<b>C01B 17/04</b> (2006.01)		
	<b>C01B 17/50</b> (2006.01)		
	<b>A61K 31/194</b> (2006.01)	3370713	TREATMENT OF MIXED DYSLIPIDEMIA
	<b>A61P 1/18</b> (2006.01)		
	<b>A61K 31/4433</b>	3370725	PEDIATRIC DOSING FOR TREATMENT OF CANCER WITH AN EZH2 INHIBITOR

Podnosilac evropske prijave patenta (71)	MKP (51)	Broj objave evropske prijave patenta (97)	Naziv pronalaska (54)
	(2006.01) <b>A61K</b> <b>31/4436</b> (2006.01) <b>A61K</b> <b>31/497</b> (2006.01) <b>A61K</b> <b>31/5355</b> (2006.01) <b>A61P 35/00</b> (2006.01) <b>E21B 23/01</b> (2006.01) <b>E21B 23/10</b> (2006.01) <b>A61K</b> <b>31/4375</b> (2006.01) <b>A61K</b> <b>31/444</b> (2006.01) <b>A61K</b> <b>31/497</b> (2006.01) <b>A61K</b> <b>31/506</b> (2006.01) <b>A61P 9/10</b> (2006.01) <b>A61P 21/02</b> (2006.01) <b>A61P 25/00</b> (2006.01) <b>A61P 25/04</b> (2006.01) <b>A61P 25/08</b> (2006.01) <b>A61P 25/14</b> (2006.01) <b>A61P 25/16</b> (2006.01) <b>A61P 25/18</b> (2006.01) <b>A61P 25/22</b> (2006.01) <b>A61P 25/24</b> (2006.01) <b>A61P 25/28</b> (2006.01) <b>A61P 25/30</b> (2006.01) <b>C07D</b> <b>491/147</b> (2006.01)		
		3374592	APPARATUSES AND METHODS FOR LOCATING WITHIN A WELLBORE
		3378863	PYRANODIPYRIDINE COMPOUND
Daewoong Pharmaceutical Co., Ltd.	<b>A61K</b> <b>31/427</b> (2006.01) <b>A61K</b> <b>31/497</b> (2006.01) <b>C07D 417/12</b> (2006.01) <b>C07D 417/14</b> (2006.01)	3375782	SODIUM CHANNEL BLOCKER
University of Leicester	<b>A61K 39/00</b> (2006.01)	3373963	METHODS FOR TREATING CONDITIONS ASSOCIATED WITH MASP-2 DEPENDENT COMPLEMENT ACTIVATION

Podnosilac evropske prijave patenta (71)	MKP (51)	Broj objave evropske prijave patenta (97)	Naziv pronalaska (54)
	<b>A61K 39/395</b> (2006.01)		
	<b>A61P 7/02</b> (2006.01)		
	<b>A61P 37/02</b> (2006.01)		
	<b>C07K 16/40</b> (2006.01)		
	<b>A61K 9/14</b> (2006.01)	3373978	AGGREGATING MICROPARTICLES FOR THERAPY
	<b>A61K 9/50</b> (2006.01)		
	<b>A61K 47/50</b> (2017.01)		
Texas Tech University System	<b>A61K 9/00</b> (2006.01)	3377069	PHEROMONE COMPOSITION TO STIMULATE REPRODUCTION IN FEMALE SUIDS AND METHODS OF USE
	<b>A61K 31/47</b> (2006.01)		
	<b>A61K 31/568</b> (2006.01)		
	<b>A61P 43/00</b> (2006.01)		
University Of Georgia Research Foundation, Inc. Aruna Biomedical, Inc.	<b>A61K 35/30</b> (2015.01)	3377078	NEURAL CELL EXTRACELLULAR VESSICLES
	<b>A61K 35/545</b> (2015.01)		
	<b>A61P 25/00</b> (2006.01)		
	<b>A61K 31/341</b> (2006.01)	3383386	MODULATORS OF CHEMOKINE RECEPTORS
	<b>C07C 225/20</b> (2006.01)		
	<b>A61K 31/404</b> (2006.01)	3377059	INHIBITORS OF CXCR2
	<b>A61K 31/407</b> (2006.01)		
	<b>A61K 31/5377</b> (2006.01)		
	<b>A61K 35/44</b> (2015.01)	3377079	NOVEL ANTI-EMR2 ANTIBODIES AND METHODS OF USE
	<b>C07K 16/28</b> (2006.01)		
Memorial Sloan Kettering Cancer Center	<b>A61K 39/00</b> (2006.01)	3377516	METHODS AND COMPOSITIONS FOR TREATING CANCER
	<b>C07K 7/08</b> (2006.01)		
	<b>C07K 14/47</b> (2006.01)		
	<b>A61K 31/56</b> (2006.01)	3377070	COMPOUNDS AND METHODS OF THEIR USE
	<b>A61K 31/57</b> (2006.01)		
	<b>A61K 31/573</b> (2006.01)		
	<b>A61K 39/00</b> (2006.01)	3377636	CMV VECTORS COMPRISING MICRORNA RECOGNITION ELEMENTS
	<b>A61K 39/015</b> (2006.01)		

Podnosilac evropske prijave patenta (71)	MKP (51)	Broj objave evropske prijave patenta (97)	Naziv pronalaska (54)
<b>A61K 39/04</b> (2006.01)			
<b>A61K 39/12</b> (2006.01)			
<b>A61K 48/00</b> (2006.01)			
<b>C12N 15/86</b> (2006.01)			
<b>A61K 31/197</b> (2006.01)		3389655	USE OF sGC STIMULATORS FOR THE TREATMENT OF GASTROINTESTINAL SPHINCTER DYSFUNCTION
<b>A61K 31/437</b> (2006.01)			
<b>A61K 31/4422</b> (2006.01)			
<b>A61K 31/506</b> (2006.01)			
<b>A61K 31/519</b> (2006.01)			
<b>A61K 31/5377</b> (2006.01)			
<b>A61K 45/06</b> (2006.01)			
<b>A61P 1/00</b> (2006.01)			
<b>A61K 39/395</b> (2006.01)		3390441	HUMAN IMMUNODEFICIENCY VIRUS NEUTRALIZING ANTIBODIES
<b>C07K 16/10</b> (2006.01)			
<b>B32B 7/00</b> (2006.01)		3386746	COMPOSITE STEEL
<b>B32B 7/12</b> (2006.01)			
<b>B32B 15/00</b> (2006.01)			
<b>B32B 15/01</b> (2006.01)			
<b>B32B 15/08</b> (2006.01)			
<b>B32B 15/20</b> (2006.01)			
<b>B62D 29/00</b> (2006.01)			
<b>C22C 1/00</b> (2006.01)			
<b>C22C 23/00</b> (2006.01)			
<b>A61B 17/32</b> (2006.01)		3389515	ULTRASONIC SURGICAL INSTRUMENT WITH CLEANING PORT
<b>A61B 18/14</b> (2006.01)			
<b>A61B 17/32</b> (2006.01)		3389516	SURGICAL INSTRUMENT WITH MULTI-FUNCTION BUTTON
<b>A61B 18/14</b> (2006.01)			
<b>A61B 17/32</b> (2006.01)		3389517	SURGICAL INSTRUMENT WITH FUNCTION SELECTOR
<b>A61B 18/14</b> (2006.01)			
<b>A61B 17/32</b> (2006.01)		3393378	SURGICAL INSTRUMENT WITH VARIABLE CLAMPING FORCE

Podnosilac evropske prijave patenta (71)	MKP (51)	Broj objave evropske prijave patenta (97)	Naziv pronalaska (54)		
Adamas Pharmaceuticals, Inc.	<b>A61B 18/14</b> (2006.01)	3397253	METHODS AND COMPOSITIONS FOR THE TREATMENT OF SEIZURE-RELATED DISORDERS		
	<b>A61K 31/19</b> (2006.01)				
	<b>A61K 31/192</b> (2006.01)				
	<b>A61K 31/395</b> (2006.01)				
	<b>A61K 31/55</b> (2006.01)	3397619	OINTMENT		
	<b>A61P 25/08</b> (2006.01)				
	<b>A61K 31/421</b> (2006.01)	3383892	MODIFIED CHIMERIC RECEPTORS AND RELATED COMPOSITIONS AND METHODS		
	<b>A61P 17/00</b> (2006.01)				
	<b>C07D 263/32</b> (2006.01)				
	<b>C07K 14/705</b> (2006.01)				
	<b>A01N 31/08</b> (2006.01)			3393247	METAL OXIDES AND/OR HYDRATES THEREOF FOR STABILISING AN AQUEOUS PREPARATION AGAINST MICROBIAL GROWTH
	<b>A01N 35/08</b> (2006.01)				
	<b>A01N 43/40</b> (2006.01)			3393801	METHOD FOR INTEGRATING A HOLOGRAM INTO THE BODY OF A SECURITY DOCUMENT AND SECURITY DOCUMENT BODY
	<b>A01N 43/80</b> (2006.01)				
<b>A01N 59/00</b> (2006.01)					
<b>A01N 59/06</b> (2006.01)					
<b>A01N 59/16</b> (2006.01)					
<b>A01P 1/00</b> (2006.01)					
<b>D21H 21/36</b> (2006.01)	3405463	PROCESS FOR THE PREPARATION OF SOFOSBUVIR			
<b>B32B 33/00</b> (2006.01)					
<b>B32B 37/18</b> (2006.01)					
<b>B32B 37/20</b> (2006.01)					
<b>B42D 25/328</b> (2014.01)	3389518	SURGICAL INSTRUMENT WITH MULTI-FUNCTIONING TRIGGER			
<b>G03H 1/18</b> (2006.01)					
Bundesdruckerei GmbH Covestro Deutschland AG	<b>C07D 307/20</b> (2006.01)	3386534	COMPOSITIONS AND METHODS FOR INTERNALIZING ENZYMES		
	<b>C07D 319/12</b> (2006.01)				
	<b>C07H 19/10</b> (2006.01)				
	<b>A61B 17/32</b> (2006.01)	3386534	COMPOSITIONS AND METHODS FOR INTERNALIZING ENZYMES		
	<b>A61K 38/46</b> (2006.01)				
	<b>A61K 38/47</b> (2006.01)				
	<b>A61P 43/00</b> (2006.01)				



Podnosilac evropske prijave patenta (71)	MKP (51)	Broj objave evropske prijave patenta (97)	Naziv pronalaska (54)
	<b>C12N 9/40</b> (2006.01)		
	<b>C12N 9/42</b> (2006.01)		
	<b>A01N 43/72</b> (2006.01)	3397638	ANTHELMINTIC DEPSIPEPTIDE COMPOUNDS
	<b>C07D 273/00</b> (2006.01)		
	<b>C07D 413/14</b> (2006.01)		
	<b>C07K 11/02</b> (2006.01)		
	<b>C07K 16/28</b> (2006.01)	3390453	ANTIBODIES SPECIFICALLY BINDING HLA-DR AND THEIR USES
	<b>E04B 1/21</b> (2006.01)	3394358	ANTI-SEISMIC CONNECTION JOINT HAVING A SLOTTED HOLE
	<b>E04H 9/02</b> (2006.01)		
	<b>A61K 31/4725</b> (2006.01)	3394045	COCRYSTAL, PRODUCTION METHOD THEREOF, AND MEDICAMENT CONTAINING COCRYSTAL
	<b>A61P 35/00</b> (2006.01)		
	<b>C07C 55/08</b> (2006.01)		
	<b>C07C 57/145</b> (2006.01)		
	<b>C07C 59/245</b> (2006.01)		
	<b>C07C 59/265</b> (2006.01)		
	<b>C07C 59/54</b> (2006.01)		
	<b>C07C 65/05</b> (2006.01)		
	<b>C07C 65/10</b> (2006.01)		
	<b>C07D 401/14</b> (2006.01)		
Bulferetti, Giovanni	<b>E04H 9/02</b> (2006.01)	3390747	ANTI-SEISMIC CONNECTION JOINT
	<b>F16F 1/38</b> (2006.01)		
	<b>F16F 7/00</b> (2006.01)		
	<b>F16F 7/04</b> (2006.01)		
	<b>A23L 3/3472</b> (2006.01)	3373946	NATURAL PRESERVATIVES AND ANTIMICROBIAL AGENTS, INCLUDING COMPOSITIONS THEREOF
	<b>A61K 8/97</b> (2017.01)		
	<b>A61K 36/48</b> (2006.01)		
	<b>A61K 36/575</b> (2006.01)		
	<b>A61Q 17/00</b> (2006.01)		
	<b>A61K 38/26</b> (2006.01)	3394104	METHOD OF TREATING OR AMELIORATING METABOLIC DISORDERS USING BINDING PROTEINS FOR GASTRIC INHIBITORY PEPTIDE RECEPTOR (GIPR) IN COMBINATION WITH GLP-1 AGONISTS
	<b>A61K 39/395</b> (2006.01)		

Podnosilac evropske prijave patenta (71)	MKP (51)	Broj objave evropske prijave patenta (97)	Naziv pronalaska (54)
Rhodia Operations	<b>A61P 3/10</b> (2006.01) <b>C07K 16/28</b> (2006.01) <b>A01N 25/04</b> (2006.01) <b>A01N 25/12</b> (2006.01) <b>A01N 25/30</b> (2006.01) <b>A01N 43/707</b> (2006.01) <b>A01N 43/78</b> (2006.01) <b>A01N 47/04</b> (2006.01) <b>A01N 51/00</b> (2006.01) <b>C09D 5/00</b> (2006.01) <b>C09D 11/00</b> (2014.01)	3386299	POLYELECTROLYTE-LAYER FORMING BLOCK COPOLYMERS AND COMPOSITIONS AND USED THEREOF
Softcar SA	<b>B62D 21/16</b> (2006.01) <b>B62D 29/04</b> (2006.01) <b>B62D 31/00</b> (2006.01) <b>B62D 63/02</b> (2006.01)	3393889	VEHICLE ARCHITECTURE
Adama Agan Ltd.	<b>C07K 16/00</b> (2006.01) <b>C07D 275/06</b> (2006.01) <b>C04B 28/14</b> (2006.01)	3390440 3397620 3397600	C-TERMINAL LYSINE CONJUGATED IMMUNOGLOBULINS PROCESS FOR PREPARING 1.1.3-TRIOXO-1.2-BENZOTHIAZOLE-6-CARBOXAMIDE FIRE RESISTANT BUILDING BOARDS WITH INCREASED AMOUNTS OF ANTI-SHRINKAGE ADDITIVES AND DECREASED DENSITIES
	<b>A61K 31/202</b> (2006.01) <b>A61P 3/08</b> (2006.01) <b>A61P 17/06</b> (2006.01) <b>A61P 25/00</b> (2006.01) <b>A61P 29/00</b> (2006.01) <b>A61P 35/00</b> (2006.01)	3389647	COMPOSITIONS COMPRISING 15-HEPE AND METHODS OF USING THE SAME
	<b>C12N 9/64</b> (2006.01) <b>C12N 9/72</b> (2006.01) <b>C12N 9/74</b> (2006.01)	3380610	RECOMBINANT SERINE PROTEASES
	<b>A61B 17/32</b> (2006.01) <b>A61B 90/70</b> (2016.01)	3393379	ULTRASONIC SURGICAL INSTRUMENT WITH BLADE CLEANING FEATURE
Narducci, Leo Aldo Avalle, Leopoldo Penco, Andrea	<b>A61B 18/02</b> (2006.01) <b>A61B 34/10</b> (2016.01)	3389526	A MACHINERY FOR SURGICAL INTERVENTIONS OF CRYOABLATION WITH CLOSED CYCLE AND MULTIPURPOSE
Materie Plastiche Pisane S.r.L.	<b>B82Y 30/00</b> (2011.01)	3393967	ANTIMICROBIAL POLYMER COMPOSITION

Podnosilac evropske prijave patenta (71)	MKP (51)	Broj objave evropske prijave patenta (97)	Naziv pronalaska (54)
	<b>C08J 5/18</b> (2006.01)		
	<b>C08L 23/08</b> (2006.01)		
	<b>C09D 123/08</b> (2006.01)		
	<b>A61K 31/336</b> (2006.01)	3411363	CRYSTALLINE AND AMORPHOUS FORMS OF CARFILZOMIB
	<b>A61K 31/5375</b> (2006.01)		
	<b>A61K 38/07</b> (2006.01)		
	<b>C07D 303/36</b> (2006.01)		
	<b>C07K 5/10</b> (2006.01)		
	<b>C07D 275/06</b> (2006.01)	3397621	PROCESS FOR PREPARING 1,1,3-TRIOXO-1,2-BENZOTHIAZOLE-6-CARBOXAMIDE
	<b>A61B 17/28</b> (2006.01)	3397179	SNAP FIT CLAMP PAD FOR ULTRASONIC SURGICAL INSTRUMENT
	<b>A61B 17/29</b> (2006.01)		
	<b>A61B 17/32</b> (2006.01)		
	<b>A61K 31/501</b> (2006.01)	3345909	TETRAHYDROOXEPINOPYRIDINE COMPOUND
	<b>A61K 31/5377</b> (2006.01)		
	<b>A61P 25/04</b> (2006.01)		
	<b>A61P 25/18</b> (2006.01)		
	<b>A61P 25/28</b> (2006.01)		
	<b>A61P 29/00</b> (2006.01)		
	<b>C07D 491/044</b> (2006.01)		
	<b>A01G 1/00</b> (2006.01)	3397054	CONTROLLED RELEASE AGROCHEMICAL DELIVERY UNITS, THEIR MANUFACTURE AND USE
	<b>A01G 3/06</b> (2006.01)		
	<b>A01G 29/00</b> (2006.01)		
	<b>A01N 25/04</b> (2006.01)		
	<b>A01N 25/26</b> (2006.01)		
	<b>A01P 21/00</b> (2006.01)		
	<b>C05G 3/00</b> (2006.01)		
	<b>C05G 3/04</b> (2006.01)		
	<b>C05G 3/06</b> (2006.01)		
Naum S.r.l.	<b>D06N 3/00</b> (2006.01)	3397804	PROCESS OF TREATING A NON-WOVEN MICROFIBROUS MATRIX MATERIAL WITH RESIN
	<b>D06N 3/18</b> (2006.01)		

Podnosilac evropske prijave patenta (71)	MKP (51)	Broj objave evropske prijave patenta (97)	Naziv pronalaska (54)
	<b>A61K 31/44</b> (2006.01) <b>A61K 31/4545</b> (2006.01) <b>A61P 31/00</b> (2006.01) <b>A61P 35/00</b> (2006.01) <b>A61P 37/04</b> (2006.01) <b>C07D 213/81</b> (2006.01) <b>C07D 213/84</b> (2006.01) <b>C07D 237/24</b> (2006.01) <b>C07D 239/28</b> (2006.01) <b>C07D 241/24</b> (2006.01) <b>C07D 401/06</b> (2006.01) <b>C07D 401/12</b> (2006.01) <b>C07D 401/14</b> (2006.01) <b>C07D 405/12</b> (2006.01) <b>C07D 405/14</b> (2006.01)	3390361	N-PHENYL-PYRIDINE-2-CARBOXAMIDE DERIVATIVES AND THEIR USE AS PD-1/PD-L1 PROTEIN/PROTEIN INTERACTION MODULATORS
LFK Global Technology Services, S.L.	<b>F25B 21/02</b> (2006.01) <b>H05K 7/14</b> (2006.01) <b>H05K 7/20</b> (2006.01)	3346209	COMPUTER WITH SPECIAL OUTER CASING ALLOWING THE SITUATION THEREOF IN EXPLOSIVE ATMOSPHERES
	<b>A61K 31/519</b> (2006.01) <b>A61P 35/00</b> (2006.01) <b>C07D 487/04</b> (2006.01)	3345907	NOVEL PYRAZOLO[3,4-d]PYRIMIDINE COMPOUND OR SALT THEREOF
Dong-A Socio Holdings Co., Ltd.	<b>A61K 31/4439</b> (2006.01) <b>A61K 31/497</b> (2006.01) <b>C07D 401/04</b> (2006.01) <b>C07D 403/04</b> (2006.01)	3344613	HETEROARYL COMPOUNDS AND THEIR USE AS THERAPEUTIC DRUGS
	<b>B21D 51/04</b> (2006.01) <b>B21D 51/44</b> (2006.01) <b>B41F 17/28</b> (2006.01) <b>B65G 47/24</b> (2006.01) <b>B65G 47/244</b> (2006.01) <b>B65G</b>	3344564	APPARATUS AND METHOD FOR ORIENTING A BEVERAGE CONTAINER END CLOSURE AND APPLYING INDICIA IN A PREDETERMINED LOCATION

Podnosilac evropske prijave patenta (71)	MKP (51)	Broj objave evropske prijave patenta (97)	Naziv pronalaska (54)		
Duke University	<b>47/248</b> (2006.01)	3344248	6-MEMBERED AZA-HETEROCYCLIC CONTAINING DELTA-OPIOID RECEPTOR MODULATING COMPOUNDS, METHODS OF USING AND MAKING THE SAME		
	<b>A61K 31/445</b> (2006.01)				
	<b>A61P 25/00</b> (2006.01)				
	<b>C07D 211/00</b> (2006.01)				
	<b>A61K 38/47</b> (2006.01)	3344337	METHODS AND COMPOSITIONS FOR THE TREATMENT OF CYTOSOLIC GLYCOGEN STORAGE DISORDERS		
	<b>A61P 3/00</b> (2006.01)				
	<b>A61K 31/05</b> (2006.01)	3344271	USE OF SECOISOLARICINESINOL DIGLUCOSIDES (SDGs) AND RELATED COMPOUNDS FOR PROTECTION AGAINST RADIATION DAMAGE		
	<b>A61K 36/55</b> (2006.01)				
	<b>A61K 31/437</b> (2006.01)	3344614	THERAPEUTIC COMPOUNDS FOR PAIN AND SYNTHESIS THEREOF		
	<b>A61K 31/4439</b> (2006.01)				
	<b>A61K 31/444</b> (2006.01)				
	<b>C07D 401/06</b> (2006.01)				
	<b>C07D 471/12</b> (2006.01)				
	<b>C07D 471/18</b> (2006.01)				
	<b>A61K 31/336</b> (2006.01)			3344626	THERAPEUTIC COMPOUNDS FOR PAIN AND SYNTHESIS THEREOF
	<b>A61K 31/437</b> (2006.01)				
	<b>A61K 31/46</b> (2006.01)			3344627	THERAPEUTIC COMPOUNDS FOR PAIN AND SYNTHESIS THEREOF
	<b>C07D 471/12</b> (2006.01)				
	<b>C07D 471/18</b> (2006.01)				
	<b>C07D 491/147</b> (2006.01)				
<b>A61K 31/437</b> (2006.01)	3344628	THERAPEUTIC COMPOUNDS AND SYNTHESIS			
<b>A61K 31/4375</b> (2006.01)					
<b>C07D 471/12</b> (2006.01)					
<b>C07D 471/18</b> (2006.01)					
<b>A61K 31/336</b> (2006.01)					
<b>A61K 31/437</b> (2006.01)					
<b>A61K 31/46</b> (2006.01)					
<b>C07D 471/12</b> (2006.01)					

Podnosilac evropske prijave patenta (71)	MKP (51)	Broj objave evropske prijave patenta (97)	Naziv pronalaska (54)
	<b>C07D 471/18</b> (2006.01)		
	<b>C07D 491/147</b> (2006.01)		
	<b>A61J 1/03</b> (2006.01)	3344212	MEDICATION PACKAGING AND DOSE REGIMEN SYSTEM
	<b>A61J 7/02</b> (2006.01)		
	<b>A61J 7/04</b> (2006.01)		
	<b>A61K 31/336</b> (2006.01)	3344629	THERAPEUTIC COMPOUND FOR PAIN AND SYNTHESIS THEREOF
	<b>A61K 31/36</b> (2006.01)		
	<b>A61K 31/437</b> (2006.01)		
	<b>C07D 317/46</b> (2006.01)		
	<b>C07D 471/12</b> (2006.01)		
	<b>C07D 471/18</b> (2006.01)		
	<b>C07D 491/147</b> (2006.01)		
Topical Remedy, LLC	<b>A61K 35/52</b> (2015.01)	3344265	TOPICAL ANTIVIRAL COMPOSITIONS
	<b>A61P 31/12</b> (2006.01)		
AgBiome, Inc.	<b>A01H 5/00</b> (2018.01)	3394269	PESTICIDAL GENES AND METHODS OF USE
	<b>A01N 63/00</b> (2006.01)		
	<b>A01N 63/02</b> (2006.01)		
	<b>C07K 14/195</b> (2006.01)		
	<b>C12N 15/82</b> (2006.01)		
	<b>A61K 39/395</b> (2006.01)	3348572	ANTI-EPHA4 ANTIBODY
	<b>A61P 21/02</b> (2006.01)		
	<b>A61P 43/00</b> (2006.01)		
	<b>C07K 16/28</b> (2006.01)		
	<b>C12N 15/09</b> (2006.01)		
Hubtex Maschinenbau GmbH & Co. Kg	<b>B60P 3/40</b> (2006.01)	2687403	Transport system for long loads
	<b>B62D 53/02</b> (2006.01)		
	<b>A61K 31/437</b> (2006.01)	3356363	NEW IMIDAZO[4,5-B]PYRIDINE DERIVATIVES AS DUAL DYRK1/CLK1 INHIBITORS
	<b>A61P 25/16</b> (2006.01)		
	<b>A61P 25/28</b> (2006.01)		
	<b>A61P 35/00</b> (2006.01)		

Podnosilac evropske prijave patenta (71)	MKP (51)	Broj objave evropske prijave patenta (97)	Naziv pronalaska (54)
	<b>C07D 471/04</b> (2006.01)		
	<b>A61K 31/437</b> (2006.01)	3356364	NEW PYRROLO[2,3-D]PYRIMIDINE DERIVATIVES AS DUAL DYRK1/CLK1 INHIBITORS
	<b>A61K 31/519</b> (2006.01)		
	<b>A61P 25/16</b> (2006.01)		
	<b>A61P 25/28</b> (2006.01)		
	<b>A61P 35/00</b> (2006.01)		
	<b>C07D 471/04</b> (2006.01)		
	<b>C07D 487/04</b> (2006.01)		
	<b>A61K 38/17</b> (2006.01)	3359560	PEPTIDES AND COMBINATION OF PEPTIDES FOR USE IN IMMUNOTHERAPY AGAINST SMALL CELL LUNG CANCER AND OTHER CANCERS
	<b>A61K 39/00</b> (2006.01)		
	<b>C07K 7/06</b> (2006.01)		
	<b>C07K 14/47</b> (2006.01)		
	<b>G01N 33/574</b> (2006.01)		
	<b>A61P 37/06</b> (2006.01)	3350223	ANTIBODIES THAT SPECIFICALLY BIND TO TL1A
	<b>C07K 16/28</b> (2006.01)		
	<b>A61K 31/41</b> (2006.01)	3353167	MODULATORS OF INDOLEAMINE 2,3-DIOXYGENASE
	<b>A61K 31/433</b> (2006.01)		
	<b>C07D 235/30</b> (2006.01)		
	<b>C07D 263/48</b> (2006.01)		
	<b>C07D 263/58</b> (2006.01)		
	<b>C07D 277/80</b> (2006.01)		
	<b>C07D 285/08</b> (2006.01)		
	<b>C07D 403/12</b> (2006.01)		
	<b>C07D 413/12</b> (2006.01)		
	<b>C07D 417/12</b> (2006.01)		
	<b>A61K 31/421</b> (2006.01)	3353151	MODULATORS OF INDOLEAMINE 2,3-DIOXYGENASE
	<b>A61K 31/426</b> (2006.01)		
	<b>A61K 31/433</b> (2006.01)		
	<b>A61K 31/44</b> (2006.01)		
	<b>A61P 31/18</b> (2006.01)		

Podnosilac evropske prijave patenta (71)	MKP (51)	Broj objave evropske prijave patenta (97)	Naziv pronalaska (54)
	<b>C07D 213/74</b> (2006.01)		
	<b>C07D 235/30</b> (2006.01)		
	<b>C07D 239/42</b> (2006.01)		
	<b>C07D 241/20</b> (2006.01)		
	<b>C07D 253/06</b> (2006.01)		
	<b>C07D 263/48</b> (2006.01)		
	<b>C07D 263/58</b> (2006.01)		
	<b>C07D 277/82</b> (2006.01)		
	<b>C07D 285/00</b> (2006.01)		
	<b>C07D 307/66</b> (2006.01)		
	<b>C07D 309/14</b> (2006.01)		
	<b>C07D 333/20</b> (2006.01)		
	<b>B28B 1/52</b> (2006.01)	3383606	SOUND-ABSORBING GYPSUM FIBRE BOARD AND METHOD FOR MANUFACTURING SUCH A GYPSUM FIBRE BOARD
	<b>C04B 28/14</b> (2006.01)		
	<b>C04B 111/52</b> (2006.01)		
	<b>A61K 9/00</b> (2006.01)	3352734	TREATMENT OF ALOPECIA AREATA
	<b>A61K 31/519</b> (2006.01)		
	<b>A61P 17/14</b> (2006.01)		
	<b>A61K 31/443</b> (2006.01)	3350175	NON-STEROIDAL GLUCOCORTICOID RECEPTOR MODULATORS FOR LOCAL DRUG DELIVERY
	<b>A61P 29/00</b> (2006.01)		
	<b>A61P 37/00</b> (2006.01)		
	<b>C07D 405/06</b> (2006.01)		
	<b>C07D 405/14</b> (2006.01)		
	<b>C07D 413/14</b> (2006.01)		
	<b>C07D 417/14</b> (2006.01)		
	<b>C12Q 1/68</b> (2018.01)	3350346	NOVEL BIOMARKERS AND METHODS OF TREATING CANCER
	<b>A61K 38/43</b> (2006.01)	3356542	MODIFIED LYSOSOMAL PROTEIN AND PRODUCTION THEREOF
	<b>A61K 38/47</b> (2006.01)		
	<b>C12P 21/00</b> (2006.01)		
	<b>C12P 21/02</b> (2006.01)		
Benevolentai Bio Limited	<b>A61K 31/473</b> (2006.01)	3352759	TREATMENT OF NEURODEGENERATIVE DISEASES
	<b>A61K 31/49</b> (2006.01)		



Podnosilac evropske prijave patenta (71)	MKP (51)	Broj objave evropske prijave patenta (97)	Naziv pronalaska (54)
	<b>A61K 31/517</b> (2006.01)		
	<b>A61K 31/5377</b> (2006.01)		
	<b>A61K 39/395</b> (2006.01)		
	<b>A61K 45/00</b> (2006.01)		
	<b>A61P 25/28</b> (2006.01)		
	<b>A61L 27/36</b> (2006.01)	3349813	COMPOSITIONS DERIVED FROM PLACENTA AND METHODS OF PRODUCING THE SAME
	<b>A61L 27/56</b> (2006.01)		
	<b>A61L 27/60</b> (2006.01)		
Nokia Solutions and Networks Oy	<b>G01C 21/34</b> (2006.01)	3353722	METHOD, APPARATUS AND SYSTEM FOR DESTINATION RECOMMENDATION AND SELECTION
	<b>G01C 21/36</b> (2006.01)		
	<b>G06Q 10/04</b> (2012.01)		
	<b>G06Q 10/06</b> (2012.01)		
	<b>G06Q 50/30</b> (2012.01)		
	<b>H04W 4/02</b> (2009.01)		
	<b>H04W 4/04</b> (2009.01)		
	<b>C07K 14/725</b> (2006.01)	3359563	ANTIGEN RECEPTORS AND USES THEREOF
	<b>C07K 16/28</b> (2006.01)		
	<b>A61K 31/454</b> (2006.01)	3356344	ISOINDOLINONE INHIBITORS OF THE MDM2-P53 INTERACTION HAVING ANTICANCER ACTIVITY
	<b>A61K 31/506</b> (2006.01)		
	<b>A61K 35/00</b> (2006.01)		
	<b>C07B 59/00</b> (2006.01)		
	<b>C07D 401/06</b> (2006.01)		
	<b>C07D 401/14</b> (2006.01)		
	<b>C07D 403/06</b> (2006.01)		
	<b>C07D 403/14</b> (2006.01)		
	<b>C07D 405/14</b> (2006.01)		
	<b>C07D 407/14</b> (2006.01)		
	<b>C07D 409/14</b> (2006.01)		
	<b>C07D 413/14</b> (2006.01)		
	<b>C07D 417/14</b> (2006.01)		
	<b>C07D 487/04</b>		

Podnosilac evropske prijave patenta (71)	MKP (51)	Broj objave evropske prijave patenta (97)	Naziv pronalaska (54)			
Cancer Research Technology Limited	(2006.01) <b>C07D 487/08</b> (2006.01) <b>A61K 31/4035</b> (2006.01) <b>A61P 35/00</b> (2006.01) <b>C07B 59/00</b> (2006.01) <b>C07D 209/48</b> (2006.01) <b>C07D 403/06</b> (2006.01) <b>C07D 403/12</b> (2006.01) <b>C07D 405/12</b> (2006.01) <b>C07D 405/14</b> (2006.01) <b>C07D 413/06</b> (2006.01) <b>C07D 413/12</b> (2006.01) <b>C07F 9/572</b> (2006.01)	3356350	ISOINDOLINONE INHIBITORS OF THE MDM2-P53 INTERACTION HAVING ANTICANCER ACTIVITY			
	Guger Forschungs GmbH			<b>F24J 2/52</b> (2018.01) <b>H02S 20/10</b> (2014.01)	3411638	PHOTOVOLTAIC MODULE
				<b>A61K 31/397</b> (2006.01) <b>A61K 31/4025</b> (2006.01) <b>A61K 31/498</b> (2006.01) <b>A61K 31/4985</b> (2006.01) <b>C07D 241/14</b> (2006.01) <b>C07D 401/04</b> (2006.01) <b>C07D 401/06</b> (2006.01) <b>C07D 403/04</b> (2006.01) <b>C07D 403/06</b> (2006.01) <b>C07D 403/12</b> (2006.01) <b>C07D 403/14</b> (2006.01) <b>C07D 413/04</b> (2006.01) <b>C07D 413/06</b> (2006.01) <b>C07D 417/06</b> (2006.01) <b>C07D 471/04</b> (2006.01) <b>C07D 487/02</b> (2006.01) <b>C07D 491/10</b>		





Podnosilac evropske prijave patenta (71)	MKP (51)	Broj objave evropske prijave patenta (97)	Naziv pronalaska (54)
Nimrichtr, Václav	<b>C07K 16/28</b> (2006.01)	3353212	OPTIMIZED ANTI-CD3 BISPECIFIC ANTIBODIES AND USES THEREOF
	<b>C07K 16/30</b> (2006.01)		
	<b>A63B 43/00</b> (2006.01)	3344350	A DEVICE FOR TRAINING AND REHABILITATION
	<b>A63B 43/02</b> (2006.01)		
	<b>A63B 69/00</b> (2006.01)		
	<b>B01F 7/00</b> (2006.01)	3393646	DEVICE AND METHOD FOR MODIFYING POROUS SOLID SUBSTANCES
	<b>B01F 7/18</b> (2006.01)		
	<b>B01F 15/00</b> (2006.01)		
	<b>B01F 15/06</b> (2006.01)		
	<b>B01J 8/08</b> (2006.01)		
	<b>B01J 8/10</b> (2006.01)		
	<b>B01J 20/20</b> (2006.01)		
	<b>B01J 20/30</b> (2006.01)		
	<b>B01J 20/32</b> (2006.01)		
RnD by Us B.V.	<b>F26B 11/16</b> (2006.01)		
	<b>F26B 25/04</b> (2006.01)		
	<b>D21C 5/02</b> (2006.01)	3362600	PROCESS FOR THE DEINKING OF COATED PAPER OR PAPERBOARD
	<b>D21H 19/40</b> (2006.01)		
	<b>D21H 19/44</b> (2006.01)		
	<b>D21H 19/52</b> (2006.01)		
	<b>D21H 19/54</b> (2006.01)		
	<b>A63H 33/04</b> (2006.01)	3362161	HOLDING DEVICE
	<b>A63H 33/06</b> (2006.01)		
	<b>A63H 33/10</b> (2006.01)		
	<b>E04B 1/343</b> (2006.01)		
	<b>A61K 31/195</b> (2006.01)	3364975	COMBINATION OF TRAZODONE AND GABAPENTIN FOR THE TREATMENT OF PAIN
	<b>A61K 31/496</b> (2006.01)		
	<b>A61K 45/06</b> (2006.01)		
<b>A61P 25/02</b> (2006.01)			
<b>A61P 25/04</b> (2006.01)			
<b>A61M 37/00</b> (2006.01)	3352837	METHODS FOR ENHANCING TOPICAL APPLICATION OF A BENEFIT AGENT	
<b>A61N 7/00</b> (2006.01)			

Podnosilac evropske prijave patenta (71)	MKP (51)	Broj objave evropske prijave patenta (97)	Naziv pronalaska (54)
CALPEDA S.p.A.	<b>F04D 29/42</b> (2006.01)	3269984	PUMP EQUIPPED WITH IMPROVED FLANGES
	<b>F04D 29/60</b> (2006.01)		
	<b>A61K 31/4025</b> (2006.01)	3252037	PYRROLIDINE DERIVATIVES AS OXYTOCIN / VASOPRESSIN V1A RECEPTORS ANTAGONISTS
	<b>A61P 5/10</b> (2006.01)		
	<b>C07D 207/22</b> (2006.01)		
	<b>C07D 401/12</b> (2006.01)	3263566	BICYCLO[3.2.1]OCTYL AMIDE DERIVATIVES AS ALLOSTERIC MODULATORS OF THE METABOTROPIC GLUTAMATE RECEPTOR 5 (MGLU5 OR MGLUR5) FOR THE TREATMENT OF CENTRAL NERVOUS SYSTEM (CNS) DISORDERS
	<b>A61K 38/46</b> (2006.01)	3272356	COMPOSITIONS AND METHODS FOR THE TREATMENT OF HEMOGLOBINOPATHIES
	<b>C12N 9/22</b> (2006.01)		
	<b>G01B 11/06</b> (2006.01)	3264033	SYSTEMS AND METHODS OF USING ABSORPTIVE AND NON ABSORPTIVE IMAGING METROLOGY TO MEASURE THE THICKNESS OF OPHTHALMIC LENSES
	<b>G02B 1/04</b> (2006.01)		
	<b>A61K 31/4418</b> (2006.01)	3255041	PYRIMIDINES AS SODIUM CHANNEL BLOCKERS
	<b>A61P 25/08</b> (2006.01)		
	<b>C07D 233/90</b> (2006.01)		
	<b>C07D 401/12</b> (2006.01)		
	<b>C07D 401/14</b> (2006.01)		
	<b>C07D 403/04</b> (2006.01)		
	<b>C07D 403/12</b> (2006.01)		
	<b>C07D 405/12</b> (2006.01)		
	<b>C07D 405/14</b> (2006.01)		
	Kuleoglu, Mustafa Remzi Kuleoglu, Enver Ali	<b>C12Q 1/18</b> (2006.01)	3399050
<b>G01N 33/487</b> (2006.01)			
<b>A61B 17/28</b> (2006.01)		3263054	ULTRASONIC SURGICAL INSTRUMENTS HAVING CLAMP
<b>A61B 17/32</b> (2006.01)			
<b>A61B 18/14</b> (2006.01)			
<b>A61K 9/00</b> (2006.01)		3263178	FORMULATION FOR ANTI-ALPHA4BETA7 ANTIBODY
<b>A61K 9/19</b> (2006.01)			
<b>A61K 39/00</b> (2006.01)			
<b>A61K 39/395</b> (2006.01)			
<b>A61K 47/18</b> (2017.01)			
<b>A61K 47/26</b> (2006.01)			
<b>A61P 1/00</b>			

Podnosilac evropske prijave patenta (71)	MKP (51)	Broj objave evropske prijave patenta (97)	Naziv pronalaska (54)
	(2006.01) <b>C07K 16/28</b> (2006.01) <b>A61K 9/00</b> (2006.01) <b>A61K 39/395</b> (2006.01) <b>A61K 47/12</b> (2006.01) <b>A61K 47/14</b> (2017.01) <b>A61K 47/18</b> (2017.01) <b>A61K 47/26</b> (2006.01)	3311834	FORMULATION FOR ANTI-ALPHA4BETA7 ANTIBODY
Wagner GmbH & Co. KG	<b>F01M 1/18</b> (2006.01) <b>F01M 5/00</b> (2006.01) <b>F01P 3/06</b> (2006.01) <b>F01P 7/14</b> (2006.01) <b>F16K 31/06</b> (2006.01)	3269950	CONTROL VALVE FOR SUPPLYING ONE OR MORE NOZZLES WITH A PRESSURIZED FLUID
ADIENNE Pharma & Biotech SA	<b>A61J 1/10</b> (2006.01) <b>A61J 1/20</b> (2006.01) <b>F26B 5/06</b> (2006.01)	3409259	MULTI CHAMBER FLEXIBLE BAG AND METHODS OF USING SAME
	<b>A61K 9/00</b> (2006.01) <b>A61K 9/51</b> (2006.01) <b>A61K 31/00</b> (2006.01) <b>A61K 47/12</b> (2006.01)	3311845	THERAPEUTIC POLYMERIC NANOPARTICLES AND METHODS OF MAKING AND USING SAME
	<b>A61K 9/08</b> (2006.01) <b>A61K 47/34</b> (2017.01)	3257498	BIODEGRADABLE DRUG DELIVERY COMPOSITIONS
	<b>A61K 31/585</b> (2006.01) <b>A61P 35/00</b> (2006.01) <b>C07J 19/00</b> (2006.01) <b>B29D 11/00</b> (2006.01) <b>G02C 7/04</b> (2006.01)	3296313	CERTAIN CHEMICAL ENTITIES, COMPOSITIONS, AND METHODS
Lederer, Adolf	<b>E01C 5/00</b> (2006.01) <b>E01C 11/22</b> (2006.01) <b>E01F 9/529</b> (2016.01) <b>G01N 33/68</b> (2006.01)	3272937	MOLD FOR CONTACT LENS WITH NON-ROTATIONALLY SYMMETRIC RIM OR EDGE
	<b>A61K 31/4188</b> (2006.01) <b>A61P 35/00</b>	3272937 3290922 3272754	STREET SHOULDER SLAB ATYPICAL HEMOLYTIC UREMIC SYNDROME (AHUS) BIOMARKER PROTEINS IMIDAZOPYRROLIDINONE COMPOUNDS

Podnosilac evropske prijave patenta (71)	MKP (51)	Broj objave evropske prijave patenta (97)	Naziv pronalaska (54)
	(2006.01) <b>C07D 487/04</b> (2006.01)		
Translacionale Onkologije an der Universitätsmedizin der JGU Mainz gGmbH (TRON)	<b>C12N 5/074</b> (2010.01) <b>C12N 5/16</b> (2006.01) <b>C12N 9/12</b> (2006.01) <b>C12N 15/63</b> (2006.01) <b>C12N 15/67</b> (2006.01)	3282015	METHOD FOR CELLULAR RNA EXPRESSION
Steel Color SpA	<b>B21D 13/04</b> (2006.01) <b>B21D 22/10</b> (2006.01) <b>B21H 8/00</b> (2006.01) <b>B44B 5/00</b> (2006.01)	3287208	A MACHINE FOR SHAPING A METAL SHEET AND SHEET SO OBTAINED
	<b>C07D 211/96</b> (2006.01)	3312160	HEPATITIS B ANTIVIRAL AGENTS
	<b>C12Q 1/68</b> (2018.01)	3263717	NOVEL TISSUE PROTECTIVE ERYTHROPOIETIN RECEPTOR (NEPOR) AND METHODS OF USE
	<b>G01N 33/50</b> (2006.01)		
TITAGARH WAGONS AFR	<b>B61G 9/02</b> (2006.01) <b>B61G 9/04</b> (2006.01) <b>B61F 1/08</b> (2006.01)	3275761	TRACTION ASSEMBLY FOR RAILWAY COUPLING AND RAILWAY VEHICLE INCLUDING SUCH AN ASSEMBLY
	<b>E06B 7/215</b> (2006.01)	3290627	SEAL WITH A LIMIT ON THE MOVEMENT OF THE SEALING STRIP
SRT SOCIETA' A RESPONSABILITA' LIMITATA CON UNICO SOCIO	<b>B61C 9/38</b> (2006.01)	3279054	MOTOR ASSEMBLY FOR A RAILWAY AXLE HAVING A CONTINUOUS VARIATION WITH AN ENERGY RECOVERY, AND RAILWAY WAGON
	<b>A61K 9/00</b> (2006.01) <b>A61K 9/08</b> (2006.01) <b>A61K 31/167</b> (2006.01) <b>A61K 31/728</b> (2006.01) <b>A61K 31/737</b> (2006.01) <b>A61K 45/06</b> (2006.01) <b>A61K 47/02</b> (2006.01) <b>A61K 47/36</b> (2006.01) <b>A61P 13/02</b> (2006.01) <b>A61P 13/10</b> (2006.01)	3415163	COMPOSITION WITH TOPICAL ANAESTHETIC EFFECT AND THE USE THEREOF
SciFluor Life Sciences, Inc.	<b>A61K 31/4375</b> (2006.01) <b>A61K 31/444</b>	3266782	FLUORINATED INTEGRIN ANTAGONISTS



Podnosilac evropske prijave patenta (71)	MKP (51)	Broj objave evropske prijave patenta (97)	Naziv pronalaska (54)
	(2006.01) <b>A61K 31/506</b>		
	(2006.01) <b>A61K 45/06</b>		
	(2006.01) <b>A61P 3/10</b>		
	(2006.01) <b>A61P 27/00</b>		
	(2006.01) <b>C07D 471/04</b>		
	(2006.01) <b>C07H 21/02</b>	3312189	MODULATION OF HEPATITIS B VIRUS (HBV) EXPRESSION
	(2006.01) <b>A47J 31/40</b>	3298933	METHOD AND DEVICE FOR PROVIDING A HOT DRINK
	(2006.01) <b>A47J 31/56</b>		
Mosca, Domenico	(2006.01) <b>G09F 17/00</b>	3291211	FOLDING BANNER SUPPORT ASSEMBLY
	(2006.01) <b>A61K 31/7088</b>	3312281	COMPLEMENT COMPONENT C5 IRNA COMPOSITIONS AND METHODS OF USE THEREOF
	(2006.01) <b>C12N 15/113</b>		
	(2010.01) <b>C07D 237/32</b>	3275870	FUSED HETEROCYCLIC COMPOUNDS AS ION CHANNEL MODULATORS
	(2006.01) <b>A61K 31/00</b>	3305285	ANTI-ANDROGENS FOR THE TREATMENT OF NON-METASTATIC CASTRATE-RESISTANT PROSTATE CANCER
	(2006.01) <b>A61K 31/4166</b>		
	(2006.01) <b>A61K 31/4439</b>		
	(2006.01) <b>A61P 35/00</b>		
	(2006.01) <b>A61K 9/00</b>	3383958	METHOD FOR THE PRODUCTION OF GRANULES COMPRISING SURFACE-REACTED CALCIUM CARBONATE
	(2006.01) <b>C09C 1/02</b>		
	(2006.01) <b>A61K 31/437</b>	3386979	2-PHENYL-3-(PIPERAZINOMETHYL)IMIDAZO[1,2-A]PYRIDINE DERIVATIVES AS BLOCKERS OF TASK-1 AND TASK-2 CHANNELS, FOR THE TREATMENT OF SLEEP-RELATED BREATHING DISORDERS
	(2006.01) <b>A61P 11/00</b>		
	(2006.01) <b>C07D 471/04</b>		
Ardea Biosciences, Inc.	(2006.01) <b>A61K 9/14</b>	3386485	PHARMACEUTICAL COMPOSITION COMPRISING A POTENT INHIBITOR OF URAT1
Oxford University Innovation Limited	(2006.01) <b>A61K 31/404</b>	3383858	INHIBITORS OF METALLO-BETA-LACTAMASES
	(2006.01) <b>A61P 31/04</b>		
	(2006.01) <b>C07D 209/42</b>		
	(2006.01) <b>C07D 401/04</b>		
	(2006.01) <b>C07D 403/04</b>		
	(2006.01) <b>C07D 413/10</b>		
	(2006.01) <b>C07D 471/04</b>		
	(2006.01)		

Podnosilac evropske prijave patenta (71)	MKP (51)	Broj objave evropske prijave patenta (97)	Naziv pronalaska (54)
Centre Hospitalier Régional Universitaire de Lille	<b>A61F 5/44</b> (2006.01) <b>A61F 5/445</b> (2006.01) <b>A61M 1/00</b> (2006.01)	3389575	DEVICE ALLOWING AN ALIMENTARY BOLUS FLOW BETWEEN TWO STOMAS
Micor Limited	<b>A61F 2/24</b> (2006.01) <b>A61K 31/7052</b> (2006.01) <b>A61P 1/04</b> (2006.01) <b>C07D 487/04</b> (2006.01) <b>C07H 15/26</b> (2006.01)	3370648 3380486	MITRAL VALVE PROSTHESIS PRODRUGS OF A JAK INHIBITOR COMPOUND FOR TREATMENT OF GASTROINTESTINAL INFLAMMATORY DISEASE
	<b>A61K 39/00</b> (2006.01) <b>A61P 35/02</b> (2006.01) <b>C07K 16/28</b> (2006.01) <b>C07K 16/30</b> (2006.01) <b>C07K 16/46</b> (2006.01)	3380196	HETERODIMERIC ANTIBODIES THAT BIND CD3 AND CD38
	<b>C12M 1/00</b> (2006.01) <b>C12M 1/107</b> (2006.01) <b>C12P 5/02</b> (2006.01)	3374511	METHOD FOR POULTRY LITTER FERMENTATION AND BIOGAS PRODUCTION
Euro Pool System International B.v.	<b>B65D 6/18</b> (2006.01) <b>B65D 6/34</b> (2006.01) <b>B65D 21/02</b> (2006.01) <b>B65D 85/34</b> (2006.01)	3377416	CONTAINER MADE OF PLASTIC
Boehringer Ingelheim International GmbH & Co. KG	<b>A61K 39/00</b> (2006.01) <b>A61P 35/00</b> (2006.01) <b>C07K 16/18</b> (2006.01) <b>C07K 16/28</b> (2006.01) <b>C07K 16/46</b> (2006.01)	3383425	BIPARATOPIC POLYPEPTIDES ANTAGONIZING WNT SIGNALING IN TUMOR CELLS
Sooft Italia S.p.A.	<b>A61K 9/00</b> (2006.01) <b>A61K 31/7032</b> (2006.01) <b>A61K 31/728</b> (2006.01) <b>A61P 27/02</b> (2006.01)	3413868	OPHTHALMIC COMPOSITION FOR THE USE IN THE TREATMENT OF EYE DISORDERS RELATED TO ALTERATIONS OF THE CORNEAL CONJUNCTIVAL SURFACE
Chiesi Farmaceutici S.p.A.	<b>A61K 31/4709</b> (2006.01) <b>C07D 401/12</b> (2006.01)	3383867	COMPOUNDS HAVING MUSCARINIC RECEPTOR ANTAGONIST AND BETA2 ADRENERGIC RECEPTOR AGONIST ACTIVITY

Podnosilac evropske prijave patenta (71)	MKP (51)	Broj objave evropske prijave patenta (97)	Naziv pronalaska (54)
	<b>C07D 409/14</b> (2006.01)		
	<b>C07D 471/08</b> (2006.01)		
	<b>C12Q 1/68</b> (2018.01)	3384045	METHOD FOR DETERMINING CELL CLONALITY
Lovász, Sándor	<b>A61B 1/307</b> (2006.01)	3349641	ADAPTER, PROCESS AND USE FOR INSTILLATION OF AGENTS INTO THE BLADDER THROUGH THE URETHRA WITHOUT CATHETER
Rényi, Gábor	<b>A61M 3/02</b> (2006.01)		
Giber, János	<b>G01N 33/68</b> (2006.01)	3377908	BIOMARKER OF POLYCYSTIC KIDNEY DISEASE AND USES THEREOF
Genzyme Corporation	<b>G01N 33/68</b> (2006.01)	3377909	LACTOFERRIN FOR USE IN THE DIAGNOSIS OR PROGNOSIS OF ALZHEIMER'S DISEASE, OR IN THE DIAGNOSIS OF PARKINSON'S DISEASE
Geroa Diagnostics, S.L	<b>G01N 33/68</b> (2006.01)	3377909	METHODS FOR CULTURING CELLS AND KITS AND APPARATUS FOR SAME
	<b>C12N 5/00</b> (2006.01)	3365678	METHODS FOR CULTURING CELLS AND KITS AND APPARATUS FOR SAME
	<b>C12N 5/0775</b> (2010.01)		
	<b>G01N 33/569</b> (2006.01)		
	<b>A61K 9/00</b> (2006.01)	3383364	FORMULATIONS FOR INTRAVENOUS INJECTION OF DANIRIXIN
	<b>A61K 9/19</b> (2006.01)		
	<b>A61K 47/26</b> (2006.01)		
	<b>A61K 47/40</b> (2006.01)		
	<b>C07K 16/28</b> (2006.01)	3383907	COMBINATION TREATMENTS AND USES AND METHODS THEREOF
	<b>C07K 14/54</b> (2006.01)	3383891	ANTIBODY CYTOKINE ENGRAFTED COMPOSITIONS AND METHODS OF USE FOR IMMUNOREGULATION
	<b>A61K 35/17</b> (2015.01)	3370762	CHIMERIC RECEPTORS CONTAINING TRAF-INDUCING DOMAINS AND RELATED COMPOSITIONS AND METHODS
	<b>A61K 39/00</b> (2006.01)		
	<b>C07K 14/00</b> (2006.01)		
	<b>C07K 14/705</b> (2006.01)		
	<b>G01N 33/574</b> (2006.01)	3371601	FLOW CYTOMETRY FOR MONITORING HISTONE H3 METHYLATION STATUS
	<b>A61K 38/16</b> (2006.01)	3387010	COMPOSITIONS AND METHODS FOR EXPRESSION OF MULTIPLE BIOLOGICALLY ACTIVE POLYPEPTIDES FROM A SINGLE VECTOR FOR TREATMENT OF CARDIAC CONDITIONS AND OTHER PATHOLOGIES
	<b>A61K 48/00</b> (2006.01)		
	<b>C07K 14/52</b> (2006.01)		
	<b>C12N 15/62</b> (2006.01)		
	<b>A61K 38/57</b> (2006.01)	3377093	RECOMBINANT HUMAN C1 ESTERASE INHIBITOR AND USES THEREOF
	<b>C07K 14/81</b> (2006.01)		
Visterra, Inc.	<b>A61K 39/00</b> (2006.01)	3380522	ANTIBODY MOLECULES TO APRIL AND USES THEREOF
	<b>A61K 39/395</b> (2006.01)		
	<b>C07K 16/28</b> (2006.01)		

Podnosilac evropske prijave patenta (71)	MKP (51)	Broj objave evropske prijave patenta (97)	Naziv pronalaska (54)
	<b>A61K 39/00</b> (2006.01) <b>A61K 39/395</b> (2006.01) <b>A61P 27/02</b> (2006.01) <b>C07K 16/28</b> (2006.01)	3371224	COMPOSITIONS COMPRISING IL6R ANTIBODIES FOR THE TREATMENT OF UVEITIS AND MACULAR EDEMA AND METHODS OF USING SAME
	<b>A61K 31/00</b> (2006.01) <b>A61K 31/4152</b> (2006.01) <b>A61P 9/00</b> (2006.01) <b>A61P 9/10</b> (2006.01)	3380091	TARGETING OF THE FORMYL-PEPTIDE RECEPTOR 2/LIPOXIN A4 RECEPTOR (FPR2/ALX) FOR TREATMENT OF HEART DISEASE
Consorzio Bestack	<b>A01N 31/08</b> (2006.01) <b>A23B 7/154</b> (2006.01) <b>B65D 85/34</b> (2006.01)	3380413	PACKAGING FOR FRUIT AND VEGETABLE PRODUCTS TREATED WITH AN ANTIMICROBIAL SOLUTION
FORCE Technology	<b>A23L 3/18</b> (2006.01) <b>A23L 3/30</b> (2006.01) <b>A23L 3/3418</b> (2006.01) <b>A23L 3/358</b> (2006.01) <b>A23L 3/3589</b> (2006.01) <b>A61L 2/07</b> (2006.01) <b>A61L 2/18</b> (2006.01) <b>A61L 2/22</b> (2006.01)	3389398	INSTALLATION AND METHOD FOR SANITIZING FOOD PRODUCTS
Laurus Labs Private Limited	<b>C07H 1/00</b> (2006.01) <b>C07H 19/06</b> (2006.01)	3386998	DIASTEREOSELECTIVE SYNTHESIS OF PHOSPHATE DERIVATIVES AND OF THE GEMCITABINE PRODRUG NUC-1031
	<b>A47J 31/54</b> (2006.01) <b>F24H 1/10</b> (2006.01)	3364835	METHOD, MACHINE AND BOILER FOR THE PREPARATION OF BEVERAGES
Eurek S.r.l.	<b>A47J 31/54</b> (2006.01) <b>F24H 1/10</b> (2006.01)	3364836	METHOD AND MACHINE FOR PREPARING BEVERAGES
F.Ili Venturini S.r.l.	<b>A21B 1/48</b> (2006.01) <b>A21B 5/02</b> (2006.01)	3364765	METHOD AND APPARATUS FOR MAKING PANIGACCI
	<b>A61K 51/04</b> (2006.01) <b>A61K 101/02</b> (2006.01) <b>C07B 59/00</b> (2006.01) <b>C07D 487/04</b> (2006.01)	3389727	RADIOLABELLED MGLUR2/3 PET LIGANDS

Podnosilac evropske prijave patenta (71)	MKP (51)	Broj objave evropske prijave patenta (97)	Naziv pronalaska (54)
	<b>A61K 31/513</b> (2006.01) <b>A61P 9/04</b> (2006.01) <b>A61P 9/10</b> (2006.01) <b>A61P 9/12</b> (2006.01) <b>C07D 239/54</b> (2006.01) <b>C07D 401/10</b> (2006.01) <b>C07D 401/14</b> (2006.01) <b>C07D 403/06</b> (2006.01) <b>C07D 403/10</b> (2006.01) <b>C07D 413/06</b> (2006.01) <b>C07D 413/10</b> (2006.01) <b>C07D 417/06</b> (2006.01) <b>C07D 417/14</b> (2006.01)	3383860	APELIN RECEPTOR AGONISTS AND METHODS OF USE
	<b>A61K 39/00</b> (2006.01) <b>A61K 39/135</b> (2006.01) <b>C07K 14/32</b> (2006.01)	3380119	FMDV AND E2 FUSION PROTEINS AND USES THEREOF
	<b>A61K 31/497</b> (2006.01) <b>A61P 35/00</b> (2006.01) <b>C07D 403/12</b> (2006.01)	3386975	5-(5-(2-(3-AMINOPROPOXY)-6-METHOXYPHENYL)-1H-PYRAZOL-3-YLAMINO)PYRAZINE-2-CARBONITRILE (S)-LACTATE MONOHYDRATE
Buchanan, L. Stephen	<b>A61C 5/55</b> (2017.01)	3383306	SELF-HEATING ELECTRIC PLUGGER/SYRINGE NEEDLE FOR USE IN FILLING A ROOT CANAL
Buchanan, Stephen L.	<b>A61C 5/40</b> (2017.01) <b>A61C 17/02</b> (2006.01) <b>C09K 17/32</b> (2006.01) <b>E21D 9/06</b> (2006.01)	3383313	MULTI-CANNULA NEGATIVE PRESSURE IRRIGATION SYSTEM
	<b>C01B 32/10</b> (2017.01) <b>C01B 32/336</b> (2017.01)	3394205	FOAMING ADDITIVE FOR SOIL CONDITIONING IN THE PRESENCE OF MECHANISED EXCAVATION FOR TUNNEL CONSTRUCTION
	<b>B01D 53/18</b> (2006.01) <b>B01D 53/62</b> (2006.01) <b>B01D 53/78</b> (2006.01) <b>B01D 53/96</b> (2006.01) <b>F23J 15/04</b> (2006.01)	3362407	METHOD FOR PRODUCING ACTIVATED CARBON AND ACTIVATED CARBON OBTAINED IN THIS WAY, AND USE THEREOF
Capsol-Eop AS	<b>B01D 53/18</b> (2006.01) <b>B01D 53/62</b> (2006.01) <b>B01D 53/78</b> (2006.01) <b>B01D 53/96</b> (2006.01) <b>F23J 15/04</b> (2006.01)	3359281	METHOD AND PLANT FOR CO2 CAPTURE

Podnosilac evropske prijave patenta (71)	MKP (51)	Broj objave evropske prijave patenta (97)	Naziv pronalaska (54)
Iowa State University Research Foundation, Inc.	<b>A61K 39/12</b> (2006.01) <b>A61P 31/00</b> (2006.01)	3344289	PESTIVIRUS VACCINES FOR CONGENITAL TREMORS
Def-Tech SAS. Di Ettore De Francesco&C.	<b>B60F 3/00</b> (2006.01) <b>B62D 37/00</b> (2006.01) <b>B62D 61/00</b> (2006.01)	3347215	SELF-STABILISING TWO-WHEELED VEHICLE, IN PARTICULAR AN AMPHIBIOUS VEHICLE
	<b>A61K 31/454</b> (2006.01) <b>A61K 31/519</b> (2006.01) <b>A61K 31/573</b> (2006.01) <b>A61K 35/00</b> (2006.01) <b>A61K 39/00</b> (2006.01) <b>C07K 16/28</b> (2006.01)	3344254	BTK INHIBITOR COMBINATIONS FOR TREATING MULTIPLE MYELOMA
	<b>A61K 31/4178</b> (2006.01) <b>A61K 31/496</b> (2006.01) <b>A61K 31/513</b> (2006.01) <b>A61K 31/565</b> (2006.01) <b>A61P 15/00</b> (2006.01) <b>F01K 23/10</b> (2006.01) <b>F01K 25/10</b> (2006.01) <b>F02C 1/00</b> (2006.01) <b>F02C 3/34</b> (2006.01) <b>F02C 6/02</b> (2006.01)	3344656	ANTI-PD-1 ANTIBODIES AND METHODS OF USE THEREOF
	<b>A61K 47/68</b> (2017.01) <b>A61P 35/00</b> (2006.01) <b>B60W 30/18</b> (2012.01) <b>B62D 15/02</b> (2006.01)	3344245	METHODS OF ADMINISTERING ELAGOLIX
	<b>A61K 31/404</b> (2006.01) <b>A61P 31/12</b> (2006.01) <b>C07D 209/12</b> (2006.01)	3344856	SYSTEMS AND METHODS FOR POWER PRODUCTION USING NESTED CO2 CYCLES
	<b>A01K 67/027</b> (2006.01)	3347054	DOSING REGIMENS FOR ANTI-TF-ANTIBODY DRUG-CONJUGATES
		3350059	METHOD AND DEVICE IN A MOTOR VEHICLE FOR AN AUTOMATIC DRIVE
		3350162	MONO- OR DI-SUBSTITUTED INDOLE DERIVATIVES AS DENGUE VIRAL REPLICATION INHIBITORS
		3344034	RODENT MODEL OF PROSTATE CANCER

Podnosilac evropske prijave patenta (71)	MKP (51)	Broj objave evropske prijave patenta (97)	Naziv pronalaska (54)
	<b>C12N 15/85</b> (2006.01)		
	<b>A61K 31/7072</b> (2006.01)	3344642	ANTI-VIRAL TETRAHYDROFURANE DERIVATIVES
	<b>A61P 31/14</b> (2006.01)		
	<b>C07H 19/06</b> (2006.01)		
F.R. Drake Company	<b>B65B 19/34</b> (2006.01)	3344551	LAUNCHING SYSTEM FOR ROBOTIC SAUSAGE LOADING MACHINE
	<b>B65B 35/08</b> (2006.01)		
	<b>B65B 35/24</b> (2006.01)		
	<b>B65G 15/14</b> (2006.01)		
	<b>B65G 47/31</b> (2006.01)		
Sylentis SAU	<b>A61K 31/713</b> (2006.01)	3347470	SIRNA AND THEIR USE IN METHODS AND COMPOSITIONS FOR INHIBITING THE EXPRESSION OF THE NRARP GENE
	<b>A61P 9/10</b> (2006.01)		
	<b>A61P 27/02</b> (2006.01)		
	<b>C07H 21/02</b> (2006.01)		
	<b>C12N 15/113</b> (2010.01)		
	<b>A61K 9/00</b> (2006.01)	3347377	THYMIC STROMAL LYMPHOPOIETIN (TSLP)-BINDING ANTIBODIES AND METHODS OF USING THE ANTIBODIES
	<b>A61P 11/06</b> (2006.01)		
	<b>A61P 37/08</b> (2006.01)		
	<b>C07K 16/24</b> (2006.01)		
	<b>A61K 31/438</b> (2006.01)	3347360	COMPOUNDS USEFUL FOR INHIBITING ROR-GAMMA-T
	<b>A61P 17/06</b> (2006.01)		
	<b>A61P 37/00</b> (2006.01)		
	<b>C07D 495/20</b> (2006.01)		
Primoreels A/S	<b>B65B 7/16</b> (2006.01)	3347277	DEVICE FOR FORWARDING CLOSURE BLANKS FROM A WEB
	<b>B65B 7/28</b> (2006.01)		
	<b>A61K 31/501</b> (2006.01)	3344615	PYRIDINONE DICARBOXAMIDE FOR USE AS BROMODOMAIN INHIBITORS
	<b>C07D 401/12</b> (2006.01)		
	<b>B65D 75/32</b> (2006.01)	3353086	INDIVIDUAL BLISTER PACK FOR OPTIMIZED STACKING
	<b>B63B 1/12</b> (2006.01)	3353045	FLOATING VESSEL
	<b>B63B 7/00</b> (2006.01)		
	<b>B63B 35/73</b> (2006.01)		
	<b>B63H 21/17</b> (2006.01)		

Podnosilac evropske prijave patenta (71)	MKP (51)	Broj objave evropske prijave patenta (97)	Naziv pronalaska (54)
	<b>G05B 11/38</b> (2006.01)		
	<b>A61K 31/501</b> (2006.01)	3353162	PYRIDINONE DICARBOXAMIDE FOR USE AS BROMODOMAIN INHIBITORS
	<b>C07D 401/12</b> (2006.01)		
	<b>B31B 50/59</b> (2017.01)	3347196	METHOD FOR THREE-DIMENSIONAL SHAPING OF MATERIAL
	<b>B31D 5/02</b> (2017.01)		
	<b>B31F 1/00</b> (2006.01)		
	<b>B31F 1/36</b> (2006.01)		
	<b>B65B 47/06</b> (2006.01)		
	<b>A61K 31/454</b> (2006.01)	3350163	MONO- OR DI-SUBSTITUTED INDOLE DERIVATIVES AS DENGUE VIRAL REPLICATION INHIBITORS
	<b>A61P 31/14</b> (2006.01)		
	<b>C07D 209/12</b> (2006.01)		
ONCOARENDI THERAPEUTICS S.A.	<b>A61K 31/4523</b> (2006.01)	3344616	SUBSTITUTED AMINO TRIAZOLES USEFUL AS HUMAN CHITINASE INHIBITORS
	<b>A61P 17/00</b> (2006.01)		
	<b>A61P 25/00</b> (2006.01)		
	<b>A61P 35/00</b> (2006.01)		
	<b>A61P 37/08</b> (2006.01)		
	<b>C07D 401/14</b> (2006.01)		
	<b>C07D 413/14</b> (2006.01)		
	<b>C07D 417/14</b> (2006.01)		
	<b>C07D 487/04</b> (2006.01)		
	<b>C07D 498/04</b> (2006.01)		
	<b>A61B 17/04</b> (2006.01)	3344159	END EFFECTORS FOR WOUND CLOSURE DEVICES
	<b>A61B 17/06</b> (2006.01)		
Energy Resonance Magnetic, S.L.	<b>H02K 3/04</b> (2006.01)	3258575	GENERATOR OF ELECTRICAL CURRENT BY MOVEMENT AND INDUCTION BY MEANS OF PERMANENT MAGNETS AND RESONANT COILS
	<b>H02K 21/14</b> (2006.01)		
	<b>H02K 53/00</b> (2006.01)		
FATRO S.p.A.	<b>A61K 9/00</b> (2006.01)	3349726	MICROSPHERES CONTAINING ANTHELMINTIC MACROCYCLIC LACTONES
	<b>A61K 9/14</b> (2006.01)		
	<b>A61K 9/16</b> (2006.01)		
	<b>A61K 31/00</b> (2006.01)		
DILLMANN,, Alexandra	<b>A24B 15/10</b> (2006.01)	3349604	A METHOD AND A DISPENSING ARRANGEMENT FOR TREATING A FLOW OF VAPORIZED LIQUID PROVIDED BY AN E-CIGARETTE AND AN E-CIGARETTE FOR THE ORAL INTAKE
	<b>A24F 47/00</b> (2006.01)		



Podnosilac evropske prijave patenta (71)	MKP (51)	Broj objave evropske prijave patenta (97)	Naziv pronalaska (54)
	<b>A61M 15/06</b> (2006.01)		OF VAPORIZED LIQUID CONTAINING AN ADDITIONAL COMPOSITION
	<b>A61Q 19/08</b> (2006.01)		
	<b>A61P 37/00</b> (2006.01)	3353207	DOSING REGIMEN OF COMBINATION OF ANTI-CD20 AND ANTI-BLYS ANTIBODIES
	<b>C07K 16/28</b> (2006.01)		
	<b>A61K 31/4418</b> (2006.01)	3353163	2,3,4,5-TETRAHYDROPYRIDIN-6-AMINE DERIVATIVES
	<b>A61P 25/16</b> (2006.01)		
	<b>A61P 25/28</b> (2006.01)		
	<b>C07D 401/12</b> (2006.01)		
	<b>A61K 35/12</b> (2015.01)	3347453	ENGINEERED HOST CELLS AND METHODS OF USE THEREOF
	<b>C12N 5/0783</b> (2010.01)		
	<b>A61K 31/4709</b> (2006.01)	3347351	SALTS OF A PIM KINASE INHIBITOR
	<b>A61P 35/00</b> (2006.01)		
	<b>C07D 215/60</b> (2006.01)		
	<b>C07D 221/18</b> (2006.01)		
	<b>C07D 401/12</b> (2006.01)		
	<b>C07D 401/14</b> (2006.01)		
	<b>C07F 7/18</b> (2006.01)		
	<b>B65D 1/26</b> (2006.01)	3347287	PACKAGING
	<b>B65D 85/804</b> (2006.01)		
	<b>A61K 31/437</b> (2006.01)	3350180	8-[6-[3-(AMINO)PROPOXY]-3-PYRIDYL]-1-ISOPROPYL-IMIDAZO[4,5-C]QUINOLIN-2-ONE DERIVATIVES AS SELECTIVE MODULATORS OF ATAXIA TELANGIECTASIA MUTATED (ATM) KINASE FOR THE TREATMENT OF CANCER
	<b>A61P 35/00</b> (2006.01)		
	<b>C07D 471/04</b> (2006.01)		
ViiV Healthcare UK Limited	<b>A61K 31/55</b> (2006.01)	3350174	BENZOAZEPINE DERIVATIVES
	<b>A61P 31/18</b> (2006.01)		
	<b>C07D 223/16</b> (2006.01)		
	<b>C07D 405/10</b> (2006.01)		
	<b>C07D 405/14</b> (2006.01)		
Acerta Pharma B.V.	<b>A61K 31/454</b> (2006.01)	3349798	THERAPEUTIC COMBINATIONS OF A CD19 INHIBITOR AND A BTK INHIBITOR
	<b>A61K 31/4985</b> (2006.01)		
	<b>A61K 31/519</b>		

Podnosilac evropske prijave patenta (71)	MKP (51)	Broj objave evropske prijave patenta (97)	Naziv pronalaska (54)
Prothena Biosciences Limited	(2006.01) <b>A61K 45/06</b> (2006.01) <b>A61P 35/00</b> (2006.01) <b>A61P 35/02</b> (2006.01) <b>C07K 14/70</b> (2006.01) <b>C07K 16/28</b> (2006.01) <b>C12N 5/07</b> (2010.01) <b>C07K 16/30</b> (2006.01)	3350226	USE OF ANTI-MCAM ANTIBODIES FOR TREATMENT OR PROPHYLAXIS OF GIANT CELL ARTERITIS, POLYMYALGIA RHEUMATICA OR TAKAYASU'S ARTERITIS
	<b>A61B 17/00</b> (2006.01) <b>A61M 5/19</b> (2006.01) <b>C04B 28/14</b> (2006.01) <b>C04B 40/00</b> (2006.01) <b>B01D 1/18</b> (2006.01) <b>C08J 3/12</b> (2006.01) <b>D21C 9/00</b> (2006.01) <b>F26B 3/12</b> (2006.01)	3352679	SPRAY OR DRIP TIPS HAVING MULTIPLE OUTLET CHANNELS
	<b>C04B 28/14</b> (2006.01) <b>C04B 40/00</b> (2006.01) <b>B01D 1/18</b> (2006.01) <b>C08J 3/12</b> (2006.01) <b>D21C 9/00</b> (2006.01) <b>F26B 3/12</b> (2006.01)	3383822	ADDITIVE FOR GYPSUM BUILDING MATERIALS
	<b>B01D 1/18</b> (2006.01) <b>C08J 3/12</b> (2006.01) <b>D21C 9/00</b> (2006.01) <b>F26B 3/12</b> (2006.01)	3353232	SUPERCRITICAL CO2 CELLULOSE SPRAYDRYING
	<b>A61K 31/519</b> (2006.01) <b>A61P 3/00</b> (2006.01) <b>A61P 25/00</b> (2006.01) <b>A61P 35/00</b> (2006.01) <b>C07D 487/04</b> (2006.01) <b>C07D 495/04</b> (2006.01)	3350185	1-PHENYLPYRROLIDIN-2-ONE DERIVATIVES AS PERK INHIBITORS
	<b>A61K 31/519</b> (2006.01) <b>A61P 31/18</b> (2006.01) <b>A61K 31/53</b> (2006.01) <b>A61K 31/664</b> (2006.01) <b>A61K 31/675</b> (2006.01) <b>A61K 31/683</b> (2006.01) <b>A61K 31/685</b> (2006.01) <b>A61P 31/12</b> (2006.01)	3349757	MODULATORS OF TOLL-LIKE RECEPTORS FOR THE TREATMENT OF HIV
	<b>A61K 31/53</b> (2006.01) <b>A61K 31/664</b> (2006.01) <b>A61K 31/675</b> (2006.01) <b>A61K 31/683</b> (2006.01) <b>A61K 31/685</b> (2006.01) <b>A61P 31/12</b> (2006.01)	3349758	METHODS FOR TREATING ARENAVIRIDAE AND CORONAVIRIDAE VIRUS INFECTIONS

Podnosilac evropske prijave patenta (71)	MKP (51)	Broj objave evropske prijave patenta (97)	Naziv pronalaska (54)		
Synlogic Operating Company, Inc.	<b>A61K 31/56</b> (2006.01)	3353158	COMPOUNDS WITH HIV MATURATION INHIBITORY ACTIVITY		
	<b>A61P 31/18</b> (2006.01)				
	<b>C07D 211/96</b> (2006.01)				
	<b>C07D 279/12</b> (2006.01)				
	<b>C07J 63/00</b> (2006.01)				
	<b>A23L 33/135</b> (2016.01)	3368696	BACTERIA ENGINEERED TO TREAT DISEASES THAT BENEFIT FROM REDUCED GUT INFLAMMATION AND/OR TIGHTENED GUT MUCOSAL BARRIER		
	<b>A61K 31/404</b> (2006.01)				
	<b>A61K 35/74</b> (2015.01)				
	<b>A61K 35/741</b> (2015.01)				
	<b>C12N 1/20</b> (2006.01)				
	<b>C12N 15/70</b> (2006.01)				
	<b>C12R 1/01</b> (2006.01)				
	<b>C12R 1/19</b> (2006.01)				
	<b>A61K 31/137</b> (2006.01)			3349740	CO-THERAPY COMPRISING CANAGLIFLOZIN AND PHENTERMINE FOR THE TREATMENT OF OBESITY AND OBESITY RELATED DISORDERS
	<b>A61K 31/7042</b> (2006.01)				
	<b>A61P 1/16</b> (2006.01)				
	<b>A61P 3/00</b> (2006.01)				
	<b>A61P 3/04</b> (2006.01)				
	<b>A61P 9/00</b> (2006.01)				
	<b>A61P 9/12</b> (2006.01)				
	<b>A61P 13/00</b> (2006.01)				
	<b>A61P 43/00</b> (2006.01)				
	<b>A61K 39/00</b> (2006.01)	3355915	CANINE PARVOVIRUS (CPV) VIRUS-LIKE PARTICLE (VLP) VACCINES AND USES THEREOF		
	<b>A61K 39/12</b> (2006.01)				
	<b>A61K 39/135</b> (2006.01)				
	<b>A61K 39/23</b> (2006.01)	3350216	TETRAVALENT BISPECIFIC AND TETRASPECIFIC ANTIGEN BINDING PROTEINS AND USES THEREOF		
	<b>C07K 16/00</b> (2006.01)				
<b>C07K 16/24</b> (2006.01)					
<b>C07K 16/28</b> (2006.01)					
<b>C07K 16/46</b> (2006.01)					

Podnosilac evropske prijave patenta (71)	MKP (51)	Broj objave evropske prijave patenta (97)	Naziv pronalaska (54)
	<b>A61L 27/36</b> (2006.01)	3349812	COMPOSITIONS DERIVED FROM PLACENTA AND METHODS OF PRODUCING THE SAME
	<b>A61L 27/56</b> (2006.01)		
	<b>A61L 27/60</b> (2006.01)		
Mauerhofer, Franz Aksüz, Hasan Masca, Abdullah Ismail	<b>C10L 1/12</b> (2006.01)	3153565	FUEL ADDITIVE
	<b>C10L 1/16</b> (2006.01)		
	<b>C10L 1/182</b> (2006.01)		
	<b>C10L 1/188</b> (2006.01)		
	<b>C10L 1/189</b> (2006.01)		
	<b>C10L 1/222</b> (2006.01)		
	<b>C10L 1/224</b> (2006.01)		
	<b>C10L 1/232</b> (2006.01)		
	<b>C10L 1/233</b> (2006.01)		
	<b>C10L 1/24</b> (2006.01)		
	<b>C10L 10/02</b> (2006.01)		
	<b>A61K 51/00</b> (2006.01)	3309796	RUBIDIUM ELUTION SYSTEM CONTROL
	<b>A61K 51/12</b> (2006.01)		
	<b>A61M 36/00</b> (2006.01)		
	<b>G21G 1/00</b> (2006.01)		
	<b>A61K 31/4375</b> (2006.01)	3318565	PYRROLO[2,3-D]PYRIMIDINYL, PYRROLO[2,3-B]PYRAZINYL AND PYRROLO[2,3-D]PYRIDINYL ACRYLAMIDES
	<b>A61P 35/00</b> (2006.01)		
	<b>C07D 471/04</b> (2006.01)		
	<b>C07D 487/04</b> (2006.01)		
Boehringer Ingelheim Vetmedica GmbH	<b>A61K 9/00</b> (2006.01)	3318247	TASTE MASKED PHARMACEUTICAL COMPOSITION
	<b>A61K 9/50</b> (2006.01)		
	<b>A61K 31/55</b> (2006.01)		
	<b>A61P 9/04</b> (2006.01)		
	<b>A61K 39/00</b> (2006.01)	3318272	CGRP ANTIBODIES
	<b>A61K 39/395</b> (2006.01)		
	<b>C07K 16/18</b> (2006.01)		
	<b>C07K 16/26</b> (2006.01)		
	<b>A61K 9/20</b> (2006.01)	3318249	DIMETHYL FUMARATE DOSAGE REGIMENS FOR THE TREATMENT OF MULTIPLE SCLEROSIS
	<b>A61K 9/32</b> (2006.01)		
	<b>A61K</b>		

Podnosilac evropske prijave patenta (71)	MKP (51)	Broj objave evropske prijave patenta (97)	Naziv pronalaska (54)
	<b>31/225</b> (2006.01)		
	<b>A61P 25/28</b> (2006.01)		
	<b>C07K 11/02</b> (2006.01)	3301109	NOVEL DEPSIPEPTIDE AND USES THEREOF
	<b>A61K</b> <b>31/535</b> (2006.01)	3321270	SODIUM (2R, 5S, 13AR) -7, 9-DIOXO-10- ( 2,4,6-TRIFLUOROBENZYL) CARBAMOYL) -2, 3, 4, 5, 7, 9, 13, 13A-OCTAHYDRO-2, 5-METHANOPYRIDO [1',2' : 4.5] PYRAZINO [2, 1-B] OXAZEPIN-8-OLATE
	<b>A61P 31/18</b> (2006.01)		
	<b>C07D 498/14</b> (2006.01)		
	<b>A23P 10/30</b> (2016.01)	3318268	ROSEBURIA FLAGELLIN AND IMMUNE MODULATION
	<b>A61K 38/16</b> (2006.01)		
	<b>A61K 39/02</b> (2006.01)		
	<b>A61K 48/00</b> (2006.01)		
	<b>A61P 1/00</b> (2006.01)		
	<b>A61P 17/00</b> (2006.01)		
	<b>A61P 19/00</b> (2006.01)		
	<b>A61P 29/00</b> (2006.01)		
	<b>A61P 37/00</b> (2006.01)		
	<b>C07K</b> <b>14/195</b> (2006.01)		
	<b>A61K</b> <b>31/485</b> (2006.01)	3345604	NALMEFENE FOR REDUCTION OF ALCOHOL CONSUMPTION IN SPECIFIC TARGET POPULATIONS
	<b>A61P 25/32</b> (2006.01)		
	<b>A61K</b> <b>39/395</b> (2006.01)	3318273	METHODS FOR INCREASING EFFICACY OF FOLR1 CANCER THERAPY
	<b>B23K 26/00</b> (2014.01)	3363576	METHOD AND IDENTIFICATION AND/OR MARKING OF GALVANIZED, IN PARTICULAR HOT DIPPED COMPONENTS
	<b>B23K</b> <b>26/0622</b> (2014.01)		
	<b>B23K</b> <b>26/082</b> (2014.01)		
	<b>B23K 26/12</b> (2014.01)		
	<b>B23K 26/14</b> (2014.01)		
	<b>B23K</b> <b>26/322</b> (2014.01)		
	<b>B23K</b> <b>26/352</b> (2014.01)		
	<b>B23K 26/60</b> (2014.01)		
	<b>A61K 39/00</b> (2006.01)	3348644	NUCLEIC ACID COMPRISING OR CODING FOR A HISTONE STEM-LOOP AND A POLY(A) SEQUENCE OR A POLYADENYLATION SIGNAL FOR INCREASING THE EXPRESSION OF AN ENCODED TUMOUR ANTIGEN
	<b>C12N 15/63</b> (2006.01)		

Podnosilac evropske prijave patenta (71)	MKP (51)	Broj objave evropske prijave patenta (97)	Naziv pronalaska (54)		
Ethicon LLC	<b>C12N 15/67</b> (2006.01)	3323451	SURGICAL NEEDLE COATINGS AND METHODS		
	<b>A61B 17/06</b> (2006.01)				
	<b>A61L 31/02</b> (2006.01)				
	<b>A61L 31/10</b> (2006.01)				
	<b>A61M 5/32</b> (2006.01)				
Ethicon LLC	<b>A61K 31/7125</b> (2006.01)	3366775	MODIFIED RNAI AGENTS		
	<b>C12N 15/113</b> (2010.01)				
	<b>E04F 15/024</b> (2006.01)				
	<b>F24D 3/12</b> (2006.01)				
	<b>B01D 17/00</b> (2006.01)				
Casprini, Matteo	<b>B01D 17/04</b> (2006.01)	3369874	A MODULAR FLOATING SCREED WITH INCORPORATED HEATING ELEMENTS		
	<b>E03F 5/16</b> (2006.01)				
Delfin Sp. z o.o.	<b>A61K 9/00</b> (2006.01)	3238801	COALESCING SEPARATOR		
	<b>A61K 9/20</b> (2006.01)				
Delfin Sp. z o.o.	<b>A61K 31/4164</b> (2006.01)	3388063	TREATMENT OF A BACTERIAL VAGINAL INFECTION		
	<b>A61K 31/4178</b> (2006.01)				
	<b>A61K 31/7048</b> (2006.01)				
	<b>A61K 45/06</b> (2006.01)				
	<b>A61K 47/06</b> (2006.01)				
	<b>A61P 31/04</b> (2006.01)				
	<b>B27N 3/02</b> (2006.01)				
	<b>B27N 3/04</b> (2006.01)				
	<b>B27N 3/06</b> (2006.01)				
	<b>B27N 3/10</b> (2006.01)				
	<b>B27N 3/12</b> (2006.01)				
	<b>C09C 1/02</b> (2006.01)				
	<b>B25B 13/46</b> (2006.01)			3400120	IN-LINE COATED WOOD-BASED BOARDS
	<b>B26D 1/547</b> (2006.01)				
	Belron International Limited			<b>A61K 31/426</b> (2006.01)	3402846
<b>A61K 45/06</b> (2006.01)					
<b>B25B 13/46</b> (2006.01)		3408063	WINDER UNIT FOR VEHICLE GLAZING PANEL CUT OUT		
<b>B26D 1/547</b> (2006.01)					
<b>A61K 31/426</b> (2006.01)	3397622	ALPHA-AMINO ESTERS OF HYDROXYPROPYLTHIAZOLIDINE CARBOXAMIDE DERIVATIVE AND SALT FORM, CRYSTAL POLYMORPH THEREOF			
<b>A61K 45/06</b> (2006.01)					

Podnosilac evropske prijave patenta (71)	MKP (51)	Broj objave evropske prijave patenta (97)	Naziv pronalaska (54)
	<b>A61P 15/00</b> (2006.01)		
	<b>A61P 15/06</b> (2006.01)		
	<b>C07D 277/06</b> (2006.01)		
	<b>A61K 31/426</b> (2006.01)	3400217	L-VALINATE OF HYDROXYPROPYLTHIAZOLIDINE CARBOXAMIDE DERIVATIVE AND SALT FORM, CRYSTAL POLYMORPH THEREOF
	<b>A61K 45/06</b> (2006.01)		
	<b>A61P 15/00</b> (2006.01)		
	<b>A61P 15/06</b> (2006.01)		
	<b>C07D 277/06</b> (2006.01)		
Syncerus S.à R.I.	<b>C07K 16/26</b> (2006.01)	3397965	COMPOSITIONS AND METHODS FOR ASSESSING THE RISK OF CANCER OCCURRENCE
	<b>C07K 16/30</b> (2006.01)		
	<b>G01N 33/574</b> (2006.01)		
	<b>G01N 33/74</b> (2006.01)		
Replicon Health OY	<b>A61K 31/191</b> (2006.01)	3399969	METHOD FOR PREVENTION, TREATMENT AND ALLEVIATION OF INFECTIOUS DISEASES AND DISORDERS
	<b>A61P 31/00</b> (2006.01)		
	<b>A61P 33/00</b> (2006.01)		
	<b>A61P 33/02</b> (2006.01)		
	<b>A61K 39/00</b> (2006.01)	3400004	THERAPEUTIC ANTICANCER NEOEPITOPE VACCINE
	<b>A61P 35/00</b> (2006.01)		
	<b>A61K 39/00</b> (2006.01)	3400005	NEOEPITOPE RNA CANCER VACCINE
	<b>A61P 35/00</b> (2006.01)		
	<b>C23C 2/02</b> (2006.01)	3400317	HOT-DIP GALVANIZATION SYSTEM AND HOT-DIP GALVANIZATION METHOD, IN PARTICULAR FOR MASS PRODUCTION
	<b>C23C 2/06</b> (2006.01)		
	<b>C23C 2/14</b> (2006.01)		
	<b>C23C 2/26</b> (2006.01)		
	<b>C23C 2/30</b> (2006.01)		
	<b>A61K 31/437</b> (2006.01)	3405466	ARYL SUBSTITUTED PYRIMIDINES FOR USE IN INFLUENZA VIRUS INFECTION
	<b>A61P 31/16</b> (2006.01)		
	<b>C07D 403/04</b> (2006.01)		
	<b>C07D 403/12</b> (2006.01)		
	<b>C07D 471/04</b> (2006.01)		
	<b>C07D 487/04</b> (2006.01)		

Podnosilac evropske prijave patenta (71)	MKP (51)	Broj objave evropske prijave patenta (97)	Naziv pronalaska (54)
	<b>C07D 495/04</b> (2006.01)		
	<b>D06P 1/653</b> (2006.01)	3390711	METHOD OF DYE CLEARING TEXTILES
	<b>D06P 3/54</b> (2006.01)		
	<b>D06P 5/04</b> (2006.01)		
	<b>A61K 31/437</b> (2006.01)	3400225	FUNCTIONALIZED PENTANOIC ACIDS FOR USE IN INFLUENZA VIRAL INFECTIONS
	<b>A61K 31/519</b> (2006.01)		
	<b>A61P 31/16</b> (2006.01)		
	<b>C07D 471/04</b> (2006.01)		
	<b>C07D 487/04</b> (2006.01)		
Chromition Limited	<b>A61K 49/00</b> (2006.01)	3405216	NANOPARTICLE CONJUGATES
Puertas y Sistemas anti Inundaciones S.L.	<b>E05C 19/00</b> (2006.01)	3405635	DOOR DEVICE
	<b>E06B 7/18</b> (2006.01)		
Vesuvius Group S.A	<b>B22D 41/22</b> (2006.01)	3408043	SLIDING GATE VALVE PLATE
	<b>B22D 41/28</b> (2006.01)		
	<b>B22D 41/34</b> (2006.01)		
	<b>A61P 35/00</b> (2006.01)	3405490	MONO AND BISPECIFIC ANTIBODIES FOR EPIDERMAL GROWTH FACTOR RECEPTOR VARIANT III AND CD3 AND THEIR USES
	<b>C07K 16/28</b> (2006.01)		
	<b>C07K 16/30</b> (2006.01)		
	<b>A61K 9/20</b> (2006.01)	3405177	FORMULATIONS/COMPOSITIONS COMPRISING A BTK INHIBITOR
	<b>A61K 9/48</b> (2006.01)		
	<b>A61K 31/00</b> (2006.01)		
	<b>A61K 9/20</b> (2006.01)	3405178	FORMULATIONS/COMPOSITIONS COMPRISING A BTK INHIBITOR
	<b>A61K 31/00</b> (2006.01)		
Auspex Pharmaceuticals, Inc.	<b>C07D 205/04</b> (2006.01)	3400211	AZETIDINE MODULATORS OF THE SPHINGOSINE 1-PHOSPHATE RECEPTOR
	<b>C23C 2/02</b> (2006.01)	3400318	HOT-DIP GALVANIZATION SYSTEM AND HOT-DIP GALVANIZATION METHOD
	<b>C23C 2/06</b> (2006.01)		
	<b>C23C 2/14</b> (2006.01)		
	<b>C23C 2/26</b> (2006.01)		
	<b>C23C 2/30</b> (2006.01)		
	<b>A61K 31/506</b> (2006.01)	3405196	NEW SUBSTITUTED CYANOINDOLINE DERIVATIVES AS NIK INHIBITORS
	<b>A61K 31/5377</b> (2006.01)		
	<b>A61K 31/55</b>		



Podnosilac evropske prijave patenta (71)	MKP (51)	Broj objave evropske prijave patenta (97)	Naziv pronalaska (54)
	(2006.01) <b>A61P 3/00</b> (2006.01) <b>A61P 29/00</b> (2006.01) <b>A61P 35/00</b> (2006.01) <b>A61P 37/00</b> (2006.01) <b>C07D 401/14</b> (2006.01) <b>C07D 403/14</b> (2006.01) <b>C07D 405/14</b> (2006.01) <b>C07D 413/14</b> (2006.01) <b>C07D 471/10</b> (2006.01) <b>C07D 487/04</b> (2006.01) <b>C07D 487/10</b> (2006.01) <b>A61K</b> <b>31/506</b> (2006.01) <b>A61K</b> <b>31/5377</b> (2006.01) <b>A61K</b> <b>31/553</b> (2006.01) <b>A61P 3/00</b> (2006.01) <b>A61P 29/00</b> (2006.01) <b>A61P 35/00</b> (2006.01) <b>A61P 37/00</b> (2006.01) <b>C07D 401/14</b> (2006.01) <b>C07D 403/04</b> (2006.01) <b>C07D 403/14</b> (2006.01) <b>C07D 405/14</b> (2006.01) <b>C07D 413/14</b> (2006.01) <b>A61K 38/00</b> (2006.01) <b>A61K 48/00</b> (2006.01) <b>C07K 14/47</b> (2006.01) <b>C07K 16/28</b> (2006.01) <b>C07K 16/30</b> (2006.01) <b>A61K</b> <b>31/506</b> (2006.01) <b>A61P 35/00</b> (2006.01) <b>C07D 401/14</b> (2006.01)		
		3405464	NEW 6-MEMBERED HETEROAROMATIC SUBSTITUTED CYANOINDOLINE DERIVATIVES AS NIK INHIBITORS
		3405481	CHIMERIC ANTIGEN RECEPTORS TARGETING EPIDERMAL GROWTH FACTOR RECEPTOR VARIANT III
		3400221	PYRIDINE AND PYRIDIMINE COMPOUNDS AS PI3K-GAMMA INHIBITORS

Podnosilac evropske prijave patenta (71)	MKP (51)	Broj objave evropske prijave patenta (97)	Naziv pronalaska (54)	
Teobaldelli, Ivan	<b>C07D 403/14</b> (2006.01)	3400212	TETRAHYDROCARBAZOLE INHIBITORS OF SIRT1 RECEPTORS	
	<b>A61K 31/403</b> (2006.01)			
	<b>A61P 25/00</b> (2006.01)	3402819	IMMUNE-STIMULATING HUMANIZED MONOCLONAL ANTIBODIES AGAINST HUMAN INTERLEUKIN-2, AND FUSION PROTEINS THEREOF	
	<b>C07D 209/56</b> (2006.01)			
	<b>A61K 38/20</b> (2006.01)			
	<b>C07K 16/24</b> (2006.01)	3405551	NANOPARTICLES FOR USE IN LIGHT EMITTING APPLICATIONS	
	<b>C09K 11/06</b> (2006.01)			
	<b>H01L 51/00</b> (2006.01)	3411532	FOUNDATION	
	<b>E02D 27/34</b> (2006.01)			
	<b>C07C 251/72</b> (2006.01)	3411360	CATALYTIC HYDROGENATION PROCESS FOR PREPARING PYRAZOLES	
	<b>C07D 231/14</b> (2006.01)	3407874	FAST DISPERSIBLE PHARMACEUTICAL COMPOSITION COMPRISING TYROSINE-KINASE INHIBITOR	
	<b>A61K 9/20</b> (2006.01)			
	<b>A61K 31/506</b> (2006.01)	3402503	THERAPEUTIC COMBINATIONS OF AN ANTIFOLATE AND A BTK INHIBITOR	
	<b>A61K 31/454</b> (2006.01)			
	<b>A61K 31/4985</b> (2006.01)			
	<b>A61K 31/517</b> (2006.01)			
	<b>A61K 31/519</b> (2006.01)			
	<b>A61K 31/52</b> (2006.01)			
	<b>A61K 31/522</b> (2006.01)			
	<b>A61K 38/00</b> (2006.01)			
	<b>A61K 39/00</b> (2006.01)			
	<b>A61K 45/06</b> (2006.01)			
	<b>A61P 35/00</b> (2006.01)			
<b>A61P 35/02</b> (2006.01)				
<b>F17C 1/16</b> (2006.01)	3397892			INTEGRATED COMPOSITE MOUNTING STRUCTURE FOR USE IN PRESSURE VESSELS AND PRESSURE VESSEL SYSTEMS
<b>F17C 13/08</b> (2006.01)	3402474			IL-8 INHIBITORS FOR USE IN THE TREATMENT OF CHEMOTHERAPY-INDUCED PERIPHERAL NEUROPATHY
<b>A61K 31/165</b> (2006.01)				
<b>A61K 31/19</b> (2006.01)				
<b>A61P 25/02</b> (2006.01)				

Podnosilac evropske prijave patenta (71)	MKP (51)	Broj objave evropske prijave patenta (97)	Naziv pronalaska (54)
	<b>A61K 31/437</b> (2006.01)	3402790	SPIROHEPTANE SALICYLAMIDES AND RELATED COMPOUNDS AS INHIBITORS OF ROCK
	<b>A61K 31/4427</b> (2006.01)		
	<b>C07D 213/64</b> (2006.01)		
	<b>C07D 231/12</b> (2006.01)		
	<b>C07D 231/18</b> (2006.01)		
	<b>C07D 231/54</b> (2006.01)		
	<b>C07D 401/12</b> (2006.01)		
	<b>C07D 401/14</b> (2006.01)		
	<b>C07D 413/12</b> (2006.01)		
	<b>C07D 471/04</b> (2006.01)		
	<b>C07D 471/12</b> (2006.01)		
	<b>C07D 513/04</b> (2006.01)		
	<b>A61P 35/00</b> (2006.01)	3402822	AXL-SPECIFIC ANTIBODY-DRUG CONJUGATES FOR CANCER TREATMENT
	<b>C07K 16/28</b> (2006.01)		
	<b>C23C 2/02</b> (2006.01)	3411510	HOT-DIP GALVANIZATION SYSTEM AND HOT-DIP GALVANIZATION METHOD
	<b>C23C 2/06</b> (2006.01)		
	<b>C23C 2/14</b> (2006.01)		
	<b>C23C 2/26</b> (2006.01)		
	<b>C23C 2/30</b> (2006.01)		
	<b>A61K 31/41</b> (2006.01)	3411028	COMBINATION PRODUCTS FOR THE TREATMENT OF RSV
	<b>A61K 31/4184</b> (2006.01)		
	<b>A61K 31/437</b> (2006.01)		
	<b>A61K 31/519</b> (2006.01)		
	<b>A61K 31/52</b> (2006.01)		
	<b>A61K 31/53</b> (2006.01)		
	<b>A61K 31/5377</b> (2006.01)		
	<b>A61K 31/55</b> (2006.01)		
	<b>A61K 31/5513</b> (2006.01)		
	<b>A61K 31/70</b> (2006.01)		
	<b>A61K 31/7056</b>		

Podnosilac evropske prijave patenta (71)	MKP (51)	Broj objave evropske prijave patenta (97)	Naziv pronalaska (54)
	(2006.01)		
	<b>A61K 39/395</b>		
	(2006.01)		
	<b>A61P 31/12</b>		
	(2006.01)		
	<b>C07K 16/28</b>	3405492	MULTISPECIFIC MOLECULES TARGETING CLL-1
	(2006.01)		
	<b>A61J 1/20</b>	3411005	MEDICAL METERING DEVICE
	(2006.01)		
	<b>A61M 5/24</b>		
	(2006.01)		
	<b>A61M 5/28</b>		
	(2006.01)		
	<b>A61M 39/24</b>		
	(2006.01)		
	<b>A61K 39/395</b>	3405493	ANTI-ROR1 ANTIBODIES, ROR1 X CD3 BISPECIFIC ANTIBODIES, AND METHODS OF USING THE SAME
	(2006.01)		
	<b>A61P 35/00</b>		
	(2006.01)		
	<b>C07K 16/28</b>		
	(2006.01)		
	<b>C07K 14/08</b>	3408280	INACTIVATION OF VIRUSES BY DELIPIDATION
	(2006.01)		
	<b>C12N 7/06</b>		
	(2006.01)		
	<b>A61K 9/00</b>	3402465	FORMULATION FOR ANTIBODY AND DRUG CONJUGATE THEREOF
	(2006.01)		
	<b>A61K 9/19</b>		
	(2006.01)		
	<b>A61K 39/395</b>		
	(2006.01)		
	<b>A61K 47/18</b>		
	(2017.01)		
	<b>A61K 47/26</b>		
	(2006.01)		
	<b>C07K 16/28</b>		
	(2006.01)		
	<b>A61P 35/00</b>	3405495	NEUTRALIZATION OF INHIBITORY PATHWAYS IN LYMPHOCYTES
	(2006.01)		
	<b>C07K 16/28</b>		
	(2006.01)		
	<b>C10L 1/00</b>	3402862	USE OF RARE EARTH COMPLEXES AS MARKERS OF PETROLEUM PRODUCTS, CRUDE OILS, BIOFUELS OR LUBRICANTS
	(2006.01)		
	<b>C10L 1/30</b>		
	(2006.01)		
	<b>C10M 171/00</b>		
	(2006.01)		
	<b>A61K 31/575</b>	3405474	AMINE DERIVATIVES OF LUPANES WITH HIV MATURATION INHIBITORY ACTIVITY
	(2006.01)		
	<b>A61P 31/18</b>		
	(2006.01)		
	<b>C07J 63/00</b>		
	(2006.01)		
	<b>A61K 39/00</b>	3405489	HIGH DOSE TREATMENTS FOR ALZHEIMER'S DISEASE
	(2006.01)		
	<b>C07K 16/00</b>		
	(2006.01)		
	<b>C07K 16/18</b>		
	(2006.01)		
	<b>G01N 33/15</b>		
	(2006.01)		

Inoventeam  
 Université Claude  
 Bernard Lyon 1  
 Centre National de la  
 Recherche Scientifique  
 (CNRS)

Podnosilac evropske prijave patenta (71)	MKP (51)	Broj objave evropske prijave patenta (97)	Naziv pronalaska (54)	
Bahlsen GmbH & Co. KG	<b>A21D 13/00</b> (2017.01)	3407725	BAKED PRODUCT WITH A LONG SHELF LIFE AND METHOD FOR PRODUCING SAME	
	<b>A21D 13/14</b> (2017.01)			
	<b>A21D 13/32</b> (2017.01)			
	<b>A23G 3/54</b> (2006.01)	3408295		PHARMACEUTICAL COMPOSITION COMPRISING BISPECIFIC ANTIBODY CONSTRUCTS
	<b>A61K 39/395</b> (2006.01)			
	<b>A61K 47/00</b> (2006.01)			
	<b>C07K 16/28</b> (2006.01)			
	<b>A63F 1/12</b> (2006.01)			
	<b>A63F 1/18</b> (2006.01)	3407990		METHOD AND SYSTEM FOR CARD SHUFFLE INTEGRITY TRACKING
	<b>G07F 17/32</b> (2006.01)			
	<b>A61K 39/12</b> (2006.01)	3407910		RECOMBINANT MODIFIED VACCINIA VIRUS ANKARA (MVA) EQUINE ENCEPHALITIS VIRUS VACCINE
	<b>C07K 14/005</b> (2006.01)			
	<b>C12N 15/86</b> (2006.01)			
	<b>A61K 39/00</b> (2006.01)			
	<b>C07K 14/705</b> (2006.01)			
	<b>C07K 16/32</b> (2006.01)	3411394		ENGINEERED ANTIGEN PRESENTING CELLS AND USES THEREOF
	<b>B05B 11/00</b> (2006.01)			
	<b>B65D 83/20</b> (2006.01)			
	<b>B65D 83/22</b> (2006.01)			
	<b>B65D 83/30</b> (2006.01)	3416747		DISPENSER WITH ARTICULATED DISPENSING TUBE
	<b>A61K 31/56</b> (2006.01)			
	<b>A61K 31/58</b> (2006.01)			
	<b>A61K 31/585</b> (2006.01)			
<b>A61P 29/00</b> (2006.01)				
<b>C07J 63/00</b> (2006.01)				
<b>C07J 71/00</b> (2006.01)				
<b>A61K 31/445</b> (2006.01)	3353190		C4-MODIFIED OLEANOLIC ACID DERIVATIVES FOR INHIBITION OF IL-17 AND OTHER USES	
<b>A61K 31/58</b> (2006.01)				
<b>A61K 31/585</b> (2006.01)				
<b>A61P 29/00</b> (2006.01)				
<b>C07J 63/00</b> (2006.01)	3356360		THERAPEUTIC COMPOUNDS AND METHODS OF USE THEREOF	
<b>C07J 71/00</b> (2006.01)				
<b>A61K 31/445</b> (2006.01)				
<b>A61P 29/00</b> (2006.01)				
<b>C07D 417/12</b> (2006.01)				
<b>C07D 417/14</b> (2006.01)	3355922		COMBINATION THERAPY OF BROMODOMAIN INHIBITORS AND CHECKPOINT BLOCKADE	
<b>A61K 31/437</b>				

Dana Farber Cancer Institute, Inc.

Podnosilac evropske prijave patenta (71)	MKP (51)	Broj objave evropske prijave patenta (97)	Naziv pronalaska (54)
Peter MacCallum Cancer Institute	(2006.01) <b>A61K 31/495</b> (2006.01) <b>A61K 31/519</b> (2006.01) <b>A61K 31/551</b> (2006.01) <b>A61K 45/00</b> (2006.01) <b>A61K 45/06</b> (2006.01) <b>A61P 35/00</b> (2006.01) <b>C07K 14/47</b> (2006.01) <b>C07K 16/18</b> (2006.01) <b>G01N 33/53</b> (2006.01)	3359565	ANTI-WT1/HLA-SPECIFIC ANTIBODIES
TBSP Engineering Technical Company Societe Anonyme For Trading, Construction, Support of Systems and Projects of High Technology and Safety and AstraZeneca Aktiebolag	<b>H04M 11/00</b> (2006.01) <b>H04M 19/00</b> (2006.01)  <b>A61K 31/522</b> (2006.01) <b>A61K 47/54</b> (2017.01) <b>A61K 47/69</b> (2017.01) <b>A61P 35/00</b> (2006.01) <b>C07D 473/34</b> (2006.01)	3350981	LOW POWER MODEM AND CONTROLLER
	<b>A61K 38/18</b> (2006.01) <b>G01N 33/50</b> (2006.01) <b>G01N 33/68</b> (2006.01)	3353546	METHODS FOR TREATING CARDIAC INJURY
Sawyer, Douglas, B.	<b>A61K 38/12</b> (2006.01) <b>A61P 3/04</b> (2006.01) <b>C07K 7/54</b> (2006.01)	3356386	METHOD OF TREATING MELANOCORTIN-4 RECEPTOR PATHWAY-ASSOCIATED DISORDERS
	<b>A61K 8/19</b> (2006.01) <b>A61K 8/73</b> (2006.01) <b>A61K 9/16</b> (2006.01) <b>A61Q 19/00</b> (2006.01)	3355855	COMPOSITION FOR DUST PARTICLE REDUCTION
Rhythm Pharmaceuticals, Inc. Charité - Universitätsmedizin Berlin	<b>A61K 38/12</b> (2006.01) <b>A61P 3/04</b> (2006.01)	3355905	METHOD OF TREATING MELANOCORTIN-4 RECEPTOR PATHWAY-ASSOCIATED DISORDERS
	<b>A61K 38/18</b> (2006.01)	3355908	TREATMENT OF BILE ACID DISORDERS

Podnosilac evropske prijave patenta (71)	MKP (51)	Broj objave evropske prijave patenta (97)	Naziv pronalaska (54)
	<b>A61P 1/16</b> (2006.01)		
	<b>A61K 31/337</b> (2006.01)	3359196	RATIONAL COMBINATION THERAPY FOR THE TREATMENT OF CANCER
	<b>A61K 31/52</b> (2006.01)		
	<b>A61K 31/704</b> (2006.01)		
	<b>A61K 45/06</b> (2006.01)		
	<b>A61P 35/00</b> (2006.01)		
	<b>A61K 31/4709</b> (2006.01)	3359536	COMPOUNDS, COMPOSITIONS, AND METHODS FOR MODULATING CFTR
	<b>A61P 11/00</b> (2006.01)		
	<b>C07D 401/04</b> (2006.01)		
	<b>C07D 405/04</b> (2006.01)		
	<b>C07D 405/14</b> (2006.01)		
	<b>C07D 409/04</b> (2006.01)		
	<b>C07D 409/14</b> (2006.01)		
	<b>C07D 413/04</b> (2006.01)		
	<b>C07D 413/14</b> (2006.01)		
	<b>C07D 417/04</b> (2006.01)		
	<b>C07D 471/04</b> (2006.01)		
	<b>C07D 487/04</b> (2006.01)		
	<b>C07D 493/08</b> (2006.01)		
EVER Neuro Pharma GmbH	<b>A61K 9/00</b> (2006.01)	3355887	AQUEOUS COMPOSITION OF APOMORPHINE FOR SUBCUTANEOUS ADMINISTRATION
	<b>A61K 31/473</b> (2006.01)		
	<b>A61K 47/12</b> (2006.01)		
	<b>A61K 47/20</b> (2006.01)		
	<b>A61P 15/00</b> (2006.01)		
	<b>A61P 15/10</b> (2006.01)		
	<b>A61P 25/00</b> (2006.01)		
	<b>A61P 25/16</b> (2006.01)		
	<b>A61P 25/18</b> (2006.01)		
	<b>A61P 25/28</b> (2006.01)		
Alpha Innovation Inc.	<b>H05F 3/02</b> (2006.01)	3354117	STATIC ELIMINATOR
	<b>A61K 39/39</b> (2006.01)	3365010	CYTOTOXIC IMMUNOSTIMULATING PARTICLES AND USES THEREOF

Podnosilac evropske prijave patenta (71)	MKP (51)	Broj objave evropske prijave patenta (97)	Naziv pronalaska (54)	
<b>A61K 47/64</b> (2017.01)		3365024	METHODS AND MEANS FOR INDUCING AN IMMUNE RESPONSE	
<b>A61P 37/00</b> (2006.01)				
<b>A61P 37/04</b> (2006.01)				
<b>A61K 31/41</b> (2006.01)		3371167	ARYLCYCLOHEXYL PYRAZOLES AS NRF2 REGULATORS	
<b>A61K 31/4196</b> (2006.01)				
<b>A61K 31/445</b> (2006.01)				
<b>C07D 401/04</b> (2006.01)				
<b>C07D 401/06</b> (2006.01)				
<b>C07D 401/10</b> (2006.01)				
<b>C07D 401/12</b> (2006.01)				
<b>C07D 401/14</b> (2006.01)				
<b>A61K 39/00</b> (2006.01)		3359571		ANTI-LAG3 ANTIBODIES AND USES THEREOF
<b>A61P 35/00</b> (2006.01)				
<b>A61P 37/00</b> (2006.01)				
<b>C07K 16/28</b> (2006.01)				
<b>A61K 31/424</b> (2006.01)		3365346	OXA-DIAZASPIRO COMPOUNDS HAVING ACTIVITY AGAINST PAIN	
<b>C07D 498/10</b> (2006.01)				
<b>A61K 31/41</b> (2006.01)		3359532	BIARYL PYRAZOLES AS NRF2 REGULATORS	
<b>A61K 31/4196</b> (2006.01)				
<b>A61K 31/445</b> (2006.01)				
<b>C07D 401/04</b> (2006.01)				
<b>C07D 401/06</b> (2006.01)				
<b>C07D 401/10</b> (2006.01)				
<b>C07D 401/12</b> (2006.01)				
<b>C07D 401/14</b> (2006.01)				
<b>A61K 31/4196</b> (2006.01)		3356355		COMPOUNDS AND COMBINATIONS FOR THE TREATMENT OF HIV
<b>A61P 31/18</b> (2006.01)				
<b>C07D 249/10</b> (2006.01)				
<b>C07D 405/12</b> (2006.01)				
<b>A61K 31/437</b> (2006.01)		3359539	SUBSTITUTED PYRAZOLO[3,4-B]PYRIDIN-6-CARBOXYLIC ACIDS AND THEIR USE	



Podnosilac evropske prijave patenta (71)	MKP (51)	Broj objave evropske prijave patenta (97)	Naziv pronalaska (54)			
AbbVie S.À.R.L.	<b>A61P 11/12</b> (2006.01)	3359540	NOVEL COMPOUNDS FOR TREATMENT OF CYSTIC FIBROSIS			
	<b>C07D 471/04</b> (2006.01)					
	<b>C07D 519/00</b> (2006.01)					
	<b>A61K 31/437</b> (2006.01)					
	<b>A61P 11/00</b> (2006.01)					
	<b>C07D 471/04</b> (2006.01)					
	<b>C07D 519/00</b> (2006.01)					
	<b>G01N 33/68</b> (2006.01)					
	<b>A23K 10/00</b> (2016.01)					
	<b>A23K 10/40</b> (2016.01)					
Mitobridge, Inc.	<b>A61K 31/4174</b> (2006.01)	3359528	PPAR AGONISTS, COMPOUNDS, PHARMACEUTICAL COMPOSITIONS, AND METHODS OF USE THEREOF			
	<b>A61K 31/4439</b> (2006.01)					
	<b>A61P 21/00</b> (2006.01)					
	<b>C07D 233/64</b> (2006.01)					
	<b>C07D 401/04</b> (2006.01)					
	<b>C07D 405/10</b> (2006.01)					
	Bayer CropScience AG			<b>C07K 4/04</b> (2006.01)	3362466	AXMI554 DELTA-ENDOTOXIN GENE AND METHODS FOR ITS USE
				<b>C07K 14/21</b> (2006.01)		
				<b>C12N 15/82</b> (2006.01)		
				<b>A61K 38/26</b> (2006.01)		
Elanco US Inc.	<b>C07K 14/605</b> (2006.01)	3368061	GLUCAGON RECEPTOR AGONISTS			
	<b>A61K 31/437</b> (2006.01)					
	<b>A61K 31/5025</b> (2006.01)	3365340	HETEROCYCLIC COMPOUNDS AS IMMUNOMODULATORS			
	<b>A61K 31/519</b> (2006.01)					
	<b>A61P 31/12</b> (2006.01)					
	<b>A61P 35/00</b> (2006.01)					
	<b>C07D 471/04</b> (2006.01)					
	<b>C07D 487/04</b> (2006.01)					
	3360135			<b>G10L 19/008</b> (2013.01)	3360135	LAYERED CODING FOR COMPRESSED SOUND OR SOUND FIELD REPRESENTATIONS

Podnosilac evropske prijave patenta (71)	MKP (51)	Broj objave evropske prijave patenta (97)	Naziv pronalaska (54)		
Ted-Bed JSC	<b>G10L 19/24</b> (2013.01)	3400251	POLYURETHANE FOAM COMPOSITION		
	<b>C08G 18/16</b> (2006.01)				
	<b>C08G 18/20</b> (2006.01)				
	<b>C08G 18/24</b> (2006.01)				
	<b>C08G 18/40</b> (2006.01)				
	<b>C08G 18/48</b> (2006.01)				
	<b>C08G 18/63</b> (2006.01)				
	<b>C08G 18/76</b> (2006.01)				
	<b>C08G 101/00</b> (2006.01)				
	<b>A61K 31/519</b> (2006.01)			3362453	CYCLIC ETHER DERIVATIVES OF PYRAZOLO[1,5-A]PYRIMIDINE-3-CARBOXYAMIDE
	<b>C07D 487/04</b> (2006.01)	3368101	SINGLE-USE AUTO-INJECTOR		
	<b>A61M 5/142</b> (2006.01)				
	<b>A61M 5/145</b> (2006.01)				
	<b>A61M 5/20</b> (2006.01)				
	<b>A61M 5/315</b> (2006.01)				
	<b>A61M 5/32</b> (2006.01)				
	<b>A61K 31/195</b> (2006.01)			3359148	COMBINATION OF DEUTERATED LEVODOPA WITH CARBIDOPA AND OPICAPONE FOR THE TREATMENT OF PARKINSON'S DISEASE
	<b>A61K 31/198</b> (2006.01)				
	<b>A61K 31/454</b> (2006.01)				
	<b>A61P 25/16</b> (2006.01)			3359541	N-SULFONYLATED PYRAZOLO[3,4-B]PYRIDIN-6-CARBOXAMIDES AND METHOD OF USE
	<b>A61K 31/437</b> (2006.01)				
	<b>A61P 11/12</b> (2006.01)				
	<b>C07D 471/04</b> (2006.01)				
<b>C07D 519/00</b> (2006.01)					
<b>A61K 47/64</b> (2017.01)	3362100	HINDERED DISULFIDE DRUG CONJUGATES			
<b>A61K 47/68</b> (2017.01)	3362455	PROCESSES FOR THE PREPARATION OF (3S,4R)-3-ETHYL-4-(3H-IMIDAZO[1,2-a]PYRROLO[2,3-e]-PYRAZIN-8-YL)-N-(2,2,2-TRIFLUOROETHYL)PYRROLIDINE-1-CARBOXAMIDE AND SOLID STATE FORMS THEREOF			
<b>A61P 35/00</b> (2006.01)					
<b>C07D 487/14</b> (2006.01)					

Podnosilac evropske prijave patenta (71)	MKP (51)	Broj objave evropske prijave patenta (97)	Naziv pronalaska (54)
Cancer Research Technology Limited The Francis Crick Institute Limited	<b>C12N 5/0783</b> (2010.01)	3368658	EXPANSION OF NON-HAEMATOPOIETIC TISSUE-RESIDENT GAMMA DELTA T CELLS AND USES OF THESE CELLS
Topgan SP. Z O.O. Instytut Wysokich Cisnien Polskiej Akademii Nauk	<b>H01L 33/00</b> (2010.01) <b>H01L 33/16</b> (2010.01) <b>G06F 19/00</b> (2018.01) <b>A61K 31/444</b> (2006.01) <b>A61K 31/4545</b> (2006.01) <b>A61P 35/00</b> (2006.01) <b>C07D 471/04</b> (2006.01) <b>A61K 31/4035</b> (2006.01) <b>A61P 35/00</b> (2006.01) <b>C07D 401/14</b> (2006.01) <b>C07D 403/14</b> (2006.01) <b>C07D 405/14</b> (2006.01) <b>C07D 409/14</b> (2006.01) <b>C07D 413/14</b> (2006.01) <b>C07D 417/14</b> (2006.01) <b>C07D 471/04</b> (2006.01) <b>C07D 471/08</b> (2006.01) <b>A61K 47/68</b> (2017.01) <b>A61P 35/00</b> (2006.01) <b>A61K 31/4427</b> (2006.01) <b>A61P 35/00</b> (2006.01) <b>A61P 37/00</b> (2006.01) <b>C07D 207/12</b> (2006.01) <b>C07D 213/71</b> (2006.01) <b>C07D 213/85</b> (2006.01) <b>C07D 401/12</b> (2006.01) <b>C07D 401/14</b> (2006.01) <b>C07D 403/12</b> (2006.01) <b>C07D 455/02</b> (2006.01)	3353820 3360066 3370722 3365334 3365025 3362443	ALINGAN-BASED SUPERLUMINESCENT DIODE SYSTEMS AND METHODS FOR PREDICTING VITREAL HALF-LIFE OF THERAPEUTIC AGENT-POLYMER CONJUGATES IMIDAZO[4,5-C]QUINOLIN-2-ONE COMPOUNDS AND THEIR USE IN TREATING CANCER BENZOLACTAM COMPOUNDS AS PROTEIN KINASE INHIBITORS CALICHEAMICIN-ANTIBODY-DRUG CONJUGATES AND METHODS OF USE COMPOUNDS USEFUL AS IMMUNOMODULATORS

Podnosilac evropske prijave patenta (71)	MKP (51)	Broj objave evropske prijave patenta (97)	Naziv pronalaska (54)
	<b>A61K 9/127</b> (2006.01)	3362049	STABILIZING CAMPTOTHECIN PHARMACEUTICAL COMPOSITIONS
	<b>A61K 31/4745</b> (2006.01)		
Dode S.A.	<b>A23L 7/161</b> (2016.01)	3351120	IMPROVEMENTS TO PATENT P201231330 "METHOD FOR THE TREATMENT OF CORN KERNELS INTENDED FOR THE PRODUCTION OF POPCORN USING MICROWAVE APPLIANCES, AND RESULTING PRODUCT"
	<b>A23P 20/10</b> (2016.01)		
Gold&Green Foods Oy	<b>A23J 3/14</b> (2006.01)	3361880	A METHOD OF MANUFACTURING A TEXTURED FOOD PRODUCT AND A TEXTURED FOOD PRODUCT
	<b>A23L 7/117</b> (2016.01)		
	<b>A23L 7/17</b> (2016.01)		
	<b>A23L 33/185</b> (2016.01)		
	<b>A23L 33/21</b> (2016.01)		
CARINOPHARM GmbH	<b>A61K 9/00</b> (2006.01)	3370693	IMPROVED FORMULATIONS OF LEVOSIMENDAN FOR INTRAVENOUS ADMINISTRATION AS INFUSION OR INJECTION AND OF INFUSION CONCENTRATE
	<b>A61K 9/19</b> (2006.01)		
	<b>A61K 31/50</b> (2006.01)		
	<b>A61B 5/00</b> (2006.01)	3352650	VAGINAL RING SENSOR
	<b>A61B 5/01</b> (2006.01)		
	<b>A61B 5/021</b> (2006.01)		
	<b>A61B 5/024</b> (2006.01)		
	<b>A61B 5/07</b> (2006.01)		
	<b>A61B 5/145</b> (2006.01)		
	<b>A61B 5/1459</b> (2006.01)		
	<b>A61B 5/1486</b> (2006.01)		
	<b>A61B 5/16</b> (2006.01)		
	<b>A61K 9/00</b> (2006.01)		
	<b>C07K 14/715</b> (2006.01)	3359567	BIOMARKERS RELATED TO INTERLEUKIN-33 (IL-33)-MEDIATED DISEASES AND USES THEREOF
	<b>C07K 16/24</b> (2006.01)		
	<b>G01N 33/50</b> (2006.01)		
	<b>A61K 31/4188</b> (2006.01)	3362454	EP4 ANTAGONISTS
	<b>A61P 35/00</b> (2006.01)		
	<b>C07D 487/04</b> (2006.01)		
	<b>C07D 519/00</b> (2006.01)		
	<b>A61J 1/03</b> (2006.01)	3364934	MEDICATION PACKAGING AND DISPENSING SYSTEM
	<b>A61J 7/04</b>		

Podnosilac evropske prijave patenta (71)	MKP (51)	Broj objave evropske prijave patenta (97)	Naziv pronalaska (54)
Di Pompeo, Christophe Forest, Olivier	(2006.01) <b>B65D 75/32</b> (2006.01) <b>A61K 31/437</b> (2006.01) <b>A61P 35/00</b> (2006.01) <b>C07D 471/04</b> (2006.01) <b>C12C 5/00</b> (2006.01) <b>C12C 12/02</b> (2006.01) <b>A61K 31/52</b> (2006.01) <b>A61K 47/68</b> (2017.01) <b>A61P 35/00</b> (2006.01) <b>C07D 473/34</b> (2006.01) <b>A61P 31/14</b> (2006.01) <b>C07K 16/10</b> (2006.01) <b>C12N 5/09</b> (2010.01) <b>C12Q 1/02</b> (2006.01) <b>A01N 43/90</b> (2006.01) <b>A61K 31/519</b> (2006.01) <b>A61P 3/04</b> (2006.01) <b>A61P 3/06</b> (2006.01) <b>A61P 31/00</b> (2006.01) <b>C07D 495/04</b> (2006.01) <b>A61M 11/00</b> (2006.01) <b>A61M 15/00</b> (2006.01) <b>A61K 39/00</b> (2006.01) <b>C07K 16/24</b> (2006.01) <b>A61K 31/4985</b> (2006.01) <b>A61P 35/00</b> (2006.01) <b>C07D 403/04</b> (2006.01) <b>C07D 487/04</b> (2006.01) <b>A61K 9/19</b> (2006.01) <b>A61K 35/16</b> (2015.01) <b>C07K 14/755</b> (2006.01)	3371183	IMIDAZO[4,5-C]QUINOLIN-2-ONE COMPOUNDS AND THEIR USE IN TREATING CANCER
	3359636	METHOD FOR PRODUCING A BEER CONTAINING A REDUCED CARBOHYDRATE CONTENT AND ASSOCIATED BEER	
	3368092	ANTIBODY CONJUGATES COMPRISING TOLL-LIKE RECEPTOR AGONIST	
	3368562	ANTIBODY NEUTRALIZING HUMAN RESPIRATORY SYNCYTIAL VIRUS	
	3365436	METHODS OF PREPARING A PRIMARY CELL SAMPLE	
	3368540	ACC INHIBITORS AND USES THEREOF	
	3368110	ASEPTIC AEROSOL MISTING DEVICE	
	3371218	TREATMENT PARADIGM	
	3374359	DIHYDROIMIDAZOPYRAZINONE DERIVATIVES USEFUL IN THE TREATMENT OF CANCER	
	3373912	METHOD FOR THE PRODUCTION OF FREEZE-DRIED PELLETS COMPRISING FACTOR VIII	

Podnosilac evropske prijave patenta (71)	MKP (51)	Broj objave evropske prijave patenta (97)	Naziv pronalaska (54)
	<b>F26B 3/12</b> (2006.01)		
	<b>F26B 5/06</b> (2006.01)		
	<b>A61K 39/395</b> (2006.01)	3368903	PROGNOSTIC METHOD
	<b>G01N 33/574</b> (2006.01)		
	<b>A61K 38/20</b> (2006.01)	3359182	COMBINATION OF AN IL-2RBETA-SELECTIVE AGONIST AND A LONG-ACTING IL-15 AGONIST
	<b>A61P 35/00</b> (2006.01)		
	<b>A61M 11/00</b> (2006.01)	3368111	ASEPTIC AEROSOL MISTING DEVICE
	<b>A61M 15/00</b> (2006.01)		
	<b>A61M 11/00</b> (2006.01)	3368112	ASEPTIC AEROSOL MISTING DEVICE
	<b>B05B 17/06</b> (2006.01)		
	<b>A61M 11/00</b> (2006.01)	3368113	UNIT DOSE ASEPTIC AEROSOL MISTING DEVICE
	<b>A61M 15/00</b> (2006.01)		
	<b>E04B 1/86</b> (2006.01)	3394360	ACOUSTIC DRYWALL PANEL
	<b>E04C 2/04</b> (2006.01)		
	<b>E04F 13/08</b> (2006.01)		
	<b>A61P 25/18</b> (2006.01)	3371188	[1,2,4]TRIAZOLO[1,5-a]PYRIMIDIN-7-YL COMPOUND
	<b>C07D 487/04</b> (2006.01)		
Pedevilla, Patrick Airhelmet S.r.l.	<b>A42B 3/06</b> (2006.01)	3349607	A COMPOSITE GEOMETRY STRUCTURE FOR THE ABSORPTION AND DISSIPATION OF THE ENERGY GENERATED BY AN IMPACT AND A SAFETY HELMET COMPRISING SAID STRUCTURE.
	<b>F16F 7/12</b> (2006.01)		
Samp S.p.a. Con Unico Socio	<b>F16H 1/28</b> (2006.01)	3350477	PRECISION PLANETARY GEAR
	<b>A63H 15/06</b> (2006.01)	3365086	TOY PUPPET
Koninklijke Nederlandse Akademie van Wetenschappen Ocello B.V. Institute For Research In Biomedicine (IRB Barcelona) Institució Catalana de Recerca I Estudis Avançats Grabat Energy, S.L.	<b>C07K 16/28</b> (2006.01)	3365373	BINDING MOLECULES THAT INHIBIT CANCER GROWTH
	<b>C07K 16/30</b> (2006.01)		
	<b>C07K 16/40</b> (2006.01)		
	<b>H01M 4/133</b> (2010.01)	3375029	CARBON COMPOSITES
	<b>H01M 4/136</b> (2010.01)		
	<b>H01M 4/1393</b> (2010.01)		
	<b>H01M 4/1397</b> (2010.01)		
	<b>H01M 4/36</b>		

Podnosilac evropske prijave patenta (71)	MKP (51)	Broj objave evropske prijave patenta (97)	Naziv pronalaska (54)
	(2006.01) <b>H01M 4/38</b> (2006.01) <b>H01M 4/587</b> (2010.01) <b>H01M 4/62</b> (2006.01) <b>H01M 4/66</b> (2006.01) <b>H01M 10/052</b> (2010.01) <b>A61K 8/02</b> (2006.01) <b>A61K 8/19</b> (2006.01) <b>A61K 8/25</b> (2006.01) <b>A61Q 11/00</b> (2006.01) <b>B01D 53/56</b> (2006.01) <b>B01D 53/60</b> (2006.01) <b>B01D 53/64</b> (2006.01) <b>B01D 53/78</b> (2006.01) <b>F23J 15/04</b> (2006.01)		
	<b>A61K 8/02</b> (2006.01) <b>A61K 8/19</b> (2006.01) <b>A61K 8/25</b> (2006.01) <b>A61Q 11/00</b> (2006.01) <b>B01D 53/56</b> (2006.01) <b>B01D 53/60</b> (2006.01) <b>B01D 53/64</b> (2006.01) <b>B01D 53/78</b> (2006.01) <b>F23J 15/04</b> (2006.01)	3383353	ORAL CARE COMPOSITION FOR REMINERALISATION AND WHITENING OF TEETH
	<b>B01D 53/56</b> (2006.01) <b>B01D 53/60</b> (2006.01) <b>B01D 53/64</b> (2006.01) <b>B01D 53/78</b> (2006.01) <b>F23J 15/04</b> (2006.01)	3365094	SYSTEMS AND METHODS FOR REMOVING COMBUSTION PRODUCTS FROM A POWER GENERATION CYCLE
THE USA, AS REPRESENTED BY THE SECRETARY, DEPARTMENT OF HEALTH AND HUMAN SERVICES	<b>A61K 39/42</b> (2006.01) <b>C07K 16/10</b> (2006.01)	3365366	TRISPECIFIC AND/OR TRIVALENT BINDING PROTEINS FOR PREVENTION OR TREATMENT OF HIV INFECTION
	<b>A61K 31/4375</b> (2006.01) <b>A61P 25/00</b> (2006.01) <b>C07D 471/04</b> (2006.01) <b>C12Q 1/68</b> (2018.01)	3368534	VALBENAZINE SALTS AND POLYMORPHS THEREOF
	<b>A61K 31/4985</b> (2006.01) <b>A61P 35/00</b> (2006.01) <b>C07D 487/04</b> (2006.01)	3374519	DETECTION OF FOETAL CHROMOSOMAL ANEUPLOIDIES USING DNA REGIONS THAT ARE DIFFERENTIALLY METHYLATED BETWEEN THE FOETUS AND THE PREGNANT FEMALE
	<b>A61K 31/164</b> (2006.01) <b>A61K 31/337</b> (2006.01) <b>A61K 31/495</b> (2006.01) <b>A61K 31/505</b> (2006.01)	3371189	IMIDAZOPYRAZINE INHIBITORS OF BRUTON'S TYROSINE KINASE
	<b>A61K 31/164</b> (2006.01) <b>A61K 31/337</b> (2006.01) <b>A61K 31/495</b> (2006.01) <b>A61K 31/505</b> (2006.01)	3368026	HDAC INHIBITORS FOR THE TREATMENT OF DIABETIC PERIPHERAL NEUROPATHY

Podnosilac evropske prijave patenta (71)	MKP (51)	Broj objave evropske prijave patenta (97)	Naziv pronalaska (54)
	<b>A61P 25/02</b> (2006.01)		
	<b>A61K 38/17</b> (2006.01)	3371208	CD80 EXTRACELLULAR DOMAIN POLYPEPTIDES AND THEIR USE IN CANCER TREATMENT
	<b>C07K 14/705</b> (2006.01)		
Janssen Pharmaceutica NV	<b>A61K 39/395</b> (2006.01)	3371220	ANTI-IL1RAP ANTIBODIES, BISPECIFIC ANTIGEN BINDING MOLECULES THAT BIND IL1RAP AND CD3, AND USES THEREOF
	<b>C07K 16/28</b> (2006.01)		
	<b>C08J 5/18</b> (2006.01)	3383939	SURFACE-TREATED FILLERS FOR ULTRATHIN BREATHABLE FILMS
	<b>C08K 3/26</b> (2006.01)		
	<b>C08K 9/02</b> (2006.01)		
	<b>C09C 1/02</b> (2006.01)		
Iproteos S.L	<b>A61K 38/06</b> (2006.01)	3377515	GELATINASE INHIBITORS AND USE THEREOF
	<b>C07K 5/097</b> (2006.01)		
Berkes, Mihály	<b>B65D 19/34</b> (2006.01)	3344555	PALLET MADE OF CORRUGATED PAPERBOARD
	<b>C12N 9/12</b> (2006.01)	3362555	MODIFICATION OF RNA-RELATED ENZYMES FOR ENHANCED PRODUCTION
	<b>C12N 15/62</b> (2006.01)		
	<b>B41M 3/14</b> (2006.01)	3380331	PRINTED WATERMARK
	<b>B41M 7/00</b> (2006.01)		
	<b>D21H 21/30</b> (2006.01)		
	<b>D21H 21/48</b> (2006.01)		
	<b>A61K 39/00</b> (2006.01)	3377528	BINDING AGONISTS FOR TREATMENT OF NEUROLOGICAL AND OTHER DISORDERS
	<b>A61K 39/395</b> (2006.01)		
	<b>A61P 25/00</b> (2006.01)		
	<b>C07K 16/28</b> (2006.01)		
	<b>G01N 33/50</b> (2006.01)	3371593	CELL-BASED ASSAYS FOR DETECTION OF ANTIBODIES OR OTHER FACTORS THAT NEUTRALIZE UPTAKE OF LYSOSOMAL ENZYMES
	<b>G01N 33/573</b> (2006.01)		
	<b>A61K 31/7072</b> (2006.01)	3253773	SUBSTITUTED NUCLEOSIDES, NUCLEOTIDES AND ANALOGS THEREOF
	<b>A61K 31/7076</b> (2006.01)		
	<b>A61K 31/708</b> (2006.01)		
	<b>A61P 31/14</b> (2006.01)		
	<b>C07H 19/067</b> (2006.01)		
	<b>C07H</b>		



Podnosilac evropske prijave patenta (71)	MKP (51)	Broj objave evropske prijave patenta (97)	Naziv pronalaska (54)
	<b>19/073</b> (2006.01)		
	<b>C07H 19/10</b> (2006.01)		
	<b>C07H 19/11</b> (2006.01)		
	<b>C07H</b> <b>19/173</b> (2006.01)		
	<b>C07H 19/20</b> (2006.01)		
	<b>C07H</b> <b>19/213</b> (2006.01)		
	<b>A01C 15/04</b>	3247190	METERING SYSTEM FOR SOLID PARTICULATE
	(2006.01)		
	<b>B65G 53/16</b> (2006.01)		
	<b>B65G 53/52</b> (2006.01)		
	<b>G01F 11/00</b> (2006.01)		
Montag Investments, LLC	<b>A01C 7/08</b>	3247191	SINGLE PARTICULATE METERING SYSTEM WITH VARIABLE RATE CONTROLS
	(2006.01)		
	<b>A01C 7/10</b> (2006.01)		
	<b>A01C 7/16</b> (2006.01)		
	<b>A01C 15/00</b> (2006.01)		
	<b>A01C 15/04</b> (2006.01)		
	<b>A01C 15/16</b> (2006.01)		
	<b>A01C 19/02</b> (2006.01)		
	<b>G01F 13/00</b> (2006.01)		
	<b>G05D 7/06</b> (2006.01)		
	<b>G05D 11/12</b> (2006.01)		
	<b>G05D 11/13</b> (2006.01)		
Taiho Pharmaceutical Co., Ltd.	<b>A61K</b>	3381916	CONDENSED PYRIMIDINE COMPOUND OR SALT THEREOF
	<b>31/519</b> (2006.01)		
	<b>A61K 31/55</b> (2006.01)		
	<b>A61P 35/00</b> (2006.01)		
	<b>A61P 43/00</b> (2006.01)		
	<b>C07D 471/04</b> (2006.01)		
	<b>C07D 519/00</b> (2006.01)		
	<b>A61K 31/40</b>	3381896	NOVEL BIPHENYL COMPOUND OR SALT THEREOF
	(2006.01)		
	<b>A61K</b> <b>31/404</b> (2006.01)		
	<b>A61K</b> <b>31/407</b> (2006.01)		
	<b>A61K</b> <b>31/416</b>		

Podnosilac evropske prijave patenta (71)	MKP (51)	Broj objave evropske prijave patenta (97)	Naziv pronalaska (54)		
Clean Air Essentials 797 Inc.	(2006.01) <b>A61K 31/4184</b>	3383602	ISOLATOR SLEEVE SYSTEMS		
	(2006.01) <b>C07D 207/04</b>				
	(2006.01) <b>A41D 19/015</b>				
	(2006.01) <b>A61B 42/10</b>				
	(2016.01) <b>A61B 42/50</b>				
	(2016.01) <b>A61J 3/00</b>				
	(2006.01) <b>B25J 21/02</b>				
	(2006.01) <b>G21F 7/053</b>				
	(2006.01) <b>B60P 1/36</b>			3383774	EQUIPMENT FOR MOVING A PALLET
	(2006.01) <b>B65G 17/06</b>				
	(2006.01) <b>B65G 17/12</b>				
(2006.01) <b>B65G 17/26</b>					
(2006.01) <b>B65G 67/20</b>					
(2006.01) <b>B65G 67/24</b>					
(2006.01) <b>B65G 67/46</b>					
(2006.01) <b>B66F 9/06</b>					
STCUBE, INC.	(2006.01) <b>A61K 35/13</b>	3383412	ANTIBODIES SPECIFIC TO GLYCOSYLATED PD-1 AND METHODS OF USE THEREOF		
	(2015.01) <b>A61K 39/395</b>				
	(2006.01) <b>A61K 49/16</b>				
	(2006.01) <b>C07K 16/18</b>				
	(2006.01) <b>C07K 16/28</b>				
	(2006.01) <b>C12P 21/08</b>				
	(2006.01) <b>A61K 31/55</b>			3383917	NOVEL ANTI-CLAUDIN ANTIBODIES AND METHODS OF USE
	(2006.01) <b>A61K 45/06</b>				
	(2006.01) <b>A61P 35/02</b>				
	(2006.01) <b>C07D 519/00</b>				
	(2006.01) <b>C07K 16/30</b>			3383430	ANTIBODIES AND METHODS OF USE THEREOF
(2006.01) <b>A61K 39/395</b>					
(2006.01) <b>A61K 47/68</b>					
(2017.01) <b>C07K 16/28</b>					
(2006.01) <b>C07K 16/30</b>					

Podnosilac evropske prijave patenta (71)	MKP (51)	Broj objave evropske prijave patenta (97)	Naziv pronalaska (54)
	<b>A61K 39/395</b> (2006.01)	3383431	ANTI-GITR ANTIBODIES AND METHODS OF USE THEREOF
	<b>C07K 16/28</b> (2006.01)		
	<b>C07K 16/30</b> (2006.01)		
North Carolina State University	<b>A01H 1/00</b> (2006.01)	3383170	TARGETED MUTAGENESIS OF TOBACCO BERBERINE BRIDGE ENZYME-LIKE NUCLEIC ACIDS
	<b>A01H 5/10</b> (2018.01)		
	<b>A24D 1/00</b> (2006.01)		
	<b>C12N 15/63</b> (2006.01)		
	<b>A61K 39/395</b> (2006.01)	3383914	ANTI-OX40 ANTIBODIES AND METHODS OF USE THEREOF
	<b>C07K 16/28</b> (2006.01)		
	<b>G01N 33/68</b> (2006.01)		
	<b>A61B 17/29</b> (2006.01)	3393380	ULTRASONIC SURGICAL INSTRUMENT WITH BLADE REPLACEMENT FEATURES
	<b>A61B 17/32</b> (2006.01)		
Injekta Environmental Pty Ltd	<b>G01N 27/26</b> (2006.01)	3387425	SOIL ANALYSIS METHOD
	<b>G01N 33/24</b> (2006.01)		
Fominaya, S.A.	<b>E03D 1/24</b> (2006.01)	3388587	DEVICE FOR REGULATING THE HEIGHT OF A CISTERN FLUSHING MECHANISM
Arcactive Limited	<b>B29C 70/72</b> (2006.01)	3387690	LEAD-ACID BATTERY ELECTRODE MANUFACTURE
	<b>H01M 4/04</b> (2006.01)		
	<b>H01M 4/20</b> (2006.01)		
	<b>H01M 4/22</b> (2006.01)		
	<b>H01M 4/68</b> (2006.01)		
	<b>A61K 31/421</b> (2006.01)	3388425	AMINOAZOLE DERIVATIVE
	<b>A61K 31/422</b> (2006.01)		
	<b>A61K 31/4245</b> (2006.01)		
	<b>A61K 31/426</b> (2006.01)		
	<b>A61K 31/427</b> (2006.01)		
	<b>A61K 31/428</b> (2006.01)		
	<b>A61K 31/433</b> (2006.01)		
	<b>A61K 31/4439</b> (2006.01)		
	<b>A61K</b>		

Podnosilac evropske prijave patenta (71)	MKP (51)	Broj objave evropske prijave patenta (97)	Naziv pronalaska (54)
	<b>31/454</b> (2006.01) <b>A61K</b> <b>31/4709</b> (2006.01) <b>A61K</b> <b>31/4725</b> (2006.01) <b>A61K</b> <b>31/497</b> (2006.01) <b>A61K</b> <b>31/498</b> (2006.01) <b>A61K</b> <b>31/501</b> (2006.01) <b>A61K</b> <b>31/5377</b> (2006.01) <b>A61P 21/00</b> (2006.01) <b>A61P 21/04</b> (2006.01) <b>A61P 43/00</b> (2006.01) <b>C07C 335/12</b> (2006.01) <b>C07D 263/48</b> (2006.01)		
Dow Corning Toray Co., Ltd. Ricoh Company, Ltd.	<b>C10M</b> <b>103/00</b> (2006.01) <b>C10M</b> <b>103/02</b> (2006.01) <b>C10M</b> <b>103/06</b> (2006.01) <b>C10M</b> <b>107/04</b> (2006.01) <b>C10M</b> <b>107/06</b> (2006.01) <b>C10M</b> <b>107/38</b> (2006.01) <b>C10M</b> <b>107/44</b> (2006.01) <b>C10M</b> <b>107/50</b> (2006.01) <b>C10M</b> <b>171/00</b> (2006.01) <b>C10N 50/08</b> (2006.01)	3388501	SLIDING MEMBER EXCLUDING THOSE USED FOR IMAGE FORMATION DEVICE, COMPONENT, AND METHOD FOR REDUCING NOISE IN MACHINE DEVICE
	<b>A61K 9/127</b> (2006.01) <b>A61K 9/133</b> (2006.01) <b>A61K</b> <b>31/7088</b> (2006.01)	3386484	COMPOSITIONS AND METHODS FOR DELIVERY OF THERAPEUTIC AGENTS

Podnosilac evropske prijave patenta (71)	MKP (51)	Broj objave evropske prijave patenta (97)	Naziv pronalaska (54)
Definiens AG	<b>C12N 15/88</b> (2006.01)	3387155	METHODS FOR TREATMENT AND SELECTION OF PATIENTS RESPONSIVE TO IMMUNE MEDIATED CANCER THERAPY
	<b>C12Q 1/68</b> (2018.01)		
Universal Research Solutions LLC	<b>G01N</b> <b>33/574</b> (2006.01)	3387561	DATABASE MANAGEMENT FOR A LOGICAL REGISTRY
	<b>G06F 15/16</b> (2006.01)		
3-D Matrix Ltd.	<b>G06F 17/30</b> (2006.01)	3391897	HEMOSTATIC COMPOSITION AND HEMOSTATIC METHOD USING HEMOSTATIC COMPOSITION
	<b>A61K 9/12</b> (2006.01)		
	<b>A61K 38/00</b> (2006.01)		
	<b>A61L 26/00</b> (2006.01)		
	<b>A61P 7/04</b> (2006.01)		
	<b>A61P 17/02</b> (2006.01)		
	<b>A61P 43/00</b> (2006.01)		
	<b>C07K 7/00</b> (2006.01)		
	<b>A01N 43/50</b> (2006.01)	3395801	ARYLAZOLE COMPOUND AND PEST CONTROL AGENT
	<b>A01N 43/56</b> (2006.01)		
	<b>A01N</b> <b>43/647</b> (2006.01)		
	<b>A01N</b> <b>43/653</b> (2006.01)		
	<b>A01N 55/00</b> (2006.01)		
	<b>A01P 7/02</b> (2006.01)		
	<b>A01P 7/04</b> (2006.01)		
	<b>A61K</b> <b>31/415</b> (2006.01)		
	<b>A61K</b> <b>31/4164</b> (2006.01)		
	<b>A61K</b> <b>31/4178</b> (2006.01)		
	<b>A61K</b> <b>31/4192</b> (2006.01)		
	<b>A61K</b> <b>31/4196</b> (2006.01)		
	<b>A61K</b> <b>31/4439</b> (2006.01)		
	<b>A61K</b> <b>31/695</b> (2006.01)		
	<b>A61P 33/10</b> (2006.01)		
	<b>A61P 33/14</b> (2006.01)		
	<b>C07D 231/12</b>		

Podnosilac evropske prijave patenta (71)	MKP (51)	Broj objave evropske prijave patenta (97)	Naziv pronalaska (54)
Mitsui Chemicals Agro, Inc.	(2006.01) <b>C07D 231/14</b> (2006.01) <b>C07D 231/38</b> (2006.01) <b>C07D 233/64</b> (2006.01) <b>C07D 233/68</b> (2006.01) <b>C07C 231/10</b> (2006.01) <b>C07C 237/42</b> (2006.01) <b>A61K 39/395</b> (2006.01) <b>C07K 16/28</b> (2006.01) <b>C07K 16/30</b> (2006.01) <b>C07K 16/46</b> (2006.01) <b>A61K 31/397</b> (2006.01) <b>A61P 31/04</b> (2006.01) <b>C07D 205/08</b> (2006.01) <b>A61K 38/00</b> (2006.01) <b>A61K 39/00</b> (2006.01) <b>A61K 39/395</b> (2006.01) <b>C07K 16/28</b> (2006.01) <b>C12P 21/08</b> (2006.01) <b>A61K 47/50</b> (2017.01) <b>A61P 21/00</b> (2006.01) <b>A61P 31/16</b> (2006.01) <b>A61K 31/4433</b> (2006.01) <b>A61K 31/497</b> (2006.01) <b>A61P 1/10</b> (2006.01) <b>C07D 405/04</b> (2006.01) <b>A61K 39/00</b> (2006.01) <b>A61K 39/395</b> (2006.01) <b>C07K 16/00</b> (2006.01) <b>C12P 21/08</b> (2006.01)	3392236	METHOD FOR PRODUCING AROMATIC AMIDE DERIVATIVE
	3389714	BISPECIFIC MOLECULES HAVING IMMUNOREACTIVITY WITH PD-1 AND CTLA-4, AND METHODS OF USE THEREOF	
	3390357	BIARYL MONOBACTAM COMPOUNDS AND METHODS OF USE THEREOF FOR THE TREATMENT OF BACTERIAL INFECTIONS	
	3399989	ANTI-LAG3 ANTIBODIES AND ANTIGEN-BINDING FRAGMENTS	
	3389719	PEPTIDE OLIGONUCLEOTIDE CONJUGATES	
	3389657	METHODS OF TREATING HYPERALGESIA	
	Trevena, Inc.		
	Oncoimmune, Inc.		

Podnosilac evropske prijave patenta (71)	MKP (51)	Broj objave evropske prijave patenta (97)	Naziv pronalaska (54)
	<b>A61K 31/425</b> (2006.01) <b>A61P 43/00</b> (2006.01) <b>C07C 311/15</b> (2006.01)	3389654	DIAMINO-ALKYLAMINO-LINKED ARYLSULFONAMIDE COMPOUNDS WITH SELECTIVE ACTIVITY IN VOLTAGE-GATED SODIUM CHANNELS
University of Miami	<b>A61P 9/10</b> (2006.01) <b>A61P 37/06</b> (2006.01) <b>C12N 5/071</b> (2010.01)	3389781	INHIBITORS OF TNF SUPERFAMILY COSTIMULATORY INTERACTIONS AND METHODS FOR USES OF THE SAME
	<b>A61K 31/165</b> (2006.01) <b>A61K 31/439</b> (2006.01) <b>A61K 31/444</b> (2006.01)	3389656	COMBINATIONS OF OPIOID RECEPTOR LIGANDS AND CYTOCHROME P450 INHIBITORS
Gritstone Oncology, Inc.	<b>A61K 9/10</b> (2006.01) <b>A61K 35/15</b> (2015.01) <b>A61K 39/00</b> (2006.01) <b>A61K 39/39</b> (2006.01) <b>A61K 39/395</b> (2006.01) <b>A61P 35/00</b> (2006.01)	3389630	NEOANTIGEN IDENTIFICATION, MANUFACTURE, AND USE
	<b>A61K 31/70</b> (2006.01) <b>A61K 31/7036</b> (2006.01) <b>A61K 39/00</b> (2006.01) <b>A61K 39/02</b> (2006.01)	3389705	LISTERIA-BASED IMMUNOTHERAPY AND METHODS OF USE THEREOF
	<b>A61K 31/282</b> (2006.01) <b>A61K 31/555</b> (2006.01) <b>A61K 47/50</b> (2017.01) <b>A61P 35/00</b> (2006.01) <b>C08G 65/334</b> (2006.01) <b>C08G 69/08</b> (2006.01) <b>C08G 69/48</b> (2006.01) <b>C08G 81/00</b> (2006.01)	3395857	POLYMER CONJUGATE OF SULFOXIDE DERIVATIVE-COORDINATED PLATINUM(II) COMPLEX
	<b>A23L 29/206</b> (2016.01) <b>A23L</b>	3395187	GEL-LIKE FOOD COMPOSITION

Podnosilac evropske prijave patenta (71)	MKP (51)	Broj objave evropske prijave patenta (97)	Naziv pronalaska (54)
	<b>33/135</b> (2016.01) <b>A23L</b> <b>33/175</b> (2016.01) <b>A61K</b> <b>31/167</b> (2006.01) <b>A61K</b> <b>31/282</b> (2006.01) <b>A61K</b> <b>31/337</b> (2006.01) <b>A61K</b> <b>31/357</b> (2006.01) <b>A61K</b> <b>31/4045</b> (2006.01) <b>A61K</b> <b>31/4164</b> (2006.01) <b>A61K</b> <b>31/436</b> (2006.01) <b>A61K 31/44</b> (2006.01) <b>A61K</b> <b>31/454</b> (2006.01) <b>A61K</b> <b>31/4545</b> (2006.01) <b>A61K 31/47</b> (2006.01) <b>A61K</b> <b>31/4709</b> (2006.01) <b>A61K</b> <b>31/473</b> (2006.01) <b>A61K</b> <b>31/4747</b> (2006.01) <b>A61K</b> <b>31/497</b> (2006.01) <b>A61K</b> <b>31/502</b> (2006.01) <b>A61K</b> <b>31/5025</b> (2006.01) <b>A61K</b> <b>31/513</b> (2006.01) <b>A61K</b> <b>31/519</b> (2006.01) <b>A61K 31/52</b> (2006.01)	3395345	ANTITUMOR EFFECT POTENTIATOR COMPRISING PYRROLOPYRIMIDINE COMPOUND
Zogenix International Limited	<b>B01J 23/72</b> (2006.01) <b>B01J</b> <b>27/055</b> (2006.01)	3393655	FENFLURAMINE COMPOSITIONS AND METHODS OF PREPARING THE SAME



Podnosilac evropske prijave patenta (71)	MKP (51)	Broj objave evropske prijave patenta (97)	Naziv pronalaska (54)
	<b>B01J 27/122</b> (2006.01)		
	<b>B01J 27/25</b> (2006.01)		
	<b>C07C 45/54</b> (2006.01)		
	<b>C07C 49/223</b> (2006.01)		
	<b>A61K 31/551</b> (2006.01)	3394106	NOVEL ANTI-MMP16 ANTIBODIES AND METHODS OF USE
	<b>A61K 47/68</b> (2017.01)		
	<b>C07K 16/40</b> (2006.01)		
	<b>A61K 31/551</b> (2006.01)	3394107	NOVEL ANTI-TNFSF9 ANTIBODIES AND METHODS OF USE
	<b>A61K 47/68</b> (2017.01)		
	<b>C07K 16/40</b> (2006.01)		
	<b>A61K 39/395</b> (2006.01)	3393516	NOVEL ANTI-UPK1B ANTIBODIES AND METHODS OF USE
	<b>A61P 35/00</b> (2006.01)		
Dana Farber Cancer Institute, Inc.	<b>A61K 31/00</b> (2006.01)	3393458	METHODS OF USE OF A CLASS IIA HDAC INHIBITOR
	<b>A61K 31/33</b> (2006.01)		
	<b>A61K 31/395</b> (2006.01)		
	<b>A61K 31/495</b> (2006.01)		
	<b>A61K 31/505</b> (2006.01)		
Androvia Life Sciences LLC	<b>G01N 1/00</b> (2006.01)	3394589	A METHOD TO IDENTIFY AN APPROACH FOR ACHIEVING MAMMALIAN FERTILIZATION AND TIME PERIOD FOR INSEMINATION
Nicca Chemical Co., Ltd.	<b>C08G 18/00</b> (2006.01)	3398980	AQUEOUS-DISPERSION TYPE POLYCARBONATE-BASED POLYURETHANE RESIN COMPOSITION, TEXTILE PRODUCT TREATED WITH SAME, AND PROCESS FOR PRODUCING AQUEOUS-DISPERSION TYPE POLYCARBONATE-BASED POLYURETHANE RESIN COMPOSITION
	<b>C08G 18/10</b> (2006.01)		
	<b>C08G 18/44</b> (2006.01)		
	<b>C08G 18/48</b> (2006.01)		
	<b>C08G 18/65</b> (2006.01)		
	<b>C08L 75/04</b> (2006.01)		
	<b>D06M 15/564</b> (2006.01)		
	<b>A61K 31/131</b> (2006.01)	3394047	DEUTERATED COMPOUNDS FOR TREATING CANCER AND RELATED DISEASES AND CONDITIONS, AND COMPOSITIONS AND METHODS THEREOF
	<b>A61K 31/282</b> (2006.01)		
	<b>A61K</b>		

Podnosilac evropske prijave patenta (71)	MKP (51)	Broj objave evropske prijave patenta (97)	Naziv pronalaska (54)
	<b>31/337</b> (2006.01) <b>A61K</b>		
	<b>31/409</b> (2006.01) <b>A61K</b>		
	<b>31/506</b> (2006.01) <b>A61K</b>		
	<b>31/517</b> (2006.01) <b>A61K</b>		
	<b>31/519</b> (2006.01) <b>A61K</b>		
	<b>31/5377</b> (2006.01) <b>A61K</b>		
	<b>31/7068</b> (2006.01) <b>A61K</b>		
	<b>39/395</b> (2006.01) <b>A61P 35/00</b> (2006.01) <b>C07B 59/00</b> (2006.01) <b>C07D 403/04</b> (2006.01) <b>A61K</b>	3397282	METHODS RELATED TO BIOLOGICS
	<b>39/395</b> (2006.01) <b>C12P 21/00</b> (2006.01) <b>G01N 33/68</b> (2006.01) <b>A61K</b>	3397625	TREATMENT OF TUMORS INCORPORATING MUTANT ISOCITRATE DEHYDROGENASE
	<b>31/496</b> (2006.01) <b>A61K</b>		
	<b>31/551</b> (2006.01) <b>C07D 333/38</b> (2006.01) <b>B41J 2/045</b> (2006.01)	3400137	MULTIPLEXED MULTILEVEL CONVERTER AMPLIFIER
Apex Microtechnology, Inc. Taizhou Forever Biotechnology Co., Ltd.	<b>A61K</b> <b>31/352</b> (2006.01) <b>A61K 36/41</b> (2006.01) <b>C07D 311/30</b> (2006.01)	3418274	METHOD FOR EXTRACTING HERBACETIN FROM RHODIOLA ROSEA
	<b>C12N 5/00</b> (2006.01) <b>C12N 5/09</b> (2010.01) <b>C12N 5/095</b> (2010.01) <b>G01N</b>	3406714	METHOD FOR DETECTING OR SEPARATING/OBTAINING CIRCULATING TUMOR CELL EMPLOYING CELL PROLIFERATION METHOD
	<b>33/574</b> (2006.01) <b>B41J 2/175</b> (2006.01) <b>E01F 15/00</b> (2006.01)	3415326 3366841	INK BOX CHIP, INK BOX AND OPERATION METHOD FOR RESPONDING TO PRINTING WORK DAMPING DEVICE
Umezu, Yasuiki			
Hangzhou Chipjet Technology Co., Ltd. Makarov, Georgy Vladimirovich			

Podnosilac evropske prijave patenta (71)	MKP (51)	Broj objave evropske prijave patenta (97)	Naziv pronalaska (54)
Sav, Monica Olimpia	<b>E01F 15/14</b> (2006.01) <b>A41D 19/00</b> (2006.01) <b>A45D 33/00</b> (2006.01) <b>A45D 34/04</b> (2006.01) <b>A45D 44/00</b> (2006.01) <b>A47K 7/02</b> (2006.01)	3372107	COSMETIC GLOVE
Lincoln Global, Inc.	<b>G01S 7/481</b> (2006.01) <b>G02B 27/00</b> (2006.01) <b>G03B 11/04</b> (2006.01) <b>G03B 15/04</b> (2006.01) <b>G03B 17/02</b> (2006.01) <b>B65C 9/18</b> (2006.01)	3258314	ENCLOSURE DEVICE
Herchenbach Industrie-Zeltebau GmbH	<b>B32B 5/26</b> (2006.01) <b>B32B 27/12</b> (2006.01) <b>D04H 1/4218</b> (2012.01) <b>E04H 15/54</b> (2006.01)	3381823 3269901	DEVICE FOR FORMING AND TRANSFERRING DECORATIVE BANNERS FOR THERMOFORMING PACKAGING MACHINES IMPROVED INDUSTRIAL TENT AND PLANNING COMPOSITE
F. Leskovec, d.o.o.	<b>B23B 49/00</b> (2006.01) <b>B23B 51/04</b> (2006.01) <b>E04B 1/76</b> (2006.01)	3299529	A CUTTER AND METHOD FOR MAKING DENTS AND FIXING INSULATION
Bio-Oils Huelva, S.L. Universidad De Malaga	<b>C11C 3/00</b> (2006.01)	3299444	HIGH EFFICIENCY METHOD AND CATALYST FOR THE PRODUCTION OF ALKYL ESTERS FROM FATTY ACIDS WITH ACID CATALYSIS
KATHREIN Sachsen GmbH	<b>H01Q 1/22</b> (2006.01) <b>H01Q 1/52</b> (2006.01) <b>H01Q 3/30</b> (2006.01) <b>H01Q 5/35</b> (2015.01) <b>H01Q 9/04</b> (2006.01) <b>H01Q 21/28</b> (2006.01)	3331094	ANTENNA ASSEMBLY
Pomoziné Gyarmathy, Ágnes	<b>A61M 16/00</b> (2006.01) <b>A61M 16/12</b> (2006.01) <b>A61K 39/00</b> (2006.01) <b>A61K 39/395</b> (2006.01) <b>C07K 16/18</b> (2006.01) <b>C07K 16/24</b> (2006.01)	3258999 3368066	DEVICE FOR ADJUSTMENT AND/OR CONDITIONING OF THE CO2 CONTENT OF THE INHALED AIR ANTI-CGRP/ANTI-IL-23 BISPECIFIC ANTIBODIES AND USES THEREOF

Podnosilac evropske prijave patenta (71)	MKP (51)	Broj objave evropske prijave patenta (97)	Naziv pronalaska (54)
Valimail Inc.	<b>C07K 16/26</b> (2006.01)	3257192	SECURE AND DELEGATED DISTRIBUTION OF PRIVATE KEYS VIA DOMAIN NAME SERVICE
	<b>H04L 9/08</b> (2006.01)		
	<b>H04L 9/32</b> (2006.01)		
	<b>H04L 29/06</b> (2006.01)	3256481	NOVEL CRYSTALLINE FORM OF A PROTEASOME INHIBITOR
	<b>H04L 29/12</b> (2006.01)		
	<b>C07F 5/05</b> (2006.01)		
	<b>C12N 7/00</b> (2006.01)	3256571	METHODS FOR PRODUCING VIRUS FOR VACCINE PRODUCTION
	<b>C07C 51/09</b> (2006.01)	3257009	SYSTEMS AND PROCESSES FOR POLYMER PRODUCTION
	<b>C08F 122/02</b> (2006.01)	3256442	SYSTEMS AND PROCESSES FOR POLYACRYLIC ACID PRODUCTION
	<b>G06Q 30/02</b> (2012.01)		
	<b>C07C 51/12</b> (2006.01)		
	<b>C07C 51/14</b> (2006.01)		
	<b>C07C 51/145</b> (2006.01)		
	<b>C07C 51/16</b> (2006.01)		
	<b>C07C 51/377</b> (2006.01)		
	<b>C07C 57/04</b> (2006.01)		
	<b>C07C 59/01</b> (2006.01)		
	<b>C08F 2/01</b> (2006.01)		
	<b>C08F 2/18</b> (2006.01)		
	<b>C08F 20/00</b> (2006.01)		
	<b>C08F 20/06</b> (2006.01)		
	<b>C07C 29/147</b> (2006.01)		
	<b>C07C 51/09</b> (2006.01)	3256439	PROCESS FOR PRODUCTION OF ACRYLIC ACID
	<b>C07C 57/04</b> (2006.01)		
	<b>C07C 67/00</b> (2006.01)		
	<b>C07C 67/03</b> (2006.01)		
	<b>C07C 69/54</b> (2006.01)		
	<b>C07D 301/02</b> (2006.01)		
	<b>C07D 305/12</b> (2006.01)		
	<b>C07D 307/60</b> (2006.01)		
	<b>C08G 63/78</b> (2006.01)		
	<b>C07C 51/09</b> (2006.01)		

Podnosilac evropske prijave patenta (71)	MKP (51)	Broj objave evropske prijave patenta (97)	Naziv pronalaska (54)
	<b>C07C 57/04</b> (2006.01)		
	<b>B01J 19/24</b> (2006.01)	3256440	DISTILLATION PROCESS FOR PRODUCTION OF ACRYLIC ACID
	<b>C07C 51/09</b> (2006.01)		
	<b>C07C 57/04</b> (2006.01)		
	<b>C08G 63/08</b> (2006.01)		
	<b>C08G 63/82</b> (2006.01)		
	<b>C07D 305/12</b> (2006.01)	3256454	INTEGRATED METHODS FOR CHEMICAL SYNTHESIS
	<b>C07D 307/60</b> (2006.01)		
	<b>A61B 3/117</b> (2006.01)	3256084	DEVICE, SYSTEM, AND METHOD FOR FUNCTIONAL IMAGING OF EPISCLERAL VESSELS
	<b>A61B 3/14</b> (2006.01)		
	<b>A61F 9/00</b> (2006.01)		
	<b>A61F 9/007</b> (2006.01)		
	<b>A61K 31/4155</b> (2006.01)	3347349	FLUOROINDOLE DERIVATIVES AS MUSCARINIC M1 RECEPTOR POSITIVE ALLOSTERIC MODULATORS
	<b>A61K 31/416</b> (2006.01)		
	<b>A61K 31/427</b> (2006.01)		
	<b>A61K 31/428</b> (2006.01)		
	<b>A61K 31/4439</b> (2006.01)		
	<b>A61K 31/4545</b> (2006.01)		
	<b>A61P 25/00</b> (2006.01)		
	<b>C07D 401/06</b> (2006.01)		
	<b>C07D 401/12</b> (2006.01)		
	<b>C07D 401/14</b> (2006.01)		
	<b>C07D 403/06</b> (2006.01)		
	<b>C07D 403/14</b> (2006.01)		
	<b>C07D 417/06</b> (2006.01)		
	<b>C07D 417/14</b> (2006.01)		
Akrapovic d.d.	<b>F01N 1/16</b> (2006.01)	3347579	EXHAUST SYSTEM FOR AN INTERNAL COMBUSTION AUTOMOTIVE ENGINE
	<b>F01N 3/00</b> (2006.01)		
	<b>F01N 9/00</b> (2006.01)		
	<b>F01N 13/04</b> (2010.01)		

Podnosilac evropske prijave patenta (71)	MKP (51)	Broj objave evropske prijave patenta (97)	Naziv pronalaska (54)
	<b>F01N 13/08</b> (2010.01)		
	<b>A61K 36/04</b> (2006.01)	3380109	COMPOSITION FOR THE TREATMENT OF COLDS AND ALLERGIES
	<b>A61K 36/09</b> (2006.01)		
	<b>A61K 36/185</b> (2006.01)		
	<b>A61K 36/48</b> (2006.01)		
	<b>A61K 36/68</b> (2006.01)		
	<b>A61K 36/73</b> (2006.01)		
	<b>A61K 36/888</b> (2006.01)		
	<b>A61K 36/8988</b> (2006.01)		
The Provost, Fellows, Foundation Scholars, and The Other Members of Board, of The College of The Holy and Undivided Trinity of Queen Elizabeth	<b>C07C 311/54</b> (2006.01)	3259253	SULFONYLUREAS AND RELATED COMPOUNDS AND USE OF SAME
	<b>C07C 311/56</b> (2006.01)		
	<b>C07D 213/71</b> (2006.01)		
	<b>C07D 217/22</b> (2006.01)		
	<b>C07D 231/18</b> (2006.01)		
	<b>C07D 249/04</b> (2006.01)		
	<b>C07D 249/12</b> (2006.01)		
	<b>C07D 271/12</b> (2006.01)		
	<b>C07D 277/36</b> (2006.01)		
	<b>C07D 307/18</b> (2006.01)		
	<b>C07D 307/64</b> (2006.01)		
	<b>C07D 307/82</b> (2006.01)		
	<b>C07D 309/08</b> (2006.01)		
	<b>C07D 311/60</b> (2006.01)		
	<b>C07D 333/34</b> (2006.01)		
	<b>C07D 333/62</b> (2006.01)		
	<b>C07D 403/12</b> (2006.01)		
	<b>C07D 405/12</b> (2006.01)		
	<b>C07D 407/12</b> (2006.01)		
	<b>C07D 417/12</b> (2006.01)		
	<b>A01N 25/04</b> (2006.01)	3259992	AGROCHEMICAL COMPOSITION
	<b>A01N 25/22</b> (2006.01)		
	<b>A01N 43/90</b> (2006.01)		

Podnosilac evropske prijave patenta (71)	MKP (51)	Broj objave evropske prijave patenta (97)	Naziv pronalaska (54)
	<b>A01P 7/02</b> (2006.01)		
	<b>A61K 31/69</b> (2006.01)	3258965	COMBINATION THERAPY FOR CANCER TREATMENT
	<b>A61K 39/395</b> (2006.01)		
	<b>A61K 45/06</b> (2006.01)		
	<b>A61P 35/00</b> (2006.01)		
	<b>C07K 16/00</b> (2006.01)		
	<b>C07K 16/18</b> (2006.01)		
The Board of Trustees of The Leland Stanford Junior University	<b>A61K 9/20</b> (2006.01)	3258962	MIXED ALLERGEN COMPOSITIONS AND METHODS FOR USING THE SAME
	<b>A61K 31/07</b> (2006.01)		
	<b>A61K 31/375</b> (2006.01)		
	<b>A61K 39/35</b> (2006.01)		
	<b>A61P 37/08</b> (2006.01)		
Baxalta GmbH	<b>A61K 38/37</b> (2006.01)	3260132	FVIII PEPTIDES FOR IMMUNE TOLERANCE INDUCTION AND IMMUNODIAGNOSTICS
	<b>A61P 7/04</b> (2006.01)		
	<b>C07K 14/755</b> (2006.01)		
	<b>G01N 33/50</b> (2006.01)		
	<b>G01N 33/569</b> (2006.01)		
Ipsen Biopharm Ltd.	<b>A61K 9/00</b> (2006.01)	3266456	COMBINATIONS OF LIPOSOMAL IRINOTECAN, 5-FU AND LEUCOVORIN FOR THE TREATMENT OF PANCREATIC CANCER
	<b>A61K 9/127</b> (2006.01)		
	<b>A61K 31/4745</b> (2006.01)		
	<b>A61K 31/513</b> (2006.01)		
	<b>A61K 31/519</b> (2006.01)		
	<b>A61K 45/06</b> (2006.01)		
	<b>A61P 35/00</b> (2006.01)		
	<b>A61K 31/437</b> (2006.01)	3284744	INDAZOLE INHIBITORS OF THE WNT SIGNAL PATHWAY AND THERAPEUTIC USES THEREOF
	<b>A61K 31/444</b> (2006.01)		
	<b>A61K 31/4545</b> (2006.01)		
	<b>A61K 31/496</b> (2006.01)		

Podnosilac evropske prijave patenta (71)	MKP (51)	Broj objave evropske prijave patenta (97)	Naziv pronalaska (54)
<b>A61K 31/5377</b> (2006.01)			
<b>A61P 19/00</b> (2006.01)			
<b>A61P 25/28</b> (2006.01)			
<b>A61P 31/10</b> (2006.01)			
<b>A61P 31/12</b> (2006.01)			
<b>A61P 35/00</b> (2006.01)			
<b>C07D 471/04</b> (2006.01)			
<b>B65D 30/18</b> (2006.01)	3257776		BAG AND METHOD FOR MANUFACTURING THE SAME
<b>B65D 30/20</b> (2006.01)			
<b>B65D 33/06</b> (2006.01)			
<b>B65D 33/10</b> (2006.01)			
<b>A23K 20/24</b> (2016.01)	3400810		SURFACE-REACTED CALCIUM CARBONATE IN FOOD
<b>A23L 29/00</b> (2016.01)			
<b>A23P 10/43</b> (2016.01)			
<b>A61K 33/10</b> (2006.01)			
<b>C09C 1/02</b> (2006.01)			
<b>A61K 39/395</b> (2006.01)	3254695		COMBINATION THERAPY INVOLVING ANTIBODIES AGAINST CLAUDIN 18.2 FOR TREATMENT OF CANCER
<b>A61K 45/06</b> (2006.01)			
<b>C07K 16/30</b> (2006.01)			
<b>A01N 59/00</b> (2006.01)	3403505		BIOCIDE FREE PRESERVATION
<b>A01N 59/16</b> (2006.01)			
<b>A01P 3/00</b> (2006.01)			
<b>A61K 48/00</b> (2006.01)	3251700		A CONDITIONAL REPLICATING CYTOMEGALOVIRUS AS A VACCINE FOR CMV
<b>C07H 21/04</b> (2006.01)			
<b>A61K 31/664</b> (2006.01)	3290428		TABLET COMPRISING CRYSTALLINE (S)-ISOPROPYL 2-(((S)-(((2R,3R,4R,5R)-5-(2,4-DIOXO-3,4-DIHYDROPYRIMIDIN-1 (2H)-YL)-4-FLUORO-3-HYDROXY-4-METHYLTETRAHYDROFURAN-2-YL)METHOXY)(PHENOXY)PHOSPHORYL)AMINO)PROPANOATE
<b>A61K 31/7072</b> (2006.01)			
<b>A61K 31/716</b> (2006.01)			
<b>A61P 31/14</b> (2006.01)			
<b>C07F 9/22</b> (2006.01)			
<b>C07F 9/24</b> (2006.01)			
<b>C07F 9/6558</b>			



Podnosilac evropske prijave patenta (71)	MKP (51)	Broj objave evropske prijave patenta (97)	Naziv pronalaska (54)
	(2006.01) <b>C07H 19/073</b>		
	(2006.01) <b>C07H 19/10</b>		
	(2006.01) <b>B41M 3/00</b>	3406455	METHOD FOR PRODUCING WATER-INSOLUBLE QUANTUM DOT PATTERNS
	(2006.01) <b>B41M 3/14</b>		
	(2006.01) <b>C09D 11/54</b>		
	(2014.01) <b>C07K 16/00</b>	3275896	PROCESS FOR OBTAINING ANTIBODIES
	(2006.01) <b>A61K 9/08</b>	3400950	BLADDER INSTILLATION COMPOSITION CONTAINING CHONDOITIN SULFATE (20 MG/ML), HYALURONIC ACID (16 MG/ML) AND PHOSPHATE BUFFER (PH 6,1 TO 7,9) WITH AN IMPROVED STORAGE STABILITY FOR THE TREATMENT OF CYSTITIS
	(2006.01) <b>A61K 31/728</b>		
	(2006.01) <b>A61K 31/737</b>		
	(2006.01) <b>A61P 13/10</b>		
	(2006.01) <b>A61P 29/00</b>		
	(2006.01) <b>A61K 9/08</b>	3400951	BLADDER INSTILLATION COMPOSITION CONTAINING CHONDOITIN SULFATE (4,5 MG/ML), HYALURONIC ACID (16 MG/ML) AND PHOSPHATE BUFFER (PH 6,1 TO 7,9) WITH AN IMPROVED STORAGE STABILITY FOR THE TREATMENT OF CYSTITIS
	(2006.01) <b>A61K 31/728</b>		
	(2006.01) <b>A61K 31/737</b>		
	(2006.01) <b>A61P 13/10</b>		
	(2006.01) <b>A61P 29/00</b>		
	(2006.01) <b>A61K 31/728</b>	3400949	COMPOSITION FOR TOPICAL USE, IN PARTICULAR FOR BLADDER INSTILLATION
	(2006.01) <b>A61K 31/737</b>		
	(2006.01) <b>A61P 13/10</b>		
	(2006.01) <b>A61B 5/00</b>	3254612	SPINE CONSTRUCTION FOR BASKET CATHETER
	(2006.01) <b>A61B 17/00</b>		
	(2006.01) <b>A61B 18/00</b>		
Merus N.V.	(2006.01) <b>C07K 16/00</b>	3263597	GENERATION OF BINDING MOLECULES
	(2006.01) <b>C07K 16/10</b>		
	(2006.01) <b>C07K 16/28</b>		
	(2006.01) <b>C07K 16/30</b>		
	(2006.01) <b>C07K 16/46</b>		
	(2006.01) <b>A61B 5/00</b>	3254614	MULTI-FUNCTION CONDUCTING ELEMENTS FOR A CATHETER
	(2006.01) <b>A61B 5/042</b>		
	(2006.01)		

Podnosilac evropske prijave patenta (71)	MKP (51)	Broj objave evropske prijave patenta (97)	Naziv pronalaska (54)
	<b>A61B 5/06</b> (2006.01)		
	<b>A61B 5/00</b> (2006.01)	3254618	IDENTIFICATION AND VISUALIZATION OF CARDIAC ACTIVATION SEQUENCE IN MULTI-CHANNEL RECORDINGS
	<b>A61B 5/04</b> (2006.01)		
	<b>A61B 5/042</b> (2006.01)		
	<b>A61B 5/044</b> (2006.01)		
	<b>A61B 5/0452</b> (2006.01)		
	<b>A61B 5/046</b> (2006.01)		
	<b>A61K 31/422</b> (2006.01)	3257847	FXR (NR1H4) MODULATING COMPOUNDS
	<b>A61K 31/4439</b> (2006.01)		
	<b>A61P 1/16</b> (2006.01)		
	<b>A61P 3/04</b> (2006.01)		
	<b>A61P 3/10</b> (2006.01)		
	<b>A61P 29/00</b> (2006.01)		
	<b>A61P 35/00</b> (2006.01)		
	<b>C07D 401/14</b> (2006.01)		
	<b>C07D 413/12</b> (2006.01)		
	<b>C07D 413/14</b> (2006.01)		
	<b>F23D 14/22</b> (2006.01)	3293456	BURNER
	<b>F23L 7/00</b> (2006.01)		
	<b>F23Q 1/02</b> (2006.01)		
	<b>B66F 3/06</b> (2006.01)	3260735	THRUST CHAIN
	<b>F16G 13/20</b> (2006.01)		
	<b>F16H 19/06</b> (2006.01)		
Wippermann jr. GmbH	<b>B66F 3/06</b> (2006.01)	3258132	DEVICE FOR DEFLECTING PUSH CHAINS AND PUSH CHAIN
	<b>F16G 13/20</b> (2006.01)		
	<b>F16H 19/06</b> (2006.01)		
	<b>C08K 9/00</b> (2006.01)	3415570	PROCESS FOR PREPARING A SURFACE TREATED FILLER MATERIAL PRODUCT WITH MONO-SUBSTITUTED SUCCINIC ANHYDRIDE(S) AND A MIXTURE OF ALIPHATIC LINEAR OR BRANCHED CARBOXYLIC ACIDS COMPRISING STEARIC ACID
	<b>C09C 1/02</b> (2006.01)		
	<b>A61K 31/567</b> (2006.01)	3252069	(11.BETA.,17.BETA.)-17-HYDROXY-11-[4-(METHYLSULFONYL)PHENYL]-17-(PENTAFUOROMETHYL)ESTRA-4,9-DIEN-3-ONE FOR USE IN THE TREATMENT OF DISEASES
	<b>A61K 31/573</b> (2006.01)		
	<b>A61P 5/36</b> (2006.01)		

Podnosilac evropske prijave patenta (71)	MKP (51)	Broj objave evropske prijave patenta (97)	Naziv pronalaska (54)
	<b>C07J 31/00</b> (2006.01)		
	<b>C07J 41/00</b> (2006.01)		
	<b>A61K 31/497</b> (2006.01)	3309151	HETEROCYCLIC COMPOUNDS FOR THE TREATMENT OF NEUROLOGICAL AND PSYCHOLOGICAL DISORDERS
	<b>C07D 215/227</b> (2006.01)		
	<b>C07D 263/58</b> (2006.01)		
	<b>C07D 401/12</b> (2006.01)		
	<b>C07D 417/12</b> (2006.01)		
	<b>C07D 471/04</b> (2006.01)		
	<b>C07F 9/6558</b> (2006.01)		
Anacor Pharmaceuticals, Inc.	<b>A61K 31/69</b> (2006.01)	3251678	BENZOZABOROLE DERIVATIVES FOR TREATING BACTERIAL INFECTIONS
	<b>A61P 31/04</b> (2006.01)		
	<b>C07F 5/02</b> (2006.01)		
Roof Planet S.r.l.	<b>E04D 3/363</b> (2006.01)	3266952	PANEL FOR CLADDING SURFACES
	<b>C07K 16/36</b> (2006.01)	3275903	THROMBIN-BINDING ANTIBODY MOLECULES AND USES THEREOF
OBO Bettermann GmbH & Co. KG	<b>H01T 1/22</b> (2006.01)	3270474	SPARK GAP ARRESTER
	<b>H01T 4/12</b> (2006.01)		
	<b>F01K 1/04</b> (2006.01)	3260803	STEAM STORAGE
	<b>F28D 20/00</b> (2006.01)		
	<b>F28D 20/02</b> (2006.01)		
	<b>B41M 3/00</b> (2006.01)	3418064	TAMPER-PROOF MEDIUM FOR THERMAL PRINTING
	<b>B41M 3/14</b> (2006.01)		
	<b>B41M 5/323</b> (2006.01)		
	<b>G06F 3/048</b> (2013.01)	3258446	METHOD AND SYSTEM FOR PROVIDING INFORMATION FROM A PATIENT-SPECIFIC MODEL OF BLOOD FLOW
	<b>G06T 19/20</b> (2011.01)		
FEDRA SOCIETA' COOPERATIVA	<b>C10B 53/02</b> (2006.01)	3260521	GASIFIER WITH IMPROVED AIR INLET ASSEMBLY
	<b>C10J 3/26</b> (2006.01)		
	<b>B01D 21/00</b> (2006.01)	3263221	DIRT MAGNETIC SEPARATOR FOR THERMAL PLANTS
	<b>B03C 1/28</b> (2006.01)		
	<b>F24D 19/00</b> (2006.01)		
	<b>B65H 51/10</b> (2006.01)	3165487	CONDUIT TRANSPORTATION DEVICE, IN PARTICULAR FOR CABLES TO BE PROCESSED IN CABLE PROCESSING MACHINES
	<b>B65H 51/32</b> (2006.01)		
	<b>H01R</b>		

Podnosilac evropske prijave patenta (71)	MKP (51)	Broj objave evropske prijave patenta (97)	Naziv pronalaska (54)
	<b>43/052</b> (2006.01)		
	<b>B21D 7/024</b> (2006.01)	3377240	MACHINE FOR BENDING PIPES OR SECTIONS IN PARTICULAR OF METAL, TO OBTAIN ANY SHAPE
	<b>B21D 7/12</b> (2006.01)		
RUAG Ammotec AG	<b>F42B 5/02</b> (2006.01)	3390958	IMPROVED FRAGMENTATION PROJECTILE AND METHOD FOR ITS MANUFACTURING
	<b>F42B 5/03</b> (2006.01)		
	<b>F42B 8/14</b> (2006.01)		
	<b>F42B 12/06</b> (2006.01)		
	<b>F42B 12/36</b> (2006.01)		
	<b>A61K</b> <b>31/4709</b> (2006.01)	3390384	QUINOLINE-3-CARBOXAMIDES AS H-PGDS INHIBITORS
	<b>A61P 21/00</b> (2006.01)		
	<b>C07D 215/20</b> (2006.01)		
	<b>C07D 215/54</b> (2006.01)		
	<b>C07D 401/04</b> (2006.01)		
	<b>C07D 401/12</b> (2006.01)		
	<b>C07D 401/14</b> (2006.01)		
	<b>C07D 405/12</b> (2006.01)		
	<b>C07D 413/12</b> (2006.01)		
	<b>C07D 413/14</b> (2006.01)		
	<b>C07D 417/12</b> (2006.01)		
	<b>C07D</b> <b>491/048</b> (2006.01)		
Vitae Pharmaceuticals, Inc.	<b>C07D 217/04</b> (2006.01)	3377482	MODULATORS OF ROR-GAMMA
	<b>C07D 217/16</b> (2006.01)		
	<b>C07D 217/24</b> (2006.01)		
	<b>C07D 231/56</b> (2006.01)		
	<b>C07D 239/88</b> (2006.01)		
	<b>C07D 401/04</b> (2006.01)		
	<b>C07D 401/06</b> (2006.01)		
	<b>C07D 401/12</b> (2006.01)		
	<b>C07D 401/14</b> (2006.01)		
	<b>C07D 405/12</b> (2006.01)		
	<b>C07D 471/04</b> (2006.01)		
	<b>C07D 495/04</b> (2006.01)		

Podnosilac evropske prijave patenta (71)	MKP (51)	Broj objave evropske prijave patenta (97)	Naziv pronalaska (54)
	<b>A61K 31/335</b> (2006.01) <b>A61P 35/00</b> (2006.01) <b>A61P 37/00</b> (2006.01) <b>C07D 303/46</b> (2006.01)	3386956	FUMAGILLOL DERIVATIVES AND POLYMORPHS THEREOF
Koninklijke KPN N.V.	<b>H04L 29/06</b> (2006.01) <b>H04N 21/218</b> (2011.01) <b>H04N 21/2343</b> (2011.01) <b>H04N 21/262</b> (2011.01) <b>H04N 21/845</b> (2011.01) <b>H04N 21/854</b> (2011.01)	3398346	VIDEO STREAMS
	<b>C04B 11/00</b> (2006.01) <b>C04B 28/14</b> (2006.01)	3393997	METHOD FOR THE PRODUCTION OF GYPSUM-BASED BOARDS AND STUCCO SLURRY COMPRISING NON-PREGELATINIZED MIGRATORY STARCH FOR USE THEREWITH
Loxo Oncology Inc.	<b>A61K 31/415</b> (2006.01) <b>A61K 31/4155</b> (2006.01) <b>A61P 35/00</b> (2006.01) <b>C07D 231/14</b> (2006.01) <b>C07D 401/04</b> (2006.01) <b>C07D 401/06</b> (2006.01) <b>C07D 403/04</b> (2006.01) <b>C07D 405/04</b> (2006.01) <b>C07D 405/06</b> (2006.01) <b>C07D 405/08</b> (2006.01) <b>C07D 405/14</b> (2006.01) <b>C07D 413/06</b> (2006.01)	3390395	COMPOUNDS USEFUL AS KINASE INHIBITORS
	<b>A61K 31/4025</b> (2006.01) <b>A61K 31/407</b> (2006.01) <b>A61P 25/28</b> (2006.01) <b>A61P 35/00</b> (2006.01) <b>C07D 207/09</b>	3390391	NOVEL COMPOUNDS

Podnositelj evropske prijave patenta (71)	MKP (51)	Broj objave evropske prijave patenta (97)	Naziv pronalaska (54)
	(2006.01) <b>C07D 401/12</b> (2006.01) <b>C07D 403/12</b> (2006.01) <b>C07D 403/14</b> (2006.01) <b>C07D 413/12</b> (2006.01) <b>C07D 417/12</b> (2006.01) <b>C07D 417/14</b> (2006.01) <b>C07D 471/04</b> (2006.01) <b>C07D 487/04</b> (2006.01)		
	<b>A61K 9/16</b> (2006.01) <b>A61K 9/20</b> (2006.01) <b>A61K 31/506</b> (2006.01) <b>A61P 9/00</b> (2006.01)	3383372	SOLID DISPERSIONS COMPRISING A SGC STIMULATOR
	<b>A61K 31/4745</b> (2006.01) <b>A61K 31/497</b> (2006.01) <b>A61P 35/00</b> (2006.01)	3389660	COMBINATION THERAPY FOR CANCER
	<b>A61K 31/519</b> (2006.01) <b>A61K 31/661</b> (2006.01) <b>A61P 35/00</b> (2006.01) <b>C07D 495/04</b> (2006.01) <b>C07F 9/6561</b> (2006.01)	3405471	NEW AMMONIUM DERIVATIVES, A PROCESS FOR THEIR PREPARATION AND PHARMACEUTICAL COMPOSITIONS CONTAINING THEM
Beth Israel Deaconess Medical Center	<b>A61K 38/17</b> (2006.01) <b>A61P 35/00</b> (2006.01)	3377087	COMPOSITIONS AND METHODS OF TREATING CANCER
	<b>A61K 31/454</b> (2006.01) <b>A61K 45/06</b> (2006.01) <b>A61P 35/00</b> (2006.01) <b>A61P 35/02</b> (2006.01)	3383433	METHODS OF TREATMENT OF MALIGNANCIES
	<b>C12N 15/867</b> (2006.01)	3394271	STABLE INTEGRATION OF SIN TRANSFER VECTORS
	<b>A61K 47/68</b> (2017.01) <b>A61P 35/00</b> (2006.01)	3383909	ANTI-huLRRC15 ANTIBODY DRUG CONJUGATES AND METHODS FOR THEIR USE

Podnosilac evropske prijave patenta (71)	MKP (51)	Broj objave evropske prijave patenta (97)	Naziv pronalaska (54)
	<b>C07K 16/28</b> (2006.01)		
	<b>C07K 16/30</b> (2006.01)		
	<b>A61K 31/519</b> (2006.01)	3390405	NOVEL TETRAHYDROTRIAZOLOPYRIMIDINE DERIVATIVES AS NHE INHIBITORS
	<b>A61P 11/00</b> (2006.01)		
	<b>A61P 11/06</b> (2006.01)		
	<b>A61P 37/08</b> (2006.01)		
	<b>C07D 487/04</b> (2006.01)		
	<b>A01N 25/04</b> (2006.01)	3393239	COMPOSITION FOR AQUATIC PEST CONTROL
	<b>A01N 43/90</b> (2006.01)		
	<b>A01N 59/06</b> (2006.01)		
	<b>A01N 65/20</b> (2009.01)		
PCC Prodex GmbH	<b>B41M 5/28</b> (2006.01)	3344674	THERMOCHROMIC POLYURETHANE FOAM
	<b>C08G 18/10</b> (2006.01)		
	<b>C08G 18/18</b> (2006.01)		
	<b>C08G 18/24</b> (2006.01)		
	<b>C08G 18/32</b> (2006.01)		
	<b>C08G 18/42</b> (2006.01)		
	<b>C08G 18/76</b> (2006.01)		
	<b>C07D 209/46</b> (2006.01)	3386950	SUBSTITUTED BENZAZINONES AS ANTIBACTERIAL COMPOUNDS
	<b>C07D 217/24</b> (2006.01)		
	<b>C07D 239/88</b> (2006.01)		
	<b>C07D 253/08</b> (2006.01)		
	<b>C07D 401/04</b> (2006.01)		
	<b>C07D 401/10</b> (2006.01)		
	<b>C07D 403/10</b> (2006.01)		
	<b>C07D 405/04</b> (2006.01)		
	<b>C07D 409/04</b> (2006.01)		
	<b>C07D 417/04</b> (2006.01)		
	<b>A61K 47/68</b> (2017.01)	3383910	ANTI-huLRRC15 ANTIBODY DRUG CONJUGATES AND METHODS FOR THEIR USE
	<b>C07K 16/28</b> (2006.01)		
	<b>C07K 16/30</b> (2006.01)		
Mach, Zdenek Machová, Zdenka	<b>F01N 1/08</b> (2006.01)	3371424	COMBINED EXHAUST GAS SILENCER
	<b>A61K 31/381</b>	3394051	CRYSTALLIZATION PROCEDURE FOR OBTAINING CANAGLIFLOZIN HEMIHYDRATE CRYSTALS

Podnosilac evropske prijave patenta (71)	MKP (51)	Broj objave evropske prijave patenta (97)	Naziv pronalaska (54)
	(2006.01) <b>A61P 5/00</b> (2006.01) <b>C07D 409/10</b> (2006.01) <b>A61K 31/7068</b> (2006.01) <b>A61K 33/00</b> (2006.01) <b>A61P 35/00</b> (2006.01)	3393478	COMBINATION THERAPY
Clexio Biosciences Ltd.	(2006.01) <b>A61K 9/00</b> (2006.01) <b>A61K 47/38</b> (2006.01) <b>A61M 31/00</b> (2006.01)	3383365	GASTRIC RETENTIVE DEVICES
FMC Corporation	<b>A01C 7/06</b> (2006.01) <b>A01C 7/20</b> (2006.01) <b>A01N 25/16</b> (2006.01) <b>A01N 53/00</b> (2006.01) <b>A01N 63/00</b> (2006.01) <b>A61M 5/50</b> (2006.01) <b>G06F 19/00</b> (2018.01) <b>A61K 31/519</b> (2006.01) <b>A61P 19/00</b> (2006.01) <b>A61P 35/00</b> (2006.01) <b>A61P 37/00</b> (2006.01) <b>C07D 495/16</b> (2006.01) <b>C07D 519/00</b> (2006.01)	3393240	IN SITU TREATMENT OF SEED IN FURROW
	<b>A61M 5/50</b> (2006.01) <b>G06F 19/00</b> (2018.01) <b>A61K 31/519</b> (2006.01) <b>A61P 19/00</b> (2006.01) <b>A61P 35/00</b> (2006.01) <b>A61P 37/00</b> (2006.01) <b>C07D 495/16</b> (2006.01) <b>C07D 519/00</b> (2006.01)	3386573	AUTO-INJECTOR WITH SIGNALING CAP
	<b>A61K 31/519</b> (2006.01) <b>A61P 19/00</b> (2006.01) <b>A61P 35/00</b> (2006.01) <b>A61P 37/00</b> (2006.01) <b>C07D 495/16</b> (2006.01) <b>C07D 519/00</b> (2006.01)	3386991	POLYCYCLIC COMPOUNDS AS INHIBITORS OF BRUTON'S TYROSINE KINASE
	<b>A61K 31/519</b> (2006.01) <b>A61P 19/00</b> (2006.01) <b>A61P 35/00</b> (2006.01) <b>A61P 37/00</b> (2006.01) <b>C07D 495/16</b> (2006.01) <b>C07D 519/00</b> (2006.01)	3386992	INHIBITORS OF BRUTON'S TYROSINE KINASE AND METHODS OF THEIR USE
	<b>A61K 39/02</b> (2006.01) <b>A61K 39/12</b> (2006.01) <b>A61K 38/17</b> (2006.01) <b>A61K 39/395</b> (2006.01) <b>C07K 16/28</b> (2006.01)	3397279	M HYO MULTIVALENT VACCINE AND USES THEREOF
	<b>A61K 38/17</b> (2006.01) <b>A61K 39/395</b> (2006.01) <b>C07K 16/28</b> (2006.01)	3389710	BISPECIFIC ANTIBODY PLATFORM
	<b>A61K 31/4433</b> (2006.01) <b>A61P 35/00</b>	3394044	TANK-BINDING KINASE INHIBITOR COMPOUNDS



Podnosilac evropske prijave patenta (71)	MKP (51)	Broj objave evropske prijave patenta (97)	Naziv pronalaska (54)
	(2006.01) <b>A61P 37/00</b> (2006.01) <b>C07D 239/42</b> (2006.01) <b>C07D 401/10</b> (2006.01) <b>C07D 401/12</b> (2006.01) <b>C07D 401/14</b> (2006.01) <b>C07D 405/12</b> (2006.01) <b>C07D 413/12</b> (2006.01) <b>C07D 413/14</b> (2006.01)		
	<b>A61K 31/4035</b> (2006.01) <b>A61P 1/04</b> (2006.01) <b>A61P 1/18</b> (2006.01) <b>A61P 11/06</b> (2006.01) <b>A61P 11/12</b> (2006.01) <b>A61P 17/06</b> (2006.01) <b>A61P 37/00</b> (2006.01) <b>C07D 209/44</b> (2006.01) <b>C07D 407/06</b> (2006.01)	3390396	ISOINDOLE COMPOUNDS
	<b>C12Q 1/66</b> (2006.01)	3394285	MICROBIAL CELL VIABILITY ASSAY FOR DETECTION OF OR DETERMINING SLURRY CONTAMINATION
Societa'Italiana Acetilene & Derivati S.I.A.D. S.p.A. in breve S.I.A.D. S.p.A.	<b>B01F 3/04</b> (2006.01) <b>B01F 5/06</b> (2006.01) <b>B01F 15/00</b> (2006.01)	3374069	DEVICE AND CORRESPONDING METHOD FOR THE DISPERSION OF GAS IN LIQUIDS
	<b>A61K 31/5377</b> (2006.01) <b>A61P 35/02</b> (2006.01) <b>C12Q 1/68</b> (2018.01)	3386513	INHIBITORS OF EZH2 AND METHODS OF USE THEREOF
	<b>A61K 31/4168</b> (2006.01) <b>A61K 31/4178</b> (2006.01) <b>A61K 31/4196</b> (2006.01) <b>A61K 31/551</b> (2006.01) <b>A61P 11/14</b> (2006.01) <b>A61P 29/00</b> (2006.01)	3390374	HYDROXYALKYLAMINE- AND HYDROXYCYCLOALKYLAMINE-SUBSTITUTED DIAMINE-ARYLSULFONAMIDE COMPOUNDS WITH SELECTIVE ACTIVITY IN VOLTAGE-GATED SODIUM CHANNELS

Podnosilac evropske prijave patenta (71)	MKP (51)	Broj objave evropske prijave patenta (97)	Naziv pronalaska (54)
	<b>C07D 277/52</b> (2006.01)		
	<b>C07D 285/08</b> (2006.01)		
	<b>C07D 417/12</b> (2006.01)		
	<b>A61K 31/513</b> (2006.01)	3390400	HETEROARYLHYDROXYPYRIMIDINONES AS AGONISTS OF THE APJ RECEPTOR
	<b>A61P 9/00</b> (2006.01)		
	<b>C07D 403/04</b> (2006.01)		
	<b>C07D 413/04</b> (2006.01)		
	<b>C07D 413/14</b> (2006.01)		
	<b>C07D 417/14</b> (2006.01)		
	<b>C07K 16/00</b> (2006.01)	3390449	ANTIBODIES TO RISPERIDONE AND USE THEREOF
	<b>C07K 16/28</b> (2006.01)		
	<b>C07K 16/44</b> (2006.01)		
	<b>A61K 39/00</b> (2006.01)	3390447	PACAP ANTIBODIES AND USES THEREOF
	<b>C07K 16/26</b> (2006.01)		
	<b>A61K 31/47</b> (2006.01)	3389659	COMBINATION PRODUCT
	<b>A61K 31/4709</b> (2006.01)		
	<b>A61P 31/04</b> (2006.01)		
	<b>A61P 31/06</b> (2006.01)		
	<b>A61K 31/40</b> (2006.01)	3394049	CYANOPYRROLIDINE DERIVATIVES AS INHIBITORS FOR DUBS
	<b>A61P 35/00</b> (2006.01)		
	<b>C07D 207/10</b> (2006.01)		
	<b>C07D 403/12</b> (2006.01)		
	<b>C07D 413/12</b> (2006.01)		
	<b>C07D 413/14</b> (2006.01)		
	<b>C07D 417/12</b> (2006.01)		
	<b>C07D 417/14</b> (2006.01)		
NuCana plc	<b>A61K 9/00</b> (2006.01)	3393453	FORMULATIONS OF PHOSPHORAMIDATE DERIVATIVES OF NUCLEOSIDE DRUGS
	<b>A61K 9/08</b> (2006.01)		
	<b>A61K 31/7072</b> (2006.01)		
	<b>A61K 31/7076</b> (2006.01)		
	<b>A61P 35/00</b> (2006.01)		

Podnosilac evropske prijave patenta (71)	MKP (51)	Broj objave evropske prijave patenta (97)	Naziv pronalaska (54)
The Bluedot Alliance B.V.	<b>F23C 99/00</b> (2006.01)	3384207	SYSTEM, METHOD AND DEVICE TO OPTIMIZE THE EFFICIENCY OF THE COMBUSTION OF GASES FOR THE PRODUCTION OF CLEAN ENERGY
	<b>C07K 14/16</b> (2006.01)	3390430	HUMAN IMMUNODEFICIENCY VIRUS ANTIGENS, VECTORS, COMPOSITIONS, AND METHODS OF USE THEREOF
	<b>B01D 46/32</b> (2006.01)	3383552	PAINTING BOOTH WITH OVERSPRAY REMOVAL SYSTEM, METHOD FOR REMOVING THE OVERSPRAY, AND PLANT
	<b>B05B 15/12</b> (2006.01)		
Samsung Life Public Welfare Foundation	<b>G01N 33/68</b> (2006.01)	3384294	METHODS AND COMPOSITIONS RELATED TO TOXICITY ASSOCIATED WITH CELL THERAPY
	<b>A01K 67/027</b> (2006.01)	3390644	ADENO-ASSOCIATED VIRAL VECTORS FOR TREATING MUCOLIPIDOSIS TYPE II
	<b>A61K 48/00</b> (2006.01)		
	<b>C12N 9/12</b> (2006.01)		
	<b>C12N 15/86</b> (2006.01)		
	<b>A61K 48/00</b> (2006.01)	3394270	ADENO-ASSOCIATED VIRAL VECTORS USEFUL IN TREATMENT OF SPINAL MUSCULAR ATROPY
	<b>A61P 21/00</b> (2006.01)		
	<b>C12N 15/864</b> (2006.01)		
	<b>C07K 16/24</b> (2006.01)	3390444	ANTI-TL1A/ANTI-TNF-ALPHA BISPECIFIC ANTIGEN BINDING PROTEINS AND USES THEREOF
	<b>A61K 9/127</b> (2006.01)	3390630	POLYNUCLEOTIDES ENCODING METHYLMALONYL-CoA MUTASE
Moderna, Inc.	<b>A61K 31/7088</b> (2006.01)		
	<b>A61P 3/00</b> (2006.01)		
	<b>C12N 9/90</b> (2006.01)		
	<b>C12N 15/61</b> (2006.01)		
	<b>C07K 16/18</b> (2006.01)	3390445	MULTI-SPECIFIC ANTIBODY MOLECULES HAVING SPECIFICITY FOR TNF-ALPHA, IL-17A AND IL-17F
	<b>C07K 16/24</b> (2006.01)		
	<b>A01H 1/04</b> (2006.01)	3370507	BRASSICACEAE PLANTS RESISTANT TO PLASMODIOPHORA BRASSICAE (CLUBROOT)
	<b>A01H 5/10</b> (2018.01)		
	<b>C07K 14/415</b> (2006.01)		
	<b>C12N 15/82</b> (2006.01)		
	<b>C12Q 1/68</b> (2018.01)		
	<b>A61K 51/04</b> (2006.01)	3389728	RADIOLABELLED MGLUR2/3 PET LIGANDS
	<b>A61K 101/02</b> (2006.01)		
	<b>C07B 59/00</b> (2006.01)		
<b>C07D 487/04</b> (2006.01)			
<b>A61K 31/713</b> (2006.01)	3387129	STEROL REGULATORY ELEMENT BINDING PROTEIN (SREBP) CHAPERONE (SCAP) iRNA COMPOSITIONS AND METHODS OF USE THEREOF	
<b>A61P 3/06</b>			

Podnosilac evropske prijave patenta (71)	MKP (51)	Broj objave evropske prijave patenta (97)	Naziv pronalaska (54)
Centro Nacional de Tecnología y Seguridad alimentaria (CNTA)	(2006.01) <b>C12N</b> <b>15/113</b> (2010.01) <b>A23K 10/18</b> (2016.01) <b>A23K</b> <b>20/147</b> (2016.01) <b>A23K 20/24</b> (2016.01) <b>A23K 40/10</b> (2016.01) <b>A23L 3/46</b> (2006.01) <b>A23L 29/00</b> (2016.01) <b>A23L</b> <b>29/281</b> (2016.01) <b>A23L</b> <b>29/294</b> (2016.01) <b>A23L</b> <b>33/135</b> (2016.01) <b>A23P 10/20</b> (2016.01) <b>A23P 10/30</b> (2016.01) <b>A61K 9/00</b> (2006.01) <b>A61K 9/16</b> (2006.01) <b>A61K 39/00</b> (2006.01) <b>A61K 39/02</b> (2006.01) <b>A61K 47/02</b> (2006.01) <b>A61K 47/42</b> (2017.01) <b>A61K</b> <b>31/506</b> (2006.01) <b>A61P 3/06</b> (2006.01) <b>A61P 3/10</b> (2006.01) <b>A61P 7/02</b> (2006.01) <b>A61P 9/00</b> (2006.01) <b>A61P 25/02</b> (2006.01) <b>A61P 25/30</b> (2006.01) <b>A61P 35/00</b> (2006.01) <b>A61P 37/00</b> (2006.01) <b>C07D 401/14</b> (2006.01) <b>C07D 403/04</b> (2006.01) <b>C07D 403/14</b> (2006.01)	3389399	MICROPARTICLES FOR ENCAPSULATING PROBIOTICS, OBTAINING SAID MICROPARTICLES AND USES THEREOF
	<b>A61K</b> <b>31/506</b> (2006.01) <b>A61P 3/06</b> (2006.01) <b>A61P 3/10</b> (2006.01) <b>A61P 7/02</b> (2006.01) <b>A61P 9/00</b> (2006.01) <b>A61P 25/02</b> (2006.01) <b>A61P 25/30</b> (2006.01) <b>A61P 35/00</b> (2006.01) <b>A61P 37/00</b> (2006.01) <b>C07D 401/14</b> (2006.01) <b>C07D 403/04</b> (2006.01) <b>C07D 403/14</b> (2006.01)	3397631	SUBSTITUTED 3-AZABICYCLO[3.1.0]HEXANES AS KETOHEXOKINASE INHIBITORS

Podnosilac evropske prijave patenta (71)	MKP (51)	Broj objave evropske prijave patenta (97)	Naziv pronalaska (54)
	<b>A61B 17/064</b> (2006.01)	3397176	APPLICATOR INSTRUMENTS HAVING OFF-AXIS SURGICAL FASTENER DELIVERY
	<b>A61B 17/068</b> (2006.01)		
	<b>A61B 17/29</b> (2006.01)		
	<b>A61B 90/00</b> (2016.01)		
	<b>A61F 2/00</b> (2006.01)		
	<b>A61K 31/4025</b> (2006.01)	3368532	D-PROLINE DERIVATIVES AS SAP DEPLETING AGENT
	<b>A61P 25/28</b> (2006.01)		
	<b>C07D 405/14</b> (2006.01)		
	<b>A61K 31/381</b> (2006.01)	3394053	4-HYDROXY-2-PHENYL-1,3-THIAZOL-5-YL METHANONE DERIVATIVES AS TRPM8 ANTAGONISTS
	<b>A61K 31/4025</b> (2006.01)		
	<b>A61K 31/4155</b> (2006.01)		
	<b>A61K 31/4436</b> (2006.01)		
	<b>A61K 31/4535</b> (2006.01)		
	<b>A61K 31/5355</b> (2006.01)		
	<b>A61K 31/5377</b> (2006.01)		
	<b>A61P 11/00</b> (2006.01)		
	<b>A61P 13/00</b> (2006.01)		
	<b>A61P 29/00</b> (2006.01)		
	<b>C07D 277/56</b> (2006.01)		
	<b>C07D 417/06</b> (2006.01)		
New Gluten World S.r.l.	<b>A21D 13/06</b> (2017.01)	3389400	METHOD FOR THE DETOXIFICATION OF GLUTEN PROTEINS FROM CEREAL GRAINS AND USES THEREOF IN MEDICAL FIELD
	<b>A21D 13/066</b> (2017.01)		
	<b>A23L 5/20</b> (2016.01)		
	<b>A23L 5/30</b> (2016.01)		
	<b>A23L 7/10</b> (2016.01)		
	<b>A23L 7/196</b> (2016.01)		
	<b>C12C 1/02</b> (2006.01)		

Podnosilac evropske prijave patenta (71)	MKP (51)	Broj objave evropske prijave patenta (97)	Naziv pronalaska (54)
	<b>C12N 15/113</b> (2010.01)	3394259	COMPOSITIONS AND METHODS FOR DECREASING TAU EXPRESSION
	<b>A61F 13/20</b> (2006.01)	3397557	METHOD OF FORMING PRIMARY PACKAGE TUBE FOR TAMPONS
	<b>B65B 11/32</b> (2006.01)		
	<b>B65B 19/00</b> (2006.01)		
	<b>B65B 47/06</b> (2006.01)		
	<b>B65B 49/12</b> (2006.01)		
	<b>A61K 31/7105</b> (2006.01)	3386533	MODIFIED MRNA ENCODING A URIDINE DIPHOSPHATE GLUCURONOSYL TRANSFERASE AND USES THEREOF
	<b>A61K 31/7115</b> (2006.01)		
	<b>A61K 38/45</b> (2006.01)		
	<b>A61P 3/00</b> (2006.01)		
	<b>A61B 17/00</b> (2006.01)	3397182	SURGICAL INSTRUMENT WITH STAGED APPLICATION OF ELECTROSURGICAL AND ULTRASONIC ENERGY
	<b>A61B 17/29</b> (2006.01)		
	<b>A61B 17/32</b> (2006.01)		
	<b>A61B 18/14</b> (2006.01)		
	<b>A46B 15/00</b> (2006.01)	3393377	ULTRASONIC SURGICAL INSTRUMENT WITH TUBULAR ACOUSTIC WAVEGUIDE SEGMENT
	<b>A61B 17/28</b> (2006.01)		
	<b>A61B 17/32</b> (2006.01)		
	<b>A61K 31/4704</b> (2006.01)	3390392	ALKYL DIHYDROQUINOLINE SULFONAMIDE COMPOUNDS
	<b>A61P 29/00</b> (2006.01)		
	<b>C07D 403/12</b> (2006.01)		
	<b>C07D 413/12</b> (2006.01)		
	<b>A61K 31/4704</b> (2006.01)	3390393	ALKYNYL DIHYDROQUINOLINE SULFONAMIDE COMPOUNDS
	<b>C07D 215/36</b> (2006.01)		
	<b>C07D 241/44</b> (2006.01)		
	<b>C07D 403/12</b> (2006.01)		
	<b>C07D 413/12</b> (2006.01)		
	<b>C07D 413/14</b> (2006.01)		
	<b>C07D 417/12</b> (2006.01)		
	<b>A61K 31/519</b> (2006.01)	3394067	4-AMINO-2-(1H-PYRAZOLO[3,4-B]PYRIDIN-3-YL)-6-OXO-6,7-DIHYDRO-5H-PYRROLO[2,3-D]PYRIMIDINE DERIVATIVES AND THE RESPECTIVE (1H-INDAZOL-3-YL) DERIVATIVES AS CGMP MODULATORS FOR TREATING CARDIOVASCULAR DISEASES
	<b>A61P 9/00</b> (2006.01)		
	<b>A61P 9/04</b>		

Podnosilac evropske prijave patenta (71)	MKP (51)	Broj objave evropske prijave patenta (97)	Naziv pronalaska (54)
	(2006.01) <b>A61P 9/10</b> (2006.01) <b>A61P 9/12</b> (2006.01) <b>C07D 487/04</b> (2006.01) <b>A61M 5/142</b> (2006.01) <b>A61M 5/24</b> (2006.01)	3393555	WEARABLE AUTOMATIC INJECTION DEVICE AND RELATED METHODS OF ASSEMBLY AND USE
Shy Therapeutics LLC	<b>A61K 31/519</b> (2006.01) <b>A61P 29/00</b> (2006.01) <b>A61P 35/00</b> (2006.01) <b>C07D 221/04</b> (2006.01) <b>C07D 239/94</b> (2006.01) <b>C07D 401/04</b> (2006.01) <b>C07D 401/12</b> (2006.01) <b>C07D 401/14</b> (2006.01) <b>C07D 407/14</b> (2006.01) <b>C07D 409/14</b> (2006.01) <b>C07D 413/14</b> (2006.01) <b>C07D 471/04</b> (2006.01) <b>C07D 473/30</b> (2006.01) <b>C07D 495/04</b> (2006.01) <b>C07D 495/14</b> (2006.01) <b>A61K 31/34</b> (2006.01) <b>A61K 31/341</b> (2006.01) <b>A61K 31/42</b> (2006.01) <b>A61K 31/422</b> (2006.01) <b>A61K 31/4245</b> (2006.01) <b>A61K 31/5377</b> (2006.01) <b>A61P 11/00</b> (2006.01)	3394056	COMPOUNDS FOR THE TREATMENT OF CANCER AND INFLAMMATORY DISEASE
	<b>A61K 31/34</b> (2006.01) <b>A61K 31/341</b> (2006.01) <b>A61K 31/42</b> (2006.01) <b>A61K 31/422</b> (2006.01) <b>A61K 31/4245</b> (2006.01) <b>A61K 31/5377</b> (2006.01) <b>A61P 11/00</b> (2006.01)	3393465	METHODS OF TREATING PULMONARY DISEASES AND DISORDERS
Neurocrine Biosciences Inc.	<b>C07D 471/04</b> (2006.01)	3394057	SYNTHETIC METHODS FOR PREPARATION OF (S)-(2R,3R,11BR)-3-ISOBUTYL-9,10-DIMETHOXY-2,3,4,6,7,11B-HEXAHYDRO-1H-PYRIDO[2,1,-A]ISOQUINOLIN-2-YL 2-AMINO-3-METHYLBUTANOATE DI(4-METHYLBENZENESULFONATE)
	<b>C07K 14/54</b> (2006.01)	3390433	NOVEL CYTOKINE FUSION PROTEINS

Podnosilac evropske prijave patenta (71)	MKP (51)	Broj objave evropske prijave patenta (97)	Naziv pronalaska (54)
	<b>C07K</b>		
	<b>14/705</b>		
	(2006.01)		
	<b>C12N 15/62</b>		
	(2006.01)		
	<b>A61K</b>	3394058	N-[3-(3-{4-[[1,2,4]TRIAZOLO[4,3-A]PYRIDIN-6-YLOXY]-1,2,3,4-TETRAHYDRO-NAPHTHALEN-1-YL} -UREIDO)-PHENYL]-METHANESULFONAMIDE DERIVATIVES AND THEIR USE AS P38 MAPK INHIBITORS
	<b>31/437</b>		
	(2006.01)		
	<b>A61P 11/00</b>		
	(2006.01)		
	<b>A61P 11/06</b>		
	(2006.01)		
	<b>C07D 471/04</b>		
	(2006.01)		
	<b>A61K</b>	3394059	1-(3-TERT-BUTYL-PHENYL)-3-(4-([1,2,4]TRIAZOLO[4,3-A]PYRIDIN-6-YLOXY)-1,2,3,4-TETRAHYDRO-NAPHTHALEN-1-YL)-UREA DERIVATIVES AND THEIR USE AS P38 MAPK INHIBITORS
	<b>31/437</b>		
	(2006.01)		
	<b>A61P 11/00</b>		
	(2006.01)		
	<b>A61P 11/06</b>		
	(2006.01)		
	<b>C07D 471/04</b>		
	(2006.01)		
	<b>A61K</b>	3394060	1-(3-TERT-BUTYL-2H-PYRAZOL-5-YL OR 5-TERT-BUTYL-ISOXAOL-3-YL)-3-(4-([1,2,4]TRIAZOLO[4,3-A]PYRIDIN-6-YLOXY)-1,2,3,4-TETRAHYDRO-NAPHTHALENYL) UREA DERIVATIVES AND THEIR USE AS P38 MAPK INHIBITORS
	<b>31/437</b>		
	(2006.01)		
	<b>A61P 11/00</b>		
	(2006.01)		
	<b>A61P 11/06</b>		
	(2006.01)		
	<b>C07D 471/04</b>		
	(2006.01)		
Manifattura Del Seveso S.p.A.	<b>D06P 1/52</b>	3397805	PROCESS FOR OBTAINING A CLOTH WITH HIGH PERFORMANCES FOR DIGITAL PRINTING AND RELATIVE CLOTH
	(2006.01)		
	<b>D06P 5/00</b>		
	(2006.01)		
	<b>D06P 5/30</b>		
	(2006.01)		
VF Agency Limited	<b>A45C 5/03</b>	3389430	A SUITCASE, PREFERABLY OF THE RIGID TYPE, WITH AN INTERCHANGEABLE EXTERNAL CASE
	(2006.01)		
	<b>A45C 5/14</b>		
	(2006.01)		
	<b>A45C 13/00</b>		
	(2006.01)		
	<b>A45C 13/08</b>		
	(2006.01)		
Metalco Active S.r.l.	<b>A63B 9/00</b>	3377187	REVERSIBLY INSTALLABLE MODULAR FITNESS AREA
	(2006.01)		
	<b>A63B 17/04</b>		
	(2006.01)		
	<b>A63C 19/02</b>		
	(2006.01)		
	<b>A63G 31/00</b>		
	(2006.01)		
	<b>H02S 30/20</b>		
	(2014.01)		
Metalco Active S.r.l.	<b>A63B 7/02</b>	3377186	PERSONALIZABLE MODULAR FITNESS AREA
	(2006.01)		
	<b>A63B 9/00</b>		
	(2006.01)		
	<b>A63B 17/04</b>		
	(2006.01)		
	<b>A63B 21/08</b>		
	(2006.01)		
	<b>A63B 23/12</b>		
	(2006.01)		



Podnosilac evropske prijave patenta (71)	MKP (51)	Broj objave evropske prijave patenta (97)	Naziv pronalaska (54)
	<b>A63G 31/00</b> (2006.01)		
	<b>C07K 14/195</b> (2006.01)	3377634	BACTERIA-BASED PROTEIN DELIVERY
	<b>C12N 1/21</b> (2006.01)		
	<b>C12N 15/62</b> (2006.01)		
	<b>C12N 15/70</b> (2006.01)		
	<b>C12N 15/74</b> (2006.01)		
BISY E.U.	<b>C12N 1/19</b> (2006.01)	3394281	YEAST CELL
	<b>C12N 15/63</b> (2006.01)		
	<b>C12P 21/02</b> (2006.01)		
	<b>C12R 1/84</b> (2006.01)		
	<b>A61K 38/04</b> (2006.01)	3383419	COMPOSITIONS AND METHODS FOR REDUCING IMMUNE RESPONSES AGAINST CHIMERIC ANTIGEN RECEPTORS
	<b>A61K 38/17</b> (2006.01)		
	<b>C07K 7/04</b> (2006.01)		
	<b>C07K 16/28</b> (2006.01)		
	<b>C07K 16/30</b> (2006.01)		
	<b>A61K 31/00</b> (2006.01)	3387017	METHODS FOR REDUCING OR PREVENTING GROWTH OF TUMORS RESISTANT TO EGFR AND/OR ERBB3 BLOCKADE
	<b>A61P 35/00</b> (2006.01)		
	<b>C07K 16/28</b> (2006.01)		
	<b>C07K 16/32</b> (2006.01)		
	<b>A61K 48/00</b> (2006.01)	3400304	GENE THERAPY FOR TREATING FAMILIAL HYPERCHOLESTEROLEMIA
	<b>C07K 14/705</b> (2006.01)		
	<b>C12N 15/86</b> (2006.01)		
	<b>C07K 14/765</b> (2006.01)	3394265	DKK2 CYSTEINE RICH DOMAIN 2 CONTAINING PROTEINS AND USES THEREOF
	<b>C12N 15/62</b> (2006.01)		
President and Fellows of Harvard College	<b>A61K 39/00</b> (2006.01)	3393504	MESOTHELIN CHIMERIC ANTIGEN RECEPTOR (CAR) AND ANTIBODY AGAINST PD-L1 INHIBITOR FOR COMBINED USE IN ANTICANCER THERAPY
Fiberight Limited	<b>B03B 9/00</b> (2006.01)	3386655	WASTE PROCESSING
	<b>B03B 9/06</b> (2006.01)		
	<b>B09B 3/00</b> (2006.01)		
	<b>B29B 17/00</b> (2006.01)		
	<b>B29B 17/02</b> (2006.01)		
	<b>C05F 9/00</b> (2006.01)		
	<b>C10L 5/48</b>		

Podnosilac evropske prijave patenta (71)	MKP (51)	Broj objave evropske prijave patenta (97)	Naziv pronalaska (54)
	(2006.01)		
	<b>D21B 1/02</b>		
	(2006.01)		
	<b>D21C 5/02</b>		
	(2006.01)		
	<b>A61F 13/20</b>	3397223	METHOD OF WINDING UP TAMPON MATERIAL
	(2006.01)		
	<b>A61F 13/34</b>		
	(2006.01)		
	<b>B65H 65/00</b>		
	(2006.01)		
	<b>B65H 69/04</b>		
	(2006.01)		
	<b>A61K 31/437</b>	3386980	COMPOUNDS AND METHODS FOR KINASE MODULATION, AND INDICATIONS THEREFOR
	(2006.01)		
	<b>A61P 35/00</b>		
	(2006.01)		
	<b>C07D 471/04</b>		
	(2006.01)		
	<b>C08B 3/08</b>	3394108	ACYLATION OF BIOPOLYMER COMPRISING ANHYDROGLUCOSE UNITS
	(2006.01)		
	<b>C08B 3/10</b>		
	(2006.01)		
	<b>A61B 17/29</b>	3383286	DEVICES AND METHODS FOR INCREASING ROTATIONAL TORQUE DURING END EFFECTOR ARTICULATION
	(2006.01)		
	<b>A61B 18/14</b>		
	(2006.01)		
	<b>C07K 16/44</b>	3390455	ANTIBODIES TO QUETIAPINE AND USE THEREOF
	(2006.01)		
	<b>G01N 33/94</b>		
	(2006.01)		
	<b>A61K 31/4375</b>	3394033	HETEROCYCLIC COMPOUNDS AS IMMUNOMODULATORS
	(2006.01)		
	<b>A61K 31/47</b>		
	(2006.01)		
	<b>A61K 31/4985</b>		
	(2006.01)		
	<b>A61K 31/519</b>		
	(2006.01)		
	<b>A61P 31/00</b>		
	(2006.01)		
	<b>A61P 35/00</b>		
	(2006.01)		
	<b>C07D 215/40</b>		
	(2006.01)		
	<b>C07D 471/04</b>		
	(2006.01)		
	<b>A61K 31/5025</b>	3397639	FUSED TRICYCLIC HETEROCYCLIC COMPOUNDS AS HIV INTEGRASE INHIBITORS
	(2006.01)		
	<b>A61P 31/18</b>		
	(2006.01)		
	<b>C07D 471/16</b>		
	(2006.01)		
	<b>A61K 31/4196</b>	3397633	NUCLEAR TRANSPORT MODULATORS AND USES THEREOF
	(2006.01)		
	<b>A61P 11/00</b>		
	(2006.01)		
	<b>A61P 25/28</b>		
	(2006.01)		
	<b>A61P 27/02</b>		
	(2006.01)		

Podnosilac evropske prijave patenta (71)	MKP (51)	Broj objave evropske prijave patenta (97)	Naziv pronalaska (54)
	<b>A61P 31/12</b> (2006.01)		
	<b>A61P 35/00</b> (2006.01)		
	<b>A61P 37/00</b> (2006.01)		
	<b>C07D 249/08</b> (2006.01)		
	<b>C07D 401/12</b> (2006.01)		
	<b>C07D 403/12</b> (2006.01)		
	<b>C07D 413/12</b> (2006.01)		
	<b>A61K 31/4965</b> (2006.01)	3397634	NUCLEAR TRANSPORT MODULATORS AND USES THEREOF
	<b>A61P 35/00</b> (2006.01)		
	<b>C07D 239/26</b> (2006.01)		
	<b>C07D 241/12</b> (2006.01)		
	<b>C07D 401/08</b> (2006.01)		
	<b>C07D 401/12</b> (2006.01)		
	<b>C07D 403/06</b> (2006.01)		
	<b>C07D 403/08</b> (2006.01)		
	<b>C07D 403/12</b> (2006.01)		
	<b>C07D 409/06</b> (2006.01)		
	<b>C07D 413/06</b> (2006.01)		
	<b>A61K 31/445</b> (2006.01)	3397273	AUGMENTED ACID ALPHA-GLUCOSIDASE FOR THE TREATMENT OF POMPE DISEASE
	<b>A61K 38/47</b> (2006.01)		
	<b>A61K 35/17</b> (2015.01)	3344263	CANCER ANTIGEN TARGETS AND USES THEREOF
	<b>A61K 39/00</b> (2006.01)		
	<b>A61P 35/02</b> (2006.01)		
Tianjin University	<b>A61B 17/00</b> (2006.01)	3345552	NATURAL CHANNEL-BASED MICROSURGICAL DEVICE
Regeneron Pharmaceuticals, Inc.	<b>A01K 67/027</b> (2006.01)	3407709	NON-HUMAN ANIMALS HAVING AN ENGINEERED IMMUNOGLOBULIN LAMBDA LIGHT CHAIN LOCUS
	<b>C07K 16/00</b> (2006.01)		
	<b>C12N 15/85</b> (2006.01)		
	<b>C12N 15/90</b> (2006.01)		
Regen Lab SA	<b>A61K 35/14</b> (2015.01)	3403659	PROCESS, TUBE AND DEVICE FOR THE PREPARATION OF WOUND HEALANT COMPOSITION
	<b>A61K 35/16</b> (2015.01)		
	<b>A61K 38/48</b> (2006.01)		
	<b>A61K 31/55</b> (2006.01)	3375780	HETEROCYCLIC AMIDES AS KINASE INHIBITORS

Podnosilac evropske prijave patenta (71)	MKP (51)	Broj objave evropske prijave patenta (97)	Naziv pronalaska (54)
	<b>A61K 31/5513</b> (2006.01)		
	<b>A61K 31/553</b> (2006.01)		
	<b>A61K 31/554</b> (2006.01)		
	<b>A61P 17/06</b> (2006.01)		
	<b>A61P 25/28</b> (2006.01)		
	<b>A61P 29/00</b> (2006.01)		
	<b>A61P 37/00</b> (2006.01)		
	<b>C07D 223/08</b> (2006.01)		
	<b>C07D 267/14</b> (2006.01)		
	<b>C07D 281/10</b> (2006.01)		
	<b>C07D 403/12</b> (2006.01)		
	<b>C07D 403/14</b> (2006.01)		
	<b>C07D 409/12</b> (2006.01)		
	<b>C07D 413/12</b> (2006.01)		
	<b>C07D 413/14</b> (2006.01)		
	<b>C07D 417/12</b> (2006.01)		
	<b>C07D 487/04</b> (2006.01)		
	<b>C07D 498/04</b> (2006.01)		
	<b>A61K 38/46</b> (2006.01)	3401400	METHODS AND COMPOSITIONS FOR RNA-DIRECTED TARGET DNA MODIFICATION AND FOR RNA-DIRECTED MODULATION OF TRANSCRIPTION
	<b>A61K 48/00</b> (2006.01)		
	<b>C07K 19/00</b> (2006.01)		
	<b>C12N 15/10</b> (2006.01)		
	<b>C12N 15/11</b> (2006.01)		
	<b>C12N 15/63</b> (2006.01)		
	<b>C12N 15/90</b> (2006.01)		
	<b>B65D 1/34</b> (2006.01)	3357823	AN INNOVATIVE TRAY OF BIODEGRADABLE TYPE FOR CARRYING FINDINGS AND DELICATE OBJECTS
Friedrich Binder GmbH & Co. KG	<b>A44C 11/00</b> (2006.01)	3354153	ORNAMENTAL CHAIN
	<b>A61K 39/00</b> (2006.01)	3348645	NUCLEIC ACID COMPRISING OR CODING FOR A HISTONE STEM-LOOP AND A POLY(A) SEQUENCE OR A POLYADENYLATION SIGNAL FOR INCREASING THE EXPRESSION OF AN ENCODED PATHOGENIC ANTIGEN
	<b>A61K 39/12</b> (2006.01)		
	<b>C12N 15/63</b> (2006.01)		
	<b>C12N 15/67</b> (2006.01)		
	<b>C07C</b> <b>51/347</b>	3398931	METHODS OF SYNTHESIZING A PROSTACYCLIN ALALOG

Podnosilac evropske prijave patenta (71)	MKP (51)	Broj objave evropske prijave patenta (97)	Naziv pronalaska (54)
	(2006.01) <b>C07C 205/57</b> (2006.01) <b>C07D 301/32</b> (2006.01) <b>C07F 7/18</b> (2006.01) <b>A61K 39/00</b> (2006.01) <b>A61K 39/395</b> (2006.01) <b>A61P 29/00</b> (2006.01) <b>C07K 16/24</b> (2006.01) <b>A61K 31/415</b> (2006.01) <b>A61P 3/00</b> (2006.01) <b>A61P 3/04</b> (2006.01) <b>A61P 3/10</b> (2006.01) <b>A61P 9/04</b> (2006.01) <b>A61P 9/10</b> (2006.01) <b>A61P 11/00</b> (2006.01) <b>A61P 13/12</b> (2006.01) <b>A61P 25/00</b> (2006.01) <b>A61P 27/02</b> (2006.01) <b>A61P 27/12</b> (2006.01) <b>A61P 43/00</b> (2006.01) <b>C07D 231/12</b> (2006.01)		
MorphoSys AG		3338794	TOXICITY MANAGEMENT FOR ANTI-TUMOR ACTIVITY OF CARS
		3345923	TREATMENT FOR RHEUMATOID ARTHRITIS WITH ANTI-GM-CSF ANTIBODY
		3348545	PYRAZOLE-AMIDE COMPOUND AND MEDICINAL USES THEREFOR
immatics Biotechnologies GmbH		3363456	NOVEL IMMUNOTHERAPY AGAINST SEVERAL TUMORS INCLUDING GASTROINTESTINAL AND GASTRIC CANCER
HOPPE AG		3363969	ACTUATION HANDLE
		3360897	ANTAGONISTS OF IL17C FOR THE TREATMENT OF INFLAMMATORY DISORDERS
		3346272	WHOLE CELL ASSAYS AND METHODS

Podnosilac evropske prijave patenta (71)	MKP (51)	Broj objave evropske prijave patenta (97)	Naziv pronalaska (54)
Officine Cucini S.r.l.	<b>G01N 33/50</b> (2006.01)		
	<b>G01N 33/574</b> (2006.01)		
	<b>B60P 1/26</b> (2006.01)	3392083	AN INNOVATIVE, PREFERABLY REAR PILLAR OF DISMOUNTABLE TYPE FOR LORRIES
	<b>B62D 33/037</b> (2006.01)		
	<b>A61K 31/495</b> (2006.01)	3418281	COMPOUNDS USEFUL AS INHIBITORS OF ATR KINASE FOR THE TREATMENT OF CANCER DISEASES
	<b>A61P 35/00</b> (2006.01)		
	<b>C07D 487/04</b> (2006.01)		
	<b>C01D 15/08</b> (2006.01)	3363930	PROCESSES FOR PREPARING LITHIUM CARBONATE
	<b>C22B 3/04</b> (2006.01)		
	<b>C22B 26/12</b> (2006.01)		
	<b>C25B 1/16</b> (2006.01)		
	<b>A61K 31/44</b> (2006.01)	3357921	BIARYL COMPOUNDS USEFUL FOR THE TREATMENT OF HUMAN DISEASES IN ONCOLOGY, NEUROLOGY AND IMMUNOLOGY
	<b>A61K 31/505</b> (2006.01)		
	<b>A61K 31/506</b> (2006.01)		
	<b>A61P 25/02</b> (2006.01)		
	<b>A61P 35/00</b> (2006.01)		
	<b>A61P 37/00</b> (2006.01)		
	<b>C07D 239/30</b> (2006.01)		
	<b>C07D 401/14</b> (2006.01)		
	<b>C07D 403/12</b> (2006.01)		
	<b>C07D 409/14</b> (2006.01)		
	<b>C07D 413/14</b> (2006.01)		
	<b>C07D 417/12</b> (2006.01)		
	<b>C07D 417/14</b> (2006.01)		
	<b>C07D 495/04</b> (2006.01)		
	<b>C07D 513/04</b> (2006.01)		
	<b>C07F 5/02</b> (2006.01)		
<b>A61K 31/44</b> (2006.01)	3357921	BIARYL COMPOUNDS USEFUL FOR THE TREATMENT OF HUMAN DISEASES IN ONCOLOGY, NEUROLOGY AND IMMUNOLOGY	
<b>A61K 31/505</b> (2006.01)			
<b>A61K 31/506</b> (2006.01)			

Podnosilac evropske prijave patenta (71)	MKP (51)	Broj objave evropske prijave patenta (97)	Naziv pronalaska (54)
	<b>A61P 25/02</b> (2006.01)		
	<b>A61P 35/00</b> (2006.01)		
	<b>A61P 37/00</b> (2006.01)		
	<b>C07D 239/30</b> (2006.01)		
	<b>C07D 401/14</b> (2006.01)		
	<b>C07D 403/12</b> (2006.01)		
	<b>C07D 409/14</b> (2006.01)		
	<b>C07D 413/14</b> (2006.01)		
	<b>C07D 417/12</b> (2006.01)		
	<b>C07D 417/14</b> (2006.01)		
	<b>C07D 495/04</b> (2006.01)		
	<b>C07D 513/04</b> (2006.01)		
	<b>C07F 5/02</b> (2006.01)		
Immersion Corporation	<b>G06F 3/01</b> (2006.01)	3352055	SYSTEMS AND METHODS FOR HAPTIC AUGMENTATION OF VOICE-TO-TEXT CONVERSION
	<b>G06F 3/16</b> (2006.01)		
	<b>G08B 6/00</b> (2006.01)		
	<b>G10L 15/26</b> (2006.01)		
	<b>G10L 21/16</b> (2013.01)		
	<b>G10L 25/03</b> (2013.01)		
	<b>A61K 39/395</b> (2006.01)	3354280	STABILIZED FORMULATIONS CONTAINING ANTI-INTERLEUKIN-4 RECEPTOR (IL-4R) ANTIBODIES
	<b>A61M 5/315</b> (2006.01)		
	<b>C07K 16/28</b> (2006.01)		
VIIV Healthcare Company	<b>A61K 31/4985</b> (2006.01)	3351249	ANTIVIRAL THERAPY
	<b>A61K 31/505</b> (2006.01)		
	<b>A61K 31/513</b> (2006.01)		
	<b>A61K 31/52</b> (2006.01)		
	<b>A61K 31/536</b> (2006.01)		
	<b>A61K 31/5365</b> (2006.01)		
	<b>A61P 31/18</b> (2006.01)		

Podnosilac evropske prijave patenta (71)	MKP (51)	Broj objave evropske prijave patenta (97)	Naziv pronalaska (54)
Istituto Nazionale per l'Assicurazione contro gli Infortuni sul lavoro - INAIL	<b>G09B 9/00</b> (2006.01)	3382674	SIMULATOR FOR TRAINING IN ENVIRONMENTS CONFINED AND / OR SUSPECTED OF POLLUTION
	<b>A61K 31/138</b> (2006.01)	3351527	TRANS-CLOMIPHENE METABOLITES AND USES THEREOF
	<b>A61P 3/06</b> (2006.01)		
	<b>C07C 217/18</b> (2006.01)		
	<b>A61K 31/506</b> (2006.01)	3357919	AROMATIC HETEROCYCLIC COMPOUNDS AS ANTIINFLAMMATORY COMPOUNDS
	<b>A61P 11/00</b> (2006.01)		
	<b>A61P 29/00</b> (2006.01)		
	<b>A61P 31/00</b> (2006.01)		
	<b>C07D 401/14</b> (2006.01)		
	<b>C07D 409/14</b> (2006.01)		
	<b>A61K 31/7084</b> (2006.01)	3366691	CYCLIC PURINE DINUCLEOTIDES AS MODULATORS OF STING
	<b>A61K 39/00</b> (2006.01)		
	<b>A61K 39/39</b> (2006.01)		
	<b>A61P 31/12</b> (2006.01)		
	<b>A61P 35/00</b> (2006.01)		
	<b>C07F 9/6574</b> (2006.01)		
	<b>C07H 21/00</b> (2006.01)		
	<b>C07H 21/02</b> (2006.01)		
	<b>C07H 21/04</b> (2006.01)		
	<b>C07K 16/28</b> (2006.01)	3406633	MULTISPECIFIC ANTIBODIES, MULTISPECIFIC ACTIVATABLE ANTIBODIES AND METHODS OF USING THE SAME
	<b>C07K 16/24</b> (2006.01)	3369744	ANTIGEN BINDING PROTEINS TO ONCOSTATIN M (OSM)
	<b>A61K 39/00</b> (2006.01)	3415531	BCMA (CD269/TNFRSF17) - BINDING PROTEINS
	<b>A61K 47/68</b> (2017.01)		
	<b>C07K 16/28</b> (2006.01)		
	<b>A61P 25/00</b> (2006.01)	3404027	NUCLEAR TRANSPORT MODULATORS AND USES THEREOF
	<b>A61P 35/00</b> (2006.01)		
	<b>C07D 249/08</b> (2006.01)		
	<b>C07D 403/12</b> (2006.01)		
	<b>C07D 413/12</b> (2006.01)		
	<b>A61K 35/74</b> (2015.01)	3360559	COMPOSITIONS COMPRISING BACTERIAL STRAINS
	<b>A61K 35/745</b>		



Podnosilac evropske prijave patenta (71)	MKP (51)	Broj objave evropske prijave patenta (97)	Naziv pronalaska (54)
Bruno Presezzi S.p.A.	(2015.01) <b>A61P 11/06</b> (2006.01) <b>A61P 35/00</b> (2006.01) <b>B22D 11/06</b> (2006.01) <b>B22D 11/128</b> (2006.01) <b>A61K 31/712</b> (2006.01) <b>A61K 31/713</b> (2006.01) <b>A61P 1/16</b> (2006.01) <b>A61P 11/00</b> (2006.01) <b>A61P 35/00</b> (2006.01) <b>C12N 15/113</b> (2010.01) <b>A61K 31/221</b> (2006.01) <b>C07C 219/08</b> (2006.01) <b>C07C 229/12</b> (2006.01) <b>C07C 229/16</b> (2006.01) <b>C07C 309/18</b> (2006.01) <b>C07K 16/28</b> (2006.01) <b>C07K 16/30</b> (2006.01) <b>G01N 33/68</b> (2006.01) <b>C07D 471/04</b> (2006.01) <b>A61K 9/127</b> (2006.01) <b>A61K 31/7105</b> (2006.01) <b>A61K 48/00</b> (2006.01) <b>C07H 21/02</b> (2006.01) <b>A61K 39/00</b> (2006.01) <b>A61K 39/35</b> (2006.01) <b>C12N 15/117</b> (2010.01) <b>C12N 15/68</b> (2006.01) <b>A61B 5/06</b> (2006.01) <b>A61B 34/20</b> (2016.01) <b>H01F 38/14</b>	3385012	JACKET FOR A ROLLER USED IN CONTINUOUS CASTING, PARTICULARLY FOR THE PRODUCTION OF ALUMINUM OR ALUMINUM ALLOY STRIPS AND OF ZINC-BASED ALLOY STRIPS
	3412774	SERPINA1 IRNA COMPOSITIONS AND METHODS OF USE THEREOF	
	3366668	PRODRUGS OF FUMARATES AND THEIR USE IN TREATING VARIOUS DISEASES	
	3409689	ANTI-CD134 (OX40) ANTIBODIES AND USES THEREOF	
	3395818	2-(MORPHOLIN-4-YL)-1,7-NAPHTHYRIDINES	
	3403647	DELIVERY OF MRNA FOR THE AUGMENTATION OF PROTEINS AND ENZYMES IN HUMAN GENETIC DISEASES	
	3404103	NUCLEIC ACID COMPRISING OR CODING FOR A HISTONE STEM-LOOP AND A POLY(A) SEQUENCE OR A POLYADENYLATION SIGNAL FOR INCREASING THE EXPRESSION OF AN ENCODED ALLERGENIC ANTIGEN OR AN AUTOIMMUNE SELF-ANTIGEN	
	3396810	USING LOCATION TRANSMISSION SIGNALS FOR CHARGING A WIRELESS TOOL OF AN ELECTROMAGNETIC NAVIGATION SYSTEM	

Podnosilac evropske prijave patenta (71)	MKP (51)	Broj objave evropske prijave patenta (97)	Naziv pronalaska (54)
	(2006.01) <b>H02J 7/00</b> (2006.01) <b>H02J 50/10</b> (2016.01) <b>H02J 50/40</b> (2016.01)		
Universiteit Gent	<b>A61L 27/00</b> (2006.01) <b>A61L 31/08</b> (2006.01) <b>A61L 31/16</b> (2006.01) <b>C07K 14/00</b> (2006.01)	3384939	MOLECULES AND METHODS FOR INHIBITION AND DETECTION OF PROTEINS
BiocerOX Products B.V.	<b>C07K 16/28</b> (2006.01) <b>C07K 16/00</b> (2006.01) <b>C07K 16/18</b> (2006.01) <b>C07K 16/44</b> (2006.01) <b>C07K 19/00</b> (2006.01) <b>C12P 21/08</b> (2006.01)	3409690 3385279	HUMANIZED ANTI-CD134 (OX40) ANTIBODIES AND USES THEREOF CARRIER IMMUNOGLOBULINS AND USES THEREOF
	<b>A61B 17/064</b> (2006.01) <b>A61B 17/072</b> (2006.01) <b>A61B 90/00</b> (2016.01)	3403593	DEVICES FOR STABILIZING FASTENERS POST-DEPLOYMENT
W-A Progettazioni S.r.l.	<b>F24D 19/06</b> (2006.01) <b>A61K 39/00</b> (2006.01) <b>C07K 14/47</b> (2006.01) <b>A61K 39/00</b> (2006.01) <b>C07K 14/47</b> (2006.01) <b>A61K 39/00</b> (2006.01) <b>C07K 14/47</b> (2006.01) <b>A61K 39/00</b> (2006.01) <b>C07K 14/47</b> (2006.01) <b>A61K 39/00</b> (2006.01) <b>C07K 14/47</b> (2006.01) <b>A61K 39/00</b> (2006.01) <b>C07K 14/47</b> (2006.01) <b>A61K 39/00</b> (2006.01) <b>C07K 14/47</b> (2006.01)	3412977 3388075 3388076 3388077 3388078 3388079 3388080	RADIANT MODULE FOR FORMING A RADIANT BODY NOVEL PEPTIDES AND COMBINATION OF PEPTIDES FOR USE IN IMMUNOTHERAPY AGAINST VARIOUS TUMORS (SEQ ID 25 - MRAX5-003) NOVEL PEPTIDES AND COMBINATION OF PEPTIDES FOR USE IN IMMUNOTHERAPY AGAINST VARIOUS TUMORS (SEQ ID 274 - IGF-004) NOVEL PEPTIDES AND COMBINATION OF PEPTIDES FOR USE IN IMMUNOTHERAPY AGAINST VARIOUS TUMORS (SEQ ID 245 - MAGEA4-003) NOVEL PEPTIDES AND COMBINATION OF PEPTIDES FOR USE IN IMMUNOTHERAPY AGAINST VARIOUS TUMORS (SEQ ID 23 - MMP-002) NOVEL PEPTIDES AND COMBINATION OF PEPTIDES FOR USE IN IMMUNOTHERAPY AGAINST VARIOUS TUMORS (SEQ ID 253 - RAD54B) NOVEL PEPTIDES AND COMBINATION OF PEPTIDES FOR USE IN IMMUNOTHERAPY AGAINST VARIOUS TUMORS (SEQ ID 243 - SPC25-001)
Pierre Fabre Dermatologie	<b>A61K 9/00</b> (2006.01) <b>A61K 31/13</b> (2006.01) <b>C07H 15/26</b> (2006.01)	3384899 3388441	PAEDIATRIC SOLUTIONS COMPRISING A BETA-BLOCKER MANNOSE DERIVATIVES FOR TREATING BACTERIAL INFECTIONS

Podnosilac evropske prijave patenta (71)	MKP (51)	Broj objave evropske prijave patenta (97)	Naziv pronalaska (54)
NeuroVive Pharmaceutical AB	<b>A61P 9/00</b> (2006.01) <b>A61P 11/00</b> (2006.01) <b>A61P 21/00</b> (2006.01) <b>A61P 35/00</b> (2006.01)	3391941	NOVEL CELL-PERMEABLE SUCCINATE COMPOUNDS
GLAXO GROUP LIMITED	<b>C07D 453/02</b> (2006.01) <b>C07D 471/04</b> (2006.01)	3401316 3415515	CHEMICAL PROCESS METHOD FOR THE PREPARATION OF METHYL-{4,6-DIAMINO-2-[1-(2-FLUOROBENZYL)-1H-PYRAZOLO[3,4-B]PYRIDIN-3-YL]PYRIMIDIN-5-YL}METHYL CARBAMATE
The Board of Trustees of the Leland Stanford Junior University	<b>A61K 31/554</b> (2006.01) <b>A61P 1/16</b> (2006.01) <b>C07K 16/00</b> (2006.01) <b>C07K 16/12</b> (2006.01) <b>C12N 5/10</b> (2006.01) <b>G01N 33/68</b> (2006.01)	3400944 3415619	IBAT INHIBITORS FOR THE TREATMENT OF LIVER DISEASES IDENTIFICATION OF POLYNUCLEOTIDES ASSOCIATED WITH A SAMPLE
Genzyme Corporation	<b>C07D 401/04</b> (2006.01) <b>C07D 401/14</b> (2006.01) <b>C07D 403/04</b> (2006.01) <b>C07D 403/14</b> (2006.01) <b>C07D 405/12</b> (2006.01) <b>C07D 405/14</b> (2006.01) <b>C07D 471/04</b> (2006.01)	3409669	HETEROARYL COMPOUNDS FOR KINASE INHIBITION
The Regents of the University of California	<b>A01N 43/54</b> (2006.01) <b>A61K 31/425</b> (2006.01) <b>A61K 31/505</b> (2006.01) <b>A61P 35/00</b> (2006.01) <b>A61K 9/51</b> (2006.01) <b>A61K 9/00</b> (2006.01) <b>A61K 31/506</b> (2006.01) <b>A61K 47/26</b> (2006.01) <b>A61P 11/00</b> (2006.01) <b>A61P 29/00</b> (2006.01) <b>A61P 31/00</b> (2006.01) <b>C07D 401/12</b> (2006.01)	3406141 3412282 3418279	COMBINATION THERAPY FOR TREATING CANCER MEMBRANE ENCAPSULATED NANOPARTICLES AND METHOD OF USE AROMATIC HETEROCYCLIC COMPOUNDS AS ANTIINFLAMMATORY COMPOUNDS

Podnosilac evropske prijave patenta (71)	MKP (51)	Broj objave evropske prijave patenta (97)	Naziv pronalaska (54)
Pharma Mar S.A.	<b>C07D 401/14</b> (2006.01)	3395820	ANTITUMORAL COMPOUNDS
	<b>C07D 409/14</b> (2006.01)		
	<b>C07D 413/14</b> (2006.01)		
	<b>C07D 487/04</b> (2006.01)		
	<b>A61K 31/4995</b> (2006.01)		
	<b>A61P 35/00</b> (2006.01)		
	<b>C07D 515/22</b> (2006.01)		
	<b>A61K 31/4995</b> (2006.01)		
	<b>A61P 35/00</b> (2006.01)		
	<b>C07D 515/22</b> (2006.01)		
InflaRx GmbH	<b>C07K 16/18</b> (2006.01)	3411400	TREATMENT OF INFLAMMATORY DISEASES WITH INHIBITORS OF C5A ACTIVITY
	<b>G05B 9/02</b> (2006.01)	3299909	SAFETY CIRCUIT FOR THE FAIL-SAFE SHUTDOWN OF A DANGEROUS TECHNICAL INSTALLATION
Pilz GmbH & Co. KG	<b>H01H 47/00</b> (2006.01)	3309174	ANTI-PD-L1 ANTIBODIES AND DIAGNOSTIC USES THEREOF
	<b>C07K 16/28</b> (2006.01)		
SAVENCIA SA	<b>G01N 33/53</b> (2006.01)	3289884	FOOD COMPOSITION BASED ON DAIRY PRODUCTS AND METHOD FOR MANUFACTURING SAME
	<b>A23C 15/04</b> (2006.01)		
	<b>A23C 15/16</b> (2006.01)		
	<b>A23D 9/00</b> (2006.01)		
	<b>A23D 9/04</b> (2006.01)		
	<b>A23G 3/34</b> (2006.01)		
	<b>A61K 39/00</b> (2006.01)		
	<b>A61K 39/395</b> (2006.01)		
	<b>A61P 35/00</b> (2006.01)		
	<b>C07K 14/705</b> (2006.01)		
Ethicon LLC	<b>C07K 16/28</b> (2006.01)	3305813	ANTIBODIES SPECIFIC FOR CLAUDIN 6 (CLDN6)
	<b>C07K 16/30</b> (2006.01)		
	<b>C12N 5/00</b> (2006.01)		
	<b>C12N 5/071</b> (2010.01)		
	<b>C12N 5/09</b> (2010.01)		
	<b>G01N 33/50</b> (2006.01)		
	<b>A61B 17/072</b> (2006.01)		
	<b>A61K 39/00</b> (2006.01)		
	<b>A61K 39/395</b> (2006.01)		
	<b>A61P 35/00</b> (2006.01)		
Ethicon LLC	<b>C07K 16/28</b> (2006.01)	3318627	CULTURE MEDIA FOR STEM CELLS
	<b>C07K 16/30</b> (2006.01)		
	<b>C12N 5/00</b> (2006.01)		
	<b>C12N 5/071</b> (2010.01)		
	<b>C12N 5/09</b> (2010.01)		
	<b>G01N 33/50</b> (2006.01)		
	<b>A61B 17/072</b> (2006.01)		
	<b>A61K 39/00</b> (2006.01)		
	<b>A61K 39/395</b> (2006.01)		
	<b>A61P 35/00</b> (2006.01)		
Ethicon LLC	<b>C07K 16/28</b> (2006.01)	3275378	TISSUE THICKNESS COMPENSATOR COMPRISING A PLURALITY OF CAPSULES
	<b>C07K 16/30</b> (2006.01)		
	<b>C12N 5/00</b> (2006.01)		
	<b>C12N 5/071</b> (2010.01)		
	<b>C12N 5/09</b> (2010.01)		
	<b>G01N 33/50</b> (2006.01)		
	<b>A61B 17/072</b> (2006.01)		
	<b>A61K 39/00</b> (2006.01)		
	<b>A61K 39/395</b> (2006.01)		
	<b>A61P 35/00</b> (2006.01)		

Podnosilac evropske prijave patenta (71)	MKP (51)	Broj objave evropske prijave patenta (97)	Naziv pronalaska (54)
	<b>A61L 31/04</b> (2006.01)		
	<b>A61L 31/12</b> (2006.01)		
	<b>A61L 31/14</b> (2006.01)		
	<b>C07H 5/10</b> (2006.01)	3301102	RIBONUCLEIC ACIDS WITH 4'-THIO-MODIFIED NUCLEOTIDES AND RELATED METHODS
	<b>C12N 15/11</b> (2006.01)		
	<b>C12N 15/67</b> (2006.01)		
San Jamar, Inc.	<b>A47J 43/28</b> (2006.01)	3305717	FOOD BAG WORKING TOOL
	<b>B67B 7/46</b> (2006.01)		
	<b>A61P 35/02</b> (2006.01)	3284754	ANTI-CD38 ANTIBODIES
	<b>C07K 16/28</b> (2006.01)		
Applications Logiciels Pour Ingénierie ALPI	<b>G06F 17/50</b> (2006.01)	3293650	METHOD, DEVICE AND COMPUTER PROGRAM TO ASSIST WITH THE SELECTION AND INSTALLATION OF CONSTRUCTION MATERIAL ELEMENTS
SYSMEX CORPORATION	<b>C12Q 1/68</b> (2018.01)	3293273	METHOD FOR ASSISTING JUDGMENT OF PROGNOSIS OF BREAST CANCER, AND APPARATUS FOR ASSISTING JUDGMENT OF PROGNOSIS OF BREAST CANCER
	<b>C07D 403/12</b> (2006.01)	3299367	BIARYL AMIDE COMPOUNDS AS KINASE INHIBITORS
	<b>A61K 38/00</b> (2006.01)	3308796	ACTIVIN-ACTRII ANTAGONISTS AND USES FOR TREATING BONE AND OTHER DISORDERS
	<b>A61K 38/17</b> (2006.01)		
	<b>A61K 38/22</b> (2006.01)		
	<b>A61K 38/27</b> (2006.01)		
	<b>A61K 38/29</b> (2006.01)		
	<b>A61P 19/08</b> (2006.01)		
	<b>A61P 19/10</b> (2006.01)		
	<b>C12N 5/00</b> (2006.01)	3305890	REVERSING THE EFFECTS OF THE TUMOR MICROENVIRONMENT USING CHIMERIC CYTOKINE RECEPTORS
	<b>A61K 9/00</b> (2006.01)	3351546	LONG-ACTING INJECTABLE MOXIDECTIN FORMULATIONS
	<b>A61K 31/365</b> (2006.01)		
	<b>A61K 47/34</b> (2017.01)		
	<b>A61P 33/00</b> (2006.01)		
	<b>C07D 493/22</b> (2006.01)		
	<b>A61K 31/4439</b> (2006.01)	3284742	SUBSTITUTED PYRIDINE DERIVATIVES USEFUL AS C-FMS KINASE INHIBITORS
	<b>A61P 3/00</b> (2006.01)		
	<b>A61P 11/00</b> (2006.01)		
	<b>A61P 25/00</b> (2006.01)		
	<b>A61P 29/00</b> (2006.01)		

Podnosilac evropske prijave patenta (71)	MKP (51)	Broj objave evropske prijave patenta (97)	Naziv pronalaska (54)
PERI GMBH	<b>A61P 31/00</b> (2006.01)		
	<b>A61P 35/00</b> (2006.01)		
	<b>C07D 405/14</b> (2006.01)		
	<b>F16B 7/18</b> (2006.01)	3301311	COUPLING
	<b>A61K 31/519</b> (2006.01)	3290421	COMBINATION OF PYRROLO [2, 3 -D]PYRIMIDINE DERIVATIVES WITH ONE OR MORE ADDITIONAL AGENTS AS INHIBITORS OF JANUS- RELATED KINASES (JAK)
	<b>A61P 37/00</b> (2006.01)		
	<b>C07D 487/04</b> (2006.01)		
	<b>C07D 519/00</b> (2006.01)		
	<b>A61K 39/395</b> (2006.01)	3287142	METHODS FOR TREATING CONDITIONS ASSOCIATED WITH MASP-2 DEPENDENT COMPLEMENT ACTIVATION
	<b>C07K 16/40</b> (2006.01)		
MERCK SHARP & DOHME CORP.	<b>C12N 15/11</b> (2006.01)		
	<b>A61K 31/513</b> (2006.01)	3295942	COMBINATIONS COMPRISING 5-PHENOXY-3H-PYRIMIDIN-4-ONE DERIVATIVES AND THEIR USE FOR THE PROPHYLAXIS OR TREATMENT OF INFECTION BY HIV
	<b>A61P 31/18</b> (2006.01)		
	<b>A61K 39/00</b> (2006.01)	3305798	USE OF CHIMERIC ANTIGEN RECEPTOR-MODIFIED T CELLS TO TREAT CANCER
HUF Hülsbeck & Fürst GmbH & Co. KG	<b>C07H 21/04</b> (2006.01)		
	<b>B60R 25/021</b> (2013.01)	3296163	SECURED DEVICE FOR BLOCKING AN ESSENTIAL COMPONENT OF A MOTOR VEHICLE
	<b>B60R 25/023</b> (2013.01)		
	<b>C07K 16/00</b> (2006.01)	3339322	IMMUNOGLOBULIN SINGLE VARIABLE DOMAIN ANTIBODIES WITH A C-TERMINAL EXTENSION FOR REDUCED IMMUNOGENICITY
	<b>C07K 16/22</b> (2006.01)		
	<b>C07K 16/28</b> (2006.01)		
	<b>C07K 16/42</b> (2006.01)		
	<b>B05C 1/04</b> (2006.01)	3273134	DEVICE FOR APPLYING OIL TO A CHAIN OF A TWO-WHEELED VEHICLE, IN PARTICULAR A BICYCLE
	<b>B62J 31/00</b> (2006.01)		
	<b>F16H 57/05</b> (2006.01)		
CeQur SA	<b>F16N 3/04</b> (2006.01)		
	<b>F16N 9/00</b> (2006.01)		
	<b>A61M 5/142</b> (2006.01)	3287161	LOW-DEAD VOLUME MICROFLUIDIC CIRCUIT AND METHODS
	<b>A61M 5/158</b> (2006.01)		
	<b>F15C 5/00</b> (2006.01)		
	<b>F16K 99/00</b> (2006.01)		

Podnosilac evropske prijave patenta (71)	MKP (51)	Broj objave evropske prijave patenta (97)	Naziv pronalaska (54)
	<b>G01L 9/00</b> (2006.01)		
	<b>C11D 1/83</b> (2006.01)	3299445	ADDITIVE COMPOSITION WITH INTEGRATED ACTION
	<b>C11D 3/00</b> (2006.01)		
	<b>C11D 3/22</b> (2006.01)		
	<b>C11D 3/37</b> (2006.01)		
	<b>C11D 3/50</b> (2006.01)		
	<b>C11D 11/00</b> (2006.01)		
	<b>C11D 17/00</b> (2006.01)		
	<b>D06F 35/00</b> (2006.01)	3299505	OPTIMIZED METHOD FOR WASHING IN WASHING MACHINES
	<b>D06F 39/02</b> (2006.01)		
	<b>A61K 31/44</b> (2006.01)	3293176	CRYSTAL FORM OF A PDE4 INHIBITOR
	<b>A61P 11/00</b> (2006.01)		
	<b>C07D 213/89</b> (2006.01)		
ECCO WOOD Spolka z ograniczona odpowiedzialnoscia	<b>B65D 90/00</b> (2006.01)	3305709	A SYSTEM FOR TRANSPORTING AND UNLOADING CONTAINERS FOR GOODS, IN PARTICULAR FOR BULK MATERIAL, A CONTAINER AND A CONTAINER SPREADER
	<b>B66C 1/10</b> (2006.01)		
	<b>B66C 1/66</b> (2006.01)		
	<b>B66F 9/065</b> (2006.01)		
	<b>E05B 83/08</b> (2014.01)		
Sangiorgio, Luciano	<b>A21D 6/00</b> (2006.01)	3305078	NEW METHOD FOR MAKING (FERMENTED) BAKERY PRODUCTS
	<b>A21D 8/02</b> (2006.01)		
	<b>A21D 8/04</b> (2006.01)		
	<b>A61K 31/506</b> (2006.01)	3323818	MODULATORS OF THE GPR119 RECEPTOR AND THE TREATMENT OF DISORDERS RELATED THERETO
	<b>A61P 3/00</b> (2006.01)		
	<b>C07D 413/14</b> (2006.01)		
	<b>A61K 39/395</b> (2006.01)	3299390	METHODS OF TREATING PSORIASIS USING IL-17 ANTAGONISTS
	<b>C07K 16/24</b> (2006.01)		
	<b>A61K 39/395</b> (2006.01)	3295957	ANTIBODY FORMULATION AND THERAPEUTIC REGIMENS
	<b>A61P 17/06</b> (2006.01)		
	<b>C07K 16/28</b> (2006.01)		
Unicum Transmission de Puissance	<b>E04H 4/08</b> (2006.01)	3312364	MOTOR ASSEMBLY INCLUDING AT LEAST ONE GEAR MOTOR UNIT
	<b>E04H 4/10</b> (2006.01)		
Minebea Mitsumi Inc.	<b>G01B 7/16</b> (2006.01)	3312550	STRAIN GAUGE

Podnosilac evropske prijave patenta (71)	MKP (51)	Broj objave evropske prijave patenta (97)	Naziv pronalaska (54)	
Nisi, Cristian	<b>G01L 1/22</b> (2006.01)	3308675	ANGLE-ADJUSTER FOR A HEADREST	
	<b>H01C 17/24</b> (2006.01)			
	<b>A47C 7/38</b> (2006.01)	3309358	CARRYING WHEEL ASSEMBLY	
	<b>B60N 2/838</b> (2018.01)			
	<b>B60B 17/00</b> (2006.01)	3308730	CATHETER WITH ANGLED IRRIGATION HOLES	
	<b>B61F 9/00</b> (2006.01)			
	<b>E21D 11/10</b> (2006.01)	3299391	ANTI-B7-H4 ANTIBODIES AND IMMUNOCONJUGATES	
	<b>A61B 18/14</b> (2006.01)			
	Cyberderm Laboratories Inc.	<b>A61K 39/395</b> (2006.01)	3315116	TOPICAL SUNSCREEN COMPOSITION, METHOD OF PREPARATION, AND USE THEREOF
		<b>A61P 35/00</b> (2006.01)		
<b>C07K 16/28</b> (2006.01)				
<b>A61K 8/02</b> (2006.01)				
<b>A61K 8/19</b> (2006.01)				
<b>A61K 8/27</b> (2006.01)				
<b>A61K 8/29</b> (2006.01)				
<b>A61K 8/85</b> (2006.01)				
<b>A61Q 17/04</b> (2006.01)				
<b>A61K 9/00</b> (2006.01)		3311800		
<b>A61K 9/107</b> (2006.01)				
General Services Spain Italy S.L.	<b>A61K 9/50</b> (2006.01)	3312169	5-HT3 RECEPTOR ANTAGONISTS	
	<b>A61K 36/28</b> (2006.01)			
	<b>A61K 31/19</b> (2006.01)	3312169	5-HT3 RECEPTOR ANTAGONISTS	
	<b>A61K 31/5386</b> (2006.01)			
	<b>C07C 53/18</b> (2006.01)			
	<b>C07C 53/40</b> (2006.01)			
	<b>C07D 221/22</b> (2006.01)			
	<b>C07D 401/04</b> (2006.01)			
	<b>C07D 401/12</b> (2006.01)			
	<b>C07D 401/14</b> (2006.01)			
<b>C07D 403/04</b> (2006.01)				
<b>C07D 451/12</b> (2006.01)				
<b>C07D 453/02</b> (2006.01)				
<b>C07D 471/02</b>				



Podnosilac evropske prijave patenta (71)	MKP (51)	Broj objave evropske prijave patenta (97)	Naziv pronalaska (54)
	(2006.01) <b>C07D 471/04</b> (2006.01) <b>C07D 471/08</b> (2006.01) <b>C07D 487/14</b> (2006.01) <b>C07D 498/08</b> (2006.01) <b>C07D 519/00</b> (2006.01)		
Meier Betonwerke GmbH	<b>E04B 5/38</b> (2006.01) <b>E04B 5/48</b> (2006.01) <b>E04B 9/00</b> (2006.01)	3315682	FORMWORK ELEMENT AND METHOD FOR MANUFACTURING A CEILING
GMC Software AG	<b>H04L 29/08</b> (2006.01)	3319301	COMPUTER-IMPLEMENTED METHOD AND COMPUTER SYSTEM FOR DISTRIBUTING PUSH NOTIFICATIONS
Chemia S.p.A.	<b>A01N 31/16</b> (2006.01) <b>A01N 45/00</b> (2006.01) <b>A01P 3/00</b> (2006.01)	3318125	ANTIFUNGAL COMPOSITION
L&J Underwear	<b>A41B 9/02</b> (2006.01)	3320793	MEN'S UNDERGARMENT
Intrexon Actobiotics NV	<b>A61K 35/744</b> (2015.01) <b>A61K 38/20</b> (2006.01) <b>A61K 39/00</b> (2006.01) <b>A61P 3/10</b> (2006.01) <b>A61P 37/06</b> (2006.01) <b>C12N 1/00</b> (2006.01) <b>C12N 1/20</b> (2006.01) <b>C12N 15/09</b> (2006.01) <b>C12R 1/01</b> (2006.01)	3402499	COMPOSITIONS AND METHODS FOR THE TREATMENT OF TYPE 1 DIABETES
	<b>A61K 51/04</b> (2006.01) <b>A61K 101/02</b> (2006.01) <b>C07B 59/00</b> (2006.01) <b>C07D 401/14</b> (2006.01)	3411083	TAU PET IMAGING LIGANDS
	<b>A61K 31/4439</b> (2006.01) <b>A61P 35/00</b> (2006.01) <b>C07D 401/04</b> (2006.01) <b>C07D 401/14</b> (2006.01) <b>C07D 405/14</b> (2006.01) <b>C07D 409/14</b> (2006.01)	3402791	SUBSTITUTED THIOHYDANTOIN DERIVATIVES AS ANDROGEN RECEPTOR ANTAGONISTS

Podnosilac evropske prijave patenta (71)	MKP (51)	Broj objave evropske prijave patenta (97)	Naziv pronalaska (54)
<b>C07D 413/14</b> (2006.01)			
<b>C07D 451/02</b> (2006.01)			
<b>C07D 451/06</b> (2006.01)			
<b>C07D 487/04</b> (2006.01)			
<b>C07D 491/044</b> (2006.01)			
<b>C07D 491/048</b> (2006.01)			
<b>A61K 48/00</b> (2006.01)	3400023		THERAPEUTIC MRNAS ENCODING ANTI CTLA-4 ANTIBODIES
<b>C07K 16/28</b> (2006.01)			
<b>A61P 7/02</b> (2006.01)	3405498		ANTI-COAGULATION FACTOR XI ANTIBODIES
<b>C07K 16/36</b> (2006.01)			
<b>C07K 16/28</b> (2006.01)	3411402		BCMA AND CD3 BISPECIFIC T CELL ENGAGING ANTIBODY CONSTRUCTS
<b>C07K 16/28</b> (2006.01)	3411403		BISPECIFIC T CELL ENGAGING ANTIBODY CONSTRUCTS
<b>C07K 16/30</b> (2006.01)			
<b>A23L 2/54</b> (2006.01)	3411336		INSTALLATION FOR THE PREPARATION OF AN AQUEOUS SOLUTION COMPRISING AT LEAST ONE EARTH ALKALI HYDROGEN CARBONATE
<b>C02F 1/44</b> (2006.01)			
<b>C02F 1/66</b> (2006.01)			
<b>C02F 1/68</b> (2006.01)			
<b>A61K 31/5377</b> (2006.01)	3408261		CRYSTALLINE FORM OF 1,3-THIAZOL-5-YLMETHYL [(2R,5R)-5-{{(2S)-2-[(METHYL[[2-(PROPAN-2-YL)-1,3-THIAZOL-4-YL]METHYL}CARBAMOYL)AMINO]-4-(MORPHOLIN-4-YL)BUTANOYL 9AMINO}-1,6-DIPHENYLHEXAN-2-YL]CARBAMATE OR COBICISTAT
<b>A61K 45/06</b> (2006.01)			
<b>C07D 277/28</b> (2006.01)			
<b>C07K 16/18</b> (2006.01)	3408291		ANTI-C5 ANTIBODIES WITH ENHANCED PH SWITCH
<b>C07K 16/40</b> (2006.01)			
<b>A61K 31/4184</b> (2006.01)	3408268		BENZIMIDAZOLE DERIVATIVES AS MODULATORS OF ROR-GAMMA
<b>A61K 31/4433</b> (2006.01)			
<b>A61P 17/06</b> (2006.01)			
<b>A61P 25/00</b> (2006.01)			
<b>A61P 29/00</b> (2006.01)			
<b>A61P 35/00</b> (2006.01)			
<b>C07D 233/88</b> (2006.01)			
<b>C07D 233/90</b> (2006.01)			
<b>C07D 405/06</b> (2006.01)			

Podnosilac evropske prijave patenta (71)	MKP (51)	Broj objave evropske prijave patenta (97)	Naziv pronalaska (54)
	<b>C07D 405/14</b> (2006.01)		
	<b>C07D 471/04</b> (2006.01)		
	<b>A61K 31/519</b> (2006.01)	3411497	COPANLISIB BIOMARKERS
	<b>C12Q 1/68</b> (2018.01)		
	<b>A61K 31/519</b> (2006.01)	3411498	COPANLISIB BIOMARKERS
	<b>C12Q 1/68</b> (2018.01)		
	<b>C07K 16/28</b> (2006.01)	3411404	PSMA AND CD3 BISPECIFIC T CELL ENGAGING ANTIBODY CONSTRUCTS
	<b>C07K 16/30</b> (2006.01)		
	<b>C09C 1/02</b> (2006.01)	3417013	PROCESS FOR MANUFACTURING WHITE PIGMENT CONTAINING PRODUCTS
	<b>C09C 1/40</b> (2006.01)		
	<b>C09C 1/42</b> (2006.01)		
	<b>D21H 17/00</b> (2006.01)		
	<b>A61K 9/00</b> (2006.01)	3405173	PREPARATION OF MICRONIZED PARTICLES OF AN ANTIMUSCARINIC COMPOUND BY HYDRODYNAMIC CAVITATION
	<b>A61K 9/14</b> (2006.01)		
	<b>A61K 9/50</b> (2006.01)		
	<b>A61K 31/40</b> (2006.01)		
	<b>A61J 1/00</b> (2006.01)	3414170	HEALTHCARE PRODUCT PACKAGE
	<b>B65D 5/00</b> (2006.01)		
	<b>B65D 5/42</b> (2006.01)		
	<b>G09F 3/00</b> (2006.01)		
	<b>C09C 1/02</b> (2006.01)	3417014	PROCESS FOR MANUFACTURING WHITE PIGMENT CONTAINING PRODUCTS
	<b>C09C 1/40</b> (2006.01)		
	<b>C09C 1/42</b> (2006.01)		
	<b>A61K 31/56</b> (2006.01)	3411381	C-3 AND C-17 MODIFIED TRITERPENOID AS HIV-1 INHIBITORS
	<b>A61K 31/575</b> (2006.01)		
	<b>A61K 31/58</b> (2006.01)		
	<b>A61P 31/18</b> (2006.01)		
	<b>C07J 63/00</b> (2006.01)		
	<b>C12N 9/50</b> (2006.01)		
	<b>A61K 31/535</b> (2006.01)	3408271	MAYTANSINOID DERIVATIVES, CONJUGATES THEREOF, AND METHODS OF USE
	<b>A61P 35/00</b> (2006.01)		

Podnosilac evropske prijave patenta (71)	MKP (51)	Broj objave evropske prijave patenta (97)	Naziv pronalaska (54)		
Innate Tumor Immunity, Inc.	<b>C07D 498/18</b> (2006.01)	3411406	MULTISPECIFIC ANTIGEN-BINDING MOLECULE WITH IMPROVED INTERNALIZATION CHARACTERISTICS		
	<b>A61K 47/68</b> (2017.01)				
	<b>A61P 35/00</b> (2006.01)				
	<b>C07K 16/28</b> (2006.01)				
	<b>C07K 16/32</b> (2006.01)				
	<b>A23L 2/54</b> (2006.01)	3411337	PROCESS FOR THE PREPARATION OF AN AQUEOUS SOLUTION COMPRISING AT LEAST ONE EARTH ALKALI HYDROGEN CARBONATE		
	<b>B01D 61/14</b> (2006.01)				
	<b>C02F 1/44</b> (2006.01)				
	<b>C02F 1/66</b> (2006.01)				
	<b>C02F 1/68</b> (2006.01)				
	<b>A61K 31/496</b> (2006.01)	3414228	CHEMICAL COMPOUNDS AS INHIBITORS OF KINASE ACTIVITY		
	<b>A61P 9/00</b> (2006.01)				
	<b>A61P 11/00</b> (2006.01)				
	<b>A61P 15/08</b> (2006.01)				
	<b>A61P 25/24</b> (2006.01)				
	<b>A61P 25/28</b> (2006.01)				
	<b>A61P 37/08</b> (2006.01)				
	<b>C07D 213/76</b> (2006.01)				
	<b>A61K 47/68</b> (2017.01)			3413923	PYRROLOBENZODIAZEPINE CONJUGATES
	<b>A61K 31/7084</b> (2006.01)			3402801	CYCLIC DINUCLEOTIDES FOR TREATING CONDITIONS ASSOCIATED WITH STING ACTIVITY SUCH AS CANCER
	<b>A61P 35/00</b> (2006.01)	3411026	USE OF sGC STIMULATORS FOR THE TREATMENT OF NONALCOHOLIC STEATOHEPATITIS (NASH)		
	<b>C07H 21/00</b> (2006.01)				
	<b>A61K 31/197</b> (2006.01)				
	<b>A61K 31/198</b> (2006.01)				
	<b>A61K 31/506</b> (2006.01)				
	<b>A61K 31/5377</b> (2006.01)				
	<b>A61P 1/16</b> (2006.01)				
<b>A61K 47/68</b> (2017.01)	3411075			GCC-TARGETED ANTIBODY-DRUG CONJUGATES	
<b>A61P 35/00</b> (2006.01)					
<b>C07K 16/30</b> (2006.01)					

Podnosilac evropske prijave patenta (71)	MKP (51)	Broj objave evropske prijave patenta (97)	Naziv pronalaska (54)
Evolution Malta Ltd	<b>C07K 16/40</b> (2006.01)	3403249	ROULETTE WHEEL BIAS TRACKING
hairtalk GmbH	<b>G07F 17/32</b> (2006.01)	3407746	HAIR BAND WITH HAIR CARRYING STRIPS
	<b>A41G 3/00</b> (2006.01)		
	<b>A41G 5/00</b> (2006.01)		
	<b>A45D 8/36</b> (2006.01)		
	<b>F41H 5/04</b> (2006.01)	3362761	BALLISTIC PROTECTION MATERIAL AND USE THEREOF
Greentech	<b>A01N 37/06</b> (2006.01)	3405032	PLANT EXTRACT ACTING AS ANTIFUNGAL AGENT, AND PREPARATION METHOD
	<b>A01N 65/12</b> (2009.01)		
	<b>A01P 3/00</b> (2006.01)		
	<b>A61K 31/4985</b> (2006.01)	3414249	PDE1 INHIBITOR
	<b>A61P 7/12</b> (2006.01)		
	<b>A61P 9/12</b> (2006.01)		
	<b>A61P 13/12</b> (2006.01)		
	<b>C07D 487/04</b> (2006.01)		
	<b>A01K 67/027</b> (2006.01)	3411392	NON-HUMAN ANIMALS HAVING AN ENGINEERED ANGPLT8 GENE
	<b>A61K 39/00</b> (2006.01)		
	<b>A61K 49/00</b> (2006.01)		
	<b>C07K 14/515</b> (2006.01)		
	<b>C07K 16/22</b> (2006.01)		
The University Of Queensland The Provost, Fellows, Foundation Scholars, and the other members of Board, of the College of the Holy & Undiv. Trinity of Queen Elizabeth near Dublin	<b>A61P 29/00</b> (2006.01)	3416948	SULFONYLUREAS AND RELATED COMPOUNDS AND USE OF SAME
	<b>C07C 307/06</b> (2006.01)		
	<b>C07C 307/08</b> (2006.01)		
	<b>C07C 307/10</b> (2006.01)		
	<b>C07D 231/18</b> (2006.01)		
	<b>C07D 295/26</b> (2006.01)		
	<b>A61K 31/4745</b> (2006.01)	3416946	TETRACYCLIC PYRIDONE COMPOUNDS AS ANTIVIRALS
	<b>A61P 31/12</b> (2006.01)		
	<b>C07D 217/08</b> (2006.01)		
	<b>C07D 491/14</b> (2006.01)		
	<b>A61K 31/435</b> (2006.01)	3411358	SUBSTITUTED PIPERIDINE COMPOUND AND USE THEREOF
	<b>A61P 3/04</b> (2006.01)		

Podnosilac evropske prijave patenta (71)	MKP (51)	Broj objave evropske prijave patenta (97)	Naziv pronalaska (54)
Denali Therapeutics Inc.	<b>C07D 211/36</b> (2006.01)		
	<b>C07D 403/12</b> (2006.01)	3414239	INHIBITORS OF RECEPTOR-INTERACTING PROTEIN KINASE 1
	<b>A61K 31/4192</b> (2006.01)	3414233	SUBSTITUTED 1,2,3-TRIAZOLES AS NR2B-SELECTIVE NMDA MODULATORS
	<b>A61P 9/10</b> (2006.01)		
	<b>A61P 25/02</b> (2006.01)		
	<b>A61P 25/04</b> (2006.01)		
	<b>A61P 25/06</b> (2006.01)		
	<b>A61P 25/16</b> (2006.01)		
	<b>A61P 25/24</b> (2006.01)		
	<b>A61P 25/28</b> (2006.01)		
	<b>A61P 25/30</b> (2006.01)		
	<b>C07D 401/12</b> (2006.01)		
	<b>C07D 401/14</b> (2006.01)		
	<b>C07D 403/12</b> (2006.01)		
	<b>C07D 403/14</b> (2006.01)		
	<b>C07D 405/14</b> (2006.01)		
	<b>C07D 409/14</b> (2006.01)		
	<b>A61K 31/519</b> (2006.01)	3411375	PYRAZOLE DERIVATIVES AS PHOSPHOINOSITIDE 3-KINASES INHIBITORS
	<b>A61P 11/00</b> (2006.01)		
	<b>C07D 487/04</b> (2006.01)		
<b>A61K 39/00</b> (2006.01)	3416983	ANTIBODIES FOR IL-17C	
<b>C07K 16/24</b> (2006.01)			
<b>C07K 14/47</b> (2006.01)	3416980	NOVEL PEPTIDES AND COMBINATION OF PEPTIDES FOR USE IN IMMUNOTHERAPY AGAINST NHL AND OTHER CANCERS	
<b>C08B 1/00</b> (2006.01)	3411415	METHOD FOR PRODUCING REGENERATED CELLULOSE FIBERS FROM COTTON CONTAINING TEXTILE WASTE	
Stichting Saxion	<b>C08B 16/00</b> (2006.01)		
	<b>C08J 11/08</b> (2006.01)		
	<b>D01F 2/00</b> (2006.01)		
	<b>D04H 1/425</b> (2012.01)		
	<b>D21H 11/20</b> (2006.01)		
	<b>A61K 9/50</b> (2006.01)	3413879	PHARMACEUTICAL BEAD FORMULATIONS COMPRISING DIMETHYL FUMARATE
	<b>A61K 31/225</b> (2006.01)		
	<b>A61P 25/00</b> (2006.01)		

Podnositelj evropske prijave patenta (71)	MKP (51)	Broj objave evropske prijave patenta (97)	Naziv pronalaska (54)
	<b>A61K 31/7076</b> (2006.01)	3413897	METHODS FOR TREATMENT AND PROPHYLAXIS OF HIV AND AIDS
ELANCO US INC.	<b>A61P 31/18</b> (2006.01) <b>A61K 39/12</b> (2006.01) <b>C12N 7/00</b> (2006.01)	3416682	PORCINE REPRODUCTIVE AND RESPIRATORY SYNDROME VACCINE VIRUS
	<b>A61K 31/4985</b> (2006.01) <b>A61P 35/00</b> (2006.01) <b>A61P 37/00</b> (2006.01) <b>C07D 495/04</b> (2006.01)	3414251	THIENOPYRAZINE CARBOXAMIDES AS UBIQUITIN-SPECIFIC PROTEASE INHIBITORS
Hay, Ly Eang	<b>A23L 2/52</b> (2006.01) <b>A23L 33/105</b> (2016.01) <b>A61K 9/20</b> (2006.01) <b>A61K 9/48</b> (2006.01) <b>A61K 36/67</b> (2006.01) <b>A61P 1/16</b> (2006.01)	3405207	DETOXIFYING COMPOSITION FOR ORAL ADMINISTRATION AND METHOD FOR PREPARING SAME
OLMA S.r.l.	<b>B21D 5/04</b> (2006.01)	3416765	A BENDING GROUP OF A PANELLING MACHINE TOOL
Averon US, Inc.	<b>H04L 29/06</b> (2006.01) <b>H04W 12/06</b> (2009.01) <b>H04W 12/08</b> (2009.01)	3412017	METHOD AND APPARATUS FOR FACILITATING FRICTIONLESS TWO-FACTOR AUTHENTICATION
	<b>C21D 8/02</b> (2006.01) <b>C21D 8/04</b> (2006.01) <b>C21D 9/46</b> (2006.01) <b>C21D 9/48</b> (2006.01)	3402906	WARM ROLLING OF STEELS CONTAINING METASTABLE AUSTENITE
Save-Insight B.V.	<b>A47K 10/32</b> (2006.01) <b>A47K 10/38</b> (2006.01)	3410910	SYSTEM FOR STORING AND DISPENSING WIPES
	<b>A61K 39/00</b> (2006.01) <b>C07K 16/28</b> (2006.01)	3416984	CHIMERIC CANINE ANTI-CD20 ANTIBODY
	<b>C07D 295/096</b> (2006.01)	3414231	SYNTHESIS OF 1-[2-(2,4-DIMETHYL-PHENYLSULFANYL)-PHENYL]PIPERAZINE
Balancair APS	<b>A61M 16/00</b> (2006.01)	3416712	A BREATHING DEVICE
Mission Therapeutics Limited	<b>A61K 31/4025</b> (2006.01) <b>A61K 31/407</b> (2006.01) <b>A61P 35/00</b>	3416960	NOVEL COMPOUNDS

Podnosilac evropske prijave patenta (71)	MKP (51)	Broj objave evropske prijave patenta (97)	Naziv pronalaska (54)
	(2006.01)		
	<b>C07D 401/06</b>		
	(2006.01)		
	<b>C07D 401/12</b>		
	(2006.01)		
	<b>C07D 401/14</b>		
	(2006.01)		
	<b>C07D 403/06</b>		
	(2006.01)		
	<b>C07D 403/14</b>		
	(2006.01)		
	<b>C07D 413/06</b>		
	(2006.01)		
	<b>C07D 413/12</b>		
	(2006.01)		
	<b>C07D 417/12</b>		
	(2006.01)		
	<b>C07D 417/14</b>		
	(2006.01)		
	<b>C07D 471/04</b>		
	(2006.01)		
	<b>C07D 487/04</b>		
	(2006.01)		
	<b>C07D 487/10</b>		
	(2006.01)		
	<b>A61K 39/00</b>	3411488	GENE THERAPY FOR TREATING MUCOPOLYSACCHARIDOSIS TYPE I
	(2006.01)		
	<b>A61K 48/00</b>		
	(2006.01)		
	<b>C12N 9/24</b>		
	(2006.01)		
	<b>C12N 15/86</b>		
	(2006.01)		
	<b>A61K 39/395</b>	3416684	METHODS FOR TREATING OR PREVENTING ATHEROSCLEROSIS BY ADMINISTERING AN INHIBITOR OF ANGPTL3
	(2006.01)		
	<b>A61P 3/06</b>		
	(2006.01)		
	<b>C07K 16/22</b>		
	(2006.01)		
	<b>A61K 47/69</b>	3411077	EFFICIENT PROCESS FOR PREPARING CELL-BINDING AGENT- CYTOTOXIC AGENT CONJUGATES
	(2017.01)		
	<b>C07K 1/13</b>		
	(2006.01)		
	<b>A61K 39/395</b>	3416982	TGFBETA 2 ANTIBODIES
	(2006.01)		
	<b>C07K 16/22</b>		
	(2006.01)		
	<b>C07C 233/23</b>	3408256	INDANE DERIVATIVES AS MGLUR7 MODULATORS
	(2006.01)		
	<b>C07C 233/41</b>		
	(2006.01)		
	<b>C07C 235/36</b>		
	(2006.01)		
	<b>C07C 271/24</b>		
	(2006.01)		
	<b>C07C 311/06</b>		
	(2006.01)		
	<b>C07C 317/30</b>		
	(2006.01)		
	<b>C07D 205/04</b>		
	(2006.01)		
	<b>C07D 231/12</b>		
	(2006.01)		
	<b>C07D 231/14</b>		
	(2006.01)		



Podnosilac evropske prijave patenta (71)	MKP (51)	Broj objave evropske prijave patenta (97)	Naziv pronalaska (54)
	<b>C07D 237/14</b> (2006.01)		
	<b>C07D 239/42</b> (2006.01)		
	<b>C07D 261/10</b> (2006.01)		
	<b>C07D 309/08</b> (2006.01)		
	<b>C07D 309/14</b> (2006.01)		
	<b>C07D 413/12</b> (2006.01)		
	<b>A61M 5/142</b> (2006.01)	3413953	DRUG DELIVERY DEVICE AND METHOD OF MANUFACTURE
	<b>A61M 5/145</b> (2006.01)		
	<b>A61M 5/315</b> (2006.01)		
	<b>A61K 31/4365</b> (2006.01)	3414252	THIENOPYRIDINE CARBOXAMIDES AS UBIQUITIN-SPECIFIC PROTEASE INHIBITORS
	<b>A61K 31/437</b> (2006.01)		
	<b>A61K 31/438</b> (2006.01)		
	<b>A61K 31/496</b> (2006.01)		
	<b>A61K 31/4985</b> (2006.01)		
	<b>A61K 31/506</b> (2006.01)		
	<b>A61K 31/5386</b> (2006.01)		
	<b>A61K 31/551</b> (2006.01)		
	<b>A61P 29/00</b> (2006.01)		
	<b>A61P 31/04</b> (2006.01)		
	<b>A61P 31/12</b> (2006.01)		
	<b>A61P 35/00</b> (2006.01)		
	<b>A61P 37/00</b> (2006.01)		
	<b>C07D 495/04</b> (2006.01)		
	<b>A61K 38/46</b> (2006.01)	3416678	METHODS AND COMPOSITIONS FOR CNS DELIVERY OF ARYLSULFATASE A
	<b>A61P 3/00</b> (2006.01)		
	<b>A61K 9/00</b> (2006.01)	3399971	PHARMACEUTICAL COMPOSITIONS COMPRISING DGLA AND USE OF SAME
	<b>A61K 31/202</b> (2006.01)		

Podnosilac evropske prijave patenta (71)	MKP (51)	Broj objave evropske prijave patenta (97)	Naziv pronalaska (54)		
Cell Care Therapeutics	<b>A61P 17/00</b> (2006.01)	3414320	ADIPOSE TISSUE DERIVED MESENCHYMAL STROMAL CELL CONDITIONED MEDIA AND METHODS OF MAKING AND USING THE SAME		
	<b>A61K 9/00</b> (2006.01)				
	<b>A61K 35/28</b> (2015.01)				
	<b>C12N 5/00</b> (2006.01)				
	<b>C12N 5/0775</b> (2010.01)				
	<b>F03G 3/08</b> (2006.01)	3417170	FLYWHEEL ENERGY STORAGE DEVICE AND METHOD OF ITS USE		
	<b>H02K 7/02</b> (2006.01)	3416479	NON-HUMAN ANIMALS HAVING A MUTANT KYNURENINASE GENE		
	<b>A01K 67/027</b> (2006.01)				
Morpho B.V.	<b>C07K 16/10</b> (2006.01)	3417392	METHOD, SYSTEM, DEVICE AND SOFTWARE PROGRAMME PRODUCT FOR THE REMOTE AUTHORIZATION OF A USER OF DIGITAL SERVICES		
	<b>C12N 9/14</b> (2006.01)				
	<b>G06F 21/32</b> (2013.01)				
GOTHAM S.r.l.	<b>H04L 29/06</b> (2006.01)	3407883	FORMULATION FOR TREATING MIGRAINE		
	<b>A61K 31/365</b> (2006.01)				
	<b>A61K 31/405</b> (2006.01)				
	<b>A61K 33/06</b> (2006.01)				
	<b>A61K 33/08</b> (2006.01)				
	<b>A61K 36/28</b> (2006.01)				
	<b>A61K 36/48</b> (2006.01)				
	<b>A61P 25/06</b> (2006.01)				
	<b>C10J 3/84</b> (2006.01)			3417037	SYSTEM AND METHOD FOR POWER PRODUCTION INCLUDING METHANATION
	<b>B09C 1/10</b> (2006.01)			3416759	METHOD FOR DECOMPOSITION OF THE METALLOORGANIC MATTER OF GRAPTOLITE-ARGILLITE BY MICROBIAL CONSORTIUM
	<b>C12P 1/04</b> (2006.01)				
	<b>C12P 5/02</b> (2006.01)				
<b>C22B 3/00</b> (2006.01)					
Servizi Ospedalieri S.p.A.	<b>C22B 3/18</b> (2006.01)	3413828	METHOD FOR THE PREPARATION AND PACKAGING OF A STERILE PROCEDURE PACK OR KIT FOR OPERATING ROOM USE		
	<b>E21B 43/00</b> (2006.01)				
	<b>A61B 50/30</b> (2016.01)				
	<b>A61B 90/90</b> (2016.01)				
	<b>A61B 90/98</b> (2016.01)				
	<b>A61L 2/24</b> (2006.01)				
<b>A61K 31/42</b> (2006.01)	3408260	CRYSTALLINE(2S,4R)-5-(5'-CHLORO-2'-FLUORO-[1,1'-BIPHENYL]-4-YL)-2-(ETHOXYMETHYL)-4-(3-			
	<b>A61P 9/00</b>				

Podnosilac evropske prijave patenta (71)	MKP (51)	Broj objave evropske prijave patenta (97)	Naziv pronalaska (54)
	(2006.01) <b>C07D 261/18</b> (2006.01)		HYDROXYISOXAZOLE-5-CARBOXAMIDO)-2-METHYLPENTANOIC ACID AND USES THEREOF
Reaxing S.r.l.	<b>A63B 21/28</b> (2006.01) <b>A63B 22/16</b> (2006.01) <b>A63B 22/18</b> (2006.01) <b>A63B 26/00</b> (2006.01) <b>A63B 69/00</b> (2006.01)	3407985	MOBILE SUPPORT FOR PHYSICAL EXERCISE
	<b>A61B 5/103</b> (2006.01) <b>A61H 1/02</b> (2006.01) <b>A63B 21/00</b> (2006.01) <b>A63B 21/005</b> (2006.01) <b>A63B 22/18</b> (2006.01) <b>A63B 23/08</b> (2006.01) <b>A63B 24/00</b> (2006.01) <b>A63B 26/00</b> (2006.01) <b>A63B 69/00</b> (2006.01)	3407987	MOVABLE PLATFORM FOR PHYSICAL EXERCISE
	<b>A43B 1/12</b> (2006.01) <b>B29C 43/00</b> (2006.01) <b>B29C 44/02</b> (2006.01) <b>B29D 35/00</b> (2010.01) <b>B29D 35/12</b> (2010.01) <b>B29D 35/14</b> (2010.01) <b>C08J 9/33</b> (2006.01)	3416819	A METHOD OF MOULDING AN OBJECT IN POLYURETHANE, IN PARTICULAR A SOLE FOR FOOTWEAR, OBTAINED FROM POLYURETHANE SCRAPS, AND MOULDED OBJECT IN POLYURETHANE THEREOF
Borbet Austria GmbH	<b>B21D 53/26</b> (2006.01) <b>B21H 1/10</b> (2006.01) <b>B60B 3/00</b> (2006.01) <b>B60B 3/02</b> (2006.01) <b>B60B 3/06</b> (2006.01)	3365185	METHOD FOR PRODUCING A WHEEL
Orthogen AG	<b>A61K 35/14</b> (2015.01) <b>A61K 35/16</b> (2015.01) <b>A61P 17/00</b> (2006.01) <b>A61P 17/18</b> (2006.01) <b>A61P 29/00</b> (2006.01)	3352769	ANTI-AGEING PHARMACEUTICAL PREPARATION

Podnosilac evropske prijave patenta (71)	MKP (51)	Broj objave evropske prijave patenta (97)	Naziv pronalaska (54)
	<b>A61P 39/00</b> (2006.01)		
	<b>A61K 35/14</b> (2015.01)	3352770	ANTI-AGEING PHARMACEUTICAL PREPARATION
	<b>A61K 35/16</b> (2015.01)		
	<b>A61P 17/00</b> (2006.01)		
	<b>A61P 17/18</b> (2006.01)		
	<b>A61P 29/00</b> (2006.01)		
	<b>A61P 39/00</b> (2006.01)		
	<b>A61K 31/506</b> (2006.01)	3400963	ANTI-TUMOR AGENT CONTAINING IMMUNOMODULATOR, AND ANTI-TUMOR EFFECT ENHANCER
	<b>A61K 31/7072</b> (2006.01)		
	<b>A61K 39/395</b> (2006.01)		
	<b>A61K 45/06</b> (2006.01)		
	<b>A61P 35/00</b> (2006.01)		
	<b>A61P 37/02</b> (2006.01)		
University Of Leicester	<b>A61K 39/395</b> (2006.01)	3400012	METHODS FOR INHIBITING FIBROSIS IN A SUBJECT IN NEED THEREOF
	<b>A61K 45/06</b> (2006.01)		
	<b>C07K 16/40</b> (2006.01)		
	<b>A61B 5/00</b> (2006.01)	3400549	PROCESSING OF PORTABLE DEVICE DATA
	<b>G06F 19/26</b> (2011.01)		
	<b>G06Q 50/24</b> (2018.01)		
	<b>G08B 21/04</b> (2006.01)		
Transrail Innovation Inc.	<b>B61D 5/00</b> (2006.01)	3403060	DEVICE AND METHOD FOR MEASURING COMMODITY VOLUME IN A RAIL TANK CAR
	<b>G01F 23/284</b> (2006.01)		
National University Corporation Chiba University	<b>A61K 39/395</b> (2006.01)	3404040	ANTI-MYL9 ANTIBODY
	<b>A61P 1/04</b> (2006.01)		
	<b>A61P 11/00</b> (2006.01)		
	<b>A61P 35/00</b> (2006.01)		
	<b>A61P 37/08</b> (2006.01)		
	<b>C07K 16/18</b> (2006.01)		
	<b>C07K 16/46</b> (2006.01)		
	<b>C12N 15/09</b> (2006.01)		

Podnositelj evropske prijave patenta (71)	MKP (51)	Broj objave evropske prijave patenta (97)	Naziv pronalaska (54)
	<b>B21D 51/38</b> (2006.01)	3402618	SYSTEM AND METHOD FOR ORIENTING THE ROLLING DIRECTION OF AN END SHELL IN A METAL CONTAINER MANUFACTURING PROCESS
	<b>B21D 51/44</b> (2006.01)		
	<b>B65B 35/58</b> (2006.01)		
	<b>B65G 47/24</b> (2006.01)		
	<b>B65G 47/244</b> (2006.01)		
	<b>B65G 47/252</b> (2006.01)		
	<b>A61K 48/00</b> (2006.01)	3402532	
	<b>A61K 31/4468</b> (2006.01)	3402485	
	<b>A61K 31/496</b> (2006.01)		
	<b>A61K 39/145</b> (2006.01)	3402513	
	<b>A61P 31/16</b> (2006.01)		
	<b>C07K 14/11</b> (2006.01)		
	<b>C07K 16/08</b> (2006.01)		
	<b>C07K 16/10</b> (2006.01)		
	<b>C12N 15/44</b> (2006.01)		
	<b>A61K 31/517</b> (2006.01)	3402486	METHOD OF TREATING C3 GLOMERULOPATHY
	<b>A61K 31/551</b> (2006.01)		
Pharma Consult Ges.m.b.H.	<b>A61M 5/178</b> (2006.01)	3402556	INJECTION DEVICE
	<b>A61M 5/20</b> (2006.01)		
	<b>A61M 5/24</b> (2006.01)		
	<b>A61M 5/31</b> (2006.01)		
	<b>A61M 5/315</b> (2006.01)		
	<b>A61M 5/32</b> (2006.01)		
Spinalcyte, LLC	<b>A61K 48/00</b> (2006.01)	3402534	CELLULAR BLEND FOR THE REGENERATION OF CHONDROCYTES OR CARTILAGE TYPE CELLS
Compass Therapeutics LLC	<b>A61K 39/395</b> (2006.01)	3402519	MULTISPECIFIC IMMUNOMODULATORY ANTIGEN-BINDING CONSTRUCTS
	<b>A61P 35/00</b> (2006.01)		
	<b>C07K 16/00</b> (2006.01)		
	<b>C07K 16/18</b> (2006.01)		
	<b>C07K 16/46</b>		

Podnosilac evropske prijave patenta (71)	MKP (51)	Broj objave evropske prijave patenta (97)	Naziv pronalaska (54)
	(2006.01) <b>C12N 1/15</b> (2006.01) <b>C07C 49/753</b> (2006.01)	3406586	MANUFACTURING METHOD FOR HIGH-PURITY CYCLOHEXENONE LONG-CHAIN ALCOHOL
Velasco, Horacio Caltec Overseas, Inc.	<b>G06Q 10/04</b> (2012.01) <b>G06Q 50/06</b> (2012.01)	3405914	METHOD FOR OPERATION OF HYDROPOWER RESERVOIR WITH A 2-PARAMETER ELEVATION RULE CURVE
ExxonMobil Research and Engineering Company	<b>C10M 107/02</b> (2006.01) <b>C10M 135/08</b> (2006.01) <b>C10M 139/00</b> (2006.01) <b>C10M 145/14</b> (2006.01) <b>C10M 169/04</b> (2006.01) <b>C10N 20/02</b> (2006.01) <b>C10N 20/04</b> (2006.01) <b>C10N 30/00</b> (2006.01) <b>C10N 30/04</b> (2006.01) <b>C10N 30/06</b> (2006.01) <b>C10N 40/04</b> (2006.01)	3406694	LUBRICATING OIL COMPOSITION
	<b>C07D 209/00</b> (2006.01) <b>C07D 209/34</b> (2006.01)	3405455	2-OXINDOLE COMPOUNDS
	<b>A61K 31/436</b> (2006.01) <b>A61K 31/55</b> (2006.01) <b>A61K 38/31</b> (2006.01)	3405211	ORAL OCTREOTIDE FOR THE TREATMENT OF DISEASE
Ópticas Claravisión, S.L.	<b>A61B 3/10</b> (2006.01) <b>A61B 3/18</b> (2006.01) <b>G02C 5/00</b> (2006.01) <b>G02C 7/00</b> (2006.01) <b>G06T 7/60</b> (2017.01)	3410397	METHOD FOR PRODUCING LENSES AND FRAMES WITH PERSONALISED DESIGN AND REMOTE BEVELLING OF CORRECTIVE LENSES, AND OPTICAL DEVICE FOR MORPHOLOGICAL MEASUREMENT FOR PERFORMING SAID METHOD
ExxonMobil Research and Engineering Company	<b>C10M 105/04</b> (2006.01) <b>C10M 107/02</b> (2006.01) <b>C10M 135/04</b> (2006.01)	3409751	LUBRICANT COMPOSITION

Podnosilac evropske prijave patenta (71)	MKP (51)	Broj objave evropske prijave patenta (97)	Naziv pronalaska (54)
<b>C10M</b>			
<b>169/04</b>			
(2006.01)			
<b>C10N 20/02</b>			
(2006.01)			
<b>C10N 30/00</b>			
(2006.01)			
<b>C10N 30/06</b>			
(2006.01)			
<b>C10N 40/04</b>			
(2006.01)			
<b>A61K</b>	3407914		METHODS FOR PREPARING ANTIBODIES WITH A DEFINED
<b>39/395</b>			GLYCOSYLATION PATTERN
(2006.01)			
<b>C07K 16/00</b>			
(2006.01)			
<b>C12P 21/00</b>			
(2006.01)			
<b>C07K 16/24</b>	3408293		BISPECIFIC ANTI-TNF-ALPHA/IL-17A ANTIBODIES AND ANTI-
(2006.01)			TNF-ALPHA ANTIBODIES AND METHODS OF THEIR USE
<b>C07K 16/46</b>			
(2006.01)			
<b>A61K</b>	3407978		COMBINATION THERAPY FOR TREATING CANCER
<b>31/444</b>			
(2006.01)			
<b>A61K</b>			
<b>31/5377</b>			
(2006.01)			
<b>A61P 35/00</b>			
(2006.01)			
<b>A61K 35/74</b>	3408395		PERSONALIZED DELIVERY VECTOR-BASED
(2015.01)			IMMUNOTHERAPY AND USES THEREOF
<b>A61K 39/00</b>			
(2006.01)			
<b>A61K 48/00</b>			
(2006.01)			
<b>C07K 5/10</b>			
(2006.01)			
<b>C07K</b>			
<b>14/705</b>			
(2006.01)			
<b>C12N 15/66</b>			
(2006.01)			
<b>C12N 15/74</b>			
(2006.01)			
<b>C07D 257/04</b>	3408298		G PROTEIN-COUPLED RECEPTOR (GPCR) MODULATION BY
(2006.01)			IMIPRIDONES
<b>C07D 401/04</b>			
(2006.01)			
<b>C07K</b>			
<b>14/705</b>			
(2006.01)			
<b>C07K 14/72</b>			
(2006.01)			
<b>C07K 16/28</b>			
(2006.01)			
<b>G01N</b>			
<b>33/566</b>			
(2006.01)			
<b>C12N</b>	3408391		BRANCHED OLIGONUCLEOTIDES
<b>15/113</b>			
(2010.01)			
<b>A47G 1/02</b>	3410897		MODULAR BUILT MEDICAL DEVICE FOR HELPING SELF-
(2006.01)			CATHETERIZATION AND/OR INSTILLATION OF DRUG-
<b>A61F 5/455</b>			SOLUTIONS INTO THE BLADDER IN FEMALE PATIENTS
(2006.01)			

Podnosilac evropske prijave patenta (71)	MKP (51)	Broj objave evropske prijave patenta (97)	Naziv pronalaska (54)
Chia Tai Tianqing Pharmaceutical Group Co.,Ltd	<b>A61M 25/01</b> (2006.01)	3412671	TLR7 AGONIST MALEATE SALT, CRYSTALLINE FORMS C, D AND E THEREOF, PREPARATION METHODS AND USES OF MALEATE SALT AND CRYSTALLINE FORMS
	<b>A61K 31/519</b> (2006.01)		
	<b>A61P 31/12</b> (2006.01)	3412672	TLR7 AGONIST CRYSTALLINE FORM A, PREPARATION METHOD AND USE THEREOF
	<b>C07D 487/04</b> (2006.01)		
	<b>A61K 31/519</b> (2006.01)	3412673	METHOD FOR PREPARING PYRROLO[3,2-D]PYRIMIDINE COMPOUND, AND INTERMEDIATES THEREOF
	<b>A61P 31/12</b> (2006.01)		
	<b>C07D 487/04</b> (2006.01)	3412674	TLR7 AGONIST TRIFLUOROACETATE SALT AND CRYSTALLINE FORM B THEREOF, PREPARATION METHODS AND USES
	<b>C07D 487/04</b> (2006.01)		
	<b>A61K 31/519</b> (2006.01)	3412295	METHOD FOR TREATING CANCER PATIENTS WITH SEVERE RENAL DYSFUNCTION
	<b>A61P 31/12</b> (2006.01)		
<b>C07D 487/04</b> (2006.01)	3412664	HETEROCYCLIC SULFONAMIDE DERIVATIVE AND MEDICINE CONTAINING SAME	
<b>A61K 31/506</b> (2006.01)			
<b>A61K 31/7072</b> (2006.01)			
<b>A61P 1/00</b> (2006.01)			
<b>A61P 35/00</b> (2006.01)			
<b>A61K 31/4439</b> (2006.01)			
<b>A61K 31/506</b> (2006.01)			
<b>A61P 1/04</b> (2006.01)			
<b>A61P 1/18</b> (2006.01)			
<b>A61P 3/10</b> (2006.01)			
<b>A61P 11/06</b> (2006.01)			
<b>A61P 11/08</b> (2006.01)			
<b>A61P 11/14</b> (2006.01)			
<b>A61P 17/04</b> (2006.01)			
<b>A61P 19/02</b> (2006.01)			
<b>A61P 25/00</b> (2006.01)			
<b>A61P 25/04</b> (2006.01)			
<b>A61P 29/00</b> (2006.01)			
<b>A61P 37/08</b> (2006.01)			
<b>A61P 43/00</b> (2006.01)			



Podnosilac evropske prijave patenta (71)	MKP (51)	Broj objave evropske prijave patenta (97)	Naziv pronalaska (54)
	<b>C07D 403/12</b> (2006.01)		
	<b>C07D 405/14</b> (2006.01)		
	<b>C07D 409/14</b> (2006.01)		
	<b>C07D 491/048</b> (2006.01)		
	<b>C07K 14/705</b> (2006.01)		
Emory University REGENXBIO Inc.	<b>A61K 48/00</b> (2006.01)	3411484	INJECTION OF SINGLE-STRANDED OR SELF-COMPLEMENTARY ADENO-ASSOCIATED VIRUS 9 INTO THE CEREBROSPINAL FLUID
	<b>C12N 15/63</b> (2006.01)		
	<b>C12N 15/861</b> (2006.01)		
	<b>A61K 39/00</b> (2006.01)	3411411	BENZOPYRAZOLE COMPOUNDS AND ANALOGUES THEREOF
	<b>A61P 9/00</b> (2006.01)		
	<b>A61P 37/06</b> (2006.01)		
	<b>C07K 16/28</b> (2006.01)		
Oncoimmune Inc.	<b>A61K 38/17</b> (2006.01)	3411062	USE OF CD24 PROTEINS FOR TREATING LEPTIN-DEFICIENT CONDITIONS
	<b>C07K 14/00</b> (2006.01)		
	<b>C07K 14/435</b> (2006.01)		
	<b>C07K 14/705</b> (2006.01)		
Horizon Orphan LLC	<b>A61K 31/496</b> (2006.01)	3411503	FLUOROQUINOLONE FORMULATIONS FOR CYSTIC FIBROSIS
	<b>C12Q 1/68</b> (2018.01)		
	<b>C12Q 1/68</b> (2018.01)	3411504	ANTI-TNF ANTIBODIES, COMPOSITIONS, METHODS AND USE FOR THE TREATMENT OR PREVENTION OF TYPE 1 DIABETES
Kennesaw State University Research And Services Foundation Inc. Mcmurry, Jonathan L. Salerno, John C. Nowak, Scott J. Davis, Marcus C. Bartlow, Kathleen Cinrx Pharma, LLC	<b>C07K 7/08</b> (2006.01)	3411387	SIGNAL MOLECULES AS CELL PENETRATION AGENTS
	<b>A61K 31/454</b> (2006.01)	3411031	DEUTERATED DOMPERIDONE COMPOSITIONS AND METHODS FOR THERAPY OF DISORDERS
	<b>A61P 1/08</b> (2006.01)		
	<b>C07D 401/14</b> (2006.01)		
Shake-n-Go Fashion, Inc.	<b>A41G 5/00</b> (2006.01)	3416513	HAIR BUNDLE APPARATUS AND METHOD OF MANUFACTURING SAME
Pharmaxis Ltd.	<b>A61K 31/33</b> (2006.01)	3414244	HALOALLYLAMINE INDOLE AND AZAINDOLE DERIVATIVE INHIBITORS OF LYSYL OXIDASES AND USES THEREOF
	<b>A61K 31/404</b> (2006.01)		
	<b>A61P 1/16</b>		

Podnosilac evropske prijave patenta (71)	MKP (51)	Broj objave evropske prijave patenta (97)	Naziv pronalaska (54)
	(2006.01) <b>A61P 9/00</b> (2006.01) <b>A61P 13/12</b> (2006.01) <b>A61P 29/00</b> (2006.01) <b>A61P 35/00</b> (2006.01) <b>C07D 209/10</b> (2006.01) <b>C07D 401/04</b> (2006.01) <b>C07D 403/04</b> (2006.01) <b>C07D 405/04</b> (2006.01) <b>C07D 413/04</b> (2006.01) <b>C07D 471/04</b> (2006.01) <b>A61K 31/00</b> (2006.01) <b>A61K 31/404</b> (2006.01) <b>A61P 35/00</b> (2006.01) <b>C07D 209/24</b> (2006.01) <b>C07D 471/04</b> (2006.01) <b>C07D 487/04</b> (2006.01)		
		3414226	INDOLE AND AZAINDOLE HALOALLYLAMINE DERIVATIVE INHIBITORS OF LYSYL OXIDASES AND USES THEREOF
	<b>H04L 9/28</b> (2006.01)	3414867	A SYSTEM AND METHOD FOR DOCUMENT INFORMATION AUTHENTICITY VERIFICATION
Moloney, Lindsay Scott, Guy Krantz, Alexander Wilczynski, Andrzej	<b>A61K 47/66</b> (2017.01) <b>A61K 47/68</b> (2017.01) <b>A61P 35/00</b> (2006.01)	3413921	SITE-SELECTIVE FUNCTIONALIZATION OF PROTEINS USING TRACELESS AFFINITY LABELS
Imago Systems, Inc.	<b>A61B 6/00</b> (2006.01) <b>G06K 9/00</b> (2006.01) <b>G06K 9/36</b> (2006.01)	3399916	SYSTEM AND METHOD FOR THE VISUALIZATION AND CHARACTERIZATION OF OBJECTS IN IMAGES
	<b>G01J 3/447</b> (2006.01) <b>G01N 21/19</b> (2006.01) <b>G02F 1/11</b> (2006.01)	3414620	METHODS OF IMPROVING THE RETARDATION ACCURACY AND STABILITY OF PHOTOELASTIC MODULATOR DEVICES
	<b>A61K 31/47</b> (2006.01) <b>C07D 217/08</b> (2006.01)	3413892	TETRAHYDROISOQUINOLINE DERIVATIVES
	<b>C07D 403/02</b> (2006.01) <b>C07D 411/02</b> (2006.01) <b>C07D 495/04</b> (2006.01)	3414235	DEUTERIUM-MODIFIED CFTR MODULATORS
	<b>B65D 19/00</b> (2006.01) <b>B65D 19/38</b>	3416896	TRANSFER EQUIPMENT AND LOAD TRANSFER APPLIANCE

Podnosilac evropske prijave patenta (71)	MKP (51)	Broj objave evropske prijave patenta (97)	Naziv pronalaska (54)
	(2006.01) <b>B65G 65/02</b> (2006.01) <b>B65G 67/04</b> (2006.01) <b>B65G 69/22</b> (2006.01)		
Phoenix Molecular Designs	<b>A61K</b> <b>31/4155</b> (2006.01) <b>A61K</b> <b>31/4525</b> (2006.01) <b>A61K</b> <b>31/454</b> (2006.01) <b>A61K</b> <b>31/4985</b> (2006.01) <b>A61P 35/00</b> (2006.01) <b>C07D 403/12</b> (2006.01) <b>C07D 405/12</b> (2006.01) <b>C07D 409/12</b> (2006.01) <b>C07D 471/04</b> (2006.01) <b>C07D 471/14</b> (2006.01) <b>C07D 487/04</b> (2006.01) <b>C07D</b> <b>491/048</b> (2006.01) <b>A61K</b> <b>31/4439</b> (2006.01) <b>A61K</b> <b>31/444</b> (2006.01) <b>A61K</b> <b>31/4545</b> (2006.01) <b>A61K 31/46</b> (2006.01) <b>A61K</b> <b>31/4709</b> (2006.01) <b>A61K</b> <b>31/498</b> (2006.01) <b>A61K</b> <b>31/5355</b> (2006.01) <b>A61K</b> <b>31/5377</b> (2006.01) <b>A61P 13/12</b> (2006.01) <b>A61P 43/00</b> (2006.01) <b>C07D 401/04</b> (2006.01) <b>C07D 401/14</b> (2006.01)	3416964	CARBOXAMIDE DERIVATIVES USEFUL AS RSK INHIBITORS
	<b>A61K</b> <b>31/4439</b> (2006.01) <b>A61K</b> <b>31/444</b> (2006.01) <b>A61K</b> <b>31/4545</b> (2006.01) <b>A61K 31/46</b> (2006.01) <b>A61K</b> <b>31/4709</b> (2006.01) <b>A61K</b> <b>31/498</b> (2006.01) <b>A61K</b> <b>31/5355</b> (2006.01) <b>A61K</b> <b>31/5377</b> (2006.01) <b>A61P 13/12</b> (2006.01) <b>A61P 43/00</b> (2006.01) <b>C07D 401/04</b> (2006.01) <b>C07D 401/14</b> (2006.01)	3418276	AZOLE-SUBSTITUTED PYRIDINE COMPOUND

Podnosilac evropske prijave patenta (71)	MKP (51)	Broj objave evropske prijave patenta (97)	Naziv pronalaska (54)
	<b>C07D 405/14</b> (2006.01)		
	<b>C07D 409/14</b> (2006.01)		
	<b>C07D 413/14</b> (2006.01)		
	<b>C07D 417/14</b> (2006.01)		
	<b>C07D 451/02</b> (2006.01)		
The United States of America, as Represented By the Secretary, Department of Health and Human Services	<b>A61K 38/00</b> (2006.01) <b>A61K 39/395</b> (2006.01) <b>A61K 48/00</b> (2006.01) <b>A61P 35/00</b> (2006.01) <b>G01N 33/574</b> (2006.01)	3417294	METHODS COMPRISING FIXED INTERMITTENT DOSING OF CEDIRANIB
II-VI INCORPORATED	<b>C01B 32/10</b> (2017.01) <b>H01M 2/14</b> (2006.01) <b>H01M 4/134</b> (2010.01) <b>H01M 4/36</b> (2006.01) <b>H01M 4/38</b> (2006.01) <b>H01M 10/052</b> (2010.01) <b>H01M 10/058</b> (2010.01)	3417502	IMMOBILIZED SELENIUM, A METHOD OF MAKING, AND USES OF IMMOBILIZED SELENIUM IN A RECHARGEABLE BATTERY
	<b>A61K 8/00</b> (2006.01) <b>A61K 39/00</b> (2006.01) <b>A61K 48/00</b> (2006.01) <b>C07K 14/435</b> (2006.01) <b>C07K 14/47</b> (2006.01) <b>C12N 9/00</b> (2006.01)	3416679	PATHOGEN VACCINES AND METHODS OF PRODUCING AND USING THE SAME
	<b>A61K 31/4365</b> (2006.01) <b>C07D 495/04</b> (2006.01)	3416639	POSITIVE ALLOSTERIC MODULATORS OF THE MUSCARINIC ACETYLCHOLINE RECEPTOR M1
	<b>C12N 5/00</b> (2006.01) <b>G01N 1/30</b> (2006.01) <b>G01N 33/50</b> (2006.01) <b>G01N 33/68</b> (2006.01)	3417051	METHODS AND TEST KITS FOR DETERMINING MALE FERTILITY STATUS

Podnosilac evropske prijave patenta (71)	MKP (51)	Broj objave evropske prijave patenta (97)	Naziv pronalaska (54)
	<b>A61K 31/4439</b> (2006.01)	3347352	THERAPEUTIC COMPOUNDS USEFUL FOR THE PROPHYLACTIC OR THERAPEUTIC TREATMENT OF AN HIV VIRUS INFECTION
	<b>A61P 31/18</b> (2006.01)		
	<b>C07D 401/14</b> (2006.01)		
Carnegie Mellon University	<b>B64C 39/02</b> (2006.01)	3400676	A SAFETY ARCHITECTURE FOR AUTONOMOUS VEHICLES
	<b>G05B 19/418</b> (2006.01)		
	<b>H04L 9/32</b> (2006.01)		
Intrabio Ltd	<b>A61K 31/13</b> (2006.01)	3359146	PHARMACEUTICAL COMPOSITIONS AND USES DIRECTED TO LYSOSOMAL STORAGE DISORDERS
	<b>A61P 25/00</b> (2006.01)		
	<b>A61K 31/13</b> (2006.01)	3416631	THERAPEUTIC AGENTS FOR NEURODEGENERATIVE DISEASES
	<b>A61P 25/00</b> (2006.01)		
CAO, Shangwen	<b>G06F 17/50</b> (2006.01)	3347879	METHOD FOR IMMEDIATE BOOLEAN OPERATIONS USING GEOMETRIC FACETS
	<b>G06T 17/10</b> (2006.01)		
	<b>G06T 19/00</b> (2011.01)		
	<b>A61K 35/74</b> (2015.01)	3359172	COMPOSITIONS COMPRISING BACTERIAL STRAINS
	<b>A61P 1/14</b> (2006.01)		
	<b>A61P 29/00</b> (2006.01)		
Interroll Holding AG	<b>B65G 39/04</b> (2006.01)	3408197	CONVEYOR ROLLER WITH CONICAL TAPERED ELEMENT
	<b>B65G 39/07</b> (2006.01)		
Accutar Biotechnology Inc.	<b>A61K 9/00</b> (2006.01)	3368011	NOVEL COMPOUNDS AND USES THEREOF
	<b>A61K 31/137</b> (2006.01)		
	<b>A61K 45/06</b> (2006.01)		

# OBJAVA PROMJENA PROŠIRENIH EVROPSKIH PAT.UPISANIH U REGISTAR PATENATA

---

**P-2008-354****Vrsta promjene**

Ime i adresa

**Datum promjene**

30.10.2018

**Stari podatak**BIOGEN IDEC MA INC., 14 Cambridge  
Center, Cambridge, MA 02142, US**Novi podatak**BIOGEN MA INC., 250 Binney Street,  
Cambridge, MA 02142, US

---

**P-2008-451****Vrsta promjene**

Ime i adresa

**Datum promjene**

30.10.2018

**Stari podatak**AGOURON PHARMACEUTICALS, INC.,  
10350 North Torrey Pines Road , La Jolla  
CA 92037-1022, US**Novi podatak**AGOURON PHARMACEUTICALS, LLC,  
10646 Science Center Drive,, San Diego,  
CA 92121, US, US

---

**P-2014-22****EP2462124****Vrsta promjene**

Adresa

**Datum promjene**

07.11.2018

**Stari podatak**E. I. DU PONT DE NEMOURS AND  
COMPANY, 1007 Market Street, Wilmington  
DE 19898, US**Novi podatak**E. I. DU PONT DE NEMOURS AND  
COMPANY, 974 Centre Road, Wilmington,  
DE 19805, US

---

**P-2014-94****EP2470526****Vrsta promjene**

Ime i adresa

**Datum promjene**

02.11.2018

**Stari podatak**NOVARTIS INTERNATIONAL  
PHARMACEUTICAL LTD., 131 Front Street  
P.O. Box HM 2899, Hamilton HM LX,  
Bermuda, BM**Novi podatak**NOVARTIS LINTERNATIONAL  
PHARMACEUTICAL AG, Lichtstrasse 35,  
4056, Basel, CH

---

**P-2015-215****EP2809846****Vrsta promjene**

Ime i adresa

**Datum promjene**

02.11.2018

**Stari podatak**GREENRAIL S.R.L., Via Giorgio Castriota 9,  
90139, Palermo, IT

**Novi podatak**

GREENRAIL GROUP SRL, Via Belsiana  
n.71, I-00187, Roma, IT

---

**P-2015-350****EP2511297****Vrsta promjene**

Adresa

**Datum promjene**

02.11.2018

**Stari podatak**

MORPHOSYS AG, Lena-Christ-Strasse 48,  
82152, Martinsried/München, DE

**Novi podatak**

MORPHOSYS AG, Semmelweisstrasse 7,  
82152, Planegg, DE

---

**P-2016-205****EP2982694****Vrsta promjene**

Ime i adresa

**Datum promjene**

02.11.2018

**Stari podatak**

ENGMAB AG, Etzelstrass 27, 8808,  
Pfaffikon, CH

**Novi podatak**

ENGMAB SÀRL, route de Perreux 1, 2017,  
Boudry, CH

---

**P-2016-236****EP1901479****Vrsta promjene**

Ime i adresa

**Datum promjene**

02.11.2018

**Stari podatak**

RAPTOR PHARMACEUTICALS INC., 7  
Hamilton Landing, Suite 100 , Novato, CA  
94949 , US

**Novi podatak**

HORIZON ORPHAN LLC, 150 South  
Saunders Road, Lake Forest, IL 60045, US

---

**P-2016-26****EP2403834****Vrsta promjene**

Adresa

**Datum promjene**

02.11.2018

**Stari podatak**

E. I. DU PONT DE NEMOURS AND  
COMPANY, , Wilmington, DE 19805, US

**Novi podatak**

E. I. DU PONT DE NEMOURS AND  
COMPANY, 974 Centre Road, Wilmington,  
DE 19805, US

---

**P-2016-95****EP2785700****Vrsta promjene**

Ime

**Datum promjene**

02.11.2018

**Stari podatak**

PEROSPHERE, INC., 20 Kenosia Avenue,  
Danbury, CT 06810, US

**Novi podatak**

PEROSPHERE PHARMACEUTICALS INC.,  
20 Kenosia Avenue, Danbury, CT 06810,  
US

---

**P-2017-175**

**EP2885978**

**Vrsta promjene**

Ime

**Datum promjene**

04.05.2018

**Stari podatak**

BONGRAIN S.A., 42, rue Rieussec, 78220,  
Viroflay, FR

**Novi podatak**

SAVENCIA SA, 42, rue Rieussec, 78220,  
Viroflay, FR



## PRIJENOS PRAVA

---

**P-2010-167**

**Datum ugovora**

13.06.2018

**Opseg prenosa prava**

U cijelosti

**Nosilac**

CRYSTAL LAGOONS CORPORATION  
LLC, 16192 Coastal Highway, Lewes DE  
19958-9776, US

**Sticalac**

CRYSTAL LAGOONS(CURAÇAO ) B.V.,  
Kaya W.F.G. (Jombi), Mensing 14, Kurasao,  
CW

---

**P-2014-22**

**EP2462124**

**Datum ugovora**

26.04.2018

**Opseg prenosa prava**

U cijelosti

**Nosilac**

E. I. DU PONT DE NEMOURS AND  
COMPANY, 974 Centre Road, Wilmington,  
DE 19805, US

**Sticalac**

FMC AGRO SINGAPORE PTE. LTD, 77  
Robinson Road, #13-00 Robinson 77,  
Singapore 068896, Singapore, SG  
FMC CORPORATION, 2929 Walnut Street,  
Philadelphia, PA 19104, US

---

**P-2014-94**

**EP2470526**

**Datum ugovora**

05.01.2015

**Opseg prenosa prava**

U cijelosti

**Nosilac**

NOVARTIS AG, Lichtstrasse 35, 4056,  
Basel, CH  
IRM LLC, 131 Front Street, P.O. Box 2899,  
Hamilton, HM LX, BM

**Sticalac**

NOVARTIS INTERNATIONAL  
PHARMACEUTICAL LTD., 131 Front Street  
P.O. Box HM 2899, Hamilton HM LX,  
Bermuda, BM

---

**P-2014-94**

**EP2470526**

**Datum ugovora**

02.03.2015

**Opseg prenosa prava**

U cijelosti

**Nosilac**

NOVARTIS AG, Lichtstrasse 35, 4056,  
Basel, CH  
NOVARTIS LINTERNATIONAL  
PHARMACEUTICAL AG, Lichtstrasse 35,  
4056, Basel, CH

**Sticalac**

NOVARTIS AG, Lichtstrasse 35, 4056,  
Basel, CH

---

**P-2014-94**

**EP2470526**

**Datum ugovora**

03.11.2016

**Opseg prenosa prava**

U cijelosti

**Nosilac**

NOVARTIS AG, Lichtstrasse 35, 4056,  
Basel, CH  
NOVARTIS AG, Lichtstrasse 35, 4056,  
Basel, CH

**Sticalac**

ARRAY BIOPHARMA, INC., 3200 Walnut  
Street, Boulder, CO 80301, US

---

**P-2015-124**

**EP2435432**

**Datum ugovora**

01.05.2015

**Opseg prenosa prava**

U cijelosti

**Nosilac**

ABBVIE BAHAMAS LTD., Sassoon House  
Shirley Street & Victoria Avenue, BS

**Sticalac**

ABBVIE IRELAND UNLIMITED COMPANY,  
c/o Conyers Corporate Services (Bermuda)  
Limited, Clarendon House, 2 Church Street,,  
Hamilton HM11, BM

---

**P-2015-57**

**EP2618830**

**Datum ugovora**

31.01.2018

**Opseg prenosa prava**

U cijelosti

**Nosilac**

ELI LILLY AND COMPANY, Lilly Corporate  
Center, Indianapolis, IN 46285, US

**Sticalac**

ELANCO US INC., 2500 Innovation Way,  
Greenfield, IN 46140, US

---

**P-2015-73**

**EP2710000**

**Datum ugovora**

31.01.2018

**Opseg prenosa prava**

U cijelosti

**Nosilac**

ELI LILLY AND COMPANY, Lilly Corporate  
Center, Indianapolis, IN 46285, US

**Sticalac**

ELANCO US INC., 2500 Innovation Way,  
Greenfield, IN 46140, US

# PRESTANAK PRAVA

---

---

**P-1998-520**

**Razlog**

Cessation Validity Of The Patent (Up To 20 Years)

---

---

**P-2000-18**

**Razlog**

Cessation Validity Of The Patent (Up To 20 Years)

---

---

**P-2000-612**

**Razlog**

Cessation Validity Of The Patent (Non-Payment Of Maintenance)

---

---

**P-2007-71**

**Razlog**

Cessation Validity Of The Patent (Non-Payment Of Maintenance)

---

---

**P-2008-16**

**Razlog**

Cessation Validity Of The Patent (Non-Payment Of Maintenance)

---

---

**P-2008-408**

**Razlog**

Cessation Validity Of The Patent (Non-Payment Of Maintenance)

---

---

**P-2008-493**

**Razlog**

Cessation Validity Of The Patent (Non-Payment Of Maintenance)

---

---

**P-2008-533**

**Razlog**

Cessation Validity Of The Patent (Non-Payment Of Maintenance)

---

---

**P-2008-561**

**Razlog**

Cessation Validity Of The Patent (Non-Payment Of Maintenance)

---

---

**P-2008-671**

**Razlog**

Cessation Validity Of The Patent (Non-Payment Of Maintenance)

---

---

**P-2008-702**

**Razlog**

Cessation Validity Of The Patent (Up To 20 Years)

---

---

**P-2008-749**

**Razlog**

Cessation Validity Of The Patent (Non-Payment Of Maintenance)

---

---

**P-2008-957**

**Razlog**

Cessation Validity Of The Patent (Non-Payment Of Maintenance)

---

---

**P-2009-327**

**Razlog**

Cessation Validity Of The Patent (Non-Payment Of Maintenance)

---

---

**P-2009-331**

**Razlog**

Cessation Validity Of The Patent (Non-Payment Of Maintenance)

---

---

**P-2009-350**

**Razlog**

Cessation Validity Of The Patent (Non-Payment Of Maintenance)

---

---

**P-2009-369**

**Razlog**

Cessation Validity Of The Patent (Non-Payment Of Maintenance)

---

---

**P-2010-173**

**Razlog**

Cessation Validity Of The Patent (Non-Payment Of Maintenance)

---

---

**P-2010-200**

**Razlog**

Cessation Validity Of The Patent (Non-Payment Of Maintenance)

---

---

**P-2010-87**

**Razlog**

Cessation Validity Of The Patent (Non-Payment Of Maintenance)

---

---

**P-2013-145**

**Razlog**

Cessation Validity Of The Patent (Non-Payment Of Maintenance)

---

---

**P-2013-76**

**Razlog**

Cessation Validity Of The Patent (Non-Payment Of Maintenance)

---

---

**P-2015-131**

**Razlog**

Cessation Validity Of The Patent (Non-Payment Of Maintenance)

---

---

**P-2015-168**

**Razlog**

Cessation Validity Of The Patent (Non-Payment Of Maintenance)

---

---

**P-2015-170**

**Razlog**

Cessation Validity Of The Patent (Non-Payment Of Maintenance)

---

---

**P-2015-175**

**Razlog**

Cessation Validity Of The Patent (Non-Payment Of Maintenance)

---

---

**P-2015-176**

**Razlog**

Cessation Validity Of The Patent (Non-Payment Of Maintenance)

---

---

**P-2015-184**

**Razlog**

Cessation Validity Of The Patent (Non-Payment Of Maintenance)

---

---

**P-2015-188**

**Razlog**

Cessation Validity Of The Patent (Non-Payment Of Maintenance)

---

---

**P-2015-192****Razlog**

Cessation Validity Of The Patent (Non-Payment Of Maintenance)

---

---

**P-2015-193****Razlog**

Cessation Validity Of The Patent (Non-Payment Of Maintenance)

---

---

**P-2015-194****Razlog**

Cessation Validity Of The Patent (Non-Payment Of Maintenance)

---

---

**P-2015-195****Razlog**

Cessation Validity Of The Patent (Non-Payment Of Maintenance)

---

---

**P-2015-203****Datum prestopa važenja**

29.05.2017

**Razlog**

Cessation Validity Of The Patent (Non-Payment Of Maintenance)

---

---

**P-2015-204****Razlog**

Cessation Validity Of The Patent (Non-Payment Of Maintenance)

---

---

**P-2015-205****Razlog**

Cessation Validity Of The Patent (Non-Payment Of Maintenance)

---

---

**P-2015-210****Razlog**

Cessation Validity Of The Patent (Non-Payment Of Maintenance)

---

---

**P-2015-653**

**Razlog**

Cessation Validity Of The Patent (Non-Payment Of Maintenance)

---

**P-2015-68**

**Razlog**

**ŽIGOVI**  
**TRADEMARKS**

MEĐUNARODNI KODOVI ZA IDENTIFIKACIJU BIBLIOGRAFSKIH PODATAKA O ŽIGOVIMA PREMA  
WIPO ST 60  
RECOMMENDATION CONCERNING BIBLIOGRAFIC DATA RELATING TO TRADEMARKS- WIPO-  
ST. 60

<b>CRNOGORSKI</b>	<b>MDK</b>	<b>ENGLESKI</b>
REGISTRARSKI BROJ	<b>111</b>	NUMBER OF THE REGISTRATION
DATUM REGISTRACIJE	<b>151</b>	DATE OF THE REGISTRATION
OČEKIVANI DATUM PRESTANKA VAŽENJA ŽIGA	<b>181</b>	EXPECTED EXPIRATION DATE OF THE REGISTRATION
BROJ PRIJAVE	<b>210</b>	NUMBER OF THE APPLICATION
DATUM PODNOŠENJA PRIJAVE	<b>220</b>	DATE OF FILING OF THE APPLICATION
PODACI O IZLOŽBENOM PRAVU PRVENSTVA	<b>230</b>	DATA CONCERNING EXHIBITIONS
PODACI O PRAVU PRVENSTVA NA OSNOVU PARISKE KONVENCIJE	<b>300</b>	DATA RELATING TO PRIORITY UNDER THE PARIS CONVENTION
DATUM OBJAVLJIVANJA PRIJAVE	<b>442</b>	DATA OF PUBLICATION OF APPLICATION
SPISAK ROBA I USLUGA PREMA NIČANSKOJ KLASIFIKACIJI ROBA I USLUGA	<b>511</b>	LIST OF GOODS AND SERVICES ACCORDING THE NICE CLASSIFICATION OF GOODS AND SERVICE
IZJAVA PODNOSIOCA PRIJAVE DA NE TRAŽE EKSKLUZIVNO PRAVO ZA POJEDINE NEDINSTIKTIVNE ELEMENTE ZNAKA	<b>526</b>	DISCLAIMER
IZGLED ZNAKA	<b>540</b>	REPRODUCTION OF THE MARK
NAZNAKA O PRIRODI ILI VRSTI ZNAKA	<b>550</b>	INDICATION RELATING TO THE NATURE OR KIND OF MARK
INFORMACIJA O ZATRAŽENIM BOJAMA NA ZNAKU	<b>591</b>	INFORMATION CONCERNING THE COLORS CLAIMED
PODACI O PODNOSIOCU PRIJAVE	<b>731</b>	NAME AND ADDRESS OF THE APPLICANT
IME I ADRESA NOSIOCA ŽIGA	<b>732</b>	NAME AND ADDRESS OF THE HOLDER OF THE REGISTRATION
INFORMACIJA O ZATRAŽENIM BOJAMA NA ZNAKU	<b>591</b>	INFORMATION CONCERNING THE COLORS CLAIMED
PODACI O PODNOSIOCU PRIJAVE	<b>731</b>	NAME AND ADDRESS OF THE APPLICANT
IME I ADRESA NOSIOCA ŽIGA	<b>732</b>	NAME AND ADDRESS OF THE HOLDER OF THE REGISTRATION
IME I ADRESA PUNOMOĆNIKA	<b>740</b>	NAME AND ADDRESS OF THE REPRESENTATIVE



**OBJAVA PRIJAVA ŽIGOVA**  
PUBLICATION OF TRADEMARK APPLICATIONS

(210) 2017-365

(442) 20.01.2019

(220) 9/11/2017

(731) BioHorizons Australia Pty. Ltd., an Australian corporation, 25-33 Allen Street, Waterloo, NSW 2019, Australia, AU;

(540) BIOHORIZONS

(550) I

(740) Jusić Jasna, Dalmatinska 2, Podgorica ME

(511) Klasa 10: Medicinski i stomatološki Uređaji i proizvodi, odnosno zubni implantati, hirurške komponente, naime, zubne bušilice i specijalizovani vijci, komponente za zubne proteze;

Klasa 35: Usluge distribucije u vezi sa stomatološkim i medicinskim proizvodima implantata;

Klasa 42: Biotehnološke konsultantske usluge i istraživačke usluge u oblasti zubnih i medicinskih proizvoda implantata; usluge konsultacija na razvoju proizvoda u oblasti zubnih i medicinskih proizvoda implantata; razvoj zubnih i medicinskih proizvoda implantata;

-----  
(210) 2017-460

(442) 20.01.2019

(220) 11/21/2017

(731) SL MONTENEGRO doo,, Ul. Njegoševa br. 2, Nikšić, ME;



The  
**Beer  
Factory**  
PREMIUM CRAFT BEER

(540)

(550) I

(740) Milačić Dražen, ul. 13. Jula 3, Podgorica ME

(511) Klasa 01: Hemijski proizvodi za industriju, nauku, fotografsku djelatnost, hortikulturu, oljoprivredu i šumarstvo; sirova vještačka smola, sirova plastika; dubrivo za zemlju; mješavine za gašenje požara; preparati za kaljenje, zavarivanje i lemljenje metala; hemijski proizvodi za konzervisanje hrane; sredstva za štavljenje kože; ljepila (ljepljive supstance) namijenjene za industriju; hemijske proizvode namijenjene industriji, nauci i hortikulturi, uključujući i one proizvode koji ulaze u sastav proizvoda koji su obuhvaceni drugim klasama; mješavinu, stelju (dubrivo); so za konzerviranje, osim soli za konzerviranje hrane.

Klasa 02: Boje, lakovi i glazure za industriju, rucne radove i umjetnost; zaštite od rđe, od propadanja i truljenja drveta; materije za bojenje; nagrizajući materijali; prirodne sirove smole; metali u listovima i u prahu za slikare, dekoratere, štampare i umjetnike; boje, bojajuće materijale te proizvode za zaštitu od

nagrivanja, (korozije); boje, lakove i glazure za industriju, rucne radove i umjetnost; sredstva za bojenje odjevnih predmeta; sredstva za bojenje hrane i napitaka.

Klasa 07: Mašine i alatne mašine; motori ( osim motora za kopnena vozila); spojnice, transmisioni Uređaji (osim onih za kopnena vozila); poljoprivredne sprave osim onih koje se pokrecu rucno; inkubatori za jaja; automatske mašine; mašinske alate i motore; dijelove motora (svake vrste); elektricne mašine i aparate za šišćenje.

Klasa 16: Papir, karton i proizvodi od tih materijala koji nisu obuhvaceni drugim klasama; štamparski proizvodi; proizvodi za uvezivanje knjiga; fotografije; pribor za pisanje; ljepila (ljepljive materije za papirnate proizvode ili za kućne potrebe ); slikarski pribor; kistovi; pisace mašine i kancelarijski pribor (osim namještaja); oprema za nastavu i obuku (osim aparata); plasticni materijali za ambalažu (koji nisu obuhvaćeni drugim klasama); štamparska slova; klišei; papir, papirnate proizvode kancelarijski pribor; noževe za papir; aparate za umnožavanje; plasticne folije, torbe i vrećice od plasticnog materijala, za ambalažu.

Klasa 21: Pribor i posuđe za domaćinstvo ili za kuhinju; češljeve i sunđere; cetke (osim kicica); materijali za četke; pribor za šišćenje; žica za struganje parketa; sirovo ili polu obradeno staklo (osim gradevinskog stakla); stakleni proizvodi, porculansko i keramičko posude koje nije obuhvaceno drugim klasama; sitni pribor i aparate za domacinstvo i za kuhinju, koji se pokrecu ručno, kao i toaletni pribor, staklene i porculanske proizvode; pribor i posuđe za domacinstvo i za kuhinju, kao na primjer: kuhinjsko metalno posuđe, kante, kotlice limene, aluminijske, plasticne ili od nekog drugog materijala, male, rucno pokretane aparate za sjeckanje, mljevenje, presovanje i sl.; elektricne češljeve; električne četkice za zube; podmetače za posude i podmetace za boce (posude).

Klasa 32: Pivo; mineralne i gazirane vode i ostala Bezalkoholna pića; pica od voca i vocni sokovi; sirupi i ostali preparati za pripremanje napitaka. ;

-----  
(210) 2017-470

(442) 20.01.2019

(220) 4/12/2017

(731) Finance plus d.o.o. Podgorica, Džordža Vašingtona 44, 81000 Podgorica, ME;



(540)

(550) I,F

(740) Nikola Pješčić, Bar, Borska 1/9;

(511) Klasa 35: Oglašavanje; vodenje poslova; poslovno upravljanje; kancelarijski poslovi; usluge koje pružaju lica ili organizacije uglavnom radi; pomoci u radu ili upravljanju preduzecima, pomoci u upravljanju poslovnom ili komercijalnom djelatnošću u industrijskim ili komercijalnim privrednim društvima; usluge koje pružaju preduzeća koja se bave oglašavanjem (reklamiranjem), tako što, za Račun drugih lica, komuniciraju sa javnošću (reklama) putem prenosa bilo kakvih informacija o svim vrstama prizvoda

proizvodima i uslugama; sakupljanje u korist drugih, citavog niza roba (uključujući i njihov transport) omogućavajući klijentima da zgodno razgledaju i kupuju ovu robu; takve usluge mogu se pružati u prodavnicama na malo, rasprodajama, porudžbinama poštom preko kataloga ili putem elektronskih medija, na primjer preko web site-a ili televizijskih programa za kupovinu; u usluge koje se sastoje od registracije, transkripcije, kompozicije, kompilacije ili sistematizacije pisanih saopštenja i registracija i takode kompilacije matematičkih ili statističkih podataka; usluge reklamnih agencija i usluge kao što je dijeljenje prospekata direktno ili poštom ili distribucija uzoraka; reklamiranje u vezi sa drugim uslugama, kao što su one u vezi sa bankarskim zajmovima ili reklamiranje putem radija.

Klasa 42: Naučne i tehnološke usluge i istraživanje i projektovanje u vezi navedenih usluga; usluge industrijske analize i istraživanja; projektovanje i razvoj kompjuterskog hardvera i softvera; usluge koje pružaju lica, individualno ili kolektivno, u vezi teorijskih i praktičnih aspekata složenog polja aktivnosti; takve usluge obezbjeđuju profesionalci kao što su hemičari, fizičari, inženjeri, kompjuterski stručnjaci i drugi; usluge inženjera koje se preduzimaju radi planiranja, ocjene, istraživanja i izvještavanja u naučnim i tehnološkim oblastima; usluge naučnog istraživanja u medicinske svrhe.

Klasa 45: Pravne usluge; usluge obezbjeđenja radi zaštite imovine i lica; individualne i društvene usluge koje pružaju drugi, radi zadovoljavanja potreba pojedinaca; usluge koje pružaju advokati individualnim licima, grupama, organizacijama i preduzecima; usluge istrage i prismothe u vezi sigurnosti lica i entiteta; usluge koje se pružaju pojedincima u vezi društvenih dešavanja, kao što su usluge društvene pratnje, agencije za sklapanje braka, i pogrebne usluge.;

-----  
(210) 2017-471

(442) 20.01.2019

(220) 4/12/2017

(300) CA, 7 jun 2017, 1841262

(731) Nutrien Ltd., 122-1st Avenue South, Suite 500, S7K 7G3 Saskatoon Saskatchewan, Canada, CA;

(540) NUTRIEN

(550) I

(740) Jusić Jasna, Dalmatinska 2, Podgorica ME

(511) **Klasa 01:** Potaša; dubriva; hemikalije za upotrebu u proizvodnji dubriva, uključujući azot, amonijak, amonijum, kalijum, potaša, fosfat, sumpor, kalijum nitrat, amonijum nitrat, amonijum fosfat, urea, sumporna kisjelina i fosforna kisjelina; hemikalije za upotrebu u proizvodnji pesticida; poljoprivredne hemikalije, odnosno surfaktanti (supstance koje snižavaju površinski napon vode), adjuvansi (farmakoloski i imunoloski agensi koji modifikuju dejstvo drugih agenasa) i sredstva za vlaženje za upotrebu u primjeni herbicida, insekticida, pesticida i hranljivih materija; adjuvansi za upotrebu sa poljoprivrednim hemikalijama; adjuvansi za ulje za prskanje za upotrebu sa poljoprivrednim insekticidima i fungicidima; aktivni hemijski sastojci za upotrebu u proizvodnji dubriva, pesticida, herbicida, fungicida, insekticida i rodenticida; poboljšivači tla za poljoprivredu upotrebu; hranljivi dodaci za poboljšanje biološke aktivnosti vode i zemljišta u svrhu oplodnje, poboljšanja pH tla i pH vode za navodnjavanje, poboljšanja propustljivosti zemljišta i poboljšanja učinka pesticida i dubriva; hemijski preparati za upotrebu u poljoprivredi, odnosno hemijski preparati za tretman sjemena; surfaktant tla koji se koristi za unaprijedivanje ujednaceno gretanja vode u tlu; zemljišni inokulanti (kalemi) za primjenu na sjemena koja se koriste u poljoprivredi; hemijski aditivi za dubriva; sredstvo za omekšavanje, sredstvo za širenje, sredstvo za prodiranje i surfaktant za upotrebu u vezi sa pesticidima, herbicidima, desikantima (hemijska jedinjenja koje upijaju vodu), defoliantima (hemijska jedinjenja koja uzrokuju prijevremeno opadanje

lišca), insekticidima, fungicidima, akaracidima (pesticidi koji ubijaju krpelje, grinje, itd.), regulatorima rasta biljaka i hranjivim materijama koje se nanose na list (foliranje) Uređaji za vodu, naime, fosfati za tretiranje pitke vode; sredstva koja sprečavaju pojavljivanje pjene, hemijska jedinjenja koja sprečavaju pojavljivanje pjene za upotrebu u poljoprivredi; aminokiseline za upotrebu sa proizvodima za hranjenje biljaka rastvorljivim u vodi; aminokiseline kao izvor azota za upotrebu sa proizvodima za hranjenje biljaka rastvorljivim u vodi; i aminokiseline kao izvori azota za upotrebu u kombinaciji sa proizvodima za hranjenje biljaka rastvorljivim u vodi formulisani za upotrebu kod djubrenja biljaka preko lista iii navodnjavanje kapanjem; hranjivi sastojci za rast biljaka; biljna hrana; dodatak za tretman vode za upotrebu na zelenim površinama golf terena; rastvor ureje visoke cistoce za tretman i kontrolu emisije izduvnih gasova, azotnih oksida i azot-dioksida, odnosno hemijskih aditiva za izduvne gasove.

**Klasa 05:** Pesticidi; herbicidi; fungicidi; insekticidi; rodenticidi; parazitici.

**Klasa 44:** Prilagodena primjena, odnosno primjena dubriva i drugih poljoprivrednih hemikalija; agronomske konsultantske usluge; agronomske usluge, naime, konsultantske usluge u smislu pružanja informacija o usjevu i upravljanju proizvedenim usjevima i prinosima u vidu poljoprivrednih savjeta i preporuka o usjevu, preporuke za upravljanje štetocinima i preporuke o sjemenima; agronomski menadžment, naime, pružanje informacija koje se odnose na preciznu poljoprivredu i tehnologiju varijabilnih stopa koristeći globalne sisteme pozicioniranja, geografske informacione sisteme i satelitske snimke; usluge kontrole štetocina u poljoprivredi; savjetovanje u poljoprivredi i informacije u oblasti proizvodnje usjeva, planiranje usjeva, izvodljivost usjeva, sjemena za usjeve, uzgoj usjeva, monitoring usjeva, plodnost usjeva, selekciju sjemena i poboljšanje usjeva.

-----  
(210) 2017-474

(442) 20.01.2019

(220) 5/12/2017

(731) McDonal's International Property Company, Ltd. a corporation organized and existing under the laws of the State of Delaware, 110 N. Carpenter Street, Chicago, Illinois 60607, USA, US;

(540) HAPPY STUDIO

(550) I

(740) AOD "Ćupić", Dalmatinska 10, Podgorica ME

(511) Klasa 09: Publikacije, e-knjige, video zapisi, igre i elektronski muzički snimci koji se mogu preuzeti; mobilne aplikacije koje se mogu preuzeti.

Klasa 41: Pružanje online elektronskih publikacija, e-knjiga, video zapisa, igara i elektronskih muzičkih zapisa ( koji se ne mogu preuzeti).;

-----  
(210) 2017-476

(442) 20.01.2019

(220) 5/12/2017

(731) Dunhill Tobacco of London Limited, Globe House 4 Temple Place London WC2R 2PG Ujedinjeno Kraljevstvo, UK;

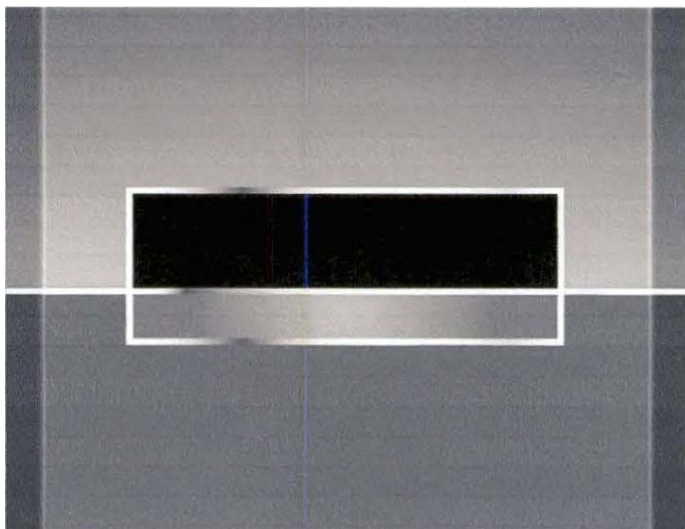

(540)

(550) I,F

(740) Popović Miladin, Đoka Miraševića 21/III, Podgorica ME

(511) Klasa 34: Cigarete; duvan, sirov ili prerađen; proizvodi od duvana; zamjene za duvan ( ne u medicinske svrhe); cigare, cigarilosi; upaljaci; šibice; artikli za pušace; cigaret papir, cigaret tube, filteri za cigarete; džepni aparati za zamotavanje cigareta; rucne mešine za ubrizgavanje duvana u papirne tube; elektronske cigarete; tečnosti za elektronske cigarete; duvanski proizvodi namjenjeni za zagrijavanje.;

---

(210) 2017-483

(442) 20.01.2019

(220) 6/12/2017

(731) Amazon Europe Core S.à.r.l., 5, Rue Plaetis, L-2338 Luxembourg, LU;

(550) I

(740) Jusić Jasna, Dalmatinska 2, Podgorica ME

(511) **Klasa 09:** Kontrolni Uređaji za kucnu automatizaciju; bežicni komunikacioni Uređaji za prenos glasa, podataka iii slika; Uređaji za prenos i prijem glasa i podataka; samostalni informacioni Uređaji koji se kontrolisu pomocu glasa; nezavisni glasovno-aktivirani lični (virtualni) asistenti koji integriraju usluge koje se pružaju putem aplikacija; zvučnici koji se kontrolisu pomocu glasa; aparati i instrumenti Naučni, pomorski, geodetski, fotografski, kinematografski, optički, za vaganje, mjerenje, signalizaciju , kontrolu (inspekciju), spasavanje i nastavu; aparati za snimanje, prenos iii reprodukciju zvuka iii slika; Računske mašine; oprema za obradu podataka; kompjuteri; aparati i instrumenti za provodenje, prekid, transformaciju, akumulaciju, regulisanje iii kontrolu elektricne energije; magnetni nosaci podataka; diskovi za snimanje; kompakt diskovi, DVD i drugi digitalni nosaci podataka; mehanizmi za aparate koji se pokrecu novcem; računarski softver; prenosivi elektronski Uređaji za prijem, prenos i citanje teksta, slika i zvuka putem bezicnog internet pristupa; daljinski kontrolni Uređaji za Uređaje za snimanje; daljinski kontrolni Uređaji; bežicni kontrolni Uređaj za daljinski nadzor i kontrolu funkcije i statusa drugih elektricnih, elektronskih, i mehaničkih Uređaja i sistema; kompjuterski ekrani osjetljivi na dodir; digitalni audio plejeri; audio rekorderi; digitalni video plejeri; prenosivi Uređaji za snimanje, prenos i reprodukciju muzike, slika i videa; elektronski aparati i instrumenti za obuku i nastavu; kamere; digitalne kamere; softver za preusmjeravanje poruka; kompjuterski hardver i softver za obradu, reprodukciju, sinhronizaciju, snimanje, organizovanje, preuzimanje, postavljanje, prenos, striming, prijem, pustanje i gledanje

televizijskih emisija, filmova, teksta, slika, digitalnih medija, multimedija, audio, video i fajlova sa podacima; kompjuterski softver za pristup, nadgledanje, procenje, pretraživanje, čuvanje i dijeljenje informacija u vezi sa temama od opšteg interesa; kompjuterski softver i periferne jedinice za personalizovano, interaktivno televizijsko (TV) programiranje; kompjuterski softver i periferni Uređaji za upotrebu kod prikazivanja i manipulisanja vizuelnim medijima, grafičkim slikama, tekstovima, fotografijama, ilustracijama, digitalnim animacijama, video klipovima, filmskim snimcima i audio podacima i za upotrebu kod društvenog umrežavanja; kompjuterski programi za pristup, pregledanje i pretrazivanje onlajn baza podataka; kompjuterski hardver i softver za pružanje integrirane telefonske komunikacije za kompjuterizovanim globalnim informacionim mrežama; kompjuterski softver koji se koristi za kontrolu nezavisnih glasovno-aktiviranih licnih (virtualnih) asistenata koji integrisu usluge koje se pružaju putem aplikacija; kompjuterski softver koji se koristi u vezi sa uslugama pretplate na digitalne sadržaje, osiguravanjem platforme za pretragu koje omogućavaju korisnicima da traže i primaju sadržaj digitalnih medija; kompjuterski softver za kreiranje, autorstvo, distribuciju, preuzimanje, prenos, prijem, igranje, formatiranje, editovanje, ekstrakciju, kodiranje, dekodiranje, konvertovanje, prikazivanje, skladištenje i organizaciju teksta, vizuelnih, audio i audio-vizuelnih literarnih radova, podataka, fajlova, dokumenata i elektronskih radova i multimedijalnog sadržaja; kompjuterski softver koji omogućava da se sadržaj, tekst, vizuelni, audio i audio-vizuelni radovi, literarni radovi, podaci, fajlovi, dokumenta i elektronski radovi budu preuzeti na i da im se može pristupiti na kompjuteru ili drugim prenosivim elektronskim Uređajima; kompjuterski softver za prenos, dijeljenje, prijem, preuzimanje, striming, prikazivanje i prebacivanje sadržaja, teksta, vizuelnih, audio i audio-vizuelnih radova, literarnih radova, podataka, fajlova, dokumenata i elektronskih radova putem prenosivih elektronskih Uređaja i kompjutera i globalnih kompjuterskih i komunikacionih mreža; stereo zvučnici za ličnu upotrebu; mikrofoni; softver za prepoznavanje slova, simbola; softver za prepoznavanje glasa; softver za elektronsku poštu i poruke; kompjuterski softver za formatiranje i konvertovanje sadržaja, teksta, vizuelnih, audio i audio-vizuelnih radova, literarnih radova, podataka, fajlova, dokumenata i elektronskih radova u format kompatibilan sa prenosivim elektronskim Uređajima i kompjuterima; kompjuterski softver za upravljanje licnim informacijama i za pristup, pregledanje i pretragu audio i multimedijalnog sadržaja, igrice i softverskih aplikacija; softver za prepoznavanje glasa i glasovne komande, softver za pretvaranje govora u tekst i softverske aplikacije koje se aktiviraju putem glasa; softver koji se može preuzeti sa interneta u vidu mobilnih aplikacija za kompjutere ili druge prenosive elektronske Uređaje široke potrošnje; kompjuterski softver iz oblasti prenosa i prikaza teksta, slika i zvuka.

**Klasa 35:** Oglašavanje; marketinške usluge i usluge oglašavanja, naime, promocija proizvoda i usluga drugih strana; usluge za realizaciju porudžbina, naime, usluge u vezi sa prijemom i obradom porudžbina; pružanje informacija o proizvodima u svrhu asistiranja pri odabiru standardne potrošačke robe, a radi zadovoljenja potreba potrošača; obezbjeđivanje usluga za optimizaciju pretraživaca; usluge uporedne kupovine, naime, promovisanje roba i usluga drugih strana; elektronsko upravljanje bazama podataka i fajlovima; kreiranje indeksa informacija, sajtova i drugih izvora dostupnih na globalnim kompjuterskim mrežama i drugim elektronskim i komunikacionim mrežama za druge; pružanje informacija o potrošačkim proizvodima u cilju odabira standardne potrošačke robe, a radi zadovoljenja specifikacija i potreba potrošača; komercijalne informacije i savjeti za potrošače, naime, pružanje mogućnosti internet korisnicima da postavje ocjene, napisu recenzije i preporuke za širok spektar potrošačkih proizvoda; usluge onlajn maloprodajnih objekata koje nude širok spektar potrošačke robe drugih strana; usluge maloprodajnih objekata koje nude širok spektar potrošačke robe drugih strana; maloprodajne i onlajn maloprodajne usluge u vezi sa knjigama, elektronikom, hranom, vinom i napicima, kuhinjskim

proizvodima, proizvodima za šišćenje, posudem za kuvanje, proizvodima za domacinstvo, odjecom, proizvodima za ličnu njegu, proizvodima za kućne ljubimce, sportskom opremom, opremom za kampovanje, igračkama, nakitom, cvijećem, obućom i pokrivalima za glavu; vodenje poslova, poslovno upravljanje; kancelarijski poslovi; obezbjeđivanje direktorijuma za telefonske brojeve, poslovne adrese, adrese elektronske pošte, adrese internet stranica, adrese i telefonski brojevi ljudi, mjesta i organizacija.

**Klasa 38:** Telekomunikacione usluge; telekomunikacione usluge, naime, elektronski prenos emitovanih fajlova sa audio, vizuelnim i multimedijalnim sadržajem koji se može preuzimati putem kompjutera i drugih komunikacionih mreža; elektronski prenos poruka, glasa, podataka i slika putem globalnih komunikacionih mreža; elektronska komunikacija; elektronski prenos informacija i podataka; dostava poruka putem elektronskog prenosa; obezbjeđivanje pristupa forumima za diskusiju; obezbjeđivanje onlajn oglasnih tabli za prenos poruka među kompjuterskim korisnicima u vezi sa informacijama o potrošačkim proizvodima; audio emotivne izgovorene riječi; audio emitovanje i prenos obrazovnih i zabavnih digitalnih medija; bezicne širokopojasne komunikacione usluge; obezbjeđivanje pristupa interaktivnoj bazi podataka za prenos poruka između kompjuterskih korisnika i pretplatnika a u vezi sa knjigama, filmovima, igranim filmovima, igrama, igračkama, sportskom opremom, elektronikom, multimedijalnim prezentacijama i drugim proizvodima za domacinstva i potrošačkim proizvodima; obezbjeđivanje pristupa onlajn direktorijumima, bazama podataka, internet stranicama i blogovima na temu aktuelnih događaja i onlajn referentnim materijalima; obezbjeđivanje onlajn portal i internet stranica obrazovnog i zabavnog sadržaja, naime, filmovi, televizijske emisije, audiovizuelni radovi, muzika, audio radovi, knjige, pozorišni radovi, literarni radovi, sportski događaji, rekreativne aktivnosti, slobodne aktivnosti u vidu hobija, turnira, umjetnosti, plesa, mjuzikala, kulture, sportskih i izložbi aktuelnih događaja, sportskih instrukcija, klubova, radio programa, komedija, drama, takmicenja, vizuelnih umjetničkih djela, igara, igrice, festival, muzeja, parkova, kulturnih događaja, koncerata, elektronskih editorijala, animacija, aktuelnih događaja, modnih revija, multimedijalnih prezentacija i interaktivnih edukativnih kvizova; prenos podkastova, prenos vebkastova; usluge tekstualnih i numeričkih bežičnih poruka; obezbjeđivanje onlajn mreže koja omogućava korisnicima pristup i dijeljenje sadržaja, teksta, vizuelnih, audio i audiovizuelnih radova, literarnih radova, podataka, fajlova, dokumenata i elektronskih radova; obezbjeđivanje telekomunikacionog vremenskog pristupa korisnicima komunikacionim mrežama putem identifikacije, lociranja, grupisanja, distribuiranja i upravljanja podacima i linkovima kompjuterskih servera trećih strana, kompjuterskih procesora i kompjuterskih korisnika; obezbjeđivanje kompjuterskih direktorijuma za telefonske brojeve, poslovne adrese, adrese elektronske pošte, adrese internet stranica, adrese i telefonske brojeve ljudi, mjesta i organizacija; obezbjeđivanje pristupa pomoćnim Uređajima iii elektronskim Uređajima u vidu obezbjeđivanja usluga telekomunikacione povezanosti za prenos slika, poruka, audio, vizuelnih i audiovizuelnih i multimedijalnih radova između čitača elektronskih knjiga, mobilnih telefona, pametnih telefona, prenosivih elektronskih Uređaja, prenosivih digitalnih Uređaja, tableta iii kompjutera; emitovanje audio, vizuelnog i audiovizuelnog materijala preko internet iii drugih kompjuterskih iii komunikacionih mreža; obezbjeđivanje onlajn saba za caskanje, internet foruma i onlajn zajednica za prenos fotografija, videa, teksta, podataka, slika i drugih elektronskih radova; obezbjeđivanje informativnih, konsultacionih i savjetodavnih usluga u vezi sa gore navedenim.

**Klasa 41:** Obezbjeđivanje informacija koje se odnose na zabavu; izdavanje časopisa; pružanje onlajn elektronskih publikacija (koje se ne mogu preuzeti); objavljivanje elektronskih knjiga, novina; objavljivanje materijala na magnetnim ili optičkim medijima; objavljivanje muzike na mreži; pružanje informacija u oblasti zabave na mreži; obezbjeđivanje unaprijed snimljene muzike i podkastova koji se ne mogu preuzeti; pružanje edukativnih i zabavnih informacija, vijesti i komentara u oblasti aktuelnih događaja,

zabave, kulturnih događaja, vijesti, sparta, zabave, poslovanja i finansija, politike i javnog upravljanja, zdravlja i fizičke kondicije, vremenskih uslova, nauke i tehnologije, putovanja, umjetnosti i knjizevnosti, nacina života i licnog razvoja, prevoza robe u kopnenim i transportnim vozilima, obrazovanja i razvoja djece, nekretnina, mode i dizajna, recepata, sastojaka i kivanja, uredjenja kuce, muzike i bioskopa, istorije, medicine, prava i pružanja obrazovnih i zabavnih informacija o pravima kupaca; obezbjeđivanje internet stranice sa informacijama, audio sadržajem i publikacijama koje se odnose na zabavu; obezbjeđivanje vijesti i informacija u oblasti zabave u vezi sa informacijama, takmicenjima, tekstovima, zvukom, publikacijama koje se odnose na zabavu; konsultantske usluge u oblasti zabave i industrije zabave; pružanje informacija o zabavi, filmovima i televizijskim emisijama preko društvenih mreža; distribucija radio zabave i interaktivnog oglašavanja; zabavne informativne usluge, naime, pružanje mogućnosti za razmjenu informacija i razgovor o širokom spektru tema putem događaja uživo i informacija putem elektronske pošte; pružanje informacija, pregleda i personalizovanih preporuka iz oblasti zabave putem globalnih komunikacionih mreža; pružanje informacija i komentara u oblasti zabave ili obrazovanja putem globalne računarske mreže, odnosno informacija u oblasti muzike, knjiga, filmova, igranih filmova, igara, igračaka, sportskih proizvoda, elektronike, multimedijalnih prezentacija i drugih proizvoda za domaćinstvo i potrošačkih proizvoda; usluge za zabavu, naime, obezbjeđivanje onlajn unaprijed snimljenih audio programa iz oblasti muzike, knjiga, filmova, igranih filmova, igara, igračaka, sportskih proizvoda, elektronike, multimedijalnih prezentacija i drugih proizvoda za domaćinstvo i potrošačkih proizvoda; usluge zabave, naime, pružanje onlajn kritika, ocjena i preporuka muzike, knjiga, filmova, igranih filmova, igara, igračaka, sportskih proizvoda, elektronike, multimedijalnih prezentacija i drugih proizvoda za domaćinstvo i potrošačkih proizvoda; usluge zabave, naime, obezbjeđivanje dijela unaprijed snimljenih audio radova putem interneta; izdavanje knjiga, časopisa, periodičnih časopisa, književnih radova, audio radova i audiovizuelnih radova; obezbjeđivanje unaprijed snimljenih audio, vizuelnih i audio-vizuelnih radova koji se ne mogu preuzimati preko bezicnih mreža; pružanje onlajn kompjuterskih igara i onlajn interaktivnih prica; obezbjeđivanje informacija, vijesti, članaka i komentara u oblasti edukacije i obrazovnih institucija; edukativne usluge u ime nastave u ucionici i onlajn ucenje na daljinu na temu aktuelnih događaja, obrazovanja, istorije, jezika, liberalnih umjetnosti, matematike, biznisa, nauke, hobija, tehnologije, kulture, sparta, umjetnosti, psihologije i filozofije; interaktivne obrazovne usluge u vidu instrukcija na kompjuterima iii pomocu kompjutera a na temu aktuelnih događaja, obrazovanja, istorije, jezika, liberalnih umjetnosti, književnosti, matematike, biznisa, nauke, hobija, tehnologije, kulture, sparta, umjetnosti, psihologije i filozofije; edukativne i zabavne usluge koje se odnose na podkastove, vebkastove i kontinuirane programe sa vijestima i komentarima iz oblasti muzike, audio radova, knjiga, pozorišta, književnih radova, sportskih događaja, rekreativnih aktivnosti, slobodnih aktivnosti, turnira, umjetnosti, plesa, mjuzikala, izlozbi, sportske nastave, klubova, radia, komedije, takmicenja, vizuelnih radova, igara, igrice, festivala, muzeja, parkova, kulturnih događaja, koncerata, izdavaštva, animacija, aktuelnih događaja, mode i multimedijalnih prezentacija koje su dostupne putem interneta ili drugog računara na komunikacionim mrežama; proizvodnja radio programa; radio zabave; usluge studijskog snimanja; pružanje onlajn informacija u vezi sa kompjuterskim igricama i računarskim poboljšanjima za igrice; obezbjeđivanje baze podataka za onlajn zabavu koja se može pretraživati, uključujući onlajn muziku koja se ne može preuzeti i drugi digitalni tekst, audio datoteke sa knjigama, časopisima, vijestima i informacijama; pružanje informacija, konsultantskih i savjetodavnih usluga u vezi sa gore navedenim.

**Klasa 42:** Obezbjeđivanje alata za pretraživanje; kompjuterske usluge, naime, daljinski hosting operativnih sistema i kompjuterskih aplikacija; hosting operativnih sistema i kompjuterskih aplikacija preko interneta; kompjutersko programiranje; konsultantske usluge u vezi sa upravljanjem, prezentacijom



i kontrolom multimedijalnih aplikacija; dizajn hardvera, softvera i kompjuterskih sistema; usluge uređivanja, ažuriranja, održavanja i podrške za softverske i kompjuterske sisteme; kompjuterske usluge u vezi sa upravljanjem, prezentacijom i kontrolom multimedijalnih aplikacija, istraživanje, upravljanje bazama podataka, upravljanje objektima, usluge podugovaranja; kompjuterske usluge, naime, hosting preko interneta onlajn baza podataka koje sadrže širok spektar informacija od opšteg interesa; kompjuterske usluge, naime, obezbjeđivanje alata za pretraživanje informacija od opšteg interesa; hosting interaktivne baze podataka za prenos poruka među kompjuterskim korisnicima i pretplatnicima; hosting interaktivne baze podataka za prenos poruka među kompjuterskim korisnicima i pretplatnicima, a u vezi sa knjigama, filmovima, igranim filmovima, televizijskim programima, igrana, igračkama, sportskom opremom, elektronskim Uređajima, multimedijalnim prezentacijama i drugom potrošačkom robom i robom za domaćinstvo, ocjenama proizvoda i informacijama o kupovini na internetu; pružanje softvera onlajn internet pregledaca koji se ne može preuzeti; pružanje softvera koji se ne može preuzeti za mobilni komunikacioni Uređaj za poboljšanje mobilnog pristupa internetu putem računara, mobilnih računara i mobilnih komunikacionih Uređaja; tehnička podrška, naime, rješavanje problema kompjuterskog hardvera i softvera i hardverskih i softverskih problema na mobilnim računarima i mobilnim komunikacionim Uređajima; konsultacije i dizajn u vezi sa kompjuterskim hardverom i softverom; dizajn kompjuterskog softvera za druge; konsultacije i dizajn u vezi sa mobilnim računarima i mobilnim komunikacionim Uređajima; hosting sadržaja, fotografija, teksta, podataka, slika, internet stranica i drugih elektronskih radova za treća lica; pružanje platformi za pretragu kako bi se korisnicima omogućilo da traže i primaju fotografije, tekst, podatke, slike, elektronske radove, vizuelne radove, audio radove, audio-vizuelne radove, literarne radove i dokumenta; interaktivne hosting usluge koje dozvoljavaju korisnicima da objavljuju i dijele sopstvene fotografije, tekst, podatke i slike onlajn; održavanje i ažuriranje softvera u vezi sa računarima, internetom i sigurnošću lozinki i prevencija rizika za računare, internet i lozinke; instalacija i održavanje kompjuterskog softvera; pružanje internet stranice koja sadrži tehničke informacije u vezi sa kompjuterskim softverom i hardverom; kompjuterske konsultacije; transfer podataka iz dokumenata iz jednog kompjuterskog sistema u drugi; hosting digitalnog sadržaja na globalnim računarskim mrežama, bezicnim mrežama i mrežama elektronske komunikacije; pružanje privremene upotrebe kompjuterskog softvera i onlajn postrojenja, koji se ne mogu preuzeti, kako bi se korisnicima omogućio pristup i preuzimanje kompjuterskog softvera; pružanje privremene upotrebe kompjuterskog softvera koji se ne može preuzeti, a koji generise prilagodene preporuke softverskih aplikacija na osnovu korisničkih preferenci; pracenje kompjuterizovanih podataka i kompjuterskih sistema i mreža za sigurnosne namjene; hosting, prilagodavanje i održavanje onlajn baza podataka za druge; računarstvo u oblaku sa softverom za upotrebu u upravljanju bazama podataka; hosting elektronskih baza podataka u oblaku; pružanje usluga aplikacija (ASP) za softver za upotrebu u upravljanju bazama podataka; platforma u vidu servisa (PAAS) za kompjuterske softverske platforme za upotrebu u upravljanju bazama podataka; softver u vidu servisa (SAAS za upotrebu u upravljanju bazama podataka; softver u vidu servisa (SaaS) za pristup, monitoring, pracenje, pretragu, čuvanje i dijeljenje informacija o temama od opšteg interesa; softver u vidu servisa (SaaS) za upravljanje licnim informacijama i za pristup, pregled i pretragu onlajn baza podataka, audio i multimedijalnog sadržaja, igara, softverskih aplikacija, tržišta softverskih aplikacija, programskih listi i vodica i videa na zahtjev; softver u vidu servisa (SaaS) koji koristi softver za glasovne komande i prepoznavanje glasa, softver za pretvaranje govora u tekst, softverske aplikacije koje se aktiviraju glasom, upravljanje licnim informacijama i softver za pristup, pregled i pretragu onlajn baza podataka, audio i multimedijalnog sadržaja, igara, softverskih aplikacija, tržišta softverskih aplikacija, programskih listi i vodica i videa na zahtjev; softver u vidu servisa (SaaS) kojim se omogućava preuzimanje

i pristup na računaru ili drugom nosivom potrošačkom elektronskom Uređaju audio i multimedijalnih datoteka; softver u vidu servisa (SaaS) za mobilne Uređaje kojim se korisniku dozvoljava da pretražuje sadržaj Uređaja radi informacija, kontakata i aplikacija; softver u vidu servisa (SaaS) za kreiranje indeksa informacija, internet stranica i drugih informativnih resursa; softver u vidu servisa (SaaS) za glasovne komande i prepoznavanje glasa; softver u vidu servisa (SaaS) za kontrolu pametnih audio zvučnika; softver u vidu servisa (SaaS) za upotrebu u vezi sa uslugama pretplate na digitalne sadržaje; softver u vidu servisa (SaaS) za kreiranje, autorstvo, distribuciju, preuzimanje, prenošenje, primanje, reprodukciju, uređivanje, izvlačenje, kodiranje, dekodiranje, prikazivanje, čuvanje i organizaciju audio i multimedijalnog sadržaja; pružanje platformi za pretragu kako bi se korisnicima omogućilo da traže i primaju digitalni medijski sadržaj i aplikacije; pružanje privremene upotrebe onlajn softvera i aplikacija koji se ne mogu preuzeti za pristup strimingu audio i video datoteka, igrama, društvenim mrežama, tekstualnim i multimedijalnim datotekama; kompjuterske usluge, naime, pružanje servera baza podataka različitih kapaciteta drugima; pružanje internet stranica na kojima se nalazi softver za upravljanje bazama podataka koji se ne mogu preuzeti; pružanje operativnih sistema i kompjuterskih aplikacija preko interneta; iznajmljivanje kompjuterskih i postrojenja za čuvanje podataka različitih kapaciteta; pružanje, razvijanje i dizajn softvera za upravljanje kompjuterskim aplikacijama, koji se ne može preuzeti, a kojem se može pristupiti preko globalne kompjuterske mreže; dizajn, upravljanje i nadgledanje onlajn foruma za diskusiju; kreiranje internet stranica za onlajn usluge i internet, koje se čuvaju elektronski; skladištenje podataka; razrada i održavanje internet stranica za treća lica; upravljanje internet stranicama za druge; iznajmljivanje veb servera; održavanje internet stranica, usluge kreiranja i hostinga; pružanje usluga aplikacija, naime, pružanje, hosting, upravljanje, razvoj i održavanje aplikacija, softvera, internet stranica i baza podataka u oblasti elektronskog poslovanja, onlajn placanja, redosleda naloga, dizajna internet stranica, čuvanja podataka, prilagodavanje kapaciteta računarstva koje se može dijeliti, usluge poruka i izračunavanje rangiranja internet stranica na osnovu protoka korisnika; hosting internet stranica koje korisniku omogućavaju da ocijeni različite stampane, fotografske i grafičke slike i audio sadržaj i koristi prilagođeni sablon kako bi pružio stav, svidanje, nesvidanje, uređivanje, promjene, modifikacije, mišljenja, prijedloge i komentare i učestvovao u društvenom, poslovnom i umrežavanju u zajednici; kompjuterske usluge, naime, kreiranje onlajn zajednice za registrovane korisnike kako bi učestvovali u diskusijama, dobili povratnu informaciju od sebi jednakih, formirali virtuelne zajednice i učestvovali u društvenom umrežavanju; dizajn i razvoj kompjuterskog hardvera i softvera; dizajn i razvoj softvera za kompjuterske igre; pružanje privremene upotrebe onlajn alata za razvoj softvera, koji se ne mogu preuzeti, za dizajn i razvoj elektronskih igara; usluge tehničke podrške, naime, rješavanje problema softvera kompjuterskih igara; pružanje softverskih aplikacija koje se ne mogu preuzeti; pružanje privremene upotrebe onlajn softvera za računarstvo u oblaku, koji se ne može preuzeti, za upotrebu u elektronskom skladištenju podataka; razvoj kompjuterskog softvera u oblasti mobilnih aplikacija; pružanje usluga aplikacija, naime, hosting, upravljanje, razvoj i održavanje aplikacija, softvera i internet stranica u oblasti licne produktivnosti, bezicne komunikacije i mobilne tehnologije; Naučne i tehnološke usluge i istraživanje i dizajn s tim u vezi; industrijske analize i usluge istraživanja; pružanje informacija, konsultacija i savjetodavnih usluga u vezi sa gore navedenim.

**Klasa 45:** Usluge predstavljanja, društvenih mreža i upoznavanja putem interneta; pružanje kontakata i olakšavanje upoznavanja u svrhu stvaranja i razvijanja produktivnih licnih odnosa za ljude koji imaju zajedničku želju da upoznaju druge ljude sa sličnim interesovanjima; upoznavanje, lični odnos i usluge društvenih mreža koje se obezbjeđuju putem interneta i druge računarske ili komunikacione mreže; usluge onlajn društvenih mreža, naime, olakšavanje društvenih upoznavanja ili interakcija među

pojedincima; usluge onlajn društvene mreže; usluge onlajn društvenog umrežavanja u oblasti zabave; usluge društvenih mreža u oblasti zabave obezbijedene putem veb stranice i komunikacionih mreža; usluge licnog konsijerza; pravne usluge; bezbjednosne usluge za zaštitu imovine i pojedinaca; obezbjeđivanje onlajn računarskih baza podataka i onlajn baza podataka koje se mogu pretraživati u oblasti društvenih mreža; obezbjeđivanje veb stranice za društvene mreže za zabavu; obezbjeđivanje usluga društvenog umrežavanja u svrhu komentarisanja, upoređivanja, saradnje, konsultovanja, savjeta, diskusije, istraživanja, razmjene informacija, indeksiranja, informacija o lokaciji i zabave; usluge licne kupovine; obezbjeđivanje baze za pretragu koja sadrži audio, video i audiovizuelne sadržaje dostupne putem interneta, telekomunikacionih mreža i bezicnih telekomunikacionih mreža u oblasti onlajn društvenih mreža.

---

(210) 2018-101

(442) 20.01.2019

(220) 4/2/2018

(731) Soho Gradnja d.o.o Bar, Bulevar Revolucije 10A, ;



(540)

(550) I

(511) **Klasa 37:** izgradnja - usluge preduzetnika i podizvodaca u podrucju izgradnje ili proizvodnje trajnih gradevina, usluge izgradnje zgrada, puteva, mostova, brana, dalekovoda kao i usiuge specijalizovanih preduzeća u podrucju izgradnje, kao što su moleri, limari, postavljači centrainog grijanja i pokrivaci krovova;- dodatne gradevinske usluge kao sto je nadziranje gradevinskih projekata;;

---

(210) 2018-102

(442) 20.01.2019

(220) 4/2/2018

(731) Soho Gradnja d.o.o Bar, Bulevar Revolucije 10A, ;



(540)

(550) I

(511) **Klasa 36:** upravljanje nekretninama - usluge administriranja zgradama, to jest usluge iznajmljivanja, procjene nekretnina ili usluge finansiranja; usluge iznajmljivanja nekretnina kao što su kuće, stanovi, itd. namijenjeni za stalno korišćenje.

**Klasa 39:** prevoz ,usluge prevoza osoba ili proizvoda s jednog mjesta na drugo (željeznicom, putem, vodenim putem, vazduhom ili cjevovodima i dalekovodima) i usluge koje su neophodno vezane za te prevoze, konsultacije u vezi prevoza, usluge iznajmljivanja prevoznih sredstava; usluge obavještanja o putovanjima ili prevozu robe preko posrednika ili turističkih agencija; usluge organiziranja putovanja koje pružaju turističke agencije, usluge pracenja putnika;

**Klasa 41:** razonoda, usluge čiji je osnovni cilj razbibriga, zabava ili rekreacija lica; usluge diskoteka.;

-----  
(210) 2018-103

(442) 20.01.2019

(220) 4/2/2018

(731) Soho Gradnja d.o.o. Bar, Bulevar Revolucije 10A, ;



(540)

(550) I

(511) **Klasa 41:** razonoda ,usluge čiji je osnovni cilj razbibriga, zabava ili rekreacija lica; usluge diskoteka.

**Klasa 43:** usluge obezbjeđenja hrane i pića, usluge koje pružaju lica ili preduzeća čiji cilj je priprema jela ili pica za potrošnju kao i usluge ishrane i smještaja, koje pružaju hoteli, pansioni ili druga preduzeća koja osiguravaju privremeni smještaj.;

-----  
(210) 2018-104

(442) 20.01.2019

(220) 4/2/2018

(731) Soho Gradnja d.o.o. Bar, Bulevar Revolucije 10A, ;



**SOHO GROUP**

(540) MONTENEGRO

(550) I

(511) **Klasa 35:** vodenje komercijalnih poslova, komercijalna administracija, kanceiarijski poslovi -pomoć u radu i upravljanju privrednim društvima, i pomoć u vodenju poslova ili komercijalnih funkcija industrijskog ili trgovačkog preduzeća, konsultacije u vezi vodenja komercijalnih poslova.

**Klasa 36:** upravljanje nekretninama - usluge administriranja zgradama, to jest usluge iznajmljivanja, procjene nekretnina ili usluge finansiranja; usluge iznajmljivanja nekretnina kao što su kuće, stanovi, itd. namijenjeni za stalno korišćenje.

**Klasa 37:** izgradnja - usluge preduzetnika i podizvodaca u području izgradnje ili proizvodnje trajnih građevina, usluge izgradnje zgrada, puteva, mostova, brana, dalekovoda kao i usluge specijalizovanih preduzeća u području izgradnje, kao što su moleri, limari, postavljači centralnog grijanja i pokrivači krovova;- dodatne građevinske usluge kao što je nadziranje građevinskih projekata;; prevoz ,usluge prevoza osoba ili proizvoda s jednog mjesta na drugo (željeznicom, putem, vodenim putem, vazduhom ili cjevovodima i dalekovodima) i usluge koje su neophodno vezane za te prevoze, konsultacije u vezi prevoza, usluge iznajmljivanja prevoznih sredstava; usluge obavještanja o putovanjima ili prevozu robe preko posrednika ili turističkih agencija; usluge organiziranja putovanja koje pružaju turističke agencije, usluge pracenja putnika;

**Klasa 41:** razonoda ,usluge čiji je osnovni cilj zabava, zabava ili rekreacija lica; usluge diskoteka.

**Klasa 43:** usluge obezbjeđenja hrane i pića, usluge koje pružaju lica ili preduzeća čiji cilj je priprema jela ili pica za potrošnju kao i usluge ishrane i smještaja, koje pružaju hoteli, pansioni ili druga preduzeća koja osiguravaju privremeni smještaj.;

-----  
(210) 2018-105

(442) 20.01.2019

(220) 4/3/2018

(731) Falcon Group d.o.o., Dajbabe b.b. 81000 Podgorica, ;

(540)

(550) I,F

(511) **Klasa 29:** meso,riba,živina i divljac -mesni ekstrakti -konzervirano,sušeno i kuvano voće i povrće - želei, džemovi, kompoti -jaja,mlijeko,mlijecni proizvodi- jestiva ulja i masti.

**Klasa 30:** kafa, čaj, kakao, šećer, riža, tapioka- sago, zamjene za kafu -brašno, proizvodi od žitarica, hleb - kolaci, poslastice, bombon i,sladoled- med,sirup od melase kvasac, prašak za pecivo - so, senf, sirce, preliv, zacini, razni zacini, led za hlađenje, e.

**Klasa 35:** maloprodaja i veleprodaja gore navedenih roba.;

---

(210) 2018-7

(442) 20.01.2019

(220) 1/15/2018

(731) Instagram, LLC, 1601 Willow Road, Menlo Park, California 94025, US, US;



(540)

(550) I,F

(740) AOD "Ćupić", Dalmatinska 10, Podgorica ME

(511) **Klasa 09:** Kompjuterski hardver; kompjuterski softver za društvene mreže i interakciju sa online zajednicom; alati za razvoj kompjuterskog softvera; kompjuterski softver koji se koristi kao aplikacijski programski interfejs (API); aplikacijski programski interfejs (A PI) za kompjuterski softver koj i olakšava online usluge za društvene mreže i omogućuje povlačenje, postavljanje, skidanje, pristup i upravljanje podacima; kompjuterski softver za kreiranje, upravljanje i interakciju sa online zajednicom; kompjuterski softver za kreiranje, obradu, postavljanje, skidanje, pristup, gledanje, pisanje, pregled, označavanje, postavljanje na blog, strimovanje, povezivanje, dodavanje napomena, ukazivanje na osjećaje, komentarisanje, usadivanje, prenos i dijeljenje iii na drugi način pružanje usluga elektronskih medija iii informacija putem interneta i komunikacionih mreža; kompjuterski softver za izmjenu i omogućavanje prenosa slika, audio, audio-vizuelnog i video sadržaja i podataka; kompjuterski softver za izmjenu fotografija, slika i audio, video, i audio-vizuelnog sadržaja sa fotografskim filterima sa efektima izmjenjene realnosti (AR),naime grafika, animacija, tekstovi, crteži, geotagovi , tagovi metapodataka, hiperlinkovi ; kompjuterski softver za prikupljanje, upravljanje, obradu, organizaciju, izmjenu, prenos, dijeljenje i skladištenje podataka i informacija; kompjuterski softver za slanje i prijem elektronskih poruka, upozorenje, obavještenje i opomene; kompjuterski pretrazivački softver; kompjuterski softver za upotrebu pri kreiranju, upravljanju, mjerenju i diseminaciji reklamiranja za druge; reklamni server, naime kompjuterski server za skladištenje reklama i isporucivanje reklama web-siteovima; softver za izmjenjenu realnost; kompjuterski softver za integrisanje elektronskih podataka sa okruženjem realnog svijeta u svrhe zabave, obrazovanja, igara, komunikacije i društvenih mreža; kompjuterski softver koji omogućava razvoj , procjenu, testiranje I održavanje mobilnih softverskih aplikacija za prenosive elektronske komunikacione Uređaje, naime, mobilne telefone, smart telefone, rucne kompjutere I kompjuterske tablete; kompjuterski softver, naime, interpretativan interfejs koji omogućava interakciju između ljudi i mašina; kompjuterski softver koji prepoznaje lokaciju, kompjuterski softver koji se može skinuti i softver mobilne

aplikacije za pretragu, određivanje i podjelu lokacija; kompjuterski softver za bežičnu isporuku sadržaja, podataka i informacija; kompjuterski softver koji omogućava pristup, prikazivanje, obradu, povezivanje, dijeljenje i obezbjeđivanje na drugi način elektronskih medija i informacija putem interneta i komunikacionih mreža; kompjuterski softver, naime aplikacija koja obezbjeđuje funkcionalnost društvenih mreža; kompjuterski softver, kompjuterski softver koji se može skinuti i softver mobilne aplikacije za kreiranje, upravljanje i pristup grupama u okviru virtuelnih zajednica; kompjuterski softver koji se može skinuti za pregled i interakciju sa primljenim slikama, audio, audio-vizuelnim i video sadržajem i pripadajucim tekstom i podacima; kompjuterski softver koji se može skinuti za pronalaženje sadržaja i sadržajem objavljiivača, kao i za pretp laćivanje na sadržaj ; softver za kreiranje i upravljanje profilima društvenih medija i korisničkih naloga; interaktivna fotografska i video oprema, naime kiosci za snimanje, postavljanje, uređivanje, štampanje i dijeljenje digitalnih slika i video materijala; softver koji omogućava pojedincima, grupama, kompanijama i brendovima da kreiraju i održavaju online prisustvo u marketinške svrhe, softver za oglašivace kako bi komunicirali i uzajamno djelovali sa online zajednicama; softver za strimovanje multimedijalnog zabavnog sadržaja; kompjuterski softver; kompjuterski softver za slanje i prijem elektronskih poruka, grafika, slika, audio i audio-vizuelnog sadržaja putem kompjutera, interneta i komunikacionih mreža; kompjuterski softver za obradu slika, grafika, audio, video i teksta; softver za slanje poruka.

**Klasa 25:** Odjeća za muskarce, žene i djecu, naime košulje, majice, jakne, gornji djelovi, duksevi, pokrivala za glavu, šeširi, kape; obuća.

**Klasa 35:** Usluge marketinga, oglašavanja i promocije, naime pružanje informacija o popustima, kupovnama, rabatima, vaucerima, linkovima za websiteove maloprodaje za druge, i specijalne ponude za robu i usluge drugih; pružanje usluga ispitivanja i informacija o tržištu; promocija robe i usluga drugih putem internet i komunikacionih mreža; usluge poslovanja i reklamiranja, naime medijsko planiranje i kupovina medija za druge; usluge poslovanja reklamiranja, naime usluge reklamiranja za pracenje marketinskih performansi, za upravljanje, distribuciju i prikazivanje reklama, za analizu reklamnih podataka, za izvještavanje reklamnih podataka i za optimizaciju reklamnih performansi; usluge konsultacija iz reklamne i marketinške oblasti, naime prilagodavanje reklama i marketinskog truda za druge; obezbjeđivanje online prostora za povezivanje prodavaca sa kupcima; reklamiranje, marketing i promocija roba i usluga za druge putem obezbjeđivanja foto i video opreme na specijalnim događajima; obezbjeđivanje online prostora za uživo strimovanje videa sa promotivnih događaja; organizovanje i vodenje specijalnih događaja u komercijalne, promotivne i reklamne svrhe; obezbjeđivanje online poslovnih direktorijuma koji prikazuju poslove, proizvode i usluge drugih; nijedna od gore navedenih usluga se ne odnosi na oblast energije, grijanja, hlađenja, vode, nafte, struje, gasa, detekciju dima i vatre, kontrolu osvjjetljenja u okruženju, temperature, klimatizacije prostorija i komunalija, kao i na mjerenje, regulaciju, kontrolu, provjeru, snimanje, displej, prikupljanje, obradu, upravljanje, nap laćivanje i prenos podataka i informacija koje se nato odnose.

**Klasa 38:** Usluge dijeljenja fotografija i videa, naime elektronsko slanje digitalnih foto fajlova, videa i audio-vizuelnog sadržaja među internet korisnicima; telekomunikacija; obezbjeđivanje pristupa kompjuterskim, elektronskim i online bazama podataka; usluge telekomunikacije, naime elektronsko slanje podataka, poruka, grafika, fotografija, slika, audio, video, audio-vizuelnog sadržaja i informacija; obezbjeđivanje online foruma za komunikaciju, naime prenosi na temu od opšteg interesovanja; obezbjeđivanje online komunikacijskih linkova koji povezuju korisnike mobilnih uređaja i interneta sa drugim lokalnim i globalnim online lokacijama; obezbjeđivanje pristupa websiteovima trećih lica ili drugim elektronskim sadržajima trećih lica putem univerzalne prijave; obezbjeđivanje online chat soba, usluge email i instant poruka i

elektronskih oglasnih tabli; obezbjeđivanje pristupa kompjuterskim bazama podataka iz oblasti društvenih mreža i društvenog upoznavanja i izlazaka radi zabavljanja; usluge peer-to-peer dijeljenja fotografija i podataka, naime elektronski prenos digitalnih foto fajlova, grafika i audio sadržaja među internet korisnicima; usluge telekomunikacije i peer-to-peer kompjuterske mreže, naime elektronski prenos slika, audio-vizuelnog i video sadržaja, fotografija, videa, podataka, tekstova, poruka, reklama, komunikacionih i informacionih reklamnih medija; striming I striming uživo video, audio-vizuelnog i interaktivnog audi o-vizuelnog sadržaja putem interneta; usluge audio, tekst i video emitovanja preko interneta i drugih komunikacionih mreža.

**Klasa 41:** Usluge zabave, naime obezbjeđivanje online foruma za diseminaciju sadržaja, podataka i informacija u svrhe zabave i društvenog i poslovnog umrežavanja; usluge zabave, naime obezbjeđivanje pristupa interaktivnim elektronskim i online bazama podataka korisnički definisanog sadržaja, sadržajima trećih lica, fotografija, videa, audio, vizuelnog i audi o-vizuelnog materijala iz oblasti opšteg interesovanja; usluge dijeljenja fotografija i videa; usluge elektronskog objavljivanja za druge; online žurnali, naime weblogs (b logovi) koji prikazuju korisnički definisan sadržaj; obezbjeđivanje kompjuterskih, elektronskih i online baza podataka iz oblasti zabave; usluge objavljivanja, naime objavljivanje elektronskih publikacija za druge; izdavanje kioska za pravljenje fotografija i videografija za snimanje, postavljanje, obradu i dijeljenje slika i videa; usluge zabave, naime obezbjeđivanje online prostora za striming zabavnog sadržaja i uživo striming videa zabavnih događaja; organizovanje uživo izložbi i konferencija iz oblasti kulture, zabave i društvenih mreža u neposlovne i nekomercijalne svrhe; obezbjeđivanje zabavnih informacija iz indeksa i baza podataka informacija koje se mogu pretraživati, uključujući tekst, elektronska dokumenta, baze podataka, grafike, fotografske slike i audio-vizuelne informacije putem interneta i komunikacionih mreža; usluge zabave i obrazovanja, naime obezbjeđivanje filmova koj i se ne mogu skidati, televizijskih sou programa, web emitovanja, audiovizuelnih i multimedijalnih radova putem interneta, kao i informacije, pregledi, preporuke koje se tiču filmova, televizije, šou programa, web emitovanja, audio-vizuelnih i multimedijalnih radova.

**Klasa 42:** Kompjuterske usluge, naime kreiranje virtualnih zajednica za registrovane korisnike radi organizovanja grupa, sastanaka, i događaja, učestvovanja u diskusijama i angažovanja u društvenim, poslovnim mrežama i mrežama zajednice; kompjuterske usluge, naime hostovanje online web prostora za druge radi organizacije i vodenje sastanaka, događaja i interaktivnih diskusija putem interneta I komunikacionih mreža; kompjuterske usluge prilagodene elektronskom licnom i grupnom profilu iii web stranicama koje oslikavaju korisnički definisanu ili odredenu informaciju, uključujući audio, video, slike, tekstove, sadržaje i podatke; kompjuterske usluge, naime obezbjeđivanje pretraživaca za dobijanje podataka putem internet i komunikacionih mreža; obezbjeđivanje online prostora koji oslikava tehnologiju koja omogućava online korisnicima da kreiraju licne profile koji oslikavaju društvene I poslovne mrežne informacije, kako bi prenijeli i podijelili takvu informaciju između višestrukih online prostora, radi angažovanja na društvenim mrežama i kako bi upravljali svojim naložima na društvenim mrežama; obezbjeđivanje privremenog korišćenja softvera koji se ne može skinuti, kreirajući virtuelnu zajednicu i prenos audio, video, slika, tekstova, sadržaja i podataka; pružaoc aplikacionih usluga (ASP), naime hostovanje kompjuterskih softverskih aplikacija za druge; usluge obezbjeđivanja online mreže, koja omogućava korisnicima prenos licnih podataka i dijeljenje licnih podataka sa i među višestrukim aplikacijama ili web siteovima; usluge softver kao usluga (SAAS) koji oslikava softver za slanje I prijem elektronskih poruka, napomena i upozorenja; obezbjeđivanje privremenog korišćenja online softvera koji se ne može skinuti u svrhe kreiranja, upravljanja, mjerenja, analize, diseminacije i prikaz reklama za druge; provajder online platforme za kupovinu reklame, naime obezbjeđivanje softverskih programa koji se ne



moгу skinuti kako bi omogućili kupcima i prodavcima online reklamiranje da kupuju i prodaju reklamni inventar; pružaoc aplikacionih usluga (ASP) koji oslikava softver koji se koristi za kupovinu, prodaju, dizajniranje, upravljanje, nalaženje, vrednovanje, optimizaciju, ciljanje, analizu, dostavu i izvještavanje o online reklamiranju i marketingu; obezbjeđivanje online sajtova koji omogućavaju korisnicima da postavе, izmjene i dijele sadržaj izmjenjene realnosti, informacije, iskustva i podatke; obezbjeđivanje privremenog korišćenja kompjuterskog softvera koji se ne može skinuti, a koji omogućava razvoj, procjenu, testiranje i održavanje mobilne softverske aplikacije za prenosive kompjuterske Uređaje, naime mobilne telefone, smart telefone, rucne kompjutere i kompjuterske tablete; obezbjeđivanje softvera aplikacijskog programskog interfejsa (API) za upotrebu u elektronskom slanju poruka i prenosu audio, video, slika, tekstova, sadržaja i podataka; obezbjeđivanje privremenog korišćenja softvera koji se ne može skinuti za elektronske poruke; usluge mapiranja; obezbjeđivanje privremenog pristupa kompjuterskom softveru koji se ne može skinuti za usluge mapiranja; pružaoc aplikacionih usluga (ASP) koji oslikava softver za usluge mapiranja; obezbjeđivanje privremenog korišćenja kompjuterskog softvera koji se ne može skinuti za dijeljenje i prikazivanje lokacije korisnika, planiranje aktivnosti sa drugim korisnicima i davanje preporuka; pružaoc aplikacionih usluga (ASP) koji oslikava softver koji omogućava ili obezbjeđuje dijeljenje i prikaz lokacije korisnika, planiranje aktivnosti sa drugim korisnicima i davanje preporuka; obezbjeđivanje privremenog korišćenja kompjuterskog softvera koji se ne može skinuti za mapiranje društva i destinacije; obezbjeđivanje privremenog korišćenja kompjuterskog softvera koji prepoznaje lokaciju i koji se ne može skinuti, za pretragu, utvrđivanje i dijeljenje lokacije roba, usluga i događaja od interesa; pružaoc aplikacionih usluga (ASP) koji oslikava softver koji prepoznaje lokaciju za pretragu, utvrđivanje i dijeljenje lokacija roba, usluga i događaja od interesa; platforma kao servis (PAAS) koji sadrži kompjuterske softverske platforme za upotrebu u kupovini i diseminaciji reklama; dizajniranje i razvoj kompjuterskog softvera; obezbjeđivanje web sitea koji omogućava korisnicima sposobnost angažovanja na društvenim mrežama i u upravljanju njihovim sadržajem na društvenim mrežama; obezbjeđivanje privremenog korišćenja softvera koji se ne može skinuti za kreiranje i upravljanje profilima društvenih medija i korisničkih naloga; obezbjeđivanje privremenog korišćenja softvera koji se ne može skinuti za modifikaciju fotografija, slika i audio, video i audio-video sadržaja sa fotografskim filterima i efektima izmjenjene realnosti (AR), naime grafika, animacija, tekstovi, crteži, geo tagova, tagova metapodataka, hiperlinkova; obezbjeđivanje privremenog korišćenja softvera koji se ne može skinuti za gledanje i interakciju sa prilivom elektronskih medija, naime slika, audio-vizuelnog i video sadržaja, video striming uživo, komentarisanje, reklamiranje, vijesti i internet linkovi; obezbjeđivanje privremenog korišćenja kompjuterskog softvera koji se ne može skinuti za pronalaženje sadržaja i sadržaja objavljiivača i za pretplatu na sadržaj ; obezbjeđivanje privremenog korišćenja softvera koji se ne može skinuti za organizovanje slika, videa, i audio-vizuelnog sadržaja korišćenjem tagova meta podataka; obezbjeđivanje pretraživaca radi dobijanja podataka putem komunikacionih mreža; kompjuterske usluge, naime kreiranje virtuelne zajednice za registrovane korisnike da dijele, gledaju, pretplacuju se i uzajamno djeluju sa slikama, audio-vizuelnim i video sadržajima i srodnim podacima i informacijama; pružaoc aplikacionih usluga (ASP) koji oslikava softver za društvene mreže, upravljanje sadržajem društvenih mreža, kreiranje virtuelne zajednice i prenos slika, audio-vizuelnog i video sadržaja, fotografija, videa, podataka, tekstova, poruka, reklama, komunikacije i informacije medijskog reklamiranja; pružaoc aplikacionih usluga (ASP) koji oslikava softver aplikacijskog programskog interfejsa (API) koji omogućava online usluge za društvene mreže, razvoj softverskih aplikacija i kupovinu i diseminaciju reklama; platforma kao servis (PAAS) koji sadrži platforme sa računarskim softverom za društvene mreže, upravljanje sadržajem društvenih mreža, stvaranje virtuelne zajednice i slanje slika, audio-vizuelnog i video sadržaja, fotografija, videa, podataka,

tekstova, poruka, reklama, komunikacija i informacija medijskog reklamiranja; izdavanje kompjuterskog softvera koji omogućava korisnicima da postavljaju, uređuju i dijele slike, videa, i audio-vizuelni sadržaj; kompjuterske usluge, naime odabir korisnički definisanog sadržaja i reklame i kreiranje priliva društvenih mreža; obezbjeđivanje privremenog korišćenja softvera koji se ne može skinuti za slikanje i snimanje audio, audio-vizuelnog i video sadržaja; obezbjeđivanje privremenog korišćenja softvera koji se ne može skinuti za postavljanje, skidanje, arhiviranje, omogućavanje prenosa i dijeljenje slika, audio-vizuelnog i video sadržaja i pripadajućeg teksta i podataka; obezbjeđivanje privremenog korišćenja softvera koji se ne može skinuti za strimovanje multimedijalnog zabavnog sadržaja; obezbjeđivanje privremenog korišćenja softvera koji se ne može skinuti za slanje i prijem tekst poruka, video poruka, i grafičke komunikacije; obezbjeđivanje privremenog korišćenja softvera koji se ne može skinuti za kreiranje i održavanje online prisustva za pojedince, grupe, kompanije i brendove; obezbjeđivanje privremenog korišćenja softvera koji se ne može skinuti za kreiranje, upravljanje i diseminaciju reklama, i za mjerenje i analizu reklamnih podataka; obezbjeđivanje privremenog korišćenja softvera koji se ne može skinuti za oglašivace radi komunikacije i interakcije sa online zajednicama; obezbjeđivanje privremenog korišćenja softvera koji se ne može skinuti za upotrebu pri slikanju i prikazivanju fotografija i snimanje i obrada videa; pružaoc aplikacionih usluga (ASP) koji sadrži softver koji omogućava ili potpomažeslikanje i obradu fotografija i snimanja i obradu videa; razvoj kompjuterskog softvera; obezbjeđivanje online softvera koji se ne može skinuti; pružaoc aplikacionih usluga (ASP); obezbjeđivanje online opreme koja omogućava korisnicima da postavljaju, modifikuju i dijele audio, video, fotografske slike, tekstove, grafike i podatke.

**Klasa 45:** Usluge društvenog upoznavanja na internetu, mrežama i usluge upoznavanja radi ostvarivanja veze; obezbjeđivanje pristupa kompjuterskim bazama podataka i online bazama podataka koje se mogu pretražiti iz oblasti društvenih mreža, društvenog upoznavanja i upoznavanja radi ostvarivanja veze.;

-----

(210) 2018-8

(442) 20.01.2019

(220) 1/15/2018

(731) Instagram, LLC, 1601 Willow Road, Menlo Park, California 94025, US, US;

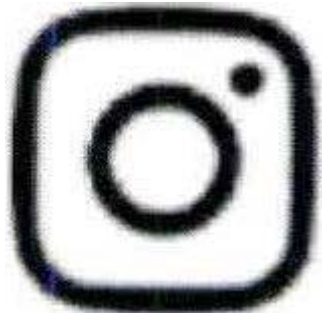

(540)

(550) I,F

(740) AOD "Ćupić", Dalmatinska 10, Podgorica ME

(511) **Klasa 09:** Kompjuterski hardver; kompjuterski softver za društvene mreže i interakciju sa online zajednicom; alati za razvoj kompjuterskog softvera; kompjuterski softver koji se koristi kao aplikacijski programski interfejs (API); aplikacijski programski interfejs (A PI) za kompjuterski softver koji olakšava online usluge za društvene mreže i omogućuje povlacenje, postavljanje, skidanje, pristup i upravljanje podacima; kompjuterski softver za kreiranje, upravljanje i interakciju sa online zajednicom; kompjuterski softver za kreiranje, obradu, postavljanje, skidanje, pristup, gledanje, pisanje, pregled, označavanje, postavljanje na blog, strimovanje, povezivanje, dodavanje napomena, ukazivanje na osjecaje,

komentarisanje, usadivanje, prenos i dijeljenje ili na drugi način pružanje usluga elektronskih medija ili informacija putem interneta i komunikacionih mreža; kompjuterski softver za izmjenu i omogućavanje prenosa slika, audio, audio-vizuelnog i video sadržaja i podataka; kompjuterski softver za izmjenu fotografija, slika i audio, video, i audio-vizuelnog sadržaja sa fotografskim filterima sa efektima izmjenjene realnosti (AR), naime grafika, animacija, tekstovi, crteži, geotagovi, tagovi metapodataka, hiperlinkovi; kompjuterski softver za prikupljanje, upravljanje, obradu, organizaciju, izmjenu, prenos, dijeljenje i skladištenje podataka i informacija; kompjuterski softver za slanje i prijem elektronskih poruka, upozorenje, obavještenje i opomene; kompjuterski pretraživački softver; kompjuterski softver za upotrebu pri kreiranju, upravljanju, mjerenju i diseminaciji reklamiranja za druge; reklamni server, naime kompjuterski server za skladištenje reklama i isporucivanje reklama web-siteovima; softver za izmjenjenu realnost; kompjuterski softver za integrisanje elektronskih podataka sa okruženjem realnog svijeta u svrhe zabave, obrazovanja, igara, komunikacije i društvenih mreža; kompjuterski softver koji omogućava razvoj, procjenu, testiranje i održavanje mobilnih softverskih aplikacija za prenosive elektronske komunikacione Uređaje, naime, mobilne telefone, smart telefone, rucne kompjutere i kompjuterske tablete; kompjuterski softver, naime, interpretativan interfejs koji omogućava interakciju između ljudi i mašina; kompjuterski softver koji prepoznaje lokaciju, kompjuterski softver koji se može skinuti i softver mobilne aplikacije za pretragu, određivanje i podjelu lokacija; kompjuterski softver za bežičnu isporuku sadržaja, podataka i informacija; kompjuterski softver koji omogućava pristup, prikazivanje, obradu, povezivanje, dijeljenje i obezbjeđivanje na drugi način elektronskih medija i informacija putem interneta i komunikacionih mreža; kompjuterski softver, naime aplikacija koja obezbjeđuje funkcionalnost društvenih mreža; kompjuterski softver, kompjuterski softver koji se može skinuti i softver mobilne aplikacije za kreiranje, upravljanje i pristup grupama u okviru virtuelnih zajednica; kompjuterski softver koji se može skinuti za pregled i interakciju sa primljenim slikama, audio, audio-vizuelnim i video sadržajem i pripadajucim tekstom i podacima; kompjuterski softver koji se može skinuti za pronalaženje sadržaja i sadržajem objavljiivača, kao i za pretp laćivanje na sadržaj; softver za kreiranje i upravljanje profilima društvenih medija i korisničkih naloga; interaktivna fotografska i video oprema, naime kiosci za snimanje, postavljanje, uređivanje, štampanje i dijeljenje digitalnih slika i video materijala; softver koji omogućava pojedincima, grupama, kompanijama i brendovima da kreiraju i održavaju online prisustvo u marketinške svrhe, softver za oglašivace kako bi komunicirali i uzajamno djelovali sa online zajednicama; softver za strimovanje multimedijalnog zabavnog sadržaja; kompjuterski softver; kompjuterski softver za slanje i prijem elektronskih poruka, grafika, slika, audio i audio-vizuelnog sadržaja putem kompjutera, interneta i komunikacionih mreža; kompjuterski softver za obradu slika, grafika, audio, video i teksta; softver za slanje poruka.

**Klasa 25:** Odjeća za muskarce, žene i djecu, naime košulje, majice, jakne, gornji djelovi, duksevi, pokrivala za glavu, šeširi, kape; obuća.

**Klasa 35:** Usluge marketinga, oglašavanja i promocije, naime pružanje informacija o popustima, kupovcima, rabatima, vaučerima, linkovima za websiteove maloprodaje za druge, i specijalne ponude za robu i usluge drugih; pružanje usluga ispitivanja i informacija o tržištu; promocija robe i usluga drugih putem internet i komunikacionih mreža; usluge poslovanja i reklamiranja, naime medijsko planiranje i kupovina medija za druge; usluge poslovanja reklamiranja, naime usluge reklamiranja za pracenje marketinskih performansi, za upravljanje, distribuciju i prikazivanje reklama, za analizu reklamnih podataka, za izvještavanje reklamnih podataka i za optimizaciju reklamnih performansi; usluge konsultacija iz reklamne i marketinške oblasti, naime prilagodavanje reklama i marketinskog truda za druge; obezbjeđivanje online prostora za povezivanje prodavaca sa kupcima; reklamiranje, marketing i

promocija roba i usluga za druge putem obezbjeđivanja foto i video opreme na specijalnim događajima; obezbjeđivanje online prostora za uživo strimovanje videa sa promotivnih događaja; organizovanje i vodenje specijalnih događaja u komercijalne, promotivne ili reklamne svrhe; obezbjeđivanje online poslovnih direktorijuma koji prikazuju poslove, proizvode i usluge drugih; nijedna od gore navedenih usluga se ne odnosi na oblast energije, grijanja, hlađenja, vode, nafte, struje, gasa, detekciju dima i vatre, kontrolu osvjjetljenja u okruženju, temperature, klimatizacije prostorija i komunalija, kao i na mjerenje, regulaciju, kontrolu, provjeru, snimanje, displej, prikupljanje, obradu, upravljanje, naplaćivanje i prenos podataka i informacija koje se nato odnose.

**Klasa 38:** Usluge dijeljenja fotografija i videa, naime elektronsko slanje digitalnih foto fajlova, videa i audio-vizuelnog sadržaja među internet korisnicima; telekomunikacija; obezbjeđivanje pristupa kompjuterskim, elektronskim i online bazama podataka; usluge telekomunikacije, naime elektronsko slanje podataka, poruka, grafika, fotografija, slika, audio, video, audio-vizuelnog sadržaja i informacija; obezbjeđivanje online foruma za komunikaciju, naime prenosi na temu od opšteg interesovanja; obezbjeđivanje online komunikacijskih linkova koji povezuju korisnike mobilnih uređaja i interneta sa drugim lokalnim i globalnim online lokacijama; obezbjeđivanje pristupa websiteovima trećih lica ili drugim elektronskim sadržajima trećih lica putem univerzalne prijave; obezbjeđivanje online chat soba, usluge email i instant poruka i elektronskih oglasnih tabli; obezbjeđivanje pristupa kompjuterskim bazama podataka iz oblasti društvenih mreža i društvenog upoznavanja i izlazaka radi zabavljanja; usluge peer-to-peer dijeljenja fotografija i podataka, naime elektronski prenos digitalnih foto fajlova, grafika i audio sadržaja među internet korisnicima; usluge telekomunikacije i peer-to-peer kompjuterske mreže, naime elektronski prenos slika, audio-vizuelnog i video sadržaja, fotografija, videa, podataka, tekstova, poruka, reklama, komunikacionih i informacionih reklamnih medija; striming i striming uživo video, audio-vizuelnog i interaktivnog audio-vizuelnog sadržaja putem interneta; usluge audio, tekst i video emitovanja preko interneta i drugih komunikacionih mreža.

**Klasa 41:** Usluge zabave, naime obezbjeđivanje online foruma za diseminaciju sadržaja, podataka i informacija u svrhe zabave i društvenog i poslovnog umrežavanja; usluge zabave, naime obezbjeđivanje pristupa interaktivnim elektronskim i online bazama podataka korisnički definisanog sadržaja, sadržajima trećih lica, fotografija, videa, audio, vizuelnog i audio-vizuelnog materijala iz oblasti opšteg interesovanja; usluge dijeljenja fotografija i videa; usluge elektronskog objavljivanja za druge; online žurnali, naime weblogs (b logovi) koji prikazuju korisnički definisan sadržaj; obezbjeđivanje kompjuterskih, elektronskih i online baza podataka iz oblasti zabave; usluge objavljivanja, naime objavljivanje elektronskih publikacija za druge; izdavanje kioska za pravljenje fotografija i videografija za snimanje, postavljanje, obradu i dijeljenje slika i videa; usluge zabave, naime obezbjeđivanje online prostora za striming zabavnog sadržaja i uživo striming videa zabavnih događaja; organizovanje uživo izložbi i konferencija iz oblasti kulture, zabave i društvenih mreža u neposlovne i nekomercijalne svrhe; obezbjeđivanje zabavnih informacija iz indeksa i baza podataka informacija koje se mogu pretraživati, uključujući tekst, elektronska dokumenta, baze podataka, grafike, fotografske slike i audio-vizuelne informacije putem interneta i komunikacionih mreža; usluge zabave i obrazovanja, naime obezbjeđivanje filmova koji se ne mogu skidati, televizijskih show programa, web emitovanja, audiovizuelnih i multimedijalnih radova putem interneta, kao i informacije, pregledi, preporuke koje se tiču filmova, televizije, show programa, web emitovanja, audio-vizuelnih i multimedijalnih radova.

**Klasa 42:** Kompjuterske usluge, naime kreiranje virtualnih zajednica za registrovane korisnike radi organizovanja grupa, sastanaka, i događaja, učestvovanja u diskusijama i angažovanja u društvenim, poslovnim mrežama i mrežama zajednice; kompjuterske usluge, naime hostovanje online web prostora

za druge radi organizacije i vodenje sastanaka, događaja i interaktivnih diskusija putem interneta i komunikacionih mreža; kompjuterske usluge prilagodene elektronskom licnom i grupnom profilu iiii web stranicama koje oslikavaju korisnički definisanu ili odredenu informaciju, uključujući audio, video, slike, tekstove, sadržaje i podatke; kompjuterske usluge, naime obezbjeđivanje pretraživaca za dobijanje podataka putem internet i komunikacionih mreža; obezbjeđivanje online prostora koji oslikava tehnologiju koja omogućava online korisnicima da kreiraju licne profile koji oslikavaju društvene i poslovne mrežne informacije, kako bi prenijeli i podijelili takvu informaciju između višestrukih online prostora, radi angažovanja na društvenim mrežama i kako bi upravljali svojim naložima na društvenim mrežama; obezbjeđivanje privremenog korišćenja softvera koji se ne može skinuti, kreirajući virtuelnu zajednicu i prenos audio, video, slika, tekstova, sadržaja i podataka; pružaoc aplikacionih usluga (ASP), naime hostovanje kompjuterskih softverskih aplikacija za druge; usluge obezbjeđivanja online mreže, koja omogućava korisnicima prenos licnih podataka i dijeljenje licnih podataka sa i među višestrukim aplikacijama ili web siteovima; usluge softver kao usluga (SAAS) koji oslikava softver za slanje i prijem elektronskih poruka, napomena i upozorenja; obezbjeđivanje privremenog korišćenja online softvera koji se ne može skinuti u svrhe kreiranja, upravljanja, mjerenja, analize, diseminacije i prikaz reklama za druge; provajder online platforme za kupovinu reklame, naime obezbjeđivanje softverskih programa koji se ne mogu skinuti kako bi omogućili kupcima i prodavcima online reklamiranje da kupuju i prodaju reklamni inventar; pružaoc aplikacionih usluga (ASP) koji oslikava softver koji se koristi za kupovinu, prodaju, dizajniranje, upravljanje, nalaženje, vrednovanje, optimizaciju, ciljanje, analizu, dostavu i izvještavanje o online reklamiranju i marketingu; obezbjeđivanje online sajtova koji omogućavaju korisnicima da postavljaju, izmjenjuju i dijele sadržaj izmjenjene realnosti, informacije, iskustva i podatke; obezbjeđivanje privremenog korišćenja kompjuterskog softvera koji se ne može skinuti, a koji omogućava razvoj, procjenu, testiranje i održavanje mobilne softverske aplikacije za prenosive kompjuterske Uređaje, naime mobilne telefone, smart telefone, rucne kompjutere i kompjuterske tablete; obezbjeđivanje softvera aplikacijskog programskog interfejsa (API) za upotrebu u elektronskom slanju poruka i prenosu audio, video, slika, tekstova, sadržaja i podataka; obezbjeđivanje privremenog korišćenja softvera koji se ne može skinuti za elektronske poruke; usluge mapiranja; obezbjeđivanje privremenog pristupa kompjuterskom softveru koji se ne može skinuti za usluge mapiranja; pružaoc aplikacionih usluga (ASP) koji oslikava softver za usluge mapiranja; obezbjeđivanje privremenog korišćenja kompjuterskog softvera koji se ne može skinuti za dijeljenje i prikazivanje lokacije korisnika, planiranje aktivnosti sa drugim korisnicima i davanje preporuka; pružaoc aplikacionih usluga (ASP) koji oslikava softver koji omogućava ili obezbjeđuje dijeljenje i prikaz lokacije korisnika, planiranje aktivnosti sa drugim korisnicima i davanje preporuka; obezbjeđivanje privremenog korišćenja kompjuterskog softvera koji se ne može skinuti za mapiranje društva i destinacije; obezbjeđivanje privremenog korišćenja kompjuterskog softvera koji prepoznaje lokaciju i koji se ne može skinuti, za pretragu, utvrđivanje i dijeljenje lokacije roba, usluga i događaja od interesa; pružaoc aplikacionih usluga (ASP) koji oslikava softver koji prepoznaje lokaciju za pretragu, utvrđivanje i dijeljenje lokacija roba, usluga i događaja od interesa; platforma kao servis (PAAS) koji sadrži kompjuterske softverske platforme za upotrebu u kupovini i diseminaciji reklama; dizajniranje i razvoj kompjuterskog softvera; obezbjeđivanje web sitea koji omogućava korisnicima sposobnost angažovanja na društvenim mrežama i u upravljanju njihovim sadržajem na društvenim mrežama; obezbjeđivanje privremenog korišćenja softvera koji se ne može skinuti za kreiranje i upravljanje profilima društvenih medija i korisničkih naloga; obezbjeđivanje privremenog korišćenja softvera koji se ne može skinuti za modifikaciju fotografija, slika i audio, video i audio-video sadržaja sa fotografskim filterima i efektima izmjenjene realnosti (AR), naime grafika, animacija, tekstovi, crteži, geo tagova, tagova metapodataka, hiperlinkova;

obezbjeđivanje privremenog korišćenja softvera koji se ne može skinuti za gledanje i interakciju sa prilivom elektronskih medija, naime slika, audio-vizuelnog i video sadržaja, video striming uživo, komentarisanje, reklamiranje, vijesti i internet linkovi; obezbjeđivanje privremenog korišćenja kompjuterskog softvera koji se ne može skinuti za pronalaženje sadržaja i sadržaja objavljivača i za pretplatu na sadržaj ; obezbjeđivanje privremenog korišćenja softvera koji se ne može skinuti za organizovanje slika, videa, i audio-vizuelnog sadržaja korišćenjem tagova meta podataka; obezbjeđivanje pretraživaca radi dobijanja podataka putem komunikacionih mreža; kompjuterske usluge, naime kreiranje virtuelne zajednice za registrovane korisnike da dijele, gledaju, pretplacuju se i uzajamno djeluju sa slikama, audio-vizuelnim i video sadržajima i srodnim podacima i informacijama; pružaoc aplikacionih usluga (ASP) koji oslikava softver za društvene mreže, upravljanje sadržajem društvenih mreža, kreiranje virtuelne zajednice i prenos slika, audio-vizuelnog i video sadržaja, fotografija, videa, podataka, tekstova, poruka, reklama, komunikacije i informacije medijskog reklamiranja; pružaoc aplikacionih usluga (ASP) koji oslikava softver aplikacijskog programskog interfejsa (API) koji omogućava online usluge za društvene mreže, razvoj softverskih aplikacija i kupovinu i diseminaciju reklama; platforma kao servis (PAAS) koji sadrži platforme sa računarskim softverom za društvene mreže, upravljanje sadržajem društvenih mreža, stvaranje virtuelne zajednice i slanje slika, audio-vizuelnog i video sadržaja, fotografija, videa, podataka, tekstova, poruka, reklama, komunikacija i informacija medijskog reklamiranja; izdavanje kompjuterskog softvera koji omogućava korisnicima da postavljaju, uređuju i dijele slike, videa, i audio-vizuelni sadržaj; kompjuterske usluge, naime odabir korisnički definisanog sadržaja i reklame i kreiranje priliva društvenih mreža; obezbjeđivanje privremenog korišćenja softvera koji se ne može skinuti za slikanje i snimanje audio, audio-vizuelnog i video sadržaja; obezbjeđivanje privremenog korišćenja softvera koji se ne može skinuti za postavljanje, skidanje, arhiviranje, omogućavanje prenosa i dijeljenje slika, audio-vizuelnog i video sadržaja i pripadajućeg teksta i podataka; obezbjeđivanje privremenog korišćenja softvera koji se ne može skinuti za strimovanje multimedijalnog zabavnog sadržaja; obezbjeđivanje privremenog korišćenja softvera koji se ne može skinuti za slanje i prijem tekst poruka, video poruka, i grafičke komunikacije; obezbjeđivanje privremenog korišćenja softvera koji se ne može skinuti za kreiranje i održavanje online prisustva za pojedince, grupe, kompanije i brendove; obezbjeđivanje privremenog korišćenja softvera koji se ne može skinuti za kreiranje, upravljanje i diseminaciju reklama, i za mjerenje i analizu reklamnih podataka; obezbjeđivanje privremenog korišćenja softvera koji se ne može skinuti za oglašivace radi komunikacije i interakcije sa online zajednicama; obezbjeđivanje privremenog korišćenja softvera koji se ne može skinuti za upotrebu pri slikanju i prikazivanju fotografija i snimanje i obrada videa; pružaoc aplikacionih usluga (ASP) koji sadrži softver koji omogućava ili potpomažeslikanje i obradu fotografija i snimanja i obradu videa; razvoj kompjuterskog softvera; obezbjeđivanje online softvera koji se ne može skinuti; pružaoc aplikacionih usluga (ASP); obezbjeđivanje online opreme koja omogućava korisnicima da postavljaju, modifikuju i dijele audio, video, fotografske slike, tekstove, grafike i podatke.

**Klasa 45:** Usluge društvenog upoznavanja na internetu, mrežama i usluge upoznavanja radi ostvarivanja veze; obezbjeđivanje pristupa kompjuterskim bazama podataka i online bazama podataka koje se mogu pretražiti iz oblasti društvenih mreža, društvenog upoznavanja i upoznavanja radi ostvarivanja veze.;

-----

(210) 2018-82

(442) 20.01.2019

(220) 3/15/2018

(731) Deciem Beauty Group Inc., 517 Richmond St. E., Toronto, Ontario M5A 1R4, Canada, ;

(540) THE ABNORMAL BEAUTY COMPANY

(550) I

(740) Jusić Jasna, Dalmatinska 2, Podgorica ME

(511) **Klasa 03:** Kozmetički preparati za njegu kože; proizvodi za njegu kože i tijela, naime, preparati za hidrataciju lica, preparati za hidrataciju tijela, proizvodi za zaštitu od starenja lica; proizvodi za zaštitu od starenja tijela, naime, kreme za tijelo protiv starenja, losioni, gelovi, ulja, sredstva za šišćenje, sapun za tijelo, pilinzi, preparati za hidrataciju, regeneratori za kožu, sredstva za omekšavanje kože (emolijensi) i preparati za njegu kože koji uklanjaju bore; topikalni (lokalni) tretmani za vrat, naime, losioni, kreme, gelovi, ulja, sredstva za šišćenje, pilinzi, preparati za hidrataciju, regeneratori za kožu, sredstva za omekšavanje kože (emolijensi) i preparati za njegu kože koji uklanjaju bore na vratu; ne-medicinski tretmani za strije, naime, losioni, kreme, gelovi, ulja, sredstva za šišćenje, pilinzi, preparati za hidrataciju, regeneratori za kožu, sredstva za omekšavanje kože (emolijensi) i preparati za njegu kože za tretiranje strija; ne-medicinski tretmani za celulit, naime, losioni, kreme, gelovi, ulja, sredstva za šišćenje, preparati za hidrataciju, regeneratori za kožu za smanjenje celulita; tretmani za izbjeljivanje i I iii tretmani za posvjetljivanje kože, naime, losioni, kreme, gelovi, ulja, sredstva za šišćenje, preparati za hidrataciju, regeneratori za izbjeljivanje kože i posvjetljivanje kože; proizvodi za njegu kose, naime, sprejevi za kosu, losioni za kosu, regeneratori za kosu i gel za kosu; kozmetika; preparati za šišćenje, preparati za izbjeljivanje i ostale supstance za pranje veša, odnosno izbjeljivač za pranje veša, deterdženti za pranje veša i vosak za veš; preparati za šišćenje, poliranje, ribanje i abrazivni preparati; sapuni, naime, sapuni protiv znojenja, sapuni za tijelo, sapun za kupanje i sapun za ruke; etericna ulja, losioni za kosu; paste za zube, kreme za lice i tijelo, preparati za pranje tijela, šamponi, preparati za hidrataciju tijela, kolonjska veda; toaletna veda; parfemi; dezodoransi za ličnu upotrebu.

**Klasa 35:** Usluge maloprodaje u oblasti kozmetike, proizvoda za ličnu njegu, kože, proizvoda za njegu lica i tijela i kozmetičkih proizvoda; onlajn maloprodajne usluge u oblasti kozmetike, proizvoda za ličnu njegu kože, proizvoda za njegu lica i tijela i kozmetičkih proizvoda.

;

-----  
(210) 2018-87

(442) 20.01.2019

(220) 3/20/2018

(731) Amicus Pharma d.o.o., Moskovska 63-4 81000 Podgorica Crna Gora, ;

(540) FLAZAK

(550) I

(740) Popović Miladin, Đoka Miraševića 21/III, Podgorica ME

(511) **Klasa 05:** Farmaceutski, medicinski i veterinarski preparati; sanitami preparati za upotrebu u medicini; dijetetska hrana i supstance prilagodene za upotrebu u medicini ili veterinarsku upotrebu, hrana za bebe; dijetetski dodaci (dodaci ishrani) za ljude i životinje; flasteri, materijali za zavijanje; materijali za plombiranje zuba, zubarska smola; dezinfekciona sredstva; preparati za uništavanje životinjskih štetocina; fungicidi, herbicidi.;

-----  
(210) 2018-89

(442) 20.01.2019

(220) 3/20/2018

(731) Goodyear Dunlop Tires UK Limited, 2920 Trident Court, Solihull Parkway Birmingham Business Park, Birmingham, B37 7YN, United Kingdom, ;

(540) TRAILMAX MIXTOUR

(550) I

(740) Jusić Jasna, Dalmatinska 2, Podgorica ME

(511) **Klasa 12:** Gume za motocikle.;

---

(210) 2018-90

(442) 20.01.2019

(220) 3/23/2018

(731) Western Digital Technologies, Inc., 5601 Great Oaks Parkway San Jose, California 95119 United States of America, ;

(540) UPTHERE

(550) I

(740) MSA IP Milojević Sekulić, Karađorđeva 65, Beograd SR

(511) **Klasa 09:** Aparati za snimanje, prenos i reprodukovanje zvuka ili slika; audio muzički plejeri; aparati za snimanje medija; Uređaji za audio reprodukciju; jedinice za čuvanje rezervne kopije za računare; prazne fleš memorijske kartice; prazni USB priključci; torbe za prenos računarskog hardvera (opreme); aparati za računarsku analizu, naime, integrisani hardver računara koji sadrži sistem firmvera i softvera za upravljanje centrima podataka velikih razmjera, analizu podataka, skladištenje podataka, i analizu performansi sistema skladištenja; disk drajveri za računare; računarski hardver i softver za skladištenje podataka; računarski hardver koji obuhvata šasiju, kucište, napajanje, kablove; računarski hardver za otpremanje, skladištenje, pronalaženje, preuzimanje, prenos i isporuku digitalnog sadržaja; računarski hardver, naime, jedinice hard diskova i poluprovodničkih diskova; računarski hardver; računarska memorija; Uređaji računarske memorije; Uređaji za skladištenje računarskih mreža, naime, medijski plejeri, prazni digitalni mediji za skladištenje, prenosivi hard diskovi, jedinice poluprovodničkih diskova, fles memorijske jedinice, hibridne disk jedinice i kompjuterske periferne jedinice za skladištenje i čuvanje rezervnih elektronskih podataka bilo lokalno ili preko telekomunikacione mreže ili preko oblaka; Uređaji za skladištenje računarske mreže, odnosno skladištenje i čuvanje rezervnih elektronskih podataka bilo lokalno ili preko telekomunikacione mreže; futrole za prenos kompjuterskih perifernih jedinica; kompjuterske periferne jedinice; računarski proizvodi koji se koriste za prenos, prosledivanje, prikazivanje i reprodukciju tekstova, podataka, audio i video datoteka, digitalnih slika i multimedijalnog sadržaja sa Uređaja za skladištenje podataka, hard diskova, diskova i računarskih perifernih jedinica na televizore, video monitore, projektore, računare i mobilne Uređaje, naime, računarske tablete, pametne telefone, laptopove; računarski softver koji omogućava pronalaženje podataka; računarski softver; Uređaji za čuvanje podataka na računaru, naime, Uređaji za mrežno pohranjivanje podataka za dijeljenje datoteka i čuvanje rezervnih datoteka u oblaku; Uređaji za čuvanje podataka na računaru, naime, hardver za računarsku memoriju, hard diskovi za računare i poluprovodnički (SSD) Uređaji za računare; Uređaji za čuvanje podataka na računaru, naime, sistemi ili podsistemi za skladištenje i arhiviranje elektronskih podataka; hardver za skladištenje na računaru u obliku sistema ili podsistema za skladištenje i arhiviranje elektronskih podataka; komponente računara; kablovi za prenos podataka za upotrebu u računarstvu; softver za kompresiju podataka; oprema za obradu podataka; Uređaji za skladištenje podataka, naime, jedinice hard diskova, jedinice digitalnih diskova, medijski plejeri, prazni digitalni mediji za skladištenje, prenosive jedinice hard diskova, jedinice poluprovodničkih diskova, fleš memorijske jedinice, jedinice hibridnih diskova i kompjuterske periferne jedinice; Uređaji za skladištenje podataka; programi za skladištenje podataka; dijagnostički aparati, koji nisu za medicinsku upotrebu, naime Uređaji koji se koriste za analizu i



optimizaciju računarskih sistema; memorijski diskovi; disk drajveri; priključne stanice za Uređaje za skladištenje podataka, naime, jedinice hard diskova, prenosive jedinice hard diskova, jedinice poluprovodničkih diskova i jedinice hibridnih diskova; računarski softver za daljinski nadzor i analizu koji se može preuzeti; elektronski bilteni za preuzimanje; mobilne aplikacije za preuzimanje; publikacije koje se mogu preuzeti; elektricne integrisane kartice; elektronske komponente za računare; elektronske memorije; futrole za eksterne hard diskove; futrole za eksterne poluprovodničke diskove; citaci memorijskih fles kartica; fles prikljucci; memorijske fleš kartice; fleš memorijski cipovi; fleš memorija; cipovi integrisanih kola; integrisana kola; interfejsi za računare; kucišta internih hard diskova; futrola unutrašnjih poluprovodničkih jedinica; kucišta unutrašnjih poluprovodničkih jedinica; magnetni nosaci podataka, diskovi za snimanje; memorijske kartice; mp3 plejeri; prenosive fleš memorije; elektricni kablovi; jedinice za elektricno napajanje; štampana kola; Naučni aparati i instrumenti; poluprovodničke memorije i memorijski kontrolori; softver za pristup video zapisima i podacima koji se cuvaju na distribuiranim računarskim Uređajima za skladištenje; softver za kompresovanje podataka; softver za analizu i optimizaciju računarskih sistema; softver za šifrovanje podataka; softver za maksimalno skladištenje podataka; softver za upravljanje i administriranje Uređaja za čuvanje podataka; poluprovodničke jedinice; Uređaji za skladištenje podataka i njihova pronalaženje; strukturalna kucišta za elektronsku i data opremu; poluprovodničke pločice za izradu integrisanih kola; kompjuterske priključne stanice; računarski hardver za sistemsku analizu sa firmverom i softverom za upravljanje centrima podataka velikih razmjera, analizom podataka, skladištenjem podataka, i analizom performansi sistema skladištenja; hardver za računarske mreže; kompjuterske periferne jedinice; računarski softver za procenje kompjuterskih sistema; Uređaji za čuvanje podataka na računaru, naime, hardver za mrežno pohranjivanje podataka; elektronski Uređaji za skladištenje podataka, naime, jedinice hard diskova, jedinice digitalnih diskova, prazni digitalni mediji za skladištenje, prenosivi hard diskovi, jedinice poluprovodničkih diskova, fles memorijske jedinice, hibridne disk jedinice i kompjuterske periferne jedinice; adapteri fles kartica; jedinice hard diskova; futrole internih hard diskova; montazna postolja prilagodena za računarski hardver; pokretni sistemi za čuvanje rezervnih podataka, naime, kompjuterska oprema koja se sastoji prije svega od jedinica hard diskova i poluprovodničkih diskova, a sekundarno od računarskog softvera; sistem za čuvanje rezervnih podataka zasnovan na pokretnom hard disku; USB prikljucci.

**Klasa 38:** Elektronski prenos podataka i dokumenata preko računarskih mreža.

**Klasa 42:** Računarsko programiranje; savjetovanje u oblasti računarskog softvera; analiza računarskih sistema; dizajniranje računarskih sistema; savjetovanje u oblasti dizajna i razvoja računarskog hardvera; dizajn i razvoj računarskog hardvera i softvera; usluge dizajna, razvoja, ažuriranja i održavanja podataka sa hard diskova (HOD), poluprovodničkih diskova (SSD) i računarskih Uređaja za pohranjivanje podataka; elektronsko pohranjivanje podataka; industrijska istraživanja u oblasti analize sistema i optimizacije Uređaja sa postojanom fleš memorijom, centara za čuvanje i obradu podataka, hiperskalabilnih računarskih sistema i sistema računarstva u oblaku (klaudu); pružanje informacija o računarskim tehnologijama; instaliranje računarskog softvera; održavanje ugrađenog softvera (firmvera) i softvera; procenje računarskih sistema daljinskim pristupom; čuvanje rezervne kopije (bekapovanje) podataka van mreže; pružanje informacija o računarskim tehnologijama i programiranju; usluge tehničke podrške u oblasti računarskog hardvera i softvera; usluge tehničke podrške u oblasti računarskog hardvera, pohranjivanja računarskih podataka, pohranjivanja informacija, umrežavanje računara i interfejsova, kao i disk drajvova, Računarskih disk drajvova i elektronske memorije; Naučne i tehnoloske usluge, istraživanje i dizajniranje u vezi sa istim; Naučne i tehnološke usluge u vidu analize sistema i optimizacije Uređaja sa postojanom fleš memorijom, centara za čuvanje i obradu podataka, analize hiperskalabilnih računarskih

sistema (računarski sistemi koji imaju mogućnost dodavanja novih procesora, hard diskova i/ili memorije postojećem računarskom i/ili distributivnom okruženju, karakteristični za servere sa velikim brojem računara) i analiza sistema računarstva u oblaku (klaudnu) i optimizacija, istraživanje i dizajn svega u vezi sa gorenavedenim; server hosting; usluge tehničke podrške, naime, tehnička administracija serverima za druge i rešavanje problema u vidu dijagnostikovanja problema servera; usluge tehničke podrške, naime, rešavanje problema računarskog softvera; ažuriranje ugrađenog softvera (firmvera) i softvera; računarstvo u oblaku (klaudnu); usluge kompjuterskog i elektronskog pohranjivanja podataka; usluge kompjuterske tehnoloske podrške; usluge elektronskog pohranjivanja podataka za arhiviranje baza podataka, slika i drugih elektronskih podataka; pracenje računarskih sistema daljinskim pristupom da bi se obezbjeđio pravilan rad i optimizacija navedenih sistema; usluge platformi preko računarskih softverskih platformi; ponovno uspostavljanje (oporavak) računarskih podataka; usluge tehničkog savjetovanja u oblasti informacione tehnologije; usluge tehničke podrške, naime, usluge migracije data centara, servera i aplikacija baza podataka.;

-----  
(210) 2018-91

(442) 20.01.2019

(220) 3/23/2018

(731) Sea Trade doo Kotor, Put Prvoborca, Škaljari Kotor, ;

(540) SUMOSAN

(550)

(740) Anastasija Lashmanova, Kotor, Kriva ulica bb, Dobrota;

(511) Klasa 43: Usluge obezbjeđivanja hrane i pića;

-----  
(210) 2018-92

(442) 20.01.2019

(220) 3/23/2018

(731) Sea Trade doo Kotor, Put Prvoborca bb, Škaljari, Kotor, ;

(540) UKEMOCHI

(550) I

(740) Anastasija Lashmanova, Kotor, Kriva ulica bb, Dobrota;

(511) Klasa 43: Usluge obezbjeđivanja hrane i pića;

-----  
(210) 2018-93

(442) 20.01.2019

(220) 3/23/2018

(731) Sea Trade doo Kotor, Put Prvoborca bb, Škaljari, Kotor, ;

(540) GALLARDO

(550)

(740) Anastasija Lashmanova, Kotor, Kriva ulica bb, Dobrota;

(511) Klasa 43: Usluge obezbjeđivanja hrane i pića;

-----  
(210) 2018-94

(442) 20.01.2019

(220) 3/26/2018

(731) GOLDEN LEAF ( MACAU) TOBACCO'S MANUFACTURING LIMITED, RUA DOS PESCADORES, N°66, BLOCOII, 3°ANDAR-A, MACAU, ;



GUIA

(540)

(550) I,F

(740) Raičević Dejan, Vojvode Boža 1, Cetinje ME

(511) Klasa 34: duvan; cigarete; elektronske cigarete; kutije šibica; upaljaci za pušace.;

---

(210) 2018-95

(442) 20.01.2019

(220) 3/26/2018

(300) iz Azerbejdžana br. prijave 2017 33791 od 28.09.2017. godine

(731) Nicoventures Holdings Limited, Globe House 1 Water Street London WC2R 3 LA Ujedinjeno Kraljevstvo,

(540) VUSE

(550) I

(740) Popović Miladin, Đoka Miraševića 21/III, Podgorica ME

(511) Klasa 34: Elektronske cigarete; kertridži za elektronske cigarete; tečnosti za elektronske cigarete; cigarete koje sadrže zamjene za duvan; zamjene za duvan; cigarete; duvan; duvanski proizvodi; futrole za cigarete; kutije za cigarete. ;

---

(210) 2018-96

(442) 20.01.2019

(220) 3/27/2018

(731) Tricontinental Export Import, Peka Pavlovica 1 81250 Cetinje Crna Gora, ;

(540) MILLENNIUM

(550) I,V

(511) Klasa 29: Konzervisana tunjevina.;

---

(210) 2018-98

(442) 20.01.2019

(220) 3/30/2018

(731) Davor Pentek, Ulica Borik 5, 52000 Pula, Hrvatska, ;

(540) ACCORD CASE

(550) I

(740) Lutovac Branislav, Bulevar Crnojevića 93, Podgorica ME

(511) **Klasa 15:** Zvučne ploče za žicane muzičke instrumente; Zvona (muzički instrumenti) ; Zviždaljke [muzički instrumenti]; Zvečke [muzički instrumenti]; Lice za muzičke instrumente; žicani muzički instrumenti; Vjetrovodi za orgulje; Violoncela; Violine; Virole; Vijci za zatezanje žica na žicanim muzičkim instrumentima; Ventili muzičkih instrumenata; Usne harmonike; Uređaj za ugadanje instrumenata; Ukulele [mala havajska gitara]; Udaraljke [muzički instrumenti]; Tube [muzički instrumenti]; Trzalice za

muzičke instrumente; Trube; Tromboni; Trokuti [muzički instrumenti]; Triangli [muzički instrumenti]; Torbe za nošenje muzitcih klavijatura; Torbe za nošenje muzičkih instrumenata; Torbe posebno prilagodene za nošenje muzičkih instrumenata; Tonometri [muzičke vilice za intonaciju]; Tipke muzičkih instrumenata; Timpani; Tamtam [muzički instrument]; Tamburini; Strune [žice] muzičkih instrumenata; Strune za gudala; štapici za udaranje ritma; Stalci za note; Stalci za timpane; Stalci prilagodeni za držanje muzičkih instrumenata; Snimati [muzički instrumenti]; Serpentine [muzički instrumenti]; Sedla za gitare; Saksofoni; Rucna zvona [muzički instrumenti]; Rogovi [muzički instrumenti]; Ritam mašina; Remeni za gitare; Regulatori jacine zvuka za mehaničke klavire; Rainmaker [muzički instrumenti]; Računalno upravljani muzički instrumenti; Duvački instrumenti; Probušeni muzički svici [valjci] za upotrebu u mehaničkim klavirima; Prigušivaci za muzičke instrumente; Prekidaci na gitari; Pokretaci za muzičke kutije; Podloge za vježbanje bubnjeva; Plektron; Pisci duvačkih instrumenata; Pipa [kineska gitara]; Pikola [duvački muzički instrument]; Pedale za muzičke instrumente; Palice za bubnjeve; Oslonci za bradu na violini; Orijentalni gudački instrumenti [kokyu]; Orgulje; Okarine; Oboe; Noge za violoncela; Noge za kontrabase; Navlake za muzičke instrumente; Navlake za klavir [oblikovane]; Nasloni za ruke na gitari; Motalice za gitare; Mjehovi za muzičke instrumente; Metalofon; Metalna zvona [muzički instrumenti]; Melodike; Mehanički, električni i elektronski muzički instrumenti; Mandoline; Mandole; Mali bubnjevi (doboši); Lutnje; Lukovi gudala; Lire [muzički instrumenti]; Limeni duvački muzički instrumenti; Ksilofoni; Kratke flaute od bambusa [Danso]; Koža za bubnjeve; Kontrafagoti; Kontrabasi; Konjska dlaka za violinska gudala; Koncertne [male harmonike]; Kolofonij za gudačke muzičke instrumente; Kobilice na muzičkim instrumentima; Kljucevi za ugadanje žica muzičkih instrumenata; Klavijature muzičkih instrumenata; Klarineti; Japanski tradicionalni muzički instrumenti; Instrumenti s klavijaturama [muzički instrumenti]; Hvataljka za žicane muzičke instrumente; Harmonike; Harmoniji; Harte; Gudala za muzičke instrumente; Gudački instrumenti; Gongovi; Muzički stalci prilagodeni za upotrebu sa muzičkim instrumentima; Muzički pribor; Muzički instrumenti za djecu; Muzički instrumenti s tipkama; Muzički instrumenti; Muzički vrpce; Muzičke svirale za ugadanje muzičkih instrumenata; Muzičke kutije; Muzika (Uređaji za okretanje stranica muzičkih partitura); Klaviri; Gitare; Gajde; Francuski rogovi; Flaute; Fagoti; Eufoniji; Engleski rogovi; Elektronski Uređaji za zvučne efekte [sintesajzeri]; Elektronski Uređaji za sintetiziranje muzike [muzički instrumenti]; Elektronski Uređaji za ritam; Elektronski kompjuterski upravljani muzički Uređaji; Elektronske pozadinske muzičke mašine; Elektronski melodijski instrumenti; Elektronski muzički Uređaji za vježbanje; Elektronski muzički Uređaji I instrumenti; Elektronski glazbeni sintetizajzeri; Elektronski klaviri; Elektronski bubnjevi; Elektronski automatski upravljani Uređaji za ritam; Elektronske orgulje; Elektronske klavijature [muzički instrumenti]; Elektronički prigušivaci za muzičke instrumente za upotrebu prilikom vježbanja; Električni i elektronski muzički instrumenti; Električni klaviri; Električni basevi; Električne klavijature [muzički instrumenti]; Električne gitare; Električne bas gitare; Električna zvona [muzički instrumenti]; Drveni duvački muzički instrumenti; Drombulja [muzički instrumenti]; Citre; Cinele; Cembala; Celicni bubnjevi [muzički instrumenti]; Celicne žice za gitaru; Celeste; Bušene muzičke trake; Bubnjevi [muzički instrumenti]; Bendž a; Bas gitare; Bas bubnjevi; Bandoneoni; Balalajke [žicani muzički instrumenti]; Automatski električni klaviri; Akusticne gitare; Akusticne bas gitare; Trske kao dijelovi muzičkih instrumenata; Jezicci [dijelovi muzičkih instrumenata]; Koferi i torbe za muzičke instrumente; Torbe prilagodene za muzičke instrumente; Muzički podupiraci za muzičke instrumente; Stalci za muzičke instrumente; Tronošci za muzičke instrumente; Kutije za muzičke instrumente; Navlake za muzičke instrumente; Kutije za muzičke instrumente izradene od karbona; Udaraljke.

**Klasa 35:** Veleprodajne usluge u vezi s torbama; Maloprodajne usluge u vezi s torbama; Maloprodajne usluge vezane uz muzičke instrumente; Veleprodajne usluge vezane uz muzičke instrumente;

Maloprodajne usluge vezane uz kutije za muzičke instrumente; Veleprodajne usluge vezane uz kutije za muzičke instrumente; Veleprodajne usluge u vezi s muzičkom opremom; Maloprodajne usluge u vezi s muzičkom opremom; Maloprodajne usluge na internetu povezane s muzičkim instrumentima; Veleprodajne usluge na internetu povezane s muzičkim instrumentima; Maloprodajne usluge na internetu povezane s muzičkom opremom; Veleprodajne usluge na internetu povezane s muzičkom opremom; Maloprodajne usluge na internetu povezane s kutijama za muzičke instrumente; Veleprodajne usluge na internetu povezane s kutijama za muzičke instrumente.

**Klasa 37:** Usluge premazivanja [bojenja); Tapetarske popravke; Tapaciranje; Pružanje informacija o popravci torbi i torbica; Popravka torbi; Popravka prtljaga; Glacnje i poliranje; Lakiranje; Krpljenje; Brušenje pješčnim brusnim papirom; Bojenje i lakiranje; Bojenje; Pružanje informacija o popravci ili održavanju muzičkih instrumenata; Popravka ili održavanje muzičkih instrumenata; Ugadanje muzičkih instrumenata; Popravka muzičkih instrumenata; Restauriranje muzičkih instrumenata; Popravak ili održavanje muzičke opreme; Popravka ili održavanje kutija za muzičke instrumente; Lakiranje karbonskih materijala; Pružanje informacija o popravci ili održavanju kutija za muzičke instrumente; Popravka i obnova kutija za muzičke instrumente; Popravka i obnova predmeta od karbona; Izrada predmeta od karbonskih vlakana; Kitanje; Tapetarsko oblaganje unutrašnjosti kutija za muzičke instrumente; Popravka i obnova unutrašnjosti kutija za muzičke instrumente. ;

-----  
(210) 2018-99

(442) 20.01.2019

(220) 3/30/2018

(731) HGST Netherlands B.V., Herikerbergweg 238 Luna ArenA Amsterdam 1101 CM Netherlands, ;

(540) G-TECHNOLOGY

(550) I,V

(740) MSA IP Milojević Sekulić, Karađorđeva 65, Beograd SR

(511) **Klasa 09:** Naučni aparati i instrumenti; računarski hardver; računarske periferne jedinice; računarske komponente; hardver za računarske mreže; električni kablovi; računarski softver; programi za pohranjivanje podataka; računarski softver za omogućavanje preuzimanja podataka; računarski softver za kodiranje; računarski softver za kompresiju podataka; aplikacije koje se mogu preuzeti za upotrebu na mobilnim Uređajima; računarski softver za daljinsko upravljanje i analizu koji se može preuzeti; računarski softver za pracenje računarskih sistema; kablovi za prenos podataka; priključne stanice; interfejsi za računare; integrisana kola; kartice sa elektronskim integrisanim kolom; torbe za prenošenje računarskih perifernih jedinica; torbe za eksterni hard disk; torbe za eksterni SSD diskove; torbe za interne hard diskove; torbe za interne SSD diskove; kucišta za interne hard diskove; kucišta za interne SSD diskove; aparati za snimanje medija; Uređaji za skladištenje podataka; računarska memorija; magnetni nosaci podataka, diskovi za snimanje; elektronske memorije; memorijske kartice; USB priključci; fleš memorija; adapteri za fleš kartice; citaci fleš kartica; prazni USB priključci; fleš memorijska kartica; prazne fleš memorijske kartice; prenosivi Uređaji fleš memorije; poluprovodnički memorijski Uređaji; računarski disk drajveri; hard diskovi; SSD diskovi; bačkup drajveri za računare (drajveri za čuvanje rezervnih kopija); publikacije koje se mogu preuzimati; elektronska obavještenja (bilteni) koja se mogu preuzimati.

**Klasa 16:** Papir; samoljepljivi papir; papir za upotrebu u proizvodnji kesa i pakovanja; kancelarijski materijal; štampane stvari; štampani priručnici; štampani prospekti; katalogi; papirne etikete; natpisi od papira ili kartona; kutije od papira; kartonske kutije; priručnici iz oblasti računarske tehnologije, računarskog hardvera, računarskog softvera, skladištenja podataka i specifikacije računarskih proizvoda;

štampani pamfleti, dijagrami, brošure, priručnici, knjige, knjižice, propagandni listici, informativni reklamni materijal, informativni listovi i bilteni, samoljepljive naljepnice I kompleti koji se sastoje isključivo od jednog ili više prethodno navedenih materijala iz oblasti računarske tehnologije, računarskog hardvera, računarskog softvera, skladištenja podataka, i specifikacije računarskih proizvoda; uputstva iz oblasti računarske tehnologije, računarskog hardvera, računarskog softvera, skladištenja podataka, i specifikacije računarskih proizvoda; štampani materijal za obuku iz oblasti računarske tehnologije, računarskog hardvera, računarskog softvera, skladištenja podataka, i specifikacije računarskih proizvoda; papir za umotavanje I pakovanje; plasticna pučketava folija za umotavanje i pakovanje; plasticne ili papirne kese za pakovanje robe, koverta i vrecice; plasticna folija za pakovanje; papirne rolne za pakovanje.

**Klasa 42:** Naučne i tehnološke usluge; usluge elektronskog pohranjivanja za arhiviranje baza podataka, slika i drugih elektronskih podataka; savjetovanje u oblasti informacione tehnologije; dizajn i razvoj računarskog softvera; dizajn, održavanje, razvoj I ažuriranje računarskog softvera; usluge tehničkog savjetovanja koje se odnose na informacionu tehnologiju; pružanje usluga tehničkog savjetovanja koje se odnose na računarski hardver i softver; utvrđivanje problema računarskog softvera (tehnička podrška); usluge migracije podataka; čuvanje rezervne kopije podataka van mreže; ponovno uspostavljanje računarskih podataka; pružanje informacija koje se odnose na računarsku tehnologiju i programiranje.

-----  
(210) 2018-181

(442) 20.01.2019

(220) 5/23/2018

(731) Bosnalijek, farmaceutska i hemijska industrija, dioničko društvo, Jukićeva 53, 71000 Sarajevo, Bosna i Hercegovina / BA, ;

(540) FERAL KID

(550) I,V

(740) Radulovic Božidar, Podgorica, Studenska bb,Lamela 3/18;

(511) **Klasa 05:** Farmaceutski proizvodi.;

-----  
(210) 2018-182

(442) 20.01.2019

(220) 5/23/2018

(731) Bosnalijek, farmaceutska i hemijska industrija, dioničko društvo, Jukićeva 53, 71000 Sarajevo, Bosna i hercegovina /BA, ;

(540) FERAL DAILY

(550) I,V

(740) Radulovic Božidar, Podgorica, Studenska bb,Lamela 3/18;

(511) **Klasa 05:** Farmaceutski proizvodi;

-----  
(210) 2018-183

(442) 20.01.2019

(220) 5/23/2018

(731) British American Tobacco ( Germany) GmbH, Alsterufer 4 20354, Hamburg Njemačka, ;

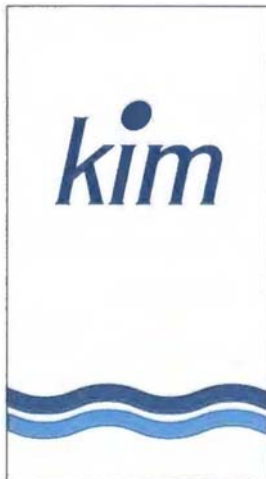

(540)

(550) I,F

(740) Popović Miladin, Đoka Miraševića 21/III, Podgorica ME

(511) **Klasa 34:** Cigarete; duvan, sirov ili prerađen; rezani duvan; duvan za lule; proizvodi od duvana; zamjene za duvan (ne u medicinske svrhe); cigare, cigarilosi; upaljaci za cigarete; upaljaci za cigare; šibice; artikli za pušace; cigaret papir; cigaret tube; filteri za cigarete; dzepni aparati za zamotavanje cigareta; rucne mašine za ubrizgavanje duvana u papime tube; elektronske cigarete; tečnosti za elektronske cigarete; duvanski proizvodi namijenjeni za zagrijavanje.;

---

(210) 2018-184

(442) 20.01.2019

(220) 5/24/2018

(731) Montenegro's one Investment and consulting, Bulevar Džordža Vašingtona, Capital Plaza, 4 sprat, 98 Podgorica, ;

(540) IQOS SHOP

(550) V

(740) Sandra Šušlavčević, Podgorica, Zagrebačka 88, Podgorica; ME

(511) **Klasa 34:** Duvan; pribor za pušace; šibice.

**Klasa 35:** Oglašavanje i reklamiranje; vodenje komercijalnih poslova; komercijalna administracija; kancelarijski poslovi.;

---

(210) 2018-185

(442) 20.01.2019

(220) 5/25/2018

(731) Montenegro's one Investment and consulting, Bulevar Džordža Vašingtona, Capital Plaza, 4 sprat, 98 Podgorica, ;



(540)

(550) F

(740) Sandra Šušlavčević, Podgorica, Zagrebačka 88, Podgorica; ME

(511) **Klasa 29:** meso, riba, živina i divljac; mesni ekstrakti; konzervirano, suseno i kuvano voće i povrće; zeleti, dzemovi, kompoti; jaja, mlijeko i mlijecni proizvodi; jestiva ulja i masti

**Klasa 30:** kafa, čaj, kakao, secer, riza, tapioka, sago, zamjene za kafu; brasno i proizvodi od zitarica, hleb, kolaci, poslastice bomboni, sladoled; med, sirup od melase; kvasac, prasak za pecivo; so, senf; sirce, prelivei zacini, razni zacini led za hlađenje.

**Klasa 31:** poljoprivredni, povrtlarski, sumski proizvodi i bobice, koji nisu obuhvaceni drugim klasama; zive zivotinje; svježe voće i povrće; sjeme, prirodne biljke i cvijeće; hrana za zivotinje; slad.

**Klasa 32:** pivo; mineralne i gazirane vode i ostala Bezalkoholna pića; pica od voca i vocni sokovi; sirupi i ostali preparati za pripremanje napitaka.; alkoholna pića (osim piva); usluge obezbjeđivanja hrane i pića; privremeno primanje na stan.;

-----  
(210) 2018-186

(442) 20.01.2019

(220) 5/25/2018

(731) Montenegro's one Investment and consulting, Bulevar Džordža Vašingtona, Capital Plaza, 4 sprat, 98 Podgorica, ;



(540)

(550) F

(740) Sandra Šušlavčević, Podgorica, Zagrebačka 88, Podgorica; ME

(511) **Klasa 30:** kafa, čaj, kakao, secer, riza, tapioka, sago, zamjene za kafu; brasno i proizvodi od zitarica, hleb, kolaci, poslastice bomboni, sladoled; med, sirup od melase; kvasac, prasak za pecivo; so, senf; sirce, prelivei; zacini, razni zacini, led za hlađenje.

**Klasa 32:** pivo; mineralne i gazirane vode i ostala Bezalkoholna pića; pica od voca i vocni sokovi; sirupi i ostali preparati za pripremanje napitaka.

**Klasa 33:** alkoholna pića (osim piva);

**Klasa 43:** usluge obezbjeđivanja hrane i pića ; privremeno primanje na stan.;

-----  
(210) 2018-51

(442) 20.01.2019



(220) 2/15/2018

(731) Colgate-Palmolive Company, a Delaware corporation, 300 Park Avenue New York, 10022 New York, U.S.A., ;



(540)

(550) I

(740) Jusić Jasna, Dalmatinska 2, Podgorica ME

(511) **Klasa 03:** Proizvodi za ličnu higijenu, odnosno, preparati za šišćenje kože i tijela; sapun; tecni sapun za ruke; gelovi i kreme za tuširanje; kupke; preparati za njegu kose; dezodoransi, preparati protiv znojenja i sprejevi za ispod pazuha za ličnu upotrebu; preparati za hidrataciju tijela i kože, losioni i kreme; puder u prahu; preparati za brijanje; preparati za kozmetičko potamnjanje i preparati za zaštitu kože od uticaja sunca; maramice natopljene rastvorom za šišćenje.;

-----  
(210) 2018-52

(442) 20.01.2019

(220) 2/16/2018

(731) ETI GIDA SANAYI VE TICARET ANONIM SIRKETI, Organize Sanayi Bolgesi 11. Cadde Eskisehir Turska, ;



(540)

(550) I,F

(740) Popović Miladin, Đoka Miraševića 21/III, Podgorica ME

(511) **Klasa 30:** Biskviti, čokolade, kolači, krekeri, vafli, peciva, pite, sladoled, jestivi led.;

-----  
(210) 2018-53

(442) 20.01.2019

(220) 2/19/2018

(731) Montenegro's one investment and consulting, Bulevar Džordža Vašingtona, Capital Plaza, sprat IV, br. 98, Podgorica, ;



(540)

(550) F

(740) Sandra Šušakčević, Podgorica, Zagrebačka 88, Podgorica; ME

(511) **Klasa 29:** Meso, riba, živina, divljac, mesni ekstrati, konzervirano, sušeno i kuvano voće i povrće, želei, džemovi, kompoti, jaja, mlijeko i mliječni proizvodi, jestiva ulja i masti.

**Klasa 30:** Kafa, čaj, kakao, šećer, riža, tapioka, sago, zamjena za kafu, brašno i proizvodi od žitarica, hleb, kolaci, poslastice, bomboni, sladoled, med, sirup od melase, kvasac, prašak za pecivo, so, senf, sirce, preliv, začini, razni začini, led za hlađenje.

**Klasa 31:** Poljoprivredni, povrtlarski, šumski proizvodi i bobice, koji nisu obuhvaćeni drugim klasama, žive životinje, svježe voće i povrće, sjeme, prirodne biljke i cvijeće, hrana za životinje, slad.

**Klasa 32:** Pivo, mineralne i gazirane vode i ostala bezalkoholna pića, pića od voća i voćni sokovi, sirupi i ostali preparati za pripremanje napitaka;

-----  
(210) 2018-54

(442) 20.01.2019

(220) 2/19/2018

(731) Montenegro's one investment and consulting, Bulevar Džordža Vašingtona, Capital Plaza, 4.sprat, 98, Podgorica, ;



(540)

(550) F

(740) Sandra Šušakčević, Podgorica, Zagrebačka 88, Podgorica; ME

(511) **Klasa 35:** Oglašavanje i reklamiranje, vođenje komercijalnih poslova, komercijalna administracija, kancelarijski poslovi; Usluge koje pružaju lica ili organizacije čija je glavna svrha : pomoć u radu i upravljanju privrednim društvima ili pomoć u vodenju poslova ili komercijalnih funkcija industrijskog ili trgovačkog preduzeća, kao i usluge reklamnih ustanova koje se bave uglavnom reklamiranjem proizvoda i usluga putem svih vrsta medija; Usluge koje se odnose na registraciju, prijepis, sastavljanje, kompilaciju ili sistematizaciju pisanih saopštenja i zapisa kao i obradu ili kompilaciju matematičkih ili statističkih podataka; Usluge agencije za oglašavanje kao i usluge distribuiranja prospekata direktno ili poštom ili distribucija uzoraka. Oglašavanja u vezi sa drugim uslugama kao što su usluge u vezi bankarskih zajmova i oglašavanja putem radija, sortiranje za Račun drugih osoba, raznih proizvoda ( ne uključuje njihov prevoz) radi omogućavanja potrošaču njihovog lakšeg razgledanja i kupovine, ove usluge se mogu pružiti u okviru prodavnica na malo, trgovina na veliko, posredstvom prodajnih kataloga, dopisno ili elektronskim putem, na pr. posredstvom weba ili putem telefona.;

-----  
(210) 2018-55

(442) 20.01.2019

(220) 2/19/2018

(731) Amazon Europe Core S.à.r.l, 5, Rue Plaetis, L-2338, Luxembourg, ;

**prime video**



(540)

(550) I

(740) Jusić Jasna, Dalmatinska 2, Podgorica ME

(511) **Klasa 09:** Aparati i instrumenti Naučni, pomorski, geodetski, fotografski, kinematografski, optički, za vaganje, mjerenje, signalizaciju, kontrolu (inspekciju), spasavanje i nastavu; aparati i instrumenti za provođenje, prekid, transformaciju, akumulaciju, regulisanje iii kontrolu elektricne energije; aparati za snimanje, prenos i reprodukciju zvuka iii slika; magnetni nosaci podataka, diskovi za snimanje; kompakt diskovi, DVD i drugi digitalni nosaci podataka; mehanizmi za aparate koji se pokrecu novcem; registar kase, Računske masine, oprema za obradu podataka, računarski softver: računarski softver za striming, prenos, distribuciju, reprodukciju, organizaciju i razmjenu muzike, zvuka, video zapisa, igara, audiovizuelnih zapisa, multimedijalnih sadžaja i drugih podataka putem globalne komunikacione mreže; računarski softveri za koriscenje pri stvaranju, preuzimanju, prenosu, prijemu, uredivanju, izvlicenju, kodiranju, dekodiranju, reprodukcij i, pregledavanju, pohranjivanju i organizaciji teksta, podataka, slika, audio i video datoteka, i multimedijalnih sadžaja; računarski softver koji omogućava korisnicima da pregledaju iii slusaju zvucne, video, tekstualne i multimedijalne sadžaje; računarski softver za izradu i omogućavanje korisničkog pristupa pretrazivim bazama podataka sa informacijama i podacima; softver za pretrazivace; računarski softver za bezicnu dostavu sadžaja; računarski softver za pristup onlajn informacijama; računarski softver za jednostavnije placanje i transakcije na internetu; računarski softver za koriscenje u distribuciji oglasavanja za druge; računarski softver koji se koristi za dijeljenje informacija o proizvodima, uslugama i kupovinama; računarski softver za elektronsko čuvanje podataka; računarski softver za prepoznavanje slika i govora; računarski softver za automatizaciju doma; računarski softver za kupovinu, pristup i gledanje filmova, tv emisija, videozapisa, muzike i multimedijalnih sadžaja; softver za internet pretrazivace; audiovizuelni zapisi za zabavne programe; muzičke datoteke koje se mogu preuzimati sa interneta; audiovizuelni i multimedijalni sadžaji koji se mogu preuzimati sa fikcijskim i nefikcijskim pricama na razne teme koji se obezbjeđuju putem usluge video na zahtjev; igrani filmovi i televizijske emisije koje se mogu preuzeti sa fikcijskim i nefikcijskim pricama na razne teme, audio i video zapisi sa fikcijskim i nefikcijskim pricama na razne teme; digitalni mediji, naime prethodno snimljeni digitalni video diskovi, digitalni visenamjenski diskovi; zvucni i video zapisi, DVD, i digitalni diskovi visoke definicije sa fikcijskim i dokumentarnim pricama na razne teme koji se mogu preuzmati sa interneta; audio datoteke, multimedijalne datoteke, tekstualne datoteke, pisana dokumenta, audio materijali, video materijali sa fikcijskim i nefikcijskim sadžajem na razne teme koji se mogu preuzeti sa interneta; mobilne aplikacije koje se mogu preuzeti sa interneta koje omogućavaju korisnicima pristup muzici, audio snimcima, video snimcima, igrama, audiovizuelnim snimcima, multimedijalnim sadžajima i drugim podacima; digitalni medija striming Uređaji; set top boks uređaji (upravljačke kutije za televiziju); prenosni i rucni elektronski Uređaji za prenos, čuvanje, uredivanje, snimanje i pregled teksta, slika, audio zapisa, video zapisa i podataka, i to preko globalnih računarskih mreza, bezicnih mreza i elektronskih komunikacionih mreza i elektronski i mehanički djelovi i opreme za iste; računari, tablet računari, audio i video plejeri, lični elektronski planeri, lični digitalni asistenti, Uređaji za globalni pozicioni sistem i elektronski i mehanički

djelovi i oprema za iste; računarski periferni Uređaji; računarske komponente; monitori, ekrani, zice, kablovi, modemi, stampaci, .disk drajveri, adapteri, kartice za adaptere, konektori kablova, priključni konektori, konektori za elektricnu energiju, stanice za povezivanje i drajveri; punjaci za baterije; kompleti baterija; memorijske kartice i citaci memorijskih kartica; slusalice koje se nose na glavi, slusalice koje se nose u usima; zvcnici, mikrofoni i slusalice sa mikrofonom; futrole, navlake i stalci za prenosne i rucne elektronske Uređaje i računare; daljinski upravljacii za prenosne i rucne elektronske Uređaje i računare; magnetski kodirane poklon kartice; računarski softver za sakupljanje, organizaciju, izmjenu, oznacavanje, prenos, čuvanje i dijeljenje podataka i informacija; softveri za prenos i prikazivanje teksta, slike i zvuka; računarski softver za onlajn kupovinu; računarski hardver; računarski cipovi; baterije; rucni Uređaji za upravljanje televizorima, zvučnicima, pojačivacima, stereo sistemima i sistemima za zabavu; računarski softver za upravljanje informacijama; softveri za sinhronizaciju baza podataka; računarski programi za pristup, pregledanje i pretrazivanje onlajn baza podataka; softver za sinhronizaciju podataka između udaljene stanice i fiksne udaljene stanice; softver za telekomunikaciju i komunikaciju preko lokalnih i globalnih komunikacionih mreza; softver za pristup komunikacionim mrezama uključujući internet; softver za analizu i povrat podataka; softver za računarski bekap sistem; radio, radio transmiteri i prijemnici; medija plejeri, zvcnici; audio komponente i prateća oprema; telefoni; mobilni telefoni; audio pojačivaci i resiveri; aparati za zvcne efekte i instrumenti za upotrebu sa muzičkim instrumentima; elektronski generatori tona za upotrebu sa muzičkim instrumentima; elektronske komponente za upotrebu sa muzičkim instrumentima; audio Uređaji za igračke; audio zvcnici, telefonski aparati, telekomunikacioni Uređaji i računari za koriscenje u motornim vozilima; aparati za snimanje i prepoznavanje glasa; aparati za komunikacione mreze; elektronska komunikaciona oprema i instrumenti; telekomunikacioni aparati i instrumenti; kamere; kamkorderi; kinematografske kamere; futrole posebno napravljene za fotografske aparate i instrumente; aparati za centriranje fotografskih slajdova; objektivii za snimanje iz blizine (close up); platna za projektore; aparati za projekciju; televizori; televizijski prijemnici; televizijski monitori; stereo sistemi, sistemi kucnih bioskopa i sistemi kucne zabave; softver za razvoj aplikacija; računarski softver koji se koristi za razvoj drugih softverskih aplikacija; softver za računarski operativni sistem; računarski softver za konfiguraciju, upravljanje i kontrolu mobilnih Uređaja, prenosivih Uređaja, mobilnih telefona, računara. računarskih perifernih Uređaja i audio i video plejera; računarski softver za izradu baza podataka i informacija za peer-to-peer baze podataka drustvenih mreza, koje se mogu pretrazivati; računarski softveri za igre; elektronske knjige, magazini, periodicne publikacije, bilteni, novine, zurnali i ostale publikacije koje se mogu preuzimati; informaciona tehnologija i audiovizuelna oprema; pozivne melodije za mobilne telefone koji se mogu preuzeti sa interneta; crtani filmovi; interkomunikacioni aparati; pametni telefoni; prenosni telefoni; telefonski Uređaji; telefonski prijemnici; telefonski predajnici; video telefoni; fonografski zapisi, diskovi za snimanje zvuka; trake za snimanje zvuka; nosaci zvcnih zapisa; video kasete; kertridzi za video igrice; video trake; računarski memorijski Uređaji; mikroprocesori; modemi; 3D naočare; remeni, povezi za ruke, vrpce za nosenje oko vrata i spojnice za prenosive i rucne digitalne elektronske Uređaje za snimanje, organizaciju, prenos, uređivanje i pregled teksta, podataka, audio zapisa, slika i video datoteka; torbe i futrole prilagodene i oblikovane da drže digitalne muzičke i/ili video plejere, rucne računare, licne digitalne asistente, elektronske planere i elektronske beljeznice; korisnička uputstva u elektronski, masinski i računarski citljivoj formi za upotrebu sa, i koji se prodaju zajedno sa gore navedenom robom.

**Klasa 38:** Telekomunikacije; prenos video sadriaaja na zahtjev; usluge prenosa televizije putem interneta (IPTV); elektronski prenos strimovanih audio i video datoteka koje se mogu preuzeti putem računarskih i drugih komunikacionih mreza; elektronski prenos informacija i podataka; elektronski prenos i striming

digitalnih medijskih sadriaaja za druge putem globalnih i lokalnih računarskih mreza; telekomunikacione usluge, naime prenos i striming glasa, podataka, slika, filmova, televizijskih programa, audio i audiovizuelnih programa i drugih digitalnih medijskih sadriaaja i informacija putem telekomunikacionih mreza, bezicnih komunikacionih mreza i interneta; striming audio, video i audiovizuelnih materijala na internetu, komunikacionim mrezama i bezicnim telekomunikacionim mrezama; striming podataka; striming muzike, filmova, igranih filmova, TV serija i igara na internet; usluge emitovanja; usluge audio i video emitovanja; emitovanje kinematografskih filmova i audiovizuelnih programa; usluge audio i video emitovanja bazirane na pretplati preko interneta; usluge emitovanja i omogućavanja telekomunikacionog pristupa filmovima, televizijskim programima, audio i audiovizuelnim programima i drugim digitalnim medijskim sadrijajima i informacijama, obezbijedenim putem usluge video na zahtjev; usluge internet emitovanja; usluge internet radio emitovanja; telekomunikacione usluge, naime, prenos webcast sadriaaja; prenos digitalnih datoteka; prenos digitalnih sadriaaja putem računarskih mreza, interneta, DSL, kablovskih mreza, digitalnog preuzimanja, digitalnog strimovanja, videa na zahtjev, videa na zahtjev po intervalima (near-video-on-demand), TV, besplatnog TV-a (free-to-air TV), plati da gledas TV-a (pay-per-view TV), satelita, kablovske, telefona iii mobilnog telefona; elektronski prenos digitalnih foto datoteka izmedu internet korisnika; obezbjeđivanje pristupa onlajn direktorijumima, bazama podataka, web stranicama, blogovima i referentnim materijalima; prenos vijesti; dostavljanje poruka eletkronskim prenosom; elektronski prenos poste i poruka; podkasting usluge; pružanje usluga onlajn soba za caskanje za drustvene mreze; pružanje usluga onlajn forum a za prenos poruka izmedu korisnika računara i prenos fotografija, videa, teksta, podataka, slika i zvuka; telekomunikacione usluge, naime pružanje usluga elektronskih oglasnih tabli za prenos poruka izmedu korisnika računara koje se odnose na zabavu; pružanje usluga telekomunikacionog povezivanja za prenos slika, poruka, audio, vizuelnih, audiovizuelnih i multimedijskih radova izmedu mobilnih telefona, pametnih telefona, prenosnih elektronskih Uređaja, prenosnih digitalnih Uređaja, tableta iii računara; multimedijalnih radova; prenos televizijskih i filmskih vodica; komunikacija izmedju računara; obezbjeđenje pristupnog vremena multimedijalnim materijalima na internetu; obezbjeđivanje telekomunikacionih veza za računarske baze podataka; prenos podataka audio-vizuelnim aparatima kontrolisanim Uređajima iii računarima za obradu podataka; usluge telekomunikacionog usmjeravanja i povezivanja; iznajmljivanje pristupnog vremena globalnim računarskim mrezama; onlajn prenos cestitki; iznajmljivanje Uređaja za slanje poruka; iznajmljivanje modema; iznajmljivanje telekomunikacione opreme.

**Klasa 41:** Obrazovne usluge; pružanje obuke; razonoda; sportske i kulturne aktivnosti; usluge razonode, naime, pružanje informacija putem globalne računarske mreze u oblasti zabavnih i tema u vezi sa zabavom; obezbedivanje veb sajtova koji nude audio, video i audiovizuelne sadržaje iz oblasti igranih filmova, TV emisija, videa i muzike, koji se ne mogu preuzeti; usluge razonode, naime pružanje privremenog koriscenja video zapisa koji se ne mogu preuzimati onlajn; obezbedivanje video zapisa koji sene mogu preuzeti na programima sa širokim spektrom zabavnih tema putem usluge video-na zahtev; obezbedivanje filmova, igranih filmova i televizijskih emisija koji se ne mogu preuzeti putem usluge video-na zahtev; distribucija i iznajmljivanja zabavnih sadržaja, naime kompjuterizovane usluge onlajn pretrazivanja i narucivanja filmova, igranih filmova, dokumentaraca, filmova, televizijskih programa, grafičkih, animiranih i multimedijalnih prezentacija, i drugih audiovizuelnih radova u formi digitalnog preuzimanja i direktnog digitalnog prenosa koji se mogu gledati putem računarskih mreza i globalnih komunikacionih mreza; usluge iznajmljivanja filmova i video sadržaja; iznajmljivanje audiovizuelnih radova, posebno igranih filmova, televizijskih programa, video zapisa, muzičkih videa i muzike; produkcija i distribucija filmova, igranih filmova, TV emisija i videa; kreiranje i razvoj koncepata za filmove i televizijske

programe; usluge snimanja audio i video sadržaja; obezbjeđivanje pretraživih baza podataka sa audio, video i audiovizuelnim sadržajima preko interneta, telekomunikacionih mreža i bezicnih telekomunikacionih mreža iz oblasti filmova, TV emisija, videa i muzike; obezbjeđivanje onlajn radio programa; usluge objavljivanja digitalnih audio, video i multimedijalnih sadržaja; usluge razonode, naime pružanje, bez mogućnosti preuzimanja, unaprijed snimljene muzike i audio programa sa fikcijskim i nefikcijskim pričama na razne teme, kao i informacija iz oblasti muzike i komentara i članaka o muzici, sve onlajn putem globalne računarske mreže; usluge razonode, naime predstavljanje uživo vizuelnih i audio sadržaja, mjuzikala, varijeteta, vijesti, dramskih i humorističkih emisija; usluge razonode, naime obezbjeđivanje virtuelnog okruženja u kome korisnici mogu vršiti interakciju u rekreacijske, slobodne ili zabavne svrhe; usluge razonode, naime, obezbjeđivanje veb sajtova koji sadrže ocjene i kritike televizijskih sadržaja, filmova, videa, muzike, filmskih scenarija, scenarija, knjiga i sadržaja video igara; informacije o razonodi; online pružanje vijesti, informacija i komentara iz oblasti zabave; onlajn novine, odnosno blogovi sa informacijama iz oblasti zabave; organizovanje takmicenja; usluge nagradne lutrije; usluge nagradne lutrije koja se obezbjeđuje preko globalne računarske mreže putem usluge onlajn hostinga za nagradne lutrije i takmicenja za druge; objavljivanje knjiga, magazina, periodičnih izdanja, literarnih djela, vizuelnih, audio i audio vizuelnih radova; predstavljanje uživo muzičkih koncerata i priredbi; usluge muzičke produkcije; usluge muzičkog izdavaštva; usluge razonode, naime, profilisanje muzicara, umjetnika i bendova pružanjem video klipova muzičkih izvedbi, bez mogućnosti preuzimanja, putem globalne računarske mreže; obezbjeđivanje interaktivnog izvora za pretraživanje, odabir, organizovanje i gledanje audiovizuelnih sadržaja iz oblasti filmova, TV emisija, videa i muzike koji se ne mogu preuzimati; pružanje onlajn biltena iz oblasti televizije, filmova i videa putem elektronske poste; usluge prevodenja i tumačenja; pružanje online elektronskih publikacija, koje se ne mogu preuzeti; objavljivanje tekstova, osim reklamnih tekstova; pisanje tekstova, osim reklamnih tekstova; iznajmljivanje audio opreme; prikazivanje filmova u bioskopima; organizovanje i izvođenje koncerata; zabava, razonoda; usluge igara obezbijedenih onlajn sa računarske mreže; iznajmljivanje opreme za igrice; obezbjeđivanje karaoke usluga; iznajmljivanje filmskih projektor i opreme; usluge filmiskih studija; usluge komponovanje muzike; organizovanje predstava, svečanosti (usluge impresarija); razonoda putem radija; iznajmljivanje radio i televizijskih setova; produkcija radio i televizijskih programa; iznajmljivanje zvučnih snimaka; titlovanje; razonoda putem televizije; pozorišna produkcija; organizovanje takmicenja (obrazovanje ili zabava); organizovanje izložbi u kulturne ili obrazovne svrhe; usluge studija za snimanje; montaža video traka; snimanje video traka; pružanje informacija o obrazovanju; religijsko obrazovanje; nastava, obrazovne usluge, usluge pružanja obuke. ;

-----  
(210) 2018-56

(442) 20.01.2019

(220) 2/22/2018

(731) Hankook Tire Co., Ltd. , 133, Teheran-ro ( Yeoksam - dong), Gangnam-gu, Seoul, Južna Koreja, ;

# Technoring

(540)

(550) I,F

(740) MSA IP Milojević Sekulić, Karađorđeva 65, Beograd SR

(511) **Klasa 36:** Upravljanje zgradama (usluge u vezi sa nekretninama); iznajmljivanje ili rentiranje zgrada; izdavanje u zakup zgrada; iznajmljivanje kancelarijskog prostora; rentiranje poslovnog prostora

(nepokretnosti); pružanje informacija koje se odnose na iznajmljivanje zgrada; iznajmljivanje industrijskog prostora; ulaganje u nekretnine; usluge upravljanja nekretninama koje se odnose na trgovačke centre; usluge prodaje trgovačkih centara; iznajmljivanje trgovačkih centara; iznajmljivanje poslovnih prostorija; agencije za posredništvo u iznajmljivanju zgrada; usluge upravljanja nekretninama koje se odnose na komercijalne zgrade.

**Klasa 42:** Usluge istraživanja u vezi sa gumama; tehničko ispitivanje (pregled) automobilskih guma; tehničko ispitivanje (pregled) vozila; pregled (ispitivanje) motornih vozila prije prevoza (za provjeru ispravnosti); tehničko ispitivanje (pregled) motornih vozila (za provjeru ispravnosti); testiranje ispravnosti vozila; tehnički savjeti u vezi sa proizvodnjom guma; usluge analize (pregleda) guma; usluge projektovanja poslovnih prostora za trgovinu gumama; testiranje automobilskih točkova; testiranje automobilskih guma; istraživanje i razvoj proizvoda; ispitivanje kvaliteta proizvoda; analiza razvoja proizvoda; ocjenjivanje razvoja proizvoda; ispitivanje bezbjednosti proizvoda; procjena proizvoda.;

-----  
(210) 2018-57

(442) 20.01.2019

(220) 2/22/2018

(731) Hankook Tire Co., Ltd., 133, Teheran-ro ( Yeoksam-dong), Gangnam-gu, Seoul, Južna Koreja, ;

(540) **Technodome**

(550) I,F

(740) MSA IP Milojević Sekulić advokati, Beograd, Karadordeva 65;

(511) **Klasa 36:** Upravljanje zgradama (usluge u vezi sa nekretninama); iznajmljivanje ili rentiranje zgrada; izdavanje u zakup zgrada; iznajmljivanje kancelarijskog prostora; rentiranje poslovnog prostora (nepokretnosti); pružanje informacija koje se odnose na iznajmljivanje zgrada; iznajmljivanje industrijskog prostora; ulaganje u nekretnine; usluge upravljanja nekretninama koje se odnose na trgovačke centre; usluge prodaje trgovačkih centara; iznajmljivanje trgovačkih centara; iznajmljivanje poslovnih prostorija; agencije za posredništvo u iznajmljivanju zgrada; usluge upravljanja nekretninama koje se odnose na komercijalne zgrade.

**Klasa 42:** Usluge istraživanja u vezi sa gumama; tehničko ispitivanje (pregled) automobilskih guma; tehničko ispitivanje (pregled) vozila; pregled (ispitivanje) motornih vozila pre prevoza (za provjeru ispravnosti); tehničko ispitivanje (pregled) motornih vozila (za provjeru ispravnosti); testiranje ispravnosti vozila; tehnički savjeti u vezi sa proizvodnjom guma; usluge analize (pregleda) guma; usluge projektovanja poslovnih prostora za trgovinu gumama; testiranje automobilskih točkova; testiranje automobilskih guma; istraživanje i razvoj proizvoda; ispitivanje kvaliteta proizvoda; analiza razvoja proizvoda; ocjenjivanje razvoja proizvoda; ispitivanje bezbjednosti proizvoda; procjena proizvoda; laboratorijsko istraživanje u oblasti automobilskih guma; mjerenje težine vozila; razvoj proizvoda za izradu vozila i karoserije; dizajn vozila i djelova i komponenti za vozila; usluge dizajniranja vozila; usluge dizajniranja djelova za vozila; unutrašnji dizajn vozila; testiranje proizvoda u okviru originalnih fermi vozila; razvoj tehnologija za proizvodnju integrisanih kola za bezicnu komunikaciju, elektronsku obradu podataka, potrošačke elektronske Uređaje, auto elektroniku; istraživanje automobilske tehnologije; istraživanje i razvoj točkova automobila; istraživanje i razvoj djelova za automobile; pregledi automobila (tehnički); razvoj računarskih programa za simuliranje eksperimenata u oblasti ispravnosti automobilskih guma; usluge laboratorijskog istraživanja u vezi sa automobilskim gumama; usluge testiranja i istraživanja u vezi sa mašinama, aparatima i instrumentima; mehaničko istraživanje u oblasti moto-sportova; usluge strukturnog

inženjeringa u industriji kopnenih vozila; inženjerske usluge u industriji kopnenih vozila; usluge inženjeringa materijala u industriji kopnenih vozila; istraživanje i razvoj automobilskih točkova za druge; pružanje Naučnih informacija u vezi sa performansama i radom automobila; dizajniranje modula za automobile; usluge inženjeringa i usluge kontrole kvaliteta i testiranja materijala; ispitivanje sirovina; kontrola kvaliteta sirovina; dizajn i razvoj softvera virtualne realnosti.;

-----  
(210) 2018-58

(442) 20.01.2019

(220) 2/22/2018

(731) Hankook Tire Co., Ltd., 133, Teheran-ro ( Yeoksam-dong), Gangnam-gu, Seoul, Južna Koreja, ;

(540) **Technotr**ac

(550) I,F

(740) MSA IP Milojević Sekulić, Karađorđeva 65, Beograd SR

(511) **Klasa 36:** Upravljanje zgradama (usluge u vezi sa nekretninama); iznajmljivanje ili rentiranje zgrada; izdavanje u zakup zgrada; iznajmljivanje kancelarijskog prostora; rentiranje poslovnog prostora (nepokretnosti); pružanje informacija koje se odnose na iznajmljivanje zgrada; iznajmljivanje industrijskog prostora; ulaganje u nekretnine; usluge upravljanja nekretninama koje se odnose na trgovačke centre; usluge prodaje trgovačkih centara; iznajmljivanje trgovačkih centara; iznajmljivanje poslovnih prostorija; agencije za posredništvo u iznajmljivanju zgrada; usluge upravljanja nekretninama koje se odnose na komercijalne zgrade.

**Klasa 42:** Usluge istraživanja u vezi sa gumama; tehničko ispitivanje (pregled) automobilskih guma; tehničko ispitivanje (pregled) vozila; pregled (ispitivanje) motornih vozila pre prevoza (za provjeru ispravnosti); tehničko ispitivanje (pregled) motornih vozila (za provjeru ispravnosti); testiranje ispravnosti vozila; tehnički savjeti u vezi sa proizvodnjom guma; usluge analize (pregleda) guma; usluge projektovanja poslovnih prostora za trgovinu gumama; testiranje automobilskih točkova; testiranje automobilskih guma; istraživanje i razvoj proizvoda; ispitivanje kvaliteta proizvoda; analiza razvoja proizvoda; ocjenjivanje razvoja proizvoda; ispitivanje bezbjednosti proizvoda; procjena proizvoda.;

-----  
(210) 2018-59

(442) 20.01.2019

(220) 2/22/2018

(731) Philip Morris Products S.A., Quai Jeanrenaud 3, Neuchâtel, 2000, Švajcarska, ;

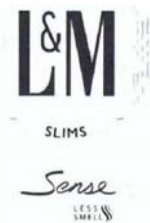

(540)

(550) I,F

(740) Milena Pejović, Podgorica, Cetinjska 11/IV, The Capital Plaza;

(511) **Klasa 34:** Duvan, sirov ili prerađen; duvanski proizvodi; cigare, cigarete, cigarilosi, duvan za zavijanje cigareta, duvan za lute, duvan za žvakanje, duvan za šmrkanje, kretek; snus (duvan u prahu); zamjena za



duvan (za nemedicinsku upotrebu); elektronske cigarete; duvanski proizvodi za paljenje; elektronski Uređaji i njihovi djelovi koji se koriste za zagrijavanje cigareta ili duvana u cilju oslobadanja aerosola koji sadrži nikotin za inhalaciju; tecni nikotinski rastvori za upotrebu u elektronskim cigaretama; artikli za pušace, papir za cigarete, tube za cigarete, filteri za cigarete, kutije za duvan, tabakere (kutije za cigarete), pepeljare, lute, rucni aparati i spravice za uvijanje cigareta, upaljači, šibice.;

-----  
(210) 2018-60

(442) 20.01.2019

(220) 2/22/2018

(731) Philip Morris Products S.A., Quai Jeanrenaud 3, Neuchâtel, 2000, Švajcarska, ;

(540) L&M SENSE

(550) I,F

(740) Milena Pejović, Podgorica, Cetinjska 11/IV, The Capital Plaza;

(511) **Klasa 34:** Duvan, sirov ili prerađen; duvanski proizvodi; cigare, cigarete, cigarilosi, duvan za zavijanje cigareta, duvan za lute, duvan za žvakanje, duvan za šmrkanje, kretek; snus (duvan u prahu); zamjena za duvan (za nemedicinsku upotrebu); elektronske cigarete; duvanski proizvodi za paljenje; elektronski Uređaji i njihovi djelovi koji se koriste za zagrijavanje cigareta ili duvana u cilju oslobadanja aerosola koji sadrži nikotin za inhalaciju; tecni nikotinski rastvori za upotrebu u elektronskim cigaretama; artikli za pušace, papir za cigarete, tube za cigarete, filteri za cigarete, kutije za duvan, tabakere (kutije za cigarete), pepeljare, lute, rucni aparati i spravice za uvijanje cigareta, upaljac, šibice.;

-----  
(210) 2018-61

(442) 20.01.2019

(220) 2/23/2018

(731) Grendene S.A., Av. Pimentel Gomes, 214 Bairro: Expectativa, 62040-125-Sobral-CE, Brasil, ;



(540)

(550) I

(740) Čolović Mladen, Dalmatinska 2, Podgorica ME

(511) **Klasa 25:** Ženska i dječija obuća, odnosno sandale, obuća za plažu, papuce, papuce za kupanje, cizme, obuća uopšte.;

-----  
(210) 2018-62

(442) 20.01.2019

(220) 2/23/2018

(731) Grendene S.A., Av. Pimentel Gomes, 214 Bairro: Expectativa, 62040-125- Sobral-CE, Brasil, ;



(540)

(550) I

(740) Čolović Mladen, Dalmatinska 2, Podgorica ME

(511) **Klasa 25:** Muške cipele, odnosno sandale, obuća za plažu, papuče za kupanje, čizme i patike.;

---

(210) 2018-63

(442) 20.01.2019

(220) 2/23/2018

(300) iz Andore prij. br. 32033 od 12.09.2017.

(731) British American Tobacco ( Brands) Limited, Globe House 4 Temple Place London WC2R 2PG  
Ujedinjeno Kraljevstvo, ;



(540)

(550) I,F

(740) Popović Miladin, Đoka Miraševića 21/III, Podgorica ME

(511) **Klasa 34:** Duvan, sirov ili prerađen, proizvodi od duvana; zamjene za duvan ( ne u medicinske svrhe); sve za svrhe zagrijavanja ali ne spaljivanja; artikli za pušace; elektronski Uređaji i njihovi djelovi za svrhu zagrijavanja duvana.;

---

(210) 2018-64

(442) 20.01.2019

(220) 2/23/2018

(731) Hewton park limited, kompanija osnovana po zakonu Gibraltara, 7B & 8B 50 Twon Range , ;



(540)

(550) I

(740) Goran Petrović, Bar, Bulevar Revolucije B11 lamela A; ME

(511) **Klasa 32:** Pivo, mineralne i gazirane vode i ostala Bezalkoholna pića; pica od voca i vocni sokovi; sirupi i ostali preparati za pripremanje napitaka.

**Klasa 33:** Alkoholna pića ( osim piva);

**Klasa 35:** Oglašavanje i reklamiranje; vodenje komercijalnih poslova; komercijalna administracija; kancelarijski poslovi; usluge koje pružaju lica ili organizacije, cija je glavna svrha : pomoć u radu i upravljanju privrednim društvima ili pomoć u vodenju poslova ili komercijalnih funkcija industrijskog ili trgovačkog preduzeća, kao i usluge reklamnih ustanova koje se bave uglavnomreklamiranjem proizvoda i usluga putem svih vrsta medija; usluge koje se odnose na registraciju, prijepis, sastavljanje, kompilaciju ili sistematizaciju pisanih saopštenja i zapisa kao i obradu ili kompilaciju matematičkih ili statističkih podataka; usluge agencije za oglašavanje kao i usluge distribuiranja prospekata direktno ili poštom ili distribuiranje uzoraka, može se odnositi i na oglašavanje u vezi sa drugim uslugama kao što su usluge u vezi bankarskih zajmova i oglašavanje putem radija; sortiranje za Račun drugih osoba, raznih proizvoda (

ne uključuje njihov prevoz) radi omogućavanja potrošaču njihovog lakšeg razgledanja i kupovine; ove usluge se mogu pružati u okviru prodavnica na malo, trgovina na veliko, na pr. posredstvom weba ili putem telefona.

**Klasa 43:** Usluge obezbjeđivanja hrane i pića; privremeno primanje na stan; usluge koje pružaju lica ili preduzeća čiji cilj je priprema jela ili pica za potrošnju kao i usluge ishrane i smještaja, koje pružaju hoteli, pansioni ili druga preduzeća koja osiguravaju privremeni sještaj; usluge rezervisanja smještaja za putnike, koje pružaju putničke agencije ili posrednici; usluge pansiona za životinje.;

---

(210) 2018-65

(442) 20.01.2019

(220) 2/26/2018

(731) QBRANDS SALES FORCE, S.L., Marie Curie, 31, 03203 Elche ( Alicante), Španija, ;



(540)

(550) I,F

(740) Kojić Ivana, Serdara Jola Piletića bb, Podgorica ME

(511) Klasa 34: Nargile; kutije za cigare; futrole za cigare; rezaci cigara; papiri za cigarete; kutije za cigarete; filteri za cigarete, papir za uvijanje cigareta, cigarete, cigare; upaljaci za pušace; šibice; duvan; filteri za duvan; duvan za lule; kutije za duvan.;

---

(210) 2018-66

(442) 20.01.2019

(220) 2/26/2018

(731) DRUŠTVO SA OGRANIČENOM ODGOVORNOŠĆU HUMAN RESOURCE PARTNERS D.O.O. BUDVA, BUDVA, ;



(540)

(550) I,F

(511) **Klasa 35:** Sajmovi ( organizovanje sajmova u komercijalne svrhe ili reklamne svrhe);

**Klasa 41:** organizovanje i vodenje radionica za strucno osposobljavanje;

**Klasa 44:** psiholog ( usluge psihologa);

---

(210) 2018-68

(442) 20.01.2019

(220) 3/2/2018

(731) NLB Banka a.d. Podgorica, Bulevar Stanka Dragojeviæa 46, 81000 Podgorica, ;

(540) Za sve što dolazi

(550) I

(511) **Klasa 36:** Bankarski poslovi; kreditno-garantni poslovi ; izdavanje garancija i preuzimanje drugih vanbilansnih obaveza; kupovinu, prodaju i naplatu potraživanja ( faktoring, forfeiting i dr) izdavanje , obradu i evidentiranje platnih instrumenata: platni promet u zemlji sa inostranstvom, u skladu sa propisima kojim ase ureduje platni promet; finansijski lizing; poslove sa hartijama od vrijednosti, u skladu sa zakonom kojim se ureduju hartije od vrijednosti;trgovanje u svoje ime i za svoj Račun ili za Račun klijenta: stranim sredstvima placanja, uključujući mjenjačke poslove, finansijskim derivatima; depo poslove; izradu analiza i davanje informacija i savjeta o kreditnoj sposobnosti privrednih društva i preduzetnika i drugim pitanjima u vezi poslovanja; iznajmljivanje sefova; poslove koji su dio bankarskih poslova, pomocne poslove u odnosu na poslove banke i poslove neposredno povezane sa poslovima te banke, u skladu sa statutom banke; usluge koje pružaju sve vrste bankarskih institucija ili mjenjačke, brokerske i klirinške usluge; kreditne usluge svih vrsta; investicione usluge holding kompanija; usluge koje se odnose na berze, akcije i svojinu; davanje garancija dužnicima u monetarnim poslovima; izdavanje putničkih cekova i kreditnih pisama.;

---

(210) 2018-69

(442) 20.01.2019

(220) 3/5/2018

(731) Deciem Beauty Group Inc., 517 Richmond St. E., Toronto, Ontario M5A 1R4, Canada, ;

(540) THE ORDINARY

(550) I

(740) Jusić Jasna, Dalmatinska 2, Podgorica ME

(511) **Klasa 03:** Kozmetički preparati za njegu kože; proizvodi za njegu kože i tijela, naime, preparati za hidrataciju lica, preparati za hidrataciju tijela, proizvodi za zaštitu od starenja lica; proizvodi za zaštitu od starenja tijela, naime, kreme za tijelo protiv starenja, losioni, gelovi, ulja, sredstva za šišćenje, sapun za tijelo, pilinzi, preparati za hidrataciju, regeneratori za kožu, sredstva za omekšavanje kože (emolijensi) i preparati za njegu kože koji uklanjaju bore; topikalni (lokalni) tretmani za vrat, naime, losioni, kreme, gelovi, ulja, sredstva za šišćenje, pilinzi, preparati za hidrataciju, regeneratori za kožu, sredstva za omekšavanje kože (emolijensi) i preparati za njegu kože koji uklanjaju bore na vratu; ne-medicinski tretmani za strije, naime, losioni, kreme, gelovi, ulja, sredstva za šišćenje, pilinzi, preparati za hidrataciju, regeneratori za kožu, sredstva za omekšavanje kože (emolijensi) i preparati za njegu kože za tretiranje strija; ne-medicinski tretmani za celulit, naime, losioni, kreme, gelovi, ulja, sredstva za šišćenje, preparati za hidrataciju, regeneratori za kožu za smanjenje celulita; tretmani za izbjeljivanje i I ili tretmani za posvjetljivanje kože, naime, losioni, kreme, gelovi, ulja, sredstva za šišćenje, preparati za hidrataciju, regeneratori za kožu za izbjeljivanje kože i posvjetljivanje kože; proizvodi za njegu kose, naime, sprejevi za kosu, losioni za kosu, regeneratori za kosu i gel za kosu; kozmetika; preparati za šišćenje, preparati za izbjeljivanje i ostale supstance za pranje veša, odnosno izbjeljivač za pranje veša, deterdženti za pranje veša i vosak za veš; preparati za šišćenje, poliranje, ribanje i abrazivni preparati; sapuni, naime, sapuni protiv znojenja, sapuni za tijelo, sapun za kupanje i sapun za ruke; eterična ulja, losioni za kosu; paste za zube, kreme za lice i tijelo, preparati za pranje tijela, šamponi, preparati za hidrataciju tijela, kolonjska voda; toaletna voda; parfemi; dezodoransi za ličnu upotrebu.

**Klasa 35:** Usluge maloprodaje u oblasti kozmetike, proizvoda za ličnu njegu, kože, proizvoda za njegu lica i tijela i kozmetičkih proizvoda; onlajn maloprodajne usluge u oblasti kozmetike, proizvoda za ličnu njegu, kože, proizvoda za njegu lica i tijela i kozmetičkih proizvoda.;

-----  
(210) 2018-70

(442) 20.01.2019

(220) 3/8/2018

(731) Deciem Beauty Group Inc., 517 Richmond St. E., Toronto, Ontario M5A 1R4, Canada, ;

(540)

AVESTAN

(550) I

(740) Jusić Jasna, Dalmatinska 2, Podgorica ME

(511) **Klasa 03:** Kozmetički preparati za njegu kože; proizvodi za njegu kože i tijela, naime, preparati za hidrataciju lica, preparati za hidrataciju tijela, proizvodi za zaštitu od starenja lica; proizvodi za zaštitu od starenja tijela, naime, kreme za tijelo protiv starenja, losioni, gelovi, ulja, sredstva za šišćenje, sapun za tijelo, pilinzi, preparati za hidrataciju, regeneratori za kožu, sredstva za omekšavanje kože (emolijensi) i preparati za njegu kože koji uklanjaju bore; topikalni (lokalni) tretmani za vrat, naime, losioni, kreme, gelovi, ulja, sredstva za šišćenje, pilinzi, preparati za hidrataciju, regeneratori za kožu, sredstva za omekšavanje kože (emolijensi) i preparati za njegu kože koji uklanjaju bore na vratu; ne-medicinski tretmani za strije, naime, losioni, kreme, gelovi, ulja, sredstva za šišćenje, pilinzi, preparati za hidrataciju, regeneratori za kožu, sredstva za omekšavanje kože (emolijensi) i preparati za njegu kože za tretiranje strija; ne-medicinski tretmani za celulit, naime, losioni, kreme, gelovi, ulja, sredstva za šišćenje, preparati za hidrataciju, regeneratori za kožu za smanjenje celulita; tretmani za izbjeljivanje i I iii tretmani za

posvjetljivanje kože, naime, losioni, kreme, gelovi, ulja, sredstva za šišćenje, preparati za hidrataciju, regeneratori za izbjeljivanje kože i posvjetljivanje kože; proizvodi za njegu kose, naime, sprejevi za kosu, losioni za kosu, regeneratori za kosu i gel za kosu; kozmetika; preparati za šišćenje, preparati za izbjeljivanje i ostale supstance za pranje veša, odnosno izbjeljivač za pranje veša, deterdženti za pranje veša i vosak za veš; preparati za šišćenje, poliranje, ribanje i abrazivni preparati; sapuni, naime, sapuni protiv znojenja, sapuni za tijelo, sapun za kupanje i sapun za ruke; eterična ulja, losioni za kosu; paste za zube, kreme za lice i tijelo, preparati za pranje tijela, šamponi, preparati za hidrataciju tijela, kolonjska veda; toaletna veda; parfemi; dezodoransi za ličnu upotrebu.

**Klasa 35:** Usluge maloprodaje u oblasti kozmetike, proizvoda za ličnu njegu, kože, proizvoda za njegu lica i tijela i kozmetičkih proizvoda; onlajn maloprodajne usluge u oblasti kozmetike, proizvoda za ličnu njegu kože, proizvoda za njegu lica i tijela i kozmetičkih proizvoda.;

-----  
(210) 2018-71

(442) 20.01.2019

(220) 3/12/2018

(731) Nevladino udruženje Asocijacija Menadžera Crne Gore Podgorica, Marka Miljanova 27, Podgorica, ;



(540)

(550) I,F

(740) Budimir Raičković, Podgorica, Marka Miljanova 27; ME

(511) Klasa 35: Oglasavanje; vodenje poslova; poslovno upravljanje;kancelarijski poslovi; usluge koje pružaju lica ili organizacije uglavnom radi: pomoci u radu ili upravljanju preduzecima; pomoci u upravljanju poslovnom ili komercijalnom delatnošću u industrijski ili komercijalnim privrednim drustvima. Kao i usluge koje pružaju preuzeca koja se bave oglašavanjem (reklamiranjem), tako sto, za Račun drugih lica, komuniciraju sa javnošću (reklama) putem prenosa bilo kakvih informacija o svim vrstama prizvoda proizvodima i uslugama. Sakupljanje u korist drugih, citavog niza roba (uključujući i njihov transport) omogućavajući klijentima da zgodno razgledaju i kupuju ovu robu; takve usluge mogu se pružati u prodavnicama na malo, rasprodajama, porudžbinama postom preko kataloga ili putem elektronskih medija, na primer preko web site-a ili televizijskih programa za kupovinu; usluge koje se sastoje od registracije, transkripcije, kompozicije, kompilacije ili sistematizacije pisanih saopštenja i registracija i takode kompilacije matematičkih ili statističkih podataka; usluge reklamnih agencija i usluge kao sto je djeljenje prospekata direktno ili poštom ili distribucija uzoraka; reklamiranje u vezi sa drugim uslugama, kao što su one u vezi sa bankarskim zajmovima ili reklamiranje putem radija.

**Klasa 41:** Obuka;strucno osposobljavanje; rasonoda; sportske i kulturne djelatnosti; usluge osoba ili ustanova koje se bave razvojem mentalnih sposobnosti lica ili životinja, kao i usluge rasonode i zaokupljanja paznje; usluge obučavanja osoba ili uvježbavanja životinja, u svim njihovim vidovima; usluge ciji je osnovni cilj razbibriga, zabava ili rekreacija lica;usluge prikazivanja javnosti umjetničkih i literarnih djela u kulturne i obrazovne svrhe.

**Klasa 45:** Pravne usluge; sigurnosne usluge za zaštitu imovine i lica ;licne i društvene usluge koje pružaju drugi, namijenjene za zadovoljenje ljudskih potreba;usluge koje pružaju advokati individualnim licima, grupama, organizacijama i preduzecima; usluge istrage i prismothe u vezi sigurnosti lica i entiteta; usluge koje se pružaju pojedincima u vezi društvenih dešavanja, kao što su usluge društvene pratnje, agencije za sklapanje braka, i pogrebne usluge.

-----  
(210) 2018-72

(442) 20.01.2019

(220) 3/12/2018

(300) br. prijave 017560178 od 04.12.2017. godine

(731) Krypto Labs Limited, Of Office No. 135-FD, Level 1, Incubator Building, Masdar City, Abu Dhabi, United Arab Emirates, ;

(540) KRYPTO LABS

(550) I

(740) Jusić Jasna, Dalmatinska 2, Podgorica ME

(511) **Klasa 35:** Oglašavanje; poslovni menadžment; poslovna administracija; kancelarijsko funkcionisanje; pomoć u poslovnom menadžmentu; pomoć u poslovnom menadžmentu preduzetnicima, novim i start-up kompanijama; poslovni menadžment i konsultacije u vezi sa organizacijom; poslovni menadžment i konsultacije u vezi sa organizacijom preduzetnicima, novim i start-up kompanijama; strucne usluge za poslovnu efikasnost; poslovne procjene; poslovne informacije; pružanje poslovnih informacija putem veb sajta; pomoć u komercijalnom ili inudstrijskom menadžmentu; pomoć u komercijalnom ili inudstrijskom menadžmentu preduzetnicima, novim i start-up kompanijama; usluge komercijalnog posredovanja; prikupljanje informacija u kompjuterske servise; savjetodavne usluge za poslovno upravljanje; strucne poslovne konsultacije; konsultacije u vezi sa poslovnom organizacijom; revizija poslovanja; Računovodstvo; marketinske studije; marketinško istraživanje; organizovanje izlozbi u privredne ili reklamne svrhe; organizovanje sajмова za privredne ili reklamne svrhe; usluge podugovaranja (pomoc u poslovanju); konsultacije u vezi sa kadrovskim upravljanjem; odnosi sa javnošcu; izdavanja reklamnih tekstova; iznajmljivanje oglasnih materijala; prodajne promocije za druge; pružanje podrške pocetnog poslovnog upravljanja za druge firme; usluge pružanja konsultacija, savjeta i informacija za preduzetnike, nove kompanije i start-up kompanije; marketinške i promotivne usluge; usluge poslovnog umrežavanja putem interneta; iznajmljivanje kancelarijskih mašina i opreme; usluge kancelarijskog upravljanja; komercijalno upravljanje kancelarijama, kancelarijskim prostorom i komercijalnom imovinom; usluge podrške poslovnim kancelarijama; sekretarske usluge; cinovničke usluge; umnožavanje dokumenata; zapošljavanje osoblja; usluge poslovnog inkubatora; komercijalno upravljanje poslovnim inkubatorom; usluge pružanja savjeta, konsultacija i informacija u vezi sa svim naprijed pomenutim uslugama. Klasa 36: Usluge u vezi sa nekretninama; poslovi u vezi sa nekretninama; iznajmljivanje, lizing i upravljanje privrednim nekretninama, kancelarijama i kancelarijskim prostorom; obezbjeđivanje kancelarijskog prostora, kancelarija i privrednih nekretnina uz održavanje i upravljanje; investicione usluge; usluge kapitalnog investiranja; usluge ulaganja preduzetničkog (rizicnog) kapitala; usluge finansijske procjene; finansijska procjena preduzeća; savjeti u vezi sa finansijskim upravljanjem; savjeti u vezi sa finansijskim upravljanjem preduzetnicima, novima kompanijama i start-up kompanijama; finansijska analiza; finansijska analiza preduzeća; finansijske informacije; finansijske informacije u vezi sa preduzecima; finansijske informacije za preduzetnike, nove kompanije i start-up kompanije; usluge obezbjeđivanja pocetnih kapitala za preduzetnike, nove kompanije i start-up kompanije; finansijsko sponzorstvo;

finansijsko sponzorstvo za preduzetnike, nove kompanije i startup kompanije; pružanje finansijskih informacija putem veb sajta; pružanje informacija u vezi sa privrednim investicijama, putem veb sajta; investiranje fondova; upravljanje fondovima; konsultacije u vezi sa investicijama; savjeti u vezi sa investicijama; konsultacije u vezi sa investicijama; investiciona analiza; posredovanje kod investicija; investiciono istraživanje; upravljanje investicijama; upravljanje portfolijom investicija; upravljanje investicionim fondovima i kapitalnim investicionim fondovima; usluge pružanja savjeta, konsultacija i informacija u vezi sa kapitalnim investicijama; upravljanje kapitalnim investicionim fondovima; obezbjeđivanje finansiranja preduzetnicima, novim i start-up kompanijama; upravljanje rizicnim kapitalom; usluge finansiranja rizičnog kapitala za preduzeća i preduzetnike ; usluge pružanja savjeta, konsultacija i informacija u vezi sa svim naprijed pomenutim uslugama.

-----  
(210) 2018-73

(442) 20.01.2019

(220) 3/13/2018

(731) THE HEADHUNTER MONTENEGRO DOO,, VUCEDOLSKA 1-5/1, PODGORICA, ;

(540) The logo for HeadHunter features a stylized 'H' icon on the left, composed of three horizontal bars of varying lengths, followed by the word 'HeadHunter' in a bold, blue, sans-serif font. A registered trademark symbol (®) is positioned to the upper right of the word.

(550) I,F

(511) **Klasa 09:** Operativni računarski programi, snimljeni, računarski softver, računarski programi (softveri koji se mogu preuzimati), računarske platforme, snimljene ili daunloadovane.

**Klasa 35:** Usluge agencija za zapošljavanje, obavještenja o poslovima, pronalženje osoblja, pregovaranje o poslovnim ugovorima za druge, psihološko testiranje za izbor zaposlenih, konsultacije u vezi sa izborom osoblja, pisanje radnih biografija za druge, pomoć u poslovnom upravljanju, usluge agencija za pružanje informacija, profesionalne poslovne konsultacije, poslovno upravljanje i organizaciono savjetovanje, konsultacije u poslovnom upravljanju, strucne usluge u poslovnoj efikasnosti, istraživanje tržišta, poslovne procjene, poslovna ispitivanja, konsultacije u vezi sa poslovnim organizovanjem, savjetodavne usluge u poslovnom upravljanju, pružanje poslovnih informacija putem internet stranice, usluge zakazivanja sastanaka (kancelarijske usluge), usluge podsjećanja na ugovorene sastanke (kancelarijski poslovi). Klasa 41: Profesionalno usmjeravanje (savjetovanje u vezi sa obrazovanjem ili obukom), usluge profesionalne prekvalifikacije, nastava, obuka, obrazovne usluge, usluge pružanja obuke.

-----  
(210) 2018-74

(442) 20.01.2019

(220) 3/13/2018

(731) Deciem Beauty Group Inc., 517 Richmond St. E., Toronto, Ontario M5A 1R4, Canada, ;

(540)

(550) I

(740) Jusić Jasna, Dalmatinska 2, Podgorica ME

(511) **Klasa 03:** Kozmetički preparati za njegu kože; proizvodi za njegu kože i tijela, naime, preparati za hidrataciju lica, preparati za hidrataciju tijela, proizvodi za zastitu od starenja lica; proizvodi za zaštitu od starenja tijela, naime, kreme za tijelo protiv starenja, losioni, gelovi, ulja, sredstva za šišćenje, sapun za tijelo, pilinzi, preparati za hidrataciju, regeneratori za kožu, sredstva za omekšavanje kože (emolijensi) i preparati za njegu kože koji uklanjaju bore; topikalni (lokalni) tretmani za vrat, naime, losioni, kreme,



gelovi, ulja, sredstva za šišćenje, pilinzi, preparati za hidrataciju, regeneratori za kožu, sredstva za omekšavanje kože (emolijensi) i preparati za njegu kože koji uklanjaju bore na vratu; ne-medicinski tretmani za strije, naime, losioni, kreme, gelovi, ulja, sredstva za šišćenje, pilinzi, preparati za hidrataciju, regeneratori za kožu, sredstva za omekšavanje kože (emolijensi) i preparati za njegu kože za tretiranje strija; ne-medicinski tretmani za celulit, naime, losioni, kreme, gelovi, ulja, sredstva za šišćenje, preparati za hidrataciju, regeneratori za kožu za smanjenje celulita; tretmani za izbjeljivanje i I iii tretmani za posvjetljivanje kože, naime, losioni, kreme, gelovi, ulja, sredstva za šišćenje, preparati za hidrataciju, regeneratori za izbjeljivanje kože i posvjetljivanje kože; proizvodi za njegu kose, naime, sprejevi za kosu, losioni za kosu, regeneratori za kosu i gel za kosu; kozmetika; preparati za šišćenje, preparati za izbjeljivanje i ostale supstance za pranje veša, odnosno izbjeljivač za pranje veša, deterdženti za pranje veša i vosak za veš; preparati za šišćenje, poliranje, ribanje i abrazivni preparati; sapuni, naime, sapuni protiv znojenja, sapuni za tijelo, sapun za kupanje i sapun za ruke; eterična ulja, losioni za kosu; paste za zube, kreme za lice i tijelo, preparati za pranje tijela, šamponi, preparati za hidrataciju tijela, kolonjska veda; toaletna veda; parfemi; dezodoransi za ličnu upotrebu.

**Klasa 35:** Usluge maloprodaje u oblasti kozmetike, proizvoda za ličnu njegu, kože, proizvoda za njegu lica i tijela i kozmetičkih proizvoda; onlajn maloprodajne usluge u oblasti kozmetike, proizvoda za ličnu njegu kože, proizvoda za njegu lica i tijela i kozmetičkih proizvoda. ;

-----  
(210) 2018-76

(442) 20.01.2019

(220) 3/13/2018

(731) DRUŠTVO SA OGRANICENOM ODGOVORNOŠĆU HUMAN RESOURCE PARTNERS D.O.O. BUDVA, , ;



(540) career center

(550) I,F

(511) **Klasa 35:** sajmovi ( organizovanje sajмова u komercijalne ili reklamne svrhe);

**Klasa 41:** organizovanje i vodenje radionica za strucno osposobljavanje;

**Klasa 44:** psiholog ( usluge psihologa);

-----  
(210) 2018-78

(442) 20.01.2019

(220) 3/14/2018

(731) PHARMANOVA DOO DRUŠTVO ZA PROIZVODNJU FARMACEUTSKIH PROIZVODA OBRENOVAC, Industrijska 8 11500 Obrenovac, Republika Srbija, ;

(540) SOLD3EVIT

(550) I

(740) MSA IP Milojević Sekulić, Karađorđeva 65, Beograd SR

(511) **Klasa 05:** Farmaceutski, medicinski i veterinarski preparati; dijetetska hrana i supstance prilagodene za upotrebu u medicini ili veterinarsku upotrebu; dijetetski dodaci (dodaci ishrani) za ljude ili životinje.

-----  
(210) 2018-79

(442) 20.01.2019

(220) 3/14/2018

(731) Domaca trgovina doo Podgorica, Ul. Josipa Broza Tita br. 23a, Podgorica, ;

(540) Naše gore list

(550) V

(511) **Klasa 35:** Trgovina na malo u nespecijalizovanim prodavnicama, pretežno hranom, picem i duvanom, kao i kozmetičkog i higijenskog programa, proizvoda kućne galanterije, malih kućanskih aparata i sezonskih programa.;

-----

(210) 2018-80

(442) 20.01.2019

(220) 3/14/2018

(731) Domaća trgovina doo Podgorica, Ul. Josipa Broza Tita br. 23a, ;



(540)

(550) F

(511) **Klasa 35:** Trgovina na malo u nespecijalizovanim prodavnicama, pretežno hranom, picem i duvanom, kao i kozmetičkog i higijenskog programa, proizvoda kućne galanterije, malih kućanskih aparata i sezonskih programa.;

-----

(210) 2017-440

(442) 20.01.2019

(220) 7/11/2017

(731) EA LOGISTICS SHPK, Rruga e Kavajes, Pallati 141/7, Tirane, ALBANIA, AL, AL;

(540) DS

(550) I

(740) Radulovic Božidar, Podgorica, Studenska bb, Lamela 3/18;

(511) **Klasa 34:** Cigarete; cigarilosi; cigar; duvanski proizvodi; upaljaci; šibice; proizvodi za pušace; filteri za cigarete; lule; burmut, duvan za žvakanje; cigarete i/ili kutija za cigare: puro [ako je cigara u potpunosti izgrađena (punilo, veziva i omotac) od duvana proizvedenog u samo jednoj zemlji, u industriji cigara se pominje kao puro, iz španske riječi za cisto]; muštikle.;

-----

(210) 2017-441

(442) 20.01.2019

(220) 8/11/2017

(731) MEIZU TECHNOLOGY CO., LTD., MEIZU TECHNOLOGY BUILDING, TECHNOLOGY & INNOVATION COAST, ZHUHAI CITY, GUANGDONG, P.R. CHINA, CH, CN;

(540) mblu

(550) I,F

(740) Radulovic Božidar, Podgorica, Studenska bb,Lamela 3/18;

(511) **Klasa 09:** Aparati za obradu podataka; softverske aplikacije za mobilne telefone, koje su pogodne za preuzimanje; kompjuterski periferni Uređaji; tablet računari; pametne naočare; pametni satovi; Uređaji za prepoznavanje lica; vage; smartfoni [pametni telefoni]; handsfree kompleti za telefone; mrežna komunikacijska oprema; nosivi Uređaji za mjerenje aktivnosti; maske za pametne telefone; zaštitne folije prilagodene za pametne telefone; mrežni ruteri; televizijski Uređaji; slušalice; videokamere; rekorderi za vozila; uređaj za prijem digitalnog zemaljskog ili satelitskog televizijskog i radio signala; virtuelne slušalice; kutije za zvučnike; fotografska kamera; selfi štapovi [ručni monopodi]; aparati za analizu vazduha; pametne narukvice[mjerni instrumenti]; materijali za elektricne vodove [žice, kablovi]; data kablovi; električni adapteri; uticnice, utikaci i drugi kontakti[elektricne veze]; adapter za napajanje elektronskih uređaja; 3D naočare; elektricne instalacije za sprecavanje provala; prenosivi izvori napajanja[punjive baterije]; električni akumulatori; punjaci za elektricne akumulatore;

**Klasa 35:** Oglašavanje; prezentacija proizvoda putem sredstava komunikacije, u svrhu prodaje na malo; organizovanje izložbi u komercijalne ili reklamne svrhe; pružanje poslovnih informacija putem internet stranice; komercijalna administracija za licence roba i usluge trećih lica; promocija prodaje za druge; obezbjeđivanje onlajn tržišta za kupce i prodavce roba i usluga; agencije za uvoz-izvoz; sistemacija informacija u kompjuterskim bazama podataka; ažuriranje i održavanje podataka u računarskim bazama podataka;

-----  
(210) 2018-1

(442) 20.01.2019

(220) 1/9/2018

(731) Goodyear Dunlop Tyres UK Limited, 2920 Trident Court, Solihull Parkway Birmingham Business Park, Birmingham, B37 7YN, United Kingdom, UK;

(540) TRAILMAX MERIDIAN

(550) I

(740) Čolović Mladen, Dalmatinska 2, Podgorica ME

(511) **Klasa12:** Gume za motocikle.;

-----  
(210) 2018-106

(442) 20.01.2019

(220) 4/3/2018

(731) Davor Pentek, Ulica Borik 5, 52000 Pula, Hrvatska, ;



(540)

(550) I

(740) Lutovac Branislav, Bulevar Crnojevića 93, Podgorica ME

(511) **Klasa 15:** Zvučne ploče za žičane muzičke instrumente; Zvona (muzički instrumenti) ; Zviždaljke [muzički instrumenti]; Zvečke [muzički instrumenti]; Lice za muzičke instrumente; žičani muzički instrumenti; Vjetrovodi za orgulje; Violoncela; Violine; Viole; Vijci za zatezanje žica na žičanim muzičkim instrumentima; Ventili muzičkih instrumenata; Usne harmonike; Uređaj za ugadanje instrumenata; Ukulele [mala havajska gitara]; Udaraljke [muzički instrumenti]; Tube [muzički instrumenti]; Trzalice za muzičke instrumente; Trube; Tromboni; Trokuti [muzički instrumenti]; Triangli [muzički instrumenti]; Torbe za nošenje muzičkih klavijatura; Torbe za nošenje muzičkih instrumenata; Torbe posebno prilagodene za nošenje muzičkih instrumenata; Tonometri [muzičke vilice za intonaciju]; Tipke muzičkih instrumenata; Timpani; Tamtam [muzički instrument]; Tamburini; Strune [žice] muzičkih instrumenata; Strune za gudala; štapici za udaranje ritma; Stalci za note; Stalci za timpane; Stalci prilagodeni za držanje muzičkih instrumenata; Snimati [muzički instrumenti]; Serpentine [muzički instrumenti]; Sedla za gitare; Saksofoni; Rucna zvona [muzički instrumenti]; Rogovi [muzički instrumenti]; Ritam mašina; Remeni za gitare; Regulatori jacine zvuka za mehaničke klavire; Rainmaker [muzički instrumenti]; Računalno upravljani muzički instrumenti; Duvački instrumenti; Probušeni muzički svici [valjci] za upotrebu u mehaničkim klavirima; Prigušivaci za muzičke instrumente; Prekidaci na gitari; Pokretaci za muzičke kutije; Podloge za vježbanje bubnjeva; Plektron; Pisci duvačkih instrumenata; Pipa [kineska gitara]; Pikola [duvački muzički instrument]; Pedale za muzičke instrumente; Palice za bubnjeve; Oslonci za bradu na violini; Orijentalni gudački instrumenti [kokyu]; Orgulje; Okarine; Oboe; Noge za violoncela; Noge za kontrabase; Navlake za muzičke instrumente; Navlake za klavir [oblikovane]; Nasloni za ruke na gitari; Motalice za gitare; Mjehovi za muzičke instrumente; Metalofon; Metalna zvona [muzički instrumenti]; Melodike; Mehanički, električni i elektronski muzički instrumenti; Mandoline; Mandole; Mali bubnjevi (doboši); Lutnje; Lukovi gudala; Lire [muzički instrumenti]; Limeni duvački muzički instrumenti; Ksilofoni; Kratke flaute od bambusa [Danso]; Koža za bubnjeve; Kontrafagoti; Kontrabasi; Konjska dlaka za violinska gudala; Koncertne [male harmonike]; Kolofonij za gudačke muzičke instrumente; Kobilice na muzičkim instrumentima; Kljucevi za ugadanje žica muzičkih instrumenata; Klavijature muzičkih instrumenata; Klarineti; Japanski tradicionalni muzički instrumenti; Instrumenti s klavijaturama [muzički instrumenti]; Hvataljka za žičane muzičke instrumente; Harmonike; Harmoniji; Harte; Gudala za muzičke instrumente; Gudački instrumenti; Gongovi; Muzički stalci prilagodeni za upotrebu sa muzičkim instrumentima; Muzički pribor; Muzički instrumenti za djecu; Muzički instrumenti s tipkama; Muzički instrumenti; Muzički vrpce; Muzičke svirale za ugadanje muzičkih instrumenata; Muzičke kutije; Muzika (Uređaji za okretanje stranica muzičkih partitura); Klaviri; Gitare; Gajde; Francuski rogovi; Flaute; Fagoti; Eufoniji; Engleski rogovi; Elektronski Uređaji za zvučne efekte [sintesajzeri]; Elektronski Uređaji za sintetiziranje muzike [muzički instrumenti]; Elektronski Uređaji za ritam; Elektronski kompjuterski upravljani muzički Uređaji; Elektronske pozadinske muzičke mašine; Elektronski melodijski instrumenti; Elektronski muzički Uređaji za vježbanje; Elektronski muzički Uređaji I instrumenti; Elektronski glazbeni sintetizajzeri; Elektronski klaviri; Elektronski bubnjevi; Elektronski automatski upravljani Uređaji za ritam; Elektronske orgulje; Elektronske klavijature [muzički instrumenti]; Elektronički prigušivaci za muzičke instrumente za upotrebu prilikom vježbanja; Električni i elektronski muzički instrumenti; Električni klaviri; Električni basevi; Električne klavijature [muzički instrumenti]; Električne gitare; Električne bas gitare; Električna zvona [muzički instrumenti]; Drveni duvački muzički instrumenti; Drombulja [muzički instrumenti]; Citre; Cinele; Cembala; Celicni bubnjevi [muzički instrumenti]; Celicne žice za gitaru; Celeste; Bušene muzičke trake; Bubnjevi [muzički instrumenti]; Bendž a; Bas gitare; Bas bubnjevi; Bandoneoni; Balalajke [žičani muzički instrumenti]; Automatski električni klaviri; Akustične gitare; Akustične bas gitare; Trske kao dijelovi muzičkih instrumenata; Jezici [dijelovi muzičkih instrumenata]; Koferi i torbe za muzičke instrumente;

Torbe prilagodene za muzičke instrumente; Muzički podupiraci za muzičke instrumente; Stalci za muzičke instrumente; Tronošci za muzičke instrumente; Kutije za muzičke instrumente; Navlake za muzičke instrumente; Kutije za muzičke instrumente izradene od karbona; Udaraljke.

**Klasa 35:** Veleprodajne usluge u vezi s torbama; Maloprodajne usluge u vezi s torbama; Maloprodajne usluge vezane uz muzičke instrumente; Veleprodajne usluge vezane uz muzičke instrumente; Maloprodajne usluge vezane uz kutije za muzičke instrumente; Veleprodajne usluge vezane uz kutije za muzičke instrumente; Veleprodajne usluge u vezi s muzičkom opremom; Maloprodajne usluge u vezi s muzičkom opremom; Maloprodajne usluge na internetu povezane s muzičkim instrumentima; Veleprodajne usluge na internetu povezane s muzičkim instrumentima; Maloprodajne usluge na internetu povezane s muzičkom opremom; Veleprodajne usluge na internetu povezane s muzičkom opremom; Maloprodajne usluge na internetu povezane s kutijama za muzičke instrumente; Veleprodajne usluge na internetu povezane s kutijama za muzičke instrumente.

**Klasa 37:** Usluge premazivanja [bojenja]; Tapetarske popravke; Tapaciranje; Pružanje informacija o popravci torbi i torbica; Popravka torbi; Popravka prtljaga; Glacnje i poliranje; Lakiranje; Krpljenje; Brušenje pješčnim brusnim papirom; Bojenje i lakiranje; Bojenje; Pružanje informacija o popravci ili održavanju muzičkih instrumenata; Popravka ili održavanje muzičkih instrumenata; Ugadanje muzičkih instrumenata; Popravka muzičkih instrumenata; Restauriranje muzičkih instrumenata; Popravak ili održavanje muzičke opreme; Popravka ili održavanje kutija za muzičke instrumente; Lakiranje karbonskih materijala; Pružanje informacija o popravci ili održavanju kutija za muzičke instrumente; Popravka i obnova kutija za muzičke instrumente; Popravka i obnova predmeta od karbona; Izrada predmeta od karbonskih vlakana; Kitanje; Tapetarsko oblaganje unutrašnjosti kutija za muzičke instrumente; Popravka i obnova unutrašnjosti kutija za muzičke instrumente.

-----  
(210) 2018-107

(442) 20.01.2019

(220) 4/4/2018

(731) CrossFit , Inc., 1500 Green Hills Road Suite 201 Scotts Valley CA 95066 Sjedinjene Američke Države,

;

(540) CROSSFIT

(550) I,V

(740) Popović Miladin, Đoka Miraševića 21/III, Podgorica ME

(511) **Klasa 25:** odjeća, obuća, pokrivala za glavu.

**Klasa 28:** igre i igračke; gimnastički i sportski predmeti koji nisu obuhvaceni drugim klasama; ukrasi za božićne jelke.

**Klasa 41:** obuka; strucno osposobljavanje; razonoda; sportske i kulturne djelatnosti.;

-----  
(210) 2018-110

(442) 20.01.2019

(220) 4/5/2018

(731) Mini Condos d.o.o., Donja Lastva b.b., 85320 Tivat, Montenegro, ;



(540)

(550) I

(740) Jusić Jasna, Dalmatinska 2, Podgorica ME

(511) **Klasa 35:** Oглаšavanje; poslovni menadžment; poslovna administracija; kancelarijski poslovi; usluge upravljanja poslovnim projektima za građevinske projekte.

**Klasa 36:** Osiguranje; finansijski poslovi; novčani (monetarni) poslovi; poslovi vezani za nepokretnosti; iznajmljivanje nekretnina; leaseback (aranžman gdje prodavac imovine iznajmljuje istu imovinu od kupca); iznajmljivanje apartmana; iznajmljivanje nekretnina; usluge agencije za nekretnine; posredovanje u prometu nekretninama; procjena nekretnina; upravljanje nekretninama.

**Klasa 37:** Građevinsko konstruisanje; popravka; instalacione usluge; izgradnja; razvoj nekretnina.;

-----

(210) 2018-112

(442) 20.01.2019

(220) 4/10/2018

(731) S.C. Johnson & Son, Inc., 1525 Howe Street, Racine, WI 53403, US, ;

(540) GLADE TOUCH & FRESH

(550) I,V

(740) Radulovic Božidar, Podgorica, Studenska bb,Lamela 3/18;

(511) **Klasa 03:** parfemi za prostorije ili ambijentalni parfemi; ambijentalna etarska ulja; mirisni preparati za vazduh; preparati za parfimisanje vazduha; potpuri(mirisi); tamjan.

-----

(210) 2018-115

(442) 20.01.2019

(220) 4/11/2018

(731) Société des Produits Nestlé S.A. , 1800 Vevey Switzerland, ;

(540) CREATIVA

(550) I,V

(740) MSA IP Milojević Sekulić, Karađorđeva 65, Beograd SR

(511) **Klasa 11:** Aparati za grijanje i kuvanje; aparati za grijanje mlijeka i pravljenje pjene uz grijanje mlijeka; električni aparati za pripremu napitaka, uključujući kafu, čaj, čokoladu, kapucino i/ili napitke na bazi kaka; električni aparati za kafu, električna kuvala za kafu i električni perkolatori; djelovi i oprema za sve prethodno navedene proizvode; električni aparati za pripremanje svih vrsta napitaka; dopune, kertridži rezervni djelovi za gore pomenute proizvode; električni filteri za kafu.

**Klasa 30:** Kafa, aromatizovana kafa, ekstrakti kafe, preparati i napici na bazi kafe; ledena kafa; zamjene za kafu, ekstrakti zamjene za kafu, preparati i napici na bazi zamjena za kafu; cikorija (zamjene za kafu); čaj, ekstrakti čaja, preparati i napici na bazi čaja; ledeni čaj; preparati na bazi slada za ljudsku ishranu; kakao i preparati i napici na bazi kaka; čokolada, proizvodi od čokolade, preparati i napici na bazi čokolade; šećer; biskviti.

-----

(210) 2018-116

(442) 20.01.2019

(220) 4/13/2018

(731) Baltazar doo,, Bulevar Svetog Petra Cetinjskog 104, Podgorica, Crna Gora, ;

(540) pause caffe- GARF

(550) I,F

(511) **Klasa 35:** Oglašavanje i reklamiranje.

**Klasa 41:** Razonoda, usluge ciji je osnovni cilj razbribriga, zabava ili rekreacija lica; sportske djelatnosti.

**Klasa 43:** Usluge obezbjeđivanja hrane i pića; privremeno primanje na stan.

-----

(210) 2018-117

(442) 20.01.2019

(220) 4/18/2018

(731) DRUŠTVO ZA UGOSTITELJSTVO I TURIZAM JAZ-JAZZ D.O.O. BUDVA,, ŽRTAVA FAŠIZMA BB, BUDVA, Montenegro, ;

restoran bar  
**HORIZONTALA**

(540)

(550) I

(740) Lutovac Branislav, Bulevar Crnojevića 93, Podgorica ME

(511) **Klasa 03:** preparati za bijeljenje i ostale materije za pranje rublja; preparati za šišćenje, poliranje, odmaščivanje i struganje; sapuni ; parfimerijski proizvodi, etericna ulja, kozmetički proizvodi, losioni za kosu; proizvodi za njegu zuba.

**Klasa 25:** odjeća, obuća, pokrivala za glavu.; igre i igračke; gimnastički i sportski predmeti koji nisu obuhvaceni drugim klasama; ukrasi za božićne jelke.

**Klasa 35:** oglašavanje i reklamiranje; vodenje komercijalnih poslova; komercijalna administracija; kancelarijski poslovi.

**Klasa 42:** Naučne i tehnološke usluge kao i pripadajuće usluge istraživanja i koncepcije; usluge industrijskih analiza i istraživanja; koncepcija i razvoj računara i računarskih programa /hardvera I softvera/.

**Klasa 43:** usluge obezbjeđivanja hrane i pića; privremeno primanje na stan.

**Klasa 44:** medicinske usluge; veterinarske usluge; higijenska njega i njega ljepote za ljude ili za životinje; usluge poljoprivrede, povrtlarstva i šumarstva . ;

-----

(210) 2018-118

(442) 20.01.2019

(220) 4/18/2018

(731) DRUŠTVO ZA UGOSTITELJSTVO I TURIZAM JAZ-JAZZ D.O.O. BUDVA,, ŽRTAVA FAŠIZMA BB, BUDVA, Montenegro, ;

apartmani  
**HORIZONT**

(540)

(550) I

(740) Lutovac Branislav, Bulevar Crnojevića 93, Podgorica ME

(511) **Klasa 03:** preparati za bijeljenje i ostale materije za pranje rublja; preparati za šišćenje, poliranje, odmašćivanje i struganje; sapuni ; parfimerijski proizvodi, etericna ulja, kozmetički proizvodi, losioni za kosu; proizvodi za njegu zuba.

**Klasa 25:** odjeća, obuća, pokrivala za glavu.

**Klasa 28:** igre i igračke; gimnastički i sportski predmeti koji nisu obuhvaceni drugim klasama; ukrasi za božićne jelke.

**Klasa 35:** oglašavanje i reklamiranje; vodenje komercijalnih poslova; komercijalna administracija; kancelarijski poslovi.

**Klasa 42:** Naučne i tehnološke usluge kao i pripadajuće usluge istraživanja i koncepcije; usluge industrijskih analiza i istraživanja; koncepcija i razvoj računara i računarskih programa /hardvera I softvera/.

**Klasa 43:** usluge obezbjeđivanja hrane i pića; privremeno primanje na stan.

**Klasa 44:** medicinske usluge; veterinarske usluge; higijenska njega i njega ljepote za ljude ili za životinje; usluge poljoprivrede, povrtlarstva i šumarstva .

-----  
(210) 2018-119

(442) 20.01.2019

(220) 4/18/2018

(731) DRUŠTVO ZA UGOSTITELJSTVO I TURIZAM JAZ-JAZZ D.O.O. BUDVA,, ŽRTAVA FAŠIZMA BB, BUDVA, Montenegro, ;



(540)

(550) I

(740) Lutovac Branislav, Bulevar Crnojevića 93, Podgorica ME

(511) **Klasa 03:** preparati za bijeljenje i ostale materije za pranje rublja; preparati za šišćenje, poliranje, odmašćivanje i struganje; sapuni ; parfimerijski proizvodi, etericna ulja, kozmetički proizvodi, losioni za kosu; proizvodi za njegu zuba.

**Klasa 25:** odjeća, obuća, pokrivala za glavu.

**Klasa 28:** igre i igračke; gimnastički i sportski predmeti koji nisu obuhvaceni drugim klasama; ukrasi za božićne jelke.

**Klasa 35:** oglašavanje i reklamiranje; vodenje komercijalnih poslova; komercijalna administracija; kancelarijski poslovi.

**Klasa 42:** Naučne i tehnološke usluge kao i pripadajuće usluge istraživanja i koncepcije; usluge industrijskih analiza i istraživanja; koncepcija i razvoj računara i računarskih programa /hardvera I softvera/.

**Klasa 43:** usluge obezbjeđivanja hrane i pića; privremeno primanje na stan.

**Klasa 44:** medicinske usluge; veterinarske usluge; higijenska njega i njega ljepote za ljude ili za životinje; usluge poljoprivrede, povrtlarstva i šumarstva .

-----  
(210) 2018-120

(442) 20.01.2019



(220) 4/18/2018

(731) Hemofarm A.D. farmaceutsko-hemijska industrija Vršac, Beogradski put bb 26300 Vršac Republika Srbija, ;

(540) **INDAPRES**

(550) I,V

(740) MSA IP Milojević Sekulić, Karađorđeva 65, Beograd SR

(511) **Klasa 05:** Ljekovi.

---

(210) 2018-121

(442) 20.01.2019

(220) 4/18/2018

(731) Sea Trade doo Kotor, Put Prvoborca bb, Škaljari, Kotor 85330, ;

(540) **NIRAN**

(550) I

(740) Anastasija Lashmanova, Kotor, Kriva ulica bb, Dobrota; ME

(511) **Klasa 43:** Usluge obezbjeđivanja hrane i pića.;

---

(210) 2018-122

(442) 20.01.2019

(220) 4/18/2018

(731) Sea Trade doo Kotor, Put Prvoborca bb, Škaljari, Kotor 85330, ;

(540) **SUN BEACH**

(550) I

(740) Anastasija Lashmanova, Kotor, Kriva ulica bb, Dobrota; ME

(511) **Klasa 43:** usluge obezbjeđivanja hrane i pića.;

---

(210) 2018-123

(442) 20.01.2019

(220) 4/19/2018

(300) iz Narodne Republike Kine, br. prijave 27251868 od 02.11.2017.godine

(731) Guangdong Puss Investment Co., Ltd., X 1301-C1486, No. 106 Fengze East Road Nansha District Guangzhou Narodna Republika Kina, ;

# NÖ ME

(540)

(550) I,F

(740) Popović Miladin, Đoka Miraševića 21/III, Podgorica ME

(511) **Klasa 35:** Usluge maloprodaje ili veleprodaje farmaceutskih, veterinarskih i sanitarnih preparata i medicinskih potrepština; Oглаšavanje; Prezentiranje roba na komunikacionim medijima, za svrhe maloprodaje; Savjetodavne usluge u vezi sa poslovnim upravljanjem i organizovanjem; Iznajmljivanje automata za prodaju; Traženje sponzora; Iznajmljivanje prodajnih standova; Usluge agencije za uvoz i izvoz; Usluge agencije za zapošljavanje; Ažuriranje i održavanje podataka u kompjuterskim bazama podataka; Marketing; Računovodstvo; Komercijalno upravljanje licenciranjem roba I usluga za druge; Pružanje poslovnih informacija putem web stranice; Pružanje on-line tržišta za kupce i prodavce roba i usluga; Usluge preseljenja poslovnog sjedišta.

-----  
(210) 2018-124

(442) 20.01.2019

(220) 4/20/2018

(731) ROHTO PHARMACEUTICAL CO., LTD., 1-8-1, Tatsumi-nishi, Ikuno-ku Osaka-shi, Osaka 544-8666  
Japan, ;

**ROHTO**  
**Perfecta**  
WARSAW TOKYO NEW YORK

(540)

(550) I,F

(740) Popović Miladin, Đoka Miraševića 21/III, Podgorica ME

(511) **Klasa 03:** Kozmetika; kozmetički setovi ; kozmetički preparati za njegu kože; preparati za uklanjanje šminke; preparati za šminkanje; kreme za izbjeljivanje kože; maske za uljepšavanje; sapun; šamponi; antiperspiranti; preparati za zaštitu od sunca; sjajevi za usne; kupke za tijelo; dezodoransi za ljudska bica ili za životinje.;

-----  
(210) 2018-125

(442) 20.01.2019

(220) 4/20/2018

(731) Pfizer Inc., 235 East 42nd Street, New York, NY 10017, U.S.A., ;

(540) IBRANCE

(550) I

(740) Jusić Jasna, Dalmatinska 2, Podgorica ME

(511) **Klasa 05:** Farmaceutski, medicinski i veterinarski preparati; sanitarni preparati za medicinske svrhe; dijetetska hrana i supstance prilagodene medicinskoj ili veterinarskoj upotrebi; hrana za bebe; dijetetski suplementi za ljude i životinje; flasteri; materijali za zavijanje; materijali za plombiranje zuba, zubarska smola; dezinfekciona sredstva; preparati za uništavanje štetocina; fungicidi, herbicidi.;

---

(210) 2018-126

(442) 20.01.2019

(220) 4/20/2018

(731) Monster Energy Company, a Delaware corporation, 1, Monster Way, Corona, California 92879, US, ;

(540) RULE YOUR KINGDOM!

(550) I

(740) Radulovic Božidar, Podgorica, Studenska bb, Lamela 3/18;

(511) **Klasa 32:** Bezalkoholna pića, uključujući gazirana pica i energetska pica; sirupi, koncentracije, praskasti preparati i drugi preparati za proizvodnju pica, uključujući gazirana pica i energetska pica; pivo.;

---

(210) 2018-127

(442) 20.01.2019

(220) 4/23/2018

(731) Vitinka AD Zvornik, Drinska dva, br. 30, 75413 Kozluk, RS, BiH, ;



(540)

(550) I,F

(740) Advokatska kancelarija Prelević OD, Bulevar Svetog Petra Cetinjskog 130/VII Podgorica ME

(511) **Klasa 32:** Pivo; mineralne i gazirane vode te ostala Bezalkoholna pića; vocni napici i vocni sokovi; sirupi i ostali preparati za pripremanje napitaka.;

---

(210) 2018-128

(442) 20.01.2019

(220) 4/23/2018

(731) Pharmaceutical chemical cosmetic industry ALKALOID AD Skopje, Blvd. Aleksandar Makedonski 12  
1000 Skopje Republika Makedonija, ;

(540) CRICEA

(550) I,V

(740) Popović Miladin, Đoka Miraševića 21/III, Podgorica ME

(511) **Klasa 05:** Hormonska kontraceptivna sredstva.;

---

(210) 2018-129

(442) 20.01.2019

(220) 4/23/2018

(731) Pharmaceutical chemical cosmetic industry ALKALOID AD Skopje, Blvd. Aleksandar Makedonski 12  
1000 Skopje Republika Makedonija, ;

(540) CRYPINEO

(550) I,V

(740) Popović Miladin, Đoka Miraševića 21/III, Podgorica ME

(511) **Klasa 05:** Farmaceutski preparati.;

---

(210) 2018-130

(442) 20.01.2019

(220) 4/24/2018

(731) Bosnalijek, farmaceutska i hemijska industrija, dioničko društvo, Jukićeva 53, 71000 Sarajevo ,  
Bosna i Hercegovina, BA, ;

(540) DOLOREX

(550) I,V

(740) Radulovic Božidar, Podgorica, Studenska bb,Lamela 3/18;

(511) **Klasa 05:** Farmaceutski proizvodi.

**OBJAVA ŽIGOVA**  
PUBLICATION OF TRADEMARKS

(111) **13746**

(151) 29.01.2018

(210) **2016-448**

(442) 20.06.2017.

(220) 11.2.2016

(731) **WM. WRIGLEY JR. COMPANY**, 1132 WEST BLACKHAWK STREET,  
CHICAGO, ILLINOIS 60642 US

(540) **TRUTH OR DARE**

(550) I

(740) Jusić Jasna, Crnogorskih serdara bb, Podgorica ME

(511) **Klasa 30:** Poslastice, žvakaće gume, žvakaće gume od kojih mogu da se prave veliki baloni, bombone, dražeje pepermint, mali okrugli bomboni (drops) i pastile;

-----  
(111) **13948**

(151) 08.06.2018.

(210) **2017-25**

(442) 20.10.2017

(220) 23.01.2017

(732) Sava Car DOO Dr Vukašina Markovića 184, Podgorica ME



(540)

(550) I

(511) **Klasa 42:** naučne i tehnološke usluge kao i pripadajuće usluge istraživanja i koncepcije; usluge industrijskih analiza i istraživanja; koncepcija i razvoj računara i računarskih programa /hardvera i softvera/, koncepcija i razvoj računara i računarskih programa /hardvera i softvera.

---

(111) **13946**

(151) 08.06.2018.

(210) **2017-24**

(442) 20.10.2017

(220) 23.01.2017

(732) Društvo za zastupanje u osiguranju Sava Agent DOO, Podgorica ME



(540)

(550) I

(511) **Klasa 36:** osiguranje; finansijski poslovi; monetarni poslovi; upravljanje nekretninama.

---

(111) **13947**

(151) 08.06.2018.

(210) **2017-23**

(442) 20.10.2017

(220) 23.01.2017

(732) Društvo za zastupanje u osiguranju Sava Agent DOO, Podgorica ME



(540)

(550) I

(511) **Klasa 36:** osiguranje; finansijski poslovi; monetarni poslovi; upravljanje nekretninama.

---

(111) **13952**

(151) 13.06.2018.

(210) **2017-118**

(442) 20.10.2017

(220) 24.03.2017

(732) Idealism Industries FZE P.O. Box 31291, Al Jazeera Al Hamra, Ras Al Khaimah AE

(540) **COCOAL**

(550) I,V

(740) Radulović Božidar, Studentska bb, Lamela 3/18, Podgorica ME

(511) **Klasa 04:** Drveni ugalj, briketi drvenog uglja

---

(111) **13951**

(151) 13.06.2018.

(210) **2017-116**

(442) 20.10.2017

(220) 24.03.2017

(732) Idealism Industries FZE P.O. Box 31291, Al Jazeera Al Hamra, Ras Al Khaimah AE

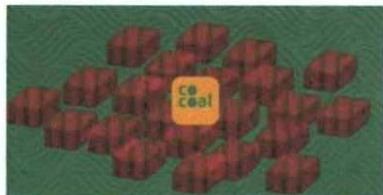

(540)

(550) I

(740) Radulović Božidar, Studentska bb, Lamela 3/18, Podgorica ME

(511) **Klasa 04:** Drveni ugalj, briketi drvenog uglja

---

(111) **13950**

(151) 13.06.2018.

(210) **2017-117**

(442) 20.10.2017

(220) 24.03.2017

(732) Idealism Industries FZE P.O. Box 31291, Al Jazeera Al Hamra, Ras Al Khaimah AE

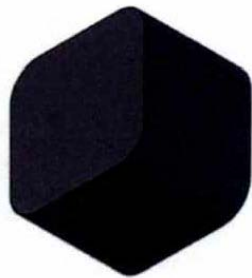

(540)

(550) I

(740) Radulović Božidar, Studentska bb, Lamela 3/18, Podgorica ME

(511) **Klasa 04:** Drveni ugalj, briketi drvenog uglja

---

(111) **13871**

(151) 26.04.2018.

(210) **2015-370**

(442) 20.10.2017

(220) 23.09.2015

(732) Društvo za proizvodstvo, promet i uslugi VIVAKS Risto i drugi DOO uvoz-izvoz Skopje UI.  
Treta Makedonska Brigada bb, 1000 Skopje MK

(540) **VIVA**

(550) I,V

(740) Rončević Milena, Bulevar Svetog Petra Cetinjskog 130/VII, Podgorica ME

(511) **Klasa 29:** Meso, riba, živina i divljač; mesne prerađevine; konzervisano, zamrznuto, sušeno i kuvano voće i povrće; želei, džemovi, kompoti; jaja, mleko i mlečni proizvodi; jestiva ulja i masti.

**Klasa 30:** Kafa, čaj, kakao i zamena kafe; pirinač; tapioka i sago; brašno i proizvodi od žitarica; hleb, kolači i poslastice; sladoledi; šećer, med, melasa; kvasac, prašak za pecivo; so; senf; sirće, sosovi (kao dodaci); začini; led.

**Klasa 32:** Pivo; mineralne i sodne vode i druga bezalkoholna pića; voćni napici i voćni sokovi; sirupi i drugi preparati za proizvodnju pića.



(111) **13868**

(151) 26.04.2018.

(210) **2017-140**

(442) 20.10.2017

(220) 13.04.2017

(732) Amanresorts Limited 25th Floor, Jardine House, 1 Connaught Place, Central, Hong Kong HK

(540) **JANU**

(550) V

(740) Rončević Milena, Bulevar Svetog Petra Cetinjskog 130/VII, Podgorica ME

(511) **Klasa 03:** Sapuni, parfimerija, eterična ulja, kreme (ne-medicinske) za upotrebu na koži, kozmetika, soli za kupanje, proizvodi za njegu tela (ne-medicinski), losioni za kosu, sredstva za njegu kose, proizvodi za njegu kože, tamjan, ulja za tijelo i kosu, preparati za njegu kože (ne-medicinski).

**Klasa 09:** Elektronske publikacije (koje se mogu preuzeti); štampane publikacije koje se mogu čitati u elektronskoj formi; publikacije koje se mogu mašinski čitati, snimanje zvuka i videa, dekorativni magneti, digitalni fotografski ramovi, naočare za sunce, kaiševi za kamere, futrole za elektronske uređaje.

**Klasa 16:** Štampani materijal; štampane publikacije; periodične publikacije; periodične publikacije u vezi sa putovanjima; pamfleti; knjige; magazine (štampane publikacije); magazine u vezi putovanja; vodiči, vodič-leci; vodič-magazini, vodič-pamfleti; štampane knjige u vezi putovanja i turistički vodiči; pribor za pisanje; instrumenti za pisanje; ukrasni papir za poklone; papirne maramice; držači za pasoše; kutije od papira ili kartona; materijal za pakovanje od papira ili plastike; papir za dekorisanje stola; slike; fotografije ili albumi za fotografije; papirne oznake.

**Klasa 25:** Odjevni artikli, majice sa kratkim rukavima, čarape, donji veš, ženske čarape, obuća i pokrivala za glavu.

**Klasa 35:** Usluge reklamiranja; usluge maloprodaje; usluge maloprodaje (odnosno usluge prezentacije proizvoda na medijima); usluge maloprodaje u vezi sa namještajem; poslovno upravljanje hotelima; usluge upravljanja hotelima za druge; upravljanje rizort klubovima; konsultantske usluge u vezi poslovnog upravljanja i organizacije; usluge poslovnog savjetovanja u vezi sa marketingom; poslovna administracija; usluge organizacije i upravljanje programima lojalnosti klijenata; usluge komercijalne administracije za licenciranje proizvoda i usluga za druge; usluge organizovanja izložbi za komercijalne svrhe i usluge reklamiranja; usluge ličnog upravljanja agencijama; kancelarijska poslovanje.

**Klasa 36:** Usluge prometa nepokretnosti vezane za razvoj u oblasti nepokretnosti i imovine; usluge agencija za promet rezidencijalnih nepokretnosti; uređivanje zajedničkog vlasništva na nepokretnostima; usluge upravljanja nepokretnostima koje se odnose na transakcije nepokretne imovine; usluge smještaja u kućama a naročito usluge akvizicije nepokretnosti; usluge agencije za izdavanja smještaja; usluge davanja informacija u vezi sa nepokretnom imovinom: usluge agencija za lizing nepokretne imovine, davanje u zakup nepokretnosti; usluge agencije za prodaju nepokretnosti uz proviziju; konsultantske usluge u oblasti nepokretne imovine; usluge agencije za nepokretnosti; usluge posredovanja u prometu nepokretnosti; upravljanje nepokretnostima; upravljanje stambenim zgradama; procjena nepokretnosti; usluge investiranja u nepokretnosti.

**Klasa 37:** Usluge razvoja nepokretnosti; usluge razvoja imovine; usluge izgradnje zgrada; konsultantske usluge u vezi zgrada; usluge izgradnja apartmana i kuća; usluge upravljanja projektima u vezi izgradnje: usluge popravljivanja i renoviranja zgrada; usluge konstrukcije zgrada; nadgledanje izgradnje zgrada; razvoj imovine; usluge održavanja imovine; usluge preuređenja enterijera zgrada.

**Klasa 39:** Organizovanje krstarenja; usluge rezervisanja krstarenja; usluge koje se pružaju na brodu za krstarenje; pružanje usluga krstarenja na jahtama i drugim vrstama brodova; usluge turističkog vodiča; rezervacija sjedišta za putovanja; rezervacija putovanja; prevoz putnika; šoferske usluge; iznajmljivanje automobila; usluge parkiranja automobila; usluge putničkih agencija; organizovanje tura i prevoza; organ izovanje putovanja i tura sa razgledanjem znamenitosti; usluge agencija za organizovanje putovanja.

**Klasa 41:** Organizovanje rekreativnih aktivnosti, zabava društvenih događaja; stavljanje na raspolaganje prostorija opreme rekreativnim klubovima; iznajmljivanje audiovizuelne opreme; edukativne i nastavne usluge u oblasti umjetnosti, zanata, kulture i sporta; stavljanje na raspolaganje prostorija i opreme zdravstvenim i sportskim klubovima; stavljanje na raspolaganje prostorija i opreme za teretane; pružanje usluga zdravstvenih i fitness klubova; stavljanje na raspolaganje prostorija i opreme za jogu i pilates; usluge bazena; usluge društvenih klubova; usluge klubova za razonodu i obrazovanje; organizovanje i vođenje konferencija, seminara i izložbi u kulturne, edukativne i zabavne svrhe; usluge umjetničkih galerija i usluga izložbu u kulturne i edukativne svrhe; infonnacione i savjetodavne usluge u vezi sa svim gore navedenim uslugama; usluge omogućavanja korišćenja elektronskih publikacija, koje se ne mogu preuzimati: izdavanje časopisa; usluge omogućavanja korišćenja elektronskih publikacija o putovanjima, koje se ne mogu preuzimati; usluge fotografisanja; pružanje informacija o razonodi elektronskim putem iz računarske baze ili sa interneta, koje spadaju u navedenu klasu

**Klasa 43:** Hoteli; hotelske usluge; usluge hotelskog keteringa; usluge hotelskog smještaja; pružanje usluga privremenog smještaja; usluge hotelskih restorana; restorani; restoranske usluge; kafići; kafeterije; snek-barovi; barovi; ketering hrane i pića; rezervacije privremenog smještaja: iznajmljivanje sala za sastanke; iznajmljivanje soba, šatora paviljona za društvene funkcije; obezbjeđivanje konferencijskih prostorija; usluge rezervacije za hotele; informacije u vezi sa hotelima; usluge elektronskih informacija u vezi sa hotelima; pružanje informacija i usluga rezervacija za hotele putem interneta; rezervacija hotelskog smještaja i restoranske usluge; usluge putničkih agencija za rezervisanje hotelskog smještaja; planiranje odmora (smještaj), informacije, usluge savjetovanja konsultacije u vezi sa svim gore navedenim uslugama.

**Klasa 44:** Pružanje spa usluga; banjske usluge; sauna; solarijum i objekti za sunčanje; usluge masaže; zdravstvena njega u vezi sa terapijskom masažom; usluge zdravstvene njege; usluge za njegu kože; usluge tretmana ljepote; usluge za njegu kose; usluge pedikira i manikira; saloni za ljepotu; frizerski saloni; zdravstvene usluge dij etetičara i nutricionista; usluge medicinskih analiza; usluge medicinskih banja; informacije, usluge savjetovanja i konsultacije u vezi sa svim gore navedenim uslugama.

-----  
(111)     **13959**

(151) 14.06.2018.

(210) **2017-35**

(442) 20.10.2017

(220) 31.01.2017

(732) Techtronic Power Tools Technology Limited Trident Chambers, P.O. Box 146, Road Town, Tortola VG



(540)

(550) I,V

(740) Jusić Jasna, Crnogorskih serdara bb, Podgorica ME

(511) **Klasa 09:** Aparati i instrumenti naučni, pomorski, geodetski, fotografski, kinematografski, optički, za vaganje, mjerenje, signalizaciju, kontrolu (inspekciju), spasavanje i nastavu; aparati i instrumenti za provođenje, prekid, transformaciju, akumulaciju, regulisanje ili kontrolu električne energije; aparati za snimanje, prenosi reprodukovanje zvuka ili slike; magnetni nosači podataka, diskovi za snimanje; kompakt diskovi, DVD i drugi digitalni nosači podataka; mehanizmi za aparate koji se pokreću novcem; registar kase, računске mašine, oprema za obradu podataka, računari; računarski softver; aparati za gašenje požara; baterije, električne; baterije za osvjetljavanje; kutije za baterije; punjači baterija; kablovi, električni; fotografska kamera; stolarski lenjiri; kutije specijalno napravljene za fotografske aparate i instrumente; reduktori, oslabljivači (za struju); odjeća za zaštitu od nesreća, radijacije i požara; aparati za mjerenje razdaljine; aparati za mjerenje udaljenosti; kutije za naočare; lančići za naočare; ramovi za naočare; naočare; blicevi (fotografski); aparati za analizu hrane; rukavice za zaštitu od nesreća; sportske naočare; slušalice; aparati i oprema za spašavanje života; brave, električne; zvučnici; mjerači (instrumenti za mjerenje); mjerni instrumenti, električni; metri; zaštitni šlemovi; radio aparati; lenjiri (mjerni instrumenti); mjerne kašike; aparati i instrumenti za mjerenje težine; grejne jakne i grijači za šake; kompaktni prenosivi punjači; mjerni laseri; MP3 plejeri; termalne kamere; kamere za inspekciju; mjerna kliješta; laser; infracrveni termometri; testeri sa fluorescentnom svjetlošću; detektori napona; djelovi i oprema za gore navedenu robu.

-----  
(111) **13960**

(151) 14.06.2018.

(210) **2017-22**

(442) 20.10.2017

(220) 20.01.2017

(732) LINPAC Group Holdings Limited LINPAC Wakefield Road, Featherstone, Pontefract, West Yorkshire, WF7 5DE GB



(540)

(550) I

(740) Jusić Jasna, Crnogorskih serdara bb, Podgorica ME

(511) **Klasa 16:** Materijali za umotavanje i pakovanje, materijali za pakovanje od pjenastih plastičnih masa, papir za pakovanje, trake za pakovanje, omoti za pakovanje, materijali za pakovanje od papira, materijali za pakovanje napravljeni od kartona, papirnih naljepnica, papirnih oznaka, plastičnih naljepnica; materijal za pakovanje od papira i plastike; ljepljiva i kohezivni materijali za pakovanje; oksidirane folije za pakovanje; providne folije za pakovanje; plastične folije za pakovanje; papir i proizvodi od papira; papir za pečenje; papirne šolje za pečenje, karton ili kartonske kutije; valoviti papir i proizvodi od kartona; posude; plastična folija; proizvodi za pakovanje od papira; premazani papir i folije; kohezivna pakovanja

**Klasa 17:** Plastični proizvodi koji se koriste u proizvodnji ambalaže za hranu; plastični pjenasti materijali za primjenu u ambalaži za hranu; plastične folije i ploče koje se koriste u proizvodnji ambalaže za pakovanje; plastični proizvodi koji se koriste u proizvodnji ambalaže od materijala koji se mogu lijepiti i koji su samoljepljivi; termoplastične ploče koje se koriste za ambalaže za pakovanje; plastične folije i materijali za plastične ploče; plastična folija, osim za umotavanje.

**Klasa 20:** Plastične tacne; posude za pakovanje izrađene od ili uglavnom od plastičnih materijala, a sve što je prikladno za pakovanje hrane; plastični dijelovi za posude za pakovanje, sve što je prikladno za pakovanje hrane; plastične posude, sve što je prikladno za pakovanje hrane; plastične tacne koje se koriste za pakovanje hrane; kutije, tacne, gajbe, palete i posude, a sve uglavnom napravljene od plastičnih materijala, i sve što je prikladno za pakovanje hrane; prozirne tacne za hranu izrađene od plastike ili pjenaste plastike za upotrebu u komercijalne svrhe; školjke za jaja izrađene od plastike; plastične kutije za pakovanje hrane.

**Klasa 21:** Posude uključene u klasu 21 napravljene od plastičnih materijala, a sve što je prikladno za pakovanje hrane; posude uključene u klasu 21 napravljene od pjenastih plastičnih materijala, a sve što je prikladno za pakovanje hrane; tacne kao pakovanja za kompletne obroke; plastične kutije za pakovanje hrane; pjenaste plastične tacne za hranu; posuđe za kuvanje hrane; posude za upotrebu u domaćinstvu napravljene od plastičnih materijala, a sve što je prikladno za pakovanje hrane; posude za upotrebu u domaćinstvu napravljene od pjenastih plastičnih materijala, a sve što je prikladno za pakovanje hrane; posude za hranu i piće; toplotno izolovane posude; toplotno izolovane posude za hranu; termički izolovane posude za hranu.

---

(111) **13961**

(151) 14.06.2018.

(210) **2017-45**

(210) **2017-45**

(442) 20.10.2017

(220) 06.02.2017

(732) Nissan Jidosha Kabushiki Kaisha (also trading as Nissan Motor Co., Ltd.) No.2, Takara-cho, Kanagawa-ku, Yokohama-shi, Kanagawa-ken JP



(540)

(550) I,F

(740) MSA IP Milojević Sekulić, Karađorđeva 65, Beograd SR

(511) **Klasa 35:** Oglašavanje; vođenje poslova; poslovno upravljanje; kancelarijski poslovi; usluge maloprodaje i veleprodaje vozila i strukturnih delova i opreme za vozila; usluge trgovine vozilima; promocija prodaje za druge; prikupljanje informacija u kompjuterske baze podataka; sistemacija informacija u kompjuterskim bazama podataka; oglašavanje i reklamne usluge za vozila; usluge agencija za uvoz i izvoz; pružanje informacija u vezi sa kopnenim vozilima, naime, pružanje informacija o proizvodima za potrošače i poređenju cena; usluge pružanja informacija, naime, usluge pružanja informacija o poređenju cena u oblasti goriva; pružanje komercijalnih saveta i informacija potrošačima [centar za pružanje saveta potrošačima]; upravljanje programima lojalnosti potrošača; organizovanje izložbi za privredne ili reklamne potrebe; organizovanje sajмова u komercijalne ili reklamne svrhe.

**Klasa 36:** Osiguranje; finansijski poslovi; novčani [monetarni] poslovi; poslovi vezani za nepokretnosti; osiguranje od posledica nesrećnog slučaja; usluge posredovanja prilikom kupovine robe na otplatu; pružanje usluga kreditnih i gotovinskih kartica; usluge pružanja finansijskih informacija; finansijske usluge; izdavanje kreditnih kartica; usluge procene vrednosti polovnih automobila; osiguranje kopnenih vozila; pružanje sveobuhvatnih jemstvenih usluga za kopnena vozila, njihovih strukturnih delova i opreme; pružanje usluga osiguranja u periodu produžene garancije; faktoring; usluge pozajmljivanja uz založno obezbeđenje; finansiranje zajmova; usluge finansiranja lizinga za automobile; lizing vozila; pružanje usluga debitnih kartica.

---

(111) **13962**

(151) 14.06.2018.

(210) **2017-46**

(442) 20.10.2017

(220) 06.02.2017

(732) Nissan Jidosha Kabushiki Kaisha (also trading as Nissan Motor Co., Ltd.) No.2, Takara-cho, Kanagawa-ku, Yokohama-shi, Kanagawa-ken JP

# NISSAN

(540)

(550) I,F

(740) MSA IP Milojević Sekulić, Karađorđeva 65, Beograd SR

(511) **Klasa 35:** Oglašavanje; vođenje poslova; poslovno upravljanje; kancelarijski poslovi; usluge maloprodaje i veleprodaje vozila i strukturnih delova i opreme za vozila; usluge trgovine vozilima; promocija prodaje za druge; prikupljanje informacija u kompjuterske baze podataka; sistemacija informacija u kompjuterskim bazama podataka; oglašavanje i reklamne usluge za vozila; usluge agencija za uvoz i izvoz; pružanje informacija u vezi sa kopnenim vozilima, naime, pružanje informacija o proizvodima za potrošače i poređenju cena; usluge pružanja informacija, naime, usluge pružanja informacija o poređenju cena u oblasti goriva; pružanje komercijalnih saveta i informacija potrošačima [centar za pružanje saveta potrošačima]; upravljanje programima lojalnosti potrošača; organizovanje izložbi za privredne ili reklamne potrebe; organizovanje sajмова u komercijalne ili reklamne svrhe.

**Klasa 36:** Osiguranje; finansijski poslovi; novčani [monetarni] poslovi; poslovi vezani za nepokretnosti; osiguranje od posledica nesrećnog slučaja; usluge posredovanja prilikom kupovine robe na otplatu; pružanje usluga kreditnih i gotovinskih kartica; usluge pružanja finansijskih informacija; finansijske usluge; izdavanje kreditnih kartica; usluge procene vrednosti polovnih automobila; osiguranje kopnenih vozila; pružanje sveobuhvatnih jemstvenih usluga za kopnena vozila, njihovih strukturnih delova i opreme; pružanje usluga osiguranja u periodu produžene garancije; faktoring; usluge pozajmljivanja uz založno obezbeđenje; finansiranje zajmova; usluge finansiranja lizinga za automobile; lizing vozila; pružanje usluga debitnih kartica.

-----  
(111) **13909**

(151) 08.05.2018.

(210) **2017-30**

(442) 20.10.2017

(220) 25.01.2017

(732) Colgate-Palmolive Company, a Delaware corporation 300 Park Avenue, New York, N.Y. 10022 US

(540) COLGATE PROFESSIONAL LAB SERIES

(550) I,V

(740) Rončević Milena, Bulevar Svetog Petra Cetinjskog 130/VII, Podgorica ME

(511) **Klasa 21:** Četkice za zube.

---

(111) **13870**

(151) 26.04.2018.

(210) **2016-535**

(442) 20.10.2017

(220) 22.12.2016

(732) Colgate-Palmolive Company, a Delaware corporation 300 Park Avenue, New York, NY 10022  
US



(540)

(550) I,F

(740) Rončević Milena, Bulevar Svetog Petra Cetinjskog 130/VII, Podgorica ME

(511) **Klasa 03:** Paste za zube i tečnost za ispiranje usta

---

(111) **13770**

(151) 29.01.2018

(210) **2016-455**

(210) 2016-455

(442) 20.06.2017.

(220) 11.4.2016

(731) **HYUNDAI MOTOR COMPANY**, 231 YANGJAE-DONG, SEOCHO-GU,  
SEOUL RS

(540) **Hyundai Smart Sense**

(550) I,V

(740) AOD "Ćupić", Dalmatinska 10, Podgorica ME

(511) **Klasa 09:** Kompjuterski hardver za automobile; kompjuterski softver za automobile; softver za GPS navigacione sisteme; prijemni komunikacioni aparati koji se mogu pričvrstiti u automobilu; OBD dijagnostički aparati za automobile; auto navigacija; aparati za daljinski nadzor; automatski aparati za kontrolu brzine vozila; elektronski kontrolni sistemi za suvozemna vozila; aparati za upozoravanje na opasnost od nalijetanja na vozilo ispred; elektronske kontrolne jedinice; kamere za automobile; senzori za detekciju pokreta; senzori akceleracije; mjerni senzori ubrzanja za automobile; senzori rastojanja; mjerni uređaji za utvrđivanje rastojanja između automobila; senzori bočnog rastojanja za automobile; bočni

sigurnosni senzori za automobile; elektronske table za obavještanje; kontrolni aparati za elektronske automobilske senzore; radarski senzori za procesor signala automobilskog senzora i kontrolni aparati; automobilski elektronski uređaji za kočenje za slučaj nužde; elektronski aparati za kontrolu brzine za automobile; elektronski aparati za automobile koji pomažu prilikom vožnje; elektronski aparati za automobile koji pomažu pri parkiranju; digitalni procesori informacija; električni aparati za sigurnosni nadzor.;

---

(111) **13930**

(151) 10.05.2018.

(210) **2016-254**

(442) 20.10.2017

(220) 17.06.2016

(732) Colgate-Palmolive Company, a Delaware corporation 300 Park Avenue, New York, N.Y. 10022, US

(540) **AJAX OPTIMAL 7**

(550) I,V

(740) Rončević Milena, Bulevar Svetog Petra Cetinjskog 130/VII, Podgorica ME

(511) **Klasa 03:** Sredstva za bijeljenje i druge supstance za upotrebu u perionicama; preparati za čišćenje, poliranje, ribanje i abrazivni preparati; sapuni; parfimerija, eterična ulja, kozmetika, losioni za kosu; paste za zube.

---

(111) **13953**

(151) 13.06.2018.

(210) **2017-115**

(442) 20.10.2017

(220) 24.03.2017

(732) Under Control Commercial Brokerage L.L.C Office 1202, owned by Al Sheikh Batty Al Maktom, Deira, Riqqat Al Buttain, Dubai AE



(540)

(550) I

(740) Radulović Božidar, Studentska bb, Lamela 3/18, Podgorica ME

(511) **Klasa 34:** Duvan; artikli za pušače; šibice.



(111) **13940**  
(151) 18.05.2018.  
(210) **2016-453**  
(442) 20.10.2017  
(220) 04.11.2016  
(732) Simo Mugoša, Lješkopoljska 88, Podgorica ME

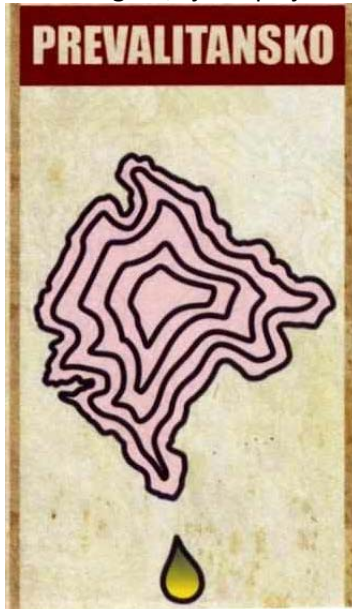

(540)

(550) F

(511) **Klasa 29:** masline, konzervisane, maslinovo ulje za ishranu.

---

(111) **13941**  
(151) 18.05.2018.  
(210) **2016-454**  
(442) 20.10.2017  
(220) 04.11.2016  
(732) Simo Mugoša, Lješkopoljska 88, Podgorica ME



(540)

(511) **Klasa 29:** masline, konzervisane, maslinovo ulje za ishranu.

(111) **13949**

(151) 08.06.2018.

(210) **2016-474**

(442) 20.10.2017

(220) 16.11.2016

(732) Vuković Predrag, Bijeli Do bb, Budva ME



(540)

(550) I,F

(511) **Klasa 35:** Agencija uvoz-izvoz, marketing, nabavka za treće, reklamiranje, sajtovi, vođenje knjiga, prodaja namještaja, vozila.

**Klasa 36:** Kompezacijski poslovi, stanovi za iznajmljivanje, upravljanje.

**Klasa 37:** Automobili održavanje, gume za točkove, zamjena guma, poliranje vozila, čišćenje vozila, unutrašnjosti zgrada, fasada, ranje automobila, vozila, vulkaniziranje.

**Klasa 39:** Cvijeće, isporuka cvijeća, isporuka robe, proizvodnja paketa, preseljenje pokretne imovine, prevoz i selidba, turistička agencija, iznajmljivanje atomobila, vozila, brodova, lična vozila, iznajmljivanje vozića, prevoz ličnim vozićima, organizovanje krstarenja, odlaganje robe, pakovanje proizvoda, putovanja, taxi usluge.

**Klasa 41:** Usluge diskoteka, iznajmljivanje dekoratera za priredbe, noćni klubovi, organizovanje i vođenje konferencija, kongresa, seminara, ljetovanja, usluge kockarnice, organizovanje lutrije, organizovanje kongresa, izleta, putovanja

**Klasa 42:** Tehnička kontrola vozila

**Klasa 43:** Ugostitelji, agencija za smještaj (hotelski smještaj), usluga barova, hotelske usluge, hotelske rezervacije, iznajmljivanje privremeng smještaja, kafane, restorani, ljetovanja, pansioni, privredni smještaj, rezervacije, smještaj

---

(111) **13939**  
(151) 16.05.2018.  
(210) **2016-475**  
(442) 20.10.2017  
(220) 17.11.2016  
(732) "Synergy Development" doo, Tivat ME  
(540) mne.today (#mnetoday)  
(550) I  
(740) Boris Žujović, Nikšić ME  
(511) **Klasa 35:** Usluge se odnose na internet magazin.

---

(111) **13864**  
(151) 25.04.2018.  
(210) **2017-97**  
(442) 20.10.2017  
(220) 15.03.2017  
(732) "NTC" D.O.O. Ulica Veselina Masleše broj 13, Nikšić ME



(540)  
(550) I  
(740) Milačić Dražen, ul. 13. Jula 3, Podgorica ME  
(511) **Klasa 03:** Preparati za bijeljenje i ostale materije za pranje rublja; preparati za čišćenje, poliranje, odmazivanje i struganje; sapuni; parfimi merijski proizvodi, eterrena ulja, kozmetički proizvodi, losioni za kosu; proizvodi za njegu zuba.

---

(111) **13875**  
(151) 27.04.2018.  
(210) **2016-555**  
(442) 20.10.2017  
(220) 28.12.2016  
(732) "VUČJE" d.o.o. Glibavac bb. Nikšić ME



(540)

(550) I

(740) Milačić Dražen, ul. 13. Jula 3, Podgorica ME

(511) **Klasa 08:** ručni alati i sprave sa ručnim pokretanjem; pribor zajelo; hladno oružje; mehaničke i elektronske sprave za brijanje, noževe, viljuške i kašike od plemenitih metala; mehaničke i elektronske brijače sprave, elektronske šišače (ručne sprave) i makaze za nokte.

**Klasa 29:** meso, riba, živina i divljač; mesni ekstrakti; konzervirano, sušeno i kuvano voće i povrće; želei, džemovi, kompoti; jaja, mlijeko i mliječni proizvodi; jestiva ulja i masti.

**Klasa 30:** kafa, čaj, kakao, šećer, riža, tapioka, sago, zamjene za kafu; brašno i proizvodi od žitarica, hleb, kolači, poslastice, bomboni, sladoled; med, sirup od melase; kvasac, prašak za pecivo; so, senf; sirće, prelivni začini, razni začini led za hlađenje, napitke od kave, kakaoa ili čokolade ili čaja; žitarice pripremljene za ljudsku prehranu (na primjer: ovsene pahuljice ili pahuljice od drugih žitarica).

**Klasa 32:** pivo; mineralne i gazirane vode i ostala bezalkoholna pića; pića od voća i voćni sokovi; sirupi i ostali preparati za pripremanje napitaka, bezalkoholna pića

**Klasa 33:** alkoholna pića (osim piva).

**Klasa 34:** duvan; pribor za pušače; šibice.zamjene duvana (za nemedicinske potrebe).

**Klasa 35:** oglašavanje i reklamiranje; vođenje komercijalnih poslova; komercijalna administracija; kancelarijski poslovi, usluge koje se odnose na registraciju, prijepis, sastavljanje, kompilaciju ili sistematizaciju pisanih saopštenja i zapisa kao i obradu ili kompilaciju matematičkih ili statističkih podataka, usluge agencija za oglašavanje kao i usluge distribuiranja prospekata direktno ili poštom ili distribuiranje uzoraka. Ova se klasa može odnositi i na oglašavanja u vezi s drugim uslugama kao što su usluge u vezi bankarskih zajmova i oglašavanja putem radija; sortiranje za račun drugih osoba, raznih proizvoda (ne uključuje njihov prevoz) radi omogućavanja potrošaču njihovog lakšeg razgledanja i kupovine; ove usluge se mogu pružati u okviru prodavnica na malo, trgovina na veliko, posredstvom prodajnih kataloga, dopisno ili elektronskim putem, na primjer posredstvom weba ili putem telefona.

**Klasa 39:** prevoz; ambalažiranje i skladištenje proizvoda; organizovanje putovanja usluge kompanija koje iskorištavaju (eksploatišu) stanice, mostove, pretovarne mostove (trajekti za vozove) koje koristi prevoznik; usluge iznajmljivanja prevoznih sredstava; usluge pomorskog tegljenja, istovara, rada luka i pristaništa, kao i spašavanja brodova i njihovoga tereta pri brodolomu; usluge ambalažiranja i pakovanja robe prije otpreme; usluge obavještanja o putovanjima ili prevozu robe preko posrednika ili turističkih agencija; usluge obavještanja o cijeni prevoza, voznom redu i o načinu prevoza; usluge pregleda (kontrole) vozila ili robe prije prevoza.

**Klasa 43:** usluge obezbjeđi vanja hrane i pića; privremeno primanje na stan, usluge rezervisanja smještaja za putnike, koje pružaju putničke agencije ili posrednici; usluge pansiona za životinje.

---

(111) **14091**

(151) 25.10.2018.

(210) **2017-353**

(220) 30.08.2017

(442) 20.04.2018.

(732) Marko Klepić Ul.Bratstva i jedinstva br.6, 5/5 Podgorica ME



(540)

(550)

(740) I;F

(511) **Klasa 41:** Dječiji hor "ZVJEZDICE", usluge koje pružaju sve vrste edukacije i obuke lica djece (obrazovanje), usluge kojima je osnovni cilj priprema i realizacija (probe, snimanje dječje muzike, koncertna aktivnost) u cilju edukacije, obuke i obrazovanja djece, kao i zabavljanje drugih lica, snimanje dječije muzike (audio-video), instrument alne i vokalne dječijeg hora zvezdice.

-----  
(111) **14146**

(151) 23.11.2018.

(210) **2017-90**

(220) 13.03.2017

(442) 20.04.2018.

(732) L'OREAL 14 Rue Royale, 75008 PARIS, FR

## BOTANIC THERAPY

(540)

(550) I, V

(740) AOD "Ćupić", Dalmatinska 10, Podgorica ME

(511) **Klasa 03:** Preparati za njegu kose i kože.

-----  
(111) **14114**

(151) 07.11.2018.

(210) **2017-152**

(442) 20.10.2017

(220) 20.04.2017

(732) PLIVAČKI VATERPOLO KLUB JADRAN Šetalište pet Danica 34 85340 Herceg Novi ME

(540) **PLIVAČKI VATERPOLO KLUB JADRAN HERCEG NOVI**

(550) V

(511) **Klasa 35:** Reklamiranje i oglašavanje, vođenje komercijalnih poslova

**Klasa 41:** Sportske i kulturne djelatnosti, razonoda i rekreacija, organizovanje sportskih događaja

---

(111) **14097**

(151) 07.11.2018.

(210) **2016-43**

(442) 20.06.2016

(220) 2/4/2016

(732) BOMVAS DOO, Orja Luka bb, Danilovgrad ME

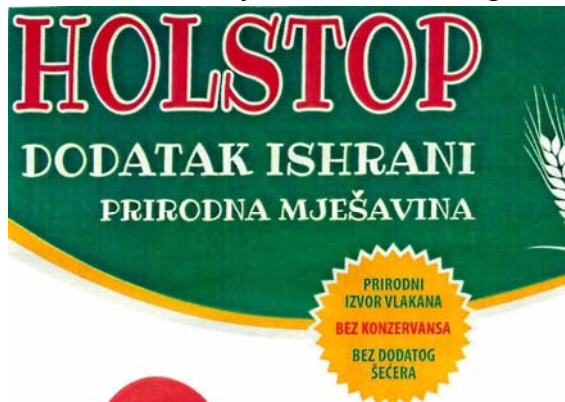

(540)

(550) I, V, F

(511) **Klasa 05:** dodaci prehrani i dijetetski preparati; zamjena za obroke; dijetalna hrana, laneno sjeme kao dodatak prehrani, pšenicne klice kao dijetetski dodatak prehrani

**Klasa 29:** sjemenke; sjemenke suncokreta očišćene, sjeme susama, sjemenke bundeve od kene, sjemenke lana, kokosovo brašno

**Klasa 30:** proizvodi od žitarica; zamjena za obrok, dijetalna hrana, pšeniče klice za ljudsku prehranu, cimet u prahu

---

(111) **14098**

(151) 07.11.2018.

(210) **2016-42**

(442) 20.06.2016

(220) 2/4/2016

(732) BOMVAS DOO, Orja Luka bb, Danilovgrad ME

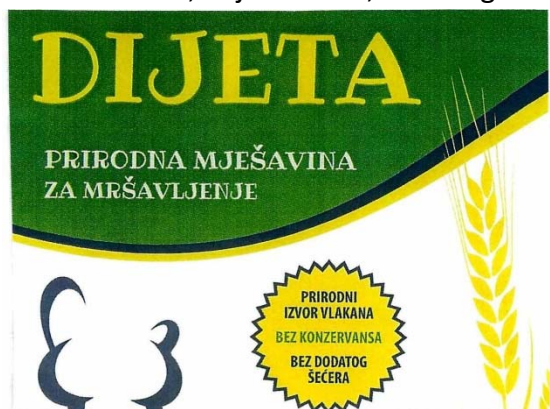

(540)

(550) I, V, F

(511) **Klasa 05:** dodaci prehrani i dijetetski preparati; zamjena za obroke; dijetalna hrana, laneno sjeme kao dodatak prehrani, ljekovite trave

**Klasa 29:** sjemenke; sjemenke suncokreta aikene, sjeme susama, sjemenke bundeve aikene, sjemenke lana

**Klasa 30:** proizvodi od žitarica; ovsene, ražane, pirindžne, sojine, ječmene pahuljice; zamjena za obroke, dijetalna hrana, musli

**Klasa 31:** sjemenke; mekinje; pšenične mekinje za ljudsku prehranu;

---

(111) **14096**

(151) 07.11.2018.

(210) **2016-41**

(442) 20.06.2016

(220) 2/4/2016

(732) BOMVAS DOO, Orja Luka bb, Danilovgrad ME



(540)

(550) I, V, F

(511) **Klasa 29:** meso, živina, konzervisano, sušeno voće i povrće, kuvano voće i povrće; džemovi, kompoti; jaja, mlijeko i mliječni proizvodi; jestiva ulja i masti, kokosovo ulje, kefir, mliječni napitci, jogurt, gotovi brzi lagani obroci od koštunjavog voća za ljudsku ishranu; košunjavo voće, uključujući i proizvode od koštunjavog voća; orašasti plodovi i mahunarke;

sjemenke; sjemenke suncokreta očišćene, sjeme susama, sjemenke bundeve očišćene, sjemenke lana, jestive sjemenke, i sve uključeno u klasu 29.

**Klasa 35:** oglašavanje, vođenje poslova, poslovno upravljanje, kancelarijski poslovi; usluge distribucije, usluge uvoza i izvoza; frangizing, naime, pružanje tehničke pomoći u uspostavljanju i radu maloprodaja zdrave hrane; usluge prodaje na malo u oblasti zdrave i dijetalne hrane i pića, i to: dijetetskih suplemenata, čajeva, čajnih mješavina; žitarica i proizvoda od žitarica, brzih laganih obroka na bazi žitarica, pirinča, integralnih pahuljica i integralnih brašna, integralnih keksa, sjemenki; pčelinjih proizvoda, meda i proizvoda na bazi meda, zdravih kolačani poslastica, svježeg voća i povrća; žutog šećera, prirodnih zaslađivača, morske i himalajske soli, začina, začinskih mješavina i začinskih umaka, proizvoda od soje, biljnih ulja, sirća i putera, hleba i peciva, upakovane i gotove hrane, hrane za bebe, bezalkoholnih pića i napitaka, usluge prodaje prirodne kozmetike i kozmetike i proizvoda za ličnu higijenu, usluge prodaje na malo u oblasti časopisa i knjiga; usluge onlajn naručivanja i usluge onlajn prodaje na malo sve u oblasti zdrave hrane od strane prodavaca ka krajnjim korisnicima; i sve uključeno u klasu 35

**Klasa 30:** med i proizvodi na bazi meda, brzi lagani obroci na bazi žitarica, prerađene žitarice i njihovi proizvodi, sjemenke susama, obrađena zrna; soli i začini, začini u prahu; čajevi; kakao i sve uključeno u klasu 30.

**Klasa 31:** poljoprivredni, vrtlarski proizvodi i zrnevljve, koji nijesu uključeni u druge klase; svježe voće i povrće; sjemenke, košunjavno voće (sirovo), neprerađene žitarice za jelo.

**Klasa 32:** bezalkoholna pića; pića od voća i voćni sokovi; sirupi i drugi preparati za proizvodnju pića

**Klasa 39:** pakovanje i skladištenje robe;

-----  
(111) **13901**

(151) 08.05.2018.

(210) **2017-149**

(442) 20.10.2017

(220) 19.04.2017

(732) Banjalučka pivara a.d. Banja Luka Slatinska 8, Banja Luka BA



(540)

(550) I, F



(511) **Klasa 32:** Pivo; Mineralne i sodne vode i druga bezalkoholna pića; Sirupi i drugi preparati za proizvodnju pića.

---

(111) **13904**

(151) 08.05.2018.

(210) **2017-83**

(442) 20.10.2017

(220) 03.03.2017

(732) Hasbro, Inc. 1027 Newport Avenue, Pawtucket, Rhode Island 02862 US



(540)

(550) I

(740) Jusić Jasna, Crnogorskih serdara bb, Podgorica ME

(511) **Klasa 28:** Igračke, igre i predmeti za igru.

---

(111) **13856**

(151) 25.04.2018.

(210) **2017-72**

(442) 20.10.2017

(220) 24.02.2017

(732) DRUŠTVO ZA POSREDOVANJE, PROMET I USLUGE "SUNTIME" D.O.O. Drobnići bb, Budva ME



**SUNTIME LUXURY**  
RESIDENCE

(540)

(550) I,F

(740) Radovan Grbović, Kapetan Mišina 15, Beograd SR

(511) **Klasa 16:** štampani materijal, fascikle za spise, kancelarijski pribor, blokovi (kancelarijski materijal), sveske, materijal za obuku (izuzev aparata); katalozi; omoti za papir; košuljice za spise; fascikle; omoti; koverte; kutije za olovke, materijali za pisanje, štampane stvari; olovke; kancelarijski materijal; nalepnice; bilteni

**Klasa 35:** oglašavanje i reklamiranje; kancelarijski poslovi

**Klasa 36:** upravljanje nekretninama

**Klasa 37:** Izgradnja; popravke; usluge postavljanja (instaliranja)

**Klasa 41:** Obrazovne usluge; pripremanje obuke; razonoda; sportske i kulturne aktivnosti

**Klasa 43:** Usluge obezbeđivanja hrane i pića; privremeni smeštaj

**Klasa 44:** Medicinske usluge; veterinarske usluge; higijenska zaštita i nega lepote za ljude ili životinje; agrikulturne, hortikulturne i šumarske usluge

---

(111) **13855**

(151) 25.04.2018.

(210) **2017-113**

(442) 20.10.2017

(220) 23.03.2017

(732) DRUŠTVO ZA POSREDOVANJE, PROMET I USLUGE "SUNTIME" D.O.O. - BUDVA, Drobnici bb, Budva ME



**SUNTIME**

R E S I D E N C E

(540)

(550) I,F

(740) Grbović Radovan, Kapetan Mišina 15, Beograd SR

(511) **Klasa 16:** štamparski proizvodi, pribor za pisanje, blokovi (notesi), brošure, fascikle za papir, kalendari, katalozi, sveske za pisanje i crtanje, omotnice, pakovanja za hranu, kancelarijski pribor (osim nameštaja), kutije kartonske ili papirne, naljepnice, štamparski blokovi, fotografije (štampane), kutije za papirne proizvode, pernice, kutije za olovke

**Klasa 35:** oglašavanje i reklamiranje; kancelarijski poslovi

**Klasa 36:** upravljanje nekretninama

**Klasa 37:** izgradnja; popravke; usluge postavljanja (instaliranja)

**Klasa 41:** obrazovne usluge; pripremanje obuke; razonoda; sportske i kulturne aktivnosti

**Klasa 43:** usluge obezbeđivanja hrane i pića; privremeni smeštaj

**Klasa 44:** medicinske usluge; veterinarske usluge; higijenska zaštita i nega lepote za ljude ili životinje; agrikulturne, hortikulturne i šumarske usluge.

---

(111) **13958**

(151) 13.06.2018.

(210) **2017-34**

(442) 20.10.2017

(220) 31.01.2017

(732) Techtronic Power Tools Technology Limited Trident Chambers, P.O. Box 146, Road Town, Tortola VG



(540)

(550) I

(740) Jusić Jasna, Crnogorskih serdara bb, Podgorica ME

(511) **Klasa 07:** Mašine i mašinski alati; motori i pogonske mašine (osim za suvozemna vozila); mašinske spojnice i transmisioni elementi (osim za suvozemna vozila); poljoprivredne sprave osim onih kojima se ručno upravlja; inkubatori za jaja; automatske mašine za prodaju; mašine za usisavanje vazduha; kaiševi za mašine; mašine za pripremu napitaka, elektromehaničke; mašine za duvanje, mjevovi; četke, na električni pogon; četke (kao djelovi mašina); mašine i aparati za šamponiranje tepiha, električni; instalacije za centralno usisavanje; motorne testere; stezne glave (djelovi mašina); uređaji za čišćenje koji koriste paru; mašine i aparati za čišćenje, električni; mlinovi za kafu, izuzev ručnih; šišači (mašine); mašine za uklanjanje boje; kompresorske mašine; električne drobilice; mašine za drobljenje; kultivatori (mašine); strujni generatori; mašine za sječenje; mašine za pranje sudova; otvarači vrata; glave za bušilice (djelovi mašina); rezači, svrdla za burgije (djelovi mašina); glave za bušenje, svrdla (djelovi mašina); mašine za bušenje; pogonski motori, izuzev za kopnena vozila; doboši (djelovi mašina); instalacije za izvlačenje prašine u cilju čišćenja; dinamo; aparati za sječenje sa električnim lukom, elektroručno sječenje; električni čekići; aparati za zavarivanje sa električnim lukom, elektroručno zavarivanje; motori, osim za kopnena vozila; mašine za graviranje; punilice, snabdjevači (djelovi mašina); mašine za filtriranje; filteri (djelovi mašina ili motora); mašine za pripremu hrane, elektromehaničke; prerađivači hrane; električni pištolji sa lijepkom; mašine za mljevenje; vođice za mašine; pištolji za bojenje raspršivanjem; čekići (djelovi mašina); pneumatski čekići; ručni alat na mehaničko pokretanje; priručni aparat za utovar i istovar; priručne mašine, automatske (manipulatori); držači (djelovi mašina); mašine za pranje pod visokim pritiskom; mašine za peglanje; kuhinjske mašine, električne; noževi, električni; mješalice (mašine); mašine za miješanje; otvarači konzervi, električni; mašine za farbanje; mašine za sijanje; mašine i aparati za poliranje (električni); čekići na struju; pumpe (mašine); mašine za čišćenje puteva (samohodne); roboti (mašine); makaze, električne; mašine za oštrenje; nastavci za usisivače za raspršivanje parfema i dezinfekcionih sredstava; kese za usisivače; crijeva za usisivače; usisivači; mašine za pranje; mašine za pranje veša; udarni ključevi; udarne bušilice; mlinovi; rotacioni čekići; višenamjenski alat; cirkularne testere; povratne testere; čekić bušilica; imbus udarni zatezači; šrafilice; alat za stiskanje dalekog domašaja; pištolji za podmazivanje; ekstraktori prašine; imbus ključevi; pištolji za zaptivanje i lijepljenje sa providnom cijevi; pištolji za silikon; bušilice sa desnim uglom; kompaktne bušilice; rotacioni alat; ključevi čegrtaljke; odvrtaći spojnica bez navoja; ručni zakivači eksera; kompleti alata za presovanje; sjekači za kablove; sjekači obloga od bakra; ubodne testere; velike makaze; tračne testere; testere za sječenje metala; ekspanzioni alat; alat za bušenje sa fiksnim postoljem; motorni alat za bušenje sa fiksnim postoljem; testere za kosi rez; brusilice za razdvajanje i sječenje metala; panelne testere; grickalice za lim; hameri za rušenje; električne tračne turpije; stalci za bušenje; pištolji za vrelli vazduh; motor za bušenje sa kukom; motor za bušenje sa rebrastom iglom; usisivači za mokro i suvo usisavanje; motorne lančane dizalice; rende za produblivanje žljebova, brusilice; mašine za poliranje; sječiva; nastavci za svrdla; držači nastavaka

za svrdla; adapteri; umeci nasadnih ključeva za udarne odvijače; produžeci; ekspanzione glave; alati za obradu travnjaka i bašte; bočna rendisaljka; motorne kose; motorne kose za žive ograde; trimeri; trimeri sa jednonitnom žicom za sječenje; trimeri za živu ogradu; duvači za lišće; vakuum duvači ; kosačice; šrederi; makaze za obradu biljaka; mašine za pranje i poliranje podova; mašine za cijepanje drva za ogrijev; perkusione bušilice; udarne bušilice; vakuumski ekstraktori prašine; sjekači; stacionarne kružne testere; stalci za bušenje; stalci za bušenje kružnim stacionarnim testerama; motori za bušenje dijamantskim krunama; glodalice za žljebove u zidovima; stacionarne kružne testere; glodalice za pljosnate tiplove; zaštita od prašine i adapteri; crijeva; djelovi i oprema za gore navedenu robu.

**Klasa 10:** Hiruški, medicinski, zubarski i veterinarski aparati i instrumenti, vještački udovi, oči i zubi; ortopedski artikli; hiruški materijali za zašivanje; štapići za čišćenje ušiju; čepovi za uši (uređaji za zaštitu ušiju); sprave za zaštitu sluha; aparati za masažu.

**Klasa 11:** Aparati za osvjetljavanje, grijanje, proizvodnju pare, kuvanje, hlađenje , sušenje, ventilaciju, snabdijevanje vodom i za sanitarne svrhe; aparati za klimatizaciju; aparati za dezodorisanje vazduha; isušivači vazduha; instalacije za filtriranje vazduha; aparati i mašine za prečišćavanje vazduha; mašine za pečenje ; mašine za pečenje hleba; tosteri za hleb; filteri za kafu, električni; mašine za kafu, električne; filteri za kafu, električni; sprave za prženje kafe; šporeti; aparati i instalacije za kuvanje; ringle za kuvanje; kuhinjski pribor, električni; oprema i instalacije za hlađenje; friteze, električne; aparati za dezodorisanje, koji nisu za ličnu upotrebu; aparati za destilaciju; fenovi (za kosu); električni aparati za pravljenje jogurta; ventilatori (za klimatizaciju); električni fenovi za ličnu upotrebu; zamrzivači; filteri za pijaću vodu; filteri za klimatizaciju; filteri (djelovi za domaćinstvo ili industrijske instalacije); pekači za voće; aparati za pečenje; aparati za grijanje; ovlaživači vazduha za radijatore za centralno grijanje; mašine i aparati za led; aparati za jonizaciju vode ili vazduha; lončići, električni; sušači veša, električni; sijalice; mikrotalasne pećnice (aparati za kuvanje); peći, rerne, koje nisu za laboratorijsku upotrebu; pločasti grijači , plotne; uređaji za kuvanje pod pritiskom (ekspres lonci), električni; električni lonci za kuvanje pod pritiskom; aparati i mašine za hlađenje; rashladne kutije i kontejneri; pekači; parni kotlovi, koji nisu djelovi mašina; instalacije za pravljenje pare; sterilizatori; peći; tosteri; grijači za šake koji se dogrijevaju pomoću dodatnog izvora energije; fenjeri za osvjetljavanje; indikaciono svjetlo; lokalno osvjetljenje; baklje; djelovi i oprema za gore navedenu robu.

-----  
(111) **14196**

(151) 27.12.2018.

(210) **2015-449**

(442) 20.06.2016

(220) 11/18/2015

(732) 3M Company, à Delaware corporation, 3M Center, 2501 Hudson Road, St. Paul, Minnesota, 55144 US

# SCOTCH-BRITE

(540)

(550) I, V

(740) Rončević Milena, Bulevar Svetog Petra Cetinjskog 130/VII, Podgorica ME

(511) **Klasa 21:** Pribor i posude za upotrebu u domaćinstvu ili kuhinjski pribor i posude; proizvodi za čišćenje; četke, jastučići? sunđeri za pranje, čišćenje i ribanje; četke, jastučići i sunđeri, svi sa drškama, za pranje, čišćenje i ribanje; krpe za brisanje i krpe za čišćenje; krpe za prašinu; rukavice za prašinu; mopovi; metle; đubrovnici; pjalice (za prašinu); aparati za uklanjanje dlačica i dlaka kućnih ljubimaca, koji sadrže lepljive trake i njihova dopuna; lepljive trake i valjci za uklanjanje dlačica sa odeće; rukavice za upotrebu u domaćinstvu; vakuum guma za otpušavanje toaleta; brisači prozora; držači za sunđere i drugi proizvodi za domaćinstvo ili kuhinju; četke sa dozerom za sapun; sunđeri za pranje sudova sa drškom i dozerom za tečnost; kofe za upotrebu u domaćinstvu.

---

(111) **14074**

(151) **24.10.2018**

(210) **2017-166**

(220) 05.05.2017

(442) 20.01.2018

(732) THE GOODYEAR TIRE & RUBBER COMPANY 200 Innovation Way, 44316 Akron, Ohio, U.S.A.



(540)

(550) I

(740) Jusić Jasna, Crnogorskih serdara bb, Podgorica ME

(511) Klasa 12: Gume.

---

(111) **14075**

(151) **24.10.2018**

(210) **2017-175**

(210) **2017-175**

(220) 16.05.2017

(442) 20.01.2018

(732) Genentech, Inc. 1 DNA Way, South San Francisco, CA 94080-4990, U.S.A.

(540) NUTROPINAQ

(550) I

(740) Jusić Jasna, Crnogorskih serdara bb, Podgorica ME

(511) **Klasa 05:** farmaceutski preparat, naime, hormon rasta.

-----  
(111) **14076**  
(151) **24.10.2018**  
(210) **2017-181**

(210) **2017-181**

(220) 19.05.2017

(442) 20.01.2018

(732) AZIENDE CHIMICHE RIUNITE ANGELINI FRANCESCO A.C.R.A.F. S.p.A. Viale Amelia 70, 00181  
Roma, Italy

(540) TANTUM LEMON

(550)

(740)

(511) **Klasa 05:** Farmaceutski, medicinski i veterinarski preparati; sanitarni preparati za medicinsku upotrebu; dijetetska hrana i supstance prilagođene za medicinsku ili veterinarsku upotrebu, hrana za bebe; dijetetski dodaci za ljude i životinje; flasteri, materijali za plombiranje zuba, zubarska smola; sredstva za dezinfekciju; preparati za uništavanje štetočina; fungicidi, herbicidi; pastile za grlo; medicinski sprejevi za grlo; tečnosti za ispiranje usta za medicinske svrhe; sredstva za čišćenje usne duplje; medicinski gelovi za oralnu njegu; tečnosti za ispiranje usta za sprečavanje karijesa, za medicinske svrhe; ljekoviti slatkiši; medicinski preparati za oralnu upotrebu u obliku kapi, kapsula, štangli i tableta

-----  
(111) **14077**  
(151) **24.10.2018**  
(210) **2017-182**

(220) 19.05.2017

(442) 20.01.2018

(732) AZIENDE CHIMICHE RIUNITE ANGELINI FRANCESCO A.C.R.A.F. S.p.A. Viale Amelia 70, 00181  
Roma, Italy

(540) TANTUM VERDE

(550) I

(740) Čolović Mladen, Dalmatinska br. 2, Podgorica ME

(511) **Klasa 05:** Farmaceutski, medicinski i veterinarski preparati; sanitarni preparati za medicinsku upotrebu; dijetetska hrana i supstance prilagođene za medicinsku ili veterinarsku upotrebu, hrana za bebe; dijetetski dodaci za ljude i životinje; flasteri, materijali za plombiranje zuba, zubarska smola; sredstva za dezinfekciju; preparati za uništavanje štetočina; fungicidi,

herbicidi; pastile za grlo; medicinski sprejevi za grlo; tečnosti za ispiranje usta za medicinske svrhe; sredstva za čišćenje usne duplje; medicinski gelovi za oralnu njegu; tečnosti za ispiranje usta za sprečavanje karijesa, za medicinske svrhe; ljekoviti slatkiši; medicinski preparati za oralnu upotrebu u obliku kapi, kapsula, štangli i tableta.

---

(111) **14078**  
(151) **24.10.2018**  
(210) **2017-200**

(220) 02.06.2017

(442) 20.01.2018

(732) Colgate-Palmolive Company, a Delaware corporation 300 Park Avenue New York, 10022 New York, U.S.A.



(540)

(550) I

(740) Jusić Jasna, Crnogorskih serdara bb, Podgorica ME

(511) **Klasa 03:** Proizvodi za ličnu higijenu, odnosno, preparati za čišćenje kože i tijela; sapun; tečni sapun za ruke; gelovi i kreme za tuširanje; kupke; preparati za njegu kose; dezodoransi, preparati protiv znojenja i sprejevi za ispod pazuha za ličnu upotrebu; preparati za hidrataciju tijela i kože, losioni i kreme; puder u prahu; preparati za brijanje; preparati za kozmetičko potamnjivanje i preparati za zaštitu kože od uticaja sunca; maramice natopljene rastvorom za čišćenje .

---

(111) **14079**  
(151) **24.10.2018**  
(210) **2017-205**

(220) 05.06.2017

(442) 20.01.2018

(732) Colgate-Palmolive Company, a Delaware corporation 300 Park Avenue New York, 10022 New York, U.S.A.



(540)

(550) I

(740) Jusić Jasna, Crnogorskih serdara bb, Podgorica ME

(511) **Klasa 03:** Proizvodi za ličnu higijenu, odnosno, preparati za čišćenje kože i tijela; sapun; tečni sapun za ruke; gelovi i kreme za tuširanje; kupke; preparati za njegu kose; dezodoransi, preparati protiv znojenja i sprejevi za ispod pazuha za ličnu upotrebu; preparati za hidrataciju tijela i kože, losioni i kreme; puder u prahu; preparati za brijanje; preparati za kozmetičko potamnjanje i preparati za zaštitu kože od uticaja sunca; maramice natopljene rastvorom za čišćenje .

-----  
(111) **14080**

(151) **24.10.2018**

(210) **2017-211**

(220) 07.06.2017

(442) 20.01.2018

(732) Merck Sharp & Dohme Corp. One Merck Drive, Whitehouse Station, 08889 New Jersey, U.S.A.

(540) SIGERTUS

(550) I

(740) Jusić Jasna, Crnogorskih serdara bb, Podgorica ME

(511) **Klasa 05:** Farmaceutski preparati za ljudsku upotrebu.

-----  
(111) **14081**

(151) **24.10.2018**

(210) **2017-212**

(220) 07.06.2017

(442) 20.01.2018

(732) Merck Sharp & Dohme Corp. One Merck Drive, Whitehouse Station, 08889 New Jersey, U.S.A.



(540) STEGLATRO

(550) I

(740) Jusić Jasna, Crnogorskih serdara bb, Podgorica ME

(511) **Klasa 05:** Farmaceutski preparati za ljudsku upotrebu.

---

(111) **14082**

(151) **24.10.2018**

(210) **2017-179**

(220) 18.05.2017

(442) 20.02.2018

(732) FRANCK d.d. Vodovodna 20 10000 Zagreb Hrvatska



(540)

(550) I,F

(740) Popović Miladin, Đoka Miraševića 21/III, Podgorica ME

(511) **Klasa 30:** Kafa.

---

(111) **14084**

(151) **24.10.2018**

(210) **2017-191**

(210) **2017-191**

(220) 31.05.2017

(442) 20.04.2018.

(732) "CRNAGORACOOP NB" DOO Landža bb 81410 Danilovgrad ME



(540)

(550) I, V, F

(511) **Klasa 29:** Meso, riba, živina i divljač; mesne prerađevine; konzervisano, zamrznuto, sušeno i kuvana voće i povrće; želei, džemovi, kompoti; jaja, mleko i mlečni proizvodi; jestiva ulja i masti.

**Klasa 30:** Kafa, čaj, kakao, šećer, pirinač, tapioka, saga, zamena kafe; brašno i proizvodi od žitarica, hleb, kolači i poslastice, sladoledi; med, melasa; kvasac, prašak za pecivo; so, senf; sirće, sosovi (kao dodaci); začini; led

---

(111) **14085**

(151) **30.10.2018**

(210) **2017-192**

(220) 31.05.2017

(442) 20.01.2018

(732) "CRNAGORACOOP NB"DOO Landža bb 81410, Danilovgrad ME



(540)

(550) I, V, F

(511) **Klasa 30:** Kafa

---

(111) **2017-193**

(151) **30.10.2018**

(210) **14086**

(220) 31.05.2017

(442) 20.04.2018.

(732) "CRNAGORACOOP NB" DOO Landža bb 81410 Danilovgrad ME

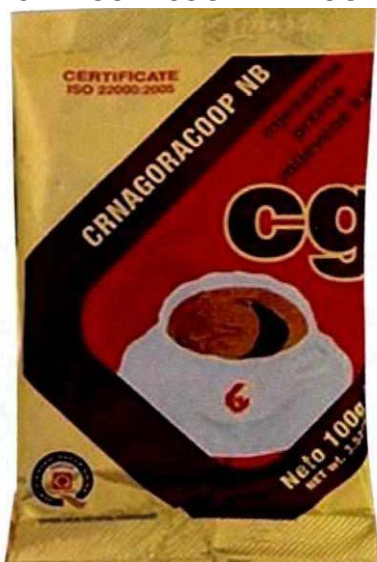

(540)

(550) I, V, F

(511) **Klasa 30:** Kafa.

---

(111) **2017-194**

(151) **30.10.2018**

(210) **14087**

(220) 31.05.2017

(442) 20.01.2018

(732) "CRNAGORACOOP NB" DOO Landža bb 81410 Danilovgrad ME



(540)

(550) I, V, F

(511) **Klasa 29:** Mliječni proizvodi.

**Klasa 30:** Kolači i poslastice

---

(111) **14088**

(151) **30.10.2018**

(210) **2017-375**

(220) 18.09.2017

(442) 20.01.2018

(732) Jumedija Mont DOO 13 Jula bb, Podgorica



(540)

(550) I

(740) Mladen Milutinović, Bul. Sv. Petra Cetinjskog 48, Podgorica ME

(511) **Klasa 16:** Papir, karton i proizvodi od tih materijala koji msu obuhvaćeni drugim klasama; štamparski proizvodi; proizvodi za uvezivanje knjiga, fotografije; pribor za pisanje; ljepila (ljepljive materije za papirne proizvode ili za kućne potrebe); slikarski pribor; kistovi; pisaće mašine i kancelarijski pribor (osim namještaja); oprema za nastavu i obuku (osim aparata); plastični materijali za ambalažu (koji nisu obuhvaćeni drugim klasama); štamparska slova; klišeji. Sve navedeno se odnosi na poslove izdavanja novina, novinskih dodataka, knjiga, novinskih

članaka, oglašavanja i reklamiranja u novinama, kao i na komercijalne, administrativne i marketinške poslove privrednog društva, a u vezi sa osnovnom djelatnošću istog-izdavanjem novine.

**Klasa 35:** Oglašavanje i reklamiranje; vođenje komercijalnih poslova; komercijalna administracija; kancelarijski poslovi, usluge koje pružaju lica ili organizacije, čija je glavna svrha: pomoć u radu i upravljanju privrednim društvima, ili pomoć u vođenju poslova ili komercijalnih funkcija industrijskog ili trgovačkog preduzeća, kao i usluge reklamnih ustanova koje se bave uglavnom reklamiranjem proizvoda i usluga putem svih vrsta medija, kao i usluge koje se odnose na registraciju, prijepis, sastavljanje, kompilaciju ili sistematizaciju pisanih saopštenja i zapisa kao i obradu ili kompilaciju matematičkih ili statističkih podataka, usluge agencija za oglašavanje kao i usluge distribuiranja prospekata direktno ili poštom ili distribuiranje uzoraka; oglašavanja u vezi s drugim uslugama kao što su usluge u vezi bankarskih zajmova i oglašavanja putem radija ; sortiranje za račun drugih osoba, raznih proizvoda (ne uključuje njihov prevoz) radi omogućavanja potrošaču njihovog lakšeg razgledanja I kupovine; ove usluge se mogu pružati u okviru prodavnica na malo, trgovina na veliko, posredstvom prodajnih kataloga, dopisno ili elektronskim putem, na primjer posredstvom weba ili putem telefona. Sve navedeno se odnosi na poslove izdavanja novina, novinskih dodataka, knjiga, novinskih članaka, oglašavanja i reklamiranja u novinama, odnosno komercijalnih, administrativnih i marketinških poslova privrednog društva, a u vezi sa novinom.

**Klasa 41** Obuka; stručno osposobljavanje; razonoda; sportske i kulturne djelatnosti, rekreacija, razonoda, odnosno svi poslovi u vezi izdavanja novina, novinskih dodataka, knjiga, novinskih članaka, oglašavanja i reklamiranja u novinama, sve u vezi sa osnovnom djelatnošću privrednog društva-izdavanjem novine.

-----  
(111) **14089**  
(151) **30.10.2018**  
(210) **2017-406**

(220) 12.10.2017

(442) 20.02.2018

(732) Farmegra doo Podgorica ul. Kritskog odreda 471 Podgorica

(540) FARMEGRA-VER

(550) V

(511) **Klasa 05:** farmaceutski i veterinarski proizvodi; higijenski proizvodi za upotrebu u medicini; dijetalne materije za medicinske potrebe, hrana za bebe; flasteri, materijal za previjanje; materijali za plombiranje zuba i za zubne otiske; dezinfekciona sredstva; proizvodi za uništavanje zivotinjskih štetočina; fungicidi, herbicidi.

**Klasa 35:** oglašavanje i reklamiranje; vođenje komercijalnih poslova; komercijalna administracija; kancelarijski poslovi.

**Klasa 39:** prevoz; ambalažiranje i skladištenje proizvoda; organizovanje putovanja

---

(111) **14099**  
(151) **03.11.2018**  
(210) **2017-383**

(220) 20.09.2017

(442) 20.02.2018

(732) Colgate-Palmolive Company, a Delaware corporation 300 Park Avenue New York, 10022 New York, U.S.A.



(540)

(550) I

(740) Jusić Jasna, Crnogorskih serdara bb, Podgorica ME

(511) **Klasa 03:** Preparati za bijeljenje; preparati za pranje veša; sredstva za čišćenje; preparati za poliranje; preparati za čišćenje; abrazivni preparati; preparati za čišćenje rerne; preparati za čišćenje odvoda; preparati za čišćenje poda; preparati za čišćenje stakla; preparati za čišćenje tepiha; preparati za čišćenje za upotrebu na pločicama; sredstva za čišćenje toaleta; sredstva za čišćenje tapacira; preparati za čišćenje u domaćinstvu .

---

(111) **14100**  
(151) **03.11.2018**

(210) **2017-384**

(220) 20.09.2017

(442) 20.01.2018

(732) Colgate-Palmolive Company, a Delaware corporation 300 Park Avenue New York, 10022 New York, U.S.A.



(540)

(550) I

(740) Jusić Jasna, Crnogorskih serdara bb, Podgorica ME

(511) **Klasa 03:** Preparati za bijeljenje; preparati za pranje veša; sredstva za čišćenje; preparati za poliranje; preparati za čišćenje; abrazivni preparati; preparati za čišćenje rerne; preparati za čišćenje odvoda; preparati za čišćenje poda; preparati za čišćenje stakla; preparati za čišćenje tepiha; preparati za čišćenje za upotrebu na pločicama; sredstva za čišćenje toaleta; sredstva za čišćenje tapacira; preparati za čišćenje u domaćinstvu .

(111) **14101**

(151) **03.11.2018**

(210) **2017-285**

(220) 28.07.2017

(442) 20.04.2018.

(732) Colgate-Palmolive Company, a Delaware corporation 300 Park Avenue New York, 10022 New York, U.S.A.

## AJAX BOOST

(540)

(550) I

(740) Jusić Jasna, Dalmatinska 2, Podgorica ME

(511) **Klasa 03:** Preparati za bijeljenje; preparati za pranje veša; sredstva za čišćenje; preparati za poliranje; preparati za čišćenje; abrazivni preparati; preparati za čišćenje rerne; preparati za čišćenje odvoda; preparati za čišćenje poda; preparati za čišćenje stakla; preparati za čišćenje tepiha; preparati za čišćenje za upotrebu na pločicama; sredstva za čišćenje toaleta; sredstva za čišćenje tapacira; preparati za čišćenje u domaćinstvu .

-----  
(111) **14102**  
(151) **03.11.2018**  
(210) **2017-407**

(220) 17.10.2017

(442) 20.01.2018

(732) VERSALIS S.p.A. Piazza Boldrini 1, San Donato Milanese (MI), Italy

(540) KOSTIL

(550) I

(740) Jusić Jasna, Crnogorskih serdara bb, Podgorica ME

(511) **Klasa 01:** Vještačke i sintetičke smole, neprerađena plastika ( u prahu, tečnom stanju ili pasti); posebni kopolimetri polistirena

-----  
(111) **14103**  
(151) **03.11.2018**  
(210) **2017-364**

(220) 11.09.2017

(442) 20.02.2018

(732) BioHorizons Australia Pty. Ltd., an Australian corporation 25-33 Allen Street, Waterloo, NSW 2019, Australia

(540) LASER-LOK

(550) I

(740) Jusić Jasna, Crnogorskih serdara bb, Podgorica ME

(511) **Klasa 10:** Medicinski implantati sa laserskim-zarezivačem površina koji uključuje biofizičke brave.

-----  
(111) **14104**  
(151) **03.11.2018**  
(210) **2017-366**

(220) 11.09.2017

(442) 20.01.2018



(732) Hearst Communications, Inc. 300 West 57th Street, New York, NY 10019, U.S.A.

(540) COSMOPOLITAN

(550) I

(740) Jusić Jasna, Crnogorskih serdara bb, Podgorica ME

(511) **Klasa 09:** Kompjuterski aplikativni softver za mobilne telefone, tablet računare i prenosive digitalne elektronske uređaje koji se mogu držati u ruci, naime, softver za pristup, gledanje, interakciju i preuzimanje sadržaja i informacija iz oblasti ličnih odnosa, ljepote, mode, zdravlja, fitnesa, lične higijene, putovanja, šopinga, finansija, dekoracije, tehnologije, vijesti o slavnim ličnostima i zabave; elektronske publikacije (koje se mogu preuzeti); elektronske publikacije, odnosno časopisi koji se izdaju periodično i magazini snimljeni na računarski medij i u elektronskom formatu.

**Klasa 41:** Obezbeđivanje elektronskih on lajn publikacija (koje se ne mogu preuzeti); objavljivanje časopisa koji se izdaju periodično, magazina i tekstova; elektronsko objavljivanje časopisa koji se izdaju periodično, magazina i biltena onlajn; usluge elektronskog objavljivanja, naime objavljivanje časopisa koji se izdaju periodično i magazina u elektronskom formatu i onlajn; usluge zabave, naime, prezentacije internet stranica u vidu fotografije, audio zapisa, video zapisa i pisane prezentacije iz oblasti ličnih odnosa, ljepote, mode, zdravlja, fitnesa, lične higijene, putovanja, šopinga, finansija, dekoracije, tehnologije, vijesti o slavnim ličnostima i zabave.

**Klasa 45:** Obezbeđivanje internet stranica za internet u svrhe socijanih mreža.

-----  
(111) **14105**

(151) **03.11.2018**

(210) **2017-382**

(220) 18.09.2017

(442) 20.02.2018

(732) Hearst Communications, Inc. 300 West 57th Street, New York, New York 10019, USA

(540) COSMOPLITAN

(550) I

(740) Jusić Jasna, Crnogorskih serdara bb, Podgorica ME

(511) Klasa 16: papir, karton i roba koja se pravi od ovih materijala, koja nije uključena u druge klase; magazini, časopisi koji se izdaju periodično , knjige i druge stvari koje se štampaju; materijali za povezivanje knjiga; fotografije; kancelarijski materijal; ljepila za upotrebu u kancelariji i domaćinstvu; materijali koje koriste umjetnici; četkice za slikanje; kućne mašine i kancelarijski rekviziti (izuzev namještaja); instrukcijski i nastavni materijal (izuzev aparata); plastični materijali za pakovanje (koji nijesu uključeni u druge klase); karte za igru; štamparska slova; kalupi za štampanje.

-----  
(111) **14115**  
(151) **12.11.2018**  
(210) **2017-389**

(220) 27.09.2017

(442) 20.01.2018

(732) Ananti Hotels, Resorts & Residences Doo ul. Obala bb, Tivat, Crna Gora ME



(540) REZERVICI MONTENEGRO

(550) I, F

(740) Radovan Grbović, Kapetan Mišina 15, Beograd SR

(511) štamparski proizvodi, pribor za pisanje, blokovi (notesi), brošure, fascikle za papir, kalendari, katalozi, sveske za pisanje i crtanje, omotnice, pakovanja za hranu, kancelarijski pribor (osim nameštaja), kutije kartonske ili papirne, naljepnice, štamparski blokovi, fotografije (štampane), kutije za papirne proizvode, pernice, kutije za olovke. štamparski proizvodi, pribor za pisanje, blokovi (notesi), brošure, fascikle za papir, kalendari, katalozi, sveske za pisanje i crtanje, omotnice, pakovanja za hranu, kancelarijski pribor (osim nameštaja), kutije kartonske ili papirne, naljepnice, štamparski blokovi, fotografije (štampane), kutije za papirne proizvode, pernice, kutije za olovke. štamparski proizvodi, pribor za pisanje, blokovi (notesi), brošure, fascikle za papir, kalendari, katalozi, sveske za pisanje i crtanje, omotnice, pakovanja za hranu, kancelarijski pribor (osim nameštaja), kutije kartonske ili papirne, naljepnice, štamparski blokovi, fotografije (štampane), kutije za papirne proizvode, pernice, kutije za olovke. štamparski proizvodi, pribor za pisanje, blokovi (notesi), brošure, fascikle za papir, kalendari, katalozi, sveske za pisanje i crtanje, omotnice, pakovanja za hranu, kancelarijski pribor (osim nameštaja), kutije kartonske ili papirne, naljepnice, štamparski blokovi, fotografije (štampane), kutije za papirne proizvode, pernice, kutije za olovke. štamparski proizvodi, pribor za pisanje, blokovi (notesi), brošure, fascikle za papir, kalendari, katalozi, sveske za pisanje i crtanje, omotnice, pakovanja za hranu, kancelarijski

pribor (osim nameštaja), kutije kartonske ili papirne, naljepnice, štamparski blokovi, fotografije (štampane), kutije za papirne proizvode, pernice, kutije za olovke štamparski proizvodi, pribor za pisanje, blokovi (notesi), brošure, fascikle za papir, kalendari, katalozi, sveske za pisanje i crtanje, omotnice, pakovanja za hranu, kancelarijski pribor (osim nameštaja), kutije kartonske ili papirne, naljepnice, štamparski blokovi, fotografije (štampane), kutije za papirne proizvode, pernice, kutije za olovke štamparski proizvodi, pribor za pisanje, blokovi (notesi), brošure, fascikle za papir, kalendari, katalozi, sveske za pisanje i crtanje, omotnice, pakovanja za hranu, kancelarijski pribor (osim nameštaja), kutije kartonske ili papirne, naljepnice, štamparski blokovi, fotografije (štampane), kutije za papirne proizvode, pernice, kutije za olovke.

Klasa 35: oglašavanje i reklamiranje; kancelarijski poslovi

Klasa 36: upravljanje nekretninama

Klasa 41: upravljanje nekretninama

Klasa 43: usluge obezbjeđivanja hrane i pića; privremeni sještaj

Klasa 44: medicinske usluge; veterinarske usluge; higijenska zaštita i njega ljepote za ljude ili životinje; agrikulturne, hortikulturne i šumarske usluge. medicinske usluge; veterinarske usluge; higijenska zaštita i njega ljepote za ljude ili životinje; agrikulturne, hortikulturne i šumarske usluge.

---

(111) **14125**

(151) **16.11.2018**

(210) **2017-308**

(442) 20.02.2017.

(220) 8.22.2016

(731) House of Prince NS Vester Farimagsgade 19 DK-1606 Copenhagen V Danska

(540)

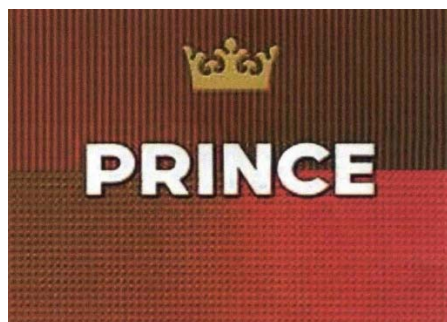

(550) I

(511) **Klasa 34:** Cigarete; duvan, sirov ili prerađen; proizvodi od duvana; supstituti za duvan (ne u medicinske svrhe); cigare, cigarilos; upaljači; šibice; artikli za pušače; cigaret papir, cigaret tube, filteri za cigarete; džepni aparati za zamotavanje cigareta; ručne mašine za ubrizgavanje duvana u papirne tube; elektronske cigarete; tečnosti za elektronske cigarete;

duvanski proizvodi namijenjeni za zagrijavanje. materijal za plombiranje zuba, zubarska smola; dezinfekciona sredstva; preparati za uništavanje štetočina; fungicidi, herbicidi.

**Klasa 10:** Hirurški, medicinski, stomatološki i veterinarski aparati i instrumenti, vještački udovi, oči i zubi; ortopedski artikli; materijali za zašivanje.

---

(111) **14126**

(151) **22.11.2018**

(210) **2017-272**

(220) 21.07.2017

(442) 20.04.2018.

(732) Hyundai Heavy Industries Co., Ltd. (Korean Corporation) 1000, Bangeojinsunhwan-doro, Dong-gu, Ulsan, Republic of Korea, KR

## HYUNDAI ELECTRIC

(540)

(550) I, V

(740) Radulović Božidar, Studentska bb, Lamela 3/18, Podgorica ME

(511) Klasa 09: Gasni senzori; mjerni aparat za napon/električnu struju/temperaturu baterije; mjerni aparat; indikator RPM (revolucija po minuti); gasni alarmi; gasni aparati za zatvaranje; alarmi; razvodnik gasa; razvodnik gasa [električni]; releji, električni; vakumski kontaktori pod visokim pritiskom; visokonaponski prekidač; zaštitnici od prenapona; kontrolni paneli za napajanje; reaktori; mašine za distribuciju električne energije; razvodne table; distributivni transformatori; transformatori; inverteri; razvodnik [električni]; prekidači električnih sklopova; elektronsko napajanje; elektronski energetski transformatori; aparat za kontrolu električne energije; regulatori napona; elektronski kontaktori; niski i srednji naponski prekidači; prekidači kola; invertor koji se koristi u proizvodnji solarne energije; aparat za mjerenje potrošnje električne energije; aparati i instrumenti za mjerenje električne energije; aparati i instrumenti za dijagnostiku elektroenergetskih instalacija; aparat za mjerenje/praćenje/analizu potrošnje električne energije; kanal sabirnice; električni kablovi, žice, provodnici i priključci za njih; konvertori; komunikacioni aparati sa broda do obale; aparati za daljinsko upravljanje; komunikacijska oprema; računarski softver za SCADA sistem; programi mrežnog operativnog sistema; računarski softver za brodove; računarski softver; računarske softverske platforme; elektronski upravljački sistemi za mašine; mrežni serveri; aparati za obradu podataka; digitalni informacioni procesori; kontrolni uređaj za nadzor [električni]; aparat za snimanje, prenos ili reprodukciju informacija; računari; računarski serveri; digitalne knjige koje se mogu preuzeti sa Interneta; baterije i punjači baterija.

---

(111) **14127**

(151) **22.11.2018**

(210) **2017-367**

(220) 12.09.2017

(442) 20.01.2018

(732) Hankook Tire Worldwide Co., Ltd. 647-15, Yoksam-dong, Kangnam-gu, Seoul, Korea, KR



(540)

(550) I

(740) Radulović Božidar, Studentska bb, Lamela 3/18, Podgorica ME

(511) Klasa 12: Automobilske gume; gume za bicikle; bandaži (felne) za pneumatike; navlake za gume; gume za motocikle; ljepljive gumene zakrpe za popravku unutrašnjih guma; unutrašnje gume za bicikle; unutrašnje gume za motocikle; unutrašnje gume za pneumatike; unutrašnje gume za točkove vozila; unutrašnje gume za gume vozila; mreže za prtljag vozila; pneumatske gume; oprema za popravku unutrašnjih guma; felne za točkove vozila; prekrivači sjedala za bicikle; prekrivači sjedala za motocikle; sigurnosni pojasevi za sjedišta vozila; dijelovi kočnica za vozila; amortizeri za vozila; nosači za skije na autima; klinovi za zimske gume; klinovi za zimske gume; gume za točkove vozila; gume, pune, za točkove vozila; šare za protektiranje guma; gusjenice za transportne trake; gazišta za vozila (gusjenice) za traktore; pneumatici bez unutrašnje gume za bicikle; pneumatici bez unutrašnje gume za motocikle; ventili za gume vozila; gume za točkove vozila.

-----

(111) **14128**

(151) **22.11.2018**

(210) **2017-376**

(220) 18.09.2017

(442) 20.01.2018

(732) Pharmaceutical chemical cosmetic industry ALKALOID AD Skopje Blvd. Aleksandar Makedonski 12 Skopje Republika Makedonija

(540) NAZOPASS

(550) I, V

(740) Popović Miladin, Đoka Miraševića 21/III, Podgorica ME

(511) Klasa 5: farmaceutski preparati

-----

(111) **14130**

(151) **22.11.2018**

(210) **2017-392**

(220) 10.05.2017

(442) 20.02.2018

(732) Jaguar Land Rover Limited Abbey Road, Whitley, Coventry CV3 4LF, United Kingdom



(540)

(550) I,F

(740) AOD "Ćupić", Dalmatinska 10, Podgorica ME

(511) Klasa 12: Vozila; motorna vozila; aparati za kretanje kopnom, vazduhom i/ili vodom; motorna kopnena vozila; kopnena vozila; terenska vozila; vozila za sve terene; samovozeća motorna vozila; autonomna motorna vozila; trkački automobili; obnovljena klasična vozila; vozila koja se prodaju u djelovima; komercijalna vozila; električna vozila; hibridna vozila; vojna vozila; vozila za upotrebu od strane službi za hitne slučajeve, službi za pretraživanje i spašavanje; pogonski sklopovi za kopnena vozila; pogoni za kopnena vozila; motori za kopnena vozila; pogoni za motocikle; motori za motocikle; pogoni za bicikle; motori za bicikle; motori za trkačke automobile; prikolice; nasloni za ruke za sjedišta vozila; torbe za prtljag posebno prilagođene za ugradnju u prtljažnik vozila; torbe za uređenje enterijera automobila, mreže i posude, posebno prilagođene za ugradnju u vozila; oblikovane ili po mjeri patosnice i podne obloge za vozila; nasloni za glavu za sjedišta vozila; pokrivač i za naslon glave za sjedišta vozila; zaštitni i ukrasni pokrivač i retrovizora; pokrivači za sjedišta automobila; pokrivači za volan vozila; pokrivač i za vozila po mjeri; točkovi za vozila; aluminijske felne; obloge na točkovima; felne; rezervni točkovi; kapice za točkove; centralne kapice za točkove; ratkapne za točkove; lančanici; spojleri za vozila; poklopci za vozila; sjedišta za vozila; sigurnosna sjedišta za vozila; sigurnosni pojasevi za vozila; sigurnosni kaiševi za vozila; sigurnosni signali [zvučni] za vozila; vazdušni jastuci za putnike; protivprovalni, zaštitni i sigurnosni uređaji i oprema za vozila; rešetke hladnjaka za vozila; zaštitni djelovi za karoserije vozila; vrata vozila; prozori vozila; vjetrobrani vozila; prozorsko staklo za prozore i vjetrobrane vozila; šiberi za vozila; krovni prozori za vozila; branici vozila; centralne konzole vozila koje se prodaju kao djelovi vozila i koji imaju elektronske interfejse; bicikli; tricikli; djelovi, pribor i akcesoari za bicikla; hover daske; skuteri; kvadricikli; motorizovani unicykli; go-kart vozila; kolica i njihovi djelovi i pribor; sjedišta za bebe, odojčad i djecu za vozila; viziri, krovni nosači, nosači prtljaga i mreže, nosači za bicikle, nosači daski za jedrenje, nosač i skija i lanci za snijeg, sve za vozila; dronovi; bespilotne letjelice; personalne letjelice; hoverkraft; podvodna

vozila; mlazna vozila za sportove na vodi; vozila na daljinsko upravljanje, ne igračke; djelovi i pribor za sve gore navedene proizvode.

-----  
(111) **14131**  
(151) **22.11.2018**  
(210) **2017-401**

(220) 10.11.2017

(442) 20.02.2018

(732) MBE WORLDWIDE S.P.A. VIALE LUNIGIANA 35/37 20125 MILANO ITALIJA



**MAIL BOXES ETC.**

(540)

(550) I,F

(740) Popović Miladin, Đoka Miraševića 21/III, Podgorica ME

(511) Klasa 35: Usluge elektronske trgovine, naime, pružanje informacija o proizvodima putem telekomunikacionih mreža za reklamne i prodajne svrhe; Maloprodaja i veleprodaja, za druge, uključujući poručivanje online i putem pošte, sljedećih roba: prehrambeni proizvodi, pića, odjeća i modni detalji, obuća, torbe, koferi, kješobrani, sportski artikli, sportska oprema, namještaj, tekstil, proizvodi za domaćinstvo i za opremanje domaćinstva, tkanine za domaćinstvo, posteljina i rublje za kupatilo, namještaj, elektronska roba, optička roba, fotografska, IT i telekomunikaciona roba, računarski softver; računarski hardver, kozmetika, parfimerija, deterdženti, proizvodi za uljepšavanje i sredstva za higijenu, zlatara, imitacija nakita, časovnici i satovi, kućansko posuđe, zemljano posuđe, artikli za kupatila, električni aparati za domaćinstvo, "uradi sam" artikli, gvoždarija, proizvodi za životinje, predmeti za vrtlarstvo i odmor; karte, materijali za pakovanje, papir za pakovanje, ambalažni karton, karton za pakovanje, papirni kontejneri za pakovanje, materijali za pakovanje od papira i recikliranog papira, kutije od papira i kartona, kutije od kartona za pakovanje, sklopive kutije za pakovanje od kartona, krute kutije za pakovanje od kartona; vreće (koverte, vrećice) od papira za pakovanje, papir i karton, štampane stvari, knjigovezački materijal, fotografije, kancelarijski materijal, lijepkovi za kancelarijske predmete ili predmete za domaćinstvo, materijali za umjetnike, kistovi, pisaće mašine i kancelarijski pribor (osim namještaja); materijali za nastavu i obuku (osim aparata), plastični materijali za pakovanje (koji nisu uključeni u druge klase), štamparska slova, blokovi za štampu; igre i igračke, vozila, motocikli, bicikli, motori, motori i rezervni djelovi, muzički instrumenti; Pružanje informacija o proizvodima koji se mogu pretraživati iz indeksa i baza podataka sa informacijama, uključujući tekst,

elektronske dokumente, baze podataka, grafičke i audio vizuelne informacije, na računarskim i komunikacionim mrežama; Elektronske poslovne usluge, posebno pružanje informacija o proizvodima i uslugama putem telekomunikacionih mreža za reklamne i prodajne svrhe; Promovisanje roba i usluga za druge kroz snižene ponude putem elektronskih komunikacionih mreža; Promovisanje roba i usluga za druge putem obezbjeđivanja veb stranice sa kuponima, popustima, informacijama o poređenju cijena, pregledima proizvoda, vezama sa maloprodajnim internet stranicama drugih i diskontnim informacijama; Komercijalne informacije I savjeti za potrošače; Usluge poređenja cijena; Promocija prodaje za druge; Širenje reklama za druge putem onlajn komunikacione mreže; obezbjeđivanje baze podataka koja se može pretraživati u oblastima poslovnih informacija; obezbjeđivanje onlajn vodiča za oglašavanje koji može pretraživati robe i usluge drugih onlajn i oftline prodavaca; promovisanje roba i usluga drugih putem ograničenih ponuda sa popustom putem on-line elektronske komunikacione mreže; pregledi proizvoda (promocija prodaje i testiranje); Marketing usluge; Oglašavanje; Poslovni menadžment; Poslovna administracija; Kancelarijska upravljanje (usluge za druge).

Klasa 38: Prenos signala za elektronsku trgovinu putem telekomunikacionih sistema i sistema za prenos podataka; Pružanje online, interaktivne oglasne table za prenos poruka između korisnika računara u vezi sa hobijima, kolekcionarima, trgovinom i prodajom robe i usluga putem globalne komunikacione mreže; Telekomunikacije (usluge u ime trećih lica).

Klasa 39: Prosljeđivanje robe i tereta [isporuka robe]; Prevoz i isporuka robe koja se poručuje putem pošte; Kurirske usluge; Transport; Pakovanje i skladištenje robe; Putni aranžman (usluge za druge).

---

(111) **14132**  
(151) **22.11.2018**  
(210) **2017-394**

(220) 10.06.2017

(442) 20.01.2018

(732) Beijing Daoxiangcun Foodstuff Co., Ltd. No.19, Dongzhimennei Street, Dongcheng District, Beijing, P.R.China



(540)



(550) I, F

(740) Raičević Dejan, Vojvode Boža 1, Cetinje ME

(511) Klasa 30: Kafa; čaj; pića na bazi čaja; šećer; slatkiši (bombone); med; peciva; keksi; biskviti; hleb; pice; parena punjena peciva; jiaozi (punjene knedle); prolječne rolnice; preparati od žitarica; tjestenine; kokice; skrob za hranu; sladoled; so za očuvanje prehrambenih proizvoda; sirćet; soja sos; začini; kvasac; aromatični dodaci za hranu; gluten pripremljen kao prehrambeni proizvod; sredstva za omekšavanje mesa, za upotrebu u domaćinstu; preparati za ojačavanje mućene pavlake i šlaga.

---

(111) **14133**

(151) **29.11.2018**

(210) **2017-368**

(210) **2017-368**

(220) 13.09.2017

(442) 20.01.2018

(732) Emirates National Oil Company Limited (ENOC) LLC, UAE Company P.O. Box: 6442, Dubai, United Arab Emirates



اينوك  
enoc

(540)

(550) I, F

(740) Raičević Dejan, Vojvode Boža 1, Cetinje ME

(511) Klasa 4: Industrijska ulja i masti; maziva; sredstva za upijanje, vlaženje i vezivanje prašine; goriva (uključujući benzin za motore) i sredstva za osvetljavanje; svijće i fitilji za osvetljavanje

---

(111) **14134**

(151) **29.11.2018**

(210) **2017-59**

(220) 16.02.2017

(442) 20.02.2018

(732) Hit Montenegro d.o.o. Pržno 85315, Sveti Stefan Budva, Crna Gora

(540) MAESTRAL

(550) I

(511) Klasa 41: agencije za smjertaj [hotelski, pansionski] hotelske rezervacije (usluge rezervisanja hotela) hotelske usluge rezervisanje hotela hoteli (administrativno upravljanje hotelima) Klasa 43: kockarnice [igre] (usluge kockarnica) Klasa 45: Obezbedenje hotela, kazina, lica i imovine unutar hotela

---

(111) **14135**

(151) **29.11.2018**

(210) **2017-60**

(220) 16.02.2017

(442) 20.02.2018

(732) Hit Montenegro d.o.o. Pržno 85315, Sveti Stefan Budva, Crna Gora



(540)

(550) I

(511) Klasa 41: Agencije za smjertaj [hotelski, pansionski] hotelske rezervacije (usluge rezervisanja hotela) hotelske usluge rezervisanje hotela hoteli (administrativno upravljanje hotelima) Klasa 43: Kockarnice [igre] (usluge kockarnica) Klasa 45: Obezbedenje hotela, kazina, lica i imovine unutar hotela

---

(111) **14136**

(151) **29.11.2018**

(210) **2017-61**

(220) 16.02.2017

(442) 20.02.2018

(732) Hit Montenegro d.o.o. Pržno 85315, Sveti Stefan Budva, Crna Gora



# MAESTRAL

Resort & Casino

(540)

(550) I

(511) Klasa 41: Agencije za smjertaj [hotelski, pansionski] hotelske rezervacije (usluge rezervisanja hotela) hotelske usluge rezervisanje hotela hoteli (administrativno upravljanje hotelima) Klasa 43: Kockarnice [igre] (usluge kockarnica) Klasa 45: Obezbedenje hotela, kazina, lica i imovine unutar hotela

---

(111) **14137**

(151) **29.11.2018**

(210) **2017-209**

(220) 06.06.2017

(442) 20.02.2018

(732) LE HOANG DIEP THAO 31 Tu Xuong, Ward 7, District 3, Ho Chi Minh City, Vietnam



(540)

(550) I

(740) Radulović Božidar, Studentska bb, Lamela 3/18, Podgorica ME

(511) Klasa 30: Kafa, insant kafa, rafinisana kafa, ekstrakti kafe, mješavina kafe, ne-mliječn i krimeri [aditivi za kafu], mlijeko i šecer. zamjena za kafu.

---

(111) **14147**

(151) **29.11.2018**  
(210) **2017-278**

(220) 25.07.2017

(442) 20.04.2018.

(732) Goran Đukanović, Jelene Savojske br 12, Podgorica ME



(540)

(550) F

(511) **Klasa 35:** oglašavanje, vođenje poslova, poslovno upravljanje, prodaja majica i ostalih suvenira (majice, dresove, lopte, trenerke, privjeske)

**Klasa 39:** organizovanje putovanja

**Klasa 41:** obrazovne usluge, pripremanje obuke razonoda, sportske i kulturne aktivnosti.

---

(111) **14148**  
(151) **29.11.2018**  
(210) **2017-370**

(220) 14.09.2017

(442) 20.01.2018

(732) MCILHENNY COMPANY Avery Island State of Louisiana 70513 US



(540)

(550) I, V

(740) Popović Miladin, Đoka Miraševića 21/III, Podgorica ME

(511) Klasa 29: Meso, riba, živina i divljač; mesne prerađevine; konzervisano, sušeno, smrznuto, kiselo i kuvana voće, povrće i mahunarke; gotova jela i snek hrana od mesa, ribe, živine, divljači,

voća, povrća, mahunarki, orašastog voća i sjemenki; prerađeno meso; konzervisane i kisele masline; želei, džemovi, jaja, mlijeko i mliječni proizvodi; pića na bazi mlijeka i snek hrana; orašasto voće, sjemenke, snek hrana na bazi orašastog voća i/ili sjemenki; kikiriki puter; puter od orašastog voća; puter od sjemenki; jestiva ulja; i jestive masti.

Klasa 30: Kafa, čaj, kakao i zamjena za kafu; pirinač; tapioka i sago; brašno i proizvodi napravljeni od žitarica; hleb, peciva i slatkiši; jestivi led; šećer, med, melasa; kvasac, prašak za pecivo; so; senf; sirće, sosevi (začini); začini; led; sosevi, začini, i začinsko bilje na bazi paprike; sosevi, začini, i začinsko bilje koji nisu na bazi paprike; arome za hranu i piće; začinski dodaci uključujući senf, kečap, majonez, čatni, marinade, reliš, sirće i prelive za salate; so za hranu; začinjena so; začini od sušene paprike; kari začini; brašno i proizvodi napravljeni od pšeničnog, pirinčanog i kukuruznog brašna; žitarice, paste, knedle, pirinač, hlebovi i krekeri; kokice; poslastice i snek hrana uključujući pekarske proizvode i pečene proizvode, keksove, kolače, krekeri, krekeri sa ukusom sira, krekeri od pirinča; bombone, lizalice, žvakaće gume, gumene bombone, bombone sa ukusom cimeta i paprike, bombone od mente i druge poslastice; čokolade, sosovi, prah, bombone i tijesto na bazi čokolade; sladoled i jestivi led; pice; kvasac, prašak za pecivo; instant konditorske mješavine; čili i začinsko bilje, sosevi i čili u prahu; kafa, čaj, kakao, napici sa kafom, čajem ili na čokoladnoj bazi; šećer, med, tapioka, sago, i zamjena za kafu.

Klasa 32: Pivo; mineralne i gazirane vode i druga bezalkoholna pića; pića na bazi voća i povrća; sirupi i ostali preparati za pravljenje pića.

-----  
(111) **14149**

(151) **29.11.2018**

(210) **2017-380**

(220) 18.09.2017

(442) 20.02.2018

(732) TURKIYE CUMHURİYETİ ZIRAAT BANKASI ANONİM ŞİRKETİ DOĞANBEY M. ATATÜRK BLV.  
NO:8 ULUS ALTINDAG ANKARA TÜRSKA

# bankKart

(540)

(550) I,F

(740) Popović Miladin, Đoka Miraševića 21/III, Podgorica ME

(511) Klasa 9: Naučni , nautički , geodetski, fotografski, kinematografski i optički aparati i instrumenti, kao i aparati i instrumenti za vaganje, mjerenje, signalizaciju, kontrolu (inspekciju),

za pomoć (spašavanje) i za obuku; aparati i instrumenti za vođenje, distribuciju, transformisanje, akumuliranje, podešavanje ili upravljanje električnom strujom; aparati za snimanje, prenos, obradu i reprodukciju zvuka, slika ili podataka; magnetni nosači i podataka, diskovi za snimanje; računске mašine, oprema za obradu podataka, kompjuteri; kompakt diskovi, DVD-ijevi i drugi digitalni mediji za snimanje; uređaji za gašenje požara; kompjuterski softveri. Klasa 36: Osiguranje; finansijski poslovi; monetarni poslovi; upravljanje nekretninama.

-----  
(111) **14150**

(151) **29.11.2018**

(210) **2017-412**

(220) 18.10.2017

(442) 20.02.2018

(732) NBA Properties, Inc. Olympic Tower-645 Fifth Avenue New York, New York 10022 US



(540)

(550) I,F

(740) Popović Miladin, Đoka Miraševića 21/III, Podgorica ME

(511) **Klasa 25:** Odjeća; obuća; pokrivala za glavu; odjeća, uključujući čarape, obuću, cipele za košarku, patike za košarku, papuče, majice, košulje, polo majice, dukserice, donje djelove trenerki, pantalone, majice na bretele, džempere, kratke pantalone, pidžame, sportske majice, ragbi majice, dukseve, kaiševe, kravate, spavacice, šešire, kape, štitnike na kačketima, trenerke za zagrijavanje, donje djelove trenerki za zagrijavanje, dresove za zagrijavanje/majice za vježbanje ubacaja, jakne, vjetrovke, jakne sa kapuljacom, kapute, portikle za bebe ne od papira, trake za glavu. znojnice, kecelje, donje rublje, bokserice, široke pantalone, štitnike za uši, rukavice, rukavice samo sa palcem, šalove pletene i štrikane majice, trikotažne haljine, dresove i unifonne za navijačice, odjeću za plivanje, odijela za kupanje, kupaće kostime, bikinije tankinije, gaćice za plivanje, gacice za kupanje, šorceve za surfovanje, nepromočivu odjeću za vodu, marame za plažu, pokrivala za kupaće kostime, ogrtače za kupaće kostime, sandale, sandale za plažu, šešire za plažu, štitnike za sunce, kape za plivanje, kape za kupanje, nova pokrivala za glavu sa prikačenim umecima; dijelov i, oprema i dodaci za gore navedenu robu

**Klasa 28:** Igračke, igre i sportske stvari; gimnastički i sportski artikli koji nisu uključeni u druge klase; ukrasi za Božićnu jelku; igračke, igre i sportske stvari, uključujući košarkaske lopte, loptice za golf, lopte za igraliste, sportske lopte, gumene lopte i pjenaste lopte, plisane lopte za igru, plasticne lopte za igru, mrežice za košarku, table za košarku, minijaturne table za košarku, pumpe

i igle za naduvavanje košarkaških lopti; štapovi za golf, torbe za golf, podmetaci za golf, oprema za golf, uključujući, alat za popravku golf terena, kupice na koje se stavlja lopta, markere lopti, torbe za golf opremu, pokrivala za glave golf štapova, rukavice za golf, kutije za golf lopte, posebna zelena staza za golf; držači za bilijarke štapove, kugle za bilijar, trouglovi za bilijar, pikado ormari, elektronske table za košarkaske igrice na tabli, table za košarkaške igrice, košarkaške igrice, akcione igrice, društvene igre za odrasle i djecu, trivia informacione igrice i elektronski video arkadni uređaji, košarkaški setovi koji se sastoje od mrežice i zviždaljke, lutke, dekorativne lutke, lutke za kolekciju, akcione figure za igru, akcione figure karikature, punjene igračke, plisane igračke, puzzle, montažni blokovi za igre, ukrasi za Božićnu jelku i Božićne čarape; vozila za igru u obliku a tomobila, kamiona, vozova i kombija, svi sa temom košarke, nove pjenaste igračke u obliku prstiju i trofeja, igračke trofeji, karte za igru, igrice sa kartama, igračke koje prave zvuk, igračke za kućne ljubimce; igračke za plažu, uključujući, lopte za plažu, lopte na naduvavanje, kantice za igru, lopatice za igru, igračke za pijesak, bazen sa pijeskom, gumene igračke za vodu; oprema za bazen, uključujući plivačku opremu za plutanje, opremu za plutanje u bazenu, igračke za splavarenje na vodi, pjenastu opremu za plutanje, gume za plivanje, gume za plivanje u bazenu, pjenaste gume, daske za plivanje, daske za surfovanje, peraja za plivanje, peraja za surfovanje, misice za plutanje i mišice za pomoć pri plivanju, sve u rekreativne svrhe; odbojkaski setovi za igru koji se sastoje od lopte, mrežice, traka koje označavaju teren i zviždaljke, i vaterpolo setovi za igru koj i se sastoje od lopte, mrežice i zviždaljke: dekorativne igračke od tkanine koje se pustaju da lete na vjetru; minijature reprodukcije stadiona, uključujući, male plasticne modele stadiona za igru; staklene kugle sa sn ijegom; mašine za video igre za upotrebu sa televizorom i rucni kontroleri za konzole za video igre; pokretna traka za vježbanje; dječje kasice; dijelovi, oprema i dodaci za gore navedenu robu.

Klasa 41: Obrazovanje; obezbjeđivanje obuke; razonoda; sportske i kulturne aktivnosti; razonoda i obrazovne usluge u smislu televizijskih događaja i radio programa iz oblasti košarke i prikazivanja uživo košarkaskih igara i košarkaskih priredbi; usluge produkcije i distribucije radio i televizijskih šou programa sa košarkaskim utakmicama, košarkaskim događajima i programima iz oblasti košarke; usluge vodenja i organizovanja košarkaskih klinika i kampova, klinika i kampova za trenere, klinika i kampova za plesne timove i kosarkaske igre; usluge razonode u vidu licnog pojavljivanja kostimiziranih maskota iiii plesnih timova na kosarkaskim utakmicama i priredbama, klinikama, kampovima, promocijama, i drugim događajima, specijalnim događajima i žurkama u vezi sa košarkom; usluge kluba obozavalaca; usluge razonode, uključujući one koje pružaju vebisajt predstavljanje multimed ijskih sadriaaja koji se ne može preuzimati u vidu najvažnijih televizijskih događaja, interaktivnih najvažnijih televizijskih događaja, video snimaka, video strim snimaka, interaktivnih video izbora najvažnijih događaja, radio programa, najvažnijih radijskih događaja, i audio snimaka u polju kosarke; usluge obezbjeđivanja vijesti i informac ija u vidu statistika i drugih stvari iz oblasti kosarke; omogućavanje pristupa onlajn igricama koje se ne mogu preuzimati, uključujući, kompjuterske igrice, video igrice, interaktivne video igrice, akcione

igrice, arkadne igrice, društvene igre za odrasle i djecu, igre na tabli, slagalice, i trivia igrice; usluge elektronskog izdavaštva, uključujući, izdavanje magazina, vodica, biltena, bojanki, i igrica kod kojih se igrači određuju putem interneta, sve u vezi sa košarkom; usluge obezbjeđivanja onlajn kompjuterske baze podataka iz oblasti košarke; usluge informisanja, savjetovanja i konsultacija u vezi sa svim gore pomenutim uslugama; sve gore navedene usluge uključujući ali ne ograničavajući se na pružanje ovakvih usluga elektronskim putem, putem kompjutera, kompjuterskih mreža iiii interneta (uključujući online pružanje usluga).

-----  
(111) **14151**  
(151) **29.11.2018**  
(210) **2017-390**

(220) 28.09.2017

(442) 20.01.2018

(732) Amgen Inc (Delaware corporation) One Amgen Center Drive, Thousand Oaks, California 91320-1799, US



(540)

(550) I

(740) Radulović Božidar, Studentska bb, Lamela 3/18, Podgorica ME

(511) Klasa 5: farmaceutski preparati

-----  
(111) **14152**  
(151) **29.11.2018**  
(210) **2017-396**

(220) 10.06.2017

(442) 20.02.2018

(732) NOVARTIS AG 4002 BASEL CH

(540) TADALOVE-VER

(550) I,V

(740) MSA IP Milojević Sekulić, Karađorđeva 65, Beograd SR



(511) Klasa 5: Farmaceutski preparati za ljudsku upotrebu

-----  
(111) **14153**  
(151) **29.11.2018**  
(210) **2017-395**

(220) 10.06.2017

(442) 20.02.2018

(732) NOVARTIS AG 4002 BASEL CH

(540) SPARTAN-VER

(550) I,V

(740) MSA IP Milojević Sekulić, Karađorđeva 65, Beograd SR

(511) Klasa 5: farmaceutski preparati, naime urološki preparati.

-----  
(111) **14154**  
(151) **29.11.2018**  
(210) **2017-410**

(220) 18.10.2017

(442) 20.02.2018

(732) "TELEVIZIJA VIJESTI" d.o.o. Podgorica Trg Republike b.b., Podgorica

(540) BEZ GRANICA

(550) V

(740) Saša Vujačić, Bulevar Ivana Crnojevića 56/2, Podgorica ME

(511) **Klasa 35:** reklamiranje dopisnim putem, reklamiranje on-line na informatičkoj mreži, reklamiranje putem radija, reklamiranje putem televizije, reklamna dokumentacija (uređenje reklamne dokumentacije), reklamni filmovi (proizvodnja reklamnih filmova), reklamni tekstovi (uređenje reklamnih tekstova).

**Klasa 38:** bežična radiodifuzija, emitovanje radio programa, emitovanje televizijskih programa, komuniciranje posredstvom mreža optičkih kablova, konferencije na daljinu (omogućavanje vodenja konferencija na daljinu), prenos digitalnih datoteka, prenos putem satelita, prenos poruka, prenos televizijskih emisija pretplatnicima putem kablova (kablovska televizija), prenos videosadržaja na zahtjev, radijska komunikacija, radiodifuzija, streaming podataka, usluge agencija za vijesti.

**Klasa 41:** elektronskepublikacije (iskorišćavanje elektronskih publikacija koje se ne mogu prenositi on line), fotografisanje, fotografske reportaže, iznajmljivanje radijskih i televizijskih aparata, iznajmljivanje rasvjetnih uređaja za pozorišnu dekoraciju i za televizijske studije,iznajmljivanje videokamera, iznajmljivanje videotraka, iznajmljivanje zvučnih

snimaka,izrada scenarija, osim za potrebe oglašavanja, mikrofilmovi (snimanje na mikrofilmove),mikroizdavaštvo, montaža radijskih i televizijskih programa, obavještenja o vaspitanju,obavještenja o razonodi, organizovanje i provođenje obrazovnih foruma uzivo, pisanje scenarija, pisanje tekstova, prikazivanje igranih filmova, pružanje filmova koji se ne mogu preuzeti putem usluga prenosa videozapisa na zahtjev, pružanje televizijskih programa kojise ne mogu preuzeti putem usluga prenosa videozapisa na zahtjev, razonoda posredstvom radija, razonoda posredstvom televizije, reporterske usluge, sinhronizacija, slobodno vrijeme (usluge za ispunjavanje slobodnog vremena), snimanje na videotrake, studio zasnimanje (usluge studija za snimanje), titlovanje filmova, usluge razonode, videotrake ( montaža video traka).

-----  
(111) **14155**  
(151) **29.11.2018**  
(210) **2017-284**

(220) 28.07.2017

(442) 20.04.2018.

(732) Hankook Tire Worldwide Co., Ltd. #647-15, Yoksam-dong, Kangnam-gu, Seoul, Korea, KR

## Hankook SMaRT TERRAIN

(540)

(550) I, V

(740) Radulović Božidar, Studentska bb, Lamela 3/18, Podgorica ME

(511) **Klasa 12:** Automobilske gume; gume za bicikle; bandaži (felne) za pneumatike; navlake za gume; gume za motocikle; ljepljive gumene zakrpe za popravku unutrašnjih guma; unutrašnje gume za bicikle; unutrašnje gume za motocikle; unutrašnje gume za pneumatske točkove; unutrašnje gume za točkove vozila; unutrašnje gume za gume vozila; mreže za prtljag vozila; pneumatske gume;oprema za popravku unutrašnjih guma; felne za točkove vozila; prekrivači sjedala za bicikle; prekrivači sjedala za motocikle; sigurnosni pojasevi za sjedišta vozila; dijelovi kočnica za vozila; amortizeri za vozila; nosači za skije na autima; klinovi za zimske gume; klinovi za zimske gume; gume za točkove vozila; gume, pune, za točkove vozila; šare za protektiranje guma; gusjenice za transportne trake; gazišta za vozila (gusjenice) za traktore; pneumatici bez unutrašnje gume za bicikle; pneumatici bez unutrašnje gume za motocikle; ventili za gume vozila; gume za točkove vozila.

-----  
(111) **14156**  
(151) **29.11.2018**  
(210) **2017-50**

(220) 07.02.2017

(442) 20.04.2018.

(732) Bayer Intellectual Property GmbH Alfred-Nobel-Strasse 10, 40789 Monheim am Rhein, Germany

## CANESTEST

(540)

(550) I

(740) Jusić Jasna, Dalmatinska 2, Podgorica ME

(511) **Klasa 05:** Farmaceutski preparati.

---

(111) **14159**

(151) **07.12.2018**

(210) **2017-414**

(220) Agencija za nadzor osiguranja ul. Moskovska 17A M/C1, Podgorica ME

(732)

(540)



Agencija za nadzor osiguranja - Crna Gora  
Insurance Supervision Agency - Montenegro

(511) **Klasa 36:** vrši nadzor nad obavljanjem djelatnosti osiguranja, primjenom zakona i propisa kojima se uređuje oblast osiguranja; izdaje dozvole za obavljanje poslova osiguranja, reosiguranja i saosiguranja, posredovanja i zastupanja I drugih poslova neposredno povezanih sa poslovima osiguranja; odlucuje o prigovorima i zahtjevima osiguranika i drugih korisnika osiguranja; prati razvoj tržišta osiguranja; sacinja i objavljuje izvjestaje o stanju na trzistu osiguranja

**Klasa 41:** organizuje stručne skupove, obuke, seminare i druge vidove obuke i usavršavanja, za svoje zaposlene i sektor osiguranja

**Klasa 45:** daje saglasnost na akte i radnje u vezi osiguranja; donosi bliza pravila, propise, smjernice, uputstva i druge opste akte, kojima obezbjeđuje primjenu zakona; pokreće postupak pred sudovima i drugim organima u cilju obezbjeđenja primjene zakona;

---

(111) **14160**  
(151) **07.12.2018**  
(210) **2017-264**  
(220) 19.07.2017  
(442) 20.01.2018  
(732) JT International S.A. Rue Kazem-Radjavi 8, 1202 Geneva, Switzerland

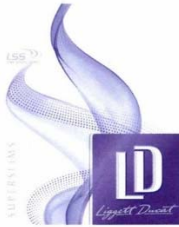

(540)  
(550) I  
(740) Čolović Mladen, Dalmatinska br. 2, Podgorica ME  
(511) **Klasa 34:** Duvan, koji je prerađen ili neprerađen; duvan za pušenje, duvan za lule, duvan za savijanje, duvan za žvakanje, duvan za sisanje, cigarete, elektronske cigarete, cigare, cigarilosi; burmut; artikli za pušače uključeni u klasu 34; papir za cigarete, fišeci za cigarete i šibice.

---

(111) **14161**  
(151) **07.12.2018**  
(210) **2017-271**  
(220) 20.07.2017  
(442) 20.04.2018.  
(732) Pharmanova doo drustvo za proizvodnju farmaceutskih proizvoda Obrenovac Industrijska 8, 11500 Obrenovac, Srbija

## GASTROREGULAR

(540)  
(550) I, V  
(740) Rončević Milena, Bulevar Svetog Petra Cetinjskog 130/VII, Podgorica ME  
(511) **Klasa 05:** Farmaceutski preparati, sredstva za varenje za medicinsku upotrebu, preparati od mikroorganizama za medicinsku i veterinarsku upotrebu, enzimi za medicinsku upotrebu, preparati od enzima za medicinsku upotrebu, enzimi kao dodatak ishrani, dijetetski.

---

(111) **14162**  
(151) **07.12.2018**  
(210) **2017-187**

(220) 29.05.2017

(442) 20.01.2018

(732) Nihon Nohyaku Co., Ltd. 19-8, Kyobashi 1-chome, Chuo-ku, Tokyo, Japan

(540) MONCUT

(550) I

(740) Ana Stanković Mugoša, Trg Republike 13, Podgorica ME

(511) Klasa 5: Insekticidi za upotrebu u poljoprivredne svrhe; insekticidi; herbicidi; preparati za uništavanje štetnih biljaka; fungicidi za upotrebu u poljoprivredne svrhe; fungicidi; preparati za sterilizaciju; antiparazitski preparati; preparati za uništavanje štetočina; miticidi; dezinfekciona sredstva za upotrebu u higijenske svrhe; farmaceutski preparati za upotrebu u poljoprivredne svrhe.

---

(111) **14163**

(151) **07.12.2018**

(210) **2016-533**

(220) 22.12.2016

(442) 20.01.2018

(732) Philip Morris Brands Sarl Quai Jeanrenaud 3, Neuchatel, 2000, CH



(540)

(550) I, F

(740) Rončević Milena, Bulevar Svetog Petra Cetinjskog 130/VII, Podgorica ME

(511) Klasa 34: Duvan, sirov ili prerađen; duvanski proizvodi; cigare, cigarete, cigarilosi, duvan za uvijanje cigareta, duvan za. lule, duvan za žvakanje, duvan za šrnkanje, kretek; snus (duvan u prahu); zamena za duvan (za nemedicinsku upotrebu); elektronske cigarete; duvanski proizvodi za paljenje; elektronski uređaji i njihovi djelovi koji se koriste za paljenje cigareta ili duvana kako bi ispustili aerosoli za inhalaciju, koje sadrže nikotin; tečni rastvori nikotina za upotrebu u elektronskim cigaretama; artikli za pušaće, papir za cigarete, tube za cigarete, filteri za cigarete, kutije za duvan, tabakere (kutije za cigarete), pepeljare, lule, ručni aparati za uvijanje cigareta, upaljači; šibice.

---

(111) **14164**

(151) **07.12.2018**

(210) **2017-150**

(220) 19.04.2017

(442) 20.01.2018

(732) Banjalučka pivara a.d. Banja Luka Slatinska 8, Banja Luka



(540)

(550) I, F

(511) Klasa 32: Pivo; Mineralne i sodne vode i druga bezalkoholna pića; Sirupi i drugi preparati za proizvodnju pića.

---

(111) **14165**

(151) **07.12.2018**

(210) **2017-172**

(220) 11.05.2017

(442) 20.02.2018

(732) Biocon Limited 20th Km., Hosur Road, Electronic City P.O., Bangalore-560100, India, IN

(540) INSUGEN

(550) I,V

(740) Radulović Božidar, Studentska bb, Lamela 3/18, Podgorica ME

(511) Klasa 5: Farmaceutski i veterinarski preparati; dijetetski dodaci za ljude i životinje; nutritivni preparati za terapijske ili medicinske namjene; sanitarni preparati za medicinsku upotrebu; dijetetske supstance prilagođene za medicinske svrhe, hrana za bebe; flasteri, materijali za zavijanje; materijal za plombiranje zuba, zubarska smola; sredstva za dezinfekciju; preparati za uništavanje štetočina; fungicidi, herbicidi.

Klasa 10: Medicinski aparati, oprema i instrumenti

---

(111) **14166**

(151) **20.12.2018**

(210) **2017-275**

(220) 25.07.2017

(442) 20.04.2018.

(732) British American Tobacco (Brands) Inc. 2711 Centerville Road Suite 300 Wilmington Delaware 19808 Sjedinjene Američke Države



(540)

(550) I, F

(740) Popović Miladin, Đoka Miraševića 21/III, Podgorica ME

(511) **Klasa 34:** Cigarette; duvan, sirov ili prerađen; proizvodi od duvana; supstituti za duvan (ne u medicinske svrhe); cigare, cigarilosi; upaljači; šibice; artikli za pušače; cigaret papir, cigaret tube, filteri za cigarete; džepni aparati za zamotavanje cigareta; ručne mašine za ubrizgavanje duvana u papirne tube; elektronske cigarete; tečnosti za elektronske cigarete; duvanski proizvodi namijenjeni za zagrijavanje; elektronski uređaji i njihovi dijelovi namijenjeni za zagrijavanje cigareta ili duvana.

-----  
(111) **14167**

(151) **20.12.2018**

(210) **2017-280**

(220) 28.07.2017

(442) 20.04.2018.

(732) Dunhill Tobacco of London Limited Globe House 4 Temple Place London WC2R 2PG Ujedinjeno Kraljevstvo



(540)

(550) I, F

(740) Popović Miladin, Đoka Miraševića 21/III, Podgorica ME

(511) **Klasa 34:** Cigarete; duvan, sirov ili prerađen; proizvodi od duvana; supstituti za duvan (ne u medicinske svrhe); cigare, cigarilosi; upaljači; šibice; artikli za pu šače; cigaret papir, cigaret tube, filteri za cigarete; džepni aparati za zamotavanje cigareta; ručne mašine za ubrizgavanje duvana u papirne tube; elektronske cigarete; tečnosti za elektronske cigarete; duvanski proizvodi namijenjeni za zagrijavanje; duvanski proizvodi namijenjeni za zagrijavanje istih.

---

(111) **14168**

(151) **20.12.2018**

(210) **2017-281**

(220) 28.07.2017

(442) 20.04.2018.

(732) Dunhill Tobacco of London Limited Globe House 4 Temple Place London WC2R 2PG  
Ujedinjeno Kraljevstvo

## RELOC

(540)

(550) I, V

(740) Popović Miladin, Đoka Miraševića 21/III, Podgorica ME

(511) **Klasa 34:** Cigarete; duvan, sirov ili prerađen; proizvodi od duvana; supstituti za duvan (ne u medicinske svrhe); cigare, cigarilosi; upaljači; šibice; artikli za pu šače; cigaret papir, cigaret tube, filteri za cigarete; džepni aparati za zamotavanje cigareta; ručne mašine za ubrizgavanje duvana u papirne tube; elektronske cigarete; tečnosti za elektronske cigarete; duvanski proizvodi namijenjeni za zagrijavanje; duvanski proizvodi namijenjeni za zagrijavanje istih.



(111) **14169**  
(151) **20.12.2018**  
(210) **2017-282**

(220) 28.07.2017

(442) 20.04.2018.

(732) Dunhill Tobacco of London Limited Globe House 4 Temple Place London WC2R 2PG  
Ujedinjeno Kraljevstvo



(540)

(550) I, F

(740) Popović Miladin, Đoka Miraševića 21/III, Podgorica ME

(511) **Klasa 34:** Cigarete, cigare, cigarilosi, duvan za uvijanje, duvan za lule i proizvodi od duvana

---

(111) **14170**  
(151) **20.12.2018**  
(210) **2017-283**

(220) 28.07.2017

(442) 20.04.2018.

(732) Dunhill Tobacco of London Limited Globe House 4 Temple Place London WC2R 2PG  
Ujedinjeno Kraljevstvo

**DUNHILL BLONDE BLEND**

(540)

(550) I, V

(740) Popović Miladin, Đoka Miraševića 21/III, Podgorica ME

(511) **Klasa 34:** Cigarete, cigare, cigarilosi, duvan za uvijanje, duvan za lule i proizvodi od duvana

---

(111) **14175**  
(151) **20.12.2018**  
(210) **2017-369**

(220) 13.09.2017

(442) 20.01.2018

(732) British American Tobacco (Brands) Inc. 2711 Centerville Road Suite 300 Wilmington Delaware 19808 US

(540) LUCKY STRIKE WILD

(550) I, V

(740) Popović Miladin, Đoka Miraševića 21/III, Podgorica ME

(511) Klasa 34: Cigarete; duvan, sirov ili prerađen; proizvodi od duvana; zamjene za duvan (ne u medicinske svrhe); cigare, cigarilosi; upaljači; šibice; artikli za pušače; cigaret papir, cigaret tube, filteri za cigarete; džepni aparati za zamotavanje cigareta; ručne mašine za ubrizgavanje duvana u papirne tube; elektronske cigarete; tečnosti za elektronske cigarete; duvanski proizvodi namijenjeni za zagrijavanje.

---

(111) **14176**

(151) **20.12.2018**

(210) **2017-388**

(220) 25.09.2017

(442) 20.02.2018

(732) British American Tobacco (Brands) Inc. 2711 Centerville Road Suite 300 Wilmington Delaware 19808 US



(540)

(550) I,F

(740) Popović Miladin, Đoka Miraševića 21/III, Podgorica ME

(511) Klasa 34: Cigarete; duvan, sirov ili prerađen; proizvodi od duvana; zamjene za duvan (ne u medicinske svrhe); cigare, cigarilosi; upaljači; šibice; artikli za pušače; cigaret papir, cigaret tube, filteri za cigarete; džepni aparati za zamotavanje cigareta; ručne mašine za ubrizgavanje duvana u papirne tube; elektronske cigarete; tečnosti za elektronske cigarete; duvanski proizvodi namijenjeni za zagrijavanje.

(111) **14177**  
(151) **20.12.2018**  
(210) **2017-391**  
(220) 28.09.2017  
(442) 20.01.2018  
(732) POSCO DAEWOO Corporation 10 Tongil-ro, Jung-gu, Seoul, Republic of Korea, KR  
(540) DAEWOO  
(550) I, V  
(740) Radulović Božidar, Studentska bb, Lamela 3/18, Podgorica ME  
(511) Klasa 35: agencije za uvoz i izvoz, poslovno upravljanje benzinskim stanicama, prodajne agencije, organizovanje prodaje, aukcionarstvo(licitacija), poslovno upravljanje hotelima, organizovanje prodaje farmaceutskih proizvoda.

---

(111) **14178**  
(151) **20.12.2018**  
(210) **2017-129**  
(220) 05.04.2017  
(442) 20.01.2018  
(732) PepsiCo, Inc., 700 Anderson Hill Road, Purchase, NY 10577, U.S.A.



(540)  
(550) I  
(740) Jusić Jasna, Crnogorskih serdara bb, Podgorica ME  
(511) Klasa **29** Grickalice na bazi krompira, odnosno čips.

---

(111) **14179**  
(151) **20.12.2018**  
(210) **2017-132**  
(220) 07.04.2017  
(442) 20.02.2018

(732) The Goodyear Tire & Rubber Company 200 Innovation Way, 44316 Akron, Ohio

(540) POWERLOAD

(550) I

(740) Jusić Jasna, Crnogorskih serdara bb, Podgorica ME

(511) Klasa 12: Gume.

---

(111) **14180**

(151) **20.12.2018**

(210) **2017-363**

(220) 08.09.2017

(442) 20.01.2018

(732) E. I. du Pont de Nemours and Company Chestnut Run Plaza, 974 Centre Road, Wilmington, DE 19805, U.S.A.

(540) LUMIPOSA

(550) I

(740) Jusić Jasna, Crnogorskih serdara bb, Podgorica ME

(511) Klasa 5: Insekticidi; insekticidi koji se koriste za liječenje poljoprivrednog sjemena.

---

(111) **14116**

(151) **27.11.2018.**

(210) **2017-462**

(220) 23.11.2017

(442) 20.04.2018.

(732) Dompe farmaceutici S.p.A. Via San Martino della Battaglia, 12 I-20 122 Milano Italija

**OKI**

(540)

(550) I, V

(740) Popović Miladin, Đoka Miraševića 21/III, Podgorica ME

(511) **Klasa 05:** Analgetički proizvodi; antipiretički preparati; nesteroidni antiinflamatorni preparati; preparati protiv bolova; preparati protiv gripa; preparati za smanjivanje kongestije.

---

(111) **14093**

(151) **27.11.2018.**

(210) **2017-319**

(220) 16.08.2017

(442) 20.01.2018

(732) Terranova investicije građevine turizam doo. Podgorica, Pera Četkovića, lamela 3, blok X, Stari aerodrom, Podgorica ME



(540)

(550) I, F

(511) Klasa 37: izgradnja, popravke, usluge postavljanja.

Klasa 39: prevoz, organizovanje putovanja.

Klasa 45: pravne usluge.

-----  
(111) **14138**  
(151) **27.11.2018.**  
(210) **2017-459**

(220) 16.11.2017

(442) 20.04.2018.

(732) The Gillette Company LLC One Gillette Park Boston Massachusetts 02127 United States of America

**START**

(540)

(550) I

(740) Lutovac Branislav, Bulevar Ivana Crnojevića 93, Podgorica ME

(511) **Klasa 08:** Brijači i nožići za brijanje; dozne, kasete, držači i patrone, sve izričito projektovano za, i koje sadrži, nožiće za brijanje; djelovi i oprema za svu naprijed navedenu robu.

-----  
(111) **14139**  
(151) **27.11.2018.**  
(210) **2017-467**

(220) 29.11.2017

(442) 20.04.2018.

(732) Open type Joint Stock Company " Fast and Oil Integrated Works" ul. Titova 27, Ekaterinburg, RU-620085 Sverdlovskaya oblast, Russian Federation, RU

**Щедрое лето**

(540)

(550) F

(740) Radulović Božidar, Studentska bb, Lamela 3/18, Podgorica ME

(511) **Klasa 29:** Đumbirov džem; voćni želej; loj za ishranu; jestive masti; puter krem; margarin; mermelada; ulja za ishranu; suncokretovo ulje za ishranu; puter, džemovi; želej; džemovi, kompoti.

-----  
(111) **14118**

(151) **27.11.2018.**

(210) **2017-469**

(220) 12.01.2017

(442) 20.04.2018.

(732) PHARMANOVA DOO DRUŠTVO ZA PROIZVODNJU FARMACEUTSKIH PROIZVODA  
OBRENOVAC Industrijska 8 11500 Obrenovac Republika Srbija

**ZANKAF**

(540)

(550) I, V

(740) MSA IP Milojević Sekulić, Karađorđeva 65, Beograd SR

(511) **Klasa 05:** Farmaceutski proizvodi

-----  
(111) **14140**

(151) **27.11.2018.**

(210) **2017-473**

(220) 12.04.2017

(442) 20.04.2018.

(732) Mars, Incorporated 6885 Elm Street, McLean, VA 22101-3883, U.S.A

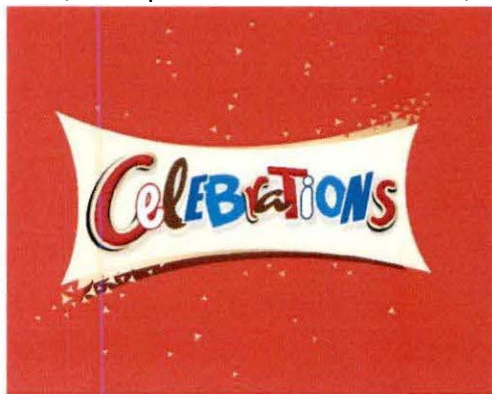

(540)

(550) Jusić Jasna, Dalmatinska 2, Podgorica ME

(740) I

(511) **Klasa 30:** Čokoladne poslastice; slatkiši od šećera; čokolada; bombone; deserti; slatkiši; kafa; čaj; kakao; šećer; žitarice i proizvodi od žitarica; grickalice na bazi žitarica; pločice od žitarica

i energetske pločice; biskviti; kolači; slatka peciva; peciva; keksi; musli; pića na bazi kaka; napolitanke; sladoled na bazi vade; sladoled; smrznuti jogurti; led (prirodni ili veštački); praškovi za sladoled; smrznute poslastice; čokoladni musevi; šerbeti; arome za pića, osim eteričnih ulja; arome za hranu osim eteričnih ulja; voće sa čokoladnim prelivom; kostunjavo voće sa čokoladnim prelivom; grickalice na bazi zrnavlja; granola; pločice za užinu na bazi granole; čokoladni namazi; kakao namazi; čokoladni sosevi; preparati za ucvrščivanje slaga; čokoladni sirup; sirup za glazuru; brašno.

-----  
(111) **14143**

(151) **27.11.2018.**

(210) **2017-475**

(220) 12.05.2017

(442) 20.04.2018.

(732) Chevron Intellectual Property LLC (Delaware limited liability company) 6001 Bollinger Canyon Road, San Ramon, California 94583, US

# DELO

(540)

(550) I, V

(740) Radulović Božidar, Studentska bb, Lamela 3/18, Podgorica ME

(511) **Klasa 01:** Rashladna sredstva, rashladna sredstva za motore, rashladna sredstva za motore protiv korozije, smrzavanja i ključanja; antifriz tečnosti za vetrobrane; aditivi za goriva; sredstva za čišćenje goriva, sistema za napajanje gorivom i motora; tečnosti za hidraulični sistem, tečnosti za kočioni sistem, tečnosti za servo upravljanje, transmisione tečnosti.

**Klasa 03:** Tečnosti za pranje vetrobrana; sredstva za čišćenje sistema za klimatizaciju.

-----  
(111) **14119**

(151) **27.11.2018.**

(210) **2017-477**

(220) 12.05.2017

(442) 20.04.2018.

(732) Zeltiq Aesthetics, Inc., a United States / Delaware corporation 4410 Rosewood Drive Pleasanton, California 94588 Sjedinjene Američke Države

# COOLSCULPTING

(540)

(550) I, V

(740) Popović Miladin, Đoka Miraševića 21/III, Podgorica ME

(511) **Klasa 10:** Medicinski uređaji, naime, aparati za hlađenje tkiva, konturisanje i saniranje celulita; medicinski uređaji koji se koriste za uništavanje masnih ćelija.

**Klasa 44:** Medicinske usluge, naime dijagnostičke i tretmanske procedure i usluge u smislu konturisanja tkiva, saniranja celulita i uništavanja masnih ćelija kod ljudi; medicinske konsultacije vezane za uništavanje masnih ćelija kod ljudi.

---

(111) **14120**  
(151) **27.11.2018.**  
(210) **2017-478**

(220) 12.05.2017

(442) 20.04.2018.

(732) Zeltiq Aesthetics, Inc., a United States / Delaware corporatio 4410 Rosewood Drive Pleasanton, California 94588 Sjedinjene Američke Države

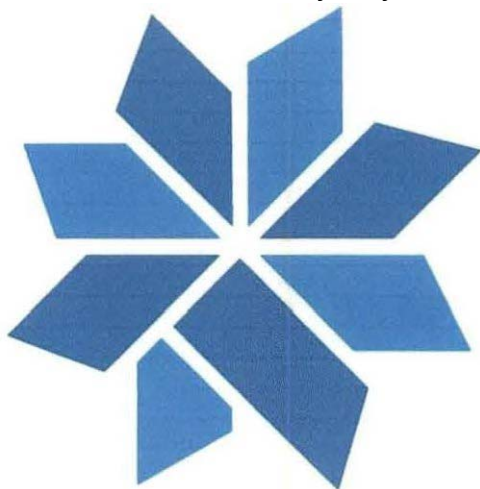

(540)

(550) I, F

(740) Popović Miladin, Đoka Miraševića 21/III, Podgorica ME

(511) **Klasa 10:** Medicinski uređaji, naime, aparati za hlađenje tkiva, konturisanje i saniranje celulita; medicinski uređaji koji se koriste za uništavanje masnih ćelija.

**Klasa 44:** Medicinske usluge, naime dijagnostičke i tretmanske procedure i usluge u smislu konturisanja tkiva, saniranja celulita i uništavanja masnih ćelija kod ljudi; medicinske konsultacije vezane za uništavanje masnih ćelija kod ljudi.

---

(111) **14112**  
(151) **27.11.2018.**  
(210) **2017-355**

(220) 31.08.2017

(442) 20.01.2018



(732) CRYSTAL LAGOONS (Curacao) B.V. Kaya W.F.G. (Jombi) Mensing 14, 2nd floor Willemstad, Curacao

(540) CRYSTAL LAGOONS

(550) V

(740) Saša Vujačić, Bul. Ivana Crnojevića 56/2, Podgorica ME

(511) Klasa 36: iznajmljivanja smještaja [nekretnine] upravljanje građevinskim objektima iznajmljivanje stanova posredovanje [mešetarenje] iznajmljivanje nekretnina usluge agencija za nekretnine posredovanje u trgovini nekretninama procjena nekretnin upravljanje nekretninama Klasa 37: nadzor građevinskih radova [vođenje] iznajmljivanje mašina za čišćenje iznajmljivanje mašina za gradilišta izgradnja izgradnja (informacije o izgradnji) konzultacije u svezi izgradnje dezinfekcija iznajmljivanje odvodnih pumpi OS informacije o po prav kama bazeni (održavanje bazena) podmorska izgradnja III podmorske popravke

Klasa 41: akademije [obuka] cirkusi [zabavni parkovi] prikazivanje igranih filmova klubovi (usluge klubova) [zabava ili obrazovanje] treniranje [fizička vježba] organizovanje i vođenje razgovora organizovanje i vođenje koncerata organizovanje i vođenje konferencija organizovanje i vođenje kongresa diskoteke (usluge diskoteka) usluge umjetnika zabavljača usluge razonode informacije o razonodi pružanje filmova koji se ne mogu preuzeti putem usluga prijenosa videozapisa na zahtjev, fitnes časovi ( vođenje fitnes časova) igre (usluge igara) pružene on-line [sjedne informatičke mreže] golf (stavlanje na raspolaganje igrališta za golf) gimnastička obuka zdravstveni klubovi (usluge zdravstvenih klubova) [održavanje zdravlja i fizičke forme] kampovi za ljetovanje (usluge kampova za ljetovanje) [zabava] organizovanje i provođenje obrazovnih foruma uživo usluge noćnih klubova [zabava] organizovanje takmičenja [obrazovanje ili razonoda] organizovanje izložbi u kulturne i obrazovne svrhe organizovanje sportskih takmičenja organizovanje lutrije organizovanje plesova organizovanje spektakla [usluge impresarija] modne revije za zabavne svrhe (organizovanje) praktična obuka [demonstriranje] prikazivanje varijetskih predstava priredbe (održavanje priredbi) slobodno vrijeme (usluge za ispunjavanje slobodnog vremena) informacije u vezi rekreacije organizovanje i vođenje seminara priredbe (proizvodnja priredbi) kampovi za sportsko usavršavanje sportska oprema (stavlanje na raspolaganje sportske opreme) iznajmljivanje sportske opreme [osim vozila] iznajmljivanje sportskih terena iznajmljivanje stadiona simpoziji (organizovanje i vođenje simpozija) obuka [predavanje] pružanje televizijskih programa koji se ne mogu preuzeti putem usluga prijenosa videozapisa na zahtjev iznajmljivanje teniskih igralista usluge osposobljavanja putem simulatora profesionalna orijentacija [savjeti u vezi obrazovanja ili osposobljavanja] organizovanje i vođenje radionica za stručno osposobljavanje

Klasa 42: arhitektonsko savjetovanje, bakteriološka istraživanja hemijske analize istraživanje u hemiji inženjering industrijski dizajn daljinski nadzor kompjuterskih sistema istraživanje i razvoj

novih proizvoda [za treće osobe] laboratorijske, naučne usluge istraživanja u tehnici tehnološke savjetodavne usluge analiza vode

Klasa 43: usluge iznajmljivanja smještaja [hotelski, pansionski] barovi (usluge barova) usluge kafića usluge kafeterija kampovanje (stavljanje na raspolaganje terena za kampovanje) ugostitelji (usluge ugostitelja) kampovi za ljetovanje (usluge kampova za ljetovanje) [smještaj] hotelske usluge hotelske rezervacije (usluge rezerviranja hotela) usluge restorana usluge snek barova iznajmljivanje privremenog smještaja rezervisanje privremenog smještaja iznajmljivanje prenosivih građevinskih objekata

-----  
(111) **14142**

(151) **27.11.2018.**

(210) **2017-100**

(220) 17.03.2017

(442) 20.04.2018.

(732) SUBARU CORPORATION 1-20-8, Ebisu, Shibuya-ku, Tokyo, Japan

# EyeSight

(540)

(550) I

(740) Lutovac Branislav, Bulevar Ivana Crnojevića 93, Podgorica ME

(511) **Klasa 09:** Fotografске mašine i aparati; kinematografske mašine i aparati; optičke mašine i aparati; telekomunikacione mašine i aparati; kompjuteri; kompjuterski periferali; kontrolni uređaji za automobile; elektronski kontrolni instrumenti i aparati kao i njihovi djelovi i oprema za automobile; elektronski kontrolni instrumenti i aparati kao i njihovi delovi i oprema za vozila; mašine i instrumenti za mjerenje ili testiranje; simulatori za upravljanje i kontrolu nad vozilom; elektronske publikacije; mašine i aparati za distribuciji ili kontrolu snage; rotacioni pretva rači; fazni modifikatori; monitori i kamere za vozila; sistemi za automatizovano upravljanje vozilom koji se sastoji prvenstveno iz elektronskih kontrolnih uređaja, kamera i senzora; kontrolni uređaj i za video kamere za nadzor kao i sastavni delovi za iste; uređaji za merenje brzine automobila; elektronski kontrolni uređaji za voznju konstantnom brzinom za automobile; elektronski kontrolni uređaj i za vožnju konstantnom brzinom za motorna vozila na dva točka; elektronski kontrolni uređaji za vožnju konstantnom brzinom za bicikle; kompjuterizovane kontrole za rukovanje vozilom uključujući elektronske kontrolne uređaje, kamere, video kamere i senzore; aparati za mjerenje razdaljine za automobile, naime a nalizatori oblaka tačaka; sistem kontrole vozača koji se sastoji prvenstveno iz kamera; softver za kontrolu vozila; softver za kontrolu vozila u režimu vožnje konstantnom brzinom; softver za kontrolu monitora i kamera; softver za sistem za automatizovano upravljanje vozilom; softver za sistem kontrole vozača.

**Klasa 35:** Oglašavanje; poslovno upravljanje, poslovna administracija; kancelarijski poslovi; usluge prodaje na malo automobila, njihovih sastavnih delova i njihove sastavne opreme; usluge prodaje na malo električnih aparata i instrumenata, njihovih sastavnih djelova i njihove sastavne opreme; usluge prodaje na malo fotografskih aparata i instrumenata, njihovih sastavnih djelova i njihove sastavne opreme; usluge prodaje na malo kinematografskih aparata i uređaja, njihovih sastavnih djelova i njihove sastavne opreme.

**Klasa 42:** Naučne i tehnološke usluge, kao i usluge istraživanja i projektovanja u vezi sa njima; usluge industrijskih analiza i istraživanja; projektovanje i razvoj računarskog hardvera i sofvera.

-----  
(111) **14122**

(151) **27.11.2018.**

(210) **2017-495**

(220) 12.12.2017

(442) 20.04.2018.

(732) Dogus Croatia d.o.o. Petrinjska ulica 3, Zagreb HR



(540)

(550) I, F

(740) Bogetić Jelena, Bulevar Džordža Vašingtona S1, Podgorica ME

(511) **Klasa 12:** Brodovi; brodska rebra; brodski trupovi; upravljački uređaji za brodove; jarboli (brodarstvo); plovna vozila; jahte.

**Klasa 35:** Pomoć u vođenju poslova; savjetovanje o organizaciji i vođenju poslova; konsultacije u vezi vođenja poslova; stručne usluge o poslovnoj efikasnosti; poslovne procjene; savjetovanje o organizovanju poslova; poslovna istraživanja; usluge savjetovanja u vezi vođenja poslova; stručno savjetovanje o poslovima; poslovne informacije; pružanje poslovnih informacija putem internet stranice; usluge podugovaranja (pomoć u poslovanju).

**Klasa 37:** Održavanje vozila; molerske usluge; unutrašnje i spoljašnje (bojanje); obavljanje podvodnih popravki; održavanje i popravak blagajni; brodogradnja.

**Klasa 39:** Usluge prevoza; vazdušni prevoz; željeznički prevoz; prevoz sa blindiranim kolima; prevoz feribotom (trajektom); riječni prevoz; taxi prevoz; prevoz namještaja; prevoz brodom; usluge brodova za razonodu; tramvajske usluge; prevoz putnika; prevoz tegljačima; pomorski prevoz; autobuski prevoz; organizovanje krstarenja; pratnja putnika; zakup broda za prevoz tereta i putnika; usluge pošiljki; obezbjeđen prevoz dragocjenosti; prevoz kamionima; usluge prevoza skelom; preseljenje pokretne imovine; posredovanje u prevozu; rezervacije za prevoz; posredovanje u zakupu broskog prostora; pomorsko posredovanje (mešetarenje); prevoz kolima hitne pomoći; usuge vozača; pilotarenje; turističke kancelarije; rezervacije za putovanja; rezervisanje mijesta za putovanje; organizovanje izleta; turistička razgledanja; usluge prevoza poštanskih pošiljki ili robe; razdjela pošte; isporuka proizvoda naručenih putem pošte; isporuka (distribucija) proizvoda; isporuka novina; isporuka paketa; iznajmljivanje automobila;

iznajmljivanje trkačkih vozila; iznajmljivanje skladišnih kontejnera; iznajmljivanje vozila; iznajmljivanje kamiona; iznajmljivanje skladišta; iznajmljivanje nosača gepeka za automobile; informacije u vezi skladištenja; vuča (tegljenje); tegljenje vozila; skladišni kontejneri; odsukavanje nasukanih brodova; prevoz cjevovodom; dovod vode; spašavanje; spašavanje brodova; službe za spašavanje; spašavanje u podmorju; pružanje pomoći (prevoz); odlaganje robe; ambalažiranje proizvoda; prevoz i istovar smeća; prevoz i istovar vodopada; iznajmljivanje skafandera (teških); iznajmljivanje ronilačkih zvana.

-----  
(111) **14113**

(151) **27.11.2018.**

(210) **2017-461**

(220) 22.11.2017

(442) 20.04.2018.

(732) NGK SPARK PLUG CO., LTD. 14-18, Takatsuji-cho Mizuho-ku Nagoya City, 467-8525 Japan



(540)

(550) I, F

(740) Popović Miladin, Đoka Miraševića 21/III, Podgorica ME

(511) **Klasa 09:** Aparati za mjerenje koncentracije isparenja goriva, kiseonika, azota, oksida, ugljovodonika, metana, alkohola i vodonika u vazduhu ili gasu; aparati za mjerenje koncentracije isparenja goriva, kiseonika, azotnog oksida, ugljovodonika, metana, alkohola i vodonika i kontrolu odnosa vazduha i goriva u izduvnim gasovima motora sa unutrašnjim sagorijevanjem, kotlova, peći za spaljivanje, gasnih turbina, generatora i gorivnih ćelija; senzori lupanja; senzori pritiska; temperaturni senzori; spoljašnji senzori za mjerenje kvaliteta vazduha; senzori opterećenja; senzori za detekciju curenja vodonika; urea senzori; senzori brzine; senzori za mjerenje položaja tečnosti; senzori položaja; senzori za mjerenje protoka gasa, vazduha i tečnosti; senzor položaja prenosnika mjenjača; infracrveni senzor protiv krađe; senzori za detekciju tečnosti; senzori za detekciju udara; senzori osvjetljenja; senzor za mjerenje brzine inhalacije vazduha; senzori (aparati za mjerenje), osim za medicinsku upotrebu; senzori ubrzanja; senzori vibracije; senzori brzine; senzori pokreta; senzori gasa; optički senzori; infracrveni senzori; fotoelektrični senzori; dijelovi i komponente za elektronske aparate kao što su paketi integrisanog kola, supstrati integrisanih kola, kontejneri za silikonske ispravljače, vakumski prekidači kola, zaptivne terminalne ploce, terminali za vađenje, nosači foto dioda, keramički grijaci, keramički ozonizator; piezoelektrični keramički uređaji, kao što su keramički filteri, zujalice, dijafragme, zvučnici, ultrazvučni senzori, ultrazvučni transduktori, ultrazvučni generatori, ultrazvučni brojači, sistemi za paljenje, gasni ignitori, pokretači, monolitske konstrukcije koje se sastoje od keramičkih ploča

povezanih strujom (piezo-stack), bimorfi, optički skeneri, kompozitni materijali, naime piezoelektrične gumene ploče piezoelektrično spajanje žicom; mikrotalasni dielektrični materijali.

-----  
(111) **14117**

(151) **27.11.2018.**

(210) **2017-466**

(220) 29.11.2017

(442) 20.04.2018.

(732) SHARP KABUSHIKI KAISHA also trading as SHARP CORPORATION, a corporation organized and existing under the laws of Japan, Manufacturers and Merchants o 1 Takumi-cho, Sakai-ku, Sakai City, Osaka 590-8522, Japan

(540) **SHARP**

(550) I, F

(740) MSA IP Milojević Sekulić, Karađorđeva 65, Beograd SR

(511) **Klasa 07:** Mašinski alati; motori i pogonske mašine (osim za suvozemna vozila); mašinske spojnice i transmisioni elementi (osim za suvozemna vozila); poljoprivredne sprave osim onih kojima se ručno upravlja; inkubatori za jaja; automatske mašine za prodaju; električni usisivači za kućnu upotrebu; automatski usisivači (samohodni) koji koriste sisteme računarstva u oblaku za kućnu upotrebu; automatski usisivači (samohodni) za kućnu upotrebu; automatski usisivači (samohodni), naime, roboti koji koriste sisteme računarstva u oblaku za održavanje domaćinstva i koji imaju jonizirajuću funkciju; električni automatski usisivači (samohodni), naime, roboti za održavanje domaćinstva; električni usisivači za futon (japanske dušeke) za kućnu upotrebu; električne mašine za pranje veša za kućnu upotrebu; električne mašine za pranje veša koje imaju opciju susenja veša, za kućnu upotrebu; mašine za pranje posuda za kućnu upotrebu; električne mašine za poliranje voskom za kućnu upotrebu; električni prerađivači hrane za kućnu upotrebu; mašine za mešanje hrane za kućnu upotrebu; električni blenderi za kućnu i industrijsku upotrebu; uređaji za seckanje hrane, električni; mašine za seckanje mesa; mašine za mlevenje mesa; električni sokovnici za kućnu upotrebu; sokovnici niske brzine za kućnu upotrebu; električne prese za voće, za upotrebu u domaćinstvu; električni usisivači za industrijsku upotrebu; automatski usisivači (samohodni) koji koriste sisteme računarstva u oblaku za industrijsku upotrebu; automatski usisivaci (samohodni) za industrijsku upotrebu; automatski usisivači (samohodni), naime, roboti koji koriste sisteme računarstva u oblaku za industrijsku upotrebu i koji imaju jonizirajuću funkciju; električni automatski usisivači (samohodni), naime, roboti za industrijsku upotrebu; automatski usisivači (samohodni), naime, roboti za čišćenje modula solarnih ćelija; električne mašine za pranje veša za industrijsku upotrebu; mašine za pranje posuda za industrijsku upotrebu; sokovnici, električni; električni sokovnici za industrijsku upotrebu; mašine za struganje voća; mašine za mesanje hrane za industrijsku upotrebu; mašine

za ljustenje hrane za industrijsku upotrebu; mašine za secenje, rezanje i sitnjenje hrane za industrijsku upotrebu; mašine za pripremu hrane i preradu napitaka; mlinovi za kafu kojima se ne upravlja ručno; mašine za glodanje (glodalice); mašine za poliranje voskom, električne, za industrijsku upotrebu; roboti za nosace prtljaga; elevatori (liftovi); oprema za uklanjanje statičnog elektriciteta; automatske mašine za distribuciju.

**Klasa 08:** Ručni alati i sprave (kojima se ručno upravlja); pribor za jelo; hladno oružje; brijači; pegle, električne; električne pegle na paru; ručne sprave za uvijanje kose; pegle za uvijanje kose; sprave za ravnjanje kose; sprave za oblikovanje kose; brijači, električni; električne mašine za brijanje; električni uređaji za depilaciju.

**Klasa 09:** Aparati i instrumenti naučni, pomorski, geodetski, fotografski, kinematografski, optički, za vaganje, merenje, signalizaciju, kontrolu (inspekciju), spasavanje i nastavu; aparati i instrumenti za provodenje, prekid, transformaciju, akumulaciju, regulisanje ili kontrolu električne energije; aparati za snimanje, prenos ili reprodukovanje zvuka ili slike; magnetni nosači podataka, diskovi za snimanje; kompakt diskovi, DVD diskovi i digitalni nosači podataka; mehanizmi za aparate koji se pokrecu novcem; registar kase, računske masine, oprema za obradu podataka, računari; računarski softver; aparati za gasenje požara; soundbarovi (zvučni sistemi u obliku poluge); oprema za kućni bioskop; slusalice, internet radio aparati, gramofoni; LCD televizijski prijemnici; smartfoni (pametni telefoni) u obliku robota; smartfoni (pametni telefoni); mobilni telefoni; telefoni; delovi i oprema za telefone; tablet računari; prenosivi digitalni pomoćnici u obliku tablet računara; prenosivi digitalni pomoćnici u obliku ručnih časovnika; prenosivi digitalni pomoćnici; integrisane interaktivne table; interaktivne table, integrisane interaktivne table sa ekranima na dodir; interaktivne table sa ekranima na dodir; aplikacijski softver za smartfone (pametne telefone) i digitalne pomoćnike u obliku tablet računara; aplikacijski softver; telekomunikacijski aparati; aparati koji se koriste u elektronici i njihovi delovi; baterije; električne zice i kablovi; mašine i aparati za distribuciju i/ili kontrolu električne energije; samohodni roboti za nadzor bezbednosti; samohodni roboti za nadzor koji se koriste u sigurnosne svrhe; roboti za nadzor koji se koriste u bezbednosne svrhe; mašine i instrumenti sa automatskom kontrolom na osnovu temperature i registrovanja pokreta, za potrebe klimatizacije ili zamrzavanja; regulatori jacine svetlosti za rasvetna tela; strujni kontroleri za rasvetna tela; mašine i instrumenti za merenje ili testiranje temperature, vlažnosti i atmosferskog pritiska; automatski i daljinski upravljači za svrhe merenja, nadgledanja i kontrolisanja za klima uređaje; kamere za svrhe nadgledanja; kamere za video nadzor; protivprovalni i protivpožarni upozoravajući aparati; senzori pokreta; aparati za praćenje, električni; kamere za nadgledanje sa sensorima pokreta; nosači podataka za prenos i skladištenje na uređajima sa elektronskom memorijom, bežično ili pomoću kabla; audio-prijemnici; aparati za prenos zvuka ili slika; aparati za snimanje zvuka ili slika; aparati za upozoravanje sa mogućnošću nadgledanja pokreta beba pomoću kamkordera ili senzora; elektronski prevodioci na osnovu zvuka; elektronski prevodioci; unapred snimljeni nosači podataka za sisteme za prepoznavanje glasa; plejeri za reprodukovanje zvuka; zvučnici; aparati za snimanje kompjuterskih podataka; aparati za obradu podataka; računarski programi koji se mogu preuzeti putem interneta; računarski programi (softveri koji se mogu preuzimati); računari i računarski softver; fotonaponski moduli ćelija; solarne baterije; fotonaponski aparati i

instalacije; televizijski prijemnici sa ekranom koji maze da se upotrebljava kao ogledalo; monitori sa ekranom koji maze da se upotrebljava kao ogledalo; bezbednosni protivprovalni alarmi za vrata; alarmi za curenje gasa; alarmi za dim; alarm za curenje vade; alarmi protiv krade; elektronski mehanizmi za zakljucavanje sefova; strujni kontroleri na daljinsko upravljanje; vatmetri; transformatori električne energije; aparati za merenje napona električne struje; detektori mikroba; senzori mikroba; mašine i instrumenti za merenje i ispitivanje; brojac koraka; brojac; senzori vibracija; video zapisi poput unapred snimljenih video diskova i video traka; muzičke datoteke, fajlovi, koje se mogu preuzimati; datoteke slika koje se mogu preuzimati; zvučni zapisi ili slike koji se mogu preuzimati; računarski aplikativni softver za prenosive digitalne pomocnike; računarski softver za računarstvo u oblaku; aplikativni softver; aplikacijski programi za smartfone koji koriste bezicnu lokalnu mrezu za upravljanje električnim uređajima u domaćinstvu; programi za igre za mobilne telefone koji se mogu preuzimati; programi za računarske igre koji su preuzeti sa interneta; programi za prenosive igre sa ekranom od tecnih kristala koji su preuzeti sa interneta; računarski softver koji se maze peuzeti; melodije za mobilne telefone koje se mogu preuzimati; elektronske publikacije koje se mogu preuzimati; elektronske publikacije; senzori AGE (završnih produkata glikacije); aparati za analizu proteina; uređaji za elektroforezu; uređaji za blot; aparat za fluorescenciju; uređaji za analizu zemljišta; vage za kupatila.

**Klasa 10:** Hirurški, medicinski, zubarski i veterinarski aparati i instrumenti; veštački udovi, oči i zubi; ortopedski artikli; hiruški materijali za zašivanje; terapijski i pomoćni uređaji za hendikepirane osobe; aparati za masažu; aparati, uređaji i proizvodi za odojčad; aparati, uređaji i proizvodi za seksualne aktivnosti; aparati za masažu za tijela; aparati za masažu za lice.

**Klasa 11:** Aparati za osvetljavanje, grejanje, proizvodnju pare, kuvanje, hladenje, susenje, ventilaciju, snabdevanje vodom i za sanitarne svrhe; jonizatori za upotrebu u domaćinstvu; električni automatski aparati za jonizaciju (samohodni) za upotrebu u domaćinstvu; električni automatski aparati za jonizaciju (samohodni) koji koriste sisteme računarstva u oblaku, za upotrebu u domaćinstvu; klima uređaji za upotrebu u domaćinstvu; pročišćivači vazduha za kućnu upotrebu; isusivači vlage za kućnu upotrebu; ovlaživači za kućnu upotrebu; električni ventilatori; električni ventilatori za ventilaciju; kuhinjski aspiratori; električni sporeti; mašine za duvanje koje sadrže jonizujuće uređaje za potrebe klimatizacije; električne mašine za duvanje za potrebe klimatizacije; sušaći za futon (japanski dušek) za kućnu upotrebu; električne mašine za sušenje veša za kućnu upotrebu; električni frizideri za kućnu upotrebu; parne pećnice sa superzagrevanjem za kućnu upotrebu; parne pećnice sa superzagrevanjem sa funkcijom mikrotalasne pećnice, za kućnu upotrebu; parni tosteri-pećnice sa superzagrevanjem za kućnu upotrebu; mikrotalasne peći; električne pećnice; elektromagnetni indukcijski sporeti za kućnu i industrijsku upotrebu; električni rostilji; grejači za kuvanje koji se zagrevaju pomoću indukcije; place za kuvanje i ugradne mikortalasne rerne; električne grejne fioke; električni aparati za kuvanje pirinca za kućnu upotrebu; električni tosteri za hleb; električni tosteri-pećnice; električni tiganji; električne šerpe za kuvanje; električni lonci za kuvanje; električno kuvalo; šerpe, električne; električna posuda za zagrevanje hrane; električni parni lonac; električne mašine za kafu; električni aparati za pravljenje toplih sendviča; električne friteze; električni uređaji za

pripremu supe; električni uređaji za pripremu jogurta; aparati za pravljenje hleba; električni aparati za čaj; električne posude za pripremu toplih napitaka; električni uređaji za kuvanje pod pritiskom; jonski generatori za kacige, čistači kaciga; električni aparati za lice za proizvodnju pare sa jonizirajućom funkcijom; električni aparati za lice sa jonizirajućom funkcijom; fenovi za kosu za kućnu upotrebu; elektrotermički uređaji za potrebe lepote ili za sanitarne potrebe, za kućnu upotrebu; elektrotermički uređaji za kućnu upotrebu; rasvetne instalacije sa diodama koje emituju svetlo (LED); električne lampe i uređaj i za rasvetu; ulična rasveta; ulična rasveta koja se sastoji od modula solarnih ćelija; rashladne vitrine; mašine i aparati za zamrzavanje za industrijsku upotrebu; vitrine za hlađenje i/ili zamrzavanje; električni čajnici; električni grejači vode; električni gorionici za industrijsku upotrebu; gasni gorionici za industrijsku upotrebu; električni grejači za kuvanje za industrijsku upotrebu; mašine za sušenje sudova za industrijsku upotrebu; aparati za dezinfekciju sudova za industrijsku upotrebu; aparati za sušenje; aparati za grejanje poda; aparati za klimatizovanje i grejanje; električni aparati za grejanje; klima uređaji za industrijsku upotrebu; jonizatori za industrijsku upotrebu; aparati za filtriranje vode; aparati za prečišćavanje vode; električni automat i za vodu; električni automati za vruću vodu; grejači vode za kadu za kupanje; električni aparati za tuširanje koji se sastoje od grejača za vodu i glave tuša; električni aparati za tuširanje koji se sastoje od grejača za vodu, glave tuša i pumpe; toaletne šolje sa bide funkcijom; električni aparati za grejanje i sušenje za kupatilo; električni aparati za sušenje za kupatilo; aparati za grejanje i sušenje na gas za kupatilo; aparati za sušenje na gas za kupatilo; električni dispenceri za pice za kućnu upotrebu; električni dispenceri gaziranih pića za industrijsku upotrebu; električni dispenceri za pice za industrijsku upotrebu; toaletne solje sa uređajem za ispiranje; toaletne soje; daske za upotrebu sa toaletnim soljama u japanskom stilu; fenovi za kosu za industrijsku upotrebu; uređaj za pravljenje tečnog natrijum hipohlorita; električni jonizatori vode za kućne potrebe; električni jonizatori vode.

**Klasa 21:** Kućne ili kuhinjske sprave i posude; češljevi i sunderi; četke (izuzev kičica); materijali za pravljenje četki; pribor za čišćenje; neobrađeno ili poluobrađeno staklo, osim građevinskog stakla; staklarija, porcelan i grnčarija; električne daske za peglanje.

- 
- (111) **14110**
- (151) **27.11.2018.**
- (210) **2017-341**
- (220) 23.08.2017
- (442) 20.01.2018
- (732) Starbucks Corporation 2401 Utah Avenue South, Seattle, WA 98134, U.S.A
- (540) DOUBLESHOT
- (550) I
- (740) Jusić Jasna, Crnogorskih serdara bb, Podgorica ME
- (511) Klasa 29: Mlijeko; mlijeko sa aromom; milkšejkovi; prehrambena pića na bazi mlijeka, izuzimajući milkšejkove; pića na bazi mlijeka koja sadrže kafu; pića na bazi mlijeka koja sadrže voćni sok; pića na bazi mlijeka koja sadrže voće; pića na bazi mlijeka koja sadrže čokoladu; pića



na bazi mlijeka koja sadrže čaj; prehrambena pića na bazi soje koja se koriste kao zamjena za mlijeko; energetska pića na bazi mlijeka; sojino mlijeko; pića na bazi jogurta.

Klasa 30: Pića na bazi kafe; pića na bazi espresso kafe; pića na bazi čokolade; pića na bazi čaja; pića na bazi biljnih čajeva; smrznute poslastice sa čajem, biljnim čajem i/ili voćnom aromom; arome, drugačije od esencijalnih ulja, za pića.

Klasa 32: Bezalkoholna pića, naime gazirana pića, negazirana pića, bezalkoholna osvežavajuća pića; energetska pića, izotonična pića; nutritivno obogaćena pića, vitaminski obogaćena pića .

-----  
(111) **14106**

(151) **27.11.2018.**

(210) **2017-330**

(220) 21.08.2017

(442) 20.02.2018

(732) Evolution Fresh, Inc. 1055 Cooley Avenue, San Bernardino, California 92408, U.S.A.

(540) EVOLUTION FRESH

(550) I

(740) Jusić Jasna, Crnogorskih serdara bb, Podgorica ME

(511) Klasa 32: Pića od voća , voćni sokovi, i pića na bazi voća; pića od povrća , sokovi od povrća , i pića na bazi povrća; bezalkoholna pića , naime gazirana pića , blaga pića; energetska pića , izotonična pića; tečne mješavine za pravljenje bezalkoholnih pića i pića na bazi voća; praškovi koji se koriste u pripremi bezalkoholnih pića i pića na bazi voća; sirupi za pića; flaširana voda za piće sa aromom ili bez arome, mineralna voda, gazirane vode; pića na bazi soje koja nisu zamjena za mlijeko; voćni koncentрати i pirei koji se koriste za pravljenje pića; nutritivno obogaćena pića , vitaminski obogaćena pića .

-----  
(111) **14108**

(151) **27.11.2018.**

(210) **2017-314**

(220) 11.08.2017

(442) 20.01.2018

(732) KE M.O. HOUSE CO., LTD. 15th Building, Tongfuyu Industrial Park, Xinhe Road, Buchong Community, Shajing Street,

**COPPER X CHEF**

(540)

(550) I

(740) Radulović Božidar, Studentska bb, Lamela 3/18, Podgorica ME

(511) Klasa 11: kuhinjske sprave, električne; grej ni šporeti; aparati i instalacije za kuvanje; aparati za pečenje; uređaji za pečenje; multi šporeti; električni tiganji; električni tiganji za pečenje (kuhinjski alat); peći za kuvanje; uređaji za kuvanje pod pritiskom, električni;

Klasa 21: kompleti posuda za kuvanje; šerpe; kazani, kotlovi; poklopci za lonce; kuhinjsko posuđe; tiganji; modle za kolače (kalupi); roštilj (sprava za kuvanje); kuhinjski pribor; pribor za kuvanje, ne-električni

---

(111) **14109**

(151) **27.11.2018.**

(210) **2017-262**

(220) 18.07.2017

(442) 20.02.2018

(732) Celgene Corporation 86 Morris Avenue, Summit, NJ 07901, U.S.A.

## РИБЛОЗЕЛ

(540)

(550) I

(740) Čolović Mladen, Dalmatinska br. 2, Podgorica ME

(511) Klasa 5: Farmaceutski preparati koji se koriste u liječenju beta talasemije i mielodisplastičnih sindroma, autoinflamatornog oboljenja, autoimunih bolesti, bolesti krvi, raka, artritisa, muskuloskeletnih i kožnih oboljenja u oblastima onkologije, imunologije i zapaljenskih procesa; farmaceutski preparati, naime, inhibitori lijeka citokina; farmaceutski preparati koji moduliraju imunološki sistem.

---

(111) **14107**

(151) **27.11.2018.**

(210) **2017-254**

(220) 06.07.2017

(442) 20.01.2018

(732) Visa International Service Association 900 Metro Center Boulevard, Foster City, 94404 California, U.S.A.

(540) V PAY

(550) I

(740) Jusić Jasna, Crnogorskih serdara bb, Podgorica ME

(511) Klasa 36: Finansijske usluge, bankarstvo, usluge plaćanja računa, usluge debitnih kartica, usluge naplatnih kartica, usluge pripejd kartica, elektronske kreditne i debitne transakcije, elektronski prenos sredstava, usluge pametnih kartica i elektronskog keša, novčane isplate, novčana zamjena koja se vrši debitnim karticama, transakcije elektronskog keša, usluge pristupa depozitima i usluge bankomata, usluge obrade plaćanja, obrada finansijskih transakcija na mreži preko globalne računarske mreže ili putem telekomunikacionih, mobilnih ili bežičnih uređaja, usluge provjere autentičnosti i verifikacije transakcija, usluge osiguranja putnog osiguranja, elektronski transfer sredstava i usluge razmjene valuta i diseminacija finansijskih informacija i podataka elektronskog plaćanja preko globalne računarske mreže ili preko telekomunikacionih, mobilnih ili bežičnih uređaja .

---

(111) **14094**  
(151) **27.11.2018.**  
(210) **2017-247**  
(220) 30.06.2017  
(442) 20.02.2018  
(732) INA - industrija nafte d.d. Avenija Veceslava Holjevca 10, 10000 Zagreb, HR  
(540) INA ULTRA  
(550) I  
(740) Radulović Božidar, Studentska bb, Lamela 3/18, Podgorica ME  
(511) Klasa 4: Motorna ulja za vozila

---

(111) **14141**  
(151) **27.11.2018.**  
(210) **2017-110**  
(220) 23.03.2017  
(442) 20.04.2018.  
(732) The Procter & Gamble Company One Procter & Gamble Plaza, Cincinnati, Ohio 45202, U.S.A.

## AMBI PUR ONE

(540)  
(550) I  
(740) Lutovac Branislav, Lutovac B. Vuk, Bulevar Ivana Crnojevića 93, Podgorica ME  
(511) **Klasa 03:** Preparati za njegu, tretiranje i uljepšavanje tkanina; potpuri; tamjan; ulja za parfeme i mirise; mirišljava voda za upotrebu u domaćinstvu i za upotrebu na tkaninama;

mirišljivo drvo; aromatični preparati; eterična ulja; preparati za parfimisanje vazduha, ambijentalne atmosfere ili tkanine u obliku dima, pare ili gasa.

**Klasa 04:** Svijeće, ulja, vosak i fitilji.

**Klasa 05:** Osvježivati vazduha; preparati za prečišćavanje vazduha; dezodoransi; preparati za dezodorisanje tkanine, presvaka za nameštaj i ambijentalne atmosfere; preparati za neutralisanje mirisa.

**Klasa 11:** Aparati za dezodorisanje vazduha; aparati za hladjenje vazduha; aparati za zagrijavanje vazduha; aparati za sušenje vazduha; klima uređaji; uređaji za filtriranje vazduha; uređaji i mašine za prečišćavanje vazduha; uređaji za sterilizaciju vazduha; aparati za dezodorisanje, koji nisu za ličnu upotrebu; aparati za dezinfekciju; aparati za fumigaciju (nadimljavanje), koji nisu za medicinsku upotrebu .

-----  
(111) **14121**

(151) **27.11.2018.**

(210) **2017-492**

(220) 12.12.2017

(442) 20.04.2018.

(732) Ajinomoto Co., Inc. 15-1, Kyobashi 1-chome Chuo-ku Tokyo Japan



(540)

(550) I, F

(740) Popović Miladin, Đoka Miraševića 21/III, Podgorica ME

(511) **Klasa 29:** Bujon; koncentracije za bujon; supa; kocke za supu; preparati za spremanje supa; instant supa; koncentracije za supu; supa sa rezancima; instant supa pomiješana sa rezancima; instant supa pomiješana sa rižom; čorba; koncentracije za čorbe; prerađeno meso; konzervirano meso; smrznuto meso; mesni ekstrakti; pihtije; prerađeni plodovi mora; konzervirani plodovi mora; smrznuti plodovi mora; prerađeni skampi; prerađene školjke; kroketi; šunka; jetrena pašteta; smrznuto povrće; prerađeno povrće; konzervirano povrće; salate od povrća; sušeno povrće; musevi od povrća; pire od paradajza; pasta od paradajza; prerađene jestive sjemenke; prerađeno kostunjavo voće; začinjeno koštunjavo voće; prerađene pečurke: smrznuto voće; prerađeno voće; konzervirano voće; džem; sušeno voće; želei od voća; kompoti; kristalizovano voće; želei za hranu; mliječni proizvodi; mlijeko; pavlaka [mliječni proizvodi]; sir; pića na bazi

mliječne kisjeline; puter; mlijeko u prahu, ne za bebe; zamjene za mlijeko; bademovo mlijeko; jogurt; jestiva ulja i masti; margarin; mast; meso; govedina; svinjetina; piletina [meso]; živina, ne živa; jetra; kokošija jaja; jaja; jestive vodene životinje, ne žlive; školjke, ne žive; prerađena jaja; konzervirane mahunarke; protein za ljudsku konzumaciju.

---

**OBJAVA UPISA PROMJENA U REGISTAR ŽIGOVA**  
**PUBLICATION OF RECORD OF CHANGES TO THE TRADEMARK REGISTER**

**RJEŠENJA O PROMETU PRAVA**

<b>BROJ PRIJAVE (210)</b>	<b>REGISTARSKI BROJ (111)</b>	<b>IME I ADRESA RANIJEG NOSIOCA PRAVA (732)</b>	<b>IME I ADRESA STICAOCA PRAVA (732)</b>
1991-1143	(04611)	<b>A.T.X. International, Inc.</b> <b>One Albion Road, Suite 200 Lincoln, Rhode Island 02865, IE</b>	<b>A.T. Cross Company, LLC</b> <b>10990 Wilshire Blvd., Suite 440, Los Angeles, CA 90024, USA</b>
1976-56	(09002)	<b>Thales Corporate Services Limited</b> <b>350 Longwater Avenue, Green Park, Reading, Berkshire, RG2 6GF, United Kingdom</b>	<b>Thales UK Limited</b> <b>350 Longwater Avenue, Green Park, Reading, Berkshire, RG2 6GF, United Kingdom</b>
1994-9	(09716)	<b>ROVCAL INC.</b> <b>601 RAYOVAC DRIVE, MADISON, WISCONSIN 53711, USA</b>	<b>SPECTRUM BRANDS, INC.</b> <b>601 RAYOVAC DRIVE, MADISON, WISCONSIN 53711, USA</b>
1964-236	(9538)	<b>Inlas Holding S.Á.R.L.</b> <b>46A Avenue John F. Kennedy, L-1855 Luksemburg</b>	<b>A.T. Cross Company, LLC</b> <b>10990 Wilshire Blvd., Suite 440, Los Angeles, CA 90024, USA</b>
2009-144	(04963)	<b>CROSS VETPHARM GROUP LIMITED</b> <b>Broomhill Road, Tallaght, Dublin 24, Irska</b>	<b>BIMEDA ANIMAL HEALTH LIMITED</b> <b>First Floor, The Herbert Building, The Park, Carrickmines,</b>

			Dublin 18, D18K8Y4, Irska
1990-2165	(03396)	„CRNAGORACOOP“ A.D. u mješovitoj svojini Landža b.b. Danilovgrad	„CRNAGORACOOP NB“ d.o.o. Danilovgrad Landža b.b. Danilovgrad
2015-211	(13128)	Inter On Line Trading Group Inc. 51st Street, Campo Alegre, Area Bancaria, Centro Magna Corp. Building, 6th floor, Office No.608, Panama City, Panama	Savory World Ltd. Sotiriou Tofini, 4, AUDEH QUARTERS, 1st Floor, Flat/Office 101, 4102, Limassol, Kipar
2012-351	(11501)	24Kitchen Television B.V. De Passage 144, 1101 AX Amsterdam Zuidoost, Netherlands	Twentieth Century Fox Film Corporation 10201 West Pico Boulevard, Los Angeles, 90035 California, U.S.A.
	2017-86 (13786)	Cott Beverages Inc. 5519 W. Idlewild Avenue, Tampa, Florida 33634-8016 US	Cott Beverages LLC 1001 10th Avenue, Columbus, Georgia 31901 US
2004-1107	(11101)	TOLO TOYS LIMITED 5th Floor, Tower II, South Seas Centre, 75 Mody Road, Kowloon, Hong Kong, HK	TOLO MACAU LIMITED Travessa do Coronel Mesquita, No. 3, Edif. Kam Kun Kok, 5 Andar, A, Macau

2008-633	(00935)	<b>BAMBI AD</b> ĐURE ĐAKOVIĆA BB, REPUBLIKA SRBIJA	BANAT 1894 STEPE STEPANOVIĆA BR. 6, VRŠAC, REPUBLIKA SRBIJA
2018-543	(00899)	<b>BAMBI AD</b> ĐURE ĐAKOVIĆA BB, REPUBLIKA SRBIJA	BANAT 1894 STEPE STEPANOVIĆA BR. 6, VRŠAC, REPUBLIKA SRBIJA
2008-544	(00900)	<b>BAMBI AD</b> ĐURE ĐAKOVIĆA BB, REPUBLIKA SRBIJA	BANAT 1894 STEPE STEPANOVIĆA BR. 6, VRŠAC, REPUBLIKA SRBIJA
2008-477	(00392)	<b>BAMBI AD</b> ĐURE ĐAKOVIĆA BB, REPUBLIKA SRBIJA	BANAT 1894 STEPE STEPANOVIĆA BR. 6, VRŠAC, REPUBLIKA SRBIJA
2008-485	(00386)	<b>BAMBI AD</b> ĐURE ĐAKOVIĆA BB, REPUBLIKA SRBIJA	BANAT 1894 STEPE STEPANOVIĆA BR. 6, VRŠAC, REPUBLIKA SRBIJA
2008-1082	(05085)	<b>BAMBI AD</b> ĐURE ĐAKOVIĆA BB, REPUBLIKA SRBIJA	BANAT 1894 STEPE STEPANOVIĆA BR. 6, VRŠAC, REPUBLIKA SRBIJA
2008-632	(00934)	<b>BAMBI AD</b> ĐURE ĐAKOVIĆA BB, REPUBLIKA SRBIJA	BANAT 1894 STEPE STEPANOVIĆA BR. 6, VRŠAC, REPUBLIKA SRBIJA



2017-140	(13868)	<b>Amanresorts Limited</b> 25th Floor, Jardine House, 1 Connaught Place, Central, Honh Kong, Hong Kong	<b>Aman Group S.à.r.l.</b> Grabenstrasse 17, 6340 Baar, Švajcarska
2009-213 (03481)		<b>AD BJELASICA RADA</b> Industrijska bb, Bijelo Polje, Crna Gora	<b>DOO WATER GROUP</b> Trebiljevo, Kolašin, Crna Gora
2009-213	(03481)	<b>DOO WATER GROUP</b> Trebiljevo, Kolašin, Crna Gora	<b>Boris Rašković, Jovana Tomaševića 9/3, Podgorica, Crna Gora</b>  <b>Miro Perović, Serdara Jola Piletića 28/1, Podgorica, Crna Gora</b>
2000-524	(00860)	<b>EKO INDUSTRIAL AND COMMERCIAL PETROLEUM COMPANY A.E.</b> 8A Cheimarras street, 151 25 Marousi, Greece	<b>HELLENIC FULES S.A.</b> 8A Cheimarras street, 151 25 Marousi, Greece
2015-289	(13297)	<b>Triangl Pte. Ltd.</b> 16 Raffles Quay #33-03, Hong Leong Building, Singapore 048581	<b>Triangl IP Limited</b> Ingouville House, Ingouville Lane, St Helier JE2 4SG, Jersey
2008-710	(00957)	<b>JAMNICA d.d.</b> Getaldićeva 3, HR-10000 Zagreb, HR	<b>Stanić Beverages d.o.o.</b> Slavonska avenija 22, 10000 Zagreb, HR

**RJEŠENJA O PROMJENI ADRESE**

<b>BROJ PRIJAVE</b>	<b>REGISTARSK I BROJ</b>	<b>IME I ADRESA NOSIOCA ŽIGA (732)</b>	<b>IME I ADRESA NOSIOCA ŽIGA (732)</b>
---------------------	--------------------------	--	--

<b>(210)</b>	<b>(111)</b>		
1972-690	(09018)	BRIDGESTONE LICENSING SERVICES, INC.  <b>535 Marriott Drive, Nashville, Tennessee 37214, Sjedinjene Američke Države</b>	BRIDGESTONE LICENSING SERVICES, INC <b>200 4th Avenue South, Suite 100, Nashville, Tennessee 37201, Sjedinjene Američke Države</b>
2016-330	(13687)	<b>Millennium &amp; Copthorne International Limited 36 Robinson Road # 04-01 City House, Singapore 068877, SG</b>	<b>Millennium &amp; Copthorne International Limited 9 Raffles Place, #12-01 Republic Plaza, Singapore 048619 / SG</b>
1988-468 (00548)		KENTUCKY FRIED CHICKEN INTERNATIONAL HOLDINGS LLC <b>1441 Gardiner Lane, 40213 Louisville, Kentucky, U.S.A.</b>	KENTUCKY FRIED CHICKEN INTERNATIONAL HOLDINGS LLC <b>7100 Corporate Drive, 75024 Plano TX, U.S.A.</b>
2008-1191	()02847)	Novartis AG <b>Lichtstr. 35, 4056 Basel</b>	Novartis AG <b>4002 Basel, Švajcarska</b>
2009-21	(05061)	SUN SAME ENTERPRISES CO., LTD. <b>NO. 31, LANE 349, CHUNG CHENG S. ROAD, YUAN KANG, TAINAN HSIEN, TAIWAN, R.O.C., TW</b>	Novartis AG <b>NO. 31, LANE 349, CHUNG CHENG S. RD., YONGKANG DIST., TAINAN CITY 710, TAIWAN</b>
2008-471	(00481)	Raffles International Limited <b>250 North Bridge Road, # 10-00 Raffles City Tower, 179101 Singapore, Singapore</b>	Raffles International Limited <b>1 Wallich Street, #17-01 Guoco Tower, Singapore 078881, Singapore</b>
2005-1661	(11 236 )	UNITED STATES POLO ASSOCIATION <b>771 Corporate Drive, Suite 505, 40503 Lexington, Kentucky, US</b>	UNITED STATES POLO ASSOCIATION <b>1400 Centrepark Blvd., Suite 200, West Palm Beach, Florida 33401, U.S.A.</b>

2005-14361	(10443)	UNITED STATES POLO ASSOCIATION 771 Corporate Drive, Suite 505, 40503 Lexington, Kentucky, US	UNITED STATES POLO ASSOCIATION 1400 Centrepark Blvd., Suite 200, West Palm Beach, Florida 33401, U.S.A.
2005-14351	(10442)	UNITED STATES POLO ASSOCIATION 771 Corporate Drive, Suite 505, 40503 Lexington, Kentucky, US	UNITED STATES POLO ASSOCIATION 1400 Centrepark Blvd., Suite 200, West Palm Beach, Florida 33401, U.S.A.
2005-1438	(10445)	UNITED STATES POLO ASSOCIATION 771 Corporate Drive, Suite 505, 40503 Lexington, Kentucky, US	UNITED STATES POLO ASSOCIATION 1400 Centrepark Blvd., Suite 200, West Palm Beach, Florida 33401, U.S.A.
2005-1439	(11234)	UNITED STATES POLO ASSOCIATION 771 Corporate Drive, Suite 505, 40503 Lexington, Kentucky, US	UNITED STATES POLO ASSOCIATION 1400 Centrepark Blvd., Suite 200, West Palm Beach, Florida 33401, U.S.A.
2008-1167	(03283)	PHARMASWISS DOO VOJVODE STEPE 18 BEOGRAD SRBIJA	PHARMASWISS DOO Batajnički drum 5A, 11080 Belgrade, Serbia / RS
1998-766	(01452)	Citigroup Inc. (Delaware corporation) 399 Park Avenue New York, New York 10043, U.S.A.	Citigroup Inc. (Delaware corporation) 388 Greenwich Street, New York, New York, 10013, U.S.A.

2016-54	( )13368	TELEGRAM MESSENGER LLP <b>Suite 2, 23-24 Great James Street, LONDON WC1N 3ES / GB</b>	TELEGRAM MESSENGER LLP <b>71-75 Shelton Street, Covent Garden, London, WC2H 9JQ, United Kingdom / GB</b>
2016-240	(13598)	Goodyear Dunlop Tyres UK Limited <b>Tyre Fort 88-98, Wingfoot Way, B24 9HY Birmingham, United Kingdom</b>	Goodyear Dunlop Tyres UK Limited <b>2920 Trident Court, Solihull Parkway, Birmingham Business Park, Birmingham, B37 7YN, United Kingdom</b>
2008-980	(01741)	McDonald's International Property Company, Ltd. <b>251 Little Falls Drive, Wilmington, Delaware 19808, USA</b>	McDonald's International Property Company, Ltd. <b>110 N. Carpenter Street, Chicago, Illinois 60607, USA</b>
1991-1185	(06922)	Saucony, Inc. <b>CENTENNIAL PARK, CENTENNIAL DRIVE, P.O. BOX 6046, PEABODY, MASSACHUSETTS 01961, US</b>	Saucony, Inc. <b>500 Totten Pond Road, Waltham, Massachusetts 02451, USA</b>
2011-186	(10767)	Goodyear Dunlop Tyres UK Limited <b>Tyre Fort 88-98, Wingfoot Way, B24 9HY Birmingham, United Kingdom</b>	Goodyear Dunlop Tyres UK Limited <b>2920 Trident Court, Solihull Parkway, Birmingham Business Park, Birmingham, B37 7YN, United Kingdom</b>
2006-901	(03012)	Goodyear Dunlop Tyres UK Limited	Goodyear Dunlop Tyres UK Limited <b>2920 Trident Court, Solihull Parkway, Birmingham Business</b>

		<b>Tyre Fort 88-98, Wingfoot Way, B24 9HY Birmingham, United Kingdom</b>	<b>Park, Birmingham, B37 7YN, United Kingdom</b>
2016-239	(13600)	Goodyear Dunlop Tyres UK Limited  <b>Tyre Fort 88-98, Wingfoot Way, B24 9HY Birmingham, United Kingdom</b>	Goodyear Dunlop Tyres UK Limited  <b>2920 Trident Court, Solihull Parkway, Birmingham Business Park, Birmingham, B37 7YN, United Kingdom</b>
2008-95	(00082)	LIDL STIFTUNG & Co. KG <b>Stiftsbergstrasse 1, 74167 Neckarsulm, DE</b>	LIDL STIFTUNG & Co. KG <b>Stiftsbergstrasse 1, 74172 Neckarsulm, DE</b>
1998-1094	(00612)	Wyeth LLC <b>Five Giralda Farms, 07940 Madison, NJ, US</b>	Wyeth LLC <b>235 East 42nd Street, 10017 New York, NY, U.S.A.</b>
2016-233	(13592)	Tequila Sauza, S de R.L. de C.V. (a Mexican limited liability company) <b>Avenida Vallarta 6503, Interior 49, Colonia Ciudad Granja C.P. 45010, Zapopan, Jalisco, Mexico, MX</b>	Tequila Sauza, S de R.L. de C.V. (a Mexican limited liability company) <b>Francisco Javier Sauza 80 Colonia Centro Tequila, Jalisco Mexico 46400</b>
2016-237	(13594)	Jim Beam Brands Co. (a Delaware corporation) <b>Sio Lake Cook Road, Deerfield, Illinois 60015, United States of America, US</b>	Jim Beam Brands Co. (a Delaware corporation) <b>222 West Merchandise Mart Plaza Suite 1600 Chicago, Illinois 60654, United States of America, USA</b>
1998-1204	(00794)	MASSEY FERGUSON CORP. <b>4830 River Green Parkway, Duluth, GA 30136-2574, US</b>	MASSEY FERGUSON CORP. <b>4205 RIVER GREEN PARKWAY, DULUTH, GA 30096, US</b>
1974-633	(00649)	SHARP KABUSHIKI KAISHA <b>22-22, Nagaike-Cho, Abeno-Ku, Osaka 545, Japan</b>	SHARP KABUSHIKI KAISHA <b>1 Takumi-cho, Sakai-ku, Sakai City, Osaka 590-8522, Japan</b>
1998-821	(03065)	<b>MCDonald's International Property Company, Ltd.</b>	<b>MCDonald's International Property Company, Ltd.</b>

		<b>251 Little Falls Drive, Wilmington, Delaware 19808, USA</b>	<b>110 N. Carpenter Street, Chicago, Illinois 60607, USA</b>
1980-404	(04314)	<b>Toshiba Tec Kabushiki Kaisha (TOSHIBA TEC CORPORATION) 2-17-2, Hihashi Gotanda, Shinagawa-ku, Tokyo, JP</b>	<b>Toshiba Tec Kabushiki Kaisha (TOSHIBA TEC CORPORATION) 1-11-1, Osaki, Shinagawa-ku, Tokyo, JAPAN, JP</b>
1979-210	(04629)	<b>MCDonald's International Property Company, Ltd. 251 Little Falls Drive, Wilmington, Delaware 19808, USA</b>	<b>MCDonald's International Property Company, Ltd. 110 N. Carpenter Street, Chicago, Illinois 60607, USA</b>
1979-366	(04697)	<b>CBS Studios Inc. 51 West 52nd Street New York, NY 10019 , US</b>	<b>CBS Studios Inc. 4024 Radford Avenue, Studio City, California 91604, USA</b>
1979-205	(04074)	<b>MCDonald's International Property Company, Ltd. 251 Little Falls Drive, Wilmington, Delaware 19808, USA</b>	<b>MCDonald's International Property Company, Ltd. 110 N. Carpenter Street, Chicago, Illinois 60607, USA</b>
2000-523	(00861)	<b>EKO INDUSTRIAL AND COMMERCIAL PETROLEUM COMPANY A.E. Tower of Athens, 2 Mesogion Avenue, Athens, Greece, GR</b>	<b>EKO INDUSTRIAL AND COMMERCIAL PETROLEUM COMPANY A.E. 8A Cheimarras street, 15125 Marousi, Greece</b>
2000-524	(00860)	<b>EKO INDUSTRIAL AND COMMERCIAL PETROLEUM COMPANY A.E.</b>	<b>EKO INDUSTRIAL AND COMMERCIAL PETROLEUM COMPANY A.E.</b>

		<b>Tower of Athens, 2 Mesogion Avenue, Athens, Greece, GR</b>	<b>8A Cheimarras street, 15125 Marousi, Greece</b>
2011-185	(10766)	<b>Goodyear Dunlop Tyres UK Limited Tyre Fort 88-98, Wingfoot Way, B24 9HY Birmingham, United Kingdom</b>	<b>Goodyear Dunlop Tyres UK Limited 2920 Trident Court, Solihull Parkway, Birmingham Business Park, Birmingham B37 7YN, United Kingdom</b>
2002-476	(03023)	<b>MCDonald's International Property Company, Ltd. 251 Little Falls Drive, Wilmington, Delaware 19808, USA</b>	<b>MCDonald's International Property Company, Ltd. 110 N. Carpenter Street, Chicago, Illinois 60607, USA</b>
1979-204	(04620)	<b>MCDonald's International Property Company, Ltd. 251 Little Falls Drive, Wilmington, Delaware 19808, USA</b>	<b>MCDonald's International Property Company, Ltd. 110 N. Carpenter Street, Chicago, Illinois 60607, USA</b>
1979-207	(04625)	<b>MCDonald's International Property Company, Ltd. 251 Little Falls Drive, Wilmington, Delaware 19808, USA</b>	<b>MCDonald's International Property Company, Ltd. 110 N. Carpenter Street, Chicago, Illinois 60607, USA</b>
1992-51	(06085)	<b>MCDonald's International Property Company, Ltd. 251 Little Falls Drive, Wilmington, Delaware 19808, USA</b>	<b>MCDonald's International Property Company, Ltd. 110 N. Carpenter Street, Chicago, Illinois 60607, USA</b>

1990-899	(06084)	<b>MCDonald's International Property Company, Ltd. 251 Little Falls Drive, Wilmington, Delaware 19808, USA</b>	<b>MCDonald's International Property Company, Ltd. 110 N. Carpenter Street, Chicago, Illinois 60607, USA</b>
2010-254	(06954)	<b>MCDonald's International Property Company, Ltd. 251 Little Falls Drive, Wilmington, Delaware 19808, USA</b>	<b>MCDonald's International Property Company, Ltd. 110 N. Carpenter Street, Chicago, Illinois 60607, USA</b>
2010-14	(06859)	<b>MCDonald's International Property Company, Ltd. 251 Little Falls Drive, Wilmington, Delaware 19808, USA</b>	<b>MCDonald's International Property Company, Ltd. 110 N. Carpenter Street, Chicago, Illinois 60607, USA</b>
1998-965	(08136)	<b>Aloe Vera Of America, Inc. 9660 Dilworth, Dallas, TX 75243, US</b>	<b>Aloe Vera Of America, Inc. 13745 Jupiter Road, Dallas, Texas 75238, United States (US)</b>
1998-783	(03066)	<b>MCDonald's International Property Company, Ltd. 251 Little Falls Drive, Wilmington, Delaware 19808, USA</b>	<b>MCDonald's International Property Company, Ltd. 110 N. Carpenter Street, Chicago, Illinois 60607, USA</b>
1979-367	(04698)	<b>CBS Studios Inc. 51 West 52nd Street New York, NY 10019 , US</b>	<b>CBS Studios Inc. 4024 Radford Avenue, Studio City, California 91604, USA</b>

**RIJEŠENJA O PROMJENI IMENA**

<b>BROJ PRIJAVE</b>	<b>REGISTARSKI BROJ (111)</b>	<b>IME I ADRESA RANIJEG NOSIOCA PRAVA</b>	<b>IME I ADRESA STICAOCA PRAVA (732)</b>
-------------------------	-----------------------------------	---	--



(210)		(732)	
2016-178	(13094)	<b>Hit Montenegro d.o.o.</b> <b>Budva</b>  Pržno b.b.,Budva	<b>Maestral Hotels and Casinos d.o.o.</b> <b>Budva</b>  Pržno b.b.,Budva
2000-524	(00860)	<b>HELLENIC FULES S.A.</b> 8A Cheimarras street, 151 25 Marousi, Greece	<b>HELLENIC FULES AND LUBRICANTS INDUSTRIAL AND COMMERCIAL S.A. also trading as EKO ABEE</b> 8A Cheimarras street, 151 25 Marousi, Greece
2000-523	(00861)	<b>HELLENIC FULES S.A.</b> 8A Cheimarras street, 151 25 Marousi, Greece	<b>HELLENIC FULES AND LUBRICANTS INDUSTRIAL AND COMMERCIAL S.A. also trading as EKO ABEE</b> 8A Cheimarras street, 151 25 Marousi, Greece
2008-790	(01274)	<b>Rudolf Wild GmbH &amp; Co. KG</b>  Rudolf-Wild Str. 107-115, 69214 Eppelheim, DE	<b>ADM WILD Europe GmbH &amp; Co. KG</b>  Rudolf-Wild Str. 107-115, 69214 Eppelheim, DE
2012-180	(12231)	<b>Pentair Technical Solution UK Limited</b>  3 Rutheford Road, Stephenson Industrial Estate, Washington, Tyne and Wear, United Kingdom, NE37 3HX	<b>nVent Solutions (UK) Limited</b> 3 Rutheford Road, Stephenson Industrial Estate, Washington, Tyne and Wear, United Kingdom, NE37 3HX
2008-789	(02566)	<b>Rudolf Wild GmbH &amp; Co. KG</b>  Rudolf-Wild Str. 107-115, 69214 Eppelheim, DE	<b>ADM WILD Europe GmbH &amp; Co. KG</b>  Rudolf-Wild Str. 107-115, 69214 Eppelheim, DE

**RIJEŠENJA O PROMJENI IMENA I ADRESE**

<b>Broj prijave (210)</b>	<b>Registarski broj (111)</b>	<b>IME I ADRESA RANIJEG NOSIOCA PRAVA (732)</b>	<b>IME I ADRESA STICAOCA PRAVA (732)</b>
2008-204	(00157)	Lafarge Roofing Components GmbH & Co. KG Lafarge Roofing Components GmbH & Co. KG	Monier Roofing Components GmbH Frankfurter Landstrasse 2-4, 61440 Oberursel, GERMANY, DE
2008-627	(00954)	Reckitt Benckiser Inc. Morris Corporate Center IV, 399 Interpace Parkway, PO Box 225, Parsippany, NJ 07454-1115, Sjedinjene Američke Države	Reckitt Benckiser LLC Morris Corporate Center IV, 399 Interpace Parkway, Parsippany, New Jersey 07054-0225, Sjedinjene Američke Države
1991-531	(03527)	HONEYWELL BREMSBELAG GmbH Glinder Weg 1, 21501 Glinde, DE	Federal-Mogul Bremsbelag GmbH Glinder Weg 1, 21509 Glinde, DE
1998-1040	(00577)	SHARP KABUSHIKI KAISHA 22-22, Nagaike-cho, Abeno-ku, Osaka 545-8522, Japan	SHARP KABUSHIKI KAISHA also trading as SHARP CORPORATION 1 Takumi-cho, Sakai-ku, Sakai City, Osaka 590-8522, Japan
2008-633	(00935)	BAMBI BANAT AD BULEVAR ZORANA ĐINĐIĆA 8A BEOGRAD	Bambi a.d. Požarevac Đure Đakovića bb, 12000 Požarevac, RS

2008-543	(00899)	<b>BAMBI BANAT AD BULEVAR ZORANA ĐINĐIĆA 8A BEOGRAD</b>	<b>Bambi a.d. Požarevac Đure Đakovića bb, 12000 Požarevac, RS</b>
2008-544	(00900)	<b>BAMBI BANAT AD BULEVAR ZORANA ĐINĐIĆA 8A BEOGRAD</b>	<b>Bambi a.d. Požarevac Đure Đakovića bb, 12000 Požarevac, RS</b>
2008-485	(00386)	<b>BAMBI BANAT AD BULEVAR ZORANA ĐINĐIĆA 8A BEOGRAD</b>	<b>Bambi a.d. Požarevac Đure Đakovića bb, 12000 Požarevac, RS</b>
2008-477	(00392)	<b>BAMBI BANAT AD BULEVAR ZORANA ĐINĐIĆA 8A BEOGRAD</b>	<b>Bambi a.d. Požarevac Đure Đakovića bb, 12000 Požarevac, RS</b>
2008-1082	(05085)	<b>BAMBI BANAT AD BULEVAR ZORANA ĐINĐIĆA 8A BEOGRAD</b>	<b>Bambi a.d. Požarevac Đure Đakovića bb, 12000 Požarevac, RS</b>
2008-632	(00934)	<b>BAMBI BANAT AD BULEVAR ZORANA ĐINĐIĆA 8A BEOGRAD</b>	<b>Bambi a.d. Požarevac Đure Đakovića bb, 12000 Požarevac, RS</b>
2008-1171	(04863)	<b>São Paulo Alpargatas S.A. Rua Funchal, 160, Vila Olimpia, São Paulo, SP, BR</b>	<b>Alpargatas S.A. Avenida Doutor Cardoso de Melo, 1336, 14 andar, Vila Olimpia, São Paulo, SP- BRAZIL-04548-004, BR</b>

1998-965	(08136)	<b>ALOE VERA OF AMERICA, INC. 9660 Dilworth, Dallas, TX 75243, US</b>	<b>Alpargatas S.A. Avenida Doutor Cardoso de Melo, 1336, 14 andar, Vila Olimpia, São Paulo, SP- BRAZIL-04548-004, BR</b>
----------	---------	---	--

## OBJAVA ISPRAVKI CORRECTIONS

U „Crnogorskom glasniku intelektualne svojine“ broj 28. od 20.10.2018. godine, objavljeni su pogrešni podaci za predmet Ž-2013-5 registrovan pod brojem 13999

### Pogrešni podaci

- (111) **13999**  
(151) 01.10.2018.
- (210) **2013-5**
- (442) **20.09.2014.**
- (220) 1/11/2013
- (732) **CHINA TOBACCO GUANGDONG INDUSTRIAL CO.LTD**, 8TH-16TH FLOOR,  
NO.186, LINHEXIHENG ROAD, TIANHE, GUANGZHOU CN
- (540) SHUANGXI
- (550) I, V
- (740) Đakonović Vido, Bajova 9, Cetinje ME
- (511) **Klasa 34:** cigarete, cigare, duvan, cigarete koje sadrže zamjenu za duvan, ne za medicinske svrhe, tabakere, muštikle, pepeljare za pušače, šibice, upaljači za pušače, filteri za cigarete, papir za cigarete.

### Ispravni podaci

- (111) **13999**  
(151) 01.10.2018.
- (210) **2013-5**
- (442) **20.09.2014.**
- (220) 1/11/2013
- (732) **CT BAT International Co. Limited**, 29th Floor, Oxford House, Taikoo Place,  
979 King's Road, Island East, Hong Kong  
FLOOR, NO.186, LINHEXIHENG ROAD, TIANHE, GUANGZHOU CN
- (540) SHUANGXI
- (550) I, V
- (740) Popović Miladin, Đoka Miraševića 21/III, Podgorica ME
- (511) **Klasa 34:** cigarete; cigare; duvan; cigarete koje sadrže zamjenu za duvan; ne za medicinske svrhe; tabakere; muštikle; pepeljare za pušače; šibice; upaljači za pušače; filteri za cigarete; papir za cigarete.



CIP - Каталогизација у публикацији  
Централна народна библиотека Црне Горе, Цетиње  
347.77/78(497.16)  
CRNOGORSKI glasnik intelektualne svojine : Službeni glasnik  
Zavoda za Intelektualnu svojinu Crne Gore = Journal of  
intellectual  
property in Montenegro = Official Gazete of the Intellectual  
Property Office of Montenegro / glavni i odgovorni urednik  
Valentna Radulović Šćepanović - 2017, br.24 - 742. - Podgorica  
(Bulevar Revolucije 9) : Zavod za intelektualnu svojinu Crne  
Gore, 2010. - 30 cm  
Tromjesečno.  
ISSN 1800-8003 = Crnogorski glasnik intelektualne svojine  
(Podgorica)  
COBISS.CG-ID 15168784